

CIV-47534
Pt. 1

2

AD-A279 290

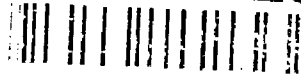

U. S. DEPARTMENT OF COMMERCE
NATIONAL BUREAU OF STANDARDS

**SCREW-THREAD STANDARDS
FOR FEDERAL SERVICES
1957**

Amends in part H28 (1944) (and in part its 1950 Supplement)

HANDBOOK H28 (1957)—Part I

DTIC
ELECTE
MAY 09 1994
S

Reprinted November 1960 with corrections

This document has been approved
for public release and sale; its
distribution is unlimited.

DTIC QUALITY INSPECTED 8

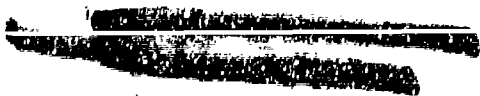

94-13142

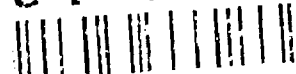

U. S. DEPARTMENT OF COMMERCE

Sinclair Weeks, Secretary

NATIONAL BUREAU OF STANDARDS

A. V. Astin, Director



The National Bureau of Standards

Functions and Activities

The functions of the National Bureau of Standards are set forth in the Act of Congress, March 3, 1901, as amended by Congress in Public Law 619, 1950. These include the development and maintenance of the national standards of measurement and the provision of means and methods for making measurements consistent with these standards; the determination of physical constants and properties of materials; the development of methods and instruments for testing materials, devices, and structures; advisory services to Government Agencies on scientific and technical problems; invention and development of devices to serve special needs of the Government; and the development of standard practices, codes, and specifications. The work includes basic and applied research, development, engineering, instrumentation, testing, evaluation, calibration services, and various consultation and information services. A major portion of the Bureau's work is performed for other Government Agencies, particularly the Department of Defense and the Atomic Energy Commission. The scope of activities is suggested by the listing of divisions and sections on the inside of the back cover.

Publications

The results of the Bureau's work take the form of either actual equipment and devices or published papers; these papers appear either in the Bureau's own series of publications or in the journals of professional and scientific societies. The Bureau itself publishes three monthly periodicals, available from the Government Printing Office: The Journal of Research, which presents complete papers reporting technical investigations; the Technical News Bulletin, which presents summary and preliminary reports on work in progress; and Basic Radio Propagation Predictions, which provides data for determining the best frequencies to use for radio communications throughout the world. There are also five series of nonperiodical publications: The Applied Mathematics Series, Circulars, Handbooks, Building Materials and Structures Reports, and Miscellaneous Publications.

Information on the Bureau's publications can be found in NBS Circular 460, Publications of the National Bureau of Standards (\$1.25) and its Supplement (\$0.75), available from the Superintendent of Documents, Government Printing Office, Washington 25, D. C.

NATIONAL BUREAU OF STANDARDS HANDBOOK H28 (1957)

**SCREW-THREAD STANDARDS
FOR FEDERAL SERVICES
1957**

PART I

**UNIFIED, AMERICAN, AMERICAN NATIONAL, AND
NATIONAL MINIATURE THREADS**



Amends in part H28 (1944) (and in part its 1950 Supplement)

[Issued September 10, 1957]

Reprinted November 1960 with corrections
See list on page II

UNITED STATES GOVERNMENT PRINTING OFFICE, WASHINGTON : 1957

BEST QUALITY UNEXPECTED 3

Reprinted with Corrections

November 1960

Pages 9, 12, 18, 20, 29, 30, 35, 51, 61, 69, 80 to 91, 99, 107, 109, 112, 117 to 119, 129, 163, 182 to 185, 187, 190, and 191 of this reprint contain corrections to the previous (March 1958) reprint. These corrections are shown by a double dagger. Single asterisks indicate corrections to the original printing as shown in the 1958 reprint. These corrections are shown on pages 39, 49, 105, 157, 183, 187, 190, and 193. On page 114, table VI.2, column 13; also the first paragraph of text, and the footnote 16 have been corrected.

The corrections on page 99 occur within the two blocks in which the daggers are placed. The corrections on pages 80 through 91 occur in the line when the daggers occur in the "number of pitches column," otherwise, the correction only pertains to the daggered value. The correction on page 107 is in the daggered line. The correction on page 109 is in the daggered paragraph. On page 112, the formula in the upper right-hand corner of figure VI.2 has been revised to read:

$$\frac{3}{8}H - (0.060 \sqrt{p^2} + 0.017p)/2"; \text{ the } \left. \begin{array}{c} \rightarrow \\ | \\ \leftarrow \end{array} \right| \frac{p}{8} "$$

has been deleted from the upper part of the right-hand view in figure VI.3.

Foreword

The Interdepartmental Screw Thread Committee has been established by the Departments of Defense, Army, Navy, Air Force, and Commerce to promote uniformity in screw-thread standards in the Departments concerned.

The Committee is charged: (1) With the development of standards for screw threads; (2) the standardization of gages, dies, and taps; and (3) the standardization of dimensions of nuts, bolt heads, wrenches, and other items associated with the manufacture and use of interchangeable threaded parts. Standards developed by the Committee, when approved by the Departments concerned, are to be published together with a joint order making their use mandatory in the Departments of Defense and Commerce, except where a need for deviations therefrom is shown. Standards thus established are subject to such extension and revision as the Committee may find desirable.

The basis for this Handbook is the 1933 report, and preceding reports, of the National Screw Thread Commission, and Handbooks H25 dated 1939, and H28 dated 1942 and 1944, which superseded those reports and which this Handbook supersedes, together with pertinent standards approved and promulgated by the American Standards Association.

The current Handbook is to be issued in three volumes or parts, of which this volume constitutes Part I, superseding sections I, II, III, IV, V, XV, and XVI and appendixes 1, 2, 6, and 8 of Handbook H28 (1944). Sections XI, XII, XIII, XIV, and XVII and appendix 7 of H28 (1944) are superseded by Federal Specifications listed in appendix 6 herein. Part II will include standards for hose-coupling, pipe, and gas cylinder threads, and will be issued when the revised standards have been completely formulated. This will be followed by Part III, to include Acme, Stub-Acme, Buttress, and miscellaneous standard threads.

The standardization of bolts, nuts, screws, and related items, for purposes of procurement by the Federal Government, is covered by several pertinent Federal Specifications which are listed in the Index of Federal Specifications and Standards, available on a subscription basis from the Superintendent of Documents.

ARCHIBALD T. McPHERSON, *Chairman.*

Accession For	
NTIS CRA&I	<input checked="" type="checkbox"/>
DTIC TAB	<input type="checkbox"/>
Unannounced	<input type="checkbox"/>
Justification	
By	
Distribution /	
Availability Codes	
Dist	Avail and/or Special
A-1	

C-1636-A

APPROVAL BY THE SECRETARIES OF DEFENSE AND COMMERCE

The accompanying Handbook H28 (1957), Part I, on screw-thread standards for Federal Services, submitted by the Interdepartmental Screw Thread Committee, is hereby approved for use by the Departments of Defense and Commerce.

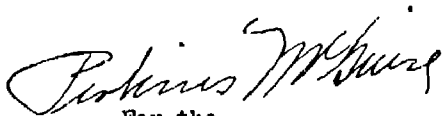
For the
Secretary of Defense

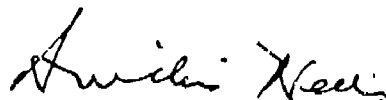
Secretary of Commerce

Contents

	Page	SECTION VI—Continued	Page
Foreword.....	iii		
Approval by the Secretaries of Defense and Commerce.....	v		
SECTION I. Introduction.....	1		
1. Purpose of Federal standards for threaded products.....	1		
2. Personnel of the Committee.....	1		
SECTION II. Nomenclature, definitions, and letter symbols.....	1		
1. Introductory.....	1		
2. Definitions of terms.....	2		
(a) Terms relating to types of screw threads.....	2		
(b) Terms relating to size and fit.....	2		
(c) Terms relating to geometrical elements of screw threads.....	3		
(d) Terms relating to dimensions of screw threads.....	4		
(e) Terms relating only to taper screw threads.....	6		
3. Letter symbols and abbreviations.....	7		
(a) Dimensional symbols.....	7		
(b) Identification designations.....	8		
SECTION III. Unified thread form and thread series for bolts, machine screws, nuts, tapped holes, and general applications.....	10		
1. Introduction.....	10		
2. The Unified form of thread.....	12		
3. Thread series, symbols, and suggested applications.....	13		
4. Classification and tolerances.....	18		
(a) General.....	18		
(b) Screw-thread classes.....	23		
5. Method of designating a screw thread.....	26		
6. Limits of size, standard thread series, table III.10.....	26		
7. Limits of size of gages.....	38		
8. Sizes of tap drills.....	68		
SECTION IV. Unified threads of special diameters, pitches, and lengths of engagement.....	74		
1. Introduction.....	74		
2. Unified form of thread.....	75		
3. Preferred diameters and pitches.....	75		
4. Classification and tolerances.....	75		
(a) General.....	75		
(b) Screw-thread classes.....	79		
5. Method of designating.....	98		
6. Directions for determining limits of size of special threads.....	100		
7. Gages.....	100		
SECTION V. National Miniature screw threads.....	100		
1. Introduction.....	100		
2. Form of thread.....	101		
3. National Miniature thread series.....	104		
4. Classification and tolerances.....	104		
5. Thread designations.....	105		
6. Limits of size.....	105		
7. Gages and gaging.....	107		
SECTION VI. Gages and gaging for Unified, American, and American National threads.....	107		
1. Introduction.....	107		
2. Fundamentals.....	108		
3. Specifications for gage elements.....	109		
(a) General design.....	109		
(b) Specifications for thread form.....	110		
		(c) Specifications for thread length.....	114
		(d) Marking of gages.....	116
		4. Gage tolerances and wear allowances.....	117
		5. Recommended gage practices.....	118
		Appendix 1. American National form of thread and thread series for bolts, machine screws, nuts, tapped holes, and general applications.....	121
		1. Introduction.....	121
		2. American National form of thread.....	121
		(a) Specifications.....	121
		(b) Illustration.....	121
		(c) Basic thread data.....	121
		3. Thread series.....	122
		(a) American National coarse-thread series.....	122
		(b) American National fine-thread series.....	122
		(c) American National extra-fine thread series.....	123
		(d) American National 8-thread series.....	123
		(e) American National 12-thread series.....	123
		(f) American National 16-thread series.....	124
		4. Classification and tolerances.....	124
		(a) General specifications.....	125
		(b) Screw-thread classes.....	130
		5. Method of designating an American National thread.....	132
		6. Limits of size of gages.....	145
		Appendix 2. American National screw threads of special diameters, pitches, and lengths of engagement.....	179
		1. Form of thread.....	179
		2. Standard pitches.....	179
		3. Classification and tolerances.....	179
		(a) General specifications.....	179
		(b) Classification of threads.....	179
		4. Tables of dimensions.....	180
		5. Gages.....	186
		Appendix 3. Hole-size limits.....	186
		Appendix 4. Wire methods of measurement of pitch diameter of 60° threads.....	194
		1. Size of wires.....	195
		2. Methods of measuring and using wires.....	195
		3. Standard specification for wires and standard practice in measurement of wires.....	196
		4. General formula for measurement of pitch diameter.....	196
		5. Measurement of pitch diameter of Unified, American, and American National straight thread.....	197
		6. Measurement of pitch diameter of American Standard taper threads.....	197
		7. Measurement of pitch diameter of thread ring gages.....	200
		Appendix 5. Design of special threads.....	200
		1. General.....	200
		2. Eccentricity of assembly and gross threading.....	201
		3. Strength factors.....	201
		4. Thread proportions in relation to tapping.....	204
		5. Examples of thread design.....	204
		Appendix 6. References.....	205
		Index.....	207

Tables

	Page
Table II.1.—General symbols (see figs. II.2 and II.3).....	9
Table II.2.—Pipe-thread symbols (see fig. II.4).....	9
Table II.3.—Identification designations.....	10
Table III.1.—Thread data, Unified thread form (see fig. III.2).....	12
Table III.2.—Unified and American, screw thread standard series.....	15
Table III.3.—Coarse thread series, basic dimensions, UNC and NC.....	16
Table III.4.—Fine thread series, basic dimensions, UNF and NF.....	16
Table III.5.—Extra-fine thread series, basic dimensions, UNEF and NEF.....	17
Table III.6.—8-thread series, basic dimensions, 8UN and 8N.....	17
Table III.7.—12-thread series, basic dimensions, 12UN and 12N.....	18
Table III.8.—16-thread series, basic dimensions, 16UN and 16N.....	19
Table III.9.—Increments in pitch-diameter tolerance formula.....	20
Table III.10.—Standard series limits of size—Unified and American screw threads.....	27-32
Table III.11.—Deviations in lead and half-angle equivalent to one-half of pitch diameter tolerances, Unified and American screw threads.....	32-38
Table III.12.—Gages for standard thread series, Unified and American screw threads.....	39-55
Table III.13.—Setting plug gages, Unified and American screw threads.....	56-68
Table III.14.—Tap drill sizes, Unified and American screw threads, classes 1B and 2B.....	69-71
Table III.15.—Tap drill sizes, Unified and American screw threads, class 3B.....	72-74
Table IV.1.—Thread data, Unified and American thread form.....	76
Table IV.2.—Allowances for external threads of special diameters and pitches, classes 1A and 2A.....	77
Table IV.2A.—Allowances, class 1AR.....	77
Table IV.3.—Major diameter tolerances for external threads of special diameters, pitches, and lengths of engagement, classes 1A, 1AR, 2A, and 3A.....	78
Table IV.4.—Pitch diameter tolerances for external threads of special diameters, pitches, and lengths of engagement, classes 1A and 1AR.....	80, 81
Table IV.5.—Pitch diameter tolerances for external threads of special diameters, pitches, and lengths of engagement, class 2A.....	82, 83
Table IV.6.—Pitch diameter tolerances for external threads of special diameters, pitches, and lengths of engagement, class 3A.....	84, 85
Table IV.7.—Pitch diameter tolerances for internal threads of special diameters, pitches, and lengths of engagement, class 1B.....	86, 87
Table IV.8.—Pitch diameter tolerances for internal threads of special diameters, pitches, and lengths of engagement, class 2B.....	88, 89
Table IV.9.—Pitch diameter tolerances for internal threads of special diameters, pitches, and lengths of engagement, class 3B.....	90, 91
Table IV.10.—Minor diameter tolerances for internal special screw threads, classes 1B and 2B.....	92, 93
Table IV.11.—Minor diameter tolerances for internal special screw threads, class 3B.....	94-97
Table IV.12.—Unified special diameter-pitch combinations.....	99
Table IV.13.—Consolidated method for the calculation of dimensions of special threads.....	99
Table V.1.—Thread form data, National Miniature screw threads.....	102
Table V.2.—Basic and design sizes, National Miniature thread series.....	104
Table V.3.—Limits of size and tolerances, National Miniature thread series.....	105
Table VI.1.—Specifications and format for tables of limits of size of threaded and plain gages for Unified, American, and American National external and internal threads.....	113
Table VI.2.—Specifications and format for tables of limits of size of threaded setting plug gages for Unified, American, and American National external threads.....	114
Table VI.3.—Constants for computing thread gage dimensions.....	115
Table VI.4.—Lengths of standard taperlock and trilock thread plug gage blanks.....	115
Table VI.5.—Lengths of standard thread ring gage blanks and total thread lengths of standard truncated setting plug gage blanks.....	115
Table VI.6.—Tolerances for W "go" and "not go" thread gages.....	117
Table VI.7.—Tolerances for X "go" and "not go" thread gages.....	118
Table VI.8.—Tolerances for Y "go" thread gages for classes 1, 1A, 1B, 2A, and 2B, NS and UNS threads only.....	119
Table VI.9.—Tolerances for plain gages.....	119
Table I.1.—Basic thread data, American National form of thread.....	127
Table I.2.—American National coarse-thread series, NC.....	128
Table I.3.—American National fine-thread series, NF.....	129
Table I.4.—American National extra-fine-thread series, NEF.....	129
Table I.5.—American National 8-thread series, 8N.....	130
Table I.6.—American National 12-thread series, 12N.....	131
Table I.7.—American National 16-thread series, 16N.....	132
Table I.8.—Limits of size and tolerances, classes 1, 2, 3, and 4, American National coarse-thread series, NC.....	133, 134
Table I.9.—Limits of size and tolerances, classes 1, 2, 3, and 4, American National fine thread series, NF.....	135, 136
Table I.10.—Limits of size and tolerances, classes 2 and 3, American National extra-fine-thread series, NEF.....	137
Table I.11.—Limits of size and tolerances, classes 2 and 3, American National 8-thread series, 8N.....	138, 139
Table I.12.—Limits of size and tolerances, classes 2 and 3, American National 12-thread series, 12N.....	140-142

Tables—Continued

	Page
Table 1.13.—Limits of size and tolerances, classes 2 and 3, American National 16-thread series, 16N.....	143, 144
Table 1.14.—Allowances and tolerances, classes 1 and 2.....	145
Table 1.15.—Allowances and tolerances, classes 3 and 4.....	145
Table 1.16.—Gages for standard thread series, American National screw threads.....	146-163
Table 1.17.—Setting plug gages, American National screw threads.....	164-178
Table 2.1.—Thread data for recommended pitches for threads of special diameters, pitches, and lengths of engagement.....	180
Table 2.2.—Schedule of tolerance increments for threads of special diameters, pitches, and lengths of engagement.....	180
Table 2.3.—Values for obtaining thread dimensions of screw threads of special diameters, pitches, and lengths of engagement, classes 1, 2, 3, and 4.....	181
Table 2.4.—Pitch diameter tolerances for screw threads of special diameters, pitches, and lengths of engagement, class 1.....	182
Table 2.5.—Pitch diameter tolerances for screw threads of special diameters, pitches, and lengths of engagement, class 2.....	183
Table 2.6.—Pitch diameter tolerances for screw threads of special diameters, pitches, and lengths of engagement, class 3.....	184
Table 2.7.—Pitch diameter tolerances for screw threads of special diameters, pitches, and lengths of engagement, class 4.....	185
Table 3.1.—Recommended hole size limits before threading for different lengths of engagement, UNC, UNE, UNEF, UN, UNS, NC, NF, NEF, and N series, classes 1B and 2B.....	187-189
Table 3.2.—Recommended hole size limits before threading for different lengths of engagement, UNC, UNE, UNEF, UN, UNS, NC, NF, NEF, and N series, class 3B.....	190-193
Table 3.3.—Recommended hole size limits before threading for different lengths of engagement, National Miniature thread series.....	193
Table 4.1.—Wire sizes and constants, Unified and American, American National, hose-coupling, and pipe threads (60°).....	195
Table 4.2.—Relation of best wire diameters and pitches—wires for Unified and American, American National, hose-coupling, and pipe threads (60°).....	196
Table 5.1.—Data for determining strength factors in special thread design.....	203

Figures

Figure II.1.—Blunt start.....	4
Figure II.2.—General screw thread symbols.....	6
Figure II.3.—General screw thread symbols.....	7
Figure II.4.—Pipe thread symbols.....	8
Figure III.1.—Unified internal and external screw thread design forms (maximum material condition).....	11
Figure III.2.—Symbols for thread data in table III.1.....	13
Figure III.3.—Disposition of tolerances, allowances, and crest clearances for classes 1A, 2A, 1B, and 2B.....	24
Figure III.4.—Disposition of tolerances and crest clearances for classes 3A and 3B.....	25
Figure IV.1.—Thread dimensions to be determined for a special thread.....	99
Figure V.1.—Basic thread form, National Miniature threads.....	101
Figure V.2.—National Miniature internal and external screw thread design forms (maximum material condition).....	103
Figure V.3.—Disposition of tolerances and crest clearances, National Miniature threads.....	106
Figure V.4.—Suggested chart for projection inspection of external National Miniature threads.....	107
Figure VI.1.—Thread form of gages for external and internal threads.....	110
Figure VI.2.—Thread form of truncated thread setting plug gages.....	112
Figure VI.3.—Thread form of basic-crest thread setting plug gages.....	112
Figure 1.1.—American National form of thread.....	121
Figure 1.2.—Disposition of tolerances, allowance (neutral space), and crest clearances for class 1.....	122
Figure 1.3.—Disposition of tolerances and crest clearances for class 2.....	123
Figure 1.4.—Disposition of tolerances and crest clearances for class 3.....	124
Figure 1.5.—Disposition of tolerances, allowance (interference), and crest clearances for class 4.....	125
Figure 1.6.—Relation of maximum and minimum pitch diameters of classes 1, 2, 3, and 4 to basic pitch diameters.....	126
Figure 3.1.—Distribution of hole size limits before tapping, Unified and American threads.....	186
Figure 3.2.—Distribution of hole size limits before tapping, National Miniature threads.....	186
Figure 4.1.—Three-wire method of measuring pitch diameter of thread plug gages.....	194
Figure 4.2.—Measurement of pitch diameter of taper thread gages by the 2-wire method.....	198
Figure 4.3.—Measurement of pitch diameter of taper thread gages by the 3-wire method.....	199
Figure 4.4.—Measurement of pitch diameter of taper thread gages by the 4-wire method.....	200
Figure 5.1.—Critical sections in a thread assembly.....	201
Figure 5.2.—Chart for determining minimum length of thread engagement.....	202

1957 HANDBOOK OF SCREW-THREAD STANDARDS FOR FEDERAL SERVICES

As Approved 1957

SECTION I. INTRODUCTION

1. PURPOSE OF FEDERAL STANDARDS FOR THREADED PRODUCTS

The purpose of this Handbook is to present complete dimensional data upon which specifications may be based for threaded products for Government requirements. So far as practicable, these data are intended to conform to generally accepted commercial practice, although certain special requirements of the Government necessitate the inclusion of some standards not generally applicable outside of the Government services. References are cited throughout the text to the standards promulgated by the American Standards Association, and to such other published standards as are in agreement with the specifications herein.

There are included in the body of the Handbook specifications for threaded products and gages, embodying sufficient information to permit the writing of definite and complete specifications for the purchase of screw-thread products. In the appendixes there is arranged supplementary information of both a general and a technical nature, including such specifications as are not intended to be mandatory.

2. PERSONNEL OF THE COMMITTEE

The personnel of the Interdepartmental Screw Thread Committee is as follows:

Representing the Department of Defense:

MR. SPENCER B. TERRY, Standardization Division, Supply and Logistics, Office of the Assistant Secretary of Defense, Washington 25, D. C.

Representing the Department of the Army:

MR. EUGENE VON LOESCH, Research and Development Division, Office of the Chief of Engineers, Department of the Army, Washington 25, D. C.
MR. M. L. FRUCHTENICHT, Gage Laboratory, Frankford Arsenal, Ordnance Corps, Department of the Army, Philadelphia 37, Pennsylvania.

Representing the Department of the Navy:

MR. JAMES W. JENKINS, Metallurgical Branch, Material Development Division (Code 343), Department of the Navy, Washington 25, D. C.
MR. J. E. WALTER, Engineering Department, U. S. Naval Gun Factory, Washington 25, D. C.

Representing the Department of the Air Force:

MR. ROY F. BOSRON, WCXP, Wright Air Development Center, Wright-Patterson Air Force Base, Ohio.
COL. IRVING H. HARE, RDTEB, Air Research and Development Command, (now retired).

Representing the Department of Commerce:

DR. ARCHIBALD T. McPHERSON, chairman, Associate Director, National Bureau of Standards, Washington 25, D. C.
MR. IRVIN H. FULLMER, Secretary, Chief, Engineering Metrology Section, Optics and Metrology Division, National Bureau of Standards, Washington 25, D. C.

Liaison Representatives of Sectional Committees Organized Under the Procedure of the American Standards Association and Sponsored by The American Society of Mechanical Engineers and the Society of Automotive Engineers or the American Gas Association:

- MR. WILLIAM L. BARTH, Executive Secretary, Engineering Standards, General Motors Corporation, 3044 West Grand Blvd., Detroit 2, Michigan. (Member of ASA Committees B1, B2, and B18.)
MR. W. P. ENGLISH, Engine Technical Committee, Aircraft Industries Association, Inc.; mail to Fairchild Engine Division, Fairchild Engine and Airplane Corp., Deer Park, Long Island, New York. (Member of ASA Committee B1.)
MR. H. C. ERDMAN, Technical Asst. to Pres., The National Screw & Manufacturing Co., 2440 E. 75th Street, Cleveland 4, Ohio. (Member of ASA Committees B1 and B18.)
MR. H. W. ROBB, Manager, Company Standards, Engineering Services Division, General Electric Co., 1 River Road, Schenectady, New York. (Member of ASA Committees B1, B2, and B18.)
MR. PAUL G. SCHULZ, Assistant Engineer of Standards, Engineering Division, Crane Co., 836 S. Michigan Avenue, Chicago 5, Ill. (Member of ASA Committees B1 and B2.)
MR. WM. C. STEWART, Technical Adviser, Industrial Fasteners Institute, 1517 Terminal Tower, Cleveland 13, Ohio. (Member of ASA Committees B1 and B18.)
MR. FRANK F. TISCH, Voi-Shan Manufacturing Co., division of Theell Manufacturing Co., Culver City, Calif. (Member of ASA Committees B1 and B18.)
MR. W. G. WALTERMIRE, Chief Products Engineer, The Lamson & Sessions Company, 1971 West 85th Street, Cleveland 2, Ohio. (Member of ASA Committees B1, B2, and B18.)
MR. E. L. WILCOX, National Aircraft Standards Committee, Aircraft Industries Association of America, Inc.; mail to Republic Aviation Corp., Farmingdale, Long Island, New York.

Subgroup Members Who Participated in the Preparation of the 1957 Revision:

- MR. P. S. CARTER, WCXP, Wright Air Development Center, Wright-Patterson Air Force Base, Ohio.
MR. W. L. COLEMAN, RDTEB, Air Research and Development Command, P. O. Box 1395, Baltimore 3, Md.
MR. J. L. HERRING, Metallurgical Branch, Material Development Division (Code 343), Department of the Navy, Washington 25, D. C.
MR. F. F. JACOBS, Bureau of Aeronautics, Department of the Navy, Washington 25, D. C.
MR. JACK RATZKIN, Design Department, U. S. Naval Gun Factory, Washington 25, D. C.
MR. J. E. WATSON, National Control Division, Inco Laboratory, Frankford Arsenal, Ordnance Corps, Department of the Army, Philadelphia 37, Pa.

SECTION II. NOMENCLATURE, DEFINITIONS, AND LETTER SYMBOLS

1. INTRODUCTORY

The purposes of this section¹ are to establish uniform practices with regard to: (1) Screw-thread nomenclature, and (2) letter symbols for designating dimensions of screw threads for use on drawings, in tables of dimensions which set forth dimensional standards, and in other records, and for expressing mathematical relationships.

¹ This standard is in general agreement with American Standard ASA B1.7, "Nomenclature, Definitions, and Letter Symbols for Screw Threads," published by The American Society of Mechanical Engineers, 29 West 39th St., New York 18, N. Y. The latest revision should be consulted when referring to such standards.

The section consists of a glossary of terms, two tables of screw-thread dimensional symbols, three illustrations showing the application of dimensional symbols, and one table of identification designations.

Typography.—In accordance with the usual practice in published text, letter symbols and letter subscripts, whether upper or lower case, should be printed in italic type. An exception is Greek letters; Greek capital letters are always vertical, and lower case always resemble italics. In manuscripts this is indicated by underlining each symbol to be italicized. Coefficients, numeral subscripts, and exponents should be printed in vertical Arabic numerals. Standard mathematical notation should be followed.

2. DEFINITION OF TERMS

The terms commonly applied to screw threads may be classified in five general groups, namely: (1) Those relating to types of screw threads; (2) those relating to size and fit of mechanical parts in general; (3) those relating to geometrical elements of both straight and taper screw threads; (4) those relating to dimensions of screw threads; and (5) those relating only to taper screw threads.

The definitions presented herein apply to theoretically correct thread forms unless otherwise indicated.

(a) **TERMS RELATING TO TYPES OF SCREW THREADS.**—Screw threads and the terms generally applied to designate the types of screw threads are defined as follows:

1. *Screw thread.*—A screw thread (hereinafter referred to as a thread), is a ridge of uniform section in the form of a helix on the external or internal surface of a cylinder, or in the form of a conical spiral on the external or internal surface of a cone or frustum of a cone. A thread formed on a cylinder is known as a *straight* or *parallel* thread, to distinguish it from a *taper* thread which is formed on a cone or frustum of a cone.

2. *External thread.*—An external thread is a thread on the external surface of a cylinder or cone.

3. *Internal thread.*—An internal thread is a thread on the internal surface of a hollow cylinder or cone.

4. *Right-hand thread.*—A thread is a right-hand thread if, when viewed axially, it winds in a clockwise and receding direction.

5. *Left-hand thread.*—A thread is a left-hand thread if, when viewed axially, it winds in a counterclockwise and receding direction. All left-hand threads are designated *LH*.

6. *Single thread.*—A single (single-start) thread is one having lead equal to the pitch. (See (d) 1 and (d) 2, p. 4.)

7. *Multiple thread.*—A multiple (multiple-start) thread is one in which the lead is an integral multiple of the pitch. (See (d) 1 and (d) 2.)

8. *Classes of threads.*—Classes of threads are distinguished from each other by the amount of tolerance or tolerance and allowance specified.

(b) **TERMS RELATING TO SIZE AND FIT.**—Terms relating to the size and fit of parts, which are generally applicable to mechanical parts, including threads, are defined as follows:

1. *Nominal size.*—The nominal size is the designation which is used for the purpose of general identification.

2. *Dimension.*—A dimension is a geometrical characteristic such as diameter, length, angle, or center distance.

3. *Size.*—Size is a designation of magnitude. When a value is assigned to a dimension it is referred to hereinafter as the size of that dimension.

NOTE. It is recognized that the words "dimension" and "size" are both used at times to convey the meaning of magnitude.

4. *Allowance.*—An allowance is an intentional difference between the maximum material limits of mating parts. It is the minimum clearance (positive allowance) or maximum interference (negative allowance) between such parts. (See definition of "Fit.")

5. *Tolerance.*—A tolerance is the total permissible variation of a size. The tolerance is the difference between the limits of size.

6. *Basic size.*—The basic size is that size from which the limits of size are derived by the application of allowances and tolerances.

7. *Design size.*—The design size is that size from which the limits of size are derived by the application of tolerances. When there is no allowance the design size is the same as the basic size.

8. *Actual size.*—An actual size is a measured size.

9. *Limits of size.*—The limits of size are the applicable maximum and minimum sizes.

10. *Maximum material limit.*—A maximum material limit is the maximum limit of size of an external dimension or the minimum limit of size of an internal dimension.

11. *Minimum material limit.*—A minimum material limit is the minimum limit of size of an external dimension or the maximum limit of size of an internal dimension.

12. *Tolerance limit.*—A tolerance limit is the variation, positive or negative, by which a size is permitted to depart from the design size.

13. *Unilateral tolerance.*—A unilateral tolerance is a tolerance in which variation is permitted only in one direction from the design size.

14. *Bilateral tolerance.*—A bilateral tolerance is a tolerance in which variation is permitted in both directions from the design size.

15. *Unilateral tolerance system.*—A design plan which uses only unilateral tolerances is known as a Unilateral Tolerance System.

16. *Bilateral tolerance system.*—A design plan which uses only bilateral tolerances is known as a Bilateral Tolerance System.

17. *Fit.*—Fit is the general term used to signify the range of tightness which may result from the application of a specific combination of allowances and tolerances in the design of mating parts.

18. *Actual fit*.—The actual fit between two mating parts is the relation existing between them with respect to the amount of clearance or interference that is present when they are assembled.

NOTE. Fits are of three general types: clearance, transition, and interference.

19. *Clearance fit*.—A clearance fit is one having limits of size so prescribed that a clearance always results when mating parts are assembled.

20. *Interference fit*.—An interference fit is one having limits of size so prescribed that an interference always results when mating parts are assembled.

21. *Transition fit*.—A transition fit is one having limits of size so prescribed that either a clearance or an interference may result when mating parts are assembled.

22. *Basic hole system*.—A basic hole system is a system of fits in which the design size of the hole is the basic size and the allowance is applied to the shaft.

23.—*Basic shaft system*.—A basic shaft system is a system of fits in which the design size of the shaft is the basic size and the allowance is applied to the hole.

(c) TERMS RELATING TO GEOMETRICAL ELEMENTS OF SCREW THREADS.—Terms relating to geometrical elements of both straight and taper threads are defined as follows:

1. *Axis*.—The axis of a thread is the axis of its pitch cylinder or cone.

2. *Pitch line*.—The pitch line is a generator of the cylinder or cone specified in the definition of pitch diameter.

3. *Form*.—The form of thread is its profile in an axial plane for a length of one pitch.

4. *Basic form of thread*.—The basic form of a thread is the theoretical profile of the thread for a length of one pitch in an axial plane, on which the design forms of the threads for both the external and internal threads are based.

5. *Design forms of thread*.—The design forms for a thread are the maximum material forms permitted for the external and internal threads.

6. *Fundamental triangle*.—The fundamental triangle is the triangle whose corners coincide with three consecutive intersections of the extended flanks of the basic form.

7. *Flank*.—The flank (or side) of a thread is either surface connecting the crest with the root, the intersection of which, with an axial plane, is theoretically a straight line.

8. *Leading flank*.—The leading flank of a thread is the one which, when the thread is about to be assembled with a mating thread, faces the mating thread.

9. *Following flank*.—The following flank of a thread is the one that is opposite to the leading flank.

10. *Pressure flank*.—The pressure flank is that which takes the thrust or load in an assembly. The term is used particularly in relation to buttress and other similar threads.

11. *Clearance (or trailing) flank*.—The clearance flank is that which does not take the thrust or load in an assembly.

12. *Crest*.—The crest is that surface of the thread that joins the flanks of the thread and is farthest from the cylinder or cone from which the thread projects.

13. *Root*.—The root is that surface of the thread that joins the flanks of adjacent thread forms and is identical with or immediately adjacent to the cylinder or cone from which the thread projects.

14. *Sharp crest (or crest apex)*.—The sharp crest is the apex formed by the intersection of the flanks of a thread when extended, if necessary, beyond the crest.

15. *Sharp root (or root apex)*.—The sharp root is the apex formed by the intersection of the flanks of adjacent thread forms when extended, if necessary, beyond the root.

16. *Base*.—The base of a thread is that section of the thread that coincides with the cylinder or cone from which the thread projects.

17. *Major cylinder or cone*.—See "major diameter" and "major cone."

18. *Minor cylinder or cone*.—See "minor diameter" and "minor cone."

19. *Pitch cylinder or cone*.—See "pitch diameter" and "pitch cone."

20. *Complete thread*.—The complete (or full) thread is that part of the thread having full form at both crest and root. When there is a chamfer at the start of the thread, not exceeding two pitches in length on an external thread or one pitch in length on an internal thread, it is included within the length of complete thread. When designing threaded products, it is necessary to take cognizance of: (1) Such permissible length of chamfer and (2) the first three threads which by virtue of "not go" gaging practice may exceed the product limits and which may be included within the length of complete thread. However, when the application is such as to require a minimum number of turns engagement, the specification shall so state and shall specify the minimum number of turns required.

21. *Incomplete thread*.—This is also known as the vanish or washout thread. On straight threads, the incomplete thread is that portion at the end having roots not fully formed by the lead or chamfer on threading tools.

On taper threads, the crest at the end may also be not fully formed due to the intersection of the major cone of an external thread, or the minor cone of an internal thread, with the cylindrical surface of the work.

22. *Effective thread*.—The effective (or useful) thread includes the complete thread and that portion of the incomplete thread having fully formed roots but having crests not fully formed.

23. *Total thread*. The total thread includes the complete or effective thread and the incomplete thread.

24. *Vanish conc.*—The vanish cone is a cone, the surface of which would pass through the roots of the incomplete thread formed by the lead or chamfer of the threading tool.

25. *Vanish point.*—The vanish point of an external thread is the intersection of a generator of the vanish cone with a generator of the cylinder of the largest major diameter of the thread.

26. *Blunt start.*—“Blunt start” designates the removal of the partial thread at the entering end of thread. This is a feature of threaded parts that are repeatedly assembled by hand, such as hose couplings and thread plug gages, to prevent cutting of hands and crossing of threads, and which was formerly known as a *Higbee cut*. (See fig. II.1.)

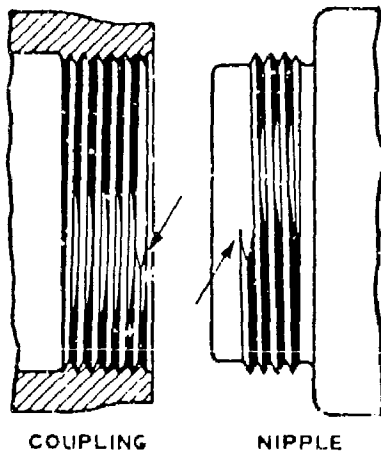

FIGURE II.1.—Blunt start.

(d) TERMS RELATING TO DIMENSIONS OF SCREW THREADS.—Terms relating to dimensions of both straight and taper threads are defined as follows:

1. *Pitch.*—The pitch of a thread is the distance, measured parallel to its axis, between corresponding points on adjacent thread forms in the same axial plane and on the same side of the axis.

2. *Lead.*—The lead is the distance a threaded part moves axially, with respect to a fixed mating part, in one complete rotation.

3. *Threads per inch.*—The number of threads per inch is the reciprocal of the pitch in inches.

4. *Turns per inch.*—The number of turns per inch is the reciprocal of the lead in inches.

5. *Included angle.*—The included angle of a thread (or angle of thread) is the angle between the flanks of the thread measured in an axial plane.

6. *Flank angle.*—The flank angles are the angles between the individual flanks and the perpendicular to the axis of the thread, measured in an axial plane. A flank angle of a symmetrical thread is commonly termed the *half-angle of thread*.

7. *Lead angle.*—On a straight thread the lead angle is the angle made by the helix of the thread at the pitch line with a plane perpendicular to the axis. On a taper thread, the lead angle at a given axial position is the angle made by the conical

spiral of the thread at the pitch line with the plane perpendicular to the axis at that position.

8. *Thickness of thread.*—The thickness of thread is the distance between the flanks of the thread measured at a specified position and parallel to the axis.

9. *Height of fundamental triangle.*—The height of the fundamental triangle of a thread, or the height of a sharp-V thread, is the distance, measured perpendicular to the axis, between the sharp major and minor cylinders or cones, respectively.

10. *Height of thread.*—The height (or depth) of thread is the distance, measured perpendicular to the axis, between the major and minor cylinders or cones, respectively.

11. *Addendum.*—The addendum of an external thread is the distance, measured perpendicular to the axis, between the major and pitch cylinders or cones, respectively. The addendum of an internal thread is the distance, measured perpendicular to the axis, between the minor and pitch cylinders or cones, respectively.

12. *Dedendum.*—The dedendum of an external thread is the distance, measured perpendicular to the axis, between the pitch and minor cylinders or cones, respectively. The dedendum of an internal thread is the distance, measured perpendicular to the axis, between the major and pitch cylinders or cones, respectively.

13. *Crest truncation.*—The crest truncation of a thread is the distance, measured perpendicular to the axis, between the sharp crest (or crest apex) and the cylinder or cone that would bound the crest.

14. *Root truncation.*—The root truncation of a thread is the distance, measured perpendicular to the axis, between the sharp root (or root apex) and the cylinder or cone that would bound the root.

15. *Major diameter.*—On a straight thread, the major diameter is the diameter of the coaxial cylinder that would bound the crest of an external thread or the root of an internal thread.

On a taper thread, the major diameter, at a given position on the thread axis, is the diameter of the major cone at that position.

16. *Minor diameter.*—On a straight thread, the minor diameter is the diameter of the coaxial cylinder that would bound the root of an external thread or the crest of an internal thread.

On a taper thread, the minor diameter, at a given position on the thread axis, is the diameter of the minor cone at that position.

17. *Pitch diameter (simple effective diameter).*—On a straight thread, the pitch diameter is the diameter of the coaxial cylinder, the surface of which would pass through the thread profiles at such points as to make the width of the groove equal to one-half of the basic pitch. On a perfect thread this occurs at the points where the widths of the thread and groove are equal.

On a taper thread, the pitch diameter at a given position on the thread axis is the diameter of the pitch cone at that position.

18. *Virtual diameter (or effective size).*--The virtual diameter of an external or internal thread is the diameter derived by adding to the pitch diameter in the case of an external thread, or subtracting from the pitch diameter in the case of an internal thread, the cumulative effects of deviations from specified profile, including variations in lead, in uniformity of helix, in flank angle, taper, out-of-roundness, and surface defects.

19. *Depth of thread engagement.*--The depth (or height) of thread engagement between two mating threads is the distance, measured perpendicular to the axis, by which their thread forms overlap each other.

20. *Length of thread engagement.*--The length of thread engagement of two mating threads is the distance between the extreme points of contact on the pitch cylinders or cones, measured parallel to the axis.

21. *Crest clearance.*--The crest clearance in a thread assembly is the distance, measured perpendicular to the axis, between the crest of a thread and the root of its mating thread.

22. *Tensile stress area.*--The tensile stress area is the assumed area of an external threaded part that is used for the purpose of computing the tensile strength.

Tabulated stress areas in section III and appendix 1, applicable to steel parts, are computed from the following formula:

$$A_s = 3.1416 \left(\frac{E}{2} - \frac{3H}{16} \right)^2$$

or $A_s = 0.7854 (D - 0.9743/n)^2$,

where E = basic pitch diameter
 D = basic major diameter
 n = threads per inch

For $\frac{3H}{16}$, see table III.1.

This formula correlates with test results for steels up to 100,000 psi ultimate strength.

For steels having ultimate strengths greater than 100,000 psi, it is recommended that the following formula be used to determine the stress area:

$$A_s = 3.1416 \left(\frac{E_{min}}{2} - \frac{3H}{16} \right)^2$$

where E_{min} equals minimum pitch diameter of the class of thread specified.

23. *Thread shear area.* The thread shear area of the external thread is the effective area at a diameter equal to the maximum minor diameter of the internal thread. The thread shear area of the internal thread is the effective area at a diameter equal to the minimum major diameter of the external thread. The formula for shear area of the external thread at a diameter equal to the

maximum minor diameter of the internal thread (AS_i) is as follows:

$$AS_i =$$

$$3.1416nL_eK_n \max \left[\frac{1}{2n} + 0.57735(E_e \min - K_n \max) \right]$$

The formula for shear area of the internal thread at a diameter equal to the minimum major diameter of the external thread (AS_n) is as follows:

$$AS_n =$$

$$3.1416nL_eD_s \min \left[\frac{1}{2n} + 0.57735(D_s \min - E_n \max) \right]$$

where n = number of threads per inch
 L_e = length of engagement
 $K_n \max$ = maximum minor diameter of internal thread
 $E_e \min$ = minimum pitch diameter of external thread
 $D_s \min$ = minimum major diameter of external thread
 $E_n \max$ = maximum pitch diameter of internal thread.

As materials bearing the same name vary greatly in ultimate strength and in other essential characteristics, the formulas given below are included in order that a safe length of external thread mating with internal threads may be calculated. It is desirable that the length of internal thread and the dimensions of this thread, particularly its minor diameter, be such that, taking into account a possible difference in strength of material of the internal and external threads, the threaded portion of the external thread will break before either the external or internal threads strip. For this reason, the shearing strength of the assembled unit should be taken as $\frac{1}{2}$ the tensile strength, which gives a small factor of safety.

The length of engagement of a threaded unit, that will develop maximum strength of an assembled (threaded unit with external) and internal threads manufactured of materials of equal tensile strength, is computed from the following formula:

$$L_e =$$

$$\frac{2 \angle \text{Stress area}}{3.1416nK_n \max \left[\frac{1}{2n} + 0.57735(E_e \min - K_n \max) \right]}$$

This formula has the factor " $\frac{1}{2}$ " for relation of shearing strength to tensile strength incorporated therein. The formula, while given for steel external and internal threads, may be used for brass external and internal threads and provides an additional safety factor.

Where the external and internal threads are manufactured of materials of different tensile

strengths, the factor J for the relative strength in shear of external threads with respect to internal threads must be considered. The factor J is computed from the following formula:

$$J = \frac{AS_e \times \text{Tensile strength of external thread}}{AS_i \times \text{Tensile strength of internal thread}}$$

The length of engagement of a threaded unit adjusted to obtain proper relation of strength to cause breakage of the bolt before threads will shear is Q and is computed from the following formulas:

If J is less than 1, $Q = L_e$

If J is greater than 1, $Q = J \times L_e$

(c) TERMS RELATING ONLY TO TAPER SCREW THREADS. — Terms relating only to taper threads are defined as follows:

1. *Pitch cone.*—The pitch cone is a cone, the surface of which would pass through the thread profiles at such points as to make the width of the groove equal to one half of the basic pitch. On a perfect thread this occurs at the point where the widths of the thread and groove are equal.

2. *Major cone.*—The major cone is a cone having an apex angle equal to that of the pitch cone, the surface of which would bound the crest of an external thread or the root of an internal thread.

3. *Sharp major cone.*—The sharp major cone is a cone having an apex angle equal to that of the pitch cone, the surface of which would pass through the sharp crest of an external thread or the sharp root of an internal thread.

4. *Minor cone.*—The minor cone is a cone having an apex angle equal to that of the pitch cone, the surface of which would bound the root of an external thread or the crest of an internal thread.

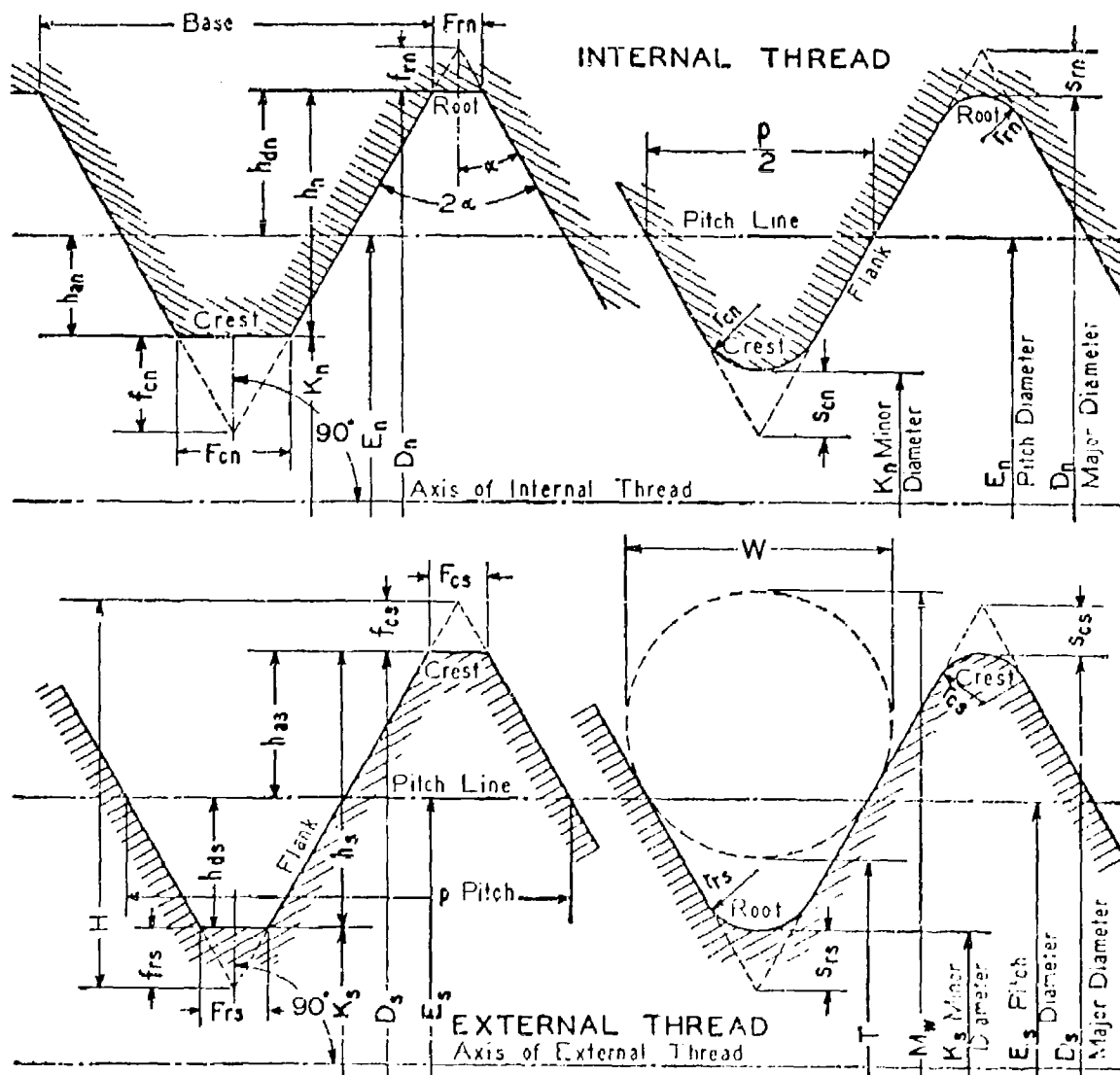

FIGURE 11.2.—General screw thread symbols.

NOTE. These diagrams are not intended to show standard thread forms; but illustrate only the application of symbols.

5. *Sharp minor cone.*—The sharp minor cone is a cone having an apex angle equal to that of the pitch cone, the surface of which would pass through the sharp root of an external thread or the sharp crest of an internal thread.

6. *Standoff.*—The standoff is the axial distance between specified reference points on external and internal taper threaded members or gages, when assembled with a specified torque or under other specified conditions.

7. *Bottom of chamfer.*—On a chamfered internal taper thread the bottom of the chamfer is defined as the intersection of the chamfer cone and the pitch cone of the thread.

3. LETTER SYMBOLS AND ABBREVIATIONS

Symbols associated with screw threads are of two kinds: (1) Letter symbols for designating dimensions of screw threads and threaded products; and (2) abbreviations used as designations for various standard thread forms and thread series.

(a) **DIMENSIONAL SYMBOLS.**—Standard letter symbols to designate the dimensions of screw threads are given in tables II.1 and II.2. General symbols are given in table II.1 and pipe-thread symbols in table II.2. The application of general symbols is illustrated in figures II.2 and II.3, inclusive, and pipe-thread symbols in figure II.4.

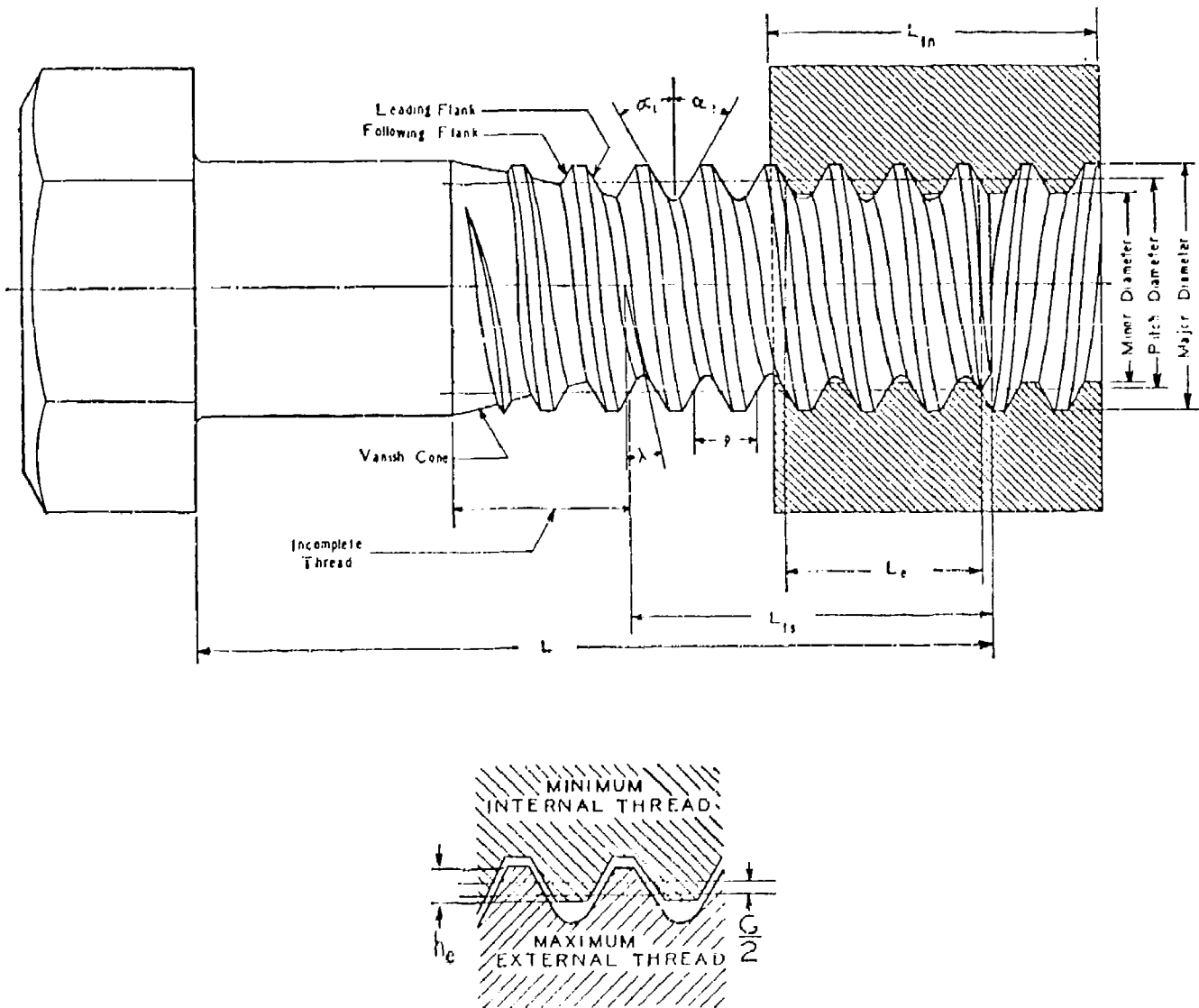

FIGURE II.3. —General screw thread symbols.

TABLE II.1.—General symbols (see figs. II.2 and II.3)

Symbols	Dimensions	Remarks
<i>D</i>	Major diameter.....	<i>Exception:</i> <i>D</i> is used for basic major diameter when this differs from the nominal major diameter. Subscripts <i>s</i> or <i>n</i> , indicating external or internal thread, may be used if necessary.
<i>E</i>	Pitch diameter.....	Subscripts <i>s</i> or <i>n</i> , indicating external or internal thread, may be used if necessary.
<i>K</i>	Minor diameter.....	
<i>p</i>	Pitch.....	Equals $1/n$.
<i>l</i>	Lead.....	Equals $1/N$.
<i>n</i>	Number of threads per unit of length (per inch).....	Equals $1/p$.
<i>N</i>	Number of turns per unit of length (per inch).....	Equals $1/l$.
<i>H</i>	Height of fundamental triangle.....	
<i>h</i>	Height of thread.....	Subscripts <i>s</i> or <i>n</i> , indicating external or internal thread, may be used if necessary.
<i>h_a</i>	Addendum.....	
<i>h_d</i>	Dedendum.....	
<i>h_s</i>	Equals $2h_a$ of basic external thread.....	
<i>h_e</i>	Depth of thread engagement.....	
α (alpha).....	Half-angle of symmetrical thread.....	
α_1	Angle between leading flank of thread and normal to axis of thread.....	
α_2	Angle between following flank of thread and normal to axis of thread.....	
λ (lambda).....	Lead angle.....	$\tan \lambda = \frac{l}{\pi E}$
<i>r</i>	Radius of rounding at crest, or radius of rounding at root.....	Subscripts <i>e</i> or <i>r</i> indicating crest or root, and <i>s</i> or <i>n</i> indicating external or internal thread may be used if necessary.
<i>a</i>	Depth from apex of fundamental triangle to adjacent root or crest of thread:	
<i>a₁</i>	(1) If rounded.....	
<i>a₂</i>	(2) If flat.....	
$\frac{1}{2}a$	Depth from apex of fundamental triangle to:	
$\frac{1}{2}a_1$	(1) Flat at crest of external thread.....	
$\frac{1}{2}a_2$	(2) Flat at root of external thread.....	
$\frac{1}{2}a_3$	(3) Flat at crest of internal thread.....	
$\frac{1}{2}a_4$	(4) Flat at root of internal thread.....	
<i>F</i>	Width of:	
<i>F₁</i>	(1) Flat (general).....	
<i>F₂</i>	(2) Flat at crest of external thread.....	
<i>F₃</i>	(3) Flat at root of external thread.....	
<i>F₄</i>	(4) Flat at crest of internal thread.....	
<i>F₅</i>	(5) Flat at root of internal thread.....	
<i>L</i>	Length of bolt or screw.....	
<i>L_t</i>	Length of full thread.....	Subscripts <i>s</i> or <i>n</i> may be used.
<i>L_e</i>	Length of thread engagement.....	
<i>M_w</i>	Diameter of measuring wires.....	
<i>T_w</i>	Measurement over wires.....	
<i>C</i>	Correction to measurement over wires to give pitch diameter.....	$E = M_w - C - c$ $C = w (1.4 \cos \alpha - \cot \alpha) / 2n$ $E = T_4 P - c$ $P = 1/2p \cot \alpha - (\cos \alpha - 1)w$
<i>P</i>	Correction to measurement under wires to give pitch diameter.....	
<i>W</i>	Wire angle.....	See N.P.L. "Gauging and Measuring Screw Threads," 1951, p. 23, or NBS Handbook H28 (1957), p. 197
<i>c</i>	Wire angle correction.....	
Prefix symbol with δ (delta).....	Deviation in any dimension.....	<i>Examples:</i> Deviation in pitch, δp ; deviation in half-angle, $\delta \alpha$ or $\delta \alpha_1$.
δE_{α} (delta E_{α}).....	Pitch-diameter equivalent of deviations in flank angles.....	
δE_p (delta E_p).....	Pitch diameter equivalent of deviation in pitch.....	
<i>A</i>	Allowance at pitch diameter.....	

TABLE II.2.—Pipe-thread symbols (see fig. II.4)

Symbols	Dimensions	Remarks
<i>D</i>	Outside diameter of pipe.....	Subscript 4 is used for dimensions in plane of vanish point when these differ from <i>D</i> , <i>d</i> , or <i>t</i> , respectively.
<i>d</i>	Inside diameter of pipe.....	
<i>t</i>	Wall thickness of pipe.....	
<i>D_s</i>	Major diameter.....	Subscript <i>s</i> denotes plane containing the diameter. For axial positions of planes see foot of this table. Subscripts <i>s</i> or <i>n</i> designating screw or nut may also be used if necessary.
<i>E_s</i>	Pitch diameter.....	
<i>K_s</i>	Minor diameter.....	
<i>L_s</i>	Length of thread from plane of pipe end to plane containing basic diameter <i>D_s</i> , <i>E_s</i> , or <i>K_s</i>	For axial position of plane containing basic diameter, see foot of this table.
<i>V</i>	Length of washout (vanish cone) threads.....	
β (beta).....	Half apex angle of pitch cone of taper thread.....	
γ (gamma).....	Angle of chamfer at end of pipe measured from a plane normal to the axis.....	
<i>A</i>	Handlight standoff of face of coupling from plane containing vanish point on pipe.....	
<i>M</i>	Length from plane of handlight engagement to the face of coupling on internally threaded member.....	
<i>S</i>	Distance of gaging step of plug gage from face of ring gage for handlight engagement.....	
<i>L_a</i>	Length from center line of coupling, face of flange, or bottom of internal thread chamber to face of fitting.....	
<i>b</i>	Width of bearing face on coupling.....	
τ (tau).....	Angle of chamfer at bottom of recess or counterbore measured from the axis.....	
ϵ (epsilon).....	Half apex angle of vanish cone.....	
<i>J</i>	Length from center line of coupling, face of flange, or bottom of internal thread chamber to end of pipe, wrenched engagement.....	
<i>L₁</i>	(1) Length of straight full thread (see table II.1). (2) Length from plane of handlight engagement to small end of full internal taper thread.....	
<i>Q</i>	Diameter of recess or counterbore in fitting.....	
<i>q</i>	Depth of recess or counterbore in fitting.....	
<i>W</i>	Outside diameter of coupling or hub of fitting.....	

DEFINITION OF PLANES DENOTED BY SUBSCRIPT *s*

$s=0$	Plane of pipe end.....
$s=1$	Plane of handlight engagement or plane at mouth of coupling (excluding recess, if present). On British pipe threads this is designated the "gauge plane," and the major diameter in this plane is designated the "gauge diameter."
$s=2$	Plane at which washout threads on pipe commence.....
$s=3$	Plane in coupling reached by end of pipe in wrenched condition. (<i>L₁</i> is measured from plane containing pipe end in position of handlight engagement.)
$s=4$	Plane containing vanish point of thread on pipe.....
$s=5$	Plane at which major diameter cone of thread intersects outside diameter of pipe.....

NOTE.—Additional special subscripts are as follows: Plane $s=6$ is the plane of the pipe end for mating joints. Plane $s=7$ is the plane of the API gage point at a specified length from the plane of vanish point. Plane $s=8$ is the plane of the large end of the "L₁ thread ring gage" for the compressed-gas cylinder valve inlet connection thread. Plane $s=9$ is the plane of the small end of the "L₁ thread plug gage" for the compressed-gas cylinder inlet thread.

TABLE II.3.—Identification designations^{1, 2}

Designation	Thread series	References	
		ASA Standards	Handbook H28 (1957), section No.
Acme-C	Acme threads, centralizing	B1.5	XII.
Acme-G	Acme threads, general purpose	B1.5	XII.
Stub Acme	Stub Acme thread	B1.8	XIII.
AMO	American Standard microscope objective thread		
N, Butt	National Buttress thread	B1.9	XIV.
NC	American National coarse thread series	B1.1	Appendix 1.
NF	American National fine thread series	B1.1	Appendix 1.
NFF	American National extra-fine thread series	B1.1	Appendix 1.
8N	American National 8-thread series	B1.1	Appendix 1.
12N	American National 12-thread series	B1.1	Appendix 1.
16N	American National 16-thread series	B1.1	Appendix 1.
NH	American National hose coupling and fire hose coupling threads	B26, B33.1	X.
NGO	American National gas outlet thread	B57.1	IX.
NM	National Miniature thread series	B1.4	V.
NS	Special threads of American National form	B1.1	Appendix 2.
NC	American Standard coarse thread series	B1.1	III.
NF	American Standard fine thread series	B1.1	III.
NPT	American Standard taper pipe thread	B2.1	VII.
NPTF	American Standard taper pipe thread (dryseal)	B2.2	VIII.
NPTR	American Standard taper pipe thread for rolling fittings	B2.1	VII.
NPS	American Standard straight pipe thread	B2.1	VII.
NPSC	American Standard straight pipe thread in couplings	B2.1	VII.
NPSF	American Standard internal straight pipe thread (dryseal)	B2.2	VIII.
NPSI	American Standard intermediate internal straight pipe thread (dryseal)	B2.2	VIII.
NPSM	American Standard straight pipe thread for mechanical joints	B2.1	VII.
NPSL	American Standard straight pipe thread for locknuts and locknut pipe threads	B2.1	VII.
NPSH	American Standard straight pipe thread for hose couplings and nipples	B2.1, B33.1	X.
ANPT	Aeronautical taper pipe thread	(9)	(9).
RMS	American Standard surveying instrument mounting thread	Under development	
UNC	Unified coarse thread series	B1.1	III.
UNEF	Unified selected diameter-pitch combinations of the extra-fine thread series	B1.1	III.
UNF	Unified fine thread series	B1.1	III.
UNS	Unified selected diameter-pitch combinations of the 8-, 12-, and 16-thread series	B1.1	III.
	Unified threads of selected special diameters, pitches, and lengths of engagement	B1.1	IV.

¹ Methods of designating multiple threads are shown in ASA B1.5 Acme Screw Threads, and Part III of Handbook H28 (1957).
² All threads, except NGO, are right hand, unless otherwise designated. For NGO threads, designations "RH" or "LH" are required.
³ Military Specification M11-P-7105, Pipe Threads, Taper, Aeronautical National Form.

SECTION III. UNIFIED THREAD FORM AND THREAD SERIES FOR BOLTS, MACHINE SCREWS, NUTS, TAPPED HOLES, AND GENERAL APPLICATIONS

1. INTRODUCTION

The Unified thread standards,² which have been agreed upon by standards bodies of Canada, the United Kingdom, and the United States, constitute the basic American standards for fastening screw threads. They are a complete and integrated system of threads for fastening purposes in mechanisms and structures. Their outstanding characteristic is general interchangeability of threads achieved through the standardization of thread form, diameter-pitch combinations, and limits of size.

The standards have as their original basis the work done about a century ago by William Sellers in the United States and Sir Joseph Whitworth in Great Britain. Throughout the intervening years there have been many further developments and revisions, culminating in the system of Unified Threads approved and adopted for use by all inch-using countries.

² The Unified thread standards presented in this section are in general agreement with ASA B1.1, "Unified and American Screw Threads," published by the ASME, 20 West 30th Street, New York 18, N. Y.; also with CSA B1.1, "Standard for Unified and American Screw Threads," published by the Canadian Standards Association, Ottawa, Canada; and with British Standard 1580, "Unified Screw Threads," published by the British Standards Institution, 2 Park Street, London, W. 1. The latest revision should be consulted when referring to such standards.

Unification of screw thread standards received its impetus from the need for interchangeability among the billions of fasteners used in the complex equipment of modern warfare which was, and continues to be made in different countries. Equally important, however, are international trade in mechanisms of all kinds and the servicing of transportation equipment which moves from country to country. These have made unification not only highly advantageous but practically essential. In sizes 1/4 in. and larger, complete unification of certain thread series and six tolerance classes was signaled by the signing of an accord on November 18, 1948. Since that time a limited unification of seven sizes only for attachment purposes has been extended into smaller sizes. Although thread sizes less than 1/4 in. have not been unified, the tolerances and allowances based on Unified formulation are applied to these sizes in the United States and Canada, and they are known as American Standard threads.

In relation to previous American practice, as covered by appendixes 1 and 2 of this Handbook, Unified threads have substantially the same thread form and are mechanically interchangeable with American National threads of the same diameter and pitch.

The principal differences between the two systems relate to the application of allowances, the variation of tolerances with size, difference in amount of pitch diameter tolerance on external and internal threads, and differences in thread designations. Under the Unified system an allow-

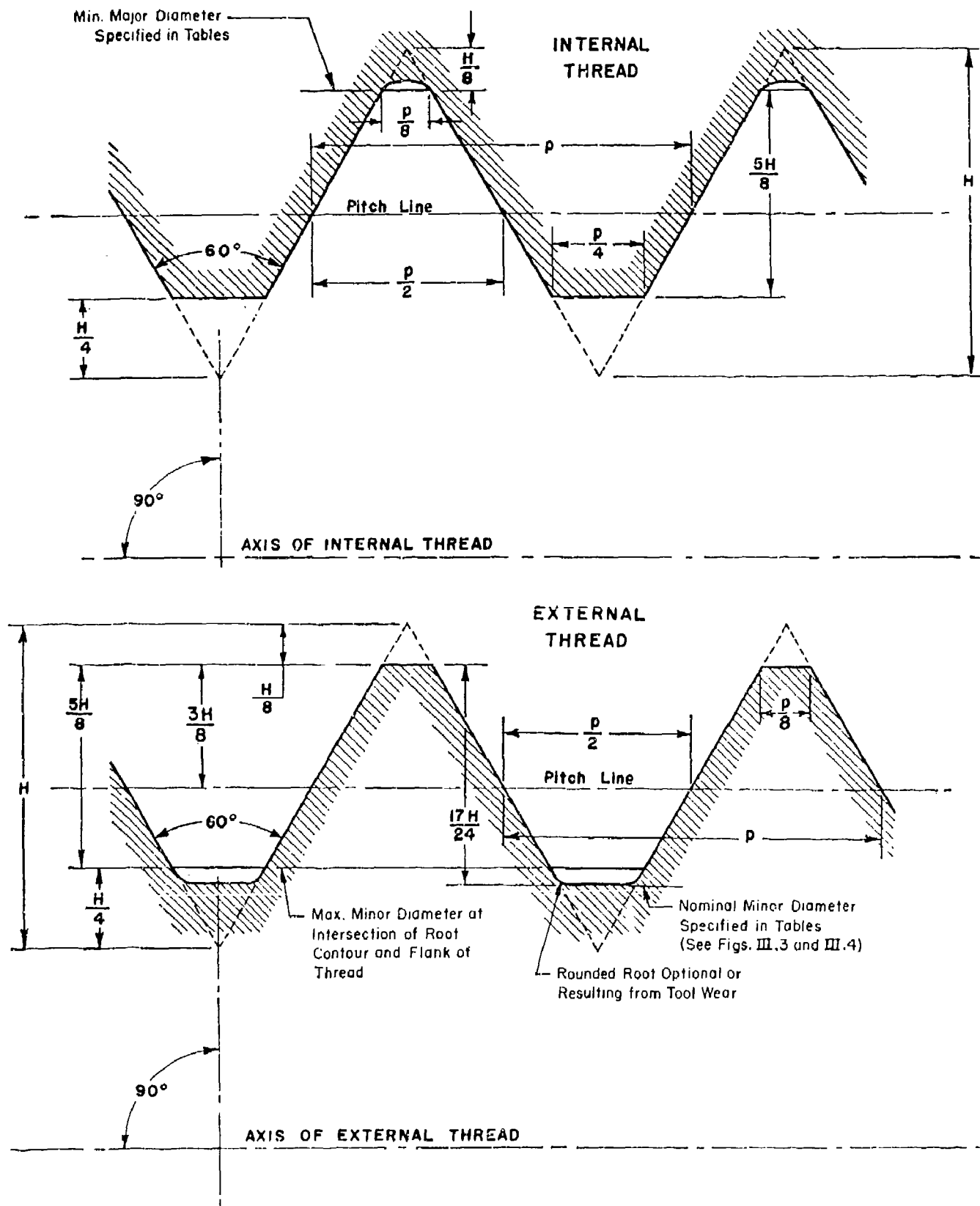

FIGURE III.1.—Unified internal and external screw thread design forms (maximum material condition).

NOTE.—See table III.1 for numerical values. In practice the crests of external threads may be rounded.

ance is provided on both the classes 1A and 2A external threads, whereas under the American National system only the class 1 external thread has an allowance. Under the Unified system, the pitch diameter tolerance of an internal thread is 30 percent greater than that of the external thread, but such tolerances are equal under the American National system. Unified tolerances and allowances for both standard and special diameter-pitch combinations are derived from the same formula, but American National tolerances for special threads have a different basis from that for some standard threads.

2. THE UNIFIED FORM OF THREAD

1. ANGLE OF THREAD.—The basic angle of thread between the flanks of the thread, measured in an axial plane, is 60°. The line bisecting this 60° angle is perpendicular to the axis of the screw thread.

2. FORM OF CREST.—The form of the crest of external threads is flat. The crest of the basic thread form of the external thread shall be truncated from the sharp crest an amount equal to

$H/8$, where H is the depth of the fundamental triangle. The form of the crest of internal threads is flat and the crest shall be truncated from the sharp crest an amount equal to $H/4$.

3. FORM OF ROOT.—The crest clearances allowed are such as to permit rounded root forms in both the external and internal threads. Rounded roots are required in some applications and are made by tools that are purposely rounded. Otherwise, rounded roots may be the result of tool wear.

4. CLEARANCE AT MINOR DIAMETER.—A clearance is provided at the minor diameter of the internal thread by truncating from the sharp crest an amount equal to $H/4$.

5. CLEARANCE AT MAJOR DIAMETER.—A clearance is provided at the major diameter of the internal thread by making the thread form at the root such that its width is less than $p/8$.

6. ILLUSTRATIONS.—Figure III.1 shows the design forms (maximum material condition) of the external and internal threads of the Unified form of thread.

7. BASIC THREAD DATA.—The basic thread data for all standard pitches of the Unified form of thread are given in table III.1.

TABLE III.1.—Thread data, Unified thread form (see fig. III.2)

Threads per inch,	Pitch,	Flat at internal thread root, F_{in} ,	Flat at internal thread root and external thread crest, $F_{in} = F_{ex} = p/8 = 0.125p$,	Height of sharp thread, $H = 0.866025p$,	Truncation of internal thread root and external thread crest, $f_{in} = f_{ex} = H/8 = 0.10825p$,	Truncation of external thread root, $h_e = H/6 = 0.14434p$,	Half addendum of external thread, $3/8 H = 0.16238p$,	Truncation of internal thread crest, $f_{in} = H/4 = 0.21651p$,	Addendum of external thread, $h_{ex} = 3/4 H = 0.32470p$,	Height of internal thread and depth of thread engagement, $h_n = h_e = 5/8 H = 0.54127p$,	Height of external thread, $h_e = 17/8 H = 0.61343p$,	Twice the external thread addendum, $2h_e = 3/2 H = 0.649619p$,	Difference between max. major and pitch diameters of internal thread, $1/2 H = 0.79386p$,	Double height of internal thread, $2h_n = 1 1/4 H = 1.08253p$,	Double height of external thread, $1 5/8 H = 1.22677p$,
n	p	$F_{in} = p/8 = 0.25p$	$F_{in} = F_{ex} = p/8 = 0.125p$	$H = 0.866025p$	$f_{in} = f_{ex} = H/8 = 0.10825p$	$h_e = H/6 = 0.14434p$	$3/8 H = 0.16238p$	$f_{in} = H/4 = 0.21651p$	$h_{ex} = 3/4 H = 0.32470p$	$h_n = h_e = 5/8 H = 0.54127p$	$h_e = 17/8 H = 0.61343p$	$2h_e = 3/2 H = 0.649619p$	$1/2 H = 0.79386p$	$2h_n = 1 1/4 H = 1.08253p$	$1 5/8 H = 1.22677p$
1	2	3	4	5	6	7	8	9	10	11	12	13	14	15	16
80	0.012500	0.00312	0.00156	0.010825	0.00135	0.00180	0.00203	0.00271	0.00406	0.00677	0.00767	0.009119	0.00992	0.01353	0.01534
72	0.013889	0.00347	0.00174	0.012028	0.00150	0.00200	0.00226	0.00301	0.00451	0.00752	0.00852	0.00999	0.01103	0.01504	0.01704
64	0.015625	0.00391	0.00195	0.013532	0.00169	0.00226	0.00254	0.00338	0.00507	0.00846	0.00958	0.01149	0.01240	0.01691	0.01917
56	0.017857	0.00446	0.00223	0.015465	0.00193	0.00258	0.00290	0.00387	0.00580	0.00967	0.01095	0.01309	0.01418	0.01933	0.02191
48	0.020833	0.00521	0.00260	0.018042	0.00226	0.00301	0.00338	0.00451	0.00677	0.01128	0.01278	0.015532	0.01654	0.02255	0.02556
44	0.022727	0.00568	0.00284	0.019682	0.00246	0.00328	0.00369	0.00492	0.00738	0.01230	0.01394	0.014762	0.01804	0.02450	0.02788
40	0.025000	0.00625	0.00312	0.021651	0.00271	0.00361	0.00406	0.00541	0.00812	0.01353	0.01534	0.016238	0.01985	0.02706	0.03067
36	0.027778	0.00694	0.00347	0.024056	0.00301	0.00401	0.00451	0.00601	0.00902	0.01504	0.01704	0.018042	0.02205	0.03007	0.03408
32	0.031250	0.00781	0.00391	0.027063	0.00338	0.00451	0.00507	0.00677	0.01015	0.01691	0.01917	0.020297	0.02481	0.03383	0.03884
28	0.035714	0.00883	0.00446	0.030929	0.00387	0.00516	0.00580	0.00773	0.01160	0.01933	0.02191	0.023197	0.02835	0.03866	0.04382
27	0.037037	0.00926	0.00463	0.032075	0.00401	0.00535	0.00601	0.00802	0.01203	0.02005	0.02272	0.024056	0.02940	0.04009	0.04544
24	0.041667	0.01042	0.00521	0.036084	0.00451	0.00601	0.00677	0.00902	0.01353	0.02255	0.02556	0.027063	0.03308	0.04511	0.05112
20	0.050000	0.01250	0.00625	0.043301	0.00541	0.00722	0.00812	0.01083	0.01624	0.02706	0.03067	0.032476	0.03969	0.05413	0.06134
18	0.055556	0.01389	0.00694	0.048113	0.00601	0.00802	0.00902	0.01203	0.01804	0.03007	0.03408	0.036084	0.04410	0.06014	0.06816
16	0.062500	0.01562	0.00781	0.054127	0.00677	0.00902	0.01015	0.01353	0.02030	0.03383	0.03834	0.040595	0.04962	0.06766	0.07668
14	0.071429	0.01786	0.00903	0.061850	0.00773	0.01031	0.01160	0.01546	0.02320	0.03866	0.04382	0.046394	0.05670	0.07752	0.08761
13	0.076923	0.01923	0.00982	0.066617	0.00833	0.01110	0.01249	0.01665	0.02498	0.04154	0.04719	0.049983	0.06107	0.08327	0.09447
12	0.083333	0.02083	0.01042	0.072160	0.00902	0.01203	0.01353	0.01804	0.02706	0.04511	0.05112	0.054127	0.06615	0.09021	0.10224
11 1/2	0.086957	0.02174	0.01087	0.075307	0.00941	0.01255	0.01412	0.01883	0.02824	0.04707	0.05334	0.056690	0.06903	0.09413	0.10628
11	0.090909	0.02273	0.01136	0.078730	0.00984	0.01312	0.01476	0.01968	0.02952	0.04921	0.05577	0.059047	0.07217	0.09841	0.11153
10	0.100000	0.02500	0.01250	0.086603	0.01083	0.01443	0.01624	0.02105	0.03218	0.05413	0.06134	0.064952	0.07939	0.1025	0.12289
9	0.111111	0.02778	0.01389	0.096225	0.01203	0.01604	0.01804	0.02406	0.03608	0.06014	0.06816	0.072109	0.08821	0.12028	0.13632
8	0.125000	0.03125	0.01562	0.108253	0.01353	0.01804	0.02030	0.02706	0.04059	0.06766	0.07668	0.081190	0.09923	0.13362	0.15336
7	0.142857	0.03571	0.01786	0.123718	0.01546	0.02062	0.02320	0.03003	0.04639	0.07732	0.08763	0.092788	0.11341	0.1485	0.17227
6	0.166667	0.04167	0.02083	0.144338	0.01804	0.02406	0.02706	0.03608	0.05413	0.08021	0.09224	0.098253	0.12321	0.16042	0.20448
5	0.200000	0.05000	0.02500	0.173206	0.02165	0.02887	0.03248	0.04330	0.06495	0.10825	0.12279	0.12904	0.15877	0.21651	0.24537
4 1/2	0.222222	0.05556	0.02778	0.192450	0.02406	0.03208	0.03608	0.04811	0.07217	0.12028	0.13632	0.14338	0.17641	0.23656	0.27264
4	0.250000	0.06250	0.03125	0.216505	0.02706	0.03608	0.04059	0.05413	0.08119	0.13552	0.15226	0.15929	0.19846	0.27003	0.30672

* Equivalent to the "basic height" h of the original American National form.

NOTE: $h_{ex} - f_{in} = \frac{H}{4}$
 $h_n - h_e = \frac{3}{8} H$

The coarse-thread series is suitable for bolts, screws, nuts, and general use where the wall thickness will accommodate the thread dimensions. It is particularly advantageous for applications requiring rapid assembly or disassembly or for threading into lower-strength materials, such as castings, soft metals, and plastics.

3. FINE-THREAD SERIES.—The basic dimensions of the fine-thread series, including both Unified thread sizes and additional American standard thread sizes, are given in table III.4. The limits of size, allowances, and tolerances for the Unified classes, based on a length of engagement of one diameter, are given in table III.10. Thread sizes of the fine-thread series which are recognized as Unified are designated by the symbol "UNF". See footnote c, p. 16. All others are designated "NF" with the Unified class designations to indicate their conformance to the Unified thread formulation.

The fine thread series is suitable for bolts, screws, and nuts, and other applications where a closer ratio is desired between the static strengths of the bolt and thread, where length of engagement is limited, where a smaller lead angle is desired, or where the wall thickness requires a smaller thread. Caution should be observed when using this series in castings, soft metals, plastics, and similar lower-strength materials.

4. EXTRA-FINE THREAD SERIES.—The extra-fine-thread series is applicable where (1) thin-walled material is to be threaded, (2) thread height of nuts clearing ferrules, coupling flanges, etc., must be held to a minimum, and (3) a maximum practicable number of threads is required within a given thread length. The basic dimensions of the extra-fine-thread series are given in table III.5. The limits of size, allowances, and tolerances for the Unified classes, based on a length of engagement of 9 pitches, are given in table III.10. Thread sizes of the extra-fine-thread series which are recognized as Unified are designated by the symbol "UNEF". All others are designated by "NEF" with the Unified class designations to indicate their conformance to the Unified thread formulation.

5. 8-THREAD SERIES.—The 8-thread series is a uniform-pitch series for large diameters. Although originally intended for high-pressure-joint bolts and nuts, it is now widely used as a substitute for the coarse-thread series for diameters larger than 1 in. It is used particularly on bolts for high-pressure pipe flanges, cylinder-head studs, and similar fasteners against pressure. The basic dimensions of the 8-thread series are given in table III.6. In American practice, the limits of size of this series are customarily based on a length of engagement of one diameter, as given in table III.10. Such threads are designated "8N" with the Unified class designations to indicate their conformance to the Unified thread formulation. Sizes of the 8-thread series³ larger than 1½

in. in even ¼ in. are recognized as Unified sizes when limits of size are based on a length of engagement of 9 pitches, or 1¼ in.

6. 12-THREAD SERIES.—The 12-thread series is a uniform-pitch series for large diameters requiring threads of medium-fine pitch. It is widely used in machine construction for thin nuts on shafts and sleeves. It also allows the specification of shoulder diameters in steps of ⅛ in., as from the standpoints of good design and simplification of practice it is desirable to limit shoulder diameters to ⅛-in. steps. Twelve threads per inch is the coarsest pitch in general use which will permit a threaded collar, which screws onto a threaded shoulder, to slip over a shaft, the difference in diameter between shoulder and shaft being ⅛ in. Sizes of the 12-thread series from ½ in. to and including 1¼ in. are used in boiler practice, which requires that worn stud holes be retapped with a tap of the next larger size, the increment being ⅛ in. throughout most of the range. The 12-thread series also provides continuation of the fine-thread series for diameters larger than 1½ in.

The basic dimensions of the 12-thread series are given in table III.7. The limits of size, allowances, and tolerances for the Unified classes, based on a length of engagement of 9 pitches or ¾ in., are given in table III.10. Thread sizes of the 12-thread series which are recognized as Unified are designated by the symbol "12UN." All others are designated "12N" with the Unified class designations to indicate their conformance to the Unified thread formulation.³

7. 16-THREAD SERIES.—The 16-thread series is a uniform-pitch series for large diameters requiring fine-pitch threads. It is suitable for adjusting collars and retaining nuts, and also serves as a continuation of the extra-fine-thread series for diameters larger than 2 in. The basic dimensions of the 16-thread series are given in table III. 8. The limits of size, allowances, and tolerances for the Unified classes, based on a length of engagement of 9 pitches or ⅝ in., are given in table III. 10. Thread sizes of the 16-thread series which are recognized as Unified are designated by the symbol "16UN." All others are designated "16N" with the Unified class designations to indicate their conformance to the Unified thread formulation (see footnote 3).

8. UNIFORM PITCH SERIES.—The above 8-, 12-, and 16-thread series have application on parts that are repeatedly assembled and disassembled where it might be advantageous to rethread oversize to recondition the thread portions of the parts in service.

Whenever a thread in the 8-, 12-, and 16-thread series also appears in the UNC, NC, UNF, NF, UNEF or NEF series the designations, tolerances, and limits of size of these standard series are applicable.

³The British designation for Unified sizes in this series is "UN8".

TABLE III.2.—Unified and American, screw thread standard series

Size	Basic major diameter	Threads per inch					Size
		Coarse (UNC or NC)	Fine * (UNF or NF)	Extra fine † (UNEF or NEF)	8-Thread series (N)	12-Thread series (UN or N)	
0	0.0600		80				0
1	.0730	64	72				1
2	.0860	66	64				2
3	.0990	48	56				3
4	.1120	40	48				4
5	.1250	40	44				5
6	.1390	32	40				6
8	.1640	32	36				8
10	.1900	24	32				10
12	.2100	24	28	32			12
1/4	.2500	20	28	32			1/4
5/16	.3125	18	24	32			5/16
3/8	.3750	16	24	32			3/8
7/16	.4375	14	20	28			7/16
1/2	.5000	13	20	28		12	1/2
9/16	.5625	12	18	24		12	9/16
5/8	.6250	11	18	24		12	5/8
11/16	.6875			24		12	11/16
3/4	.7500	10	16	20		12	3/4
13/16	.8125			20		12	13/16
7/8	.8750	9	14	20		12	7/8
15/16	.9375			20		12	15/16
1	1.0000		14				1
1 1/16	1.0625	8	12	20	8	12	1 1/16
1 1/8	1.1250			18	8	12	1 1/8
1 1/4	1.1875	7	12	18	8	12	1 1/4
1 1/2	1.2500			18	8	12	1 1/2
1 5/8	1.3125	7	12	18	8	12	1 5/8
1 3/4	1.3750			18	8	12	1 3/4
1 7/8	1.4375	6	12	18	8	12	1 7/8
1 1/2	1.5000			18	8	12	1 1/2
1 9/16	1.5625	6	12	18	8	12	1 9/16
1 5/8	1.6250			18	8	12	1 5/8
1 3/4	1.6875			18	8	12	1 3/4
1 7/8	1.7500	5		16	8	12	1 7/8
1 15/16	1.8125					12	1 15/16
2	2.0000					12	2
2 1/16	2.0625	4 1/2		16	8	12	2 1/16
2 1/8	2.1250					12	2 1/8
2 1/4	2.1875					12	2 1/4
2 1/2	2.2500					12	2 1/2
2 5/8	2.3125	4 1/2			8	12	2 5/8
2 3/4	2.3750					12	2 3/4
2 7/8	2.4375					12	2 7/8
2 1/2	2.5000	4			8	12	2 1/2
2 5/4	2.6250					12	2 5/4
2 3/2	2.7500	4			8	12	2 3/2
2 7/8	2.8750					12	2 7/8
3	3.0000	4			8	12	3
3 1/4	3.1250					12	3 1/4
3 1/2	3.2500	4			8	12	3 1/2
3 3/4	3.3750					12	3 3/4
3 1/2	3.5000	4			8	12	3 1/2
3 3/4	3.6250					12	3 3/4
3 3/4	3.7500	4			8	12	3 3/4
3 7/8	3.8750					12	3 7/8
4	4.0000	4			8	12	4
4 1/4	4.2500					12	4 1/4
4 1/2	4.5000				8	12	4 1/2
4 3/4	4.7500				8	12	4 3/4
5	5.0000				8	12	5
5 1/4	5.2500				8	12	5 1/4
5 1/2	5.5000				8	12	5 1/2
5 3/4	5.7500				8	12	5 3/4
6	6.0000				8	12	6

* For diameters over 1 1/2 in., use 12-thread series.
† For diameters over 2 in., use 16-thread series.
‡ For series symbols applying to a particular thread, see table III.10. Where the same thread is in two series, use symbols as explained in par. 8, p. 14.
§ Designated 8 UNS in the British Standard.
¶ NS. Formerly a standard size of the fine thread series.

TABLE III.3.—Coarse thread series, basic dimensions
UNC and NC

Designation			Basic major diameter, <i>D</i>	Basic pitch diameter, <i>E</i>	Minor diameter, external threads, <i>K_e</i>	Minor diameter, internal threads, <i>K_i</i>	Lead angle at basic pitch diameter, λ	Sectional area at minor diameter at $D-2h_s$	Tensile stress area ^a $\left(\frac{E-3H}{2-16}\right)^2$
Size	Threads per inch, <i>n</i>	Thread symbol							
1	2	3	4	5	6	7	8	9	10
No.	in.		in.	in.	in.	in.	deg min	in. ²	in. ²
1 (.073)	64	NC	0.0730	0.0629	0.0538	0.0501	4 31	0.00218	0.00263
2 (.086)	56	NC	0.0860	0.0744	0.0641	0.0657	4 22	0.00310	0.00370
3 (.099)	48	NC	0.0990	0.0855	0.0734	0.0764	4 26	0.00406	0.00487
4 (.112)	40	NC	0.1120	0.0958	0.0813	0.0849	4 45	0.00496	0.00604
5 (.125)	40	NC	0.1250	0.1088	0.0943	0.0979	4 11	0.00672	0.00796
6 (.138)	32	NC	0.1380	0.1177	0.0997	0.1042	4 50	0.00745	0.00909
8 (.164)	32	NC	0.1640	0.1437	0.1257	0.1302	3 58	0.01196	0.0140
10 (.190)	24	NC	0.1900	0.1629	0.1389	0.1449	4 39	0.01450	0.0175
12 (.216)	24	NC	0.2160	0.1889	0.1649	0.1709	4 1	0.0206	0.0242
1/4	20	UNC	0.2500	0.2175	0.1887	0.1959	4 11	0.0296	0.0318
5/16	18	UNC	0.3125	0.2764	0.2443	0.2524	3 40	0.0454	0.0524
3/8	16	UNC	0.3750	0.3344	0.2983	0.3073	3 24	0.0678	0.0775
7/16	14	UNC	0.4375	0.3911	0.3499	0.3602	3 20	0.0933	0.1063
1/2	13	UNC	0.5000	0.4500	0.4056	0.4167	3 7	0.1257	0.1419
9/16	12	UNC	0.5625	0.5084	0.4603	0.4723	2 59	0.162	0.182
5/8	11	UNC	0.6250	0.5660	0.5135	0.5266	2 56	0.202	0.226
3/4	10	UNC	0.7500	0.6850	0.6273	0.6417	2 40	0.302	0.334
7/8	9	UNC	0.8750	0.8028	0.7387	0.7547	2 31	0.419	0.462
1	8	UNC	1.0000	0.9188	0.8466	0.8647	2 29	0.551	0.606
1 1/4	7	UNC	1.1250	1.0322	0.9497	0.9704	2 31	0.693	0.763
1 1/2	7	UNC	1.2500	1.1572	1.0747	1.0954	2 15	0.890	0.969
1 3/4	6	UNC	1.3750	1.2667	1.1705	1.1946	2 24	1.054	1.155
1 1/2	6	UNC	1.5000	1.3917	1.2955	1.3196	2 11	1.294	1.405
1 3/4	5	UNC	1.7500	1.6201	1.5046	1.5335	2 15	1.74	1.90
2	4 1/2	UNC	2.0000	1.8557	1.7274	1.7594	2 11	2.30	2.50
2 1/4	4 1/2	UNC	2.2500	2.1057	1.9774	2.0094	1 55	3.02	3.25
2 1/2	4	UNC	2.5000	2.3376	2.1933	2.2294	1 57	3.72	4.00
2 3/4	4	UNC	2.7500	2.5876	2.4433	2.4794	1 46	4.62	4.93
3	4	UNC	3.0000	2.8376	2.6933	2.7294	1 36	5.62	5.97
3 1/4	4	UNC	3.2500	3.0876	2.9433	2.9794	1 29	6.72	7.10
3 1/2	4	UNC	3.5000	3.3376	3.1933	3.2294	1 22	7.92	8.33
3 3/4	4	UNC	3.7500	3.5876	3.4433	3.4794	1 16	9.21	9.66
4	4	UNC	4.0000	3.8376	3.6933	3.7294	1 11	10.61	11.08

^a See formula under definition of tensile stress area in Section 11, p. 5.

^b For attaching purposes only, numbered sizes 2-56, 4-40, 6-32, 8-32, and 10-24 are now included in the Unified thread series, designation NC.

Bold type indicates Unified threads, UNC. See footnote b and table III.10.

TABLE III.4.—Fine thread series, basic dimensions
UNF and NF

Designation			Basic major diameter, <i>D</i>	Basic pitch diameter, <i>E</i>	Minor diameter, external threads, <i>K_e</i>	Minor diameter, internal threads, <i>K_i</i>	Lead angle at basic pitch diameter, λ	Sectional area at minor diameter at $D-2h_s$	Tensile stress area ^a $\left(\frac{E-3H}{2-16}\right)^2$
Size ^c	Threads per inch, <i>n</i>	Thread symbol							
1	2	3	4	5	6	7	8	9	10
No.	in.		in.	in.	in.	in.	deg min	in. ²	in. ²
0 (.060)	80	NF	0.0600	0.0519	0.0447	0.0465	4 23	0.00151	0.00180
1 (.073)	72	NF	0.0730	0.0640	0.0560	0.0580	3 57	0.00237	0.00278
2 (.086)	64	NF	0.0860	0.0759	0.0668	0.0691	3 45	0.00339	0.00394
3 (.099)	56	NF	0.0990	0.0874	0.0771	0.0797	3 43	0.00451	0.00523
4 (.112)	48	NF	0.1120	0.0985	0.0864	0.0894	3 51	0.00696	0.00861
5 (.125)	44	NF	0.1250	0.1102	0.0971	0.1004	3 45	0.00716	0.00830
6 (.138)	40	NF	0.1380	0.1218	0.1073	0.1109	3 44	0.00874	0.01015
8 (.164)	36	NF	0.1640	0.1480	0.1280	0.1339	3 28	0.01285	0.01474
10 (.190)	32	NF	0.1900	0.1697	0.1517	0.1562	3 21	0.0175	0.0200
12 (.216)	28	NF	0.2160	0.1928	0.1722	0.1773	3 22	0.0226	0.0258
1/4	28	UNF	0.2500	0.2268	0.2062	0.2113	2 52	0.0285	0.0364
5/16	24	UNF	0.3125	0.2854	0.2614	0.2674	2 40	0.0324	0.0390
3/8	24	UNF	0.3750	0.3479	0.3239	0.3299	2 11	0.0409	0.0478
7/16	20	UNF	0.4375	0.4050	0.3762	0.3834	2 15	0.0490	0.0571
1/2	20	UNF	0.5000	0.4675	0.4387	0.4459	1 57	0.0486	0.0569
9/16	18	UNF	0.5625	0.5264	0.4943	0.5024	1 55	0.049	0.057
5/8	18	UNF	0.6250	0.5889	0.5568	0.5649	1 43	0.040	0.046
3/4	16	UNF	0.7500	0.7094	0.6733	0.6823	1 36	0.031	0.035
7/8	14	UNF	0.8750	0.8286	0.7874	0.7977	1 34	0.040	0.046
1	12	UNF	1.0000	0.9459	0.8978	0.9098	1 36	0.025	0.028
1 1/4	12	UNF	1.1250	1.0709	1.0228	1.0348	1 25	0.012	0.013
1 1/2	12	UNF	1.2500	1.1959	1.1478	1.1598	1 16	0.024	0.026
1 3/4	12	UNF	1.3750	1.3209	1.2728	1.2848	1 10	0.015	0.016
1 1/2	12	UNF	1.5000	1.4459	1.3978	1.4098	1 3	0.012	0.013

^a For sizes larger than 1 1/4 in., use the 12-thread series. See table III.7.

^b See formula under definition of tensile stress area in Section 11, p. 5.

^c For attaching purposes only, numbered sizes 0-80 and 19-32 are now included in the Unified thread series, designation NF.

Bold type indicates Unified threads, UNF. See footnote c and table III.10.

TABLE III.5.—Extra-fine thread series, basic dimensions
UNEF and NEF

Designation			Basic major diameter, <i>D</i>	Basic pitch diameter, <i>E</i>	Minor diameter, external threads, <i>K_e</i>	Minor diameter, internal threads, <i>K_i</i>	Lead angle at basic pitch diameter, λ	Sectional area at minor diameter at $D-2h_s$	Tensile stress area A_t , $\left(\frac{E-3H}{2} - \frac{3H}{16}\right)^2$
Size *	Threads per inch, <i>n</i>	Thread symbol							
1	2	3	4	5	6	7	8	9	10
No. 12	<i>in.</i> (.216)		<i>in.</i>	<i>in.</i>	<i>in.</i>	<i>in.</i>	<i>deg</i> <i>min</i>	<i>in.</i> ²	<i>in.</i> ²
	32	NEF	0.2160	0.1957	0.1777	0.1822	2 55	0.0242	0.0270
	32	NEF	.2500	.2207	.2117	.2162	2 29	.0344	.0379
	32	NEF	.3125	.2922	.2742	.2787	1 57	.0581	.0625
	32	NEF	.3750	.3547	.3367	.3412	1 36	.0878	.0932
	28	UNEF	.4375	.4143	.3937	.3988	1 34	.1201	.1274
	28	UNEF	.5000	.4768	.4562	.4613	1 22	.162	.170
	24	NEF	.5625	.5354	.5114	.5174	1 25	.203	.214
	24	NEF	.6250	.5979	.5739	.5799	1 16	.256	.268
	24	NEF	.6875	.6604	.6364	.6424	1 9	.315	.329
	20	UNEF	.7500	.7175	.6887	.6959	1 16	.369	.386
	20	UNEF	.8125	.7800	.7512	.7584	1 10	.439	.458
	20	UNEF	.8750	.8425	.8137	.8209	1 5	.515	.536
	20	UNEF	.9375	.9050	.8762	.8834	1 0	.598	.620
	20	UNEF	1.0000	.9675	.9387	.9459	6 57	.687	.711
	18	NEF	1.0625	1.0261	.9943	1.0024	0 59	.770	.799
	18	NEF	1.1250	1.0889	1.0569	1.0649	0 56	.871	.901
	18	NEF	1.1875	1.1514	1.1193	1.1274	0 53	.977	1.009
	18	NEF	1.2500	1.2139	1.1818	1.1899	0 50	1.090	1.123
	18	NEF	1.3125	1.2764	1.2443	1.2524	0 48	1.208	1.244
	18	NEF	1.3750	1.3389	1.3068	1.3149	0 45	1.333	1.370
	18	NEF	1.4375	1.4014	1.3693	1.3774	0 43	1.464	1.503
	18	NEF	1.5000	1.4639	1.4318	1.4399	0 42	1.60	1.64
	18	NEF	1.5625	1.5264	1.4943	1.5024	0 40	1.74	1.79
	18	NEF	1.6250	1.5889	1.5568	1.5649	0 38	1.89	1.94
	18	NEF	1.6875	1.6514	1.6193	1.6274	0 37	2.05	2.10
	16	UNEF	1.7500	1.7094	1.6733	1.6823	0 40	2.19	2.24
	16	UNEF	2.0000	1.9594	1.9233	1.9323	0 35	2.89	2.95

* For sizes larger than 2 in., use 16-thread series. See table III. 8.
 † See formula under definition of tensile stress area in section II, p. 5.
 ‡ Bold type indicates Unified threads, UNEF. See table III. 10.

TABLE III.6.—8-thread series, basic dimensions
8UN and 8N^b

Designation			Basic major diameter, <i>D</i>	Basic pitch diameter, <i>E</i>	Minor diameter, external threads, <i>K_e</i>	Minor diameter, internal threads, <i>K_i</i>	Lead angle at basic pitch diameter, λ	Sectional area at minor diameter at $D-2h_s$	Tensile stress area A_t , $\left(\frac{E-3H}{2} - \frac{3H}{16}\right)^2$
Size	Threads per inch, <i>n</i>	Thread symbol							
1	2	3	4	5	6	7	8	9	10
<i>in.</i>			<i>in.</i>	<i>in.</i>	<i>in.</i>	<i>in.</i>	<i>deg</i> <i>min</i>	<i>in.</i> ²	<i>in.</i> ²
.1	8	UNC	1.0000	0.9188	0.8466	0.8647	2 29	0.551	0.606
1/8	8	N	1.1250	1.0438	.9716	.9897	2 11	.728	.790
1/4	8	N	1.2500	1.1688	1.0966	1.1147	1 57	.929	1.000
3/8	8	N, UNS	1.3750	1.2938	1.2216	1.2397	1 46	1.155	1.233
1/2	8	N, UNS	1.5000	1.4188	1.3466	1.3647	1 36	1.495	1.492
5/8	8	N, UNS	1.6250	1.5438	1.4716	1.4897	1 29	1.68	1.78
3/4	8	N, UNS	1.7500	1.6688	1.5966	1.6147	1 22	1.98	2.08
7/8	8	N, UNS	1.8750	1.7938	1.7216	1.7397	1 16	2.30	2.41
2	8	N, UNS	2.0000	1.9188	1.8466	1.8647	1 11	2.65	2.77
2 1/8	8	N, UNS	2.1250	2.0438	1.9716	1.9897	1 7	3.03	3.15
2 1/4	8	N, UNS	2.2500	2.1688	2.0966	2.1147	1 3	3.42	3.56
2 3/8	8	N, UNS	2.3750	2.2938	2.2216	2.2397	0 57	4.29	4.44
2 1/2	8	N, UNS	2.5000	2.4188	2.3466	2.3647	0 51	5.26	5.43
3	8	N, UNS	3.0000	2.9188	2.8466	2.8647	0 47	6.32	6.51
3 1/4	8	N, UNS	3.2500	3.1688	3.0966	3.1147	0 43	7.49	7.69
3 1/2	8	N, UNS	3.5000	3.4188	3.3466	3.3647	0 40	8.75	8.96
3 3/4	8	N, UNS	3.7500	3.6688	3.5966	3.6147	0 37	10.11	10.34
4	8	N, UNS	4.0000	3.9188	3.8466	3.8647	0 35	11.57	11.81
4 1/4	8	N, UNS	4.2500	4.1688	4.0966	4.1147	0 33	13.12	13.38
4 1/2	8	N, UNS	4.5000	4.4188	4.3466	4.3647	0 31	14.78	15.06
4 3/4	8	N, UNS	4.7500	4.6688	4.5966	4.6147	0 29	16.53	16.82
5	8	N, UNS	5.0000	4.9188	4.8466	4.8647	0 28	18.38	18.69
5 1/4	8	N, UNS	5.2500	5.1688	5.0966	5.1147	0 26	20.33	20.66
5 1/2	8	N, UNS	5.5000	5.4188	5.3466	5.3647	0 25	22.38	22.72
5 3/4	8	N, UNS	5.7500	5.6688	5.5966	5.6147	0 24	24.52	24.88
6	8	N, UNS	6.0000	5.9188	5.8466	5.8647	0 23	26.76	27.14

* The 1"-8 size is in the coarse thread series, (table III. 3, p. 16).
 † The 8N specified limits for all sizes are shown in table III. 6 in light type, based on a length of engagement equal to the basic major (nominal) diameter. For special applications, where tolerances based on a length of engagement of 9 threads are more suitable than those of the standard 8 thread series (8N), the 8UNS limits for all sizes larger than 1 1/4 in. may be derived from the tables in section IV. The 1 1/8 and 1 1/4 in. sizes are in table III. 10 and designated N, as the 1 diameter and 8 thread engagements are substantially equal.
 ‡ See formula under definition of tensile stress area in section II, p. 5.
 †† Bold type indicates Unified threads, UNS.

TABLE III.7.—12-thread series, basic dimensions
12UN and 12N

Designation			Basic major diameter, <i>D</i>	Basic pitch diameter, <i>E</i>	Minor diameter, external threads, <i>K_e</i>	Minor diameter, internal threads, <i>K_i</i>	Lead angle at basic pitch diameter, λ		Sectional area at minor diameter at $D-2a_b$	Tensile stress area A_s $\pi \left(\frac{E}{2} - \frac{3H}{16} \right)^2$
Size	Threads per inch, <i>n</i>	Thread symbol					deg	min		
1	2	3	4	5	6	7	8	9	10	
<i>in.</i>			<i>in.</i>	<i>in.</i>	<i>in.</i>	<i>in.</i>	<i>deg</i>	<i>min</i>	<i>in.²</i>	<i>in.³</i>
1/2	12	M	0.5000	0.4169	0.3978	0.4098	3	24	0.121	0.138
5/16	12	UNC	.5625	.4684	.4603	.4723	2	59	.162	.182
3/8	12	N	.6250	.5709	.5228	.5348	2	40	.210	.232
1/2	12	N	.6875	.6334	.5853	.5973	2	24	.264	.289
3/4	12	N	.7500	.6959	.6478	.6598	2	11	.323	.351
1 1/16	12	N	.8125	.7584	.7103	.7223	2	0	.390	.420
7/8	12	N	.8750	.8209	.7728	.7848	1	51	.462	.495
15/16	12	UN	.9375	.8834	.8353	.8473	1	43	.540	.570
1	12	UNF	1.0000	.9459	.8978	.9098	1	36	.625	.663
1 1/16	12	UN	1.0625	1.0034	.9605	.9723	1	30	.715	.756
1 1/8	12	UNF	1.1250	1.0709	1.0228	1.0348	1	25	.812	.856
1 3/16	12	UN	1.1875	1.1334	1.0853	1.0973	1	20	.915	.961
1 1/2	12	UNF	1.2500	1.1959	1.1478	1.1598	1	16	1.024	1.073
1 5/16	12	UN	1.3125	1.2584	1.2103	1.2223	1	12	1.135	1.191
1 3/4	12	UNF	1.3750	1.3209	1.2728	1.2848	1	9	1.250	1.315
1 7/16	12	UN	1.4375	1.3834	1.3353	1.3473	1	6	1.368	1.445
1 1/2	12	UNF	1.5000	1.4459	1.3978	1.4098	1	3	1.52	1.58
1 5/8	12	UN	1.6250	1.5709	1.5228	1.5348	0	58	1.81	1.87
1 3/4	12	UN	1.7500	1.6859	1.6478	1.6598	0	54	2.12	2.19
1 7/8	12	UN	1.8750	1.8209	1.7728	1.7848	0	50	2.45	2.53
2	12	UN	2.0000	1.9459	1.8978	1.9098	0	47	2.81	2.89
2 1/8	12	UN	2.1250	2.0739	2.0228	2.0348	0	41	3.19	3.28
2 1/4	12	UN	2.2500	2.1959	2.1478	2.1598	0	42	3.60	3.69
2 3/8	12	UN	2.3750	2.3209	2.2728	2.2848	0	39	4.04	4.13
2 1/2	12	UN	2.5000	2.4459	2.3978	2.4098	0	37	4.49	4.60
2 5/8	12	UN	2.6250	2.5709	2.5228	2.5348	0	35	4.97	5.08
2 3/4	12	UN	2.7500	2.6959	2.6478	2.6598	0	34	5.46	5.59
2 7/8	12	UN	2.8750	2.8209	2.7728	2.7848	0	32	6.01	6.13
3	12	UN	3.0000	2.9459	2.8978	2.9098	0	31	6.57	6.69
3 1/8	12	UN	3.1250	3.0709	3.0228	3.0348	0	30	7.15	7.28
3 1/4	12	UN	3.2500	3.1959	3.1478	3.1598	0	29	7.75	7.89
3 3/8	12	UN	3.3750	3.3209	3.2728	3.2848	0	27	8.38	8.52
3 1/2	12	UN	3.5000	3.4459	3.3978	3.4098	0	26	9.03	9.18
3 5/8	12	UN	3.6250	3.5709	3.5228	3.5348	0	26	9.71	9.86
3 3/4	12	UN	3.7500	3.6959	3.6478	3.6598	0	25	10.42	10.57
3 7/8	12	UN	3.8750	3.8209	3.7728	3.7848	0	24	11.14	11.30
4	12	UN	4.0000	3.9459	3.8978	3.9098	0	23	11.88	12.06
4 1/8	12	UN	4.1250	4.0709	4.0228	4.0348	0	22	12.64	12.83
4 1/4	12	UN	4.2500	4.1959	4.1478	4.1598	0	22	13.42	13.65
4 3/8	12	UN	4.3750	4.3209	4.2728	4.2848	0	21	14.21	14.47
4 1/2	12	UN	4.5000	4.4459	4.3978	4.4098	0	21	15.01	15.3
4 3/4	12	UN	4.6250	4.5709	4.5228	4.5348	0	19	15.82	16.15
5	12	UN	5.0000	4.9459	4.8978	4.9098	0	18	18.8	19.0
5 1/8	12	UN	5.1250	5.0709	5.0228	5.0348	0	18	20.8	21.0
5 1/4	12	UN	5.2500	5.1959	5.1478	5.1598	0	17	22.8	23.1
5 3/8	12	UN	5.3750	5.3209	5.2728	5.2848	0	16	24.8	25.2
5 1/2	12	UN	5.5000	5.4459	5.3978	5.4098	0	15	26.8	27.5

* These are standard sizes of the UNC or UNF series.
 † See formula under definition of tensile stress area in section II, p. 5.
Bold type indicates Unified threads, UN. See table III.10.

9. HIGH-TEMPERATURE, HIGH-STRENGTH APPLICATIONS.—For these applications the coarse-thread series is recommended in sizes from 1/4 to 1 in. and the 8-thread series in sizes over 1 in. Limits of size are given in table III.10. Some high-temperature applications involving special physical characteristics or conditions may require modification of dimensions, and it is recommended that when such are necessary, they be applied to the external thread. See par. (b) 2, p. 23.

4. CLASSIFICATION AND TOLERANCES

(a) GENERAL

1. THREAD CLASSES.—Thread classes are distinguished from each other by the amounts of tolerance and allowance. There are established for general use six distinct classes of screw-thread tolerances and allowances. These classes, together with the accompanying specifications, are for the purpose of assuring the interchangeable

TABLE III.8.—16-thread series, basic dimensions
16UN and 16N

Designation			Basic major diameter, <i>D</i>	Basic pitch diameter, <i>E</i>	Minor diameter, external threads, <i>K_e</i>	Minor diameter, internal threads, <i>K_i</i>	Lead angle at basic pitch diameter, <i>λ</i>		Sectional area at minor diameter at <i>D</i> - 2 <i>a</i> ₁	Tensile stress area ¹ $\left(\frac{E}{2} - \frac{3H}{16}\right)^2$
Size	Threads per inch, <i>n</i>	Thread symbol					deg	min		
1	2	3	4	5	6	7	8	9	10	
<i>in.</i>			<i>in.</i>	<i>in.</i>	<i>in.</i>	<i>in.</i>		<i>in</i> ²	<i>in</i> ²	
3/4	16	UNF	0.7500	0.7094	0.6733	0.6823	1	0.351	0.373	
13/16	16	UN	.8125	.7719	.7358	.7448	1	.420	.444	
7/8	16	UN	.8750	.8344	.7983	.8073	1	.495	.521	
15/16	16	UN	.9375	.8969	.8608	.8698	1	.570	.604	
1	16	UN	1.0000	.9594	.9233	.9323	1	.643	.693	
1 1/16	16	UN	1.0625	1.0219	.9858	.9948	1	.750	.798	
1 1/8	16	UN	1.1250	1.0844	1.0483	1.0573	1	.850	.899	
1 1/4	16	UN	1.1875	1.1469	1.1108	1.1198	1	.961	.997	
1 1/2	16	UN	1.2500	1.2094	1.1733	1.1823	0	1.073	1.111	
1 5/16	76	UN	1.3125	1.2719	1.2358	1.2448	0	1.191	1.230	
1 3/8	16	UN	1.3750	1.3344	1.2983	1.3073	0	1.315	1.356	
1 7/16	16	UN	1.4375	1.3969	1.3608	1.3698	0	1.445	1.488	
1 1/2	16	UN	1.5000	1.4594	1.4233	1.4323	0	1.58	1.63	
1 9/16	18	UN	1.5625	1.5219	1.4858	1.4948	0	1.72	1.77	
1 5/8	16	UN	1.6250	1.5844	1.5483	1.5573	0	1.87	1.92	
1 11/16	16	UN	1.6875	1.6469	1.6108	1.6198	0	2.03	2.08	
1 3/4	16	UNEF	1.7500	1.7094	1.6733	1.6823	0	2.19	2.24	
1 13/16	16	UN	1.8125	1.7719	1.7358	1.7448	0	2.35	2.41	
1 7/8	16	UN	1.8750	1.8344	1.7983	1.8073	0	2.53	2.58	
1 15/16	16	UN	1.9375	1.8969	1.8608	1.8698	0	2.71	2.77	
2	16	UNEF	2.0000	1.9594	1.9233	1.9323	0	2.89	2.95	
2 1/16	16	UN	2.0625	2.0219	1.9858	1.9948	0	3.08	3.15	
2 1/8	16	UN	2.1250	2.0844	2.0483	2.0573	0	3.24	3.35	
2 1/4	16	UN	2.1875	2.1469	2.1108	2.1198	0	3.48	3.55	
2 1/2	16	UN	2.2500	2.2094	2.1733	2.1823	0	3.69	3.76	
2 3/16	16	UN	2.3125	2.2719	2.2358	2.2448	0	3.91	3.98	
2 1/8	16	UN	2.3750	2.3344	2.2983	2.3073	0	4.13	4.21	
2 1/2	16	UN	2.4375	2.3969	2.3608	2.3698	0	4.30	4.41	
2 3/8	16	UN	2.5000	2.4594	2.4233	2.4323	0	4.60	4.67	
2 5/8	16	UN	2.6250	2.5844	2.5483	2.5573	0	5.00	5.10	
2 3/4	16	UN	2.7500	2.7094	2.6733	2.6823	0	5.59	5.68	
2 7/8	16	UN	2.8750	2.8344	2.7983	2.8073	0	6.13	6.22	
3	16	UN	3.0000	2.9594	2.9233	2.9323	0	6.69	6.78	
3 1/16	16	UN	3.1250	3.0844	3.0483	3.0573	0	7.28	7.37	
3 1/8	16	UN	3.2500	3.2094	3.1733	3.1823	0	7.89	7.99	
3 1/4	16	UN	3.3750	3.3344	3.2983	3.3073	0	8.52	8.63	
3 1/2	16	UN	3.5000	3.4594	3.4233	3.4323	0	9.18	9.29	
3 3/8	16	UN	3.6250	3.5844	3.5483	3.5573	0	9.86	9.98	
3 1/2	16	UN	3.7500	3.7094	3.6733	3.6823	0	10.57	10.69	
3 3/4	16	UN	3.8750	3.8344	3.7983	3.8073	0	11.30	11.43	
4	16	UN	4.0000	3.9594	3.9233	3.9323	0	12.06	12.19	
4 1/16	16	UN	4.1250	4.0844	4.0483	4.0573	0	13.65	13.78	
4 1/8	16	UN	4.2500	4.2094	4.1733	4.1823	0	15.34	15.5	
4 1/4	16	UN	4.3750	4.3344	4.2983	4.3073	0	17.1	17.3	
5	16	UN	5.0000	4.9594	4.9233	4.9323	0	19.6	19.8	
5 1/2	16	UN	5.2500	5.2094	5.1733	5.1823	0	21.1	21.4	
5 1/4	16	UN	5.5000	5.4594	5.4233	5.4323	0	23.1	23.2	
5 3/4	16	UN	5.7500	5.7094	5.6733	5.6823	0	25.2	25.4	
6	16	UN	6.0000	5.9594	5.9233	5.9323	0	27.5	27.7	

*These are standard sizes of the UNF or UNEF series.
¹ See formula under definition of tensile stress area in section II, p. 6.
Bold type indicates Unified threads, UN. See table III.10.

manufacture of screw-thread parts. This standard includes classes 1A, 2A, and 3A, applied to external threads only, and classes 1B, 2B, and 3B applied to internal threads only. The requirements for a screw-thread fit for specific applications can be met by specifying the proper combination of classes for the components. For example, an external thread made to class 2A limits can be used with tapped holes made to classes 1B, 2B, or 3B limits for specific applications. It is not the purpose of this standard to limit applications of the various standard classes.

2. UNIFORM MINIMUM INTERNAL THREAD.
 The minimum major, pitch, and minor diameters

of the internal thread are respectively the same for classes 1B, 2B, and 3B.

3. DIRECTION AND SCOPE OF TOLERANCES.—

(a) The tolerance on the internal thread is plus, and is applied from the basic size to above basic size.

(b) The tolerance on the external thread is minus, and is applied from the maximum (or design) size to below the maximum size.

(c) The tolerances specified represent the extreme variations permitted on the product.

4. BASIC FORMULA FOR ALLOWANCES AND TOLERANCES.—Classes identified by a numeral fol-

TABLE III.9.--Increments in pitch-diameter tolerance formula¹

$$(PD \text{ tolerance} = C(0.0015 \sqrt[3]{D} + 0.0015 \sqrt{L_e} + 0.015 \sqrt[3]{p^2}))$$

Diameter, <i>D</i>				Length of engagement, <i>L_e</i>														
<i>D</i>	0.0015 $\sqrt[3]{D}$	<i>D</i>	0.0015 $\sqrt[3]{D}$	Based on			<i>L_e</i>	0.0015 $\times \sqrt{L_e}$	Based on			<i>L_e</i>	0.0015 $\times \sqrt{L_e}$	Based on			<i>L_e</i>	0.0015 $\times \sqrt{L_e}$
				1 <i>D</i> for sizes	9 <i>p</i> for tpi	20 <i>p</i> for tpi			1 <i>D</i> for sizes	9 <i>p</i> for tpi	20 <i>p</i> for tpi			1 <i>D</i> for sizes	9 <i>p</i> for tpi	20 <i>p</i> for tpi		
in.	in.	in.	in.	#0			in.	in.	3/16			in.	in.			in.	in.	
0.1500	0.00058	1.9375	0.001870				0.0690	0.000367				0.4375	0.000992			3.1250	0.002656	
0.0625	0.000595	2.0000	0.001890				0.0625	0.000375		20		0.4500	0.001006	3/32		3.2500	0.002706	
0.0750	0.000627	2.0625	0.001909	#1			0.0730	0.000405		44		0.4545	0.001011		6	3.3333	0.002732	
0.0860	0.000662	2.1250	0.001928				0.0781	0.000419	1/2	13	40	0.5000	0.001061			3.3750	0.002754	
0.0938	0.000682	2.1875	0.001947	#2			0.0800	0.000440		36		0.5556	0.001118	3/32		3.5000	0.002809	
0.0990	0.000694	2.2500	0.001966				0.0838	0.000459	9/16	16		0.5625	0.001125			3.6250	0.002856	
0.1120	0.000723	2.3125	0.001984	#3			0.0900	0.000472	5/8	32		0.6250	0.001186	3/32		3.7500	0.002905	
0.1250	0.000750	2.3750	0.002001				1.1034	0.00495		14		0.6429	0.001203			3.8750	0.002953	
0.1380	0.000775	2.4375	0.002019	#4			1.1201	0.00502				0.6875	0.001244	4	5	4.0000	0.003000	
0.1640	0.000821	2.5000	0.002036		80		1.125	0.00505		28		0.7143	0.001268			4.1250	0.003047	
0.1875	0.000859	2.6250	0.002060	#5	72		1.250	0.005530		27		0.7407	0.001291	4 1/2		4.2500	0.003092	
0.1900	0.000862	2.7500	0.002102	#6			1.380	0.005557	3/4	12		0.7509	0.001299			4.3750	0.003137	
0.2160	0.000900	2.8750	0.02133		64		1.406	0.00562				0.8125	0.001352	4 1/2		4.5000	0.003182	
0.2506	0.000945	3.0000	0.02175				1.563	0.00593		24		0.8333	0.001369			4.6250	0.003226	
0.3125	0.001018	3.1250	0.02193		56		1.607	0.00601	3/4			0.8750	0.001403	4 3/4		4.7500	0.003269	
0.3750	0.001082	3.2500	0.02222	#8			1.640	0.00607		10		0.9000	0.001423			4.8750	0.003312	
0.4375	0.001139	3.3750	0.02250				1.719	0.00622				0.9375	0.001452	5	4	5.0000	0.003354	
0.5000	0.001191	3.5000	0.02277		48		1.875	0.00650	1	9	20	1.0000	0.001506			5.1250	0.003396	
0.5625	0.001238	3.6250	0.02304	#10			1.900	0.00654				1.0625	0.001546	5 1/4		5.2500	0.003437	
0.6250	0.001282	3.7500	0.02330				2.031	0.00676		18		1.1111	0.001581			5.3750	0.003478	
0.6875	0.001324	3.8750	0.02356		44		2.045	0.00678	1 1/8	8		1.1250	0.001591	5 1/2		5.5000	0.003518	
0.7500	0.001353	4.0000	0.02381	#12			2.150	0.00697				1.1875	0.001635			5.6250	0.003558	
0.8125	0.001400	4.2500	0.02430				2.188	0.00702	1 1/4	16		1.2500	0.001677	5 3/4		5.7500	0.003597	
0.8750	0.001435	4.5000	0.02476		40		2.250	0.00712				1.3125	0.001718			5.8750	0.003636	
0.9375	0.001468	4.7500	0.02521				2.344	0.00726	1 3/8			1.3750	0.001759	6		6.0000	0.003674	
1.0000	0.001509	5.0000	0.02565	3/4	36	80	2.500	0.00750		14		1.4286	0.001793			6.5000	0.003824	
1.0625	0.001531	5.2500	0.02607				2.656	0.00773				1.4375	0.001798			7.0000	0.003969	
1.1250	0.001560	5.5000	0.02648			72	2.776	0.00791	1 1/2	6		1.5000	0.001837			7.5000	0.004104	
1.1875	0.001588	5.7500	0.02687		32		2.812	0.00795	1 5/8			1.6250	0.001912			8.0000	0.004243	
1.2500	0.001616	6.0000	0.02726				2.960	0.00817		12		1.6667	0.001930			8.5000	0.004372	
1.3125	0.001642	7.0000	0.02809	5/8		64	3.125	0.00839	1 3/4			1.7500	0.001984			9.0000	0.004500	
1.3750	0.001668	8.0000	0.03000		28		3.214	0.00850	1 7/8			1.8750	0.02054			9.5000	0.004623	
1.4375	0.001693	9.0000	0.03120				3.281	0.00859	2	4 1/2	10	2.0000	0.02121			10.0000	0.004743	
1.5000	0.001717	10.0000	0.03232		27	60	3.333	0.00866	2 1/8			2.1250	0.02187			10.5000	0.004863	
1.5625	0.001741	12.0000	0.03344				3.438	0.00880	2 1/4	4		2.2500	0.02250			11.0000	0.004975	
1.6250	0.001764	14.0000	0.03615			56	3.571	0.00896				2.3750	0.02312			11.5000	0.005087	
1.6875	0.001786	16.0000	0.03780				3.694	0.00909	2 3/8		8	2.5000	0.02372			12.0000	0.005196	
1.7500	0.001808	18.0000	0.03931	3/4	24		3.750	0.00919				2.6250	0.02430					
1.8125	0.001829	20.0000	0.04072				3.803	0.00937	2 1/2			2.7500	0.02487					
1.8750	0.001850	24.0000	0.04327			46	4.063	0.00956				2.8750	0.02543					
							4.167	0.00968		3		3.0000	0.02598					
							4.219	0.00974										

Pitch, *p*

Threads per inch	0.015 $\sqrt[3]{p^2}$	Threads per inch	0.015 $\sqrt[3]{p^2}$	Threads per inch	0.015 $\sqrt[3]{p^2}$	Threads per inch	0.015 $\sqrt[3]{p^2}$	Threads per inch	0.015 $\sqrt[3]{p^2}$	Threads per inch	0.015 $\sqrt[3]{p^2}$	Threads per inch	0.015 $\sqrt[3]{p^2}$	Threads per inch	0.015 $\sqrt[3]{p^2}$
80	0.00908	50	0.001105	35	0.001376	27	0.001667	18	0.002184	11 1/2	0.002804	7	0.004099		
72	0.00867	48	0.001136	36	0.001429	26	0.001709	16	0.02362	11	0.003033	6	0.004543		
64	0.00808	44	0.001204	32	0.001488	24	0.001803	14	0.02582	10	0.003232	5 1/2	0.004814		
60	0.00799	42	0.001241	30	0.001554	22	0.001910	13	0.02713	9	0.003467	5	0.005130		
56	0.00785	40	0.001292	28	0.001627	20	0.002036	12	0.02862	8	0.003750	4 1/2	0.005503		
												4	0.005853		

¹ For class 2A, *C* = 1. For other classes, values of *C* are given in the text, pp. 21 and 22.

lowed by the letters A and B are derived from Unified formulas in which the pitch diameter tolerances are based on increments of the basic major (nominal) diameter, the pitch, and the length of engagement. These formulas and the class designations apply to all of the threads specified in section III.

The basic formula, from which allowances on all diameters and tolerances on pitch diameter are derived, is:

$$\text{Tolerance (or allowance)} = C(0.0015 \sqrt[3]{D} + 0.0015 \sqrt{L_e} + 0.015 \sqrt[3]{p^2})$$

where

C = a factor which differs for the allowance or tolerance for each class

D = basic major diameter

L_e = length of engagement

p = pitch.

This formula is based on the accuracy of present-day threading practice, and is applicable to all reasonable combinations of diameter, pitch, and length of engagement. Numerical values of the increments in the formula for standard diameters, pitches, and lengths of engagement are given in table III. 9.

5. ALLOWANCES.—Allowances are applied only to external threads. The values of the factor C (par. 4 above) for allowances are as follows:

Class	Factor C
1A	0.300
2A	.300
3A	.000

6. MAJOR DIAMETER TOLERANCES.—(a) *External threads.*—The tolerance on major diameter for class 1A is equal to $0.090 \sqrt[3]{p^3}$ and for classes 2A and 3A is equal to $0.060 \sqrt[3]{p^2}$. Tolerances equal to $0.090 \sqrt[3]{p^2}$ are provided for class 2A coarse and 8-thread series threads of unfinished, hot-rolled material.

(b) *Internal threads.*—The tolerance on major diameter of internal threads is equal to $H/6$ plus the pitch diameter tolerance of the class of thread involved. The maximum major diameter of the internal thread may be determined by adding $0.7939p$ ($=11H/12$, table III.1) to the maximum pitch diameter of the internal thread. In dimensioning internal threads the maximum major diameter is not specified, being established by the crest of an unworn tool. In practice, the major diameter of an internal thread is satisfactory when accepted by a gage or gaging method that represents the maximum material condition of an external thread which has no allowance.

7. MINOR DIAMETER TOLERANCES.—(a) *External threads.*—The tolerance on minor diameter of external threads is for reference only. At the nominal minor diameter, that is at the intersection of the rounded root with its center line (see fig. III.1) it equals the pitch diameter tolerance plus $H/12$ and applies only where the rounded root is a requirement of the design. Otherwise the tolerance shall be $H/4$ plus the pitch diameter tolerance. The minimum minor diameter of the external thread may be determined by subtracting $0.6495p$ ($=3H/4$, table III.1) from the minimum pitch diameter of the external thread. In dimensioning external threads the minimum minor diameter is not specified, being established by the crest of an unworn tool. In practice, the minor diameter of an external thread is satisfactory when accepted by a gage or gaging method that represents the maximum material condition of the internal thread less the allowance, if any.

(b) *Internal threads.*—Internal thread minor diameter tolerances specified in the dimensional tables are based on the use of materials of equal tensile strength for screw or bolt and nut or tapped hole and a length of engagement equal to the nominal diameter. See p. 5. For general applications these tolerances are suitable for lengths of engagement up to $1\frac{1}{2}$ diameters. They are based on formulas as follows:

Classes 1B and 2B:

All thread series in sizes less than $\frac{1}{4}$ inch, tolerance= $[0.05 \sqrt[3]{p^3} + 0.03p/D] - 0.002$ in., within the following limitations:

Tolerances shall not be greater than $0.394p$. (This corresponds to 53 percent of the basic thread height and applies in the range of the smallest number sizes of the NC and NF thread series.)

Tolerances shall not be less than $0.25p - 0.4p^2$. (This corresponds to a thread height of 65 percent for 80 to 24 threads per inch.)

The formulas are suitable for general applications having lengths of engagement up to $1\frac{1}{2} D$. However, some thread applications require lengths of engagement which are greater than $1\frac{1}{2} D$ or less than D . For such applications it may be advantageous to increase or decrease tolerances, respectively, as explained in section IV or to use recommended hole size limits for different lengths of engagement, appendix 3, table 3.1, p. 187.

All thread series $\frac{1}{4}$ in. and larger,⁴ tolerance= $0.25p - 0.4p^2$.

(This corresponds to a thread height of 64.5 percent for 32 threads per inch graduating to 71.8 percent for 4 threads per inch.)

Class 3B, all thread series:

Tolerance = $0.05 \sqrt[3]{p^3} + 0.03p/D - 0.002$ in., within the following limitations:

Tolerance shall not be greater than $0.394p$. (This corresponds to 53 percent of the basic thread height and applies in the range of the smallest numbered sizes of the UNC, UNF, NC, and NF thread series.)

Tolerance shall not be less than:

For 80 to 13 threads per inch, inclusive, $0.23p - 1.5p^2$. (This corresponds to a thread height of 67 percent for 80 threads per inch, graduating to 74 percent for 13 threads per inch.)

For 12 threads per inch and coarser, $0.120p$. (This corresponds to a thread height of 74 percent and is the tolerance for all sizes, 12 threads and coarser and 1 in. and larger.)

The formulas are suitable for general applications having lengths of engagement up to $1\frac{1}{2} D$. However, some thread applications require lengths of engagement which are greater than $1\frac{1}{2} D$ or less than D . For such applications it may be advantageous to increase or decrease tolerances, respectively, as explained in section IV or to use recommended hole size limits for different lengths of engagement, appendix 3, table 3.2, p. 190.

8. PITCH DIAMETER⁵ TOLERANCES.—(a) *Values of factor C .*—The values of the factor C (par. 4

⁴ The formula is not applicable to threads coarser than 4 tpi. For such threads use tolerance = $0.15p$.

⁵ The British designation for "pitch diameter" is "effective diameter."

above) for pitch diameter tolerances are as follows:

Class	Factor <i>C</i>
1A	1.500
1B	1.950
2A	1.000
2B	1.300
3A	0.750
3B	.975

It will be noted that the factor *C* is 30 percent greater for internal than for external threads of a given class number on account of the relative difficulties of manufacture.

(b) *Length of engagement.*—The tolerances on pitch diameter, and the allowances on all diameters, for the coarse-, fine-, and 8-thread series are based on a length of engagement equal to the basic major (nominal) diameter and are applicable to lengths of engagement up to $1\frac{1}{2}$ diameters. For the extra-fine-, 12-, and 16-thread series they are based on a length of engagement of 9 pitches and are applicable to lengths of engagement from 5 to 15 pitches. Where the length of engagement exceeds that for which the tolerances are applicable, tolerances and allowances should be obtained from the tabulated tolerances or increments for special threads, if applicable, or computed from the formulas.

(c) *Limits of size.*^{5a}—With respect to the pitch diameter limits of size, it is intended, except as hereinafter qualified, that no portion of the complete thread be permitted to project beyond the envelope defined by the maximum-metal limits on the one hand, or beyond that defined by the minimum-metal limits on the other, and thus be outside of the tolerance zone as illustrated in figures III.3 and III.4.^{5b} Also, the diameter equivalent of the variation in any given element except pitch diameter shall not exceed one-half of the pitch diameter tolerance. Deviations from specified size and profile include variations in lead, uniformity of helix, flank angle, taper, out-of-roundness, and surface defects. Accordingly, values are given in table III.11, for the standard thread series and classes, of one-half of the pitch diameter tolerances and the deviations in lead and flank angle which are equivalent thereto. Flank angle equivalents are based on a depth of thread engagement of $5H/8$.

The diameter equivalents of variations in lead, uniformity of helix, and flank angle are always in the direction toward maximum material, that is, they increase the virtual diameter of the external thread and decrease that of the internal thread. Thus, the maximum-material pitch diameter limits

are a limitation of the virtual diameter (effective size) and are so specified herein for all thread classes.

Variations in taper and roundness of the pitch diameter, together with variations of the pitch diameter as a whole, may be in the direction of minimum material, and thus the minimum-material pitch diameter limit may be specified as a limitation of the pitch diameter as a single element. However, in view of the interrelation of the pitch diameter, variation in lead and flank angle, etc., together with practical considerations relating to established production processes, product application, and inspection procedures, it is customary to interpret the minimum pitch diameter of the external thread and the maximum pitch diameter of the internal thread as virtual diameters (effective sizes) in classes 1A, 2A, 1B, 2B, and 3B, for application to various mass-produced bolts, nuts, screws, and other similar threaded fasteners, and to some custom threaded parts where design requirements are fulfilled. See "Limit gages" and "Acceptability of threads," section VI, pp. 108 and 118.

(1) *Diameter equivalent of angle deviation.*—The general formula expressing the relation between deviation in the half angle of thread and its diameter equivalent—that is, the amount of the pitch diameter tolerance absorbed by such a deviation—is:

$$\cot \delta\alpha = \frac{h_e}{\delta E \sin \alpha \cos \alpha} \pm \cot \alpha,$$

in which

δE —pitch diameter increment due to deviation in half angle

h_e —depth of thread engagement

α —basic half angle of thread

$\delta\alpha$ —error in half angle of thread.

In solving for δE the average value of $\delta\alpha$ for two sides of the thread, regardless of their sign, should be taken. The sign of $\cot \alpha$ is plus when the half angle of thread is less than basic, minus when the half angle is greater than basic. By omitting $\pm \cot \alpha$ from the formula an approximate mean value for $\delta\alpha$ or δE is obtained which differs very little from either extreme value. The Committee has, therefore, adopted for general use the formula

$$\cot \delta\alpha = \frac{h_e}{\delta E \sin \alpha \cos \alpha}$$

For threads of Unified, American, or American National form, where $h_e = 5H/8$, this formula reduces to

$$\cot \delta\alpha = \frac{5p}{4\delta E} \text{ or } \delta E = 1.25p \tan \delta\alpha.$$

^{5a} For aeronautical applications, practice may deviate from those here specified. See Military Specification M11, § 271.

^{5b} The full tolerance cannot, therefore, be used on pitch diameter unless deviations in all other thread elements are zero.

(2) *Diameter equivalent of lead deviations.*—The formula expressing the relation between lead deviation between any two threads within the length of engagement, and its diameter equivalent is as follows:

$$\delta E = (\pm \delta p) \cot \alpha,$$

in which

δE = pitch diameter increment due to lead deviation
 δp = the maximum pitch deviation between any two of the threads engaged

α = half angle of thread.

The quantity δE is always added to the measured pitch diameter in the case of an external thread, and it is always subtracted in the case of an internal thread, regardless of the sign introduced by the lead deviation δp .

For threads of Unified, American, or American National form, the above formula reduces to

$$\delta E = 1.7321 \delta p.$$

(b) SCREW-THREAD CLASSES

1. CLASSES 1A AND 1B. (a) *Definition.*—Classes 1A and 1B threads replace class 1 for new designs. These classes are intended for ordnance and other special uses. They are used on threaded components where quick and easy assembly is necessary and where a liberal allowance is required to permit ready assembly, even with slightly bruised or dirty threads.

Maximum diameters of class 1A (external) threads are less than basic by the amount of the same allowance as applied to class 2A. For the intended applications in American practice the allowance is not available for plating or coating. Where the thread is plated or coated, special provisions are necessary. The minimum diameters of class 1B (internal) threads, whether or not plated or coated, are basic, affording no allowance or clearance for assembly with maximum metal external thread components having maximum diameters which are basic.

(b) *Allowances and tolerances.* Allowances and tolerances for the respective thread series are specified in tables and their application is shown in figure III.3.

2. CLASSES 2A AND 2B. (a) *Definition.* Class 2A for external threads and 2B for internal threads are the most commonly used thread standards for general applications, including production of bolts, screws, nuts, and similar threaded fasteners.

The maximum diameters of class 2A (external) uncoated threads are less than basic by the amount of the allowance. The allowance minimizes galling and seizing in high-cycle wrench assembly, or it can be used to accommodate plated finishes or other coating. However, for threads with additive finish, the maximum diameters of class 2A may be exceeded by the amount of the allowance;

i.e., the 2A maximum diameters apply to an unplated part or to a part before plating whereas the basic diameters (the 2A maximum diameter plus allowance) apply to a part after plating. The minimum diameters of class 2B (internal) threads, whether or not plated or coated, are basic, affording no allowance or clearance in assembly at maximum metal limits. See par. 9, p. 18.

Certain applications require an allowance to permit application of the proper lubricant when making up the assembly, particularly with pressure vessels and steel pipe flanges, fittings, and valves for high-temperature, high-pressure service. For such applications class 2A, which has an allowance, and class 2B are recommended, replacing class 7 which was previously established for such applications but which has been discontinued as an American Standard. See par. 9, p. 18. In this application, when the thread is coated, the 2A allowance may not be consumed by such coating.

(b) *Allowances and tolerances.* Allowances and tolerances for the respective thread series are specified in tables and their application is shown in figure III.3.

3. CLASSES 3A AND 3B.—(a) *Definition.*—Class 3A for external threads and class 3B for internal threads provide for applications where closeness of fit and accuracy of lead and angle of thread are important. They are obtainable consistently only by the use of high quality production equipment supported by a very efficient system of gaging and inspection. The maximum diameters of class 3A (external) threads and the minimum diameters of class 3B (internal) threads, whether or not plated or coated, are basic, affording no allowance or clearance for assembly of maximum-material components.

(b) *Allowances and tolerances.*—No allowance is provided, but since the tolerances on "go" gages are within the limits of size of the product, the gages will assure a slight clearance between product made to the maximum material limits. Tolerances for the respective thread series are specified in tables and their application is shown in figure III.4.

4. COATED THREADS. It is not within the scope of this standard to make recommendations for thicknesses of, or to specify limits for, coatings. However, it will aid mechanical interchangeability if certain principles are followed wherever conditions permit.

It is desirable that the finished threads be within the limits of size established herein. To that end, external threads should not exceed the basic size after plating and internal threads should not be below the basic size after plating. It is recognized that there are some commonly used processes, such as hot-dip galvanizing, which are firmly established, and threads coated by such processes do not fall within the scope of this recommendation.

Class 2A provides both a tolerance and an allowance. Many requirements for coatings are such as those deposited by electroplating processes. In

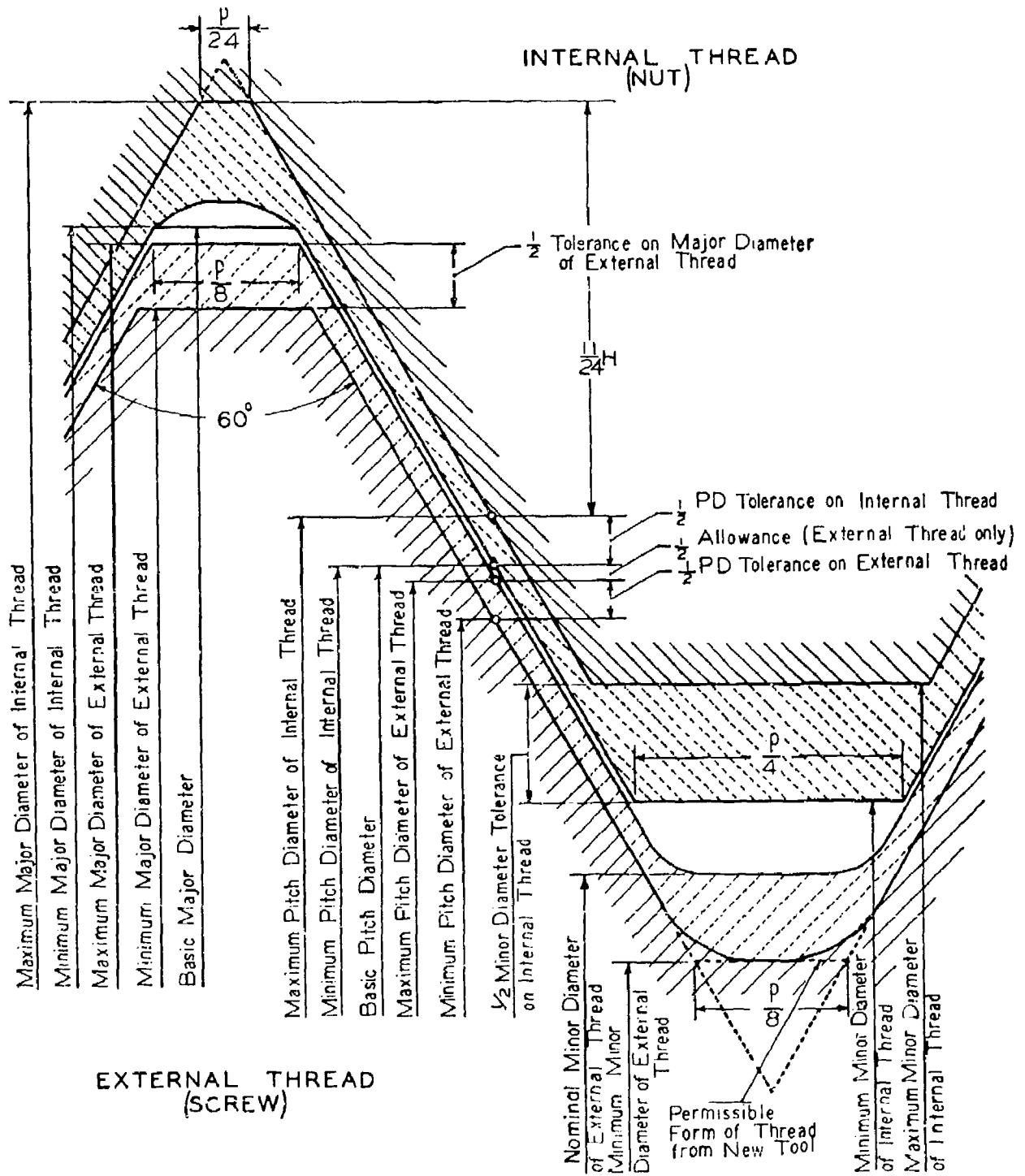

FIGURE III.3.—Disposition of tolerances, allowances, and crest clearances for classes 1A, 2A, 1B, and 2B.

NOTE: "Nominal minor diameter of screw" is that specified in tables.

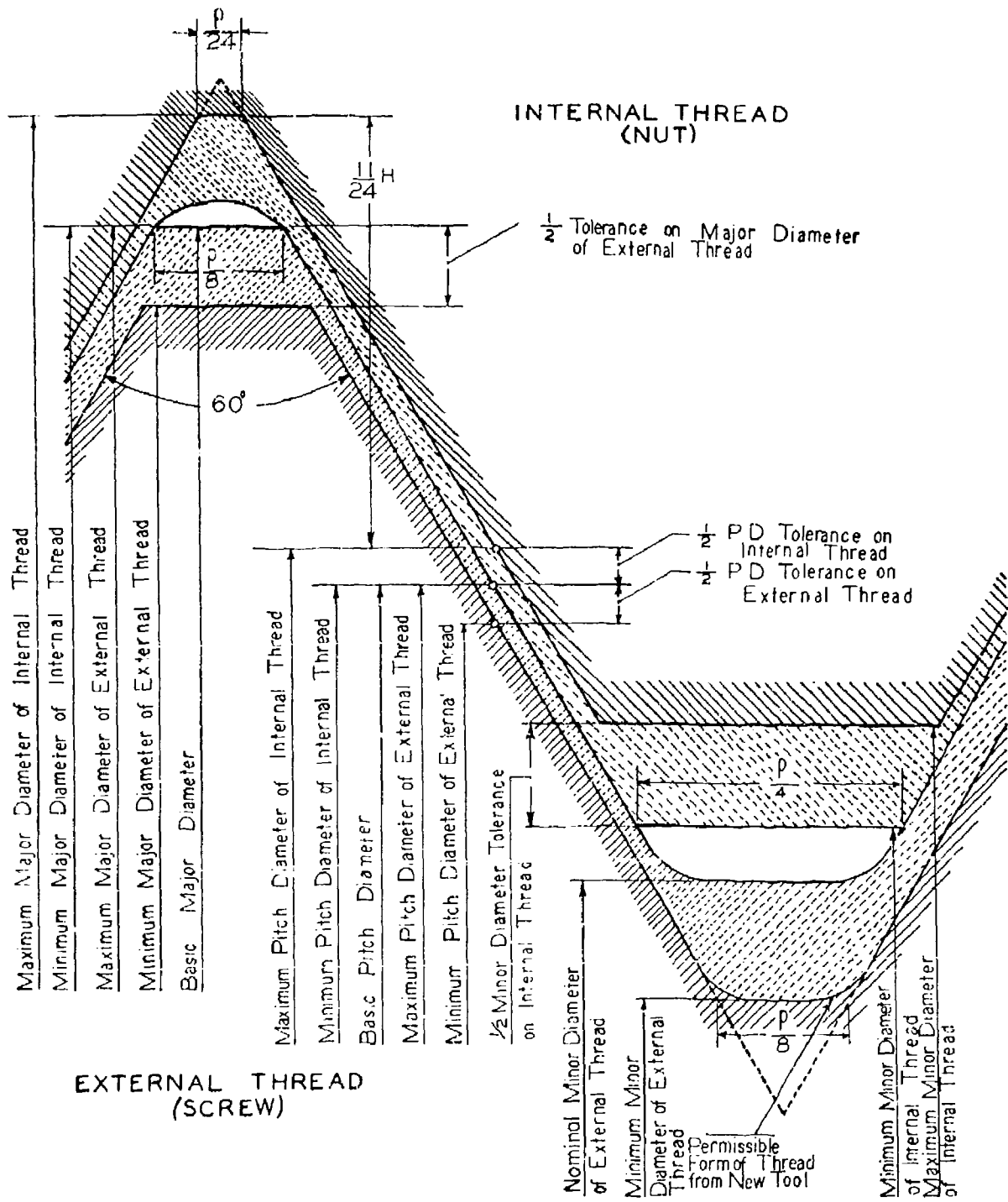

FIGURE III.4.—Disposition of tolerances and crest clearances for classes 3A and 3B.

NOTE: "Nominal minor diameter of screw" is that specified in tables.

TABLE III.10.—Standard series limits of size—Unified and American screw threads

Nominal size and threads per inch	Series designation	External *								Internal *							
		Class	Allowance	Major diameter limits			Pitch diameter limits			Minor diameter †	Class	Minor diameter limits †		Pitch diameter limits			Major diameter
				Max ‡	Min	Min †	Max ‡	Min	Tolerance			Min	Max	Min	Max	Tolerance	
in.	in.	in.	in.	in.	in.	in.	in.	in.	in.	in.	in.	in.	in.	in.	in.	in.	
0-80	NF	2A	0.0005	0.0595	0.0563	0.0514	0.0496	0.0018	0.0442	2B	0.0465	0.0514	0.0519	0.0542	0.0023	0.0600	
		3A	0.0000	0.0000	0.0588	0.0519	0.0506	0.0013	0.0447	3B	0.0465	0.0514	0.0519	0.0536	0.0017	0.0600	
		2A	0.0006	0.0724	0.0686	0.0623	0.0603	0.0020	0.0532	2B	0.0561	0.0623	0.0629	0.0655	0.0026	0.0730	
1-64	NC	3A	0.0000	0.0730	0.0692	0.0629	0.0614	0.0015	0.0538	3B	0.0561	0.0623	0.0629	0.0648	0.0019	0.0730	
		2A	0.0006	0.0724	0.0689	0.0634	0.0615	0.0019	0.0554	2B	0.0580	0.0635	0.0640	0.0665	0.0025	0.0730	
		3A	0.0000	0.0730	0.0695	0.0640	0.0626	0.0014	0.0560	3B	0.0580	0.0635	0.0640	0.0659	0.0010	0.0730	
2-56	NC	2A	0.0006	0.0854	0.0813	0.0738	0.0717	0.0021	0.0635	2B	0.0667	0.0737	0.0744	0.0772	0.0028	0.0860	
		3A	0.0000	0.0850	0.0819	0.0744	0.0728	0.0016	0.0641	3B	0.0667	0.0737	0.0744	0.0765	0.0021	0.0860	
		2A	0.0006	0.0854	0.0816	0.0753	0.0733	0.0020	0.0662	2B	0.0691	0.0753	0.0759	0.0780	0.0027	0.0860	
2-64	NF	3A	0.0000	0.0860	0.0822	0.0759	0.0744	0.0015	0.0668	3B	0.0691	0.0753	0.0759	0.0779	0.0020	0.0860	
		2A	0.0007	0.0983	0.0938	0.0858	0.0825	0.0023	0.0727	2B	0.0764	0.0845	0.0855	0.0885	0.0030	0.0990	
		3A	0.0000	0.0990	0.0945	0.0855	0.0838	0.0017	0.0734	3B	0.0764	0.0845	0.0855	0.0877	0.0022	0.0990	
3-56	NF	2A	0.0007	0.0983	0.0942	0.0867	0.0845	0.0022	0.0764	2B	0.0797	0.0865	0.0874	0.0902	0.0028	0.0990	
		3A	0.0000	0.0990	0.0949	0.0874	0.0858	0.0016	0.0771	3B	0.0797	0.0865	0.0874	0.0895	0.0021	0.0990	
		2A	0.0008	1.112	1.061	0.950	0.925	0.0025	0.805	2B	0.849	0.939	0.958	0.991	0.0033	1.120	
4-40	NC	3A	0.0000	1.120	1.069	0.958	0.939	0.0019	0.813	3B	0.849	0.939	0.958	0.982	0.0024	1.120	
		2A	0.0007	1.113	1.068	0.978	0.954	0.0024	0.857	2B	0.894	0.968	0.995	1.016	0.0031	1.120	
		3A	0.0000	1.120	1.075	0.985	0.967	0.0018	0.854	3B	0.894	0.968	0.995	1.008	0.0023	1.120	
4-48	NF	2A	0.0008	1.242	1.191	1.080	1.054	0.0026	0.935	2B	0.979	1.062	1.088	1.121	0.0033	1.250	
		3A	0.0000	1.250	1.196	1.088	1.069	0.0019	0.943	3B	0.979	1.062	1.088	1.113	0.0025	1.250	
		2A	0.0007	1.243	1.195	1.085	1.070	0.0025	0.964	2B	1.004	1.079	1.102	1.134	0.0032	1.250	
5-40	NC	3A	0.0000	1.250	1.202	1.102	1.083	0.0019	0.971	3B	1.004	1.079	1.102	1.126	0.0024	1.250	
		2A	0.0008	1.372	1.312	1.169	1.141	0.0028	0.989	2B	1.04	1.14	1.177	1.214	0.0037	1.380	
		3A	0.0000	1.380	1.320	1.177	1.156	0.0021	0.997	3B	1.040	1.140	1.177	1.204	0.0027	1.380	
6-40	NF	2A	0.0008	1.372	1.321	1.210	1.184	0.0026	1.065	2B	1.11	1.19	1.218	1.252	0.0034	1.380	
		3A	0.0000	1.380	1.329	1.218	1.198	0.0020	1.073	3B	1.110	1.186	1.218	1.243	0.0025	1.380	
		2A	0.0009	1.631	1.571	1.428	1.399	0.0029	1.248	2B	1.30	1.39	1.437	1.475	0.0038	1.640	
8-32	NC	3A	0.0000	1.640	1.580	1.437	1.415	0.0022	1.257	3B	1.300	1.389	1.437	1.465	0.0028	1.640	
		2A	0.0008	1.632	1.577	1.452	1.424	0.0028	1.291	2B	1.34	1.42	1.460	1.496	0.0036	1.640	
		3A	0.0000	1.640	1.585	1.460	1.439	0.0021	1.269	3B	1.340	1.416	1.460	1.487	0.0027	1.640	
10-24	NC	2A	0.0010	1.890	1.818	1.619	1.586	0.0033	1.379	2B	1.45	1.56	1.629	1.672	0.0043	1.900	
		3A	0.0000	1.900	1.825	1.624	1.594	0.0025	1.389	3B	1.430	1.555	1.629	1.661	0.0032	1.900	
		2A	0.0009	1.891	1.821	1.688	1.658	0.0030	1.408	2B	1.56	1.64	1.697	1.735	0.0039	1.900	
10-32	NF	3A	0.0000	1.900	1.840	1.697	1.674	0.0023	1.517	3B	1.560	1.641	1.697	1.726	0.0029	1.900	
		2A	0.0010	2.150	2.078	1.879	1.845	0.0034	1.639	2B	1.71	1.81	1.889	1.933	0.0044	2.160	
		3A	0.0000	2.160	2.088	1.889	1.863	0.0026	1.649	3B	1.740	1.807	1.889	1.922	0.0032	2.160	
12-24	NC	2A	0.0010	2.150	2.085	1.918	1.886	0.0032	1.712	2B	1.77	1.86	1.928	1.970	0.0042	2.160	
		3A	0.0000	2.160	2.085	1.928	1.894	0.0024	1.722	3B	1.770	1.857	1.928	1.959	0.0031	2.160	
		2A	0.0009	2.151	2.081	1.948	1.917	0.0031	1.768	2B	1.82	1.90	1.957	1.998	0.0041	2.160	
12-32	NEF	3A	0.0000	2.160	2.100	1.957	1.937	0.0024	1.777	3B	1.820	1.895	1.957	1.988	0.0031	2.160	
		1A	0.0011	2.489	2.367	2.164	2.108	0.0056	1.876	1B	1.96	2.07	2.175	2.248	0.0073	2.500	
		2A	0.0011	2.489	2.408	2.164	2.127	0.0037	1.876	2B	1.96	2.07	2.176	2.223	0.0048	2.500	
1/4-20	UNC	3A	0.0000	2.500	2.419	2.175	2.147	0.0028	1.887	3B	1.960	2.067	2.175	2.211	0.0036	2.500	
		1A	0.0010	2.490	2.392	2.258	2.208	0.0050	2.052	1B	2.11	2.20	2.268	2.333	0.0065	2.500	
		2A	0.0010	2.490	2.425	2.258	2.225	0.0033	2.052	2B	2.11	2.20	2.268	2.311	0.0043	2.500	
1/4-28	UNF	3A	0.0000	2.500	2.435	2.268	2.243	0.0025	2.062	3B	2.110	2.190	2.268	2.300	0.0032	2.500	
		2A	0.0010	2.490	2.430	2.268	2.243	0.0022	2.062	2B	2.110	2.190	2.268	2.300	0.0032	2.500	
		3A	0.0000	2.500	2.440	2.297	2.273	0.0024	2.062	3B	2.110	2.190	2.268	2.300	0.0032	2.500	
3/8-32	NEF	2A	0.0000	2.500	2.440	2.297	2.273	0.0024	2.062	2B	2.110	2.190	2.268	2.300	0.0032	2.500	
		3A	0.0000	2.500	2.440	2.297	2.273	0.0024	2.062	3B	2.110	2.190	2.268	2.300	0.0032	2.500	
		1A	0.0012	3.113	2.982	2.752	2.691	0.0061	2.451	1B	2.52	2.65	2.764	2.843	0.0079	3.125	
5/16-18	UNC	2A	0.0012	3.113	3.026	2.752	2.712	0.0040	2.451	2B	2.52	2.65	2.764	2.817	0.0053	3.125	
		3A	0.0000	3.125	3.038	2.764	2.731	0.0030	2.443	3B	2.520	2.650	2.764	2.803	0.0039	3.125	
		1A	0.0011	3.114	3.006	2.843	2.788	0.0055	2.603	1B	2.67	2.77	2.854	2.925	0.0071	3.125	
5/16-24	UNF	2A	0.0011	3.114	3.042	2.843	2.806	0.0037	2.603	2B	2.67	2.77	2.854	2.902	0.0048	3.125	
		3A	0.0000	3.125	3.053	2.854	2.827	0.0027	2.614	3B	2.670	2.754	2.854	2.890	0.0036	3.125	
		2A	0.0010	3.115	3.055	2.912	2.880	0.0032	2.732	2B	2.79	2.86	2.922	2.964	0.0042	3.125	
5/16-32	NEF	3A	0.0000	3.125	3.065	2.922	2.890	0.0024	2.742	3B	2.790	2.847	2.922	2.953	0.0031	3.125	
		1A	0.0013	3.737	3.595	3.331	3.266	0.0065	2.970	1B	3.07	3.21	3.344	3.429	0.0085	3.750	
		2A	0.0013	3.737	3.643	3.331	3.287	0.0044	2.970	2B	3.07	3.21	3.344	3.401	0.0057	3.750	
3/8-16	UNC	3A	0.0000	3.750	3.656	3.344	3.311	0.0033	2.983	3B	3.070	3.182	3.344	3.387	0.0043	3.750	
		1A	0.0011	3.739	3.631	3.468	3.411	0.0057	3.228	1B	3.30	3.40	3.479	3.553	0.0074	3.750	
		2A	0.0011	3.739	3.667	3.468	3.430	0.0038	3.228	2B	3.30	3.40	3.479	3.528	0.0049	3.750	
3/8-24	UNF	3A	0.0000	3.750	3.678	3.479	3.450	0.0029	3.239	3B	3.300	3.372	3.479	3.516	0.0037	3.750	
		2A	0.0010	3.740	3.680	3.537	3.503	0.0034	3.357	2B	3.41	3.49	3.547	3.594	0.0044	3.750	
		3A	0.0000	3.750	3.690	3.547	3.522	0.0025	3.367	3B	3.410	3.469	3.547	3.580	0.0033	3.750	
3/8-32	NEF	1A	0.0014	4.361	4.206	3.897	3.826	0.0071	3.485								

TABLE III.10.—Standard series limits of size—Unified and American screw threads—Continued

Nominal size and threads per inch	Series designation	External *									Internal *						
		Class	Allowance	Major diameter limits			Pitch diameter limits			Minor diameter ^d	Class	Minor diameter limits ^e		Pitch diameter limits			Major diameter
				Max ^b	Min	Min ^c	Max ^b	Min	Tolerance			Min	Max	Min	Max	Tolerance	
1/2 20	UNF	1A	0.0013	0.4987	0.4865	0.4662	0.4588	0.0064	0.4374	1B	0.446	0.457	0.4675	0.4759	0.0084	0.5000	
		2A	0.0013	0.4987	0.4906	0.4662	0.4619	0.0043	0.4374	2B	0.445	0.457	0.4675	0.4731	0.0056	0.5000	
		3A	0.0030	0.5000	0.4919	0.4675	0.4643	0.0032	0.4387	3B	0.4460	0.4537	0.4675	0.4717	0.0042	0.5000	
1/2 28	UNEF	2A	0.0011	0.4989	0.4824	0.4757	0.4720	0.0037	0.4551	2B	0.461	0.470	0.4768	0.4816	0.0048	0.5000	
		3A	0.0030	0.5000	0.4935	0.4768	0.4740	0.0028	0.4562	3B	0.4610	0.4676	0.4768	0.4804	0.0036	0.5000	
		1A	0.0016	0.5009	0.4837	0.5068	0.4990	0.0078	0.4587	1B	0.472	0.490	0.5084	0.5186	0.0102	0.5625	
9/16-12	UNC	2A	0.0016	0.5609	0.5495	0.5368	0.5016	0.0052	0.4587	2B	0.472	0.490	0.5084	0.5152	0.0068	0.5625	
		3A	0.0030	0.5625	0.5511	0.5084	0.5015	0.0039	0.4603	3B	0.4720	0.4813	0.5084	0.5135	0.0051	0.5625	
		1A	0.0014	0.5611	0.5480	0.5250	0.5182	0.0068	0.4929	1B	0.502	0.515	0.5264	0.5353	0.0089	0.5625	
9/16-18	UNF	2A	0.0014	0.5611	0.5524	0.5250	0.5205	0.0045	0.4929	2B	0.502	0.515	0.5264	0.5323	0.0059	0.5625	
		3A	0.0030	0.5625	0.5538	0.5264	0.5230	0.0034	0.4945	3B	0.5020	0.5106	0.5264	0.5308	0.0044	0.5625	
		2A	0.0012	0.5613	0.5541	0.5342	0.5303	0.0039	0.5102	2B	0.517	0.527	0.5354	0.5405	0.0051	0.5625	
9/16-24	NEF	3A	0.0030	0.5625	0.5553	0.5354	0.5325	0.0029	0.5114	3B	0.5170	0.5244	0.5354	0.5392	0.0038	0.5625	
		1A	0.0016	0.6234	0.6052	0.5841	0.5561	0.0083	0.5119	1B	0.527	0.546	0.5660	0.5767	0.0107	0.6250	
		2A	0.0016	0.6234	0.6113	0.5841	0.5589	0.0055	0.5119	2B	0.527	0.546	0.5660	0.5732	0.0072	0.6250	
5/8-12	UNC	3A	0.0030	0.6250	0.6129	0.5660	0.5619	0.0041	0.5135	3B	0.5270	0.5394	0.5660	0.5714	0.0054	0.6250	
		2A	0.0016	0.6234	0.6120	0.5903	0.5630	0.0073	0.5212	2B	0.535	0.553	0.5709	0.5780	0.0071	0.6250	
		3A	0.0030	0.6250	0.6136	0.5709	0.5608	0.0041	0.5223	3B	0.5350	0.5403	0.5709	0.5762	0.0053	0.6250	
5/8-18	UNF	1A	0.0014	0.6236	0.6105	0.5875	0.5805	0.0070	0.5554	1B	0.565	0.578	0.5889	0.5980	0.0091	0.6250	
		2A	0.0014	0.6236	0.6149	0.5875	0.5828	0.0047	0.5574	2B	0.565	0.578	0.5889	0.5949	0.0060	0.6250	
		3A	0.0030	0.6250	0.6163	0.5889	0.5854	0.0035	0.5568	3B	0.5650	0.5730	0.5889	0.5934	0.0045	0.6250	
5/8-24	NEF	2A	0.0012	0.6238	0.6106	0.5979	0.5929	0.0040	0.5727	2B	0.580	0.590	0.5979	0.6044	0.0052	0.6250	
		3A	0.0030	0.6250	0.6178	0.5979	0.5949	0.0030	0.5730	3B	0.5800	0.5869	0.5979	0.6018	0.0039	0.6250	
		2A	0.0016	0.6250	0.6145	0.6318	0.6264	0.0054	0.5837	2B	0.597	0.615	0.6334	0.6403	0.0071	0.6250	
11/16-12	N	3A	0.0030	0.6250	0.6163	0.6334	0.6293	0.0041	0.5853	3B	0.5970	0.6082	0.6334	0.6387	0.0053	0.6250	
		2A	0.0012	0.6234	0.6191	0.6392	0.6352	0.0040	0.6352	2B	0.612	0.622	0.6304	0.6376	0.0052	0.6250	
		3A	0.0030	0.6250	0.6163	0.6392	0.6352	0.0040	0.6352	3B	0.6120	0.624	0.6304	0.6376	0.0052	0.6250	
3/4-10	UNC	1A	0.0018	0.7482	0.7288	0.6832	0.6741	0.0088	0.6255	1B	0.642	0.663	0.6830	0.6957	0.0115	0.7500	
		2A	0.0018	0.7482	0.7353	0.6832	0.6773	0.0059	0.6255	2B	0.642	0.663	0.6830	0.6927	0.0077	0.7500	
		3A	0.0030	0.7500	0.7371	0.6850	0.6806	0.0044	0.6273	3B	0.6420	0.6545	0.6850	0.6907	0.0057	0.7500	
3/4-12	N	2A	0.0017	0.7483	0.7369	0.6912	0.6887	0.0025	0.6461	2B	0.649	0.678	0.6970	0.7031	0.0062	0.7500	
		3A	0.0030	0.7500	0.7386	0.6959	0.6918	0.0041	0.6473	3B	0.6490	0.6707	0.6970	0.7033	0.0054	0.7500	
		1A	0.0015	0.7485	0.7343	0.7049	0.7004	0.0045	0.6718	1B	0.682	0.696	0.7094	0.7192	0.0098	0.7500	
3/4-16	UNF	2A	0.0015	0.7485	0.7391	0.7079	0.7029	0.0050	0.6718	2B	0.682	0.696	0.7094	0.7159	0.0065	0.7500	
		3A	0.0030	0.7500	0.7406	0.7094	0.7056	0.0038	0.6733	3B	0.6820	0.6908	0.7094	0.7145	0.0049	0.7500	
		2A	0.0013	0.7487	0.7406	0.7162	0.7118	0.0044	0.6874	2B	0.696	0.707	0.7175	0.7232	0.0057	0.7500	
3/4-20	UNEF	3A	0.0030	0.7500	0.7419	0.7175	0.7142	0.0033	0.6887	3B	0.6960	0.7037	0.7175	0.7218	0.0043	0.7500	
		2A	0.0017	0.8108	0.7994	0.7567	0.7512	0.0055	0.7086	2B	0.722	0.740	0.7584	0.7656	0.0072	0.8125	
		3A	0.0030	0.8125	0.8011	0.7594	0.7543	0.0041	0.7103	3B	0.7220	0.7429	0.7584	0.7658	0.0054	0.8125	
13/16-16	UN	2A	0.0015	0.8110	0.8016	0.7704	0.7655	0.0049	0.7343	2B	0.745	0.759	0.7719	0.7782	0.0063	0.8125	
		3A	0.0030	0.8125	0.8031	0.7719	0.7683	0.0036	0.7358	3B	0.7450	0.7533	0.7719	0.7766	0.0047	0.8125	
		2A	0.0013	0.8112	0.8031	0.7787	0.7743	0.0044	0.7498	2B	0.758	0.770	0.7800	0.7857	0.0057	0.8125	
13/16-20	UNEF	3A	0.0030	0.8125	0.8044	0.7800	0.7767	0.0033	0.7512	3B	0.7580	0.7662	0.7800	0.7843	0.0043	0.8125	
		1A	0.0019	0.8131	0.8052	0.8009	0.7914	0.0095	0.7368	1B	0.755	0.778	0.8028	0.8151	0.0123	0.8750	
		2A	0.0019	0.8131	0.8052	0.8069	0.7948	0.0063	0.7368	2B	0.755	0.778	0.8028	0.8110	0.0082	0.8750	
7/8-9	UNC	3A	0.0030	0.8750	0.8611	0.8028	0.7981	0.0047	0.7387	3B	0.7550	0.7681	0.8028	0.8089	0.0061	0.8750	
		2A	0.0017	0.8733	0.8619	0.8192	0.8137	0.0055	0.7411	2B	0.785	0.803	0.8209	0.8281	0.0072	0.8750	
		3A	0.0030	0.8750	0.8636	0.8209	0.8168	0.0041	0.7428	3B	0.7850	0.7932	0.8209	0.8263	0.0054	0.8750	
7/8-14	UNF	1A	0.0016	0.8734	0.8579	0.8270	0.8189	0.0081	0.7858	1B	0.798	0.814	0.8286	0.8392	0.0106	0.8750	
		2A	0.0016	0.8734	0.8631	0.8270	0.8216	0.0054	0.7858	2B	0.798	0.814	0.8286	0.8355	0.0070	0.8750	
		3A	0.0030	0.8750	0.8647	0.8286	0.8245	0.0041	0.7874	3B	0.7980	0.8068	0.8286	0.8339	0.0053	0.8750	
7/8-16	UN	2A	0.0015	0.8735	0.8641	0.8329	0.8280	0.0049	0.7968	2B	0.807	0.821	0.8344	0.8407	0.0063	0.8750	
		3A	0.0030	0.8750	0.8656	0.8344	0.8308	0.0036	0.7983	3B	0.8070	0.8158	0.8344	0.8391	0.0047	0.8750	
		2A	0.0013	0.8737	0.8656	0.8412	0.8368	0.0044	0.8124	2B	0.824	0.832	0.8425	0.8482	0.0057	0.8750	
7/8-20	UNEF	3A	0.0030	0.8750	0.8669	0.8425	0.8392	0.0033	0.8137	3B	0.8210	0.8287	0.8425	0.8468	0.0043	0.8750	
		2A	0.0017	0.8738	0.8641	0.8417	0.8376	0.0041	0.8336	2B	0.847	0.865	0.8834	0.8908	0.0074	0.9375	
		3A	0.0030	0.8750	0.8654	0.8434	0.8393	0.0041	0.8353	3B	0.8470	0.8575	0.8834	0.8889	0.0055	0.9375	
15/16-12	UN	2A	0.0015	0.9360	0.9266	0.8954	0.8911	0.0050	0.8593	2B	0.870	0.884	0.8969	0.9034	0.0065	0.9375	
		3A	0.0030	0.9375	0.9281	0.8969	0.8932	0.0037	0.8608	3B	0.8700	0.8783	0.8969	0.9018	0.0049	0.9375	
		2A	0.0014	0.9361	0.9280	0.9036	0.8991	0.0045	0.8748	2B	0.883	0.895	0.9059	0.9109	0.0059	0.9375	
15/16-20	UNEF	3A	0.0030	0.9375	0.9294	0.9050	0.9016	0.0034	0.8762	3B	0.8830	0.8912	0.9050	0.9094	0.0044	0.9375	
		1A	0.0020	0.9380	0.9255	0.9168	0.9067	0.0101	0.8446	1B	0.865	0.890	0.9188	0.9320	0.0132	1.0000	
		2A	0.0020	0.9380	0.9300	0.9168	0.9100	0.0068	0.8446	2B	0.865	0.890	0.9188	0.9276	0.0088	1.0000	
1 8	UNC	3A	0.0030	1.0000	0.9850	0.9188	0.9137	0.0051	0.8466	3B	0.8650	0.8797	0.9188	0.9254	0.0066	1.0000	
		1A	0.0018	0.9982	0.9810	0.944											

TABLE III.10.—Standard series limits of size—Unified and American screw threads—Continued

Nominal size and threads per inch	Series designation	External •								Internal •								
		Class	Allowance	Major diameter limits			Pitch diameter limits			Minor diameter ⁴	Class	Minor diameter limits ⁴		Pitch diameter limits			Major diameter	
				Max ^b	Min	Min ^c	Max ^b	Min	Tolerance			Min	Max	Min	Max	Tolerance		Min
		in.	in.	in.	in.	in.	in.	in.	in.	in.	in.	in.	in.	in.	in.	in.		
1 1/4-16	UN	2A	0.0015	1.1235	1.1141	in.	1.0829	1.0779	0.0050	1.0468	2B	1.057	1.071	1.0844	1.0909	0.0065	1.1250	
		3A	0.0000	1.1250	1.1156	1.0844	1.0807	0.0037	1.0483	3B	1.0570	1.0658	1.0844	1.0893	0.0049	1.1250	
		3A	0.014	1.1235	1.1149	1.0875	1.0828	0.0047	1.0564	2B	1.065	1.078	1.0889	1.0951	0.0062	1.1250	
1 3/16-12	UN	2A	0.0017	1.1858	1.1744	1.1317	1.1259	0.0058	1.0836	2B	1.097	1.115	1.1354	1.1409	0.0075	1.1875	
		3A	0.0000	1.1875	1.1761	1.1334	1.1291	0.0043	1.0853	3B	1.0970	1.1073	1.1334	1.1390	0.0056	1.1875	
		2A	0.0015	1.1860	1.1766	1.1454	1.1403	0.0051	1.1093	2B	1.120	1.134	1.1469	1.1535	0.0066	1.1875	
1 3/16-16	UN	2A	0.0000	1.1875	1.1781	1.1469	1.1431	0.0038	1.1108	3B	1.1200	1.1283	1.1469	1.1519	0.0050	1.1875	
		2A	0.0015	1.1860	1.1773	1.1499	1.1450	0.0049	1.1178	2B	1.127	1.140	1.1514	1.1577	0.0063	1.1875	
		3A	0.0000	1.1875	1.1788	1.1514	1.1478	0.0036	1.1193	3B	1.1270	1.1355	1.1514	1.1561	0.0017	1.1875	
1 1/4-7	UNC	1A	0.0022	1.2478	1.2232	1.1550	1.1439	0.0111	1.0725	1B	1.095	1.123	1.1572	1.1716	0.0144	1.2500	
		2A	0.0022	1.2478	1.2314	1.2232	1.1550	1.1476	0.0074	1.0725	2B	1.095	1.123	1.1572	1.1668	0.0096	1.2500
		3A	0.0000	1.2500	1.2336	1.1572	1.1517	0.0055	1.0747	3B	1.0950	1.1125	1.1572	1.1644	0.0072	1.2500	
1 1/4-8	N	2A	0.0021	1.2479	1.2329	1.2254	1.1667	1.1597	0.0070	1.0915	2B	1.115	1.140	1.1888	1.1780	0.0092	1.2500
		3A	0.0000	1.2500	1.2350	1.1688	1.1635	0.0053	1.0966	3B	1.1150	1.1207	1.1888	1.1757	0.0069	1.2500	
		1A	0.0018	1.2482	1.2310	1.1941	1.1849	0.0092	1.1460	1B	1.160	1.178	1.1959	1.2079	0.0120	1.2500	
1 1/4-12	UNF	2A	0.0018	1.2482	1.2368	1.1941	1.1879	0.0062	1.1460	2B	1.160	1.178	1.1959	1.2039	0.0080	1.2500	
		3A	0.0000	1.2500	1.2386	1.1959	1.1913	0.0046	1.1478	3B	1.1600	1.1698	1.1959	1.2019	0.0060	1.2500	
		2A	0.0015	1.2485	1.2391	1.2079	1.2028	0.0051	1.1718	2B	1.182	1.196	1.2094	1.2160	0.0066	1.2500	
1 1/4-16	UN	2A	0.0000	1.2500	1.2406	1.2094	1.2056	0.0038	1.1733	3B	1.1820	1.1908	1.2094	1.2144	0.0050	1.2500	
		2A	0.0015	1.2485	1.2398	1.2124	1.2075	0.0049	1.1803	2B	1.190	1.203	1.2139	1.2202	0.0063	1.2500	
		3A	0.0000	1.2500	1.2413	1.2139	1.2103	0.0036	1.1818	3B	1.1900	1.1980	1.2139	1.2186	0.0047	1.2500	
1 5/16-12	UN	2A	0.0017	1.3108	1.2994	1.2567	1.2509	0.0058	1.2086	2B	1.222	1.240	1.2584	1.2659	0.0075	1.3125	
		3A	0.0000	1.3125	1.3011	1.2584	1.2541	0.0043	1.2103	3B	1.2220	1.2323	1.2584	1.2610	0.0056	1.3125	
		2A	0.0015	1.3110	1.3016	1.2704	1.2653	0.0051	1.2343	2B	1.245	1.259	1.2719	1.2785	0.0066	1.3125	
1 5/16-16	UN	2A	0.0000	1.3125	1.3031	1.2719	1.2681	0.0038	1.2358	3B	1.2450	1.2543	1.2719	1.2769	0.0050	1.3125	
		2A	0.0015	1.3110	1.3023	1.2749	1.2700	0.0049	1.2428	2B	1.252	1.265	1.2764	1.2827	0.0063	1.3125	
		3A	0.0000	1.3125	1.3038	1.2764	1.2728	0.0036	1.2443	3B	1.2520	1.2645	1.2764	1.2814	0.0047	1.3125	
1 1/2-6	UNC	1A	0.0024	1.3726	1.3453	1.3453	1.2643	1.2523	0.0120	1.1684	1B	1.195	1.225	1.2667	1.2822	0.0155	1.3750
		2A	0.0024	1.3726	1.3544	1.3453	1.2643	1.2563	0.0080	1.1684	2B	1.195	1.225	1.2667	1.2771	0.0104	1.3750
		3A	0.0000	1.3750	1.3568	1.2667	1.2607	0.0060	1.1705	3B	1.1950	1.2146	1.2667	1.2745	0.0078	1.3750	
1 3/8-8	N	2A	0.0022	1.3728	1.3578	1.3503	1.2916	1.2844	0.0072	1.2104	2B	1.249	1.265	1.2938	1.3031	0.0093	1.3750
		3A	0.0000	1.3750	1.3590	1.2938	1.2884	0.0054	1.2216	3B	1.2460	1.2547	1.2938	1.3008	0.0070	1.3750	
		1A	0.0019	1.3731	1.3559	1.3190	1.3096	0.0094	1.2709	1B	1.285	1.303	1.3209	1.3332	0.0123	1.3750	
1 3/8-12	UNF	2A	0.0018	1.3731	1.3617	1.3190	1.3127	0.0063	1.2709	2B	1.285	1.303	1.3209	1.3291	0.0082	1.3750	
		3A	0.0000	1.3750	1.3636	1.3209	1.3162	0.0047	1.2728	3B	1.2850	1.2948	1.3209	1.3270	0.0061	1.3750	
		2A	0.0015	1.3735	1.3641	1.3329	1.3278	0.0051	1.2968	2B	1.307	1.321	1.3344	1.3410	0.0066	1.3750	
1 3/8-16	UN	2A	0.0000	1.3750	1.3656	1.3344	1.3306	0.0038	1.2983	3B	1.3070	1.3158	1.3344	1.3394	0.0050	1.3750	
		2A	0.0015	1.3735	1.3648	1.3373	1.3325	0.0049	1.3053	2B	1.315	1.328	1.3389	1.3452	0.0063	1.3750	
		3A	0.0000	1.3750	1.3663	1.3389	1.3353	0.0036	1.3078	3B	1.3150	1.3230	1.3389	1.3436	0.0047	1.3750	
1 7/16-12	UN	2A	0.0018	1.4357	1.4243	1.3816	1.3757	0.0059	1.3335	2B	1.347	1.365	1.3834	1.3910	0.0076	1.4375	
		3A	0.0000	1.4375	1.4261	1.3834	1.3790	0.0044	1.3353	3B	1.3470	1.3573	1.3834	1.3891	0.0057	1.4375	
		2A	0.0016	1.4359	1.4265	1.3953	1.3901	0.0052	1.3592	2B	1.370	1.384	1.3969	1.4037	0.0068	1.4375	
1 7/16-16	UN	3A	0.0000	1.4375	1.4281	1.3969	1.3930	0.0039	1.3608	3B	1.3700	1.3783	1.3969	1.4020	0.0051	1.4375	
		2A	0.0015	1.4360	1.4273	1.3999	1.3940	0.0050	1.3678	2B	1.377	1.390	1.4014	1.4070	0.0065	1.4375	
		3A	0.0000	1.4375	1.4288	1.4014	1.3977	0.0037	1.3693	3B	1.3770	1.3855	1.4014	1.4062	0.0048	1.4375	
1 1/2-6	UNC	1A	0.0024	1.4976	1.4703	1.4703	1.3893	1.3772	0.0121	1.2931	1B	1.320	1.350	1.3917	1.4075	0.0158	1.5000
		2A	0.0024	1.4976	1.4794	1.4703	1.3893	1.3812	0.0081	1.2931	2B	1.320	1.350	1.3917	1.4022	0.0105	1.5000
		3A	0.0000	1.5000	1.4818	1.3917	1.3856	0.0061	1.2955	3B	1.3200	1.3396	1.3917	1.3996	0.0079	1.5000	
1 1/2-8	N	2A	0.0022	1.4978	1.4828	1.4753	1.4166	1.4093	0.0073	1.3444	2B	1.365	1.390	1.4188	1.4289	0.0095	1.5000
		3A	0.0000	1.5000	1.4850	1.4188	1.4133	0.0055	1.3466	3B	1.3650	1.3797	1.4188	1.4239	0.0071	1.5000	
		1A	0.0019	1.4981	1.4809	1.4440	1.4344	0.0096	1.3959	1B	1.410	1.428	1.4459	1.4584	0.0125	1.5000	
1 1/2-12	UNF	2A	0.0019	1.4981	1.4867	1.4440	1.4376	0.0064	1.3959	2B	1.410	1.428	1.4459	1.4542	0.0083	1.5000	
		3A	0.0000	1.5000	1.4886	1.4459	1.4411	0.0048	1.3978	3B	1.4100	1.4198	1.4459	1.4522	0.0063	1.5000	
		2A	0.0016	1.4964	1.4890	1.4578	1.4526	0.0052	1.4217	2B	1.432	1.446	1.4594	1.4662	0.0068	1.5000	
1 1/2-16	UN	3A	0.0000	1.5000	1.4906	1.4594	1.4555	0.0039	1.4233	3B	1.4320	1.4408	1.4594	1.4645	0.0051	1.5000	
		2A	0.0015	1.4985	1.4898	1.4623	1.4574	0.0050	1.4303	2B	1.440	1.452	1.4639	1.4704	0.0065	1.5000	
		3A	0.0000	1.5000	1.4913	1.4639	1.4602	0.0037	1.4318	3B	1.4400	1.4480	1.4639	1.4687	0.0048	1.5000	
1 9/16-16	N	2A	0.0016	1.5909	1.5515	1.5203	1.5151	0.0052	1.4542	2B	1.495	1.509	1.5219	1.5277	0.0068	1.6250	
		3A	0.0000	1.5925	1.5531	1.5219	1.5180	0.0039	1.4558	3B	1.4950	1.5043	1.5219	1.5270	0.0051	1.6250	
		2A	0.0015	1.5910	1.5523	1.5249	1.5199	0.0050	1.4928	2B	1.502	1.515	1.5264	1.5329	0.0065	1.6250	
1 9/16-18	NEF	3A	0.0000	1.5925	1.5538	1.5264	1.5227	0.0037	1.4943	3B	1.5020						

TABLE III.10.—Standard series limits of size—Unified and American screw threads—Continued

Nominal size and threads per inch	Series designation	External •									Internal •						Major diameter
		Class	Allowance	Major diameter limits			Pitch diameter limits			Minor diameter ^d	Class	Minor diameter limits •		Pitch diameter limits			
				Max ^b	Min	Min ^c	Max ^e	Min	Tolerance			Min	Max	Min	Max	Tolerance	
			<i>in.</i>	<i>in.</i>	<i>in.</i>	<i>in.</i>	<i>in.</i>	<i>in.</i>	<i>in.</i>		<i>in.</i>	<i>in.</i>	<i>in.</i>	<i>in.</i>	<i>in.</i>	<i>in.</i>	
1 1/4-16	UNEF	2A	0.0016	1.7484	1.7390	-----	1.7078	1.7025	0.0053	1.6717	2B	1.682	1.696	1.7094	1.7163	0.0069	1.7500
		3A	0.0000	1.7500	1.7406	-----	1.7094	1.7054	0.0010	1.6783	3B	1.6820	1.6908	1.7094	1.7146	0.0052	1.7500
		2A	0.0016	1.8109	1.8015	-----	1.7703	1.7650	0.0053	1.7342	2B	1.745	1.759	1.7719	1.7788	0.0069	1.825
1 1/2-16	N	3A	0.0000	1.8125	1.8031	-----	1.7719	1.7679	0.0010	1.7358	3B	1.7450	1.7533	1.7719	1.7771	0.0052	1.825
		2A	0.0023	1.8727	1.8577	1.8502	1.7915	1.7838	0.0077	1.7193	2B	1.740	1.765	1.7938	1.8038	0.0060	1.8750
		3A	0.0000	1.8750	1.8600	-----	1.7938	1.7881	0.0057	1.7216	3B	1.7400	1.7547	1.7938	1.8013	0.0075	1.8750
1 3/8-8	N	2A	0.0018	1.8732	1.8618	-----	1.8191	1.8131	0.0060	1.7710	2B	1.785	1.803	1.8209	1.8287	0.0078	1.8750
		3A	0.0000	1.8750	1.8636	-----	1.8269	1.8164	0.0015	1.7728	3B	1.7850	1.7948	1.8209	1.8267	0.0058	1.8750
1 3/8-16	UN	2A	0.0016	1.8734	1.8640	-----	1.8328	1.8275	0.0053	1.7967	2B	1.807	1.821	1.8344	1.8413	0.0069	1.8750
		3A	0.0000	1.8750	1.8656	-----	1.8344	1.8304	0.0010	1.7983	3B	1.8070	1.8158	1.8344	1.8396	0.0052	1.8750
1 1/2-16	N	2A	0.0016	1.9359	1.9265	-----	1.8953	1.8899	0.0054	1.8592	2B	1.870	1.884	1.8969	1.9039	0.0070	1.9375
		3A	0.0000	1.9375	1.9281	-----	1.8969	1.8929	0.0040	1.8608	3B	1.8700	1.8783	1.8969	1.9021	0.0052	1.9375
		1A	0.0029	1.9971	1.9641	-----	1.8528	1.8385	0.0143	1.7245	1B	1.759	1.795	1.8557	1.8743	0.0186	2.0000
2-4 1/2	UNC	2A	0.0029	1.9971	1.9751	1.9641	1.8528	1.8433	0.0095	1.7245	2B	1.759	1.795	1.8557	1.8681	0.0124	2.0000
		3A	0.0000	2.0000	1.9780	-----	1.8557	1.8486	0.0071	1.7274	3B	1.7590	1.7861	1.8557	1.8650	0.0093	2.0000
		2A	0.0023	1.9977	1.9827	1.9752	1.9165	1.9087	0.0078	1.8143	2B	1.865	1.890	1.9188	1.9259	0.0101	2.0000
		3A	0.0000	2.0000	1.9830	-----	1.9188	1.9130	0.0058	1.8166	3B	1.8650	1.8797	1.9188	1.9263	0.0076	2.0000
2-8	N	2A	0.0018	1.9982	1.9868	-----	1.9441	1.9380	0.0061	1.8960	2B	1.910	1.928	1.9459	1.9538	0.0079	2.0000
		3A	0.0000	2.0000	1.9886	-----	1.9459	1.9414	0.0045	1.8978	3B	1.9100	1.9198	1.9459	1.9518	0.0059	2.0000
2-12	UN	2A	0.0016	1.9984	1.9890	-----	1.9578	1.9521	0.0054	1.9217	2B	1.932	1.946	1.9594	1.9664	0.0070	2.0000
		3A	0.0000	2.0000	1.9906	-----	1.9594	1.9554	0.0040	1.9233	3B	1.9320	1.9408	1.9594	1.9646	0.0052	2.0000
2-16	UNEF	2A	0.0016	2.0609	2.0515	-----	2.0203	2.0149	0.0054	1.9842	2B	1.995	2.009	2.0219	2.0289	0.0070	2.0625
		3A	0.0000	2.0625	2.0531	-----	2.0219	2.0179	0.0040	1.9858	3B	1.9950	2.0033	2.0219	2.0271	0.0052	2.0625
2 1/8-8	N	2A	0.0024	2.1246	2.1076	2.1001	2.0414	2.0335	0.0079	1.9692	2B	1.980	2.015	2.0408	2.0510	0.0102	2.1250
		3A	0.0000	2.1250	2.1100	-----	2.0438	2.0379	0.0059	1.9716	3B	1.9800	2.0017	2.0408	2.0515	0.0077	2.1250
2 1/8-12	UN	2A	0.0018	2.1232	2.1118	-----	2.0691	2.0630	0.0061	2.0210	2B	2.035	2.053	2.0709	2.0788	0.0079	2.1250
		3A	0.0000	2.1250	2.1136	-----	2.0709	2.0664	0.0045	2.0228	3B	2.0350	2.0448	2.0709	2.0768	0.0059	2.1250
2 1/8-16	UN	2A	0.0016	2.1234	2.1140	-----	2.0828	2.0774	0.0054	2.0467	2B	2.057	2.071	2.0843	2.0914	0.0070	2.1250
		3A	0.0000	2.1250	2.1156	-----	2.0844	2.0803	0.0041	2.0483	3B	2.0570	2.0658	2.0844	2.0896	0.0052	2.1250
2 1/8-16	N	2A	0.0016	2.1859	2.1765	-----	2.1153	2.1099	0.0054	2.1092	2B	2.120	2.131	2.1499	2.1539	0.0070	2.1875
		3A	0.0000	2.1875	2.1781	-----	2.1469	2.1428	0.0041	2.1108	3B	2.1200	2.1283	2.1469	2.1521	0.0052	2.1875
2 3/8-4 1/2	UNC	1A	0.0029	2.2471	2.2141	-----	2.1028	2.0882	0.0146	1.9745	1B	2.009	2.045	2.1057	2.1247	0.0190	2.2500
		2A	0.0029	2.2471	2.2251	2.2141	2.1028	2.0931	0.0097	1.9745	2B	2.009	2.045	2.1057	2.1185	0.0126	2.2500
		3A	0.0000	2.2500	2.2280	-----	2.1057	2.0984	0.0073	1.9774	3B	2.0090	2.0361	2.1057	2.1152	0.0095	2.2500
		2A	0.0024	2.2476	2.2326	2.2251	2.1664	2.1584	0.0080	2.0942	2B	2.115	2.140	2.1688	2.1792	0.0104	2.2500
		3A	0.0000	2.2500	2.2350	-----	2.1688	2.1628	0.0060	2.0965	3B	2.1150	2.1297	2.1688	2.1766	0.0078	2.2500
2 3/8-8	N	2A	0.0018	2.2482	2.2368	-----	2.1941	2.1880	0.0061	2.1460	2B	2.160	2.178	2.1959	2.2038	0.0079	2.2500
		3A	0.0000	2.2500	2.2386	-----	2.1959	2.1914	0.0045	2.1478	3B	2.1600	2.1698	2.1959	2.2018	0.0059	2.2500
2 3/8-12	UN	2A	0.0016	2.2484	2.2390	-----	2.2078	2.2021	0.0054	2.1717	2B	2.182	2.196	2.2094	2.2164	0.0070	2.2500
		3A	0.0000	2.2500	2.2406	-----	2.2094	2.2053	0.0041	2.1733	3B	2.1820	2.1908	2.2094	2.2146	0.0052	2.2500
2 3/8-16	UN	2A	0.0017	2.3108	2.3014	-----	2.2702	2.2647	0.0055	2.2311	2B	2.245	2.259	2.2719	2.2791	0.0072	2.3125
		3A	0.0000	2.3125	2.3031	-----	2.2719	2.2678	0.0041	2.2358	3B	2.2450	2.2543	2.2719	2.2773	0.0054	2.3125
2 3/8-12	UN	2A	0.0019	2.3731	2.3617	-----	2.3190	2.3128	0.0062	2.2709	2B	2.285	2.303	2.3209	2.3290	0.0081	2.3750
		3A	0.0000	2.3750	2.3636	-----	2.3209	2.3163	0.0046	2.2728	3B	2.2850	2.2948	2.3209	2.3269	0.0060	2.3750
2 3/8-16	UN	2A	0.0017	2.3733	2.3639	-----	2.3327	2.3272	0.0055	2.2966	2B	2.307	2.321	2.3344	2.3416	0.0072	2.3750
		3A	0.0000	2.3750	2.3656	-----	2.3344	2.3303	0.0041	2.2983	3B	2.3070	2.3158	2.3344	2.3398	0.0054	2.3750
2 3/8-16	N	2A	0.0017	2.4358	2.4264	-----	2.3952	2.3897	0.0055	2.3591	2B	2.370	2.384	2.3969	2.4041	0.0072	2.4375
		3A	0.0000	2.4375	2.4281	-----	2.3969	2.3928	0.0041	2.3608	3B	2.3700	2.3783	2.3969	2.4023	0.0054	2.4375
2 3/8-16	N	1A	0.0031	2.4969	2.4612	-----	2.3345	2.3190	0.0155	2.1902	1B	2.229	2.267	2.3376	2.3578	0.0202	2.5000
		2A	0.0031	2.4969	2.4731	2.4612	2.3345	2.3211	0.0104	2.1902	2B	2.229	2.267	2.3376	2.3511	0.0135	2.5000
		3A	0.0000	2.5000	2.4762	-----	2.3376	2.3298	0.0078	2.1933	3B	2.2290	2.2594	2.3376	2.3477	0.0101	2.5000
2 1/2-4	UNC	2A	0.0024	2.4976	2.4826	2.4751	2.4164	2.4082	0.0082	2.3412	2B	2.395	2.390	2.4188	2.4291	0.0106	2.5000
		3A	0.0000	2.5000	2.4850	-----	2.4188	2.4127	0.0061	2.3466	3B	2.3950	2.3797	2.4188	2.4268	0.0080	2.5000
2 1/2-12	UN	2A	0.0019	2.4981	2.4867	-----	2.4440	2.4378	0.0062	2.3959	2B	2.410	2.428	2.4459	2.4540	0.0081	2.5000
		3A	0.0000	2.5000	2.4886	-----	2.4459	2.4413	0.0046	2.3978	3B	2.4100	2.4198	2.4459	2.4519	0.0060	2.5000
2 1/2-16	UN	2A	0.0017	2.4983	2.4889	-----	2.4577	2.4522	0.0055	2.4216	2B	2.432	2.446	2.4594	2.4666	0.0072	2.5000
		3A	0.0000	2.5000	2.4906	-----	2.4594	2.4553	0.0041	2.4233	3B	2.4320	2.4408	2.4594	2.4648	0.0054	2.5000
2 3/8-12	UN	2A	0.0019	2.6231	2.6117	-----	2.5690	2.5628	0.0062	2.5209	2B	2.535	2.553	2.5709	2.5790	0.0081	2.6250
		3A	0.0000	2.6250	2.6136	-----	2.5709	2.5663	0.0046	2.5228	3B	2.5350	2.5448	2.5709	2.5769	0.0060	2.6250
2 3/8-16	UN	2A	0.0017														

TABLE III.10.—Standard series limits of size—Unified and American screw threads—Continued

Nominal size and threads per inch	Series designation	External •									Internal •						Major diameter
		Class	Allowance	Major diameter limits			Pitch diameter limits			Minor diameter ^d	Class	Minor diameter limits •		Pitch diameter limits			
				Max ^b	Min	Min ^c	Max ^b	Min	Tolerance			Min	Max	Min	Max	Tolerance	
			<i>in.</i>	<i>in.</i>	<i>in.</i>	<i>in.</i>	<i>in.</i>	<i>in.</i>	<i>in.</i>		<i>in.</i>	<i>in.</i>	<i>in.</i>	<i>in.</i>	<i>in.</i>	<i>in.</i>	
3/8-12	UN	2A	0.0019	3.1231	3.1117	3.1117	3.0690	3.0627	0.0063	3.0209	2B	3.035	3.053	3.0709	3.0791	0.0082	3.1250
		3A	0.0000	3.1250	3.1136	3.1136	3.0709	3.0662	0.0047	3.0228	3B	3.0350	3.0448	3.0709	3.0771	0.0062	3.1250
		2A	0.0017	3.1233	3.1139	3.1139	3.0827	3.0771	0.0056	3.0466	2B	3.057	3.071	3.0844	3.0917	0.0073	3.1250
		3A	0.0000	3.1250	3.1156	3.1156	3.0844	3.0802	0.0042	3.0483	3B	3.0570	3.0658	3.0844	3.0899	0.0055	3.1250
3/8-16	UN	1A	0.0033	3.2467	3.2110	3.2110	3.0843	3.0680	0.0163	2.9400	1B	2.979	3.017	3.0876	3.1088	0.0212	3.2500
		2A	0.0033	3.2467	3.2229	3.2110	3.0843	3.0734	0.0109	2.9400	2B	2.979	3.017	3.0876	3.1017	0.0141	3.2500
		3A	0.0000	3.2500	3.2262	3.2110	3.0876	3.0794	0.0082	2.9453	3B	2.9790	3.0094	3.0876	3.0982	0.0106	3.2500
3/4-8	N	2A	0.0026	3.2474	3.2324	3.2249	3.1662	3.1575	0.0087	3.0940	2B	3.115	3.140	3.1688	3.1801	0.0113	3.2500
		3A	0.0000	3.2500	3.2350	3.2250	3.1688	3.1623	0.0065	3.0966	3B	3.1150	3.1297	3.1688	3.1772	0.0084	3.2500
3/4-12	UN	2A	0.0019	3.2181	3.2367	3.2367	3.1940	3.1877	0.0063	3.1459	2B	3.160	3.178	3.1959	3.2041	0.0082	3.2500
		3A	0.0000	3.2500	3.2386	3.2386	3.1959	3.1912	0.0047	3.1478	3B	3.1600	3.1698	3.1959	3.2021	0.0062	3.2500
3/4-16	UN	2A	0.0017	3.2183	3.2389	3.2389	3.2077	3.2021	0.0056	3.1716	2B	3.182	3.196	3.2094	3.2167	0.0073	3.2500
		3A	0.0000	3.2500	3.2406	3.2406	3.2094	3.2052	0.0042	3.1733	3B	3.1820	3.1908	3.2094	3.2149	0.0055	3.2500
3/8-12	UN	2A	0.0019	3.3731	3.3617	3.3617	3.3190	3.3126	0.0064	3.2709	2B	3.285	3.303	3.3209	3.3293	0.0084	3.3750
		3A	0.0000	3.3750	3.3636	3.3636	3.3209	3.3161	0.0048	3.2728	3B	3.2850	3.2948	3.3209	3.3272	0.0063	3.3750
3/8-16	UN	2A	0.0017	3.3733	3.3639	3.3639	3.3227	3.3269	0.0058	3.2966	2B	3.307	3.321	3.3344	3.3419	0.0075	3.3750
		3A	0.0000	3.3750	3.3656	3.3656	3.3344	3.3301	0.0042	3.2983	3B	3.3070	3.3158	3.3344	3.3400	0.0056	3.3750
3/2-4	UNC	1A	0.0033	3.4967	3.4610	3.4610	3.3343	3.3177	0.0166	3.1900	1B	3.229	3.267	3.3376	3.3591	0.0215	3.5000
		2A	0.0033	3.4967	3.4729	3.4610	3.3343	3.3233	0.0110	3.1900	2B	3.229	3.267	3.3376	3.3519	0.0143	3.5000
		3A	0.0000	3.5000	3.4762	3.4610	3.3376	3.3293	0.0083	3.1933	3B	3.2290	3.2594	3.3376	3.3484	0.0108	3.5000
3/2-8	N	2A	0.0026	3.4974	3.4824	3.4749	3.4162	3.4074	0.0088	3.3110	2B	3.365	3.390	3.4188	3.4303	0.0115	3.5000
		3A	0.0000	3.5000	3.4850	3.4750	3.4188	3.4122	0.0065	3.3165	3B	3.3650	3.3797	3.4188	3.4274	0.0086	3.5000
3/2-12	UN	2A	0.0019	3.4981	3.4867	3.4867	3.4440	3.4376	0.0064	3.3959	2B	3.419	3.428	3.4459	3.4543	0.0084	3.5000
		3A	0.0000	3.5000	3.4886	3.4886	3.4459	3.4411	0.0048	3.3978	3B	3.4100	3.4198	3.4459	3.4522	0.0063	3.5000
3/2-16	UN	2A	0.0017	3.4983	3.4889	3.4889	3.4577	3.4519	0.0058	3.4216	2B	3.432	3.446	3.4594	3.4669	0.0075	3.5000
		3A	0.0000	3.5000	3.4906	3.4906	3.4594	3.4551	0.0043	3.4233	3B	3.4320	3.4408	3.4594	3.4650	0.0056	3.5000
3/8-12	UN	2A	0.0019	3.6231	3.6117	3.6117	3.5690	3.5626	0.0064	3.5209	2B	3.535	3.553	3.5709	3.5793	0.0084	3.6250
		3A	0.0000	3.6250	3.6136	3.6136	3.5709	3.5661	0.0048	3.5228	3B	3.5350	3.5448	3.5709	3.5772	0.0063	3.6250
3/8-16	UN	2A	0.0017	3.6233	3.6139	3.6139	3.5827	3.5769	0.0058	3.5466	2B	3.557	3.571	3.5844	3.5919	0.0075	3.6250
		3A	0.0000	3.6250	3.6156	3.6156	3.5844	3.5801	0.0043	3.5483	3B	3.5570	3.5658	3.5844	3.5900	0.0056	3.6250
3/4-4	UNC	1A	0.0034	3.7466	3.7109	3.7109	3.5812	3.5674	0.0168	3.4399	1B	3.479	3.517	3.5876	3.6094	0.0218	3.7500
		2A	0.0034	3.7466	3.7228	3.7109	3.5812	3.5730	0.0112	3.4399	2B	3.479	3.517	3.5876	3.6021	0.0145	3.7500
		3A	0.0000	3.7500	3.7262	3.7109	3.5876	3.5792	0.0084	3.4422	3B	3.4799	3.5094	3.5876	3.5985	0.0109	3.7500
3/4-8	N	2A	0.0027	3.7173	3.7023	3.7023	3.6661	3.6571	0.0090	3.5992	2B	3.615	3.640	3.6688	3.6805	0.0117	3.7500
		3A	0.0000	3.7500	3.7350	3.7350	3.6688	3.6621	0.0067	3.5995	3B	3.6150	3.6297	3.6688	3.6776	0.0088	3.7500
3/4-12	UN	2A	0.0019	3.7481	3.7367	3.7367	3.6940	3.6876	0.0064	3.6418	2B	3.660	3.678	3.6959	3.7043	0.0084	3.7500
		3A	0.0000	3.7500	3.7386	3.7386	3.6959	3.6911	0.0048	3.6448	3B	3.6600	3.6698	3.6959	3.7022	0.0063	3.7500
3/4-16	UN	2A	0.0017	3.7483	3.7389	3.7389	3.7077	3.7019	0.0058	3.6716	2B	3.682	3.696	3.7094	3.7169	0.0075	3.7500
		3A	0.0000	3.7500	3.7406	3.7406	3.7094	3.7051	0.0043	3.6733	3B	3.6820	3.6908	3.7094	3.7150	0.0056	3.7500
3/8-12	UN	2A	0.0020	3.8730	3.8616	3.8616	3.8189	3.8124	0.0065	3.7708	2B	3.785	3.803	3.8209	3.8291	0.0085	3.8750
		3A	0.0000	3.8750	3.8636	3.8636	3.8209	3.8160	0.0049	3.7728	3B	3.7850	3.7948	3.8209	3.8273	0.0064	3.8750
3/8-16	UN	2A	0.0018	3.8732	3.8638	3.8638	3.8326	3.8267	0.0059	3.7965	2B	3.807	3.821	3.8344	3.8420	0.0076	3.8750
		3A	0.0000	3.8750	3.8656	3.8656	3.8344	3.8300	0.0044	3.7983	3B	3.8070	3.8158	3.8344	3.8401	0.0057	3.8750
4-4	UNC	1A	0.0034	3.9966	3.9609	3.9609	3.8342	3.8172	0.0170	3.6899	1B	3.729	3.767	3.8376	3.8597	0.0221	4.0000
		2A	0.0034	3.9966	3.9728	3.9609	3.8342	3.8229	0.0113	3.6899	2B	3.729	3.767	3.8376	3.8523	0.0147	4.0000
		3A	0.0000	4.0000	3.9762	3.9609	3.8376	3.8291	0.0085	3.6933	3B	3.7290	3.7594	3.8376	3.8487	0.0111	4.0000
4-8	N	2A	0.0027	3.9973	3.9823	3.9748	3.9161	3.9070	0.0091	3.8439	2B	3.865	3.899	3.9188	3.9307	0.0119	4.0000
		3A	0.0000	4.0000	3.9850	3.9850	3.9188	3.9120	0.0068	3.8466	3B	3.8650	3.8797	3.9188	3.9277	0.0089	4.0000
4-12	UN	2A	0.0020	3.9980	3.9866	3.9866	3.9439	3.9374	0.0065	3.8958	2B	3.910	3.928	3.9459	3.9544	0.0085	4.0000
		3A	0.0000	4.0000	3.9886	3.9886	3.9459	3.9410	0.0049	3.8978	3B	3.9100	3.9198	3.9459	3.9523	0.0061	4.0000
4-16	UN	2A	0.0018	3.9982	3.9888	3.9888	3.9576	3.9517	0.0059	3.9215	2B	3.932	3.946	3.9594	3.9670	0.0076	4.0000
		3A	0.0000	4.0000	3.9906	3.9906	3.9594	3.9550	0.0044	3.9233	3B	3.9320	3.9408	3.9594	3.9651	0.0057	4.0000
4 1/4-8	N	2A	0.0028	4.2472	4.2322	4.2247	4.1660	4.1567	0.0093	4.0938	2B	4.115	4.140	4.1688	4.1809	0.0121	4.2500
		3A	0.0000	4.2500	4.2350	4.2350	4.1988	4.1918	0.0076	4.0966	3B	4.1150	4.1297	4.1688	4.1778	0.0090	4.2500
4 1/4-12	UN	2A	0.0020	4.2480	4.2366	4.2366	4.1939	4.1874	0.0065	4.1458	2B	4.160	4.178	4.1959	4.2044	0.0085	4.2500
		3A	0.0000	4.2500	4.2386	4.2386	4.1959	4.1910	0.0049	4.1478	3B	4.1600	4.1698	4.1959	4.2023	0.0064	4.2500
4 1/4-16	UN	2A	0.0018	4.2482	4.2388	4.2388	4.2076	4.2017	0.0059	4.1715	2B	4.182	4.196	4.2094	4.2170	0.0076	4.2500
		3A	0.0000	4.2500	4.2406	4.2406	4.2094	4.2050	0.0044	4.1733	3B	4.1820	4.1908	4.2094	4.2151	0.0057	4.2500
4 1/2-8	N																

TABLE III.10.—Standard series limits of size—Unified and American screw threads—Continued

Nominal size and threads per inch	Series designation	External •										Internal •					
		Class	Allowance	Major diameter limits			Pitch diameter limits			Minor diameter ⁴	Class	Minor diameter limits •		Pitch diameter limits			Major diameter
				Max •	Min	Min •	Max •	Min	Tolerance			Min	Max	Min	Max	Tolerance	
5/4-16	UN	2A	0.0018	5.2482	5.2383	5.2076	5.2015	0.0061	5.1715	2B	5.182	5.196	5.2094	5.2173	0.0079	5.2500	
		3A	0.0000	5.2500	5.2406	5.2094	5.2049	0.0045	5.1733	3B	5.1820	5.1968	5.2094	5.2153	0.0059	5.2500	
5/2-8	N	2A	0.0030	5.4970	5.4820	5.4745	5.4158	0.0090	5.3436	2B	5.365	5.390	5.4188	5.4317	0.0129	5.5000	
		3A	0.0000	5.5000	5.4850	5.4188	5.4114	0.0074	5.3496	3B	5.3650	5.3797	5.4188	5.4285	0.0097	5.5000	
3/2-12	UN	2A	0.0020	5.4980	5.4866	5.4439	5.4372	0.0067	5.3958	2B	5.410	5.428	5.4459	5.4546	0.0087	5.5000	
		3A	0.0000	5.5000	5.4886	5.4459	5.4409	0.0050	5.3978	3B	5.4100	5.4198	5.4459	5.4525	0.0066	5.5000	
5/2-16	UN	2A	0.0013	5.4982	5.4886	5.4576	5.4515	0.0061	5.4235	2B	5.432	5.446	5.4594	5.4673	0.0079	5.5000	
		3A	0.0000	5.5000	5.4906	5.4594	5.4549	0.0045	5.4233	3B	5.4320	5.4408	5.4594	5.4653	0.0059	5.5000	
5/4-8	N	2A	0.0030	5.7170	5.7320	5.7245	5.6658	0.0100	5.5936	2B	5.615	5.640	5.6688	5.6818	0.0130	5.7500	
		3A	0.0000	5.7500	5.7350	5.6688	5.6613	0.0075	5.5966	3B	5.6150	5.6297	5.6688	5.6786	0.0098	5.7500	
5/4-12	UN	2A	0.0021	5.7449	5.7365	5.6938	5.6869	0.0069	5.6457	2B	5.660	5.678	5.6959	5.7049	0.0090	5.7500	
		3A	0.0000	5.7500	5.7386	5.6959	5.6907	0.0052	5.6478	3B	5.6600	5.6689	5.6959	5.7026	0.0067	5.7500	
5/4-16	UN	2A	0.0019	5.7481	5.7387	5.7075	5.7013	0.0062	5.6711	2B	5.682	5.696	5.7094	5.7175	0.0081	5.7500	
		3A	0.0000	5.7500	5.7406	5.7091	5.7047	0.0047	5.6733	3B	5.6820	5.6998	5.7094	5.7155	0.0061	5.7500	
6-8	N	2A	0.0030	5.9570	5.9820	5.9745	5.9158	0.0102	5.8436	2B	5.865	5.890	5.9188	5.9320	0.0132	6.0000	
		3A	0.0000	6.0000	5.9850	5.9188	5.9112	0.0076	5.8496	3B	5.8650	5.8797	5.9188	5.9257	0.0090	6.0000	
6-12	UN	2A	0.0021	5.9973	5.9865	5.9438	5.9369	0.0069	5.8957	2B	5.910	5.928	5.9459	5.9549	0.0090	6.0000	
		3A	0.0000	6.0000	5.9886	5.9459	5.9407	0.0052	5.8978	3B	5.9100	5.9198	5.9459	5.9526	0.0067	6.0000	
6-16	UN	2A	0.0019	5.9981	5.9887	5.9575	5.9513	0.0062	5.9214	2B	5.932	5.946	5.9594	5.9675	0.0081	6.0000	
		3A	0.0000	6.0000	5.9906	5.9594	5.9547	0.0047	5.9233	3B	5.9320	5.9408	5.9594	5.9655	0.0061	6.0000	

• Regarding combinations of thread classes, see par. 1, p. 18.

• For class 2A threads having an additive finish the maximum is increased to the basic size, the value being the same as for class 3A shown in this column, see par. 2, and 4, p. 23.

• For unfinished hot-rolled material.

• See figs. III.1, III.3, and III.4, pp. 11, 24, and 25.

• Revised minor diameter limits of classes 1B and 2B are in process of ratification as Unified Standard.

TABLE III.11.—Deviations in lead and half-angle equivalent to one-half of pitch diameter tolerances, Unified and American screw threads

Designation		External				Internal			
Size	Threads per inch	Thread symbol	Half of pitch diameter tolerance	Eqv. deviation in lead	Eqv. deviation in half-angle	Thread symbol	Half of pitch diameter tolerance	Eqv. deviation in lead	Eqv. deviation in half-angle
1	2	3	4	5	6	7	8	9	10
No. in.			in.	in	deg min		in.	in.	deg min
0.0690	80	NF 2A	0.00090	0.00052	3 18	ZF 2B	0.00117	0.00066	4 13
		NF 3A	0.00065	0.00038	2 23	ZF 3B	0.00085	0.00049	3 7
1.073	64	NC 2A	0.00100	0.00058	2 56	ZC 2B	0.00130	0.00075	3 48
		NC 3A	0.00075	0.00043	2 12	ZC 3B	0.00095	0.00055	2 47
1.073	72	NF 2A	0.00095	0.00055	3 8	ZF 2B	0.00125	0.00072	4 7
		NF 3A	0.00070	0.00040	2 19	ZF 3B	0.00095	0.00055	3 8
2.086	66	NC 2A	0.00105	0.00061	2 42	ZC 2B	0.00140	0.00084	3 35
		NC 3A	0.00080	0.00046	2 3	ZC 3B	0.00105	0.00061	2 42
2.086	64	NF 2A	0.00100	0.00058	2 56	ZF 2B	0.00135	0.00078	3 57
		NF 3A	0.00075	0.00043	2 12	ZF 3B	0.00100	0.00058	2 56
3.099	48	ZC 2A	0.00115	0.00066	2 32	ZC 2B	0.00150	0.00087	3 18
		ZC 3A	0.00085	0.00049	1 52	ZC 3B	0.00110	0.00064	2 25
3.099	56	NF 2A	0.00110	0.00064	2 49	ZF 2B	0.00140	0.00081	3 35
		NF 3A	0.00080	0.00046	2 3	ZF 3B	0.00105	0.00061	2 42
4.112	40	NC 2A	0.00125	0.00072	2 17	ZC 2B	0.00165	0.00095	3 1
		NC 3A	0.00095	0.00055	1 44	ZC 3B	0.00120	0.00069	2 12
4.112	48	NF 2A	0.00120	0.00069	2 38	ZF 2B	0.00155	0.00089	3 24
		NF 3A	0.00090	0.00052	1 59	ZF 3B	0.00115	0.00066	2 32
5.125	40	NC 2A	0.00130	0.00075	2 23	ZC 2B	0.00175	0.00105	3 1
		NC 3A	0.00095	0.00055	1 41	ZC 3B	0.00125	0.00072	2 17
5.125	44	NF 2A	0.00125	0.00072	2 31	ZF 2B	0.00160	0.00092	3 13
		NF 3A	0.00095	0.00055	1 55	ZF 3B	0.00120	0.00069	2 25
6.138	32	ZC 2A	0.00140	0.00081	2 3	ZC 2B	0.00185	0.0107	2 43
		ZC 3A	0.00106	0.00061	1 32	ZC 3B	0.00135	0.00078	1 59

TABLE III.11.—Deviations in lead and half-angle equivalent to one-half of pitch diameter tolerances, Unified and American screw threads—Continued

Designation		External				Internal						
Size	Threads per inch	Thread symbol	Half of pitch diameter tolerance	Equiv. deviation in lead	Equiv. deviation in half-angle		Thread symbol	Half of pitch diameter tolerance	Equiv. deviation in lead	Equiv. deviation in half-angle		
1	2	3	4	5	6		7	8	9	10		
No. in.			in.	in.	deg	min		in.	in.	deg	min	
6	0.138	40	NF 2A	0.00130	0.00075	2	23	NF 2B	0.00170	0.00098	3	7
			NF 3A	.00100	.00058	1	50	NF 3B	.00125	.00072	2	17
			NC 2A	.00145	.00083	2	8	NC 2B	.00190	.00110	2	47
8	.164	32	NC 3A	.00110	.00064	1	37	NC 3B	.00140	.00081	2	3
			NF 2A	.00140	.00081	2	19	NF 2B	.00180	.00104	2	58
			NF 3A	.00105	.00061	1	44	NF 3B	.00135	.00078	2	14
8	.164	36	NC 2A	.00165	.00095	1	49	NC 2B	.00215	.00124	2	22
			NF 2A	.00125	.00072	1	22	NC 3B	.00160	.00092	1	46
			NF 3A	.00150	.00087	2	12	NF 2B	.00195	.00113	2	52
10	.190	24	NF 3A	.00115	.00066	1	41	NF 3B	.00145	.00084	2	8
			NC 2A	.00170	.00098	1	52	NC 2B	.00220	.00127	2	25
			NC 3A	.00130	.00075	1	25	NC 3B	.00165	.00095	1	49
12	.216	24	NF 2A	.00160	.00092	2	3	NF 2B	.00210	.00121	2	42
			NF 3A	.00120	.00069	1	32	NF 3B	.00155	.00089	1	59
			NF 2A	.00155	.00089	2	16	NF 2B	.00205	.00118	3	0
12	.216	28	NF 3A	.00120	.00069	1	46	NF 3B	.00155	.00089	2	16
			UNC 1A	.00280	.00162	2	34	UNC 1B	.00365	.00211	3	21
			UNC 2A	.00185	.00107	1	42	UNC 2B	.00240	.00139	2	12
1/4	20	UNC 3A	.00140	.00081	1	17	UNC 3B	.00180	.00104	1	39	
		UNF 1A	.00250	.00144	3	12	UNF 1B	.00325	.00188	4	10	
		UNF 2A	.00165	.00095	2	7	UNF 2B	.00215	.00124	2	45	
1/4	28	UNF 3A	.00125	.00072	1	36	UNF 3B	.00160	.00092	2	3	
		NF 2A	.00160	.00092	2	21	NF 2B	.00210	.00121	3	5	
		NF 3A	.00120	.00069	1	46	NF 3B	.00155	.00089	2	16	
5/16	18	UNC 1A	.00305	.00176	2	31	UNC 1B	.00385	.00228	3	15	
		UNC 2A	.00200	.00115	1	39	UNC 2B	.00265	.00153	2	11	
		UNC 3A	.00150	.00087	1	14	UNC 3B	.00195	.00113	1	37	
5/16	24	UNF 1A	.00275	.00159	3	1	UNF 1B	.00355	.00205	3	54	
		UNF 2A	.00185	.00107	2	2	UNF 2B	.00240	.00139	2	38	
		UNF 3A	.00135	.00078	1	20	UNF 3B	.00180	.00104	1	59	
5/16	32	NF 2A	.00165	.00092	2	21	NF 2B	.00210	.00121	3	5	
		NF 3A	.00120	.00069	1	46	NF 3B	.00155	.00089	2	16	
		UNC 1A	.00305	.00176	2	31	UNC 1B	.00385	.00228	3	15	
3/8	18	UNC 2A	.00200	.00115	1	39	UNC 2B	.00265	.00153	2	11	
		UNC 3A	.00150	.00087	1	14	UNC 3B	.00195	.00113	1	37	
		UNF 1A	.00275	.00159	3	1	UNF 1B	.00355	.00205	3	54	
3/8	24	UNF 2A	.00185	.00107	2	2	UNF 2B	.00240	.00139	2	38	
		UNF 3A	.00135	.00078	1	20	UNF 3B	.00180	.00104	1	59	
		NF 2A	.00165	.00092	2	21	NF 2B	.00210	.00121	3	5	
3/8	32	NF 3A	.00120	.00069	1	46	NF 3B	.00155	.00089	2	16	
		UNC 1A	.00305	.00176	2	31	UNC 1B	.00385	.00228	3	7	
		UNC 2A	.00200	.00115	1	37	UNC 2B	.00265	.00153	2	5	
3/8	24	UNC 3A	.00150	.00087	1	13	UNC 3B	.00195	.00113	1	35	
		UNF 1A	.00285	.00165	3	8	UNF 1B	.00370	.00214	4	4	
		UNF 2A	.00190	.00110	2	5	UNF 2B	.00245	.00141	2	42	
3/8	32	UNF 3A	.00145	.00084	1	36	UNF 3B	.00185	.00107	2	2	
		NF 2A	.00170	.00098	2	30	NF 2B	.00220	.00127	3	13	
		NF 3A	.00125	.00072	1	50	NF 3B	.00165	.00095	2	26	
7/16	14	UNC 1A	.00355	.00205	2	17	UNC 1B	.00460	.00266	2	57	
		UNC 2A	.00235	.00136	1	30	UNC 2B	.00305	.00176	1	57	
		UNC 3A	.00175	.00101	1	7	UNC 3B	.00230	.00133	1	29	
7/16	20	UNF 1A	.00310	.00179	2	59	UNF 1B	.00405	.00234	3	42	
		UNF 2A	.00210	.00121	1	55	UNF 2B	.00270	.00156	2	28	
		UNF 3A	.00155	.00089	1	25	UNF 3B	.00205	.00118	1	53	
7/16	28	UNEF 2A	.00180	.00104	2	19	UNEF 2B	.00230	.00133	2	57	
		UNEF 3A	.00135	.00078	1	44	UNEF 3B	.00175	.00101	2	15	
		N 2A	.00270	.00156	1	29	N 2B	.00350	.00202	1	55	
1/2	12	N 3A	.00200	.00115	1	6	N 3B	.00260	.00150	1	26	
		UNC 1A	.00370	.00214	2	19	UNC 1B	.00485	.00285	2	53	
		UNC 2A	.00250	.00144	1	29	UNC 2B	.00325	.00188	1	56	
1/2	13	UNC 3A	.00185	.00107	1	6	UNC 3B	.00240	.00139	1	26	
		UNF 1A	.00320	.00185	2	56	UNF 1B	.00420	.00242	3	51	
		UNF 2A	.00215	.00124	1	58	UNF 2B	.00280	.00162	2	31	
1/2	20	UNF 3A	.00160	.00092	1	28	UNF 3B	.00210	.00121	1	55	
		UNEF 2A	.00185	.00107	2	22	UNEF 2B	.00240	.00139	2	5	
		UNEF 3A	.00140	.00081	1	48	UNEF 3B	.00180	.00104	2	19	
1/2	28	UNC 1A	.00390	.00225	2	9	UNC 1B	.00510	.00291	2	48	
		UNC 2A	.00260	.00150	1	26	UNC 2B	.00340	.00196	1	52	
		UNC 3A	.00195	.00113	1	4	UNC 3B	.00255	.00147	1	21	
5/16	12	UNF 1A	.00340	.00196	2	48	UNF 1B	.00445	.00257	3	40	
		UNF 2A	.00225	.00130	1	51	UNF 2B	.00295	.00170	2	26	
		UNF 3A	.00170	.00098	1	24	UNF 3B	.00220	.00127	1	49	
5/16	24	NF 2A	.00195	.00113	2	9	NF 2B	.00255	.00147	2	48	
		NF 3A	.00145	.00084	1	36	NF 3B	.00190	.00110	2	5	
		UNC 1A	.00415	.00240	2	5	UNC 1B	.00535	.00309	2	52	
5/8	11	UNC 2A	.00275	.00159	1	23	UNC 2B	.00390	.00208	1	49	
		UNC 3A	.00205	.00118	1	2	UNC 3B	.00270	.00156	1	22	
		N 2A	.00270	.00156	1	29	N 2B	.00355	.00205	1	57	
5/8	12	N 3A	.00205	.00118	1	8	N 3B	.00265	.00153	1	27	
		UNF 1A	.00360	.00202	2	53	UNF 1B	.00455	.00263	3	45	
		UNF 2A	.00235	.00135	1	56	UNF 2B	.00300	.00173	2	28	
5/8	18	UNF 3A	.00175	.00101	1	27	UNF 3B	.00225	.00130	1	51	
		NF 2A	.00200	.00115	2	12	NF 2B	.00260	.00150	2	51	
		NF 3A	.00150	.00087	1	32	NF 3B	.00195	.00113	2	9	
1 1/16	12	N 2A	.00270	.00156	1	29	N 2B	.00355	.00205	1	57	
		N 3A	.00205	.00118	1	8	N 3B	.00265	.00153	1	27	
		NF 2A	.00200	.00115	2	12	NF 2B	.00260	.00150	2	51	
1 1/16	24	NF 3A	.00150	.00087	1	30	NF 3B	.00195	.00113	2	9	

TABLE III.11.—Deviations in lead and half-angle equivalent to one-half of pitch diameter tolerances, Unified and American screw threads—Continued

Designation		External				Internal					
Size	Threads per inch	Thread symbol	Half of pitch diameter tolerance	Equiv. deviation in lead	Equiv. deviation in half-angle		Thread symbol	Half of pitch diameter tolerance	Equiv. deviation in lead	Equiv. deviation in half-angle	
1	2	3	4	5	6		7	8	9	10	
No. in.			in.	in.	deg	min		in.	in.	deg	min.
3/4	10	UNC-1A	0.00440	0.00254	2	1	UNC-1B	0.00575	0.00332	2	38
		UNC-2A	.00295	.00170	1	21	UNC-2B	.00385	.00222	1	40
		UNC-3A	.00220	.00127	1	0	UNC-3B	.00285	.00165	1	19
3/4	12	N-2A	.00275	.00159	1	31	N-2B	.00360	.00208	1	59
		N-3A	.00205	.00118	1	8	N-3B	.00270	.00156	1	29
		UNF-1A	.00375	.00217	2	45	UNF-1B	.00490	.00283	3	35
3/4	16	UNF-2A	.00250	.00144	1	50	UNF-2B	.00325	.00188	2	23
		UNF-3A	.00190	.00110	1	24	UNF-3B	.00245	.00141	1	48
		UNEF-2A	.00220	.00127	2	1	UNEF-2B	.00285	.00165	2	37
3/4	20	UNEF-3A	.00165	.00095	1	31	UNEF-3B	.00215	.00124	1	58
		N-2A	.00275	.00159	1	31	N-2B	.00360	.00208	1	59
		N-3A	.00205	.00118	1	8	N-3B	.00270	.00156	1	29
3/4	18	UN-2A	.00245	.00141	1	48	UN-2B	.00315	.00182	2	19
		UN-3A	.00180	.00104	1	19	UN-3B	.00235	.00136	1	43
		UNEF-2A	.00220	.00127	2	1	UNEF-2B	.00285	.00165	2	37
3/4	20	UNEF-3A	.00165	.00095	1	31	UNEF-3B	.00215	.00124	1	58
		UNC-1A	.00475	.00274	1	58	UNC-1B	.00615	.00355	2	32
		UNC-2A	.00315	.00182	1	18	UNC-2B	.00410	.00237	1	41
3/4	9	UNC-3A	.00235	.00136	0	58	UNC-3B	.00305	.00176	1	15
		N-2A	.00275	.00159	1	31	N-2B	.00360	.00208	1	59
		N-3A	.00205	.00118	1	8	N-3B	.00270	.00156	1	29
3/4	12	UNF-1A	.00405	.00234	2	36	UNF-1B	.00530	.00306	3	24
		UNF-2A	.00270	.00156	1	44	UNF-2B	.00350	.00202	2	15
		UNF-3A	.00205	.00118	1	19	UNF-3B	.00285	.00155	1	42
3/4	14	UN-2A	.00245	.00141	1	48	UN-2B	.00315	.00182	2	19
		UN-3A	.00180	.00104	1	19	UN-3B	.00235	.00136	1	43
		UNEF-2A	.00220	.00127	2	1	UNEF-2B	.00285	.00165	2	37
3/4	20	UNEF-3A	.00165	.00095	1	31	UNEF-3B	.00215	.00124	1	58
		UNC-1A	.00475	.00274	1	58	UNC-1B	.00615	.00355	2	32
		UNC-2A	.00315	.00182	1	18	UNC-2B	.00410	.00237	1	41
3/4	12	UNC-3A	.00235	.00136	0	58	UNC-3B	.00305	.00176	1	15
		N-2A	.00275	.00159	1	31	N-2B	.00360	.00208	1	59
		N-3A	.00205	.00118	1	8	N-3B	.00270	.00156	1	29
3/4	16	UNF-1A	.00405	.00234	2	36	UNF-1B	.00530	.00306	3	24
		UNF-2A	.00270	.00156	1	44	UNF-2B	.00350	.00202	2	15
		UNF-3A	.00205	.00118	1	19	UNF-3B	.00285	.00155	1	42
3/4	16	UN-2A	.00245	.00141	1	48	UN-2B	.00315	.00182	2	19
		UN-3A	.00180	.00104	1	19	UN-3B	.00235	.00136	1	43
		UNEF-2A	.00220	.00127	2	1	UNEF-2B	.00285	.00165	2	37
3/4	20	UNEF-3A	.00165	.00095	1	31	UNEF-3B	.00215	.00124	1	58
		UNC-1A	.00475	.00274	1	58	UNC-1B	.00615	.00355	2	32
		UNC-2A	.00315	.00182	1	18	UNC-2B	.00410	.00237	1	41
3/4	12	UNC-3A	.00235	.00136	0	58	UNC-3B	.00305	.00176	1	15
		N-2A	.00275	.00159	1	31	N-2B	.00360	.00208	1	59
		N-3A	.00205	.00118	1	8	N-3B	.00270	.00156	1	29
3/4	16	UNF-1A	.00405	.00234	2	36	UNF-1B	.00530	.00306	3	24
		UNF-2A	.00270	.00156	1	44	UNF-2B	.00350	.00202	2	15
		UNF-3A	.00205	.00118	1	19	UNF-3B	.00285	.00155	1	42
3/4	14	UN-2A	.00245	.00141	1	48	UN-2B	.00315	.00182	2	19
		UN-3A	.00180	.00104	1	19	UN-3B	.00235	.00136	1	43
		UNEF-2A	.00220	.00127	2	1	UNEF-2B	.00285	.00165	2	37
3/4	20	UNEF-3A	.00165	.00095	1	31	UNEF-3B	.00215	.00124	1	58
		UNC-1A	.00475	.00274	1	58	UNC-1B	.00615	.00355	2	32
		UNC-2A	.00315	.00182	1	18	UNC-2B	.00410	.00237	1	41
3/4	9	UNC-3A	.00235	.00136	0	58	UNC-3B	.00305	.00176	1	15
		N-2A	.00275	.00159	1	31	N-2B	.00360	.00208	1	59
		N-3A	.00205	.00118	1	8	N-3B	.00270	.00156	1	29
3/4	12	UNF-1A	.00405	.00234	2	36	UNF-1B	.00530	.00306	3	24
		UNF-2A	.00270	.00156	1	44	UNF-2B	.00350	.00202	2	15
		UNF-3A	.00205	.00118	1	19	UNF-3B	.00285	.00155	1	42
3/4	14	UN-2A	.00245	.00141	1	48	UN-2B	.00315	.00182	2	19
		UN-3A	.00180	.00104	1	19	UN-3B	.00235	.00136	1	43
		UNEF-2A	.00220	.00127	2	1	UNEF-2B	.00285	.00165	2	37
3/4	20	UNEF-3A	.00165	.00095	1	31	UNEF-3B	.00215	.00124	1	58
		UNC-1A	.00475	.00274	1	58	UNC-1B	.00615	.00355	2	32
		UNC-2A	.00315	.00182	1	18	UNC-2B	.00410	.00237	1	41
3/4	12	UNC-3A	.00235	.00136	0	58	UNC-3B	.00305	.00176	1	15
		N-2A	.00275	.00159	1	31	N-2B	.00360	.00208	1	59
		N-3A	.00205	.00118	1	8	N-3B	.00270	.00156	1	29
3/4	16	UNF-1A	.00405	.00234	2	36	UNF-1B	.00530	.00306	3	24
		UNF-2A	.00270	.00156	1	44	UNF-2B	.00350	.00202	2	15
		UNF-3A	.00205	.00118	1	19	UNF-3B	.00285	.00155	1	42
3/4	14	UN-2A	.00245	.00141	1	48	UN-2B	.00315	.00182	2	19
		UN-3A	.00180	.00104	1	19	UN-3B	.00235	.00136	1	43
		UNEF-2A	.00220	.00127	2	1	UNEF-2B	.00285	.00165	2	37
3/4	20	UNEF-3A	.00165	.00095	1	31	UNEF-3B	.00215	.00124	1	58
		UNC-1A	.00475	.00274	1	58	UNC-1B	.00615	.00355	2	32
		UNC-2A	.00315	.00182	1	18	UNC-2B	.00410	.00237	1	41
3/4	9	UNC-3A	.00235	.00136	0	58	UNC-3B	.00305	.00176	1	15
		N-2A	.00275	.00159	1	31	N-2B	.00360	.00208	1	59
		N-3A	.00205	.00118	1	8	N-3B	.00270	.00156	1	29
3/4	12	UNF-1A	.00405	.00234	2	36	UNF-1B	.00530	.00306	3	24
		UNF-2A	.00270	.00156	1	44	UNF-2B	.00350	.00202	2	15
		UNF-3A	.00205	.00118	1	19	UNF-3B	.00285	.00155	1	42
3/4	14	UN-2A	.00245	.00141	1	48	UN-2B	.00315	.00182	2	19
		UN-3A	.00180	.00104	1	19	UN-3B	.00235	.00136	1	43
		UNEF-2A	.00220	.00127	2	1	UNEF-2B	.00285	.00165	2	37
3/4	20	UNEF-3A	.00165	.00095	1	31	UNEF-3B	.00215	.00124	1	58
		UNC-1A	.00475	.00274	1	58	UNC-1B	.00615	.00355	2	32
		UNC-2A	.00315	.00182	1	18	UNC-2B	.00410	.00237	1	41
3/4	12	UNC-3A	.00235	.00136	0	58	UNC-3B	.00305	.00176	1	15
		N-2A	.00275	.00159	1	31	N-2B	.00360	.00208	1	59
		N-3A	.00205	.00118	1	8	N-3B	.00270	.00156	1	29
3/4	16	UNF-1A	.00405	.00234	2	36	UNF-1B	.00530	.00306	3	24
		UNF-2A	.00270	.00156	1	44	UNF-2B	.00350	.00202	2	15
		UNF-3A	.00205	.00118	1	19	UNF-3B	.00285	.00155	1	42
3/4	14	UN-2A	.00245	.00141	1	48	UN-2B	.00315	.00182	2	19
		UN-3A	.00180	.00104	1	19	UN-3B	.00235	.00136	1	43
		UNEF-2A	.00220	.00127	2	1	UNEF-2B	.00285	.00165	2	37
3/4	20	UNEF-3A	.00165	.00095	1	31	UNEF-3B	.00215	.00124	1	58
		UNC-1A	.00475	.00274	1	58	UNC-1B	.00615	.00355	2	32
		UNC-2A	.00315	.00182	1	18	UNC-2B	.00410	.00237	1	41
3/4	9	UNC-3A	.00235	.00136	0	58	UNC-3B	.00305	.00176	1	15
		N-2A	.00275	.00159	1	31	N-2B	.00360	.00208	1	59
		N-3A	.00205	.00118	1	8	N-3B	.00270	.00156	1	29
3/4	12	UNF-1A	.00405	.00234	2	36	UNF-1B	.00530	.00306	3	24
		UNF-2A	.00270	.00156	1	44	UNF-2B	.00350	.00202	2	15
		UNF-3A	.00205	.00118	1	19	UNF-3B	.00285	.00155	1	42
3/4	14	UN-2A	.00245	.00141	1	48	UN-2B	.00315	.00182	2	19
		UN-3A	.00180	.00104	1	19	UN-3				

TABLE III.11.—Deviations in lead and half-angle equivalent to one-half of pitch diameter tolerances, Unified and American screw threads—Continued

Designation		External				Internal					
Size	Threads per inch	Thread symbol	Half of pitch diameter tolerance	Equiv. deviation in lead	Equiv. deviation in half-angle		Thread symbol	Half of pitch diameter tolerance	Equiv. deviation in lead	Equiv. deviation in half-angle	
1	2	3	4	5	6		7	8	9	10	
No. in.			in.	in.	deg	min		in.	in.	deg	min
1 3/4	16	UN-2A	0.00255	0.00147	1	52	UN-2B	0.00330	0.00191	2	25
		UN-3A	0.00190	0.00110	1	24	UN-3B	0.00250	0.00144	1	50
		NEF-2A	0.00245	0.00141	2	1	NEF-2B	0.00315	0.00182	1	36
1 3/8	18	NEF-3A	0.00180	0.00104	1	29	NEF-3B	0.00235	0.00136	1	56
		UN-2A	0.00280	0.00167	1	36	UN-2B	0.00375	0.00217	2	4
		UN-3A	0.00215	0.00124	1	11	UN-3B	0.00280	0.00162	1	32
1 3/16	16	UN-2A	0.00255	0.00147	1	52	UN-2B	0.00330	0.00191	2	25
		UN-3A	0.00190	0.00110	1	24	UN-3B	0.00250	0.00144	1	50
		NEF-2A	0.00245	0.00141	2	1	NEF-2B	0.00315	0.00182	2	36
1 3/16	18	NEF-3A	0.00180	0.00104	1	29	NEF-3B	0.00235	0.00136	1	56
		UNC-1A	0.00600	0.00346	1	39	UNC-1B	0.00780	0.00450	2	9
		UNC-2A	0.00400	0.00231	1	6	UNC-2B	0.00520	0.00300	1	26
1 3/8	8	UNC-3A	0.00300	0.00173	0	50	UNC-3B	0.00390	0.00225	1	4
		N-2A	0.00360	0.00208	1	19	N-2B	0.00465	0.00268	1	42
		N-3A	0.00270	0.00156	0	59	N-3B	0.00350	0.00202	1	17
1 3/8	12	UNF-1A	0.00470	0.00271	2	35	UNF-1B	0.00615	0.00355	3	23
		UNF-2A	0.00315	0.00182	1	44	UNF-2B	0.00410	0.00237	2	15
		UNF-3A	0.00235	0.00136	1	18	UNF-3B	0.00305	0.00176	1	41
1 3/8	16	UN-2A	0.00255	0.00147	1	52	UN-2B	0.00330	0.00191	2	25
		UN-3A	0.00190	0.00110	1	24	UN-3B	0.00250	0.00144	1	50
		NEF-2A	0.00245	0.00141	2	1	NEF-2B	0.00315	0.00182	2	36
1 3/8	18	NEF-3A	0.00180	0.00104	1	29	NEF-3B	0.00235	0.00136	1	56
		UN-2A	0.00295	0.00170	1	37	UN-2B	0.00380	0.00219	2	5
		UN-3A	0.00220	0.00127	1	13	UN-3B	0.00285	0.00165	1	34
1 1/16	16	UN-2A	0.00290	0.00150	1	54	UN-2B	0.00340	0.00196	2	39
		UN-3A	0.00195	0.00113	1	26	UN-3B	0.00255	0.00147	1	52
		NEF-2A	0.00250	0.00144	2	4	NEF-2B	0.00325	0.00188	2	41
1 1/16	18	NEF-3A	0.00185	0.00107	1	32	NEF-3B	0.00240	0.00139	1	59
		UNC-1A	0.00605	0.00349	1	40	UNC-1B	0.00795	0.00456	2	10
		UNC-2A	0.00405	0.00234	1	7	UNC-2B	0.00525	0.00302	1	27
1 1/2	6	UNC-3A	0.00305	0.00176	0	50	UNC-3B	0.00395	0.00229	1	5
		N-2A	0.00365	0.00211	1	20	N-2B	0.00475	0.00274	1	44
		N-3A	0.00275	0.00159	1	0	N-3B	0.00355	0.00205	1	18
1 1/2	12	UNF-1A	0.00480	0.00277	2	38	UNF-1B	0.00625	0.00361	3	26
		UNF-2A	0.00320	0.00185	1	46	UNF-2B	0.00415	0.00240	2	17
		UNF-3A	0.00240	0.00139	1	19	UNF-3B	0.00315	0.00182	1	44
1 1/2	10	UN-2A	0.00290	0.00150	1	54	UN-2B	0.00340	0.00196	2	30
		UN-3A	0.00195	0.00113	1	26	UN-3B	0.00255	0.00147	1	52
		NEF-2A	0.00250	0.00144	2	4	NEF-2B	0.00325	0.00188	2	41
1 1/2	18	NEF-3A	0.00185	0.00107	1	32	NEF-3B	0.00240	0.00139	1	59
		N-2A	0.00260	0.00150	1	54	N-2B	0.00340	0.00196	2	30
		N-3A	0.00195	0.00113	1	26	N-3B	0.00255	0.00147	1	52
1 1/16	18	NEF-2A	0.00250	0.00144	2	4	NEF-2B	0.00325	0.00188	2	41
		NEF-3A	0.00185	0.00107	1	32	NEF-3B	0.00240	0.00139	1	59
		N-2A	0.00370	0.00214	1	21	N-2B	0.00485	0.00280	1	47
1 3/8	8	N-3A	0.00280	0.00162	1	2	N-3B	0.00360	0.00208	1	19
		UN-2A	0.00295	0.00170	1	37	UN-2B	0.00380	0.00219	2	5
		UN-3A	0.00220	0.00127	1	13	UN-3B	0.00285	0.00165	1	34
1 3/8	12	UN-2A	0.00290	0.00150	1	54	UN-2B	0.00340	0.00196	2	30
		UN-3A	0.00195	0.00113	1	26	UN-3B	0.00255	0.00147	1	52
		NEF-2A	0.00250	0.00144	2	4	NEF-2B	0.00325	0.00188	2	41
1 3/8	18	NEF-3A	0.00185	0.00107	1	32	NEF-3B	0.00240	0.00139	1	59
		N-2A	0.00265	0.00153	1	57	N-2B	0.00345	0.00199	2	32
		N-3A	0.00200	0.00115	1	28	N-3B	0.00260	0.00150	1	54
1 1/16	18	NEF-2A	0.00255	0.00147	2	6	NEF-2B	0.00330	0.00191	2	43
		NEF-3A	0.00190	0.00110	1	34	NEF-3B	0.00245	0.00141	2	1
		UNC-1A	0.00670	0.00387	1	32	UNC-1B	0.00870	0.00502	2	0
1 3/4	5	UNC-2A	0.00445	0.00257	1	1	UNC-2B	0.00580	0.00335	1	20
		UNC-3A	0.00335	0.00193	0	46	UNC-3B	0.00435	0.00251	1	0
		N-2A	0.00375	0.00217	1	22	N-2B	0.00490	0.00283	1	48
1 3/4	8	N-3A	0.00280	0.00162	1	2	N-3B	0.00370	0.00214	1	21
		UN-2A	0.00300	0.00173	1	30	UN-2B	0.00390	0.00225	2	9
		UN-3A	0.00225	0.00130	1	14	UN-3B	0.00280	0.00167	1	36
1 3/4	16	UNEF-2A	0.00265	0.00153	1	57	UNEF-2B	0.00345	0.00199	2	32
		UNEF-3A	0.00200	0.00115	1	28	UNEF-3B	0.00260	0.00150	1	54
		N-2A	0.00265	0.00153	1	57	N-2B	0.00345	0.00199	2	32
1 3/16	16	N-3A	0.00200	0.00115	1	28	N-3B	0.00260	0.00150	1	54
		N-2A	0.00385	0.00222	1	25	N-2B	0.00500	0.00289	1	50
		N-3A	0.00285	0.00165	1	3	N-3B	0.00375	0.00217	1	22
1 3/8	12	UN-2A	0.00300	0.00173	1	39	UN-2B	0.00390	0.00225	2	9
		UN-3A	0.00225	0.00130	1	14	UN-3B	0.00280	0.00167	1	36
		UN-2A	0.00265	0.00153	1	57	UN-2B	0.00345	0.00199	2	32
1 3/8	16	UN-3A	0.00200	0.00115	1	28	UN-3B	0.00260	0.00150	1	54
		N-2A	0.00270	0.00156	1	59	N-2B	0.00350	0.00202	2	34
		N-3A	0.00200	0.00115	1	28	N-3B	0.00260	0.00150	1	54

TABLE III.11.—Deviations in lead and half-angle equivalent to one-half of pitch diameter tolerances, Unified and American screw threads—Continued

Designation		External				Internal					
Size	Threads per inch	Thread symbol	Half of pitch diameter tolerance	Equiv. deviation in lead	Equiv. deviation in half-angle		Thread symbol	Half of pitch diameter tolerance	Equiv. deviation in lead	Equiv. deviation in half-angle	
1	2	3	4	5	6		7	8	9	10	
No. in.			<i>in.</i>	<i>in.</i>	<i>deg</i>	<i>min</i>		<i>in.</i>	<i>in.</i>	<i>deg</i>	<i>min</i>
2	4½	UNC-1A	0.00715	0.00413	1	28	UNC-1B	0.00930	0.00537	1	55
		UNC-2A	.00475	.00274	0	59	UNC-2B	.00620	.00358	1	17
		UNC-3A	.00355	.00205	0	44	UNC-3B	.00465	.00258	0	58
2	8	N-2A	.00390	.00225	1	26	N-2B	.00505	.00292	1	51
		N-3A	.00280	.00167	1	4	N-3B	.00380	.00219	1	24
		UN-2A	.00305	.00176	1	41	UN-2B	.00395	.00228	2	10
2	12	UN-3A	.00225	.00130	1	14	UN-3B	.00295	.00170	1	37
		UNEF-2A	.00270	.00156	1	59	UNEF-2B	.00350	.00202	2	34
		UNEF-3A	.00200	.00115	1	28	UNEF-3B	.00280	.00150	1	54
2½	16	N-2A	.00270	.00156	1	59	N-2B	.00350	.00202	2	34
		N-3A	.00200	.00115	1	28	N-3B	.00280	.00150	1	54
		UN-2A	.00305	.00176	1	41	UN-2B	.00395	.00228	2	10
2½	8	N-3A	.00225	.00130	1	14	N-3B	.00295	.00170	1	37
		UN-2A	.00270	.00156	1	59	UN-2B	.00350	.00202	2	34
		UN-3A	.00225	.00130	1	14	UN-3B	.00295	.00170	1	37
2½	12	UN-2A	.00270	.00156	1	59	UN-2B	.00350	.00202	2	34
		UN-3A	.00225	.00130	1	14	UN-3B	.00295	.00170	1	37
		N-2A	.00270	.00156	1	59	N-2B	.00350	.00202	2	34
2½	16	N-3A	.00200	.00115	1	28	N-3B	.00280	.00150	1	54
		UNC-1A	.00730	.00421	1	30	UNC-1B	.00950	.00548	1	58
		UNC-2A	.00485	.00280	1	0	UNC-2B	.00630	.00364	1	18
2½	4½	UNC-3A	.00365	.00211	0	45	UNC-3B	.00475	.00274	0	59
		N-2A	.00400	.00231	1	28	N-2B	.00520	.00300	1	54
		N-3A	.00300	.00173	1	6	N-3B	.00390	.00225	1	26
2½	12	UN-2A	.00305	.00176	1	41	UN-2B	.00395	.00228	2	10
		UN-3A	.00225	.00130	1	14	UN-3B	.00295	.00170	1	37
		UN-2A	.00270	.00156	1	59	UN-2B	.00350	.00202	2	34
2½	16	UN-3A	.00225	.00130	1	14	UN-3B	.00295	.00170	1	37
		N-2A	.00275	.00159	2	1	N-2B	.00360	.00208	2	38
		N-3A	.00205	.00118	1	30	N-3B	.00270	.00156	1	59
2½	12	UN-2A	.00310	.00179	1	42	UN-2B	.00405	.00234	2	14
		UN-3A	.00230	.00123	1	16	UN-3B	.00300	.00173	1	39
		UN-2A	.00275	.00159	2	1	UN-2B	.00360	.00208	2	38
2½	16	UN-3A	.00205	.00118	1	30	UN-3B	.00270	.00156	1	59
		N-2A	.00275	.00159	2	1	N-2B	.00360	.00208	2	38
		N-3A	.00205	.00118	1	30	N-3B	.00270	.00156	1	59
2½	4	UNC-1A	.00775	.00447	1	25	UNC-1B	.01010	.00583	1	51
		UNC-2A	.00520	.00300	0	57	UNC-2B	.00775	.00390	1	14
		UNC-3A	.00390	.00225	0	43	UNC-3B	.00505	.00292	0	56
2½	8	N-2A	.00410	.00237	1	30	N-2B	.00530	.00300	1	57
		N-3A	.00305	.00176	1	7	N-3B	.00400	.00231	1	28
		UN-2A	.00310	.00179	1	42	UN-2B	.00405	.00234	2	14
2½	12	UN-3A	.00230	.00123	1	16	UN-3B	.00300	.00173	1	39
		UN-2A	.00275	.00159	2	1	UN-2B	.00360	.00208	2	38
		UN-3A	.00205	.00118	1	30	UN-3B	.00270	.00156	1	59
2½	16	UN-2A	.00310	.00179	1	42	UN-2B	.00405	.00234	2	14
		UN-3A	.00230	.00123	1	16	UN-3B	.00300	.00173	1	39
		UN-2A	.00275	.00159	2	1	UN-2B	.00360	.00208	2	38
2½	12	UN-3A	.00205	.00118	1	30	UN-3B	.00270	.00156	1	59
		UN-2A	.00310	.00179	1	42	UN-2B	.00405	.00234	2	14
		UN-3A	.00230	.00123	1	16	UN-3B	.00300	.00173	1	39
2½	16	UN-2A	.00310	.00179	1	42	UN-2B	.00405	.00234	2	14
		UN-3A	.00230	.00123	1	16	UN-3B	.00300	.00173	1	39
		UN-2A	.00275	.00159	2	1	UN-2B	.00360	.00208	2	38
2½	12	UN-3A	.00205	.00118	1	30	UN-3B	.00270	.00156	1	59
		UN-2A	.00315	.00182	1	44	UN-2B	.00410	.00237	2	15
		UN-3A	.00235	.00136	1	18	UN-3B	.00310	.00179	1	42
2½	16	UN-2A	.00290	.00162	2	3	UN-2B	.00365	.00211	2	40
		UN-3A	.00210	.00121	1	32	UN-3B	.00275	.00159	2	1
		UNC-1A	.00805	.00465	1	29	UNC-1B	.01045	.00603	1	55
3	4	UNC-2A	.00535	.00309	0	59	UNC-2B	.00695	.00401	1	16
		UNC-3A	.00400	.00231	0	44	UNC-3B	.00520	.00300	0	57
		N-2A	.00425	.00245	1	33	N-2B	.00555	.00320	2	2
3	8	N-3A	.00320	.00185	1	10	N-3B	.00415	.00240	1	31
		UN-2A	.00315	.00182	1	44	UN-2B	.00410	.00237	2	15
		UN-3A	.00235	.00136	1	18	UN-3B	.00310	.00179	1	42
3	12	UN-2A	.00290	.00162	2	3	UN-2B	.00365	.00211	2	40
		UN-3A	.00210	.00121	1	32	UN-3B	.00275	.00159	2	1
		UN-2A	.00315	.00182	1	44	UN-2B	.00410	.00237	2	15
3½	12	UN-3A	.00235	.00136	1	18	UN-3B	.00310	.00179	1	42

TABLE III.11.—Deviations in lead and half-angle equivalent to one-half of pitch diameter tolerances, Unified and American screw threads—Continued

Designation		External				Internal			
Size	Threads per inch	Thread symbol	Half of pitch diameter tolerance	Equlv. deviation in lead	Equlv. deviation in half-angle	Thread symbol	Half of pitch diameter tolerance	Equlv. deviation in lead	Equlv. deviation in half-angle
1	2	3	4	5	6	7	8	9	10
No. in.			in.	in.	deg min		in.	in.	deg min
5/8	12	UN-2A	0.00335	0.00193	1 51	UN-2B	0.00435	0.00251	2 23
		UN-3A	.00250	.00144	1 22	UN-3B	.00330	.00191	1 49
5/8	16	UN-2A	.00305	.00176	2 14	UN-2B	.00395	.00228	2 54
		UN-3A	.00225	.00130	1 39	UN-3B	.00295	.00170	2 10
5/8	8	N-2A	.00495	.00286	1 49	N-2B	.00645	.00372	2 22
		N-3A	.00370	.00214	1 21	N-3B	.00485	.00280	1 47
5/8	12	UN-2A	.00335	.00193	1 51	UN-2B	.00435	.00251	2 23
		UN-3A	.00250	.00144	1 22	UN-3B	.00330	.00191	1 49
5/8	16	UN-2A	.00305	.00176	2 14	UN-2B	.00395	.00228	2 54
		UN-3A	.00225	.00130	1 39	UN-3B	.00295	.00170	2 10
5/8	8	N-2A	.00500	.00289	1 50	N-2B	.00650	.00375	2 23
		N-3A	.00375	.00217	1 22	N-3B	.00490	.00283	1 48
5/8	12	UN-2A	.00345	.00199	1 54	UN-2B	.00450	.00260	2 28
		UN-3A	.00260	.00150	1 26	UN-3B	.00335	.00193	1 51
5/8	16	UN-2A	.00310	.00179	2 16	UN-2B	.00405	.00234	2 58
		UN-3A	.00235	.00136	1 43	UN-3B	.00305	.00176	2 14
6	8	N-2A	.00510	.00294	1 52	N-2B	.00660	.00381	2 25
		N-3A	.00380	.00219	1 24	N-3B	.00495	.00286	1 49
6	12	UN-2A	.00345	.00199	1 54	UN-2B	.00450	.00260	2 28
		UN-3A	.00260	.00150	1 26	UN-3B	.00335	.00193	1 51
6	16	UN-2A	.00310	.00179	2 16	UN-2B	.00405	.00234	2 58
		UN-3A	.00235	.00136	1 43	UN-3B	.00305	.00176	2 14

7. LIMITS OF SIZE OF GAGES

The limits of size of plain and thread gages applicable to the standard series of Unified and American screw threads are presented in table III.12. In this table *X* tolerances are applied to thread gages and *Z* tolerances to plain gages.

The limits of size of *W* truncated thread setting plug gages, and of both *W* and *X* basic-crest thread setting plug gages, are presented in table III.13 or as indicated in the footnotes to table III.13. These limits are developed in accordance with the requirements for gages and gaging stated in section VI, p. 107.

TABLE III.12.—Gages for standard thread series, Unified and American screw threads—Continued

Nominal size and threads per inch	Series designation	Gages for external threads										Gages for internal threads										Class	Series designation	Nominal size and threads per inch
		X thread gages					Z plain gages for major diameter					X thread gages					Z plain gages for minor diameter							
		Go		Not go			Go		Not go			Go		Not go			Go		Not go					
		Pitch diameter	Minor diameter	Pitch diameter	Plus tolerance	Minus tolerance	Major diameter	Unfinished material	Semi-finished	Go	Not go	Major diameter	Pitch diameter	Major diameter	Minus tolerance	Plus tolerance	Pitch diameter	Go	Not go					
6-32	NC	2A	0.1179	0.1084	0.1141	0.1073	0.1372	0.1312	0.1349	0.1177	0.1349	0.1214	0.1214	0.1214	0.1214	0.1214	0.1040	0.1139	0.1139	2B	NC	6-32		
		3A	0.1177	0.1082	0.1138	0.1070	0.1371	0.1311	0.1348	0.1175	0.1348	0.1213	0.1213	0.1213	0.1213	0.1039	0.1138	0.1138						
		3B	0.1174	0.1079	0.1135	0.1067	0.1370	0.1310	0.1347	0.1172	0.1347	0.1212	0.1212	0.1212	0.1212	0.1038	0.1137	0.1137						
6-40	NF	2A	0.1210	0.1102	0.1184	0.1103	0.1372	0.1321	0.1370	0.1218	0.1370	0.1252	0.1252	0.1252	0.1252	0.1110	0.1190	0.1190	2B	NF	6-40			
		3A	0.1208	0.1100	0.1182	0.1101	0.1371	0.1320	0.1369	0.1217	0.1369	0.1251	0.1251	0.1251	0.1109	0.1189	0.1189							
		3B	0.1205	0.1097	0.1179	0.1096	0.1370	0.1319	0.1368	0.1216	0.1368	0.1250	0.1250	0.1250	0.1108	0.1188	0.1188							
8-32	NC	2A	0.1428	0.1293	0.1390	0.1293	0.1571	0.1571	0.1450	0.1571	0.1450	0.1450	0.1450	0.1450	0.1300	0.1380	0.1380	2B	NC	8-32				
		3A	0.1425	0.1288	0.1385	0.1288	0.1570	0.1570	0.1449	0.1570	0.1449	0.1449	0.1449	0.1299	0.1379	0.1379								
		3B	0.1422	0.1285	0.1382	0.1285	0.1569	0.1569	0.1448	0.1569	0.1448	0.1448	0.1448	0.1298	0.1378	0.1378								
8-36	NF	2A	0.1452	0.1322	0.1424	0.1322	0.1632	0.1632	0.1510	0.1632	0.1510	0.1510	0.1510	0.1510	0.1360	0.1440	0.1440	2B	NF	8-36				
		3A	0.1450	0.1320	0.1422	0.1320	0.1631	0.1631	0.1509	0.1631	0.1509	0.1509	0.1509	0.1359	0.1439	0.1439								
		3B	0.1448	0.1318	0.1420	0.1318	0.1630	0.1630	0.1508	0.1630	0.1508	0.1508	0.1508	0.1358	0.1438	0.1438								
10-24	NC	2A	0.1319	0.1149	0.1266	0.1149	0.1496	0.1496	0.1374	0.1496	0.1374	0.1374	0.1374	0.1374	0.1220	0.1300	0.1300	2B	NC	10-24				
		3A	0.1317	0.1147	0.1264	0.1147	0.1495	0.1495	0.1373	0.1495	0.1373	0.1373	0.1373	0.1219	0.1299	0.1299								
		3B	0.1315	0.1145	0.1262	0.1145	0.1494	0.1494	0.1372	0.1494	0.1372	0.1372	0.1372	0.1218	0.1298	0.1298								
10-32	NF	2A	0.1368	0.1208	0.1325	0.1208	0.1550	0.1550	0.1428	0.1550	0.1428	0.1428	0.1428	0.1428	0.1274	0.1354	0.1354	2B	NF	10-32				
		3A	0.1366	0.1206	0.1323	0.1206	0.1549	0.1549	0.1427	0.1549	0.1427	0.1427	0.1427	0.1273	0.1353	0.1353								
		3B	0.1364	0.1204	0.1321	0.1204	0.1548	0.1548	0.1426	0.1548	0.1426	0.1426	0.1426	0.1272	0.1352	0.1352								
12-24	NC	2A	0.1529	0.1369	0.1486	0.1369	0.1775	0.1775	0.1653	0.1775	0.1653	0.1653	0.1653	0.1653	0.1500	0.1580	0.1580	2B	NC	12-24				
		3A	0.1527	0.1367	0.1484	0.1367	0.1774	0.1774	0.1652	0.1774	0.1652	0.1652	0.1652	0.1499	0.1579	0.1579								
		3B	0.1525	0.1365	0.1482	0.1365	0.1773	0.1773	0.1651	0.1773	0.1651	0.1651	0.1651	0.1498	0.1578	0.1578								
12-28	NF	2A	0.1578	0.1418	0.1535	0.1418	0.1825	0.1825	0.1703	0.1825	0.1703	0.1703	0.1703	0.1703	0.1550	0.1630	0.1630	2B	NF	12-28				
		3A	0.1576	0.1416	0.1533	0.1416	0.1824	0.1824	0.1702	0.1824	0.1702	0.1702	0.1702	0.1549	0.1629	0.1629								
		3B	0.1574	0.1414	0.1531	0.1414	0.1823	0.1823	0.1701	0.1823	0.1701	0.1701	0.1701	0.1548	0.1628	0.1628								
12-32	NEF	2A	0.1645	0.1485	0.1602	0.1485	0.1975	0.1975	0.1853	0.1975	0.1853	0.1853	0.1853	0.1853	0.1700	0.1780	0.1780	2B	NEF	12-32				
		3A	0.1643	0.1483	0.1600	0.1483	0.1974	0.1974	0.1852	0.1974	0.1852	0.1852	0.1852	0.1700	0.1780	0.1780								
		3B	0.1641	0.1481	0.1598	0.1481	0.1973	0.1973	0.1851	0.1973	0.1851	0.1851	0.1851	0.1699	0.1779	0.1779								
14-20	UNC	1A	0.2154	0.1994	0.2051	0.1994	0.2499	0.2499	0.2377	0.2499	0.2377	0.2377	0.2377	0.2377	0.2224	0.2304	0.2304	13	UNC	14-20				
		2A	0.2152	0.1992	0.2049	0.1992	0.2497	0.2497	0.2375	0.2497	0.2375	0.2375	0.2375	0.2375	0.2222	0.2302	0.2302							
		3A	0.2150	0.1990	0.2047	0.1990	0.2495	0.2495	0.2373	0.2495	0.2373	0.2373	0.2373	0.2373	0.2220	0.2300	0.2300							

TABLE III. 12.—Gages for standard thread series, Unified and American screw threads—Continued

Nominal size and threads per inch	Series designation	Gages for external threads										Gages for internal threads										Series designation	Class	Nominal size and threads per inch								
		X thread gages					Z plain gages for major diameter					X thread gages					Z plain gages for minor diameter															
		Go		Not go			Go		Not go			Go		Not go			Go		Not go													
		Pitch diameter	Minor diameter	Plus tolerance range	Minus tolerance range	Pitch diameter	Minor diameter	Unfinished hot-rolled material	Seal-finished	Unfinished hot-rolled material	Major diameter	Pitch diameter	Major diameter	Pitch diameter	Major diameter	Minus tolerance range	Plus tolerance range	Pitch diameter	Major diameter	Pitch diameter	Major diameter				Minus tolerance range	Plus tolerance range						
in.	in.	in.	in.	in.	in.	in.	in.	in.	in.	in.	in.	in.	in.	in.	in.	in.	in.	in.	in.	in.	in.	in.	in.									
1-16-12	UN	2A	0.8817	0.8430	0.8750	0.8750	0.8550	0.9250	0.9250	0.9250	0.8834	0.8908	0.8908	0.8908	0.8908	0.8908	0.8908	0.8908	0.8908	0.8908	0.8908	0.8908	0.8908	0.8908	0.8908	UN	2B	0.94750	0.94750	0.94750	1-16-12	
		3A	0.8834	0.8450	0.8750	0.8750	0.8550	0.9250	0.9250	0.9250	0.8851	0.8925	0.8925	0.8925	0.8925	0.8925	0.8925	0.8925	0.8925	0.8925	0.8925	0.8925	0.8925	0.8925	0.8925	UN	3B	0.94750	0.94750	0.94750	1-16-12	
		2A	0.8831	0.8450	0.8750	0.8750	0.8550	0.9250	0.9250	0.9250	0.8828	0.8902	0.8902	0.8902	0.8902	0.8902	0.8902	0.8902	0.8902	0.8902	0.8902	0.8902	0.8902	0.8902	0.8902	UN	2B	0.94750	0.94750	0.94750	1-16-12	
1-16-16	UN	2A	0.8954	0.8550	0.8904	0.8904	0.8700	0.9300	0.9300	0.9300	0.8979	0.9053	0.9053	0.9053	0.9053	0.9053	0.9053	0.9053	0.9053	0.9053	0.9053	0.9053	0.9053	0.9053	0.9053	UN	2B	0.95000	0.95000	0.95000	1-16-16	
		3A	0.8971	0.8550	0.8904	0.8904	0.8700	0.9300	0.9300	0.9300	0.8996	0.9070	0.9070	0.9070	0.9070	0.9070	0.9070	0.9070	0.9070	0.9070	0.9070	0.9070	0.9070	0.9070	UN	3B	0.95000	0.95000	0.95000	1-16-16		
		2A	0.8968	0.8550	0.8904	0.8904	0.8700	0.9300	0.9300	0.9300	0.8976	0.9050	0.9050	0.9050	0.9050	0.9050	0.9050	0.9050	0.9050	0.9050	0.9050	0.9050	0.9050	0.9050	0.9050	UN	2B	0.95000	0.95000	0.95000	1-16-16	
1-16-20	UNEF	2A	0.9036	0.8600	0.8991	0.8991	0.8750	0.9300	0.9300	0.9300	0.9011	0.9085	0.9085	0.9085	0.9085	0.9085	0.9085	0.9085	0.9085	0.9085	0.9085	0.9085	0.9085	0.9085	0.9085	UNEF	2B	0.95750	0.95750	0.95750	1-16-20	
		3A	0.9053	0.8600	0.8991	0.8991	0.8750	0.9300	0.9300	0.9300	0.9028	0.9102	0.9102	0.9102	0.9102	0.9102	0.9102	0.9102	0.9102	0.9102	0.9102	0.9102	0.9102	0.9102	0.9102	UNEF	3B	0.95750	0.95750	0.95750	1-16-20	
		2A	0.9050	0.8600	0.8991	0.8991	0.8750	0.9300	0.9300	0.9300	0.9025	0.9099	0.9099	0.9099	0.9099	0.9099	0.9099	0.9099	0.9099	0.9099	0.9099	0.9099	0.9099	0.9099	0.9099	UNEF	2B	0.95750	0.95750	0.95750	1-16-20	
1-8	UNC	1A	0.9168	0.8700	0.9071	0.9071	0.8800	0.9400	0.9400	0.9400	0.9173	0.9247	0.9247	0.9247	0.9247	0.9247	0.9247	0.9247	0.9247	0.9247	0.9247	0.9247	0.9247	0.9247	0.9247	UNC	1B	0.96500	0.96500	0.96500	1-8	
		2A	0.9185	0.8700	0.9071	0.9071	0.8800	0.9400	0.9400	0.9400	0.9190	0.9264	0.9264	0.9264	0.9264	0.9264	0.9264	0.9264	0.9264	0.9264	0.9264	0.9264	0.9264	0.9264	0.9264	UNC	2B	0.96500	0.96500	0.96500	1-8	
		3A	0.9168	0.8700	0.9071	0.9071	0.8800	0.9400	0.9400	0.9400	0.9173	0.9247	0.9247	0.9247	0.9247	0.9247	0.9247	0.9247	0.9247	0.9247	0.9247	0.9247	0.9247	0.9247	0.9247	UNC	3B	0.96500	0.96500	0.96500	1-8	
1-12	UNF	1A	0.9441	0.9000	0.9353	0.9353	0.9100	0.9500	0.9500	0.9500	0.9456	0.9530	0.9530	0.9530	0.9530	0.9530	0.9530	0.9530	0.9530	0.9530	0.9530	0.9530	0.9530	0.9530	0.9530	UNF	1B	0.99000	0.99000	0.99000	1-12	
		2A	0.9458	0.9000	0.9353	0.9353	0.9100	0.9500	0.9500	0.9500	0.9473	0.9547	0.9547	0.9547	0.9547	0.9547	0.9547	0.9547	0.9547	0.9547	0.9547	0.9547	0.9547	0.9547	0.9547	UNF	2B	0.99000	0.99000	0.99000	1-12	
		3A	0.9441	0.9000	0.9353	0.9353	0.9100	0.9500	0.9500	0.9500	0.9456	0.9530	0.9530	0.9530	0.9530	0.9530	0.9530	0.9530	0.9530	0.9530	0.9530	0.9530	0.9530	0.9530	0.9530	UNF	3B	0.99000	0.99000	0.99000	1-12	
1-16	UN	2A	0.9579	0.9000	0.9529	0.9529	0.9250	0.9650	0.9650	0.9650	0.9594	0.9668	0.9668	0.9668	0.9668	0.9668	0.9668	0.9668	0.9668	0.9668	0.9668	0.9668	0.9668	0.9668	0.9668	UN	2B	0.99500	0.99500	0.99500	1-16	
		3A	0.9594	0.9000	0.9529	0.9529	0.9250	0.9650	0.9650	0.9650	0.9609	0.9683	0.9683	0.9683	0.9683	0.9683	0.9683	0.9683	0.9683	0.9683	0.9683	0.9683	0.9683	0.9683	0.9683	UN	3B	0.99500	0.99500	0.99500	1-16	
		2A	0.9579	0.9000	0.9529	0.9529	0.9250	0.9650	0.9650	0.9650	0.9594	0.9668	0.9668	0.9668	0.9668	0.9668	0.9668	0.9668	0.9668	0.9668	0.9668	0.9668	0.9668	0.9668	0.9668	UN	2B	0.99500	0.99500	0.99500	1-16	
1-20	UNEF	2A	0.9651	0.9100	0.9616	0.9616	0.9300	0.9700	0.9700	0.9700	0.9676	0.9750	0.9750	0.9750	0.9750	0.9750	0.9750	0.9750	0.9750	0.9750	0.9750	0.9750	0.9750	0.9750	0.9750	UNEF	2B	1.00000	1.00000	1.00000	1-20	
		3A	0.9677	0.9100	0.9616	0.9616	0.9300	0.9700	0.9700	0.9700	0.9692	0.9766	0.9766	0.9766	0.9766	0.9766	0.9766	0.9766	0.9766	0.9766	0.9766	0.9766	0.9766	0.9766	0.9766	UNEF	3B	1.00000	1.00000	1.00000	1-20	
		2A	0.9651	0.9100	0.9616	0.9616	0.9300	0.9700	0.9700	0.9700	0.9676	0.9750	0.9750	0.9750	0.9750	0.9750	0.9750	0.9750	0.9750	0.9750	0.9750	0.9750	0.9750	0.9750	0.9750	UNEF	2B	1.00000	1.00000	1.00000	1-20	
1-16-12	UN	2A	0.9654	0.9100	0.9616	0.9616	0.9300	0.9700	0.9700	0.9700	0.9679	0.9753	0.9753	0.9753	0.9753	0.9753	0.9753	0.9753	0.9753	0.9753	0.9753	0.9753	0.9753	0.9753	0.9753	UN	2B	1.00000	1.00000	1.00000	1-16-12	
		3A	0.9679	0.9100	0.9616	0.9616	0.9300	0.9700	0.9700	0.9700	0.9694	0.9768	0.9768	0.9768	0.9768	0.9768	0.9768	0.9768	0.9768	0.9768	0.9768	0.9768	0.9768	0.9768	0.9768	UN	3B	1.00000	1.00000	1.00000	1-16-12	
		2A	0.9654	0.9100	0.9616	0.9616	0.9300	0.9700	0.9700	0.9700	0.9679	0.9753	0.9753	0.9753	0.9753	0.9753	0.9753	0.9753	0.9753	0.9753	0.9753	0.9753	0.9753	0.9753	0.9753	UN	2B	1.00000	1.00000	1.00000	1-16-12	
1-16-16	UN	2A	0.9704	0.9150	0.9654	0.9654	0.9400	0.9800	0.9800	0.9800	0.9729	0.9803	0.9803	0.9803	0.9803	0.9803	0.9803	0.9803	0.9803	0.9803	0.9803	0.9803	0.9803	0.9803	0.9803	0.9803	UN	2B	1.00500	1.00500	1.00500	1-16-16
		3A	0.9729	0.9150	0.9654	0.9654	0.9400	0.9800	0.9800	0.9800	0.9754	0.9828	0.9828	0.9828	0.9828	0.9828	0.9828	0.9828	0.9828	0.9828	0.9828	0.9828	0.9828	0.9828	0.9828	UN	3B	1.00500	1.00500	1.00500	1-16-16	
		2A	0.9704	0.9150	0.9654	0.9654	0.9400	0.9800	0.9800	0.9800	0.9729	0.9803	0.9803	0.9803	0.9803	0.9803	0.9803	0.9803	0.9803	0.9803	0.9803	0.9803	0.9803	0.9803	0.9803	UN	2B	1.00500	1.00500	1.00500	1-16-16	
1-16-18	NEF	2A	0.9720	0.9150	0.9654	0.9654	0.9400	0.9800	0.9800	0.9800	0.9745	0.9819	0.9819	0.9819	0.9819	0.9819	0.9819	0.9819	0.9819	0.9819	0.9819	0.9819	0.9819	0.9819	0.9819	NEF	2B	1.00500	1.00500	1.00500	1-16-18	
		3A	0.9745	0.9150	0.9654	0.9654	0.9400	0.9800	0.9800	0.9800	0.9770	0.9844	0.9844	0.9844	0.9844	0.9844	0.9844	0.9844	0.9844	0.9844	0.9844	0.9844	0.9844	0.9844	0.9844	NEF	3B	1.00500	1.00500	1.00500	1-16-18	
		2A	0.9720	0.9150	0.9654	0.9654	0.9400	0.9800	0.9800	0.9800	0.9745	0.9819	0.9819	0.9819	0.9819	0.9819	0.9819	0.9819	0.9819	0.9819	0.9819	0.9819	0.9819	0.9819	0.9819	NEF	2B	1.00500	1.00500	1.00500	1-16-18	

TABLE III.12.—Gages for standard thread series, Unified and American screw threads—Continued

Nominal size and threads per inch	Series designation	Gages for internal threads																																																																																																																																																																																																																																																																																																																																																																																																																																																																																																																																																																																																																																																																																																																																																																																																																																																																																																																																																																																																																																																																																																																		
		X thread gages							Z plain gages for major diameter							N thread gages			Z plain gages for minor diameter																																																																																																																																																																																																																																																																																																																																																																																																																																																																																																																																																																																																																																																																																																																																																																																																																																																																																																																																																																																																																																																																																																	
		Go			Not go				Go			Not go				Go		Not go	Go	Not go																																																																																																																																																																																																																																																																																																																																																																																																																																																																																																																																																																																																																																																																																																																																																																																																																																																																																																																																																																																																																																																																																																
		Pitch diameter	Major diameter	Minor diameter	Plus tolerance gage	Minus tolerance gage	Pitch diameter	Major diameter	Minor diameter	Unfinished hot-rolled material	Semi-finished material	Unfinished hot-rolled material	Major diameter	Pitch diameter	Major diameter	Minor diameter	Plus tolerance gage	Minus tolerance gage	Pitch diameter	Major diameter	Minor diameter																																																																																																																																																																																																																																																																																																																																																																																																																																																																																																																																																																																																																																																																																																																																																																																																																																																																																																																																																																																																																																																																																															
1 1/4-16	N	1A	1.433	1.434	1.435	1.436	1.437	1.438	1.439	1.440	1.441	1.442	1.443	1.444	1.445	1.446	1.447	1.448	1.449	1.450	1.451	1.452	1.453	1.454	1.455	1.456	1.457	1.458	1.459	1.460	1.461	1.462	1.463	1.464	1.465	1.466	1.467	1.468	1.469	1.470	1.471	1.472	1.473	1.474	1.475	1.476	1.477	1.478	1.479	1.480	1.481	1.482	1.483	1.484	1.485	1.486	1.487	1.488	1.489	1.490	1.491	1.492	1.493	1.494	1.495	1.496	1.497	1.498	1.499	1.500	1.501	1.502	1.503	1.504	1.505	1.506	1.507	1.508	1.509	1.510	1.511	1.512	1.513	1.514	1.515	1.516	1.517	1.518	1.519	1.520	1.521	1.522	1.523	1.524	1.525	1.526	1.527	1.528	1.529	1.530	1.531	1.532	1.533	1.534	1.535	1.536	1.537	1.538	1.539	1.540	1.541	1.542	1.543	1.544	1.545	1.546	1.547	1.548	1.549	1.550	1.551	1.552	1.553	1.554	1.555	1.556	1.557	1.558	1.559	1.560	1.561	1.562	1.563	1.564	1.565	1.566	1.567	1.568	1.569	1.570	1.571	1.572	1.573	1.574	1.575	1.576	1.577	1.578	1.579	1.580	1.581	1.582	1.583	1.584	1.585	1.586	1.587	1.588	1.589	1.590	1.591	1.592	1.593	1.594	1.595	1.596	1.597	1.598	1.599	1.600	1.601	1.602	1.603	1.604	1.605	1.606	1.607	1.608	1.609	1.610	1.611	1.612	1.613	1.614	1.615	1.616	1.617	1.618	1.619	1.620	1.621	1.622	1.623	1.624	1.625	1.626	1.627	1.628	1.629	1.630	1.631	1.632	1.633	1.634	1.635	1.636	1.637	1.638	1.639	1.640	1.641	1.642	1.643	1.644	1.645	1.646	1.647	1.648	1.649	1.650	1.651	1.652	1.653	1.654	1.655	1.656	1.657	1.658	1.659	1.660	1.661	1.662	1.663	1.664	1.665	1.666	1.667	1.668	1.669	1.670	1.671	1.672	1.673	1.674	1.675	1.676	1.677	1.678	1.679	1.680	1.681	1.682	1.683	1.684	1.685	1.686	1.687	1.688	1.689	1.690	1.691	1.692	1.693	1.694	1.695	1.696	1.697	1.698	1.699	1.700	1.701	1.702	1.703	1.704	1.705	1.706	1.707	1.708	1.709	1.710	1.711	1.712	1.713	1.714	1.715	1.716	1.717	1.718	1.719	1.720	1.721	1.722	1.723	1.724	1.725	1.726	1.727	1.728	1.729	1.730	1.731	1.732	1.733	1.734	1.735	1.736	1.737	1.738	1.739	1.740	1.741	1.742	1.743	1.744	1.745	1.746	1.747	1.748	1.749	1.750	1.751	1.752	1.753	1.754	1.755	1.756	1.757	1.758	1.759	1.760	1.761	1.762	1.763	1.764	1.765	1.766	1.767	1.768	1.769	1.770	1.771	1.772	1.773	1.774	1.775	1.776	1.777	1.778	1.779	1.780	1.781	1.782	1.783	1.784	1.785	1.786	1.787	1.788	1.789	1.790	1.791	1.792	1.793	1.794	1.795	1.796	1.797	1.798	1.799	1.800	1.801	1.802	1.803	1.804	1.805	1.806	1.807	1.808	1.809	1.810	1.811	1.812	1.813	1.814	1.815	1.816	1.817	1.818	1.819	1.820	1.821	1.822	1.823	1.824	1.825	1.826	1.827	1.828	1.829	1.830	1.831	1.832	1.833	1.834	1.835	1.836	1.837	1.838	1.839	1.840	1.841	1.842	1.843	1.844	1.845	1.846	1.847	1.848	1.849	1.850	1.851	1.852	1.853	1.854	1.855	1.856	1.857	1.858	1.859	1.860	1.861	1.862	1.863	1.864	1.865	1.866	1.867	1.868	1.869	1.870	1.871	1.872	1.873	1.874	1.875	1.876	1.877	1.878	1.879	1.880	1.881	1.882	1.883	1.884	1.885	1.886	1.887	1.888	1.889	1.890	1.891	1.892	1.893	1.894	1.895	1.896	1.897	1.898	1.899	1.900	1.901	1.902	1.903	1.904	1.905	1.906	1.907	1.908	1.909	1.910	1.911	1.912	1.913	1.914	1.915	1.916	1.917	1.918	1.919	1.920	1.921	1.922	1.923	1.924	1.925	1.926	1.927	1.928	1.929	1.930	1.931	1.932	1.933	1.934	1.935	1.936	1.937	1.938	1.939	1.940	1.941	1.942	1.943	1.944	1.945	1.946	1.947	1.948	1.949	1.950	1.951	1.952	1.953	1.954	1.955	1.956	1.957	1.958	1.959	1.960	1.961	1.962	1.963	1.964	1.965	1.966	1.967	1.968	1.969	1.970	1.971	1.972	1.973	1.974	1.975	1.976	1.977	1.978	1.979	1.980	1.981	1.982	1.983	1.984	1.985	1.986	1.987	1.988	1.989	1.990	1.991	1.992	1.993	1.994	1.995	1.996	1.997	1.998	1.999	2.000	2.001	2.002	2.003	2.004	2.005	2.006	2.007	2.008	2.009	2.010	2.011	2.012	2.013	2.014	2.015	2.016	2.017	2.018	2.019	2.020	2.021	2.022	2.023	2.024	2.025	2.026	2.027	2.028	2.029	2.030	2.031	2.032	2.033	2.034	2.035	2.036	2.037	2.038	2.039	2.040	2.041	2.042	2.043	2.044	2.045	2.046	2.047	2.048	2.049	2.050	2.051	2.052	2.053	2.054	2.055	2.056	2.057	2.058	2.059	2.060	2.061	2.062	2.063	2.064	2.065	2.066	2.067	2.068	2.069	2.070	2.071	2.072	2.073	2.074	2.075	2.076	2.077	2.078	2.079	2.080	2.081	2.082	2.083	2.084	2.085	2.086	2.087	2.088	2.089	2.090	2.091	2.092	2.093	2.094	2.095	2.096	2.097	2.098	2.099	2.100	2.101	2.102	2.103	2.104	2.105	2.106	2.107	2.108	2.109	2.110	2.111	2.112	2.113	2.114	2.115	2.116	2.117	2.118	2.119	2.120	2.121	2.122	2.123	2.124	2.125	2.126	2.127	2.128	2.129	2.130	2.131	2.132	2.133	2.134	2.135	2.136	2.137	2.138	2.139	2.140	2.141	2.142	2.143	2.144	2.145	2.146	2.147	2.148	2.149	2.150	2.151	2.152	2.153	2.154	2.155	2.156	2.157	2.158	2.159	2.160	2.161	2.162	2.163	2.164	2.165	2.166	2.167	2.168	2.169	2.170	2.171	2.172	2.173	2.174	2.175	2.176	2.177	2.178	2.179	2.180	2.181	2.182	2.183	2.184	2.185	2.186	2.187	2.188	2.189	2.190	2.191	2.192	2.193	2.194	2.195	2.196	2.197	2.198	2.199	2.200	2.201	2.202	2.203	2.204	2.205	2.206	2.207	2.208	2.209	2.210	2.211	2.212	2.213	2.214	2.215	2.216	2.217	2.218	2.219	2.220	2.221	2.222	2.223	2.224	2.225	2.226	2.227	2.228	2.229	2.230	2.231	2.232	2.233	2.234	2.235	2.236	2.237	2.238	2.239	2.240	2.241	2.242	2.243	2.244	2.245	2.246	2.247	2.248	2.249	2.250	2.251	2.252	2.253	2.254	2.255	2.256	2.257	2.258	2.259	2.260	2.261	2.262	2.263	2.264	2.265	2.266	2.267	2.268	2.269	2.270	2.271	2.272	2.273	2.274	2.275	2.276	2.277	2.278	2.279	2.280	2.281	2.282	2.283	2.284	2.285	2.286	2.287	2.288	2.289	2.290	2.291	2.292	2.293	2.294	2.295	2.296	2.297	2.298	2.299	2.300	2.301	2.302	2.303	2.304	2.305	2.306	2.307	2.308	2.309	2.310	2.311	2.312	2.313	2.314	2.315	2.316	2.317	2.318	2.319	2.320	2.321	2.322	2.323	2.324	2.325	2.326	2.327	2.328	2.329	2.330	2.331	2.332	2.333	2.334	2.335	2.336	2.337	2.338	2.339	2.340	2.341	2.342	2.343	2.344	2.345	2.346	2.347	2.348	2.349	2.350	2.351	2.352	2.353	2.354	2.355	2.356	2.357	2.358	2.359	2.360	2.361	2.362	2.363	2.364	2.365	2.366	2.367	2.368	2.369	2.370	2.371	2.372	2.373	2.374	2.375	2.376	2.377	2.378	2.379	2.380	2.381	2.382	2.383	2.384	2.385	2.386	2.387	2.388	2.389	2.390	2.391	2.392	2.393	2.394	2.395	2.396	2.397	2.398	2.399	2.400	2.401	2.402	2.403	2.404	2.405	2.406	2.407	2.408	2.409	2.410	2.411	2.412	2.413	2.414	2.415	2.416	2.417	2.418	2.419	2.420	2.421	2.422	2.423	2.424	2.425	2.426	2.427	2.428	2.429	2.430	2.431	2.432	2.433	2.434	2.435	2.436	2.437	2.438	2.439	2.440	2.441	2.442	2.443	2.444	2.445	2.446	2.447	2.448	2.449	2.450	2.451	2.452	2.453	2.454	2.455	2.456	2.457	2.458	2.459	2.460	2.461	2.462	2.463	2.464	2.465	2.466	2.467	2.468	2.469	2.470	2.471	2.472	2.473	2.474	2.475	2.476	2.477	2.478	2.479	2.480	2.481	2.482	2.483	2.484	2.485	2.486	2.487	2.488	2.489	2.490	2.491	2.492	2.493	2.494	2.495	2.496	2.497	2.498	2.499	2.500	2.501	2.502	2.503	2.504	2.505	2.506

TABLE III.12.—Gages for standard thread series, Unified and American screw threads—Continued

Nominal size and threads per inch	Series designation	Class	Gages for external threads										Gages for internal threads										Class	Series designation	Nominal size and threads per inch																																																																																																																																																																																																																																																																																																																																																																																																																																																																																																																																																																																																																																																																																																																																																																																																																																																																																																																																																																											
			X thread gages					Z plain gages for major diameter					X thread gages					Z plain gages for minor diameter																																																																																																																																																																																																																																																																																																																																																																																																																																																																																																																																																																																																																																																																																																																																																																																																																																																																																																																																																																																		
			Go		Not go			Go		Not go			Go		Not go			Go		Not go																																																																																																																																																																																																																																																																																																																																																																																																																																																																																																																																																																																																																																																																																																																																																																																																																																																																																																																																																																																
			Pitch diameter	Minor diameter	Plus tolerance gage	Minus tolerance gage	Pitch diameter	Minor diameter	Up-finished material	Semi-finished material	Up-finished material	Not go	Major diameter	Pitch diameter	Major diameter	Pitch diameter	Major diameter	Minus tolerance gage	Plus tolerance gage	French diameter	Not go	Go				Not go																																																																																																																																																																																																																																																																																																																																																																																																																																																																																																																																																																																																																																																																																																																																																																																																																																																																																																																																																																										
in.	in.	in.	in.	in.	in.	in.	in.	in.	in.	in.	in.	in.	in.	in.	in.	in.	in.	in.	in.	in.	in.	in.	in.	in.	in.	in.	in.																																																																																																																																																																																																																																																																																																																																																																																																																																																																																																																																																																																																																																																																																																																																																																																																																																																																																																																																																																									
3/8-12	UN	2A	3.3190	3.2829	3.3126	3.2946	3.3177	3.2986	3.3172	3.2985	3.3167	3.2993	3.3200	3.3014	3.3203	3.3028	3.3243	3.3058	3.3240	3.3065	3.3247	3.3072	3.3254	3.3067	3.3252	3.3072	3.3261	3.3072	3.3269	3.3072	3.3277	3.3072	3.3285	3.3072	3.3293	3.3072	3.3301	3.3072	3.3309	3.3072	3.3317	3.3072	3.3325	3.3072	3.3333	3.3072	3.3341	3.3072	3.3349	3.3072	3.3357	3.3072	3.3365	3.3072	3.3373	3.3072	3.3381	3.3072	3.3389	3.3072	3.3397	3.3072	3.3405	3.3072	3.3413	3.3072	3.3421	3.3072	3.3429	3.3072	3.3437	3.3072	3.3445	3.3072	3.3453	3.3072	3.3461	3.3072	3.3469	3.3072	3.3477	3.3072	3.3485	3.3072	3.3493	3.3072	3.3501	3.3072	3.3509	3.3072	3.3517	3.3072	3.3525	3.3072	3.3533	3.3072	3.3541	3.3072	3.3549	3.3072	3.3557	3.3072	3.3565	3.3072	3.3573	3.3072	3.3581	3.3072	3.3589	3.3072	3.3597	3.3072	3.3605	3.3072	3.3613	3.3072	3.3621	3.3072	3.3629	3.3072	3.3637	3.3072	3.3645	3.3072	3.3653	3.3072	3.3661	3.3072	3.3669	3.3072	3.3677	3.3072	3.3685	3.3072	3.3693	3.3072	3.3701	3.3072	3.3709	3.3072	3.3717	3.3072	3.3725	3.3072	3.3733	3.3072	3.3741	3.3072	3.3749	3.3072	3.3757	3.3072	3.3765	3.3072	3.3773	3.3072	3.3781	3.3072	3.3789	3.3072	3.3797	3.3072	3.3805	3.3072	3.3813	3.3072	3.3821	3.3072	3.3829	3.3072	3.3837	3.3072	3.3845	3.3072	3.3853	3.3072	3.3861	3.3072	3.3869	3.3072	3.3877	3.3072	3.3885	3.3072	3.3893	3.3072	3.3901	3.3072	3.3909	3.3072	3.3917	3.3072	3.3925	3.3072	3.3933	3.3072	3.3941	3.3072	3.3949	3.3072	3.3957	3.3072	3.3965	3.3072	3.3973	3.3072	3.3981	3.3072	3.3989	3.3072	3.3997	3.3072	3.4005	3.3072	3.4013	3.3072	3.4021	3.3072	3.4029	3.3072	3.4037	3.3072	3.4045	3.3072	3.4053	3.3072	3.4061	3.3072	3.4069	3.3072	3.4077	3.3072	3.4085	3.3072	3.4093	3.3072	3.4101	3.3072	3.4109	3.3072	3.4117	3.3072	3.4125	3.3072	3.4133	3.3072	3.4141	3.3072	3.4149	3.3072	3.4157	3.3072	3.4165	3.3072	3.4173	3.3072	3.4181	3.3072	3.4189	3.3072	3.4197	3.3072	3.4205	3.3072	3.4213	3.3072	3.4221	3.3072	3.4229	3.3072	3.4237	3.3072	3.4245	3.3072	3.4253	3.3072	3.4261	3.3072	3.4269	3.3072	3.4277	3.3072	3.4285	3.3072	3.4293	3.3072	3.4301	3.3072	3.4309	3.3072	3.4317	3.3072	3.4325	3.3072	3.4333	3.3072	3.4341	3.3072	3.4349	3.3072	3.4357	3.3072	3.4365	3.3072	3.4373	3.3072	3.4381	3.3072	3.4389	3.3072	3.4397	3.3072	3.4405	3.3072	3.4413	3.3072	3.4421	3.3072	3.4429	3.3072	3.4437	3.3072	3.4445	3.3072	3.4453	3.3072	3.4461	3.3072	3.4469	3.3072	3.4477	3.3072	3.4485	3.3072	3.4493	3.3072	3.4501	3.3072	3.4509	3.3072	3.4517	3.3072	3.4525	3.3072	3.4533	3.3072	3.4541	3.3072	3.4549	3.3072	3.4557	3.3072	3.4565	3.3072	3.4573	3.3072	3.4581	3.3072	3.4589	3.3072	3.4597	3.3072	3.4605	3.3072	3.4613	3.3072	3.4621	3.3072	3.4629	3.3072	3.4637	3.3072	3.4645	3.3072	3.4653	3.3072	3.4661	3.3072	3.4669	3.3072	3.4677	3.3072	3.4685	3.3072	3.4693	3.3072	3.4701	3.3072	3.4709	3.3072	3.4717	3.3072	3.4725	3.3072	3.4733	3.3072	3.4741	3.3072	3.4749	3.3072	3.4757	3.3072	3.4765	3.3072	3.4773	3.3072	3.4781	3.3072	3.4789	3.3072	3.4797	3.3072	3.4805	3.3072	3.4813	3.3072	3.4821	3.3072	3.4829	3.3072	3.4837	3.3072	3.4845	3.3072	3.4853	3.3072	3.4861	3.3072	3.4869	3.3072	3.4877	3.3072	3.4885	3.3072	3.4893	3.3072	3.4901	3.3072	3.4909	3.3072	3.4917	3.3072	3.4925	3.3072	3.4933	3.3072	3.4941	3.3072	3.4949	3.3072	3.4957	3.3072	3.4965	3.3072	3.4973	3.3072	3.4981	3.3072	3.4989	3.3072	3.4997	3.3072	3.5005	3.3072	3.5013	3.3072	3.5021	3.3072	3.5029	3.3072	3.5037	3.3072	3.5045	3.3072	3.5053	3.3072	3.5061	3.3072	3.5069	3.3072	3.5077	3.3072	3.5085	3.3072	3.5093	3.3072	3.5101	3.3072	3.5109	3.3072	3.5117	3.3072	3.5125	3.3072	3.5133	3.3072	3.5141	3.3072	3.5149	3.3072	3.5157	3.3072	3.5165	3.3072	3.5173	3.3072	3.5181	3.3072	3.5189	3.3072	3.5197	3.3072	3.5205	3.3072	3.5213	3.3072	3.5221	3.3072	3.5229	3.3072	3.5237	3.3072	3.5245	3.3072	3.5253	3.3072	3.5261	3.3072	3.5269	3.3072	3.5277	3.3072	3.5285	3.3072	3.5293	3.3072	3.5301	3.3072	3.5309	3.3072	3.5317	3.3072	3.5325	3.3072	3.5333	3.3072	3.5341	3.3072	3.5349	3.3072	3.5357	3.3072	3.5365	3.3072	3.5373	3.3072	3.5381	3.3072	3.5389	3.3072	3.5397	3.3072	3.5405	3.3072	3.5413	3.3072	3.5421	3.3072	3.5429	3.3072	3.5437	3.3072	3.5445	3.3072	3.5453	3.3072	3.5461	3.3072	3.5469	3.3072	3.5477	3.3072	3.5485	3.3072	3.5493	3.3072	3.5501	3.3072	3.5509	3.3072	3.5517	3.3072	3.5525	3.3072	3.5533	3.3072	3.5541	3.3072	3.5549	3.3072	3.5557	3.3072	3.5565	3.3072	3.5573	3.3072	3.5581	3.3072	3.5589	3.3072	3.5597	3.3072	3.5605	3.3072	3.5613	3.3072	3.5621	3.3072	3.5629	3.3072	3.5637	3.3072	3.5645	3.3072	3.5653	3.3072	3.5661	3.3072	3.5669	3.3072	3.5677	3.3072	3.5685	3.3072	3.5693	3.3072	3.5701	3.3072	3.5709	3.3072	3.5717	3.3072	3.5725	3.3072	3.5733	3.3072	3.5741	3.3072	3.5749	3.3072	3.5757	3.3072	3.5765	3.3072	3.5773	3.3072	3.5781	3.3072	3.5789	3.3072	3.5797	3.3072	3.5805	3.3072	3.5813	3.3072	3.5821	3.3072	3.5829	3.3072	3.5837	3.3072	3.5845	3.3072	3.5853	3.3072	3.5861	3.3072	3.5869	3.3072	3.5877	3.3072	3.5885	3.3072	3.5893	3.3072	3.5901	3.3072	3.5909	3.3072	3.5917	3.3072	3.5925	3.3072	3.5933	3.3072	3.5941	3.3072	3.5949	3.3072	3.5957	3.3072	3.5965	3.3072	3.5973	3.3072	3.5981	3.3072	3.5989	3.3072	3.5997	3.3072	3.6005	3.3072	3.6013	3.3072	3.6021	3.3072	3.6029	3.3072	3.6037	3.3072	3.6045	3.3072	3.6053	3.3072	3.6061	3.3072	3.6069	3.3072	3.6077	3.3072	3.6085	3.3072	3.6093	3.3072	3.6101	3.3072	3.6109	3.3072	3.6117	3.3072	3.6125	3.3072	3.6133	3.3072	3.6141	3.3072	3.6149	3.3072	3.6157	3.3072	3.6165	3.3072	3.6173	3.3072	3.6181	3.3072	3.6189	3.3072	3.6197	3.3072	3.6205	3.3072	3.6213	3.3072	3.6221	3.3072	3.6229	3.3072	3.6237	3.3072	3.6245	3.3072	3.6253	3.3072	3.6261	3.3072	3.6269	3.3072	3.6277	3.3072	3.6285	3.3072	3.6293	3.3072	3.6301	3.3072	3.6309	3.3072	3.6317	3.3072	3.6325	3.3072	3.6333	3.3072	3.6341	3.3072	3.6349	3.3072	3.6357	3.3072	3.6365	3.3072	3.6373	3.3072	3.6381	3.3072	3.6389	3.3072	3.6397	3.3072	3.6405	3.3072	3.6413	3.3072	3.6421	3.3072	3.6429	3.3072	3.6437	3.3072	3.6445	3.3072	3.6453	3.3072	3.6461	3.3072	3.6469	3.3072	3.6477	3.3072	3.6485	3.3072	3.6493	3.3072	3.6501	3.3072	3.6509	3.3072	3.6517	3.3072	3.6525	3.3072	3.6533	3.3072	3.6541	3.3072	3.6549	3.3072	3.6557	3.3072	3.6565	3.3072	3.6573	3.3072	3.6581	3.3072	3.6589	3.3072	3.6597	3.3072	3.6605	3.3072	3.6613	3.3072	3.6621	3.3072	3.6629	3.3072	3.6637	3.3072	3.6645	3.3072	3.6653	3.3072	3.6661	3.3072	3.6669	3.3072	3.6677	3.3072	3.6685	3.3072	3.6693	3.3072	3.6701	3.3072	3.6709	3.3072	3.6717	3.3072	3.6725	3.3072	3.6733	3.3072	3.6741	3.3072	3.6749	3.3072	3.6757	3.3072	3.6765	3.3072	3.6773	3.3072	3.6781	3.3072	3.6789	3.3072	3.6797	3.3072	3.6805	3.3072	3.6813	3.3072	3.6821	3.3072	3.6829	3.3072	3.6837	3.3072	3.6845	3.3072	3.6853	3.3072	3.6861	3.3072	3.6869	3.3072	3.6877	3.3072	3.6885	3.3072	3.6893	3.3072	3.6901	3.3072	3.6909	3.3072	3.6917	3.3072	3.6925	3.3072	3.6933	3.3072	3.6941	3.3072	3.6949	3.3072	3.6957	3.3072	3.6965	3.3072	3.6973	3.3072	3.6981	3.3072	3.6989	3.3072	3.6997	3.3072	3.7005	3.3072

34-12	UN	2A	3 6570	3 6576	3 6582	3 6588	3 6594	3 6600	3 6606	3 6612	3 6618	3 6624	3 6630	3 6636	3 6642	3 6648	3 6654	3 6660	3 6666	3 6672	3 6678	3 6684	3 6690	3 6696	3 6702	3 6708	3 6714	3 6720	3 6726	3 6732	3 6738	3 6744	3 6750	3 6756	3 6762	3 6768	3 6774	3 6780	3 6786	3 6792	3 6798	3 6804	3 6810	3 6816	3 6822	3 6828	3 6834	3 6840	3 6846	3 6852	3 6858	3 6864	3 6870	3 6876	3 6882	3 6888	3 6894	3 6900	3 6906	3 6912	3 6918	3 6924	3 6930	3 6936	3 6942	3 6948	3 6954	3 6960	3 6966	3 6972	3 6978	3 6984	3 6990	3 6996	3 7002	3 7008	3 7014	3 7020	3 7026	3 7032	3 7038	3 7044	3 7050	3 7056	3 7062	3 7068	3 7074	3 7080	3 7086	3 7092	3 7098	3 7104	3 7110	3 7116	3 7122	3 7128	3 7134	3 7140	3 7146	3 7152	3 7158	3 7164	3 7170	3 7176	3 7182	3 7188	3 7194	3 7200	3 7206	3 7212	3 7218	3 7224	3 7230	3 7236	3 7242	3 7248	3 7254	3 7260	3 7266	3 7272	3 7278	3 7284	3 7290	3 7296	3 7302	3 7308	3 7314	3 7320	3 7326	3 7332	3 7338	3 7344	3 7350	3 7356	3 7362	3 7368	3 7374	3 7380	3 7386	3 7392	3 7398	3 7404	3 7410	3 7416	3 7422	3 7428	3 7434	3 7440	3 7446	3 7452	3 7458	3 7464	3 7470	3 7476	3 7482	3 7488	3 7494	3 7500	3 7506	3 7512	3 7518	3 7524	3 7530	3 7536	3 7542	3 7548	3 7554	3 7560	3 7566	3 7572	3 7578	3 7584	3 7590	3 7596	3 7602	3 7608	3 7614	3 7620	3 7626	3 7632	3 7638	3 7644	3 7650	3 7656	3 7662	3 7668	3 7674	3 7680	3 7686	3 7692	3 7698	3 7704	3 7710	3 7716	3 7722	3 7728	3 7734	3 7740	3 7746	3 7752	3 7758	3 7764	3 7770	3 7776	3 7782	3 7788	3 7794	3 7800	3 7806	3 7812	3 7818	3 7824	3 7830	3 7836	3 7842	3 7848	3 7854	3 7860	3 7866	3 7872	3 7878	3 7884	3 7890	3 7896	3 7902	3 7908	3 7914	3 7920	3 7926	3 7932	3 7938	3 7944	3 7950	3 7956	3 7962	3 7968	3 7974	3 7980	3 7986	3 7992	3 7998	3 8004	3 8010	3 8016	3 8022	3 8028	3 8034	3 8040	3 8046	3 8052	3 8058	3 8064	3 8070	3 8076	3 8082	3 8088	3 8094	3 8100	3 8106	3 8112	3 8118	3 8124	3 8130	3 8136	3 8142	3 8148	3 8154	3 8160	3 8166	3 8172	3 8178	3 8184	3 8190	3 8196	3 8202	3 8208	3 8214	3 8220	3 8226	3 8232	3 8238	3 8244	3 8250	3 8256	3 8262	3 8268	3 8274	3 8280	3 8286	3 8292	3 8298	3 8304	3 8310	3 8316	3 8322	3 8328	3 8334	3 8340	3 8346	3 8352	3 8358	3 8364	3 8370	3 8376	3 8382	3 8388	3 8394	3 8400	3 8406	3 8412	3 8418	3 8424	3 8430	3 8436	3 8442	3 8448	3 8454	3 8460	3 8466	3 8472	3 8478	3 8484	3 8490	3 8496	3 8502	3 8508	3 8514	3 8520	3 8526	3 8532	3 8538	3 8544	3 8550	3 8556	3 8562	3 8568	3 8574	3 8580	3 8586	3 8592	3 8598	3 8604	3 8610	3 8616	3 8622	3 8628	3 8634	3 8640	3 8646	3 8652	3 8658	3 8664	3 8670	3 8676	3 8682	3 8688	3 8694	3 8700	3 8706	3 8712	3 8718	3 8724	3 8730	3 8736	3 8742	3 8748	3 8754	3 8760	3 8766	3 8772	3 8778	3 8784	3 8790	3 8796	3 8802	3 8808	3 8814	3 8820	3 8826	3 8832	3 8838	3 8844	3 8850	3 8856	3 8862	3 8868	3 8874	3 8880	3 8886	3 8892	3 8898	3 8904	3 8910	3 8916	3 8922	3 8928	3 8934	3 8940	3 8946	3 8952	3 8958	3 8964	3 8970	3 8976	3 8982	3 8988	3 8994	3 9000	3 9006	3 9012	3 9018	3 9024	3 9030	3 9036	3 9042	3 9048	3 9054	3 9060	3 9066	3 9072	3 9078	3 9084	3 9090	3 9096	3 9102	3 9108	3 9114	3 9120	3 9126	3 9132	3 9138	3 9144	3 9150	3 9156	3 9162	3 9168	3 9174	3 9180	3 9186	3 9192	3 9198	3 9204	3 9210	3 9216	3 9222	3 9228	3 9234	3 9240	3 9246	3 9252	3 9258	3 9264	3 9270	3 9276	3 9282	3 9288	3 9294	3 9300	3 9306	3 9312	3 9318	3 9324	3 9330	3 9336	3 9342	3 9348	3 9354	3 9360	3 9366	3 9372	3 9378	3 9384	3 9390	3 9396	3 9402	3 9408	3 9414	3 9420	3 9426	3 9432	3 9438	3 9444	3 9450	3 9456	3 9462	3 9468	3 9474	3 9480	3 9486	3 9492	3 9498	3 9504	3 9510	3 9516	3 9522	3 9528	3 9534	3 9540	3 9546	3 9552	3 9558	3 9564	3 9570	3 9576	3 9582	3 9588	3 9594	3 9600	3 9606	3 9612	3 9618	3 9624	3 9630	3 9636	3 9642	3 9648	3 9654	3 9660	3 9666	3 9672	3 9678	3 9684	3 9690	3 9696	3 9702	3 9708	3 9714	3 9720	3 9726	3 9732	3 9738	3 9744	3 9750	3 9756	3 9762	3 9768	3 9774	3 9780	3 9786	3 9792	3 9798	3 9804	3 9810	3 9816	3 9822	3 9828	3 9834	3 9840	3 9846	3 9852	3 9858	3 9864	3 9870	3 9876	3 9882	3 9888	3 9894	3 9900	3 9906	3 9912	3 9918	3 9924	3 9930	3 9936	3 9942	3 9948	3 9954	3 9960	3 9966	3 9972	3 9978	3 9984	3 9990	3 9996	4 0002	4 0008	4 0014	4 0020	4 0026	4 0032	4 0038	4 0044	4 0050	4 0056	4 0062	4 0068	4 0074	4 0080	4 0086	4 0092	4 0098	4 0104	4 0110	4 0116	4 0122	4 0128	4 0134	4 0140	4 0146	4 0152	4 0158	4 0164	4 0170	4 0176	4 0182	4 0188	4 0194	4 0200	4 0206	4 0212	4 0218	4 0224	4 0230	4 0236	4 0242	4 0248	4 0254	4 0260	4 0266	4 0272	4 0278	4 0284	4 0290	4 0296	4 0302	4 0308	4 0314	4 0320	4 0326	4 0332	4 0338	4 0344	4 0350	4 0356	4 0362	4 0368	4 0374	4 0380	4 0386	4 0392	4 0398	4 0404	4 0410	4 0416	4 0422	4 0428	4 0434	4 0440	4 0446	4 0452	4 0458	4 0464	4 0470	4 0476	4 0482	4 0488	4 0494	4 0500	4 0506	4 0512	4 0518	4 0524	4 0530	4 0536	4 0542	4 0548	4 0554	4 0560	4 0566	4 0572	4 0578	4 0584	4 0590	4 0596	4 0602	4 0608	4 0614	4 0620	4 0626	4 0632	4 0638	4 0644	4 0650	4 0656	4 0662	4 0668	4 0674	4 0680	4 0686	4 0692	4 0698	4 0704	4 0710	4 0716	4 0722	4 0728	4 0734	4 0740	4 0746	4 0752	4 0758	4 0764	4 0770	4 0776	4 0782	4 0788	4 0794	4 0800	4 0806	4 0812	4 0818	4 0824	4 0830	4 0836	4 0842	4 0848	4 0854	4 0860	4 0866	4 0872	4 0878	4 0884	4 0890	4 0896	4 0902	4 0908	4 0914	4 0920	4 0926	4 0932	4 0938	4 0944	4 0950	4 0956	4 0962	4 0968	4 0974	4 0980	4 0986	4 0992	4 0998	4 1004	4 1010	4 1016	4 1022	4 1028	4 1034	4 1040	4 1046	4 1052	4 1058	4 1064	4 1070	4 1076	4 1082	4 1088	4 1094	4 1100	4 1106	4 1112	4 1118	4 1124	4 1130	4 1136	4 1142	4 1148	4 1154	4 1160	4 1166	4 1172	4 1178	4 1184	4 1190	4 1196	4 1202	4 1208	4 1214	4 1220	4 1226	4 1232	4 1238	4 1244	4 1250	4 1256	4 1262	4 1268	4 1274	4 1280	4 1286	4 1292	4 1298	4 1304	4 1310	4 1316	4 1322	4 1328	4 1334	4 1340	4 1346	4 1352	4 1358	4 1364	4 1370	4 1376	4 1382	4 1388	4 1394	4 1400	4 1406	4 1412	4 1418	4 1424	4 1430	4 1436	4 1442	4 1448	4 1454	4 1460	4 1466	4 1472	4 1478	4 1484	4 1490	4 1496	4 1502	4 1508	4 1514	4 1520	4 1526	4 1532	4 1538	4 1544	4 1550	4 1556	4 1562	4 1568	4 1574	4 1580	4 1586	4 1592	4 1598	4 1604	4 1610	4 1616	4 1622	4 1628	4 1634	4 1640	4 1646	4 1652	4 1658	4 1664	4 1670	4 1676	4 1682	4 1688	4 1694	4 1700	4 1706	4 1712	4 1718	4 1724	4 1730	4 1736	4 1742	4 1748	4 1754	4 1760	4 1766	4 1772	4 1778	4 1784	4 1790	4 1796	4 1802	4 1808	4 1814	4 1820	4 1826	4 1832	4 1838	4 1844	4 1850	4 1856	4 1862	4 1868	4 1874	4 1880	4 1886	4 1892	4 1898	4 1904	4 1910	4 1916	4 1922	4 1928	4 1934	4 1940	4 1946	4 1952	4 1958	4 1964	4 1970	4 1976	4 1982	4 1988	4 1994	4 2000	4 2006	4 2012	4 2018	4 2024	4 2030	4 2036	4 2042	4 2048	4 2054	4 2060	4 2066	4 2072	4 2078	4 2084	4 2090	4 2096	4 2102	4 2108	4 2114	4 2120	4 2126	4 2132	4 2138	4 2144	4 2150	4 2156	4 2162	4 2168	4 2174	4 2180	4 2186	4 2192	4 2198	4 2204	4 2210	4 2216	4 2222	4 2228	4 2234	4 2240	4 2246	4 2252	4 2258	4 2264	4 2270	4 2276	4 2282	4 2288	4 2294	4 2300	4 2306	4 2312	4 2318	4 2324	4 2330	4 2336	4 2342	4 2348	4 2354	4 2360	4 2366	4 2372	4 2378	4 2384	4 2390	4 2396	4 2402	4 2408	4 2414	4 2420	4 2426	4 2432	4 2438	4 2444	4 2450	4 2456	4 2462	4 2468	4 2474	4 2480	4 2486	4 2492	4 2498	4 2504	4 2510	4 2516	4 2522	4 2528	4 2534	4 2540	4 2546	4 2552	4 2558	4 2564	4 2570	4 2576	4 2582	4 2588	4 2594	4 2600	4 2606	4 2612	4 2618	4 2624	4 2630	4 2636	4 2642	4 2648	4 2654	4 2660	4 2666	4 2672	4 2678	4 2684	4 2690	4 2696	4 2702	4 2708	4 2714	4 2720	4 2
-------	----	----	--------	--------	--------	--------	--------	--------	--------	--------	--------	--------	--------	--------	--------	--------	--------	--------	--------	--------	--------	--------	--------	--------	--------	--------	--------	--------	--------	--------	--------	--------	--------	--------	--------	--------	--------	--------	--------	--------	--------	--------	--------	--------	--------	--------	--------	--------	--------	--------	--------	--------	--------	--------	--------	--------	--------	--------	--------	--------	--------	--------	--------	--------	--------	--------	--------	--------	--------	--------	--------	--------	--------	--------	--------	--------	--------	--------	--------	--------	--------	--------	--------	--------	--------	--------	--------	--------	--------	--------	--------	--------	--------	--------	--------	--------	--------	--------	--------	--------	--------	--------	--------	--------	--------	--------	--------	--------	--------	--------	--------	--------	--------	--------	--------	--------	--------	--------	--------	--------	--------	--------	--------	--------	--------	--------	--------	--------	--------	--------	--------	--------	--------	--------	--------	--------	--------	--------	--------	--------	--------	--------	--------	--------	--------	--------	--------	--------	--------	--------	--------	--------	--------	--------	--------	--------	--------	--------	--------	--------	--------	--------	--------	--------	--------	--------	--------	--------	--------	--------	--------	--------	--------	--------	--------	--------	--------	--------	--------	--------	--------	--------	--------	--------	--------	--------	--------	--------	--------	--------	--------	--------	--------	--------	--------	--------	--------	--------	--------	--------	--------	--------	--------	--------	--------	--------	--------	--------	--------	--------	--------	--------	--------	--------	--------	--------	--------	--------	--------	--------	--------	--------	--------	--------	--------	--------	--------	--------	--------	--------	--------	--------	--------	--------	--------	--------	--------	--------	--------	--------	--------	--------	--------	--------	--------	--------	--------	--------	--------	--------	--------	--------	--------	--------	--------	--------	--------	--------	--------	--------	--------	--------	--------	--------	--------	--------	--------	--------	--------	--------	--------	--------	--------	--------	--------	--------	--------	--------	--------	--------	--------	--------	--------	--------	--------	--------	--------	--------	--------	--------	--------	--------	--------	--------	--------	--------	--------	--------	--------	--------	--------	--------	--------	--------	--------	--------	--------	--------	--------	--------	--------	--------	--------	--------	--------	--------	--------	--------	--------	--------	--------	--------	--------	--------	--------	--------	--------	--------	--------	--------	--------	--------	--------	--------	--------	--------	--------	--------	--------	--------	--------	--------	--------	--------	--------	--------	--------	--------	--------	--------	--------	--------	--------	--------	--------	--------	--------	--------	--------	--------	--------	--------	--------	--------	--------	--------	--------	--------	--------	--------	--------	--------	--------	--------	--------	--------	--------	--------	--------	--------	--------	--------	--------	--------	--------	--------	--------	--------	--------	--------	--------	--------	--------	--------	--------	--------	--------	--------	--------	--------	--------	--------	--------	--------	--------	--------	--------	--------	--------	--------	--------	--------	--------	--------	--------	--------	--------	--------	--------	--------	--------	--------	--------	--------	--------	--------	--------	--------	--------	--------	--------	--------	--------	--------	--------	--------	--------	--------	--------	--------	--------	--------	--------	--------	--------	--------	--------	--------	--------	--------	--------	--------	--------	--------	--------	--------	--------	--------	--------	--------	--------	--------	--------	--------	--------	--------	--------	--------	--------	--------	--------	--------	--------	--------	--------	--------	--------	--------	--------	--------	--------	--------	--------	--------	--------	--------	--------	--------	--------	--------	--------	--------	--------	--------	--------	--------	--------	--------	--------	--------	--------	--------	--------	--------	--------	--------	--------	--------	--------	--------	--------	--------	--------	--------	--------	--------	--------	--------	--------	--------	--------	--------	--------	--------	--------	--------	--------	--------	--------	--------	--------	--------	--------	--------	--------	--------	--------	--------	--------	--------	--------	--------	--------	--------	--------	--------	--------	--------	--------	--------	--------	--------	--------	--------	--------	--------	--------	--------	--------	--------	--------	--------	--------	--------	--------	--------	--------	--------	--------	--------	--------	--------	--------	--------	--------	--------	--------	--------	--------	--------	--------	--------	--------	--------	--------	--------	--------	--------	--------	--------	--------	--------	--------	--------	--------	--------	--------	--------	--------	--------	--------	--------	--------	--------	--------	--------	--------	--------	--------	--------	--------	--------	--------	--------	--------	--------	--------	--------	--------	--------	--------	--------	--------	--------	--------	--------	--------	--------	--------	--------	--------	--------	--------	--------	--------	--------	--------	--------	--------	--------	--------	--------	--------	--------	--------	--------	--------	--------	--------	--------	--------	--------	--------	--------	--------	--------	--------	--------	--------	--------	--------	--------	--------	--------	--------	--------	--------	--------	--------	--------	--------	--------	--------	--------	--------	--------	--------	--------	--------	--------	--------	--------	--------	--------	--------	--------	--------	--------	--------	--------	--------	--------	--------	--------	--------	--------	--------	--------	--------	--------	--------	--------	--------	--------	--------	--------	--------	--------	--------	--------	--------	--------	--------	--------	--------	--------	--------	--------	--------	--------	--------	--------	--------	--------	--------	--------	--------	--------	--------	--------	--------	--------	--------	--------	--------	--------	--------	--------	--------	--------	--------	--------	--------	--------	--------	--------	--------	--------	--------	--------	--------	--------	--------	--------	--------	--------	--------	--------	--------	--------	--------	--------	--------	--------	--------	--------	--------	--------	--------	--------	--------	--------	--------	--------	--------	--------	--------	--------	--------	--------	--------	--------	--------	--------	--------	--------	--------	--------	--------	--------	--------	--------	--------	--------	--------	--------	--------	--------	--------	--------	--------	--------	--------	--------	--------	--------	--------	--------	--------	--------	--------	--------	--------	--------	--------	--------	--------	--------	--------	--------	--------	--------	--------	--------	--------	--------	--------	--------	--------	--------	--------	--------	--------	--------	--------	--------	--------	--------	--------	--------	--------	--------	--------	--------	--------	--------	--------	--------	--------	--------	--------	--------	--------	--------	--------	--------	--------	--------	--------	--------	--------	--------	--------	--------	--------	--------	--------	--------	--------	--------	--------	--------	--------	--------	--------	--------	--------	--------	--------	--------	--------	--------	--------	--------	--------	--------	--------	--------	--------	--------	--------	--------	--------	--------	--------	--------	--------	--------	--------	--------	--------	--------	--------	--------	--------	--------	--------	--------	--------	--------	--------	--------	--------	--------	--------	--------	--------	--------	--------	--------	--------	--------	--------	--------	--------	--------	--------	--------	--------	--------	--------	--------	--------	--------	--------	--------	--------	--------	--------	--------	--------	--------	--------	--------	--------	--------	--------	--------	--------	--------	--------	--------	--------	--------	--------	--------	--------	--------	--------	--------	--------	--------	--------	--------	--------	--------	--------	--------	--------	--------	--------	--------	--------	--------	--------	--------	--------	--------	--------	--------	--------	--------	--------	--------	--------	--------	--------	--------	--------	--------	--------	--------	--------	--------	--------	--------	--------	--------	--------	--------	--------	--------	--------	--------	--------	--------	--------	--------	--------	--------	--------	--------	--------	--------	--------	--------	--------	--------	--------	--------	--------	--------	--------	--------	--------	--------	--------	--------	-----

512-16	UN	2A	5. 4576	5. 4305	5. 4515	5. 4386	5. 46920	5. 48886	5. 5000	5. 4873	5. 43200	5. 44600	UN	2B
		3A	5. 4570	5. 4296	5. 4521	5. 4389	5. 49735	5. 46905	5. 5009	5. 4877	5. 43225	5. 44575		3B
			5. 4584	5. 4323	5. 4549	5. 4414	5. 50000	5. 49060	5. 5000	5. 4851	5. 43205	5. 44080		
			5. 4588	5. 4314	5. 4555	5. 4423	5. 49775	5. 48085	5. 5009	5. 4857	5. 43225	5. 44035		
514-5	N	2A	5. 6558	5. 6117	5. 6558	5. 6287	5. 74700	5. 73200	5. 7500	5. 6815	5. 61500	5. 64500	N	2D
		3A	5. 6532	5. 6106	5. 6564	5. 6258	5. 74675	5. 73225	5. 7531	5. 6811	5. 61525	5. 63975		3B
			5. 6588	5. 6147	5. 6613	5. 6342	5. 75000	5. 73500	5. 7500	5. 6784	5. 61500	5. 62970		
			5. 6632	5. 6136	5. 6619	5. 6353	5. 74975	5. 73525	5. 7531	5. 6786	5. 61525	5. 62945		
514-12	UN	2A	5. 6938	5. 6577	5. 6939	5. 6699	5. 74790	5. 73650	5. 7500	5. 7049	5. 65000	5. 67900	UN	2B
		3A	5. 6932	5. 6568	5. 6963	5. 6698	5. 74765	5. 73675	5. 7500	5. 7043	5. 65025	5. 67775		3R
			5. 6939	5. 6590	5. 6907	5. 6727	5. 75000	5. 73960	5. 7500	5. 7026	5. 65000	5. 66980		
			5. 6933	5. 6589	5. 6901	5. 6736	5. 74975	5. 73885	5. 7509	5. 7020	5. 65025	5. 66955		
514-16	UN	2A	5. 7075	5. 6604	5. 7013	5. 6878	5. 74810	5. 73870	5. 7500	5. 7175	5. 68200	5. 69000	UN	2B
		3A	5. 7069	5. 6705	5. 7019	5. 6882	5. 74785	5. 73895	5. 7500	5. 7169	5. 68225	5. 69075		3B
			5. 7084	5. 6823	5. 7047	5. 6912	5. 75000	5. 74060	5. 7500	5. 7155	5. 68200	5. 69080		
			5. 7088	5. 6814	5. 7053	5. 6921	5. 74975	5. 74085	5. 7509	5. 7149	5. 68225	5. 69055		
6-5	N	2A	5. 9158	5. 9056	5. 9056	5. 8785	5. 99700	5. 98200	5. 0000	5. 9320	5. 95500	5. 96000	N	1B
		3A	5. 9152	5. 9062	5. 9050	5. 8796	5. 99675	5. 98225	5. 0011	5. 9314	5. 95525	5. 96075		3B
			5. 9188	5. 9077	5. 9112	5. 8840	5. 00000	5. 98500	5. 0000	5. 9287	5. 95500	5. 96100		
			5. 9182	5. 9086	5. 9115	5. 8852	5. 99975	5. 98525	5. 0011	5. 9281	5. 95525	5. 96155		
6-12	UN	2A	5. 9438	5. 9077	5. 9399	5. 9189	5. 99790	5. 98650	5. 0000	5. 9549	5. 91000	5. 92900	UN	2B
		3A	5. 9432	5. 9068	5. 9375	5. 9168	5. 99765	5. 98675	5. 0009	5. 9543	5. 91025	5. 92875		3B
			5. 9459	5. 9098	5. 9407	5. 9222	5. 00000	5. 98660	5. 0000	5. 9526	5. 91000	5. 91986		
			5. 9453	5. 9089	5. 9413	5. 9231	5. 99975	5. 98685	5. 0009	5. 9520	5. 91025	5. 91955		
6-16	UN	2A	5. 9575	5. 9304	5. 9513	5. 9377	5. 99870	5. 98870	5. 0000	5. 9575	5. 93200	5. 94600	UN	2B
		3A	5. 9570	5. 9295	5. 9519	5. 9387	5. 99755	5. 98805	5. 0009	5. 9569	5. 93225	5. 94575		3B
			5. 9584	5. 9323	5. 9547	5. 9412	5. 00000	5. 99060	5. 0000	5. 9555	5. 93200	5. 94080		
			5. 9588	5. 9314	5. 9553	5. 9421	5. 99975	5. 99085	5. 0009	5. 9549	5. 93225	5. 94055		

TABLE III.13.—Setting plug gages, Unified and American screw threads

Nominal size and threads per inch	Series designation	Class	W truncated setting plugs							Basic-crest setting plugs				
			Plug for "Go"			Plug for "Not go"				Major diameter				
			Major diameter		Pitch diameter	Major diameter		Pitch diameter		Go ¹		Not go ¹		
			Truncated	Full		Truncated	Full	Plus tolerance gage	Minus tolerance gage	W tolerance	X tolerance	W tolerance	X tolerance	
1	2	3	4	5	6	7	8	9	10	11A	11B	12A	12B	
			<i>in.</i>	<i>in.</i>	<i>in.</i>	<i>in.</i>	<i>in.</i>	<i>in.</i>	<i>in.</i>	<i>in.</i>	<i>in.</i>	<i>in.</i>	<i>in.</i>	<i>in.</i>
0-80	NF	2A	0.0561 .0558	0.0595 .0598	0.0514 .0513	0.0550 .0547	0.0584 .0587	0.0496 .0497	0.0496 .0495	0.0595 .0598	0.0595 .0598	0.0584 .0587	0.0584 .0587	
		3A	.0566 .0563	.0600 .0603	.0519 .0518	.0560 .0557	.0594 .0597	.0506 .0507	.0506 .0505	.0600 .0603	.0600 .0603	.0594 .0597	.0594 .0597	
1-64	NC	2A	.0684 .0681	.0724 .0727	.0623 .0622	.0671 .0668	.0717 .0720	.0603 .0604	.0603 .0602	.0724 .0727	.0724 .0728	.0717 .0720	.0717 .0721	
		3A	.0690 .0687	.0730 .0733	.0629 .0628	.0682 .0679	.0728 .0731	.0614 .0615	.0614 .0613	.0730 .0733	.0730 .0734	.0728 .0731	.0728 .0732	
1-72	NF	2A	.0687 .0684	.0724 .0727	.0634 .0633	.0675 .0672	.0715 .0718	.0615 .0616	.0615 .0614	.0724 .0727	.0724 .0727	.0715 .0718	.0715 .0718	
		3A	.0693 .0690	.0730 .0733	.0640 .0639	.0686 .0683	.0726 .0729	.0626 .0627	.0626 .0625	.0730 .0733	.0730 .0733	.0726 .0729	.0726 .0729	
2-56	NC	2A	.0810 .0807	.0854 .0857	.0738 .0737	.0791 .0791	.0850 .0853	.0717 .0718	.0717 .0716	.0854 .0857	.0854 .0858	.0850 .0853	.0850 .0854	
		3A	.0816 .0813	.0860 .0863	.0744 .0743	.0805 .0802	.0860 .0863	.0728 .0729	.0728 .0727	.0860 .0863	.0860 .0864	.0860 .0863	.0860 .0864	
2-64	NF	2A	.0814 .0811	.0854 .0857	.0753 .0752	.0801 .0799	.0847 .0850	.0733 .0734	.0733 .0732	.0854 .0857	.0854 .0858	.0847 .0850	.0847 .0851	
		3A	.0829 .0817	.0860 .0863	.0759 .0758	.0812 .0809	.0858 .0861	.0744 .0745	.0744 .0743	.0860 .0863	.0860 .0864	.0858 .0861	.0858 .0862	
3-48	NC	2A	.0934 .0931	.0983 .0986	.0848 .0847	.0915 .0912	.0981 .0984	.0825 .0826	.0825 .0824	.0983 .0986	.0983 .0987	.0981 .0984	.0981 .0985	
		3A	.0941 .0938	.0990 .0993	.0855 .0854	.0928 .0925	.0990 .0993	.0838 .0839	.0838 .0837	.0990 .0993	.0990 .0994	.0990 .0993	.0990 .0994	
3-56	NF	2A	.0939 .0936	.0983 .0986	.0867 .0866	.0922 .0919	.0978 .0981	.0845 .0846	.0845 .0844	.0983 .0986	.0983 .0987	.0978 .0981	.0978 .0982	
		3A	.0946 .0943	.0990 .0993	.0874 .0873	.0935 .0932	.0990 .0993	.0858 .0859	.0858 .0857	.0990 .0993	.0990 .0994	.0990 .0993	.0990 .0994	
4-40	NC	2A	.1056 .1053	.1112 .1115	.0950 .0949	.1033 .1030	.1112 .1115	.0925 .0926	.0925 .0924	.1112 .1115	.1112 .1116	.1112 .1115	.1112 .1116	
		3A	.1064 .1061	.1120 .1123	.0958 .0957	.1047 .1044	.1120 .1123	.0939 .0940	.0939 .0929	.1120 .1123	.1120 .1124	.1120 .1123	.1120 .1124	
4-48	NF	2A	.1064 .1061	.1113 .1116	.0978 .0977	.1044 .1041	.1110 .1113	.0954 .0955	.0954 .0953	.1113 .1116	.1113 .1117	.1110 .1113	.1110 .1114	
		3A	.1071 .1068	.1120 .1123	.0985 .0984	.1057 .1054	.1120 .1123	.0967 .0968	.0967 .0966	.1120 .1123	.1120 .1124	.1120 .1123	.1120 .1124	
5-40	NC	2A	.1186 .1183	.1242 .1245	.1069 .1079	.1162 .1159	.1242 .1245	.1054 .1055	.1054 .1053	.1242 .1245	.1242 .1246	.1242 .1245	.1242 .1246	
		3A	.1194 .1191	.1250 .1253	.1088 .1087	.1177 .1174	.1250 .1253	.1069 .1070	.1069 .1068	.1250 .1253	.1250 .1254	.1250 .1253	.1250 .1254	
5-44	NF	2A	.1191 .1188	.1243 .1246	.1095 .1093	.1168 .1165	.1240 .1243	.1070 .1071	.1070 .1069	.1243 .1246	.1243 .1247	.1240 .1243	.1240 .1244	
		3A	.1198 .1195	.1250 .1253	.1102 .1101	.1181 .1178	.1250 .1253	.1083 .1084	.1083 .1082	.1250 .1253	.1250 .1254	.1250 .1253	.1250 .1254	
6-32	NC	2A	.1307 .1304	.1372 .1375	.1169 .1168	.1276 .1273	.1372 .1375	.1141 .1142	.1141 .1140	.1372 .1375	.1372 .1377	.1372 .1375	.1372 .1377	
		3A	.1315 .1312	.1380 .1383	.1177 .1176	.1291 .1288	.1380 .1383	.1156 .1157	.1156 .1155	.1380 .1383	.1380 .1385	.1380 .1383	.1380 .1385	
6-40	NF	2A	.1316 .1313	.1372 .1375	.1210 .1209	.1292 .1289	.1372 .1375	.1184 .1185	.1184 .1183	.1372 .1375	.1372 .1376	.1372 .1375	.1372 .1376	
		3A	.1324 .1321	.1390 .1393	.1218 .1217	.1306 .1303	.1390 .1393	.1198 .1199	.1198 .1197	.1390 .1393	.1390 .1394	.1390 .1393	.1390 .1394	
8-32	NC	2A	.1596 .1593	.1631 .1634	.1428 .1427	.1534 .1531	.1631 .1634	.1399 .1400	.1399 .1398	.1631 .1634	.1631 .1636	.1631 .1634	.1631 .1636	
		3A	.1575 .1572	.1640 .1643	.1437 .1436	.1559 .1547	.1640 .1643	.1415 .1416	.1415 .1414	.1640 .1643	.1640 .1645	.1640 .1643	.1640 .1645	
8-36	NF	2A	.1572 .1570	.1632 .1635	.1452 .1451	.1544 .1541	.1632 .1635	.1424 .1425	.1424 .1423	.1632 .1637	.1632 .1636	.1632 .1635	.1632 .1636	
		3A	.1580 .1577	.1640 .1643	.1460 .1459	.1559 .1556	.1640 .1643	.1439 .1440	.1439 .1438	.1640 .1643	.1640 .1644	.1640 .1643	.1640 .1644	
10-24	NC	2A	.1811 .1808	.1890 .1895	.1619 .1618	.1766 .1761	.1890 .1895	.1586 .1587	.1586 .1585	.1890 .1895	.1890 .1896	.1890 .1895	.1890 .1896	
		3A	.1821 .1816	.1900 .1905	.1629 .1628	.1784 .1776	.1900 .1905	.1604 .1605	.1604 .1603	.1900 .1905	.1900 .1906	.1900 .1905	.1900 .1906	
10-32	NF	2A	.1826 .1823	.1891 .1894	.1688 .1687	.1793 .1790	.1891 .1894	.1658 .1659	.1658 .1657	.1891 .1894	.1891 .1896	.1891 .1894	.1891 .1896	
		3A	.1835 .1832	.1900 .1903	.1697 .1696	.1809 .1806	.1900 .1903	.1674 .1675	.1674 .1673	.1900 .1903	.1900 .1906	.1900 .1903	.1900 .1906	

See footnotes at end of table.

TABLE III.13.—Setting plug gages, Unified and American screw threads—Continued

Nominal size and threads per inch	Series designation	Class	W truncated setting plugs							Basic-crest setting plugs			
			Plug for "Go"			Plug for "Not go"				Major diameter			
			Major diameter		Pitch diameter	Major diameter		Pitch diameter		Go		Not go	
			Truncated	Full		Truncated	Full	Plus tolerance gage	Minus tolerance gage	W tolerance	X tolerance	W tolerance	X tolerance
1	2	3	4	5	6	7	8	9	10	11A	11B	12A	12B
12-24	NC	2A	in. 0.2071 .2066	in. 0.2150 .2155	in. 0.1879 .1878	in. 0.2025 .2020	in. 0.2150 .2155	in. 0.1845 .1844	in. 0.1845 .1844	in. 0.2150 .2155	in. 0.2156 .2155	in. 0.2150 .2155	in. 0.2166 .2165
		3A	.2081 .2076	.2160 .2165	.1889 .1888	.2043 .2038	.2160 .2165	.1863 .1864	.1863 .1862	.2160 .2165	.2160 .2165	.2160 .2165	.2160 .2165
12-28	NF	2A	.2079 .2074	.2150 .2155	.1918 .1917	.2041 .2036	.2150 .2155	.1886 .1885	.1886 .1885	.2160 .2155	.2150 .2165	.2150 .2165	.2150 .2165
		3A	.2089 .2084	.2160 .2165	.1928 .1927	.2059 .2054	.2160 .2165	.1904 .1905	.1904 .1903	.2160 .2165	.2160 .2165	.2160 .2165	.2160 .2165
12-32	NEF	2A	.2086 .2083	.2151 .2154	.1948 .1947	.2052 .2049	.2151 .2154	.1917 .1918	.1917 .1916	.2154 .2154	.2151 .2156	.2151 .2154	.2151 .2156
		3A	.2096 .2092	.2180 .2163	.1957 .1956	.2068 .2065	.2160 .2163	.1933 .1934	.1933 .1932	.2160 .2163	.2160 .2165	.2160 .2165	.2160 .2165
1/4-20	UNC	1A	.2399 .2394	.2489 .2494	.2174 .2163	.2324 .2319	.2483 .2488	.2108 .2108	.2108 .2107	.2489 .2494	.2489 .2494	.2483 .2488	.2483 .2488
		2A	.2399 .2394	.2489 .2494	.2164 .2163	.2344 .2339	.2499 .2494	.2127 .2128	.2127 .2126	.2499 .2494	.2489 .2494	.2489 .2494	.2489 .2494
1/4-28	UNF	1A	.2419 .2414	.2490 .2495	.2258 .2257	.2363 .2358	.2476 .2481	.2208 .2209	.2208 .2207	.2490 .2495	.2490 .2495	.2476 .2481	.2476 .2481
		2A	.2419 .2414	.2490 .2495	.2258 .2257	.2363 .2358	.2476 .2481	.2208 .2209	.2208 .2207	.2490 .2495	.2490 .2495	.2476 .2481	.2476 .2481
1/4-32	NEF	1A	.2425 .2422	.2490 .2493	.2267 .2266	.2369 .2367	.2480 .2480	.2255 .2256	.2256 .2254	.2490 .2493	.2490 .2495	.2480 .2492	.2480 .2494
		2A	.2425 .2422	.2490 .2493	.2267 .2266	.2369 .2367	.2480 .2480	.2255 .2256	.2256 .2254	.2490 .2493	.2490 .2495	.2480 .2492	.2480 .2494
5/16-18	UNC	1A	.3016 .3011	.3113 .3118	.2752 .2751	.2932 .2927	.3108 .3113	.2691 .2690	.2691 .2690	.3113 .3118	.3113 .3118	.3108 .3113	.3108 .3113
		2A	.3016 .3011	.3113 .3118	.2752 .2751	.2932 .2927	.3108 .3113	.2691 .2690	.2691 .2690	.3113 .3118	.3113 .3118	.3108 .3113	.3108 .3113
5/16-24	UNF	1A	.3035 .3030	.3114 .3119	.2843 .2842	.2968 .2963	.3100 .3105	.2783 .2784	.2783 .2782	.3114 .3119	.3114 .3119	.3100 .3105	.3100 .3105
		2A	.3035 .3030	.3114 .3119	.2843 .2842	.2968 .2963	.3100 .3105	.2783 .2784	.2783 .2782	.3114 .3119	.3114 .3119	.3100 .3105	.3100 .3105
5/16-32	NEF	1A	.3050 .3047	.3115 .3118	.2912 .2911	.3015 .3012	.3114 .3117	.2880 .2881	.2880 .2879	.3115 .3118	.3115 .3120	.3114 .3117	.3114 .3119
		2A	.3050 .3047	.3115 .3118	.2912 .2911	.3015 .3012	.3114 .3117	.2880 .2881	.2880 .2879	.3115 .3118	.3115 .3120	.3114 .3117	.3114 .3119
3/8-16	UNC	1A	.3632 .3626	.3737 .3743	.3331 .3330	.3537 .3531	.3735 .3741	.3264 .3267	.3264 .3267	.3737 .3743	.3737 .3743	.3735 .3741	.3735 .3741
		2A	.3632 .3626	.3737 .3743	.3331 .3330	.3537 .3531	.3735 .3741	.3264 .3267	.3264 .3267	.3737 .3743	.3737 .3743	.3735 .3741	.3735 .3741
3/8-24	UNF	1A	.3650 .3645	.3739 .3744	.3468 .3467	.3591 .3586	.3724 .3729	.3411 .3412	.3411 .3410	.3739 .3744	.3739 .3744	.3724 .3729	.3724 .3729
		2A	.3650 .3645	.3739 .3744	.3468 .3467	.3591 .3586	.3724 .3729	.3411 .3412	.3411 .3410	.3739 .3744	.3739 .3744	.3724 .3729	.3724 .3729
3/8-32	NEF	1A	.3672 .3665	.3740 .3743	.3537 .3536	.3638 .3635	.3757 .3740	.3503 .3504	.3503 .3502	.3740 .3743	.3740 .3745	.3737 .3740	.3737 .3742
		2A	.3672 .3665	.3740 .3743	.3537 .3536	.3638 .3635	.3757 .3740	.3503 .3504	.3503 .3502	.3740 .3743	.3740 .3745	.3737 .3740	.3737 .3742
1/2-14	UNC	1A	.4246 .4240	.4361 .4367	.38079 .38055	.4135 .4129	.4391 .4367	.38260 .38275	.38260 .38265	.4361 .4367	.4361 .4367	.4361 .4367	.4361 .4367
		2A	.4246 .4240	.4361 .4367	.38079 .38055	.4135 .4129	.4391 .4367	.38260 .38275	.38260 .38265	.4361 .4367	.4361 .4367	.4361 .4367	.4361 .4367
3/4-20	UNF	1A	.4272 .4267	.4392 .4367	.4037 .4036	.4192 .4187	.4350 .4355	.3975 .3974	.3975 .3974	.4362 .4367	.4362 .4367	.4362 .4367	.4362 .4367
		2A	.4272 .4267	.4392 .4367	.4037 .4036	.4192 .4187	.4350 .4355	.3975 .3974	.3975 .3974	.4362 .4367	.4362 .4367	.4362 .4367	.4362 .4367

See footnotes at end of table.

TABLE III.13. —Setting plug gages, Unified and American screw threads— Continued

Nominal size and threads per inch	Series designation	Class	W truncated setting plugs								Basic-crest setting plugs	
			Plug for "Go"			Plug for "Not go"					Major diameter	
			Major diameter		Pitch diameter	Major diameter		Pitch diameter		Go 1	Not go 2	
			Truncated	Full		Truncated	Full	Plus tolerance gage	Minus tolerance gage			W and X tolerances
1	2	3	4	5	6	7	8	9	10	11	12	
1/16-28	UNEF	2A	<i>in.</i> 0.4293	<i>in.</i> 0.4364	<i>in.</i> 0.4132	<i>in.</i> 0.4251	<i>in.</i> 0.4364	<i>in.</i> 0.4095	<i>in.</i> 0.4095	<i>in.</i> 0.4364	<i>in.</i> 0.4364	
		3A	.4288 .4304 .4299	.4369 .4375 .4380	.4131 .4143 .4142	.4246 .4271 .4266	.4369 .4375 .4380	.4097 .4116 .4117	.4095 .4116 .4115	.4369 .4375 .4380	.4369 .4375 .4380	
3/16-12	N	2A	.4855	.4984	.44439	.4750	.4984	.43890	.43890	.4984	.4984	
		3A	.4849 .4871 .4865	.4990 .5000 .5005	.44415 .44590 .44575	.4744 .4780 .4774	.4990 .5000 .5005	.43905 .44190 .44205	.43875 .44190 .44175	.4990 .5000 .5005	.4990 .5000 .5005	
3/16-13	UNC	1A	.4863	.4985	.44850	.4744	.4985	.44110	.44110	.4985	.4985	
		2A	.4857 .4863 .4857	.4991 .4985 .4991	.44835 .44850 .44835	.4738 .4768 .4762	.4991 .4985 .4991	.44125 .44350 .44365	.44095 .44350 .44365	.4991 .4985 .4991	.4991 .4985 .4991	
3/16-20	UNF	3A	.4878 .4872	.5000 .5005	.45600 .44985	.4796 .4790	.5000 .5005	.44630 .44615	.44630 .44615	.5000 .5005	.5000 .5005	
		1A	.4897	.4987	.4662	.4814	.4973	.4598	.4598	.4987	.4973	
3/16-28	UNEF	2A	.4892	.4992	.4661	.4809	.4978	.4599	.4597	.4992	.4978	
		3A	.4897 .4892 .4910 .4905	.4987 .4992 .5000 .5005	.4662 .4661 .4675 .4674	.4836 .4831 .4860 .4855	.4978 .4973 .5000 .5005	.4619 .4620 .4643 .4644	.4619 .4618 .4643 .4642	.4987 .4992 .5000 .5005	.4978 .4992 .5000 .5005	
5/16-12	UNC	2A	.5480	.5609	.5068	.5351	.5609	.5190	.4996	.5609	.5609	
		3A	.5474 .5480 .5474	.5615 .5609 .5615	.5066 .5066 .5066	.5315 .5377 .5371	.5609 .5609 .5615	.5016 .5016 .5018	.5016 .5016 .5015	.5609 .5609 .5615	.5609 .5609 .5615	
5/16-18	UNF	1A	.5514	.5611	.52500	.5423	.5599	.51820	.51820	.5611	.5599	
		2A	.5509 .5514 .5509	.5616 .5611 .5616	.52485 .52500 .52485	.5418 .5446 .5441	.5604 .5611 .5616	.51845 .52050 .52065	.51805 .52050 .52065	.5616 .5611 .5616	.5604 .5611 .5616	
9/16-24	NEF	3A	.5528 .5523	.5625 .5630	.52610 .52625	.5471 .5466	.5625 .5630	.52300 .52315	.52300 .52315	.5625 .5630	.5625 .5630	
		2A	.5534	.5613	.53420	.5483	.5613	.53040	.53030	.5613	.5613	
9/16-28	NEF	3A	.5529	.5618	.53405	.5478	.5618	.53045	.53015	.5618	.5618	
		1A	.5516 .5511	.5625 .5630	.53340 .53325	.5505 .5500	.5625 .5630	.53250 .53265	.53250 .53265	.5625 .5630	.5625 .5630	
9/16-32	UNC	1A	.6097	.6234	.5614	.5955	.6234	.5561	.5561	.6234	.6234	
		2A	.6091 .6097 .6091	.6240 .6234 .6240	.5612 .5614 .5612	.5949 .5983 .5977	.6240 .6234 .6236	.5563 .5589 .5581	.5559 .5589 .5577	.6240 .6234 .6240	.6240 .6234 .6240	
9/16-36	N	3A	.6113 .6107	.6250 .6256	.5690 .5668	.6013 .6007	.6250 .6256	.5619 .5621	.5619 .5617	.6250 .6256	.6250 .6256	
		2A	.6105	.6234	.5693	.6000	.6234	.5639	.5639	.6234	.6234	
9/16-48	UNF	3A	.6090	.6240	.5691	.5994	.6240	.5641	.5637	.6240	.6240	
		1A	.6121 .6115	.6250 .6256	.5709 .5707	.6029 .6023	.6250 .6256	.5658 .5670	.5668 .5666	.6250 .6256	.6250 .6256	
9/16-48	UNF	2A	.6139	.6236	.58750	.6046	.6222	.58050	.58050	.6236	.6222	
		3A	.6134 .6139 .6134	.6241 .6236 .6241	.58735 .58750 .58735	.6041 .6069 .6064	.6227 .6236 .6241	.58065 .58280 .58295	.58065 .58280 .58295	.6241 .6236 .6241	.6227 .6236 .6241	
9/16-48	UNF	3A	.6153 .6148	.6250 .6255	.58800 .58875	.6095 .6089	.6250 .6255	.58540 .58555	.58540 .58525	.6250 .6255	.6250 .6255	
		2A	.6159	.6238	.59670	.6107	.6248	.59270	.59270	.6238	.6238	
9/16-48	NEF	3A	.6154 .6171 .6166	.6243 .6250 .6255	.59655 .59790 .59775	.6102 .6129 .6124	.6243 .6250 .6255	.59285 .59490 .59475	.59285 .59490 .59475	.6243 .6250 .6255	.6243 .6250 .6255	
		2A	.6730	.6859	.6318	.6625	.6859	.6261	.6261	.6859	.6859	
1 1/16-12	N	3A	.6724	.6865	.6316	.6619	.6865	.6266	.6262	.6865	.6865	
		2A	.6746 .6740	.6875 .6881	.6334 .6342	.6654 .6648	.6875 .6881	.6293 .6295	.6293 .6291	.6875 .6881	.6875 .6881	
1 1/16-24	NEF	2A	.6784	.6893	.65920	.6732	.6863	.65520	.65520	.6893	.6893	
		3A	.6779 .6796 .6791	.6898 .6925 .6880	.65905 .66040 .66025	.6727 .6754 .6740	.6868 .6875 .6880	.65535 .65740 .65755	.65535 .65740 .65725	.6898 .6925 .6880	.6898 .6925 .6880	

See footnotes at end of table.

TABLE III.13.—Setting plug gages, Unified and American screw threads—Continued

Nominal size and threads per inch	Series designation	Class	W truncated setting plugs							Baste-crest setting plugs		
			Plug for "Go"			Plug for "Not go"				Major diameter		
			Major diameter		Pitch diameter	Major diameter		Pitch diameter		Go ¹	Not go ²	
			Truncated	Full		Truncated	Full	Plus tolerance gage	Minus tolerance gage			W and X tolerances
1	2	3	4	5	6	7	8	9	10	11	12	
3/4-10	UNC	1A	0.7336	0.7482	0.6832	0.7177	0.7482	0.6744	0.6744	0.7482	0.7482	
		2A	0.7330	0.7488	0.6830	0.7171	0.7488	0.6746	0.6742	0.7488	0.7488	
		3A	0.7334	0.7482	0.6832	0.7177	0.7482	0.6744	0.6744	0.7482	0.7482	
	N	2A	0.7330	0.7488	0.6830	0.7171	0.7488	0.6746	0.6742	0.7488	0.7488	
		3A	0.7334	0.7482	0.6832	0.7177	0.7482	0.6744	0.6744	0.7482	0.7482	
		3A	0.7348	0.7506	0.6848	0.7233	0.7506	0.6806	0.6804	0.7506	0.7506	
	3/4-12	N	2A	0.7354	0.7483	0.6912	0.7218	0.7483	0.6887	0.6887	0.7483	0.7483
			3A	0.7348	0.7489	0.6910	0.7212	0.7489	0.6889	0.6885	0.7489	0.7489
			3A	0.7371	0.7590	0.6959	0.7279	0.7590	0.6918	0.6918	0.7590	0.7590
3/4-16	UNF	1A	0.7380	0.7485	0.7079	0.7275	0.7473	0.7004	0.7004	0.7485	0.7473	
		2A	0.7374	0.7491	0.7077	0.7269	0.7479	0.7006	0.7002	0.7491	0.7479	
		3A	0.7380	0.7485	0.7079	0.7300	0.7485	0.7029	0.7029	0.7485	0.7485	
3/4-20	UNEF	1A	0.7374	0.7491	0.7077	0.7294	0.7491	0.7031	0.7027	0.7491	0.7491	
		2A	0.7389	0.7506	0.7094	0.7327	0.7506	0.7056	0.7056	0.7506	0.7506	
		3A	0.7389	0.7506	0.7092	0.7321	0.7506	0.7058	0.7054	0.7506	0.7506	
1 1/16-12	N	2A	0.7897	0.8108	0.7567	0.7873	0.8108	0.7512	0.7512	0.8108	0.8108	
		3A	0.7897	0.8114	0.7565	0.7867	0.8114	0.7514	0.7510	0.8114	0.8114	
		3A	0.7906	0.8125	0.7584	0.7904	0.8125	0.7543	0.7543	0.8125	0.8125	
1 1/16-16	UN	2A	0.7900	0.8131	0.7582	0.7898	0.8131	0.7545	0.7541	0.8131	0.8131	
		3A	0.7900	0.8116	0.7570	0.7920	0.8116	0.7557	0.7553	0.8116	0.8116	
		3A	0.8020	0.8125	0.7719	0.7954	0.8125	0.7683	0.7683	0.8125	0.8125	
1 1/16-20	UNEF	2A	0.8014	0.8131	0.7717	0.7918	0.8131	0.7685	0.7681	0.8131	0.8131	
		3A	0.8022	0.8112	0.77870	0.7960	0.8112	0.77430	0.77430	0.8112	0.8112	
		3A	0.8017	0.8117	0.77855	0.7955	0.8117	0.77445	0.77445	0.8117	0.8117	
3/8-9	UNC	1A	0.8035	0.8127	0.78000	0.7984	0.8125	0.77670	0.77670	0.8125	0.8125	
		2A	0.8030	0.8130	0.77985	0.7979	0.8130	0.77685	0.77655	0.8130	0.8130	
		3A	0.8030	0.8130	0.77985	0.7979	0.8130	0.77685	0.77655	0.8130	0.8130	
3/8-12	N	1A	0.8573	0.8731	0.8069	0.8395	0.8731	0.7914	0.7914	0.8731	0.8731	
		2A	0.8566	0.8738	0.8067	0.8391	0.8731	0.7916	0.7912	0.8738	0.8738	
		3A	0.8573	0.8731	0.8069	0.8427	0.8731	0.7916	0.7916	0.8731	0.8731	
3/8-14	UNF	1A	0.8566	0.8738	0.8067	0.8420	0.8738	0.7918	0.7914	0.8738	0.8738	
		2A	0.8592	0.8750	0.8028	0.8462	0.8750	0.7981	0.7981	0.8750	0.8750	
		3A	0.8585	0.8757	0.8026	0.8455	0.8757	0.7983	0.7979	0.8757	0.8757	
3/8-16	UN	2A	0.8604	0.8733	0.8192	0.8498	0.8733	0.8137	0.8137	0.8733	0.8733	
		3A	0.8598	0.8739	0.8190	0.8492	0.8739	0.8139	0.8135	0.8739	0.8739	
		3A	0.8621	0.8799	0.8209	0.8529	0.8799	0.8168	0.8168	0.8799	0.8799	
3/8-20	UNEF	2A	0.8615	0.8756	0.8207	0.8523	0.8756	0.8170	0.8166	0.8756	0.8756	
		3A	0.8619	0.8734	0.8250	0.8492	0.8734	0.8191	0.8191	0.8734	0.8734	
		3A	0.8619	0.8734	0.8250	0.8492	0.8734	0.8191	0.8191	0.8734	0.8734	
3/8-24	UNF	1A	0.8613	0.8749	0.8268	0.8519	0.8749	0.8218	0.8214	0.8749	0.8749	
		2A	0.8635	0.8759	0.8286	0.8554	0.8759	0.8245	0.8245	0.8759	0.8759	
		3A	0.8623	0.8756	0.8284	0.8548	0.8756	0.8247	0.8243	0.8756	0.8756	
3/8-32	UNEF	2A	0.8630	0.8735	0.8329	0.8551	0.8735	0.8280	0.8280	0.8735	0.8735	
		3A	0.8621	0.8741	0.8327	0.8545	0.8741	0.8282	0.8278	0.8741	0.8741	
		3A	0.8615	0.8759	0.8344	0.8579	0.8759	0.8308	0.8308	0.8759	0.8759	
1 1/16-12	UN	2A	0.8639	0.8756	0.8342	0.8573	0.8756	0.8310	0.8306	0.8756	0.8756	
		3A	0.8647	0.8737	0.84120	0.8584	0.8737	0.8360	0.8360	0.8737	0.8737	
		3A	0.8612	0.8742	0.84105	0.8579	0.8742	0.8365	0.8365	0.8742	0.8742	
1 1/16-16	UN	2A	0.8660	0.8750	0.84250	0.8608	0.8750	0.8390	0.8390	0.8750	0.8750	
		3A	0.8655	0.8759	0.84235	0.8603	0.8755	0.8395	0.8395	0.8755	0.8755	
		3A	0.8655	0.8759	0.84235	0.8603	0.8755	0.8395	0.8395	0.8755	0.8755	
1 1/16-20	UNEF	2A	0.9229	0.9358	0.8817	0.9121	0.9358	0.8799	0.8799	0.9358	0.9358	
		3A	0.9223	0.9364	0.8815	0.9115	0.9364	0.8792	0.8792	0.9364	0.9364	
		3A	0.9216	0.9375	0.8834	0.9154	0.9375	0.8793	0.8793	0.9375	0.9375	
1 1/16-24	UNEF	2A	0.9240	0.9381	0.8832	0.9148	0.9381	0.8795	0.8791	0.9381	0.9381	
		3A	0.9255	0.9360	0.8954	0.9175	0.9360	0.8901	0.8901	0.9360	0.9360	
		3A	0.9249	0.9366	0.8952	0.9169	0.9366	0.8906	0.8906	0.9366	0.9366	
1 1/16-32	UNEF	2A	0.9261	0.9381	0.8967	0.9197	0.9381	0.8934	0.8930	0.9381	0.9381	
		3A	0.9271	0.9364	0.9099	0.9208	0.9364	0.8940	0.8940	0.9364	0.9364	
		3A	0.9266	0.9375	0.9097	0.9203	0.9375	0.8942	0.8942	0.9375	0.9375	
1 1/16-40	UNEF	2A	0.9280	0.9389	0.9085	0.9227	0.9389	0.8944	0.8944	0.9389	0.9389	
		3A	0.9285	0.9375	0.9090	0.9232	0.9375	0.8940	0.8940	0.9375	0.9375	
		3A	0.9280	0.9389	0.9085	0.9227	0.9389	0.8944	0.8944	0.9389	0.9389	

See footnotes at end of table.

TABLE III.13.—Setting plug gages, Unified and American screw threads—Continued

Nominal size and threads per inch	Series designation	Class	W truncated setting plugs							Basic-crest setting plugs		
			Plug for "Go"			Plug for "Not go"				Major diameter		
			Major diameter		Pitch diameter	Major diameter		Pitch diameter		W and X tolerances	Not go 2	
			Truncated	Full		Truncated	Full	Plus tolerance gage	Minus tolerance gage			
1	2	3	4	5	6	7	8	9	10	11	12	
			<i>in.</i>	<i>in.</i>	<i>in.</i>	<i>in.</i>	<i>in.</i>	<i>in.</i>	<i>in.</i>	<i>in.</i>	<i>in.</i>	<i>in.</i>
1-8	UNC	1A	0.9809	0.9989	0.9168	0.9408	0.9180	0.9067	0.9067	0.9980	0.9980	0.9980
		2A	.9802	.9987	.9169	.9291	.9180	.9057	.9055	.9987	.9987	.9987
		3A	.9802	.9987	.9168	.9411	.9180	.9100	.9100	.9980	.9980	.9980
			.9821	1.0000	.9165	.9631	.9187	.9102	.9102	.9987	.9987	.9987
			.9822	1.0007	.9186	.9578	1.0000	.9137	.9137	1.0000	1.0000	1.0000
						.9671	1.0007	.9149	.9135	1.0007	1.0007	1.0007
1-12	UNF	1A	.9853	.9982	.9441	.9714	.9978	.9353	.9353	.9982	.9982	.9978
		2A	.9847	.9988	.9439	.9708	.9984	.9555	.9354	.9988	.9988	.9984
		3A	.9853	.9982	.9441	.9743	.9982	.9382	.9382	.9982	.9982	.9982
			.9847	.9988	.9439	.9737	.9988	.9384	.9384	.9988	.9988	.9988
			.9871	1.0000	.9459	.9776	1.0000	.9415	.9415	1.0000	1.0000	1.0000
			.9865	1.0006	.9457	.9770	1.0008	.9417	.9413	1.0009	1.0009	1.0006
1-16	UN	2A	.9880	.9985	.9579	.9900	.9985	.9520	.9520	.9985	.9985	.9985
		3A	.9874	.9991	.9577	.9794	.9991	.9631	.9527	.9991	.9991	.9991
			.9895	1.0000	.9594	.9828	1.0000	.9557	.9557	1.0000	1.0000	1.0000
			.9889	1.0006	.9592	.9822	1.0008	.9550	.9555	1.0006	1.0006	1.0006
1-20	UNEF	2A	.9896	.9986	.9610	.9832	.9986	.96160	.96160	.9986	.9986	.9986
		3A	.9891	.9991	.9605	.9827	.9991	.96175	.96145	.9991	.9991	.9991
			.9910	1.0000	.9650	.9858	1.0000	.96410	.96410	1.0000	1.0000	1.0000
			.9905	1.0005	.96735	.9852	1.0005	.96425	.96395	1.0005	1.0005	1.0005
1 1/16-12	UN	2A	1.0479	1.0608	1.0067	1.0371	1.0608	1.0010	1.0010	1.0608	1.0608	1.0608
		3A	1.0473	1.0614	1.0065	1.0365	1.0614	1.0012	1.0008	1.0614	1.0614	1.0614
			1.0496	1.0625	1.0084	1.0403	1.0625	1.0012	1.0012	1.0625	1.0625	1.0625
			1.0480	1.0631	1.0082	1.0397	1.0631	1.0014	1.0010	1.0631	1.0631	1.0631
1 1/16-16	UN	2A	1.0505	1.0610	1.0203	1.0515	1.0610	1.0154	1.0154	1.0610	1.0610	1.0610
		3A	1.0499	1.0616	1.0202	1.0419	1.0616	1.0152	1.0152	1.0616	1.0616	1.0616
			1.0520	1.0625	1.0219	1.0433	1.0625	1.0182	1.0182	1.0625	1.0625	1.0625
			1.0514	1.0631	1.0217	1.0447	1.0631	1.0184	1.0180	1.0631	1.0631	1.0631
1 1/16-18	NEF	2A	1.0514	1.0611	1.02500	1.0444	1.0611	1.02030	1.02030	1.0611	1.0611	1.0611
		3A	1.0509	1.0616	1.02485	1.0439	1.0616	1.02045	1.02015	1.0616	1.0616	1.0616
			1.0528	1.0625	1.02640	1.0469	1.0625	1.02280	1.02280	1.0625	1.0625	1.0625
			1.0523	1.0630	1.02625	1.0464	1.0630	1.02265	1.02265	1.0630	1.0630	1.0630
1 1/8-7	UNC	1A	1.1040	1.1228	1.0300	1.0810	1.1228	1.0191	1.0191	1.1228	1.1228	1.1228
		2A	1.1033	1.1235	1.0298	1.0803	1.1235	1.0193	1.0193	1.1235	1.1235	1.1235
			1.1040	1.1228	1.0300	1.0847	1.1228	1.0228	1.0228	1.1228	1.1228	1.1228
			1.1033	1.1235	1.0298	1.0840	1.1235	1.0226	1.0226	1.1235	1.1235	1.1235
			1.1062	1.1250	1.0322	1.0887	1.1250	1.0238	1.0238	1.1250	1.1250	1.1250
			1.1055	1.1257	1.0320	1.0890	1.1257	1.0240	1.0240	1.1257	1.1257	1.1257
1 1/8-8	N	2A	1.1058	1.1229	1.0417	1.0880	1.1229	1.0348	1.0348	1.1229	1.1229	1.1229
		3A	1.1051	1.1236	1.0415	1.0882	1.1236	1.0350	1.0350	1.1236	1.1236	1.1236
			1.1079	1.1250	1.0438	1.0927	1.1250	1.0386	1.0386	1.1250	1.1250	1.1250
			1.1072	1.1257	1.0436	1.0920	1.1257	1.0388	1.0384	1.1257	1.1257	1.1257
1 1/8-12	UNF	1A	1.1102	1.1232	1.0691	1.0962	1.1232	1.0691	1.0691	1.1232	1.1232	1.1232
		2A	1.1097	1.1238	1.0690	1.0955	1.1232	1.0632	1.0632	1.1238	1.1238	1.1232
			1.1103	1.1232	1.0691	1.0962	1.1232	1.0631	1.0631	1.1232	1.1232	1.1232
			1.1097	1.1238	1.0689	1.0986	1.1238	1.0633	1.0629	1.1238	1.1238	1.1238
			1.1121	1.1250	1.0709	1.1025	1.1250	1.0664	1.0664	1.1250	1.1250	1.1250
			1.1116	1.1256	1.0707	1.1019	1.1256	1.0662	1.0662	1.1256	1.1256	1.1256
1 1/8-13	UN	2A	1.1130	1.1235	1.0829	1.1050	1.1235	1.0779	1.0779	1.1235	1.1235	1.1235
		3A	1.1124	1.1241	1.0827	1.1044	1.1241	1.0781	1.0777	1.1241	1.1241	1.1241
			1.1145	1.1250	1.0844	1.1078	1.1250	1.0807	1.0807	1.1250	1.1250	1.1250
			1.1139	1.1256	1.0842	1.1072	1.1256	1.0805	1.0805	1.1256	1.1256	1.1256
1 1/8-14	NEF	2A	1.1139	1.1236	1.08750	1.1060	1.1236	1.08290	1.08290	1.1236	1.1236	1.1236
		3A	1.1134	1.1241	1.08735	1.1054	1.1241	1.08265	1.08265	1.1241	1.1241	1.1241
			1.1153	1.1250	1.08890	1.1094	1.1250	1.08530	1.08530	1.1250	1.1250	1.1250
			1.1143	1.1256	1.08876	1.1089	1.1256	1.08515	1.08515	1.1256	1.1256	1.1256
1 1/8-12	UN	2A	1.1729	1.1858	1.1317	1.1620	1.1858	1.1259	1.1259	1.1858	1.1858	1.1858
		3A	1.1723	1.1864	1.1315	1.1614	1.1864	1.1251	1.1251	1.1864	1.1864	1.1864
			1.1746	1.1875	1.1334	1.1652	1.1875	1.1291	1.1291	1.1875	1.1875	1.1875
			1.1740	1.1881	1.1332	1.1646	1.1881	1.1293	1.1289	1.1881	1.1881	1.1881
1 3/16-16	UN	2A	1.1755	1.1899	1.1444	1.1674	1.1899	1.1403	1.1403	1.1899	1.1899	1.1899
		3A	1.1749	1.1905	1.1452	1.1668	1.1905	1.1405	1.1401	1.1905	1.1905	1.1905
			1.1770	1.1875	1.1469	1.1702	1.1875	1.1431	1.1431	1.1875	1.1875	1.1875
			1.1764	1.1881	1.1467	1.1696	1.1881	1.1433	1.1429	1.1881	1.1881	1.1881
1 3/16-18	NEF	2A	1.1763	1.1922	1.14900	1.1691	1.1890	1.14500	1.14500	1.1922	1.1922	1.1922
		3A	1.1753	1.1905	1.14955	1.1685	1.1895	1.14525	1.14525	1.1905	1.1905	1.1905
			1.1778	1.1875	1.15140	1.1719	1.1875	1.14780	1.14780	1.1875	1.1875	1.1875
			1.1773	1.1880	1.15125	1.1714	1.1880	1.14795	1.14765	1.1880	1.1880	1.1880

See footnotes at end of table

TABLE III.13.—Setting plug gages, Unified and American screw threads—Continued

Nominal size and threads per inch	Series designation	Class	W truncated setting plugs							Basic-crest setting plugs		
			Plug for "Go"			Plug for "Not go"				Major diameter		
			Major diameter		Pitch diameter	Major diameter		Pitch diameter		Go ¹	Not go ¹	
			Truncated	Full		Truncated	Full	Plus tolerance gage	Minus tolerance gage			W and X tolerances
1	2	3	4	5	6	7	8	9	10	11	12	
1 3/16-7	UNC	1A	1.2200	1.2478	1.1550	1.2058	1.2478	1.1439	1.1439	1.1439	1.2478	1.2478
		2A	1.2283	1.2485	1.1548	1.2051	1.2455	1.1441	1.1437	1.1437	1.2485	1.2485
		3A	1.2312	1.2500	1.1572	1.2136	1.2485	1.1478	1.1474	1.1474	1.2500	1.2500
1 3/16-8	N	2A	1.2308	1.2479	1.1667	1.2138	1.2470	1.1587	1.1587	1.1587	1.2479	1.2479
		3A	1.2329	1.2500	1.1688	1.2176	1.2486	1.1635	1.1635	1.1635	1.2500	1.2500
			1.2322	1.2507	1.1686	1.2160	1.2507	1.1637	1.1637	1.1637	1.2507	1.2507
1 3/16-12	UNF	1A	1.2353	1.2482	1.1941	1.2210	1.2474	1.1849	1.1849	1.1849	1.2482	1.2474
		2A	1.2347	1.2488	1.1939	1.2204	1.2480	1.1851	1.1847	1.1847	1.2488	1.2480
		3A	1.2371	1.2500	1.1959	1.2274	1.2490	1.1881	1.1877	1.1877	1.2500	1.2490
1 3/16-10	UN	2A	1.2380	1.2485	1.2079	1.2290	1.2485	1.2028	1.2028	1.2028	1.2485	1.2485
		3A	1.2395	1.2500	1.2094	1.2327	1.2490	1.2056	1.2056	1.2056	1.2500	1.2500
			1.2389	1.2506	1.2092	1.2321	1.2506	1.2058	1.2058	1.2058	1.2506	1.2506
1 3/16-18	NEF	2A	1.2388	1.2485	1.21240	1.2316	1.2485	1.20750	1.20750	1.20750	1.2485	1.2485
		3A	1.2403	1.2500	1.21370	1.2344	1.2490	1.2080	1.2080	1.2080	1.2500	1.2500
			1.2395	1.2505	1.21376	1.2339	1.2505	1.2085	1.2085	1.2085	1.2505	1.2505
1 3/16-12	UN	2A	1.2979	1.3108	1.2567	1.2870	1.3108	1.2509	1.2509	1.2509	1.3108	1.3108
		3A	1.2973	1.3114	1.2565	1.2864	1.3114	1.2511	1.2511	1.2511	1.3114	1.3114
			1.2966	1.3125	1.2584	1.2862	1.3125	1.2541	1.2541	1.2541	1.3125	1.3125
1 3/16-16	UN	2A	1.3005	1.3110	1.2704	1.2824	1.3110	1.2653	1.2653	1.2653	1.3110	1.3110
		3A	1.3019	1.3116	1.2702	1.2818	1.3116	1.2655	1.2655	1.2655	1.3116	1.3116
			1.3020	1.3125	1.2719	1.2852	1.3125	1.2681	1.2681	1.2681	1.3125	1.3125
1 3/16-18	NEF	2A	1.3013	1.3110	1.27490	1.2841	1.3110	1.27000	1.27000	1.27000	1.3110	1.3110
		3A	1.3008	1.3115	1.27476	1.2836	1.3115	1.26985	1.26985	1.26985	1.3115	1.3115
			1.3028	1.3125	1.27640	1.2869	1.3125	1.27280	1.27280	1.27280	1.3125	1.3125
1 3/8-6	UNC	1A	1.3516	1.3726	1.2643	1.3245	1.3726	1.2522	1.2522	1.2522	1.3726	1.3726
		2A	1.3508	1.3734	1.2641	1.3237	1.3734	1.2524	1.2524	1.2524	1.3734	1.3734
		3A	1.3510	1.3750	1.2657	1.3259	1.3750	1.2537	1.2537	1.2537	1.3750	1.3750
1 3/8-8	N	2A	1.3557	1.3728	1.2916	1.3385	1.3728	1.2844	1.2844	1.2844	1.3728	1.3728
		3A	1.3550	1.3735	1.2914	1.3378	1.3735	1.2846	1.2846	1.2846	1.3735	1.3735
			1.3579	1.3759	1.2938	1.3425	1.3750	1.2884	1.2884	1.2884	1.3759	1.3759
1 3/8-12	UNF	1A	1.3602	1.3731	1.3190	1.3457	1.3721	1.3096	1.3096	1.3096	1.3731	1.3721
		2A	1.3596	1.3737	1.3188	1.3451	1.3727	1.3098	1.3094	1.3094	1.3737	1.3727
		3A	1.3621	1.3750	1.3209	1.3482	1.3730	1.3129	1.3125	1.3125	1.3750	1.3730
1 3/8-16	UN	2A	1.3639	1.3735	1.3329	1.3549	1.3735	1.3278	1.3278	1.3278	1.3735	1.3735
		3A	1.3621	1.3741	1.3327	1.3543	1.3741	1.3280	1.3276	1.3276	1.3741	1.3741
			1.3645	1.3759	1.3344	1.3577	1.3750	1.3306	1.3306	1.3306	1.3759	1.3759
1 3/8-18	NEF	2A	1.3638	1.3735	1.33740	1.3566	1.3735	1.33250	1.33250	1.33250	1.3735	1.3735
		3A	1.3653	1.3750	1.33900	1.3591	1.3750	1.33530	1.33530	1.33530	1.3750	1.3750
			1.3648	1.3765	1.33875	1.3589	1.3755	1.33545	1.33545	1.33545	1.3765	1.3765
1 3/8-12	UN	2A	1.4224	1.4357	1.3816	1.4118	1.4357	1.3757	1.3757	1.3757	1.4357	1.4357
		3A	1.4222	1.4363	1.3814	1.4112	1.4363	1.3759	1.3755	1.3755	1.4363	1.4363
			1.4246	1.4377	1.3834	1.4135	1.4375	1.3780	1.3780	1.3780	1.4377	1.4377
1 3/8-16	UN	2A	1.4254	1.4359	1.3953	1.4172	1.4355	1.3901	1.3901	1.3901	1.4359	1.4359
		3A	1.4248	1.4365	1.3951	1.4166	1.4365	1.3903	1.3903	1.3903	1.4365	1.4365
			1.4270	1.4375	1.3969	1.4191	1.4375	1.3930	1.3930	1.3930	1.4375	1.4375

See footnotes at end of table.

TABLE III.13.—Setting plug gages, Unified and American screw threads—Continued

Nominal size and threads per inch	Series designation	Class	W truncated setting plugs							Basic-crest setting plugs		
			Plug for "Go"			Plug for "Not go"				Major diameter		
			Major diameter		Pitch diameter	Major diameter		Pitch diameter		W and X tolerances	Not go ¹	
			Truncated	Full		Truncated	Full	Plus tolerance gage	Minus tolerance gage			
1	2	3	4	5	6	7	8	9	10	11	12	
1 1/16-18	NEF	3A	<i>in.</i>	<i>in.</i>	<i>in.</i>	<i>in.</i>	<i>in.</i>	<i>in.</i>	<i>in.</i>	<i>in.</i>	<i>in.</i>	<i>in.</i>
			1.4263	1.4379	1.39900	1.4199	1.4360	1.39490	1.39490	1.39490	1.4399	1.4360
		1.4258	1.4365	1.39975	1.4185	1.4365	1.39595	1.39595	1.39595	1.4395	1.4365	
1 1/2 6	UNC	3A	1.4278	1.4375	1.40140	1.4218	1.4375	1.39770	1.39770	1.4375	1.4375	
			1.4273	1.4380	1.40225	1.4213	1.4380	1.39785	1.39785	1.4380	1.4380	
		1A	1.4766	1.4976	1.3893	1.4494	1.4976	1.3772	1.3772	1.4976	1.4976	
1 1/2 8	N	3A	1.4758	1.4984	1.3894	1.4486	1.4984	1.3771	1.3771	1.4984	1.4984	
			1.4766	1.4976	1.3893	1.4531	1.4976	1.3812	1.3812	1.4976	1.4976	
		1A	1.4758	1.4984	1.3894	1.4526	1.4984	1.3811	1.3811	1.4984	1.4984	
1 1/2 12	UNF	3A	1.4790	1.5009	1.3917	1.4578	1.5009	1.3856	1.3856	1.5009	1.5009	
			1.4782	1.5008	1.3915	1.4570	1.5008	1.3858	1.3858	1.5008	1.5008	
		1A	1.4807	1.4978	1.4166	1.4634	1.4978	1.4693	1.4693	1.4978	1.4978	
1 1/2 16	UN	3A	1.4809	1.4985	1.4164	1.4627	1.4985	1.4695	1.4695	1.4985	1.4985	
			1.4829	1.5009	1.4188	1.4674	1.5009	1.4733	1.4733	1.5009	1.5009	
		1A	1.4822	1.5007	1.4186	1.4667	1.5007	1.4735	1.4735	1.5007	1.5007	
1 1/2 18	NEF	3A	1.4872	1.4981	1.4410	1.4765	1.4981	1.4344	1.4344	1.4981	1.4981	
			1.4895	1.4987	1.4408	1.4699	1.4987	1.4346	1.4346	1.4987	1.4987	
		1A	1.4832	1.4981	1.4410	1.4737	1.4981	1.4375	1.4375	1.4981	1.4981	
1 1/2 20	UN	3A	1.4895	1.4987	1.4408	1.4731	1.4987	1.4376	1.4376	1.4987	1.4987	
			1.4871	1.5009	1.4409	1.4772	1.5009	1.4411	1.4411	1.5009	1.5009	
		1A	1.4865	1.5006	1.4407	1.4766	1.5006	1.4413	1.4413	1.5006	1.5006	
1 1/2 24	UN	3A	1.4879	1.4984	1.4578	1.4797	1.4984	1.4526	1.4526	1.4984	1.4984	
			1.4873	1.4990	1.4576	1.4791	1.4990	1.4528	1.4528	1.4990	1.4990	
		1A	1.4895	1.5009	1.4594	1.4826	1.5009	1.4555	1.4555	1.5009	1.5009	
1 1/2 28	NEF	3A	1.4899	1.5006	1.4592	1.4820	1.5006	1.4557	1.4557	1.5006	1.5006	
			1A	1.4888	1.4985	1.46240	1.4815	1.4985	1.45740	1.45740	1.4985	1.4985
		1A	1.4882	1.4990	1.46225	1.4810	1.4990	1.45755	1.45755	1.4990	1.4990	
1 1/16 16	N	3A	1.4905	1.5009	1.49390	1.4843	1.5009	1.4920	1.4920	1.5009	1.5009	
			1.4908	1.5005	1.49375	1.4838	1.5005	1.49035	1.49035	1.5005	1.5005	
		1A	1.5004	1.5009	1.50000	1.5022	1.5009	1.50540	1.50540	1.5009	1.5009	
1 1/16 18	NEF	3A	1.5098	1.5015	1.50065	1.5116	1.5015	1.51335	1.51335	1.5015	1.5015	
			1.5020	1.5025	1.50190	1.5151	1.5025	1.51809	1.51809	1.5025	1.5025	
		1A	1.5014	1.5031	1.50165	1.5115	1.5031	1.51825	1.51775	1.5031	1.5031	
1 1/16 20	NEF	3A	1.5043	1.5046	1.5049	1.5140	1.5046	1.5169	1.5169	1.5046	1.5046	
			1.5098	1.5045	1.5047	1.5135	1.5045	1.5201	1.5197	1.5045	1.5045	
		1A	1.5028	1.5025	1.5024	1.5168	1.5025	1.5225	1.5225	1.5025	1.5025	
1 1/8 8	N	3A	1.5023	1.5030	1.5032	1.5163	1.5030	1.5229	1.5225	1.5030	1.5030	
			1.6057	1.6228	1.51090	1.5883	1.6228	1.53420	1.53420	1.6228	1.6228	
		1A	1.6050	1.6235	1.51135	1.5876	1.6235	1.53415	1.53415	1.6235	1.6235	
1 1/8 12	UN	3A	1.6079	1.6250	1.51380	1.5923	1.6250	1.53890	1.53890	1.6250	1.6250	
			1.6072	1.6257	1.51355	1.5916	1.6257	1.53815	1.53815	1.6257	1.6257	
		1A	1.6132	1.6232	1.50910	1.5963	1.6232	1.53420	1.53420	1.6232	1.6232	
1 1/8 16	UN	3A	1.6097	1.6238	1.50885	1.5967	1.6238	1.53315	1.53315	1.6238	1.6238	
			1.6121	1.6250	1.50900	1.6026	1.6250	1.53650	1.53650	1.6250	1.6250	
		1A	1.6115	1.6256	1.50885	1.6020	1.6256	1.53625	1.53625	1.6256	1.6256	
1 1/8 18	NEF	3A	1.6129	1.6234	1.50880	1.6047	1.6234	1.53760	1.53760	1.6234	1.6234	
			1.6123	1.6249	1.50855	1.6041	1.6249	1.53735	1.53735	1.6249	1.6249	
		1A	1.6145	1.6259	1.51190	1.6076	1.6259	1.54050	1.54050	1.6259	1.6259	
1 1/8 20	NEF	3A	1.6139	1.6256	1.51115	1.6070	1.6256	1.54075	1.54025	1.6256	1.6256	
			1A	1.6138	1.6235	1.50874	1.6065	1.6235	1.53824	1.53824	1.6235	1.6235
		1A	1.6133	1.6249	1.50872	1.6060	1.6249	1.53826	1.53822	1.6249	1.6249	
1 1/16 16	N	3A	1.6153	1.6259	1.51189	1.6083	1.6259	1.54054	1.54059	1.6259	1.6259	
			1.6148	1.6255	1.50887	1.6068	1.6255	1.53854	1.53859	1.6255	1.6255	
		1A	1.6254	1.6059	1.61230	1.6071	1.6059	1.61090	1.61090	1.6059	1.6059	
1 1/16 18	NEF	3A	1.6748	1.6865	1.61795	1.6655	1.6865	1.6025	1.6025	1.6865	1.6865	
			1.6779	1.6875	1.61990	1.6709	1.6875	1.61290	1.61290	1.6875	1.6875	
		1A	1.6764	1.6881	1.61995	1.6704	1.6881	1.61315	1.61295	1.6881	1.6881	
1 1/16 20	NEF	3A	1.6763	1.6860	1.6199	1.6689	1.6860	1.6148	1.6148	1.6860	1.6860	
			1.6758	1.6865	1.6197	1.6684	1.6865	1.6149	1.6149	1.6865	1.6865	
		1A	1.6778	1.6875	1.6214	1.6717	1.6875	1.6176	1.6176	1.6875	1.6875	
1 1/8 5	UNC	3A	1.6880	1.6880	1.6312	1.6712	1.6880	1.6178	1.6178	1.6880	1.6880	
			1A	1.7234	1.7173	1.61740	1.6906	1.7173	1.69400	1.69400	1.7173	1.7173
		2A	1.7226	1.7181	1.61715	1.6898	1.7181	1.69425	1.69375	1.7181	1.7181	
1 1/8 6	UNC	3A	1.7241	1.7175	1.61740	1.6921	1.7175	1.69870	1.69850	1.7175	1.7175	
			1A	1.7226	1.7181	1.61715	1.6913	1.7181	1.69855	1.69825	1.7181	1.7181
		2A	1.7294	1.7290	1.62040	1.7000	1.7290	1.64440	1.64340	1.7290	1.7290	
1A	1.7252	1.7208	1.61985	1.6992	1.7208	1.64365	1.64315	1.7208	1.7208			

See footnotes at end of table.

TABLE III.13.—Setting plug gages, Unified and American screw threads—Continued

Nominal size and threads per inch	Series designation	Class	W truncated setting plugs								Basic-crest setting plugs	
			Plug for "Go"				Plug for "Not go"				Major diameter	
			Major diameter		Pitch diameter	Major diameter		Pitch diameter		Go ¹	Not go ²	
			Truncated	Full		Truncated	Full	Plus tolerance gage	Minus tolerance gage			W and X tolerances
1	2	3	4	5	6	7	8	9	10	11	12	
			in.	in.	in.	in.	in.	in.	in.	in.	in.	in.
1/4-8	N	2A	1.7306	1.7477	1.69650	1.7131	1.7477	1.65900	1.65900	1.7477	1.7477	
		3A	1.7219	1.7481	1.69625	1.7124	1.7481	1.65925	1.65875	1.7481	1.7481	
1/4-12	UN	2A	1.7353	1.7482	1.69410	1.7242	1.7482	1.68810	1.68810	1.7482	1.7482	
		3A	1.7371	1.7500	1.69385	1.7256	1.7500	1.68835	1.68785	1.7500	1.7500	
1/2-16	UNEF	2A	1.7379	1.7484	1.70780	1.7296	1.7484	1.70250	1.70250	1.7484	1.7484	
		3A	1.7395	1.7506	1.70755	1.7290	1.7506	1.70275	1.70225	1.7506	1.7506	
1 1/4-16	N	2A	1.8004	1.8109	1.77930	1.7921	1.8109	1.76500	1.76500	1.8109	1.8109	
		3A	1.7998	1.8115	1.77905	1.7915	1.8115	1.76525	1.76475	1.8115	1.8115	
1/2-8	N	2A	1.8556	1.8727	1.79150	1.8379	1.8727	1.78380	1.78380	1.8727	1.8727	
		3A	1.8549	1.8734	1.79125	1.8372	1.8734	1.78405	1.78355	1.8734	1.8734	
1/2-12	UN	2A	1.8603	1.8732	1.81910	1.8492	1.8732	1.81310	1.81310	1.8732	1.8732	
		3A	1.8597	1.8738	1.81885	1.8485	1.8738	1.81335	1.81285	1.8738	1.8738	
1/2-16	UN	2A	1.8629	1.8734	1.83280	1.8546	1.8734	1.82750	1.82750	1.8734	1.8734	
		3A	1.8645	1.8750	1.83440	1.8575	1.8750	1.83040	1.83040	1.8750	1.8750	
1 1/4-16	N	2A	1.9254	1.9358	1.89630	1.9170	1.9358	1.88090	1.88090	1.9358	1.9358	
		3A	1.9248	1.9375	1.89605	1.9164	1.9375	1.88115	1.88065	1.9375	1.9375	
2-4 1/2	UNC	1A	1.9713	1.9971	1.85280	1.9347	1.9971	1.83850	1.83850	1.9971	1.9971	
		2A	1.9705	1.9979	1.85255	1.9339	1.9979	1.83825	1.83825	1.9979	1.9979	
		3A	1.9713	1.9971	1.85280	1.9347	1.9971	1.83850	1.83850	1.9971	1.9971	
		2A	1.9705	1.9979	1.85255	1.9339	1.9979	1.83825	1.83825	1.9979	1.9979	
2-8	N	2A	1.9896	1.9977	1.91650	1.9628	1.9977	1.90870	1.90870	1.9977	1.9977	
		3A	1.9829	2.0090	1.91880	1.9671	2.0090	1.91300	1.91300	2.0090	2.0090	
2-12	UN	2A	1.9853	1.9982	1.94410	1.9741	1.9982	1.93800	1.93800	1.9982	1.9982	
		3A	1.9847	2.0090	1.94295	1.9735	2.0090	1.93825	1.93775	2.0090	2.0090	
2-16	UNEF	2A	1.9879	1.9984	1.95790	1.9795	1.9984	1.95240	1.95240	1.9984	1.9984	
		3A	1.9873	2.0090	1.95675	1.9780	2.0090	1.95265	1.95215	2.0090	2.0090	
2 1/4-16	N	2A	2.0504	2.0699	2.02030	2.0420	2.0699	2.01450	2.01450	2.0699	2.0699	
		3A	2.0498	2.0625	2.02100	2.0411	2.0625	2.01515	2.01515	2.0625	2.0625	
2 1/2-8	N	2A	2.1055	2.1226	2.04130	2.0876	2.1226	2.03350	2.03350	2.1226	2.1226	
		3A	2.1048	2.1231	2.04115	2.0869	2.1231	2.03375	2.03325	2.1231	2.1231	
2 1/2-12	UN	2A	2.1103	2.1232	2.06910	2.0991	2.1232	2.06300	2.06300	2.1232	2.1232	
		3A	2.1121	2.1250	2.07000	2.1025	2.1250	2.06325	2.06275	2.1250	2.1250	
2 3/4-16	UN	2A	2.1129	2.1234	2.08280	2.1045	2.1234	2.07730	2.07730	2.1234	2.1234	
		3A	2.1123	2.1250	2.08255	2.1039	2.1250	2.07755	2.07705	2.1250	2.1250	
2 3/4-16	N	2A	2.1754	2.1879	2.14530	2.1670	2.1879	2.13950	2.13950	2.1879	2.1879	
		3A	2.1748	2.1885	2.14505	2.1663	2.1885	2.14015	2.13965	2.1885	2.1885	

See footnotes at end of table.

TABLE III.13.—Setting plug gages, Unified and American screw threads—Continued

Nominal size and threads per inch	Series designation	Class	W truncated setting plugs								Basic-crest setting plugs	
			Plug for "Go"			Plug for "Not go"					Major diameter	
			Major diameter		Pitch diameter	Major diameter		Pitch diameter			Go ¹	Not go ¹
			Truncated	Full		Truncated	Full	Plus tolerance gage	Minus tolerance gage	W and X tolerances		
1	2	3	4	5	6	7	8	9	10	11	12	
2 1/4-4 1/2	UNC	1A	in. 2.2213	in. 2.2471	in. 2.10280	in. 2.1844	in. 2.2471	in. 2.08520	in. 2.09420	in. 2.2471	in. 2.2471	
		2A	2.2205	2.2479	2.10255	2.1836	2.2470	2.08448	2.08795	2.2470	2.2479	
		3A	2.2213	2.2471	2.10280	2.1893	2.2471	2.08310	2.08310	2.2471	2.2471	
	N	2A	2.2205	2.2479	2.10255	2.1885	2.2479	2.08335	2.09285	2.2479	2.2479	
		3A	2.2242	2.2500	2.10570	2.1946	2.2500	2.08840	2.09840	2.2500	2.2500	
			2.2234	2.2508	2.10545	2.1938	2.2508	2.09605	2.09815	2.2508	2.2508	
	2 1/4-8	N	2A	2.2305	2.2476	2.16040	2.2125	2.2476	2.15840	2.15840	2.2476	2.2476
			3A	2.2298	2.2483	2.16615	2.2118	2.2483	2.15865	2.15815	2.2483	2.2483
				2.2323	2.2500	2.16990	2.2169	2.2500	2.16280	2.16290	2.2500	2.2500
2 1/4-12	UN	2A	2.2353	2.2482	2.19410	2.2241	2.2482	2.18900	2.18900	2.2482	2.2482	
		3A	2.2347	2.2488	2.19365	2.2235	2.2485	2.18925	2.18775	2.2488	2.2488	
			2.2371	2.2500	2.19590	2.2275	2.2500	2.19140	2.19140	2.2500	2.2500	
2 1/4-16	UN	2A	2.2379	2.2484	2.20780	2.2295	2.2484	2.20240	2.20240	2.2484	2.2484	
		3A	2.2373	2.2490	2.20755	2.2289	2.2490	2.20265	2.20215	2.2490	2.2490	
			2.2395	2.2500	2.20940	2.2325	2.2500	2.20530	2.20530	2.2500	2.2500	
2 1/4-16	N	2A	2.2399	2.2506	2.20915	2.2319	2.2506	2.20555	2.20505	2.2506	2.2506	
		3A	2.2303	2.2408	2.20720	2.2218	2.2408	2.20470	2.20470	2.2408	2.2408	
			2.2297	2.2414	2.20995	2.2312	2.2414	2.20495	2.20445	2.2414	2.2414	
2 1/2-4	UNC	1A	in. 2.3002	in. 2.3731	in. 2.31900	in. 2.3489	in. 2.3731	in. 2.31260	in. 2.31280	in. 2.3731	in. 2.3731	
		2A	2.3006	2.3737	2.31876	2.3483	2.3737	2.31306	2.31255	2.3737	2.3737	
		3A	2.3021	2.3760	2.32060	2.3524	2.3760	2.31630	2.31630	2.3760	2.3760	
2 1/2-8	N	2A	2.3014	2.3131	2.27165	2.2943	2.3131	2.26905	2.26755	2.3131	2.3131	
		3A	2.3002	2.3731	2.31900	2.3489	2.3731	2.31260	2.31280	2.3731	2.3731	
			2.3096	2.3737	2.31876	2.3483	2.3737	2.31306	2.31255	2.3737	2.3737	
2 1/2-12	UN	2A	2.3021	2.3760	2.32060	2.3524	2.3760	2.31630	2.31630	2.3760	2.3760	
		3A	2.3015	2.3756	2.32035	2.3518	2.3756	2.31655	2.31605	2.3756	2.3756	
			2.3028	2.3733	2.32270	2.3543	2.3733	2.32270	2.32270	2.3733	2.3733	
2 1/2-16	UN	2A	2.3022	2.3739	2.33245	2.3537	2.3739	2.32695	2.32695	2.3739	2.3739	
		3A	2.3045	2.3750	2.33440	2.3574	2.3750	2.33030	2.33030	2.3750	2.3750	
			2.3039	2.3756	2.33415	2.3568	2.3756	2.33055	2.33005	2.3756	2.3756	
2 1/2-16	N	2A	2.4253	2.4358	2.39520	2.4168	2.4358	2.38970	2.38970	2.4358	2.4358	
		3A	2.4247	2.4364	2.39495	2.4182	2.4364	2.38995	2.38945	2.4364	2.4364	
			2.4270	2.4375	2.39890	2.4199	2.4375	2.39290	2.39290	2.4375	2.4375	
2 3/4-4	UNC	1A	in. 2.4688	in. 2.4969	in. 2.35470	in. 2.4272	in. 2.4969	in. 2.31900	in. 2.31900	in. 2.4969	in. 2.4969	
		2A	2.4679	2.4978	2.35425	2.4283	2.4978	2.31925	2.31875	2.4978	2.4978	
		3A	2.4694	2.4969	2.35450	2.4324	2.4969	2.32410	2.32410	2.4969	2.4969	
2 3/4-8	N	2A	2.4679	2.4978	2.35425	2.4315	2.4978	2.32435	2.32385	2.4978	2.4978	
		3A	2.4719	2.5000	2.35760	2.4390	2.5000	2.32990	2.32990	2.5000	2.5000	
			2.4710	2.5000	2.35735	2.4371	2.5000	2.33005	2.32955	2.5000	2.5000	
2 3/4-12	UN	2A	2.4805	2.4976	2.41940	2.4523	2.4976	2.40820	2.40820	2.4976	2.4976	
		3A	2.4799	2.4983	2.41615	2.4516	2.4983	2.40846	2.40795	2.4983	2.4983	
			2.4829	2.5000	2.41890	2.4548	2.5000	2.41270	2.41270	2.5000	2.5000	
2 3/4-16	UN	2A	2.4822	2.5007	2.41855	2.4561	2.5007	2.41295	2.41245	2.5007	2.5007	
		3A	2.4852	2.4981	2.44400	2.4739	2.4981	2.43780	2.43780	2.4981	2.4981	
			2.4846	2.4987	2.44375	2.4733	2.4987	2.43805	2.43755	2.4987	2.4987	
2 3/4-16	N	2A	2.4871	2.5000	2.44500	2.4774	2.5000	2.44130	2.44130	2.5000	2.5000	
		3A	2.4855	2.5006	2.44565	2.4768	2.5006	2.44155	2.44105	2.5006	2.5006	
			2.4878	2.4983	2.45770	2.4793	2.4983	2.45220	2.45220	2.4983	2.4983	
2 3/4-16	UN	2A	2.4872	2.4989	2.45745	2.4787	2.4989	2.45245	2.45195	2.4989	2.4989	
		3A	2.4886	2.5000	2.45940	2.4824	2.5000	2.45530	2.45530	2.5000	2.5000	
			2.4889	2.5006	2.45915	2.4818	2.5006	2.45555	2.45505	2.5006	2.5006	
2 5/8-12	UN	2A	2.6102	2.6251	2.57900	2.5989	2.6251	2.56280	2.56280	2.6251	2.6251	
		3A	2.6096	2.6257	2.59875	2.6083	2.6257	2.56305	2.56255	2.6257	2.6257	
			2.6121	2.6250	2.57990	2.6024	2.6250	2.56630	2.56630	2.6250	2.6250	
2 5/8-16	UN	2A	2.6115	2.6256	2.57965	2.6018	2.6250	2.56655	2.56605	2.6256	2.6256	
		3A	2.6128	2.6253	2.58270	2.6043	2.6253	2.57720	2.57720	2.6253	2.6253	
			2.6122	2.6259	2.58245	2.6037	2.6259	2.57745	2.57695	2.6259	2.6259	
2 5/8-16	N	2A	2.6145	2.6250	2.58440	2.6074	2.6250	2.58030	2.58030	2.6250	2.6250	
		3A	2.6139	2.6256	2.58415	2.6068	2.6256	2.58055	2.58005	2.6256	2.6256	
			2.7187	2.7408	2.68440	2.6795	2.7408	2.68960	2.68960	2.7408	2.7408	
2 7/8-4	UNC	1A	in. 2.7187	in. 2.7477	in. 2.58440	in. 2.6759	in. 2.7477	in. 2.68960	in. 2.68960	in. 2.7477	in. 2.7477	
		2A	2.7187	2.7468	2.58440	2.6822	2.7468	2.67380	2.67380	2.7468	2.7468	
		3A	2.7175	2.7477	2.58415	2.6813	2.7477	2.67415	2.67365	2.7477	2.7477	
2 7/8-8	N	2A	2.7219	2.7500	2.68760	2.6980	2.7500	2.68960	2.68960	2.7500	2.7500	
		3A	2.7210	2.7509	2.68735	2.6971	2.7509	2.67995	2.67945	2.7509	2.7509	
			2.7210	2.7509	2.68735	2.6971	2.7509	2.67995	2.67945	2.7509	2.7509	

See footnotes at end of table.

TABLE III.13.—Setting plug gages, Unified and American screw threads—Continued

Nominal size and threads per inch	Series designation	Class	W truncated setting plugs								Basic-crest setting plugs	
			Plug for "Go"				Plug for "Not go"				Major diameter	
			Major diameter		Pitch diameter	Major diameter		Pitch diameter		Go ¹	Not go ¹	
			Truncated	Full		Truncated	Full	Plus tolerance gage	Minus tolerance gage			W and X tolerances
1	2	3	4	5	6	7	8	9	10	11	12	
2 3/4-8	N	2A	in.	in.	in.	in.	in.	in.	in.	in.	in.	in.
			2.7304	2.7475	2.66630	2.7121	2.7475	2.65800	2.65800	2.7475	2.7475	
		2.7297	2.7482	2.66605	2.7114	2.7482	2.65825	2.65775	2.7482	2.7482		
		2.7329	2.7500	2.66880	2.7107	2.7500	2.66200	2.66200	2.7500	2.7500		
		2.7322	2.7507	2.66855	2.7100	2.7507	2.66285	2.66235	2.7507	2.7507		
		2.7352	2.7481	2.66400	2.7239	2.7481	2.66780	2.66780	2.7481	2.7481		
2 3/4-12	UN	2A	2.7346	2.4787	2.69375	2.7233	2.7487	2.68805	2.68755	2.7487	2.7487	
			2.7371	2.7500	2.69500	2.7274	2.7500	2.69130	2.69130	2.7500	2.7500	
		2.7365	2.7506	2.69565	2.7288	2.7506	2.69155	2.69105	2.7506	2.7506		
		2.7378	2.7443	2.70770	2.7293	2.7443	2.70220	2.70220	2.7443	2.7443		
		2.7372	2.7489	2.70745	2.7287	2.7489	2.70245	2.70195	2.7489	2.7489		
		2.7395	2.7500	2.70940	2.7324	2.7500	2.70530	2.70530	2.7500	2.7500		
2 3/4-16	UN	2A	2.7389	2.7506	2.70915	2.7318	2.7506	2.70555	2.70555	2.7506	2.7506	
			2.7402	2.7731	2.81900	2.8488	2.7731	2.81270	2.81270	2.8731	2.8731	
		2.8506	2.8737	2.81875	2.8482	2.8737	2.81295	2.81245	2.8737	2.8737		
		2.8621	2.8750	2.82050	2.8523	2.8750	2.81520	2.81520	2.8750	2.8750		
		2.8615	2.8750	2.82065	2.8517	2.8750	2.81545	2.81595	2.8750	2.8750		
		2.8628	2.8733	2.83270	2.8542	2.8733	2.82710	2.82710	2.8733	2.8733		
2 3/4-16	UN	2A	2.8622	2.8739	2.83245	2.8536	2.8739	2.82735	2.82735	2.8739	2.8739	
			2.8645	2.8750	2.83410	2.8573	2.8750	2.83020	2.83020	2.8750	2.8750	
		2.8639	2.8750	2.83415	2.8567	2.8750	2.83045	2.83095	2.8750	2.8750		
		2.9087	2.9098	2.83440	2.9295	2.9098	2.81830	2.81830	2.9098	2.9098		
		2.9078	2.9177	2.83415	2.9257	2.9195	2.81855	2.81805	2.9077	2.9077		
		2.9097	2.9200	2.83440	2.9320	2.9098	2.82370	2.82370	2.9098	2.9098		
3-4	UNC	2A	2.9678	2.9677	2.83415	2.9311	2.9677	2.82395	2.82395	2.9677	2.9677	
			2.9678	3.0000	2.83760	2.9378	3.0000	2.82980	2.82980	3.0000	3.0000	
		2.9719	3.0000	2.83735	2.9369	3.0000	2.82955	2.82955	3.0000	3.0000		
		2.9710	2.9974	2.91520	2.9518	2.9974	2.90770	2.90770	2.9974	2.9974		
		2.9803	2.9981	2.91595	2.9611	2.9981	2.90795	2.90745	2.9981	2.9981		
		2.9796	3.0000	2.91880	2.9658	3.0000	2.91240	2.91240	3.0000	3.0000		
3-8	N	2A	2.9822	3.0007	2.91855	2.9658	3.0007	2.91265	2.91265	3.0007	3.0007	
			2.9852	2.9981	2.94400	2.9738	2.9981	2.93770	2.93770	2.9981	2.9981	
		2.9846	2.9987	2.94375	2.9732	2.9987	2.93745	2.93745	2.9987	2.9987		
		2.9871	3.0000	2.94580	2.9773	3.0000	2.94120	2.94120	3.0000	3.0000		
		2.9865	3.0006	2.94565	2.9767	3.0006	2.94146	2.94096	3.0006	3.0006		
		2.9878	2.9883	2.95770	2.9792	2.9883	2.95210	2.95210	2.9883	2.9883		
3-10	UN	2A	2.9872	2.9899	2.95745	2.9789	2.9899	2.95235	2.95235	2.9899	2.9899	
			2.9895	3.0000	2.95940	2.9823	3.0000	2.95520	2.95520	3.0000	3.0000	
		2.9889	3.0006	2.95915	2.9817	3.0006	2.95495	2.95495	3.0006	3.0006		
		3.1102	3.1231	3.06900	3.0988	3.1231	3.06270	3.06270	3.1231	3.1231		
		3.1086	3.1237	3.06875	3.0982	3.1237	3.06205	3.06205	3.1237	3.1237		
		3.1121	3.1250	3.07090	3.1023	3.1250	3.06520	3.06520	3.1250	3.1250		
3 1/4-12	UN	2A	3.1115	3.1256	3.07065	3.1017	3.1256	3.06595	3.06595	3.1256	3.1256	
			3.1128	3.1233	3.09270	3.1042	3.1233	3.07710	3.07710	3.1233	3.1233	
		3.1122	3.1239	3.09245	3.1036	3.1239	3.07735	3.07735	3.1239	3.1239		
		3.1145	3.1250	3.09440	3.1073	3.1250	3.08020	3.08020	3.1250	3.1250		
		3.1139	3.1256	3.09415	3.1067	3.1256	3.08045	3.07995	3.1256	3.1256		
		3.2180	3.2467	3.08430	3.1762	3.2467	3.06800	3.06800	3.2467	3.2467		
3 3/4-4	UNC	1A	3.2177	3.2476	3.08405	3.1763	3.2476	3.06825	3.06775	3.2476	3.2476	
			3.2186	3.2467	3.08430	3.1816	3.2467	3.07340	3.07340	3.2467	3.2467	
		3.2177	3.2476	3.08405	3.1807	3.2476	3.07315	3.07315	3.2476	3.2476		
		3.2210	3.2500	3.08780	3.1876	3.2500	3.07940	3.07940	3.2500	3.2500		
		3.2210	3.2500	3.08735	3.1867	3.2500	3.07865	3.07815	3.2500	3.2500		
		3.2403	3.2474	3.19520	3.2116	3.2474	3.15750	3.15750	3.2474	3.2474		
3 3/4-8	N	2A	3.2206	3.2381	3.19505	3.2109	3.2481	3.15775	3.15725	3.2481	3.2481	
			3.2320	3.2500	3.19890	3.2164	3.2500	3.16230	3.16230	3.2500	3.2500	
		3.2322	3.2507	3.19865	3.2157	3.2507	3.16255	3.16205	3.2507	3.2507		
		3.2352	3.2481	3.19400	3.2238	3.2481	3.18770	3.18770	3.2481	3.2481		
		3.2346	3.2487	3.19375	3.2232	3.2487	3.18745	3.18745	3.2487	3.2487		
		3.2371	3.2500	3.19580	3.2273	3.2500	3.19120	3.19120	3.2500	3.2500		
3 3/4-12	UN	2A	3.2365	3.2506	3.19665	3.2287	3.2506	3.19145	3.19095	3.2506	3.2506	
			3.2378	3.2483	3.20770	3.2292	3.2483	3.20210	3.20210	3.2483	3.2483	
		3.2372	3.2489	3.20745	3.2286	3.2489	3.20235	3.20185	3.2489	3.2489		
		3.2395	3.2500	3.20940	3.2324	3.2500	3.20520	3.20520	3.2500	3.2500		
		3.2389	3.2506	3.20915	3.2317	3.2506	3.20546	3.20496	3.2506	3.2506		
		3.3092	3.3151	3.31000	3.3181	3.3151	3.31290	3.31290	3.3151	3.3151		
3 3/4-16	UN	2A	3.3096	3.3177	3.31875	3.3187	3.3151	3.31235	3.31235	3.3177	3.3177	
			3.3021	3.3179	3.32000	3.3152	3.3179	3.31610	3.31610	3.3179	3.3179	
		3.3015	3.3176	3.32065	3.3146	3.3176	3.31636	3.31636	3.3176	3.3176		

See footnote at end of table.

TABLE III.13.—Setting plug gages, Unified and American screw threads --Continued

Nominal size and threads per inch	Series designation	Class	W truncated setting plugs							Basic-crest setting plugs	
			Plug for "Go"			Plug for "Not go"				Major diameter	
			Major diameter		Pitch diameter	Major diameter		Pitch diameter		Go ¹	Not go ²
			Truncated	Full		Truncated	Full	Plus tolerance gage	Minus tolerance gage		
1	2	3	4	5	6	7	8	9	10	11	12
3/8-16	UN	2A	<i>in.</i> 3.3628 3.3622	<i>in.</i> 3.3733 3.3739	<i>in.</i> 3.38270 3.38245	<i>in.</i> 3.3540 3.3534	<i>in.</i> 3.3733 3.3739	<i>in.</i> 3.32690 3.32715	<i>in.</i> 3.32690 3.32665	<i>in.</i> 3.3733 3.3739	<i>in.</i> 3.3733 3.3739
		3A	3.3615 3.3639	3.3750 3.3756	3.38140 3.38115	3.3572 3.3566	3.3750 3.3756	3.33010 3.33035	3.33010 3.32985	3.3750 3.3756	3.3750 3.3756
		1A	3.4686 3.4677	3.4967 3.4976	3.48330 3.48305	3.4260 3.4251	3.4967 3.4976	3.31770 3.31795	3.31770 3.31745	3.4967 3.4976	3.4967 3.4976
3/8-18	UNC	2A	3.4686 3.4677	3.4967 3.4976	3.48330 3.48305	3.4316 3.4307	3.4967 3.4976	3.32330 3.32355	3.32330 3.32305	3.4967 3.4976	3.4967 3.4976
		3A	3.4719 3.4710	3.5000 3.5009	3.48760 3.48735	3.4376 3.4367	3.5000 3.5009	3.32630 3.32655	3.32630 3.32605	3.5000 3.5009	3.5000 3.5009
		2A	3.4803 3.4796	3.4974 3.4981	3.41620 3.41595	3.4615 3.4608	3.4974 3.4981	3.40740 3.40765	3.40740 3.40715	3.4974 3.4981	3.4974 3.4981
3/8-24	N	3A	3.4829 3.4822	3.5000 3.5007	3.41880 3.41855	3.4663 3.4656	3.5000 3.5007	3.41220 3.41245	3.41220 3.41195	3.5000 3.5007	3.5000 3.5007
		2A	3.4852 3.4846	3.4981 3.4987	3.41400 3.41375	3.4737 3.4731	3.4981 3.4987	3.43760 3.43785	3.43760 3.43735	3.4981 3.4987	3.4981 3.4987
		3A	3.4871 3.4865	3.5000 3.5006	3.41590 3.41565	3.4772 3.4766	3.5000 3.5006	3.41110 3.41135	3.41110 3.41085	3.5000 3.5006	3.5000 3.5006
3/8-32	UN	2A	3.4878 3.4872	3.4983 3.4989	3.45770 3.45745	3.4790 3.4781	3.4983 3.4989	3.45190 3.45215	3.45190 3.45165	3.4983 3.4989	3.4983 3.4989
		3A	3.4905 3.4899	3.5000 3.5006	3.45910 3.45915	3.4822 3.4816	3.5000 3.5006	3.45510 3.45535	3.45510 3.45485	3.5000 3.5006	3.5000 3.5006
		2A	3.6162 3.6099	3.6231 3.6237	3.59990 3.59875	3.5687 3.5681	3.6231 3.6237	3.56260 3.56285	3.56260 3.56235	3.6231 3.6237	3.6231 3.6237
3/8-40	UN	3A	3.6121 3.6115	3.6250 3.6256	3.57090 3.57065	3.6022 3.6016	3.6250 3.6256	3.56610 3.56635	3.56610 3.56585	3.6250 3.6256	3.6250 3.6256
		2A	3.6129 3.6122	3.6233 3.6239	3.58270 3.58245	3.6040 3.6034	3.6233 3.6239	3.57690 3.57715	3.57690 3.57665	3.6233 3.6239	3.6233 3.6239
		3A	3.6145 3.6139	3.6250 3.6256	3.58110 3.58115	3.6052 3.6046	3.6250 3.6256	3.58010 3.58035	3.58010 3.57985	3.6250 3.6256	3.6250 3.6256
3/8-48	UNC	1A	3.7185 3.7176	3.7196 3.7175	3.58120 3.58095	3.6759 3.6747	3.7196 3.7175	3.59740 3.59765	3.59740 3.59715	3.7196 3.7175	3.7196 3.7175
		2A	3.7185 3.7176	3.7196 3.7175	3.58120 3.58095	3.6812 3.6805	3.7196 3.7175	3.57390 3.57365	3.57390 3.57365	3.7196 3.7175	3.7196 3.7175
		3A	3.7219 3.7210	3.7500 3.7500	3.58740 3.58735	3.6874 3.6865	3.7500 3.7500	3.57920 3.57945	3.57920 3.57895	3.7500 3.7500	3.7500 3.7500
3/8-56	N	2A	3.7392 3.7395	3.7473 3.7480	3.69010 3.69085	3.7112 3.7105	3.7473 3.7480	3.65710 3.65735	3.65710 3.65685	3.7473 3.7480	3.7473 3.7480
		3A	3.7329 3.7322	3.7500 3.7507	3.68890 3.68965	3.7162 3.7155	3.7500 3.7507	3.66210 3.66235	3.66210 3.66185	3.7500 3.7507	3.7500 3.7507
		2A	3.7352 3.7346	3.7481 3.7487	3.69400 3.69375	3.7237 3.7231	3.7481 3.7487	3.68760 3.68785	3.68760 3.68735	3.7481 3.7487	3.7481 3.7487
3/8-64	UN	3A	3.7371 3.7365	3.7500 3.7506	3.69590 3.69565	3.7272 3.7266	3.7500 3.7506	3.69110 3.69135	3.69110 3.69085	3.7500 3.7506	3.7500 3.7506
		2A	3.7378 3.7372	3.7483 3.7489	3.70770 3.70745	3.7290 3.7281	3.7483 3.7489	3.70190 3.70215	3.70190 3.70165	3.7483 3.7489	3.7483 3.7489
		3A	3.7345 3.7339	3.7500 3.7506	3.70950 3.70915	3.7322 3.7316	3.7500 3.7506	3.70510 3.70535	3.70510 3.70485	3.7500 3.7506	3.7500 3.7506
3/8-80	UNC	2A	3.8601 3.8595	3.8739 3.8736	3.81960 3.81965	3.8485 3.8479	3.8739 3.8750	3.81210 3.81215	3.81210 3.81215	3.8739 3.8750	3.8739 3.8750
		3A	3.8621 3.8615	3.8750 3.8756	3.82090 3.82065	3.8521 3.8515	3.8750 3.8756	3.81690 3.81695	3.81690 3.81675	3.8750 3.8756	3.8750 3.8756
		2A	3.8627 3.8621	3.8732 3.8738	3.83200 3.83245	3.8538 3.8532	3.8732 3.8738	3.82670 3.82695	3.82670 3.82645	3.8732 3.8738	3.8732 3.8738
3/8-96	UN	3A	3.8615 3.8609	3.8750 3.8756	3.83140 3.83115	3.8571 3.8565	3.8750 3.8756	3.83090 3.83125	3.83090 3.82975	3.8750 3.8756	3.8750 3.8756
		1A	3.9685 3.9676	3.9969 3.9975	3.93120 3.93095	3.9254 3.9245	3.9969 3.9975	3.91720 3.91745	3.91720 3.91695	3.9969 3.9975	3.9969 3.9975
		2A	3.9685 3.9676	3.9969 3.9975	3.93120 3.93095	3.9312 3.9303	3.9969 3.9975	3.92290 3.92315	3.92290 3.92265	3.9969 3.9975	3.9969 3.9975
4-4	UNC	3A	3.9719 3.9710	4.0000 4.0009	3.93700 3.93735	3.9571 3.9565	4.0000 4.0009	3.92910 3.92935	3.92910 3.92885	4.0000 4.0009	4.0000 4.0009
		2A	3.9692 3.9705	3.9973 3.9980	3.91610 3.91585	3.9511 3.9504	3.9973 3.9980	3.96790 3.96765	3.96790 3.96765	3.9973 3.9980	3.9973 3.9980
		3A	3.9829 3.9822	4.0000 4.0007	3.91890 3.91855	3.9651 3.9654	4.0000 4.0007	3.91290 3.91225	3.91290 3.91175	4.0000 4.0007	4.0000 4.0007
4-8	N	2A	3.9851 3.9845	3.9980 3.9986	3.91300 3.91305	3.9235 3.9229	3.9980 3.9986	3.93740 3.93765	3.93740 3.93715	3.9980 3.9986	3.9980 3.9986
		3A	3.9871 3.9865	4.0000 4.0006	3.91590 3.91565	3.9571 3.9565	4.0000 4.0006	3.91100 3.91125	3.91100 3.91075	4.0000 4.0006	4.0000 4.0006
		2A	3.9851 3.9845	3.9980 3.9986	3.91300 3.91305	3.9235 3.9229	3.9980 3.9986	3.93740 3.93765	3.93740 3.93715	3.9980 3.9986	3.9980 3.9986

See footnotes at end of table.

TABLE III.13.—Setting plug gages, Unified and American screw threads—Continued

Nominal size and threads per inch	Series designation	Class	W truncated setting plugs							Best-crest setting plugs	
			Plug for "Go"			Plug for "Not go"				Major diameter	
			Major diameter		Pitch diameter	Major diameter		Pitch diameter		Go ¹	Not go ²
			Truncated	Full		Truncated	Full	Plus tolerance gage	Minus tolerance gage		
1	2	3	4	5	6	7	8	9	10	11	12
4-16	UN	2A	<i>in.</i> 3.9877 3.9871 3.9895 3.9889	<i>in.</i> 3.9982 3.9988 4.0000 4.0006	<i>in.</i> 3.95760 3.95735 3.95910 3.95915	<i>in.</i> 3.9788 3.9789 3.9821 3.9815	<i>in.</i> 3.9982 3.9988 4.0000 4.0006	<i>in.</i> 3.95170 3.95195 3.95500 3.95525	<i>in.</i> 3.95170 3.95145 3.95500 3.95475	<i>in.</i> 3.9982 3.9988 4.0000 4.0006	<i>in.</i> 3.9982 3.9988 4.0000 4.0006
		3A	4.2301 4.2200 4.2329 4.2318	4.2472 4.2483 4.2500 4.2511	4.1690 4.1657 4.1688 4.1685	4.2168 4.2167 4.2159 4.2148	4.2172 4.2183 4.2500 4.2511	4.1567 4.1570 4.1618 4.1621	4.1567 4.1564 4.1618 4.1615	4.2472 4.2483 4.2500 4.2511	4.2472 4.2483 4.2500 4.2511
		2A	4.2351 4.2312 4.2371 4.2362	4.2480 4.2480 4.2500 4.2509	4.1939 4.1936 4.1959 4.1956	4.2235 4.2226 4.2271 4.2262	4.2180 4.2189 4.2500 4.2509	4.1873 4.1877 4.1910 4.1913	4.1874 4.1871 4.1910 4.1907	4.2480 4.2489 4.2500 4.2509	4.2480 4.2489 4.2500 4.2509
4 1/4-8	N	2A	4.2377 4.2368 4.2395 4.2386	4.2482 4.2491 4.2500 4.2509	4.2076 4.2073 4.2091 4.2091	4.2288 4.2279 4.2321 4.2312	4.2182 4.2191 4.2500 4.2509	4.2017 4.2020 4.2050 4.2053	4.2017 4.2014 4.2050 4.2047	4.2482 4.2491 4.2500 4.2509	4.2482 4.2491 4.2500 4.2509
		3A	4.4801 4.4790 4.4829 4.4818	4.4972 4.4983 4.5000 4.5011	4.4160 4.4157 4.4188 4.4185	4.4907 4.4906 4.4958 4.4947	4.4972 4.4983 4.5000 4.5011	4.4066 4.4069 4.4117 4.4120	4.4066 4.4063 4.4117 4.4114	4.4972 4.4983 4.5000 4.5011	4.4972 4.4983 4.5000 4.5011
		2A	4.4851 4.4842 4.4871 4.4862	4.4980 4.4989 4.5000 4.5009	4.4430 4.4436 4.4459 4.4456	4.4735 4.4726 4.4771 4.4762	4.4980 4.4989 4.5000 4.5009	4.4374 4.4377 4.4410 4.4407	4.4374 4.4371 4.4410 4.4407	4.4980 4.4989 4.5000 4.5009	4.4980 4.4989 4.5000 4.5009
4 1/2-8	N	2A	4.4877 4.4868 4.4895 4.4886	4.4982 4.4991 4.5000 4.5009	4.4576 4.4573 4.4591 4.4591	4.4788 4.4779 4.4821 4.4812	4.4982 4.4991 4.5000 4.5009	4.4517 4.4520 4.4550 4.4553	4.4517 4.4514 4.4550 4.4547	4.4982 4.4991 4.5000 4.5009	4.4982 4.4991 4.5000 4.5009
		3A	4.7300 4.7289 4.7329 4.7318	4.7471 4.7482 4.7500 4.7511	4.6659 4.6656 4.6688 4.6685	4.7105 4.7101 4.7157 4.7146	4.7371 4.7382 4.7500 4.7511	4.6561 4.6567 4.6616 4.6619	4.6561 4.6564 4.6616 4.6613	4.7471 4.7482 4.7500 4.7511	4.7471 4.7482 4.7500 4.7511
		2A	4.7351 4.7342 4.7371 4.7362	4.7480 4.7489 4.7500 4.7509	4.6939 4.6936 4.6959 4.6956	4.7233 4.7224 4.7270 4.7261	4.7480 4.7489 4.7500 4.7509	4.6872 4.6875 4.6909 4.6912	4.6872 4.6869 4.6909 4.6906	4.7480 4.7489 4.7500 4.7509	4.7480 4.7489 4.7500 4.7509
4 3/4-16	UN	2A	4.7377 4.7368 4.7395 4.7386	4.7482 4.7491 4.7500 4.7509	4.7076 4.7073 4.7091 4.7091	4.7286 4.7277 4.7320 4.7311	4.7482 4.7491 4.7500 4.7509	4.7015 4.7018 4.7049 4.7052	4.7015 4.7012 4.7049 4.7046	4.7482 4.7491 4.7500 4.7509	4.7482 4.7491 4.7500 4.7509
		3A	4.9800 4.9789 4.9829 4.9818	4.9971 4.9982 5.0000 5.0011	4.9159 4.9156 4.9188 4.9185	4.9943 4.9934 4.9977 4.9966	4.9971 4.9982 5.0000 5.0011	4.9062 4.9065 4.9116 4.9119	4.9062 4.9059 4.9116 4.9113	4.9971 4.9982 5.0000 5.0011	4.9971 4.9982 5.0000 5.0011
		2A	4.9851 4.9842 4.9871 4.9862	4.9980 4.9989 5.0000 5.0009	4.9439 4.9436 4.9459 4.9456	4.9743 4.9734 4.9770 4.9761	4.9980 4.9989 5.0000 5.0009	4.9372 4.9375 4.9409 4.9412	4.9372 4.9369 4.9409 4.9406	4.9980 4.9989 5.0000 5.0009	4.9980 4.9989 5.0000 5.0009
5-16	UN	2A	4.9877 4.9868 4.9895 4.9886	4.9982 4.9991 5.0000 5.0009	4.9576 4.9573 4.9591 4.9591	4.9786 4.9777 4.9820 4.9811	4.9982 4.9991 5.0000 5.0009	4.9515 4.9518 4.9549 4.9552	4.9515 4.9512 4.9549 4.9546	4.9982 4.9991 5.0000 5.0009	4.9982 4.9991 5.0000 5.0009
		3A	5.2300 5.2289 5.2329 5.2318	5.2471 5.2482 5.2500 5.2511	5.1659 5.1656 5.1688 5.1685	5.2102 5.2091 5.2136 5.2125	5.2371 5.2382 5.2500 5.2511	5.1561 5.1564 5.1615 5.1618	5.1561 5.1558 5.1615 5.1612	5.2471 5.2482 5.2500 5.2511	5.2471 5.2482 5.2500 5.2511
		2A	5.2351 5.2342 5.2371 5.2362	5.2480 5.2489 5.2500 5.2509	5.1939 5.1936 5.1959 5.1956	5.2237 5.2224 5.2270 5.2261	5.2480 5.2489 5.2500 5.2509	5.1872 5.1875 5.1909 5.1912	5.1872 5.1869 5.1909 5.1906	5.2480 5.2489 5.2500 5.2509	5.2480 5.2489 5.2500 5.2509
5 1/4-16	UN	2A	5.2377 5.2368 5.2395 5.2386	5.2482 5.2491 5.2500 5.2509	5.2076 5.2073 5.2091 5.2091	5.2286 5.2277 5.2320 5.2311	5.2482 5.2491 5.2500 5.2509	5.2015 5.2018 5.2049 5.2052	5.2015 5.2012 5.2049 5.2046	5.2482 5.2491 5.2500 5.2509	5.2482 5.2491 5.2500 5.2509
		3A	5.4799 5.4788 5.4829 5.4818	5.4970 5.4981 5.5000 5.5011	5.4188 5.4185 5.4218 5.4215	5.4900 5.4891 5.4934 5.4923	5.4970 5.4981 5.5000 5.5011	5.4079 5.4082 5.4111 5.4114	5.4079 5.4076 5.4111 5.4108	5.4970 5.4981 5.5000 5.5011	5.4970 5.4981 5.5000 5.5011
		2A	5.4751 5.4742 5.4771 5.4762	5.4880 5.4889 5.4900 5.4909	5.4369 5.4366 5.4388 5.4385	5.4673 5.4664 5.4707 5.4696	5.4920 5.4929 5.5000 5.5009	5.4017 5.4020 5.4050 5.4053	5.4017 5.4014 5.4050 5.4047	5.4880 5.4889 5.4900 5.4909	5.4880 5.4889 5.4900 5.4909

See footnotes at end of table.

TABLE III.13.—Setting plug gages, Unified and American screw threads—Continued

Nominal size and threads per inch	Series designation	Class	W truncated setting plugs								Basic-crest setting plugs	
			Plug for "Go"				Plug for "Not go"				Major diameter	
			Major diameter		Pitch diameter	Major diameter		Pitch diameter		Go ¹	Not go ¹	
			Truncated	Full		Truncated	Full	Plus tolerance gage	Minus tolerance gage			W and X tolerances
1	2	3	4	5	6	7	8	9	10	11	12	
			in.	in.	in.	in.	in.	in.	in.	in.	in.	in.
5/4-12	UN	2A	5.4851	5.4980	5.4439	5.4733	5.4980	5.4372	5.4372	5.4372	5.4980	5.4980
			5.4842	5.4989	5.4436	5.4724	5.4989	5.4375	5.4369	5.4369	5.4989	5.4989
		3A	5.4871	5.5000	5.4459	5.4770	5.5000	5.4409	5.4409	5.4409	5.5000	5.5000
			5.4862	5.5009	5.4456	5.4761	5.5009	5.4412	5.4406	5.4406	5.5009	5.5009
5/4-16	UN	2A	5.4877	5.4982	5.4576	5.4786	5.4982	5.4515	5.4515	5.4982	5.4982	
			5.4858	5.4991	5.4573	5.4777	5.4991	5.4518	5.4512	5.4512	5.4991	5.4991
		3A	5.4935	5.5000	5.4594	5.4820	5.5000	5.4549	5.4549	5.5000	5.5000	
			5.4886	5.5009	5.4591	5.4811	5.5009	5.4552	5.4546	5.4546	5.5009	5.5009
5/4-8	N	2A	5.7299	5.7470	5.6658	5.7099	5.7470	5.6554	5.6558	5.7470	5.7470	
			5.7288	5.7471	5.6655	5.7088	5.7481	5.6561	5.6555	5.7481	5.7481	
		3A	5.7329	5.7500	5.6698	5.7154	5.7500	5.6613	5.6613	5.7500	5.7500	
			5.7318	5.7511	5.6685	5.7143	5.7511	5.6616	5.6610	5.7511	5.7511	
5/4-12	UN	2A	5.7350	5.7479	5.6938	5.7230	5.7479	5.6869	5.6869	5.7479	5.7479	
			5.7341	5.7488	5.6935	5.7221	5.7488	5.6872	5.6866	5.7488	5.7488	
		3A	5.7371	5.7500	5.6959	5.7268	5.7500	5.6907	5.6907	5.7500	5.7500	
			5.7362	5.7509	5.6956	5.7259	5.7509	5.6910	5.6904	5.7509	5.7509	
5/4-16	UN	2A	5.7376	5.7481	5.7075	5.7284	5.7481	5.7013	5.7013	5.7481	5.7481	
			5.7367	5.7490	5.7072	5.7275	5.7490	5.7016	5.7010	5.7490	5.7490	
		3A	5.7395	5.7500	5.7094	5.7318	5.7500	5.7047	5.7047	5.7500	5.7500	
			5.7386	5.7509	5.7091	5.7309	5.7509	5.7050	5.7044	5.7509	5.7509	
6-8	N	2A	5.9799	5.9970	5.9158	5.9597	5.9970	5.9056	5.9056	5.9970	5.9970	
			5.9788	5.9981	5.9155	5.9586	5.9981	5.9059	5.9053	5.9981	5.9981	
		3A	5.9829	6.0000	5.9188	5.9553	6.0000	5.9112	5.9112	6.0000	6.0000	
			5.9818	6.0011	5.9185	5.9542	6.0011	5.9115	5.9109	6.0011	6.0011	
6-12	UN	2A	5.9850	5.9970	5.9438	5.9730	5.9970	5.9369	5.9369	5.9970	5.9970	
			5.9841	5.9988	5.9435	5.9721	5.9988	5.9372	5.9366	5.9988	5.9988	
		3A	5.9871	6.0000	5.9459	5.9768	6.0000	5.9407	5.9407	6.0000	6.0000	
			5.9862	6.0009	5.9456	5.9759	6.0009	5.9410	5.9404	6.0009	6.0009	
6-16	UN	2A	5.9876	5.9981	5.9576	5.9784	5.9981	5.9513	5.9513	5.9981	5.9981	
			5.9867	5.9990	5.9572	5.9775	5.9990	5.9516	5.9510	5.9990	5.9990	
		3A	5.9895	6.0000	5.9594	5.9818	6.0000	5.9547	5.9547	6.0000	6.0000	
			5.9886	6.0009	5.9591	5.9809	6.0009	5.9550	5.9544	6.0009	6.0009	

¹ Pitch diameter limits of W basic-crest setting plug gages are given in column 6 of this table. Pitch diameter limits of X basic-crest setting plug gages are given in column 4 of table III.12.
² Pitch diameter limits of W basic-crest setting plug gages are given in columns 9 and 10 of this table. Pitch diameter limits of X basic-crest setting plug gages are given in columns 6 and 7 of table III.12.

8. SIZES OF TAP DRILLS

When it is important that the minor diameter of an internal thread conform to specified limits it may be necessary to use a reamer to finish the hole. However, a drill often can be made to cut sufficiently accurately for this requirement. A variety of factors enter into the production of a clean, round, straight hole of the correct diameter. For a discussion of these and other data on drilling and tapping reference should be made to "Drilled Holes for Tapping," published by the Drill and Reamer Division and the Tap and Die Division of the Metal Cutting Tool Institute.⁶

Table III.14 gives minor diameter limits and corresponding percentages of basic thread height, $\frac{1}{2}H$, for all standard series threads to and including 3/4 in. diameter, classes 1B and 2B. Table III.15 is a similar table for class 3B. These tables also list sizes of drills that may be expected to drill holes within or near the specified minor

diameter limits. The diameter of the drill, the probable hole size, and the corresponding percentages of basic thread height are tabulated.

As a drill may normally be expected to cut oversize, probable hole sizes are tabulated that are derived from probable mean oversizes, also tabulated. The following is quoted from the above-mentioned report: "These oversizes were determined from a series of tests conducted by a number of drill manufacturers. Using six sizes of drills ranging from 1/16 to 1 in. a total of 2,808 holes were drilled in cast iron and steel. Commercial high speed drills were used and the drilling equipment was of the same type and condition that is normally encountered in metal working shops. The average depth of hole drilled was equal to 1 1/2 times the drill diameter, and the measurement of the hole was made at the midpoint of the depth drilled. . . . With good drilling practices and with reasonable care in the resharpening of drills the average user may expect to drill oversize in the same manner."

⁶ Address: 3114 Chrysler Bldg., 405 Lexington Ave., New York 17, N. Y.

TABLE III.14.—Tap drill sizes, Unified and American screw threads, classes 1B and 2B

Thread size	Threads per inch	Designation	Classes 1B and 2B minor diameter, internal threads				Tap drills and percent basic thread height						
			Minimum	Percent basic thread height	Maximum	Percent basic thread height	Nominal size	Diameter	Theoretical percent of thread	Probable oversize, mean	Probable hole size	Percent of thread	
No. in.			in.		in.		in.		in.	in.			
9	0.060	80	NF	0.0465	83.1	0.0514	52.9	#56 3/64 in.	0.0465 .0469	83 81	0.0015 .0016	0.0480 .0484	74 71
11	.073	64	NC	.0561	83.3	.0623	52.7	#54 #53	.0550 .0595	89 87	.0015 .0016	.0565 .0610	81 80
11	.073	72	NF	.0680	83.1	.0635	52.7	#53 #51 #50 #49	.0595 .0670 .0700 .0730	85 82 80 79	.0015 .0017 .0017 .0017	.0610 .0640 .0687 .0747	81 80 75 70
2	.086	56	NC	.0667	83.2	.0737	53.0	#49 #48	.0700 .0730	80 79	.0017 .0017	.0717 .0747	62 49
2	.086	64	NF	.0691	83.3	.0753	52.7	#50 #49 #48	.0730 .0750 .0760	79 64 85	.0017 .0017 .0019	.0717 .0747 .0779	70 56 78
3	.099	48	NC	.0764	83.5	.0845	53.6	3/64 in. #47 #46 #45 #44	.0781 .0785 .0810 .0820 .0810	77 76 67 63 78	.0019 .0019 .0019 .0019	.0800 .0804 .0829 .0839 .0829	70 69 60 56 69
3	.099	56	NF	.0797	83.2	.0865	53.9	#45 #44 #43 #42	.0820 .0860 .0890 .0935	63 56 80 71	.0019 .0019 .0019 .0020	.0839 .0879 .0879 .0910	65 48 74 65
4	.112	40	NC	.0849	83.4	.0939	55.7	#42 #41 #40	.0935 .0938 .0938	57 56 86	.0020 .0020 .0020	.0955 .0958 .0910	51 50 78
4	.112	48	NF	.0894	83.5	.0908	56.2	3/32 in. #41 #40 #39 #38	.0938 .0970 .0980 .0995 .1015	67 59 83 79	.0020 .0020 .0023 .0023	.0958 .0980 .1003 .1018	60 52 70 71
6	.125	40	NC	.0979	83.4	.1062	57.9	#38 #37 #36	.1015 .1040 .1065	72 65 80	.0023 .0023 .0023	.1038 .1063 .1038	65 58 72
5	.125	44	NF	.1004	83.3	.1079	57.9	#37 #36 #35	.1040 .1065 .1100	71 63 69	.0023 .0023 .0026	.1063 .1088 .1126	63 55 64
6	.128	32	NC	.104	83.8	.114	59.1	7/64 in. #35 #34 #33	.1094 .1100 .1110 .1130	70 69 67 62	.0026 .0026 .0026 .0026	.1120 .1126 .1136 .1156	64 63 60 55
6	.138	40	NF	.111	83.1	.119	58.5	#34 #33 #32	.1110 .1130 .1160	83 77 68	.0026 .0026 .0026	.1136 .1156 .1186	75 69 60
8	.164	32	NC	.130	83.8	.139	61.6	#32 #29 #28	.1360 .1360 .1360	69 78 65	.0029 .0029 .0029	.1389 .1389 .1434	62 70 57
8	.164	36	NF	.134	83.1	.142	61.0	#28 #27 #26	.1405 .1406 .1440	65 65 85	.0029 .0029 .0032	.1434 .1436 .1472	57 57 79
10	.190	24	NC	.145	83.1	.156	62.8	#26 #25 #24 #23	.1470 .1495 .1520 .1540	79 75 70 66	.0032 .0032 .0032 .0032	.1502 .1527 .1552 .1572	74 69 64 61
10	.190	32	NF	.156	83.8	.164	64.1	5/32 in. #23 #22 #21 #20	.1540 .1562 .1570 .1590 .1610	66 83 81 76 71	.0032 .0032 .0032 .0032	.1572 .1604 .1602 .1622 .1642	75 73 73 68 64
12	.216	24	NC	.171	83.1	.181	64.7	3/16 in. #17 #16 #15 #14	.1719 .1730 .1770 .1800 .1820	82 79 72 67 73	.0032 .0035 .0035 .0035	.1754 .1765 .1805 .1835 .1855	75 73 66 60 66
12	.216	28	NF	.177	84.1	.186	64.7	#14 #13 #12 #11	.1800 .1820 .1850 .1870	78 73 67 67	.0035 .0035 .0035 .0035	.1845 .1855 .1885 .1885	70 66 59 59
12	.216	32	NEF	.182	83.8	.190	64.0	#11 #10 #9 #8 #7	.1820 .1850 .1870 .1900 .1960	84 84 83 83 83	.0035 .0035 .0038 .0038 .0038	.1885 .1885 .1925 .1928 .1998	76 68 77 73 70
1/4		20	UNC	.196	83.1	.207	66.2	1/16 in. #6 #5 #4	.2010 .2031 .2040 .2055	75 72 71 69	.0038 .0038 .0038 .0038	.2059 .2078 .2078 .2093	70 66 65 63
1/4		28	UNF	.211	84.1	.220	64.7	#3 #2 #1	.2130 .2188 .2188	80 67 77	.0038 .0038 .0038	.2168 .2226 .2226	72 59 67
1/4		32	NEF	.216	83.8	.224	64.1	7/32 in. #2 #1	.2188 .2210 .2210	67 71 80	.0038 .0038 .0038	.2226 .2248 .2248	67 62 70
1/4		36	UNS	.220	83.1	.226	66.5	#1	.2276	77	.0038	.2308	72
5/16		18	UNC	.252	83.8	.265	65.8	(J) (I) (H)	.2610 .2660 .2660	71 86 86	.0041 .0041 .0041	.2651 .2701 .2701	66 78 81
5/16		24	UNF	.267	84.1	.277	65.6	(J) (I) (H) (G)	.2720 .2770 .2770 .2810	75 66 78 77	.0041 .0041 .0041 .0042	.2751 .2811 .2811 .2852	67 64 67 67
5/16		32	NEF	.279	82.5	.286	65.3	(K) 3/16 in.	.2810 .2812	78 77	.0042 .0042	.2852 .2854	67 67
5/16		36	UNS	.282	84.5	.289	65.1	7/25 mm (L)	.2851 .3125	75 77	.0045 .0044	.2885 .3109	65 72
3/8		16	UNC	.307	83.8	.321	66.5	1/2 in. (M) (N)	.3160 .3160 .3160	73 73 70	.0044 .0044 .0044	.3204 .3204 .3304	67 67 71
3/8		24	UNF	.330	83.1	.340	64.7	(O) (P) (Q)	.3300 .3300 .3326	67 67 70	.0041 .0041 .0041	.3334 .3334 .3364	68 68 71
3/8		32	NEF	.341	83.8	.349	64.1	11/32 in. (R)	.3438 .3480	77 67	.0045 .0045	.3453 .3525	66 55

TABLE III.14.—Tap drill sizes, Unified and American screw threads, classes 1B and 2B—Continued

Thread size	Threads per inch	Designation	Classes 1B and 2B minor diameter, internal threads				Tap drills and percent basic thread height					
			Minimum	Percent basic thread height	Maximum	Percent basic thread height	Nominal size	Diameter	Theoretical percent of thread	Probable oversize, mean	Probable hole size	Percent of thread
No. 3/16	36	UNS	0.345	83.1	0.352	63.7	S	0.3180	75	0.3045	0.3525	62
3/16	14	UNC	.300	83.5	.376	66.3	T	.3580	86	.0016	.3626	81
3/16	20	UNF	.383	83.9	.395	65.4	W	.3591	84	.0046	.3640	79
3/16	28	UNEF	.399	83.0	.407	65.7	X	.3860	79	.0043	.3906	72
1/2	12	N	.410	83.1	.428	66.5	Y	.3906	72	.0046	.3952	65
1/2	13	UNC	.417	83.1	.431	66.1	Z	.4010	80	.0047	.4117	76
1/2	20	UNF	.455	83.1	.457	66.2	27.64 in.	.4219	72	.0046	.4266	62
1/2	28	UNEF	.461	81.1	.470	64.7	27.64 in.	.4219	78	.0047	.4266	73
9/16	12	UNC	.472	83.6	.490	67.0	27.64 in.	.4219	72	.0047	.4266	65
9/16	18	UNF	.502	83.8	.515	65.8	27.64 in.	.4219	87	.0048	.4296	82
9/16	24	NEF	.517	81.1	.527	65.6	27.64 in.	.4219	67	.0048	.4296	62
9/16	28	UNS	.521	83.0	.532	65.7	27.64 in.	.4219	72	.0048	.4296	68
5/8	11	UNC	.597	83.0	.546	66.9	27.64 in.	.4219	78	.0049	.4302	75
5/8	12	N	.555	83.1	.553	66.5	27.64 in.	.4219	72	.0049	.4302	68
5/8	18	UNF	.565	83.1	.578	65.1	27.64 in.	.4219	87	.0049	.4302	80
5/8	21	NEF	.580	83.1	.590	64.7	27.64 in.	.4219	78	.0049	.4302	71
5/8	28	UNS	.586	81.1	.595	61.7	27.64 in.	.4219	87	.0049	.4302	78
1 1/16	12	N	.597	83.6	.615	67.0	27.64 in.	.4219	67	.0049	.4302	62
1 1/16	24	NEF	.612	81.1	.652	65.6	27.64 in.	.4219	87	.0050	.4313	68
1 1/16	34	UNC	.612	83.1	.663	67.0	27.64 in.	.4219	84	.0050	.4313	77
3/4	12	N	.690	83.1	.678	66.5	27.64 in.	.4219	72	.0050	.4313	63
3/4	16	UNF	.682	83.8	.696	66.5	27.64 in.	.4219	87	.0050	.4313	82
3/4	20	UNEF	.696	83.1	.720	66.2	27.64 in.	.4219	72	.0051	.4329	66
3/4	28	UNS	.711	81.1	.720	61.7	27.64 in.	.4219	72	.0051	.4329	56
1 1/8	12	N	.722	85.6	.749	67.0	27.64 in.	.4219	72	.0051	.4329	62
1 1/8	16	UNF	.735	83.1	.759	65.9	27.64 in.	.4219	87	.0051	.4329	71
1 1/8	20	UNEF	.758	83.9	.779	65.1	27.64 in.	.4219	72	.0052	.4345	64
1 1/8	0	UNC	.755	83.1	.778	67.2	27.64 in.	.4219	72	.0052	.4345	72
7/8	12	N	.785	83.1	.803	66.5	27.64 in.	.4219	67	.0052	.4345	62
7/8	14	UNF	.798	83.0	.814	65.7	27.64 in.	.4219	81	.0052	.4345	70
7/8	16	UN	.807	83.8	.821	66.5	27.64 in.	.4219	72	.0052	.4345	62
7/8	20	UNEF	.821	83.1	.832	66.2	27.64 in.	.4219	77	.0053	.4358	70
7/8	28	UNS	.836	81.1	.845	61.7	27.64 in.	.4219	72	.0053	.4358	61
1 1/4	12	UN	.847	83.6	.865	67.0	27.64 in.	.4219	67	.0055	.4393	55
1 1/4	16	UNF	.850	82.1	.881	65.3	27.64 in.	.4219	87	.0055	.4393	81
1 1/4	20	UNEF	.883	84.9	.895	65.1	27.64 in.	.4219	72	.0057	.4407	67
1 1/4	0	UNC	.865	83.1	.890	67.7	27.64 in.	.4219	72	.0057	.4407	70
1	12	UNF	.910	83.1	.928	66.5	27.64 in.	.4219	87	.0059	.4453	63
1	14	NS	.923	83.0	.938	66.8	27.64 in.	.4219	77	.0059	.4453	63
1	16	UN	.932	83.8	.946	66.5	27.64 in.	.4219	87	.0059	.4453	83
1	20	UNEF	.946	83.1	.961	66.2	27.64 in.	.4219	72	.0059	.4453	67
1	28	UNS	.961	81.1	.970	61.7	27.64 in.	.4219	72	.0059	.4453	73
1 1/8	12	UN	.972	83.6	.990	67.0	27.64 in.	.4219	67	.0059	.4453	62
1 1/8	16	UN	.995	83.1	1.009	65.9	1 in.	1.0000	77	.0060	1.0060	68
1 1/8	18	NEF	1.002	83.8	1.015	65.8	1 in.	1.0000	87	.0060	1.0060	77
1 1/8	7	UNC	.970	83.5	.998	68.1	1 in.	.9988	81	.0062	.9750	81
1 1/8	8	N	.990	83.1	1.015	67.7	1 in.	.9811	76	.0067	.9911	72
1 1/8	12	UNF	1.035	83.1	1.053	66.5	1 in.	1.0000	77	.0069	1.0069	73
1 1/8	16	UN	1.057	83.8	1.071	66.5	1 in.	1.0169	87	.0072	1.0511	80
1 1/8	18	NEF	1.065	83.1	1.078	65.1	1 in.	1.0225	77	.0074	1.0609	65
1 1/8	20	UNS	1.071	83.1	1.082	66.2	1 in.	1.0282	87			
1 1/8	24	UNS	1.096	81.1	1.095	61.7	1 in.	1.0219	72			
1 1/8	12	UN	1.097	83.6	1.115	67.0	1 in.	1.0312	87			
1 1/8	16	UN	1.120	83.1	1.131	65.9	1 in.	1.0469	72			
1 1/8	18	NEF	1.127	83.8	1.140	65.8	1 in.	1.0625	87			
1 1/8	7	UNC	1.095	83.5	1.123	68.1	1 in.	1.0781	81			
1 1/8	8	N	1.115	83.1	1.140	67.7	1 in.	1.0938	76			
1 1/8	12	UNF	1.169	83.1	1.178	66.5	1 in.	1.1094	87			
1 1/8	16	UN	1.182	83.8	1.196	66.5	1 in.	1.1250	72			
1 1/8	18	NEF	1.190	83.1	1.203	66.5	1 in.	1.1406	87			
1 1/8	20	UNS	1.196	83.1	1.207	66.2	1 in.	1.1562	72			
1 1/8	24	UNS	1.222	83.6	1.240	67.0	1 in.	1.1718	87			
1 1/8	16	UN	1.245	83.1	1.259	65.9	1 in.	1.1875	72			
1 1/8	18	NEF	1.252	83.8	1.265	65.8	1 in.	1.2031	87			

TABLE III.14.—Tap drill sizes, Unified and American screw threads, classes 1B and 2B—Continued

Thread size	Threads per inch	Designation	Classes 1B and 2B minor diameter, internal threads				Tap drills and percent basic thread height					
			Minimum	Percent basic thread height	Maximum	Percent basic thread height	Nominal size	Diameter	Theoretical percent of thread	Probable oversize, mean	Probable hole size	Percent of thread
No. in.			in.		in.		in.		in.		in.	
1/16	6	UNC	1.195	83.1	1.225	69.3	1 1/16 in.	1.1875	87			
							1 1/16 in.	1.2031	79			
							1 1/16 in.	1.2188	72			
1/8	8	N	1.240	83.1	1.265	67.7	1 1/8 in.	1.2344	87			
							1 1/8 in.	1.2500	77			
1/8	12	UNF	1.285	83.1	1.303	66.5	1 1/8 in.	1.2812	87			
1/8	16	UN	1.307	83.8	1.321	66.5	1 1/8 in.	1.2969	72			
1/8	18	NEF	1.315	83.1	1.328	65.1	1 1/8 in.	1.3125	77			
							1 1/8 in.	1.3125	87			
1 1/16	12	UN	1.347	83.6	1.360	71.6	1 1/16 in.	1.3281	65			
							1 1/16 in.	1.3438	87			
1 1/16	16	UN	1.370	83.1	1.384	65.9	1 1/16 in.	1.3594	72			
1 1/16	18	NEF	1.377	83.8	1.390	65.8	1 1/16 in.	1.3750	77			
1/2	6	UNC	1.320	83.1	1.350	69.3	1 1/2 in.	1.3125	87			
							1 1/2 in.	1.3281	79			
1/2	8	N	1.365	83.1	1.390	67.7	1 1/2 in.	1.3594	87			
							1 1/2 in.	1.3750	77			
1/2	12	UNF	1.410	83.1	1.428	66.5	1 1/2 in.	1.4062	87			
1/2	16	UN	1.432	83.8	1.446	66.5	1 1/2 in.	1.4219	72			
1/2	18	NEF	1.440	83.1	1.452	66.5	1 1/2 in.	1.4375	77			
1/2	20	UNF	1.446	83.1	1.457	66.2	1 1/2 in.	1.4375	87			
1 1/8	16	N	1.495	83.1	1.509	65.9	1 1/8 in.	1.4531	72			
							1 1/8 in.	1.5000	77			
1 1/8	18	NEF	1.502	83.8	1.515	65.8	1 1/8 in.	1.5000	87			
							1 1/8 in.	1.5156	65			
1 1/8	8	N	1.490	83.1	1.515	67.7	1 1/8 in.	1.4811	87			
							1 1/8 in.	1.5000	77			
1 1/8	12	UN	1.535	83.1	1.553	66.5	1 1/8 in.	1.5312	87			
1 1/8	16	UN	1.557	83.8	1.571	66.5	1 1/8 in.	1.5469	72			
1 1/8	18	NEF	1.565	83.1	1.578	65.1	1 1/8 in.	1.5625	77			
1 1/16	16	N	1.620	83.1	1.634	65.9	1 1/16 in.	1.5781	65			
							1 1/16 in.	1.6250	77			
1 1/16	18	NEF	1.627	83.8	1.640	65.8	1 1/16 in.	1.6250	87			
							1 1/16 in.	1.6406	65			
1 3/8	5	UNC	1.534	55.1	1.566	70.1	1 3/8 in.	1.5312	84			
							1 3/8 in.	1.5469	78			
							1 3/8 in.	1.6004	87			
1 3/8	8	N	1.615	83.1	1.640	67.7	1 3/8 in.	1.6250	77			
							1 3/8 in.	1.6406	67			
1 3/8	12	UN	1.660	83.1	1.678	66.5	1 3/8 in.	1.6562	87			
1 3/8	16	UNEF	1.682	83.8	1.696	66.5	1 3/8 in.	1.6719	72			
1 3/8	20	UNF	1.696	83.1	1.707	66.2	1 3/8 in.	1.6875	77			
1 3/16	16	N	1.745	83.1	1.759	65.9	1 3/16 in.	1.7031	72			
1 3/16	8	N	1.740	83.1	1.765	67.7	1 3/16 in.	1.7500	77			
1 3/8	12	UN	1.785	83.1	1.803	66.5	1 3/8 in.	1.7812	87			
1 3/8	16	UN	1.807	83.8	1.821	66.5	1 3/8 in.	1.7969	72			
1 3/16	16	N	1.870	83.1	1.884	65.9	1 3/16 in.	1.8125	77			
2	4 1/2	UNC	1.759	83.5	1.795	71.0	2 in.	1.8750	77			
2	8	N	1.895	83.1	1.890	67.7	2 in.	1.7812	79			
2	12	UN	1.910	83.1	1.928	66.5	2 in.	1.8750	77			
2	16	UNEF	1.932	83.8	1.946	66.5	2 in.	1.9062	87			
2	20	UNF	1.946	83.1	1.957	66.2	2 in.	1.9219	72			
2 1/16	16	N	1.995	83.1	2.009	65.9	2 1/16 in.	1.9375	77			
2 1/8	8	N	2.000	83.1	2.015	67.7	2 1/8 in.	1.9531	72			
2 1/8	12	UN	2.035	83.1	2.052	66.5	2 1/8 in.	2.0000	77			
2 1/8	16	UN	2.057	83.8	2.071	66.5	2 1/8 in.	2.0312	87			
2 1/16	16	N	2.120	83.1	2.134	65.9	2 1/16 in.	2.0625	77			
2 1/8	4 1/2	UNC	2.099	83.5	2.045	71.0	2 1/8 in.	2.1250	77			
2 1/8	8	N	2.115	83.1	2.140	67.7	2 1/8 in.	2.0312	79			
2 1/8	12	UN	2.160	83.1	2.178	66.5	2 1/8 in.	2.1562	77			
2 1/8	16	UN	2.182	83.8	2.196	66.5	2 1/8 in.	2.1562	87			
2 1/8	20	UNF	2.196	83.1	2.207	66.2	2 1/8 in.	2.1875	77			
2 1/16	16	N	2.245	83.1	2.259	65.9	2 1/16 in.	2.1875	77			
2 1/8	12	UN	2.285	83.1	2.303	66.5	2 1/8 in.	2.2300	77			
2 1/8	16	UN	2.307	83.8	2.321	66.5	2 1/8 in.	2.3125	77			
2 1/16	16	N	2.370	83.1	2.384	65.9	2 1/16 in.	2.3500	77			
2 1/2	4	UNC	2.229	83.4	2.267	71.7	2 1/2 in.	2.2188	87			
2 1/2	8	N	2.395	83.1	2.396	67.7	2 1/2 in.	2.2900	77			
2 1/2	12	UN	2.410	85.1	2.428	66.5	2 1/2 in.	2.3750	77			
2 1/2	16	UN	2.432	83.8	2.446	66.5	2 1/2 in.	2.4375	77			
2 3/8	12	UN	2.535	83.1	2.553	66.5	2 3/8 in.					
2 3/8	16	UN	2.557	83.8	2.571	66.5	2 3/8 in.	2.5625	77			
2 3/4	4	UNC	2.479	83.4	2.517	71.7	2 3/4 in.	2.5000	77			
2 3/4	8	N	2.615	83.1	2.640	67.7	2 3/4 in.	2.6250	77			
2 3/4	12	UN	2.690	83.1	2.678	66.5	2 3/4 in.					
2 3/4	16	UN	2.682	83.8	2.696	66.5	2 3/4 in.	2.6875	77			
2 3/4	12	UN	2.785	83.1	2.803	66.5	2 3/4 in.	2.7500	115			
2 3/4	16	UN	2.807	83.8	2.821	66.5	2 3/4 in.	2.8125	77			
3	4	UNC	2.729	83.4	2.767	71.7	3 in.	2.7000	77			
3	8	N	2.865	83.1	2.890	67.7	3 in.	2.8750	77			
3	12	UN	2.940	83.1	2.928	66.5	3 in.					
3	16	UN	2.932	83.8	2.946	66.5	3 in.	2.9375	77			
3 1/4	4	UNC	2.979	83.4	3.017	71.7	3 1/4 in.	3.0000	77			
3 1/2	4	UNC	3.229	83.4	3.267	71.7	3 1/2 in.	3.2000	77			
3 3/4	4	UNC	3.479	83.4	3.517	71.7	3 3/4 in.	3.5000	77			

TABLE III.15.—Tap drill sizes, Unified and American screw threads, class 3B—Continued

Thread size	Threads per inch	Designation	Class 3B minor diameter, internal threads				Tap drills and percent basic thread height					
			Minimum	Percent basic thread height	Maximum	Percent basic thread height	Nominal size	Diameter	Theoretical percent of thread	Probable oversize, mean	Probable hole size	Percent of thread
No.	in.		in.		in.		in.		in.	in.		
7/16	28	UNEF	0.3990	83.0	0.4051	69.8	Y	0.4040	72	0.0048	0.4086	62
1/2	12	N	.4100	83.1	.4223	71.8	Z	.4130	80	.0047	.4177	76
1/2	13	UNC	.4170	83.1	.4284	71.7	3/16 in.	.4219	72	.0047	.4236	68
1/2	20	UNF	.4460	83.1	.4537	71.3	23/64 in.	.4219	78	.0047	.4296	73
1/2	28	UNEF	.4610	84.1	.4676	69.8	29/64 in.	.4631	72	.0047	.4578	66
9/16	12	UNO	.4720	83.6	.4843	72.2	1/2 in.	.4688	87	.0048	.4736	82
9/16	18	UNF	.5020	83.8	.5106	71.9	3/16 in.	.4844	72	.0048	.4892	68
9/16	24	NEF	.5170	84.1	.5244	70.4	1/2 in.	.5000	87	.0048	.5048	80
5/8	11	UNO	.5270	83.0	.5391	72.7	0.5002 in.	.5062	78	.0048	.5110	71
5/8	12	N	.5350	83.1	.5403	72.7	3/16 in.	.5156	87	.0048	.5204	78
5/8	18	UNF	.5650	83.1	.5730	72.1	0.5203 in.	.5203	78	.0048	.5251	69
5/8	24	NEF	.5800	83.1	.5869	70.4	17/32 in.	.5312	79	.0049	.5362	75
3/4	12	N	.5970	83.6	.6085	73.0	3/8 in.	.5469	72	.0049	.5518	68
3/4	24	NEF	.6420	84.1	.6494	70.4	3/8 in.	.5469	72	.0049	.5518	68
3/4	10	UNO	.6420	83.1	.6645	73.5	3/4 in.	.5625	87	.0049	.5674	80
3/4	12	N	.6600	83.1	.6707	73.3	13/32 in.	.5662	87	.0050	.5712	82
3/4	16	UNF	.6820	83.8	.6908	72.9	13/16 in.	.5875	77	.0050	.5925	71
3/4	20	UNEF	.6960	83.1	.7037	71.3	5/8 in.	.7031	72	.0051	.7082	64
3/4	12	N	.7220	83.6	.7329	73.5	18.5 mm	.7285	78	.0051	.7334	73
3/4	16	UN	.7450	83.1	.7633	72.9	3/4 in.	.7500	77	.0052	.7552	71
3/4	20	UNEF	.7580	83.9	.7662	71.3	3/4 in.	.7856	72	.0052	.7706	64
7/8	9	UNC	.7850	83.1	.7921	74.1	49/64 in.	.7856	76	.0052	.7908	72
7/8	12	N	.7850	83.1	.7957	73.7	25/32 in.	.7812	87	.0052	.7864	82
7/8	14	UNF	.7980	83.0	.8068	73.5	31/64 in.	.7969	84	.0052	.8021	79
7/8	16	UN	.8070	83.8	.8158	72.9	0.8024 in.	.8024	78	.0052	.8076	73
7/8	20	UNEF	.8210	83.1	.8287	71.3	13/16 in.	.8126	77	.0053	.8178	70
1 1/16	12	UN	.8470	83.6	.8575	73.9	3/4 in.	.8281	72	.0054	.8333	64
1 1/16	16	UN	.8700	83.1	.8783	72.9	27/32 in.	.8438	87	.0055	.8493	81
1 1/16	20	UNEF	.8840	83.9	.8912	71.3	3/4 in.	.8750	77	.0057	.8807	70
1	8	UNC	.8650	83.1	.8797	74.1	3/4 in.	.8006	72	.0059	.8065	63
1	12	UNF	.9100	83.1	.9198	74.1	5/8 in.	.8594	87	.0059	.8653	83
1	14	NS	.9230	83.0	.9316	73.8	7/8 in.	.8750	77	.0059	.8809	73
1	16	UN	.9320	83.8	.9408	72.0	29/32 in.	.9029	84	.0060	.9081	78
1	20	UNEF	.9460	83.1	.9537	71.3	0.9274 in.	.9274	78	.0061	.9325	72
1 1/8	12	UN	.9720	83.6	.9823	74.1	1 1/8 in.	.9375	77	.0062	.9427	66
1 1/8	16	UN	.9950	83.1	1.0033	72.9	1 1/8 in.	.9531	72	.0063	.9584	63
1 1/8	18	NEF	1.0020	83.8	1.0106	72.1	31/32 in.	.9698	87	.0063	.9753	61
1 1/8	7	UNO	.9700	83.5	.9876	74.1	1 in.	1.0000	87	.0069	1.0069	68
1 1/8	8	N	.9900	83.1	1.0047	74.1	1 in.	1.0000	84	.0069	1.0069	77
1 1/8	12	UNF	1.0350	83.1	1.0448	74.1	1 1/8 in.	.9844	76	.0067	.9911	72
1 1/8	16	UN	1.0570	83.8	1.0658	72.9	1 1/8 in.	1.0000	77	.0069	1.0069	73
1 1/8	18	NEF	1.0650	83.1	1.0730	72.1	1 1/8 in.	1.0312	87	.0071	1.0384	80
1 1/8	12	UN	1.0970	83.6	1.1073	74.1	1 1/8 in.	1.0526	77	.0074	1.0600	08
1 1/8	16	UN	1.1200	83.1	1.1283	72.9	1 1/8 in.	1.0625	87			
1 1/8	18	NEF	1.1270	83.8	1.1356	72.1	1 1/8 in.	1.0938	87			
1 1/8	7	UNO	1.0950	83.6	1.1125	74.1	1 1/8 in.	1.1250	77			
1 1/8	8	N	1.1150	83.1	1.1297	74.1	1 1/8 in.	1.1250	84			
1 1/8	12	UNF	1.1600	83.1	1.1698	74.1	1 1/2 in.	1.0938	87			
1 1/8	16	UN	1.1820	83.8	1.1908	72.9	1 1/2 in.	1.1662	77			
1 1/8	18	NEF	1.1900	83.1	1.1980	72.1	1 1/2 in.	1.1875	87			
1 1/8	12	UN	1.2220	83.6	1.2323	74.1	1 1/2 in.	1.1875	87			
1 1/8	16	UN	1.2450	83.1	1.2533	72.9	1 1/2 in.	1.2188	87			
1 1/8	18	NEF	1.2520	83.8	1.2606	72.1	1 1/2 in.	1.2500	77			
1 3/8	6	UNO	1.1950	83.1	1.2146	74.1	1 1/2 in.	1.2500	87			
1 3/8	8	N	1.2400	83.1	1.2547	74.1	1 3/8 in.	1.1875	87			
1 3/8	12	UNF	1.2850	83.1	1.2948	74.1	1 3/8 in.	1.2031	79			
1 3/8	16	UN	1.3070	83.8	1.3158	72.9	1 3/8 in.	1.2344	87			
1 3/8	18	NEF	1.3150	83.1	1.3230	72.1	1 3/8 in.	1.2500	77			
1 3/8	12	UN	1.3470	83.6	1.3573	74.1	1 3/8 in.	1.2600	87			
1 3/8	16	UN	1.3700	83.1	1.3783	72.9	1 3/8 in.	1.2812	87			
1 3/8	18	NEF	1.3770	83.8	1.3855	72.1	1 3/8 in.	1.3125	77			
1 3/8	6	UNC	1.3200	83.1	1.3396	74.1	1 3/8 in.	1.3438	87			
1 3/8	8	N	1.3650	83.1	1.3797	74.1	1 3/8 in.	1.3750	77			
1 3/8	12	UNF	1.4100	83.1	1.4198	74.1	1 3/8 in.	1.3750	87			
1 3/8	16	UN	1.4320	83.8	1.4408	72.9	1 3/8 in.	1.3125	87			
1 3/8	18	NEF	1.4400	83.1	1.4490	72.1	1 3/8 in.	1.3125	77			
1 3/8	16	N	1.4950	83.1	1.5033	72.9	1 3/8 in.	1.4375	87			
1 3/8	18	NEF	1.5020	83.8	1.5106	72.1	1 3/8 in.	1.4375	77			
1 3/8	8	N	1.4900	83.1	1.5047	74.1	1 3/8 in.	1.5000	87			
1 3/8	12	UN	1.5300	83.1	1.5448	74.1	1 3/8 in.	1.5000	87			
1 3/8	16	UN	1.5570	83.8	1.5658	72.9	1 3/8 in.	1.4844	87			
1 3/8	18	NEF	1.5650	83.1	1.5730	72.1	1 3/8 in.	1.5225	87			
1 3/8	16	N	1.6200	83.1	1.6283	72.9	1 3/8 in.	1.5625	87			
1 3/8	18	NEF	1.6270	83.8	1.6355	72.1	1 3/8 in.	1.6250	77			

ameters and pitches, allowances and tolerances, and detailed directions for specifying special threads on drawings. A discussion of factors affecting the design of special threads is presented in appendix 5, p. 200.

2. UNIFIED FORM OF THREAD

The Unified form of thread profile as specified in section III shall be used.

3. PREFERRED DIAMETERS AND PITCHES

The use, wherever possible, of the standard thread series in section III is recommended for all applications. Whenever sizes and pitches in the Unified or American Standard coarse, fine, or extra-fine, or the 8-, 12-, 16-thread series are not suitable, the designer can usually select a diameter or pitch from a preferred list. See table IV.12, p. 99.

1. PREFERRED DIAMETERS.—Whenever possible, the basic diameter should be selected from series of diameter increments as follows:

Range	Diameter increments	
	First choice	Second choice
<i>in.</i> ¼ to ½	<i>in.</i> ⅓	<i>in.</i> —
¾ to 1½	⅜	⅓
1½ to 6	¼	0.1
6 to 16	⅓	¼
16 to 24	1	⅓

It is recommended that diameters less than ¼ inch conform to the numbered sizes of screws as there is virtually no necessity for the selection of a diameter not included in the numbered sizes. Furthermore, the coarse and fine thread series provide ample choice as to diameter-pitch combinations.

2. PREFERRED PITCHES.—Whenever possible, the pitch should be selected from the series 40, 36, 32, 28, 24, 20, 16, 12, 10, 8, 6, and 4 threads per inch. Intermediate pitches should be used only when absolutely necessary. Pitches coarser than 4 threads per inch are not recommended.

There are practical limits to both the largest and smallest diameters suitable for any pitch. The curves of figure 5.2, p. 202, stop at such limits.

3. BASIC THREAD DATA.—Basic thread data for standard pitches are given in table IV.1. These are to be used in conjunction with the directions for specifying special threads on drawings, as given on p. 98.

4. CLASSIFICATION AND TOLERANCES

There are established for general use six distinct classes of screw thread tolerances and two classes of allowances, as specified in the following brief summary. These, together with the accompanying illustrations, are for the purpose of manufacturing of screw-

thread parts. This standard includes Unified classes 1A, 2A, and 3A, applied to external threads only, and classes 1B, 2B, and 3B applied to internal threads only. In addition, it includes American class 1AR, applied to external threads only, 16 threads per inch and coarser, produced by combining the American National class 1 allowances with class 1A tolerances. The requirements for a screw thread fit for specific applications can be met by specifying the proper combinations of classes for the components. For example, an external thread made to class 2A limits can be used with tapped holes made to classes 1B, 2B, or 3B limits for specific applications.

(a) GENERAL

The following general specifications apply to all classes specified for applications of the Unified form of thread.

1. UNIFORM MINIMUM INTERNAL THREAD.—The minimum major, pitch, and minor diameters of the internal thread are, respectively, the same for classes 1B, 2B, and 3B.

2. DIRECTION AND SCOPE OF TOLERANCES.—

(a) The tolerance on the internal thread is plus, and is applied from the basic size to above basic size.

(b) The tolerance on the external thread is minus, and is applied from the maximum (or design) size to below the maximum size.

(c) The tolerances specified represent the extreme variations permitted on the product.

3. BASIC FORMULA FOR ALLOWANCES AND TOLERANCES.—The basic formula, from which allowances on all diameters and tolerances on pitch diameter are derived, is

$$\text{Tolerance (or allowance)} = C(0.0015 \sqrt[3]{D} + 0.0015 \sqrt{L_e} + 0.015 \sqrt[3]{p^2}),$$

where

C = a factor which differs for the allowance or tolerance for each class

D = basic major diameter

L_e = length of engagement

p = pitch

This formula is based on the accuracy of present day threading practice, and is applicable to all reasonable combinations of diameter, pitch, and length of engagement. Numerical values of the increments in the formula for standard diameters, pitches, and lengths of engagement are given in table III.9, p. 20.

4. ALLOWANCES.—Allowances are applied only to external threads. The values of the factor C (par. 3 above) for allowances are as follows:

Class	Factor C
1A	0.300
2A	0.306
3A	0.300

TABLE IV.1.—Thread data, Unified and American thread form

Threads per inch,	Pitch,	Flat at internal thread crest,	Flat at internal thread root and external thread crest,	Height of sharp thread,	Truncation of internal thread root and external thread crest,	Truncation of external thread root,	Half addendum of external thread,	Truncation of internal thread crest,	Addendum of external thread,	Height of internal thread and depth of thread engagement,	Height of external thread,	Twice the external thread addendum,*	Difference between max. major and pitch diameters of internal thread,	Double height of internal thread,	Double height of external thread,
n	p	$F_{ra} = \frac{p}{4} = 0.25p$	$F_{ra} = \frac{p}{8} = 0.125p$	$H = 0.866025p$	$f_{ra} = \frac{H}{8} = 0.10826p$	$r_{ra} = \frac{H}{6} = 0.14434p$	$\frac{3}{8}H = 0.16238p$	$f_{ra} = \frac{H}{4} = 0.21651p$	$h_{ra} = \frac{3}{8}H = 0.32476p$	$h_a = \frac{5}{8}H = 0.64127p$	$h_e = \frac{1}{2}H = 0.61343p$	$2h_a = \frac{5}{4}H = 0.649519p$	$\frac{1}{2}H = 0.79386p$	$2h_e = 1.08253p$	$\frac{1}{2}H = 1.22087p$
1	2	3	4	5	6	7	8	9	10	11	12	13	14	15	16
80	in. 0.012500	in. 0.00312	in. 0.00156	in. 0.039825	in. 0.00135	in. 0.00186	in. 0.00203	in. 0.00271	in. 0.00406	in. 0.00677	in. 0.00707	in. 0.008119	in. 0.00692	in. 0.01353	in. 0.01534
72	0.013889	0.00347	0.00174	0.02928	0.00150	0.00200	0.00226	0.00301	0.00451	0.00752	0.00852	0.00921	0.0103	0.01504	0.01704
64	0.015625	0.00391	0.00196	0.02532	0.00169	0.00226	0.00254	0.00338	0.00507	0.00846	0.00968	0.01049	0.01240	0.01691	0.01917
56	0.017857	0.00446	0.00223	0.02223	0.00193	0.00258	0.00290	0.00387	0.00580	0.00967	0.01095	0.01199	0.01418	0.01933	0.02161
48	0.020833	0.00521	0.00260	0.018942	0.00226	0.00301	0.00338	0.00451	0.00677	0.01128	0.01278	0.013532	0.01654	0.02255	0.02566
44	0.022727	0.00568	0.00284	0.016982	0.00246	0.00328	0.00369	0.00492	0.00738	0.01230	0.01394	0.014762	0.01804	0.02490	0.02788
40	0.025000	0.00625	0.00312	0.01531	0.00271	0.00361	0.00406	0.00541	0.00812	0.01353	0.01534	0.016238	0.01985	0.02706	0.03067
36	0.027778	0.00694	0.00347	0.014063	0.00301	0.00401	0.00451	0.00601	0.00912	0.01504	0.01704	0.018042	0.02305	0.03097	0.03498
32	0.031250	0.00781	0.00391	0.012763	0.00338	0.00451	0.00507	0.00677	0.01015	0.01691	0.01917	0.020257	0.02681	0.03583	0.04084
28	0.035714	0.00893	0.00446	0.010929	0.00387	0.00515	0.00580	0.00773	0.01160	0.01933	0.02191	0.023197	0.03085	0.04095	0.04582
27	0.037037	0.00926	0.00463	0.02075	0.00401	0.00535	0.00601	0.00802	0.01203	0.02005	0.02272	0.024056	0.03240	0.04099	0.04544
24	0.041667	0.01042	0.00521	0.03684	0.00451	0.00601	0.00677	0.00902	0.01353	0.02255	0.02556	0.027063	0.03698	0.04711	0.05112
20	0.050000	0.01250	0.00625	0.04301	0.00515	0.00722	0.00812	0.01083	0.01624	0.02706	0.03067	0.032476	0.04399	0.05613	0.06134
18	0.055556	0.01389	0.00694	0.048113	0.00541	0.00802	0.00902	0.01203	0.01814	0.03007	0.03498	0.037084	0.04410	0.05814	0.06384
16	0.062500	0.01562	0.00781	0.054127	0.00577	0.00902	0.01015	0.01353	0.02030	0.03383	0.03934	0.040596	0.04962	0.06766	0.07608
14	0.071429	0.01786	0.00893	0.061850	0.00773	0.01031	0.01160	0.01546	0.02320	0.03896	0.04382	0.046394	0.05670	0.07732	0.08763
12	0.083333	0.02083	0.01042	0.072109	0.00902	0.01203	0.01353	0.01804	0.02706	0.04511	0.05112	0.054127	0.06615	0.09021	0.10224
10	0.100000	0.02500	0.01250	0.086993	0.01083	0.01443	0.01624	0.02165	0.03248	0.05413	0.06134	0.064952	0.07939	0.10825	0.12259
8	0.125000	0.03125	0.01562	0.108253	0.01353	0.01804	0.02030	0.02706	0.04059	0.06795	0.07699	0.081190	0.09923	0.13532	0.15336
6	0.166667	0.04167	0.02083	0.144338	0.01804	0.02406	0.02706	0.03608	0.05413	0.08221	0.09226	0.09253	0.12211	0.16842	0.20448
4	0.250000	0.06250	0.03125	0.216500	0.02706	0.03608	0.04059	0.06413	0.08119	0.13532	0.15336	0.162380	0.19846	0.27063	0.30672

* Equivalent to the "basic height" h of the original American National form.

Note.— $h_{ra} = f_{ra} = \frac{H}{4}$
 $h_{ra} = h_{ra} = \frac{3}{8}H$

The formula on p. 75 is not applicable to class 1AR as this class is produced by combining the American National class 1 allowances with class 1A tolerances. These allowances are larger than those for classes 1A and 2A and provide for ready assembly under adverse conditions. Numerical values of allowances for each pitch are given in tables IV.2 and IV.2A.

5. MAJOR DIAMETER TOLERANCES.—(a) *External threads.*—The tolerance on major diameter for special threads is not specified, as it must be determined in relation to the requirements of a given design in accordance with the procedure outlined on p. 201. Preferred tolerances equal to $0.060\sqrt[3]{p^2}$ for classes 2A and 3A, and equal to $0.090\sqrt[3]{p^2}$ for classes 1A and 1AR are given in table IV.3.

(b) *Internal threads.*—The tolerance on major diameter is for reference only. It is equal to $H/6$ plus the pitch diameter tolerance of the class of thread involved. The maximum major diameter of the internal thread may be determined by adding $0.7939p$ ($11/12H$, table IV.1) to the maximum pitch diameter of the internal thread. In dimensioning internal threads the maximum major diameter is not specified, being established

by the crest of an unworn tool. In practice, the major diameter of an internal thread is satisfactory when accepted by a gage or gaging method that represents the maximum material condition of an external thread which has no allowance.

6. MINOR DIAMETER TOLERANCES.—(a) *External threads.*—The tolerance on minor diameter of external threads is for reference only. At the nominal minor diameter, that is at the intersection of the rounded root with its center line (see figure III.1, p. 11) it equals the pitch diameter tolerance plus $H/12$ and applies only where the rounded root is a requirement of the design. Otherwise the tolerance shall be $H/4$ plus the pitch diameter tolerance. The minimum minor diameter of the external thread may be determined by subtracting $0.6495p$ ($3/4H$, table IV.1) from the minimum pitch diameter of the external thread. In dimensioning external threads the minimum minor diameter is not specified, being established by the crest of an unworn tool. In practice, the minor diameter of an external thread is satisfactory when accepted by a gage or gaging method that represents the maximum material condition of the internal thread less the allowances, if any.

TABLE IV.2.—Allowances for external threads of special diameters and pitches, classes 1A and 2A
(UNS and NS threads, see subsection 5, p. 98)

Threads per inch	Major, pitch, and minor diameter allowances *											
	$\frac{3}{16}$ 0.0600 to 0.0781	$\frac{3}{32}$ 0.0782 to 0.1095	$\frac{1}{4}$ 0.1095 to 0.1563	$\frac{5}{16}$ 0.1564 to 0.2188	$\frac{3}{8}$ 0.2189 to 0.3125	$\frac{7}{16}$ 0.3126 to 0.4375	$\frac{1}{2}$ 0.4376 to 0.5625	$\frac{5}{8}$ 0.5626 to 0.6875	$\frac{3}{4}$ 0.6876 to 0.8750	1 0.8751 to 1.1250	1 1/4 1.1251 to 1.3750	1 3/4 1.3751 to 1.6250
80	in.	in.	in.	in.	in.	in.	in.	in.	in.	in.	in.	in.
72	0.0006	0.0006	0.0006	0.0007	0.0007	0.0007	0.0008	0.0008	0.0009	0.0009	0.0010	0.0011
64	.0006	.0006	.0006	.0007	.0007	.0007	.0008	.0008	.0009	.0009	.0010	.0011
48	.0006	.0007	.0007	.0007	.0007	.0007	.0008	.0008	.0009	.0009	.0010	.0011
44		.0007	.0007	.0008	.0008	.0008	.0009	.0009	.0009	.0010	.0010	.0011
40			.0008	.0008	.0009	.0009	.0010	.0010	.0010	.0010	.0011	.0012
36			.0008	.0009	.0009	.0010	.0010	.0010	.0010	.0011	.0011	.0012
32			.0009	.0009	.0010	.0010	.0010	.0011	.0011	.0011	.0012	.0012
28				.0010	.0010	.0011	.0011	.0011	.0012	.0012	.0012	.0013
27				.0010	.0010	.0011	.0011	.0011	.0012	.0012	.0012	.0013
24				.0011	.0011	.0011	.0012	.0012	.0012	.0013	.0013	.0013
20					.0012	.0012	.0013	.0013	.0013	.0014	.0014	.0014
18						.0013	.0013	.0013	.0014	.0014	.0015	.0015
16						.0014	.0014	.0014	.0015	.0015	.0015	.0016
14							.0015	.0015	.0015	.0016	.0016	.0017
12								.0016	.0016	.0017	.0017	.0018
10									.0018	.0018	.0019	.0019
8										.0021	.0021	.0021
6											.0021	.0021
4												.0024

Threads per inch	Major, pitch, and minor diameter allowances *											
	1 1/4 1.6251 to 1.8750	2 1.8751 to 2.2500	2 1/2 2.2501 to 2.7500	3 2.7501 to 3.2500	3 1/2 3.2501 to 3.7500	4 3.7501 to 4.5000	5 4.5001 to 5.5000	6 5.5001 to 7.0000	8 7.0001 to 9.0000	10 9.0001 to 11.0000	12 11.0001 to 13.0000	
80	in.	in.	in.	in.	in.	in.	in.	in.	in.	in.	in.	
72												
64												
60												
48												
44												
40												
36												
32	0.0012	0.0013	0.0013	0.0013	0.0014	0.0015	0.0015	0.0016	0.0016			
28	.0013	.0013	.0014	.0014	.0014	.0015	.0015	.0016	.0016			
27	.0013	.0013	.0014	.0014	.0014	.0015	.0015	.0016	.0016			
24	.0014	.0014	.0014	.0015	.0015	.0015	.0016	.0016	.0016			
20	.0016	.0015	.0015	.0016	.0016	.0016	.0017	.0017	.0017			
18	.0016	.0015	.0016	.0016	.0017	.0017	.0017	.0018	.0018	0.0019		
16	.0016	.0016	.0017	.0017	.0017	.0018	.0018	.0019	.0019	.0019		
14	.0017	.0017	.0017	.0018	.0018	.0018	.0019	.0020	.0020	.0020	0.0022	
12	.0018	.0018	.0019	.0019	.0019	.0020	.0020	.0021	.0021	.0022	.0022	
10	.0019	.0020	.0020	.0020	.0021	.0021	.0022	.0022	.0023	.0023	.0024	
8	.0021	.0022	.0022	.0023	.0023	.0023	.0024	.0024	.0025	.0025	.0026	
6	.0025	.0025	.0026	.0026	.0026	.0027	.0027	.0027	.0028	.0028	.0029	
4	.0030	.0030	.0031	.0031	.0031	.0032	.0032	.0033	.0034	.0034	.0036	

Classes 1A and 2A allowances are determined by multiplying class 2A pitch diameter tolerances (computed to six decimal places) by 0.3 and are based on lengths of engagement of nine pitches.

* Allowances are based on diameters given in common fractions, which are the means of the diameter ranges expressed in decimals.

TABLE IV.2A.—Allowances, class 1AR

Threads per inch, n	Allowance, G , classes 1 and 1AR ¹
40	in. (0.0010)
36	(.0011)
32	(.0011)
28	(.0012)
24	(.0013)
20	(.0015)
18	(.0015)
16	.0018
14	.0021
12	.0024
10	.0028
8	.0034
6	.0044
4	.0062

¹ For values in parentheses there is no class 1AR as these are identical with those for class 1A.

(b) *Internal threads.*—Internal thread minor diameter tolerances specified in tables IV.10 and IV.11 are based on the use of materials of equal tensile strength for screw or bolt and nut or tapped hole and a length of engagement equal to the nominal diameter. See p. 5. For general applications these tolerances are suitable for lengths of engagement up to $1\frac{1}{2}$ diameters. They are based on formulas as follows:

Classes 1B and 2B:

All special threads in sizes less than $\frac{1}{4}$ in., tolerance = $0.05 \sqrt[3]{p^3} + 0.03p/D - 0.002$ in., within the following limitations:

Tolerances shall not be greater than $0.394p$. (This corresponds to 53 percent of the basic thread height and applies in the range of the smallest number sizes of the NC and NF thread series.)

TABLE IV.3.—Major diameter tolerances for external threads of special diameters, pitches, and lengths of engagement, classes 1A, 1AR, 2A, and 3A

(UNS and NS threads, see subsection 5, p. 98)

Threads per inch	Major diameter tolerance	
	Classes 1A and 1AR, $0.090\sqrt{p^3}$	Classes 2A and 3A, $0.060\sqrt{p^3}$
	in.	in.
80	-----	0.0032
72	-----	.0035
64	-----	.0038
56	-----	.0041
48	-----	.0045
44	-----	.0048
40	0.0077	.0051
36	.0083	.0055
32	.0089	.0060
28	.0096	.0065
27	.0100	.0067
24	.0108	.0072
20	.0122	.0081
18	.0131	.0087
16	.0142	.0094
14	.0155	.0103
12	.0172	.0114
10	.0194	.0129
8	.0225	.0150
6	.0273	.0182
4	.0357	.0238

Tolerances shall not be less than $0.25p - 0.4p^2$. (This corresponds to a thread height of 65 percent for 80 to 24 threads per inch.)

The formulas are suitable for general applications having lengths of engagement up to $1\frac{1}{2}$ diameters. For specific applications within this range or for longer lengths of engagement see table IV.10, p. 92, and table 3.1, p. 187.

All special threads $\frac{1}{4}$ in. and larger, 80 to 4 threads per inch, inclusive,⁷

$$\text{tolerance} = 0.25p - 0.4p^2.$$

(This corresponds to a thread height of 64.5 percent for 80 threads per inch graduating to 71.8 percent for 4 threads per inch.)

Class 3B, all special threads:

Tolerance = $0.05\sqrt{p^2} + 0.03p/D - 0.002$ in., within the following limitations:

Tolerance shall not be greater than $0.394p$. (This corresponds to 53 percent of the basic thread height and applies in the range of the smallest numbered sizes of the UNC, UNF, NC and NF thread series.)

Tolerance shall not be less than:

For 80 to 13 threads per inch, inclusive, $0.23p - 1.5p^2$. (This corresponds to a thread height of 67 percent for 80 threads per inch, graduating to 74 percent for 13 threads per inch.)

For 12 threads per inch and coarser, tolerance = $0.120p$. (This corresponds to a thread height of 74 per cent and is the tolerance for all sizes 12 threads and coarser and 1 in. and larger.)

The formulas are suitable for general applications having lengths of engagement up to $1\frac{1}{2}$ diameters. For specific applications within this range or for longer lengths of engagement see table IV.11, p. 94 and table 3.2, p. 190.

⁷ Formula is not applicable to threads coarser than 4 tpi. For such threads use formula 3.17.

Some thread applications have lengths of engagement which are greater than $1\frac{1}{2}$ diameters or less than 1 diameter. For applications having shorter or longer lengths of engagement it may be advantageous to decrease or increase the tolerance, respectively, as explained below.

The principal practical factors that govern these tolerances are tapping difficulties, particularly tap breakage in the small sizes, availability of standard drill sizes in the medium and large sizes, and depth of engagement. Depth of engagement correlates with the stripping strength of the thread assembly, and thus also with the length of engagement. It also correlates with the tendency toward disengagement of the threads on one side when assembly is eccentric. The amount of possible eccentricity is one half of the sum of the pitch diameter allowance and tolerance on both mating threads. For a given pitch or height of thread this sum increases with the diameter, and accordingly this factor would require a decrease in minor diameter tolerance with increase in diameter. However, such decrease in tolerance often is not feasible without requiring special drill sizes; therefore, to be able to use as many as possible of the available standard drill sizes listed in ASA B5.12, the minor diameter tolerance for classes 1B and 2B of a given pitch for $\frac{1}{4}$ in. diameter and larger is constant, in accordance with a formula given above.

There may be applications where the lengths of engagement of the mating threads or the combination of materials used for mating threads are such that the maximum tolerance may not provide the desired strength of the fastening. Experience has shown that for lengths of engagement less than $\frac{3}{8}D$ (the minimum thickness of standard nuts) the minor diameter tolerance may be reduced without causing tapping difficulties.

In other applications the length of engagement of mating threads may be long because of design considerations or the combination of materials used for mating threads. As the threads engaged increase in number, their depth of engagement may be shallower and still develop stripping strength greater than the external thread breaking strength. In these cases the maximum tolerance should be increased to reduce the possibility of tapping difficulties.

To reduce the number of minor diameter tolerances to a practical minimum, tolerances for all recommended diameters, lengths of engagement, and selected pitches are given in table IV.10 for classes 1B and 2B and in table IV.11 for class 3B.

In these tables, the tolerances for lengths of engagement less than $\frac{3}{8}D$ are $\frac{1}{2}$ the formula values. For lengths of engagement from $\frac{3}{8}D$ to $\frac{1}{2}D$, the tolerances are three quarters of the formula values; for lengths of engagement from $\frac{1}{2}D$ to $1\frac{1}{2}D$, the tolerances are equal to the formula values; and for lengths of engagement over $1\frac{1}{2}D$, the tolerances are $1\frac{1}{4}$ times the formula values. Where the tolerance value so computed is more than $0.394p$,

which corresponds to a resulting minimum thread height of 53 percent, the value is adjusted to equal 0.394p.

7. PITCH DIAMETER TOLERANCES.—(a) *Values of factor C.*—The values of factor *C* (par. 3 above) for pitch diameter tolerances are as follows:

Class	Factor <i>C</i>
1A and 1AR	1.500
1B	1.950
2A	1.000
2B	1.300
3A	0.750
3B	.975

It will be noted that the factor *C* is 30 percent greater for internal than for external threads of a given class number on account of the relative difficulties of manufacture.

(b) *Limits of size.*—With respect to the pitch diameter limits of size, it is intended, except as hereinafter qualified, that no portion of the complete thread be permitted to project beyond the envelope defined by the maximum material limits on the one hand, or beyond that defined by the minimum-material limits on the other, and thus be outside of the tolerance zone as illustrated in figures III.3 and III.4, pp. 24 and 25.^{7a} Also, the diameter equivalent of the variation in any given element except pitch diameter shall not exceed one-half of the pitch diameter tolerance. Deviations from specified size and profile include variations in lead, uniformity of helix, flank angle, taper, out-of-roundness, and surface defects.⁸

The diameter equivalents of variations in lead, uniformity of helix, and flank angle are always in the direction toward maximum material, that is they increase the virtual diameter of the external thread and decrease that of the internal thread. Thus, the maximum-material pitch diameter limits are a limitation of the virtual diameter (effective size) and are so specified herein for all thread classes.

Variations in taper and roundness of the pitch diameter, together with variations of the pitch diameter as a whole, may be in the direction of minimum material, and thus the minimum-material pitch diameter limit may be specified as a limitation of the pitch diameter as a single element. However, in view of the interrelation of the pitch diameter, variation in lead and flank angle, etc., together with practical considerations relating to established production processes, product application, and inspection procedures, it is

^{7a} The full tolerance cannot, therefore, be used on pitch diameter unless deviation in other thread elements are zero.

⁸ In accordance with the requirement, values are given in table III.11, p. 22, for the tolerances of three series and classes, of one-half of the pitch diameter for deviations in lead and flank angle which are equivalent to the tolerances on the corresponding elements based on a depth of thread engagement of 1.5 times the pitch diameter. See section III, p. 22. For aeronautical applications, the tolerances are those specified. See Military Specific-

customary to interpret the minimum pitch diameter of the external thread and the maximum pitch diameter of the internal thread as virtual diameters (effective sizes) in classes 1A, 2A, 1B, 2B, and 3B, for application to various mass-produced bolts, nuts, screws, and other similar threaded fasteners, and to some custom threaded parts where design requirements are fulfilled. See "Limit gages" and "Acceptability of threads," section VI, pp. 108 and 118.

(c) *Tables of pitch diameter tolerances.*—Numerical values of pitch diameter tolerances for classes 1A, 1AR, 1B, 2A, 2B, 3A, and 3B are given in tables IV.4 to IV.9, inclusive. Two sets of tolerances are given: Those for 5 to 15 pitches length of engagement, based on lengths of 9 pitches, and those for 16 to 30 pitches length of engagement, based on lengths of 20 pitches. If excessively small or large lengths of engagement are encountered, the thread tolerances may be calculated from the formulas, if considered advisable. Also, for threads per inch not included in the tables, tolerances should be calculated by applying the formulas.

(b) SCREW THREAD CLASSES

1. CLASSES 1A, 1AR, and 1B.—(a) *Definition.*—The combinations of classes 1A or 1AR and 1B are intended to cover the manufacture of threaded parts where quick and easy assembly is necessary, and where an allowance is required to permit ready assembly, even when the threads are slightly bruised or dirty.

Maximum diameters of class 1A (external) threads are less than basic by the amount of the same allowance as applied to class 2A. For the intended applications in American practice the allowance is not available for plating or coating. Where the thread is plated or coated, special provisions are necessary. The minimum diameters of class 1B (internal) threads, whether or not plated or coated, are basic, affording no allowance or clearance for assembly with maximum metal external thread components having maximum diameters which are basic.

(b) *Allowances and tolerances.*—Allowances for all diameters and pitch diameter tolerances are specified in table IV.2, IV.2A, IV.4, and IV.7, and their application is shown in figure III.3 p. 24.

2. CLASSES 2A and 2B.—(a) *Definition.*—Classes 2A for external threads and 2B for internal threads are designed for general use. A moderate allowance is provided for class 2A threads.

The maximum diameters of class 2A (external) uncoated threads are less than basic by the amount of the allowance. The allowance minimizes galling and seizing in high-cycle wrench assembly, or it can be used to accommodate plated finishes or other coating. However, for threads with additive finish, the maximum diameters of class 2A may be exceeded by the amount of the allowance; i.e., the 2A maximum diameters apply to an unplated part or

TABLE IV.4.—Pitch diameter tolerances for external threads of special
(UNS and NS threads.)

Threads per inch	Lengths of engagement		Pitch diameter tolerances *									
	Number of pitches	Inches	$\frac{3}{16}$ 0.0600 to 0.0781	$\frac{3}{32}$ 0.0782 to 0.1094	$\frac{1}{4}$ 0.1095 to 0.1563	$\frac{5}{16}$ 0.1564 to 0.2188	$\frac{3}{8}$ 0.2189 to 0.3125	$\frac{7}{16}$ 0.3126 to 0.4375	$\frac{1}{2}$ 0.4376 to 0.6875	$\frac{5}{8}$ 0.6876 to 0.8750	$\frac{3}{4}$ 0.8751 to 1.1250	1 1.1250 to 1.1250
80	5 to 15	0.06 to 0.19		in.	in.	in.	in.	in.	in.	in.	in.	in.
	16 to 30	0.191 to 0.38										
72	5 to 15	0.07 to 0.21										
	16 to 30	0.211 to 0.42										
64	5 to 15	0.08 to 0.23										
	16 to 30	0.231 to 0.46										
56	5 to 15	0.09 to 0.27										
	16 to 30	0.271 to 0.54										
48	5 to 15	0.10 to 0.31										
	16 to 30	0.311 to 0.62										
44	5 to 15	0.11 to 0.34		0.0038	0.0039	0.0041	0.0042	0.0044	0.0046	0.0047	0.0049	0.0051
	16 to 30	0.341 to 0.68		.0043	.0044	.0046	.0047	.0049	.0051	.0052	.0054	.0056
40	5 to 15	0.12 to 0.38			.0041	.0043	.0044	.0046	.0048	.0049	.0051	.0052
	16 to 30	0.381 to 0.76			.0043	.0046	.0048	.0051	.0053	.0054	.0056	.0058
36	5 to 15	0.14 to 0.42			.0043	.0045	.0046	.0048	.0050	.0051	.0052	.0054
	16 to 30	0.421 to 0.84			.0045	.0050	.0052	.0054	.0056	.0057	.0058	.0060
32	5 to 15	0.16 to 0.47			.0045	.0047	.0048	.0050	.0052	.0053	.0055	.0057
	16 to 30	0.471 to 0.94			.0047	.0053	.0054	.0056	.0058	.0059	.0061	.0063
28	5 to 15	0.18 to 0.54			.0045	.0050	.0051	.0053	.0055	.0056	.0058	.0060
	16 to 30	0.541 to 1.08			.0050	.0056	.0058	.0060	.0061	.0063	.0064	.0066
27	5 to 15	0.19 to 0.56			.0045	.0051	.0052	.0054	.0056	.0057	.0058	.0060
	16 to 30	0.561 to 1.12			.0051	.0057	.0059	.0061	.0062	.0064	.0065	.0067
24	5 to 15	0.21 to 0.62			.0045	.0055	.0055	.0057	.0059	.0060	.0061	.0063
	16 to 30	0.621 to 1.24			.0055	.0062	.0062	.0064	.0065	.0067	.0068	.0070
20	5 to 15	0.25 to 0.75			.0045	.0060	.0060	.0062	.0063	.0065	.0066	.0068
	16 to 30	0.751 to 1.50			.0060	.0067	.0069	.0071	.0071	.0072	.0073	.0076
18	5 to 15	0.28 to 0.83			.0045	.0065	.0065	.0067	.0068	.0070	.0071	.0073
	16 to 30	0.831 to 1.66			.0065	.0073	.0073	.0074	.0074	.0076	.0077	.0079
16	5 to 15	0.31 to 0.94			.0045	.0070	.0070	.0072	.0073	.0075	.0076	.0078
	16 to 30	0.941 to 1.88			.0070	.0077	.0077	.0078	.0078	.0080	.0081	.0083
14	5 to 15	0.35 to 1.07			.0045	.0075	.0075	.0077	.0078	.0080	.0081	.0083
	16 to 30	1.071 to 2.14			.0075	.0083	.0083	.0085	.0085	.0086	.0088	.0090
12	5 to 15	0.42 to 1.25			.0045	.0080	.0080	.0082	.0083	.0085	.0086	.0088
	16 to 30	1.251 to 2.50			.0080	.0090	.0090	.0091	.0091	.0092	.0093	.0095
10	5 to 15	0.50 to 1.50			.0045	.0090	.0090	.0092	.0093	.0095	.0096	.0098
	16 to 30	1.501 to 3.00			.0090	.0101	.0101	.0101	.0101	.0101	.0101	.0103
8	5 to 15	0.62 to 1.88			.0045	.0103	.0103	.0105	.0106	.0108	.0109	.0111
	16 to 30	1.881 to 3.75			.0103	.0114	.0114	.0114	.0114	.0114	.0114	.0116
6	5 to 15	0.83 to 2.50			.0045	.0114	.0114	.0116	.0117	.0119	.0120	.0122
	16 to 30	2.501 to 5.00			.0114	.0125	.0125	.0125	.0125	.0125	.0125	.0127
4	5 to 15	1.25 to 3.75			.0045	.0125	.0125	.0127	.0128	.0130	.0131	.0133
	16 to 30	3.751 to 7.50			.0125	.0136	.0136	.0136	.0136	.0136	.0136	.0138

* Tolerances are based on diameters given in common fractions, which are the means of the diameter ranges expressed in decimals.

diameters, pitches, and lengths of engagement, classes 1A and 1AR

See subsection 5, p. 98.)

Pitch diameter tolerances *—Continued													Threads per inch	
1 1/4 1.251 to 1.3750	1 1/2 1.3751 to 1.6250	1 3/4 1.6251 to 1.8750	2 1.8751 to 2.2500	2 1/4 2.2501 to 2.7500	3 2.7501 to 3.2500	3 1/4 3.2501 to 3.7500	4 3.7501 to 4.5000	5 4.5001 to 5.2500	6 5.2501 to 7.0000	8 7.0001 to 9.0000	10 9.0001 to 11.0000	12 11.0001 to 13.0000		
in.			LEGENDS											
			1. These values do not agree with and shall not be used in place of any tabulated values for the UNC, UNF, and 8N thread series, in table III.10.										80	
			2. Formula: Class 1A tolerances for external threads are determined by multiplying class 2A tolerances (computed to six decimal places) by 1.500. See legend 2, table IV.5, for formula for class 2A tolerances.										72	
			3. Length of engagement increments included in the tabulated tolerances for lengths of engagement of from 5 to 16 pitches are based on lengths of 9 pitches; those for lengths of engagement greater than 15 to 30 pitches are based on lengths of 20 pitches. For lengths of engagement not tabulated, the formula in legend 2 should be applied.										64	
			4. Pitches listed are those used most commonly and are recommended. Where intermediate pitches are specified, the formula in legend 2 should be applied.										56	
			5. Tolerances are tabulated only for combinations of diameter, pitch, and length of engagement which are considered to be generally used. For other combinations encountered, see Design of Special Threads, appendix 5, p. 200.										48	
			in.	in.	in.	in.	in.	in.	in.	in.	in.	in.	in.	44
														40
0.0056 .0062	0.0058 .0063													36
.0065 .0064	.0060 .0066	0.0061 .0067	0.0063 .0068	0.0065 .0071	0.0067 .0073									32
.0061 .0068	.0063 .0069	.0064 .0071	.0066 .0072	.0068 .0074	.0070 .0076	0.0071 .0078	0.0073 .0079							28
.0061 .0069	.0064 .0070	.0065 .0071	.0066 .0073	.0069 .0075	.0070 .0077	.0072 .0079	.0074 .0080	0.0076 .0083	0.0079 .0085					27
.0065 .0072	.0067 .0073	.0066 .0075	.0069 .0076	.0071 .0078	.0073 .0080	.0075 .0082	.0077 .0083	.0079 .0086	.0082 .0088					24
.0070 .0077	.0071 .0079	.0073 .0080	.0074 .0081	.0076 .0084	.0078 .0085	.0080 .0087	.0081 .0089	.0084 .0092	.0087 .0094					20
.0073 .0081	.0074 .0082	.0076 .0084	.0077 .0085	.0079 .0087	.0081 .0089	.0083 .0091	.0084 .0092	.0087 .0095	.0090 .0097	0.0094 .0101				18
.0077 .0085	.0078 .0085	.0079 .0087	.0081 .0089	.0083 .0091	.0085 .0093	.0086 .0095	.0088 .0096	.0091 .0099	.0093 .0101	.0097 .0105	0.0101 .0109			16
.0081 .0090	.0083 .0091	.0084 .0093	.0085 .0094	.0087 .0096	.0089 .0098	.0091 .0100	.0092 .0101	.0095 .0104	.0098 .0107	.0102 .0111	.0105 .0114	0.0108 .0117		14
.0087 .0095	.0088 .0098	.0090 .0099	.0091 .0100	.0093 .0103	.0095 .0104	.0097 .0106	.0098 .0108	.0101 .0110	.0103 .0113	.0107 .0117	.0111 .0120	.0114 .0123		12
.0094 .0105	.0096 .0106	.0097 .0107	.0098 .0109	.0100 .0111	.0102 .0113	.0104 .0114	.0106 .0116	.0108 .0119	.0111 .0121	.0115 .0125	.0118 .0129	.0121 .0132		10
.0104 .0116	.0106 .0118	.0107 .0119	.0108 .0120	.0111 .0122	.0113 .0124	.0114 .0125	.0116 .0128	.0119 .0130	.0121 .0133	.0125 .0137	.0129 .0140	.0132 .0143		8
	.0121 .0135	.0123 .0136	.0124 .0138	.0126 .0140	.0128 .0142	.0130 .0143	.0131 .0145	.0134 .0148	.0137 .0150	.0141 .0154	.0144 .0158	.0147 .0161		6
			.0161 .0168	.0164 .0170	.0165 .0172	.0167 .0174	.0169 .0176	.0172 .0178	.0176 .0180	.0180 .0185	.0184 .0188	.0187 .0191		4

TABLE IV.5.—Pitch diameter tolerances for external threads of
(UNS and NS threads.)

Threads per inch	Lengths of engagement		Pitch diameter tolerances ^a									
	Number of pitches	Inches	$\frac{1}{16}$ 0.0600 to 0.0781	$\frac{3}{32}$ 0.0782 to 0.1094	$\frac{1}{8}$ 0.1095 to 0.1563	$\frac{3}{16}$ 0.1564 to 0.2188	$\frac{1}{4}$ 0.2189 to 0.3125	$\frac{5}{16}$ 0.3126 to 0.4375	$\frac{3}{8}$ 0.4376 to 0.5625	$\frac{7}{16}$ 0.5626 to 0.6875	$\frac{1}{2}$ 0.6876 to 0.8750	$\frac{5}{8}$ 0.8751 to 1.1250
80	5 to 15	0.06 to 0.19	<i>in.</i> 0.0019	<i>in.</i> 0.0020	<i>in.</i> 0.0021	<i>in.</i> 0.0022	<i>in.</i> 0.0023	<i>in.</i> 0.0024	<i>in.</i> 0.0025			
	16 to 30	0.191 to 0.38	.0022	.0022	.0023	.0023	.0023	.0023	.0023			
72	5 to 15	0.07 to 0.21	.0020	.0021	.0021	.0023	.0023	.0025	.0026	.0027		
	16 to 30	0.211 to 0.42		.0023	.0024	.0025	.0026	.0027	.0028	.0029		
64	5 to 15	0.08 to 0.23	.0021	.0022	.0022	.0024	.0024	.0026	.0027	.0029	.0030	
	16 to 30	0.231 to 0.46		.0025	.0025	.0026	.0027	.0028	.0029	.0030	.0031	
56	5 to 15	0.09 to 0.27		.0023	.0024	.0025	.0026	.0027	.0028	.0030	.0032	.0033
	16 to 30	0.271 to 0.54		.0026	.0027	.0028	.0029	.0030	.0031	.0032	.0033	.0034
48	5 to 15	0.10 to 0.31		.0025	.0025	.0026	.0027	.0029	.0030	.0033	.0034	.0035
	16 to 30	0.311 to 0.62			.0029	.0030	.0030	.0032	.0033	.0034	.0035	
44	5 to 15	0.11 to 0.34		.0026	.0026	.0027	.0028	.0030	.0031	.0034	.0035	.0037
	16 to 30	0.341 to 0.68			.0030	.0031	.0032	.0033	.0034	.0035	.0036	
40	5 to 15	0.12 to 0.38			.0027	.0029	.0029	.0031	.0032	.0033	.0034	.0035
	16 to 30	0.381 to 0.76			.0031	.0032	.0033	.0034	.0035	.0036	.0037	.0038
36	5 to 15	0.14 to 0.42			.0029	.0030	.0031	.0032	.0033	.0034	.0035	.0036
	16 to 30	0.421 to 0.84				.0034	.0034	.0036	.0037	.0038	.0039	.0040
32	5 to 15	0.16 to 0.47			.0030	.0031	.0032	.0033	.0034	.0035	.0036	.0038
	16 to 30	0.471 to 0.94				.0035	.0036	.0038	.0039	.0040	.0041	.0042
28	5 to 15	0.18 to 0.54				.0033	.0034	.0036	.0037	.0038	.0038	.0040
	16 to 30	0.541 to 1.08				.0038	.0038	.0040	.0041	.0042	.0043	.0044
27	5 to 15	0.19 to 0.56				.0034	.0035	.0036	.0037	.0038	.0039	.0040
	16 to 30	0.561 to 1.12				.0038	.0039	.0040	.0041	.0042	.0043	.0045
24	5 to 15	0.21 to 0.62				.0036	.0037	.0038	.0039	.0040	.0041	.0042
	16 to 30	0.621 to 1.24					.0041	.0043	.0044	.0045	.0045	.0047
20	5 to 15	0.25 to 0.75					.0040	.0041	.0042	.0043	.0044	.0045
	16 to 30	0.751 to 1.50					.0045	.0046	.0047	.0048	.0049	.0050
18	5 to 15	0.28 to 0.83						.0043	.0044	.0045	.0046	.0047
	16 to 30	0.831 to 1.66						.0048	.0050	.0050	.0051	.0053
16	5 to 15	0.31 to 0.94						.0046	.0047	.0048	.0049	.0050
	16 to 30	0.941 to 1.88						.0051	.0052	.0053	.0054	.0056
14	5 to 15	0.36 to 1.07							.0050	.0051	.0051	.0053
	16 to 30	1.071 to 2.14							.0056	.0057	.0057	.0059
12	5 to 15	0.42 to 1.25							.0054	.0054	.0055	.0057
	16 to 30	1.251 to 2.50							.0060	.0061	.0062	.0063
10	5 to 15	0.50 to 1.50									.0060	.0062
	16 to 30	1.501 to 3.00									.0067	.0069
8	5 to 15	0.62 to 1.88										.0068
	16 to 30	1.881 to 3.76										.0070
6	5 to 15	0.83 to 2.50										
	16 to 30	2.501 to 5.00										
4	5 to 15	1.25 to 3.75										
	16 to 30	3.751 to 7.50										

^a Tolerances are based on diameters given in common fractions, which are the means of the diameter ranges expressed in decimals.

special diameters, pitches, and lengths of engagement, class 2A

See subsection 5, p. 98.)

Pitch diameter tolerances — Continued												Threads per inch		
1¼ 1.1251 to 1.3750	1½ 1.3751 to 1.6250	1¾ 1.6251 to 1.8750	2 1.8751 to 2.2500	2½ 2.2501 to 2.7500	3 2.7501 to 3.2500	3¼ 3.2501 to 3.7500	4 3.7501 to 4.5000	5 4.5001 to 5.5000	6 5.5001 to 7.0000	8 7.0001 to 9.0000	10 9.0001 to 11.0000		12 11.0001 to 13.0000	
in.	in.	in.	LEGENDS											
			1. These values do not agree with and shall not be used in place of any tabulated values for the UNC, UNF and 8N thread series, in table III.10.										80	
			2. Formula: Class 2A tolerances = $0.0015\sqrt{D} + 0.0015\sqrt{L_e} + 0.015\sqrt{p^3}$ where D = basic major diameter L_e = length of engagement p = pitch										72	
			3. Length of engagement increments included in the tabulated tolerances for lengths of engagement of from 5 to 15 pitches are based on lengths of 9 pitches; those for lengths of engagement greater than 15 to 30 pitches are based on lengths of 20 pitches. For lengths of engagement not tabulated, the formula in legend 2 should be applied.										64	
			4. Pitches listed are those used most commonly and are recommended. Where intermediate pitches are specified, the formula in legend 2 should be applied.										56	
			5. Tolerances are tabulated only for combinations of diameter, pitch and length of engagement which are considered to be generally used. For other combinations encountered, see Design of Special Threads, appendix 5, p. 200.										48	
			in.	in.	in.	in.	in.	in.	in.	in.	in.	in.	in.	44
														40
0.0037 .0041	0.0038 .0042													36
.0039 .0043	.0040 .0044	0.0041 .0045	0.0042 .0046	0.0043 .0047	0.0044 .0048	0.0045 .0049	0.0046 .0051	0.0047 .0052	0.0048 .0053					32
.0041 .0045	.0042 .0046	.0043 .0047	.0044 .0048	.0045 .0050	.0046 .0051	.0047 .0052	.0048 .0053	.0049 .0053	0.0051 .0055	0.0053 .0057				28
.0041 .0046	.0042 .0047	.0043 .0048	.0044 .0048	.0045 .0050	.0046 .0051	.0047 .0052	.0048 .0053	.0049 .0053	.0051 .0055	.0053 .0057				27
.0043 .0048	.0044 .0049	.0045 .0050	.0046 .0051	.0047 .0052	.0048 .0053	.0049 .0054	.0050 .0055	.0051 .0056	.0053 .0057	.0054 .0059				24
.0047 .0052	.0048 .0053	.0049 .0054	.0050 .0055	.0051 .0056	.0052 .0057	.0053 .0058	.0054 .0059	.0055 .0061	.0056 .0063	.0058 .0063				20
.0049 .0054	.0050 .0055	.0051 .0056	.0052 .0057	.0053 .0058	.0054 .0059	.0055 .0060	.0056 .0061	.0058 .0063	.0059 .0065	.0060 .0065	0.0062 .0068			18
.0051 .0057	.0052 .0058	.0053 .0058	.0054 .0059	.0055 .0061	.0056 .0062	.0057 .0063	.0058 .0064	.0059 .0066	.0061 .0068	.0062 .0068	.0065 .0070	0.0067 .0073		16
.0054 .0060	.0055 .0061	.0056 .0062	.0057 .0063	.0058 .0064	.0059 .0065	.0061 .0067	.0062 .0068	.0064 .0069	.0065 .0071	.0068 .0074	.0070 .0076	0.0072 .0078		14
.0058 .0064	.0059 .0065	.0060 .0066	.0061 .0067	.0062 .0068	.0063 .0069	.0064 .0071	.0065 .0072	.0067 .0074	.0069 .0077	.0072 .0078	.0074 .0080	.0076 .0082		12
.0063 .0070	.0064 .0071	.0065 .0072	.0066 .0072	.0067 .0074	.0068 .0075	.0069 .0076	.0070 .0077	.0072 .0079	.0074 .0081	.0077 .0084	.0079 .0086	.0081 .0088		10
.0070 .0077	.0071 .0078	.0072 .0079	.0073 .0080	.0074 .0082	.0075 .0083	.0076 .0084	.0077 .0085	.0079 .0087	.0081 .0088	.0083 .0091	.0086 .0094	.0088 .0096		8
	.0081 .0088	.0082 .0091	.0083 .0092	.0084 .0093	.0085 .0094	.0087 .0096	.0088 .0097	.0090 .0098	.0091 .0100	.0094 .0103	.0096 .0105	.0098 .0107		6
			.0091 .0112	.0092 .0113	.0094 .0115	.0095 .0116	.0097 .0117	.0098 .0119	.0099 .0120	.0101 .0123	.0103 .0125	.0105 .0127		4

TABLE IV.6.—Pitch diameter tolerances for external threads of

(UNS and NS threads.)

Threads per inch	Lengths of engagement		Pitch diameter tolerances *									
	Number of pitches	Inches	$\frac{3}{16}$ 0.0600 to 0.0781	$\frac{1}{4}$ 0.0782 to 0.1094	$\frac{1}{2}$ 0.1095 to 0.1563	$\frac{3}{8}$ 0.1564 to 0.2188	$\frac{1}{2}$ 0.2189 to 0.3125	$\frac{3}{4}$ 0.3126 to 0.4375	$\frac{1}{2}$ 0.4376 to 0.6625	$\frac{3}{4}$ 0.6626 to 0.6875	$\frac{1}{2}$ 0.6876 to 0.8750	1 0.8751 to 1.1250
80	5 to 15	0.06 to 0.10	in. 0.0014	in. 0.0015	in. 0.0015	in. 0.0016	in. 0.0017	in.	in.	in.	in.	in.
	16 to 30	0.191 to 0.38	.0016	.0017	.0017	.0018	.0019					
72	5 to 15	0.07 to 0.21	.0015	.0016	.0016	.0017	.0018	0.0019				
	16 to 30	0.211 to 0.42		.0018	.0018	.0019	.0020	.0021				
64	5 to 15	0.08 to 0.23	.0016	.0016	.0017	.0018	.0018	.0019	0.0020			
	16 to 30	0.231 to 0.46		.0018	.0019	.0020	.0020	.0021	.0022			
60	5 to 15	0.09 to 0.27		.0017	.0018	.0019	.0019	.0020	.0021	0.0022	0.0022	
	16 to 30	0.271 to 0.54		.0020	.0020	.0021	.0021	.0023	.0023	.0024	.0025	
48	5 to 15	0.10 to 0.31		.0019	.0019	.0020	.0020	.0022	.0022	.0023	.0024	
	16 to 30	0.311 to 0.62			.0021	.0022	.0023	.0024	.0025	.0026	.0026	
44	5 to 15	0.11 to 0.34		.0019	.0020	.0021	.0021	.0022	.0023	.0024	.0024	0.0025
	16 to 30	0.341 to 0.68			.0022	.0023	.0024	.0025	.0026	.0026	.0027	.0028
40	5 to 15	0.12 to 0.38			.0021	.0021	.0022	.0023	.0024	.0025	.0025	.0026
	16 to 30	0.381 to 0.76			.0023	.0024	.0025	.0026	.0027	.0027	.0028	.0029
36	5 to 15	0.14 to 0.42			.0022	.0022	.0023	.0024	.0025	.0026	.0026	.0027
	16 to 30	0.421 to 0.84				.0025	.0026	.0027	.0028	.0028	.0029	.0030
32	5 to 15	0.16 to 0.47			.0023	.0024	.0024	.0025	.0026	.0027	.0027	.0028
	16 to 30	0.471 to 0.94				.0026	.0027	.0028	.0029	.0030	.0030	.0031
28	5 to 15	0.18 to 0.54				.0025	.0026	.0027	.0028	.0028	.0029	.0030
	16 to 30	0.541 to 1.08				.0028	.0029	.0030	.0031	.0031	.0032	.0033
27	5 to 15	0.19 to 0.56				.0025	.0026	.0027	.0028	.0029	.0029	.0030
	16 to 30	0.561 to 1.12				.0029	.0029	.0030	.0031	.0032	.0032	.0033
24	5 to 15	0.21 to 0.62				.0027	.0028	.0029	.0029	.0030	.0031	.0032
	16 to 30	0.621 to 1.24					.0031	.0032	.0033	.0033	.0034	.0035
20	5 to 15	0.25 to 0.75					.0030	.0031	.0032	.0033	.0033	.0034
	16 to 30	0.761 to 1.50					.0034	.0035	.0036	.0037	.0037	.0038
18	5 to 15	0.28 to 0.83						.0032	.0033	.0034	.0035	.0036
	16 to 30	0.831 to 1.66						.0036	.0037	.0038	.0038	.0039
16	5 to 15	0.31 to 0.94						.0034	.0035	.0036	.0036	.0037
	16 to 30	0.941 to 1.88						.0038	.0039	.0040	.0041	.0042
14	5 to 15	0.36 to 1.07							.0037	.0038	.0039	.0040
	16 to 30	1.071 to 2.14							.0042	.0042	.0043	.0044
12	5 to 15	0.42 to 1.25								.0040	.0041	.0042
	16 to 30	1.251 to 2.50								.0045	.0046	.0047
10	5 to 15	0.50 to 1.50									.0045	.0046
	16 to 30	1.501 to 3.00									.0050	.0051
8	5 to 15	0.62 to 1.88										.0051
	16 to 30	1.881 to 3.75										.0057
6	5 to 15	0.83 to 2.50										
	16 to 30	2.501 to 5.00										
4	5 to 15	1.25 to 3.75										
	16 to 30	3.761 to 7.50										

* Tolerances are based on diameters given in common fractions, which are the means of the diameter ranges expressed in decimals.

special diameters, pitches, and lengths of engagement, class 3A

See subsection 5, p. 98.)

Pitch diameter tolerances *--Continued													Threads per inch
1 1/4 1.1251 to 1.3760	1 1/8 1.3751 to 1.6250	1 1/2 1.6251 to 1.8760	2 1.8751 to 2.2500	2 1/2 2.2501 to 2.7500	3 2.7501 to 3.2500	3 1/2 3.2501 to 3.7500	4 3.7501 to 4.5000	5 4.5001 to 5.5000	6 5.5001 to 7.0000	8 7.0001 to 9.0000	10 9.0001 to 11.0000	12 11.0001 to 13.0000	
in.	in.	in.	LEGENDS										
			1. These values do not agree with and shall not be used in place of any tabulated values for the UNC, UNF, and 8N thread series, in table III.10.										80
			2. Formula: Class 3A tolerances for external threads are determined by multiplying class 2A tolerances (computed to six decimal places) by 0.750. See legend 2, table IV.5, for formula for class 2A tolerances.										72
			3. Length of engagement increments included in the tabulated tolerances for lengths of engagement from 5 to 15 pitches are based on lengths of 9 pitches; those for lengths of engagement greater than 15 to 30 pitches are based on lengths of 20 pitches. For lengths of engagement not tabulated, the formula in legend 2 should be applied.										64
			4. Pitches listed are those used most commonly and are recommended. Where intermediate pitches are specified, the formula in legend 2 should be applied.										56
			5. Tolerances are tabulated only for combinations of diameter, pitch, and length of engagement which are considered to be generally used. For other combinations encountered, see Design of Special Threads, appendix 5, p. 200.										48
			in.	in.	in.	in.	in.	in.	in.	in.	in.	in.	
													44
													40
0.0028 .0031	0.0029 .0032												36
.0029 .0032	.0030 .0033	0.0031 .0034	0.0031 .0034	0.0032 .0035	0.0033 .0036								32
.0031 .0034	.0031 .0035	.0032 .0035	.0033 .0036	.0034 .0037	.0035 .0038	0.0036 .0039	0.0036 .0040						28
.0031 .0034	.0032 .0035	.0033 .0036	.0033 .0035	.0034 .0037	.0035 .0038	.0035 .0039	.0037 .0040	0.0038 .0041	0.0039 .0043	0.0039 .0044			27
.0032 .0036	.0032 .0037	.0033 .0037	.0033 .0038	.0035 .0039	.0037 .0040	.0037 .0041	.0038 .0042	.0040 .0043	.0041 .0044				24
.0035 .0039	.0036 .0039	.0036 .0040	.0037 .0041	.0038 .0042	.0039 .0043	.0040 .0044	.0041 .0045	.0042 .0047	.0043 .0049	.0043 .0051			20
.0036 .0040	.0037 .0041	.0038 .0042	.0039 .0044	.0040 .0044	.0041 .0045	.0041 .0045	.0042 .0048	.0044 .0049	.0045 .0051	0.0047 .0051			18
.0038 .0042	.0039 .0043	.0040 .0044	.0040 .0045	.0041 .0046	.0042 .0047	.0043 .0048	.0043 .0049	.0045 .0051	.0047 .0053	.0049 .0055	0.0050 .0055		16
.0041 .0045	.0041 .0046	.0042 .0046	.0043 .0047	.0044 .0048	.0045 .0049	.0045 .0050	.0046 .0051	.0048 .0052	.0049 .0053	.0051 .0055	.0053 .0057	0.0054 .0059	14
.0043 .0048	.0044 .0049	.0045 .0050	.0045 .0050	.0046 .0051	.0047 .0052	.0048 .0053	.0049 .0054	.0050 .0055	.0052 .0058	.0054 .0058	.0055 .0060	.0057 .0062	12
.0047 .0052	.0048 .0053	.0048 .0054	.0049 .0054	.0050 .0055	.0051 .0056	.0052 .0057	.0053 .0058	.0054 .0059	.0055 .0061	.0057 .0063	.0059 .0064	.0061 .0066	10
.0052 .0058	.0053 .0059	.0054 .0059	.0054 .0060	.0055 .0061	.0056 .0062	.0057 .0063	.0058 .0064	.0059 .0065	.0061 .0066	.0063 .0068	.0064 .0070	.0066 .0072	8
	.0061 .0067	.0061 .0068	.0062 .0069	.0063 .0070	.0064 .0071	.0065 .0072	.0066 .0073	.0067 .0074	.0068 .0075	.0070 .0077	.0072 .0079	.0074 .0080	6
			.0076 .0081	.0077 .0085	.0078 .0086	.0079 .0087	.0079 .0088	.0081 .0089	.0082 .0090	.0084 .0092	.0086 .0094	.0087 .0096	4

TABLE IV.7.—Pitch diameter tolerances for internal threads of
UNS and NS threads.

Threads per inch	Lengths of engagement		Pitch diameter tolerances *									
	Number of pitches	Inches	$\frac{1}{16}$ 0.0625 to 0.0781	$\frac{3}{32}$ 0.0782 to 0.1094	$\frac{1}{8}$ 0.1095 to 0.1563	$\frac{3}{16}$ 0.1564 to 0.2188	$\frac{1}{4}$ 0.2189 to 0.3125	$\frac{5}{16}$ 0.3126 to 0.4375	$\frac{3}{8}$ 0.4376 to 0.5625	$\frac{7}{16}$ 0.5626 to 0.6875	$\frac{1}{2}$ 0.6876 to 0.8750	$\frac{3}{4}$ 0.8751 to 1.1250
80	5 to 15	0.06 to 0.19		<i>m.</i>	<i>m.</i>	<i>m.</i>	<i>m.</i>	<i>m.</i>	<i>m.</i>	<i>m.</i>	<i>m.</i>	<i>m.</i>
	16 to 30	0.191 to 0.38										
72	5 to 15	0.07 to 0.21										
	16 to 30	0.211 to 0.42										
64	5 to 15	0.08 to 0.23										
	16 to 30	0.231 to 0.46										
60	5 to 15	0.09 to 0.27										
	16 to 30	0.271 to 0.54										
48	5 to 15	0.10 to 0.31										
	16 to 30	0.311 to 0.62										
44	5 to 15	0.11 to 0.34		0.0050	0.0051	0.0053	0.0055	0.0058	0.0060	0.0062	0.0063	0.0064
	16 to 30	0.341 to 0.68		.0056	.0058	.0060	.0062	.0064	.0066	.0068	.0070	.0072
40	5 to 15	0.12 to 0.38			.0054	.0056	.0057	.0060	.0062	.0065	.0065	.0068
	16 to 30	0.381 to 0.76			.0060	.0062	.0064	.0067	.0069	.0071	.0072	.0075
36	5 to 15	0.11 to 0.42			.0056	.0058	.0060	.0063	.0065	.0066	.0068	.0071
	16 to 30	0.421 to 0.84			.0065	.0068	.0067	.0070	.0072	.0074	.0075	.0078
32	5 to 15	0.16 to 0.47			.0059	.0061	.0063	.0066	.0068	.0070	.0071	.0074
	16 to 30	0.471 to 0.94			.0069	.0071	.0073	.0076	.0077	.0079	.0079	.0081
28	5 to 15	0.18 to 0.54				.0065	.0067	.0069	.0072	.0073	.0075	.0078
	16 to 30	0.541 to 1.08				.0073	.0075	.0078	.0080	.0081	.0083	.0086
27	5 to 15	0.19 to 0.56				.0066	.0068	.0070	.0073	.0074	.0076	.0079
	16 to 30	0.561 to 1.12				.0074	.0076	.0079	.0081	.0082	.0084	.0087
24	5 to 15	0.21 to 0.62				.0070	.0072	.0074	.0076	.0078	.0080	.0082
	16 to 30	0.621 to 1.24				.0080	.0083	.0083	.0085	.0087	.0088	.0091
20	5 to 15	0.25 to 0.75					.0078	.0080	.0083	.0084	.0086	.0089
	16 to 30	0.751 to 1.50					.0087	.0090	.0092	.0094	.0096	.0098
18	5 to 15	0.28 to 0.83						.0084	.0087	.0088	.0090	.0093
	16 to 30	0.831 to 1.66						.0095	.0097	.0098	.0100	.0103
16	5 to 15	0.31 to 0.94						.0089	.0091	.0093	.0095	.0097
	16 to 30	0.941 to 1.88						.0100	.0102	.0101	.0105	.0108
14	5 to 15	0.36 to 1.07							.0097	.0099	.0100	.0103
	16 to 30	1.071 to 2.14							.0109	.0110	.0112	.0115
12	5 to 15	0.42 to 1.25								.0104	.0106	.0110
	16 to 30	1.251 to 2.50								.0117	.0119	.0123
10	5 to 15	0.50 to 1.50									.0117	.0120
	16 to 30	1.501 to 3.00									.0131	.0134
8	5 to 15	0.62 to 1.88										.0133
	16 to 30	1.881 to 3.76										.0149
6	5 to 15	0.83 to 2.50										
	16 to 30	2.501 to 5.00										
4	5 to 15	1.25 to 3.75										
	16 to 30	3.751 to 7.50										

*Tolerances are based on diameters given in common fractions, which are the means of the diameter ranges expressed in decimals.

special diameters, pitches, and lengths of engagement, class 1B

See subsection 5, p. 08.)

Pitch diameter tolerances * - Continued												Threads per inch		
1 1/4 1.1251 to 1.3750	1 1/2 1.3751 to 1.6250	1 3/4 1.6251 to 1.8750	2 1.8751 to 2.2500	2 1/2 2.2501 to 2.7500	3 2.7501 to 3.2500	3 1/2 3.2501 to 3.7500	4 3.7501 to 4.5000	5 4.5001 to 5.5000	6 5.5001 to 7.0000	8 7.0001 to 9.0000	10 9.0001 to 11.0000		12 11.0001 to 13.0000	
<i>in.</i>	<i>in.</i>	<i>in.</i>	LEGENDS											
			1. These values do not agree with and shall not be used in place of any tabulated values for the UNC, UNF, and 8N thread series, in table III.10.										80	
			2. Formula: Class 1B tolerances for internal threads are 1.5 times class 2B tolerances and are determined by multiplying 2A tolerances (computed to six decimal places) by 1.50. See Legend 2, table IV.5, for formula for class 2A tolerances.										72	
			3. Length of engagement increments include <i>d</i> in the tabulated tolerances for lengths of engagement from 5 to 15 pitches are based on lengths of 9 pitches; those for lengths of engagement greater than 15 to 30 pitches are based on lengths of 20 pitches. For lengths of engagement not tabulated, the formula in legend 2 should be applied.										64	
			4. Pitches listed are those used most commonly and are recommended. Where intermediate pitches are specified, the formula in legend 2 should be applied.										56	
			5. Tolerances are tabulated only for combinations of diameter, pitch, and length of engagement which are considered to be generally used. For other combinations encountered, see Design of Special Threads, appendix 5, p. 200.										48	
			<i>in.</i>	<i>in.</i>	<i>in.</i>	<i>in.</i>	<i>in.</i>	<i>in.</i>	<i>in.</i>	<i>in.</i>	<i>in.</i>	<i>in.</i>		44
														40
0.0073 .0080	0.0075 .0082													36
.0076 .0084	.0078 .0086	0.0080 .0087	0.0081 .0089	0.0084 .0092	0.0087 .0091									32
.0090 .0088	.0082 .0090	.0084 .0092	.0085 .0093	.0088 .0096	.0090 .0099	0.0093 .0101	0.0095 .0103							28
.0090 1.0089	.0083 .0091	.0085 .0093	.0085 .0095	.0089 .0097	.0092 .0100	.0094 .0102	.0096 .0104	0.0099 .0108	0.0103 .0111					27
.0085 .0093	.0087 .0095	.0088 .0097	.0090 .0099	.0093 .0102	.0095 .0104	.0097 .0106	.0100 .0108	.0103 .0112	.0106 .0115					24
.0091 .0100	.0093 .0102	.0095 .0104	.0096 .0106	.0099 .0109	.0101 .0111	.0104 .0113	.0106 .0115	.0109 .0119	.0112 .0122					20
.0095 .0105	.0097 .0107	.0099 .0109	.0100 .0110	.0103 .0113	.0105 .0116	.0108 .0118	.0110 .0120	.0113 .0123	.0116 .0127	0.0122 .0132				18
.0100 .0110	.0101 .0112	.0103 .0114	.0105 .0116	.0108 .0118	.0110 .0121	.0112 .0123	.0114 .0125	.0118 .0129	.0121 .0132	.0126 .0137	0.0131 .0142			16
.0105 .0117	.0107 .0119	.0109 .0121	.0111 .0122	.0114 .0125	.0116 .0127	.0118 .0130	.0120 .0132	.0121 .0135	.0127 .0138	.0132 .0144	.0137 .0148	0.0141 .0152		14
.0113 .0125	.0115 .0127	.0116 .0129	.0118 .0130	.0121 .0133	.0123 .0136	.0126 .0138	.0128 .0140	.0131 .0144	.0134 .0147	.0140 .0152	.0144 .0157	.0148 .0161		12
.0122 .0136	.0124 .0138	.0126 .0140	.0128 .0141	.0130 .0144	.0133 .0147	.0135 .0149	.0137 .0151	.0141 .0154	.0144 .0158	.0149 .0163	.0154 .0167	.0158 .0171		10
.0136 .0151	.0138 .0153	.0140 .0155	.0141 .0156	.0144 .0159	.0146 .0162	.0149 .0164	.0151 .0166	.0154 .0169	.0157 .0173	.0163 .0178	.0167 .0182	.0171 .0186		8
	.0158 .0175	.0160 .0177	.0161 .0179	.0164 .0182	.0167 .0184	.0169 .0186	.0171 .0188	.0174 .0192	.0178 .0195	.0182 .0200	.0187 .0205	.0191 .0209		6
			.0197 .0218	.0200 .0221	.0202 .0224	.0204 .0226	.0206 .0228	.0209 .0232	.0213 .0235	.0218 .0240	.0223 .0245	.0227 .0248		4

TABLE IV.8.—Pitch diameter tolerances for internal *ti* reads of

(UNS and NS threads.)

Threads per inch	Lengths of engagement		Pitch diameter tolerances *									
	Number of pitches	Inches	$\frac{1}{4}$ 0.0600 to 0.0781	$\frac{3}{16}$ 0.0782 to 0.1004	$\frac{1}{2}$ 0.1095 to 0.1563	$\frac{5}{16}$ 0.1564 to 0.2188	$\frac{3}{4}$ 0.2189 to 0.3125	$\frac{1}{2}$ 0.3126 to 0.4375	$\frac{1}{2}$ 0.4376 to 0.5625	$\frac{3}{4}$ 0.5626 to 0.6875	$\frac{1}{2}$ 0.6876 to 0.8750	1 0.8751 to 1.1250
80	5 to 15	0.56 to 0.19	<i>in.</i>	<i>in.</i>	<i>in.</i>	<i>in.</i>	<i>in.</i>	<i>in.</i>	<i>in.</i>	<i>in.</i>	<i>in.</i>	<i>in.</i>
	16 to 30	0.101 to 0.38	0.0025 .0028	0.0026 .0029	0.0027 .0030	0.0028 .0031	0.0029 .0033					
72	5 to 15	0.07 to 0.21	.0026	.0027	.0028	.0029	.0030	0.0032				
	16 to 30	0.211 to 0.42		.0030	.0031	.0033	.0034	.0036				
64	5 to 15	0.08 to 0.23	.0027	.0028	.0029	.0031	.0032	.0034	0.0035			
	16 to 30	0.231 to 0.46		.0032	.0033	.0034	.0035	.0037	.0039			
56	5 to 15	0.09 to 0.27		.0030	.0031	.0032	.0033	.0035	.0037	0.0038	0.0039	
	16 to 30	0.271 to 0.54		.0034	.0035	.0036	.0037	.0039	.0040	.0042	.0043	
48	5 to 15	0.10 to 0.31		.0032	.0033	.0034	.0036	.0037	.0039	.0040	.0041	
	16 to 30	0.311 to 0.62			.0037	.0039	.0040	.0041	.0043	.0044	.0045	
44	5 to 15	0.11 to 0.34		.0033	.0034	.0036	.0037	.0039	.0040	.0041	.0042	0.0044
	16 to 30	0.341 to 0.68			.0039	.0040	.0041	.0043	.0044	.0045	.0047	.0048
40	5 to 15	0.12 to 0.38			.0036	.0037	.0038	.0040	.0041	.0043	.0044	.0045
	16 to 30	0.381 to 0.76			.0040	.0042	.0043	.0045	.0046	.0047	.0048	.0050
36	5 to 15	0.14 to 0.42			.0037	.0039	.0040	.0042	.0043	.0044	.0045	.0047
	16 to 30	0.421 to 0.84				.0044	.0045	.0046	.0048	.0049	.0050	.0052
22	5 to 15	0.16 to 0.47			.0039	.0041	.0042	.0044	.0045	.0046	.0047	.0049
	16 to 30	0.471 to 0.94				.0046	.0047	.0049	.0050	.0051	.0052	.0054
28	5 to 15	0.18 to 0.51				.0043	.0044	.0046	.0048	.0049	.0050	.0052
	16 to 30	0.511 to 1.08				.0049	.0050	.0052	.0053	.0054	.0055	.0057
27	5 to 15	0.19 to 0.56				.0044	.0045	.0047	.0048	.0050	.0051	.0052
	16 to 30	0.561 to 1.12				.0050	.0051	.0053	.0054	.0055	.0056	.0058
24	5 to 15	0.21 to 0.62				.0047	.0048	.0049	.0051	.0052	.0053	.0055
	16 to 30	0.621 to 1.24					.0054	.0055	.0057	.0058	.0059	.0061
20	5 to 15	0.25 to 0.75					.0052	.0054	.0055	.0056	.0057	.0059
	16 to 30	0.751 to 1.50					.0055	.0060	.0061	.0063	.0064	.0065
18	5 to 15	0.28 to 0.82						.0056	.0058	.0059	.0060	.0062
	16 to 30	0.821 to 1.66						.0063	.0064	.0066	.0067	.0068
16	5 to 15	0.31 to 0.94						.0059	.0061	.0062	.0063	.0065
	16 to 30	0.941 to 1.88						.0067	.0068	.0069	.0070	.0072
14	5 to 15	0.36 to 1.07							.0065	.0066	.0067	.0069
	16 to 30	1.071 to 2.14							.0072	.0074	.0075	.0076
12	5 to 15	0.42 to 1.25							.0070	.0071	.0072	.0074
	16 to 30	1.251 to 2.50							.0078	.0079	.0080	.0082
10	5 to 15	0.50 to 1.50									.0075	.0080
	16 to 30	1.501 to 3.00									.0087	.0089
8	5 to 15	0.62 to 1.88										.0089
	16 to 30	1.881 to 3.76										.0099
6	5 to 15	0.75 to 2.50										
	16 to 30	2.501 to 5.00										
4	5 to 15	1.25 to 3.75										
	16 to 30	3.751 to 7.50										

* Tolerances are based on diameters given in common fractions, which are the means of the diameter ranges expressed in decimals.

special diameters, pitches, and lengths of engagement, class 2B

See subsection 5, p. 98.)

Pitch diameter tolerances * - Continued													Threads per inch	
1 ₄ 1.1251 to 1.3750	1 ₂ 1.3751 to 1.6250	1 ₁ 1.6251 to 1.8750	2 1.8751 to 2.2500	2 ₁ 2.2501 to 2.7500	3 2.7501 to 3.2500	3 ₁ 3.2501 to 3.7500	4 3.7501 to 4.5000	5 4.5001 to 5.5000	6 5.5001 to 7.0000	8 7.0001 to 9.0000	10 9.0001 to 11.0000	12 11.0001 to 13.0000		
<i>in.</i>	<i>in.</i>	<i>in.</i>	LEGENDS											
			1. These values do not agree with and shall not be used in place of any tabulated values for the UNC, UNF and 8N thread series, in table III.10.										80	
			2. Formula: Class 2B tolerances are determined by multiplying class 2A tolerances (computed to six decimal places) by 1.300. See legend 2, table IV.5, for formula for class 2A tolerances.										72	
			3. Length of engagement increments included in the tabulated tolerances for lengths of engagement from 5 to 15 pitches are based on lengths of 9 pitches; those for lengths of engagement greater than 15 to 30 pitches are based on lengths of 20 pitches. For lengths of engagement not tabulated, the formula in legend 2 should be applied.										64	
			4. Pitches listed are those used most commonly and are recommended. Where intermediate pitches are specified, the formula in legend 2 should be applied.										50	
			5. Tolerances are tabulated only for combinations of diameter, pitch, and length of engagement which are considered to be generally used. For other combinations encountered, see Design of Special Threads, appendix 5, p. 200.										48	
			<i>in.</i>	<i>in.</i>	<i>in.</i>	<i>in.</i>	<i>in.</i>	<i>in.</i>	<i>in.</i>	<i>in.</i>	<i>in.</i>	<i>in.</i>		44
														40
0.0040 .0053	0.0050 .0055													36
.0051 .0056	.0052 .0057	0.0053 .0058	0.0054 .0059	0.0055 .0061	0.0058 .0063									32
.0053 .0059	.0055 .0060	.0056 .0061	.0057 .0062	.0059 .0063	.0059 .0063	0.0062 .0067	0.0063 .0069							28
.0053 .0059	.0055 .0061	.0056 .0062	.0057 .0063	.0059 .0065	.0061 .0067	.0063 .0068	.0064 .0069	0.0066 .0072	0.0068 .0074					27
.0056 .0062	.0058 .0064	.0059 .0065	.0060 .0066	.0062 .0068	.0064 .0069	.0065 .0071	.0066 .0072	.0069 .0075	.0071 .0077					24
.0061 .0067	.0062 .0068	.0063 .0069	.0064 .0071	.0066 .0072	.0068 .0074	.0069 .0076	.0070 .0077	.0073 .0079	.0075 .0081					20
.0063 .0070	.0065 .0071	.0066 .0072	.0067 .0074	.0069 .0075	.0070 .0077	.0072 .0079	.0073 .0080	.0076 .0082	.0078 .0084	0.0081 .0088				18
.0066 .0074	.0068 .0075	.0069 .0076	.0070 .0077	.0072 .0079	.0073 .0081	.0075 .0082	.0076 .0083	.0079 .0085	.0081 .0088	.0084 .0092	0.0087 .0095			16
.0070 .0078	.0072 .0079	.0073 .0080	.0074 .0081	.0076 .0083	.0077 .0085	.0079 .0086	.0080 .0088	.0083 .0090	.0085 .0092	.0088 .0096	.0091 .0099	0.0094 .0102		14
.0075 .0083	.0076 .0085	.0078 .0086	.0079 .0087	.0081 .0089	.0082 .0090	.0084 .0092	.0085 .0093	.0087 .0096	.0090 .0098	.0093 .0101	.0096 .0104	.0099 .0107	.0099 .0107	12
.0082 .0091	.0083 .0092	.0084 .0093	.0085 .0094	.0087 .0096	.0089 .0098	.0090 .0099	.0091 .0101	.0094 .0103	.0096 .0105	.0100 .0109	.0103 .0112	.0105 .0114	.0105 .0114	10
.0090 .0101	.0092 .0102	.0093 .0103	.0094 .0104	.0096 .0105	.0098 .0108	.0099 .0109	.0100 .0111	.0103 .0113	.0105 .0115	.0108 .0119	.0111 .0122	.0114 .0124	.0114 .0124	8
	.0105 .0117	.0106 .0118	.0108 .0119	.0109 .0121	.0111 .0123	.0113 .0124	.0114 .0126	.0116 .0128	.0118 .0130	.0122 .0134	.0125 .0137	.0128 .0139	.0128 .0139	6
			.0131 .0146	.0133 .0147	.0135 .0149	.0136 .0151	.0138 .0152	.0140 .0154	.0142 .0156	.0146 .0160	.0149 .0163	.0151 .0166	.0151 .0166	4

TABLE IV.9.—Pitch diameter tolerances for internal threads of
(UNS and NS threads)

Threads per inch	Lengths of engagement		Pitch diameter tolerances ^a										
	Number of pitches	Inches	$3/4$ 0.6600 to 0.0781	$3/32$ 0.0782 to 0.1094	$1/8$ 0.1095 to 0.1563	$3/16$ 0.1564 to 0.2188	$1/4$ 0.2189 to 0.3125	$3/8$ 0.3126 to 0.4375	$1/2$ 0.4376 to 0.5625	$5/8$ 0.5626 to 0.6875	$3/4$ 0.6876 to 0.8750	1 0.8751 to 1.1250	
80	5 to 15	0.06 to 0.10	<i>in.</i> 0.0010	<i>in.</i> 0.0010	<i>in.</i> 0.0020	<i>in.</i> 0.0021	<i>in.</i> 0.0022	<i>in.</i>	<i>in.</i>	<i>in.</i>	<i>in.</i>	<i>in.</i>	
	16 to 30	0.191 to 0.38	.0021	.0022	.0023	.0024	.0024						
72	5 to 15	0.07 to 0.21	.0019	.0020	.0021	.0022	.0023	0.0024					
	16 to 30	0.271 to 0.42	.0023	.0023	.0023	.0025	.0025	.0027					
64	5 to 15	0.08 to 0.23	.0020	.0021	.0022	.0023	.0024	.0025	0.0026				
	16 to 30	0.281 to 0.46		.0024	.0025	.0026	.0027	.0028	.0029				
56	5 to 15	0.09 to 0.27		.0023	.0023	.0024	.0025	.0026	.0027	0.0028	0.0029		
	16 to 30	0.271 to 0.54		.0025	.0026	.0027	.0028	.0029	.0030	.0031	.0032		
48	5 to 15	0.10 to 0.31		.0024	.0025	.0026	.0027	.0028	.0029	.0030	.0031		
	16 to 30	0.311 to 0.62			.0028	.0029	.0030	.0031	.0032	.0033	.0034		
44	5 to 15	0.11 to 0.34		0.025	.0025	.0027	.0028	.0029	.0030	.0031	.0032	0.0033	
	16 to 30	0.341 to 0.68			.0029	.0030	.0031	.0032	.0033	.0034	.0035	.0036	
40	5 to 15	0.12 to 0.38			.0027	.0028	.0029	.0030	.0031	.0032	.0033	.0034	
	16 to 30	0.381 to 0.76			.0030	.0031	.0032	.0033	.0034	.0035	.0036	.0037	
36	5 to 15	0.14 to 0.42			.0028	.0029	.0030	.0031	.0032	.0033	.0034	0.0035	
	16 to 30	0.421 to 0.84			.0033	.0034	.0034	.0035	.0036	.0037	.0038	.0039	
32	5 to 15	0.16 to 0.47			.0030	.0031	.0031	.0033	.0034	.0035	.0036	.0037	
	16 to 30	0.471 to 0.94			.0034	.0034	.0035	.0037	.0038	.0039	.0040	.0041	
28	5 to 15	0.18 to 0.54			.0033	.0033	.0033	.0035	.0036	.0037	.0037	.0039	
	16 to 30	0.541 to 1.08			.0037	.0037	.0037	.0039	.0040	.0041	.0042	.0043	
27	5 to 15	0.19 to 0.56				.0033	.0034	.0035	.0036	.0037	.0038	.0039	
	16 to 30	0.561 to 1.12				.0037	.0038	.0039	.0040	.0041	.0042	.0043	
24	5 to 15	0.21 to 0.62				.0035	.0036	.0037	.0038	.0039	.0040	.0041	
	16 to 30	0.621 to 1.24				.0040	.0040	.0041	.0042	.0043	.0044	.0045	
20	5 to 15	0.25 to 0.75					.0039	.0040	.0041	.0042	.0043	.0044	
	16 to 30	0.751 to 1.50					.0044	.0045	.0046	.0047	.0048	.0049	
18	5 to 15	0.28 to 0.83						.0042	.0043	.0044	0.0045	.0046	
	16 to 30	0.831 to 1.66						.0047	.0048	.0049	.0050	.0051	
16	5 to 15	0.31 to 0.94						.0045	.0046	.0046	.0047	.0049	
	16 to 30	0.941 to 1.88						.0050	.0051	.0052	.0053	.0054	
14	5 to 15	0.36 to 1.07							.0049	.0049	.0050	.0052	
	16 to 30	1.071 to 2.14							.0054	.0055	.0056	.0057	
12	5 to 15	0.42 to 1.25							.0052	.0053	.0054	.0056	
	16 to 30	1.251 to 2.50							.0058	.0059	.0060	.0061	
10	5 to 15	0.50 to 1.50									.0059	.0060	
	16 to 30	1.501 to 3.00									.0066	.0067	
8	5 to 15	0.62 to 1.88										.0067	
	16 to 30	1.881 to 3.76										.0074	
6	5 to 15	0.84 to 2.50											
	16 to 30	2.501 to 5.00											
4	5 to 15	1.25 to 3.75											
	16 to 30	3.751 to 7.50											

^a Tolerances are based on diameters given in common fractions, which are the means of the diameter ranges expressed in decimals.

special diameters, pitches, and lengths of engagement, class 3B

See subsection 5, p. 98.)

Pitch diameter tolerances • Continued													Threads per inch	
1 $\frac{1}{4}$ 1.1251 to 1.3750	1 $\frac{1}{2}$ 1.3751 to 1.6250	1 $\frac{3}{4}$ 1.6251 to 1.8750	2 1.8751 to 2.2500	2 $\frac{1}{2}$ 2.2501 to 2.7500	3 2.7501 to 3.2500	3 $\frac{1}{2}$ 3.2501 to 3.7500	4 3.7501 to 4.5000	5 4.5001 to 5.5000	6 5.5001 to 7.0000	8 7.0001 to 9.0000	10 9.0001 to 11.0000	12 11.0001 to 13.0000		
LEGENDS														
1. These values do not agree with and shall not be used in place of any tabulated values for the UNC, UNF, and 8N thread series, in table III.10.													80	
2. Formula: Class 3B tolerances for internal threads are 0.75 times class 2B tolerances and are determined by multiplying class 2A tolerances (computed to six decimal places) by 0.975. See legend 2, table IV.5 for formula for class 2A tolerances.													72	
3. Length of engagement increments included in the tabulated tolerances for lengths of engagement from 5 to 15 pitches are based on lengths of 9 pitches; those for lengths of engagement greater than 15 to 30 pitches are based on lengths of 20 pitches. For lengths of engagement not tabulated, the formula in legend 2 should be applied.													64	
4. Pitches listed are those used most commonly and are recommended. Where intermediate pitches are specified the formula in legend 2 should be applied.													56	
5. Tolerances are tabulated only for combinations of diameter, pitch, and length of engagement which are considered to be generally used. For other combinations encountered, see Design of Special Threads, appendix 5, p. 200.													48	
			<i>in.</i>	<i>in.</i>	<i>in.</i>	<i>in.</i>	<i>in.</i>	<i>in.</i>	<i>in.</i>	<i>in.</i>	<i>in.</i>	<i>in.</i>	<i>in.</i>	44
														40
0.0036 .0040	0.0037 .0041													36
.0038 .0042	.0039 .0043	0.0040 .0044	0.0041 .0044	0.0042 .0046	0.0043 .0047									32
.0040 .0044	.0041 .0045	.0042 .0046	.0043 .0047	.0044 .0048	.0045 .0049	0.0046 .0050	0.0047 .0051							28
.0040 0.0045	.0041 .0046	.0042 .0046	.0043 .0047	.0045 .0049	.0046 .0050	.0047 .0051	.0048 .0052	0.0050 .0054	0.0051 .0055					27
.0042 .0047	.0043 .0048	.0044 .0049	.0045 .0049	.0046 .0051	.0048 .0052	.0049 .0053	.0050 .0054	.0052 .0056	.0053 .0058					24
.0045 .0050	.0046 .0051	.0047 .0052	.0048 .0053	.0050 .0054	.0051 .0055	.0052 .0056	.0053 .0058	.0055 .0059	.0056 .0061					20
.0047 .0052	.0048 .0053	.0049 .0054	.0050 .0055	.0051 .0057	.0053 .0058	.0054 .0059	.0055 .0060	.0057 .0062	.0058 .0063	0.0061 .0066				18
.0050 0.0055	.0051 .0056	.0052 .0057	.0053 .0058	.0054 .0059	.0055 .0060	.0056 .0061	.0057 .0062	.0059 .0064	.0061 .0065	.0063 .0069	0.0066 .0071			16
.0053 .0058	.0054 .0059	.0055 .0060	.0055 .0061	.0057 .0063	.0058 .0064	.0059 .0065	.0060 .0066	.0062 .0068	.0063 .0069	.0066 .0072	.0068 .0074	0.0070 .0076		14
.0056 .0063	.0057 .0064	.0058 .0064	.0059 .0065	.0060 .0067	.0062 .0068	.0063 .0069	.0064 .0070	.0066 .0072	.0067 .0073	.0070 .0076	.0072 .0078	.0074 .0080	0.0076 .0082	12
.0061 .0068	.0062 .0069	.0063 .0070	.0064 .0071	.0065 .0072	.0066 .0073	.0068 .0074	.0069 .0075	.0070 .0077	.0072 .0079	.0075 .0081	.0077 .0084	.0079 .0086	.0081 .0088	10
.0068 .0076	.0069 .0076	.0070 .0077	.0071 .0078	.0072 .0080	.0073 .0081	.0074 .0082	.0075 .0083	.0077 .0085	.0079 .0086	.0081 .0089	.0083 .0091	.0085 .0093	.0087 .0095	8
	.0070 .0088	.0080 .0089	.0081 .0089	.0082 .0091	.0083 .0092	.0084 .0093	.0085 .0094	.0087 .0094	.0089 .0098	.0091 .0100	.0094 .0103	.0096 .0104	.0098 .0107	6
			.0088 .0109	.0091 .0111	.0092 .0112	.0093 .0113	.0094 .0114	.0096 .0116	.0098 .0117	.0099 .0120	.0101 .0122	.0103 .0124	.0105 .0124	4

TABLE IV.10.—Minor diameter tolerances for internal special screw threads, classes 1B and 2B

(UNS and NS threads. See subsection 5, p. 88.)

Threads per inch	Tolerance ratios	Lengths of engagement in terms of diameter *		Minor diameter tolerances † for all lead sizes having the same major diameters:											
		Tolerances based on—		0.060	0.073	0.086	0.109	0.132	0.161	0.198	0.244	0.301	0.370	0.454	
		Above—		0.053	0.066	0.079	0.092	0.105	0.128	0.151	0.177	0.203	0.233	0.263	0.293
		to— and including	0.066	0.079	0.092	0.105	0.118	0.131	0.151	0.177	0.203	0.233	0.263	0.293	
80	1/32	1/32 D	3/32 D	in.	0.0035	0.0029	0.0025	0.0022	0.0020	0.0018	0.0017	0.0016	0.0016	0.0016	0.0016
	1/16	1/16 D	3/16 D	in.	0.0049	0.0041	0.0038	0.0034	0.0030	0.0028	0.0026	0.0023	0.0023	0.0023	0.0023
	1/8	1/8 D	3/8 D	in.	0.0049	0.0049	0.0049	0.0049	0.0049	0.0049	0.0049	0.0049	0.0049	0.0049	0.0049
72	1/32	1/32 D	3/32 D	in.	0.0039	0.0033	0.0029	0.0026	0.0023	0.0021	0.0020	0.0017	0.0017	0.0017	0.0017
	1/16	1/16 D	3/16 D	in.	0.0055	0.0049	0.0043	0.0038	0.0035	0.0032	0.0029	0.0026	0.0026	0.0026	0.0026
	1/8	1/8 D	3/8 D	in.	0.0055	0.0055	0.0055	0.0055	0.0055	0.0055	0.0055	0.0055	0.0055	0.0055	0.0055
64	1/32	1/32 D	3/32 D	in.	0.0015	0.0038	0.0033	0.0029	0.0027	0.0024	0.0023	0.0020	0.0019	0.0019	0.0019
	1/16	1/16 D	3/16 D	in.	0.0062	0.0057	0.0049	0.0044	0.0040	0.0037	0.0034	0.0030	0.0028	0.0028	0.0028
	1/8	1/8 D	3/8 D	in.	0.0062	0.0062	0.0062	0.0062	0.0062	0.0062	0.0062	0.0062	0.0062	0.0062	0.0062
56	1/32	1/32 D	3/32 D	in.	0.0044	0.0038	0.0034	0.0031	0.0029	0.0026	0.0023	0.0022	0.0022	0.0022	0.0022
	1/16	1/16 D	3/16 D	in.	0.0066	0.0057	0.0051	0.0046	0.0043	0.0040	0.0036	0.0032	0.0032	0.0032	0.0032
	1/8	1/8 D	3/8 D	in.	0.0070	0.0070	0.0070	0.0070	0.0070	0.0070	0.0070	0.0070	0.0070	0.0070	0.0070
48	1/32	1/32 D	3/32 D	in.	0.0045	0.0040	0.0037	0.0034	0.0032	0.0029	0.0028	0.0025	0.0025	0.0025	0.0025
	1/16	1/16 D	3/16 D	in.	0.0068	0.0061	0.0055	0.0051	0.0047	0.0044	0.0042	0.0038	0.0038	0.0038	0.0038
	1/8	1/8 D	3/8 D	in.	0.0082	0.0082	0.0082	0.0082	0.0082	0.0082	0.0082	0.0082	0.0082	0.0082	0.0082
44	1/32	1/32 D	3/32 D	in.	0.0050	0.0044	0.0040	0.0038	0.0035	0.0033	0.0031	0.0028	0.0028	0.0028	0.0028
	1/16	1/16 D	3/16 D	in.	0.0067	0.0061	0.0056	0.0051	0.0048	0.0045	0.0042	0.0038	0.0038	0.0038	0.0038
	1/8	1/8 D	3/8 D	in.	0.0089	0.0089	0.0089	0.0089	0.0089	0.0089	0.0089	0.0089	0.0089	0.0089	0.0089
40	1/32	1/32 D	3/32 D	in.	0.0049	0.0045	0.0041	0.0039	0.0036	0.0034	0.0031	0.0031	0.0031	0.0031	0.0031
	1/16	1/16 D	3/16 D	in.	0.0071	0.0067	0.0063	0.0059	0.0056	0.0053	0.0050	0.0047	0.0047	0.0047	0.0047
	1/8	1/8 D	3/8 D	in.	0.0098	0.0098	0.0098	0.0098	0.0098	0.0098	0.0098	0.0098	0.0098	0.0098	0.0098
36	1/32	1/32 D	3/32 D	in.	0.0050	0.0046	0.0043	0.0040	0.0038	0.0035	0.0033	0.0030	0.0030	0.0030	0.0030
	1/16	1/16 D	3/16 D	in.	0.0075	0.0069	0.0063	0.0059	0.0056	0.0053	0.0050	0.0047	0.0047	0.0047	0.0047
	1/8	1/8 D	3/8 D	in.	0.0100	0.0100	0.0100	0.0100	0.0100	0.0100	0.0100	0.0100	0.0100	0.0100	0.0100
32	1/32	1/32 D	3/32 D	in.	0.0049	0.0043	0.0039	0.0037	0.0034	0.0032	0.0030	0.0028	0.0028	0.0028	0.0028
	1/16	1/16 D	3/16 D	in.	0.0073	0.0065	0.0059	0.0055	0.0052	0.0049	0.0047	0.0045	0.0045	0.0045	0.0045
	1/8	1/8 D	3/8 D	in.	0.0098	0.0098	0.0098	0.0098	0.0098	0.0098	0.0098	0.0098	0.0098	0.0098	0.0098
28	1/32	1/32 D	3/32 D	in.	0.0045	0.0042	0.0039	0.0037	0.0034	0.0032	0.0030	0.0028	0.0028	0.0028	0.0028
	1/16	1/16 D	3/16 D	in.	0.0068	0.0063	0.0059	0.0055	0.0052	0.0049	0.0047	0.0045	0.0045	0.0045	0.0045
	1/8	1/8 D	3/8 D	in.	0.0091	0.0091	0.0091	0.0091	0.0091	0.0091	0.0091	0.0091	0.0091	0.0091	0.0091

* Tolerances for lengths of engagement in terms of pitch should be selected from equivalent lengths of engagement in terms of diameter ranges.
 † Revised minor diameter tolerances for classes 1B and 2B are in process of ratification as Unified Standard.

NOTE.—If the minor diameter tolerance as selected from this table is less than the pitch diameter tolerance, use the latter. See "Design of Special Threads," appendix 5.

TABLE IV.10.—Minor diameter tolerances for internal special screw threads, classes 1B and 2B—Continued

(UNS and NS threads. See subsection 5, p. 98.)

Threads per inch	Tolerance ratios	Lengths of engagement in terms of diameter *		Minor diameter tolerances ^b for thread sizes having basic major diameters:											
		Tolerances based on—		0.060	0.073	0.086	0.099	0.112	0.125	0.138	0.164	0.190	0.216	All larger diameters	
		↓ Above—		0.053	0.066	0.079	0.092	0.105	0.118	0.131	0.151	0.177	0.203		
		to— and including ↓	0.066	0.079	0.092	0.105	0.118	0.131	0.151	0.177	0.203	0.233			
27	1/32	1/32 D	1/32 D										in.		in.
	1/16	3/32 D	3/32 D										0.0044	0.0044	0.0044
	3/32	1/8 D	1/8 D										0.0071	0.0065	0.0065
24	1/16	1/16 D	1/16 D										0.0094	0.0087	0.0087
	3/32	3/32 D	3/32 D										0.0118	0.0109	0.0109
	1/8	1/8 D	1/8 D										0.0053	0.0049	0.0048
20	3/32	3/32 D	3/32 D										0.0079	0.0073	0.0073
	1/8	1/8 D	1/8 D										0.0106	0.0098	0.0097
	3/16	3/16 D	3/16 D										0.0132	0.0122	0.0121
18	1/8	1/8 D	1/8 D												0.0058
	3/16	3/16 D	3/16 D												0.0086
	1/4	1/4 D	1/4 D												0.0118
16	3/16	3/16 D	3/16 D												0.0144
	1/4	1/4 D	1/4 D												0.0004
	5/16	5/16 D	5/16 D												0.0005
14	1/4	1/4 D	1/4 D												0.0127
	3/8	3/8 D	3/8 D												0.0159
	1/2	1/2 D	1/2 D												0.0070
12	3/8	3/8 D	3/8 D												0.0100
	1/2	1/2 D	1/2 D												0.0106
	5/8	5/8 D	5/8 D												0.0141
10	1/2	1/2 D	1/2 D												0.0176
	3/4	3/4 D	3/4 D												0.0079
	7/8	7/8 D	7/8 D												0.0118
8	3/4	3/4 D	3/4 D												0.0158
	1	1 D	1 D												0.0198
	1 1/8	1 1/8 D	1 1/8 D												0.0000
6	1	1 D	1 D												0.0135
	1 1/4	1 1/4 D	1 1/4 D												0.0180
	1 1/2	1 1/2 D	1 1/2 D												0.0225
4	1 1/4	1 1/4 D	1 1/4 D												0.0105
	1 1/2	1 1/2 D	1 1/2 D												0.0158
	2	2 D	2 D												0.0210
4	2	2 D	2 D												0.0202
	2 1/4	2 1/4 D	2 1/4 D												0.0125
	2 1/2	2 1/2 D	2 1/2 D												0.0188
4	2 1/2	2 1/2 D	2 1/2 D												0.0250
	3	3 D	3 D												0.0312
	3 1/2	3 1/2 D	3 1/2 D												0.0163
4	3 1/2	3 1/2 D	3 1/2 D												0.0230
	4	4 D	4 D												0.0306
	4 1/2	4 1/2 D	4 1/2 D												0.0382
4	4 1/2	4 1/2 D	4 1/2 D												0.0184
	5	5 D	5 D												0.0281
	5 1/2	5 1/2 D	5 1/2 D												0.0375
4	5 1/2	5 1/2 D	5 1/2 D												0.0469
	6	6 D	6 D												
	6 1/2	6 1/2 D	6 1/2 D												

* Tolerances for lengths of engagement in terms of pitch should be selected from equivalent lengths of engagement in terms of diameter ranges.

^b Revised minor diameter tolerances for Classes 1B and 2B are in process of ratification as Unified Standard.

NOTE.—If the minor diameter tolerance as selected from this table is less than the pitch diameter tolerance, use the latter. See "Design of Special Threads," appendix b.

TABLE IV.11. - Minor diameter tolerances

(UNS and NS threads.)

Threads per inch	Tolerance ratios	Lengths of engagement in terms of diameter *		Minor diameter tolerances for thread sizes having basic major diameters.								
		Tolerances based on →		0.060	0.073	0.086	0.099	0.112	0.125	0.138	0.164	0.190
		↓ Above →		0.065	0.066	0.079	0.092	0.105	0.118	0.131	0.161	0.177
			to → and including	0.066	0.079	0.092	0.105	0.118	0.131	0.151	0.177	0.203
80	3/4		3/4 D	in.	in.	in.	in.	in.	in.	in.	in.	in.
	3/4	3/4 D	3/4 D	0.0035	0.0029	0.0025	0.0022	0.0020	0.0018	0.0017	0.0015	0.0013
	1	3/4 D	3/4 D	.0040	.0044	.0038	.0034	.0030	.0028	.0026	.0022	.0020
	1 1/4	3/4 D	3/4 D	.0049	.0049	.0049	.0045	.0040	.0037	.0034	.0030	.0027
72	3/4		3/4 D	.0039	.0033	.0029	.0026	.0023	.0021	.0020	.0017	.0016
	3/4	3/4 D	3/4 D	.0055	.0049	.0043	.0038	.0035	.0032	.0029	.0026	.0023
	1	3/4 D	3/4 D	.0055	.0055	.0055	.0051	.0046	.0042	.0039	.0034	.0031
	1 1/4	3/4 D	3/4 D	.0055	.0055	.0055	.0055	.0055	.0053	.0049	.0043	.0039
64	3/4		3/4 D	.0045	.0038	.0033	.0029	.0027	.0024	.0023	.0020	.0018
	3/4	3/4 D	3/4 D	.0062	.0057	.0049	.0044	.0040	.0037	.0034	.0030	.0027
	1	3/4 D	3/4 D	.0062	.0062	.0062	.0059	.0053	.0049	.0045	.0040	.0036
	1 1/4	3/4 D	3/4 D	.0062	.0062	.0062	.0062	.0062	.0061	.0057	.0050	.0045
66	3/4		3/4 D		.0044	.0038	.0034	.0031	.0029	.0026	.0023	.0021
	3/4	3/4 D	3/4 D		.0066	.0057	.0051	.0046	.0043	.0040	.0035	.0032
	1	3/4 D	3/4 D		.0070	.0070	.0068	.0062	.0057	.0053	.0047	.0042
	1 1/4	3/4 D	3/4 D		.0070	.0070	.0070	.0070	.0070	.0066	.0059	.0053
48	3/4		3/4 D			.0045	.0040	.0037	.0034	.0032	.0028	.0025
	3/4	3/4 D	3/4 D			.0068	.0061	.0055	.0051	.0047	.0042	.0038
	1	3/4 D	3/4 D			.0082	.0081	.0074	.0068	.0063	.0056	.0051
	1 1/4	3/4 D	3/4 D			.0082	.0082	.0082	.0082	.0079	.0070	.0063
44	3/4		3/4 D			.0050	.0044	.0041	.0037	.0035	.0031	.0028
	3/4	3/4 D	3/4 D			.0075	.0067	.0061	.0056	.0052	.0046	.0042
	1	3/4 D	3/4 D			.0090	.0088	.0081	.0075	.0070	.0062	.0056
	1 1/4	3/4 D	3/4 D			.0090	.0090	.0090	.0090	.0087	.0077	.0070
40	3/4		3/4 D				.0040	.0035	.0031	.0029	.0024	.0021
	3/4	3/4 D	3/4 D				.0074	.0067	.0062	.0058	.0051	.0047
	1	3/4 D	3/4 D				.0098	.0090	.0083	.0077	.0068	.0062
	1 1/4	3/4 D	3/4 D				.0098	.0098	.0098	.0096	.0086	.0078
66	3/4		3/4 D					.0050	.0046	.0043	.0038	.0035
	3/4	3/4 D	3/4 D					.0075	.0069	.0065	.0058	.0052
	1	3/4 D	3/4 D					.0100	.0093	.0086	.0077	.0070
	1 1/4	3/4 D	3/4 D					.0109	.0109	.0108	.0096	.0087
32	3/4		3/4 D							.0049	.0043	.0039
	3/4	3/4 D	3/4 D							.0073	.0065	.0059
	1	3/4 D	3/4 D							.0098	.0087	.0079
	1 1/4	3/4 D	3/4 D							.0122	.0108	.0099
28	3/4		3/4 D									.0045
	3/4	3/4 D	3/4 D									.0068
	1	3/4 D	3/4 D									.0091
	1 1/4	3/4 D	3/4 D									.0113
27	3/4		3/4 D									.0047
	3/4	3/4 D	3/4 D									.0071
	1	3/4 D	3/4 D									.0094
	1 1/4	3/4 D	3/4 D									.0118
24	3/4		3/4 D									.0053
	3/4	3/4 D	3/4 D									.0079
	1	3/4 D	3/4 D									.0106
	1 1/4	3/4 D	3/4 D									.0132

* Tolerances for lengths of engagement in terms of pitch should be selected from equivalent lengths of engagement in terms of diameter ranges.

NOTE: - If the minor diameter tolerance as selected from this table is less than the pitch diameter tolerance, use the latter. See Design of Special Threads, appendix 6.

for internal special screw threads, class 3B

See subsection 5, p. 98.)

Minor diameter tolerances for thread sizes having basic major diameters:													All larger diameters	Threads per inch
0.216	0.260	0.3125	0.375	0.4375	0.500	0.5625	0.625	0.6875	0.750	0.8125	0.875	0.9375		
0.203	0.243	0.281	0.344	0.406	0.460	0.531	0.594	0.656	0.719	0.781	0.844	0.906	0.969	
0.233	0.281	0.344	0.406	0.460	0.531	0.594	0.656	0.719	0.781	0.844	0.906	0.969	0.969	
in.	in.	in.	in.	in.	in.	in.	in.	in.	in.	in.	in.	in.	in.	
0.0013	0.0013	0.0013												
.0020	.0020	.0020												
.0026	.0026	.0026												
.0033	.0033	.0033												
.0015	.0015	.0015	0.0015	0.0015										
.0022	.0022	.0022	.0022	.0022										
.0029	.0029	.0029	.0029	.0029										
.0036	.0036	.0036	.0036	.0036										
.0016	.0016	.0016	.0016	.0016	0.0016	0.0016								
.0024	.0024	.0024	.0024	.0024	.0024	.0024								
.0032	.0032	.0032	.0032	.0032	.0032	.0032								
.0040	.0040	.0040	.0040	.0040	.0040	.0040								
.0018	.0018	.0018	.0018	.0018	.0018	.0018	0.0018	0.0018	0.0018	0.0018	0.0018	0.0018	0.0018	
.0027	.0027	.0027	.0027	.0027	.0027	.0027	.0027	.0027	.0027	.0027	.0027	.0027	.0027	
.0036	.0036	.0036	.0036	.0036	.0036	.0036	.0036	.0036	.0036	.0036	.0036	.0036	.0036	
.0045	.0045	.0045	.0045	.0045	.0045	.0045	.0045	.0045	.0045	.0045	.0045	.0045	.0045	
.0023	.0021	.0021	.0021	.0021	.0021	.0021	.0021	.0021	.0021	.0021	.0021	.0021	.0021	
.0035	.0032	.0031	.0031	.0031	.0031	.0031	.0031	.0031	.0031	.0031	.0031	.0031	.0031	
.0047	.0043	.0041	.0041	.0041	.0041	.0041	.0041	.0041	.0041	.0041	.0041	.0041	.0041	
.0059	.0054	.0052	.0052	.0052	.0052	.0052	.0052	.0052	.0052	.0052	.0052	.0052	.0052	
.0026	.0024	.0022	.0022	.0022	.0022	.0022	.0022	.0022	.0022	.0022	.0022	.0022	0.0022	
.0039	.0036	.0033	.0033	.0033	.0033	.0033	.0033	.0033	.0033	.0033	.0033	.0033	.0033	
.0052	.0047	.0045	.0045	.0045	.0045	.0045	.0045	.0045	.0045	.0045	.0045	.0045	.0045	
.0055	.0050	.0050	.0050	.0050	.0050	.0050	.0050	.0050	.0050	.0050	.0050	.0050	.0050	
.0029	.0026	.0024	.0024	.0024	.0024	.0024	.0024	.0024	.0024	.0024	.0024	.0024	.0024	
.0043	.0040	.0035	.0036	.0036	.0036	.0036	.0036	.0036	.0036	.0036	.0036	.0036	.0036	
.0057	.0053	.0048	.0048	.0048	.0048	.0048	.0048	.0048	.0048	.0048	.0048	.0048	.0048	
.0072	.0066	.0062	.0062	.0060	.0060	.0060	.0060	.0060	.0060	.0060	.0060	.0060	.0060	
.0032	.0030	.0026	.0026	.0026	.0026	.0026	.0026	.0026	.0026	.0026	.0026	.0026	.0026	
.0048	.0044	.0039	.0039	.0039	.0039	.0039	.0039	.0039	.0039	.0039	.0039	.0039	.0039	
.0064	.0059	.0053	.0052	.0052	.0052	.0052	.0052	.0052	.0052	.0052	.0052	.0052	.0052	
.0081	.0074	.0066	.0065	.0065	.0065	.0065	.0065	.0065	.0065	.0065	.0065	.0065	.0065	
.0036	.0034	.0030	.0029	.0029	.0029	.0029	.0029	.0029	.0029	.0029	.0029	.0029	.0029	
.0055	.0050	.0045	.0043	.0043	.0043	.0043	.0043	.0043	.0043	.0043	.0043	.0043	.0043	
.0073	.0067	.0060	.0057	.0057	.0057	.0057	.0057	.0057	.0057	.0057	.0057	.0057	.0057	
.0091	.0084	.0075	.0072	.0072	.0072	.0072	.0072	.0072	.0072	.0072	.0072	.0072	.0072	
.0042	.0039	.0034	.0032	.0032	.0032	.0032	.0032	.0032	.0032	.0032	.0032	.0032	.0032	
.0063	.0058	.0051	.0047	.0047	.0047	.0047	.0047	.0047	.0047	.0047	.0047	.0047	.0047	
.0084	.0077	.0069	.0063	.0063	.0063	.0063	.0063	.0063	.0063	.0063	.0063	.0063	.0063	
.0105	.0098	.0086	.0079	.0079	.0079	.0079	.0079	.0079	.0079	.0079	.0079	.0079	.0079	
.0044	.0040	.0036	.0032	.0032	.0032	.0032	.0032	.0032	.0032	.0032	.0032	.0032	.0032	
.0065	.0060	.0053	.0048	.0048	.0048	.0048	.0048	.0048	.0048	.0048	.0048	.0048	.0048	
.0087	.0080	.0071	.0065	.0065	.0065	.0065	.0065	.0065	.0065	.0065	.0065	.0065	.0065	
.0109	.0100	.0089	.0081	.0081	.0081	.0081	.0081	.0081	.0081	.0081	.0081	.0081	.0081	
.0049	.0045	.0040	.0037	.0035	.0035	.0035	.0035	.0035	.0035	.0035	.0035	.0035	.0035	
.0073	.0068	.0060	.0055	.0052	.0052	.0052	.0052	.0052	.0052	.0052	.0052	.0052	.0052	
.0098	.0090	.0080	.0073	.0070	.0070	.0070	.0070	.0070	.0070	.0070	.0070	.0070	.0070	
.0122	.0113	.0100	.0092	.0087	.0087	.0087	.0087	.0087	.0087	.0087	.0087	.0087	.0087	

TABLE IV.11.—Minor diameter tolerances for

(UNS and NS threads.

Threads per inch	Tolerance ratios	Lengths of engagement in terms of diameter		Minor diameter tolerances for thread sizes having basic major diameters:									
		Tolerances based on →		0.060	0.073	0.086	0.099	0.112	0.125	0.138	0.151	0.164	0.177
		↓ Above →	↓ and including	0.053	0.066	0.079	0.092	0.105	0.118	0.131	0.144	0.157	0.170
20	1/4	1/4 D	1/4 D										
	1/8	3/8 D	3/8 D										
	1/16	1 1/2 D	3 D										
18	1/4	1/4 D	1/4 D										
	1/8	3/8 D	3/8 D										
	1/16	1 1/2 D	3 D										
16	1/4	1/4 D	1/4 D										
	1/8	3/8 D	3/8 D										
	1/16	1 1/2 D	3 D										
14	1/4	1/4 D	1/4 D										
	1/8	3/8 D	3/8 D										
	1/16	1 1/2 D	3 D										
12	1/4	1/4 D	1/4 D										
	1/8	3/8 D	3/8 D										
	1/16	1 1/2 D	3 D										
10	1/4	1/4 D	1/4 D										
	1/8	3/8 D	3/8 D										
	1/16	1 1/2 D	3 D										
8	1/4	1/4 D	1/4 D										
	1/8	3/8 D	3/8 D										
	1/16	1 1/2 D	3 D										
7	1/4	1/4 D	1/4 D										
	1/8	3/8 D	3/8 D										
	1/16	1 1/2 D	3 D										
6	1/4	1/4 D	1/4 D										
	1/8	3/8 D	3/8 D										
	1/16	1 1/2 D	3 D										
4	1/4	1/4 D	1/4 D										
	1/8	3/8 D	3/8 D										
	1/16	1 1/2 D	3 D										

* Tolerances for lengths of engagement in terms of pitch should be selected from equivalent lengths of engagement in terms of diameter ranges.

NOTE.—If the minor-diameter tolerance as selected from the table is less than pitch-diameter tolerance, use the latter. See "Design of Special Threads," appendix 5.

internal special screw threads, class SB - Continued

See subsection 5 p. 98.)

Minor diameter tolerances for thread sizes having basic major diameters:														Threads per inch
0.216	0.250	0.3125	0.375	0.4375	0.500	0.5625	0.625	0.6875	0.750	0.8125	0.875	0.9375	All larger diameters	
0.263	0.281	0.281	0.344	0.406	0.469	0.531	0.594	0.656	0.719	0.781	0.844	0.906	0.969	20
0.233	0.281	0.344	0.406	0.469	0.531	0.594	0.656	0.719	0.781	0.844	0.906	0.969	18	
	<i>in.</i> 0.0054 .0081 .0108 .0135	<i>in.</i> 0.0048 .0072 .0096 .0120	<i>in.</i> 0.0044 .0066 .0088 .0110	<i>in.</i> 0.0041 .0062 .0082 .0103	<i>in.</i> 0.0039 .0058 .0078 .0097	<i>in.</i> 0.0039 .0058 .0078 .0097	<i>in.</i> 0.0039 .0058 .0078 .0097	<i>in.</i> 0.0039 .0058 .0078 .0097	<i>in.</i> 0.0039 .0058 .0078 .0097	<i>in.</i> 0.0039 .0058 .0078 .0097	<i>in.</i> 0.0039 .0058 .0078 .0097	<i>in.</i> 0.0039 .0058 .0078 .0097		<i>in.</i> 0.0039 .0058 .0078 .0097
	.0053 .0080 .0106 .0133	.0049 .0073 .0097 .0122	.0045 .0068 .0091 .0114	.0043 .0065 .0086 .0108	.0041 .0062 .0082 .0103	.0041 .0061 .0081 .0102	.0041 .0061 .0081 .0102	.0041 .0061 .0081 .0102	.0041 .0061 .0081 .0102	.0041 .0061 .0081 .0102	.0041 .0061 .0081 .0102	.0041 .0061 .0081 .0102	.0041 .0061 .0081 .0102	14
		.0054 .0082 .0109 .0136	.0051 .0076 .0102 .0127	.0048 .0070 .0092 .0115	.0046 .0069 .0092 .0115	.0044 .0067 .0089 .0111	.0043 .0064 .0086 .0108	.0043 .0064 .0085 .0106	.0043 .0064 .0085 .0106	.0043 .0064 .0085 .0106	.0043 .0064 .0085 .0106	.0043 .0064 .0085 .0106	.0043 .0064 .0085 .0106	
			.0058 .0086 .0115 .0144	.0054 .0082 .0109 .0136	.0052 .0078 .0104 .0130	.0050 .0075 .0100 .0125	.0049 .0073 .0097 .0122	.0047 .0071 .0095 .0118	.0046 .0069 .0092 .0116	.0045 .0068 .0091 .0113	.0044 .0067 .0089 .0111	.0044 .0067 .0089 .0111	.0044 .0067 .0089 .0111	10
				.0063 .0094 .0125 .0157	.0060 .0090 .0120 .0150	.0058 .0087 .0115 .0144	.0056 .0083 .0112 .0140	.0054 .0082 .0109 .0136	.0053 .0080 .0107 .0133	.0052 .0078 .0104 .0130	.0051 .0077 .0102 .0128	.0050 .0077 .0102 .0128	.0050 .0077 .0102 .0128	
							.0066 .0090 .0131 .0164	.0064 .0086 .0128 .0160	.0062 .0083 .0125 .0160	.0061 .0081 .0122 .0153	.0060 .0080 .0120 .0150	.0060 .0080 .0120 .0150	.0060 .0080 .0120 .0150	7
									.0075 .0112 .0150 .0188	.0075 .0112 .0150 .0188	.0075 .0112 .0150 .0188	.0075 .0112 .0150 .0188	.0075 .0112 .0150 .0188	
											.0086 .0129 .0171 .0214	.0086 .0129 .0171 .0214	.0086 .0129 .0171 .0214	4
												.0100 .0150 .0200 .0250	.0100 .0150 .0200 .0250	
													.0130 .0225 .0300 .0375	

to a part before plating, whereas the basic diameters (the 2A maximum diameter plus allowance) apply to a part after plating. The minimum diameters of class 2B (internal) threads, whether or not plated or coated, are basic, affording no allowance or clearance in assembly at maximum material limits.

(b) *Allowances and tolerances.*—Allowances for all diameters and pitch diameter tolerances are specified in tables IV.2, IV.2A, IV.5, and IV.8, and their application is shown in figure III.3, p. 24.

3. CLASSES 3A AND 3B.—(a) *Definition.*—Classes 3A for external threads and 3B for internal threads provides for applications where closeness of fit and accuracy of lead and angle of thread are important. They are obtainable consistently only by the use of high quality production equipment supported by a very efficient system of gaging and inspection. The maximum diameters of class 3A (external) threads and the minimum diameters of class 3B (internal) threads, whether or not plated or coated, are basic, affording no allowance or clearance for assembly of maximum metal components.

(b) *Allowances and tolerances.*—No allowance is provided, but since the tolerances on “go” gages are within the limits of size of the product, the gages will assure a slight clearance between product made to the maximum-metal limits. Pitch diameter tolerances are specified in tables IV.6 and IV.9 and their application is shown in figure III. 4, p. 25.

4. SELECTION OF CLASS OF THREAD.—Consideration should first be given to the use of a class 2A external thread with a class 2B internal thread since these classes are designed for general use. The use of class 2A provides that there will always be a small clearance between maximum-material parts except when the external thread is plated. Plated parts are intended to be gaged with basic-size “go” gages. In either case, it is expected that parts will assemble readily without galling or seizing. Tolerances are sufficiently large so that ordinary production methods are generally applicable.

Past experience with similar designs may indicate that a more accurately made or closer fitting thread is required than that which is permitted by classes 2A and 2B tolerances. In such cases consideration should be given to the use of classes 3A and 3B. If these tolerances are not sufficiently close, it may be necessary to apply the American National class 3 tolerances. The necessary increase in cost should not be overlooked.

In some designs there may be advantages in providing for greater average looseness of fit than that obtained with classes 2A and 2B. Such greater average looseness is provided by classes 1A and 1B or the assembly of class 1A external threads with class 2B internal threads. The minimum looseness, however, is the same as for classes 2A and 2B except that a positive allowance is provided

for plated parts. When a greater minimum looseness is requisite to provide for adverse conditions of assembly, class 1AR is available, which is not a Unified class and is based on the American National class 1 allowance combined with class 1A tolerance. These classes also provide larger tolerances to the manufacturer, which may be of advantage if the thread is difficult to produce.

It should be noted that any class of external thread may be associated with any class of internal thread, there being no requirement to combine classes of like number.

5. METHOD OF DESIGNATING

1. STANDARD METHOD OF DESIGNATING.—The method of designating a special thread is by the use of the letters UNS or NS, as indicated in tables IV. 2 to IV. 11, inclusive, preceded by the diameter in inches and the number of threads per inch, all in Arabic characters, and followed by the tolerance classification, with or without pitch diameter tolerances or limits of size. See “Method of designating a screw thread,” p. 26.

The symbol “UNS” is applicable to each of 69 Unified special diameter-pitch combinations listed in table IV.12 which are common to the lists of preferred combinations of the American, British, and Canadian standards.

An example of an external thread designation and its meaning is given as follows:

Example: $\frac{1}{4}$ —36 UNS—2A

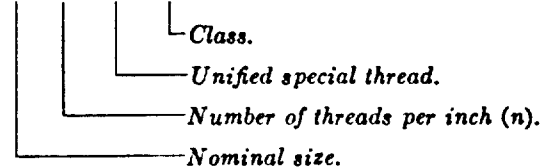

The designation “NS” applies only to threads not listed in table III.2 or IV.12 for which the limits of size are computed from the tables of this section, or increment tables (table III.2), or threads derived from the Unified formulations for all elements.

For all “NS” threads, specifications of the thread class and the pitch diameter limits are required. In addition the specification of the length of engagement is required.

Example:

$\frac{1}{4}$ —24NS—3A (Required)
 PD 0.2229—0.2198 (Required)
 Length of engagement 0.875 (Required)

2. MODIFIED THREADS.—It is occasionally necessary to modify the limits of size of the major diameter of an external thread or the minor diameter of an internal thread from the limits established for special threads in order to fit a specific purpose but without change in class of thread or pitch diameter limits. Such threads should be specified with the established thread designation followed by a statement of the modified diameter limits and the designation “MOD.”

TABLE IV.12.—Unified special diameter-pitch combinations

UNS						
Preferred diameters	Preferred pitches, threads per inch					
	26	28	20	8	6	4
3/4	26					
5/16	26					
3/8	26					
9/16		28				
5/8		28				
3/4		28				
7/8		28				
1		28				
1 1/8		28	20			
1 1/4		28	20			
1 3/8			20	8		
1 1/2			20	8	6	
1 5/8			20	8	6	
1 3/4			20	8	6	
1 7/8			20	8	6	
2			20	8	6	
2 1/8			20	8	6	
2 1/4			20	8	6	
2 3/8			20	8	6	
2 1/2			20	8	6	
2 3/4			20	8	6	
3				8	6	
3 1/4				8	6	
3 1/2				8	6	
3 3/4				8	6	
4				8	6	
4 1/4				8	6	4
4 1/2				8	6	4
4 3/4				8	6	4
5				8	6	4
5 1/4				8	6	4
5 1/2				8	6	4
5 3/4				8	6	4
6				8	6	4

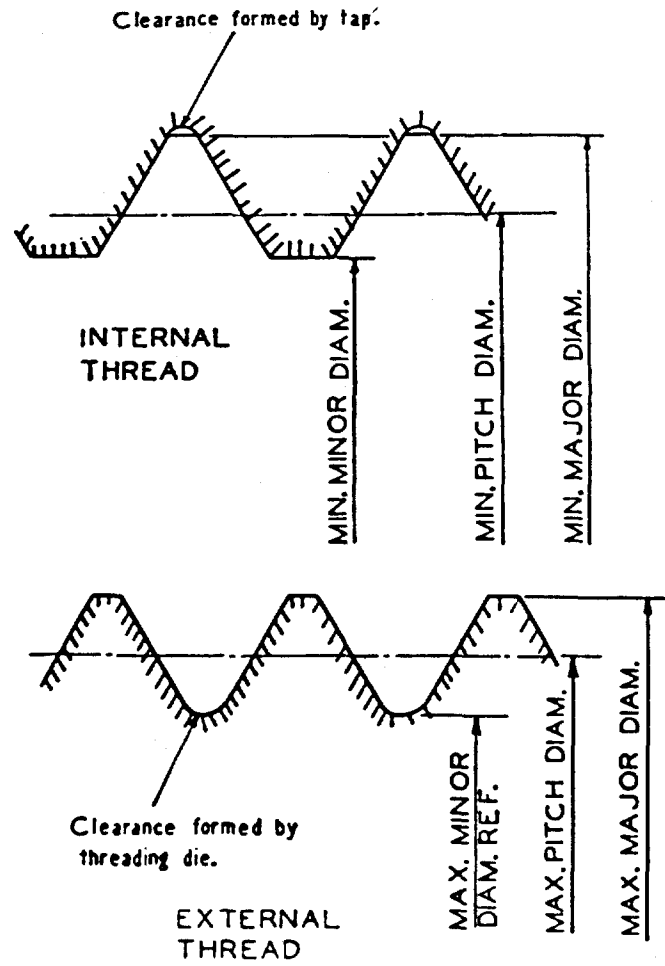

FIGURE IV.1.—Thread dimensions to be determined for a special thread.

TABLE IV.13.—Consolidated method for the calculation of dimensions of special threads

Thread element	External thread				Internal thread		
	Class 1A	Class 1A R	Class 2A	Class 3A	Class 1B	Class 2B	Class 3B
1	2	3	4	5	6	7	8
Major diameter	Nominal size minus allowance			Nominal size	Nominal size		
	Table IV. 2	Table IV. 2A	Table IV. 2				
Tolerance on major diameter	Use value in table IV. 3 or compute in accordance with directions for designing special threads p. 200. Apply minus				None specified as the maximum is established by the crest of an unworn tool		
Pitch diameter	Subtract $3/4H$, table IV. 1, col. 13 from maximum major diameter				Subtract $3/4H$, table IV. 1, col. 13 from basic major diameter		
Tolerance on pitch diameter	Table IV. 4 Apply minus	Table IV. 4 Apply minus	Table IV. 5 Apply minus	Table IV. 6 Apply minus	Table IV. 7 Apply plus	Table IV. 8 Apply plus	Table IV. 9 Apply plus
Minor diameter	Subtract $1/5/12H$, table IV.1, col. 16 from maximum major diameter. This is a reference dimension only				Subtract $1/11H$, table IV.1, col. 15 from the basic major diameter and round off to the nearest 0.001 inch for sizes 0.138 inch and larger. For class 3B a cipher is added to yield four decimal places.		
Tolerance on minor diameter	None specified as the minimum is established by the crest of an unworn tool				For general applications use value for $2/3D$ to $1 1/2D$ length of engagement from table IV.10 or IV.11; for specific applications use values for applicable length of engagement or compute in accordance with directions for designing special threads p. 200. Apply plus to four-place value of min minor diameter and round off for classes 1B and 2B values to the nearest 0.001 inch for sizes 0.138 inch and larger; class 3B values are to be rounded off to the nearest 0.0001 inch.		

EXAMPLES:

- External thread:
2-14 NS-2A MOD.
Major diameter 1.995-1.985 MOD.
- Internal thread:
1 1/2-10 NS-3 MOD.
Minor diameter 1.398-1.408 MOD.

3. THREADS OTHERWISE ALTERED—If a standard series or special thread is altered in any respect other than major or minor diameter, as above stated, it is designated in accordance with the following examples:

- Special external thread:
1/8-24 Am. Nat. form—SPECIAL
Major diameter 0.4340-0.4280 SPL.
Pitch diameter 0.4065-0.4025 SPL.
Length of engagement 1/8 in. min.
- Special form external thread:
1/8-18 SPECIAL FORM
Thread angle 60°
Major diameter 0.8750-0.8668
Pitch diameter 0.8384-0.8343
Max. minor diameter 0.8068 (as gaged)
Length of engagement 1/8 in. min.

6. DIRECTIONS FOR DETERMINING LIMITS OF SIZE OF SPECIAL THREADS

The following directions are intended to simplify the task of the designer or specification writer in preparing the specification for a special thread:

The procedure to be followed in determining values for the essential thread elements, as shown in figure IV.1, and the associated tolerances, is outlined in table IV.13. The application of this and other tables is illustrated by the following example:

Internal thread, 1 1/2-28UNS-2B
Length of engagement, 1 inch

Min major diameter.....	= 1.5000 inches
Min pitch diameter=basic major diameter-3/4H, table IV.1,=1.5000-0.0232.....	= 1.4768
Max pitch diameter=min pitch diameter+tolerance, table IV.8,=1.4768+0.0060.....	= 1.4828
Min minor diameter=basic major diameter-1 1/4H, table IV.1,=1.5000-0.0387.....	= 1.461
Max minor diameter=min minor diameter+tolerance, table IV.10,=1.4613+0.0063.....	= 1.468

The dimensions of the above internal thread may be stated on the drawing as follows:

- Major diameter, 1.5000 min
- Pitch diameter, 1.4768 +0.0060
-0.0000
- Minor diameter, 1.461 +0.0063
-0.0000

External thread, 1 1/2-28UNS-2A
To mate with the above thread

Max major diameter=basic major diameter-allowance, table IV.2, =1.5000-0.0013.....	= 1.4987
Min major diameter=max major diameter-tolerance, table IV.3, =1.4987-0.0065.....	= 1.4922
Max pitch diameter=max major diameter-3/4H, table IV.1, =1.4987-0.0232.....	= 1.4755
Min pitch diameter=max pitch diameter-tolerance, table IV.5, =1.4755-0.0046.....	= 1.4709
Min minor diameter=max major diameter-1 1/4H, table IV.1, =1.4987-0.0438.....	= 1.4549

The dimensions of the above external thread may be stated on the drawing as follows:

- Major diameter, 1.4987 +0.0000
-0.0065
- Pitch diameter, 1.4755 +0.0000
-0.0046
- Minor diameter; 1.4549 nominal.

The design of a special thread usually requires that consideration be given to various factors in order that the thread assembly will function properly. These factors are discussed in appendix 5. It is to be noted particularly that deviations from the preferred tolerances for major diameter of the external thread and for minor diameter of the internal thread may be necessary in order to arrive at the optimum design.

7. GAGES

The specifications for gages as presented in section VI apply also to gages for special threads. With regard to the marking of gages, each gage shall be plainly marked, for identification, with the diameter, number of threads per inch, and class of thread. NOTE: No class is put on marking for "go" thread plug gages (all classes) and "go" thread ring gages, classes 2, 3, and 3A, because these are basic gages.

SECTION V. NATIONAL MINIATURE SCREW THREADS

1. INTRODUCTION

This standard presents a new thread series to be known as National Miniature Screw Threads and is intended for general purpose fastening screws and similar uses in watches, instruments, and miniature mechanisms.* The series covers a diameter range from 0.30 to 1.40 mm (0.0118 to 0.0551 in.) and thus supplements the Unified and American thread series that begin at 0.060 in. (No. 0 of the machine screw series).

The 14 sizes are systematically distributed, providing a uniformly proportioned selection over the entire range. They are alternately separated into two categories. The sizes shown in italics are selections made in the interest of simplification and are those to which it is recommended that usage be confined wherever the circumstances of design permit. For more restrictive conditions the intermediate sizes shown in light type are available.

The diameter-pitch combinations have been determined to provide both maximum strength against stripping and optimum conditions for manufacture on an interchangeable basis.

* This standard is identical in all technical features with the current draft standard developed by subcommittee No. 4 of ASA Sectional Committee B1 on the Standardization and Unification of Screw Threads. The thread sizes are those endorsed by the American-British-Canadian Conference as the basis for a unified standard among the inch-using countries and coincide with the corresponding range of sizes in ISO (International Organization for Standardization) Recommendation No. 84. Additionally, it utilizes thread forms which are compatible in all significant respects with both the Unified and ISO basic thread profiles. Thus, this thread series is in both the American-British-Canadian and the ISO standardization programs.

The values of all dimensions are supplied in both metric and inch units. The standard being basically metric, only the metric values of the nominal diameters and pitches are rational. Consequently, metric units are stipulated for all formulas and the inch dimensions derived by conversion of the unrounded metric values, using the conversion factor 25.4 mm/in.¹⁰

Use of this series is recommended on all new products in place of the many improvised and unsystematized sizes now in existence that have never arrived at broad acceptance nor recognition by any standardization bodies.

2. FORM OF THREAD

1. BASIC THREAD FORM.—The theoretical profile on which the design forms of the threads covered by this standard are based is, except for one element, the Unified and American basic thread form as specified in section III and shown in figure V. 1. In exception is thread height, for which a basic value of $0.52p$ is used instead of $0.54127p$ ($=5H/8$). Selection of this value is based on the extensive simplification that it

¹⁰ American Standard ASA B48.1-1933.

affords throughout the calculations for this standard. Resulting coefficients in the formulas for many of the other thread dimensions derived from this property thereby become simple, finite multiples of the lowest common denominator (40) of the fractional equivalents of all but two of the metric pitches, thus yielding values for the majority of metric dimensions that are finite within the decimal place limits of the tables. Also, the calculation of inch equivalents from the terminal metric values is thereby simplified and discrepancies between the metric and inch tables kept to a minimum. This modification will not affect interchangeability with product made to any other standards retaining $0.54127p$, as the resulting difference is negligible and completely offset by practical considerations in tapping, full internal thread heights being invariably avoided in these small sizes to escape excessive tap breakage.

2. DESIGN FORMS OF THREADS.—The design forms (maximum material condition) of external and internal National Miniature threads are shown in figure V.2.

3. BASIC THREAD DATA.—(a) *Thread form.*—The formulas for the various features of the thread form are as follows:

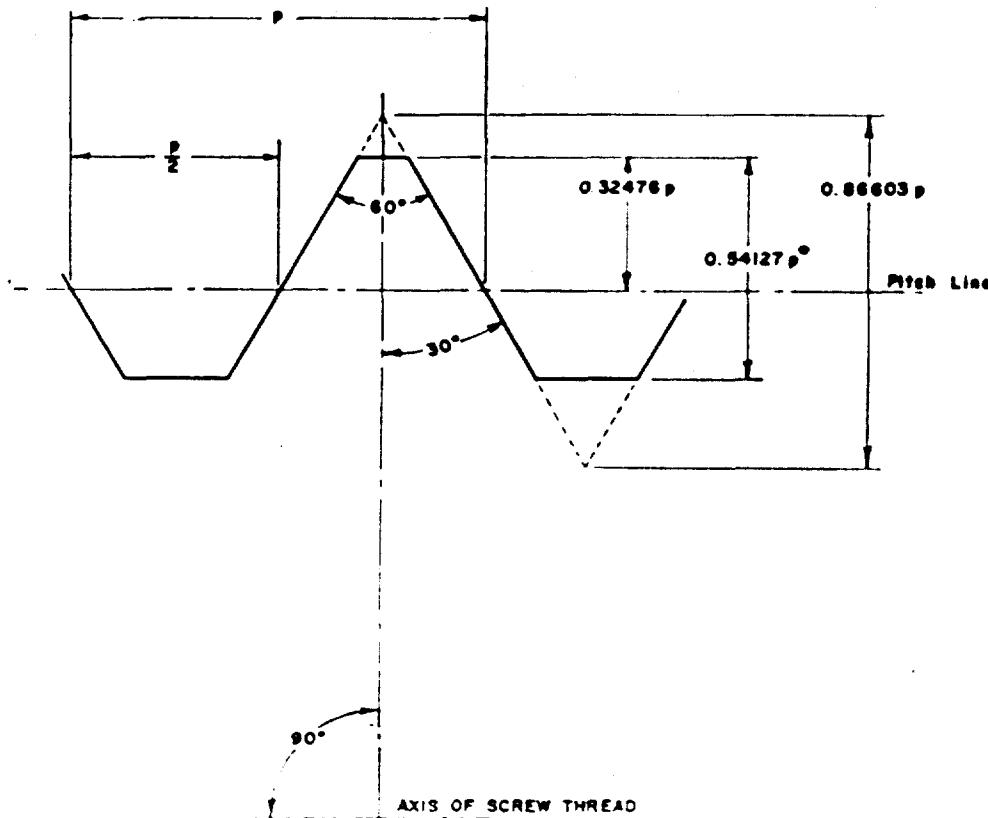

FIGURE V.1—Basic thread form, National Miniature threads.

Dimension	Symbol	Formula ^a
Basic thread form		
Angle of thread	2α	60°.
Half angle of thread	α	30°.
Pitch of thread	p	
No. of threads per inch	n	25.4/ p .
Height of sharp-V thread	H	0.866025 p .
Addendum of basic thread	h_{ab}	0.32476 p .
Height of basic thread (Unified and ISO) ^b	h_b	0.54127 p .
Height of basic thread (NM series).	h_b	0.52 p .
Design thread form		
Addendum of external thread.	h_{ea}	0.32476 p .
Height of external thread	h_e	0.60 p .
Flat at crest of external thread.	r_{ea}	0.125 p .
Radius at root of external thread.	r_{ra}	0.158 p (approx.).
Depth of thread engagement.	h_r, h_t	0.52 p .
Height of internal thread	h_i	0.556 p .
Flat at crest of internal thread.	r_{en}	0.27456 p .
Radius at root of internal thread.	r_{rn}	0.072 p (approx.).

^a The formulas are applied to the metric values of p . Tabulated inch dimensions are derived from the unrounded metric dimensions.
^b This item is listed for reference only. For the present standard all dependent details of thread form and dimensions are based on a height of 0.52 p .

The corresponding thread data for the various standard pitches are shown in table V.1.
 (b) *Thread sizes.* The formulas for basic and design thread sizes are as follows:

Dimension	Symbol	Formula
Major diameter, nominal and basic.	D	
Major diameter of external thread.	D_e	D .
Major diameter of internal thread.	D_n	$D - 2h_b + 2h_{ra} = D - 0.072p$.
Pitch diameter, basic	E	$D - 2h_{ab} = D - 0.64952p$.
Pitch diameter of external thread.	E_e	E .
Pitch diameter of internal thread.	E_n	E .
Minor diameter, basic	K	$D - 2h_b = D - 1.04p$.
Minor diameter of external thread.	K_e	$D - 2h_{ea} = D - 1.20p$.
Minor diameter of internal thread.	K_n	K .

TABLE V.1. Thread form data, National Miniature screw threads

Threads per inch ^a	Basic				External thread					Internal thread		
	Pitch, p	Height of sharp V thread, H = 0.866025 p	Height, h_b = 0.52 p	Addendum, h_{ab} = 0.32476 p	Height, h_e = 0.60 p	Flat at crest, r_{ea} = 0.125 p	Radius at root, r_{ra} = 0.158 p	Basic for minimum flat at root, 0.61 p	Min. flat at root, 0.136 p	Height, h_i = 0.556 p	Flat at crest, r_{en} = 0.27456 p	Radius at root, r_{rn} = 0.072 p
1	2	3	4	5	6	7	8	9	10	11	12	13
	mm	mm	mm	mm	mm	mm	mm	mm	mm	mm	mm	mm
0.050	0.6653	0.6116	0.0250	0.018	0.0100	0.0126	0.0126	0.0119	0.0109	0.0115	0.0230	0.0058
0.060	0.779	0.198	0.0292	0.054	0.0112	0.0142	0.0576	0.122	0.0260	0.0247	0.065	0.0065
0.100	0.866	0.520	0.0325	0.60	0.0125	0.0158	0.040	0.136	0.0556	0.275	0.072	0.0072
0.125	1.083	0.650	0.0406	0.75	0.0156	0.0198	0.040	0.170	0.0665	0.343	0.060	0.0060
0.150	1.299	0.780	0.0487	0.90	0.0188	0.0237	0.0499	0.204	0.0834	0.412	0.108	0.0108
0.175	1.516	0.910	0.0568	1.05	0.0219	0.0277	0.1129	0.238	0.0973	0.480	0.126	0.0126
0.200	1.732	1.040	0.0650	1.20	0.0250	0.0316	0.1280	0.272	0.1112	0.549	0.144	0.0144
0.225	1.949	1.170	0.0731	1.35	0.0281	0.0356	0.1440	0.306	0.1251	0.618	0.162	0.0162
0.250	2.165	1.300	0.0812	1.50	0.0312	0.0395	0.1600	0.340	0.1390	0.686	0.180	0.0180
0.300	2.598	1.590	0.0974	1.80	0.0375	0.0474	0.1920	0.408	0.1698	0.824	0.216	0.0216
	in.	in.	in.	in.	in.	in.	in.	in.	in.	in.	in.	in.
317½	0.063150	0.06273	0.00161	0.00162	0.00185	0.00039	0.00050	0.00202	0.00013	0.00175	0.00086	0.00023
282¾	0.0353	0.0607	0.0184	0.0115	0.0213	0.0014	0.0016	0.0227	0.0018	0.0156	0.0095	0.0026
254	0.03937	0.0341	0.0128	0.0235	0.0235	0.0015	0.0016	0.0252	0.0054	0.0108	0.0058	0.0018
203¼	0.01921	0.0126	0.0076	0.0140	0.0295	0.00062	0.00078	0.0315	0.0007	0.0074	0.0035	0.0011
169½	0.05095	0.0514	0.0307	0.0192	0.0354	0.00074	0.00092	0.0378	0.00080	0.0098	0.0052	0.0015
145¼	0.00890	0.0097	0.0038	0.0224	0.0113	0.00086	0.0010	0.0441	0.0011	0.0120	0.0050	0.0012
127	0.07874	0.082	0.0109	0.0245	0.0172	0.00094	0.00120	0.0494	0.00107	0.0138	0.0070	0.0017
112¾	0.0858	0.0927	0.0161	0.0288	0.0251	0.00111	0.00140	0.0547	0.00129	0.0153	0.0074	0.0018
101¼	0.0833	0.0872	0.01512	0.0320	0.0291	0.00123	0.00156	0.0600	0.00134	0.0157	0.0075	0.0017
84¾	0.1151	0.1023	0.0014	0.0384	0.0399	0.00148	0.00187	0.0756	0.00161	0.0097	0.0024	0.00085

^a In all subsequent tables these values are rounded to the nearest whole number.

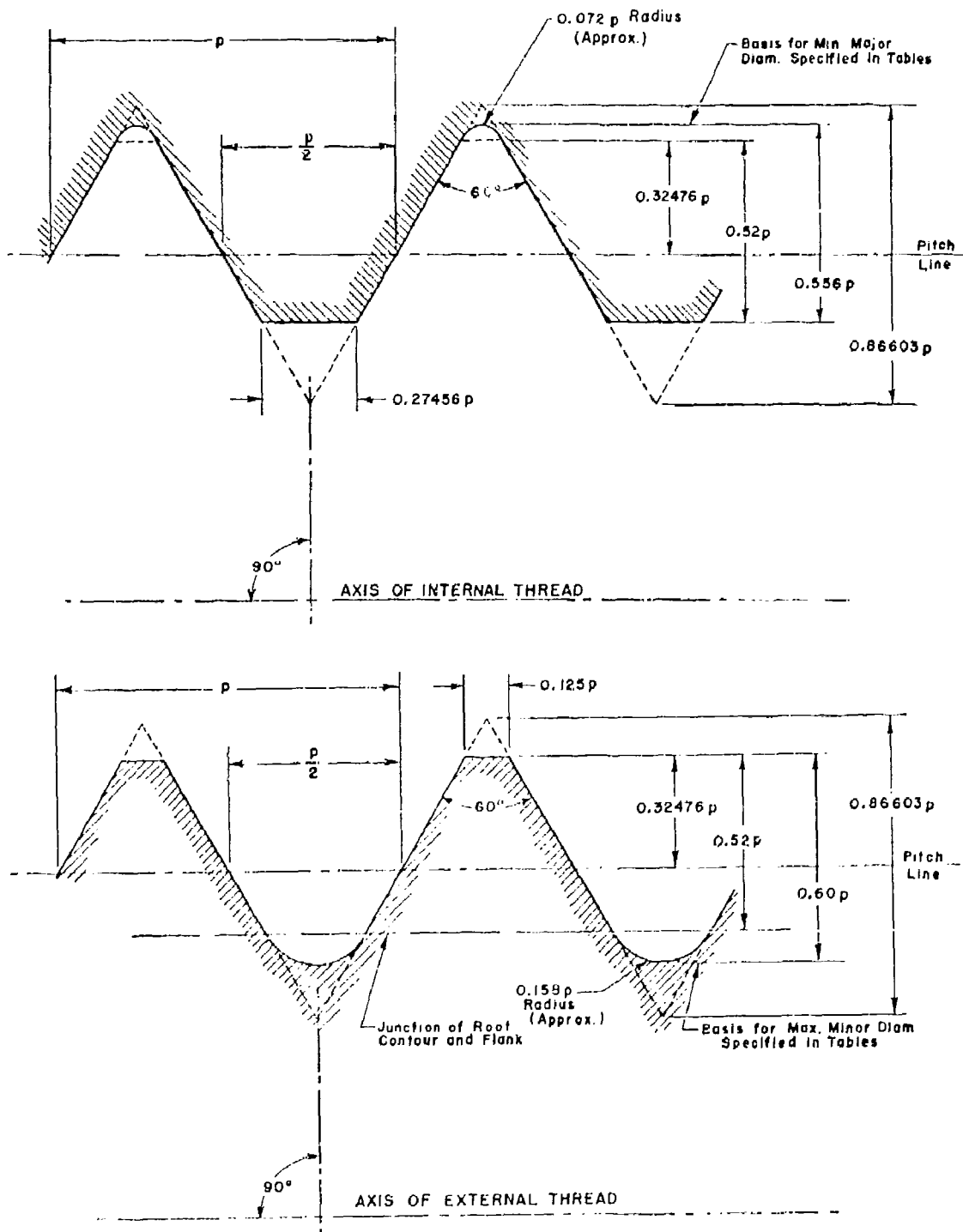

FIGURE V.2. — National Miniature internal and external screw thread design forms (maximum material condition).

3. NATIONAL MINIATURE THREAD SERIES

The diameter-pitch combinations which constitute the National Miniature thread series, and the design sizes, are those shown in table V.2, p. 104. All threads are of the single (single-start) type.

4. CLASSIFICATION AND TOLERANCES

1. CLASSIFICATION.—There is established herein only one class of thread, with zero allowance on all diameters.

2. TOLERANCES.—All tolerances governing limits of size are based on functions of the pitch only and apply to lengths of engagement from $\frac{3}{4}$ to $1\frac{1}{2}$ times the nominal diameter. (See note, table V.3, p. 107.) The limits of size resulting from the application of the specified tolerances are illustrated in figure V.3, p. 106. Length of engagement and nominal diameter have not been incorporated in any of the tolerance formulas in view of the following: (1) In the small thread sizes covered by this standard, lengths of engagement appreciably below or above the range covered by the formulas are seldom employed. (2) Functional fitness in these small sizes is dependent principally upon the properties of the thread rather than the size of the threaded member. (3) Total tolerances are too small to permit the imposition of minor order modifications.

(a) Tolerances on external threads.—Tolerances on external threads are applied to the design sizes in the minus direction. They are tabulated in table V.3, p. 105, and are based on the following formulas:

Tolerances on major diameter are equal to $0.12p + 0.006$.¹¹
 Tolerances on pitch diameter are equal to $0.08p + 0.008$.¹¹
 Tolerances on minor diameter are equal to $0.16p + 0.008$.¹¹

The third formula is for reference only. In practice, the form of the threading tool is relied upon for controlling the minimum minor diameter, and this limit is not gaged, except in confirming new tools.

(b) Tolerances on internal threads.—Tolerances on internal threads are applied to the design sizes in the plus direction. They are tabulated in table V.3, p. 105.

Tolerances on major diameter are equal to $0.168p + 0.008$.¹¹ This formula is for reference only and is comprised of the pitch diameter tolerance and an extension of the thread form of $0.08p$ beyond the basic major diameter. In practice, this limit is applied to the threading tool (tap) and is not gaged on the product.

Tolerances on pitch diameter are equal to $0.08p + 0.008$.¹¹
 Tolerances on minor diameter are equal to $0.32p + 0.012$.¹¹

¹¹ Metric units (in millimeters) apply in these formulas. Inch tolerances are not derived by direct conversion of the metric values but are the differences between the rounded-off limits of size in inch units.

TABLE V.2. Basic and design sizes, National Miniature thread series

Size designation	Pitch, p	Basic major diameter, D	Basic pitch diameter, F , $D - 0.64952p$	Minor diameter external threads, K , $D - 1.20p$	Minor diameter internal threads, K , $K = D - 1.04p$	Major diameter internal threads, D , $D + 0.012p$	Lead angle at basic pitch diameter, λ	Sectional area at minor diameter at $D - 1.28p$
1	2	3	4	5	6	7	8	9
	mm	mm	mm	mm	mm	mm	deg min	mm ²
30NM	0.080	0.300	0.248	0.204	0.217	0.306	5 52	0.0297
35NM	.090	.350	.292	.242	.256	.356	5 37	.0423
40NM	.100	.400	.336	.290	.296	.407	5 26	.0581
45NM	.100	.450	.385	.336	.345	.457	4 44	.0814
60NM	.125	.600	.419	.350	.370	.609	5 26	.0668
65NM	.125	.650	.469	.400	.420	.659	4 51	.1195
60NM	.150	.600	.503	.420	.444	.611	5 26	.1267
70NM	.175	.700	.596	.490	.518	.713	5 26	.1780
80NM	.200	.800	.674	.560	.592	.814	5 26	.232
90NM	.225	.900	.754	.630	.666	.916	5 26	.291
100NM	.250	1.000	.838	.700	.740	1.018	5 26	.363
110NM	.270	1.100	.938	.800	.840	1.158	4 51	.458
120NM	.270	1.200	1.038	.900	.940	1.218	4 33	.668
140NM	.300	1.400	1.205	1.040	1.088	1.422	4 32	.811
	threads per inch	in.	in.	in.	in.	in.	deg min	sq in. $\times 10^{-4}$
30NM	318	0.0118	0.0068	0.0080	0.0085	0.0120	5 52	0.455
35NM	292	.0138	.0115	.0095	.0101	.0140	5 37	.671
40NM	254	.0157	.0132	.0110	.0117	.0160	5 26	.901
45NM	254	.0177	.0152	.0130	.0136	.0180	4 44	1.262
60NM	203	.0197	.0165	.0138	.0146	.0200	5 26	1.407
65NM	203	.0217	.0185	.0157	.0165	.0220	4 51	1.872
60NM	169	.0236	.0198	.0165	.0175	.0240	5 26	2.03
70NM	145	.0256	.0231	.0192	.0204	.0281	5 26	3.76
80NM	127	.0315	.0264	.0220	.0233	.0321	5 26	5.00
90NM	113	.0354	.0297	.0248	.0262	.0361	5 26	6.56
100NM	102	.0394	.0330	.0276	.0291	.0394	5 26	8.32
110NM	102	.0433	.0365	.0315	.0331	.0440	4 51	9.41
120NM	102	.0472	.0404	.0354	.0370	.0480	4 33	13.43
140NM	86	.0551	.0473	.0419	.0438	.0560	4 32	12.57

3. ROOT FLATS.—The width of flat at the root of external threads, F_{rs} , at the minimum-material condition is $0.136p$, corresponding to a thread height of $0.64p$. Values for the various pitches are given in table V.1, page 102.

4. COATED THREADS.—It is not within the scope of this standard to make recommendations for thicknesses of, or to specify limits for, coatings. However, it is obvious that in these small sizes any coatings applied must be kept thin because of the smallness of the threads. Generally, the coatings employed in practice are confined to those of the electroplated or oxide types and are limited to a flash thickness. For applications where these coatings are inadequate the product is usually made of a corrosion-resistant material, thereby avoiding the problems attendant to providing for heavier coatings. However, where coatings of a measurable thickness are required, it is essential that they be included within the maximum-material limits since no allowance is provided between these limits of the external and internal thread. In other words, the maximum material limits given in this standard apply to both uncoated and coated threads.

5. THREAD DESIGNATIONS

Screw threads of this series shall be designated on engineering drawings, in specifications, and on tools and gages (when space permits) by the size designations shown in the first column of table V.2, in which the symbol "NM" designates the National Miniature series. To these designations may be affixed, in parentheses, the inch equivalent of the basic major diameter, but this addition is optional. Thus, for example, the thread size identified by the designation 80 NM may also be designated 80 NM (0.0315).

6. LIMITS OF SIZE

The limits of size of both external and internal threads, resulting from the application of the specified tolerances, are given in table V.3, p. 105, in both the metric and English systems and are illustrated in figure V.3. For hole size limits before tapping, see appendix 3, table 3.3 and figure 3.2, pp. 186, 193.

TABLE V.3.—Limits of size and tolerances, National Miniature thread series

Size designation ^a	Pitch	External threads									Internal threads							
		Major diameter limits			Pitch diameter limits			Minor diameter limits			Minor diameter limits			Pitch diameter limits			Major diameter limits	
		Max.	Min.	Tol.	Max.	Min.	Tol.	Max. ^b	Min. ^c	Tol.	Min.	Max.	Tol.	Min.	Max.	Tol.	Min. ^d	Max. ^e
i	2	3	4	5	6	7	8	9	10	11	12	13	14	15	16	17	18	
	<i>mm</i>	<i>mm</i>	<i>mm</i>	<i>mm</i>	<i>mm</i>	<i>mm</i>	<i>mm</i>	<i>mm</i>	<i>mm</i>	<i>mm</i>	<i>mm</i>	<i>mm</i>	<i>mm</i>	<i>mm</i>	<i>mm</i>	<i>mm</i>	<i>mm</i>	<i>mm</i>
50NM	0.080	0.300	0.284	0.016	0.215	0.234	0.019	0.204	0.183	0.217	0.234	0.037	0.218	0.202	0.016	0.206	0.206	0.000
35NM	0.060	0.350	0.333	0.017	0.292	0.277	0.015	0.242	0.230	0.256	0.287	0.041	0.292	0.307	0.015	0.306	0.306	0.000
40NM	0.130	0.400	0.382	0.018	0.335	0.319	0.016	0.280	0.266	0.298	0.310	0.041	0.335	0.351	0.016	0.347	0.347	0.000
45NM	0.100	0.450	0.432	0.018	0.385	0.369	0.016	0.330	0.306	0.346	0.360	0.041	0.385	0.401	0.016	0.407	0.407	0.000
60NM	0.125	0.500	0.479	0.021	0.419	0.401	0.018	0.350	0.322	0.370	0.422	0.052	0.419	0.437	0.018	0.509	0.509	0.000
55NM	0.125	0.550	0.529	0.021	0.469	0.451	0.018	0.400	0.372	0.420	0.472	0.052	0.469	0.487	0.018	0.559	0.559	0.000
65NM	0.150	0.600	0.576	0.024	0.503	0.483	0.020	0.420	0.388	0.444	0.504	0.066	0.503	0.523	0.020	0.611	0.611	0.000
70NM	0.175	0.700	0.673	0.027	0.586	0.564	0.022	0.490	0.454	0.518	0.586	0.068	0.586	0.608	0.022	0.713	0.713	0.000
80NM	0.200	0.800	0.770	0.030	0.645	0.616	0.024	0.560	0.520	0.592	0.668	0.076	0.645	0.694	0.024	0.814	0.814	0.000
90NM	0.225	0.900	0.867	0.033	0.754	0.728	0.026	0.630	0.586	0.666	0.750	0.084	0.754	0.780	0.026	0.916	0.916	0.000
100NM	0.250	1.000	0.964	0.036	0.838	0.810	0.028	0.700	0.652	0.740	0.822	0.092	0.838	0.862	0.028	1.024	1.024	0.000
110NM	0.250	1.100	1.064	0.036	0.938	0.910	0.028	0.800	0.752	0.840	0.922	0.092	0.938	0.962	0.028	1.128	1.128	0.000
120NM	0.250	1.200	1.164	0.036	1.038	1.010	0.028	0.900	0.852	0.940	1.022	0.092	1.038	1.062	0.028	1.248	1.248	0.000
140NM	0.300	1.400	1.358	0.042	1.205	1.173	0.032	1.040	0.984	1.068	1.196	0.108	1.205	1.237	0.032	1.422	1.422	0.000
	<i>threads per in.</i>	<i>in.</i>	<i>in.</i>	<i>in.</i>	<i>in.</i>	<i>in.</i>	<i>in.</i>	<i>in.</i>	<i>in.</i>	<i>in.</i>	<i>in.</i>	<i>in.</i>	<i>in.</i>	<i>in.</i>	<i>in.</i>	<i>in.</i>	<i>in.</i>	<i>in.</i>
35NM	318	0.0118	0.0112	0.0006	0.0098	0.0092	0.0006	0.0080	0.0072	0.0085	0.0100	0.0015	0.0098	0.0104	0.0006	0.0120	0.0120	0.0000
40NM	282	0.0138	0.0131	0.0007	0.0115	0.0109	0.0006	0.0095	0.0086	0.0101	0.0117	0.0016	0.0115	0.0121	0.0006	0.0140	0.0140	0.0000
45NM	254	0.0157	0.0150	0.0007	0.0132	0.0126	0.0006	0.0110	0.101	0.0117	0.0134	0.0017	0.0132	0.0138	0.0006	0.0160	0.0160	0.0000
60NM	203	0.0197	0.0189	0.0008	0.0165	0.0158	0.0007	0.0138	0.0127	0.0146	0.0166	0.0020	0.0165	0.0172	0.0007	0.0200	0.0200	0.0000
55NM	203	0.0217	0.0208	0.0009	0.0185	0.0177	0.0008	0.0157	0.0146	0.0165	0.0186	0.0021	0.0185	0.0192	0.0007	0.0220	0.0220	0.0000
65NM	169	0.0236	0.0227	0.0009	0.0198	0.0190	0.0008	0.0165	0.0153	0.0175	0.0198	0.0023	0.0198	0.0206	0.0008	0.0240	0.0240	0.0000
70NM	145	0.0276	0.0265	0.0011	0.0231	0.0222	0.0009	0.0193	0.0179	0.0204	0.0231	0.0027	0.0231	0.0239	0.0009	0.0280	0.0280	0.0000
80NM	127	0.0315	0.0303	0.0012	0.0264	0.0254	0.0010	0.0220	0.0206	0.0233	0.0263	0.0029	0.0263	0.0273	0.0009	0.0320	0.0320	0.0000
90NM	113	0.0354	0.0341	0.0013	0.0287	0.0277	0.0010	0.0238	0.0231	0.0262	0.0295	0.0033	0.0295	0.0307	0.0010	0.0360	0.0360	0.0000
100NM	102	0.0394	0.0380	0.0014	0.0300	0.0290	0.0011	0.0270	0.0257	0.0291	0.0327	0.0036	0.0320	0.0331	0.0011	0.0400	0.0400	0.0000
110NM	102	0.0433	0.0419	0.0014	0.0319	0.0308	0.0011	0.0315	0.0296	0.0331	0.0367	0.0036	0.0360	0.0371	0.0011	0.0440	0.0440	0.0000
120NM	102	0.0472	0.0458	0.0014	0.0339	0.0327	0.0012	0.0314	0.0305	0.0320	0.0400	0.0036	0.0400	0.0410	0.0011	0.0480	0.0480	0.0000
140NM	85	0.0551	0.0535	0.0016	0.0474	0.0462	0.0012	0.0409	0.0387	0.0428	0.0471	0.0043	0.0474	0.0485	0.0013	0.560	0.560	0.0000

^a Sizes shown in Italics are preferred. It is recommended that selections be confined to these sizes insofar as possible.

^b This limit, in conjunction with root form shown in figure V.2, is advocated for use when optical projection methods of racing are employed. For mechanical racing the minimum material condition of the hole and thread is applied.

^c This limit is provided for reference only. In practice, the form of the thread tool is relied upon for this limit. Control by gaging is not imposed.

^d This limit is provided for reference only, and is not gaged. For gaging, the maximum major diameter of the external thread is applied.

NOTE.—Tol. limits in this table have been determined by direct conversion of corresponding metric dimensions prior to rounding off. Such tolerances at the differences between the inch limits and, consequently, differ in some instances, by 0.0001 inch from the inch equivalent of the metric tolerance.

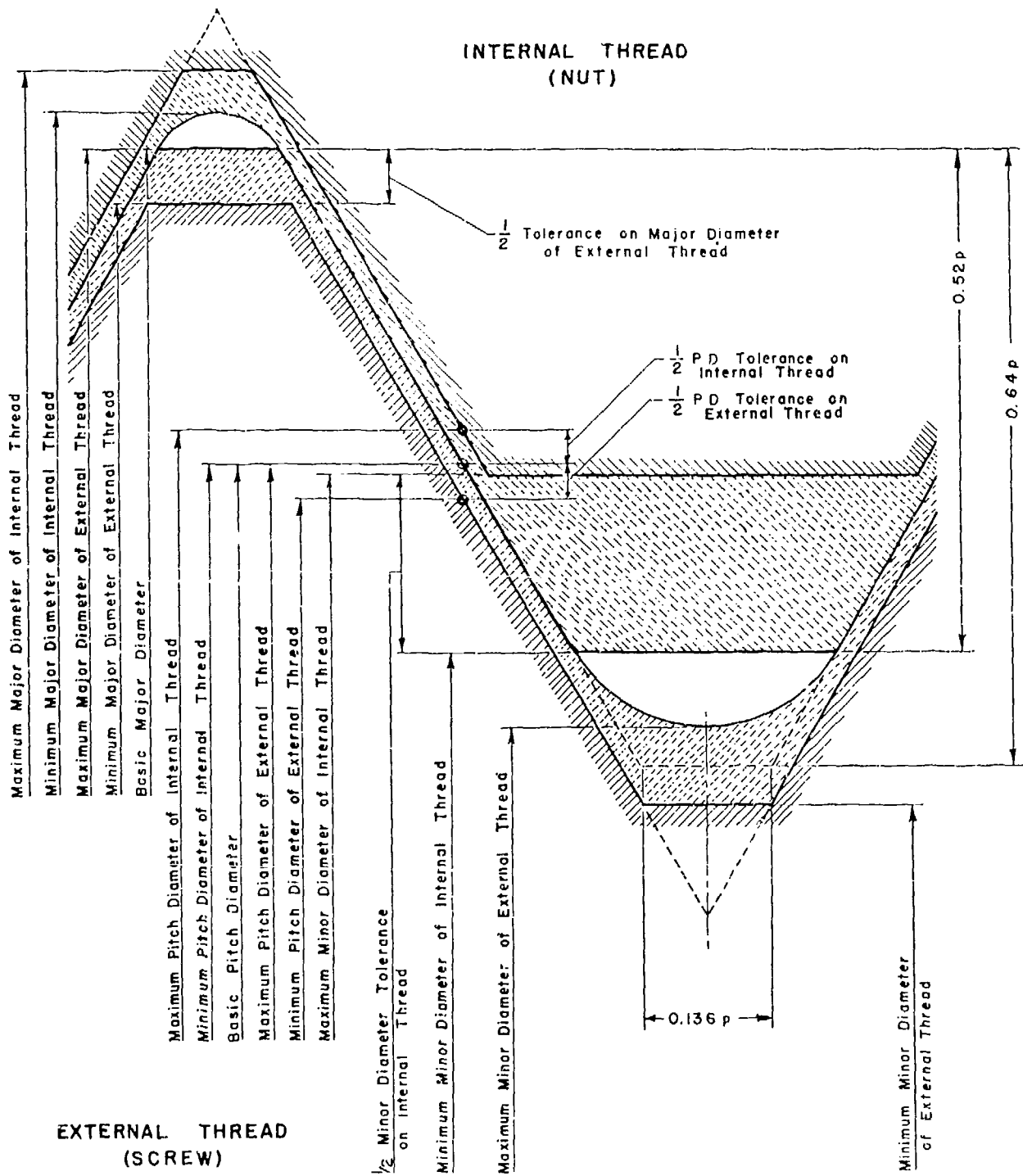

FIGURE V.3.—Disposition of tolerances and crest clearances, National Miniature threads.

7. GAGES AND GAGING

The development of a gaging standard for National Miniature threads is anticipated after the accumulation of more experience with this new standard. The following procedures are at present being successfully used by some producers:

1. **GAGING OF EXTERNAL THREADS.**—The major diameter of the external thread is inspected by either contact gaging or optical projection. All other dimensions, such as pitch diameter, lead, thread form, and minor diameter are inspected by optical projection methods. There is presented in figure V.4 an illustration of a chart which has been found very satisfactory for the optical projection method of inspection of external threads. Inspection at a magnification of 100 is recommended and at this scale the charts should be accurate to within ± 0.01 in. on all diameters and $\frac{1}{4}$ on pitches cumulatively up to five.

2. **GAGING OF INTERNAL THREADS.**—The minor diameter of the internal thread is gaged with "go" and "not go" plain cylindrical plug gages. All other elements are checked only for assembleability limits by means of a "go" thread plug gage. For the minimum-material limit of the internal thread the accuracy and performance of the tap is relied upon. This implies that the major and pitch diameters of the tap do not exceed the maximum internal thread limits for these elements and disregards overcutting, which is rarely incurred because of the flexibility of these small taps and the manner in which they are generally fluted.

SECTION VI. GAGES AND GAGING FOR UNIFIED, AMERICAN, AND AMERICAN NATIONAL THREADS

1. INTRODUCTION

Gaging of screw threads is the process of investigating or determining the extent to which they conform dimensionally to prescribed limits of size. Dimensional gages are the means applied for that purpose.

This standard for gages and gaging practice is supplementary to sections III and IV, and appendixes 1 and 2, and is intended to facilitate adherence to the limits of size specified therein without in any sense restricting the requirements more severely than those specified. Adherence to the gaging principles laid down, which have been tested by many years of practical use, will assure assembleability of threads interchangeably, the acceptance of satisfactory threads, and segregation or rejection of threads that are significantly outside of prescribed limitations.

There are two general methods of approach to the dimensional inspection of threads, namely inspection by attributes and inspection by variables. Inspection by attributes involves the application of limit gages to assure that the product is within the prescribed limits of size, whereas inspection by variables involves the application of indicating gages or measuring instruments to measure the extent of deviation of the elements of screw threads from prescribed

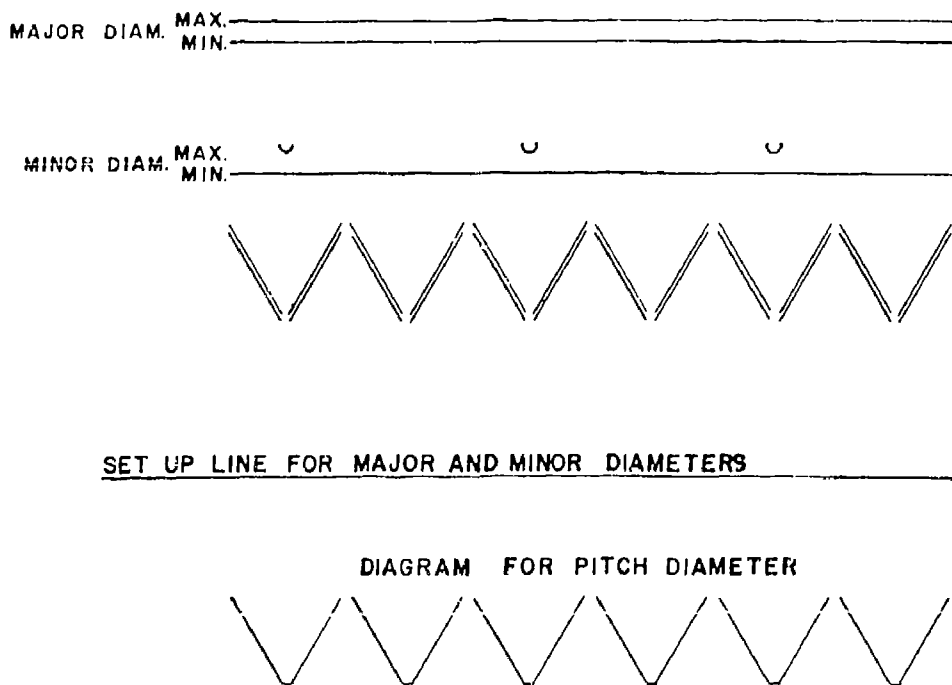

FIGURE V.4.—Suggested chart for projection inspection of external National Miniature threads.

limits of size. Inspection by variables is primarily useful in the control of production tools and processes. Such inspection may be applied, when necessary, to enforce the limits on deviations of individual thread elements, stated on pp. 22, 79, and 130, or to collect data for the analysis of screw thread defects. However, inspection by attributes generally forms the basis for the acceptance or rejection of threads with respect to conformity to specified limits of size.

2. FUNDAMENTALS

1. GAGE CLASSIFICATION.—The limits of size of the threads to be produced should be represented in: (1) Gages used in checking the threads as they are produced, known as “working gages”; (2) gages for use in the acceptance of the product, known as “inspection gages”; and (3) gages used to determine the accuracy of the two preceding classes of gages, known as “master” and “setting gages.”

2. GAGES FOR REFERENCE.—(a) *Master gage*.—The master gage is a thread plug gage which represents the physical dimensions of the basic size of the part. It clearly establishes the minimum size of the internal thread and the maximum size of the external thread at the point at which interference between mating parts begins when no allowance is provided. A master gage shall be accompanied by a record of its measurement.

(b) *Setting gage (check gage)*.—(1) *Threaded setting gages*.—A setting gage is a thread plug gage to which adjustable thread ring gages, thread snap gages, and other thread comparators are set to size. Threaded setting plug gages are of two standard designs, which are designated as “basic-crest setting plugs” and “truncated setting plugs.”

The basic-crest setting plug is one having a width of flat at the crest equal to $p/8$. It is commonly used for setting thread snap gages and is also used for setting adjustable thread ring gages to size, when adequate facilities are available for checking the thread form and clearance at the major diameter. (See “procedure,” p. 118.)

The truncated setting plug of standard design¹² is the same as the basic-crest setting plug except that the crest of the thread is truncated for one-half of the length of the gage, giving a full-form portion and a truncated portion, as specified in par. 2 (a) p. 111. In setting thread gages to size, the truncated portion controls the pitch diameter, and the full-form portion assures that proper clearance is provided at the major diameter of the ring gage. Also, the use of the full-form portion in conjunction with the truncated portion checks to some degree the flank angle of the thread gage.

(2) *Plain cylindrical plug acceptance check gages*.—“Go” and “not go” plain cylindrical plug acceptance check gages are required to check the minor diameter limits of thread ring gages of the smaller

sizes, after the gage has been properly set to the thread setting plug gage. Standard measuring equipment is usually employed in lieu of plain cylindrical plug gages for sizes larger than $\frac{3}{8}$ in. nominal diameter thread.

3. LIMIT GAGES.—Limit gages are of two categories, namely (1) maximum-metal-limit gages, designated “go” gages, and (2) minimum-metal-limit gages, designated “not go” gages.

(a) *Maximum-metal or “go” gages*.—The maximum-metal-limit or “go” gages check or control the extent of the tolerance, as applied to a specific screw thread, in the direction of the limit of maximum material and represent the maximum limit of external threads and the minimum limit of internal threads. The ideal maximum-metal-limit or “go” gage is a threaded counterpart of the thread, made exactly to its prescribed maximum-material limits and in length equal to the length of engagement of the thread with its mating thread. Such gages would most nearly duplicate the assembly conditions of threads. They control the virtual diameter (or effective size) at the maximum-material limit. See “Acceptability of Threads,” p. 118.

(b) *Minimum-metal or “not go” gages*.—The minimum-metal gages control the extent of the tolerance in the direction of the limit of minimum material and represent the minimum limit of external threads and the maximum limit of internal threads.

As stated on p. 22, the minimum-material pitch diameter limits are necessarily a limitation of the pitch diameter as a single thread element. Also, it is a principle of limit gaging that each element or dimension can be checked only singly by a minimum-metal-limit gage. Accordingly, separate gages are required to check pitch, major, and minor diameters at minimum-material limits. That is, for external threads two gages are necessary, one to check the major diameter and the other, pitch diameter; internal threads require a gage to check the pitch diameter and the other, minor diameter. A third factor in minimum-material-limit gaging is nontechnical but of practical importance, namely the economics of the gaging means and procedures, as thorough checking of a thread requires several individual gaging operations along and around the thread. It is not feasible, therefore, to establish an ideal gage design for gaging pitch diameter and approach that ideal closely in practice, as is done for maximum-metal-limit gages.

As a result, two distinct gaging practices are widely used, as follows:

(1) The use of “not go” thread plug and ring gages provides a satisfactory means of gaging when proper functioning of the thread assembly only requires control of the virtual diameter (or effective size) of the threads at the minimum material limits. The use of such gages is referred to as “virtual diameter (or effective size) gaging practice.” See “Acceptability of Threads,” p. 118.

¹² See Commercial Standard C28, for sale by the Superintendent of Documents, U. S. Government Printing Office, Washington 25, D. C. The latest revision should be consulted when referring to such standards.

(2) The use of "not go" thread snap or indicating gages conforming to the thread length requirements stated on p. 114, controls to a close degree the pitch diameter at the minimum-material limit as a single element. Thus, without further checking, their use provides an economical means of control over such other variables as lead, uniformity of helix, flank angle, taper, roundness, and surface condition. The use of such gages, however, is referred to as "single element gaging practice." See "Acceptability of Threads," p. 118.

4. **DIRECTION OF TOLERANCES ON GAGES.**—The dimensions of all gages used for the *production* of screw threads and "go" gages used for inspection shall be within the extreme limits of size of the product. The limits of size specified for screw threads represent the extreme limitation of an acceptable product. The tolerances are those necessary to include all errors or variations in the sizes of *production* tools, gages, and all other manufacturing variations. However, in order to avoid needless controversy on parts close to the minimum-material sizes or "not go" limits, because of possible small differences in sizes of the gages used, the pitch diameter tolerances on all "not go" gages used for *final inspection* and for inspection of purchased product may be outside the product limits if specifically authorized.

5. **TEMPERATURE AT WHICH GAGES SHALL BE STANDARD.**—*The nominal dimensions of gages and product shall be correct at a temperature of 68° F (20° C).* As gages and products are ordinarily checked at room temperature, whatever it may happen to be, it is desirable that the coefficient of thermal expansion of gages be the same as that of the product on which they are used. Inasmuch as the majority of threaded products consist of iron and steel, and as screw-thread gages are ordinarily made of hardened steel, this condition is ordinarily fulfilled without giving it special attention.

6. **MEASURING PRESSURE FOR WIRE MEASUREMENTS.**¹³ In measuring the pitch diameter of hardened screw-thread gages by means of wires, and in measuring the wires themselves, the same contact load should be used. A contact load of 1 lb is recommended for pitches finer than 20 threads per inch and 2½ lb for 20 threads per inch and coarser. It is also recommended as standard practice that wires be measured between a flat contact and a cylindrical contact 0.750 in. in diameter. The contacts shall be of hardened steel, accurately ground and lapped.

3. SPECIFICATIONS FOR GAGE ELEMENTS

The design of gages is specified in this section only to the extent that it affects the results obtained in the gaging of threads. Other details of design and dimensions are left to the discretion

of individual departments and agencies of the Government. However, to serve their intended purposes satisfactorily, thread gages should be produced by employing only the latest and best manufacturing techniques. The type of steel or wear-resistant material selected, together with the heat-treating and stabilization processes, should provide for maximum wear life and reduce the dimensional instability to a minimum, thereby insuring that the gages will remain within the tolerances specified over a maximum period. Thread gages should be precision plug or ring lapped to insure adequate refinement of surface finish, removal of amorphous or smear metal after grinding, and uniformity of thread form over the entire length of the gaging member.

(a) GENERAL DESIGN

1. **DESIGN OF GAGE BLANKS.**—Designs of standard blanks for thread plug and ring gages, setting plug gages, plain cylindrical plug and ring gages, and plain snap gages have been developed by the American Gage Design Committee. The designs have proved satisfactory in many years of use and have been published in Commercial Standard CSS, Gage Blanks (see footnote 12).

‡2. **REMOVAL OF SHARP END THREADS.**—To avoid feather edges on "go" and "not go" thread plug and ring gages and thread setting plug gages, the partial thread at both ends of the gage shall be removed to a blunt start (see definition 26, p. 4.) Not more than one complete turn of the thread shall be removed to the point where the full thread form is obtained. On thread ring gages of ½ in. nominal size or smaller or of 20 threads per inch and finer, and on all thread plug gages and setting plug gages of 28 threads per inch and finer, a 60° chamfer from the axis of the gage is permitted in lieu of removal of the partial thread. On truncated thread setting plugs of 28 threads per inch or coarser, where the truncated portion meets the full portion, the feather edge shall be completely removed.

3. **CHIP GROOVES IN "GO" THREAD PLUG GAGES.**—Each "go" thread plug gage, except in sizes 0.150 in. and smaller, shall be provided with a chip groove at the entering end. On reversible gages a chip groove is required at each end. Chip grooves are acceptable that are in accordance with general commercial practice such as a longitudinal groove cut parallel with the axis and extending the complete length of the gaging member, or a groove cut at an angle with the axis. The groove shall be located circumferentially at the start of the full thread and in all cases the depth shall extend below the root of the first full thread space. The widths recommended for chip grooves are as follows: Over 0.150 to 0.385 in. nominal diameter, ½ in.; above 0.385 to and including 2.010 in. nominal diameter, ⅝ in.; and above 2.010 in. nominal diameter, ¾ in. "Go" thread ring gages of the adjustable type (AGD standard) do not require chip grooves as the adjusting slots serve this purpose.

¹³ Methods of measuring pitch diameter of thread plug gages are described, and specifications for wires are given in appendix 4, p. 194.

(b) SPECIFICATIONS FOR THREAD FORM

1. THREAD FORM OF "GO" AND "NOT GO" THREAD GAGES.—The specifications for thread form of thread gages applicable to both external and internal threads, as exemplified by thread plug and ring gages, are stated in detail below, and are summarized in table VI.1 and figure VI.1. These specifications for thread form apply over the entire circumference and length of the gaging element.

(a) "Go" thread gages.—(1) *Thread crests*.—The major diameter of the "go" thread plug gage shall be the same as the minimum (basic) major diameter of the internal thread, with a plus gage tolerance. The minor diameter of the "go" thread ring gage shall be equal to the maximum pitch diameter of the external thread minus $H/2$, with a minus gage tolerance. The thread crests of plug and ring gages shall be flat in an axial section and parallel to the axis.

(2) *Thread roots*.—The minor diameter of the "go" thread plug gage shall be cleared beyond a $p/8$ width of flat either by an extension of the sides of the thread toward a sharp V or by an undercut to any dimension no wider than the width resulting from $p/8$ maximum width either side of the centerline of the thread space (see fig. VI.1). The major diameter of the "go" thread ring gage shall be cleared by a clearance cut of substantially $p/8$ width and approximately central.

(3) *Concentricity of pitch and major or minor diameters*.—The pitch and major diameters of "go" thread plug gages, and the pitch and minor diameters of "go" thread ring gages shall be concentric. On thread plug gages an eccentric condition produces an oversize effective major diameter, having a width of flat less than $p/8$, which may encroach on the minimum permissible limit for the root profile of the internal thread. Similarly, on thread ring gages an eccentric condition produces an undersize effective minor diameter,

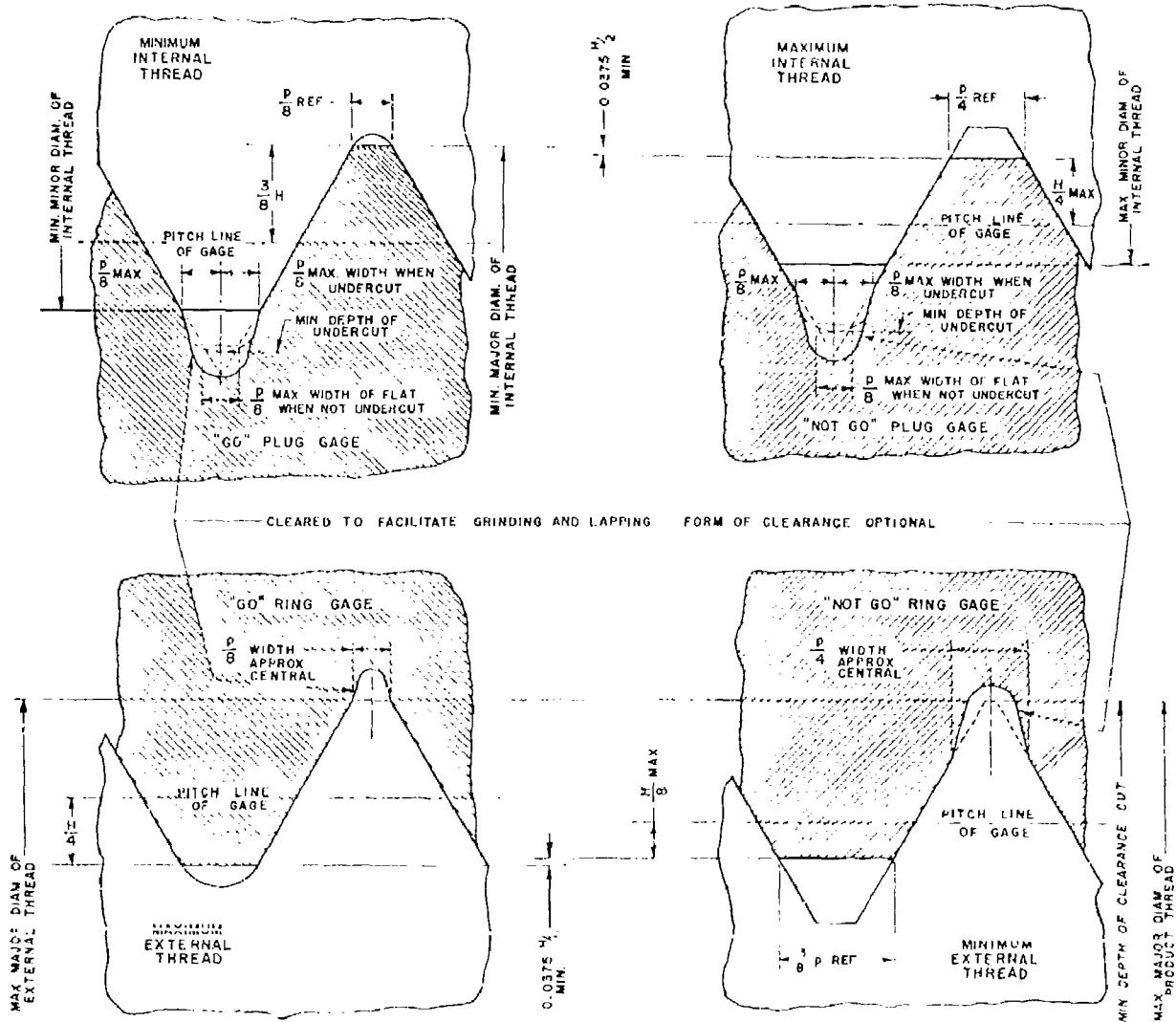

FIGURE VI.1. Thread form of gages for external and internal threads.

having a width of flat less than $p/4$, which may encroach on the maximum permissible limit for the root profile of the external thread. The following are the permissible maximum effective major and minimum effective minor diameters as determined by measurements of runout (total indicator reading) with respect to the pitch cylinder:

"Go" thread plug gage: maximum effective major diameter = maximum major diameter specified

"Go" thread ring gage: minimum effective minor diameter = measured minor diameter¹⁴ - (pitch diameter gage tolerance + minor diameter gage tolerance)

(b) "Not go" thread gages.—(1) *Thread crests.*—The maximum major diameter of the "not go" thread plug or equivalent gage shall be equal to the maximum pitch diameter of the internal thread plus $H/2$. This corresponds to a width of flat at the crest of the gage equal to one-fourth of the pitch. However, the maximum major diameter of the "not go" thread plug gage shall not exceed¹⁵ the minimum major diameter of the internal thread minus $0.0375H$ ($=0.05h_b$).

The minimum minor diameter of the "not go" thread ring or equivalent gage shall be equal to the minimum pitch diameter of the external thread minus $H/4$. This corresponds to a width of flat at the crest of the gage equal to three-eighths of the pitch. However, the minimum minor diameter of the "not go" thread ring gage shall not be less than the minimum minor diameter of the "go" thread ring gage plus $0.0375H$ ($=0.05h_b$). This requirement is necessary to insure that the minor diameter of the "not go" thread ring gage is not less than the minor diameter of the "go" ring gage, which may occur with a three-eighths pitch flat on the "not go" thread ring crest when there is a pitch diameter allowance on the external thread combined with a large pitch diameter tolerance.¹⁶

(2) *Thread roots.*—The minor diameter of the "not go" thread plug gage shall be cleared beyond a $p/4$ width of flat by an undercut to any dimension no wider than the width resulting from $p/8$ maximum width either side of the centerline of the thread space (see fig. VI.1). In small diameters and fine pitches this relief may be an extension of the sides of the thread from the position corresponding to this approximate width toward a sharp V. The major diameter of the "not go" thread ring gage shall be cleared by a clearance cut of substantially $p/4$ width and approximately central. The "not go" thread ring gage shall clear the maximum major diameter of the external thread or the maximum major diameter of the full-form portion of the truncated thread setting plug for the "not go" thread ring gage, whichever is the greater.

¹⁴ Required to be within the specified tolerance.

¹⁵ This condition occurs in connection with small sizes of class 1 gears and one series threads and may occur for extreme combinations of large diameter and the pitch of class 1 threads of special diameters, pitches, and lengths of engagement.

Thus contact of the thread gage can occur on the sides of the threads, but not on the crest or root. Also the effect of angle deviation on the fit of the gage with the thread is minimized.

(3) *Concentricity of pitch and major or minor diameters.* The pitch and major diameters of "not go" thread plug gages, and the pitch and minor diameters of "not go" thread ring gages shall be concentric. On thread plug gages an eccentric condition produces an oversize effective major diameter, having a width of flat less than $p/4$, which may encroach on the minimum permissible limit for the root profile of the internal thread. Similarly, on thread ring gages an eccentric condition produces an undersize effective minor diameter, having a width of flat less than $3p/8$, which may encroach on the maximum permissible limit for the root profile of the external thread. The following are the permissible maximum effective major and minimum effective minor diameters as determined by measurements of runout (total indicator reading) with respect to the pitch cylinder:

"Not go" thread plug gage: maximum effective major diameter = maximum major diameter specified.

"Not go" thread ring gage: minimum effective minor diameter = measured minor diameter¹⁴ - 2 (pitch diameter gage tolerance + minor diameter gage tolerance).

2. THREAD FORM OF SETTING PLUG GAGES.

The specifications for thread form of setting plug gages are stated in detail below, and are summarized in table VI.2 and figures VI.2 and VI.3.

(a) *Truncated and basic-crest maximum-metal-limit ("go") thread setting plugs.* (1) *Thread crests.*—The major diameter of the basic-crest setting plug, and of the full-form portion of the truncated maximum-metal-limit thread setting plug shall correspond to the maximum major diameter of the external thread (one-eighth pitch flat).

The major diameter of the truncated portion of the truncated maximum-metal-limit setting plug is equal to the maximum major diameter of the external thread (or the minimum major diameter of the full-form portion of the plug) minus $(0.060\sqrt[3]{p^2} + 0.017p)$.

(2) *Thread roots.*—The minor diameter of maximum-metal-limit ("go") thread setting plug shall be cleared beyond a $p/8$ width of flat either by an extension of the sides of the thread toward a sharp V or by an undercut no wider than a width obtained from $p/8$ maximum width either side of the centerline of the thread space (see figs. VI.2 and VI.3.).

(b) *Truncated and basic-crest minimum-metal-limit ("not go") thread setting plugs.* (1) *Thread crests.*—The major diameter of the truncated portion of the minimum-metal-limit ("not go") thread setting plug shall be equal to the minimum pitch diameter of the external thread plus $H/2$. The major diameter of the basic-crest setting

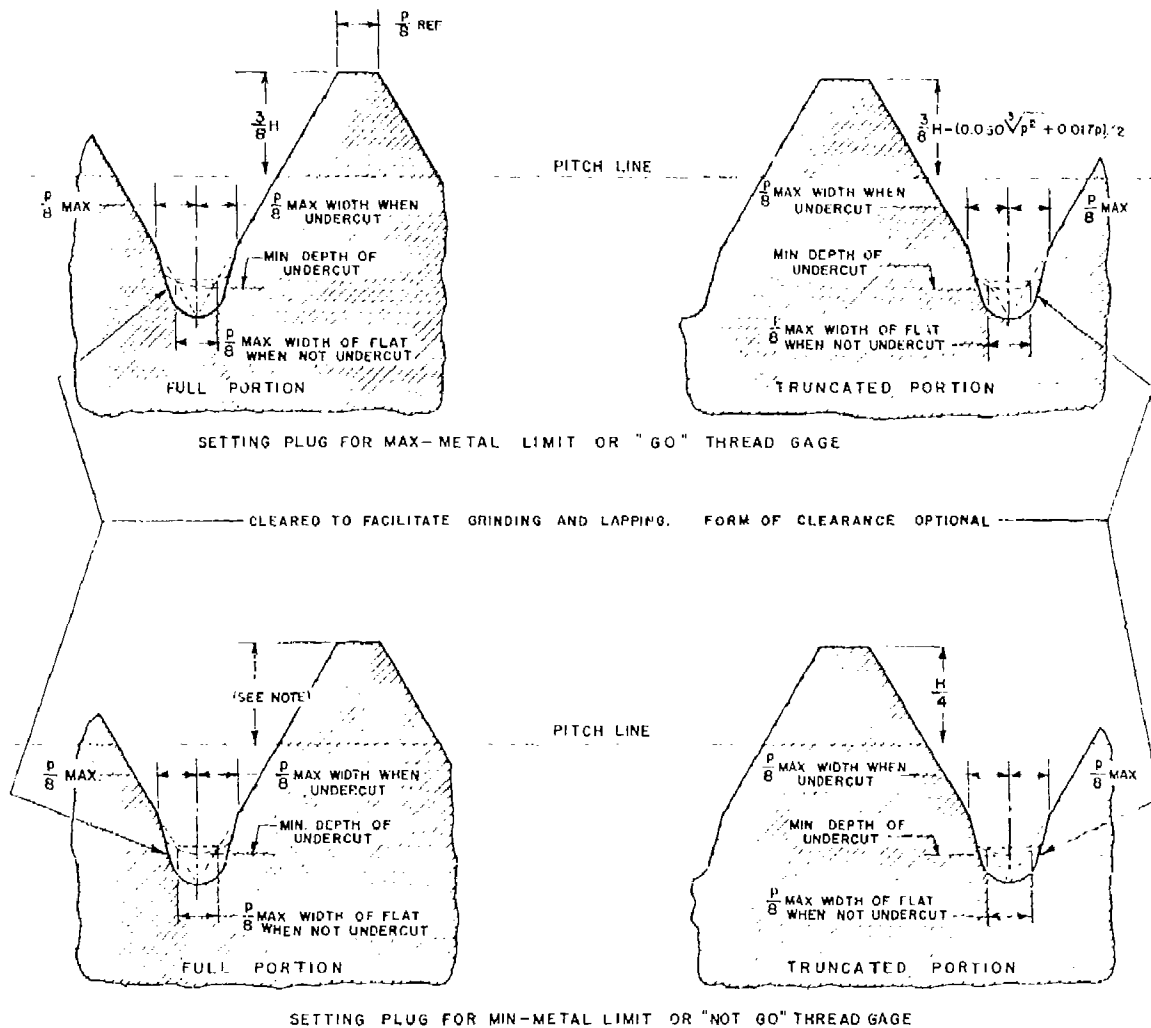

‡ FIGURE VI.2.—Thread form of truncated thread setting plug gages.

NOTE.—See table VI.2, column 13.

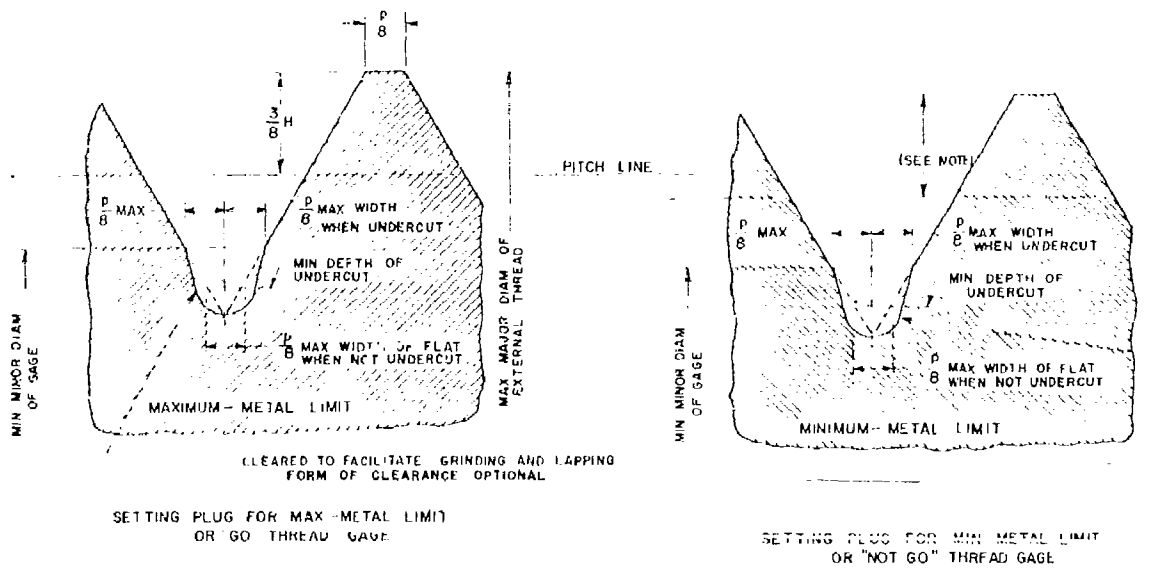

‡ FIGURE VI.3.—Thread form of basic-crest thread setting plug gages.

NOTE.—See table VI.2, column 13.

TABLE VI. 1.—Specifications and format for tables of limits of size of threaded and plain gages for Unified, American, and American National external and internal threads

Nominal size and threads per inch	Series designation	Class	Gages for external threads										Gages for internal threads						Class	Series designation	Nominal size and threads per inch		
			Thread gages					Plain gages for major diameter					Thread gages									Plain gages for minor diameter	
			Go		Not go			Go		Not go			Go		Not go		Go					Not go	
1	2	3	4	5	6	7	8	9	10	11	12	13	14	15	16	17	18	19	20	21			
			Max. pitch diameter of external thread, (gage tolerance minus. When wear allowance is required, subtract the applicable wear allowance from the max. pitch diameter and then apply the gage tolerance minus.	Max. pitch diameter of external thread minus $H/2$. (Gage tolerance minus.	Min. pitch diameter of external thread, (gage tolerance plus.	Min. pitch diameter of external thread minus $H/4$ but not less than min. minor diameter of "Go" thread gage for external thread plus $0.0375H (= 0.054s)$. (Gage tolerance plus.	Max. major diameter of external thread, (gage tolerance minus.	Min. major diameter of external thread, (gage tolerance plus.	Min. major diameter of external thread of hot-rolled material in UNC-2A, NC-2A, 8N-2A, and 8N-2. (Gage tolerance plus.	Min. major diameter of internal thread, (gage tolerance plus.	Min. pitch diameter of internal thread, (gage tolerance plus. When wear allowance is required, add the applicable wear allowance to the min. pitch diameter and then apply the gage tolerance plus.	Max. pitch diameter of internal thread plus $H/2$, but not to exceed min. major diameter of "Go" thread gage for internal thread minus $0.0375H (= 0.054s)$. (Gage tolerance minus.	Max. pitch diameter of internal thread, (gage tolerance minus.	Max. pitch diameter of internal thread, (gage tolerance plus, (optional), see par. 4, p. 109.	Min. minor diameter of internal thread, (gage tolerance plus.	Max. minor diameter of internal thread, (gage tolerance minus.							

TABLE VI.2.—Specifications and format for tables of limits of size of threaded setting plug gages for Unified, American, and American National external threads

Nominal size and threads per inch	Series designation	Class	Truncated setting plugs								Basic-crest setting plugs				
			Plug for Go				Plug for Not go				Plug for Go		Plug for Not go		
			Major diameter		Pitch diameter	Major diameter		Pitch diameter		Major diameter	Pitch diameter	Major diameter		Pitch diameter	
			Truncated	Full-form		Truncated	Full-form	Plus tol. gage	Minus tol. gage			Plus tol. gage	Minus tol. gage		
1	2	3	4	5	6	7	8	9	10	11	12	13	14	15	
			Max. major diameter of external thread (minimum major diameter of full portion of "go" setting plug, see col. 5, minus 0.0043 p 24-1017 <i>p</i>). Gage tolerance minus plus.	Max. major diameter of external thread. Gage tolerance plus.	Max. pitch diameter of external thread. Gage tolerance minus. When wear allowance is required subtract the applicable wear allowance from the max. pitch diameter and then apply the gage tolerance minus.	Min. pitch diameter of external thread plus $H/2$. Gage tolerance minus minus.	Same as column 12.	Min. pitch diameter of external thread. Gage tolerance plus.	Min. pitch diameter of external thread. Gage tolerance minus (optional), see par. 4, p. 109.	Max. major diameter of external thread. Gage tolerance plus.	Same as column 6.	Max. major diameter of external thread provided that the min. major diameter corresponds to a truncation of not less than 0.067 H and the max. major diameter of the plug corresponds to a truncation of not less than 0.0669 H . Gage tolerance plus. See footnote 16, p. 114.	Min. pitch diameter of external thread. Gage tolerance plus.	Min. pitch diameter of external thread. Gage tolerance minus (optional), see par. 4, p. 109.	

plug and of the full form portion of the truncated minimum-metal-limit ("not go") thread setting plug equal to the maximum major diameter of the external thread (equals that of the maximum-metal-limit ("go") thread setting plug for the same external thread), provided that the minimum major diameter of the plug corresponds to a truncation of not less than 0.067 H (width of flat equals 0.067 p). An additional requirement is that the maximum major diameter of the plug shall correspond to a truncation of not less than 0.0009 in. (width of flat equals 0.001 in.). When the latter requirement controls the maximum, the minimum of both A and W gages is less than this maximum by the amount of the X tolerance.¹⁶

(2) *Thread roots.* The minor diameter of the minimum metal limit ("not go") thread setting plug shall be cleared beyond a $p/8$ width of flat either by an extension of the sides of the thread toward a sharp V or by an undercut no wider than a width obtained from $p/8$ maximum width either side of the centreline of the thread space (see figs. VI.2 and VI.3).

(c) *Pitch diameter straightness.* To effect proper setting of a thread gage, the pitch cylinder¹⁷ of the setting plug is required to be straight. The maximum permissible taper over the entire length

of the setting plug shall be within the following limits: For sizes to and including 4 in. nominal diameter maximum taper equals 0.0001 in., except that for threads coarser than 16 threads per inch the maximum taper equals 0.00015 in. For sizes larger than 4 in. nominal diameter, maximum taper equals 0.0002 in. The permissible taper should be back taper (largest diameter at entering end) and shall be confined within the pitch diameter limits.

3. SPECIFICATIONS FOR LIMITS OF SIZE.—The specifications and format for tables of limits of size of thread gages and setting plugs are summarized in tables VI.1 and VI.2 (see tables III.12, III.13, I.16, and I.17).

Constants for the various standard thread pitches which are required to determine gage dimensions are tabulated in table VI.3.

(c) SPECIFICATIONS FOR THREAD LENGTH

1. "GO" GAGES.—The ideal "go" thread gage, as stated in par. 3 (a), p. 108, should have a length equal to the length of engagement of the thread with its mating thread. The proper control of deviations from correct lead and zero taper requires (1) a length equal to the length of engagement and (2) that the gage should assemble its full length with the thread under inspection. In practice, the lengths of "go" gages made from standard blanks are usually about as long as the length of engagement, but exceptionally long engagements, or short engagements as for fine-pitch threads, may require modifications of the gage length. In specifying "go" thread gages, reference should be made to Commercial Standard CSS (see footnote

¹⁶The procedure for computing the maximum and minimum major diameters is as follows: Minimum major diameter of A and W setting plug equals maximum pitch diameter of external thread plus $M/4$. If this is greater than minimum pitch diameter of external thread plus $M/4$, use the latter sum. Then add the X major diameter tolerance and compute the sum with the minimum pitch diameter of the external thread plus $H/2$ minus 0.0043 p . If the latter is the smaller of the two values, it is the maximum major diameter for both A and W setting plug. Then apply W tolerance plus for the W setting plug and the A tolerance plus for the A setting plug. ¹⁷See definition 17, p. 4.

TABLE VI.3. Constants for computing thread gage dimensions

Threads per inch, <i>n</i>	Pitch, <i>p</i>	$\frac{3}{4}p = 0.75p$	$p/4 = 0.25p$	$p/8 = 0.125p$	$0.067p$	$0.10018p$	$0.060\sqrt{Vp^2}$	$0.017p$	$0.980\sqrt{p^2} + 0.017p$	Height of sharp V-thread, $H = 0.866025p$	$\frac{1}{4}H = 0.21651p$	$H/2 = 0.43301p$	$3/4H = 0.64951p$	$0.3395H = 0.1166p$ $= (2\sqrt{0.058}p)$	$0.0375H = 0.0584p$ $= 0.03248p$
1	3	4	5	6	7	8	9	10	11	12	13	14	15	16	
80	0.012500	0.009375	0.003125	0.001562	0.000781	0.001266	0.000633	0.000316	0.000221	0.00034	0.000221	0.00034	0.00051	0.000316	0.000158
72	0.013889	0.010417	0.003472	0.001736	0.000868	0.001297	0.000648	0.000324	0.000229	0.00035	0.000229	0.00035	0.00052	0.000324	0.000162
64	0.015625	0.011719	0.003906	0.001953	0.000976	0.001411	0.000705	0.000352	0.000235	0.00037	0.000235	0.00037	0.00055	0.000352	0.000175
56	0.017857	0.013393	0.004438	0.002219	0.001109	0.001573	0.000786	0.000393	0.000254	0.00040	0.000254	0.00040	0.00060	0.000393	0.000187
48	0.020833	0.015625	0.005208	0.002604	0.001302	0.001822	0.000911	0.000455	0.000281	0.00045	0.000281	0.00045	0.00067	0.000455	0.000214
44	0.022727	0.017045	0.005668	0.002834	0.001417	0.001978	0.000989	0.000494	0.000300	0.00048	0.000300	0.00048	0.00071	0.000494	0.000227
40	0.025000	0.018750	0.006250	0.003125	0.001562	0.002143	0.001071	0.000536	0.000324	0.00052	0.000324	0.00052	0.00076	0.000536	0.000243
36	0.027778	0.020833	0.006944	0.003472	0.001736	0.002361	0.001180	0.000581	0.000352	0.00056	0.000352	0.00056	0.00080	0.000581	0.000259
32	0.031250	0.023438	0.007812	0.003906	0.001953	0.002636	0.001318	0.000620	0.000370	0.00060	0.000370	0.00060	0.00084	0.000620	0.000275
28	0.035714	0.026786	0.008833	0.004417	0.002208	0.002971	0.001456	0.000661	0.000390	0.00064	0.000390	0.00064	0.00088	0.000661	0.000292
27	0.037037	0.027778	0.009259	0.004629	0.002314	0.003082	0.001501	0.000673	0.000396	0.00065	0.000396	0.00065	0.00090	0.000673	0.000297
24	0.041667	0.031250	0.010417	0.005208	0.002604	0.003452	0.001667	0.000721	0.000420	0.00068	0.000420	0.00068	0.00094	0.000721	0.000312
20	0.050000	0.037500	0.012500	0.006250	0.003125	0.004167	0.002083	0.000812	0.000455	0.00072	0.000455	0.00072	0.00099	0.000812	0.000338
18	0.055556	0.041667	0.013889	0.006944	0.003472	0.004545	0.002273	0.000861	0.000470	0.00075	0.000470	0.00075	0.00101	0.000861	0.000354
16	0.062500	0.046875	0.015625	0.007812	0.003906	0.005000	0.002500	0.000909	0.000480	0.00077	0.000480	0.00077	0.00104	0.000909	0.000363
14	0.071429	0.053571	0.017857	0.008929	0.004464	0.005625	0.002812	0.001033	0.000500	0.00079	0.000500	0.00079	0.00108	0.001033	0.000375
13	0.076923	0.057692	0.019231	0.009615	0.004808	0.005952	0.002976	0.001061	0.000510	0.00080	0.000510	0.00080	0.00110	0.001061	0.000381
12	0.083333	0.062500	0.020833	0.010417	0.005208	0.006333	0.003167	0.001090	0.000520	0.00081	0.000520	0.00081	0.00112	0.001090	0.000389
11 $\frac{1}{2}$	0.086957	0.065222	0.021545	0.010787	0.005393	0.006502	0.003251	0.001100	0.000520	0.00081	0.000520	0.00081	0.00112	0.001100	0.000390
11	0.090909	0.068182	0.022727	0.011364	0.005682	0.006667	0.003333	0.001110	0.000520	0.00081	0.000520	0.00081	0.00112	0.001110	0.000391
10	0.100000	0.075000	0.025000	0.012500	0.006250	0.007143	0.003571	0.001120	0.000520	0.00081	0.000520	0.00081	0.00112	0.001120	0.000393
9	0.111111	0.083333	0.027778	0.013889	0.006944	0.007619	0.003762	0.001130	0.000520	0.00081	0.000520	0.00081	0.00112	0.001130	0.000394
8	0.125000	0.093750	0.031250	0.015625	0.007812	0.008167	0.004000	0.001140	0.000520	0.00081	0.000520	0.00081	0.00112	0.001140	0.000395
7	0.142857	0.107143	0.035714	0.017857	0.008929	0.008750	0.004286	0.001150	0.000520	0.00081	0.000520	0.00081	0.00112	0.001150	0.000396
6	0.166667	0.125000	0.041667	0.020833	0.011111	0.009524	0.004762	0.001160	0.000520	0.00081	0.000520	0.00081	0.00112	0.001160	0.000397
5	0.200000	0.150000	0.050000	0.025000	0.013400	0.010600	0.005300	0.001170	0.000520	0.00081	0.000520	0.00081	0.00112	0.001170	0.000398
4 $\frac{1}{2}$	0.222222	0.166667	0.055556	0.027778	0.014815	0.011524	0.005762	0.001180	0.000520	0.00081	0.000520	0.00081	0.00112	0.001180	0.000399
4	0.250000	0.187500	0.062500	0.031250	0.016750	0.012500	0.006250	0.001190	0.000520	0.00081	0.000520	0.00081	0.00112	0.001190	0.000400

TABLE VI.4.—Lengths of standard taperlock and trilock thread plug gage blanks

Thread sizes				Thread lengths			
Nominal range, inclusive		Decimal range		Thread plug gages		Fine-pitch instrument thread plug gages	
From	To	Above	To and including	Go (see notes)	Not go	Go	Not go
1	2	3	4	5	6	7	8
#0	#3	0.059	0.105	$\frac{1}{16}$	$\frac{1}{8}$	$\frac{3}{16}$	$\frac{1}{2}$
#1	#6	0.105	0.150	$\frac{3}{16}$	$\frac{1}{2}$	$\frac{7}{16}$	$\frac{5}{8}$
#8	#12	0.150	0.240	$\frac{1}{2}$	$\frac{5}{8}$	$\frac{7}{8}$	$\frac{15}{16}$
$\frac{1}{4}$	$\frac{5}{16}$	0.240	0.365	$\frac{5}{8}$	$\frac{7}{8}$	$\frac{15}{16}$	$\frac{15}{16}$
$\frac{3}{8}$	$\frac{1}{2}$	0.365	0.510	$\frac{7}{8}$	$\frac{15}{16}$	$\frac{15}{16}$	$\frac{15}{16}$
$\frac{7}{16}$	$\frac{3}{4}$	0.510	0.825	$\frac{15}{16}$	$\frac{15}{16}$	$\frac{15}{16}$	$\frac{15}{16}$
$\frac{5}{8}$	$\frac{11}{16}$	0.825	1.135	$\frac{15}{16}$	$\frac{15}{16}$	$\frac{15}{16}$	$\frac{15}{16}$
$\frac{11}{16}$	$\frac{15}{16}$	1.135	1.510	$\frac{15}{16}$	$\frac{15}{16}$	$\frac{15}{16}$	$\frac{15}{16}$
$\frac{15}{16}$	2	1.510	2.010	$\frac{15}{16}$	$\frac{15}{16}$	$\frac{15}{16}$	$\frac{15}{16}$
2	2 $\frac{1}{2}$	2.010	2.510	$\frac{15}{16}$	$\frac{15}{16}$	$\frac{15}{16}$	$\frac{15}{16}$
2 $\frac{1}{2}$	3	2.510	3.010	$\frac{15}{16}$	$\frac{15}{16}$	$\frac{15}{16}$	$\frac{15}{16}$
3	12	3.010	12.010	$\frac{15}{16}$	$\frac{15}{16}$	$\frac{15}{16}$	$\frac{15}{16}$

1 For 12 threads per inch and finer.
 2 For threads coarser than 12 per inch.
 3 For 7 threads per inch and coarser.
 4 For threads finer than 7 and coarser than 16 per inch.
 5 For 16 threads per inch and finer.

TABLE VI.5.—Lengths of standard thread ring gage blanks and total thread lengths of standard truncated setting plug gage blanks

Thread sizes				Lengths of thread ring gages		Thread lengths of truncated setting plug gages	
Nominal range, inclusive		Decimal range		Thin ring	Thick ring	For thin ring	For thick ring
From	To	Above	To and including	1	2	3	4
1	2	3	4	5	6	7	8
#0	#3	0.059	0.105	$\frac{1}{16}$	$\frac{1}{8}$	$\frac{3}{16}$	$\frac{1}{2}$
#3	#6	0.105	0.150	$\frac{3}{16}$	$\frac{1}{2}$	$\frac{7}{16}$	$\frac{5}{8}$
#6	#12	0.150	0.240	$\frac{1}{2}$	$\frac{5}{8}$	$\frac{7}{8}$	$\frac{15}{16}$
$\frac{1}{4}$	$\frac{5}{16}$	0.240	0.365	$\frac{5}{8}$	$\frac{7}{8}$	$\frac{15}{16}$	$\frac{15}{16}$
$\frac{3}{8}$	$\frac{1}{2}$	0.365	0.510	$\frac{7}{8}$	$\frac{15}{16}$	$\frac{15}{16}$	$\frac{15}{16}$
$\frac{7}{16}$	$\frac{3}{4}$	0.510	0.825	$\frac{15}{16}$	$\frac{15}{16}$	$\frac{15}{16}$	$\frac{15}{16}$
$\frac{5}{8}$	$\frac{11}{16}$	0.825	1.135	$\frac{15}{16}$	$\frac{15}{16}$	$\frac{15}{16}$	$\frac{15}{16}$
$\frac{11}{16}$	$\frac{15}{16}$	1.135	1.510	$\frac{15}{16}$	$\frac{15}{16}$	$\frac{15}{16}$	$\frac{15}{16}$
2	2 $\frac{1}{2}$	1.510	2.010	$\frac{15}{16}$	$\frac{15}{16}$	$\frac{15}{16}$	$\frac{15}{16}$
2 $\frac{1}{2}$	3	2.010	2.510	$\frac{15}{16}$	$\frac{15}{16}$	$\frac{15}{16}$	$\frac{15}{16}$
3	12	2.510	12.010	$\frac{15}{16}$	$\frac{15}{16}$	$\frac{15}{16}$	$\frac{15}{16}$

1 Also applicable to fine-pitch instrument thread ring gages in the range from $\frac{1}{4}$ to $\frac{3}{16}$ in., inclusive.
 2 These sizes of thread ring gages have counter-bored ends, so that the thread length of Nos. 0 to 2 is 1/16 in. and of No. 3 to 6 is 1/8 in.

12) which gives lengths of standard gage blanks. If such lengths are not satisfactory, the required lengths of gages should be specified. Tables VI.4 and VI.5 are the pertinent tables taken from the current edition of CSS.

Similarly, the lengths of plain "go" gages, used to check major and minor diameters, should be such that the thread may be checked for taper throughout its length.

Where indicating gages are used as either threaded or plain "go" gages, the contact elements should engage the thread both along and around the thread over an area approximately equivalent to that of the "go" plug or ring gages.

2. "NOT GO" GAGES.—(a) *Thread plug and ring gages.*—As "not go" gages are intended to check only the pitch diameter at the minimum-material limit, the length of the "not go" thread plug gage need be no more than the number of threads required to obtain an accurate three-wire measurement of pitch diameter—about three full threads. The lengths of standard blanks for "not go" gages, as in tables VI.4 and VI.5, are less than those for "go" gages.

As "not go" thread plug and ring gages normally check only the end threads of the threads under inspection, and as such end threads are not usually representative of the entire thread, a standard practice has been adopted with respect to permissible entry when plug and ring gages are used, as follows:

Threads are acceptable as within the minimum material limits if, when using plug and ring thread gages, the "not go" plug gage does not enter or the "not go" ring gage is not entered. Threads may be accepted if all complete threads can enter in, or be entered by the "not go" gage, provided that a definite drag results from metal to metal contact on or before the third turn of entry. Neither working nor final inspection "not go" gages should be forced after the drag is definite. The requirements of extreme applications such as exceptionally thin or ductile material, small number of threads, etc., may necessitate modification of this practice, and in such cases the "not go" gaging practice shall be as specified by the responsible department or agency of the Government.

(b) *Thread snap gages.* Thread snap gages are generally adjustable and have contact anvils consisting of cone-points, wedge-shaped prisms with rounded edges, serrated or grooved plates, or grooved or threaded cylinders adjustably mounted and suitably spaced in a U-shaped frame. The positions of the anvils are set to a threaded setting plug gage, and the anvils are then clamped in position and sealed. The foregoing specifications for thread form are applicable to contact anvils, but the permissible eccentricity of the pitch and minor diameters of thread ring gages is not applicable to the anvils or rolls of thread snap gages.

"Not go" thread snap gages shall engage the thread over a length of two pitches. They permit

checking the thread at various positions along and around the thread. Thus, their use provides a more critical check than that of thread ring gages and definite information regarding other than the end threads.

(c) *Indicating thread gages.*—Indicating gages, having contact elements corresponding to the anvils specified for "not go" thread snap gages, provide an approximately equivalent check of the minimum-material pitch diameter limit. Indicating gages measure by electrical, optical, mechanical, or other indicating and amplifying means the dimensions or deviations in the dimensions of threads. Indicating gages are also extensively used as limit gages.

3. SETTING PLUG GAGES. —The lengths of truncated setting plugs shall be such as to provide engagement of the full length of thread of the ring or other gage being checked with the truncated threads and with the full threads. The lengths of basic-crest setting plugs shall similarly provide for full engagement. Lengths of standard blanks for truncated setting plugs are given in Commercial Standard CS8. (See footnote 12.) Table VI.5 is taken from the current edition of CS8.

(d) MARKING OF GAGES

Each gage shall be plainly and permanently marked with the minimum marking essential for positive identification. In the cases of thread plug and thread setting plug gages it may be desirable to identify both the gaging element and the handle. Recommended marking practices are as follows:

1. *THREAD PLUG GAGES.* —The "go" thread plug gage members are common to all classes of threads, both standard and special, and are identified by the nominal size, threads per inch, "GO," and pitch diameter. Example: " $\frac{1}{4}$ -20, GO, PD .2175." The "not go" thread plug gage members may be marked with: Nominal size, threads per inch, class, "NOT GO" and pitch diameter. Example: " $\frac{1}{4}$ 20-2B, NOT GO, PD .2223."

2. *PLAIN PLUG GAGES FOR MINOR DIAMETER.* —The "go" plain plug gage members are common to all classes of threads and as such may be marked with: Nominal size, threads per inch, "GO," and minor diameter. Example: " $\frac{1}{4}$ 20, GO, .1960."

The "not go" plain plug gage member may be marked with: Nominal size, threads per inch, "NOT GO," and minor diameter. Example: " $\frac{1}{4}$ 20, NOT GO, .2067."

3. *THREAD RING GAGES AND SETTING PLUGS.* —The "go" thread ring gages, and setting plug gage members therefor, may be marked with: Nominal size, threads per inch, "GO," and pitch diameter. Example: " $\frac{1}{4}$ 20, GO, PD .2175." Gages for classes 2, 3, and 3A are basic. Gages for classes 1A, 2A, and in some instances class 1, are common.

The "not go" thread ring or snap gages, and setting plug gage members therefor, may be marked with: Nominal size, threads per inch,

"NOT GO," and pitch diameter. Example: "1/4-20, NOT GO, PD .2127."

4. PLAIN GAGES FOR MAJOR DIAMETER.—The "go" gages for major diameter of external threads may be marked with: Nominal size, threads per inch, "GO," and diameter. Example: "1/4-20, GO, .2500."

The "not go" gages for major diameters may be marked with: Nominal size, threads per inch "NOT GO," and diameter. Example: "1/4-20, NOT GO, .2408."

5. PLAIN PLUG ACCEPTANCE CHECK GAGES.—The "go" plain plug acceptance check gage members may be marked: "GO ACCEPT CHK FOR DIA. XXXX."

The "not go" plain plug acceptance check gage members may be marked: "NOT GO ACCEPT CHK FOR DIA. XXXX."

4. GAGE TOLERANCES AND WEAR ALLOWANCES

1. STANDARD TOLERANCE CLASSES.—Standard tolerances for thread plug and ring gages and threaded setting plugs are of three classes: (1) *W* tolerances, shown in table VI.6, which represent the highest commercial grade of accuracy or workmanship and which are required especially for truncated setting plugs, (2) *X* tolerances, shown in table VI.7, which are larger than *W*

tolerances and are an economical compromise among such factors as gage cost, amount of product tolerance consumed by gage tolerances, and possible observational errors in the measurement of gages with generally available measuring equipment¹⁸; and (3) *Y* tolerances, shown in table VI.8, which include a wear allowance and are applicable only to UNS and NS threads in classes 1, 1A, 1B, 2A, and 2B.

2 TOLERANCE SPECIFICATIONS.—(a) *Direction of tolerances*¹⁹.—The directions of tolerances for the individual elements of the various types of gages are specified in tables VI.1 and VI.2.

(b) *Tolerances on lead*.—Tolerances on lead (pitch and helix) are specified as an allowable variation between any two threads not farther apart than the length of the standard gage, shown in CS8, Gage Blanks (see footnote 12), omitting one full turn at each end of the gage, except that in the case of setting plugs, the length shall be that of the thread in the mating ring gage. On truncated setting plugs, the sign of any lead error present shall be the same on the full-form portion

¹⁸ While *X* tolerances on gages are generally acceptable, occasionally a combination of gage and tool errors may cut seriously into product limits, especially in the finer threads. When trouble is encountered in securing class-3 limits on 20 threads per inch or finer, a careful inspection of tools and gages is suggested. A change to "*W*" gages may be economical as the closer tolerance gage may leave enough margin of the working tolerance to ease the problem.
¹⁹ See par. 4, p. 165.

TABLE VI.6—Tolerances for *W* "go" and "not go" thread gages

Threads per inch	Tolerance on lead ¹		Tolerance on half angle of thread	Tolerance on major or minor diameters			Tolerance on pitch diameter				
	To and including 1/2 in. diam	Above 1/2 in. diam		To and including 1/2 in. diam	Above 1/2 in. to 4 in. diam	Above 4 in. diam	To and including 1/2 in. diam	Above 1/2 in. to 1 1/2 in. diam	Above 1 1/2 in. to 4 in. diam	Above 4 in. to 8 in. diam	Above 8 in. to 12 in. diam ²
1	2	3	4	5	6	7	8	9	10	11	12
	in.	in.	deg min ±	in.	in.	in.	in.	in.	in.	in.	in.
80	0.0001	0.00015	0 20	0.0002	0.0003	-----	0.0001	0.00015	-----	-----	-----
72	.0001	.00015	0 20	.0002	.0003	-----	.0001	.00015	-----	-----	-----
64	.0001	.00015	0 20	.0002	.0003	-----	.0001	.00015	-----	-----	-----
56	.0001	.00015	0 20	.0002	.0003	-----	.0001	.00015	0.0002	-----	-----
48	.0001	.00015	0 18	.0002	.0003	-----	.0001	.00015	.0002	-----	-----
44	.0001	.00015	0 15	.0002	.0003	-----	.0001	.00015	.0002	-----	-----
40	.0001	.00015	0 15	.0002	.0003	-----	.0001	.00015	.0002	-----	-----
36	.0001	.00015	0 12	.0002	.0003	-----	.0001	.00015	.0002	-----	-----
32	.0001	.00015	0 12	.0002	.0003	0.0007	.0001	.00015	.0002	0.00025	0.0003
28	.00015	.00016	0 8	.0005	.0006	.0007	.0001	.00015	.0002	.00025	.0003
27	.00015	.00015	0 8	.0005	.0005	.0007	.0001	.00015	.0002	.00025	.0003
24	.00015	.00015	0 8	.0005	.0005	.0007	.0001	.00015	.0002	.00025	.0003
20	.00015	.00015	0 8	.0005	.0005	.0007	.0001	.00015	.0002	.00025	.0003
18	.00015	.00015	0 8	.0005	.0005	.0007	.0001	.00015	.0002	.00025	.0003
16	.00016	.00015	0 8	.0005	.0005	.0009	.0001	.0002	.00025	.0003	.0004
14	.0002	.0002	0 6	.0006	.0006	.0009	.00015	.0002	.00025	.0003	.0004
13	.0002	.0002	0 6	.0006	.0006	.0009	.00015	.0002	.00025	.0003	.0004
12	.0002	.0002	0 6	.0006	.0006	.0009	.00015	.0002	.00025	.0003	.0004
11 1/2	.0002	.0002	0 6	.0006	.0006	.0009	.00015	.0002	.00025	.0003	.0004
11	.0002	.0002	0 6	.0006	.0006	.0009	.00015	.0002	.00025	.0003	.0004
10	-----	.00025	0 6	-----	.0006	.0009	-----	.0002	.00025	.0003	.0004
9	-----	.00025	0 6	-----	.0007	.0011	-----	.0002	.00025	.0003	.0004
8	-----	.00025	0 5	-----	.0007	.0011	-----	.0002	.00025	.0003	.0004
7	-----	.0003	0 5	-----	.0007	.0011	-----	.0002	.00025	.0003	.0004
6	-----	.0003	0 5	-----	.0008	.0013	-----	.0002	.00025	.0003	.0004
5	-----	.0003	0 4	-----	.0008	.0013	-----	-----	.00025	.0003	.0004
4 1/2	-----	.0003	0 4	-----	.0008	.0013	-----	-----	.00025	.0003	.0004
4	-----	.0003	0 4	-----	.0009	.0015	-----	-----	.00025	.0003	.0004

¹ Allowable variation in lead between any 2 threads not farther apart than the length of the standard gage, shown in CS8, omitting 1 full thread at each end of the gage.

² Above 12 in. the tolerance is directly proportional to the tolerance in this column, in the ratio of the diameter to 12 in.

and the truncated portion, and such error shall be uniform within 0.0001 in. over any portion equivalent to the length of the thread ring gage.

(c) *Tolerances on flank angle.*—Tolerances are specified for the flank angles rather than the included angle to assure that the bisector of the included angle will be perpendicular to the axis of the thread within proper limits. The equivalent of the deviation from the true thread form caused by such irregularities as convex or concave flanks, rounded crests, or slight projections on the thread form, should not exceed the tolerances permitted on flank angle.

(d) *Tolerances not cumulative.*—Tolerances on lead, flank angle, and pitch diameter are not cumulative; that is, the tolerance on any one element may not be exceeded even though the errors in the other two elements are smaller than the respective tolerances.

(e) *Tolerances for plain gages.*—Standard tolerances for plain plug gages for minor diameter of internal threads and for gages for major diameter of external threads are Z tolerances, as shown in table VI.9.

TABLE VI.7.—Tolerances for X "go" and "not go" thread gages

Threads per inch	Tolerance on lead ¹	Tolerance on half angle of thread	Tolerance on major or minor diameters		Tolerance on pitch diameter			
			To and including 4 in. diam.	Above 4 in. diam.	To and including 1½ in. diam.	Above 1½ to 4 in. diam.	Above 4 to 8 in. diam.	Above 8 to 12 in. diam. ²
1	2	3	4	5	6	7	8	9
	in.	deg. min.	in.	in.	in.	in.	in.	in.
80	0.0002	0 30	0.0003	-----	0.0002	-----	-----	-----
72	0.0002	0 30	0.0003	-----	0.0002	-----	-----	-----
64	0.0002	0 30	0.0004	-----	0.0002	-----	-----	-----
56	0.0002	0 30	0.0004	-----	0.0002	0.0003	-----	-----
48	0.0002	0 30	0.0004	-----	0.0002	0.0003	-----	-----
44	0.0002	0 20	0.0004	-----	0.0002	0.0003	-----	-----
40	0.0002	0 20	0.0004	-----	0.0002	0.0003	-----	-----
36	0.0002	0 20	0.0004	-----	0.0002	0.0003	-----	-----
32	0.0003	0 15	0.0005	0.0007	0.0003	0.0004	0.0005	0.0006
28	0.0003	0 15	0.0005	0.0007	0.0003	0.0004	0.0005	0.0006
27	0.0003	0 15	0.0005	0.0007	0.0003	0.0004	0.0005	0.0006
24	0.0003	0 15	0.0005	0.0007	0.0003	0.0004	0.0005	0.0006
20	0.0003	0 15	0.0005	0.0007	0.0003	0.0004	0.0005	0.0006
18	0.0003	0 10	0.0005	0.0007	0.0003	0.0004	0.0005	0.0006
16	0.0003	0 10	0.0005	0.0007	0.0003	0.0004	0.0005	0.0006
14	0.0003	0 10	0.0005	0.0007	0.0003	0.0004	0.0005	0.0006
13	0.0003	0 10	0.0005	0.0007	0.0003	0.0004	0.0005	0.0006
12	0.0003	0 10	0.0005	0.0007	0.0003	0.0004	0.0005	0.0006
11½	0.0003	0 10	0.0005	0.0007	0.0003	0.0004	0.0005	0.0006
11	0.0004	0 10	0.0005	0.0007	0.0003	0.0004	0.0005	0.0006
10	0.0003	0 10	0.0005	0.0007	0.0003	0.0004	0.0005	0.0006
9	0.0003	0 10	0.0007	0.011	0.003	0.004	0.005	0.008
8	0.0004	0 6	0.0007	0.011	0.004	0.005	0.006	0.008
7	0.0004	0 5	0.0007	0.011	0.004	0.005	0.006	0.008
6	0.0004	0 5	0.0008	0.013	0.004	0.005	0.006	0.008
5	0.0004	0 5	0.0008	0.013	-----	0.005	0.006	0.008
4½	0.0004	0 5	0.0008	0.013	-----	0.005	0.006	0.008
4	0.0004	0 5	0.0009	0.015	-----	0.005	0.006	0.008

¹ Allowable variation in lead between any two threads not farther apart than the length of the standard gage, shown in C58, omitting one full thread at each end of the gage.

² Above 12 in., the tolerance is directly proportional to the tolerance in this column, in the ratio of the diameter to 12 in.

NOTE.—When a wear allowance is wanted on "go" gages, it is recommended that the X pitch diameter tolerance be divided, one-half for wear and one-half for tolerance.

5. RECOMMENDED GAGE PRACTICES

1. *ACCEPTABILITY OF THREADS.*—(a) *At maximum-material limits.*—In case of question, the acceptability of threads at the maximum-material limits shall be based on gaging with "go" thread plug and ring gages conforming as closely as practicable to the limits of size of the thread and to the thread form and length specified for such gages (see par. 3(a), Maximum-metal or "go" gages, p. 108.)

(b) *At minimum-material limits.*—A choice of either of two gaging practices is available, as outlined under par. 3(b), p. 108. The practice to be chosen and applied will depend on whether virtual diameter (or effective size) gaging is specified for the particular application, or whether single element gaging practice is required.

Virtual diameter gaging practice, as previously noted, involving the use of thread plug and ring gages, is specified for all "go" limits of size. Virtual diameter gaging practice is customary for the "not go" limits of classes 1, 1A, 1B, 2, 2A, 2B, and 3B, and 3 internal threads. Single element gaging practice involving the use of thread snap gages, indicating type gages, or their equivalent, is recommended for the "not go" limits of size of all classes 3A and 3 external threads. However, for technical and economical reasons, all classes of external and internal threads larger than 6-in. nominal diameter shall be subject to measurement of the thread elements for acceptance. This is not to preclude the use of gages where economically feasible and acceptable to the producer and consumer.

2. *USES OF W AND X THREAD GAGES.*—(a) *"Go" and "not go" thread gages.*—It is recommended that W tolerances be applied to "go" and "not go" inspection and working thread gages for class 4. X tolerances are recommended as applicable to all inspection and working thread gages for classes 1, 1A, 1AR, 1B, 2, 2A, 2B, 3, 3A, and 3B, except as follows: Y tolerances, which include a wear allowance are applicable to UNS and NS threads in classes 1, 1A, 1B, 2A, and 2B.

(b) *Setting plugs for "go" and "not go" gages.*—It is recommended that W tolerances be applied on lead and angle to all setting plugs regardless of class. The pitch diameter tolerances shall be W or X as specified.

3. *BASIC-SIZE "GO" THREAD GAGES.*—Basic size "go" thread gages for internal threads are applicable to all internal thread classes. Basic size "go" thread ring gages and setting plugs are applicable to class 2A when coated. They are also applicable to external thread classes 2, 3A, and 3.

4. *PROCEDURE IN SETTING ADJUSTABLE THREAD RING GAGES.*—In setting an adjustable thread ring gage the sealing compound should be removed and the locking screw loosened. Turning the adjusting screw to the right enlarges the ring so

TABLE VI.8.—Tolerances for Y "go" thread gages for classes 1, 1A, 1B, 2A, and 2B, NS and UNS threads only

Threads per inch	Tolerance on lead ¹	Tolerance on half angle of thread	Tolerance on major or minor diameters		Limits on pitch diameter							
			To and including 4 in. diameter	Above 4 in. diameter	To and including 1½ in. diameter		Above 1½ in. to 4 in. diameter		Above 4 in. to 8 in. diameter		Above 8 in. to 12 in. diameter ²	
					From—	To—	From—	To—	From—	To—	From—	To—
1	2	3	4	5	6	7	8	9	10	11	12	13
	<i>in.</i>	<i>deg min</i> ±	<i>in.</i>	<i>in.</i>	<i>in.</i>	<i>in.</i>	<i>in.</i>	<i>in.</i>	<i>in.</i>	<i>in.</i>	<i>in.</i>	<i>in.</i>
80	0.0002	0 45	0.0003	-----	0.0001	0.0003	-----	-----	-----	-----	-----	-----
72	.0002	0 45	.0003	-----	.0001	.0003	-----	-----	-----	-----	-----	-----
64	.0002	0 45	.0004	-----	.0001	.0004	-----	-----	-----	-----	-----	-----
56	.0002	0 45	.0004	-----	.0001	.0004	0.0001	0.0006	-----	-----	-----	-----
48	.0002	0 45	.0004	-----	.0001	.0004	.0001	.0006	-----	-----	-----	-----
44	.0002	0 30	.0004	-----	.0001	.0004	.0001	.0006	-----	-----	-----	-----
40	.0002	0 30	.0004	-----	.0001	.0004	.0001	.0006	-----	-----	-----	-----
36	.0002	0 30	.0004	-----	.0001	.0004	.0001	.0006	-----	-----	-----	-----
32	.0003	0 20	.0005	0.0007	.0001	.0004	.0001	.0006	0.0001	0.0008	0.0001	0.0010
28	.0003	0 20	.0005	.0007	.0002	.0005	.0002	.0007	.0002	.0009	.0002	.0011
27	.0003	0 20	.0005	.0007	.0002	.0005	.0002	.0007	.0002	.0009	.0002	.0011
24	.0003	0 20	.0005	.0007	.0002	.0005	.0002	.0007	.0002	.0009	.0002	.0011
20	.0003	0 20	.0005	.0007	.0002	.0005	.0002	.0007	.0002	.0009	.0002	.0011
18	.0003	0 15	.0005	.0007	.0002	.0005	.0002	.0007	.0002	.0009	.0002	.0011
16	.0003	0 15	.0006	.0009	.0002	.0006	.0002	.0008	.0002	.0010	.0002	.0011
14	.0003	0 15	.0006	.0009	.0002	.0006	.0002	.0008	.0002	.0010	.0002	.0012
13	.0003	0 15	.0006	.0009	.0002	.0006	.0002	.0008	.0002	.0010	.0002	.0012
12	.0003	0 10	.0006	.0009	.0002	.0006	.0002	.0008	.0002	.0010	.0002	.0012
11½	.0003	0 10	.0006	.0009	.0002	.0006	.0002	.0008	.0002	.0010	.0002	.0012
11	.0003	0 10	.0006	.0009	.0002	.0006	.0002	.0008	.0002	.0010	.0002	.0012
10	.0003	0 10	.0006	.0009	.0002	.0006	.0002	.0008	.0002	.0010	.0002	.0012
9	.0003	0 10	.0007	.0011	.0002	.0007	.0002	.0009	.0002	.0011	.0002	.0013
8	.0004	0 5	.0007	.0011	.0002	.0007	.0002	.0009	.0002	.0011	.0002	.0013
7	.0004	0 5	.0007	.0011	.0002	.0007	.0002	.0009	.0002	.0011	.0002	.0013
6	.0004	0 5	.0008	.0013	.0003	.0008	.0003	.0010	.0003	.0012	.0003	.0014
5	.0004	0 5	.0008	.0013	-----	-----	.0003	.0010	.0003	.0012	.0003	.0014
4½	.0004	0 5	.0008	.0013	-----	-----	.0003	.0010	.0003	.0012	.0003	.0014
4	.0004	0 5	.0009	.0015	-----	-----	.0003	.0011	.0003	.0013	.0003	.0015

¹ Allowable variation in lead between any two threads not farther apart than the length of the standard gage, shown in CSS, omitting one full thread at each end of the gage.

² Above 12 in. the tolerance is directly proportional to the tolerance in this column, in the ratio of the diameter to 12 in.

TABLE VI.9.—Tolerances for plain gages

Size range		Tolerances				
Above--	To and including	XX	X	Y	Z	ZZ
1	2	3	4	5	6	7
<i>in.</i>	<i>in.</i>	<i>in.</i>	<i>in.</i>	<i>in.</i>	<i>in.</i>	<i>in.</i>
0.029	0.825	0.00002	0.00004	0.00007	0.00010	0.00020
.825	1.510	.00003	.00005	.00009	.00012	.00024
1.510	2.510	.00004	.00008	.00012	.00015	.00032
2.510	4.510	.00005	.00010	.00015	.00020	.00040
4.510	6.510	.00005	.00013	.00019	.00025	.00060
6.510	9.010	.00008	.00016	.00024	.00032	.00064
9.010	12.010	.00010	.00020	.00030	.00040	.00080

that it turns freely onto the setting plug. Alternately adjusting the adjusting screw and tightening the locking screw, a firm fit on the smallest portion of the thread in the ring should result. While making the adjustment the knurled outside diameter and both sides of the ring should be lightly tapped with a soft-tip or plastic hammer to permit the threads of the ring to wrap themselves around the thread of the setting plug. After satisfactory adjustment has been obtained, the ring is to be removed from the plug and the same procedure of tapping is repeated with slightly

greater emphasis to the sides. If the thread ring gage possesses proper rigidity, the same feel should be still there when the setting gage again is turned into the ring. A tighter fit or inability to reenter the setting gage denotes a fault of the locking device, that should then be taken apart and checked for dimensional conformity to CSS. It is often advisable to do this before even attempting to adjust the thread ring gage. When proper adjustment has been obtained the gage should be sealed.

In setting to a truncated setting plug the ring

gage may be set to either the full or the truncated portion. It is common practice to set slightly freer than a snug fit to the truncated portion and then to check the root clearance and wear of flank angle by screwing the ring onto the full portion. Extreme caution is required when this practice is followed to prevent damage to the thread crest of the setting plug. The opposite practice is to adjust and set the ring to the full portion and then determine the fit of the gage on the truncated portion. If the thread form of the ring gage is satisfactory, there will be a slight or no change of fit. In the case of a worn thread ring gage, the presence of shake or play when on the truncated portion indicates that the sides of the thread are no longer straight near the root, and the gage should be relapped or discarded.

In order to provide maximum wear life of a setting plug, the plug should be threaded into a ring as few times as possible. This will prevent uneven wear and a taper on the truncated end of the plug. When setting plugs are thus used properly they do not wear unevenly. However, when setting plugs are applied repeatedly to check thread ring gages, the criteria for acceptability will vary with the type and application of the ring. A "not go" ring, for example, should be a snug fit at full engagement and provide some resistance to turning at one or two turns engagement. "Go" thread ring gages should also be a snug fit at full engagement. When the length of the product thread permits engagement with the full length of the "go" ring, the requirement as to partial engagement may be relaxed to permit a slightly freer fit. However, there should be no relaxation in the requirements when short product threads, that only partly engage the "go" ring, are being engaged.

If a basic-crest setting plug is used to set a thread ring gage, root clearance of the thread in the ring should be determined by the procedure outlined below.

The ring gage should be given further inspection to determine whether or not the minor diameter is within the specified limits. The minor diameter may be inspected by means of "go" and "not go" plain cylindrical plug acceptance check gages or by direct measurement.

5. PROCEDURE FOR DETERMINING THE CLEARANCE IN THREAD RING GAGES.—The roots of threads of ring gages, particularly "not go" ring gages, frequently do not clear the maximum major diameter of the external thread. To assist the gage maker and gage inspector, the recommended procedure for determining the clearance at root of thread of ring gages is given to supplement, or substitute for, the use of truncated setting plugs described in paragraph 4, above. For this purpose an optical examination of a sulfur-graphite, plaster of Paris, copper-amalgam, or other suitable cast of the thread is made by means of a projection comparator, toolmaker's microscope, or universal

measuring microscope. The actual magnification of the instrument as used must be known.

(a) *Methods of making sulfur-graphite casts.*—Sulfur-graphite casts are made from a thorough mixture of finely powdered graphite and crushed lump sulfur which is heated in a ladle until the sulfur is completely melted and becomes viscous. This mixture may be used repeatedly by crushing and remelting. The graphite should constitute about 7 percent of the mixture by weight, although in the practice of various users, the proportion varies from 4 to 20 percent. The graphite is added to eliminate reflections that would be produced by a plain sulfur cast, and to reduce the tendency to shrink upon cooling.

The casting mold may be formed by holding the ring gage between thin plates in the jaws of a vise, the top edge of the plate on one side being well below the thread axis. For small sizes of threads, a convenient arrangement is to use a taper mandrel that is provided with a lengthwise groove having smooth surfaces and an included angle of about 90°, into which the mixture is poured, and in which the cast is later mounted for examination. The bottom of the slot has a slight taper toward the axis at the small end. A square metal stop clamped in the groove serves as a wall in casting. The mandrel is also useful in making copper-amalgam casts, in which case the casting mixture is pressed in.

The sulfur-graphite casting mixture is poured into the mold when the temperature is from 260° to 266° F, and allowed to solidify with slow cooling. The cast may be marked with an identification number with a steel stylus. Sulfur-graphite casts warp considerably after a few hours.

(b) *Method of making plaster of Paris casts.*—A plaster of Paris cast is usually made to determine errors in thread angle, and this cast can usually be used to determine clearance. Such a cast is made by mixing 5 parts (28 g, or 1 oz) of a good grade of dental plaster of Paris with from 4 to 5 (26 ml) parts by weight of potassium-bichromate solution made by dissolving 40 g in 1 liter of water. The potassium bichromate inhibits rusting of the gage. This mixture is applied to the threads inside a mold which may be fashioned from cardboard or a strip of copper, with modeling clay pressed into the threads along the outside bottom edges of the mold. It should be allowed to harden completely before removal. Plaster of Paris casts have less shrinkage than sulfur-graphite, but do not retain dimensions over extended periods of time. They are difficult to remove from rough finish threads without damage.

(c) *Determining clearance of "go" thread ring gages.*—The flat at crest of the maximum external thread is one-eighth of the pitch, therefore, if the root of thread of the "go" ring is relieved to a width of one-eighth the pitch, the ring

threads clear the maximum major diameter of the thread. If the roots of the "go" ring gage threads are not relieved, they must be to a sharp enough V to clear a flat of one-eighth the pitch. The flanks of the thread should be straight to the point where the $\frac{1}{8}$ -pitch flat will make contact with the flanks of the thread. The width of flat on the chart, or template, used should be one-eighth of the pitch times the magnification of the comparator.

(d) *Determining clearance of "not go" thread ring gages.*—The flat at the crest of a screw with maximum major diameter and minimum pitch diameter is determined by the formula:

$$\text{Flat} = \frac{p}{2} - h' \tan 30^\circ = \frac{p}{2} - 0.57735h'$$

for Unified or American National form of thread, where, h' = maximum major diameter minus minimum pitch diameter.

If the "not go" ring gage has a relief of $\frac{1}{4}$ pitch, as recommended, it is necessary to determine whether or not the relief is deep enough. To do this, make a chart, or template, representing a 60° thread with a flat at crest equal to the flat, as determined by the above formula, times the magnification of the comparator. This chart, or template, should fit the image of the thread and contact the flanks of the thread image without contacting in the relief. If ring threads are not relieved, they must be sharp enough to permit the chart, or template, to contact on the flanks of the image rather than in the root.

APPENDIX 1. AMERICAN NATIONAL FORM OF THREAD AND THREAD SERIES FOR BOLTS, MACHINE SCREWS, NUTS, TAPPED HOLES, AND GENERAL APPLICATIONS

1. INTRODUCTION

The American National standards for thread form and thread series as published in previous editions of this Handbook are republished here in condensed form. Except for class 5 threads they are largely superseded by the Unified and American threads as specified in section III. They are thus made available for continued use in existing design and for applications where Unified threads are considered to be less suitable, or where the application is not covered by Unified and American threads. If American National threads are specified, they shall conform to the requirements herein.

2. AMERICAN NATIONAL FORM OF THREAD

The form of thread profile specified herein, known previously as the "United States standard or Sellers' profile," is known as the "American National form of thread."

(a) SPECIFICATIONS

1. **ANGLE OF THREAD.**—The basic angle of thread (2α) between the sides of the thread measured in an axial

plane is 60° . The line bisecting this 60° angle is perpendicular to the axis of the screw thread.

2. **FLAT AT CREST AND ROOT.**—The flat at the root and crest of the basic thread form is $\frac{1}{8} \times p$, or $0.125 \times p$.

3. **DEPTH OF THREAD.**—The depth of the basic thread form is

$$h = 0.649519 \times p, \text{ or } h = \frac{0.649519}{n}$$

where

p = pitch in inches
 n = number of threads per inch
 h = basic depth of thread

4. **CLEARANCE AT MINOR DIAMETER.**—A clearance shall be provided at the minor diameter of the internal thread by removing from the crest of the basic thread form an amount such as to provide a depth of thread not less than 53 to 75 percent (depending on the size), and not more than $83\frac{1}{2}$ percent of the basic thread depth.

5. **CLEARANCE AT MAJOR DIAMETER.**—A clearance shall be provided at the major diameter of the internal thread by making the thread form such that the width of flat shall be less than $\frac{1}{8} \times p$ but not less than $\frac{1}{4} \times p$.

(b) ILLUSTRATION

There are indicated in figure 1.1 the relations as specified herein for the American National form of thread for the minimum internal thread and maximum external thread, classes 2 and 3. These relations are further shown in figures 1.3 and 1.4.

(c) BASIC THREAD DATA

The basic thread data for this form of thread and for all standard pitches are given in table 1.1.

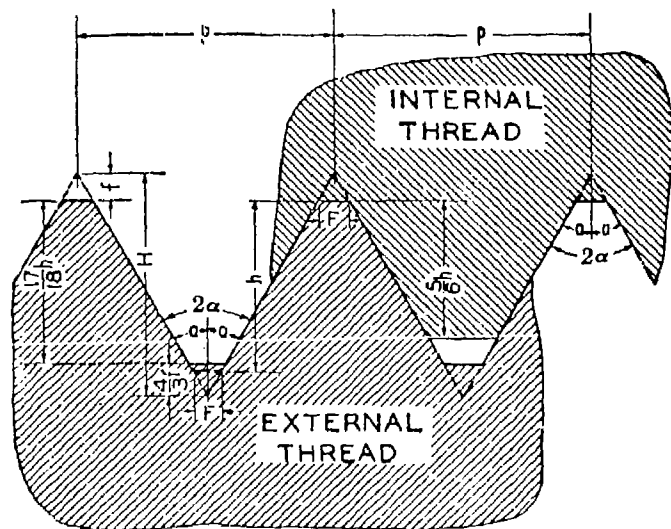

FIGURE 1.1.—American National form of thread.

NOTE.—No allowance is shown. This condition exists in classes 2 and 3 where both the minimum internal thread and the maximum external thread are basic.

NOTATION

$2\alpha = 60^\circ$
 $\alpha = 30^\circ$
 n = number of threads per inch
 $H = 0.866025 p$ = depth of 60° sharp V thread
 $h = 0.649519 p$ = depth of American National form of thread
 $3h = 0.541266 p$ = maximum depth of engagement
 $1\frac{1}{2}h = 0.487274 p$
 $F = 0.125 p$ = width of flat at crest and root of American National form
 $f = 0.108253 p$
 $f = \frac{1}{8} H$
 $f = \frac{1}{8} h$ } = depth of truncation

3. THREAD SERIES

It was the aim of the Committee, in establishing thread systems, to eliminate all unnecessary sizes and, in addition, to utilize, as far as possible existing predominating sizes. The coarse-thread and fine-thread series are maintained, the coarse-thread series being the "United States standard" threads, supplemented in the sizes below $\frac{1}{4}$ -in. by sizes taken from the standard established by The American Society of Mechanical Engineers (ASME). The fine-thread series is composed of standards that have been found necessary, and consists of sizes taken from the standards of the Society of Automotive Engineers (SAE) and the fine-thread series of The American Society of Mechanical Engineers.

(a) AMERICAN NATIONAL COARSE-THREAD SERIES

In table 1.2 are specified the nominal sizes and basic dimensions of the "American National coarse-thread series."

The American National coarse-thread series is recommended for general use in engineering work, in machine construction where conditions are favorable to the use of bolts, screws, and other threaded components where quick and easy assembly of the parts is desired, and for all work where conditions do not require the use of fine-pitch threads.

(b) AMERICAN NATIONAL FINE-THREAD SERIES

In table 1.3 are specified the nominal sizes and basic dimensions of the "American National fine-thread series."

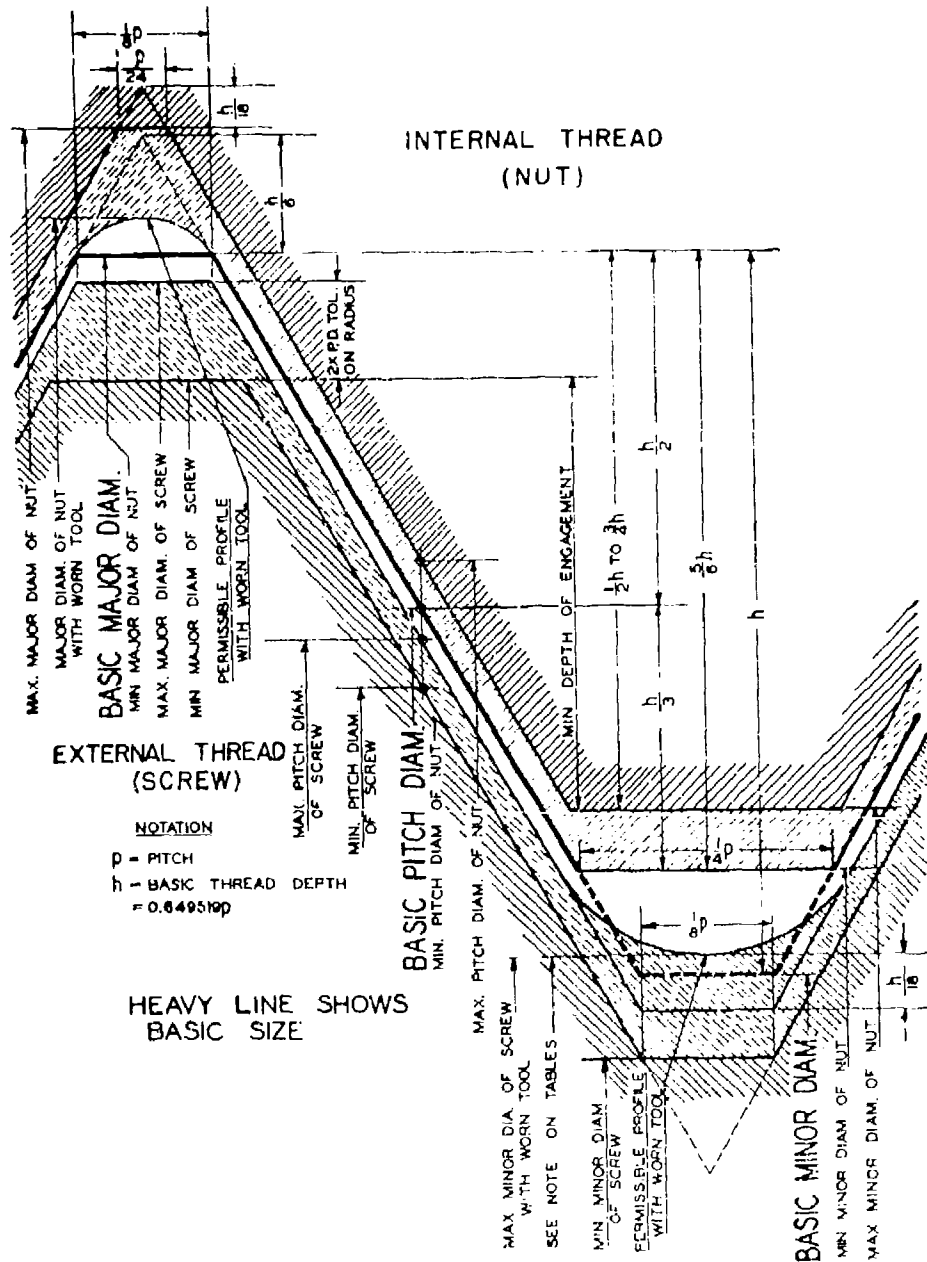

FIGURE 1.2.—Disposition of tolerances, allowance (neutral space), and crest clearances for class 1.

The American National fine-thread series is recommended for general use in automotive and aircraft work, and where special conditions require a fine thread.

(c) AMERICAN NATIONAL EXTRA-FINE-THREAD SERIES

In table 1.4 are specified the nominal sizes and basic dimensions of the "American National extra-fine-thread series."

The American National extra-fine-thread series is intended for special uses where (1) thin-walled material is to be threaded, (2) thread depth of nuts clearing ferrules, coupling flanges, etc., must be held to a minimum, and (3) a maximum practicable number of threads are required within a given thread length. This thread series is the same as the SA¹ extra-fine-thread series, but it includes additional sizes.

(d) AMERICAN NATIONAL 8-THREAD SERIES

In table 1.5 are specified the nominal sizes and basic dimensions of the "American National 8-thread series."

Bolts for high-pressure pipe flanges, cylinder-head studs, and similar fastenings against pressure require that an initial tension be set up in the fastening, by elastic deformation of the fastening and the components held together, such that the joint will not open up when the steam or other pressure is applied. To secure a proper initial tension it is not practicable that the pitch should increase with the diameter of the thread, as the torque required to assemble the fastening would be excessive. Accordingly, for such purposes the 8-thread series has come into general use.

(e) AMERICAN NATIONAL 12-THREAD SERIES

The nominal sizes and basic dimensions of the "American National 12-thread series" are specified in table 1.6.

Sizes of the 12-thread series from 1/2 in. to and including 1 3/4 in. are used in boiler practice, which requires that worn stud holes be retapped with a tap of the next larger size, the increment being 1/16 in. throughout most of the range. Die-head chasers for sizes up to 3 in. are stocked by manufacturers.

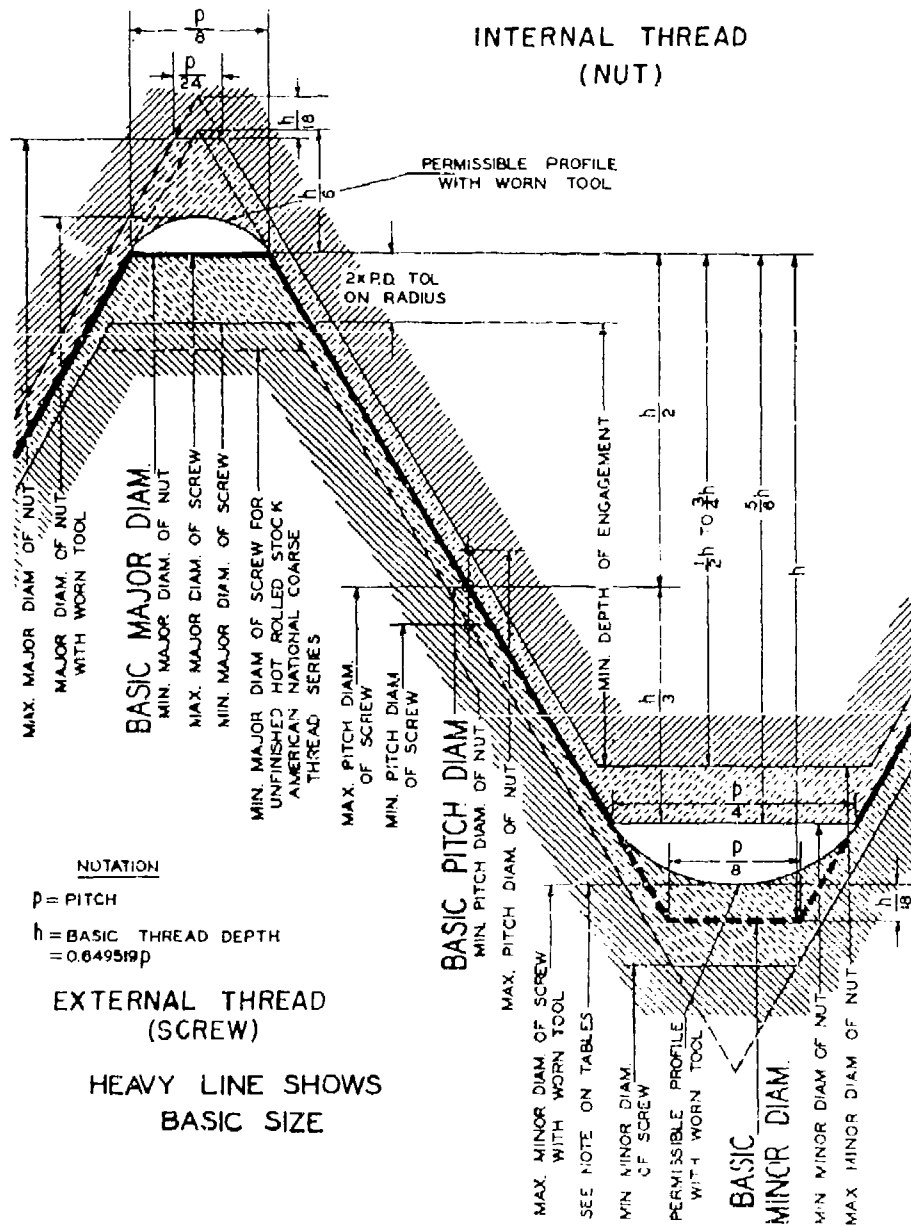

FIGURE 1.3.— Disposition of tolerances and crest clearances for class 2.

The 12-thread series is also widely used in machine construction as for thin nuts on shafts and sleeves. It also allows the specification of shoulder diameters in steps of $\frac{1}{8}$ in., as from the standpoints of good design and simplification of practice, it is desirable to limit shoulder diameters to $\frac{1}{8}$ in. steps. Twelve threads per inch is the coarsest pitch in general use, which will permit a threaded collar which screws onto a threaded shoulder to slip over a shaft, the difference in diameter between shoulder and shaft being $\frac{1}{8}$ in.

(f) AMERICAN NATIONAL 16-THREAD SERIES

The nominal sizes and basic dimensions of the "American National 16-thread series" are specified in table 1.7.

The 16-thread series is a uniform pitch series for such applications as require a relatively fine thread. It is intended primarily for use on threaded adjusting collars and bearing retaining nuts.

4. CLASSIFICATION AND TOLERANCES

Thread classes are distinguished from each other by the amounts of tolerance and allowance. There are established herein for general use four distinct classes of threads as specified in the following brief outline. These four classes, together with the accompanying specifications, are for the purpose of assuring the interchangeable manufacture of screw-thread parts throughout the country.

It is not the intention of the Committee arbitrarily to place a general class or grade of work in a specific class. Each manufacturer and user of screw threads is free to select the class best adapted to his particular needs. The limits of size and tolerances for four classes of threads are given in tables 1.8 to 1.13, inclusive.

- Class 1----- } Includes screw-thread work in which the threads must assemble readily.
- Class 2----- } Includes the major portion of interchangeable screw-thread work, finished and semifinished bolts and nuts, machine screws, etc.

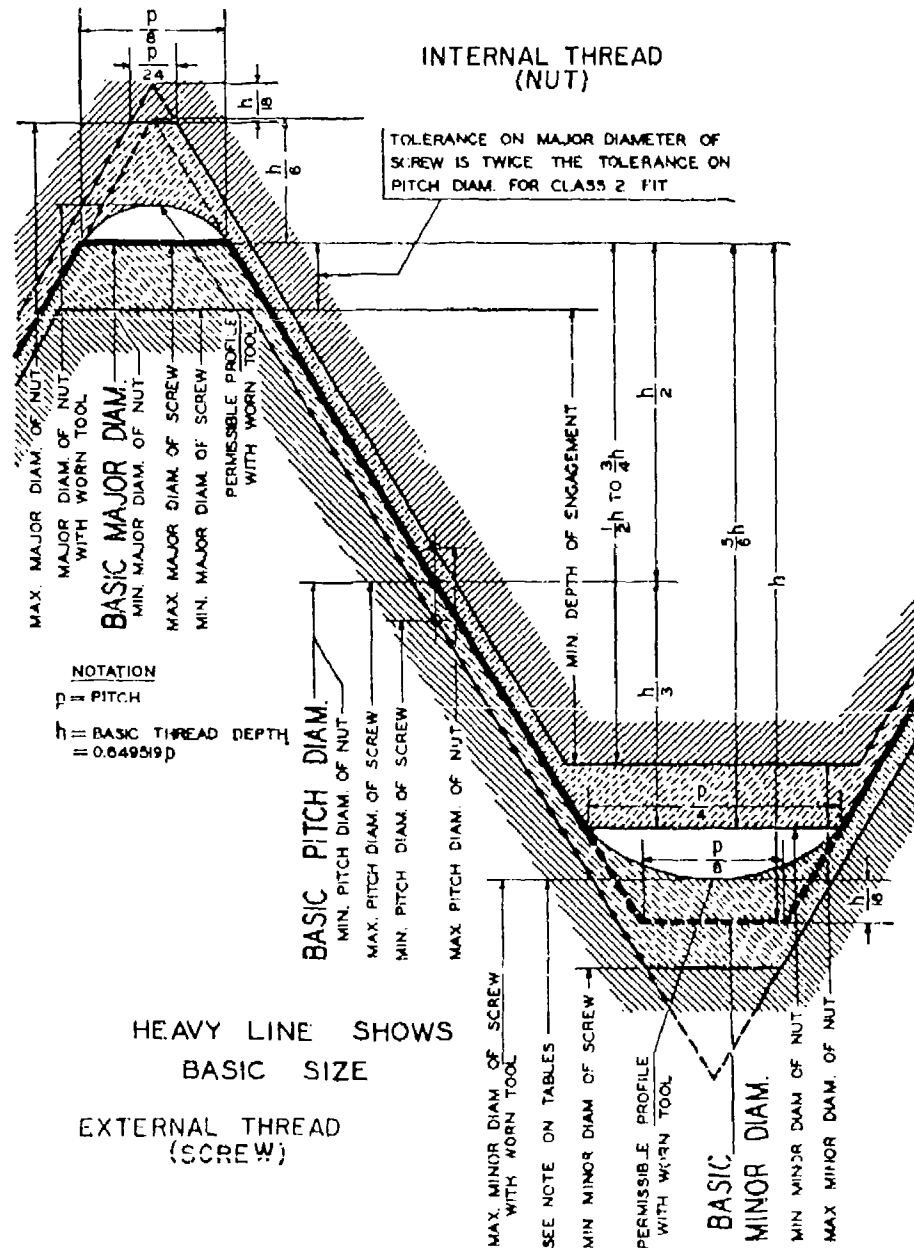

FIGURE 1.4.—Disposition of tolerances and crest clearances for class 3.

- Class 3..... } Includes the highest grade of inter-changeable screw-thread work.
- Class 4..... } Includes screw-thread work requiring a fine snug fit, somewhat closer than class 3. In this class selective assembly of parts may be necessary.

It should be noted that, in the classification of screw threads, the class number designates the permissible limits of looseness or tightness. It has no connotations of quality in any other sense. Class 1 provides for the greatest permissible looseness between minimum external thread and maximum internal thread; class 4 provides for the smallest permissible looseness. Classes 2 and 3 are between classes 1 and 4 as regards looseness. Each class has its proper place and none should be regarded as superior or inferior provided that there is compliance with specification requirements under which it is manufactured and sold.

An examination of the dimensional specifications for the various classes shows that an external thread made to the tolerances and allowances of one class may be used with an internal thread of some other class. Thus, the requirements for a screw-thread fit for specific applications can be met by specifying the proper combination of classes for the components. For example, an external thread made to class 2 limits can be used with internal threads made to classes 1, 2, or 3 limits for specific applications. It is not the purpose of this standard to limit applications of the various standard classes.

(a) GENERAL SPECIFICATIONS

The following general specifications apply to the four classes of threads specified for applications of the American National form of thread.

1. UNIFORM MINIMUM INTERNAL THREAD.—The pitch diameter of the minimum internal thread corresponds to the basic size. The minimum major diameter of the

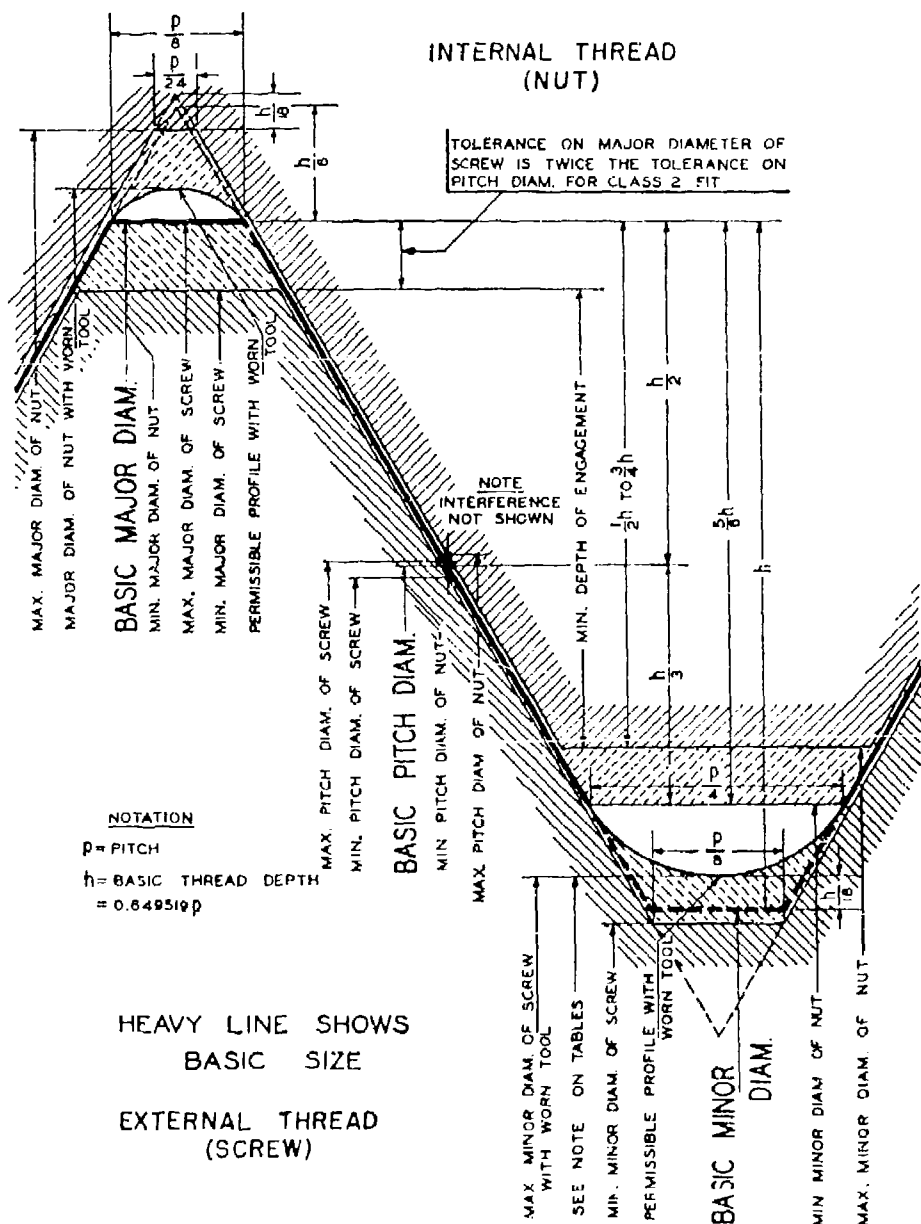

FIGURE 1.5.—Disposition of tolerances, allowance (interference), and crest clearances for class 4.

internal thread is the basic major diameter and is the same for all classes. In no case should the minimum major diameter of the internal thread, as results from a worn tap or cutting tool, be less than specified. The minimum minor diameter of the internal thread is the same for all classes.

2. **MAXIMUM EXTERNAL THREAD.**—The major and pitch diameters of the maximum external thread are equal to the respective basic diameters minus the allowance, if any. The maximum minor diameter of an external thread of a given pitch may be such as results from the use of a worn or rounded threading tool, when the pitch diameter is at its maximum value. In no case, however, should the maximum minor diameter of the thread, as results from tool wear, be greater than that corresponding to a $p/4$ width of flat.

3. **DIRECTION AND SCOPE OF TOLERANCES.**—(a) The tolerance on the internal thread is plus, and is applied from the basic size to above basic size.

(b) The tolerance on the external thread is minus, and is applied from the maximum (or design) size to below the maximum size.

(c) The tolerances specified represent the extreme variations permitted on the product.

4. **MAJOR DIAMETER TOLERANCES.**—(a) *External threads.*—The tolerances on the major diameters of class 1 or class 2 external threads are twice the tolerance values allowed on the pitch diameters of the same respective classes and pitches with the following exception: On class 2, American National coarse-thread series, externally threaded parts of unfinished, hot-rolled material, the same tolerances on major diameter are applied as on class 1 external threads.

The tolerances on the major diameters of classes 3 and 4 external threads American National coarse-thread series, are the same as those on class 2 finished screws of the same thread series; and for the American National fine-thread series are the same as those on class 2 of that series.

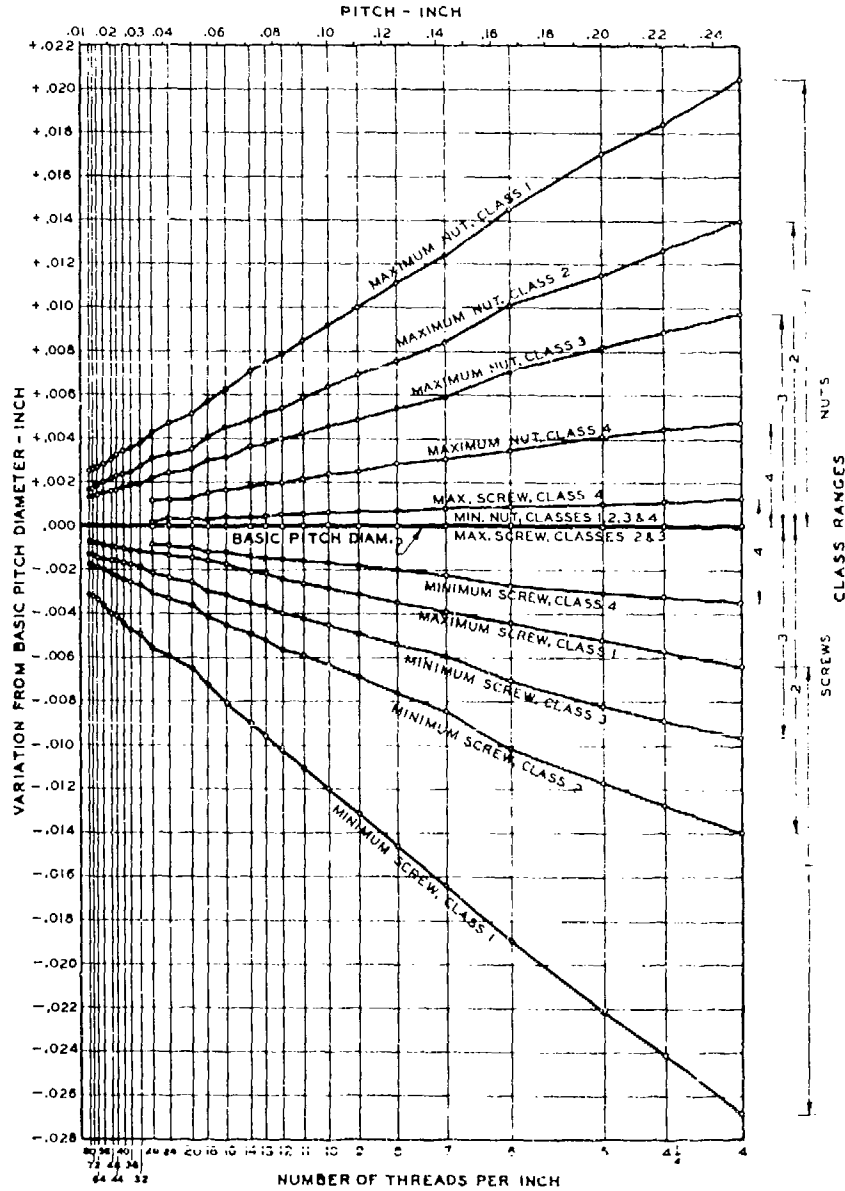

FIGURE 1.6.—Relation of maximum and minimum pitch diameters of classes 1, 2, 3, and 4 to basic pitch diameters.

TABLE 1.1.—Basic thread data, American National form of thread

Threads per inch, n	Pitch, p	Basic width of flat, p/8	Minimum width of flat at major diameter of nut, p/4	Minimum width of flat at minor diameter of nut, p/4	Depth of thread, h = 0.548319p	5h/6 = 0.541266p	3h/4 = 0.451199p	2h/3 = 0.432033p	A/2 = 0.324760p	5h/12 = 0.270633p	A/3 = 0.216506p	h/6 = 0.108253p	h/9 = 0.072169p	h/15 = 0.036084p	Depth of sharp-v thread, h _f = 0.866025p
1	2	3	4	5	6	7	8	9	10	11	12	13	14	15	16
80	0.012500	0.015625	0.015625	0.01312	0.00819	0.00877	0.00909	0.00941	0.00973	0.00338	0.00271	0.00335	0.00490	0.00045	0.010925
72	0.013889	0.017361	0.017361	0.01432	0.00921	0.00979	0.01017	0.01054	0.01091	0.00376	0.00301	0.00375	0.00530	0.00050	0.012028
64	0.015625	0.019531	0.019531	0.01600	0.01049	0.01117	0.01161	0.01203	0.01245	0.00423	0.00339	0.00423	0.00590	0.00056	0.013332
56	0.017857	0.022286	0.022286	0.01744	0.01199	0.01277	0.01337	0.01401	0.01464	0.00463	0.00357	0.00458	0.00639	0.00064	0.014645
48	0.020833	0.026042	0.026042	0.01951	0.01332	0.01428	0.01515	0.01612	0.01717	0.00564	0.00451	0.00564	0.00757	0.00074	0.016042
44	0.022727	0.028284	0.028284	0.02068	0.01462	0.01570	0.01677	0.01794	0.01920	0.00615	0.00492	0.00615	0.00824	0.00082	0.016962
40	0.025000	0.031250	0.031250	0.02250	0.01625	0.01750	0.01875	0.02013	0.02160	0.00677	0.00541	0.00677	0.00910	0.00090	0.021651
36	0.027778	0.034444	0.034444	0.02444	0.01804	0.01944	0.02094	0.02254	0.02424	0.00752	0.00601	0.00752	0.01000	0.00100	0.024056
32	0.031250	0.039063	0.039063	0.02750	0.02081	0.02237	0.02401	0.02574	0.02756	0.00846	0.00677	0.00846	0.01113	0.00113	0.027063
28	0.035714	0.044464	0.044464	0.03114	0.02397	0.02561	0.02734	0.02916	0.03107	0.00967	0.00773	0.00967	0.01258	0.00125	0.029529
24	0.041667	0.0521	0.0521	0.03571	0.02705	0.02879	0.03060	0.03250	0.03449	0.01128	0.00902	0.01128	0.01501	0.00150	0.032054
21	0.050000	0.0625	0.0625	0.04286	0.03278	0.03461	0.03651	0.03849	0.04056	0.01353	0.01083	0.01353	0.01821	0.00182	0.035301
18	0.055556	0.06944	0.06944	0.04722	0.03604	0.03797	0.03996	0.04201	0.04414	0.01504	0.01203	0.01504	0.02000	0.00200	0.038113
16	0.062500	0.07813	0.07813	0.05294	0.04056	0.04261	0.04474	0.04694	0.04924	0.01691	0.01353	0.01691	0.02226	0.00222	0.04127
14	0.071429	0.08959	0.08959	0.05952	0.04634	0.04854	0.05081	0.05316	0.05559	0.01833	0.01546	0.01833	0.02515	0.00251	0.045129
13	0.076923	0.09642	0.09642	0.06321	0.04993	0.05221	0.05456	0.05699	0.05950	0.02082	0.01685	0.02082	0.02879	0.00287	0.049117
12	0.083333	0.10417	0.10417	0.06803	0.05417	0.05654	0.05899	0.06152	0.06414	0.02255	0.01804	0.02255	0.03091	0.00309	0.052169
11	0.090909	0.11287	0.11287	0.07317	0.05880	0.06127	0.06381	0.06642	0.06910	0.02453	0.01953	0.02453	0.03344	0.00334	0.055307
10	0.100000	0.12500	0.12500	0.07917	0.06394	0.06641	0.06896	0.07159	0.07429	0.02666	0.02166	0.02666	0.03615	0.00361	0.058754
9	0.111111	0.13889	0.13889	0.08500	0.06952	0.07200	0.07456	0.07719	0.07989	0.02890	0.02406	0.02890	0.03893	0.00389	0.062303
8	0.125000	0.15625	0.15625	0.09167	0.07619	0.07875	0.08139	0.08411	0.08690	0.03133	0.02706	0.03133	0.04202	0.00420	0.066222
7	0.142857	0.17857	0.17857	0.09923	0.08278	0.08541	0.08809	0.09086	0.09371	0.03386	0.03093	0.03386	0.04581	0.00458	0.070578
6	0.166667	0.20833	0.20833	0.10750	0.09253	0.09521	0.09793	0.10070	0.10351	0.03649	0.03404	0.03649	0.04940	0.00494	0.075338
5	0.200000	0.25000	0.25000	0.12500	0.10417	0.10700	0.10987	0.11279	0.11574	0.03921	0.03704	0.03921	0.05303	0.00530	0.080601
4 1/2	0.222222	0.27778	0.27778	0.13556	0.11287	0.11571	0.11858	0.12149	0.12443	0.04206	0.04011	0.04206	0.05694	0.00569	0.086225
4	0.250000	0.31250	0.31250	0.15000	0.12380	0.12666	0.12954	0.13244	0.13536	0.04521	0.04381	0.04521	0.06166	0.00616	0.092218

TABLE 1.2.—American National coarse-thread series, NC

Identification		Basic diameters			Thread data								
Size	Threads per inch, <i>n</i>	Major diameter, <i>D</i>	Pitch diameter, <i>E</i>	Minor diameter, <i>K</i>	Metric equivalent of major diameter	Pitch, <i>p</i>	Depth of thread, <i>h</i>	Basic width of flat, <i>p/8</i>	Minimum width of flat at major diameter of nut, <i>p/24</i>	Lead angle at basic pitch diameter, λ	Sectional area at minor diameter at $D-2A$, $\frac{\pi K^2}{4}$	Tensile stress area, $\left(\frac{2E+3H}{16}\right)^2$	
1	2	3	4	5	6	7	8	9	10	11	12	13	
No.	in.	in.	in.	in.	mm	in.	in.	in.	in.	deg min	in. ²	in. ²	
1	0.073	64	0.073	0.0629	0.0527	1.854	0.01562	0.01015	0.00195	0.00065	4 31	0.00218	0.00263
2	.086	56	.086	.0744	.0629	2.144	.01736	.01160	.00223	.00074	4 22	.00310	.00370
3	.090	48	.090	.0755	.0719	2.815	.02083	.01353	.00260	.00087	4 26	.00406	.00487
4	.112	40	.112	.0858	.0795	2.845	.02500	.01624	.00312	.00104	4 45	.00496	.00604
5	.125	40	.125	.1088	.0925	3.175	.02800	.01624	.00312	.00104	4 11	.00672	.00796
6	.138	32	.138	.1177	.0974	3.505	.03125	.02030	.00251	.00130	4 50	.00745	.00909
8	.164	32	.164	.1437	.1234	4.166	.03125	.02030	.00251	.00130	3 58	.01186	.0140
10	.190	24	.190	.1629	.1359	4.826	.04107	.02706	.00321	.00174	4 39	.01450	.0175
12	.211	24	.211	.1889	.1619	5.486	.04107	.02706	.00321	.00174	4 1	.0206	.0242
1/4	20	.2500	.2175	.1850	6.350	.05000	.03248	.00625	.00208	4 11	.0269	.0318	
5/16	18	.3125	.2764	.2403	7.938	.05556	.03908	.00694	.00231	3 40	.0454	.0524	
3/8	16	.3750	.3344	.2938	9.525	.06250	.04059	.00781	.00260	3 24	.0678	.0775	
7/16	14	.4375	.3911	.3447	11.113	.07143	.04639	.00893	.00298	3 20	.0923	.1063	
1/2	13	.5000	.4500	.4001	12.700	.07992	.04996	.00962	.00321	3 7	.1257	.1419	
5/8	12	.5625	.5064	.4542	14.288	.08333	.05413	.01042	.00347	2 59	.162	.182	
3/4	11	.6250	.5660	.5089	15.875	.09091	.05905	.01136	.00370	2 56	.202	.229	
7/8	10	.7500	.6850	.6201	19.050	.10000	.06495	.01250	.00417	2 40	.302	.334	
1	8	.8750	.8028	.7307	22.225	.11111	.07217	.01389	.00463	2 31	.482	.534	
1 1/8	7	1.0000	.9188	.8376	25.400	.12500	.08119	.01562	.00521	2 29	.551	.606	
1 1/4	7	1.1250	1.0322	.9394	28.575	.14286	.09279	.01786	.00595	2 31	.693	.763	
1 1/2	7	1.2500	1.1572	1.0644	31.750	.16250	.09279	.01786	.00595	2 15	.891	.969	
1 3/8	6	1.3750	1.2687	1.1585	34.925	.18182	.10425	.02083	.00694	2 24	1.054	1.155	
1 3/4	6	1.5000	1.3917	1.2835	38.100	.20000	.10425	.02083	.00694	2 11	1.294	1.405	
1 7/8	5	1.5000	1.4001	1.3002	44.450	.20000	.12000	.02500	.00833	2 15	1.744	1.90	
2	4 1/2	2.0000	1.8557	1.7113	50.800	.22222	.14434	.02778	.00926	2 11	2.30	2.50	
2 1/4	4 1/2	2.2500	2.1057	1.9613	57.150	.22222	.14434	.02778	.00926	1 58	3.02	3.25	
2 1/2	4	2.5000	2.3376	2.1752	63.500	.25000	.16228	.03125	.01042	1 57	3.72	4.00	
2 3/4	4	2.7500	2.5676	2.4252	69.850	.25000	.16238	.03125	.01042	1 46	4.62	4.93	
3	4	3.0000	2.8376	2.6752	76.200	.25000	.16238	.03125	.01042	1 36	5.62	5.97	
3 1/4	4	3.2500	3.0676	2.9252	82.550	.25000	.16238	.03125	.01042	1 29	6.72	7.10	
3 1/2	4	3.5000	3.3376	3.1752	88.900	.25000	.16238	.03125	.01042	1 22	7.92	8.33	
3 3/4	4	3.7500	3.5676	3.4252	95.250	.25000	.16238	.03125	.01042	1 16	9.21	9.66	
4	4	4.0000	3.8376	3.6752	101.600	.25000	.16238	.03125	.01042	1 11	10.61	11.08	

(b) *Internal threads*.—No tolerance is specified, as the maximum major diameter is established by the crest of an unwork tool. See footnote, tables 1.8 to 1.13, inclusive.

5. BASIS FOR PITCH DIAMETER TOLERANCES.—(a) *NC and NF series, classes 1, 2, 3, and 4*.—The tolerances for screw threads specified for the coarse- and fine-thread series were arrived at by combining two factors, known as the net pitch diameter tolerance and the gage tolerance. The theoretical net tolerances for all threads of a given class bear a definite mathematical relationship to each other, and it was intended that these should in no way be reduced by permissible manufacturing tolerances for master gages; that is, gages within the original gage tolerances in the 1921 NISTC Progress Report, which were approximately equivalent to class X tolerances. Consequently the net tolerances were increased by the equivalent diametrical space required to provide for the gage tolerances on diameter, lead, and angle, to produce the extreme tolerances specified for the product. In practice, the actual net tolerances will depend upon the method of gaging and upon the accuracy of the gages used.

The net pitch diameter tolerances for the various classes are based on the following series for a pitch of 1/16 in.:

Class 1	0.0045
Class 2	.0030
Class 3	.0020
Class 4	.0010

Pitch diameter tolerances for pitches finer than 1/16 in. are to each other and to the tolerance for 1/16 in. as the 0.6th power of their respective pitches.

Pitch diameter tolerances for pitches coarser than 1/16 in. are to each other and to the tolerance for 1/16 in. as the 0.9th power of their respective pitches.

The exponent 0.6 was chosen for pitches finer than 1/16 in. because the resulting tolerances, except in two instances, do not vary more than 0.0001 in. from the pitch diameter tolerances specified in the original ASME Machine Screw Standard.

The tolerances on pitch diameter for the coarse- and fine-thread series are based on a length of engagement equal to the nominal diameter, but may be used for lengths of engagement up to 1 1/2 diameters.

(b) *NEF, 8N, 12N, and 16N series, classes 2 and 3*.—The class 2 pitch diameter tolerances for the extra-fine-, 8-, 12-, and 16-thread series are equal to $0.002\sqrt{D} + 0.00133L + 0.010\sqrt{p}$, and the class 3 tolerances are 70 percent of the class 2 tolerances. The tolerances for the 8-thread series are based on a length of engagement equal to the nominal diameter and for the extra-fine-, 12-, and 16-thread series on a length of engagement of 9 pitches.

(c) *Limits of size*.—With respect to the pitch diameter limits of size, it is intended, except as hereinafter qualified, that no portion of the complete thread be permitted to project beyond the envelope defined by the maximum-material limits on the one hand, or beyond that defined

TABLE 1.3.—American National fine-thread series, NF

Identification		Basic diameters			Thread data							
Sizes	Threads per inch, n	Major diameter, D	Pitch diameter, E	Minor diameter, K	Metric equivalent of major diameter	Pitch, p	Depth of thread, A	Basic width of flat, p/8	Minimum width of flat at major diameter of nut, p/24	Lead angle at basic pitch diameter, λ	Sectional area at minor diameter at $D-2A$, $\frac{\pi K^2}{4}$	Tensile stress area, $\pi \left(\frac{E-3H}{16}\right)^2$
1	2	3	4	5	6	7	8	9	10	11	12	13
No.	in.	in.	in.	in.	mm	in.	in.	in.	in.	deg min	in. ²	in. ²
0	0.060	80	0.060	0.0519	0.0438	1.524	0.00812	0.00156	0.00052	4 23	0.00151	0.00180
1	0.073	72	0.073	0.0640	0.550	1.864	0.01389	0.00902	0.00174	3 57	0.00237	0.00278
2	0.086	64	0.086	0.0719	0.635	2.194	0.01562	0.01015	0.00195	3 45	0.00339	0.00394
3	0.099	56	0.099	0.0874	0.708	2.515	0.01786	0.01160	0.00223	3 33	0.00451	0.00523
4	0.112	48	0.112	0.0955	0.849	2.845	0.02093	0.01353	0.00250	3 51	0.00566	0.00661
5	0.125	44	0.125	0.1102	0.955	3.175	0.02273	0.01476	0.00264	3 45	0.00716	0.00830
6	0.138	40	0.138	0.1218	1.055	3.505	0.02500	0.01624	0.00312	3 44	0.00874	0.01015
8	0.164	36	0.164	0.1460	1.279	4.166	0.02778	0.01804	0.00347	3 28	0.01235	0.01474
10	0.190	32	0.190	0.1697	1.494	4.826	0.03125	0.02030	0.00391	3 21	0.0175	0.0200
12	0.210	28	0.210	0.1923	1.696	5.486	0.03571	0.02320	0.00446	3 22	0.0226	0.0258
1/4	28	0.2500	0.2268	0.2036	6.350	0.03671	0.02320	0.00446	0.00140	2 52	0.0326	0.0364
3/8	24	0.3125	0.2854	0.2584	7.938	0.04167	0.02706	0.00521	0.00174	2 40	0.0524	0.0580
1/2	20	0.3750	0.3479	0.3200	9.525	0.04167	0.02706	0.00521	0.00174	2 11	0.0909	0.0978
5/8	18	0.4375	0.4050	0.3725	11.113	0.05000	0.03248	0.00625	0.00208	2 15	0.1090	0.1187
3/4	16	0.5000	0.4675	0.4350	12.700	0.05000	0.03248	0.00625	0.00208	1 57	0.1496	0.1599
7/8	14	0.5625	0.5204	0.4903	14.288	0.05556	0.03608	0.00694	0.00231	1 55	0.189	0.203
1	12	0.6250	0.5829	0.5528	15.875	0.05556	0.03608	0.00694	0.00231	1 43	0.240	0.256
1 1/8	11	0.7500	0.7079	0.6688	19.050	0.06250	0.04059	0.00781	0.00260	1 36	0.351	0.373
1 1/4	10	0.8750	0.8296	0.7822	22.225	0.07143	0.04639	0.00893	0.00298	1 34	0.480	0.509
1 1/2	9	1.0000	0.9536	0.9072	25.400	0.07143	0.04639	0.00893	0.00298	1 22	0.646	0.680
1 3/8	8	1.0900	1.0459	0.9978	25.400	0.08333	0.05113	0.01042	0.00347	1 35	0.625	0.663
1 3/4	7	1.1250	1.0709	1.0167	28.575	0.08333	0.05413	0.01042	0.00347	1 25	0.812	0.856
1 7/8	6	1.2500	1.1959	1.1417	31.750	0.08333	0.05413	0.01042	0.00347	1 16	1.024	1.073
2	5	1.3750	1.3209	1.2667	34.925	0.08333	0.05413	0.01042	0.00347	1 9	1.260	1.315
2 1/8	4	1.5000	1.4459	1.3917	38.100	0.08333	0.05413	0.01042	0.00347	1 3	1.521	1.581

* The designation of this size has been changed from "NF" to "NS."

TABLE 1.4.—American National extra-fine-thread series, NEF

Identification		Basic diameters			Thread data							
Sizes	Threads per inch, n	Major diameter, D	Pitch diameter, E	Minor diameter, K	Metric equivalent of major diameter	Pitch, p	Depth of thread, A	Basic width of flat, p/8	Minimum width of flat at major diameter of nut, p/24	Lead angle at basic pitch diameter, λ	Sectional area at minor diameter at $D-2A$, $\frac{\pi K^2}{4}$	Tensile stress area, $\pi \left(\frac{E-3H}{16}\right)^2$
1	2	3	4	5	6	7	8	9	10	11	12	13
in.		in.	in.	in.	mm	in.	in.	in.	in.	deg min	in. ²	in. ²
1/4	32	0.2500	0.2297	0.2094	6.350	0.03125	0.02030	0.00391	0.00130	2 29	0.0344	0.0379
3/8	32	0.3125	0.2922	0.2719	7.928	0.03125	0.02030	0.00391	0.00130	1 57	0.0581	0.0625
1/2	32	0.3750	0.3547	0.3344	9.525	0.03125	0.02030	0.00391	0.00130	1 36	0.0878	0.0932
5/8	28	0.4375	0.4143	0.3911	11.113	0.03571	0.02320	0.00446	0.00149	1 34	0.1201	0.1274
3/4	28	0.5000	0.4768	0.4536	12.700	0.03571	0.02320	0.00446	0.00149	1 22	0.162	0.170
7/8	24	0.5625	0.5354	0.5084	14.288	0.04167	0.02706	0.00521	0.00174	1 25	0.203	0.214
1	24	0.6250	0.5979	0.5709	15.875	0.04167	0.02706	0.00521	0.00174	1 16	0.250	0.268
1 1/8	24	0.6875	0.6604	0.6334	17.463	0.04167	0.02706	0.00521	0.00174	1 9	0.315	0.329
1 1/4	20	0.7500	0.7175	0.6850	19.050	0.05000	0.03248	0.00625	0.00208	1 16	0.369	0.393
1 3/8	20	0.8125	0.7800	0.7475	20.638	0.05000	0.03248	0.00625	0.00208	1 10	0.439	0.458
1 1/2	18	0.8750	0.8425	0.8100	22.225	0.05000	0.03248	0.00625	0.00208	1 4	0.515	0.536
1 3/4	16	0.9375	0.9050	0.8725	23.813	0.05000	0.03248	0.00625	0.00208	1 0	0.598	0.620
1 7/8	14	1.0000	0.9675	0.9350	25.400	0.05000	0.03248	0.00625	0.00208	0 57	0.687	0.711
2	12	1.0625	1.0264	0.9903	26.988	0.05556	0.03608	0.00694	0.00231	0 59	0.770	0.799
2 1/8	11	1.1250	1.0889	1.0528	28.575	0.05556	0.03608	0.00694	0.00231	0 56	0.871	0.901
2 1/4	10	1.1875	1.1514	1.1153	30.163	0.05556	0.03608	0.00694	0.00231	0 53	0.977	1.009
2 3/8	9	1.2500	1.2139	1.1778	31.750	0.05556	0.03608	0.00694	0.00231	0 50	1.086	1.123
2 1/2	8	1.3125	1.2764	1.2403	33.338	0.05556	0.03608	0.00694	0.00231	0 48	1.208	1.244
2 7/8	7	1.3750	1.3389	1.3028	34.925	0.05556	0.03608	0.00694	0.00231	0 45	1.333	1.370
3	6	1.4375	1.4014	1.3653	36.513	0.05556	0.03608	0.00694	0.00231	0 43	1.464	1.503
3 1/8	5	1.5000	1.4639	1.4278	38.100	0.05556	0.03608	0.00694	0.00231	0 42	1.601	1.64
3 1/4	4	1.5625	1.5264	1.4903	39.688	0.05556	0.03608	0.00694	0.00231	0 40	1.74	1.79
3 3/8	3	1.6250	1.5889	1.5528	41.275	0.05556	0.03608	0.00694	0.00231	0 38	1.89	1.94
3 1/2	2	1.6875	1.6514	1.6153	42.863	0.05556	0.03608	0.00694	0.00231	0 37	2.05	2.10
3 7/8	1	1.7500	1.7094	1.6688	44.450	0.06250	0.04059	0.00781	0.00260	0 40	2.19	2.24
4	16	2.0000	1.9594	1.9188	50.800	0.06250	0.04059	0.00781	0.00260	0 35	2.89	2.95

TABLE 1.5.—American National 8-thread series, 8N

Identification		Basic diameters			Thread data			
Sizes	Threads per inch	Major diameter, <i>D</i>	Pitch diameter, <i>E</i>	Minor diameter, <i>K</i>	Metric equivalent of major diameter	Lead angle at basic pitch diameter, λ	Sectional area at minor diameter at $D-2h$, $\frac{\pi K^2}{4}$	Tensile-stress area, $\pi \left(\frac{E-3H}{2} \right)^2$
1	2	3	4	5	6	7	8	9
in.		in.	in.	in.	mm	deg min	in. ²	in. ²
1	8	1.0000	0.9188	0.8376	25.400	2 29	0.551	0.606
1 1/8	8	1.1250	1.0438	0.9628	28.575	2 11	0.728	0.790
1 1/4	8	1.2500	1.1688	1.0876	31.750	1 57	0.929	1.000
1 3/8	8	1.3750	1.2938	1.2120	34.925	1 46	1.155	1.233
1 1/2	8	1.5000	1.4188	1.3376	38.100	1 36	1.405	1.492
1 5/8	8	1.6250	1.5438	1.4626	41.275	1 29	1.68	1.78
1 3/4	8	1.7500	1.6688	1.5876	44.450	1 22	1.98	2.08
1 7/8	8	1.8750	1.7938	1.7126	47.625	1 16	2.30	2.41
2	8	2.0000	1.9188	1.8376	50.800	1 11	2.65	2.77
2 1/8	8	2.1250	2.0438	1.9626	53.975	1 7	3.03	3.15
2 1/4	8	2.2500	2.1688	2.0876	57.150	1 3	3.42	3.56
2 3/8	8	2.3750	2.2938	2.2126	60.325	0 57	3.82	3.97
2 1/2	8	2.5000	2.4188	2.3376	63.500	0 51	4.24	4.40
2 5/8	8	2.6250	2.5438	2.4626	66.675	0 47	4.68	4.85
3	8	3.0000	2.9188	2.8376	76.200	0 43	6.32	6.51
3 1/8	8	3.2500	3.1688	3.0876	82.550	0 43	7.49	7.69
3 1/4	8	3.5000	3.4188	3.3376	88.900	0 40	8.75	8.96
3 3/8	8	3.7500	3.6688	3.5876	95.250	0 37	10.11	10.34
4	8	4.0000	3.9188	3.8376	101.600	0 35	11.57	11.81
4 1/8	8	4.2500	4.1688	4.0876	107.950	0 33	13.12	13.38
4 1/4	8	4.5000	4.4188	4.3376	114.300	0 31	14.78	15.05
4 3/8	8	4.7500	4.6688	4.5876	120.650	0 29	16.53	16.82
5	8	5.0000	4.9188	4.8376	127.000	0 28	18.38	18.69
5 1/8	8	5.2500	5.1688	5.0876	133.350	0 26	20.33	20.65
5 1/4	8	5.5000	5.4188	5.3376	139.700	0 25	22.38	22.72
5 3/8	8	5.7500	5.6688	5.5876	146.050	0 24	24.52	24.88
6	8	6.0000	5.9188	5.8376	152.400	0 23	26.76	27.14

* Standard size of the American National coarse-thread series.

NOTE.—Pitch, $p=0.12600$ in.; depth of thread, $h=0.08119$ in.; basic width of dat, $p/8=0.01575$ in.; minimum width of flat at major diameter of nut, $p/24=0.00521$ in.

by the minimum-material limits on the other, and thus be outside of the tolerance zone as illustrated in figures 1.2 to 1.5 inclusive. Also, the diameter equivalent of the variation in any given element except pitch diameter shall not exceed one-half of the pitch diameter tolerance. (The full tolerance cannot, therefore, be used on pitch diameter unless deviations in other thread elements are zero.) Deviations from specified size and profile include variations in lead, uniformity of helix, flank angle, taper, out-of-roundness, and surface defects. Accordingly, values are given in tables 1.14 and 1.15, for the standard thread series and classes, of one-half of the pitch diameter tolerances and the deviations in lead and flank angle which are equivalent thereto. Flank angle equivalents are based on a depth of thread engagement of $5H/8$.

The diameter equivalents of variations in lead, uniformity of helix, and flank angle are always in the direction toward maximum material, that is they increase the virtual diameter of the external thread and decrease that of the internal thread. Thus, the maximum material pitch diameter limits are a limitation of the virtual diameter (effective size) and are so specified herein for all thread classes.

Variations in taper and roundness of the pitch diameter, together with variations of the pitch diameter as a whole, may be in the direction of minimum material, and thus the minimum-material pitch diameter limit may be specified as a limitation of the pitch diameter as a single element. However, in view of the interrelation of the pitch diameter, variation in lead and flank angle, etc., together with practical considerations relating to established production processes, product application, and inspection procedures, it is customary to interpret the minimum pitch diameter of the external thread and the maximum pitch diameter of the internal thread as virtual diameters (effective sizes) in classes 1 and 2, and classes

3 and 4 internal threads, for application to various mass-produced bolts, nuts, screws, and other similar threaded fasteners, and to some custom threaded parts where design requirements are fulfilled. See "Limit gages" and "Acceptability of threads," section VI, pp. 108 and 118.

6. MINOR DIAMETER TOLERANCES.—(a) *External threads*.—No tolerance is specified, as the minimum minor diameter is established by the crest of an unworn tool. See footnote, tables 1.8 to 1.13, inclusive.

(b) *Internal threads*.—The tolerance on minor diameter for a given size and pitch of thread is the same for all classes. For sizes 1 in. and larger the tolerance is equal to $0.10825p$. For most sizes less than 1 in., tolerances have been made arbitrarily larger than $0.10825p$ to minimize tapping difficulties.

(b) SCREW THREAD CLASSES

1. CLASS 1.—(a) *Definition*.—Class 1 is intended to cover the manufacture of threaded parts where quick and easy assembly is necessary, and where an allowance is required.

(b) *Limits of size and tolerances*.—Limits of size and tolerances for the respective thread pitches are specified in tables 1.8 and 1.9, and their application is shown in figure 1.2.

2. CLASS 2.—(a) *Definition*.—Class 2 is intended to apply to the major portion of threaded work in interchangeable manufacture, where no allowance is required.

(b) *Limits of size and tolerances*.—No allowance is provided, but since the tolerances on "go" gages are within the limits of size of the thread, the gages will assure a slight clearance between external and internal threads made to the maximum-material limits. Limits of size and tolerances for the respective thread pitches

TABLE 1.6.—American National 12-thread series, 12*N*

Identification		Basic diameters			Thread data			
Sizes	Threads per inch	Major diameter, <i>D</i>	Pitch diameter, <i>E</i>	Minor diameter, <i>K</i>	Metric equivalent of major diameter	Lead angle at basic pitch diameter, λ	Sectional area at minor diameter at $D-2h$ $= \frac{\pi K^2}{4}$	Tensile stress area, $\pi \left(\frac{E+3H}{2} - 1.6 \right)^2$
1	2	3	4	5	6	7	8	9
in.		in.	in.	in.	mm	deg min	in. ²	in. ²
¹ / ₃₂	12	0.5000	0.4450	0.3917	12.700	3 24	0.121	0.138
¹ / ₁₆	12	.5625	.5084	.4542	14.288	2 50	.162	.182
³ / ₁₆	12	.6250	.5709	.5167	15.875	2 40	.210	.232
¹ / ₈	12	.6875	.6334	.5792	17.463	2 24	.264	.289
³ / ₈	12	.7500	.6959	.6417	19.050	2 11	.323	.351
¹ / ₄	12	.8125	.7584	.7042	20.638	2 0	.390	.420
³ / ₄	12	.8750	.8209	.7667	22.225	1 51	.462	.495
¹ / ₂	12	.9375	.8834	.8292	23.813	1 43	.540	.576
1	12	1.0000	.9459	.8917	25.400	1 36	.625	.663
¹ / ₂	12	1.0625	1.0084	.9542	26.988	1 30	.715	.766
³ / ₄	12	1.1250	1.0709	1.0167	28.575	1 25	.812	.856
¹ / ₂	12	1.1875	1.1334	1.0792	30.163	1 20	.915	.961
¹ / ₂	12	1.2500	1.1959	1.1417	31.750	1 16	1.024	1.073
¹ / ₂	12	1.3125	1.2584	1.2042	33.338	1 12	1.139	1.191
¹ / ₂	12	1.3750	1.3209	1.2667	34.925	1 9	1.260	1.315
¹ / ₂	12	1.4375	1.3834	1.3292	36.513	1 6	1.388	1.445
¹ / ₂	12	1.5000	1.4459	1.3917	38.100	1 3	1.52	1.58
¹ / ₂	12	1.6250	1.5709	1.5167	41.275	0 58	1.81	1.87
¹ / ₂	12	1.7500	1.6959	1.6417	44.450	0 54	2.12	2.19
¹ / ₂	12	1.8750	1.8209	1.7667	47.625	0 50	2.45	2.53
2	12	2.0000	1.9459	1.8917	50.800	0 47	2.81	2.89
² / ₃	12	2.1250	2.0709	2.0167	53.975	0 44	3.19	3.28
² / ₃	12	2.2500	2.1959	2.1417	57.150	0 42	3.60	3.69
² / ₃	12	2.3750	2.3209	2.2667	60.325	0 39	4.04	4.13
² / ₃	12	2.5000	2.4459	2.3917	63.500	0 37	4.49	4.60
² / ₃	12	2.6250	2.5709	2.5167	66.675	0 35	4.97	5.08
² / ₃	12	2.7500	2.6959	2.6417	69.850	0 34	5.48	5.59
² / ₃	12	2.8750	2.8209	2.7667	73.025	0 32	6.01	6.13
3	12	3.0000	2.9459	2.8917	76.200	0 31	6.57	6.69
³ / ₄	12	3.1250	3.0709	3.0167	79.375	0 30	7.15	7.28
³ / ₄	12	3.2500	3.1959	3.1417	82.550	0 29	7.75	7.89
³ / ₄	12	3.3750	3.3209	3.2667	85.725	0 27	8.38	8.52
³ / ₄	12	3.5000	3.4459	3.3917	88.900	0 26	9.03	9.18
³ / ₄	12	3.6250	3.5709	3.5167	92.075	0 26	9.71	9.86
³ / ₄	12	3.7500	3.6959	3.6417	95.250	0 25	10.42	10.57
³ / ₄	12	3.8750	3.8209	3.7667	98.425	0 24	11.14	11.30
4	12	4.0000	3.9459	3.8917	101.600	0 23	11.90	12.06
⁴ / ₃	12	4.2500	4.1959	4.1417	107.750	0 22	13.47	13.65
⁴ / ₃	12	4.5000	4.4459	4.3917	114.900	0 21	15.1	15.3
⁴ / ₃	12	4.7500	4.6959	4.6417	120.650	0 19	16.9	17.1
5	12	5.0000	4.9459	4.8917	127.000	0 18	18.8	19.0
⁵ / ₄	12	5.2500	5.1959	5.1417	133.350	0 18	20.8	21.0
⁵ / ₄	12	5.5000	5.4459	5.3917	139.700	0 17	22.8	23.1
⁵ / ₄	12	5.7500	5.6959	5.6417	146.050	0 16	25.0	25.2
6	12	6.0000	5.9459	5.8917	152.400	0 15	27.3	27.5

* Standard size of the American National coarse-thread series.

* Standard size of the American National fine-thread series.

NOTE.—Pitch, $p=0.08333$ in.; depth of thread, $h=0.06413$ in.; basic width of flat, $p/8=0.010413$ in.; minimum width of flat at major diameter of nut, $p/24=0.00347$ in.

are specified in tables 1.8 to 1.13, inclusive, and their application is shown in figure 1.3.

3. CLASS 3.—(a) *Definition*.—Class 3 is intended for applications where closeness of fit and accuracy of lead and angle of thread are important. It is obtainable consistently only by the use of high quality production equipment supported by a very efficient system of gaging and inspection. It is the same in every particular as class 2, except that the tolerances are smaller.

(b) *Limits of size and tolerances*.—No allowance is provided, but since the tolerances on "go" gages are within the limits of size of the thread, the gages will assure a slight clearance between external and internal threads made to the maximum-material limits. Limits of size and tolerances for the respective thread pitches are

specified in tables 1.8 to 1.13, inclusive, and their application is shown in figure 1.4.

4. CLASS 4.—(a) *Definition*.—Class 4 is intended for threaded work requiring a fine snug fit, and where a screwdriver or wrench may be necessary for assembly. In the manufacture of screw-thread products belonging in this class it will be necessary to use precision tools,²⁰ gages made to special tolerances for this class, and other refinements. This class should, therefore, be used only in cases where requirements of the mechanism being produced are exacting, or where special conditions require screws having a precision fit. In order to secure the fit desired it may be necessary in some cases to select the parts when the product is being assembled.

²⁰ Including positive control of taps and dies by means of a lead screw.

TABLE 1.7.—American National 16-thread series, 16N

Identification		Basic diameters			Thread data			
Sizes	Threads per inch	Major diameter, <i>D</i>	Pitch diameter, <i>E</i>	Minor diameter, <i>K</i>	Metric equivalent of major diameter	Lead angle at basic pitch diameter, λ	Sectional area at minor diameter at $D-2a$, $\frac{\pi K^2}{4}$	Tensile-stress area, $\pi \left(\frac{E+3I}{2+16} \right)^2$
1	2	3	4	5	6	7	8	9
<i>in.</i>		<i>in.</i>	<i>in.</i>	<i>in.</i>	<i>mm</i>	<i>deg min</i>	<i>in.³</i>	<i>in.³</i>
$\frac{1}{8}$	16	0.7500	0.7094	0.6688	19.050	1 38	0.351	0.373
$\frac{1}{4}$	16	.8125	.7719	.7313	20.638	1 29	.420	.444
$\frac{3}{8}$	16	.8750	.8344	.7938	22.225	1 22	.495	.521
$\frac{1}{2}$	16	.9375	.8969	.8563	23.813	1 16	.578	.604
1	16	1.0000	.9594	.9188	25.400	1 11	.663	.688
$1\frac{1}{8}$	16	1.0625	1.0219	.9813	26.988	1 7	.756	.788
$1\frac{1}{4}$	16	1.1250	1.0844	1.0438	28.575	1 3	.850	.889
$1\frac{3}{8}$	16	1.1875	1.1469	1.1063	30.163	1 0	.951	.997
$1\frac{1}{2}$	16	1.2500	1.2094	1.1688	31.750	0 57	1.073	1.131
$1\frac{3}{4}$	16	1.3125	1.2719	1.2313	33.338	0 54	1.191	1.250
$1\frac{7}{8}$	16	1.3750	1.3344	1.2938	34.925	0 51	1.315	1.356
$1\frac{1}{2}$	16	1.4375	1.3969	1.3563	36.513	0 49	1.445	1.488
$1\frac{5}{8}$	16	1.5000	1.4594	1.4188	38.100	0 47	1.58	1.63
$1\frac{3}{4}$	16	1.5625	1.5219	1.4813	39.688	0 45	1.72	1.77
$1\frac{7}{8}$	16	1.6250	1.5844	1.5438	41.275	0 43	1.87	1.92
$1\frac{1}{2}$	16	1.6875	1.6469	1.6063	42.863	0 42	2.03	2.08
$1\frac{5}{8}$	16	1.7500	1.7094	1.6688	44.450	0 40	2.19	2.24
$1\frac{3}{4}$	16	1.8125	1.7719	1.7313	46.038	0 39	2.35	2.41
$1\frac{7}{8}$	16	1.8750	1.8344	1.7938	47.625	0 37	2.53	2.58
$1\frac{1}{2}$	16	1.9375	1.8969	1.8563	49.213	0 36	2.71	2.77
2	16	2.0000	1.9594	1.9188	50.800	0 35	2.89	2.95
$2\frac{1}{8}$	16	2.0625	2.0219	1.9813	52.388	0 34	3.08	3.15
$2\frac{1}{4}$	16	2.1250	2.0844	2.0438	53.975	0 33	3.28	3.35
$2\frac{3}{8}$	16	2.1875	2.1469	2.1063	55.563	0 32	3.48	3.55
$2\frac{1}{2}$	16	2.2500	2.2094	2.1688	57.150	0 31	3.69	3.76
$2\frac{5}{8}$	16	2.3125	2.2719	2.2313	58.738	0 30	3.91	3.98
$2\frac{3}{4}$	16	2.3750	2.3344	2.2938	60.325	0 29	4.13	4.21
$2\frac{7}{8}$	16	2.4375	2.3969	2.3563	61.913	0 29	4.38	4.44
$2\frac{1}{2}$	16	2.5000	2.4594	2.4188	63.500	0 28	4.60	4.67
$2\frac{5}{8}$	16	2.6250	2.5844	2.5438	66.675	0 26	5.08	5.16
$2\frac{3}{4}$	16	2.7500	2.7094	2.6688	69.850	0 25	5.59	5.68
$2\frac{7}{8}$	16	2.8750	2.8344	2.7938	73.025	0 24	6.13	6.22
3	16	3.0000	2.9594	2.9188	76.200	0 23	6.69	6.78
$3\frac{1}{8}$	16	3.1250	3.0844	3.0438	79.375	0 22	7.28	7.37
$3\frac{1}{4}$	16	3.2500	3.2094	3.1688	82.550	0 21	7.89	7.99
$3\frac{3}{8}$	16	3.3750	3.3344	3.2938	85.725	0 21	8.52	8.63
$3\frac{1}{2}$	16	3.5000	3.4594	3.4188	88.900	0 20	9.18	9.29
$3\frac{5}{8}$	16	3.6250	3.5844	3.5438	92.075	0 19	9.86	9.98
$3\frac{3}{4}$	16	3.7500	3.7094	3.6688	95.250	0 18	10.57	10.69
$3\frac{7}{8}$	16	3.8750	3.8344	3.7938	98.425	0 18	11.30	11.43
4	16	4.0000	3.9594	3.9188	101.600	0 17	12.06	12.19

* Standard size of the American National fine-thread series.

NOTE.—Pitch, $p=0.0625$ in., depth of thread, $h=0.04069$ in.; basic width of flat, $p/8=0.00781$ in.; minimum width of flat at major diameter of nut, $p/24=0.02604$ in.

(b) *Limits of size and tolerances.*—A small negative allowance is provided. Limits of size and tolerances for the respective thread pitches are specified in tables 1.8 and 1.9, and their application is shown in figure 1.5.

5. CLASS 5.—This is a wrench fit class intended for studs and tapped holes which are to be assembled permanently. As the earlier specifications have proved to be not entirely satisfactory this class is in process of revision. Reference should be made to previous editions of this handbook for the earlier specifications.

5. METHOD OF DESIGNATING AN AMERICAN NATIONAL THREAD

1. STANDARD AMERICAN NATIONAL THREADS.—The standard method of designating a screw thread is given in section III, p. 26. For all standard threads listed in tables 1.2 to 1.7, inclusive, only the thread designations need be placed on a drawing, it being understood that

the limits of size shall be in accordance with tables 1.8 to 1.13, inclusive, or the corresponding table in ASA B1.1.

Examples: 0.250-28NF-3
2.000-8N-2

2. MODIFIED AMERICAN NATIONAL THREADS.—It is occasionally necessary to modify the limits of size of the major diameter of an external thread or the minor diameter of an internal thread from the limits established for standard series and special threads in order to fit a specific purpose but without change in class of thread or pitch diameter limits. Such threads should be specified with the established thread designation followed by a statement of the modified diameter limits and the designation "MOD."

External thread:

$\frac{3}{8}$ 24NF-3 MOD.

Major diameter .3720-.3648 MOD.

Internal thread:

$\frac{3}{8}$ 24NF-2 MOD.

Minor diameter .330-.336 MOD.

For further examples see section III, p. 26.

TABLE 1.8.—Limits of size and tolerances, classes 1, 2, 3, and 4, American National coarse-thread series, NC

Limits of size and tolerances	Machine screw number or nominal size															
	1	2	3	4	5	6	8	10	12	14	16	18	20	24	28	32
	Threads per inch															
	64	56	48	40	40	32	32	24	24	20	18	16	14	13	12	11
EXTERNAL THREADS																
Class 1, major diameter...	in.	in.	in.	in.	in.	in.	in.	in.	in.	in.	in.	in.	in.	in.	in.	in.
	Max	0.0723	0.0852	0.0981	0.1110	0.1240	0.1369	0.1629	0.1887	0.2147	0.2485	0.3109	0.3732	0.4354	0.4978	0.5601
	Min	0.0671	0.0796	0.0919	0.1042	0.1172	0.1293	0.1553	0.1795	0.2055	0.2383	0.2905	0.3506	0.4124	0.4830	0.5443
Classes 2, 3, and 4, major diameter	in.	0.0730	0.0860	0.0990	0.1120	0.1250	0.1380	0.1640	0.1900	0.2160	0.2500	0.3125	0.3750	0.4375	0.5000	0.5625
	Max	0.0692	0.0820	0.0946	0.1072	0.1202	0.1326	0.1586	0.1834	0.2094	0.2428	0.3043	0.3660	0.4277	0.4896	0.5513
	Min	0.0652	0.0776	0.0902	0.1028	0.1154	0.1280	0.1540	0.1788	0.2036	0.2370	0.2985	0.3600	0.4215	0.4830	0.5445
Class 2, major diameter (threaded parts of unfinished, hot-rolled material)	in.	0.0730	0.0860	0.0990	0.1120	0.1250	0.1380	0.1640	0.1900	0.2160	0.2500	0.3125	0.3750	0.4375	0.5000	0.5625
	Max	0.0678	0.0804	0.0928	0.1052	0.1182	0.1304	0.1564	0.1808	0.2068	0.2398	0.3011	0.3624	0.4235	0.4852	0.5467
	Min	0.0632	0.0756	0.0882	0.1008	0.1134	0.1260	0.1520	0.1768	0.2016	0.2350	0.2965	0.3580	0.4195	0.4810	0.5425
Class 1, minor diameter	Max	0.0531	0.0633	0.0725	0.0803	0.0933	0.0986	0.1246	0.1376	0.1636	0.1872	0.2427	0.2955	0.3478	0.4034	0.4579
	Min	0.0538	0.0641	0.0734	0.0813	0.0943	0.0997	0.1257	0.1389	0.1649	0.1887	0.2443	0.2983	0.3499	0.4056	0.4603
Class 1, pitch diameter	in.	0.0622	0.0736	0.0846	0.0948	0.1078	0.1166	0.1426	0.1616	0.1876	0.2180	0.2748	0.3326	0.3890	0.4478	0.5060
	Max	0.0596	0.0708	0.0815	0.0914	0.1044	0.1128	0.1388	0.1570	0.1830	0.2109	0.2601	0.3203	0.3800	0.4404	0.4981
	Min	0.0626	0.0738	0.0841	0.0938	0.1068	0.1152	0.1412	0.1602	0.1862	0.2141	0.2633	0.3235	0.3832	0.4436	0.5013
Class 2, pitch diameter	in.	0.0629	0.0744	0.0855	0.0958	0.1088	0.1177	0.1437	0.1629	0.1889	0.2175	0.2764	0.3344	0.3911	0.4500	0.5084
	Max	0.0610	0.0724	0.0833	0.0934	0.1064	0.1150	0.1410	0.1596	0.1856	0.2159	0.2723	0.3299	0.3862	0.4448	0.5028
	Min	0.0619	0.0730	0.0839	0.0940	0.1070	0.1156	0.1416	0.1602	0.1862	0.2165	0.2729	0.3305	0.3878	0.4464	0.5043
Class 3, pitch diameter	in.	0.0629	0.0744	0.0855	0.0958	0.1088	0.1177	0.1437	0.1629	0.1889	0.2175	0.2764	0.3344	0.3911	0.4500	0.5084
	Max	0.0615	0.0729	0.0839	0.0941	0.1071	0.1158	0.1418	0.1605	0.1865	0.2169	0.2733	0.3312	0.3875	0.4463	0.5044
	Min	0.0614	0.0725	0.0835	0.0937	0.1067	0.1154	0.1414	0.1600	0.1860	0.2163	0.2727	0.3303	0.3876	0.4462	0.5041
Class 4, pitch diameter	in.	0.0629	0.0744	0.0855	0.0958	0.1088	0.1177	0.1437	0.1629	0.1889	0.2175	0.2764	0.3344	0.3911	0.4500	0.5084
	Max	0.0615	0.0729	0.0839	0.0941	0.1071	0.1158	0.1418	0.1605	0.1865	0.2169	0.2733	0.3312	0.3875	0.4463	0.5044
	Min	0.0614	0.0725	0.0835	0.0937	0.1067	0.1154	0.1414	0.1600	0.1860	0.2163	0.2727	0.3303	0.3876	0.4462	0.5041
INTERNAL THREADS																
Classes 1, 2, 3, and 4, major diameter	Min	0.0730	0.0860	0.0990	0.1120	0.1250	0.1380	0.1640	0.1900	0.2160	0.2500	0.3125	0.3750	0.4375	0.5000	0.5625
	Max	0.0561	0.0667	0.0764	0.0849	0.0979	0.1042	0.1302	0.1449	0.1709	0.1959	0.2524	0.3073	0.3602	0.4187	0.4723
Classes 1, 2, 3, and 4, minor diameter	in.	0.0623	0.0737	0.0841	0.0938	0.1062	0.1145	0.1384	0.1559	0.1801	0.2060	0.2630	0.3184	0.3721	0.4290	0.4850
	Max	0.0623	0.0737	0.0841	0.0938	0.1062	0.1145	0.1384	0.1559	0.1801	0.2060	0.2630	0.3184	0.3721	0.4290	0.4850
	Min	0.0623	0.0737	0.0841	0.0938	0.1062	0.1145	0.1384	0.1559	0.1801	0.2060	0.2630	0.3184	0.3721	0.4290	0.4850
Classes 1, 2, 3, and 4, pitch diameter	Min	0.0629	0.0744	0.0855	0.0958	0.1088	0.1177	0.1437	0.1629	0.1889	0.2175	0.2764	0.3344	0.3911	0.4500	0.5084
	Max	0.0655	0.0772	0.0886	0.0992	0.1122	0.1215	0.1475	0.1675	0.1935	0.2226	0.2821	0.3407	0.3981	0.4574	0.5163
Class 1, pitch diameter	in.	0.0655	0.0772	0.0886	0.0992	0.1122	0.1215	0.1475	0.1675	0.1935	0.2226	0.2821	0.3407	0.3981	0.4574	0.5163
	Max	0.0626	0.0738	0.0841	0.0938	0.1068	0.1152	0.1412	0.1602	0.1862	0.2141	0.2633	0.3235	0.3832	0.4436	0.5013
	Min	0.0626	0.0738	0.0841	0.0938	0.1068	0.1152	0.1412	0.1602	0.1862	0.2141	0.2633	0.3235	0.3832	0.4436	0.5013
Class 2, pitch diameter	in.	0.0648	0.0764	0.0877	0.0982	0.1112	0.1204	0.1454	0.1642	0.1922	0.2211	0.2805	0.3389	0.3960	0.4552	0.5140
	Max	0.0619	0.0730	0.0839	0.0940	0.1070	0.1156	0.1416	0.1602	0.1862	0.2165	0.2729	0.3305	0.3878	0.4464	0.5043
	Min	0.0619	0.0730	0.0839	0.0940	0.1070	0.1156	0.1416	0.1602	0.1862	0.2165	0.2729	0.3305	0.3878	0.4464	0.5043
Class 3, pitch diameter	in.	0.0648	0.0764	0.0877	0.0982	0.1112	0.1204	0.1454	0.1642	0.1922	0.2211	0.2805	0.3389	0.3960	0.4552	0.5140
	Max	0.0613	0.0725	0.0835	0.0937	0.1067	0.1154	0.1414	0.1600	0.1860	0.2163	0.2727	0.3303	0.3876	0.4462	0.5041
	Min	0.0613	0.0725	0.0835	0.0937	0.1067	0.1154	0.1414	0.1600	0.1860	0.2163	0.2727	0.3303	0.3876	0.4462	0.5041
Class 4, pitch diameter	in.	0.0648	0.0764	0.0877	0.0982	0.1112	0.1204	0.1454	0.1642	0.1922	0.2211	0.2805	0.3389	0.3960	0.4552	0.5140
	Max	0.0613	0.0725	0.0835	0.0937	0.1067	0.1154	0.1414	0.1600	0.1860	0.2163	0.2727	0.3303	0.3876	0.4462	0.5041
	Min	0.0613	0.0725	0.0835	0.0937	0.1067	0.1154	0.1414	0.1600	0.1860	0.2163	0.2727	0.3303	0.3876	0.4462	0.5041

See footnotes on p. 134.

TABLE 1.8.—Limits of size and tolerances, classes 1, 2, 3, and 4, American National coarse-thread series, NC—Continued

Limits of size and tolerances	Size (inches)																												
	Threads per inch																												
	3/4	7/8	1	1 1/8	1 1/4	1 3/8	1 1/2	1 5/8	2	2 1/4	2 1/2	2 3/4	3	3 1/4	3 1/2	3 3/4	4												
EXTERNAL THREAD*	in.	0.7472	0.8719	1.0000	1.1250	1.2500	1.3750	1.5000	1.6250	1.7500	1.8750	2.0000	2.1250	2.2500	2.3750	2.5000	2.6250	2.7500	2.8750	3.0000	3.1250	3.2500	3.3750	3.5000	3.6250	3.7500	3.8750	4.0000	
	Max.	0.7472	0.8719	1.0000	1.1250	1.2500	1.3750	1.5000	1.6250	1.7500	1.8750	2.0000	2.1250	2.2500	2.3750	2.5000	2.6250	2.7500	2.8750	3.0000	3.1250	3.2500	3.3750	3.5000	3.6250	3.7500	3.8750	4.0000	4.0000
	Min.	0.7388	0.8635	0.9942	1.1191	1.2440	1.3689	1.4938	1.6187	1.7436	1.8685	1.9934	2.1183	2.2432	2.3681	2.4930	2.6179	2.7428	2.8677	2.9926	3.1175	3.2424	3.3673	3.4922	3.6171	3.7420	3.8669	3.9918	4.1167
Tol.	0.0184	0.0284	0.0058	0.0259	0.0260	0.0251	0.0251	0.0251	0.0251	0.0251	0.0251	0.0251	0.0251	0.0251	0.0251	0.0251	0.0251	0.0251	0.0251	0.0251	0.0251	0.0251	0.0251	0.0251	0.0251	0.0251	0.0251	0.0251	0.0251
Classes 2, 3, and 4, major diameter	in.	0.7500	0.8750	1.0000	1.1250	1.2500	1.3750	1.5000	1.6250	1.7500	1.8750	2.0000	2.1250	2.2500	2.3750	2.5000	2.6250	2.7500	2.8750	3.0000	3.1250	3.2500	3.3750	3.5000	3.6250	3.7500	3.8750	4.0000	
	Max.	0.7500	0.8750	1.0000	1.1250	1.2500	1.3750	1.5000	1.6250	1.7500	1.8750	2.0000	2.1250	2.2500	2.3750	2.5000	2.6250	2.7500	2.8750	3.0000	3.1250	3.2500	3.3750	3.5000	3.6250	3.7500	3.8750	4.0000	
	Min.	0.7372	0.8621	0.9928	1.1177	1.2426	1.3675	1.4924	1.6173	1.7422	1.8671	1.9920	2.1169	2.2418	2.3667	2.4916	2.6165	2.7414	2.8663	2.9912	3.1161	3.2410	3.3659	3.4908	3.6157	3.7406	3.8655	3.9904	4.1153
Tol.	0.0128	0.0129	0.0072	0.0273	0.0274	0.0265	0.0265	0.0265	0.0265	0.0265	0.0265	0.0265	0.0265	0.0265	0.0265	0.0265	0.0265	0.0265	0.0265	0.0265	0.0265	0.0265	0.0265	0.0265	0.0265	0.0265	0.0265	0.0265	0.0265
Class 2, major diameter—threaded parts of unfinished, hot-dipped material	in.	0.7500	0.8750	1.0000	1.1250	1.2500	1.3750	1.5000	1.6250	1.7500	1.8750	2.0000	2.1250	2.2500	2.3750	2.5000	2.6250	2.7500	2.8750	3.0000	3.1250	3.2500	3.3750	3.5000	3.6250	3.7500	3.8750	4.0000	
	Max.	0.7500	0.8750	1.0000	1.1250	1.2500	1.3750	1.5000	1.6250	1.7500	1.8750	2.0000	2.1250	2.2500	2.3750	2.5000	2.6250	2.7500	2.8750	3.0000	3.1250	3.2500	3.3750	3.5000	3.6250	3.7500	3.8750	4.0000	
	Min.	0.7315	0.8564	0.9871	1.1120	1.2369	1.3618	1.4867	1.6116	1.7365	1.8614	1.9863	2.1112	2.2361	2.3610	2.4859	2.6108	2.7357	2.8606	2.9855	3.1104	3.2353	3.3602	3.4851	3.6100	3.7349	3.8598	3.9847	4.1096
Tol.	0.0185	0.0186	0.0129	0.0330	0.0331	0.0322	0.0322	0.0322	0.0322	0.0322	0.0322	0.0322	0.0322	0.0322	0.0322	0.0322	0.0322	0.0322	0.0322	0.0322	0.0322	0.0322	0.0322	0.0322	0.0322	0.0322	0.0322	0.0322	0.0322
Class 1, minor diameter	in.	0.6245	0.7536	0.8832	1.0128	1.1424	1.2720	1.4016	1.5312	1.6608	1.7904	1.9200	2.0496	2.1792	2.3088	2.4384	2.5680	2.6976	2.8272	2.9568	3.0864	3.2160	3.3456	3.4752	3.6048	3.7344	3.8640	3.9936	
	Max.	0.6245	0.7536	0.8832	1.0128	1.1424	1.2720	1.4016	1.5312	1.6608	1.7904	1.9200	2.0496	2.1792	2.3088	2.4384	2.5680	2.6976	2.8272	2.9568	3.0864	3.2160	3.3456	3.4752	3.6048	3.7344	3.8640	3.9936	
	Min.	0.6245	0.7536	0.8832	1.0128	1.1424	1.2720	1.4016	1.5312	1.6608	1.7904	1.9200	2.0496	2.1792	2.3088	2.4384	2.5680	2.6976	2.8272	2.9568	3.0864	3.2160	3.3456	3.4752	3.6048	3.7344	3.8640	3.9936	
Classes 2, 3, and 4, minor diameter	in.	0.6273	0.7579	0.8885	1.0191	1.1497	1.2803	1.4109	1.5415	1.6721	1.8027	1.9333	2.0639	2.1945	2.3251	2.4557	2.5863	2.7169	2.8475	2.9781	3.1087	3.2393	3.3699	3.5005	3.6311	3.7617	3.8923	4.0229	
	Max.	0.6273	0.7579	0.8885	1.0191	1.1497	1.2803	1.4109	1.5415	1.6721	1.8027	1.9333	2.0639	2.1945	2.3251	2.4557	2.5863	2.7169	2.8475	2.9781	3.1087	3.2393	3.3699	3.5005	3.6311	3.7617	3.8923	4.0229	
	Min.	0.6273	0.7579	0.8885	1.0191	1.1497	1.2803	1.4109	1.5415	1.6721	1.8027	1.9333	2.0639	2.1945	2.3251	2.4557	2.5863	2.7169	2.8475	2.9781	3.1087	3.2393	3.3699	3.5005	3.6311	3.7617	3.8923	4.0229	
Class 1, pitch diameter	in.	0.6850	0.8028	0.9206	1.0384	1.1562	1.2740	1.3918	1.5096	1.6274	1.7452	1.8630	1.9808	2.0986	2.2164	2.3342	2.4520	2.5698	2.6876	2.8054	2.9232	3.0410	3.1588	3.2766	3.3944	3.5122	3.6300	3.7478	3.8656
	Max.	0.6850	0.8028	0.9206	1.0384	1.1562	1.2740	1.3918	1.5096	1.6274	1.7452	1.8630	1.9808	2.0986	2.2164	2.3342	2.4520	2.5698	2.6876	2.8054	2.9232	3.0410	3.1588	3.2766	3.3944	3.5122	3.6300	3.7478	3.8656
	Min.	0.6796	0.7974	0.9152	1.0330	1.1508	1.2686	1.3864	1.5042	1.6220	1.7398	1.8576	1.9754	2.0932	2.2110	2.3288	2.4466	2.5644	2.6822	2.8000	2.9178	3.0356	3.1534	3.2712	3.3890	3.5068	3.6246	3.7424	3.8602
Tol.	0.0054	0.0054	0.0054	0.0054	0.0054	0.0054	0.0054	0.0054	0.0054	0.0054	0.0054	0.0054	0.0054	0.0054	0.0054	0.0054	0.0054	0.0054	0.0054	0.0054	0.0054	0.0054	0.0054	0.0054	0.0054	0.0054	0.0054	0.0054	
Class 3, pitch diameter	in.	0.8570	1.0140	1.1710	1.3280	1.4850	1.6420	1.7990	1.9560	2.1130	2.2700	2.4270	2.5840	2.7410	2.8980	3.0550	3.2120	3.3690	3.5260	3.6830	3.8400	3.9970	4.1540	4.3110	4.4680	4.6250	4.7820	4.9390	5.0960
	Max.	0.8570	1.0140	1.1710	1.3280	1.4850	1.6420	1.7990	1.9560	2.1130	2.2700	2.4270	2.5840	2.7410	2.8980	3.0550	3.2120	3.3690	3.5260	3.6830	3.8400	3.9970	4.1540	4.3110	4.4680	4.6250	4.7820	4.9390	5.0960
	Min.	0.8570	1.0140	1.1710	1.3280	1.4850	1.6420	1.7990	1.9560	2.1130	2.2700	2.4270	2.5840	2.7410	2.8980	3.0550	3.2120	3.3690	3.5260	3.6830	3.8400	3.9970	4.1540	4.3110	4.4680	4.6250	4.7820	4.9390	5.0960
Class 4, pitch diameter	in.	0.9333	1.1000	1.2667	1.4333	1.6000	1.7667	1.9333	2.1000	2.2667	2.4333	2.6000	2.7667	2.9333	3.1000	3.2667	3.4333	3.6000	3.7667	3.9333	4.1000	4.2667	4.4333	4.6000	4.7667	4.9333	5.1000	5.2667	5.4333
	Max.	0.9333	1.1000	1.2667	1.4333	1.6000	1.7667	1.9333	2.1000	2.2667	2.4333	2.6000	2.7667	2.9333	3.1000	3.2667	3.4333	3.6000	3.7667	3.9333	4.1000	4.2667	4.4333	4.6000	4.7667	4.9333	5.1000	5.2667	5.4333
	Min.	0.9333	1.1000	1.2667	1.4333	1.6000	1.7667	1.9333	2.1000	2.2667	2.4333	2.6000	2.7667	2.9333	3.1000	3.2667	3.4333	3.6000	3.7667	3.9333	4.1000	4.2667	4.4333	4.6000	4.7667	4.9333	5.1000	5.2667	5.4333
INTERNAL THREADS	in.	0.7500	0.8750	1.0000	1.1250	1.2500	1.3750	1.5000	1.6250	1.7500	1.8750	2.0000	2.1250	2.2500	2.3750	2.5000	2.6250	2.7500	2.8750	3.0000	3.1250	3.2500	3.3750	3.5000	3.6250	3.7500	3.8750	4.0000	
	Max.	0.7500	0.8750	1.0000	1.1250	1.2500	1.3750	1.5000	1.6250	1.7500	1.8750	2.0000	2.1250	2.2500	2.3750	2.5000	2.6250	2.7500	2.8750	3.0000	3.1250	3.2500	3.3750	3.5000	3.6250	3.7500	3.8750	4.0000	
	Min.	0.7416	0.8665	0.9914	1.1163	1.2412	1.3661	1.4910	1.6159	1.7408	1.8657	1.9906	2.1155	2.2404	2.3653	2.4902	2.6151	2.7400	2.8649	2.9898	3.1147	3.2396	3.3645	3.4894	3.6143	3.7392	3.8641	3.9890	4.1139
Classes 1, 2, 3, and 4, major diameter	in.	0.8417	0.9847	1.1277	1.2707	1.4137	1.5567	1.6997	1.8427	1.9857	2.1287	2.2717	2.4147	2.5577	2.7007	2.8437	2.9867	3.1297	3.2727	3.4157	3.5587	3.7017	3.8447	3.9877	4.1307	4.2737	4.4167	4.5597	4.7027
	Max.	0.8417	0.9847	1.1277	1.2707	1.4137	1.5567	1.6997	1.8427	1.9857	2.1287	2.2717	2.4147	2.5577	2.7007	2.8437	2.9867	3.1297	3.2727	3.4157	3.5587	3.7017	3.8447	3.9877	4.1307	4.2737	4.4167	4.5597	4.7027
	Min.	0.8333	0.9763	1.1193	1.2623	1.4053	1.5483	1.6913	1.8343	1.9773	2.1203	2.2633	2.4063	2.5493	2.6923	2.8353	2.9783	3.1213	3.2643	3.4073	3.5503	3.6933	3.8363	3.9793	4.1223	4.2653	4.4083	4.5513	4.6943
Class 1, pitch diameter	in.	0.8850	1.0380	1.1910	1.3440	1.49																							

TABLE 1.9.—Limits of size and tolerances, classes 1, 2, 3, and 4, American National fine-thread series, NF

Limits of size and tolerances	Machine screw number or nominal size														
	0	1	2	3	4	5	6	8	10	12	14	16	18	20	
	Threads per inch														
	80	72	64	56	48	44	40	36	32	28	28	24	24	20	
EXTERNAL THREADS															
Class 1, major diameter	in. .0593	in. 0.0723	in. 0.0853	in. 0.0982	in. 0.1111	in. 0.1241	in. 0.1370	in. 0.1500	in. 0.1629	in. 0.1880	in. 0.2148	in. 0.2488	in. 0.3112	in. 0.3737	in. 0.4360
	Min. .0545	Min. .0673	Min. .0801	Min. .0926	Min. .1049	Min. .1177	Min. .1302	Min. .1457	Min. .1602	Min. .1813	Min. .2062	Min. .2402	Min. .3020	Min. .3645	Min. .4258
	Tol. .0048	Tol. .0050	Tol. .0052	Tol. .0050	Tol. .0062	Tol. .0064	Tol. .0068	Tol. .0072	Tol. .0076	Tol. .0086	Tol. .0086	Tol. .0086	Tol. .0092	Tol. .0092	Tol. .0102
Classes 2, 3, and 4, major diameter	Min. .0600	Min. .0730	Min. .0860	Min. .0990	Min. .1120	Min. .1250	Min. .1380	Min. .1540	Min. .1640	Min. .1900	Min. .2160	Min. .2500	Min. .3125	Min. .3750	Min. .4375
	Max. .0565	Max. .0694	Max. .0822	Max. .0950	Max. .1076	Max. .1204	Max. .1332	Max. .1500	Max. .1640	Max. .1846	Max. .2098	Max. .2438	Max. .3059	Max. .3684	Max. .4303
	Tol. .0034	Tol. .0036	Tol. .0038	Tol. .0040	Tol. .0044	Tol. .0046	Tol. .0048	Tol. .0050	Tol. .0051	Tol. .0054	Tol. .0062	Tol. .0062	Tol. .0066	Tol. .0066	Tol. .0072
Class 1, minor diameter	Max. .0440	Max. .0553	Max. .0661	Max. .0763	Max. .0855	Max. .0962	Max. .1063	Max. .1288	Max. .1506	Max. .1710	Max. .2050	Max. .2601	Max. .3220	Max. .3747	Max. .4374
Classes 2, 3, and 4, minor diameter	Max. .0447	Max. .0560	Max. .0668	Max. .0771	Max. .0864	Max. .0971	Max. .1073	Max. .1299	Max. .1517	Max. .1722	Max. .2062	Max. .2614	Max. .3239	Max. .3762	Max. .4389
Class 1, pitch diameter	Max. .0512	Max. .0633	Max. .0752	Max. .0866	Max. .0976	Max. .1083	Max. .1208	Max. .1449	Max. .1686	Max. .1916	Max. .2256	Max. .2841	Max. .3466	Max. .4035	Max. .4605
	Min. .0488	Min. .0608	Min. .0726	Min. .0838	Min. .0945	Min. .1051	Min. .1174	Min. .1411	Min. .1648	Min. .1873	Min. .2213	Min. .2795	Min. .3420	Min. .3984	Min. .4551
	Tol. .0024	Tol. .0025	Tol. .0026	Tol. .0028	Tol. .0031	Tol. .0032	Tol. .0034	Tol. .0036	Tol. .0038	Tol. .0043	Tol. .0043	Tol. .0046	Tol. .0046	Tol. .0051	Tol. .0051
Class 2, pitch diameter	Max. .0519	Max. .0640	Max. .0759	Max. .0874	Max. .0985	Max. .1102	Max. .1218	Max. .1460	Max. .1697	Max. .1928	Max. .2268	Max. .2854	Max. .3479	Max. .4050	Max. .4621
	Min. .0502	Min. .0622	Min. .0740	Min. .0854	Min. .0963	Min. .1079	Min. .1194	Min. .1435	Min. .1670	Min. .1897	Min. .2237	Min. .2821	Min. .3446	Min. .4014	Min. .4584
	Tol. .0017	Tol. .0018	Tol. .0019	Tol. .0020	Tol. .0022	Tol. .0023	Tol. .0024	Tol. .0025	Tol. .0027	Tol. .0031	Tol. .0031	Tol. .0033	Tol. .0033	Tol. .0036	Tol. .0036
Class 3, pitch diameter	Max. .0519	Max. .0640	Max. .0759	Max. .0874	Max. .0985	Max. .1102	Max. .1218	Max. .1460	Max. .1697	Max. .1928	Max. .2268	Max. .2854	Max. .3479	Max. .4050	Max. .4621
	Min. .0506	Min. .0627	Min. .0745	Min. .0859	Min. .0969	Min. .1085	Min. .1201	Min. .1442	Min. .1678	Min. .1906	Min. .2246	Min. .2830	Min. .3455	Min. .4024	Min. .4593
	Tol. .0013	Tol. .0013	Tol. .0014	Tol. .0015	Tol. .0016	Tol. .0016	Tol. .0017	Tol. .0018	Tol. .0019	Tol. .0022	Tol. .0022	Tol. .0024	Tol. .0024	Tol. .0026	Tol. .0026
Class 4, pitch diameter	Max. .0519	Max. .0640	Max. .0759	Max. .0874	Max. .0985	Max. .1102	Max. .1218	Max. .1460	Max. .1697	Max. .1928	Max. .2268	Max. .2854	Max. .3479	Max. .4050	Max. .4621
	Min. .0506	Min. .0627	Min. .0745	Min. .0859	Min. .0969	Min. .1085	Min. .1201	Min. .1442	Min. .1678	Min. .1906	Min. .2246	Min. .2830	Min. .3455	Min. .4024	Min. .4593
	Tol. .0013	Tol. .0013	Tol. .0014	Tol. .0015	Tol. .0016	Tol. .0016	Tol. .0017	Tol. .0018	Tol. .0019	Tol. .0022	Tol. .0022	Tol. .0024	Tol. .0024	Tol. .0026	Tol. .0026
Class 4, pitch diameter	Max. .0519	Max. .0640	Max. .0759	Max. .0874	Max. .0985	Max. .1102	Max. .1218	Max. .1460	Max. .1697	Max. .1928	Max. .2268	Max. .2854	Max. .3479	Max. .4050	Max. .4621
	Min. .0506	Min. .0627	Min. .0745	Min. .0859	Min. .0969	Min. .1085	Min. .1201	Min. .1442	Min. .1678	Min. .1906	Min. .2246	Min. .2830	Min. .3455	Min. .4024	Min. .4593
	Tol. .0013	Tol. .0013	Tol. .0014	Tol. .0015	Tol. .0016	Tol. .0016	Tol. .0017	Tol. .0018	Tol. .0019	Tol. .0022	Tol. .0022	Tol. .0024	Tol. .0024	Tol. .0026	Tol. .0026
INTERNAL THREADS															
Classes 1, 2, 3, and 4, major diameter	Min. .0600	Min. .0730	Min. .0860	Min. .0990	Min. .1120	Min. .1250	Min. .1380	Min. .1540	Min. .1640	Min. .1900	Min. .2160	Min. .2500	Min. .3125	Min. .3750	Min. .4375
Classes 1, 2, 3, and 4, minor diameter	Max. .0465	Max. .0580	Max. .0691	Max. .0797	Max. .0894	Max. .1004	Max. .1109	Max. .1339	Max. .1562	Max. .1773	Max. .2113	Max. .2674	Max. .3299	Max. .3834	Max. .4366
	Min. .0514	Min. .0634	Min. .0746	Min. .0856	Min. .0960	Min. .1068	Min. .1179	Min. .1402	Min. .1624	Min. .1835	Min. .2173	Min. .2739	Min. .3364	Min. .3906	Min. .4448
	Tol. .0049	Tol. .0054	Tol. .0055	Tol. .0059	Tol. .0066	Tol. .0064	Tol. .0070	Tol. .0063	Tol. .0062	Tol. .0062	Tol. .0060	Tol. .0065	Tol. .0065	Tol. .0072	Tol. .0072
Classes 1, 2, 3, and 4, pitch diameter	Min. .0519	Min. .0640	Min. .0759	Min. .0874	Min. .0985	Min. .1102	Min. .1218	Min. .1460	Min. .1697	Min. .1928	Min. .2268	Min. .2854	Min. .3479	Min. .4050	Min. .4621
Class 1, pitch diameter	Max. .0543	Max. .0665	Max. .0785	Max. .0902	Max. .1016	Max. .1134	Max. .1252	Max. .1496	Max. .1735	Max. .1971	Max. .2311	Max. .2890	Max. .3525	Max. .4101	Max. .4676
	Min. .0524	Min. .0645	Min. .0765	Min. .0882	Min. .0996	Min. .1114	Min. .1232	Min. .1476	Min. .1715	Min. .1951	Min. .2291	Min. .2870	Min. .3505	Min. .4081	Min. .4656
	Tol. .0024	Tol. .0025	Tol. .0026	Tol. .0028	Tol. .0031	Tol. .0032	Tol. .0034	Tol. .0036	Tol. .0038	Tol. .0043	Tol. .0043	Tol. .0046	Tol. .0046	Tol. .0051	Tol. .0051
Class 2, pitch diameter	Max. .0536	Max. .0658	Max. .0778	Max. .0894	Max. .1007	Max. .1125	Max. .1242	Max. .1485	Max. .1724	Max. .1959	Max. .2299	Max. .2887	Max. .3512	Max. .4086	Max. .4661
	Min. .0517	Min. .0639	Min. .0759	Min. .0876	Min. .0989	Min. .1107	Min. .1224	Min. .1467	Min. .1706	Min. .1941	Min. .2281	Min. .2869	Min. .3494	Min. .4068	Min. .4643
	Tol. .0017	Tol. .0018	Tol. .0019	Tol. .0020	Tol. .0022	Tol. .0023	Tol. .0024	Tol. .0025	Tol. .0027	Tol. .0031	Tol. .0031	Tol. .0033	Tol. .0033	Tol. .0036	Tol. .0036
Class 3, pitch diameter	Max. .0532	Max. .0653	Max. .0773	Max. .0889	Max. .1001	Max. .1118	Max. .1235	Max. .1478	Max. .1716	Max. .1950	Max. .2290	Max. .2878	Max. .3503	Max. .4076	Max. .4649
	Min. .0513	Min. .0634	Min. .0754	Min. .0870	Min. .0982	Min. .1100	Min. .1217	Min. .1460	Min. .1698	Min. .1932	Min. .2272	Min. .2860	Min. .3485	Min. .4058	Min. .4631
	Tol. .0013	Tol. .0013	Tol. .0014	Tol. .0015	Tol. .0016	Tol. .0016	Tol. .0017	Tol. .0018	Tol. .0019	Tol. .0022	Tol. .0022	Tol. .0024	Tol. .0024	Tol. .0026	Tol. .0026
Class 4, pitch diameter	Max. .0532	Max. .0653	Max. .0773	Max. .0889	Max. .1001	Max. .1118	Max. .1235	Max. .1478	Max. .1716	Max. .1950	Max. .2290	Max. .2878	Max. .3503	Max. .4076	Max. .4649
	Min. .0513	Min. .0634	Min. .0754	Min. .0870	Min. .0982	Min. .1100	Min. .1217	Min. .1460	Min. .1698	Min. .1932	Min. .2272	Min. .2860	Min. .3485	Min. .4058	Min. .4631
	Tol. .0013	Tol. .0013	Tol. .0014	Tol. .0015	Tol. .0016	Tol. .0016	Tol. .0017	Tol. .0018	Tol. .0019	Tol. .0022	Tol. .0022	Tol. .0024	Tol. .0024	Tol. .0026	Tol. .0026

See footnotes on p. 136

TABLE 1.9.—Limits of size and tolerances, classes 1, 2, 3, and 4, American National fine-thread series, NF—Continued

Limits of size and tolerances	Size (Inches)										
	½	¾	¾	¾	¾	1	1¼	1½	1¾	1⅞	
	Threads per inch										
	20	18	18	16	14	14NS	12	12	12	12	
EXTERNAL THREADS											
Class 1, major diameter.....	in.	0.4965	0.5000	0.6234	0.7482	0.8720	0.9970	1.1226	1.2475	1.3726	1.4976
	Min	.4883	.5495	.6120	.7356	.8589	.9839	1.1068	1.2318	1.3568	1.4818
	Tol	.0102	.0114	.0114	.0126	.0140	.0140	.0158	.0158	.0158	.0158
Classes 2, 3, and 4, major diameter.....	in.	.5000	.5625	.6250	.7500	.8750	1.0000	1.1250	1.2500	1.3750	1.5000
	Min	.4928	.5543	.6168	.7410	.8652	.9902	1.1138	1.2388	1.3638	1.4888
	Tol	.0072	.0082	.0082	.0090	.0098	.0098	.0112	.0112	.0112	.0112
Class 1, minor diameter.....	Max ¹	.4372	.4927	.5552	.6715	.7853	.9103	1.0204	1.1454	1.2704	1.3954
	Max ¹	.4387	.4943	.5568	.6733	.7874	.9124	1.0228	1.1478	1.2728	1.3978
	Max ¹	.4660	.5248	.5873	.7076	.8265	.9515	1.0685	1.1935	1.3185	1.4435
Class 1, pitch diameter.....	Min	.4659	.5191	.5816	.7013	.8196	.9445	1.0606	1.1856	1.3106	1.4356
	Tol	.0051	.0057	.0057	.0063	.0070	.0070	.0079	.0079	.0079	.0079
	Max ²	.4675	.5264	.5889	.7094	.8286	.9536	1.0709	1.1959	1.3209	1.4459
Class 2, pitch diameter.....	Min	.4639	.5223	.5848	.7049	.8237	.9487	1.0653	1.1903	1.3153	1.4403
	Tol	.0036	.0041	.0041	.0045	.0049	.0049	.0056	.0056	.0056	.0056
	Max ²	.4675	.5264	.5889	.7094	.8286	.9536	1.0709	1.1959	1.3209	1.4459
Class 3, pitch diameter.....	Min	.4649	.5234	.5859	.7062	.8250	.9500	1.0669	1.1919	1.3169	1.4419
	Tol	.0026	.0030	.0030	.0032	.0036	.0036	.0040	.0040	.0040	.0040
	Max ²	.4678	.5267	.5892	.7098	.8290	.9540	1.0714	1.1964	1.3214	1.4464
Class 4, pitch diameter.....	Min	.4665	.5252	.5877	.7082	.8272	.9522	1.0694	1.1944	1.3194	1.4444
	Tol	.0013	.0015	.0015	.0016	.0018	.0018	.0020	.0020	.0020	.0020
	Max ²	.4678	.5267	.5892	.7098	.8290	.9540	1.0714	1.1964	1.3214	1.4464
INTERNAL THREADS											
Classes 1, 2, 3, and 4, major diameter.....	Min ³	.5000	.5625	.6250	.7500	.8750	1.0000	1.1250	1.2500	1.3750	1.5000
Classes 1, 2, 3, and 4, minor diameter.....	Min	.4459	.5024	.5649	.6823	.7977	.9227	1.0348	1.1598	1.2848	1.4098
	Max	.4531	.5100	.5725	.6933	.8082	.9312	1.0438	1.1688	1.2938	1.4188
	Tol	.0072	.0076	.0076	.0080	.0085	.0085	.0090	.0090	.0090	.0090
Classes 1, 2, 3, and 4, pitch diameter.....	Min ³	.4675	.5264	.5889	.7094	.8286	.9536	1.0709	1.1959	1.3209	1.4459
Class 1, pitch diameter.....	Max	.4726	.5321	.5946	.7157	.8356	.9606	1.0788	1.2038	1.3288	1.4538
	Tol	.0051	.0057	.0057	.0063	.0070	.0070	.0079	.0079	.0079	.0079
	Max	.4711	.5305	.5930	.7139	.8335	.9585	1.0765	1.2015	1.3265	1.4515
Class 2, pitch diameter.....	Min	.4636	.5241	.5861	.7065	.8250	.9499	1.0656	1.2015	1.3265	1.4515
	Tol	.0036	.0041	.0041	.0045	.0049	.0049	.0056	.0056	.0056	.0056
	Max	.4701	.5294	.5919	.7126	.8322	.9572	1.0749	1.1999	1.3249	1.4499
Class 3, pitch diameter.....	Min	.4626	.5230	.5850	.7052	.8236	.9485	1.0653	1.1903	1.3153	1.4403
	Tol	.0026	.0030	.0030	.0032	.0036	.0036	.0040	.0040	.0040	.0040
	Max	.4678	.5267	.5892	.7098	.8290	.9540	1.0714	1.1964	1.3214	1.4464
Class 4, pitch diameter.....	Min	.4665	.5252	.5877	.7082	.8272	.9522	1.0694	1.1944	1.3194	1.4444
	Tol	.0013	.0015	.0015	.0016	.0018	.0018	.0020	.0020	.0020	.0020
	Max	.4678	.5267	.5892	.7098	.8290	.9540	1.0714	1.1964	1.3214	1.4464

¹ Dimensions given for the maximum minor diameter of the external thread are figured to the intersection of the worn tool arc with a center line through crest and root. The minimum minor diameter of the external thread shall be that corresponding to a flat at the minor diameter of the minimum external thread equal to 1/4 x p, and may be determined by subtracting the basic thread depth, h (or 0.6495p), from the minimum pitch diameter of the external thread.

² Dimensions for the minimum major diameter of the internal thread correspond to the basic fit (1/4 x p) and the profile at the major diameter produced by a worn tool must not fall below the basic outline. The maximum major diameter of the internal thread shall be that corresponding to a flat at the major diameter of the maximum internal thread equal to 1/4 x p, and may be determined by adding 1/4 x p (or 0.7930p) to the maximum pitch diameter of the internal thread.

³ These dimensions are the maximum material or "go" size, and are those which should be placed on the component drawing with the tolerances.

TABLE 1.10.—Limits of size and tolerances, classes 2 and 3, American National extra-fine-thread series, NEF

Limits of size and tolerances ¹	Size (inches)													
	3/4	7/16	3/8	7/16	1/2	9/16	5/8	1 1/16	3/4	1 1/16	7/8	1 1/2	1	
	Threads per inch													
	32	32	32	28	28	24	24	24	20	20	20	20	20	
EXTERNAL THREADS														
Classes 2 and 3, major diameter.....	Max.....	in. 0.2500	in. 0.3125	in. 0.3750	in. 0.4375	in. 0.5000	in. 0.5625	in. 0.6250	in. 0.6875	in. 0.7500	in. 0.8125	in. 0.8750	in. 0.9375	in. 1.0000
	Min.....	.2446	.3071	.3696	.4313	.4938	.5559	.6184	.6809	.7428	.8053	.8678	.9303	.9928
	Tol.....	.0054	.0054	.0054	.0062	.0062	.0066	.0066	.0066	.0072	.0072	.0072	.0072	.0072
Classes 2 and 3, minor diameter.....	Max ²2117	.2742	.3367	.3997	.4622	.5247	.5872	.6497	.7122	.7747	.8372	.8997	.9622
	Min.....	.2097	.2722	.3347	.3972	.4597	.5222	.5847	.6472	.7097	.7722	.8347	.8972	.9597
	Tol.....	.0032	.0033	.0034	.0036	.0037	.0040	.0041	.0041	.0046	.0046	.0047	.0047	.0048
Class 2, pitch diameter.....	Max ⁴2297	.2922	.3547	.4172	.4797	.5422	.6047	.6672	.7297	.7922	.8547	.9172	.9797
	Min.....	.2275	.2899	.3523	.4148	.4772	.5396	.6020	.6644	.7268	.7892	.8516	.9140	.9764
	Tol.....	.0022	.0023	.0024	.0025	.0026	.0028	.0029	.0029	.0032	.0032	.0033	.0033	.0034
Class 3, pitch diameter.....	Max ⁴2297	.2922	.3547	.4172	.4797	.5422	.6047	.6672	.7297	.7922	.8547	.9172	.9797
	Min.....	.2275	.2899	.3523	.4148	.4772	.5396	.6020	.6644	.7268	.7892	.8516	.9140	.9764
	Tol.....	.0022	.0023	.0024	.0025	.0026	.0028	.0029	.0029	.0032	.0032	.0033	.0033	.0034

Limits of size and tolerances ¹	Size (inches)													
	1 1/16	1 1/8	1 1/4	1 1/2	1 3/4	2	2 1/4	2 1/2	2 3/4	3	3 1/2	4		
	Threads per inch													
	18	18	18	16	18	18	18	18	18	18	18	16	16	
EXTERNAL THREADS														
Classes 2 and 3, major diameter.....	Max.....	in. 1.0625	in. 1.1250	in. 1.1875	in. 1.2500	in. 1.3125	in. 1.3750	in. 1.4375	in. 1.5000	in. 1.5625	in. 1.6250	in. 1.6875	in. 1.7500	in. 2.0000
	Min.....	1.0543	1.1168	1.1793	1.2418	1.3043	1.3668	1.4293	1.4918	1.5543	1.6168	1.6793	1.7418	1.9910
	Tol.....	.0082	.0082	.0082	.0082	.0082	.0082	.0082	.0082	.0082	.0082	.0082	.0082	.0090
Classes 2 and 3, minor diameter.....	Max ²9943	1.0568	1.1193	1.1818	1.2443	1.3068	1.3693	1.4318	1.4943	1.5568	1.6193	1.6733	1.9233
	Min.....	1.0284	1.0909	1.1534	1.2159	1.2784	1.3409	1.4034	1.4659	1.5284	1.5909	1.6534	1.7094	1.9594
	Tol.....	.0051	.0052	.0052	.0053	.0053	.0054	.0054	.0055	.0055	.0056	.0056	.0059	.0061
Class 2, pitch diameter.....	Max ⁴	1.0264	1.0889	1.1514	1.2139	1.2764	1.3389	1.4014	1.4639	1.5264	1.5889	1.6514	1.7094	1.9594
	Min.....	1.0213	1.0837	1.1462	1.2086	1.2711	1.3335	1.3960	1.4584	1.5209	1.5833	1.6458	1.7033	1.9533
	Tol.....	.0051	.0052	.0052	.0053	.0053	.0054	.0054	.0055	.0055	.0056	.0056	.0059	.0061
Class 3, pitch diameter.....	Max ⁴	1.0264	1.0889	1.1514	1.2139	1.2764	1.3389	1.4014	1.4639	1.5264	1.5889	1.6514	1.7094	1.9594
	Min.....	1.0228	1.0853	1.1478	1.2102	1.2727	1.3351	1.3976	1.4601	1.5225	1.5850	1.6475	1.7033	1.9551
	Tol.....	.0036	.0036	.0036	.0037	.0037	.0038	.0038	.0038	.0039	.0039	.0039	.0041	.0043
INTERNAL THREADS														
Classes 2 and 3, major diameter.....	Min ³	1.0625	1.1250	1.1875	1.2500	1.3125	1.3750	1.4375	1.5000	1.5625	1.6250	1.6875	1.7500	2.0000
	Max.....	1.0024	1.0649	1.1274	1.1899	1.2524	1.3149	1.3774	1.4399	1.5024	1.5649	1.6274	1.6823	1.9323
	Tol.....	1.0100	1.0725	1.1350	1.1975	1.2600	1.3225	1.3850	1.4475	1.5100	1.5725	1.6350	1.6903	1.9403
Class 2, pitch diameter.....	Min ⁴	1.0264	1.0889	1.1514	1.2139	1.2764	1.3389	1.4014	1.4639	1.5264	1.5889	1.6514	1.7094	1.9594
	Max.....	1.0315	1.0941	1.1566	1.2192	1.2817	1.3443	1.4068	1.4694	1.5319	1.5945	1.6570	1.7153	1.9653
	Tol.....	.0051	.0052	.0052	.0053	.0053	.0054	.0054	.0055	.0055	.0056	.0056	.0059	.0061
Class 3, pitch diameter.....	Min ⁴	1.0264	1.0889	1.1514	1.2139	1.2764	1.3389	1.4014	1.4639	1.5264	1.5889	1.6514	1.7094	1.9594
	Max.....	1.0300	1.0925	1.1550	1.2176	1.2801	1.3427	1.4052	1.4677	1.5303	1.5928	1.6553	1.7135	1.9637
	Tol.....	.0036	.0036	.0036	.0037	.0037	.0038	.0038	.0038	.0039	.0039	.0039	.0041	.0043

¹ Pitch diameter tolerances include deviations of lead and angle. The class 2 tolerances are based on the formulas in table 2.2 and a length of engagement of 9 threads. The class 3 tolerances are 70 percent of the class 2 tolerances.
² Dimensions given for the maximum minor diameter of the external thread are figured to the intersection of the worn tool arc with a center line through crest and root. The minimum minor diameter of the external thread shall be that corresponding to a flat at the minor diameter of the minimum external thread equal to $3/8 \times p$, and may be determined by subtracting the basic thread depth, h (or $0.6495 p$), from the minimum pitch diameter of the external thread.
³ Dimensions for the minimum major diameter of the internal thread correspond to the basic flat ($3/8 \times p$), and the profile at the major diameter produced by a worn tool must not fall below the basic outline. The maximum major diameter of the internal thread shall be that corresponding to a flat at the major diameter of the maximum internal thread equal to $3/4 \times p$, and may be determined by adding $1/4 \times h$ (or $0.709 p$) to the maximum pitch diameter of the internal thread.
⁴ These dimensions are the maximum material or "go" size, and are those which should be placed on the component drawing with the tolerances.

TABLE 1.11.—Limits of size and tolerances, classes 2 and 3, American National 8-thread series, 8N

Limits of size and tolerances ¹		Size (inches)								
		1 1/8	1 1/4	1 3/8	1 1/2	1 5/8	1 3/4	1 7/8	2	
EXTERNAL THREADS		<i>in.</i>	<i>in.</i>	<i>in.</i>	<i>in.</i>	<i>in.</i>	<i>in.</i>	<i>in.</i>	<i>in.</i>	<i>in.</i>
Classes 2 and 3, major diameter	{Max	1.0000	1.1250	1.2500	1.3750	1.5000	1.6250	1.7500	1.8750	2.0000
	{Min	.9848	1.1098	1.2348	1.3598	1.4848	1.6098	1.7348	1.8598	1.9848
	{Tol	.0152	.0152	.0152	.0152	.0152	.0152	.0152	.0152	.0152
Classes 2 and 3, minor diameter	Max ³	.8466	.9716	1.0966	1.2216	1.3466	1.4716	1.5966	1.7216	1.8466
Class 2, pitch diameter (for general use)	{Max ³	.9188	1.0438	1.1688	1.2938	1.4188	1.5438	1.6688	1.7938	1.9188
	{Min	.9112	1.0359	1.1605	1.2852	1.4098	1.5345	1.6591	1.7838	1.9084
	{Tol	.0076	.0079	.0083	.0086	.0090	.0093	.0097	.0100	.0104
Class 3, pitch diameter	{Max ³	.9188	1.0438	1.1688	1.2938	1.4188	1.5438	1.6688	1.7938	1.9188
	{Min	.9134	1.0383	1.1633	1.2877	1.4125	1.5373	1.6620	1.7868	1.9115
	{Tol	.0054	.0055	.0058	.0061	.0063	.0065	.0068	.0070	.0073
INTERNAL THREADS										
Classes 2 and 3, major diameter	Min ⁴	1.0000	1.1250	1.2500	1.3750	1.5000	1.6250	1.7500	1.8750	2.0000
Classes 2 and 3, minor diameter	{Min	.8647	.9897	1.1147	1.2397	1.3647	1.4897	1.6147	1.7397	1.8647
	{Max	.8795	1.0045	1.1295	1.2545	1.3795	1.5045	1.6295	1.7545	1.8795
	{Tol	.0148	.0148	.0148	.0148	.0148	.0148	.0148	.0148	.0148
Classes 2 and 3, pitch diameter	Min ⁴	.9188	1.0438	1.1688	1.2938	1.4188	1.5438	1.6688	1.7938	1.9188
Class 2, pitch diameter (for general use)	{Max	.9264	1.0517	1.1771	1.3024	1.4278	1.5531	1.6785	1.8038	1.9292
	{Tol	.0076	.0079	.0083	.0086	.0090	.0093	.0097	.0100	.0104
	{Max	.9242	1.0493	1.1746	1.2999	1.4251	1.5503	1.6756	1.8008	1.9261
Class 3, pitch diameter	{Tol	.0054	.0055	.0058	.0061	.0063	.0065	.0068	.0070	.0073

Limits of size and tolerances ¹		Size (inches)								
		2 3/8	2 1/4	2 1/2	2 3/4	3	3 1/4	3 1/2	3 3/4	4
EXTERNAL THREADS		<i>in.</i>	<i>in.</i>	<i>in.</i>	<i>in.</i>	<i>in.</i>	<i>in.</i>	<i>in.</i>	<i>in.</i>	<i>in.</i>
Classes 2 and 3, major diameter	{Max	2.1250	2.2500	2.5000	2.7500	3.0000	3.2500	3.5000	3.7500	4.0000
	{Min	2.1098	2.2348	2.4848	2.7348	2.9848	3.2348	3.4848	3.7348	3.9848
	{Tol	.0152	.0152	.0152	.0152	.0152	.0152	.0152	.0152	.0152
Classes 2 and 3, minor diameter	Max ³	1.9716	2.0966	2.3466	2.5966	2.8466	3.0966	3.3466	3.5966	3.8466
Class 2, pitch diameter (for general use)	{Max ³	2.0438	2.1688	2.4188	2.6688	2.9188	3.1688	3.4188	3.6688	3.9188
	{Min	2.0331	2.1578	2.4071	2.6564	2.9058	3.1556	3.4055	3.6554	3.9053
	{Tol	.0107	.0110	.0117	.0124	.0130	.0132	.0133	.0134	.0135
Class 3, pitch diameter	{Max ³	2.0438	2.1688	2.4188	2.6688	2.9188	3.1688	3.4188	3.6688	3.9188
	{Min	2.0323	2.1611	2.4166	2.6701	2.9096	3.1595	3.4095	3.6594	3.9093
	{Tol	.0075	.0077	.0082	.0087	.0092	.0093	.0093	.0094	.0095
INTERNAL THREADS										
Classes 2 and 3, major diameter	Min ⁴	2.1250	2.2500	2.5000	2.7500	3.0000	3.2500	3.5000	3.7500	4.0000
Classes 2 and 3, minor diameter	{Min	1.9897	2.1147	2.3647	2.6147	2.8647	3.1147	3.3647	3.6147	3.8647
	{Max	2.0045	2.1295	2.3795	2.6295	2.8795	3.1295	3.3795	3.6295	3.8795
	{Tol	.0148	.0148	.0148	.0148	.0148	.0148	.0148	.0148	.0148
Classes 2 and 3, pitch diameter	Min ⁴	2.0438	2.1688	2.4188	2.6688	2.9188	3.1688	3.4188	3.6688	3.9188
Class 2, pitch diameter (for general use)	{Max	2.0545	2.1798	2.4305	2.6812	2.9318	3.1820	3.4321	3.6822	3.9323
	{Tol	.0107	.0110	.0117	.0124	.0130	.0132	.0133	.0134	.0135
	{Max	2.0513	2.1765	2.4270	2.6775	2.9280	3.1781	3.4281	3.6782	3.9283
Class 3, pitch diameter	{Tol	.0075	.0077	.0082	.0087	.0092	.0093	.0093	.0094	.0095

See footnotes at end of table.

TABLE 1.11. *Limits of size and tolerances, classes 2 and 3, American National 8-thread series, 3N* Continued

Limits of size and tolerances ¹		Size (inches)							
		4 ¹ / ₄	4 ¹ / ₂	4 ³ / ₄	5	5 ¹ / ₄	5 ¹ / ₂	5 ³ / ₄	6
EXTERNAL THREADS		<i>m.</i>	<i>m.</i>	<i>m.</i>	<i>m.</i>	<i>m.</i>	<i>m.</i>	<i>m.</i>	<i>m.</i>
Classes 2 and 3, major diameter	Max	4.2500	4.5000	4.7500	5.0000	5.2500	5.5000	5.7500	6.0000
	Min	4.2348	4.4848	4.7348	4.9848	5.2348	5.4848	5.7348	5.9848
	Tol	.0152	.0152	.0152	.0152	.0152	.0152	.0152	.0152
Classes 2 and 3, minor diameter	Max. ²	4.0966	4.3466	4.5966	4.8466	5.0966	5.3466	5.5966	5.8466
Class 2, pitch diameter (for general use)	Max. ³	4.1683	4.4183	4.6683	4.9183	5.1683	5.4183	5.6683	5.9183
	Min	4.1551	4.4050	4.6549	4.9048	5.1547	5.4046	5.6545	5.9044
	Tol	.0137	.0138	.0139	.0140	.0141	.0142	.0143	.0144
Class 3, pitch diameter	Max. ³	4.1688	4.4188	4.6688	4.9188	5.1688	5.4188	5.6688	5.9188
	Min	4.1592	4.4091	4.6590	4.9089	5.1589	5.4088	5.6587	5.9086
	Tol	.0096	.0097	.0098	.0099	.0099	.0100	.0101	.0102
INTERNAL THREADS									
Classes 2 and 3, major diameter	Min. ⁴	4.2500	4.5000	4.7500	5.0000	5.2500	5.5000	5.7500	6.0000
Classes 2 and 3, minor diameter	Min	4.1147	4.3647	4.6147	4.8647	5.1147	5.3647	5.6147	5.8647
	Max	4.1295	4.3795	4.6295	4.8795	5.1295	5.3795	5.6295	5.8795
	Tol	.0148	.0148	.0148	.0148	.0148	.0148	.0148	.0148
Classes 2 and 3, pitch diameter	Min. ⁵	4.1688	4.4188	4.6688	4.9188	5.1688	5.4188	5.6688	5.9188
Class 2, pitch diameter (for general use)	Max	4.1825	4.4325	4.6825	4.9325	5.1825	5.4325	5.6831	5.9332
	Tol	.0137	.0138	.0139	.0140	.0141	.0142	.0143	.0144
Class 3, pitch diameter	Max	4.1784	4.4285	4.6786	4.9287	5.1787	5.4288	5.6789	5.9289
	Tol	.0096	.0097	.0098	.0099	.0099	.0100	.0101	.0102

¹ Pitch diameter tolerances include deviations of lead and angle. The class 2 tolerances are based on the formulas in table 2.2 and a length of engagement equal to the basic major diameter for sizes from 1/8 to 3 inches, inclusive, and a length of engagement of 3 inches for sizes over this 3-inch. The class 3 tolerances are 70 percent of the class 2 tolerances. The 1-inch size being in the American National coarse-thread series, the tolerances for this size correspond to that series.

² Standard size of the American National coarse-thread series

³ Dimensions given for the maximum minor diameter of the external thread are figured to the intersection of the worn tool line with a center line through crest and root. The minimum minor diameter of the external thread shall be that corresponding to a flat at the minor diameter of the minimum external thread equal to $\frac{1}{8} \times p$, and may be determined by subtracting 0.0812 inch from the minimum pitch diameter of the external thread.

⁴ Dimensions for the minimum major diameter of the internal thread correspond to the basic flat ($\frac{1}{8} \times p$), and the profile at the major diameter produced by a worn tool must not fall below the basic outline. The maximum major diameter of the internal thread shall be that corresponding to a flat at the major diameter of the maximum internal thread equal to $\frac{1}{4} \times p$, and may be determined by adding 0.0392 inch to the maximum pitch diameter of the internal thread.

⁵ These dimensions are the maximum material or "go" size, and are those which should be placed on the component drawing with the tolerances.

TABLE 1.12. --Limits of size and tolerances, classes 2 and 3, American National 12-thread series, 12N

Limits of size and tolerances ¹		Size (inches)							
		3/2	9/16 ²	3/4	13/16	7/8	15/16	7/8	15/16
EXTERNAL THREADS		in.	in.	in.	in.	in.	in.	in.	in.
Classes 2 and 3, major diameter.....	{Max.....	0.5000	0.5025	0.6250	0.6875	0.7500	0.8125	0.8750	0.9375
	{Min.....	.4888	.5513	.6138	.6763	.7388	.8013	.8638	.9263
	{Tol.....	.0112	.0112	.0112	.0112	.0112	.0112	.0112	.0112
Classes 2 and 3, minor diameter.....	Max ⁴3978	.4603	.5228	.5853	.6478	.7103	.7728	.8353
Class 2, pitch diameter (for general use).....	{Max ⁵4459	.5084	.5709	.6334	.6959	.7584	.8209	.8834
	{Min.....	.4403	.5028	.5653	.6278	.6903	.7528	.8153	.8778
	{Tol.....	.0056	.0056	.0056	.0056	.0056	.0056	.0056	.0056
Class 3, pitch diameter.....	{Max ⁵4459	.5084	.5709	.6334	.6959	.7584	.8209	.8834
	{Min.....	.4419	.5044	.5669	.6294	.6919	.7544	.8169	.8794
	{Tol.....	.0040	.0040	.0040	.0040	.0040	.0040	.0040	.0040
INTERNAL THREADS									
Classes 2 and 3, major diameter.....	Min ⁴5000	.5025	.6250	.6875	.7500	.8125	.8750	.9375
Classes 2 and 3, minor diameter.....	{Min.....	.4098	.4723	.5348	.5973	.6598	.7223	.7848	.8473
	{Max.....	.4225	.4850	.5475	.6100	.6725	.7350	.7975	.8600
	{Tol.....	.0127	.0127	.0090	.0090	.0090	.0090	.0090	.0090
Classes 2 and 3, pitch diameter.....	Min ⁶4459	.5084	.5709	.6334	.6959	.7584	.8209	.8834
Class 2, pitch diameter (for general use).....	{Max.....	.4515	.5140	.5765	.6390	.7015	.7640	.8265	.8890
	{Min.....	.0056	.0056	.0056	.0056	.0056	.0056	.0056	.0056
	{Tol.....	.0056	.0056	.0056	.0056	.0056	.0056	.0056	.0056
Class 3, pitch diameter.....	{Max.....	.4499	.5124	.5749	.6374	.6999	.7624	.8249	.8874
	{Min.....	.0040	.0040	.0040	.0040	.0040	.0040	.0040	.0040
	{Tol.....	.0040	.0040	.0040	.0040	.0040	.0040	.0040	.0040

Limits of size and tolerances ¹		Size (inches)						
		1	1 1/16 ²	1 1/8 ³	1 3/16	1 1/4 ⁴	1 5/16	1 3/8 ⁵
EXTERNAL THREADS		in.	in.	in.	in.	in.	in.	in.
Classes 2 and 3, major diameter.....	{Max.....	1.0000	1.0625	1.1250	1.1875	1.2500	1.3125	1.3750
	{Min.....	.9888	1.0513	1.1138	1.1763	1.2388	1.3013	1.3638
	{Tol.....	.0112	.0112	.0112	.0112	.0112	.0112	.0112
Classes 2 and 3, minor diameter.....	Max ⁴8978	.9603	1.0228	1.0853	1.1478	1.2103	1.2728
Class 2, pitch diameter (for general use).....	{Max ⁵9459	1.0084	1.0709	1.1334	1.1959	1.2584	1.3209
	{Min.....	.9403	1.0028	1.0653	1.1278	1.1903	1.2528	1.3153
	{Tol.....	.0056	.0056	.0056	.0056	.0056	.0056	.0056
Class 3, pitch diameter.....	{Max ⁵9459	1.0084	1.0709	1.1334	1.1959	1.2584	1.3209
	{Min.....	.9419	1.0044	1.0669	1.1294	1.1919	1.2544	1.3169
	{Tol.....	.0040	.0040	.0040	.0040	.0040	.0040	.0040
INTERNAL THREADS								
Classes 2 and 3, major diameter.....	Min ⁴	1.0000	1.0625	1.1250	1.1875	1.2500	1.3125	1.3750
Classes 2 and 3, minor diameter.....	{Min.....	.9098	.9723	1.0348	1.0973	1.1598	1.2223	1.2848
	{Max.....	.9188	.9813	1.0438	1.1063	1.1688	1.2313	1.2938
	{Tol.....	.0090	.0090	.0090	.0090	.0090	.0090	.0090
Classes 2 and 3, pitch diameter.....	Min ⁶9459	1.0084	1.0709	1.1334	1.1959	1.2584	1.3209
Class 2, pitch diameter (for general use).....	{Max.....	.9515	1.0140	1.0765	1.1390	1.2015	1.2640	1.3265
	{Min.....	.0056	.0056	.0056	.0056	.0056	.0056	.0056
	{Tol.....	.0056	.0056	.0056	.0056	.0056	.0056	.0056
Class 3, pitch diameter.....	{Max.....	.9499	1.0124	1.0749	1.1374	1.1999	1.2624	1.3249
	{Min.....	.0040	.0040	.0040	.0040	.0040	.0040	.0040
	{Tol.....	.0040	.0040	.0040	.0040	.0040	.0040	.0040

See footnotes at end of table.

TABLE 1.12.—Limits of size and tolerances, classes 2 and 3, American National 12-thread series, 12N—Continued

Limits of size and tolerances ¹		Size (inches)							
		1 3/16	1 1/2	1 5/8	1 3/4	1 7/8	2	2 1/8	2 1/4
EXTERNAL THREADS		<i>in.</i>	<i>in.</i>	<i>in.</i>	<i>in.</i>	<i>in.</i>	<i>in.</i>	<i>in.</i>	<i>in.</i>
Classes 2 and 3, major diameter.....	Max.....	1.4375	1.5000	1.6250	1.7500	1.8750	2.0000	2.1250	2.2500
	Min.....	1.4263	1.4888	1.6138	1.7388	1.8638	1.9888	2.1138	2.2388
	Tol.....	.0112	.0112	.0112	.0112	.0112	.0112	.0112	.0112
Classes 2 and 3, minor diameter.....	Max ⁴	1.3353	1.3978	1.5228	1.6478	1.7728	1.8978	2.0228	2.1478
Class 2, pitch diameter (for general use).....	Max ⁶	1.3834	1.4459	1.5709	1.6959	1.8209	1.9459	2.0709	2.1959
	Min.....	1.3778	1.4403	1.5645	1.6894	1.8143	1.9392	2.0641	2.1890
	Tol.....	.0056	.0056	.0064	.0065	.0066	.0067	.0068	.0069
Class 3, pitch diameter.....	Max ⁶	1.3834	1.4459	1.5709	1.6959	1.8209	1.9459	2.0709	2.1959
	Min.....	1.3794	1.4419	1.5664	1.6913	1.8163	1.9412	2.0661	2.1911
	Tol.....	.0040	.0040	.0045	.0046	.0046	.0047	.0048	.0048
INTERNAL THREADS									
Classes 2 and 3, major diameter.....	Min ⁵	1.4375	1.5000	1.6250	1.7500	1.8750	2.0000	2.1250	2.2500
Classes 2 and 3, minor diameter.....	Min.....	1.3473	1.4098	1.5348	1.6598	1.7848	1.9098	2.0348	2.1598
	Max.....	1.3563	1.4188	1.5438	1.6688	1.7938	1.9188	2.0438	2.1688
	Tol.....	.0090	.0090	.0090	.0090	.0090	.0090	.0090	.0090
Classes 2 and 3, pitch diameter.....	Min ⁶	1.3834	1.4459	1.5709	1.6959	1.8209	1.9459	2.0709	2.1959
Class 2, pitch diameter (for general use).....	Max.....	1.3890	1.4515	1.5773	1.7024	1.8275	1.9526	2.0777	2.2028
	Min.....	1.3794	1.4419	1.5664	1.6915	1.8166	1.9417	2.0668	2.1919
	Tol.....	.0056	.0056	.0064	.0065	.0066	.0067	.0068	.0069
Class 3, pitch diameter.....	Max.....	1.3874	1.4499	1.5754	1.7005	1.8255	1.9506	2.0757	2.2007
	Tol.....	.0040	.0040	.0045	.0046	.0046	.0047	.0048	.0048

Limits of size and tolerances ¹		Size (inches)						
		2 3/8	2 1/2	2 5/8	2 3/4	2 7/8	3	3 1/8
EXTERNAL THREADS		<i>in.</i>	<i>in.</i>	<i>in.</i>	<i>in.</i>	<i>in.</i>	<i>in.</i>	<i>in.</i>
Classes 2 and 3, major diameter.....	Max.....	2.3750	2.5000	2.6250	2.7500	2.8750	3.0000	3.1250
	Min.....	2.3638	2.4888	2.6138	2.7388	2.8638	2.9888	3.1138
	Tol.....	.0112	.0112	.0112	.0112	.0112	.0112	.0112
Classes 2 and 3, minor diameter.....	Max ⁴	2.2728	2.3978	2.5228	2.6478	2.7728	2.8978	3.0228
Class 2, pitch diameter (for general use).....	Max ⁶	2.3209	2.4459	2.5709	2.6959	2.8209	2.9459	3.0709
	Min.....	2.3139	2.4388	2.5638	2.6887	2.8136	2.9385	3.0635
	Tol.....	.0070	.0071	.0071	.0072	.0073	.0074	.0074
Class 3, pitch diameter.....	Max ⁶	2.3209	2.4459	2.5709	2.6959	2.8209	2.9459	3.0709
	Min.....	2.3160	2.4410	2.5659	2.6909	2.8158	2.9408	3.0657
	Tol.....	.0049	.0049	.0050	.0050	.0051	.0051	.0052
INTERNAL THREADS								
Classes 2 and 3, major diameter.....	Min ⁵	2.3750	2.5000	2.6250	2.7500	2.8750	3.0000	3.1250
Classes 2 and 3, minor diameter.....	Min.....	2.2848	2.4098	2.5348	2.6598	2.7848	2.9098	3.0348
	Max.....	2.2938	2.4188	2.5438	2.6688	2.7938	2.9188	3.0438
	Tol.....	.0090	.0090	.0090	.0090	.0090	.0090	.0090
Classes 2 and 3, pitch diameter.....	Min ⁶	2.3209	2.4459	2.5709	2.6959	2.8209	2.9459	3.0709
Class 2, pitch diameter (for general use).....	Max.....	2.3279	2.4530	2.5780	2.7031	2.8282	2.9533	3.0783
	Min.....	2.3170	2.4420	2.5670	2.6921	2.8172	2.9423	3.0674
	Tol.....	.0070	.0071	.0071	.0072	.0073	.0074	.0074
Class 3, pitch diameter.....	Max.....	2.3258	2.4508	2.5759	2.7009	2.8260	2.9510	3.0761
	Tol.....	.0049	.0049	.0050	.0050	.0051	.0051	.0052

See footnotes at end of table.

TABLE 1.12. Limits of size and tolerances, classes 2 and 3, American National 12-thread series, 12N—Continued

Limits of size and tolerances ¹		Size (inches)							
		3¼	3½	3¾	3⅞	3⅞	3⅞	4	4¼
EXTERNAL THREADS									
Classes 2 and 3, major diameter	Max	<i>in.</i> 3.2500	<i>in.</i> 3.3750	<i>in.</i> 3.5000	<i>in.</i> 3.6250	<i>in.</i> 3.7500	<i>in.</i> 3.8750	<i>in.</i> 4.0000	<i>in.</i> 4.2500
	Min	3.2388	3.3638	3.4888	3.6138	3.7388	3.8638	3.9888	4.2388
	Tol	.0112	.0112	.0112	.0112	.0112	.0112	.0112	.0112
Classes 2 and 3, minor diameter	Max	3.1478	3.2728	3.3978	3.5228	3.6478	3.7728	3.8978	4.1478
Class 2, pitch diameter (for general use)	Max	3.1959	3.3209	3.4459	3.5709	3.6959	3.8209	3.9459	4.1959
	Min	3.1841	3.3133	3.4383	3.5632	3.6881	3.8131	3.9380	4.1879
	Tol	.0075	.0076	.0076	.0077	.0078	.0078	.0079	.0080
Class 3, pitch diameter	Max	3.1959	3.3209	3.4459	3.5709	3.6959	3.8209	3.9459	4.1959
	Min	3.1302	3.3156	3.4406	3.5655	3.6905	3.8154	3.9404	4.1903
	Tol	.0052	.0053	.0053	.0054	.0054	.0055	.0055	.0056
INTERNAL THREADS									
Classes 2 and 3, major diameter	Min	3.2500	3.3750	3.5000	3.6250	3.7500	3.8750	4.0000	4.2500
Classes 2 and 3, minor diameter	Min	3.1398	3.2808	3.4098	3.5318	3.6598	3.7898	3.9098	4.1598
	Max	3.1988	3.2938	3.4188	3.5438	3.6688	3.7938	3.9188	4.1688
	Tol	.0090	.0090	.0090	.0090	.0090	.0090	.0090	.0090
Classes 2 and 3, pitch diameter	Min	3.1959	3.3209	3.4459	3.5709	3.6959	3.8209	3.9459	4.1959
Class 2, pitch diameter (for general use)	Max	3.2034	3.3285	3.4535	3.5786	3.7037	3.8287	3.9538	4.2039
	Min	3.1302	3.3156	3.4406	3.5655	3.6905	3.8154	3.9404	4.1903
	Tol	.0075	.0076	.0076	.0077	.0078	.0078	.0079	.0080
Class 3, pitch diameter	Max	3.2011	3.3262	3.4512	3.5763	3.7013	3.8264	3.9514	4.2015
	Tol	.0052	.0053	.0053	.0054	.0054	.0055	.0055	.0056

Limits of size and tolerances ¹		Size (inches)						
		4½	4¾	5	5¼	5½	5¾	6
EXTERNAL THREADS								
Classes 2 and 3, major diameter	Max	<i>in.</i> 4.5000	<i>in.</i> 4.7500	<i>in.</i> 5.0000	<i>in.</i> 5.2500	<i>in.</i> 5.5000	<i>in.</i> 5.7500	<i>in.</i> 6.0000
	Min	4.4888	4.7388	4.9888	5.2388	5.4888	5.7388	5.9888
	Tol	.0112	.0112	.0112	.0112	.0112	.0112	.0112
Class 2 and 3, minor diameter	Max	4.3978	4.6478	4.8978	5.1478	5.3978	5.6478	5.8978
Class 2, pitch diameter (for general use)	Max	4.4459	4.6959	4.9459	5.1959	5.4459	5.6959	5.9459
	Min	4.4378	4.6878	4.9378	5.1878	5.4378	5.6878	5.9378
	Tol	.0081	.0083	.0084	.0085	.0086	.0087	.0088
Class 3, pitch diameter	Max	4.4459	4.6959	4.9459	5.1959	5.4459	5.6959	5.9459
	Min	4.4402	4.6902	4.9402	5.1902	5.4402	5.6902	5.9402
	Tol	.0057	.0058	.0059	.0059	.0060	.0061	.0062
INTERNAL THREADS								
Classes 2 and 3, major diameter	Min	4.5000	4.7500	5.0000	5.2500	5.5000	5.7500	6.0000
Classes 2 and 3, minor diameter	Min	4.4098	4.6598	4.9098	5.1598	5.4098	5.6598	5.9098
	Max	4.4188	4.6688	4.9188	5.1688	5.4188	5.6688	5.9188
	Tol	.0090	.0090	.0090	.0090	.0090	.0090	.0090
Classes 2 and 3, pitch diameter	Min	4.4459	4.6959	4.9459	5.1959	5.4459	5.6959	5.9459
Class 2, pitch diameter (for general use)	Max	4.4549	4.7049	4.9549	5.2049	5.4549	5.7049	5.9549
	Min	4.4402	4.6902	4.9402	5.1902	5.4402	5.6902	5.9402
	Tol	.0081	.0083	.0084	.0085	.0086	.0087	.0088
Class 3, pitch diameter	Max	4.4516	4.7016	4.9516	5.2016	5.4516	5.7016	5.9516
	Tol	.0057	.0058	.0059	.0059	.0060	.0061	.0062

¹ Pitch diameter tolerances include deviations of lead and angle. The class 2 tolerances for sizes above 1½ in. are based on the formulas in table 2.2 and a length of engagement of 0.75 in. or ¾ in. The class 3 tolerances are 70 percent of the class 2 tolerances. For lengths of engagement of 1 in., 0.0019 in. may be added to these tolerances. As a rule, sizes up to 1½ in. are included in the American National coarse or fine thread series, the tolerances to and including 1½ in. correspond to those series.

² Standard size of the American National coarse thread series.

³ Standard size of the American National fine thread series.

⁴ Dimensions given for the maximum minor diameter of the external thread are figured to the intersection of the worm tool add with a center line through crest and root. The minimum minor diameter of the external thread shall be that corresponding to a flat at the minor diameter of the minimum external thread equal to $3/8p$, and may be determined by subtracting 0.0541 in. from the minimum pitch diameter of the external thread.

⁵ Dimensions for the minimum major diameter of the internal thread correspond to the basic flat $0.5/8p$ and the profile at the major diameter produced by a worm tool must not fall below the basic outline. The maximum major diameter of the internal thread shall be that corresponding to a flat at the major diameter of the maximum external thread equal to $3/8p$, and may be determined by adding 0.0562 in. to the maximum pitch diameter of the internal thread.

⁶ These dimensions are the maximum material or "go" size, and are those which should be placed on the component drawing with the tolerances.

TABLE 1.13.—Limits of size and tolerances, classes 2 and 3, American National 16-thread series, 16X

Limits of size and tolerances 1		Size (inches)									
		3/16	7/16	1/2	5/8	3/4	7/8	1	1 1/8	1 1/4	1 1/2
EXTERNAL THREADS											
Classes 2 and 3, major diameter	Max	0.7500	0.8125	0.8750	0.9375	1.0000	1.0625	1.1250	1.1875	1.2500	1.3125
	Min	.7410	.8035	.8660	.9285	.9910	1.0535	1.1160	1.1785	1.2410	1.3035
	Tol	.0088	.0090	.0090	.0090	.0090	.0090	.0090	.0090	.0090	.0090
Classes 2 and 3, minor diameter	Max	.6733	.7358	.7983	.8608	.9233	.9858	1.0483	1.1108	1.1733	1.2358
Class 2, pitch diameter (for general use)	Max	.7094	.7719	.8344	.8969	.9594	1.0219	1.0844	1.1469	1.2094	1.2719
	Min	.7048	.7673	.8298	.8923	.9548	1.0173	1.0798	1.1423	1.2048	1.2673
	Tol	.0045	.0051	.0055	.0059	.0062	.0063	.0064	.0064	.0065	.0065
Class 3, pitch diameter	Max	.7054	.7679	.8304	.8929	.9554	1.0179	1.0804	1.1429	1.2054	1.2679
Min	.7002	.7627	.8252	.8877	.9502	1.0127	1.0752	1.1377	1.2002	1.2627	
Tol	.0052	.0055	.0056	.0057	.0057	.0057	.0058	.0058	.0058	.0059	
INTERNAL THREADS											
Classes 2 and 3, major diameter	Min	.7569	.8195	.8820	.9445	1.0070	1.0695	1.1320	1.1945	1.2570	1.3195
Classes 2 and 3, minor diameter	Min	.6823	.7448	.8073	.8698	.9323	.9948	1.0573	1.1198	1.1823	1.2448
	Max	.6913	.7538	.8163	.8788	.9413	1.0038	1.0663	1.1288	1.1913	1.2538
	Tol	.0090	.0090	.0090	.0090	.0090	.0090	.0090	.0090	.0090	.0090
Class 2, pitch diameter (for general use)	Min	.7094	.7719	.8344	.8969	.9594	1.0219	1.0844	1.1469	1.2094	1.2719
	Max	.7139	.7764	.8389	.9014	.9639	1.0264	1.0889	1.1514	1.2139	1.2764
	Tol	.0045	.0051	.0055	.0059	.0062	.0063	.0064	.0064	.0065	.0065
Class 3, pitch diameter	Min	.7094	.7719	.8344	.8969	.9594	1.0219	1.0844	1.1469	1.2094	1.2719
Max	.7126	.7751	.8376	.9001	.9626	1.0251	1.0876	1.1501	1.2126	1.2751	
Tol	.0032	.0035	.0036	.0036	.0037	.0037	.0038	.0038	.0038	.0039	
EXTERNAL THREADS											
Classes 2 and 3, major diameter	Max	1.3750	1.4375	1.5000	1.5625	1.6250	1.6875	1.7500	1.8125	1.8750	1.9375
	Min	1.3660	1.4285	1.4910	1.5535	1.6160	1.6785	1.7410	1.8035	1.8660	1.9285
	Tol	.0090	.0090	.0090	.0090	.0090	.0090	.0090	.0090	.0090	.0090
Classes 2 and 3, minor diameter	Max	1.2983	1.3608	1.4233	1.4858	1.5483	1.6108	1.6733	1.7358	1.7983	1.8608
Class 2, pitch diameter (for general use)	Max	1.3344	1.3969	1.4594	1.5219	1.5844	1.6469	1.7094	1.7719	1.8344	1.8969
	Min	1.3288	1.3913	1.4537	1.5161	1.5786	1.6411	1.7035	1.7660	1.8284	1.8909
	Tol	.0056	.0056	.0057	.0058	.0058	.0058	.0059	.0059	.0060	.0060
Class 3, pitch diameter	Max	1.3344	1.3969	1.4594	1.5219	1.5844	1.6469	1.7094	1.7719	1.8344	1.8969
Min	1.3305	1.3929	1.4554	1.5179	1.5803	1.6428	1.7053	1.7677	1.8302	1.8927	
Tol	.0039	.0040	.0040	.0040	.0041	.0041	.0041	.0042	.0042	.0042	
INTERNAL THREADS											
Classes 2 and 3, major diameter	Min	1.3750	1.4375	1.5000	1.5625	1.6250	1.6875	1.7500	1.8125	1.8750	1.9375
Classes 2 and 3, minor diameter	Min	1.3025	1.3650	1.4275	1.4900	1.5525	1.6150	1.6775	1.7400	1.8025	1.8650
	Max	1.3153	1.3778	1.4403	1.5028	1.5653	1.6278	1.6903	1.7528	1.8153	1.8778
	Tol	.0080	.0080	.0080	.0080	.0080	.0080	.0080	.0080	.0080	.0080
Class 2, pitch diameter (for general use)	Min	1.3344	1.3969	1.4594	1.5219	1.5844	1.6469	1.7094	1.7719	1.8344	1.8969
	Max	1.3400	1.4025	1.4651	1.5277	1.5902	1.6527	1.7153	1.7778	1.8404	1.9029
	Tol	.0056	.0056	.0057	.0058	.0058	.0058	.0059	.0059	.0060	.0060
Class 3, pitch diameter	Min	1.3344	1.3969	1.4594	1.5219	1.5844	1.6469	1.7094	1.7719	1.8344	1.8969
Max	1.3383	1.4009	1.4634	1.5259	1.5885	1.6510	1.7135	1.7761	1.8386	1.9011	
Tol	.0039	.0040	.0040	.0040	.0041	.0041	.0041	.0042	.0042	.0042	

See footnotes at end of table.

TABLE 1.13.—Limits of size and tolerances, classes 2 and 3, American National 16-thread series, 16N—Continued

Limits of size and tolerances ¹		Size (inches)									
		2	2 1/16	2 1/8	2 1/4	2 1/2	2 3/8	2 1/2	2 3/4	2 7/8	2 3/4
EXTERNAL THREADS											
Classes 2 and 3, major diameter.....	Max.....	2.0000	2.0625	2.1250	2.1875	2.2500	2.3125	2.3750	2.4375	2.5000	2.6250
	Min.....	1.9910	2.0535	2.1160	2.1785	2.2410	2.3035	2.3660	2.4285	2.4910	2.6160
	Tol.....	.0090	.0090	.0090	.0090	.0090	.0090	.0090	.0090	.0090	.0090
Classes 2 and 3, minor diameter.....	Max ²	1.9233	1.9858	2.0483	2.1108	2.1733	2.2358	2.2983	2.3608	2.4233	2.5483
Class 2, pitch diameter (for general use).....	Max ³	1.9594	2.0219	2.0844	2.1469	2.2094	2.2719	2.3344	2.3969	2.4594	2.5844
	Min.....	1.9504	2.0129	2.0754	2.1379	2.2004	2.2629	2.3254	2.3879	2.4504	2.5754
	Tol.....	.0090	.0090	.0090	.0090	.0090	.0090	.0090	.0090	.0090	.0090
Class 3, pitch diameter.....	Max ⁴	1.9594	2.0219	2.0844	2.1469	2.2094	2.2719	2.3344	2.3969	2.4594	2.5844
	Min.....	1.9551	2.0176	2.0801	2.1426	2.2051	2.2676	2.3301	2.3926	2.4551	2.5801
	Tol.....	.0043	.0043	.0043	.0043	.0043	.0043	.0043	.0043	.0043	.0043
INTERNAL THREADS											
Classes 2 and 3, major diameter.....	Min ⁴	2.0000	2.0625	2.1250	2.1875	2.2500	2.3125	2.3750	2.4375	2.5000	2.6250
Classes 2 and 3, minor diameter.....	Min.....	1.9323	1.9948	2.0573	2.1198	2.1823	2.2448	2.3073	2.3698	2.4323	2.5573
	Max.....	1.9403	2.0028	2.0653	2.1278	2.1903	2.2528	2.3153	2.3778	2.4403	2.5653
	Tol.....	.0080	.0080	.0080	.0080	.0080	.0080	.0080	.0080	.0080	.0080
Class 2, pitch diameter (for general use).....	Min ⁴	1.9594	2.0219	2.0844	2.1469	2.2094	2.2719	2.3344	2.3969	2.4594	2.5844
	Max.....	1.9655	2.0280	2.0905	2.1531	2.2156	2.2782	2.3407	2.4033	2.4658	2.5908
	Tol.....	.0061	.0061	.0061	.0061	.0061	.0061	.0061	.0061	.0061	.0061
Class 3, pitch diameter.....	Min ⁴	1.9594	2.0219	2.0844	2.1469	2.2094	2.2719	2.3344	2.3969	2.4594	2.5844
	Max.....	1.9637	2.0262	2.0887	2.1512	2.2138	2.2763	2.3388	2.4014	2.4639	2.5889
	Tol.....	.0043	.0043	.0043	.0043	.0043	.0043	.0043	.0043	.0043	.0043

Limits of size and tolerances ¹		Size (inches)										
		2 3/4	2 7/8	3	3 1/8	3 1/4	3 3/8	3 1/2	3 5/8	3 3/4	3 7/8	4
EXTERNAL THREADS												
Classes 2 and 3, major diameter.....	Max.....	2.7500	2.8750	3.0000	3.1250	3.2500	3.3750	3.5000	3.6250	3.7500	3.8750	4.0000
	Min.....	2.7410	2.8660	2.9910	3.1160	3.2410	3.3660	3.4910	3.6160	3.7410	3.8660	3.9910
	Tol.....	.0090	.0090	.0090	.0090	.0090	.0090	.0090	.0090	.0090	.0090	.0090
Classes 2 and 3, minor diameter.....	Max ²	2.6733	2.7983	2.9233	3.0483	3.1733	3.2983	3.4233	3.5483	3.6733	3.7983	3.9233
Class 2, pitch diameter (for general use).....	Max ³	2.7094	2.8344	2.9594	3.0844	3.2094	3.3344	3.4594	3.5844	3.7094	3.8344	3.9594
	Min.....	2.7028	2.8278	2.9527	3.0778	3.2028	3.3278	3.4528	3.5778	3.7028	3.8278	3.9528
	Tol.....	.0066	.0066	.0067	.0068	.0069	.0069	.0070	.0071	.0071	.0072	.0072
Class 3, pitch diameter.....	Max ⁴	2.7094	2.8344	2.9594	3.0844	3.2094	3.3344	3.4594	3.5844	3.7094	3.8344	3.9594
	Min.....	2.7048	2.8298	2.9547	3.0797	3.2046	3.3296	3.4545	3.5795	3.7044	3.8294	3.9543
	Tol.....	.0046	.0046	.0047	.0047	.0048	.0048	.0049	.0049	.0050	.0050	.0051
INTERNAL THREADS												
Classes 2 and 3, major diameter.....	Min ⁴	2.7500	2.8750	3.0000	3.1250	3.2500	3.3750	3.5000	3.6250	3.7500	3.8750	4.0000
Classes 2 and 3, minor diameter.....	Min.....	2.6823	2.8073	2.9323	3.0573	3.1823	3.3073	3.4323	3.5573	3.6823	3.8073	3.9323
	Max.....	2.6903	2.8153	2.9403	3.0653	3.1903	3.3153	3.4403	3.5653	3.6903	3.8153	3.9403
	Tol.....	.0080	.0080	.0080	.0080	.0080	.0080	.0080	.0080	.0080	.0080	.0080
Class 2, pitch diameter (for general use).....	Min ⁴	2.7094	2.8344	2.9594	3.0844	3.2094	3.3344	3.4594	3.5844	3.7094	3.8344	3.9594
	Max.....	2.7160	2.8410	2.9661	3.0912	3.2163	3.3413	3.4664	3.5915	3.7165	3.8416	3.9666
	Tol.....	.0066	.0066	.0067	.0068	.0069	.0069	.0070	.0071	.0071	.0072	.0072
Class 3, pitch diameter.....	Min ⁴	2.7094	2.8344	2.9594	3.0844	3.2094	3.3344	3.4594	3.5844	3.7094	3.8344	3.9594
	Max.....	2.7140	2.8390	2.9641	3.0891	3.2142	3.3392	3.4643	3.5893	3.7143	3.8394	3.9645
	Tol.....	.0046	.0046	.0047	.0047	.0048	.0048	.0049	.0049	.0050	.0050	.0051

¹ Pitch-diameter tolerances include deviations of lead and angle. The class 2 tolerances are based on formulas in table 2.2, p. 180, and a length of engagement of 9 threads or 9/16 in. The class 3 tolerances are 70 percent of the class 2 tolerances. The 3/4-in. size being in the American National fine-thread series, the tolerance for this size corresponds to that series.

² Standard size thread of the American National fine-thread series.

³ Dimensions given for the maximum minor diameter of the external thread are figured to the intersection of the worn-tool arc with a center line through crest and root. The minimum minor diameter of the external thread shall be that corresponding to a flat at the minor diameter of the minimum external thread equal to $3/8 \times p$, and may be determined by subtracting 0.0406 in. from the minimum pitch diameter of the external thread.

⁴ Dimensions for the minimum major diameter of the internal thread correspond to the basic flat ($3/8 \times p$) and the profile at the major diameter produced by a worn tool must not fall below the basic outline. The maximum major diameter of the internal thread shall be that corresponding to a flat at the major diameter of the maximum internal thread equal to $3/4 \times p$, and may be determined by adding 0.0406 in. to the maximum pitch diameter of the internal thread.

⁵ These dimensions are the maximum material or "go" size, and are those which should be placed on the component drawing with the tolerances.

TABLE 1.14.—Allowances and tolerances, classes 1 and 2

Threads per inch	Class 1					Class 2				
	Allowances	Major diameter tolerances, external thread	Pitch-diameter tolerances	Lead deviations consuming one-half of pitch-diameter tolerances ¹	Deviations in half-angle consuming one-half of pitch-diameter tolerances	Major diameter tolerances, ² external threads	Pitch-diameter tolerances	Lead deviations consuming one-half of pitch-diameter tolerances ¹	Deviations in half-angle consuming one-half of pitch-diameter tolerances	
	1	2	3	4	5	6	7	8	9	10
	<i>in.</i>	<i>in.</i>	<i>in.</i>	<i>in.</i>	<i>deg min</i>	<i>in.</i>	<i>in.</i>	<i>in.</i>	<i>deg min</i>	
80	0.0007	0.0048	0.0024	0.0007	3 40	0.0034	0.0017	0.0005	2 35	
72	.0007	.0050	.0025	.0007	3 26	.0036	.0018	.0005	2 28	
64	.0007	.0052	.0026	.0008	3 50	.0038	.0019	.0005	2 19	
56	.0008	.0056	.0028	.0008	3 0	.0040	.0020	.0006	2 8	
48	.0009	.0062	.0031	.0009	2 50	.0044	.0022	.0008	2 1	
44	.0009	.0064	.0032	.0009	2 41	.0046	.0023	.0007	1 56	
40	.0010	.0068	.0034	.0010	2 38	.0048	.0024	.0007	1 50	
36	.0011	.0072	.0036	.0010	2 28	.0050	.0025	.0007	1 43	
32	.0011	.0076	.0038	.0011	2 19	.0054	.0027	.0008	1 39	
28	.0012	.0085	.0043	.0012	2 18	.0062	.0031	.0009	1 39	
24	.0013	.0092	.0048	.0013	2 6	.0066	.0033	.0010	1 31	
20	.0015	.0102	.0051	.0015	1 57	.0072	.0036	.0010	1 22	
18	.0016	.0114	.0057	.0016	1 58	.0072	.0041	.0012	1 25	
16	.0012	.0120	.0063	.0018	1 55	.0080	.0045	.0013	1 22	
14	.0021	.0140	.0070	.0020	1 52	.0098	.0049	.0014	1 19	
13	.0022	.0143	.0074	.0021	1 50	.0104	.0052	.0015	1 17	
12	.0024	.0158	.0077	.0023	1 49	.0112	.0056	.0016	1 17	
11	.0026	.0170	.0085	.0025	1 47	.0118	.0059	.0017	1 14	
10	.0028	.0184	.0092	.0027	1 45	.0128	.0064	.0018	1 13	
9	.0031	.0200	.0100	.0029	1 42	.0140	.0070	.0020	1 12	
8	.0034	.0222	.0111	.0032	1 42	.0152	.0076	.0022	1 10	
7	.0039	.0248	.0124	.0036	1 39	.0170	.0085	.0025	1 8	
6	.0044	.0280	.0145	.0042	1 40	.0202	.0101	.0029	1 9	
5	.0052	.0338	.0169	.0049	1 37	.0232	.0110	.0033	1 6	
4½	.0057	.0368	.0183	.0053	1 35	.0254	.0127	.0037	1 5	
4	.0064	.0408	.0204	.0059	1 33	.0280	.0149	.0040	1 4	

¹ Between any 2 threads not farther apart than the length of engagement.

² The tolerances in column 3 apply to class 2 unfinished hot-rolled material, NC and 8N series.

TABLE 1.15.—Allowances and tolerances, classes 3 and 4

Threads per inch	Class 3					Class 4				
	Major diameter tolerances, external thread	Pitch-diameter tolerances	Lead deviations consuming one-half of pitch-diameter tolerances ¹	Deviations in half-angle consuming one-half of pitch-diameter tolerances	Major diameter tolerances, external threads	Interferences or negative allowances	Pitch-diameter tolerances	Lead deviations consuming one-half of pitch-diameter tolerances ¹	Deviations in half-angle consuming one-half of pitch-diameter tolerances	
	1	2	3	4	5	6	7	8	9	10
	<i>in.</i>	<i>in.</i>	<i>in.</i>	<i>deg min</i>	<i>in.</i>	<i>in.</i>	<i>in.</i>	<i>in.</i>	<i>deg min</i>	
80	0.0034	0.0013	0.0004	1 59	-----	-----	-----	-----	-----	
72	.0036	.0013	.0004	1 47	-----	-----	-----	-----	-----	
64	.0038	.0014	.0004	1 43	-----	-----	-----	-----	-----	
56	.0040	.0015	.0004	1 36	-----	-----	-----	-----	-----	
48	.0044	.0016	.0005	1 28	-----	-----	-----	-----	-----	
44	.0046	.0016	.0005	1 21	-----	-----	-----	-----	-----	
40	.0048	.0017	.0005	1 18	-----	-----	-----	-----	-----	
36	.0050	.0018	.0005	1 14	-----	-----	-----	-----	-----	
32	.0054	.0019	.0005	1 10	-----	-----	-----	-----	-----	
28	.0062	.0022	.0006	1 11	0.0002	0.0002	0.0011	0.0003	0 35	
24	.0066	.0024	.0007	1 6	.0006	.0003	.0012	.0003	0 23	
20	.0072	.0026	.0008	1 0	.0072	.0003	.0013	.0004	0 30	
18	.0082	.0030	.0009	1 2	.0082	.0003	.0015	.0004	0 31	
16	.0090	.0032	.0009	0 59	.0090	.0004	.0016	.0005	0 29	
14	.0096	.0036	.0010	0 58	.0098	.0004	.0018	.0005	0 29	
13	.0104	.0037	.0011	0 55	.0104	.0004	.0019	.0005	0 29	
12	.0112	.0040	.0012	0 55	.0112	.0005	.0020	.0005	0 28	
11	.0118	.0042	.0012	0 53	.0118	.0005	.0021	.0006	0 26	
10	.0126	.0045	.0013	0 52	.0128	.0006	.0023	.0007	0 25	
9	.0136	.0049	.0014	0 51	.0146	.0006	.0024	.0007	0 25	
8	.0152	.0054	.0016	0 50	.0152	.0007	.0027	.0008	0 25	
7	.0170	.0059	.0017	0 47	.0170	.0009	.0030	.0009	0 24	
6	.0202	.0071	.0020	0 49	.0202	.0006	.0036	.0010	0 25	
5	.0232	.0082	.0024	0 47	.0232	.0010	.0041	.0012	0 23	
4½	.0254	.0089	.0025	0 46	.0254	.0011	.0044	.0013	0 23	
4	.0280	.0097	.0028	0 44	.0280	.0013	.0048	.0014	0 22	

¹ Between any 2 threads not farther apart than the length of engagement.

6. LIMITS OF SIZE OF GAGES

The limits of size of plain and thread gages applicable to the standard series of American National screw threads are presented in table 1.16. In this table X tolerances are applied to thread gages for classes 1, 2, and 3, W tolerances to thread gages for class 4, and Z tolerances to

plain gages. The limits of size of W truncated thread setting plug gages, and of both W and X basic-crest thread setting plug gages, are presented in table 1.17 or as indicated in the footnotes to table 1.17. These limits are developed in accordance with the requirements for gages and gaging stated in section VI, p. 107.

4-8	NF	1	0976	0846	0945	0901	1111	1049		1120	0851	1106	1016	1016	0854	0860	4-8
		2	0974	0882	0943	0905	1120	1049		1124	0857	1102	1014	1016	0854	0856	4-8
		3	0983	0895	0963	0918	1121	1076	1057		1124	0885	1093	1037	1016	0894	0894
5-40	NC	1	1078	0970	1044	0990	1240	1173	1250	1088	1233	1122	1122	1122	1062	1062	5-40
		2	1076	0966	1045	0994	1239	1173	1254	1088	1228	1120	1124	1124	1062	1062	5-40
		3	1086	0976	1065	1014	1240	1202	1249	1183	1254	1090	1216	1114	1114	1062	1062
5-4	NF	1	1082	0985	1061	1012	1241	1177	1250	1088	1233	1122	1122	1122	1062	1062	5-4
		2	1081	0991	1063	1016	1240	1178	1254	1088	1228	1120	1124	1124	1062	1062	5-4
		3	1100	1000	1081	1031	1246	1245	1254	1104	1223	1125	1125	1125	1062	1062	5-4
6-32	NC	1	1166	1031	1128	1060	1369	1263	1380	1177	1350	1215	1215	1215	1042	1042	6-32
		2	1163	1028	1131	1065	1368	1264	1380	1180	1345	1212	1212	1212	1042	1042	6-32
		3	1174	1042	1153	1087	1379	1304	1365	1201	1385	1204	1204	1204	1042	1042	6-32
6-40	NF	1	1208	1100	1174	1151	1379	1333	1384	1220	1353	1233	1233	1233	1110	1110	6-40
		2	1206	1096	1172	1152	1379	1333	1384	1220	1353	1233	1233	1233	1110	1110	6-40
		3	1216	1106	1193	1151	1379	1333	1384	1220	1353	1233	1233	1233	1110	1110	6-40
8-32	NC	1	1425	1271	1388	1388	1629	1533	1640	1437	1610	1475	1475	1475	1302	1302	8-32
		2	1423	1268	1391	1385	1628	1532	1645	1442	1608	1472	1472	1472	1302	1302	8-32
		3	1434	1287	1413	1401	1639	1547	1664	1458	1634	1461	1461	1461	1302	1302	8-32
8-36	NF	1	1449	1329	1413	1413	1629	1557	1640	1460	1616	1496	1496	1496	1302	1302	8-36
		2	1447	1325	1415	1411	1628	1558	1644	1462	1612	1494	1494	1494	1302	1302	8-36
		3	1458	1336	1431	1423	1639	1567	1664	1478	1634	1508	1478	1478	1302	1302	8-36
10-24	NC	1	1615	1495	1570	1570	1887	1795	1900	1629	1855	1675	1675	1675	1449	1449	10-24
		2	1613	1491	1573	1568	1886	1792	1905	1632	1850	1672	1672	1672	1449	1449	10-24
		3	1629	1449	1590	1585	1909	1809	1905	1632	1837	1659	1659	1659	1449	1449	10-24
10-32	NF	1	1686	1531	1648	1648	1889	1813	1900	1629	1855	1675	1675	1675	1562	1562	10-32
		2	1683	1526	1651	1643	1888	1814	1905	1636	1853	1683	1683	1683	1562	1562	10-32
		3	1694	1537	1673	1667	1899	1846	1900	1646	1861	1697	1697	1697	1562	1562	10-32
12-24	NC	1	1876	1686	1800	1800	2147	2035	2180	1889	2115	1935	1935	1935	1709	1709	12-24
		2	1873	1684	1802	1795	2146	2036	2180	1889	2102	1922	1922	1709	1709	12-24	
		3	1889	1709	1805	1799	2160	2065	2180	1899	2007	1925	1925	1709	1709	12-24	
12-28	NF	1	1916	1741	1873	1873	2145	2002	2180	1889	2115	1935	1935	1935	1773	1773	12-28
		2	1913	1736	1876	1870	2147	2003	2180	1889	2102	1922	1922	1773	1773	12-28	
		3	1925	1753	1897	1894	2160	2065	2180	1899	2007	1925	1925	1773	1773	12-28	

TABLE 1.16.—Gages for standard thread series, American National screw threads—Continued

Nominal size and threads per inch	Series designation	Gages for external threads										Gages for internal threads										Class	Nominal size and threads per inch														
		Turned gages					Z plain gages for major diameter					Thread gages					Z plain gages for minor diameter																				
		Go		Not go			Go		Not go			Go		Not go			Go		Not go																		
		Pitch diameter	Minor diameter	Plus tol. gage	Minus tol. gage	Minor diameter	Semi-finished	Unfin-ished (hot-rolled material)	Pitch diameter	Major diameter	Minor diameter	Major diameter	Plus tol. gage	Minus tol. gage	Pitch diameter	Major diameter	Minor diameter	Major diameter	Plus tol. gage	Minus tol. gage																	
1	2	3	NEF	2	0.1945	0.1822	0.1926	0.1926	0.1838	0.2160	0.2106	0.2106	0.1957	0.2123	0.1988	0.1823	0.1875	20	10	18	17	16	15	14	13	12	11	10	9	8	7	6	5	4	3	2	21
				3	0.1954	0.1817	0.1923	0.1923	0.1863	0.2159	0.2106	0.2106	0.1960	0.2118	0.1991	0.1823	0.1874																				
				3	0.1957	0.1820	0.1925	0.1925	0.1865	0.2160	0.2106	0.2106	0.1963	0.2114	0.1979	0.1822	0.1875																				
12-32	NEF	3	NEF	1	0.1984	0.1817	0.1982	0.1982	0.1872	0.2159	0.2106	0.2106	0.1960	0.2109	0.1982	0.1823	0.1874	20	10	18	17	16	15	14	13	12	11	10	9	8	7	6	5	4	3	2	21
				1	0.1988	0.1817	0.1987	0.1987	0.1872	0.2159	0.2106	0.2106	0.1960	0.2109	0.1982	0.1823	0.1874																				
				1	0.1984	0.1817	0.1982	0.1982	0.1872	0.2159	0.2106	0.2106	0.1960	0.2109	0.1982	0.1823	0.1874																				
				1	0.1984	0.1817	0.1982	0.1982	0.1872	0.2159	0.2106	0.2106	0.1960	0.2109	0.1982	0.1823	0.1874																				
14-20	NC	3	NC	1	0.2100	0.2001	0.2100	0.2100	0.2001	0.2485	0.2485	0.2485	0.2175	0.2443	0.2226	0.2000	20	10	18	17	16	15	14	13	12	11	10	9	8	7	6	5	4	3	2	21	
				2	0.2106	0.2006	0.2106	0.2106	0.2006	0.2485	0.2485	0.2485	0.2175	0.2443	0.2226	0.2000																					
				2	0.2106	0.2006	0.2106	0.2106	0.2006	0.2485	0.2485	0.2485	0.2175	0.2443	0.2226	0.2000																					
				2	0.2106	0.2006	0.2106	0.2106	0.2006	0.2485	0.2485	0.2485	0.2175	0.2443	0.2226	0.2000																					
14-28	NF	3	NF	1	0.2288	0.2183	0.2288	0.2288	0.2183	0.2690	0.2690	0.2690	0.2271	0.2645	0.2500	0.2271	20	10	18	17	16	15	14	13	12	11	10	9	8	7	6	5	4	3	2	21	
				2	0.2294	0.2183	0.2294	0.2294	0.2183	0.2690	0.2690	0.2690	0.2271	0.2645	0.2500	0.2271																					
				2	0.2294	0.2183	0.2294	0.2294	0.2183	0.2690	0.2690	0.2690	0.2271	0.2645	0.2500	0.2271																					
				2	0.2294	0.2183	0.2294	0.2294	0.2183	0.2690	0.2690	0.2690	0.2271	0.2645	0.2500	0.2271																					
14-32	NEF	3	NEF	2	0.2394	0.2289	0.2394	0.2394	0.2289	0.2800	0.2800	0.2800	0.2389	0.2764	0.2628	0.2389	20	10	18	17	16	15	14	13	12	11	10	9	8	7	6	5	4	3	2	21	
				3	0.2400	0.2289	0.2400	0.2400	0.2289	0.2800	0.2800	0.2800	0.2389	0.2764	0.2628	0.2389																					
				3	0.2400	0.2289	0.2400	0.2400	0.2289	0.2800	0.2800	0.2800	0.2389	0.2764	0.2628	0.2389																					
				3	0.2400	0.2289	0.2400	0.2400	0.2289	0.2800	0.2800	0.2800	0.2389	0.2764	0.2628	0.2389																					
16-18	NC	3	NC	1	0.2748	0.2643	0.2748	0.2748	0.2643	0.3109	0.3109	0.3109	0.2764	0.3062	0.2921	0.2643	20	10	18	17	16	15	14	13	12	11	10	9	8	7	6	5	4	3	2	21	
				2	0.2754	0.2643	0.2754	0.2754	0.2643	0.3109	0.3109	0.3109	0.2764	0.3062	0.2921	0.2643																					
				2	0.2754	0.2643	0.2754	0.2754	0.2643	0.3109	0.3109	0.3109	0.2764	0.3062	0.2921	0.2643																					
				2	0.2754	0.2643	0.2754	0.2754	0.2643	0.3109	0.3109	0.3109	0.2764	0.3062	0.2921	0.2643																					
16-24	NF	3	NF	1	0.2851	0.2746	0.2851	0.2851	0.2746	0.3125	0.3125	0.3125	0.2764	0.3062	0.2921	0.2746	20	10	18	17	16	15	14	13	12	11	10	9	8	7	6	5	4	3	2	21	
				2	0.2857	0.2746	0.2857	0.2857	0.2746	0.3125	0.3125	0.3125	0.2764	0.3062	0.2921	0.2746																					
				2	0.2857	0.2746	0.2857	0.2857	0.2746	0.3125	0.3125	0.3125	0.2764	0.3062	0.2921	0.2746																					
				2	0.2857	0.2746	0.2857	0.2857	0.2746	0.3125	0.3125	0.3125	0.2764	0.3062	0.2921	0.2746																					
16-32	NEF	3	NEF	2	0.2957	0.2852	0.2957	0.2957	0.2852	0.3141	0.3141	0.3141	0.2764	0.3062	0.2921	0.2852	20	10	18	17	16	15	14	13	12	11	10	9	8	7	6	5	4	3	2	21	
				3	0.2963	0.2852	0.2963	0.2963	0.2852	0.3141	0.3141	0.3141	0.2764	0.3062	0.2921	0.2852																					
				3	0.2963	0.2852	0.2963	0.2963	0.2852	0.3141	0.3141	0.3141	0.2764	0.3062	0.2921	0.2852																					
				3	0.2963	0.2852	0.2963	0.2963	0.2852	0.3141	0.3141	0.3141	0.2764	0.3062	0.2921	0.2852																					

TABLE 1.16.—Gages for standard thread series, American National screw threads—Continued

Nominal size and threads per inch	Series designation	Gages for external threads										Gages for internal threads												
		Thread gages					Z plain gages for major diameter					Thread gages					Z plain gages for minor diameter							
		Go		Not go		Pitch diameter	Minor diameter	Go	Semi-finished	Unfin-ished material	Not go	Major diameter		Pitch diameter		Major diameter		Pitch diameter		Go	Not go	Class	Series designation	Nominal size and threads per inch
		Plus tol. gage	Minus tol. gage	Plus tol. gage	Minus tol. gage							Plus tol. gage	Minus tol. gage	Plus tol. gage	Minus tol. gage	Plus tol. gage	Minus tol. gage							
1	2	3	4	5	6	7	8	9	10	11	12	13	14	15	16	17	18	19	20	21				
1/4-12	N	2	0.8834	0.8473	0.8778	0.8778	0.8598	0.9378	0.9263	0.9263	0.9375	0.8834	0.9251	0.8890	0.8890	0.8890	0.8473	0.8530	2	N	1/4-12			
		3	8834	8473	8778	8778	8598	9378	9263	9263	9375	8834	9251	8890	8890	8890	8473	8530	3	N	1/4-12			
		3	8831	8467	8797	8794	8614	9375	9262	9262	9375	8831	9229	8877	8877	8877	8474	8530	3	N	1/4-12			
1/4-16	N	2	8969	8698	8917	8914	8782	9378	9250	9250	9375	8969	9292	9021	9021	9021	8699	8778	2	N	1/4-16			
		3	8966	8692	8933	8933	8798	9378	9250	9250	9375	8966	9292	9021	9021	9021	8692	8778	3	N	1/4-16			
		3	8966	8692	8933	8933	8798	9378	9250	9250	9375	8966	9292	9021	9021	9021	8692	8778	3	N	1/4-16			
1/4-20	NEF	2	9050	8834	9003	9003	8885	9378	9300	9300	9375	9050	9640	9097	9097	9097	8834	8900	2	NEF	1/4-20			
		3	8969	8829	9006	9006	8900	9378	9300	9300	9375	8969	9640	9097	9097	9097	8834	8900	3	NEF	1/4-20			
		3	8966	8829	9017	9017	8909	9378	9300	9300	9375	8966	9640	9097	9097	9097	8834	8900	3	NEF	1/4-20			
1-8	NC	1	9154	8613	9043	9043	8772	9966	9744	9744	1.0000	9154	9640	9299	9299	9299	8613	8750	1	NC	1-8			
		2	9088	8606	9047	9047	8779	9966	9744	9744	1.0000	9088	9640	9299	9299	9299	8606	8750	2	NC	1-8			
		3	9188	8640	9116	9116	8841	1.0000	9966	9744	9744	1.0000	9188	9640	9299	9299	9299	8640	8750	3	NC	1-8		
		4	9188	8640	9134	9134	8863	1.0000	9966	9744	9744	1.0000	9188	9640	9299	9299	9299	8640	8750	4	NC	1-8		
1-12	N	2	9459	9088	9403	9403	9223	1.0000	9880	9880	1.0000	9459	9676	9515	9515	9515	9088	9188	2	N	1-12			
		3	9459	9088	9419	9419	9239	1.0000	9880	9880	1.0000	9459	9676	9515	9515	9515	9088	9188	3	N	1-12			
		3	9456	9092	9422	9422	9245	9966	9892	9892	1.0000	9456	9654	9496	9496	9496	9092	9188	3	N	1-12			
1-14	NS	1	9515	9206	9445	9445	9290	9979	9830	9830	1.0000	9515	9536	9606	9606	9606	9206	9310	1	NS	1-14			
		2	9536	9227	9487	9487	9332	1.0000	9979	9830	1.0000	9536	9536	9606	9606	9606	9227	9310	2	NS	1-14			
		3	9536	9227	9490	9490	9338	9966	9903	9903	1.0000	9536	9538	9606	9606	9606	9227	9310	3	NS	1-14			
		4	9540	9231	9503	9503	9351	9966	9903	9903	1.0000	9540	9538	9606	9606	9606	9231	9310	4	NS	1-14			
1-16	N	2	9675	9459	9627	9627	9519	1.0000	9988	9988	1.0000	9675	9657	9646	9646	9646	9459	9430	2	N	1-16			
		3	9672	9454	9630	9630	9524	9966	9912	9912	1.0000	9672	9657	9646	9646	9646	9454	9430	3	N	1-16			
		3	9691	9617	9657	9657	9422	1.0000	9912	9912	1.0000	9691	9657	9646	9646	9646	9617	9430	3	N	1-16			
1-20	NEF	2	9875	9459	9627	9627	9519	1.0000	9988	9988	1.0000	9875	9675	9723	9723	9723	9459	9430	2	NEF	1-20			
		3	9872	9454	9630	9630	9524	9966	9920	9920	1.0000	9872	9675	9723	9723	9723	9454	9430	3	NEF	1-20			
		3	9872	9454	9644	9644	9538	9966	9920	9920	1.0000	9872	9675	9723	9723	9723	9454	9430	3	NEF	1-20			
1/4-12	N	2	1.0084	0.9723	1.0028	1.0028	0.9848	1.0625	1.0513	1.0513	1.0625	1.0084	1.0501	1.0140	1.0140	1.0140	0.9723	0.9818	2	N	1/4-12			
		3	1.0084	0.9723	1.0044	1.0044	0.9854	1.0625	1.0513	1.0513	1.0625	1.0084	1.0501	1.0140	1.0140	1.0140	0.9723	0.9818	3	N	1/4-12			
		3	1.0081	0.9717	1.0047	1.0047	0.9870	1.0623	1.0514	1.0514	1.0623	1.0081	1.0501	1.0121	1.0121	1.0121	0.9717	0.9818	3	N	1/4-12			
1/4-16	N	2	1.0219	0.9848	1.0166	1.0166	1.0031	1.0625	1.0530	1.0530	1.0625	1.0219	1.0219	1.0272	1.0272	1.0272	0.9848	1.0028	2	N	1/4-16			
		3	1.0219	0.9842	1.0169	1.0169	1.0031	1.0623	1.0530	1.0530	1.0623	1.0219	1.0219	1.0272	1.0272	1.0272	0.9842	1.0028	3	N	1/4-16			
		3	1.0216	0.9842	1.0182	1.0182	1.0047	1.0625	1.0530	1.0530	1.0625	1.0216	1.0216	1.0272	1.0272	1.0272	0.9842	1.0028	3	N	1/4-16			

1 1/4-18	NEF	2	1.01000	1.00240	1.0315	1.0556	1.0281	1.0625	1.0430	1.09250	1.0093	1.0213	1.0213	1.0213	1.0023	1.0264	1.0261	1.0261	1.0261
		3	1.00988	1.00252	1.0318	1.051	1.0287	1.0630	1.0442	1.06238	1.0098	1.0216	1.0216	1.0216	1.0018	1.0264	1.0261	1.0261	1.0261
		1	1.01000	1.00252	1.0303	1.0536	1.0267	1.0630	1.05442	1.06238	1.0113	1.0225	1.0225	1.0225	1.0018	1.0261	1.0261	1.0261	1.0261
1 1/4-7	NC	1	98580	97040	1.0446	1.1065	1.0322	1.1250	1.09630	1.12110	9850	1.0159	1.0159	1.0159	9664	1.0283	1.0273	1.0273	1.0273
		2	98568	97032	1.0450	1.1058	1.0326	1.1257	1.09642	1.12098	9857	1.0155	1.0155	1.0155	9667	1.0273	1.0263	1.0263	1.0263
		3	98568	97052	1.0411	1.1009	1.0326	1.1257	1.09812	1.12188	9835	1.0233	1.0233	1.0233	9666	1.0318	1.0308	1.0308	1.0308
		4	98580	97052	1.0385	1.0993	1.0326	1.1257	1.09812	1.12488	9861	1.0259	1.0259	1.0259	9666	1.0318	1.0308	1.0308	1.0308
		2	98568	97052	1.0354	1.0964	1.0324	1.1257	1.09812	1.12488	9991	1.0300	1.0300	1.0300	9704	1.0324	1.0314	1.0314	1.0314
		3	1.00450	98970	1.0517	1.1058	1.0438	1.1250	1.09880	1.12500	1.0088	1.0359	1.0359	1.0359	9897	1.0438	1.0428	1.0428	1.0428
		4	1.00438	98982	1.0521	1.1051	1.0438	1.1250	1.09892	1.12488	1.0095	1.0355	1.0355	1.0355	9897	1.0433	1.0423	1.0423	1.0423
1 1/4-8	N	2	1.00438	98982	1.0497	1.1027	1.0442	1.1257	1.09992	1.12488	1.0119	1.0379	1.0379	1.0379	9897	1.0434	1.0424	1.0424	1.0424
		3	1.04380	98480	1.0788	1.1149	1.0709	1.1250	1.06880	1.12488	1.0426	1.0696	1.0696	1.0696	1.0324	1.0685	1.0675	1.0675	1.0675
		1	1.04380	98480	1.0781	1.1143	1.0712	1.1256	1.06892	1.12488	1.0432	1.0693	1.0693	1.0693	1.0318	1.0682	1.0672	1.0672	1.0672
		2	1.04380	98480	1.0765	1.1126	1.0709	1.1256	1.06892	1.12488	1.0432	1.0693	1.0693	1.0693	1.0318	1.0682	1.0672	1.0672	1.0672
		3	1.04380	98480	1.0768	1.1110	1.0709	1.1256	1.06892	1.12488	1.0432	1.0693	1.0693	1.0693	1.0318	1.0682	1.0672	1.0672	1.0672
		4	1.04380	98480	1.0752	1.1104	1.0746	1.1256	1.06892	1.12488	1.0432	1.0693	1.0693	1.0693	1.0318	1.0682	1.0672	1.0672	1.0672
		2	1.04380	98480	1.0729	1.1084	1.0729	1.1250	1.06892	1.12488	1.0432	1.0693	1.0693	1.0693	1.0318	1.0682	1.0672	1.0672	1.0672
		3	1.04380	98480	1.0731	1.1084	1.0711	1.1256	1.06892	1.12488	1.0432	1.0693	1.0693	1.0693	1.0318	1.0682	1.0672	1.0672	1.0672
1 1/4-16	N	2	1.06530	1.05730	1.0898	1.1169	1.0844	1.1250	1.10600	1.12500	1.0655	1.0790	1.0790	1.0790	1.0573	1.0844	1.0834	1.0834	1.0834
		3	1.06530	1.05730	1.0882	1.1153	1.0844	1.1250	1.10600	1.12488	1.0661	1.0787	1.0787	1.0787	1.0573	1.0844	1.0834	1.0834	1.0834
		2	1.06518	1.05742	1.0885	1.1147	1.0847	1.1256	1.10612	1.12488	1.0677	1.0803	1.0803	1.0803	1.0567	1.0841	1.0831	1.0831	1.0831
		3	1.07250	1.06490	1.0941	1.1182	1.0889	1.1250	1.10680	1.12488	1.0717	1.0837	1.0837	1.0837	1.0567	1.0841	1.0831	1.0831	1.0831
		2	1.07258	1.06502	1.0928	1.1161	1.0892	1.1255	1.10692	1.12488	1.0738	1.0856	1.0856	1.0856	1.0567	1.0841	1.0831	1.0831	1.0831
		3	1.06300	1.09730	1.1390	1.1745	1.1337	1.1875	1.17630	1.18750	1.1098	1.1278	1.1278	1.1278	1.0973	1.1334	1.1324	1.1324	1.1324
		2	1.06300	1.09730	1.1393	1.1745	1.1337	1.1875	1.17630	1.18750	1.1114	1.1294	1.1294	1.1294	1.0973	1.1334	1.1324	1.1324	1.1324
		3	1.06300	1.09730	1.1374	1.1735	1.1337	1.1875	1.17630	1.18750	1.1114	1.1294	1.1294	1.1294	1.0973	1.1334	1.1324	1.1324	1.1324
		2	1.12780	1.11980	1.1523	1.1794	1.1469	1.1875	1.17630	1.18750	1.1280	1.1415	1.1415	1.1415	1.1108	1.1466	1.1456	1.1456	1.1456
		3	1.12780	1.11980	1.1507	1.1778	1.1469	1.1875	1.17630	1.18750	1.1286	1.1415	1.1415	1.1415	1.1108	1.1466	1.1456	1.1456	1.1456
		2	1.12780	1.11992	1.1510	1.1772	1.1472	1.1881	1.17662	1.18738	1.1302	1.1428	1.1428	1.1428	1.1108	1.1466	1.1456	1.1456	1.1456
		3	1.13500	1.12740	1.1566	1.1807	1.1514	1.1875	1.17630	1.18750	1.1342	1.1462	1.1462	1.1462	1.1108	1.1466	1.1456	1.1456	1.1456
		2	1.13500	1.12740	1.1566	1.1807	1.1514	1.1875	1.17630	1.18750	1.1342	1.1462	1.1462	1.1462	1.1108	1.1466	1.1456	1.1456	1.1456
		3	1.13488	1.12752	1.1550	1.1791	1.1514	1.1880	1.17630	1.18738	1.1358	1.1478	1.1478	1.1478	1.1108	1.1466	1.1456	1.1456	1.1456
		2	1.13488	1.12752	1.1553	1.1786	1.1517	1.1880	1.17642	1.18738	1.1363	1.1475	1.1475	1.1475	1.1108	1.1466	1.1456	1.1456	1.1456
		3	1.10800	1.096540	1.1696	1.2315	1.1572	1.2500	1.23130	1.24610	1.1100	1.1409	1.1409	1.1409	1.0914	1.1533	1.1523	1.1523	1.1523
		2	1.10800	1.096540	1.1692	1.2308	1.1572	1.2500	1.23130	1.24598	1.1107	1.1405	1.1405	1.1405	1.0907	1.1529	1.1519	1.1519	1.1519
		3	1.10800	1.096540	1.1657	1.2276	1.1572	1.2500	1.23130	1.24598	1.1178	1.1487	1.1487	1.1487	1.0907	1.1529	1.1519	1.1519	1.1519
		1	1.10800	1.096540	1.1631	1.2250	1.1572	1.2500	1.23130	1.24598	1.1185	1.1483	1.1483	1.1483	1.0907	1.1529	1.1519	1.1519	1.1519
		2	1.10800	1.096540	1.1631	1.2250	1.1572	1.2500	1.23130	1.24598	1.1204	1.1513	1.1513	1.1513	1.0907	1.1529	1.1519	1.1519	1.1519
		3	1.10800	1.096540	1.1635	1.2243	1.1572	1.2500	1.23130	1.24598	1.1211	1.1517	1.1517	1.1517	1.0907	1.1529	1.1519	1.1519	1.1519
		4	1.10800	1.096540	1.1602	1.2221	1.1572	1.2500	1.23130	1.24598	1.1241	1.1550	1.1550	1.1550	1.0907	1.1529	1.1519	1.1519	1.1519
		2	1.12950	1.11470	1.1771	1.2312	1.1688	1.2500	1.23180	1.24600	1.1605	1.1635	1.1635	1.1635	1.1147	1.1684	1.1674	1.1674	1.1674
		3	1.12950	1.11482	1.1775	1.2305	1.1688	1.2500	1.23180	1.24592	1.1601	1.1630	1.1630	1.1630	1.1147	1.1684	1.1674	1.1674	1.1674
		1	1.12938	1.11482	1.1750	1.2280	1.1692	1.2507	1.23180	1.24592	1.1636	1.1636	1.1636	1.1636	1.1140	1.1684	1.1674	1.1674	1.1674
		2	1.16880	1.15980	1.2038	1.2399	1.1959	1.2500	1.23180	1.24760	1.1856	1.1856	1.1856	1.1856	1.1574	1.1935	1.1925	1.1925	1.1925
		3	1.16880	1.15980	1.2011	1.2393	1.1959	1.2506	1.23192	1.24748	1.1853	1.1853	1.1853	1.1853	1.1574	1.1932	1.1922	1.1922	1.1922
		1	1.16880	1.15980	1.2018	1.2376	1.1959	1.2506	1.23192	1.24748	1.1853	1.1853	1.1853	1.1853	1.1574	1.1932	1.1922	1.1922	1.1922
		2	1.16880	1.15980	1.2018	1.2376	1.1959	1.2506	1.23192	1.24748	1.1853	1.1853	1.1853	1.1853	1.1574	1.1932	1.1922	1.1922	1.1922
		3	1.16880	1.15980	1.2018	1.2376	1.1959	1.2506	1.23192	1.24748	1.1853	1.1853	1.1853	1.1853	1.1574	1.1932	1.1922	1.1922	1.1922
		4	1.16880	1.15980	1.2018	1.2376	1.1959	1.2506	1.23192	1.24748	1.1853	1.1853	1.1853	1.1853	1.1574	1.1932	1.1922	1.1922	1.1922
		2	1.19030	1.18240	1.2149	1.2334	1.1961	1.2506	1.23192	1.24748	1.1853	1.1853	1.1853	1.1853	1.1574	1.1932	1.1922	1.1922	1.1922
		3	1.19030	1.18240	1.2146	1.2334	1.1961	1.2506	1.23192	1.24748	1.1853	1.1853	1.1853	1.1853	1.1574	1.1932	1.1922	1.1922	1.1922
		1	1.19030	1.18240	1.2146	1.2334	1.1961	1.2506	1.23192	1.24748	1.1853	1.1853	1.1853	1.1853	1.1574	1.1932	1.1922	1.1922	1.1922
		2	1.19030	1.18240	1.2146	1.2334	1.1961	1.2506	1.23192	1.24748	1.1853	1.1853	1.1853	1.1853	1.1574	1.1932	1.1922	1.1922	1.1922
		3	1.19030	1.18240	1.2146	1.2334	1.												

1/4-12	N	2	1.3473	1.3598	1.3778	1.4251	1.3890	1.3893	1.3470	1.3593	1.3773
		3	1.3467	1.3604	1.3775	1.4245	1.3887	1.3893	1.3474	1.3598	1.3778
			1.3473	1.3614	1.3794	1.4233	1.3874	1.3874	1.3470	1.3593	1.3778
			1.3467	1.3620	1.3791	1.4229	1.3871	1.3877	1.3472	1.3598	1.3778
1/4-16	N	2	1.3698	1.3778	1.3913	1.4296	1.4025	1.3698	1.3778	1.3913	1.4025
		3	1.3692	1.3816	1.3916	1.4286	1.4022	1.3692	1.3778	1.3913	1.4022
			1.3698	1.3829	1.3929	1.4270	1.4009	1.3698	1.3778	1.3929	1.4009
			1.3692	1.3832	1.3932	1.4274	1.4006	1.3692	1.3778	1.3932	1.4012
1/4-18	NEF	2	1.4014	1.3960	1.3920	1.4309	1.4068	1.3960	1.3774	1.3850	1.4068
		3	1.3763	1.3845	1.3857	1.4304	1.4065	1.3763	1.3752	1.3848	1.4071
			1.3778	1.3856	1.3873	1.4293	1.4052	1.3778	1.3740	1.3840	1.4052
			1.3763	1.3861	1.3873	1.4288	1.4049	1.3763	1.3752	1.3848	1.4055
1/4-6	NC	1	1.3151	1.3367	1.3728	1.4784	1.4062	1.3151	1.3196	1.3370	1.4062
		2	1.3143	1.3375	1.3732	1.4776	1.4058	1.3143	1.3197	1.3374	1.4058
		3	1.3157	1.3463	1.3816	1.4740	1.4018	1.3157	1.3196	1.3370	1.4018
		4	1.3145	1.3485	1.3820	1.4732	1.4014	1.3145	1.3196	1.3370	1.4014
			1.3157	1.3493	1.3846	1.4710	1.3988	1.3157	1.3196	1.3370	1.3988
			1.3145	1.3493	1.3846	1.4702	1.3984	1.3145	1.3197	1.3374	1.3982
			1.3157	1.3500	1.3890	1.4675	1.3953	1.3157	1.3196	1.3370	1.3953
			1.3145	1.3537	1.3888	1.4661	1.3951	1.3145	1.3197	1.3374	1.3955
1/4-8	N	2	1.4188	1.4098	1.4098	1.4819	1.4278	1.4188	1.3647	1.3795	1.4278
		3	1.3647	1.3834	1.4102	1.4779	1.4274	1.3647	1.3648	1.3795	1.4282
			1.3647	1.3854	1.4125	1.4782	1.4251	1.3647	1.3648	1.3795	1.4282
			1.3640	1.3861	1.4129	1.4785	1.4247	1.3640	1.3648	1.3798	1.4255
1/4-12	NF	1	1.4435	1.4356	1.4356	1.4889	1.4538	1.4435	1.4098	1.4188	1.4538
		2	1.4432	1.4359	1.4403	1.4876	1.4531	1.4432	1.4098	1.4188	1.4531
		3	1.4456	1.4406	1.4419	1.4850	1.4518	1.4456	1.4098	1.4188	1.4518
		4	1.4456	1.4422	1.4416	1.4832	1.4496	1.4456	1.4098	1.4188	1.4496
			1.4464	1.4444	1.4424	1.4825	1.4482	1.4464	1.4098	1.4188	1.4482
			1.4462	1.4446	1.4442	1.4820	1.4479	1.4462	1.4098	1.4188	1.4479
1/4-16	N	2	1.4594	1.4323	1.4537	1.4922	1.4651	1.4594	1.4430	1.4403	1.4651
		3	1.4323	1.4317	1.4534	1.4912	1.4648	1.4323	1.4403	1.4408	1.4648
			1.4323	1.4357	1.4554	1.4905	1.4634	1.4323	1.4430	1.4430	1.4634
			1.4317	1.4357	1.4551	1.4899	1.4637	1.4317	1.4408	1.4418	1.4637
1/4-18	NEF	2	1.4639	1.4368	1.4584	1.4935	1.4694	1.4639	1.4390	1.4473	1.4694
		3	1.4368	1.4363	1.4587	1.4920	1.4677	1.4368	1.4473	1.4473	1.4677
			1.4639	1.4398	1.4601	1.4918	1.4677	1.4639	1.4473	1.4473	1.4677
			1.4636	1.4398	1.4604	1.4913	1.4674	1.4636	1.4473	1.4473	1.4674
1/4-16	N	2	1.5219	1.4948	1.5161	1.5535	1.5277	1.5219	1.5028	1.5028	1.5277
		3	1.4948	1.4948	1.5179	1.5530	1.5281	1.4948	1.5028	1.5028	1.5281
			1.4948	1.4948	1.5179	1.5530	1.5281	1.4948	1.5028	1.5028	1.5281
			1.4942	1.4942	1.5175	1.5536	1.5255	1.4942	1.5028	1.5028	1.5255
1/4-18	NEF	2	1.5264	1.5023	1.5209	1.5625	1.5319	1.5264	1.5024	1.5100	1.5319
		3	1.5023	1.5018	1.5213	1.5620	1.5315	1.5023	1.5024	1.5100	1.5315
			1.5023	1.5023	1.5225	1.5625	1.5303	1.5023	1.5024	1.5100	1.5303
			1.5018	1.5018	1.5229	1.5624	1.5298	1.5018	1.5024	1.5100	1.5298
1/4-8	N	2	1.5438	1.4897	1.5345	1.6250	1.5531	1.5438	1.4897	1.5045	1.5531
		3	1.4897	1.4897	1.5340	1.6246	1.5526	1.4897	1.5045	1.5045	1.5526
			1.4897	1.4897	1.5340	1.6246	1.5526	1.4897	1.5045	1.5045	1.5526
			1.4890	1.4890	1.5368	1.6248	1.5498	1.4890	1.5045	1.5045	1.5498
1/4-12	N	2	1.5709	1.5348	1.5645	1.6250	1.5773	1.5709	1.5348	1.5480	1.5773
		3	1.5348	1.5348	1.5641	1.6246	1.5769	1.5348	1.5348	1.5480	1.5769
			1.5348	1.5348	1.5664	1.6246	1.5754	1.5348	1.5348	1.5480	1.5754
			1.5342	1.5342	1.5668	1.6248	1.5758	1.5342	1.5348	1.5480	1.5758
1/4-16	N	2	1.5844	1.5573	1.5786	1.6250	1.5802	1.5844	1.5573	1.5650	1.5802
		3	1.5573	1.5573	1.5782	1.6246	1.5798	1.5573	1.5573	1.5650	1.5798
			1.5573	1.5573	1.5803	1.6250	1.5802	1.5573	1.5573	1.5650	1.5802
			1.5567	1.5567	1.5799	1.6248	1.5811	1.5567	1.5573	1.5650	1.5811
1/4-18	NEF	2	1.5889	1.5649	1.5833	1.6250	1.5945	1.5889	1.5649	1.5725	1.5945
		3	1.5649	1.5649	1.5820	1.6246	1.5945	1.5649	1.5649	1.5725	1.5945
			1.5649	1.5649	1.5837	1.6246	1.5945	1.5649	1.5649	1.5725	1.5945
			1.5643	1.5643	1.5837	1.6246	1.5945	1.5643	1.5649	1.5725	1.5945

TABLE 1.16.—Gages for standard thread series, American National screw threads—Continued

Nominal size and threads per inch	Series designation	Gages for external threads										Gages for internal threads												
		Thread gages					Z plain gages for major diameter					Thread gages					Z plain gages for minor diameter							
		Go		Not go		Pitch diameter Plus tol. gage	Minor diameter	Go	Semi-finished	Unfin-ished hot-rolled material	Not go	Major diameter	Pitch diameter	Go		Not go		Major diameter	Pitch diameter Plus tol. gage	Go	Not go			
		Pitch diameter	Minor diameter	Plus tol. gage	Minus tol. gage									Major diameter	Pitch diameter	Major diameter	Pitch diameter							
Class	2	3	2	3	2	3	2	3	2	3	2	3	2	3	2	3	2	3	2	3	2	3		
1 1/4-16	N	in. 1.6469	in. 1.6198	in. 1.6411	in. 1.6276	in. 1.6875	in. 1.6785	in. 1.6785	in. 1.6875	in. 1.6469	in. 1.6469	in. 1.6473	in. 1.6875	in. 1.6875	in. 1.6527	in. 1.6798	in. 1.6527	in. 1.6527	in. 1.6198	in. 1.6198	in. 1.6198	in. 1.6276	in. 1.6276	in. 1.6276
		1.6465	1.6194	1.6407	1.6282	1.6881	1.6786	1.6786	1.6881	1.6473	1.6473	1.6473	1.6875	1.6875	1.6510	1.6792	1.6510	1.6510	1.6196	1.6196	1.6196	1.6274	1.6274	1.6274
		1.6465	1.6192	1.6432	1.6299	1.6881	1.6786	1.6786	1.6881	1.6473	1.6473	1.6473	1.6875	1.6875	1.6506	1.6775	1.6506	1.6506	1.6196	1.6196	1.6196	1.6274	1.6274	1.6274
1 1/4-18	NEF	in. 1.6314	in. 1.6268	in. 1.6458	in. 1.6338	in. 1.6790	in. 1.6790	in. 1.6790	in. 1.6875	in. 1.6314	in. 1.6314	in. 1.6314	in. 1.6875	in. 1.6875	in. 1.6570	in. 1.6811	in. 1.6570	in. 1.6570	in. 1.6274	in. 1.6274	in. 1.6274	in. 1.6348	in. 1.6348	in. 1.6348
		1.6310	1.6268	1.6454	1.6335	1.6790	1.6790	1.6790	1.6875	1.6314	1.6314	1.6314	1.6875	1.6875	1.6553	1.6894	1.6553	1.6553	1.6274	1.6274	1.6274	1.6348	1.6348	1.6348
		1.6310	1.6268	1.6471	1.6380	1.6794	1.6794	1.6794	1.6880	1.6314	1.6314	1.6314	1.6875	1.6875	1.6549	1.6789	1.6549	1.6549	1.6274	1.6274	1.6274	1.6348	1.6348	1.6348
1 1/4-5	NC	in. 1.6149	in. 1.5283	in. 1.5980	in. 1.5547	in. 1.7448	in. 1.7448	in. 1.7448	in. 1.7500	in. 1.6149	in. 1.6149	in. 1.6201	in. 1.7500	in. 1.7500	in. 1.6370	in. 1.7236	in. 1.6370	in. 1.6370	in. 1.5330	in. 1.5330	in. 1.5330	in. 1.5510	in. 1.5510	in. 1.5510
		1.6144	1.5275	1.5975	1.5555	1.7448	1.7448	1.7448	1.7500	1.6144	1.6144	1.6201	1.7500	1.7500	1.6375	1.7236	1.6375	1.6375	1.5330	1.5330	1.5330	1.5510	1.5510	1.5510
		1.6196	1.5327	1.6080	1.5652	1.7494	1.7494	1.7494	1.7500	1.6196	1.6196	1.6262	1.7500	1.7500	1.6312	1.7183	1.6312	1.6312	1.5330	1.5330	1.5330	1.5510	1.5510	1.5510
		1.6196	1.5327	1.6119	1.5686	1.7494	1.7494	1.7494	1.7500	1.6196	1.6196	1.6262	1.7500	1.7500	1.6283	1.7149	1.6283	1.6283	1.5330	1.5330	1.5330	1.5510	1.5510	1.5510
1 1/4-8	N	in. 1.6211	in. 1.5345	in. 1.6170	in. 1.5737	in. 1.7494	in. 1.7494	in. 1.7494	in. 1.7500	in. 1.6211	in. 1.6211	in. 1.6211	in. 1.7500	in. 1.7500	in. 1.6278	in. 1.7108	in. 1.6278	in. 1.6278	in. 1.5330	in. 1.5330	in. 1.5330	in. 1.5510	in. 1.5510	in. 1.5510
		1.6205	1.5337	1.6175	1.5745	1.7494	1.7494	1.7494	1.7500	1.6205	1.6205	1.6205	1.7500	1.7500	1.6295	1.7100	1.6295	1.6295	1.5330	1.5330	1.5330	1.5510	1.5510	1.5510
		1.6593	1.5691	1.6591	1.6320	1.7494	1.7494	1.7494	1.7500	1.6593	1.6593	1.6593	1.7500	1.7500	1.6785	1.7326	1.6785	1.6785	1.5330	1.5330	1.5330	1.5510	1.5510	1.5510
1 1/4-12	N	in. 1.6959	in. 1.6598	in. 1.6904	in. 1.6714	in. 1.7380	in. 1.7380	in. 1.7380	in. 1.7500	in. 1.6959	in. 1.6959	in. 1.6959	in. 1.7500	in. 1.7500	in. 1.7024	in. 1.7385	in. 1.7024	in. 1.7024	in. 1.6598	in. 1.6598	in. 1.6598	in. 1.6984	in. 1.6984	in. 1.6984
		1.6955	1.6592	1.6898	1.6720	1.7380	1.7380	1.7380	1.7500	1.6955	1.6955	1.6955	1.7500	1.7500	1.7028	1.7379	1.7028	1.7028	1.6598	1.6598	1.6598	1.6984	1.6984	1.6984
		1.6955	1.6592	1.6913	1.6733	1.7380	1.7380	1.7380	1.7500	1.6955	1.6955	1.6955	1.7500	1.7500	1.7005	1.7366	1.7005	1.7005	1.6598	1.6598	1.6598	1.6984	1.6984	1.6984
1 1/4-16	NEF	in. 1.7094	in. 1.6823	in. 1.7035	in. 1.6900	in. 1.7500	in. 1.7500	in. 1.7500	in. 1.7500	in. 1.7094	in. 1.7094	in. 1.7094	in. 1.7500	in. 1.7500	in. 1.7153	in. 1.7494	in. 1.7153	in. 1.7153	in. 1.6823	in. 1.6823	in. 1.6823	in. 1.7030	in. 1.7030	in. 1.7030
		1.7094	1.6817	1.7039	1.6918	1.7500	1.7500	1.7500	1.7500	1.7094	1.7094	1.7094	1.7500	1.7500	1.7149	1.7418	1.7149	1.7149	1.6823	1.6823	1.6823	1.7030	1.7030	1.7030
		1.7090	1.6817	1.7057	1.6924	1.7500	1.7500	1.7500	1.7500	1.7090	1.7090	1.7090	1.7500	1.7500	1.7135	1.7406	1.7135	1.7135	1.6823	1.6823	1.6823	1.7030	1.7030	1.7030
1 1/4-16	N	in. 1.7719	in. 1.7448	in. 1.7660	in. 1.7525	in. 1.8250	in. 1.8250	in. 1.8250	in. 1.8331	in. 1.7719	in. 1.7719	in. 1.7719	in. 1.8250	in. 1.8250	in. 1.7778	in. 1.8049	in. 1.7778	in. 1.7778	in. 1.7448	in. 1.7448	in. 1.7448	in. 1.7528	in. 1.7528	in. 1.7528
		1.7715	1.7448	1.7664	1.7531	1.8250	1.8250	1.8250	1.8331	1.7715	1.7715	1.7715	1.8250	1.8250	1.7774	1.8043	1.7774	1.7774	1.7448	1.7448	1.7448	1.7528	1.7528	1.7528
		1.7715	1.7442	1.7681	1.7548	1.8250	1.8250	1.8250	1.8331	1.7715	1.7715	1.7715	1.8250	1.8250	1.7757	1.8026	1.7757	1.7757	1.7448	1.7448	1.7448	1.7528	1.7528	1.7528
1 1/4-8	N	in. 1.7933	in. 1.7397	in. 1.7838	in. 1.7674	in. 1.8500	in. 1.8500	in. 1.8500	in. 1.8526	in. 1.7933	in. 1.7933	in. 1.7933	in. 1.8500	in. 1.8500	in. 1.8033	in. 1.8570	in. 1.8033	in. 1.8033	in. 1.7397	in. 1.7397	in. 1.7397	in. 1.7543	in. 1.7543	in. 1.7543
		1.7933	1.7397	1.7868	1.7688	1.8500	1.8500	1.8500	1.8526	1.7933	1.7933	1.7933	1.8500	1.8500	1.8033	1.8570	1.8033	1.8033	1.7397	1.7397	1.7397	1.7543	1.7543	1.7543
		1.7933	1.7390	1.7873	1.7683	1.8500	1.8500	1.8500	1.8526	1.7933	1.7933	1.7933	1.8500	1.8500	1.8003	1.8542	1.8003	1.8003	1.7397	1.7397	1.7397	1.7543	1.7543	1.7543
1 1/4-12	N	in. 1.8209	in. 1.7848	in. 1.8143	in. 1.7983	in. 1.8750	in. 1.8750	in. 1.8750	in. 1.8756	in. 1.8209	in. 1.8209	in. 1.8209	in. 1.8750	in. 1.8750	in. 1.8275	in. 1.8636	in. 1.8275	in. 1.8275	in. 1.7848	in. 1.7848	in. 1.7848	in. 1.7938	in. 1.7938	in. 1.7938
		1.8205	1.7842	1.8147	1.7969	1.8750	1.8750	1.8750	1.8756	1.8205	1.8205	1.8205	1.8750	1.8750	1.8271	1.8636	1.8271	1.8271	1.7848	1.7848	1.7848	1.7938	1.7938	1.7938
		1.8205	1.7842	1.8167	1.7989	1.8750	1.8750	1.8750	1.8756	1.8205	1.8205	1.8205	1.8750	1.8750	1.8255	1.8616	1.8255	1.8255	1.7848	1.7848	1.7848	1.7938	1.7938	1.7938
1 1/4-16	N	in. 1.8344	in. 1.8073	in. 1.8284	in. 1.8149	in. 1.8750	in. 1.8750	in. 1.8750	in. 1.8756	in. 1.8344	in. 1.8344	in. 1.8344	in. 1.8750	in. 1.8750	in. 1.8404	in. 1.8756	in. 1.8404	in. 1.8404	in. 1.8073	in. 1.8073	in. 1.8073	in. 1.8154	in. 1.8154	in. 1.8154
		1.8340	1.8067	1.8280	1.8155	1.8750	1.8750	1.8750	1.8756	1.8340	1.8340	1.8340	1.8750	1.8750	1.8400	1.8756	1.8400	1.8400	1.8073	1.8073	1.8073	1.8154	1.8154	1.8154
		1.8340	1.8067	1.8280	1.8173	1.8750	1.8750	1.8750	1.8756	1.8340	1.8340	1.8340	1.8750	1.8750	1.8400	1.8756	1.8400	1.8400	1.8073	1.8073	1.8073	1.8154	1.8154	1.8154

TABLE 1.16.—Gages for standard thread series, American National screw threads—Continued

Gages for external threads										Gages for internal threads										Series designation	Nominal size and threads per inch																														
Thread gages					Z plain gages for major diameter					Thread gages					Z plain gages for minor diameter																																				
Class	Go	Not go		Minor diameter	Go	Unfinished hot-rolled material	Semi-finished	Go	10	11	Major diameter	Pitch diameter	Major diameter	Not go		Major diameter	Pitch diameter	Major diameter	Pitch diameter	Go	Not go																														
		Plus tol. Fake	Minus tol. gage											Plus tol. gage	Minus tol. gage																																				
2	3	4	5	6	7	8	9	10	11	12	13	14	15	16	17	18	19	20	21	22																															
2	N	4.188	4.3647	4.4050	4.4050	4.4050	4.4988	4.4988	4.4778	4.5000	4.4188	4.4867	4.4826	4.4326	4.3647	4.3795	2	N	4.188	4.3647	4.4050	4.4050	4.4988	4.4988	4.4778	4.5000	4.4188	4.4867	4.4826	4.4326	4.3647	4.3795	2	N	4.188	4.3647	4.4050	4.4050	4.4988	4.4988	4.4778	4.5000	4.4188	4.4867	4.4826	4.4326	4.3647	4.3795			
3	N	4.182	4.3586	4.4021	4.4021	4.4021	4.4959	4.4959	4.4749	4.4971	4.4159	4.4838	4.4797	4.4297	4.4297	4.3618	4.3766	3	N	4.182	4.3586	4.4021	4.4021	4.4959	4.4959	4.4749	4.4971	4.4159	4.4838	4.4797	4.4297	4.3618	4.3766	3	N	4.182	4.3586	4.4021	4.4021	4.4959	4.4959	4.4749	4.4971	4.4159	4.4838	4.4797	4.4297	4.3618	4.3766		
2	N	4.439	4.6153	4.6596	4.6596	4.6596	4.7534	4.7534	4.7324	4.7546	4.6726	4.7405	4.7364	4.6864	4.6364	4.5685	4.5833	2	N	4.439	4.6153	4.6596	4.6596	4.7534	4.7534	4.7324	4.7546	4.6726	4.7405	4.7364	4.6864	4.6364	4.5685	4.5833	2	N	4.439	4.6153	4.6596	4.6596	4.7534	4.7534	4.7324	4.7546	4.6726	4.7405	4.7364	4.6864	4.6364	4.5685	4.5833
3	N	4.433	4.6088	4.6531	4.6531	4.6531	4.7469	4.7469	4.7259	4.7481	4.6661	4.7340	4.7299	4.6799	4.6299	4.5620	4.5768	3	N	4.433	4.6088	4.6531	4.6531	4.7469	4.7469	4.7259	4.7481	4.6661	4.7340	4.7299	4.6799	4.6299	4.5620	4.5768	3	N	4.433	4.6088	4.6531	4.6531	4.7469	4.7469	4.7259	4.7481	4.6661	4.7340	4.7299	4.6799	4.6299	4.5620	4.5768
2	N	4.683	4.8587	4.9030	4.9030	4.9030	5.0000	5.0000	4.9790	5.0012	4.9170	4.9849	4.9808	4.9308	4.8808	4.8129	4.8277	2	N	4.683	4.8587	4.9030	4.9030	5.0000	5.0000	4.9790	5.0012	4.9170	4.9849	4.9808	4.9308	4.8808	4.8129	4.8277	2	N	4.683	4.8587	4.9030	4.9030	5.0000	5.0000	4.9790	5.0012	4.9170	4.9849	4.9808	4.9308	4.8808	4.8129	4.8277
3	N	4.677	4.8522	4.8965	4.8965	4.8965	4.9935	4.9935	4.9725	4.9947	4.9305	4.9984	4.9943	4.9443	4.8943	4.8264	4.8412	3	N	4.677	4.8522	4.8965	4.8965	4.9935	4.9935	4.9725	4.9947	4.9305	4.9984	4.9943	4.9443	4.8943	4.8264	4.8412	3	N	4.677	4.8522	4.8965	4.8965	4.9935	4.9935	4.9725	4.9947	4.9305	4.9984	4.9943	4.9443	4.8943	4.8264	4.8412
2	N	4.704	4.8798	4.9241	4.9241	4.9241	5.0211	5.0211	4.9999	5.0221	4.9479	5.0158	5.0117	4.9617	4.9117	4.8438	4.8586	2	N	4.704	4.8798	4.9241	4.9241	5.0211	5.0211	4.9999	5.0221	4.9479	5.0158	5.0117	4.9617	4.9117	4.8438	4.8586	2	N	4.704	4.8798	4.9241	4.9241	5.0211	5.0211	4.9999	5.0221	4.9479	5.0158	5.0117	4.9617	4.9117	4.8438	4.8586
3	N	4.700	4.8754	4.9197	4.9197	4.9197	5.0167	5.0167	4.9955	5.0177	4.9535	5.0214	5.0173	4.9673	4.9173	4.8494	4.8642	3	N	4.700	4.8754	4.9197	4.9197	5.0167	5.0167	4.9955	5.0177	4.9535	5.0214	5.0173	4.9673	4.9173	4.8494	4.8642	3	N	4.700	4.8754	4.9197	4.9197	5.0167	5.0167	4.9955	5.0177	4.9535	5.0214	5.0173	4.9673	4.9173	4.8494	4.8642
2	N	4.918	5.0942	5.1385	5.1385	5.1385	5.2355	5.2355	5.2145	5.2367	5.1725	5.2404	5.2363	5.1863	5.1363	5.0684	5.0832	2	N	4.918	5.0942	5.1385	5.1385	5.2355	5.2355	5.2145	5.2367	5.1725	5.2404	5.2363	5.1863	5.1363	5.0684	5.0832	2	N	4.918	5.0942	5.1385	5.1385	5.2355	5.2355	5.2145	5.2367	5.1725	5.2404	5.2363	5.1863	5.1363	5.0684	5.0832
3	N	4.912	5.0877	5.1320	5.1320	5.1320	5.2290	5.2290	5.2080	5.2302	5.1640	5.2279	5.2238	5.1738	5.1238	5.0559	5.0707	3	N	4.912	5.0877	5.1320	5.1320	5.2290	5.2290	5.2080	5.2302	5.1640	5.2279	5.2238	5.1738	5.1238	5.0559	5.0707	3	N	4.912	5.0877	5.1320	5.1320	5.2290	5.2290	5.2080	5.2302	5.1640	5.2279	5.2238	5.1738	5.1238	5.0559	5.0707
2	N	5.168	5.3442	5.3885	5.3885	5.3885	5.4855	5.4855	5.4645	5.4867	5.4225	5.4904	5.4863	5.4363	5.3863	5.3184	5.3332	2	N	5.168	5.3442	5.3885	5.3885	5.4855	5.4855	5.4645	5.4867	5.4225	5.4904	5.4863	5.4363	5.3863	5.3184	5.3332	2	N	5.168	5.3442	5.3885	5.3885	5.4855	5.4855	5.4645	5.4867	5.4225	5.4904	5.4863	5.4363	5.3863	5.3184	5.3332
3	N	5.162	5.3377	5.3820	5.3820	5.3820	5.4790	5.4790	5.4580	5.4802	5.4140	5.4779	5.4738	5.4238	5.3738	5.3059	5.3207	3	N	5.162	5.3377	5.3820	5.3820	5.4790	5.4790	5.4580	5.4802	5.4140	5.4779	5.4738	5.4238	5.3738	5.3059	5.3207	3	N	5.162	5.3377	5.3820	5.3820	5.4790	5.4790	5.4580	5.4802	5.4140	5.4779	5.4738	5.4238	5.3738	5.3059	5.3207
2	N	5.169	5.345	5.3898	5.3898	5.3898	5.4868	5.4868	5.4658	5.4880	5.4248	5.4927	5.4886	5.4386	5.3886	5.3207	5.3355	2	N	5.169	5.345	5.3898	5.3898	5.4868	5.4868	5.4658	5.4880	5.4248	5.4927	5.4886	5.4386	5.3886	5.3207	5.3355	2	N	5.169	5.345	5.3898	5.3898	5.4868	5.4868	5.4658	5.4880	5.4248	5.4927	5.4886	5.4386	5.3886	5.3207	5.3355
3	N	5.163	5.339	5.3842	5.3842	5.3842	5.4812	5.4812	5.4602	5.4824	5.4162	5.4801	5.4760	5.4260	5.3760	5.3081	5.3229	3	N	5.163	5.339	5.3842	5.3842	5.4812	5.4812	5.4602	5.4824	5.4162	5.4801	5.4760	5.4260	5.3760	5.3081	5.3229	3	N	5.163	5.339	5.3842	5.3842	5.4812	5.4812	5.4602	5.4824	5.4162	5.4801	5.4760	5.4260	5.3760	5.3081	5.3229

TABLE 1.17.--Setting plug gages, American National screw threads

Nominal size and threads per inch	Series designation	Class	W truncated setting plugs							Basic-crest setting plugs					
			Plug for "Go"			Plug for "Not go"				Major diameter					
			Major diameter		Pitch diameter	Major diameter		Pitch diameter		Go ¹		Not go ²			
			Truncated	Full		Truncated	Full	Plus tol. gage	Minus tol. gage	W tolerance	X tolerance	W tolerance	X tolerance		
1	2	3	4	5	6	7	8	9	10	11A	11B	12A	12B		
0.80	NF	1	.0559	.0593	.0512	.0542	.0576	.0488	.0488	.0488	.0488	.0488	.0488	.0488	.0488
		2	.0566	.0600	.0519	.0556	.0590	.0502	.0502	.0502	.0502	.0502	.0502	.0502	.0502
		3	.0566	.0600	.0519	.0556	.0590	.0502	.0502	.0502	.0502	.0502	.0502	.0502	.0502
1-61	NC	1	.0683	.0723	.0622	.0664	.0710	.0596	.0596	.0596	.0596	.0596	.0596	.0596	.0596
		2	.0680	.0730	.0629	.0678	.0724	.0610	.0610	.0610	.0610	.0610	.0610	.0610	.0610
		3	.0680	.0730	.0629	.0678	.0724	.0610	.0610	.0610	.0610	.0610	.0610	.0610	.0610
1-72	NF	1	.0686	.0723	.0633	.0668	.0708	.0608	.0608	.0608	.0608	.0608	.0608	.0608	.0608
		2	.0683	.0726	.0632	.0665	.0704	.0604	.0604	.0604	.0604	.0604	.0604	.0604	.0604
		3	.0683	.0726	.0632	.0665	.0704	.0604	.0604	.0604	.0604	.0604	.0604	.0604	.0604
2-56	NC	1	.0808	.0852	.0736	.0785	.0841	.0708	.0708	.0708	.0708	.0708	.0708	.0708	.0708
		2	.0805	.0855	.0744	.0792	.0844	.0709	.0709	.0709	.0709	.0709	.0709	.0709	.0709
		3	.0805	.0855	.0744	.0792	.0844	.0709	.0709	.0709	.0709	.0709	.0709	.0709	.0709
2-64	NF	1	.0813	.0853	.0752	.0794	.0840	.0726	.0726	.0726	.0726	.0726	.0726	.0726	.0726
		2	.0810	.0856	.0751	.0791	.0843	.0727	.0727	.0727	.0727	.0727	.0727	.0727	.0727
		3	.0810	.0856	.0751	.0791	.0843	.0727	.0727	.0727	.0727	.0727	.0727	.0727	.0727
3-48	NC	1	.0932	.0981	.0846	.0905	.0971	.0845	.0845	.0845	.0845	.0845	.0845	.0845	.0845
		2	.0929	.0980	.0845	.0902	.0971	.0845	.0845	.0845	.0845	.0845	.0845	.0845	.0845
		3	.0929	.0980	.0845	.0902	.0971	.0845	.0845	.0845	.0845	.0845	.0845	.0845	.0845
3-56	NF	1	.0938	.0982	.0856	.0915	.0971	.0838	.0838	.0838	.0838	.0838	.0838	.0838	.0838
		2	.0935	.0985	.0855	.0912	.0971	.0839	.0839	.0839	.0839	.0839	.0839	.0839	.0839
		3	.0935	.0985	.0855	.0912	.0971	.0839	.0839	.0839	.0839	.0839	.0839	.0839	.0839
4-40	NC	1	1.051	1.110	.0948	1.022	1.102	.0911	.0911	.0911	.0911	.0911	.0911	.0911	.0911
		2	1.051	1.113	.0947	1.019	1.095	.0915	.0915	.0915	.0915	.0915	.0915	.0915	.0915
		3	1.051	1.113	.0947	1.019	1.095	.0915	.0915	.0915	.0915	.0915	.0915	.0915	.0915
4-48	NF	1	1.062	1.111	.0956	1.035	1.101	.0915	.0915	.0915	.0915	.0915	.0915	.0915	.0915
		2	1.059	1.114	.0955	1.032	1.104	.0916	.0916	.0916	.0916	.0916	.0916	.0916	.0916
		3	1.059	1.114	.0955	1.032	1.104	.0916	.0916	.0916	.0916	.0916	.0916	.0916	.0916
5-40	NC	1	1.181	1.239	1.078	1.159	1.232	1.041	1.041	1.041	1.041	1.041	1.041	1.041	1.041
		2	1.181	1.243	1.077	1.149	1.235	1.045	1.045	1.045	1.045	1.045	1.045	1.045	1.045
		3	1.181	1.243	1.077	1.149	1.235	1.045	1.045	1.045	1.045	1.045	1.045	1.045	1.045
6-44	NF	1	1.189	1.241	1.093	1.159	1.232	1.061	1.061	1.061	1.061	1.061	1.061	1.061	1.061
		2	1.186	1.244	1.092	1.156	1.235	1.062	1.062	1.062	1.062	1.062	1.062	1.062	1.062
		3	1.186	1.244	1.092	1.156	1.235	1.062	1.062	1.062	1.062	1.062	1.062	1.062	1.062
6-32	NC	1	1.301	1.372	1.166	1.263	1.362	1.178	1.178	1.178	1.178	1.178	1.178	1.178	1.178
		2	1.301	1.372	1.166	1.263	1.362	1.178	1.178	1.178	1.178	1.178	1.178	1.178	1.178
		3	1.301	1.372	1.166	1.263	1.362	1.178	1.178	1.178	1.178	1.178	1.178	1.178	1.178

See footnotes at end of table.

TABLE I.17. *Setting plug gages, American National screw threads - Continued*

Nominal size and threads per inch	Series designation	Class	W truncated setting plugs							Basic crest setting plugs				
			Plug for "Go"			Plug for "Not go"				Major diameter				
			Major diameter		Pitch diameter	Major diameter		Pitch diameter		Go 1		Not go 2		
			Truncated	Full		Truncated	Full	Plus tol. gage	Minus tol. gage	W tolerance	X tolerance	W tolerance	X tolerance	
1	2	3	4	5	6	7	8	9	10	11A	11B	12A	12B	
			<i>in.</i>	<i>in.</i>	<i>in.</i>	<i>in.</i>	<i>in.</i>	<i>in.</i>	<i>in.</i>	<i>in.</i>	<i>in.</i>	<i>in.</i>	<i>in.</i>	<i>in.</i>
6-40	NF	1	0.1314	0.1370	0.1308	0.1292	0.1362	0.1174	0.1174	0.1370	0.1370	0.1362	0.1362	
			0.1311	0.1372	0.1297	0.1279	0.1365	0.1175	0.1175	0.1373	0.1373	0.1365	0.1366	
			0.1324	0.1380	0.1218	0.1302	0.1389	0.1194	0.1194	0.1380	0.1380	0.1380	0.1380	
		2	0.1321	0.1383	0.1217	0.1299	0.1383	0.1195	0.1195	0.1383	0.1383	0.1381	0.1381	0.1381
			0.1324	0.1380	0.1218	0.1309	0.1380	0.1201	0.1201	0.1380	0.1380	0.1380	0.1380	0.1380
			0.1321	0.1383	0.1217	0.1309	0.1383	0.1202	0.1202	0.1383	0.1383	0.1381	0.1381	0.1381
		3	0.1564	0.1629	0.1426	0.1523	0.1622	0.1388	0.1388	0.1629	0.1629	0.1622	0.1622	0.1622
			0.1561	0.1632	0.1425	0.1526	0.1625	0.1389	0.1389	0.1632	0.1632	0.1625	0.1625	0.1627
			0.1575	0.1619	0.1437	0.1545	0.1619	0.1410	0.1410	0.1619	0.1619	0.1619	0.1619	0.1619
8-32	NC	1	0.1572	0.1643	0.1486	0.1542	0.1643	0.1414	0.1414	0.1643	0.1643	0.1643	0.1643	
			0.1575	0.1640	0.1487	0.1553	0.1640	0.1418	0.1418	0.1640	0.1640	0.1640	0.1640	
			0.1572	0.1643	0.1486	0.1530	0.1643	0.1419	0.1419	0.1643	0.1643	0.1645	0.1645	
8-36	NF	1	0.1569	0.1629	0.1440	0.1533	0.1621	0.1413	0.1413	0.1629	0.1629	0.1621	0.1621	
			0.1566	0.1632	0.1448	0.1530	0.1624	0.1414	0.1414	0.1632	0.1632	0.1623	0.1623	
			0.1580	0.1616	0.1469	0.1555	0.1616	0.1435	0.1435	0.1616	0.1616	0.1616	0.1616	
2	0.1577	0.1613	0.1439	0.1552	0.1613	0.1436	0.1436	0.1613	0.1613	0.1611	0.1611	0.1611		
	0.1580	0.1610	0.1460	0.1562	0.1610	0.1442	0.1442	0.1610	0.1610	0.1610	0.1610	0.1610		
	0.1577	0.1613	0.1439	0.1559	0.1613	0.1443	0.1443	0.1613	0.1613	0.1611	0.1611	0.1611		
10-24	NC	1	0.1808	0.1887	0.1616	0.1750	0.1882	0.1570	0.1570	0.1887	0.1887	0.1882	0.1882	
			0.1803	0.1892	0.1615	0.1745	0.1887	0.1571	0.1571	0.1892	0.1892	0.1887	0.1887	
			0.1821	0.1900	0.1629	0.1776	0.1900	0.1596	0.1596	0.1900	0.1900	0.1900	0.1900	
2	0.1816	0.1865	0.1628	0.1771	0.1905	0.1597	0.1597	0.1865	0.1865	0.1865	0.1865			
	0.1821	0.1900	0.1629	0.1785	0.1900	0.1605	0.1605	0.1900	0.1900	0.1900	0.1900			
	0.1816	0.1865	0.1628	0.1780	0.1905	0.1606	0.1606	0.1900	0.1900	0.1905	0.1905			
10-32	NF	1	0.1824	0.1889	0.1636	0.1787	0.1882	0.1618	0.1618	0.1889	0.1889	0.1882	0.1882	
			0.1831	0.1892	0.1635	0.1780	0.1885	0.1619	0.1619	0.1892	0.1892	0.1885	0.1887	
			0.1835	0.1900	0.1637	0.1805	0.1900	0.1670	0.1670	0.1900	0.1900	0.1900	0.1900	
2	0.1832	0.1903	0.1636	0.1822	0.1903	0.1671	0.1671	0.1903	0.1903	0.1903	0.1903			
	0.1835	0.1900	0.1637	0.1813	0.1903	0.1678	0.1678	0.1900	0.1900	0.1900	0.1900			
	0.1832	0.1903	0.1636	0.1819	0.1903	0.1679	0.1679	0.1903	0.1903	0.1903	0.1903			
12-24	NC	1	0.2098	0.2147	0.1976	0.2010	0.2142	0.1830	0.1830	0.2147	0.2147	0.2142	0.2142	
			0.2093	0.2152	0.1975	0.2005	0.2147	0.1831	0.1831	0.2152	0.2152	0.2147	0.2147	
			0.2081	0.2169	0.1989	0.2036	0.2169	0.1856	0.1856	0.2169	0.2169	0.2169	0.2169	
2	0.2076	0.2165	0.1988	0.2041	0.2165	0.1857	0.1857	0.2165	0.2165	0.2165	0.2165			
	0.2081	0.2161	0.1989	0.2045	0.2160	0.1865	0.1865	0.2160	0.2160	0.2160	0.2160			
	0.2076	0.2165	0.1988	0.2040	0.2165	0.1866	0.1866	0.2165	0.2165	0.2165	0.2165			
12-28	NF	1	0.2077	0.2148	0.1916	0.2028	0.2141	0.1873	0.1873	0.2148	0.2148	0.2141	0.2141	
			0.2072	0.2153	0.1915	0.2023	0.2146	0.1873	0.1873	0.2153	0.2153	0.2146	0.2146	
			0.2089	0.2160	0.1928	0.2052	0.2160	0.1897	0.1897	0.2160	0.2160	0.2160	0.2160	
2	0.2081	0.2165	0.1927	0.2047	0.2165	0.1898	0.1898	0.2165	0.2165	0.2165	0.2165			
	0.2089	0.2160	0.1928	0.2061	0.2160	0.1906	0.1906	0.2160	0.2160	0.2160	0.2160			
	0.2081	0.2165	0.1927	0.2056	0.2165	0.1907	0.1907	0.2165	0.2165	0.2165	0.2165			
12-36	NRF	2	0.2095	0.2160	0.1957	0.2061	0.2160	0.1926	0.1926	0.2160	0.2160	0.2160	0.2160	
			0.2092	0.2163	0.1956	0.2058	0.2163	0.1927	0.1927	0.2163	0.2163	0.2163	0.2163	
			0.2095	0.2160	0.1957	0.2070	0.2160	0.1935	0.1935	0.2160	0.2160	0.2160	0.2160	
3	0.2092	0.2163	0.1956	0.2067	0.2163	0.1936	0.1936	0.2163	0.2163	0.2163	0.2163			
	0.2095	0.2160	0.1957	0.2091	0.2160	0.1926	0.1926	0.2160	0.2160	0.2160	0.2160			
	0.2092	0.2163	0.1956	0.2067	0.2163	0.1936	0.1936	0.2163	0.2163	0.2163	0.2163			
14-20	NC	1	0.2395	0.2485	0.2160	0.2291	0.2484	0.2169	0.2169	0.2485	0.2485	0.2481	0.2481	
			0.2390	0.2490	0.2159	0.2321	0.2489	0.2140	0.2140	0.2490	0.2490	0.2489	0.2489	
			0.2410	0.2500	0.2175	0.2356	0.2500	0.2139	0.2139	0.2500	0.2500	0.2500	0.2500	
2	0.2405	0.2505	0.2174	0.2351	0.2505	0.2140	0.2140	0.2505	0.2505	0.2505	0.2505			
	0.2410	0.2500	0.2175	0.2366	0.2500	0.2149	0.2149	0.2500	0.2500	0.2500	0.2500			
	0.2405	0.2505	0.2174	0.2361	0.2505	0.2150	0.2150	0.2505	0.2505	0.2505	0.2505			
3	0.2413	0.2503	0.2178	0.2382	0.2503	0.2155	0.2155	0.2500	0.2500	0.2500	0.2500			
	0.2408	0.2508	0.2177	0.2377	0.2508	0.2166	0.2166	0.2505	0.2505	0.2505	0.2505			
	0.2413	0.2503	0.2178	0.2377	0.2508	0.2166	0.2166	0.2505	0.2505	0.2505	0.2505			
14-28	NF	1	0.2417	0.2488	0.2256	0.2368	0.2481	0.2213	0.2213	0.2488	0.2488	0.2481	0.2481	
			0.2412	0.2493	0.2255	0.2363	0.2486	0.2214	0.2214	0.2493	0.2493	0.2486	0.2486	
			0.2429	0.2500	0.2268	0.2392	0.2500	0.2237	0.2237	0.2500	0.2500	0.2500	0.2500	
2	0.2424	0.2505	0.2267	0.2387	0.2505	0.2238	0.2238	0.2505	0.2505	0.2505	0.2505			
	0.2429	0.2500	0.2268	0.2401	0.2500	0.2246	0.2246	0.2500	0.2500	0.2500	0.2500			
	0.2424	0.2505	0.2267	0.2396	0.2505	0.2247	0.2247	0.2505	0.2505	0.2505	0.2505			
3	0.2431	0.2501	0.2270	0.2414	0.2501	0.2259	0.2259	0.2500	0.2500	0.2500	0.2500			
	0.2426	0.2507	0.2269	0.2409	0.2507	0.2260	0.2260	0.2505	0.2505	0.2505	0.2505			
	0.2431	0.2501	0.2270	0.2409	0.2507	0.2260	0.2260	0.2505	0.2505	0.2505	0.2505			
14-32	NRF	2	0.2435	0.2500	0.2297	0.2400	0.2499	0.2265	0.2265	0.2500	0.2500	0.2499	0.2499	
			0.2432	0.2503	0.2296	0.2397	0.2502	0.2266	0.2266	0.2503	0.2503	0.2502	0.2502	
			0.2435	0.2500	0.2297	0.2410	0.2500	0.2275	0.2275	0.2500	0.2500	0.2500	0.2500	
3	0.2432	0.2503	0.2296	0.2407	0.2503	0.2276	0.2276	0.2503	0.2503	0.2503	0.2503			
	0.2435	0.2500	0.2297	0.2407	0.2503	0.2276	0.2276	0.2503	0.2503	0.2503	0.2503			
	0.2432	0.2503	0.2296	0.2407	0.2503	0.2276	0.2276	0.2503	0.2503	0.2503	0.2503			
1/16-18	NC	1	0.3012	0.3109	0.2748	0.2932	0.3108	0.2691	0.2691	0.3109	0.3109	0.3108	0.3108	
			0.3007	0.3114	0.2747	0.2927	0.3113	0.2692	0.2692	0.3114	0.3114	0.3113	0.3113	
			0.3028	0.3125	0.2761	0.2964	0.3125	0.2723	0.2723	0.3125	0.3125	0.3125	0.3125	
2	0.3023	0.3130	0.2763	0.2959	0.3130	0.2724	0.2724	0.3130	0.3130	0.3130	0.3130			
	0.3028	0.3125	0.2764	0.2975	0.3125	0.2734	0.2734	0.3125	0.3125	0.3125	0.3125			
	0.3023	0.3130	0.2763	0.2970	0.3130	0.2735	0.2735	0.3130	0.3130	0.3130	0.3130			
3	0.3041	0.3128	0.2767	0.2993	0.3128	0.2752	0.2752	0.3125	0.3125	0.3125	0.3125			
	0.3041	0.3133	0.2766	0.2988	0.3133	0.2753	0.2753							

TABLE 1.17.—Setting plug gages, American National screw threads—Continued

Nominal size and threads per inch	Series designation	Class	W truncated setting plugs								Basic-croset setting plugs				
			Plug for "Go"				Plug for "Not go"				Major diameter				
			Major diameter		Pitch diameter	Major diameter		Pitch diameter		Go ¹		Not go ²			
			Truncated	Full		Truncated	Full	Plus tol. gage	Minus tol. gage	W tolerance	X tolerance	W tolerance	X tolerance		
1	2	3	4	5	6	7	8	9	10	11A	11B	12A	12B		
5/16-24	NF	1	<i>in.</i>	<i>in.</i>	<i>in.</i>	<i>in.</i>	<i>in.</i>	<i>in.</i>	<i>in.</i>	<i>in.</i>	<i>in.</i>	<i>in.</i>	<i>in.</i>	<i>in.</i>	<i>in.</i>
			0.3033	0.3112	0.2841	0.2975	0.3108	0.2795	0.2795	0.3112	0.3112	0.3108	0.3108	0.3108	0.3108
			.3028	.3117	.2840	.2970	.3113	.2796	.2794	.3117	.3117	.3113	.3113	.3113	.3113
			.3046	.3125	.2854	.2991	.3125	.2821	.2821	.3125	.3125	.3125	.3125	.3125	.3125
	NF	2	.3041	.3130	.2853	.2995	.3130	.2822	.2820	.3130	.3130	.3130	.3130	.3130	.3130
			.3046	.3125	.2854	.3010	.3125	.2830	.2830	.3125	.3125	.3125	.3125	.3125	.3125
			.3041	.3130	.2853	.3005	.3130	.2831	.2829	.3130	.3130	.3130	.3130	.3130	.3130
			.3049	.3128	.2857	.3025	.3128	.2845	.2845	.3125	.3125	.3125	.3125	.3125	.3125
	NEF	3	.3044	.3133	.2856	.3020	.3133	.2846	.2844	.3130	.3130	.3130	.3130	.3130	.3130
			.3060	.3125	.2922	.3024	.3123	.2889	.2889	.3125	.3125	.3123	.3123	.3123	.3123
			.3057	.3128	.2921	.3021	.3126	.2880	.2888	.3128	.3130	.3126	.3130	.3126	.3130
			.3060	.3125	.2922	.3034	.3125	.2899	.2899	.3125	.3125	.3125	.3125	.3125	.3125
NEF	3	.3057	.3128	.2921	.3021	.3128	.2900	.2898	.3128	.3130	.3128	.3130	.3128	.3130	
		.3027	.3732	.3326	.3534	.3732	.3263	.3263	.3732	.3732	.3732	.3732	.3732	.3732	
		.3021	.3738	.3325	.3528	.3738	.3261	.3262	.3738	.3738	.3738	.3738	.3738	.3738	
		.3045	.3750	.3344	.3570	.3750	.3299	.3299	.3750	.3750	.3750	.3750	.3750	.3750	
NC	1	.3039	.3756	.3343	.3564	.3756	.3300	.3298	.3756	.3756	.3756	.3756	.3756	.3756	
		.3045	.3750	.3344	.3583	.3750	.3312	.3312	.3750	.3750	.3750	.3750	.3750	.3750	
		.3039	.3756	.3343	.3577	.3756	.3313	.3311	.3756	.3756	.3756	.3756	.3756	.3756	
		.3049	.3754	.3348	.3593	.3754	.3332	.3332	.3750	.3750	.3750	.3750	.3750	.3750	
NC	1	.3043	.3760	.3347	.3597	.3760	.3333	.3331	.3756	.3756	.3756	.3756	.3756	.3756	
		.3058	.3737	.3466	.3600	.3732	.3420	.3420	.3737	.3737	.3732	.3732	.3732	.3732	
		.3053	.3742	.3465	.3595	.3737	.3421	.3419	.3742	.3742	.3737	.3737	.3737	.3737	
		.3071	.3750	.3479	.3626	.3750	.3446	.3446	.3750	.3750	.3750	.3750	.3750	.3750	
NF	2	.3066	.3755	.3478	.3621	.3755	.3447	.3445	.3755	.3755	.3755	.3755	.3755	.3755	
		.3071	.3750	.3479	.3635	.3750	.3455	.3455	.3750	.3750	.3750	.3750	.3750	.3750	
		.3066	.3755	.3478	.3630	.3755	.3456	.3454	.3755	.3755	.3755	.3755	.3755	.3755	
		.3074	.3753	.3482	.3650	.3753	.3470	.3470	.3750	.3750	.3750	.3750	.3750	.3750	
NF	2	.3069	.3758	.3481	.3645	.3758	.3471	.3469	.3755	.3755	.3755	.3755	.3755	.3755	
		.3085	.3750	.3547	.3648	.3747	.3513	.3513	.3750	.3750	.3747	.3750	.3747	.3747	
		.3082	.3753	.3546	.3645	.3750	.3514	.3512	.3753	.3755	.3750	.3750	.3752	.3752	
		.3085	.3750	.3547	.3658	.3750	.3523	.3523	.3750	.3750	.3750	.3750	.3750	.3750	
NEF	3	.3082	.3753	.3546	.3655	.3753	.3524	.3522	.3753	.3755	.3753	.3753	.3753	.3753	

See footnotes at end of table.

TABLE 1.17. Setting plug gages, American National screw threads --Continued

Nominal size and threads per inch	Series designation	Class	W truncated setting plugs							Basic-crest setting plugs		
			Plug for "Go"			Plug for "Not go"				Major diameter		
			Major diameter		Pitch diameter	Major diameter		Pitch diameter		Go ¹	Not go ²	
			Truncated	Full		Truncated	Full	Plus tol. gage	Minus tol. gage			
1	2	3	4	5	6	7	8	9	10	11	12	
			<i>in.</i>	<i>in.</i>	<i>in.</i>	<i>in.</i>	<i>in.</i>	<i>in.</i>	<i>in.</i>	<i>in.</i>	<i>in.</i>	<i>in.</i>
3/16-14	NC	1	0.4230	0.4354	0.38900	0.4129	0.4354	0.38200	0.38200	0.38200	0.4354	0.4354
		2	.4233	.4360	.38885	.4123	.4360	.38217	.38185	.38217	.4360	.4360
		3	.4260	.4375	.39110	.4171	.4375	.38620	.38620	.38620	.4375	.4375
		4	.4254	.4381	.39095	.4165	.4381	.38635	.38635	.38635	.4381	.4381
	NF	1	.4260	.4375	.39110	.4183	.4375	.38770	.38770	.38770	.4375	.4375
		2	.4254	.4381	.39095	.4178	.4381	.38735	.38735	.38735	.4381	.4381
		3	.4264	.4379	.39170	.4209	.4379	.38970	.38970	.38970	.4379	.4379
		4	.4278	.4385	.39135	.4200	.4385	.38985	.38985	.38985	.4385	.4385
3/16-20	NF	1	.4270	.4360	.4035	.4260	.4379	.3984	.3984	.3984	.4360	.4359
		2	.4265	.4365	.4034	.4195	.4364	.3985	.3983	.3983	.4365	.4364
		3	.4285	.4375	.4050	.4231	.4375	.4014	.4014	.4014	.4375	.4375
		4	.4280	.4380	.4049	.4226	.4380	.4015	.4013	.4013	.4380	.4380
3/16-28	NEF	1	.4287	.4375	.4050	.4241	.4375	.4024	.4024	.4024	.4375	.4375
		2	.4280	.4380	.4049	.4236	.4380	.4025	.4023	.4023	.4380	.4380
		3	.4288	.4378	.4052	.4231	.4378	.4010	.4010	.4010	.4378	.4378
		4	.4283	.4383	.4052	.4251	.4383	.4041	.4039	.4039	.4383	.4383
3/16-32	N	1	.4304	.4375	.4143	.4262	.4375	.4107	.4107	.4107	.4375	.4375
		2	.4299	.4380	.4142	.4277	.4380	.4108	.4106	.4106	.4380	.4380
		3	.4304	.4375	.4143	.4273	.4375	.4118	.4118	.4118	.4375	.4375
		4	.4299	.4380	.4142	.4298	.4380	.4119	.4117	.4117	.4380	.4380
3/16-40	NC	1	.4856	.4978	.44780	.4737	.4978	.44040	.44040	.44040	.4978	.4978
		2	.4850	.4984	.44765	.4731	.4984	.44055	.44055	.44055	.4984	.4984
		3	.4878	.5000	.45000	.4781	.5000	.44480	.44480	.44480	.5000	.5000
		4	.4872	.5006	.44985	.4775	.5006	.44495	.44495	.44495	.5006	.5006
3/16-48	NF	1	.4878	.5000	.45000	.4796	.5000	.44630	.44630	.44630	.5000	.5000
		2	.4872	.5006	.44985	.4790	.5006	.44645	.44645	.44645	.5006	.5006
		3	.4882	.5004	.45010	.4818	.5004	.44850	.44850	.44850	.5004	.5004
		4	.4876	.5010	.45025	.4812	.5010	.44865	.44865	.44865	.5010	.5010
3/16-56	NF	1	.4895	.4985	.4660	.4826	.4984	.4600	.4600	.4600	.4985	.4984
		2	.4890	.4990	.4659	.4821	.4989	.4610	.4608	.4608	.4990	.4989
		3	.4910	.5000	.4675	.4876	.5000	.4639	.4639	.4639	.5000	.5000
		4	.4905	.5005	.4674	.4851	.5005	.4640	.4638	.4638	.5005	.5005
3/16-64	NEF	1	.4910	.5000	.4675	.4866	.5000	.4649	.4649	.4649	.5000	.5000
		2	.4905	.5005	.4674	.4851	.5005	.4650	.4648	.4648	.5005	.5005
		3	.4913	.5003	.4678	.4882	.5003	.4665	.4665	.4665	.5003	.5003
		4	.4908	.5008	.4677	.4877	.5008	.4666	.4664	.4664	.5008	.5008
3/16-72	NEF	1	.4929	.5000	.4768	.4886	.4999	.4731	.4731	.4731	.5000	.4999
		2	.4924	.5005	.4767	.4881	.5004	.4732	.4730	.4730	.5005	.5004
		3	.4929	.5000	.4768	.4897	.5000	.4742	.4742	.4742	.5000	.5000
		4	.4924	.5005	.4767	.4892	.5005	.4743	.4741	.4741	.5005	.5005
3/16-80	NC	1	.5472	.5601	.5090	.5342	.5601	.4981	.4981	.4981	.5601	.5601
		2	.5466	.5607	.5088	.5336	.5607	.4983	.4979	.4979	.5607	.5607
		3	.5496	.5625	.5084	.5389	.5625	.5028	.5028	.5028	.5625	.5625
		4	.5490	.5631	.5082	.5383	.5631	.5030	.5026	.5026	.5631	.5631
3/16-90	NF	1	.5496	.5625	.5084	.5405	.5625	.5044	.5044	.5044	.5625	.5625
		2	.5490	.5631	.5082	.5399	.5631	.5046	.5042	.5042	.5631	.5631
		3	.5501	.5630	.5089	.5430	.5630	.5069	.5069	.5069	.5630	.5630
		4	.5495	.5636	.5087	.5424	.5636	.5071	.5067	.5067	.5636	.5636
3/16-100	NF	1	.5512	.5609	.52180	.5439	.5609	.51910	.51910	.51910	.5609	.5609
		2	.5507	.5614	.52165	.5427	.5613	.51925	.51895	.51895	.5614	.5613
		3	.5528	.5625	.52340	.5494	.5625	.52240	.52240	.52240	.5625	.5625
		4	.5523	.5630	.52325	.5479	.5630	.52255	.52215	.52215	.5630	.5630
3/16-110	NEF	1	.5528	.5625	.52340	.5475	.5625	.52340	.52340	.52340	.5625	.5625
		2	.5523	.5630	.52325	.5470	.5630	.52355	.52325	.52325	.5630	.5630
		3	.5531	.5628	.52370	.5493	.5628	.52526	.52520	.52520	.5628	.5628
		4	.5526	.5633	.52355	.5488	.5633	.52535	.52505	.52505	.5633	.5633
3/16-120	NEF	1	.5546	.5625	.53540	.5494	.5625	.53140	.53140	.53140	.5625	.5625
		2	.5541	.5630	.53525	.5489	.5630	.53155	.53125	.53125	.5630	.5630
		3	.5546	.5625	.53540	.5506	.5625	.53290	.53290	.53290	.5625	.5625
		4	.5541	.5630	.53525	.5501	.5630	.53275	.53245	.53245	.5630	.5630
3/16-140	NC	1	.6087	.6224	.5634	.5943	.6224	.5549	.5549	.5549	.6224	.6224
		2	.6081	.6230	.5632	.5937	.6230	.5551	.5547	.5547	.6230	.6230
		3	.6113	.6250	.5660	.5995	.6250	.5601	.5601	.5601	.6250	.6250
		4	.6107	.6256	.5658	.5989	.6256	.5603	.5599	.5599	.6256	.6256
3/16-160	NF	1	.6113	.6250	.5660	.6012	.6250	.5618	.5618	.5618	.6250	.6250
		2	.6107	.6256	.5658	.6006	.6256	.5620	.5616	.5616	.6256	.6256
		3	.6118	.6255	.5665	.6008	.6255	.5614	.5614	.5614	.6255	.6255
		4	.6112	.6261	.5663	.6002	.6261	.5616	.5612	.5612	.6261	.6261

See footnotes at end of table.

TABLE 1.17.—Setting plug gages, American National screw threads—Continued

Nominal size and threads per inch	Series designation	Class	W truncated setting plugs								Basic-crest setting plugs	
			Plug for "Go"				Plug for "Not go"				Major diameter	
			Major diameter		Pitch diameter	Major diameter		Pitch diameter		Go 1	Not go 2	
			Truncated	Full		Truncated	Full	Plus tol. gage	Minus tol. gage			W and X tolerances
1	2	3	4	5	6	7	8	9	10	11	12	
			<i>in.</i>	<i>in.</i>	<i>in.</i>	<i>in.</i>	<i>in.</i>	<i>in.</i>	<i>in.</i>	<i>in.</i>	<i>in.</i>	<i>in.</i>
5/8-12	N	2	0.6121	0.6250	0.5709	0.6014	0.6250	0.5653	0.5953	0.6250	0.6250	0.6250
		3	.6115	.6250	.5707	.6008	.6250	.5655	.5951	.6250	.6256	.6250
5/8-18	NF	1	.6137	.6234	.58730	.6095	.6233	.58490	.58490	.6234	.6233	.6233
		2	.6132	.6239	.58715	.6092	.6238	.58475	.58475	.6239	.6238	.6238
		3	.6133	.6250	.58890	.6089	.6250	.58480	.58480	.6250	.6250	.6250
		4	.6148	.6255	.58875	.6081	.6255	.58495	.58495	.6255	.6255	.6255
5/8-24	NEF	2	.6171	.6250	.59790	.6118	.6250	.59390	.59390	.6250	.6250	.6250
		3	.6166	.6255	.59775	.6113	.6255	.59395	.59395	.6255	.6255	.6255
		4	.6171	.6250	.59790	.6118	.6250	.59390	.59390	.6250	.6250	.6250
		5	.6166	.6255	.59775	.6113	.6255	.59395	.59395	.6255	.6255	.6255
3/16-12	N	2	.6746	.6875	.6334	.6639	.6875	.6278	.6278	.6875	.6875	.6875
		3	.6740	.6881	.6332	.6633	.6881	.6280	.6276	.6881	.6881	.6881
3/16-24	NEF	2	.6796	.6875	.66040	.6743	.6875	.65630	.65630	.6875	.6875	.6875
		3	.6791	.6880	.66025	.6738	.6880	.65645	.65645	.6880	.6880	.6880
3/4-10	NC	1	.7326	.7512	.6822	.7193	.7472	.6730	.6730	.7472	.7472	.7472
		2	.7320	.7478	.6820	.7187	.7478	.6732	.6728	.7478	.7478	.7478
		3	.7354	.7506	.6850	.7213	.7506	.6786	.6786	.7506	.7506	.7506
		4	.7348	.7506	.6848	.7213	.7506	.6788	.6784	.7506	.7506	.7506
3/4-12	N	2	.7371	.7500	.6959	.7264	.7500	.6903	.6903	.7500	.7500	.7500
		3	.7365	.7506	.6957	.7258	.7506	.6905	.6901	.7506	.7506	.7506
		4	.7371	.7500	.6959	.7264	.7500	.6903	.6903	.7500	.7500	.7500
		5	.7365	.7506	.6957	.7258	.7506	.6905	.6901	.7506	.7506	.7506
3/4-16	NF	1	.7377	.7482	.7076	.7284	.7482	.7013	.7013	.7482	.7482	.7482
		2	.7371	.7488	.7074	.7278	.7488	.7015	.7011	.7488	.7488	.7488
		3	.7395	.7506	.7094	.7320	.7506	.7049	.7049	.7506	.7506	.7506
		4	.7389	.7506	.7092	.7314	.7506	.7051	.7047	.7506	.7506	.7506
3/4-20	NEF	2	.7410	.7500	.71750	.7345	.7500	.71290	.71290	.7500	.7500	.7500
		3	.7405	.7505	.71735	.7341	.7505	.71305	.71275	.7505	.7505	.7505
		4	.7410	.7500	.71750	.7345	.7500	.71330	.71310	.7500	.7500	.7500
		5	.7405	.7505	.71735	.7345	.7505	.71345	.71315	.7505	.7505	.7505
3/16-12	N	2	.7996	.8125	.7584	.7889	.8125	.7528	.7528	.8125	.8125	.8125
		3	.7990	.8131	.7582	.7883	.8131	.7530	.7525	.8131	.8131	.8131
3/16-16	N	2	.8020	.8125	.7719	.7949	.8125	.7668	.7668	.8125	.8125	.8125
		3	.8014	.8131	.7717	.7943	.8131	.7670	.7666	.8131	.8131	.8131
3/16-20	NEF	2	.8035	.8125	.78000	.7971	.8125	.77540	.77540	.8125	.8125	.8125
		3	.8030	.8130	.77985	.7965	.8130	.77555	.77525	.8130	.8130	.8130
3/8-9	NC	1	.8561	.8719	.8097	.8378	.8719	.857	.857	.8719	.8719	.8719
		2	.8554	.8726	.8095	.8371	.8726	.859	.859	.8726	.8726	.8726
		3	.8592	.8750	.8128	.8409	.8750	.8598	.8598	.8750	.8750	.8750
		4	.8585	.8757	.8126	.8402	.8757	.8600	.8596	.8757	.8757	.8757
3/8-12	NEF	2	.8592	.8750	.8128	.8409	.8750	.85979	.85979	.8750	.8750	.8750
		3	.8585	.8757	.8126	.8402	.8757	.85981	.85977	.8757	.8757	.8757
		4	.8598	.8756	.8133	.8401	.8756	.86010	.86010	.8756	.8756	.8756
		5	.8591	.8763	.8132	.8401	.8763	.86012	.86008	.8763	.8763	.8763

See footnotes at end of table.

TABLE L.17. — Setting plug gages, American National screw threads—Continued

Nominal size and threads per inch	Series designation	Class	W truncated setting plugs								Basic-crest setting plugs	
			Plug for "Go"				Plug for "Not go"				Major diameter	
			Major diameter		Pitch diameter	Major diameter		Pitch diameter		Go ¹	Not go ²	
			Truncated	Full		Truncated	Full	Plus tol. gage	Minus tol. gage			W and X tolerances
1	2	3	4	5	6	7	8	9	10	11	12	
3/8-12	N	2	<i>in.</i> 0.8621	<i>in.</i> 0.8750	<i>in.</i> 0.8209	<i>in.</i> 0.8514	<i>in.</i> 0.8750	<i>in.</i> 0.8153	<i>in.</i> 0.8153	<i>in.</i> 0.8153	<i>in.</i> 0.8750	<i>in.</i> 0.8750
		3	.8615	.8756	.8207	.8508	.8756	.8155	.8151	.8151	.8756	.8756
			.8621	.8750	.8209	.8530	.8750	.8169	.8169	.8169	.8750	.8750
	NF	1	.8614	.8729	.8265	.8504	.8729	.8195	.8195	.8195	.8729	.8729
		2	.8628	.8745	.8263	.8498	.8735	.8197	.8193	.8193	.8745	.8745
		3	.8635	.8750	.8266	.8516	.8750	.8237	.8237	.8237	.8750	.8750
3/8-14	NF	2	.8629	.8756	.8284	.8540	.8756	.8229	.8225	.8225	.8756	.8756
		3	.8635	.8750	.8286	.8559	.8750	.8250	.8250	.8250	.8750	.8750
		4	.8629	.8746	.8284	.8533	.8756	.8252	.8248	.8248	.8756	.8756
			.8639	.8754	.8290	.8581	.8754	.8272	.8272	.8272	.8754	.8754
3/8-16	N	2	.8645	.8750	.8344	.8594	.8750	.8294	.8293	.8293	.8750	.8750
		3	.8639	.8756	.8342	.8558	.8756	.8265	.8261	.8261	.8756	.8756
			.8645	.8750	.8344	.8579	.8750	.8308	.8308	.8308	.8750	.8750
3/8-20	NEF	2	.8660	.8750	.84250	.8565	.8750	.83780	.83780	.83780	.8750	.8750
		3	.8655	.8755	.84245	.8590	.8755	.83795	.83795	.83795	.8755	.8755
			.8660	.8750	.84250	.8608	.8750	.83920	.83920	.83920	.8750	.8750
1/2-12	N	2	.9246	.9375	.8834	.9139	.9375	.8778	.8778	.8778	.9375	.9375
		3	.9240	.9381	.8832	.9133	.9381	.8780	.8776	.8776	.9381	.9381
			.9246	.9375	.8834	.9155	.9375	.8794	.8794	.8794	.9375	.9375
1/2-16	N	2	.9270	.9375	.8969	.9188	.9375	.8847	.8847	.8847	.9375	.9375
		3	.9264	.9381	.8967	.9182	.9381	.8859	.8859	.8859	.9381	.9381
			.9270	.9375	.8969	.9204	.9375	.8933	.8933	.8933	.9375	.9375
1/2-20	NEF	2	.9285	.9375	.90500	.9220	.9375	.90030	.90030	.90030	.9375	.9375
		3	.9280	.9380	.90485	.9215	.9380	.90115	.90115	.90115	.9380	.9380
			.9285	.9375	.90500	.9234	.9375	.90170	.90170	.90170	.9375	.9375
1-8	NC	1	.9795	.9956	.9154	.9584	.9956	.9643	.9643	.9643	.9956	.9956
		2	.9788	.9973	.9152	.9577	.9973	.9645	.9641	.9641	.9973	.9973
		3	.9820	1.0000	.9188	.9653	1.0000	.9642	.9642	.9642	1.0000	1.0000
		4	.9822	1.0007	.9186	.9646	1.0007	.9644	.9644	.9644	1.0007	1.0007
1-12	N	2	.9871	1.0090	.9459	.9764	1.0090	.9693	.9693	.9693	1.0090	1.0090
		3	.9865	1.0006	.9457	.9758	1.0006	.9695	.9691	.9691	1.0006	1.0006
			.9871	1.0060	.9459	.9780	1.0060	.9694	.9694	.9694	1.0060	1.0060
			.9865	1.0006	.9457	.9774	1.0006	.9692	.9692	.9692	1.0006	1.0006
1-14	NC	1	.9864	.9979	.9545	.9754	.9979	.9645	.9645	.9645	.9979	.9979
		2	.9858	.9985	.9543	.9748	.9985	.9647	.9647	.9647	.9985	.9985
		3	.9885	1.0000	.9546	.9766	1.0000	.9687	.9687	.9687	1.0000	1.0000
		4	.9879	1.0006	.9534	.9759	1.0006	.9689	.9687	.9687	1.0006	1.0006
1-16	N	2	.9895	1.0000	.9594	.9813	1.0000	.9592	.9592	.9592	1.0000	1.0000
		3	.9889	1.0006	.9592	.9807	1.0006	.9594	.9594	.9594	1.0006	1.0006
			.9895	1.0000	.9594	.9828	1.0000	.9597	.9597	.9597	1.0000	1.0000
			.9889	1.0006	.9592	.9822	1.0006	.9595	.9595	.9595	1.0006	1.0006
1-20	NEF	2	.9910	1.0000	.96750	.9844	1.0000	.96270	.96270	.96270	1.0000	1.0000
		3	.9905	1.0005	.96735	.9839	1.0005	.96285	.96255	.96255	1.0005	1.0005
			.9910	1.0000	.96750	.9858	1.0000	.96410	.96410	.96410	1.0000	1.0000
1 1/8-12	N	2	1.0196	1.0625	1.0081	1.0389	1.0625	1.0028	1.0028	1.0028	1.0625	1.0625
		3	1.0190	1.0631	1.0082	1.0383	1.0631	1.0026	1.0026	1.0026	1.0631	1.0631
			1.0196	1.0625	1.0081	1.0399	1.0625	1.0044	1.0044	1.0044	1.0625	1.0625
1 1/8-16	N	2	1.0529	1.0625	1.0219	1.0437	1.0625	1.0166	1.0166	1.0166	1.0625	1.0625
		3	1.0514	1.0631	1.0217	1.0431	1.0631	1.0168	1.0168	1.0168	1.0631	1.0631
			1.0529	1.0625	1.0219	1.0453	1.0625	1.0182	1.0182	1.0182	1.0625	1.0625
	1.0514	1.0631	1.0217	1.0447	1.0631	1.0184	1.0184	1.0184	1.0631	1.0631		

See footnotes at end of table.

TABLE 1.17.—Setting plug gages, American National screw threads—Continued

Nominal size and threads per inch	Series designation	Class	W truncated setting plugs								Basic-crest setting plugs	
			Plug for "Go"				Plug for "Not go"				Major diameter	
			Major diameter		Pitch diameter	Major diameter		Pitch diameter		Go ¹	Not go ²	
			Truncated	Full		Truncated	Full	Plus tol. gage	Minus tol. gage			W and X tolerances
1	2	3	4	5	6	7	8	9	10	11	12	
1 3/16-18	NEF	2	in.	in.	in.	in.	in.	in.	in.	in.	in.	in.
			1.0528	1.0625	1.02640	1.0454	1.0625	1.02130	1.02130	1.0625	1.0625	
		1.0523	1.0630	1.02625	1.0449	1.0630	1.02145	1.02115	1.0630	1.0630		
		3	1.0528	1.0625	1.02640	1.0469	1.0625	1.02280	1.02290	1.0625	1.0625	
			1.0523	1.0630	1.02625	1.0464	1.0630	1.02295	1.02265	1.0630	1.0630	
		1 3/8-7	NC	1	1.1023	1.1211	1.0283	1.0778	1.1211	1.0159	1.0159	1.1211
1.1016	1.1218				1.0281	1.0771	1.1218	1.0161	1.0167	1.1218	1.1218	
2	1.1062			1.1250	1.0322	1.0856	1.1250	1.0237	1.0237	1.1250	1.1250	
	1.1055			1.1257	1.0320	1.0849	1.1257	1.0239	1.0235	1.1257	1.1257	
3	1.1062			1.1250	1.0322	1.0882	1.1250	1.0263	1.0263	1.1250	1.1250	
	1.1055			1.1257	1.0320	1.0875	1.1257	1.0265	1.0261	1.1257	1.1257	
4	1.1070	1.1258	1.0330	1.0919	1.1258	1.0300	1.0300	1.1250	1.1250			
	1.1063	1.1265	1.0328	1.0912	1.1265	1.0302	1.0298	1.1257	1.1257			
1 3/8-8	N	2	1.1079	1.1250	1.0438	1.0900	1.1250	1.0350	1.0359	1.1250	1.1250	
			1.1072	1.1257	1.0436	1.0893	1.1257	1.0361	1.0357	1.1257	1.1257	
		3	1.1079	1.1250	1.0438	1.0924	1.1250	1.0383	1.0383	1.1250	1.1250	
1.1072	1.1257		1.0436	1.0917	1.1257	1.0385	1.0381	1.1257	1.1257			
1 3/8-12	NF	1	1.1097	1.1226	1.0685	1.0967	1.1226	1.0606	1.0606	1.1226	1.1226	
			1.1091	1.1232	1.0683	1.0961	1.1232	1.0608	1.0604	1.1232	1.1232	
		2	1.1121	1.1250	1.0709	1.1014	1.1250	1.0653	1.0653	1.1250	1.1250	
			1.1115	1.1256	1.0707	1.1008	1.1256	1.0655	1.0651	1.1256	1.1256	
		3	1.1121	1.1250	1.0709	1.1030	1.1250	1.0669	1.0669	1.1250	1.1250	
			1.1115	1.1256	1.0707	1.1024	1.1256	1.0671	1.0667	1.1256	1.1256	
4	1.1126	1.1255	1.0714	1.1055	1.1255	1.0694	1.0694	1.1250	1.1250			
	1.1120	1.1261	1.0712	1.1049	1.1261	1.0696	1.0692	1.1256	1.1256			
1 3/8-16	N	2	1.1145	1.1250	1.0844	1.1061	1.1250	1.0790	1.0790	1.1250	1.1250	
			1.1139	1.1256	1.0842	1.1055	1.1256	1.0792	1.0788	1.1256	1.1256	
		3	1.1145	1.1250	1.0844	1.1077	1.1250	1.0806	1.0806	1.1250	1.1250	
1.1139	1.1256		1.0842	1.1071	1.1256	1.0808	1.0804	1.1256	1.1256			
1 3/8-18	NEF	2	1.1153	1.1250	1.08800	1.1078	1.1250	1.08370	1.08370	1.1250	1.1250	
			1.1148	1.1255	1.08875	1.1073	1.1255	1.08385	1.08355	1.1255	1.1255	
		3	1.1153	1.1250	1.08800	1.1094	1.1250	1.08530	1.08530	1.1250	1.1250	
1.1148	1.1255		1.08875	1.1089	1.1255	1.08545	1.08515	1.1255	1.1255			
1 3/8-12	N	2	1.1746	1.1875	1.1334	1.1639	1.1875	1.1278	1.1278	1.1875	1.1875	
			1.1740	1.1881	1.1332	1.1633	1.1881	1.1280	1.1276	1.1881	1.1881	
		3	1.1746	1.1875	1.1334	1.1655	1.1875	1.1294	1.1294	1.1875	1.1875	
1.1740	1.1881		1.1332	1.1649	1.1881	1.1296	1.1292	1.1881	1.1881			
1 3/8-16	N	2	1.1770	1.1875	1.1469	1.1686	1.1875	1.1415	1.1415	1.1875	1.1875	
			1.1764	1.1881	1.1467	1.1680	1.1881	1.1417	1.1413	1.1881	1.1881	
		3	1.1770	1.1875	1.1469	1.1702	1.1875	1.1431	1.1431	1.1875	1.1875	
1.1764	1.1881		1.1467	1.1696	1.1881	1.1433	1.1429	1.1881	1.1881			
1 3/8-18	NEF	2	1.1778	1.1875	1.15140	1.1703	1.1875	1.14620	1.14620	1.1875	1.1875	
			1.1773	1.1880	1.15125	1.1698	1.1880	1.14635	1.14605	1.1880	1.1880	
		3	1.1778	1.1875	1.15140	1.1719	1.1875	1.14780	1.14780	1.1875	1.1875	
1.1773	1.1880		1.15125	1.1714	1.1880	1.14795	1.14765	1.1880	1.1880			
1 3/8-7	NC	1	1.2273	1.2461	1.1533	1.2028	1.2461	1.1409	1.1409	1.2461	1.2461	
			1.2266	1.2468	1.1531	1.2021	1.2468	1.1411	1.1407	1.2468	1.2468	
		2	1.2312	1.2500	1.1572	1.2106	1.2500	1.1487	1.1487	1.2500	1.2500	
			1.2305	1.2507	1.1570	1.2099	1.2507	1.1489	1.1485	1.2507	1.2507	
		3	1.2312	1.2500	1.1572	1.2132	1.2500	1.1513	1.1513	1.2500	1.2500	
			1.2305	1.2507	1.1570	1.2125	1.2507	1.1515	1.1511	1.2507	1.2507	
4	1.2320	1.2508	1.1580	1.2169	1.2508	1.1550	1.1550	1.2500	1.2500			
	1.2313	1.2515	1.1578	1.2162	1.2515	1.1552	1.1548	1.2507	1.2507			
1 3/8-8	N	2	1.2320	1.2500	1.1688	1.2146	1.2500	1.1605	1.1605	1.2500	1.2500	
			1.2322	1.2507	1.1686	1.2139	1.2507	1.1607	1.1603	1.2507	1.2507	
		3	1.2329	1.2500	1.1688	1.2171	1.2500	1.1630	1.1630	1.2500	1.2500	
1.2322	1.2507		1.1686	1.2164	1.2507	1.1632	1.1628	1.2507	1.2507			
1 3/8-12	NF	1	1.2347	1.2476	1.1635	1.2217	1.2476	1.1856	1.1856	1.2476	1.2476	
			1.2341	1.2482	1.1633	1.2211	1.2482	1.1858	1.1854	1.2482	1.2482	
		2	1.2371	1.2500	1.1659	1.2264	1.2500	1.1903	1.1903	1.2500	1.2500	
			1.2365	1.2506	1.1657	1.2258	1.2506	1.1905	1.1901	1.2506	1.2506	
		3	1.2371	1.2500	1.1659	1.2280	1.2500	1.1919	1.1919	1.2500	1.2500	
			1.2365	1.2506	1.1657	1.2274	1.2506	1.1921	1.1917	1.2506	1.2506	
4	1.2376	1.2505	1.1664	1.2305	1.2505	1.1944	1.1944	1.2500	1.2500			
	1.2370	1.2511	1.1662	1.2299	1.2511	1.1946	1.1942	1.2506	1.2506			
1 3/8-16	N	2	1.2395	1.2500	1.2004	1.2310	1.2500	1.2030	1.2030	1.2500	1.2500	
			1.2389	1.2506	1.2002	1.2304	1.2506	1.2032	1.2028	1.2506	1.2506	
		3	1.2395	1.2500	1.2004	1.2327	1.2500	1.2050	1.2050	1.2500	1.2500	
1.2389	1.2506		1.2002	1.2321	1.2506	1.2052	1.2048	1.2506	1.2506			

1. See Table 1.16 for details of table.

TABLE 1.17.—Setting plug gages, American National screw threads—Continued

Nominal size and threads per inch	Series designation	Class	W truncated setting plugs							Basic-crest setting plugs		
			Plug for "Go"			Plug for "Not go"				Major diameter		
			Major diameter		Pitch diameter	Major diameter		Pitch diameter		Go ¹	Not go ²	
			Truncated	Full		Truncated	Full	Plus tol. gage	Minus tol. gage	W and X tolerances	W and X tolerances	
1	2	3	4	5	6	7	8	9	10	11	12	
1/4-18	NEF	2	in.	in.	in.	in.	in.	in.	in.	in.	in.	in.
			1.2403	1.2500	1.21390	1.2327	1.2500	1.20860	1.20860	1.2500	1.2500	1.2500
1/4-12	N	2	1.2398	1.2505	1.21375	1.2322	1.2505	1.20875	1.20875	1.2505	1.2505	1.2505
			1.2403	1.2500	1.21390	1.2343	1.2500	1.21020	1.21020	1.2500	1.2500	1.2500
1/4-16	N	3	1.2398	1.2505	1.21375	1.2338	1.2505	1.21035	1.21035	1.2505	1.2505	1.2505
			1.2996	1.3125	1.2584	1.2880	1.3125	1.2528	1.2528	1.3125	1.3125	1.3125
1/4-12	N	3	1.2990	1.3131	1.2582	1.2883	1.3131	1.2530	1.2530	1.3131	1.3131	1.3131
			1.2996	1.3125	1.2584	1.2905	1.3125	1.2544	1.2544	1.3125	1.3125	1.3125
1/4-18	NEF	2	1.3020	1.3125	1.2719	1.2935	1.3125	1.2664	1.2664	1.3125	1.3125	1.3125
			1.3014	1.3131	1.2717	1.2929	1.3131	1.2666	1.2662	1.3131	1.3131	1.3131
1/4-16	N	3	1.3020	1.3125	1.2719	1.2951	1.3125	1.2680	1.2680	1.3125	1.3125	1.3125
			1.3014	1.3131	1.2717	1.2945	1.3131	1.2682	1.2678	1.3131	1.3131	1.3131
1/4-18	NEF	2	1.3028	1.3125	1.27640	1.2952	1.3125	1.27110	1.27110	1.3125	1.3125	1.3125
			1.3023	1.3130	1.27625	1.2947	1.3130	1.27125	1.27095	1.3130	1.3130	1.3130
1/4-12	NC	2	1.3028	1.3125	1.27640	1.2968	1.3125	1.27270	1.27270	1.3125	1.3125	1.3125
			1.3023	1.3130	1.27625	1.2963	1.3130	1.27285	1.27255	1.3130	1.3130	1.3130
1/4-8	N	2	1.3406	1.3706	1.2623	1.3200	1.3706	1.2478	1.2478	1.3706	1.3706	1.3706
			1.3488	1.3714	1.2621	1.3192	1.3714	1.2480	1.2476	1.3714	1.3714	1.3714
1/4-6	NC	2	1.3540	1.3750	1.2607	1.3288	1.3750	1.2566	1.2566	1.3750	1.3750	1.3750
			1.3532	1.3758	1.2605	1.3280	1.3758	1.2568	1.2564	1.3758	1.3758	1.3758
1/4-8	N	3	1.3540	1.3750	1.2607	1.3318	1.3750	1.2596	1.2596	1.3750	1.3750	1.3750
			1.3541	1.3767	1.2674	1.3302	1.3767	1.2642	1.2638	1.3767	1.3767	1.3767
1/4-12	NF	1	1.3579	1.3750	1.2938	1.3393	1.3750	1.2852	1.2852	1.3750	1.3750	1.3750
			1.3572	1.3757	1.2936	1.3386	1.3757	1.2854	1.2850	1.3757	1.3757	1.3757
1/4-16	N	2	1.3579	1.3750	1.2938	1.3418	1.3750	1.2877	1.2877	1.3750	1.3750	1.3750
			1.3572	1.3757	1.2936	1.3411	1.3757	1.2879	1.2875	1.3757	1.3757	1.3757
1/4-18	NEF	2	1.3597	1.3726	1.3185	1.3467	1.3726	1.3106	1.3106	1.3726	1.3726	1.3726
			1.3591	1.3732	1.3183	1.3461	1.3732	1.3108	1.3104	1.3732	1.3732	1.3732
1/4-12	NF	2	1.3621	1.3750	1.3209	1.3514	1.3750	1.3153	1.3153	1.3750	1.3750	1.3750
			1.3615	1.3756	1.3207	1.3508	1.3756	1.3155	1.3151	1.3756	1.3756	1.3756
1/4-16	N	3	1.3621	1.3750	1.3209	1.3530	1.3750	1.3169	1.3169	1.3750	1.3750	1.3750
			1.3615	1.3756	1.3207	1.3524	1.3756	1.3171	1.3167	1.3756	1.3756	1.3756
1/4-18	NEF	2	1.3626	1.3755	1.3214	1.3555	1.3755	1.3194	1.3194	1.3755	1.3755	1.3755
			1.3620	1.3761	1.3212	1.3549	1.3761	1.3196	1.3192	1.3761	1.3761	1.3761
1/4-12	N	2	1.3645	1.3750	1.3344	1.3559	1.3750	1.3288	1.3288	1.3750	1.3750	1.3750
			1.3639	1.3756	1.3342	1.3553	1.3756	1.3290	1.3286	1.3756	1.3756	1.3756
1/4-16	N	3	1.3645	1.3750	1.3344	1.3576	1.3750	1.3305	1.3305	1.3750	1.3750	1.3750
			1.3639	1.3756	1.3342	1.3570	1.3756	1.3307	1.3303	1.3756	1.3756	1.3756
1/4-18	NEF	2	1.3653	1.3750	1.33800	1.3570	1.3750	1.33350	1.33350	1.3750	1.3750	1.3750
			1.3648	1.3755	1.33875	1.3571	1.3755	1.33365	1.33335	1.3755	1.3755	1.3755
1/4-12	N	2	1.4246	1.4375	1.3834	1.4139	1.4375	1.3778	1.3778	1.4375	1.4375	1.4375
			1.4240	1.4381	1.3832	1.4133	1.4381	1.3780	1.3776	1.4381	1.4381	1.4381
1/4-16	N	3	1.4246	1.4375	1.3834	1.4155	1.4375	1.3794	1.3794	1.4375	1.4375	1.4375
			1.4240	1.4381	1.3832	1.4149	1.4381	1.3796	1.3792	1.4381	1.4381	1.4381
1/4-18	NEF	2	1.4270	1.4375	1.3960	1.4184	1.4375	1.3913	1.3913	1.4375	1.4375	1.4375
			1.4264	1.4381	1.3967	1.4178	1.4381	1.3915	1.3911	1.4381	1.4381	1.4381
1/4-12	N	2	1.4270	1.4375	1.3960	1.4200	1.4375	1.3929	1.3929	1.4375	1.4375	1.4375
			1.4264	1.4381	1.3967	1.4194	1.4381	1.3931	1.3927	1.4381	1.4381	1.4381
1/4-16	N	3	1.4278	1.4375	1.40140	1.4201	1.4375	1.39600	1.39600	1.4375	1.4375	1.4375
			1.4273	1.4380	1.40125	1.4212	1.4380	1.39615	1.39585	1.4380	1.4380	1.4380
1/4-18	NEF	2	1.4278	1.4375	1.40140	1.4217	1.4375	1.39760	1.39760	1.4375	1.4375	1.4375
			1.4273	1.4380	1.40125	1.4212	1.4380	1.39775	1.39745	1.4380	1.4380	1.4380
1/4-12	N	2	1.4716	1.4956	1.3873	1.4450	1.4956	1.3728	1.3728	1.4956	1.4956	1.4956
			1.4708	1.4961	1.3871	1.4442	1.4961	1.3730	1.3726	1.4961	1.4961	1.4961
1/4-16	N	3	1.4708	1.4956	1.3873	1.4478	1.4956	1.3816	1.3816	1.4956	1.4956	1.4956
			1.4702	1.4968	1.3915	1.4470	1.4968	1.3818	1.3814	1.4968	1.4968	1.4968
1/4-18	NEF	2	1.4708	1.4956	1.3873	1.4508	1.4956	1.3846	1.3846	1.4956	1.4956	1.4956
			1.4702	1.4968	1.3915	1.4500	1.4968	1.3848	1.3844	1.4968	1.4968	1.4968
1/4-12	N	2	1.4708	1.4956	1.3873	1.4512	1.4956	1.3880	1.3880	1.4956	1.4956	1.4956
			1.4702	1.4967	1.3924	1.4504	1.4967	1.3882	1.3888	1.4967	1.4967	1.4967
1/4-16	N	3	1.4708	1.4956	1.3873	1.4532	1.4956	1.4008	1.4008	1.4956	1.4956	1.4956
			1.4702	1.4967	1.3915	1.4524	1.4967	1.4010	1.4006	1.4967	1.4967	1.4967
1/4-18	NEF	2	1.4708	1.4956	1.3873	1.4546	1.4956	1.4125	1.4125	1.4956	1.4956	1.4956
			1.4702	1.4967	1.3915	1.4538	1.4967	1.4127	1.4123	1.4967	1.4967	1.4967

TABLE 1.17.—Setting plug gages, American National screw threads—Continued

Nominal size and threads per inch	Series designation	Class	W truncated setting plugs							Basic-crest setting plugs		
			Plug for "Go"			Plug for "Not go"				Major diameter		
			Major diameter		Pitch diameter	Major diameter		Pitch diameter		Go ¹	Not go ²	
			Truncated	Full		Truncated	Full	Plus tol. gage	Minus tol. gage	W and X tolerances	W and X tolerances	
1	2	3	4	5	6	7	8	9	10	11	12	
			<i>in.</i>	<i>in.</i>	<i>in.</i>	<i>in.</i>	<i>in.</i>	<i>in.</i>	<i>in.</i>	<i>in.</i>	<i>in.</i>	<i>in.</i>
1 1/4-12	NF	1	1.4847	1.4976	1.4435	1.4717	1.4976	1.4350	1.4350	1.4350	1.4976	1.4976
		2	1.4841	1.4982	1.4433	1.4711	1.4982	1.4358	1.4358	1.4354	1.4982	1.4982
		3	1.4871	1.5000	1.4459	1.4764	1.5000	1.4403	1.4403	1.4403	1.5000	1.5000
		4	1.4865	1.5006	1.4457	1.4758	1.5006	1.4405	1.4405	1.4401	1.5006	1.5006
1 1/4-16	N	2	1.4871	1.5000	1.4459	1.4780	1.5000	1.4419	1.4419	1.4419	1.5000	1.5000
		3	1.4865	1.5006	1.4457	1.4774	1.5006	1.4421	1.4421	1.4417	1.5006	1.5006
		4	1.4876	1.5005	1.4464	1.4805	1.5005	1.4444	1.4444	1.4444	1.5000	1.5000
			1.4870	1.5011	1.4462	1.4799	1.5011	1.4446	1.4446	1.4442	1.5006	1.5006
1 1/4-18	NEF	2	1.4895	1.5000	1.4594	1.4808	1.5000	1.4537	1.4537	1.4537	1.5000	1.5000
		3	1.4889	1.5006	1.4592	1.4802	1.5006	1.4539	1.4539	1.4535	1.5006	1.5006
			1.4895	1.5000	1.4594	1.4825	1.5000	1.4554	1.4554	1.4554	1.5000	1.5000
1 3/8-16	N	2	1.4889	1.5006	1.4592	1.4810	1.5006	1.4556	1.4556	1.4552	1.5006	1.5006
		3	1.4903	1.5000	1.46390	1.4825	1.5000	1.45840	1.45840	1.45840	1.5000	1.5000
			1.4898	1.5005	1.46375	1.4820	1.5005	1.45855	1.45855	1.45825	1.5005	1.5005
1 3/8-18	NEF	3	1.4903	1.5000	1.46390	1.4842	1.5000	1.46010	1.46010	1.46010	1.5000	1.5000
			1.4898	1.5005	1.46375	1.4837	1.5005	1.46025	1.45995	1.45995	1.5005	1.5005
		2	1.5520	1.5625	1.52190	1.5432	1.5625	1.51610	1.51610	1.51610	1.5625	1.5625
1 3/8-20	N	3	1.5514	1.5631	1.52165	1.5426	1.5631	1.51635	1.51585	1.51585	1.5631	1.5631
			1.5520	1.5625	1.52190	1.5450	1.5625	1.51790	1.51790	1.51790	1.5625	1.5625
			1.5514	1.5631	1.52165	1.5444	1.5631	1.51815	1.51865	1.51865	1.5631	1.5631
1 3/8-24	NEF	2	1.5528	1.5625	1.5264	1.5450	1.5625	1.5209	1.5209	1.5209	1.5625	1.5625
		3	1.5523	1.5630	1.5262	1.5445	1.5630	1.5211	1.5207	1.5207	1.5630	1.5630
			1.5528	1.5625	1.5264	1.5466	1.5625	1.5225	1.5225	1.5225	1.5625	1.5625
1 3/8-30	N	3	1.5523	1.5630	1.5262	1.5461	1.5630	1.5227	1.5223	1.5223	1.5630	1.5630
		2	1.6079	1.6250	1.54380	1.5886	1.6250	1.53450	1.53450	1.53450	1.6250	1.6250
			1.6072	1.6257	1.54355	1.5879	1.6257	1.53475	1.53425	1.53425	1.6257	1.6257
1 3/8-36	N	3	1.6079	1.6250	1.54380	1.5914	1.6250	1.53730	1.53730	1.53730	1.6250	1.6250
			1.6072	1.6257	1.54355	1.5907	1.6257	1.53755	1.53705	1.53705	1.6257	1.6257
		2	1.6121	1.6250	1.57090	1.6006	1.6250	1.56450	1.56450	1.56450	1.6250	1.6250
1 3/8-40	N	3	1.6115	1.6256	1.57065	1.6000	1.6256	1.56475	1.56425	1.56425	1.6256	1.6256
			1.6121	1.6250	1.57090	1.6025	1.6250	1.56640	1.56640	1.56640	1.6250	1.6250
			1.6115	1.6256	1.57065	1.6019	1.6256	1.56665	1.56615	1.56615	1.6256	1.6256
1 3/8-48	N	2	1.6145	1.6250	1.58440	1.6057	1.6250	1.57860	1.57860	1.57860	1.6250	1.6250
		3	1.6139	1.6256	1.58415	1.6051	1.6256	1.57885	1.57835	1.57835	1.6256	1.6256
			1.6145	1.6250	1.58440	1.6074	1.6250	1.58030	1.58030	1.58030	1.6250	1.6250
1 3/8-54	NEF	3	1.6139	1.6256	1.58415	1.6068	1.6256	1.58055	1.58005	1.58005	1.6256	1.6256
		2	1.6153	1.6250	1.5889	1.6074	1.6250	1.5833	1.5833	1.5833	1.6250	1.6250
			1.6148	1.6255	1.5887	1.6069	1.6255	1.5835	1.5831	1.5831	1.6255	1.6255
1 3/8-60	N	3	1.6153	1.6250	1.5889	1.6091	1.6250	1.5850	1.5850	1.5850	1.6250	1.6250
			1.6148	1.6255	1.5887	1.6086	1.6255	1.5852	1.5848	1.5848	1.6255	1.6255
		2	1.6770	1.6875	1.64690	1.6682	1.6875	1.64110	1.64110	1.64110	1.6875	1.6875
1 3/8-72	N	3	1.6764	1.6881	1.64665	1.6676	1.6881	1.64135	1.64085	1.64085	1.6881	1.6881
			1.6770	1.6875	1.64690	1.6699	1.6875	1.64280	1.64280	1.64280	1.6875	1.6875
			1.6764	1.6881	1.64665	1.6693	1.6881	1.64305	1.64255	1.64255	1.6881	1.6881
1 3/8-84	NEF	2	1.6778	1.6875	1.6514	1.6699	1.6875	1.6458	1.6458	1.6458	1.6875	1.6875
		3	1.6773	1.6880	1.6512	1.6694	1.6880	1.6460	1.6456	1.6456	1.6880	1.6880
			1.6778	1.6875	1.6514	1.6716	1.6875	1.6475	1.6475	1.6475	1.6875	1.6875
1 3/8-96	N	3	1.6773	1.6880	1.6512	1.6711	1.6880	1.6477	1.6473	1.6473	1.6880	1.6880
		1	1.7209	1.7448	1.61400	1.6846	1.7448	1.59800	1.59800	1.59800	1.7448	1.7448
			1.7201	1.7456	1.61405	1.6838	1.7456	1.59825	1.59775	1.59775	1.7456	1.7456
1 3/8-108	NC	2	1.7261	1.7500	1.62010	1.6951	1.7500	1.60850	1.60850	1.60850	1.7500	1.7500
		3	1.7253	1.7508	1.61985	1.6943	1.7508	1.60875	1.60825	1.60825	1.7508	1.7508
			1.7261	1.7500	1.62010	1.6985	1.7500	1.61100	1.61100	1.61100	1.7500	1.7500
1 3/8-120	N	4	1.7253	1.7508	1.61985	1.6977	1.7508	1.61215	1.61165	1.61165	1.7508	1.7508
			1.7271	1.7510	1.62110	1.7036	1.7510	1.61700	1.61700	1.61700	1.7500	1.7500
			1.7263	1.7518	1.62085	1.7028	1.7518	1.61725	1.61675	1.61675	1.7508	1.7508
1 3/8-144	N	2	1.7329	1.7500	1.60880	1.7132	1.7500	1.65010	1.65010	1.65010	1.7500	1.7500
		3	1.7322	1.7507	1.60855	1.7125	1.7507	1.65035	1.65035	1.65035	1.7507	1.7507
			1.7329	1.7500	1.60880	1.7161	1.7500	1.66200	1.66200	1.66200	1.7500	1.7500
1 3/8-168	N	3	1.7322	1.7507	1.60855	1.7154	1.7507	1.66225	1.66175	1.66175	1.7507	1.7507
		2	1.7371	1.7500	1.60950	1.7255	1.7500	1.68040	1.68040	1.68040	1.7500	1.7500
			1.7365	1.7506	1.60955	1.7249	1.7506	1.68065	1.68015	1.68015	1.7506	1.7506
1 3/8-180	N	3	1.7371	1.7500	1.60950	1.7274	1.7500	1.68130	1.68130	1.68130	1.7500	1.7500
			1.7365	1.7506	1.60955	1.7268	1.7506	1.68155	1.68105	1.68105	1.7506	1.7506
		2	1.7395	1.7500	1.70910	1.7306	1.7500	1.70350	1.70350	1.70350	1.7500	1.7500
1 3/8-200	N	3	1.7389	1.7500	1.70915	1.7300	1.7500	1.70375	1.70375	1.70375	1.7500	1.7500
			1.7395	1.7506	1.70910	1.7324	1.7506	1.70530	1.70530	1.70530	1.7500	1.7500
			1.7389	1.7506	1.70915	1.7318	1.7506	1.70555	1.70505	1.70505	1.7500	1.7500

TABLE 1.17.—Setting plug gages, American National screw threads—Continued

Nominal size and threads per inch	Series designation	Class	W truncated setting plugs							Basic-crest setting plugs			
			Plug for "Go"			Plug for "Not go"				Major diameter			
			Major diameter		Pitch diameter	Major diameter		Pitch diameter		Go ¹	Not go ²		
			Truncated	Full		Truncated	Full	Plus tol. rage	Minus tol. rage	W and X tolerances	W and X tolerances		
1	2	3	4	5	6	7	8	9	10	11	12		
			in.	in.	in.	in.	in.	in.	in.	in.	in.	in.	
1 1/16-16	N	2	1.8020	1.8125	1.77190	1.7931	1.8125	1.76000	1.76000	1.8125	1.8125		
			1.8014	1.8131	1.77165	1.7925	1.8131	1.76025	1.76075	1.8131	1.8131		
		3	1.8020	1.8125	1.77190	1.7948	1.8125	1.76770	1.76800	1.8125	1.8125		
			1.8014	1.8131	1.77165	1.7942	1.8131	1.76795	1.76745	1.8131	1.8131		
		1 3/16-8	N	2	1.8579	1.8750	1.79380	1.8379	1.8750	1.78380	1.78380	1.8750	1.8750
					1.8572	1.8757	1.79355	1.8372	1.8757	1.78405	1.78355	1.8757	1.8757
3	1.8579			1.8750	1.79380	1.8409	1.8750	1.78680	1.78680	1.8750	1.8750		
	1.8572			1.8757	1.79355	1.8402	1.8757	1.78705	1.78655	1.8757	1.8757		
1 3/4-12	N			2	1.8621	1.8750	1.82000	1.8504	1.8750	1.81430	1.81430	1.8750	1.8750
					1.8615	1.8756	1.82005	1.8498	1.8756	1.81455	1.81405	1.8756	1.8756
		3	1.8621	1.8750	1.82000	1.8524	1.8750	1.81030	1.81030	1.8750	1.8750		
			1.8615	1.8756	1.82005	1.8518	1.8756	1.81055	1.81005	1.8756	1.8756		
		1 3/8-16	N	2	1.8045	1.8750	1.83440	1.8555	1.8750	1.82840	1.82840	1.8750	1.8750
					1.8039	1.8756	1.83415	1.8549	1.8756	1.82865	1.82815	1.8756	1.8756
3	1.8045			1.8750	1.83440	1.8573	1.8750	1.83020	1.83020	1.8750	1.8750		
	1.8039			1.8756	1.83415	1.8567	1.8756	1.83045	1.82995	1.8756	1.8756		
1 1/2-16	N			2	1.9270	1.9375	1.89690	1.9180	1.9375	1.89090	1.89090	1.9375	1.9375
					1.9264	1.9381	1.89665	1.9174	1.9381	1.89115	1.89065	1.9381	1.9381
		3	1.9270	1.9375	1.89690	1.9198	1.9375	1.89270	1.89270	1.9375	1.9375		
			1.9264	1.9381	1.89665	1.9192	1.9381	1.89295	1.89245	1.9381	1.9381		
		2-4 1/2	NC	1	1.9685	1.9943	1.85000	1.9278	1.9943	1.83160	1.83160	1.9943	1.9943
					1.9677	1.9951	1.84975	1.9270	1.9951	1.83185	1.83135	1.9951	1.9951
2	1.9742			2.0000	1.85570	1.9392	2.0000	1.84300	1.84300	2.0000	2.0000		
	1.9734			2.0008	1.85545	1.9384	2.0008	1.84325	1.84275	2.0008	2.0008		
3	1.9742			2.0000	1.85570	1.9430	2.0000	1.84680	1.84680	2.0000	2.0000		
	1.9734			2.0008	1.85545	1.9422	2.0008	1.84705	1.84655	2.0008	2.0008		
2-8	N	2	1.9829	2.0000	1.91880	1.9625	2.0000	1.90840	1.90840	2.0000	2.0000		
			1.9822	2.0007	1.91855	1.9618	2.0007	1.90865	1.90815	2.0007	2.0007		
		3	1.9829	2.0000	1.91880	1.9659	2.0000	1.91150	1.91150	2.0000	2.0000		
			1.9822	2.0007	1.91855	1.9649	2.0007	1.91175	1.91125	2.0007	2.0007		
		2-12	N	2	1.9871	2.0000	1.94590	1.9753	2.0000	1.93920	1.93920	2.0000	2.0000
					1.9865	2.0006	1.94565	1.9747	2.0006	1.93945	1.93895	2.0006	2.0006
3	1.9871			2.0000	1.94590	1.9773	2.0000	1.94120	1.94120	2.0000	2.0000		
	1.9865			2.0006	1.94565	1.9767	2.0006	1.94145	1.94095	2.0006	2.0006		
2-16	NEF			2	1.9895	2.0000	1.95940	1.9804	2.0000	1.95330	1.95330	2.0000	2.0000
					1.9889	2.0006	1.95915	1.9798	2.0006	1.95355	1.95305	2.0006	2.0006
		3	1.9895	2.0000	1.95940	1.9822	2.0000	1.95510	1.95510	2.0000	2.0000		
			1.9889	2.0006	1.95915	1.9816	2.0006	1.95535	1.95485	2.0006	2.0006		
		2 1/4-16	N	2	2.0520	2.0625	2.02190	2.0420	2.0625	2.01580	2.01580	2.0625	2.0625
					2.0514	2.0631	2.02165	2.0423	2.0631	2.01605	2.01555	2.0631	2.0631
3	2.0520			2.0625	2.02190	2.0447	2.0625	2.01760	2.01760	2.0625	2.0625		
	2.0514			2.0631	2.02165	2.0441	2.0631	2.01785	2.01735	2.0631	2.0631		
2 3/8-8	N			2	2.1079	2.1250	2.04380	2.0872	2.1250	2.03310	2.03310	2.1250	2.1250
					2.1072	2.1257	2.04355	2.0865	2.1257	2.03335	2.03285	2.1257	2.1257
		3	2.1079	2.1250	2.04380	2.0904	2.1250	2.03630	2.03630	2.1250	2.1250		
			2.1072	2.1257	2.04355	2.0897	2.1257	2.03655	2.03605	2.1257	2.1257		
		2 3/4-12	N	2	2.1121	2.1250	2.07090	2.1002	2.1250	2.06410	2.06410	2.1250	2.1250
					2.1115	2.1256	2.07065	2.0996	2.1256	2.06435	2.06385	2.1256	2.1256
3	2.1121			2.1250	2.07090	2.1022	2.1250	2.06610	2.06610	2.1250	2.1250		
	2.1115			2.1256	2.07065	2.1016	2.1256	2.06635	2.06585	2.1256	2.1256		
2 3/4-16	N			2	2.1145	2.1250	2.08440	2.1053	2.1250	2.07820	2.07820	2.1250	2.1250
					2.1139	2.1256	2.08415	2.1047	2.1256	2.07845	2.07795	2.1256	2.1256
		3	2.1145	2.1250	2.08440	2.1072	2.1250	2.08010	2.08010	2.1250	2.1250		
			2.1139	2.1256	2.08415	2.1066	2.1256	2.08035	2.07985	2.1256	2.1256		
		2 3/8-16	N	2	2.1770	2.1875	2.14690	2.1678	2.1875	2.14070	2.14070	2.1875	2.1875
					2.1764	2.1881	2.14665	2.1672	2.1881	2.14095	2.14045	2.1881	2.1881
3	2.1770			2.1875	2.14690	2.1697	2.1875	2.14260	2.14260	2.1875	2.1875		
	2.1764			2.1881	2.14665	2.1691	2.1881	2.14285	2.14235	2.1881	2.1881		
2 3/4-16	N			1	2.2187	2.2443	2.10000	2.1778	2.2443	2.08160	2.08160	2.2443	2.2443
					2.2177	2.2451	1.99975	2.1770	2.2451	2.08185	2.08135	2.2451	2.2451
		2	2.2242	2.2500	2.10570	2.1802	2.2500	2.09300	2.09300	2.2500	2.2500		
			2.2234	2.2508	2.10545	2.1794	2.2508	2.09325	2.09275	2.2508	2.2508		
		3	2.2242	2.2500	2.10570	2.1830	2.2500	2.09680	2.09680	2.2500	2.2500		
			2.2234	2.2508	2.10545	2.1822	2.2508	2.09705	2.09655	2.2508	2.2508		
2 3/4-20	N	1	2.2551	2.2511	2.19680	2.1986	2.2511	2.10210	2.10210	2.2511	2.2511		
			2.2545	2.2519	2.19655	2.1978	2.2519	2.10235	2.10215	2.2519	2.2519		

TABLE 1.17.—Setting plug gages, American National screw threads—Continued

Nominal size and threads per inch	Series designation	Class	W truncated setting plugs							Basic-crest setting plugs		
			Plug for "Go"			Plug for "Not go"				Major diameter		
			Major diameter		Pitch diameter	Major diameter		Pitch diameter		Go ¹	Not go ²	
			Truncated	Full		Truncated	Full	Plus tol. gage	Minus tol. gage	W and X tolerances	W and X tolerances	
1	2	3	4	5	6	7	8	9	10	11	12	
2 1/4-8	N	2	in.	in.	in.	in.	in.	in.	in.	in.	in.	in.
			2.2329	2.2500	2.16880	2.2119	2.2500	2.15780	2.15780	2.2500	2.2500	
			2.2322	2.2507	2.16855	2.2112	2.2507	2.15805	2.15755	2.2507	2.2507	
2 1/4-12	N	2	2.2329	2.2500	2.16880	2.2152	2.2500	2.16110	2.16110	2.2500	2.2500	
			2.2322	2.2507	2.16855	2.2145	2.2507	2.16135	2.16085	2.2507	2.2507	
			2.2371	2.2500	2.19590	2.2251	2.2500	2.18900	2.18900	2.2500	2.2500	
2 1/4-16	N	2	2.2365	2.2506	2.19565	2.2245	2.2506	2.18925	2.18875	2.2506	2.2506	
			2.2371	2.2500	2.19590	2.2272	2.2500	2.19110	2.19110	2.2500	2.2500	
			2.2365	2.2506	2.19565	2.2266	2.2506	2.19135	2.19085	2.2506	2.2506	
2 1/4-16	N	2	2.2395	2.2500	2.20940	2.2303	2.2500	2.20320	2.20320	2.2500	2.2500	
			2.2389	2.2506	2.20915	2.2297	2.2506	2.20345	2.20295	2.2506	2.2506	
			2.2395	2.2500	2.20940	2.2321	2.2500	2.20500	2.20500	2.2500	2.2500	
2 3/16-16	N	2	2.2389	2.2506	2.20915	2.2315	2.2506	2.20525	2.20475	2.2506	2.2506	
			2.3020	2.3125	2.27190	2.2927	2.3125	2.26560	2.26560	2.3125	2.3125	
			2.3014	2.3131	2.27165	2.2921	2.3131	2.26585	2.26535	2.3131	2.3131	
2 3/16-16	N	2	2.3020	2.3125	2.27190	2.2946	2.3125	2.26750	2.26750	2.3125	2.3125	
			2.3014	2.3131	2.27165	2.2940	2.3131	2.26775	2.26725	2.3131	2.3131	
			2.3621	2.3750	2.32090	2.3500	2.3750	2.31390	2.31390	2.3750	2.3750	
2 3/16-12	N	2	2.3615	2.3756	2.32065	2.3494	2.3756	2.31415	2.31365	2.3756	2.3756	
			2.3621	2.3750	2.32090	2.3521	2.3750	2.31600	2.31600	2.3750	2.3750	
			2.3615	2.3756	2.32065	2.3515	2.3756	2.31625	2.31575	2.3756	2.3756	
2 3/16-16	N	2	2.3621	2.3750	2.32090	2.3552	2.3750	2.32810	2.32810	2.3750	2.3750	
			2.3639	2.3756	2.33415	2.3546	2.3756	2.32835	2.32785	2.3756	2.3756	
			2.3645	2.3750	2.33440	2.3571	2.3750	2.33000	2.33000	2.3750	2.3750	
2 3/16-16	N	2	2.3639	2.3756	2.33415	2.3565	2.3756	2.33025	2.32975	2.3756	2.3756	
			2.4270	2.4375	2.39690	2.4176	2.4374	2.39050	2.39050	2.4375	2.4374	
			2.4264	2.4381	2.39665	2.4170	2.4380	2.39075	2.39025	2.4381	2.4380	
2 3/4-4	NC	1	2.4270	2.4375	2.39690	2.4195	2.4375	2.39240	2.39240	2.4375	2.4375	
			2.4655	2.4936	2.33120	2.4190	2.4936	2.31080	2.31080	2.4936	2.4936	
			2.4646	2.4945	2.33095	2.4181	2.4945	2.31105	2.31055	2.4945	2.4945	
2 3/4-4	NC	2	2.4719	2.5009	2.33760	2.4319	2.5009	2.32360	2.32360	2.5009	2.5009	
			2.4710	2.5009	2.33735	2.4310	2.5009	2.32385	2.32335	2.5009	2.5009	
			2.4719	2.5000	2.33760	2.4362	2.5000	2.32790	2.32790	2.5000	2.5000	
2 3/4-8	N	2	2.4710	2.5009	2.33735	2.4353	2.5009	2.32815	2.32765	2.5009	2.5009	
			2.4732	2.5013	2.33890	2.4424	2.5013	2.33410	2.33410	2.5000	2.5000	
			2.4723	2.5022	2.33865	2.4415	2.5022	2.33435	2.33385	2.5009	2.5009	
2 3/4-8	N	2	2.4829	2.5000	2.41880	2.4612	2.5000	2.40710	2.40710	2.5000	2.5000	
			2.4822	2.5007	2.41855	2.4605	2.5007	2.40735	2.40685	2.5007	2.5007	
			2.4829	2.5000	2.41880	2.4647	2.5000	2.41060	2.41060	2.5000	2.5000	
2 3/4-12	N	2	2.4822	2.5007	2.41855	2.4640	2.5007	2.41085	2.41035	2.5007	2.5007	
			2.4871	2.5000	2.44590	2.4749	2.5000	2.43880	2.43880	2.5000	2.5000	
			2.4865	2.5006	2.44565	2.4743	2.5006	2.43905	2.43855	2.5006	2.5006	
2 3/4-12	N	2	2.4871	2.5000	2.44590	2.4771	2.5000	2.44100	2.44100	2.5000	2.5000	
			2.4865	2.5006	2.44565	2.4765	2.5006	2.44125	2.44075	2.5006	2.5006	
			2.4895	2.5000	2.45940	2.4795	2.5000	2.45300	2.45300	2.5000	2.5000	
2 3/4-16	N	2	2.4895	2.5006	2.45915	2.4814	2.5006	2.45515	2.45465	2.5006	2.5006	
			2.4889	2.5006	2.45915	2.4814	2.5006	2.45515	2.45465	2.5006	2.5006	
			2.6121	2.6250	2.57090	2.5999	2.6250	2.56380	2.56380	2.6250	2.6250	
2 3/4-12	N	2	2.6115	2.6256	2.57065	2.5993	2.6256	2.56405	2.56355	2.6256	2.6256	
			2.6121	2.6250	2.57090	2.6020	2.6250	2.56590	2.56590	2.6250	2.6250	
			2.6115	2.6256	2.57065	2.6014	2.6256	2.56615	2.56565	2.6256	2.6256	
2 3/4-16	N	2	2.6145	2.6250	2.58440	2.6050	2.6250	2.6245	2.57790	2.57790	2.6250	2.6248
			2.6139	2.6256	2.58415	2.6044	2.6254	2.57815	2.57765	2.6256	2.6254	
			2.6145	2.6250	2.58440	2.6070	2.6250	2.57990	2.57990	2.6250	2.6250	
2 3/4-4	NC	1	2.6139	2.6256	2.58415	2.6064	2.6256	2.58015	2.57965	2.6256	2.6256	
			2.7155	2.7436	2.58120	2.6690	2.7436	2.56080	2.56080	2.7436	2.7436	
			2.7146	2.7445	2.58095	2.6681	2.7445	2.56105	2.56055	2.7445	2.7445	
2 3/4-4	NC	2	2.7219	2.7500	2.58760	2.6819	2.7500	2.57390	2.57390	2.7500	2.7500	
			2.7210	2.7509	2.58735	2.6810	2.7509	2.57385	2.57335	2.7509	2.7509	
			2.7219	2.7500	2.58760	2.6802	2.7500	2.57790	2.57790	2.7500	2.7500	
2 3/4-8	N	2	2.7210	2.7509	2.58735	2.6853	2.7509	2.57815	2.57765	2.7509	2.7509	
			2.7232	2.7513	2.58890	2.6924	2.7513	2.58410	2.58410	2.7500	2.7500	
			2.7223	2.7522	2.58865	2.6915	2.7522	2.58435	2.58385	2.7509	2.7509	
2 3/4-8	N	2	2.7329	2.7500	2.60880	2.7105	2.7500	2.65640	2.65640	2.7500	2.7500	
			2.7322	2.7507	2.60855	2.7098	2.7507	2.65665	2.65615	2.7507	2.7507	
			2.7329	2.7500	2.60880	2.7142	2.7500	2.66010	2.66010	2.7500	2.7500	
2 3/4-8	N	2	2.7322	2.7507	2.60855	2.7135	2.7507	2.66035	2.65985	2.7507	2.7507	

See tolerances at end of table.

TABLE 1.17.—Setting plug gages, American National screw threads—Continued

Nominal size and threads per inch	Series designation	Class	W truncated setting plugs							Basic-crest setting plugs		
			Plug for "Go"			Plug for "Not go"				Major diameter		
			Major diameter		Pitch diameter	Major diameter		Pitch diameter		Go ¹	Not go ²	
			Truncated	Full		Truncated	Full	Plus tol. gage	Minus tol. gage	W and X tolerances	W and X tolerances	
1	2	3	4	5	6	7	8	9	10	11	12	
2 3/4-12	N	2	in.	in.	in.	in.	in.	in.	in.	in.	in.	in.
			2.7371	2.7500	2.69590	2.7248	2.7500	2.68870	2.68870	2.7500	2.7500	
		3	2.7365	2.7506	2.69565	2.7242	2.7506	2.68895	2.68845	2.7506	2.7506	
			2.7371	2.7500	2.69590	2.7270	2.7500	2.69090	2.69090	2.7500	2.7500	
		2	2.7365	2.7506	2.69565	2.7264	2.7506	2.69115	2.69065	2.7506	2.7506	
			2.7397	2.7500	2.70940	2.7299	2.7497	2.70280	2.70280	2.7500	2.7497	
2 3/4-16	N	2	2.7389	2.7506	2.70915	2.7293	2.7503	2.70305	2.70255	2.7506	2.7503	
			2.7395	2.7500	2.70940	2.7319	2.7500	2.70480	2.70480	2.7500	2.7500	
		3	2.7389	2.7506	2.70915	2.7313	2.7506	2.70505	2.70455	2.7506	2.7506	
			2.8621	2.8750	2.82090	2.8497	2.8750	2.81360	2.81360	2.8750	2.8750	
		2	2.8615	2.8756	2.82065	2.8491	2.8756	2.81385	2.81335	2.8756	2.8756	
			2.8621	2.8750	2.82090	2.8519	2.8750	2.81580	2.81580	2.8750	2.8750	
3	2.8615	2.8756	2.82065	2.8513	2.8756	2.81605	2.81555	2.8756	2.8756			
	2.8645	2.8750	2.83440	2.8549	2.8747	2.82780	2.82780	2.8750	2.8747			
2 7/8-16	N	2	2.8639	2.8756	2.83415	2.8543	2.8753	2.82805	2.82755	2.8756	2.8753	
			2.8645	2.8750	2.83440	2.8569	2.8750	2.82980	2.82980	2.8750	2.8750	
		3	2.8639	2.8756	2.83415	2.8563	2.8756	2.83005	2.82955	2.8756	2.8756	
			2.9655	2.9936	2.83120	2.9190	2.9936	2.81080	2.81080	2.9936	2.9936	
		1	2.9646	2.9945	2.83095	2.9181	2.9945	2.81105	2.81055	2.9945	2.9945	
			2.9719	3.0000	2.83760	2.9319	3.0000	2.82360	2.82360	3.0000	3.0000	
3-4	NC	2	2.9710	3.0009	2.83735	2.9310	3.0009	2.82385	2.82335	3.0009	3.0009	
			2.9719	3.0000	2.83760	2.9362	3.0000	2.82790	2.82790	3.0000	3.0000	
		3	2.9710	3.0009	2.83735	2.9353	3.0009	2.82815	2.82765	3.0009	3.0009	
			2.9732	3.0013	2.83890	2.9424	3.0013	2.83410	2.83410	3.0000	3.0000	
		4	2.9723	3.0022	2.83865	2.9415	3.0022	2.83435	2.83385	3.0009	3.0009	
			2.9829	3.0000	2.91880	2.9599	2.9996	2.90580	2.90380	3.0000	2.9996	
3-8	N	2	2.9822	3.0007	2.91855	2.9592	3.0003	2.90555	2.9007	3.0007	3.0003	
			2.9829	3.0000	2.91880	2.9637	3.0000	2.90960	2.90960	3.0000	3.0000	
		3	2.9822	3.0007	2.91855	2.9630	3.0007	2.90985	2.90935	3.0007	3.0007	
			2.9871	3.0000	2.94590	2.9746	3.0000	2.93850	2.93850	3.0000	3.0000	
		2	2.9865	3.0006	2.94565	2.9730	3.0006	2.93875	2.93825	3.0006	3.0006	
			2.9871	3.0000	2.94590	2.9769	3.0000	2.94080	2.94080	3.0000	3.0000	
3	2.9865	3.0006	2.94565	2.9763	3.0006	2.94105	2.94055	3.0006	3.0006			
	2.9895	3.0000	2.95940	2.9798	2.9996	2.95270	2.95270	3.0000	2.9996			
3-16	N	2	2.9889	3.0006	2.95915	2.9792	3.0002	2.95295	2.95245	3.0006	3.0002	
			2.9895	3.0000	2.95940	2.9818	3.0000	2.95470	2.95470	3.0000	3.0000	
		3	2.9889	3.0006	2.95915	2.9812	3.0006	2.95495	2.95445	3.0006	3.0006	
			3.1121	3.1250	3.07090	3.0996	3.1250	3.06350	3.06350	3.1250	3.1250	
		2	3.1115	3.1256	3.07065	3.0990	3.1256	3.06375	3.06325	3.1256	3.1256	
			3.1121	3.1250	3.07090	3.1018	3.1250	3.06570	3.06570	3.1250	3.1250	
3	3.1115	3.1256	3.07065	3.1012	3.1256	3.06595	3.06545	3.1256	3.1256			
	3.1145	3.1250	3.08440	3.1047	3.1245	3.07760	3.07760	3.1250	3.1245			
3 3/8-16	N	2	3.1139	3.1256	3.08415	3.1041	3.1251	3.07785	3.07735	3.1256	3.1251	
			3.1145	3.1250	3.08440	3.1068	3.1250	3.07970	3.07970	3.1250	3.1250	
		3	3.1139	3.1256	3.08415	3.1062	3.1256	3.07995	3.07945	3.1256	3.1256	
			3.2155	3.2436	3.08120	3.1690	3.2436	3.06080	3.06080	3.2436	3.2436	
		1	3.2146	3.2445	3.08095	3.1681	3.2445	3.06105	3.06055	3.2445	3.2445	
			3.2219	3.2500	3.08760	3.1819	3.2500	3.07360	3.07360	3.2500	3.2500	
3 1/4-4	NC	2	3.2210	3.2509	3.08735	3.1810	3.2509	3.07385	3.07335	3.2509	3.2509	
			3.2219	3.2500	3.08760	3.1862	3.2500	3.07790	3.07790	3.2500	3.2500	
		3	3.2210	3.2509	3.08735	3.1853	3.2509	3.07815	3.07765	3.2509	3.2509	
			3.2232	3.2513	3.08890	3.1924	3.2513	3.08410	3.08410	3.2500	3.2500	
		4	3.2223	3.2522	3.08865	3.1915	3.2522	3.08435	3.08385	3.2509	2.2509	
			3.2329	3.2500	3.16880	3.2097	3.2494	3.15560	3.15560	3.2500	3.2494	
3 1/4-8	N	2	3.2322	3.2507	3.16855	3.2136	3.2500	3.15950	3.15950	3.2500	3.2500	
			3.2322	3.2507	3.16855	3.2129	3.2507	3.15975	3.15925	3.2507	3.2507	
		3	3.2371	3.2500	3.19590	3.2245	3.2500	3.18840	3.18840	3.2500	3.2500	
			3.2365	3.2506	3.19565	3.2239	3.2506	3.18865	3.18815	3.2506	3.2506	
		2	3.2371	3.2500	3.19590	3.2268	3.2500	3.19070	3.19070	3.2500	3.2500	
			3.2365	3.2506	3.19565	3.2262	3.2506	3.19095	3.19045	3.2506	3.2506	
3 1/4-12	N	2	3.2395	3.2500	3.20940	3.2296	3.2494	3.20250	3.20250	3.2500	3.2494	
			3.2389	2.2506	3.20915	3.2290	3.2500	3.20275	3.20225	3.2506	3.2500	
		3	3.2395	3.2500	3.20940	3.2317	3.2500	3.20460	3.20460	3.2500	3.2500	
			3.2389	3.2506	3.20915	3.2311	3.2506	3.20485	3.20435	3.2506	3.2506	
		2	3.3621	3.3750	3.32090	3.3494	3.3750	3.31330	3.31330	3.3750	3.3750	
			3.3615	3.3756	3.32065	3.3488	3.3756	3.31355	3.31305	3.3756	3.3756	
3	3.3621	3.3750	3.32090	3.3517	3.3750	3.31560	3.31560	3.3750	3.3750			
	3.3615	3.3756	3.32065	3.3511	3.3756	3.31585	3.31535	3.3756	3.3756			

See footnotes at end of table.

TABLE 1.17.—Setting plug gages, American National screw threads—Continued

Nominal size and threads per inch	Series designation	Class	W truncated setting plugs								Basic-crest setting plugs	
			Plug for "Go"				Plug for "Not go"				Major diameter	
			Major diameter		Pitch diameter	Major diameter		Pitch diameter		Go ¹	Not go ²	
			Truncated	Full		Truncated	Full	Plus tol. gage	Minus tol. gage			W and X tolerances
1	2	3	4	5	6	7	8	9	10	11	12	
			<i>in.</i>	<i>in.</i>	<i>in.</i>	<i>in.</i>	<i>in.</i>	<i>in.</i>	<i>in.</i>	<i>in.</i>	<i>in.</i>	<i>in.</i>
3/8-16	N	2	3.3645	3.3750	3.33440	3.3546	3.3744	3.32750	3.32750	3.3750	3.3750	3.3744
			3.3639	3.3756	3.33415	3.3540	3.3750	3.32775	3.32725	3.3756	3.3750	3.3750
		3	3.3645	3.3750	3.33440	3.3567	3.3750	3.32960	3.32960	3.3750	3.3750	3.3750
			3.3639	3.3756	3.33415	3.3561	3.3756	3.32985	3.32935	3.3756	3.3756	3.3756
3/4-4	NC	1	3.4655	3.4936	3.33120	3.4190	3.4936	3.31090	3.31090	3.4936	3.4936	3.4936
			3.4646	3.4945	3.33095	3.4181	3.4945	3.31105	3.31055	3.4945	3.4945	3.4945
		2	3.4719	3.5000	3.33760	3.4319	3.5000	3.32360	3.32360	3.5000	3.5000	3.5000
			3.4710	3.5009	3.33735	3.4310	3.5009	3.32385	3.32335	3.5009	3.5009	3.5009
3/4-8	N	2	3.4719	3.5000	3.33760	3.4362	3.5000	3.32790	3.32790	3.5000	3.5000	3.5000
			3.4710	3.5009	3.33735	3.4353	3.5009	3.32815	3.32765	3.5009	3.5009	3.5009
		3	3.4732	3.5013	3.33890	3.4424	3.5013	3.33410	3.33410	3.5000	3.5000	3.5000
			3.4723	3.5022	3.33865	3.4415	3.5022	3.33435	3.33385	3.5009	3.5009	3.5009
3/4-12	N	2	3.4829	3.5000	3.41890	3.4596	3.4992	3.40550	3.40550	3.5000	3.4992	3.4992
			3.4822	3.5007	3.41855	3.4589	3.4999	3.40575	3.40525	3.5007	3.4999	3.4999
		3	3.4829	3.5000	3.41890	3.4636	3.5000	3.40950	3.40950	3.5000	3.5000	3.5000
			3.4822	3.5007	3.41855	3.4629	3.5007	3.40975	3.40925	3.5007	3.5007	3.5007
3/4-16	N	2	3.4871	3.5000	3.44590	3.4744	3.5000	3.43830	3.43830	3.5000	3.5000	3.5000
			3.4865	3.5006	3.44565	3.4738	3.5006	3.43855	3.43805	3.5006	3.5006	3.5006
		3	3.4871	3.5000	3.44590	3.4767	3.5000	3.44060	3.44060	3.5000	3.5000	3.5000
			3.4865	3.5006	3.44565	3.4761	3.5006	3.44085	3.44035	3.5006	3.5006	3.5006
3/8-12	N	2	3.4889	3.5000	3.45940	3.4795	3.4993	3.45240	3.45240	3.5000	3.4993	3.4993
			3.4889	3.5006	3.45915	3.4789	3.4999	3.45265	3.45215	3.5006	3.4999	3.4999
		3	3.4889	3.5000	3.45940	3.4816	3.5000	3.45450	3.45450	3.5000	3.5000	3.5000
			3.4889	3.5006	3.45915	3.4810	3.5006	3.45475	3.45425	3.5006	3.5006	3.5006
3/8-16	N	2	3.6121	3.6250	3.57090	3.5993	3.6250	3.56320	3.56320	3.6250	3.6250	3.6250
			3.6115	3.6256	3.57065	3.5987	3.6256	3.56345	3.56295	3.6256	3.6256	3.6256
		3	3.6121	3.6250	3.57090	3.6016	3.6250	3.56550	3.56550	3.6250	3.6250	3.6250
			3.6115	3.6256	3.57065	3.6010	3.6256	3.56575	3.56525	3.6256	3.6256	3.6256
3/8-20	N	2	3.6145	3.6250	3.58440	3.6044	3.6242	3.57730	3.57730	3.6250	3.6242	3.6242
			3.6139	3.6256	3.58415	3.6038	3.6248	3.57755	3.57705	3.6256	3.6248	3.6248
		3	3.6145	3.6250	3.58440	3.6066	3.6250	3.57950	3.57950	3.6250	3.6250	3.6250
			3.6139	3.6256	3.58415	3.6060	3.6256	3.57975	3.57925	3.6256	3.6256	3.6256
3/4-4	NC	1	3.7155	3.7436	3.58120	3.6690	3.7436	3.56090	3.56090	3.7436	3.7436	3.7436
			3.7146	3.7445	3.58095	3.6681	3.7445	3.56105	3.56055	3.7445	3.7445	3.7445
		2	3.7219	3.7500	3.58760	3.6819	3.7500	3.57360	3.57360	3.7500	3.7500	3.7500
			3.7210	3.7509	3.58735	3.6810	3.7509	3.57385	3.57335	3.7509	3.7509	3.7509
3/4-8	N	2	3.7219	3.7500	3.58760	3.6862	3.7500	3.57790	3.57790	3.7500	3.7500	3.7500
			3.7210	3.7509	3.58735	3.6853	3.7509	3.57815	3.57765	3.7509	3.7509	3.7509
		3	3.7232	3.7513	3.58900	3.6924	3.7513	3.58410	3.58410	3.7500	3.7500	3.7500
			3.7223	3.7522	3.58865	3.6915	3.7522	3.58435	3.58385	3.7509	3.7509	3.7509
3/4-12	N	2	3.7329	3.7500	3.66880	3.7095	3.7492	3.65540	3.65540	3.7500	3.7492	3.7492
			3.7322	3.7507	3.66855	3.7088	3.7499	3.65565	3.65515	3.7507	3.7499	3.7499
		3	3.7329	3.7500	3.66880	3.7135	3.7500	3.65940	3.65940	3.7500	3.7500	3.7500
			3.7322	3.7507	3.66855	3.7128	3.7507	3.65965	3.65915	3.7507	3.7507	3.7507
3/4-16	N	2	3.7371	3.7500	3.69590	3.7242	3.7500	3.68810	3.68810	3.7500	3.7500	3.7500
			3.7365	3.7506	3.69565	3.7236	3.7506	3.68835	3.68785	3.7506	3.7506	3.7506
		3	3.7371	3.7500	3.69590	3.7266	3.7500	3.69050	3.69050	3.7500	3.7500	3.7500
			3.7365	3.7506	3.69565	3.7260	3.7506	3.69075	3.69025	3.7506	3.7506	3.7506
3/4-20	N	2	3.7395	3.7500	3.70940	3.7294	3.7492	3.70230	3.70230	3.7500	3.7492	3.7492
			3.7389	3.7506	3.70915	3.7288	3.7498	3.70255	3.70205	3.7506	3.7498	3.7498
		3	3.7395	3.7500	3.70940	3.7315	3.7500	3.70440	3.70440	3.7500	3.7500	3.7500
			3.7389	3.7506	3.70915	3.7309	3.7506	3.70465	3.70415	3.7506	3.7506	3.7506
3/8-12	N	2	3.8621	3.8750	3.82090	3.8492	3.8750	3.81310	3.81310	3.8750	3.8750	3.8750
			3.8615	3.8756	3.82065	3.8486	3.8756	3.81335	3.81285	3.8756	3.8756	3.8756
		3	3.8621	3.8750	3.82090	3.8515	3.8750	3.81540	3.81540	3.8750	3.8750	3.8750
			3.8615	3.8756	3.82065	3.8509	3.8756	3.81565	3.81515	3.8756	3.8756	3.8756
3/8-16	N	2	3.8645	3.8750	3.83440	3.8543	3.8741	3.82720	3.82720	3.8750	3.8741	3.8741
			3.8639	3.8756	3.83415	3.8537	3.8747	3.82745	3.82695	3.8756	3.8747	3.8747
		3	3.8645	3.8750	3.83440	3.8565	3.8750	3.82940	3.82940	3.8750	3.8750	3.8750
			3.8639	3.8756	3.83415	3.8559	3.8756	3.82965	3.82915	3.8756	3.8756	3.8756
4-4	NC	1	3.9655	3.9936	3.83120	3.9190	3.9936	3.81080	3.81080	3.9936	3.9936	3.9936
			3.9646	3.9945	3.83095	3.9181	3.9945	3.81105	3.81055	3.9945	3.9945	3.9945
		2	3.9719	4.0000	3.83760	3.9319	4.0000	3.82360	3.82360	4.0000	4.0000	4.0000
			3.9710	4.0009	3.83735	3.9310	4.0009	3.82385	3.82335	4.0009	4.0009	4.0009
4-8	N	2	3.9719	4.0000	3.83760	3.9362	4.0000	3.82790	3.82790	4.0000	4.0000	4.0000
			3.9710	4.0009	3.83735	3.9353	4.0009	3.82815	3.82765	4.0009	4.0009	4.0009
		3	3.9732	4.0013	3.83890	3.9424	4.0013	3.83410	3.83410	4.0000	4.0000	4.0000
			3.9723	4.0022	3.83865	3.9415	4.0022	3.83435	3.83385	4.0000	4.0000	4.0000

Continued at end of table.

TABLE 1.17.—Setting plug gages, American National screw threads—Continued

Nominal size and threads per inch	Series designation	Class	W truncated setting plugs								Basic-crest setting plugs		
			Plug for "Go"				Plug for "Not go"				Major diameter		
			Major diameter		Pitch diameter	Major diameter		Pitch diameter		Go 1	Not go 2		
			Truncated	Full		Truncated	Full	Plus tol. gage	Minus tol. gage			W and X tolerances	W and X tolerances
1	2	3	4	5	6	7	8	9	10	11	12		
4-8	N	2	<i>in.</i>	<i>in.</i>	<i>in.</i>	<i>in.</i>	<i>in.</i>	<i>in.</i>	<i>in.</i>	<i>in.</i>	<i>in.</i>	<i>in.</i>	<i>in.</i>
			3.9820	4.0000	3.91880	3.9594	3.9990	3.90530	3.96530	4.0090	3.9990		
		3	3.9822	4.0007	3.91855	3.9587	3.9997	3.90555	3.96555	4.0007	3.9997		
			3.9829	4.0000	3.91880	3.9594	4.0000	3.90530	3.96530	4.0000	4.0000		
		2	3.9871	4.0000	3.91590	3.9741	4.0000	3.93800	3.93800	4.0000	4.0000		
			3.9865	4.0006	3.91595	3.9735	4.0006	3.93825	3.93775	4.0006	4.0006		
3	3.9871	4.0000	3.91590	3.9735	4.0000	3.93400	3.93400	4.0000	4.0000				
	3.9865	4.0006	3.91565	3.9759	4.0006	3.94065	3.94015	4.0006	4.0006				
4-12	N	2	3.9895	4.0000	3.95910	3.9793	3.9991	3.95220	3.95220	4.0000	3.9991		
			3.9889	4.0006	3.95915	3.9787	3.9997	3.95245	3.95195	4.0006	3.9997		
		3	3.9895	4.0000	3.95910	3.9814	4.0000	3.95430	3.95430	4.0000	4.0000		
			3.9889	4.0006	3.95915	3.9808	4.0006	3.95455	3.95405	4.0006	4.0006		
		2	4.2329	4.2500	4.1688	4.2092	4.2488	4.1551	4.1551	4.2500	4.2488		
			4.2318	4.2511	4.1685	4.2081	4.2499	4.1548	4.1548	4.2511	4.2499		
3	4.2329	4.2500	4.1688	4.2133	4.2500	4.1592	4.1592	4.2500	4.2500				
	4.2318	4.2511	4.1685	4.2122	4.2511	4.1589	4.1589	4.2511	4.2511				
4 1/4-8	N	2	4.2371	4.2500	4.1959	4.2210	4.2590	4.1879	4.1879	4.2500	4.2500		
			4.2362	4.2509	4.1956	4.2201	4.2599	4.1882	4.1876	4.2509	4.2499		
		3	4.2371	4.2500	4.1959	4.2264	4.2596	4.1903	4.1903	4.2500	4.2500		
			4.2362	4.2509	4.1956	4.2255	4.2509	4.1906	4.1900	4.2509	4.2509		
		2	4.2395	4.2500	4.2094	4.2291	4.2489	4.2020	4.2020	4.2500	4.2489		
			4.2386	4.2509	4.2091	4.2282	4.2498	4.2023	4.2017	4.2509	4.2498		
3	4.2395	4.2500	4.2094	4.2313	4.2590	4.2012	4.2012	4.2500	4.2500				
	4.2386	4.2509	4.2091	4.2301	4.2599	4.2015	4.2009	4.2509	4.2499				
4 1/2-8	N	2	4.4820	4.5000	4.4188	4.4591	4.4988	4.4050	4.4050	4.5000	4.4988		
			4.4818	4.5011	4.4185	4.4580	4.4999	4.4047	4.4047	4.5011	4.4999		
		3	4.4820	4.5000	4.4188	4.4632	4.5000	4.4091	4.4091	4.5000	4.5000		
			4.4818	4.5011	4.4185	4.4621	4.5011	4.4088	4.4088	4.5011	4.5011		
		2	4.4871	4.5000	4.4459	4.4739	4.5000	4.4378	4.4378	4.5000	4.5000		
			4.4862	4.5009	4.4456	4.4730	4.5009	4.4381	4.4375	4.5009	4.5009		
3	4.4871	4.5000	4.4459	4.4783	4.5000	4.4402	4.4402	4.5000	4.5000				
	4.4862	4.5009	4.4456	4.4771	4.5009	4.4405	4.4399	4.5009	4.5009				
4 1/2-12	N	2	4.4895	4.5000	4.4594	4.4790	4.4988	4.4519	4.4519	4.5000	4.4988		
			4.4886	4.5009	4.4591	4.4781	4.4997	4.4522	4.4516	4.5009	4.4997		
		3	4.4895	4.5000	4.4594	4.4812	4.5000	4.4511	4.4511	4.5000	4.5000		
			4.4886	4.5009	4.4591	4.4803	4.5009	4.4514	4.4508	4.5009	4.5009		
		2	4.7329	4.7500	4.6688	4.7090	4.7486	4.6519	4.6519	4.7500	4.7486		
			4.7318	4.7511	4.6685	4.7079	4.7497	4.6516	4.6516	4.7511	4.7497		
3	4.7329	4.7500	4.6688	4.7131	4.7500	4.6590	4.6590	4.7500	4.7500				
	4.7318	4.7511	4.6685	4.7120	4.7511	4.6593	4.6587	4.7511	4.7511				
4 3/4-8	N	2	4.7371	4.7500	4.6959	4.7237	4.7500	4.6876	4.6876	4.7500	4.7500		
			4.7362	4.7509	4.6956	4.7228	4.7509	4.6879	4.6873	4.7509	4.7509		
		3	4.7371	4.7500	4.6959	4.7292	4.7500	4.6901	4.6901	4.7500	4.7500		
			4.7362	4.7509	4.6956	4.7283	4.7509	4.6904	4.6898	4.7509	4.7509		
		2	4.7395	4.7500	4.7091	4.7289	4.7487	4.7018	4.7018	4.7500	4.7487		
			4.7386	4.7509	4.7091	4.7280	4.7496	4.7021	4.7015	4.7509	4.7496		
3	4.7395	4.7500	4.7091	4.7312	4.7500	4.7011	4.7011	4.7500	4.7500				
	4.7386	4.7509	4.7091	4.7303	4.7509	4.7014	4.7008	4.7509	4.7509				
5-8	N	2	4.9829	5.0000	4.9188	4.9589	4.9986	4.9048	4.9048	5.0000	4.9986		
			4.9818	5.0011	4.9185	4.9578	4.9997	4.9045	4.9045	5.0011	4.9997		
		3	4.9829	5.0000	4.9188	4.9630	5.0000	4.9095	4.9095	5.0000	5.0000		
			4.9818	5.0011	4.9185	4.9619	5.0011	4.9092	4.9086	5.0011	5.0011		
		2	4.9871	5.0000	4.9459	4.9736	5.0000	4.9375	4.9375	5.0000	5.0000		
			4.9862	5.0009	4.9456	4.9727	5.0009	4.9378	4.9372	5.0009	5.0009		
3	4.9871	5.0000	4.9459	4.9781	5.0000	4.9400	4.9400	5.0000	5.0000				
	4.9862	5.0009	4.9456	4.9772	5.0009	4.9403	4.9397	5.0009	5.0009				
5-12	N	2	4.9895	5.0000	4.9594	4.9788	4.9986	4.9517	4.9517	5.0000	4.9986		
			4.9886	5.0009	4.9591	4.9779	4.9997	4.9520	4.9514	5.0009	4.9997		
		3	4.9895	5.0000	4.9594	4.9811	5.0000	4.9530	4.9530	5.0000	5.0000		
			4.9886	5.0009	4.9591	4.9802	5.0009	4.9533	4.9527	5.0009	5.0009		
		2	5.2329	5.2500	5.1688	5.2088	5.2484	5.1547	5.1547	5.2500	5.2484		
			5.2318	5.2511	5.1685	5.2077	5.2495	5.1544	5.1544	5.2511	5.2495		
3	5.2329	5.2500	5.1688	5.2130	5.2500	5.1589	5.1589	5.2500	5.2500				
	5.2318	5.2511	5.1685	5.2119	5.2511	5.1592	5.1586	5.2511	5.2511				

See footnotes at end of table.

TABLE 1.17. —Setting plug gages, American National screw threads—Continued

Nominal size and threads per inch	Series designation	Class	W truncated setting plugs								Basic-crest setting plugs	
			Plug for "Go"				Plug for "Not go"				Major diameter	
			Major diameter		Pitch diameter	Major diameter		Pitch diameter		Go ¹	Not go ²	
			Truncated	Full		Truncated	Full	Plus tol. gage	Minus tol. gage	W and X tolerances	W and X tolerances	
1	2	3	4	5	6	7	8	9	10	11	12	
5/16-12	N	2	<i>in.</i>	<i>in.</i>	<i>in.</i>	<i>in.</i>	<i>in.</i>	<i>in.</i>	<i>in.</i>	<i>in.</i>	<i>in.</i>	<i>in.</i>
			5.2371	5.2500	5.1959	5.2235	5.2499	5.1874	5.1874	5.2567	5.2400	
		3	5.2369	5.2500	5.1956	5.2226	5.2505	5.1877	5.1877	5.2509	5.2508	
			5.2371	5.2500	5.1959	5.2261	5.2500	5.1900	5.1900	5.2501	5.2500	
5/16-16	N	2	5.2395	5.2500	5.2094	5.2287	5.2485	5.2043	5.2043	5.2046	5.2500	5.2485
			5.2384	5.2500	5.2094	5.2278	5.2494	5.2043	5.2043	5.2509	5.2494	
		3	5.2395	5.2500	5.2094	5.2310	5.2500	5.2039	5.2039	5.2500	5.2500	
			5.2384	5.2500	5.2091	5.2301	5.2509	5.2042	5.2036	5.2500	5.2509	
5/16-8	N	2	5.4829	5.5000	5.4188	5.4587	5.4984	5.4390	5.4390	5.4985	5.5000	5.4984
			5.4818	5.5011	5.4185	5.4576	5.4995	5.4393	5.4393	5.5011	5.4995	
		3	5.4829	5.5000	5.4188	5.4629	5.5000	5.4088	5.4088	5.5000	5.5000	
			5.4818	5.5011	5.4185	5.4618	5.5011	5.4091	5.4085	5.5011	5.5011	
5/16-12	N	2	5.4871	5.5000	5.4459	5.4734	5.4908	5.4373	5.4373	5.5000	5.4908	
			5.4862	5.5009	5.4456	5.4725	5.5007	5.4373	5.4370	5.5009	5.5007	
		3	5.4871	5.5000	5.4459	5.4750	5.5000	5.4399	5.4399	5.5000	5.5000	
			5.4862	5.5009	5.4456	5.4751	5.5009	5.4402	5.4396	5.5009	5.5009	
5/16-16	N	2	5.4895	5.5000	5.4501	5.4786	5.4984	5.4515	5.4515	5.5000	5.4984	
			5.4886	5.5009	5.4501	5.4777	5.4993	5.4515	5.4512	5.5009	5.4993	
		3	5.4895	5.5000	5.4501	5.4809	5.5000	5.4538	5.4538	5.5000	5.5000	
			5.4886	5.5009	5.4501	5.4800	5.5009	5.4541	5.4535	5.5009	5.5009	
5/16-8	N	2	5.7320	5.7500	5.6888	5.7096	5.7382	5.6545	5.6545	5.7500	5.7382	
			5.7318	5.7511	5.6885	5.7075	5.7393	5.6548	5.6542	5.7511	5.7393	
		3	5.7320	5.7500	5.6888	5.7128	5.7500	5.6587	5.6587	5.7500	5.7500	
			5.7318	5.7511	5.6885	5.7117	5.7511	5.6590	5.6584	5.7511	5.7511	
5/16-12	N	2	5.7371	5.7500	5.6959	5.7233	5.7497	5.6872	5.6872	5.7500	5.7497	
			5.7362	5.7509	5.6956	5.7224	5.7506	5.6875	5.6869	5.7509	5.7506	
		3	5.7371	5.7500	5.6959	5.7259	5.7500	5.6898	5.6898	5.7500	5.7500	
			5.7362	5.7509	5.6956	5.7250	5.7509	5.6901	5.6895	5.7509	5.7509	
5/16-16	N	2	5.7395	5.7500	5.7094	5.7285	5.7483	5.7014	5.7014	5.7500	5.7483	
			5.7386	5.7509	5.7091	5.7276	5.7492	5.7017	5.7011	5.7509	5.7492	
		3	5.7395	5.7500	5.7094	5.7306	5.7500	5.7038	5.7038	5.7500	5.7500	
			5.7386	5.7509	5.7091	5.7300	5.7509	5.7041	5.7035	5.7509	5.7509	
6-8	N	2	5.9829	6.0000	5.9188	5.9585	5.9982	5.9044	5.9044	6.0000	5.9982	
			5.9818	6.0011	5.9185	5.9574	5.9993	5.9047	5.9041	6.0011	5.9993	
		3	5.9829	6.0000	5.9188	5.9627	6.0000	5.9086	5.9086	6.0000	6.0000	
			5.9818	6.0011	5.9185	5.9616	6.0011	5.9089	5.9083	6.0011	6.0011	
6-12	N	2	5.9871	6.0000	5.9359	5.9732	5.9996	5.9371	5.9371	6.0000	5.9996	
			5.9862	6.0009	5.9356	5.9723	6.0005	5.9374	5.9368	6.0009	6.0005	
		3	5.9871	6.0000	5.9359	5.9758	6.0000	5.9397	5.9397	6.0000	6.0000	
			5.9862	6.0009	5.9356	5.9749	6.0009	5.9400	5.9394	6.0009	6.0009	
6-16	N	2	5.9895	6.0000	5.9594	5.9784	5.9982	5.9518	5.9518	6.0000	5.9982	
			5.9886	6.0009	5.9591	5.9775	5.9991	5.9521	5.9515	6.0009	5.9991	
		3	5.9895	6.0000	5.9594	5.9808	6.0000	5.9547	5.9547	6.0000	6.0000	
			5.9886	6.0009	5.9591	5.9799	6.0009	5.9550	5.9544	6.0009	6.0009	

¹ Pitch diameter limits of **W** basic-crest setting plug gages are given in column 6 of this table. Pitch diameter limits of **X** basic-crest setting plug gages are given in column 4 of table 1.16.

² Pitch diameter limits of **W** basic-crest setting plug gages are given in columns 9 and 10 of this table. Pitch diameter limits of **X** basic-crest setting plug gages are given in columns 6 and 7 of table 1.16.

APPENDIX 2. AMERICAN NATIONAL SCREW THREADS OF SPECIAL DIAMETERS, PITCHES, AND LENGTHS OF ENGAGEMENT

The American National standards for screw threads of special diameters, pitches, and lengths of engagement are republished here as useful information. They are largely superseded by the Unified and American standards which are specified in section IV. If American National threads are specified, they shall conform to the requirements herein.

The tolerances specified in appendix 1 of this handbook apply in general to bolts, nuts, and tapped holes of standard pitches and diameters. They are based on the pitch of the thread and a length of engagement equal to the basic major diameter, but are used for lengths of engagement up to $1\frac{1}{2}$ diameters.

In addition to the foregoing threaded components, there are large quantities of threaded parts produced, such as hub and radiator caps in the automotive industry, threaded collars on machine tools, etc., where the diameters are larger, the pitches finer, and the lengths of engagement shorter than for bolt and nut practice. The following specifications have been adopted for such threaded parts, and the tolerances are based on the diameter, pitch, and length of engagement of the components.

1. FORM OF THREAD

The American National form of thread profile as specified in appendix 1 shall be used.

2. STANDARD PITCHES

In appendix 1 there are given the limits of size for standard thread series. The use of these series, wherever possible, is recommended for all applications.

Whenever sizes and pitches in the American National coarse, fine, or extra-fine, or the 8-, 12-, or 16-thread series are not suitable, it is recommended that one of the following pitches be selected: 4, 6, 8, 10, 12, 14, 16, 18, 20, 24, 28, 32, 36, 40, 48, 56, or 64 threads per inch.

Basic thread data for these pitches are given in table 2.1, and also in table 1.1.

3. CLASSIFICATION AND TOLERANCES

There are established herein for general use four classes of screw-thread tolerances and allowances, which are named and numbered to correspond to the regular classification given in appendix 1. These four classes, together with the accompanying specifications, are intended to assure a uniform practice for screw threads not included in the American National coarse, fine, or extra-fine thread series, nor in the 8-, 12-, or 16-thread series.

It is not the intention of the Committee arbitrarily to place a general class or grade of work in a specific class of thread. Each manufacturer and user of screw threads is free to select the class best adapted to his particular needs.

(a) GENERAL SPECIFICATIONS

The following general specifications apply to all classes of thread specified for screw threads of special diameters, pitches, and lengths of engagement.

1. UNIFORM MINIMUM INTERNAL THREAD.—The pitch diameter of the minimum internal thread corresponds to the basic size.²¹

2. TOLERANCES.—(a) The tolerances specified represent the extreme variations allowed on the product.

(b) The tolerance on the internal thread is plus and is applied from the basic size to above basic size.

(c) The tolerance on the external thread is minus and

²¹ Special cases will arise, however, when a class 1 thread is required on free-drawn tubing with thin walls, and in such cases, the allowance should be made in the internal thread.

is applied from the maximum size to below the maximum size.

(d) The pitch diameter tolerances for an external and an internal thread of a given class are the same.

(e) The pitch diameter tolerances are obtained by adding three values, or increments; one dependent upon the basic major diameter, another upon the length of engagement, and the third upon the pitch of the thread. These increments are based on formulas given in table 2.2. However, where tolerance values so obtained exceed those given in appendix 1 for corresponding pitches of the American National coarse or fine thread series, and for any diameters equal to or less than these standard sizes and lengths of engagement equal to or less than one diameter, the tolerances given in appendix 1 are used. (See rules for using tolerance tables on p. 180.)

(f) Pitch diameter limits of size are interpreted in accordance with appendix 1, par. 5 (c), p. 128.

(g) The tolerances on the major diameters of the external threads and minor diameters of the internal threads are based on the pitch of the thread, as these control the depth of engagement; they are, therefore, based on the pitch alone.

(h) The minimum minor diameter of an external thread of a given pitch is such as to result in a basic flat ($\frac{1}{2} \times p$) at the root when the pitch diameter of the external thread is at its minimum value. When the maximum external thread is basic, the minimum minor diameter of the external thread will be below the basic minor diameter by the amount of the specified pitch diameter tolerance.

(i) The maximum minor diameter of an external thread of a given pitch may be such as results from the use of a worn or rounded threading tool, when the pitch diameter is at its maximum value. In no case, however, should the form of the external thread, as results from tool wear, be such as to cause the external thread to be rejected on the maximum minor diameter by a "go" thread ring gage, the minor diameter of which is equal to the minimum minor diameter of the internal thread.

(j) The maximum major diameter of the internal thread of a given pitch is such as to result in a flat equal to one-third of the basic flat ($\frac{1}{2} \times p$) when the pitch diameter of the internal thread is at its maximum value. When the minimum internal thread is basic, its maximum major diameter will be above the basic major diameter by the amount of the specified pitch diameter tolerance plus two-ninths of the basic thread depth.

(k) The nominal minimum major diameter of an internal thread is the basic major diameter. In no case, however, should the minimum major diameter of the internal thread, as results from a worn tap or cutting tool, be such as to cause the internal thread to be rejected on the minimum major diameter by a "go" plug gage made to the maximum major diameter of the external thread.

(l) The tolerance on the minor diameter of an internal thread of a given pitch is one-sixth of the basic thread height regardless of the class of thread.²²

(b) CLASSIFICATION OF THREADS

1. CLASS 1.—This class is intended to cover the manufacture of threaded parts where quick and easy assembly is necessary and where an allowance is required.

This class is made with an allowance on the external thread, so as to permit ready assembly, even when the threads are slightly bruised or dirty, in conformity with the practice in appendix 1.²³

²² Special threads having a length of engagement considerably less than one diameter will not develop the full strength of the external thread. The minimum minor diameter of the internal thread of the American National form of thread is such as to provide a minimum clearance on diameter at the minor diameter equal to two-ninths of the basic thread depth. If this clearance is reduced by providing a greater percentage of thread depth in the internal thread, the strength of such a fastening is increased. In such cases when the external thread is subject to considerable tension, it is permissible to make the minor diameter of the internal thread less than the minimum specified in order to give the necessary depth of engagement.

On the other hand, when the length of engagement is exceptionally long the minor diameter of the internal thread may be greater than the maximum specified without impairing the strength of the fastening.

²³ See footnote 21.

Tables 2.3 and 2.4 give the limits of size and tolerances for major, pitch, and minor diameters of threads of special diameters, pitches, and lengths of engagement.

2. CLASS 2.—This class is intended to apply to the major portion of threaded work in interchangeable manufacture, where no allowance is required. It is the same in every particular as class 1 except that it has no allowance and the tolerances are smaller.

Tables 2.3 and 2.5 give the limits of size and tolerances for major, pitch, and minor diameters of threads of special diameters, pitches, and lengths of engagement.

3. CLASS 3.—This class is intended to apply to the higher grade of interchangeable screw thread work. It is the same as class 2 in every particular except that the tolerances are smaller.

Tables 2.3 and 2.6 give the limits of size and tolerances for major, pitch, and minor diameters of threads of special diameters, pitches, and lengths of engagement.

4. CLASS 4.—This class is intended for threaded work requiring a fine, snug fit, and where a screwdriver or wrench may be necessary for assembly.

In the manufacture of screw-thread products belonging to this class it may be necessary to use precision tools, gages made to special tolerances for this class (see table VI.6, p. 117), and other refinements. This quality of work should, therefore, be used only in cases where requirements of the mechanism being produced are exacting. In order to secure the fit desired, it may be necessary in some cases to select the parts when the product is being assembled.

The maximum pitch diameters of the external threads are slightly larger than the minimum pitch diameters of the internal threads determined from table 2.3.

Tables 2.3 and 2.7 give the limits of size and tolerances for major, pitch, and minor diameters of threads of special diameters, pitches, and lengths of engagement.

4. TABLES OF DIMENSIONS

In order to simplify the specification of dimensions of special fastening screw threads, tables 2.3, 2.4, 2.5, 2.6, and 2.7 are arranged herein, and are intended to cover all practical combinations of diameter, pitch, length of engagement, and class of thread. The use of these tables instead of the application of formulas to determine limits of size of a special thread facilitates placing dimensions on drawings. Also, in cases of special threads of the same diameter, pitch, and class of thread, but slightly different lengths of engagement, the threads may be gaged by a single set of gages, as identical pitch diameter tolerances will be applied.

1. ARRANGEMENT OF TABLES.—The arrangement of dimensions and tolerances given in these tables has the following features:

All thread dimensions of threads of special diameters, pitches, and lengths of engagement, except pitch diameter tolerances are derived from table 2.3.

Pitch diameter tolerances are taken from tables 2.4, 2.5, 2.6, or 2.7, depending upon the class required. These pitch diameter tolerances were obtained by adding increments, in accordance with table 2.2, corresponding to the major diameters at the top, the threads per inch at the side of the table, and mean lengths of engagement of $\frac{1}{4}$, 1, and $2\frac{1}{4}$ inches for pitches from 64 to 12 threads per inch, inclusive, and $\frac{1}{2}$, 2, and $4\frac{1}{2}$ inches for pitches from 10 to 4 threads per inch, inclusive. Thus, the increments of the pitch diameter tolerances based on length of engagement and on diameter vary by definite steps instead of continuously. However, in order that the tolerances given in these tables might be wholly consistent with those given in appendix 1, certain values as listed are greater or less than those yielded by the above method. This modification was made by inserting in the tables, in the positions corresponding to standard sizes, pitches, and lengths of engagement of the American National coarse- and fine-thread series, the pitch diameter tolerances listed in appendix 1. Then, wherever necessary, all values above and to the left of these inserted values were reduced so that none of them should exceed these standard values, and those below and to the right were increased so that none

should be less than the standard values. This has the important advantage that in a series of sizes, frequently occurring in practice, consisting partly of standard sizes and partly of special sizes, there will be no undue irregularity in the progression of the pitch diameter tolerance, with consequent difficulties in securing gages, etc.

The maximum pitch diameter tolerances listed are equal to the tolerances on the major diameter of the external threads of the same pitch, as given in table 2.3.

2. RULES FOR USE OF TABLES.—For consistent application of the pitch diameter tolerance tables to all cases, adherence to the following rules relative to the use of the tables is necessary:

1. Tolerances on pitch diameter corresponding to major diameters between those for which values are given in the tables shall be those of the next larger diameter.

2. Tolerances on pitch diameter for pitches between those for which values are given in the tables shall be those of the next coarser pitch, except that for screws having 80, 72, 44, 13, 11, 9, 7, 5, or $4\frac{1}{2}$ threads per inch, lengths of engagement of one and one-half diameters or less, and diameters less than the standard diameters for the respective pitches as given in appendix 1, the tolerances given in appendix 1 shall be used.

3. Tolerances on pitch diameter for pitches coarser than 4 threads per inch shall be the same as those for 4 threads per inch.

4. Tolerances on pitch diameter when the length of engagement is exactly $\frac{1}{2}$ or $1\frac{1}{2}$ in. for 12 threads per inch and finer, or 1 or 3 in. for pitches coarser than 12 threads per inch, shall correspond to the interval of which these are the upper limits.

5. Tolerances on pitch diameter for lengths of engagement greater than those for which values are given shall be the maximum values listed for the pitch concerned.

TABLE 2.1.—Thread data for recommended pitches for threads of special diameters, pitches, and lengths of engagement

Threads per inch, n	Pitch, p	Depth of thread, h	Basic width of flat, $p/8$	Minimum width of flat at major diameter of nut, $p/24$
1	2	3	4	5
	<i>in.</i>	<i>in.</i>	<i>in.</i>	<i>in.</i>
64.....	0.01562	0.01015	0.00195	0.00065
56.....	.01786	.01160	.00223	.00074
48.....	.02033	.01353	.00250	.00087
40.....	.02500	.01624	.00312	.00104
36.....	.02778	.01804	.00347	.00116
32.....	.03125	.02030	.00391	.00130
28.....	.03571	.02320	.00446	.00149
24.....	.04167	.02706	.00521	.00174
20.....	.05000	.03248	.00625	.00208
18.....	.05556	.03608	.00694	.00231
16.....	.06250	.04059	.00781	.00260
14.....	.07143	.04639	.00893	.00298
12.....	.08333	.05413	.01042	.00347
10.....	.10000	.06495	.01250	.00417
8.....	.12500	.08119	.01562	.00521
6.....	.16667	.10825	.02083	.00694
4.....	.25000	.16238	.03125	.01042

TABLE 2.2.—Schedule of tolerance increments for threads of special diameters, pitches, and lengths of engagement

Class of thread	Diameter increment	Length of engagement increment	Pitch increment
1	2	3	4
Class 1.....	0.002 \sqrt{D}	0.002 ϕ	0.020 \sqrt{p}
Class 2.....	.002 \sqrt{D}	.002 ϕ	.010 \sqrt{p}
Class 3.....	.002 \sqrt{D}	.002 ϕ	.005 \sqrt{p}
Class 4.....	.001 \sqrt{D}	.001 ϕ	.0025 \sqrt{p}

6. For pitches finer than 64 threads per inch, apply the formulas in table 2.2. If the resulting tolerance is greater than that for 64 threads per inch as given in tables 2.4 to 2.7, for the same diameter and class, apply the tolerance for 64 threads.

3. **EXAMPLES.**—The following examples illustrate the use of these tables:

Example: 3/4-in., 16-thread, class 1, with allowance on external threads, 1/2 in. length of engagement:

From table 2.4:

Pitch diameter tolerance..... = 0.0095

Also from table 2.3, for the external thread:

Maximum major diameter = 3.2500 - 0.0018 = 3.2482

Minimum major diameter = 3.2482 - .0126 = 3.2356

Maximum minor diameter = 3.2500 - .0785 = 3.1715

Maximum pitch diameter = 3.2500 - .0424 = 3.2076

Minimum pitch diameter = 3.2076 - .0095 = 3.1981

And for the internal thread:

Minimum major diameter..... = 3.2500

Minimum minor diameter = 3.2500 - 0.0677 = 3.1823

Maximum minor diameter = 3.1823 + .0068 = 3.1891

Minimum pitch diameter = 3.2500 - .0406 = 3.2094

Maximum pitch diameter = 3.2094 + .0095 = 3.2189

Example: 3-in., 24-thread, class 2, 5/8 in. length of engagement:

From table 2.5:

Pitch diameter tolerance..... = 0.0066

In this instance the pitch diameter tolerance is printed in italics. In accordance with the footnote under table 2.5 it is desirable to avoid the use of tolerances set in italics as the combination of class of thread, length of engagement, pitch, and diameter is disproportionate. If it is decided to use a closer class, class 3 or class 4 may be chosen. As-

suming the choice of class 3, the following dimensions are obtained:

From table 2.6:

Pitch diameter tolerance..... = 0.0065

From table 2.3 for the external thread:

Maximum major diameter..... = 3.0000

Minimum major diameter = 3.0000 - 0.0066 = 2.9934

Maximum minor diameter = 3.0000 - .0511 = 2.9489

Maximum pitch diameter = 3.0000 - .0271 = 2.9729

Minimum pitch diameter = 2.9729 - .0065 = 2.9664

And for the internal thread:

Minimum major diameter..... = 3.0000

Minimum minor diameter = 3.0000 - 0.0451 = 2.9549

Maximum minor diameter = 2.9549 + .0045 = 2.9594

Minimum pitch diameter = 3.0000 - .0271 = 2.9729

Maximum pitch diameter = 2.9729 + .0065 = 2.9794

If, instead, it is decided to reduce the length of engagement to 1/2 in., the following dimensions are obtained:

From table 2.5:

Pitch diameter tolerance..... = 0.0060

From table 2.3 for the external thread:

Maximum major diameter..... = 3.0000

Minimum major diameter = 3.0000 - 0.0066 = 2.9934

Maximum minor diameter = 3.0000 - .0511 = 2.9489

Maximum pitch diameter = 3.0000 - .0271 = 2.9729

Minimum pitch diameter = 2.9729 - .0060 = 2.9669

And for the internal thread:

Minimum major diameter..... = 3.0000

Minimum minor diameter = 3.0000 - 0.0451 = 2.9549

Maximum minor diameter = 2.9549 + .0045 = 2.9594

Minimum pitch diameter = 3.0000 - .0271 = 2.9729

Maximum pitch diameter = 2.9729 + .0060 = 2.9789

TABLE 2.3.—Values for obtaining thread dimensions of screw threads of special diameters, pitches, and lengths of engagement, classes 1, 2, 3, and 4

Threads per inch	EXTERNAL THREAD SIZES									INTERNAL THREAD SIZES			
	To obtain maximum dimensions for major, pitch, and minor diameters, subtract the values in the "maximum" columns from the basic major diameter. Apply tolerances minus. See tables 2.4, 2.5, 2.6, and 2.7 for pitch diameter tolerances.									To obtain minimum dimensions for minor, pitch, and major diameters, subtract the values in the "minimum" columns from the basic major diameter. Apply tolerances plus. See tables 2.4, 2.5, 2.6, and 2.7 for pitch diameter tolerances.			
	Major diameter				Pitch diameter, maximum			Minor diameter, ¹ maximum		Minor diameter		Pitch diameter, minimum	Major diameter, ² minimum
	Maximum		Tolerance		Class 1	Classes 2, 3, 4	Class 4	Class 1	Classes 2, 3, 4	Minimum	Tolerance		
	Class 1	Classes 2, 3, 4	Class 1	Classes 2, 3, 4								Class 1	Classes 2, 3
1	2	3	4	5	6	7	8	9	10	11	12	13	14
64	0.0007	0.0000	0.0052	0.0038	0.0108	0.0101	0.0100	0.0199	0.0192	0.0169	0.0017	0.0101	0.0000
56	0.0008	0.0000	0.0054	0.0040	0.0124	0.0116	0.0114	0.0227	0.0219	0.0193	0.0019	0.0116	0.0000
48	0.0009	0.0000	0.0062	0.0044	0.0144	0.0135	0.0133	0.0265	0.0256	0.0226	0.0023	0.0135	0.0000
40	0.0010	0.0000	0.0068	0.0048	0.0172	0.0162	0.0160	0.0317	0.0307	0.0271	0.0027	0.0162	0.0000
36	0.0011	0.0000	0.0072	0.0050	0.0191	0.0180	0.0178	0.0352	0.0341	0.0301	0.0030	0.0180	0.0000
32	0.0011	0.0000	0.0076	0.0054	0.0214	0.0203	0.0201	0.0394	0.0383	0.0338	0.0034	0.0203	0.0000
28	0.0012	0.0000	0.0086	0.0062	0.0244	0.0232	0.0230	0.0450	0.0438	0.0387	0.0039	0.0232	0.0000
24	0.0013	0.0000	0.0092	0.0066	0.0284	0.0271	0.0268	0.0524	0.0511	0.0451	0.0045	0.0271	0.0000
20	0.0015	0.0000	0.0102	0.0072	0.0340	0.0325	0.0322	0.0628	0.0613	0.0541	0.0054	0.0325	0.0000
18	0.0016	0.0000	0.0114	0.0082	0.0377	0.0361	0.0358	0.0688	0.0682	0.0601	0.0060	0.0361	0.0000
16	0.0018	0.0000	0.0126	0.0090	0.0424	0.0406	0.0402	0.0785	0.0767	0.0677	0.0068	0.0406	0.0000
14	0.0021	0.0000	0.0140	0.0098	0.0485	0.0464	0.0460	0.0897	0.0876	0.0773	0.0073	0.0464	0.0000
12	0.0024	0.0000	0.0158	0.0112	0.0565	0.0541	0.0536	0.1046	0.1022	0.0902	0.0090	0.0541	0.0000
10	0.0028	0.0000	0.0184	0.0128	0.0678	0.0650	0.0644	0.1255	0.1227	0.1083	0.0109	0.0650	0.0000
8	0.0034	0.0000	0.0222	0.0152	0.0846	0.0812	0.0805	0.1568	0.1534	0.1377	0.0135	0.0812	0.0000
6	0.0044	0.0000	0.0280	0.0202	0.1127	0.1083	0.1074	0.2089	0.2045	0.1877	0.0180	0.1083	0.0000
4	0.0064	0.0000	0.0408	0.0280	0.1688	0.1624	0.1611	0.3131	0.3067	0.2766	0.0270	0.1624	0.0000

¹ Dimension given for the maximum minor diameter of the external thread are figured to the intersection of the worn tool arc with a center line through crest and root. The minimum minor diameter of the external thread shall be that corresponding to a flat at the minor diameter of the minimum external thread equal to $1/2 \times p$, and may be determined by subtracting the basic thread depth, h (or $0.6495p$) from the minimum pitch diameter of the external thread.

² Dimension given for the minimum major diameter of the internal thread correspond to the basic flat ($1/2 \times p$), and the profile at the major diameter produced by a worn tool that fall below the basic outline. The maximum major diameter of the internal thread shall be that corresponding to a flat at the major diameter equal to $1/2 \times p$, and may be determined by adding $1/2 \times h$ (or $0.7939p$) to the maximum pitch diameter of the internal thread.

TABLE 2.4.—Pitch diameter tolerances for screw threads of special diameters, pitches, and lengths of engagement, class 1

Pitch diameter tolerances for diameters up to and including—

Diameter inches	Lengths of engagement— event		Pitch diameter tolerances for diameters up to and including—																									
	From— in.	To and in- cluding— in.	1/16 in.	1/8 in.	3/16 in.	1/4 in.	5/16 in.	3/8 in.	1/2 in.	5/8 in.	3/4 in.	1 in.	1 1/4 in.	2 in.	3 in.	4 in.	6 in.	8 in.	10 in.	12 in.	14 in.	16 in.	18 in.	20 in.	24 in.			
64	in.	1/2	0.0026	0.0026	0.0034	0.0038	0.0042	0.0044	0.0047	0.0050	0.0052	0.0052	0.0052	0.0052	0.0052	0.0052	0.0052	0.0052	0.0052	0.0052	0.0052	0.0052	0.0052	0.0052	0.0052	0.0052	0.0052	
36	1/2	1 1/2	0.0028	0.0034	0.0034	0.0038	0.0044	0.0046	0.0049	0.0052	0.0056	0.0056	0.0056	0.0056	0.0056	0.0056	0.0056	0.0056	0.0056	0.0056	0.0056	0.0056	0.0056	0.0056	0.0056	0.0056	0.0056	0.0056
48	1/2	1 1/2	0.0031	0.0034	0.0034	0.0038	0.0046	0.0048	0.0051	0.0054	0.0057	0.0057	0.0057	0.0057	0.0057	0.0057	0.0057	0.0057	0.0057	0.0057	0.0057	0.0057	0.0057	0.0057	0.0057	0.0057	0.0057	0.0057
40	1/2	1 1/2	0.0034	0.0034	0.0034	0.0038	0.0046	0.0051	0.0054	0.0057	0.0057	0.0057	0.0057	0.0057	0.0057	0.0057	0.0057	0.0057	0.0057	0.0057	0.0057	0.0057	0.0057	0.0057	0.0057	0.0057	0.0057	0.0057
36	1/2	1 1/2	0.0036	0.0036	0.0036	0.0038	0.0045	0.0051	0.0056	0.0058	0.0063	0.0063	0.0063	0.0063	0.0063	0.0063	0.0063	0.0063	0.0063	0.0063	0.0063	0.0063	0.0063	0.0063	0.0063	0.0063	0.0063	0.0063
32	1/2	1 1/2	0.0038	0.0038	0.0038	0.0038	0.0046	0.0051	0.0057	0.0060	0.0065	0.0065	0.0065	0.0065	0.0065	0.0065	0.0065	0.0065	0.0065	0.0065	0.0065	0.0065	0.0065	0.0065	0.0065	0.0065	0.0065	0.0065
28	1/2	1 1/2	0.0043	0.0043	0.0043	0.0043	0.0046	0.0051	0.0057	0.0063	0.0067	0.0067	0.0067	0.0067	0.0067	0.0067	0.0067	0.0067	0.0067	0.0067	0.0067	0.0067	0.0067	0.0067	0.0067	0.0067	0.0067	0.0067
24	1/2	1 1/2	0.0046	0.0046	0.0046	0.0046	0.0046	0.0051	0.0057	0.0066	0.0070	0.0070	0.0070	0.0070	0.0070	0.0070	0.0070	0.0070	0.0070	0.0070	0.0070	0.0070	0.0070	0.0070	0.0070	0.0070	0.0070	0.0070
20	1/2	1 1/2	0.0051	0.0051	0.0051	0.0051	0.0051	0.0051	0.0057	0.0067	0.0074	0.0074	0.0074	0.0074	0.0074	0.0074	0.0074	0.0074	0.0074	0.0074	0.0074	0.0074	0.0074	0.0074	0.0074	0.0074	0.0074	0.0074
18	1/2	1 1/2	0.0057	0.0057	0.0057	0.0057	0.0057	0.0057	0.0057	0.0067	0.0079	0.0079	0.0079	0.0079	0.0079	0.0079	0.0079	0.0079	0.0079	0.0079	0.0079	0.0079	0.0079	0.0079	0.0079	0.0079	0.0079	0.0079
16	1/2	1 1/2	0.0063	0.0063	0.0063	0.0063	0.0063	0.0063	0.0063	0.0070	0.0083	0.0083	0.0083	0.0083	0.0083	0.0083	0.0083	0.0083	0.0083	0.0083	0.0083	0.0083	0.0083	0.0083	0.0083	0.0083	0.0083	0.0083
14	1/2	1 1/2	0.0070	0.0070	0.0070	0.0070	0.0070	0.0070	0.0070	0.0079	0.0093	0.0093	0.0093	0.0093	0.0093	0.0093	0.0093	0.0093	0.0093	0.0093	0.0093	0.0093	0.0093	0.0093	0.0093	0.0093	0.0093	0.0093
12	1/2	1 1/2	0.0075	0.0075	0.0075	0.0075	0.0075	0.0075	0.0075	0.0087	0.0109	0.0109	0.0109	0.0109	0.0109	0.0109	0.0109	0.0109	0.0109	0.0109	0.0109	0.0109	0.0109	0.0109	0.0109	0.0109	0.0109	0.0109
10	1	3	0.0087	0.0087	0.0087	0.0087	0.0087	0.0087	0.0087	0.0099	0.0124	0.0124	0.0124	0.0124	0.0124	0.0124	0.0124	0.0124	0.0124	0.0124	0.0124	0.0124	0.0124	0.0124	0.0124	0.0124	0.0124	0.0124
8	1	3	0.0095	0.0095	0.0095	0.0095	0.0095	0.0095	0.0095	0.0111	0.0145	0.0145	0.0145	0.0145	0.0145	0.0145	0.0145	0.0145	0.0145	0.0145	0.0145	0.0145	0.0145	0.0145	0.0145	0.0145	0.0145	0.0145
6	1	3	0.0109	0.0109	0.0109	0.0109	0.0109	0.0109	0.0109	0.0131	0.0175	0.0175	0.0175	0.0175	0.0175	0.0175	0.0175	0.0175	0.0175	0.0175	0.0175	0.0175	0.0175	0.0175	0.0175	0.0175	0.0175	0.0175
4	1	3	0.0124	0.0124	0.0124	0.0124	0.0124	0.0124	0.0124	0.0150	0.0206	0.0206	0.0206	0.0206	0.0206	0.0206	0.0206	0.0206	0.0206	0.0206	0.0206	0.0206	0.0206	0.0206	0.0206	0.0206	0.0206	0.0206

¹ Standard size of the American National coarse-thread series. ² Standard size of the American National fine-thread series.

NOTE.—It is preferable to avoid the use of tolerances set in italics by choosing a closer class, shorter length of engagement, coarser pitch, or smaller diameter. When the length of engagement exceeds one diameter and the pitch diameter tolerance exceeds 90 percent of the major diameter tolerance, table 2.3 column 4, the major diameter tolerance shall be 110 percent of the pitch diameter tolerance.

TABLE 2.5.—Pitch diameter tolerances for screw threads of special diameters, pitches, and lengths of engagement, class 2 (see note 2)

Threads per inch	Lengths of engagement		Pitch diameter tolerances for diameters up to and including—																			
	From—	To and including—	1/2 inch	3/8 inch	1/2 inch	5/8 inch	3/4 inch	1 inch	1 1/4 inches	2 inches	3 inches	4 inches	6 inches	8 inches	10 inches	12 inches	14 inches	16 inches	18 inches	20 inches	24 inches	
4	in.	in.	0.0019	0.0019	0.0024	0.0027	0.0030	0.0032	0.0035	0.0048	0.0048	0.0048	0.0048	0.0048	0.0048	0.0048	0.0048	0.0048	0.0048	0.0048	0.0048	0.0048
5	1/2	1/2	0.0020	0.0024	0.0027	0.0031	0.0033	0.0036	0.0039	0.0042	0.0046	0.0046	0.0046	0.0046	0.0046	0.0046	0.0046	0.0046	0.0046	0.0046	0.0046	0.0046
	1 1/2	1 1/2	0.0038	0.0040	0.0040	0.0040	0.0040	0.0040	0.0040	0.0040	0.0040	0.0040	0.0040	0.0040	0.0040	0.0040	0.0040	0.0040	0.0040	0.0040	0.0040	0.0040
45	1/2	1/2	0.0022	0.0024	0.0027	0.0032	0.0034	0.0037	0.0041	0.0044	0.0044	0.0044	0.0044	0.0044	0.0044	0.0044	0.0044	0.0044	0.0044	0.0044	0.0044	0.0044
	1 1/2	1 1/2	0.0039	0.0041	0.0041	0.0041	0.0041	0.0041	0.0041	0.0041	0.0041	0.0041	0.0041	0.0041	0.0041	0.0041	0.0041	0.0041	0.0041	0.0041	0.0041	0.0041
40	1/2	1/2	0.0024	0.0024	0.0027	0.0033	0.0035	0.0038	0.0041	0.0045	0.0048	0.0048	0.0048	0.0048	0.0048	0.0048	0.0048	0.0048	0.0048	0.0048	0.0048	0.0048
	1 1/2	1 1/2	0.0041	0.0041	0.0041	0.0041	0.0041	0.0041	0.0041	0.0041	0.0041	0.0041	0.0041	0.0041	0.0041	0.0041	0.0041	0.0041	0.0041	0.0041	0.0041	0.0041
36	1/2	1/2	0.0025	0.0025	0.0027	0.0033	0.0036	0.0039	0.0042	0.0046	0.0046	0.0046	0.0046	0.0046	0.0046	0.0046	0.0046	0.0046	0.0046	0.0046	0.0046	0.0046
	1 1/2	1 1/2	0.0041	0.0041	0.0041	0.0041	0.0041	0.0041	0.0041	0.0041	0.0041	0.0041	0.0041	0.0041	0.0041	0.0041	0.0041	0.0041	0.0041	0.0041	0.0041	0.0041
32	1/2	1/2	0.0027	0.0027	0.0027	0.0033	0.0036	0.0039	0.0043	0.0047	0.0051	0.0054	0.0054	0.0054	0.0054	0.0054	0.0054	0.0054	0.0054	0.0054	0.0054	0.0054
	1 1/2	1 1/2	0.0041	0.0041	0.0041	0.0041	0.0041	0.0041	0.0041	0.0041	0.0041	0.0041	0.0041	0.0041	0.0041	0.0041	0.0041	0.0041	0.0041	0.0041	0.0041	0.0041
28	1/2	1/2	0.0031	0.0031	0.0031	0.0036	0.0036	0.0036	0.0041	0.0044	0.0048	0.0052	0.0052	0.0052	0.0052	0.0052	0.0052	0.0052	0.0052	0.0052	0.0052	0.0052
	1 1/2	1 1/2	0.0041	0.0041	0.0041	0.0041	0.0041	0.0041	0.0041	0.0041	0.0041	0.0041	0.0041	0.0041	0.0041	0.0041	0.0041	0.0041	0.0041	0.0041	0.0041	0.0041
24	1/2	1/2	0.0033	0.0033	0.0033	0.0036	0.0036	0.0036	0.0041	0.0045	0.0050	0.0054	0.0054	0.0054	0.0054	0.0054	0.0054	0.0054	0.0054	0.0054	0.0054	0.0054
	1 1/2	1 1/2	0.0041	0.0041	0.0041	0.0041	0.0041	0.0041	0.0041	0.0041	0.0041	0.0041	0.0041	0.0041	0.0041	0.0041	0.0041	0.0041	0.0041	0.0041	0.0041	0.0041
20	1/2	1/2	0.0036	0.0036	0.0036	0.0036	0.0036	0.0036	0.0041	0.0047	0.0052	0.0056	0.0056	0.0056	0.0056	0.0056	0.0056	0.0056	0.0056	0.0056	0.0056	0.0056
	1 1/2	1 1/2	0.0041	0.0041	0.0041	0.0041	0.0041	0.0041	0.0041	0.0041	0.0041	0.0041	0.0041	0.0041	0.0041	0.0041	0.0041	0.0041	0.0041	0.0041	0.0041	0.0041
18	1/2	1/2	0.0039	0.0039	0.0039	0.0041	0.0041	0.0041	0.0041	0.0049	0.0053	0.0057	0.0057	0.0057	0.0057	0.0057	0.0057	0.0057	0.0057	0.0057	0.0057	0.0057
	1 1/2	1 1/2	0.0041	0.0041	0.0041	0.0041	0.0041	0.0041	0.0041	0.0041	0.0041	0.0041	0.0041	0.0041	0.0041	0.0041	0.0041	0.0041	0.0041	0.0041	0.0041	0.0041
16	1/2	1/2	0.0040	0.0040	0.0040	0.0045	0.0045	0.0045	0.0049	0.0054	0.0058	0.0062	0.0062	0.0062	0.0062	0.0062	0.0062	0.0062	0.0062	0.0062	0.0062	0.0062
	1 1/2	1 1/2	0.0045	0.0045	0.0045	0.0045	0.0045	0.0045	0.0045	0.0045	0.0045	0.0045	0.0045	0.0045	0.0045	0.0045	0.0045	0.0045	0.0045	0.0045	0.0045	0.0045
14	1/2	1/2	0.0045	0.0045	0.0045	0.0045	0.0045	0.0045	0.0049	0.0056	0.0060	0.0066	0.0066	0.0066	0.0066	0.0066	0.0066	0.0066	0.0066	0.0066	0.0066	0.0066
	1 1/2	1 1/2	0.0049	0.0049	0.0049	0.0049	0.0049	0.0049	0.0049	0.0049	0.0049	0.0049	0.0049	0.0049	0.0049	0.0049	0.0049	0.0049	0.0049	0.0049	0.0049	0.0049
12	1/2	1/2	0.0046	0.0046	0.0046	0.0046	0.0046	0.0046	0.0051	0.0056	0.0062	0.0068	0.0068	0.0068	0.0068	0.0068	0.0068	0.0068	0.0068	0.0068	0.0068	0.0068
	1 1/2	1 1/2	0.0056	0.0056	0.0056	0.0056	0.0056	0.0056	0.0056	0.0056	0.0056	0.0056	0.0056	0.0056	0.0056	0.0056	0.0056	0.0056	0.0056	0.0056	0.0056	0.0056
10	1	1	0.0056	0.0056	0.0056	0.0056	0.0056	0.0056	0.0064	0.0069	0.0073	0.0077	0.0077	0.0077	0.0077	0.0077	0.0077	0.0077	0.0077	0.0077	0.0077	0.0077
	3	3	0.0064	0.0064	0.0064	0.0064	0.0064	0.0064	0.0064	0.0064	0.0064	0.0064	0.0064	0.0064	0.0064	0.0064	0.0064	0.0064	0.0064	0.0064	0.0064	0.0064
8	1	1	0.0060	0.0060	0.0060	0.0060	0.0060	0.0060	0.0069	0.0076	0.0083	0.0089	0.0089	0.0089	0.0089	0.0089	0.0089	0.0089	0.0089	0.0089	0.0089	0.0089
	3	3	0.0064	0.0064	0.0064	0.0064	0.0064	0.0064	0.0064	0.0064	0.0064	0.0064	0.0064	0.0064	0.0064	0.0064	0.0064	0.0064	0.0064	0.0064	0.0064	0.0064
6	1	1	0.0068	0.0068	0.0068	0.0068	0.0068	0.0068	0.0076	0.0085	0.0091	0.0099	0.0099	0.0099	0.0099	0.0099	0.0099	0.0099	0.0099	0.0099	0.0099	0.0099
	3	3	0.0068	0.0068	0.0068	0.0068	0.0068	0.0068	0.0068	0.0068	0.0068	0.0068	0.0068	0.0068	0.0068	0.0068	0.0068	0.0068	0.0068	0.0068	0.0068	0.0068
4	1	1	0.0070	0.0070	0.0070	0.0070	0.0070	0.0070	0.0076	0.0084	0.0091	0.0099	0.0099	0.0099	0.0099	0.0099	0.0099	0.0099	0.0099	0.0099	0.0099	0.0099
	3	3	0.0070	0.0070	0.0070	0.0070	0.0070	0.0070	0.0070	0.0070	0.0070	0.0070	0.0070	0.0070	0.0070	0.0070	0.0070	0.0070	0.0070	0.0070	0.0070	0.0070

¹ Standard size of the American National coarse-thread series. ² Standard size of the American National fine-thread series.

NOTE 1.—It is preferable to avoid the use of tolerances set in italics by choosing a closer class, shorter length of engagement, coarser pitch, or smaller diameter. When the length of engagement exceeds one diameter and the pitch diameter tolerance exceeds 90 percent of the major diameter tolerance, table 2.3, column 5, the major diameter tolerance shall be 110 percent of the pitch diameter tolerance.

NOTE 2.—When it is expedient to apply class 2 to new design, the pitch and minor diameter tolerances published in tables 12 and 15 of ASA B1.1-1957, Unified and American Screw Threads, should be applied.

TABLE 2.7.—Pitch diameter tolerances for screw threads of special diameters, pitches, and lengths of engagement, class 4

Pitch diameter tolerances for diameters up to and including—

Pitch diameter	Pitch diameter tolerances for diameters up to and including—																		
	1/8 inch	1/4 inch	3/8 inch	1/2 inch	3/4 inch	1 inch	1 1/4 inches	2 inches	3 inches	4 inches	6 inches	8 inches	10 inches	12 inches	14 inches	16 inches	18 inches	20 inches	24 inches
1/8	in. 0.0011	in. 0.0012	in. 0.0013	in. 0.0015	in. 0.0015	in. 0.0017	in. 0.0019	in. 0.0021	in. 0.0024	in. 0.0027	in. 0.0032	in. 0.0036	in. 0.0039	in. 0.0042	in. 0.0045	in. 0.0047	in. 0.0050	in. 0.0052	in. 0.0056
1/4	in. 0.0015	in. 0.0015	in. 0.0015	in. 0.0015	in. 0.0015	in. 0.0018	in. 0.0020	in. 0.0022	in. 0.0025	in. 0.0028	in. 0.0032	in. 0.0036	in. 0.0039	in. 0.0042	in. 0.0045	in. 0.0047	in. 0.0050	in. 0.0052	in. 0.0056
3/8	in. 0.0020	in. 0.0020	in. 0.0020	in. 0.0020	in. 0.0020	in. 0.0023	in. 0.0025	in. 0.0027	in. 0.0030	in. 0.0033	in. 0.0036	in. 0.0039	in. 0.0042	in. 0.0045	in. 0.0047	in. 0.0050	in. 0.0052	in. 0.0056	in. 0.0060
1/2	in. 0.0025	in. 0.0025	in. 0.0025	in. 0.0025	in. 0.0025	in. 0.0028	in. 0.0030	in. 0.0032	in. 0.0035	in. 0.0038	in. 0.0042	in. 0.0046	in. 0.0049	in. 0.0052	in. 0.0055	in. 0.0057	in. 0.0060	in. 0.0062	in. 0.0066
3/4	in. 0.0030	in. 0.0030	in. 0.0030	in. 0.0030	in. 0.0030	in. 0.0033	in. 0.0035	in. 0.0037	in. 0.0040	in. 0.0043	in. 0.0046	in. 0.0049	in. 0.0052	in. 0.0055	in. 0.0057	in. 0.0060	in. 0.0062	in. 0.0066	in. 0.0070
1	in. 0.0035	in. 0.0035	in. 0.0035	in. 0.0035	in. 0.0035	in. 0.0038	in. 0.0040	in. 0.0042	in. 0.0045	in. 0.0048	in. 0.0052	in. 0.0056	in. 0.0059	in. 0.0062	in. 0.0065	in. 0.0068	in. 0.0070	in. 0.0072	in. 0.0076
1 1/4	in. 0.0040	in. 0.0040	in. 0.0040	in. 0.0040	in. 0.0040	in. 0.0043	in. 0.0045	in. 0.0047	in. 0.0050	in. 0.0053	in. 0.0056	in. 0.0059	in. 0.0062	in. 0.0065	in. 0.0068	in. 0.0070	in. 0.0072	in. 0.0074	in. 0.0078
2	in. 0.0045	in. 0.0045	in. 0.0045	in. 0.0045	in. 0.0045	in. 0.0048	in. 0.0050	in. 0.0052	in. 0.0055	in. 0.0058	in. 0.0062	in. 0.0066	in. 0.0069	in. 0.0072	in. 0.0075	in. 0.0077	in. 0.0080	in. 0.0082	in. 0.0086
3	in. 0.0050	in. 0.0050	in. 0.0050	in. 0.0050	in. 0.0050	in. 0.0053	in. 0.0055	in. 0.0057	in. 0.0060	in. 0.0063	in. 0.0066	in. 0.0069	in. 0.0072	in. 0.0075	in. 0.0078	in. 0.0080	in. 0.0082	in. 0.0084	in. 0.0088
4	in. 0.0055	in. 0.0055	in. 0.0055	in. 0.0055	in. 0.0055	in. 0.0058	in. 0.0060	in. 0.0062	in. 0.0065	in. 0.0068	in. 0.0072	in. 0.0076	in. 0.0079	in. 0.0082	in. 0.0085	in. 0.0087	in. 0.0090	in. 0.0092	in. 0.0096
5	in. 0.0060	in. 0.0060	in. 0.0060	in. 0.0060	in. 0.0060	in. 0.0063	in. 0.0065	in. 0.0067	in. 0.0070	in. 0.0073	in. 0.0077	in. 0.0081	in. 0.0084	in. 0.0088	in. 0.0091	in. 0.0094	in. 0.0096	in. 0.0098	in. 0.0102
6	in. 0.0065	in. 0.0065	in. 0.0065	in. 0.0065	in. 0.0065	in. 0.0068	in. 0.0070	in. 0.0072	in. 0.0075	in. 0.0078	in. 0.0082	in. 0.0086	in. 0.0089	in. 0.0092	in. 0.0095	in. 0.0098	in. 0.0100	in. 0.0102	in. 0.0106
8	in. 0.0070	in. 0.0070	in. 0.0070	in. 0.0070	in. 0.0070	in. 0.0073	in. 0.0075	in. 0.0077	in. 0.0080	in. 0.0083	in. 0.0087	in. 0.0091	in. 0.0094	in. 0.0098	in. 0.0101	in. 0.0104	in. 0.0106	in. 0.0108	in. 0.0112
10	in. 0.0075	in. 0.0075	in. 0.0075	in. 0.0075	in. 0.0075	in. 0.0078	in. 0.0080	in. 0.0082	in. 0.0085	in. 0.0088	in. 0.0092	in. 0.0096	in. 0.0099	in. 0.0102	in. 0.0105	in. 0.0108	in. 0.0110	in. 0.0112	in. 0.0116
12	in. 0.0080	in. 0.0080	in. 0.0080	in. 0.0080	in. 0.0080	in. 0.0083	in. 0.0085	in. 0.0087	in. 0.0090	in. 0.0093	in. 0.0097	in. 0.0101	in. 0.0104	in. 0.0108	in. 0.0111	in. 0.0114	in. 0.0116	in. 0.0118	in. 0.0122
14	in. 0.0085	in. 0.0085	in. 0.0085	in. 0.0085	in. 0.0085	in. 0.0088	in. 0.0090	in. 0.0092	in. 0.0095	in. 0.0098	in. 0.0102	in. 0.0106	in. 0.0109	in. 0.0112	in. 0.0115	in. 0.0118	in. 0.0120	in. 0.0122	in. 0.0126
16	in. 0.0090	in. 0.0090	in. 0.0090	in. 0.0090	in. 0.0090	in. 0.0093	in. 0.0095	in. 0.0097	in. 0.0100	in. 0.0103	in. 0.0107	in. 0.0111	in. 0.0114	in. 0.0118	in. 0.0121	in. 0.0124	in. 0.0126	in. 0.0128	in. 0.0132
18	in. 0.0095	in. 0.0095	in. 0.0095	in. 0.0095	in. 0.0095	in. 0.0098	in. 0.0100	in. 0.0102	in. 0.0105	in. 0.0108	in. 0.0112	in. 0.0116	in. 0.0119	in. 0.0122	in. 0.0125	in. 0.0128	in. 0.0130	in. 0.0132	in. 0.0136
20	in. 0.0100	in. 0.0100	in. 0.0100	in. 0.0100	in. 0.0100	in. 0.0103	in. 0.0105	in. 0.0107	in. 0.0110	in. 0.0113	in. 0.0117	in. 0.0121	in. 0.0124	in. 0.0128	in. 0.0131	in. 0.0134	in. 0.0136	in. 0.0138	in. 0.0142
24	in. 0.0105	in. 0.0105	in. 0.0105	in. 0.0105	in. 0.0105	in. 0.0108	in. 0.0110	in. 0.0112	in. 0.0115	in. 0.0118	in. 0.0122	in. 0.0126	in. 0.0129	in. 0.0132	in. 0.0135	in. 0.0138	in. 0.0140	in. 0.0142	in. 0.0146

¹ Standard size of the American National fine-thread series.

² Standard size of the American National coarse-thread series.

Note.—It is preferable to avoid the use of tolerances set in italics by choosing a shorter length of engagement, coarser pitch, or smaller diameter. When the length of engagement exceeds one diameter and the pitch diameter tolerance exceeds 90 percent of the major diameter tolerance, table 2.3, column 5, the major diameter tolerance shall be 110 percent of the pitch diameter tolerance.

5. GAGES

The classification of gages as presented in section VI applies also to gages for special threads.

In ordering gages for a special thread, the length of engagement of the component thread (as distinct from the length of the gage), and the diameter, pitch, and class of thread, should be stated, in order that the minimum material product limit, (pitch diameter of "not go" gage) may be determined correctly. With regard to the length of the "go" gage, and gage tolerances, for threads of exceptionally long lengths of engagement, the following practices are recommended: (1) For threads of classes 1 or 2, use the standard length of "go" gage as given in Commercial Standard CS8, and apply *X* tolerances; (2) for threads of classes 3 or 4, make the length of the "go" gage equal to the length of engagement and apply *W* tolerances.

With regard to the marking of gages, each gage shall be plainly marked, for identification, with the diameter, threads per inch, thread series—that is, "NS" to indicate a special thread of American National form—and class of thread.

APPENDIX 3. HOLE SIZE LIMITS

Recommended hole size limits before threading and the corresponding tolerances are derived, to provide for optimum strength of fastenings and tapping conditions, from the minimum and maximum minor diameters of the internal thread, using the following rules, as illustrated in figure 3.1:

For the range to and including $\frac{1}{2} D$ the minimum hole size is equal to the minimum minor diameter of the internal thread and the maximum hole size is larger by one-half the minor diameter tolerance.

For the range from $\frac{1}{2} D$ to $\frac{3}{4} D$ the minimum and maximum hole sizes are each one quarter of the minor diameter tolerance larger than the corresponding limits for the length of engagement to and including $\frac{1}{2} D$.

For the range from $\frac{3}{4} D$ to $1\frac{1}{2} D$ the minimum hole size is larger than the minimum minor diameter of the internal thread by one-half the minor diameter tolerance, and the maximum hole size is equal to the maximum minor diameter.

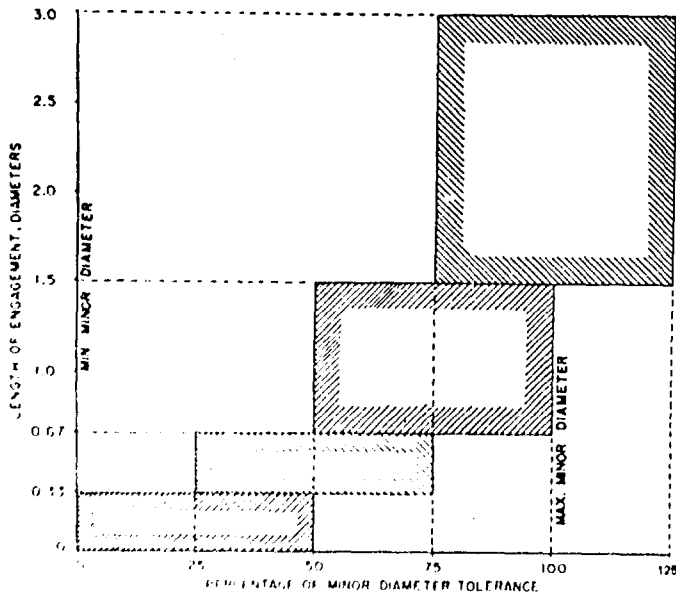

FIGURE 3.1.—Distribution of hole size limits before tapping, Unified and American threads.

For the range from $1\frac{1}{2} D$ to $3 D$ the minimum and maximum hole sizes are each one quarter of the minor diameter tolerance of the internal thread larger than the corresponding limits for the $\frac{3}{4} D$ to $1\frac{1}{2} D$ length of engagement.

From the foregoing it will be seen that the difference between limits in each range is the same and equal to one-half of the minor diameter tolerance. This is a general rule. However, the minimum differences for sizes below $\frac{1}{4}$ in. are equal to the minor diameter tolerances given in tables IV.10 and IV.11 for lengths of engagement to and including $\frac{1}{2} D$. For lengths of engagement greater than $\frac{1}{2} D$ and for sizes $\frac{1}{4}$ in. and larger the values are adjusted so that the difference between limits is never less than 0.0040 in.

For diameter-pitch combinations other than those given in tables 3.1 and 3.2, the tolerances given in table III.10, or the tolerance derived from the formula, should be similarly applied to determine the hole size limits.

Internal threads requiring modified minor diameters for lengths of engagement less than $\frac{3}{4} D$ to develop the optimum strength of the fastening, or longer than $1\frac{1}{2} D$ to reduce tapping difficulties, should be designated in accordance with par. 3, p. 26.

For National Miniature threads the distribution of hole size limits differs from the above, to accord with conditions peculiar to miniature threads, and is shown in figure 3.2. The maximum limits are based on providing a functionally adequate fastening for the most common applications, where the material of the externally threaded member is of a strength essentially equal to or greater than that of its mating part. In applications where, because of considerations other than the fastening, the screw is made of an appreciably weaker material, the use of smaller hole sizes is usually necessary to extend thread engagement to a greater depth on the external thread. However, hole sizes down to the minimum limit of the minor diameters must be avoided to allow for the spin-up developed as the result of the negative rake with which these small taps are ground.

Recommended hole size limits are tabulated in tables 3.1, 3.2, and 3.3.

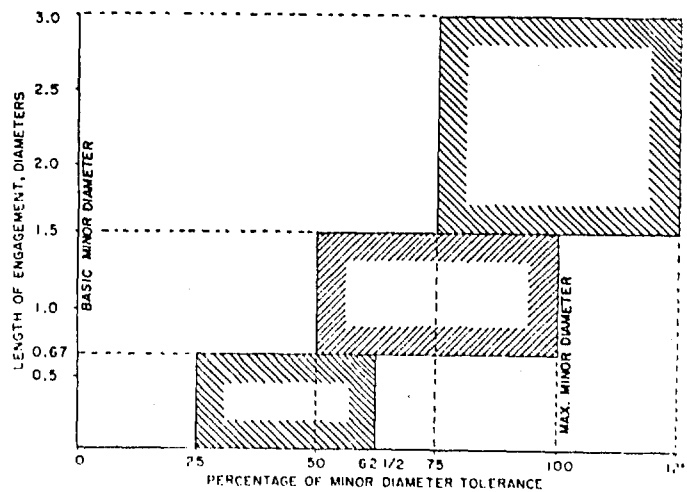

FIGURE 3.2.—Distribution of hole size limits before tapping, National Miniature threads.

TABLE 3.1.—Recommended hole size limits before threading for different lengths of engagement, UNC, UNF, UNEF, UN, UNS, NC, NF, NEF, and N series, classes 1B and 2B

(Based on table IV.10 *)

Designation		Minor diameter, internal threads				Recommended hole size limits for different lengths of engagement							
Thread size	Threads per inch	Minimum	Percent of basic thread height ^b	Maximum	Percent of basic thread height ^b	To and including $\frac{1}{4} D$		Above $\frac{1}{4} D$ to $\frac{3}{4} D$		Above $\frac{3}{4} D$ to $1\frac{1}{2} D$		Above $1\frac{1}{2} D$ to $3 D$	
						Min	Max	Min	Max	Min	Max	Min	Max
No.	in.	in.		in.		in.	in.	in.	in.	in.	in.	in.	in.
0	.060	80	0.0465	83.1	0.0514	153.0	0.0465	0.0500	0.0479	0.0514	0.0479	0.0514	0.0514
1	.073	64	.0561	83.3	.0623	52.7	.0561	.0599	.0585	.0623	.0585	.0623	.0623
1	.073	72	.0580	83.1	.0635	52.7	.0580	.0613	.0596	.0620	.0602	.0635	.0635
2	.086	56	.0667	83.2	.0737	53.0	.0667	.0705	.0686	.0724	.0699	.0737	.0737
2	.086	64	.0691	83.3	.0753	52.7	.0691	.0724	.0707	.0740	.0720	.0753	.0753
3	.098	48	.0764	83.5	.0845	53.6	.0764	.0804	.0785	.0825	.0805	.0845	.0845
3	.098	56	.0797	83.2	.0865	53.9	.0797	.0831	.0814	.0848	.0821	.0865	.0865
4	.112	40	.0849	83.4	.0939	55.7	.0849	.0894	.0871	.0916	.0894	.0939	.0939
4	.112	48	.0894	83.5	.0998	56.2	.0894	.0931	.0912	.0949	.0931	.0998	.0998
5	.125	40	.0979	83.4	.1062	57.9	.0979	.1020	.1000	.1041	.1021	.1062	.1062
5	.125	44	.1004	83.3	.1079	57.9	.1004	.1042	.1023	.1060	.1042	.1079	.1079
6	.138	32	.104	83.8	.114	59.1	.104	.109	.106	.112	.109	.114	.114
6	.138	40	.111	83.1	.119	58.5	.111	.115	.113	.117	.115	.119	.119
8	.164	32	.130	83.8	.139	61.6	.130	.134	.132	.137	.134	.139	.139
8	.164	36	.134	83.1	.142	61.0	.134	.138	.136	.140	.138	.142	.142
10	.190	24	.145	83.1	.156	62.8	.145	.150	.148	.154	.150	.156	.156
10	.190	25	.156	83.8	.164	64.0	.156	.160	.159	.162	.160	.164	.164
12	.216	24	.171	83.1	.181	64.7	.171	.176	.174	.179	.176	.181	.181
12	.216	28	.177	84.1	.186	64.7	.177	.182	.180	.184	.182	.186	.186
12	.216	32	.182	83.8	.190	64.0	.182	.187	.185	.188	.186	.190	.190
14	.20	20	.196	83.1	.207	66.2	.196	.202	.199	.204	.202	.207	.207
14	.20	28	.211	84.1	.220	64.7	.211	.216	.214	.218	.216	.220	.220
14	.20	32	.216	83.8	.224	64.0	.216	.220	.218	.222	.220	.224	.224
14	.20	36	.220	83.1	.226	66.5	.220	.224	.221	.225	.224	.226	.226
16	.18	18	.252	83.8	.265	65.8	.252	.259	.255	.262	.259	.265	.265
16	.18	24	.277	84.1	.286	65.6	.277	.282	.279	.285	.282	.286	.286
16	.18	32	.282	83.5	.290	65.3	.282	.287	.284	.289	.287	.290	.290
16	.18	36	.282	84.5	.289	65.1	.282	.286	.284	.288	.286	.289	.289
18	.16	16	.307	83.8	.321	66.5	.307	.314	.311	.318	.314	.321	.321
18	.16	24	.330	84.1	.340	64.7	.330	.335	.333	.338	.335	.340	.340
18	.16	32	.341	83.8	.349	64.0	.341	.345	.343	.347	.345	.349	.349
18	.16	36	.345	83.1	.352	63.7	.345	.349	.346	.350	.347	.352	.352
20	.14	14	.360	83.5	.370	66.3	.360	.368	.364	.372	.368	.372	.372
20	.14	20	.383	83.9	.395	65.4	.383	.389	.386	.391	.388	.395	.395
20	.14	28	.390	83.0	.407	65.7	.390	.403	.401	.406	.403	.407	.407
22	.13	13	.417	83.1	.434	66.0	.417	.426	.421	.430	.426	.434	.434
22	.13	18	.440	83.1	.457	66.5	.440	.444	.441	.444	.441	.447	.447
22	.13	24	.440	83.1	.457	66.2	.440	.446	.444	.449	.445	.452	.452
22	.13	28	.461	84.1	.470	64.7	.461	.467	.463	.468	.463	.470	.470
24	.12	12	.472	83.6	.490	67.0	.472	.476	.474	.476	.476	.480	.480
24	.12	18	.502	83.8	.515	65.8	.502	.509	.505	.512	.509	.515	.515
24	.12	24	.517	84.1	.527	65.6	.517	.522	.520	.525	.522	.527	.527
24	.12	28	.524	83.0	.532	65.7	.524	.528	.526	.531	.528	.532	.532
26	.11	11	.527	83.0	.540	66.9	.527	.536	.531	.541	.536	.546	.546
26	.11	16	.535	83.1	.553	66.5	.535	.541	.540	.549	.541	.553	.553
26	.11	24	.565	83.1	.578	65.1	.565	.572	.570	.575	.572	.578	.578
26	.11	28	.580	83.1	.590	64.7	.580	.585	.583	.588	.585	.590	.590
26	.11	32	.586	84.1	.595	64.7	.586	.591	.589	.593	.591	.595	.595
28	.12	12	.587	83.6	.615	67.0	.587	.606	.602	.611	.606	.615	.615
28	.12	18	.612	84.1	.622	65.6	.612	.617	.615	.620	.617	.622	.622
30	.10	10	.642	83.1	.663	67.0	.642	.656	.647	.658	.653	.663	.663
30	.10	14	.669	83.1	.678	66.5	.669	.670	.665	.674	.669	.678	.678
30	.10	20	.682	83.8	.696	65.8	.682	.689	.686	.693	.689	.696	.696
30	.10	28	.696	83.1	.707	65.2	.696	.702	.699	.704	.702	.707	.707
30	.10	32	.711	84.1	.720	64.7	.711	.715	.713	.718	.715	.720	.720
32	.12	12	.722	83.6	.740	67.0	.722	.731	.727	.736	.731	.740	.740
32	.12	16	.745	83.1	.759	65.9	.745	.749	.746	.752	.749	.759	.759
32	.12	20	.759	83.9	.770	65.4	.759	.764	.761	.766	.764	.770	.770
34	.9	9	.755	83.1	.778	67.2	.755	.765	.761	.771	.767	.778	.778
34	.9	12	.785	83.1	.803	66.5	.785	.794	.790	.799	.794	.803	.803
34	.9	14	.798	83.0	.814	65.7	.798	.806	.802	.810	.806	.814	.814
34	.9	16	.807	83.8	.821	65.5	.807	.814	.811	.818	.814	.821	.821
34	.9	20	.821	83.1	.832	66.2	.821	.827	.824	.829	.827	.832	.832
34	.9	28	.836	84.1	.845	64.7	.836	.840	.838	.843	.840	.845	.845
36	.12	12	.847	83.6	.865	67.0	.847	.856	.852	.861	.856	.865	.865
36	.12	16	.870	83.1	.884	65.9	.870	.877	.874	.881	.877	.884	.884
36	.12	20	.883	83.9	.895	65.4	.883	.889	.886	.891	.889	.895	.895
38	.8	8	.865	83.1	.890	67.7	.865	.878	.871	.884	.878	.890	.890
38	.8	12	.910	83.1	.928	66.5	.910	.919	.915	.924	.919	.928	.928
38	.8	14	.923	83.0	.938	66.8	.923	.927	.921	.931	.921	.931	.931
38	.8	16	.932	83.8	.946	66.5	.932	.939	.936	.943	.939	.946	.946
38	.8	20	.946	83.1	.957	66.2	.946	.952	.950	.954	.952	.957	.957
38	.8	28	.961	84.1	.970	64.7	.961	.966	.963	.968	.966	.970	.970
40	.12	12	.972	83.6	.999	67.0	.972	.981	.977	.986	.981	.990	.990
40	.12	16	.995	83.1	1.009	65.9	.995	1.002	.999	1.002	.999	1.005	1.005
40	.12	18	1.002	83.8	1.015	68.8	1.002	1.009	1.005	1.012	1.009	1.012	1.012

See footnotes at end of table.

TABLE 3.1.—Recommended hole size limits before threading for different lengths of engagement, UNC, UNF, UNEF, UN, UNS, NC, NF, NEF, and N series, classes 1B and 2B—Continued

(Based on table IV.10*)

Designation		Minor diameter, internal threads				Recommended hole limits, including chamfers of engagement							
Thread size	Threads per inch	Minimum	Percent of basic thread height ^b	Maximum ^c	Percent of basic thread height ^b	To and including 1½ D		Above 1½ D to 3 D		D to 1½ D		Above 1½ D to 3 D	
						Min	Max	Min	Max	Min	Max	Min	Max
No., in.		in.		in.		in.	in.	in.	in.	in.	in.	in.	in.
1¼	7	0.970	83.5	0.998	68.4	0.970	0.984	0.977	0.991	0.984	0.998	0.991	1.005
1¼	8	0.990	83.1	1.018	67.7	0.990	1.003	0.996	1.009	1.003	1.015	1.009	1.021
1¼	12	1.035	83.1	1.053	66.5	1.035	1.041	1.040	1.049	1.044	1.053	1.049	1.058
1¼	16	1.057	83.8	1.071	66.5	1.057	1.061	1.061	1.068	1.064	1.071	1.068	1.075
1¼	18	1.065	83.1	1.078	65.1	1.065	1.072	1.068	1.075	1.072	1.078	1.075	1.081
1¼	20	1.071	83.1	1.082	66.2	1.071	1.077	1.074	1.079	1.077	1.082	1.079	1.085
1¼	28	1.086	84.1	1.095	64.7	1.086	1.091	1.088	1.093	1.091	1.095	1.093	1.097
1½	12	1.097	83.6	1.115	67.0	1.097	1.106	1.102	1.111	1.106	1.115	1.111	1.120
1½	16	1.120	83.1	1.133	65.9	1.120	1.127	1.124	1.131	1.127	1.134	1.131	1.138
1½	18	1.127	83.8	1.140	65.8	1.127	1.134	1.130	1.137	1.134	1.140	1.137	1.143
1½	7	1.095	83.5	1.123	68.4	1.095	1.109	1.102	1.116	1.109	1.123	1.116	1.130
1½	8	1.115	83.1	1.149	67.7	1.115	1.128	1.121	1.134	1.128	1.140	1.134	1.146
1½	12	1.160	83.1	1.178	66.5	1.160	1.169	1.165	1.174	1.169	1.178	1.174	1.183
1½	16	1.182	83.8	1.196	66.5	1.182	1.189	1.186	1.193	1.189	1.196	1.193	1.200
1½	18	1.186	83.1	1.203	65.1	1.186	1.197	1.193	1.200	1.197	1.203	1.200	1.206
1½	20	1.196	83.1	1.207	66.2	1.196	1.202	1.199	1.204	1.202	1.207	1.204	1.210
1½	12	1.222	83.6	1.240	67.0	1.222	1.231	1.227	1.236	1.231	1.240	1.236	1.245
1½	16	1.245	83.1	1.259	65.9	1.245	1.252	1.249	1.256	1.252	1.259	1.256	1.263
1½	18	1.252	83.8	1.265	65.8	1.252	1.259	1.256	1.262	1.259	1.265	1.262	1.268
1¾	6	1.195	83.1	1.225	69.3	1.195	1.210	1.203	1.221	1.210	1.225	1.221	1.239
1¾	8	1.240	83.1	1.265	67.7	1.240	1.253	1.246	1.259	1.253	1.265	1.259	1.271
1¾	12	1.285	83.1	1.303	66.5	1.285	1.294	1.290	1.299	1.294	1.303	1.299	1.308
1¾	16	1.307	83.8	1.321	66.5	1.307	1.314	1.311	1.318	1.314	1.321	1.318	1.325
1¾	18	1.315	83.1	1.328	65.1	1.315	1.322	1.318	1.325	1.322	1.328	1.325	1.331
1¾	12	1.347	83.6	1.365	67.0	1.347	1.354	1.350	1.357	1.354	1.365	1.361	1.370
1¾	16	1.370	83.1	1.384	65.9	1.370	1.377	1.374	1.381	1.377	1.384	1.381	1.388
1¾	18	1.377	83.8	1.390	65.8	1.377	1.384	1.380	1.387	1.384	1.390	1.387	1.393
1¾	6	1.320	83.1	1.350	69.3	1.320	1.335	1.328	1.346	1.335	1.350	1.346	1.364
1¾	8	1.365	83.1	1.390	67.7	1.365	1.378	1.371	1.384	1.378	1.390	1.384	1.396
1¾	12	1.410	83.1	1.428	66.5	1.410	1.417	1.415	1.423	1.419	1.428	1.423	1.433
1¾	16	1.432	83.8	1.445	66.5	1.432	1.439	1.436	1.443	1.439	1.445	1.443	1.449
1¾	18	1.440	83.1	1.452	66.5	1.440	1.446	1.443	1.449	1.446	1.452	1.449	1.456
1¾	20	1.446	83.1	1.457	66.2	1.446	1.452	1.449	1.454	1.452	1.457	1.454	1.460
1¾	16	1.495	83.1	1.509	65.9	1.495	1.502	1.499	1.506	1.502	1.509	1.506	1.513
1¾	18	1.502	83.8	1.515	65.8	1.502	1.509	1.505	1.512	1.509	1.515	1.512	1.518
1¾	8	1.490	83.1	1.515	67.7	1.490	1.498	1.494	1.506	1.498	1.515	1.509	1.521
1¾	12	1.535	83.1	1.553	66.5	1.535	1.543	1.540	1.549	1.544	1.553	1.549	1.558
1¾	16	1.557	83.8	1.571	66.5	1.557	1.564	1.561	1.568	1.564	1.571	1.568	1.575
1¾	18	1.565	83.1	1.578	65.1	1.565	1.572	1.568	1.575	1.572	1.578	1.575	1.581
1¾	16	1.620	83.1	1.644	65.9	1.620	1.627	1.624	1.631	1.627	1.634	1.631	1.638
1¾	18	1.627	83.8	1.640	65.8	1.627	1.634	1.630	1.637	1.634	1.640	1.637	1.643
1¾	5	1.531	83.1	1.568	70.1	1.531	1.551	1.543	1.569	1.551	1.568	1.569	1.577
1¾	8	1.615	83.1	1.640	67.7	1.615	1.628	1.621	1.634	1.628	1.640	1.634	1.646
1¾	12	1.660	83.1	1.678	66.5	1.660	1.669	1.665	1.673	1.669	1.678	1.673	1.683
1¾	16	1.682	83.8	1.696	66.5	1.682	1.689	1.686	1.693	1.689	1.696	1.693	1.700
1¾	20	1.696	83.1	1.707	66.2	1.696	1.702	1.699	1.704	1.702	1.707	1.704	1.710
1¾	16	1.745	83.1	1.759	65.9	1.745	1.752	1.749	1.756	1.752	1.759	1.756	1.763
1¾	8	1.740	83.1	1.765	67.7	1.740	1.752	1.746	1.759	1.752	1.765	1.759	1.771
1¾	12	1.785	83.1	1.803	66.5	1.785	1.791	1.790	1.799	1.794	1.803	1.799	1.808
1¾	16	1.807	83.8	1.821	66.5	1.807	1.814	1.810	1.818	1.814	1.821	1.818	1.825
1¾	16	1.870	83.1	1.884	65.9	1.870	1.877	1.874	1.881	1.877	1.884	1.881	1.888
2	4½	1.759	83.5	1.795	71.0	1.759	1.777	1.768	1.786	1.777	1.795	1.786	1.804
2	8	1.865	83.1	1.890	67.7	1.865	1.878	1.871	1.884	1.878	1.890	1.884	1.896
2	12	1.910	83.1	1.928	66.5	1.910	1.919	1.915	1.923	1.919	1.928	1.923	1.933
2	16	1.932	83.8	1.946	66.5	1.932	1.939	1.936	1.943	1.939	1.946	1.943	1.950
2	20	1.946	83.1	1.957	66.2	1.946	1.952	1.949	1.954	1.952	1.957	1.954	1.960
2½	16	1.995	83.1	2.009	65.9	1.995	2.002	2.000	2.006	2.002	2.009	2.006	2.012
2½	8	1.990	83.1	2.015	67.7	1.990	2.005	1.996	2.009	2.005	2.015	2.009	2.021
2½	12	2.035	83.1	2.053	66.5	2.035	2.041	2.040	2.049	2.044	2.053	2.049	2.058
2½	16	2.057	83.8	2.071	66.5	2.057	2.064	2.061	2.068	2.064	2.071	2.068	2.075
2½	16	2.120	83.1	2.134	65.9	2.120	2.127	2.124	2.131	2.127	2.134	2.131	2.138
2½	4½	2.069	83.5	2.045	71.0	2.069	2.027	2.018	2.036	2.027	2.045	2.036	2.054
2½	8	2.115	83.1	2.140	67.7	2.115	2.128	2.121	2.134	2.128	2.140	2.134	2.146
2½	12	2.160	83.1	2.178	66.5	2.160	2.169	2.165	2.173	2.169	2.178	2.174	2.182
2½	16	2.182	83.8	2.196	66.5	2.182	2.189	2.186	2.193	2.189	2.196	2.193	2.200
2½	20	2.196	83.1	2.207	66.2	2.196	2.202	2.199	2.204	2.202	2.207	2.204	2.210
2½	16	2.245	83.1	2.259	65.9	2.245	2.252	2.249	2.256	2.252	2.259	2.256	2.263
2½	12	2.285	83.1	2.303	66.5	2.285	2.291	2.290	2.299	2.294	2.303	2.299	2.308
2½	16	2.307	83.8	2.321	66.5	2.307	2.314	2.311	2.318	2.314	2.321	2.318	2.325
2½	16	2.370	83.1	2.384	65.9	2.370	2.377	2.374	2.381	2.377	2.384	2.381	2.388

See footnotes at end of table.

TABLE 3.1.—Recommended hole size limits before threading for different lengths of engagement, UNC, UNF, UNEF, UN, UNS, NC, NF, NEF, and N series, classes 1B and 2B—Continued

(Based on table IV.10*)

Designation		Minor diameter, internal threads				Recommended hole size limits for different lengths of engagement							
Thread size	Threads per inch	Minimum	Percent of basic thread height ^b	Maximum ^c	Percent of basic thread height ^c	To and including 1½ D		Above ¾ D to ¾ D		Above ¾ D to 1½ D		Above 1½ D to 3 D	
						Min	Max	Min	Max	Min	Max	Min	Max
No. in.		in.		in.		in.	in.	in.	in.	in.	in.	in.	in.
2½	4	2.229	83.4	2.267	71.7	2.229	2.248	2.238	2.238	2.248	2.267	2.258	2.277
2½	8	2.365	83.1	2.399	67.7	2.365	2.378	2.371	2.384	2.378	2.399	2.384	2.396
2½	12	2.410	83.1	2.428	66.5	2.410	2.419	2.415	2.421	2.419	2.428	2.424	2.433
2½	16	2.432	83.8	2.446	66.5	2.432	2.439	2.436	2.443	2.440	2.448	2.445	2.450
2½	20	2.446	83.1	2.457	66.2	2.446	2.452	2.449	2.454	2.452	2.457	2.454	2.460
2¾	12	2.535	83.1	2.553	66.5	2.535	2.544	2.540	2.549	2.544	2.553	2.549	2.558
2¾	16	2.557	83.8	2.571	66.5	2.557	2.564	2.561	2.568	2.564	2.571	2.568	2.575
2¾	4	2.479	83.4	2.517	71.7	2.479	2.498	2.489	2.508	2.498	2.517	2.508	2.527
2¾	8	2.615	83.1	2.640	67.7	2.615	2.628	2.621	2.634	2.628	2.640	2.634	2.644
2¾	12	2.660	83.1	2.678	66.5	2.660	2.669	2.665	2.674	2.669	2.678	2.674	2.683
2¾	16	2.682	83.8	2.696	66.5	2.682	2.689	2.686	2.693	2.689	2.696	2.693	2.700
2¾	12	2.785	83.1	2.803	66.5	2.785	2.794	2.790	2.809	2.794	2.803	2.809	2.808
2¾	16	2.837	83.8	2.851	66.5	2.837	2.844	2.841	2.848	2.844	2.851	2.848	2.855
3	4	2.729	83.1	2.767	71.7	2.729	2.748	2.739	2.758	2.748	2.767	2.758	2.777
3	8	2.865	83.1	2.890	67.7	2.865	2.878	2.871	2.884	2.878	2.890	2.884	2.896
3	12	2.910	83.1	2.928	66.5	2.910	2.919	2.915	2.924	2.919	2.928	2.924	2.933
3	16	2.932	83.8	2.946	66.5	2.932	2.939	2.936	2.943	2.939	2.946	2.943	2.950
3¼	12	3.035	83.1	3.053	66.5	3.035	3.044	3.040	3.049	3.044	3.053	3.049	3.058
3¼	16	3.057	83.8	3.071	66.5	3.057	3.064	3.061	3.068	3.064	3.071	3.068	3.075
3¼	4	2.979	83.4	3.017	71.7	2.979	2.998	2.989	3.008	2.998	3.017	3.008	3.027
3¼	8	3.115	83.1	3.140	67.7	3.115	3.128	3.121	3.134	3.128	3.140	3.134	3.146
3¼	12	3.160	83.1	3.178	66.5	3.160	3.169	3.165	3.174	3.169	3.178	3.174	3.183
3¼	16	3.182	83.8	3.196	66.5	3.182	3.189	3.186	3.193	3.189	3.196	3.193	3.200
3½	12	3.285	83.1	3.303	66.5	3.285	3.294	3.290	3.299	3.294	3.303	3.299	3.308
3½	16	3.307	83.8	3.321	66.5	3.307	3.314	3.311	3.318	3.314	3.321	3.317	3.325
3½	4	3.229	83.4	3.267	71.7	3.229	3.248	3.239	3.258	3.248	3.267	3.258	3.277
3½	8	3.365	83.1	3.390	67.7	3.365	3.378	3.371	3.384	3.378	3.390	3.384	3.396
3½	12	3.410	83.1	3.428	66.5	3.410	3.419	3.415	3.424	3.419	3.428	3.424	3.433
3½	16	3.432	83.8	3.446	66.5	3.432	3.439	3.436	3.443	3.439	3.446	3.443	3.450
3¾	12	3.535	83.1	3.553	66.5	3.535	3.544	3.540	3.549	3.544	3.553	3.549	3.558
3¾	16	3.557	83.8	3.571	66.5	3.557	3.564	3.561	3.568	3.564	3.571	3.568	3.575
3¾	4	3.479	83.4	3.517	71.7	3.479	3.498	3.489	3.508	3.498	3.517	3.508	3.527
3¾	8	3.615	83.1	3.640	67.7	3.615	3.628	3.621	3.634	3.628	3.640	3.634	3.646
3¾	12	3.660	83.1	3.678	66.5	3.660	3.669	3.665	3.674	3.669	3.678	3.674	3.683
3¾	16	3.682	83.8	3.696	66.5	3.682	3.689	3.686	3.693	3.689	3.696	3.693	3.700
3¾	12	3.785	83.1	3.803	66.5	3.785	3.794	3.790	3.799	3.794	3.803	3.799	3.808
3¾	16	3.807	83.8	3.821	66.5	3.807	3.814	3.811	3.818	3.814	3.821	3.817	3.825
4	4	3.729	83.4	3.767	71.7	3.729	3.748	3.739	3.758	3.748	3.767	3.758	3.777
4	8	3.865	83.1	3.890	67.7	3.865	3.878	3.871	3.884	3.878	3.890	3.884	3.896
4	12	3.910	83.1	3.928	66.5	3.910	3.919	3.915	3.924	3.919	3.928	3.924	3.933
4	16	3.932	83.8	3.946	66.5	3.932	3.939	3.936	3.943	3.939	3.946	3.943	3.950
4¼	4	3.979	83.4	4.017	71.7	3.979	3.998	3.989	4.008	3.998	4.017	4.008	4.027
4¼	8	4.115	83.1	4.140	67.7	4.115	4.128	4.121	4.134	4.128	4.140	4.134	4.146
4¼	12	4.160	83.1	4.178	66.5	4.160	4.169	4.165	4.174	4.169	4.178	4.174	4.183
4¼	16	4.182	83.8	4.196	66.5	4.182	4.189	4.186	4.193	4.189	4.196	4.193	4.200
4½	4	4.229	83.1	4.267	71.7	4.229	4.248	4.239	4.258	4.248	4.267	4.258	4.277
4½	8	4.365	83.1	4.390	67.7	4.365	4.378	4.371	4.384	4.378	4.390	4.384	4.396
4½	12	4.410	83.1	4.428	66.5	4.410	4.419	4.415	4.424	4.419	4.428	4.424	4.433
4½	16	4.432	83.8	4.446	66.5	4.432	4.439	4.436	4.443	4.439	4.446	4.443	4.450
4¾	8	4.615	83.1	4.640	67.7	4.615	4.628	4.621	4.634	4.628	4.640	4.634	4.646
4¾	12	4.660	83.1	4.678	66.5	4.660	4.669	4.665	4.674	4.669	4.678	4.674	4.683
4¾	16	4.682	83.8	4.696	66.5	4.682	4.689	4.686	4.693	4.689	4.696	4.693	4.700
5	8	4.865	83.1	4.890	67.7	4.865	4.878	4.871	4.884	4.878	4.890	4.884	4.896
5	12	4.910	83.1	4.928	66.5	4.910	4.919	4.915	4.924	4.919	4.928	4.924	4.933
5	16	4.932	83.8	4.946	66.5	4.932	4.939	4.936	4.943	4.939	4.946	4.943	4.950
5¼	8	5.115	83.1	5.140	67.7	5.115	5.128	5.121	5.134	5.128	5.140	5.134	5.146
5¼	12	5.160	83.1	5.178	66.5	5.160	5.169	5.165	5.174	5.169	5.178	5.174	5.183
5¼	16	5.182	83.8	5.196	66.5	5.182	5.189	5.186	5.193	5.189	5.196	5.193	5.200
5½	8	5.365	83.1	5.390	67.7	5.365	5.378	5.371	5.384	5.378	5.390	5.384	5.396
5½	12	5.410	83.1	5.428	66.5	5.410	5.419	5.415	5.424	5.419	5.428	5.424	5.433
5½	16	5.432	83.8	5.446	66.5	5.432	5.439	5.436	5.443	5.439	5.446	5.443	5.450
5¾	8	5.615	83.1	5.640	67.7	5.615	5.628	5.621	5.634	5.628	5.640	5.634	5.646
5¾	12	5.660	83.1	5.678	66.5	5.660	5.669	5.665	5.674	5.669	5.678	5.674	5.683
5¾	16	5.682	83.8	5.696	66.5	5.682	5.689	5.686	5.693	5.689	5.696	5.693	5.700
6	8	5.865	83.1	5.890	67.7	5.865	5.878	5.871	5.884	5.878	5.890	5.884	5.896
6	12	5.910	83.1	5.928	66.5	5.910	5.919	5.915	5.924	5.919	5.928	5.924	5.933
6	16	5.932	83.8	5.946	66.5	5.932	5.939	5.936	5.943	5.939	5.946	5.943	5.950

* The differences between limits are equal to the minor diameter tolerances given in table IV.10 for lengths of engagement to and including 1½ D. However, the minimum values for lengths of engagement greater than 1½ D in sizes ¼ in. and larger are adjusted so that the difference between limits is not less than 0.0010 in. For diameter-pitch combinations other than those given in this table, the tolerances given in table IV.10 should be similarly applied to determine hole size limits.

^b Based on values as rounded off in the preceding column.
^c Based on a length of engagement equal to the nominal diameter.

TABLE 3.2.—Recommended hole size limits before threading for different lengths of engagement, UNC, UNF, UNBF, UN, UNS, NC, NF, NBF, and N series, class 3B

(Based on table IV.11*)

Designation		Minor diameter, internal threads				Recommended hole size limits for different lengths of engagement							
Thread size	Threads per inch	Minimum	Percent of basic thread height ^a	Maximum ^c	Percent of basic thread height ^b	To and including $\frac{1}{8} D$		Above $\frac{1}{8} D$ to $\frac{1}{2} D$		Above $\frac{1}{2} D$ to $1\frac{1}{2} D$		Above $1\frac{1}{2} D$ to $3 D$	
						Min	Max	Min	Max	Min	Max	Min	Max
No. in.		in.		in.		in.	in.	in.	in.	in.	in.	in.	in.
0 0.060	80	0.0465	83.1	0.0514	453.0	0.0465	0.0500	0.0479	0.0514	0.0479	0.0514	0.0479	0.0514
1 .073	64	.0561	83.3	.0623	52.7	.0561	.0599	.0585	.0623	.0585	.0623	.0585	.0623
1 .073	72	.0580	83.1	.0635	52.7	.0580	.0613	.0596	.0629	.0602	.0635	.0602	.0635
2 .086	56	.0667	83.2	.0737	53.0	.0667	.0705	.0686	.0724	.0699	.0737	.0699	.0737
2 .086	64	.0691	83.3	.0753	52.7	.0691	.0724	.0707	.0740	.0720	.0753	.0720	.0753
3 .099	48	.0764	83.5	.0845	53.6	.0764	.0801	.0785	.0825	.0805	.0845	.0806	.0846
3 .099	56	.0797	83.2	.0865	53.9	.0797	.0831	.0814	.0854	.0831	.0865	.0833	.0867
4 .112	40	.0849	83.4	.0939	55.7	.0849	.0884	.0871	.0916	.0894	.0939	.0902	.0947
4 .112	48	.0894	83.5	.0968	55.2	.0894	.0931	.0912	.0949	.0931	.0968	.0937	.0976
5 .125	40	.0979	83.4	.1062	57.9	.0979	.1020	.1000	.1041	.1021	.1062	.1036	.1077
5 .125	44	.1004	83.3	.1079	57.9	.1004	.1042	.1023	.1060	.1042	.1079	.1050	.1097
6 .138	32	.1040	83.8	.1140	59.1	.1040	.1091	.1066	.1115	.1091	.1140	.1115	.1164
6 .138	40	.1110	83.1	.1186	59.7	.1110	.1148	.1128	.1167	.1147	.1186	.1166	.1205
8 .164	32	.1300	83.8	.1389	61.8	.1300	.1345	.1324	.1367	.1346	.1389	.1367	.1410
8 .164	36	.1340	83.1	.1416	62.1	.1340	.1377	.1359	.1397	.1378	.1416	.1397	.1435
10 .190	24	.1450	83.1	.1555	63.7	.1450	.1502	.1475	.1528	.1502	.1555	.1524	.1581
10 .190	32	.1500	83.8	.1641	63.8	.1500	.1561	.1531	.1591	.1561	.1641	.1621	.1681
12 .216	24	.1710	83.1	.1807	65.2	.1710	.1758	.1733	.1782	.1758	.1807	.1782	.1831
12 .216	28	.1770	81.1	.1857	65.3	.1770	.1815	.1791	.1835	.1815	.1857	.1835	.1878
12 .216	32	.1820	83.8	.1895	65.3	.1820	.1858	.1837	.1877	.1858	.1895	.1873	.1913
14 .240	20	.1960	83.1	.2067	66.7	.1960	.2013	.1986	.2040	.2013	.2067	.2040	.2094
14 .240	24	.2010	81.1	.2100	66.8	.2010	.2052	.2031	.2071	.2050	.2100	.2079	.2120
14 .240	28	.2060	83.8	.2150	66.8	.2060	.2106	.2082	.2122	.2101	.2150	.2129	.2170
14 .240	32	.2110	83.1	.2200	67.1	.2110	.2158	.2137	.2177	.2156	.2200	.2179	.2220
16 .270	18	.2520	83.8	.2630	68.6	.2520	.2577	.2551	.2604	.2577	.2630	.2604	.2657
16 .270	24	.2570	81.1	.2654	68.5	.2570	.2614	.2594	.2634	.2614	.2654	.2634	.2674
16 .270	32	.2620	83.5	.2707	68.5	.2620	.2667	.2642	.2682	.2662	.2707	.2682	.2727
16 .270	36	.2670	81.5	.2757	68.7	.2670	.2720	.2693	.2733	.2713	.2757	.2733	.2780
18 .300	16	.2870	83.8	.3182	70.0	.2870	.3127	.3101	.3155	.3128	.3182	.3155	.3209
18 .300	24	.2920	83.1	.3072	69.5	.2920	.3066	.3044	.3094	.3072	.3120	.3094	.3140
18 .300	32	.2970	83.8	.3159	69.2	.2970	.3114	.3091	.3145	.3122	.3169	.3145	.3191
18 .300	36	.3020	83.1	.3201	69.0	.3020	.3168	.3149	.3198	.3161	.3201	.3174	.3214
20 .330	14	.3090	83.5	.3217	70.9	.3090	.3290	.3268	.3308	.3289	.3317	.3288	.3346
20 .330	20	.3140	83.9	.3316	70.7	.3140	.3335	.3315	.3355	.3335	.3366	.3346	.3396
20 .330	28	.3190	83.0	.3405	69.8	.3190	.3395	.3375	.3415	.3395	.3417	.3395	.3447
24 .360	12	.3360	83.1	.3484	71.7	.3360	.3577	.3551	.3594	.3577	.3610	.3594	.3637
24 .360	16	.3410	83.1	.3533	71.8	.3410	.3614	.3594	.3634	.3614	.3647	.3627	.3670
24 .360	20	.3460	83.1	.3582	71.3	.3460	.3667	.3647	.3687	.3667	.3700	.3687	.3730
24 .360	28	.3510	81.1	.3631	69.8	.3510	.3710	.3685	.3720	.3700	.3733	.3710	.3753
28 .390	12	.3720	83.6	.3843	72.2	.3720	.3943	.3913	.3953	.3933	.3963	.3943	.4003
28 .390	18	.3770	83.8	.3916	71.9	.3770	.3965	.3945	.3985	.3965	.3996	.3976	.4036
28 .390	24	.3820	81.1	.3944	70.4	.3820	.3995	.3975	.4015	.3995	.4021	.4001	.4061
28 .390	28	.3870	83.0	.3991	68.8	.3870	.4020	.4005	.4045	.4021	.4051	.4031	.4091
32 .420	12	.4170	83.1	.4284	71.7	.4170	.4425	.4396	.4454	.4426	.4484	.4455	.4513
32 .420	16	.4220	83.1	.4333	71.8	.4220	.4461	.4439	.4492	.4469	.4523	.4492	.4555
32 .420	20	.4270	83.1	.4382	71.3	.4270	.4499	.4477	.4517	.4497	.4537	.4517	.4566
32 .420	28	.4320	81.1	.4476	69.8	.4320	.4465	.4460	.4500	.4486	.4526	.4506	.4562
36 .450	12	.4470	83.6	.4643	72.2	.4470	.4783	.4753	.4813	.4783	.4843	.4813	.4873
36 .450	18	.4520	83.8	.4716	71.9	.4520	.4805	.4785	.4836	.4805	.4866	.4836	.4896
36 .450	24	.4570	81.1	.4744	70.4	.4570	.4829	.4809	.4859	.4839	.4889	.4869	.4929
36 .450	28	.4620	83.0	.4801	68.8	.4620	.4820	.4825	.4865	.4845	.4891	.4871	.4931
40 .480	12	.4720	83.0	.4991	72.7	.4720	.5028	.5008	.5060	.5039	.5091	.5070	.5122
40 .480	16	.4770	82.1	.5042	72.7	.4770	.5066	.5046	.5096	.5076	.5126	.5106	.5156
40 .480	24	.4820	83.1	.5130	72.1	.4820	.5090	.5070	.5111	.5090	.5140	.5120	.5170
40 .480	28	.4870	83.1	.5189	70.4	.4870	.5081	.5081	.5121	.5101	.5151	.5131	.5181
40 .480	36	.4920	81.1	.5226	69.8	.4920	.5095	.5095	.5135	.5115	.5165	.5145	.5195
48 .510	12	.5070	83.6	.5295	73.0	.5070	.5409	.5379	.5439	.5409	.5469	.5439	.5509
48 .510	16	.5120	84.1	.5344	70.4	.5120	.5450	.5420	.5480	.5450	.5510	.5480	.5540
48 .510	24	.5170	83.1	.5432	73.5	.5170	.5481	.5461	.5501	.5481	.5531	.5511	.5561
48 .510	28	.5220	83.1	.5481	72.9	.5220	.5496	.5496	.5536	.5516	.5566	.5546	.5596
48 .510	36	.5270	83.1	.5530	72.1	.5270	.5501	.5501	.5541	.5521	.5571	.5551	.5601
48 .510	44	.5320	83.1	.5579	70.4	.5320	.5531	.5531	.5571	.5551	.5601	.5581	.5631
56 .540	12	.5340	83.0	.5611	72.7	.5340	.5699	.5669	.5729	.5699	.5759	.5729	.5789
56 .540	16	.5390	83.0	.5660	72.7	.5390	.5700	.5670	.5730	.5710	.5760	.5740	.5790
56 .540	24	.5440	83.1	.5709	72.1	.5440	.5720	.5720	.5760	.5740	.5790	.5770	.5820
56 .540	28	.5490	83.1	.5758	70.4	.5490	.5731	.5731	.5771	.5751	.5801	.5781	.5831
56 .540	36	.5540	81.1	.5807	69.8	.5540	.5751	.5751	.5791	.5771	.5821	.5801	.5851
64 .570	12	.5660	83.6	.5951	73.0	.5660	.6049	.6019	.6079	.6049	.6109	.6079	.6139
64 .570	16	.5710	84.1	.6000	70.4	.5710	.6100	.6070	.6130	.6100	.6160	.6130	.6190
64 .570	24	.5760	83.1	.6049	73.5	.5760	.6151	.6121	.6181	.6151	.6211	.6181	.6241
64 .570	28	.5810	83.1	.6098	72.9	.5810	.6200	.6170	.6230	.6200	.6260	.6230	.6290
64 .570	36	.5860	83.1	.6147	72.1	.5860	.6211	.6211	.6251	.6231	.6281	.6261	.6311
64 .570	44	.5910	83.1	.6196	70.4	.5910	.6221	.6221	.6261	.6241	.6291	.6271	.6321
72 .600	12	.5970	83.0	.6281	72.7	.5970	.6399	.6369	.6429	.6399	.6459	.6429	.6489
72 .600	16	.6020	83.0	.6330	72.7	.6020	.6450	.6420	.6480	.6450	.6510	.6480	.6540
72 .600	24	.6070	83.1	.6379	72.1	.6070	.6490	.6490	.6530	.6510	.6560	.6540	.6590
72 .600	28	.6120	83.1	.6428	70.4	.6120	.6501	.6501	.6541	.6521	.6571	.6551	.6601
72 .600	36	.6170	81.1	.6477	69.8	.6170	.6511	.6511	.6551	.6531	.6581	.6561	.6611
80 .630	12	.6240	83.6	.6531	73.0	.6240	.6649	.6619	.6679	.6649	.6709	.6679	.6739
80 .630	16	.6290	84.1	.6580	70.4	.6290	.6690	.6660	.6720	.6690	.6750	.6720	.6780
80 .630</													

TABLE 3.2.—Recommended hole size limits before threading for different lengths of engagement, UNC, UNF, UNEF, UN, UNS, NC, NF, NEF, and N series, class 3B—Continued

(Based on table IV.11^a)

Designation		Minor diameter, internal threads				Recommended hole size limits for different lengths of engagement							
Thread size	Threads per inch	Minimum	Percent of basic thread height ^b	Maximum ^c	Percent of basic thread height ^a	To and including $\frac{1}{2} D$		Above $\frac{1}{2} D$ to $\frac{3}{4} D$		Above $\frac{3}{4} D$ to $1\frac{1}{2} D$		Above $1\frac{1}{2} D$ to $3 D$	
						Min	Max	Min	Max	Min	Max	Min	Max
No. in.		<i>in.</i>		<i>in.</i>		<i>in.</i>	<i>in.</i>	<i>in.</i>	<i>in.</i>	<i>in.</i>	<i>in.</i>	<i>in.</i>	<i>in.</i>
1	8	0.8650	83.1	0.8792	74.1	0.8650	0.8792	0.8684	0.8759	0.8722	0.8797	0.8769	0.8835
1	12	0.9100	83.1	0.9198	74.1	0.9100	0.9148	0.9123	0.9173	0.9148	0.9198	0.9173	0.9223
1	14	0.9340	83.0	0.9315	73.8	0.9330	0.9271	0.9219	0.9293	0.9271	0.9315	0.9293	0.9337
1	16	0.9520	83.8	0.9498	72.9	0.9520	0.9566	0.9544	0.9587	0.9565	0.9608	0.9586	0.9629
1	20	0.9699	83.1	0.9537	71.3	0.9600	0.9498	0.9477	0.9517	0.9497	0.9537	0.9516	0.9556
1	28	0.9610	84.1	0.9676	69.8	0.9610	0.9645	0.9620	0.9660	0.9636	0.9676	0.9652	0.9692
1 1/16	12	0.9720	83.6	0.9823	74.1	0.9720	0.9773	0.9748	0.9798	0.9773	0.9823	0.9798	0.9848
1 1/16	16	0.9650	83.1	1.0053	72.9	0.9650	0.9991	0.9969	1.0012	0.9990	1.0033	1.0011	1.0054
1 1/16	18	1.0020	83.8	1.0105	72.1	1.0020	1.0065	1.0044	1.0085	1.0064	1.0105	1.0085	1.0126
1 1/8	7	0.9700	84.0	0.9875	74.1	0.9700	0.9790	0.9747	0.9833	0.9789	0.9875	0.9832	0.9918
1 1/8	8	0.9900	83.1	1.0017	74.1	0.9900	0.9972	0.9941	1.0009	0.9972	1.0017	1.0016	1.0085
1 1/8	12	1.0350	83.1	1.0418	74.1	1.0350	1.0398	1.0373	1.0423	1.0398	1.0448	1.0423	1.0473
1 1/8	16	1.0570	83.8	1.0658	72.9	1.0570	1.0616	1.0594	1.0637	1.0615	1.0658	1.0636	1.0679
1 1/8	18	1.0550	83.1	1.0730	72.1	1.0550	1.0690	1.0669	1.0710	1.0689	1.0730	1.0710	1.0751
1 1/8	20	1.0710	83.1	1.0787	71.3	1.0710	1.0748	1.0727	1.0767	1.0747	1.0787	1.0766	1.0806
1 1/8	28	1.0860	84.1	1.0923	69.8	1.0860	1.0895	1.0870	1.0910	1.0886	1.0926	1.0902	1.0942
1 1/16	12	1.0970	83.6	1.1073	74.1	1.0970	1.1023	1.0998	1.1048	1.1023	1.1073	1.1048	1.1098
1 1/16	16	1.1200	83.1	1.1283	72.9	1.1200	1.1241	1.1219	1.1262	1.1240	1.1283	1.1261	1.1304
1 1/16	18	1.1270	83.8	1.1355	72.1	1.1270	1.1315	1.1291	1.1335	1.1314	1.1355	1.1335	1.1376
1 1/4	7	1.0950	83.5	1.1125	74.1	1.0950	1.1040	1.0987	1.1083	1.1039	1.1125	1.1082	1.1168
1 1/4	8	1.1150	83.1	1.1297	74.1	1.1150	1.1222	1.1184	1.1259	1.1222	1.1297	1.1260	1.1335
1 1/4	12	1.1600	83.1	1.1638	74.1	1.1600	1.1648	1.1623	1.1673	1.1648	1.1698	1.1673	1.1723
1 1/4	16	1.1820	83.8	1.1923	72.9	1.1820	1.1866	1.1844	1.1887	1.1865	1.1908	1.1886	1.1929
1 1/4	18	1.1900	83.1	1.1980	72.1	1.1900	1.1940	1.1919	1.1960	1.1939	1.1980	1.1969	1.2011
1 1/4	20	1.1960	83.1	1.2037	71.3	1.1960	1.1998	1.1977	1.2017	1.1996	1.2037	1.2016	1.2056
1 3/16	12	1.2220	83.6	1.2323	74.1	1.2220	1.2273	1.2248	1.2298	1.2273	1.2323	1.2298	1.2348
1 3/16	16	1.2450	83.1	1.2533	72.9	1.2450	1.2491	1.2469	1.2512	1.2490	1.2533	1.2511	1.2554
1 3/16	18	1.2520	83.8	1.2605	72.1	1.2520	1.2565	1.2544	1.2585	1.2564	1.2605	1.2585	1.2626
1 3/8	6	1.1950	83.1	1.2146	74.1	1.1950	1.2046	1.1996	1.2096	1.2046	1.2146	1.2096	1.2196
1 3/8	8	1.2400	83.1	1.2547	74.1	1.2400	1.2472	1.2434	1.2509	1.2472	1.2547	1.2540	1.2587
1 3/8	12	1.2850	83.1	1.2918	74.1	1.2850	1.2898	1.2873	1.2923	1.2898	1.2948	1.2923	1.2973
1 3/8	16	1.3070	83.8	1.3158	72.9	1.3070	1.3116	1.3094	1.3137	1.3115	1.3158	1.3136	1.3179
1 3/8	18	1.3150	83.1	1.3230	72.1	1.3150	1.3190	1.3169	1.3210	1.3189	1.3230	1.3210	1.3251
1 3/16	12	1.3170	83.6	1.3573	74.1	1.3170	1.3523	1.3498	1.3548	1.3523	1.3573	1.3548	1.3598
1 3/16	16	1.3700	83.1	1.3783	72.9	1.3700	1.3741	1.3719	1.3762	1.3740	1.3783	1.3761	1.3804
1 3/16	18	1.3770	83.8	1.3855	72.1	1.3770	1.3815	1.3794	1.3835	1.3814	1.3855	1.3835	1.3876
1 1/2	6	1.3200	83.1	1.3396	74.1	1.3200	1.3296	1.3246	1.3346	1.3296	1.3346	1.3346	1.3446
1 1/2	8	1.3650	83.1	1.3797	74.1	1.3650	1.3722	1.3684	1.3759	1.3722	1.3797	1.3759	1.3835
1 1/2	12	1.4100	83.1	1.4198	74.1	1.4100	1.4148	1.4123	1.4173	1.4148	1.4198	1.4173	1.4223
1 1/2	16	1.4320	83.8	1.4408	72.9	1.4320	1.4366	1.4344	1.4387	1.4365	1.4408	1.4386	1.4429
1 1/2	18	1.4400	83.1	1.4480	72.1	1.4400	1.4440	1.4419	1.4460	1.4439	1.4480	1.4469	1.4511
1 1/2	20	1.4460	83.1	1.4537	71.3	1.4460	1.4498	1.4477	1.4517	1.4497	1.4537	1.4516	1.4556
1 5/16	16	1.4950	83.1	1.5033	72.9	1.4950	1.4991	1.4969	1.5012	1.4990	1.5033	1.5011	1.5054
1 5/16	18	1.5020	83.8	1.5105	72.1	1.5020	1.5065	1.5044	1.5085	1.5064	1.5105	1.5085	1.5126
1 3/4	8	1.4900	83.1	1.5047	74.1	1.4900	1.4972	1.4934	1.5009	1.4972	1.5047	1.5040	1.5087
1 3/4	12	1.5350	83.1	1.5448	74.1	1.5350	1.5398	1.5373	1.5423	1.5398	1.5448	1.5423	1.5473
1 3/4	16	1.5570	83.8	1.5658	72.9	1.5570	1.5616	1.5594	1.5637	1.5615	1.5658	1.5636	1.5679
1 3/4	18	1.5650	83.1	1.5730	72.1	1.5650	1.5690	1.5669	1.5710	1.5689	1.5730	1.5710	1.5751
1 7/16	16	1.6200	83.1	1.6283	72.9	1.6200	1.6241	1.6219	1.6262	1.6240	1.6283	1.6261	1.6304
1 7/16	18	1.6270	83.8	1.6355	72.1	1.6270	1.6315	1.6294	1.6335	1.6314	1.6355	1.6335	1.6376
1 7/8	5	1.5310	83.1	1.5575	74.1	1.5310	1.5455	1.5396	1.5545	1.5455	1.5575	1.5545	1.5635
1 7/8	8	1.6150	83.1	1.6297	74.1	1.6150	1.6222	1.6184	1.6259	1.6222	1.6297	1.6260	1.6335
1 7/8	12	1.6990	83.1	1.6948	74.1	1.6990	1.6958	1.6923	1.6973	1.6948	1.6973	1.6952	1.7023
1 7/8	16	1.6520	83.8	1.6608	72.9	1.6520	1.6566	1.6544	1.6587	1.6565	1.6608	1.6586	1.6629
1 7/8	20	1.6660	83.1	1.6737	71.3	1.6660	1.6698	1.6677	1.6717	1.6697	1.6737	1.6716	1.6756
1 15/16	16	1.7450	83.1	1.7533	72.9	1.7450	1.7491	1.7469	1.7512	1.7490	1.7533	1.7511	1.7554
1 15/8	8	1.7100	83.1	1.7517	74.1	1.7100	1.7472	1.7434	1.7509	1.7472	1.7517	1.7510	1.7585
1 15/8	12	1.7850	83.1	1.7918	74.1	1.7850	1.7898	1.7873	1.7923	1.7898	1.7948	1.7923	1.7973
1 15/8	16	1.8070	83.8	1.8158	72.9	1.8070	1.8116	1.8094	1.8137	1.8115	1.8158	1.8136	1.8179
1 15/16	16	1.8700	83.1	1.8783	72.9	1.8700	1.8741	1.8719	1.8762	1.8740	1.8783	1.8761	1.8804
2	4 1/2	1.7590	83.5	1.7861	74.1	1.7590	1.7727	1.7661	1.7794	1.7728	1.7861	1.7794	1.7927
2	8	1.8650	83.1	1.8797	74.1	1.8650	1.8722	1.8684	1.8759	1.8722	1.8797	1.8760	1.8835
2	12	1.9100	83.1	1.9198	74.1	1.9100	1.9148	1.9123	1.9173	1.9148	1.9198	1.9173	1.9223
2	16	1.9390	83.8	1.9468	72.9	1.9390	1.9436	1.9414	1.9457	1.9435	1.9468	1.9446	1.9489
2	20	1.9460	83.1	1.9537	71.3	1.9460	1.9498	1.9477	1.9517	1.9497	1.9537	1.9516	1.9556
2 1/16	16	1.9950	83.1	2.0033	72.9	1.9950	1.9991	1.9969	2.0012	1.9990	2.0033	2.0011	2.0054
2 1/8	8	1.9900	83.1	2.0047	74.1	1.9900	1.9972	1.9934	2.0009	1.9972	2.0047	2.0040	2.0087
2 1/8	12	2.0350	83.1	2.0418	74.1	2.0350	2.0398	2.0373	2.0423	2.0398	2.0448	2.0423	2.0473
2 1/8	16	2.0570	83.8	2.0658	72.9	2.0570	2.0616	2.0594	2.0637	2.0615	2.0658	2.0636	2.0679

See footnotes at end of table.

TABLE 3.2.—Recommended hole size limits before threading for different lengths of engagement, UNC, UNF, UNEF, UN, UNS, NC, NF, NEF, and N series, class 3B—Continued

(Based on table IV.11)

Designation		Minor diameter, internal threads				Recommended hole size limits for different lengths of engagement								
Thread size	Threads per inch	Minimum	Percent of basic thread height ^b	Maximum ^c	Percent of basic thread height ^b	To and including $\frac{1}{4} D$		Above $\frac{1}{4} D$ to $\frac{1}{2} D$		Above $\frac{1}{2} D$ to $1\frac{1}{2} D$		Above $1\frac{1}{2} D$ to $3 D$		
						Min	Max	Min	Max	Min	Max	Min	Max	
No.	<i>m</i>	<i>i</i> _m		<i>i</i> _m		<i>i</i> _m	<i>i</i> _m	<i>i</i> _m	<i>i</i> _m	<i>i</i> _m	<i>i</i> _m	<i>i</i> _m	<i>i</i> _m	
	22 ₁₆	16	2.1200	83.1	2.1283	72.9	2.1200	2.1244	2.1219	2.1262	2.1240	2.1283	2.1261	2.1304
21 ₄	4 ₁₆	2.0090	83.5	2.0361	74.1	2.0090	2.0227	2.0161	2.0291	2.0228	2.0361	2.0291	2.0427	
21 ₈	8	2.1150	83.1	2.1297	74.1	2.1150	2.1222	2.1184	2.1259	2.1252	2.1267	2.1260	2.1335	
21 ₁₂	12	2.1600	83.1	2.1698	74.1	2.1600	2.1648	2.1623	2.1673	2.1648	2.1668	2.1673	2.1723	
21 ₁₆	16	2.1820	83.8	2.1908	72.9	2.1820	2.1866	2.1844	2.1887	2.1865	2.1909	2.1886	2.1929	
21 ₂₀	20	2.1960	83.1	2.2037	71.3	2.1960	2.1998	2.1977	2.2017	2.1997	2.2037	2.2016	2.2056	
25 ₁₆	16	2.2450	83.1	2.2523	72.9	2.2450	2.2491	2.2469	2.2512	2.2490	2.2533	2.2511	2.2554	
23 ₈	12	2.2850	83.1	2.2948	74.1	2.2850	2.2898	2.2873	2.2923	2.2898	2.2948	2.2923	2.2973	
23 ₁₆	16	2.3070	83.8	2.3158	72.9	2.3070	2.3116	2.3094	2.3137	2.3115	2.3158	2.3136	2.3179	
27 ₁₆	16	2.3700	83.1	2.3783	72.9	2.3700	2.3741	2.3719	2.3762	2.3740	2.3783	2.3761	2.3804	
21 ₂	4	2.2290	83.4	2.2591	74.1	2.2290	2.2411	2.2369	2.2519	2.2411	2.2591	2.2519	2.2679	
21 ₄	8	2.3650	83.1	2.3797	74.1	2.3650	2.3722	2.3684	2.3759	2.3722	2.3797	2.3760	2.3835	
21 ₈	12	2.4100	83.1	2.4198	74.1	2.4100	2.4148	2.4123	2.4173	2.4148	2.4198	2.4173	2.4223	
21 ₁₂	16	2.4320	83.8	2.4408	72.9	2.4320	2.4366	2.4344	2.4387	2.4365	2.4408	2.4386	2.4429	
21 ₂₀	20	2.4460	83.1	2.4537	71.3	2.4460	2.4498	2.4478	2.4517	2.4497	2.4537	2.4516	2.4556	
23 ₈	12	2.5250	83.1	2.5448	74.1	2.5250	2.5398	2.5373	2.5423	2.5398	2.5448	2.5423	2.5473	
23 ₁₆	16	2.5570	83.8	2.5658	72.9	2.5570	2.5616	2.5594	2.5637	2.5615	2.5658	2.5636	2.5679	
24 ₄	4	2.4790	83.4	2.5091	74.1	2.4790	2.4911	2.4869	2.5019	2.4911	2.5091	2.5019	2.5169	
24 ₈	8	2.6150	83.1	2.6297	74.1	2.6150	2.6222	2.6184	2.6259	2.6222	2.6297	2.6260	2.6335	
24 ₁₂	12	2.6600	83.1	2.6698	74.1	2.6600	2.6648	2.6623	2.6673	2.6648	2.6698	2.6673	2.6723	
24 ₁₆	16	2.6820	83.8	2.6908	72.9	2.6820	2.6866	2.6844	2.6887	2.6865	2.6908	2.6886	2.6929	
27 ₈	12	2.7850	83.1	2.7948	74.1	2.7850	2.7898	2.7873	2.7923	2.7898	2.7948	2.7923	2.7973	
27 ₁₆	16	2.8070	83.8	2.8158	72.9	2.8070	2.8116	2.8094	2.8137	2.8115	2.8158	2.8136	2.8179	
3	4	2.7290	83.4	2.7591	74.1	2.7290	2.7411	2.7369	2.7519	2.7411	2.7591	2.7519	2.7669	
3	8	2.8650	83.1	2.8797	74.1	2.8650	2.8722	2.8684	2.8759	2.8722	2.8797	2.8760	2.8835	
3	12	2.9100	83.1	2.9198	74.1	2.9100	2.9148	2.9123	2.9173	2.9148	2.9198	2.9173	2.9223	
3	16	2.9320	83.8	2.9408	72.9	2.9320	2.9366	2.9344	2.9387	2.9365	2.9408	2.9386	2.9429	
31 ₈	12	3.0340	83.1	3.0448	74.1	3.0340	3.0398	3.0373	3.0423	3.0398	3.0448	3.0423	3.0473	
31 ₁₆	16	3.0570	83.8	3.0658	72.9	3.0570	3.0616	3.0594	3.0637	3.0615	3.0658	3.0636	3.0679	
31 ₄	4	2.9790	83.4	3.0091	74.1	2.9790	2.9944	2.9869	3.0019	2.9911	3.0091	2.9919	3.0169	
31 ₈	8	3.1150	83.1	3.1297	74.1	3.1150	3.1222	3.1184	3.1259	3.1222	3.1297	3.1260	3.1335	
31 ₁₂	12	3.1600	83.1	3.1698	74.1	3.1600	3.1648	3.1623	3.1673	3.1648	3.1698	3.1673	3.1723	
31 ₁₆	16	3.1820	83.8	3.1908	72.9	3.1820	3.1866	3.1844	3.1887	3.1865	3.1908	3.1886	3.1929	
33 ₈	12	3.2850	83.1	3.2948	74.1	3.2850	3.2898	3.2873	3.2923	3.2898	3.2948	3.2923	3.2973	
33 ₁₆	16	3.3070	83.8	3.3158	72.9	3.3070	3.3116	3.3094	3.3137	3.3115	3.3158	3.3136	3.3179	
31 ₄	4	3.2290	83.4	3.2591	74.1	3.2290	3.2411	3.2369	3.2519	3.2411	3.2591	3.2519	3.2669	
31 ₈	8	3.3650	83.1	3.3797	74.1	3.3650	3.3722	3.3684	3.3759	3.3722	3.3797	3.3760	3.3835	
31 ₁₂	12	3.4100	83.1	3.4198	74.1	3.4100	3.4148	3.4123	3.4173	3.4148	3.4198	3.4173	3.4223	
31 ₂₀	20	3.4320	83.8	3.4408	72.9	3.4320	3.4366	3.4344	3.4387	3.4365	3.4408	3.4386	3.4429	
35 ₈	12	3.5340	83.1	3.5448	74.1	3.5340	3.5398	3.5373	3.5423	3.5398	3.5448	3.5423	3.5473	
35 ₁₆	16	3.5570	83.8	3.5658	72.9	3.5570	3.5616	3.5594	3.5637	3.5615	3.5658	3.5636	3.5679	
31 ₄	4	3.4790	83.4	3.5091	74.1	3.4790	3.4944	3.4869	3.5019	3.4911	3.5091	3.4919	3.5169	
31 ₈	8	3.6150	83.1	3.6297	74.1	3.6150	3.6222	3.6184	3.6259	3.6222	3.6297	3.6260	3.6335	
31 ₁₂	12	3.6600	83.1	3.6698	74.1	3.6600	3.6648	3.6623	3.6673	3.6648	3.6698	3.6673	3.6723	
31 ₁₆	16	3.6820	83.8	3.6908	72.9	3.6820	3.6866	3.6844	3.6887	3.6865	3.6908	3.6886	3.6929	
37 ₈	12	3.7850	83.1	3.7948	74.1	3.7850	3.7898	3.7873	3.7923	3.7898	3.7948	3.7923	3.7973	
37 ₁₆	16	3.8070	83.8	3.8158	72.9	3.8070	3.8116	3.8094	3.8137	3.8115	3.8158	3.8136	3.8179	
4	4	2.7290	83.4	2.7591	74.1	2.7290	2.7411	2.7369	2.7519	2.7411	2.7591	2.7519	2.7669	
4	8	3.8650	83.1	3.8797	74.1	3.8650	3.8722	3.8684	3.8759	3.8722	3.8797	3.8760	3.8835	
4	12	3.9100	83.1	3.9198	74.1	3.9100	3.9148	3.9123	3.9173	3.9148	3.9198	3.9173	3.9223	
4	16	3.9320	83.8	3.9408	72.9	3.9320	3.9366	3.9344	3.9387	3.9365	3.9408	3.9386	3.9429	
43 ₄	4	3.9790	83.4	4.0091	74.1	3.9790	3.9944	3.9869	4.0019	3.9911	4.0091	3.9919	4.0169	
43 ₈	8	4.1150	83.1	4.1297	74.1	4.1150	4.1222	4.1184	4.1259	4.1222	4.1297	4.1260	4.1335	
43 ₁₂	12	4.1600	83.1	4.1698	74.1	4.1600	4.1648	4.1623	4.1673	4.1648	4.1698	4.1673	4.1723	
43 ₁₆	16	4.1820	83.8	4.1908	72.9	4.1820	4.1866	4.1844	4.1887	4.1865	4.1908	4.1886	4.1929	
41 ₄	4	4.2290	83.4	4.2591	74.1	4.2290	4.2411	4.2369	4.2519	4.2411	4.2591	4.2519	4.2669	
41 ₈	8	4.3650	83.1	4.3797	74.1	4.3650	4.3722	4.3684	4.3759	4.3722	4.3797	4.3760	4.3835	
41 ₁₂	12	4.4100	83.1	4.4198	74.1	4.4100	4.4148	4.4123	4.4173	4.4148	4.4198	4.4173	4.4223	
41 ₂₀	20	4.4320	83.8	4.4408	72.9	4.4320	4.4366	4.4344	4.4387	4.4365	4.4408	4.4386	4.4429	
41 ₄	4	4.6150	83.1	4.6297	74.1	4.6150	4.6222	4.6184	4.6259	4.6222	4.6297	4.6260	4.6335	
41 ₈	8	4.6600	83.1	4.6698	74.1	4.6600	4.6648	4.6623	4.6673	4.6648	4.6698	4.6673	4.6723	
41 ₁₆	16	4.6820	83.8	4.6908	72.9	4.6820	4.6866	4.6844	4.6887	4.6865	4.6908	4.6886	4.6929	
5	8	4.8650	83.1	4.8797	74.1	4.8650	4.8722	4.8684	4.8759	4.8722	4.8797	4.8760	4.8835	
5	12	4.9100	83.1	4.9198	74.1	4.9100	4.9148	4.9123	4.9173	4.9148	4.9198	4.9173	4.9223	
5	16	4.9320	83.8	4.9408	72.9	4.9320	4.9366	4.9344	4.9387	4.9365	4.9408	4.9386	4.9429	

See footnotes at end of table.

TABLE 3.2.—Recommended hole size limits before threading for different lengths of engagement, UNC, UNF, UNEF, UN, UNS, NC, NF, NEF, and N series, class 5B—Continued

(Based on table IV.11*)

Designation		Minor diameter, internal threads				Recommended hole size limits for different lengths of engagement							
Thread size	Threads per inch	Minimum	Percent of basic thread height ^b	Maximum	Percent of basic thread height ^b	To and including 1/4 D		Above 1/4 D to 3/4 D		Above 3/4 D to 1 1/2 D		Above 1 1/2 D to 3 D	
						Min	Max	Min	Max	Min	Max	Min	Max
No. in.		in.		in.		in.	in.	in.	in.	in.	in.	in.	in.
5/16	8	5.1150	83.1	5.1297	74.1	5.1150	5.1222	5.1184	5.1259	5.1222	5.1297	5.1260	5.1335
5/16	12	5.1600	83.1	5.1698	74.1	5.1600	5.1648	5.1623	5.1673	5.1648	5.1696	5.1673	5.1723
5/16	16	5.1820	83.8	5.1908	72.9	5.1820	5.1866	5.1844	5.1887	5.1865	5.1908	5.1886	5.1929
5/8	8	5.3650	83.1	5.3797	74.1	5.3650	5.3722	5.3684	5.3759	5.3722	5.3797	5.3760	5.3835
5/8	12	5.4100	83.1	5.4198	74.1	5.4100	5.4148	5.4123	5.4173	5.4148	5.4196	5.4173	5.4223
5/8	16	5.4320	83.8	5.4408	72.9	5.4320	5.4366	5.4344	5.4387	5.4365	5.4408	5.4386	5.4429
5/8	8	5.6150	83.1	5.6297	74.1	5.6150	5.6222	5.6184	5.6259	5.6222	5.6297	5.6260	5.6335
5/8	12	5.6600	83.1	5.6698	74.1	5.6600	5.6648	5.6623	5.6673	5.6648	5.6696	5.6673	5.6723
5/8	16	5.6820	83.8	5.6908	72.9	5.6820	5.6866	5.6844	5.6887	5.6865	5.6908	5.6886	5.6929
6	8	5.8650	83.1	5.8797	74.1	5.8650	5.8722	5.8684	5.8759	5.8722	5.8797	5.8760	5.8835
6	12	5.9100	83.1	5.9198	74.1	5.9100	5.9148	5.9123	5.9173	5.9148	5.9196	5.9173	5.9223
6	16	5.9320	83.8	5.9408	72.9	5.9320	5.9366	5.9344	5.9387	5.9365	5.9408	5.9386	5.9429

* The differences between limits are equal to the minor-diameter tolerances given in table IV.11 for lengths of engagement to and including 1/4 D. However, the minimum values for lengths of engagements greater than 1/4 D in sizes 1/4 in. and larger are adjusted so that the difference between limits is never less than 0.0040 in. For diameter-pitch combinations other than those given in this table, the tolerances given in table IV.11 should be similarly applied to determine hole size limits.

- ^b Based on values as rounded off in the preceding column.
- ^c Based on a length of engagement equal to the nominal diameter.

TABLE 3.3.—Recommended hole size limits before threading for different lengths of engagement, National Miniature thread series

Designation		Minor diameter, internal threads				Recommended hole size limits for different lengths of engagement ^b					
Thread designation ^a	Pitch	Minimum	Percent basic thread height	Maximum	Percent basic thread height	To and including 3/8 D		Above 3/8 D to 1 1/2 D		Above 1 1/2 D to 3 D	
						Min.	Max.	Min.	Max.	Min.	Max.
	mm	mm		mm		mm	mm	mm	mm	mm	mm
30NM	0.080	0.217	100	0.254	54.8	0.226	0.240	0.236	0.254	0.245	0.264
35NM	.090	.256	100	.297	56.4	.267	.282	.277	.297	.287	.307
40NM	.100	.296	100	.340	57.7	.307	.324	.318	.340	.329	.351
45NM	.100	.346	100	.390	57.7	.357	.374	.368	.390	.379	.401
50NM	.125	.370	100	.422	60.0	.383	.402	.396	.422	.409	.435
55NM	.125	.420	100	.472	60.0	.433	.452	.446	.472	.459	.485
60NM	.150	.444	100	.504	61.5	.459	.482	.474	.504	.489	.519
70NM	.175	.518	100	.586	62.6	.535	.560	.552	.586	.569	.603
80NM	.200	.592	100	.668	63.5	.611	.640	.630	.668	.649	.687
90NM	.225	.666	100	.750	64.1	.687	.718	.708	.750	.729	.771
100NM	.250	.740	100	.832	64.6	.763	.798	.786	.832	.809	.855
110NM	.250	.840	100	.932	64.6	.863	.898	.886	.932	.909	.955
120NM	.250	.940	100	1.032	64.6	.963	.998	.986	1.032	1.009	1.055
140NM	.300	1.088	100	1.196	65.4	1.115	1.156	1.142	1.196	1.169	1.223
	Threads per inch	in.		in.		in.	in.	in.	in.	in.	in.
30NM	318	0.0085	100	0.0100	54.8	0.0080	0.0095	0.0093	0.0100	0.0096	0.0104
35NM	282	.0101	100	.0117	56.4	.0105	.0111	.0109	.0117	.0113	.0121
40NM	254	.0117	100	.0134	57.7	.0121	.0127	.0125	.0134	.0130	.0138
45NM	254	.0136	100	.0154	57.7	.0141	.0147	.0145	.0154	.0149	.0158
50NM	203	.0146	100	.0166	60.0	.0150	.0158	.0156	.0166	.0161	.0171
55NM	203	.0165	100	.0186	60.0	.0170	.0178	.0176	.0186	.0181	.0191
60NM	169	.0175	100	.0198	61.5	.0181	.0190	.0187	.0198	.0193	.0204
70NM	145	.0204	100	.0231	62.6	.0211	.0221	.0217	.0231	.0224	.0237
80NM	127	.0233	100	.0263	63.5	.0241	.0252	.0248	.0263	.0256	.0270
90NM	113	.0262	100	.0295	64.1	.0270	.0283	.0279	.0295	.0287	.0304
100NM	102	.0291	100	.0327	64.6	.0300	.0314	.0309	.0327	.0319	.0337
110NM	102	.0331	100	.0367	64.6	.0340	.0354	.0349	.0367	.0358	.0376
120NM	102	.0370	100	.0406	64.6	.0379	.0393	.0388	.0406	.0397	.0415
140NM	85	.0428	100	.0471	65.4	.0439	.0455	.0450	.0471	.0460	.0481

^a The sizes shown in *italic* are preferred. It is recommended that selections be confined to these sizes insofar as possible.

^b The limits recommended in this table are subject to further exploration. Limited experience with this new standard to date indicates these sizes to be suitable for use in a wide variety of materials (brass, nickel-silver, etc.). For materials more difficult to machine, hole size limits in the next larger category are suggested. In the larger size hole sizes, in excess of the maximum minor diameter are necessary, the excess is usually recovered in the thread form by the spin-up operation. The spin-up operation is the one with which these small taps must be ground.

APPENDIX 4. WIRE METHODS OF MEASUREMENT OF PITCH DIAMETER OF 60° THREADS

Pitch diameter is defined in section II, p. 4, as follows: "On a straight thread, the pitch diameter is the diameter of the coaxial cylinder, the surface of which would pass through the thread profiles at such points as to make the width of the groove equal to one-half of the basic pitch. On a perfect thread this occurs at the points where the widths of the thread and groove are equal."

"On a taper thread, the pitch diameter at a given position on the thread axis is the diameter of the pitch cone at that position."

The degree of accuracy to which the pitch diameter can be measured will depend on the accuracy of lead, helix, and form of thread. As thread plug gages and thread setting plug gages have highly accurate threads, their pitch diameters may be measured to a correspondingly high degree of accuracy by applying the methods described in this appendix. In turn, the virtual diameters (or effective sizes) of thread ring, snap, and indicating gages may be determined by fitting or comparison with such plug gages.

As most threads of mechanical fasteners and components are made to a lesser degree of accuracy than that of gage threads, their pitch diameters are not susceptible to accurate determination by direct measuring methods. On such threads the pitch diameter is to be regarded as the pitch cylinder or cone which would bound, on the maximum material side, the approximately cylindrical or conical surface which would pass through the thread profiles at all points such that the widths of the thread and groove are equal. Accordingly, the conformity of such threads with specified pitch diameter limits is determined by gaging means and methods specified in section VI.

The accurate measurement of pitch diameter of a thread, which may be perfect as to form and lead, presents certain difficulties which result in some uncertainty as to its true value. The adoption of a standard uniform practice in making such measurements is, therefore, desirable in order to reduce such uncertainty of measurement to a minimum. The so-called "three-wire method" of measuring pitch diameter, as here outlined, has been found to be the most generally satisfactory method when properly carried out, and is recommended for universal use in the direct measurement of thread plug and thread setting plug gages. (See fig. 4.1.)

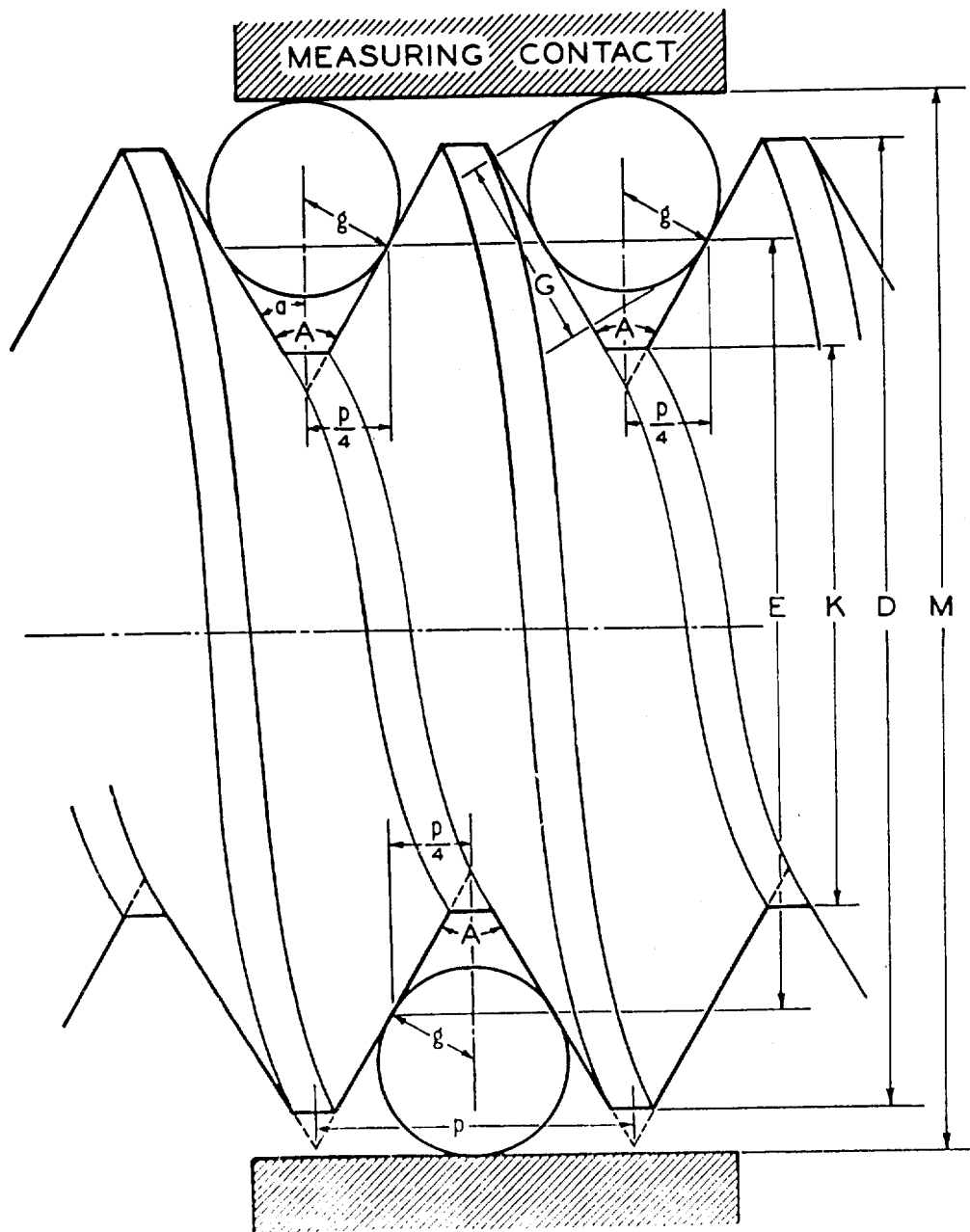

FIGURE 4.1 Three-wire method of measuring pitch diameter of thread plug gages.

1. SIZE OF WIRES

In the three-wire method of measuring pitch diameter small hardened steel cylinders or wires of correct size are placed in the thread space, two on one side of the screw and one on the opposite side, as shown in figure 4.1. The contact face of the comparator, measuring machine, or micrometer anvil or spindle over the two wires must be sufficiently large in diameter to touch both wires; that is, the diameter must be greater than the pitch of the thread. It is best to select wires of such a size that they touch the sides of the thread at the midslope, for the reason that the measurement of pitch diameter is least affected by any error in thread angle that may be present when such size is used. The size of wire that touches exactly at the midslope of a perfect thread of a given pitch is termed the "best-size" wire for that pitch. Any size, however, may be used that will permit the wires to rest on the sides of the thread and also project above the crest of the thread.

The depth at which a wire of given diameter will rest in a thread space depends primarily on the pitch and included angle of the thread; and secondarily, on the angle made by the helix, at the point of contact of the wire and the thread, with a plane perpendicular to the axis of the thread. Inasmuch as variation in the lead angle has a very small effect in determining the diameter of the wire that touches at the midslope of the thread, and as it is desirable to use one size of wire to measure all threads of a given pitch and included angle, the best size wire is taken as that size which will touch at the midslope of a groove cut around a cylinder perpendicular to the axis of the cylinder, and of the same angle and depth as the thread of the given pitch. This is equivalent to a thread of zero lead angle. The size of wire touching at the midslope, or "best-size" wire, is given by the formula:

$$G = \frac{p}{2} \sec \alpha$$

in which

G = diameter of wire

p = pitch

α = $\frac{1}{2}$ included angle of thread.

This formula reduces to —

$$G = 0.57735 \times p, \text{ for } 60^\circ \text{ threads.}$$

It is frequently desirable, as, for example, when a best-size wire is not available, to measure pitch diameter by means of wires of other than the best size. The minimum size that may be used is limited to that permitting the wire to project above the crest of the thread, and the maximum to that permitting the wire to rest on the sides of the thread just below the crest, and not ride on the crest of the thread. The diameters of the best size, maximum, and minimum wires for Unified and American, American National, hose-coupling, and pipe threads are given in tables 4.1 and 4.2.

2. METHODS OF MEASURING AND USING WIRES

The computed value for the pitch diameter of a screw thread gage obtained from readings over wires will depend upon the accuracy of the measuring instrument used, the contact load, and the value of the diameter of the wires used in the computations. In order to measure the pitch diameter of a screw-thread gage to an accuracy within 0.0001 in. by means of wires, it is necessary to know the wire diameters to 0.00002 in. If the diameters of the wires are known only to an accuracy of 0.0001 in., an accuracy better than 0.0003 in. in the measurement of pitch diameter cannot be expected. Accordingly, it is necessary to use a measuring instrument that reads accurately to 0.00001 in.

Variations in diameter around the wire should be determined by rotating the wire between a measuring contact and an anvil having the form of a V-groove cut on a cylinder. The V-groove may be the thread space in a hardened and well-finished thread plug gage. Variations in

TABLE 4.1.—Wire sizes and constants, Unified and American, American National, hose-coupling, and pipe threads (60°)

Threads per inch, n	Pitch, $\frac{1}{n}$	Pitch $\frac{1}{2n}$	Depth of V thread, $\frac{\cot 30^\circ}{2n}$	Wire sizes, ¹		
				Best, 0.57735p	Maximum, 1.01036p	Minimum, 0.505182p
1	2	3	4	5	6	7
80	0.012500	0.006250	0.010825	0.00722	0.01263	0.00631
72	0.013889	0.006944	0.012028	0.00802	0.01403	0.00702
64	0.015625	0.007812	0.013532	0.00902	0.01579	0.00789
56	0.017857	0.008928	0.015385	0.01031	0.01801	0.00902
50	0.020000	0.010000	0.017321	0.01155	0.02021	0.01010
48	0.020833	0.010412	0.018042	0.01203	0.02105	0.01052
44	0.022727	0.01136	0.019682	0.01312	0.02296	0.01148
40	0.025000	0.012500	0.021651	0.01443	0.02526	0.01263
36	0.027778	0.01389	0.024076	0.01601	0.02807	0.01404
32	0.031250	0.015625	0.027068	0.01801	0.03157	0.01579
30	0.033333	0.01667	0.028888	0.01921	0.03388	0.01684
28	0.035714	0.01786	0.030929	0.02062	0.03608	0.01801
27	0.037037	0.01852	0.032075	0.02148	0.03742	0.01851
26	0.038462	0.01923	0.033409	0.02221	0.03886	0.01943
24	0.041667	0.02083	0.036084	0.02406	0.04210	0.02105
22	0.045455	0.02273	0.039665	0.02624	0.04592	0.02296
20	0.050000	0.025000	0.043301	0.02857	0.05052	0.02526
18	0.055556	0.02778	0.048139	0.03208	0.05614	0.02807
16	0.062500	0.03125	0.054123	0.03608	0.06315	0.03157
14	0.071429	0.03571	0.061859	0.04124	0.07217	0.03608
13	0.076923	0.03846	0.066467	0.04411	0.07772	0.03886
12	0.083333	0.04167	0.072109	0.04811	0.08420	0.04210
11 $\frac{1}{2}$	0.087037	0.04352	0.075307	0.05020	0.08786	0.04393
11	0.090909	0.04545	0.078730	0.05249	0.09185	0.04593
10	0.100000	0.050000	0.086603	0.05774	0.10104	0.05052
9	0.111111	0.05556	0.096225	0.06415	0.11226	0.05613
8	0.125000	0.06250	0.108263	0.07217	0.12630	0.06315
7 $\frac{1}{2}$	0.133333	0.06667	0.11470	0.07698	0.13444	0.06736
7	0.142857	0.07143	0.123718	0.08248	0.14444	0.07217
6	0.166667	0.08333	0.144638	0.09623	0.16839	0.08420
5 $\frac{1}{2}$	0.181818	0.09091	0.157459	0.10497	0.18370	0.09185
5	0.200000	0.10000	0.173295	0.11547	0.20297	0.10104
4 $\frac{1}{2}$	0.222222	0.11111	0.192450	0.12830	0.22459	0.11226
4	0.250000	0.12500	0.216306	0.14434	0.25239	0.12630

¹ These wire sizes are based on zero lead angle. Also maximum and minimum sizes are based on a width of flat at the crest equal to $\frac{1}{8} \times p$. The width of flat of American Standard pipe thread gages is slightly less than this, so that the minimum size listed is slightly too small for such gages. In any case the use of wires of either extreme size is to be avoided.

diameter along the wire should be determined by measuring between a flat contact and a cylindrical anvil.

A wire presses on the sides of a 60° thread with the load that is applied to the wire by the measuring instrument. This fact would indicate that the diameter of the wire should be determined by readings made on the wire over a hardened and lapped cylinder having a radius equal to the radius of curvature of the helical surface of the thread at the point of contact, using the load to be used in determining the pitch diameter of the gage. However, it is not practical to employ such a variety of cylinders as would be required, and it is recommended for standard practice that diameters of wires be measured between a flat contact and a 0.750-in. hardened and accurately ground and lapped steel cylinder with the load used in measuring the pitch diameter of the gage. The plane of the flat contact should be parallel to the contact element of the cylinder within 0.00001 in.

To avoid a deformation of the material of the wires and gages it is necessary to limit the contact load, and for consistent results a standard practice as to contact load in making wire measurements of hardened screw thread gages is necessary. Such a standard practice is included in the specifications below, and in section VI, p. 109. The use of different contact loads will cause a difference in the readings over the wires, and such errors can be compensated only by the use of a value for the diameter of the wires depending on the contact load used. The effect of variation in contact load in measuring threads of fine pitches is indicated by the difference in readings obtained with 2

TABLE 4.2.—Relation of best wire diameters and pitches¹—wires for Unified and American, American National, hose-coupling, and pipe threads (60°)

Best wire sizes (in inches)	Threads per inch																																				
	80	72	64	56	50	48	44	40	36	32	30	28	27	26	24	22	20	18	16	14	13	12	11½	11	10	9	8	7½	7	6	5½	5	4½	4			
0.00722																																					
0.00892																																					
0.01062																																					
0.0131																																					
0.0155																																					
0.01203																																					
0.01312																																					
0.01443																																					
0.01604																																					
0.01804																																					
0.01924																																					
0.02062																																					
0.02138																																					
0.02221																																					
0.02406																																					
0.02624																																					
0.02887																																					
0.03208																																					
0.03608																																					
0.04124																																					
0.04441																																					
0.04811																																					
0.05219																																					
0.05249																																					
0.05774																																					
0.06415																																					
0.07212																																					
0.07698																																					
0.08248																																					
0.09623																																					
0.10492																																					
0.11517																																					
0.12889																																					
0.14434																																					

¹ The crosses (X) indicate those wire diameters which can be used for each pitch. An encircled cross (⊗) indicates the "best wire" diameter for that pitch which begins the column.

and 5 lb loads on a 24-pitch thread plug gage. The reading over the wires with 5 lb load was 0.0001 in. less than with 2 lb load. The common shop practice of holding the wires in contact with the thread by means of elastic bands has a tendency to prevent the wires from adjusting themselves to the proper position in the thread spaces; thus a false measurement is obtained. In some cases it has also been the practice to support the gage being measured on two wires, which are in turn supported on a horizontal surface, and measuring from this surface to the top of a wire placed in a thread over the gage. If the gage is of large diameter, its weight causes a distortion of the wires and an inaccurate reading is obtained. For these reasons these practices should be avoided.

Measurements of a thread plug gage made in accordance with these instructions, with wires that conform to the following specifications, should be accurate to within 0.0001 in.

3. STANDARD SPECIFICATION FOR WIRES AND STANDARD PRACTICE IN MEASUREMENT OF WIRES

The following specifications represent present practice relative to thread measuring wires:

1. **COMPOSITION.** The wires shall be accurately finished hardened steel cylinders of the maximum possible hardness without being brittle. The hardness shall not be less than that corresponding to a Knoop indentation number of 630. A wire of this hardness can be cut with a file only with difficulty. The surface shall not be rougher than the equivalent of one measuring 3 microminches average deviation from a true cylindrical surface, as measured with a tracer instrument.

2. **CONSTRUCTION.** The working surface shall be at least 1 in. in length. The wire may be provided with a suitable means of suspension.

3. **CONTAINER AND MARKING.**—A suitable container shall be provided for each set of wires, and the pitch for which the wires are the best size and the diameter of the working part of the wires, as determined by measurements under standard conditions as specified below, shall be marked on the container.

4. **DIAMETER OF WIRES.**—One set of wires shall consist of three wires that shall have the same diameter within 0.00002 in., and this common diameter shall be within 0.0001 in. of that corresponding to the best size for the pitch for which the wire is to be used. Wires shall be measured between a flat contact and a 0.750-in. hardened and accurately ground and lapped steel cylinder with contact loads as follows: Wires for 60° threads and pitches finer than 20 threads per inch, 1 lb; wires for pitches of 20 threads per inch and coarser, 2½ lb. It is recommended that wires, which are to be used where the contact of the wire is a line contact, be measured between flat, parallel measuring contacts under a 1-lb load.

5. **VARIATIONS IN DIAMETER.**—Variations in diameter around the wire (roundness) shall not exceed 0.00002 in., as determined by measuring between a measuring contact and a hardened and well-finished 60° V-groove cut on a cylinder. Variations in diameter along the wire (taper), over the ½ in. interval at the center of its length, shall not exceed 0.00002 in., as determined by measuring between a flat contact and a cylindrical contact.

Tests for compliance of thread-measuring wires with the above specifications are made by the National Bureau of Standards for a stated fee.

4. GENERAL FORMULA FOR MEASUREMENT OF PITCH DIAMETER

The general formula for determining the pitch diameter of any thread whose sides are symmetrical with respect to a line drawn through the vertex and perpendicular to

the axis of the thread, in which the slight effect of lead angle is taken into account, is

$$E = M_w + \frac{\cot \alpha}{2n} - w[1 + (\operatorname{cosec}^2 \alpha + \cot^2 \alpha \tan^2 \lambda')^2], \quad (1)$$

in which

- E = pitch diameter
- M_w = measurement over wires
- α = half angle of thread
- n = number of threads per inch = $1/p$
- w = mean diameter of wires
- λ' = angle between axis of wire and plane perpendicular to axis of thread.

This formula is a very close approximation, being based on certain assumptions regarding the positions of the points of contact between the wire and the thread.

Formula 1 can be converted to the following simplified form, which is particularly useful when measuring threads of large lead angle:

$$E = M_w + \frac{\cot \alpha}{2n} - w(1 + \operatorname{cosec} \alpha'), \quad (2)$$

in which α' = the angle whose tangent = $\tan \alpha \cos \lambda'$.

When formula 1 is used, the usual practice is to expand the square root term as a series, retaining only the first and second terms, which gives the following:

$$E = M_w + \frac{\cot \alpha}{2n} - w \left(1 + \operatorname{cosec} \alpha + \frac{\tan^2 \lambda' \cos \alpha \cot \alpha}{2} \right). \quad (3)$$

For large lead angles it is necessary to measure the wire angle, λ' , but for lead angles of 5° or less, if the "best-size" wire is used, this angle may be assumed to be equal to the lead angle of the thread at the pitch line, λ . The value of $\tan \lambda$, the tangent of the lead angle, is given by the formula

$$\tan \lambda = \frac{l}{3.1416E} = \frac{l}{3.1416NE}$$

in which

- l = lead
- N = number of turns per inch
- E = nominal pitch diameter, or an approximation of the measured pitch diameter.

5. MEASUREMENT OF PITCH DIAMETER OF UNIFIED, AMERICAN, AND AMERICAN NATIONAL STRAIGHT THREADS

For threads of the Unified, American, and American National coarse, fine, extra-fine, 8-, 12-, and 16-thread series, the term

$$\frac{w \tan^2 \lambda' \cos \alpha \cot \alpha}{2}$$

is neglected, as its value is small, being in all cases less than 0.00015 in. for standard fastening screws when the best-size wire is used, and the above formula 3 takes the simplified form

$$E = M_w + \frac{\cot \alpha}{2n} - w(1 + \operatorname{cosec} \alpha). \quad (4)$$

The practice is permissible provided that it is uniformly followed, and in order to maintain uniformity of practice, and thus avoid confusion, the National Bureau of Standards uses formula 4 for such threads. The Bureau also uses formula 4 for special 60° threads, except when the value of the term

$$\left(\frac{w \tan^2 \lambda' \cos \alpha \cot \alpha}{2} \right)$$

exceeds 0.00015 in., as in the case of multiple threads, or other threads having exceptionally large lead angles. For 60° threads this term exceeds 0.00015 when $NE\sqrt{n}$ is less than 17.1.

For a 60° thread of correct angle and thread form the formula 4 simplifies to

$$E = M_w + \frac{0.86603}{n} - 3w. \quad (5)$$

For a given set of best-size wires

$$E = M_w - C$$

when

$$C = w(1 + \operatorname{cosec} \alpha) - \frac{\cot \alpha}{2n}.$$

The quantity C is a constant for a given thread angle, and, when the wires are used for measuring threads of the pitch and angle for which they are the best size, the pitch diameter is obtained by the simple operation of subtracting this constant from the measurement taken over the wires. In fact, when best-size wires are used, this constant is changed very little by a moderate deviation or error in the angle of the thread. Consequently, the constants for the various sets of wires in use may be tabulated, thus saving a considerable amount of time in the inspection of gages. However, when wires of other than the best size are used, this constant changes appreciably with a deviation in the angle of the thread.

It has been shown that, with the exception of coarse pitch screws, variation in angle from the basic size causes no appreciable change in the quantity C for the best-size wires. On the other hand, when a wire near the maximum or minimum allowable size is used, a considerable change occurs, and the values of the cotangent and cosecant of the actual measured half angle are to be used. It is apparent, therefore, that there is a great advantage in using wires very closely approximating the best size. For convenience in carrying out computations, the values of $\cot \alpha/2n$ for standard pitches are given in table 4.1, p. 195.

6. MEASUREMENT OF PITCH DIAMETER OF AMERICAN STANDARD TAPER THREADS

The pitch diameter of a taper thread plug gage is measured in much the same manner as that of a straight thread gage, except that a definite position at which the measurement is to be made must be located. A point at a known distance L from the reference end of the gage is located by means of a combination of precision gage blocks and the cone point furnished as an accessory with these blocks, as shown in the inset in figure 4.2. The gage is set vertically on a surface plate, the cone point is placed with its axis horizontal at the desired height, and the plug is turned until the point fits accurately into the thread. The position of this point is marked carefully with a pencil or a bit of prussian blue.

1. TWO-WIRE METHOD.—Assuming that the measurement is to be made with a horizontal comparator, the gage is set in the comparator with its axis vertical, that is, the line of measurement and the thread axis are perpendicular to each other. The measurement is made with two wires, as shown in figure 4.2, one of which is placed in the thread to make contact at the same axial section of the thread as was touched by the cone point. This wire is designated the fixed wire. The second wire is placed in the thread space, on the opposite side of the gage, which is next above the fixed wire, and the measurement over the wires is made. The second wire is then placed in the thread space next below the fixed wire, and a second measurement is made. The average of these two measurements is M_w , the measurement over the wires at the position of the fixed wire.

The general formula for a taper thread, corresponding to formula 3 is

$$E = M_w + \frac{\cot \alpha}{2n} - \frac{\tan^2 \beta \tan \alpha}{2n} - w \left(1 + \operatorname{cosec} \alpha + \frac{\tan^2 \lambda' \cos \alpha \cot \alpha}{2} \right), \quad (6)$$

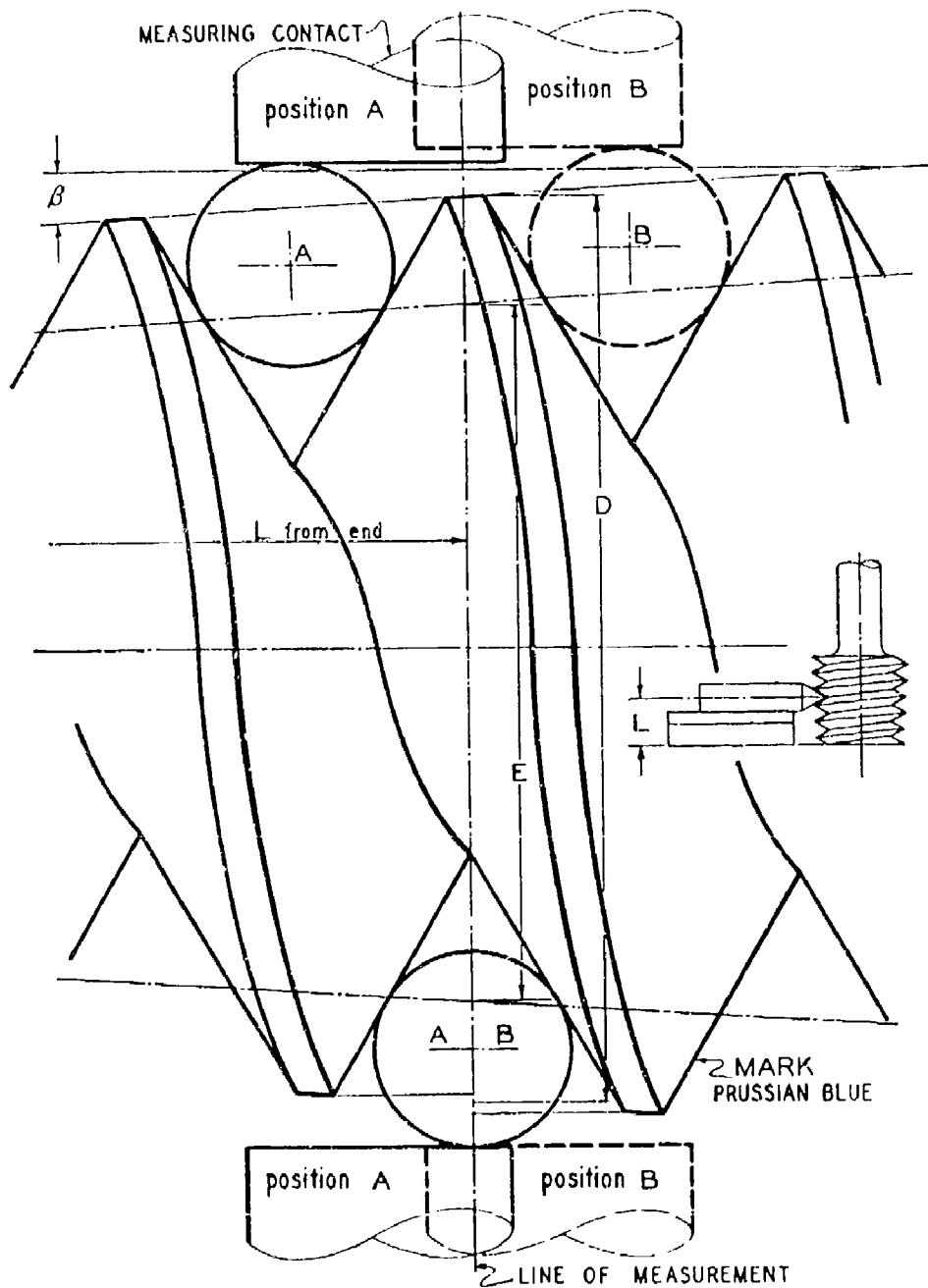

FIGURE 4.2.—Measurement of pitch diameter of taper thread gages by the 2-wire method.

in which

- E = pitch diameter
- M_w = measurement over wires
- β = half angle of taper of thread
- n = number of threads per inch = $1/p$
- α = half angle of thread
- w = mean diameter of wires
- λ' = wire angle.

The term

$$\frac{\cot \alpha - \tan^2 \beta \tan \alpha}{2n}$$

is the exact value of the depth of the fundamental triangle of a taper thread, which is less than that of the same-pitch thread cut on a cylinder. For steep-tapered thread gages, having an included taper larger than $\frac{3}{4}$ in./ft this more

accurate term should be applied. For such a thread, which has a small lead angle, formula 6 takes the form

$$E = M_w + \frac{\cot \alpha - \tan^2 \beta \tan \alpha}{2n} - w(1 + \operatorname{cosec} \alpha) \quad (7)$$

Otherwise, as for American standard taper pipe threads having an included taper of $\frac{3}{4}$ in./ft, the simplified formula 5

$$E = M_w + \frac{0.86603}{n} - 3w$$

for 60° threads may be used. This simplified formula gives a value of E that is 0.00005 in. larger than that given by the above general formula 6 for the $2\frac{1}{2}$ in.-8 American Standard taper pipe thread, the worst case in this thread series.

The pitch diameter at any other point along the thread, as at the gaging notch, is obtained by multiplying the distance parallel to the axis of the thread, between this point and the point at which the measurement was taken, by the taper per inch, then adding the product to or subtracting it from the measured pitch diameter according to the direction in which the second point is located with respect to the first.

2. **THREE-WIRE METHOD.**—Depending on the measuring facilities available or other circumstances, it is sometimes more convenient to use three wires. In such cases measurement is made in the usual manner, but care must be taken that the measuring contacts touch all three wires, as the line of measurement is not perpendicular to the axis of the screw when there is proper contact (see fig. 4.3).

On account of this inclination, the measured distance between the axes of the wires must be multiplied by the secant of the half angle of the taper of the thread. The

formula for the pitch diameter of any taper thread plug gage, the threads of which are symmetrical with respect to a line perpendicular to the axis, then has the form corresponding to formula 4:

$$E = (M_w - w) \sec \beta + \frac{\cot \alpha}{2n} - w \operatorname{cosec} \alpha, \quad (8)$$

in which β = half-angle of taper of thread. Thus the pitch diameter of an American Standard pipe-thread gage having correct angle (60°) and taper ($\frac{3}{4}$ in./ft.) is then given by the formula

$$E = 1.00049(M_w - w) + 0.86603 p - 2w. \quad (9)$$

An adaption of the three-wire method is frequently used to reduce the time required when the pitch diameter of a

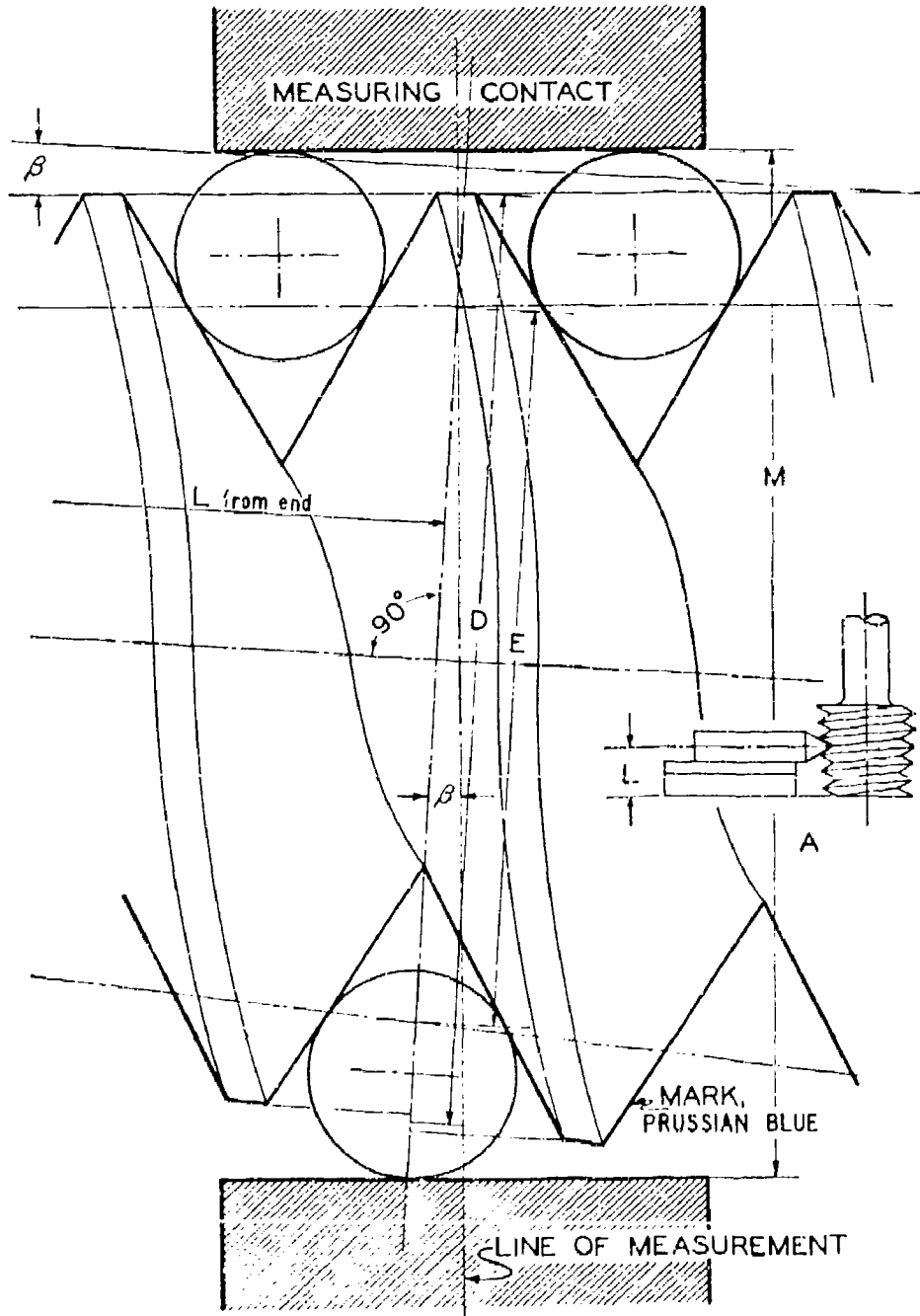

FIGURE 4.3.—Measurement of pitch diameter of taper thread gages by the 3-wire method

number of gages of the same size is to be measured. Only light gages, up to about 2 in., can be measured accurately by this method. The gage is supported on two wires placed several threads apart, which are in turn supported on a taper thread testing fixture. The third wire is placed in the threads at the top of the gage and measurement is made from the top of this wire to the bottom of the fixture with a vertical comparator or having a flat anvil, using a gage block combination as the standard. The fixture consists of a block, the upper surface of which is at an angle to the base plane equal to the nominal angle of taper of the thread, 2 β . Thus the element of the cone at the top of the thread gage is made parallel to the base of the instrument. The direction of measurement is not perpendicular to the axis of the gage but at an angle, β , from perpendicularity. A stop is provided at the thick end of the block with respect to which the gage is positioned on the fixture. As the plane of the end of the gage may not be perpendicular to the axis, a roll approximately equal to the diameter of the gage should be inserted between the stop and the gage to assure contact at the axis of the gage. For a given fixture and roll, a constant is computed which, when subtracted from the measured distance from the top of the upper wire to the base plane, gives M corresponding to the pitch diameter, E_0 , at the small end of the gage. E_0 is then determined by applying formula 8 or 9.

3. FOUR-WIRE METHOD.—A four-wire method of measurement that yields measurements of the pitch diameter, E_0 , at the small end of the gage, and the half-angle of taper, β , is also sometimes used. This method is illustrated in figure 4.4 and requires four thread wires of equal diameter, a pair of gage blocks of equal thickness, and two pairs of rolls of different diameters, the rolls of each pair being equal in diameter. Two measurements, M_1 and M_2 , are made over the rolls and formulas are applied as follows:

$$\cot \frac{90^\circ - \beta}{2} = \frac{M_2 - M_1 + d_1 - d_2}{d_2 - d_1}, \quad (10)$$

$$M_w = M_2 - d_2 \left(1 + \cot \frac{90^\circ - \beta}{2} \right) - 2g \sec \beta, \quad (11)$$

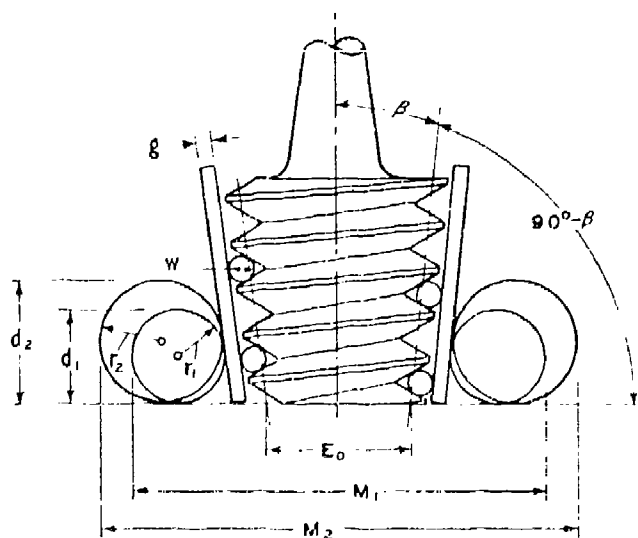

FIGURE 4.4.—Measurement of pitch diameter of taper thread gages by the 4-wire method.

in which

- M_2 = measurement over larger rolls
- M_1 = measurement over smaller rolls
- d_2 = diameter of larger rolls
- d_1 = diameter of smaller rolls
- β = actual half-angle of taper of thread
- g = thickness of each gage block.

To determine E_0 , the pitch diameter at the small end of the gage, M_w , as determined from formula 11, is substituted in formula 6 or 7.

The errors of measurement by this method may be slightly but not significantly larger than by the other methods described, on account of elastic deformations of the rolls and gage blocks under the measuring load, and differing conditions of loading of the thread wires.

7. MEASUREMENT OF PITCH DIAMETER OF THREAD RING GAGES

The application of direct methods of measurement to determine the pitch diameter of thread ring gages presents serious difficulties, particularly in securing proper contact load when a high degree of precision is required. The usual practice is to fit the ring gage to a threaded setting plug. When the thread ring gage is of correct lead, angle, and thread form, within close limits, this method is satisfactory and represents standard American practice. It is the only method available for small sizes of threads. For the larger sizes, various more or less satisfactory methods have been devised, but none of these have found wide application.

APPENDIX 5. DESIGN OF SPECIAL THREADS

1. GENERAL

In general, any given problem in thread design may be susceptible to several more or less satisfactory solutions based on the preliminary selection of certain elements of the design and the proper adjustment of the other elements. In other words, thread design is to a large extent empirical and is partially based on previous experience with similar designs and the judgment of the designer. Accordingly, it is not practicable to present a definite system of approach to the design of a threaded assembly but merely to present a discussion of various design factors.

The interrelation of length of engagement, minimum major diameter of the external thread, maximum minor diameter of the internal thread, and the strength of the assembled thread needs to be understood and carefully considered in order to produce the optimum design of a special thread. It is not economical to use either a length of thread engagement which is longer than required or shorter than that which will develop the full strength of the externally threaded member. Other factors, such as control of tap breakage, proper seating of a threaded part on a shoulder, the prevention of cross threading, conditions of loading when the assembled parts are not concentric, and possible collapse of a hollow externally threaded member, require careful analysis and adjustment of the design with respect to selection of the diameter-pitch combination, the class of thread, length of engagement, and major and minor diameter tolerances.

In redesigning threads from American National to Unified standards, it should be remembered that exact correspondence between the old and new class numbers does not exist. For most, but not all, diameter-pitch combinations, the combined tolerances and allowances of the Unified classes are somewhat larger than American National classes of corresponding number. Recommended procedure is to convert the thread to the corresponding class of Unified thread, compare the new major, pitch, and minor diameter tolerances with the old tolerances, and then give careful consideration to the desirability of the new limits of size.

Taking, for example, the conversion of a class 1 thread to classes 1A and 1B: Under ordinary conditions where the thread is being used only as a simple fastener and the length of engagement is normal, such substitution may be made. If, for any reason, the previously specified tolerances may not be exceeded, it may be necessary to specify class 2A or 2B or both. Also, if the thread must carry a high axial stress or if concentricity of the two mating parts is a factor, the conversion should be from class 1 to classes 2A and 2B.

A close fitting thread assembly under some conditions may fail, whereas the cause of failure may be eliminated by providing a looser fit. A cap screw that seats only on one side of the bearing surface under the head may break off when the screw is tightened. When a screw has a large bearing surface under the head or when the head must be square with a projecting pin, sufficient pitch diameter clearance must be provided to allow for any out-of-square-ness of the screw axis with the bearing surface under the head. Thus, as large a pitch diameter tolerance as possible, together with providing proper tolerances on squareness of face with the thread axis where seating is required, may avoid the necessity for specifying a heat treated bolt.

2. ECCENTRICITY OF ASSEMBLY AND CROSS THREADING

In assembly and use, the combined tolerances and allowances on both mating parts should not allow threads to disengage on one side when assembly is eccentric. The axis of the internal thread can be displaced radially from coincidence with the axis of the external thread by an amount equal to the sum of the pitch diameter tolerances and the allowance. This radial displacement may be sufficient so that the flank contact is entirely on one side and on the opposite side the crest of the external thread will be in line with the crest of the internal thread with the following results when the screw is constrained in such a position in a tapped hole: (1) There will be danger of crossing the threads in starting, and (2) the screw may pull out of the hole when tension is exerted in this constrained position. The minimum amount of overlap is arbitrary and controversial, but the following general rule can be used in lieu of more specific data:

As the first step to assure the minimum safe overlap on both sides when the assembly is concentric, the difference between the minimum major diameter of the ex-

ternal thread and the maximum minor diameter of the internal thread should not be less than twice the addendum of the external thread ($\frac{3}{4} H$, table III, 1, p. 12). (Otherwise stated, the sum of the major-diameter tolerance and allowance, if any, of the external thread and the minor-diameter tolerance of the internal thread should not be greater than $\frac{4}{3}$ the addendum of the external thread, $H/2$, table III, 1. This provides for a minimum of 50 percent thread engagement. As the second step, to assure the minimum safe overlap on one side when the assembly is eccentric, the difference between the maximum pitch diameter of the internal thread and the minimum pitch diameter of the external thread should not be greater than twice the addendum of the external thread ($\frac{3}{4} H$, table III, 1). (Otherwise stated, the sum of the pitch-diameter tolerances of both threads and the allowance, if any, should not be greater than twice the addendum of the external thread, $\frac{3}{4} H$, table III, 1). This provides for an eccentric assembly condition equal to the addendum of external thread ($\frac{3}{4} H$, table III, 1) and zero minimum overlap on one side. If the results from the limits of size selected violate the above rules, the tolerances should be reduced by using a closer class of tolerance, assuming tolerances consistent with manufacturing possibility, or a coarser pitch should be used to increase the amount of overlap. The major-diameter tolerance of the external thread or minor-diameter tolerance of the internal thread should not be less than the pitch-diameter tolerance of the respective thread to maintain thread form.

It should be noted that, if the tolerance on the minor diameter of the internal thread must necessarily be large, the major diameter of the external thread must be held close to the maximum major diameter and vice versa.

3. STRENGTH FACTORS

1. CRITICAL AREAS.—The critical areas of mating threads, as related to the tensile strength of the thread assembly, are: (1) The effective cross-sectional area, or stress area, of the external thread, (2) the shear area of the external thread that depends principally on the minor diameter of the tapped hole, and (3) the shear area of the internal thread that depends principally on the major diameter of the external thread. The formulas for tensile stress area and thread shear area are given in section II, p. 5, and these areas are indicated in figure 5.1.

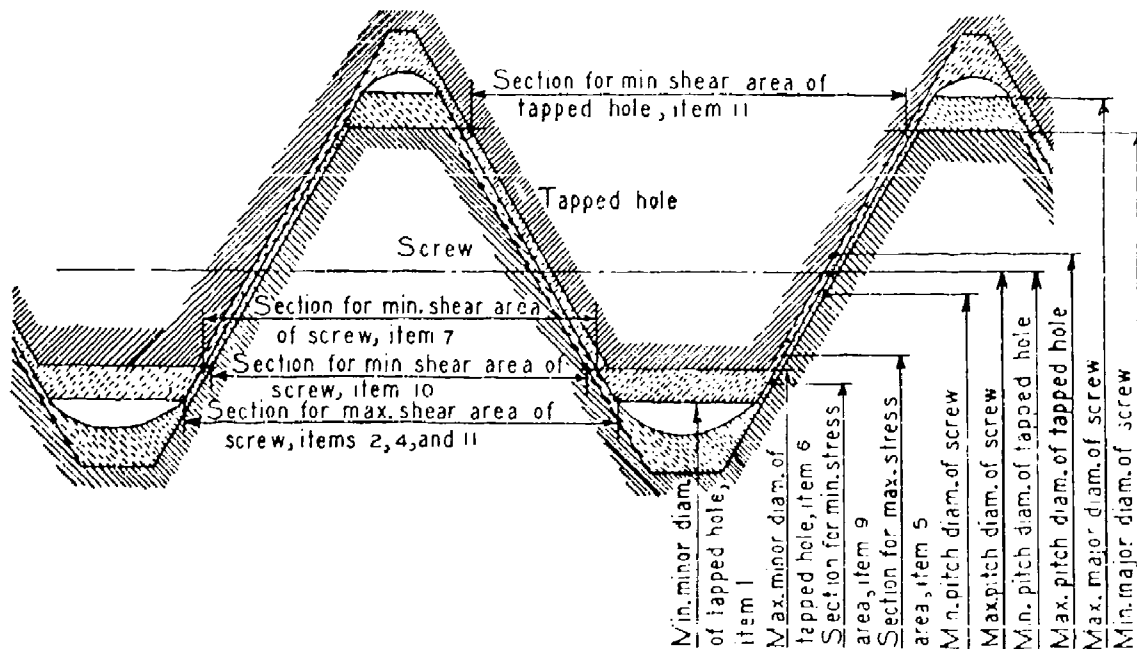

FIGURE 5.1.—Critical sections in a thread assembly.

See table 5.1 for formulas corresponding to item numbers.

If failure of a thread assembly should occur it is desirable that the external thread (screw) will break rather than that either the external or internal thread will strip. In other words, the length of thread engagement shall be sufficient to develop the full strength of the screw. Thus, the length of internal thread and the dimensions of this thread, particularly its minor diameter, should be such that, taking into account a possible difference in strength of material of the internal and external threads, the threaded portion of the external thread will break before either the external or internal threads strip.

2. LENGTH OF THREAD ENGAGEMENT.—The length of engagement of a threaded unit, which will develop maximum strength of assembled threads with external and internal threads manufactured of materials of equal tensile strength, is computed from the following formula:

$$L_e = \frac{2 \times \text{stress area}}{3.1416nK_n \max \left[\frac{1}{2n} + 0.57735(E_t \text{ min} - K_n \text{ max}) \right]}$$

The factor 2 used in the numerator of this formula means that it is assumed that the area in shear must be twice the tensile stress area to develop the full strength of the screw. This assumption is based on experiments made by the National Bureau of Standards in 1929, in which it was found that for hot-rolled and cold-rolled steel, and brass screws and nuts, this factor varied from 1.7 to 2.0. Taking the factor as 2 provides in general a small factor of safety against stripping of the threads.

To facilitate the application of this formula various notations, constants, and formulas applicable to the determination of the relation of critical areas to thread dimensions are given in table 5.1 and are discussed below.

(a) Length of engagement determined by shear area of

external thread.—Formula 8, table 5.1, gives the length of engagement required to develop the full strength of the screw when the strength of the material in which the hole is tapped is the same as, or slightly less than, the strength of the material of the screw. The value of L_e thus obtained is sufficient for a permanently-fastened connection. If, however, the screw is an adjusting or lead screw, or if the connection will be frequently unscrewed, L_e should be increased to allow for the expected wear on the flanks of the threads during the useful life of the components.

For tapped holes in sheet metal, the maximum size of the screw to be specified should be such that the thickness of sheet equals the L_e required to develop full strength. In order to use the largest possible screw, it is necessary that the tolerance, T_{K_n} , on the minor diameter of the hole should be the practical minimum. If it should prove to be impracticable to reduce the minor diameter tolerance to such a value, it may be necessary to decrease the minimum minor diameter of the internal thread and to increase the minor diameter tolerance by the same amount. If this is done, the maximum minor diameter of the screw must be reduced by the same amount to prevent interference, and the minor diameter of the "go" thread ring gage must likewise be decreased, as this is the only control of the minor diameter of the screw. In all such cases, where dimensions are altered from those calculated according to the standard, the method of designation for modified threads, stated in section III, p. 26, should be followed.

(b) Length of engagement determined by shear area of internal thread.—The ratio of the area in shear in the screw and the area in shear in the tapped hole is given by formula 12, table 5.1. This ratio, R_1 , will usually be less than 1 and the strength of the material of the tapped hole can be less than the strength of the material of the screw by this ratio with no indicated increase in

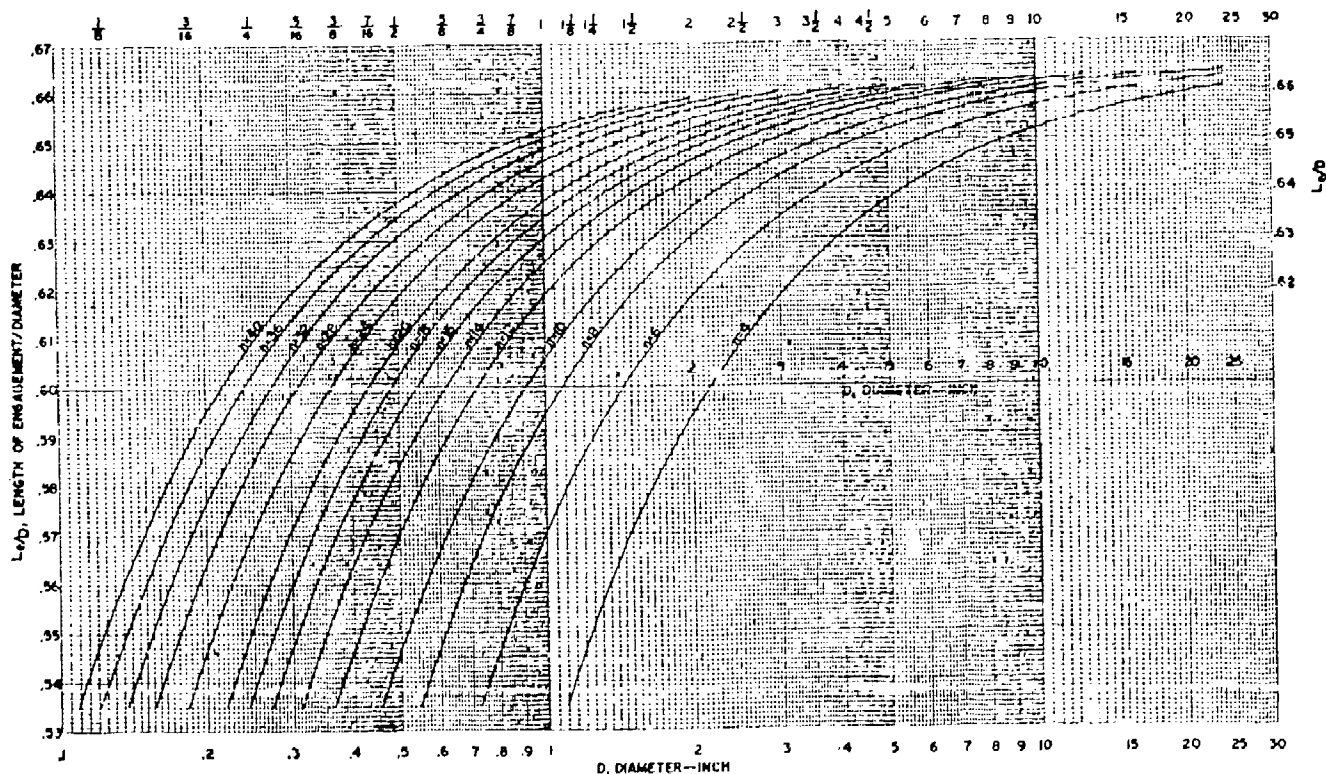

FIGURE 5 2.—Chart for determining minimum length of thread engagement.

L_e by formula 8. If, however, the ratio

$$R_2 = \frac{\text{tensile strength of the material of the tapped hole}}{\text{tensile strength of the material of the screw}}$$

is less than R_1 , then L_e should be multiplied by R_1/R_2 to provide sufficient length of thread to prevent stripping of the threads in the tapped hole.

For retaining collars on shafts where the expected axial force resisted by the collar is appreciably less than the tensile force that the shaft itself is capable of resisting, L_e need only be long enough to withstand the expected axial force on the collar. If P_c is the axial force to be carried by the collar and uts is the tensile strength of the material of the shaft in pounds per square inch, then the length of thread engagement required on the shaft is equal to $2P_c/(uts \times S_s \text{ min})$, where $S_s \text{ min}$ is given by formula 7, when the strength of material of the collar is the same or slightly less than the strength of material of the shaft. Ratios R_1 and R_2 should be computed as previously explained to determine whether or not a greater length is

required to prevent stripping of the threads in the collar.

(c) *Hollow externally threaded parts.*—For screws with through axial holes, the length of engagement required is of course less than if the screw is solid. For this condition, formula 8 becomes

$$L_e \text{ max} = \frac{2(A_s \text{ max} - A_n \text{ max})}{S_s \text{ min per inch}}$$

where A_n is the cross-sectional area of the hole.

However, as the wall thickness of either or both the internal and external members becomes thin, the tendency of the external member to enlarge and the internal member to neck down in the thread means that an L_e greater than given by the above formula must be used, also that the tolerances on minor diameter of the internal thread and major diameter of the external thread, T_{K_n} and T_{D_n} , must be small to obtain the maximum practicable depth of thread engagement. For components having threads on thin-wall tubing, tests under actual working conditions should be made to determine proper selection of wall thicknesses, length of engagement, and pitch of thread.

TABLE 5.1.—Data for determining strength factors in special thread design

NOTATION

D = basic major diameter.
 D_e = major diameter of external thread.
 K_n = minor diameter of internal thread.
 T_{K_n} = tolerance on minor diameter of internal thread.
 T_{P_n} = tolerance on pitch diameter of external thread.

G = allowance on all diameters of external thread.
 L_e = length of thread engagement.
 A_s = stress area of external thread.
 S_s = area in shear on external thread in line with K_n .
 S_n = area in shear in internal thread in line with D_i .

CONSTANTS

$$C_1 = \frac{3}{4} \pi = 2.356$$

	Threads per inch, n														
	40	36	32	28	27	24	20	18	16	14	12	10	8	6	4
$C_2 = \frac{5 \cot 30^\circ}{8n} = \frac{1.08253}{n}$	0.0271	0.0301	0.0338	0.0387	0.0401	0.0451	0.0541	0.0601	0.0677	0.0773	0.0902	0.1083	0.1353	0.1804	0.2706
$C_3 = \frac{9 \cot 30^\circ}{16n} = \frac{0.974279}{n}$.0241	.0271	.0304	.0348	.0361	.0406	.0487	.0541	.0609	.0696	.0812	.0974	.1218	.1624	.2436
$C_4 = n \tan 30^\circ = 0.57735n$	23.09	20.78	18.48	16.17	15.59	13.86	11.55	10.39	9.328	8.083	6.928	5.774	4.619	3.464	2.309
$C_5 = \pi n \tan 30^\circ = 1.8138n$	72.55	65.30	58.01	50.79	48.97	43.53	36.25	32.65	29.02	25.39	21.76	18.14	14.51	10.88	7.255

FORMULAS

MAXIMUM MATERIAL FOR BOTH EXTERNAL AND INTERNAL THREADS

- Item
- $K_n \text{ min} = D - C_2$.
- Max area in shear of external thread per inch = $S_s \text{ max per inch} = C_1 K_n \text{ min}$.
- Min length of thread engagement, $L_e \text{ min} = \frac{L_e}{D} \times D_i \text{ max}$, with $\frac{L_e}{D}$ taken from graph, figure 5.2.
- Area in shear of external thread in length $L_e \text{ min} = S_s \text{ max per inch} \times L_e \text{ min}$ (= Item 2 \times Item 3).
- Max stress area of external thread = $A_s \text{ max} = \frac{S_s \text{ max per inch} \times L_e \text{ min}}{2} \left(\frac{1}{2} \text{ Item 4} \right) = \frac{C_1 K_n \text{ min} \times \frac{L_e}{D} \times D_i \text{ max}}{2}$.

MAXIMUM MATERIAL EXTERNAL THREAD, K_n MAXIMUM

- $K_n \text{ max} = K_n \text{ min} + T_{K_n}$.
- Min area in shear of external thread per inch = $S_s \text{ min per inch} = K_n \text{ max} (C_1 - C_2 T_{K_n})$.
- L_e required to develop full strength of external thread for T_{K_n} selected = $\frac{2 A_s \text{ max}}{S_s \text{ min per inch}} = \left(\frac{2 \times \text{item 5}}{\text{item 7}} \right)$ or $\left(\frac{\text{item 4}}{\text{item 7}} \right)$.

MINIMUM MATERIAL FOR BOTH EXTERNAL AND INTERNAL THREADS

- Min stress area of external thread = $A_s \text{ min} = 0.785 [D - C_2 - (T_{R_n} + G)]^2$.
- Min area in shear of external thread in length $L_e = S_s \text{ min} = K_n \text{ max} [C_1 - C_2 (T_{K_n} + T_{R_n} + G)] L_e$, or $= \pi K_n \text{ max} [0.75 - C_2 (T_{K_n} + T_{R_n} + G)] L_e$.
- Min area in shear of internal thread in length $L_e = S_n \text{ min} = \pi D_i \text{ min} [0.875 - C_2 (T_{D_i} + T_{R_n} + G)] L_e$.

MINIMUM TAPPED HOLE, D_i MINIMUM, WHEN TAPPED MATERIAL IS WEAKER THAN SCREW MATERIAL

- $R_1 = \frac{\text{area in shear of screw in length } L_e}{\text{area in shear of tapped hole in length } L_e} = \frac{(\text{item 4})}{(\text{item 11})} = \frac{0.75 K_n \text{ min}}{D_i \text{ min} [0.875 - C_2 (T_{D_i} + T_{R_n} + G)]}$
- $R_2 = \frac{\text{ultimate tensile strength of tapped material}}{\text{ultimate tensile strength of screw material}}$
- If $R_1 < R_2$, then L_e required = L_e for T_{K_n} selected $\times \frac{R_1}{R_2} = \left(\frac{\text{item 8} \times \text{item 12}}{\text{item 13}} \right)$.

4. THREAD PROPORTIONS IN RELATION TO TAPPING

In the production of threads it is considered impractical to tap a thread unless its diameter is greater than six times the basic thread height; therefore, when the ratio of D to H is less than 4.5, the use of a larger diameter, a finer pitch of thread, or both, should be considered.

The size of K_n is a factor in controlling tap breakage. Tap breakage is infrequent if the diameter of the tap is over $\frac{1}{2}$ in. or if the length of thread to be tapped is less than $\frac{1}{2}D$. For sizes less than $\frac{1}{2}$ in. and length of thread over $\frac{1}{2}D$, tap breakage can be minimized by use of a large K_n , that is T_{K_n} maximum. However, this means that L_s may have to be increased to develop the full strength of the screw.

5. EXAMPLES OF THREAD DESIGN

The design of special threads for particular purposes is illustrated by the following examples:

Example: A gun barrel is subjected to an internal explosive pressure that produces a tensile stress in the threaded end. The length of engagement of the threads should be sufficient to produce a minimum area in shear on the threads of the screw in line with the minor diameter of the tapped hole threads equal to twice the maximum stress area of the threaded portion of the barrel.

Assume that the thread on the barrel is 1.5-8N-2A and the minimum internal diameter of the barrel at the threaded end is 0.792 in.

In table III.10 will be found the following maximum dimensions of the external thread:

$$D_s \text{ max} = 1.4978 \text{ in.}$$

$$E_s \text{ max} = 1.4166 \text{ in.}$$

$$K_s \text{ max} = 1.3441 \text{ in.}$$

From table III.10, $K_n \text{ min} = 1.365$ in. If we select the tolerance for minor diameter of hole $T_{K_n} = 0.025$ in., $K_n \text{ max}$ will equal $1.365 + 0.025 = 1.390$, which will permit the use of a $1\frac{3}{8}$ (1.375)-in. tap drill.

The minimum area in shear per inch can be computed, using formula 7, table 5.1:

$$\begin{aligned} S_s \text{ min} &= K_n \text{ max} (C_1 - C_2 T_{K_n}) \\ &= 1.390 (2.356 - 14.51 \times 0.025) \\ &= 2.7703 \text{ in.}^2 \end{aligned}$$

The maximum stress area of the external thread, if solid, using formula 5, table 5.1, is

$$\begin{aligned} A_s \text{ max} &= \frac{C_1 K_n \text{ min} \times \frac{L_s}{D} \times D_s \text{ max}}{2}, \\ \frac{L_s}{D} \text{ from chart} &= 0.622, \\ &= \frac{2.356 \times 1.365 \times 0.622 \times 1.4978}{2} = 1.4977 \end{aligned}$$

$$\begin{aligned} \text{Area of minimum center hole} \\ &= (\pi/4) \times 0.792^2 = 0.4926 \end{aligned}$$

$$\begin{aligned} \text{Max stress area of external threaded member} \\ &= 1.0051 \end{aligned}$$

$$\begin{aligned} \text{Length of thread engagement required} \\ &= L_s = \frac{2 \times \text{max } A_s}{S_s \text{ min}} \\ &= \frac{2 \times 1.005}{2.7703} \\ &= 0.726 \text{ in.} \end{aligned}$$

If a length of engagement of 0.73 in. cannot be obtained, the tolerance on minor diameter, T_{K_n} , of the internal thread should be reduced. If a space for a longer length of engagement is available, T_{K_n} can be increased.

Example: The dimension is required of the large steel cap screw that can be used to hold a bracket on a cast iron body. The tensile strength of the steel is 60,000 lbs/in.², the tensile strength of the cast iron 20,000 lb/in.², and the thickness of the cast iron is such that the length of thread engagement cannot exceed 1.750 in. The screws on the top side of the bracket will be in tension. From the ratio of the tensile strengths of the two materials, $R_2 = 20,000/60,000 = 0.333$, it is evident that the length of the tapped hole thread must be considerably longer than the length of thread engagement required to develop the full strength of the screw. R_1 will be of the order of 0.85 and the length of thread in the tapped hole will be approximately $R_1/R_2 = 0.85/0.333 = 2.55$ times as long as the length required to develop the full strength of the screw. L_s required to develop the full strength of the screw must be of the order of $1.750/2.55 = 0.686$ in.

Inasmuch as the hole is tapped in cast iron, a relatively coarse thread would be required, that is UNC or coarser. For such threads L_s/D , as shown on the chart, figure 5.2, varies between 0.57 and 0.61. Taking $L_s/D = 0.59$, the approximate diameter required is $0.686/0.59 = 1.163$. Try $D = 1\frac{1}{8} = 1.0625$ in. The selected pitch could be either 10 or 8 threads per inch with 8 threads per inch preferred. For a bracket screw, class 2A would be the preferred class. Thus, the screw is $1\frac{1}{8}$ -8NS-2A and the hole $1\frac{1}{8}$ -8NS-2B.

Next, compute the dimensions of the screw and hole to determine whether or not the above selection is correct.

$$\begin{aligned} \text{Max major diameter of screw, } D_s \text{ max, table IV.2,} \\ &= \text{basic } D - G = 1.0625 - 0.0021 = 1.0604 \end{aligned}$$

$$\begin{aligned} \text{Min major diameter of screw, } D_s \text{ min, table IV.3,} \\ &= D_s \text{ max} - T_{D_s} = 1.0604 - 0.0150 = 1.0454 \end{aligned}$$

$$\begin{aligned} \text{Min minor diameter of tapped hole, } K_n \text{ min, table IV.1,} \\ &= D - 1\frac{1}{4}H = 1.0625 - 0.1353 = 0.9272 \end{aligned}$$

The number of $1\frac{1}{8}$ -8 screws required will depend on the torque that may develop on the bracket that will produce tension in the screws. It should be possible to tighten these screws to the yield strength of the steel without stripping the cast iron threads.

The complete table of dimensions of the tapped hole and screw is

Internal thread, $1\frac{1}{16}$ -8NS-2B

Min major diameter	$= 1.0625$
Min pitch diameter, table IV.1,	$1.0625 - 0.0812 = 0.9813$
Max pitch diameter, table IV.8,	$0.9813 + 0.0089 = 0.9902$
Min minor diameter, table IV.1,	$1.0625 - 0.1353 = 0.9272$
Max minor diameter, table IV.10,	$0.9272 + 0.0312 = 0.9584$

External thread, $1\frac{1}{16}$ -8NS-2A

Max major diameter, table IV.2,	$1.0625 - 0.0021 = 1.0604$
Min major diameter, table IV.3,	$1.0604 - 0.0150 = 1.0454$
Max pitch diameter, table IV.1,	$1.0604 - 0.0812 = 0.9792$
Min pitch diameter, table IV.5,	$0.9792 - 0.0068 = 0.9724$
Max minor diameter, table IV.1,	$1.0604 - 0.1534 = 0.9070$

L_e/D from chart, figure 5.2 = 0.5990

$$L_e \text{ min} = L_e/D \times D_s \text{ max} = 0.5990 \times 1.0604 = 0.6352$$

$$T_{En} \text{ (table IV.8)} = 0.0089$$

$$R_1, \text{ table 5.1, formula 12} = \frac{0.75 K_n \text{ min}}{D_s \text{ min} [0.875 - C_1(T_{En} + T_{Ds} + G)]}$$

$$= \frac{0.75 \times 0.9272}{1.0454 [0.875 - 4.619(0.0089 + 0.0150 + 0.0021)]}$$

$$= 0.8812$$

$$L_e \text{ required in hole} = L_e \text{ min} \times \frac{R_1}{R_2} = 0.6352 \times 0.8812 / 0.3333 = 1.6794 \text{ in.},$$

which is less than the L_e (1.750 in.) permitted.

APPENDIX 6. REFERENCES

The following Federal Specifications may be obtained at the prices indicated upon application, accompanied by check, money order, cash, or Government Printing Office coupons to the Business Service Center, General Services Administration, Regional Office Building, Seventh and D Streets SW., Washington 25, D. C.

Federal Specifications:

FF-B-561.	Bolts, Lag (10 cents).
FF-B-575.	Bolts, Hexagon and Square (15 cents).
FF-B-00584.	Bolts (Square Neck, Machine, Ribbed Neck, Finned Neck, Tee Head, Key Head) (Round Head).
FF-B-588.	Bolts, Toggle (5 cents).
FF-D-00200.	Devices, Anchoring, Masonry.
FF-N-836.	Nuts, Hexagon and Square (25 cents).
FF-N-845.	Nut, Plain, Wing.
FF-S-85.	Screws, Cap, Slotted and Hexagon Head (15 cents).
FF-S-86.	Screws, Cap, Socket Head (25 cents).
FF-S-88.	Screw Eyes (10 cents).
FF-S-92.	Screws, Machine; Slotted or Cross-Recessed (25 cents).
FF-S-103.	Screws, Set (10 cents).
FF-S-107.	Screws, Tapping, Slotted and Plain Head (Sheet Metal, Machine, and Drive) (20 cents).
FF-S-00109.	Screws, Wood; Cross-Recessed Head.
FF-S-111.	Screws, Wood, Slotted-Head (10 cents).
FF-T-305.	Thumb screws (10 cents).
FF-W-84.	Washers, Lock (Spring) (15 cents).
FF-W-92.	Washers, Metal, Flat (Plain) (15 cents).
FF-W-00100.	Washers, Tooth Lock.

The following standards and specifications may be purchased from the Superintendent of Documents, U. S. Government Printing Office, Washington 25, D. C.

Commercial Standards of the U. S. Department of Commerce, Office of Technical Services:
CS8. Gage Blanks (40 cents).

Simplified Practice Recommendations of the U. S. Department of Commerce, Business and Defense Services Administration:

R23.	Bolts, plow (5 cents).
R51.	Chasers for Self-opening and Adjustable Die Heads (10 cents).
R60.	Bolts, Carriage, Machine and Lag; Packaging of (5 cents).
R169.	Machine, Carriage, and Lag Bolts (Steel), (Stock Production Sizes (10 cents)).

The following standards have been approved and promulgated by the American Standards Association, and issued by The American Society of Mechanical Engineers, 29 West 39th Street, New York 18, N. Y.:

B1.1.	Unified and American Screw Threads for Screws, Bolts, Nuts, and Other Threaded Products (\$3.00).
B1.2.	Screw Thread Gages and Gaging (\$4.00).
B1.5.	Acme Screw Threads (\$2.25).
B1.7.	Nomenclature, Definitions, and Letter Symbols for Screw Threads (50 cents).
B1.8.	Stub Acme Screw Threads (\$1.25).
B1.9.	Buttress Screw Threads (\$1.50).
B2.1.	Pipe Threads (\$1.50).
B5.4.	Taps, Cut and Ground Threads (\$1.50).
B5.12.	Twist Drills, Straight Shank and Taper Shank (75 cents).
B18.2.	Square and Hexagon Bolts and Nuts (\$2.00).
B18.3.	Socket Head Cap Screws and Socket Set Screws (\$1.00).
B18.5.	Round Head Bolts (\$1.00).
B18.6.1.	Slotted and Recessed Head Wood Screws (\$1.00).
B18.6.2.	Tapping Screws.
B18.6.3.	Slotted and Recessed Head Machine Screws.
B18.8.	High-Strength, High-Temperature Internal Wrenching Bolts (50 cents).
B18.9.	Plow Bolts (55 cents).
B18.10.	Track Bolts and Nuts (\$1.00).

INDEX

A	Page
Abbreviations, screw thread	7, 10
Acceptability of threads	118
Actual fit, definition	3
Actual size, definition	2
Addendum, definition	4
Allowance, definition	2
Allowances (see Tolerances and allowances)	
Altered threads	100
American National screw threads	121
Comparison with Unified screw threads	10
Form of thread	121
Limits of gage sizes	143
Limits of thread sizes	128
Method of designating	132
Thread classes	130
Thread form	121
Thread series	122
Coarse	122, 128, 133
Extra-fine	123, 128, 137
Fine	122, 128, 135
8-thread	123, 130, 138
16-thread	124, 132, 143
12-thread	123, 131, 140
Tolerances and allowances	124, 128, 131, 145
American National special screw threads	179
Form of thread	179
Gages for	185
Recommended pitches	179
Thread classes	179
Selection of	124
Tolerances and allowances	126
American Standard screw threads (see under Unified and American)	
Angle deviations, diameter equivalent of	22, 32
Angle, included, of thread, definition	4
Axis of thread, definition	3
B	
Base of thread, definition	3
Basic form of thread, definition	3
Basic hole system, definition	3
Basic size, definition	2
Basic shaft system, definition	3
Bilateral tolerance, definition	2
Bilateral tolerance system, definition	2
Blunt start, definition	4
C	
Classes of threads	18
1	130, 179
1A	23, 79
1AR	75, 79
1B	23, 79
2	130, 180
2A	23, 79
2B	23, 79
3	131, 180
3A	23, 98
3B	23, 98
4	131, 180
5	132
Classes of threads, definition	18
Clearance fit, definition	3
Clearance (or trailing) flank, definition	3
Coarse-thread series	13, 16, 122
Conted threads	23
Complete thread, definition	3
Core diameter (see Minor diameter)	
Crest, definition	3
Crest clearance, definition	5
Crest truncation, definition	4
Cross threading	201
D	
Dadendum, definition	4
Definitions	2
Depth of thread engagement, definition	5
Design forms of thread, definition	3
Design forms of threads	3
American National	122-125
National miniature	103
Unified	11
Design information, screw threads of special diameters, pitches, and lengths of engagement	200
American National	180
Unified	98
Design size, definition	2
Designating screw threads	8
Method of	26
Method of special thread	98
Designations, identification, screw thread	8, 26
Diameter equivalent	22, 32
Of angle deviations	22, 32
Of lead deviations	23, 32
Dimension, definition	2
Drills, tap, sizes of	68

E	Page
Effective size, definition (see Virtual diameter)	
Effective thread, definition	3
Eight-thread series	14, 17, 123, 130, 138
Engagement, depth of, definition	5
Engagement, length of	22, 128
Definition	5
External thread, definition	2
External thread tolerances	19, 75
Major diameter	21, 76
Minor diameter	21, 76
Pitch diameter	21, 79, 128
Extra-fine-thread series	14, 17, 123, 129, 137

F	Page
Fine-thread series	11, 16, 122, 129
Fit, definition	2
Flank, definition	3
Flank angle, definition	4
Following flank, definition	3
Form of thread, definition	3
Fundamental triangle, definition	3

G	Page
Gage classification	108
Gage sizes, limits of	38, 145
Gage tolerances and wear allowances	117
Gages	38, 100, 107
Constants for computing dimensions of	115
Direction of tolerance on	109
For reference	108
Master	108
Plain plug acceptance check	108
Setting (check)	108
General design	109
Limit	108
Maximum-metal ("go")	108
Minimum-metal ("not go")	108
Limits of size	38, 113
Plain and thread	39, 113, 146
Setting plug	38, 56, 114, 164
Marking of	116
Standard temperature	109
Thread form	110
"Go" and "Not go" thread gages	110
Setting plug gages	111
Thread length	114
Gages, ring	110
Measurement of pitch diameter of	100
Gaging practices, recommended	118
Procedure in setting adjustable thread ring gages	118
Procedure for determining clearance in thread ring gages	120
Uses of W and X thread gages	118
Gauging, screw thread	107
Practices	118
Virtual (or effective size)	118
Single element	118

H	Page
Height of fundamental triangle, definition	4
Height of thread, definition	4
High-temperature, high-strength applications	23
Hole size limits	186

I	Page
Incomplete thread, definition	3
Included angle, definition	4
Interference fit, definition	3
Internal thread, definition	2
Internal thread tolerances	19, 75
Major diameter	21, 76
Minor diameter	21, 77
Pitch diameter	21, 79, 128

L	Page
Lead, definition	4
Lead angle, definition	4
Lead deviations, diameter equivalent of	23, 32
Lead, variations in	32
Leading flank, definition	3
Left-hand thread, definition	2
Length of engagement	22, 128
Length of thread engagement, definition	5
Limit gages, maximum-metal or "go"	108
Minimum-metal or "not go"	108
Limit of size	26, 79, 128
Definition	2
Gages (see Gage sizes)	
General	22, 79, 128
Thread (see under Screw threads)	

M	Page
Major cone, definition	6
Major diameter, definition	4
Major cylinder or cone, definition	3
Maximum material limit, definition	2
Measuring pressure	109
Measurement of pitch diameter	194
Wire method of	194
Method of designating threads	26, 98, 132
Miniature screw threads (<i>see</i> National Miniature screw threads)	
Minimum material limit, definition	2
Minor cone, definition	6
Minor cylinder or cone, definition	3
Minor diameter, definition	4
Modified threads	26, 98
Multiple thread, definition	2

N

National Miniature screw threads	100
Limits of thread size	105
Thread designations	105
Thread form	101
Tolerances	104
Net tolerances, basis of	128
Nomenclature (<i>see</i> Definitions)	
Nominal size, definition	2

P

Personnel of the Committee	1
Pipe thread	9
Symbols	9
Designations	10
Plating, screw thread (<i>see</i> Coated threads)	
Pitch, definition	4
Pitch cone, definition	6
Pitch cylinder or cone, definition	3
Pitch diameter (simple effective diameter), definition	4
Pitch line, definition	3
Preferred diameters and pitches	75, 179
Pressure flank, definition	3

R

Recommended gage practices	118
References	205
Right-hand thread, definition	2
Root, definition	3
Root truncation, definition	4
Rules for use of tables, special threads	180

S

Screw thread	2
Classes	18, 75, 130, 179
Definition	2
Designating, method of	26, 98, 132
Elements, definitions	3
Forms	12, 101, 121
American National (<i>see</i> American National screw threads)	
National Miniature (<i>see</i> National Miniature screw threads)	
Unified (<i>see</i> Unified and American screw threads)	
Limits of size	22, 79, 105, 128
Series	13, 104, 122
Definition	13
Shear area	5, 202
Definition	5
Formula	5
Symbols	7
Types, definitions	2
Sharp crest (or crest apex), definition	3
Sharp major cone, definition	6
Sharp minor cone, definition	7
Sharp root (or root apex), definition	3
Shear area, thread (<i>see</i> Screw thread shear area)	
Single thread, definition	2
Sixteen-thread series	14, 18, 123, 143
Size, actual, basic, design, etc., definitions	2
Special screw threads (<i>see</i> Unified and American special screw threads; American National special screw threads)	
Design	200
Standoff, definition	7
Strength factors in thread design	201
Stress area (<i>see</i> Tensile stress area)	
Symbols	9, 13
Pipe thread	9
Screw thread	9

T

T	Page
Tap drill sizes	68
Taper screw thread elements, definitions	6
Taper threads, measurement of	197
Tapping, thread proportions in relation to	204
Temperature at which gages shall be standard	109
Tensile stress area	5, 16-19
Definition	5
Formula	5
Terminology (<i>see</i> Definitions)	
Thickness of thread, definition	4
Thread (<i>see</i> screw threads)	
Thread design, examples of	204
Thread engagement	6, 22, 128
Depth of, definition	5
Eccentric	201
Length of, definition	5
Threads per inch, definition	4
Thread shear area, definition	5
Tolerance, definition	2
Tolerance limit, definition	2
Tolerance, unilateral, bilateral, definitions	2
Tolerances and allowances	20
Basic formula for	20
Definition of	2
Direction and scope of	19, 75, 104, 125, 179
Direction on gages	109
Gages	117
Major diameter	21
Minor diameter	21
Pitch diameter	21
Screw thread classes	18, 23
Total thread, definition	3
Transition fit, definition	3
Turns per inch, definition	4
Twelve-thread series	14, 18, 123, 140

U

Unified and American screw threads	19
Applications	13
Limits of gage sizes	38
Limits of thread sizes	22, 79
Method of designating	26
Tap drill sizes	68
Thread classes	18, 75
Thread form	12
Thread series	13
Course	13, 16
Extra-fine	14, 17
Fine	14, 16
8-thread	15, 17
16-thread	14, 19
12-thread	14, 18
Tolerances and allowances	18
Variations in	22
Unified and American special screw threads	74
Diameter-pitch combinations	13, 15
Directions for determining limits of size of	100
Method for calculation of dimensions	99
Method of designating	98
Preferred diameters and pitches	75
Thread classes	75, 79
Selection of	98
Thread form	75
Tolerances and allowances	79
Unified form of thread	12

Unified thread series (*see under* Unified and American)

Uniform pitch series	14
Unilateral tolerance, definition	2
Unilateral tolerance system, definition	2

V

Vanish cone, definition	4
Vanish point, definition	4
Variations in lead and angle	32
Virtual diameter (or effective size), definition	5

W

Wire methods of measurement of pitch diameter	194
Measuring pressure for	109
Wires, thread measuring	195
Methods of measuring	195
Methods of using	195
Size of	195
Specifications for	198

THE NATIONAL BUREAU OF STANDARDS

The scope of activities of the National Bureau of Standards at its headquarters in Washington, D. C., and its major field laboratories in Boulder, Colorado, is suggested in the following listing of the divisions and sections engaged in technical work. In general, each section carries out specialized research, development, and engineering in the field indicated by its title. A brief description of the activities, and of the resultant publications, appears on the inside front cover.

WASHINGTON, D. C.

Electricity and Electronics. Resistance and Reactance. Electron Devices. Electrical Instruments. Magnetic Measurements. Dielectrics. Engineering Electronics. Electronic Instrumentation. Electrochemistry.

Optics and Metrology. Photometry and Colorimetry. Optical Instruments. Photographic Technology. Length. Engineering Metrology.

Heat and Power. Temperature Physics. Thermodynamics. Cryogenic Physics. Rheology. Engine Fuels. Free Radicals Research.

Atomic and Radiation Physics. Spectroscopy. Radiometry. Mass Spectrometry. Solid State Physics. Electron Physics. Atomic Physics. Neutron Physics. Nuclear Physics. Radioactivity. X-rays. Betatron. Nucleonic Instrumentation. Radiological Equipment. AEC Radiation Instruments.

Chemistry. Organic Coatings. Surface Chemistry. Organic Chemistry. Analytical Chemistry. Inorganic Chemistry. Electrodeposition. Gas Chemistry. Physical Chemistry. Thermochemistry. Spectrochemistry. Pure Substances.

Mechanics. Sound. Mechanical Instruments. Fluid Mechanics. Engineering Mechanics. Mass and Scale. Capacity, Density, and Fluid Meters. Combustion Controls.

Organic and Fibrous Materials. Rubber. Textiles. Paper. Leather. Testing and Specifications. Polymer Structure. Plastics. Dental Research.

Metallurgy. Thermal Metallurgy. Chemical Metallurgy. Mechanical Metallurgy. Corrosion. Metal Physics.

Mineral Products. Engineering Ceramics. Glass. Refractories. Enameled Metals. Concrete Materials. Constitution and Microstructure.

Building Technology. Structural Engineering. Fire Protection. Air Conditioning, Heating, and Refrigeration. Floor, Roof, and Wall Coverings. Codes and Specifications. Heat Transfer.

Applied Mathematics. Numerical Analysis. Computation. Statistical Engineering. Mathematical Physics.

Data Processing Systems. SEAC Engineering Group. Components and Techniques. Digital Circuitry. Digital Systems. Analog Systems. Application Engineering.

● Office of Basic Instrumentation

● Office of Weights and Measures

BOULDER, COLORADO

Cryogenic Engineering. Cryogenic Equipment. Cryogenic Processes. Properties of Materials. Gas Liquefaction.

Radio Propagation Physics. Upper Atmosphere Research. Ionospheric Research. Regular Propagation Services. Sun-Earth Relationships.

Radio Propagation Engineering. Data Reduction Instrumentation. Modulation Systems. Navigation Systems. Radio Noise. Tropospheric Measurements. Tropospheric Analysis. Radio Systems Application Engineering.

Radio Standards. High Frequency Electrical Standards. Radio Broadcast Service. High Frequency Impedance Standards. Calibration Center. Microwave Physics. Microwave Circuit Standards.