

WEAF

AD-A277 133



94-08502



DISTRIBUTION STATEMENT A

Approved for public release
Distribution Unlimited

DIIC
ELECTE
MAR 17 1994
S B

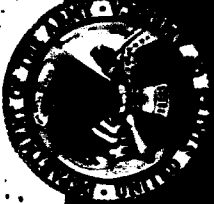

DISCLAIMER NOTICE

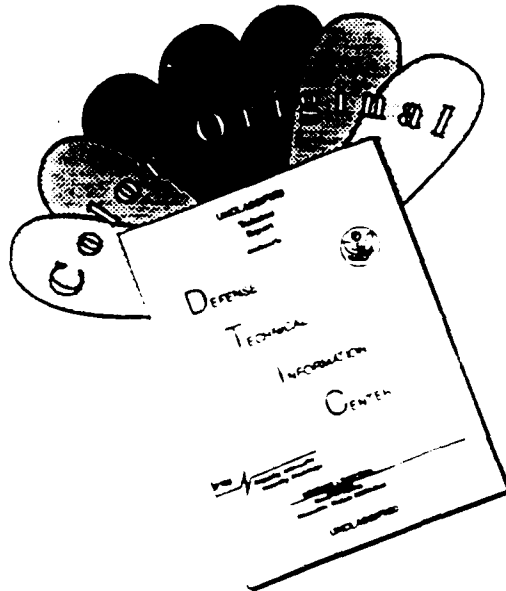

THIS DOCUMENT IS BEST QUALITY AVAILABLE. THE COPY FURNISHED TO DTIC CONTAINED A SIGNIFICANT NUMBER OF COLOR PAGES WHICH DO NOT REPRODUCE LEGIBLY ON BLACK AND WHITE MICROFICHE.



DEPARTMENT OF THE ARMY
 WASHINGTON, D.C. 20310

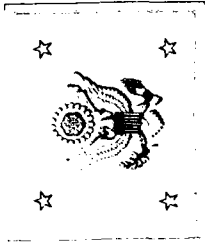

To The Reader:

March 1, 1992

As the Army reshapes to a smaller force, a sound, continuous modernization program is essential. The strategy of continuous modernization has served us well by providing the structure for an overwhelming victory in the Persian Gulf and an equally impressive victory in the Cold War in Europe. Through the development and fielding of technologically advanced weapons and equipment to our fully trained and well-led soldiers, the Army has deterred war, and when necessary, fought and won.

It is this success of the Army's long-term modernization program that we must preserve and protect. We cannot emphasize too strongly the need to continuously modernize our equipment so that our soldiers have a wide advantage over any adversary -- anytime. This requires balanced investment from the technology base to production. Without the proper balance, the acquisition system will deteriorate and cease to put superior technology into the hands of the soldier.

This handbook provides an overview of the Army's major weapon systems and support equipment in their various stages of development. It highlights our efforts to maintain a trained, ready and well-equipped Army. In this new era, we must remember that it takes a long time to develop and field superior warfighting capabilities.

We hope you will find this information useful. Currently, we have the most capable and modern Army in the world. We are working to maintain that decisive edge.

 August M. Cianciolo
 Lieutenant General, GS
 Military Deputy to the ASA(RDA)

 Stephen K. Conner
 Assistant Secretary of the Army
 (Research, Development and Acquisition)

07 3 16 00 1

Prepared by:

**OASA(RDA)
ATTN: SARD-CC
The Pentagon
Washington, DC 20310-0103**

Editor:

Ms. Beverly A. Popelka

For sale by the U. S. Government Printing Office
Superintendent of Documents, Mail Stop, SSOP, Washington, DC 20402-9138
ISBN 0-16-036138-9

TABLE OF CONTENTS

CLOSE COMBAT

TECH BASE:	5
DEVELOPMENT:	9
	11
	13
	15
	17
	19
	21
PRODUCTION:	23
FIELDIED:	25
	27
	29
	31
	33
	35
	37
	39
	41
	43
	45
	47

AIR DEFENSE

TECH BASE:	51
DEVELOPMENT:	53
	55
	57
	59
	61
	63
PRODUCTION:	65
FIELDIED:	67
	69
	71

Accession For	
DTIS GRA&I	<input checked="" type="checkbox"/>
DTIC TAB	<input type="checkbox"/>
Unannounced	<input type="checkbox"/>
Justification	
By	
Distribution/	
Availability Codes	
Dist	Avail and/or Special

A-1

FIRE SUPPORT

TECH BASE:	
DEVELOPMENT:	
Overview.....	75
Advanced Field Artillery System-Cannon (AFAS-C).....	77
Future Armored Resupply Vehicle-Ammunition (FARV-A).....	77
Brilliant Anit-Armor Technology (BAT).....	79
Sense and Destroy Armor (SADARM).....	81
Army Tactical Missile System (Army TACMS).....	83
155mm Self-Propelled Howitzer(Paladin) (M109A6).....	85
105mm Howitzer (M119).....	87
Multiple Launch Rocket System (MLRS).....	89
Air-To-Ground Missile Systems (AGMS).....	91

COMBAT SUPPORT

TECH BASE:	
Overview.....	95
Joint Surveillance and Target Attack Radar System (Joint STARS).....	97
Trackwolf.....	99
Ground Based Common Sensors.....	101
Special Operations Aircraft (SOA).....	103
Lightweight Manportable Radio Direction Finding System.....	105
Black Hawk.....	107
High Mobility Multipurpose Wheeled Vehicle (HMMWV).....	109
Smoke and Obscurants.....	111
Nuclear, Biological, and Chemical Reconnaissance System (NBCRS)(XM93).....	113
Mohawk (OV-1D) Surveillance System.....	115
Quick Fix.....	117
Guardrail.....	119
Armored Combat Earthmover (ACE)(M-9).....	121
Recovery Vehicle (M88A1).....	123

DEVELOPMENT: PRODUCTION: FIELDED:

COMBAT SERVICE SUPPORT

TECH BASE:	
DEVELOPMENT:	
PRODUCTION:	
Overview.....	127
Tactical Quiet Generators (TQG).....	129
Heavy Expanded Transporter System (HETS).....	131
Palletized Load System (PLS).....	133
Family of Medium Tactical Vehicles (FMTV).....	135
Reverse Osmosis Water Purification Unit (ROWPU).....	137
Integrated Family of Test Equipment (IFTE).....	139
5 Ton Truck.....	141
Heavy Expanded Mobility Tactical Truck (HEMTT).....	143
Deployable Medical Systems (DEPMEDS).....	145
Logistics Support Vessel.....	147

FIELDED:

COMMAND, CONTROL, AND COMMUNICATIONS

TECH BASE:	
DEVELOPMENT:	
	Overview..... 151
	Combat Service Support Control System (CSSCS)..... 155
	Forward Area Air Defense Command, Control and Intelligence (FAAD C2I)..... 157
	Maneuver Control System (MCS)..... 159
	Army Data Distribution System (ADDS)..... 161
	Standardized Integrated Command Post System (SICPS)..... 163
	All Source System Analysis (ASAS)..... 165
	Advanced Field Artillery Tactical Data System (AFATDS)..... 167
	Single Channel Ground and Airborne Radio System (SINGGARS)..... 169
FIELDED:	
	MobileSubscriber Equipment (MSE)..... 171
	NAVSTAR Global Positioning System (GPS)..... 173
	Military Satellite Communications (MILSATCOM)..... 175
	Communication System Control Element..... 177
	Digital Transmission Assemblages..... 179
	Circuit Switch and Message Switch..... 181

SOLDIER SUPPORT

TECH BASE:	
DEVELOPMENT:	
FIELDED WITH DEVELOPMENT:	
	Overview..... 185
	Close Combat Tactical Trainer (CCTT)..... 189
	Soldier Support Items..... 191
	Nuclear, Biological, and Chemical Defense..... 193

STRATEGIC CONFLICT

TECH BASE:	
DEVELOPMENT:	
	Overview..... 197
	Extended Range Interceptor Technology (ERINT)..... 199
	Airborne Surveillance Testbed (AST)..... 201
	High Endoatmospheric Defense Interceptor (HEDI)..... 203
	Theater High Altitude Area Defense (THAAD)..... 205
	Ground Based Anti-Satellite (ASAT) System..... 207
	Ground Based Interceptor (GBI)..... 209
	Ground Based Surveillance and Tracking System (GSTS)..... 211
	Ground Based Radar (GBR)..... 213

SCIENCE/TECHNOLOGY

Overview..... 215

This handbook is arranged by functional area. Within each functional area the systems are listed by their stage in the Life Cycle System Management Model. The model that is used for this book is an abbreviated version, discussed below. In the lower right corner of each system description will be a visual representation of where that system is in the life cycle.

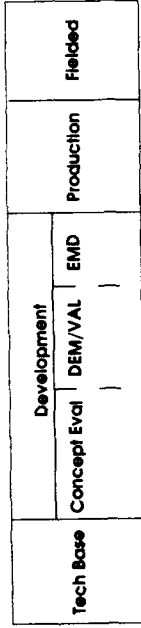

Tech Base:

Efforts focused on the identification and development of promising technologies (not directly tied to specific acquisition programs) are collectively called the technology base. It encompasses programs in basic research, exploratory development, and advanced technology development.

Concept Evaluation:

Alternative system design and support concepts are explored within the context of the mission need and program objectives. Emphasis is on generating innovation and conceptual competition from industry, both foreign and domestic, and U. S. government research, development and engineering centers and laboratories.

Demonstration and Validation:

Focuses on defining critical design characteristics, addressing manufacturing technological deficiencies, and assessing production feasibility. Analysis, simulation models, or prototypes are used to optimize design and resolve problems.

Engineering and Manufacturing Development (EMD):

The purpose of EMD is to design, fabricate, test, and evaluate a complete system. This includes the principal items necessary for its production, operation, and support, and serves to validate the production process. Reliability and Maintenance design, testing, and evaluation of components should be integrated into the earliest part of this phase.

Production:

After successful completion of technical and user tests, production begins at rates based on manufacturing efficiency, operational demand, and resource availability.

Fielded:

During this phase, the materiel system is operated, supported, and maintained in accordance with its intended operational concept, and opportunities are explored for continued improvement in cost, performance, and reliability based on actual experience. The system is sustained in

CLOSE COMBAT

The Close Combat mission area relates to the application of direct combat power. As the term indicates, close combat involves two adversaries standing eyeball to eyeball, with man pitted against man, weapon against weapon. This mission area includes such items as tanks, fighting vehicle systems, direct line-of-sight weapons, and short-range mortars that are used by the infantryman.

Tech Base	DEVELOPMENT			Production	Fielded
Concept Development	DEM/VAL	EMD			
Component Advanced Technology Test Bed	Comanche	Longbow	120 mm Mortar	Abrams Tank	
Rotorcraft Pilot's Associate	LOSAT	Javelin		Bradley	
Advance Pilot's Aid		Stingray		Family of Vehicles	
Multi-Sensor Aided Targeting		Armored Gun System		Apache	
Armor/Anti-Armor				Kiowa Warrior	
Combat Vehicle Command and Control				TOW Weapon	
Composite Armored Vehicle				Rifle M16A2	
Electric Guns				Personal Defense Weapon	
Enhanced Kinetic Energy Weapon				Automatic Grenade Launcher	
Multiple Purpose Individual Munition				Squad Automatic Weapon	
				120mm Tank Main Gun Ammunition	
				Night Vision and Electro-Optics	

AUTOMATIC TARGET CLASSIFICATION

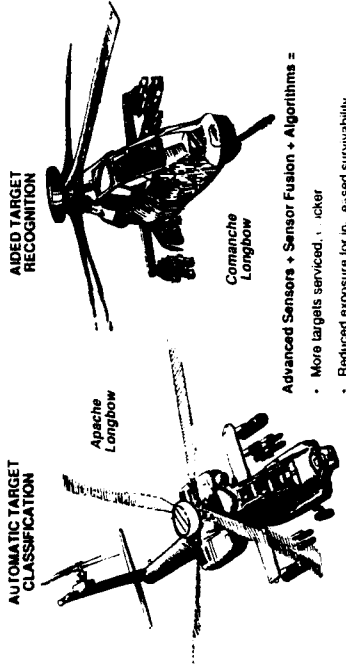

AIDED TARGET RECOGNITION

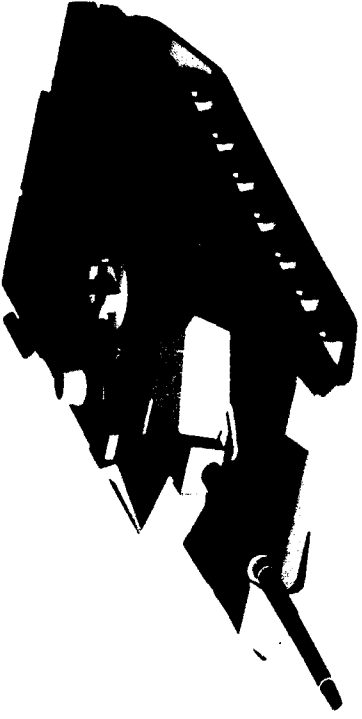

Advanced Sensors + Sensor Fusion + Algorithms =

- More targets serviced, faster
- Reduced exposure for improved survivability
- Own the night and bad weather

See, Shoot & Kill First

MULTI-SENSOR AIDED TARGETING - AIR

COMPONENT ADVANCED TECHNOLOGY TEST BED

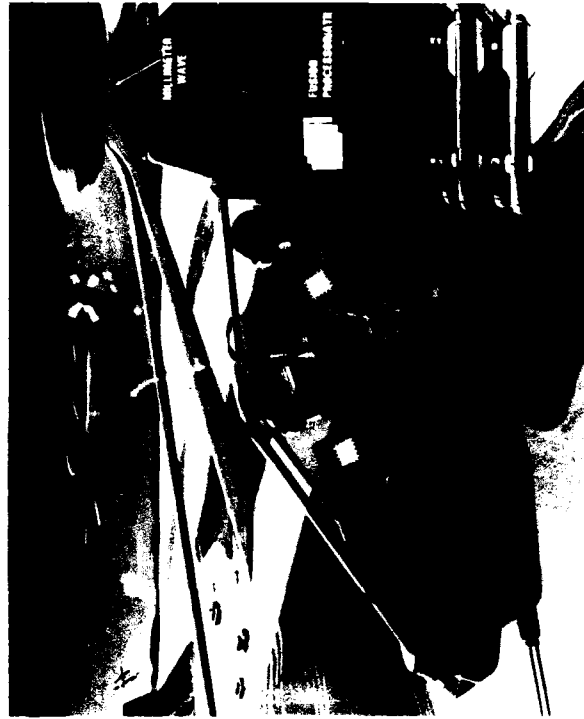

ROTORCRAFT PILOT'S ASSOCIATE



ADVANCED PILOT'S AID

CLOSE COMBAT - TECH BASE

OVERVIEW:

The goal of the Army Technology Base program in Close Combat is to provide the technology for overcoming air and land systems to give our soldiers the winning edge on the battlefield. The demonstrations described below (also see list of Advanced Technology Transition Demonstrations) are focused on advanced technologies to provide increased lethality, survivability, mobility and sustainability, both for upgrades to fielded systems and for next generation systems. Lessons learned from operations such as Desert Storm have led the Army to focus on both evolutionary and revolutionary technologies that can improve force projectability and provide a decisive advantage in future operations.

COMPONENT ADVANCED TECHNOLOGY TEST BED:

This demonstration uses a modified Abrams chassis to demonstrate the integrated, advanced components and technologies for combat vehicles. It includes a compact propulsion system that consumes half the fuel of the current tank system; an external suspension system that frees space now occupied by torsion bars; more durable, lighter track; and a modular electronics architecture for power and data distribution. These technologies enable upgrades to fielded systems and more capable, next generation systems.

ROTORCRAFT PILOT'S ASSOCIATE (RPA):

The RPA demonstration will integrate and demonstrate mission equipment package technologies for maximum rotorcraft crew and system performance through a "system of systems" to enhance the pilot's ability to see the battlefield in day, night and adverse weather. It also allows the crew to rapidly handle threat and obstacle information, and take immediate and effective actions.

ADVANCED PILOT'S AID (APA):

The APA demonstration will exploit technology advances in image intensification, optics materials, and design and human factors research to enhance aviator's effectiveness and reduce pilot workload. The goal is to provide all aviators with increased visual acuity and field of view, integrated flight symbology, and improved human factors. The results of this demonstration will be used on current and future scout, utility and cargo aircraft.

MULTI-SENSOR AIDED TARGETING (MSAT) - AIR:

MSAT will demonstrate aided target recognition sensor fusion and supporting algorithm technology that will reduce the time to detect and recognize targets by more than half. MSAT will process target features obtained from multi-spectral sensors. Millimeter wave radar, second generation forward-looking infrared, lasers, signal processing, and artificial intelligence are some of the technologies being used. Lethality and survivability will be greatly enhanced.

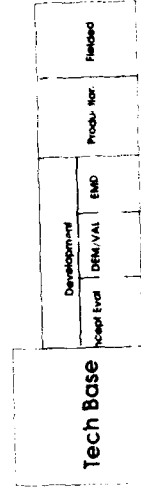



ARMOR / ANTI - ARMOR

ELECTRIC GUN LETHALITY / PROTECTION BENEFITS

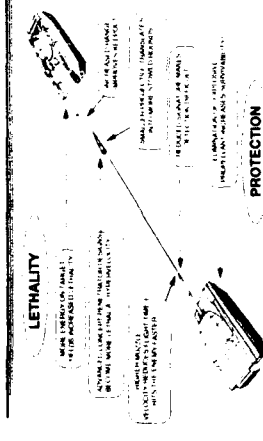

ELECTRIC GUN

- Composite Armor Vehicle Advanced Technology Transition Demonstration**
- Reduced Weight & Profile
 - Improved Deployability
 - Superior Reliability and Survivability
 - Reduced Crew
 - Superior Range
 - 2 Crewmembers
- Technologies**
- Composite Structures
 - Verrones & Improved Sensors
 - Integrated Survivability
 - Integrated Automated Fire Control
 - Hybrid Electric Drive

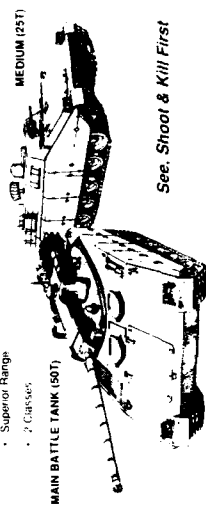

See, Shoot & Kill First

COMPOSITE ARMORED VEHICLE

- Electronic map ("birdseye" view of battlefield)
- Burst transmission of preformatted messages
- Improved decision time

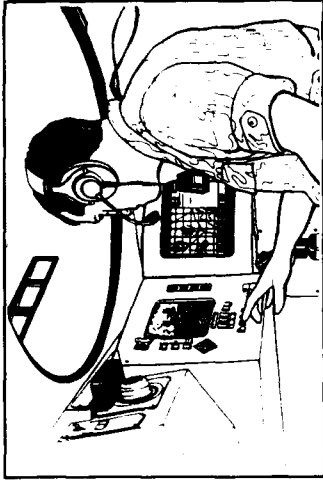

Battlefield opaque to enemy ...
Transparent to us

COMBAT VEHICLE COMMAND AND CONTROL

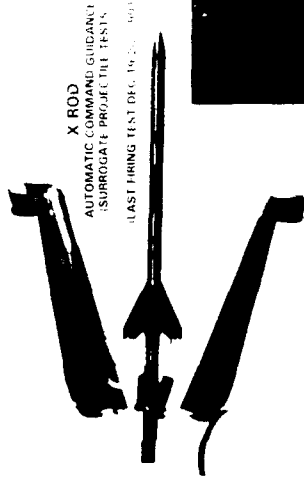

ENHANCED KINETIC ENERGY WEAPON
(X - ROD)



CLOSE COMBAT - TECH BASE (CON'T)

ARMOR/ANTI-ARMOR (A3):

This joint program among the Army, Defense Advanced Research Projects Agency and the Marine Corps was established in 1985 with a goal of enhancing the A3 technology base within the United States and establishing a competitive modernization rate for the long term. Key activities include armors for all classes of vehicles, warheads, penetrators, related materials research and advanced computer modeling of the effect of penetrators on armor. Technology transfer opportunities include gun and missile systems, the current fleet of armored vehicles and next generation combat vehicles.

COMBAT VEHICLE COMMAND AND CONTROL (CVC2):

The CVC2 concept will provide real-time, data linked tactical information at battalion level and below. In-vehicle displays will provide map information, enemy and friendly locations and graphic overlays which will show a "bird's eye" view of the battlefield. In addition, CVC2 provides easy preparation and transmittal of standard reports. Collectively, these features will enable synchronization of combat power and reduce potential for fratricide.

COMPOSITE ARMORED VEHICLE (CAV):

The primary goal of this ATTD is demonstration of composite structures, such as fiber reinforced plastics and ceramics, and integrated signature reduction techniques to lighten combat vehicles, thereby making them more deployable while maintaining high levels of survivability. Issues include ballistic and structural integrity, producibility and repairability. Spin-off benefits include lightening current and future medium-to-heavy classes of vehicles and creation of new, light weight systems that are more capable than is possible with today's technology.

ELECTRIC GUNS:

The Electric Armament Program will demonstrate two types of prototype electric guns for anti-armor, as well as other potential applications, such as air and missile defense. Electrothermal guns use pulses of electrical energy to initiate and control chemical reactions and electromagnetic guns use intense magnetic fields to accelerate projectiles. Electrothermal and electromagnetic gun technologies, along with power supplies and projectiles, can provide significant increases in muzzle energy over conventional systems, extend engagement ranges, reduce projectile time of flight, and increase hit-and-kill probabilities.

ENHANCED KINETIC ENERGY WEAPON (X-ROD):

X-ROD is an advanced, tank-fired, guided kinetic energy projectile system capable of defeating targets at extended ranges. Superior hit probability is expected by using one of two competing concepts, command guided or fire-and-forget guidance. This technology has applications for fielded main tank armaments or a future main battle tank.

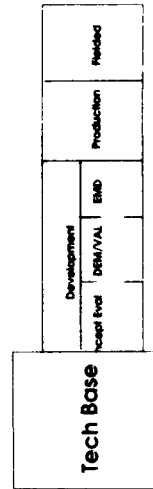

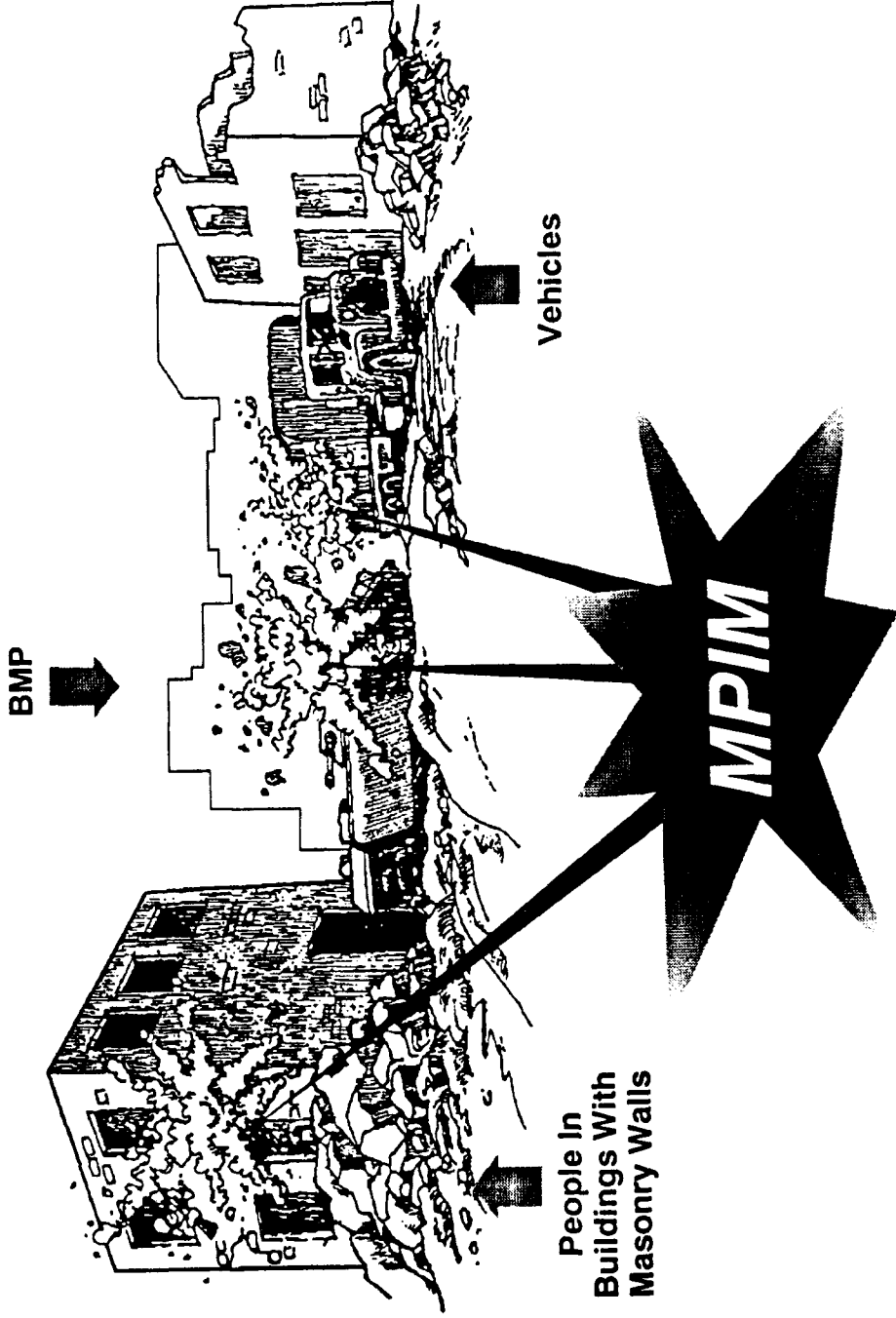

MULTIPURPOSE INDIVIDUAL MUNITION (MPIM)

MISSION:

The MPIM is an individual soldier weapon that will augment the M72 series and AT4 Light Antiarmor Weapons currently in inventory. The weapon will have the ability to defeat armored personnel carriers and incapacitate enemy personnel entrenched behind masonry structures and inside bunkers.

CHARACTERISTICS:

The MPIM is a shoulder-fired weapon:

Weight: 12-15 lbs
Length: < 32 inches

ability to fire from enclosures
disposable round

FOREIGN COUNTERPART:

None. No single weapon exists that can satisfy the wide range of requirements in one system.

PROGRAM STATUS:

The MPIM has transitioned from Proof-of-Principle (POP) to Technology Base. Technical problems with a warhead that would defeat all targets and a propulsion system that could be fired safely from enclosures with a 12 pound weight limit precluded entry into EMD. The MPIM is in the Anti-Armor Master Plan and the Army Armor/Anti-Armor Modernization Plan.

POINT OF CONTACT:

Project Officer - MPIM
U. S. Army Research, Development, and Engineering Center
AMSMLRD-AC-CC
Redstone Arsenal, AL 35898-5242
(205) 842-8769 or DSN 788-8769

CONTRACTORS:

To be determined.

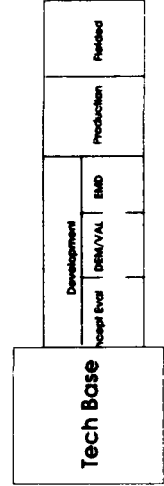



COMANCHE HELICOPTER

MISSION:

The Comanche (RAH-66) is the Army's next generation rotorcraft which will replace the aging scouts and AH-1 attack helicopters. This aircraft in the Army's air cavalry and attack organizations will significantly expand the Army's capability to conduct tactical operations in all types of terrain, adverse weather and battlefield environments, during day/night operations with increased survivability. The Comanche with its increased speed, survivability, air-to-air capability and mission equipment will enhance the combat operation of supported forces. The Comanche supports forward deployed and contingency forces by conducting both close and deep operations with improved lethality and survivability. The force agility will be significantly improved with the Comanche. Its 1260 nautical miles self-deployment range and smaller size will improve Army aviation's rapid strategic deployment. One helicopter, the Comanche will be able to perform the missions currently being performed by three types of helicopters (AH-1, OH-58 and OH-6) better with greater operational and support efficiency.

CHARACTERISTICS:

Weight: 7,500 lbs (target empty weight at production)

Speed: 170 knots (cruise)

Endurance: 2.5 hours (+5 hour reserve)

Crew: 2 pilots (single pilot operable)

Armaments: Air-to-ground and air-to-air missiles

Mission Equipment Package:

Provisions for additional stores and a turret mounted cannon, night vision pilotage system, helmet mounted display, electro-optical target acquisition and designation system, aided target recognition, and integrated displays. Each aircraft will have Longbow capability.

FOREIGN COUNTERPART:

Current Soviet-developed HIND series helicopters and developmental HOKUM and HOAVOC series helicopters present the air-to-air threat.

PROGRAM STATUS:

As a result of the decision to indefinitely delay production of the Comanche, the Dem/Val Phase will be extended by two years (Aug 95 - Aug 97). The Longbow integration effort and T800 development will continue. The Program Manager has decided to uprate the T800 engine by approximately 12% to better support recently validated user requirements.

POINT OF CONTACT:

PM-Comanche
4300 Goodfellow Boulevard
ATTN: SFAAE-AV-RAH (Bldg 6105)
St. Louis, MO. 63120-1795

CONTRACTORS:

Boeing/Sikorsky (Stratford, CT)
Garrett/Allison (LHTEC) (Indianapolis, IN)

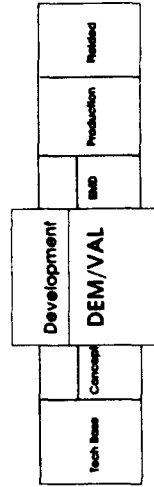



LINE-OF-SIGHT ANTITANK (LOSAT)

MISSION:

The Line-of-Sight Antitank (LOSAT), in the dedicated antitank companies of the Mechanized Infantry Battalions, will provide organic antitank fire to fix and destroy enemy armored formations. This fixing fire will provide tanks and infantry the freedom to rapidly maneuver into the enemy's vulnerable flanks and rear. The LOSAT weapon system consists of a Kinetic Energy Missile (KEM) mounted on a stretched Bradley Fighting Vehicle System (BFVS) chassis. LOSAT will replace the Improved TOW Vehicle (ITV). The key attraction of the LOSAT is the tremendous overmatch lethality of the KEM (defeats all predicted future armored vehicles). LOSAT will also provide the increased mobility, survivability and fleet commonality of the BFVS over the aging ITV. LOSAT will operate out to the maximum range of direct fire combat engagements and will provide dramatically increased rates of fire and enhanced performance under day/night, adverse weather, and obscured battlefield conditions.

CHARACTERISTICS:

KEM

Weight: 170 lbs
Length: 112 in
Diameter: 6.4 in
Range: Greater than TOW
Crew: 3

FOREIGN COUNTERPART:

There are no known foreign antitank missile systems in production or advanced development that operate in the velocity regime of LOSAT or which utilize kinetic energy as the kill mechanism.

PROGRAM STATUS:

The LOSAT program is completing the Demonstration and Validation phase of development and will seek a Milestone II decision to enter Engineering and Manufacturing Development in the 1st quarter of FY93. LOSAT is building upon the earlier Joint Service Hypervelocity Missile Demonstration (approved in August 1988). Under the current acquisition strategy, the First Unit Equipped date will occur in the 4th quarter of FY99.

POINT OF CONTACT:

PM LOSAT
ATTN: SFAE-ASM-LS
Redstone Arsenal, AL 35898

CONTRACTORS:

LTV Aerospace and Defense (Dallas, TX) - Prime
Texas Instruments (Dallas, TX) - Sub
FMC Corporation (San Jose, CA) - Sub

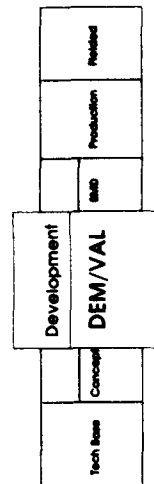

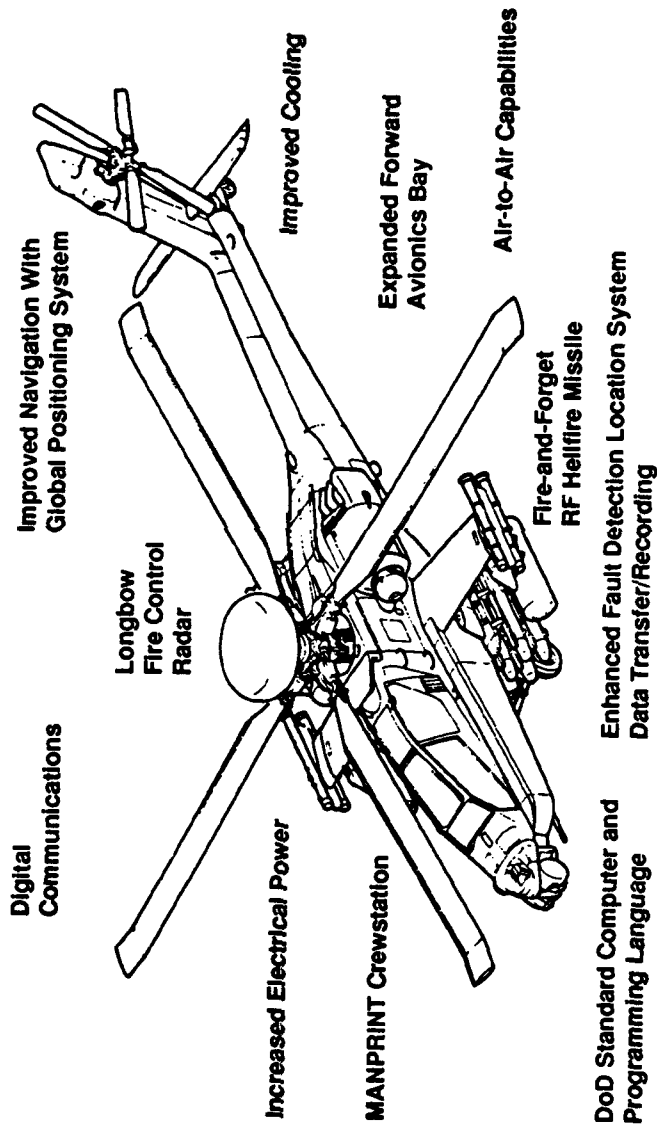

LONGBOW

MISSION:

Longbow is a development and acquisition program for an air/ground targeting radar capable of being used day or night in adverse weather and with battlefield obscurants. The Longbow system is being developed for integration into the Apache attack helicopter and the Comanche armed reconnaissance helicopter. Longbow consists of a mast mounted millimeter wave Fire Control Radar (FCR), a Radio Frequency Interferometer (RFI), and a radio frequency fire and forget Hellfire Missile. The FCR detects ground or air targets, and the RFI identifies active emitters. The central processor then classifies the targets, establishes priority for engagement and passes target information to the missile seeker. The pilot may then engage the targets with significantly reduced decision and exposure times. Longbow is being planned for integration into eleven pure Longbow Apache Battalions in Force Package I, and into one third of the Comanche fleet.

CHARACTERISTICS:

The Longbow Fire Control Radar antenna and RFI are housed in a mast mounted assembly above the helicopter rotor system. The processors for the radar are located in the aircraft's avionics bays. The Longbow Apache consists of the AH-64 aircraft modified with changes necessary to effectively and efficiently integrate the Longbow radar and missile. Changes are additional power, expanded avionics bays, additional cooling, upgraded processors, integrated avionics, and a MANPRINT crewstation.

FOREIGN COUNTERPART:

There are presently no known comparable helicopter radar systems.

PROGRAM STATUS:

The Longbow Apache System entered Full Scale Development in December 1990 following an extremely successful Proof of Principle (POP) Phase. Technical success during POP culminated with the live firing of nine missiles against a wide variety of targets, moving and stationary, through smoke and obscurants. Only one missile missed its target due to a failed missile gyro, not related to the Longbow seeker. The current program objective calls for 227 Longbow Apache aircraft with first flight of the integrated radar commencing in August of 1993. The Longbow Apache will add significant warfighting capability to the Apache fleet in survivability, lethality, and versatility, as well as long term reliability improvements.

POINT OF CONTACT:

PM Longbow
Attn: SFAE-AV-1B
4300 Goodfellow Blvd.
St. Louis, Missouri 63120

CONTRACTORS:

McDonnell Douglas Helicopter Company (Mesa, AZ) Martin Marietta (Orlando, FL)
Westinghouse (Baltimore, MD)

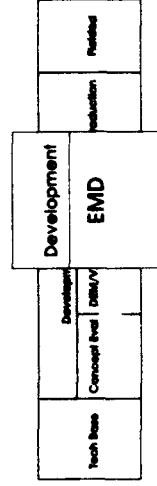



JAVELIN

MISSION:

The Javelin is a man-portable anti-tank system for the U.S. Army and U.S. Marines. The system provides high lethality against conventional and reactive armor and will replace the Dragon. The Javelin is comprised of two major components: a reusable Command and Launch Unit (CLU) and a missile sealed in a disposable launcher container. The CLU incorporates an integrated day/night sight and provides target engagement capability in adverse weather. The CLU may be used in stand-alone mode for battlefield surveillance and target detection.

CHARACTERISTICS:

The Javelin system will weigh less than 49.5 pounds and will have a maximum range of 2000 meters. Dismounted infantry and U. S. Marines are the primary users. The key feature of the Javelin is the utilization of fire-and-forget technology. This technology allows the gunner to fire and immediately take cover. Additional special features are the top attack or direct fire mode (for targets under cover), integrated day/night sight, dual warhead, imaging infrared seeker, target lock-on, and soft launch. Javelin can also be safely fired from enclosures and covered fighting positions.

FOREIGN COUNTERPART:

No other fire and forget systems exist. Similar systems are the Soviet-developed AT-7, Swedish Bofors Bill, and the French MILAN 2.

PROGRAM STATUS:

The Javelin program is beginning the third year of Engineering and Manufacturing Development. There have been five successful guided flight tests thus far. Production deliveries are expected to begin in Jul 95 and extend into the year 2006.

POINT OF CONTACT:

Project Manager
ATTN: SFAE-FS-AM
Redstone Arsenal, AL 35898-5650

CONTRACTORS:

Texas Instruments/Martin Marietta JAVELIN Joint Venture (Denton, TX)	Denton, TX
Prime System	Orlando, FL
Prime System	Martin Marietta
SubContractors:	
Seeker Focal Plane Array	SBRC
Propulsion Unit	ARC
Warhead Main Charge	Physics Intl
Electronic Safe Arm & Fire	Magnavox
Control Actuation System	National Waterlift
Launch Tube Assembly	ABB
	Santa Barbara, CA
	Gainesville, VA
	Oakland, CA
	Fi. Wayne, IN
	Kalamazoo, MI
	Irvine, CA

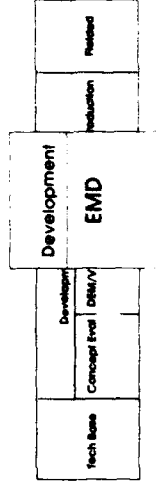

STINGRAY

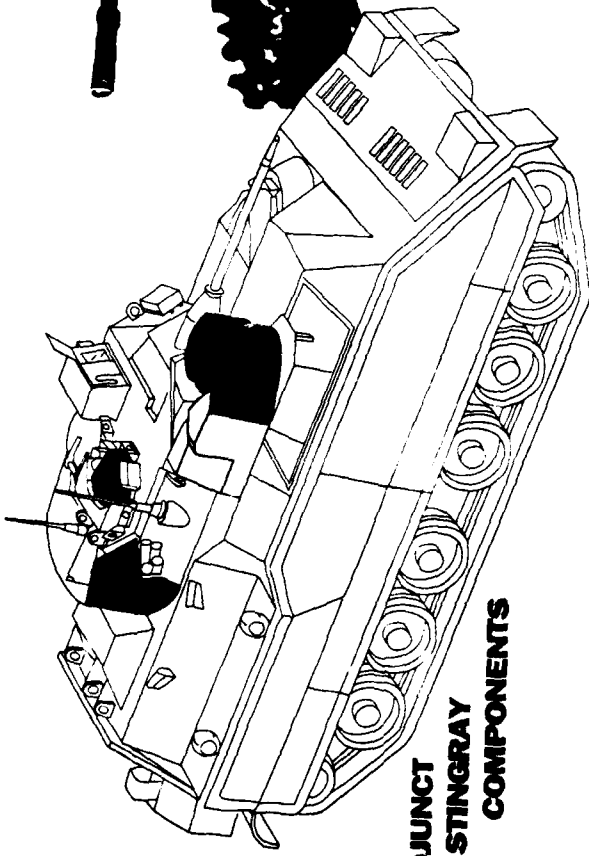

ADJUNCT
STINGRAY
COMPONENTS



ADVANCED DEVELOPMENT STINGRAY



STINGRAY FIELD OF GUARD

STINGRAY

MISSION:

Stingray is a protection system which increases the survivability of the host vehicle and adjacent forces against Optical and Electro-Optical (OEO) equipped threats by disrupting threat fire control systems long enough for the user to engage the hostile system by fire or to take other appropriate action. Stingray will detect, track, and countermeasure (CM) systems by neutralizing the Target Acquisition System on the threat forces' tanks, combat vehicles, and other ground and airborne systems beyond the threat's effective ranges. Stingray will be employed to disrupt surveillance by countermeasuring OEO devices servicing threat combat vehicles and weapon systems. This CM capability acts as a force multiplier against numerically superior threat armored and mechanized forces.

CHARACTERISTICS:

The system consists of four basic components: (1) sensor assembly with optics, stabilization, and high resolution detector; (2) laser transmitter; (3) commander's controls and display; and (4) system electronics which contain signal processing, built-in test, host vehicle interface and target handoff. The system operates in 3 modes - Automatic, Semi-Automatic (man-in-the-loop), and Manual; provides target acquisition and range-finding capability; and operates both stationary and on the move, detecting stationary and moving targets.

FOREIGN COUNTERPART:

It is believed that Soviets had developed significant numbers of similar type weapons. With the break-up of the Soviet Union, other nations may try to obtain some of these systems. China also has an R&D program.

PROGRAM STATUS:

Stingray has been in advanced development since 1982. One system was built and tested for over 36 months. A second system was assembled for Desert Storm and both were deployed to support ground operations. The program was approved for entry into engineering and Manufacturing Development at the Milestone II ASARC. Subsequent decisions may direct the program to continue as a research and development effort that will produce "fieldable" prototypes for evaluation, doctrinal development, and contingencies. Final decision is pending.

PERFORMANCE IN SWA:

Two systems deployed; 100% operational. Not used in combat due to short duration of ground combat.

POINT OF CONTACT:

PM Stingray
Attn: SFAE-IEW-EW
Evans Area
Ft. Monmouth, N.J. 07703-5000

CONTRACTORS:

Martin Marietta Corporation (Orlando, FL)

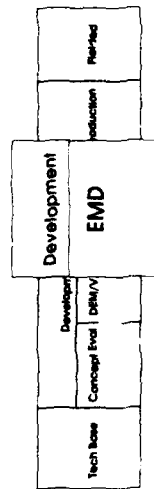

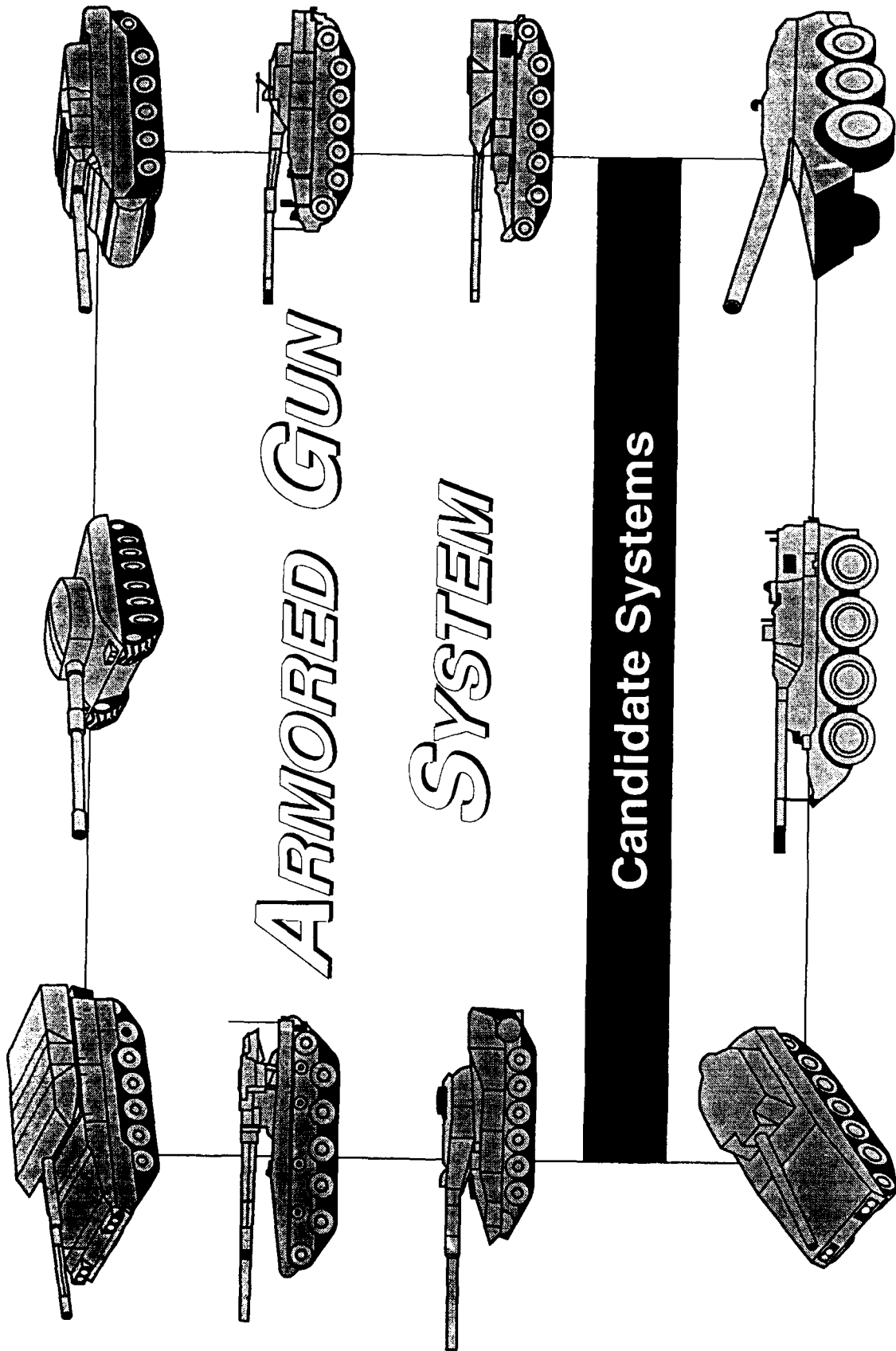

ARMORED GUN SYSTEM (AGS)

MISSION:

The Armored Gun System (AGS) is the lightweight strategically and tactically deployable weapon system which will replace the M551A1 Sheridan. The AGS will provide direct fire support to the 82nd ABN DIV, Light Infantry Contingency Forces and other light armor operational requirements. The vehicle will be capable of being committed to areas where timely deployment of the main battle tank may not be feasible or practical. The AGS will be deployable by Low Velocity Air Drop (LVAD) from United States Air Force (USAF) tactical transport aircraft (C-17 required and C-130 desired) and will provide C-130/C-14; Roll-On/Roll-Off (RO/RO) capability.

CHARACTERISTICS:

Weight: RO/RO < 44,000 lbs
Mobility: LVAD (C-17) < 49,500 lbs
Range: > M551A1 Sheridan
Speed: 160 km (LVAD configuration)
480 km (combat loaded)
64 kph hard surface roads
40 kph secondary roads
Ordnance: M109mm/30rds
Crew: 3 - 4

FOREIGN COUNTERPART:

The Soviet-developed counterpart is the ASU-85, which is a versatile air-transportable and air-droppable weapon system principally employed in an antitank role, but is capable of providing general direct fire support.

PROGRAM STATUS:

Contract award for Engineering and Manufacturing Development (EMD) of the AGS is planned for May, 1992. Delivery of prototype vehicles for Technical Test/Early User Test and Evaluation is expected within two years of contract award.

POINT OF CONTACT:

PM, Armored Gun System
ATTN: SFAE - ASM - AG
Warren, MI 48397-5000

CONTRACTORS:

To be determined.

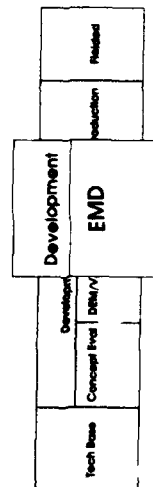

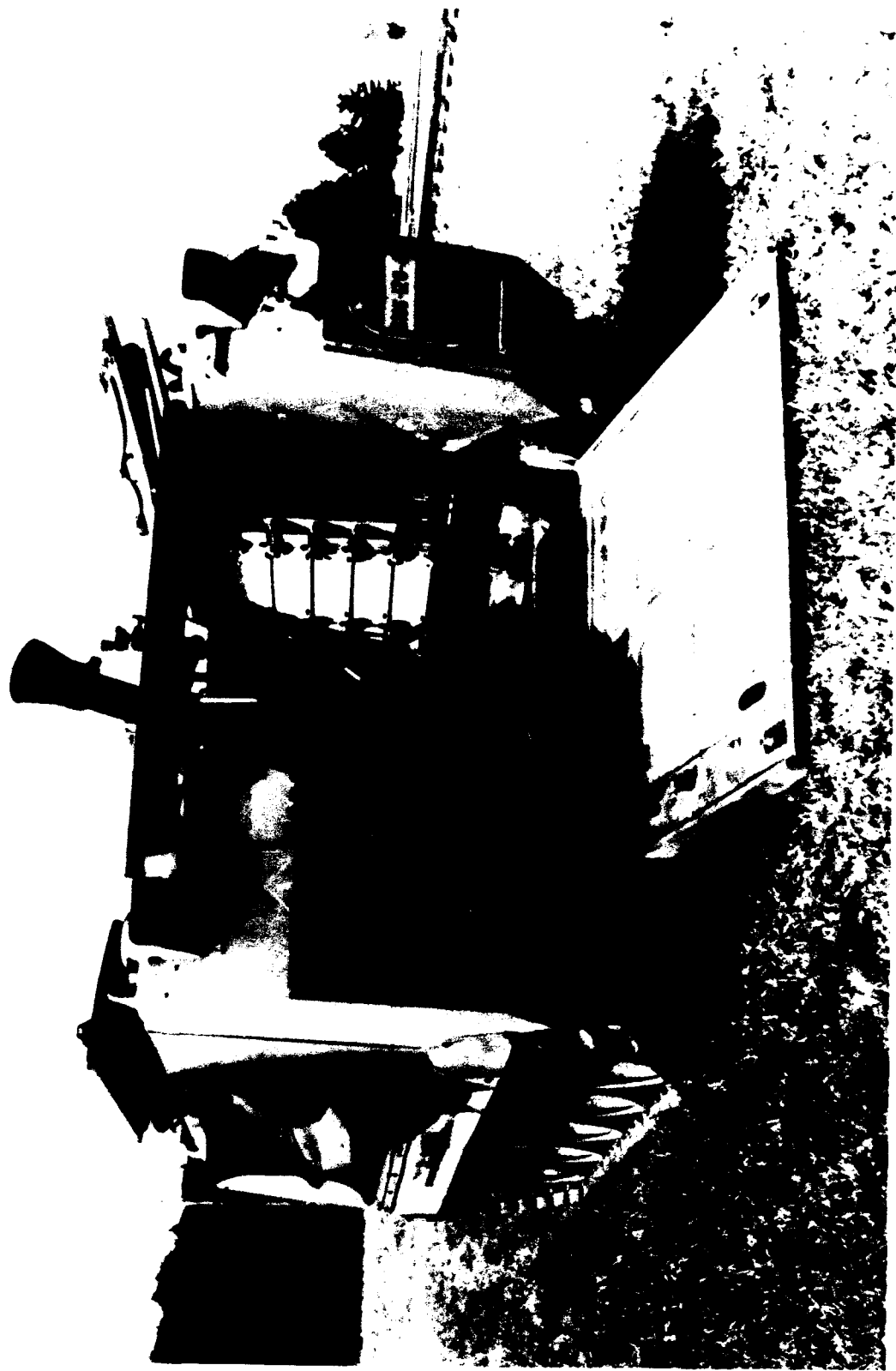

120mm MORTAR

MISSION:

The 120mm mortar system will provide improved organic indirect fire support capability to the maneuver unit commander. The 120mm mortar was acquired as a nondevelopmental system from Israel. It is a conventional smoothbore, muzzle-loaded mortar system which provides increased range and lethality over the 4.2-inch heavy mortar system. It will be employed in both towed and carrier-mounted versions. The 120mm mortar will fire a family of enhanced ammunition being produced in the U.S. It will replace the WWII vintage 4.2-inch heavy mortars in the mechanized infantry, motorized, armored and cavalry units.

CHARACTERISTICS:

Range: 7,240 meters
Weight: 319 pounds (ground-mounted)
Rate of Fire: 4 rounds per minute, sustained
Crew: 5 (ground-mounted)
Ammunition: HE, Smoke, Illumination

FOREIGN COUNTERPART:

The 120mm smoothbore mortar is used by France, Germany, Denmark and other allied armies. The Soviet-developed counterpart is the M43 120mm mortar which has a range of 5,700 meters, weighs 602 pounds and has a 6 man crew.

PROGRAM STATUS:

The 120mm mortar is currently in low-rate production at Watervliet Arsenal, New York. The 120mm mortar towed system, M120, was fielded in September 1991 to the 199th Infantry Brigade, Ft Lewis, Washington. The M121 carrier mounted version will be fielded to all remaining heavy maneuver units beginning in 4QFY93. The Army plans to field a total of 1725 systems to replace all the 4.2-inch mortars currently in the inventory. The 120mm mortar enhanced ammunition is currently being produced by Martin Marietta Ordnance System, Orlando, Florida. The Army has type classified the M933/934 HE and M930 illumination rounds for production in 1991. The XM929, Smoke round is scheduled for type classification in early April 1992.

POINT OF CONTACT:

U.S. Armament, Munitions And Chemical Command
ATTN: AMCPM-MO
Picatinny Arsenal, NJ 07806-5000

CONTRACTORS:

Weapon: Watervliet Arsenal, NY
Ammunition: Martin Marietta Ordnance Systems (Milan, TN); Scranton AAP, PA; Radford AAP, VA;
Brockway Standard Inc., GA; United Ammunition Container Corp. TN; Polymer Technologies, Inc. NJ;
ARMTEC Defence Products, Inc., CA; Loral Corp., PA

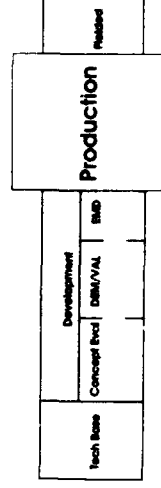



ABRAMS TANK

MISSION:

The mission of the Abrams tank is to close with and destroy enemy forces on the integrated battlefield using mobility, firepower and shock effect. The 105mm main gun on the M1 and IPM1 and the 120mm main gun on the M1A1 combined with the powerful 1500 HP turbine engine and special armor make the Abrams particularly suitable for attacking or defending against large concentrations of heavy armor forces on a highly lethal battlefield. Additional features of the M1A1 are increased armor protection, suspension improvements and an NBC protection system which provides additional survivability in a contaminated environment. The M1A2 development program builds on the M1A1 to provide an Abrams tank with the necessary improvements in lethality, survivability, and fightability required to defeat the threat of the mid nineties. Improvements being developed for the M1A2 include a Commander's Independent Thermal Viewer, an Independent Commander's Weapon Station, Position Navigation equipment, and a distributed data and power architecture.

CHARACTERISTICS:

	M1/IPM1	M1A1	M1A2
Length:	32.04 ft	32.25 ft	32.25 ft
Width:	12.0 ft	12.0 ft	12.0 ft
Height:	7.79 ft	8.0 ft	8.0 ft
Top Speed:	45.0 mph	41.5 mph	41.5 mph
Weight:	60 tons	67 tons	68.9 tons
Armament:	105mm	120mm	120mm
Crew:	4	4	4

FOREIGN COUNTERPART:

There are numerous main battle tanks throughout the world such as the British Challenger, the German Leopard, the French LeClerc and the Soviet-developed T-64, T-72 and T-80 which are in the same class as the Abrams series tanks.

PROGRAM STATUS:

The Abrams tank is in its eleventh year of production. Over 7,000 tanks are in the field as of the beginning of 1992. By the end of FY 92 all active component armor units will be equipped with the M1A1 or M1. Reserve Component Roundout units are also receiving the Abrams tank. The M1A2 has begun Technical and Operational testing and is expected to enter low rate production in 1992.

PERFORMANCE IN SWA:

The Abrams received outstanding comments on its lethality, mobility and reliability. The Abrams was employed in fast paced, complex, offensive and defensive, day and night operations. The Abrams vastly overmatched Iraqi systems' lethality, mobility, survivability, target acquisition and fire control. The Abrams Operational Readiness (OR) rate exceeded 90% in all units throughout the conflict.

POINT OF CONTACT:

PM-Abrams Tank System,
SFAE-ASM-AB
Warren, MI 48397-5000.

CONTRACTORS:

General Dynamics Land Systems Div. (Sterling Hts, MI)

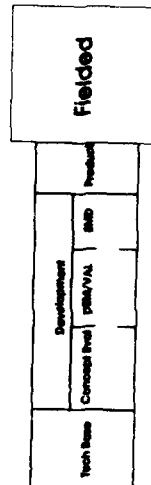



BRADLEY FIGHTING VEHICLE SYSTEM (BFVS)

MISSION:

The BFVS is a lightly armored, full-track fighting vehicle which provides cross-country mobility, mounted firepower, and protection from artillery and small-arms fire to mounted infantry and cavalry combat operations and support to dismounted combat operations.

CHARACTERISTICS:

Weight: 60,000 lbs (M2/M3A2 W/O Armor Tiles) Crew: 3
 Length: 21.5 ft. Power Train: 600 Hp
 Height: 9.75 ft. Range: 300 Mi
 Width: 10.5 ft. Road Speed: 38 Mph
 Main Armament: 25mm Cannon Swim Speed: 4.4 Mph
 Secondary Armament: TOW, 7.62 Coaxial MG

FOREIGN COUNTERPART:

The BMP is the Soviet-developed infantry fighting vehicle and mounts a 73mm smoothbore cannon, an AT3, AT5, or AT6 antitank guided missile and permits the infantry squad to fire from the inside. The BMP-2 is another variant with a 30mm gun, which fires the AT4 or AT5 and is also being fielded.

PROGRAM STATUS:

At the end of the latest contract with FMC in FY94, the Army will have produced a total of 6724 Bradleys, 4641 in the M2 or Infantry configuration and 2083 in the M3 or Cavalry configuration. Both the M2 and M3 were produced in three versions: the Army initially purchased 2300 basic or A0 Bradleys; then 1371 vehicles in the A1 configuration which incorporates the TOW 2 Subsystem; and currently 3053 vehicles in the A2 High Survivability configuration. The Army is also in the process of converting all A1's to the A2 configuration at Mainz and Red River Army Depots.

PERFORMANCE IN SWA:

The BFVS exceeded expectations in lethality, mobility and operational readiness. The 25mm cannon and TOW Subsystem proved to be exceptionally lethal against Iraqi armor.

POINT OF CONTACT:

Program Manager, Bradley Fighting Vehicle System
 ATTN: SFAE-ASM-BV
 Warren, MI 48397-5000

CONTRACTORS:

FMC Corp. (San Jose, CA) Alliant Tec Systems (Minneapolis, MN)
 General Electric Corp. (Pittsfield, MA) General Electric Corp. (Burlington, MA)
 Cummins (Columbus, IN) Pentastar (Huntsville, AL)
 Hughes Aircraft Corp. (LaGrange, GA) McDonnell Douglas (Mesa, AZ)

Tech Base	Development		Fielded
	Concept Eval	DMA/VAL BMD	

M113 FAMILY OF VEHICLES

M577A2



M548



M125A2



M106A2

M113A3



M667A1



M113 ARMORED
MAINTENANCE VEHICLE



M730A2

M113 FAMILY OF VEHICLES (FOV)

MISSION:

The M113 FOV has been in continuous production since 1960 with over 85,000 vehicles, consisting of 35 different variants, in use by over 44 countries. The Army's fleet of 32,000 vehicles are used for a variety of missions to include transport of infantry and engineer units, medical evacuation, fire support and Command and Control functions on the battlefield.

CHARACTERISTICS:

Weight:	27,180 lbs (M113A3)	Crew:	2
Length:	17.1 ft	Power Train:	275 hp
Height:	8.1 ft	Range:	300 mi
Width:	8.8 ft	Road Speed:	42 mph
Main Armament:	.50 Cal machine gun	Swim Speed:	4 mph

FOREIGN COUNTERPART:

The Soviet-developed wheeled BTR-60, BTR-70, and new BTR-80 series amphibious armored personnel carriers are roughly equivalent in function to the M113. The MTLB amphibious, multipurpose, tracked carrier is used to carry infantry and as a prime mover for towed artillery and antitank guns.

PROGRAM STATUS:

Deliveries of the M113A3 began in FY86 and are scheduled for completion in FY92. The A3 configuration adds spall suppression liners, armored external fuel tanks and upgraded engine and transmission to accommodate the added weight of bolt on armor. Depot conversion programs are ongoing in CONUS and OCONUS to modify fielded M113A2's to the M113A3 configuration.

PERFORMANCE IN SWA:

Commanders and crews were impressed with the performance of the M113A3. The system's mobility and speed were impressive.

POINT OF CONTACT:

Program Manager, AMCPM-M113/M60 FOV
 US Army Tank and Automotive Command
 Warren, MI 48379-5000

CONTRACTORS:

FMC Corp (San Jose, CA)
 GMC, Detroit Diesel Allison (Detroit, MI)

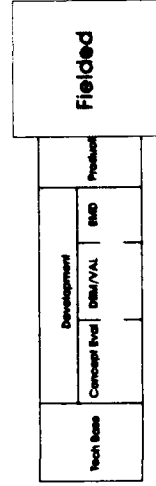



APACHE

MISSION:

The AH-64 Apache is the Army's primary attack helicopter. It is a quick-reacting, airborne antitank weapon system. Terrain limitations and the unknown placement of numerically superior enemy armor dictate the need for a system that can deploy quickly to the heaviest enemy penetration and destroy, disrupt, or delay the attack long enough for friendly ground maneuver units to reach the scene. The Apache is designed to fight and survive at day, night, and in adverse weather throughout the world. It is equipped with a Target Acquisition Designation Sight and Pilot Night Vision Sensor (TADS/PNVS) which permit its two-man crew to navigate and attack in darkness and in adverse weather conditions. The principal mission of the Apache is the destruction of enemy armor with the Hellfire missile. It is also capable of employing a 30mm M230 chain gun and Hydra 70 (2.75 inch) rockets that are lethal against a wide variety of targets. The Apache has a full range of aircraft survivability equipment and has the ability to withstand hits from rounds up to 23mm in critical areas.

CHARACTERISTICS:

Mission Gross Weight: 14,770 lbs
Cruise Speed: 145 knots
Crew: 2
Armament: Hellfire Missiles, Hydra 70 rockets and 30mm M230 chain gun

FOREIGN COUNTERPART:

The Soviet-developed HIND is the Apache's closest counterpart. The Soviets have deployed significant numbers of HINDs in Europe and have exported the HIND to many third world countries. They will deploy the new HAVOC soon. The HAVOC closely resembles the Apache and is expected to be employed similarly. They are also developing the HOKUM attack helicopter. The HOKUM will probably be used as an air-to-air system against other helicopters. The Italian A-129 Mangusta is the nearest NATO counterpart to the Apache. The Germans and French are co-developing the PAH-2 Tiger attack helicopter which has many of the capabilities of the Apache.

PROGRAM STATUS:

Apache production began in FY82 and the first unit deployed in FY86. As of December 1991, 705 Apaches were delivered to the Army. The last Army Apache delivery is scheduled for February 1995. Twenty-five attack battalions are deployed and ready for combat. The Army is procuring a total of 811 Apaches to support a force structure of 40 battalions (26 Active; 2 Reserve; 12 National Guard). The Apache has been sold to Israel, Egypt, Saudi Arabia, the UAE, and Greece.

PERFORMANCE IN SWA:

Apaches fired the first shots of the Gulf war. The Apache performed admirably during day, night and adverse weather against both moving and stationary targets, while maintaining high availability rates in an extremely harsh environment.

POINT OF CONTACT:

PM Advanced Attack Helicopter
4300 Goodfellow Boulevard
St. Louis, MO 63120

CONTRACTORS:

McDonnell Douglas Helicopter Company (Mesa, AZ) General Electric (Lynn, MA)
Martin Marietta (Orlando, FL)

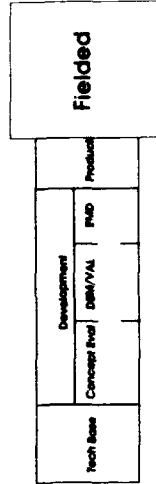



KIOWA WARRIOR

MISSION:

OH-58D Kiowa Warrior is the Army's first true scout helicopter. The armed version is currently the only practical armed reconnaissance aircraft in the inventory until RAH - 66 fieldings in FY 99. The OH-58D supports Army Airland Battle with reconnaissance, security, command and control, target acquisition/designation and Defensive Air Combat. The armed OH-58D adds armed reconnaissance, light attack and Multipurpose Light Helicopter (MPLH - rapid deployment, troop lift, cargo and Medivac) to the aircraft's mission capabilities. The OH-58D has a Mast Mounted Sight that houses a Thermal Imaging System, Low-light Television, and a Laser Rangefinder/Designator. A highly accurate navigation system permits precise target designation that can be handed off to other engagement systems via the Airborne Target Handover System. The Laser Designator can provide designation for other laser guided precision weapons. Air-to-Air Stinger (ATAS) provides security against threat aircraft. The armed retrofit program began in FY 91 and provides Air-to-Ground weapons and other improvements to previously produced OH-58Ds.

CHARACTERISTICS:

Max Gross Weight: 5,500 lbs.
 Max Speed: 118 kts - Clean; 113 KTAS - Armed
 Armament: ATAS, .50 cal. Machine Gun, 2.75" Hydra 70 rockets (7 shot pod), Hellfire missiles
 choices; 1 system per side
 Crew: 2

FOREIGN COUNTERPART:

Germany - BO - 105; France - Gazelle, Alouette; numerous Soviet-developed helicopters (HINDs, HIPs, Hoplites)

PROGRAM STATUS:

Kiowa Warrior is in the eighth year of production. There have been 222 aircraft accepted through November, 1991. Aircraft deployments include the training bases at Fort Rucker and Fort Eustis, and two operational units in CONUS, USAREUR, and Korea. The Procurement Objective is currently 291, with 255 for the active components and 36 for the National Guard Bureau. Deliveries will end in June 1993. Armed retrofit is scheduled to complete in FY 96.

PERFORMANCE IN SWA:

Armed OH-58Ds (Prime Chance) operating from Navy vessels liberated the first Kuwaiti territory (Qurah Island) during the Gulf War. Additional armed OH-58D successes were the damage/destruction of numerous Iraqi watercraft, air defense and anti-ship missile sites (oil platforms). Unarmed OH-58Ds led the Second Armored Cavalry Regiment's (VII Corps) main effort into Iraq, providing ground maneuver forces critical "real time" intelligence in their rout of the Republican Guards. Additional unarmed missions included Laser designation for precision munitions (HELLFIRE, Copperhead, and USAF laser guided munitions), Cavalry missions (screens, reconnaissance, etc.), and forward observation for field artillery adjustment.

POINT OF CONTACT:

PM Kiowa Warrior
 4300 Goodfellow BLVD
 ATTN: (SFAE-AV-ASH-T)
 ST. Louis, MO. 63120-1798

CONTRACTORS:

Bell Helicopter Textron, Inc. (Ft. Worth, TX)
 Allison Gas Turbine Division (GM) (Indianapolis, IN)
 Litton Laser Systems (Orlando, FL)
 McDonnell Douglas Electronics Systems (Monrovia, CA)
 Northrop Corp (Anaheim, CA)
 Honeywell, Inc. (Defense Avionic Sys Div (Albuquerque, NM)

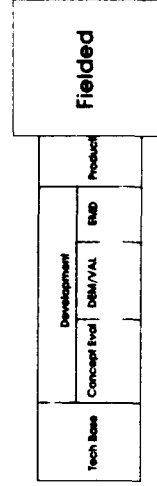



TOW WEAPON SYSTEM

MISSION:

The TOW (Tube-Launched, Optically-Tracked, Wire Command-Link Guided) missile is a long range heavy antitank system designed to attack and defeat armored vehicles and other targets such as field fortifications. It is found at battalion level and is mounted on the Bradley Fighting Vehicle System (BFVS), the Improved TOW Vehicle (ITV), the High Mobility Multipurpose Wheeled Vehicle (HMMWV), and the AH-1S Cobra Helicopter. The system consists of a tripod, traversing unit, missile guidance set, launch tube, optical sight, and battery assembly and any of the five missile variations. The system also includes a thermal sight which provides a capability for operations at night, in reduced visibility and in a countermeasure environment. The missiles are all-up rounds encased in a disposable container.

CHARACTERISTICS:

	<u>TOW2A</u>	<u>TOW2B</u>
Crew Size	3	3
System Weight:	280 lbs	280 lbs
Reliability:	95%	95%
Minimum Range:	65M	200M
Maximum Range:	3750M	3750M

FOREIGN COUNTERPART:

Bofors Bill (Sweden) AT-4/5/6 (Russia) TRIGAT-Heavy (France/Germany/U.K.)
 MILAN 2 (France/Germany/U.K.) HOT 2 (France/Germany)

PROGRAM STATUS:

The TOW Weapon System entered its Production and Development Phase with the Basic TOW in 1970. Since that time there have been five variations of the missile and two variations of the TOW Sub-system. The TOW 2B will replace the TOW 2A as the standard production missile in 2QFY92, and will join the over 100,000 missiles and 14,000 platforms already in the field. The TOW is currently in use by over 40 other nations as their primary heavy antiarmor weapon system. A requirement for an integrated target acquisition system is addressed by an ongoing program of technical demonstrations and risk reduction efforts.

PERFORMANCE IN SWA:

Both the Army and the Marine Corps used the TOW as their heavy antiarmor weapon. Mounted on the M2/M3, HMMWV, ITV, AH-1S helicopter, and in its ground mounted version, it was extremely effective out to its maximum effective range and under degraded visibility conditions.

POINT OF CONTACT:

PM-TOW
 ATTN: SFAE-FS-TO
 Building 5250
 Redstone Arsenal, AL 35898-5710

CONTRACTORS:

Hughes Aircraft Company (Tucson, AZ)

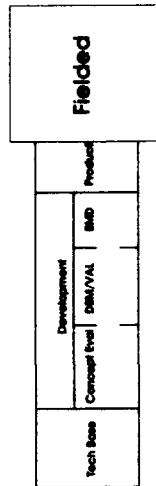

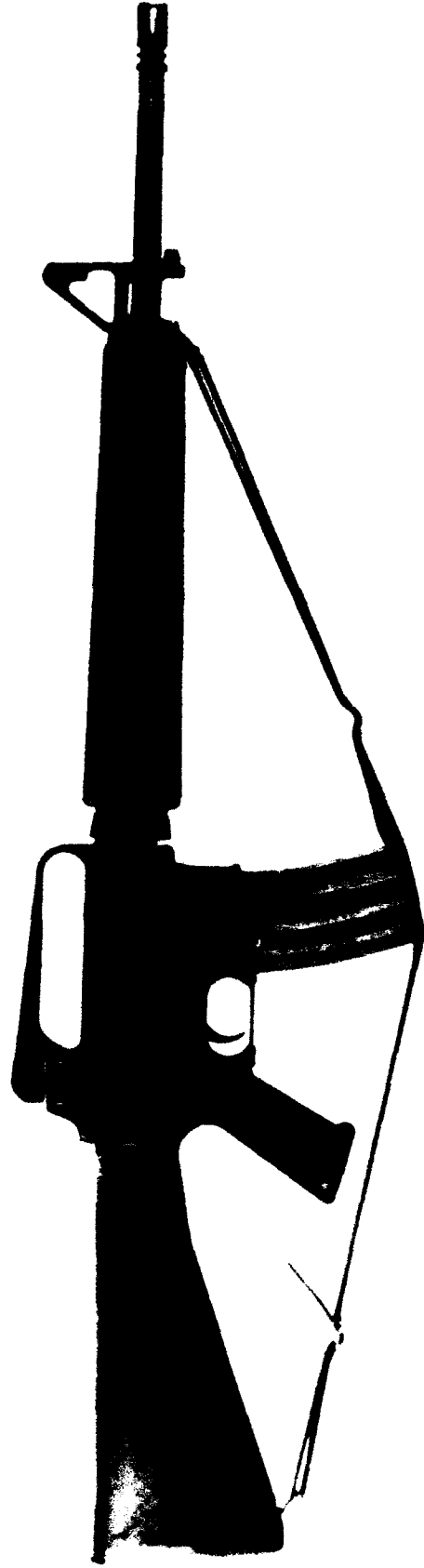

M16 A2 RIFLE

RIFLE

MISSION:

The M16A2 is an improved version of the M16A1 and is being issued to front line combat soldiers as the Army's primary combat rifle. The M16A2 is a lightweight, air-cooled gas operated, low impulse rifle. It incorporates improvements in sight, pistol grip, stock and overall combat effectiveness. Accuracy is improved by incorporating an improved muzzle compensator, three round burst control, a heavier barrel and by using the heavier NATO standard ammunition which is also fired by the Squad Automatic Weapon.

CHARACTERISTICS:

Caliber: 5.56mm
Weight: 8.9 lbs
Range: 550 meters
Type of Fire: Semi-automatic, three round burst
Magazine capacity: 30 rounds

FOREIGN COUNTERPART:

The 5.45mm AK-74 Assault Rifle is currently in service in The Commonwealth of Independent States as well as in some Eastern European forces.

PROGRAM STATUS:

The Army First Unit Equipped (FUE) occurred in January 1987 and to date, approximately 286,000 new weapons have been fielded. Approximately 100,000 M16A1 rifles will be converted to M16A2 rifles during depot overhaul using modification kits. A five year, competitively selected, firm fixed price contract was awarded in September 1988 for approximately 260,000 rifles.

POINT OF CONTACT:

Armament Munitions and Chemical Command
Attn: AMSMC-ASJ
Rock Island, IL 61299-7150

CONTRACTORS:

Colt Industries (Hartford, CT) began original production in June 1983.
Current contractor is FN Manufacturing Inc. (Columbia, SC).

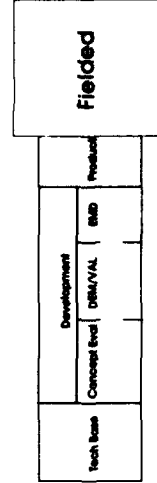

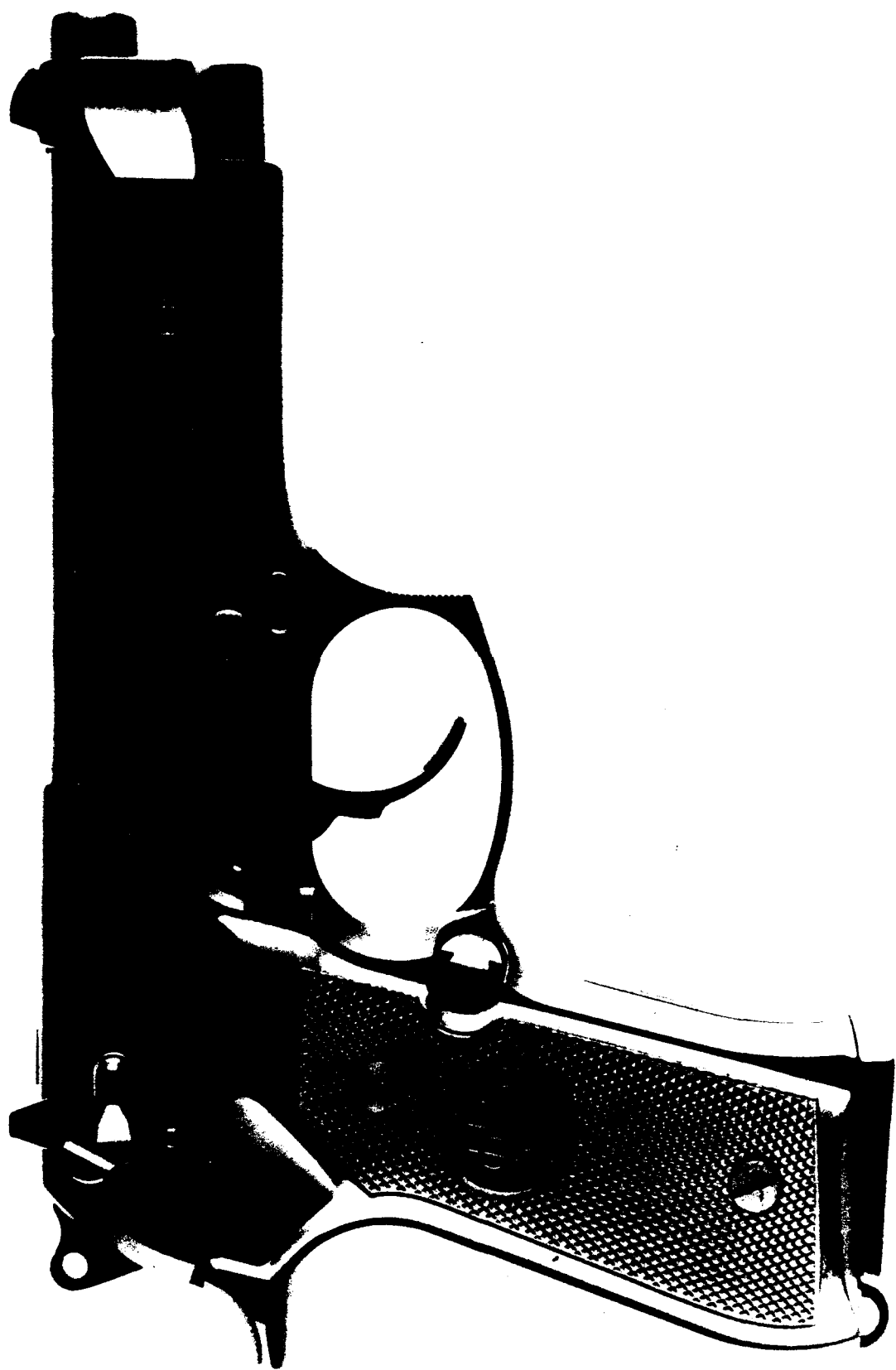

9mm PERSONAL DEFENSE WEAPON

MISSION:

The M9 9mm pistol replaces the M1911A1 .45 caliber pistol and the four-inch .38 caliber revolver currently used by the Department of Defense. The M9 is a semiautomatic double-action pistol that is more lethal, lighter, and safer than the M1911A1 pistol. It can be used effectively by either right or left handed shooters. The weapon is carried by service members who are not issued rifles, and others who have a close quarter personal defense requirement such as law enforcement personnel and aviators.

CHARACTERISTICS:

Caliber: 9mm
Weight (loaded): 2.6 lbs
Range: 50 meters
Trigger action: Double
Magazine Capacity: 15 rounds

FOREIGN COUNTERPART:

The Soviet-developed 9mm Makarov is the standard pistol for many Eastern European forces. 9mm semiautomatic pistols used by NATO allies include Beretta's 92F series, Heckler & Koch's P7/P9 series, Walther's P5/P88 series, Browning HiPower, and weapons manufactured by Glock, SIG, and Star. Performance of the M9 pistol and foreign counterparts are comparable.

PROGRAM STATUS:

The M9 pistol is in production. An initial five-year multiyear, firm fixed price contract was awarded in April 1985 for 315,930 weapons for all DoD uniformed services. A follow-on competition was conducted in FY 1988-1989 resulting in the award of option quantities totaling 56,705 pistols to Beretta beginning May 1989. As of January 1992, 262,932 M9 pistols have been delivered.

POINT OF CONTACT:

Product Manager, 9mm Pistol
ATTN: SFAE-AR-9MM
Rock Island, IL 61299-7150

CONTRACTORS:

Beretta, USA (Accokeek, MD)

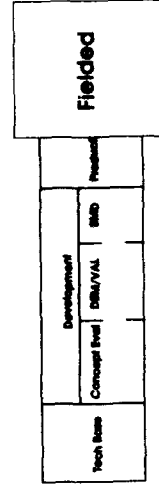

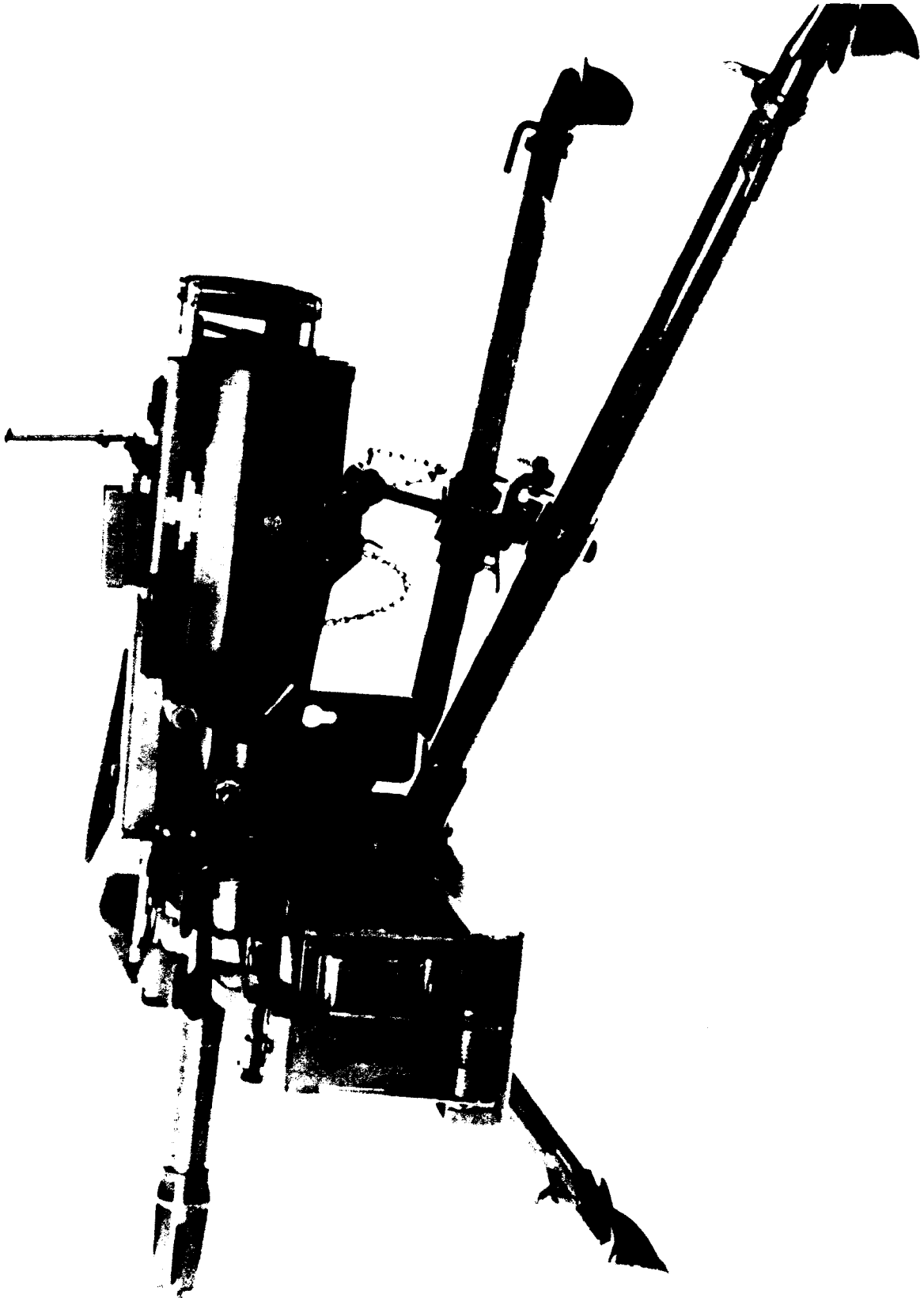

40mm AUTOMATIC GRENADE LAUNCHER

MISSION:

The MK 19-3 is designed to deliver accurate, intense, decisive firepower against enemy personnel and lightly armored vehicles to a maximum effective range of 1600 meters against point targets and 2200 meters against area targets. It is used in offensive and defensive operations in the main battle area and will be the primary suppressive weapon for combat support and combat service support units. The MK19-3 is mounted on the High Mobility Multi-Purpose Wheeled Vehicle (HMMWV), M113 Armored Personnel Carriers, 5 ton trucks, and selected M88A1 recovery vehicles.

CHARACTERISTICS:

Caliber: 40mm
Weight: 72.5 lbs
Rate of fire: 325-375 rds/min
Max effective range: 1500 meters (Point targets); 2200 meters (area targets)
Lethality: Anti-personnel--5 meters (Expected Casualty Radius)
Anti-armor--2.00 inches penetration to maximum range of 2200M

FOREIGN COUNTERPART:

The Soviet 30mm AGS-17 automatic grenade launcher was developed as a result of the fielding of the U.S. 40mm MK19 Mod O machine gun, which saw extensive service in Vietnam.

PROGRAM STATUS:

The MK 19-3 was developed and approved for Service use by the Navy in 1981. The Army type classified the MK 19-3 standard "A" in January 1986. Initial procurement of MK 19-3 for the 9th Infantry Division was contracted for by the Navy in October 1983. The Army assumed program management responsibilities from the Navy in FY88. A competitive five-year contract was awarded in December 1988. First Unit Equipped (FUE) occurred in November 1989.

POINT OF CONTACT:

Armament Research Development and Engineering Center
Attn: SMCAR-GMG
Picatinny Arsenal, N.J. 07806-5000

CONTRACTORS:

SACO Defense Inc. (Saco, ME)

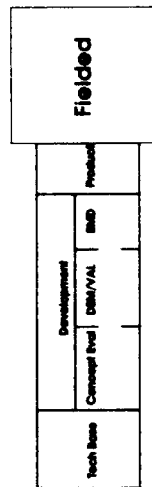



SQUAD AUTOMATIC WEAPON

MISSION:

The M249 Squad Automatic Weapon (SAW) provides a lightweight, one-man-portable machine gun capable of delivering a large volume of effective fire for infantry squads. It also provides a sustained fire capability and increased range in rifle squads in order to enhance their survivability. This lightweight machinegun will replace the two automatic M16A1 rifles in the rifle squad on a one-for-one basis in all infantry type units and in elements of air cavalry and other non-infantry units.

CHARACTERISTICS:

Caliber: 5.56mm
Weight: 16.3 lbs
Rate: 750 rds/min
Range: 800 meters
Magazine Capacity: 200 rds

FOREIGN COUNTERPART:

The closest equivalent systems are the Soviet-developed 7.62mm PKM and the 5.45mm RPK 74 which are fielded with Eastern European nations.

PROGRAM STATUS:

Fielding of the M249 started in FY84. Improvements recommended by users have been successfully tested and approved. These changes have been incorporated into the current 5-year, competitively selected, firm fixed price contract awarded in September 1988 for 28,000 guns.

POINT OF CONTACT:

Armaments Munitions and Chemical Command
Attn: AMSMC-ASI
Rock Island, IL 61299-7150

CONTRACTORS:

FN Manufacturing Inc. (Columbia, SC)

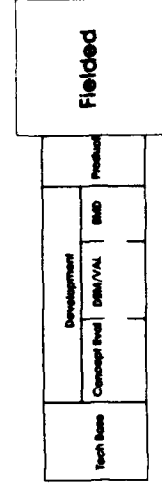

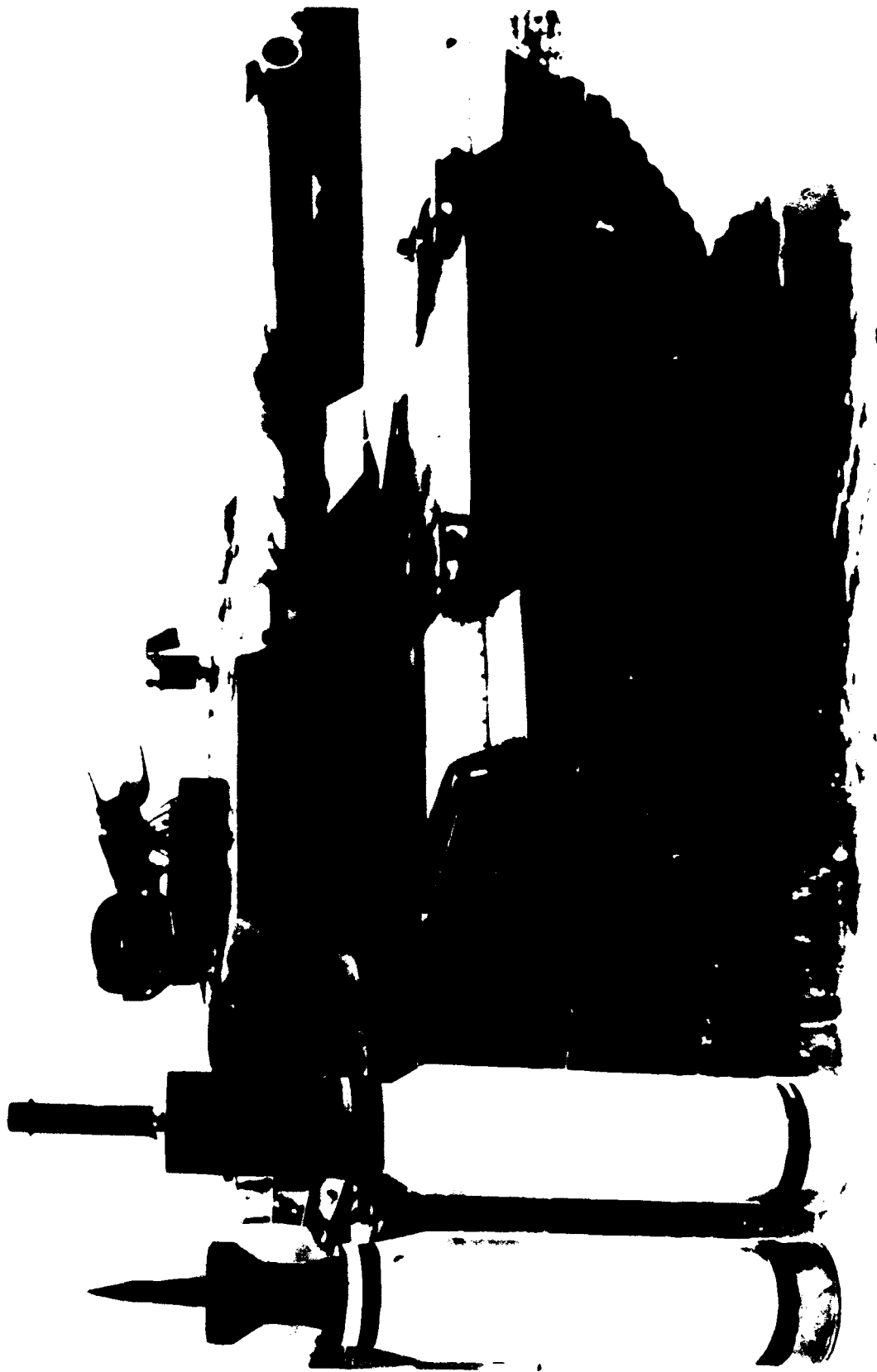

TANK MAIN GUN AMMUNITION

MISSION:

The 120mm family of tank ammunition is fired from the M256 Cannon on the M1A1/M1A2 tank. There are four basic cartridge types: Kinetic Energy (KE); Armor Piercing, Fin Stabilized, Discarding Sabot-Tracer (APFSDS-T); Chemical Energy High Explosive (HEAT); and training rounds for each of the tactical cartridges. The Armaments Enhancement Initiative (AEI) program provides upgrades to 120mm ammunition capability which will defeat current armor threats.

CHARACTERISTICS:

Armor Piercing - One piece depleted uranium penetrator, combustible case, discarding sabot- 120mm M829, M829A1, M829E2 and 105mm - M900 (steel case).
High Explosive Anti-Tank - Shaped charge warhead, combustible case, multiaction fuzing - M830, and with air defense capability - M830A1.
Smart Ammunition - High explosive, target activated, "fire and forget" (XM943 - STAFF) and armor piercing, boosted, with terminal guidance (X-ROD).

FOREIGN COUNTERPART:

NATO Allies and Soviet-developed tanks employ similar types of KE and HEAT ammunition.

PROGRAM STATUS:

The basic 120mm ammunition was fielded with the M1A1 Tank. The AEI program provides ammunition required to defeat Soviet threat armor vehicles of the 1990's and later. Two munitions from the AEI program have reached production status (M829A1 and M830A1). A third, M829E2, is scheduled for FY93 production. The M830A1 extends range capability and provides a new anti-helicopter, air defense capability.

PERFORMANCE IN SWA:

The accuracy and lethality of the 120mm family of munitions were superb. Commanders and crews were so impressed with the M829A1 that they nicknamed it the "Silver Bullet".

POINT OF CONTACT:

Project Manager for Tank Main Armament Systems (PM-TMAS)
 ATTN: SFAE-AR-TM
 Picatinny Arsenal, NJ 07806-5000

CONTRACTORS:

Alliant TechSystems, Inc. (Bronoklyn Park, MN)
 Olin Ordnance (ST. Petersburg, FL)
 Chamberlain Mfg Corp (Waterloo, IA)
 Ar.mtec Defense Products (Coachella, CA)
 Mason and Hangar (Middletown, IA)
 Hercules, Inc (Radford, VA)
 Nuclear Metals, Inc (Concord, MA)
 Aerojet Ordnance (Jonesboro, TN)
 Martin Marietta (Milan, TN)

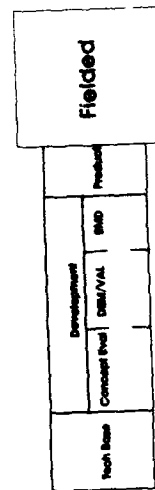

NIGHT VISION DEVICES

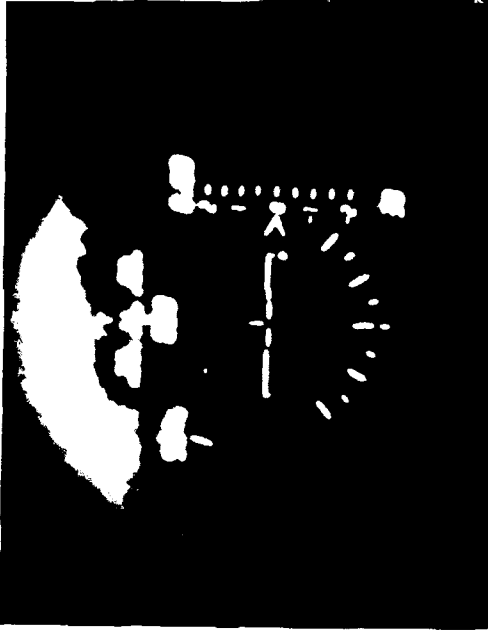

IMAGERY WITH HEADS-UP
DISPLAY OVERLAY



AVIATOR'S NIGHT VISION IMAGING
SYSTEM WITH HEADS-UP DISPLAY



NIGHT VISION GOGGLE AND INFRARED
AIMING LIGHT



THERMAL IMAGERY

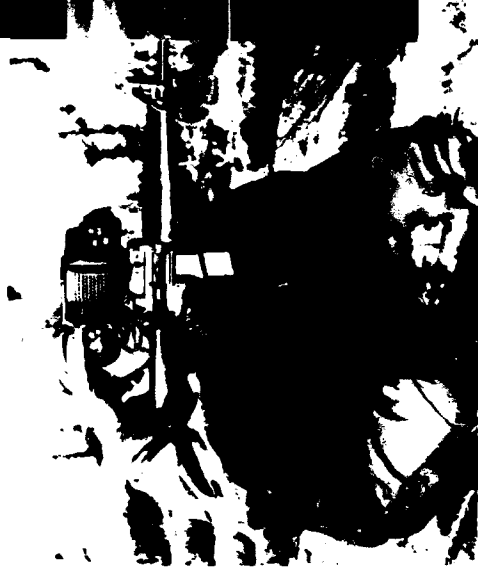

THERMAL WEAPON SIGHT

MINI EYESAFE LASER INFRARED
OBSERVATION SET

NIGHT VISION & ELECTRO-OPTICS

MISSION:

Night vision (NV) image intensification (I2) and laser thermal technologies provide today's soldier with the capability to operate more effectively and safely at night.

CHARACTERISTICS:

NV Goggles (Third generation image intensification):

AN/AVS-6 Aviator's Night Vision Imaging System: Lightweight, high performance, binocular unit for helicopter pilots

AN/PVS-7 Night Vision Goggle (NVG): Lightweight, head mounted, monocular unit used to operate ground vehicles, for navigation, map reading, first aid, etc.

NV Goggles (Second generation):

AN/PVS-4 Individual Served Weapon Sight AN/TVS-5 Crew Served Weapon Sight

AN/VVS-2 Driver's Viewer AN/PVS-5 Night Vision Goggle

Miscellaneous: AN/PAQ-4A Infrared Aiming Light (IAL): can be mounted on and boresighted to the M16A1/A2 rifle, M60 machine gun, M67 recoilless rifle, and the M72A1 rocket launcher. Provides target sighting with an infrared beam which can only be seen when used with NVG.

Laser/Thermal Technology:

AN/PVS-6 Mini Eyesafe Laser Infrared Observation Set (MELIOS): Eyesafe laser rangefinder which measures and displays range.

Thermal Weapon Sights (TWS): Infrared imaging devices used for surveillance and fire control of individual, crew-served, and heavy weapons during day, night and 'dirty' battlefield conditions.

FOREIGN COUNTERPART:

Second generation NV devices are produced in many countries including the Commonwealth of Independent States, Belgium, France, Germany, Israel, Italy, The Netherlands, Spain, Sweden, Switzerland, and the United Kingdom. The bulk of the equipment consists of passive I2 systems and first generation thermal devices.

PROGRAM STATUS:

There are presently several on-going contracts for the production of I2 devices/spares and laser/thermal devices. Additional device acquisitions began in FY92.

PERFORMANCE IN SWA:

Prototype thermal devices, with their ability to 'see' through thick smoke on the battlefield, received the highest praise. The AN/PAQ-4A (IAL), used as a weapon sight and terrain perception aid, was mounted on helicopter skids alerting crew to terrain changes. MELIOS was used for ranging as a handheld unit, and mounted on the Bradley.

POINT OF CONTACT:

PM Night Vision & Electro-Optics
ATTN: S. AE-JEW-NV
Fort Belvoir, VA 22060-5677

CONTRACTORS:

ITT Corp. Electro-Optical Products Division (Roanoke, VA)
Electro-Optical Sensors, Inc (Palo Alto, CA)
Litton Industries (Tempe, AZ)
Insight Technology, Inc. (Manchester, MH)

Hughes Aircraft (El Segundo, CA)
IMO/Optic-Electronic Corp (Dallas, TX)
IMO/Varo (Garland, TX)
IMO/Baird (Bedford, MA)

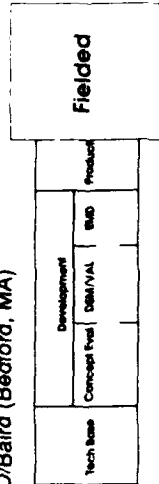

AIR DEFENSE

The Air Defense mission area relates to the detection and engagement of the air threat with ground fire systems. Air defense systems must protect all ground forces elements including troop formations, depots, communications, air bases, key command and control facilities, and other vital assets.

Tech Base	Concept Development	DEVELOPMENT DEM/VAL	EMD	Production	Fielded
The Army's Combined Arms Weapons System Advanced Air Defense Electro-Optical Optical Counter-Measures	Corps Surface-To-Air Missile	Non-Line of Sight	Light & Special Division Interim Sensor Ground Based Sensor	Avenger	Patriot Hawk Chaparral Stinger

TACAWS Technology Base Program

- Light weight Anti-helicopter, multi-role
- Acquisition in "clutter"/masked target kill
- True fire and forget
- On-board IFF capability

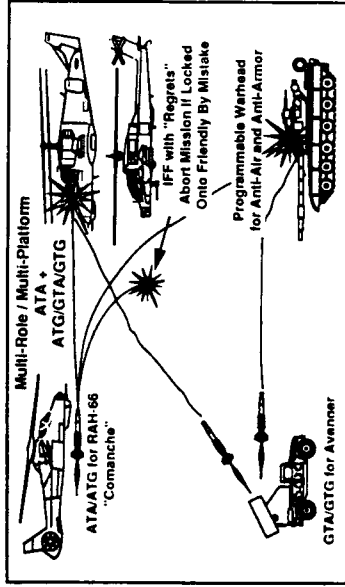

THE ARMY'S COMBINED ARMS WEAPONS SYSTEM

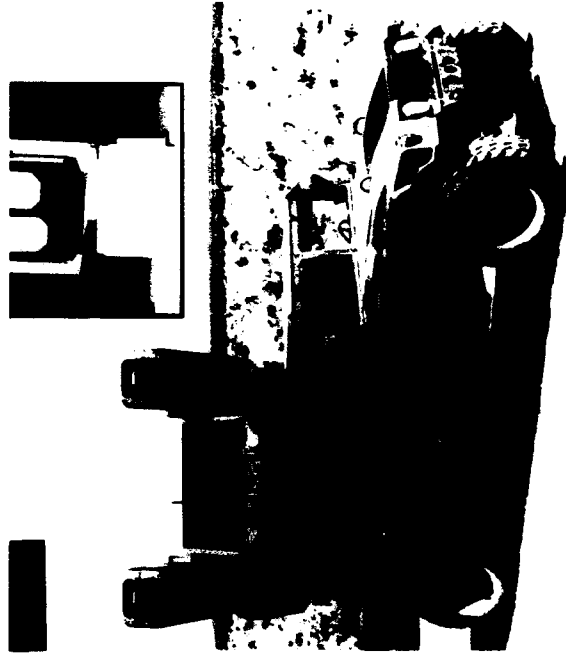

ADVANCED AIR DEFENSE ELECTRO - OPTICAL SYSTEM



MULTI-ROLE SURVIVABLE RADAR



OPTICAL COUNTERMEASURES

AIR DEFENSE - TECH BASE

OVERVIEW:

The goal of the Army Technology Base program in Air Defense is to provide advanced detection, tracking and engagement capabilities for weapon platforms to negate threat targets while enhancing survivability of high value U. S. assets. Improved target acquisition, positive identification and missile engagement technologies are being pursued to provide the leap ahead capabilities required to meet the ever increasing threat.

THE ARMY'S COMBINED ARMS WEAPONS SYSTEM (TACAWS) ATTD:

The TACAWS ATTD will demonstrate technologies for a light weight, fire-and-forget, air-to-air multirole missile in support of future Air-to-Air (primary), and secondary missions of Ground-to-Air, Air-to-Ground, Ground-to-Ground. The demonstration will include the integration of common guidance, control, propulsion, airframe and warhead technologies capable of performing in high clutter/obscured, day/night adverse weather environments, and under countermeasure conditions. Capabilities demonstrated must exceed current baseline of air-to-air Stinger.

ADVANCED AIR DEFENSE ELECTRO-OPTICAL (AADEOS) ATTD:

Demonstration will be conducted of an infrared search and track sensor to detect and acquire helicopters and fixed-wing aircraft. The proliferation of radar warning receivers on threat Close Air Support helicopters and fixed-wing aircraft provides an incentive for incorporating passive acquisition devices on forward area air defense weapons such as the Line of Sight-Forward Heavy (LOS-FH). Anti-radiation missile employment adds another stimulus to the development of passive acquisition capabilities. Infrared sensors, processors, advanced cooling, optics, and algorithms will be used to assure adequate ability to track clutter-bound, low-signature helicopters to ranges in excess of 4-6 km.

MULTI-ROLE SURVIVABLE RADAR (MRSR) ATTD:

The MRSR ATTD will demonstrate a multi-function, track-while-scan, continuous-wave radar capable of operating in the presence of anti-radiation missiles and electronic countermeasures (ECM). The MRSR is a mobile sensor on a single vehicle capable of supporting both forward area air defense and corps weapons and Patriot air defense systems in contingency operations. The demonstration focuses on low side lobe antenna designs, very wide bandwidths, frequency agility, and non-cooperative target recognition techniques. Design is structured for optimal insertion of very high speed integrated circuit and millimeter and microwave integrated circuits.

OPTICAL COUNTER- MEASURES ATTD:

The ATTD will demonstrate a laser technology, anti-sensor tactical weapon to be effective against hardened electro-optical threats for protection of air defense and armor systems. The demonstration will be on a mobile host vehicle against air defense targets to include threat sensors as well as threat missiles. The laser system will significantly reduce flyout time thus enhancing the lethality and survivability of U. S. weapon systems.

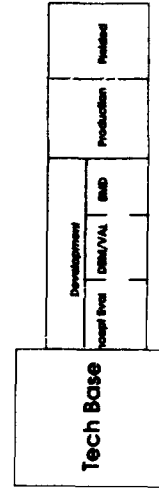

CORPS SAM

NOTIONAL CORPS SAM CONCEPT

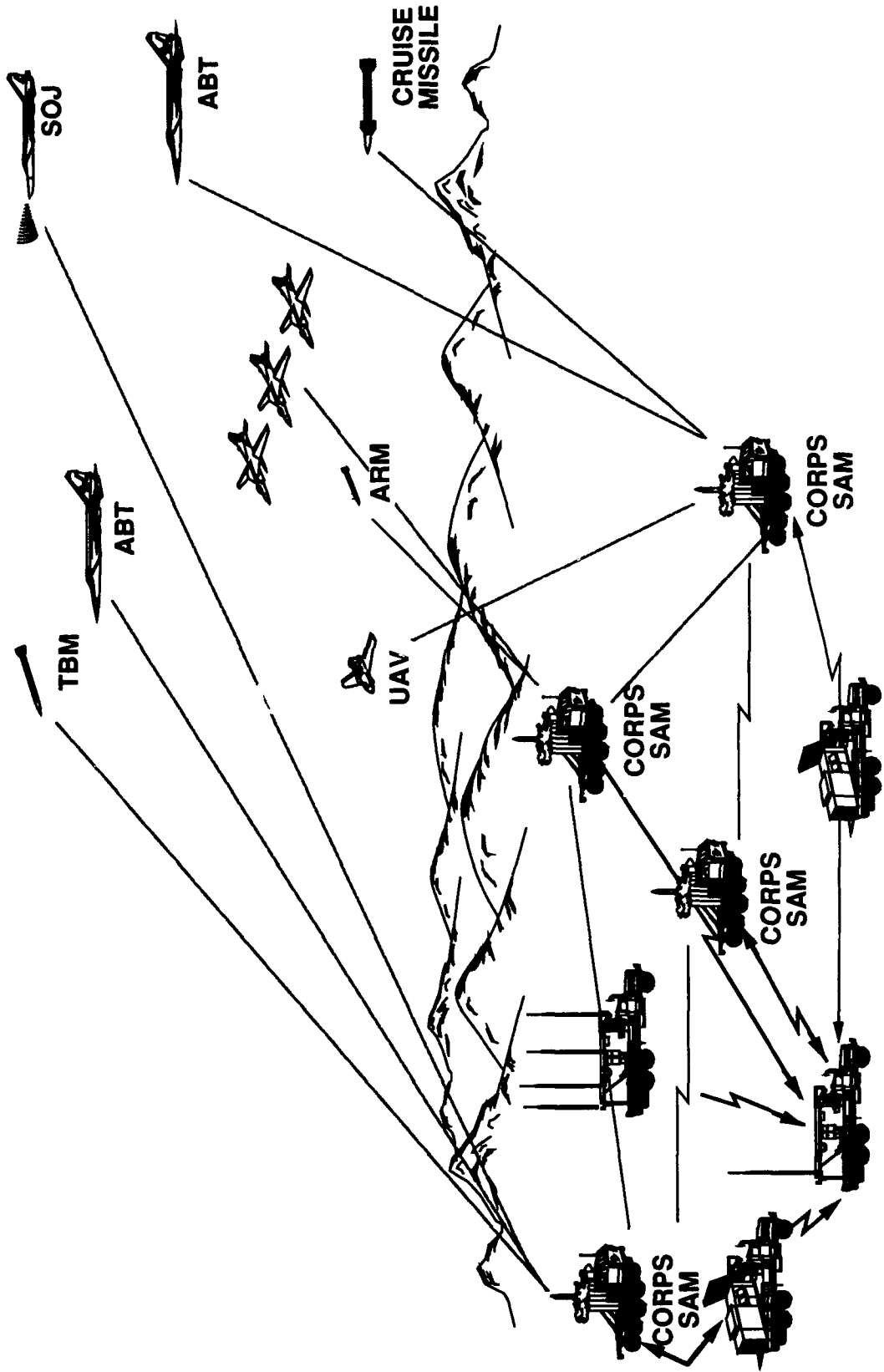

CORPS SURFACE-TO-AIR MISSILE (CORPS SAM)

MISSION:

The Corps SAM mission is to protect key military assets in the Corps area and to provide continuous air defense for the supported forces as they maneuver. This mission must be accomplished in the context of Air Land Operations in both mature and contingency theaters. It will have the capability to defeat tactical missiles, tactical ballistic missiles (TBMs), air-to-surface missiles (ASMs), anti-radiation missiles (ARMs) and air-breathing threats (ABTs) which consist of fixed and rotary wing aircraft, cruise missiles, and unmanned aerial vehicles (UAVs).

CHARACTERISTICS:

Corps SAM will be a highly mobile, low-to-medium altitude air defense system designed to replace Hawk in the U.S. Army Corps and theater Air Defense Brigades. It will be strategically and tactically deployable to support rapid deployment to contingency theaters and for rapid reinforcement of deployed forces in mature theaters. Corps SAM's high firepower and flexible design will sustain operations in high and medium intensity conflicts. Its high mobility will allow for rapid deployment of its elements in response to evolving battlefield requirements. Corps SAM will consist of a weapon element, a sensor element and a tactical operations center element. A modular concept is envisioned, enabling the tactical commander to organize tasks based on mission, enemy, troops, terrain and time.

FOREIGN COUNTERPART:

Allied France/Italy -- Joint Famille Surface Air Futur (FSAF) Program
Germany -- Medium Surface -to-Air Missile (MSAM) System

PROGRAM STATUS:

Corps SAM was approved by the Secretary of Defense for entry into the Concept Exploration and Definition Phase on 6 AUG 90. This phase focuses on development of operational requirements and materiel concept studies. A request for information was issued to industry on 11 OCT 91 and a request for proposals (RFP) is scheduled to be released during the 2nd quarter FY92. The RFP will facilitate preparation of concept studies providing trade-off analyses and alternative materiel solutions to the Corps Air Defense Capability Mission Need Statement, System Operational Description, and the releasable threats/scenarios.

POINT OF CONTACT:

PM Corps SAM
ATTN: AMCPM-SM
Redstone Arsenal, AL 35898-5797

CONTRACTORS:

To be determined.

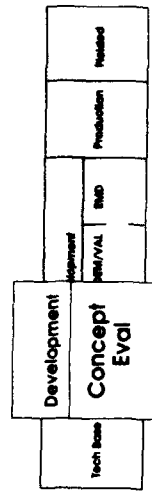

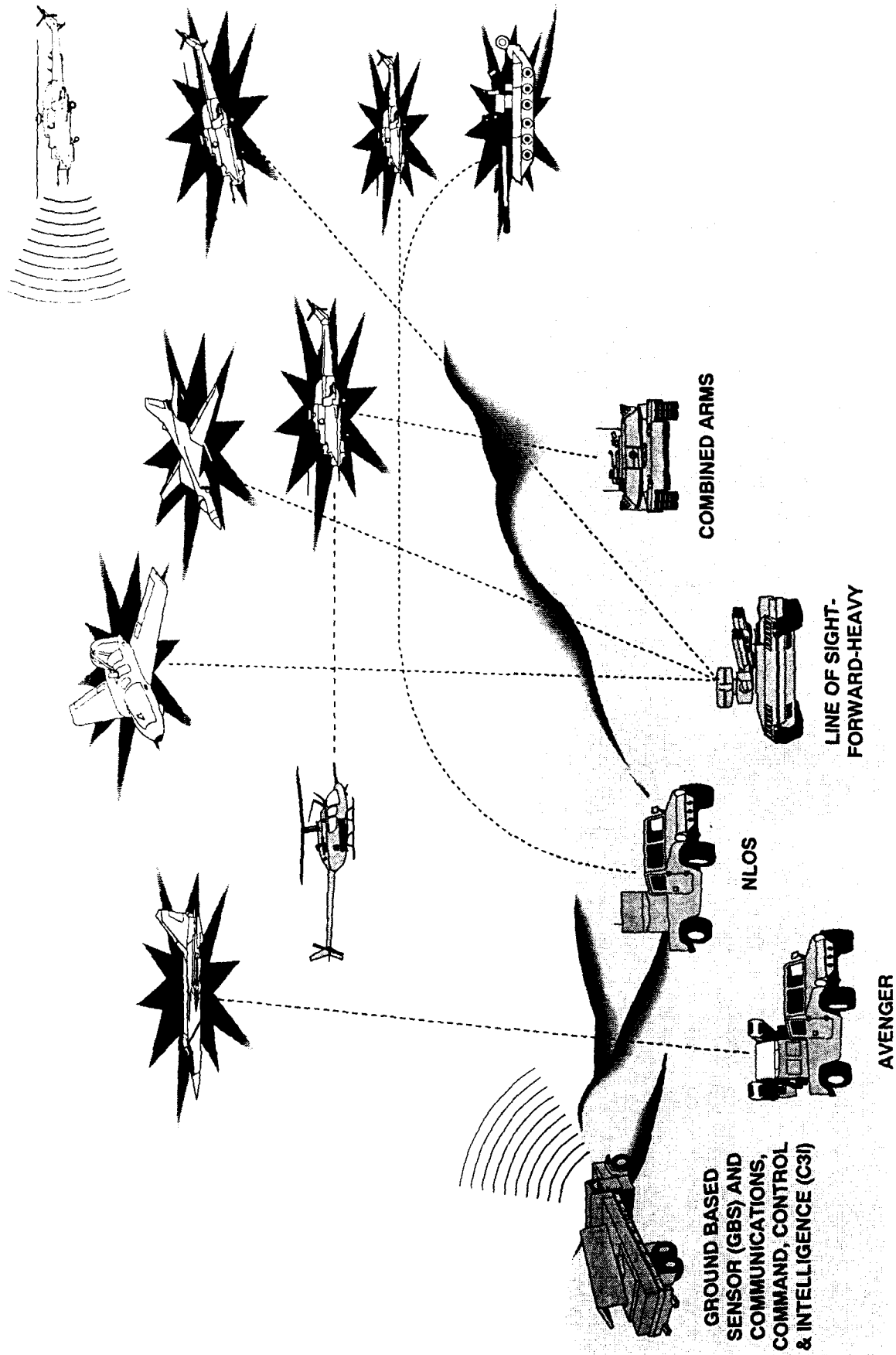

FORWARD AREA AIR DEFENSE SYSTEM (FAADS)

MISSION:

FAADS is an integrated program of complementary systems which will provide Army divisions with dedicated Air Defense Artillery (ADA) and integrate Joint and Combined Arms efforts to counter the threat. The FAADS concept is designed to provide total coverage in the division area and permits the enemy no preferred attack option through the 1990's and beyond.

CHARACTERISTICS:

FAADS consists of five components: Line of Sight-Forward-Heavy (LOS-F-H); Line of Sight-Rear (LOS-R); Non-Line of Sight (NLOS); FAAD Command, Control and Intelligence (FAAD C2I); and Combined Arms Initiatives (CAI).

FOREIGN COUNTERPART:

Soviet-developed ZS6, ZSU-23/4, SA-6, SA-9.

PROGRAM STATUS:

Boeing's AVENGER was selected for the LOS-R role. The First Unit Equipped (FUE) for AVENGER was FY89. FAAD C2I's Command and Control initial fielding to light forces will begin late FY93. Ground Based Sensor (GBS) and one passive identification component are scheduled for initial fielding in FY97. The Air-to-Air STINGER component of CAI is in production for the OH-58C/D. The Bradley Fighting Vehicle sight reticle enhancement was incorporated in production in May 1987. Engineering development continues on upgrading 120mm tank ammunition with an anti-helicopter capability.

PERFORMANCE IN SWA:

AVENGER was deployed in SWA and demonstrated outstanding operational availability. Ground force commanders relied on AVENGER to provide air and ground surveillance during night and limited visibility.

POINT OF CONTACT:

Program Executive Office, Air Defense
ATTN: SFAE-AD
Redstone Arsenal, AL 35898-5750
Program Executive Office, IEW (GBS)
ATTN: SFAE-IEW-EW
Ft. Monmouth, NJ 07703-5304

CONTRACTORS:

LOS-R - Boeing Aerospace Co. (Huntsville, AL)
FAAD C2 Software - TRW (Redondo Beach, CA)
FAAD Ground Based Sensor - TBD

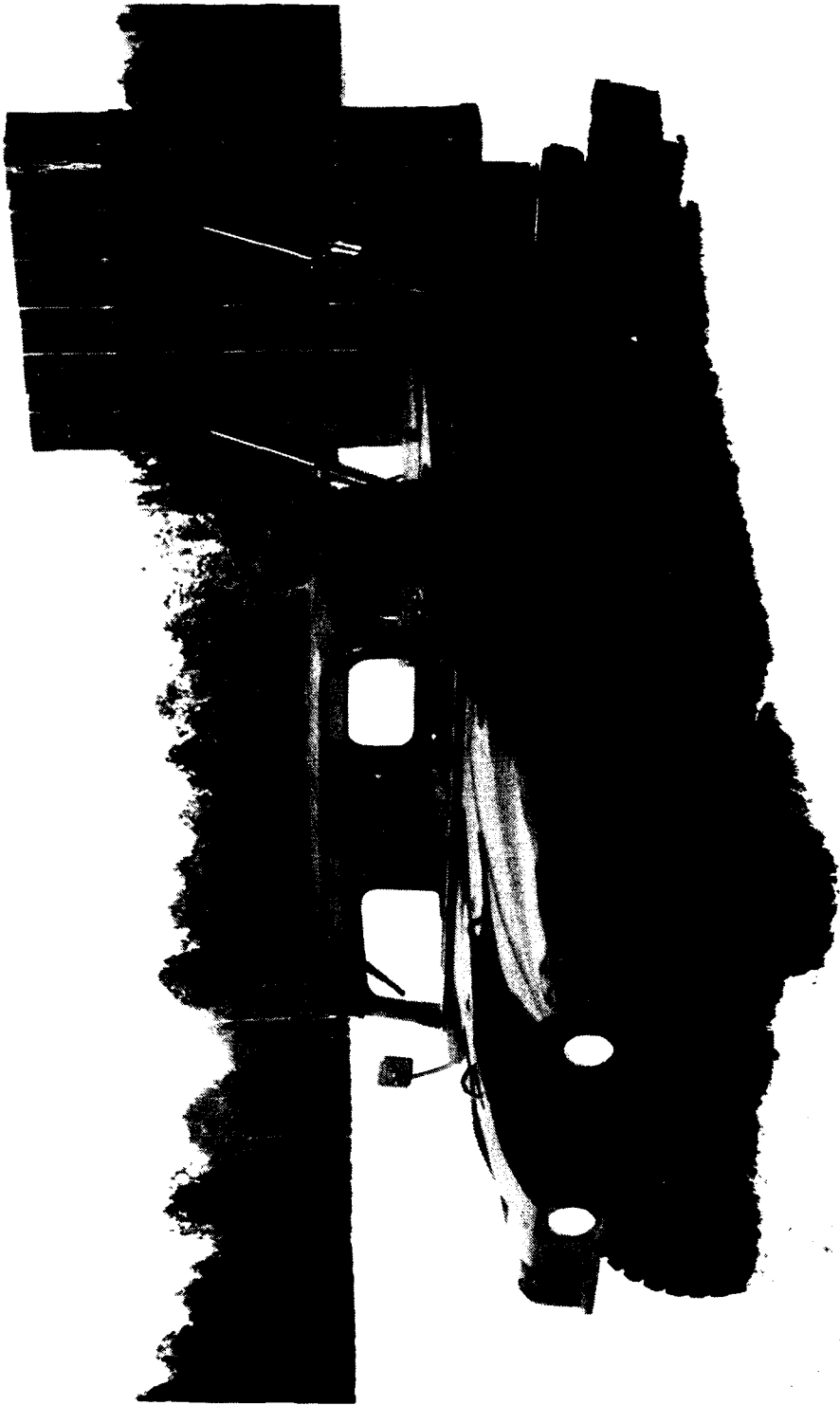

NON-LINE OF SIGHT

MISSION:

Non-Line of Sight (NLOS) is a multiple mission combined arms weapons system which provides a fully adequate anti-armor capability against threat armor well beyond the maximum range of tank main guns or direct fire anti-tank missiles. In addition, NLOS provides air defense protection to the maneuver force against masked, standoff rotary-wing aircraft as well as the capability to destroy other moving or fixed point targets.

CHARACTERISTICS:

Guidance:
Engagement:
Control:
Mobility:

Command Via Fiber Optic Datalink
Launch from DeFlade, Non-Ballistic Flight Path
Gunner-In-The-Loop Provides Positive Identification Capability
Gunner's Station and Six Ready Missiles Self Contained On
High Mobility Multi-Purpose Wheeled Vehicle (HMMWV)

FOREIGN COUNTERPART:

None

PROGRAM STATUS:

Currently in the proof-of-principle phase. NLOS is planned to enter the Engineering and Manufacturing Development (EMD) Phase in third quarter FY93 to mature the Initial Operational Evaluation (IOE) design into a NLOS Tactical Weapon System. Initial fielding of a test unit and day equipped missiles will occur in the second quarter FY97. First unit equipped is scheduled for second quarter FY99.

POINT OF CONTACT:

Non-Line of Sight Project Office
ATTN: AMSMI-NL
Redstone Arsenal, AL 35898

CONTRACTORS:

To be selected.

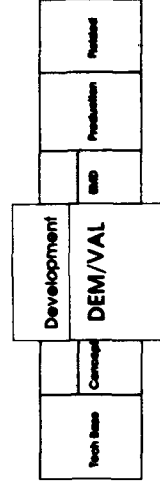

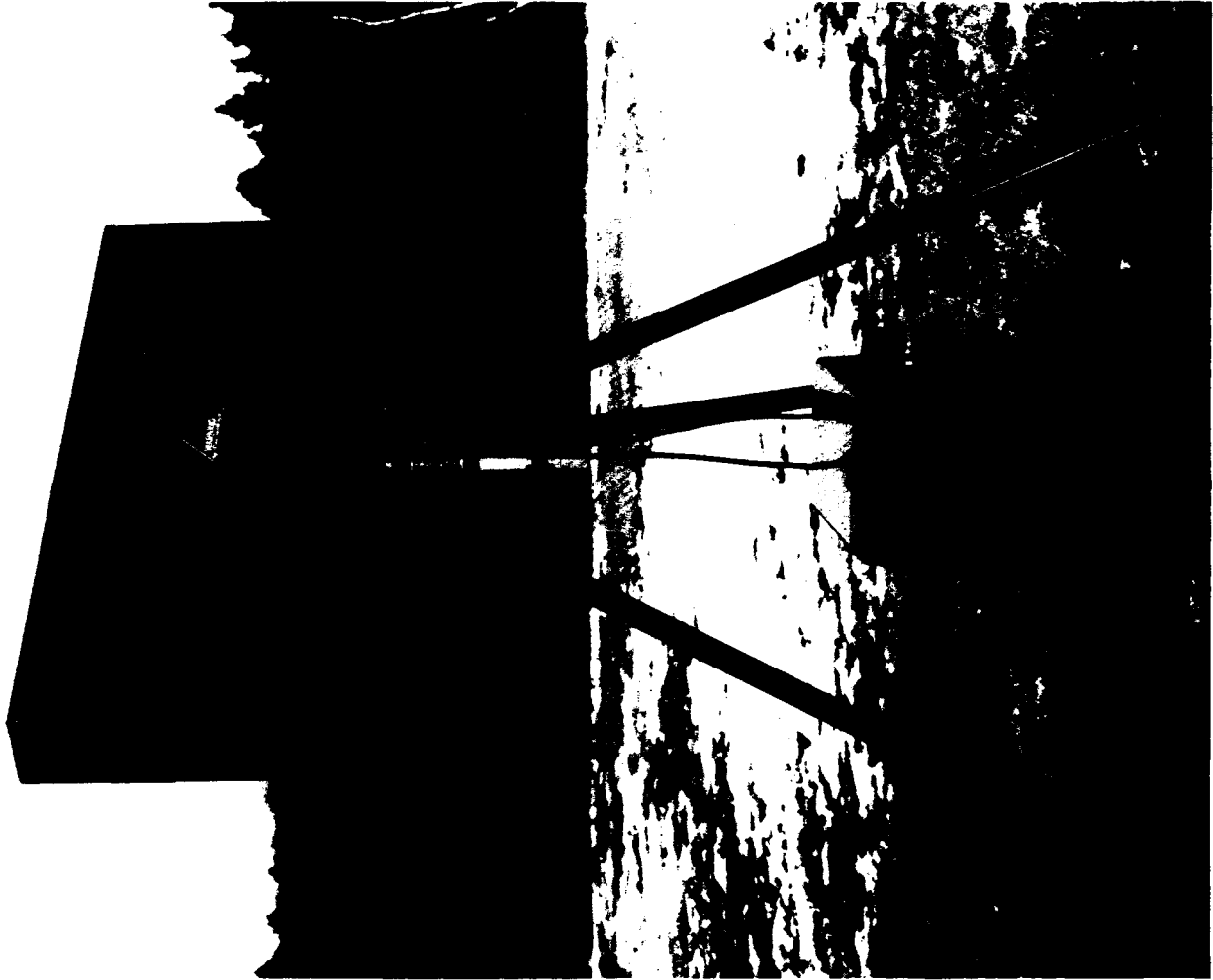

LIGHT AND SPECIAL DIVISION INTERIM SENSOR (LSDIS)

MISSION:

The Light and Special Division Interim Sensor (LSDIS) is being deployed as a stand alone system urgently needed to provide air defense early warning for U.S. Army Light and Special Divisions and Contingency Corps Air Defense Artillery (ADA) Battalions and supported maneuver forces. The LSDIS provides 360 degree coverage of airspace to alert and directionally orient air defense weapon system gunners significantly enhancing their ability to engage and destroy hostile fixed and rotary wing aircraft.

CHARACTERISTICS:

20 km range, continuous volume surveillance of aircraft, 360 degrees stand alone system, manportable, air droppable, HMMWV mountable, relatively simple, reliable, lightweight radar.

FOREIGN COUNTERPART:

None.

PROGRAM STATUS:

Completed First Article Test. Proceeding into Production Qualification Tests.

POINT OF CONTACT:

FAAD Sensor & Target Identification Project Office
ATTN: SFAE-AD-LS
Redstone Arsenal, AL, 35898-8052

CONTRACTORS:

Lockheed-Sanders (Nashua, NH)

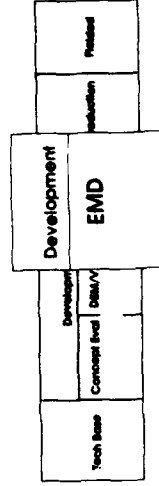

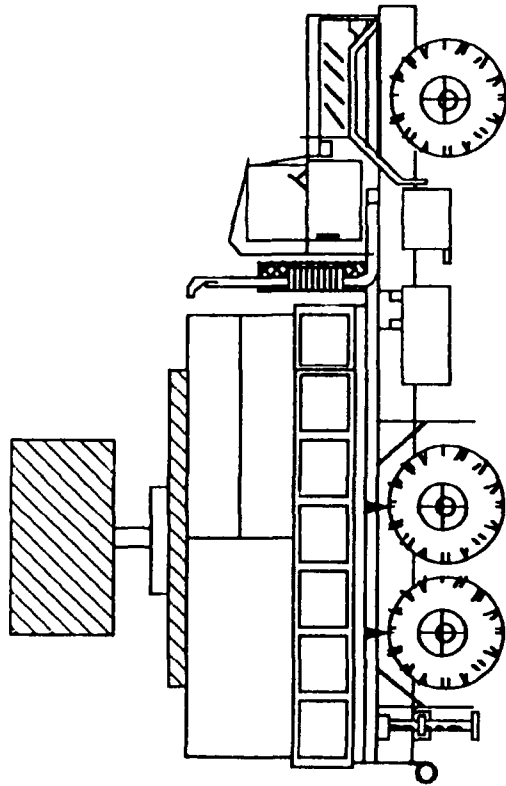

FAAD-GBS prototype sensor mounted on a 5 ton truck.

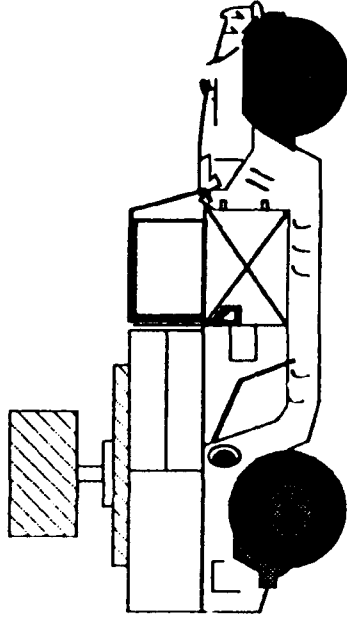

FAAD-GBS prototype sensor mounted on a HMMWV.

FORWARD AREA AIR DEFENSE (FAAD) GROUND BASED SENSOR (GBS)

MISSION:

The Forward Area Air Defense (FAAD) Ground Based Sensor (GBS) is the only sensor providing key target acquisition and tracking capability for the division's FAAD system and the C2I component. The GBS consists of a radar sensor system with its prime mover/power, Identification Friend or Foe (IFF), Non-Cooperative Target Recognition (NCTR) devices, and C2I interfaces. GBS is the prime contributor to FAAD C2I's development of the recognized air picture over the division area and beyond the forward line of troops. Air targets include fixed and rotary wing aircraft with growth capabilities to acquire cruise missiles and Remotely Piloted Vehicles/Unmanned Aerial Vehicles (RPV/UAV). Its primary missions are to cue Avenger fire units, protect friendly aircraft from fratricide, and provide targeting information to Line of Sight-Forward-Heavy (LOS-F-H).

CHARACTERISTICS:

Exact FAAD GBS characteristics will be determined at the conclusion of the ongoing Source Selection Evaluation. General characteristics are as follows:

- Short to medium range air defense sensor
- Acquire and track fixed and rotary wing (growth to cruise missile/UAV)
- 360° azimuth, 10 meters to 4 km altitude cueing capability
- Electronic Countermeasures (ECM) and Anti-Radiation Missile resistant
- High mobility, transportability, and reliability
- Standard Army wheeled carrier (5 ton or HMMWV)

FOREIGN COUNTERPART:

Soviet-developed Straight Flush and long track radars.

PROGRAM STATUS:

Source selection process ongoing. Contract award 2QFY92. It is in the Engineering and Manufacturing Development (EMD) phase of pre-production.

POINT OF CONTACT:

FAAD Sensor & Target Identification Project Office
ATTN: SFAE-AD-GSI
Redstone Arsenal, AL, 35898-5796

CONTRACTORS:

To be determined.

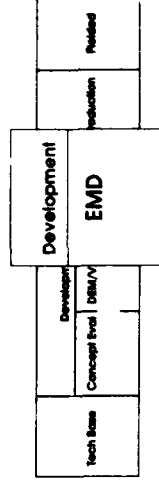



AVENGER

MISSION:

To provide air defense support in all divisions, armored cavalry regiments, separate heavy brigades, and corps air defense brigades. Avenger is designed to counter hostile low-flying, high-speed, fixed-wing aircraft and helicopters attacking or transiting the division. Avenger fills the Line of Sight-Rear (LOS-R) portion of the Forward Area Air Defense System (FAADS).

CHARACTERISTICS:

This integrated system provides all the necessary functions to perform day/night and adverse weather target detection, acquisition, tracking, target ranging and friend or foe aircraft identification with either missile or machine gun. The Avenger's Standard Vehicle Mounted Launchers (SVMLs) interface and function with standard unmodified Basic Stinger, Stinger-POST and Stinger-RMP missile rounds.

Crew: 2 Armament: 8 ready Stinger missiles/.50 cal machine gun
Sensors: FLIR/Laser/Optical Chassis: Modified HMMWV
Fire Control: Digital fire control computer/gyro-stabilized electronic turret

FOREIGN COUNTERPART:

The Soviet-developed SA-9, introduced in the late 1960's, is the counterpart to Avenger. It has approximately the same range and also uses an infrared homing guidance system. The SA-9 is mounted on a two-axle amphibious vehicle.

PROGRAM STATUS:

The initial production contract was awarded competitively to the Boeing Aerospace Company in August 1987. The Secretary of the Army approved the Avenger system for Type Classification - Standard in February 1990. The Avenger went into full-scale production in April 1990. In 1991, a five year multiyear procurement to buy fire units for the U.S. Army and the Marine Corps began.

PERFORMANCE IN SWA:

Avenger was deployed during Operation Desert Shield/Storm and performed exceptionally. Its operational availability exceeded all requirements. Ground force commanders relied on Avenger to provide air and ground surveillance during night and limited visibility conditions.

POINT OF CONTACT:

Avenger Product Office
ATTN: SFAE-AD-AVG
Redstone Arsenal, AL 35898-5630

CONTRACTORS:

Boeing Aerospace Company (Huntsville, AL) - Production.

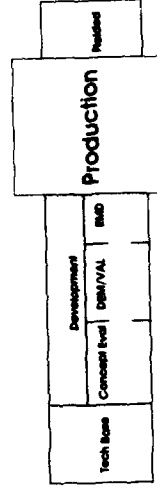

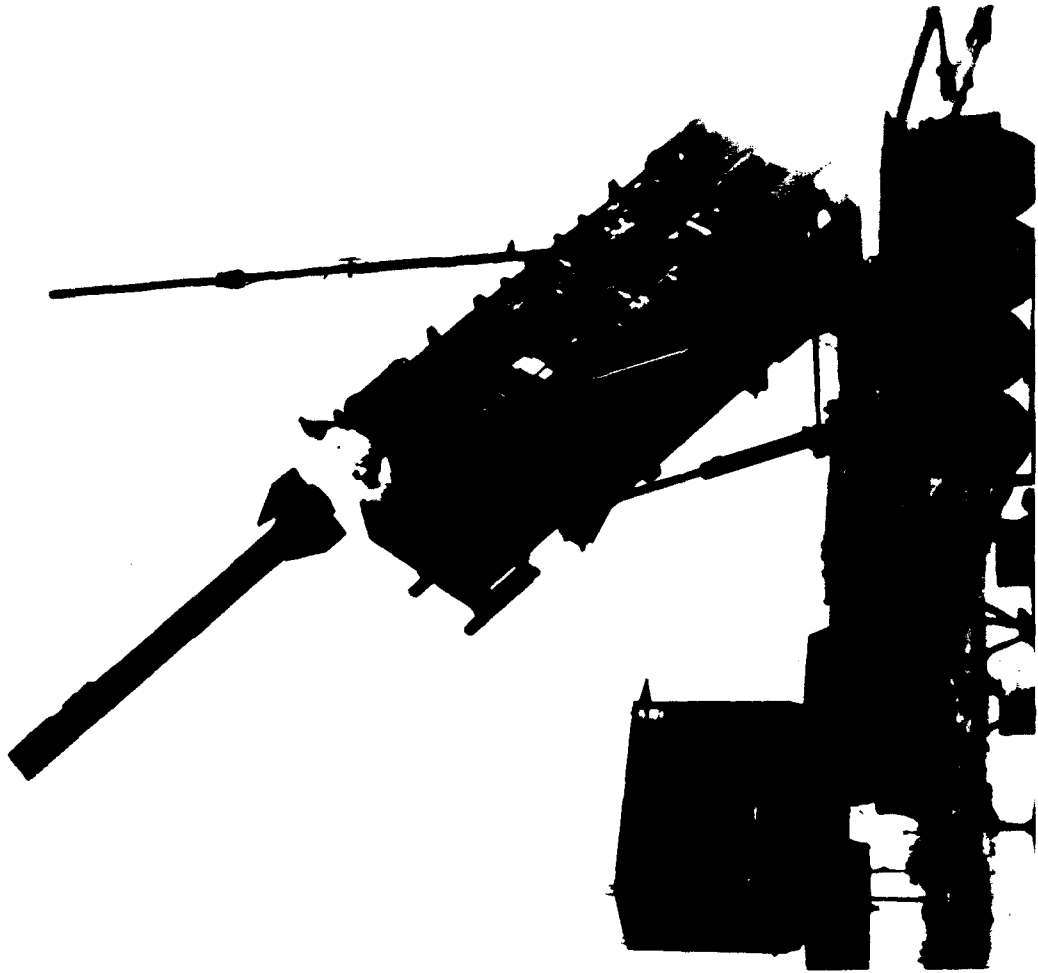

PATRIOT

MISSION:

The Patriot Missile System provides high and medium altitude defense against aircraft and tactical ballistic missiles at the Theater and Corps levels.

CHARACTERISTICS:

Patriot's fast reaction capability, high firepower, and ability to operate in a severe electronic countermeasure environment are features not previously available in the systems Patriot replaces. The Patriot design eases the field logistic burden since its overall performance is achieved with less equipment, less manpower, and fewer repair parts than previous systems. The combat element of the system is the fire unit which consists of a radar set, an engagement control station, a power plant, antenna mast group, and eight remotely located launchers. The single phased array radar provides all tactical functions of airspace surveillance, target detection and track, and missile guidance. The engagement control station provides the human interface for control of operations. Each launcher contains four ready-to-fire missiles, sealed in canisters, which serve a dual purpose as shipping containers and launch tubes. Maximum range is 37 nautical miles. It has the ability to track 50 targets simultaneously.

FOREIGN COUNTERPART:

The Soviets have developed several missile systems, including the SA-1, SA-2, SA-4, SA-5, SA-10, and SA-12, that are used to attack aircraft in the regime for which Patriot was designed. Only the SA-10 and SA-12 are considered as advanced or effective as Patriot.

PROGRAM STATUS:

Patriot is in its thirteenth year of production and is fielded in CONUS, Europe, and Southwest Asia. Production of U.S. fire units is complete. U.S. missile production deliveries include Patriot Anti-tactical Missile (ATM) Capability Level 2 (PAC-2), Germany, The Netherlands, Italy, Japan, Saudi Arabia and Israel are currently participating in PATRIOT acquisition programs. Discussions with other interested allies for Patriot acquisition are ongoing.

PERFORMANCE IN SWA:

Patriot played a key role in Operation Desert Storm. Patriot protected key military assets and civilian population centers from tactical ballistic missile attack. Deployment of Patriot to Allied countries in the region promoted political cohesion. The production of PAC-2 was accelerated in order to field the ATM capability to SWA. Patriot performance exceeded all expectations and validated its ATM capability.

POINT OF CONTACT:

Patriot Project Office
ATTN: SFAE-AD-PA
Redstone Arsenal, AL 35898-5620

CONTRACTORS:

Raytheon Company (Bedford, MA)
Martin Marietta Corporation (Orlando, FL)

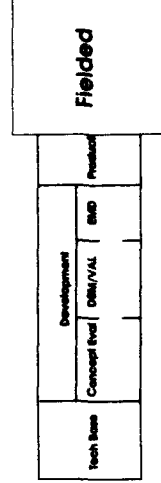

HAWK

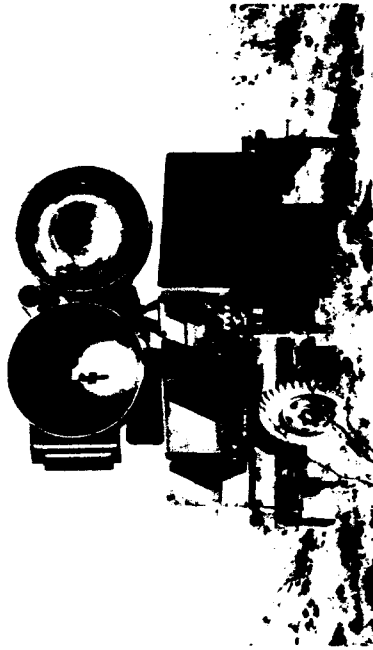

HIGH POWER ILLUMINATOR

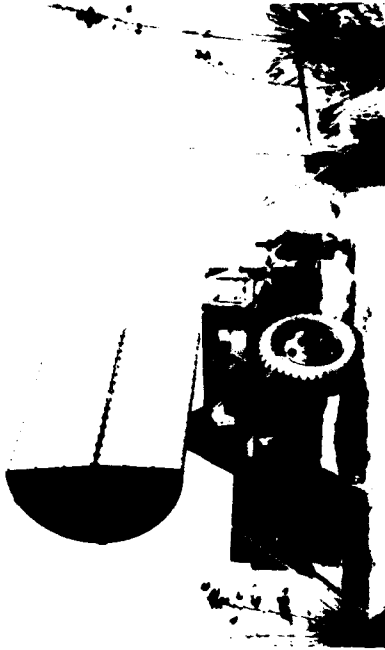

CONTINUOUS WAVE ACQUISITION RADAR



LAUNCHER

HAWK

MISSION:

Hawk is a medium range, surface-to-air guided missile system designed to provide Air Defense protection for critical assets and maneuver forces against aircraft attack. First fielded in 1960, Hawk has been continuously upgraded through a series of preplanned product improvements which have enhanced all aspects of the Hawk system. Each Hawk firing platoon is comprised of a platoon command post, an acquisition radar, a tracking radar with optical tracking system, and four launchers with three missiles each.

CHARACTERISTICS:

The system is transportable by helicopter and provides all weather, day or night coverage. The missile has a two stage, solid propellant motor with supersonic speed, and a high-explosive proximity-fuzed warhead. It has semi-active homing guidance.

Range: 40 km Speed: 800 m/sec Diameter: 14.8 in
Weight: 1400 lbs Length: 198 in

FOREIGN COUNTERPART:

The Soviet-developed SA-6 is similar to Hawk. Its range and altitude capabilities are less than Hawk, but the SA-6 is more mobile. The basic SA-6 unit is a regiment which includes five missile batteries.

PROGRAM STATUS:

Hawk will remain with the active U.S. Army until 2005. It will be replaced by Corps Surface-to-Air Missile (SAM) which is now in concept definition.

PERFORMANCE IN SWA:

During Desert Shield and Desert Storm Hawk had an excellent readiness record. Reports from the Kuwaiti Air Force stated that at the beginning of the war, Hawk downed numerous enemy aircraft.

POINT OF CONTACT:

Hawk Project Office
ATTN: AMCPM-AP
Redstone Arsenal, AL 35898-5660

CONTRACTORS:

Raytheon Company (Andover, MA)
Aerojet (Sacramento, CA)
General Electric (Huntsville, AL)
Westinghouse Electric Corp. (Baltimore, MD)
Universal Technology, Inc. (Estill Springs, TN)

Electro Design Mfg. Inc. (Decatur, AL)
Northrup Corp (Anaheim, CA)
Summa Technology (Huntsville, AL)
Harris Corp (Orlando, FL)

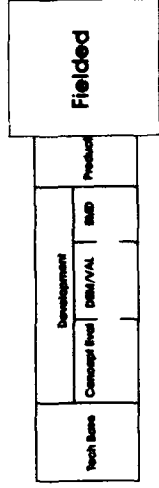



CHAPARRAL

MISSION:

Chaparral is one of the Army's Short-Range Air Defense (SHORAD) surface-to-air missile systems. It is effective against all types of aircraft at low altitudes and provides protection for corps, theater rear areas and, currently, division areas. Chaparral is a self-propelled system. Its tracked carrier provides excellent cross-country mobility. The launch station can be removed from the carrier and operated from a ground emplacement. It is equipped with a Forward Looking Infrared subsystem that provides day/night and adverse weather capability and extends system acquisition range. The missile is lightweight, supersonic, fire-and-forget, with an all aspect passive infrared homing guidance system capable of engaging both approaching and receding targets. To enhance missile acquisition range and infrared countermeasure rejection capability the Rosette Scan Seeker (RSS) guidance section has been retrofitted to inventory missiles upon shelf-life expiration of the current "smoky" motors. To assist the gunner in identifying targets as friendly, Chaparral has an Identification Friend-or-Foe (IFF) subsystem. Chaparral carries four ready missiles on launch rails and eight additional missiles in storage compartments. Chaparral, which was initially fielded in 1969, is continually being improved and will remain in the inventory into the 21st Century.

CHARACTERISTICS:

Crew: Four
Guidance: Infrared Homing, Fire and Forget
Warhead: Blast-fragmentation
Fuze: Radio Frequency (RF) Directional Doppler

FOREIGN COUNTERPART:

The Soviet-developed SA-9 and SA-13, introduced in late 1960's and 1970's respectively, are the counterparts to Chaparral. They have approximately the same range and also use an infrared homing guidance system. The SA-9 is mounted on a two-axle amphibious vehicle; the SA-13 is on an MTLB tracked vehicle.

PROGRAM STATUS:

Chaparral has been in production since 1969. Hughes Aircraft Co. was awarded the FY90 RSS missile production contract. The FY90 RSS missiles will be delivered in FY92. With this delivery, a program total of 14,232 missiles and 569 fire units will be achieved.

PERFORMANCE IN SWA:

Chaparral demonstrated outstanding readiness rates in SWA. It proved to be a venerable Air Defense System which provided short range air defense protection for the massive multi-national heavy forces.

POINT OF CONTACT:

Chaparral Project Office
ATTN: AMCPM-CF
Redstone Arsenal, AL 35898-5000

CONTRACTORS:

Loral Aeronutronic (Newport Beach, CA) - System Development and RSS Production
Hughes Aircraft Company (Tucson, AZ) - RSS Production

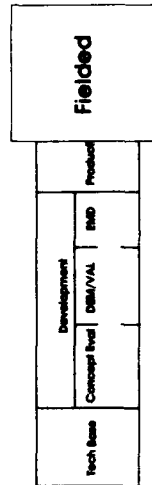

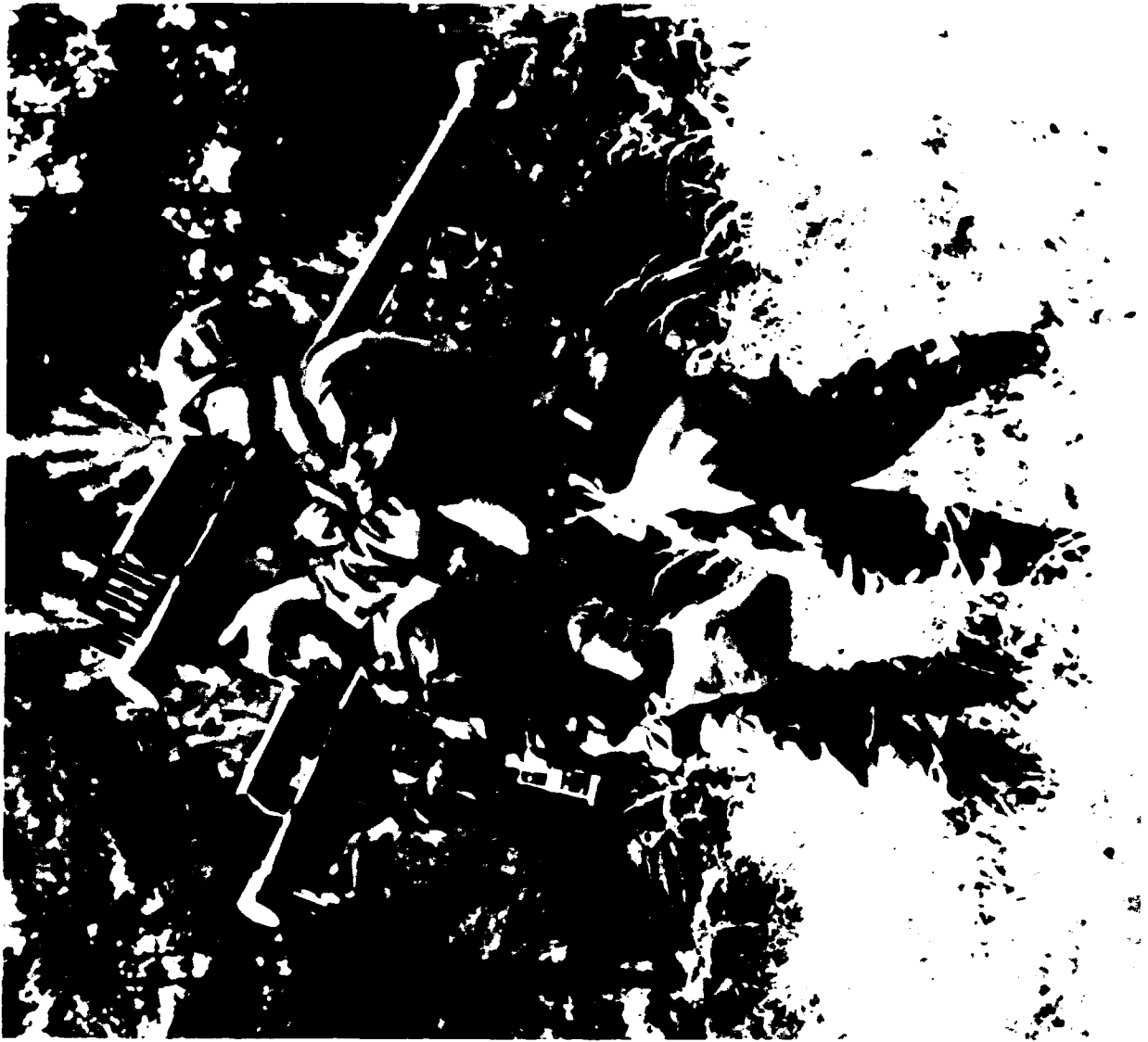

STINGER

MISSION:

To provide short range air defense coverage to combat units throughout the battlefield. Stinger is a shoulder-fired, infrared homing missile system which homes on the heat emitted by either jet or propeller-driven fixed-wing aircraft or helicopters.

CHARACTERISTICS:

The Stinger system employs a proportional navigation system that allows it to fly an intercept course to the target. Once the missile has traveled a safe distance from the gunner, its main engine ignites and propels it to the target. Stinger employs the wooden round concept. It can attack much faster targets than Redeye, and most importantly, can destroy aircraft from any aspect. A follow-on seeker (Stinger-Post) improved the capability of the system in certain infrared countermeasures environments. Stinger-Reprogrammable Microprocessor (RMP) further enhances the performance in infrared countermeasures environments and provides the capability for software upgrades to the missile as the threat evolves.

Guidance: Passive Infrared & Ultraviolet homing Speed: Supersonic
Navigation: Proportional with lead bias Weight: 34.5 lbs
Diameter: 2.75 in Length: 60 in

FOREIGN COUNTERPART:

There are several similar Soviet-developed systems. The SA-14, fielded in the late 1970's, has similar performance characteristics to the Stinger. The SA-14 is replacing the SA-7. The SA-16, fielded in the 1980's, is replacing the SA-14.

PROGRAM STATUS:

Stinger-RMP is currently in production by two manufacturers. Basic Stinger was operationally deployed to Germany in 1981 and production has been completed. Stinger-Post entered production in FY83, first deliveries were made in September 1986, and production was completed in August 1987. Stinger-Post missiles were deployed in FY87. Stinger-RMP entered development in September 1984, transition to production began in November 1985, and initial deliveries began in FY89; fielding began in FY90. The FY91 buy combined a competitive winner-take-all and a sustainment base procurement. Stinger-RMP production was accelerated to meet Desert Shield/Storm requirements.

PERFORMANCE IN SWA:

Stinger-RMP was deployed and provided highly mobile and lethal short range air defense protection to the maneuver forces.

POINT OF CONTACT:

Air-to-Air Missile Project Office
ATTN: SFAE-AD-ATA
Redstone Arsenal, AL, 35898-5630

CONTRACTORS:

General Dynamics Valley Systems Division (Rancho Cucamonga, CA) - Prime
Raytheon (Lowell, MA) - Second Source.

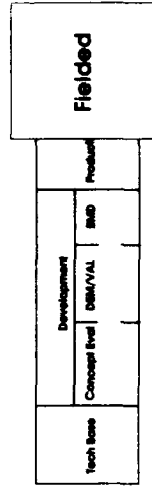

FIRE SUPPORT

The Fire Support mission area includes those systems directly related to the generation of indirect firepower. This mission area includes fire support provided by cannons, rockets, and missile systems, and also the target acquisition and communication systems integral to field artillery operations.

Tech Base	DEVELOPMENT			Production	Fielded
	Concept Development	DEM/VAL	EMD		
Explosively Formed Penetrators Long Fog/Deep Attack Missile Insensitive Munitions	Advanced Field Artillery System-Cannon Future Armored Resupply Vehicle-Ammunition		BAT SADARM	Army TACMS Paladin	105mm Howitzer MLRS Air-to-Ground Missile Systems

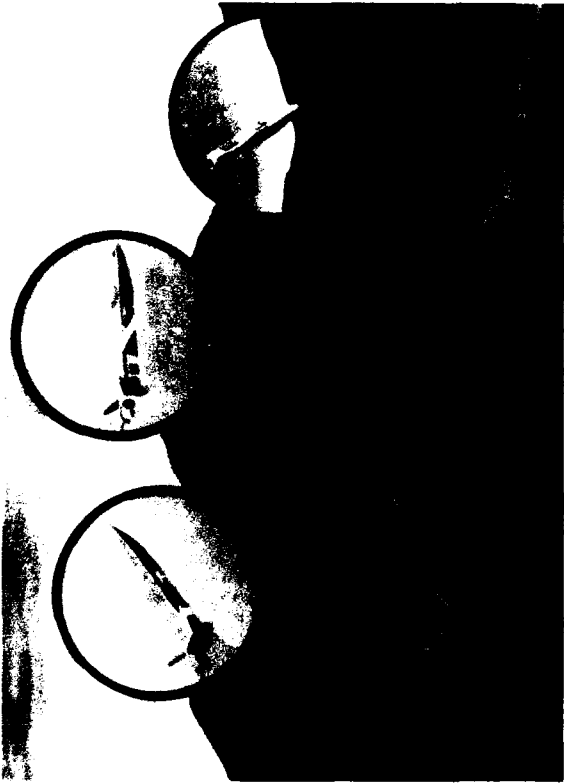

LONG "FOG" / DEEP ATTACK MISSILE



INSENSITIVE MUNITIONS



**EXPLOSIVELY FORMED
PENETRATORS**

FIRE SUPPORT - TECH BASE

OVERVIEW:

The Technology Base strategy produces advanced technologies to improve accuracy, range, mobility, survivability and lethality while decreasing logistics and training burdens. Among technologies that have recently transitioned from the Technology Base are Liquid Propellant and Unicharge for the Advanced Field Artillery System and for upgrades to fielded artillery systems, respectively.

EXPLOSIVELY FORMED PENETRATORS (EFP):

An EFP consists of a dish-shaped metal liner (like a saucer) with an explosive charge. The metal liner is typically made of a heavy metal such as tantalum. In these warheads, the metal liner is rapidly accelerated and shaped by the explosive charge to form a high velocity, stable penetrator. Its range of several hundred meters provides a long standoff especially suitable for smart munitions. The Technology Base program demonstrates other materials, such as molybdenum, and configurations to increase lethality, range and accuracy and provide greater flexibility, such as choices of single or multiple warheads from the same weapon to best match target characteristics.

LONG FOG/DEEP ATTACK MISSILE:

This demonstration uses a fiber optically guided missile system that will provide a long range (100 plus kilometers), precision weapon for surgical strikes against hardened and other high value targets. A human operator guides the missile by viewing an image transmitted through the fiber optic cable. This program capitalizes on technology developed under the Non-Line-of-Sight (NLOS) program with greater range, reduced system detectability, improved lethality and reconnaissance capabilities.

INSENSITIVE MUNITIONS:

The Insensitive Munitions program is designed to provide munitions that are less likely to be detonated unintentionally by such stimuli as explosive blasts, shrapnel and fires. The challenge is to develop less sensitive, yet, energetic molecules and formulations which fulfill all performance requirements for gun propellants and other propulsion systems such as shaped charges and explosively formed penetrators. This technology applies to all weapons systems, such as tank and artillery ammunition and missile warheads and propellants, to increase their survivability.

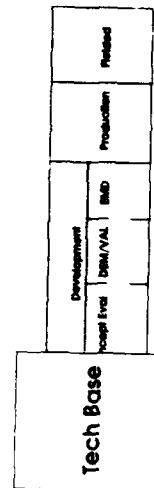

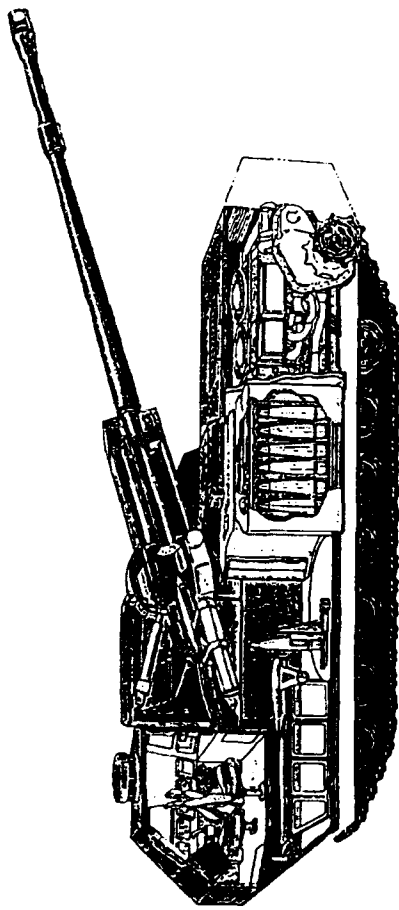

**Advanced Field
Artillery System**

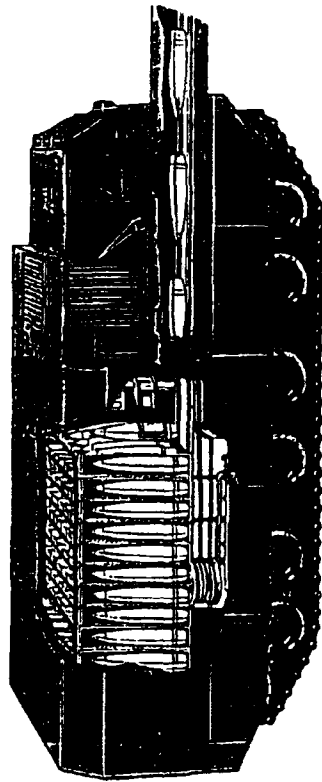

**Future Armored Resupply
Vehicle - Ammunition**

ADVANCED FIELD ARTILLERY SYSTEM-CANNON & FUTURE ARMORED RESUPPLY VEHICLE-AMMUNITION

MISSION: The Advanced Field Artillery System - Cannon (AFAS-C) and the Future Armored Resupply Vehicle - Ammunition (FARV-A) have become the core of the modified Armored Systems Modernization program. The goals of both AFAS-C and FARV-A programs are to develop a more survivable, longer range, self-propelled artillery system that is based on the common component approach to system development. AFAS-C and FARV-A are being developed to displace the M109A6 howitzer and M992 resupply vehicle within Force Package One. Together, they provide the capability for increased rates of fire, reduction in section size, and a fully automated ammunition handling system. Lessons learned from development of these two systems will eventually be incorporated into other developing artillery weapon systems.

CHARACTERISTICS:

AFASC-C	FARV-A
Range (km): 30km HE 40km RAP	Automated REARM: 12 rds/min REFUEL: 35-50 gals/min 400 miles
Rate of Fire: Max: 12-16 rds/min (5 min) Sustained: 3-6 rds/min	Range: 53 mph Crew: 2-3 Stowage Capacity: 200 rds std 155mm Macro NBC Protection
Time on Target: (1 gun): 4 rd simultaneous impact 3-4 (operable by 1)	
Crew: None known.	

FOREIGN COUNTERPART: In 1991, the Army selected liquid propellant as the propellant of choice for its 21st century artillery system. Liquid propellant provides a greater degree of flexibility in system design and amplifies crew operations. In FY93, the Army will continue technology maturation programs in common componentry, regenerative liquid propellant gun technology, extended armament and automated ammunition handling for AFAS-C, as well as key technologies associated with FARV-A.

POINT OF CONTACT: AFAS Program Office
Attn: SFAE-ASM-AF
Picatinny Arsenal, NJ 07806

FARV-A Program Office
Attn: SFAE-ASM-FR
Picatinny Arsenal, NJ 07806

CONTRACTORS: Teledyne (Muskegon, MI)
FMC Ground Systems Division (San Jose, CA)

GDLS (Sterling Heights, MI)

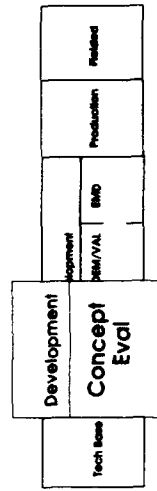



BRILLIANT ANTI-ARMOR SUBMUNITION (BAT)

MISSION:

BAT is a self-guided submunition that uses two sensors: acoustic and infrared. It autonomously locates, attacks, and destroys moving tanks and other armored vehicles. It is this autonomous capability that makes this submunition "brilliant." BAT submunitions can be carried deep into enemy territory by a delivery vehicle, then dispersed over a target to selectively attack and destroy it.

CHARACTERISTICS:

Length: 36 in
Weight: 44 lbs
Payload: Tandem shaped warhead
Delivery Vehicles: Army variant of Tri-Service Standoff Attack Missile (TSSAM)
Army Tactical Missile System (ATACMS)

Diameter: 5.5 in
Seekers: Acoustic and Infrared
Guidance: Autonomous

FOREIGN COUNTERPART:

None.

PROGRAM STATUS:

BAT has just entered a 42-month Engineering and Manufacturing Development program. The BAT system was approved by the Defense Acquisition Executive for entry into Engineering and Manufacturing Development on May 15, 1991. A contract was awarded to the Northrop Corporation on June 5, 1991. The program was initiated in 1984 and has matured under extensive development and testing. These efforts have successfully demonstrated the system capability to autonomously acquire, track and impact moving armor targets with the necessary accuracy and lethality. Northrop Corporation is currently finalizing the system tactical design leading to a Critical Design Review in the second quarter of fiscal year 1992.

POINT OF CONTACT:

Project Manager BAT
ATTN: SFAE-FS-XB
Redstone Arsenal, AL 35898-7998

CONTRACTORS:

Northrop Corporation (Hawthorne, CA) (Prime)
Raytheon Company (Manchester, NH)

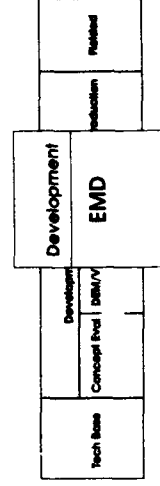

The SADARM System

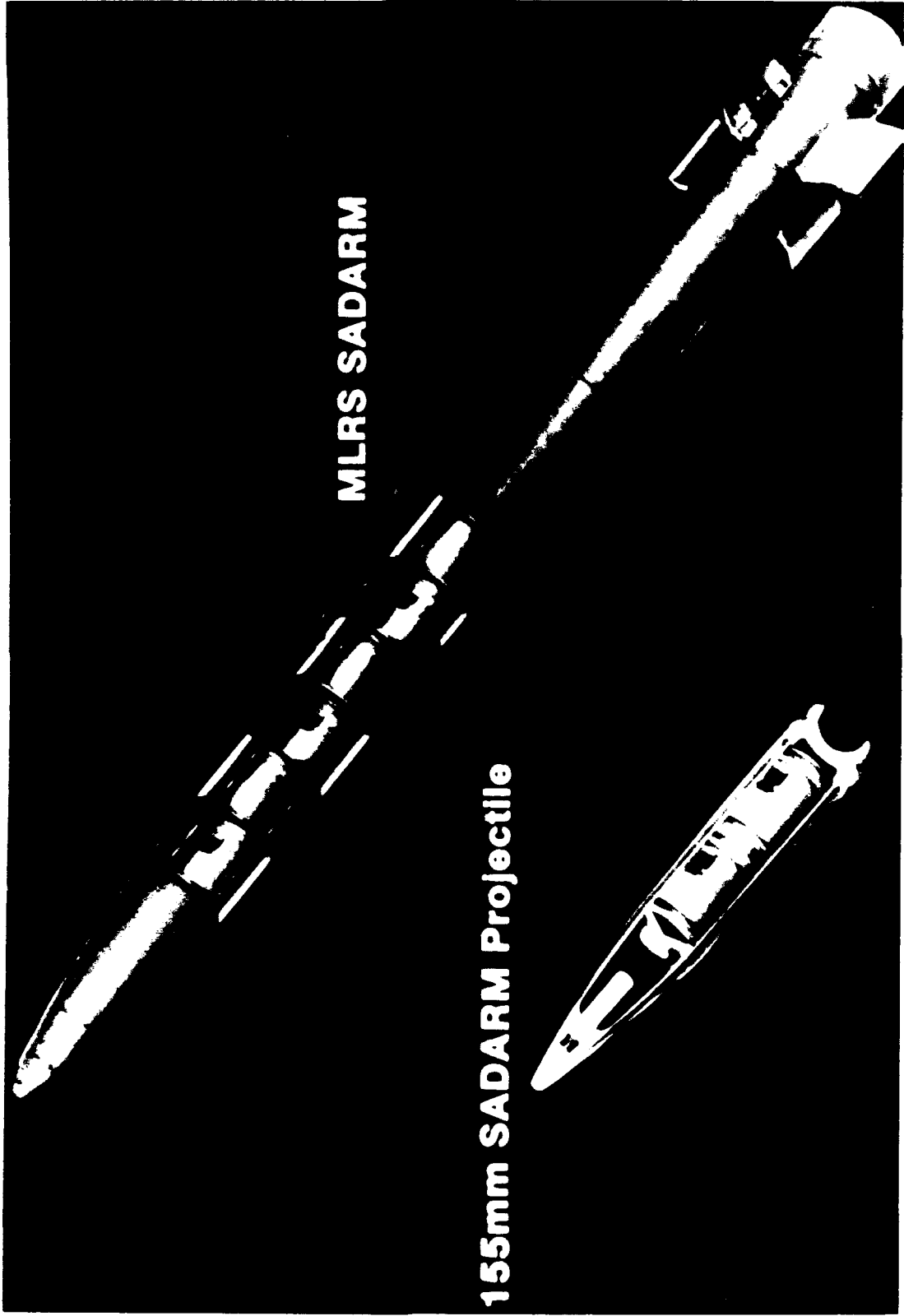

SENSE AND DESTROY ARMOR (SADARM)

MISSION:

SADARM is a comparatively low cost, fire-and-forget, sensor-fuzed submunition designed to detect and destroy lightly armored vehicles, primarily self-propelled artillery. SADARM is delivered to the target area by 155mm artillery projectiles or by the Multiple Launch Rocket System (MLRS). Once dispensed from its carrier, the submunition detects appropriate targets using dual-mode millimeter wave and infrared sensors and fires an explosively formed penetrator through the top of the target.

CHARACTERISTICS:

Caliber:	155mm	MLRS
Weight:	5.8 in	6.9 in
Range:	26.4 lbs	30.8 lbs
Number Submunitions:	22.5 km*	30 km**
	2/round	6/rocket

* From M109A6 Howitzer
** From M270 MLRS Launcher

FOREIGN COUNTERPART:

The Russians are developing a SADARM-like weapon for application to both cannon artillery and rockets.

PROGRAM STATUS:

SADARM entered Engineering Manufacturing Development in March 1988 and is scheduled for a Low Rate Production decision in March 1993. SADARM is scheduled to be fielded in FY94 in 155mm and FY96 in MLRS.

POINT OF CONTACT:

PM, Sense and Destroy Armor
ATTN: SFAE-AR-SD
Picatinny Arsenal, NJ 07806-5000

CONTRACTORS:

AEROJET (Azusa, CA)
LTV Aerospace and Defense (Grand Prairie, TX)

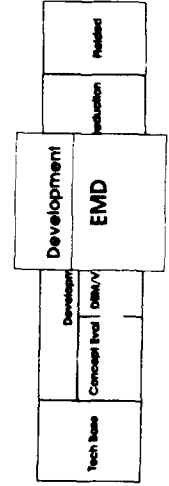



ARMY TACTICAL MISSILE SYSTEM (Army TACMS)

MISSION:

Army TACMS provides a long range missile system that operates in near all-weather conditions, day or night. It is air transportable and capable of effectively engaging high priority land targets at ranges beyond the capability of cannons, rockets, and the LANCE Missile System. The Block I System will be used to attack tactical surface-to-surface missile sites, air defense systems, logistics elements, and command/control/communications complexes, while the Block II System will attack second echelon maneuver units arrayed in depth throughout the corps area of influence.

CHARACTERISTICS:

Army TACMS is a ground-launched, conventional, surface-to-surface, semi-guided ballistic missile with an Anti-Personnel/Anti-Materiel (APAM) warhead. The Block II System will carry a "smart" antiarmor submunition. Both missile versions are designed to be fired from the modified M270 MLRS launcher, utilizing the same targeting systems, engagement systems, and command and control systems as MLRS.

FOREIGN COUNTERPART:

SCUD Variants and SS-21 (Soviet-developed); Jericho (Israel)

PROGRAM STATUS:

Army TACMS is currently in its first year of Full Scale Production. Low Rate Initial Production 1 (LRIP 1) began in 1989 and LRIP 2 began in 1990. Both LRIP 1 & 2 were accelerated in support of Operation Desert Shield/Desert Storm. Full Scale Production was accelerated in FY91 to prevent a production gap following the completion of LRIP 2. Current Procurement Objective is 1573 missiles. It is the first weapon system to be fielded in the modernization program for a "system of systems" deep fires suite, and it has seen combat action in SWA. Army is currently examining the possibility of an extended range version of Block I to perform an anti-tactical ballistic missile mission.

PERFORMANCE IN SWA:

Army TACMS was used to neutralize or destroy several surface-to-air missile sites, a logistics site, a refueling point, vehicles on a pontoon bridge, and several multiple launch rocket and howitzer batteries while in a counter-fire mode. One of the important lessons learned was the need to develop a joint doctrine for employment and airspace coordination when engaging targets.

POINT OF CONTACT:

Project Manager, Army TACMS
ATTN: SFAE-FS-AT
Redstone Arsenal, AL 35898-5650

CONTRACTORS:

LTV Aerospace and Defense (Dallas, TX)

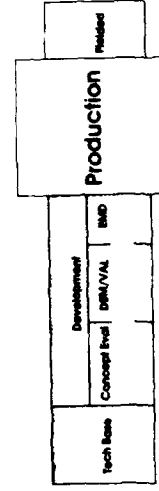



M109A6 SELF-PROPELLED HOWITZER (PALADIN)

MISSION:

Like the earlier M109 models, the Paladin (M109A6) will provide the primary indirect fire support to the maneuver brigades of armor and mechanized infantry divisions. The Paladin is capable of firing both conventional and nuclear 155mm munitions. The M109A6 modifications include an onboard ballistic computer and navigation system, secure communications, an improved cannon and gun mount, automotive improvements, improved crew nuclear-biological-chemical protection, driver's night vision capability, and built-in test equipment. The Paladin possesses improved responsiveness, survivability, lethality, and reliability.

CHARACTERISTICS:

Range: 30 km (with Rocket Assisted Projectile)
 24 km (with unassisted projectiles)
 Rate of Fire: Maximum: 4 rounds/min. for 3 minutes
 Sustained: 1 round/min.
 Main Armament: M284 155mm Cannon
 Secondary Armament: Caliber .50 Machine Gun
 Weight (combat loaded): 32 tons

FOREIGN COUNTERPART:

AS90 (U.K.)
 PzH 2000 (Germany)
 155 GCT (France)
 Slammer (Israel)

PROGRAM STATUS:

Low rate production began in FY 1991 to achieve a First Unit Equipped date in 1993. The Army will acquire 824 Paladins as a product improvement of the current M109A2/A3 howitzer. The balance of the M109 howitzer fleet will receive the M109A5 upgrade which includes some automotive and crew nuclear-biological-chemical protection improvements and Paladin's M284 cannon.

POINT OF CONTACT:

Product Manager, Paladin
 ATTN: SFAE-AR-HIP
 Picatinny Arsenal, NJ 07806-5000

CONTRACTORS:

BMV (York, PA)
 Honeywell (Clearwater, FL)
 Alliant Techsystems (Minneapolis, MN),
 GE (Burlington, MA),
 Carrier (Ft. Washington, PA)

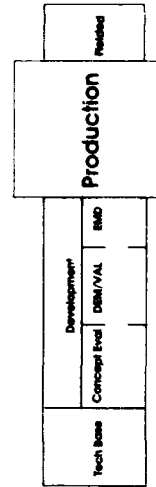



M119A1 HOWITZER

MISSION:

The M119A1 provides improved direct support artillery capabilities for the Army's Light Contingency forces. The M119A1 was procured as a non-developmental item based on the L119 British Light Gun. It is a lightweight, 105mm, towed howitzer that improves fire support for the Army's Airborne, Air Assault and Light Infantry Divisions and Separate Brigades. It fires all conventional 105mm ammunition in the inventory, the M913 High Explosive Rocket Assisted (HERA) ammunition now in production, and the new Dual Purpose Improved Conventional Munition (DPICM) in development. It is airmobile with the UH-60 Black Hawk helicopter and its prime mover is the High Mobility Multipurpose Wheel Vehicle (HMMWV).

CHARACTERISTICS:

Range: 14.3 HE, 19.5 HERA, 14.9 DPICM
Weight: 4,000 lbs
Width: 70 in
Length: 241.5 in
Height: 54 in (travelling configuration)
Crew: 7
Ammunition: HE, Smoke, Illumination, HERA, DPICM

FOREIGN COUNTERPART:

The nearest counterpart is the L119 British Light Gun and the Soviet-developed D-30 122mm howitzer.

PROGRAM STATUS:

The M119 was first fielded to the 7th Infantry Division, Ft Ord, California in December 1989. Since the initial fielding, it has been reclassified the M119A1 and was fielded to the 82nd Airborne Division in July 1991.

POINT OF CONTACT:

U.S. Armament, Munitions, and Chemical Command
ATTN: AMSMC-ASA-H
Rock Island Arsenal, IL 61299-6000

CONTRACTORS:

Watervliet Arsenal, NY
Rock Island Arsenal, IL

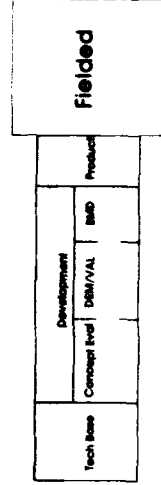



MULTIPLE LAUNCH ROCKET SYSTEM (MLRS)

MISSION:

The primary missions of MLRS are counterfire and suppression of enemy air defenses, light materiel and personnel targets. The MLRS is a free-flight, area fire, artillery rocket system which supplements cannon artillery fires by delivering large volumes of firepower in a short time against critical, time-sensitive targets. The basic warhead carries improved conventional submunitions. A growth program is underway to add the Sense and Destroy Armor (SADARM) warhead to improve counterbattery fires. The MLRS M270 launcher is being updated to accommodate launching a new MLRS family of munitions (MFOM), including the Army Tactical Missile System (ATACMS).

CHARACTERISTICS:

Length:	6.8 m	Cruising Range:	483 km	Rocket Range:	32 km
Width:	3 m	Average speed:	40 kph	Crew:	3
Weight:	24,756 kg	Maximum speed:	56 kph		

FOREIGN COUNTERPART:

There are nine systems which have a broad range of capabilities similar to MLRS, e.g. Soviet-developed 220 mm BM-22, Yugoslavian 262 mm ORKAN and Chinese 273 mm MRL.

PROGRAM STATUS:

The second multiyear procurement contract for FY89-93 was awarded in July 1989 for MLRS. The U.S. initial operational capability for MLRS was achieved in 1983. Starting in FY89, MLRS has been coproduced by the United States, United Kingdom, Germany, France, and Italy. As of 5 Dec 1991, a total of 406 units have been fielded. Potential improvements to the system include the improved fire control system (IFCS). The IFCS will mitigate electronic obsolescence currently existing in the fire control system (FCS) and will accommodate the needs of the MFOM weapon systems under development and provide growth for future weapon systems.

PERFORMANCE IN SWA:

MLRS performed extremely well in Operation Desert Storm (ODS). Significant numbers of MLRS launchers were deployed. All operational requirements were met and, in most cases, exceeded for readiness, reliability, and maintainability. MLRS units from the United Kingdom were also involved in ODS and proved the value of this multi-national system. The new upgraded MLRS (Deep Attack Launcher) also demonstrated its enormous capability during the first operational firings of the longer range ATACMS.

POINT OF CONTACT:

Project Manager MLRS
Attn: SFAE-FS-ML
Redstone Arsenal, AI 35896

CONTRACTORS:

LTV Aerospace and Defense (Dallas, TX)	Brunswick Corp (Camden, AR)
Norden System (Norwalk, CT)	Norris Industries (Los Angeles, CA)
Atlantic Research (Camden, AR)	Bendix Corp (Teterboro, NJ)

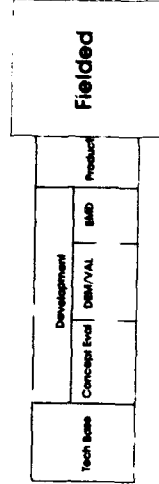



AIR-TO-GROUND MISSILE SYSTEMS (AGMS) (Formerly Hellfire)

MISSION:

AGMS is a third-generation airborne antiarmor weapon. It is presently employed as the main armament of the Apache helicopter. AGMS homes on a laser spot that can be projected from ground observers, other aircraft and the launching aircraft itself. This enables the system to be employed in a variety of modes: autonomous, air or ground, direct or indirect, single shot, rapid or ripple fire.

CHARACTERISTICS:

Version:	Basic	Improved	HOMS	Longbow
Diameter:	7 in	7 in	7 in	7 in
Weight:	100 lbs	106 lbs	100 lbs	106 lbs
Length:	64 in	72 in	64 in	68 in

FOREIGN COUNTERPART:

Numerous countries possess one or more wire, radio, or laser homing antiarmor missiles of varying accuracy and lethality.

PROGRAM STATUS:

There are four versions of the AGMS missile in various stages of the life cycle:
Basic Hellfire - Semi-active laser seeker, approximately 35,000 produced by both Martin Marietta and Rockwell International since 1983. All deliveries have been completed.
Improved Hellfire - (Adds precursor for reactive armor) Final buy of Improved Hellfire missiles currently being produced by Rockwell.
Hellfire Optimized Missile System (HOMS) - Under development by Martin Marietta (Engineering and Manufacturing Development (EMD) contract 1990-92), with Low Rate Initial Production award in FY 92 and priced production options for 1993-96. Lethal against the threat, fully Electro-Optical Counter Measure (EOCM) capable, restores the baseline weight and length (lost with the Improved Hellfire).
Longbow - Millimeter wave seeker variation for the HOMS missile body. Under EMD by a joint venture (JV) between Martin Marietta and Westinghouse.

PERFORMANCE IN SWA:

AGMS missiles performed exceptionally well, as evidenced by the high percentage of hits and overall mission success reported by the using units. While the Hellfire is designed for an Air-To-Ground antiarmor role, it was used in a number of missions other than antiarmor (i.e., fixed structures, air targets and other missions requiring precision guidance).

POINT OF CONTACT:

Project Manager
 Air-To-Ground Missile Sys.
 ATTN: SFAE-FS-HD
 Redstone Arsenal, Alabama 35898

CONTRACTORS:

Rockwell International Corporation (Duluth, GA) (Improved Hellfire Warhead Missile)
 Martin Marietta (Orlando, FL) (Hellfire Optimized Missile System and part of Longbow JV)
 Westinghouse (Baltimore, MD) (Part of Longbow JV)

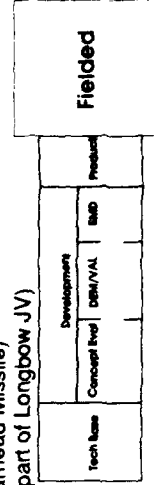

COMBAT SUPPORT

Combat Support includes those items providing operational assistance to the combat arms in planning, combat operations, and readiness. This mission area includes essential force multipliers to improve the commander's battle management and sustainment in the highly lethal and mobile AirLand Battlefield.

Tech Base	Concept Development	DEVELOPMENT DEM/VAL	EMD	Production	Fielded
Radar Deception and Jamming Countermine Joint Air/Land/Sea Precision Strike Demonstration			Joint Surveillance and Target Attack Radar System Trackwolf Ground Based Common Sensors Special Operations Aircraft	Lightweight Manportable Radio Direction Finding System	Black Hawk HMMWV Smoke and Obscurants Nuclear, Biological, and Chemical Reconnaissance System Mohawk Quick Fix Guardrail Armored Combat Earthmover Recovery Vehicle



COUNTERMINE

Joint Air/Land/Sea Precision Strike Demonstration

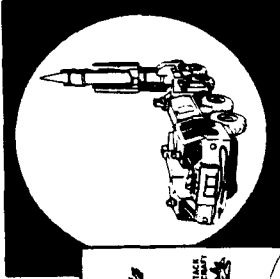
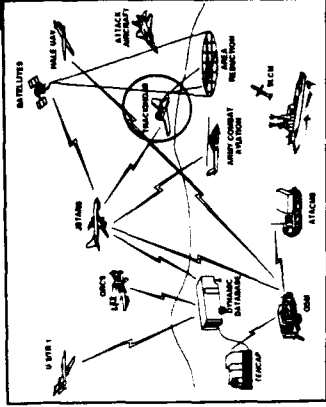

Critical Mobile and Stationary Targets

Lethal strike before the enemy can react

JOINT AIR / LAND / SEA PRECISION STRIKE DEMONSTRATION



RADAR DECEPTION AND JAMMING

COMBAT SUPPORT - TECH BASE

OVERVIEW:

The goal of the Army Technology Base program in Combat Support is to provide the technologies to identify, locate and classify high priority targets and direct weapon systems for engagement. Additionally, investments in this mission area focus on the demonstration of advanced techniques/devices to detect and neutralize enemy mines/minifields to support mobility and survivability of U. S. troops and assets.

RADAR DECEPTION AND JAMMING ATTD:

This ATTD will demonstrate sensor fusion and power management of Identification Friend or Foe (IFF) and other avionics for situation awareness, survivability, and targeting. It will also demonstrate state-of-the-art suppression of enemy air defense (SEAD) and deception to protect attack and Special Operations Aircraft. Demonstrations will include Apache and Blackhawk escort and standoff jammers, wideband/expert systems upgrades and airborne deception of an integrated air defense network. Specialized advances in high power microwave control components and wide band space-fed antenna arrays will be demonstrated.

COUNTERMINE:

Operation Desert Shield/Desert Storm highlighted the capabilities in landmine warfare possessed by hostile countries. The Army will aggressively exploit novel mine neutralization technologies in high power microwave, magnetic signature silencing and wide area neutralization to counter both antipersonnel and antiarmor mines possessed by potential adversaries. These technologies will provide a more rapid fielding of a next generation countermine solution and will help in leveraging industry efforts.

JOINT AIR/LAND/SEA PRECISION STRIKE DEMONSTRATION (ARMY LEAD):

A Joint Air/Land/Sea Precision Strike demonstration (Army lead) will be initiated in FY93 in response to the DoD Science & Technology Thrust which identifies a requirement for all-weather, day/night precision strike against 21st century critical mobile and fixed targets. The demonstration, conducted in FY93-96, will integrate surveillance, target acquisition, processing and attack for rapid response execution at extended-range, short-dwell targets. Linkage and integration will be demonstrated in a test exercise between surveillance and aided target recognition (ATR) assets, Joint Surveillance and Target Attack Radar System (JSTARS), Army Tactical Missile System (ATACMS) and Air Force and Navy precision munitions to achieve an all-weather precision strike execution capability. End-to-end system capabilities to successfully engage targets with high accuracy will be simulated on a combined arms electronic battlefield (EB) and correlated to test exercise data. Promising advanced technologies will then be evaluated using the correlated EB model for real-time assessment of weapons effectiveness in a dynamic battlefield. An assessment will also be made of clutter, countermeasures and execution times.

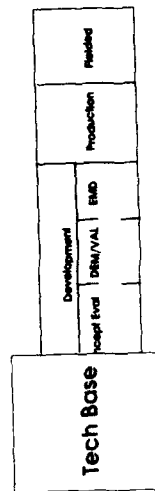



USAF E-8
Joint STARS Aircraft

US Army
Joint STARS
Ground Station Module (GSM)

JOINT SURVEILLANCE TARGET ATTACK RADAR SYSTEM (Joint STARS) GROUND STATION MODULE (GSM)

MISSION:

The Joint STARS system provides tactical air and ground commanders near real time wide area surveillance and deep targeting data on both moving and fixed targets during daylight, darkness and near all weather conditions to detect, locate, track, classify and assist in attacking targets beyond the Forward Line of Troops (FLOT). Joint STARS is a joint Air Force/Army program. Orbiting a safe distance on the friendly side of the FLOT, the Joint STARS radar covers a wide area at great depth on the unfriendly side of the FLOT. The radar data is simultaneously received by Air Force and Army operators aboard the aircraft and by multiple GSMs at Echelons Above Corps (EAC), Corps, Corps Artillery, Division, and Division Artillery.

CHARACTERISTICS:

Ground Station Module (GSM): It is a mobile, tactical, multi-sensor ground processor that receives, displays, analyzes and disseminates information. GSM is being developed in three versions: Block I on a 5-Ton truck, Block II in an Electronic Fighting Vehicle System (EFVS) on a Bradley chassis and Block IIA on a HMMWV. Airborne Platform: USAF E-8 (Militarized Boeing 707), multi-mode radar (wide area surveillance and synthetic aperture), 18 operation and control consoles, surveillance and control data link, secure communications.

FOREIGN COUNTERPART:

British ASTOR (airborne radar on Pilatus Britten-Norman Defender aircraft), French HORIZON (airborne radar on Aerospatiale Super Puma helicopter). GSM is interoperable with both.

PROGRAM STATUS:

The Joint STARS GSM is in Engineering and Manufacturing Development (E&MD). Six Interim GSMs (IGSM) are available for test, demonstration and contingency operations. An Operational Field Demonstration (OFD) of the E-8 aircraft and GSMs was successfully completed in the fall of 1990 in Europe gaining wide acceptance and support from senior US and allied commanders.

PERFORMANCE IN SWA:

Two E-8 Joint STARS aircraft and six IGSMs deployed to SWA from 11 Jan to 6 Mar 1991. The Army's GSMs were in direct support of deployed ground forces. The Joint STARS system made significant contributions to the coalition effort, saved innumerable lives and proved that it is a major force multiplier. The Army Central Command (ARCENT) Deputy Chief of Staff for Intelligence stated that Joint STARS was the single most valuable intelligence and targeting system in Desert Storm.

POINT OF CONTACT:

Army Project Manager, Joint STARS
SFAE-IEW-US
Fort Monmouth, N.J. 07703-5304

CONTRACTORS:

Motorola Corporation (Scottsdale, AZ)
Hughes Simulation Systems, Inc (Minneapolis, MN)
Norden Systems Div of United Technologies (Norwalk, CT)

Grumman Aerospace (Melbourne, FL)
CUBIC Defense Systems (San Diego, CA)

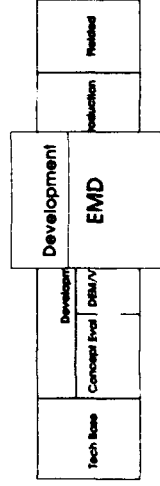



TRACKWOLF

MISSION:

The AN/TSQ-152 Special Purpose Receiving System (Trackwolf) is a High Frequency (HF) sky wave, intelligence, and emitter location system. The Trackwolf system is comprised of two separate interactive subsystems: a Collection and Processing Subsystem (CPS) and a Direction Finding Subsystem (DFS). The CPS consists of command and control, receiving system, and collection analysis shelters. The DFS consists of a Net Control Station (NCS) collocated with the CPS and three remotely located DF outstations which net together by landline or HF radio. Trackwolf has two primary missions: signals intercept, performed by the CPS; and direction finding, performed by the DFS. The CPS is normally located in the theater rear area approximately 200 kilometers behind the Forward Line of Troops (FLOT). The system supports Echelon Above Corps (EAC) commanders by supplying intelligence information to the theater level All Source Analysis System (ASAS). It communicates with the ASAS through the Single Source Processor - SIGINT (SSP-S) link.

CHARACTERISTICS:

The DFS is capable of both netted Direction Finding (DF) and Single Station Location (SSL) operations. The CPS is modular with all components linked together via a Local Area Network (LAN). This allows systems to be tactically sized to meet operational requirements ranging from Field Station operations to rapid deployment Corps operations. The hardware suite of equipment within the CPS is a combination of non-developmental item (NDI) and field station components. The software is the NDI Conventional Signal Upgrade (CSU) utilized in field stations.

FOREIGN COUNTERPART:

None known.

PROGRAM STATUS:

Trackwolf is being handled as a Quick Reaction Capability (QRC) Program that is now in Full Scale Development. Initial Key Personnel (IKP) training and Phase I Initial Operational Test and Evaluation (IOT&E) have been completed. System is scheduled to arrive OCONUS in 2nd QTR FY92. Phase II IOT&E is scheduled for 4th QTR FY92. System handoff is scheduled for 2nd QTR FY93. Procurement of a second downsized Trackwolf is scheduled for FY94, pending the results of IOT&E.

PERFORMANCE IN SWA:

Tactical HF skywave DF was a noted deficiency in Operation Desert Shield/Storm. Pre-Trackwolf proof of principle systems performed well.

POINT OF CONTACT:

PM Signals Warfare
Vint Hill Farms Station
Warrenton, VA 22186

CONTRACTORS:

TCI, Technology for Communications International (Fremont, CA)

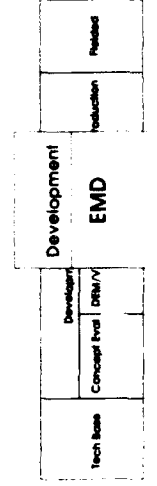

GROUND BASED COMMON SENSORS



GBCS - L

GBCS - H

IEW GROUND BASED COMMON SENSORS

MISSION:

Ground Based Common Sensor - Light (GBCS-L) and Ground Based Common Sensor - Heavy (GBCS-H) are mounted signals intercept and emitter location systems which search, intercept, locate, identify and provide electronic countermeasures against enemy communications and noncommunications emitters. GBCS-L is HMMWV mounted while GBCS-H is mounted in an Electronic Fighting Vehicle System (EFVS), which uses a MLRS chassis (M993). Both GBCS-L and GBCS-H, are elements of the Intelligence Electronic Warfare Common Sensor (IEWCS) program, interoperates with the other elements of the IEWCS and the Advanced Quickfix in order to locate and acquire targets beyond the Forward Line of Troops. Situation development information is transmitted to the Technical Control and Analysis Element (TCAE) of the All Source Analysis System (ASAS) and targeting information is transmitted through the TACFIRE system to their respective users. Both GBCS-H and GBCS-L will be built with "open systems architecture" to accommodate rapid technology insertion and keep pace with changes in threat characteristics. The light and heavy variant of the IEWCS system have the same common sensor subsystems as the Advanced Quickfix.

CHARACTERISTICS:

Vehicular operation: All terrain
 Mission operation: Twenty-four hours
 Intercept, locate & jam: HF, VHF, UHF
 Setup/Teardown time: 10 min/3 min
 Roll-on, roll-off (RO-RO): C-5 (GBCS-H); C-130, C-141 (GBCS-L)

FOREIGN COUNTERPART:

None known

PROGRAM STATUS:

Both are in Engineering and Manufacturing Development. The Technical Test/User Test is scheduled for FY93 - FY94.

PERFORMANCE IN SWA:

The advanced development system, Tomcat, was fielded with the Marines and was the only ground system able to operate against low probability of intercept signals. Key lesson learned in SWA is that IEW systems require deployability and mobility equal to the supported force.

POINT OF CONTACT:

PM Signals Warfare
 Vint Hill Farms Station
 Warrenton, VA 22186

CONTRACTORS:

ELECTROSPACE Systems Inc. (Richardson, TX)
 Sanders/AEL Joint Venture (Hudson, NH)
 Motorola Inc. (Scottsdale, AZ)

IBM Corp. (Owego, NY)
 Magnavox (Fort Wayne, IN)
 FMC Corp. (Santa Clara, CA)

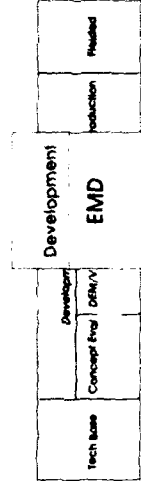



MH - 47E



MH - 60K

SPECIAL OPERATIONS AIRCRAFT (SOA)

MISSION:

The Special Operations Aircraft (SOA) are modified Black Hawk (UH-60L) and medium-lift Chinook (CH-47D) helicopters that will provide the Army with the capability for low level, night, adverse weather, extended range, and precision navigation through unfamiliar mountainous terrain. Both the utility and medium-lift version (designated MH-60K and MH-47E, respectively) will be provisioned with extended range fuel systems including an aerial refueling capability, upgraded engines and worldwide communications equipment. Additional improvements include a totally integrated cockpit, which dramatically reduces pilot workload, as well as improved terrain following/terrain avoidance radar and forward looking infrared radar capability. Their missions cover rapid deployment, strategic intelligence strikes, and other operational missions supported by the Special Operations Forces.

CHARACTERISTICS:

	<u>MH-47E</u>	<u>MH-60K</u>
Mission Weight:	54,000 lbs	24,5000 lbs
Cruise Speed:	138 kts	122 kts
Endurance*:	9.8 hrs	7.6 hrs
Maximum Self Deployment Range*:	1,260 nm	755 nm
Crew:	4	4
Payload:	42 troops	12 troops
Armament:	3 - 7.62 mm (M134) machine guns	2 - 7.62 mm (M134) machine guns
	* unrefueled w/30 min reserve; however, also has air-to-air refuel capability.	

FOREIGN COUNTERPART:

The Soviet-developed MI-8 is a medium-lift helicopter and the MI-26 is a heavy lift helicopter. The HIP series and HALO perform troop carrier and general cargo transport.

PROGRAM STATUS:

The MH-47E and MH-60K are currently under Engineering and Manufacturing Development. MH-47E production started in FY91 with First Unit Equipped (FUE) date during the 4th Qtr, FY93; for MH-60K, 1st Qtr, FY93. The SOA program will provide 23 MH-60K and 26 MH-47E aircraft.

POINT OF CONTACT:

PM Special Operations Aircraft (SOA)
4300 Goodfellow BLVD
SFAE-AV-SOA
ST. Louis, MO 63120-1798

CONTRACTORS:

Boeing Helicopter Company (Philadelphia, PA)
Siskorsky Aircraft Division (Stratford, CT)
IBM FSD (Owego, NY)

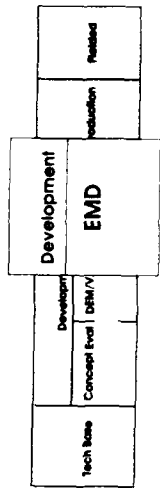

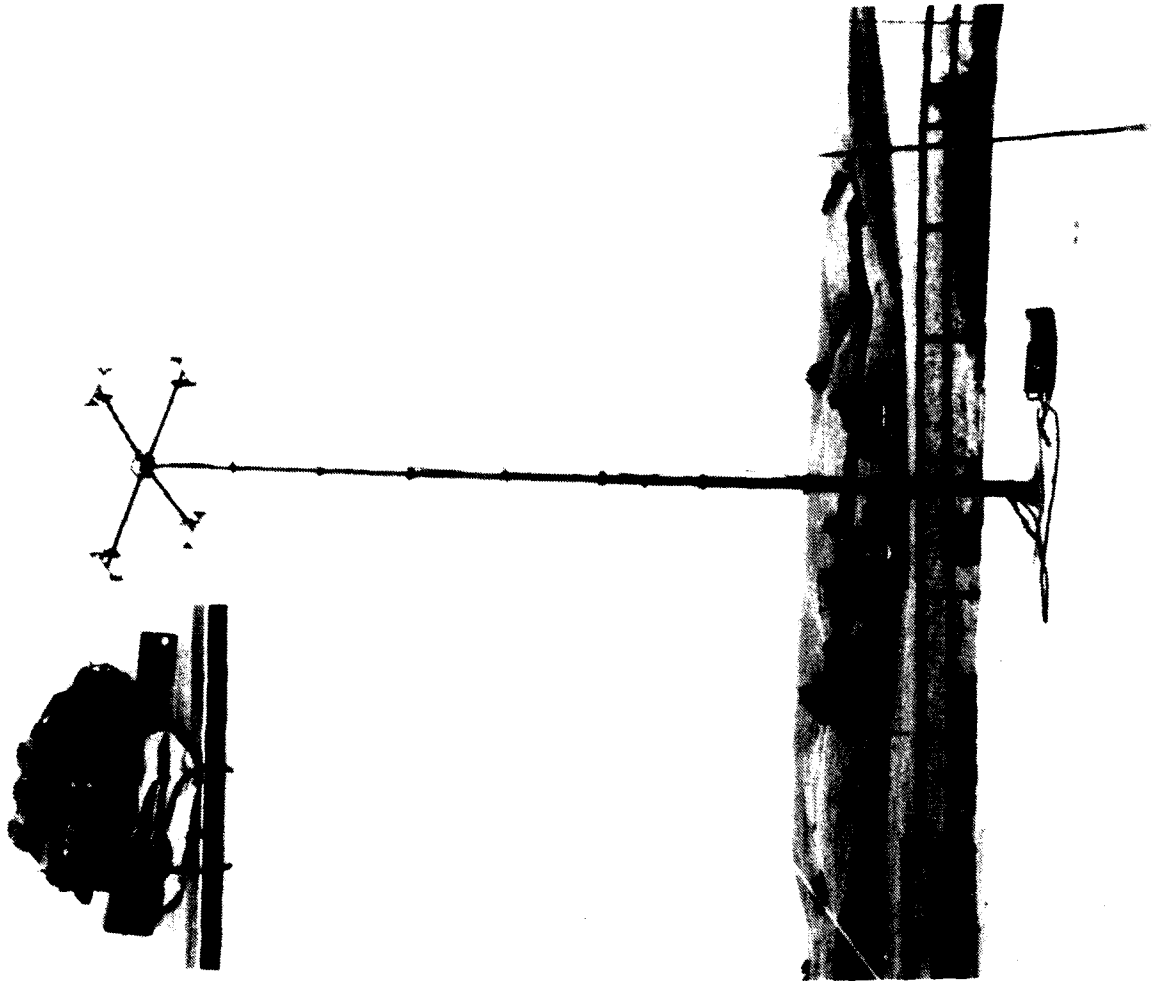

LIGHTWEIGHT MANPORTABLE RADIO DIRECTION FINDING SYSTEM

MISSION:

AN/PRD-12 is a man-transportable ground-based communications intercept and direction finding (DF) system. It consists of a receiver processor and two antenna subsystems. The system can be deployed by two people. The system provides intercept and direction finding of enemy HF/VHF/UHF communications emitters. The system also nets with the AN/TRQ-32(V) Teammate. The basis of issue is six per Light Division and four per Special Forces Group.

CHARACTERISTICS:

Intercept Frequency Range: 0.5 - 500 Mhz
 DF Frequency Range: 0.5 - 500 Mhz
 Weight: 53 lbs

FOREIGN COUNTERPART:

There are several commercially available systems similar to the AN/PRD-12 available from US & UK firms.

PROGRAM STATUS:

The system is in production and will begin fielding in 2QFY92. There are currently two materiel changes underway to extend the intercept and DF frequency range to 1.2 Ghz and to provide a smaller antenna for Special Operations Forces (SOF) operations.

POINT OF CONTACT:

PM Signals Warfare
 Vint Hill Farms Station
 Warrenton, VA 22186

CONTRACTORS:

ESL Inc. (Sunnyvale, CA).

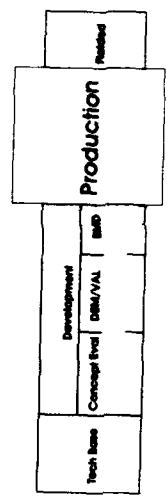



BLACK HAWK

MISSION:

The UH-60 Black Hawk is replacing the UH-1 "HUEY" in air assault, air cavalry, air cavalry, and aeromedical evacuation missions. The Black Hawk can carry more than twice the payload and is capable of transporting an entire 11-man, fully equipped squad faster and in most weather conditions. The Black Hawk is the first utility/assault helicopter that adds to the Army's Division level mobility; for example it can reposition a 105mm howitzer, its crew of 6, and up to 30 rounds of ammunition in a single lift. Its critical components and systems are armored or redundant to enable it to withstand multiple small arms hits, and its airframe is designed to progressively crush on impact to protect the crew and passengers in a crash. Advanced technology in the Black Hawk makes it easier to maintain in the field than any other helicopter in the world. Black Hawk's full squad carrying ability significantly improves the small-unit commander's ability to retain control of his forces under combat conditions, and permits more rapid replacement of ammunition and other combat consumables in a high intensity war.

CHARACTERISTICS:

Max Gross Weight: 22,000 lbs
Cruise Speed: 159 kts
Endurance: 2.3 hrs
Max Range: 330 nm
Crew: 2 pilots, 1 crew chief
Armament: two 7.62mm machine guns
Payload: 2640 lbs (or 11 combat equipped troops)
External Load: 9000 lbs

FOREIGN COUNTERPART:

The Soviet-developed HIP series is much slower and is used as a troop carrier and general cargo transport, can carry up to 24 troops.

PROGRAM STATUS:

Black Hawk is being procured under a new five year, multiyear contract covering FY92 to FY96. This new multiyear program will allow the Army to modernize the National Guard and Reserves with the Black Hawk. The Army is presently fielding the UH-60L to its high-priority units.

PERFORMANCE IN SWA:

The UH-60 was well represented in the Desert Shield/Storm Operation with over 400 aircraft operating in all areas of the combat mission area. The UH-60's were heavily used for positioning and resupplying the troops. The Black Hawk flew over 44,000 flight hours during the operation. Additional missions included MEDIVAC, Command and Control, and Special Operations. The UH-60 Black Hawk was considered the "backbone" of Army Aviation.

POINT OF CONTACT:

PM Utility Helicopter
4300 Goodfellow BLVD
ATTN: (SFAE-AV-BH)
ST. Louis, MO 63120-1798

CONTRACTORS:

Sikorsky (Stratford, CT) General Electric (W. Lynn, MA)

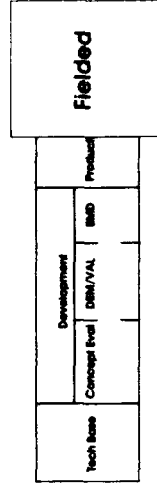

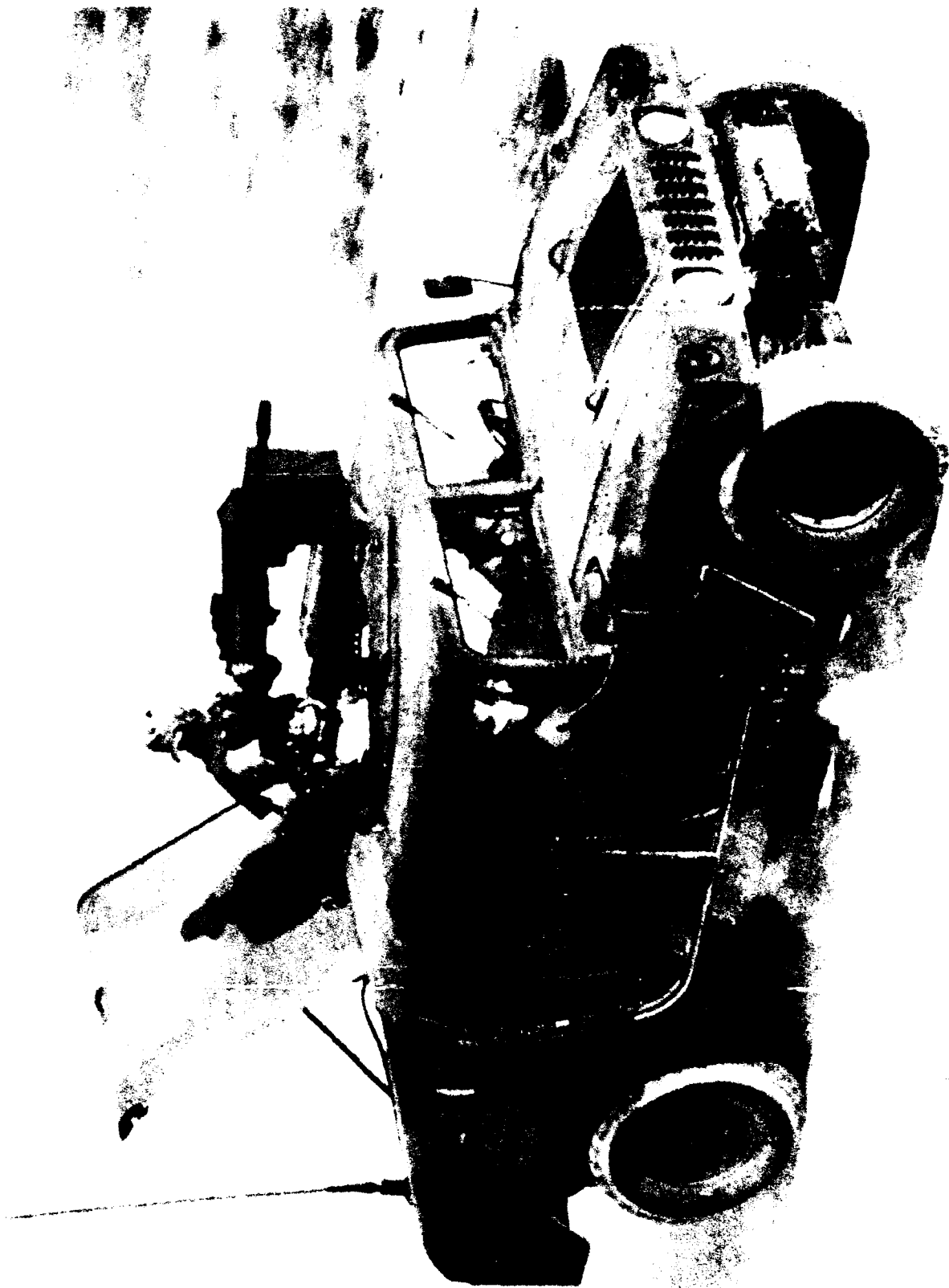

HIGH MOBILITY MULTIPURPOSE WHEELED VEHICLE (HMMWV)

MISSION:

The HMMWV is a light, highly mobile, diesel powered, four-wheel drive tactical vehicle that uses a common 1 1/4 ton payload chassis. The HMMWV can be configured through the use of common components and kits to become a cargo/troop carrier, armament carrier, S250 shelter carrier, two or four litter ambulance, or TOW missile carrier. The HMMWV provides a successor to the 1/4 ton Jeep, M718A1 Ambulance, 1/2 ton M274 Mule, 1 1/4 ton Gamma Goat, and M792 Ambulance. The HMMWV is a Tri-Service program that also provides vehicles to satisfy Marine Corps and Air Force requirements. The HMMWV program is complementary to the 1 1/4 Ton Commercial Utility and Cargo Vehicle (CUCV) Non-development Item (NDI) program. Other developmental models include prime mover for the light howitzer, towed VULCAN system, and heavy variant shelter carriers.

CHARACTERISTICS:

	Cargo/Troop Carrier	Armament Carrier	TOW Carrier	Ambulance Carrier	S250 Carrier	Heavy Variant
Curb Weight:	5200	5960	6051	7180	5483	5600
Payload, lbs	2500	2240	2149	1920	3177	4400
GVW, lbs:	7700	8200	8200	9100	8660	10000
Crew/Cab:	2/4	4	4	2/4 (litters)	2	2/4
Length, in:	180	180	180	203	188	180
Height, in:	72	72 w/o launcher	74	72 w/o	105	104
Width, in:	85	85	85	85	85	85
Trailer Towing						
Capacity:	3400lbs					4200lbs
Range:	300 miles					

FOREIGN COUNTERPART:

No known foreign counterpart.

PROGRAM STATUS:

A new five-year letter contract was awarded in August 1989. Total multiyear quantity is approximately 33,000 vehicles.

PERFORMANCE IN SWA:

Excellent.

POINT OF CONTACT:

PM-Light Tactical Vehicle
PEO-Combat Support
Warren, MI 48397-5000
Commodity Command US Tank
Automotive Command
Warren, MI 48397-5000

CONTRACTOR:

AM General Corporation (South Bend, IN)

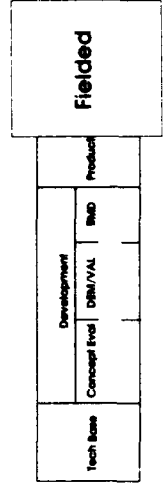

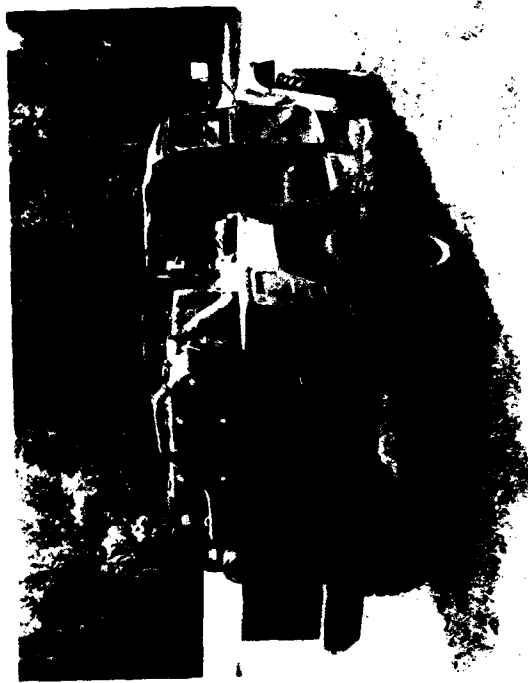

**LARGE AREA
SMOKE GENERATOR
SYSTEM**



**SMOKE GENERATOR
SYSTEM MAKING A
LARGE AREA
SMOKE SCREEN**



**SMOKE GRENADE PATTERN FIRED FROM
AN ARMORED VEHICLE TO DISRUPT ENEMY
OBSERVATION AND WEAPONS GUIDANCE**

SMOKE and OBSCURANTS

MISSION:

Smoke and obscurants greatly improve survivability on today's high intensity battlefield. Smoke grenades fired from combat vehicles produce an instantaneous screen that defeats enemy electro-optic sensors and weapon guidance systems. Artillery, mortar and rocket delivered smoke rounds degrade enemy vision or screen the advance of friendly forces. Mounted on tactical vehicles, large area smoke systems help obscure high priority targets (airfields, bridges and ammunition depots) as well as convoys and troop movements. Smoke projectiles, mortars, grenades and rockets are also used for signaling and marking.

FOREIGN COUNTERPART:

Countries using Soviet doctrine emphasize extensive use of smoke during tactical operations. Many nations, especially those in the Middle East, are realizing the benefits of smoke and have developed programs in this area.

PROGRAM STATUS:

Smoke and obscurants technology initiatives focus on enhancing obscurant effects in the infrared and millimeter wave (radar) spectrum bands. These expanded capabilities will defeat advanced target and guidance systems.

VEHICLE DEFENSE: Visual and infrared smoke grenades for vehicle self protection are available. A millimeter/infrared screening grenade is being developed. Multi-salvo launchers for wheeled and tracked vehicles are also being developed.

PROJECTED SMOKE: Improved submunition rounds are available for artillery and mortars. A new smoke warhead for the 2.75 rocket is completing development.

LARGE AREA SMOKE: New tracked and wheeled smoke generators have been fielded. System upgrades with enhanced infrared/millimeter wave screening and other mission enhancements are already being developed.

POINT OF CONTACT:

PM SMOKE U.S. Army CRDEC
ATTN: AMCPM-SMK ATTN: SMCCR-MU
Aberdeen Proving Ground, MD 21010 Aberdeen Proving Ground, MD 21010

CONTRACTORS:

MRC Division of Chamberlain Manufacturing Corp (XM56 Development) (Hunt Park, MD)
Minowitz Manufacturing Corp (M157 production) (Detroit, MI) (Completed)
Tierney (Turbines for XM56 development) (Detroit, MI)
Brunswick Defense (Deland, FL) (XM6)
BEI Corporation (Eulers, TX) (XM264)

Tech Base	Development		Product
	Concept Eval	D8M/VAL	
Fielded			



NUCLEAR, BIOLOGICAL, CHEMICAL RECONNAISSANCE SYSTEM (NBCRS) - FOX

MISSION:

The M93 is a wheeled armored vehicle equipped with a fully integrated NBC detection, warning and communication system. It will detect, identify and mark areas of NBC contamination; collect soil, water and vegetation samples for later analysis; mark areas of nuclear and chemical contamination; and transmit NBC information to unit commanders in the area of operation. The hazards to the NBCRS crew will be minimized through the inclusion of vehicle NBC collective protection providing overpressure with heating and cooling for crewmen.

CHARACTERISTICS:

Body Style: 6 wheel, armored-collective protection
Engine: V8 Diesel - 320 HP
Weight: 18.7 ton
Speed: 65 mph
Range: 500 miles
Crew: 4 soldiers (3 soldiers - system improvement vehicle)

FOREIGN COUNTERPART:

BRDM-ZRKH, MTLB, RKHM, UAZ-469RKH (Soviet-developed). Chinese also have a NBC Recon System.

PROGRAM STATUS:

The NBCRS is a new non-developmental item (NDI) program consisting of four phases: (1) Proposal Evaluation and Shoot-off Phase during which proposals were evaluated, competition conducted and a winner selected; (2) Interim System Production Phase which provides 48 contractor supported (FY90-8, FY91-15, FY92-25) interim systems for urgent fielding to Central Command; (3) A System Improvement Phase to design, fabricate and test the NBCRS that will satisfy all ROC requirements; (4) Full Rate Production Phase to produce the improved NBCRS for world wide fielding. As a result of Operation Desert Storm, the German government donated 60 German NBCRS to the United States Government. Fifty systems were fielded with the Army forces and 10 with the Marine Corps during Operation Desert Storm. These systems are now with their units and being used in training.

PERFORMANCE IN SWA:

Above 90% Equipment Readiness Rate. Won high praise from soldiers and commanders.

POINT OF CONTACT:

Office of Project Manager
ATTN: AMCPM-NN
Aberdeen Proving Ground, MD 21010
DSN 584-2566

CONTRACTORS:

General Dynamics Land Systems (GDLS) (Detroit, MI) Thyssen Henschel of the Federal Republic of Germany

Tech Name	Development		Fielded
	Concept Prod	DBM/VAL BMD	



MOHAWK SURVEILLANCE SYSTEM

MISSION:

The OV-1D Mohawk radar surveillance system provides Corps commanders location and moving target data on first and second echelon units during daylight, darkness and in near all weather conditions allowing tactical commanders to monitor threat disposition and movement. The OV-1D Mohawk is a two place, twin turbo-prop, combat aircraft equipped with Side Looking Airborne Radar (SLAR) and photographic systems. Radar data is data linked to ground terminals for near real time display. The OV-1D Mohawk is assigned to the Military Intelligence Battalion (Aerial Exploitation), Military Intelligence Brigade (Combat Electronic Warfare Intelligence (CEWI)) at Corps.

CHARACTERISTICS:

Mission weight: 18,587 lbs Cruise speed: 210 kts Crew: 2
 Endurance: 4.0 hrs. Max range: 820 naut mi
 Payload: 2,129 lbs Armament: None

FOREIGN COUNTERPART:

British ASTOR (airborne radar on Pilatus Britten-Norman Defender aircraft), French HORIZON (airborne radar on Aerospatiale Super Puma helicopter).

PROGRAM STATUS:

Fielding of the OV-1D Mohawk surveillance system was completed in 1987. The OV-1D Mohawk fleet has begun a phased drawdown to full retirement by FY97 when the Joint Surveillance Target Attack Radar System (Joint STARS) will fulfill the radar mission for the Army.

PERFORMANCE IN SWA:

25 OV-1D Mohawk aircraft with SLAR systems assigned to two Military Intelligence Battalions (Aerial Exploitation) successfully deployed to SWA and supported the Army's VII Corps, XVIII Airborne Corps and Coalition forces during Operations Desert Shield and Desert Storm in 1990/1991. Overall system readiness was over 90% and the SLAR performance was characterized as extremely effective.

POINT OF CONTACT:

Product Manager AN/UPD-7
 PM Radar
 SFAE-I EW-RD-UP
 Fort Monmouth, N.J. 07703-5000

CONTRACTORS:

Grumman Aerospace, Stuart, FL (aircraft and integration)
 Motorola, Incorporated, Scottsdale, AZ (airborne radar, data link and ground station)

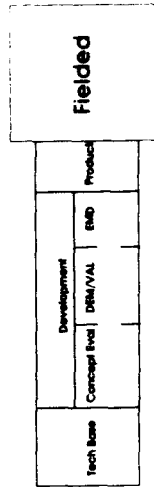

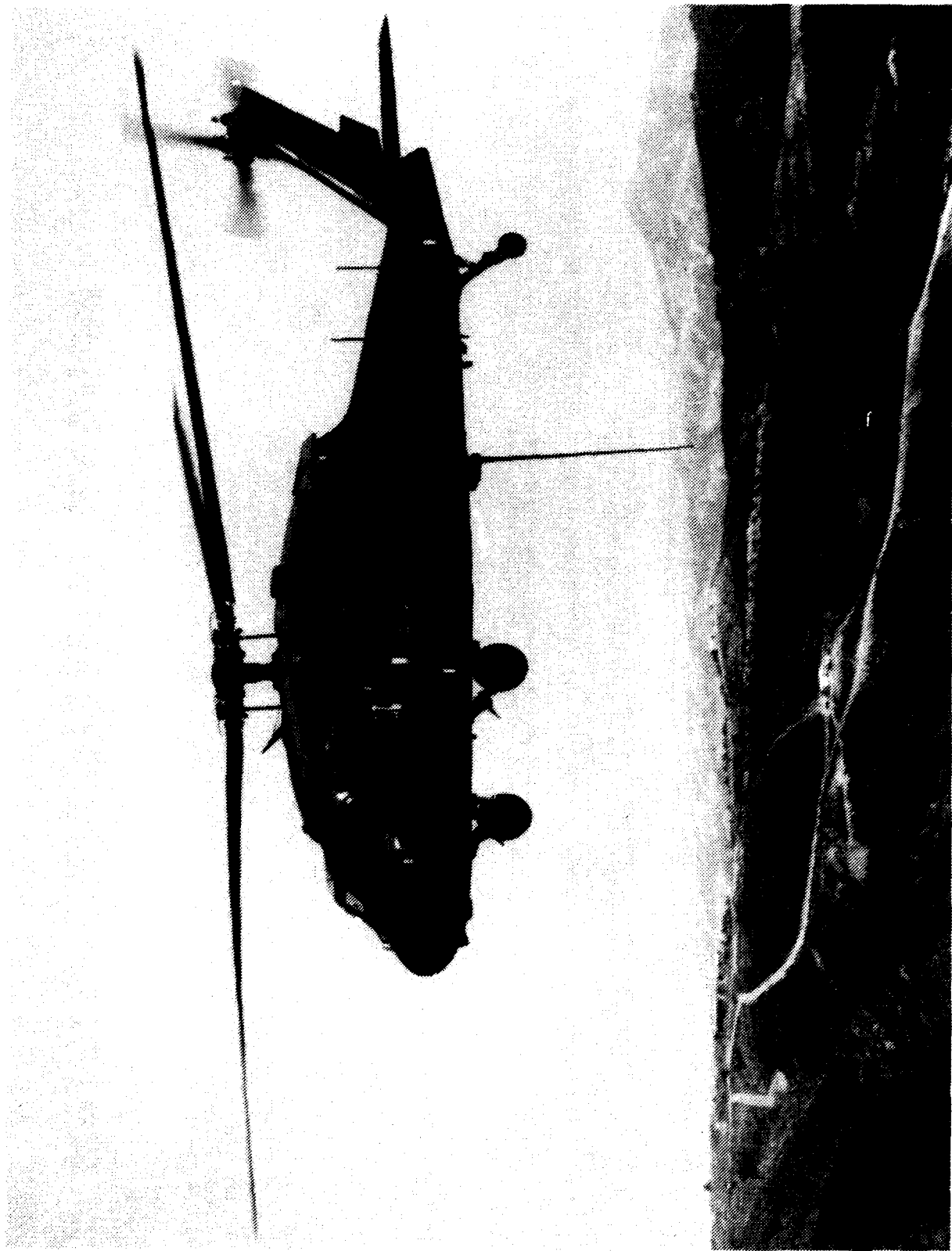

QUICKFIX

MISSION:

Quickfix is a tactical heliborne communications intercept, direction finding (DF) and electronic countermeasures system. Quickfix consists of: AN/ALQ-151 intercept and DF mission equipment, AN/TLO-17A communications jammer and airborne self-protection equipment mounted in a modified UH-60A helicopter. Quickfix systems interoperate with each other and Trailblazer in a netted configuration for DF purposes. Advanced Quickfix, an element of the Intelligence Electronic Warfare Common Sensor (IEWCS) program, interoperates with other elements of the IEWCS, the Ground Based Common Sensor - Heavy and Light in order to acquire and locate targets beyond the Forward Line of Troops. Advanced Quickfix will transmit situation development information to the Technical Control and Analysis Element (TCAE) of the All Source Analysis System (ASAS) and targeting information will be transmitted through the TACFIRE system to their respective users.

CHARACTERISTICS:

	Quickfix	Advanced Quickfix
Aircraft (Crew):	EH-60A (4)	EH-60A (4)
Mission / Payload Weight (lbs):	16,500/2,130	22,000/3,978
Cruise Speed:	137 kts	128 kts
Maximum Range / Endurance:	266 naut mi/2.0 hrs	675 naut mi/4.8 hrs
Intercept, Locate (DF):	VHF,UHF	HF,VHF,UHF
Electronics Countermeasures (jam):	VHF	HF,VHF,UHF

FOREIGN COUNTERPART:

The Soviet-developed technology consists of an extensive fleet of dedicated MI-8 HIP J / HIP K electronic warfare helicopters. The UK, France and other nations also have a heliborne electronic warfare capability.

PROGRAM STATUS:

Quickfix has been fielded and Advanced Quickfix is under development. A Materiel Change (MC) was approved on 6 Sep 91 that will evolve Quickfix into Advanced Quickfix. Advanced Quickfix will be built with an "open systems architecture" and will use the common sensor subsystems of the Intelligence and Electronic Warfare (IEW) family of common sensors.

PERFORMANCE IN SWA:

Quickfix was one of the few IEW systems able to keep up with the pace of the M1 equipped forces.

POINT OF CONTACT:

PM Signals Warfare
Vint Hill Farms Station
Warrenton, VA 22186

CONTRACTORS:

ELECTROSPACE Systems Inc. (Richardson, TX)
Sikorsky Aircraft (Stratford, CT)
IBM Corp. (Owego, NY)
Chrysler Technologies Airborne Systems (Waco, TX)
Magnavox (Fort Wayne, IN)
Motorola Inc. (Scottsdale, AZ)
Sanders/AEL Jt Venture (Hudson, NH)

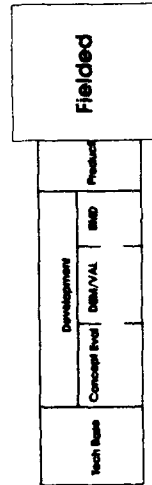

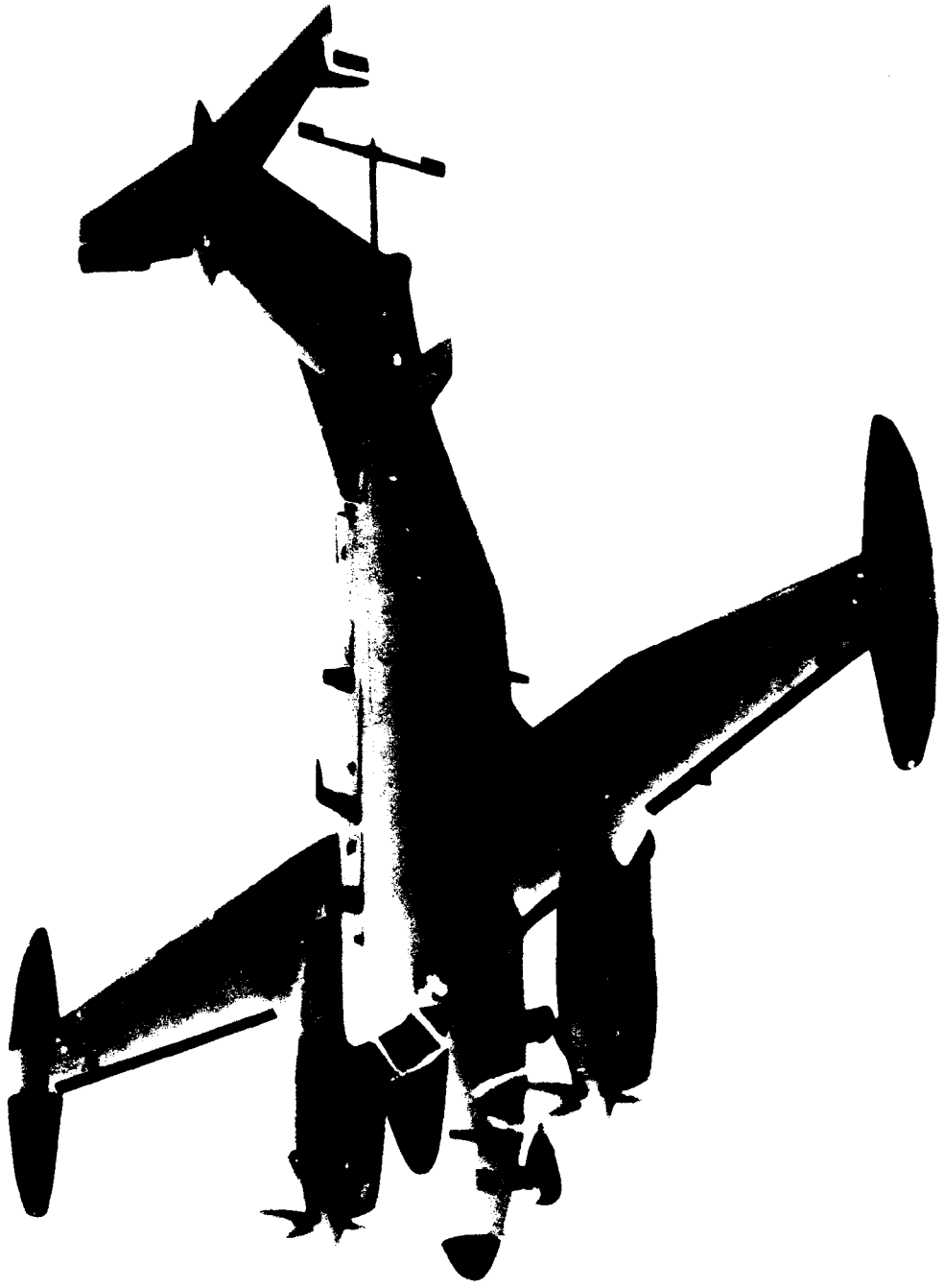

GUARDRAIL

MISSION:

To provide fixed wing communication and electronic emitter intercept and direction finding system. Provides corps and division commanders with targetable information to influence the enemy's decision cycle. Guardrail applications include follow-on force attack, contingency, counterinsurgency and counterdrug operations. Guardrail systems currently in active Army service include the Guardrail V (RU-21H aircraft), the Improved Guardrail V (RC-12D aircraft), the Guardrail Common Sensor Minus (RC-12H aircraft) and the Guardrail Common Sensor (RC-12K aircraft).

CHARACTERISTICS:

	RU-21H	RC-12D/H	RC-12K
Mission Weight/Payload:	10,200/1,126 lbs	14,200 /1,600 lbs	16,000 /2,000 lbs
Cruise Speed:	176 knots	200 knots	250 knots
Endurance:	4.0 hours	5(+)- hours	5(+)- hours
Maximum Range:	1,000 naut miles	1,200 naut miles	1,200 naut miles

FOREIGN COUNTERPART:

Numerous countries possess airborne electronic warfare systems, but none obtain the direction finding accuracy of the Guardrail system using multiple aircraft.

PROGRAM STATUS:

Guardrail Common Sensor (GRCS), combines the Improved Guardrail V (IGRV) Communication Intelligence (COMINT) sensor package with the Advanced Quicklook electronics signals (ELINT) intercept, classification, and direction finding capability, and a communication high accuracy airborne location system (CHAALS). The first GRCS system was fielded to Europe in 1991 - both IGRV systems previously there have been deployed to the CONUS for modification. GRCS(Minus) was fielded to Korea in 1988. Guardrail V systems continue to provide outstanding support to INSCOM, XVIII and III Corps. Two of these systems possess a remote relay capability, which allows forward deployment of the aircraft while the ground processing facility remains in CONUS. Two other GRCS systems are in Engineering and Manufacturing Development, are transitioning into production and will be fielded in FY93 and FY95. A remote relay capability for the GRCS system is also under development. Intelligence information is passed to users via the Commanders Tactical Terminal.

PERFORMANCE IN SWA:

Three Guardrail units deployed to Saudia Arabia and provided outstanding support during Operation Desert Shield/Storm. VII Corps' organic IGRV unit supported VII Corps operations, while XVIII ABN Corps was supported by its organic GRV unit and V Corps' IGRV unit from Germany.

POINT OF CONTACT:

PEO-I EW; PM Guardrail
ATTN: SFAE-I EW-EW
Ft. Monmouth, NJ 07703-5000

CONTRACTORS:

ESL, Inc. (Sunnyvale, CA)	IBM (Oswego, NY)	Beech Aircraft (Wichita, KS)
UNISYS (Salt Lake City, UT)	ESCO (St. Louis, MO)	

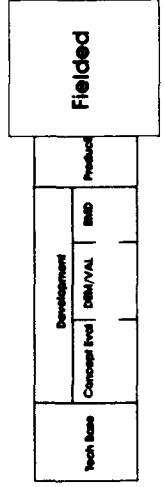

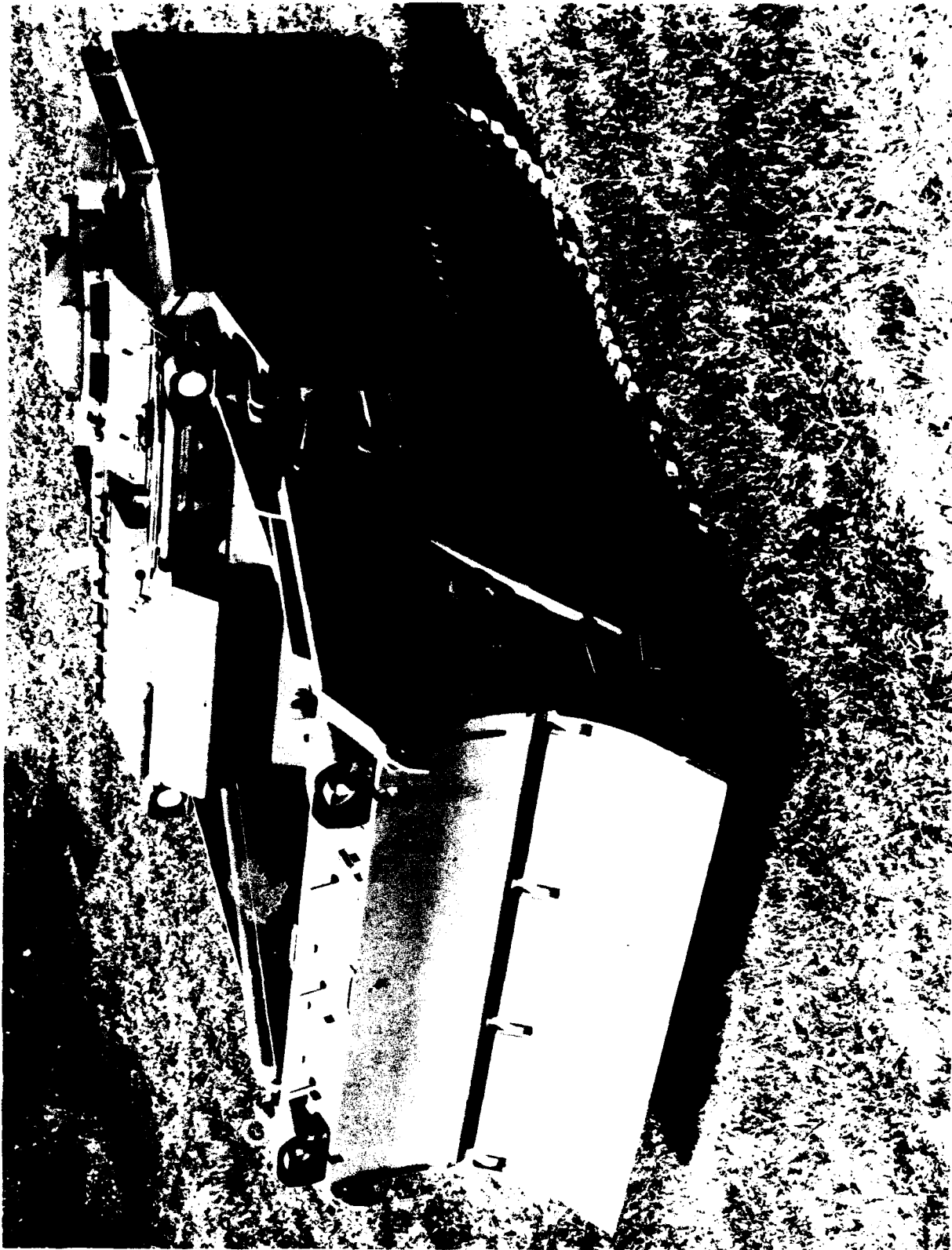

ARMORED COMBAT EARTHMOVER (ACE)

MISSION:

The M9 ACE is a highly mobile, fully tracked armored earthmover capable of performing mobility, countermobility and survivability missions in support of forces in both offensive and defensive operations. The ACE can prepare deliade and protected positions for guns, tanks and other critical battlefield systems. It can prepare combat roads, remove roadblocks, breach berms and perform limited countermobility tasks, such as preparing anti-tank ditches and hauling obstacle materials. The M9 ACE engine, drive train and driver's compartment are laid out in the rear of the vehicle, while the front is occupied by an 8.7 cubic yard scraper bowl, apron and attached dozer blade. Its unique hydro pneumatic suspension system has eight high-pressure hydraulic rotary actuators which connect to the roadwheel stations assuring a smooth ride during high-speed travel through the use of shock-absorbing accumulators.

CHARACTERISTICS:

Weight:	36,000 lbs (net); 54,000 lbs (ballasted)	Swim capability:	3 mph
Length:	20 ft 5 in	Air transportable:	C130, C141, C5A
Height:	8 ft 9 in	Bowl capacity:	8.7 cu yds
Engine:	Cummins V903, 295 hp	Speed:	30 mph (max, road travel)
Crew size:	1 operator	Suspension:	Hydropneumatic, w/rotary actuators
Transmission:	Clark, 6 forward, 2 reverse speeds		

FOREIGN COUNTERPART:

There is no vehicle similar to the M9 ACE.

PROGRAM STATUS:

The M9 ACE will complete production in 4th Quarter FY92 and is midway through worldwide fielding. As of January 1992, 219 of the 448 vehicles produced have been fielded to Combat Engineer units in CONUS and USAREUR. An additional 30 vehicles have been loaned to the US Marine Corps. As a result of the Operation Desert Storm experience, evaluation of several vehicle improvements has been accelerated. These include a fix to a battery overheating problem, removable cutting edge with ripper teeth, steel roadwheels and microclimate cooling.

PERFORMANCE IN SWA:

The ACE was used prior to and in the early stages of the ground war to breach Iraqi berms. All units stated that the ACE was available to conduct the mission, and that it performed adequately. The M9 ACE proved itself through superior mobility and crew protection, although the D7 bulldozer remains a better pure digger when mobility and protection are not required.

POINT OF CONTACT:

Product Manager, M9 Armored Combat Earthmover
 ATTN: AMCPM-M9
 Warren, MI 48397-5000 DSN 786-6635, Comm 313-574-6635

CONTRACTORS:

Production - BMY Corporation (York, PA) Systems Technical Support - AM General Corporation (Livonia, MI)

Tech Base	Development		Fielded
	Concept Eval	DEMO/VAL	

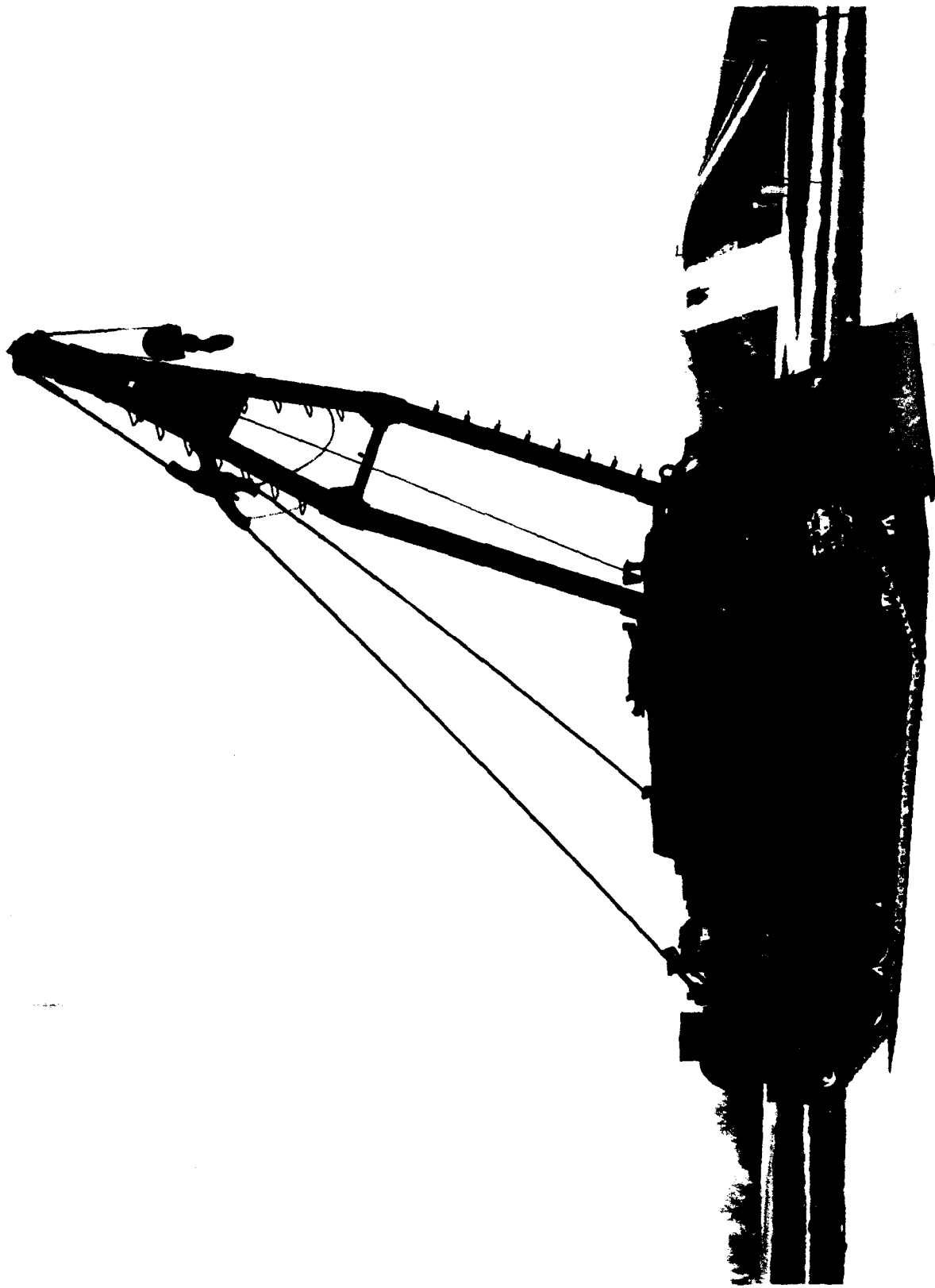

RECOVERY VEHICLE

MISSION:

The M88A1 Recovery Vehicle is a full-tracked armored vehicle designed for hoisting, winching and towing operations for battlefield recovery and evacuation of tanks and other tracked combat vehicles. The M88A1 is the primary recovery vehicle in the Army inventory for M2M3 Bradley Fighting Vehicles, M60 series tanks, and heavy self-propelled artillery. An improved M88A1 is currently under development, and is being designed specifically for towing the Abrams tank.

CHARACTERISTICS:

Length:	325 inches	Power Train:	12-cyl, 750 hp air-cooled diesel engine with 3 speed automatic transmission
Width:	135 inches	Cruising Range:	300 miles
Height:	123 inches	Draw Bar Pull:	90,000 lbs
Weight:	56 tons	Boom Capacity:	25 tons
Top Speed:	30 mph		
Armament:	One .50 cal machine gun		

FOREIGN COUNTERPART:

The Soviets have historically based recovery vehicles on existing chassis. The most current is the BREM-1 based on a T-72 chassis. T-54, T-55-T, and JSU-T recovery vehicles are still in the Soviet inventory.

PROGRAM STATUS:

Approximately 2500 M88A1s are fielded to date. An improved M88A1 is currently under development. Technical and Operational: Testing of prototypes will begin in June 1992.

PERFORMANCE IN SWA:

As a result of the military operations in SWA, it was determined that the current M88A1 Recovery Vehicle lacked the tractive power to safely tow the 65+ ton M1A1 Abrams tank without a second M88A1 or M1A1 tank to act as a brake vehicle.

POINT OF CONTACT:

Program Manager Improved Recovery Vehicle
US Army Tank-Automotive Command
Warren, MI 48397-5000

CONTRACTORS:

BMY Company (York, PA)	Bata Engineering (Ontario, Canada)
GMC, Detroit Diesel Allison Div. (Indianapolis, IN)	Adviondack (Watervliet, NY)
Teledyne Continental Motors (Muskegon, MI)	Buckeye Steel Casting (Columbus, OH)
Firestone Tire (Noblesville, IN)	Ferguson Gear (Gastonia, NC)
Goodyear Tire (St. Mary's, OK)	Berwick Forge (Berwick, PA)
Standard Products (Port Clinton, OH)	Maynard Steel Casting (Milwaukee, WI)

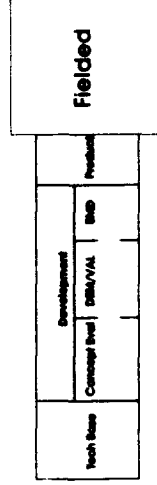

COMBAT SERVICE SUPPORT

The Combat Service Support mission area relates to providing tactical commanders with supply, maintenance, personnel and administration, civil affairs, medical, transportation, and other services. In terms of equipment modernization of the force, this handbook includes those major items that the Army is developing to improve its tactical transportation capability.

Tech Base	Concept Development	DEVELOPMENT DEM/VAL	EMD	Production	Fielded
Artillery Rearm Module Logistics Over-The-Shore Combat Casualty Care				Tactical Quiet Generators HETS Palletized Load System FMTV Reverse Osmosis Water Purification Unit Integrated Family Test Equipment	5 Ton Truck HEMTT Deployable Medical Systems Logistics Support Vessel



**LOGISTICS
OVER-THE-SHORE**



**ARTILLERY REARM
MODULE**



COMBAT CASUALTY CARE

COMBAT SERVICE SUPPORT - TECH BASE

OVERVIEW:

The goal of the Army Technology Base program in Combat Service Support focuses on exploiting Non-Developmental Items (NDI) to improve combat power through increased logistics capabilities, decreased resource requirements (e.g., O&S costs), and enhanced soldier and civilian performance. This includes technologies to improve the efficiency and effectiveness of tasks such as arming, fueling, manning and moving.

ARTILLERY REARM MODULE (ARM):

This program demonstrates rearm technologies capable of enhancing and automating the handling of projectiles and propellants which can be configured to fit a variety of vehicles. The ARM will provide rapid, automated ammunition handling capable of supporting resupply rates up to 1,000 complete rounds per artillery weapon per day, reduce numbers of resupply personnel and significantly increase crew survivability.

LOGISTICS OVER-THE-SHORE (LOTS):

The Pontoon Air Cushion Kit (PACK) is a portable air cushion which will provide increased mobility and enhanced amphibious capability for Logistics Over-the-Shore (LOTS) by providing a means of lift for heavy and outsized equipment, defeating shallow gradient environments and facilitating causeway system emplacement operations over shallow beaches. The High Sea State Container Transfer System (HISEACOTS) will be developed and demonstrated to expand a ship's operational capability to transfer cargo. The HISEACOTS will provide for automated container discharge and handling in heavy seas (i.e., sea state 3 to 4), resolving a major LOTS problem while increasing safety and productivity of cargo offloading by 100% and decreasing manpower requirements and ship offloading times by 50%.

COMBAT CASUALTY CARE:

Improvement in combat casualty care will save lives and expedite the return of soldiers to the battle. Important features of this program will include technologies and techniques supporting far-forward treatment, individual sustainment (self-aid devices and techniques) compounds to reduce the severity of ballistic, thermal and laser injuries, blood replacements and substitutes and miniature and filmless x-rays. An example of far-forward treatment is the use of Hypertonic Saline Dextran (HSD) solution to replace intravascular volume lost during hemorrhage with only 250 ml of HSD as compared to 3000 ml of conventional fluid therapy. This technology will significantly reduce the medical logistics burden and enable far-forward treatment of shock.

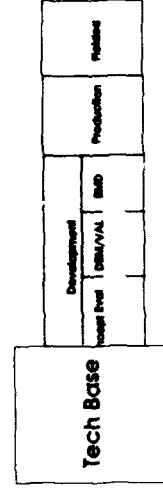



TACTICAL QUIET GENERATORS (TQG)

MISSION:

The Tactical Quiet Generator (TQG) Set is the new DOD standard family of power sources that meets the users' current and future requirements. The new 3kW-200kW TQG provides DOD with more reliable, quieter, lighter weight, single fuel, and improved High-Altitude Electromagnetic Pulse (HAEMP) protected electrical power systems for command post, C3I systems, weapon systems, logistics and maintenance functions and other battlefield support equipment. The new power generators will counter threat forces which have the capability of locating critical targets by detecting the high aural and thermal signatures.

CHARACTERISTICS:

Aural Signature:	79-85 dBA @25M	Current Fleet Performance	79 dBA @7M
Fuel:	GAS/DSL/JP4		JP8/DSL
Environment:	All Climatic Conditions		3 of 4 Climatic Conditions
KW:	1.5-200		3-100
Hertz:	DC/50/60/400		60, 50/60, 400
HAEMP:	No		Yes
IR Suppressed:	W/Nets		W/Nets
Reliability (MTBOMF)	140-408 hrs		500/600 hrs
Standard Voltage Connections:	Yes		Yes
Slave Receptacle:	Ordnance		NATO

TQG Requirements

70 dBA @7M
JP8/DSL
3 of 4 Climatic Conditions
3-100
60, 50/60, 400
Yes
W/Nets
500/600 hrs
Yes
NATO

PROGRAM STATUS:

TQG contract award for 5kW-60kW TQG sets was made in August 1988. During April 1989, a contract was awarded for the 3kW TQG. The First United Equipped (FUE) for the TQG sets is scheduled for January 1994.

POINT OF CONTACT:

DOD Project Manager-Mobile Power
7500 Baklick Road
Springfield, VA 22150-3107
Department of the Army
HQ, US Army Troop Support Command
4300 Goodfellow Boulevard
St. Louis, MO 63120-1798

CONTRACTORS:

Libby Corporation (Kansas City, MO)
Dynamics Corporation (Fermont Division) (Bridgeport, CT)
Federal Prison Industries

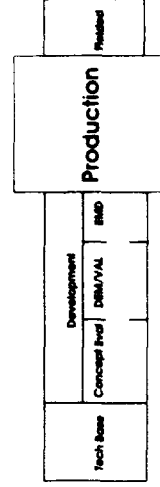



HEAVY EQUIPMENT TRANSPORTER SYSTEM (HETS)

MISSION:

The HETS is required to transport, deploy and evacuate the M1 Tank and other tracked vehicles on highway, unimproved roads and cross-country. The HETS consists of the M1070 Truck Tractor and M1000 Semitrailer, 70 ton. Each being procured under separate acquisition programs. Current HETS (M911/M746 with M747) demonstrates very poor durability when overloaded beyond 60 tons. The new HETS will transport 70 ton payloads, primarily M1 series tanks. Operates on OCONUS highways; on CONUS highways with permits. System will have automatically steerable axles and load leveling hydraulic suspension on semitrailer. The tractor will have front and rear axle steering with central tire inflation system and cab space for 5 crewmen.

CHARACTERISTICS:

Speed: 40-45 mph with 70 ton payload: 25-30 mph
 Range: 300 miles
 Transport: C-5 aircraft
 Mobility: 95% on road 5% off-road
 RAM: 3,000 MMBHMF for both tractor and trailer

FOREIGN COUNTERPART:

TATRA-813(tractor)/ChMZAP-5212 (trailer) (Soviet-developed) TRH 350 (France)
 Payload: 60 ton 55 Ton
 Speed: 40 km/h with 60 ton payload: 10 km/h 65 km/h
 Engine: Diesel Diesel

PROGRAM STATUS:

The HETS is currently in low rate initial production. The HETS is a Non-developmental Item (NDI) program. The HETS is required to meet the Army's critical need for a 70 ton tank transporter capability in support of fielding the M1 Series Tank. The current M1A1 Tank weighs over 64 tons, overloading the current HET (M911/M747) to the extent that readiness is below acceptable levels.

PERFORMANCE IN SWA:

The current HETS (M911/M747) saved wear and tear on tanks, Bradleys and self-propelled howitzers. The M911/M747 was overloaded by the M1A1 tank, was limited to roads, speed reduced to 15mph. The HETS (M1070/M1000) was not available for SWA.

POINT OF CONTACT:

PM-Heavy Tactical Vehicles
 ATTN: AMCPM-TVH
 Warren, MI 48397-5000

TACOM
 ATTN: SFAE-CS
 Warren, MI 48397-5000

CONTRACTORS:

Oshkosh (Oshkosh, WI) (Tractor)

Southwest Mobile Systems (St. Louis, MO) (Trailer)

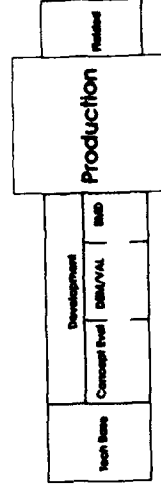



PALLETIZED LOAD SYSTEM (PLS)

MISSION:

The Palletized Load System (PLS) will be deployed in the Army's Maneuver Oriented Ammunition Distribution System (MOADS). The PLS will perform line haul, local haul, unit resupply, and other missions in the support of modernized, highly mobile organizations. The PLS is a 16.5 ton tactical vehicle composed of a prime mover with integral self-load/unload capability, a 16.5 ton trailer, and flatracks (dismountable cargo beds). Vehicles can also be equipped with materiel handling equipment and/or winch. The PLS prime movers with associated trailers will selectively replace or augment the standard tactical vehicles currently authorized in such units as Field Artillery and Transportation. Flatrack will be interoperable with United Kingdom and Germany flatracks. PLS is required for improved ammunition transport with greater efficiencies and productivity in the supply distribution role. PLS reduces dedicated personnel, Materials Handling Equipment (MHE), line haul and heavy cargo transport vehicle requirements in the current ammunition distribution system.

CHARACTERISTICS:

Truck payload, tons:	16.5	Transmission:	Automatic
Trailer payload, tons:	16.5	Number of Driven Wheels:	10
Flatrack dimensions, feet:	8x20	Range, integral fuel at	
Engine Type:	Diesel	Gross Combined Weight:	255 miles

FOREIGN COUNTERPART:

United Kingdom - Dismountable Rack Off-Loading and Pick-Up System (DROPS):

Payload: 15 ton
 Engine Type: Diesel
 Horsepower: 350
 Transmission: ZF Transmission
 Number of Driven Wheels: 8

PROGRAM STATUS:

PLS is currently in low rate initial production, the contract was signed in September 1990. PLS is a Nondevelopmental Item (NDI) program. The system is scheduled to undergo Production Qualification Testing (PQT) in FY92. The flatrack design is being upgraded to allow for its transportation as an International Standards Organization (ISO) container.

POINT OF CONTACT:

PM-Heavy Tactical Vehicles
 ATTN: AMCPM-TVH
 Warren, MI 48397-5000

TACOM
 ATTN: SFAE-CS
 Warren, MI 48397-5000

CONTRACTORS:

Oshkosh (Oshkosh, WI)

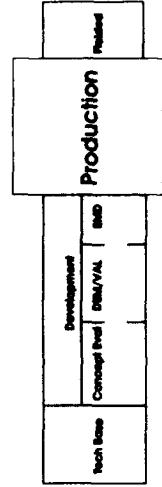



FAMILY OF MEDIUM TACTICAL VEHICLES (FMTV)

MISSION:

The FMTV consists of a family of vehicles based on a common truck chassis. The Light Medium Tactical Vehicle (LMTV) has a 2 1/2 ton payload capacity consisting of cargo and van model variants. The Medium Tactical Vehicle (MTV) has a 5 ton payload capacity and consists of the following models: cargo with and without material handling equipment (MHE), tractor, wrecker, and dump truck (van and tanker models to be developed concurrent with production of other models). The FMTV will perform line haul, local haul, unit mobility, unit resupply and other missions in combat, combat support, and combat service support units. Vehicles will operate worldwide on primary and secondary roads and trails. The FMTV will replace overaged and maintenance intensive trucks currently in the fleet.

CHARACTERISTICS:

	LMTV cargo	MTV cargo
Payload (lbs)	5000	10000
Towed Load (lbs)	7500	21000
Engine:	Diesel	Diesel
Transmission:	Automatic	Automatic
Horsepower:	225	290
Drive:	4x4	6x6

FOREIGN COUNTERPARTS:

	LMTV	MTV
Soviet:	ZIL-131 GAZ-66 ZIL-157	URAL-375 GAZ 9301 KAZ 4430 (same as 5 Ton) Fiat 6602
Italy:	Fiat, 75PM	Mercedes 1017A, MAN 5 Ton
Germany:	Urimog U1100L	RVI TRM-4000
France:	RVI Saviem TRM-2000	Peguso 3050
Spain:	Santana 2000	Steyr 1291M
Austria:	Steyr 630 M3	

PROGRAM STATUS: The FMTV production contract was awarded on 11 October 1991 and the program is currently in the Low Rate Initial Production (LRIP) phase and will be limited to 150 per month for the first two program years.

POINT OF CONTACT: PM - Medium Tactical Vehicles
ATTN: SFAE-S-TVM
Warren, MI 48397

U.S. Army Tank Automotive Command
ATTN: SFAE-CS
Warren, MI 48397

CONTRACTORS: Stewart and Stevenson Services, Inc. (Houston, TX) Engine: Caterpillar, Inc. (Peoria, IL)

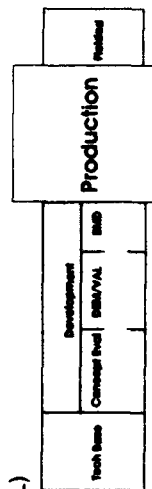

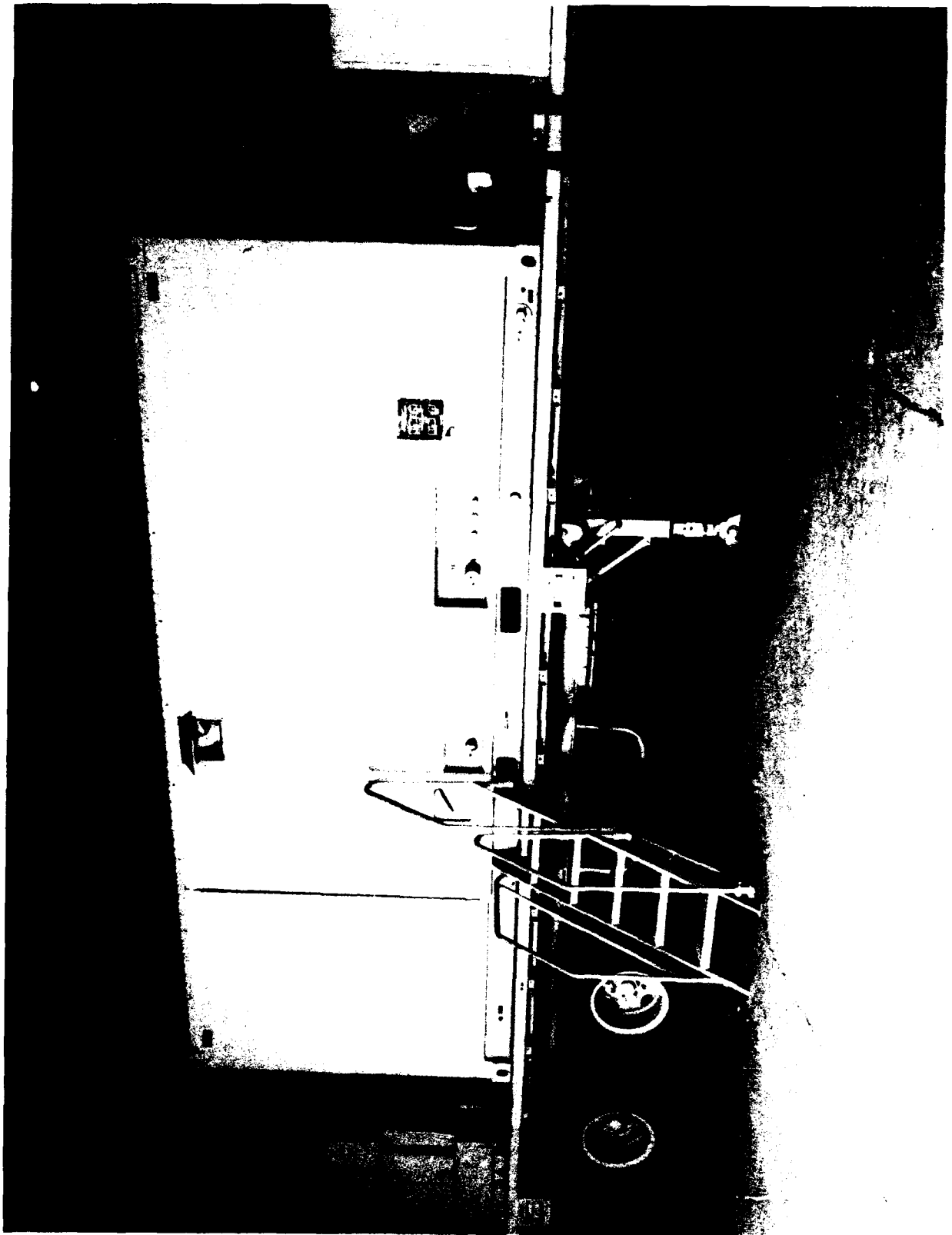

REVERSE OSMOSIS WATER PURIFICATION UNIT (ROWPU)

MISSION:

The 3000 Gallons Per Hour (GPH) ROWPU provides fresh drinking water worldwide. The ROWPU purifies fresh, saline, brackish, as well as nuclear, biological, and chemical (NBC) contaminated water. It is used in Echelon Above Divisions.

CHARACTERISTICS:

The 3000 GPH ROWPU represents state-of-the-art technology in water purification equipment. The unit consists of a raw water subsystem, clarification subsystem, reverse osmosis (RO) subsystem, NBC post treatment subsystem, chemical feed subsystem, process control station, piping, fittings, and a storage area for pumps and operating supplies. The chemical feed, clarification, RO, and NBC post treatment subsystems, along with the process control station, is enclosed in a 8-foot wide by 8 foot-high by 20-foot long container. Support system components of the system include collapsible water storage tanks, hoses, chemicals, tools, distribution and raw water pumps, a 60KW generator set and a M871 semitrailer. This equipment is designed to operate 20 hours a day at a production rate equivalent to 3000 gallons per hour of fresh water and 2000 gallons per hour of sea water. This unit is transportable by two C-230s, one C-141, rail, ship, or standard military vehicles. The ROWPU replaces the existing equipment which can purify only fresh water.

FOREIGN COUNTERPARTS:

The Soviets have developed two pieces of equipment to accomplish the task for which the United States has developed the ROWPU. To purify fresh water and NBC contaminated water, they currently use the MAFS-3. To purify brackish or saline water, they use distillation process equipment, called OPS, incorporated into their current standard desalination equipment. Japan offers similar commercial equipment of the same size and capacity.

PROGRAM STATUS:

The 3000 GPH ROWPU is in production. First Article Test was approved and a competition Technical Data Package was accepted on 10 JAN 92.

PERFORMANCE IN SWA:

The 3000 GPH ROWPU was a valuable resource to the U.S. Army water production capability in Operation Desert Shield and Desert Storm. It provided a high level of mobility, responsiveness, and water production capability.

POINT OF CONTACT:

U.S. Army Troop Support Command
ATTN: AMCPM-PWL
4300 Goodfellow Boulevard
St. Louis, MO 63120-1798

CONTRACTORS:

Aqua Chem, Inc. (Milwaukee, WI)

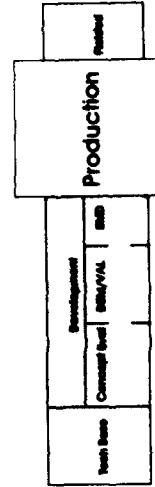

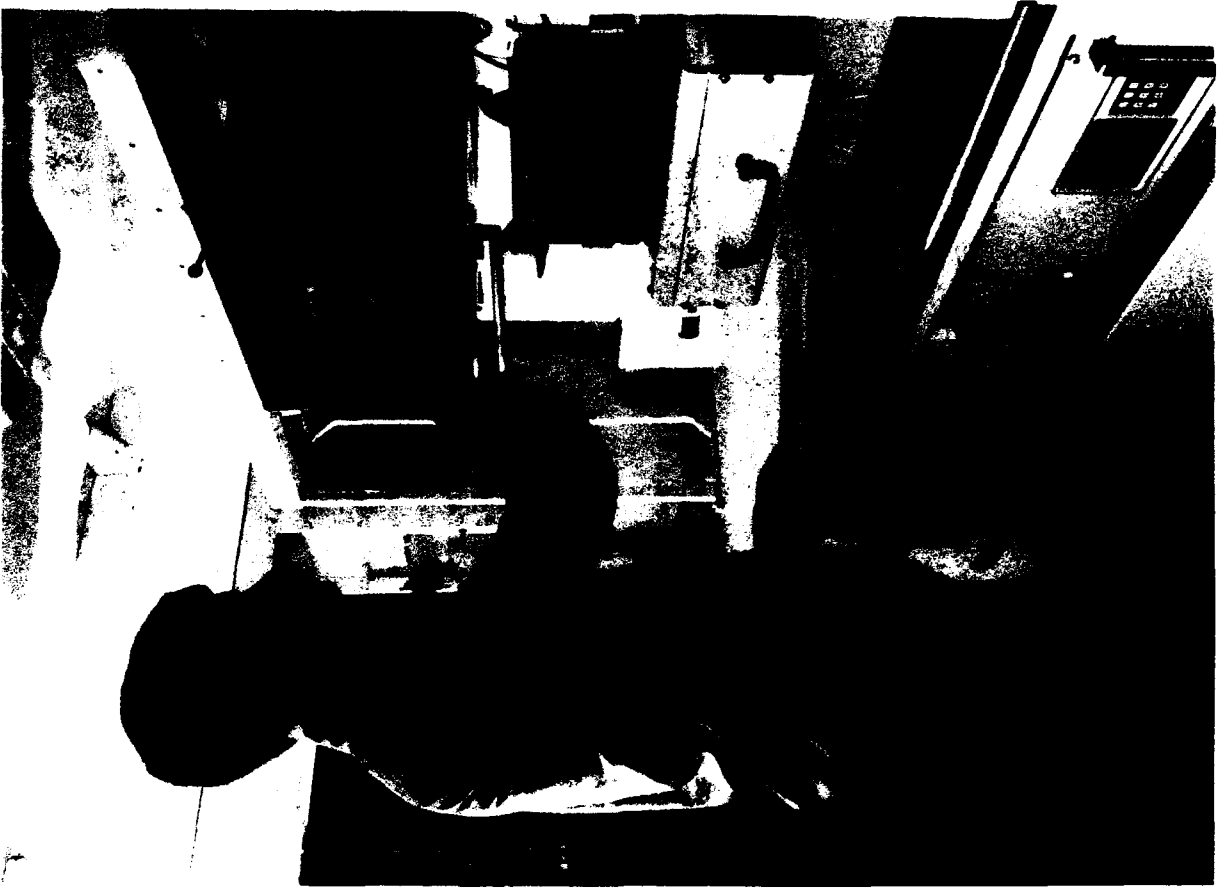
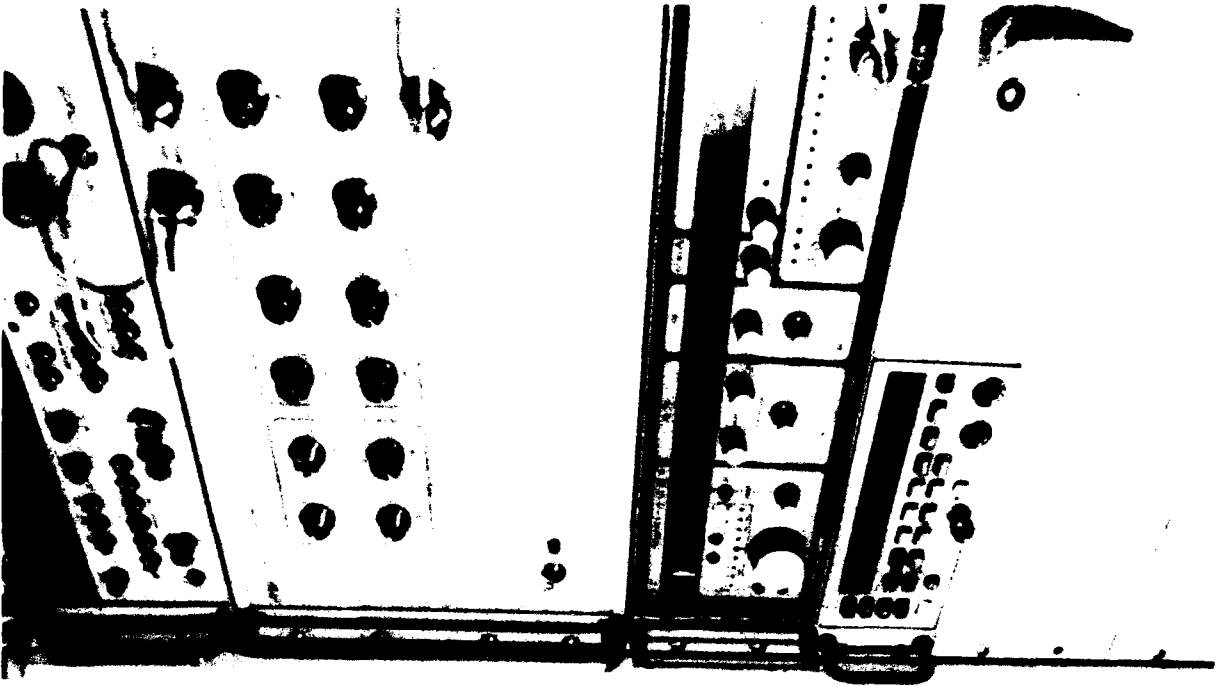

INTEGRATED FAMILY OF TEST EQUIPMENT (IFTE)

MISSION:

The Integrated Family of Test Equipment (IFTE) supports weapon systems state-of-the-art technology electronics, ensuring combat readiness for the 1990's and beyond. It allows the isolation of weapon systems faults to the electronic Line Replaceable Units (LRUs) at Direct Support (DS) areas of quick turnaround and minimum spares pipeline, isolation of faults in Shop Replaceable Units (SRUs) at General Support (GS) areas and depots, and adapts to and accepts new weapon systems.

CHARACTERISTICS:

IFTE is a modular Test, Measurement and Diagnostic Equipment (TMDE) system which consists of four interrelated systems that provide generic Automatic Test Equipment (ATE) capability through all levels of the Army maintenance structure. Two tactical systems: the Contact Test Set (CTS) and the Base Shop Test Facility (BSTF) are capable of electronic ATE support, Electronic Technical Manuals (ETM), and Electro-Optical (EO) capability will be fielded in FY 94). The CTS is a man portable ATE system that augments supported systems DIT/BITE and isolates weapon systems failure to the appropriate LIUs. The BSTF consists of the Base Shop Test Station (BSTS), in a 5-ton truck mounted S-280 shelter, plus another 5-ton truck mounted S-280 shelter for Test Program Sets (TPS) storage; powered by 60KW generator sets. It will be positioned at DS/GS levels to fault diagnose evacuated LRUs to the Shop Replaceable Line Unit (SRU) level. The TPS is the software program the Interface Connecting Device (ICD) to connect the UUT to the BSTS or Commercial Equivalent Equipment (CEE), and the documentation an operator uses to perform test operations. The non-tactical systems: the Automatic Test Set Support Environment (ATSE) and the CEE feature the software system that operates on Sun workstations and develop 65% of the software portion of the TPS. The CEE is a non-ruggedized equivalent of the BSTE that is used in Special Repair Activity (SRA)/depots.

FOREIGN COUNTERPART:

There is no known counterpart to the IFTE.

PROGRAM STATUS:

The ESTF and CTS are in the Low Rate Initial Production Phase (LRIP) which started in March 89. Initial Operational Test and Evaluation (IOTE) has been completed. A Milestone IIIB Decision Review for Full Scale Production will occur in Jan 92. First Unit Equipped (FUE) for the BSTF and CTS will take place in FY92. Electro-Optical capability will be added to IFTE in FY94.

POINT OF CONTACT:

IFTE Product Manager
Redstone Arsenal, AL 35898-5400

CONTRACTORS:

Grumman Aerospace Corp, Electronic Systems Division (Great River, NY)

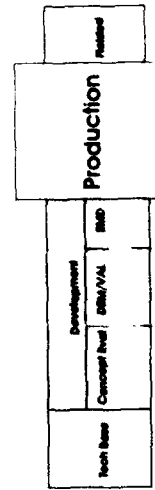



5 TON TRUCK

MISSION:

The 5 ton trucks meet the requirement for general cargo transport, unit mobility, and special purpose use. It is a diesel powered, 6 wheel drive tactical vehicle. The M939 series is improved over the old M809 series with new commercial components such as engine, transmission and brakes. It comes in six body styles: cargo, dump, tractor, wrecker, van, and long wheelbase cargo. The FY 86-90 multiyear procurement provides M939A2 series trucks which include a new lightweight, fuel efficient engine and a central tire inflation system for improved mobility in difficult terrain. It supports the fielding of many other systems such as Patriot, DEPMEDS, Apache, and MLRS.

CHARACTERISTICS: Body Styles: 6

Payload (lbs): 10,000
 Towed Load (lbs): 21,000
 Engine: Diesel
 Transmission: Automatic
 Horsepower: 240
 Drive: 6x6

FOREIGN COUNTERPART:

Soviet:	URAL 375	Italy:	Fiat 6602
	KAZ-4430	France:	RVI (Saviem) TRM-4000
	GAZ-4301	Spain:	Peguso 3050
Germany:	Mercedes 1017A	Austria:	Steyr 1291M
	MAN 5 Ton		

PROGRAM STATUS: Vehicle production for the US Army has been completed. BMY is currently producing vehicles in support of Foreign Military Sales (FMS) cases with other nations.

PERFORMANCE IN SWA:

The A2 Series trucks performed admirably in Operation Desert Storm. The central tire inflation system provided greatly enhanced off road mobility in desert terrain.

POINT OF CONTACT:

PM - Medium Tactical Vehicles U.S. Army Tank Automotive Command
 ATTN: SFAE-CS-TVM ATTN: SFAE-CS
 Warren, MI 48397 Warren, MI 48397

CONTRACTORS:

BMY (York, PA) Engine: Cummins Engine Co. (Columbus, IN)

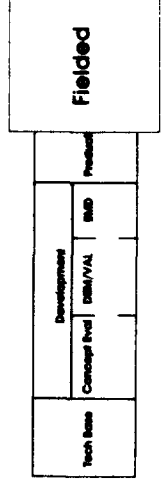

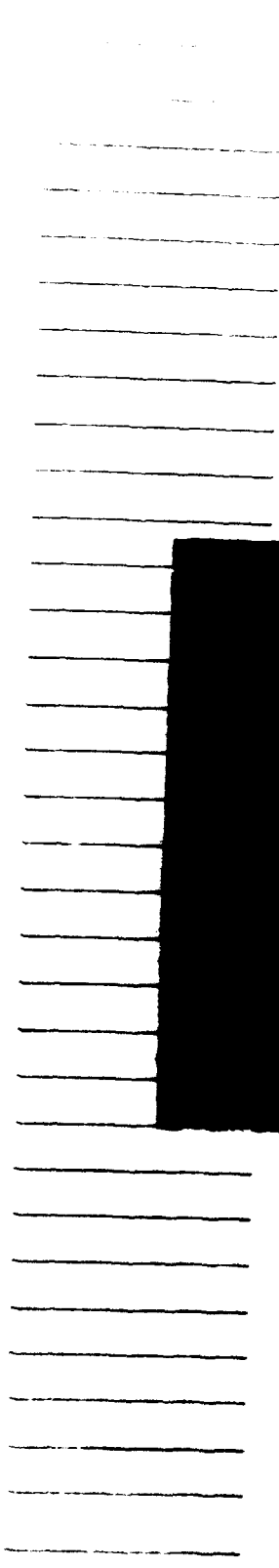

M977



M978



M984E1

Heavy Expanded Mobility Tactical Truck

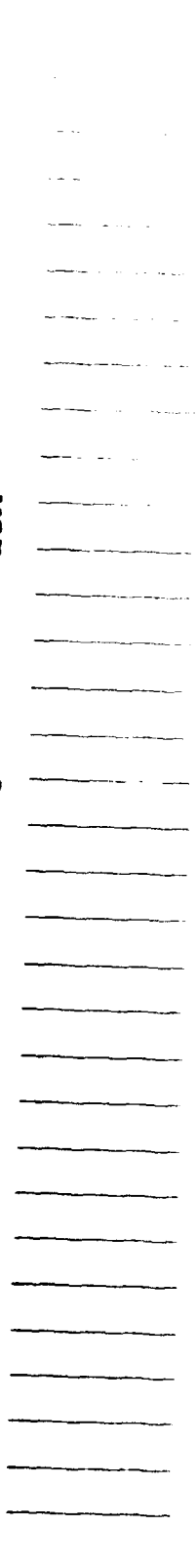

HEAVY EXPANDED MOBILITY TACTICAL TRUCK (HEMTT)

MISSION:

The HEMTT vehicles are used for resupply, refueling, and recovery operations. Doctrine states that support for combat elements should occur as far forward as possible. The HEMTT family is assigned to Armor, Field Artillery, Engineer, Missile, Air Defense Artillery, Aviation and Cavalry units worldwide. There are five configurations, a light cargo vehicle with crane (M977), a 2500 gal fuel tanker (M978), a tractor version (M983), a wrecker (M984) and a heavy cargo vehicle with material handling crane (M985).

CHARACTERISTICS:

Payload: 10 ton
 Speed: 55 mph
 Engine: Diesel
 Horsepower: 445
 Drive: 8x8
 Width: 96 in
 Ground clearance: 13 in
 Fording depth: 48 in
 445 BHP
 60% Grade at GVWR
 30% Side slope
 Fully automatic transmission
 43 Approach/45 Depart engines
 Cab/Forward
 Super single radial tires
 Traction transfer differentials (both rear axles)

FOREIGN COUNTERPART:

SAURER D330MF (SWISS)	ZIL-135 (SOVIET)	MAZ-7310 (SOVIET)	MAN LKW (GERMAN)
10 ton	8-10 ton	16 ton	10 ton
45 mph	40 mph	40 mph	90km/h
Diesel	Gas	Diesel	Diesel
Horsepower: 300	300	520	320
Drive: 6x6	8x8	8x8	8x8

PROGRAM STATUS:

The HEMTT is a fielded system. Direct Army production completed as of Oct 90 (11,492). A total of 12,638 vehicles have been built of the 13,286 ordered. Production continues at 4/day for Foreign Military Sales (FMS) and dedicated National Guard and Army Reserve requirements. An additional 177 HEMTTs are expected to be purchased for Army using Operation Desert Storm Supplemental II funds.

PERFORMANCE IN SWA:

The HEMTT displayed excellent cross-country mobility; the vehicles operated in all weather conditions over all types of terrain; made the turning movement by VII Corps possible.

POINT OF CONTACT:

PM-Heavy Tactical Vehicles
 ATTN: AMCPM-TVH
 Warren, MI 48397-5000

TACOM
 ATTN: SFAE-CS
 Warren, MI 48397-5000

CONTRACTORS:

Oshkosh (Oshkosh, WI)

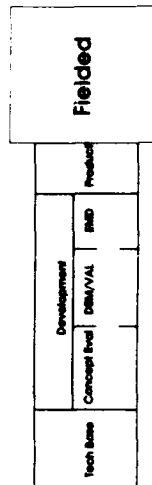

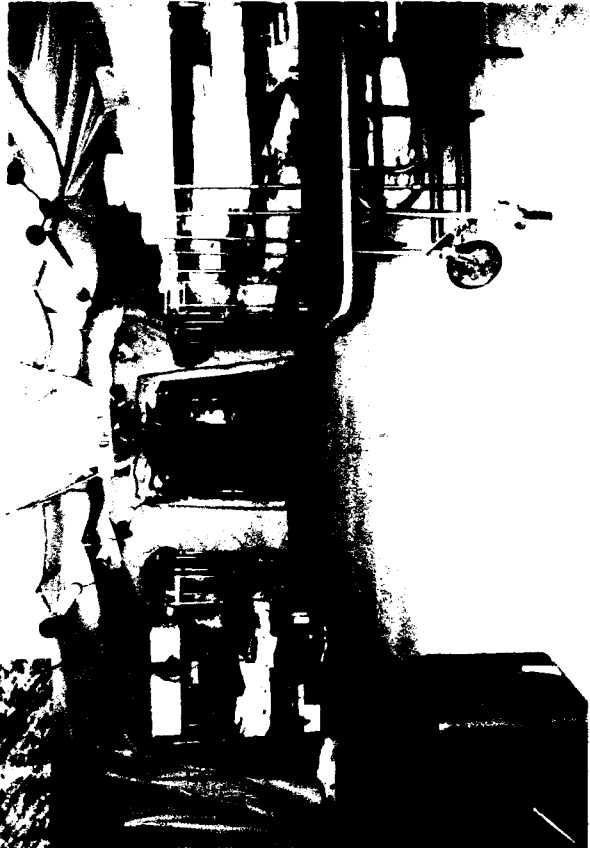

DEPLOYABLE MEDICAL SYSTEMS (DEPMEDS)

MISSION:

The DEPMEDS family of equipment is Department of Defense (DOD) approved equipment packaged into standardized modules for use by all services to equip their theater of operations deployable hospitals. There are seven types of Army hospitals, ranging from forward deployed Mobile Army Surgical Hospital (MASH) units in the combat zone to General Hospitals in the Communications Zone (COMMZ). Each is composed of different configurations of standard modules such as operating rooms, laboratories, X-ray units and wards. The DEPMEDS hospital sets standardize the use of the latest medical technology and equipment, expendable supplies, and major non-medical support equipment power units, Tent Extendable Modular Personnel (TEMPER) Tents, tactical shelters, heating and air conditioning throughout the DOD. Standard modules improve medical unit mobility and patient distribution densities. The hospital sets can be deployed under all climatic conditions. The fielding of the 129 Army hospital sets will eliminate serious shortages of field medical equipment and achieve major advances in equipping the Total Army. Gaining units will receive their DEPMEDS equipment in one package under the Total Package Fielding concept. This is the largest Total Package Fielding effort ever undertaken by the Army Medical Department.

CHARACTERISTICS:

System characteristics vary by type of hospital set. All provide adequate but austere care, are maintainable and relocatable, have modular configuration and quad-service compatibility, and are transportable by strategic air.

FOREIGN

COUNTERPART:

There is no known counterpart to DEPMEDS.

PROGRAM STATUS:

The DOD Medical Standardization Board insures compatibility among the Services. The Army program is managed by the DEPMEDS Project Manager, operating under the authority of the Secretary of the Army. Fielding began in the 4QFY87. Sixty-nine hospitals fielded, as of 30 Sep 91, for a total of 23,460 Beds and 57 Minimum Essential Equipment for Training Sets fielded.

PERFORMANCE IN SWA:

Performance of DEPMEDS equipped hospitals worked well in SWA. Lessons learned from both unit/material deploying and operation prospective are being used to rebuild/replenish units, to strengthen readiness and training capabilities commensurate with the unit mission and authorization.

POINT OF CONTACT:

PM DEPMEDS
5109 Leesburg Pike
Falls Church, VA 22041

HQ, U.S. Army Troop Support Command
4300 Goodfellow Boulevard
St. Louis, MO 63120-1798

CONTRACTORS:

A large number of contractors are involved in providing the 3,400 plus medical and non-medical components of DEPMEDS. These components are assembled into modules and hospital sets by the Defense Logistics Agency, Defense Depot, Ogden, Utah.

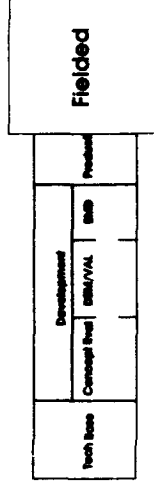



LOGISTICS SUPPORT VESSEL (LSV)

MISSION:

The LSV performs inter-theater haul of military equipment to support troop deployment, relocation and resupply operations to underdeveloped areas along coastlines and on inland waterways. The LSV can discharge sea going roll-on/roll-off ships in support of Logistics Over the Shore (LOTS) operations.

CHARACTERISTICS:

Displacement: 4,199 long tons
Full load speed: 11 kts
Range: 5,500 nm
Cargo Capacity: 2,000 short tons
Crew: 30
Length: 272 ft
Beam: 60 ft

FOREIGN COUNTERPARTS:

The LSV was developed by industry, consequently, similar vessels are found in commercial and foreign military applications.

PROGRAM STATUS:

The LSV is currently fielded. The Army's requirement for five LSV was procured, and the last vessel was delivered in December 1990. All five ships are on station and fully operational.

PERFORMANCE IN SWA:

The self-deployment of LSV to Southwest Asia, carrying much needed containers and material handling equipment was a first for this type of vessel. LSV were also used to transport Air Force munitions and airbase defense tanks to ports nearest the airfield where they were stored and used. Army watercraft moved over 2,000 pieces of equipment for the Army and Marines.

POINT OF CONTACT:

U.S. Army Troop Support Command
ATTN: AMCSTR-PD
4300 Goodfellow Boulevard
St. Louis, MO 63120-1798

CONTRACTORS:

Trinity Marine Group, Inc. (Gulfport, MS)

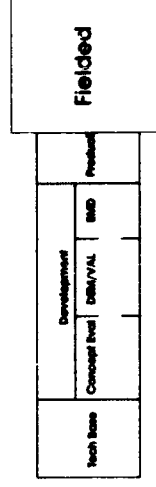

COMMAND, CONTROL, AND COMMUNICATIONS (C3)

The Tactical Command, Control, and Communications (C3) mission area includes resources for providing effective command and control, automation, and communications support to combat units. In order for a commander to effectively control tactical elements, the commander must know where they are located and must have a means by which to talk to them even in an enemy electronic countermeasure environment. The systems included in this mission area provide that capability. Without them, the Army would be as helpless as a person without a nervous system.

Tech Base	DEVELOPMENT			Production	Fielded
Concept Development	DEM/VAL	EMD			
Airland Battle Management	Combat Service Support Control System	Army Distribution System		SINGARS	
Survivable Adaptive System Technology	Forward Area Air Defense Command, Control and Intelligence	Standardized Integrated Command Post System		Mobile Subscriber Equipment	
Multiband Multimode Radio	Maneuver Control System	All Source Analysis System		GPS	
		Advanced Field Artillery Tactical Data System		Military Satellite Communications	
				Communication System Control Element	
				Digital Transmission Assemblages	
				Circuit Switch and Message Switch	



AIRLAND BATTLE MANAGEMENT

**SURVIVABLE ADAPTIVE SYSTEM
TECHNOLOGY**

COMMAND CONTROL and COMMUNICATION (C3) - TECH BASE

OVERVIEW:

Significant strides are being made to introduce automation into the C3 Mission Area through the development of the Army Tactical Command and Control System (ATCCS). The Army will continue to modify and upgrade ATCCS capabilities by using the information technologies available from the commercial market as well as from government-sponsored R&D. When fully deployed, ATCCS will provide the Army with a survivable and robust system capable of supporting the commander's decision making process.

AIRLAND BATTLE MANAGEMENT (ALBM):

This Advanced Technology Transition Demonstration (ATTD) will demonstrate computer technology-based planning and battle execution monitoring decision and application prototypes to support the enhancement and evolution of the ATCCS by FY93. It will provide the Commander and his staff automated reasoning capabilities and supervisory tools to manage the large volume of data which must be processed, analyzed, and implemented to yield combat decisions. The integration of artificial intelligence, simulation modeling, soldier-machine interface, and distribution data based technologies are key to the demonstration. The results will be software packages which will transition to ATCCS. This ATTD has been abbreviated in scope until 1993 at which time ALBM will become a living testbed/beta site that will assess opportunities for other transitions. System supported: ATCCS upgrades, Force Level Knowledge Systems, and Command & Control Lower Echelons.

SURVIVABLE ADAPTIVE SYSTEM TECHNOLOGY (SAST):

This ATTD will demonstrate combat survivable C3 systems consisting of dispersed assets supported by multi-media data links. SAST will enhance system survivability through emerging communications (wireless Local Area Networks (LANs), high capacity fiber optic backbone LAN, automated gateway) and distributed processing (automated network management, multi-function host capability) to meet some of the objectives of Command and Control (C2) on the move, expanded Command Post dispersion, and complement Multiple Subscriber Equipment (MSE) in providing long-haul/inter-echelon connectivity. With focus on C2 on the move, borne of recent lessons learned in Southwest Asia, an early demonstration in FY93 of secure packet-switched wireless LAN (data only) will provide 20Kb/s effective data rate transfer over 10 km range. A follow-on phase in FY95 will demonstrate an EHF wireless LAN capable of 10Mb/s transfer rate over 2 to 10 km with fiber optic backbone handling voice, data, and video. Integration into MSE will also be complete. System supported: ATCCS. Future systems will include: Local Area Transport System and Force Level Knowledge System.

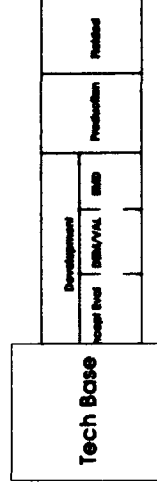

COMMAND CONTROL and COMMUNICATION (C3) - TECH BASE (Con't)

MULTIBAND MULTIMODE RADIO (MBMR):

This technology will demonstrate a tactical (HF, VHF, UHF) radio system with an architecture which allows rapid firmware and software reconfiguration to meet the dynamic changing requirements of threat, interoperability, and modes of operation. The firmware and software allow the control of electronic counter countermeasure waveforms, data waveforms, signal modulation and demodulation, and interface to ancillary devices. Integration of digital technology, very high speed integrated circuits (VHSIC), millimeter wave/microwave monolithic integrated circuit (MMIC), and signal processing is required. The results of this demonstration will form the baseline for the objective combat net radio and will support the development of the Future Local Area Transport System. It will provide the survivability, reliability, interoperability, and adaptability required for C2. Systems supported : Wide Area Transport System and MSE, SINGGARS upgrades, Objective Combat Net Radio, LAN, and Wide Area and Range Extension Transport Systems.

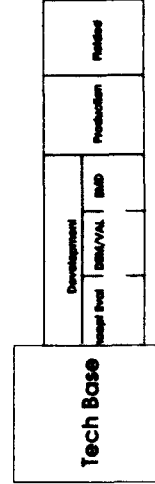

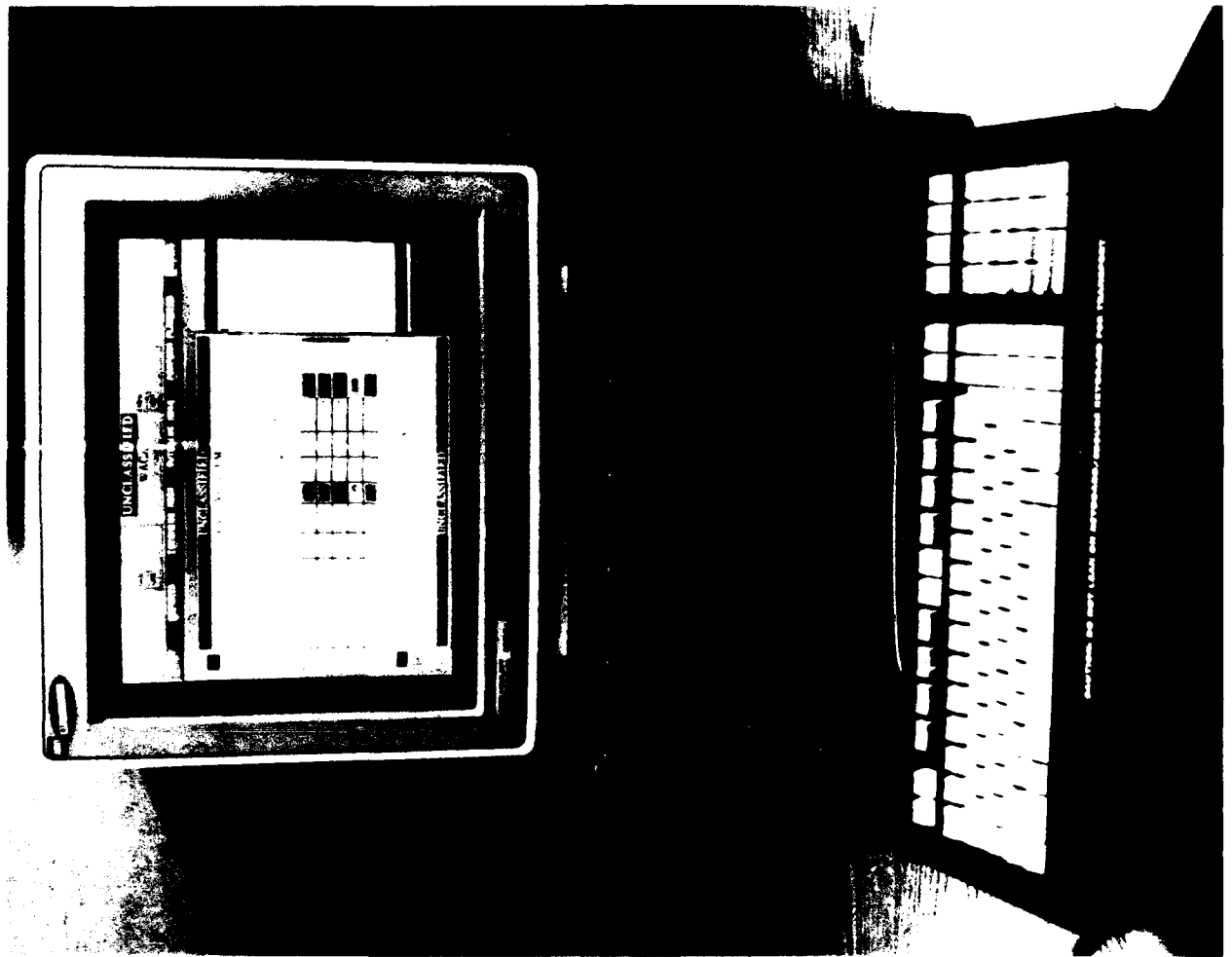

COMBAT SERVICE SUPPORT CONTROL SYSTEM (CSSCS)

MISSION:

The Combat Service Support Control System (CSSCS) is a computer software system designed to assist the CSS commander and his staff to rapidly collect, store, analyze, and disseminate CSS information to support the functions of command, control and resource management. The CSSCS implementation automates the CSS commander and staff with an analysis tool to evaluate CSS information with respect to the force level commander's tactical courses of actions. CSSCS will be organic to CSS units and headquarters staffs within the maneuver brigades, separate brigades, armored cavalry regiments, divisions, Corps and Echelons Above Corps (EAC).

CHARACTERISTICS:

The CSSCS will consist of transportable and lightweight computer units (LCU) procured through the Program Manager (PM) Common Hardware/Software (CHS), shelters provided by PM CHS, Common ATCCS Support Software (CASS), CSSCS-unique software, and any CSSCS unique items identified during development.

FOREIGN COUNTERPART:

Great Britain, Canada, and Australia are monitoring the status of CSSCS development.

PROGRAM STATUS:

The CSSCS is currently in full scale development. Program development has been structured to evolve over five versions. Initial development of the CSSCS software (Versions 1 and 2) began in early 1988 by TRW under the Maneuver Control System (MCS) contract with PM OPTADS. A RFP was released in June 1990 for the Versions 3 and 4 software. In February 1991, TRW was awarded the software development contract for these two versions. In FY93, version 3 will provide the Army an integrated Army Tactical Command & Control System (ATCCS) capability. Improvements and added capabilities for all echelons will continue in Versions 4 and 5. Version 3 is to be completed and tested by the end of FY93. Version 4 will be completed and tested by the end of FY95. Fielding of the CSSCS is scheduled to begin in April 1994.

POINT OF CONTACT:

PM CSSCS
ATTN: SFAS-CSSCS
Ft Belvoir, Va 22060

CONTRACTORS:

TRW, Systems Engineering & Development Division (Carson, CA)

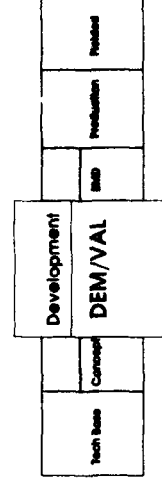



FAAD C2 CONTINGENCY/LIGHT FORCES ARCHITECTURE

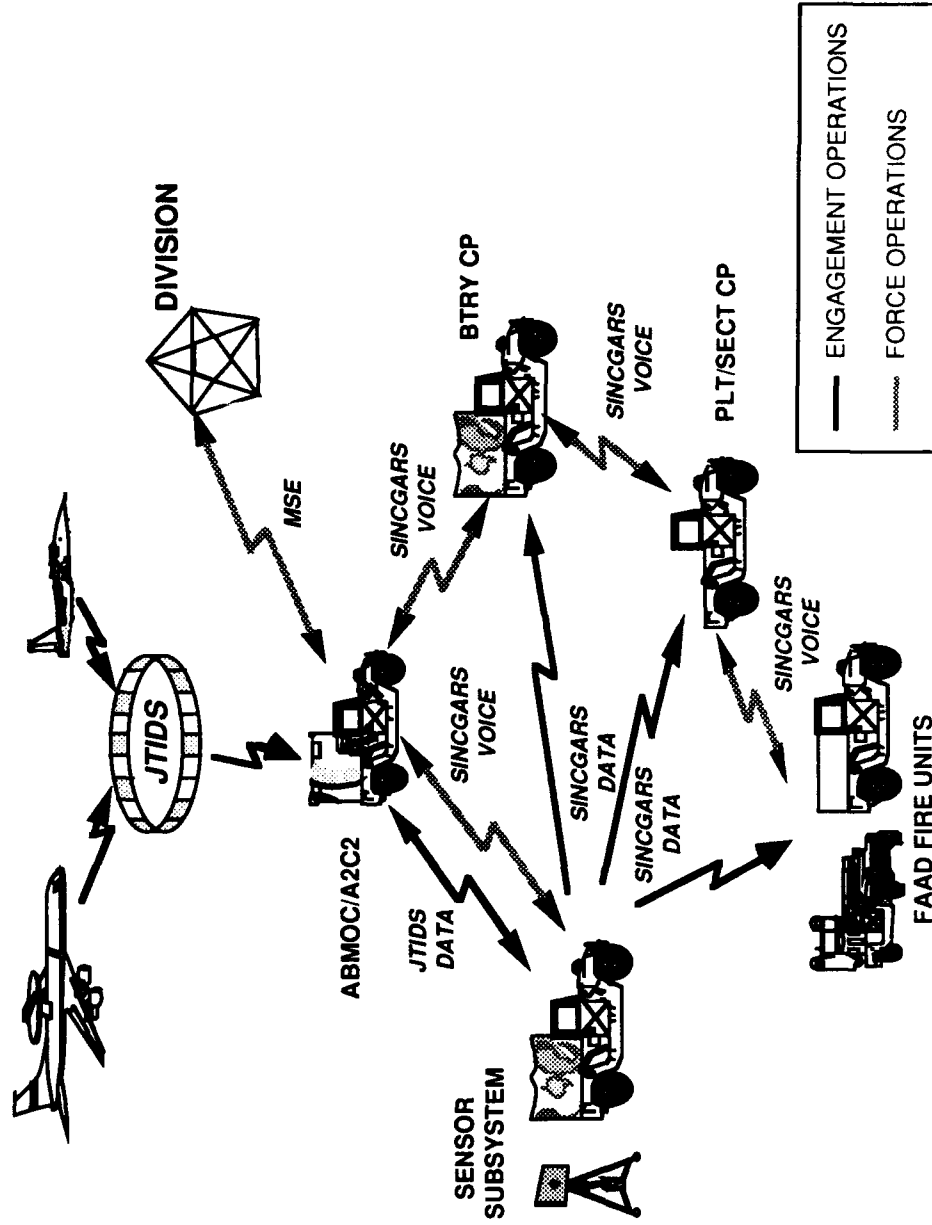

FORWARD AREA AIR DEFENSE COMMAND and CONTROL (FAADC2)

MISSION:

The mission of FAADC2 is to provide an automated means of providing timely target data to FAAD weapons, to protect friendly aircraft and to facilitate management of the air battle. The system consists of non developmental computers, displays and printers that are common to the Army Tactical Command and Control System (ATCCS), non developmental ground sensors and the requisite software. The system will be fully integrated with other FAAD elements and the ATCCS. The initially deployed light system will use Single Channel Ground to Air Radio System (SINGARS) for data transfer while the objective heavy system will use the Army Data Distribution System (ADDS). The system will provide an automated exchange of (Air Defense Artillery) command information, dissemination and acknowledgement of Air Defense Artillery air battle management data, air track and remote sensors.

CHARACTERISTICS:

The systems consist of multiple subsystems for deployment to various echelons of command. The subsystems are tailored to the functions to be performed and vary in size and complexity from the fire unit processor to the Air Battle Management Operation Center (ABMOC). The fire unit subsystem consists of a simplified, hand held terminal unit weighing approximately 8 pounds with battery, cables, and carrying case. The ABMOC is in a standard integrated command post shelter (rigid wall).

FOREIGN COUNTERPART:

None known.

PROGRAM STATUS:

The FAAD C2 system is currently in the engineering and manufacturing development phase. The basic development effort consists primarily of software development, which is being developed incrementally. Versions 1 & 2 have completed and successfully passed a laboratory demonstration. Version 3, to be fielded to light forces, is currently under development with a format qualification test scheduled for 3Q FY92, followed by a contractor integration, assembly and test in 4Q FY92. Government tests are scheduled to begin 1Q FY93 and be completed 3Q FY93. First Unit Equipped for the light division is scheduled for 4Q FY93. It is currently envisioned that the system will ultimately be fielded to 9 heavy divisions, 5 light special divisions, 2 ACRs, 3 Sep Bdes, 4 Corps Hq, 10 - Corps Missile Battalions and 2 training base systems. Fielding will occur between FY93 and FY01.

POINT OF CONTACT:

US ARMY MISSILE COMMAND
ATTN: SFAE-FAAD
Redstone Arsenal, AL

CONTRACTOR:

TRW Defense System (Redondo Beach, CA)

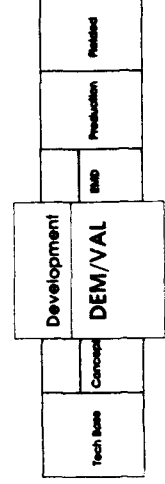

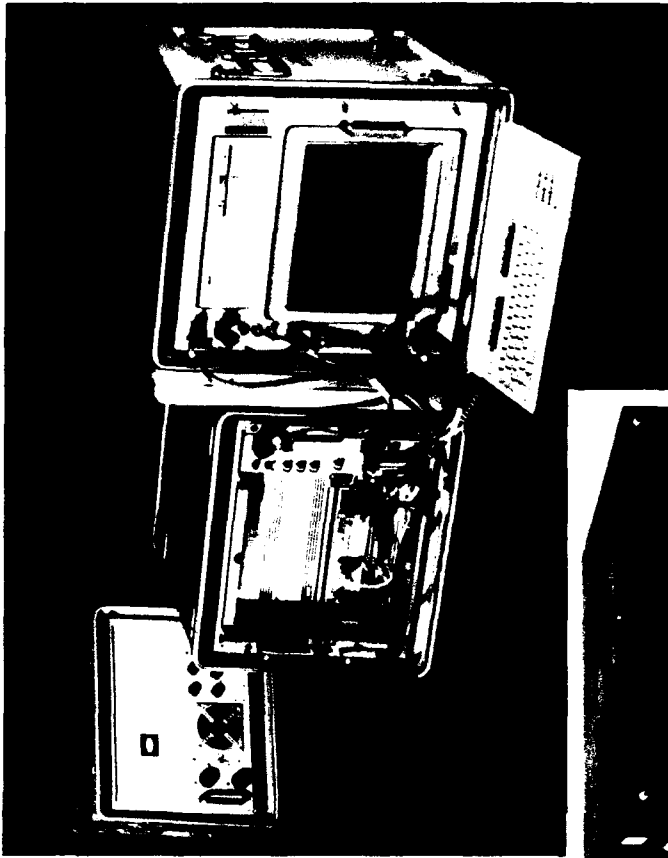

ANALYST CONSOLE



STAND - ALONE DISPLAY UNIT

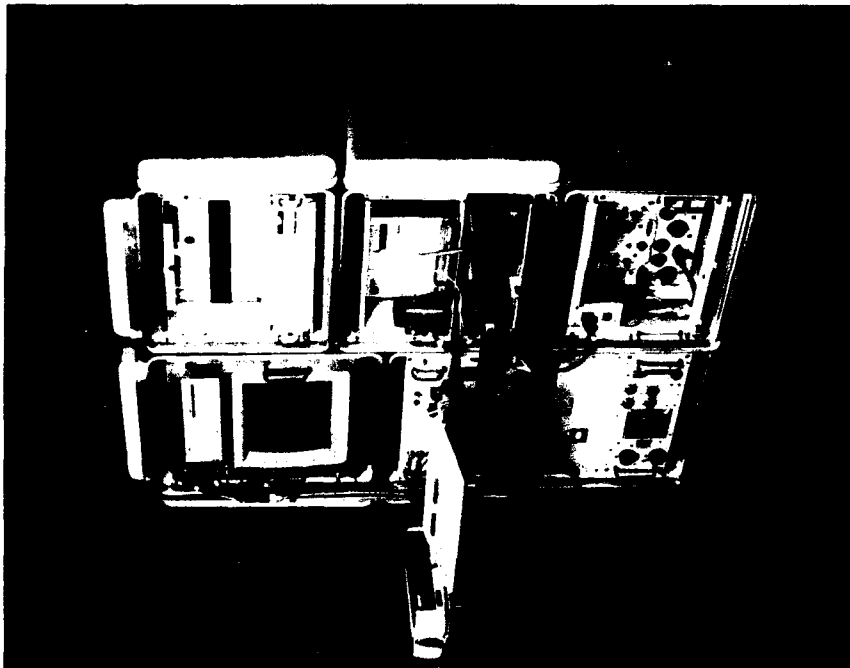

TACTICAL COMPUTER PROCESSOR

MANEUVER CONTROL SYSTEM (MCS)

MISSION:

Maneuver Control System (MCS) provides Army tactical commanders and their staffs (corps through battalion) automated on-line, near-real-time, systems for planning, coordinating, and controlling tactical operations and for receiving, processing, and displaying the increasing volume and variety of tactical command and control information available. MCS software is written in Ada. The MCS capability continues to expand in pre-planned, time-phased steps toward the objective system in the mid 1990's. Maneuver Control is one of the five battlefield functional areas (BFA) of the Army Tactical Command and Control Systems (ATCS). MCS is the force level commander's information system and integrates the maneuver function with the command and control (C2) systems of the other four functional areas (Fire Support, Air Defense, Intelligence/Electronics warfare and Combat Service Support).

CHARACTERISTICS:

Non-Developmental Item (NDI) Equipment and Common Hardware will be used with MCS. Additionally the Common Hardware will be fielded with the Standardized Integrated Command Post Systems (SICPS) (XM-1068, M998 Soft top and Rigid Wall Shelter).

NDI Analyst Console/Tactical Computer Processor (AC/TCP): AC Weight: 318 lbs
TCP Weight: 798 lbs

Common Hardware TCU Weight: 45 lbs
LCU Weight: 27.5 lbs

FOREIGN COUNTERPART:

None known.

PROGRAM STATUS:

MCS is in Milestone III with an Initial Operational Test and Evaluation (IOT&E) scheduled for Sept-Oct 92. NDI deliveries began in FY89 (III Corps) and will be completed in FY92. Common Hardware fieldings begin in FY94. Currently MCS Version 10.03.1 software is fielded to all heavy Army units on NDI, and MCS V11 will be fielded in FY94 on Common Hardware.

PERFORMANCE IN SWA:

Overall MCS performed admirably. However it was determined that more training was required for the soldiers to effectively operate Common Hardware with the MCS software. MCS V.10.03.1 software was utilized in SWA. MCS V11 will provide the more user friendly software requested by the operator.

POINT OF CONTACT:

Project Manager, Operations Tactical Data Systems
ATTN: SFAE-CC-MVR-P
Fort Monmouth, NJ 07703-5000

CONTRACTORS:

Loral Command and Control Systems (Colorado Springs, CO) (NDI and software)
TRW (Redondo Beach, CA) (System Engineering and I Integration)
MILTOPE (Milville, NY) (Command Hardware/Software)

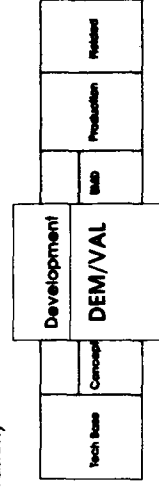

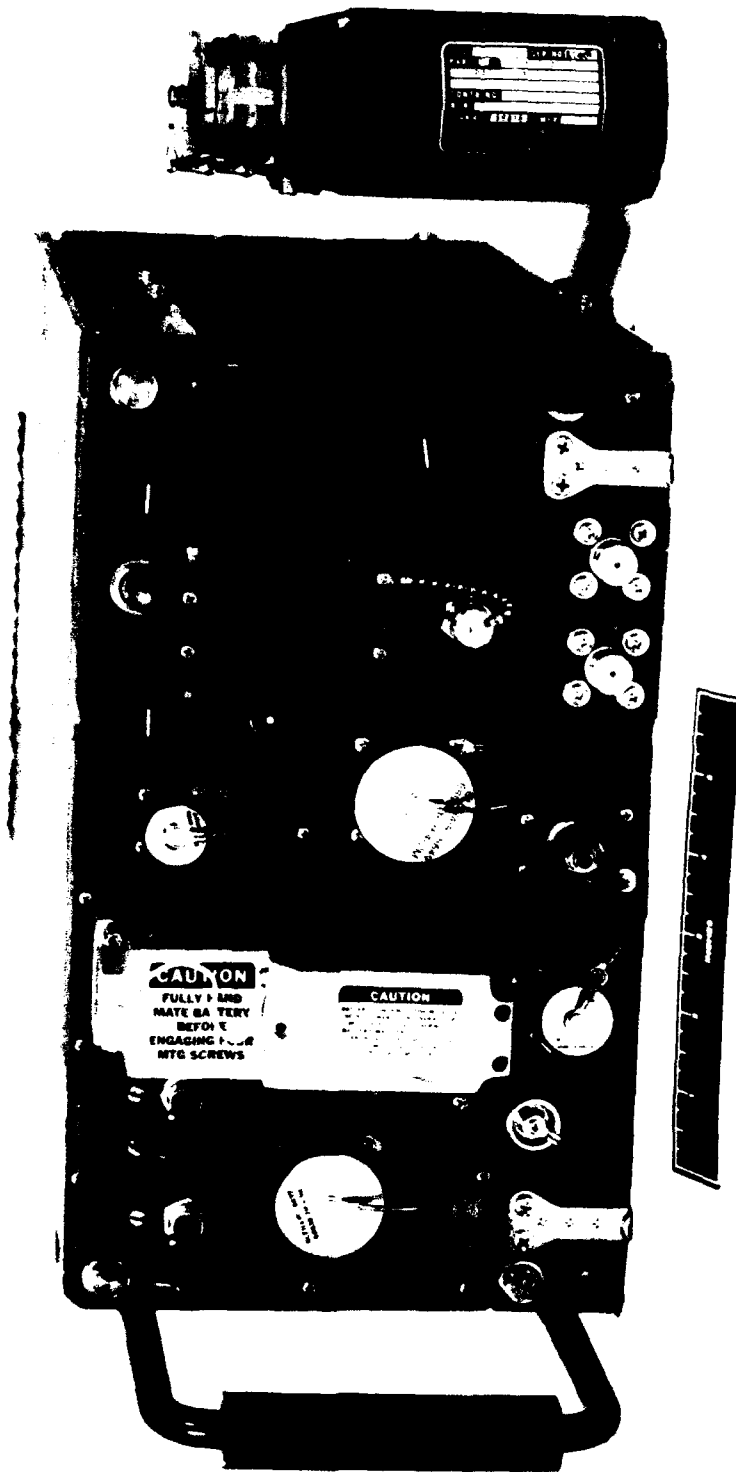

ARMY DATA DISTRIBUTION SYSTEM (ADDS)

MISSION:

To provide a tactical data distribution system designed specifically to support the needs of the multitude of computers being fielded as part of the Army Tactical Command & Control System (ATCCS) and other battlefield automated systems. The Army Data Distribution System (ADDS) consists of two major products: The Enhanced Position Location Reporting System (EPLRS) for medium speed data distribution and the Joint Tactical Information Distribution System (JTIDS) for high speed data distribution. The ADDS provides near real time data distribution in the division and corps areas under the anticipated electronic countermeasure environment.

CHARACTERISTICS:

ADDS uses Time Division Multiple Access (TDMA) communications architecture to avoid transmission contention. Frequency hopping and spread spectrum technology provide jam resistance. The EPLRS user unit (28 lbs manpack size) and JTIDS terminal (94 lbs rack mounted) will be operated by the user of the host computer. Net Control Stations and dedicated relay functions will be provided by signal units.

FOREIGN COUNTERPART:

There is no known foreign counterpart to ADDS. JTIDS is a joint and multi-national system which will be interoperable with NATO units.

PROGRAM STATUS:

EPLRS is in low rate initial production while JTIDS is completing manufacturing development and system technical testing.

PERFORMANCE IN SWA:

The USMC used the basic PLRS radio in SWA to provide position/navigation at all levels of command. JTIDS was used aboard the JSTARS to receive Airborne Warning and Control System (AWACS) data.

POINT OF CONTACT

PM ADDS
ATTN: SFAE-CM-ADD
Fort Monmouth, New Jersey 07703

CONTRACTOR:

Hughes Aircraft Company (Fullerton, CA & Forest, MS)
GEC-Marconi (Totowa, NJ & San Marcos, CA)

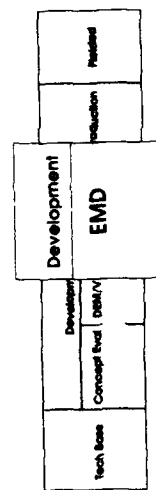



STANDARDIZED INTEGRATED COMMAND POST SYSTEM (SICPS)

MISSION: The SICPS is a family of command post facilities developed to house the Army Tactical Command and Control System (ATCCS) across all battlefield functional areas. Variants of SICPS consist of a tent Command Post (CP), a Rigid Wall Shelter CP, a Track Vehicle CP (M577 variant), and a 5-Ton Expando Van CP. These CP facilities will provide protected work area for command and control functions at corps through battalion levels. SICPS will be fielded as components of the Maneuver Control Systems, the Forward Area Air Defense Command and Control System the Advanced Field Artillery Tactical Data System, the All Source Analysis System and the Combal Service Support Control System.

CHARACTERISTICS: Tent CP: 11 ft. x 11 ft. with interchangeable sidewalls, any of which can be removed for combining two or more tents together; supported by a three-piece aluminum frame; fielded with two tables, two mapboards and a fluorescent light set. The tent CP can be attached to any of the other SICPS variants by replacing one sidewall with an interface wall. The tent CP is part of the other three SICPS variants. Rigid Wall Shelter CP: Mounts on the HMMWV shelter carrier and is integrated with 5KW power unit, 9000 BTU/hr air conditioner, collective chemical/biological protection, command and control (C2) equipment racks, power and signal import/export panels, intercom and operator seats. Track CP: Installation kit for existing M577 tracked vehicles to provide C2 equipment racks, power and signal import/export panels, and operator seats.

FOREIGN COUNTERPART: None.

PROGRAM STATUS: TENT CP: Type Classified Standard 8 Feb 90. Production contract awarded 31 Oct 90
 RIDGED WALL SHELTER: Technical Testing is ongoing
 TRACK CP: Full Scale Engineering Development Contract in place
 5-TON CP: In development

PERFORMANCE IN SWA: XM-1068 Command Track Prototypes were deployed to SWA in Support of 1 CAV DIV. Overall performance was acceptable.

CONTRACTORS: TENT CP: Camel Mft. Co. (Knoxville, TN)
 RIGID WALL SHELTER CP: Brunswick Corp, Defense Div. (Marion, VA)
 TRACK CP: FMC Corp (San Jose, CA)
 5-TON CP: CECOM Engineering Support Activity (Ft. Monmouth, NJ)

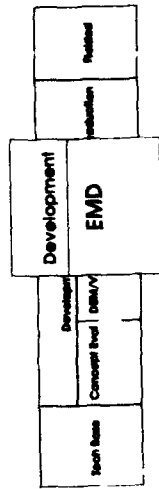

ALL SOURCE ANALYSIS SYSTEM

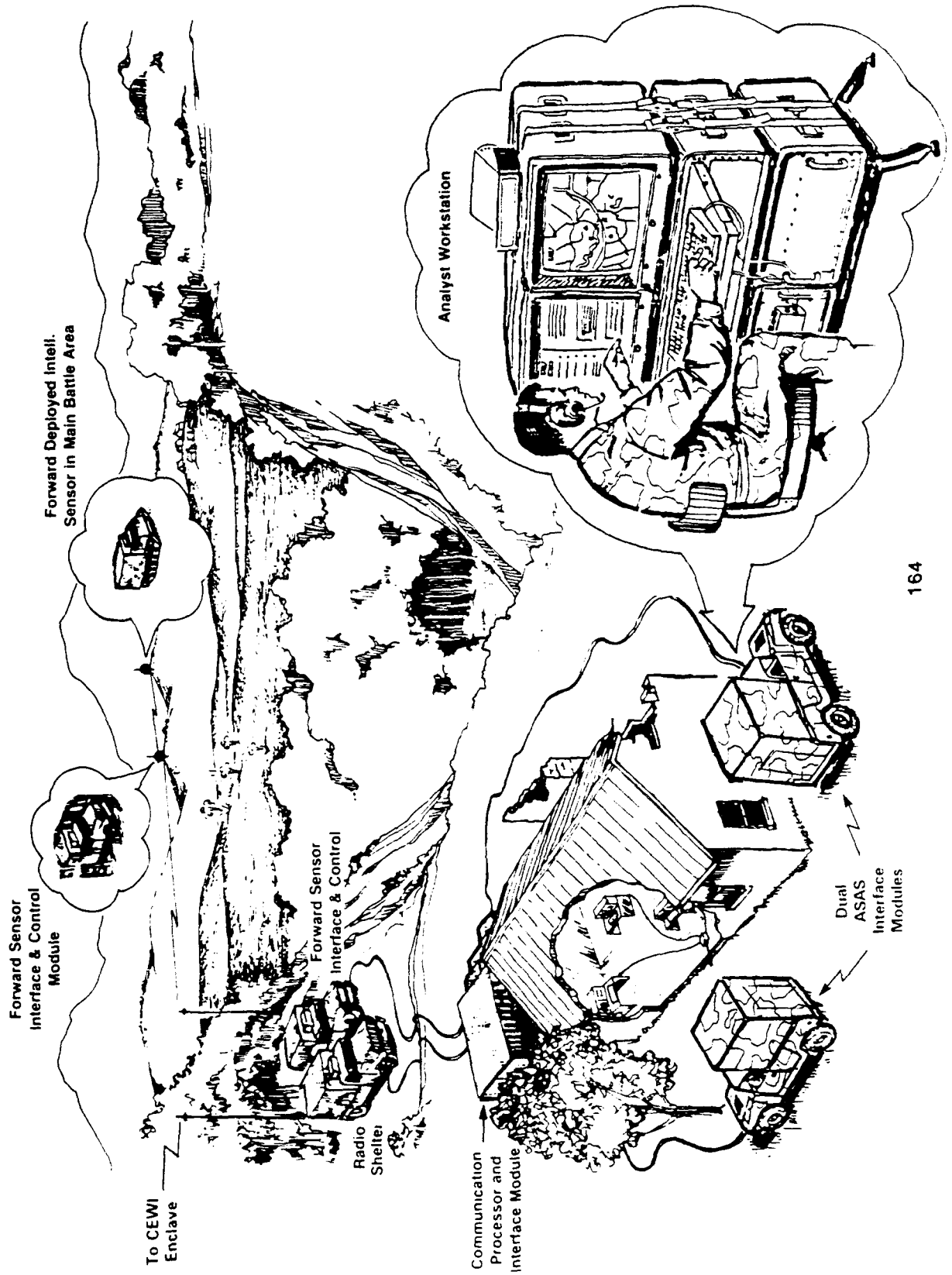

ALL SOURCE ANALYSIS SYSTEM (ASAS)

MISSION:

The All Source Analysis System (ASAS) is the central nervous system guiding field commanders to successfully execute Airland Operations, and is the Intelligence Electronic Warfare (IEW) sub-element of the Army Tactical Command and Control System (ATCCS). ASAS automates command and control of IEW operations and intelligence fusion processing. It generates a near real-time picture of the enemy situation to guide the employment of maneuver forces and systems such as the Joint Surveillance and Target Acquisition Radar System (JSTARS) and the Army Tactical Missile System (ATACMS). Today, many sophisticated sensor systems provide targeting information. The capability to process and respond to the information is limited by manual and partially automated processing methods. ASAS uses state-of-the-art computers to speed the process and improve accuracy.

FOREIGN COUNTERPART:

There is no known foreign counterpart for this system.

PROGRAM STATUS:

The program employs an evolutionary acquisition strategy. Testing of system modules began in FY86 and continued through FY89. A Limited Capability Configuration (LCC) was delivered to Ft. Hood, TX in FY89. In FY91, an Army Systems Acquisition Review Council (ASARC) restructured the program incorporating the Balanced Technology Initiative (Hawkeye). The Block I Initial Operational Test and Evaluation will take place in 4th QTR, FY92 at Ft. Hood. A materiel release decision is scheduled for Apr 93. Block I fielding is scheduled for FY93-95. Contract award for Block II development is programmed for Sep 92. Block II will transition ASAS to the ATCCS common hardware and software.

PERFORMANCE IN SWA:

Hawkeye was deployed with VII Corps and was extremely successful during Desert Shield/Storm. Hawkeye provided signal intelligence and asset management.

POINT OF CONTACT:

All Source Analysis System Project Office
1500 Planning Research Drive
McLean, Virginia 22102

CONTRACTORS:

The Jet Propulsion Laboratory (JPL), Pasadena, CA, acts in the role of prime integrator for Block I.

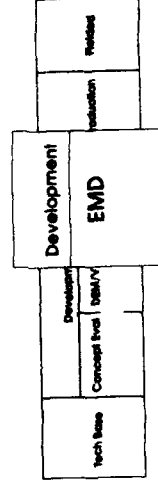



ADVANCED FIELD ARTILLERY TACTICAL DATA SYSTEM (AFATDS)

MISSION:

AFATDS is the multi-service (Army/Marine Corps) automated fire support command, control and coordination system of the Army Tactical Command and Control System (ATCCS) which satisfies the fire support requirements of AirLand Battle doctrine. AFATDS will provide integrated, automated support for the planning, coordination and control of all fire support assets (mortars, close air support, naval gunfire, attack helicopter, and offensive electronic warfare), execution of counterfire, interdiction, and suppression of enemy targets for close and deep operations. AFATDS will replace TACFIRE and Light TACFIRE.

CHARACTERISTICS:

AFATDS uses non-developmental ruggedized Common Hardware and Software. AFATDS software is being developed, in modular, object-oriented Ada computer code. Successive versions each implement additional functionality and interoperability. The System will be capable of processing fire missions at peak per hour load as follows: Version 1 - 120; Version 2 - 420; Version 3 - 720.

FOREIGN COUNTERPART:

AFATDS will interoperate with the United Kingdom and German Fire Support Systems. An automated artillery tactical command and control system was previously fielded by the Warsaw Pact. Their system provides digital linkage from battery to brigade or regiment level for fire planning, targeting, logistics and terrain management calculations.

PROGRAM STATUS:

Preliminary Design Reviews for Version 1 of the software are done and Detail Design is on-going for Version 1. Other FY92 activities will include Critical Design Review for Version 1 and Version 2 development.

POINT OF CONTACT:

PMFATDS
ATTN: SFAE-AFATDS
Fort Monmouth, NJ 07703

CONTRACTORS:

Software - MAGNAVOX (Ft. Wayne, IN)
Hardware - MILTOPE (Long Island, NY)

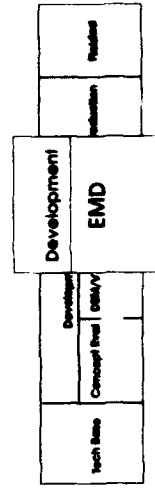

SINGGARS COMBAT NET RADIO FAMILY

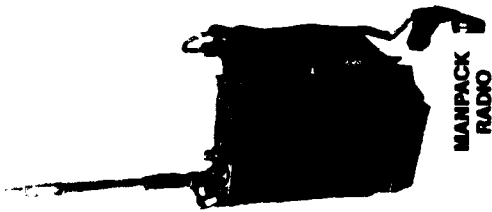

MANIPACK
RADIO



RECEIVER/
TRANSMITTER



LOUDSPEAKER

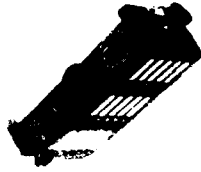

ECCM FILL DEVICE

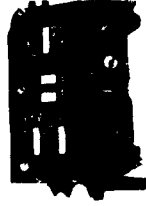

CONTROL
MONITOR (IVRC)

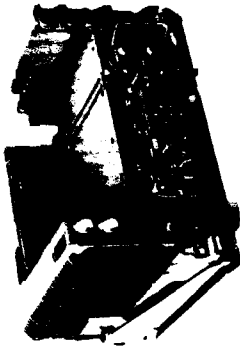

VEHICULAR
LONG RANGE
RADIO

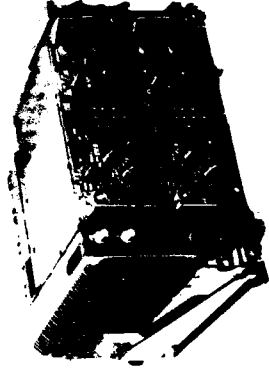

VEHICULAR
SHORT RANGE/
LONG RANGE
RADIO

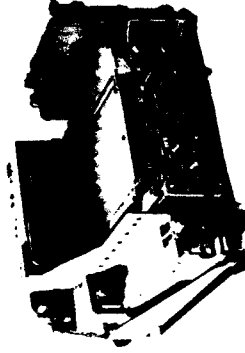

VEHICULAR
SHORT RANGE
RADIO



VEHICULAR
ANTENNA

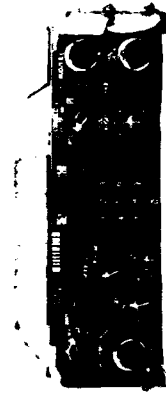

SINGGARS REMOTE CONTROL UNIT
(SRCU)

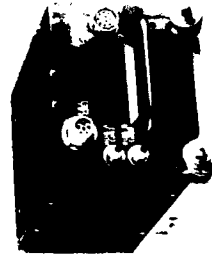

AIRBORNE REMOTE RADIO



AIRBORNE DEDICATED REMOTE
RADIO AND REMOTE CONTROL UNIT

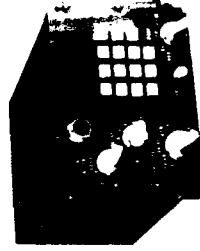

AIRBORNE PANEL
MOUNTED RADIO

SINGLE CHANNEL GROUND and AIRBORNE RADIO SYSTEM (SINGGARS)

MISSION:

SINGGARS provides commanders with a reliable, easily maintained Combat Net Radio (CNR) for command and control and provides Electronic Counter Counter Measures (ECOM) against Threat Electronic Warfare (EW). SINGGARS configurations include manpack, vehicular (both low and high power) and airborne models. COMSEC is integrated in currently produced versions of the ground and airborne models.

CHARACTERISTICS:

Weight: 22.5 lbs w/battery and COMSEC
 Frequency Range: 30.00 to 87.975 MHz
 Channels: 2320
 Range: 8-35 km

PROGRAM STATUS:

First source SINGGARS ground radios passed First Article Tests in Jan 88 and production deliveries began immediately. A Follow-On Test and Evaluation (FOTE) was successfully completed in May 88 on the non-integrated Communications Security (COMSEC) (non-ICOM) version of the radio. An Initial Operational Test and Evaluation (IOTE) and FOTE were successfully completed on the ICOM radio in Nov 90. Award for Option 3 for 8,000 radios was made in Jun 89. Option 4 for 16,000 radios was awarded in 1QFY91, completing the first source contract 44,100 ground radios. Of this quantity, 27,625 will have integrated COMSEC (ICOM). All SINGGARS produced after FY90 will be ICOM. A second source of ICOM ground radios was selected and a firm fixed price contract was awarded in Jul 88 with two options for FY91 and FY92. Full competition will begin in FY94. The program office has fielded over 15,000 radios including the training base, Army units in SOUTHCOM, WESTCOM, and CONUS. The SINGGARS airborne radio passed First Article Tests in Sep 85. Contract 3 was awarded in Jan 91.

PERFORMANCE IN SWA:

Radio worked exceptionally well in both the combat and desert environment of SWA.

POINT OF CONTACT:

PM SINGGARS
 ATTN: SFAE-CM-GAR
 FT Monmouth, NJ 07703

CONTRACTORS:

First Source: ITT Aerospace/Optical Division (Fort Wayne, IN)
 Second Source: General Dynamics (San Diego, CA)

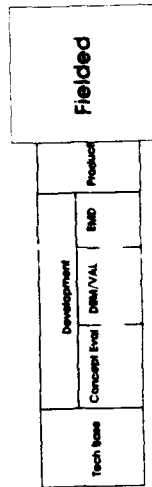

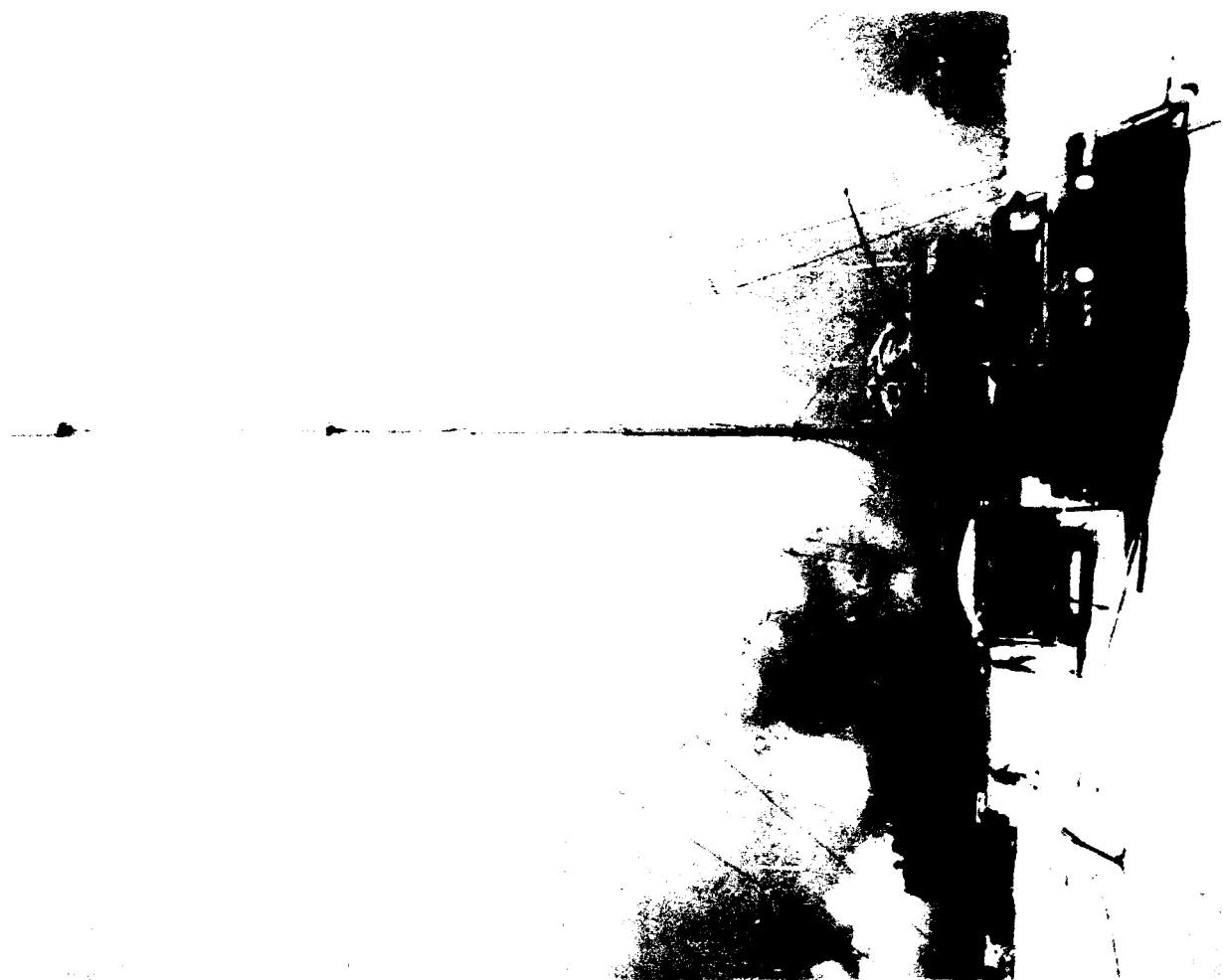

MOBILE SUBSCRIBER EQUIPMENT (MSE)

MISSION: MSE provides the tactical U.S. Army commander with a secure, automatic, highly mobile, quickly deployable survivable tactical communications system capable of passing data, facsimile and voice traffic throughout the division and corps area of operations.

CHARACTERISTICS: The major items of equipment are integrated into five functional areas: Subscriber Terminals provide the voice and data elements to interface with other functional areas of the MSE system. Mobile Subscriber Access radiotelephone terminals permit mobile and stationary users to automatically communicate secure voice and data throughout the tactical area of operations. Wire Subscriber Access allows non-radio users entry to the MSE system through concentrations of automatic switching equipment. Area coverage of the battlefield from mobile or fixed locations is achieved through secure automatic switching, continuous coverage and the ability of commanders and staff to retain the same telephone number regardless of their location. System Control provides an automated Corps-wide MSE system management capability which is itself mobile, moving with the elements it controls.

FOREIGN COUNTERPART: There is no known counterpart to the MSE system.

PROGRAM STATUS: The MSE program is progressing according to the acquisition plan. Fifty percent of the Signal Battalions scheduled to receive MSE have been successfully fielded. All fieldings will be completed by November 1994.

PERFORMANCE IN SWA: Nodes of MSE were deployed to SWA, MSE proved faster and more reliable than anything the Army ever had before. Switch reliability was solid. MSE was operational during the entire 350km high speed advance by the 3RD AD through Iraq and Kuwait.

POINT OF CONTACT: Project Manager MSE
ATTN: SFAE-MSE
Ft. Monmouth, New Jersey 07703-5210

CONTRACTORS: GTE (Taunton, MA) is the prime contractor for the MSE system. GTE is supported by over 30 subcontractors in this country and abroad.

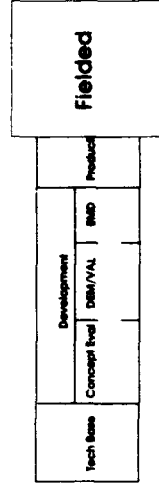

GPS RECEIVERS



MIL-SPEC
GPS RECEIVER

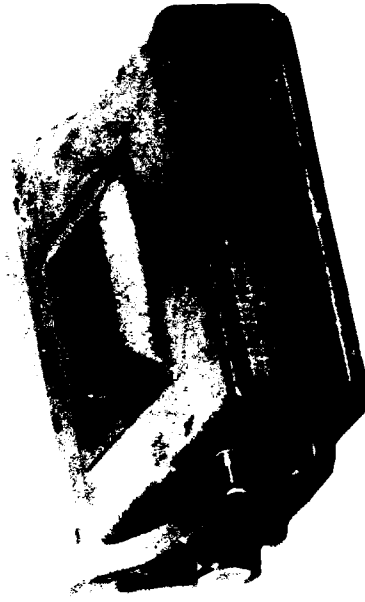

SMALL LIGHTWEIGHT
GPS RECEIVER (SLGR)

NAVSTAR GLOBAL POSITIONING SYSTEM (GPS)

MISSION:

The GPS is a Joint Army, Navy, Air Force program with the Air Force as the lead service. It is a space-based navigation, three dimensional positioning and time distribution system that will provide accurate, continuous, all-weather, common grid, worldwide navigation, positioning and timing information to land, sea, air and space-based users. GPS has three segments: space segment consisting of 24 satellites; ground control segment; and user segment. The Army is the lead service in the Joint Program Office (JPO) for the manpack/vehicular and low-to-medium dynamic aircraft receivers.

CHARACTERISTICS:

The user segment consists of receiver configurations for manpack/vehicular, low-to-medium and high dynamic aircraft and seacraft applications. The GPS receiver is a passive device that will be deployed extensively at all echelons and with Army aircraft.

FOREIGN COUNTERPART:

The Soviets have developed a similar system, GLONASS, but insufficient data are available to permit a meaningful comparison to GPS.

PROGRAM STATUS:

The JPO is planning and preparing to implement an off-the-shelf non-developmental item procurement of the Precision Lightweight GPS Receiver (PLGR), an inexpensive ground set. Milestone III for the PLGR is projected to be early FY94 following first article and operational testing with initial production sets in late FY93. The PLGR procurement will satisfy most other Army ground applications and replace the previously deployed AN/PSN-8 and AN/VSN-8, once sufficient assets are available. During Desert Shield/Desert Storm, waivers were obtained from ASD(C31) for the Army to acquire over 8000 commercially available sets called the Small Lightweight GPS Receiver (SLGR) as an interim capability until the PLGR is deployed. As SLGRs are displaced by PLGRs, it is planned that the SLGRs will be reallocated. An additional interim buy of SLGR-type devices is envisioned during FY92. Program Manager (PM) GPS will explore alternatives for functional substitutes for the 2-channel Air Set, AN/ASN-149; the Miniaturized Airborne GPS Receiver (MAGR) is being investigated as a substitute.

PERFORMANCE IN SWA:

The GPS was used extensively in SWA. Desert Storm experience has shown the utility of GPS sets for position and navigation applications.

POINT OF CONTACT:

PM GPS
ATTN: SFAE-CM-GPS
Ft Monmouth, NJ 07703

CECOM/PosNav Coordinator
ATTN: AMSEL-RD-ASCO
Ft. Monmouth, NJ 07703

CONTRACTORS:

Magellan Corp (Monrovia, CA)
Rockwell International (Cedar Rapids, IA)

Texas Instruments (Plano, TX)
Trimble Corps (Sunnyvale, CA)

SCI (Huntsville, AL)

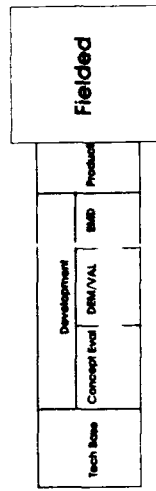

MILSATCOM TERMINALS



TACTICAL TERMINALS



STRATEGIC TERMINALS

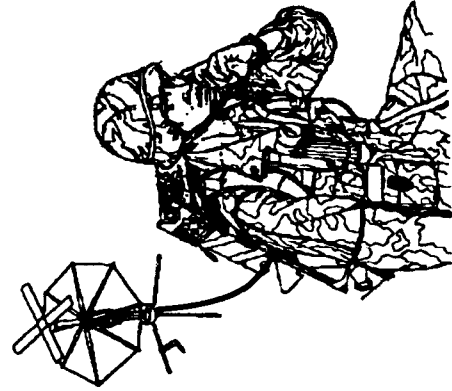

TACTICAL MANPACKS

MILITARY SATELLITE COMMUNICATIONS (MILSATCOM)

MISSION:

The Army is the DoD's executive agent for all satellite communications ground equipment, per JCS Memorandum of Policy 178, dated 1986. This equipment satisfies JCS-validated command, control, communications, and intelligence requirements supporting the President, Commanders-in-Chief (CINC), National Command Authority (NCA), Military Departments, intelligence community, and NATO. The satellite equipment use all DoD MILSATCOM systems, including Fleet Satellite/Air Force Satellite (FLTSAT/AFSAT) system; Defense Satellite Communications System (DSCS); and, the future Military Strategic/Tactical Relay (MILSTAR) system.

CHARACTERISTICS:

Fixed strategic, theater and mobile tactical satellite communications terminals.

PROGRAM STATUS:

Army is procuring commercial non-developmental item (NDI) terminals and related equipment in support of contingency force and special operations forces (SOF) unit requirements for use on FLTSAT/AFSAT. Efforts to embed Communications Security (COMSEC) and develop a demand assigned multiple access capability to increase the capacity of the existing system are underway. In the tactical DSCS, Army is modifying the AN/TSC-85B/93B terminals to provide commanders with an anti-jam capability. Strategically, Army will continue to modify its large fixed site facilities, provide digital equipment upgrades, and expand the control subsystem to enhance satellite and communications payload control operations. Army is supporting a more tactically oriented MILSTAR program by developing low data rate manpack terminals and medium data rate multichannel terminals. Army is continuing the Single Channel Objective Tactical Terminal/AN/TSC-124 terminal test and development program.

PERFORMANCE IN SWA:

Satellite communication was a success during Desert Shield/Desert Storm. It provided commanders the command and Control (C2) for long haul nets and extends terrestrial communications systems.

POINT OF CONTACT:

PM SATCOM
ATTN: SFAE-CM-SC
Ft. Monmouth, NJ 07703

PM MILSTAR (Army)
ATTN: SFAE-CM-MS
Ft. Monmouth, NJ 07703

CECOM
ATTN: AMSEL-SS
Ft. Monmouth, NJ 07703

CONTRACTORS:

GE Corp (Valley Forge, PA)
Harris Corp (Melbourne, FL)
Loral Corp (Colorado Springs, CO)
Magnavox Corp (Torrence, CA)

Motorola Corp (Scottsdale, AZ)
Titan Corp (San Diego, CA)

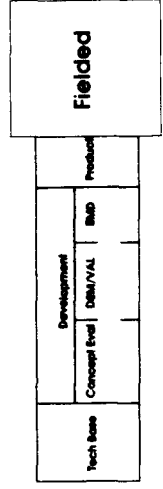

COMMUNICATIONS SYSTEM CONTROL ELEMENT

MISSION: This network management element provides the capability to plan, engineer, and control the circuit switched network, the message switched network, and the transmission network at signal brigades, battalions and communications node. The distribution of this system and its proximity to the switches provide for the rapid dissemination of directives and reports to the appropriate elements in the network at the time they are needed.

CHARACTERISTICS: AN/TYQ-30(V) 1 is a dual shelter (S-712 & S-713) unit used at theater signal command (Army) and signal brigade levels.
AN/TYQ-30(V) 2 is a single shelter unit used at signal battalion level.
AN/TYQ-31 is a single shelter used at nodes with the AN/TTC-39 Circuit Switch.

FOREIGN COUNTERPART: None.

PROGRAM STATUS: These equipments were authorized for production in FY86, and fielding began in FY90 and will continue through FY95.

PERFORMANCE IN SWA: Deployed to SWA in Dec 90. Operated and met requirements successfully.

POINT OF CONTACT: PM, MSCS
ATTN: SFAE-CM-MSC-CMS
FT. Monmouth, NJ 07703
DSN 992-23110
CECOM
ATTN: AMSEL-LC-MMR-T
Ft. Monmouth, NJ 07703
DSN 992-2436

CONTRACTORS: GTE (Raleigh, NC) (Software)
ESE (Richardson, TX) (Hardware)

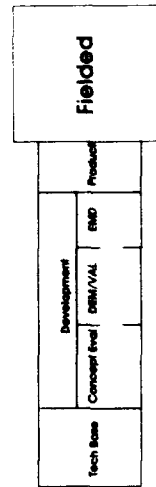

ECHELONS ABOVE CORPS COMMUNICATIONS ARCHITECTURE (2 NODES)

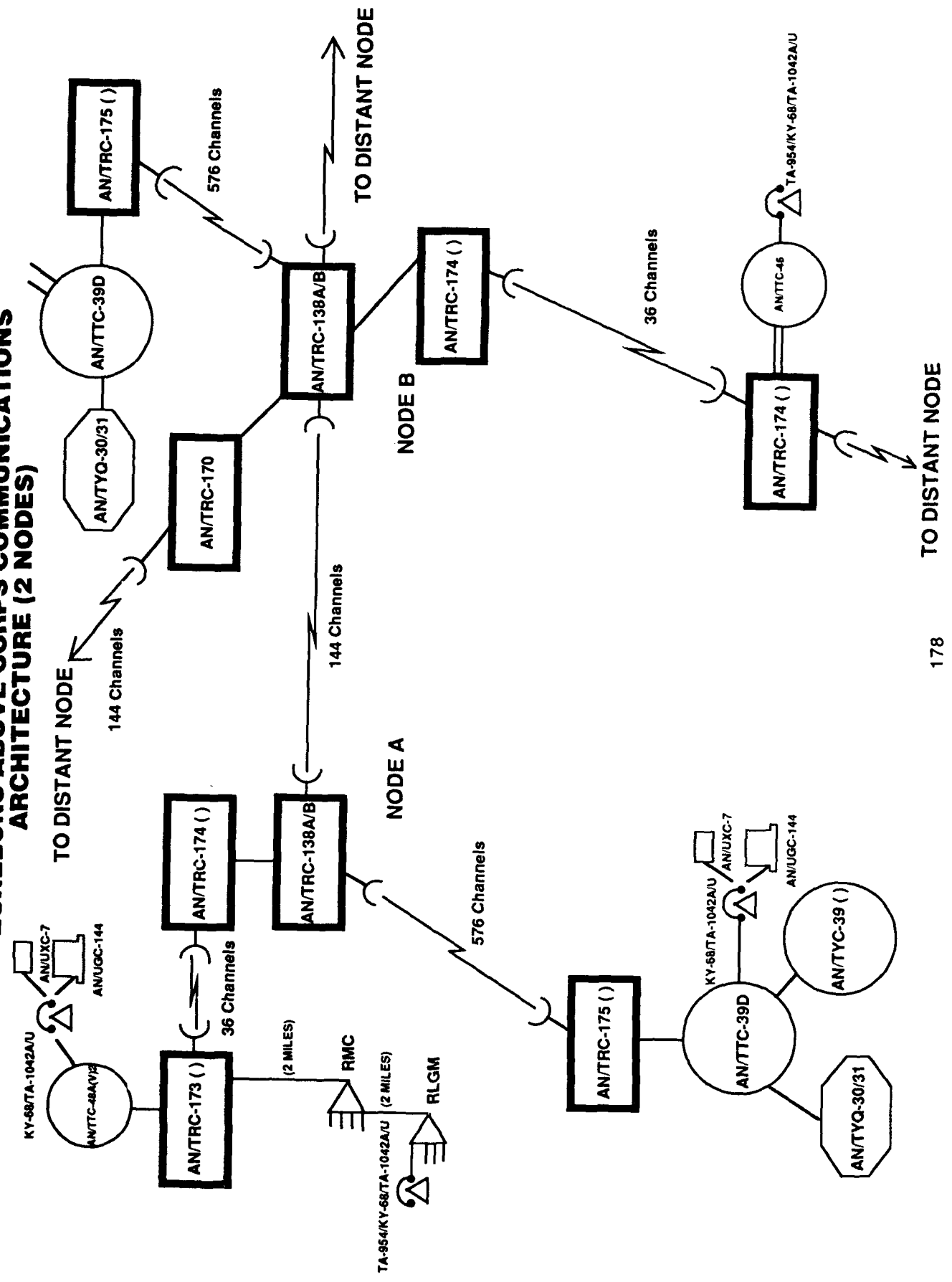

DIGITAL TRANSMISSION ASSEMBLAGES

MISSION:

This equipment represents a family of high capacity, digital radio systems which link circuit and message switches into communications networks supporting telephone and message traffic at the theater tactical level. They also provide the transmission path for linking extension switch subscriber locations into the main switching network.

CHARACTERISTICS:

The digital transmission assemblage provide a series of radio relay and radio terminal equipment in a variety of sizes, capabilities and characteristics.

FOREIGN COUNTERPART:

Unknown.

PROGRAM STATUS:

Fielding began in FY88 and is expected to be completed in FY95. Production and set assembly are expected to be completed in FY93 and FY95 respectively.

PERFORMANCE IN SWA:

Outstanding. Lessons learned did not highlight any significant problems. There were several suggestions for product improvements to provide system enhancements.

POINT OF CONTACT:

PM, MSCS
ATTN: SFAE-OM-MSC-CTS
Ft. Monmouth, New Jersey 07703
DSN 992-3474

CECOM-DMM
ATTN: AMSEL-LC-MMR-T
Ft. Monmouth, New Jersey 07703
DSN 99248

CONTRACTORS:

Digital Group Multiplex Equipment: Raytheon (Marlboro, MA); Group Technologies (Tampa, FL)
Antennas: Harris Corp. (Melbourne, FL)
Assemblages: Laguna Industries (Laguna Pueblo, NM)

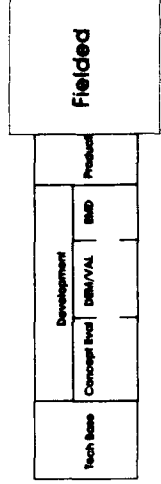

**ECHELONS ABOVE CORPS COMMUNICATIONS
ARCHITECTURE (2 NODES)**

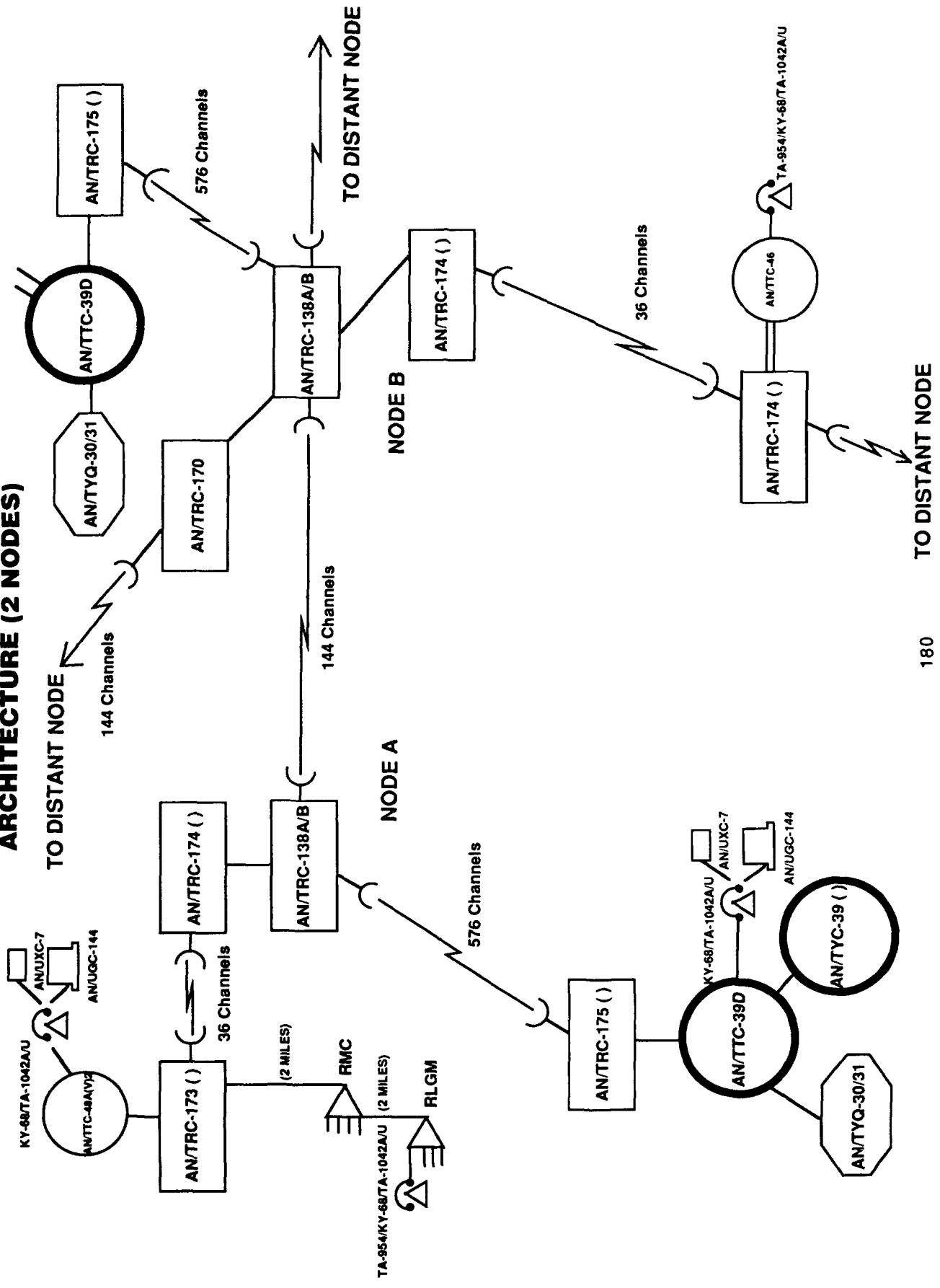

CIRCUIT SWITCH AND MESSAGE SWITCH

MISSION:

Equipment provides automatic switching service - interconnecting analog and digital users - between tactical and Defense Communication System (DCS) switches; and between U.S. and NATO national switches. The AN/TTC-39AD system is the heart of the multi-channel switched network and is a highly efficient means of connecting telephones, message traffic, and data users in both a secure and nonsecure mode in the area network at Echelons Above Corps. The AN/TTC-39 system provides corps and theater echelons tactical, automatic store and forward record traffic capability.

CHARACTERISTICS:

The AN/TTC-39 circuit switch family consists of three fielded versions. The "A" model switches are an S-280, 7444 line analog/digital switch with integral COMSEC and a downsized, modified S-250, 324 analog/digital switch. Both provide up to 7500 calls per hour service, 5 level precedence, conference and many other subscriber features. The "D" model is an S-280, 708 line analog/digital switch which incorporates the same affiliation and flood search routing as provided in Mobile Subscriber Equipment (MSE). Most features are still available in the "D" model. The AN/TTC-39 message switch family consists of three fielded versions. All are in S-280 shelters. There is a dual shelter 50 line switch and single shelter 24 and 48 line switches. All are tactical, automatic store and forward switches which provide service for both strategic (R) and intelligence (Y) communities. The switches provide interface with inventory, TRI-TAC and Automatic Digital Network (AUTODIN) equipment with precedence, security and other subscriber features.

FOREIGN COUNTERPART: None.

PROGRAM STATUS:

Both switches are currently deployed and were initially authorized for production in FY80. Both switches are currently in product improvement phases. The circuit switch "A" model has been fully fielded to the Army, Air Force and Joint communities. The "D" model fielding has begun in Germany and Korea. The message switch is currently in the engineering phase of product improvement which will result in an "A" model. The fielding of the "A" model is anticipated to begin in FY94.

PERFORMANCE IN SWA:

The multiplicity of equipments, different architectures and the analog and digital mix problems found in the operational force structure were resolved through the flexibility of the AN/TTC-39 and AN/TTC-39 communications system deployed at Echelons Above Corps (EAC).

POINT OF CONTACT:

PM, MSCS
ATTN: SFAE-CM-MSC-CSW
Ft. Monmouth, NJ 07703
DSN 002-218149

CECOM
ATTN: AMSEL-LC-MMR-T
Ft. Monmouth, NJ 07703
DSN 992-4361

CONTRACTORS:

GTE Government Systems Corp, Command and Control and Communications (Needham Heights, MA)

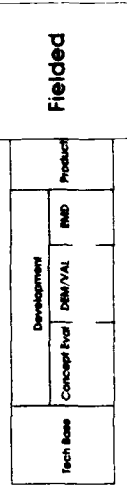

SOLDIER SUPPORT

The Soldier Support mission area includes those items that directly support the individual soldier. This mission area includes organizational clothing and individual equipment, nuclear, biological, and chemical defense equipment, and individual weapons. As we modernize the Army with new equipment, we must keep the individual soldier equally up-to-date.

Tech Base	Concept Development	DEVELOPMENT DEM/VAL EMD			Production	Fielded
Medical Battlefield Distributed Simulation- Developmental Nuclear, Biological, Chemical Defense Night Vision and Electro-Optics Soldier Integrated Protective Ensemble	Close Combat Tactical Trainer				Soldier Support Items Nuclear, Biological, and Chemical Defense	

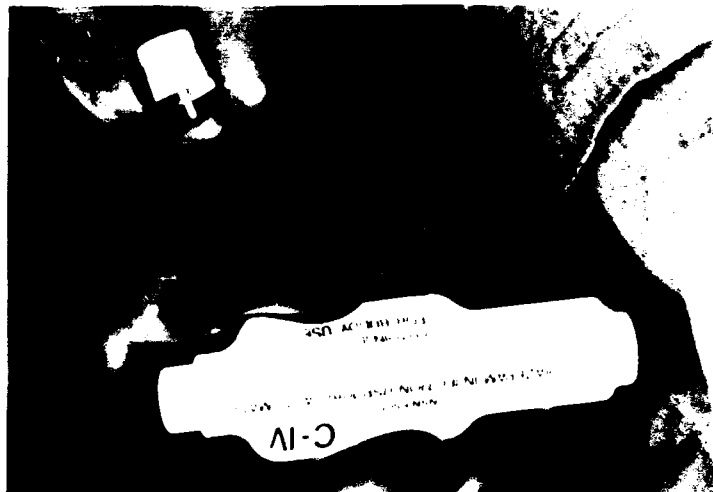

**MEDICAL
(AUTOMATIC INJECTOR)**

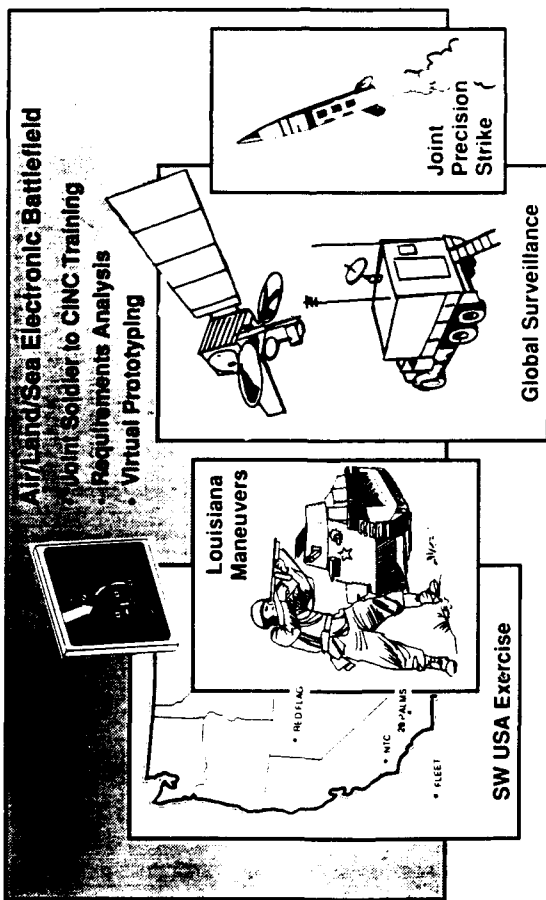

**BATTLEFIELD DISTRIBUTED
SIMULATION - DEVELOPMENTAL**

SOLDIER SUPPORT - TECH BASE

OVERVIEW:

The goal of the Army Technology Base program in Soldier Support is to enhance the soldier's winning edge. This includes medical products, Nuclear, Biological and Chemical defense equipment, night vision devices, training systems, and individual equipment.

MEDICAL:

Medical research and technology programs are designed to support the soldier in the field and to meet other Army health needs. This program encompasses: increasing efficiency of manpower through medical knowledge and equipment; enhancing recovery from combat wounds; prevention and treatment of infectious diseases; providing protection from hazardous environments; and enhancing individual performance.

BATTLEFIELD DISTRIBUTED SIMULATION-DEVELOPMENTAL (BDS-D):

The cornerstone of the Army's program to incorporate battlefield simulation technology into the acquisition process is the BDS-D project. BDS-D will create state-of-the-art distributed network links between government, university, and industry sites into a simulation of the combined arms and joint forces battlefield. Use of an object-oriented design approach for networking simulators will provide a multidimensional, virtual-reality, simulation of the battlefield environment that maintains the warfighter in the loop. The BDS-D program will support material development, combat development, training development, and operational testing by providing a cost effective alternative to proof-of-principle demonstrations, field tests, and operational evaluations. For example, Future Armored Vehicles and the Rorocratt Pilot's Associate will be virtually prototyped under the BDS-D concept. Mobility, weapons station stability, ride quality, and survivability will be evaluated in a true combined-arms simulation using BDS-D technologies, without incurring the cost of a complex and costly field training exercise.

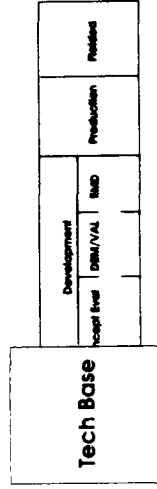

SOLDIER INTEGRATED PROTECTIVE ENSEMBLE (SIPE)

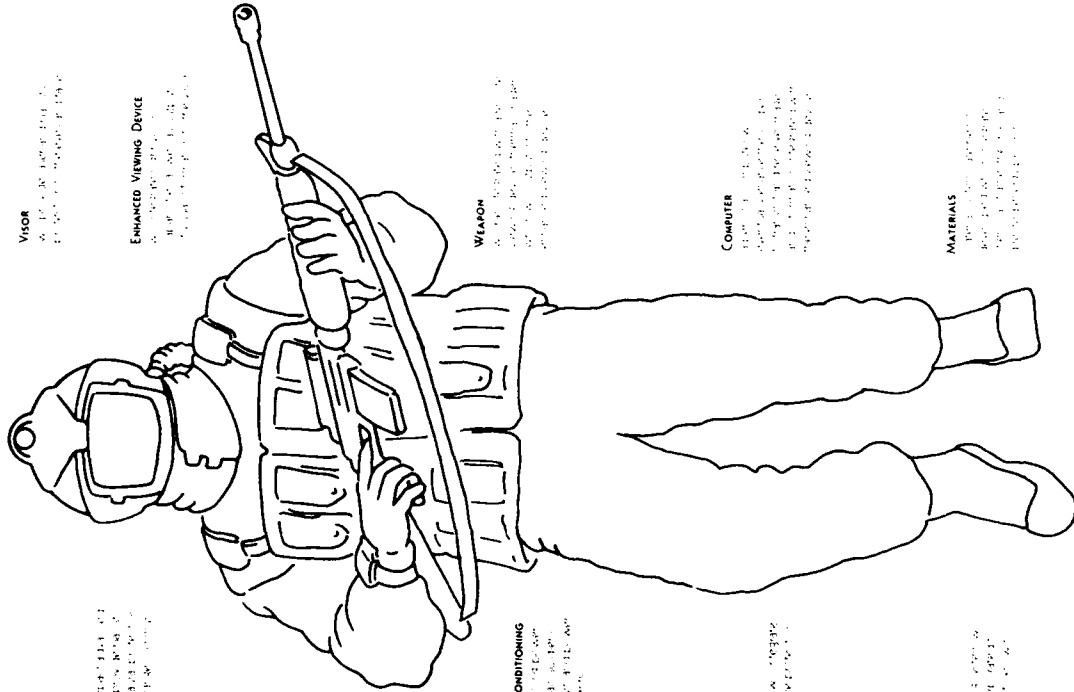

HELMET
 The helmet is designed to provide protection from shrapnel and fragmentation. It also features a built-in communication system and a night vision device.

VISOR
 The visor is made of a clear, shatter-resistant material and provides protection from ballistic threats. It also features a built-in communication system and a night vision device.

ENHANCED VIEWING DEVICE
 The enhanced viewing device is a night vision device that allows the soldier to see in low light conditions. It is mounted on the helmet and provides a clear view of the battlefield.

WEAPON

The weapon is a modern assault rifle that is capable of firing high-velocity rounds. It is equipped with a night vision device and a communication system.

MICROCLIMATE CONDITIONING
 The microclimate conditioning system is designed to regulate the soldier's body temperature. It is built into the jacket and provides a comfortable environment for the soldier.

GLOVES/BOOTS
 The gloves and boots are made of a durable, protective material and provide protection from ballistic threats. They also feature built-in communication systems and night vision devices.

NAVIGATION
 The navigation system is designed to help the soldier find their way through the battlefield. It is built into the helmet and provides a clear view of the terrain.

MATERIALS

The materials used in the SIPE are made of advanced, high-strength fibers. They are designed to provide maximum protection while maintaining a low weight.



NIGHT VISION AND ELECTRO-OPTICS

**SOLDIER INTEGRATED PROTECTIVE ENSEMBLE
 NUCLEAR, BIOLOGICAL, CHEMICAL DEFENSE**

SOLDIER SUPPORT - TECH BASE (CON'T)

NUCLEAR, BIOLOGICAL, CHEMICAL (NBC) DEFENSE:

The NBC defense technology base includes: materiel for individual physical and medical protection; collective protection; contamination avoidance; and decontamination. Individual protective equipment will offer increased respiratory protection against current and future NBC threats while providing improved weapons systems interface, and minimizing the physiological burden imposed by NBC protective equipment. Medical chemical-biological defenses will provide new pretreatments for nerve agents, topical skin protectants for vesicants, new vaccines for biological threats, and novel therapies for chemical and biological threats. Improved casualty care practices and doctrine will increase the return to duty rate, thus adding to force sustainment. The emphasis of the contamination avoidance component of NBC defense includes development of multi-agent sensors and detectors to provide real-time detection and identification of chemical and biological agents. Additionally, detectors will be more compact so they may be placed on a variety of platforms and will not have large space and power requirements. An example of such a detector is the Lightweight Standoff Chemical Agent Detector which will offer on the move standoff detection of chemical agents. This detector has been mounted on a Unmanned Aerial Vehicle platform and is designed to operate up to 5 km from the target. Decontamination systems of the future will emphasize noncorrosive, multi-agent systems for use with individual equipment and sensitive electronics.

NIGHT VISION AND AND ELECTRO-OPTICS:

Advanced Integrated Man Portable System (AIMS) will demonstrate an experimental night vision device that is a low-cost integrated system of ultra lightweight sensor, display, and laser modules configured for multiple infantry missions. The demonstration will integrate weapon sighting with the helmet displays, providing infantrymen significant increases in mobility and lethality. Uncooled sensors, optics, and laser technologies will be applied in '93 AIMS Demonstration. The demonstration follows the Soldier Integrated Protective Ensemble Advanced Technology Transition Demonstration to enhance the successfully demonstrated visual augmentation components.

SOLDIER INTEGRATED PROTECTIVE ENSEMBLE (SIPE):

SIPE will demonstrate a modular, head-to-toe, individual fighting system for the dismounted soldier to allow improved combat effectiveness, while providing balanced protection against multiple battlefield hazards. SIPE will integrate technologies and components for clothing/equipment, communications, weapons interface, night vision and microclimate conditioning/power.

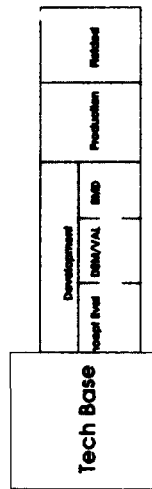

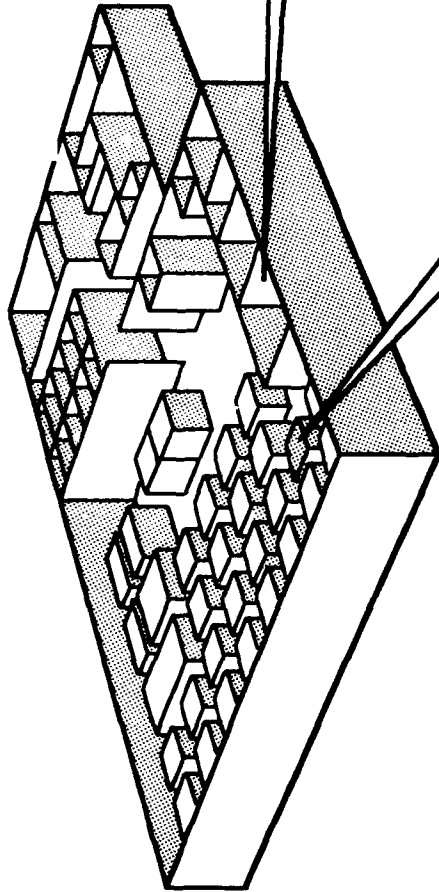

OPPOSING FORCE OPERATOR

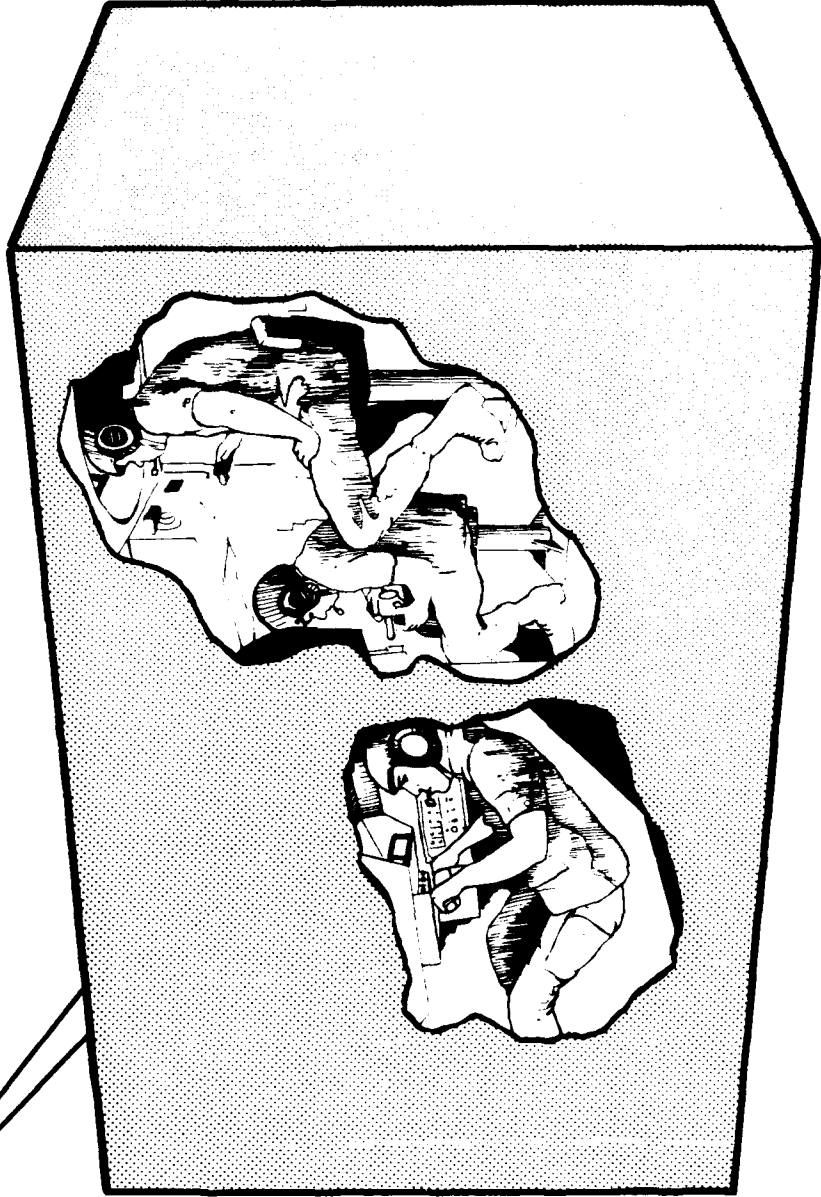

M1A1 TANK MANNED MODULE

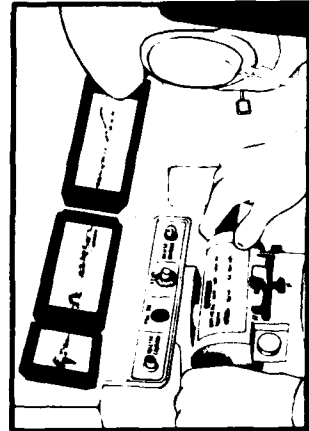

TYPICAL CREW STATION VIEW

CLOSE COMBAT TACTICAL TRAINER (CCTT)

MISSION:

To train active and reserve component M1 Tank and M2/3 Bradley crews on individual and collective (crew through battalion task force) tasks and skills in command and control, communications and maneuver on a simulated, fully interactive, real time battlefield. Will simulate, in real time, the conduct of combat operations in a realistic environment with an appropriate and challenging opposing force that will require realistic individual, crew and staff actions, placing the stresses of combat on all participants. Conduct of Joint operations, involving other US services and members of the allied forces with whom we routinely operate outside CONUS. The system will allow individuals, crews and units to operate in a simulated combat environment reducing the impact of restrictions of weapon effects, safety, terrain limitations, time, and will assist in overcoming the effects of crew turbulence and scarce resources.

CHARACTERISTICS:

A group of fully interactive networked simulators and command, control and communications work stations, replicating the M1 and M2/3 vehicles and weapon systems of a company/team operating on a simulated real-time battlefield. System will exist in both fixed and mobile versions. The fixed version will be static at all times during operation. *The mobile version will be static during operation but will move over primary and secondary roads during transport from site to site.*

PROGRAM STATUS:

The CCTT program successfully completed Milestone I/II ASARC. RFP was released Oct 91 with contract award expected 4Q92.

POINTS OF CONTACT:

PM Training Devices (PM TRADE)
12350 Research Parkway
ATTN: AMCPM-TND
Orlando, FL 32826-3276
Tel. (407) 380-8073
DSN: 960-8073

Army Materiel Command (AMC)
5001 Eisenhower Avenue
ATTN: AMCDE-S
Alexandria, VA 22333-0001
Tel. (703) 274-8605
DSN: 284-8605

CONTRACTOR:

TBD (Contract Award Expected 4Q92)

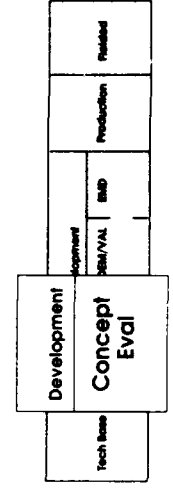



INTERMEDIATE COLD WEATHER
SLEEPING BAG

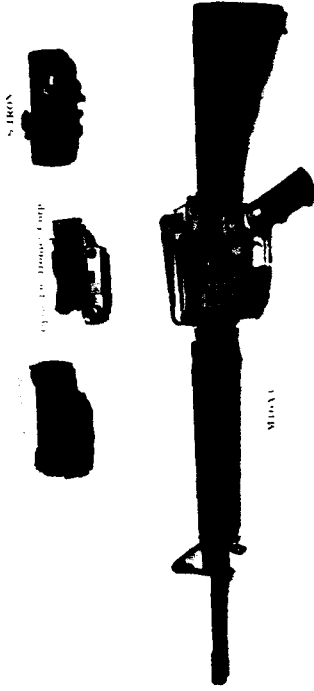

OPTICS FOR LIGHT WEAPONS

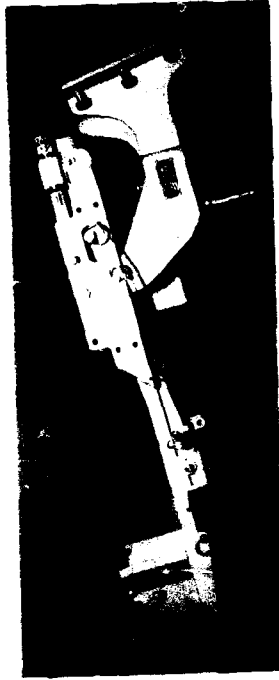

SOFT MOUNT

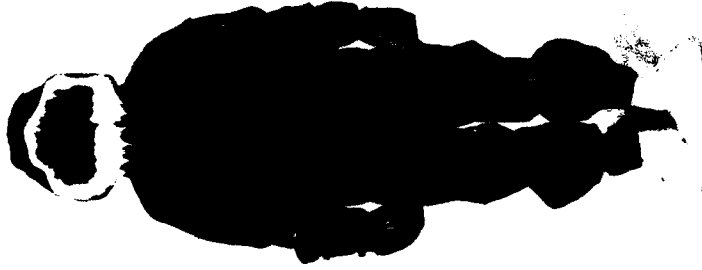

EXTREME COLD WEATHER
CLOTHING SYSTEM



IMPROVED DESERT BOOT

SOLDIER SUPPORT

MISSION:

Provide the soldier improved individual equipment, weapons, clothing, subsistence items and quality of life equipment to enhance his overall effectiveness and survivability on the battlefield. Soldier Support includes several related programs which respond to changing threat requirements and advances in state of the art technology.

CHARACTERISTICS:

The Soldier Modernization Plan is the basis for soldier support efforts. It provides a cohesive plan for the coordinated development of soldier support equipment and is the roadmap for near term, mid term and far term efforts. A key element of the soldier support and modernization process is the Soldier Enhancement Program (SEP). SEP projects are primarily Non-developmental items and are focused in four general areas: weapons and munitions, combat clothing and individual equipment, communications and navigation aids and food/water and shelter. Ongoing efforts in addition to SEP are:

CLOTHING AND INDIVIDUAL EQUIPMENT (CIE). Currently, emphasis is placed on combat CIE to improve soldier capability to counter newly emerging battlefield threats. Research and development is focused on the design of lighter weight equipment, ballistic and laser eye protection, and improved chemical protective clothing which take advantage of the latest progress in technology and advanced materials.

WEAPONS AND MUNITIONS efforts increase the lethality of the soldier on the modern battlefield. Projects include a Soft Mount for the M2 .50 caliber Machine Gun and the MK19 Grenade Machine Gun and improvements to the M24 Sniper Weapon System. Other efforts include optical lights for light weapons, a 30mm semi-automatic grenade launcher and neutralization of anti-personnel mines.

COMMUNICATION AND NAVIGATION AIDS projects include the Communication/Aural Protective System to provide improved communications capability in the Bradley while wearing the PASGT helmet and evaluation of the Digital Handheld Compass.

QUALITY OF LIFE. Ongoing efforts include improved kitchen, laundry, shower and other collective support equipment as well as items for the individual which will enhance the soldier's quality of life in the field.

PROGRAM STATUS:

There are 61 SEP projects in FY92, of which 24 are weapons and munitions, 23 CIE, 5 communications and navigation and 9 food/water and shelter. 37 projects are new starts in FY92. Work begins in FY92 on the Collective Support Package, a quality of life effort made up of latrines, kitchen, laundry, billeting and other facilities designed to support the soldier in the field.

PERFORMANCE IN SWA:

Several items were provided to the troops in SWA which not only improved their combat effectiveness, but quality of life as well. These included: Ballistic Laser Eye Protection, Sun/Wind/Dust Goggles w/laser protection, Improved Desert Boot, Machine Gun Lubricant, Flameless Ration Heater, Ammunition Pack for the Squad Assault Weapon, Lightweight Desert Uniforms, Improved Operational Ration Items and the Five Soldier Crew Tent.

POINT OF CONTACT:

PM CIE
14050 Dawson Beach Rd
Woodbridge, VA 22919

TROSCOM
4300 Goodfellow Blvd
St. Louis, MO 63120

AMCCOM
ATTN: AMSMC-RT
Rock Island, IL 61299

CECOM
ATTN: AMSEL-RD
Ft. Monmouth, NJ 07703

Tech Name	Development		Fielded
	Concept Eval	SMA/VAL	

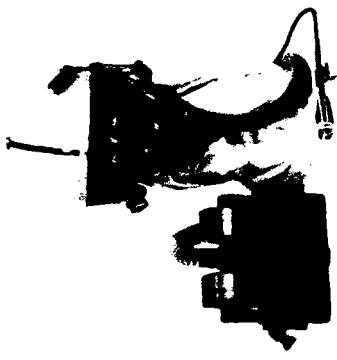

PROTECTIVE MASK WORN BY APACHE HELICOPTER PILOTS AND CREWMEN



LIGHTWEIGHT DECONTAMINATION SYSTEM DECONTAMINATING A M113 ARMORED PERSONNEL CARRIER



REMOTE SENSING CHEMICAL AGENT ALARM DEPLOYED TO SOUTHWEST ASIA DURING OPERATION DESERT STORM



PROTECTIVE MASK WORN BY A SOLDIER IN FULL CHEMICAL PROTECTIVE CLOTHING

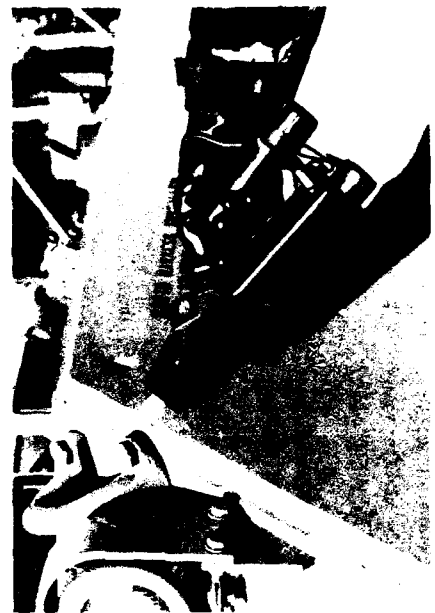

CHEMICAL AGENT MONITOR CHECKING AN ARMORED PERSONNEL CARRIER FOR POSSIBLE CHEMICAL CONTAMINATION



PROTECTIVE MASK WORN BY AN ARMORED VEHICLE CREWMAN

NUCLEAR, BIOLOGICAL, AND CHEMICAL DEFENSE

MISSION:

Nuclear, biological and chemical (NBC) defense provides essential defensive materiel to allow U.S. Forces to fight on the contaminated battlefield. NBC defense doctrine stresses contamination avoidance when the scheme of maneuver permits; protection of soldiers from incapacitating or lethal agents, NBC survivable equipment, and effective decontamination. Implementing this doctrine requires effective capabilities for reconnaissance, detection and identification; individual and collective personnel protection; decontamination of personnel and equipment, and medical management of NBC casualties. A strong NBC defensive capability deters employment of NBC weapons against U.S. Forces.

FOREIGN COUNTERPARTS:

Even though the U.S. is negotiating chemical weapons treaties, many nations still have an extensive chemical weapons arsenal. These weapons are especially becoming widespread in the Middle East. Both chemical and biological (C/B) weapons were a threat to the U.S. Forces participating in Operation DESERT STORM.

PROGRAM STATUS:

NBC defense technology initiatives emphasize maturing technologies and reducing development risk of future generation systems. Cooperative NBC defense programs include development efforts with Canada, the United Kingdom and France.
NBC DETECTION: The U.S. fielded the Fox NBC reconnaissance vehicle and is developing enhancements to remotely detect chemical agents. A new chemical and biological agent detector is in development.
PROTECTION: The new M40 mask is being fielded to soldiers throughout the Army. The new M43 series aviator mask is being issued to all Army aviators. Development of the next generation overgarments is nearing completion.
DECONTAMINATION: The M17 Lightweight Decontamination System is being deployed down to battalion level. The new Modular Decontamination System will be the new system for complete equipment decontamination.
NBC MEDICAL MANAGEMENT: The new M291 Skin Decontamination Kit has been fielded to protect soldiers from chemical agents. Drugs against nerve agents and vaccines against various biological agents are being developed.

PERFORMANCE IN SWA:

The M43 Aviator mask, Fox NBC Reconnaissance System, Chemical Agent Monitor and M17 Lightweight Decontamination system were fielded to troops during DESERT STORM. Although not required for actual use in an NBC environment, they significantly improved the confidence and morale of our soldiers.

POINT OF CONTACT:

PM NBC Defense U.S. Army CRDEC
ATTN: AMC-PM-NN ATTN: SMCOR-FP
Aberdeen Proving Ground, MD 21010 Aberdeen Proving Ground, MD 21010

CONTRACTORS:

Battelle Memorial Institute (Columbus, OH) ILC Dover (Dover, DE) ETG, Inc. (Towson, MD)
General Dynamics Land Systems (Detroit, MI) Brunswick Defense (Deland, FL) Mine Safety Appliance (Pittsburgh, PA)
Engineered Air Systems, Inc. (St. Louis, MO) Rohm and Haas Co. (Springhouse, PA)

Tech Name	Development		Produced
	Concept Prod	DSM/VAL	
Fielded			

STRATEGIC CONFLICT

The Strategic Conflict mission area relates to inter-continental or transoceanic inter-theater conflict. The U.S. Army Strategic Defense program is the Army's only strategic weapons development program.

Tech Base	Concept Development	DEVELOPMENT DEM/VAL	EMD	Production	Fielded
Extended Range Interceptor Technology Airborne Surveillance Testbed	High Endoatmospheric Defense Interceptor	Theater High Altitude Area Defense Ground Based Anti-Satellite System Ground Based Interceptor Ground Based Surveillance and Tracking System Ground Based Radar			



STRATEGIC CONFLICT - TECH BASE

OVERVIEW:

The goal of the Strategic Conflict technology base is to develop capabilities for application, by strategic forces to simulate strategic threat scenarios, to provide technologies to facilitate discrimination of threats in flight, and provide robust capability to neutralize and/or destroy threats in a strategic defense context.

The following are some initiatives in the area of strategic defense:

ADVANCED RESEARCH CENTER (ARC) in Huntsville, AL: The Advanced Research Center is a highly flexible, easily reconfigured, and cost effective research computing center. This center is designed to support Battle Management and Command, Control and Communications (BMC3) experimentation and demonstration and advance processing technology validation and evaluation. It is a node of the Strategic Defense Initiative National Test Bed and host to the Extended Air Defense Test Bed, Surveillance (Sensor) Test Bed and the Mid-Course (Space Phenomenology) Data Center.

NEUTRAL PARTICLE BEAM (NPB) GROUND TEST ACCELERATOR (GTA): The Ground Test Accelerator (GTA) is a major component of the national NPB program whose objective is to demonstrate the parameters, capabilities and technologies that are necessary to field a robust weapon discrimination system for strategic defense applications. The major deliverable of the GTA program is the demonstration of mission capable output parameters for an integrated system with technologies that are traceable to space operations.

NEUTRAL PARTICLE BEAM (NPB) CONTINUOUS WAVE DEUTERIUM DEMONSTRATOR (CWDD): The objective of the Continuous Wave Deuterium Demonstrator (CWDD) is to develop and demonstrate the low energy sections of a negative deuterium ion particle accelerator able to operate continuously at cryogenic temperatures. The fabrication, assembly and demonstration phase of the CWDD are currently in progress. The program is scheduled for completion in FY97.

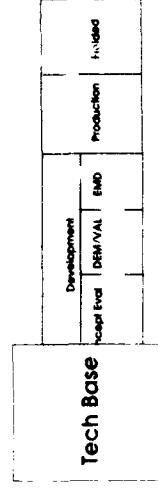

ERINT

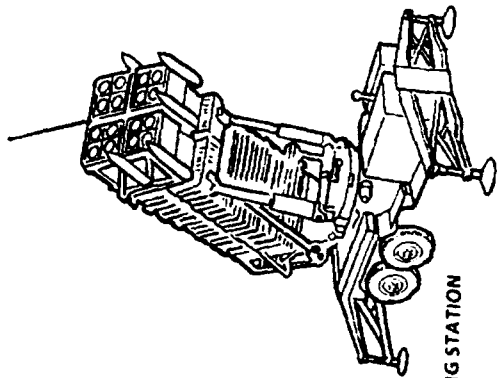

LAUNCHING STATION

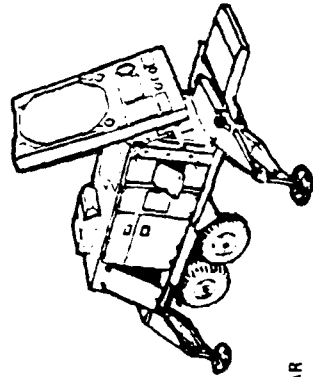

RADAR

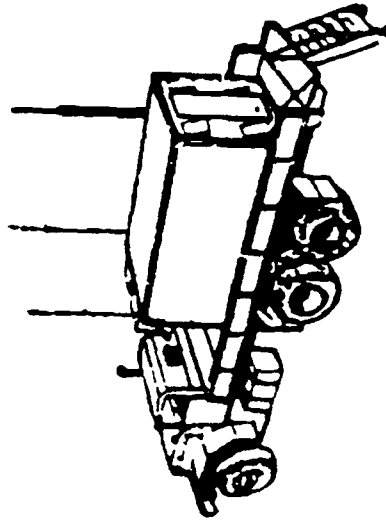

ENGAGEMENT CONTROL STATION

EXTENDED RANGE INTERCEPT TECHNOLOGY (ERINT-1)

MISSION:

The Extended Range Intercept Technology (ERINT-1) program will demonstrate a hit-to-kill capability for all systems that can be applied to Theater Missile Defense.

CHARACTERISTICS:

ERINT is being developed as a hit-to-kill anti-missile missile. Missile components and subsystems are being enhanced and miniaturized to continue the successful concept of a small, lightweight agile missile while increasing performance.

FOREIGN COUNTERPARTS:

The Soviet-developed SA-12 is comparable to ERINT in advanced technology and potential effectiveness.

PROGRAM STATUS:

The ERINT missile is a technology demonstration being considered for PATRIOT integration. The missile's onboard radar sensor performance is being improved to permit terminal homing against targets with much lower radar cross sections and more complex radar signatures at a greater range. Missile software is being expanded to engage a variety of targets.

The ERINT-1 Fire Control System (FCS) hardware is essentially the same as that used in the successful intercept by the Flexible Lightweight Agile Guided Experiment (FLAGE). FCS software, however, will be improved to perform against various targets. The FCS software is being made to be compatible with Patriot and other launchers.

The ERINT-1 flight test program consists of eight flight tests beginning in the second quarter of fiscal year 1992. The first two flights will be control rocket motor test flights, followed by two guided test flights against surrogate tactical ballistic missiles containing a simulated chemical payload (one bulk and one submunition). The third guided test flight will be conducted against an aircraft drone. The fourth guided test flight will be another simulated bulk chemical ballistic target with the final two guided tests flights against surrogate Maneuvering Tactical Ballistic Missiles containing a simulated submunition chemical payload.

POINT OF CONTACT:

U.S. Army Strategic Defense Command
ATTN: CSSD-KE-F
P.O. Box 1500
Huntsville, AL 35807-3801

CONTRACTORS:

LTV Aerospace and Defense (Grand Prairie, TX) Honeywell (Avionics) (Clearwater, FL)
Rockwell International (Seeker) (Anaheim, CA) Hi-Shear (Safe Arm Fuze) (Torrence, CA)
Atlantic Research Corporation (Attitude Control Motors & Solid Rocket Motor) (Gainesville, VA)
Lucas Aerospace & Power Equipment Corp (Aerodynamic Maneuvering System) (Aurora, OH)

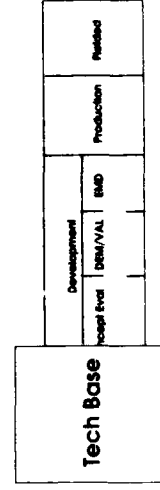

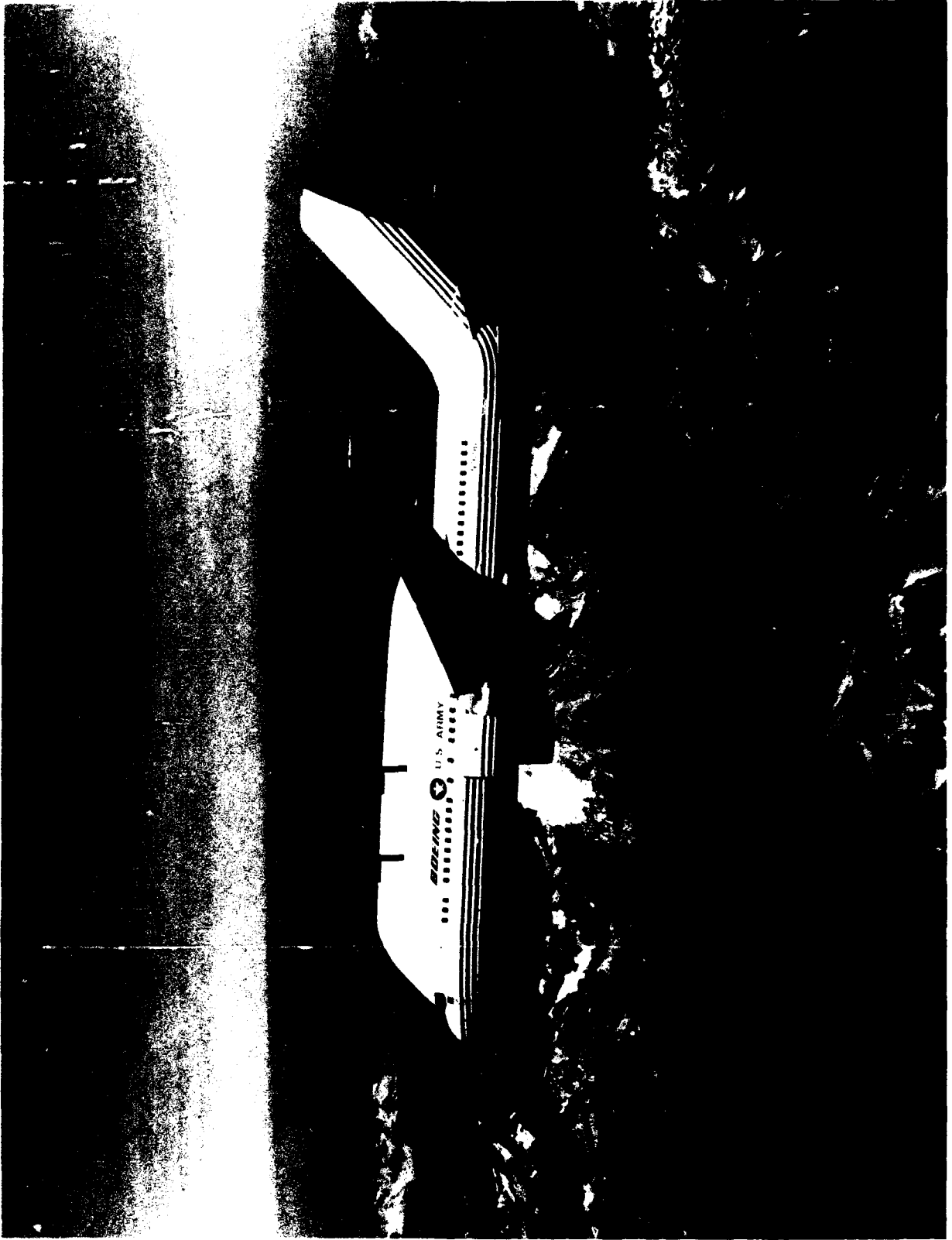

AIRBORNE SURVEILLANCE TESTBED (AST)

MISSION:

The Airborne Surveillance Testbed project, formerly called the Airborne Optical Adjunct (AOA), is an Anti-Ballistic Missile (ABM) Treaty-compliant technology experiment to validate airborne long wave infrared (LWIR) surveillance sensor functional performance and to provide a testbed for advanced surveillance technology. The technology advancements to be tested include LWIR sensor components, real-time onboard signal and data processing, target signature measurements, and aero-optic effects and controls.

CHARACTERISTICS:

The system consists of a state-of-the-art Long Wave Infrared (LWIR) sensor and data processor installed in a modified Boeing 767 commercial jet aircraft. The key to AST performance is ability of the LWIR sensor system to detect the heat of objects at long ranges against the cold space background within its field of view. The system will be used to test LWIR and data processing performance and as a testbed vehicle for other sensors and Strategic Defense Initiative systems.

FOREIGN COUNTERPART:

None.

PROGRAM STATUS:

The AST completed CONUS flight testing in the summer of 1990 and flew its first mission against a Minuteman III in September 1990 at Kwajalein Atoll. AST flew successful missions in FY91 at a variety of locations, including White Sands Missile Range, NM; Cape Canaveral, FL; Vandenberg Air Force Base, CA; and USAKA. Several challenging missions are planned for FY92.

POINT OF CONTACT:

U.S. Army Strategic Defense Command
ATTN: CSSD-AB
P.O. Box 1500
Huntsville, AL 35807-3801

CONTRACTORS:

Boeing (Prime) - (Kent, WA)
Hughes (Sensors) - (El Segundo, CA)
Honeywell (Data Processing, Computer Hardware) - (Clearwater, FL)

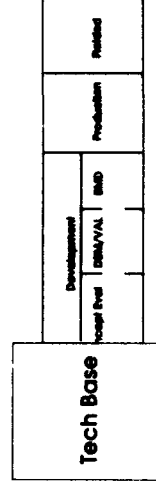

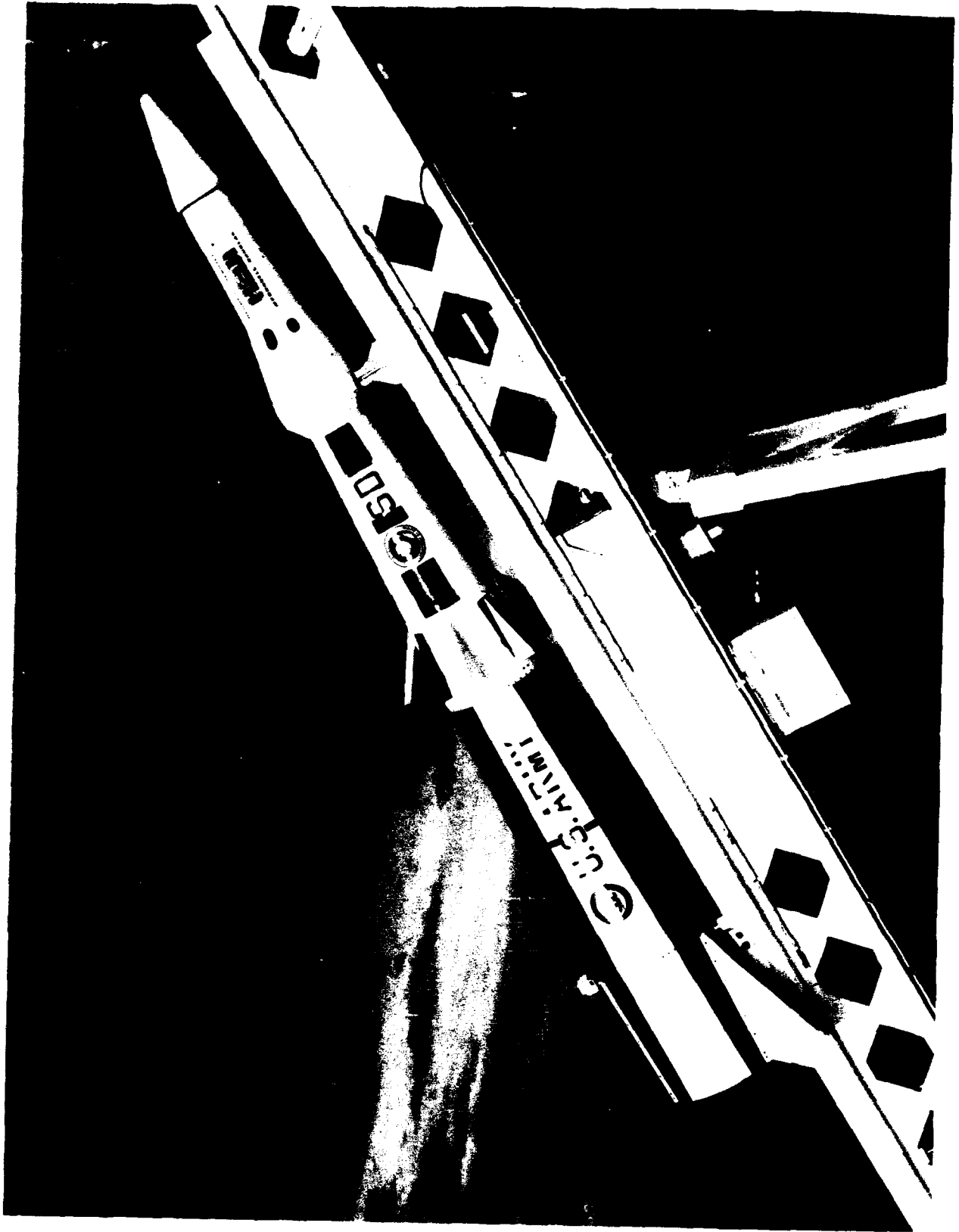

HIGHENDOATMOSPHERIC DEFENSE INTERCEPTOR (HEDI)/ EXOATMOSPHERIC ENDOATMOSPHERIC INTERCEPTOR (E2I)

MISSION:

HEDI is a strategic, ground-based, hypervelocity interceptor. This system is the terminal layer of the Ballistic Defense system. Associated with HEDI is the Kinetic Kill Vehicle Integrated Technology Experiment (KITE) which is designed to address and resolve critical issues associated with performing endoatmospheric intercepts.

The Endoatmospheric/Exoatmospheric Interceptor (E2I) is a multi-operational mode defense interceptor which retains the classical endo commit/endo intercept operational mode with the increased operational modes of exo commit/endo intercept. The multi-mode capability allows E2I to intercept Intercontinental Ballistic Missile Re-entry Vehicles before, during and after reentry, as well as short-range and depressed trajectory Sea Launched Ballistic Missiles.

CHARACTERISTICS:

The requirement for HEDI to function in the atmosphere at a high velocity requires emphasis on propulsion and rapid divert capabilities. The vehicle and its individual components must also be able to withstand the high temperatures generated by atmospheric friction.

The battlespace characteristics require E2I to be a lightweight interceptor with particular emphasis on target selection/designation using transatmospheric phenomenology effects, and propulsion and divert capabilities for hit-to-kill. The vehicle and its individual components also must be able to withstand the high temperatures and stringent environments during hypervelocities generated by atmospheric friction.

FOREIGN COUNTERPART:

Soviet-developed Gazelle.

PROGRAM STATUS:

The KITE program is a flight technology demonstration program designed to resolve critical issues associated with high velocity interceptors using existing and developing technologies (e.g., window coding, Kinetic Energy vulnerability, etc.). In FY90, the first KITE flight test (KITE-1) was successfully completed at White Sands Missile Range (WSMR). In September 1991, a second KITE test failed to achieve its objectives when a premature detonation of the test vehicle's self-destruct system destroyed the test vehicle before onboard experiments could be initiated. The second KITE test flight is expected to be rescheduled for 3QTR FY92. This flight will measure seeker performance and aero-optical effects while viewing a parachute flare target delivered by aircraft.

The HEDI KITE Program, scheduled to conclude with the KITE-3 scheduled for FY93 at WSMR, will evolve into a series of E2I flights at WSMR and the U.S. Army Kwajalein Atoll (USAKA). The procurement process for the E2I Demonstration/Validation is ongoing.

POINT OF CONTACT:

U.S. Army Strategic Defense Command
SFAE-SD-HED
P.O. Box 1500
Huntsville, AL 35807-3801

CONTRACTORS:

HEDI KITE --- McDonnell Douglas (Prime) - (Los Angeles, CA)
Hughes (Seeker) - (Canoga Park, CA)
Aerojet (Controls) - (Sacramento, CA)

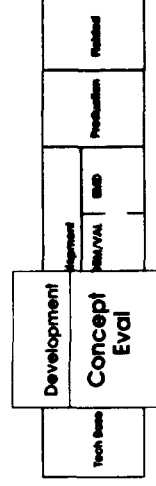

ENGAGEMENT CONCEPT

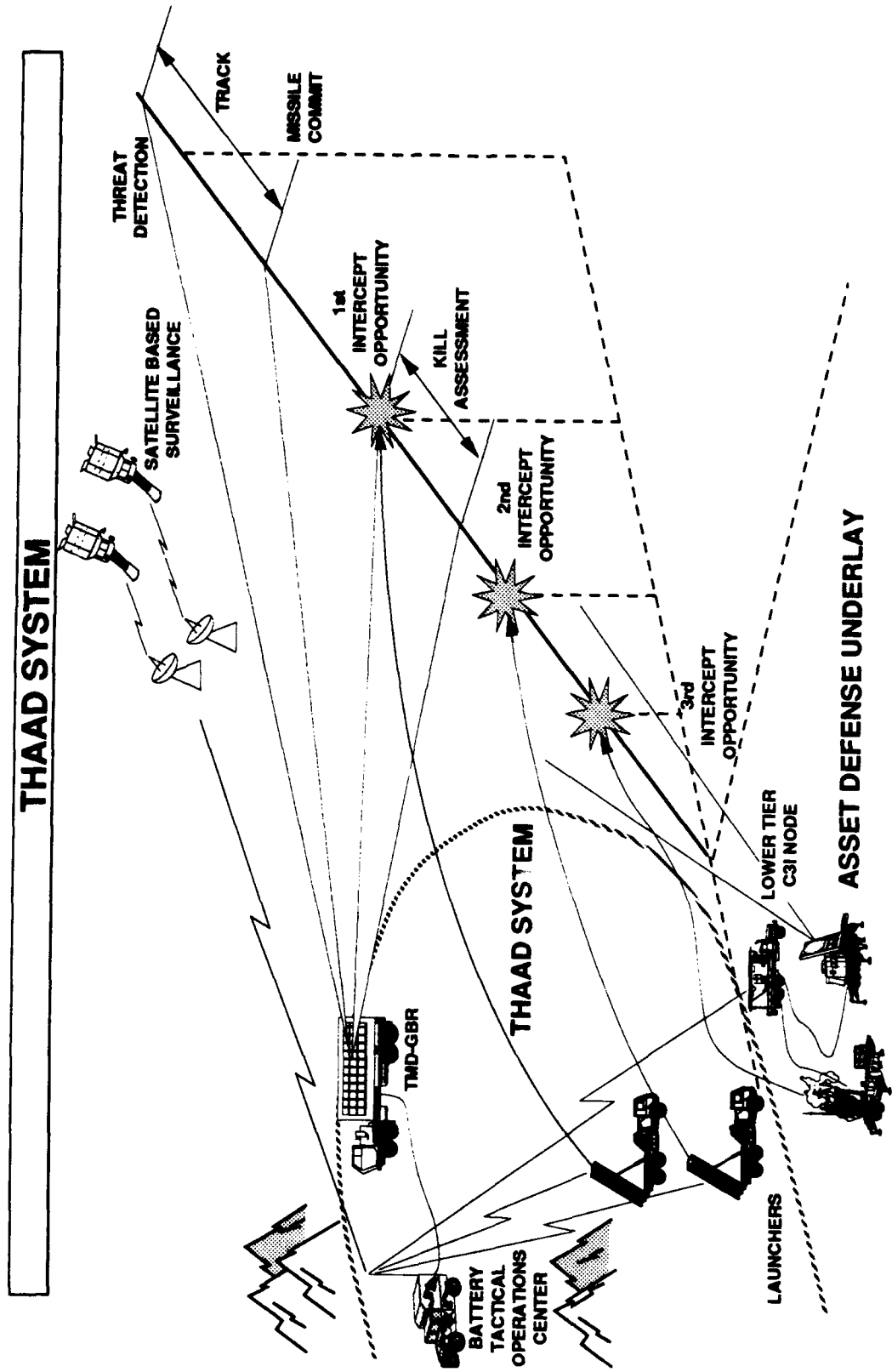

THEATER HIGH ALTITUDE AREA DEFENSE (THAAD)

MISSION:

The THAAD system, the upper tier of a two-tier active theater missile defense system, will provide large area coverage in both mature and contingency theaters. THAAD will engage tactical/theater ballistic missiles at high altitudes which minimizes debris and chemical/nuclear damage. THAAD will be interoperable with U.S. Air Defense Systems, Air Force space-based sensors and NATO systems.

CHARACTERISTICS:

The THAAD system elements include a THAAD battery with launchers, a missile with a kinetic energy kill vehicle, a battery tactical operation center (TOC) and support equipment. The Theater Missile Defense Ground Based Radar (TMD-GBR) will provide fire control and surveillance for THAAD. The THAAD battery TOC will be compatible with the battalion air defense TOC's to enable cuing to the lower tier. The THAAD system will be C-130 transportable and will use standard government power systems.

FOREIGN COUNTERPART:

Arrow/ACES (United States & Israel)
SAAM, SAMP/N and SAMP/T (France & Italy)
MSAM (Germany)

PROGRAM STATUS:

The THAAD Concept Definition phase will be completed July 92. A Defense Acquisition Board Review was held 21 Jan 92 and a demonstration/validation competitive contract award is expected in the summer of 1992. A series of ten flight tests will begin in 1994 followed by ten system tests. Completion of a prototype THAAD system is scheduled for 1996.

POINT OF CONTACT:

U.S. Army Strategic Defense Command
ATTN: CSSD-TM-H
P.O. Box 1500
Huntsville, AL 35807-3801

CONTRACTORS:

Sparta (Huntsville, AL)
Lockheed (Sunnyvale, CA)
McDonnell Douglas (Long Beach, CA)

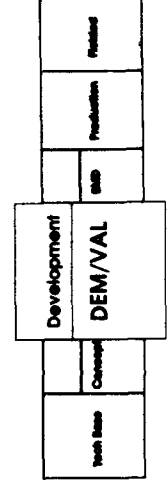

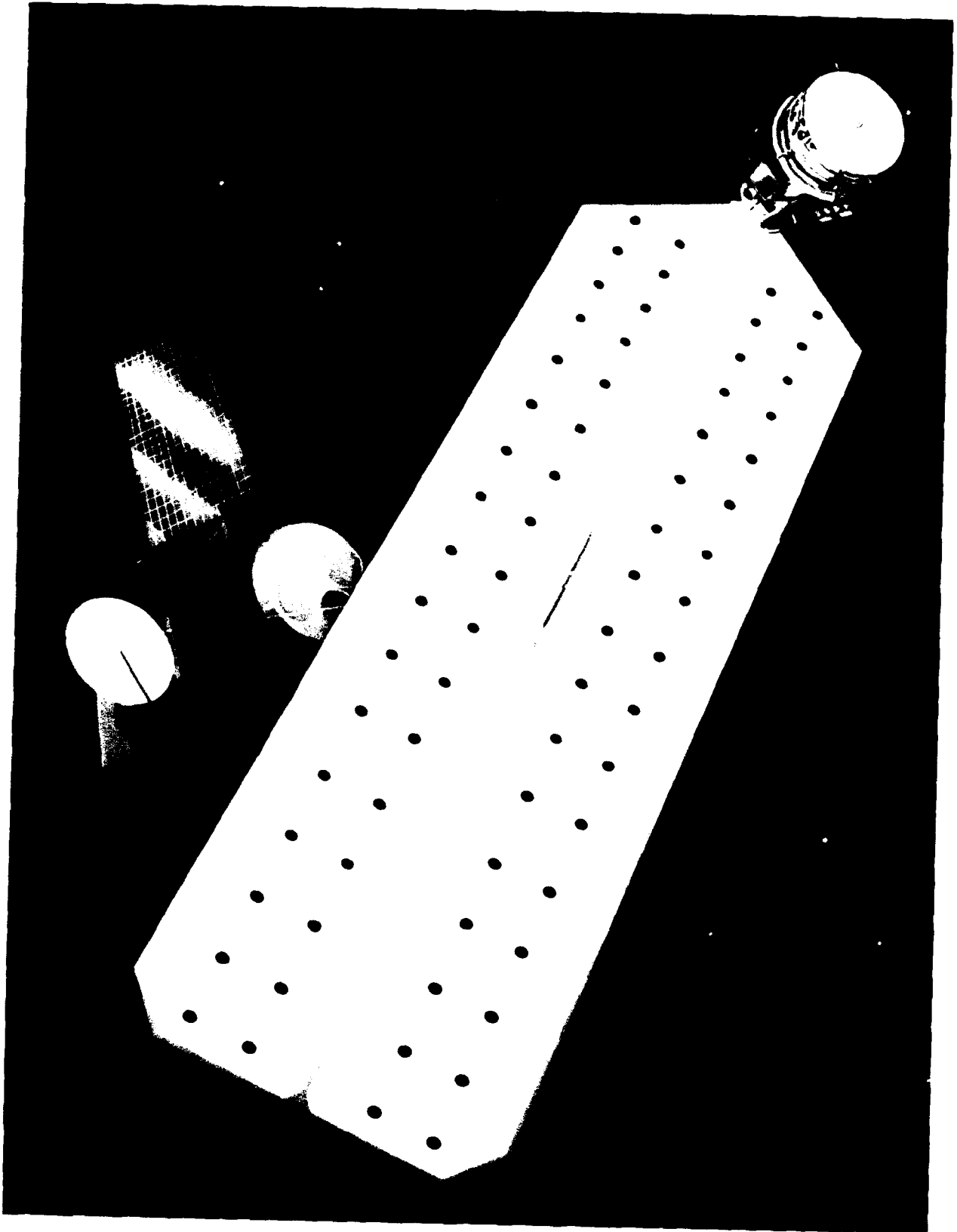

ANTISATELLITE (ASAT)

MISSION:

The objective of the ASAT System is to achieve space control. ASAT weapons and their command and control elements constitute the space forces necessary to execute space control operations. Accomplishing this mission requires the ability to provide space surveillance, actively defend friendly space systems against a variety of threats, disrupt, degrade, and destroy the warfighting potential of enemy space systems, and engage enemy satellites in space.

The military strategy for space supports U.S. policy objectives and Army mission requirements: deterrence and, if necessary, defense against enemy attack; assured access to and freedom of action in space; negation of hostile space systems; and enhancement of the operations of U.S. and Allied forces. The ASAT system will operate across the spectrum of conflict.

CHARACTERISTICS:

ASAT is designed to be a direct ascent kinetic energy missile carrying a non-nuclear hit-to-kill warhead.

FOREIGN COUNTERPART:

Indicative of the Soviet-developed military program of space is the development and maintenance of the world's only currently operational ASAT system, a ground-based co-orbital interceptor. Using a radar sensor and a pellet-type warhead, the interceptor can attack all current low-altitude satellites. Other Soviet-developed systems have ASAT capabilities. The nuclear-armed GALOSH ABM interceptor deployed around Moscow has an inherent ASAT capability against low-altitude satellites. Some of the lasers located at the Sary Shagan Missile Test Center may be capable of conducting damaging sensitive electronic warfare against space systems.

PROGRAM STATUS:

As the result of the January 1989 Defense Acquisition Board (DAB) decision, the Department of Defense (DoD) designated the Army as interim lead service for the development of a Kinetic Energy (KE) ASAT system. In preparation for the Milestone I decision, an initial Cost and Operational Effectiveness Analysis, and a Test and Evaluation Master Plan were developed along with Life Cycle Cost Estimates for both the Kinetic Energy weapon system and the Battle Management/ Command and Control portion of the program. A Major Decision Review (MDR) is scheduled for FY94.

POINT OF CONTACT:

U.S. Army Strategic Defense Command
ATTN: ASAT JPO
P.O. Box 1500
Huntsville, AL 35807-3801

CONTRACTORS:

Rockwell International Corporation (El Segundo, California)

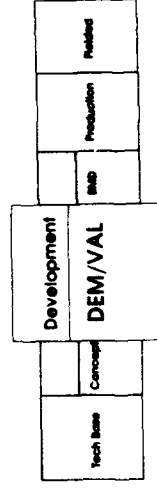

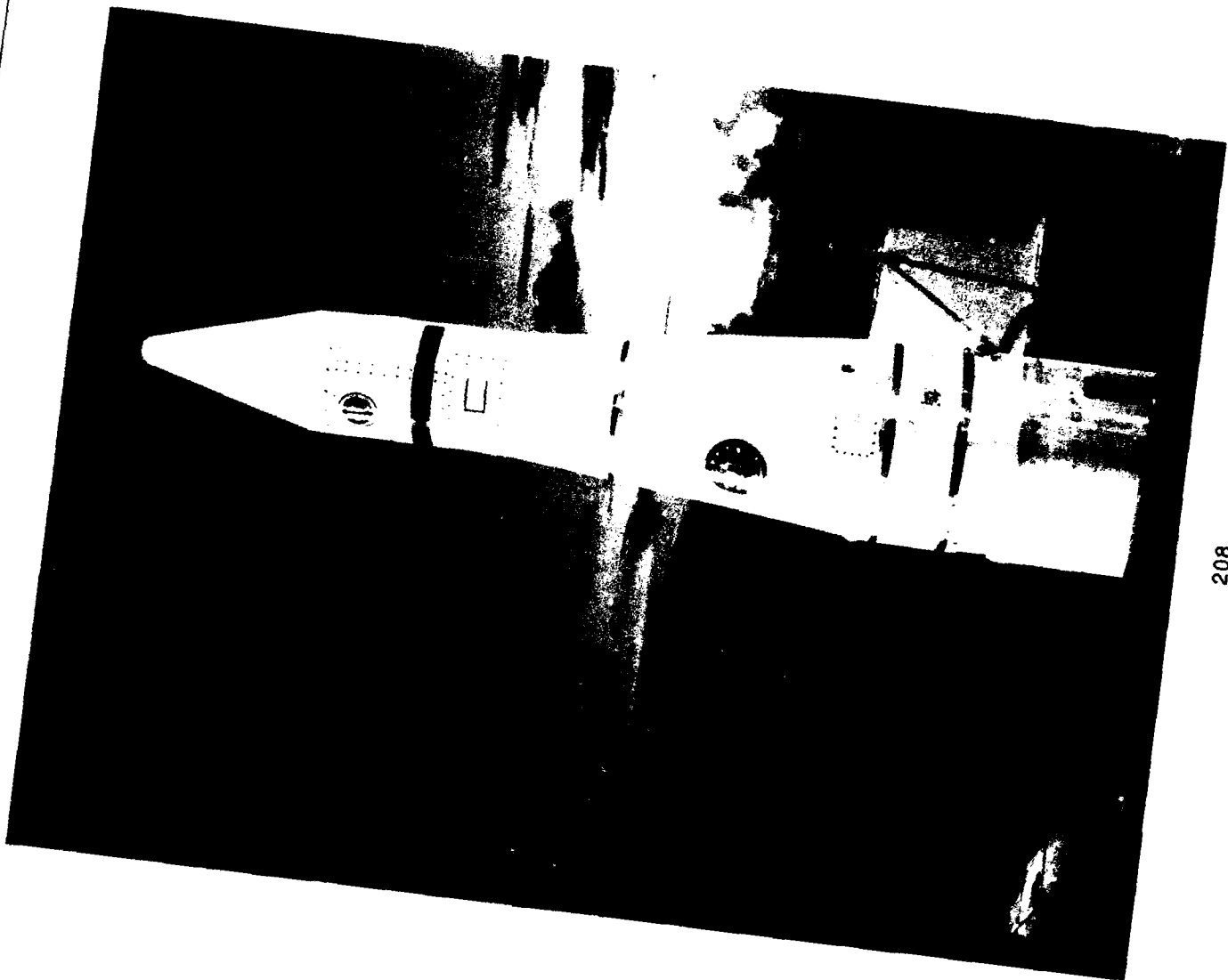

208

GROUND BASED INTERCEPTOR (GBI)

MISSION:

GBI is designed to conduct non-nuclear intercepts of reentry vehicles (RV) dispersed from Intercontinental Ballistic Missiles (ICBM) and Submarine-Launched Ballistic Missiles (SLBM). Relying on information provided by precommit sensors and battle management components, GBI would be launched toward an incoming target or target cluster. GBI's onboard computer would then receive additional updates from the precommit sensors and control intercept course correction maneuvers during the initial stage of the flight. Once uncapped, the onboard seeker would acquire, designate and track the target, providing "end game" maneuvering of the kill vehicle to achieve a direct-impact intercept.

CHARACTERISTICS:

The GBI is a lightweight vehicle, incorporating a sophisticated multi-band seeker and onboard data processor, designed to provide low cost per RV kill, estimated to be \$1-2 million. The GBI interceptor is designed to acquire and intercept the target in the presence of decoys and use the high kinetic energy of target impact to cause a non-nuclear kill. An interceptor-to-interceptor communication system will inform following interceptors of real-time target signature data. A lethality enhancement device may be used to increase the interceptor lethal radius and negate threat countermeasures.

FOREIGN COUNTERPART:

Soviet-developed GALOSH.

PROGRAM STATUS:

The GBI program consists of two phases, Exoatmospheric Reentry-vehicle Interceptor Subsystem (ERIS) Functional Technology Validation (FTV) and GBI Demonstration/Validation (DEMVAL), to resolve critical interceptor issues prior to Engineering and Manufacturing Development (EMD). ERIS is demonstrating and validating tactical and technical concepts associated with a cost-effective dormant interceptor within the strategic defense system. On January 28, 1991, an ERIS FTV test vehicle successfully intercepted a mock reentry vehicle in the presence of decoys. A second test is scheduled for early 1992. The DEMVAL effort is seeking state-of-the-art technologies (seekers, cooled optics, fiber gyro, improved avionics, and high speed processors) that are mature enough to support government baseline concepts for a Milestone II decision and provide competition for a GBI EMD.

POINT OF CONTACT:

U. S. Army Strategic Defense Command
ATTN: SFAE-SD-GBI
P.O. Box 1500
Huntsville, AL 35807-3801

CONTRACTORS:

ERIS FTV: Lockheed (Prime) - (Sunnyvale, CA)
Texas Instrument (Seeker) - (Dallas, TX)
Honeywell (Avionics) - (Clearwater, FL)
Kearfoot Navigation Controls Co (IMU) - (Little Falls, NJ)
TRW (Divert Propulsion) - (Redondo Beach, CA)
Hercules (Booster Propulsion) - (Magna, UT)
Rocket Research (Lethality Enhancement) - (Redmon, WA)
Hughes Aircraft Company (Prime) - (Canoga Park, CA)
Martin Marietta Corporation (Prime) - (Orlando, FL)
Rockwell International (Prime) - (Seal Beach, CA)

GBIDEMVAL:

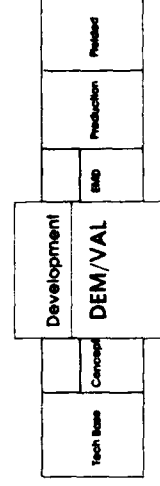

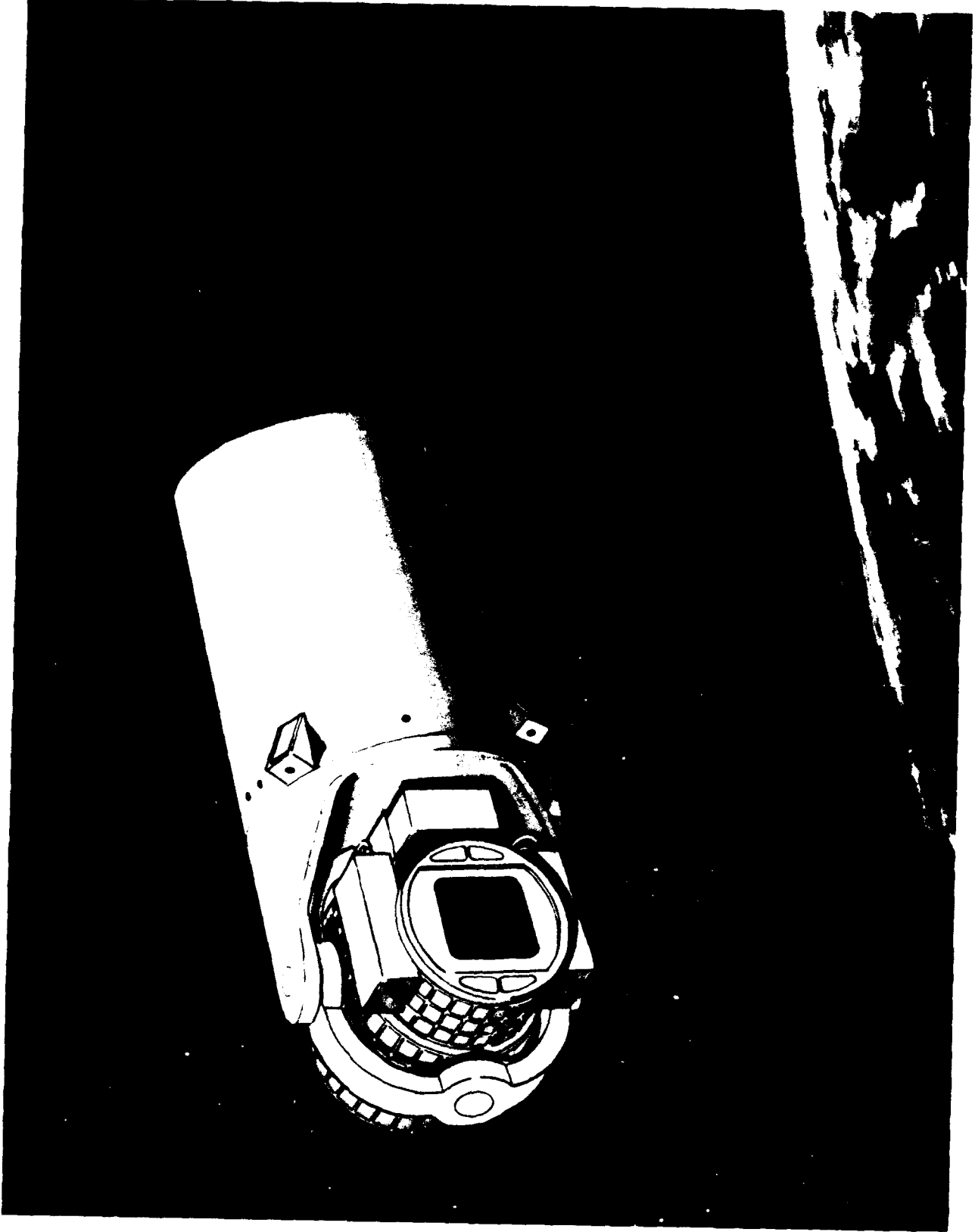

GROUND-BASED SURVEILLANCE AND TRACKING SYSTEMS (GSTS)

MISSION:

The GSTS will support tracking and discrimination in the midcourse phase of the Ballistic Missile Defense systems. It uses sensors launched at the appropriate time after attack warning to manage correlated data on reentry vehicles.

CHARACTERISTICS:

The GSTS is a missile-borne, long wave infrared (LWIR) sensor system designed to provide track, discrimination, and impact-point prediction of both intercontinental and submarine-launched ballistic missile reentry vehicles. The GSTS is a fixed, ground-based system and is launched into space on a suborbital trajectory to perform its functions during its exoatmospheric flight tracking.

FOREIGN COUNTERPART:

None.

PROGRAM STATUS:

A prototype GSTS is being developed to provide for technical validation experiments and test flights to support midcourse discrimination and tracking. The GSTS will be integrated with sensors for a full end-to-end tracking and discrimination experiment. A validation GSTS system concept will complete demonstration and validation in the mid-1990's.

POINT OF CONTACT:

U.S. Army Strategic Defense Command
ATTN: SFAE-SD-GSTS
P.O. Box 1500
Huntsville, AL 35087-3801

CONTRACTORS:

McDonnell Douglas (Prime) - (Huntington Beach, CA)
Hughes (Sensors) - (El Segundo, CA)
TRW (Software) - (Huntsville, AL)
Honeywell (Data Processor) - (Clearwater, FL)
SPARTA (Systems Engineering) - (Huntsville, AL)

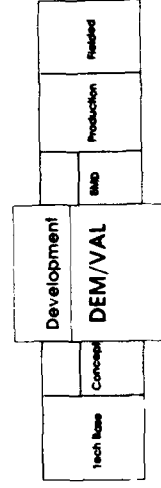

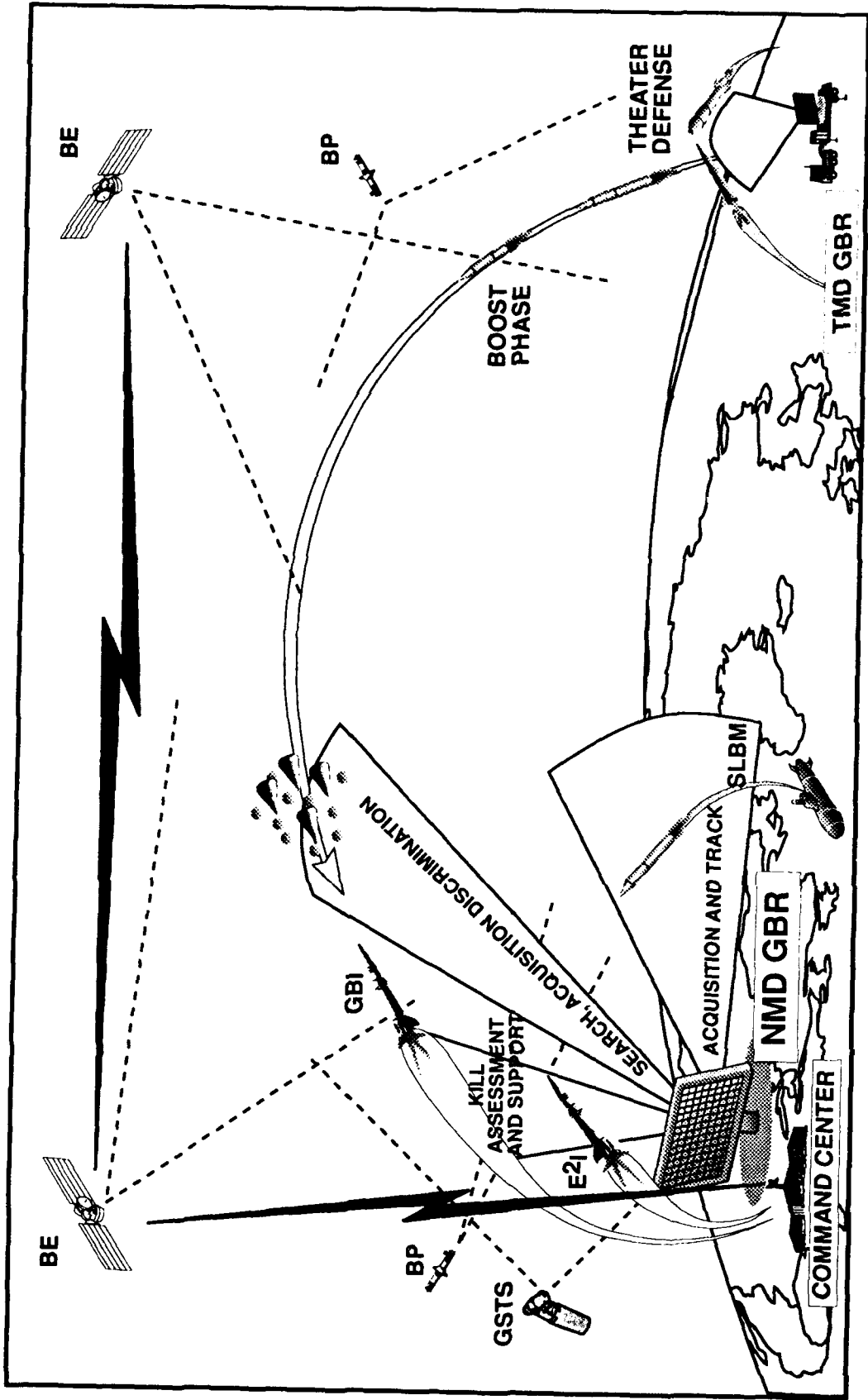

GROUND-BASED RADAR (GBR)

MISSION:

The Ground-Based Radar (GBR) encompasses the development of a family of radars which will support theater missile defense (TMD) and ballistic missile defense (BMD) interceptors in the acquisition, tracking and discrimination of incoming targets.

CHARACTERISTICS:

Each GBR is an X-Band phased array radar. The various radar missions to be performed will influence the physical size and configuration. Modularity and commonality of components will be emphasized during radar development to reduce development costs as well as production and support costs.

FOREIGN COUNTERPART:

The Soviet-developed counterpart to the GBR-T seems to consist of a suite of three ABM radar systems: the long-range Hen House radar; the Dog House radar; and the Try Adds radar. The Hen House radars appear to function as an early warning surveillance radar. They have very large array antennas and operate at about 150 MHz. The Dog House radars accept targets from the Hen House network and pass to them on to the Try Adds radar for engagement. The Dog House also employs a large array and operates around 100 MHz.

The Soviet SA-12 is thought to have capability against high performance aircraft and Tactical Ballistic Missiles similar to the TMD-GBR. The SA-12 system consists of two radars both of which appear to be phased array radars. The acquisition radar is deployed at the brigade and battalion levels and designates targets for the fire control radar. The fire control radar is an X-band radar deployed with the firing battery and appears to have autonomous search capability.

PROGRAM STATUS:

The program office has guidance from SDIO to develop the family of radars concept. Action for competitive procurement is in progress for a TMD DEM/VAL radar at White Sands Missile Range (WSMR), two User Operational Evaluation (UOE) radars at WSMR, and a strategic defense DEM/VAL radar at Kwajalein Atoll. System Engineering efforts aimed at identifying and defining modular requirements common to both the TMD and BMD versions are ongoing. Testing of the TMD DEM/VAL version is scheduled for FY94, the TMD UOEs in FY95 and the USAKA strategic defense DEM/VAL in FY96.

POINT OF CONTACT:

U.S. Army Strategic Defense Command
ATTN: SFAE-SD-GBR
P.O. Box 1500
Huntsville, AL 35807-3801

CONTRACTORS:

To be determined.

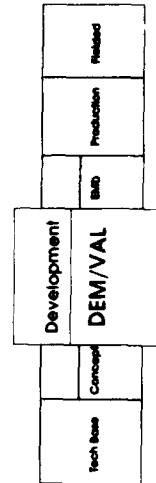

TECHNOLOGY 2000

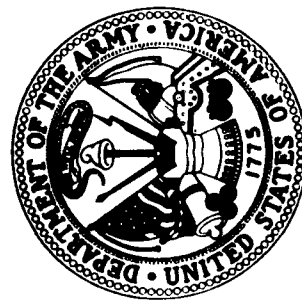
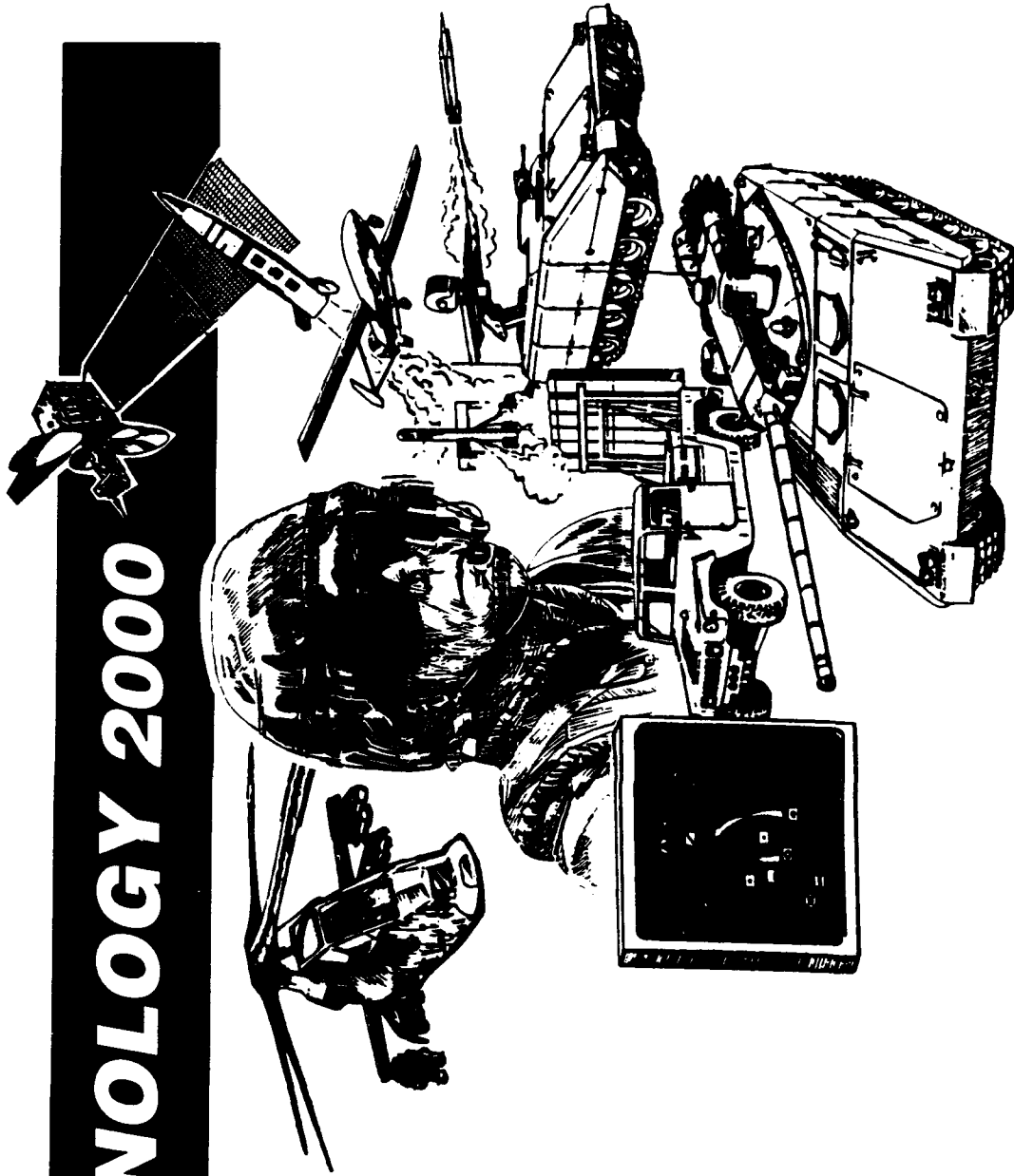

SCIENCE and TECHNOLOGY BASE

"The quality of American technology, thanks to the American worker, has enabled us to successfully deal with difficult military conditions and help minimize precious loss of life. We have given our men and women the very best. And they deserve it."

President Bush

January 1991 State of the Union Address

INTRODUCTION

The goal of the Army Technology Base is to continue providing future soldiers with the very best.

The Army's Technology Base is the genesis of a large portion of the high technology tools employed so successfully by our forces in Operation Desert Storm. Infrared and night vision technology, for example, let us own the night and saved many soldiers' lives. The Army's "Big 5" weapon systems, started two decades ago, proved themselves: the Apache and Blackhawk helicopters, Abrams tank, Patriot missile system, and Bradley Fighting Vehicle system. Operation Desert Storm also demonstrated that certain weapon system capabilities, based on superior technologies, are essential for success with minimum friendly losses on the modern day battlefield. These include: stealth, anti-tactical ballistic missiles, smart weapons/munitions, air mobility, chemical/biological detection and protection, mine/countermine, airland battle management, and exploitation of space.

Strategic plans start at the top. They contain a vision of the future, establish priorities and provide guidelines for implementation. The President's National Military Strategy (NMS) specifies that the principal focus of U. S. military planning is on deterrence and regional crisis response. The Army, in concert with the other services, is the strategic contingency force which must respond rapidly to regional crises and ensure that, if deterrence fails, these warfighting objectives can be achieved:

- Win decisively, swiftly
- Minimize casualties
- Minimize risk against future uncertainties.

Three independent categories of resources are needed for the Army to accomplish this mission throughout the next 15 years:

- A trained force of appropriate size and composition.
- Appropriate modernization of these forces throughout the next 15 years.
- Lift assets to ensure rapid deployment of these modernized forces worldwide.

As the world security environment continues to evolve, and as the Army continues to digest the many lessons from 1991's Operation Desert Storm, the Army's modernization strategy will also continue to evolve. Some things do not change, however. A central principle of the U. S. Army has been and remains that of providing the U. S. soldier with the world's best training and equipment. This principle is at the heart of the Army's force modernization strategy. This strategy calls for the continuous improvement and modernization of Army systems being put in the hands of its soldiers.

The technology base must continue to pursue technological advances that will provide tomorrow's soldiers with both evolutionary and revolutionary improvements in fighting capability. The Army modernization strategy recognizes that increased attention must be devoted to retaining viable technology and production bases in the face of declining resources for modernization. Once lost, many of these capabilities would be difficult if not impossible to recover.

The Army Technology Base Master Plan (ATBMP) is the Army's strategic plan for the technology base. It is based on the Army leadership's vision of the future Army, as constrained by realistic funding limits. It serves as "top down" guidance from the Headquarters, Department of the Army, to all Army technology base organizations, and is a vital link between DoD technology planning and the master plans of individual Army major commands, major subordinate commands, and laboratories.

BASIC PRINCIPLES

- o Satisfy our ultimate customer, the soldier, with superior technology embodied in quality equipment.
- o Strengthen the process of identifying future requirements through objective technology assessments, the sponsoring of technology demonstrations.
- o Explore revolutionary technologies and capabilities. Speed their technology maturation and transition through technology demonstrations.
- o Improve efficiency by stabilizing science and technology priorities and funding.
- o Improve program execution, oversight and peer review.
- o Focus on "world class" research relevant to the Army, aided by outside peer review and cooperative research and development agreements with industry and academia.
- o Attract, develop and retain quality scientists and engineers.
- o Restructure the Army laboratory and Research and Development Center system to better serve the Army of this decade and the next century.
- o Meet our obligations to society through support of small and disadvantaged businesses, Historically Black Colleges and Universities/Minority Institutions (HBCU/MI), youth out-reach programs, and sponsorship of environmental research.
- o Publish the Army vision, and the science and technology strategic plan in the Army Technology Base Master Plan (ATBMP).

RETURN ON INVESTMENT

The ATBMP projects the development and maturation of technologies for the Army's future systems. Indeed, it is this transfer of technology into hardware which makes the technology base a sound investment for Army resources. Over the last fifty years, Army R&D has developed and fielded a number of significant technologies.

In the future, we must be able to deploy overwhelming lethality while minimizing our losses. This requires:

- o Advanced land combat vehicles which will be lighter and more survivable due to the use of composite materials and integrated survivability technologies to be demonstrated on our Composite Armored Vehicle (CAV) technology demonstrator.
- o A product of the rotorcraft technology base, the Comanche Helicopter provides us the ability to self deploy unprecedented helicopter lethality, survivability, and versatility.
- o The Advanced Anti-Tank Weapon System (AAWS-M) provides the infantryman with a revolutionary fire and forget anti-armor capability, thanks to its focal plane array technology.

Once deployed, we must see the battlefield and command and control our forces while denying the enemy this capability. This requires:

- o Tactical application of satellites for communications, location (Global Positioning System, GPS) and intelligence.
- o AirLand Battle Management technologies including micro-electronics, artificial intelligence, data fusion and advanced displays.

The deployed force must have air defense. This requires:

- o Tactical Missile Defense.
- o Multi-role helicopter air-to-air missile with offensive as well as defensive capability.

In the battle, we need to see the enemy first, shoot first, and possess overwhelming stand-off lethality. This requires:

- * Advanced sensors and superior night vision technology.
- * Brilliant weapons and smart munitions.
- * Automatic target recognition.
- * Positive Identification Friend or Foe (IFF).

More important than any of these systems or technologies is the soldier. To prepare the soldier for the 21st century we will:

- o Exploit advanced distributed simulation coupled to modernized training ranges, centers and schools to provide the individual soldier, units, and commanders with unprecedented training.
- o Improve chemical and biological remote detection, protection, and decontamination.
- o Provide the best medical care via continued R&D for disease prevention and combat casualty care, exploiting biotechnology and vaccine research.

Finally, we need to improve the acquisition process to reduce the cost of our systems and technologies.

- o Advanced manufacturing technology and consideration of the manufacturing processes earlier in development to reduce costs.
- o Flexible, automated manufacturing for affordable quality at smaller quantities.
- o Advanced technology and product improvements for operating and support cost reduction (OSCR).
- o Increased technology demonstrations and prototyping to be sure we understand the technology, improve requirement definition, and ensure we are ready for development.

CONCLUSION

The Army Technology Base Master Plan is approved by the Secretary of the Army and the Chief of Staff of the Army. This plan is provided to government, industry, and academia to convey the Army's Science and Technology vision, objectives, priorities, and corresponding investment strategy. This document is resource constrained and is Department of Army guidance to drive funding priorities and the technology base program as a whole.

As defense budgets decline and international competition in science and technology continues to rise, we must protect our technology base. Technological superiority is a significant deterrent in itself. Technological superiority is essential if we are to defeat an increasingly lethal and wider array of potential threats to U. S. interests. Our Army Technology Base Master Plan is our road map to the future. With continued support, the Army technology base will ensure our technological superiority, avoid technological surprise, and afford us revolutionary warfighting capabilities for the next century. Today's soldiers benefit from past commitments to a robust technology base. Tomorrow's soldiers deserve no less.

Index

Abrams Tank (M1).....	25
Advanced Field Artillery System-Cannon (AFAS-C).....	77
Advanced Field Artillery Tactical Data System (AFATDS).....	167
Air-To-Ground Missile Systems (AGMS).....	91
Airborne Surveillance Testbed (AST).....	201
All Source System Analysis (ASAS).....	165
Apache.....	31
Armored Combat Earthmover (ACE)(M-9).....	121
Armored Gun System (AGS).....	21
Army Data Distribution System (ADDS).....	161
Army Tactical Missile System (Army TACMS).....	83
Automatic Grenade Launcher (40mm)(MK193).....	41
Avenger.....	63
Black Hawk.....	107
Bradley Fighting Vehicle (BFVS).....	27
Brilliant Nit-Armor Technology (BAT).....	79
Chaparral.....	69
Circuit Switch and Message Switch.....	181
Close Combat Tactical Trainer (CCTT).....	189
Comanche.....	11
Combat Service Support Control System (CSSCS).....	155
Communication System Control Element.....	177
Corps Surface-To-Air-Missile.....	53
Deployable Medical Systems (DEPMEDS).....	145
Digital Transmission Assemblages.....	179
Extended Range Interceptor Technology (ERINT).....	199
Family of Medium Tactical Vehicles (FMTV).....	135
Family of Vehicles (FOV)(M113).....	29
Forward Area Air Defense Command, Control and Intelligence (FAAD C2I).....	157
Forward Area Air Defense System (FAADS).....	55
Future Armored Resupply Vehicle-Ammunition (FARV-A).....	77
Ground Based Anti-Satellite (ASAT) System.....	207
Ground Based Common Sensors.....	101
Ground Based Interceptor (GBI).....	209
Ground Based Radar (GBR).....	213
Ground Based Sensor (GBS).....	61
Ground Based Surveillance and Tracking System (GSTS).....	211
Guardrail.....	119
Hawk.....	67
Heavy Expanded Mobility Tactical Truck (HEMTT).....	143
Heavy Expanded Transporter System (HETS).....	131
High Endoatmospheric Defense Interceptor (HEDI).....	203

High Mobility Multipurpose Wheeled Vehicle (HMMWV).....	109
Howitzer , 105 mm(M119).....	87
Integrated Family of Test Equipment (IFTE).....	139
Javelin.....	17
Joint Surveillance and Target Attack Radar System (Joint STARS).....	97
Kiowa Warrior.....	33
Light & Special Division Interim Sensor (LSDIS).....	59
Lightweight Manportable Radio Direction Finding System.....	105
Line of Sight Antitank (LOSAT).....	13
Logistics Support Vessel.....	147
Longbow.....	15
Maneuver Control System (MCS).....	159
Military Satellite Communications (MILSATCOM).....	175
MobileSubscriber Equipment (MSE).....	171
Mohawk (OV-1D) Surveillance System.....	115
Mortar, 120mm.....	23
Multiple Launch Rocket System (MLRS).....	89
Multiple Purpose Individual Munition (MPIM).....	9
NAVSTAR Global Positioning System (GPS).....	173
Night Vision and Electro-Optics.....	47
Night Vision and Electro-Optics.....	57
Non-Line of Sight (NLOS).....	193
Nuclear, Biological, and Chemical Defense.....	113
Nuclear, Biological, and Chemical Reconnaissance System (NBCRS)(XM93).....	133
Palletized Load System (PLS).....	65
Patriot.....	39
Personal Defense Weapon (M9 9mm).....	117
Quick Fix.....	123
Recovery Vehicle (M88A1).....	137
Reverse Osmosis Water Purification Unit (ROWPU).....	37
Rifle (M16A2).....	85
Self-Propelled Howitzer, 155mm (Paladin) (M109A6).....	81
Sense and Destroy Armor (SADARM).....	169
Single Channel Ground and Airborne Radio System (SINGARS).....	111
Smoke and Obscurants.....	191
Soldier Support Items.....	103
Special Operations Aircraft (SOA).....	43
Squad Automatic Weapon (SAW).....	163
Standardized Integrated Command Post System (SICPS).....	71
Stinger.....	19
Stingray.....	129
Tactical Quiet Generators (TQG).....	45
Tank Main Gun Ammunition, 120mm.....	205
Theater High Altitude Area Defense (THAAD).....	35
TOW Weapon System.....	99
Trackwolf.....	141
Truck, 5 Ton.....	141

