

20030228056

2

AD-A277 128



MAR 16 1994

ESL-TR-91-08

FIBER OPTIC CHEMICAL SENSORS

W.F. ARENDALE, R.HATCHER,
Y. GARLINGTON, J. HARWELL,
T. EVERETT, L. SHIELDS

THE UNIV OF ALABAMA IN HUNTSVILLE
LAB FOR INLINE PROCESS ANALYSES
KENNETH E. JOHNSON RESEARCH
CENTER
HUNTSVILLE, AL 35899

OCTOBER 1993

FINAL REPORT

MAY 1989 - MARCH 1991

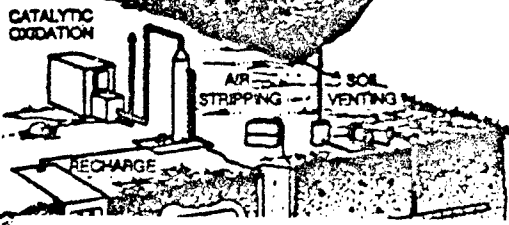
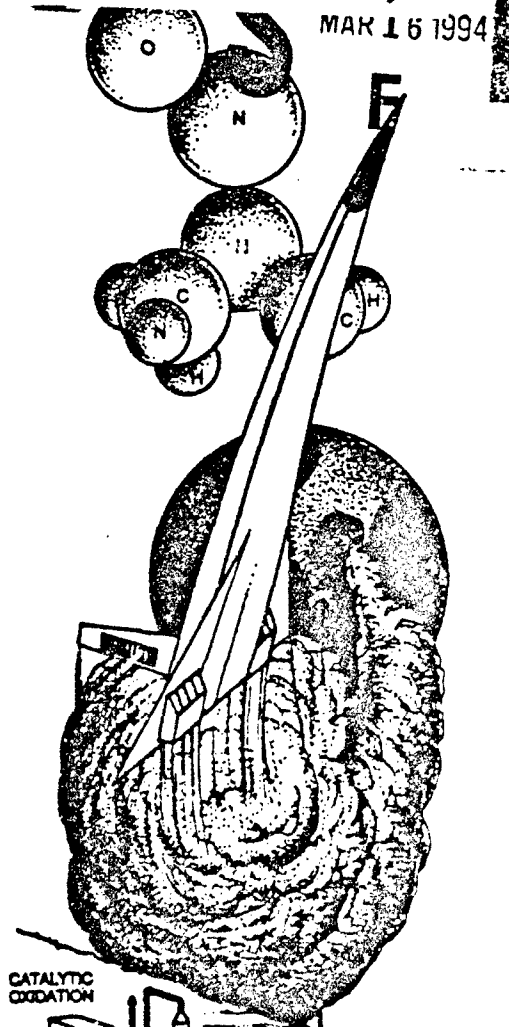

APPROVED FOR PUBLIC RELEASE:
DISTRIBUTION UNLIMITED

94-08447



ERIC QUALITY ASSURED 1



ENVIRONICS DIVISION
Air Force Engineering & Services Center
ENGINEERING & SERVICES LABORATORY
Tyndall Air Force Base, Florida 32403



94 08 447

NOTICE

PLEASE DO NOT REQUEST COPIES OF THIS REPORT FROM
HQ AFESC/RD (ENGINEERING AND SERVICES LABORATORY).

ADDITIONAL COPIES MAY BE PURCHASED FROM:

NATIONAL TECHNICAL INFORMATION SERVICE
5285 PORT ROYAL ROAD
SPRINGFIELD, VIRGINIA 22161

FEDERAL GOVERNMENT AGENCIES AND THEIR CONTRACTORS
REGISTERED WITH DEFENSE TECHNICAL INFORMATION CENTER
SHOULD DIRECT REQUESTS FOR COPIES OF THIS REPORT TO:

DEFENSE TECHNICAL INFORMATION CENTER
CAMERON STATION
ALEXANDRIA, VIRGINIA 22314

The following commercial products (requiring Trademark ®) are mentioned in this report. Because of the frequency of usage, the Trademark was not indicated. If it becomes necessary to reproduce any segment of this document containing any of these names, this notice must be included as part of that reproduction.

askSAM
dBASE
Data Junction
PC-File

Spectra Calc
SPSSX
Teflon
UNSCRAMBLER

Mention of the products listed above does not constitute Air Force endorsement or rejection of this product, and use of information contained herein for advertising purposes without obtaining clearance according to existing contractual agreement is prohibited.

REPORT DOCUMENTATION PAGE			FORM APPROVED GSA GEN. REG. NO. 27
1. AGENCY USE ONLY (Leave blank)		2. REPORT DATE October 1993	3. REPORT TYPE AND DATES COVERED Final Report 23 May 89 - 31 March 91
4. TITLE AND SUBTITLE Fiber Optic Chemical Sensors		5. FUNDING NUMBER F08635-89-C-0288	
6. AUTHOR(s) W.F. Arendale, R. Hatcher, Y. Garlington, J. Harwell, T. Everett, L. Shields		7. PERFORMING ORGANIZATION NAME(S) AND ADDRESS(ES) The University of Alabama in Huntsville Laboratory for Inline Process Analyses Kenneth E. Johnson Research Center Huntsville, AL 35899	
8. PERFORMING ORGANIZATION REPORT NUMBER JRC Research Report 91-08		9. SPONSORING/MONITORING AGENCY REPORT NUMBER TR 91-08	
10. SUBJECT TERMS AFESC 139 Barnes Drive, Suite 2 Tyndall Air Force Base, FL 32403-5319		11. SUPPLEMENTARY NOTES AFESC Project Officer: Bruce J. Nielsen	
12. DISTRIBUTION STATEMENT This technical report has been reviewed by the Public Affairs (PA) Office and is releasable to the National Technical Information Service, where it will be available to the general public, including foreign nationals.		13. ABSTRACT This final report describes a database that supports the development, engineering and manufacturing of dependable chemical sensors which include fiber-optics in the design and which are suitable for use in the field by technicians. Inexperienced investigators using the database can start with the state of the art rather than starting over each time a requirement for a new chemical sensor is established. The expectations are shorter development times and reduced development and engineering costs.	
14. SUBJECT TERMS Spectroscopy Absorption Spectroscopy ATR Spectroscopy		15. NUMBER OF PAGES 165	
16. SECURITY CLASSIFICATION Unclassified		17. SECURITY CLASSIFICATION OF ABSTRACT UL	
18. SECURITY CLASSIFICATION Unclassified		19. SECURITY CLASSIFICATION Unclassified	

(The reverse of this page is blank.)

PREFACE

This report was prepared by the Laboratory for Inline Process Analysis, Kenneth E. Johnson Research Center, University of Alabama in Huntsville, Huntsville, AL 35899 under Contract No. F08635-89-C-0288, for the Air Force Engineering and Services Center (AFESC), Suite 2, 139 Barnes Drive, Tyndall Air Force Base, Florida 32403-5319. The work was performed between May 1989 and March 1991. The AFESC project officer was Bruce Nielsen.

This final report describes a database that supports the development, engineering and manufacturing of dependable chemical sensors which include fiber-optics in the design and which are suitable for use in the field by technicians. Inexperienced investigators using the database can start with the state of the art rather than starting over each time a requirement for a new chemical sensor is established. The expectations are shorter development times and reduced development and engineering cost.

This technical report has been reviewed by the Public Affairs Office (PA) and is releasable to the National Technical Information Service, where it will be available to the general public, including foreign nationals.

This report has been reviewed and is approved for publication,

BRUCE I. NIELSEN, GS-12
Project Officer

ROBERT G. LAPOE, Maj, USAF
Chief, Site Restoration R&D Branch

MICHAEL G. KATONA, PhD
Chief Scientist, Environics Directorate

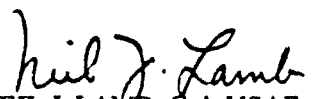
NEIL J. LAMB, Col, USAF
Chief, Environics Directorate

Accession For	
NTIS CRAS	<input checked="" type="checkbox"/>
DTIC TAB	<input type="checkbox"/>
Unannounced	<input type="checkbox"/>
Justification	
By	
Distribution/	
Availability Codes	
Dist	Avail and/or Special
A-1	

TABLE OF CONTENTS

Section	Title	Page
I	INTRODUCTION	1
	A. OBJECTIVES	1
	B. BACKGROUND.....	1
	1. General History	1
	2. Contract Work Statement.....	4
	C. APPROACH	5
II	DATABASE	7
	A. CHOICE OF SOFTWARE FOR PREPARING THE DATABASE ...	7
	B. DESCRIPTION OF askSam AS RELATED TO CONTRACT OBJECTIVES.....	8
	1. Description of "Method" File.....	9
	2. Early Observations	11
	C. COUNCIL FOR NEAR INFRARED SPECTROSCOPY DATABASE	14
III	THEORY	15
	A. REVIEW OF APPLICABLE OPTICS THEORY.....	15
	1. Reflection of Radiation From a Nonabsorbing Surface.....	15
	2. Effect of an Absorbing Film on a Reflecting Surface.....	17
	3. Absorption by Transparent Substances.....	17
	4. Reflection and Refraction of a Beam.....	18
	5. Multiple Total Internal Refraction	19
	6. Conclusion	21
	B. REVIEW OF SPECTROSCOPIC TECHNIQUES	23
	1. Absorption Spectroscopy	24
	2. Scattering of Radiation	25
	3. Conclusion	26
	C. REVIEW OF CHEMOMETRIC TECHNIQUES	26
	1. Removing Noise From Low Signal/Noise Spectra.....	27
	2. Removal of Outliers and Interferents.....	27
	3. Multivariate Statistics	28
	4. Models.....	29
	5. Conclusions.....	29

TABLE OF CONTENTS
(Continued)

Section	Title	Page
IV	EXPERIMENTAL WORK TO VALIDATE THEORY	31
	A. USE OF MULTIVARIATE ANALYSES	31
	1. Advances in Analytical Chemistry	32
	2. Quantization of Multiple Analytes	34
	3. Application to Interferents	39
	4. Selection of Training Set	40
	B. DESCRIPTION OF THE SPECTROPHOTOMETER	42
	1. The Optical Bench	46
	2. Gratings and Detectors.....	48
	3. Experimental Setup and Sample Probes	48
	4. Analyses of Benzene, Toluene and Xylene.....	50
	5. Analyses of Trichloroethylene and Related Compounds.....	63
	C. FIBER OPTICS AND RELATED OPTICAL PROBLEMS	63
	1. Temperature Fluctuations and Microbends.....	63
	2. Modification of Cladding.....	65
	3. A Sensor Using a Silicone-Clad Fiber.....	66
V	BREADBOARD DESIGNS	75
	A. DESCRIPTION OF TEST APPARATUS	75
	B. DESIGN OF UV NIR PROBE	79
	C. CONCEPT FOR AN INTEGRATED SYSTEM	80
VI	OBSERVATIONS AND CONCLUSIONS	83
APPENDIX		
A.	OPTRODE DEVELOPMENT.....	87
	A. BACKGROUND AND PROBLEM DEFINITION	89
	1. Introduction.....	89
	2. Problem Statement.....	89
	B. STATEMENT OF WORK	90
	1. Approach to Capturing and Improving FOCS Technology	90
	2. A Bolder Experimental Approach	92
B.	MODELS	97
	A. QUANTITATIVE OR ANALYTICAL.....	99
	B. QUALITATIVE.....	101

TABLE OF CONTENTS

(Continued)

Section	Title	Page
	C. HEURISTIC OR EMPIRICAL.....	101
C.	SPECIFICATIONS FOR SPECTROPHOTOMETERS.....	105
	A. SINGLE BEAM SPECTROPHOTOMETERS.....	107
	B. DOUBLE BEAM SPECTROPHOTOMETERS.....	108
D.	BIBLIOGRAPHY.....	109
	REFERENCES.....	163

LIST OF FIGURES

Figure	Title	Page
1	Screen Print of askSam Record.....	10
2	Apparatus for FOCS Implementation.....	13
3	Pattern for Reflected Light Rays.....	16
4	Reflection and Refraction at Air - Water Interface.....	18
5	Total Internal Reflection.....	19
6	Ray Transmission by Total Internal Reflection.....	20
7	Losses Due to Bend in Fiber.....	20
8	Losses in a Fiber.....	21
9	Microstrain Sensor.....	22
10	A Complete Cable.....	22
11	Interaction of Molecules With Electromagnetic energy.....	24
12	Listing of Multivariate Methods Available.....	28
13	Statistics of the Blank vs the Statistics of the Analyte.....	34
14	Spectra of Three Analytes.....	35
15	Spectra of Mixture of Three Analytes.....	35
16	K Matrix for Beer's Law.....	36
17	Noise as found using 7 Point Savitsky Golay Smooth.....	36
18	Representation of Principal Component Analyses.....	37
19	Spectra of Analyte and Interferant.....	39
20	Spectra of KI, I ₂ (aq), and KIO ₃	41
21	Scanning Fiber Spectrophotometer.....	47
22	Radiation Pattern at the Detector Slits.....	48
23	Defraction Gratings and Detectors.....	49
24	Systems Components.....	51
25	Benzene (0.5ml/l water) 5cm Absorption cell UV-VIS.....	52
26	Toluene (0.5ml/l water) 5cm Absorption cell UV-VIS.....	52
27	Xylene (0.5ml/l water) 5cm Absorption cell UV-VIS.....	53
28	1:1:1 Benzene, Toluene, Xylene 5cm Absorption Cell UV-VIS.....	53
29	Benzene (neat) ATR Dip Probe NIR.....	54
30	Toluene (neat) ATR Dip Probe NIR.....	54
31	Xylene (neat) ATR Dip Probe NIR.....	55
32	1:1:1 Benzene, Toluene, Xylene ATR Dip Probe.....	55
33	Jet A Fuel (neat) 1mm Absorption Cell NIR.....	56
34	Benzene (neat) 1mm Absorption Cell NIR.....	56
35	Toluene (neat) 1mm Absorption Cell NIR.....	57
36	Xylene (neat) 1mm Absorption Cell NIR.....	57
37	5:2:2:1 Jet A, BTX 1mm Absorption Cell NIR.....	58
38	5:1:1:2 Jet A, BTX 1mm Absorption Cell NIR.....	58
39	5:2:1:2 Jet A, BTX 1mm Absorption Cell NIR.....	59
40	Trichloroethylene (neat) 1mm Absorption Cell NIR.....	64
41	Trichloroethylene (neat) Dip Probe NIR.....	64
42	Sensor Designs Using the Evanescent Wave.....	66
43	Coiled Fiber ATR Probe.....	67
44	Benzene (1ml/liter water) Coil Above Solution (30 minutes).....	70
45	Toluene (1ml/liter water) Coil Above Solution (30 minutes).....	70
46	Xylene (1ml/liter water) Coil Above Solution (30 Minutes).....	71

LIST OF FIGURES
(CONCLUDED)

Figure	Title	Page
47	1:1:1 BTX (1ml/l water) Coil Above Solution (30 Minutes).....	71
48	Ratios of Jet A and BTX; Coil Fiber Sensor (1mL/1000mL Water); above solution	72
49	Ratios of Jet A and BTX; Coil Fiber Sensor (.2ml/1000mL Water); Sensor immersed	73
50	Trichloroethylene (neat) Coiled Fiber Sensor NIR	74
51	Trichloroethylene (0.1ml/liter water) Coiled Fiber Sensor	74
52	System Test Apparatus	76
53	UV NIR Probe	79
54	Integrated Monitoring System	81
B-1	Models	100
B-2	Prediction Error vs Complexity	104

SECTION I

INTRODUCTION

A. OBJECTIVES

The goal for this research effort was a database that supports the development, engineering and manufacturing of dependable chemical sensors which include fiber optics in the design and which are suitable for use in the field by technicians. Inexperienced investigators using the database can start with the state of the art rather than starting over each time a requirement for a new chemical sensor is established. The expectations are shorter development times and reduced development and engineering cost.

B. BACKGROUND

1. General History:

The need for increased communication system capacity at reduced cost per message unit has spurred the development and installation of hundreds of operating lightwave communication systems around the world. Compared to wire systems, optical fiber transmission systems operate with less energy per unit-message unit-mile, lower signal attenuation per unit distance, higher bandwidth for increased signal capacity, lower shock hazard, less influence from spurious radiation, smaller size, less weight, and many other advantages. These advantages have encouraged improvements in light sources; optical fibers, cables, and connectors; photodetectors; dispersion devices, for example small gratings; graded index lens; and multiplexers.

The availability of new and improved optical components has enabled significant progress toward the development of photonic sensors employing fiber optics. These sensors can detect acoustic and magnetic fields, temperature, pressure, liquid level, and many other parameters. Department of Defense researchers have developed many effective devices that have resulted in greater safety and efficiency aboard aircraft, on navy vessels, and sensors for under water detection. The Army has developed missiles guided by optical fiber communication channels.

Analytical chemists, particularly spectroscopists, recognized the potential applications of these optical developments. Optrodes (optical electrodes) at the end of optical fibers to be used for chemical analyses were described. An early application at Oak Ridge National Laboratories (ORNL) was related to the use of quartz fibers to carry optical signals for spectroscopic measurements to and from solutions at high radiation levels which made conventional sampling techniques impossible. The chemical composition (seven components) of a process stream was controlled in real time using a dedicated computer and eight filters rotating at speeds of several cycles per second. Quartz fibers of the highest purity were required for this application because impurities in the quartz cause radiation damage to the fiber which results in signal attenuation. This example of process control using small quantities of fibers preceded the building of facilities to manufacture the larger quantities of fiber required to support the telecommunication devices. Today pure quartz fibers are very important to the modern telecommunication industry.

Subsequent adaptations of spectrophotometry for remote in situ analyses have revolutionized processes for the production of many chemicals. Real-time analyses replace the time-consuming practice of collecting a sample, taking it to the laboratory, and waiting for the analyses. Multicomponent analyses of production processes for major constituents and some minor components are well developed techniques.

Dr. Tomas Hirschfeld and associates at the Lawrence Livermore National Laboratories (LLNL) began the development of a class of fiber optic chemical sensors designated as FOCS. FOCS were characterized as small chemical laboratories placed at the end of an optical fiber. The optical fiber was used to observe a color change, chemical precipitation, or an absorption of a new chemical species as a chemical reaction occurred. The various chemical reactions occurred in small ampules on the end of the fiber or in a modified cladding provided on a short section near the end of the fiber. A creative and well-executed research program demonstrated the feasibility of chemical selectivity and detection of minor and trace components. The LLNL work is documented in internal reports, patents, and abstracts of talks at professional meetings. Relatively few publications, however, are found in technical journals. Technology transfer from LLNL proceeded along two paths. License rights were negotiated

with several companies. A smaller portion of the work was pursued by the Environmental System Laboratories at Las Vegas (EMSL/LV).

Commercial activities split primarily into two groups; one group was interested in process development in chemical manufacturing, and a second group was interested in "sticks" (small needle devices that can be placed in the body to make in situ measurements). The companies interested in chemical processing have reported increase productivity through the use of proprietary devices. However, the activity is within the company as an engineering and service activity. A small number of companies have introduced packaged instruments on the market.

A separate approach was taken by Mr. David LeFebre when he founded Guided Wave Inc., El Dorado Hills, California. He recognized the need for a spectrophotometer that supported fiber research and established a company with the objective of developing, manufacturing and distributing a spectrophotometer. Most of the photonic sensor systems developed within the chemical manufacturing industry are believed to use the Guided Wave spectrophotometers as a component of the system.

In 1986 The University of Alabama in Huntsville, UAH, organized the Center for Applied Optics. Dr. John Caufield was selected as the first director. Dr. Caufield had been a professional associate of Dr. Tomas Hirschfeld at Block Engineering during the development of the Fourier Transform Infrared (FTIR) Spectrophotometer. The first cooperative effort between Dr. Caufield and Dr. Arendale, UAH Professor of Chemistry, was a small contract, Dr. Arendale as Principal Investigator, with Dr. Bernie Bulkin at Standard Oil Co., Cleveland Ohio. Dr. Hirschfeld had recently died of a heart attack. The work statement provided for review and documentation of technology related to fiber optic sensors for measurement of chemical analytes. To aid in this work, Dr. Stan Klainer, a third colleague of Dr. Hirschfeld and Dr. Caufield, was employed as a subcontractor on the program. Dr. Stan Klainer was operating as ST&E in Livermore, California and also had contracts at LLNL. Dr. Arendale was serving as a consultant with United Space Boosters, Inc., in Huntsville Alabama. USBI, Inc. is a division of

United Technologies Inc. The United Technologies Research Center has an outstanding fiber optics program. The union of these four approaches was expected to have great promise.

A decision was made by Standard Oil not to extend the effort with the University of Alabama in Huntsville Center of Applied Optics to include the development of improved new sensors. Principal stumbling blocks were disagreements on proprietary and patent rights. A major problem was identification of the property of ST&E vs LLNL. ST&E was formed to manage the activities of Dr. Hirschfeld and Dr. Klainer separate from their activities at LLNL. Although Dr. Klainer was appointed an Adjunct Scientist in the Center of Applied Optics, he did not wish to accept the University's patent policy. The work of Dr. Klainer and Dr. Arendale separated at this point.

The technical report and the UAH proposal to Standard Oil Company prepared by Dr. Arendale were not widely distributed. These documents summarize the state of the art that existed in late 1986 when the proposal which resulted in this Air Force contract was prepared. Selected portions from these two documents have been reproduced as APPENDIX A of this report.

2. Contract Work Statement

The Laboratory for Inline Process Analyses of the University of Alabama in Huntsville initiated research under contract F08635-89-C-0288 8 July, 1989 to develop "Advanced FOCS Sensors." Objectives of the effort were as follows: The first phase was to develop FOCS design data bases. The second phase was to determine design parameters and functions, such as Beer's Law, for the design of aromatic hydrocarbon FOCS. The design parameters and databases were to be organized such that they can be readily updated and utilized for developing FOCS for new analytes. The third phase was to consist of laboratory verifications of models using optical components. Phase IV provided for breadboard constructions and testing of FOCS using design databases and models. The final phase was the development of specifications for one or more prototype instruments based on the tested breadboards.

C. APPROACH

This research program was divided into five parts. The initial efforts were related to the collection and critiques of available literature references. The Principal Investigator's collection of references and reprints was augmented with additional references using the literature base of the Redstone Scientific Information Center. The references were collected into an intelligent database using askSam, a computer program from askSam Systems, Inc. At this point, critique of the references was the basis for selection of theory applicable to the research effort. A decision was made to investigate all classes of chemical sensors which include fiber optics in the design rather than limit the investigation to FOCS. Laboratory experiments were performed to validate that the selected theory was applicable. Selected components were collected and tested as breadboard configurations. Based on these experiences, recommendations were formulated for specifications that can be used for the procurement of environmental monitoring systems which include fiber optics.

SECTION II

DATABASE

The initial task was to organize the available data (several hundred publications collected by Professor Arendale) into a database that could be made available to a larger community. The collection had become so large and was growing so fast that personal memory was no longer practical as a guide to searches. A search was made for methods for organizing and searching the references to meet the objectives for this contract. Placing the information in a computerized database was an easy decision.

A. CHOICE OF SOFTWARE FOR PREPARING THE DATABASE

The contract requirement for the Data Base/Computer software product is:

The tabular data shall be produced in a MS-DOS text file format, with only ASCII printable characters and blanks in the text. The data shall have the text positions of the fields defined in a fixed format to allow its importation into file management programs both in the microcomputer and the minicomputer (DBASE, FORTRAN, BASIC, and C are presently envisioned).

The files are to be delivered in the MS-DOS 360K 5 1/4 inch floppy disk format. Files that are too large for a single disk shall be partitioned into several files capable of fitting on the media, rather than using the MS-DOS backup and restore facilities (prevents compatibility problems with different versions of MS-DOS).

Since FORTRAN, BASIC, and C programs can be written to read an ASCII file of known format, limitations to format contained in the work statement are specified by the dBASE requirement. The dBASE format is almost a de facto standard for spreadsheet and database programs. Therefore, a prime software requirement was the capability to import and export dBASE files. This requirement did not eliminate any program that was seriously considered.

DATA JUNCTION, software licensed by Tools & Technology Inc., Austin, Texas came to our attention. This software converts files from the format of all the higher sales volume database and spreadsheet software to other supported formats. The software is sufficiently well recognized that a new company will often make arrangements to be included in the list of programs supported as a means of making market penetration.

The software chosen for in-house work was askSam, a program developed by Seaside Software, Inc, now askSam Systems Inc., Perry, Florida. askSam is a free-form information manager. A few basic elements of structure can be used to create a highly structured database, or a word-wrapped, scrollable textbase. Information is broken down into files, which are broken into documents and/or records which may contain textual information and fielded data. askSam accepts assorted data types, from simple words to scientific notation, and from structured fields to unstructured text. These features were combined to produce an intelligent database with elements of artificial intelligence, AI.

B. DESCRIPTION OF askSam AS RELATED TO CONTRACT OBJECTIVES

askSam is a unique product that combines the features of a database management system and some of the features of a text editor or word processor. Unlike other database management systems, askSam handles structured as well as unstructured data. Unlike word processors, askSam handles highly structured data. askSam can be used as both a database manager and a free-form information manager. With askSam, you enter and store free-form text, then write short programs to retrieve the organized information you want. With askSam you do not have to anticipate what you need to include in your information base. The information is written in a way that makes the most sense to you, using the words you want, anywhere on the screen. With askSam, you can retrieve single characters, multiple words, or entire documents. You can do Boolean searches, arithmetic, logical, date and time comparisons. askSam includes the necessary programming features that it can be used as a complete database applications development tool.

1. Description of "METHOD" File

For some reason, now forgotten, the database file for this collection of reprints and Xerox copies was called "METHOD". Figure 1 is a reproduction of the screen that shows the record for a selected reprint. At the top of the screen are the operations which can be performed. Choosing UPDATE DOCUMENT would start the program editor word processor, to allow changes in the recorded material. Other commands permit the scanning forward or backward through the records in the file, and the selection or making of records.

Below the line is the record for a document. The search engine can be used in case-sensitive mode. Therefore, information can be coded by the use of case as well as form. The @JOURNAL statement was placed at the beginning of this record in upper case as a marker to be used when programming searches and printouts. When printing bibliographies, different forms are used for books, journals, and correspondence. If a bibliography were being printed and a search had hit on this record, then the record would be searched for @JOURNAL to determine how to format the reference. If @ BOOK was found a different format would be used. The next field is No[. Selecting the sequence by which references are to be filed in an open-ended file is difficult. With askSam, each reprint is filed in a separate folder and folders are numbered in consecutive order. As the typist processes a reprint, it is put into the next file folder. Before computerization of this collection of material, some manual sorting had been conducted. To maintain this information for individuals familiar with the collection of reprints, each of the parts of the collection was assigned a number using the first digit of the four-digit number.

The AU[field is for the author names. The search routine does not require this field identification, but the field identifier can be used as any other combination of letters. The writing of programs for printouts is simplified using field identifications. The fixed field formats are stored in templates. Entry of information is made faster by using a macro command to add a template to the screen so that data is always entered on the same line. TI[is title. Note that the titles are typed with key words beginning with capital letters. The abstract may also contain these same words, but the words would be in lower case. Therefore, abstracts and titles can be searched separately with false drops occurring only when a word is capitalized because it

UPDATE DOCUMENT Rem'br Hypertext Print <Alt-Fn> G K M S Z
 <Esc> done Delete Add Back-doc <PgUp> back-rec
 <space> next Last Edit Tag Next-doc <PgDn> next-rec

@JOURNAL

No[3019

AU[Milanovich, Fred P.; Garvis, Darrel G. and Angel, S. Michael]

TI[Remote Detection of Organochlorides with a Fiber Optic Basic Sensor]

JN[Analytical Instrumentation]

YR[1986]

VO[15(2)]

IS[AIS]

PG[137-147]

KEY[FLUORESCENCE MEMBRANE FOCUS DRAW]

ABS[Optical fibers, analytical chemistry, and fluorescence spectroscopy have been integrated to form the new technology of remote fiber fluorimetry. Among the many potential applications of this technology is the measurement of volatile organochlorides in ground water and in the vadose zone. The key to this application was the development of a fiber optic chemical sensor (FOCS) with sub-ppm sensitivity for, at least, chloroform and trichlorethylene (TCE). We present here the concept and instrumentation of remote fiber fluorimetry, the design and laboratory evaluation of an organochloride FOCS, and preliminary field results of the application of the FOCS to contaminated well water.

Figure 1. Screen Print of askSam Record

is the first word in a sentence in the abstract. JN[represents journal. By consistently entering a journal in the same format, a search can be made for all articles in the database appearing in a selected journal. A search could also be made for all publications in a given year by a selected author. VO[, IS[, and PG[are for volume, issue, and pages. The AIS entry in the IS[field is a code that this information was missing at the time this entry was made. As we refined the database, a search for these codes was used to make a list to be taken to the library.

KEY[is for key words. These were entered in upper case. A list of key words is shown as Table 1. This particular list of keywords represents the Principal Investigator's, PI's, initial interests at the time the entries were assigned. The keywords are entered in upper case to allow searches by keywords. Since each record can be edited as desired, new key words can be added as information is obtained to indicate that a new keyword is desirable. The Principal Investigator uses key words to allow retrieval of groups of documents. For an example, a key word is added so that all references used in a paper or report can be retrieved. Since the keywords are in upper case, it is possible to search for a word and select that it should occur in the title, the abstract, or as a keyword. The switch on the search can also be set to ignore case doing the search and report any occurrence of the word as all caps, caps and lower case, or lower case. ABS[contains the abstract. Although this feature is extremely useful it does not appear in the project database. This type field, variable length, is not easily adaptable to dBASE format. Distributing abstracts may also violate copyrights of some journals. This feature was extremely useful and time-saving as we searched the database for the selection of theory applicable to this research project and as we planned the experiments for validation of the theory.

2. Early Observations

As the papers were sorted and notations made for the word processors, some observations were obvious. An example would be Figure 2.

This illustration, or an adaptation, occurs in many publications. Although it gives a conceptual idea of the equipment used, details of the actual equipment were not given. The Principal Investigator saw a model on a visit to LLNL and made some notes, but these notes were of little use when we started our work on validation of theory.

**TABLE 1. KEYWORDS USED IN "METHOD" DATABASE
(COUNT OF REFERENCES SHOWN IN PARENTHESES)**

1000 SOFTWARE ALGORITHMS (201)

1. PLS	(12)	7. SIMCA	(10)	13. AI	(1)
2. FACTOR	(70)	8. SVD	(8)	14. CORRELATION	(10)
3. TARGET	(13)	9. SIGNAL	(25)	15. DECONVOLUTION	(11)
4. REGRESSION	(12)	10. KUBELKA-MUNK	(0)	16. TIME_RESOLVE	(3)
5. LEAST_SQUARE	(18)	11. EQUILIBRIUM	(15)	17. PATTERN	(6)
6. THEORY	(69)	12. DERIVATIVE	(10)		

2000 SPECTROSCOPIC PROCEDURES (185)

1. ABSORBANCE	(14)	7. NIR	(49)	13. HADAMARD	(2)
2. RAMAN	(47)	8. MIDIR	(48)	14. EMISSION	(6)
3. DIFFUSE	(45)	9. PH	(7)	15. FOURIER	(19)
4. FOCUS	(39)	10. MATH	(5)	16. DIODE_ARRAY	(6)
5. UV	(38)	11. ATR	(20)	17. MICROSCOPY	(1)
6. VISIBLE	(13)	12. FIGURE	(13)		

3000 LUMINESCENCE (138)

1. FLUORESCENCE	(73)	5. FLOW	(2)	9. TABLE	(1)
2. RESONANCE_RAMAN	(11)	6. LASER	(20)	10. DRAW	(35)
3. SUBSTRATE	(7)	7. MEMBRANE	(8)	11. EQUATION	(8)
4. WAVEGUIDE	(6)	8. PHASE	(4)	12. SERS	(2)

4000 WAVEGUIDE PROBES (11)

1. ATR	(16)	4. FLAT	(10)
2. HOLLOW	(11)	5. ROUND	(4)
3. FIBER	(48)		

5000 ANALYTIC CHARACTERISTICS (1)

1. AROMATICS	(1)	2. BENZENE	(0)	3. EOSIN B	(0)
--------------	-----	------------	-----	------------	-----

6000 COMPONENTS (151)

1. GENERAL	(119)	4. MONO-SOURCE	(4)
2. PROPERTY	(0)	5. DETECTORS	(12)
3. LED	(7)	6. MONOCHROMATORS	(7)

7000 MICROSENSORS (12)

1. ELECTRONICS	(1)
----------------	-----

8000 GTDR (8)

1. STANDARD	(1)	2. DISTRIBUTED	(1)
-------------	-----	----------------	-----

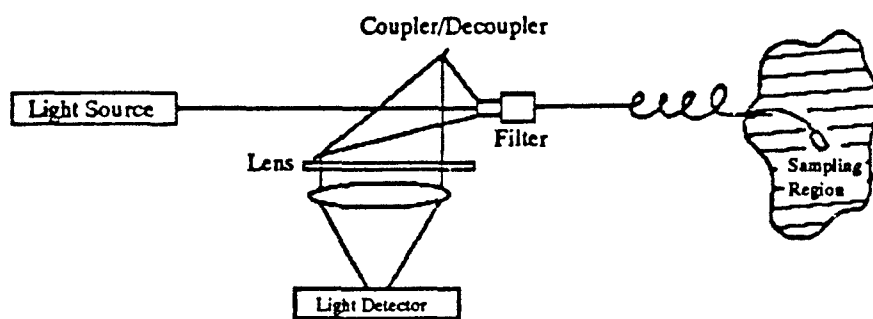

Figure 2. Apparatus for FOCS Implementation

Dr. Hirschfeld was a prolific publisher; a list that was compiled shortly after his death showed over 700 publications with approximately 50 publication related to FOCS. There are few refereed publications in the FOCS group. Also there is a very high ratio of patent applications compared to the other areas of Dr. Hirschfeld's research interests. Early patents were assigned to LLNL. Latter patents were assigned almost randomly: one was assigned to Mr. Myron Block, his former employer at Block Engineering, one with Dr. David Honig and Dr. Hiefje to Indiana University Foundation, and one to the University of Washington, Center for Process Analytical Chemistry. Dr. Hirschfeld was a respected scientist. He gave exciting and optimistic talks describing the future of FOCS. As an investigator in the field it became imperative to attend symposia arranged for by FACSS, PITTCOM, SPIE and ACS to learn of the advances in the state-of-the-art. An experimenter talking with other attendees was aware that there was extensive activity.

Most frustrating to the objectives of this project is to attend meetings and to meet with old acquaintances and to hear that they are involved in patent infringement lawsuits which are preventing the introduction of products on the market. On the other hand, industries which have in-house staffs that can develop equipment and who do not plan to market instrument systems are using photonic sensors with favorable results to solve problems and increase profits.

C. THE COUNCIL FOR INFRARED SPECTROSCOPY DATABASE

The Council For Near Infrared Spectroscopy maintains a database available at \$700 or at a discount price to members. This group has used PC-File software, Buttonware, Inc. shareware. Current purchasers of this database receive a licensed copy of PC-FILE 5.0. The database is distributed in four parts:

1. 1905 - 87 (1499 hits)
2. 1987 - 88 (558 hits)
3. 1988 - 89 (314 hits)
4. 1989 - 90 (Search in progress)

This database grew from the searches made by Professor W. Fred McClure, North Carolina State University, Raleigh, North Carolina. Professor McClure's primary interest was agricultural products. His technical interest was the use of Fourier Transform. For most of his work, he applied chemometric procedures to the interferograms as obtained rather than the transform.

Professor McClure was active in the formation of the Council of Near Infrared Spectroscopists. Recently this group became more closely affiliated with the International Committee on NIRS. In addition to the database, the group sponsors both national and international meetings as well as short courses and symposia. It also participates in the publication of books.

The database has always used Buttonware software. PC-FILE started as shareware. PC-FILE 5.0 is a respected product. The files are compatible with dBASE. Dr. Arendale purchased the first 1400 references from Professor McClure. After the database was adopted as a CNIRS project, several companies made donations to the cost of the searches. Key words have been added and several individuals have supported Dr. McClure.

CNIRS is associated with the Society of American Spectroscopists, SAS. SAS includes many associated groups. The ASTM Subcommittee E-13.09 on Fiber Optics in Molecular Spectroscopy meets each year at FACSS and Pittcom.

Newcomers to the field of fiber optic chemical sensors should consider participation with CNIRS.

SECTION III

THEORY

Qualitative ideas related to the development of satisfactory FOCS and photonic sensors were developed as the documents were coded and collected into the Database. The second task was to select applicable theory as related to the publications, related information, and experience. A review of optics literature and procedures was first. The second subject was spectroscopic instrumentation. The third area was related to methods for handling weak signals and the problems related to signal/noise ratio.

A. REVIEW OF APPLICABLE OPTICS THEORY

Arendale and Jeffreys (1) at the University of Alabama in Huntsville Research Institute in 1967 conducted an experimental study related to reflected energy from laser illuminated targets under U.S. Army Grant DA-ARO-D-31-124-12761. The University of Alabama in Huntsville was one of the first institutions to become active in the study of remote spectroscopy and spectroradiometry.

Measurement of the characteristics of scattered radiation can provide significant information about a surface.

1. Reflection of Radiation From a Nonabsorbing Surface

The first consideration in the study of reflected energy from a particular surface must be an evaluation of the general reflection characteristics. Most texts on illumination engineering recognize two extremes of reflected energy, specular represented by (A) and Lambertian represented by (B) in Figure 3. If a surface is polished (microscopically smooth) it reflects; that is, the angle between the reflected ray and the normal to the surface will equal the angle between the incident ray and the normal. A perfectly reflecting surface, will reflect all of the energy with the same angular dispersion as the incident beam. If a material has a rough surface or is composed of minute crystals or pigmented particles, the reflection is diffuse. Individual rays obey the laws of specular reflection; but, since the surface is rough or the particles may be in different planes or different orientations, the light is reflected in all possible

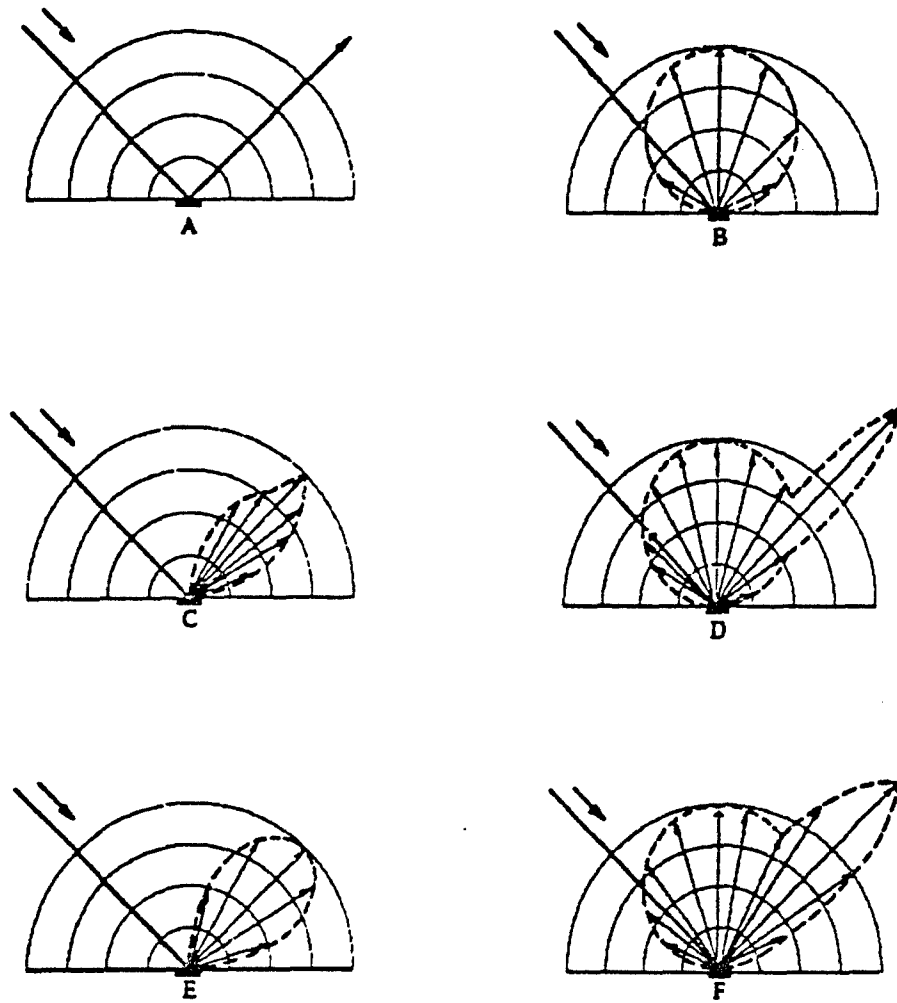

Figure 3. Patterns For Reflected Light Rays

directions. A Lambertian surface is defined as a surface where the intensity of reflected energy is independent of the angle of observation. Lambert's Law (based on many observations and not theory) can be stated:

$$I_r = I_o \cos \theta \cos \psi$$

where I_0 is the intensity of the radiation at normal incidence, θ is the angle of incidence, and ψ is the angle of observation. Many combinations of specular and diffuse radiation are observed from real surfaces. Four frequently observed patterns are shown in Figure 3. as C, D, E, and F.

Much work has been done, particularly by illumination engineers to describe the intensity of radiation from a surface under various lighting conditions. Also, many references can be found to studies of polarization upon specular reflection. Fresnel's formulas for the reflection of polarized radiation can be found in most textbooks on optics. Although these theories are applicable to reflection spectroscopy and spectroradiometry, applications to sensors related to aquifers is limited. Therefore, further review is not included in this report.

2. Effect of an Absorbing Film on a Reflecting Surface

When the reflecting surface absorbs radiation at a given frequency, or if an absorbing thin film covers the surface, the chemical composition can often be identified. The use of polarized monochromatic radiation (obtained from monochromators) to measure the index of refraction and the absorption coefficient of thin films is an important scientific tool. Chemical analyses by spectroradiometry and reflection spectrophotometry have become important tools available to the material scientist.

3. Absorption by Transparent Substances

When monochromatic light is passed through an absorbing medium with the incident collimated beam normal to the surface, the intensity of the ray decreases exponentially. This phenomena frequently follows the Beer - Lambert Law:

$$A = \text{Log } i/i_0 = E C L$$

where A is the absorptivity, I is the intensity of light passing through the sample, I_0 is the original intensity, E is the absorptivity coefficient, C is the concentration expressed in moles/liter, and L is the path length. Spectrophotometry is a well-developed science. Instrument manufactures compete to incorporate advancing technologies.

4. Reflection and Refraction of a Beam

When a ray traveling in a low index of refraction medium strikes a non opaque surface of higher index of refraction, some of the light is reflected and some of the light is refracted. This condition is represented in Figure 4.

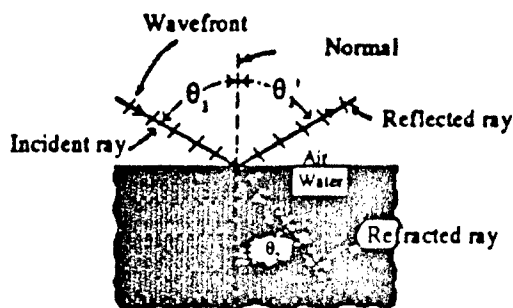

Figure 4. Reflection and Refraction at Air - Water Interface

$$n_{\text{air}} < n_{\text{water}}$$

θ_1 and θ_1' represent the angle of incidence and the angle of reflection. θ_2 is the angle of refraction. All angles are measured from the normal to the surface. The laws governing reflection and refraction can easily be found from experimentation.

1. The reflected and refracted rays lie in the plane formed by the incident ray and the normal to the surface at the point of incidence.

2. For reflection: $\theta_1' = \theta_1$

3. For refraction, $\sin \theta_1 / \sin \theta_2 = n_{21}$ where n_{21} is a constant called the index of refraction. The index of refraction of one medium with respect to another varies with wavelength. Because of this fact, refraction, unlike reflection, can be used to analyze a beam of light into its component wavelengths. The Laws of Reflection and Refraction can be derived from Maxwell's equations. These laws should hold for all regions of the electromagnetic spectrum.

The path of a beam traveling in a higher index of refraction medium passing to a medium of lower index of refraction is shown in Figure 5.

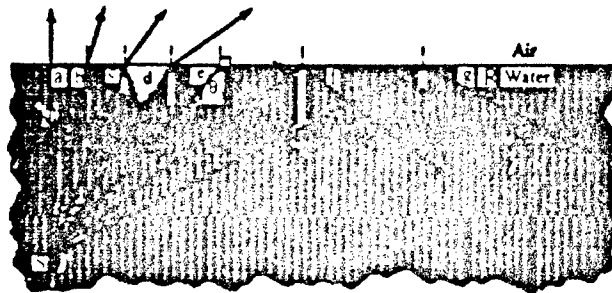

Figure 5. Total Internal Reflection

As the angle of incidence, θ , is increased, a situation is reached (see ray e) at which the refracted ray points along the surface, the angle of refraction being 90° . For angles of incidence larger than this "critical angle", no refracted ray exists, giving rise to a phenomenon called total internal reflection. The critical angle is found by putting $\theta_2 = 90^\circ$ in the law of refraction.

$$n_1 \sin \theta_c = n_2 \sin 90^\circ$$

$$\sin \theta_c = n_2/n_1$$

Total internal reflection does not occur when the ray originates in the medium of lower index of refraction.

5. Multiple Total Internal Reflections

If a ray enters a nonabsorbing rod at an angle greater than the critical angle then the ray can pass through the rod without attenuation. This condition is represented in Figure 6.

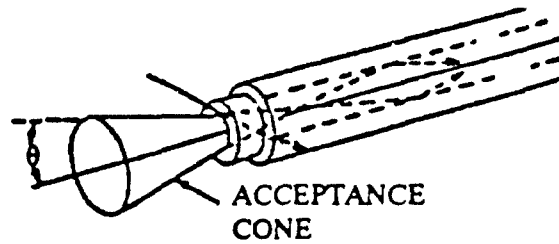

Figure 6. Ray Transmission by Total Internal Reflection

The acceptance angle is defined by the critical angle. The numerical aperture, NA, is calculated by the following formula

$$NA = \sin \theta = \sqrt{n_1^2 - n_2^2}$$

$n_1 > n_2$

The cone of light exiting the other end of the rod will be defined by a similar cone. If the entrance cone is smaller than the acceptance cone, the exit cone will usually fill the full cone. If there are bends in the fiber there will be energy losses to the cladding as shown in Figure 7.

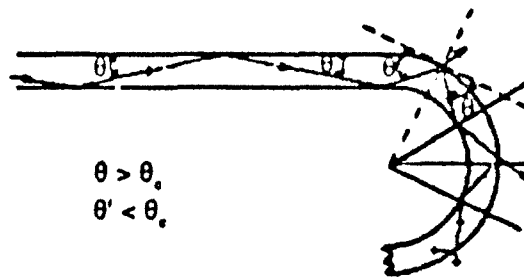

Figure 7. Losses Due to Bend in Fiber

The losses to the cladding represent loss of signal and the cladding modes also perturb the signal. If the cladding modes carry a high percentage of the energy, the exit cone can appear as a doughnut. Frequently the cladding is removed for a short distance before the detector so that only core radiation reaches the detector.

6. Conclusion

Fiber acceptable for remote spectroscopy must be carefully selected. Some flaws that are undesirable are shown in Figure 8.

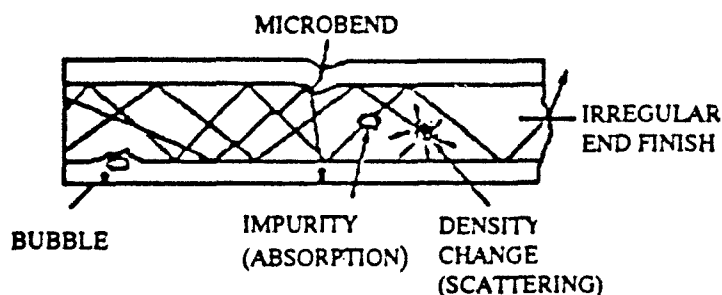

Figure 8. Losses in a Fiber

These flaws must be eliminated from fiber used for photonic sensors and from transmission lines to or from a sensor. Absorbing impurities reduce the length of fiber that can be used. Small particles in a fiber cause scattering. Fiber manufacturing has improved so that quartz fibers are available from many manufacturers. There is not a single quartz fiber that can transmit in the complete range of interest to spectroscopists. A fiber containing residual hydroxyl, OH, groups is required if the region in the ultraviolet from 190 to 250 nanometers is important. For spectroscopy in the near infrared region, NIR, all hydroxyl groups must be removed from the silica. There is a hydroxyl absorption band in the second overtone region at approximately 1450 nanometers that is extremely difficult to eliminate.

Probably the single most important parameter related to the performance of optical fibers is the surface between the core and the cladding. If the silica fiber comes in contact with moisture in the air as it leaves the drawing furnace, small cracks form. These cracks reduce tensile strength and decrease signal strength. Fiber is drawn in a moisture free inert atmosphere. The lower index of refraction required for the cladding is often obtained by drawing the fiber into a fluorine atmosphere. This not only removes the OH groups by reaction, but the fluorine diffuses into the quartz providing the desired lower index of refraction coating

that serves as the defining cladding. To prevent the penetration of moisture that would cause microcracks which would result in attenuation of signal and low tensile strength in the fiber a buffer is usually added. Polymer coatings, usually proprietary to each manufacturer, are added.

Microbends divert signal energy into cladding modes. Many excellent sensors for measuring microstrain have used this feature. A simple strain sensor is shown in Figure 9.

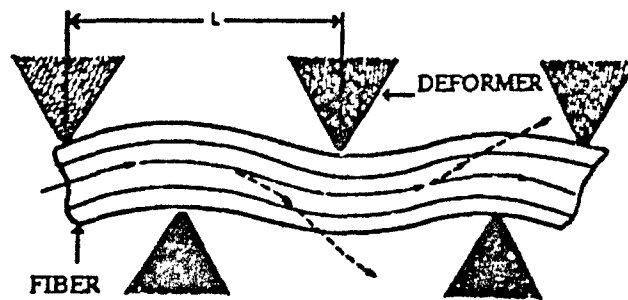

Figure 9. Microstrain Sensor

The attenuation of signal due to microbends represents an almost uncontrollable loss of signal in optical fibers used to connect sensors to the light source and detector. Better precision is obtained when the fiber is supported by cabling. One cable is shown in Figure 10.

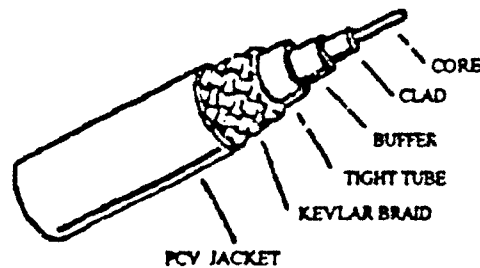

Figure 10. A Complete Cable

The use of uncabled fiber for experiments reported in the literature was judged to be a major factor that prevents reproducibility by other laboratories. When uncabled fiber is

used, the fiber should be supported in a fixed position and the sample carried to the fiber. The uncabled fiber should not be moved from sample to sample.

Guided Wave, Inc. manufactures fiber, cables, and has been a vested interest in successful applications of the spectrophotometers that they manufacture. The Laboratory for Inline Process Analyses was one of the initial customers to use the Guided Wave, Inc. spectrophotometers for chemical analyses. The Laboratory instrument and cables have been updated frequently as improvements were made. Since fiber and cables, possibly the best obtainable, were available for this experimental program, fibers from other manufactures were not tested except as sensors. The resources from this contract were used to evaluate other components of the desired system. Procedures recommended by Guided Wave, Inc. representatives were used.

B. REVIEW OF SPECTROSCOPIC TECHNIQUES

Telecommunication networks use lasers at a single frequency for each channel of information. Many frequencies can be passed over a single fiber optic cable at the same time without interference. Although lasers have been developed for many frequencies, the number is small compared to the absorption features for molecules. To use these lasers as energy sources, the spectroscopist would be limited in the number of molecules that could be observed. The spectroscopist prefers to use white light, which contains all frequencies, since each molecule has a distinctive absorption pattern that is as singular to the molecule as finger prints are to humans. In theory, a spectroscopist could identify as many different chemical species as the number of wavelengths that are recorded. This is one reason that spectroscopy is so powerful as an analytical tool. Figure 11 shows the type of information that can be obtained by spectroscopists in several regions of the electromagnetic spectrum.

Wavelength(nm)	10	100	1000	1000	100	10	.01
Wavelength (cm ⁻¹)				10 000	10 ⁵	10 ⁶	
Spectral region	Far	Middle	Near	Near	Far	Soft	Hard
Characteristic process excited in region	Microwaves	Infrared		Visible	Ultraviolet	X-ray	
Characteristics spectrum	Molecular rotation in gases	Molecular rotations in gases, inter-molecular vibrations in solids liquids	Intramolecular vibration in liquid, solids plus rotations in gases	Excitation of electrons as ν increases plus intramolecular vibration and rotations		Electronic excitation of inner shell in atoms	
Energy of transition (eV mol ⁻¹)	Pure rotational lines	Rotational-vibrational lines in gases liquids and					
	kJ mol ⁻¹ 0.12		11.96	11.96		1.196 < 10 ⁵	
	1.24 x 10 ³		0.12	12.4		1240	

Figure 11. Interaction of Molecules With Electromagnetic Energy

1. Absorption Spectroscopy

Absorption spectrophotometry is the measurement of the attenuation of a beam of light as it passes through an absorbing medium. Spectroscopy is usually characterized by the wavelength of the illuminating electromagnetic energy. One division is ultraviolet, UV, spectroscopy covers the region from 190 to 400 nanometers, visible, VIS, 400 to 900 nanometers, the near infrared, NIR, 900 to 1600 nanometers, the infrared from 1600 to 2500 nanometers, and the far infrared the region to 40 microns. With new types of sources and detectors being announced almost daily, there is vigorous competition between spectrophotometer manufacturers. Research has passed from the design of stronger sources to the design of attenuators to protect some of the newer more sensitive detectors from saturation. These developments are causing major redirection in research efforts. The availability of stronger signals and more sensitive detectors has decreased the observation times from hours to milliseconds. It would be impossible to take advantage of these technological improvements if there were not parallel developments in computer technology.

The advancement in performance of sources and detectors, has made possible a decrease in instrument size. As recently as 5 years ago a spectrophotometer occupied its own air-conditioned room. The base was isolated from room vibrations. Today spectrophotometers are being packaged in units that can be carried by one person. The instruments are being placed in stressed cases and the manufacturers claim they can be dropped from reasonable heights without damage. These instruments can be carried into the field under harsh environments.

2. Scattering of Radiation

Many types of scattered radiation can be used for the quantization of analytes. Luminescence spectrophotometry includes the phenomena of fluorescence and phosphorescence. The earliest investigations were limited to ultraviolet excitation. The higher energy photons obtained from hydrogen lamps and arc sources were required for the quantum excitation of electrons. The observations were usually limited to aromatic molecules or molecules with conjugated unsaturation. The stronger sources and more sensitive detectors available today have increased the working range and the number of molecules that can be observed. Since this is a scattering phenomenon the signal is usually obtained at right angles to the exciting beam. When a molecule absorbs the energy of the exciting radiation, it passes into an excited state. Each excited state has a characteristic stability. From some molecules, the photon is released immediately; for others the emission is delayed. Measuring the decay time is the basis for time resolved fluorescence or phosphorescence. These measurements depend on pulsed radiation and measuring decay times.

An important spectroscopy related to scattered radiation is Raman spectroscopy. When a molecule is irradiated, it enters a virtual excited state. Energy can be absorbed by many energy levels and released at different wavelengths as the molecule drops to other energy levels. The energy of the virtual state is sufficient that vibrational energy levels are involved. Raman spectroscopy is synergistic with mid-IR spectroscopy. Raman spectroscopy can take advantage of sources and detectors in the near UV, visible, and NIR. The Raman signal is the weakest of the scattered signals described for a given number of molecules. Raman spectroscopy has probably benefited more than any spectroscopy from the availability of the newer high-energy lasers that furnish the monochromatic energy required. Raman spectroscopy also can take

advantage of the new, very sensitive detectors in the 700 nanometer range. The largest improvement in Raman instrumentation design is the availability of holographic edge filters that eliminate the need for long path length and double monochromators to filter out the exciting radiation that scatters and masks the Raman signal. Over the past 10 years, observation times for Raman spectroscopy have dropped from hours (sometimes 24 hours) to milliseconds. A resurgence of interest in Raman spectroscopy occurred when the first lasers became available to replace the arc lamp. Until recently, however, the instruments were still very large and cooling water was required. One investigator, Dr. Mike Carrabba, EIC, Inc. is predicting that he will have a Raman spectrometer that can be carried as a backpack into the field within the next 2 or 3 years.

3. Conclusions

The Guided Wave, Inc. Spectrophotometer available in the laboratory was considered adequate to support the research effort related to sensors and using single optical fibers. Resources provided by this contract were not used to evaluate alternate design of spectrophotometers as the literature review did not provide descriptions of superior performance.

C. REVIEW OF CHEMOMETRIC TECHNIQUES

Most instruments today use a computer to supervise routine operations that previously required the presence of a technician. Today a laboratory microcomputer can accomplish tasks that once required a mainframe computer. When the decision is made to use a computer for routine operations and a computer is dedicated to an instrument there are significant blocks of time when the computer is waiting for the timer to indicate that the next operation is to be performed. This time can be used for calculations. These considerations have led to the development of real-time instrumentation. The measurements no longer require an attendant, and the answer for the quantization of an analytes are immediately available. This information can be used to control an industrial process or to sound an alarm that a chemical is leaking into the environment.

1. Removing Noise From Low Signal/Noise Spectra

A major problem with photonic sensors is the low signal/noise recordings that are obtained. When analog signals are recorded, the mass of the recorder pens or the gauge smooths the signal. Resistance-capacitance filters can also be used. When computers are used, discrete values are recorded. Data are available only for the time periods when the analog to digital conversions are made. As contrasted to analog recordings, no information is available concerning what has happened in the time period between the points. The human eye and mind can recognize patterns. When the computer makes the conversion at a specified time, this may also be a time at which a noise transient occurs. Two decisions are required: (1) How close together will the points be and (2) how many replications of the conversion will be made so that an average may better represent the instantaneous value without the associated noise. If the noise is Gaussian and enough measurements are taken, the noise will approach zero. When recording spectra, the spectroscopist must choose between slow scans averaging many values as the recording is made and taking points rapidly and adding several scans. The advantages of each method will be described with the experimental data in the next section. The data must always be smoothed. Again there are many different algorithms. Choice of the method for recovery of true data from the noise may be the most important criteria when evaluating instrumental methods. Two of the most widely used methods are Savitsky-Golay smoothing and Fourier smoothing. There is no correct answer. Each data set must be evaluated on its merits.

2. Removal of Outliers and Interferents

When working with samples of unknown origin, substances not included in the calibration or training set may be present as interferents. The developer of the method tries to make the calibration as robust as possible. When working with whole spectra methods, the nonfitting spectra are usually referred to as outliers. There are no absolute measurements. Therefore, statistical methods are used to evaluate the uncertainty of the method. Descriptive statistics methods are usually used for this purpose. The uncertainty is expressed as a function of the distribution of the values of the measurement. The uncertainty of the measurement is usually expressed as the standard deviation. A range of plus or minus two standard deviation includes 95 percent of the observations. When greater assurance is required, additional determinations

are made and the values added. Developments in statistical evaluation have led to algorithms where measurements are made at a number of points on either side of the desired measurement and a trend analysis is performed. This is particularly valuable where peak heights are measured. A small instrumental error treated as the abscissa can cause a large error in the evaluation of an analyte. This has led to a group of methods referred to as whole spectrum procedures. Instead of using only a few points in a spectrum, the entire spectrum is used.

3. Multivariate Statistics

One of the biggest advances in statistical methods has been the development of multivariate statistics. The literature is full of references to such algorithms as PLS, partial least squares. An incomplete enumeration of some of these methods is shown as Figure 12.

LEAST SQUARES	FACTOR
K MATRIX	SIMCA
REVERSE MATRIX	CLUSTER
PCA	PATTERN RECOGNITION
PLS - 1	PLS-2
PCR	

Figure 12. Listing of Multivariate Methods Available

These algorithms evaluate the variance-covariance matrix. A group of samples, is evaluated for the largest source of variance. This variance is removed and then the next largest source of variance is determined. These vectors are usually referred to as factors. These are mathematical processes and often it is difficult to associate the abstract factors obtained from variance measurements with causality. Malonowski (2) has described a method called target factor analysis where the abstract vectors can be assigned with higher certainty. Powerful methods for the detection of analytes are possible without rotation and/or translation of the abstract vectors into recognizable real-world vectors.

4. Models

Reproduced as Appendix B is a discussion of the different types of models that have been considered for this research effort. As will be described in the next section, we depend heavily on statistical or empirical models. A statistical model can always be found that fits a data set. The successful use of these models depends on the choice of the training or calibration set. Any variable that may be found in real samples must vary in the training set. It is not necessary to know the exact values. The major effort is placed on quantization of the analytes of interest. The calibration accuracy is reproduced in the unknown set.

5. Conclusions

Chemometrics is an interdisciplinary effort that combines statistics, computer science, and chemistry. Academic administration often dictates that chemometrician are located with the analytical chemists. The Principal Investigator, a spectroscopist by training, taught the graduate analytical chemistry course in chemometrics at The University of Alabama in Huntsville.

The conclusion reached by the Principal Investigator was that the available spectrophotometers and fiber optic cables were adequate and represented the state of the art. The major portion of the experimental effort should be concentrated on sensor designs. The evaluation of the data would include as many of the available chemometrics computer algorithms as resources permitted.

SECTION IV

EXPERIMENTAL WORK TO VALIDATE THEORY

In SECTION III, THEORY, three areas of technology were evaluated as possible sources of the delays that have been experienced in the maturation of FOCS technology. These areas were optics, spectroscopy, and failure to incorporate advances in computer technology and new software algorithms. The optical fibers and spectrophotometers available in the Laboratory for Inline Process Analyses were judged adequate for the experimental evaluations related to photonic sensors. The study of the literature did not indicate that chemometric techniques had been used for data reduction. Experiments were conducted using selected photonic sensors described in the database and multivariate analyses procedures were used during data reduction.

A. USE OF MULTIVARIATE ANALYSES

Multivariate analyses and/or analyses of variance methods have been recognized and used for many years. The popular software product SPSS (Statistical Programs for the Social Sciences) is now in the eleventh version. Nearly all of the algorithms used in the applications software available for multivariate statistical evaluation of data, directly or indirectly, use the variance-covariance matrix. Therefore, the programs are searching for variance. The search techniques are supported by statistical theory. The techniques isolate abstract factors. The identification of the meaning of these abstract factors in the real world is the responsibility of the user. Methods have been described for rotating the orthogonal axes so that the investigator may have a better chance of recognizing the sources of variance. This remains a difficult problem in the social sciences. First, the person being observed is often affected by the presence of the observer. Second, the number of samples in the population is small. When these procedures are used to discover sources of variation in the physical sciences, neither of these problems exists. The experimenter can change the experimental conditions, but the presence of the experimenter is not believed to change the response of the molecules. The predominant theory in the physical sciences, related to physical change, is the Kinetic Molecular Theory. A hypothesis of this theory is that molecules can be described as statistical populations. Also, a mole of molecules contains 10^{23} molecules. Chemical systems should meet the assumptions of the statistical procedures.

1. Advances in Analytical Chemistry

Analytical chemists, who have available to them the most advanced instrumentation can provide analyses for smaller samples and more dilute solutions than their predecessors. Implementation of computer programs based on multivariate statistical algorithms makes it possible to obtain reliable information from long data vectors that contain large amounts of extraneous information, for example, noise and/or analytes for which there is no requirement for control.

Today, data are obtained as the records of human observations and the digitized output of many sensors. This raw data becomes useful information when it relates to the system under observation. A highly useful technique is to relate the data to a MODEL. Several types of models are described in APPENDIX B. For many individuals, a model that simulates the process being monitored is the most useful. The minimum requirement for the model that we seek is that it integrate the database of past experiences with the system and the data currently being gathered and then to determine if the process is in the control region where observed variations are normally distributed. The model should also predict the near future condition of the system, and most important, for manufacturing plants, the product should satisfy the intended use.

Knowledge comes from confirmation of mental models that describe the past and/or predict the future. This statement is the heart of the Total Quality Management, TQM, movement in the Department of Defense and the Deming Method for quality. Dr. W. Edwards Deming (3) recently defined knowledge:

A statement conveys knowledge if it helps us to predict or to explain what has happened in the past. Nor there is knowledge in that statement. There are facts, of course. The dictionary is full of information. The number of prime numbers less than 100 is a number. You can put them down and count them. This is dictionary knowledge. It doesn't predict anything. Knowledge means prediction or explanation of past events. Physics is

knowledge. Chemistry (is knowledge). Science is knowledge because it explains and predicts what will happen in the future under certain conditions or explains what has happened in the past. I predict if I drop this pen it will fall to the table. A prediction, it conveys knowledge.

Sometimes prediction carries with it a high degree of belief. Sometimes extremely high as the statement about gravity that I just made. Associated with any prediction is degree of belief. How strong do we believe it. We plan, make plans for today for tomorrow. We are predicting today. We will find out later how good our prediction was.

.....There is no such thing as an absolute measurement.

Science advances with the ability to measure. A significant portion of engineering activity is related to measurement. The human desire to see further and further and to see smaller and smaller objects drives advanced technology. Advances in technology have resulted in many new types of instruments for use by the analytical chemist. The microscope when combined with the FT-IR spectrophotometer or a Raman spectrophotometer allows identification of particles as small as 10^{-12} grams of a pure material embedded in the surface of a different host. Using the hyphenated techniques such as GC-MS, LC-MS, GC-MS-MS, GC-UV, and many others, concentrations of parts per trillion or less of analyte can be quantitated in samples of microliters. Do these advances represent blessings or curses? At times those individuals who are responsible for protocols with respect to litigable procedures and standards may consider these advances as curses. Particularly, if the new measurements create new paradigms.

When working with small quantities and concentrations that push the limits of detection, the information is embedded in signals characterized by low signal-to-noise ratio. This can lead to lack of understanding and difficulties in communicating with individuals who hold to the tradition that a measurement can be made to an absolute standard. Many have not

been introduced to the techniques of multivariate statistical analyses as provided to the analytical chemist by Wold, Kawolski, Malinowski, Massart, Martens, and their many associates (4).

One example of a problem where statistics plays an important role is the quantization of an analyte at low concentrations where the signal is obtained at poor signal/noise ratio. Shown on Figure 13. are some of the required decisions.

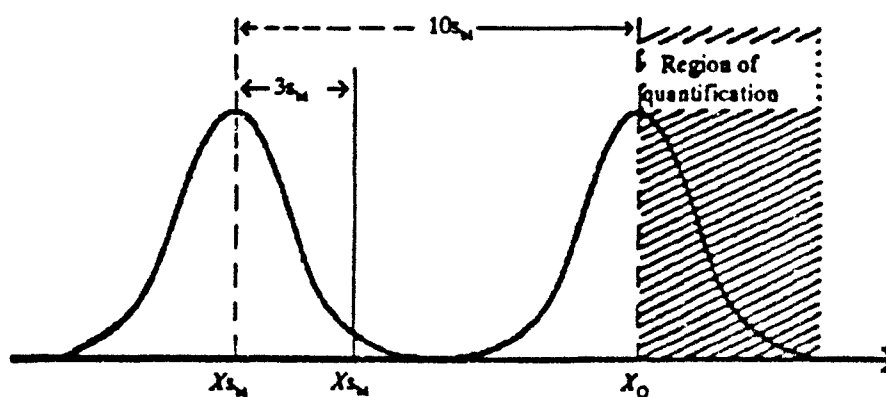

Figure 13. Statistics of the Blank vs the Statistics of the Analyte

For this example we show measurements on the blank containing no analyte and measurements on the sample as being normally distributed. Plus or minus three standard deviations about the means includes 99.9 percent of the measurements. For an enforceable litigable procedure, it is necessary to set some minimum level of detection. If we are concerned about an environmental pollutant, it is desirable to set the lowest possible limit for quantization consistent with known hazards. For such purposes, the limits of detection may be set at ten standard deviations for the blank. Although this may be the best compromise for the litigable limit, it is of little use to the plant technician who must prevent an analyte being added to a river or an aquifer.

2. Quantization of Multiple Analytes

The Beer-Lambert relationship

$$A = \text{Log } I/I_0 = E_{\lambda} C L$$

where A is the absorptivity, I is the measured power after a collimated beam of light has passed through an absorbing medium, I_0 is the power before any light has been absorbed or scattered, E_λ is the molar absorptivity coefficient, C is the concentration of the analyte in moles/liter, and L is the path length is the basis for calibration of single analytes. A simplified absorption spectra of three analytes is shown in Figure 14.

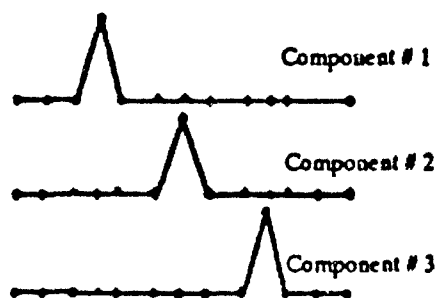

Figure 14. Spectra of Three Analytes

Spectra for several mixtures of the three analytes are shown in Figure 15.

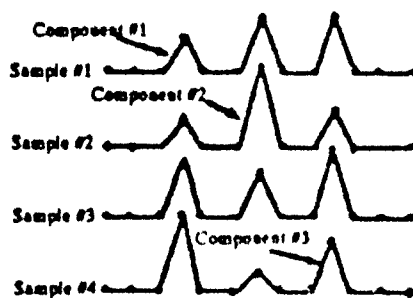

Figure 15. Spectra for Mixtures of Three Analytes

Since the absorption peaks in the three analytes do not overlap, the spectrum of the mixture can be analyzed for each component. The matrix equation for the absorptions is shown in Figure 16.

$$\text{Beer's Law } A_i = \sum_{j=1}^n k_{ij}c_j + e_i$$

$$\text{K - Matrix } A = KC$$

$$\begin{bmatrix} A_1 \\ A_2 \\ \vdots \\ A_i \end{bmatrix} = \begin{bmatrix} k_{11} & k_{12} & \dots & k_{1n} \\ k_{21} & k_{22} & \dots & k_{2n} \\ \vdots & \vdots & \ddots & \vdots \\ k_{i1} & k_{i2} & \dots & k_{in} \end{bmatrix} \begin{bmatrix} C_1 \\ C_2 \\ \vdots \\ C_n \end{bmatrix}$$

Figure 16. K Matrix for Beer's Law

Compared to the Beer-Lambert Law equation given above, the matrix equation has been simplified by assuming a constant path length or a path length of 1 centimeter, and combining E_λ times L into the constant K . The experimental problems relate to being sure the spectrophotometer is setting at the correct wave length for the highest point on the absorption peak and that there is no effect from noise. If the noise is Gaussian, with an equal number of positive and negative noise signals being added to the desired signal, the effect of noise can be minimized by averaging several measurements. The reproducibility of the spectrophotometer wave length setting is usually a function of design and the operator has minimal control. The spectrum obtained by smoothing; a spectrum using a 7-point Savitsky-Golay routine and subtracting the smoothed spectrum from the original spectrum is shown on Figure 17.

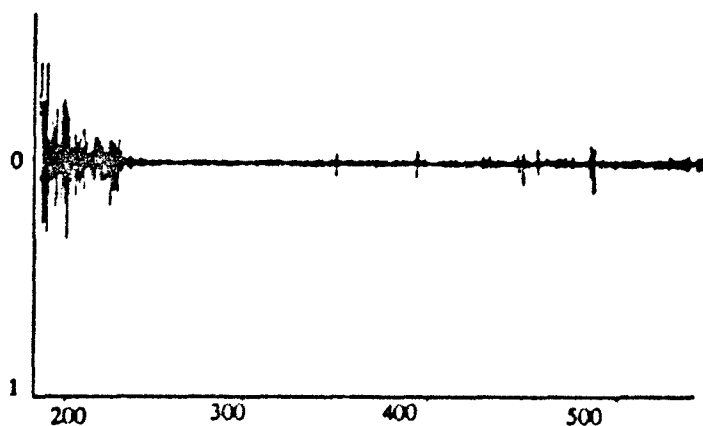

Figure 17. Noise as Found Using 7-Point Savitsky-Golay Smooth

Note that there is severe random noise at both ends of the spectrum where the signal-to-noise ratio was the poorest. However, the noise appears random and therefore meets the definition of Gaussian distribution. When a single peak is used, we use the combined signal-plus-noise observation that may be correct, high, or low. We accept the value and plot statistical control charts for the observations. If this is the measurement for a process control variable, we cannot take corrective action based on this measurement. The UCL, upper control limit, and the LCL, the lower control limit, control our actions. If the value is between the UCL and the LCL, we do not tamper with the system as the measurements are following a normal statistical distribution. Can we improve the observation by correcting for noise? Sure. Take data at several frequencies on each side of the observation point and make a statistical fit for the shape of the peak. It is the practice in this laboratory to take data at as many frequencies as the computer storage register will allow and make a statistical fit to the spectrum. This is frequently done by applying principal component analysis. The concept of principal component analyses is shown in Figure 18.

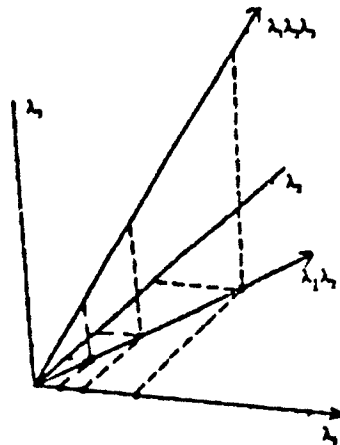

Figure 18. Representation of Principal Component Analyses

If three samples were being considered, the absorption values could be plotted on the λ_1 axis. The absorptivities for the same three samples measured at a second wavelength could be plotted on

the λ_2 axis. Unless there is an interaction between the components in the three samples then the ratio for the measured values would be the ratio of the absorptivities of the pure samples at these two wavelengths. Therefore, by vector addition, the three samples could be represented by three points on the λ_1 λ_2 axis. This principle can be extended to three wavelengths. The human mind can recognize a pattern in three dimensions. A computer can calculate the points to represent spectrum in many dimensions. As stated above, we often use as many points as the buffer in the computer will accommodate. The principal component axis that the computer calculates is the axis of best fit for all of the frequencies used. If the measurement at a given frequency includes noise in addition to the signal for that frequency, it would represent a variance from the best-fit line. Therefore, by use of the whole spectrum, we find the best representation for the spectrum using all observed spectral points. The first principal component may be subtracted from the variance - covariance matrix and the process repeated. We then find the second component. This is an abstract mathematical computation. The removal of principal components can be continued until we have a component or components for the noise. These are of little interest. Two questions must be answered. How many of the components are real components and what is the spectra of the real components? Many procedures have been proposed to answer the first question. The Screen plot is frequently used. Each component represents less and less of the variance. When the sum of the variance becomes large and little improvement is gained by adding another component, then a good compromise is reached.

The question of what the principal components represent is more difficult. Target factor analysis represents one method (2). If the analyst expects that a component is present and has the spectrum of that component, this spectrum can be multiplied into the variance - covariance matrix to find the rotation required to yield this spectrum. It is possible to use this method to construct a rotation matrix and identify the concentration of each component. This procedure requires the K Matrix, the extinction coefficient spectrum for each component in the mixture. Frequently the spectrum of some of the components in a mixture are not available and other methods must be used.

Unless the analyst wishes to establish a relationship with an interpretation based on causality, it is not necessary to identify the components or factors to perform quantitative

analyses for known components. To use this method a calibration set is required that meets the following conditions:

1. Typical samples are available for the training set.
2. The samples span each of the individual phenomena that can be controlled.
3. The samples are randomly selected to insure a chance of spanning the noncontrollable phenomena.

3. Application to Interferents

The application of multivariate analysis to the problem of interferents can be describe using Figure 19.

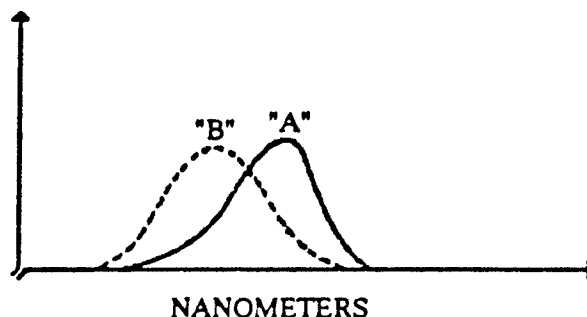

Figure 19. Spectra of Analyte and Interferent

An absorption peak in the spectrum of an analyte is represented by Curve A. The spectrum of a known or unknown interferent is represented by Curve B. The typical single point measurement technique measures the absorption at the point of maximum absorptivity. The measured value of A for a sample will depend on the ratio of the amount of the uncontrolled interferent. To minimize interference the number of points to be measured can be increased. If Spectrum A was measured as several hundred points, then the principal component analysis would find the interferent to be noise unless it had an identical spectrum. These considerations form the basis for taking as many points as the computer that we are using will allow. We

recognize that this is an overkill. The alternative is to take one point and, when the procedure is shown to be unreliable, add additional points. When the two approaches are maximized, the optimized number of points should be the same for both approaches. The question is which is the cheapest and quickest method of obtaining the desired precision. Method selection depends on the problem. If an experienced analyst is working with well-defined samples, the first method can be the quickest. When working with samples and processes where there is minimum information, only the second method can be successful. Most of the high-profit-producing applications in industry have come from the latter group. This is particularly true when reactions are continuing in the container while a sample is waiting for analysis. The greatest payoff often occurs when observing industrial processes and some upset occurs. Continuous quick analyses with many possibly redundant pieces of information always are the first analyses to recognize a signature pointing to the source of the problem.

4. Selection of Training Set

When using empirical or heuristic models, the important considerations are the Calibration Objects (training set). The calibration model

$$Y = f(X)$$

that predicts y_i from the x -variables is determined from the training set. The experimenter must ensure that the calibration set contain enough information to solve the selectivity problems involved. For simple problems only a few calibration objects are needed. But in general, the less the analyst knows about the objects being analyzed and the instrumentation being used, the larger the calibration set needed to ensure a reliable prediction ability. The calibration objects must be representative for the population of objects from which Y values are to be predicted later, both with regard to average quality and to variability. A significant VARIABILITY must also be included in the calibration objects. The level of EVERY major independent component or phenomenon, that may cause interference effects in future X -data, must vary in the Calibration Object set. The actual level of these objects does not have to be known.

These rules can be illustrated with data from work that the Laboratory For Inline Process Analyses has done on iodine speciation. (This work was supported by NASA Marshall

Space Flight Center under Contract NAS-36955 D.O. 52.) Iodine in aqueous solution can exist as HI, I⁻, I₂(aq), I₃⁻, HIO, IO⁻, HIO₃, IO₃⁻, HIO₄, IO₄⁻, and/or H₅IO₆. These species represent oxidation numbers for iodine of -1 to +7. These species compete with H₂O, dissolved O₂ and dissolved H₂ for electrons. Further competition for electrons occurs when organics are present. The redox sensitivity is believed to be responsible for many conflicts related to analytical procedures for determining iodine concentration. Determination of all species simultaneously and in real-time is possible, highly desirable, and most likely the only way that the species responsible for biocidal action can be controlled. The concentration of each species is immediately available and there is no opportunity for the concentration of a species to change while a sample awaits analysis. The requirements for a successfully controlled system are related to the requirements for solving simultaneous equations. A single unknown quantity can be evaluated with one equation. If required to solve for two unknowns a minimum of two independent equations is required. Solving for ten unknowns requires a minimum of ten independent equations.

In Figure 20. the spectra of KI, I₂(aq), and KIO₃ are shown.

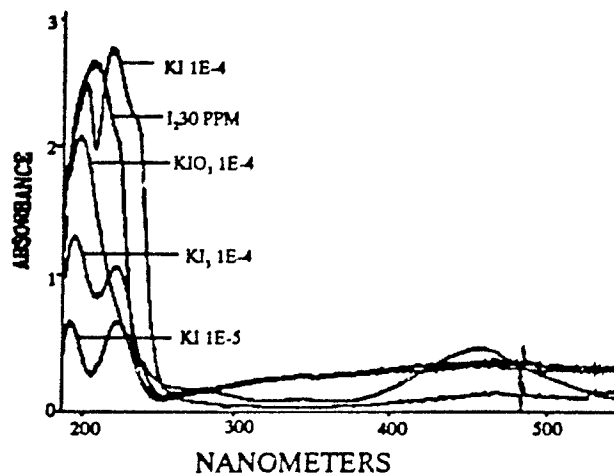

Figure 20. Spectra of KI, I₂(aq), and KIO₃

A factor analysis of this data in 1801 dimensional space should show at least five factors since we anticipate factors for HIO and I₃⁻ for which methods of making standard solutions are not

available. When the factors for these components are identified and rotated we will obtain the spectra of molecules unavailable on the storeroom shelf. The PLSplus, version 1, routine that is part of the SpectraCalc software collection was used for this analysis. Shown in Table 2 is the data obtained when the training set consisted of samples of I_2 (6 levels), KI(2 levels), and KIO_3 . The data is reasonable for the principal variable, but the values for the other species were less precise than desired. Table 3 shows the improvement when the training set contained I_2 (6 levels), KI(5 levels), KIO_3 (5 levels), KI_3 (KI plus I_2 -5 levels), and six mixtures using these samples. The spectra taken at 0.2 nanometer steps between 190 nanometers and 550 nanometers. Thus the analyses are being made in 1801 dimensional space. This is a severe overkill. However, the results for all components are as expected. In this set we gave the software the iodine values in ppm. The calibration algorithm is looking for variance in the spectra (x-points) to match to the known Y values that were supplied. Note that in this data set we are analyzing for three knowns out of a possible ten species that could be in the solution. It was not necessary to know the values for the other seven as we assumed that the species were at thermodynamic equilibrium. The I_2 (aq) samples probably contained many of the total number of species, but they were described to the software as being I_2 (aq). Analyses for every species will require additional standard solutions and additional method for preparing and analyzing the solutions in the training set.

This example is described to illustrate the power of multivariate analyses and empirical models. The responsibility of the observer to know the data set and to have knowledge of the system is illustrated.

B. DESCRIPTION OF THE SPECTROPHOTOMETER

The Laboratory for Inline Process Analyses uses the spectrophotometers manufactured by Guided Wave, Inc. Guided Wave, Inc was founded by Mr. David LeFebre in May 1983 to manufacture research grade spectrophotometers. Mr. LeFebre's immediate past experience had been in research and manufacturing of optical fibers. Developments have concentrated on using single-strand fibers to connect the spectrophotometer to the sensor. In early spring 1984, the Principal Investigator purchased one of the first five of the Model 100 instruments manufactured. The Model 100 was the first to optimize the optical components to the

TABLE 2. MULTIVARIATE CALIBRATION STANDARDS
 $I_2(aq)$, KI AND KIO_3

Analysis of d:\sc\data\NASI1.spc		Prediction	Actual
The calibration matrix is IODHA.cal			
Prediction error: 4.98557			
Component	Concentration		
IODINE(aq)	.00000595	$.595 \times 10^{-5}$	$.595 \times 10^5$ (1.5 ppm)
IODIDE	.00000027		
IO_3^-	-.00000002		
Analysis of d:\sc\data\NASI2.spc		Prediction	Actual
The calibration matrix is IODHA.cal			
Prediction error: 2.48077			
Component	Concentration		
IODINE(aq)	.00001113	1.11×10^{-5}	1.18×10^{-5} (3 ppm)
IODIDE	.00000058		
IO_3^-	.00000001		
Analysis of d:\sc\data\NASI3.spc		Prediction	Actual
The calibration matrix is IODHA.cal			
Prediction error: 1.32528			
Component	Concentration		
IODINE(aq)	.00002449	$.245 \times 10^{-4}$	$.236 \times 10^{-4}$ (6 ppm)
IODIDE	-.00000038		
IO_3^-	-.00000004		
Analysis of d:\sc\data\NASI4.spc		Prediction	Actual
The calibration matrix is IODHA.cal			
Prediction error: 1.00855			
Component	Concentration		
IODINE(aq)	.00003463	$.346 \times 10^{-4}$	$.355 \times 10^{-4}$ (9 ppm)
IODIDE	.00000069		
IO_3^-	.00000004		
Analysis of d:\sc\data\NASI5.spc		Prediction	Actual
The calibration matrix is IODHA.cal			
Prediction error: .444153			
Component	Concentration		
IODINE(aq)	.0000592	$.592 \times 10^{-4}$	$.591 \times 10^5$ (15 ppm)
IODIDE	-.00000003		
IO_3^-	7.253E-09		

TABLE 2. (CONCLUDED) MULTIVARIATE CALIBRATION

Analysis of d:\sc\data\NASI6.spc Prediction Actual
 The calibration matrix is IODHA.cal
 Prediction error: 5.0481
 Component Concentration
 IODINE(aq) .00010237 1.02×10^{-4} 1.18×10^{-4} (30 ppm)
 IODIDE -.00000179
 IO₃⁻ .00000058

Analysis of d:\sc\data\NASI7.spc
 The calibration matrix is IODHA.cal
 Prediction error: 6.37383
 Component Concentration
 IODINE(aq) .00000016
 IODIDE .0000958 $.958 \times 10^{-5}$ 1.0×10^{-5}
 IO₃⁻ -8.073E-09

Analysis of d:\sc\data\NASI8.spc
 The calibration matrix is IODHA.cal
 Prediction error:
 Component Concentration
 IODINE(aq) .00000021
 IODIDE .00009948 $.995 \times 10^{-4}$ 1.0×10^{-4}
 IO₃⁻ .00000002

Analysis of d:\sc\data\NASI12.spc
 The calibration matrix is IODHA.cal
 Prediction error: 1.60365
 Component Concentration
 IODINE(aq) .00000009
 IODIDE .00000019 $.998 \times 10^{-5}$ 1.0×10^{-5}
 IO₃⁻ .00000998

Analysis of d:\sc\data\NASI13.spc
 The calibration matrix is IODHA.cal
 Prediction error: -.00000702
 Component Concentration
 IODINE(aq) -.00000702
 IODIDE .00002057
 IO₃⁻ .00000101 1×10^{-4} 1.0×10^{-4}

**TABLE 3. MULTIVARIATE CALIBRATION
TRAINING SET MIXTURES OF I₂, KI, AND KIO₃**

Analysis of C:\sc\data\PP1.spc		Actual
The calibration matrix is IODKA.cal		
Prediction error: 3.32626		
Component	Concentration Prediction	
IODINE	.98346	1.0 ppm
IODIDE	.00001107	1 x 10 ⁻⁵ F
IO ₃ ⁻	.00001035	1 x 10 ⁻⁵ F
Analysis of C:\sc\data\PP2.spc		
The calibration matrix is IODKA.cal		
Prediction error: 6.32323		
Component	Concentration Prediction	
IODINE	1.98501	2 ppm
IODIDE	.00001015	1.0 x 10 ⁻⁵ F
IO ₃ ⁻	.00002008	2.0 x 10 ⁻⁵ F
Analysis of C:\sc\data\PP3.spc		
The calibration matrix is IODKA.cal		
Prediction error: 8.72592		
Component	Concentration Prediction	
IODINE	2.95085	3 ppm
IODIDE	.0000216	1.0 x 10 ⁻⁵ F
IO ₃ ⁻	.00001059	1 x 10 ⁻⁵ F
Analysis of C:\sc\data\PP4.spc		
The calibration matrix is IODKA.cal		
Prediction error: 7.77016		
Component	Concentration Prediction	
IODINE	2.02039	2 ppm
IODIDE	.00001714	2 x 10 ⁻⁵ F
IO ₃ ⁻	.00000903	1 x 10 ⁻⁵ F
Analysis of C:\sc\data\PP5.spc		
The calibration matrix is IODKA.cal		
Prediction error: 5.30173		
Component	Concentration Prediction	
IODINE	3.02628	3 ppm
IODIDE	.00001011	1.0 x 10 ⁻⁵ F
IO ₃ ⁻	.00001	1 x 10 ⁻⁵ F

characteristics of energy transmission over fibers. All feedback from users has been taken seriously and used in developing new models. The Model 300 double beam instrument, on the market for about one year, was an attempt to include the needs of all users. The original instrument purchased by UAH has been updated on three occasions as the Model 150, Model 200, and Model 260 were developed. A specification for the Guided Wave model 260 and Model 300 spectrophotometer is given in Appendix C.

Many spectrometer manufacturers have provided attachments to their line of spectrophotometers to allow the use of fibers. Many of the manufacturers use bundles of fiber. The spectrophotometers are multiuse instruments. Although the Principal Investigator has followed these developments through literature references, visits by representatives, and visits to trade shows, no attempt has been made to compare performance as a part of this report.

Some features of the Guided Wave instruments are described in the following sections to illustrate the requirements on an instrument which is to be used with single-strand fiber optics and to provide examples of the apparatus used to obtain the experimental data.

1. The Optical Bench

The design of classical spectrophotometers includes slits, mirrors, gratings or prisms to disperse the radiation, and a detector. There is a loss of energy at the surface of each component. Since the energy carried by a fiber is small, as many surfaces as possible are eliminated. The essential elements of the fiber spectrophotometer are shown in Figure 21.

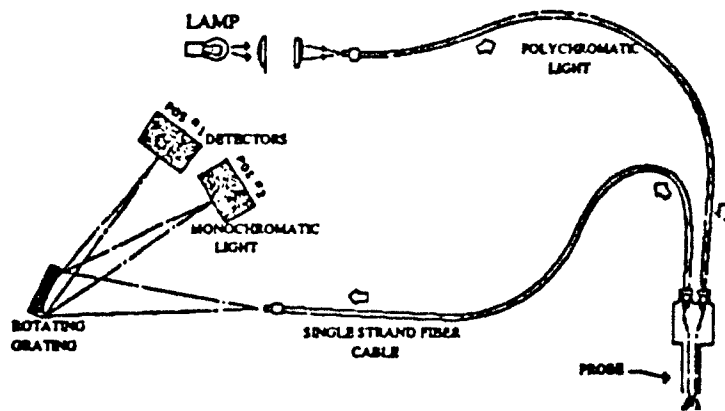

Figure 21. Scanning Fiber Spectrophotometer.

The light source is a tungsten halogen bulb or a deuterium lamp. The light source is large with respect to the diameter of the fiber core. Lens are used to focus the energy from the source onto the fiber. The entrance cone into the fiber is controlled by the numerical aperture of the fiber. The fiber transmits the energy to the sample. Shown in Figure 21 is a transmission probe where the energy from the exit cone of the fiber is focused onto a concave mirror. The mirror focuses the energy back onto a second fiber that carries the energy to the spectrophotometer. The cone of energy from the fiber falls on a holographic concave diffraction grating. Since this cone is fixed by the characteristics of the fiber, the size of the grating that can be filled with light is determined by the distance from the end of the fiber to the grating. To reduce stray light in the grating chamber, a square aperture is used so that the cone of light just fills the square grating. The longer the distance from the operator to the grating, the larger the area of light available but the lower the intensity. The Guided Wave instruments are 0.25-meter spectrophotometers. A characteristic of holographic concave gratings is that the reflected energy can be focused to a spot for only two wavelengths. The grating in this spectrophotometer has been designed so that the distance between these spots is sufficient that two detectors can be mounted on the instrument at the same time. The software can be set to change between the two detectors at any selected wavelength. The pattern of the radiation is shown in Figure 22.

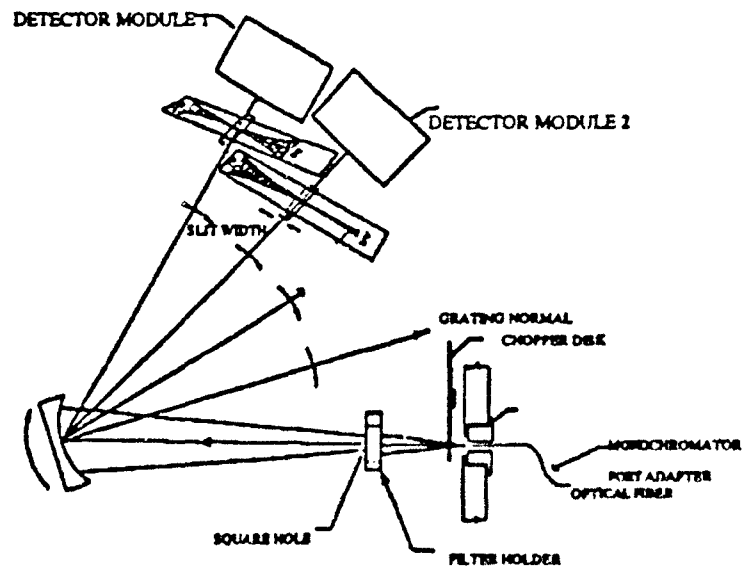

Figure 22. Radiation Pattern at the Detector Slits

This is the only point at which slits are used in this spectrophotometer.

2. Gratings and Detectors

Changing a grating or detector only takes a few minutes. Therefore, observations can be made from the ultraviolet to the near infrared with the same instrument by choice of gratings and detectors. When quartz fibers are used, the useful region is from 200 - 250 nanometers to 2.2 micrometers. Zirconium fluoride fibers are available to extend the observation region to 3.2 micrometers in the infrared. To cover the full range at high resolution photomultipliers, silicon, germanium, and lead sulfide detectors are required. To cover the entire range diffraction gratings at 1200, 800, 600, 300 lines/mm are used. A component selection guide from the Guided Wave, Inc. literature is shown as Figure 23.

3. Experimental Setup and Sample Probes

The spectrophotometer is remote from the sample as the spectrophotometer is connected to the sample by a flexible fiber optic cable and the sample is connected to the

COMPONENT SELECTION GUIDELINES

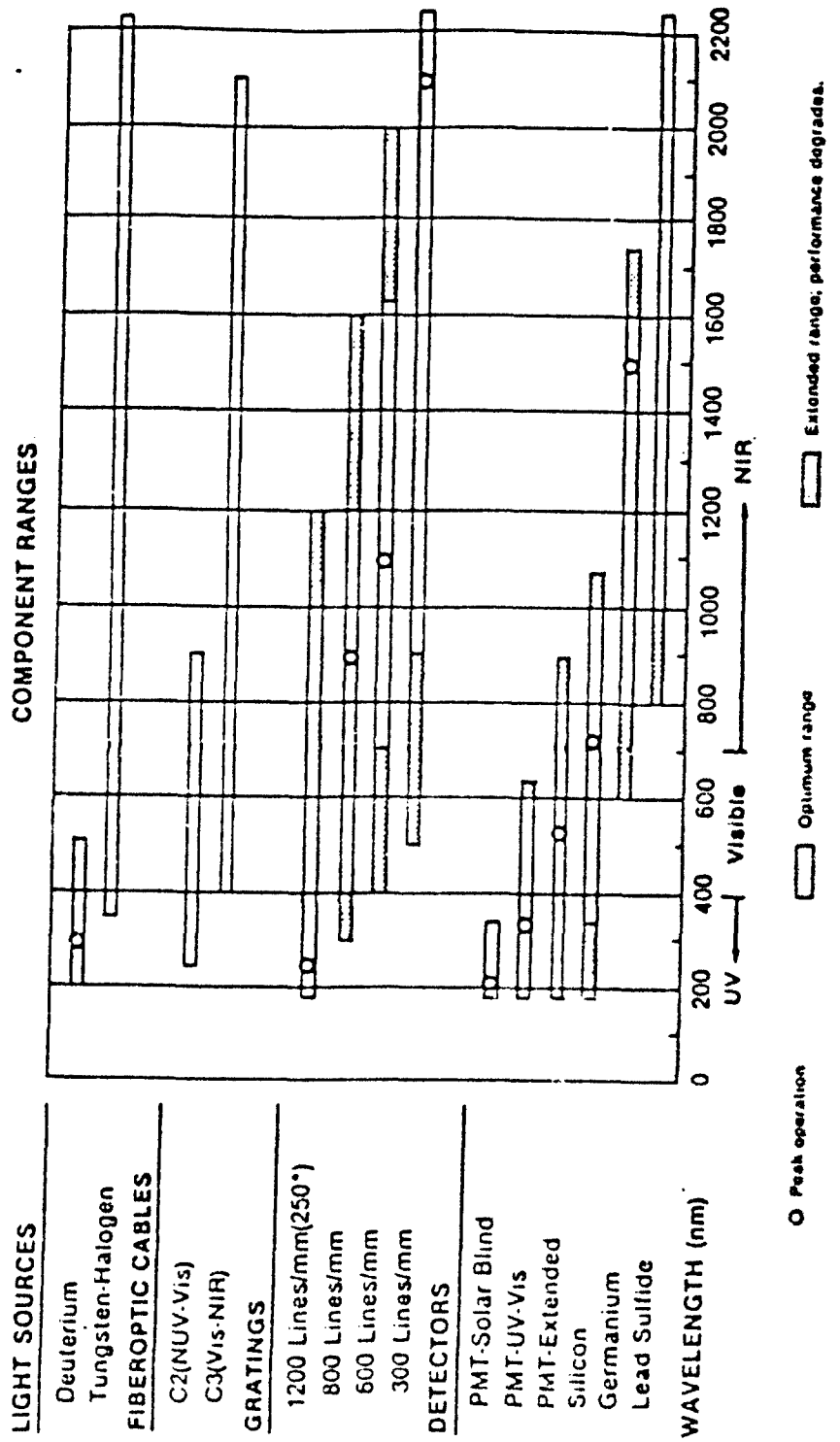

Figure 23. Diffraction Gratings and Detectors

spectrophotometer by a second fiber optic cable. This provides flexibility equal to the imagination of the experimenter. Standard probes and components as shown in Figure 24 are used to gain experience with the concepts. As the real-time problem is defined specialized components are designed to interface the system with the fibers that carry the information.

4. Analyses of Benzene, Toluene, and Xylene

Classical absorption analyses for benzene, toluene and xylene were made using the described equipment and quantitated using multivariate analyses. For these analyses, a probe, Guided Wave, Inc. Part #1RP2 SO - 6, consisting of a lens that formed the cone of light coming from the fiber into a 1-centimeter collimated beam was placed on the side of a standard 5 x 1-centimeter, 1 x 1-centimeter, or millimeter x 1 centimeter quartz absorption cell. A similar probe was placed on the opposite side to pick up the collimated beam and focus the light onto the optical fiber that returned to the spectrophotometer. Spectra were taken in both the ultraviolet and the near infrared. Spectra were obtained using neat solutions, mixtures of benzene-toluene-xylene, aqueous solutions made using the mixtures, and solutions made in Jet A fuel. These spectra have been reproduced as Figures 25 through 39. Examinations of the Figures show that each component shows its characteristics spectrum as expected. The analytical results obtained using the PLSplus, version 2, in the SpectraCalc collection are shown as Tables 4 and 5.

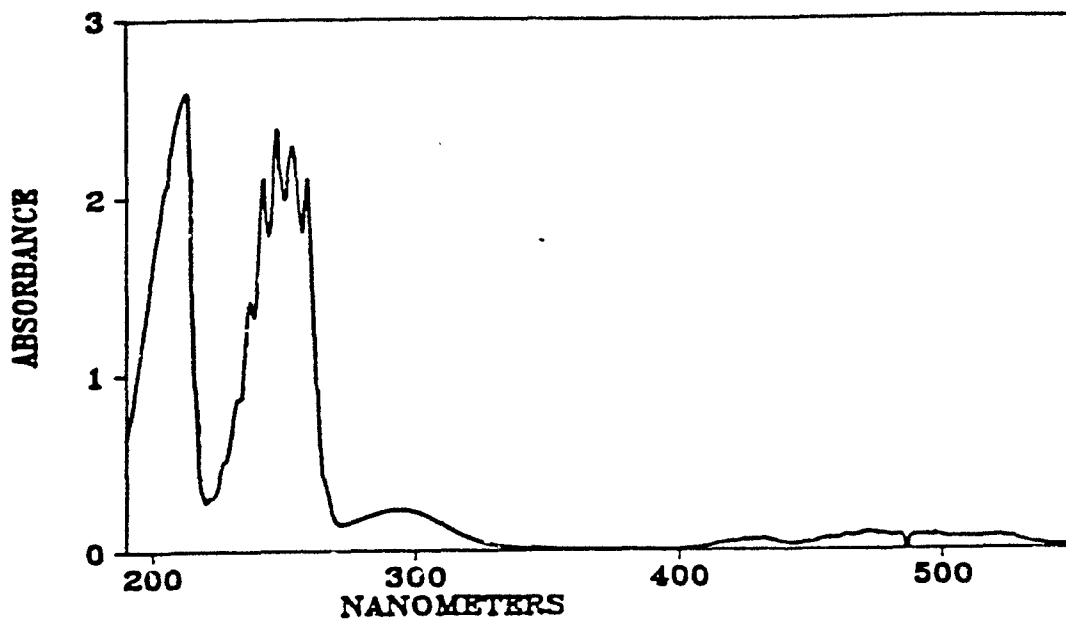

Figure 25. Benzene (0.5ml/liter water)
5cm Absorption Cell UV-VIS

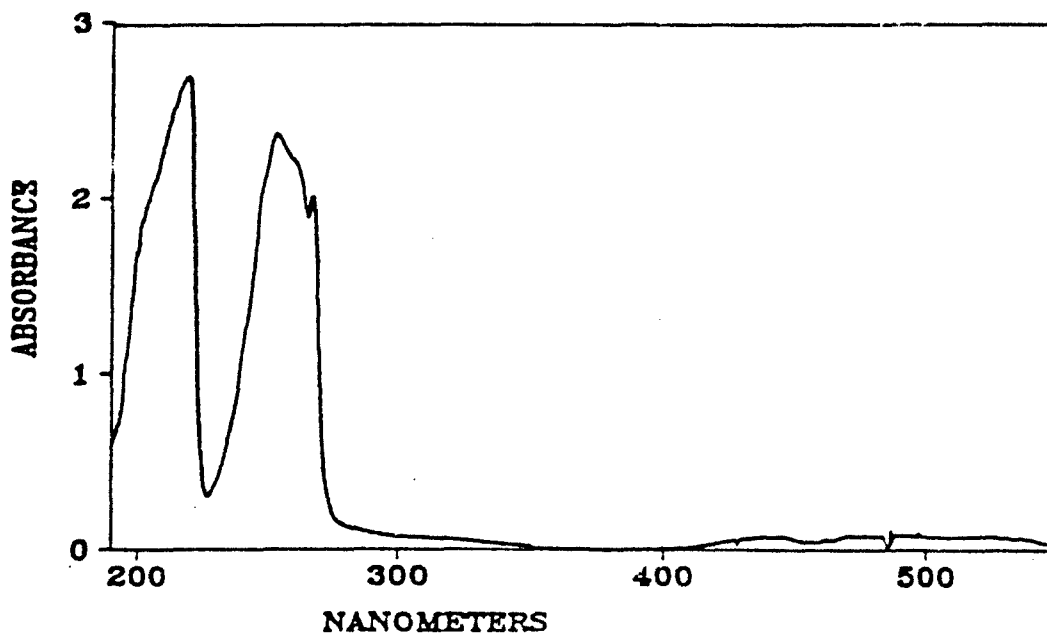

Figure 26. Toluene (0.5ml/liter water)
5cm Absorption Cell UV-VIS

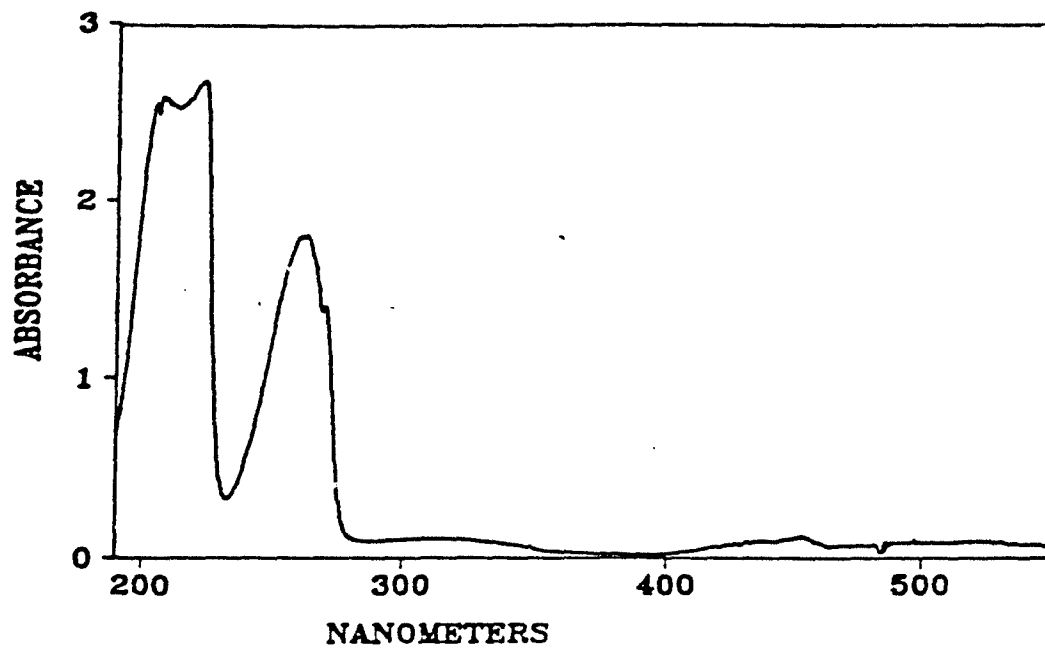

Figure 27. Xylene (0.5ml/liter water)
5cm Absorption Cell UV-VIS

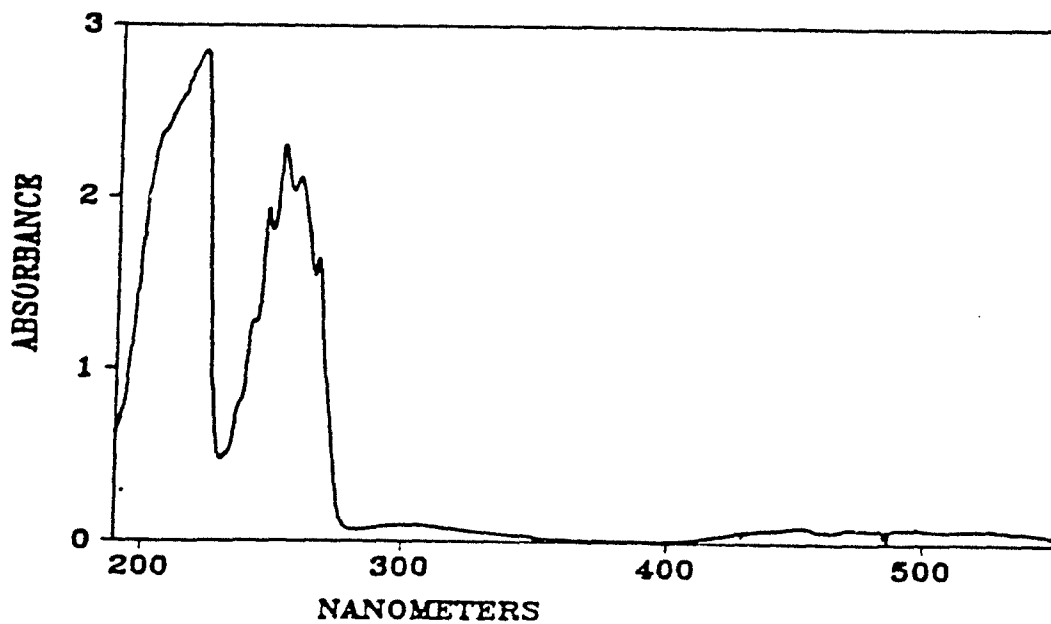

Figure 28. 1:1:1 Benzene, Toluene, Xylene
5cm Absorption Cell UV-VIS

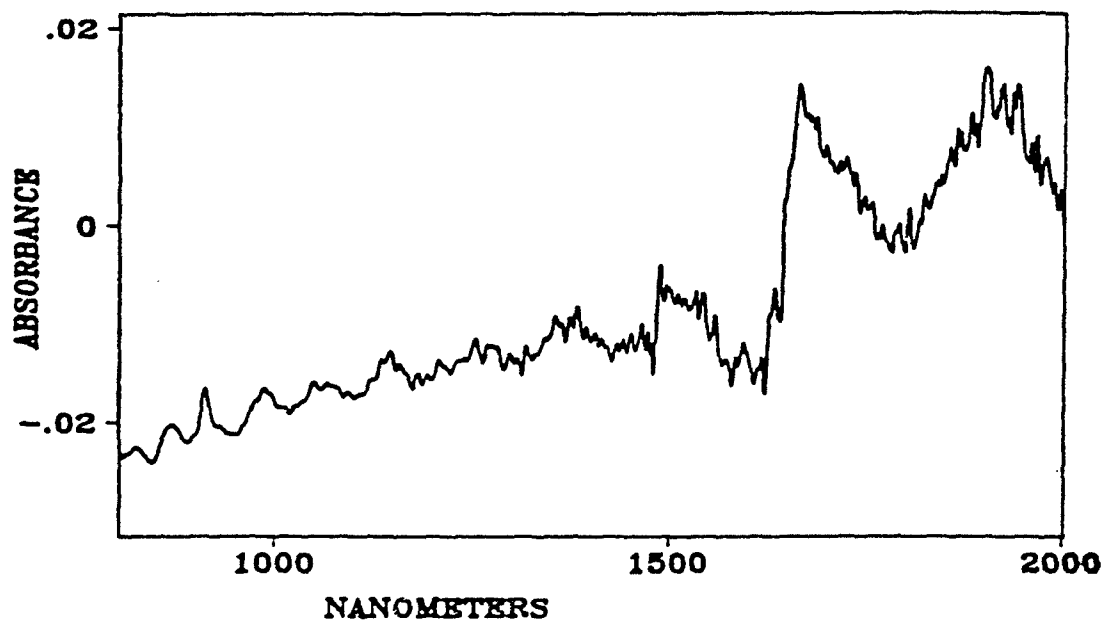

Figure 29. Benzene (neat)
ATR Dip Probe NIR

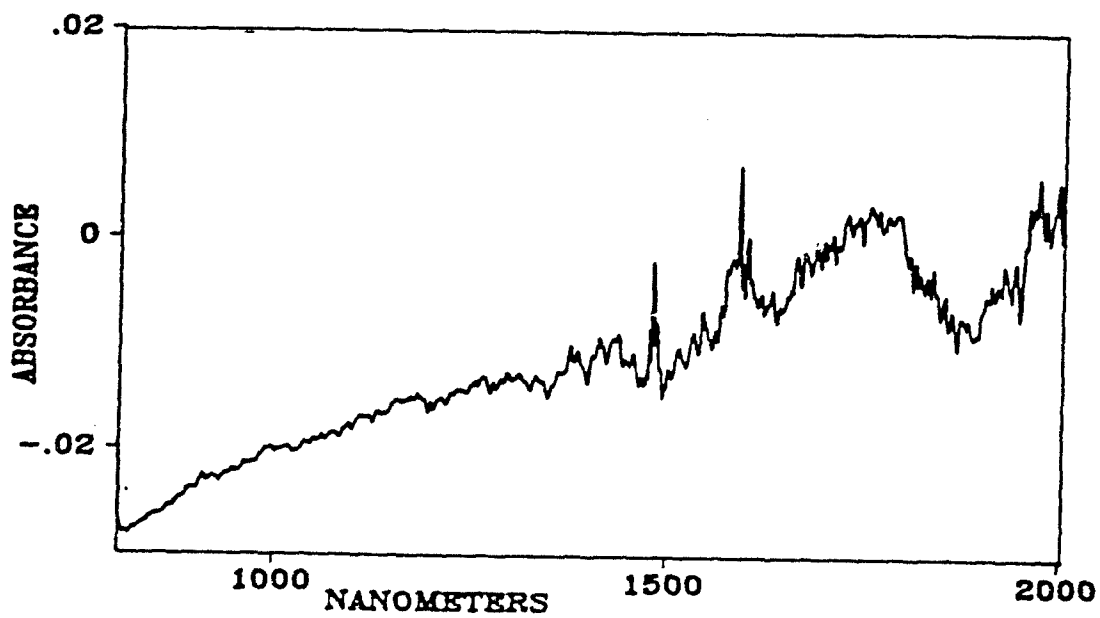

Figure 30. Toluene (neat)
ATR Dip Probe NIR

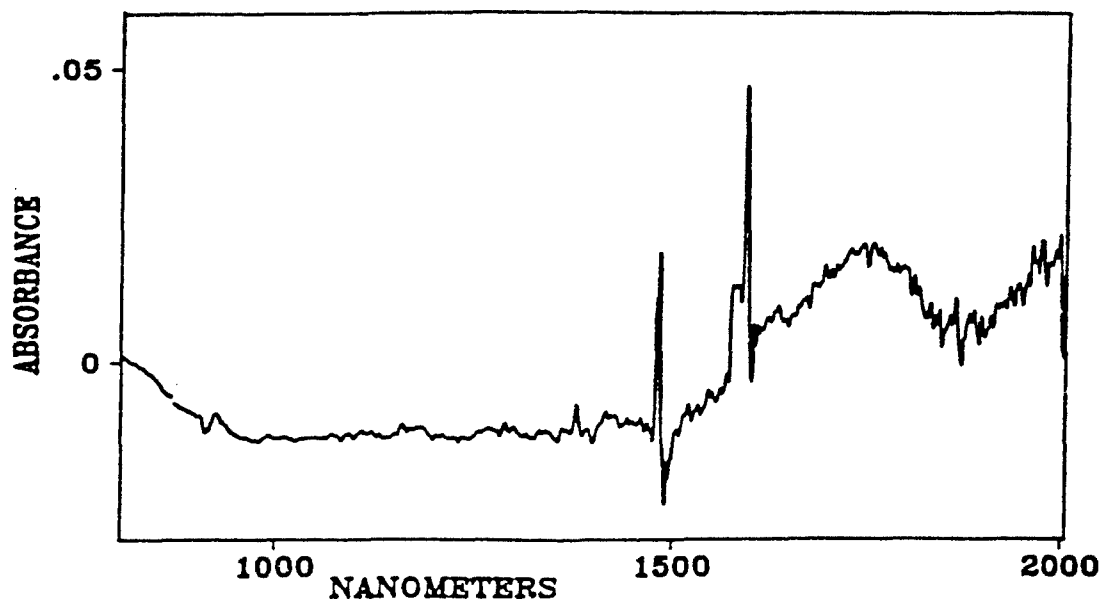

Figure 31. Xylene (neat)
ATR Dip Probe NIR

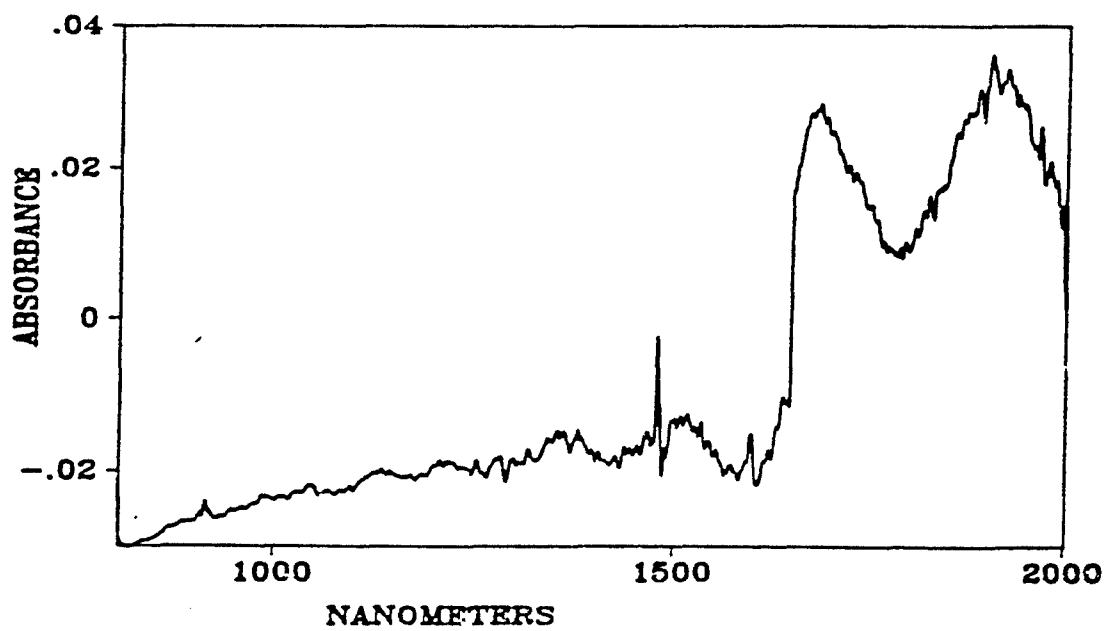

Figure 32. 1:1:1 Benzene, Toluene, Xylene (neat)
ATR Dip Probe NIR

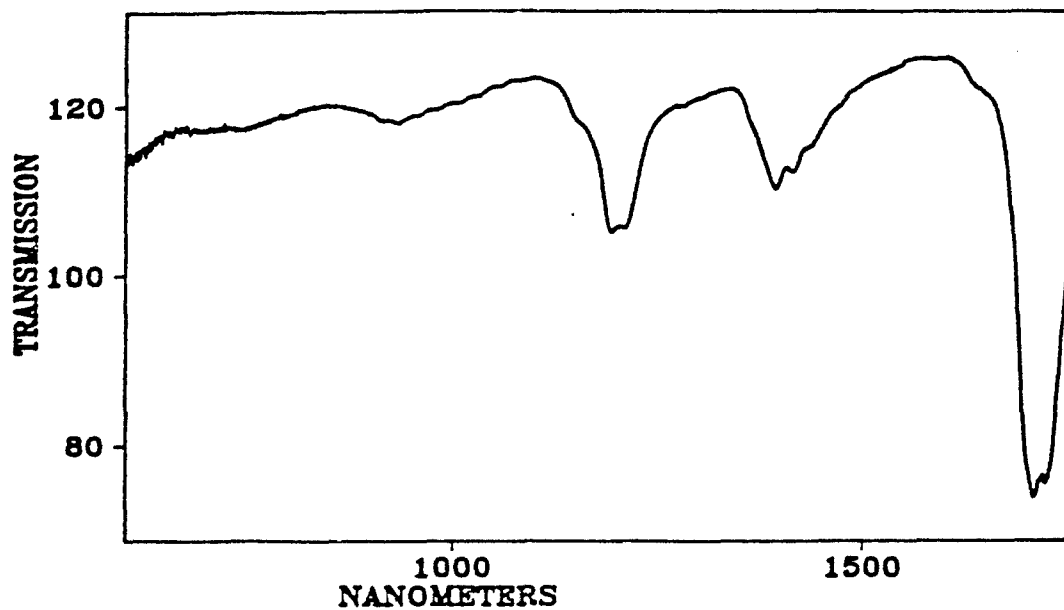

Figure 33. Jet A Fuel (neat)
1mm Absorption Cell NIR

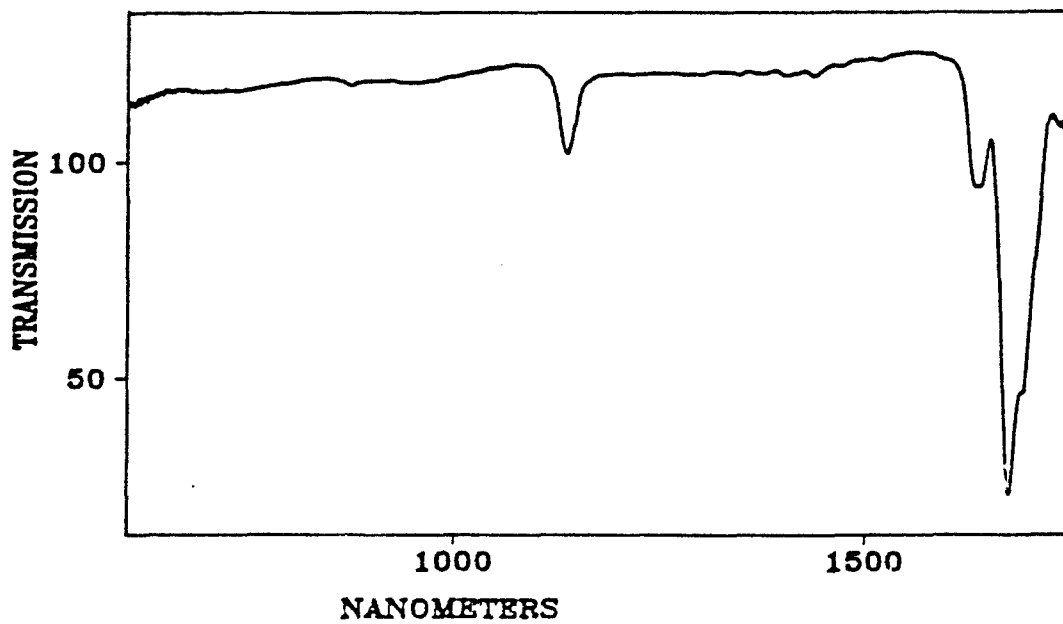

Figure 34. Benzene (neat)
1mm Absorption Cell NIR

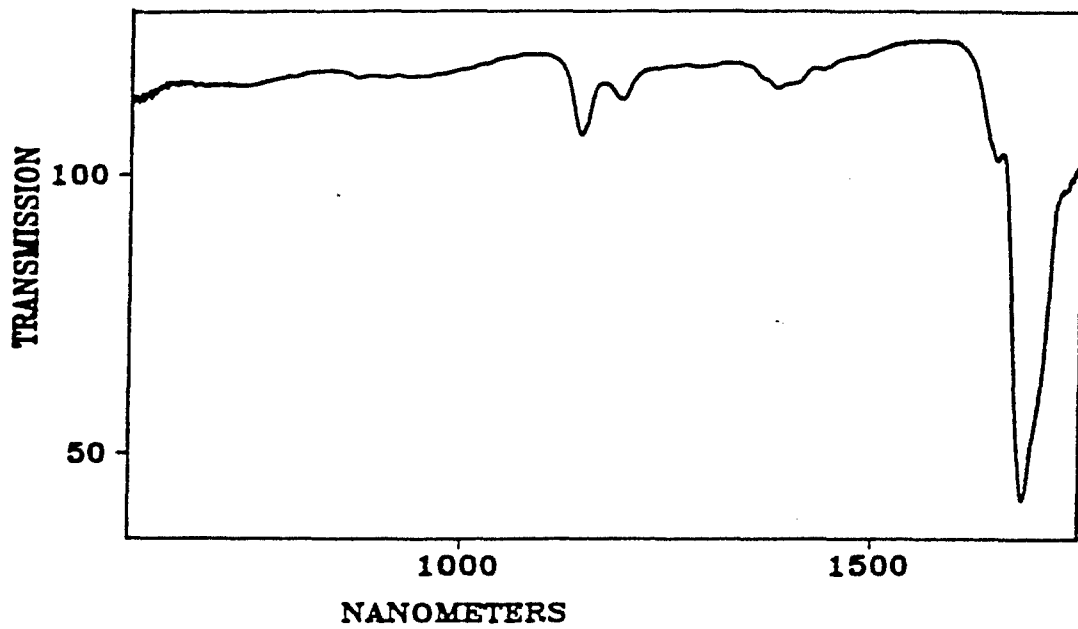

Figure 35. Toluene (neat)
1mm Absorption Cell NIR

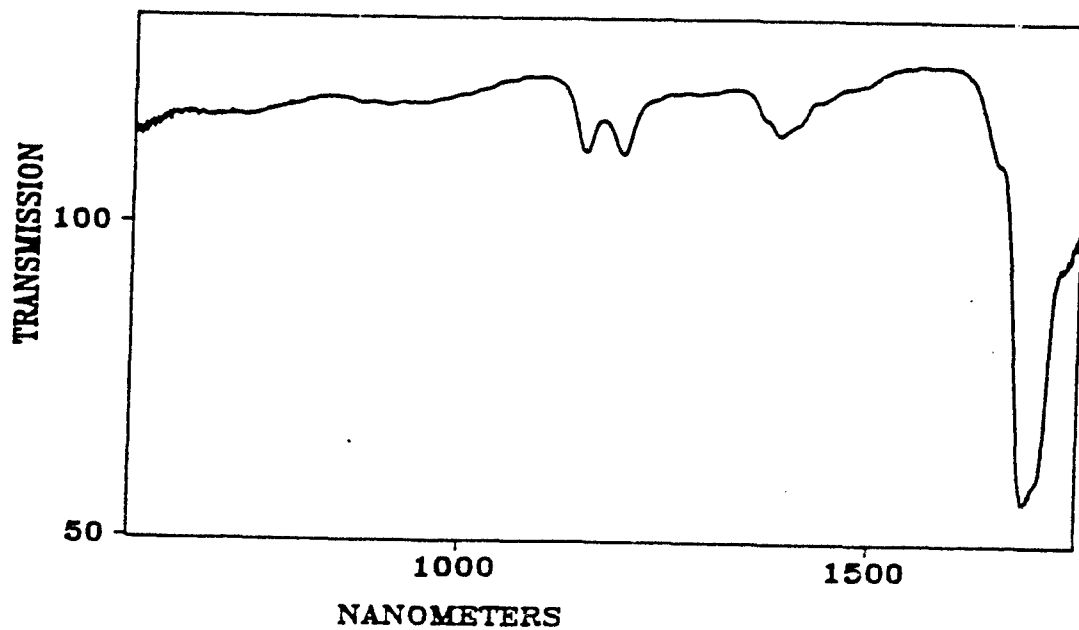

Figure 36. Xylene (neat)
1mm Absorption Cell NIR

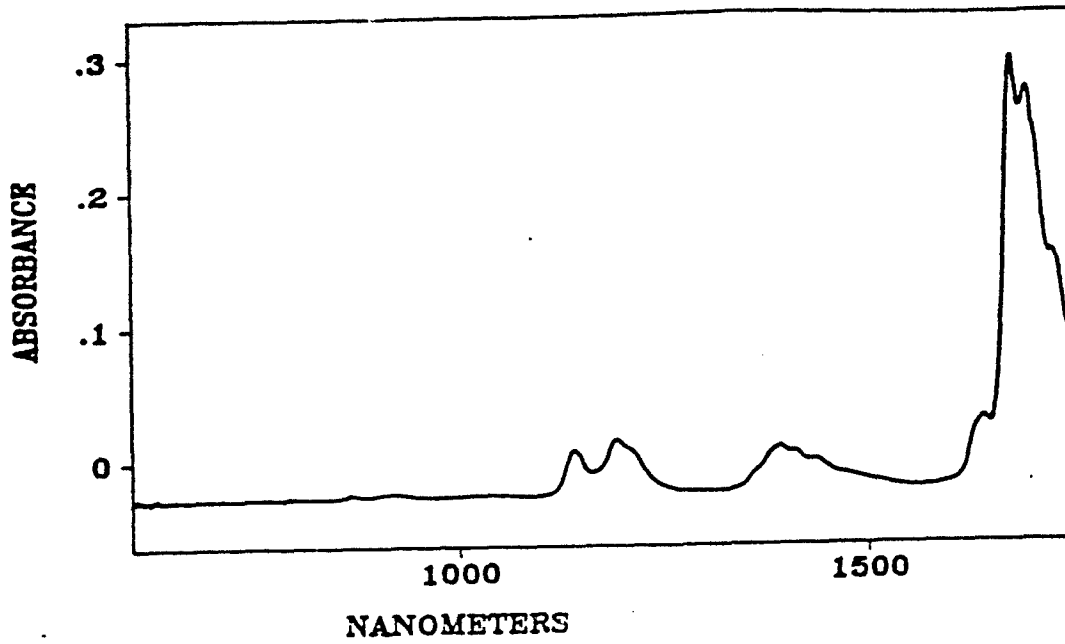

Figure 37. 5:2:2:1 Jet A BTX
1mm Absorption Cell NIR

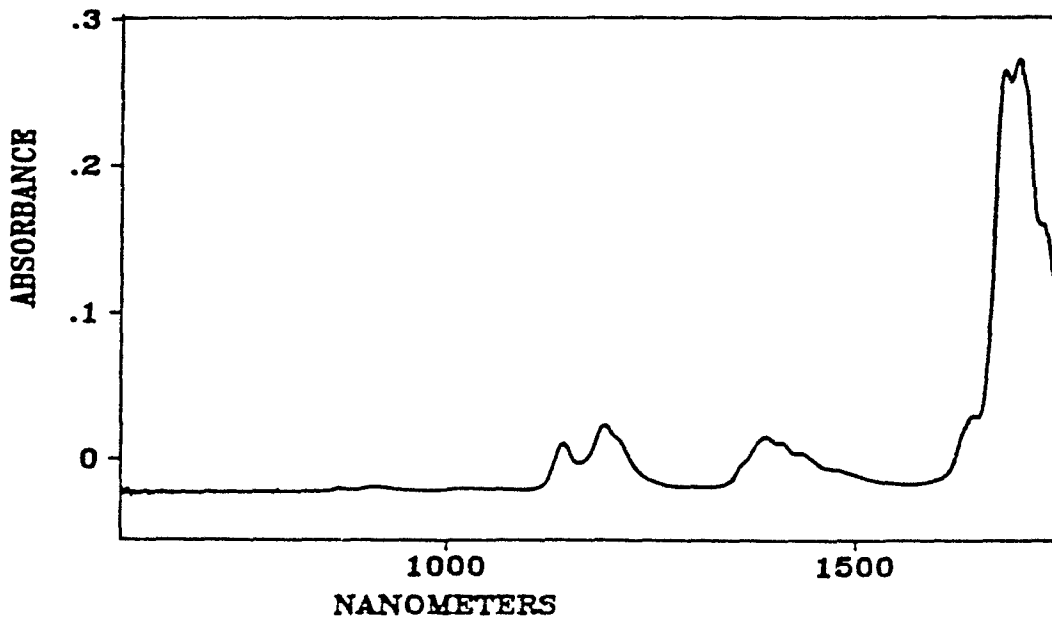

Figure 38. 5:1:1:2 Jet A BTX
1mm Absorption Cell NIR

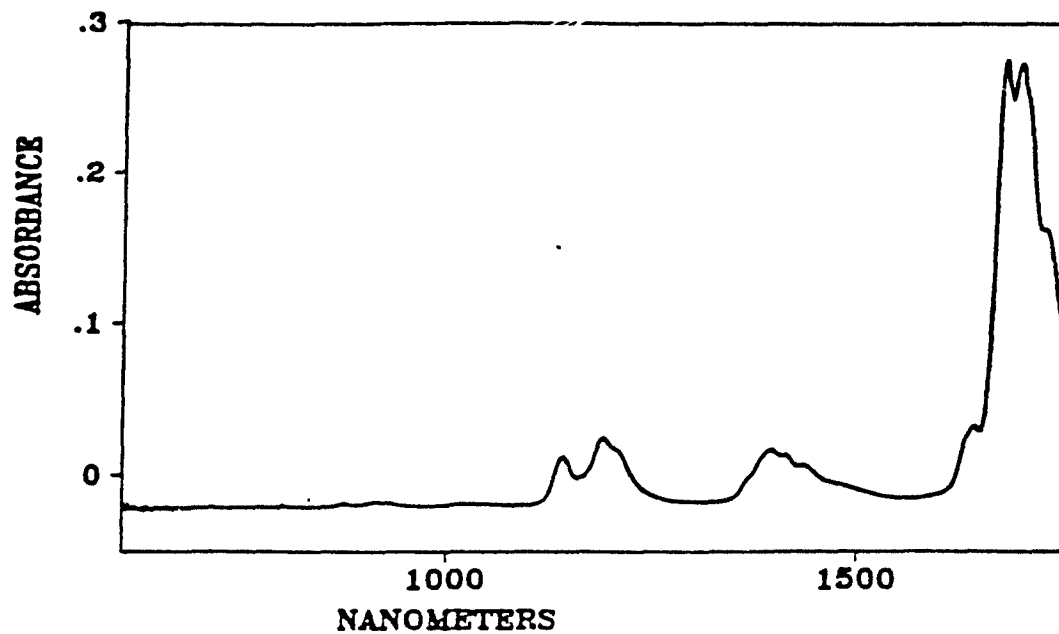

Figure 39. 5:2:1:2 Jet A BTX
1mm Absorption Cell NIR

TABLE 4. UV ABSORBANCE (190NM - 550NM)

The calibration matrix is BTXM.cal

Analysis of C:\sc\data\szb6.spc		Actual (ml/1 liter water)
Prediction error: 3.72429		
Component	Concentration	
benzene	.218886	.2
toluene	.189784	.2
xylene	.0913287	.1
Analysis of C:\sc\data\szb7.spc		
Prediction error: 1.52066		
Component	Concentration	
benzene	.204248	.2
toluene	.0983945	.1
xylene	.197357	.2
Analysis of C:\sc\data\szb8.spc		
Prediction error: 3.49068		
Component	Concentration	
benzene	.111045	.1
toluene	.1957	.2
xylene	.193253	.2
Analysis of C:\sc\data\szb9.spc		
Prediction error: 1.7435		
Component	Concentration	
benzene	.282276	.3
toluene	.108965	.1
xylene	.108758	.1
Analysis of C:\sc\data\szb10.spc		
Prediction error: 1.58934		
Component	Concentration	
benzene	.0873923	.1
toluene	.305299	.3
xylene	.107308	.1
Analysis of C:\sc\data\szb11.spc		
Prediction error: .886865		
Component	Concentration	
benzene	.0961512	.1
toluene	.101855	.1
xylene	.301994	.3

TABLE 5. NIR SAPPHIRE PROBE (900NM - 2000NM)

The calibration matrix is BTXM.cal

Analysis of C:\sc\data\szb4.spc		Actual (ml/1 liter water)
Prediction error: 7.87811		
Component	Concentration	
benzene	.4960484	.5
toluene	-.00892134	0
xylene	.0128365	0
Analysis of C:\sc\data\szb5.spc		
Prediction error: 14.0206		
Component	Concentration	
benzene	-.0107907	0
toluene	.0242955	0
xylene	.486495	.5
Analysis of C:\sc\data\szb6.spc		
Prediction error: 3.64134		
Component	Concentration	
benzene	.16986	.2
toluene	.253524	.2
xylene	.0766155	.1
Analysis of C:\sc\data\szb7.spc		
Prediction error: 34.7931		
Component	Concentration	
benzene	.25292	.2
toluene	.0617323	.1
xylene	.183975	.2
Analysis of C:\sc\data\szb8.spc		
Prediction error: 11.7541		
Component	Concentration	
benzene	.130919	.1
toluene	.143641	.2
xylene	.225438	.2
Analysis of C:\sc\data\szb9.spc		
Prediction error:		
Component	Concentration	
benzene	.220059	.3
toluene	.164532	.1
xylene	.115408	.1

TABLE 5. (CONCLUDED) NIR SAPPHIRE PROBE (900NM - 2000NM)

Analysis of C:\sc\data\szb10.spc

Prediction error: 9.1321

Component	Concentration	
benzene	.110085	.1
toluene	.260646	.3
xylene	.129268	.1

Analysis of C:\sc\data\szb11.spc

Prediction error: 2.93533

Component	Concentration	
benzene	.114971	.1
toluene	.125375	.1
xylene	.259653	.3

5. Analyses of Trichloroethylene and Related Compounds

Recently we were asked if the absorption technique could be used for trichloroethylene and related compounds. The NIR spectra are shown in Figures 40 and 41. The technique can be readily adapted to the chlorinated hydrocarbons.

C. FIBER OPTICS AND RELATED OPTICAL PROBLEMS

Our earliest evaluations, Appendix A, had indicated the possibility that improvements in Fiber Optic Chemical Sensors could be made through appropriate changes in the optics. The experimental work described above indicates that acceptable results can be obtained with the Guided Wave, Inc spectrophotometer and fiber cables. In this section we describe some problems and the methods by which the problems were eliminated or reduced to a acceptable magnitude.

1. Temperature Fluctuations and Microbends

As described in Section II, a bend in the fiber causes some of the energy to leave the fiber core and pass into the cladding. As shown in Figure 9 this phenomena can be used to design devices that can measure microstrain. These devices can be used to measure mass when calibrated, can be placed in mechanical models to measure stress distributions, and have been made into instruments to measure acoustics. Errors can be minimized for chemical sensors by use of well-buffered cables that prevent microbends. If possible, we take the sample to the probe so that each measurement is made with the cable in a fixed position. When real-time measurements are being made, a fixed cable arrangement can be used. When movement of the cable cannot be avoided, movement of the cable is included as a variable in the calibration set. Since readings are taken at multiple wavelengths and all wavelengths are not affected proportionally by movement of the cable, the multivariant search methods allot some of the frequencies to the fiber variations while finding other more reliable frequencies to use in quantitating the analytes of interest.

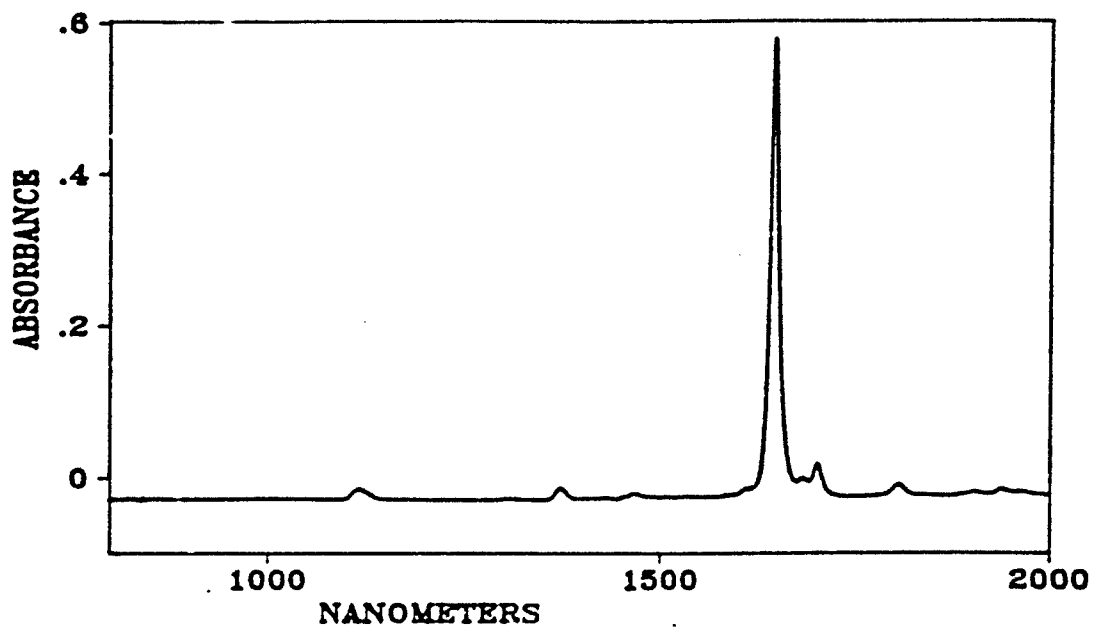

Figure 40. Trichloroethylene (neat)
1mm Absorption Cell NIR

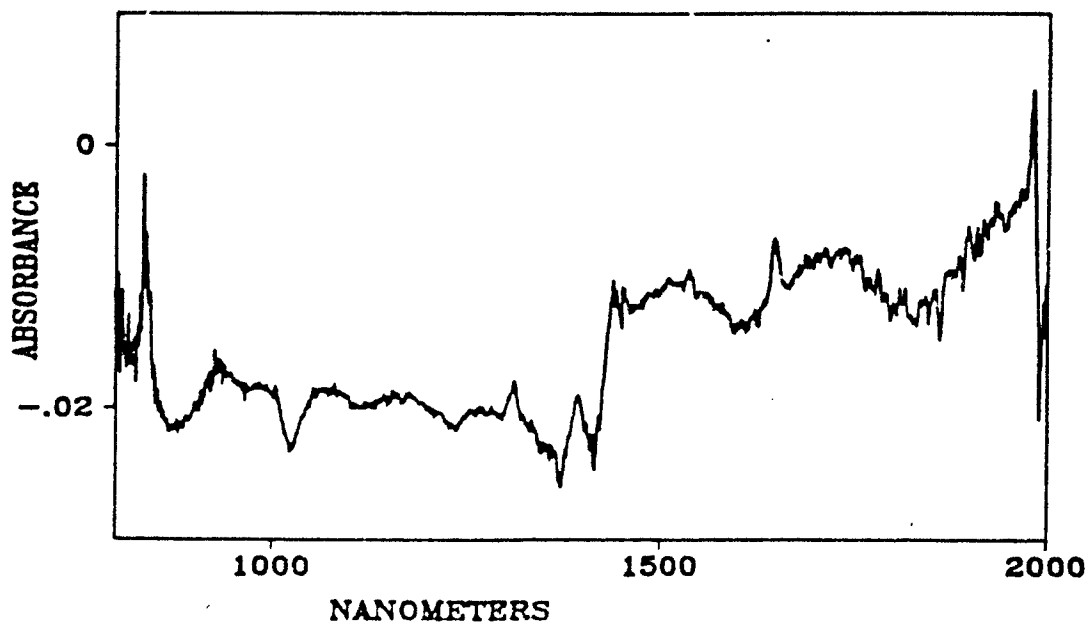

Figure 41. Trichloroethylene (neat)
Dip Probe NIR

The light beam passes down the fiber core in a number of modes. These modes depend on diameter and length of fiber. As the temperature is raised, a fiber expands in diameter and length causing a change in the magnitude of the signal which is observed. If we are dealing with low signal to noise ratio, temperature variation can be important. Changes in material properties with temperature are reversible and reproducible. When temperature changes must be included, a temperature measurement is substituted for a wavelength value. A publication described one application where a sensor was excellent for measuring temperature when strain was constant and one wavelength was used. When temperature was held constant, the sensor was excellent for measuring strain using the same wavelength. The solution was simple, use one wavelength to quantitate temperature and a second wavelength to quantitate strain. We did not encounter an example during this experimental work where temperature measurement was required. Since an excess of wavelengths over the minimum required and multivariate analyses techniques are used, the software is protecting us from this problem by assigning wavelength to temperature. As we optimize the technique and move toward a minimum number of frequencies we expect to observe the temperature effects.

A more annoying problem related to temperature has been molecular association in the dilute solutions. The wavelength maxima shift with temperature. When this problem occurs, temperature is included in the data vector.

2. Modification of Cladding

A number of sensors are described in the literature where the sensor consists of a core with a cladding with special properties. In Section III we described the energy rays as passing along the fiber if the light strikes the cladding at an angle greater than the critical angle. It has been shown that although the energy is totally reflected there is an evanescent energy wave that penetrates microinches into the cladding. Reflection is attenuated if the cladding has an absorption band at a wavelength in the illuminating radiation. Many experiments have been devised that demonstrate and use this phenomenon. Most of these designs also use the change in NA associated with the change in the ratio of refractive indices of the core and cladding. Several different arrangements are shown in Figure 42.

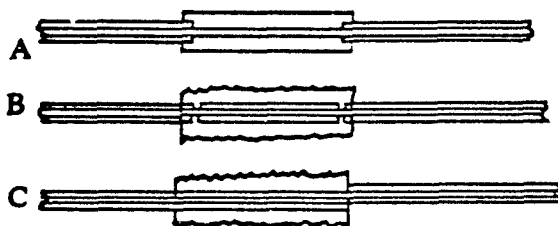

Figure 42. Sensors Designs Using the Evanescent Wave

The sensor shown as A in Figure 42 has the buffer removed and the sample is in contact with the fiber. For this arrangement, the ATR, attenuated total reflection spectra of the sample is recorded. The sensor shown as B has a special cladding placed between the core and sample. If the sample or a component of the sample is absorbed by the cladding, the ATR spectrum is obtained as this analyte reaches the core. If the sample is soluble in the cladding the cladding will swell. If the sample has a higher index of refraction than the cladding material, then n_2 may become greater than n_1 and all energy may be absorbed. The sensor shown as C has the core of one fiber terminated within the sample. A second core is placed next to the fiber bringing the light into the sample region. This second fiber picks up portions of the energy. This twin core type of sensor can be used for special types of analytes. Initially, we considered some of these arrangements, but became less interested as successful analyses were obtained using classical spectrophotometric measurements. When a fiber is drawn from the furnace, an inert atmosphere is used to prevent moisture from causing microcracks and hydroxyl groups on the surface. Unless the experimenter has available a drawing furnace, it appears to be extremely difficult to obtain reproducible sensors using these approaches. Removing the manufacturer's cladding and substituting another cladding has resulted in many extremely interesting research papers. When sufficient use is generated, a fiber manufacturer may be persuaded to add one of these fibers to the product line.

3. A Sensor Using a Silicone-Clad Fiber

Fiberguide Industries, Inc. manufactures a nylon buffer, siloxane clad fiber for the telecommunication industry that we have used to fabricate a sensor. A schematic is shown in Figure 43.

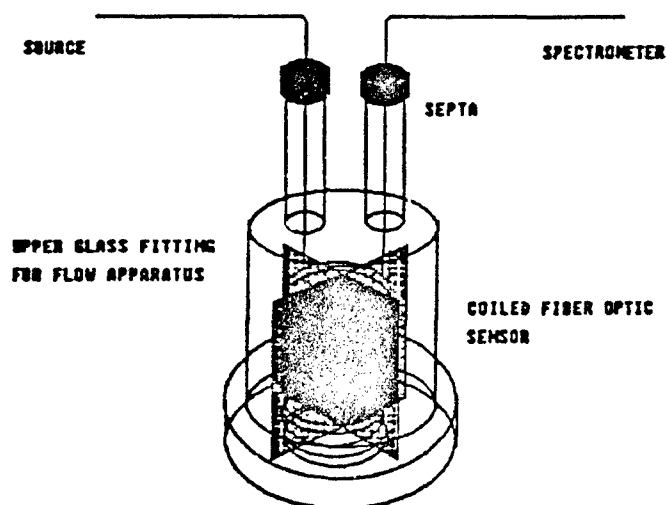

Figure 43 . Coiled Fiber ATR Sensor

The coil is wound from 3 meters of Fiberguide Industries fiber APC400N with 1.5 meters used in the sensor leaving two 1.5 meter fiber leads. This fiber is a low-hydroxy pure quartz fiber with a 400-micrometer core, 100-micrometer proprietary siloxane cladding, and a 100-micrometer nylon buffer. After the coil is wound, the nylon buffer in the coil area which is used for sensing is removed by immersing the probe in boiling propylene glycol. The fiber is threaded through small holes to give support and to prevent non reproducible microstrain. Our design is similar to the design reported by Degrandpre and Burgess (5).

Both the Guided Wave Model 200 and Model 300 spectrophotometers were used. With the Model 200 spectrophotometer a 600 l/mm grating and silicon and germanium detectors were used to record the spectrum from 800nm to 2000nm in 1nm increments. A silicon halogen lamp was used as the source of illumination. With the Model 300 a 470 l/mm grating and a proprietary detector was used to record the spectra from 800nm to 1750nm.

The sensor is connected to the spectrophotometer using the two 0.75-meter fiber-optic leads from which the nylon has not been removed. The ends of the fiber are cleaved with a sharp knife leaving a smooth optical surface perpendicular to the fiber. The fiber is mounted to the spectrophotometer port with a fiber clamp and adjusted with respect to the

spectrophotometer optics by moving in or out until the maximum signal is obtained. The leads and sensor sections are made from a continuous length of fiber. When the final sensor parameters are determined, SMA 905 connectors will be used to connect the sensor to the spectrophotometers. (The minimum order requirement for a SMA 905 for each core size prevents having all sizes available.)

The signal is recorded as a digital signal. The Model 200 is a single-beam spectrophotometer and a reference spectrum is required. The reference spectrum for gases is taken in air. The reference spectrum for aqueous solutions is water. Since the cladding is hydrophobic organophilic, the reference spectrum is the ATR (attenuated total reflection) spectrum of the siloxane cladding. Since the spectrum being obtained are ATR spectrum, total reflection does not occur at the wavelengths where the cladding has absorption bands. Therefore, less light passes to the detector. When the sensor is placed in the presence of organic liquids or vapors, the organophilic-hydrophobic cladding absorbs the organic and the cladding swells. Since there is less of the siloxane in the distance that the evanescent wave penetrates, more light remains in the fiber in the regions where the absorption were found in the reference spectrum. When the spectra are plotted as AU (absorption units) vs wavelength, regions of negative absorption appear. These bands can be used as internal standards to measure the swelling and hence the volume of the organic. When the organic material diffuses to the core, the ATR spectrum of the organic is obtained. The absorption bands can be quantitated using the methods available for quantization of ATR spectrum.

The quantity of organic that can be absorbed will be related the solubility of the organic in the cladding material and will change with the chemical composition of the cladding. In air or in aqueous solutions the quantity will also be a function of the equilibrium constant for the distribution between the cladding and air or water. For benzene, toluene, and xylene, the solubility in the siloxane is much greater than in water or air. The sensors, therefore, are very sensitive. The cladding acts as an integrating sensor. Since the organics are easily removed with acetone, the activity of the sensor can be restored by soaking in acetone and air drying.

Some spectra for benzene, toluene, xylene, Jet A, and trichloroethylene are shown as Figures 44 through 51. A quantization using PLS-2 is shown in Table 6.

TABLE 6. EXPERIMENT SUMMARY FROM SOH2.RPT
(NEAT MIXTURES 1 MM ABSORBANCE CELL)

Type: PLS2	#Spectra: 9	#Components: 4
# Regions: 1	Sampling: Avg	#Points: 751
Variance Scaling: NO	Mean Center: NO	MSC: NO
Pathlength Corrc: NO	Baseline: NO	Custom: NO
Number of factors for Press: 5	Number of samples for rotation: 1	
Name of Method file: soh2.MTD	Name of Calibration File:	SOH10.CFL

Number of factors for Calibration: 5

Region #	Left edge	Right edge	Pt spacing	# points
1	1000	1750	1	751

Sample				Found			
Jet A	B	T	X	Jet A	B	T	X
0.5	0.5	0	0	0.4995	0.4969	-0.0001	0.0027
0.5	0	0.5	0	0.5014	-0.0022	0.5055	-0.0018
0.5	0	0	0.5	0.5011	-0.0047	0.0063	0.4995
0.5	0.1	0.2	0.1	0.4997	0.1917	0.2013	0.1012
0.5	0.1	0.2	0.2	0.4991	0.111	0.1924	0.1957
0.5	0.1	0.1	0.2	0.4995	0.1881	0.1054	0.2059
0.5	0.3	0.2	0	0.5011	0.3036	0.2015	-0.004
0.5	0	0.3	0.2	0.4997	0.0007	0.2913	0.2057
0.5	0.2	0	0.3	0.5008	0.2096	-0.0038	0.295

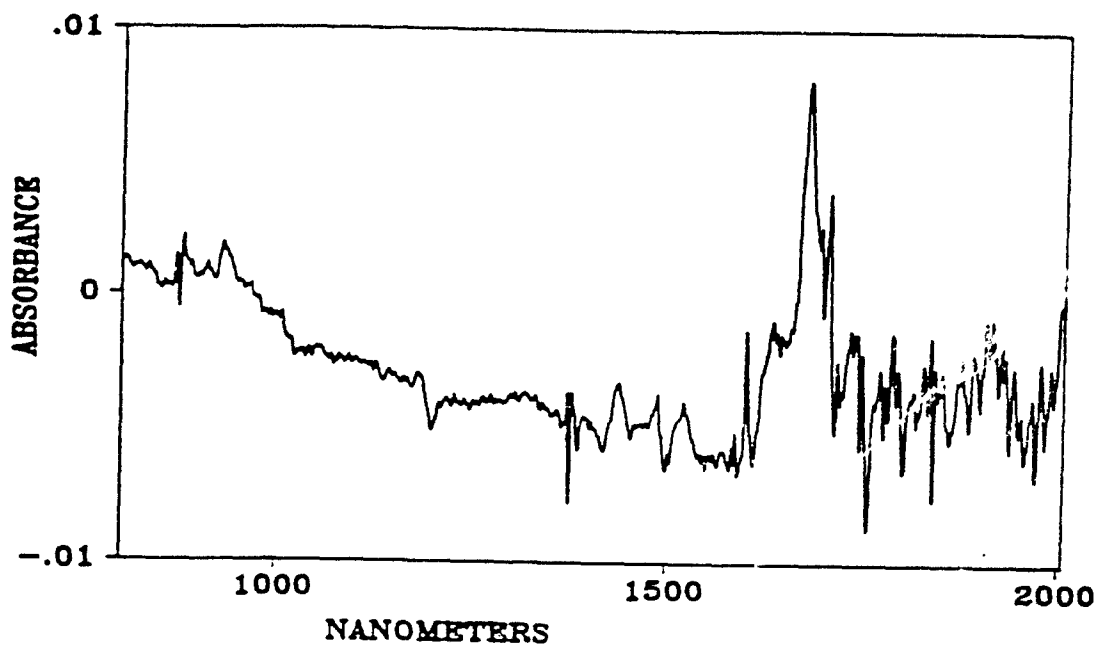

Figure 44. Benzene (1mm/liter water)
Coil Above Solution (30 minutes)

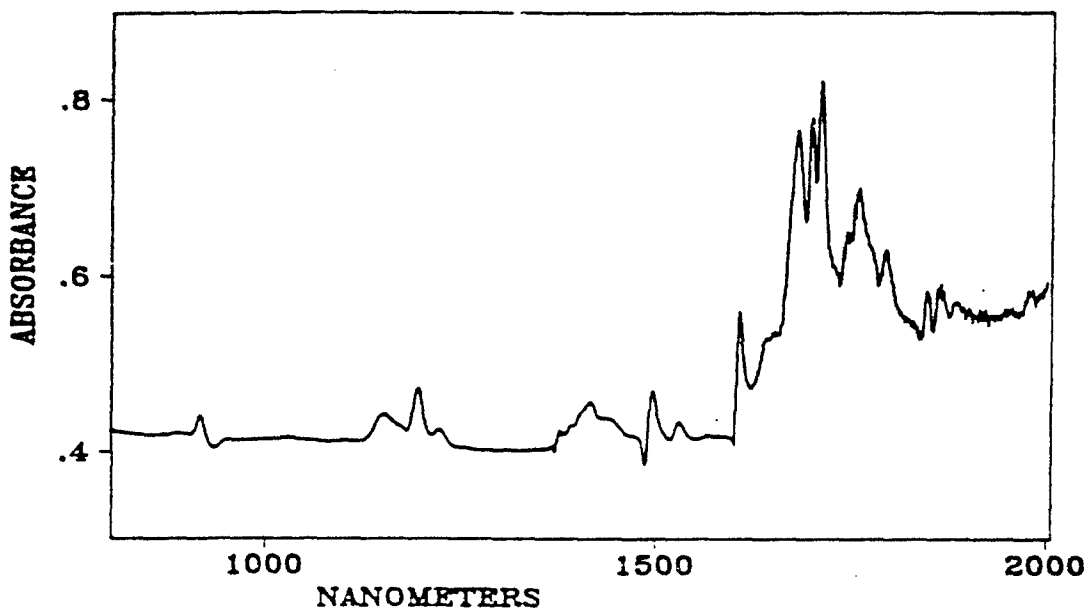

Figure 45. Toluene (1ml/liter water)
Coil Above Solution (30 minutes)

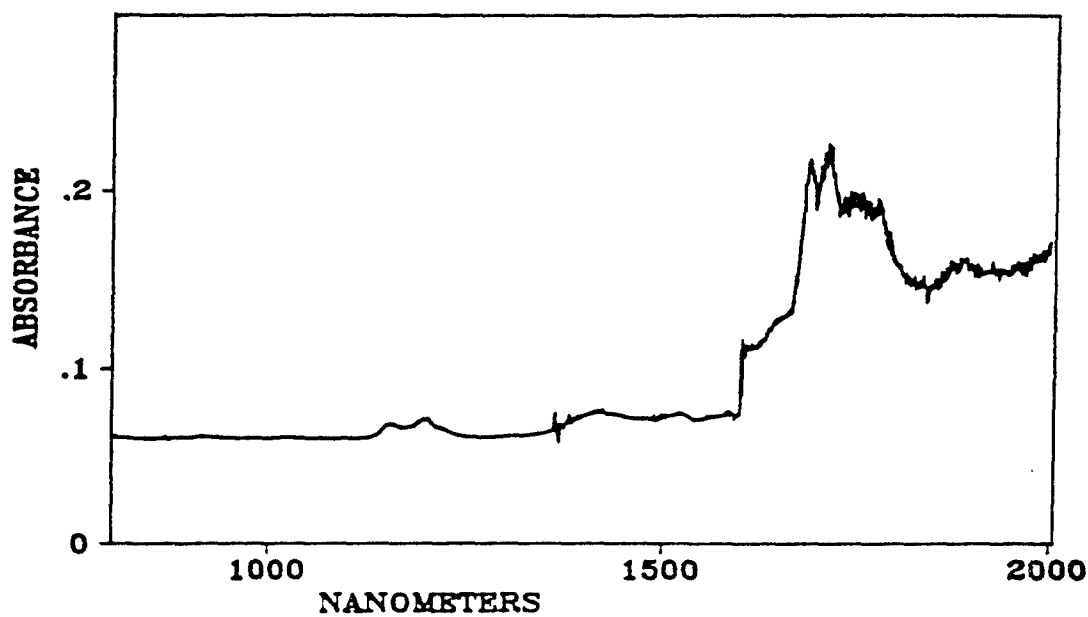

Figure 46. Xylene (1mm/liter water)
Coil Above Solution (30 minutes)

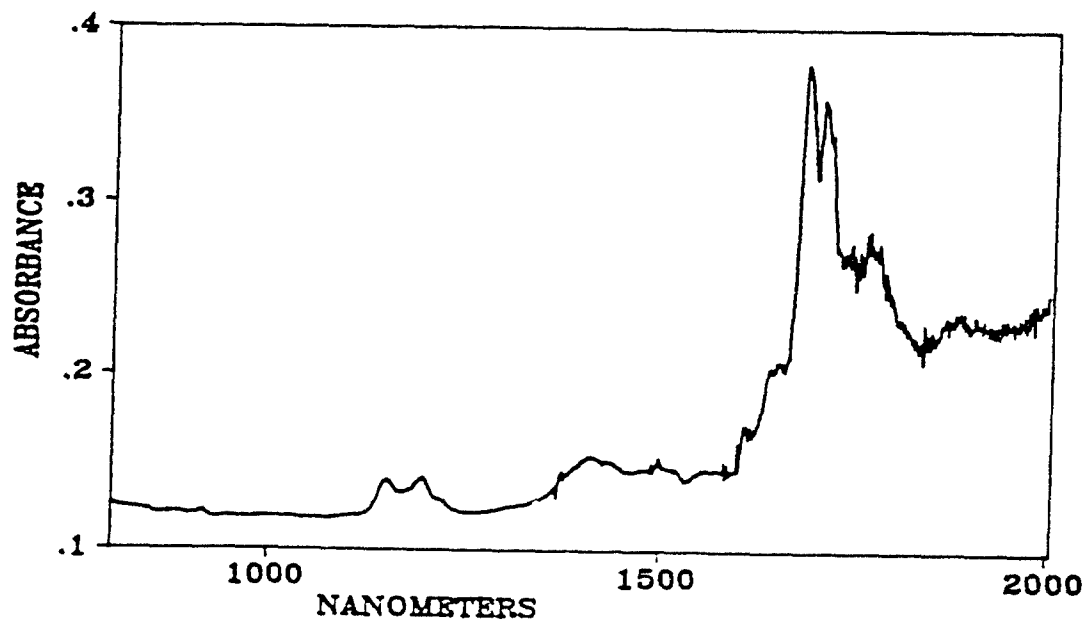

Figure 47. 1:1:1 BTX (1ml/liter water)
Coil Above Solution (30 minutes)

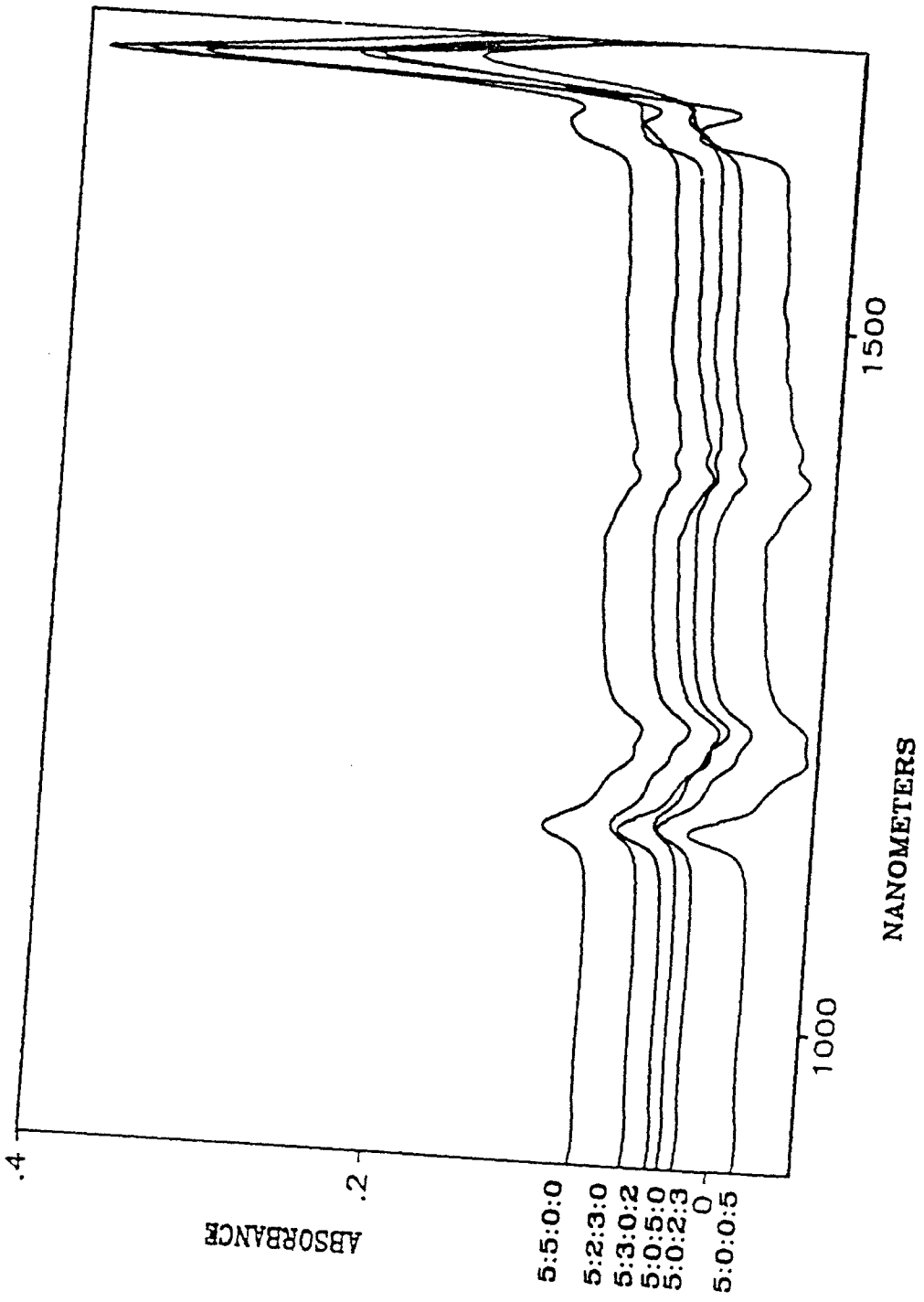

Figure 48. Ratios of Jet A, BTX; Coiled Fiber Sensor; (1mL/1000mL Water); above solution

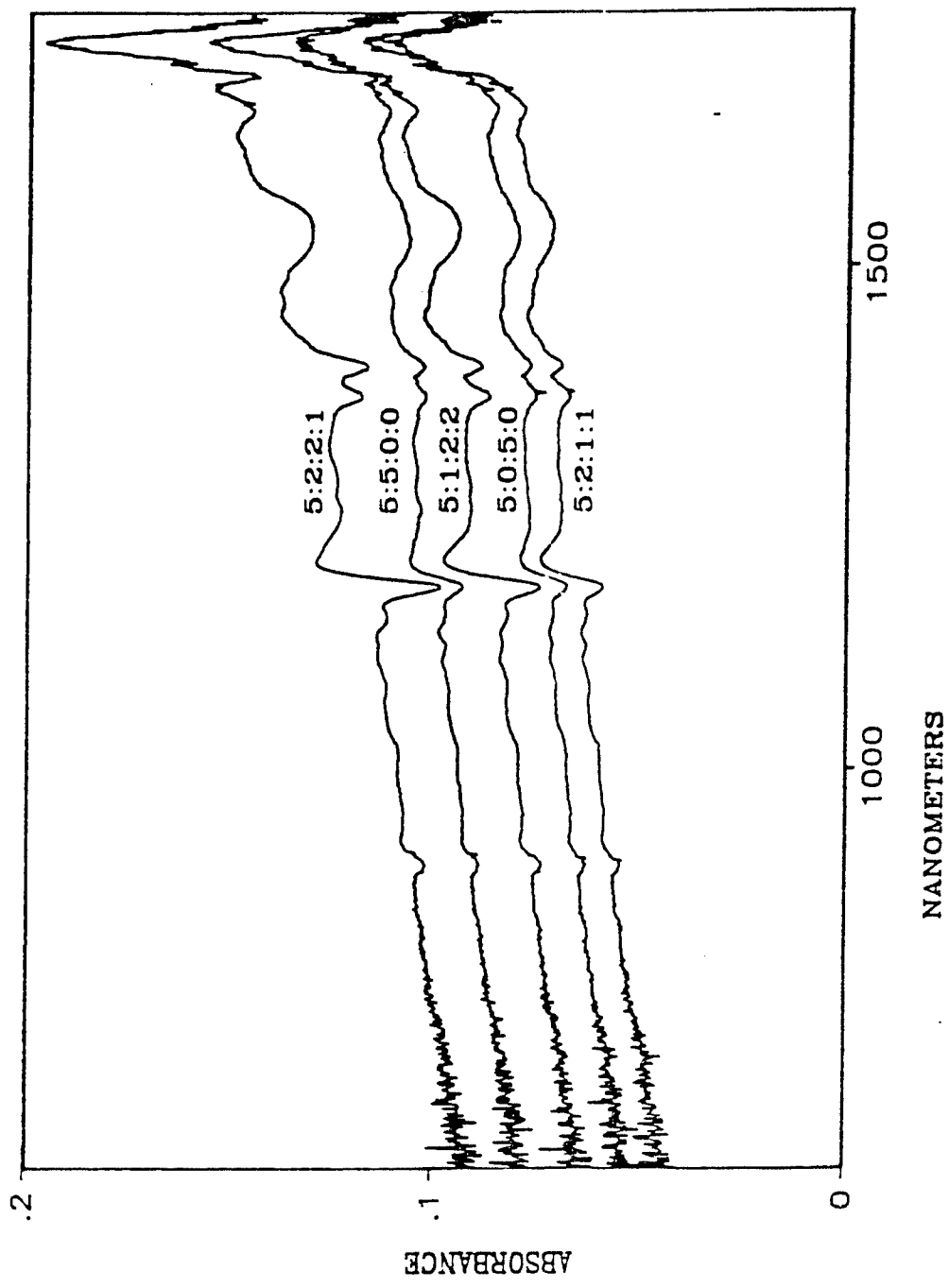

Figure 49. Ratios of Jet A, BTX; Coiled Fiber Sensor; (.2mL/1000mL Water); Sensor immersed

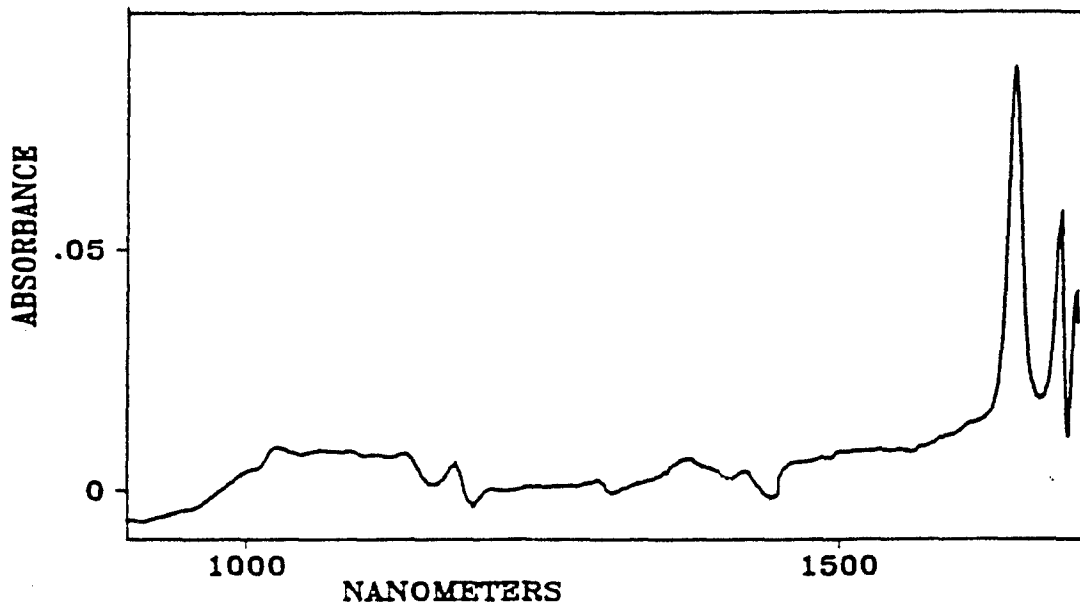

Figure 50. Trichloroethylene (neat)
Coiled Fiber Sensor NIR

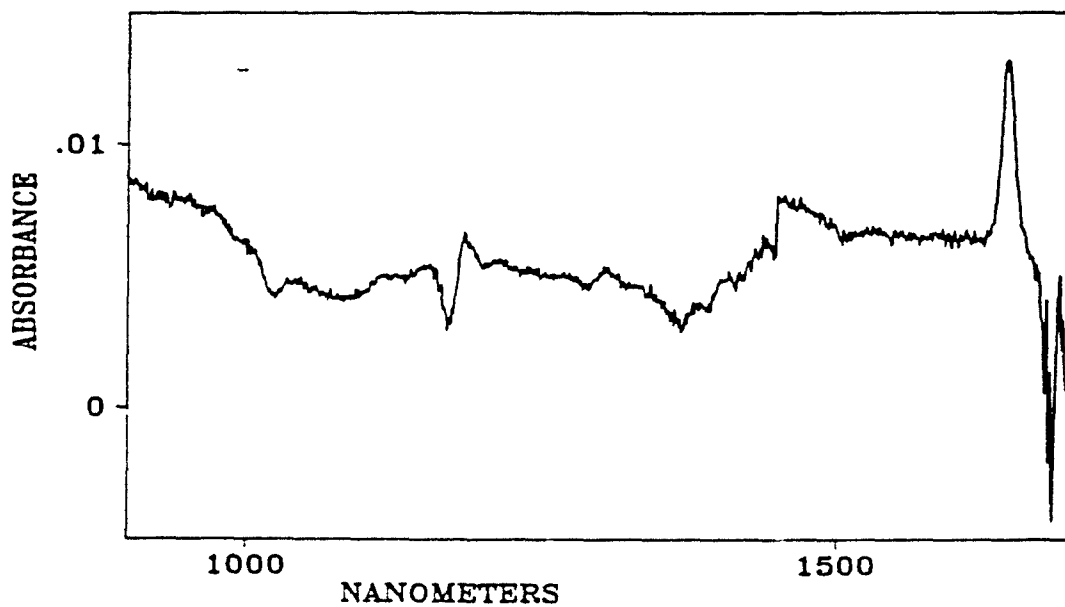

Figure 51. Trichloroethylene (0.1ml/liter water)
Coiled Fiber Sensor

SECTION V

BREADBOARD DESIGNS

The contract provided for the testing of selected components in breadboard configurations. For FOCS configurations a breadboard consist of a sensing element, fiber optic connections, and a read-out device. All of the experiments reported in Section IV included a computer and spectrophotometer (the read-out devices), fiber optic cables, and a sensing device. The sensing device used commercial components. Analyses were obtained for the required analytes without the use of chemical reactions at the end of the fiber. Therefore, each experiment was a breadboard configuration where standard spectroscopic techniques were successful.

The only modifications required for laboratory or field use of the systems would be length and type of fiber or transducer design to fit specific experiments. This section describes an apparatus designed to test a sensor in an aqueous environment. All of the parameters which are required to simulate a natural environment are provided. This apparatus can be used during the qualification program for a system, and for quality assurance measurements during manufacture and delivery of a system.

A. DESCRIPTION OF TEST APPARATUS

The apparatus shown in Figure 52 is used to evaluate the minimum number of sensors required to determine that a process is operating within statistical control. A system that is operating within statistical control has a defined identity and a defined capability. It is a random process. Its behavior in the near future is statistically predictable in the absence of an unforesee action that knocks the process out of statistical control. The apparatus can also be used for experiments to identify the statistical variations as measured simultaneously by many different sensors exposed to a completely defined condition. The capability to jolt or upset the system and follow the return to a stable system is also provided. After a system has been calibrated, the apparatus can then be used to simulate full scale equipment when engineering experiments are required for design or redesign of the system. The system was fabricated from commercially available components by the UAH glassblower. The following features are provided:

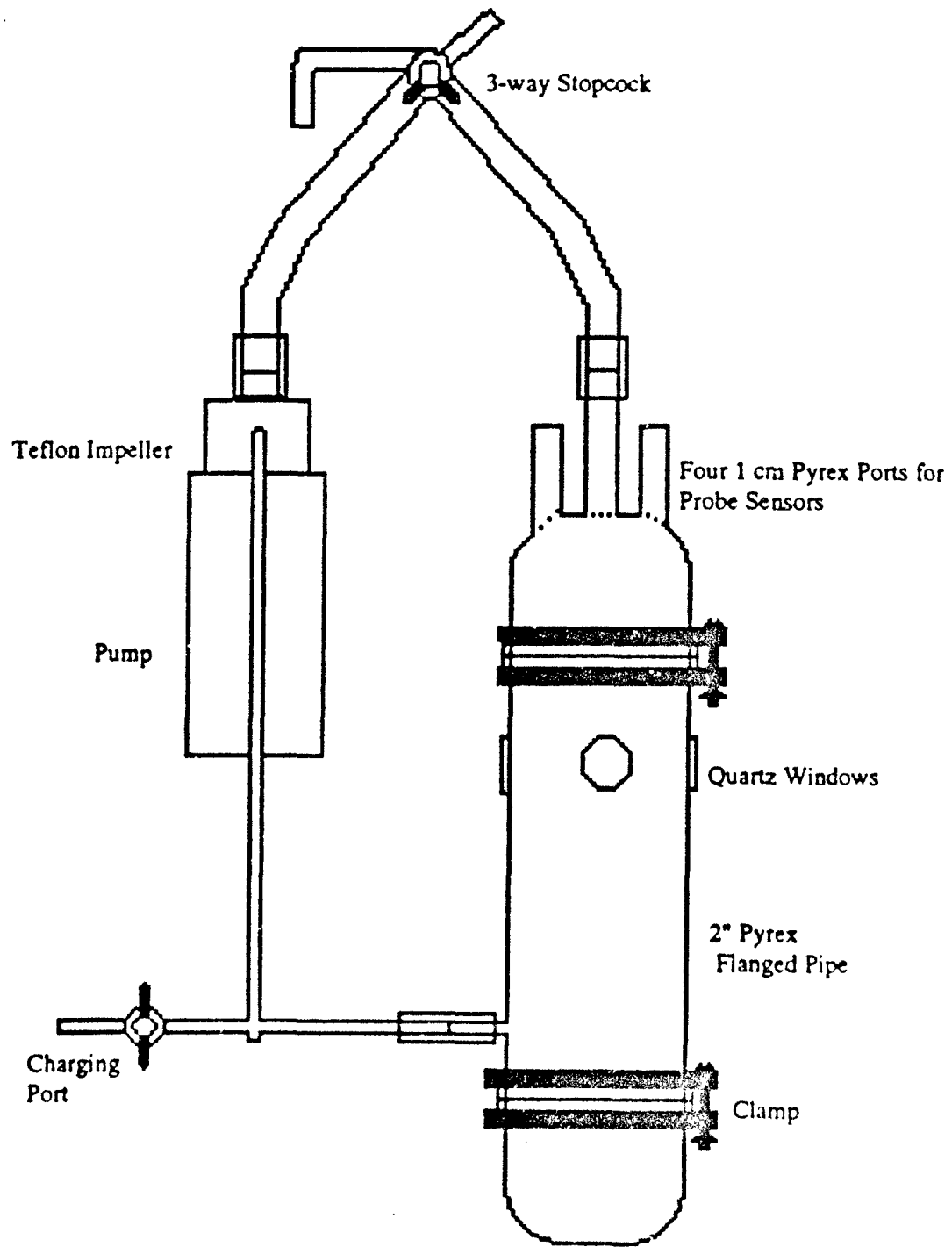

Figure 52. System Test Apparatus

1. Charging Port The tube and two way stopcock at the lower left is used to fill the system. To fill the system with water that does not contain dissolved oxygen, the system is flushed with an inert gas. Nitrogen can be used if nitrogen fixation is not being investigated. Helium or argon can be used if both nitrogen and oxygen must be excluded. When the apparatus is free of active gases, the sample bottle is pressurized and the apparatus is filled with a degassed solution. Both the two-way and three-way stopcocks are then closed to the atmosphere.

2. Septum Openings can be closed with septa as required. Samples may be taken or reagents added using a syringe and a needle placed through a septum. These ports may be used to adjust pH by adding acid or base. Carbon dioxide can be added when needed to simulate the atmospheric carbonate cycle or to adjust acidity. Oxygen can be added as required to adjust oxidation potential. The ports can be used to take samples without exposing the samples to atmospheric stimuli. The ports are used to add reagents to jolt a system and to follow the return to statistically described behavior. If temperature changes are expected, a syringe partially filled with solution is left in place at one of the ports to accommodate the differential expansion of glass and solution.

3. Test Section Glass tubing can be placed in either leg of the system if active devices are required for an experiment.

4. Impeller The solution within the system is circulated using the variable speed motor. The Teflon[®] coated impeller is magnetically driven.

5. Sensor ports Four ports are shown. These ports are used to hold sensors. Sensors currently available include pH, pI, pI₂, pO₂, pCO₂, conductivity, and pE. Four can be used simultaneously.

6. Spectroscopic windows A five centimeter path length is provided for spectroscopic measurement. UV grade quartz, NIR grade quartz, and sapphire windows are used. A window at right angles to one pair of ports is used for fluorescence measurements. Absorption probes, Guided Wave, Inc. Part # 7TP 2S - 5, with 1 and 2 centimeter path lengths are placed through the sensor ports when required for an experiment.

7. Spectrophotometer A fiber-optic cable is used to connect the light source to a window and a second fiber cable completes the path to the spectrophotometer. Detectors include a photomultiplier, silicon, germanium, and lead sulfide. Available gratings include 1200, 600, and 300 l/mm. Combinations of these gratings and detectors makes possible the recording of high-resolution spectra from 190nm to 2200nm. Resolution in the UV region is 0.05 nanometers and 2 nanometers resolution in the lead sulfide NIR region. Specifications for the spectrophotometers are given in Appendix C.

8. Additional detectors A sapphire-tipped ATR probe designed for three passes of the evanescent wave, Guided Wave, Inc. Part # 1AT4 SO -6B, is available for the visible and NIR regions. Fiber ATR probes, as described in Section IV, are also used.

9. Temperature control The temperature is controlled by wrapping the system with tubing through which water is circulated. Experiments have been run at 40°C.

Experiments are designed so that at least two sensors should respond to a given chemical species. If an acid is generated, the event should be recorded at least as a change in level of pH and conductivity sensors. In addition, organic acids often show changes in the UV or NIR region of the spectrum. Should biomass form within the system or deposit on the windows used for spectroscopic observation, it should be readily detected unless it forms in the same thickness on each type of material used in the construction of the apparatus. The fiber optic ATR cell requires diffusion of the organic material into the siloxane buffer. The NIR ATR absorption spectrum and the NIR absorption spectrum would not be expected to show the same response for high molecular species such as biomass. Organic species containing active hydrogens such as hydroxyl, hydrogen adjacent to carbonyl, or amine groups will show strong NIR absorption. Since hydrophilic compounds will not diffuse into the siloxane cladding, the opportunity for differentiation is provided. Phenols, cresols, etc. will have strong UV signatures. Most compounds containing the benzene ring can be quantitated in the UV.

The objective is to observe in real-time a sufficient number of signals so that there is enough knowledge of the system to predict the behavior of the system in the near future.

B. DESIGN OF UV NIR PROBE

The design of a combined UV NIR probe that could be used in the field is shown in Figure 53.

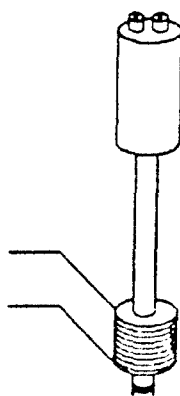

Figure 53. UV NIR Probe

A Teflon® spool is placed around the stainless steel shaft of an one or two centimeter absorption probe. A fiber-optic ATR sensor is wound on the spool. UV spectra can be recorded using the absorption probe, and NIR ATR spectra can be recorded using the fiber on the spool.

C. CONCEPT FOR AN INTEGRATED SYSTEM

Shown in Figure 54 is a concept of an integrated system that may be applicable to Air Force Bases.

The part of greatest concern is the length of the fiber optic links. If certain portions of the spectrum are required, then the lengths between the sensors and computer would be very short. For example, if the UV region from 190 nanometers to 250 nanometers is required, the fiber length would possibly be limited to less than 10 meters if white light is used. There is evidence that this could be raised to several hundred meters if predispersed illumination is used. Lengths would also be limited if information is required near the hydroxy absorption bands. Small dedicated hardened computers are available. One of these computers could be located near a cluster of sensors and the information coded at a different wavelength or to an electrical signal. An alternate configuration would place a small dedicated hardened computer at the site of each group of sensors. The purpose of this computer would be to collect data and convert the data to a format that could be passed over standard optical transmission lines.

SITE CHARACTERIZATION/SUBSURFACE
MONITORING USING
FIBER OPTIC CHEMICAL SENSORS

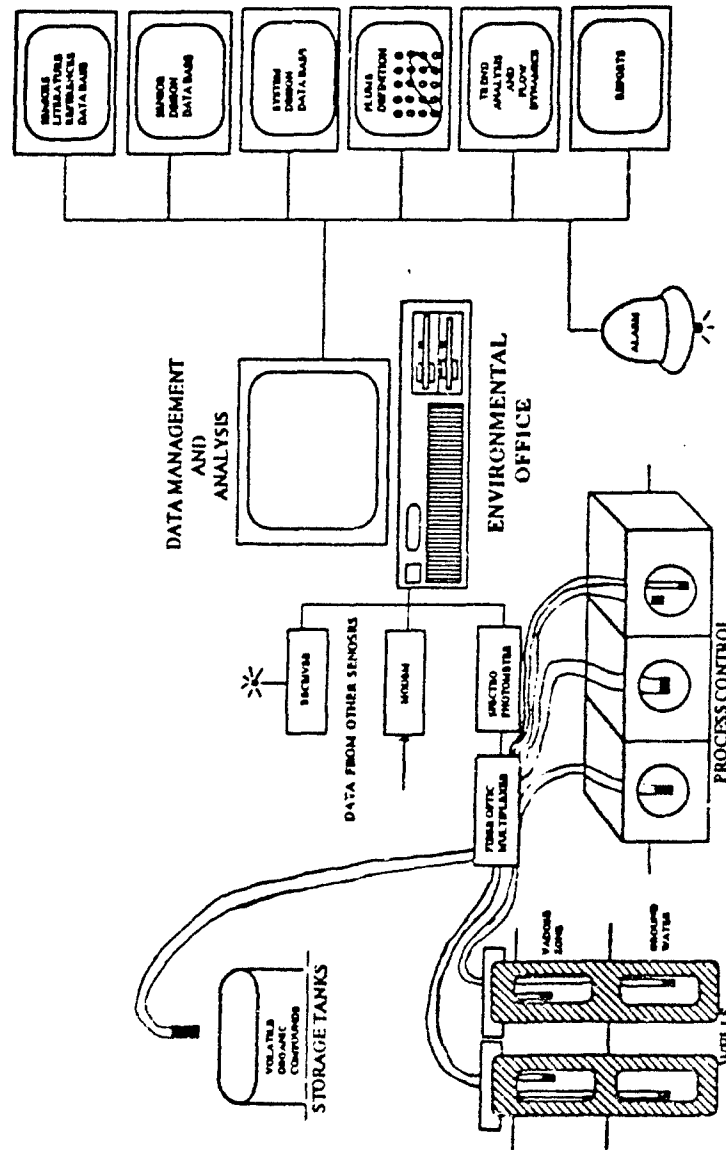

Figure 54. Integrated Monitoring System

SECTION VI

OBSERVATIONS AND CONCLUSIONS

The past 10 years has seen a period of rapid growth in instrumentation supporting analytical chemists. During the early 1980's, Dr. Tomas Hirschfeld and his colleagues began experiments with fiber optic chemical sensors (FOCS). Experimentation using these novel sensors spread rapidly into university laboratories and into the laboratories within the chemical industry. Parallel efforts were initiated in the fiber optic industry and by the manufacturers of medical instrumentation. Instrument manufacturers accepted the challenge. New markets had been created. Some of these activities with emphasis on sensors and instrumentation as applied to measurements related to the environment are described in this report.

During the same period, developments in the personal computer industry were an additional source of excitement. Investigators in even a small research laboratory today have available the computational power that only a few years earlier was reserved for the large research installations. Today, this computational power is found in portable computers with self contained power packs that can be used by investigators in the field sciences. Calculations can be made on site. Software algorithms related to multivariate analyses are now available for the portable computers.

The technological advancements have been evaluated and components selected for an instrument that can give immediate analytical results in the field. Significant time will be saved during site evaluation related to environmental concerns as field instrumentation replaces the practice of collecting samples and sending them to a laboratory for evaluation. Reduction in cost at remediation sites will be realized as immediate analyses are available. Expensive equipment will not set idle while analyses are being performed at an off site laboratory. The use of the equipment and procedures described in this study should be particularly effective in monitoring a site that awaits remediation or a site following remediation.

This research began at a time when many specialized instruments were being considered. FOCS were described as small chemical laboratories at the end of an optical fiber. The

conclusion reached in this study is that computer manufacturers, instrument manufacturers, and software houses have made innovative tricks unnecessary. (Applications to medical science excluded). When a goal is defined, sufficient research results are available so that the task is an engineering task not a research task. Unfortunately, each polluted area has its specific problems that must be considered. The task that lies ahead must be a team effort as the higher educational system has not provided interdisciplinary talent in sufficient numbers.

The analytical system selected during this study consist of a portable general purpose spectrophotometer. Gratings and detectors can be interchanged readily in the field so that the spectrophotometer can be used over the range of 190 nanometers to 2200 nanometers. This covers the ranges associated with ultraviolet, visible, and near infrared spectrophotometry. The light source housed in the spectrophotometer is connected by a fiber optic cable to the sensor which is in contact with the analyte. A second cable returns the electromagnetic radiation to the detector. The spectrophotometer is connected to a portable computer. The computer software controls the repetitive operations and calculates the analytical values for the analytes using multivariate algorithms.

The selected components can be configured for classical absorption spectroscopy and fluorescence spectroscopy. With the addition of a laser source, Raman spectroscopy would be possible. The choice of a flexible spectrophotometer permits as many spectral points as required to be acquired. Multiple points allow the software algorithms to correct for many sources of variance. The work described in this report used many redundant points. Through the use of multiple points precision was obtained. The ability to take many points increases the flexibility. New hardware is not required when the analyte changes. As use of the system increases, the database should contain the calibration data for all analytes of general interest.

When samples contain many analytes, it may be necessary to separate the components into groups. In the near infrared region, NIR, the quartz fiber used for the core makes a good attenuated total reflection, ATR, component. The ATR spectrum of a compound resembles the absorption spectra and is characteristic of the compound. The work of Degrandpre and Burgess (5) using a coated fiber that is hydrophobic and organophilic has been repeated during this investigation. Degrandpre and Burgess teaches that, "the polymer cladding is a critical

component of an evanescent-field fiber optic sensor. The cladding should provide mechanical strength, be selective for an analyte or group of analytes, have good chemical stability, and have good optical qualities such as transparency and low scattering. In order to work in the evanescent mode it must have a refractive index lower than the core index. Obviously, there will be many polymers that fit these criteria. The limited number of polymer claddings and core combinations that are commercially available dictate that researchers must develop their own manufacturing capabilities." As the result of our investigations, we add that the cladding must be added to the quartz core during the drawing operation while the fiber is in the inert atmosphere of the drawing furnace. The UAH Laboratory For Inline Process Analyses has received experimental fiber from the Guided Wave, Inc. plant. The theories have been confirmed and many new fibers are available. Since the aromatics have a higher index of refraction than quartz, the concentration range is limited before cutoff in the core. Therefore, we are also considering glasses with higher index of refraction than quartz.

The advantages of multivariate analyses are numerous. Probably the most important advantage is that many analytes can be quantitated using a single spectrophotometric system. With multivariate analyses and statistical models, analyses for the analytes of interest are obtained. All other analytes and sources of variation are considered noise. The analyst must accept the responsibility that the calibration set contains all sources of variance. It is important to carry redundant data rather than minimize the number of spectral points too early in an investigation and risk undesirable variation from interferences and non reproducible procedures.

A disadvantage of the recommended multivariate procedures is the requirement for a well characterized training set that has been analyzed by an acceptable analytical procedure. This disadvantage will decrease as use of the system increases and the database grows.

The present decade has seen many innovative changes applicable to determinations made by analytical chemists. This report has stressed the developments in spectrophotometers, computers, and computer software. An analytical system has been recommended that will expedite environmental analyses. The system will be useful during site characterization, remediation, and site monitoring.

APPENDIX A
OPTRODE DEVELOPMENT
(1986)

APPENDIX A

OPTRODE DEVELOPMENT (From a UAH Report prepared in 1986)

A. BACKGROUND AND PROBLEM DEFINITION

1. Introduction

The Center for Applied Optics at The University of Alabama in Huntsville and their subcontractor ST&E, Inc. have completed a three month study to define the state of the art related to Optrodes and, more specifically, FOCS. This study was made at the request of Dr. Bernard Bulkin, Director, Analytical Sciences Laboratory, Standard Oil Research and Development Company.

The study has confirmed the observation that most of the published studies related to FOCS have their roots at the Lawrence Livermore National Laboratories (LLNL). Dr. Tomas Hirschfeld (LLNL) did much to popularize the ideas. Efforts were primarily directed at FOCS research concepts and as a result, few, if any, of these FOCS reached the commercial market. Considerable engineering effort remains to be completed.

2. Problem Statement

FOCS are small chemical laboratories placed at the end of a fiber optic. For chemical analyses these optrodes should be specific to the chemistry confined within the light path at the end of a fiber. Our studies indicate that many chemistries have been tested under laboratory conditions, but few, if any, have made the complete journey through engineering, manufacturing and then to the commercial market. In fact, the laboratory work is often suspect, as it has been difficult, if not impossible to repeat the experiments and obtain data similar to that reported in the literature. On the other hand, private communications indicate that several types of optrodes have been successfully adopted to industrial use. A uranyl optrode (based on LLNL research) is in use at Union Carbide and a copper optrode (started by ST&E but completed by Guided Wave, Inc.) is in place at Hughes Aircraft.

Our evaluation of FOCS identified the following as needed future research and engineering objectives of interest to Standard Oil:

1. Check viability of relevant optrodes
2. Specific optrode chemistry (proprietary)
3. Improved ruggedness
4. Increased lifetime
5. Better reproducibility between FOCS
6. Better protection from contamination
7. Better control of pore size of membranes

Significant advances toward meeting these objectives are possible. The problems are common to the engineering of optical systems. Several organizations at the recent FACSS meeting pointed out to us that they felt the most important deficiency within their organization was lack of an optics engineering group. More realistically, however, the need is for a team of chemists and optical engineers, working in tandem, if the FOCS are to become a practical useful devices. The CAO-ST&E team that completed the recent study, consists of chemists, optical engineers, and analysts and is uniquely qualified to attack these problems. The team, contains individuals who have been connected with FOCS development since the beginning and the optical specialist that constitute the CAO.

B. STATEMENT OF WORK

1. Approach to Capturing and Improving FOCS Technology

The engineering objectives give in Section A have been carefully considered. All FOCS have similar shortcomings. This observation led to consideration of common components. Signal to noise ratio is low. Either the signal strength at the source must be increased or the available signal must be used more conservatively. Significant effort has been placed on obtaining increased signal strength. The Livermore group has investigated several approaches. It will be the goal of this development effort to capture as much of this experience as possible. Reproducibility has been a major problem. ST&E, since personnel have been associated with the research, will be responsible for manufacturing the initial sensors and will

provide written procedures. Using the written procedures CAO will attempt to reproduce the ST&E results. The CAO will concentrate their developmental effort on the fiber optic components. Different cores, claddings and/or protective coatings may be used. UAH will attempt to distinguish between the populations of FOCS available for testing. FOCS made at UAH will be tested at ST&E.

Inadequate noise management is believed to cause a major portion of signal degradation. The optimum system will include compromises on fiber size, cladding, buffering, and/or tensile strength. Larger fiber cores transmit more light but lead to noise from modal mixing. Mode strippers have proven useful in separating signal from noise. Although photons are lost in strippers, frequently, an overall gain in signal strength and purity can be achieved. Although they are more expensive, bundles of small fibers will be considered. Signal lost in a single fiber may be high, but the signal will be greater if the geometry of collection can be improved or if less signal is lost to higher modes.

Big improvements have been made in obtaining useful information through the use of appropriate software algorithms. The analog approach to read-out is the simplest. When only a single parameter is measured information can be obtained concerning the statistical distribution of values. When two parameters are measured, two dimensional plots can be made. The human can often distinguish patterns. A few individuals can recognize patterns when three dimensions are considered. Once the information is digitized, computer programs can be used to find patterns in multiple dimensional space. The different methods of data reduction will be compared. Trade-offs in cost between the simplicity of a FOCS using analog output possibly digitized, and systems containing more intensive computer utilization will be considered.

Some of the unsatisfactory results are believed to originate from a standardization problem. Some of the variations between measurements may result from values being compared to an improper standard. This problem may become obvious as different spectrophotometers are used.

The adapter being used by ST&E to couple light into and out of the optrode does not appear to be a source of noise. This adapter will be used until a shortcoming is observed.

Engineering is required so that the adapter will be versatile enough to be used on a number of spectrophotometers. The first adaptation will be to the Guided Wave Inc. Optical Wave Guide Spectrophotometer, since UAH has experience with this spectrophotometer in measuring optical quantities related to fiber transmissions. Use of this spectrophotometer for comparing current spectral data transmission over fiber with previous results, should quickly identify the sources of problems.

2. A Bolder Experimental Approach

FOCS development has necessarily used fibers and technology that have been developed for the communication industry. Use of different types of fibers has been considered under Section B.1. Investigation of the sensor at the distal end of the fiber, however, was limited to capturing existing technology. New approaches to manufacturing the active parts of the sensor are proposed. Normally the core has a slightly greater index of refraction than the cladding. The chemical specificity is often derived from a chemical interaction with the cladding. If experimentation is limited to claddings that match the currently available glass, quartz, or plastic core materials, selection of claddings is limited. We propose to select the appropriate cladding, and then make an appropriate core material. The core material may be a single crystal, a specialty glass, or a powdered material compressed at high pressure until optically transparent. The cladding will then be deposited by a technique common to optical technology, for examples, by evaporation, sputtering, or plating.

Historically, many chemistries have been proposed and reported in the literature but few have actually worked properly. Unfortunately, the chemistries are so varied that it is impossible to focus on a single cause or a few specific causes for poor reproducibility. One of the reasons that FOCS have not progressed faster is the wide variety between the chemistries so that no commonality exists.

The data from the overhead transparencies used for the briefing related to this report follow on the next page.

TOMAS HIRSCHFELD

1939 - 1986

YEARS	EMPHASIS	PUBLICATIONS
1962 - 1968	ATTENUATED TOTAL REFLECTION	25
1968 - 1975	RAMAN - FTIR	125
1975 - 1980	FLUORESCENCE MIXED	200
1980- 1986	FOCS	50
1982 - 1986	NIRA, ORRELATION ANALYSIS	300

OPTRODES

<u>PHYSICAL</u>	<u>CHEMICAL</u> <u>(FOCS)</u>
Natural Fluorescence	Induced Fluorescence
Light Scattering	Fluorescence by Reaction
Absorption	Refractive
Raman	
Deformation	

TYPES OF OPTRODES

Single-Fiber
Dual-Fiber
Lens
Reflection
Capillary
Self-Cleaning
ATR

TYPES OF FOCS

<u>Liquid</u>	<u>Solid</u>
Reservoirs	Direct Application
Porous Glass (Absorbed)	Immobilization (Glass & Polymers)
Polymers (Trapped)	Surface Amplification
	Coimmobilization

SELECTED ORGANIZATIONS DOING OPTRODE R&D

Lawrence Livermore National Laboratory	Livermore, CA
ST&E	Livermore, CA
NIH	Bethesda, MD
University of Tennessee	Knoxville, TN
University of Alabama Huntsville	Huntsville, AL
University of Washington	Seattle, WA
US Department of Agriculture	Beltsville, MD
Indiana University	Bloomington, IN
Standard Oil R & D	Cleveland, OH
Foxboro Company	Foxboro, MA
Hughes Aircraft	Los Angeles, CA
The Dow Chemical Company	Midland, MI
Hercules	Wilmington, DE
E.I. Du Pont de Nemours & Company	Savanah River, CA
Sperry Research Company	Sudbury, MA
University of California at San Francisco	San Francisco, CA
University of New Hampshire	Durham, NH
Karl Franzens University	Graz, Austria
Cardiovascular Devices, Inc.	Irvine, CA
Kelsius, Inc.	San Carlos, CA
Guided Wave, Inc.	El Dorado Hills, CA

ORGANIZATIONS WHICH MAY COMMERCIALIZE OPTRODE

ST&E, Inc.	Livermore, CA
In-Situ, Inc.	Larami, WY
Fibersens	Albuquerque, NM
Cardiovascular Devices, Inc.	Irvine, CA
Kelsius, Inc.	San Carlos, CA
Guided Wave, Inc.	El Dorado Hills, CA

ADVANTAGES OF FIBER SPECTROSCOPY

- Small Physical Size
- Geometric Flexibility
- Environmental Versatility
- Real Time Analyses
- Multiple Analyses
- Sample Integrity
- Instrument Reliability
- Analyte Specificity
- In-Vivo and In-Situ Analyses
- EMI Insensitive

FUTURE ENGINEERING REQUIREMENTS FOR FOCS

- Achieve Ruggedness
- Increases Lifetime
- Provide Reproducibility Between FOCS
- Control Pore Size of Membranes
- Protect Against Contamination

APPENDIX B

MODELS

APPENDIX B

MODELS

Models may be divided into three general types: (1) quantitative or analytic, (2) qualitative, and (3) heuristic or empirical.

A. QUANTITATIVE OR ANALYTICAL

A quantitative model consists of a mathematical representation of the dynamic features of a system as a set of differential equations, or a description in terms of state variables obtained from the knowledge of the fundamental physics and chemistry of the system. Stochastic techniques can be employed for systems with unpredictable behavior. Shown at the top of Figure B-1 are four quantitative models: (1) Most individuals are familiar with the equation representing an ideal gas. Data representing the state variables temperature, pressure, volume and mass can be correlated using the equation for an ideal gas. If any three of the properties are known, the fourth can be calculated. For example, mass can be evaluated by measuring the volume, temperature, and pressure of a sample of gas. (2) Beer's Law is the principal equation used by spectroscopist. If the spectrum of each component of a mixture is known and the compounds in the mixture do not react, then the percent of each component is calculated by a manipulation of matrices. (3) Constructing a quantitative model for a system for measuring pH using a glass electrode or a hydrogen electrode is straight forward. The Nernst equation defines the relationship between the electropotential and the activity of the hydrogen ion. The Nernst equation also defines the change in potential with a change in temperature. Potential and current relate to the flow of electrons in conductors and are adequately described by Ohms law. Many successful pH meters have been developed and marketed using these equations to construct the model. As demonstrated by these examples, model building is a useful technique used by many scientists and engineers. This type of model is successful if the relationships are shown are linear and the variables can be separated. A first order model can be quickly constructed and instruments developed, manufactured and calibrated. A closely related technique of model building is represented by the example taken from Diamond, William J., Practical Experimental Designs. This example represents a synthesized linear model. It is assumed that the variables are separatable. Each of the individual functions is obtained by planning experiments where

BUILDING THE MODEL ($y = f(x)$) IS THE CRITICAL STEP QUANTITATIVE OR ANALYTICAL

Ideal Gas Law $PV = nRT$ Beer's Law $A = \epsilon LC$ Nernst Equation $E = E^{\circ} - \frac{RT}{nF} \ln \left[\frac{Red}{Ox} \right]^b$

Tire Life (Diamond)
 Life of Tire = $f(\text{type of Rubber}) + f(\text{Curing Temp}) + f(\text{Additives})$
 $+ f(\text{Groove Design}) + f(\text{Mixing Procedure}) + f(\text{Size of Tire})$
 $+ f(\text{Car Design}) + f(\text{Roadbeds}) + f(\text{Operating Speeds})$
 $+ f(\text{Atmospheric Conditions}) + f(\text{Operator Of Car})$
 $+ f(\text{Maintenance}) + f(\text{Type of Rubber})$
 $f(\text{Operating Speed}) = 87 \times \text{EXP} \left[7 - \left(\text{Speed} + \frac{1}{\text{Speed}} \right)^2 \right]$

QUALITATIVE

A SYSTEM IS REPRESENTED OR DESCRIBED BY ITS COMPONENTS.
 CAUSAL RELATIONSHIPS ARE EMPHASIZED (FREQUENTLY USED IN EXPERT
 SYSTEMS AND NEURAL NETWORKS)

HEURISTIC OR EMPIRICAL

A SET OF EQUATIONS ABOUT A SYSTEM GENERATED THROUGH
 EXPERIMENTATION, STATISTICS, AND VALIDATION

Figure B-1 Models

only one variable is changed at a time, that particular variables is modeled, and then the entire set of experiments is summed.

Quantitative of analytical models are sufficient for classical science and are particularly important to demonstrating causality. Science and technology have advanced our abilities to measure with greater precision, to see smaller objects, and to see objects at greater distance. Many examples are found where the variables interact and are not linear or separatable. Pure specimens of many of the chemicals in complex mixtures as found in nature are not available. Therefore, other methods of model building must be considered.

B. QUALITATIVE.

For a qualitative model a system is represented in terms of its components. The casual relationship between the components, corresponding to physical laws are emphasized. Functional descriptions of the components are utilized to generate rules and constraints for the entire system. This type of model can be demonstrated using the Ideal Gas Law. If the temperature and pressure of a volume of gas was being monitored in a container of fixed volume and a temperature rise is observed without an increase in pressure, as would be expected in a non reacting system, a chemical reaction in which the number of molecules of gaseous product is less than the number of molecules of gaseous reactants may be postulated. This would not be a valid conclusion if a transducer malfunctions. The first rule therefore could be: if the above condition is observed check for the malfunction of a transducer. This type of model is frequently used for AI and expert system algorithms. Model of this type will be useful in describing monitoring system where detecting and quantitating a change in an analyte is more important than the base line composition. This type of model is less useful for modeling diagnostic systems.

C. HEURISTIC OR EMPIRICAL.

The amount of information obtained from an univariate statistical analysis is limited. For a single type of measurement on several samples, the samples can be represented on an axis or number line representing all possible values of the measurement. With univariate statistical

techniques, some information can be learned about the one-dimensional distribution of these points. More information can be gained when the values of a separate measurement are known for these samples. It is then possible to plot the points in a plane. As additional dimensions are added, more information is available.

The human being is the best pattern recognizer in two dimensions, or sometimes three dimensions. As additional types of measurements are made on the samples of a population, the potential to gain information about the properties of the sample increases, but the human ability to "see" patterns rapidly decreases. The computer, however, is able to manipulate points in multidimensional space, perform operation on them, and recognize the patterns in the higher order space. Cluster analysis and pattern recognition algorithms are designed to model systems and determine or predict properties of systems that are not themselves directly measurable but are related to measurements on the systems and give information that is sought. The pattern recognition approach is oriented to discover hidden relationships and to develop accurate and useful prediction and classification models for aspects (properties of categories) that are difficult or impossible to measure, using features or variable that are easy and inexpensive to measure and a training set of knowns. As each individual has a characteristic fingerprint, each instrument, each transducer, and each sample has a characteristic data vector. If the data vectors for two instruments are the same, the instruments are identical. If the data are different for identical samples by several operators then the instruments or operators are responsible. If the data vectors are not identical, they can often be separated into two or more vectors that can be identified. This type of modeling is particularly useful for evaluating data taken using several instruments and several operators to identify malfunctioning instruments and/or unqualified technicians.

Empirical models have been used beneficially for near-infrared analyses (NIRA). Data vectors (spectra) are taken for samples of known composition. An empirical model is established, based on the variance covariance matrix. The content of unknown samples can then be quantitated (predicted). These models have been used extensively for analyses of agricultural products, drugs, and textiles.

Relationship between error of prediction and complexity of the calibration are shown on Figure B-2. As indicated, if only one observable is used, the error of prediction caused by interferants is high. As longer data vectors are used the error of prediction decreases. An example from spectroscopy is the use of a single wavelength and Beer's law vs the entire spectrum and Beer's law. When a factor analysis approach is used, the use of too many factors results in including noise in the data. The training set must match the experimental conditions.

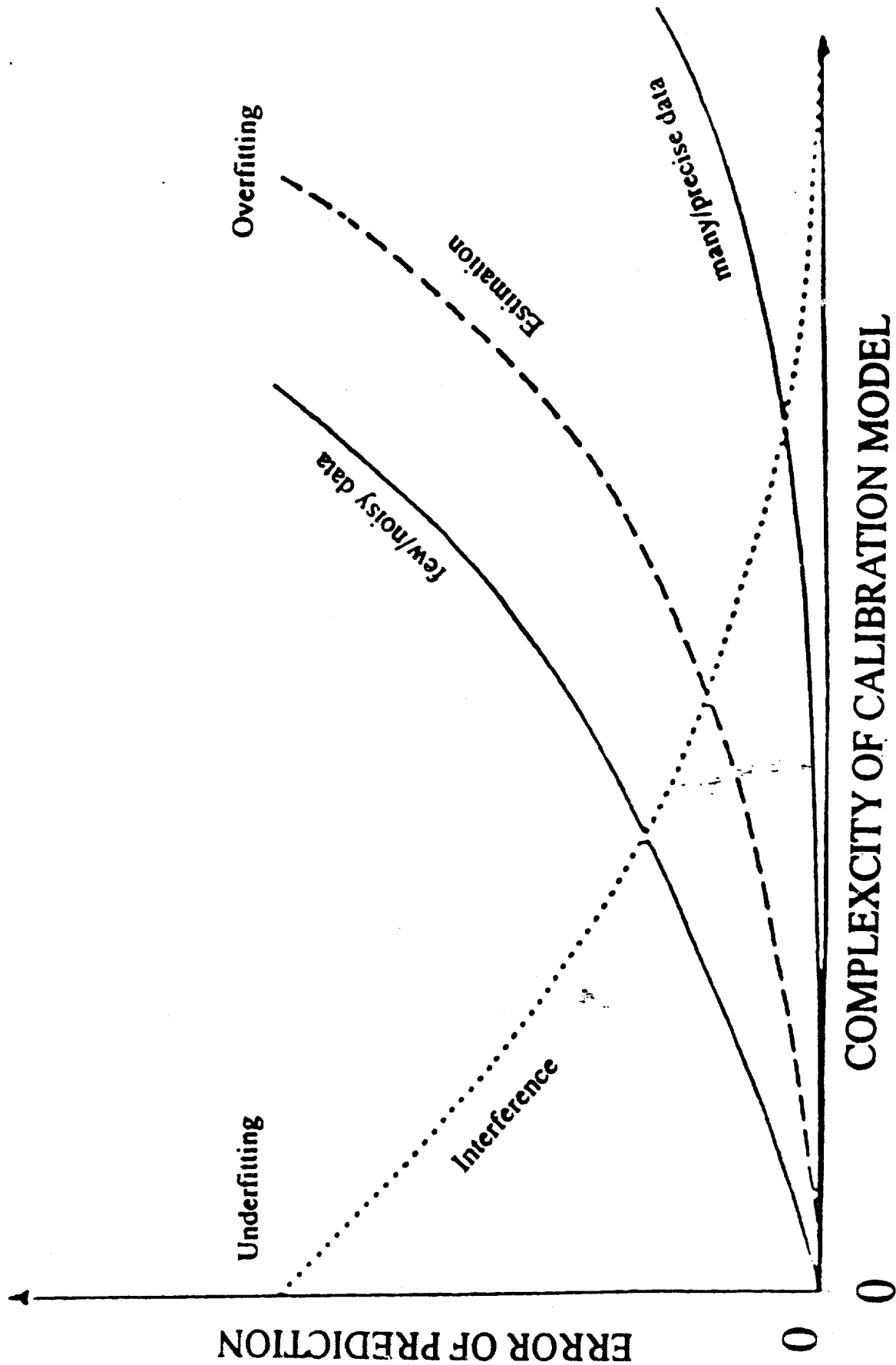

Figure B-2. Prediction Error vs Complexity

APPENDIX C
SPECIFICATIONS OF SPECTROPHOTOMETERS

APPENDIX C

SPECIFICATIONS FOR SPECTROPHOTOMETERS

One classification for spectrophotometers is related to the handling of the reference spectrum. A single beam spectrophotometer requires that the reference spectrum be taken and stored. A double beam spectrophotometer has parallel light paths and alternates readings between the reference and the sample. There are advantages and disadvantages for each method. The Guided Wave, Inc. Model 200 used for most of the work described in this report is a single beam instrument. The Model 300 is a double beam instrument. Both of the Guided Wave, Inc. instruments are optimized to the characteristics of light transmission over fiber cables. These spectrophotometers gave better signal/noise ratio than was reported in the literature for other spectrophotometer designs.

A. SINGLE BEAM SPECTROPHOTOMETER

A portable scanning spectrometer employing an optical fiber link between the sample and the spectrophotometer is required. A selection of gratings and detectors are required to allow use of the spectrometer as a UV-VIS-NIR instrument over the range of 190 nanometers to 2200 nanometers. Kinematic mounts of detectors and gratings are required so that gratings and detectors may be readily interchanged and calibrated in the field. Operating characteristics include:

1. Distance between spectral points and number of readings averaged to be software adjustable.
2. Record 2000 points in a single scan in 30 seconds or less.
3. Spectrometer bandwidth selectable from 2 - 16 nanometers by changing entrance and exit slits.
4. Signal-to-noise of 50 microabsorbance units (RMS) or better at zero absorbance units through 2 meters of single strand optical fiber (core diameter 500 micrometers or less).

5. Industry standard SMA 905 connectors provided for optical cable connections.
6. IBM-PC compatible interface and software drivers.
7. Software to collect and display spectra and store spectra to disk.

B. DOUBLE BEAM SPECTROPHOTOMETER

A scanning spectrometer employing reference and sample optical links is required. Capabilities to include:

1. Record spectra between 700 nanometers and 1900 nanometers in a single scan in 10 seconds or less.
2. Spectrometer bandwidth not greater than 16 nanometers.
3. Signal-to-noise of 20 microabsorbance units or better at zero absorbance units through 2 meters of single strand optical fiber, core diameter 500 micrometers or less.
4. IBM-PC compatible interface and software drivers.
5. IBM-PC data terminal capable of being located at least 1 kilometer from the spectrophotometer.
6. Industry standard SMA 905 connectors provided for optical fiber connections.
7. Software to collect and display spectra and store spectra to disk.
8. Software with macro language allowing automated operation including customized data collection on, reduction, and display.

APPENDIX D
BIBLIOGRAPHY

This BIBLIOGRAPHY is a computer dump of the askSam file METHOD. The following field names were used: AU, TI, JR, VO, IS, PG and YR. If the information for any of these fields was not available to the Word Processor AAU, ATI, AVO, AJR, AIS, APG or AYR was entered.

Searches for the unavailable information was made if the material was pertinent to this contract.

Barkas, W.W., "Analysis of Light Scattered From A Surface of Low Gloss Into Its Specular and Diffuse Components," Proc. Phys. Soc. (Lon.), 51, AIS, 274-295, 1939.

Wallace, Richard M., "Analysis of Absorption Spectra of Multicomponent Systems," The Journal of Physical Chemistry, 68, 12, 899-901, 3890-3892, 1960.

Wallace, Richard M., "Analysis of Absorption Spectra of Multicomponent Systems," Physical Chemistry, AVO, AIS, 899-901, 1960.

Ainsworth, S., "Spectrophotometric Analysis of Reaction Mixtures," Journal of Physical Chemistry, 65, AIS, 1968-1972, 1961.

Welford, B.P., "Note on a Method for Calculating Corrected Sums of Squares and Products," Technometrics, 4, 3, 419-420, 1962.

AAU, "A New Spectrophotometric Technique Using Multiple Attenuated Total Reflection," Analytical Chemistry, 35, 6, 765-766, 1963.

Ainsworth, S., "Spectrophotometric Analysis of Reaction Mixtures. II," Journal of Physical Chemistry, 67, AIS, 1613-1615, 1963.

Kapany, N.S. and Pontarelli D.A., "Photorefractometer I. Extension of Sensitivity and Range," Applied Optics, 2, 4, 425-430, 1963.

Kapany, N.S. and Pontarelli, D.A., "Photorefractometer II. Measurement of N and K," Applied Optics, 2, 10, 1043-1048, 1963.

Simonds, J.L., "Application of Characteristic Vector Analysis to Photographic and Optical Response Data," Journal of the Optical Society of America, 53, August, 968-974, 1963.

Wallace, R.M. and Katz, S.M., "A Method for the Determination of Rank in the Analysis of Absorption Spectra of Multicomponent Systems," Physical Chemistry, AVO, AIS, 3890-3892, 1964.

Johnson, C.D.; Katritzky, A.R.; Ridgewell, B.J. Shakir, Naeem and White,, "The Application of Hammett Acidity Function To Substituted Pyridines and Pyridine 1-Oxides," Tetrahedron, 21, AIS, 1055-1059, 1965.

Frei, R.W. and Ryan, D.E., "Simultaneous Analysis of Two-Component Systems by Diffuse Reflectance Spectroscopy,"

Canadian Journal of Chemistry, 44, AIS, 1945-1950, 1966.

Varga, Louis P. and Veatch Fred C., "Nature of Hafnium-Chloranilic Acid Metallochrome by Matrix Rank, Contour Mapping, and Iterative Analysis of Absorption Spectra," Analytical Chemistry, 39, 10, 1101-1109, 1967.

Wernimont, Grant, "Evaluating Laboratory Performance of Spectrophotometers," Analytical Chemistry, 39, 6, 554-562, 1967.

Whetsel, Kermit B., "Near-Infrared Spectrophotometry," Applied Spectroscopy Reviews, AVO, AIS, 1-67, 1968.

Lawton, William H.; and Sylvestre, Edward A., "Self Modeling Curve-Resolution," Technometrics, 13, 3, 617-633, 1969.

Coleman, J.S.; Varga, L.P. and Mastin, S.H., "Graphical Methods for Determining the Number of Species in Solution from Spectrophotometric Data," Inorganic Chemistry, 9, 5, 1015-1020, 1970.

Gill, D.; Kilponen, R.G. and Rimai, L., "Resonance Raman Scattering of Laser Radiation by Vibration Modes of Carotenoid Pigment Molecules in Inact Plant Tissues," Nature, 227, AIS, 743-744, 1970.

Kankare, Jouko J., "Computation of Equilibrium Constants for Multicomponent Systems from Spectrophotometric Data," Analytical Chemistry, 42, 12, 1332-1336, 1970.

Porchet, JP and Günthard, H.H., "Optimum Sampling and Smoothing Conditions for Digitally Recorded Spectra," Physics E: Scientific Instruments, 3, AIS, 261-264, 1970.

Weiner, Paul H.; Malinowski, Edmund R. and Levistone Alan R., "Factor Analysis of Solvent Shifts in Proton Magnetic Resonance," Physical Chemistry, 74, 26, 4537-4542, 1970.

Zupan, Jure, "Problems in Data Retrieval Systems For Analytical Spectroscopy," Analytica Chimica Acta, 103, AIS, 273-288, 1970.

Hugus Jr., Z.Z. and El-Awady, Abbas A., "Matrix Rank Treatment of Spectrophotometric Data," Physical Chemistry, 75, 19, 2954-2957, 1971.

Hugus Jr., Z.Z; and El-Awady, Abbas A., "The Determination of the Number of Species in a System: a New Matrix Rank Treatment of Spectrophotometric Data," The Journal of Physical Chemistry, 75, 19, 2954-2957, 1971.

Youngs, Edward A. and Cramer, Elliot M., "Some Results Relevant to Choice of Sum and Sum-of-Product Algorithms," Technometrics, 13, 3, 657-665, 1971.

Horlick, Gary, "Digital Data Handling of Spectra Utilizing Fourier Transformations," Analytical Chemistry, 44, 6, 943-947, 1972.

Macnaughtan Jr., David; Rogers, L.B. and Wernimont, Grant, "Principal-Component Analysis Applied to Chromatographic Data," Analytical Chemistry, 44, 8, 1421-1427, 1972.

Siegmune, Walter P. and Holliday, Clyde T., "Fiber Optics Comes of Age," SPIE, 31, AIS, 13-22, 1972.

Walrafen, G.E. and Stone J., "Intensification of Spontaneous Raman Spectra by use of Liquid Core Optical Fiber," Applied Spectroscopy, 26, 6, 585-589, 1972.

Walrafen, G.E. and Stone, J., "Intensification of Spontaneous Spectra by Use of Liquid Core Optical Fibers," Applied Spectroscopy, 26, 6, 585-589, 1972.

Weiner, H. and Howery, Darryl G., "Factor Analysis of Some Chemical and Physical Influences in Gas-Liquid Chromatography," Analytical Chemistry, 44, 7, 1189-1194, 1972.

Bulmer, J.T.; and Shurvell, H.F., "Factor Analysis as a Complement to Band Resolution Techniques. I. The Method and its Application to Self-Association of Acetic Acid.," The Journal of Physical Chemistry, 77, 2, 256-262, 1973.

Ohta, Nogoru, "Estimating Absorption Bands of Component Dyes by Means of Principal Components Analysis," Analytical Chemistry, 45, 3, 553-557, 1973.

Weiner, Paul H., "The Estimation of Relative Gas Phase Acidities of Substituted Benzoic Acidic from Solution Measurements by Factor Analysis," Journal of the American Chemical Society, 95, 18, 5845-5851, 1973.

Blume, Rüdiger; Lachmann, Heinrich und Mauser, Heinz, "New Methods for Spectrophotometric Determination of pK-Values, I Titration and Simultaneous Titration of Monovalent Protolytes," Zeitschrift Für Naturforschung, AVO, AIS, 500-513, 1974.

Sylvestre, E. A.; Lawton, W.H. and Maggio, M.S., "Curve Resolution Using a Postulated Chemical Reaction," Technometrics, 16, 3, 353-368, 1974.

Sysvestre, E.A. and Maggio, M.S., "Curve Resolution Using a Postulated Chemical Reaction," Technometrics, 16, 3, 353-368, 1974.

Blume, Rüdiger; Lachmann, Heinrich und Polster, Jürgen, "New Methods for Spectrophotometric Determination of pK-Values, II," Zeitschrift Für Natieforschung, 30, AIS, 263-274, 1975.

Jeanmaire, David L. and Van Duyne, Richard P., "V. Intensity Transients on the Millisecond Time Scale Following Double Potential Step Initiation of a Diffusion Controlled Electrode Reaction," J. Electroanal. Chem., 66, AIS, 235-247, 1975.

Rozett, Richard W. and Petersen, E. McLaughlin, "Methods of Factor Analysis of Mass Spectra," Analytical Chemistry, 47, 8, 1301-1308, 1975.

Vandeginste, B.G.M. and Galan, L. De, "Critical Evaluation of Curve Fitting in Infrared Spectrometry," Analytical Chemistry, 47, 13, 2124-2132, 1975.

Walrafen, G.E., "New Slitless Optical Fiber Laser-Raman Spectrometer," Applied Spectroscopy, 29, 2, 179-185, 1975.

Duewer, D.L. and Kowalski, B.R., "Improving the Reliability of Factor Analysis of Chemical Data by Utilizing the Measured Analytical Uncertainty," Analytical Chemistry, 48, 13, 2002-2010, 1976.

Malinowski, Edmund R., "Determination of the Number of Factors and the Experimental Error in a Data Matrix," Analytical Chemistry, 49, 4, 612-617, 1977.

Malinowski, Edmund R., "Theory of Error in Factor Analysis," Analytical Chemistry, 49, 4, 606-612, 1977.

Malinowski, Edmund R., "Theory of Error for Target Factor Analysis with Applications to Mass Spectrometry and Nuclear Magnetic Resonance Spectrometry," Analytica Chimica Acta, 103, AIS, 339-354, 1978.

Palik, E.D.; Gibson, J.W.; Holm, R.T.; Hass, M.; Braunstein, M. and Garcia, "Infrared Characterization of Surfaces and Coatings by Internal-reflection Spectroscopy," Applied Optics, 17, 11, 1776-1785, 1978.

Wold, Svante, "Cross-Validatory Estimation of the Number of Components in Factor and Principal Components Models," Technometrics, 20, 4, 395-405, 1978.

Arena, Guisepppe; Rizzarelli, Enrico; Sasmmartano, Silvio; and Rigano,, "A Non-Linear Least-Squares Approach to the

Refinement of all Parameters Involved in Acid-Base Titrations," Talanta, 26, AIS, 1-13, 1979.

Gerlach, Robert W.; Kowalski, Bruce R. and Wold, Herman O.A., "Partial Least-Squares Path Modelling with Latent Variables," Analytica Chimica Acta, 112, AIS, 417-421, 1979.

Knorr, Fritz J. and Futrell, J.H., "Separation of Mass Spectra of Mixtures by Factor Analysis," Analytical Chemistry, 51, 8, 1236-1241, 1979.

O'Connor D.V.; Ware W.R. and Andre, J.C., "Deconvolution of Fluorescence Decay Curves. A Critical Comparison of Techniques," Physical Chemistry, 83, 10, 1333-1343, 1979.

Wickersheim, K.A. and Alves, R.B., "Recent Advances in Optical Temperature Measurement," Industrial Research/Development, AVO, AIS, 82-89, 1979.

Fell, Anthony F., "Present and Future Perspectives in Derivative Spectroscopy," AJN, AVO, AIS, 5-31, 1980.

Koyama, Masao and Sato, Yuichi, "Improved Enzyme Sensor for Glucose with an Ultra-Filtration Membrane and Immobilized Glucose Oxidase," Analytica Chimica Acta, 116, AIS, 307-314, 1980.

Peterson, John I.; Goldstein, Seth R. and Fitzgerald, Raphael V., "Fiber Optic pH Probe for Physiological Use," Analytical Chemistry, 52, AIS, 864-869, 1980.

Proctor, Andrew and Sherwood, Peter M.A., "Smoothing of Digital X-ray Photoelectron Spectra by an Extended Sliding Least-Squares Approach," Analytical Chemistry, 52, AIS, 2315-2321, 1980.

Trott, G.R. and Furtak, T.E., "Angular Resolved Raman scattering using Fiber Optic Probes," Review of Scientific Instrumentation, 51(11), AIS, 1493-1496, 1980.

Yamada, Haruka and Yamamoto, Yoichiro, "Illumination of Flat or Unstabled Samples for Raman Measurements using Optical Fibers," AJN, AVO, AIS, 4-5, 1980.

Borman, Stuart A., "Optrodes," Analytical Chemistry, 53, 14, 1616-1618, 1981.

Freeman, Thompson M. and Seitz, W. Rudolf, "Oxygen Probe Based on Tetrakis(alkylamino)ethylene Chemiluminescence," Analytical Chemistry, 53, AIS, 98-102, 1981.

Ho, C.-N.; Christrian, G.D. and Davidson, E.R., "Simultaneous

Multicomponent Rank Annihilation and Applications to Multicomponent Fluorescent Data Acquired by the Video Fluorometer," Analytical Chemistry, 53, AIS, 92-98, 1981.

Jochum, Clemens; Jochum, Peter and Kowalski, Bruce R., "Error Propagation and Optimal Performance Multicomponent Analysis," Analytical Chemistry, 532, AIS, 85-92, 1981.

Kauppinen, Jyrki K.; Moffatt, Douglas J.; Mantsch, Henry H. and Cameron,, "Fourier Self-Deconvolution: A Method for Resolving Intrinsically Overlapped Bands," Applied Spectroscopy, 35, 3, 271-276, 1981.

Kauppinen, Jyrki K.; Moffatt, KDouglas J.; Mantsch, Henry H. and Cameron,, "Fourier Transforms in the Computation of Self-Deconvoluted and First-Order Derivative Spectra of Overlapped Band Contours," Analytical Chemistry, 53, AIS, 1454-1457, 1981.

Ross, Howard B. and McClain, William M., "Liquid Core Optical Fibers in Raman Spectroscopy," Applied Spectroscopy, 35, 4, 439-442, 1981.

Brown, Chris W. and Lynch, Patricia F., "Matrix Representations and Criteria for Selecting Analytical Wavelengths for Multicomponents Spectroscopic Analysis," Analytical Chemistry, 54, AIS, 1472-1479, 1982.

Christian, Sherril D. and Tucker, Edwin E., "Least Squares Analysis With the Microcomputer: Linear Relationships- Part One," Americal Laboratory, AVO, AIS, 36-41, 1982.

Derde, M.P.; Coomans, D. and Massart, D.L., "Effects of Scaling of Class Modeling with the Simca Method," Analytica Chimica Acta, 141, AIS, 187-192, 1982.

Haaland, David M. and Easterling, Robert G., "Application of New Least-Square Methods for the Quantitative infrared Analysis of Multicomponent Samples," Applied Spectroscopy, 36, 6, 665-673, 1982.

Jaeger, Raymond E., "Optical Fiber for Data Transmission," Photonic Spectra, AVO, AIS, APG, 1982.

Johnston, T.F.; Brady, R.H. and Proffitt, W., "Powerful Single-Frequency Ring Dye Laser Spanning the Visible Spectrum," Applied Optics, 21, 13, 2307-2316, 1982.

O'Haver, Thomas C., "Derivative Spectroscopy and its Application in Analysis," Anal. Proc., AVO, AIS, 21-45, 1982.

Saari, Linda A. and Seitz, Rudolf W., "pH Sensor Based on

Immobilized Fluoresceinamine," Analytical Chemistry, 54, AIS, 821-823, 1982.

Shrager, Richard I. and Hendler, Richard W., "Titration of Individual Components in a Mixture with Resolution of Difference Spectra, pKs, and Redox Transitions," Analytical Chemistry, 54, AIS, 1147-1152, 1982.

Spjøtvoll, Emil; Martens, Harald and Volden, Rolf, "Restricted Least Squares Estimation of the Spectra and Concentration of Two Unknown Constituents Available in Mixtures," Technometrics, 24, 3, 173-180, 1982.

AAU, "New Vistas for Diffraction Gratings," Electro Optics, AVO, AIS, NONE, 1983.

Asher, Sanford A.; Johnson, Craig R. and Murtaugh, James, "Development of a New UV Resonance Raman Spectrometer for the 217-400-nm Spectral Region," American Institute of Physics, 54, AIS, 1657-1652, 1983.

Bromba, Manfred U.A. and Ziegler, Horst, "Digital Smoothing of Noisy Spectra," Analytical Chemistry, 55, AIS, 648-653, 1983.

Byers, W. Arthur; Freiser, B.S. and Perone, S.P., "Structural and Activity Characterization of Organic Compounds by Electroanalysis and Pattern Recognition," Analytical Chemistry, 56, AIS, 620-625, 1983.

Fleischmann, Martin and Hendra, Patrick, "Fiber Optic Probe for Remote Raman Spectroscopy," Analytical Chemistry, 53, AIS, 146-148, 1983.

Gillette, Paul C.; Lando, Jerome B. and Loenig, Jack L., "Factor Analysis for Separation of Pure Component Spectra from Mixture Spectra," Analytical Chemistry, 55, AIS, 630-633, 1983.

Graff, Gordon, "Fiber Optics Analyze Chemical Processes," High Technology, AVO, AIS, 24-25, 1983.

Hirschfeld, T., "Process Analysis: Remote Measurement and in Product Sensors," AJN, AVO, Personal Preprint, 1-2, 1983.

Hirschfeld, Tomas, "From Measurements to Analysis: The Calculation of NIRA," Fourth International Symposium on NIRA, AVO, Personal Preprint, APG, 1983.

Hirschfeld, Tomas; Deaton, Terrence; Milanovich, Fred and Klainer, Stanley, "Feasibility of Using Fiber Optics for Monitoring Groundwater Contaminants," Optical Engineering,

22, 5, 527-531, 1983.

Honigs, E.E.; Freelin, J.M.; Hieftje, G.M. and Hirschfeld, T.B., "Near-Infrared Reflectance Analysis by Gauss-Jordan Linear Algebra," Applied Spectroscopy, 37, 6, 491-497, 1983.

Hoogerbrugge, Ronald; Willig, Simon J. and Kistemaker, Piet G., "Discriminant Analysis by Double Stage Principal Component Analysis," Analytical Chemistry, 55, AIS, 1710-1712, 1983.

Karrer, Lothar M.; Gordon, Heather L.; Rothstein, Stuart M.; Miller, Jack, "Bayesian Statistical Methods for Use in Mass Spectral Assignment," Analytical Chemistry, 55, AIS, 1723-1728, 1983.

Kormos, D.W. and Waugh, J.S., "Abstract Factor Analysis of Solid-State Nuclear Magnetic Resonance Spectra," Analytical Chemistry, 55, AIS, 633-638, 1983.

Kvalheim, Olav M.; øygard, Kjell and Grahl-Nielsen, Otto, "Simca Multivariate Data Analysis of Blue Mussel Components in Environmental Pollution Studies.," Analytica Chimica Acta, AVO, AIS, 145-152, 1983.

Maccá, Carlo and Bombi, G. Giorgio, "Symmetry Properties of Potentiometric Titration Curves," Chemical Education, 60, 12, 1026-1030, 1983.

Milanovich, Fred P. and Hirschfeld Tomas, "Process, Product, and Waste Stream Monitoring With Fiber Optics," (Instrument Society of America) Personal Preprint, 38, 1, 407-418, 1983.

Pau, L.F. and Nahas, M.Y., "An Introduction to Infrared Image Acquisition and Classification Systems," Research Studies Press Ltd, Book Chapter, AIS, 1-25, 1983.

Saarl, Linda A. and Seltz, Rudolf W., "Immobilized Morin as Fluorescence Sensor for Determination of Aluminum (III)," Analytical Chemistry, 55, AIS, 667-670, 1983.

Sasaki, Keiji; Kawata, Satoshi, and Minami, Shigeo, "Constrained Nonlinear Method for Estimating Component Spectra from Multicomponent Mixtures," Applied Optics, 22, 22, 3599-3603, 1983.

Seiyama, T.; Fueki, K.; Shiokawa, J. and Suzuki, S., "Blood Gas Analysis With Fluorescence Dyes as an Example of Their Usefulness as Quantitative Chemical Sensors," Analytical Chemistry Symposia Series, 17, AIS, 609-619, 1983.

Smit, H.C. and Meites, Louis, "Factors Affecting the

Precisions of Potentiometric Strong Acid- Strong Base and other Isovalent Ion- Combination Titrations with Data Handling By Non-Linear Regression Analysis," Analytica Chimica Acta, 153, AIS, 121-131, 1983.

Smit, H.C.; Meites, Louis and Kateman, G, "Factors Affecting the Precisions of Potentiometric Strong Acid-Strong Base and other Isovalent Ion combination Titrations with Data Handling by Nonlinear Regression Analysis," Analytica Chimica Acta, 153, AIS, 121-131, 1983.

Szabó, Klára; Nagypál, István and Fábíán, István, "Unexpected Dependence of the Protonation Constant of 2,2'-Bipyridyl on Ionic Strength," Talanta, 30, 10, 801-804, 1983.

Wahbi, A.M. and Barary, Magda A.H., "Spectrophotometric Analysis of Systems with Non-Additive Absorbances," Analytical Letters, 16(A2), AIS, 1617-1623, 1983.

Yoshiura, Masahiko; Iriyama, Keiji; Konishi, Masato; Kawamura, Takeshi, "Very Rapid and Simple Method for Preparing a Glucose Sensor of Good Quality," Analyst, 108, AIS, 419, 1983.

AAU, "Chemical Sensor Uses Optical Fibers," Chemical and Engineering News, AVO, AIS, 22-23, 1984.

Anderson, Leigh and Anderson, Norman, "Some Perspectives on Two-Dimensional Protein Mapping," Clinical Chemistry, 30, 12, 1898-1905, 1984.

Asher, Sanford A. and Johnson, Craig R., "Raman Spectroscopy of a Coal Liquid Shows That Fluorescence Interference Is Minimized with Ultraviolet Excitation," Science, 225, AIS, 311-313, 1984.

Brenci, M.; Conforti, G.; Faciai, R. and Scheggi, A.M., "Optical Fiber Thermometer for Medical Use," SPIE, 494, AIS, 13-17, 1984.

Cahill, Jerry and Retzik, Michael, "Photodiode Array, UV/VIS Spectrophotometer," American Laboratory, AVO, November, 47-55, 1984.

Coleman, Todd J.; Eastman, Jerome F. and Sepaniak, Michael J., "Fiber Optic Based Sensor for Bioanalytical Absorbance Measurements," Analytical Chemistry, 56, AIS, 2246-2249, 1984.

Culler, S.R.; Gillette, P.C.; Ishida, H. and Koenig, J.L., "Factor Analysis Applied to a Silane Coupling Agent on E-Glass Fiber System," Applied Spectroscopy, 38, 4, 495-500,

1984.

D'Amelio, Frank D.; DeLisi, Steven T. and Rega, Anthony, "Endoscopic Applications of Optical Fibers," SPIE, 494, AIS, 43-51, 1984.

Dovich, Norman J.; Martin, John C.; Jett, James H. Trkula, Mitchell and, "Laser-Induced Fluorescence of Flowing Samples as an Approach to Single-Molecule Detection in Liquids," Analytical Chemistry, 56, AIS, 348-354, 1984.

Frans, S.D. and Harris, J.M., "Reiterative Least-Squares Spectral Resolution of Organic Acid/Base Mixtures," Analytical Chemistry, 56, AIS, 466-470, 1984.

Gemperline, Paul J., "A Pricri Estimates of the Elution Profiles of the Pure Components in Overlapped Liquid Chromatography Peaks Using Target Factor Analysis," Journal of Chemical Information and Computer Science, 24, 4, 206-212, 1984.

Haggin, Joseph, "Faster, Smaller Integrated Sensors In Offing for Process Control," News Focus, AVO, AIS, 7-13, 1984.

Harrington, James A., "A Look at the Future of Infrared Fibers," Optics News, AVO, September/October, 23-29, 1984.

Hendrickson, Edwin R. and Heuman, Ronald D., "Determination of Polyacrylamide by Spectrofluorometry," Analytical Chemistry, 56, AIS, 354-357, 1984.

Hirschfeld, T.; Callis, J.B. and Kowalski, B.R., "Chemical Sensing in Process Analysis," Science, 226, AIS, 312-318, 1984.

Honigs, D.E.; Hieftje, G.M. and Hirschfeld T., "A New Method for Obtaining Individual Components Spectra from Those of Complex Mixtures," Applied Optics, 38, 3, 317-322, 1984.

Honigs, D.E.; Hieftje, G.M. and Hirschfeld, T., "Number of Samples and Wavelengths Reasured for the Training Set in Near-Infrared Reflectance Spectroscopy," Applied Spectroscopy, 38, 6, 844-847, 1984.

Johansson, Erik and Wold, Svante, "Minimizing Effects of Closure on Analytical Data," Analytical Chemistry, 56, 9, 1685-1688, 1984.

Johnson, Craig R.; Ludwig, Michael; O'Donald and Asher, Sanford A., "UV Resonance Raman Spectroscopy of the Aromatic Amino Acids and Myoglobin," Journal of the American Chemical Society, 106, AIS, 5008-50112, 1984.

Kawata, Satoshi and Minami, Sheigeo, "Adaptive Smoothing of Spectroscopic Data by a Linear Mean-Square Estimation," Applied Spectroscopy, 38, 1, 49-58, 1984.

Korany, M.A.; Wanbi, A.M.; Elsayed, M.A.; and Mandour S., "First Derivative Spectrophotometric Determination of Certain Drugs in Two-Component Mixtures," Analytical Letters, AVO, AIS, 1373-1389, 1984.

Lines, M.E., "The Search for Very Low Loss Fiber-Optic Materials," Science, 226, AIS, 663-668, 1984.

Malinowski, Edmund R.; Cox, Robin A. and Haldna, Ulo L., "Factor Analysis for Isolation of the Raman Spectra of Aqueous Sulfuric Acid Components," Analytical Chemistry, 56, AIS, 778-781, 1984.

McClure, W.F., "History of and Future for Near-infrared Analysis," Anal. Proc., 21, AIS, 485-486, 1984.

Milanovich, Fred P. and Hirschfeld, Tomas, "Remote Fiber Fluorimetry: Using Optics for On-Stream Analysis," InTech, AVO, AIS, 33-36, 1984.

Osten, David W. and Kowalski, Bruce R., "Multivariate Curve Resolution in Liquid Chromatography," Analytical Chemistry, 56, AIS, 991-995, 1984.

Peterson, John I. and Fitzgerald, Raphael V., "Fiber-Optic Probe for in Vivo Measurement of Oxygen Partial Pressure," Analytical Chemistry, 56, AIS, 62-67, 1984.

Peterson, John P. and Fitzgerald, Raphael V., "Fiber-Optic Probe for in Vivo Measurement of Oxygen Partial Pressure," Analytical Chemistry, 56, AIS, 62-67, 1984.

Polster, Jürgen, "Spectrophotometric Analysis of Simultaneous Protolysis Equilibria," Talanta, 31, 2, 113-116, 1984.

Rao, G. Ramana and Zerbi, G., "Factor Analysis and Least-Squares Curve-Fitting of Infrared Spectra: An Application to the Study of Phase Transitions in Organic Molecules.," Applied Spectroscopy, 38, 6, 795-803, 1984.

Ratzlaff, Eugene H.; Harfmann, Robert G. and Crouch, S.R., "Absorption-Corrected Fiber Optic Fluorometer," Analytical Chemistry, 56, AIS, 342-347, 1984.

Rava, Richard P. and Spiro, Thomas G., "Selective Enhancement of Tyrosine and Tryptophan Resonance Raman Spectra via Ultraviolet Laser Excitation," Journal of the American Chemical Society, 106, AIS, 4062-4064, 1984.

- Schwab, Scott D. and McCreery, Richard L., "Versatile, Efficient Raman Sampling with Fiber Optics," Analytical Chemistry, 56, ASI, 2199-2204, 1984.
- Seitz, Rudolf W., "Based on Fiber," Analytical Chemistry, 56, 1, 16A, 18A, 20A, 22A, 24A, 33A, 34A, 1984.
- Shih, L.B.; and Priest, R.G., "Factor Analysis of Raman Spectra of Polyethylene Under High Pressure," Applied Spectroscopy, 38, 5, 687-692, 1984.
- Shrager, Richard I., "Optical Spectra from Chemical Titration: An Analysis By SVD," Siam J. Alg. Disc. Meth., 5, 3, 351-358, 1984.
- Shukla, Shyam S. and Rusling, James F., "Analyzing Chemical Data with Computers: Errors & Pit Falls," Analytical Chemistry, 56, 12, 1347-1368, 1984.
- Thromberg, Bruce J.; Eastham, Jerome F. and Sepaniak, Michael J., "Optical Fiber Fluoroprobes for Biological Measurements," Applied Spectroscopy, 38, 1, 38-44, 1984.
- Tromberg, Bruce J.; Eastman, Jerome F. and Sepaniak, Michael J., "Optical Fiber Fluoroprobes for Biological Measurements," Applied Spectroscopy, 38, 1, 38-42, 1984.
- Tyson, Lesia L.; Ling, Yong-Chien and Mann, Charles K., "Simultaneous Multicomponent Quantitative Analysis by Infrared Absorption Spectroscopy," Applied Spectroscopy, 38, 5, 663-668, 1984.
- Vurek, Gerald G., "In Vivo Optical Chemical Sensors," SPIE, 494, AIS, 2-6, 1984.
- Wong, James S.; Rein, Alan J.; Wilks, Donald and Wilks Jr., Paul, "Infrared Spectroscopy of Aqueous Antibiotic Solutions," Applied Spectroscopy, 38, 1, 32-35, 1984.
- AAU, "A new Fiber for IR Transmission," Photonics Spectra, AVO, AIS, 34,35, 1985.
- Alfano, R.R. and Alfano, Michele Anne, "Medical Diagnostics: A New Optical Frontier," Photonics Spectra, AVO, ASI, 55-60, 1985.
- Arnold, Mark A., "Enzyme-Based Fiber Optic Sensor," Analytical Chemistry, 57, AIS, 565-566, 1985.
- Bardecker, Philip A., "Comments on Least-Squares Polynomial Filetes for Initial Point and Slope Estimation," Analytical Chemistry, 57, 7, 1477-1479, 1985.

Bostick, D.T. and Strain, J.E., "A New In-Line Fiber Optic Spectrometer for Remote Analysis and Process Control," AJN, AVO, Personal Preprint, 2-7, 1985.

Botez, Dan, "Laser Diodes are Power-Packed," IEEE Spectrum, AVO, AIS, 43-53, 1985.

Buchanan, B.R. and Honigs, D.E., "Advanced in Near-Infrared Spectroscopy," Spectroscopy, 1, 7, 40-42, 1985.

Buijs, Henry, "Fourier Transform Raman Spectroscopy- An Overview," Spectroscopy, 1, 8, 14,16, 1985.

Byler, D. Michael; Brouillette, Janine N. and Susi, Heino, "Quantitative Studies of Protein Structure by FT-IR Spectral Deconvolution and Curve Fitting," Spectroscopy, AVO, AIS, 29-32, 1985.

Chudyk, Byrne A; Carrabba, Michael M. and Kenney, Jonathan E., "Remote Detection of Groundwater Contaminants Using," Analytical Chemistry, 57, 7, 1242-1252, 1985.

Dudik, John M.; Johnson, Craig R. and Asher, Sanford A., "UV Resonance Raman Studies of Acetone, Acetamide, and N-Methylacetamide: Models for the Peptide Bond," Journal of Physical Chemistry, 89, AIS, 3805-3814, 1985.

Fitch, Pamela and Gargus, Greg A., "Remote UV-VIS-NIR Spectroscopy Using Fiber Optic Chemical Sensing," American Laboratory, AVO, AIS,

Fodor, Stephen P.A.; Rava, Richard P.; Hays, Thomas R. and Spiro, Thomas, "Ultraviolet Resonance Raman Spectroscopy of the Nucleotides with 266-, 240-, 218-, and 200-nm Pulse Laser Excitation," Journal of the American Chemical Society, 107, AIS, 1520-1529, 1985.

Frans, S.D. and Harris, J.M., "Least Squares Singular Value Decomposition for the Resolution of pK's and Spectra from Organic Acid/Base Mixtures," Analytical Chemistry, 57, AIS, 1718-1721, 1985.

Fredereicks, Peter M.; Lee, James B.; Osborn, Paul R. and Swinkels, Dom A., "Materials Characterization Using Factor Analysis of FT-IR Spectra. Part 2: Mathematical and Statistical Considerations," Applied Spectroscopy, 39, 2, 311-316, 1985.

Fredericks, Peter M.; Lee, James B.; Osborn, Paul R. and Swinkles, Dom, "Materials Characterization Using Factor Analysis of FT-IR Spectra. Part 1: Results," Applied Spectroscopy, 39, AIS, 303-310, 1985.

Gampp, Harald; Maeder, Marcel; Meyer, Charles J. and Zuberbühler, Andreas, "Calculation of Equilibrium Constants from Multiwavelength Spectroscopic Data-I," Talanta, 32, 2, 95-101, 1985.

Gilbert, R.A.; Lewellyn, J.A. and Swartz, Jr., W.E., "Application of Factor Analysis to the Analysis of the Kinetics and Mechanism of the X-Ray-Induced Decomposition of Potassium Perchlorate," Applied Spectroscopy, 39, 2, 316-320, 1985.

Hirschfeld, T., "Salinity Determination Using NIRA," Applied Spectroscopy, 39, 4, 740, 1985.

Hirschfeld, T.; Honigs, D. and Hieftje G., "Optimization of Sample Absorbance for Quantitative Analysis in the Presence of Pathlength Error in the IR and NIR Regions," Applied Spectroscopy, 39, 3, 430-433, 1985.

Hirschfeld, Tomas, "Instrumentation in the Next Decade," Science, 230, AIS, 286-292, 1985.

Hirschfeld, Tomas, "Photometric Sensors Using Fiber Optics," AJN, AVO, Personal Preprint, 1-6, 1985.

Honigs, D.E.; Hieftje, G.M. and Hirschfeld, T., "An Optimization of Detector-Noise-Limited Infrared Multiwavelength Determinations," Applied Spectroscopy, AVO, AIS, 253,255, 1985.

Honigs, D.E. and Hieftje, G.M., "Unique-Sample Selection via Near-Infrared Spectral Subtractor," Analytical Chemistry, 57, 12, 2299-2303, 1985.

Honigs, D.E.; Hieftje, G.M. and Hirschfeld, T., "An Optimization of Detector-Noise-Limited Infrared Multiwavelength Determinators," Applied Spectroscopy, 39, 2, 253-256, 1985.

Honigs, David E., "Near Infrared Analysis," Analytical Instrumentation, AVO, ASI, 1-62, 1985.

Kolling, Orland W., "Nonlinear Regression Model for the Representation of Dielectric Constants for Binary Aprotic Solvents," Analytical Chemistry, 57, AIS, 1721-1725, 1985.

Lemrow, Craig M. and Bhagavatula, Venkata A., "Advanced Fiber Design," Laser Focus/Electro-Optics, AVO, AIS, 82-92, 1985.

Mark, Howard L. and Tunnell, David, "Qualitative Near-Infrared Reflectance Analysis Using Mahalanobis Distances," Analytical Chemistry, 57, AIS, 1449-1456, 1985.

Mayne, L.C.; Ziegler, L.D. and Hudson, B., "Ultraviolet Resonance Raman Studies of N-Methylacetamide," Journal of Physical Chemistry, 89, AIS, 3395-3398, 1985.

Ross, H. Richard and Byrne, Christian, "The Analysis of Nonvolatile Hydrocarbon Residues by Diffuse Reflectance Infrared Fourier Transform Spectroscopy," Spectroscopy, 1, 8, 40-41, 1985.

Schreiner, Walter; Kramer, Michael; Krischer, Simon and Langsam, Yedidiah, "Nonlinear Least-squares Fitting," PC Tech, AVO, AIS, 170-181, 1985.

Seitz, W. Rudolf, "Chemical Sensors Based on Fiber Optics," Sensors, AVO, AIS, 6-9, 1985.

Wachs, Israel E. Hardcastle, Franklin D. and Chan, Shirley S., "Raman Spectroscopy of Supported Metal Oxide Catalysts," Spectroscopy, 1, 8, 30-38, 1985.

Weyer, L.G., "Near-Infrared Spectroscopy of Organic Substances," Applied Spectroscopy Review, AVO, ASI, 1-43, 1985.

Wickersheim, Kenneth and Sun, Mei, "Phosphors and Fiber Optics Removed Doubt from Difficult Temperature Measurements," Research & Development, AVO, AIS, APG, 1985.

Wilks, Paul A., "Infrared in the Real World: Quantitative Analysis- On-Line Versus Quality Control Laboratory," Spectroscopy, 1, 7, 43, 1985.

AAU, "Chalcogenide Fibers for IR Transmission," Laser Focus, AVO, AIS, 172-173, 1986.

AAU, "Fluoride Glass IR Fibers to be Implemented in Airborne Visible IR-Imaging Spectrometer," Laser Focus, AVO, AIS, 54, 1986.

AAU, "Laser-Based E-O System Analyzes RF Spectrum," Laser Focus/Electro-Optics, AVO, AIS, 18-52, 1986.

AAU, "Laser-Pulse/Fiber-Optic Liquid-Leak Detector," NASA Tech Briefs, AVO, AIS, 38-41, 1986.

AAU, "Spectran Files Patent," Photonics Spectra, AVO, ASI, 42, 1986.

AAU, "Steeper-Motor-Driven Mirror Mount," Photonics Spectra, AVO, AIS, 119, 1986.

Abraham, M.H; Doherty, R.M.; Kamlet, M.J. and Taft, R.W.,

"New Looks at Acids And Bases," Chemistry in Britain, AVO, AIS, 551-554, 1986.

Anderson, John Eric, "Light Transmission Through Multi-Mode Fiberoptics," Components for Fiber Optic Applications, 722, AIS, 74-83, 1986.

Angel, S.M., "Optrodes: Chemically Selective Fiber-Optic Sensors," Spectroscopy, 2, 4, 38-48, 1986.

Balulescu, Lano, "Solid-State Multispecies Chemical Microsensors," Sensors, AVO, AIS, 11-13, 1986.

Baum, Rudy M., "Analytical Chemists Focus on Process Control," Chemical and Engineering News, AVO, AIS, 29-30, 1986.

Bodner, George M., "Assigning the pKa's of Polyprotic Acid," Chemical Education, 63, 3, 246-247, 1986.

Boero, Francis J., "Referenced Reflectometry of Low Reflectance Optical Coatings," American Laboratory, AVO, AIS, 58-64, 1986.

Brimmer, Paul J.; Griffith, Peter R. and Harrick, N.J., "Angular Dependence of Diffuse Reflectance Infrared Spectra. Part I: FT-IR Spectrogoniophotometer," Applied Spectroscopy, 40, 2, 258-265, 1986.

Carey, W. Patrick and Kowalski, Bruce R., "Chemical Piezoelectric Sensor and Sensor Array Characterization," Analytical Chemistry, 58, AIS, 3077-3084, 1986.

Carey, W. Patrick; Beebe, Kenneth R. and Kowalski, Bruce R., "Selection of Adsorbates for Chemical Sensor Array by Pattern Recognition," Analytical Chemistry, 58, AIS, 149-153, 1986.

Carrico, J.P.; Davis, A.W.; Campbell, D.N.; Roehl, J.E.; Sima, G.R.;, "Chemical Detection and Alarm for Hazardous Chemicals," American Laboratory, AVO, AIS, 152-163, 1986.

Cartwright, Hugh, "Color Perception of Factor Analysis," Chemical Education, 63, 11, 984-987, 1986.

Chaffee, David C., "U.S. Military Programs Take Advantage of Fiberoptic Technology," Laser Focus/Electro-Optics, AVO, AIS, 80-88, 1986.

Chapados, Camille; Beliveau, Jean; Trudel, Michel; and Levesque, Charles, "Comparison of Resolution Enhancement by Different Computer Techniques of the Chlorophyll Carbonyls," Applied Spectroscopy, 40, 6, 773-782, 1986.

- Ciurczak, Emil W. and Weis, Frances M.B., "Evaluation of an Near-Infrared Detector for High Performance Liquid Chromatography," Spectroscopy, 2, 10, 33-38, 1986.
- Ciurczak, Emil W. Torlini, Ronald P. and Demkowic, Michael P., "Determination of Particle Size of Pharmaceutical Raw Materials Using Near-Infrared Reflection Spectroscopy," Spectroscopy, 1, 7, 36-39, 1986.
- Coates, John P. D'Agostino, Jeffrey M. and Friedman, Cindy R., "Quality Control Analysis by Infrared Spectroscopy," American Laboratory, AVO, AIS, 82-91, 1986.
- Copeland, Robert A. and Spiro, Thomas G., "Ultraviolet Raman Hypochromism of the Tropomyosin Amide Modes: A New Method for Estimating α -Helical Content in Proteins," Journal of the American Chemical Society, 108, AIS, 1281-1285, 1986.
- Daley, Larry S. and Breen, Patrick J., "Measurement of Biological Changes by Fourth-Derivative Visible Spectroscopy of Leaf Lamina," Spectroscopy, 2, 3, 32-35, 1986.
- Daley, Larry S.; Montano, Jose M.; Menendez, Ricardo A.; Soeldner, Alfred, "Spectroscopic Evaluation of Freeze Damage in Pear Trees Using Fourth-Derivative Visible Spectroscopy of Bark Sections," Spectroscopy, 2, 9, 32-36, 1986.
- Deming, Stanley N., "Chemometrics: an Overview," Clinical Chemistry, 32, 9, 1702-1706, 1986.
- Dreyfus, R.W.; Jasinski, J.M.; Selwyn, G.S. and Walkup, R.E., "Laser Spectroscopy in Electronic Materials Processing Research," Laser Focus/Electronic-Optics, AVO, AIS, 62-72, 1986.
- Faires, Lynda M., "Fourier Transforms for Analytical Atomic Spectroscopy," Analytical Chemistry, 58, 9, 1023-1034, 1986.
- Gauthier, Randal A., "Aerospace Temperature Sensors Applications," Sensors, AVO, AIS, 31-36, 1986.
- Gemperline, Paul J., "Target Transformation Factor Analysis with Linear Inequality Constraints Applied to Spectroscopic-Chromatographic Data," Analytical Chemistry, 58, AIS, 2656-2663, 1986.
- Grace, Roger H., "Silicon Micromachined Sensors," Sensors, AVO, AIS, 41-48, 1986.
- Hallmark, V.M. Zimba, C.G. Swalen, J.D. and Rabolt, J.F., "Fourier Transform Raman Spectroscopy: Scattering in the Near-Infrared," Spectroscopy, 2, 6, 41-51, 1986.

- Hirschfeld, T. and Chase B., "FT-Raman Spectroscopy: Development and Justification," Applied Spectroscopy, 40, 2, 133-137, 1986.
- Howery, Darryl G. and Soroka, Joseph M., "Target Factor Analysis Model for Solute-Solvent Interactions in Gas-Liquid Chromatography," Analytical Chemistry, 58, AIS, 3091-3095, 1986.
- Ishino, Yuichi and Ishida, Hatsuo, "Fourier Transform Infrared Surface Electromagnetic Wave Spectroscopy of Polymer Thin Films on Metallic Substrate," Analytical Chemistry, 58, AIS, 2448-2453, 1986.
- Johnson, Craig R.; Ludwig, Michael and Asher, Sanford A., "Ultraviolet Resonance Raman Characterization of Photochemical Transients of Phenol, Tyrosine, and Tryptophan," Journal of the American Chemical Society, 108, 5, 905-912, 1986.
- Jurs, Peter C., "Pattern Recognition Used to Investigate Multivariate Data in Analytical Chemistry," Science, 232, AIS, 1219-1224, 1986.
- Lacey, Richard F., "Deconvolution of Overlapping Chromatographic Peaks," Analytical Chemistry, 58, AIS, 1404-1410, 1986.
- Leunberger, Bruno and Schindler, Paul W., "Application of Integral pK Spectrometry to the Titration Curve of Fulvic Acid," Analytical Chemistry, 58, AIS, 1471-1474, 1986.
- Liddell, P.R. Athanasopoulos, N. Grey, R.G. and Routh, M.W., "The Effect of Background Correction Speed on the Accuracy of AA Measurements," American Laboratory, AVO, AIS, 68-75, 1986.
- Lochmuller, Charles H. and Saavedra, Steven S., "Conformational Changes in a Soil Fulvic Acid Measured by Time-Dependent Fluorescence Depolarization," Analytical Chemistry, 58, AIS, 1978-1981, 1986.
- Mann, Charles K. and Vickers, Thomas J., "Signal Enhancement by Data Domain Averaging," Applied Spectroscopy, 40, 4, 525-531, 1986.
- Mark, Howard and Workman, Jr., Jerome, "Alternative Ways to Calculate Standard Deviation," Spectroscopy, 2, 11, 38-42, 1986.
- Mark, Howard and Workman, Jr., Jerome, "The Normal Distribution," Spectroscopy, 2, 9, 37-43, 1986.

Martinez, Adolfo; Moreno, M. Cruz and Cámara, Carmen, "Sulfide Determination by N, N-Dimethyl-p-phenylenediamine Immobilization in Cationic Exchange Resin Using an Optical Fiber System," Analytical Chemistry, 58, AIS, 1877-1881, 1986.

McDonald, Robert S., "Review: Infrared Spectroscopy," Analytical Chemistry, 58, AIS, 1906-1925, 1986.

Messerchmidt, Robert G., "A New Internal Reflection Element Design for High Optical Throughput in FT-IR," Applied Spectroscopy, 40, 5, 632-635, 1986.

Milanovich, Fred P. and Daley, Paul F., "Remote Detection of Organochlorides with a Fiber Optic Based Sensor," Analytical Instrumentation, 15(4), AIS, 347-358, 1986.

Milanovich, Fred P.; Garvis, Darrel G. and Angel, S. Michael, "Remote Detection of Organochlorides with a Fiber Optic Basic Sensor," Analytical Instrumentation, 15(2), AIS, 137-147, 1986.

Montalvo, Jr., J.G. Faught, S.E. and Buco, S.M., "Matching a Sample Constituent to a Sample Property Measured by NIRA," American Laboratory, AVO, AIS, 37-55, 1986.

Munkholm, Christiane; Walt David R.; Milanovich, Fred P. and Klainer,, "Polymer Modification of Fiber Optic Chemical Sensors as a Method of Enhancing Fluorescence Signal for pH Measurement," Analytical Chemistry, 58, AIS, 1427-1430, 1986.

Murray, R.T.; Smith, D.E. and Wright, P.G., "Fiber-optic Sensors for the Chemical Industry," Optics News, AVO, AIS, 31, 33, 1986.

Nyden, Marc R., "Computer-Assisted Spectroscopic Analysis Using Orthonormalized Reference Spectra. Part I. Application to Mixtures," Applied Spectroscopy, 40, 6, 868-871, 1986.

Park, Eric D., "Fiber-Optic Sensing in the Military," Sensors, AVO, AIS, 14-19, 1986.

Peck, Konan and Morris Machael D., "Fiber-Optic Probe for Kinetic Determination of Enzyme Activities," Analytical Chemistry, 58, AIS, 2874-2879, 1986.

Pennino, Donald J., "The Use of Phase Cycling in Multipulse Fourier Transform-Nuclear Magnetic Resonance Experiments," Spectroscopy, 2, 3, 36-40, 1986.

Phillips, Gregory R. and Eyring, Edward M., "Error Estimation Using the Sequential Simplex Method in Nonlinear Least

Squares Data Analysis," Analytical Chemistry, 60, AIS, 738-741, 1986.

Plastow, Rob, "LEDS for Fiber Optic Communication Systems," Photonics Spectra, AVO, AIS, 109-114, 1986.

Puskar, Mark A. and Levine, Steven P., "Infrared Screening Technique for Automated Identification of Bulk Organic Mixtures," Analytical Chemistry, 58, AIS, 1981-1989, 1986.

Rakucewicz, John, "Fiber-Optics Methods of Level Sensing," Sensors, AVO, AIS, 5-12, 1986.

Rogers, D.W., "Solving Linear Nonhomogeneous Simultaneous Equations Using a Microcomputer," Chemical Laboratory, AVO, AIS, 38-48, 1986.

Sasaki, K.; Kawata, S; and Minami, S., "Optimal Wavelength Selection for Quantitative Analysis," Applied Spectroscopy, 40, 2, 185-190, 1986.

Siegel, Jeffery I., "Fluorescence Microspectrophotometry," American Laboratory, AVO, AIS, 107-109, 1986.

Siegmend, Walter P., "The Fiber Option for Image Transmission," Photonics Spectra, AVO, AIS, 50-61, 1986.

Snook, D. and Grillo, A., "An Innovative FT/UV-VIS Spectrometer," Chemical Laboratory, AVO, AIS, 28-32, 1986.

Synovec, Robert E. and Yeung, Edward S., "Comparison of an Integration Procedure to Fourier Transform and Data Averaging Procedures in Chromatographic Data Analysis," Analytical Chemistry, 58, AIS, 2093-2095, 1986.

Theisen, Arnold F., "Luminescence Spectroscopy: Minimizing the Effects of Stray Light for Strongly Scattering Materials," Spectroscopy, 2, 6, 48-52, 1986.

Tomasi, Giovanni P., "Fiber Optics for Military Service," Photonics Spectra, AVO, AIS, 73-84, 1986.

Troy, Charles T., "Fiber Optics: On Medicine's Cutting Edge," Photonics Spectra, AVO, AIS, 67-71, 1986.

Vo-Dinh, T.; Griffin, G.D. and Ambrose, K.R., "A Portable Fiberoptic Monitor for Fluorimetric Bioassays," Applied Spectroscopy, 40, 5, 696, 697, 700, 1986.

Wolf, Katharine and Worsfold, Paul J., "Flow Injection Analysis as a Sample Handling Technique for Diode Array Spectroscopy," Analytical Proceeding, 23, AIS, 365-366, 1986.

Wolfbeis, Otto S. and Schaffar, P.H., "Fiber-Optic Titrations-IV," Talanta, 33, 11, 867-870, 1986.

AAU, "Active Components in Fiber-Optic Sensors," Sensors, AVO, AIS, 20-34, 1987.

AAU, "Attenuation and Interference in Multimode Fiber Connections," Applied Optics, 26, 7, 1158-1160, 1987.

AAU, "CCD Technology Brings More Sensitivity to Optical Spectroscopy," Research & Development, AVO, AIS, 44, 1987.

AAU, "Fiberoptic Extenders for Monochromators," Lasers & Applications, AVO, AIS, 95, 1987.

AAU, "Huntsville to Boost Fiber Optics Industry," Photonics Spectra, AVO, AIS, 93, 1987.

AAU, "Infrared Fibers; Pencil-Sized Lasers," Lasers & Applications, AVO, AIS, 106, 1987.

AAU, "Liquid-Crystal Devices Sense Temperature," Laser Focus, AVO, AIS, 48-86, 1987.

AAU, "Optical Monitor Detects Reagent," Laser Focus, AVO, AIS, 42,44, 1987.

Aguirre-Ode, Fernando, "A General Approach for Teaching Hydrolysis of Salts," Chemical Education, 64, 11, 957-958, 1987.

Alpaugh, Virginia, "An Overview of an Underground Problem," Engineer's Digest, AVO, September, APG, 1987.

Armitage, Philip and Bixby, Carl, "ATI," Photonics Spectra, AVO, AIS, 69-76, 1987.

Bello, J.M. and Hurtubise, R.J., "Interactions of Compounds Adsorbed on an 80% α -Cyclodextrin-Sodium Chloride Mixture Investigated by Diffuse Reflectance and Luminescence Spectrometer," Analytical Chemistry, 59, AIS, 2395-2400, 1987.

Benschop, Jos and Braat, Joseph, "Gradient-Index Objectives for CD Applications," Applied Optics, 26, 7, 1195-1200, 1987.

Bergmann, Gerhard; von Oepen, Birgit and Zinn, Peter, "Improvement in the Definitions of Sensitivity and Selectivity," Analytical Chemistry, 59, AIS, 2522-2526, 1987.

Bernard, Jean-Jacques; Depresles, Emmanuel, "High-Resolution Correlation OTDR For Distributed Fiber-Optic Sensors and

- Mobile Cabling," Fiber and Integrated Optics, 7, AIS, 79-84, 1987.
- Bhagavatula, V.A. and Emig, K.A., "Dispersion Transformer for Fiber-Optic Systems," American Laboratory, AVO, AIS, 34, 1987.
- Bohn, Paul W., "Optical Waveguides and Spectroscopy: Thin Films from 10 Å to 100 μm," Spectroscopy, 3, 4, 38-46, 1987.
- Borman, Stu, "Optical and Piezoelectric Biosensors," Analytical Chemistry, 59, 19, 1161-1164, 1987.
- Burger, C.P. Dudderar, T.D. Gilbert, J.A. Peters, B.R. and Smith, J.A., "Laser Excitation Through Fiber Optics for NDE," Nondestructive Evaluation, 7, 1, 57-64, 1987.
- Burtis, Carl A., "Advanced Technology and Its Impact on the Clinical Laboratory," Clinical Chemistry, 33, 3, 352-357, 1987.
- Cameron, David G. and Moffatt, Douglas J., "A Generalized Approach to Derivative Spectroscopy," Applied Spectroscopy, 41, 4, 539-544, 1987.
- Clayton, C. Andrew; Hines, John W. and Elkins, Phyllis D., "Detection Limits with Specified Assurance Probabilities," Analytical Chemistry, 59, AIS, 2506-2514, 1987.
- Coates, John P., "Tracking Down Bad Date," Spectroscopy, 1, 3, 14, 16, 1987.
- Conway, Bruce A., "Sensor Technologies - from Aerospace to Zephyrs," NASA Tech Briefs, AVO, AIS, 9-12, 1987.
- Davis, Dwight B., "Artificial Intelligence Goes to Work," High Technology, AVO, AIS, 16-25, 1987.
- Derde, Marie-Paule; Buydens, Lutgarde; Guns, Corry and Massart, Desire L., "Comparison of Rule-Building Expert Systems with Pattern Recognition for the Classification of Analytical Data," Analytical Chemistry, 59, AIS, 1868-1871, 1987.
- Everest, Charles E., "Infrared Thermometry Theory and Practice," Sensors, AVO, AIS, 9-19, 1987.
- Fotiou, Fotios K. and Morris, Michael D., "Performance of a Hadamard Transform Photothermal Deflection Imager with Continuous Wave Laser Illumination," Analytical Chemistry, 59, AIS, 185-189, 1987.

Fuh, Ming-Ren S. and Burgess, Lloyd W., "Wavelength Division Multiplexer for Fiber Optic Sensor Readout," Analytical Chemistry, 59, AIS, 1780-1783, 1987.

Gemperline, Paul J.; Boyette, Stacey E. and Tyndall, Kimberly, "Background Correction in Multicomponent Spectroscopic Analysis Using Target Transformation Factor Analysis," Applied Spectroscopy, 41, 3, 454-459, 1987.

Gendreau, R.M.; Chittur, K.K.; Dluhy, R.A. and Hutson, T.B., "Biological FTIR Spectroscopy: An Overview," American Biological Laboratory, AVO, July/August, 10-23, 1987.

Gillespie, John W., "The HeNe Lasers & Structured Light," Photonics Spectra, AVO, AIS, 155-162, 1987.

Gillies, George T. and Allison, Stephen W., "Light as a Tool for Motion Monitoring," Photonics Spectra, AVO, AIS, 123-130, 1987.

Glasser, L., "Fourier Transforms for Chemists: Part II. Fourier Transforms in Chemistry and Spectroscopy," Chemical Education, 64, 11, 260-266, 1987.

Glatzer, Hal, "Neural Networks: Software on the Brain," Technology: Software News, AVO, AIS, 66-68, 1987.

Gritz, David N., "Near-Infrared Polarizing Glass for the Military," National Defense, AVO, AIS, 16-20, 1987.

Hagen, Dolores, "Solving Difficult Noncontact Temperature Problems," Sensors, AVO, AIS, 20-23, 1987.

Hayden, Howard C., "Data Smoothing Routine," Computers in Physics, AVO, AIS, 74-75, 1987.

Henkel, Stephanie L., "New Sensor Technology Expanding Applications," Sensors, AVO, AIS, 22-31, 1987.

Jordan, David M.; Walt, David R. and Milanovich, Fred P., "Physiological pH Fiber-Optic Chemical Sensor Based on Energy Transfer," Analytical Chemistry, 59, AIS, 437-439, 1987.

Kawaski, Shuichi; Imasaka, Titari and Ishibashi, Nobuhiko, "Therma Lens Spectrophotometry Using a Tunable Infrared Laser Generated by a Stimulated Raman Effect," Analytical Chemistry, 59, AIS, 523-525, 1987.

Kirschner, Ronald A., "In Medicine & Surgery," Photonics Spectra, AVO, September, 66-68, 1987.

Krohn, David A., "Fiber Optic Sensors: Phase Modulation,"

Photonics Spectra, AVO, AIS, 61-64, 1987.

Lacey, Anthony R., "A Student Introduction to Molecular Vibrations," Chemical Education, 64, 9, 756-761, 1987.

Lee, Eric D.; Werner, T.C. and Seitz, Rudolf W., "Luminescence Ratio Indicators for Oxygen," Analytical Chemistry, 59, AIS, 279-283, 1987.

Lin, Liang-Tsair; Mann, Charles K. and Vickers, Thomas J., "Feasibility of Quantitative UV Resonance Raman Spectroscopy with a KrF Excimer Laser," Applied Spectroscopy, 41, 3, 422-427, 1987.

Lohninger, Hans and Varmuza, Kurt, "Selective Detection of Classes of Chemical Compounds by Gas Chromatography/Mass Spectrometry/Pattern Recognition: Polycyclic Aromatic Hydrocarbons and Alkanes," Analytical Chemistry, 59, AIS, 236-244, 1987.

Mann, Charles K. and Vickers, Thomas J., "Raman Measurements in the Presence of Fluorescence," Applied Spectroscopy, 41, 3, 427-430, 1987.

Miller, D.R.; Han, O.H. and Bohn, P.W., "Quantitative Raman Spectroscopy of Homogeneous Molecular Profiles in Optical Waveguides Using Internal Standards," Applied Spectroscopy, 41, 2, 249-255, 1987.

Miller, D.R.; Han, O.H. and Bohn, P.W., "Quantitative Raman Spectroscopy of Homogeneous Molecular Profiles in Optical Waveguides via Direct Measurement," Applied Spectroscopy, 41, 2, 245-248, 1987.

Muramatsu, Hiroshi; Dicks, Jonathan M.; Tamiya, Eiichi and Karube, Isao, "Piezoelectric Crystal Biosensors Modified with Protein A for Determination of Immunoglobulins," Analytical Chemistry, 59, AIS, 2760-2763, 1987.

Murray, Royce W.; Ewing, Andrew G. and Durst, Richard A., "Chemically Modified Electrodes: Molecular Design for Electroanalysis," Analytical Chemistry, 59, 5, 379-390, 1987.

Nguyen, Dinh C. and Keller, Richard A., "Detection of Single Molecules of Phycoerythrin in Hydrodynamically Focused Flows by Laser-Induced Fluorescence," Analytical Chemistry, 59, AIS, 2158-2161, 1987.

Ozeki, Tory; Kihara, Hiroshi; and Hikime, Seiichiro, "Studies of Raman Spectra and Equilibria of Isopolymolybdate Ions in Aqueous Acetic Solutions by Factor Analysis," Analytical Chemistry, 59, AIS, 945-950, 1987.

- Pau, Chou-Pong and Warner, Isiah M., "Evaluation of a Fourier-Transform-Based Pattern-Recognition Algorithm for Two-Dimensional Fluorescence Data," Applied Spectroscopy, 41, 3, 496-502, 1987.
- Perkins W.D., "Fourier Transform Infrared Spectroscopy: Part II. Advantages of FT-IR," Chemical Education, 64, 11, 269-271, 1987.
- Peuchant, E.; Salles, C. and Jensen, R., "Determination of Serum Cholesterol by Near-infrared Reflectance Spectrometry," Analytical Chemistry, 59, AIS, 1816-1819, 1987.
- Pranitis, David M. and Meyerhoff, Mark E., "Continuous Monitoring of Ambient Ammonia with a Membrane-Electrode-Based Detector," Analytical Chemistry, 59, AIS, 2345-2350, 1987.
- Raymer, Michael G., "The Coherence Properties of Stimulated Raman Scattering," Photonics Spectra, AVO, AIS, 167-171, 1987.
- Renault, Guy, "Clinical Applications of Laser Fluorometer," Lasers & Otronics, AVO, AIS, 56-59, 1987.
- Roach, Mark C. and Harmony, Marlin D., "Determination of Amino Acids at Subfemtomole Levels by High-Performance Liquid Chromatography with Laser-Induced Fluorescence Detection," Analytical Chemistry, 59, AIS, 411-415, 1987.
- Robert, Paul; Bertrand, Dominique and Devaux, Marie Franciose, "Multivariate Analysis Applied to Near-Infrared Spectra of Milk," Analytical Chemistry, 59, AIS, 2187-2191, 1987.
- Roberts, D. Allan, "Radiometry & Photometry: Lab Notes on Units," Photonics Spectra, AVO, AIS, 59-72, 1987.
- Rotman, David, "Raman Spectroscopy Takes a Step Forward," Chemist, AVO, AIS, 13-14, 1987.
- Rutan, Sarah C. and Motley, Curtis B., "Factor Analysis and Kalman Filter Studies of Severely Overlapped Amino Acid Derivatives in Thin-Layer Chromatography," Analytical Chemistry, 59, AIS, 2045-2050, 1987.
- Schwab, Scott D. and McCreery, Richard L., "Remote, Long-Pathlength Cell for High-Sensitivity Raman Spectroscopy," Applied Spectroscopy, 41, 1, 126-130, 1987.
- Schwartz, Lowell M., "Advances in Acid-Based Gran Plot Methodology," Chemical Education, 64, 11, 947-950, 1987.

Sergides, A.R.; Chughatal and Smith, D.M., "Determination of Optical Constants of Polymer Films Using a Fourier Transform Infrared Reflection Method; Polyethylene Terephthalate (PET)," Applied Spectroscopy, 41, 1, 154-158, 1987.

Skogerboe, Kristen J. and Yeung, Edward S., "Stray Light Rejection in Fiber-Optic Probes," Analytical Chemistry, 59, AIS, 1812-1815, 1987.

Smith, Jared and Gerson, Dennis, "But FTIR Isn't Supposed to be Used for Surfaces!," Research & Development, AVO, AIS, 98-101, 1987.

Smith, Vicki J., "Determination of Sulfite Using a Sulfite Oxidase Enzyme Electrode," Analytical Chemistry, 59, AIS, 2256-2259, 1987.

Tanaka, Akira; Sawada, Hishashi; Takoshima, Takehisa; Wakatsuki, Noboru, "New Plastic Optical Fiber Using Polycarbonate Core and Fluorescence-Doped Fiber for High Temperature," Fiber and Integrated Optics, 7, AIS, 139-158, 1987.

Thomas, Norman L. and Hirschfeld, Tomas B., "Optical Fibre Chemical Sensing Networks," SPIE, 787, AIS, 24-28, 1987.

Tromberg, Bruce J. and Sepaniak, Michael, J., "Fiber-Optic Chemical Sensors for Competitive Binding Fluoroimmunoassay," Analytical Chemistry, 59, AIS, 1226-1230, 1987.

Warren, Jr., Vincent F. and Bidlingmeyer, Brian A., "Selection of Representative Wavelength Sets for Monitoring in Liquid Chromatography with Multichannel Ultraviolet-Visible," Analytical Chemistry, 59, AIS, 1890-1896, 1987.

Warren, Jr., Vincent F. and Bidlingmeyer, Brian A., "Selection of Wavelengths for Absorbance Ratio Monitoring in Liquid Chromatography," Analytical Chemistry, 59, AIS, 1897-1907, 1987.

Wopenka, Brigitte and Pasteris, Jill Dill, "Raman Intensities and Detection Limits of Geochemically Relevant Gas Mixtures for a Laser Raman Microprobe," Analytical Chemistry, 59, AIS, 2165-2170, 1987.

Workman, Jr., Jerome and Mark, Howard, "Statistics in Spectroscopy," Spectroscopy, 3, 3, 40-42, 1987.

Workman, Jr., Jerome and Mark, Howard, "Where Are We and Where Are We Going," Spectroscopy, 3, 5, 41-42, 1987.

Wright, Jeremy C., "You can Find Treasure Hidden in the Trash," Research & Development, AVO, AIS, 140-143, 1987.

Wyatt, Wayde A.; Poirier Greg E.; Bright, Frank V. and Hieftje, Gary M., "Fluorescence Spectra and Lifetimes of Several Fluorophores Immobilized on Nonionic Resins for Use in Fiber-Optic Sensors," Analytical Chemistry, 59, AIS, 572-576, 1987.

Wyatt, Wayde A; Bright, Frank V. and Hieftje, Gary M., "Characterization and Comparison of Three Fiber-Optic Sensors for Iodide Determination Based on Dynamic Fluorescence Quenching of Rhodamine," Analytical Chemistry, 59, AIS, 2272-2276, 1987.

Ying, Li-Shi and Levine, Steven P., "Self-Training, Self-Optimizing Expert System for Interpretation of the Infrared Spectra of Environmental Mixtures," Analytical Chemistry, 59, AIS, 2197-2203, 1987.

Yuan, Ping and Walt, David R., "Calculation for Fluorescence Modulation by Absorbing Species and its Application to Measurements Using Optical Fibers," Analytical Chemistry, 59, AIS, 2391-2394, 1987.

Yuan, Ping and Walt, David R., "Calculation for Fluorescence Modulation by Absorbing Species and Its Application of Measurements Using Optical Fibers," Analytical Chemistry, 59, AIS, 2391-2394, 1987.

AAU, "Breakthrough: Bake Composites and Never Botch a Batch," NASA Tech Brief, AVO, AIS, APG, 1988.

AAU, "Decoupled Fabry Report Output Fiber Optic Spectrometer," Photonics Spectra, AVO, AIS, 132-138, 1988.

AAU, "Input Coupler is Key to Least Fiber-optic Welding System," Research and Development, AVO, AIS, 24, 1988.

AAU, "Long Wavelength Fiber Sources Offer Diverse Capabilities," Laser Focus/Electro-Optics, AVO, AIS, 4, 1988.

AAU, "New Double Monochromator," Photonics Spectra, AVO, AIS, 174-192, 1988.

AAU, "New Products," Photonics Spectra, AVO, AIS, 156, 1988.

AAU, "Positioners Align Single-Mode Fiber," Laser Focus/Electro-Optics, AVO, AIS, 10, 1988.

AAU, "Review of Coatings for Excimer Lasers," Lasers & Optonics, AVO, AIS, 69-71, 1988.

AAU, "Stand for Infrared Multiple-Internal-Reflection Mount," NASA Tech Briefs, AVO, AIS, 44, 1988.

AAU, "UV and VUV lasers: Prospects and Applications," Optics News, AVO, AIS, APA, 1988.

Arachibald, D.D.; Lin, L.T. and Honigs, D.E., "Remote Near-IR Spectroscopy Over an Optical Fiber with a Modified FT Spectrometer," Applied Spectroscopy, 42, 3, 468-472, 1988.

Ashutosh, Sharma and Wolfbeis, Otto S., "Fiber-Optic Fluorosensor for Oxygen and Carbon Dioxide," Analytical Chemistry, 60, AIS, 2028-2030, 1988.

Baek, M.; Nelson, W.H. and Hargraves, P.E., "Ultra-Violet Resonance Raman Spectra of Live Cyanobacteria with 222.5-251.0 nm Pulsed Laser Excitation," Applied Spectroscopy, 43, 1, 159-162, 1988.

Beck, Jürgen; Gross, Siegfried and Giffard, Robin, "Optical Component Design for a Correlation-Based Optical Time-Domain Reflectometer," Hewlett-Packard, AVO, AIS, 22-28, 1988.

Benson, John, "New Technology in pH Analysis," AJN, AVO, AIS, 60, 62, 1988.

Bialkowski, Stephen E., "Finite Impulse Response Filters," Analytical Chemistry, 60, 5, 355-361, 1988.

Bivas, A. and Powell, R.A., "Find Water Flaws With Optical Techniques," Research & Development, AVO, AIS, 112-116, 1988.

Brayden, Thomas H.; Poropatic, Paul A. and Watanabe, Jill L., "Iterative Target Testing for Calculation of Missing Data Points," Analytical Chemistry, 60, AIS, 1154-1158, 1988.

Bright, Frank V., "Multicomponent Suppression of Fluorescent Interferants Using Phase-Resolved Raman Spectroscopy," Analytical Chemistry, 60, AIS, 1622-1633, 1988.

Brimmer, Paul J. and Griffiths, Peter R., "Angular Dependence of Diffuse Reflectance Infrared Spectra. Part III: Linearity of Kubelka-Munk Plots," Applied Spectroscopy, 42, 2, 242-247, 1988.

Brown, Chris W. and Dona, Steven M., "Searching a UV-Visible Spectral Library," Applied Spectroscopy, 42, 2, 347-352, 1988.

Brown, Steven D.; Barker, Todd Q.; Larivee, Robert J.; Monfre, Stephen L., "Chemometrics," Analytical Chemistry, 60, 12, 252R-273R, 1988.

Brownlee, Robert G. and Compton, Scott W., "Automated Instrumentation for Analytical Capillary Electrophoresis," American Laboratory, AVO, AIS, 67-76, 1988.

Chipman, John D., "Fiber Optics Test: The Tools of the Trade," Evaluation Engineering, AVO, AIS, 95-98, 1988.

Derbe, M.P. and Massart, D.L., "Comparison of the Performance of the Class Modeling Techniques UNEQ, SIMCA, and PRIMA," Chemometrics and Intelligent Laboratory Systems, 4, AIS, 65-93, 1988.

Derore, Jerald A., "A Simple Numerical Method for Solving Complex Equilibria," Chemical Education, 65, 10, 888-870, 1988.

Devaux, M.F.; Bertrand, D.; Robert, P. and Qannari M., "Application of Principal Components Analysis on NIR Spectral Collection after Elimination of Interference by a Least-Squares Procedure," Applied Spectroscopy, 42, 6, 1020-1023, 1988.

Devaux, M.F.; Bertrand, D.; Robert, P. and Qannri, M., "Application of Multidimensional Analyses to the Extraction of Discriminant Spectral Patterns from NIR Spectra," Applied Spectroscopy, 42, 6, 1015-1019, 1988.

Donahue, Steven M.; Brown, Chris W.; and Obremski, Robert J., "Multicomponent Analysis Using Fourier Transform Infrared and UV Spectra," Applied Spectroscopy, 42, 2, 353-359, 1988.

Donato, Jr., Henry and Metz, Clyde, "A Direct Method for the Propagation of Error Using a Personal Computer Spreadsheet Program," Chemical Education, 65, 10, 867-870, 1988.

Dreyfuss, Jamie, "Visible-Wavelength Diode Lasers," Lasers & Optronics, AVO, AIS, 53-58, 1988.

Driscoll, J.N.; Duffy, M. and Pappas, S., "Determination of Water and Oxygen at Low ppm Levels by GC/Far-UV Detection," American Laboratory, AVO, AIS, 68-71, 1988.

Duarte, F.J., "Narrow-Linewidth, Multiple-Prism, Pulsed Dye Lasers," Lasers & Optronics, AVO, AIS, 41-43, 1988.

Duncan, Wayne P., "Use of GC-IR-MS and Pyrolysis for Polybutadiene Characterization," American Laboratory, AVO, AIS, 40-46, 1988.

Eckbreth, Alan C., "Multi-color CARS for Multispecies Combustion Measurements," Optics News, AVO, AIS, 17-22, 1988.

Engstrom, Royce C.; Wighthman R. Mark and Kristensen, Eric W., "Diffusional Distortion in the Monitoring of Dynamic Events," Analytical Chemistry, 60, AIS, 652-656, 1988.

Fairchild, Mark D. and Daoust, Dennis J.O., "Goniospectrophotometric Analysis of Pressed PTFE Powder for Use as a Primary Transfer Standard," Applied Optics, 27, 16, 3392-3396, 1988.

Fleischer-Reunmann, Michael and Sischka, Franz, "A High-Speed Optical Time-Domain Reflectometer with Improved Dynamic Range," Hewlett-Packard, AVO, AIS, 6-13, 1988.

Fraatz, R.J. Prakash G. and Allen, F.S., "A Polarization Sensitive Light Scattering System For the Characterization of Bacteria," American Biological Laboratory, AVO, November, 24-28, 1988.

Fuh, Ming-Ren S.; Burgess, Lloyd W. and Christian, Gary D., "Single Fiber-Optic Fluorescence Enzyme-Based Sensor," Analytical Chemistry, 60, AIS, 433-435, 1988.

Fujiwara Kitao; Simeonsson J.B.; Smith B.J. and Winefordner J.D., "Waveguide Capillary Flow Cell for Fluorometry," Analytical Chemistry, 60, AIS, 1065-1068, 1988.

Fuller, M.P., Ritter, G.L., and Draper, C.S., "Partial Least-Square Quantitative Analysis of Infrared Spectroscopic Data. Part II: Application to Detergent Analysis," Applied Spectroscopy, 42, 2, 228-236, 1988.

Fuller, M.P.; Ritter, G.L. and Draper, C.S., "Partial Least-Squares Quantitative Analysis of Infrared Spectroscopy Data. Part I: Algorithm Implementation," Applied Spectroscopy, 42, 2, 217-227, 1988.

Garside, Brian K., "High Resolution OTDR Measurements," Photonics Spectra, AVO, AIS, 79-86, 1988.

Gauglitz, Günter and Krause-Bonte, Jürgen, "Spectral Interference Refractometry by Diode Array Spectrometry," Analytical Chemistry, 60, AIS, 2609-2612, 1988.

Gerow, David D. and Rutan, Sarah C., "Background Correction for Fluorescent Detection in Thin-Layer Chromatography Using Factor Analysis and the Adaptive Kalman Filter," Analytical Chemistry, 60, AIS, 847-852, 1988.

Goldblatt, Norman, "Solving Medical Problems; Part Two," Photonics Spectra, AVO, AIS, 65,66,68, 1988.

Goldman, Don S., "Chemical Sensor Development For Process and

- Environmental Monitoring," American Laboratory, AVO, AIS, 102-109, 1988.
- Gurka, Donald F.; Betwski, L. Donnelly; Hinnners, Thomas A. and, "Environmental Applications," Analytical Chemistry, 60, 7, 454-457, 1988.
- Haaland, David M., "Quantitative Infrared Analysis of Borophosphosilicate Films Using Multivariate Statistical Methods," Analytical Chemistry, 60, AIS, 1208-1217, 1988.
- Haaland, David M. and Thomas, Edward V., "Partial Least-Squares Methods for Spectral Analyses. 1. Relation to Other Quantitative Calibration Methods and the Extraction of Qualitative Information," Analytical Chemistry, 60, AIS, 1193-1202, 1988.
- Haaland, David M. and Thomas, Edward V., "Partial Least-Squares Methods for Spectral Analyses. 2. Application to Simulated and Glass Spectral Data," Analytical Chemistry, 60, AIS, 1202-1208, 1988.
- Hanlin, John, "Thin Films," Photonics Spectra, AVO, AIS, 113-118, 1988.
- Hanst, Philip L. and Stephens, Edgar R., "Infrared Analysis of Engine Exhausts: Methyl Nitrite Formation from Methanol Fuel," Spectroscopy, 4, 9, 33-38, 1988.
- Harrick, N.J., "Optical Spectroscopy: Six Sampling Techniques," American Laboratory, AVO, AIS, 98-105, 1988.
- Harrington, H.W.; Leibrand, R.J.; Hart, M.A. and Duncan, W.P., "Can a FTIR Spectrometer Really Be That Sensitive?," Research & Development, AVO, AIS, 82-88, 1988.
- Harrington, P.B. and Isenhour, T.L., "Application of Robust Eigenvectors to the Compression of Infrared Spectral Libraries," Analytical Chemistry, 60, AIS, 2687-2692, 1988.
- Henshall, H. and Cruickshank J., "Reflectance Characteristics of Selected Materials for Reference Targets for 10.- μ m Laser Radars," Applied Optics, 27, 13, 2748-2755, 1988.
- Hillerich Bernd, "Shape Analysis and Coupling Loss of Microlenses on Single-Mode Fiber Tips," Applied Optics, 27, 15, 3102-3106, 1988.
- Illman, Deborah L.; Callis James B. and Kowalski, Bruce R., "Process Analytical Instrumentation: Sources of Inspiration," AJN, AVO, November, 8,10, 1988.

Iscoff, Ron, "Ultrafast Dye Lasers," Lasers & Optronics, AVO, AIS, 47-53, 1988.

Jones, Thomas P. and Porter, Marc D., "Optical pH Sensors Based on the Chemical Modification of a Porous Polymer Film," Analytical Chemistry, 60, AIS, 404-406, 1988.

Josefson, Mats; Johansson, Erik and Torstensson, Arne, "Optical Fiber Spectrometry in Turbid Solutions by Multivariate Calibration Applied to Tablet Dissolution Testing," Analytical Chemistry, 60, AIS, 2666-2671, 1988.

Kaplan, Herbert, "FT/IR Spectrum Analyzers Go On-Line," Photonics Spectra, AVO, AIS, 76-78, 1988.

Keeley, Dean F.; Hoffpauir, Melanie A. and Meriwether, John R., "Solubility of Aromatic Hydrocarbons in Water and Sodium Chloride Solutions of Different Ionic Strengths: Benzene and Toluene," J. Chem. Eng. Data, 33, AIS, 87-89, 1988.

Korte, E.H., "Figures of Merit for a Diffuse Reflectance Accessory Using an On-Axis Ellipsoidal Collecting Mirror," Applied Spectroscopy, 42, 3, 428-433, 1988.

Korte, E.H. and Otto, A., "Infrared Diffuse Reflectance Accessory for Local Analysis on Bulky Samples," Applied Spectroscopy, 42, 1, 38-43, 1988.

Kreske, Kathi; Keren, Eliezer and Kafri, Oded, "Insights on Moire Deflectometry," Lasers & Optronics, 7, 10, 63-66, 1988.

Kvalheim, Olav M., "Interpretation of Direct Latent-Variable Projection Methods and Their Aims and Use in the Analysis of Multicomponent Spectroscopic and Chromatographic Data," Chemometrics and Intelligent Laboratory Systems, 4, AIS, 11-25, 1988.

Kvalheim, Olav M., "On-line Classification and Updating of Disjoint Principal Component Models," Chemometrics and Intelligent Laboratory Systems, 3, AIS, 243-247, 1988.

Kvalheim, Olav M., "A Partial-Least-Square Approach to Interpretative Analysis of Multivariate Data," Chemometrics and Intelligent Laboratory Systems, 3, AIS, 189-197, 1988.

Lewis, E. Neil; Kalasinsky, V.F. and Levin, Ira W., "Near-Infrared Fourier Transform Raman Spectroscopy Using Fiber-Optic Assemblies," Analytical Chemistry, 60, AIS, 2658-2661, 1988.

Lodder, Robert A. and Hieftje, Gary M., "Analysis of Intact Tablets by Near-Infrared Reflectance Spectrometry," Applied

Spectroscopy, 42, 4, 556-558, 1988.

Lodder, Robert A. and Hieftje, Gary M., "Subsurface Image Reconstruction by Near-Infrared Reflectance Analysis," Applied Spectroscopy, 42, 2, 309-312, 1988.

Lovely, Peter S., "Researchers Meet OTDR Challenges," Laser Focus/Electro-Optics, AVO, AIS, 139-141, 1988.

Luo, Mingzhao; Yee, Jeng-Hwa and Hays, Paul B., "Image Plane Detector Spectrophotometry: Application to Oxygen Atmospheric Band Nightglow," Applied Optics, 27, 15, 3255-3261, 1988.

Maeder, Marcel and Zilian, Arne, "Evolving Factor Analysis, a New Multivariate Technique in Chromatography," Chemometrics and Intelligent Laboratory Systems, 3, ASI, 205-213, 1988.

Mark, Howard, "Catalog of the Effects of Nonlinearity on Multivariate Calibrations," Applied Spectroscopy, 42, 5, 832-844, 1988.

Mark, Howard and Workman, Jr., Jerome, "The Variance of Variance," Spectroscopy, 4, 6, 43-44, 1988.

Marsili, M; Marengo, E.; and Saller, H., "Spectra: An Approach to an Expert System in Chemometrics," Analytica Chimica Acta, 210, AIS, 33-50, 1988.

McGrattan, Brain J; Schlering, David W. and Hoult, Robert A., "Infrared Spectral Discrimination: The Use of a Filtering Correlation Function for Materials Characterization," Spectroscopy, 4, 9, 39-42, 1988.

Meglen, Robert R., "Chemometrics: its Role in Chemistry and Measurement Sciences," Chemometrics and Intelligent Laboratory Systems, AVO, ASI, 17-29, 1988.

Miah, M.J. and Moore, J.M., "Parameter Design in Chemometry," Chemometrics and Intelligent Laboratory Systems, 3, AIS, 31-37, 1988.

Morris, Kevin S. and Rein, Alan J., "Part 2 FTIR in the QC Laboratory: A Chemical Analyzer for the Production Laboratory," American Laboratory, AVO, AIS, 46-52, 1988.

Muckenheim, W.; Austin, Lindsay and Bastin, Dirk, "The Pulsed Dye Laser: Today's Technology, Today's Uses," Photonics Spectra, AVO, AIS, 79-84, 1988.

Ohman, Jerker; Lindberg, Walter and Wold, Svante, "Data Reduction of Bilinear Matrices Prior to Calibration," Analytical Chemistry, 60, AIS, 2756-2760, 1988.

Ozeki, Toru; and Kihara, Hiroshi, "Study of Equilibria in 0.03 mM Molybdate Acidic Aqueous Solutions by Factor Analysis Applied to Ultraviolet Spectra," Analytical Chemistry, 60, AIS, 2055-2059, 1988.

Park N.A. and Irvine, Jr., T.F., "The Falling Needle Viscometer: A New Technique for Viscosity Measurements," American Laboratory, AVO, AIS, 57-63, 1988.

Patrick, Steve, "Optical Sensing Inside the Body," Science Impact, AVO, AIS, APG, 1988.

Pattacini, S.C. and Porro, T.J., "Problem Solving Using FTIR Spectroscopy," American Laboratory, AVO, AIS, 24-32, 1988.

Platt, J.A. and Uy, O.M., "Computer-Based Linear Regression Analysis of Desorption Mass Spectra of Microorganisms," Analytical Chemistry, 60, AIS, 1415-1419, 1988.

Porter, Marc D., "IR External Reflection Spectroscopy: A Probe for Chemically Modified Surfaces," Analytical Chemistry, 60, 20, 1143-1155, 1988.

Reichert, W.M. Druckner, C.J. and Wan, Sui-Ren, "Fiber Optic Sensing of Fluorescent Emission from Compressed Cyanine-Dye-Imregnated Fatty Acid Monolayers at the Air/Water interface," Applied Spectroscopy, 42, 4, 605-608, 1988.

Rivoir, Jochen and Pless, Wilfried, "Data Processing in the Correlating Optical Time-Domain Reflectometer," Hewlett-Packard, AVO, AIS, 29-34, 1988.

Ruslin, James F., "Minimizing Error in Numerical Analysis of Chemical Data," Chemical Education, 65, 10, 863-866, 1988.

Schirmer, R.E. and Gargus, A.G., "Monitoring Polymer Processing Through Fiber Optics," American Laboratory, AVO, AIS, 37-43, 1988.

Schwartz, Leslie J., "A Step-by-Step Picture of Pulsed (Timed-Domain) NMR," Chemical Education, 65, 9, 752-756, 1988.

Sercel, Jeffrey and Sowada, Ulrich, "Why Excimer Lasers Excel in Marking," Laser & Optronics, AVO, AIS, 69-72, 1988.

Sharma, Ashutosh and Wolfbeis, Otto S., "Fiberoptic Oxygen Sensor Based on Fluorescence Quenching and Energy Transfer," Applied Spectroscopy, 42, 6, 109-111, 1988.

Sherman, Glenn H.; Danielewicz, Edward J. and Rudisill, J.

- Earl, "Optics for Industrial CO2 Lasers," Laser & Optronics, AVO, AIS, 51-58, 1988.
- Shukov, George A. and Smith, Al, "Micromachining with Excimer Lasers," Laser & Optronics, AVO, AIS, 75-77, 1988.
- Silberman, Donn, "Fiberoptic Sensors for Medical Diagnostics: An Overview," Lasers & Optronics, 7, 10, 73-77, 1988.
- Sischka, Franz; Newton, Steven A. and Nazarathy, Moshe, "Complementary Correlation Optical Time-Domain Reflectometry," Hewlett-Packard, AVO, AIS, 14-21, 1988.
- Small, J.R. and Hassel, R.L., "On-line Application of Diode Array Spectrophotometry," American Laboratory, AVO, AIS, 88-91, 1988.
- Steensrud, J.A. and Archard, M.A., "Absolute Specular Reflectance Measurements Using a High Performance UV-VIS NIR Spectrophotometer," American Laboratory, AVO, AIS, 74-79, 1988.
- Straster, Joost K.; Billiet, Hugo A.H. and de Galan, Leo, "Reality of Iterative Target Transformation Factor Analysis When Using Multiwavelength Detection for Peak Tracking in Liquid Chromatographic Separations," Analytical Chemistry, 60, AIS, 2745-2751, 1988.
- Sundberg, Rolf, "Interplay between Chemistry and Statistics, with Spectral Reference to Calibration and the Generalized Standard Addition Method," Chemometrics and Intelligent Laboratory Systems, 4, AIS, 299-305, 1988.
- Tallant, David R.; Higgins, Karen L. and Stewart, Alan F., "Application of Waveguide Raman Spectroscopy to High-Index Dielectric Films," Applied Spectroscopy, 42, 2, 326-330, 1988.
- Taylor, Paul D.; Morrison, Ian E.G. and Hider, Robert C., "Microcomputer Application of Non-Linear Regression Analysis to Metal-Ligand Equilibria," Talanta, 35, 7, 507-512, 1988.
- Tebo, Alberto, "Spin-Casting Improves Big Telescope Mirrors," Laser Focus/Electro-Optics, AVO, AIS, 79-92, 1988.
- Thompson, Bruce N., "The Dye Laser's Broadening Reach," Photonics Spectra, AVO, AIS, 163-166, 1988.
- Wahl, John F., "New Fibers Meet Sensing Demands," Photonics Spectra, AVO, AIS, 79-84, 1988.
- Watson, Jr., Edgar, "On-line Analysis of Trace Contaminants

in Process Streams," American Laboratory, AVO, AIS, 97-101, 1988.

Weiss, Richard, "Advances in Infrared Fibers," Lasers & Optronics, AVO, AIS, 29-37, 1988.

Wentzell, Peter F; Wade, A.P. and Crouch, S.R., "Modeling Chemical Response Surfaces with the Kalman Filter," Analytical Chemistry, 60, AIS, 905-911, 1988.

Wolfbeis, Otto S. and Weis, Leonie J., "Fiber-Optic Fluorsensors for Oxygen and Carbon Dioxide," Analytical Chemistry, 60, AIS, 2028-2030, 1988.

Zhu, Bo-Shen; Owner-Petersen, Mette and Licht, Torben, "Accelerometer Design Based on Attenuated Total Reflection," Applied Optics, 27, 14, 2972-2975, 1988.

AAU, "10 Watt CW Laser Diode," Laser Focus World, 25, 12, APG, 1989.

AAU, "Advanced Components for Fiber-Optical Systems," NASA Tech Briefs, AVO, AIS, 33, 1989.

AAU, "Amoco Laser Co.," Photonics Spectra, AVO, AIS, 98, 1989.

AAU, "At-A-Glance Guide to IR Fibers," Photonics Spectra, AVO, AIS, 137-141, 1989.

AAU, "Candela Lasers- Innovators in Medicine and Science," Laser Focus World, 25, 12, APG, 1989.

AAU, "Diode Lasers and Accessories," Laser Focus World, AVO, AIS, 3, 1989.

AAU, "Examine Derivations to Improve Accuracies of Analog Digital-Domain Transformation," Personal Engineering & Instrumentation News, AVO, AIS, 69-72, 1989.

AAU, "Fluorescence Lifetime Spectroscopy," Laser Focus World, 25, 1, 203, 1989.

AAU, "GALA Diode Laser System," Laser Focus World, 25, 12, 171-172, 1989.

AAU, "High Performance Liquid Chromatography of Biopolymers," LCGC, 7, 5, 402-417, 1989.

AAU, "Laser Microanalysis, On-Line Process Analyzers, and Electrophoresis," Analytical Chemistry, 61, 24, 1376-1379, 1989.

AAU, "Laser Spectroscopy Aids Protein Research," Laser Focus World, AVO, AIS, 34, 1989.

AAU, "New Products," Photonics Spectra, AVO, September, 160-170, 1989.

AAU, "NEW! A 12-bit Slow-Scan CCD Camera... at Half the Cost of Other Cooled CCD cameras," Laser Focus World, 25, 10, APG, 1989.

AAU, "Process Measurement and Control," Analytical Chemistry, 61, 23, 1340, 1989.

AAU, "Sapphire Alternative," Photonics Spectra, AVO, AIS, 170, 1989.

AAU, "Spectrograph Measures Contamination of Optical Elements," NASA Tech Briefs, AVO, AIS, 58, 1989.

Ahn, Myong-Ku, "A Comparison of FTNMR and FTIR Techniques," Chemical Education, 66, 10, 802-804, 1989.

Alak, A.M. and Vo-Dinh, T., "Silver-Coated Fumed Silica as a Substrate Material for Surface-Enhanced Raman Scattering," Analytical Chemistry, 61, AIS, 656-660, 1989.

Andersson-Engels, Stefan; Johansson, Jonas and Svanberg Sune, "Fluorescence Diagnosis and Photochemical Treatment of Diseased Tissue Using Lasers: Part I," Analytical Chemistry, 61, 24, 1367-1373, 1989.

Andrews-Wilberforce, Daniel and Potanay, Gabor, "Fluorescence Quenching Studies of Near-Infrared Fluorophores," Applied Spectroscopy, 43, 8, 1450-1455, 1989.

Angel, S.M.; Garvis, D.G.; Sharma, S.K. and Seki, A., "Field Applications of Fiber-Optic Sensors. Part I: Temperature Measurements in a Geothermal Well," Applied Spectroscopy, 43, 3, 430-435, 1989.

Angel, S.M.; Katz, L.F.; Archibald, D.D. and Honigs, D.E., "Near-Infrared Surface-Enhanced Raman Spectroscopy. Part II: Copper and Gold Colloids," Applied Spectroscopy, 43, 3, 367-372, 1989.

Badilescu, Simona; Ashrit, P.V.; Truong, Vo-Van and Badilescu, I.I., "Enhanced Infrared ATR Spectra of o-, m-, and p-Nitrobenzoic Acid with Ag Films," Applied Spectroscopy, 43, 3, 549-552, 1989.

Barnes, R.J.; Dhanoa, M.S. and Lister, Susan J., "Standard Normal Variate Transformation and De-trending of

Near-Infrared Diffuse Reflectance Spectra," Applied Spectroscopy, 43, 5, 772-777, 1989.

Barnoski, Michael K., "Fiber Optic Components Meet Applications Needs," Laser Focus World, 25, 12, 54,56, 1989.

Baughman, E.H. and Mayes, D., "NIR applications in Process Analysis," American Laboratory, AVO, AIS, 54-58, 1989.

Beffeteau, Thierry and Desbat, Bernard, "Thin-Film Optical Constants Determined from Infrared Reflectance and Transmittance Measurements," Applied Spectroscopy, 43, 6, 1027-1032, 1989.

Bello, J.M.; Stokes, D.L. and Vo-Dinh, T., "Silver-Coated Alumina as a Nes Medium for Surfaced-Enhanced Raman Scattering Analysis," Applied Spectroscopy, 43, 8, 1325-1329, 1989.

Bialkowski, Stephen E., "Data Analysis in the Shot Noise Limit. 1. Single Parameter Estimation with Poisson and Normal Probability Density Functions," Analytical Chemistry, 61, AIS, 2479-2483, 1989.

Bialkowski, Stephen E., "Data Analysis in the Shot Noise Limit. 2. Methods for Data Regression," Analytical Chemistry, 61, AIS, 2483-2489, 1989.

Bortz, M.L. and French, R.H., "Quantitative. FFT-Based, Kramers-Krönig Analysis for Reflectance Data," Applied Spectroscopy, 43, 8, 1498-1501, 1989.

Bostick, J.M. and Carreira, L.A., "Fourier-Domain Analysis of Complex Line Shapes," Applied Spectroscopy, 43, 1, 38-44, 1989.

Branham, Jr., Richard L., "A Program for Total (orthogonal) Least Squares in Compact Storage Mode," Computers in Physics, AVO, AIS, 42-46, 1989.

Braun, David and Leyde, Kent W., "Optical Reflection Measurement System using a Swept Modulation Frequency Technique," Optical Engineering, 28, 3, 286-289, 1989.

Brereton, Richard G., "Fourier Transforms in Spectroscopy- a Chemometric Approach," Analytical Processing, 26, AIS, 311-312, 1989.

Bright, Frank V. and Litwilder, Kevin S., "Multicomponent Fluorometric Analysis Using a Fiber-Optic Probe," Analytical Chemistry, 61, AIS, 1510-1513, 1989.

Brill, Thomas B., "Fast Thermolysis/FT-IR Spectroscopy," Analytical Chemistry, 61, 15, 897-906, 1989.

Bruno, Alfredo E.; Gassmann, Ernst; Periclès, Nico and Anton, Klaus, "On-Column Capillary Flow Cell Utilizing Optical Waveguides for Chromatographic Applications," Analytical Chemistry, 61, AIS, 876-883, 1989.

Bryden, G.W. and Smith, L.R., "Sampling for Environmental Analysis Part 2: Sampling Methodology," American Laboratory, AVO, AIS, 19-24, 1989.

Campbell, William J.; Short, Nicholas M. and Treinish, Lloyd A., "Adding Intelligence to Scientific Data Management," Computers in Physics, AVO, AIS, 26-32, 1989.

Carey, W. Patrick and DeGrandpre, Michael D., "Polymer-Coated Cylindrical Waveguide Absorption Sensor for High Acidities," Analytical Chemistry, 61, AIS, 1674-1678, 1989.

Carlson, Roger J. and Wright, John C., "Absorption and Coherent Interference Effects in Multiply Resonant Four-Wave Mixing Spectroscopy," Applied Spectroscopy, 43, 7, 1195-1208, 1989.

Carroll, Mary K.; Bright, Frank V. and Hieftje, Gary M., "Fiber-Optic Time-Resolved Fluorescence Sensor for the Simultaneous Determination of AlE3+ and GaE3+ or InE3+," Analytical Chemistry, 61, AIS, 1768-1772, 1989.

Carroll, Mary K.; Bright, Frank V. and Hieftje, Gary M., "Luminescence Originating in an Optical Fiber," Applied Spectroscopy, 43, 1, 176-178, 1989.

Carson, George and Granick, Steve, "Infrared Spectra of Organic Monolayers on Mica," Applied Spectroscopy, 43, 3, 473-476, 1989.

Carts, Yvonne A., "Flashlamp Pumps Ti:sapphire Laser," Laser Focus World, AVO, AIS, 21-36, 1989.

Casale, Agatino; DeStefano, Concetta and Sammartano, Silvio, "Ionic-strength Dependence of Formation Constants-XII: A Model for the Effects of Background on the Protonation Constants of Amines and Amino-Acids," Talanta, 36, 9, 903-907, 1989.

Christian, Susan D., "New Instrumentation for Viscosity Measurements," American Laboratory, AVO, AIS, 10, 1989.

Clementi, Sergio; Bonelli, Daniela; Cruciani, Gabriele; Skagerberg, Bert;, "Chemometrics Strategy in Drug Design,"

Chimicaoggi, AVO, AIS, 19-22, 1989.

Clifton, M.J., "A Viscometer For the Quality Control and Experimental Laboratory," American Laboratory, AVO, AIS, 11, 1989.

Conway, Bruce A., "Sensors," Aerospace American, AVO, AIS, 72-74, 1989.

Cooper, M.M. and Vidmar, T.J., "Application of Integrated Data Analysis Software in Drug Development," American Laboratory, AVO, AIS, 89-91, 1989.

Cowe, Ian A.; McNicol, James W. and Cuthbertson, D. Clifford, "Reconstruction of Constituent Spectra for Individual Samples Through Principal Component Analysis of Near-infrared Spectra," Analyst, 114, AIS, 683-687, 1989.

Cruywagen J.J. and Heyns, J. B.B., "Spectrophotometric Determination of the Thermodynamic Parameters for the First Two Prorotation Reactions of Molybdate," Chemical Education, 66, 10, 861-863, 1989.

Dale, John M. and Klatt, Leon N., "Principal Component Analysis of Diffuse Near-Infrared Reflectance Data From Paper Currency," Applied Spectroscopy, 43, 8, 1399-1405, 1989.

Dance, Brian, "Britain Maintains Fiberoptic Strength," Laser Focus World, 25, 12, 161-162, 1989.

Dance, Brian, "Diode Pumps Ring Laser," Laser Focus World, 25, 12, 22,24, 1989.

Deavor, J.P.; Womack, J.B.; Smith, B.W. and Winefordner, J.D., "Fiber Optic Probe of a Flame for Copper Number Density Determination," Applied Spectroscopy, 43, 1, 165-167, 1989.

Del Fanti, Natalino; D'Alessio, Aldo; Pianca, Maurizio; Moggi, Giovanni; "FT-IR Study of Poly(vinylidene Fluoride-co-Hexafluorophopene)/Phthalate systems," ChimiCaoggi, AVO, AIS, 15-17, 1989.

Diemann, Ekkehard, "An Inexpensive Pocket Reflectometer for Semiquantitative Spot Test Analysis," Chemical Education, 66, 7, 595-596, 1989.

Dirschner, Ronald A., "Selling the Second-Generation Laser," Photonics Spectra, AVO, AIS, 70-71, 1989.

Ellerbe, Polly; Meiselman, Stanley; Sniegoski, Lorna T.; Welch, Michael J., "Determination of Serum Cholesterol by a Modification of the Isotope Dilution Mass Spectrometric

- Definitive Method," Analytical Chemistry, 61, AIS, 1718-1723, 1989.
- Engleheart, Brian T., "Trends Fiber Optics," Photonics Spectra, AVO, AIS, 87-90, 1989.
- Ewbank, John D.; Paul, David W.; Schäfer, Lothar and Bakhtiar, Reza, "Real-Time Electron Diffraction. Part III: Image Transfer Via Fiber Optics," Applied Spectroscopy, 43, 3, 415-419, 1989.
- Figueroa, L. and Hong, C.S., "Diode Laser Capabilities Expand," Laser Focus World, 25, 4, 4-5, 1989.
- Forrest, Gary T., "Japanese Exhibit Next-Generation Fiberoptic Devices," Laser Focus World, 25, 10, 145, 1989.
- Forst, Wendell, "Collisional Relaxation via Eigenfunction Eigenvalue Expansion," Chemical Education, 66, 2, 142-146, 1989.
- Fouk, Susan J. and Catalano, Vincent J., "Determination of Octane Number Using Remote Sensing NIR Spectroscopy," American Laboratory, AVO, November, 76-81, 1989.
- Gary, Ken, "On-line Electrochemical Sensors in Fermentation," American Biological Laboratory, AVO, September, 26-33, 1989.
- Gemperline, Paul J. and Hamilton, J. Craig, "Conditions for Detecting Overlapped Peaks with Principal Components Analysis in Hyphenated Chromatographic Methods," Analytical Chemistry, 61, AIS, 2240-2243, 1989.
- Gillespie, John and Miller, Preston, "Find New Industrial Worlds to Conquer," Photonics Spectra, AVO, AIS, 87-88, 1989.
- Glick, Mark R.; Jones, Bradley T.; Smith, Ben W. and Winfordner, James D., "Molecular Absorption Measurements by FT/UV-Vis Spectrometer," Applied Spectroscopy, 43, 2, 342-344, 1989.
- Goodberlet, J; Wang, J.; Fujimoto, J.G.; Henion, S.R. and Schultz, P.A., "A Passively Mode-locked Ti: Al2O3 Laser Using a Nonlinear Coupled Cavity," Optics News, AVO, AIS, 8-9, 1989.
- Hancock, Darrell O. and Sunovec, Robert E., "Early Detection of C-130 Aircraft Engine Malfunction by Principal Component Analysis of the Wear Metals in C-130 Engine Oil," Applied Spectroscopy, 43, 2, 202-208, 1989.
- Havel, Henry A.; Chao, Robert S.; Haskell, Royal J. and

Thamann, Thomas J., "Investigations of Protein Structure with Optical Spectroscopy: Bovine Growth Hormone," Analytical Chemistry, 61, AIS, 642-650, 1989.

Hecht, Jeff, "Optical Amplifiers Gain Ground with Raman-aided, Doped Fibers," Technology, AVO, AIS, 14-19, 1989.

Henderson, B.C.; Stewart, I.M. and Casuccio, G.S., "Rapid Acquisition/Storage of Electron Microscope Images," American Laboratory, AVO, AIS, 49-53, 1989.

Highfield, James G. and Bowen, Paul, "Diffuse-Reflectance Fourier Transform Infrared Spectroscopic Studies of the Stability of Aluminum Nitride Powder in an Aqueous Environment," Analytical Chemistry, 61, AVO, 2399-2402, 1989.

Hoffman, Douglas P.; Proctor, Andrew and Hercules, David M., "Improved Discrimination of Noisy Spectra in Correlation-Based Spectral Analysis," Analytical Chemistry, 61, AIS, 898-904, 1989.

Holler, Farida; Burns, David H. and Callis, James B., "Direct Use of Second Derivatives in Curve-Fitting Procedures," Applied Spectroscopy, 43, 5, 877-882, 1989.

Holmes, Lewis M., "Sapphire Fibers Transmit Infrared Power," Laser Focus World, AVO, AIS, 140, 1989.

Hong-kui, Xiao; Levine, Steven P. and D'Arcy, James B., "Iterative Least-Squares Fit Procedures for the Identification of Organic Vapor Mixtures by Fourier Transform Infrared Spectrophotometry," Analytical Chemistry, 61, 24, 2708-2714, 1989.

Howard, Brian; Levy, Gabor B; Scott, Jr., Frederick I.; Wentworth, A.N. and, "The 1989 Pittsburgh Conference: A Review," American Laboratory, AVO, AIS, 82-104, 1989.

Howard, Mark; Norris, Karl and Williams, Philip C., "Methods of Determining the True Accuracy of Analytical Methods," Analytical Chemistry, 61, AIS,

Hoy, R.M. and McClure, W.F., "Fourier Transform Near-Infrared Spectrometry: Using Interferograms to Determine Chemical Composition," Applied Spectroscopy, 43, 6, 1102-1104, 1989.

Huckins, Linda, "Suppliers of Optical Detectors," Laser Focus World, AVO, AIS, 115-120, 1989.

Hurtubise, Robert J., "Solid-Surface Luminescence Spectrometry," Analytical Chemistry, 61, 15, 889-895, 1989.

Jacobs, S.D.; Gunderman, T.E. and Marshall, K.L., "Liquid Crystal Optics," Optics News, AVO, AIS, 39-40, 1989.

Johnson, Randy W. and Vo-Dinh, Tuan, "Fumed Silica Substrates for Enhanced Fluorescence Spot Test Analysis of Benzo(a)pyrene-DNA Adduct Products," Analytical Chemistry, 61, 24, 2766-2769, 1989.

Jones, Roger W. and McClelland, John F., "Transient Infrared Emission Spectroscopy," Analytical Chemistry, 61, AIS, 650-656, 1989.

Jones, Thomas P. and Proter, Marc D., "An Optical Sensor Based on Infrared Spectroscopy," Applied Spectroscopy, 43, 6, 908-911, 1989.

Jordan, Ramiro and Dyer, Stephen A., "Adaptive Signal Processing Techniques: An Application to Raman Spectroscopy," Applied Spectroscopy, 43, 5, 750-758, 1989.

Justice, Jeff, "Automating the Chromatography Report Generation Process," American Laboratory, AVO, AIS, 54-59, 1989.

Kaihara, Mikio; Mametsuka, Hiroaki; Gunji, Naoki; Iwata, Hideo and Gohshi,, "New Dilution Materials for Sensitivity Enhancement in the FT-IR Spectroscopy of Pitches as Typical Highly Scattering Samples," Applied Spectroscopy, 43, 3, 477-480, 1989.

Kalkandjiev, T.K.; Petrov, V.P. and Nickolov, J.B., "Deconvolution Versus Derivative Spectroscopy," Applied Spectroscopy, 43, 1, 44-48, 1989.

Katon, Jack E. (editor), "Biological Applications of Raman Spectroscopy -Book Review," Applied Spectroscopy, 43, 2, 16A, 19A, 1989.

Kellar, Jon J.; Cross, W.M. and Miller, J.D., "Adsorption Density Calculations from In Situ FT-IR/IRS Data at Dilute Surfactant Concentrations," Applied Spectroscopy, 43, 8, 1456-1459, 1989.

Kesner, Laya, "The First International Symposium on Field-Flow Fractionation," American Laboratory, AVO, AIS, 16-17, 1989.

King, Roy W. and Williams, Kathryn R., "The Fourier Transform in Chemistry," Chemical Education, 66, 10, 243-248, 1989.

Kohen, Elli; Hirschberg, Joseph G. and Prince, Jeffrey, "Spatiotemporal Mapping of Fluorescence Parameters in Cell

Treated with Toxic Chemicals: the Cell's Detoxification Apparatus," Optical Engineering, 28, 3, 222-231, 1989.

Lacey, Richard F., "Elimination of Interferences in Spectral Data," Applied Spectroscopy, 43, 7, 1135-1139, 1989.

Lagesson, Verner and Newman, John M., "Microcolumn Gas Chromatography with Ultraviolet Detection and Identification Using a Photodiode Array Spectrophotometer," Analytical Chemistry, 61, AIS, 1249-1252, 1989.

Lee, Judy P. and Comisarow, Melvin B., "Advantageous Apodization Functions for Absorption-Mode Fourier Transform Spectroscopy," Applied Spectroscopy, 43, 4, 599-604, 1989.

Lerner, Jeremy M. and Adar, Fran, "Raman Microprobing Offers New Potential," Laser Focus World, AVO, AIS, 73-82, 1989.

Li-shi, Ying and Levine, Steven P., "Fourier Transform Infrared Least-Squares Methods for Quantitative Analysis of Multicomponent Mixtures of Airborne Vapors of Industrial Hygiene Concern," Analytical Chemistry, 61, AIS, 677-683, 1989.

Luo, Shufang and Walt, David R., "Fiber-Optic Sensors Based on Reagent Delivery with Controlled-Release Polymer," Analytical Chemistry, 61, AIS, 174-177, 1989.

Lytle, David, "More Limp Rhetoric on R&D," Photonics Spectra, AVO, AIS, 54, 1989.

Maccá, Carlo, "Linearity Range of Gran Plots From Logarithmic Diagrams," Analyst, 114, AIS, 689-694, 1989.

Madison, Richard T.; Carroll, Mary K. and Hieftje, Gary M., "Convenient Fiber-Optic-Based Sample Cell for Shipol'skii and Low-Temperature Phosphorescence Spectrometry," Applied Spectroscopy, 43, 3, 422-425, 1989.

Mann, Charles K. and Vickers, Thomas J., "The Use of Fourier Deconvolution to Correct for Instrument Slit Function Differences in Measurement Spectra," Applied Spectroscopy, 43, 1, 33-37, 1989.

Martinez, V. Peris; Adelantado, Gimeno; Garcia, A. Pastor and Reig, F., "Quantitative Approximation for the Selectivity of Analytical Spectrophotometric Procedures with Systems Which Do Not Obey Beer's Law," Talanta, 36, 9, 909-917, 1989.

Matsui, S.; Retzik, M. and Variano, B., "An FT, Visible Microscope, Photodiode Array Spectrometer," American Laboratory, AVO, AIS, 28-35, 1989.

- Mattson, David R., "An Advanced Series of FTIR Spectrometers," American Laboratory, AVO, AIS, 92,94,96,97-98,100, 1989.
- Mayes, David M. and Callis, James B., "A Photodiode-Array-Based Near-Infrared Spectrophotometer for the 600-1100 nm Wavelength Region," Applied Spectroscopy, 43, 1, 27-32, 1989.
- McEwen, D.J.; Drumm, C.A. and Smith, J.C., "Improved Sample Holder for Internal Reflection Infrared Spectroscopy," Applied Spectroscopy, 43, 8, 1432-1435, 1989.
- McGown, Linda B., "Fluorescence Lifetime Filtering," Analytical Chemistry, 61, 14, 839-847, 1989.
- Michell, A.J.; Nelson, P.J. and Garland, C.P., "The Light-Induced Yellowing of Paper Studied by Second-Derivative DRIFT Spectroscopy," Applied Spectroscopy, 43, 8, 1482-1487, 1989.
- Miller, Charles E., "Analysis of EPMD Terpolymers by Near-Infrared Spectroscopy and Multivariate Calibration Methods," Applied Spectroscopy, 43, 8, 1435-1443, 1989.
- Miller, Foil A. and Kauffman, George B., "C.V. Raman and the Discovery of the Raman Effect," Chemical Education, 66, 10, 795-801, 1989.
- Mittlefehldt, Eric R. and Gardella, Jr., Joseph A., "Quantitative Fourier Self-Deconvolution and Fourier Transform Infrared Analysis of Bisphenol-A-Polycarbonate/Poly(dimethylsiloxane) Random Block Copolymers," Applied Spectroscopy, 43, 7, 1172-1179, 1989.
- Moerner, W.E. and Kador L., "Optical Detection and Spectroscopy of Single Absorbers in Solids," Analytical Chemistry, 61, 21, 1217-1223, 1989.
- Montalvo, Jr., Joseph G.; Faught, Sherman E. and Bucu, Steven M., "An Investigation of the Relationship Between Cotton Fineness and Light Scattering From Thin Webs as Measured by Near-Infrared Transmission Spectroscopy," Applied Spectroscopy, 43, 8, 1459-1471, 1989.
- Moretti, Michael, "Medical-Laser Technology Responds to User Needs," Laser Focus World, AVO, AIS, 89-102, 1989.
- Moretti, Michael, "Researchers Improve Tissue Spectroscopy Techniques," Laser Focus World, AVO, AIS, 72, 1989.
- Moss, Tuckerman, "Moving Power Down a Fiber," Photonics

Spectra, AVO, AIS, 52, 1989.

Nadler, T.K.; McDaniel, S.T.; Westerhaus, M.O. and Shenk, J.S., "Deconvolution of Near-Infrared Spectra," Applied Spectroscopy, 43, 8, 1354-1358, 1989.

Nielson, Kirk K. and Rogers, Vern C., "Statistical Estimation of Analytical Data Distributions and Censored Measurements," Analytical Chemistry, 61, 24, 2719-2724, 1989.

Nyquist, R.A.; Putzig, C.L. and Hasha, D.L., "Solvent Effect Correlations for Acetone: IR versus NMR Data for the Carbonyl Group," Applied Spectroscopy, 43, 6, 1049-1053, 1989.

O'Keefe, Anthony and Lee Olive, "Trace Gas Analysis by Pulsed Laser Absorption Spectroscopy," American Laboratory, AVO, AIS, 19-22, 1989.

Ozaki, Y. and Kaneuchi F., "Nondestructive Analysis of Biological Materials by ATR/FT-IR Spectroscopy. Part II: Potential of the ATR Method in Clinical Studies of the Internal Organs," Applied Spectroscopy, 43, 4, 723-725, 1989.

Ozaki, Y.; Kaneuchi, F.; Iwamoto, T.; Yoshiura, M. and Iriyama, K., "Nondestructive Analysis of Biological Materials by FT-IR-ATR. Method I: Direct Evidence for the Existence of Collagen Helix Structure in Lens Capsule," Applied Spectroscopy, 43, 1, 138-141, 1989.

Pandya, Dinesh, "Fiberoptic Sensors Find Growing Niche in World Market," Laser Focus World, AVO, AIS, 65, 1989.

Papini, Marie, "Study of the Radiative Properties of Natural and Synthetic Fibers in the 0.25-2.5 μm Region," Applied Spectroscopy, 43, 8, 1475-1481, 1989.

Park, N.A. and Irvine, Jr., T.F., "A Multipurpose Falling Needle Viscometer to Measure Thermophysical Properties of Newtonian and Non-Newtonian Fluids," American Laboratory, AVO, AIS, 8-9, 1989.

Pasteris, Jill Dill, "In Situ Analysis in Geological Thin-Section by Laser Raman Microprobe Spectroscopy: A Cautionary Note," Applied Spectroscopy, 43, 3, 567-570, 1989.

Pope, Georgy T., "Tiny Sensors Pay Off Big," High Technology Business, AVO, AIS, 28-31, 1989.

Premoli, Amedeo and Rastello, Maria Luisa, "A Mixed Linear/Nonlinear Least-Squares Method for Determining Line Parameters from Noisy Spectra," Applied Spectroscopy, 43, 3, 558-565, 1989.

Ratzlaff, Kenneth L. and Johnson, Jean T., "Computation of Two-Dimensional Polynomial Least-Squares Convolution Smoothing Intergers," Analytical Chemistry, 61, AIS, 1303-1305, 1989.

Richmond, Marsha D. and Hurtubise, Robert J., "Analytical Characteristics of β -Cyclodextrin/Salt Mixtures in Room-Temperatures Solid-Surface Luminescence Analysis," Analytical Chemistry, 61, 23, 2643-2647, 1989.

Robert, P.; Bertrand, D.; Crochon, M. and Sabino J., "A New Mathematical Procedure for NIR Analysis: The Lattice Techniques. Application to the Prediction of Sugar Content of Apples," Applied Spectroscopy, 43, 6, 1045-1049, 1989.

Roush, Patricia B. and McGrattan, Brian J., "Evaluation and Performance of Detectors on an FTIR Spectrometer," American Laboratory, AVO, AIS, 33-37, 1989.

Roux, Ronald, "French Component Suppliers Support Fiberoptics Applications," Laser Focus World, 25, 12, 163, 1989.

Russell, David A. and Narayanaswamy, Ramaier, "Fibre Optic Fluorimetric Determination of Fluoride Ions," Analyst, 114, AIS, 381-385, 1989.

Rutherford, Michael L.; Clouthier, Dennis J. and Holler, F. James, "A Multichannel Data Acquisition and Processing System for Laser Spectroscopic Experiments," Applied Spectroscopy, 43, 3, 532-538, 1989.

Ryan, J.; Kwiatkoski, J. and Reffner, J.A., "FTIR Microscopy: Diverging Perspectives," American Laboratory, AVO, AIS, 26-31, 1989.

Sakamoto, M.; Welch, D.F.; Endriz, J.G.; Scifres, D.R. and Streifer, W., "High Power, Long Life Continuous-Wave Monolithic Laser Diode Arrays," Optics News, AVO, AIS, 9-10, 1989.

Scheller, Frieder; Shcubert, Florian; Pfeiffer, Dorothea; Hintshce,, "Research and Development of Biosensors*," Analyst, 114, AIS, 653-662, 1989.

Schiering, D.W.; McGrattan, B.J. and Hault, R.A., "A Turn-Key Method for Polymer Product Verification Using IR Spectroscopy," American Laboratory, AVO, AIS, 34-41, 1989.

Schure, Mark R., "Deconvolution of Nonequilibrium Band Broadening Effects for Accurate Particle Size Distributions by Sedimentation Field-Flow Fractionation," Analytical Chemistry, 61, 24, 2735-2743, 1989.

- Scott, M.L. and Newnam, B.E., "Multifacet Mirrors for the Extreme Ultraviolet," Optics News, AVO, AIS, 38-39, 1989.
- Sebhatu, Mesgun and Gettys, W. Edward, "A Least-Squares Method for Extracting Phase Shifts," Computers in Physics, AVO, AIS, 65-67, 1989.
- Seitzinger, Newton K; Hughes, Kenneth D. and Lytle, Fred E., "Optimization of Signal-to-Noise Ratios in Time-Filtered Fluorescence Detection," Analytical Chemistry, 23, 61, 2611-2615, 1989.
- Shaksher, Ziad M. and Seitz, W. Rudolf, "Fluorescence Study of Organic Cation Binding to Hydrocarbon-Bonded Silica Surfaces," Analytical Chemistry, 61, AIS, 590-593, 1989.
- Sheehan, T.L.; Adaskaveg, M. and Excoffier, J.L., "Powerful Implementation of Spectral Processing for Photodiode Array Detection," American Laboratory, AVO, AIS, 66-74, 1989.
- Smith, Matthew J. and Carl, Richard T., "Applications of Microspectroscopy in the Near-Infrared Region," Applied Spectroscopy, 43, 5, 865-872, 1989.
- Sondag, A.H. and Raas, M.C., "Infrared Multiple Specular Reflectance of Mono- and Submonomolecular Layers of p-Bromobenzoic Acid on Oxidized Metals," Applied Spectroscopy, 43, 1, 107-113, 1989.
- Soper, Steven A. and Kuwana, Theodore, "Matrix-Isolated Surface-Enhanced Raman Spectroscopy (SERS): The Role of the Supporting Matrix," Applied Spectroscopy, 43, 7, 1180-1187, 1989.
- Stahl, Konrad, "IR-Detectors: State-Of-The-Art, Future Trends," Photonics Spectra, AVO, AIS, 95-98, 1989.
- Stanley, Brett J. and Marshall, David B., "Application of Microcomputer-Based Robust Regression Methods to Nonlinear Data Analysis," J. Chem. Inf. Comput. Sci., 29, AIS, 244-251, 1989.
- Starkey, Timothy C., "High-Performance Bend-Resistant Fiber," Photonics Spectra, AVO, AIS, 11, 1989.
- Stolen, R.H. and Stegeman, G.I., "Materials for Nonlinear Optical Waveguides," Optics News, AVO, AIS, 8-17, 1989.
- Susca, Paul, "Prognosis Good for Optical Biosensors," Lightwave, AVO, AIS, 17-18, 1989.
- Sweedler, Jonathan V. and Denton, M. Bonner, "Spatially

Encoded Fourier Transform Spectroscopy in the Ultraviolet to Near-Infrared," Applied Spectroscopy, 43, 8, 1378-1384, 1989.

Taboudoucht, A. and Ishida, H, "Diffuse Transmittance Spectroscopy of Polymeric Fibers," Applied Spectroscopy, 43, 6, 1016-1021, 1989.

TeVrucht, Mollie L.E. and Griffiths, Peter R., "Mixed Alkali Halide Dilution Matrices for Diffuse Reflectance Infrared Spectrometry: Effect of Particle Size," Applied Spectroscopy, 43, 8, 1293-1294, 1989.

TeVrucht, Mollie L.E. and Griffiths, Peter R., "A Simple Sample Packing Accessory for Diffuse Reflectance Infrared Spectrometry," Applied Spectroscopy, 43, 8, 1492-1494, 1989.

TeVrucht, Mollie L.E. and Griffiths, Peter S., "Mixed Alkali Halide Dilution Matrices for Diffuse Reflectance Infrared Spectrometry: Effects of Particle Size," Applied Spectroscopy, 43, 8, 1293-1294, 1989.

Tomlinson, W.J., "Curious Features of Nonlinear Pulse Propagation in Single-mode Optical Fibers," Optics News, AVO, AIS, 7-11, 1989.

Tsuge, Akira; Uwamino, Yoshinori and Ishizuka, Toshio, "Applications of Laser-Induced Thermal Emission Spectroscopy to Various Samples," Applied Spectroscopy, 43, 7, 1145-1149, 1989.

Uozumi, Jun and Asakura, Toshimitsu, "Estimation Errors of components Spectra Estimated by Means of the concentration-Spectrum Correlation: Part II," Applied Spectroscopy, 43, 5, 855-860, 1989.

Vickers, Thomas J.; Mann, Charles K.; Chong, Chan Kong and Zhu, Jianxiong, "Wavelength Stability with an Injection-Locked Excimer Laser," Applied Spectroscopy, 43, 8, 1368-1370, 1989.

Walko, John, "UK Researchers Report Advances In Sensors," Photonics Spectra, AVO, AIS, 62-68, 1989.

Wang, Xue Feng; Uchida, Teruo and Minami, Shigeo, "A Fluorescence Lifetime Distribution Measurement System Based on Phase-Resolved Detection Using an Image Dissector Tube," Applied Spectroscopy, 43, 5, 840-845, 1989.

Wang, Yan and McCreery, Richard L., "Evaluation of a Diode Laser/Charge Coupled Device Spectrometer for Near-Infrared Raman Spectroscopy," Analytical Chemistry, 61, AIS, 2647-2651, 1989.

Welch, David; Streifer, William and Scifres, Donald, "High Power, Coherent Laser Diodes," Optics News, AVO, AIS, 7-10, 1989.

Wentzell, Peter D. and Wade, Adrian P., "Chemical Acoustic Emission Analysis in the Frequency Domain," Analytical Chemistry, 61, 23, 2638-2642, 1989.

Williams, Ron, "Signal-to-Noise Ratio Enhancement of Spectra Using Recursive Integration," Applied Spectroscopy, 43, 8, 1409-1413, 1989.

Williamson, James M.; Bowling, Robert J. and McCreery, Richard L., "Near-Infrared Raman Spectroscopy with a 783-nm Diode Laser and CCD Array Detector," Applied Spectroscopy, 43, 3, 372-375, 1989.

Wilson, Bruce E. and Kowalski, Bruce R., "Quantitative Analysis in the Presence of Spectral Interferents Using Second-Order Nonbilinear Data," Analytical Chemistry, 61, AIS, 2277-2284, 1989.

Wohlstein, Scott, "Lasers: The Quantum Monkey Wrench," Spectroscopy, 4, 9, 10, 14-15, 1989.

Womack, James D.; Mann, Charles K. and Vickers, Thomas J., "Correction of Absorption in Raman Measurements Using the Backscattering Geometry," Applied Spectroscopy, AVO, 43, 3, 1989.

Y.F. Li, Philip and Narayanaswamy, Ramaier, "Oxygen-Sensitive Reagent Matrices for the Development of Optical Fiber Chemical Transducers," Analyst, 114, AIS, 663-666, 1989.

Yu, Bao-Zhu; Hansen, Wilford N. and Ward, John, "The Far-IR Spectra of UO₂, α -U₃O₈, and γ -UO₃ Using the Light Pipe Reflection Method," Applied Spectroscopy, 43, 1, 113-117, 1989.

Zhu, Chu and Hieftje, Gary M., "A New Liquid-Crystal-Based Fiber-Optic Temperature Sensor," Applied Spectroscopy, 43, 8, 1333-1336, 1989.

Herron, N.R.; Whitehead, D.W. and Miller, V.J., "Evolution of and FOCs for Monitoring Dissolved Volatiles," SPIE, AVO, Personal Preprint, 1-8, AYR.

Hessefort, Norbert; Hedstrom, Mark and Greive, William, "Characterization of Phenolic-Modified Oils Using Size-Exclusion Chromatography and a diode-Array Detector," LC-GC, 7, 2, 130-136, AYR.

Oliver, M., "Guided-Wave Optical Spectroscopy of Thin Films,"
AJN, AVO, AIS, 639-657, AYR.

Srinivas, S. and Lakshman, S.V.J., "BASIC Program for
Evaluation of Wavenumbers for Wavelengths," American
Laboratory, AVO, AIS, 23-25, AYR.

REFERENCES

1. Arendale, W. F. and Jeffreys, Harold B., Study of Reflected Energy From Laser Illuminated Targets, Final Report Contract DA-01-021-AMC-12250(z). Also issued as UARI Research Report No. 58, December 1968 (not in print). Harold B. Jeffreys, The Reflection of Polarized Light From Near Diffuse Surfaces M.S. Thesis is available from the University of Alabama Library, Tucaloosa, Alabama.
2. Malinowski, Edmund A. and Howery, Darryl G., Factor Analysis in Chemistry, John Wiley and Sons, New York, 1980.
3. Deming, W. Edwards, Out of the Crisis, Massachusetts Institute of Technology Center for Advanced Engineering Study, Cambridge Mass., 1966.
4. Deming, W. Edwards, Transcribed from telecst June 21, 1990 by W. F. Arendale
5. See Massart, D. L., Dijkstra, A. and Kaufman, L., Evaluation and Optimization of Analytical Procedure, Elsevier, Amsterdam, 1978; Malinowski, Edmund A., and Howery, Darryl G., Factor Analysis in Chemistry, John Wiley and Sons, New York, 1980; Massart, D. Luc and Kaufman, Leonard, The Interpretation of Analytical Chemistry Data by the Use of Cluster Analysis, John Wiley and Sons, New York, 1983; Sharo, Muhammad A., Illman, Deborah L., and Kawolski, Bruce P., Chemometrics, John Wiley and Sons, New York, 1986; Massart, D. L., Vandeginste, B. G. M., Deming, S. N., Michotte, Y., and Kaufman, I., Chemometrics, Elsevier, Amsterdam, 1988; and Martens, Harald and Naes, Tormod, Multivariate Calibration, John Wiley and Sons, 1989.
6. Degrandpre, Michael D. and Burgess, Lloyd W., "A Fiber-Optic FT-NIR Evanescent Field Absorbance Sensor," Applied Spectroscopy, 1990, Volume 44, Number 2, pp 273-279.