



AD-A277 085



FINAL REPORT

Test Results of the RS-44 Integrated Component Evaluator Liquid Oxygen / Hydrogen Rocket Engine

by
R. F. Sutton and B. W. Lariviere

Rocketdyne Division
Rockwell International

DTIC
ELECTE
MAR 17 1994
S B D

prepared for
NATIONAL AERONAUTICS AND SPACE ADMINISTRATION

October 1993

DISTRIBUTION STATEMENT
Approved for public release
Distribution Unlimited

NASA-Lewis Research Center
Cleveland, Ohio 44135

Contract NAS3-23773

94-08580



DTIC QUALITY INSPECTED 1

94 3 16 106

PREFACE

The testing effort on the ICE Engine System reported herein was conducted by the Advanced Programs and Engineering personnel of Rocketdyne, a Division of Rockwell International Corporation, under Contract NAS3-23773 from early 1986 to May 1987. Mr. Dean Scheer at the NASA Lewis Research Center was the NASA Project Manager during the test effort while at Rocketdyne, Mr. A. T. Zachary was the Program Manager and Mr. R. Pauckert was the ICE System Project Engineer.

Important contributions during the conduct of the program and / or in the preparation of this report, were made by the following Rocketdyne personnel:

- | | |
|--------------------------------------|--------------------------|
| MK49 Turbomachinery Project Engineer | R. Sutton |
| Engine Systems Development Engineer | H. Manko |
| Combustion Devices Project Engineer | R. Bally |
| Responsible Test Engineering at APTF | B. Lariviere |
| Engine Systems Dynamic Analysis | M. Taniguchi, E. Farrell |
| Engine Systems Performance Analysis | A. Martinez |

Accession For	
NTIS GRA&I	<input checked="" type="checkbox"/>
DTIC TAB	<input type="checkbox"/>
Unannounced	<input type="checkbox"/>
Justification	
By _____	
Distribution _____	
Availability Codes	
Dist	_____
A-1	

1.0 TABLE OF CONTENTS

2.0 LIST OF ILLUSTRATIONS.....	iv
3.0 LIST OF TABLES.....	vii
4.0 LIST OF TESTS.....	viii
5.0 SUMMARY.....	1
6.0 INTRODUCTION.....	3
7.0 TECHNICAL DISCUSSION.....	8
7.1 TEST ARTICLES.....	8
7.1.1 Engine System.....	8
7.1.2 Combustion Devices.....	8
7.1.2.1 Injector Design Description.....	8
7.1.2.5 Ignition System Design.....	18
7.1.2.6 Combustion Chamber Design.....	18
7.1.3 Turbomachinery Hardware.....	20
7.1.3.1 High Pressure Fuel Turbopump (Mark 49-F).....	20
7.1.3.2 High Pressure Oxygen Turbopump (MK49-O).....	24
7.2 TEST FACILITY DESCRIPTION.....	26
7.2.1 Fluid Systems.....	26
7.2.1.1 High Pressure Fuel Turbopump Systems.....	30
7.2.1.2 High Pressure Oxidizer Turbopump Systems.....	30
7.2.1.3 Engine Ignition Systems.....	31
7.2.1.4 Engine System Purges.....	31
7.2.2 Facility Electrical & Control Systems.....	33
7.3 DATA, INSTRUMENTATION AND MEASUREMENT SYSTEMS.....	33
7.3.1 Facility Data Acquisition System and Control Functions.....	33
7.3.2 Engine System Instrumentation.....	35
7.3.2.1 Start Ok Parameters.....	42
7.4 TEST MATRIX.....	42
7.5 OPERATIONS.....	46
7.5.1 Test Procedures.....	46
7.5.1.1 Pre-Test Hardware Activities.....	48
7.5.1.2 Oxidizer Turbopump Chilldown.....	48
7.5.1.3 Fuel Turbopump Chilldown.....	49
7.5.1.4 Post-Test Hardware Activities.....	50
7.5.2 Engine Start Logic - Sequences.....	51

7.5.2.1 Engine Start Sequence	51
7.5.2.2 Cut Off Sequences	51
7.5.3 Data Reduction Procedures.....	51
7.6 TEST SERIES RESULTS.....	55
7.6.1 Test Series 1986 Results (86- 017-001 thru 86-017-007).....	59
7.6.2 Test Series 1987 Results (87-017-001 thru 87-017-006).....	102
7.7 FUEL TURBOPUMP ANOMALIES AND PLUME SPECTROMETRY.....	133
7.7.1 Fuel Turbopump Anomalies.....	133
7.7.2 Plume Spectrometry Analysis	138
8.0 CONCLUSIONS AND RECOMMENDATIONS	144
9.0 REFERENCES.....	146
10.0 APPENDICES	147

2.0 LIST OF ILLUSTRATIONS

FIGURE 5-1 RS-44 ICE ENGINE TEST 87-017-006.....	2
FIGURE 6-1 RS-44 INTEGRATED COMPONENT EVALUATOR	4
FIGURE 6-2 MK49-F LIQUID HYDROGEN TURBOPUMP.....	5
FIGURE 6-3 MK49-O LIQUID OXYGEN TURBOPUMP.....	6
FIGURE 6-4 RS-44 DESIGN PARAMETERS	7
FIGURE 7-1 RS-44 TEST BED ENGINE FLOW SCHEMATIC.....	10
FIGURE 7-2 RS-44 DUCT ASSEMBLY LOCATIONS.....	11
FIGURE 7-3 RS-44 DUCT ASSEMBLY LOCATIONS.....	12
FIGURE 7-4 RS-44 DUCT ASSEMBLY LOCATIONS.....	13
FIGURE 7-5 ICE THRUST CHAMBER ASSEMBLY	14
FIGURE 7-6 ICE COMBUSTION SYSTEM COMPONENTS	15
FIGURE 7-7 MAIN INJECTOR.....	16
FIGURE 7-8 INJECTOR ELEMENT CONFIGURATION	17
FIGURE 7-9 ADVANCED EXPANDER CYCLE COMBUSTION CHAMBER.....	19
FIGURE 7-10 MK49-F TURBOPUMP CROSS-SECTION.....	22
FIGURE 7-11 MK49-F TURBOPUMP CRITICAL SPEED VERSUS BEARING STIFFNESS.....	23
FIGURE 7-12 MK49-O TURBOPUMP CROSS-SECTION.....	25
FIGURE 7-13 MK49-O TURBOPUMP CRITICAL SPEED ANALYSIS.....	27
FIGURE 7-14 APTF OVERVIEW.....	28
FIGURE 7-15 NAN STAND ICE TEST FACILITY SCHEMATIC	29
FIGURE 7-16 RS-44 ICE PURGE SYSTEM SCHEMATIC.....	32
FIGURE 7-17 MK 49-F HIGH PRESSURE TURBOPUMP INSTRUMENTATION LOCATIONS.....	40
FIGURE 7-18 MK 49-O HIGH PRESSURE TURBOPUMP INSTRUMENTATION LOCATIONS.....	41
FIGURE 7-19 RS-44 ICE TEST PROCEDURE SEQUENCE	47
FIGURE 7-20 RS-44 ICE MAIN VALVE TIMING.....	52
FIGURE 7-21 RS-44 ICE DATA ACQUISITION AND REDUCTION LOGIC.....	54
FIGURE 7-22 RS-44 ENGINE INSTALLATION - NAN STAND (FUEL PUMP SIDE).....	57
FIGURE 7-23 RS-44 ENGINE INSTALLATION - NAN STAND (LOX PUMP SIDE)	58
FIGURE 7-24 IGNITER CHAMBER TEMP HISTORY VERSUS TEST TIME -	63
FIGURE 7-25 TURBOPUMP SPEED HISTORY VERSUS TEST TIME -	64
FIGURE 7-26 FUEL PUMP INLET PRESSURE VERSUS TEST TIME -.....	65
FIGURE 7-27 FUEL PUMP INLET TEMPERATURE VERSUS TEST TIME -.....	66
FIGURE 7-28 FUEL PUMP DISCHARGE/COMBUSTOR OUT PRESSURE VERSUS TEST TIME - 86-017-005.....	67

FIGURE 7-29 LOX PUMP INLET PRESSURE VERSUS TEST TIME -	6 8
FIGURE 7-30 LOX PUMP INLET TEMPERATURE VERSUS TEST TIME -86-017-005.....	6 9
FIGURE 7-31 LOX PUMP DISCHARGE PRESSURE VERSUS TEST TIME -86-017-005.....	7 0
FIGURE 7-32 COMBUSTOR OUTLET/NOZZLE DISCHARGE PRESSURE VERSUS TEST TIME - 86-017-005.....	7 1
FIGURE 7-33 FUEL INJECTION INLET /CHAMBER PRESSURE VERSUS TEST TIME -86- 017-005.....	7 2
FIGURE 7-34 MK49-F RADIAL ACCEL, A2 ISOPLOT -86-017-005.....	7 3
FIGURE 7-35 MK49-O RADIAL ACCEL, A8 ISOPLOT -86-017-005.....	7 4
FIGURE 7-36 TURBOPUMP SPEED HISTORY VERSUS TEST TIME -	7 6
FIGURE 7-37 FUEL PUMP INLET PRESSURE VERSUS TEST TIME -.....	7 7
FIGURE 7-38 FUEL PUMP INLET TEMPERATURE VERSUS TEST TIME -.....	7 8
FIGURE 7-39 FUEL PUMP DISCHARGE/COMBUSTOR OUTLET PRESSURE VERSUS TEST TIME -017-006.....	7 9
FIGURE 7-40 LOX PUMP INLET PRESSURE VERSUS TEST TIME -	8 0
FIGURE 7-41 LOX PUMP INLET TEMPERATURE VERSUS TEST TIME -	8 1
FIGURE 7-42 LOX PUMP DISCHARGE PRESSURE VERSUS TEST TIME -	8 2
FIGURE 7-43 COMBUSTOR OUTLET/NOZZLE DISCHARGE PRESSURE VERSUS TEST TIME - 86-017-006	8 3
FIGURE 7-44 FUEL INJECTOR INLET /CHAMBER PRESSURE VERSUS TEST TIME -86- 017-006.....	8 4
FIGURE 7-45 CHAMBER/LOX INJECTION DOME PRESSURE VERSUS TEST TIME 86-017- 006.....	8 5
FIGURE 7-46 CHAMBER PRESSURE VERSUS TEST TIME -.....	8 6
FIGURE 7-47 ENGINE PERFORMANCE DATA SUMMARY- 86-017-006	8 7
FIGURE 7-48 MK49-F PERFORMANCE DATA SUMMARY -86 017-006	8 8
FIGURE 7-49 MK49-O PERFORMANCE DATA SUMMARY 86-017-006	8 9
FIGURE 7-50 MK49-F RADIAL ACCEL, A4 ISOPLOT.....	9 3
FIGURE 7-51 MK49-O RADIAL ACCEL, A6 ISOPLOT.....	9 4
FIGURE 7-52 TURBOPUMP SPEED HISTORY VERSUS TEST TIME -	9 5
FIGURE 7-53 FUEL INJECTOR INLET/CHAMBER PRESSURE VERSUS TEST TIME 86-017- 007.....	9 6
FIGURE 7-54 LOX PUMP SYSTEM PRESSURES VERSUS TEST TIME -.....	9 7
FIGURE 7-55 MAIN CHAMBER PRESSURE VERSUS TEST TIME -.....	9 8
FIGURE 7-56 ENGINE PERFORMANCE DATA SUMMARY-.....	9 9
FIGURE 7-57 MK49-F PERFORMANCE DATA SUMMARY.....	1 0 0

FIGURE 7-58 MK49-O PERFORMANCE DATA SUMMARY.....	101
FIGURE 7-59 ENGINE PERFORMANCE.....	103
FIGURE 7-60 MK49-F TURBOPUMP PERFORMANCE.....	104
FIGURE 7-61 MK49-O TURBOPUMP PERFORMANCE.....	105
FIGURE 7-62 IGNITER CHAMBER PRESSURE.....	108
FIGURE 7-63 MK49-F TURBOPUMP SPEED HISTORY VERSUS TEST TIME -.....	109
FIGURE 7-64 MK49-O TURBOPUMP SPEED HISTORY VERSUS TEST TIME -.....	110
FIGURE 7-65 FUEL PUMP DISCHARGE PRESSURE VERSUS TEST TIME.....	111
FIGURE 7-66 LOX PUMP DISCHARGE PRESSURE VERSUS TEST TIME.....	112
FIGURE 7-67 FUEL INJECTOR PRESSURE VERSUS TEST TIME -.....	113
FIGURE 7-68 LOX INJECTOR PRESSURE VERSUS TEST TIME -.....	114
FIGURE 7-69 MAIN CHAMBER PRESSURE VERSUS TEST TIME -.....	115
FIGURE 7-70 ENGINE PERFORMANCE DATA SUMMARY-.....	116
FIGURE 7-71 MK49-F PERFORMANCE DATA SUMMARY -.....	117
FIGURE 7-72 MK49-O PERFORMANCE DATA SUMMARY -.....	118
FIGURE 7-73 IGNITER CHAMBER PRESSURE PROFILE.....	120
FIGURE 7-74 MK49-F TURBOPUMP SPEED PROFILE VERSUS TIME.....	121
FIGURE 7-75 MK49-O TURBOPUMP SPEED PROFILE VERSUS TIME.....	122
FIGURE 7-76 MK49-F TURBOPUMP DISCHARGE PRESSURE VERSUS TIME.....	123
FIGURE 7-77 MK49-F BALANCE PISTON CAVITY PRESSURE VERSUS TIME.....	124
FIGURE 7-78 MK49-F BALANCE PISTON SUMP PRESSURE VERSUS TIME.....	125
FIGURE 7-79 FUEL INJECTION PRESSURE VERSUS TIME.....	126
FIGURE 7-80 LOX INJECTION DOME PRESSURE VERSUS TIME.....	127
FIGURE 7-81 MAIN CHAMBER PRESSURE VERSUS TIME.....	128
FIGURE 7-82 ENGINE PERFORMANCE DATA SUMMARY-.....	129
FIGURE 7-83 MK49-F PERFORMANCE DATA SUMMARY -.....	130
FIGURE 7-84 MK49-O PERFORMANCE DATA SUMMARY -.....	131
FIGURE 7-85 ADDITIONAL ENGINE DATA SUMMARY -.....	132
FIGURE 7-86 MK49-F CROSS SECTION SHOWING KEY AREAS.....	135
FIGURE 7-87 PUMP PERFORMANCE SHIFT ABOVE 58,000 RPM.....	136
FIGURE 7-88 PERFORMANCE COMPARISON AT 82,000 RPM.....	137
FIGURE 7-89 EXHAUST PLUME SPECTRA OBTAINED DURING TEST.....	139
FIGURE 7-90 OH AND CAOH EMISSION INTENSITIES TEST 87-017-005.....	141
FIGURE 7-91 OH AND CACH EMISSION INTENSITIES TEST 87-017-006.....	142

3.0 LIST OF TABLES

TABLE 7-1	RS-44 ENGINE SYSTEM MAIN COMPONENTS	9
TABLE 7-2	MK49-F DESIGN REQUIREMENTS	20
TABLE 7-3	MK 49-O DESIGN REQUIREMENTS	24
TABLE 7-4	TEST AREA PROPELLANT DISTRIBUTION SYSTEM.....	28
TABLE 7-5	INTEGRATED COMPONENT EVALUATOR PURGE SYSTEMS AND REQUIREMENTS	34
TABLE 7-6	RS-44 ICE INSTRUMENTATION LIST	36
TABLE 7-7	RS-44 ICE START OK REQUIREMENTS	43
TABLE 7-8	RS-44 ICE REDLINE REQUIREMENTS.....	44
TABLE 7-9	RS-44 ICE ENGINE PLANNED TEST MATRIX.....	45
TABLE 7-10	RS-44 ICE POST TEST ACTIVITIES.....	50
TABLE 7-11	RS-44 ICE TESTING HISTORY.....	55
TABLE 7-12	MK 49-F DYNAMIC TEST DATA SUMMARY- 86-017-005.....	62
TABLE 7-13	MK49-F DYNAMIC DATA SUMMARY - 86-017-007.....	91
TABLE 7-14	MK49-O DYNAMIC DATA SUMMARY - 86-017-007.....	92

4.0 LIST OF TESTS

TEST 86-017-00159
TEST 86-017-00259
TEST 86-017-00360
TEST 86-017-00460
TEST 86-017-00561
TEST 86-017-00675
TEST 86-017-00790
TEST 87-017-001102
TEST 87-017-002102
TEST 87-017-003102
TEST 87-017-004106
TEST 87-017-005106
TEST 87-017-006119

5.0 SUMMARY

The RS-44 Integrated Component Evaluator (ICE) advanced expander rocket engine test bed was tested during the years 1986-1987 at the Rocketdyne Santa Susana Field Laboratory Advanced Propulsion Test Facility (APTF). The RS-44 ICE, as its name implies, was previously used in 1985-1986 as the test bed for the turbopump component checkout testing. A total of thirteen tests were conducted, seven in 1986 and six in 1987, with a total accumulated test time of 61.5 seconds. Tests 87-017-003, 87-017-005, and 87-017-006 demonstrated the expander cycle engine operation; ignition, transition into mainstage, steady state mainstage and shutdown. The highest fuel turbopump (MK 49-F) speed achieved was 87,400 RPM on test 87-017-006, January 28, 1987. A maximum main chamber pressure of 776 psia was also achieved on the same test. Figure 5-1 is a photograph of the RS-44 ICE engine as it achieved mainstage operation on test 87-017-006.

Nominal and emergency shutdowns were achieved without causing any damage or distress to any system component. Unplanned fuel stoppage generally results in thrust chamber burnout or severe thermal distress. Neither of these occurred when the fuel pump speed and pump pressure abruptly decayed due to the failure of the #4 turbine end bearing during test 87-017-006. Visual inspection of the injector and thrust chamber showed no evidence of heat distress due to the emergency shutdown. The thrust chamber assembly continued on in later years for a series of development tests using pressurized propellant inlets.

Operation of all the components except the fuel pump, during the tests was satisfactory. The high pressure liquid oxygen turbopump, MK49-O, performed as predicted and the thrust chamber assembly resistances and heat loads appeared nominal.

Spectrometry data were used during the test series as a validation of the health monitoring. Spectroscopic analysis of exhaust plume contaminants appears to be a valuable tool. Spectrographic observation of the CaOH in the exhaust plume proved to be coincident with the fuel pump anomaly and thereby adjudged as an excellent candidate for health monitoring. The strength of the recorded OH signature indicated that the spectrometer can be used to verify injector mixture ratio.

Figure 5-1 RS-44 ICE ENGINE TEST 87-017-006



14224178 87 SP

9C37D-9-2786

Rockwell International
Rockwell Collins

6.0 INTRODUCTION

NASA sponsored studies of the Orbit Transfer Vehicle (OTV) evaluated the use of a high-energy oxygen/hydrogen upper stage employing advanced cycle engines for the Space Transportation System. Engine studies resulting from these efforts identified the expander cycle engine as a leading contender for the upper-stage main propulsion system. The results of one of the NASA studies (reference 1) had formulated an expander cycle engine point design based on 1980 state-of-the-art technology.

A 15,000 lbf thrust, pump-fed liquid oxygen and hydrogen, advanced expander cycle LO₂/LH₂ Test Bed Engine, Figure 6-1, later to be identified as the RS-44 Integrated Component Evaluator (ICE), was designed and fabricated between the years 1982 to 1985 using Rocketdyne discretionary funds. The turbomachinery employed in the ICE were the Rocketdyne MK-49-F high pressure liquid hydrogen and the MK-49-O high pressure liquid oxygen turbopumps, Figures 6-2 and 6-3, respectively. The ICE system was conceived to demonstrate the performance and operational characteristics of an advanced expander cycle rocket engine.

During 1985, initial component testing of the MK 49 turbomachinery was accomplished (19 tests) with Rocketdyne direct labor funds and government provided propellants. The test goals were to characterize the individual MK49-F and MK 49-O turbopump performance capabilities as well as the startup transient controls. The Mk 49 turbopumps were installed on the ICE during the component tests with propellants by-passed to overboard drains and burn stacks.

Following the successful checkout test series, including head versus flow excursions at various power levels, the turbopump discharge propellant systems were routed into the thrust chamber for the start of the ICE engine testing funded by NASA Lewis Research Center under Contract NAS3-23773, Task Order F3 (Pressurants and Propellant Costs) and F4 (Labor, Pressurants and Propellants). Figure 6-4 shows the ICE engine installed in the NAN stand of the Advanced Propulsion Test Facility at the Rocketdyne Santa Susana Field Laboratory along with the engine design parameters.

Figure 6-1 RS-44 Integrated Component Evaluator



LC90-757



Figure 6-2 MK49-F Liquid Hydrogen Turbopump



Figure 6-3 MK49-O Liquid Oxygen Turbopump

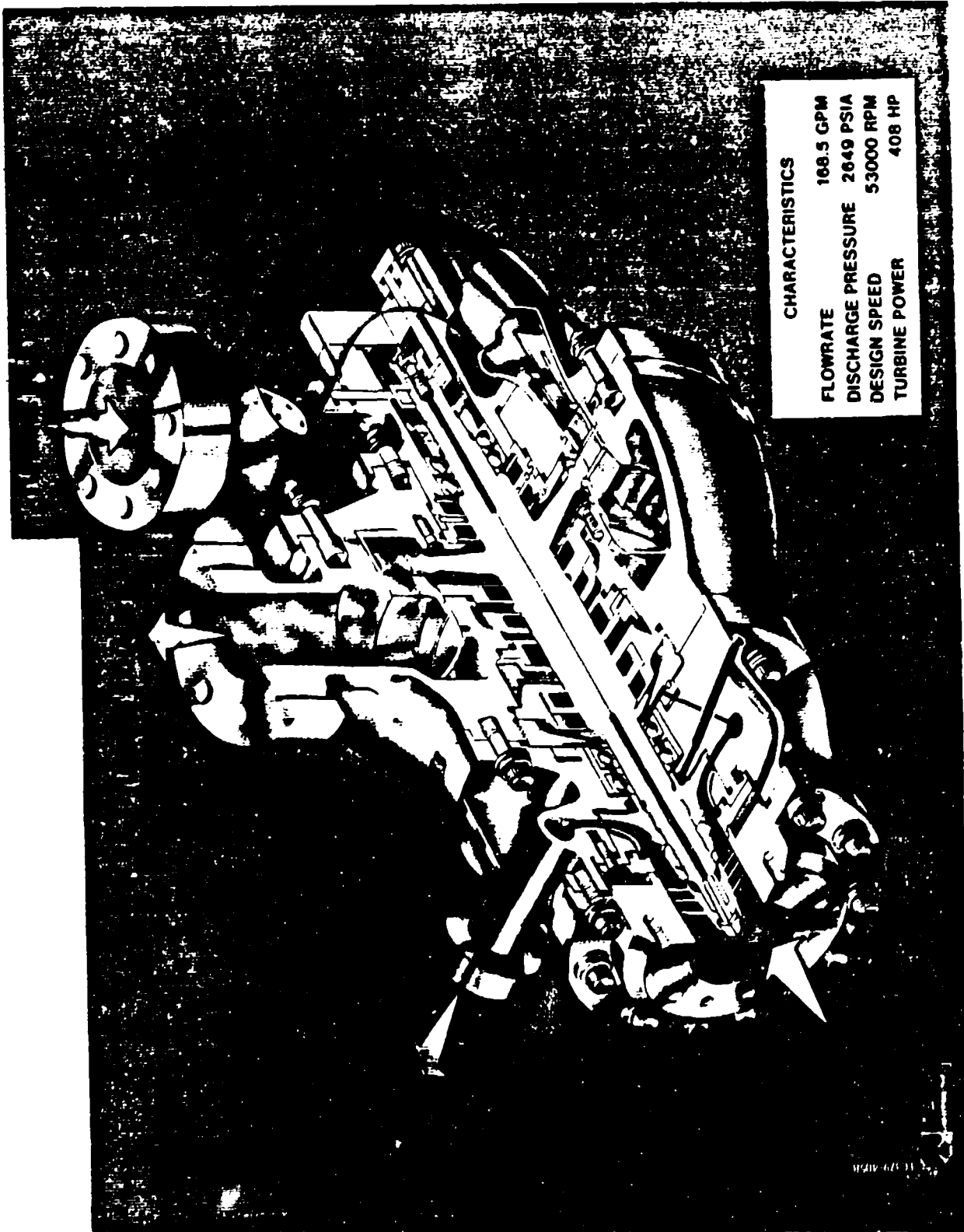
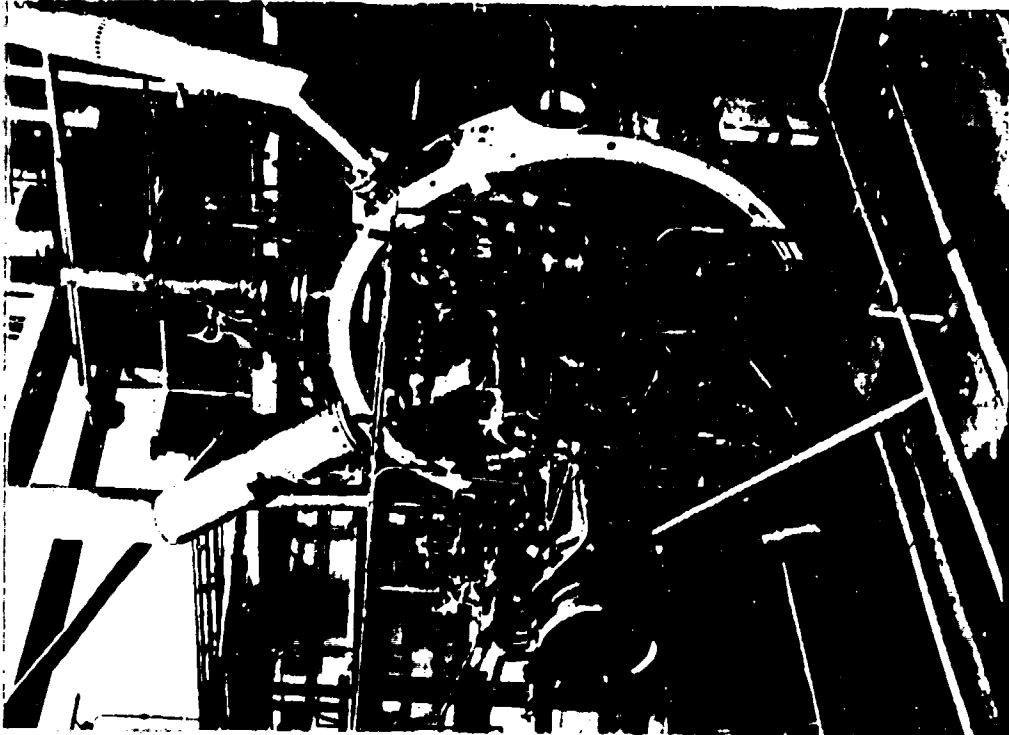

Figure 6-4 RS-44 Design Parameters

Full thrust (vac), lb	15,000
Pumped idle thrust (vac), lb	1,500
Mixture ratio	6 ± 1
Chamber pressure, psia	1,540
Service life, hr	10
Specific impulse, sec	481 ($\epsilon = 625$)



Perched International
Propulsion Division

SC67D-9-2785
10102/cab

7.0 TECHNICAL DISCUSSION

The following sections detail the description of the RS-44 Engine with its major component descriptions, the Advanced Propulsion Test Facility (APTF) where all of the hot fire testing was accomplished, the engine system instrumentation, the testing matrix, details of the test operations, and actual results for the thirteen total tests conducted.

7.1 TEST ARTICLES

7.1.1 Engine System

The RS-44 Test Bed (ICE) was reconfigured at the conclusion of the turbomachinery characterization testing to provide the required valves and ducts to operate in the closed expander mode. The ICE consisted of twelve major hardware components and fourteen interconnecting duct assemblies and attachments. The major parts of the engine system are identified in **Table 7-1** while a system flow schematic is presented in **Figure 7-1**. The major duct assemblies locations within the engine envelope are shown in **Figure 7-2** through **Figure 7-4** and are identified in the figures by the last three digits of the duct part numbers. All hardware of the ICE was fabricated using Rocketdyne company funds.

7.1.2 Combustion Devices

The main components of the RS-44 combustion devices system consists of the thrust chamber assembly (**Figure 7-5**) which includes the injector, igniter assembly, combustor and the nozzle extension (**Figure 7-6**). The thrust chamber size and operation are similar to the Advanced Space Engine (ASE) thrust chamber that was designed, fabricated and successfully tested in the late 1970's under NASA LeRC contracts NAS3-16774, NAS3-17825 and NAS3-19713 (reference 2, 3, & 4).

7.1.2.1 Injector Design Description A coaxial element injector (**Figure 7-7**) was selected for the RS-44 Thrust Chamber Assembly. This selection was based on experience indicating that high performance, stable combustion, low weight and ease of fabrication can be achieved with this type of injector. Similar coaxial element injector designs using LOX/hydrogen have been successfully used on the J-2, J-2S, SSME and ASE engines.

The RS-44 Injector incorporates many of the features from recent Rocketdyne injectors that have exhibited a high measure of success. The Space Shuttle Main Engine (SSME), the Advanced Space Engine (ASE), and the 40K SSME model injectors have all demonstrated high orders of performance and good structural integrity.

Table 7-1 RS-44 ENGINE SYSTEM MAIN COMPONENTS

<u>COMPONENT</u>	<u>PART NUMBER</u>	<u>SERIAL NUMBER</u>
MK 49-F High Pressure LH2 T/P	7R0016330-1	01-1
MK 49-O High Pressure LO2 T/P	7R0016400-1	01-1
Main Combustor Chamber (MCC)	7R0014972-1	4107917
Main Injector	7R0014466-11	4105637
Thrust Chamber Nozzle	7R0015981-1	4107898
Igniter Assembly	R0011523x-11	Unit # 1
Main Fuel Valve (MFV)	7R0016842	3
Main Lox Valve (MOV)	7R0016842	1
Turbine Shutoff Valve (TSV)	7R0016843	N/A
Turbine Bypass Valve (TBV)	7R0016844	3
Oxidizer Turbine Bypass Valve (OTBV)	7R0016845	1
Duct Assy, Fuel Turbine to Oxid Turbine	7R0015701-1	N/A
Duct Assy, Oxid Pump Disch to MOV	7R0015702-1	N/A
Duct Assy, MCC to Nozzle	7R0015706	N/A
Duct Assy, HP Fuel Pump to MFV	7R0015707	N/A
Duct Assy, MFV to Spool	7R0015708	N/A
Duct Assy, T2 to Low Pr	7R0015709	N/A
Duct Assy, Nozzle to TSV/TBV	7R0015713	N/A
Duct Assy, TBV to Spool (MCC)	7R0015714	N/A
Duct Assy, T3 to OTBV	7R0015715	N/A
Duct Assy, Oxid Pump Dsch to Spool (MCC)	7R0015716	N/A
Spool Assy, Interconnect MFV to MCC	7R0015717	N/A
Duct Assy, Spool MFV to MCC	7R0015718	N/A
Thrust Mount Assy	7R0015724	N/A
Gimbal Trunion	7R0015728	N/A
Duct Assy, TSV to Fuel Turbine	7R0015729	N/A

CP. 194443

23

22

21

G

F

E

D

C

B

A

TO SPOOL



TO COMB



DETAIL A
SYSTEM WITHOUT H₂ RE

24

23

22

21

107

LH₂

JOINT (F13)
 PRESSURE 2163 PSIA (2206)
 FLOWRATE 0.32 LB/SEC (0.35)
 TEMP 736° R (686)
 VELOCITY 463.8 FT/SEC (140.3)

LPFT SIMULATOR ORIFICE

JOINT (F14)
 PRESSURE 1913 PSIA (1985)
 FLOWRATE 0.32 LB/SEC (0.35)
 TEMP 602° R (700)
 VELOCITY 507.3 FT/SEC (156.7)

JOINT (F10)
 PRESSURE 214 PSIA (22)
 FLOWRATE 3.76 LB/SEC (3.9)
 TEMP 736° R (686)
 VELOCITY 612.0 FT/SEC (57)

JOINT (F8)
 PRESSURE 3002 PSIA
 FLOWRATE 3.76 LB/SEC
 TEMP 878° R (760)
 VELOCITY 487.5 FT/SEC (57)

LH₂ HIGH PRESS PUMP

JOINT (F1)
 PRESSURE 78.2 P
 FLOWRATE 4.08 LB
 TEMP 31° R (33)
 VELOCITY 65.7 FT/SEC

FROM OTBV, LPFT SIM

FROM HPOT

TO SPOOL

TO COMB

FROM HPFP

DETAIL A
SYSTEM WITHOUT H₂ REGEN HEX

General Information

PROJECT NO.	DATE

204

LPFT SIMULATOR ORIFICE

JOINT (F13)
 PRESSURE 3183 PSIA [3306]
 FLOWRATE 0.37 LB/SEC [0.35]
 TEMP 736° R [696]
 VELOCITY 163.8 FT/SEC [49.2]

JOINT (F14)
 PRESSURE 1813 PSIA [1825]
 FLOWRATE 0.32 LB/SEC [0.30]
 TEMP 802° R [700]
 VELOCITY 307.9 FT/SEC [94.2]

JOINT (F10)
 PRESSURE 3111 PSIA [3214]
 FLOWRATE 3.76 LB/SEC [3.33]
 TEMP 730° R [696]
 VELOCITY 630.8 FT/SEC [579.5]

JOINT (F9)
 PRESSURE 3802 PSIA [3780]
 FLOWRATE 3.76 LB/SEC [3.33]
 TEMP 878° R [764]
 VELOCITY 481.8 FT/SEC [504.9]

LH2 HIGH PRESS PUMP

JOINT (F1)
 PRESSURE 73.2 PSIA [74.3]
 FLOWRATE 4.08 LB/SEC [4.08]
 TEMP 31° R [33]
 VELOCITY 65.7 FT/SEC [65.7]

JOINT (F3)
 PRESSURE 4611 PSIA [4631]
 FLOWRATE 4.08 LB/SEC [4.08]
 TEMP 104° R [97]
 VELOCITY 117.2 FT/SEC [118.2]

MAIN FUEL VALVE

JOINT (F2)
 PRESSURE 4482 PSIA [4523]
 FLOWRATE 4.08 LB/SEC [4.08]
 TEMP 104° R [97]
 VELOCITY 117.2 FT/SEC [118.2]

JOINT (F18)
 PRESSURE 1739 PSIA [1759]
 FLOWRATE 0.32 LB/SEC [0.30]
 TEMP 802° R [700]
 VELOCITY 307.9 FT/SEC [94.2]

General Information
 Description:
 Drawing No.:

FORM NO. 882007	REV. 1
-----------------	--------

2067

13

12

11

10

9

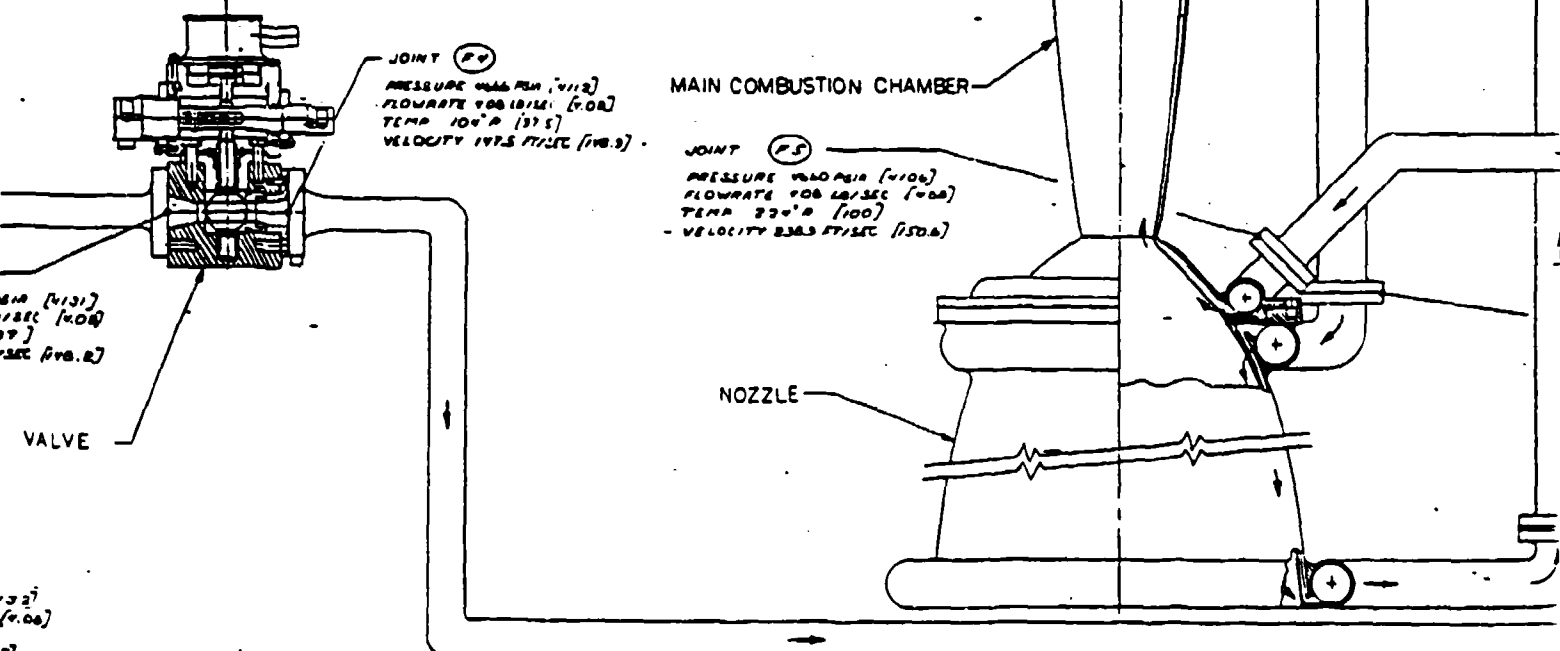
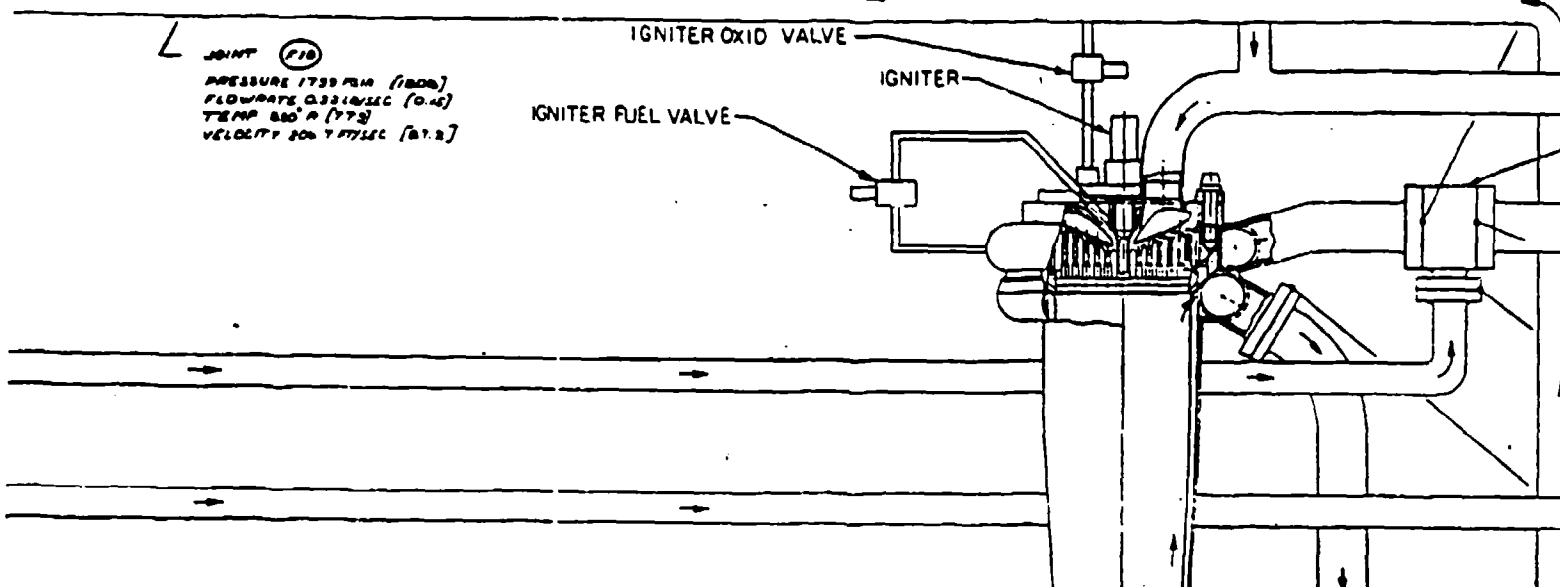
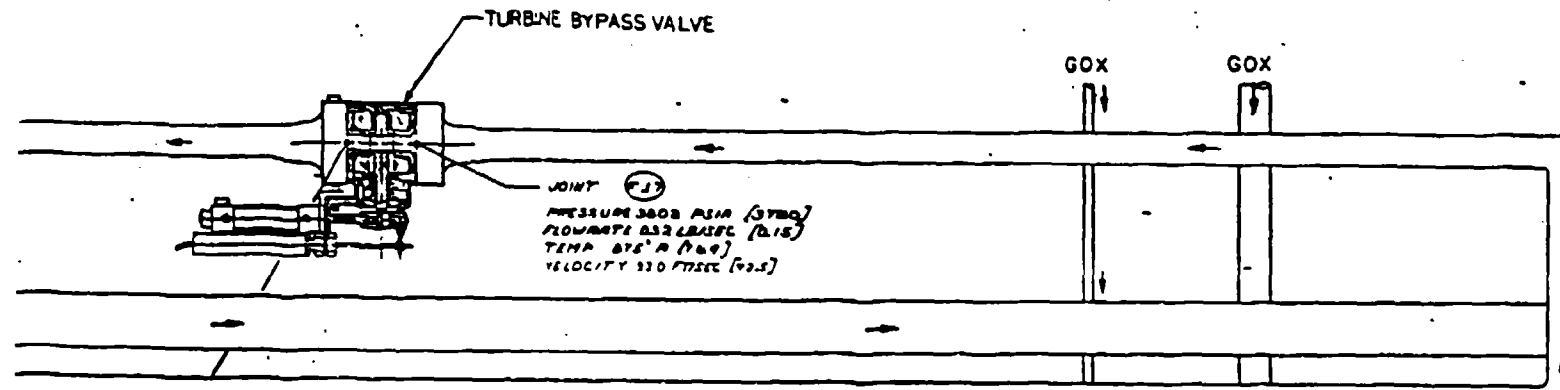

General Engineering Corporation

Engineering Division

Microfilm 6

FILE NO 8744	Sheet 1	of 1
--------------	---------	------

13

12

11

10

9

4/54

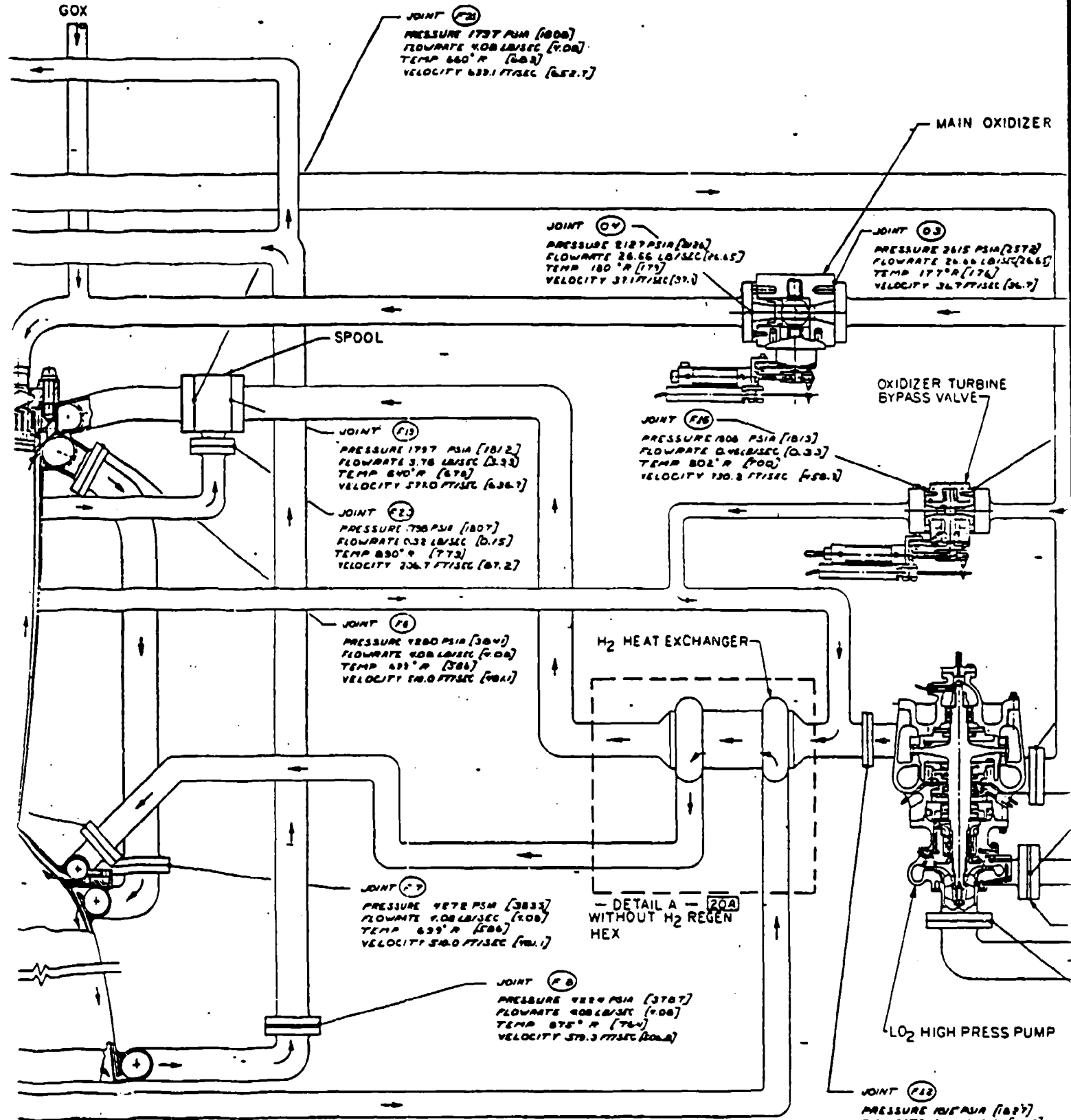

JOINT (F21)
 PRESSURE 1737 PSIA (1808)
 FLOWRATE 4.08 LB/SEC (1.86)
 TEMP 660° R (68.2)
 VELOCITY 639.1 FT/SEC (65.7)

JOINT (O4)
 PRESSURE 2127 PSIA (226)
 FLOWRATE 26.66 LB/SEC (26.65)
 TEMP 180° R (17.3)
 VELOCITY 37.1 FT/SEC (37.1)

JOINT (O3)
 PRESSURE 2615 PSIA (2572)
 FLOWRATE 26.66 LB/SEC (26.65)
 TEMP 177° R (17.6)
 VELOCITY 36.7 FT/SEC (36.7)

JOINT (F13)
 PRESSURE 1737 PSIA (1812)
 FLOWRATE 3.76 LB/SEC (3.33)
 TEMP 640° R (67.8)
 VELOCITY 570.0 FT/SEC (636.7)

JOINT (F23)
 PRESSURE 736 PSIA (807)
 FLOWRATE 0.32 LB/SEC (0.15)
 TEMP 830° R (77.3)
 VELOCITY 306.7 FT/SEC (87.2)

JOINT (F16)
 PRESSURE 1808 PSIA (1813)
 FLOWRATE 0.46 LB/SEC (0.33)
 TEMP 802° R (70.2)
 VELOCITY 130.3 FT/SEC (458.1)

JOINT (F1)
 PRESSURE 1280 PSIA (384)
 FLOWRATE 4.08 LB/SEC (4.08)
 TEMP 633° R (38.6)
 VELOCITY 618.0 FT/SEC (191.1)

JOINT (F7)
 PRESSURE 4878 PSIA (3833)
 FLOWRATE 4.08 LB/SEC (4.08)
 TEMP 633° R (38.6)
 VELOCITY 510.0 FT/SEC (156.1)

JOINT (F8)
 PRESSURE 4878 PSIA (3787)
 FLOWRATE 4.08 LB/SEC (4.08)
 TEMP 875° R (78.4)
 VELOCITY 379.3 FT/SEC (108.2)

JOINT (F22)
 PRESSURE 1814 PSIA (1827)
 FLOWRATE 2.30 LB/SEC (3.25)
 TEMP 774° R (67.5)
 VELOCITY 533.5 FT/SEC (160.1)

Standard International Organization
 Mechanical Units
 Conversion Tables
 (continued)

JOINT NO	20001	20002	20003
NAME			

584

Figure 7-1 RS-44 TEST BED EI

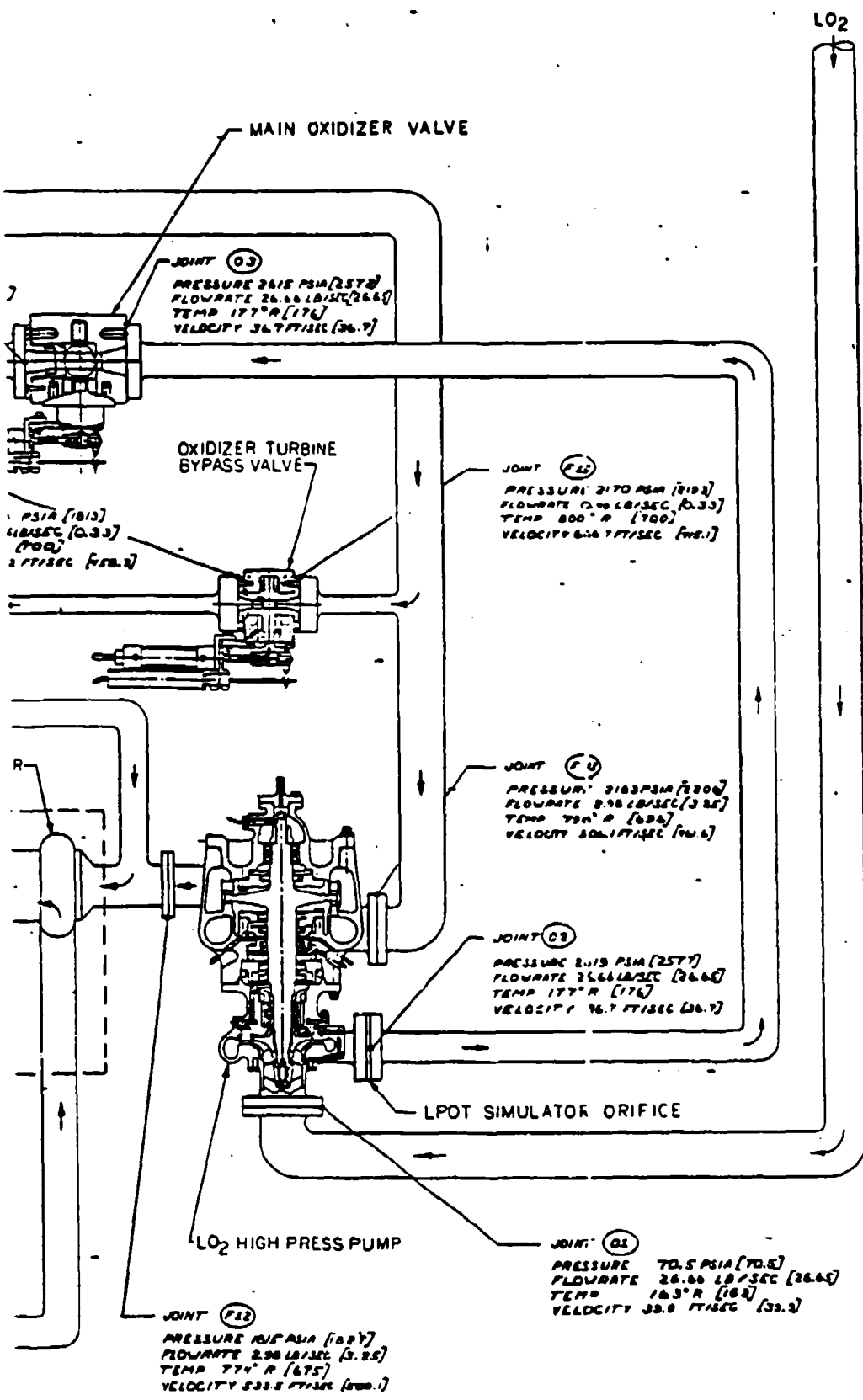

FOR INFO

NOTE: SYSTEM PARAMETERS WITH REGEN HEX ARE GIVEN IN

REV	DESCRIPTION	DATE
1	INITIAL DESIGN	10/1/68
2	REVISED FOR TEST	11/1/68
3	REVISED FOR TEST	12/1/68
4	REVISED FOR TEST	1/1/69
5	REVISED FOR TEST	2/1/69
6	REVISED FOR TEST	3/1/69
7	REVISED FOR TEST	4/1/69
8	REVISED FOR TEST	5/1/69
9	REVISED FOR TEST	6/1/69
10	REVISED FOR TEST	7/1/69
11	REVISED FOR TEST	8/1/69
12	REVISED FOR TEST	9/1/69
13	REVISED FOR TEST	10/1/69
14	REVISED FOR TEST	11/1/69
15	REVISED FOR TEST	12/1/69
16	REVISED FOR TEST	1/1/70
17	REVISED FOR TEST	2/1/70
18	REVISED FOR TEST	3/1/70
19	REVISED FOR TEST	4/1/70
20	REVISED FOR TEST	5/1/70
21	REVISED FOR TEST	6/1/70
22	REVISED FOR TEST	7/1/70
23	REVISED FOR TEST	8/1/70
24	REVISED FOR TEST	9/1/70
25	REVISED FOR TEST	10/1/70
26	REVISED FOR TEST	11/1/70
27	REVISED FOR TEST	12/1/70
28	REVISED FOR TEST	1/1/71
29	REVISED FOR TEST	2/1/71
30	REVISED FOR TEST	3/1/71
31	REVISED FOR TEST	4/1/71
32	REVISED FOR TEST	5/1/71
33	REVISED FOR TEST	6/1/71
34	REVISED FOR TEST	7/1/71
35	REVISED FOR TEST	8/1/71
36	REVISED FOR TEST	9/1/71
37	REVISED FOR TEST	10/1/71
38	REVISED FOR TEST	11/1/71
39	REVISED FOR TEST	12/1/71
40	REVISED FOR TEST	1/1/72
41	REVISED FOR TEST	2/1/72
42	REVISED FOR TEST	3/1/72
43	REVISED FOR TEST	4/1/72
44	REVISED FOR TEST	5/1/72
45	REVISED FOR TEST	6/1/72
46	REVISED FOR TEST	7/1/72
47	REVISED FOR TEST	8/1/72
48	REVISED FOR TEST	9/1/72
49	REVISED FOR TEST	10/1/72
50	REVISED FOR TEST	11/1/72
51	REVISED FOR TEST	12/1/72
52	REVISED FOR TEST	1/1/73
53	REVISED FOR TEST	2/1/73
54	REVISED FOR TEST	3/1/73
55	REVISED FOR TEST	4/1/73
56	REVISED FOR TEST	5/1/73
57	REVISED FOR TEST	6/1/73
58	REVISED FOR TEST	7/1/73
59	REVISED FOR TEST	8/1/73
60	REVISED FOR TEST	9/1/73
61	REVISED FOR TEST	10/1/73
62	REVISED FOR TEST	11/1/73
63	REVISED FOR TEST	12/1/73
64	REVISED FOR TEST	1/1/74
65	REVISED FOR TEST	2/1/74
66	REVISED FOR TEST	3/1/74
67	REVISED FOR TEST	4/1/74
68	REVISED FOR TEST	5/1/74
69	REVISED FOR TEST	6/1/74
70	REVISED FOR TEST	7/1/74
71	REVISED FOR TEST	8/1/74
72	REVISED FOR TEST	9/1/74
73	REVISED FOR TEST	10/1/74
74	REVISED FOR TEST	11/1/74
75	REVISED FOR TEST	12/1/74
76	REVISED FOR TEST	1/1/75
77	REVISED FOR TEST	2/1/75
78	REVISED FOR TEST	3/1/75
79	REVISED FOR TEST	4/1/75
80	REVISED FOR TEST	5/1/75
81	REVISED FOR TEST	6/1/75
82	REVISED FOR TEST	7/1/75
83	REVISED FOR TEST	8/1/75
84	REVISED FOR TEST	9/1/75
85	REVISED FOR TEST	10/1/75
86	REVISED FOR TEST	11/1/75
87	REVISED FOR TEST	12/1/75
88	REVISED FOR TEST	1/1/76
89	REVISED FOR TEST	2/1/76
90	REVISED FOR TEST	3/1/76
91	REVISED FOR TEST	4/1/76
92	REVISED FOR TEST	5/1/76
93	REVISED FOR TEST	6/1/76
94	REVISED FOR TEST	7/1/76
95	REVISED FOR TEST	8/1/76
96	REVISED FOR TEST	9/1/76
97	REVISED FOR TEST	10/1/76
98	REVISED FOR TEST	11/1/76
99	REVISED FOR TEST	12/1/76
100	REVISED FOR TEST	1/1/77

ENG FLOW
 RS-44 TEST
 EXPANDED
 J 02602
 (REV)

687

Figure 7-1 RS-44 TEST BED ENGINE FLOW SCHEMATIC

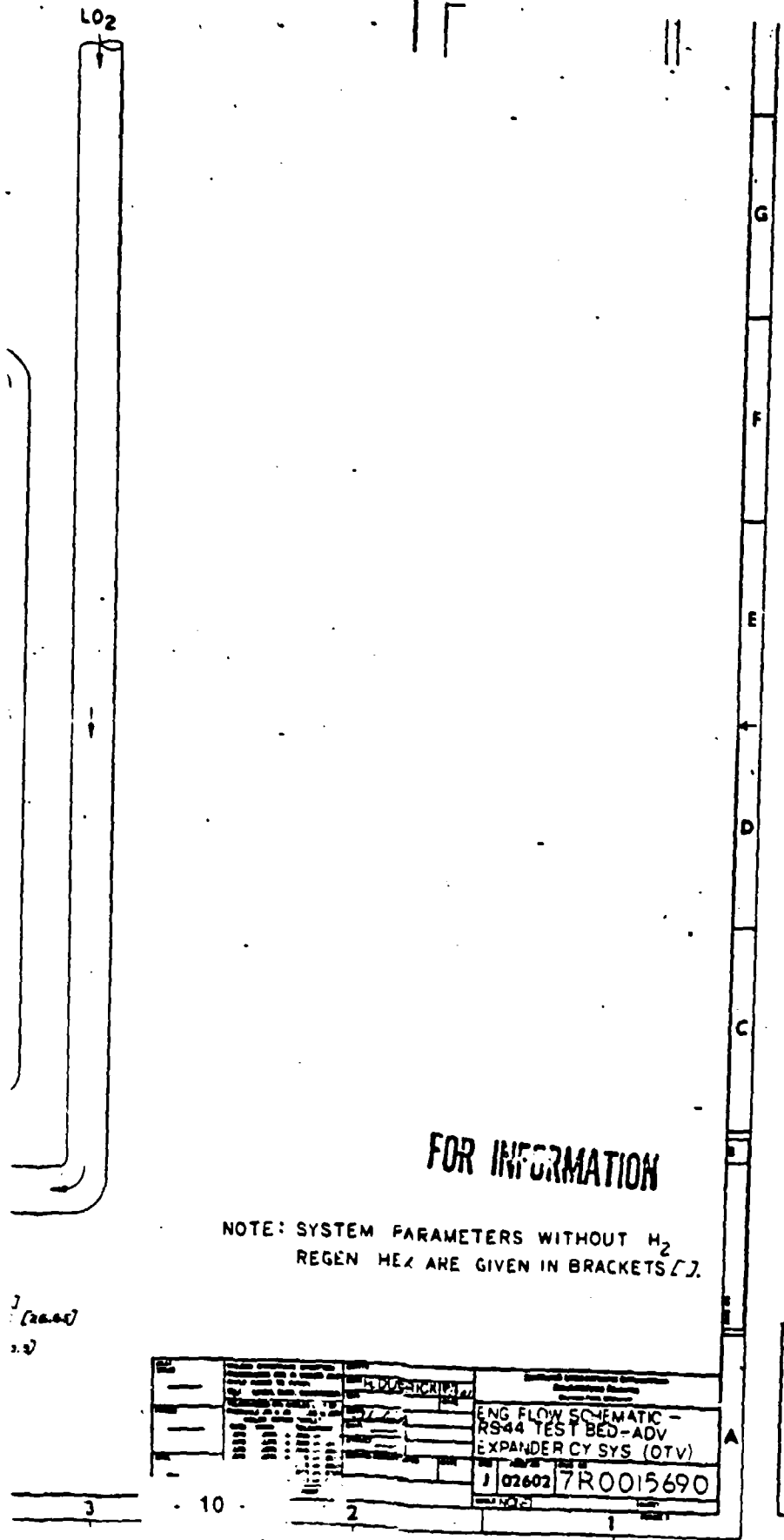

FOR INFORMATION

NOTE: SYSTEM PARAMETERS WITHOUT H₂ REGEN HEX ARE GIVEN IN BRACKETS []

NO.	DESCRIPTION	PART NUMBER
1	ENG FLOW SCHEMATIC - RS-44 TEST BED-ADV EXPANDER CY SYS (QTV)	7R0015690

17.17.7

Figure 7-2 RS-44 DUCT ASSEMBLY LOCATIONS

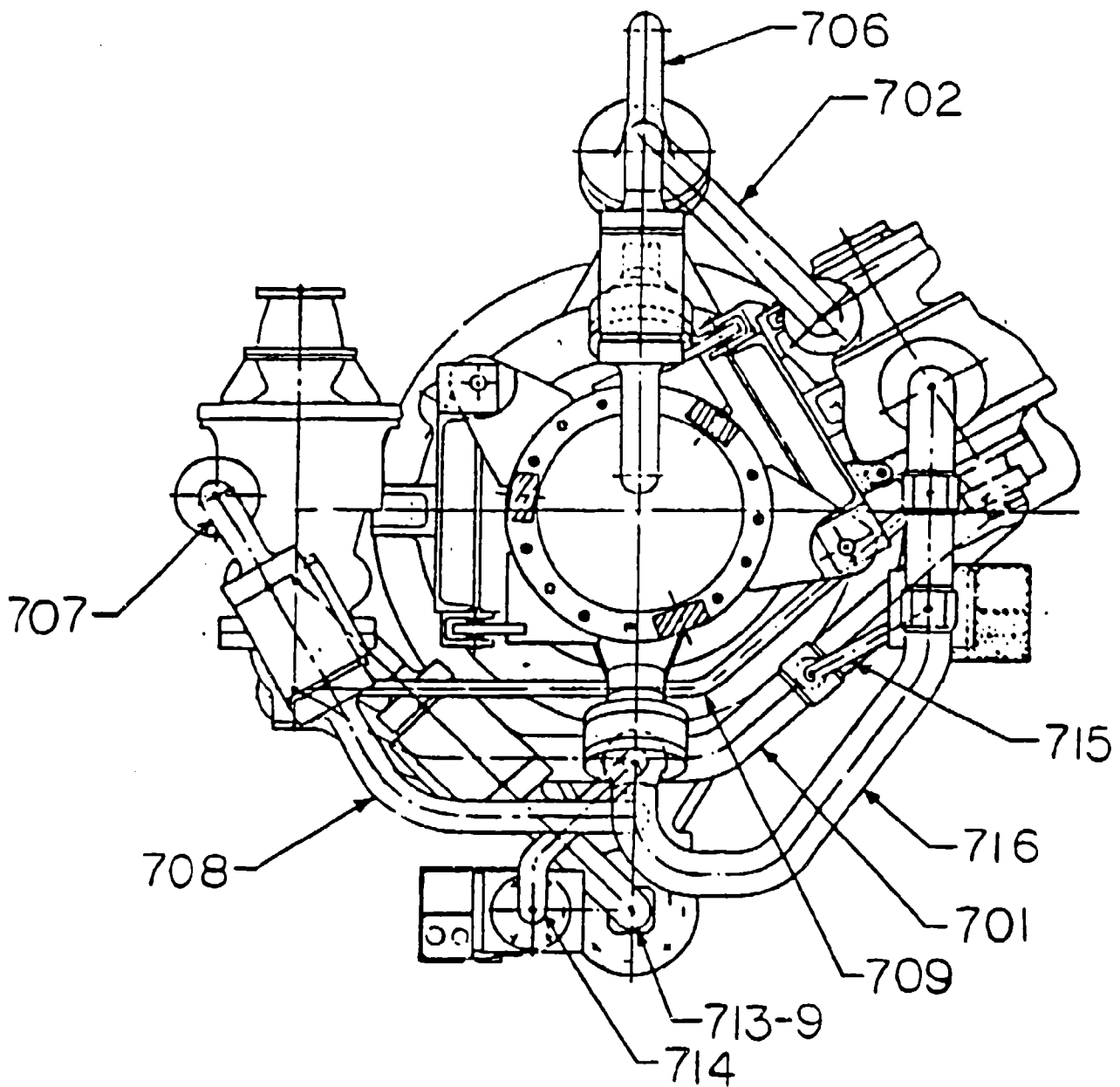

Figure 7-3 RS-44 DUCT ASSEMBLY LOCATIONS

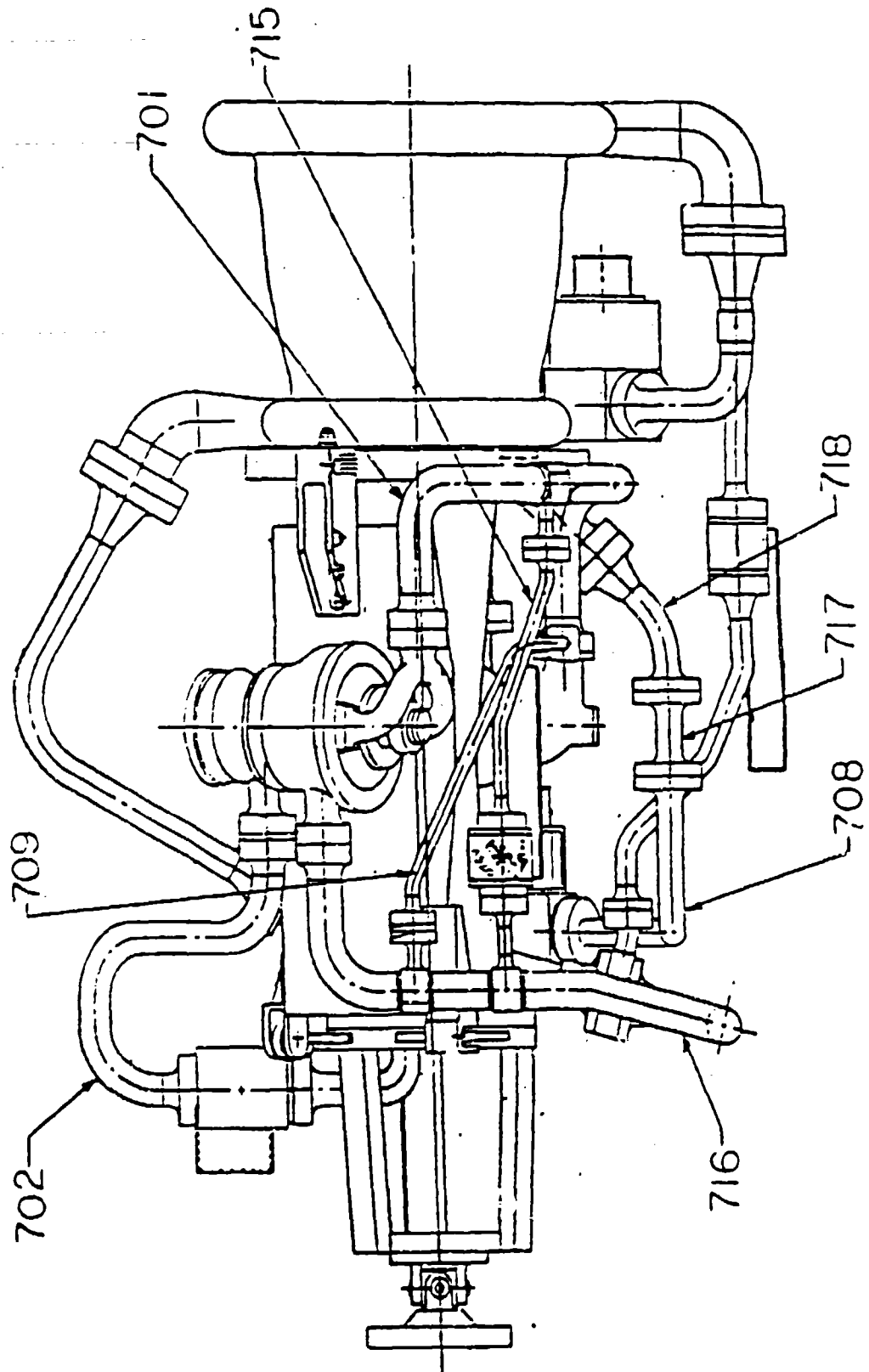

Figure 7-4 RS-44 DUCT ASSEMBLY LOCATIONS

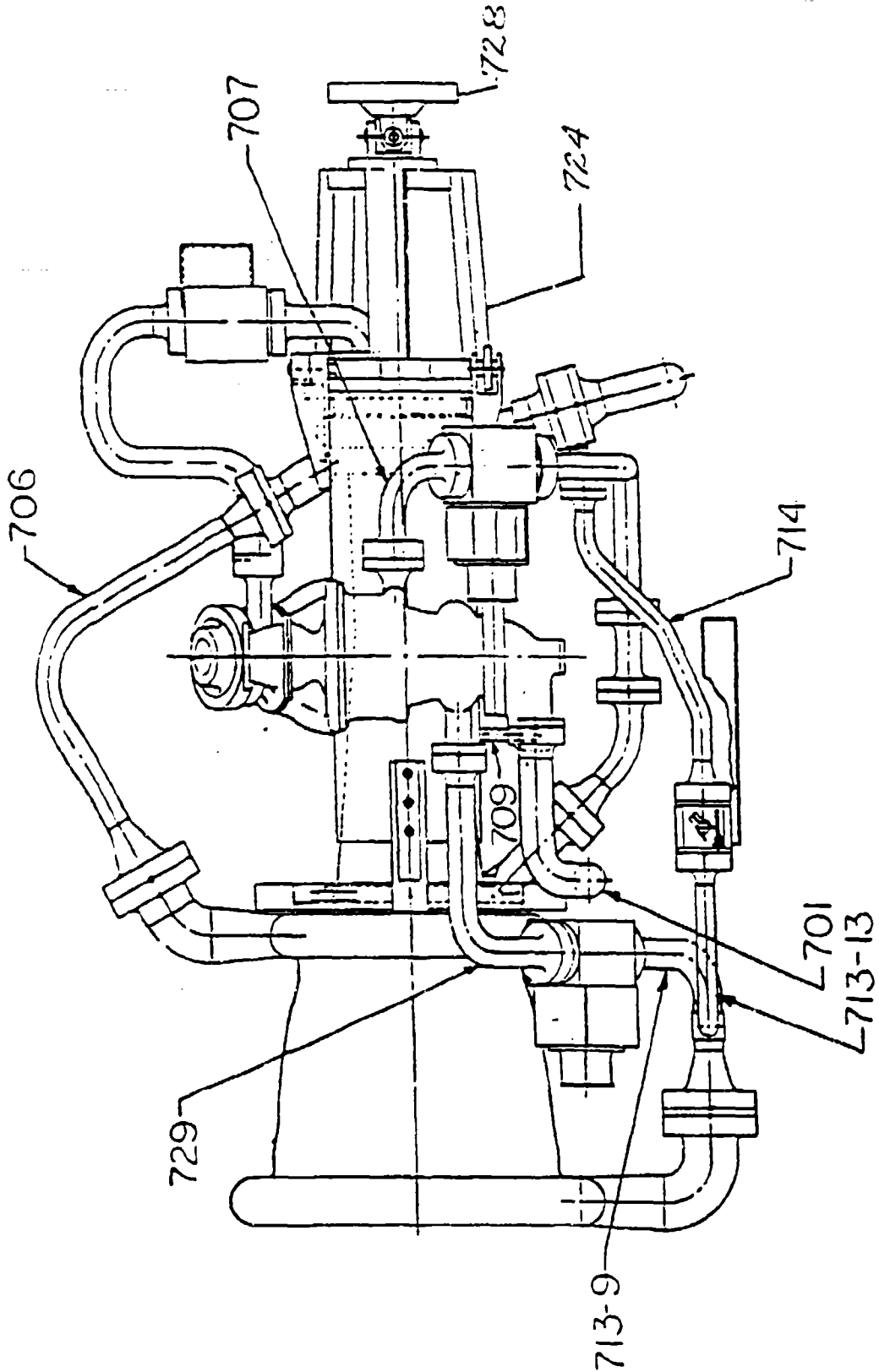

Figure 7-5 ICE THRUST CHAMBER ASSEMBLY



LCAD-594



Federal
International
Systems, Inc.

Figure 7-6 ICE COMBUSTION SYSTEM COMPONENTS

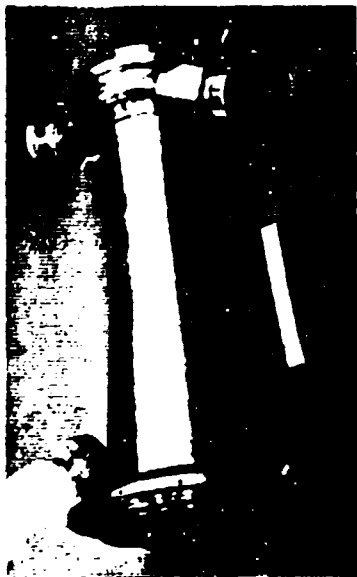

COMBUSTOR

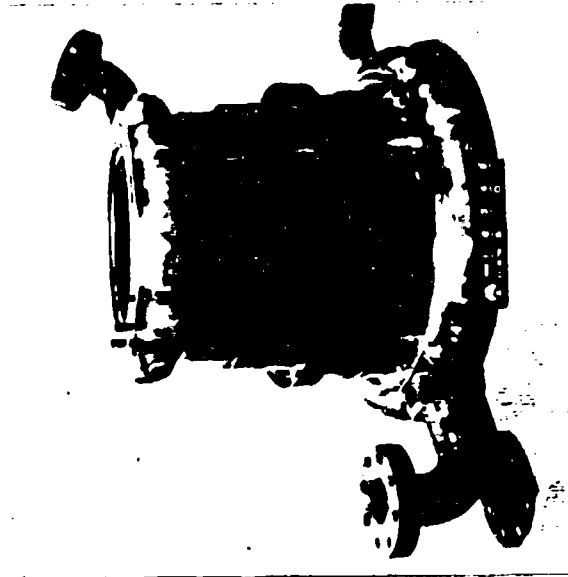

NOZZLE

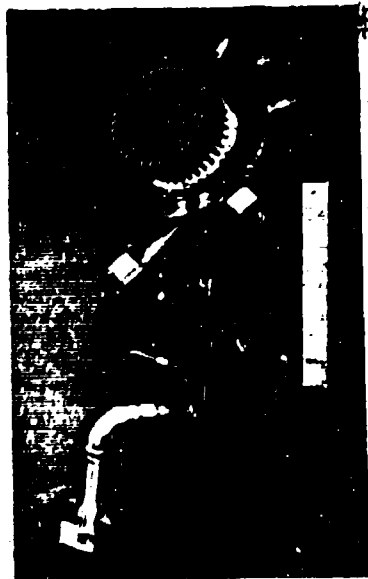

INJECTOR

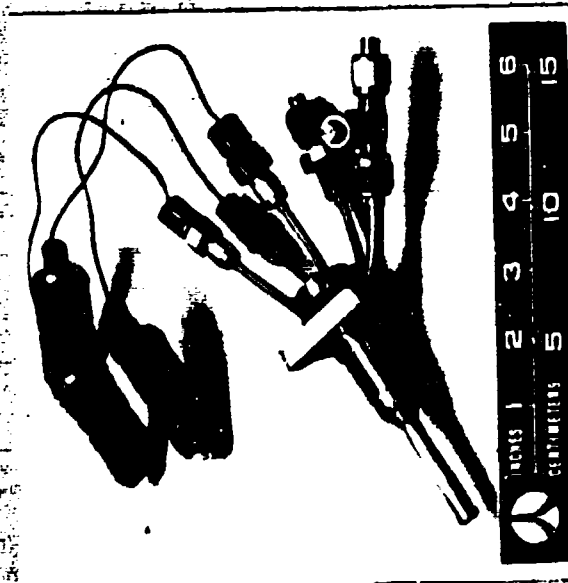

IGNITER

LC480-308

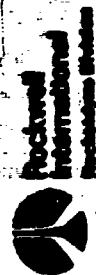

Figure 7-7 MAIN INJECTOR

DESCRIPTION

- 316L LOX POST W/COPPER TIPS
- INCONEL 718 BODY
- Ni 200 FACENUTS
- 321 CRES RIGIMESH FACEPLATE
- 304L CRES FUEL SLEEVES
- FACE DIAMETER.....4.740 INCHES
- NUMBER OF ELEMENTS.....108
- LOX INLET I.D.....1.250 INCHES
- INJECTOR CONFIGURATION.....CONCENTRIC ORIFICE
- BRAZED LOX POSTS
- BRAZED FUEL SLEEVES
- USES ASE IGNITER
- CENTER MOUNTED IGNITER

OPERATING PARAMETERS

- CHAMBER PRESSURE.....1540 PSIA
- OXIDIZER FLOWRATE.....26.71 LB/SEC
- HYDROGEN FLOWRATE.....4.05 LB/SEC
- HYDROGEN INJECTION TEMP.....660 °R
- FACEPLATE FLOWRATE......15 LB/SEC
- MIXTURE RATIO.....6.0

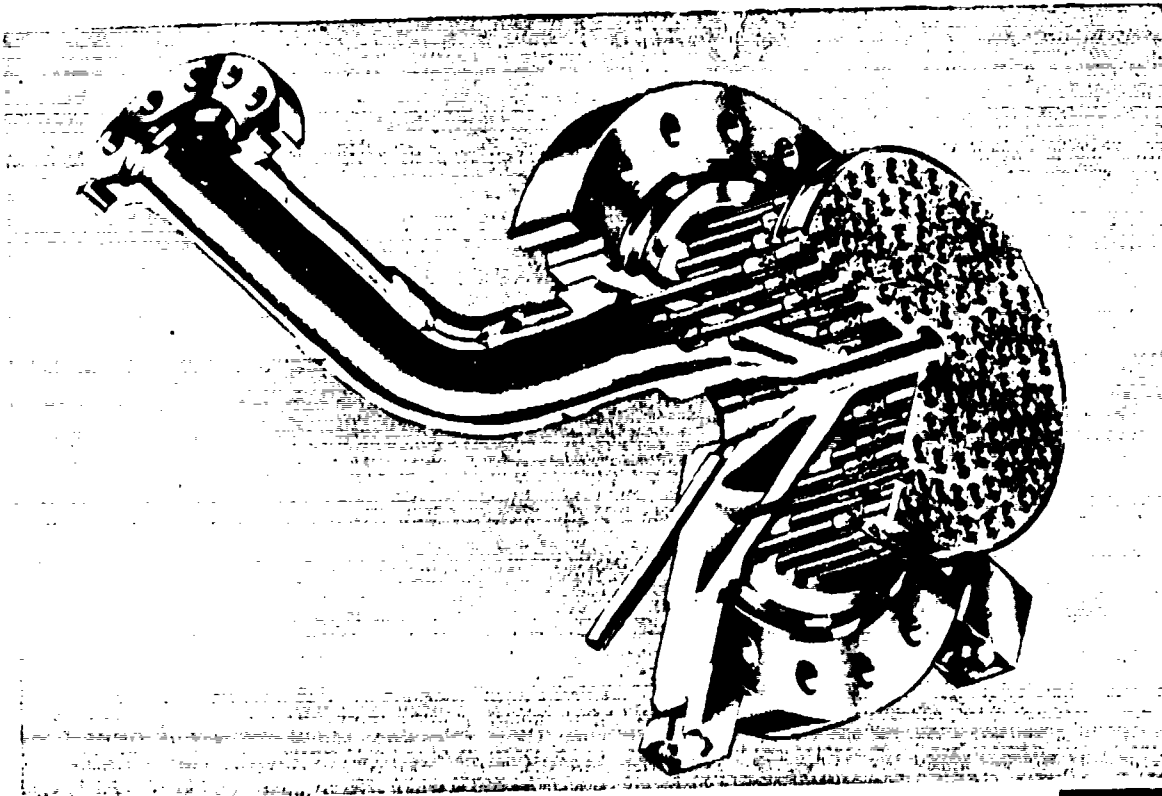

LC238-631C



Many of the mechanical design aspects of the SSME have been incorporated to improve maintainability, adjustability, and to increase the ease of disassembly for rework or inspection.

The basic injection pattern selected for this application is a coaxial-type injection element, oriented in a series of concentric circular locations with a Rigimesh porous metal injector faceplate. One hundred and eight elements are arranged in this pattern to provide a mass and mixture ratio distribution.

The element placement is essentially identical to the ASE pattern, and similar in concept to the SSME. No baffle elements (such as are used on the SSME) are required in the injector design. This is based on experience with injectors of this same physical diameter. (Acoustic damping cavities are, however, included in the combustion chamber design.)

The propellant flow distribution to the injector elements is well controlled to provide uniform mass flow distribution in the manifolds and over the entire injector face.

The injector element configuration, Figure 7-8, includes an integral centering device on each liquid oxygen central element to keep the fuel gap concentric around the oxidizer elements. This centering device is located as close to this gap as practical, while at the same time minimizing the wake effects behind each centering devices.

Figure 7-8 INJECTOR ELEMENT CONFIGURATION

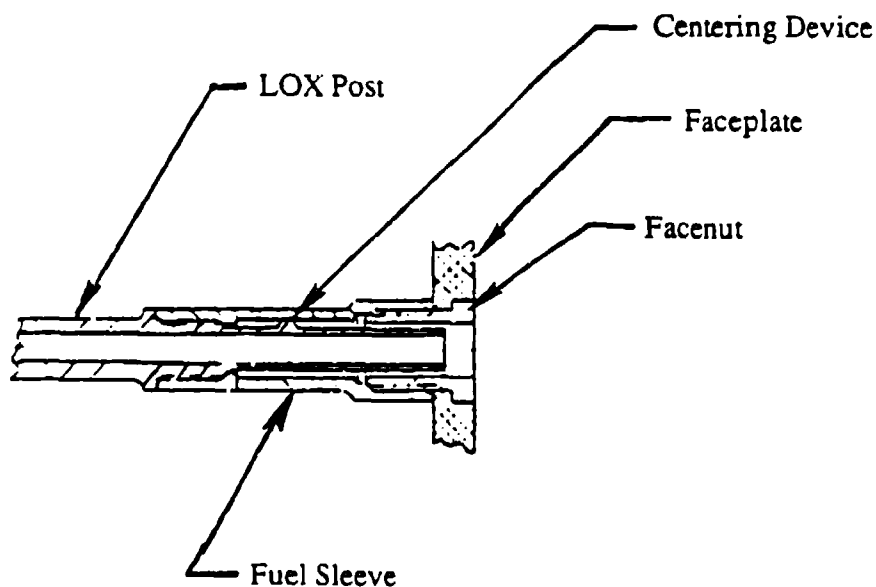

A plasma torch igniter port is provided in the center of the injection pattern for reliable multistart capability. This torch igniter has been used on the ASE program with a high degree of success.

7.1.2.5 Ignition System Design Redundancy in the ignition system required for mandating engine capability is achieved through use of a dual plasma torch igniter to provide a reliable source of ignition energy at start. This type of igniter was selected because of the potential for high spark electrode durability, predictable and repeatable ignition conditions at the spark electrode, and a high temperature downstream of the igniter exit to enhance the propellant ignition in the combustion chamber. The system consists of dual harnesses and spark plugs, operating through a single combustion chamber and flame tube.

The torch igniter has the capability for rapid re-ignition with minimum delay in the event of a flameout during the start transition. It also provides a high mixture ratio near the electrode for reliable ignition and produces a hot core for main propellant ignition.

Three thermocouples were used to provide automatic termination of the start sequence of the engine if an igniter failure were to occur. Three thermocouples, whose junctions are spot welded to relieved sections of the igniter chamber wall, are used in the ignition detection system. A logic circuit is used to terminate the start sequence if any two of the three thermocouples fails to indicate a 110°F temperature by the time that the main fuel valve is sequenced to be activated.

7.1.2.6 Combustion Chamber Design The combustion chamber, Figure. 7-9, selected for the Thrust Chamber Assembly is a single-pass, channel-wall, copper-base alloy configuration and includes a nozzle expansion section to an area ratio of 14.2. This combustion chamber concept is used successfully on the Space Shuttle Main Engine (SSME) and the 20K Advanced Space Engine assembly. The features of this design include a copper-alloy (NARloy-Z) slotted liner with an electroformed-nickel closeout, manifolds brazed to the liner, acoustic cavities, and injector manifold housing integral with the combustion chamber. The aft combustion chamber to nozzle

Figure 7-9 ADVANCED EXPANDER CYCLE COMBUSTION CHAMBER

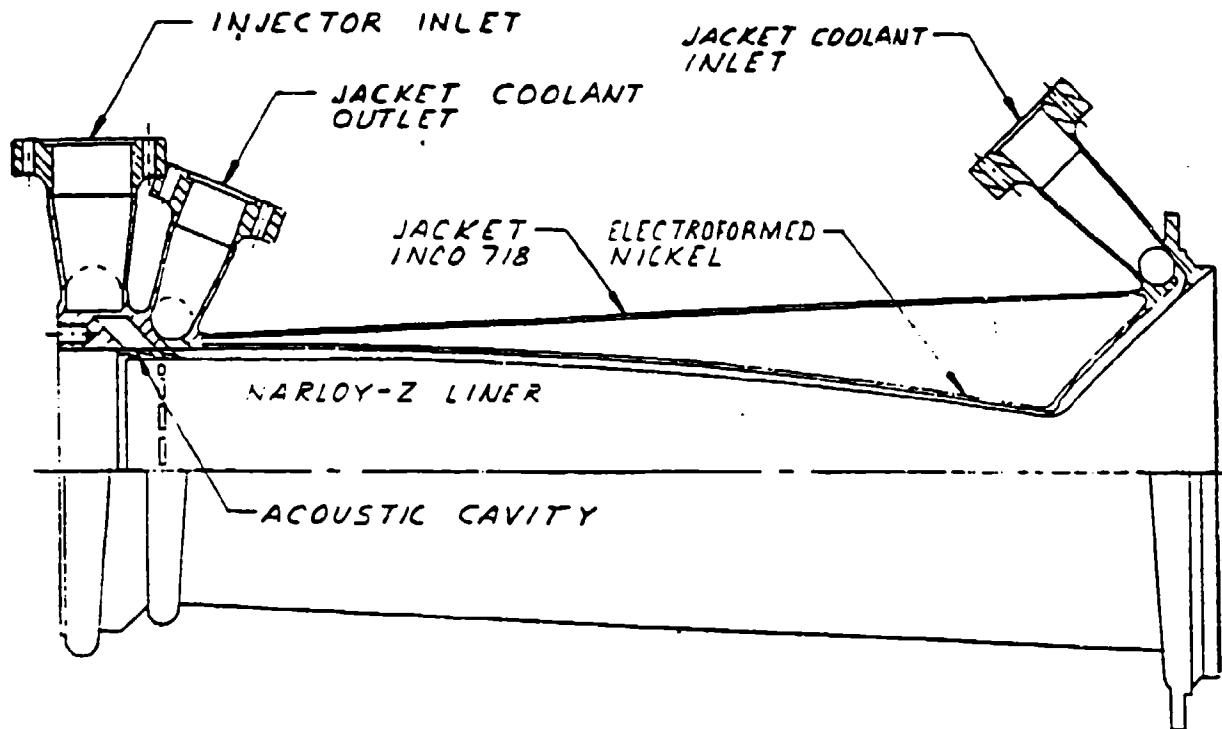

Interface is designed with a flanged joint for maximum ease of hardware interchange ability during engine development testing. This flange is reworkable into a lightweight welded design for flight application. The manifolding at the aft and forward ends of the combustion chamber have been designed to give a uniform flow distribution to and from the coolant passages.

The injector housing at the forward end of the combustion chamber incorporates a flange to allow installation and removal of the injector. The injector inlet and the housing were also designed for uniform flow upstream of the injector manifolds to ensure even fuel distribution to the injection elements.

Cooling of the combustion chamber walls is accomplished by a single up-pass hydrogen circuit with 4.09 lb/sec of H₂ coolant at the nominal operating point. The up-pass circuit was selected because it provides the maximum capability for cooling in the high heat flux region at the throat. The cooling channel configuration has been designed with the Rocketdyne regenerative cooling analysis program which details in consecutive axial stations the wall temperature (2-dimensional) and fluid conditions along the combustion chamber length.

7.1.3 Turbomachinery Hardware

The RS-44 flight engine system required four turbopumps to meet the Net Positive Suction Head (NPSH) and delivered pressure and flow requirements; a low pressure and a high pressure fuel turbopump (HPFTP) and a low pressure and a high pressure oxidizer turbopump (HPOTP). The low pressure turbopumps were conceptually designed with Rocketdyne discretionary funds, but were not fabricated. For the ICE demonstrations pressurized facility tank systems were used to adequately simulate low pressure pumps. Orifices were also included in the ICE system to simulate the low pressure fuel turbine (HPFTP turbine exhaust line) and low pressure oxidizer turbine (HPOTP pump discharge line), as previously shown in Figure 7-1.

7.1.3.1 High Pressure Fuel Turbopump (Mark 49-F) The MK49-F turbopump was designed to meet the high head and low flow requirements of the advanced LH₂/LO₂ expander cycle engine. Listed in Table 7-2 are the design data for the MK49-F turbopump as required by the advanced expander cycle engine operation at full thrust.

**Table 7-2 MK49-F DESIGN REQUIREMENTS
EXPANDER CYCLE HIGH PRESSURE HYDROGEN TURBOPUMP**

PARAMETER	15,000 lbf MR = 6	15,000 lbf MR = 7	1500 lbf MR = 6
Shaft Speed, rpm	110,000	102,000	25,700
Pumped Fluid	LH ₂	LH ₂	LH ₂
Pump Inlet Pressure, psia	63.8	68.4	34.2
Pump Inlet Temp, °R	38.5	38.1	38.2
Pump Flowrate, lbm/sec	4.12	3.68	0.44
Pump Discharge Press, psia	4671	4153	337
Turbine Drive Media	GH ₂	GH ₂	GH ₂
Turbine Inlet Pressure, psia	3787	3337	234
Turbine Inlet Temp, °R	875	941	976
Turbine Flowrate, lbm/sec	3.65	2.95	0.14
Turbine Exhaust Press, psia	2202	2100	198

The pump and turbine were optimized around the 15,000 lbf thrust and mixture ratio (MR) of 6. The MK49-F turbopump, as shown in Figure 7-10, is a three stage centrifugal pump with an axial inducer stage. Size and pump pressure rise requirements are similar to the ASE hydrogen turbopump (MK 48-F) that was designed, fabricated and successfully tested under NASA LeRC contracts NAS3-17794 and NAS3-21008 (references 5 & 6). Heated gaseous hydrogen (GH₂) from the combustor jacket is routed to the HPFTP turbine inlet manifold. The MK49-F utilizes a 2-stage pressure compounded partial admission impulse turbine. Insufficient data were available to adequately substantiate the predicted characteristics of the 2-stage partial admission design, therefore a technology project was funded by NASA Lewis Research Center (Reference 7). Performance and axial thrust characteristics were obtained during the technology project and prediction capabilities verified for the two-stage partial admission turbine design.

To develop 4600 psia pump discharge pressure requirement of the advanced expander cycle OTV engine, a high impeller exit velocity is required. However, relatively low velocity is required at the inlet of the next impeller stage for the best overall pump performance. The result is a large diffuser inlet to exit velocity ratio through the crossover. The MK49-F design uses a velocity ratio of 6.23, which approaches the diffusion limit for stable efficient design. A technology project was initiated which was sponsored by the Space Propulsion Technology Division, NASA Lewis Research Center, Cleveland, Ohio, under Contract NAS3-23773, "Orbit Transfer Rocket Engine Technology Program, Task B.2" to investigate the performance characteristics of the unique crossover design. A 2.85 times size scale model of the MK49-F inducer, impeller, and crossover was manufactured for testing in water and air using an existing tester configuration at the Rocketdyne Engineering Development Laboratory. Performance and results of the crossover testing has been reported in reference 8.

Because of the operating requirements of the advanced expander cycle engine, the MK49-F turbopump was required to run over a wide speed range. Rotordynamic responses for high speed machines can complicate the engine objectives by having critical speeds near the desired operating points. A rotor stability analysis was completed using predicted ball bearing stiffnesses, pump interstage seal stiffness and damping, and turbine tip seal inlet swirl forces (Alford effect). The MK49-F rotor design showed adequate 20% operating margins from the critical speeds at the three engine balance points. Figure 7-11 shows the critical speed versus bearing stiffness curves and the engine operating regions.

Figure 7-10 MK49-F TURBOPUMP CROSS-SECTION

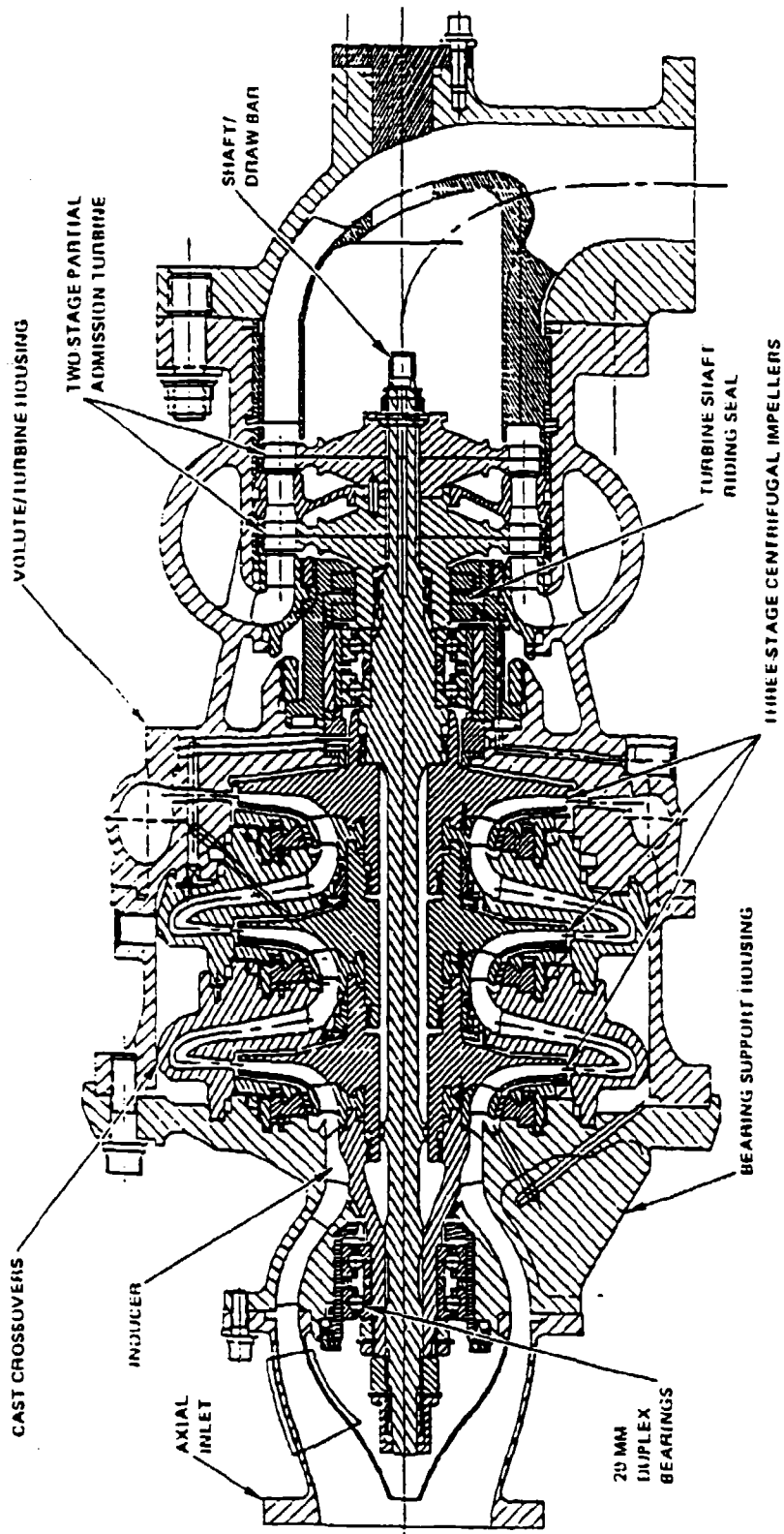
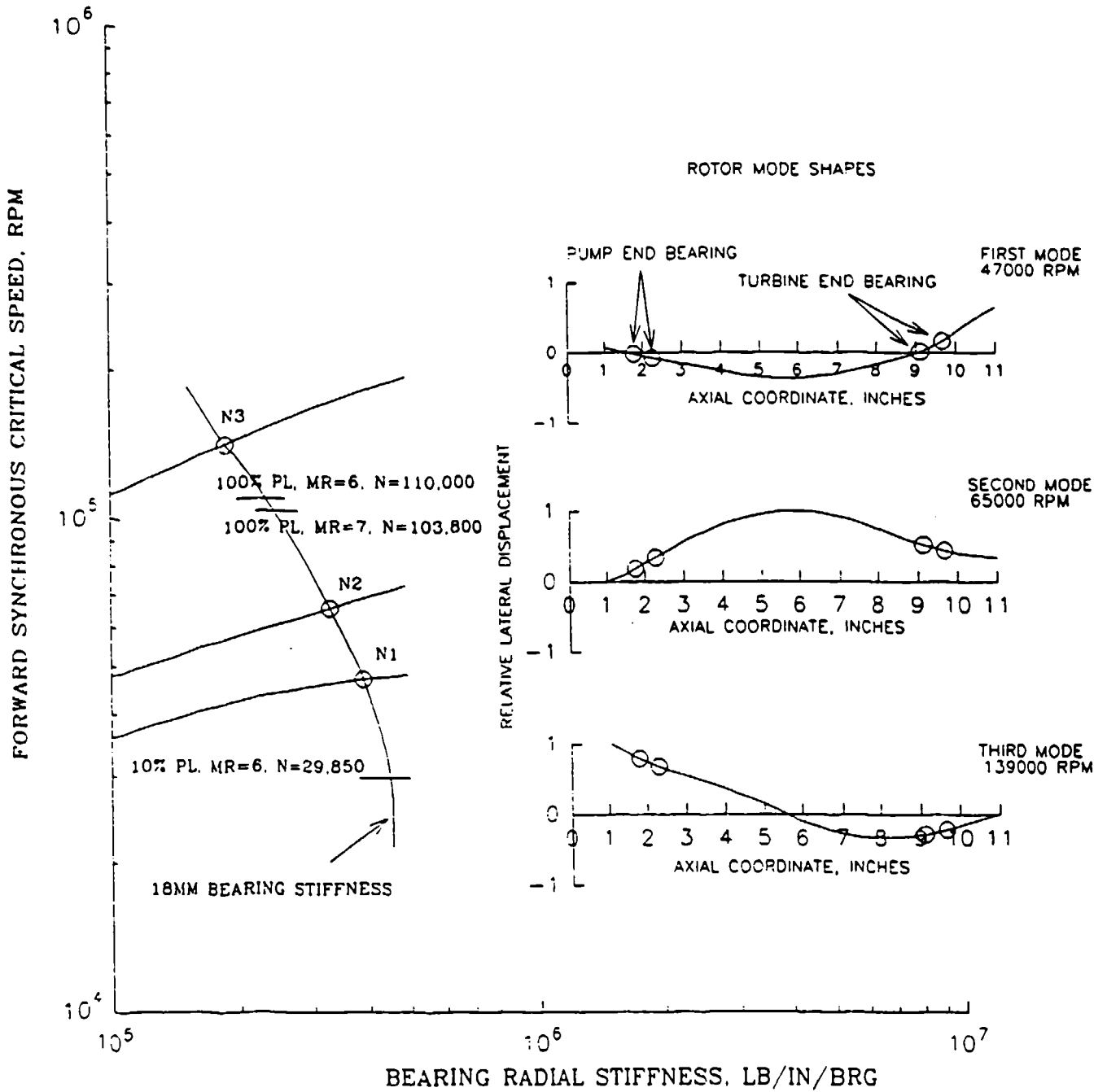

Figure 7-11 MK49-F TURBOPUMP CRITICAL SPEED VERSUS BEARING STIFFNESS



7.1.3.2 High Pressure Oxygen Turbopump (MK49-O) Due to the relatively high density of LOX and the moderate pump discharge pressure requirement, the HPOTP design is far less complex than the HPFTP. Listed below in Table 7-3 are the predicted design data for the three required engine operating points at full thrust.

**Table 7-3 MK 49-O DESIGN REQUIREMENTS
EXPANDER CYCLE HIGH PRESSURE OXYGEN TURBOPUMP**

PARAMETER	15,000 lbf MR = 6	15,000 lbf MR = 7	1500 lbf MR = 6
Shaft Speed, rpm	52,837	52,400	12,550
Pumped Fluid	LO ₂	LO ₂	LO ₂
Pump Inlet Pressure, psia	71.3	79.0	17.0
Pump Inlet Temp, °R	164	166	163
Pump Flowrate, lbfm/sec	26.9	28.2	2.98
Pump Discharge Press, psia	2649	2346	193
Turbine Drive Media	GH ₂	GH ₂	GH ₂
Turbine Inlet Pressure, psia	2156	2088	197
Turbine Inlet Temp, °R	799	861	949
Turbine Flowrate, lbfm/sec	2.90	2.63	0.12
Turbine Exhaust Press, psia	1798	1755	189

Due to the similarity in oxidizer requirements, many of the MK49-O components and design features were maintained from the MK 48-O turbopump that was designed, fabricated and successfully tested under NASA LeRC contracts NAS3-17800 and NAS3-21356 during the ASE technology development program (references 9, 10, & 11).

The MK49-O turbopump, shown in Figure 7-12, utilized an axial inducer with a single stage centrifugal pump design. The MK49-O inducer, impeller, and volute geometries were identical to that used in the MK 48-O turbopump.

Figure 7-12 MK49-O TURBOPUMP CROSS-SECTION

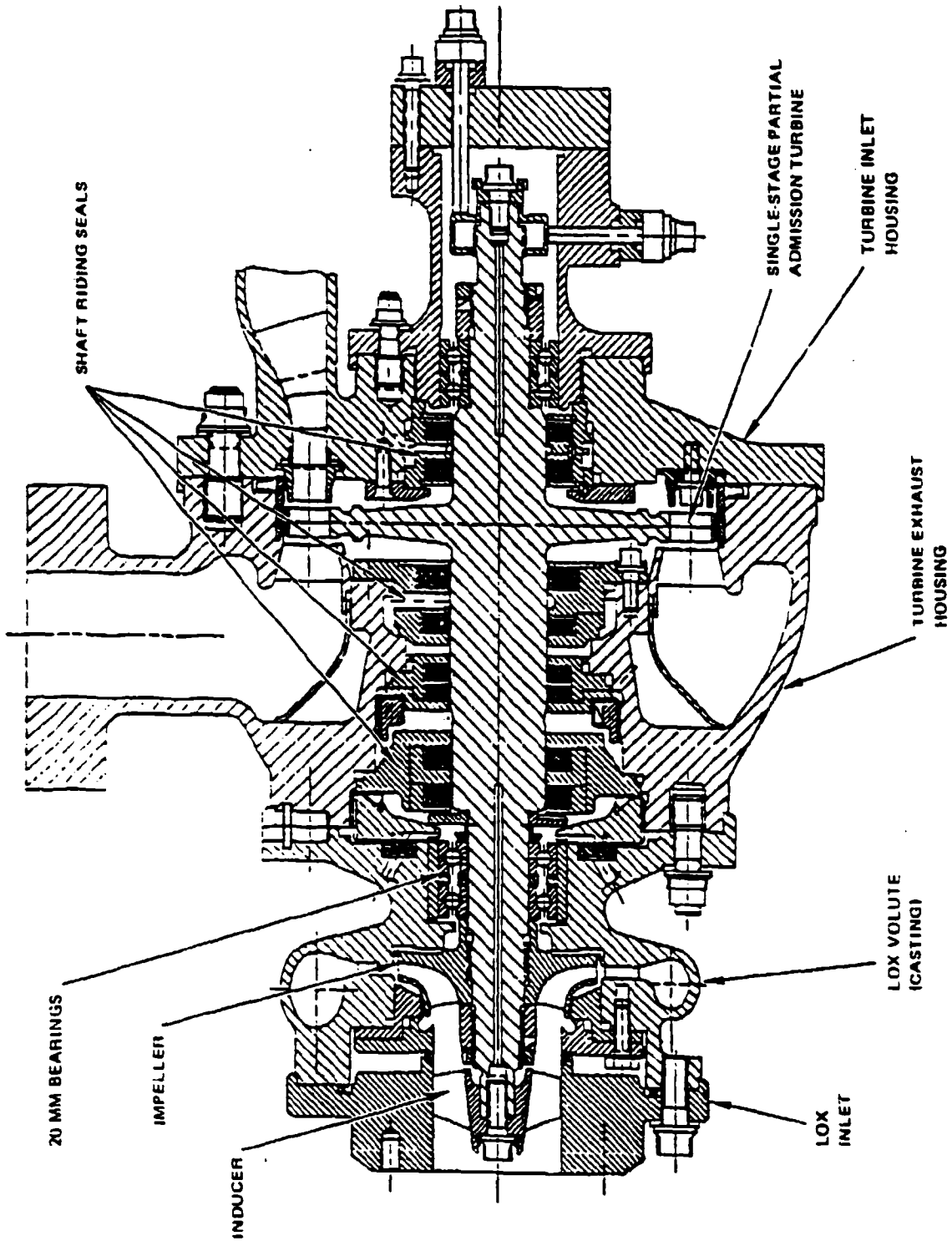

The turbine is similar in size and design to the MK 48-O turbine, and uses a single stage partial admission impulse design. The inlet flow to the HPOTP turbine comes from the exit of the HPFTP turbine in a series flow configuration. Flow is routed to the subsonic nozzles through a bifurcated inlet ducting. This configuration provides two benefits to the turbopump configuration; slightly higher efficiency due to axial inlet flow and reduced thermally induced stress interactions between the warm turbine housing and the cold pump housing.

A detailed finite element model of the rotating assembly, using a lumped parameter approach, was developed to represent the rotor structural and mass properties. The ball bearing pairs were modeled as linear radial springs to the housing which assumes the housing to be rigid (to ground). The stiff shaft design allowed the MK49-O rotating assembly to operate below its first critical speed of approximately 66,500 rpm. The undamped forward synchronous critical speed plot is shown in Figure 7-13 with the rotor mode shapes. The first critical speed is well above the maximum operating speed of 52,837 rpm giving adequate margin for safe operation at all engine conditions. Since the turbopump operates below the lowest rotor mode no stability issues due to throttling were anticipated.

7.2 TEST FACILITY DESCRIPTION

The ICE was installed and tested at Rocketdyne's NAN test stand of the Advanced Propulsion Test Facility (APTF) located in the Santa Susana Field Laboratory (SSFL) from April 1986 through January 1987. The APTF test sites encompass several test cells, each operated remotely from a central control and data acquisition center, as seen in Figure 7-14. The centrally located control center provides for visual observation of each test cell. With the exception of a few

special propellant systems, the test facility is operated on a tank-farm concept which enables network supply from a propellant storage area.

7.2.1 Fluid Systems

Facility tank and fluid distribution systems were used to simulate the output of the engines low pressure pumps. Table 7-4 describes the propellant volume capabilities available at APTF. The test facility system was complicated by the variety of fluid and control systems which had to be integrated to successfully test the ICE, as shown in Figure 7-15.

Figure 7-13 MK49-O TURBOPUMP CRITICAL SPEED ANALYSIS

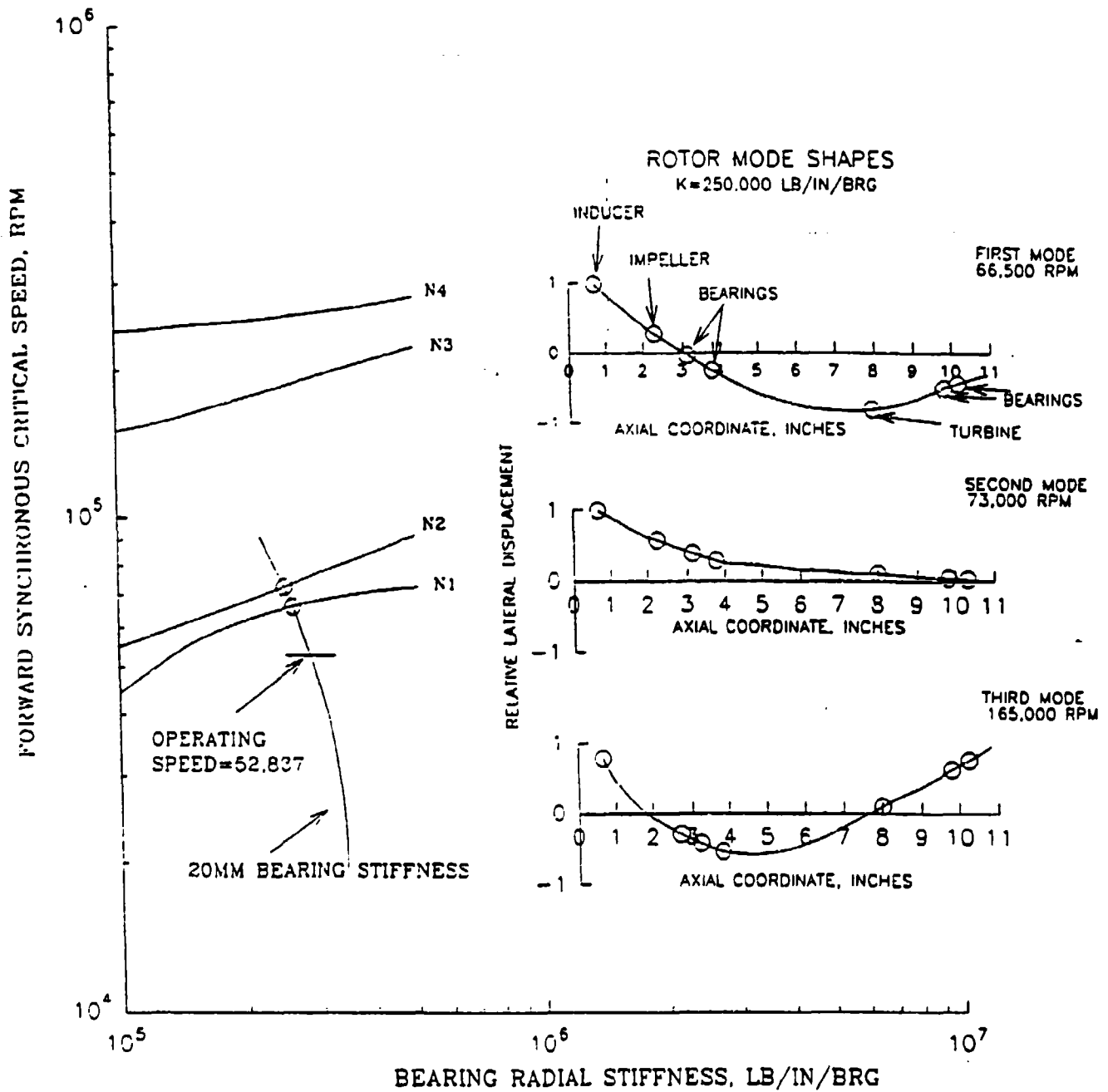
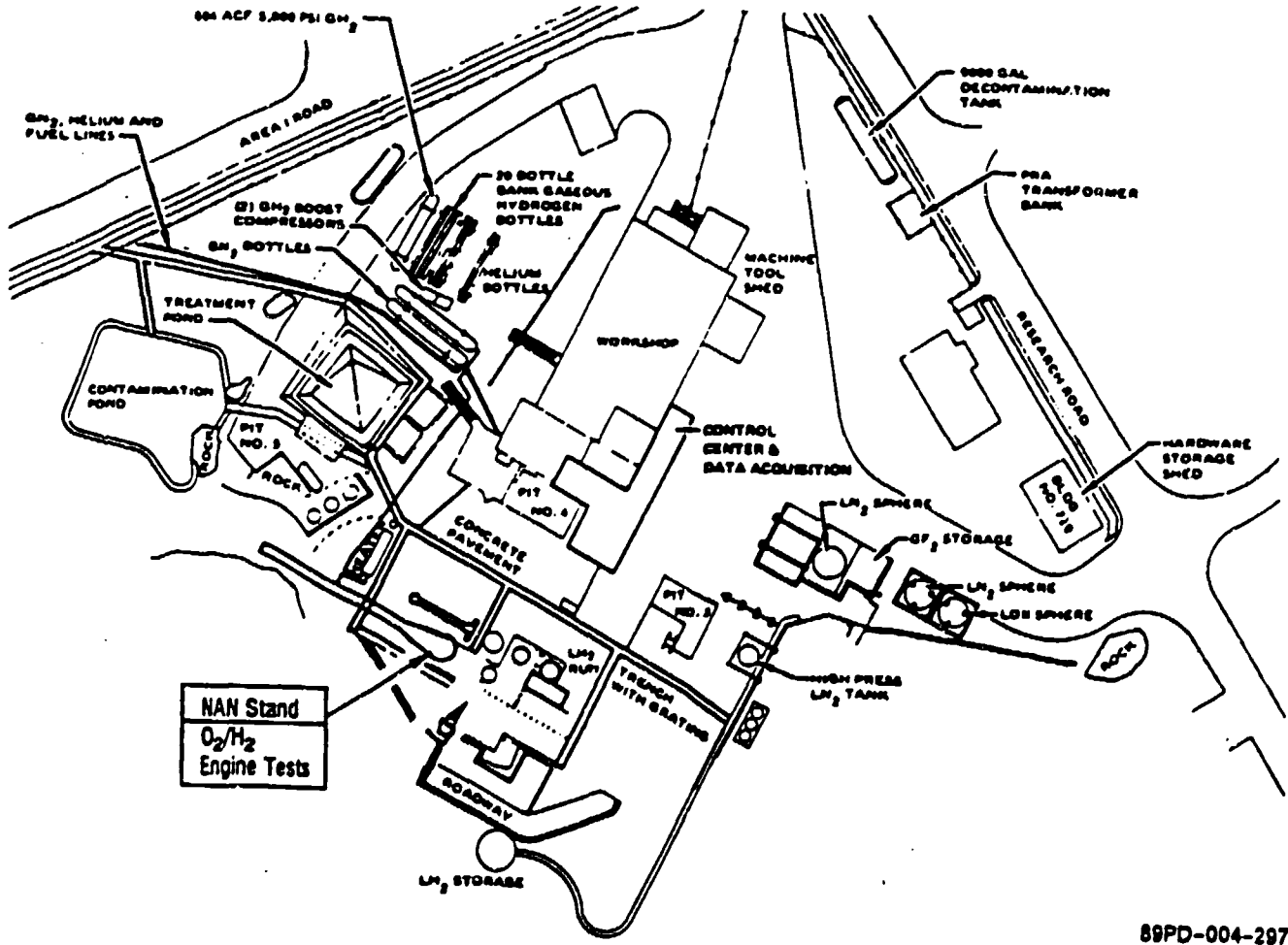

Figure 7-14 APTF OVERVIEW



89PD-004-297

CAPABILITY	DISTRIBUTION LINE DIAMETER (inch)	VOLUME STORED
3000 psig GN2	3	2 ea 470 ft ³ bottles
5500 psig GN2	3	1 ea 470 ft ³ bottles
5000 psig GHe	2	1 ea 250 ft ³ bottles
2500 psig GH2	3	20 ea 24 ft ³ bottles
5500 psig GH2	5	1 ea 604 ft ³ bottles
70 psig LO2	1.5	1 ea 10,000 gallon tank
50 psig LN2	1.5	2 ea 2,500 gallon tank
90 psig LH2	3	1 ea 15,000 gallon tank

Table 7-4 TEST AREA PROPELLANT DISTRIBUTION SYSTEM

Figure 7-15 NAN STAND ICE TEST FACILITY SCHEMATIC

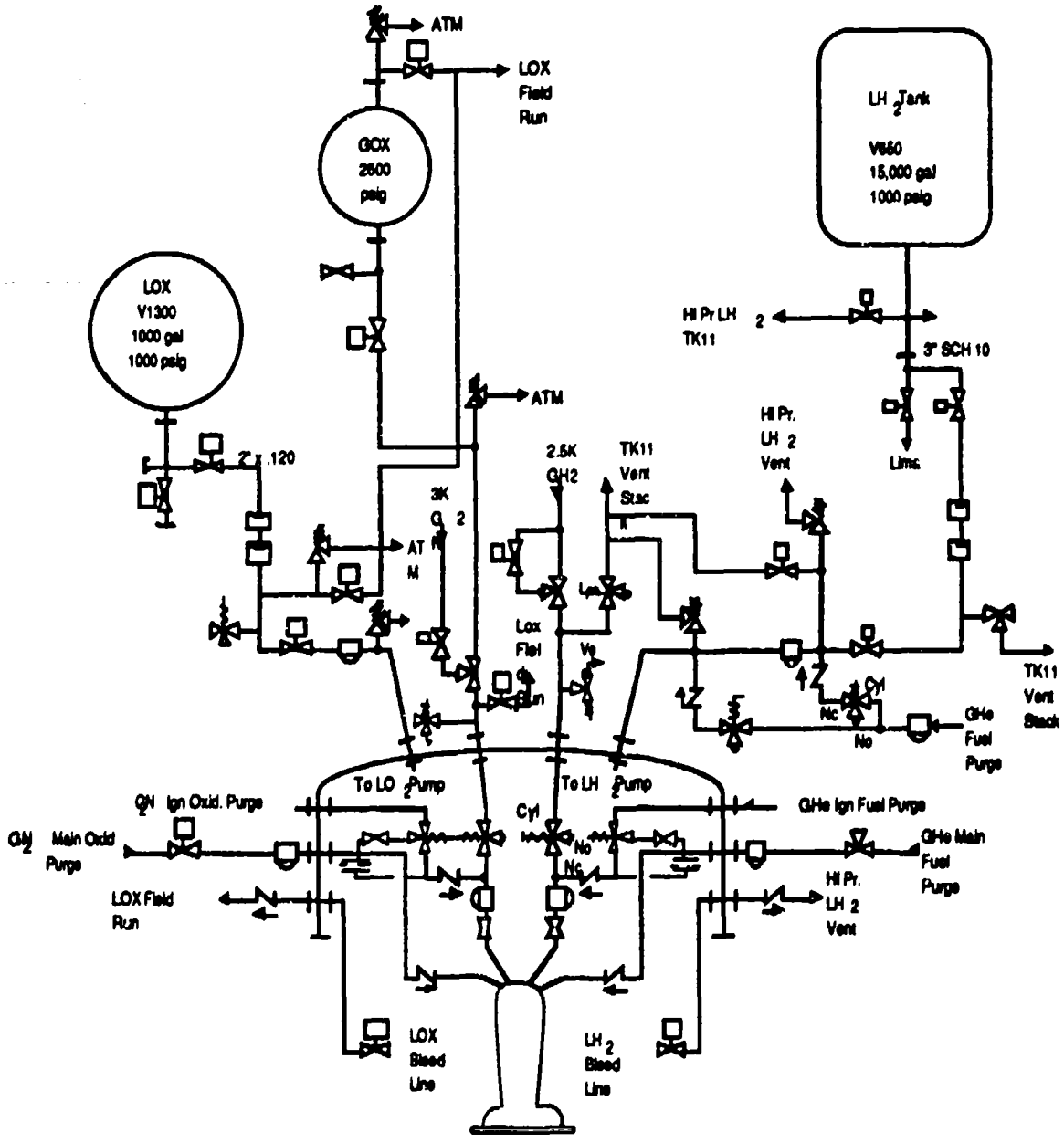

7.2.1.1 High Pressure Fuel Turbopump Systems Liquid hydrogen was delivered to the inlet of the HPFTP from a 15,000 gallon 100 psig run tank at a nominal pressure of 90 psig. Several bleed and vents systems were required to adequately chill the facility and turbopump hardware. During initial pump tests, increases in the inlet temperature during run tank pressurization precluded the start of the automatic test sequence. A constant flow bleed was added at fuel pump inlet to reduce temperature variations just prior to engine start. The overboard bleed allowed additional flow through the supply lines which maintained a lower and more consistent fluid temperature. In addition, the engine fuel bleed, located at the inlet to the main fuel valve, was sequenced to remain open until ignition was verified, to maintain flow during the start period.

Two LH₂ drain systems were included for the MK49-F turbopump which under normal engine configurations would not be required. The first was the fuel pump volute case vent. This system was required because an internal static seal leak between the volute and the second crossover was creating a higher than normal pressure in the pump volute cavity. This problem was found during the turbopump tests. The vent was a lower cost expedient to replacing the seal. The volute case vent included an orifice which was instrumented to calculate the internal seal leakage and assess the turbopump performance loss. This valve was signaled open just prior to sequence start operation.

The second overboard system was the fuel pump turbine bearing drain. To minimize potential interactions between the turbopumps during this development phase, a drain line was used to simulate the HPOTP rear bearing flowpath. An instrumented "orifice cascade" was used to simulate this flowpath. This line on the RS-44 engine system would be routed from the fuel turbopump to the turbine end or rear bearing on the high pressure oxidizer turbopump.

7.2.1.2 High Pressure Oxidizer Turbopump Systems Liquid oxygen was supplied to the HPOTP inlet on the MK49-O turbopump from a 1000 gallon run tank at a nominal inlet pressure of 160 psig. A facility bleed was used just upstream of the engine main oxidizer valve to allow chilling the HPOTP. Also plumbed to the inlet of the HPOTP was a low pressure, low flow gaseous nitrogen "trickle" purge, which was used to maintain an inert gas positive pressure within the turbopump during static conditions to prevent the entry of water. Similar to the HPFTP, modifications to the system were made to improve reliability of the hardware and reduce risk to the engine system. The HPOTP balance piston flow was drained overboard to lower the sump pressure and improve the steady-state axial thrust range. The flow was controlled by an orifice which was used to simulate the balance piston return passage

flow resistance. All overboard LOX flows were manifolded and vented to a common area.

To simulate the rear bearing coolant normally routed from the HPFTP, chilled gaseous hydrogen from a facility chiller system was provided. Room temperature gaseous hydrogen at 250 psig and 0.005 lbm/sec was passed through a temperature controlled LN2 chiller using liquid nitrogen to lower the gas temperature from 60°F to approximately -270°F. The coolant flowed through the bearing pair and past the first sealing element into the cavity formed by a two-element floating ring seal where it mixed with the turbine gas from the second sealing element and was routed overboard to a facility flare stack.

As mentioned earlier, propellant separation within the HPOTP is of critical importance. This was accomplished using a constant gaseous helium purge through the intermediate seal. The GHe flow splits within the seal and combines on the pump side with LOX in the LOX primary seal drain cavity and on the turbine side with GH₂ in the secondary turbine seal cavity. Turbine exit gaseous hydrogen leaks through the seal and is drained from the primary turbine seal cavity. Each turbopump drain was routed through individual systems to the common vent area.

7.2.1.3 Engine Ignition Systems The main combustor ignition was accomplished with a spark/torch electrical igniter system using GH₂ and GOX. The igniter fuel inlet was supplied with room temperature GH₂ regulated to 2220 psig upstream of the venturi. The flowrate was controlled and measured using a sonic venturi located between the Igniter Fuel Valve and the Igniter body.

The igniter oxidizer inlet was supplied with room temperature GOX regulated to 2250 psig from K-bottles. The flowrate was controlled and measured using a sonic venturi between the Igniter Oxidizer Valve and the igniter body.

7.2.1.4 Engine System Purges The ICE required a variety of purge systems to safely operate over all static and test conditions. The purge systems can also be separated into three categories. Pre-Test, Test, and Post-Test systems. A simplified schematic of these purge systems is shown in **Figure 7-16**.

The pre-test purges were used to produce and maintain an inert atmosphere within the test hardware between test days. These low pressure and flow purges were maintained at a level greater than 5 psig of the surrounding atmospheric pressure to prevent condensation within the systems.

Figure 7-16 RS-44 ICE PURGE SYSTEM SCHEMATIC

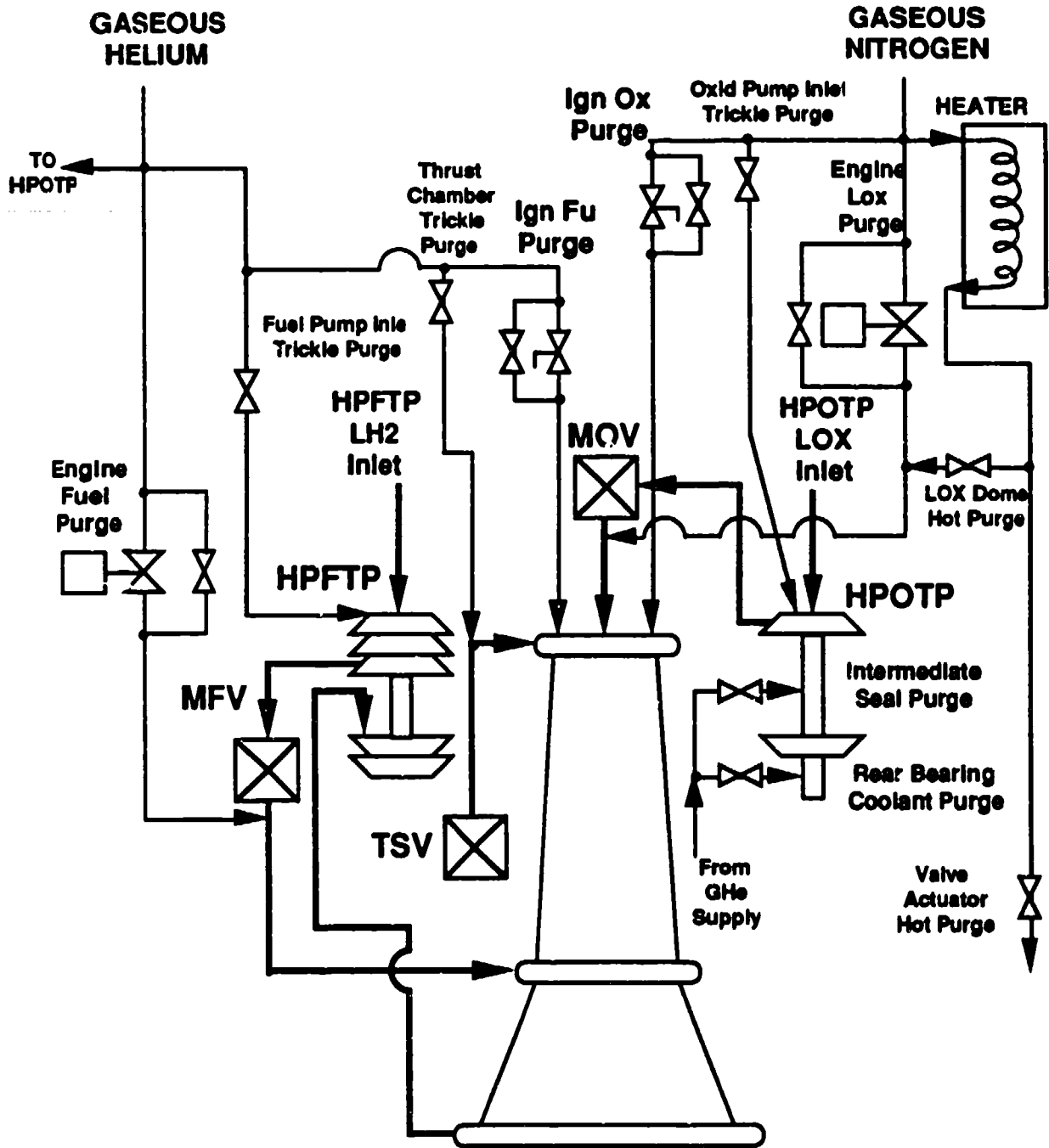

Test purges were those required during the actual engine test sequences and included the Engine LOX purge, Engine Fuel purge, Igniter GOX purge, Igniter GH₂ purge, Valve Actuator Hot GN₂ purge, and the oxidizer pump intermediate seal purges. The main engine and ignition purges cleared the engine flowpaths of propellants at cutoff. Purge pressure settings were established to prevent temperature spikes by maintaining a fuel rich combustion in the chamber until flame suppression.

Post-Test purges were set to accomplish the same tasks as the pre-test systems. Table 7-5 presents a summary of the purges employed during the ICE testing

7.2.2 Facility Electrical & Control Systems

The test sequence was controlled using the Test Control (TCON) program. TCON controlled input to the engine valves for valve timing. Actual % open and response rates (ramp times) were controlled by a closed loop position controlled servo-system. The valves were hydraulically actuated based on the command and error signals. Four engine valves, the MFV, MOV, TBV, and the OTBV, and one facility valve, the fuel tank pressurization valve, were all operated from the facility controllers.

7.3 DATA, INSTRUMENTATION AND MEASUREMENT SYSTEMS

7.3.1 Facility Data Acquisition System and Control Functions

The data acquisition system and control functions of the APTF test facility was used in place of a flight-type control and measurement system. The digital data acquisition system (DDAS), a 128 channel Data General DDAS provides simultaneous data acquisition and test control functions. It consists of three basic interfacing subsystems Data General S/140 CPU, an input/output (I/O) subsystem, and a Neff 620100 amplifier/channel multiplexer. This system provided adequate capacity for the test control and instrumentation activities of this engine test program.

The DDAS was operated at a sampling rate of 50,000 measurements per second. The analog output of each of 16 amplifiers was available to drive strip chart recorders and oscillographs. The digital data was recorded on magnetic tape for off-line data reduction.

Table 7-5 INTEGRATED COMPONENT EVALUATOR PURGE SYSTEMS AND REQUIREMENTS

PURGE SYSTEMS	FLUID	PRESSURE (psig)	CONTROL REQTS	TYPE
Engine LOX Purge	GN ₂	125	Remote/Sequenced	Test
LOX Dome Hot Purge	GN ₂	15	Manual	Post
LOX Dome Trickle Purge	GN ₂	5	Manual	Pre/Post
Igniter Oxidizer Purge	GN ₂	1250	Remote/Sequenced	Test
Igniter Oxidizer Trickle Prg	GN ₂	5	Manual	Pre/Post
HPOTP Inerting Purge	GN ₂	10	Manual	Pre
Valve Actuator Hot Purge	GN ₂	5	Manual	Test
HPOTP Intermediate Seal Prg	GHe	125	Manual	Test
Engine Fuel Purge	GHe	60	Remote/Sequenced	Test
Fuel Injector Trickle Purge	GHe	5	Manual	Pre/Post
Thrust Chamber Inerting Prg	GHe	10	Manual	Pre/Post
HPOTP Rear Brg Coolant Prg	GHe	10	Remote & Manual	Pre/Post
HPFTP Inerting Purge	GHe	10	Manual	Pre
Igniter Fuel Purge	GHe	800	Remote/Sequenced	Test
Igniter Fuel Trickle Purge	GHe	5	Manual	Pre/Post

The test control program was loaded and executed in the Data General S/140 CPU. All data acquisition, control, and redline limit comparisons were controlled by the CPU. The Neff multiplexer continuously scanned the 128 analog channels and performed the analog-to-digital conversion, then serially input the signals into the CPU. The CPU then performed a comparison check against the established redline limits in the test control program.

Actual sequencing and valve control was provided by the basic I/O subsystem. Valve commands in the control, or redline cuts, were fed to the I/O subsystem which converted the commands to control signals. The control signal completed the ground circuit for specific relays and provided valve actuation and other facility interface functions.

7.3.2 Engine System Instrumentation

During the preparation of the test plan, a comprehensive evaluation was made to include all necessary instrumentation to adequately determine the performance characteristics of the Advanced Expander Cycle RS-44 Integrated Component Evaluator. The requirements were then transmitted to the Test Facility (APTF) where the overall system was incorporated. For the pressure measurements, all low frequency parameters were measured using strain-gage-type transducers manufactured to the current Rocketdyne specifications. Both platinum resistance sensors and thermocouples were used for the temperature measurements. To measure liquid flowrates, turbine type flowmeters were used. For measurements of gas flows, critical and subcritical flow venturies or well rounded approach orifices were used. High frequency response measurements in the range of 0 to 20,000 Hertz generally were used for acceleration, dynamic position, and speed parameters. These measurements were recorded on FM magnetic tape and on direct-print oscillographs. The magnetic tape was subsequently processed in the Analog Laboratory at the Canoga Park main facility. All parameters were identified by a unique PID (Parameter Identification) number and are listed in Table 7-6 (4-sheets). Specific locations of the turbomachinery instrumentation is depicted in Figure 7-17 and Figure 7-18 for the MK49-F and MK49-O turbopumps, respectively.

Videotape coverage, Fastax high speed film, and still photography were utilized to visually document the testing. A closed circuit television system was also used which allowed additional views of the hardware for direct test observation and playback mode for trouble-shooting.

Table 7-6 RS-44 ICE INSTRUMENTATION LIST

PID #	PARAMETER	TXDCR RANGE	UNITS	Digital or FM Tape	NO TEST	TXDCR TYPE
112	OX PUMP IN T	-300	°F	Digital		RTB
113	OP PRI SEAL T	-300	°F	Digital		RTB
114	OP DISCH T	-300	°F	Digital		RTB
115	OP BP DRN T	-300	°F	Digital		RTB
116	LOX F/M TEMP	-300	°F	Digital		RTB
117	LOX TK TEMP	-300	°F	Digital		RTB
118	LOX LINE TEMP	-300	°F	Digital		RTB
120	FP VOL VNT DR T	-423	°F	Digital	X	RTB
121	OP BRG DRN T	-300	°F	Digital		RTB
122	LH2 F/M TEMP	-423	°F	Digital		RTB
124	FP INLET TEMP	-423	°F	Digital		RTB
126	FP DISCH T	-423	°F	Digital	X	RTB
127	OP RBRG IN T	-300	°F	Digital		RTB
128	LH2 PMP IN LINE	-423	°F	Digital		RTB
131	FTP ORIF CASC T	-423	°F	Digital		RTB
002	FT VNTURI IN T	-423	°F	Digital		"CA" T/C
003	COMB OUT TEMP	500	°F	Digital	X	"CA" T/C
004	OP ITSL TEMP	60	°F	Digital		"CA" T/C
005	LOX INJ DOME T	-300	°F	Digital	X	"CA" T/C
006	OT INLET TEMP	500	°F	Digital		"CA" T/C
007	FT INLET TEMP	500	°F	Digital		"CA" T/C
010	OT DSCH TMP	500	°F	Digital		"CA" T/C
011	FUEL INJ IN T	500	°F	Digital	X	"CA" T/C
012	IO VNTURI IN T	60	°F	Digital		"CA" T/C
013	IF VNTURI IN T	60	°F	Digital		"CA" T/C
017	FP SUMP T	-423	°F	Digital		"CA" T/C
018	IGN CHMBR #1 T	2000	°F	Digital	X	"CA" T/C
019	IGN CHMBR #2 T	2000	°F	Digital	X	"CA" T/C
020	IGN CHMBR #3 T	2000	°F	Digital	X	"CA" T/C
021	FP #8 SKIN T	-423	°F	Digital		"CA" T/C
024	MOV ACTU T	-200	°F	Digital	X	"CA" T/C
025	MFV ACTU T	-200	°F	Digital	X	"CA" T/C
035	IGN GOX REG PR	3000	psig	Digital		Taber
037	IGN GH2 REG PR	3000	psig	Digital		Taber
038	LOX LINE PR	200	psig	Digital		Taber
039	LH2 LINE PR	200	psig	Digital		Taber
036	IO PURG REG PR	2000	psig	Digital		Taber
041	IF PURG REG PR	1000	psig	Digital		Taber
042	DOME PURG RG P	2000	psig	Digital		Taber
044	OP BRG ORF PR	3000	psig	Digital		Taber

Table 7-6
(CONT'D)
RS-44 ICE INSTRUMENTATION LIST

PID #	PARAMETER	TXDCR RANGE	UNITS	Digital or FM Tape	NO TEST	TXDCR TYPE
045	OP ITSL DS PR	500	psig	Digital		Taber
046	OP ITSL IN PR	200	psig	Digital		Taber
047	FP VL VNT ORF P	2000	psig	Digital	X	Taber
048	OP BP ORF DS PR	1000	psig	Digital		Taber
050	IGN PC PR	2000	psig	Digital		Taber
052	FT VNTURI DP	30	psig	Digital		Taber
053	FP CASCADE PR	5000	psig	Digital	X	Taber
054	IF VNTURI IN PR	3000	psig	Digital	X	Taber
055	IO VNTURI IN PR	3000	psig	Digital	X	Taber
858	PIT 1 HYD PR	1000	psig	Digital		Taber
860	LH2 TK PR V650	200	psig	Digital		Taber
861	LOX TK PRV1300	1000	psig	Digital		Taber
110	V650 DMCTR PR	200	psig	Digital		Taber
034	F INJ PURG RG P	100	psig	Digital		Taber
061	FP INLET PRESS	100	psig	Digital		Taber
062	FP IND DISCH P	200	psig	Digital	X	Taber
063	FP 1S XOVR2IN PR	2000	psig	Digital	X	Taber
064	TBV OUT PR	2000	psig	Digital		Taber
065	LPFT OUT PR	2000	psig	Digital		Taber
066	LOX INJ PURG PR	2000	psig	Digital	X	Taber
067	CHAMBER PR 1	2000	psig	Digital		Taber
068	CHAMBER PR 2	2000	psig	Digital		Taber
069	FP BPST CAV PR	5000	psig	Digital		Taber
070	OP IMP DSCH PR	3000	psig	Digital		Taber
071	FP DSCH PRESS	5000	psig	Digital		Taber
072	FP BPST SMP PR	5000	psig	Digital		Taber
073	FT INLET PRESS	5000	psig	Digital	X	Taber
074	OP INLET PRESS	200	psig	Digital		Taber
075	FP1SXOV2OUTPR	2000	psig	Digital	X	Taber
076	SPECTRO 1 PR	1000	psig	Digital		Taber
077	FT VNTRI IN PR	5000	psig	Digital		Taber
078	OP DISCH PRESS	3000	psig	Digital		Taber
079	OP BPCAV 1 PR	2000	psig	Digital		Taber
080	FP 1SXOV IN PR	2000	psig	Digital	X	Taber
081	COMB OUT PR	5000	psig	Digital	X	Taber
082	FP1SXOV OUT PR	2000	psig	Digital	X	Taber
083	OP BPSUMP PR	2000	psig	Digital	X	Taber
085	FP2XOVRTRANPR	3000	psig	Digital	X	Taber
086	OP SEC HGSL PR	50	psig	Digital		Taber
087	OP ITSL US PR	1000	psig	Digital		Taber
088	OP PRI SEAL PR	50	psig	Digital		Taber
089	OT INLET PR	2000	psig	Digital	X	Taber
090	OP RBRG US PR	500	psig	Digital		Taber

Table 7
(CONT)
RS-44 ICE INSTRUMENTATION LIST

PID #	PARAMETER	TXDCR RANGE	UNITS	Digital or FM Tape	NO TEST	TXDCR TYPE
091	FP2SXOVR IN PR	3000	psig	Digital	X	Taber
092	LOX INJ DOME PR	2000	psig	Digital	X	Taber
094	2K HYDR PR	3000	psig	Digital		Taber
095	FUEL INJ IN PR	2000	psig	Digital	X	Taber
096	OP RBRG DS PR	500	psig	Digital		Taber
097	OP BP ORF US PR	1000	psig	Digital		Taber
098	OTBV OUT PR	5000	psig	Digital		Taber
099	OTBV IN PR	3000	psig	Digital		Taber
100	OT DSCH PR	2000	psig	Digital		Taber
051	FP VOL CASE PR	2000	psig	Digital		Taber
084	FP IND IN PR	100	psig	Digital		Taber
043	ATMOSPH PR	15	psia	Digital		Taber
811	XDUCER PWR 6V	5	Volts	Digital		Direct
824	FP SPEED 1	110,000	rpm	Dig,FM	X	Bently
812	FP SPEED 2	110,000	rpm	Dig,FM	X	Bently
825	OP SPEED 1	60,000	rpm	Dig,FM	X	Bently
819	TBV POSITION	100	% Open	Dig,FM	X	LVDT
820	OTBV POSITION	100	% Open	Dig,FM	X	LVDT
813	TSV POSITION	100	% Open	Dig,FM	X	LVDT
826	MFV POSITION	100	% Open	Dig,FM	X	LVDT
827	MOV POSITION	100	% Open	Dig,FM	X	LVDT
817	MFV CURRENT	.004	amps	Dig,FM	X	Direct
818	MOV CURRENT	.004	amps	Dig,FM	X	Direct
831	TBV CURENT	.004	amps	Dig,FM		Direct
832	OTBV CURRENT	.004	amps	Dig,FM		Direct
103	LH2 F/M 1	500	gpm	Digital	X	Trb F/M
104	LH2 F/M 2	500	gpm	Digital	X	Trb F/M
105	LOX F/M 1	200	gpm	Digital	X	Trb F/M
106	LOX F/M 2	200	gpm	Digital	X	Trb F/M

Table 7-6
(CONT'D)
RS-44 ICE INSTRUMENTATION LIST

PID #	PARAMETER	TXDCR RANGE	UNITS	DIGITAL OR FM TAPE	NO TEST	TXDCR TYPE
HF1	LOX DOME DYN PR	3000	psig	FM		Kistler
HF2	FP RAD ACCEL 1	15	GRMS	FM	X	Endevco
HF3	FP RAD ACCEL 2	15	GRMS	FM	Any 2	Endevco
HF4	FP RAD ACCEL 3	15	GRMS	FM	Radial	Endevco
HF5	FP RAD ACCEL 4	15	GRMS	FM		Endevco
HF6	FP AX ACCEL 1	15	GRMS	FM		Endevco
HF7	OP RAD ACCEL 1	10	GRMS	FM	X	Endevco
HF8	OP RAD ACCEL 2	10	GRMS	FM	Any 2	Endevco
HF9	OP RAD ACCEL 3	10	GRMS	FM	Radial	Endevco
HF10	OP RAD ACCEL 4	10	GRMS	FM		Endevco
HF11	OP AX ACCEL 1	10	GRMS	FM		Endevco
HF12	MCC RAD X	1000	GPTP	FM	X	Endevco
HF13	MCC RAD Y	1000	GPTP	FM	X	Endevco
HF14	MCC Axial	1000	GPTP	FM	X	Endevco
HF15	FP RAD POS 1	0.060	inch	FM	X	Bently
HF16	FP RAD POS 2	0.060	inch	FM	X	Bently
HF17	FP RAD POS 3	0.060	inch	FM	X	Bently
HF18	OP RAD POS 1	0.020	inch	FM	X	Bently
HF19	OP RAD POS 2	0.020	inch	FM	X	Bently
HF20	OP RAD POS 3	0.020	inch	FM	X	Bently
HF21	OP AX POS 1	0.020	inch	FM	X	Bently

Figure 7-17 MK 49-F HIGH PRESSURE TURBOPUMP INSTRUMENTATION LOCATIONS

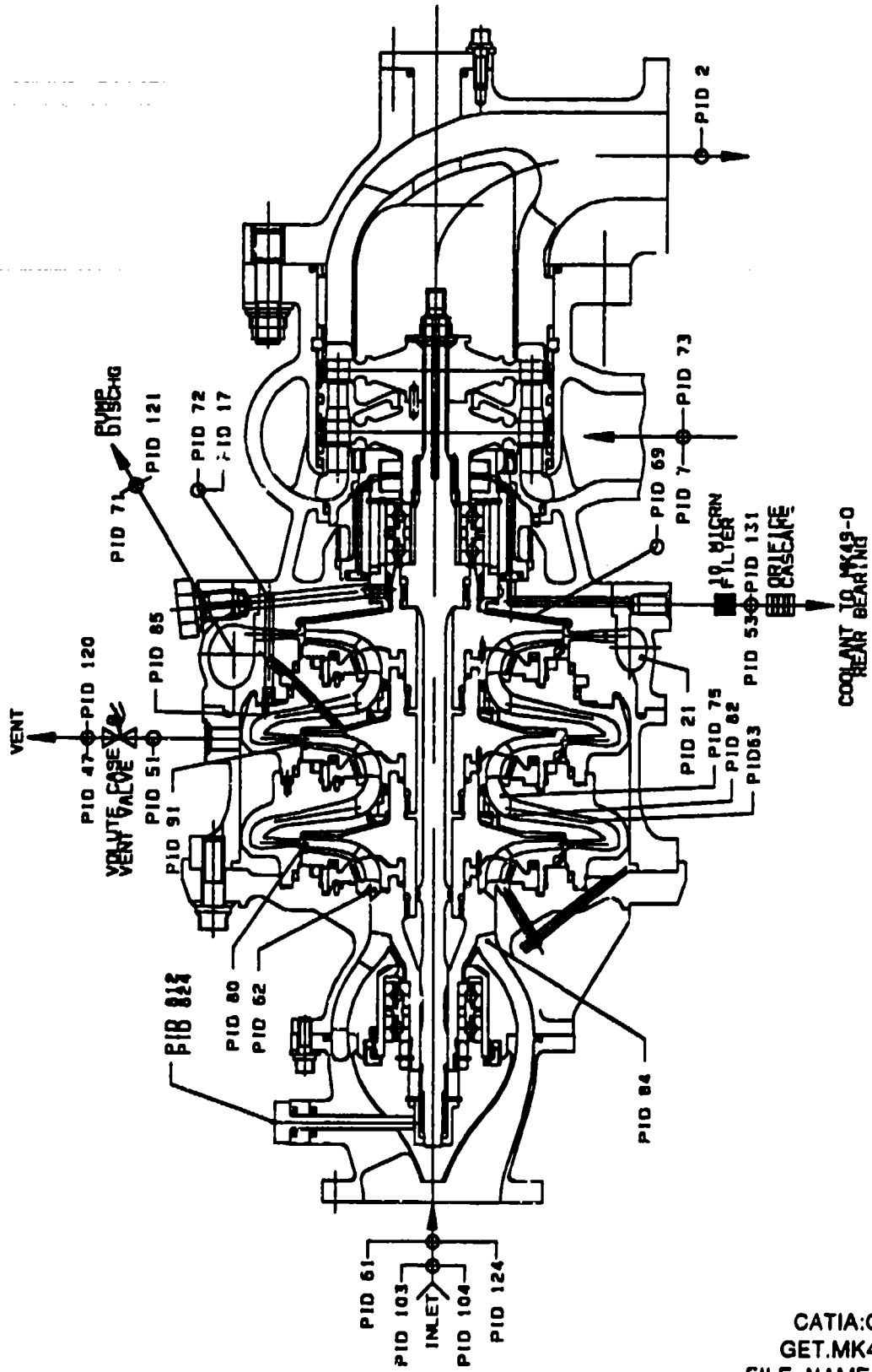

CATIA:CATROT
GET.MK49-F.L/O
FILE NAME:93-12-2

Figure 7-18 MK 49-O HIGH PRESSURE TURBOPUMP INSTRUMENTATION LOCATIONS

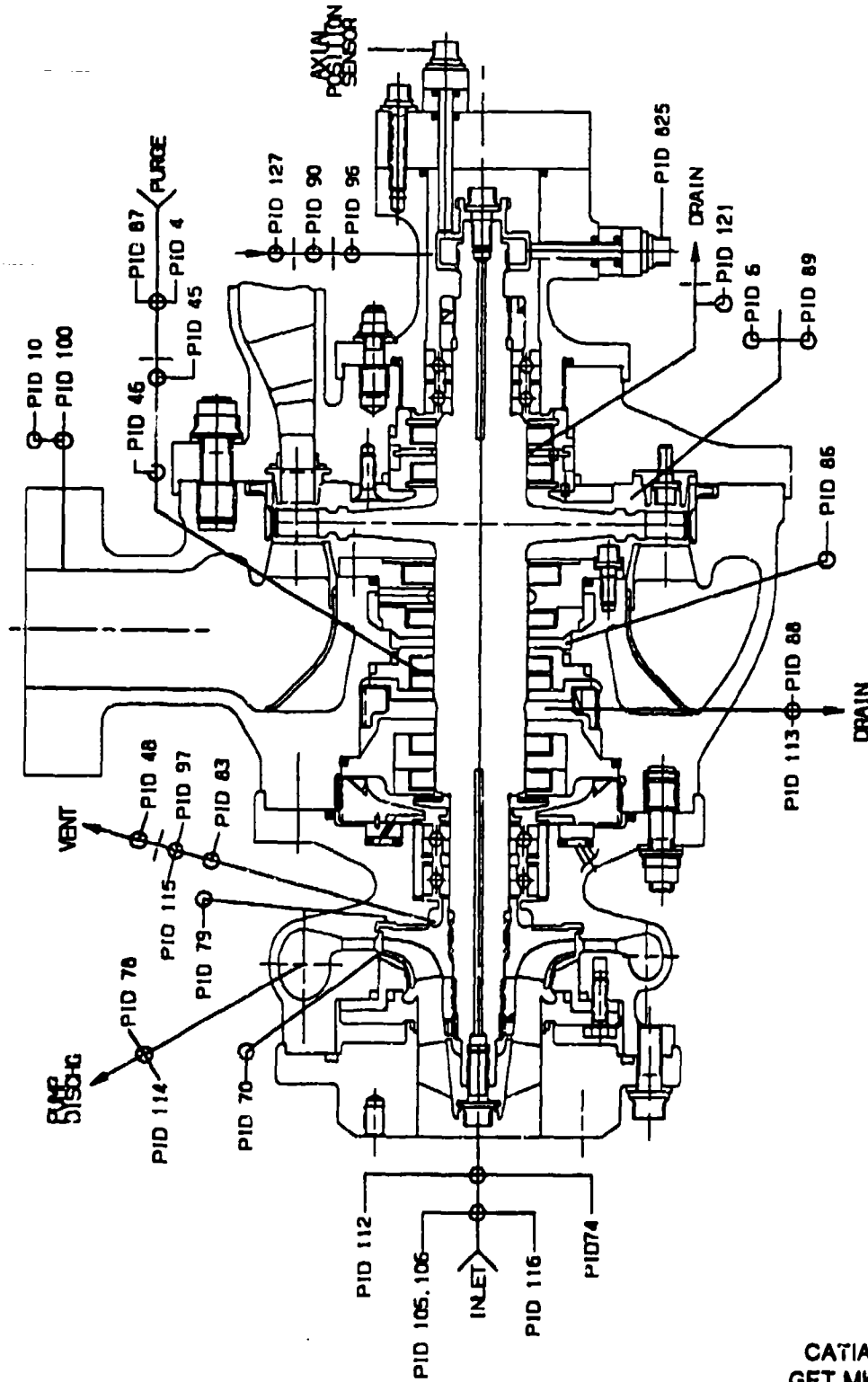

CATIA:CATROT
 GET.MK49-O.L/O
 FILE NAME:93-12-2

7.3.2.1 Start Ok Parameters The sequence of each test was controlled by a set of critical engine and facility parameters to assure the maximum probability of success and to guard against an unwanted condition which could lead to a catastrophic malfunction. The Start-OK parameters were determined largely by the engine system simulations and the limitations of the individual engine component operational requirements. Table 7-7 lists the RS-44 ICE Start-OK requirements along with the PID numbers, ranges, and particular units.

7.3.2.2 RS-44 ICE System Test Redlines In conjunction with the determination of the critical engine and facility Start OK limitations, the entire engine test system was reviewed to determine the maximum excursion of system parameters to assure for engine and facility safety. A set of redlines was established along with the specific arm time in which the redline was to take control. Table 7-8 presents the redline parameters used in the testing of the RS-44 ICE along with its PID, ranges, and specific arm times. All redlines that were used in the testing functioned extremely well with no malfunctions or incidents that caused hardware damage.

7.4 TEST MATRIX

The objective of the test program was to demonstrate by hot fire test, the advanced cycle and component technologies required for the RS-44 Advanced Expander Cycle Engine for cryogenic Orbit Transfer Vehicle applications. A series of tests were planned to 1) demonstrate the combined operation and interaction of all major advanced expander cycle engine components; 2) to determine the operating characteristics of the injector, combustor and nozzle; and 3) to expand the data base of the MK49 turbopumps. These objectives were to be achieved through a series of incremental start transients and mainstage tests to identify the parameters required for a safe engine start and shutdown. Approximately six successful tests were deemed necessary to meet the objectives of the program. The RS-44 ICE (Integrated Component Evaluator) was installed into the NAN stand at the Rocketdyne Santa Susana Field Laboratory, Advanced Propulsion Test Facility in 1985. Turbomachinery checkout testing (19 tests) was accomplished during 1985, using the engine as a test hookup device with all propellants routed to overboard drains and burn stacks. This scheme permitted the installation of the entire engine system with little down time when converting from turbopump component testing to engine testing. Once the start sequence transients were determined from the turbopump transition data, an engine sub-system checkout methodology was employed to gradually transition into full engine test operations. Table 7-9 shows the intended test matrix starting with a blowdown of the system to determine individual oxygen and hydrogen actual system resistances and valve

Table 7-7 RS-44 ICE START OK REQUIREMENTS

PID No.	Parameter	Range Min.	Range Max.	Units
61	Fuel Pump Inlet PR	90	95	psig
124	Fuel Pump Inlet Temp	N/A	-411	°F
74	LOX Pump Inlet PR	150	N/A	psig
112	LOX Pump Inlet Temp	N/A	-280	°F
46	LOX Pump Intermediate Seal Purge PR	100	150	psig
127	LOX Pump Rear Bearing Temp	N/A	-260	°F
96	LOX Pump Rear Brg Coolant Supply PR	225	325	psig
37	IGN GH2 Reg PR	2120	2220	psig
35	IGN GOX Reg PR	2150	2350	psig
41	IGN GH2 Purge Reg PR	750	850	psig
36	IGN GOX Purge Reg PR	1200	1300	psig
42	LOX Dome C/O Purge Reg PR	95	150	psig
94	Hydraulic Pressure	1800	2010	psig
820	OTBV Position	98	Open	% Open

Table 7-8 RS-44 ICE REDLINE REQUIREMENTS

PID No.	Parameter	Units	RANGE		ARM TIME
			Min	Max	
94	Eng Valve Hydraulic PR	psig	1600	2025	S/S
74	OP Inlet PR	psig	76	N/A	S/S
78	OP Disch PR	psig	N/A	2500	S/S
46	OP ITSL IN PR	psig	60	N/A	S/S
88	OP PRI Seal PR	psig	N/A	35	S/S
86	OP SEC Seal HGSL PR	psig	N/A	35	S/S
96	OP RBRG DS PR	psig	200	500	S/S
61	FP Inlet PR	psig	70	N/A	S/S
71	FP DISCH PR	psig	N/A	3500	S/S
42	LOX Dome Purge Reg PR	psig	95	150	S/S
112	OP Inlet Temp	°F	N/A	-275	S/S
124	FP Inlet Temp	°F	N/A	-410	S/S
127	OP RBRG in Temp	°F	N/A	-230	S/S
117	V1300 LOX Tank Temp	°F	N/A	-273	S/S
122	LH2 F/M Temp	°F	N/A	-409	S/S
824, 812	FP Speed 1 or 2	RPM	N/A	94K	S/S
825	OP Speed 1	RPM	N/A	55K	S/S
- .	FP RAD Accel (3)*	GRMS	N/A	15	S/S
- .	OP RAD Accel (3)*	GRMS	N/A	10	S/S
- .	Comb Axial Accel	G PTP	N/A	1000	S/S
79	OP BP Cav 1 PR	psig	900	1400	OP Spd=35K
83	OP BP Sump PR	psig	N/A	700	OP Spd=35K
69	FP BP Cav PR	psig	1525	2600	FP Spd =84K
72	FP BP Sump PR	psig	1050	1900	FP Spd =84K
67, 68	Chamber PR 1 or 2	psig	250	N/A	T2 + 2.5 sec
50	IGN Pc	psig	120	N/A	T + 1.08 sec
826	MFV POS	%	20%	N/A	T2+0.30 sec
826	MFV POS	%	60%	N/A	T2+0.80 sec
826	MFV POS	%	90%	N/A	T2+1.15 sec
827	MOV POS	%	53%	63%	T2+3.20 sec

ARM TIME LEGEND

S/S - Sequence Start
T - Time from Spark Exciter On
T2 - Time from MFV Open Signal

Table 7-9 RS-44 ICE ENGINE PLANNED TEST MATRIX

TEST #	TEST OBJECTIVE	TEST DESCRIPTION	DURATION
1	LOX Dome Prime Time	Chill Turbopumps LOX system blowdown LOX dome purge (350 psi)	MOV start to Open + 3.5 seconds
2	Igniter Operation Fuel Injector Manifold Prime Time Nf=48,000 RPM No=38,000 RPM	Chill Turbopumps Operate Igniter Open MFV and TSV	MFV start to open + 2 seconds
3	Main Propellant Ignition Transient Operation Nf=60,000 RPM MR=4.5	Chill Turbopumps Operate Igniter Open MFV, MOV, TSV	MFV start to open + 2.1 seconds
4	Main Propellant Ignition Transient Operation Nf=86,000 RPM MR=4.5	Chill Turbopumps Operate Igniter Open MFV, MOV, TSV	MFV start to open + 3.1 seconds
5	Main Propellant Ignition Steady State Operation Nf=86,000 RPM MR=4.5	Chill Turbopumps Operate Igniter Open MFV, MOV, TSV	10 seconds
6	Main Propellant Ignition Steady State Operation Nf=86,000 RPM MR=5.2	Chill Turbopumps Operate Igniter Open MFV, MOV, TSV	10 seconds
7	Main Propellant Ignition Steady State Operation Nf=86,000 RPM MR=6.0	Chill Turbopumps Operate Igniter Open MFV, MOV, TSV	10 seconds

characteristics (first two test sequences) followed by a short transitions into main combustion chamber ignition and finally into mainstage operation. Thermal equilibrium of the engine system was calculated to occur at about 10-seconds run time. Therefore, to conserve engine operation time and lower propellant and test costs, the mainstage tests were set at the 10-seconds duration.

7.5 OPERATIONS

7.5.1 Test Procedures.

To safely conduct repeatable rocket engine system tests, detailed and comprehensive operating instructions were required. For each test day, a test request was presented by the development engineering team to the responsible test engineer. A test request review (TRR) meeting was subsequently held to review the contents of the document. Each meeting reviewed the test objective, desired approach, special pre- or post test tasks, and any hardware, sequence, facility, or instrumentation changes. Reviewed in detail were the valve control timing and ramp rates, as well as engine parameter redlines and "Start OK" conditions. The test request, in coordination with the program test plan, established all the necessary information to run the desired test. Technical approach changes and special pre-and post-test operations included in the TRR were added to the test procedures. All action items generated in the TRR were cleared before the start of the test. A matrix of written procedures were required for the facility and instrumentation systems to successfully complete preparation and test, as seen in Figure 7-19.

Most important of these procedures was the sequence verification simulation tests. This task was a mechanical, electrical, and pneumatic check of the facility systems to ensure test readiness. The sequence test procedure was much more than a verification of just a successful programmed duration test simulation. This procedure simulates every type of shutdown that would be possible. The major objective was to determine if all emergency and normal test termination systems were in working order. This effort verified a safe test shutdown for all conceivable test terminations, including loss of DDAS power failure, safe shutdown using the facilities battery back up power, redline cut offs, "Start OK" cut offs, and the observer emergency cut off. In addition, valve timing and ramp rates were verified against the test request requirements. Finally, the sequence test simulated a programmed duration test.

Figure 7-19 RS-44 ICE TEST PROCEDURE SEQUENCE

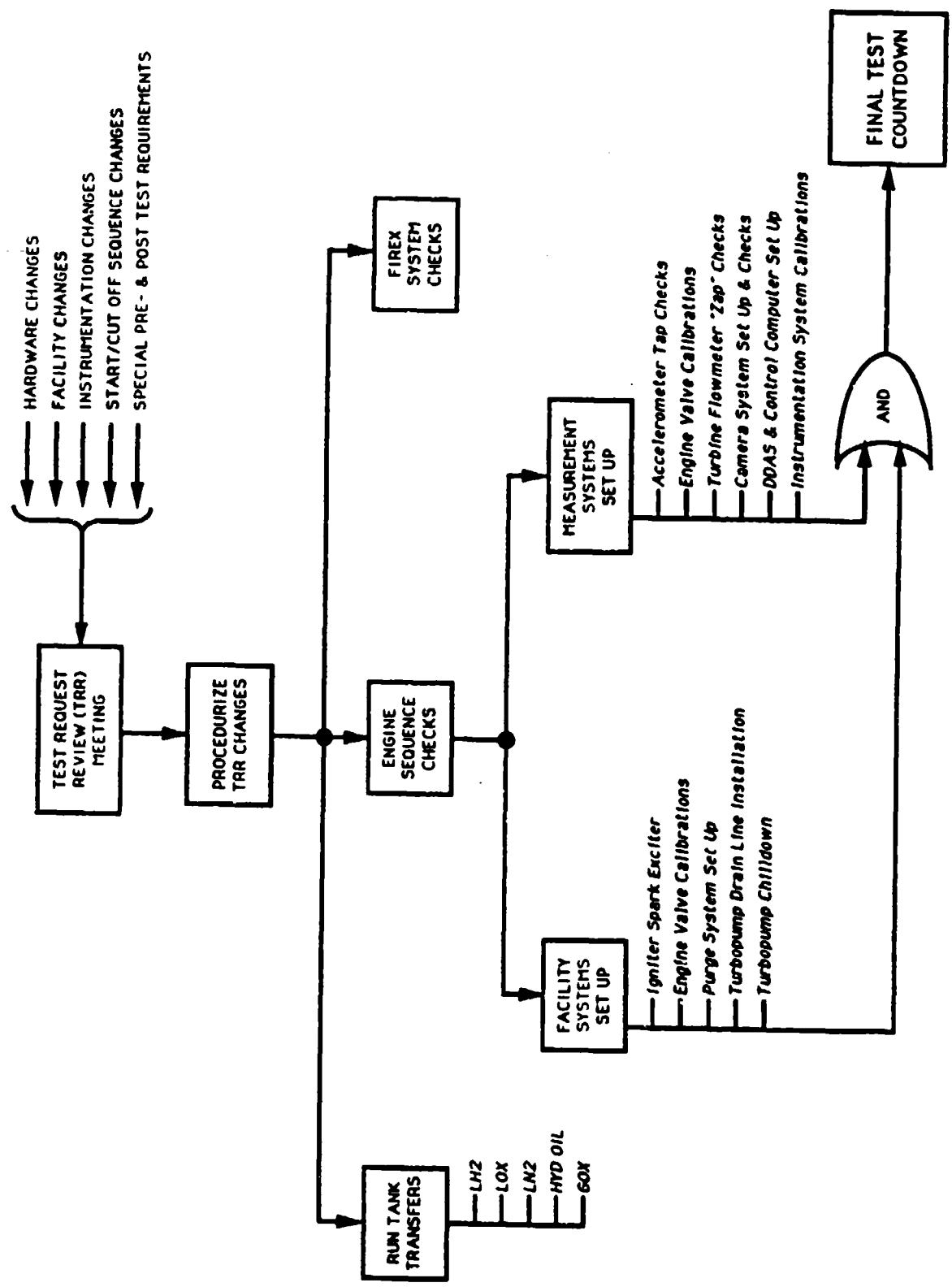

7.5.1.1 Pre-Test Hardware Activities Prior to any engine operation, many facility and engine propellant, electrical, control, and instrumentation systems must be activated, checked, and prepared for the planned test. Standardized facility set up procedures for the facility operations, instrumentation, and DDAS were followed to accomplish these pre-test operations. Special pre-test activities requested by the development team during the TRR were accomplished during the pre-test set up procedures.

The engine ignition system was visually verified before each test to provide confidence that the systems were fully operational on the test day. Before the igniter system was installed into the engine, a spark suppression test was run using gaseous nitrogen. The igniter system maintained a visual spark in the test apparatus to 200 psig. The spark exciter system was mounted in the facility and a highly insulated control cable was routed to the igniter.

In preparation for the ICE tests, propellant and hydraulic fluid systems were loaded and pressurant and pneumatic system pressures verified. Inerting purges were set to ensure a moisture and combustible mixture free atmosphere existed within the test article. A gaseous nitrogen inerting purge was used in the thrust chamber, injector, and HPOTP. Similarly, a gaseous helium purge was introduced into the HPFTP. Actually, these purges were activated as soon as the engine was installed in the test facility. However, prior to introducing propellants into the hardware, the purge pressures and purge valve positions were verified.

The HPOTP primary seal drain, primary hot gas seal drain, secondary hot gas seal drain, balance piston overboard drain, and the rear bearing coolant drain lines were not installed during static conditions. Likewise, the HPFTP rear bearing coolant drain line was disconnected. A throat plug was used within the nozzle to seal off the chamber. As a precaution, the throat plug and disconnected drain lines, in combination with the inerting purges, precluded condensation within the engine system between test days. On the test day and just prior to introducing propellants, the turbopump overboard drain lines were installed and the throat plug removed. The HPOTP GHe intermediate seal purge pressure was set at 20 psig to maintain LOX and GH₂ separation during turbopump chilldown.

7.5.1.2 Oxidizer Turbopump Chilldown Two systems were required to prepare the HPOTP LOX inlet and GH₂ rear bearing coolant. The pump end was chilled with LOX using approximately a 10 foot tank head or by pressurizing the tank to approximately 10 psig. Propellant was flowed through the turbopump and drained overboard through the Engine LOX Bleed valve located at the MOV inlet flange. Although never a serious problem, the Engine LOX

Bleed valve was cycled to control the HPOTP shaft speed. Speed limitations were used as follows: HPOTP Inlet Temperature $> -180^{\circ}\text{F}$ then 2500 rpm maximum, HPOTP Inlet Temperature $< -180^{\circ}\text{F}$ then 5000 rpm maximum. Once good quality LOX was passing through the turbopump, a very slow to zero shaft speed was observed. On average, approximately a half hour was required to chill the HPOTP.

The turbine end bearings were chilled using cold GH_2 . The LN_2 chiller, as described in the test facility section, cooled the GH_2 to approximately -265°F at 225 psig. No special bleeds or drain systems were required. Internal dynamic seal leakages were drained overboard through their normal test systems.

7.5.1.3 Fuel Turbopump Chillover Chilling the HPFTP was a very time consuming task due to three factors; the small turbopump flow area, a relatively long run of non vacuum jacketed feed line, and the high induced shaft speeds. Performed in parallel with the HPOTP chill, liquid hydrogen at 30 to 40 psig was transferred from the run tank to the inlet of the HPFTP, out the pump discharge, and drained through the Engine Fuel Bleed valve. A bleed valve was also utilized at the inlet of the HPFTP. Because of the unjacketed feed line and the small HPFTP flow areas, the run tank had to be pressurized to obtain a reasonable chill rate. However, the flow consistent with this higher pressure (60 gpm liquid) induced shaft rotation. Shaft speeds to 10,000 rpm were measured when the fluid quality included some gas. To control the shaft speed, the inlet bleed valve was held open (once the facility lines were chilled) and the HPFTP discharge bleed valve was cycled open and closed. Once good quality LH_2 was flowing through the turbopump, the shaft speed settled down to approximately 6000 rpm. A 10,000 rpm limit was imposed if pump discharge temperature was less than -300°F and 5,000 rpm if the temperature was greater. For chillover indication purposes, a thermocouple was bonded to the HPFTP (FP Skin Temp#8 - PID 021) and was used to evaluate progress. The "skin" temperature output was correlated with the fuel pump discharge temperature to verify near steady-state thermal conditions existed. The chillover process was recorded during each test days initial chillover. Facility and engine interface system leaks were inspected using a combustible gas analyzer. The technicians wore aluminized flame suits to conduct this operation. Small leaks were repaired in place, while larger leaks terminated the chillover for repair. Small, irreparable leaks were dispersed using GN_2 blanket purges.

No chilling beyond the MFV was conducted on the engine. However, leakage past the HPFTP turbine floating ring seals was expected. Because of this, the Turbine Shut Off Valve was required just upstream of the fuel injector manifold to prevent leakage into the injector and

thrust chamber. In a flight engine configuration, a no-flow dynamic shaft seal system (during chill only) would be included in the HPFTP to preclude this leakage. Consequently, the TSV would not be required in the flight engine system.

After completing the turbopump conditioning, the intermediate seal purge pressure was increased to 125 psig for test. Final system verifications were subsequently completed, including setting all purge valve positions to their test conditions and lighting the nozzle afterburner. Due to the fuel lead sequence, an afterburner, located near the nozzle exit plane, was required to burn all free hydrogen that passed through the engine during the start and shutdown transients.

With the fuel and oxidizer inlet valves closed, the MFV, MOV, OTBV, and TBV were opened manually three times to verify their operation in the chilled condition. The valve exercises were conducted because of concerns that highly viscous or frozen hydraulic fluid in the actuators during start would cause sluggish valve responses. Hot GN₂ purges were directed toward the MFV and MOV actuators during chilldown to ensure that the hydraulic oil would not freeze. Electrically operated valves were designed for the flight version, however, higher costs precluded the development of these components.

7.5.1.4 Post-Test Hardware Activities Immediately following the engine system and test facility securing, several operations were completed as listed below in Table 7-10.

Table 7-10 RS-44 ICE POST TEST ACTIVITIES

HARDWARE OPERATIONS	HARDWARE INSPECTIONS	DATA REVIEW
LOX Dome Hot GN ₂ Purge Aspirate Acoustic Cavities Disconnect HPOTP Drains Disconnect HPFTP Drain Initiate Inerting Purges	Torque HPFTP Rotor Torque HPOTP Rotor Conduct Spark Check Borescope Insp Injector Borescope Insp Throat Borescope Insp Nozzle	Generate Time Based Profiles Playback on O'scope & Spectrum Analyzer <ul style="list-style-type: none"> • Accelerometers • LOX Dome Inj Dyn Press • HPFTP Displacements • HPOTP Displacements Scaled Data Tables and Graphs

7.5.2 Engine Start Logic - Sequences

The RS-44 start sequence operation plans were developed based partly on the computer simulations, partly on past experience with the Advanced Space Engine development at APTF, and partly from the experience with the actual startup requirements from the Turbomachinery and Combustion Devices component testing. In the following sections, a process flow logic network was developed to define the start and cutoff sequences for the RS-44 engine. That network was transferred into the actual facility controls to achieve safe engine operations.

7.5.2.1 Engine Start Sequence The ICE engine start sequence was based on a system dynamic model simulation. Using specific turbopump, valve, injector, combustor, and nozzle performance characteristics, along with fluid properties and heat transfer, the model determined time-based profiles for all important parameters, such as chamber pressure, pump discharge pressures, and nozzle heat flux. Most importantly, initial main engine valve timing and ramp schedules were established. Figure 7-20 illustrates the initial valve position requirements for the MOV, MFV, OTBV, and TBV. For this test program, the OTBV was maintained at 100% open for testing at a mixture ratio = 5.

The valve position schedules were implemented into facility supplied electronic and computer control start sequence system. Ignition system sequences were also integrated into the facility control system.

7.5.2.2 Cut Off Sequences Using the same dynamic simulation model, the cut off transient sequence was also developed. This cut off sequence was designed for a redline, facility prep incomplete, or programmed duration shutdown. Using a fuel lag shutdown, a safe and repeatable sequence was demonstrated.

An emergency shutdown sequence was also available in the occurrence of a major failure. Although not used, the facility would control the fuel and oxidizer pump inlet valves closed and open the Engine Fuel and LOX bleeds. Under a normal shutdown these valves were maintained at their test positions until both turbopump shafts had come to a stop. Not until then did the test conductor secure the propellant supply systems.

7.5.3 Data Reduction Procedures

A data reduction program for the RS-44 ICE engine was required because of the large amount of

Figure 7-20 RS-44 ICE MAIN VALVE TIMING

MAIN FUEL VALVE

Time = T2 +0.00
 SP1 = 100%
 Rate = 100%/sec

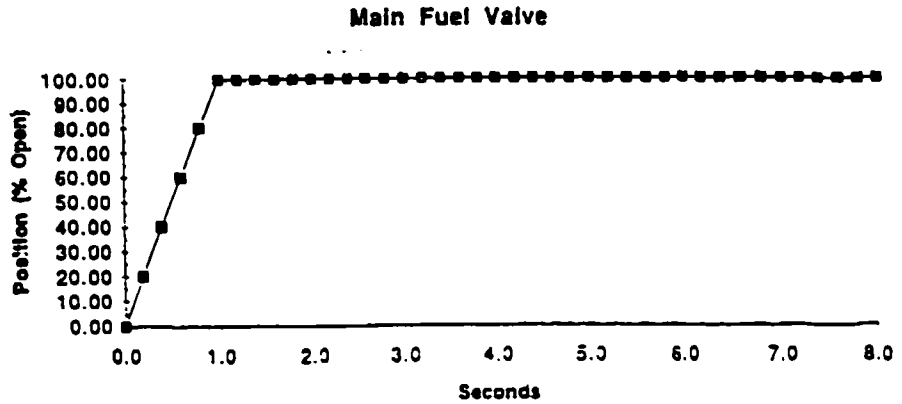

MAIN OXIDIZER VALVE

Time = T2 +0.40
 SP1 = 38%
 Rate = 100%/sec

Time = T2 +1.40
 SP2 = 53%
 Rate = 14.6%/sec

Time = T2 +2.43
 SP3 = 58%
 Rate = 6.3%/sec

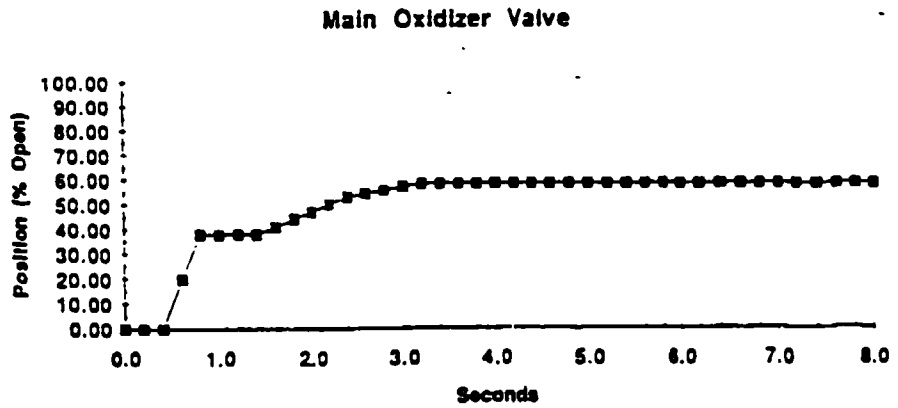

TURBINE BYPASS VALVE

Time = T +0.00
 SP1 = 60%
 Rate = 100%/sec

Time = T2 +2.17
 SP2 = 31%
 Rate = 200%/sec

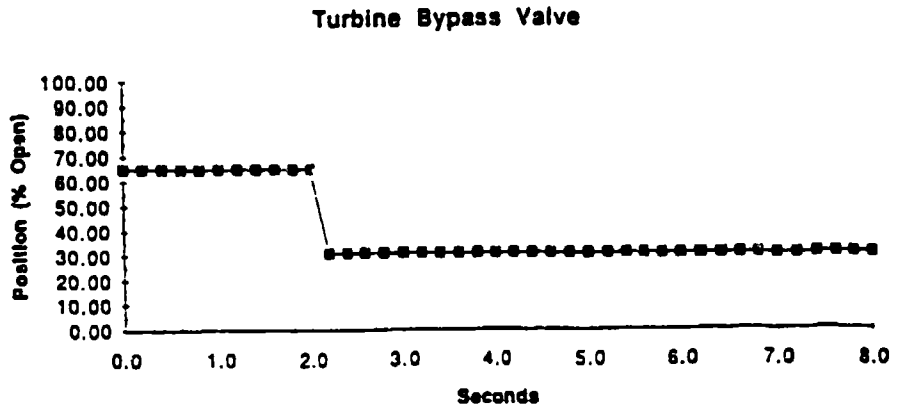

data reduction parameters required to assess the performance of components and engine . During the component testing of the MK49 turbopumps a limited amount of data reduction code was written in IBM X-basic language and consisted of balance piston performance, suction performance, and overall pump flow management systems calculations. Over nineteen separate flow calculations were necessary to define the flow splits with the two turbopump systems. For gas flows the Isentropic flow equations were used while for the liquid flows the fluid flow expression was used. The balance piston performance code was designed after the Advanced Space Engines' MK48 geometrical systems as the baseline. These codes were programmed into a single integrated program.

The program codes for the turbomachinery were then combined with the required engine performance data (injector, nozzle, and thrust chamber) and merged into one abbreviated overall engine data reduction code "ICETEST". The required input and output formats were transformed into a common spread sheet program using LOTUS 123 for a composite printout format. Initially for all computations the input parameters (pressure, temperature, raw flowmeter pulses, and the fluid properties at the various engine stations were hand input. This method was not only labor intensive but prone to input errors, with input-checkout a time consuming operation. The transformation and incorporation into the LOTUS spread sheet including other Fortran propellant state condition program codes permitted a quick post test review of the major engine and turbopump related parameters during testing at the APTF test stand. Data transfer between the facility DATA General System and the IBM-PC engineering work station computer at APTF was made possible by the use of the data communications program titled "BLAST." The logic network for the entire data reduction program and procedures is shown in Figure 7-21. Key data programs which were involved in the data reduction scheme were developed during the Rocketdyne Company Funded activity and are listed below

ICETST	Original X-Basic data reduction code
ICETEST	X-BASIC overall engine data reduction code
ICE	Templet for overall data reduction (uses LOTUS ver 1A)
RUNO2	Oxygen state conditions program (Fortran)
RUNH2	Hydrogen state conditions program(Fortran)
READDATA*	Combined propellant state conditions and input (Fortran)

*NOTE Sub-routine "CALCS" includes code to calculate the propellant state conditions within specific areas of the engine.

Figure 7-21 RS-44 ICE DATA ACQUISITION AND REDUCTION LOGIC

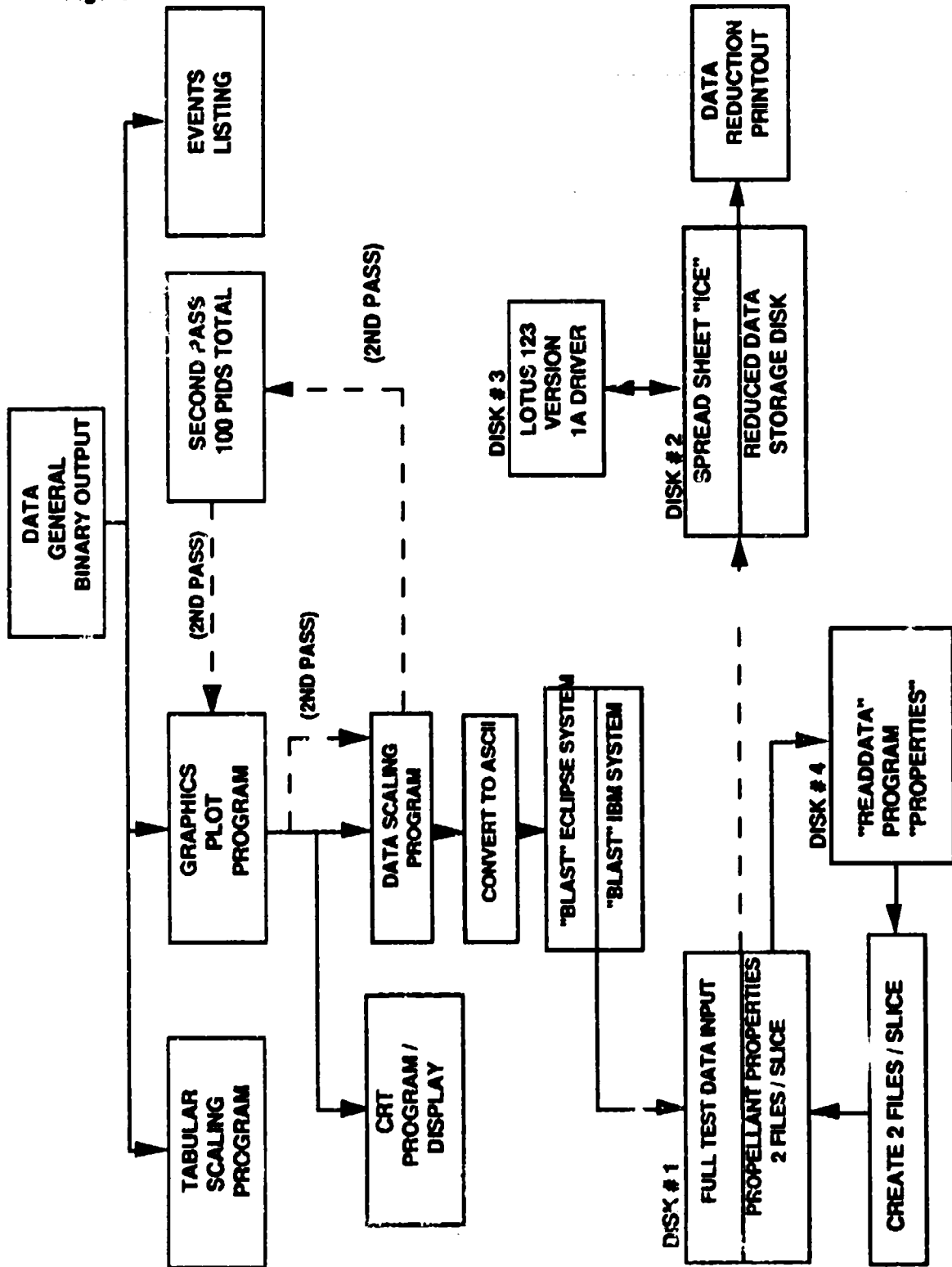

7.6 TEST SERIES RESULTS

A series of thirteen tests was conducted on the RS-44 Integrated Component Evaluator (ICE), seven of which were conducted in 1986 and six of which were conducted during the month of January 1987. Figure 7-22 and 7-23 shows the RS-44 engine system as it was installed in NAN stand capsule ready for testing in the Advanced Propulsion Test Facility (APTF), depicting the fuel pump side and Lox pump side, respectively. Listed in Table 7-11 is a summary of the tests conducted with a short description of the results. The test identification number is a code which indicates the test number and year (i.e. 86-017-002 = 1986, NAN stand at APTF, the second test of the year). Following the summary table, a detailed discussion of the RS-44 ICE tests is presented.

Table 7-11 RS-44 ICE TESTING HISTORY

Test Ident.	Test Time, sec#	Objective	Result
86-017-001	n/a	LOX Dome Prime Time	Objectives Achieved.
86-017-002	7	Igniter operation / fuel injection manifold prime time	Igniter operation satisfactory, MFV failed to open
86-017-003	7	Igniter operation / fuel injection manifold prime time	Igniter operation satisfactory, MFV opened only to 25 %.
86-017-004	7	Igniter operation / fuel injection manifold prime time	Igniter operation satisfactory, MFV failed to open-electrical.
86-017-005	6.3	Igniter operation / fuel injection manifold prime time	Objectives Achieved.
86-017-006	5.2	Main chamber ignition characteristics	Objectives Achieved.
86-017-007	5.7	Operation of engine to 50 % power level.	Objectives Achieved.

Table 7-11 RS-44 ICE TESTING HISTORY (CONTINUED)

Test Ident.	Test Time, sec#	Objective	Result
87-017-001	1.08	Igniter operation / engine transition to mainstage	Redline cutoff due to low igniter chamber pressure
87-017-002	1.09	Igniter operation / engine transition to mainstage	Redline cutoff due to low igniter chamber pressure
87-017-003	5.21	Igniter operation / engine transition to mainstage	Redline cutoff due to low engine main chamber pressure, Igniter operation satisfactory
87-017-004	1.09	Igniter operation / engine transition to mainstage	Redline cutoff due to low igniter chamber pressure
87-017-005	5.91	Igniter operation / engine transition to mainstage	Objectives Achieved.
87-017-006	8.96	Engine Mainstage Operation MK49-F balance piston operation	Redline cut-low BP Cavity Pr . Seizure of fuel pump rotor at 87,400 RPM, ignition ok, transition stage satisfactory, mainstage operation achieved, all other objectives met.

Figure 7-22 RS-44 ENGINE INSTALLATION - NAN STAND (FUEL PUMP SIDE)

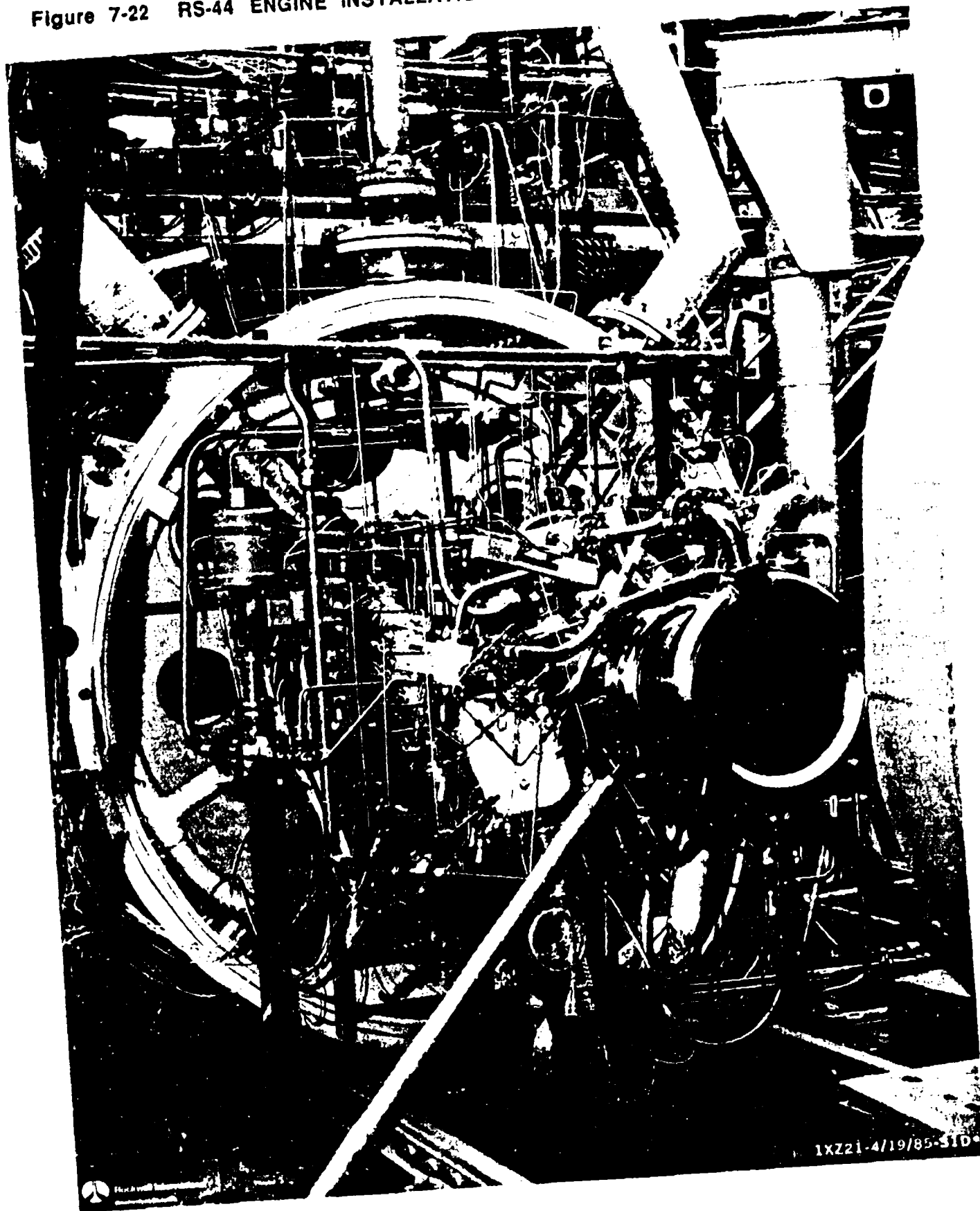

1XZ21-4/19/85-310

CR 194443

Figure 7-23 RS-44 ENGINE INSTALLATION - NAN STAND (LOX PUMP SIDE)

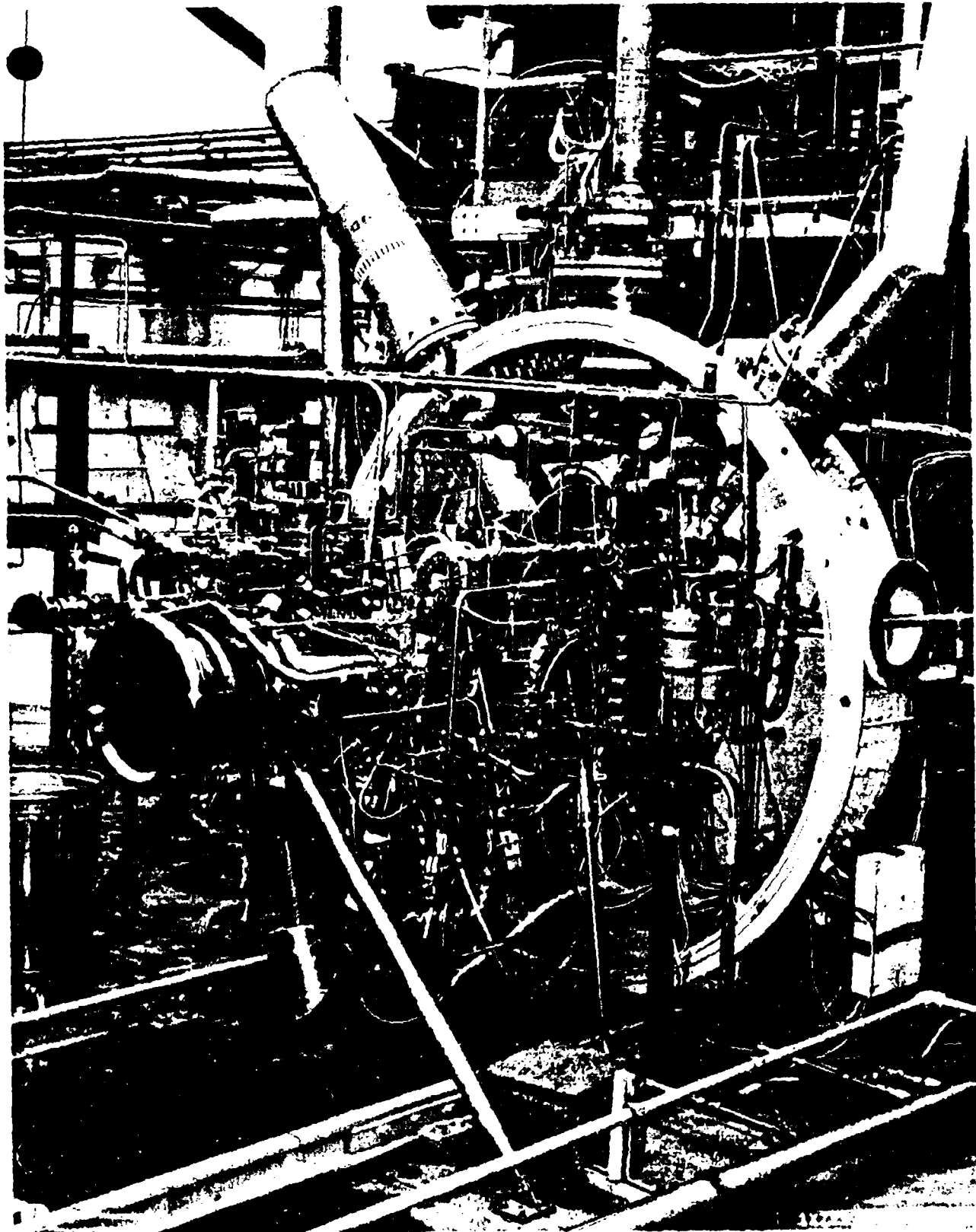

7.6.1 Test Series 1986 Results (86- 017-001 thru 86-017-007)

A series of seven blowdown and hot-firing tests were conducted between 4 and 17 April 1986. The tests consisted of flow tests of the oxidizer and fuel circuits, including in-place multiposition calibrations of the main propellant valves, igniter verification tests, combustor ignition demonstrations, and engine start transients to approximately half of the nominal thrust level. The testing began under Rocketdyne company funding with the first five tests, 86-017-001 (4/4/86) through 86-017-005 (4/9/86) to checkout the facility and test hardware, while the last two tests were conducted under Government contract NAS3-23773.. A brief discussion of the Rocketdyne company funded five tests is included below to set the scenario for the contractual effort testing that continued from April 17, 1986 and then into 1987

<u>Test</u> 86-017-001	<u>Test Date</u> 4/4/86	<u>Duration, secs</u>	N/A
<u>Objective</u> Facility and engine checkout. Determine Lox Dome prime time, Characterize the MK49 turbopumps chilldown operation, and characterize the MK49-F bleed system capabilities.			

Results Test conducted satisfactorily, system operation characterized.

Test Analysis Chilldown times for the Hydrogen turbopump took about 1 hour with a bleed flow of about 60 gallons / minute. During portions of the chill operation, the turbopump would windmill a speeds up to about 10,000 RPM. The Lox chilldown was achieved in much less time (about 1/2 hour). The oxidizer pump also windmilled but to speeds of around 2, 500 RPM. In either case, the rotation of the rotors was deemed not detrimental. The Main Lox valve was ramped to 38 % open. No thrust chamber or attendant hardware inspections were performed following the test since no ignition was planned or achieved.

<u>Test</u> 86-017-002	<u>Test Date</u> 4/4/86	<u>Duration, secs</u>	7
<u>Objective</u> Facility and engine checkout. Verify Igniter operation and determine the fuel injection manifold prime time.			

Results Test conducted satisfactorily. The main fuel valve did not open due to a system sequencing problem.

Test Analysis Igniter operation was as planned. No inspections were deemed necessary prior to setup of the next fuel system blowdown operations.

Test 86-017-003 Test Date 4/4/86 Duration, secs 7

Objective Facility and engine checkout. Verify igniter operation and determine the fuel injection manifold prime time.

Results The igniter operated as planned but the main fuel valve only reached the 25 % open position before the safety test timer set time expired.

Test Analysis The igniter exit and injector face were inspected for damage - none was observed. The main combustion chamber acoustic cavities were inspected for water residue but none was found. The chamber wall showed no discoloration and no adverse effects from the igniter operation.

Test 86-017-004 Test Date 4/9/86 Duration, secs 7

Objective Facility and engine checkout. Verify igniter operation and determine the fuel injection manifold prime time, investigate main fuel valve opening delay times.

Results Igniter operated satisfactorily but the Main fuel valve did not open due to a system controller electrical problem.

Test Analysis The igniter exit and injector face were inspected for damage - none was observed. The main combustion chamber acoustic cavities were inspected for unwanted water residue - none was found. The chamber wall showed no discoloration and no adverse effects from the igniter operation.

Test 86-017-005

Test Date 4/9/86

Duration, secs 6.3

Objective Facility and engine checkout. Verify igniter operation and determine the fuel injection manifold prime time, investigate main fuel valve opening delay times.

Results Test objectives achieved. The fuel high pressure turbopump reached 70,000 RPM while the oxidizer turbopump attained 27,000 RPM. Pump flowrates were about 1/2 that of rated power operation; 253 GPM and 100 GPM for the fuel and oxidizer turbopumps, respectively. The fuel pump discharge pressure reached 1680 psig while the oxidizer pump discharge pressure reached 880 psig. The fuel pump radial accelerometers ranged between 3.1 and 3.6 Grms at the first critical speed excursion during the downramp (cutoff). The redline levels were set at 10 Grms. The MK49-F fuel turbopumps' first critical speed was observed at 56,000 RPM. Table 7-12 presents a summary of the accelerometer maximum amplitudes at the first critical and at the maximum speed of 70,000 RPM.

Test Analysis CRT plots of the turbopump speeds and the fuel and oxidizer system pressures and temperatures of the engine system are shown in Figures 7-24 through 7-33. As can be noted in the figures, cutoff is indicated about .25 seconds before the maximum turbopump speeds and related downstream pressures are achieved. Main combustor chamber pressure only reached about 80 psig but the overall smooth transition of the engine is evident from the Figures. A post test inspection of the hardware showed no water in the acoustical cavities of the combustor, no changes to the injector face or discoloration to the surfaces of the chamber walls. Figures 7-34 and 7-35 shows ISOPLOTS of selected radial accelerometers of the fuel and oxidizer turbopumps, respectively. In Figure 7-43, there appear to be possible bearing related frequencies at 3.1 and 4.6 times the fuel pump speed. The frequency multiple of 3.1 matches the predicted bearing ball spin frequency. The frequency of 4.6 times the fuel pump speed is near the predicted ball pass frequency of the outer race of 4.3.

Table 7-12 MK 49-F DYNAMIC TEST DATA SUMMARY- 86-017-005

MAXIMUM SPEED 70,000 RPM

PARAMETER	MAXIMUM AMPLITUDE *		AMPLITUDE @ MAX SPEED	
	100-2500 HZ BAND PASS	10,000 HZ WIDEBAND	100-2500 HZ BAND PASS	10,000 HZ WIDEBAND
RADIAL ACCEL A1	3.5 Grms	27 Grms	3.3 Grms	27 Grms
RADIAL ACCEL A2	3.6 Grms	25 Grms	0.9 Grms	25 Grms
RADIAL ACCEL A4	3.1 Grms	19 Grms	1.0 Grms	22 Grms

* Maximum amplitudes occur at 1st critical speed during ramp down (~60,000 rpm)

Figure 7-24 IGNITER CHAMBER TEMP HISTORY VERSUS TEST TIME -
86-017-005

TEST 1112705 DATE 22/11/86

ROCKETTIME

SANTA SUSANA FIELD LABORATORY

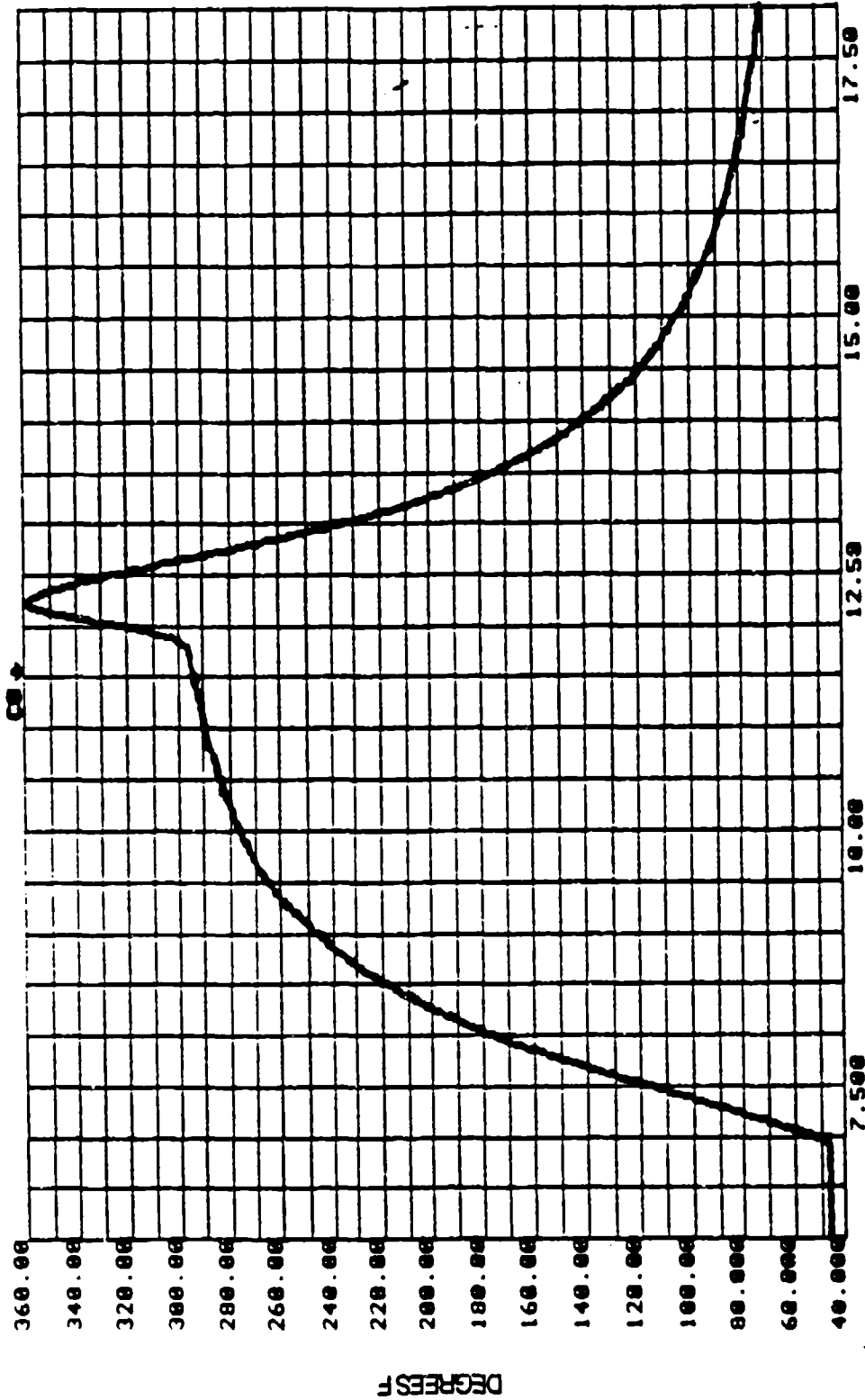

19100. 1050 IRIG CHAMBER TEMP _____ IRIG TEST TIME, SECONDS

Figure 7-25 TURBOPUMP SPEED HISTORY VERSUS TEST TIME -
86-017-005

TEST 017005 DATE 4/9/86
ZERO TIME: 0 19:23:13.600

ROCKETDOME
SANTA SUSANA FIELD LABORATORY

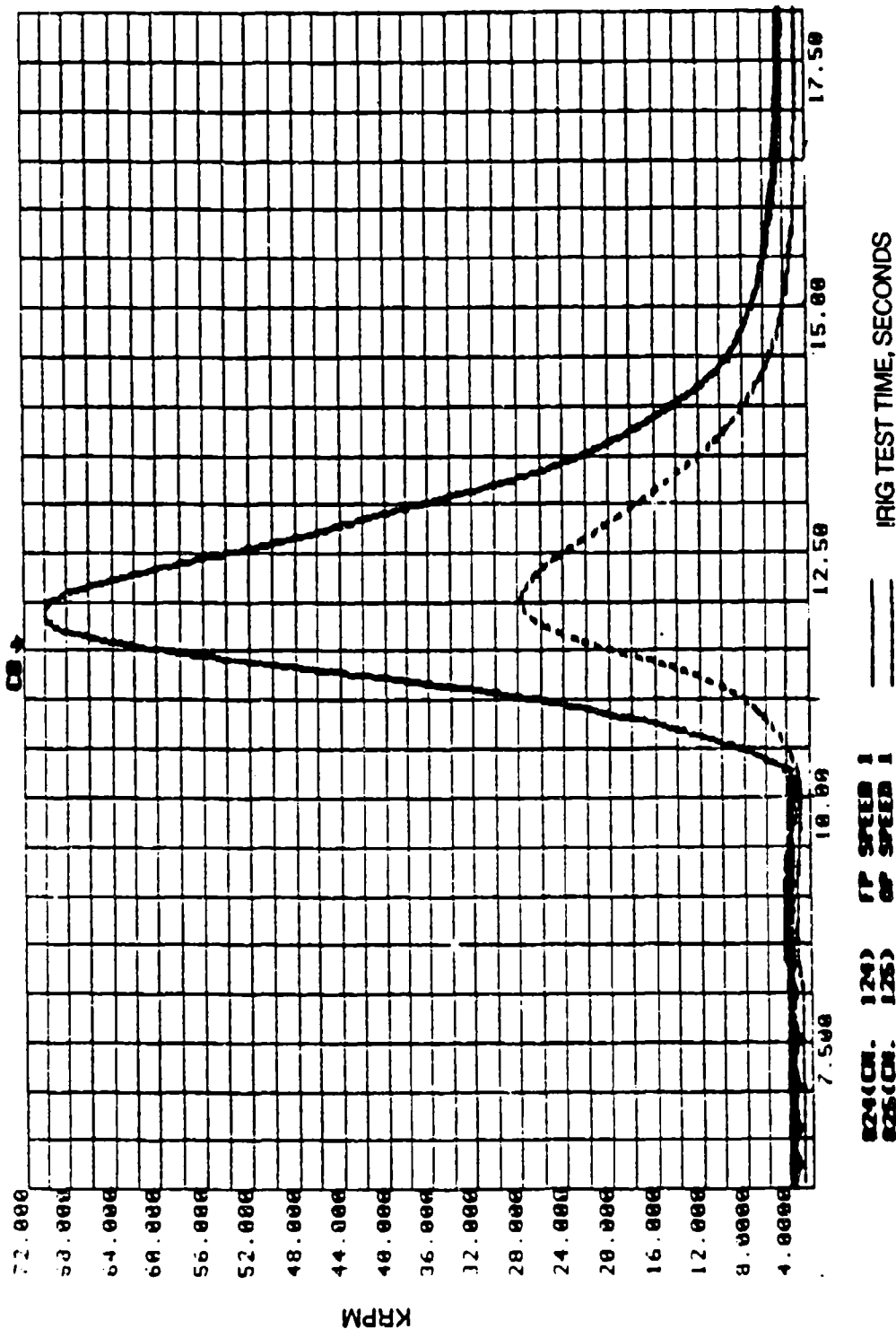

Figure 7-26 FUEL PUMP INLET PRESSURE VERSUS TEST TIME -
86-017-005

TEST TIME: 05:04:24.986

BOCCELIONE

SANTA BARBARA FIELD LABORATORY

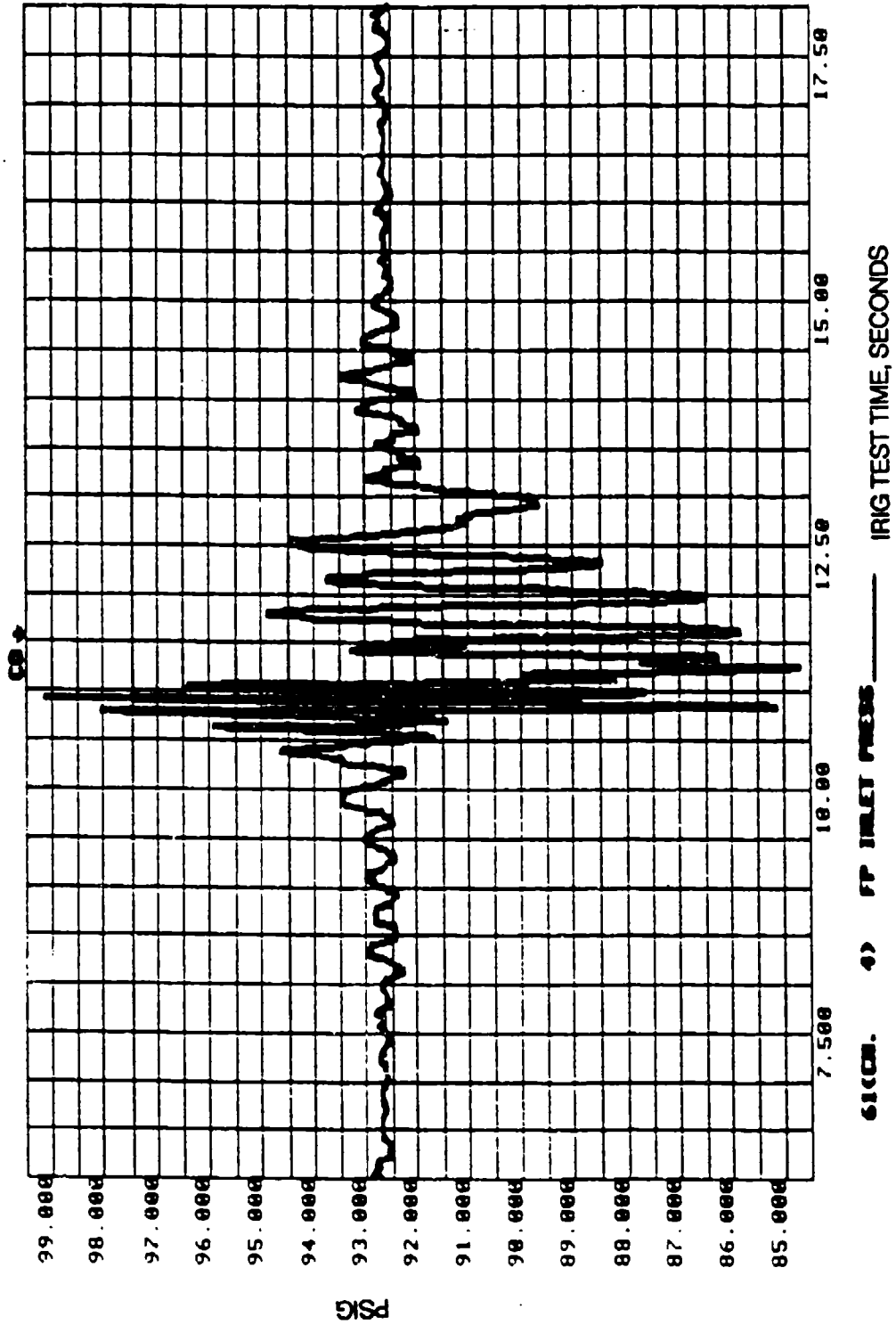
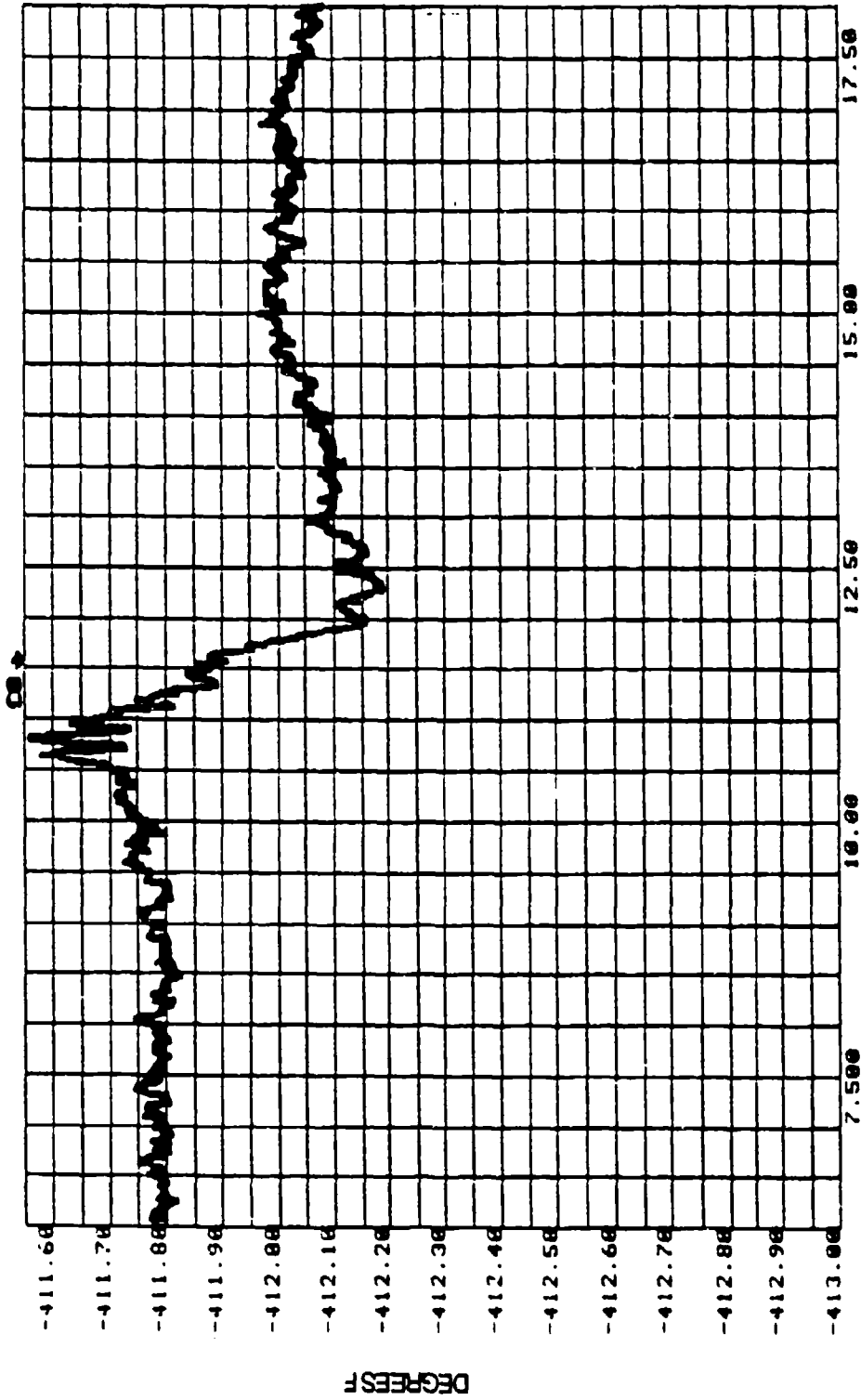

Figure 7-27 FUEL PUMP INLET TEMPERATURE VERSUS TEST TIME -
86-017-005

ROCKETDOME
TEST 1112005 J01F A 9/86

CASTLE SANDS FIELD LABORATORY



120(CS. 2) FP INLET TEMP ——— IRIG TEST TIME, SECONDS

Figure 7-28 FUEL PUMP DISCHARGE/COMBUSTOR OUT PRESSURE VERSUS TEST TIME -86-017-005

TEST 017805 DATE 4/9/86
ZERO TIME: 19:23:13.563

ROCKETDYNE

SANTA SUSANA FIELD LABORATORY

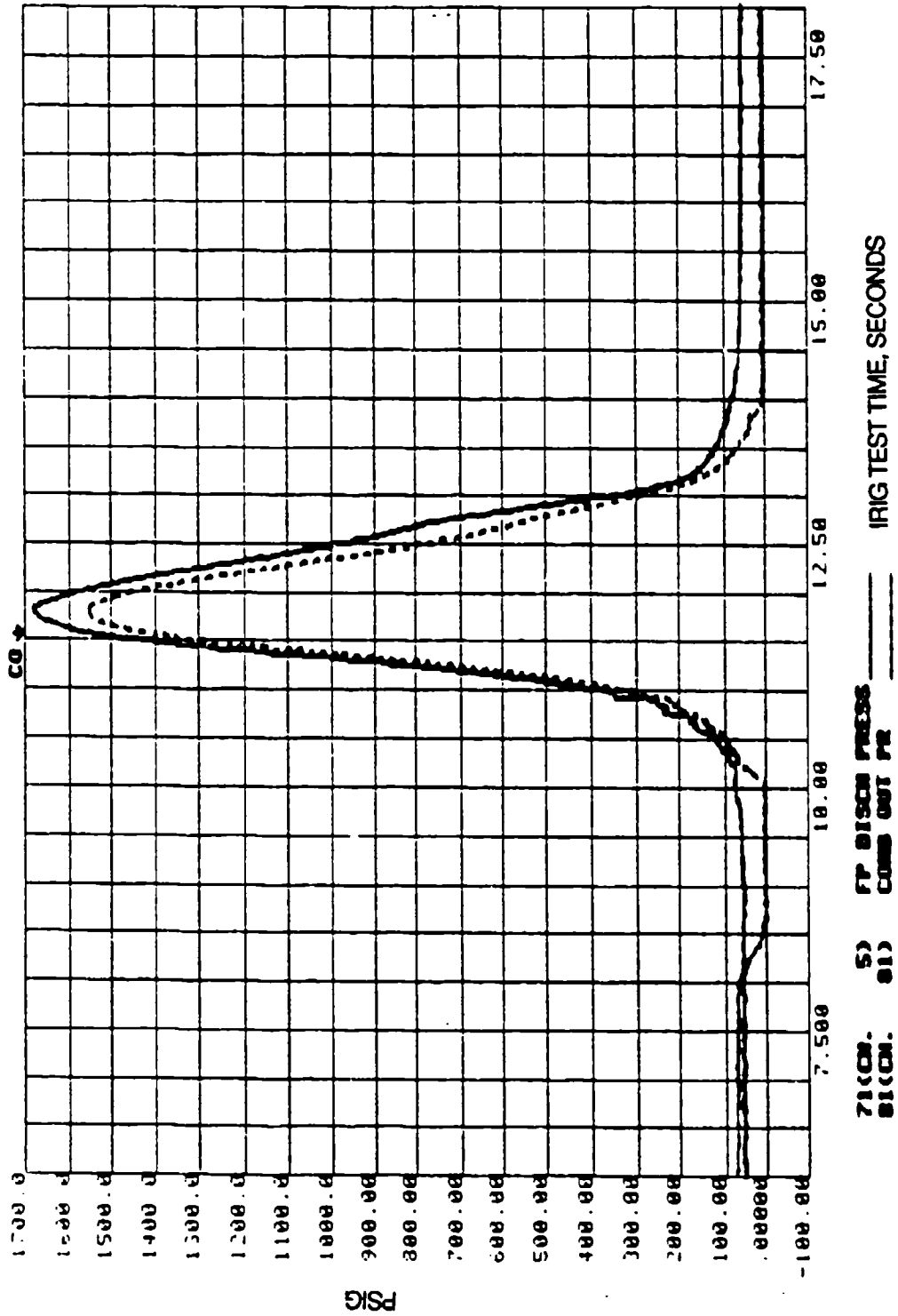
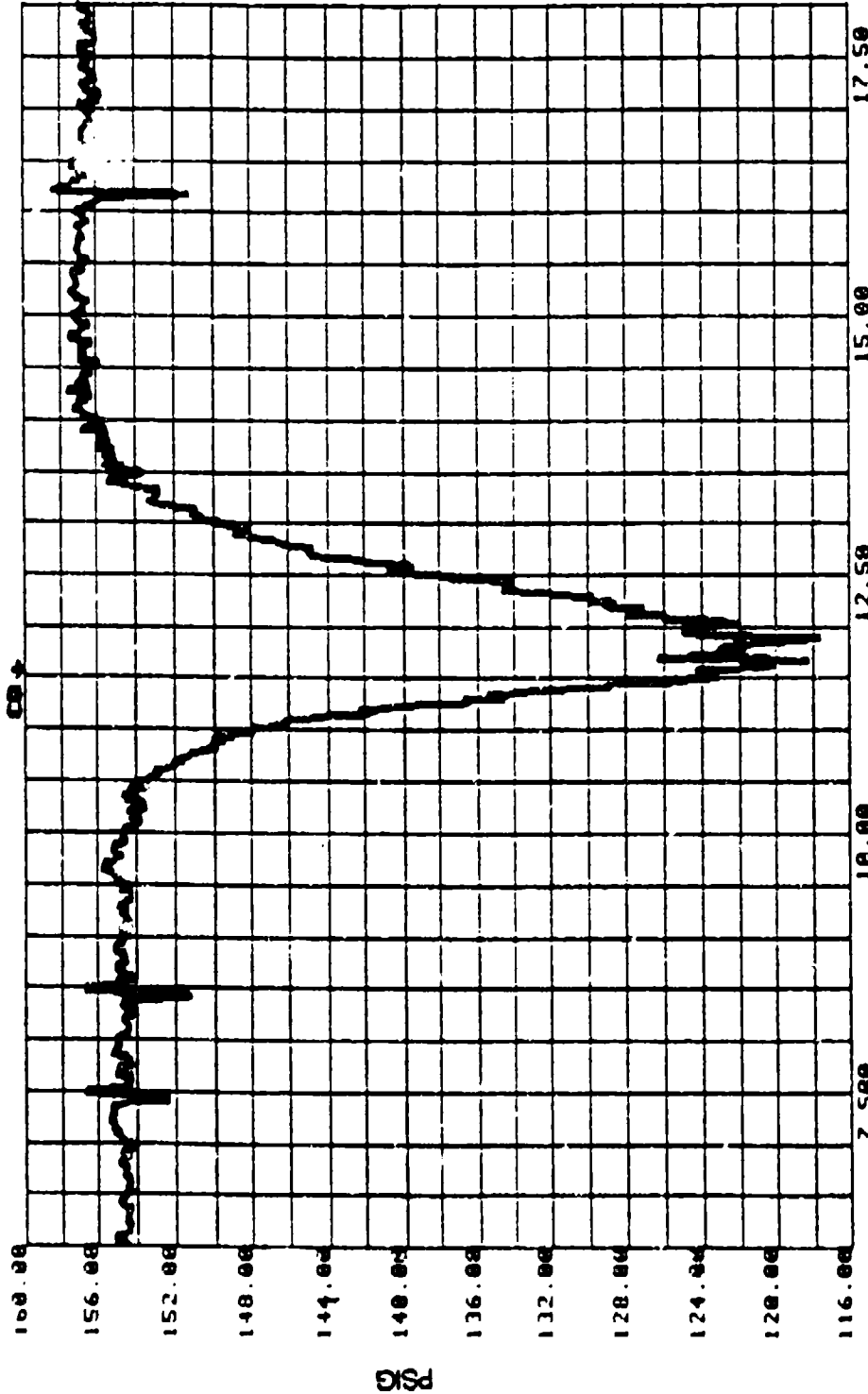

Figure 7-29 LOX PUMP INLET PRESSURE VERSUS TEST TIME -
86-017-005

TEST 017005 DATE 4/9/86
ZERO TIME: 0 19:23:13.553

BOCETESTONE

SANTA ANNA FIELD LABORATORY



744CR. 6) OF INLET PRESSURE _____ IRIG TEST TIME, SECONDS

Figure 7-30 LOX PUMP INLET TEMPERATURE VERSUS TEST TIME -86-017-005

TEST 017005 DATE 4/9/86
ZERO TIME: 0 19:23:13.000

ROCKETDOME
SANTA SUSANA FIELD LABORATORY

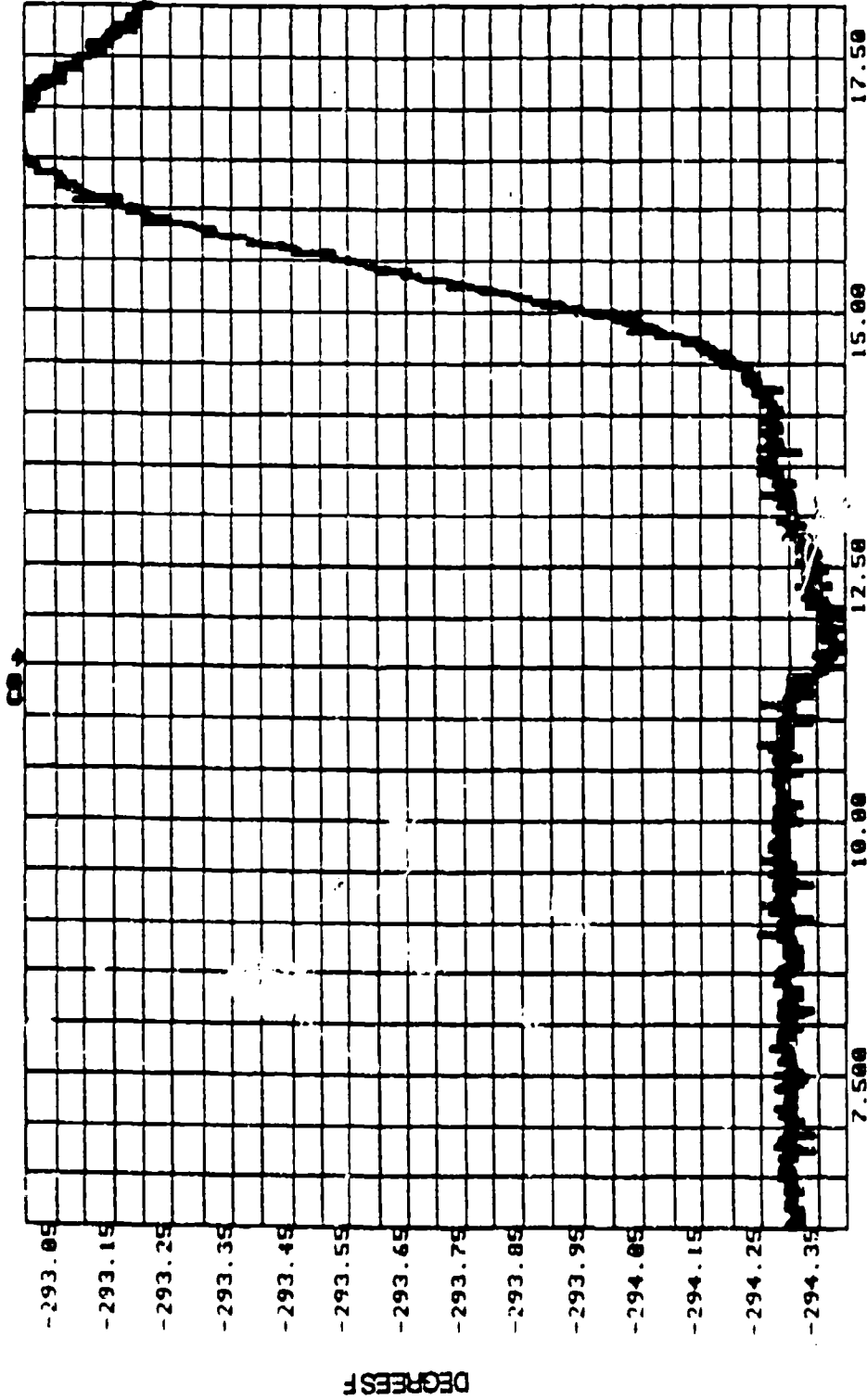

IRIG TEST TIME, SECONDS

DEGREES F

Figure 7-31 LOX PUMP DISCHARGE PRESSURE VERSUS TEST TIME -86-017-005

TEST 71012005 DATE 21/13/86

BOEING

SANTA BARBARA FIELD LABORATORY

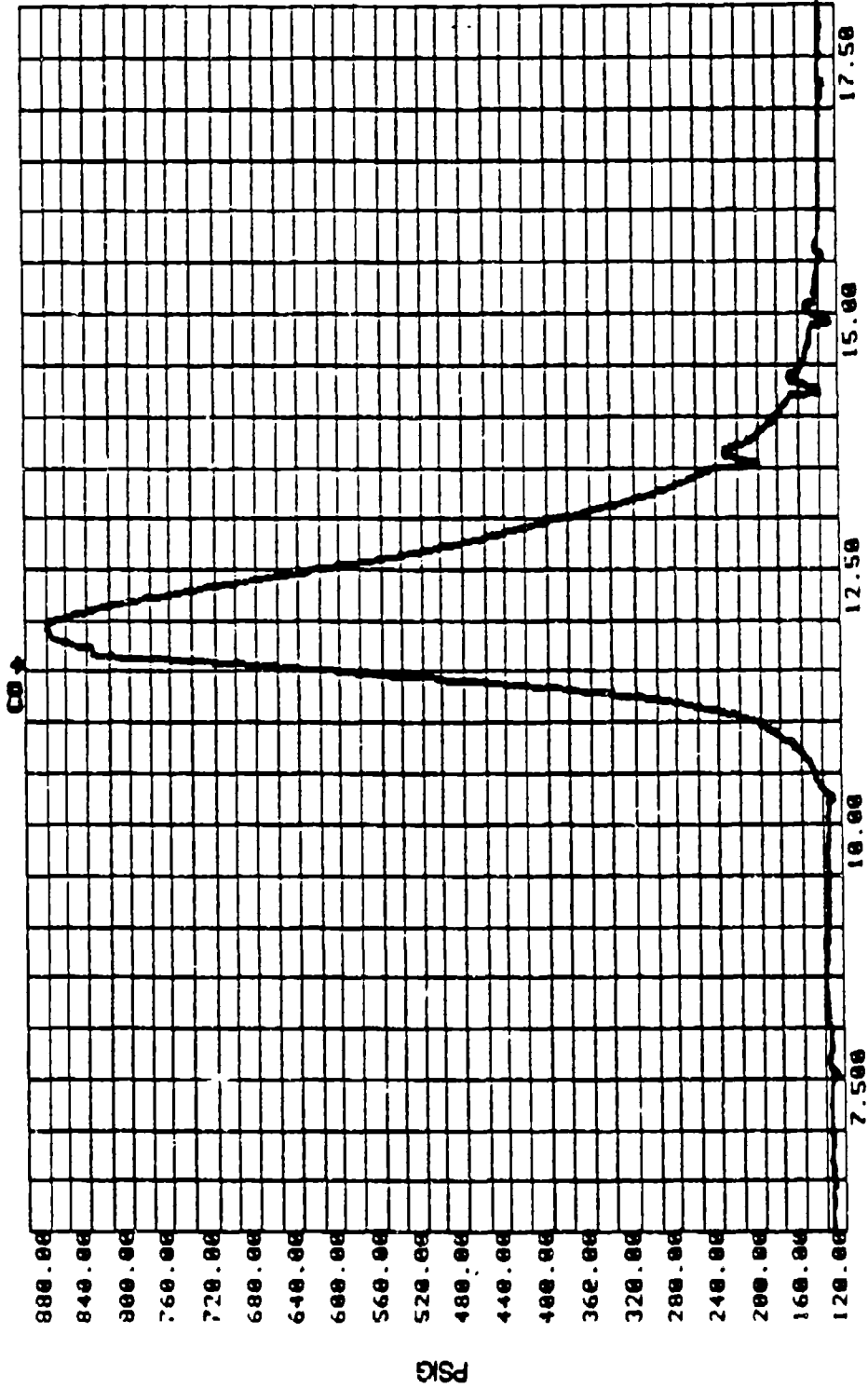

IRIG TEST TIME, SECONDS

70100. 77 OF DISCH PRESS

Figure 7-32 COMBUSTOR OUTLET/NOZZLE DISCHARGE PRESSURE VERSUS TEST TIME -86-017-005

ROCKETDYNE
SANTA SUSANA FIELD LABORATORY

TEST 017005 DATE 4/9/86
ZERO TIME: 0 19:23:13.558

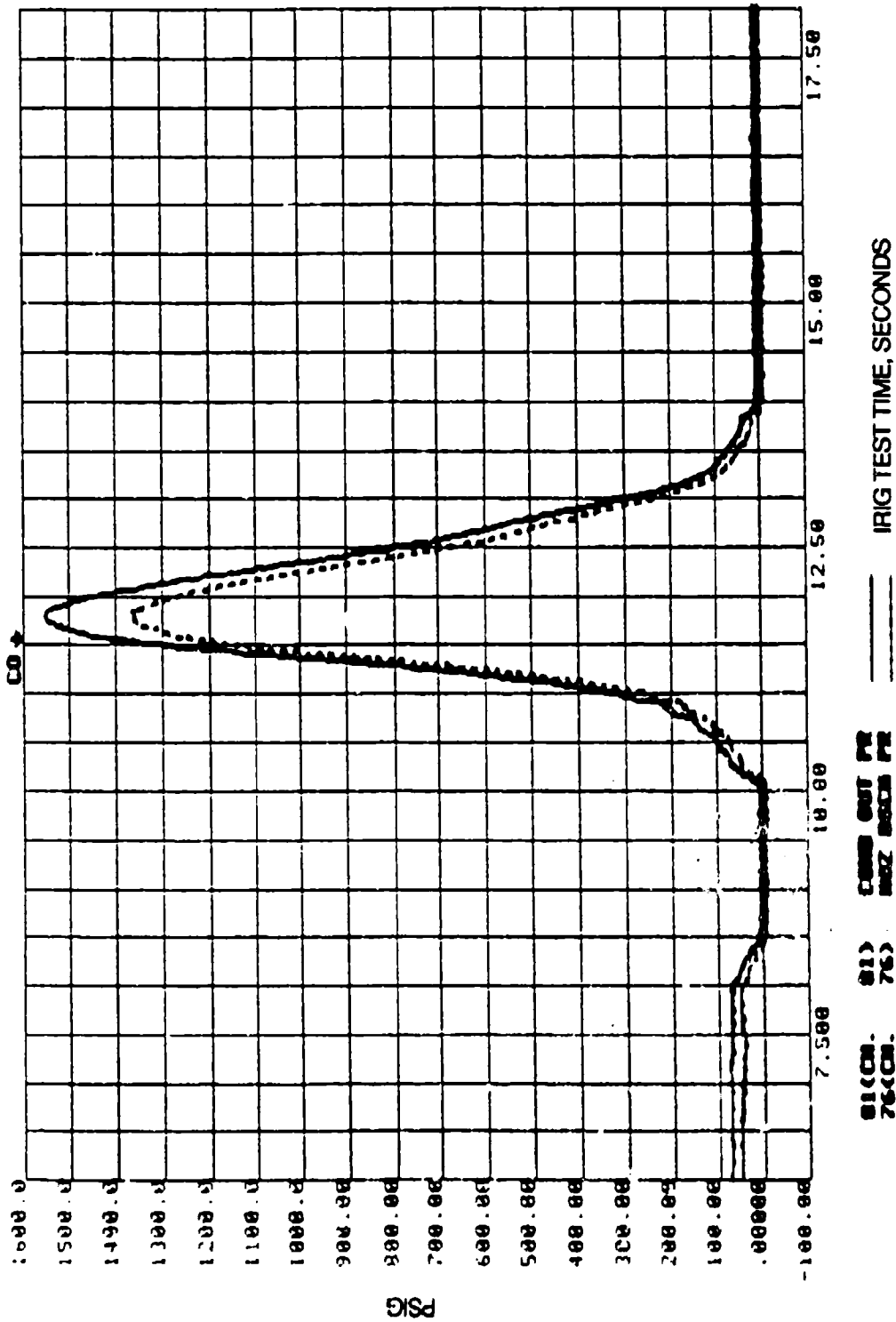
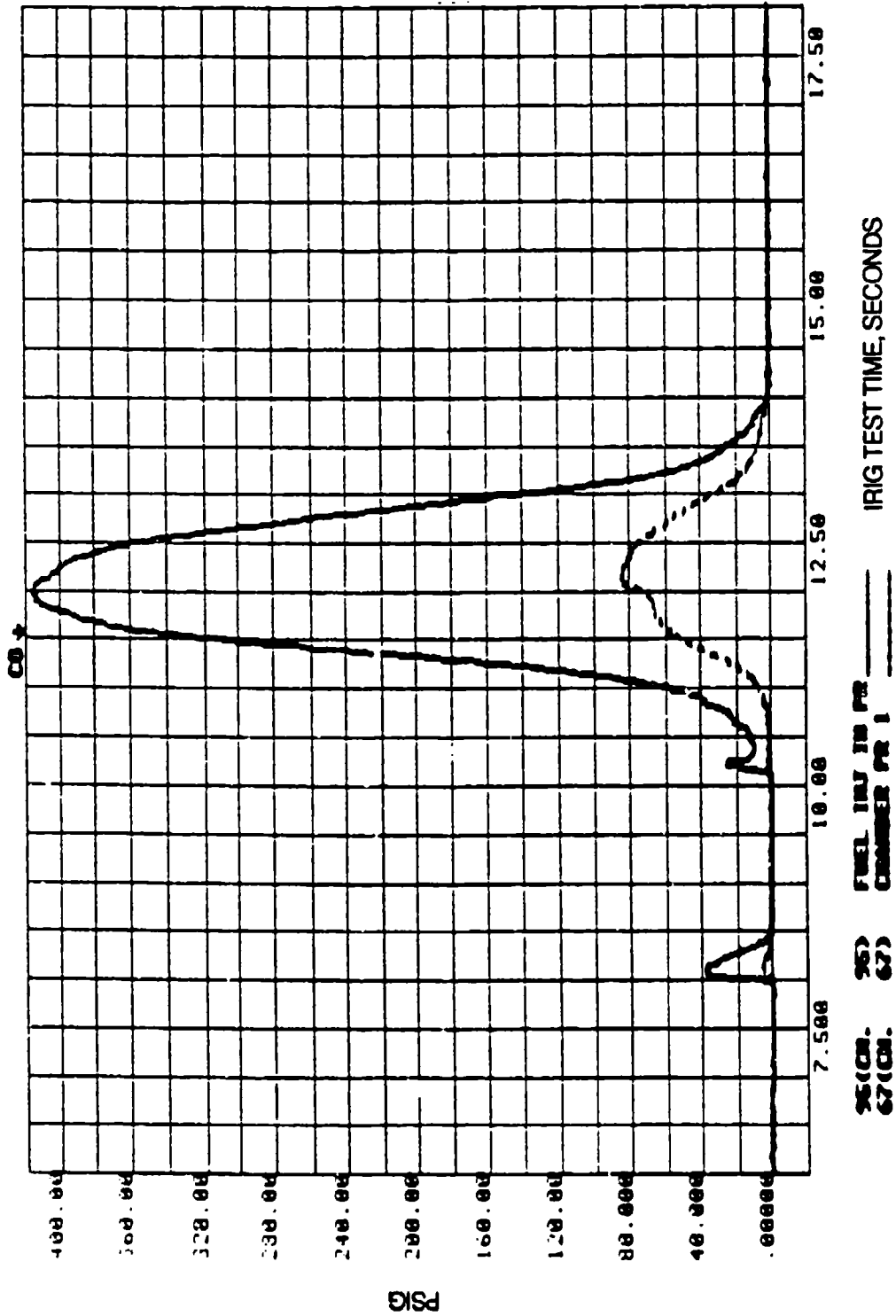

Figure 7-33 FUEL INJECTION INLET /CHAMBER PRESSURE VERSUS TEST TIME
-86-017-005

TEST 017005 DATE 4/ 9/86
ZERO TIME: 0 19:23:13.558

ROCKETDOME
SANTA SUSANA FIELD LABORATORY



25(CM): 26) FUEL INLET PR _____
67(CM): 67) CHAMBER PR 1 _____ IRIG TEST TIME, SECONDS

Figure 7-34 MK49-F RADIAL ACCEL, A2 ISOPLOT -86-017-005

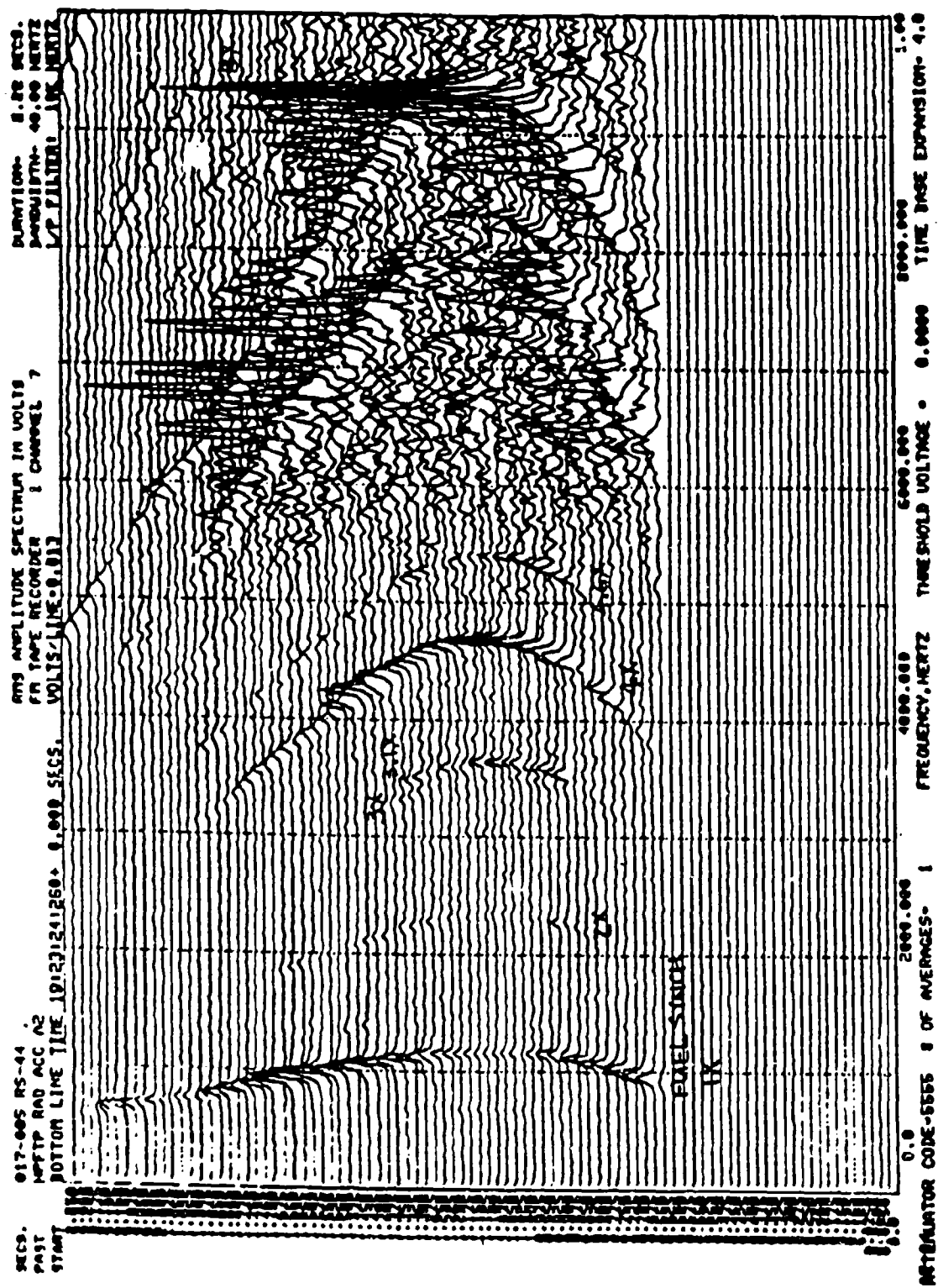
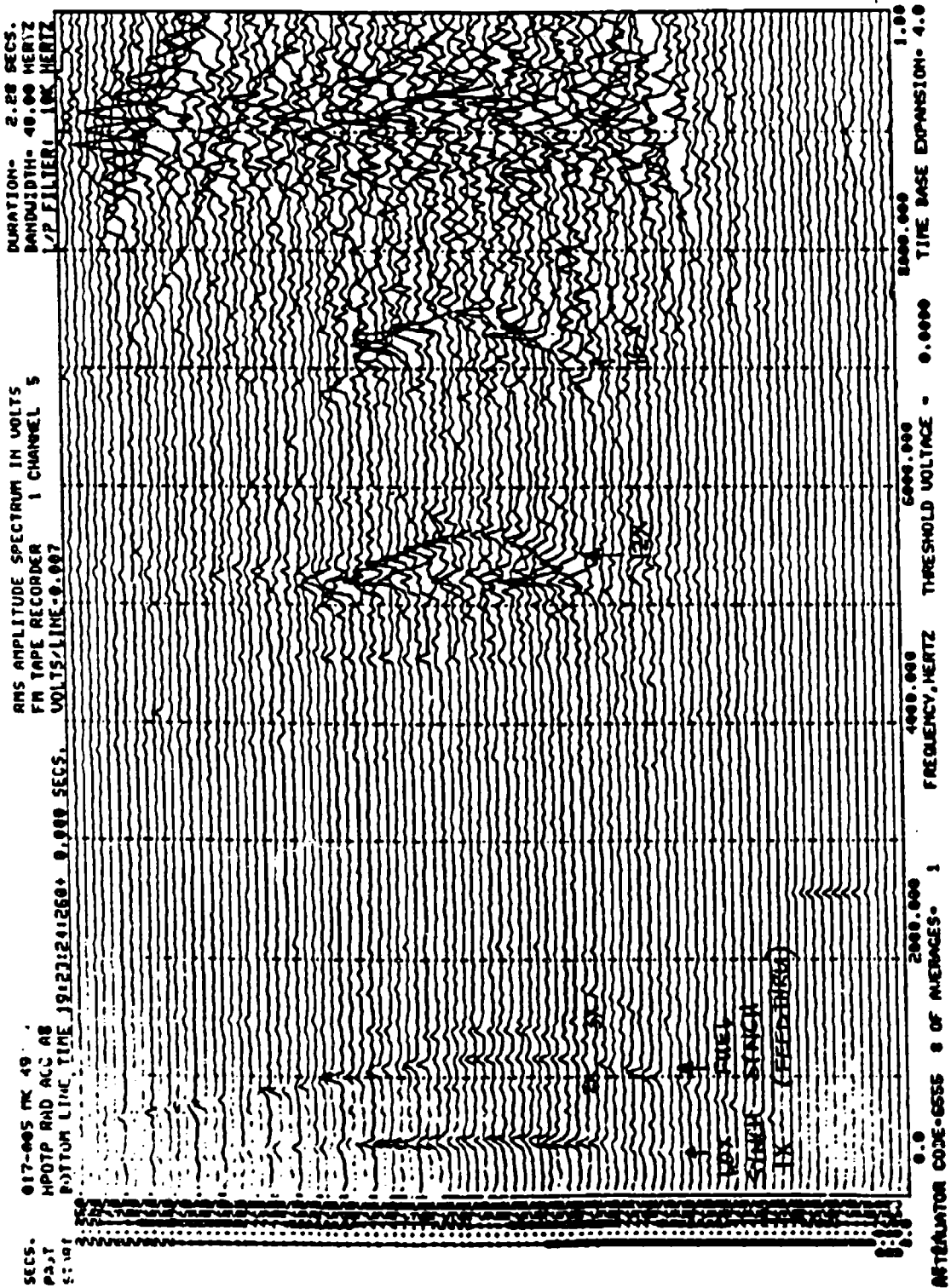

Figure 7-35 MK49-O RADIAL ACCEL, A8 ISOPLLOT -86-017-005



Test 86-017-006 Test Date 4/17/86 Duration, secs 4.0

Objective Determine main chamber ignition characteristics, characterize the engine start sequence.

Results Test objectives achieved. The fuel and oxidizer turbopumps ramped smoothly to a maximum speed of 73,660 and 30,400 RPM ,respectively. Turbopump operation lasted for 4 seconds with a main chamber pressure exceeding 160 psig for nearly 400 msec and reaching a maximum of about 440 psig. Approximately 180 msec after cutoff, a spike in chamber pressure occurred to about 560 psig. Turbopump speed decay during this period was normal with no abrupt speed changes.

Test Analysis The post cutoff after-spike in chamber pressure was attributed to a higher lockup pressure in the Lox injector done purge system than the predicted maximum chamber pressure achieved. Typically, the purge is set to exhaust all the dribble volume in the injector system at a rate which does not cause a mixture ratio excursion with possible heat damage to the injector/chamber. A post test inspection of the injector face did show some heat affected zones on the injector but no evidence was present of melting or erosion. The chamber walls showed no signs of discoloration or heat affected damage. In addition, no water was observed in the acoustical cavities. After a review of the inspection results, a decision was made to continue the testing since no damage was present. Figures 7-36 through 7-46 show the pressures and temperature profiles recorded during the test. A data reduction was made at two slices in the very short period of engine operation. Figures 7-47 through 7-49 document the overall engine performance parameters, MK49-F fuel pump operation, and the MK49-O Lox pump operation, respectively. This was the first test in which the automatic data reduction code was used.

Figure 7-36 TURBOPUMP SPEED HISTORY VERSUS TEST TIME -
86-017-006

TEST 017006 DATE 4/17/86
ZERO TIME: 0 19: 9:29.274

ROCKETDYNE



SANTA SUSANA FIELD LABORATORY

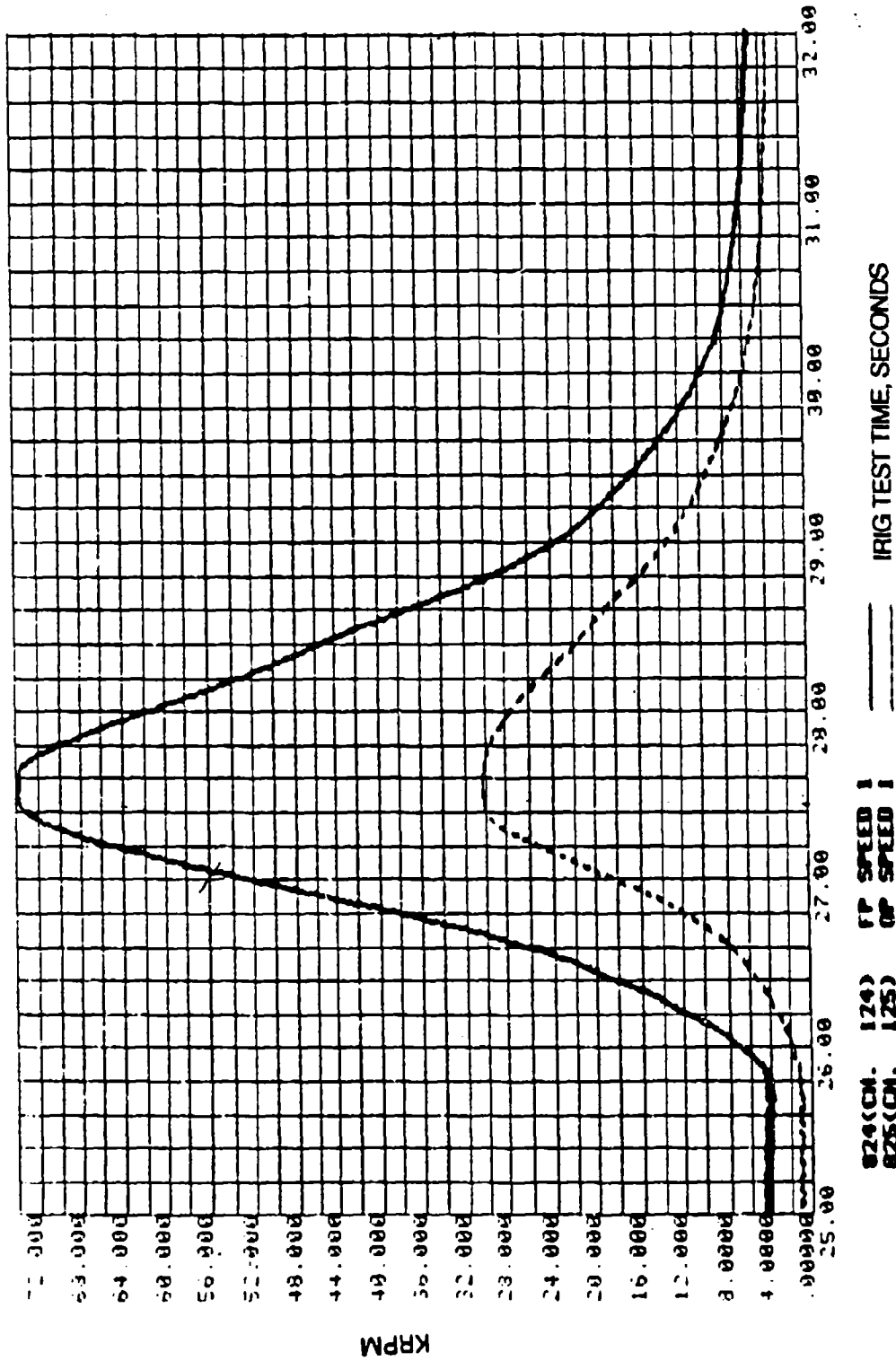

KRPM

Figure 7-37 FUEL PUMP INLET PRESSURE VERSUS TEST TIME -
86-017-006

TEST TIME 017006 DATE 4/17/86

ROCKETDOME

SANTA SUSANA FIELD LABORATORY

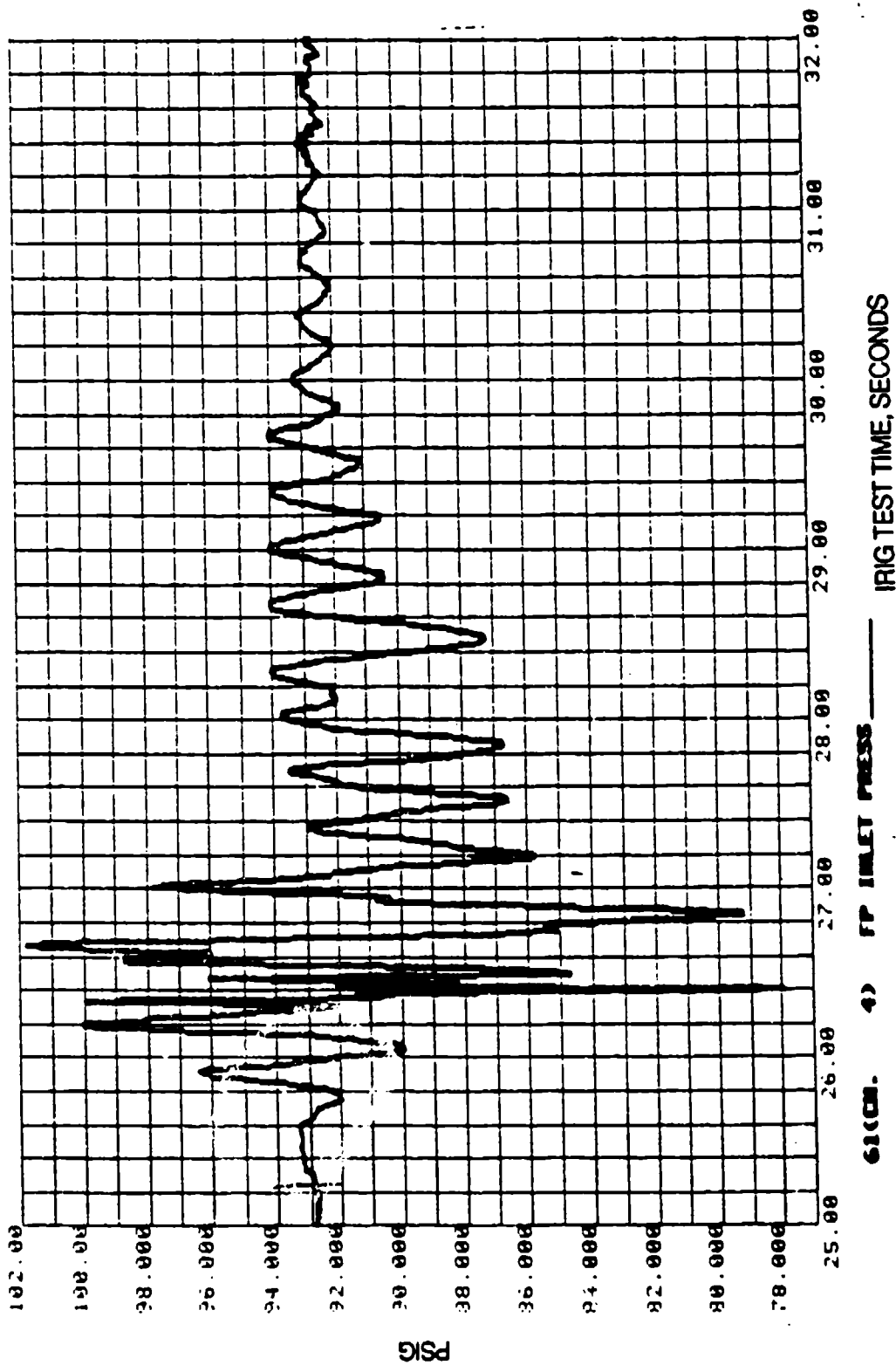

611000. 4) FP INLET PRESS ——— IRIG TEST TIME, SECONDS

Figure 7-38 FUEL PUMP INLET TEMPERATURE VERSUS TEST TIME -
86-017-006

TEST 017006 DATE 4/17/86
ZERO TIME: 0 19: 9:29.274

ROCKETDYNE
SANTA SUSANA FIELD LABORATORY

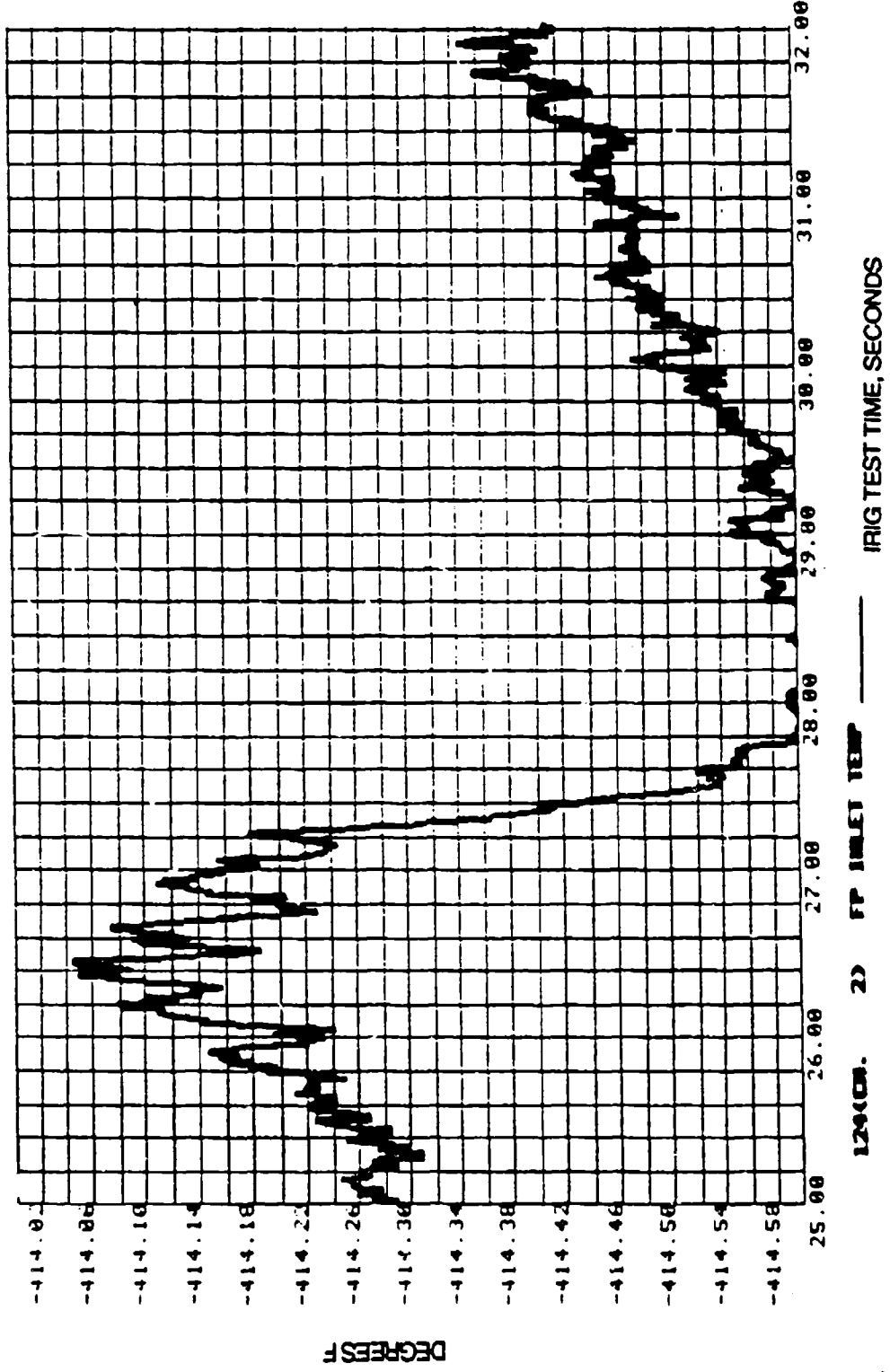
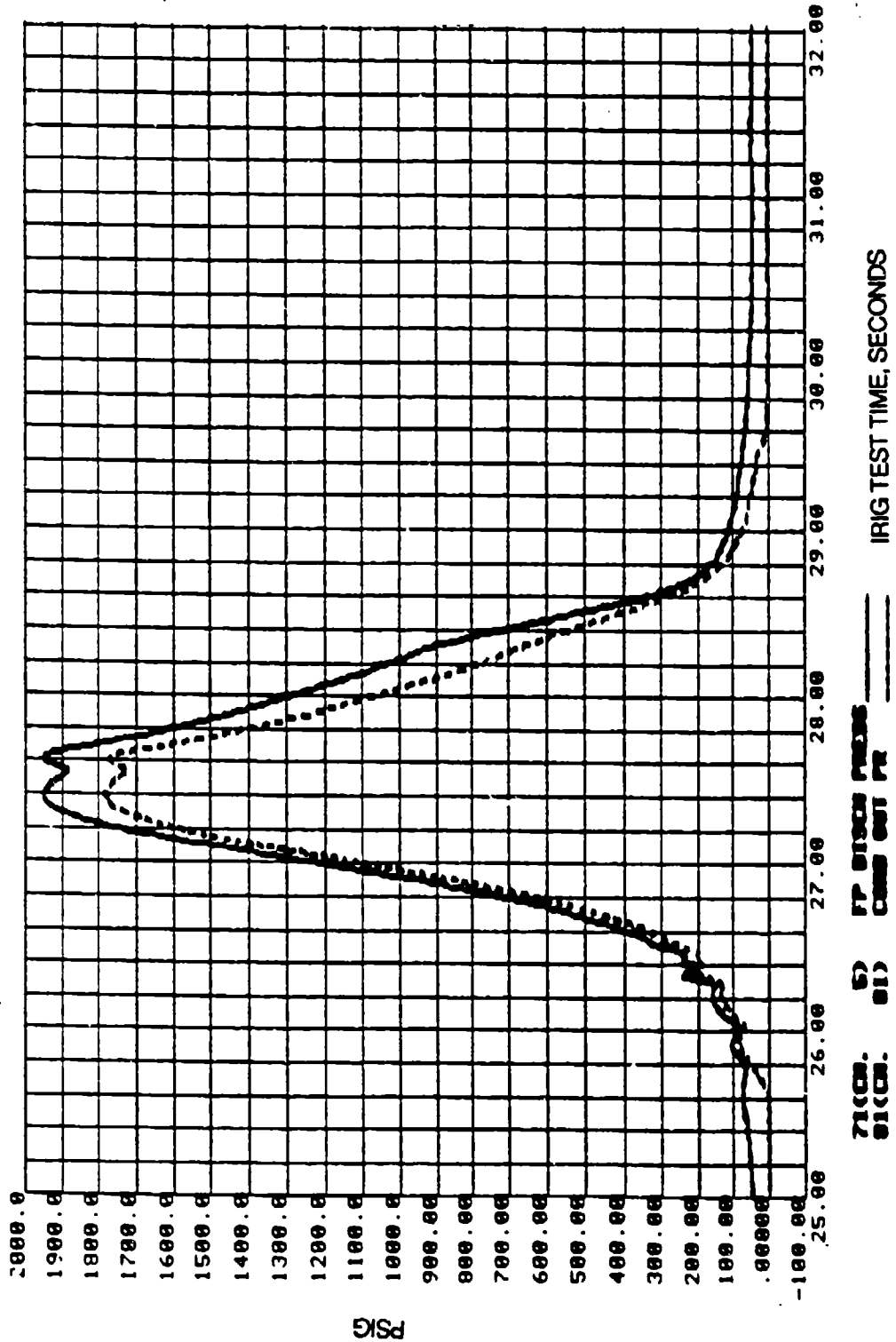

Figure 7-39 FUEL PUMP DISCHARGE/COMBUSTOR OUTLET PRESSURE VERSUS TEST TIME -017-006

TEST 017006 DATE 4/17/86
ZERO TIME: 0 19: 9:29.274

ROCKETDOME
SANTA SUSANA FIELD LABORATORY



ROCKETDOME
SANTA SUSANA FIELD LABORATORY
TEST 11-017006 DATE 4/17/76

Figure 7-40 LOX PUMP INLET PRESSURE VERSUS TEST TIME -
86-017-006

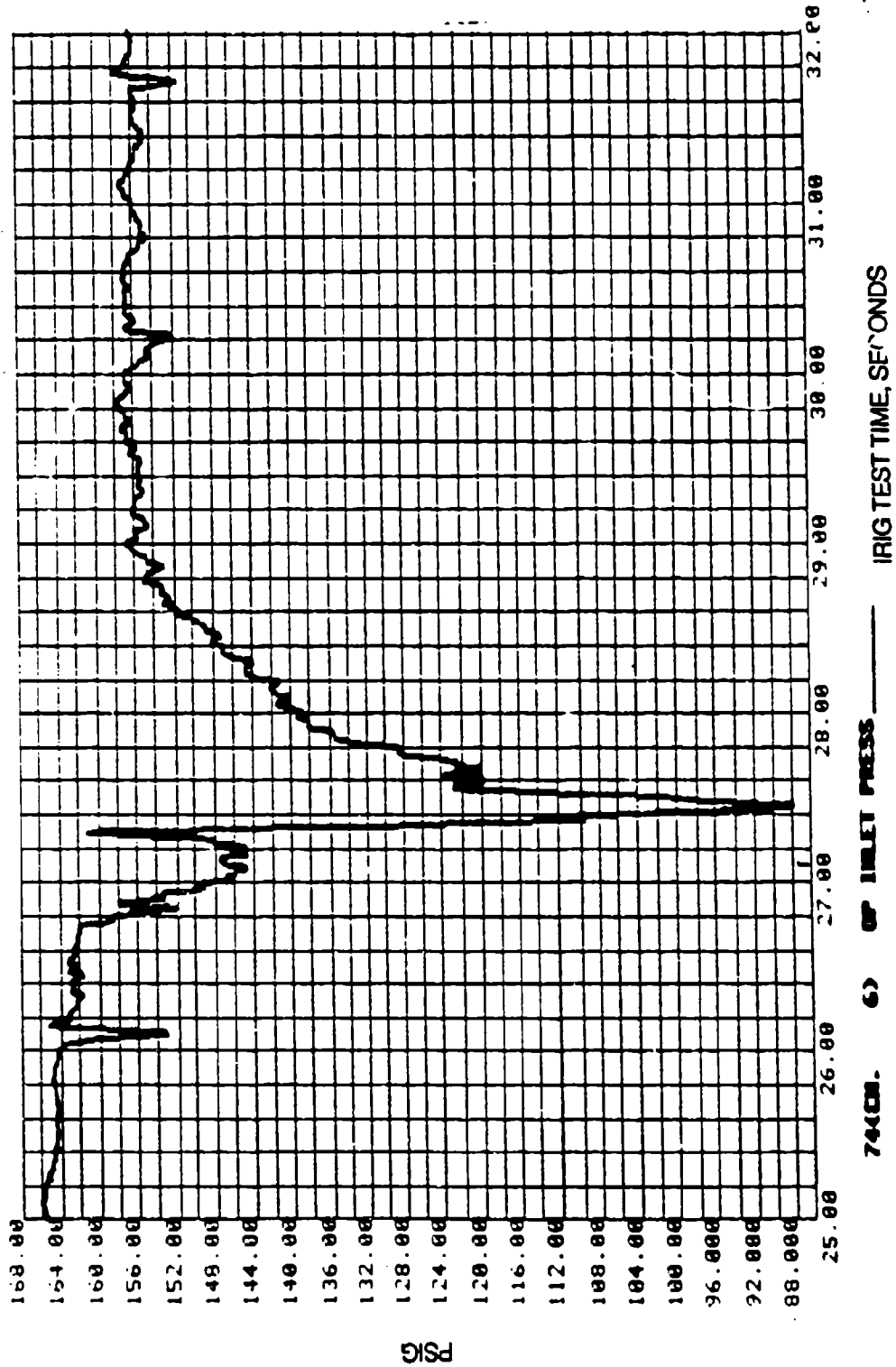

74408. 6) OF INLET PRESS _____ IRIG TEST TIME, SECONDS

Figure 7-41 LOX PUMP INLET TEMPERATURE VERSUS TEST TIME -
86-017-006

ROCKETDOME
TEST 11012006 DATE 11/17/96



SANTA SUSANA FIELD LABORATORY

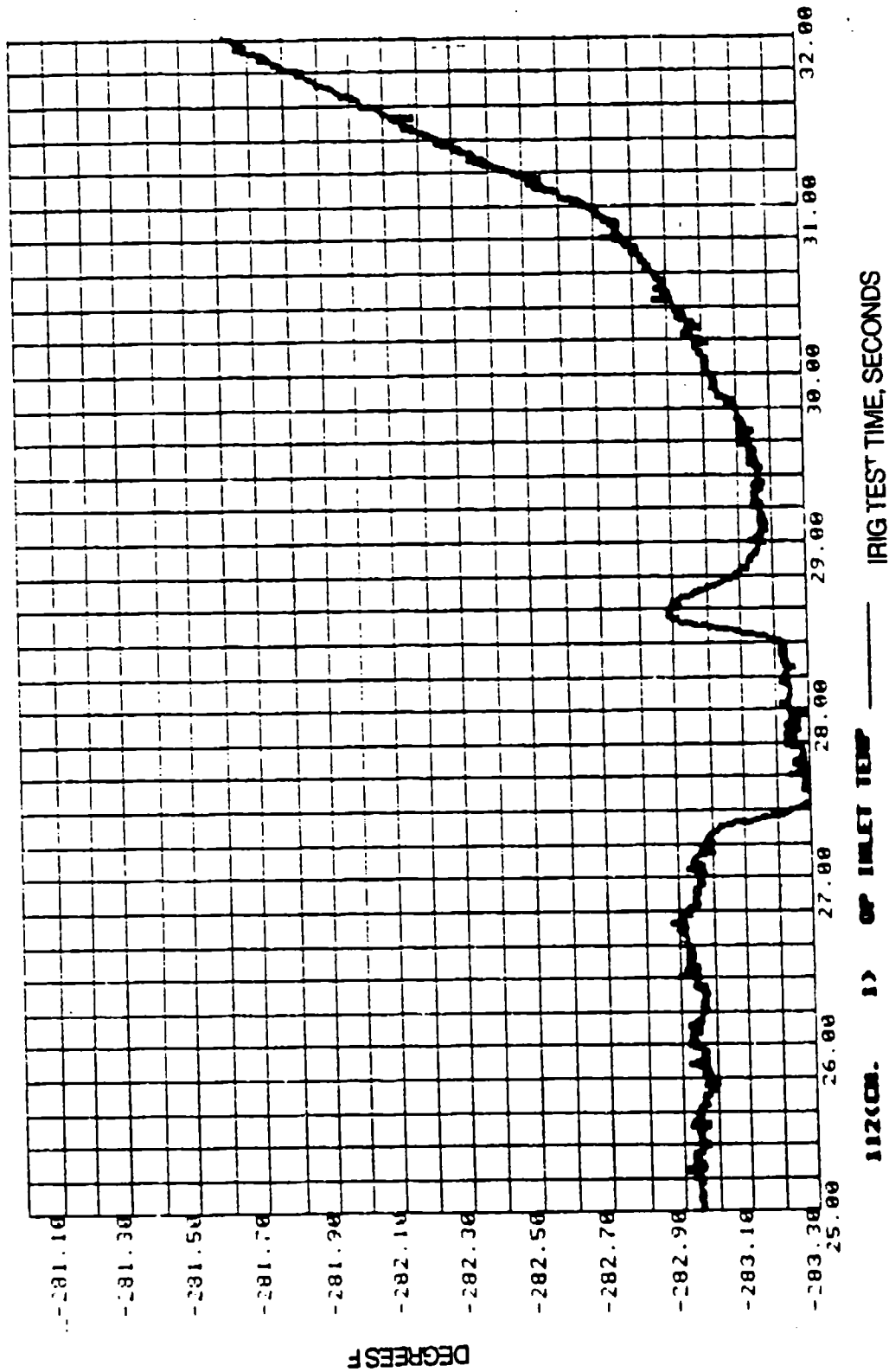

DEGREES F

IRIG TEST TIME, SECONDS

Figure 7-42 LOX PUMP DISCHARGE PRESSURE VERSUS TEST TIME -
86-017-006

TEST 017006 DATE 4/17/86
ZERO TIME: 0 19: 9:29.274

ROCKETDYNE
SANTA SUSANA FIELD LABORATORY

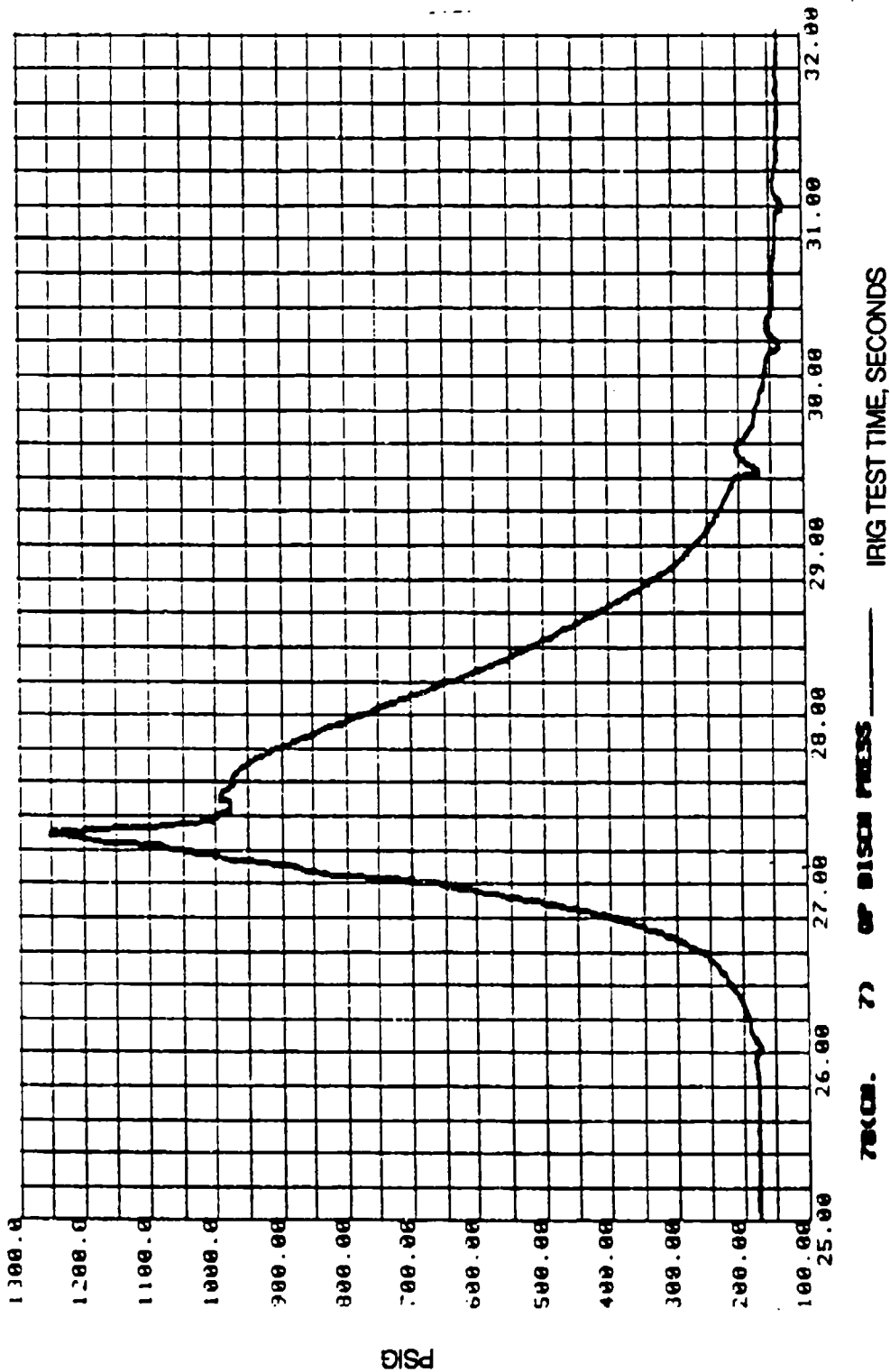

PSIG

Figure 7-43 COMBUSTOR OUTLET/NOZZLE DISCHARGE PRESSURE VERSUS TEST TIME -86-017-006

TEST 017006 DATE 4/17/86
ZERO TIME: 0 19: 9:29.274

ROCKETDYNE

SANTA SUSANA FIELD LABORATORY

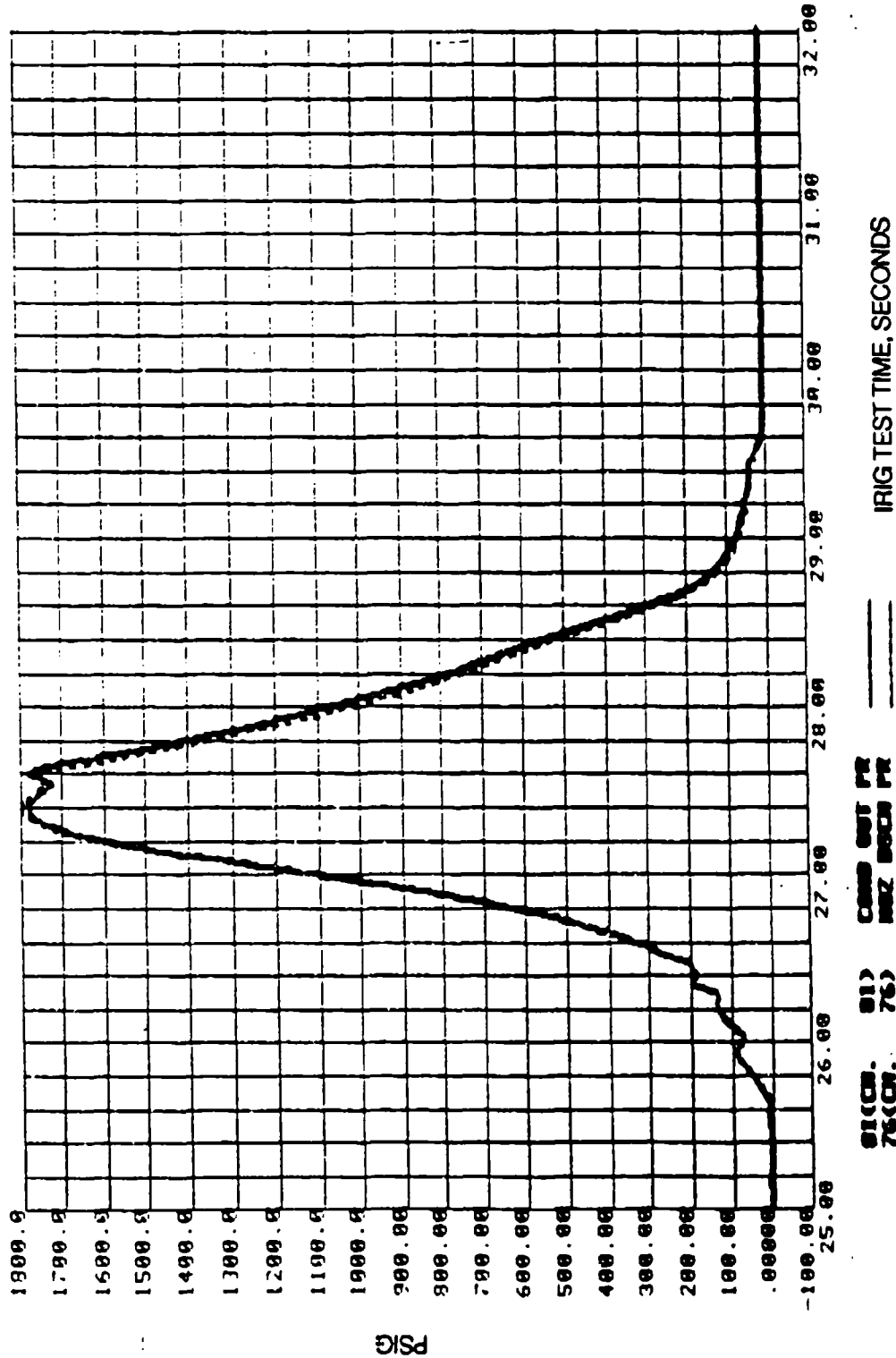
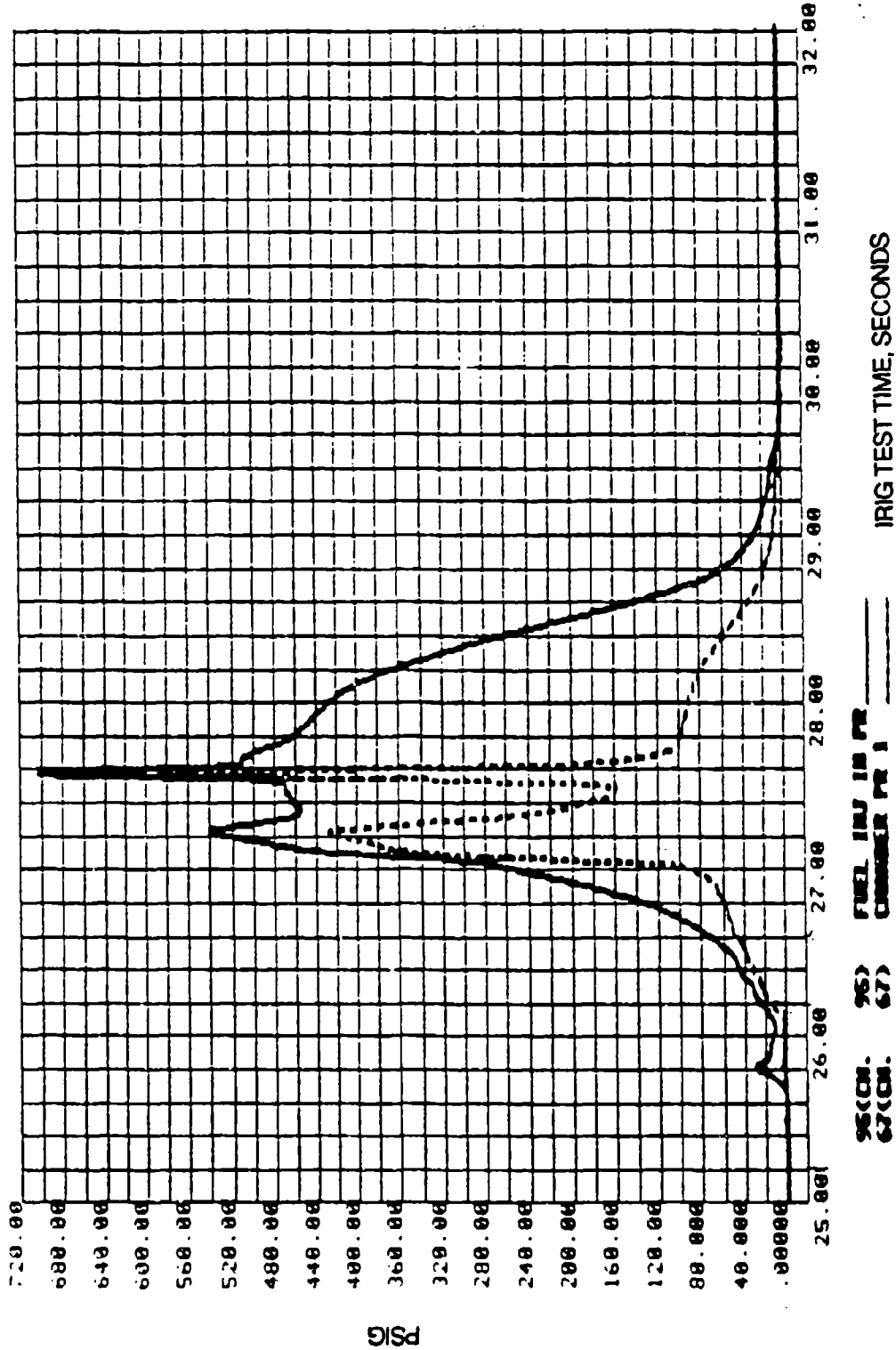

Figure 7-44 FUEL INJECTOR INLET /CHAMBER PRESSURE VERSUS TEST TIME -
86-017-006

TEST 017006 DATE 4/17/86
ZERO TIME: 0 17: 9:29.774

ROCKETDOME

SANTA SUSANA FIELD LABORATORY



96) FUEL INJ IN PR _____ IRIG TEST TIME, SECONDS
67) CHAMBER PR 1 _____

Figure 7-45 CHAMBER/LOX INJECTION DOME PRESSURE VERSUS TEST TIME

86-017-006

TEST 017006 DATE 4/17/86
ZERO TIME: 0 19: 9:29.274

ROCKETDYNE

SANTA SUSANA FIELD LABORATORY

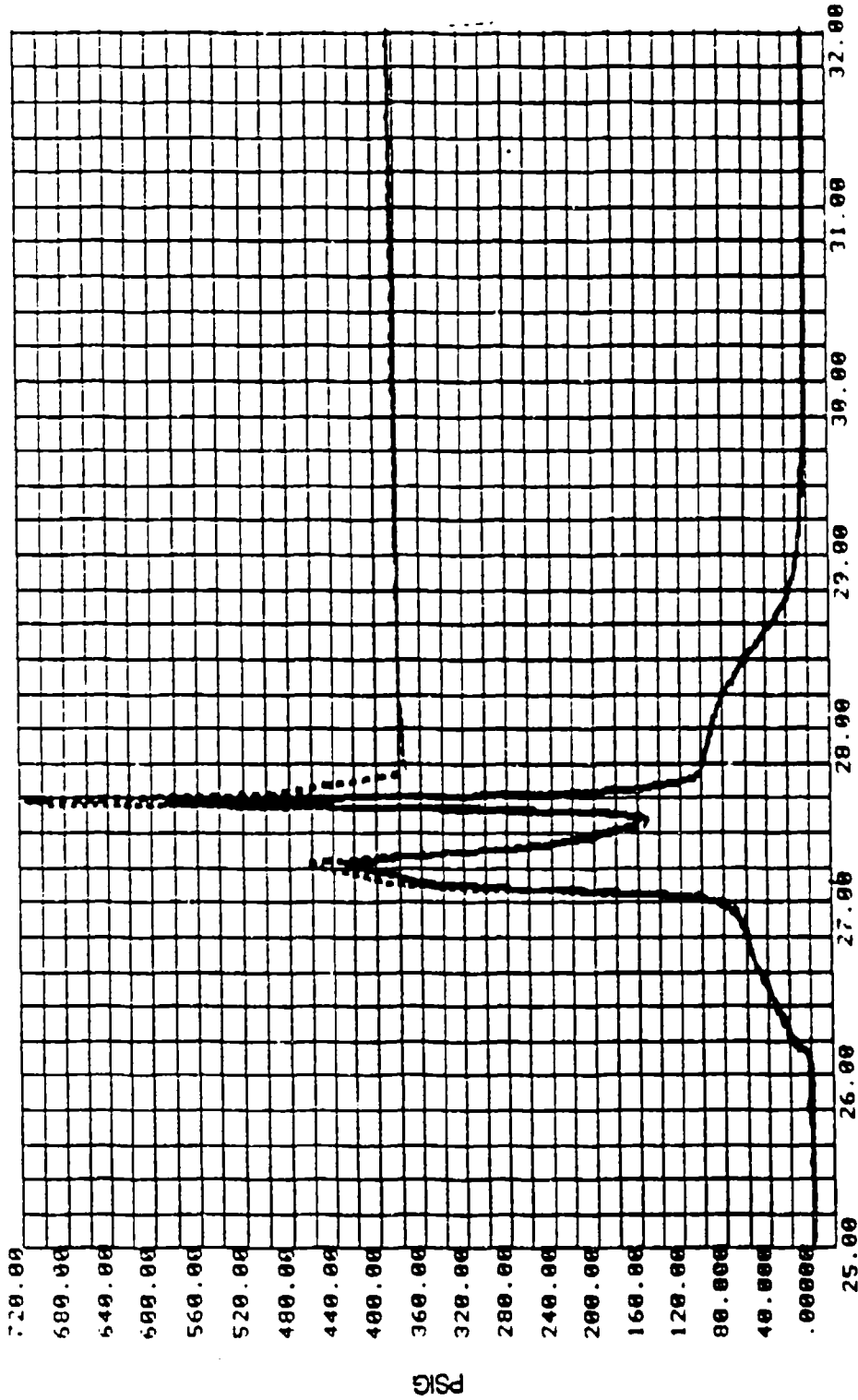

67(CH) 67) CHAMBER PR 1
92(CH) 92) LOX INJ DOME PR _____ IRIG TEST TIME, SECONDS

Figure 7-46 CHAMBER PRESSURE VERSUS TEST TIME -
86-017-006

ROCKETDUTYME
TEST 017006 DATE 4/17/86
ZERO TIME: 0 19: 9:29.274

SANTA SUSANA FIELD LABORATORY

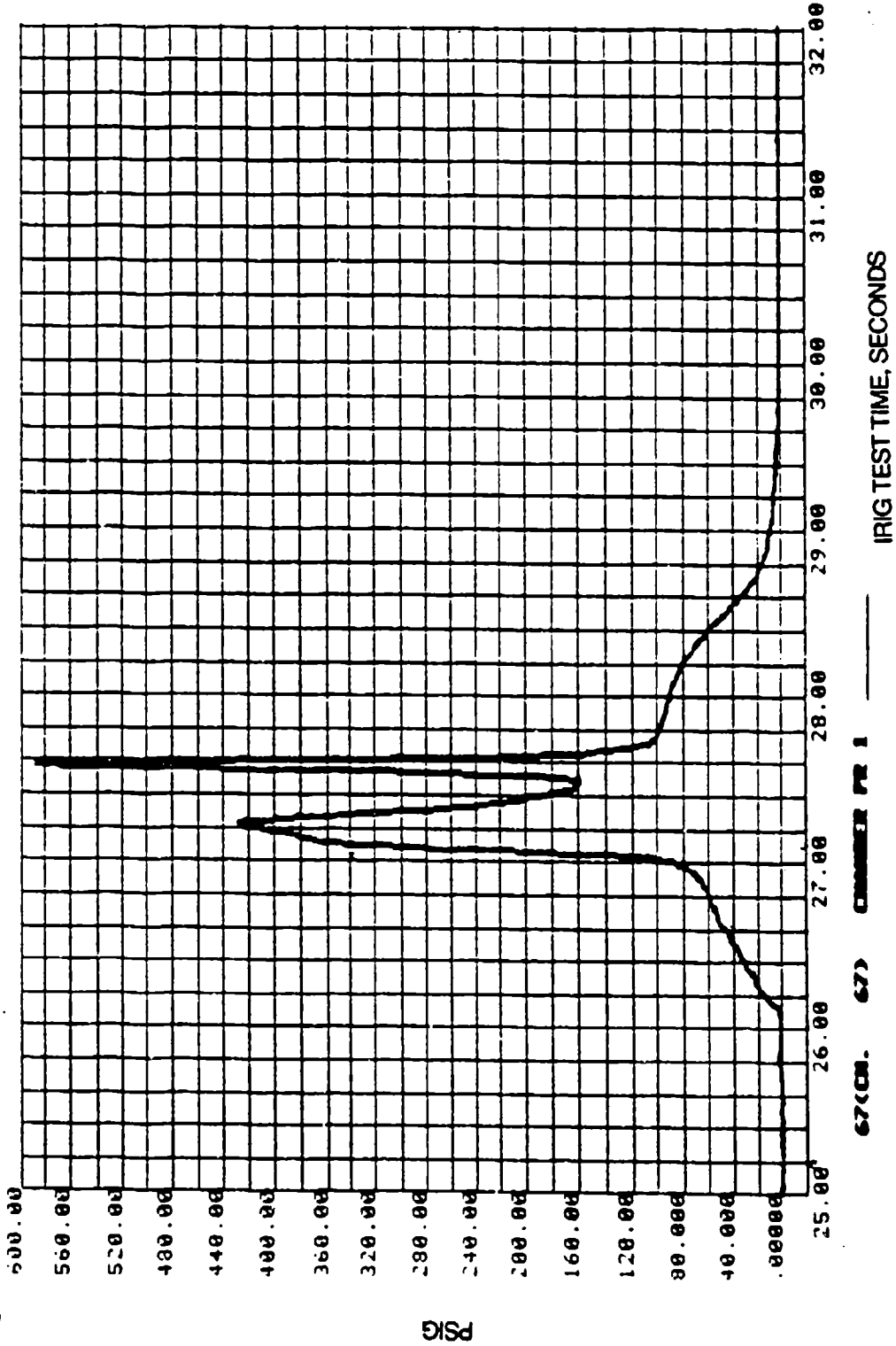

67(CM. 67) CHAMBER PR 1 _____ IRIG TEST TIME, SECONDS

Figure 7-47 ENGINE PERFORMANCE DATA SUMMARY- 86-017-006

TEST NUMBER	▪	17006	1.006
TEST DATE (YRMOYD)	▪	860417	860417
TEST AMBIENT PRESSURE, PSIA	▪	13.81	13.81
TEST DATA SLICE NO.	▪	5	15
MK49-F TURBOPUMP, RPM	▪	65,570	73,660
LH2 TURBOPUMP INLET FLOW, #/SEC	▪	1.820	2.111
LH2 TURBOPUMP OUTLET FLOW, #/SEC	▪	1.710	1.998
MK49-O TURBOPUMP, RPM	▪	25,840	30,400
LO2 TURBOPUMP INLET FLOW, #/SEC	▪	7.916	18.380
LO2 TURBOPUMP OUTLET FLOW, #/SEC	▪	6.350	17.025
THRUST CHAMBER TOTAL FUEL FLOW, #/SEC	▪	1.706	1.965
THRUST CHAMBER TOTAL LOX FLOW, #/SEC	▪	6.400	17.052
THRUST CHAMBER TOTAL FLOW, #/SEC	▪	8.106	19.016
THRUST CHAMBER MIXTURE RATIO	▪	3.783	8.679
FUEL INJECTOR RESISTANCE	▪	30.563	63.369
FUEL INJECTOR ELEMENT FLOW, #/SEC	▪	1.842	1.892
FUEL INJECTOR FACEPLATE FLOW, #/SEC	▪	0.063	0.073
FUEL INJECTOR VELOCITY, FT/SEC	▪	1134.927	1307.348
OXID INJECTOR RESISTANCE	▪	58.552	-1.965
OXID INJECTOR VELOCITY, FT/SEC	▪	18.013	47.992
INJECTOR VELOCITY RATIO	▪	63.006	27.241
FUEL IGNITER FLOW, #/SEC	▪	0.054	0.053
FUEL IGNITER CORE FLOW, #/SEC	▪	0.002	0.002
OXID IGNITER FLOW, #/SEC	▪	0.050	0.026
IGNITER CORE MIXTURE RATIO	▪	23.329	12.173
CHAMBER RESISTANCE	▪	41.712	30.837
CHAMBER HEAT LOAD, BTU/SEC	▪	2001.655	2305.747
CHAMBER DELTA PRESSURE, PSI	▪	165.990	162.830
CHAMBER DELTA TEMPERATURE, DEG F	▪	297.410	273.370
NOZZLE RESISTANCE	▪	-2.466	-1.950
NOZZLE HEAT LOAD	▪	1021.636	1176.843
NOZZLE DELTA PRESSURE, PSI	▪	-13.820	-14.500
NOZZLE DELTA TEMPERATURE, DEG F	▪	156.630	161.720
NOZZLE TOTAL FLOW, #/SEC	▪	1.706	1.965
MAIN CHAMBER PRESSURE, PSIA	▪	439.01	172.90

Figure 7-48 MK49-F PERFORMANCE DATA SUMMARY -86 017-006

TURBOPUMP SPEED, RPM	▪	85,570	73,860
BEARING DN	▪	1,311,400	1,473,200
MAIN PUMP FLOWRATES			
PUMP INLET FLOWRATE, #/SEC	▪	205.691	239.669
DESIGN INLET FLOWRATE, GPM	▪	1.820	2.111
Q/N	▪	258.182	290.036
(Q/N)/(Q/N design)	▪	0.003	0.003
PUMP DISCHARGE FLOWRATE, #/SEC	▪	0.797	0.826
	▪	1.706	1.965
MISC. FLOWRATES			
REAR BEARING COOLANT FLOW, #/SEC	▪	0.031	0.032
TURBINE SEAL LEAKAGE FLOW, #/SEC	▪	0.007	0.007
FUEL INLET BLEED FLOW, #/SEC	▪	0.079	0.082
VOLUTE CASE OVERBOARD LEAKAGE FLOW, #/SEC	▪		
SUCTION PARAMETERS			
SUCTION SPECIFIC SPEED	▪	3530.203	4082.487
NPSH, FT.	▪	1785.22	1874.53
PUMP INLET VAPOR PRESSURE, PSIA	▪	17.780	17.798
PUMP INLET DENSITY, #/CUFT	▪	3.970	3.988
BALANCE PISTON PERFORMANCE			
PUMP DISCHARGE PRESSURE, PSIA	▪	1815.49	1831.48
CALCULATED IMPELLER DISCHARGE PRESSURE, PSIA	▪	1680.64	1784.92
BALANCE PISTON CAVITY PRESSURE, PSIA	▪	1290.01	1333.43
BALANCE PISTON SUMP PRESSURE, PSIA	▪	1092.87	1194.53
CALCULATED HP ORIFICE PERCENT OPEN	▪	11.44	1.48
GENERAL COMMENTS:			
FUEL FLOWMETER #1 CONSTANT (KF1), CYCLES/GALLON	▪	46.187	
FUEL FLOWMETER #2 CONSTANT (KF2), CYCLES/GALLON	▪	46.488	

Figure 7-49 MK49-O PERFORMANCE DATA SUMMARY 86-017-006

TURBOPUMP SPEED, RPM	■	25,840	30,400
BEARING DN	■	516,800	608,000
MAIN PUMFPUMP INLET FLOWRATE, GPM	■	51.488	119.547
PUMP INLET FLOWRATE, #/SEC	■	7.916	18.380
DESIGN INLET FLOWRATE, GPM	■	81.840	96.282
Q/N	■	0.002	0.004
(Q/N)/(Q/N design)	■	0.529	1.242
PUMP DISCHARGE FLOWRATE, #/SEC	■	6.350	17.025
MISC. FLOWRATES			
FRONT BEARING FLOWRATE, #/SEC	■	0.432	0.401
BALANCE PISTON FLOWRATE, #/SEC	■	1.050	0.879
PRIMARY LOX SEAL LEAKAGE FLOWRATE, #/SEC	■	0.084	0.074
REAR BEARING COOLANT FLOWRATE, #/SEC	■	0.165	0.165
TURBINE SEAL LEAKAGE FLOWRATE, #/SEC	■	0.034	0.059
PRIMARY HOT GAS SEAL LEAKAGE FLOWRATE, #/SEC	■	0.025	0.027
INTERMEDIATE SEAL PURGE FLOWRATE, #/SEC	■	0.017	0.017
SUCTION PARAMETERS			
SUCTION SPECIFIC SPEED	■	2742.55	6087.95
NPSH, FT.	■	275.42	172.34
PUMP INLET VAPOR PRESSURE, PSIA	■	30.11	29.60
PUMP INLET DENSITY, #/CUFT	■	68.56	68.62
BALANCE PISTON PERFORMANCE			
PUMP DISCHARGE PRESSURE, PSIA	■	1111.92	989.92
IMPELLER DISCHARGE PRESSURE, PSIA	■	689.43	945.68
BALANCE PISTON CAVITY #1 PRESSURE, PSIA	■	931.58	635.11
BALANCE PISTON CAVITY #2 PRESSURE, PSIA	■	449.12	627.12
BALANCE PISTON SUMP PRESSURE, PSIA	■	323.42	256.36
CALCULATED HP ORIFICE PERCENT OPEN	■	-	22.39
GENERAL COMMENTS:			
LOX FLOWMETER #1 CONSTANT (K01), CYCLES/GALLON	■	532.053	
LOX FLOWMETER #2 CONSTANT (K02), CYCLES/GALLON	■	540.692	

Test 86-017-007 **Test Date** 4/17/86 **Duration, secs** 5.7

Objective Operate the engine to 50 % thrust level (FP speed = 86,000 RPM) at an engine mixture ratio of 4.5.

Results Maximum Turbopump speeds o. 83,000 RPM and 34,000 RPM were achieved on the hydrogen and oxygen turbopumps, respectively. Both turbopump speeds increased smoothly from the start through cutoff transients. The MK49-F first critical speed was observed at 56,000 RPM and the second critical speed was observed at 75,000 RPM, but only on the downramp. Maximum chamber pressure was about 700 psig with a similar post cutoff spike in the chamber pressure but to only about 530 psig.

Test Analysis Inspection of the injector and chamber was performed with a little more discoloration of the injector face out to the second row of injector elements from the igniter port, but no erosion. All areas of the chamber appeared to be oxidized which could be the result in the post cutoff spike in chamber pressure which is purge related. This condition was not considered detrimental especially since no evidence of erosion is present. Turbopump dynamic data summaries are presented in Table 7-13 and Table 7-14, for the MK49-F and MK49-O, respectively. The maximum accelerometer activity occurred during the downramp at the second critical for the fuel pump (maximum 7.1 Gms-radial accel A2; 3.5 and 3.8 for radial accels A1 and A3, respectively. The maximum accelerometer amplitude for the MK49-O pump occurred at the maximum speed of 34,000 RPM and was 3.4 Grms on radial accel A8 and below the first critical speed. (Note The MK49-O turbopump was designed to operate sub-critical.) ISOPLOTS for the MK49-F radial accel, A4 and the MK49-O radial accel, A6, are presented in Figure 7-50 and 7-51. Figures 7-52 through 7-55 show the pressures and temperature profiles during the test. A data reduction was made at five slices in the short period of engine operation. Figures 7-56 thru 7-58 document the overall engine performance parameters, MK49-F fuel pump operation, and the MK49-O Lox pump operation, respectively.

Table 7-13 MK49-F DYNAMIC DATA SUMMARY - 86-017-007

MAXIMUM SPEED 83,000 RPM

PARAMETER	MAXIMUM AMPLITUDE *		AMPLITUDE @ MAX SPEED		AMPLITUDE @ 70,000 RPM	
	100-2500 HZ BAND PASS	10,000 HZ WIDEBAND	100-2500 HZ BAND PASS	10,000 HZ WIDEBAND	100-2500 HZ BAND PASS	10,000 HZ WIDEBAND
RADIAL ACCEL A1	3.5 Grms	34 Grms (overdriven)	3.2 Grms	34 Grms (overdriven)	3.3 Grms	33 Grms (overdriven)
RADIAL ACCEL A2	7.1 Grms	44 Grms (overdriven)	4.2 Grms	32 Grms (overdriven)	1.9 Grms	27 Grms
RADIAL ACCEL A4	3.8 Grms	25 Grms	2.1 Grms	23 Grms	1.1 Grms	22 Grms
RADIAL BENTLY S1	—	0.001 IN PTP	—	0.001 IN PTP	—	0.001 IN PTP
RADIAL BENTLY S2	—	0.001 IN PTP	—	0.001 IN PTP	—	0.001 IN PTP

* Maximum amplitudes in 100-2500 Hz range occurs at 2nd critical speed during ramp down.
 Maximum amplitudes in 10,000 Hz range occurs at 73,000 rpm during ramp up.

Table 7-14 MK49-O DYNAMIC DATA SUMMARY - 86-017-007

MAXIMUM SPEED: 34,000 RPM

PARAMETER	MAXIMUM AMPLITUDE *	
	100-2600 HZ BAND PASS	10,000 HZ WIDEBAND
RADIAL ACCEL A6	2.8 Grms	27 Grms
RADIAL ACCEL A7	2.7 Grms	25 Grms
RADIAL ACCEL A8	3.4 Grms	19 Grms
RADIAL BENTLY S4	—	0.0035 IN PTP

* Maximum amplitudes occur at the maximum speed

Figure 7-50 MK49-F RADIAL ACCEL, A4 ISOPLLOT
86-017-007

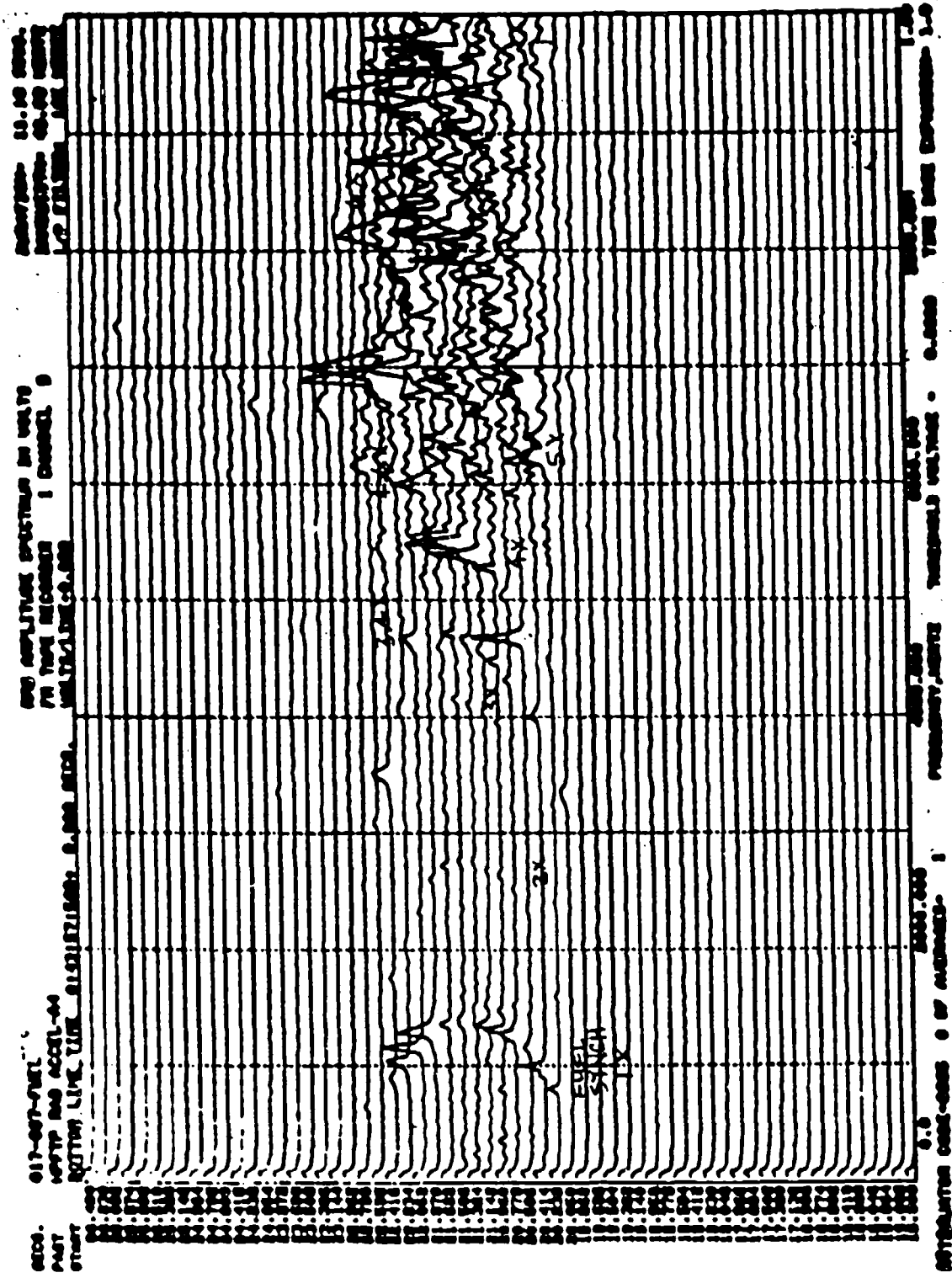

Figure 7-51 MK49-O RADIAL ACCEL, A6 ISOPLOT

86-017-007

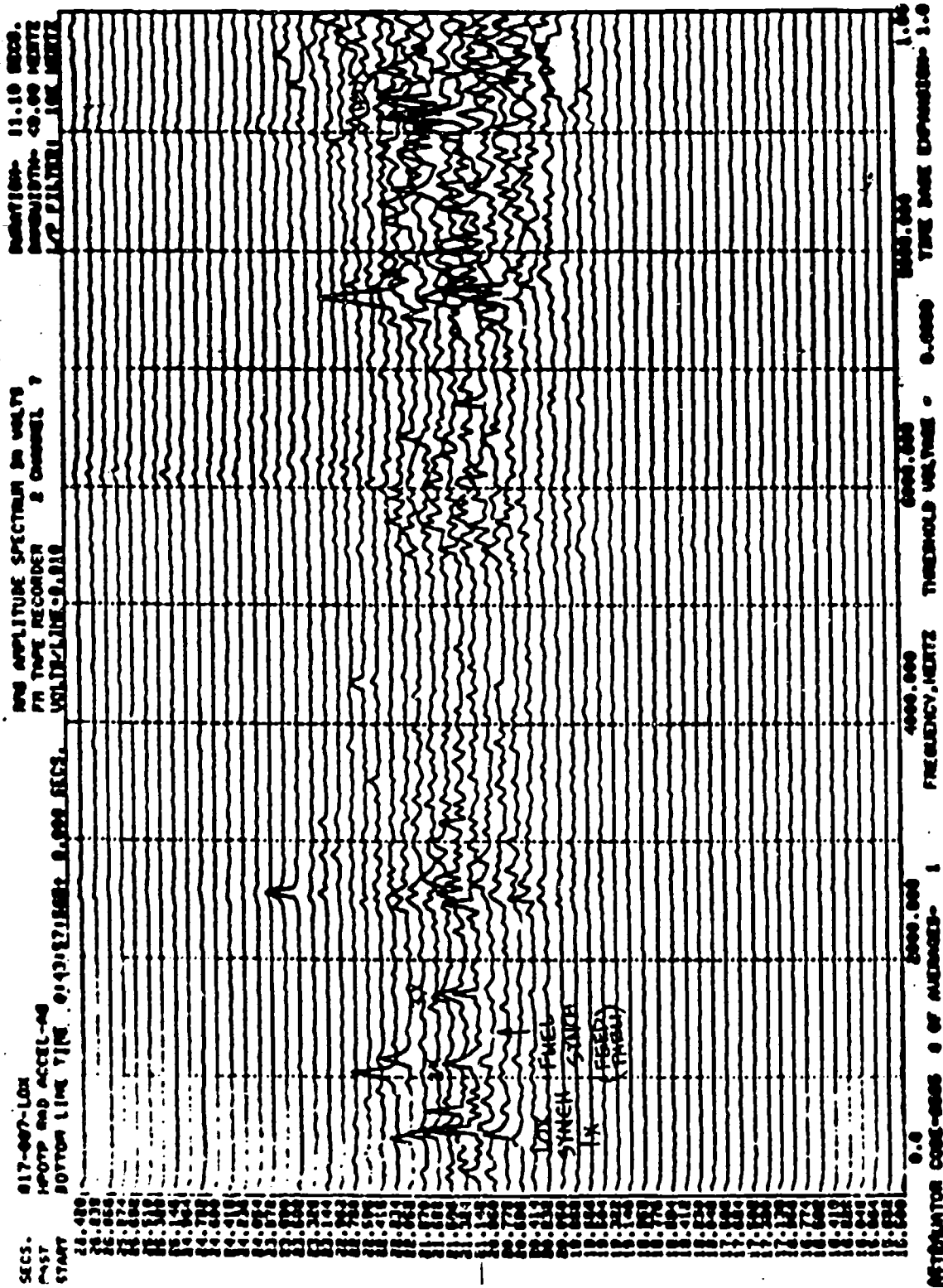

Figure 7-52 TURBOPUMP SPEED HISTORY VERSUS TEST TIME -
86-017-007

TEST 017007 DATE 4/17/86
ZERO TIME: 0 0:43:42.63

ROCKETDYNE
SANTA SUSANA FIELD LABORATORY

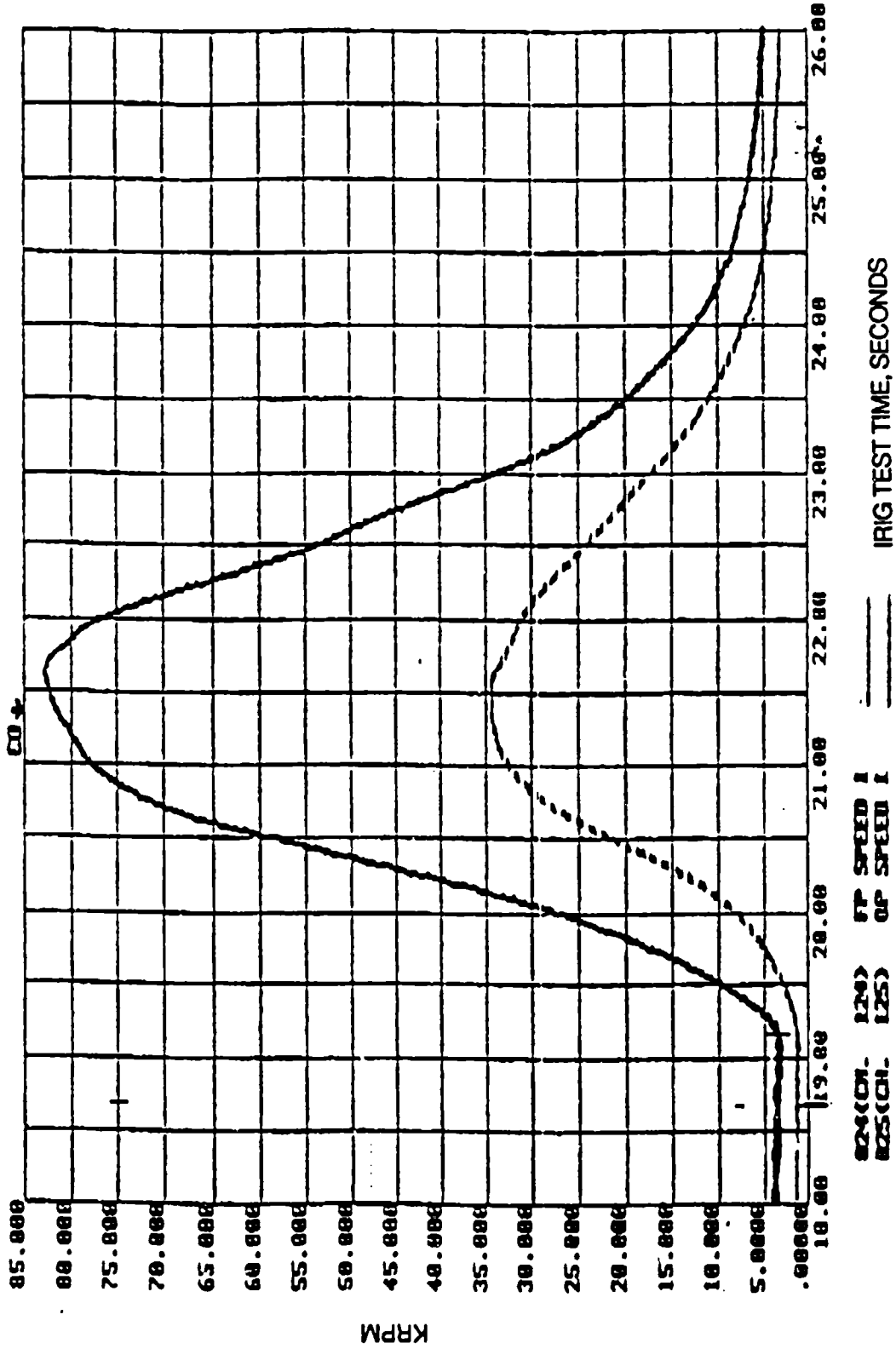

Figure 7-53 FUEL INJECTOR INLET/CHAMBER PRESSURE VERSUS TEST TIME
86-017-007

TEST 017007 DATE 4/17/86
ZERO TIME: 0 0:43:42. 63

ROCKETDYNE
SANTA SUSANA FIELD LABORATORY

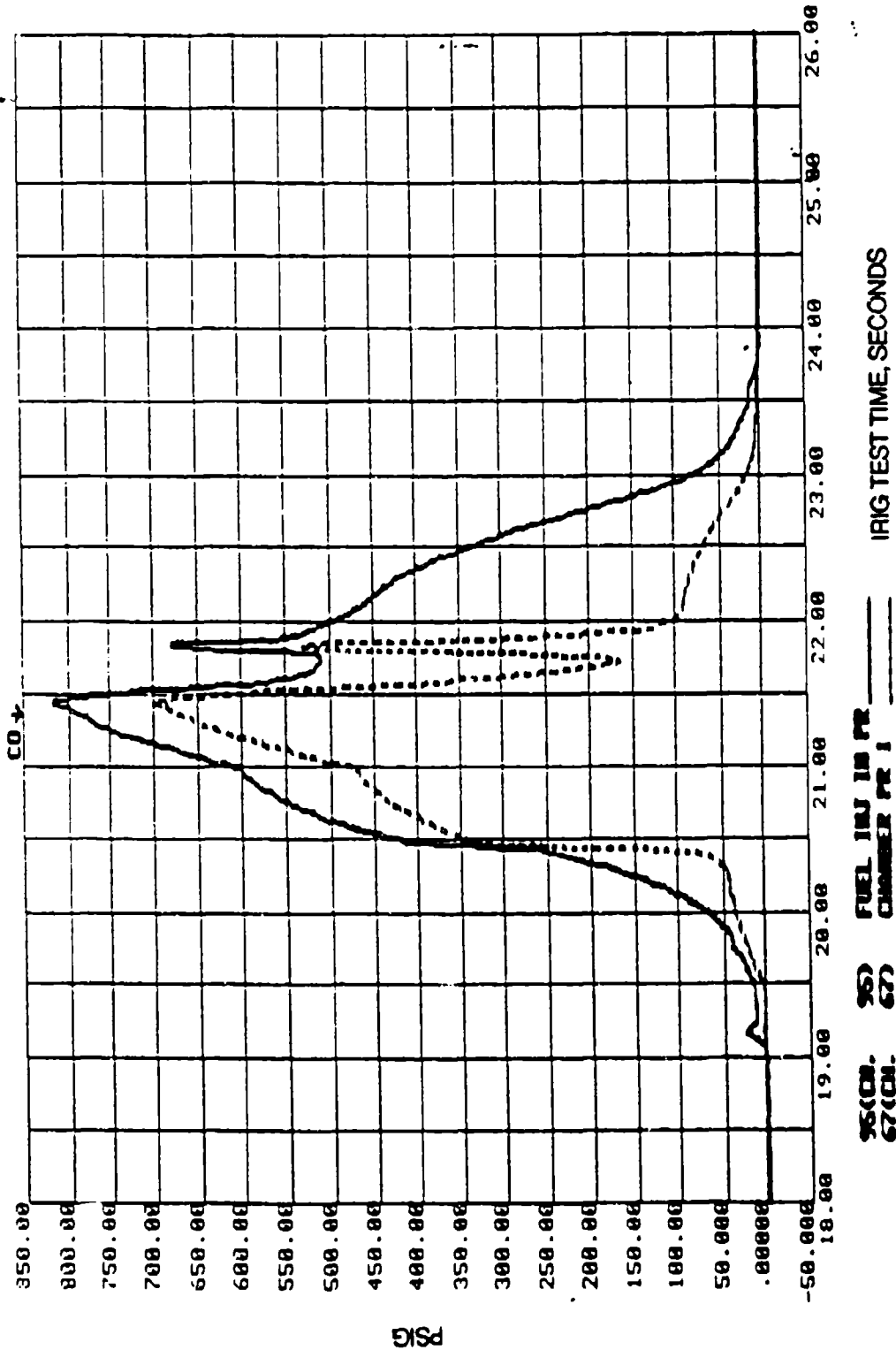
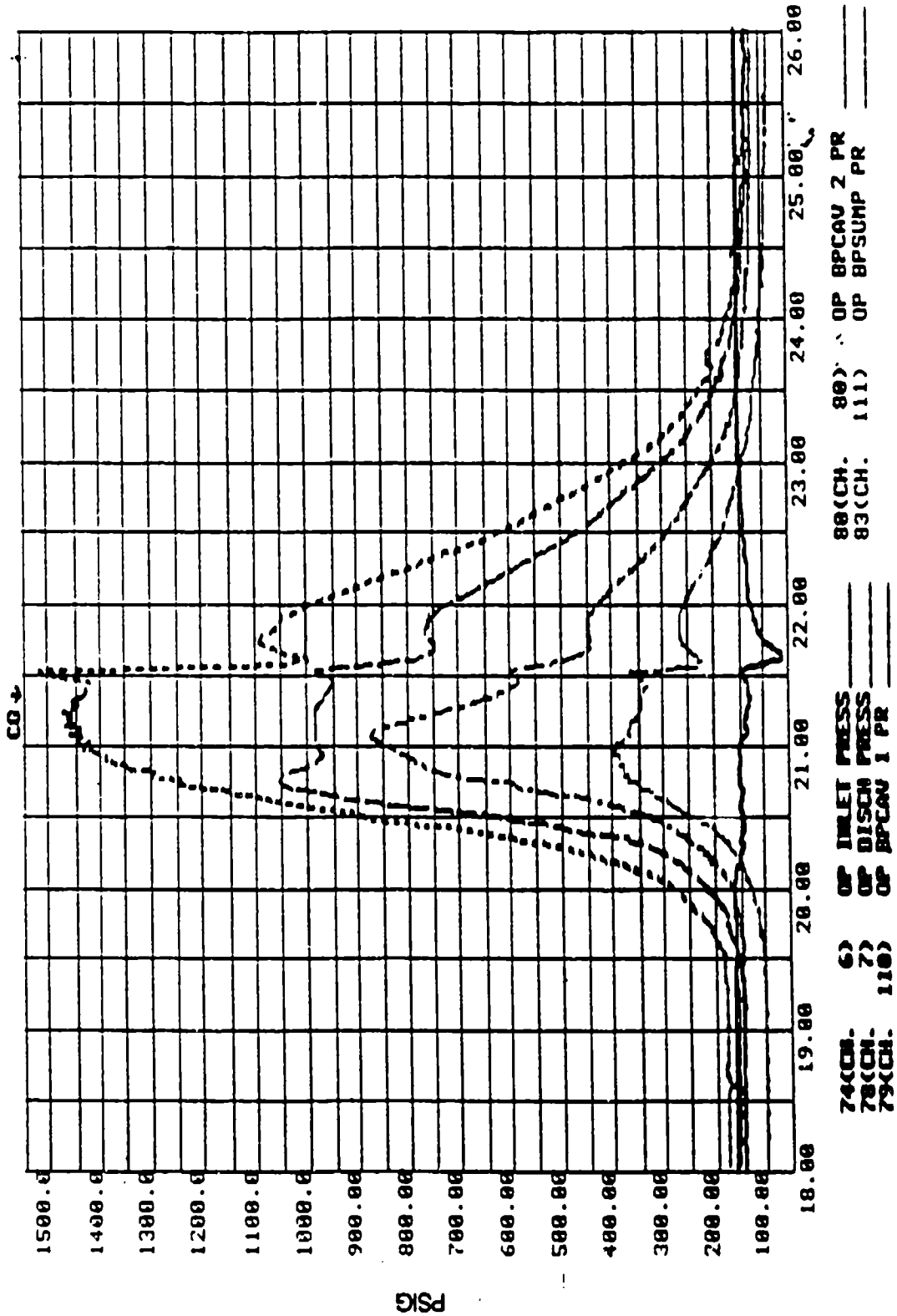

Figure 7-54 LOX PUMP SYSTEM PRESSURES VERSUS TEST TIME -
86-017-007

TEST 017007 DATE 4/17/86
ZERO TIME: 0 0:43:42. 63

ROCKETDYNE
SANTA SUSANA FIELD LABORATORY



IRIG TEST TIME, SECONDS

Figure 7-55 MAIN CHAMBER PRESSURE VERSUS TEST TIME -
86-017-007

TEST 017807 DATE 4/17/86
ZERO TIME: 0 0:43:42. 63

ROCKETDYNE
SANTA SUSANA FIELD LABORATORY

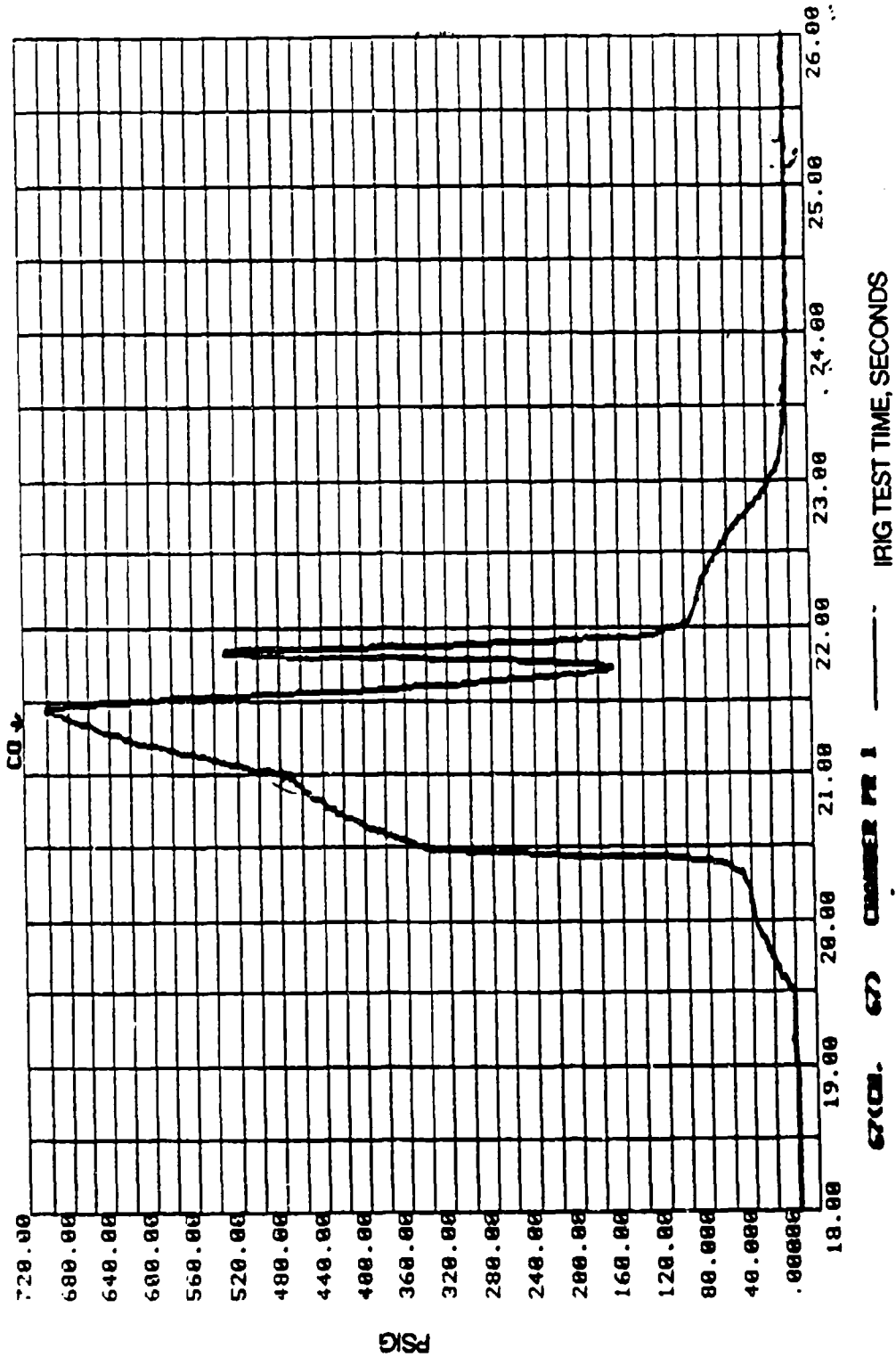

Figure 7-56 ENGINE PERFORMANCE DATA SUMMARY-
86-017-007

COMPUTATION DATE: 4-24-86 TIME: 14:16

TEST NUMBER	▪	17007	17007	17007	17007	17007
TEST DATE	▪	860417	860417	860417	860417	860417
TEST AMBIENT PRESSURE, PSIA	▪	13.82	13.82	13.82	13.82	13.82
TEST DATA SLICE NO.	▪	32	33	34	35	47
MK49-F TURBOPUMP, RPM	▪	78,120	78,530	78,820	79,050	81,880
LH2 TURBOPUMP INLET FLOW, #/SEC	▪	2.095	2.195	2.292	2.365	2.200
LH2 TURBOPUMP OUTLET FLOW, #/SEC	▪	-	-	-	-	2.148
MK49-O TURBOPUMP, RPM	▪	32,790	33,030	33,210	33,380	34,230
LO2 TURBOPUMP INLET FLOW, #/SEC	▪	8.316	8.475	8.670	8.931	13.253
LO2 TURBOPUMP OUTLET FLOW, #/SEC	▪	7.620	7.781	8.024	8.245	11.669
THRUST CHAMBER TOTAL FUEL FLOW, #/SEC	▪	2.118	2.216	2.311	2.382	2.204
THRUST CHAMBER TOTAL LOX FLOW, #/SEC	▪	7.671	7.832	8.075	8.296	11.720
THRUST CHAMBER TOTAL FLOW, #/SEC	▪	9.789	10.048	10.387	10.678	13.924
THRUST CHAMBER MIXTURE RATIO	▪	3.622	3.535	3.494	3.482	5.317
FUEL INJECTOR RESISTANCE	▪	26.020	23.212	21.416	20.254	21.355
FUEL INJECTOR ELEMENT FLOW, #/SEC	▪	1.987	2.082	2.174	2.242	2.071
FUEL INJECTOR FACEPLATE FLOW, #/SEC	▪	0.076	0.080	0.084	0.086	0.080
FUEL INJECTOR VELOCITY, FT/SEC	▪	1327.085	1359.002	1392.021	1414.818	1114.886
OXID INJECTOR RESISTANCE	▪	48.071	50.536	50.812	51.671	48.785
OXID INJECTOR VELOCITY, FT/SEC	▪	25.337	24.960	25.709	26.386	37.236
INJECTOR VELOCITY RATIO	▪	52.377	54.447	54.145	53.620	29.941
FUEL IGNITER FLOW, #/SEC	▪	0.054	0.054	0.054	0.054	0.054
FUEL IGNITER CORE FLOW, #/SEC	▪	0.002	0.002	0.002	0.002	0.002
OXID IGNITER FLOW, #/SEC	▪	0.051	0.051	0.051	0.051	0.051
IGNITER CORE MIXTURE RATIO	▪	23.372	23.361	23.353	23.344	23.372
COMBUSTOR RESISTANCE	▪	31.747	29.775	27.847	26.537	32.214
COMBUSTOR HEAT LOAD, BTU/SEC	▪	2419.914	2548.429	2670.238	2766.910	2767.619
COMBUSTOR DELTA PRESSURE, PSI	▪	177.070	181.480	182.620	185.580	199.290
COMBUSTOR DELTA TEMPERATURE, DEG F	▪	296.910	298.540	299.540	300.980	325.900
NOZZLE RESISTANCE	▪	-2.138	-2.048	-2.981	-1.755	-1.952
NOZZLE HEAT LOAD	▪	1013.732	1053.317	1094.250	1124.092	898.967
NOZZLE DELTA PRESSURE, PSI	▪	-15.550	-16.230	-25.560	-15.900	-14.970
NOZZLE DELTA TEMPERATURE, DEG F	▪	130.740	129.780	129.200	128.750	112.690
NOZZLE TOTAL FLOW, #/SEC	▪	2.064	2.162	2.257	2.328	2.150
MAIN CHAMBER PRESSURE, PSIA	▪	523.81	539.43	553.40	564.38	702.19

Figure 7-57 MK49-F PERFORMANCE DATA SUMMARY

86-017-007

TURBOPUMP SPEED, RPM	▪	78,120	78,530	78,820	79,050	81,880
BEARING DN	▪	1,862,400	1,570,600	1,576,400	1,581,000	1,637,600
MAIN PUMP PUMP INLET FLOWRATE, GPM	▪	240.395	251.702	262.867	271.057	251.858
PUMP INLET FLOWRATE, #/SEC	▪	2.095	2.195	2.292	2.365	2.200
DESIGN INLET FLOWRATE, GPM	▪	307.598	309.212	310.354	311.259	322.403
Q/N	▪	0.003	0.003	0.003	0.003	0.003
(Q/N)/(Q/N design)	▪	0.782	0.814	0.847	0.871	0.781
PUMP DISCHARGE FLOWRATE, #/SEC	▪	2.118	2.216	2.311	2.382	2.204
MISC. FLOWRATES						
REAR BEARING COOLANT FLOW, #/SEC	▪	0.024	0.024	0.024	0.025	0.025
TURBINE SEAL LEAKAGE FLOW, #/SEC	▪	-	-	-	-	-0.0001
FUEL INLET BLEED FLOW, #/SEC	▪	0.018	0.018	0.019	0.019	0.019
VOLUTE CASE OVERBOARD LEAKAGE FLOW, #/SEC	▪	0.000	0.000	0.000	0.000	0.010
SUCTION PARAMETERS						
SUCTION SPECIFIC SPEED	▪	5730.749	5654.280	5602.009	5518.260	5604.540
NPSH, FT.	▪	1266.285	1338.329	1401.405	1465.602	1432.437
PUMP INLET VAPOR PRESSURE, PSIA	▪	17.656	17.656	17.654	17.655	17.660
PUMP INLET DENSITY, #/CUFT	▪	3.836	3.836	3.834	3.835	3.840
BALANCE PISTON PERFORMANCE						
PUMP DISCHARGE PRESSURE, PSIA	▪	2030.72	2047.07	2062.29	2079.34	2166.87
CALCULATED IMPELLER DISCHARGE PRESSURE, PSIA	▪	1805.83	1826.97	1847.37	1867.86	1921.09
BALANCE PISTON CAVITY PRESSURE, PSIA	▪	1363.91	1377.17	1386.93	1396.98	1444.39
BALANCE PISTON SUMP PRESSURE, PSIA	▪	1235.78	1242.35	1251.21	1259.09	1311.25
CALCULATED HP ORIFICE PERCENT OPEN	▪	-1.18	-0.30	-0.71	-0.87	-2.11
TURBINE PERFORMANCE PARAMETERS						
TURBINE INLET FLOWRATE, #/SEC	▪	1.314	1.323	1.328	1.333	1.366
GENERAL COMMENTS:						
FUEL FLOWMETER # 1 CONSTANT (KF1), CYCLES/GALLON	▪					48.187
FUEL FLOWMETER # 2 CONSTANT (KF2), CYCLES/GALLON	▪					48.488

Figure 7-58 MK49-O PERFORMANCE DATA SUMMARY

86-017-007

TURBOPUMP SPEED, RPM	=	32,790	33,030	33,210	33,380	34,230
BEARING DN	=	655,800	660,600	664,200	667,600	684,600
MAIN PUMP PUMP INLET FLOWRATE, GPM	=	89.219	90.232	91.481	93.139	94.285
PUMP INLET FLOWRATE, #/SEC	=	9.316	9.475	9.670	9.931	13.255
DESIGN INLET FLOWRATE, GPM	=	103.852	104.612	105.182	105.721	108.413
Q/N	=	0.002	0.002	0.002	0.002	0.002
(Q/N)/(Q/N design)	=	0.570	0.576	0.585	0.597	0.777
PUMP DISCHARGE FLOWRATE, #/SEC	=	7.520	7.781	8.024	8.245	11.669
MISC. FLOWRATES						
FRONT BEARING FLOWRATE, #/SEC	=	0.506	0.507	0.509	0.506	0.507
BALANCE PISTON FLOWRATE, #/SEC	=	1.097	1.094	1.045	1.089	0.991
PRIMARY LOX SEAL LEAKAGE FLOWRATE, #/SEC	=	0.093	0.092	0.092	0.092	0.088
REAR BEARING COOLANT FLOWRATE, #/SEC	=	0.139	0.139	0.139	0.139	0.137
TURBINE SEAL LEAKAGE FLOWRATE, #/SEC	=	-0.039	-0.038	-0.037	-0.035	-0.034
PRIMARY HOT GAS SEAL LEAKAGE FLOWRATE, #/SEC	=	0.028	0.028	0.028	0.028	0.029
INTERMEDIATE SEAL PURGE FLOWRATE, #/SEC	=	0.018	0.018	0.018	0.018	0.018
SUCTION PARAMETERS						
SUCTION SPECIFIC SPEED	=	3569.628	3718.828	3881.027	3964.882	4668.655
NPSH, FT.	=	292.279	282.634	272.641	271.564	273.769
PUMP INLET VAPOR PRESSURE, PSIA	=	18.249	18.241	18.241	18.241	18.218
PUMP INLET DENSITY, #/CUFT	=	70.245	70.247	70.247	70.247	70.252
BALANCE PISTON PERFORMANCE						
PUMP DISCHARGE PRESSURE, PSIA	=	1461.32	1453.34	1468.55	1454.10	1437.54
IMPELLER DISCHARGE PRESSURE, PSIA	=	1127.18	1115.85	1115.00	1071.87	1064.78
BALANCE PISTON CAVITY #1 PRESSURE, PSIA	=	994.39	995.58	996.24	996.01	968.78
BALANCE PISTON CAVITY #2 PRESSURE, PSIA	=	871.72	883.01	882.42	872.85	813.36
BALANCE PISTON SUMP PRESSURE, PSIA	=	388.35	378.71	378.82	382.74	349.42
CALCULATED HP ORIFICE PERCENT OPEN	=	21.69	20.51	20.42	17.21	24.16
GENERAL COMMENTS:						
LOX FLOWMETER NUMBER 1 CONSTANT (KO1), CYCLES/GALLON	=	532.053				
LOX FLOWMETER NUMBER 2 CONSTANT (KO2), CYCLES/GALLON	=	540.692				

7.6.2 Test Series 1987 Results (87-017-001 thru 87-017-006)

Test 87-017-001 Test Date 1/23/87 Duration, secs 1.08

Objective Transient Engine Operation to a Fuel Pump speed of 75,000 RPM to evaluate the Fuel Pump Balance Piston Position, fuel pump performance, and initial exhaust plume spectrometry.

Results Test prematurely terminated due to low igniter chamber pressure redline. The redline sequence activation time was not timed to the actual system pressure buildup sequence of the engine. Adjustments of the redline sensor activation was made.

Test 87-017-002 Test Date 1/23/87 Duration, secs 1.09

Objective Operate engine to fuel pump speed of 86,000 RPM at an engine mixture ratio of 5.0 to define steady state characteristics and exhaust plume spectrometry.

Results Test prematurely terminated by low igniter chamber pressure redline. The redline sequence activation time setting was still out of synchronization to the actual system pressure buildup sequence of the engine. Adjustments of the redline sensor activation was again made.

Test 87-017-003 Test Date 1/23/87 Duration, secs 5.21

Objective Transient engine operation to a fuel pump speed of 75,000 RPM to evaluate fuel pump balance piston position and fuel pump performance and exhaust plume spectrometry.

Results Test prematurely terminated by low main engine chamber pressure redline. The redline sensor setting for Pc OK was not set for the appropriate startup of the engine. Adjustments were made to assure for maximum protection of the engine during these first phases of engine testing.

Test Analysis Ignition satisfactory. Transition to mainstage reached only about 322 psia when the pressure sensed for main engine Pc OK was too low for the test sequence time. The fuel pump operated smoothly to 56,590 RPM with the Lox pump achieving 22,430 RPM. No damage to the hardware was noted therefore testing was recommended to continue. **Figures 7-59 through 7-61** presents the data reduction output for the engine, MK49-F turbopump, and the MK49-O turbopump performance, respectively.

Figure 7-59 ENGINE PERFORMANCE
TEST 87-017-003

COMPUTATION DATE:	870211	COMPUTATION TIME	17.25		
TEST NUMBER	=	87003	87003	87003	87003
TEST DATE	=	872301	872301	872301	872301
TEST DATA SLICE START TIME	=	17.5	17.62	17.64	17.68
TEST DATA SLICE IRIG TIME	=	0.6	0.616	0.64	0.656
MK49-F TURBOPUMP, RPM	=	54,080	54,570	55,360	55,850
LH2 TURBOPUMP INLET FLOW, #/SEC	=	1.821	1.859	1.896	1.918
LH2 TURBOPUMP OUTLET FLOW, #/SEC	=	1.715	1.755	1.791	1.811
MK49-O TURBOPUMP, RPM	=	20,370	20,790	21,520	21,960
LO2 TURBOPUMP INLET FLOW, #/SEC	=	5.423	5.538	5.696	5.789
LO2 TURBOPUMP OUTLET FLOW, #/SEC	=	4.028	4.100	4.255	4.379
THRUST CHAMBER TOTAL FUEL FLOW, #/SEC	=	1.755	1.794	1.830	1.850
THRUST CHAMBER TOTAL LOX FLOW, #/SEC	=	4.077	4.150	4.304	4.429
THRUST CHAMBER TOTAL FLOW, #/SEC	=	5.832	5.944	6.134	6.279
THRUST CHAMBER MIXTURE RATIO	=	2.324	2.313	2.352	2.394
FUEL INJECTOR RESISTANCE	=	17.497	17.503	18.178	18.336
FUEL INJECTOR ELEMENT FLOW, #/SEC	=	1.637	1.675	1.710	1.729
FUEL INJECTOR FACEPLATE FLOW, #/SEC	=	0.063	0.064	0.066	0.068
FUEL INJECTOR VELOCITY, FT/SEC	=	1902.830	1856.541	1821.319	1794.269
OXID INJECTOR RESISTANCE	=	2.874	3.319	3.626	3.662
OXID INJECTOR VELOCITY, FT/SEC	=	318.247	294.868	272.631	257.432
INJECTOR VELOCITY RATIO	=	5.979	6.300	6.663	6.970
FUEL IGNITER FLOW, #/SEC	=	0.054	0.055	0.054	0.055
FUEL IGNITER CORE FLOW, #/SEC	=	0.002	0.002	0.002	0.002
OXID IGNITER FLOW, #/SEC	=	0.050	0.050	0.049	0.050
IGNITER CORE MIXTURE RATIO	=	22.697	22.639	22.540	22.687
COMBUSTOR RESISTANCE	=	18.321	18.367	19.453	20.711
COMBUSTOR HEAT LOAD, BTU/SEC	=	1996.052	1991.669	1977.266	1967.204
COMBUSTOR DELTA PRESSURE, PSI	=	119.900	120.600	127.000	135.000
COMBUSTOR DELTA TEMPERATURE, DEG F	=	300.18	292.92	284.02	280.20
NOZZLE RESISTANCE	=	5.651	5.834	5.818	5.117
NOZZLE HEAT LOAD	=	736.224	787.929	829.113	852.715
NOZZLE DELTA PRESSURE, PSI	=	50.600	53.200	53.300	46.800
NOZZLE DELTA TEMPERATURE, DEG F	=	115.340	119.970	123.370	125.100
NOZZLE TOTAL FLOW, #/SEC	=	1.700	1.739	1.776	1.795
MAIN CHAMBER PRESSURE, PSIA	=	273.44	288.14	301.84	311.54

Figure 7-60 MK49-F TURBOPUMP PERFORMANCE
TEST 87-017-003

TURBOPUMP SPEED, RPM	■	54,080	54,570	55,360	55,850	56,590
BEARING DN	■	1,081,600	1,091,400	1,107,200	1,117,000	1,131,800
MAIN PUMP PUMP INLET FLOWRATE, GPM	■	207.730	212.012	216.235	218.568	224.319
PUMP INLET FLOWRATE, #/SEC	■	1.821	1.859	1.898	1.918	1.971
DESIGN INLET FLOWRATE, GPM	■	212.940	214.869	217.980	219.909	222.823
Q/N	■	0.004	0.004	0.004	0.004	0.004
(Q/N)/(Q/N design)	■	0.976	0.987	0.992	0.994	1.007
PUMP DISCHARGE FLOWRATE, #/SEC	■	1.755	1.794	1.830	1.850	1.903
MISC. FLOWRATES						
REAR BEARING COOLANT FLOW, #/SEC (WRBRG)	■	0.010	0.010	0.010	0.011	0.011
TURBINE SEAL LEAKAGE FLOW, #/SEC (WTSL)	■	-0.0001	0.000	0.000	0.000	0.000
FUEL INLET BLEED FLOW, #/SEC (WFINB)	■	0.019	0.019	0.019	0.019	0.019
VOLUTE CASE OVERBOARD LEAKAGE FLOW, #/SEC (WC)	■	0.077	0.075	0.076	0.077	0.078
LOW PRESSURE FUEL TURBINE FLOW, #/SEC (WLPT)	■	0.136	0.138	0.142	0.144	0.148
SUCTION PARAMETERS						
SUCTION SPECIFIC SPEED	■	3397.922	3456.886	3564.283	3542.784	3544.199
NPSH, FT.	■	1413.878	1417.492	1405.319	1443.654	1493.895
PUMP INLET VAPOR PRESSURE, PSIA	■	17.570	17.570	17.570	17.577	17.577
PUMP INLET DENSITY, #/CUFT	■	3.830	3.830	3.830	3.837	3.837
PUMP INLET TEMPERATURE, DEG F	■	-412.000	-412.000	-412.000	-412.100	-412.100
PUMP INLET PRESSURE, PSIA	■	104.510	104.600	104.270	104.640	105.970
BALANCE PISTON PERFORMANCE:						
PUMP DISCHARGE PRESSURE, PSIA	■	1104.74	1128.74	1161.74	1181.74	1209.74
BALANCE PISTON CAVITY # 1 PRESSURE, PSIA	■	859.34	876.44	898.14	913.54	931.64
BALANCE PISTON SUMP PRESSURE, PSIA	■	303.54	310.54	320.84	333.24	346.54
CALCULATED HP ORIFICE PERCENT OPEN	■	36.30	36.15	35.90	35.80	35.50
BALANCE PISTON DELTA P (IMP-CAV1/CAV1-SUMP)	■	0.27	0.27	0.28	0.29	0.30
CALCULATED IMPELLER DISCHARGE PRESSURE, PSIA	■	1006.91	1030.20	1061.13	1079.73	1106.35
TURBINE PERFORMANCE PARAMETERS						
TURBINE INLET FLOWRATE, #/SEC	■	0.722	0.738	0.758	0.771	0.789
TURBINE PRESSURE RATIO	■	1.71	1.71	1.69	1.70	1.69
TURBINE FIRST STAGE HUB PRESSURE, PSIA	■	734.74	751.44	772.74	788.64	809.49
GENERAL COMMENTS:						
FUEL FLOWMETER # 1 CONSTANT (KF1), CYCLES/GALLO	■	46.008	46.008	46.008	46.008	46.008
FUEL FLOWMETER # 2 CONSTANT (KF2), CYCLES/GALLO	■	46.497	46.497	46.497	46.497	46.497
ATMOSPHERIC PRESSURE, PSIA	■	13.740	13.740	13.740	13.740	13.740
ADDITIONAL PUMP PARAMETERS:						
1ST XOVER INLET PRESSURE, PSIA	■	384.24	384.94	376.64	387.94	407.24
1ST XOVER 2ND DIFFUSER INLET PRESSURE, PSIA	■	454.44	460.14	450.64	453.94	473.64
1ST XOVER 2ND DIFFUSER OUTLET PRESSURE, PSIA	■	450.54	457.24	466.74	475.64	482.94
1ST XOVER OUTLET PRESSURE, PSIA	■	447.54	460.24	467.84	472.34	484.34
2ND XOVER INLET PRESSURE, PSIA	■	714.44	727.84	740.64	747.44	762.64
2ND XOVER TRANS OUTLET PRESSURE, PSIA	■	771.04	785.94	803.84	822.94	838.44

**Figure 7-61 MK49-O TURBOPUMP PERFORMANCE
TEST 87-017-003**

TURBOPUMP SPEED, RPM	=	20,370	20,790	21,520	21,960	22,430
BEARING DN	=	407,400	415,800	430,400	439,200	448,600
MAIN PUMP PUMP INLET FLOWRATE, GPM	=	34.970	35.696	36.730	37.328	38.368
PUMP INLET FLOWRATE, #/SEC	=	5.423	5.536	5.696	5.789	5.950
DESIGN INLET FLOWRATE, GPM	=	64.516	65.846	68.158	69.551	71.040
Q/N	=	0.002	0.002	0.002	0.002	0.002
(Q/N)/(Q/N design)	=	0.542	0.542	0.539	0.537	0.540
PUMP DISCHARGE FLOWRATE, #/SEC	=	4.028	4.100	4.255	4.379	4.489
MISCELLANEOUS FLOWRATES						
BALANCE PISTON OVERBOARD DUMP FLOW, #/SEC (WBI)	=	1.323	1.362	1.368	1.336	1.367
FRONT BEARING FLOWRATE, #/SEC (WOFB)	=	0.357	0.362	0.370	0.377	0.383
BALANCE PISTON FLOWRATE, #/SEC (WBP)	=	0.966	1.000	0.998	0.959	1.004
PRIMARY LOX SEAL LEAKAGE FLOWRATE, #/SEC (WPLS)	=	0.072	0.073	0.074	0.074	0.075
REAR BEARING COOLANT FLOWRATE, #/SEC (WORB)	=	0.328	0.232	0.402	0.232	0.328
TURBINE SEAL LEAKAGE FLOWRATE, #/SEC	=	4.078	4.165	3.980	4.140	4.027
PRIMARY HOT GAS SEAL LEAK FLOWRATE, #/SEC (WPHK)	=	0.015	0.015	0.016	0.016	0.017
INTERMEDIATE SEAL PURGE FLOWRATE, #/SEC (WISL)	=	0.017	0.017	0.017	0.017	0.017
SUCTION PARAMETERS						
PUMP INLET PRESSURE, PSIA	=	169.640	170.040	168.240	167.440	168.740
SUCTION SPECIFIC SPEED	=	1658.945	1707.043	1809.020	1868.673	1942.028
NPSH, FT.	=	302.929	303.778	300.064	298.418	296.991
PUMP INLET VAPOR PRESSURE, PSIA	=	24.016	24.016	24.016	24.016	24.016
PUMP INLET DENSITY, #/CUFT	=	69.320	69.320	69.320	69.320	69.320
PUMP INLET TEMPERATURE, DEG F	=	-287.500	-287.500	-287.500	-287.500	-287.500
BALANCE PISTON PERFORMANCE						
PUMP DISCHARGE PRESSURE, PSIA	=	794.04	808.54	816.44	826.74	852.04
IMPELLER DISCHARGE PRESSURE, PSIA	=	444.64	464.94	503.34	527.64	563.24
BALANCE PISTON CAVITY #1 PRESSURE, PSIA	=	580.64	595.14	603.24	634.44	682.94
BALANCE PISTON CAVITY #2 PRESSURE, PSIA	=	497.14	508.19	510.13	537.54	581.86
BALANCE PISTON SUMP PRESSURE, PSIA	=	240.24	244.24	252.24	252.94	257.64
CALCULATED HP ORIFICE PERCENT OPEN	=					
BALANCE PISTON DELTA P RATIO (IMP-CAV1/CAV2-SUM)	=	-0.53	-0.49	-0.39	-0.38	-0.37
GENERAL COMMENTS:						
LOX FLOWMETER # 1 CONSTANT (KO1), CYCLES/GALLOI	=	539.653	539.653	539.653	539.653	539.653
LOX FLOWMETER # 2 CONSTANT (KO2), CYCLES/GALLOI	=	533.918	533.918	533.918	533.918	533.918
ATMOSPHERIC PRESSURE, PSIA	=	13.740	13.740	13.740	13.740	13.740

Test 87-017-004: Test Date 1/28/87 Duration, secs 1.09

Objective Transient engine operation to a fuel pump speed of 75,000 RPM to evaluate the fuel pump balance piston position and fuel pump performance and analysis of the nozzle exhaust plume contaminations.

Results Test again prematurely terminated by low igniter chamber pressure redline. A reset of the sensor time for activation was again adjusted.

Test Analysis Ignition sequence satisfactory but the level of the igniter chamber pressure was below acceptable at the redline check time.

Test 87-017-005 Test Date 1/28/87 Duration, secs 5.91

Objective Transient engine operation to a fuel pump speed of 75,000 RPM to evaluate the fuel pump balance piston position and fuel pump performance and analysis of the nozzle exhaust plume contaminations.

Results The test objectives were met and the planned cutoff was initiated when the high pressure fuel pump exceeded the maximum redline speed setting of 75,000 RPM.

Test Analysis Igniter operation was nominal with the igniter chamber pressure reaching about 210 psig during the time prior to main propellant ignition (Figure 7-62). Prior to main pumps spinup, both turbopumps were spinning freely (motoring) due to a combination of applied fuel and LOX inlet pressures and the applicable pump chill-bleed flowrates. Figure 7-63 shows the fuel pump motoring prior to engine powered operation to a speed of between about 6000 and 9000 RPM. Figure 7-64 shows the Lox pump speed much lower at this period in the test to just over 1000 RPM. Each of these conditions was a normal occurrence in all of the turbopump and engine tests. Maximum spin speeds (reached after cutoff signal) were 76,800 RPM for the fuel pump and 34,700 RPM for the Lox pump. Both pump discharge pressures ramped smoothly to the maximum showing evidence of system priming down to the injection pressures, all of which was considered normal. Main chamber pressure for this test reached about 640 psig at the time the maximum pump speeds were attained. Figures 7-65 through 7-69 show the system pressures from pump discharge to the main chamber. Note that during this test, no cutoff spike was evident in the chamber pressure. A modification in the purge plumbing is attributed to the problem solution

pointing out that the system plenums must be addressed during purge designs. Figures 7-70 through 7-72 presents the results of the data reduction for specific test time periods for the engine, MK49-F turbopump, the MK49-O turbopump, and additional engine parameters. Time based data plots for all of the measured parameters are included in Appendix A. Engine post test inspections revealed some water in the 6:00 o'clock position cavity (down) which was aspirated with a tube. No other changes in the condition of the injector or combustor were noted.

Figure 7-62 IGNITER CHAMBER PRESSURE
VERSUS TEST TIME 87-017-005

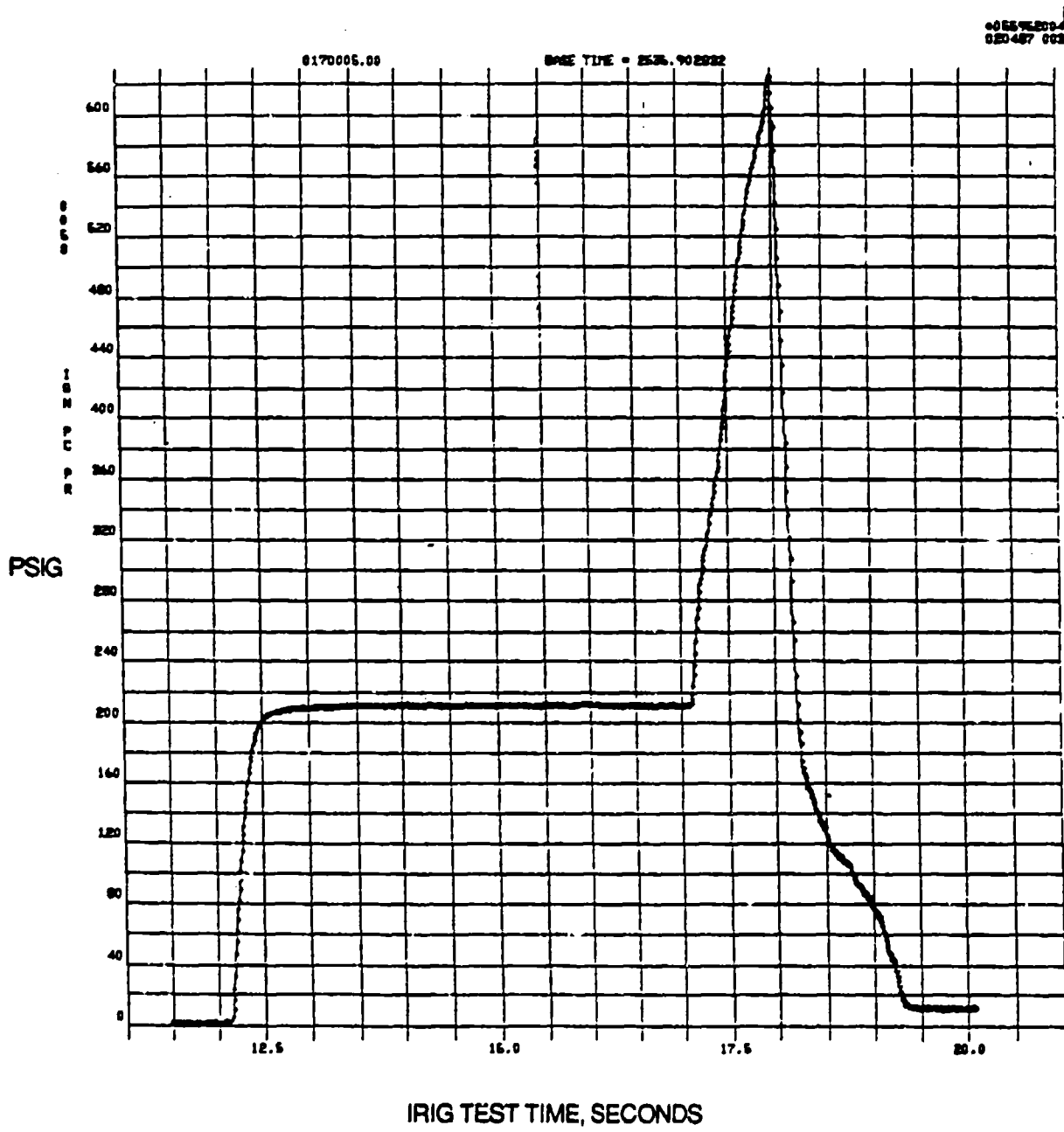

Figure 7-63 MK49-F TURBOPUMP SPEED HISTORY VERSUS TEST TIME -
87-017-005

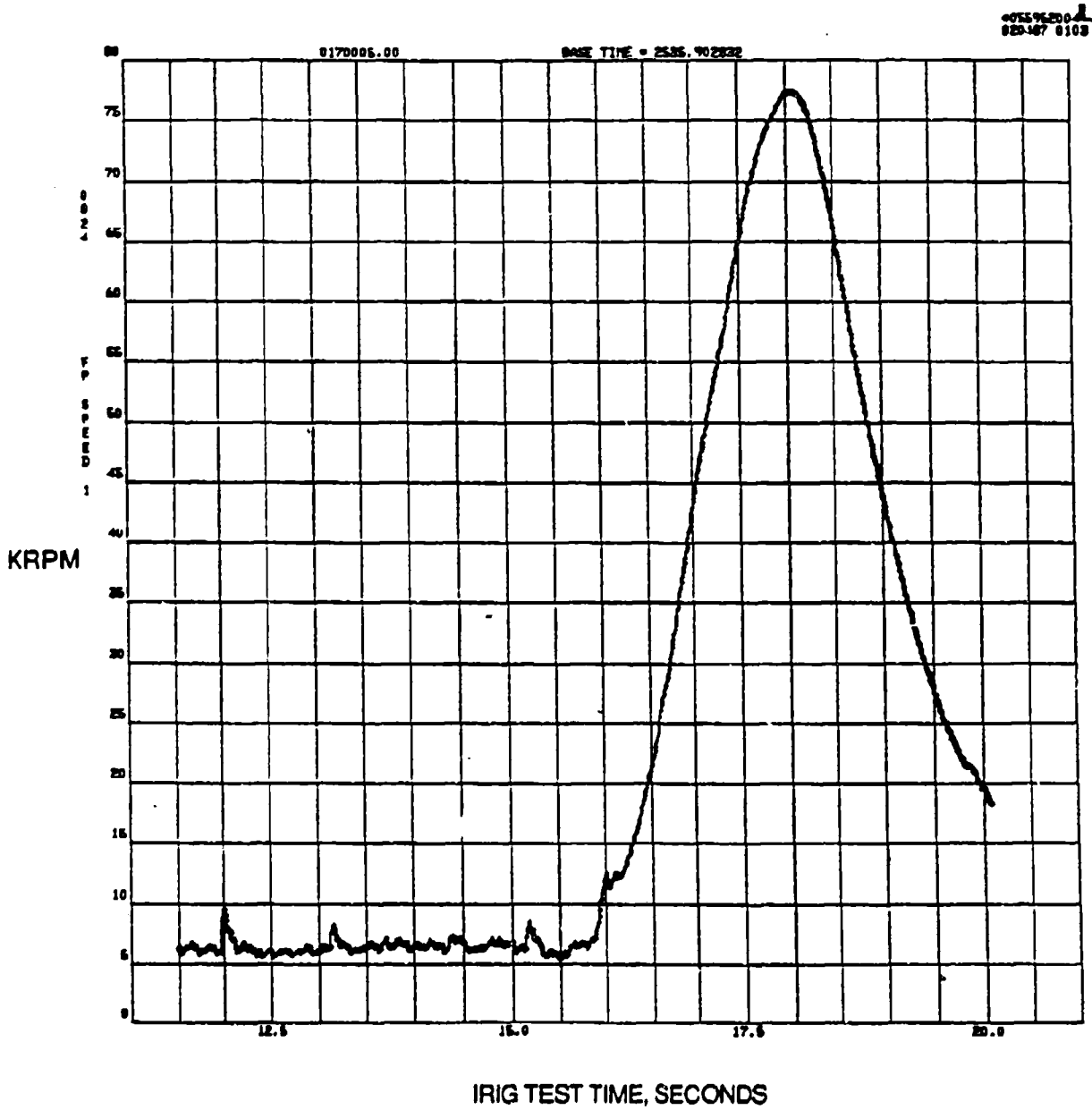

Figure 7-64 MK49-O TURBOPUMP SPEED HISTORY VERSUS TEST TIME -
87-017-005

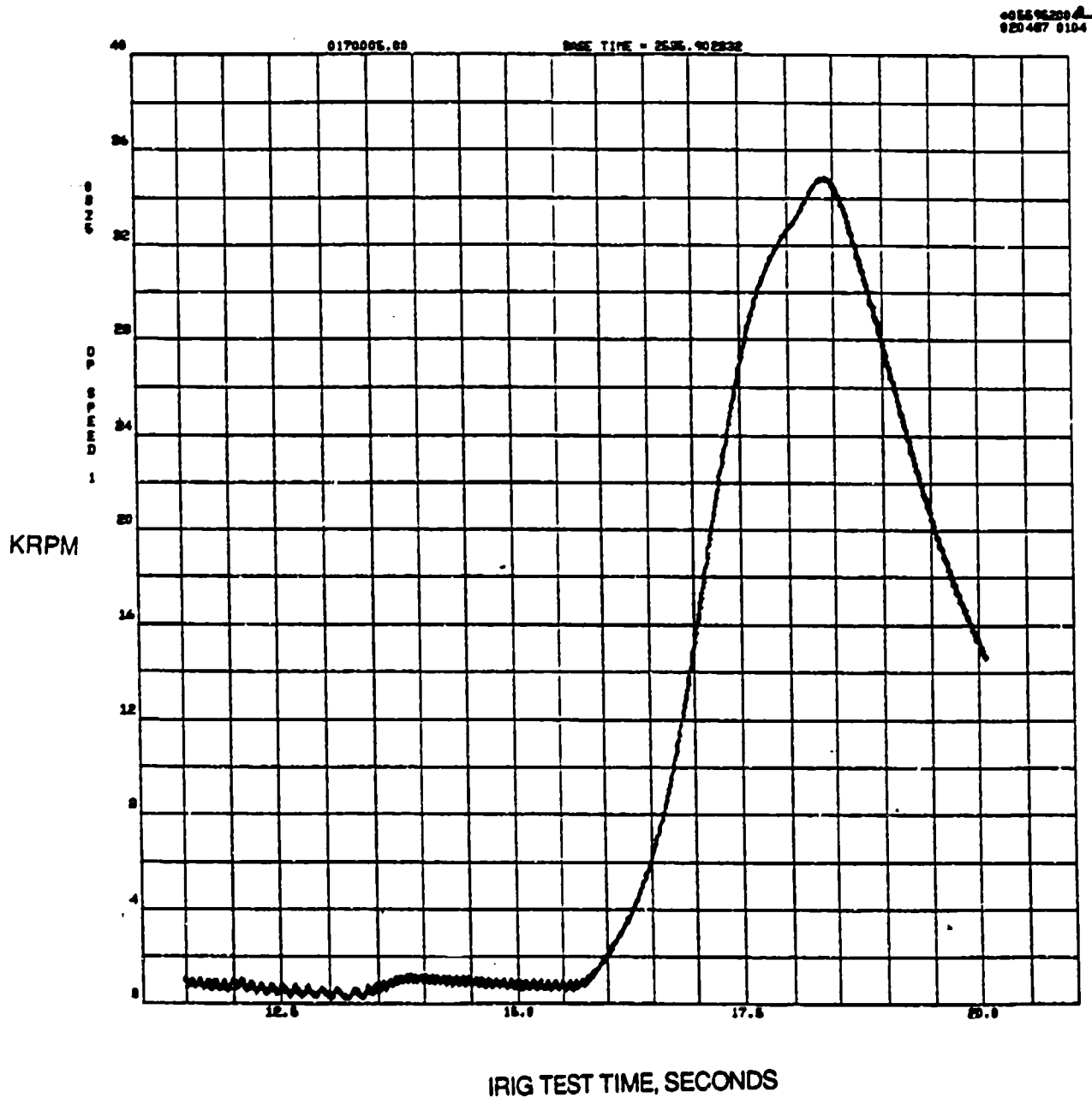

Figure 7-65 FUEL PUMP DISCHARGE PRESSURE VERSUS TEST TIME
87-017-005

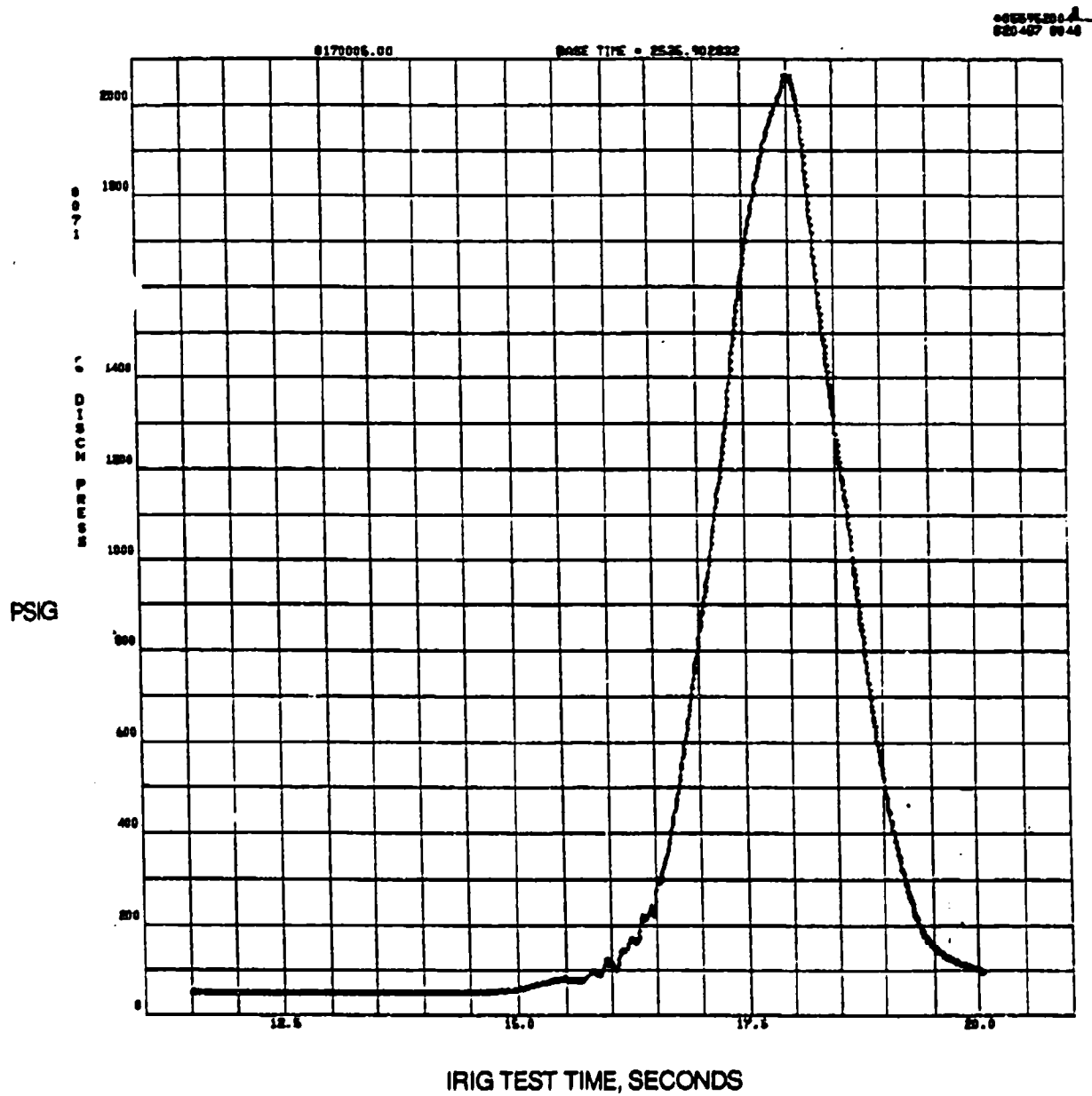

Figure 7-66 LOX PUMP DISCHARGE PRESSURE VERSUS TEST TIME
87-017-005

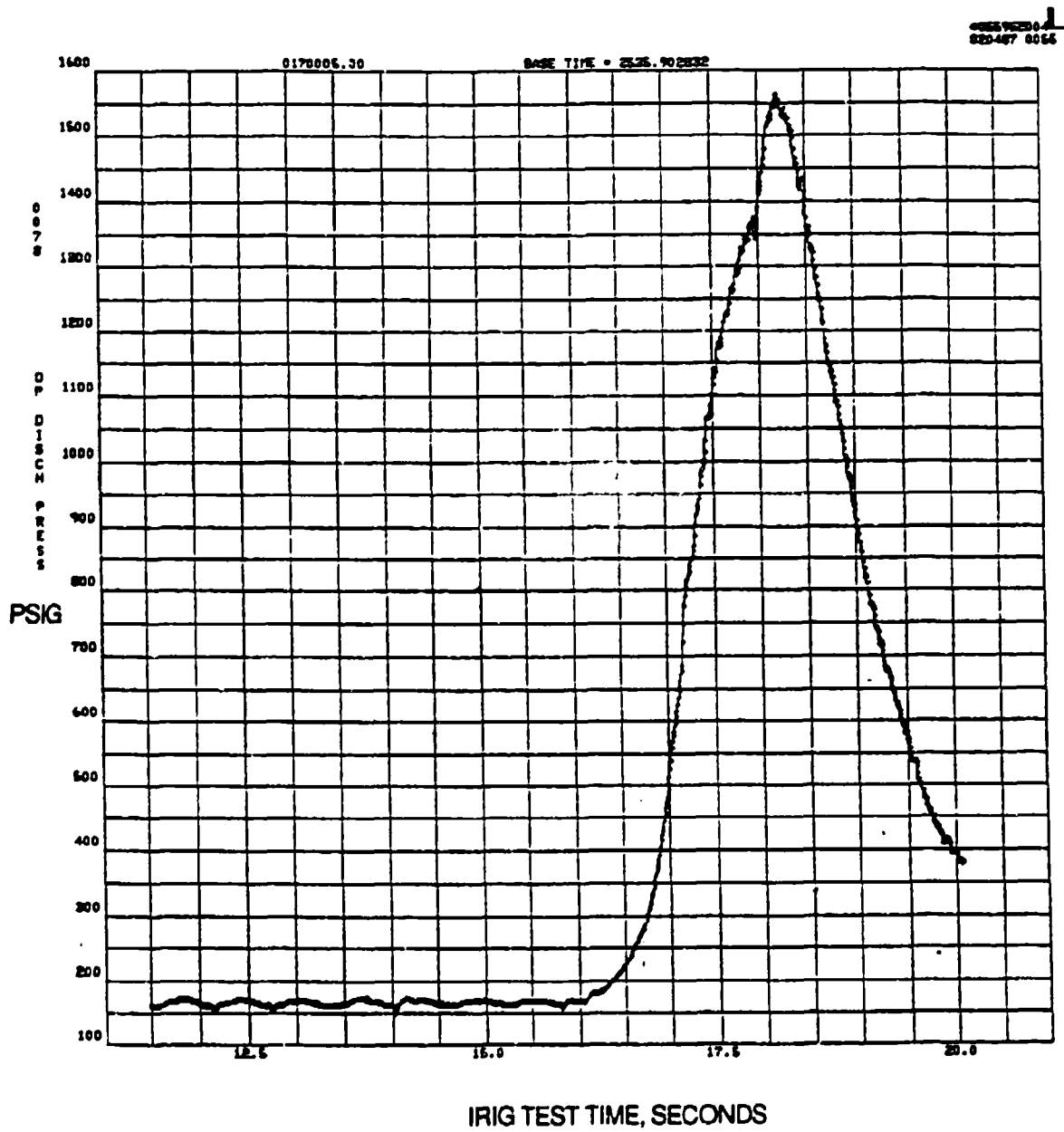

Figure 7-67 FUEL INJECTOR PRESSURE VERSUS TEST TIME -
87-017-005

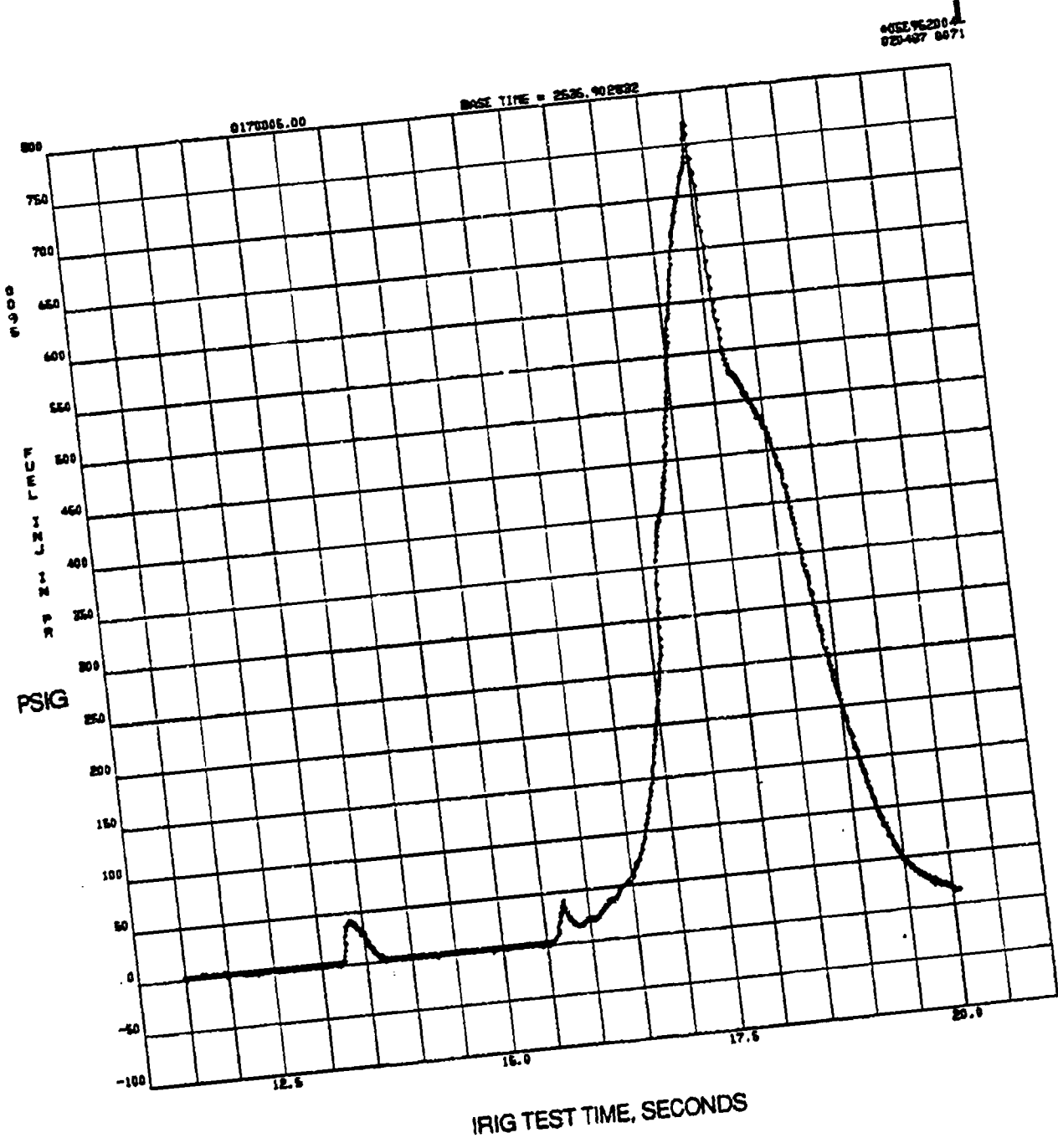

Figure 7-68 LOX INJECTOR PRESSURE VERSUS TEST TIME -
87-017-005

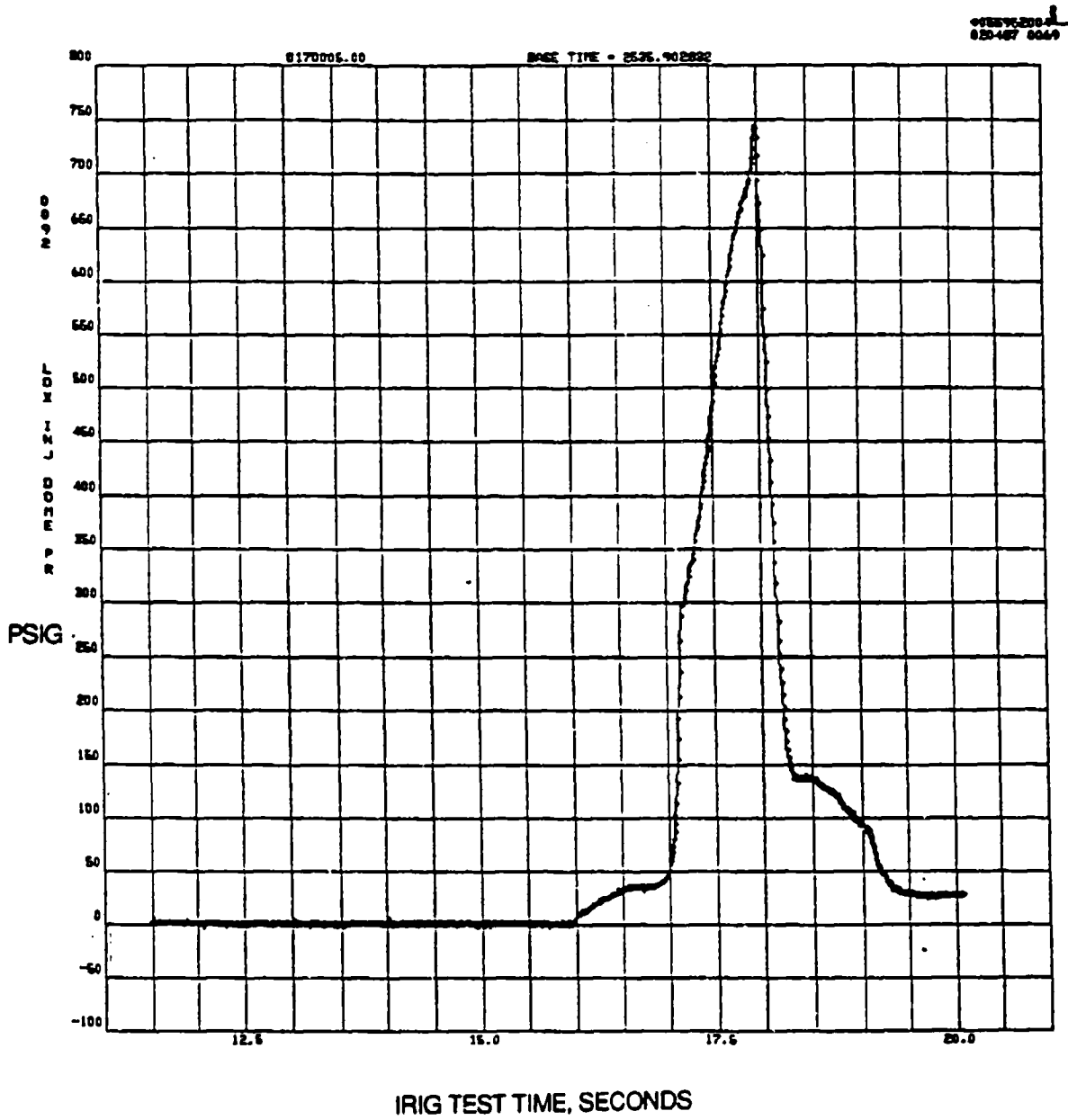

Figure 7-69 MAIN CHAMBER PRESSURE VERSUS TEST TIME -
87-017-005

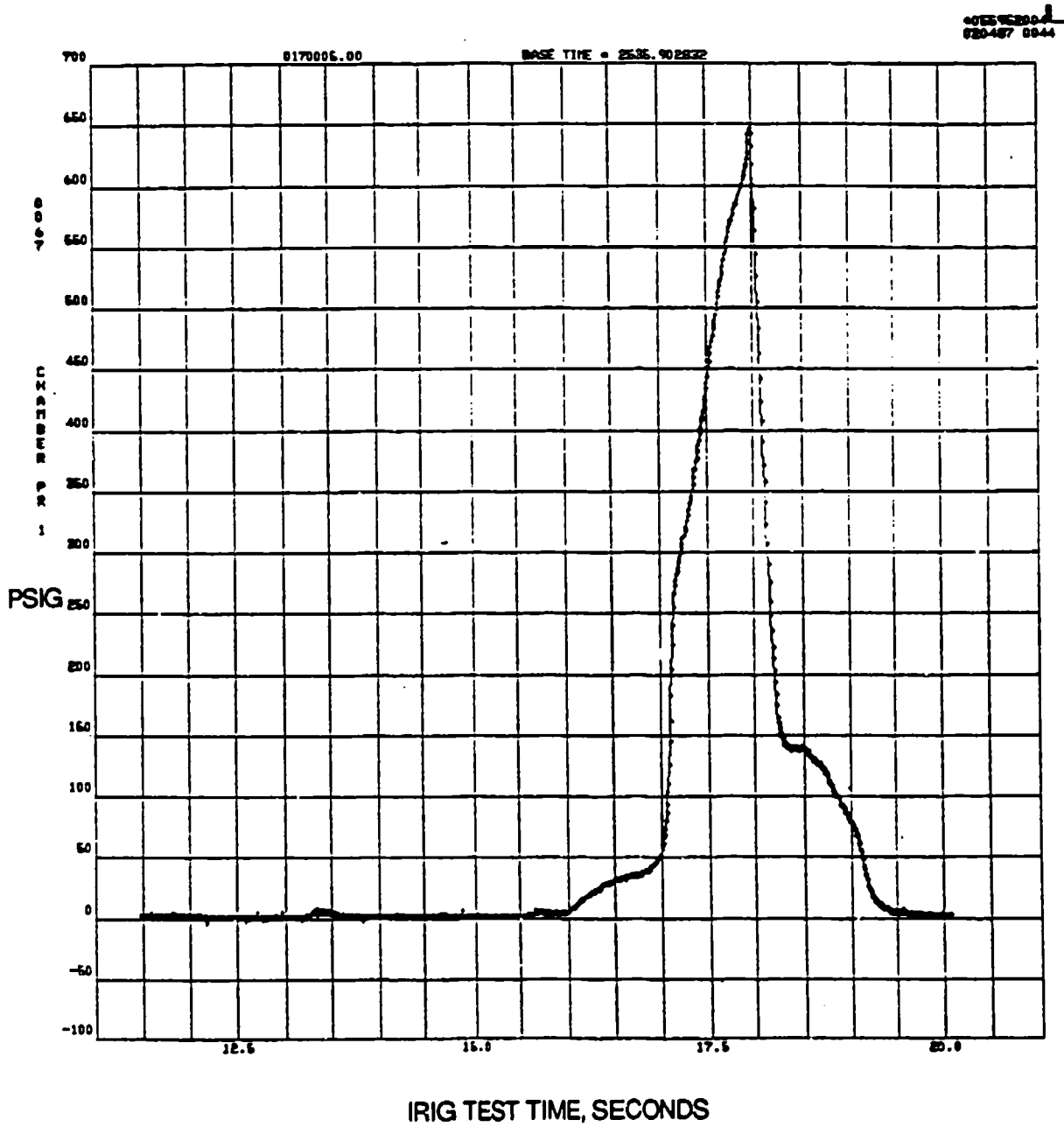

Figure 7-70 ENGINE PERFORMANCE DATA SUMMARY-
87-017-005

COMPUTATION DATE:	870211	COMPUTATION TIME:	17.05		
TEST NUMBER	▪ 87005	87005	87005	87005	87005
TEST DATE	▪ 872801	872801	872801	872801	872801
TEST DATA SUCE START TIME	▪ 17.6	17.8	17.975	17.99	18.01
TEST DATA SUCE IRIG TIME	▪ 0.51	0.711	0.879	0.895	0.919
WK49-F TURBOPUMP, RPM	▪ 68,950	74,030	76,780	76,820	76,930
.H2 TURBOPUMP INLET FLOW, #/SEC	▪ 2.080	2.239	2.317	2.355	2.401
.H2 TURBOPUMP OUTLET FLOW, #/SEC	▪ 1.978	2.137	2.218	2.255	2.301
#K49-O TURBOPUMP, RPM	▪ 28,960	31,320	32,480	32,540	32,640
.O2 TURBOPUMP INLET FLOW, #/SEC	▪ 9.949	12.183	12.742	12.765	12.797
.O2 TURBOPUMP OUTLET FLOW, #/SEC	▪ 8.283	10.528	11.118	11.094	11.092
THRUST CHAMBER TOTAL FUEL FLOW, #/SEC	▪ 2.007	2.164	2.244	2.281	2.327
THRUST CHAMBER TOTAL LOX FLOW, #/SEC	▪ 8.336	10.581	11.172	11.146	11.139
THRUST CHAMBER TOTAL FLOW, #/SEC	▪ 10.343	12.746	13.415	13.427	13.466
THRUST CHAMBER MIXTURE RATIO	▪ 4.155	4.889	4.979	4.887	4.787
FUEL INJECTOR RESISTANCE	▪ 23.473	21.692	21.438	21.105	22.347
FUEL INJECTOR ELEMENT FLOW, #/SEC	▪ 1.880	2.032	2.109	2.145	2.189
FUEL INJECTOR FACEPLATE FLOW, #/SEC	▪ 0.072	0.078	0.081	0.082	0.084
FUEL INJECTOR VELOCITY, FT/SEC	▪ 1230.456	1192.587	1155.714	1205.166	1336.710
OXID INJECTOR RESISTANCE	▪ 47.900	42.891	47.805	42.589	32.904
OXID INJECTOR VELOCITY, FT/SEC	▪ 28.160	33.419	34.252	34.159	34.757
INJECTOR VELOCITY RATIO	▪ 43.696	35.686	33.742	35.282	38.459
FUEL IGNITER FLOW, #/SEC	▪ 0.054	0.054	0.054	0.054	0.054
FUEL IGNITER CORE FLOW, #/SEC	▪ 0.002	0.002	0.002	0.002	0.002
OXID IGNITER FLOW, #/SEC	▪ 0.054	0.054	0.053	0.052	0.048
IGNITER CORE MIXTURE RATIO	▪ 24.641	24.625	24.535	24.350	21.954
COMBUSTOR RESISTANCE	▪ 32.744	31.732	32.122	30.783	29.934
COMBUSTOR HEAT LOAD, BTU/SEC	▪ 2140.276	2494.142	2748.421	2816.376	2893.225
COMBUSTOR DELTA PRESSURE, PSI	▪ 170.000	188.000	208.000	207.000	211.000
COMBUSTOR DELTA TEMPERATURE, DEG F	▪ 279.180	300.340	318.820	321.120	323.480
NOZZLE RESISTANCE	▪ 9.343	8.994	8.893	8.590	8.520
NOZZLE HEAT LOAD	▪ 1093.352	1101.576	1068.616	1075.735	1091.054
NOZZLE DELTA PRESSURE, PSI	▪ 70.000	74.000	78.000	78.000	81.000
NOZZLE DELTA TEMPERATURE, DEG F	▪ 148.040	139.390	131.890	130.650	129.860
NOZZLE TOTAL FLOW, #/SEC	▪ 1.952	2.110	2.190	2.227	2.273
MAIN CHAMBER PRESSURE, PSIA	▪ 520.980	597.780	659.380	644.180	594.080

Figure 7-71 MK49-F PERFORMANCE DATA SUMMARY -
87-017-005

TURBOPUMP SPEED, RPM	=	68,950	74,030	76,780	76,820	76,930
BEARING DN	=	1,379,000	1,480,600	1,535,600	1,535,400	1,538,600
MAIN PUMP PUMP INLET FLOWRATE, GPM	=	234.37	252.06	260.64	265.11	270.22
PUMP INLET FLOWRATE, #/SEC	=	2.08	2.24	2.32	2.36	2.40
DESIGN INLET FLOWRATE, GPM	=	271.49	291.49	302.32	302.48	302.91
Q/N	=	0.003	0.003	0.003	0.003	0.004
(Q/N)/(Q/N design)	=	0.863	0.865	0.862	0.876	0.892
PUMP DISCHARGE FLOWRATE, #/SEC	=	2.007	2.164	2.244	2.281	2.327
MISC. FLOWRATES						
REAR BEARING COOLANT FLOW, #/SEC (WRBRG)	=	0.024	0.025	0.025	0.025	0.025
TURBINE SEAL LEAKAGE FLOW, #/SEC (WTSI)	=	-0.0001	0.000	0.000	0.000	0.000
FUEL INLET BLEED FLOW, #/SEC (WFINB)	=	0.019	0.019	0.019	0.019	0.019
VOLUTE CASE OVERBOARD LEAKAGE FLOW, #/SEC (WC)	=	0.060	0.058	0.055	0.056	0.056
LOW PRESSURE FUEL TURBINE FLOW, #/SEC (WLPT)	=	0.750	0.257	0.242	0.246	0.251
SUCTION PARAMETERS						
SUCTION SPECIFIC SPEED	=	4375.263	4624.595	4973.547	5015.854	5047.912
NPSH, FT.	=	1510.883	1618.892	1576.879	1577.920	1587.528
PUMP INLET VAPOR PRESSURE, PSIA	=	17.663	17.669	17.676	17.676	17.669
PUMP INLET DENSITY, #/CUFT	=	3.883	3.889	3.896	3.896	3.889
PUMP INLET TEMPERATURE, DEG F	=	-412.800	-412.900	-413.000	-413.000	-412.900
PUMP INLET PRESSURE, PSIA	=	102.030	104.310	102.560	102.580	103.430
BALANCE PISTON PERFORMANCE:						
PUMP DISCHARGE PRESSURE, PSIA	=	1808.780	1984.780	2069.780	2068.780	2068.780
BALANCE PISTON CAVITY # 1 PRESSURE, PSIA	=	1283.780	1379.780	1430.780	1431.780	1431.780
BALANCE PISTON SUMP PRESSURE, PSIA	=	782.980	939.180	1054.780	1059.780	1074.780
CALCULATED HP ORIFICE PERCENT OPEN	=	27.264	23.787	20.823	20.647	19.934
BALANCE PISTON DELTA P (IMP-CAV1/CAV1-SUMP)	=	0.718	0.946	1.163	1.176	1.232
CALCULATED IMPELLER DISCHARGE PRESSURE, PSIA	=	1643.5255	1796.6252	1867.959	1869.332	1871.5266
TURBINE PERFORMANCE PARAMETERS						
TURBINE INLET FLOWRATE, #/SEC	=	1.180	1.277	1.308	1.306	1.301
TURBINE PRESSURE RATIO	=	0.551	1.636	1.684	1.680	1.681
TURBINE FIRST STAGE HUB PRESSURE, PSIA	=	2213.280	1388.780	1426.280	1425.280	1420.780
GENERAL COMMENTS:						
FUEL FLOWMETER # 1 CONSTANT (KF1), CYCLES/GALLO	=	46.008	46.008	46.008	46.008	46.008
FUEL FLOWMETER # 2 CONSTANT (KF2), CYCLES/GALLO	=	46.497	46.497	46.497	46.497	46.497
ATMOSPHERIC PRESSURE, PSIA	=	13.780	13.780	13.780	13.780	13.780
ADDITIONAL PUMP PARAMETERS:						
1ST XOVER INLET PRESSURE, PSIA	=	538.680	579.880	599.980	600.180	602.080
1ST XOVER 2ND DIFFUSER INLET PRESSURE, PSIA	=	660.180	711.380	738.680	740.280	741.180
1ST XOVER 2ND DIFFUSER OUTLET PRESSURE, PSIA	=	674.380	725.380	753.880	756.280	755.880
1ST XOVER OUTLET PRESSURE, PSIA	=	672.280	722.380	752.480	753.580	753.080
2ND XOVER INLET PRESSURE, PSIA	=	1124.780	1225.780	1286.780	1284.780	1283.780
2ND XOVER TRANS OUTLET PRESSURE, PSIA	=	1235.780	1346.780	1409.780	1410.780	1407.780

**Figure 7-72 MK49-O PERFORMANCE DATA SUMMARY -
87-017-005**

TURBOPUMP SPEED, RPM	=	28,960	31,320	32,460	32,540	32,640
BEARING DN	=	579,200	626,400	649,200	650,800	652,800
MAIN PUMF PUMP INLET FLOWRATE, GPM	=	63.08	77.25	80.80	80.95	81.14
PUMP INLET FLOWRATE, #/SEC	=	9.95	12.18	12.74	12.77	12.80
DESIGN INLET FLOWRATE, GPM	=	91.72	99.20	102.81	103.06	103.38
Q/N	=	0.002	0.002	0.002	0.002	0.902
(Q/N)/(Q/N design)	=	0.688	0.779	0.786	0.785	0.785
PUMP DISCHARGE FLOWRATE, #/SEC	=	8.283	10.528	11.118	11.094	11.092
MISCELLANEOUS FLOWRATES						
BALANCE PISTON OVERBOARD DUMP FLOW, #/SEC (WBI)	=	1.581	1.568	1.537	1.584	1.617
FRONT BEARING FLOWRATE, #/SEC (WOFB)	=	0.463	0.488	0.497	0.502	0.506
BALANCE PISTON FLOWRATE, #/SEC (WBP)	=	1.118	1.080	1.040	1.082	1.111
PRIMARY LOX SEAL LEAKAGE FLOWRATE, #/SEC (WPLS)	=	0.086	0.087	0.087	0.088	0.090
REAR BEARING COOLANT FLOWRATE, #/SEC (WORB)	=	0.488	0.406	0.235	0.332	0.191
TURBINE SEAL LEAKAGE FLOWRATE, #/SEC	=	0.574	0.587	0.720	0.620	0.756
PRIMARY HOT GAS SEAL LEAK FLOWRATE, #/SEC (WPH)	=	0.025	0.027	0.028	0.028	0.028
INTERMEDIATE SEAL PURGE FLOWRATE, #/SEC (WISL)	=	0.017	0.017	0.017	0.017	0.017
SUCTION PARAMETERS						
PUMP INLET PRESSURE, PSIA	=	152.58	151.78	151.28	152.78	162.88
SUCTION SPECIFIC SPEED	=	3381.19	4057.21	4310.07	4290.03	4083.29
NPSH, FT.	=	277.68	276.73	275.90	278.89	299.56
PUMP INLET VAPOR PRESSURE, PSIA	=	17.49	17.49	17.49	17.56	17.56
PUMP INLET DENSITY, #/CUFT	=	70.40	70.40	70.40	70.39	70.39
PUMP INLET TEMPERATURE, DEG F	=	-294.40	-294.40	-294.40	-294.30	-294.30
BALANCE PISTON PERFORMANCE						
PUMP DISCHARGE PRESSURE, PSIA	=	1225.78	1332.78	1380.78	1418.78	1439.78
IMPELLER DISCHARGE PRESSURE, PSIA	=	1126.40	1224.62	1268.69	1303.57	1322.85
BALANCE PISTON CAVITY #1 PRESSURE, PSIA	=	900.68	942.18	944.78	951.28	964.88
BALANCE PISTON CAVITY #2 PRESSURE, PSIA	=	572.53	598.67	600.31	604.41	612.97
BALANCE PISTON SUMP PRESSURE, PSIA	=	328.98	341.58	341.58	348.28	363.88
CALCULATED HP ORIFICE PERCENT OPEN	=	33.71	35.64	37.15	38.26	38.78
BALANCE PISTON DELTA P RATIO (IMP-CAV1/CAV2-SUMI)	=	0.93	1.10	1.25	1.38	1.44

GENERAL COMMENTS:

LOX FLOWMETER # 1 CONSTANT (KO1), CYCLES/GALLOI	=	539.653	539.653	539.653	539.653	539.653
LOX FLOWMETER # 2 CONSTANT (KO2), CYCLES/GALLOI	=	533.915	533.915	533.915	533.915	533.915
ATMOSPHERIC PRESSURE, PSIA	=	13.780	13.780	13.780	13.780	13.780

IMPELLER DSCH PR = PUMP DSCH PR * 0.918 (ASSUMED CALCS)
BP CAV # 2 = BP CAV # 1 * 0.63 (ASSUMED CALCS)

Test 87-017-006 Test Date 1/28/87 Duration, secs 8.96

Objective Engine operation to a fuel pump speed of 86,000 RPM to evaluate the fuel pump balance piston position and fuel pump performance and analysis of the nozzle exhaust plume contaminations.

Results Test prematurely terminated by a low fuel pump balance piston cavity pressure redline. This redline was the first parameter that fell outside of the normal operation of the fuel high pressure pump.

Test Analysis The start of the test appeared normal with motoring of the MK49-F and MK49-O turbopumps during the pre-pressurization cycle. The igniter operation was nearly a duplicate of test 87-017-005 with the igniter stage at about 210 psig for 5 seconds prior to main propellant ignition in the chamber (Figure 7-73). A smooth transition into mainstage operation occurred with the chamber pressure stabilizing out at about 750 psig with the fuel pump reaching 87,360 RPM and the Lox pump reaching 36,400 RPM. At 8.65 seconds into the test (from igniter Pc start) the fuel pump rotor seized and abruptly decayed in speed within 300 msec and finally stopped within 650 msec of the point of rotor seizure (Figure 7-74). Since the engine was an expander cycle, hot gaseous hydrogen supply to the Lox turbine was lost and the Lox pump speed decayed smoothly with no problem noted. The engine responded with a smooth cutoff and no outward evidence that a problem had occurred. Figure 7-75 through Figure 7-81 present the parameters of the fuel and Lox systems, including the fuel balance piston cavity and sump pressure profiles which would eventually provide the clue as to the actual problem with the axial thrust control of the MK49-F turbopump. Figures 7-82 through 7-85 presents the engine performance, MK49-F turbopump performance, MK49-O Performance, and other engine parameters for the slices that reached maximum engine pressures. Time based data plots for all of the measured parameters are included in Appendix B.

Figure 7-73 IGNITER CHAMBER PRESSURE PROFILE

87-017-006

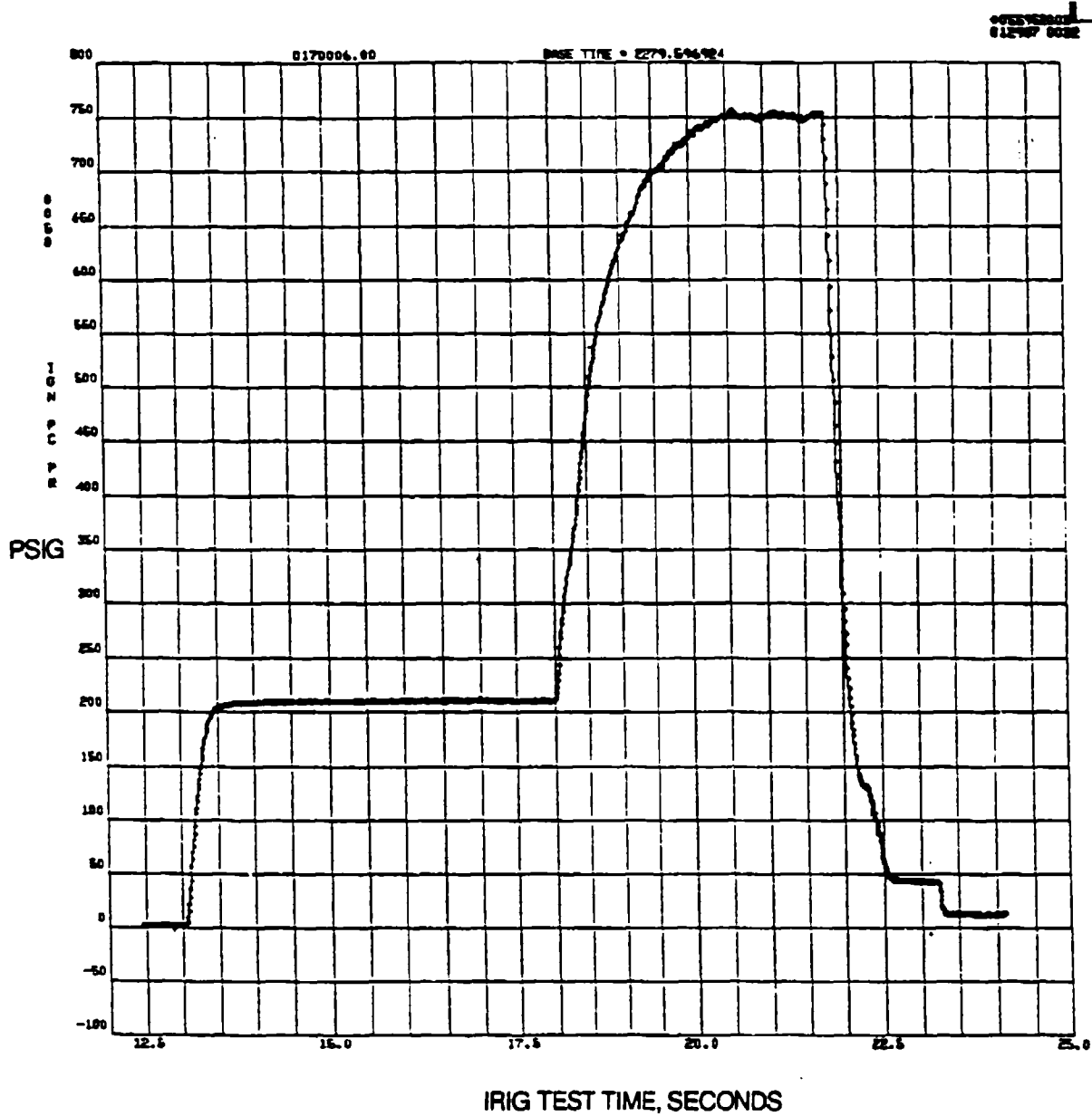

Figure 7-74 MK49-F TURBOPUMP SPEED PROFILE VERSUS TIME
87-017-006

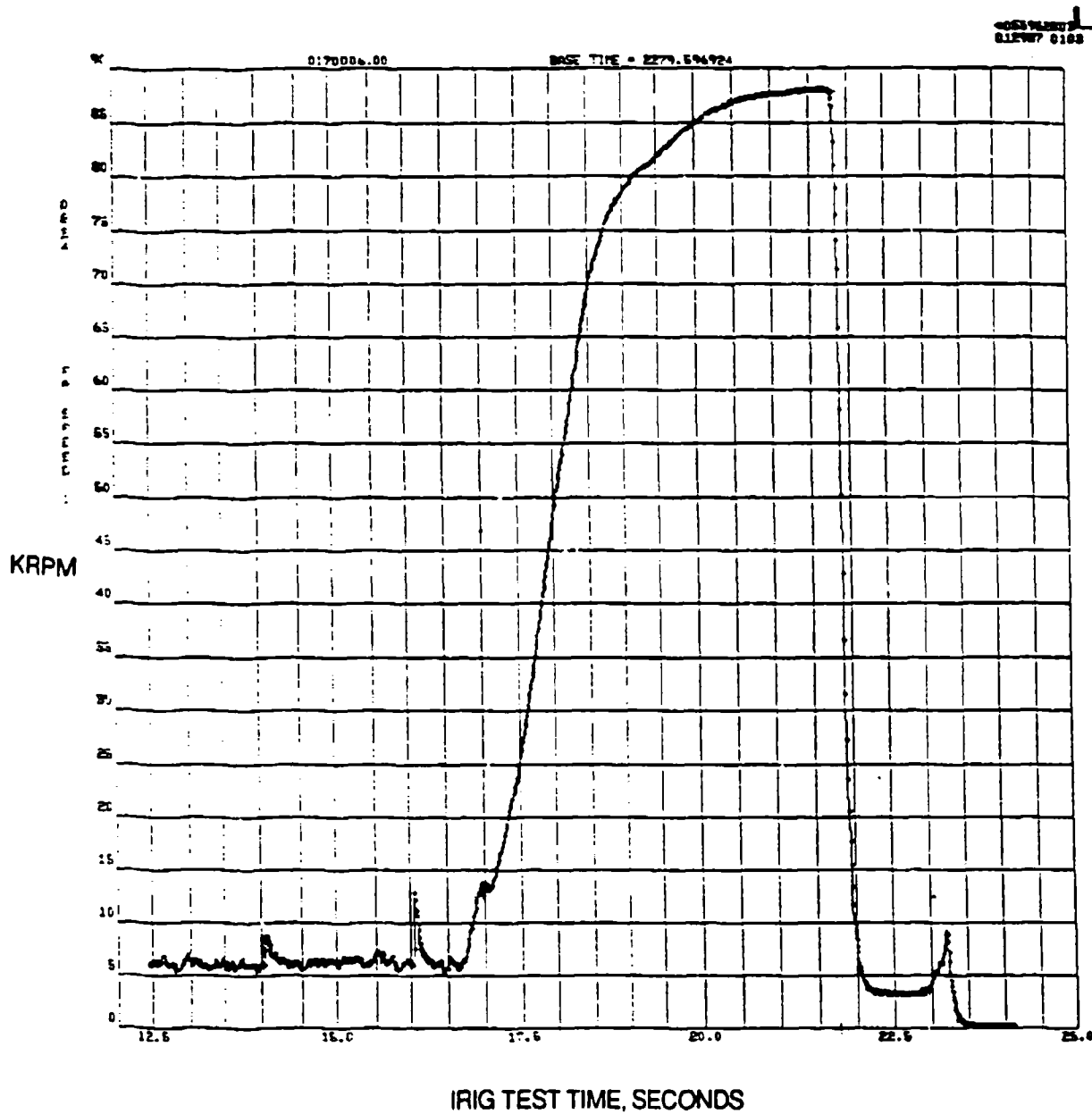

Figure 7-75 MK49-O TURBOPUMP SPEED PROFILE VERSUS TIME
87-017-006

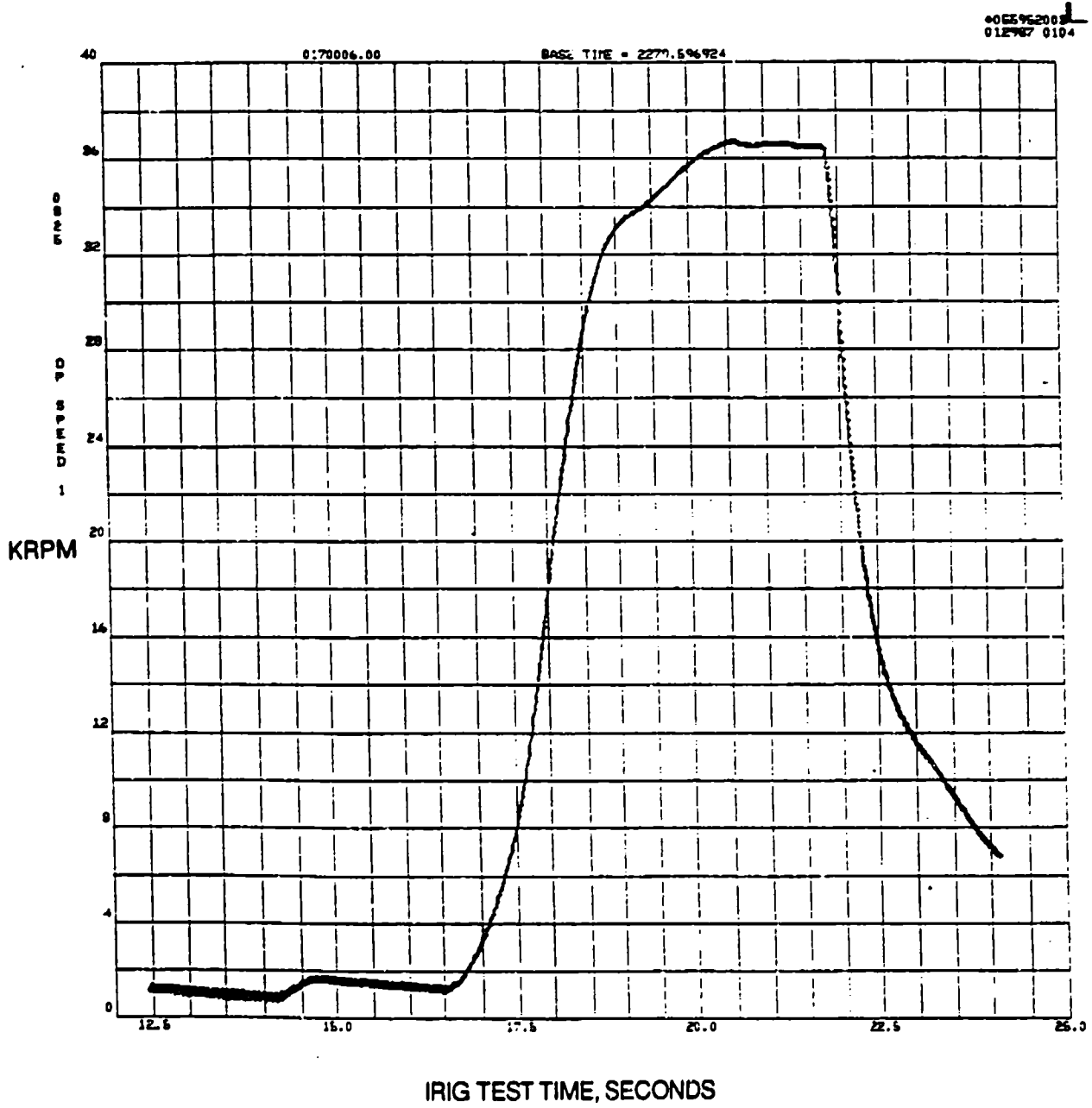
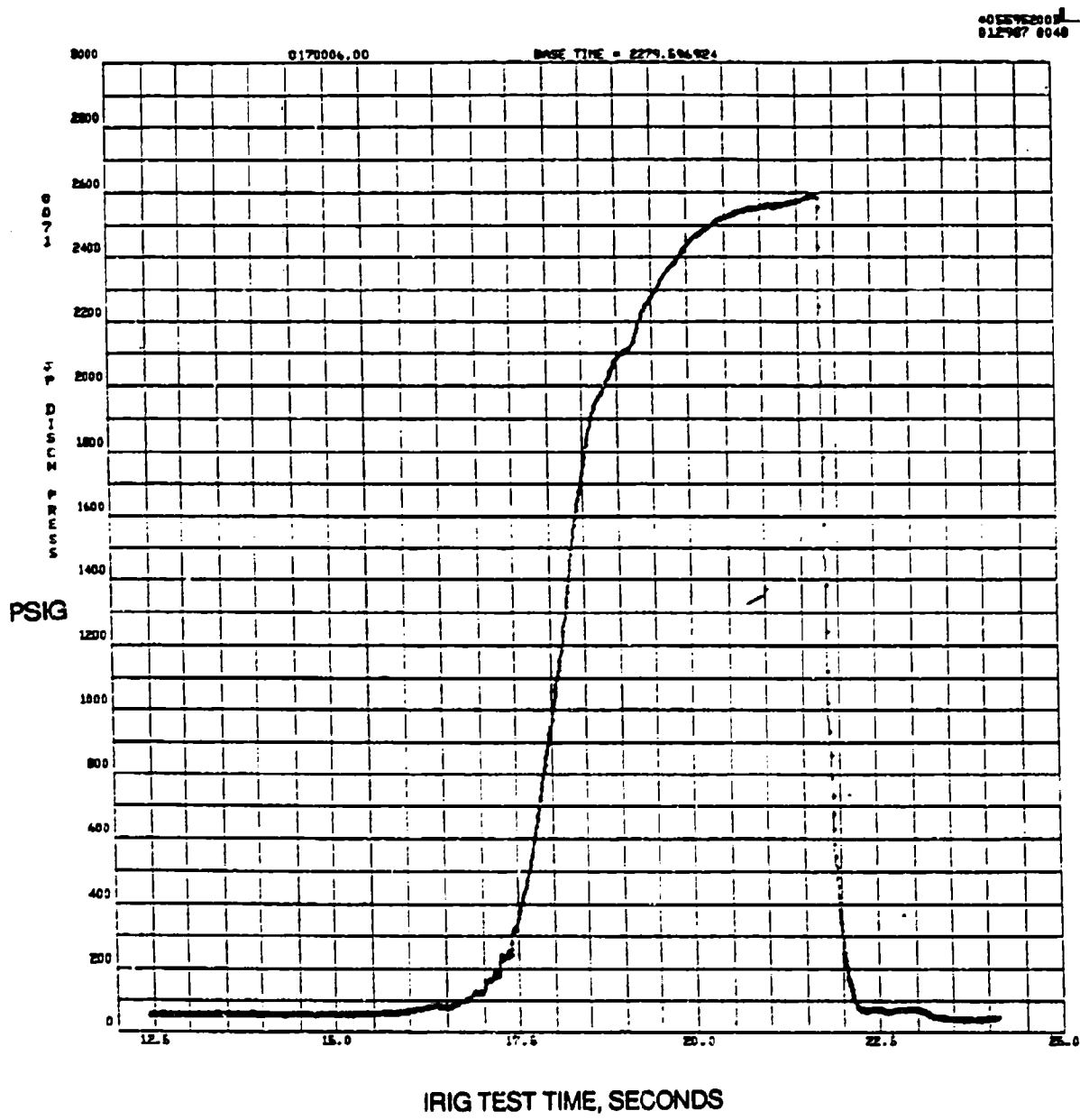

Figure 7-76 MK49-F TURBOPUMP DISCHARGE PRESSURE VERSUS TIME
87-017-006



CR 194443

Figure 7-77 MK49-F BALANCE PISTON CAVITY PRESSURE VERSUS TIME
87-017-006

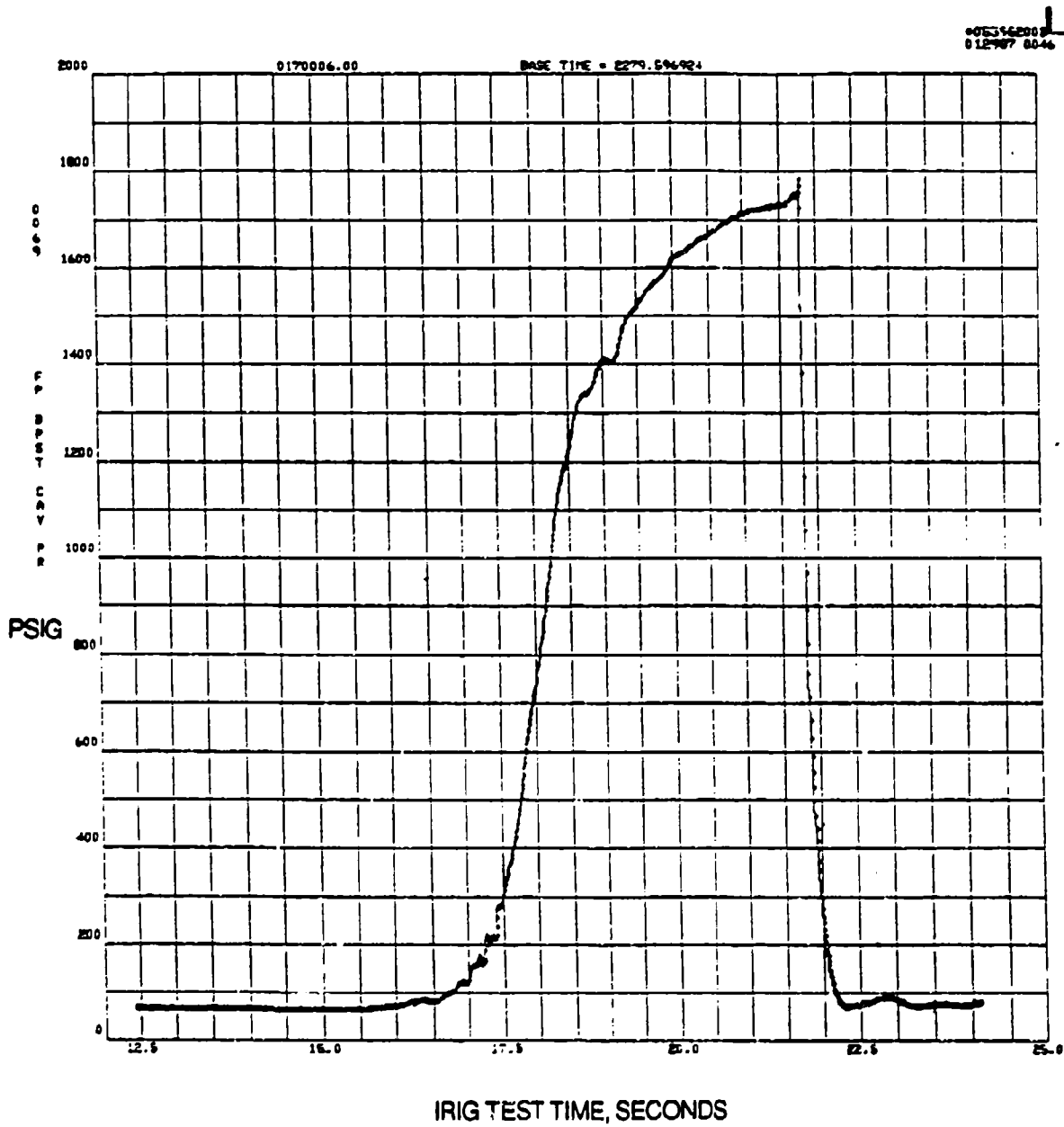

Figure 7-78 MK49-F BALANCE PISTON SUMP PRESSURE VERSUS TIME
87-017-006

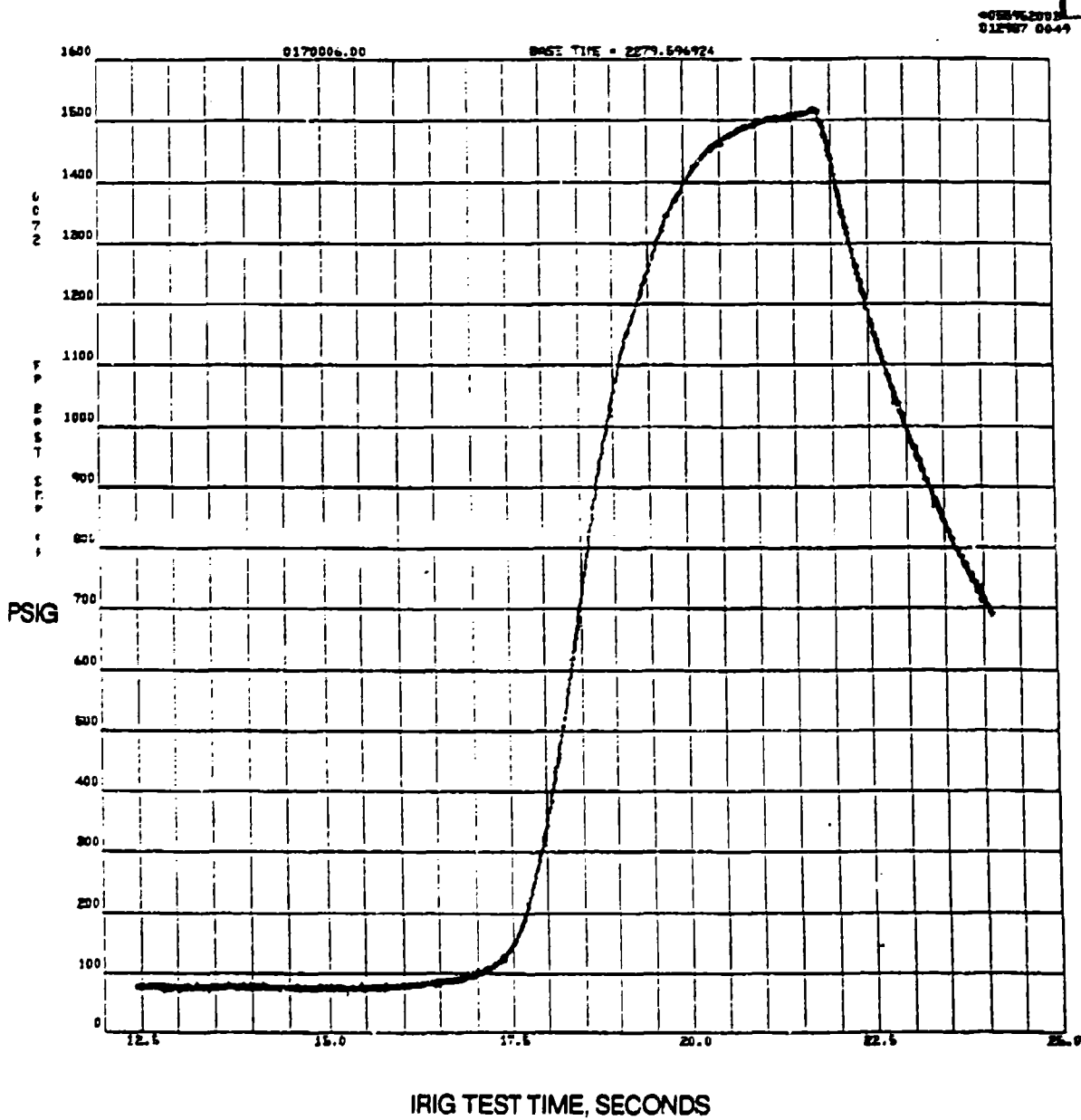

Figure 7-79 FUEL INJECTION PRESSURE VERSUS TIME

87-017-006

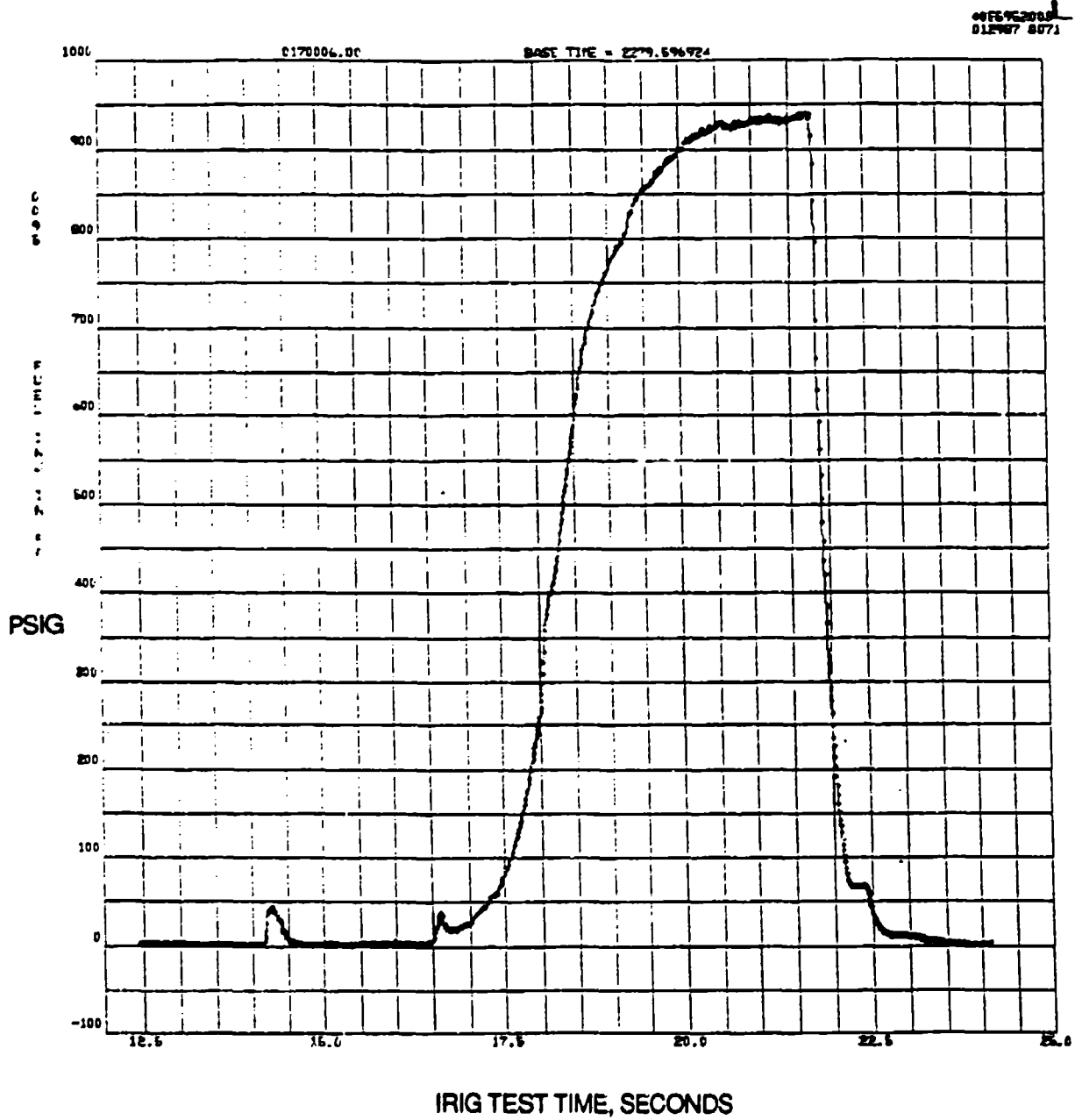

Figure 7-80 LOX INJECTION DOME PRESSURE VERSUS TIME
87-017-006

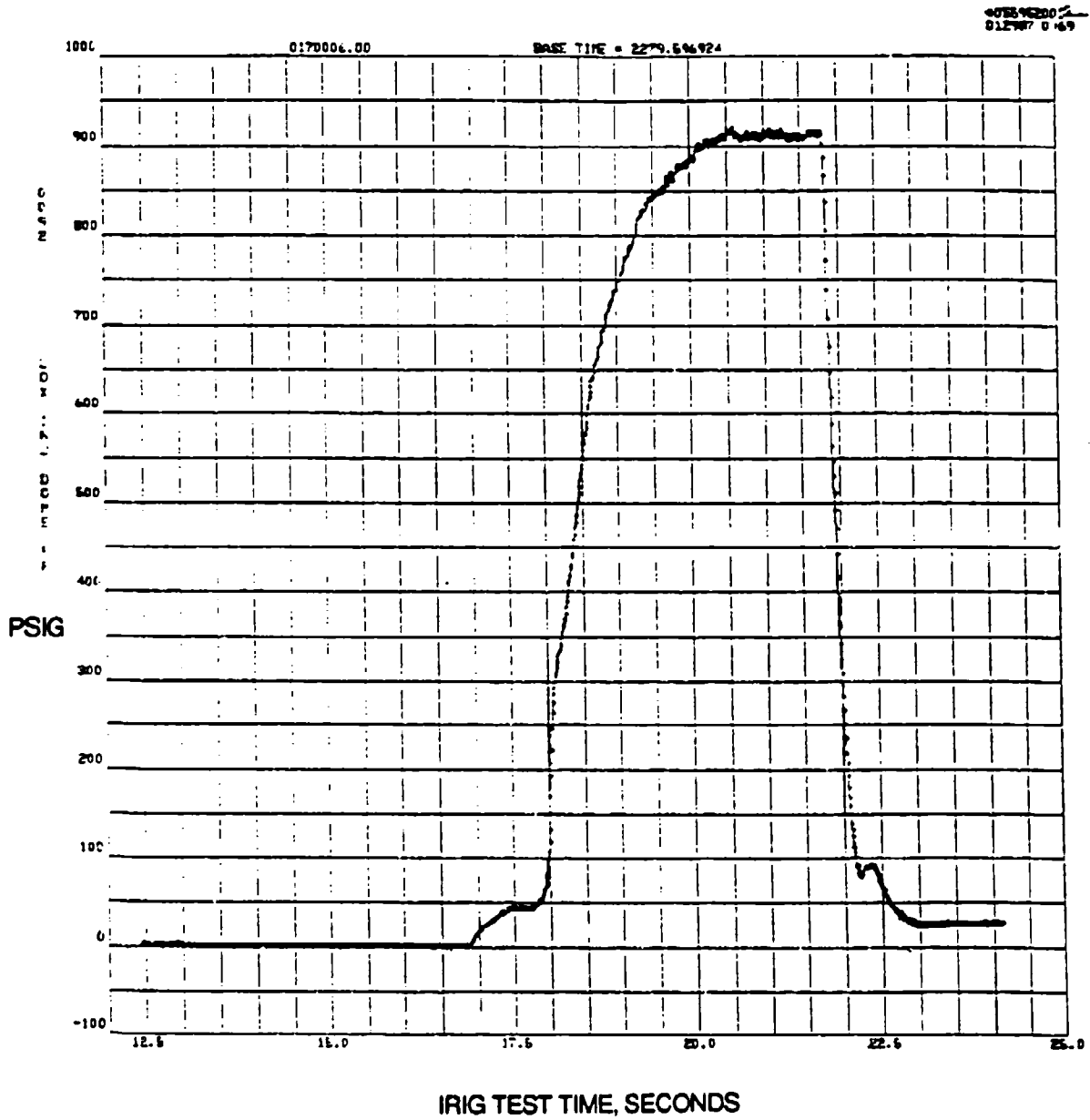

Figure 7-81 MAIN CHAMBER PRESSURE VERSUS TIME
87-017-006

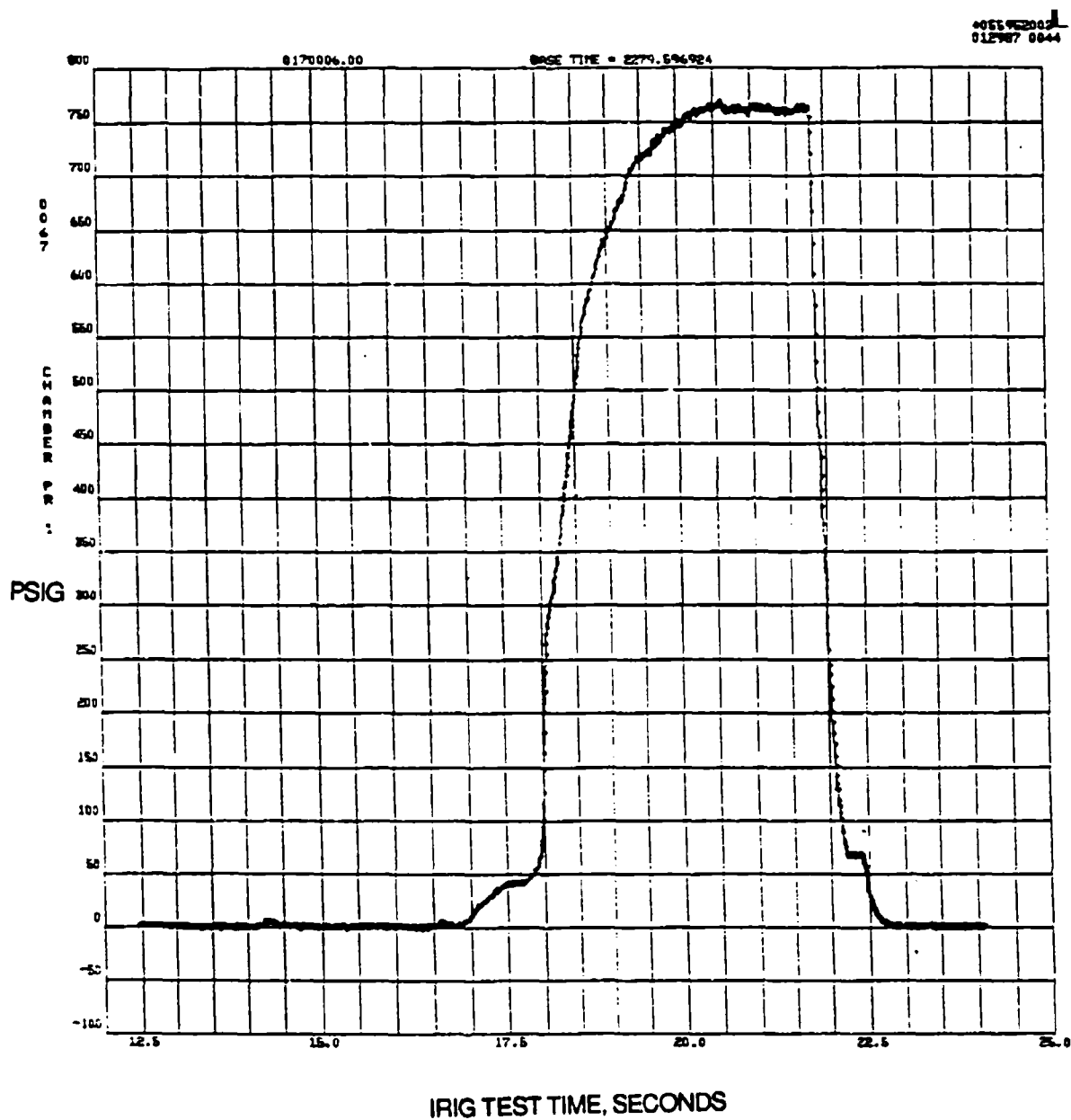

Figure 7-82 ENGINE PERFORMANCE DATA SUMMARY-

87-017-006

ENGINE PERFORMANCE CALCULATIONS					
COMPUTATION DATE:	870211	COMPUTATION TIME:	15.41		
TEST NUMBER	87006	87006	87006	87006	87006
TEST DATE	872801	872801	872801	872801	872801
TEST DATA SLICE START TIME	19	20	20.5	21	21.7
TEST DATA SLICE IRIG TIME	0.599	0.601	0.098	0.603	0.3
MK49-F TURBOPUMP, RPM	77,890	84,310	86,150	88,980	87,360
LH2 TURBOPUMP INLET FLOW, #/SEC	2.403	2.641	2.581	2.676	2.693
LH2 TURBOPUMP OUTLET FLOW, #/SEC	2.307	2.542	2.483	2.578	2.592
MK49-O TURBOPUMP, RPM	33,010	35,650	36,860	36,500	36,400
LO2 TURBOPUMP INLET FLOW, #/SEC	12.689	14.801	15.092	14.902	14.831
LO2 TURBOPUMP OUTLET FLOW, #/SEC	11.069	13.118	13.398	13.186	13.134
THRUST CHAMBER TOTAL FUEL FLOW, #/SEC	2.328	2.566	2.506	2.601	2.615
THRUST CHAMBER TOTAL LOX FLOW, #/SEC	11.182	13.171	13.451	13.239	13.188
THRUST CHAMBER TOTAL FLOW, #/SEC	13.480	15.737	15.957	15.840	15.803
THRUST CHAMBER MIXTURE RATIO	4.790	5.132	5.366	5.090	5.043
FUEL INJECTOR RESISTANCE	6.812	6.914	7.489	6.980	7.045
FUEL INJECTOR ELEMENT FLOW, #/SEC	2.189	2.419	2.361	2.452	2.466
FUEL INJECTOR FACEPLATE FLOW, #/SEC	0.084	0.093	0.091	0.094	0.095
FUEL INJECTOR VELOCITY, FT/SEC	1241.576	1377.729	1387.148	1492.195	1538.259
OXID INJECTOR RESISTANCE	48.674	51.566	54.250	55.569	56.590
OXID INJECTOR VELOCITY, FT/SEC	35.347	39.430	39.680	39.331	39.268
INJECTOR VELOCITY RATIO	35.125	34.941	34.958	37.939	39.174
FUEL IGNITER FLOW, #/SEC	0.055	0.055	0.055	0.055	0.055
FUEL IGNITER CORE FLOW, #/SEC	0.002	0.002	0.002	0.002	0.002
OXID IGNITER FLOW, #/SEC	0.053	0.053	0.053	0.053	0.053
IGNITER CORE MIXTURE RATIO	24.040	24.126	24.202	24.273	24.326
COMBUSTOR RESISTANCE	27.76	28.35	28.71	27.10	27.91
COMBUSTOR HEAT LOAD, BTU/SEC	3009.39	3915.06	3888.00	4069.59	4117.14
COMBUSTOR DELTA PRESSURE, PSI	198.00	228.00	234.00	237.00	245.00
COMBUSTOR DELTA TEMPERATURE, DEG F	336.75	398.46	405.65	406.81	411.60
NOZZLE RESISTANCE	8.10	8.40	8.68	8.13	7.90
NOZZLE HEAT LOAD	1078.90	1170.40	1208.72	1308.91	1357.10
NOZZLE DELTA PRESSURE, PSI	77.00	94.00	92.00	83.00	91.00
NOZZLE DELTA TEMPERATURE, DEG F	129.16	129.74	137.66	143.59	148.10
NOZZLE TOTAL FLOW, #/SEC	2.273	2.512	2.452	2.547	2.561
MAIN CHAMBER PRESSURE, PSIA	655.98	760.58	776.38	774.38	776.88

Figure 7-83 MK49-F PERFORMANCE DATA SUMMARY -

87-017-006

MK49-F TURBOPUMP OPERATION						
TURBOPUMP SPEED, RPM	■	77,890	84,310	86,150	86,980	87,360
BEARING DN	■	1,557,860	1,686,200	1,723,000	1,739,600	1,747,200
MAIN PUMP PUMP INLET FLOWRATE, GPM	■	275.012	302.998	295.961	306.471	306.737
PUMP INLET FLOWRATE, #/SEC	■	2.403	2.641	2.581	2.676	2.683
DESIGN INLET FLOWRATE, GPM	■	306.892	331.971	339.216	342.484	343.980
Q/N	■	0.004	0.004	0.003	0.004	0.004
(Q/N)/(Q/N design)	■	0.897	0.913	0.872	0.895	0.892
PUMP DISCHARGE FLOWRATE, #/SEC	■	2.328	2.568	2.506	2.601	2.615
MISC FLOWRATES						
TURBINE BYPASS VALVE FLOW, #/SEC (WTBV)	■	0.155	0.171	0.174	0.176	0.177
REAR BEARING COOLANT FLOW, #/SEC (WRBRG)	■	0.025	0.026	0.026	0.026	0.026
TURBINE SEAL LEAKAGE FLOW, #/SEC (WTSL)	■	-0.0001	0.000	0.000	0.000	0.000
FUEL INLET BLEED FLOW, #/SEC (WFINB)	■	0.019	0.019	0.019	0.019	0.019
VOLUTE CASE OVERBOARD LEAKAGE FLOW, #/SEC (WC)	■	0.058	0.053	0.053	0.053	0.056
LOW PRESSURE FUEL TURBINE FLOW, #/SEC (WLPT)	■	0.249	0.274	0.280	0.283	0.287
SUCTION PARAMETERS						
SUCTION SPECIFIC SPEED	■	5250.44	6390.54	6663.87	6756.90	6487.77
NPSH, FT.	■	1549.77	1413.01	1383.98	1377.76	1483.77
PUMP INLET VAPOR PRESSURE, PSIA	■	17.60	17.60	17.60	17.60	17.63
PUMP INLET DENSITY, #/CUFT	■	3.817	3.817	3.824	3.824	3.850
PUMP INLET TEMPERATURE, DEG F	■	-411.90	-411.80	-411.90	-411.90	-412.30
PUMP INLET PRESSURE, PSIA	■	109.31	105.63	103.42	104.03	103.74
BALANCE PISTON PERFORMANCE:						
PUMP DISCHARGE PRESSURE, PSIA	■	2097.78	2444.78	2526.78	2559.78	2601.78
BALANCE PISTON CAVITY # 1 PRESSURE, PSIA	■	1418.78	1628.78	1676.78	1718.78	1758.78
BALANCE PISTON SUMP PRESSURE, PSIA	■	1068.78	1408.78	1478.78	1504.78	1521.78
CALCULATED HP ORIFICE PERCENT OPEN	■	18.32	5.35	2.48	4.43	6.79
BALANCE PISTON DELTA P (IMP-CAV1/CAV1-SUMP)	■	1.37	2.66	3.01	2.77	2.50
CALCULATED 3RD STG IMP DISCH PRESS., PSIA	■	1896.73	2214.82	2278.81	2312.06	2351.33
TURBINE PERFORMANCE PARAMETERS						
TURBINE INLET FLOWRATE, #/SEC (VENTURI)	■	1.34	1.48	1.50	1.51	1.51
TURBINE PRESSURE RATIO	■	1.69	1.68	1.68	1.68	1.68
TURBINE 1ST STG HUB PRESS., PSIA (CALC)	■	1456.78	1703.28	1763.78	1788.28	1816.78
TURBINE INLET FLOWRATE, #/SEC (PUMP - TBV)	■	2.15	2.37	2.31	2.40	2.42
GENERAL COMMENTS:						
FUEL FLOWMETER # 1 CONSTANT (KF1), CYCLES/GALLO	■	46.008	46.008	46.008	46.008	46.008
FUEL FLOWMETER # 2 CONSTANT (KF2), CYCLES/GALLO	■	46.497	46.497	46.497	46.497	46.497
ATMOSPHERIC PRESSURE, PSIA	■	13.780	13.780	13.780	13.780	13.780
ADDITIONAL PUMP PARAMETERS:						
1ST XOVER INLET PRESSURE, PSIA	■	596.78	687.18	708.38	718.58	731.88
1ST XOVER 2ND DIFFUSER INLET PRESSURE, PSIA	■	726.38	850.88	875.08	887.38	910.28
1ST XOVER 2ND DIFFUSER OUTLET PRESSURE, PSIA	■	742.28	867.28	890.08	903.98	926.88
1ST XOVER OUTLET PRESSURE, PSIA	■	741.58	865.28	887.88	901.78	925.08
2ND XOVER INLET PRESSURE, PSIA	■	1275.78	1490.78	1535.78	1559.78	1592.78
2ND XOVER TRANS OUTLET PRESSURE, PSIA	■	1410.78	1645.78	1697.78	1720.78	1784.78

Figure 7-84 MK49-O PERFORMANCE DATA SUMMARY -
87-017-006

***** MK49-O TURBOPUMP OPERATION *****					
TURBOPUMP SPEED, RPM	=	35,650	38,560	36,500	36,400
BEARING DN	=	713,000	731,200	730,000	728,000
MAIN PUMP PUMP INLET FLOWRATE, GPM	=	80.74	94.08	95.93	94.72
PUMP INLET FLOWRATE, #/SEC	=	12.70	14.80	15.09	14.90
DESIGN INLET FLOWRATE, GPM	=	104.55	112.91	115.79	115.60
Q/N	=	0.002	0.003	0.003	0.003
(Q/N)/(Q/N design)	=	0.77	0.83	0.83	0.82
PUMP DISCHARGE FLOWRATE, #/SEC	=	11.10	13.12	13.40	13.19
MISCELLANEOUS FLOWRATES					
BALANCE PISTON OVERBOARD DUMP FLOW, #/SEC (WBI)	=	1.511	1.592	1.604	1.624
FRONT BEARING FLOWRATE, #/SEC (WOFB)	=	0.502	0.537	0.547	0.546
BALANCE PISTON FLOWRATE, #/SEC (WBP)	=	1.010	1.055	1.057	1.078
PRIMARY LOX SEAL LEAKAGE FLOWRATE, #/SEC (WPLS)	=	0.087	0.091	0.092	0.092
REAR BEARING COOLANT FLOWRATE, #/SEC (WORB)	=	0.272	0.271	0.235	0.332
TURBINE SEAL LEAKAGE FLOWRATE, #/SEC	=	0.654	0.543	0.550	0.434
PRIMARY HOT GAS SEAL LEAK FLOWRATE, #/SEC (WPHK)	=	0.028	0.031	0.032	0.032
INTERMEDIATE SEAL PURGE FLOWRATE, #/SEC (WISL)	=	0.017	0.017	0.017	0.017
SUCTION PARAMETERS					
PUMP INLET PRESSURE, PSIA	=	151.18	143.88	142.28	142.68
SUCTION SPECIFIC SPEED	=	4397.51	5331.05	5571.36	5515.22
NPSH, FT.	=	274.57	260.60	257.45	258.19
PUMP INLET VAPOR PRESSURE, PSIA	=	18.38	18.23	18.23	18.15
PUMP INLET DENSITY, #/CUFT	=	70.22	70.25	70.25	70.27
PUMP INLET TEMPERATURE, DEG F	=	-293.20	-293.40	-293.40	-293.40
BALANCE PISTON PERFORMANCE					
PUMP DISCHARGE PRESSURE, PSIA	=	1402.78	1583.78	1646.78	1638.78
IMPELLER DISCHARGE PRESSURE, PSIA	=	1288.88	1455.04	1512.87	1505.53
BALANCE PISTON CAVITY #1 PRESSURE, PSIA	=	944.08	1044.78	1084.78	1074.78
BALANCE PISTON CAVITY #2 PRESSURE, PSIA	=	599.87	663.31	688.51	682.21
BALANCE PISTON SUMP PRESSURE, PSIA	=	342.38	372.08	382.48	382.68
CALCULATED HP ORIFICE PERCENT OPEN	=	37.94	38.54	38.46	38.78
BALANCE PISTON DELTA P RATIO (IMP-CAV1/CAV2-SUMI)	=	1.34	1.41	1.40	1.44
GENERAL COMMENTS:					
LOX FLOWMETER # 1 CONSTANT (KO1), CYCLES/GALLOP	=	539.853	539.853	539.853	539.853
LOX FLOWMETER # 2 CONSTANT (KO2), CYCLES/GALLOP	=	533.915	533.915	533.915	533.915
ATMOSPHERIC PRESSURE, PSIA	=	13.780	13.780	13.780	13.780
IMPELLER DSCH PR = PUMP DSCH PR * 0.918 (ASSUMED CALCS)					
BP CAV # 2 = BP CAV # 1 * 0.63 (ASSUMED CALCS)					

**Figure 7-85 ADDITIONAL ENGINE DATA SUMMARY -
87-017-006**

***** ADDITIONAL ENGINE PARAMETERS *****

FUEL INJECTION INLET PRESSURE, PSIA	777	911	936	777	951
FUEL INJECTION INLET TEMPERATURE, DEG F	-18	54	81	100	116
OXIDIZER INJECTION INLET PRESSURE, PSIA	755	898	925	923	928
OXIDIZER INJECTION INLET TEMPERATURE, DEG F	-227	-244	-249	-247	-246
COMBUSTOR INLET TEMPERATURE, DEG F	-367	-361	-358	-357	-357
IGNITER FUEL VENTURI INLET PRESSURE, PSIA	2036	2038	2038	2037	2037
IGNITER OXIDIZER VENTURI INLET PRESSURE, PSIA	2216	2215	2215	2215	2214

7.7 FUEL TURBOPUMP ANOMALIES AND PLUME SPECTROMETRY

7.7.1 Fuel Turbopump Anomalies

During the component and engine level tests, four operational anomalies were identified which may have contributed to the failure of the MK49-F turbopump turbine end ball bearing. These anomalies were 1) the apparent closure of the balance piston high pressure orifice with increasing speed, 2) an internal leak which pressurized the volute case housing, 3) pump performance degradation above 60,000 rpm, and 4) turbine gas leakage into the turbine end #4 ball bearing cavity.

Balance Piston High Pressure Orifice Closure - The first anomaly was attributed to an apparent lack of axial thrust capability. The balance piston high pressure orifice clearance was calculated based on pressure measurements and geometric assumptions (e.g., radially overlapped high pressure orifice and predicted rotating disk pumping factors). Throughout the component and engine test programs, the high pressure orifice clearance apparently was reducing as speed increased. Due to this anomalous trend, the turbopump operating speed was limited to approximately 87,000 rpm. The balance piston capability was always a point of concern because of the location of the balance piston sump return. The predicted high pressure orifice axial clearance was approximately 0.0022 inch at the design condition (110,000 rpm).

Post test turbopump disassembly and inspection revealed the balance piston sump pressure port and the rear bearing coolant drain port were mis-identified and consequently incorrectly plumbed. The balance piston high pressure orifice closure trend reported throughout the test program was actually calculated using the bearing coolant drain pressure measurement which was higher than the balance piston sump pressure. Using the correct balance piston sump pressure and the thermodynamic model, the balance piston clearance was calculated to be 0.0022 inch at 87,620 rpm. This was close to the predicted operating position, although the sump pressure was much lower than expected. Visual inspection of the high pressure orifice axial and radial surfaces and the third stage impeller tip showed no significant rubbing which is inconsistent with insufficient axial thrust capacity of the balance piston. These analytical results and hardware condition favor another failure scenario, and in fact, the MK49-F turbopump had sufficient axial thrust capability up to the test conditions.

Second Interstage Crossover Seal Leak - The second anomaly, which was recognized early in the component level test program, was a pressure build-up in the volute case (see

Figure 7-86). The maximum allowable pressure capability of this region also placed restrictions on the pump operating speed. Based on calculations made from measured pressures during the component tests, the leak source was isolated to a static seal located between the volute housing and the second interstage crossover (see **Figure 7-86**).

The MK49-F second stage crossover static seals were damaged when the two seals were pinched between the crossover housing and the volute housing during assembly. These seals are made with a high strength steel, spiral wound spring sheathed by a formed teflon-based non-metallic cover. These radial seals use pressure and spring load to assist its C-shaped cross-section to seal on the inner and outer radii of the mating surfaces. The seal installation in the MK49-F is "blind", in that the crossover seal is placed in the volute housing, and the crossover housing is then placed on top, making visual confirmation impossible. In the free-state, the seal is approximately 50% larger than the seal gland dimension, also making it difficult to slip the seal into the seal gland without damage or crossover housing misalignment.

Due to funding constraints, the turbopump was not disassembled between the component and engine tests, instead, a facility volute case vent system was installed. However, the vent system was not useful because the 0.063 inch inner diameter fitting (0.125 inch female flared tube fitting normally a pressure sense port) choked the volute case flow rendering the downstream pressure and flow measurements ineffective. Therefore, it was not possible to determine actual volute case pressure during operation and hence, difficult to estimate the flow being injected into the eye of the first stage impeller. Potentially, the leak was sufficient enough to degrade the performance by injecting warm propellant into the eye of the impeller.

Pump Performance Degradation - MK49-F Pump performance characteristics were demonstrated at speeds up to 48,000 rpm during the component test phase. Pressure rise at this speed matched well with the predicted values. As the pump speed was increased for the ICE engine tests, pump pressure rise fell below the predicted values. This change in pressure rise, shown in **Figure 7-87** at 90% of the design Q/N, indicates a significant change in pump performance. The crossing point of the pressure rise and speed curve is around 60,000 rpm. Operationally, there are no specific events that correspond to this speed.

Figure 7-86 MK49-F CROSS SECTION SHOWING KEY AREAS OF INVESTIGATION

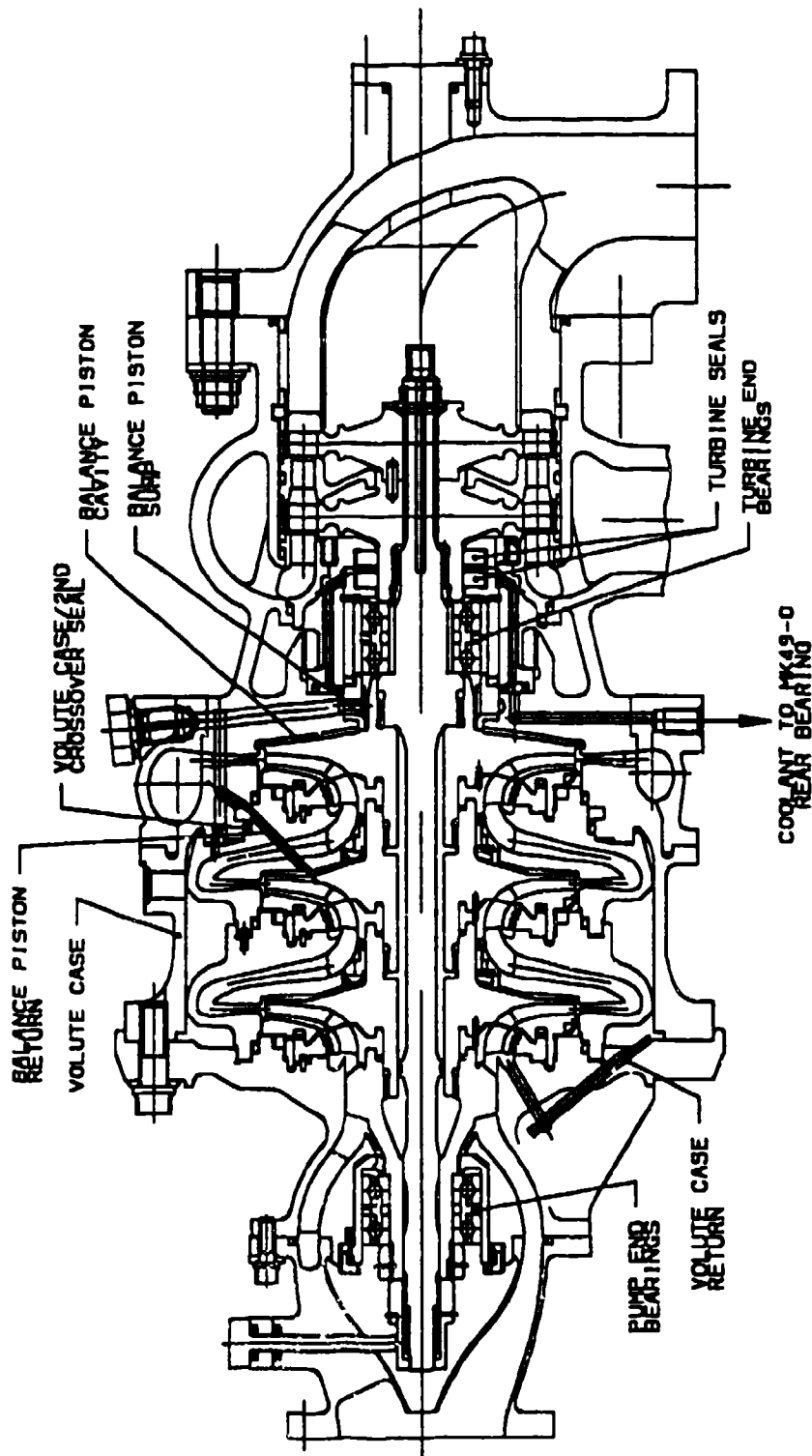

CATIA:CATROT
GET.MK49-F.LO.OLD
FILE DATE:93-12-2

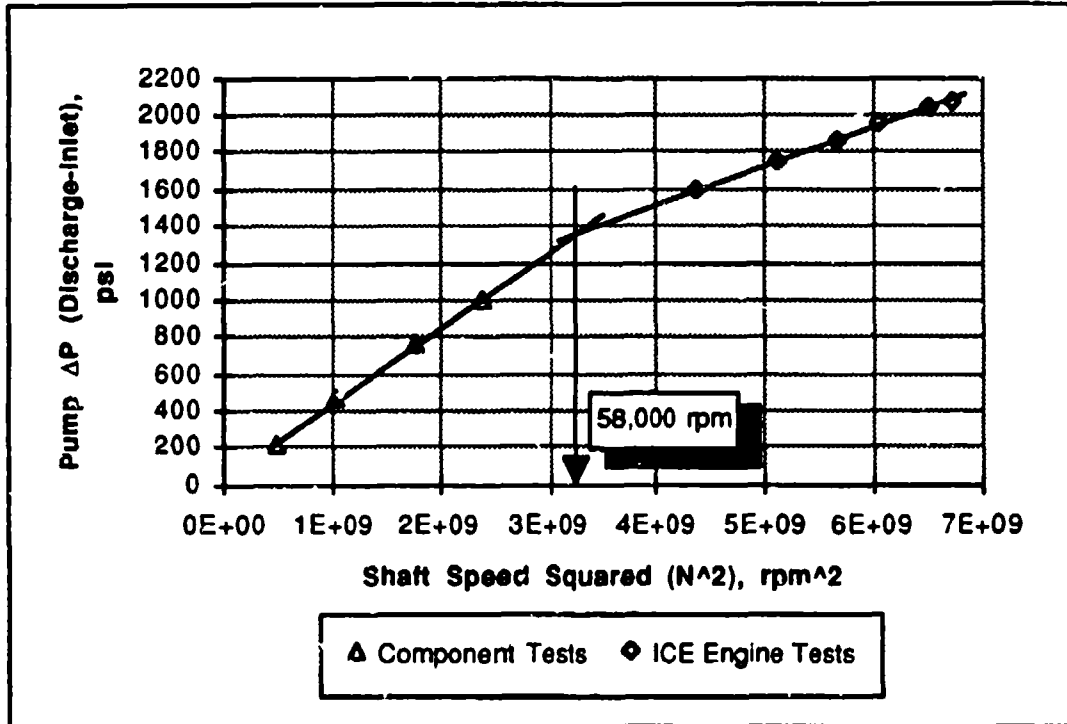

Figure 7-87 Pump Performance Shift above 58,000 RPM

A thermodynamic model was used to predict the turbopump primary and secondary flows as well as the fluid conditions (pressure, temperature, and flow) at specific locations within the turbopump in an attempt to analytically verify the measured results. The original MK49-F model was thus modified to simulate the mis-plumbed bearing coolant drain and balance piston sump pressure lines and the crossover seal leakage to the volute case. The original prediction and modified thermodynamic model results were compared against the measured pressure data at 82,000 rpm, as shown in Figure 7-88 (some "measured" points were calculated based on upstream and downstream test data). Although the modified model did not match the data, it was apparent that the major influence on performance was in the first stage.

Due to the abnormally high leakage into volute case cavity from the crossover seals, more fluid was recirculated into the primary pump flow lowering the overall performance of this stage. Under normal operation, fluid which has accumulated in the volute case drains to the inlet of the first stage impeller through a single passage, maintaining approximately inducer discharge pressure in the volute case cavity. Additional flow vented overboard through the volute case, which further lowered the overall performance. This performance effect was not observed in

the lower speed tests because the pressure differences between the volute case and the inducer discharge were lower and the volute cavity was not vented, reducing the mass flow exiting the pump system.

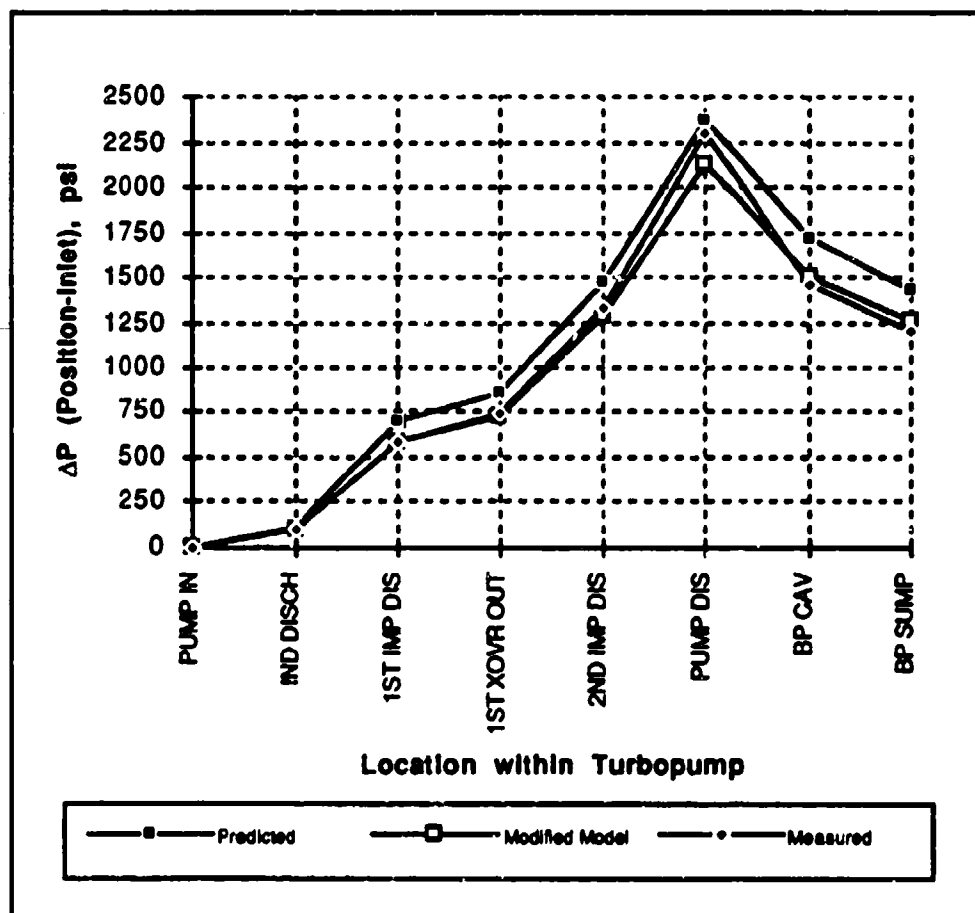

Figure 7-88 Performance Comparison at 82,000 rpm

Turbine Gas Leakage into Bearing Cavity - The fourth anomaly was identified during the engine test data analysis in which the first stage turbine hub pressure was calculated to be higher than the balance piston sump pressure. The adverse pressure gradient across the turbine buffer seal allowed warm turbine gas to leak into the turbine bearing cavity. Again, the thermodynamic model was used to predict the turbopump performance and axial thrust with the turbine gas flow added. Several cases were run to determine if the turbine gas significantly effected pump performance.

Axial thrust was also not effected by the addition of hot gas into the secondary flow systems.

Analytically, only by "forcing" the third stage impeller tip to be radially under the balance piston high pressure orifice could an axial thrust overload be simulated. Post-test turbopump disassembly measurements reaffirmed the impeller tip and balance piston high pressure orifice diameters were radially over-lapped during operation. Minor rub damage was found on the bore of the stationary balance piston high pressure orifice, but this is suspected to be caused by previous start transient conditions and/or by the bearing failure shutdown sequence.

Fuel Turbopump Anomaly Conclusions - The failure of the MK49-F turbopump #4 ball bearing was caused by the loss of internal clearance associated with lack of sufficient coolant. The root cause which contributed to the failure of the bearing was the second stage crossover static seal leakage. The seal, damaged during turbopump assembly, allowed leakage sufficient enough to change critical secondary flow paths within the turbopump. Most critically, the leakage was sufficient enough to lower the balance piston sump pressure to the point where turbine gas was drawn into the turbine bearing cavity. This problem was compounded by the mis-plumbed bearing coolant drain line. The seal leakage was also attributed with the first stage performance degradation at the higher turbopump speeds.

Initial test data indicated that the balance piston did not provide sufficient thrust range to control the hydrodynamic loads as the turbopump speed increased. This theory was refuted by the results of the thermodynamic model of the primary and secondary pump flow systems. With all the anomalous flow conditions simulated in the model, the balance piston closure could not be simulated unless the impeller was not radially over-lapped. Post-test hardware dimensional and visual inspections did not support this failure mode.

7.7.2 Plume Spectrometry Analysis

Installation and checkout of a the real-time telescopic spectrometer was achieved on tests prior to test 87-017-006. The spectrometer was positioned to view the exhaust plume 4.3 feet downstream of the nozzle exit. The spectrometer functioned nominally during all tests and in fact lends good creditability for sensing hardware failures such as was present for this test. The spectrometer start signal was coincident with the engine sequence start signal and immediately began acquiring spectral data in the 300-900 nanometer range every 0.2 sec for the entire test duration.

Figure 7-89 represents the spectra obtained during Test 87-017-006. Each test began with a hydrogen rich ignition flame, which is characterized by the strong spectral features of

Figure 7-89 EXHAUST PLUME SPECTRA OBTAINED DURING TEST
97-017-006

OTV/ICE Plume Spectra
28 January 1987
APTF Test 87-017-006
Exposure Time: 0.2 second
Frame Rate: 5 scans/second
Background subtracted

First OH emission: Scan 27, T + 5.2 to 5.4 seconds
Last OH emission: Scan 46, T + 9.0 to 9.2 seconds
H₂ Flame emission only: Scans 47-49, T + 9.2 to 9.8 seconds
Large CaOH and Li emission: Scans 50-53, T + 9.8 to 10.6 seconds

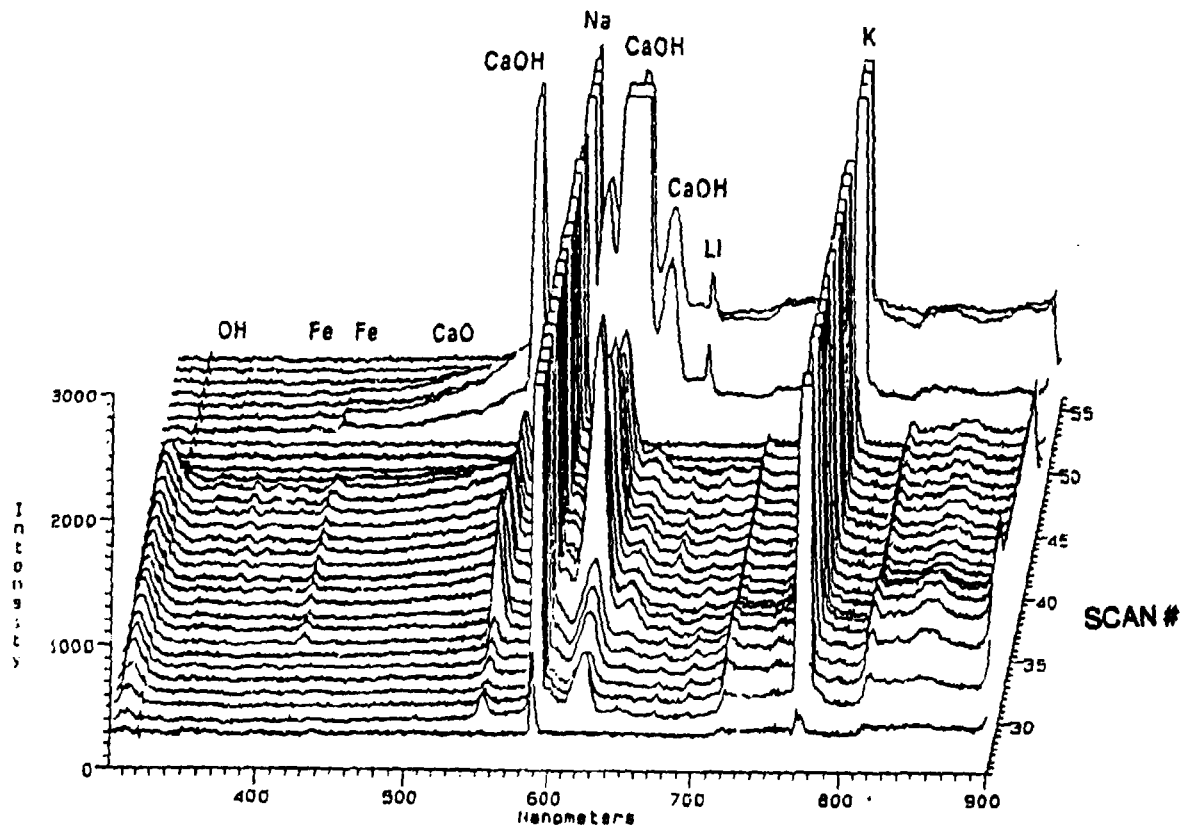

the D-lines of sodium at approximately 589 nanometers and the two potassium lines at 766 and 770 nanometers. These are common trace contaminants of LH2. These features remain through the full test duration, and are joined by the characteristic spectral features of OH and CaOH (calcium hydroxide) at main propellant ignition. Since there is a greater hydrogen flowrate at this time, the sodium and potassium peaks are much stronger during this period. At cutoff, the sodium and potassium peaks are reduced to approximately the ignition levels and the OH and CaOH bands disappear. (These overall characteristics of the OTV/ICE plane spectral output are consistent with those obtained during SSME hot-firings.)

Time profiles of these spectral features provide an independent confirmation of the times of key operational events during the tests. Figure 7-90 and Figure 7-91 show the intensities of OH and CaOH emission as a function of time for Tests 87-017-005 and 87-017-006, respectively. The sudden increase in OH band emission is consistent with main propellant ignition, as is its decrease at cutoff for each test. The CaOH emission tracks the OH emission during this operational phase of each test.

Anomalies in the OTV/ICE plume spectra were observed in Test 87-017-006. At approximately 6.4 seconds into the tests a substantial increase in the heights of all four CaOH peaks was observed. These peaks subsided slightly at 6.8 seconds, but maintained a relatively high level until test cutoff. Towards the end of the shutdown transients, from 9.2 and 9.8 seconds, the plume shows high level sodium and potassium spectral features typical of a hydrogen rich shutdown phase. Then at 9.8 to 10.6 seconds, when the cutoff helium purge of the hydrogen system occurred, large sodium and potassium lines appear and all four CaOH bands reappear at the highest levels seen in these tests. Lithium is also observed at this time, as previously shown in Figure 7-88. This CaOH/Lithium after burst is atypical of previous ICE or SSME tests, as is the sudden CaOH emission increase well into main propellant combustion at 6.4 seconds.

The spectrometric results were correlated to the operational, dynamic, and turbopump events of Test 87-017-006 to fully characterize the sequence of events leading to the failure. Additionally, the spectrometry of the previous test was analyzed to establish a plume characteristic under transient conditions. Preliminary laboratory work has been performed to identify the combustion signatures of non-metallic components of the turbopumps in order to establish the possible sources of calcium in the plume. It has been determined that calcium comprises approximately six percent of the bearing cage material, and that the combustion of bearing cage material in an O₂H₂ flame results in strong CaOH and lithium emission features.

Figure 7-90 OH AND CaOH EMISSION INTENSITIES TEST 87-017-005

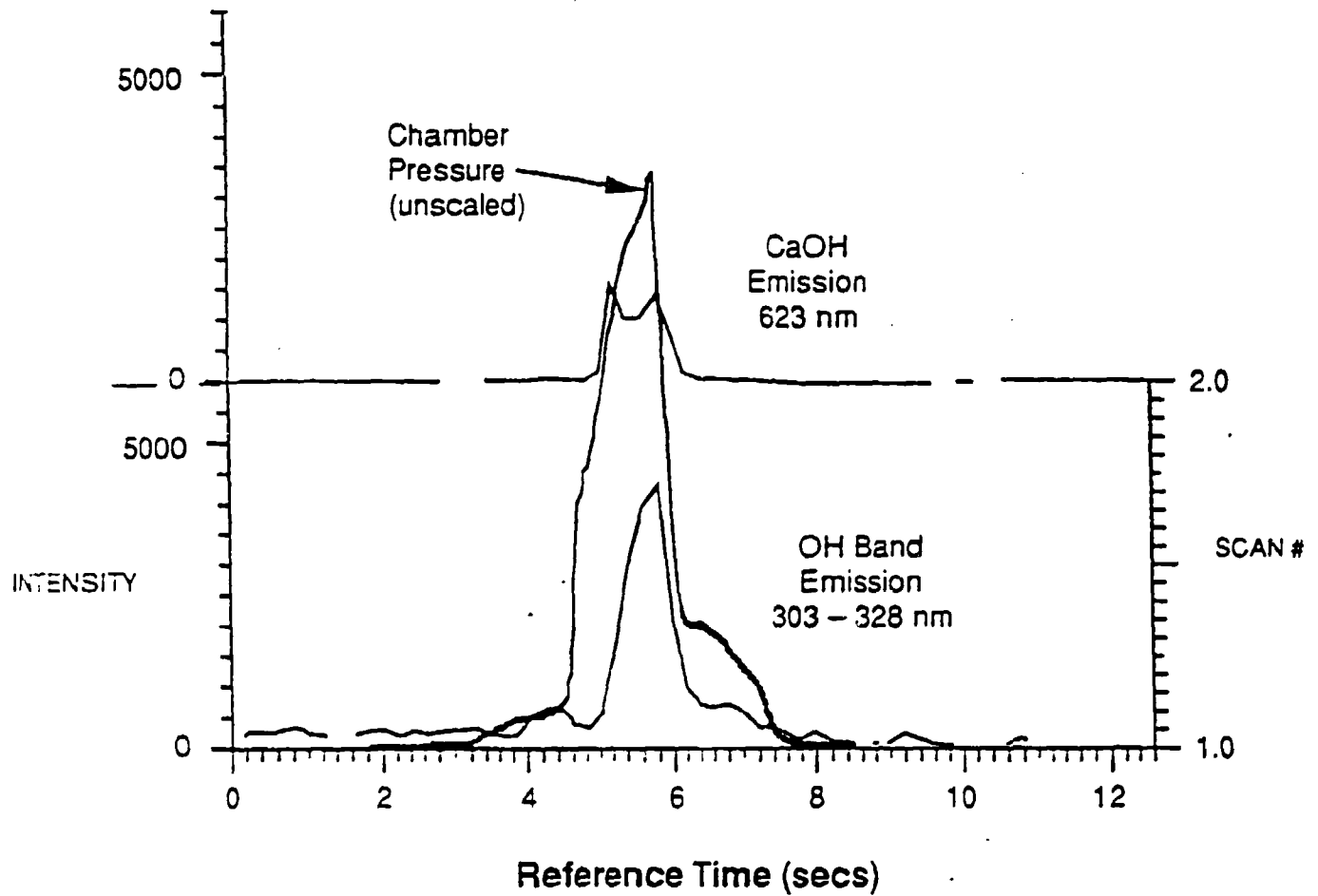
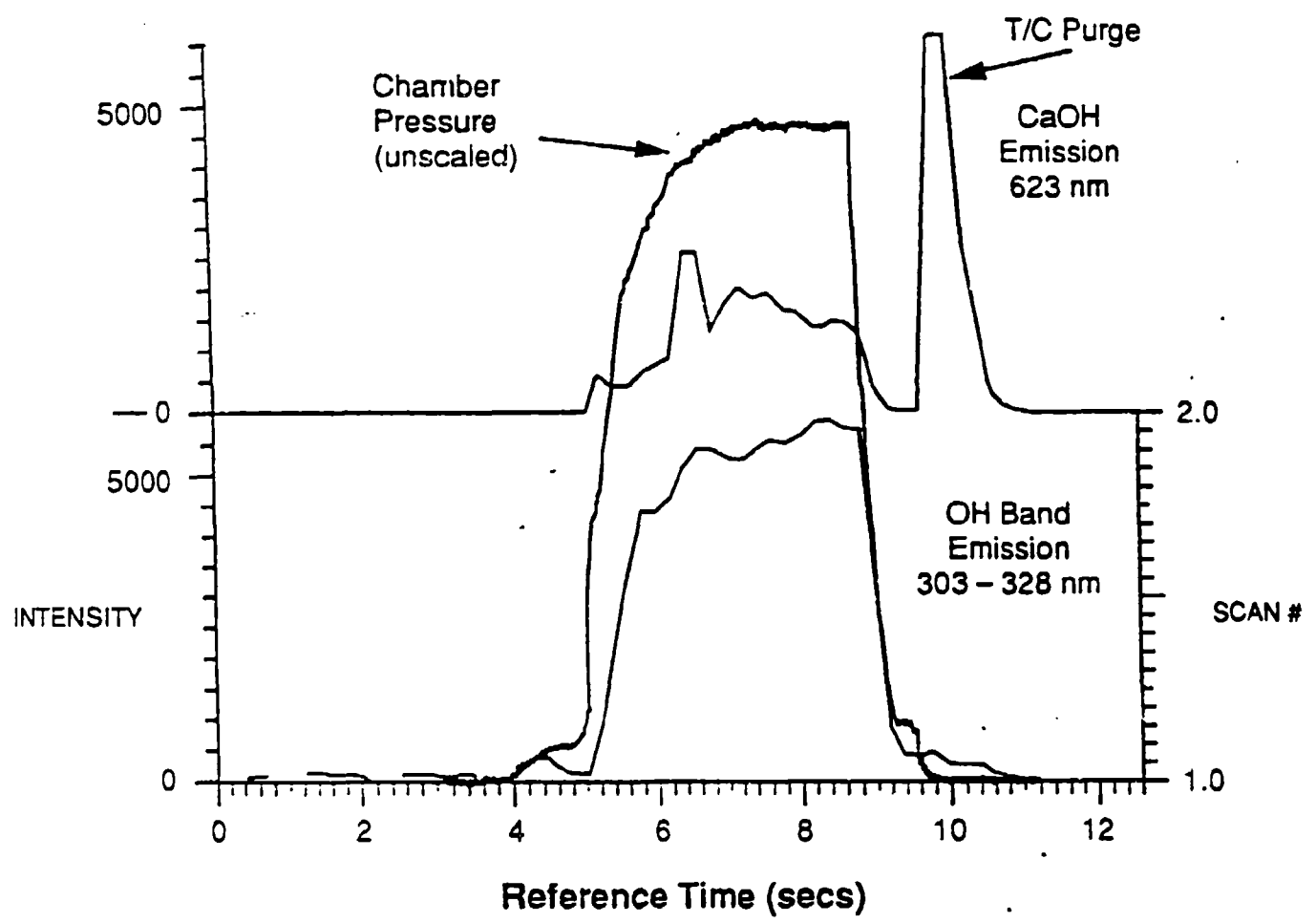

Figure 7-91 OH AND CaOH EMISSION INTENSITIES TEST 87-017-006



Injection of a contaminant solution into the plume near the nozzle exit occurred during Test 87-017-006. The injection system, containing a weak solution of iron chloride and copper chloride in distilled water, was commanded to open at 6.83 seconds after sequence start. Analysis of the spectral data shows no definite signs of contaminant combustion, although two iron atomic lines are observed from 5.6 seconds until test cutoff. No copper atomic lines, or CuOH or FeO spectral bands were observed in this test. The absence of copper and the appearance of iron before contaminant injection suggest an alternative source of iron, of unknown origin. The absence of contaminant spectral features is due to two potential causes.

The primary spectral wavelengths measured in the laboratory (543nm for CaOH and 625nm for FeO) are very close to high intensity CaOH emission wavelengths observed in Test 006 and could have been masked. A second possibility is that the area of high intensity emission of the injected contaminants was not in the fairly narrow spatial field of view of the spectrometer. This could be caused by a slight misalignment of the contaminant injector (The spectrometer aim point was shifted to attempt to compensate.) or uncertainty as to the axial location of the high intensity region.

Had the implications of a strong CaOH emission been known at the time of the test, a warning would have been recognizable in excess of one second before the siezing of the pump. The potential use of plume spectrometry as a health monitoring tool was demonstrated.

8.0 CONCLUSIONS AND RECOMMENDATIONS

Engine tests 87-017-003, 87-017-005 and 87-017-006 demonstrated the expander cycle operation ignition, transition, steady state mainstage and shutdown. The highest fuel turbopump speed (87,400 RPM) was achieved on Test 87-017-006 where the maximum test chamber pressure of 776 PSIA was also recorded.

Nominal and emergency shutdowns were achieved without causing any damage or distress to any system component. Unplanned fuel stoppage generally results in thrust chamber burnout or severe thermal distress. Neither of these resulted when the fuel pump speed and pump pressure abruptly decayed. Visual inspection of the injector and thrust chamber showed no evidence of heat distress due to the emergency shutdown, thus demonstrating an inherent safety feature of the expander power cycle with the hydrogen pump, then the oxygen pump driven in series.

Operation of all the components except the fuel pump, during the tests were satisfactory. The oxidizer turbopump performed as predicted and the thrust chamber assembly resistances and heat loads appear nominal.

Further evaluation of the fuel pump anomaly and recommended modifications were made under a company funded effort. The results of the evaluation showed that the failure of the MK49-F turbopump #4 ball bearing was caused by the loss of internal clearance associated with lack of sufficient coolant. The root cause which contributed to the failure of the bearing was the second stage crossover static seal leakage. The seal, damaged during turbopump assembly, allowed leakage sufficient enough to change critical secondary flow paths within the turbopump. Most critically, the leakage was sufficient enough to lower the balance piston sump pressure to the point where turbine gas was drawn into the turbine bearing cavity. This problem was compounded by the mis-plumbed bearing coolant drain line. The seal leakage was also attributed with the first stage performance degradation at the higher turbopump speeds.

Initial test data indicated that the balance piston did not provide sufficient thrust range to control the hydrodynamic loads as the turbopump speed increased. This theory was refuted by the results of the thermodynamic model of the primary and secondary pump flow systems. With all the anomalous flow conditions simulated in the model, the balance piston closure could not be simulated unless the impeller was not radially over-lapped. Post-test hardware dimensional and visual inspections did not support this failure mode. Repair and modification of the fuel pump is recommended. Testing of the thrust chamber is recommended to demonstrate operation

and performance. Continuation of the complete ICE tests should be accomplished to complete the demonstration of the feasibility of a high performance expander cycle LO₂/LH₂ engine.

Spectrometry data were used during the test series as a validation of the health monitoring. Spectroscopic analysis of exhaust plume contaminants appears to be a valuable tool. Spectrographic observation of the CaOH in the exhaust plume proved to be coincident with the fuel pump anomaly and thereby adjudged as an excellent candidate for health monitoring. The strength of the recorded OH signature indicated that the spectrometer can be used to verify injector mixture ratio .

9.0 REFERENCES

1. Anon: Orbit Transfer Vehicle Advanced Expander Cycle Engine Point Design Study (Volume II: Study Results). Report No. RI/RD80-218-2, Contract NAS8-33568, Rocketdyne, December 1980.
2. Shoji, James M.: Advanced Hydrogen/Oxygen Thrust Chamber Design Analysis. NASA CR 121213, Contract NAS3-16774, Rocketdyne, November 1973
3. Yost, M.C.; Marker, H.E.; and Dennies, P.C.: Advanced Thrust Chamber Technology. NASA CR 135221, Contract NAS3-17825, Rocketdyne, July 1977
4. Yost, M.C.: Preburner of Staged Combustion Cycle Engine. NASA CR 135356, Contract NAS3-19713, Rocketdyne, February 1978
5. Csomor, A.; and Sutton, R.: Small, High Pressure Liquid Hydrogen Turbopump. NASA CR 135186, Contract NAS3-17794, Rocketdyne, May 1977.
6. Csomor, A. , and Warren, D. J.; Small, High Pressure Liquid Hydrogen Turbopump. NASA CR 159821, Contract NAS3-21008, Rocketdyne, May 1980.
7. Sutton, R.; Boynton, J.L.; and Akian, R.A. : Two Stage Partial Admission Turbine, NASA CR 179548, Contract NAS3-23773, Task B.1 and B.4, Rocketdyne, December 1992
8. Lariviere, B. W.: Orbital Transfer Vehicle Engine Technology High Velocity Ratio Diffusing Crossover, Task B.2, RI/RD89-111, Contract NAS3-23773, Rocketdyne, December 1992
9. Csomor, A.; and Sutton, R.: Small, High Pressure Liquid Oxygen Turbopump. Interim Report. NASA CR 135211, Contract NAS3-17800, Rocketdyne, July 1977.
10. Csomor, A.: Small, High Pressure Liquid Oxygen Turbopump. NASA CR 159509, Contract NAS3-17800, Rocketdyne, October 1978.
11. Nielson, C.E.: Liquid Oxygen Turbopump Technology, Final Report. NASA CR 165487, Contract NAS3-21356, Rocketdyne, November 1981.

10.0 APPENDICES

Appendix A:

Test 87-017-005 Time Based Data Plots (1/28/87)
Pages 149 through 259

Appendix B:

Test 87-017-006 Time Based Data Plots (1/28/87)
Pages 261 through 372

Appendix A:

Test 87-017-005 Time Based Data Plots (1/28/87)

**Note: Units for the abscissa in all plots are seconds;
Units for ordinate parameters are given in Table 7-6**

Appendix A: Test 87-017-005 Time Based Data Plots (1/28/87)

05595200
080487 0067

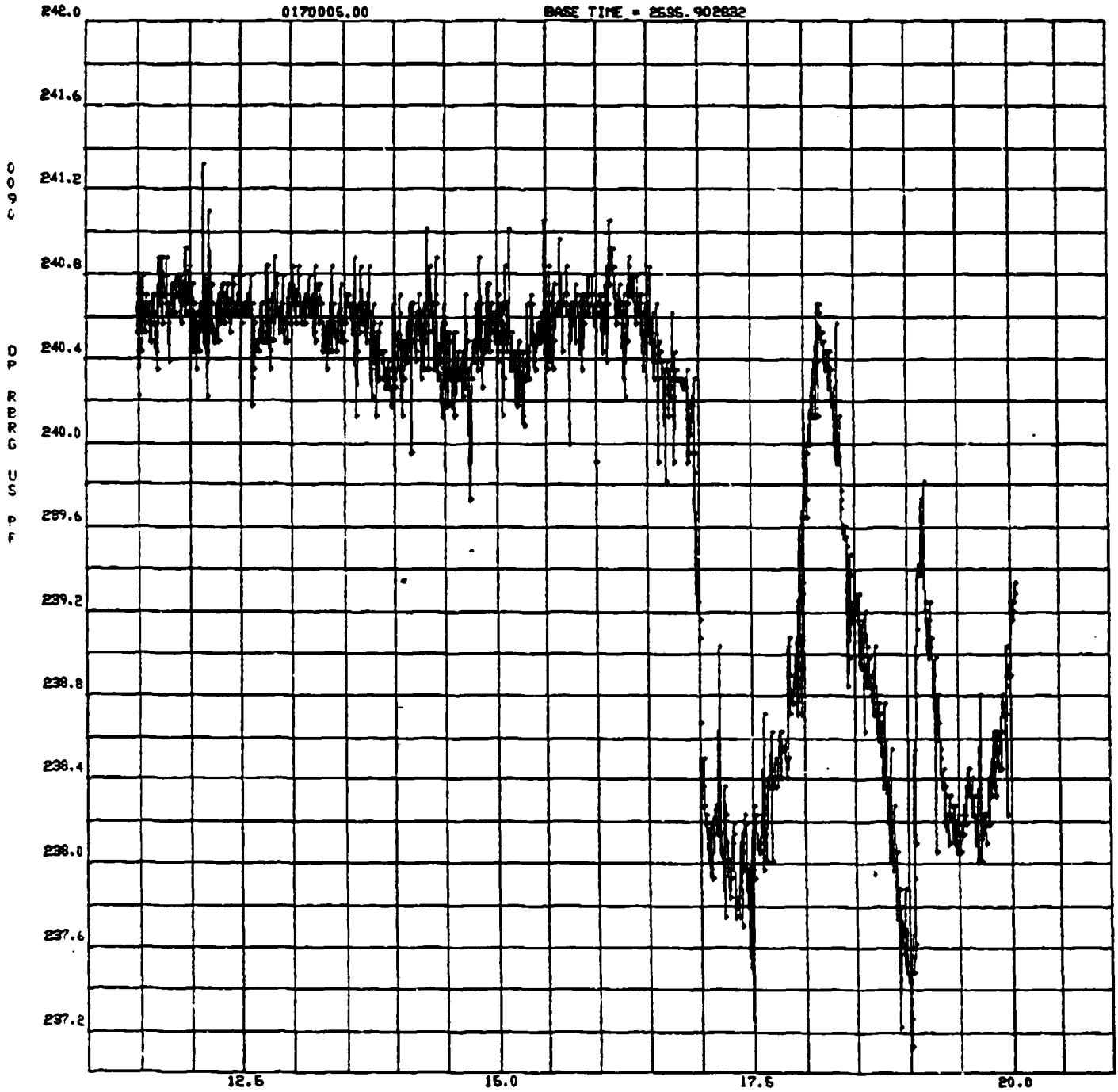

Appendix A: Test 87-017-005 Time Based Data Plots (1/28/87)

405595206
020487 0068

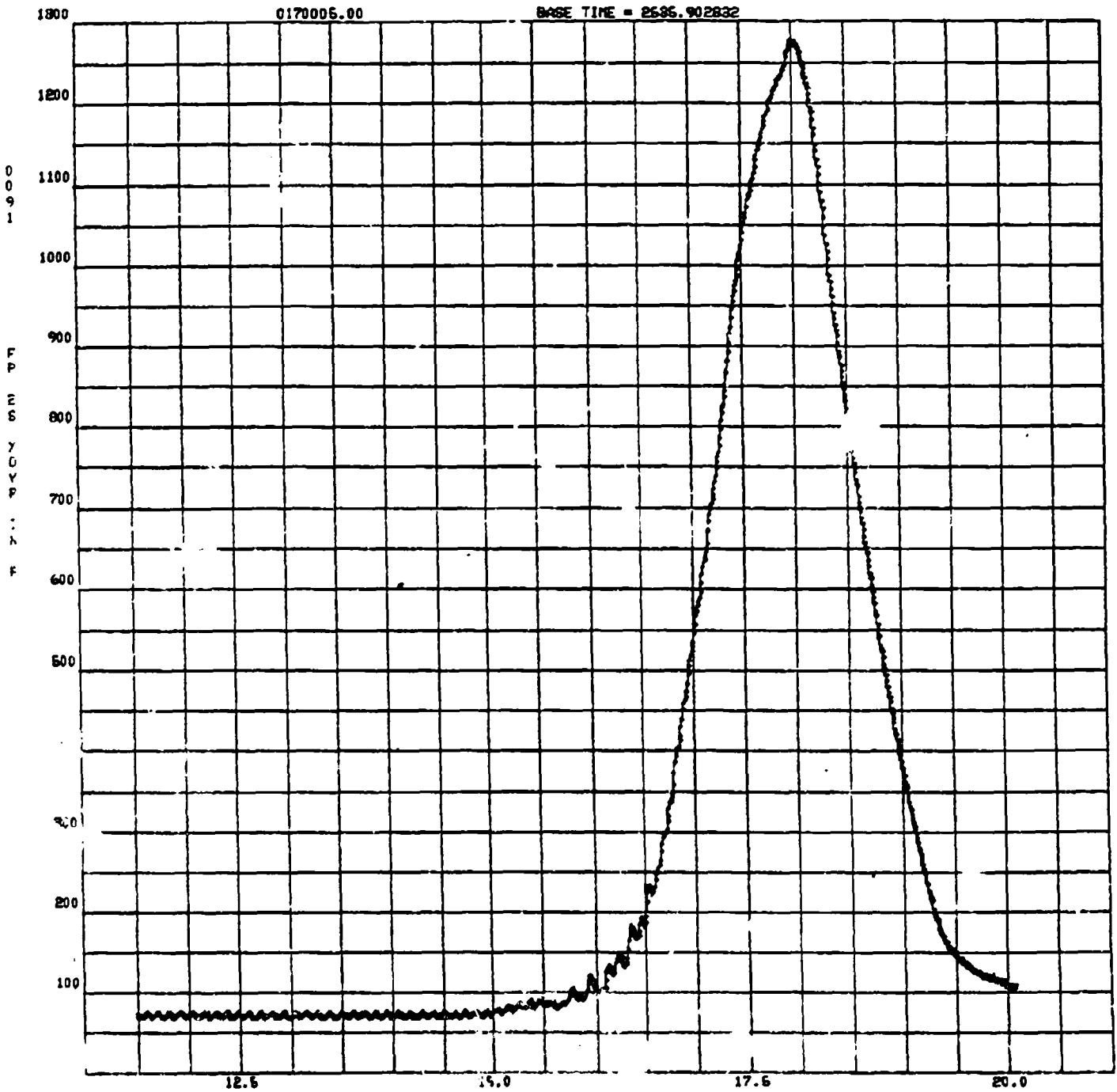

Appendix A: Test 87-017-005 Time Based Data Plots (1/28/87)

405595200#
020467 0069

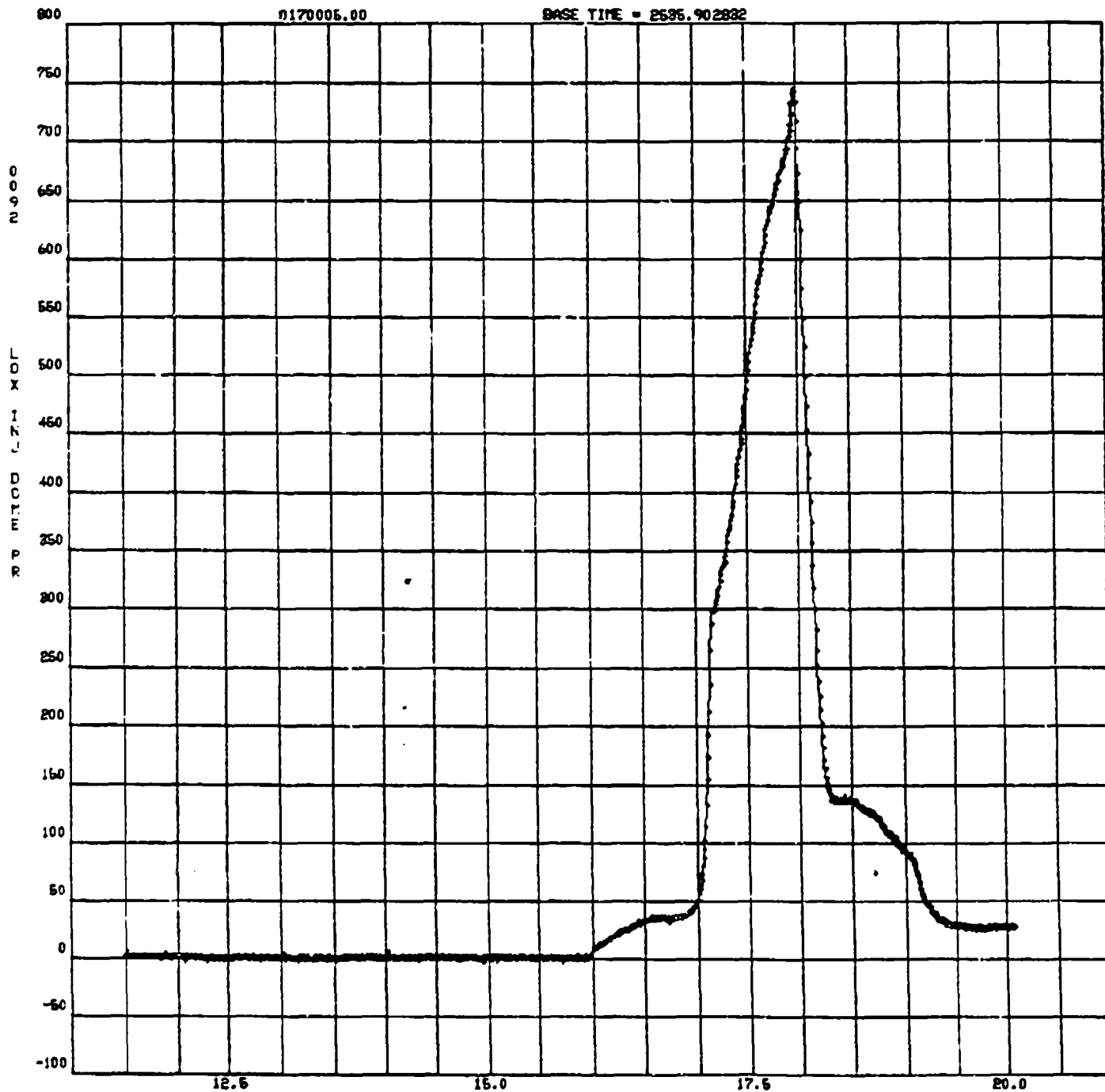

Appendix A: Test 87-017-005 Time Based Data Plots (1/28/87)

4055952004
020487 0070

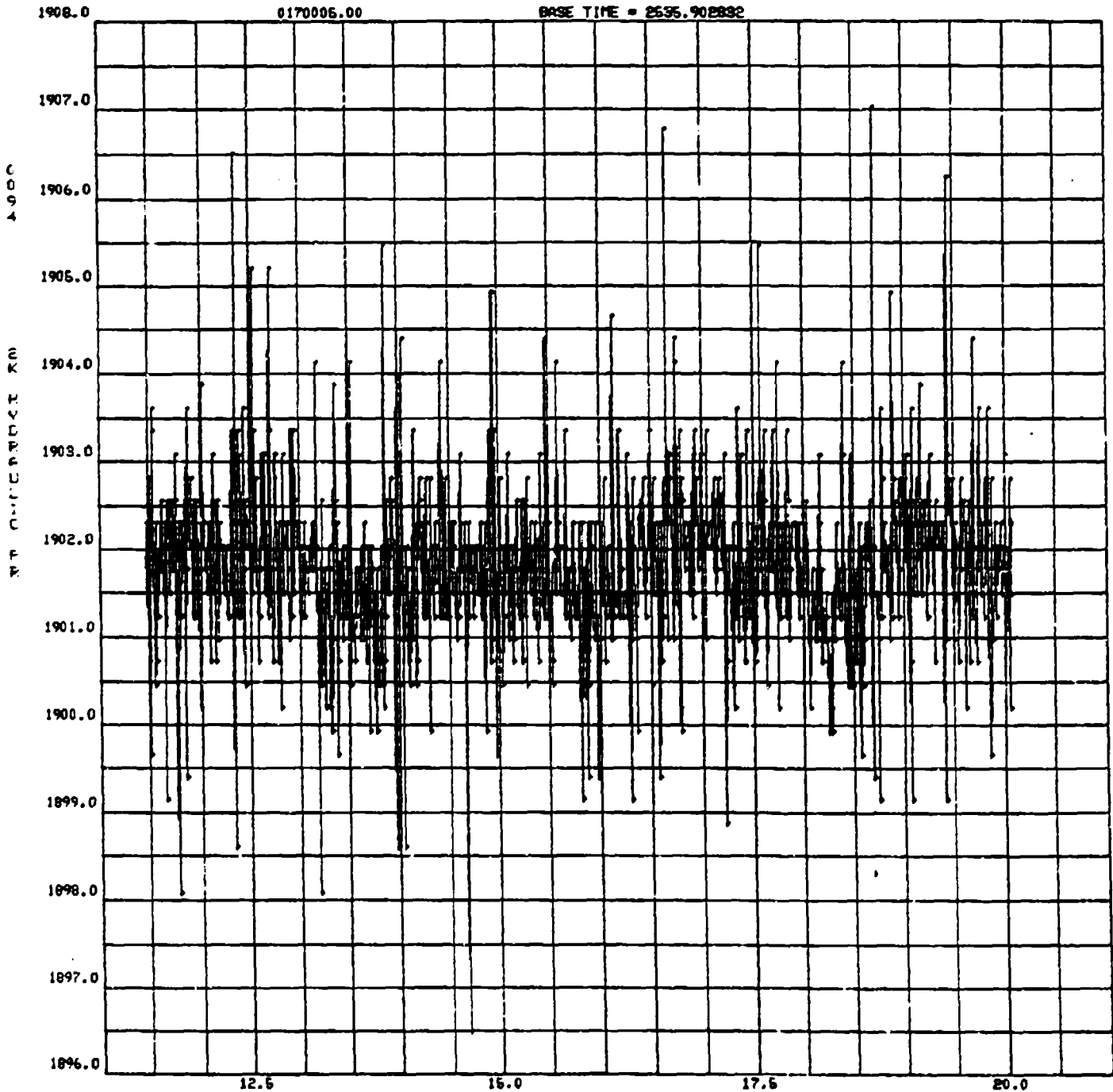

Appendix A: Test 87-017-005 Time Based Data Plots (1/28/87)

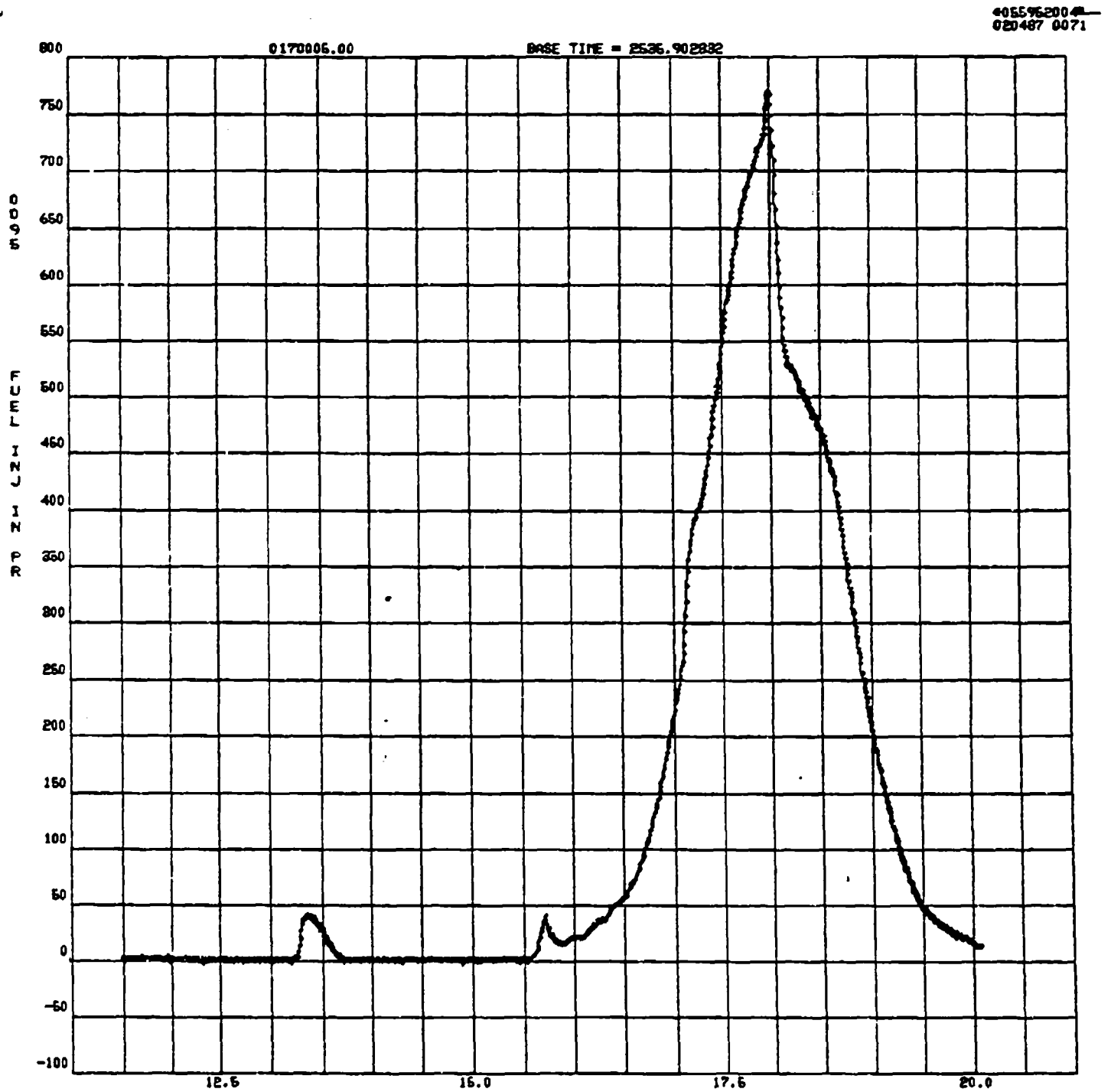

Appendix A: Test 87-017-005 Time Based Data Plots (1/28/87)

05595200
020487 0072

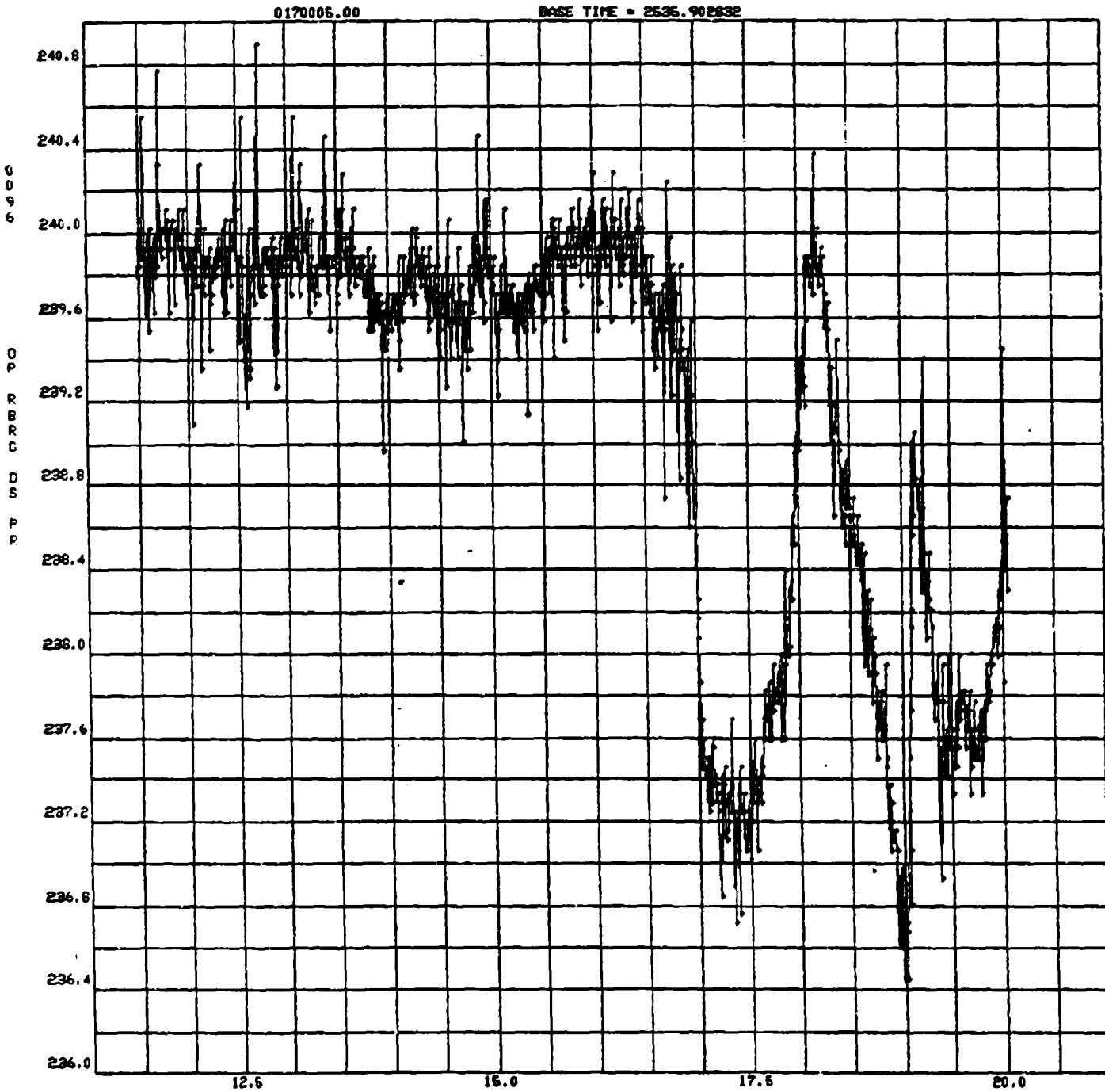

Appendix A: Test 87-017-005 Time Based Data Plots (1/28/87)

05595200
020487 0078

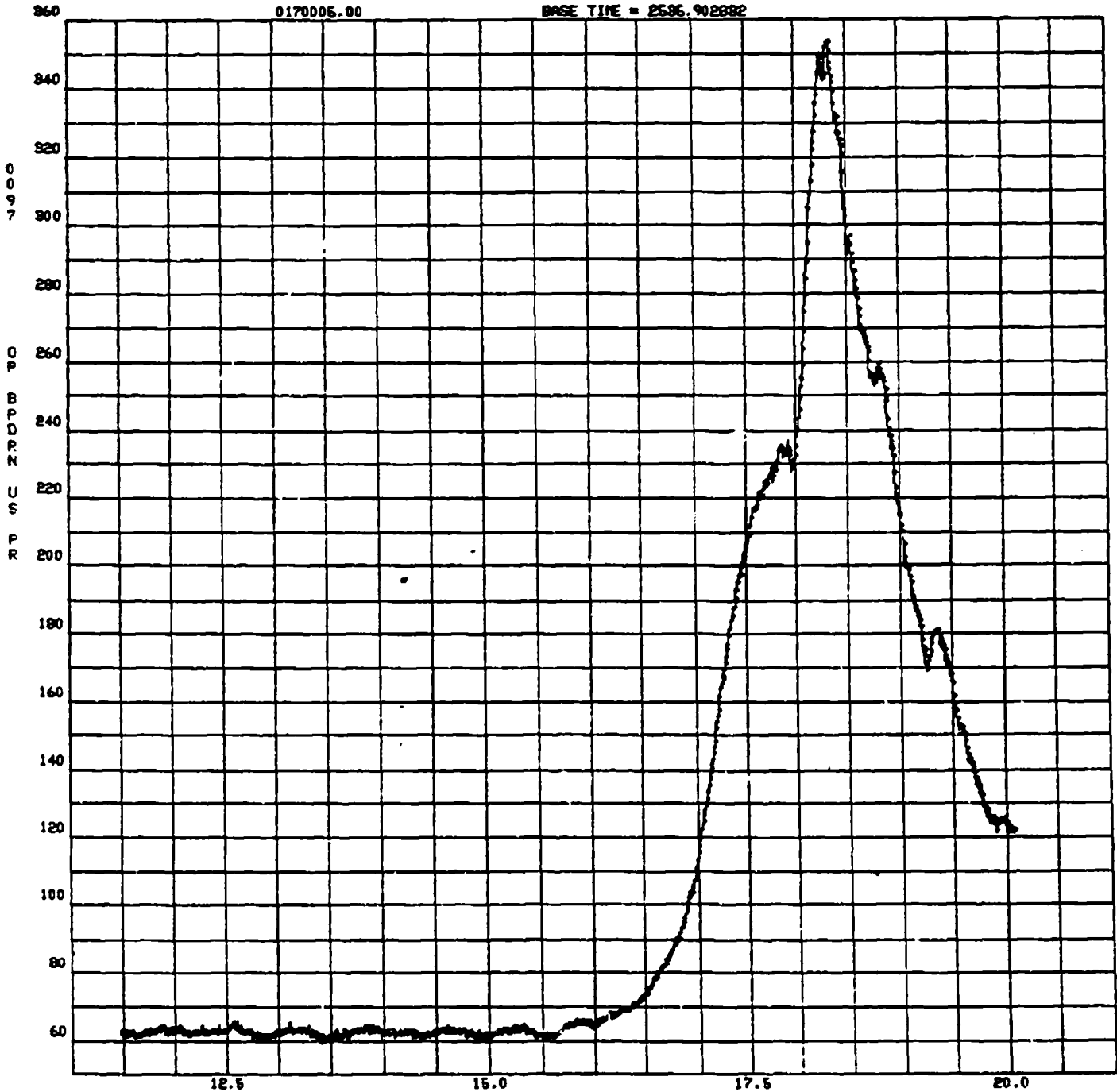

Appendix A: Test 87-017-005 Time Based Data Plots (1/28/87)

4055952004
020487 0074

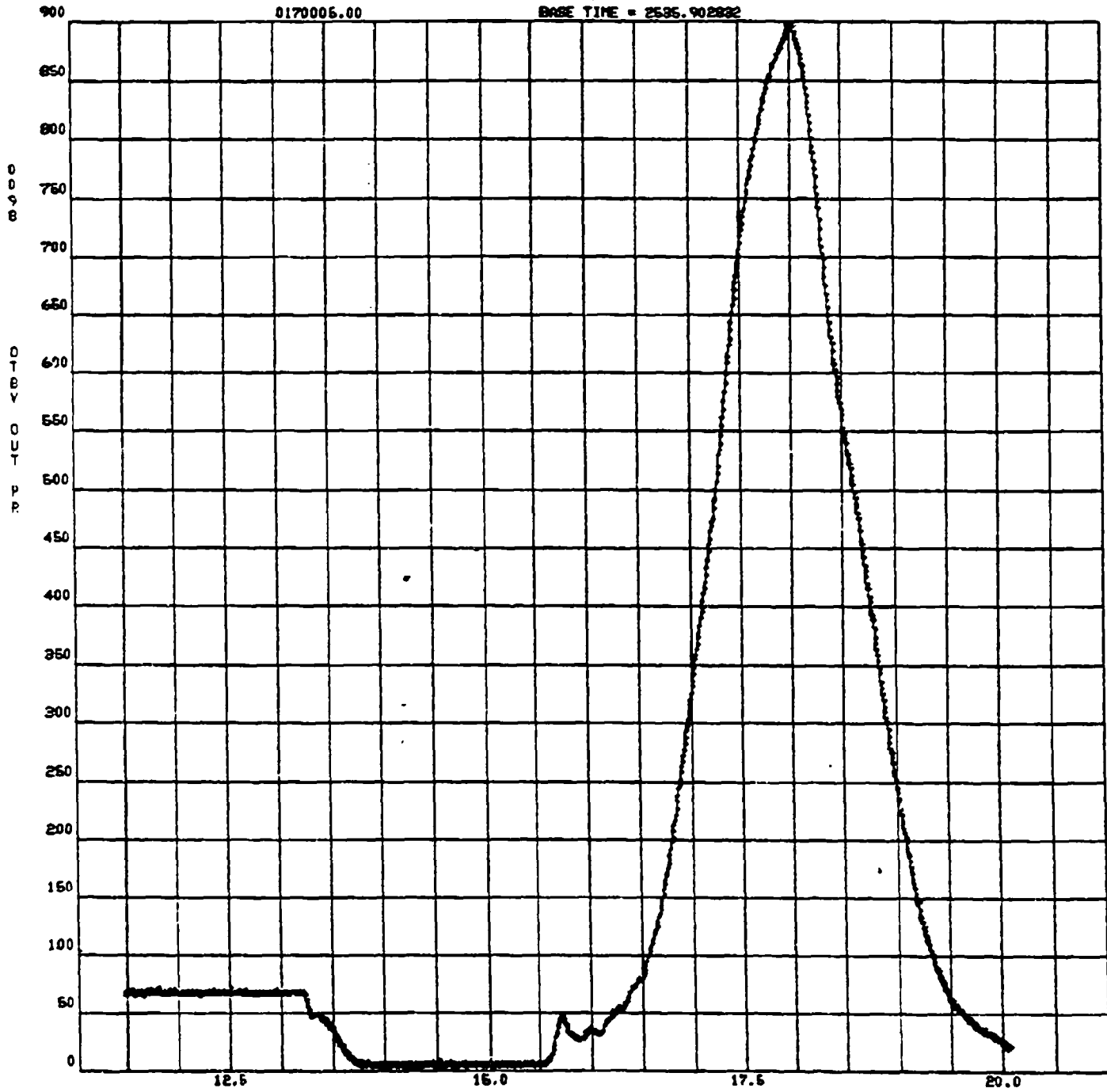

Appendix A: Test 87-017-005 Time Based Data Plots (1/28/87)

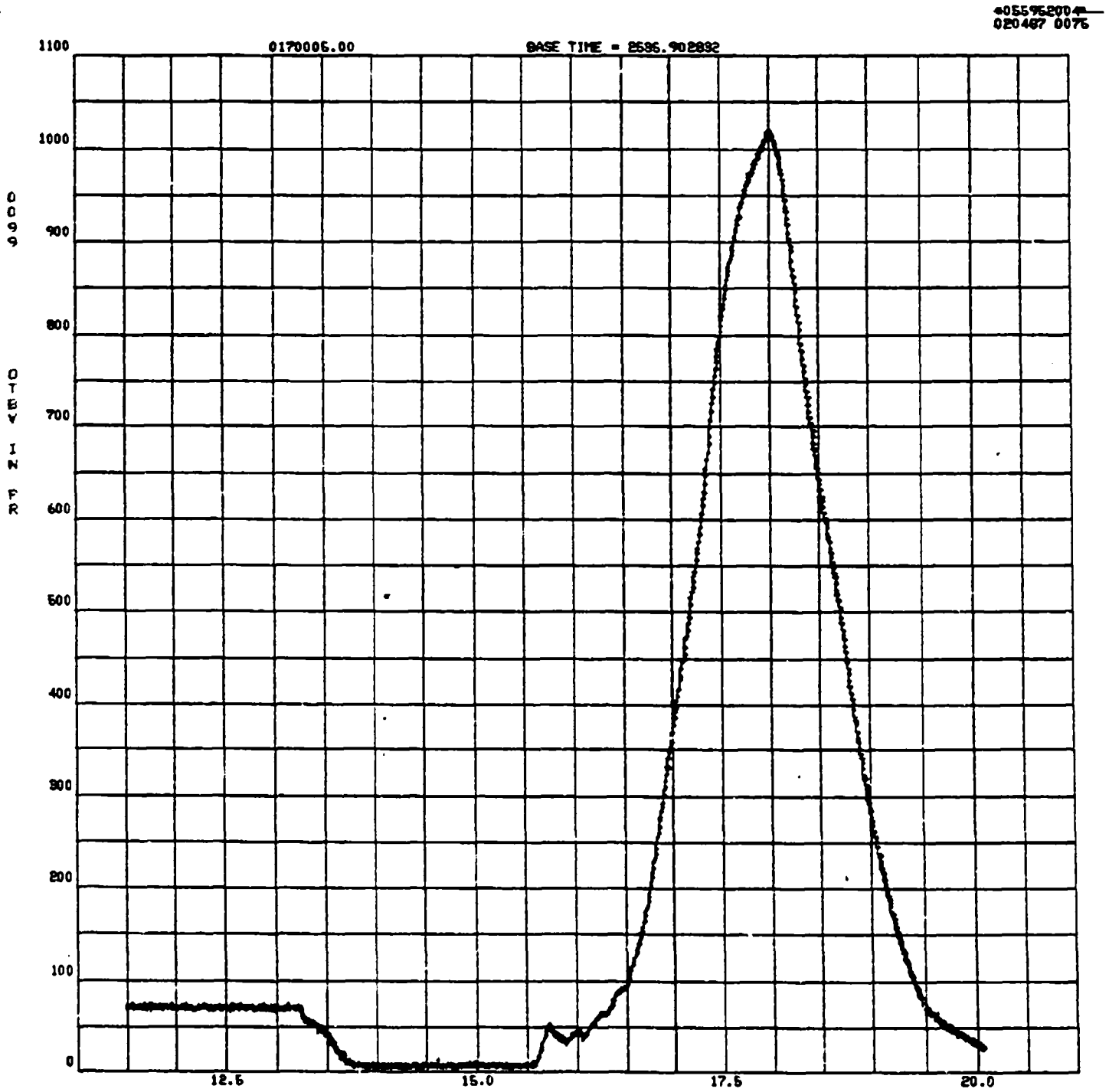

Appendix A: Test 87-017-005 Time Based Data Plots (1/28/87)

05596200
020487 0076

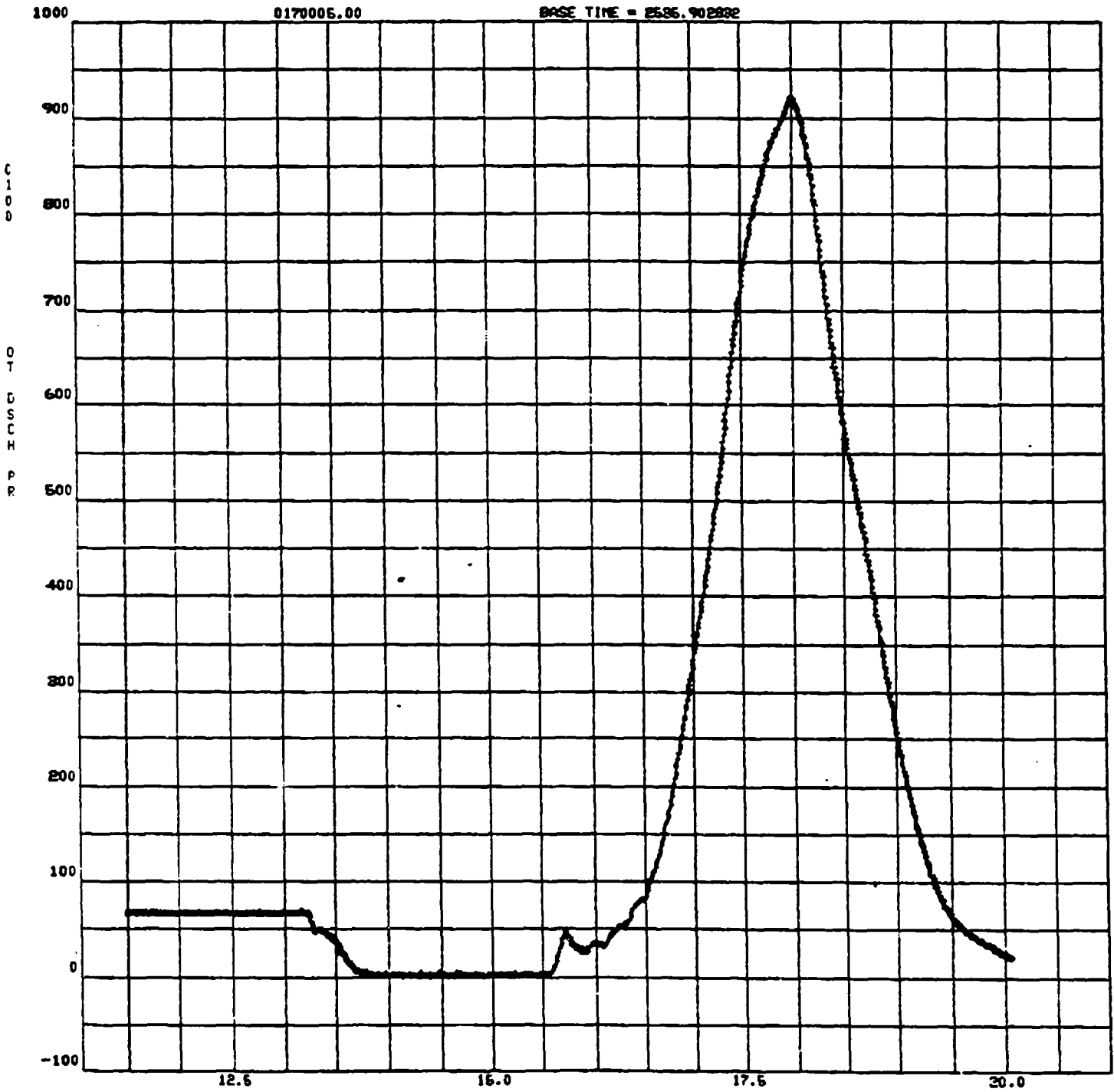

Appendix A: Test 87-017-005 Time Based Data Plots (1/28/87)

405595200
020487 0077

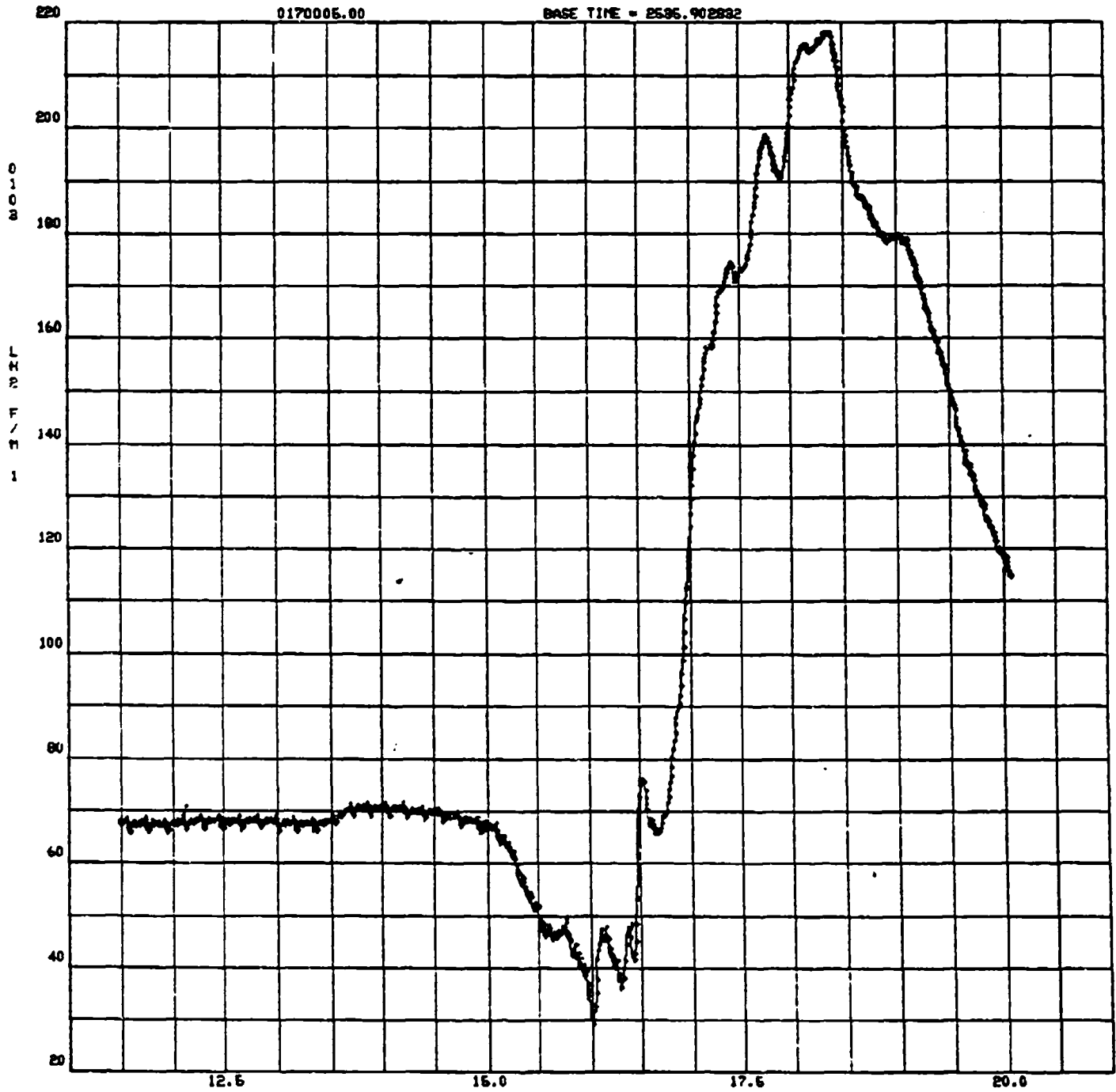

Appendix A: Test 87-017-005 Time Based Data Plots (1/28/87)

055962004
020487 0078

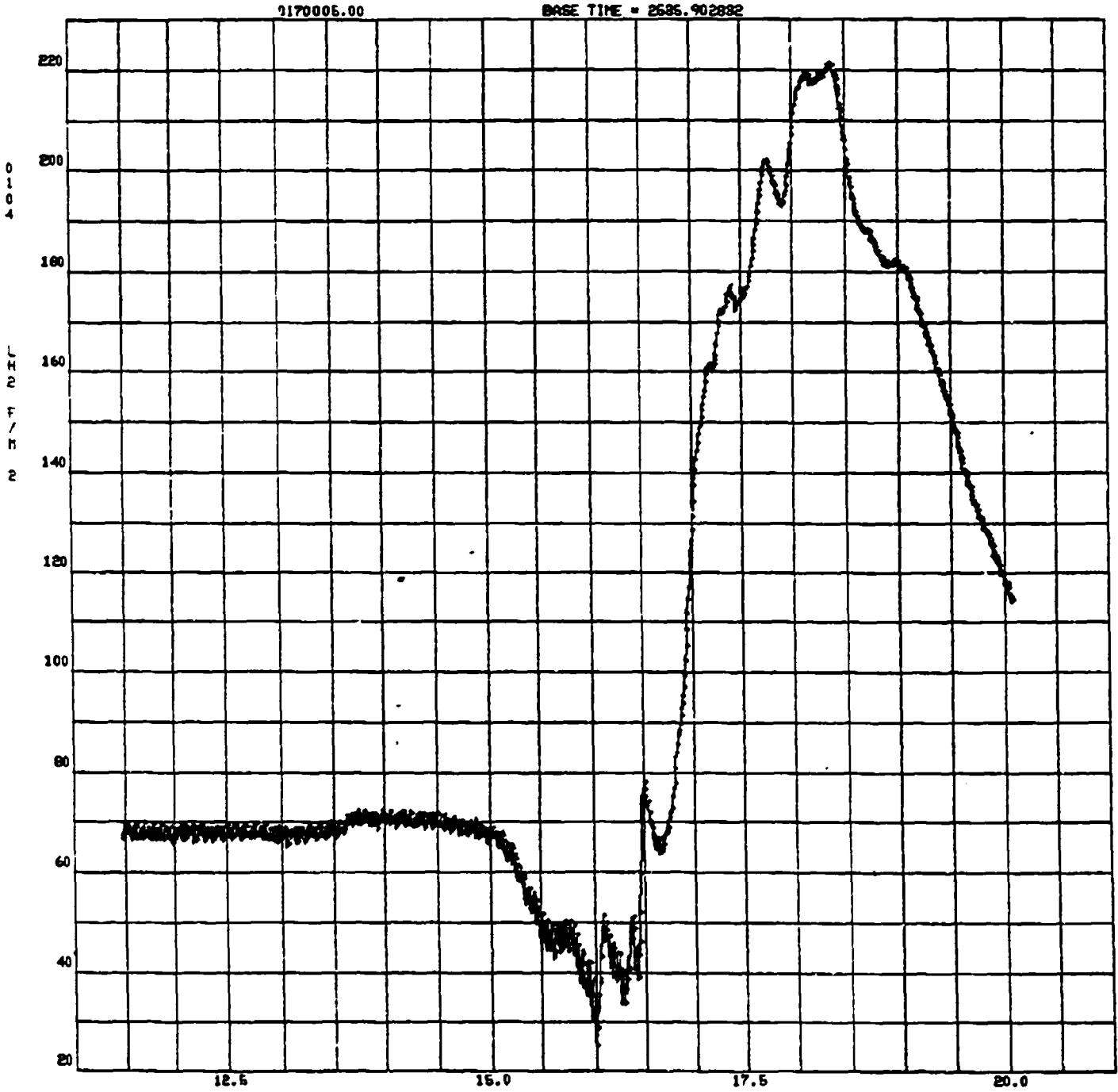

Appendix A: Test 87-017-005 Time Based Data Plots (1/28/87)

05595200
020487 0079

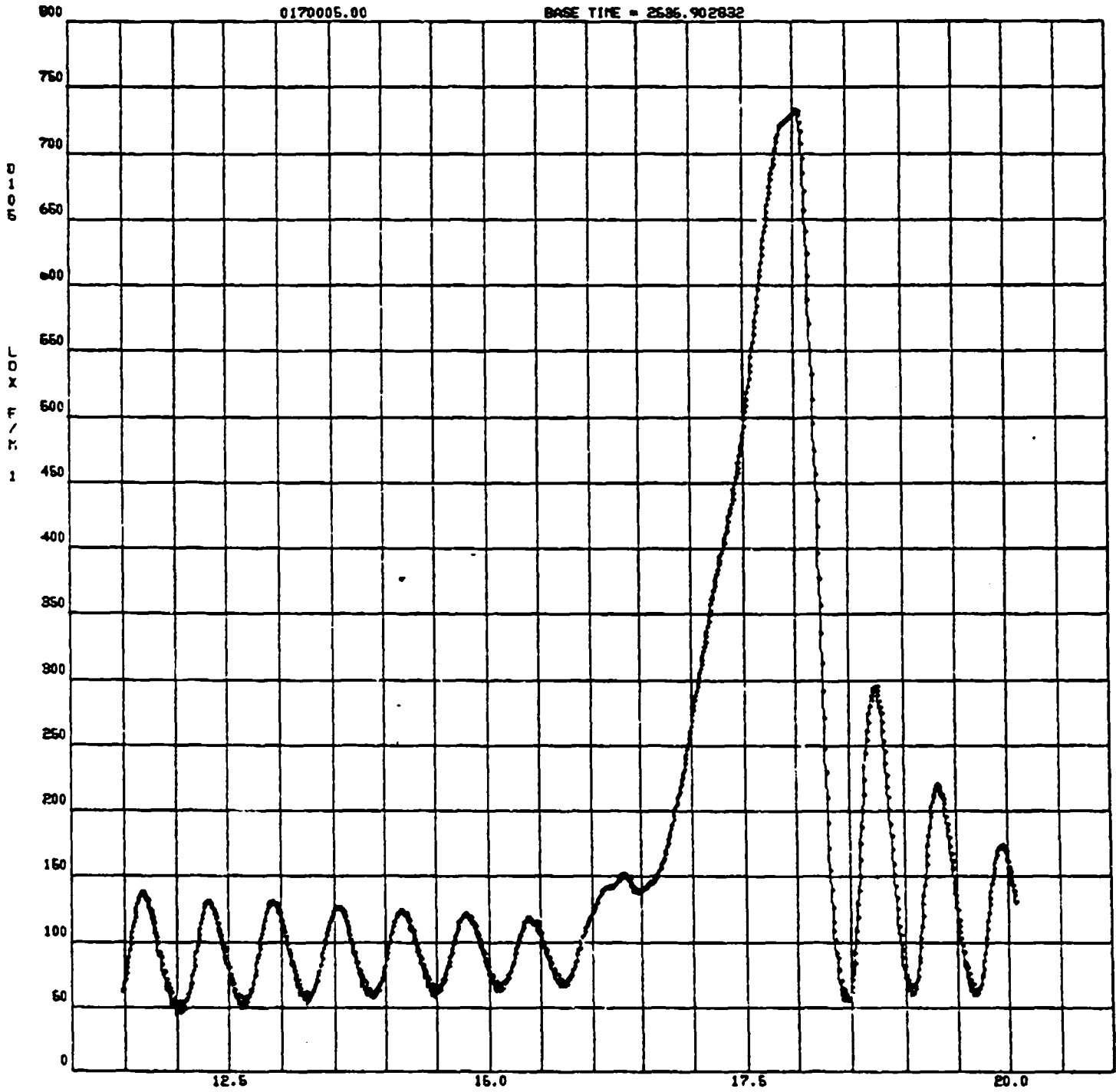

Appendix A: Test 87-017-005 Time Based Data Plots (1/28/87)

005596200
020487 0080

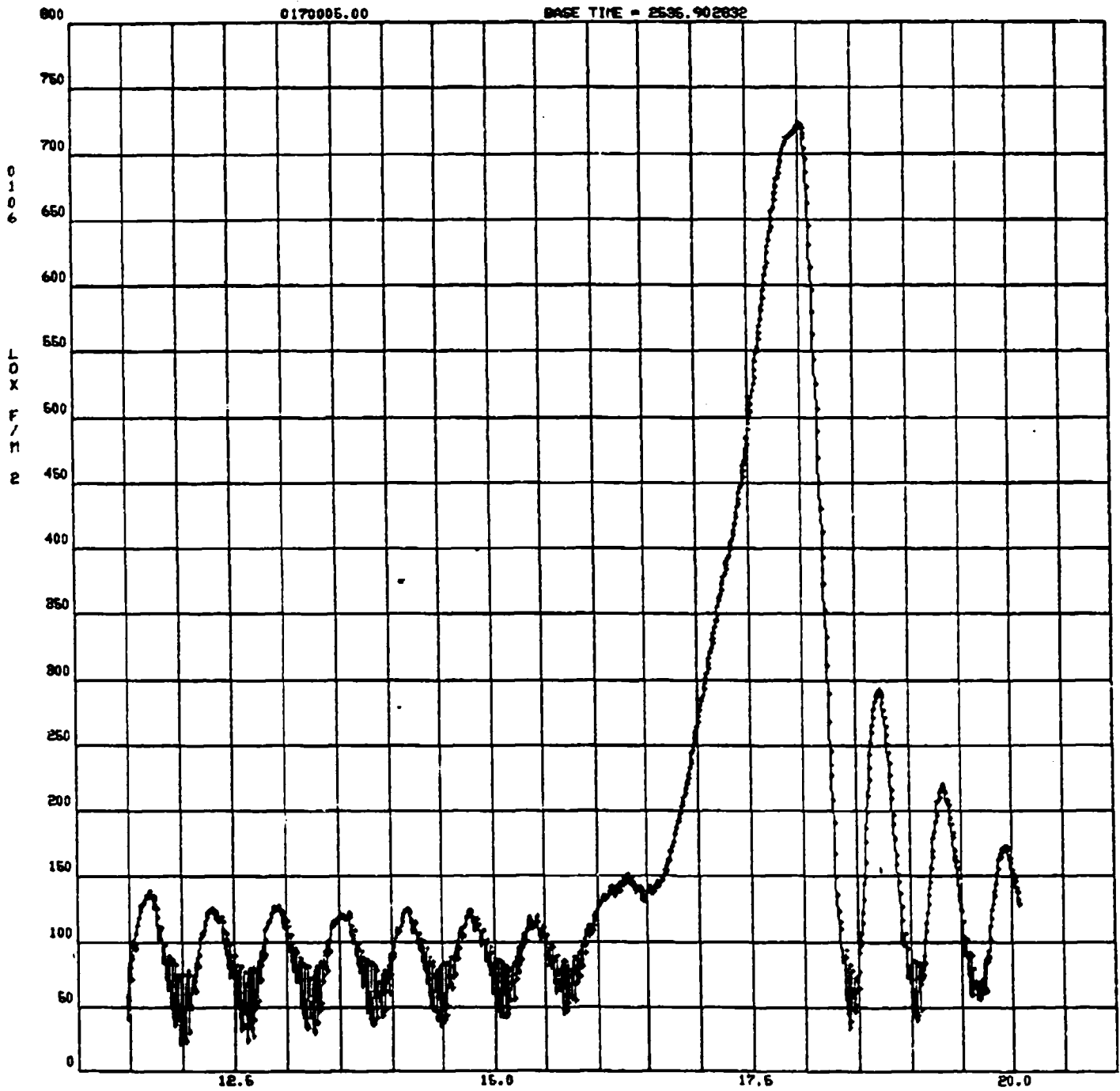

Appendix A: Test 87-017-005 Time Based Data Plots (1/28/87)

05595230.4
020487 0001

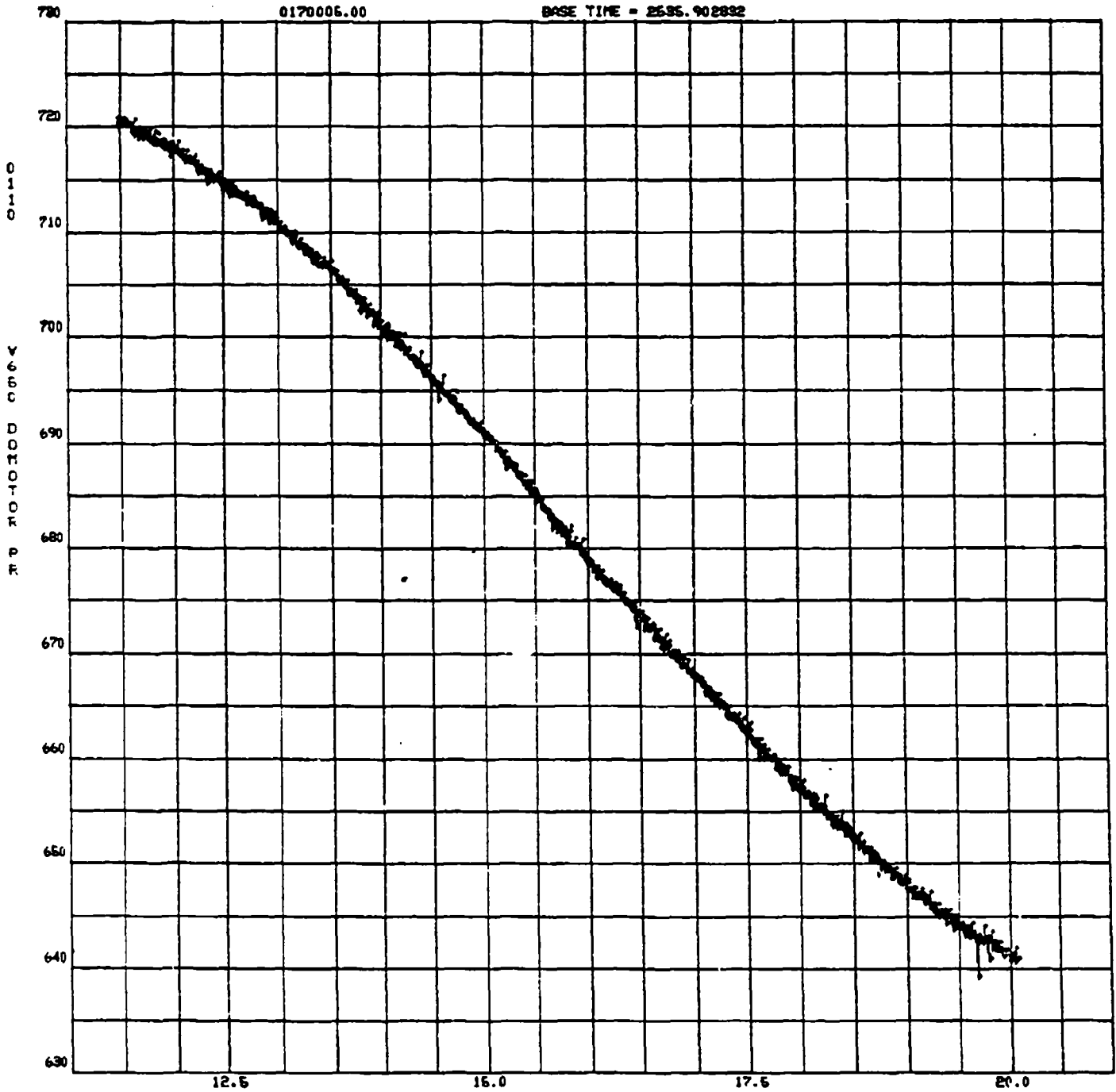

Appendix A: Test 87-017-005 Time Based Data Plots (1/28/87)

*05596200-
020487 0082

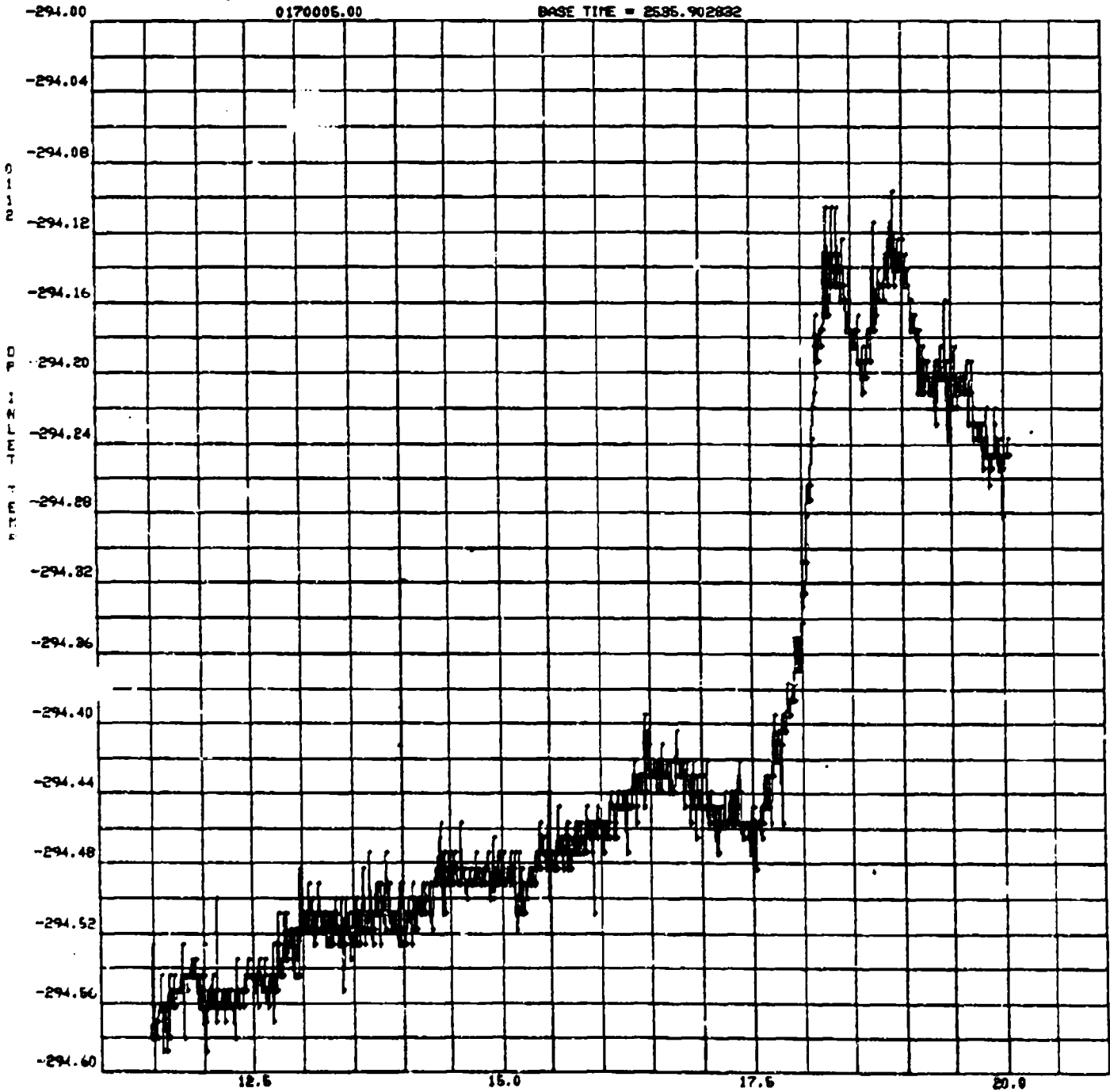

Appendix A: Test 87-017-005 Time Based Data Plots (1/28/87)

05596200
020487 0083

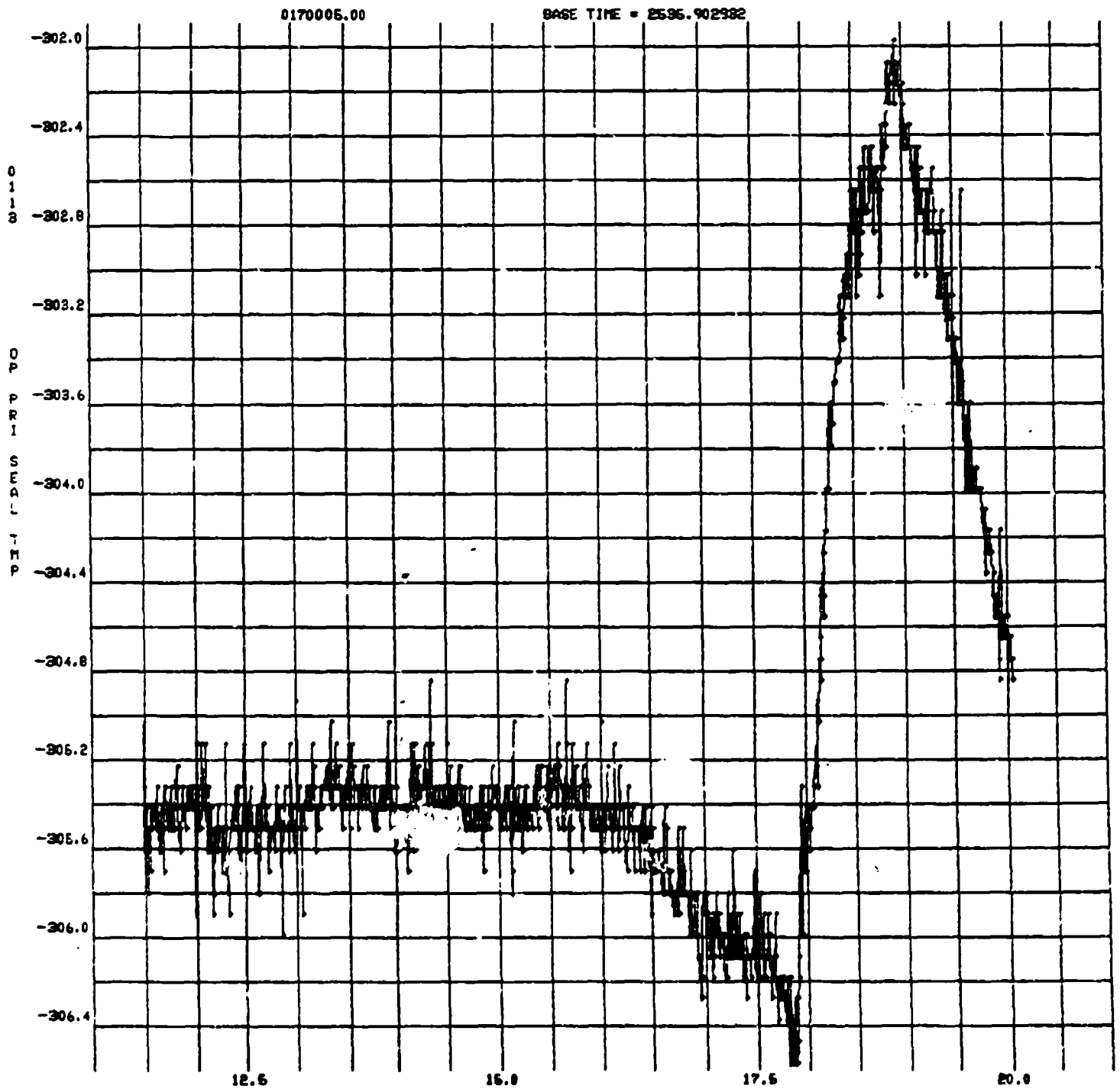

Appendix A: Test 87-017-005 Time Based Data Plots (1/28/87)

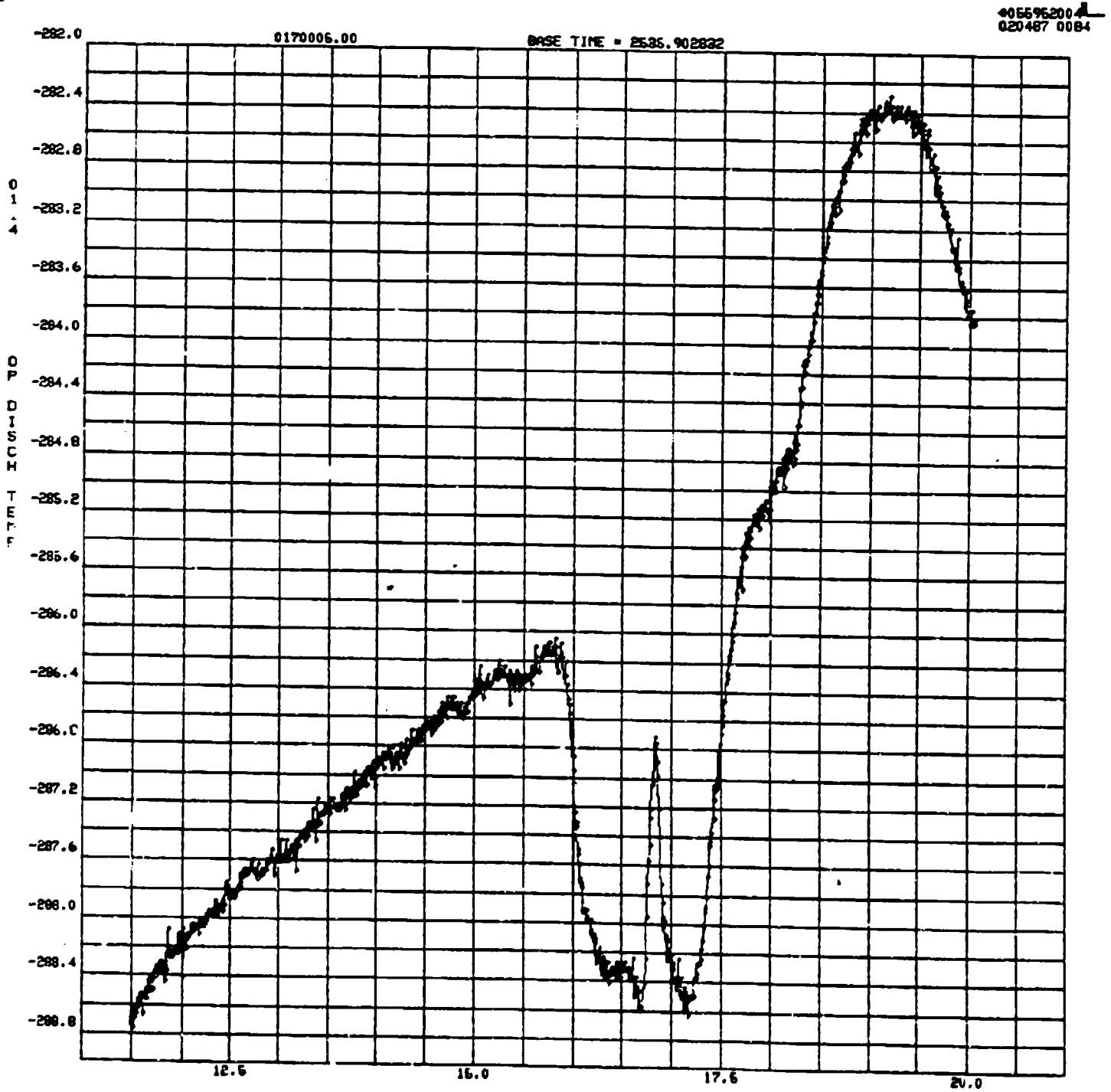

Appendix A: Test 87-017-005 Time Based Data Plots (1/28/87)

405596200
020487 0086

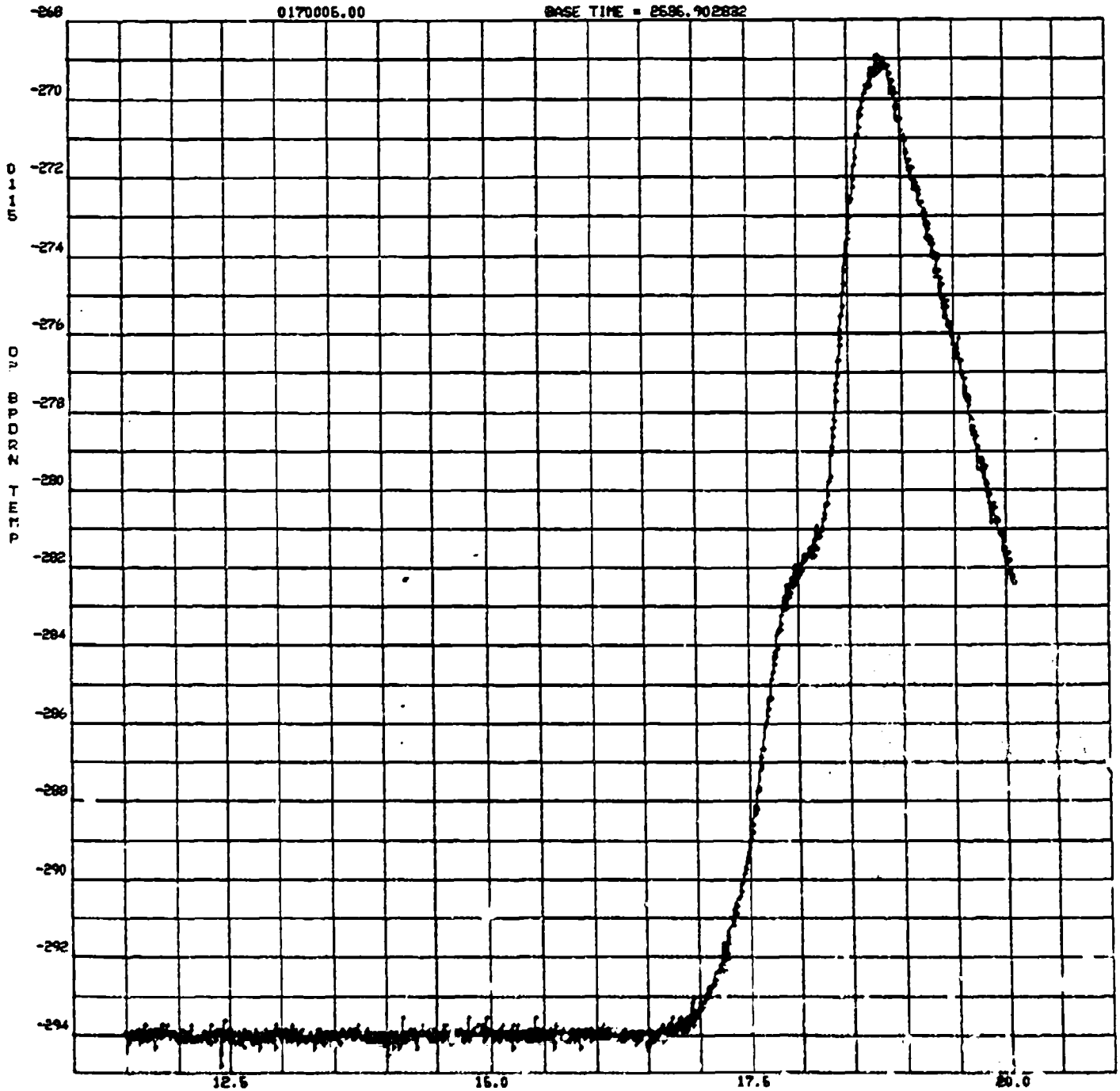

Appendix A: Test 87-017-005 Time Based Data Plots (1/28/87)

015595200.4
020487 0086

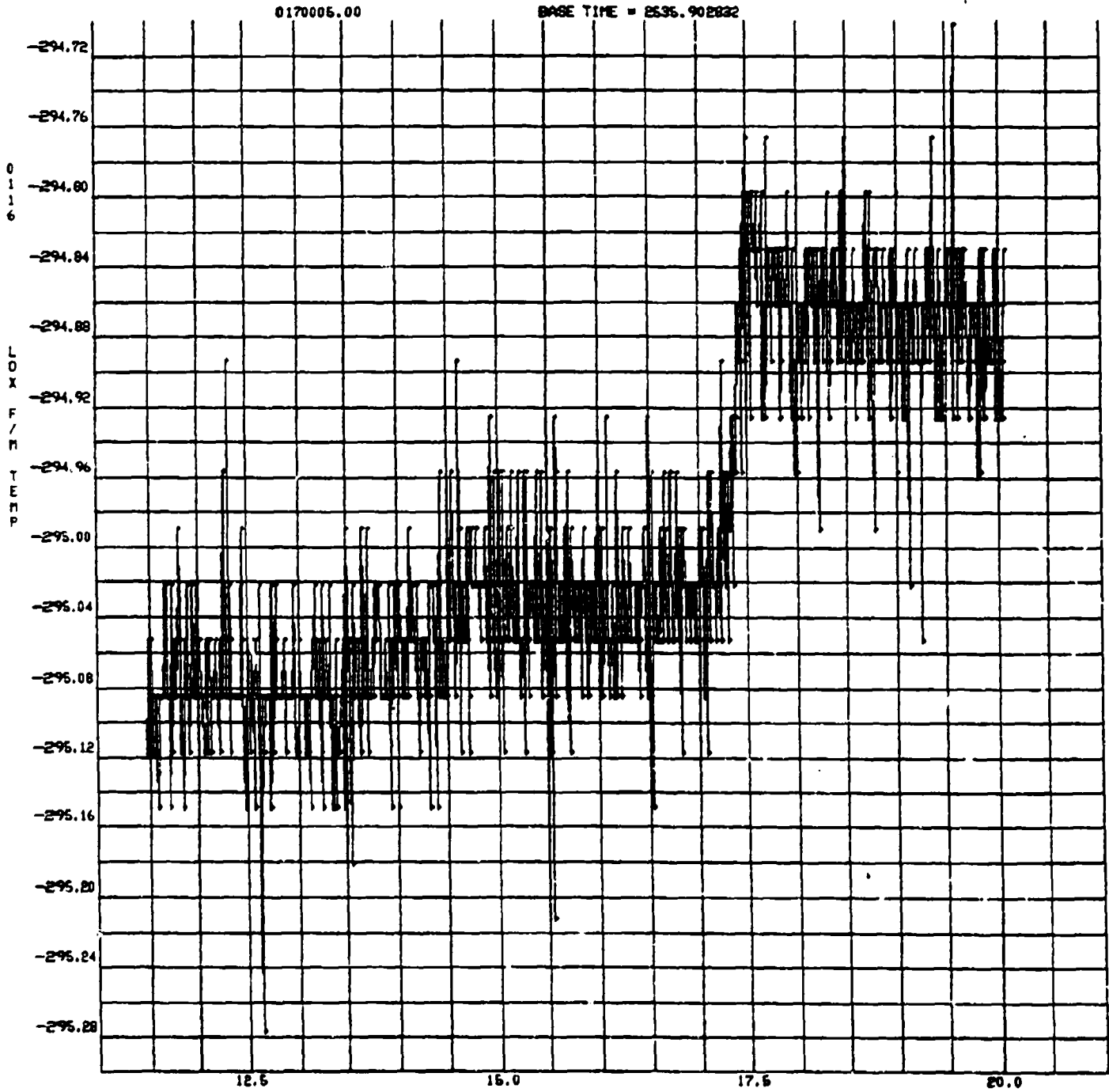

Appendix A: Test 87-017-005 Time Based Data Plots (1/28/87)

4055952004
020487 0087

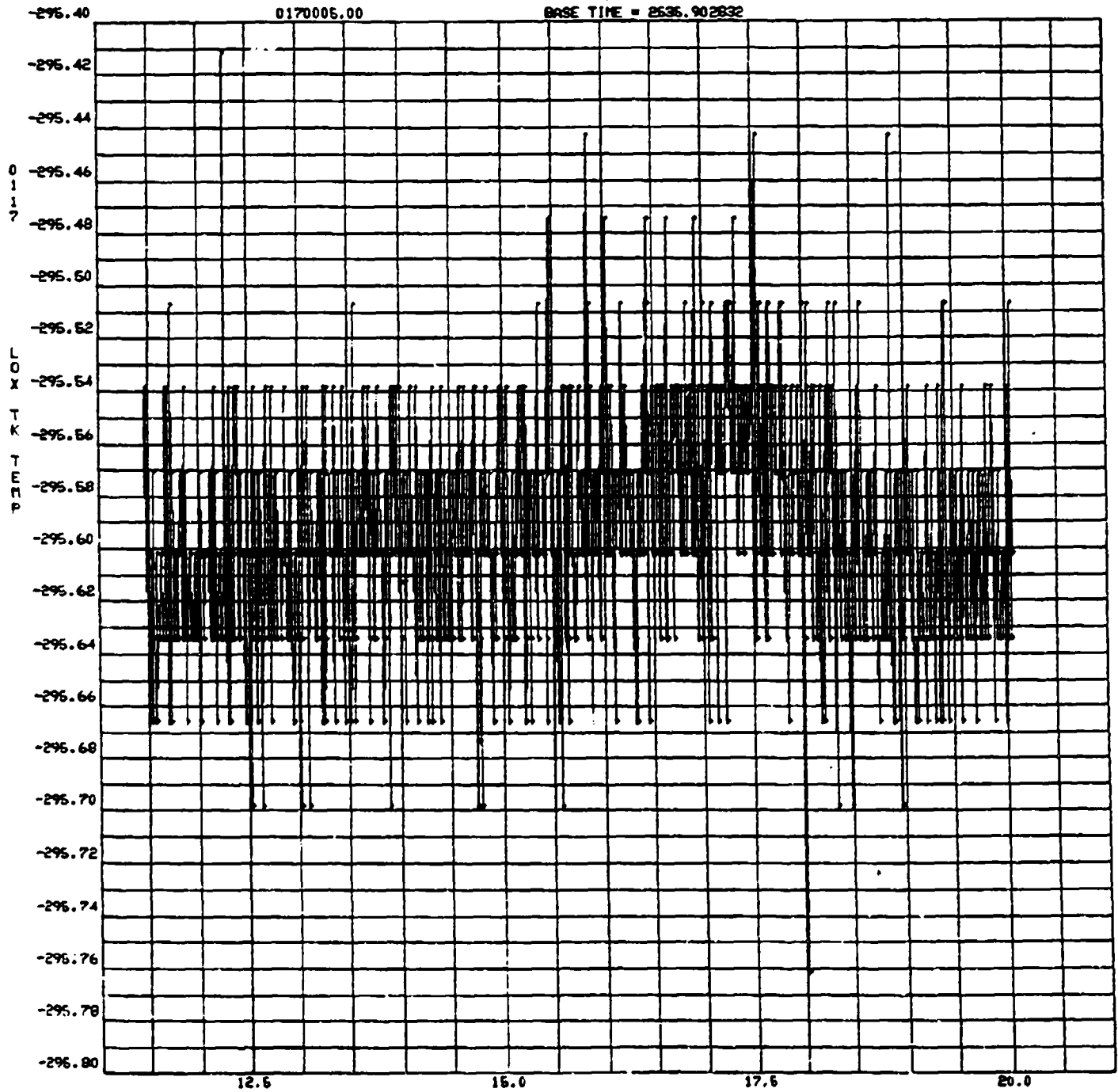

Appendix A: Test 87-017-005 Time Based Data Plots (1/28/87)

*055952004
020487 0088

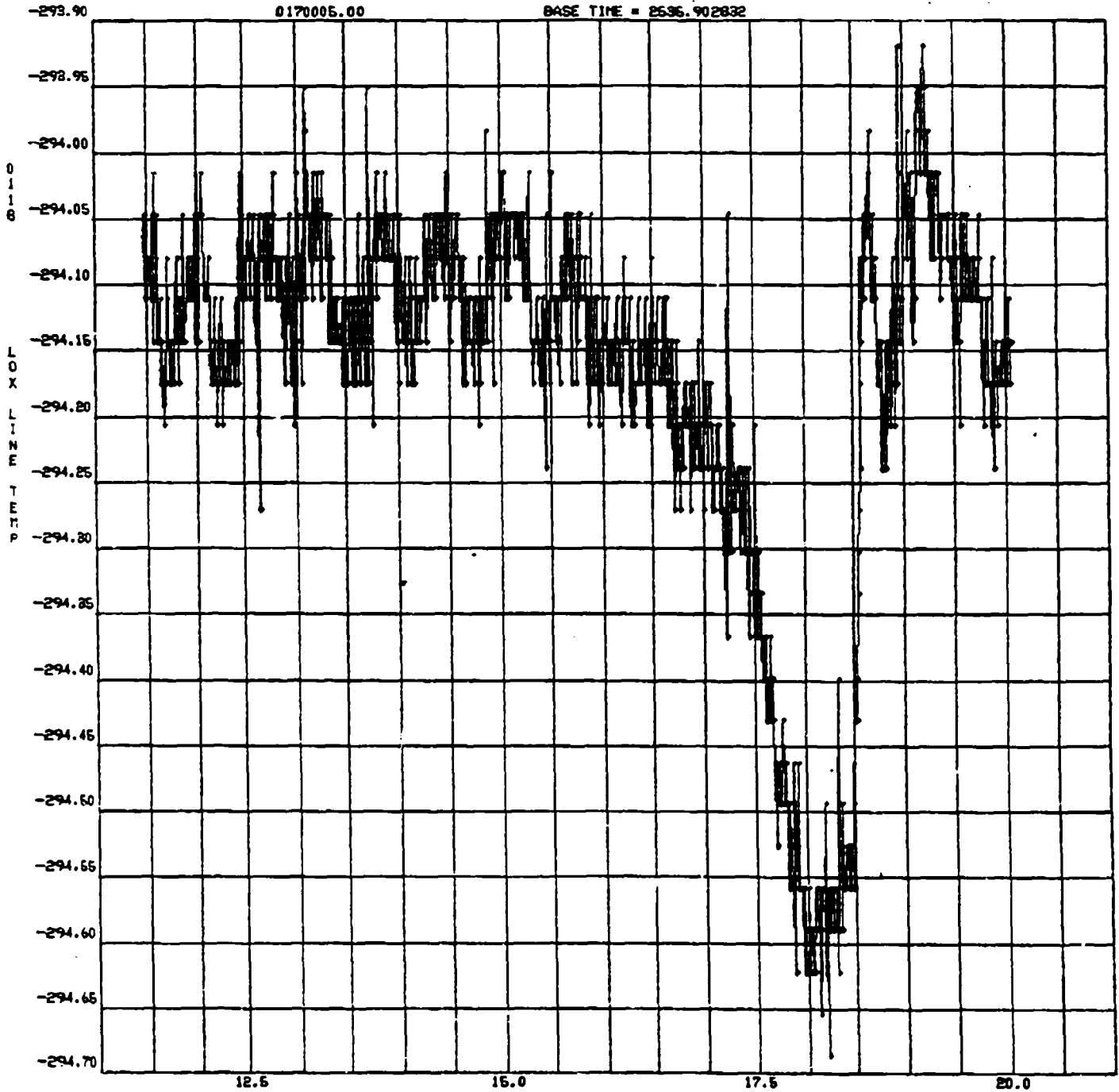

Appendix A: Test 87-017-005 Time Based Data Plots (1/28/87)

055962004
020487 0089

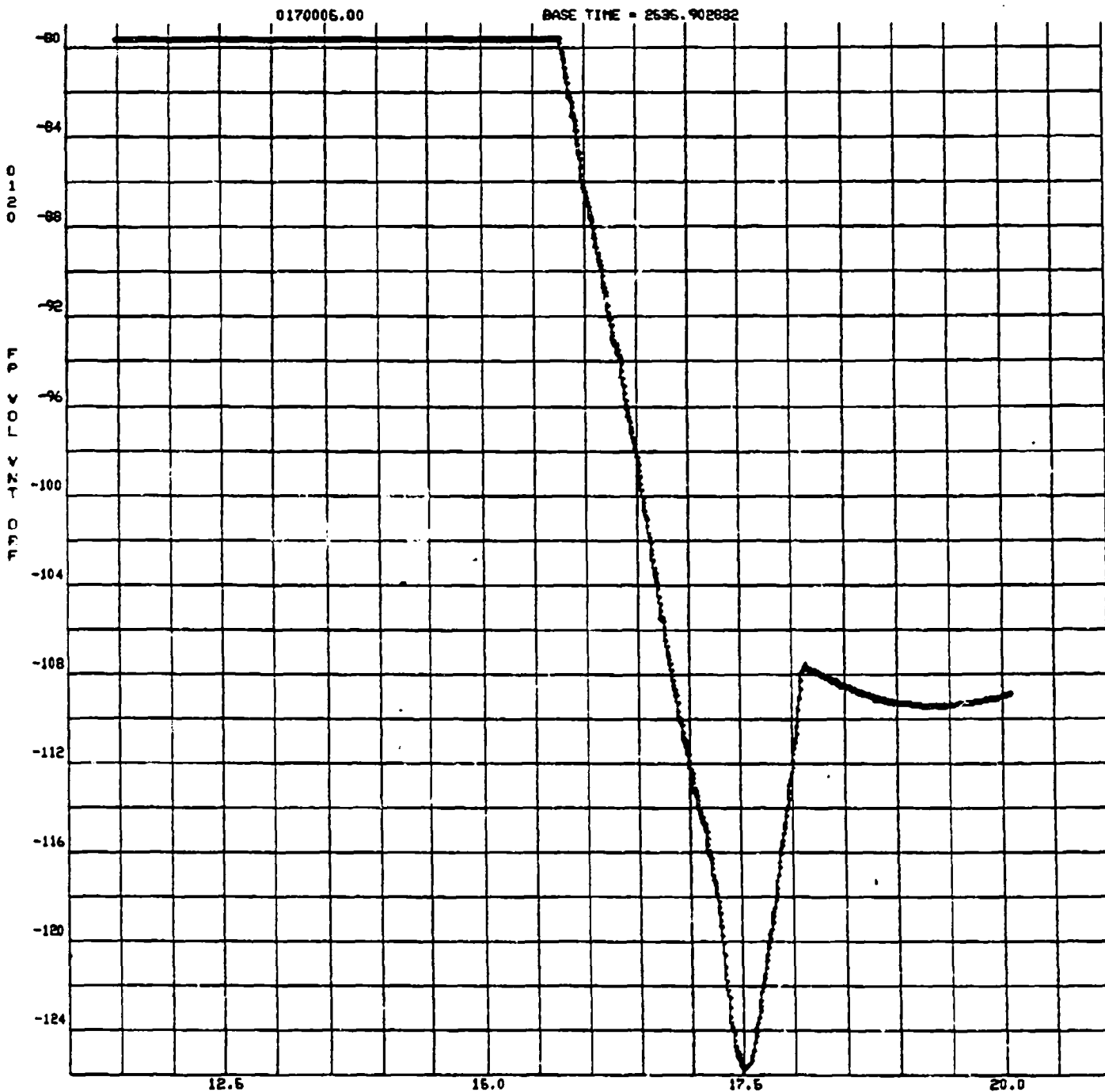

Appendix A: Test 87-017-005 Time Based Data Plots (1/28/87)

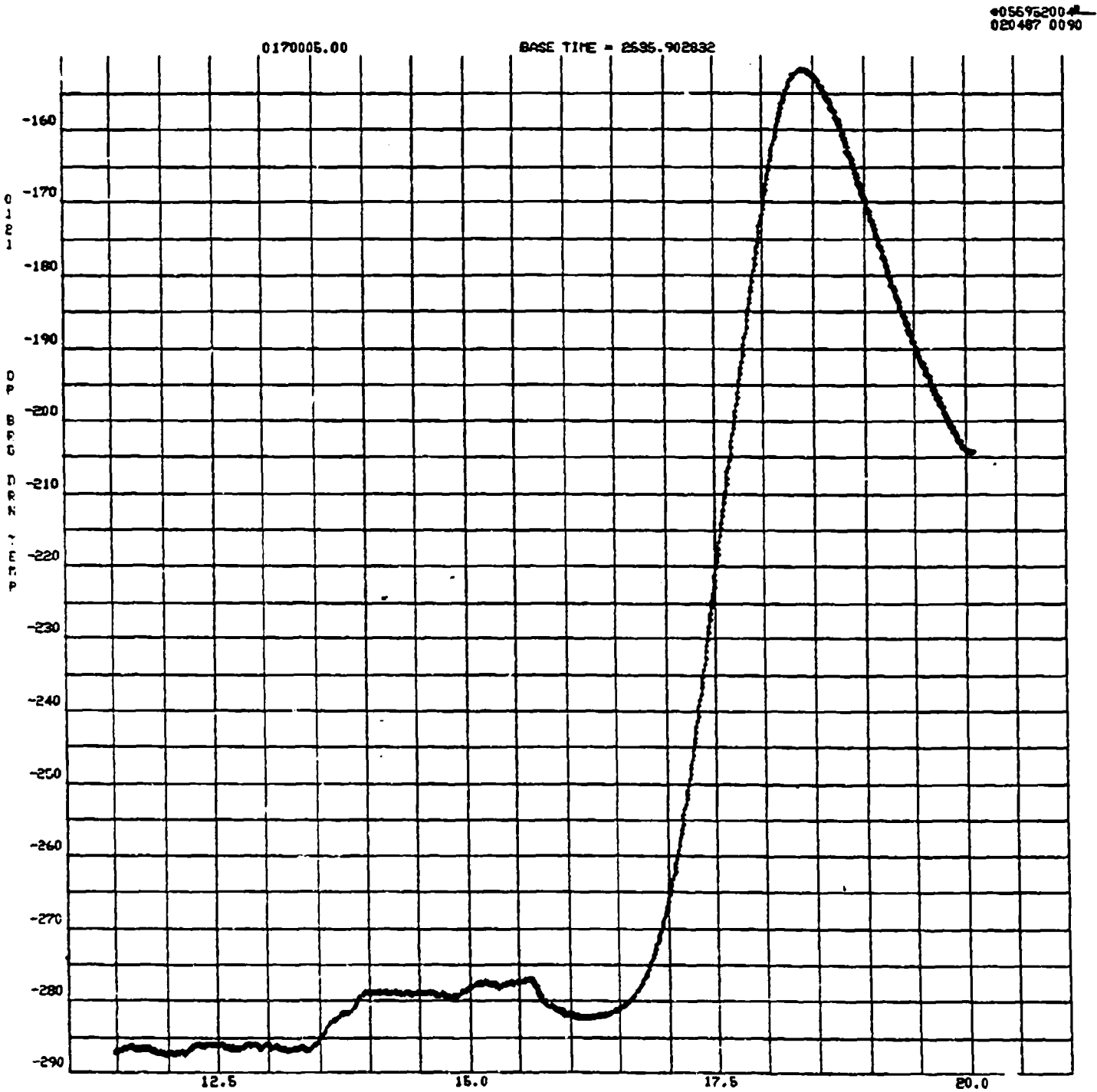

Appendix A: Test 87-017-005 Time Based Data Plots (1/28/87)

020487 0091

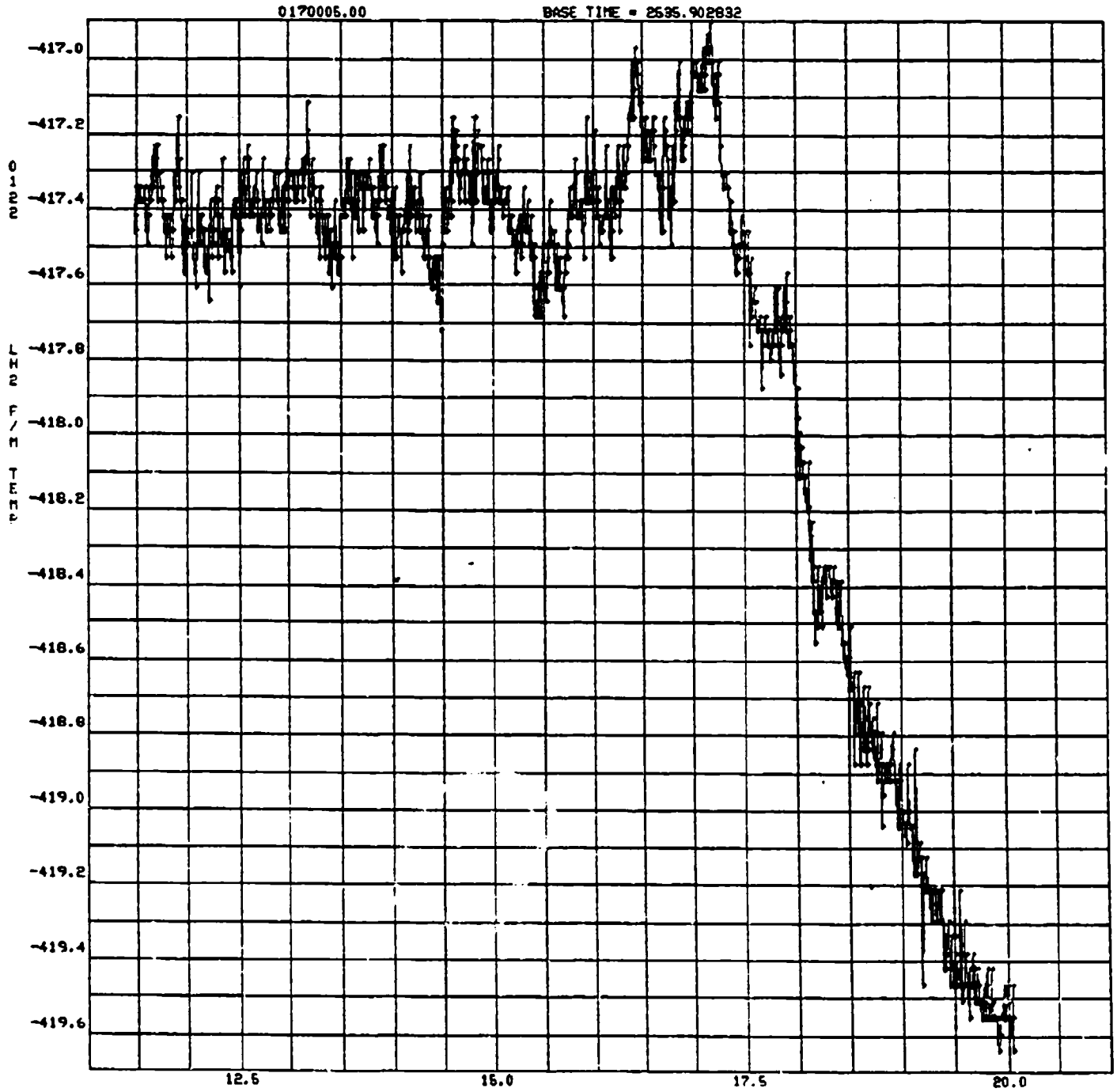

Appendix A: Test 87-017-005 Time Based Data Plots (1/28/87)

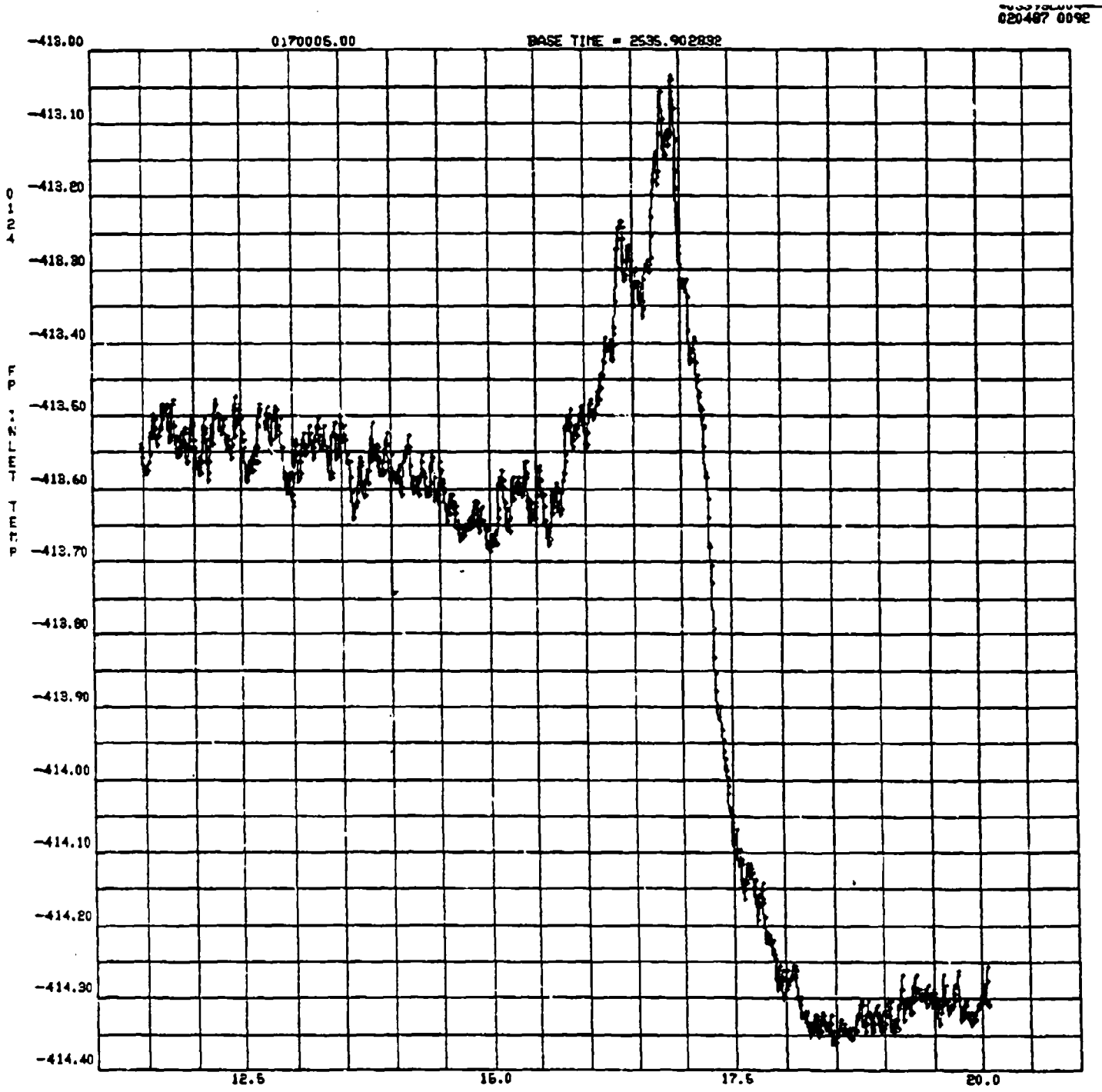

Appendix A: Test 87-017-005 Time Based Data Plots (1/28/87)

05595200
020487 0098

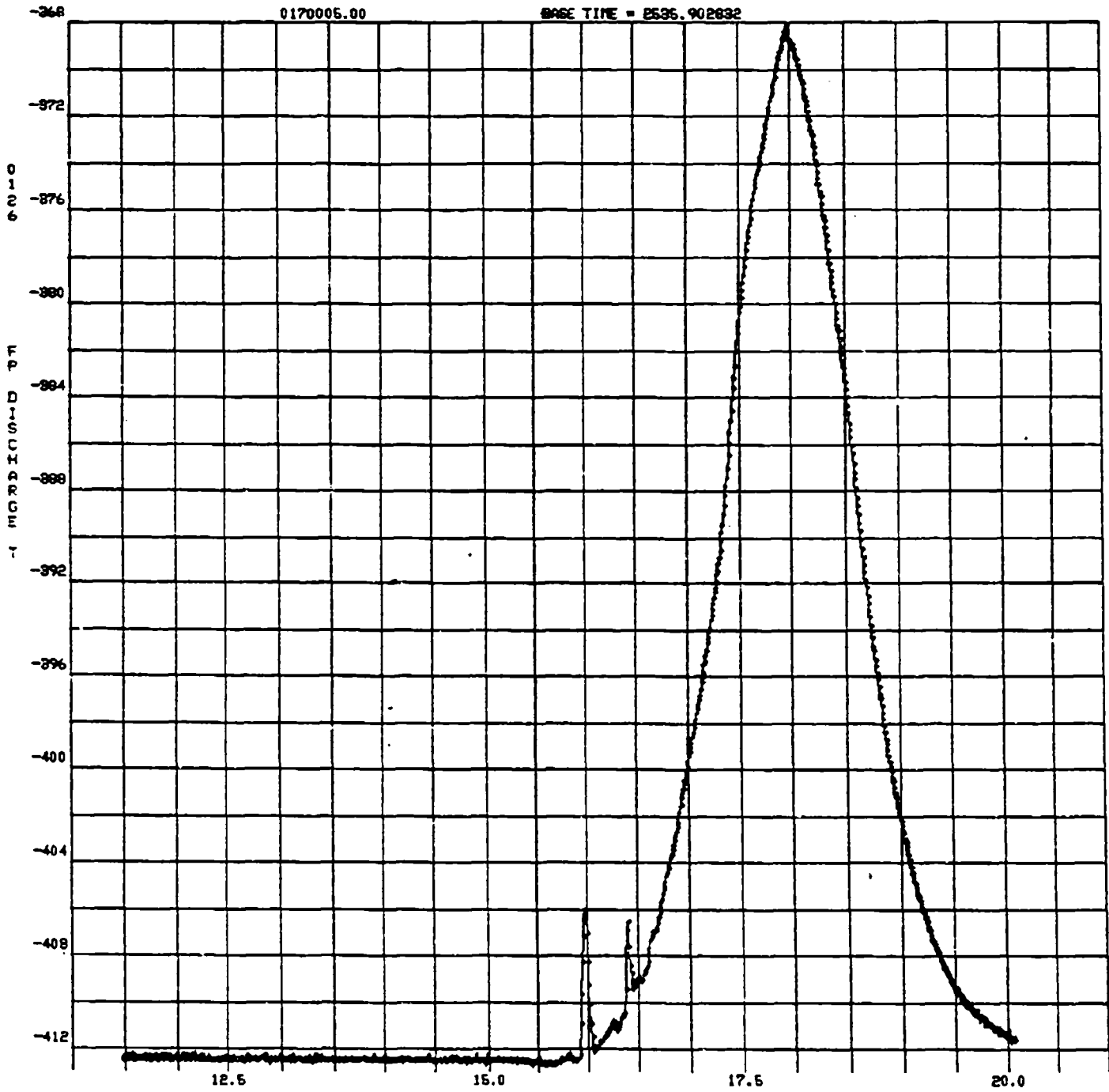

Appendix A: Test 87-017-005 Time Based Data Plots (1/28/87)

405595200
020487 0094

0170005.00

BASE TIME = 2535.902832

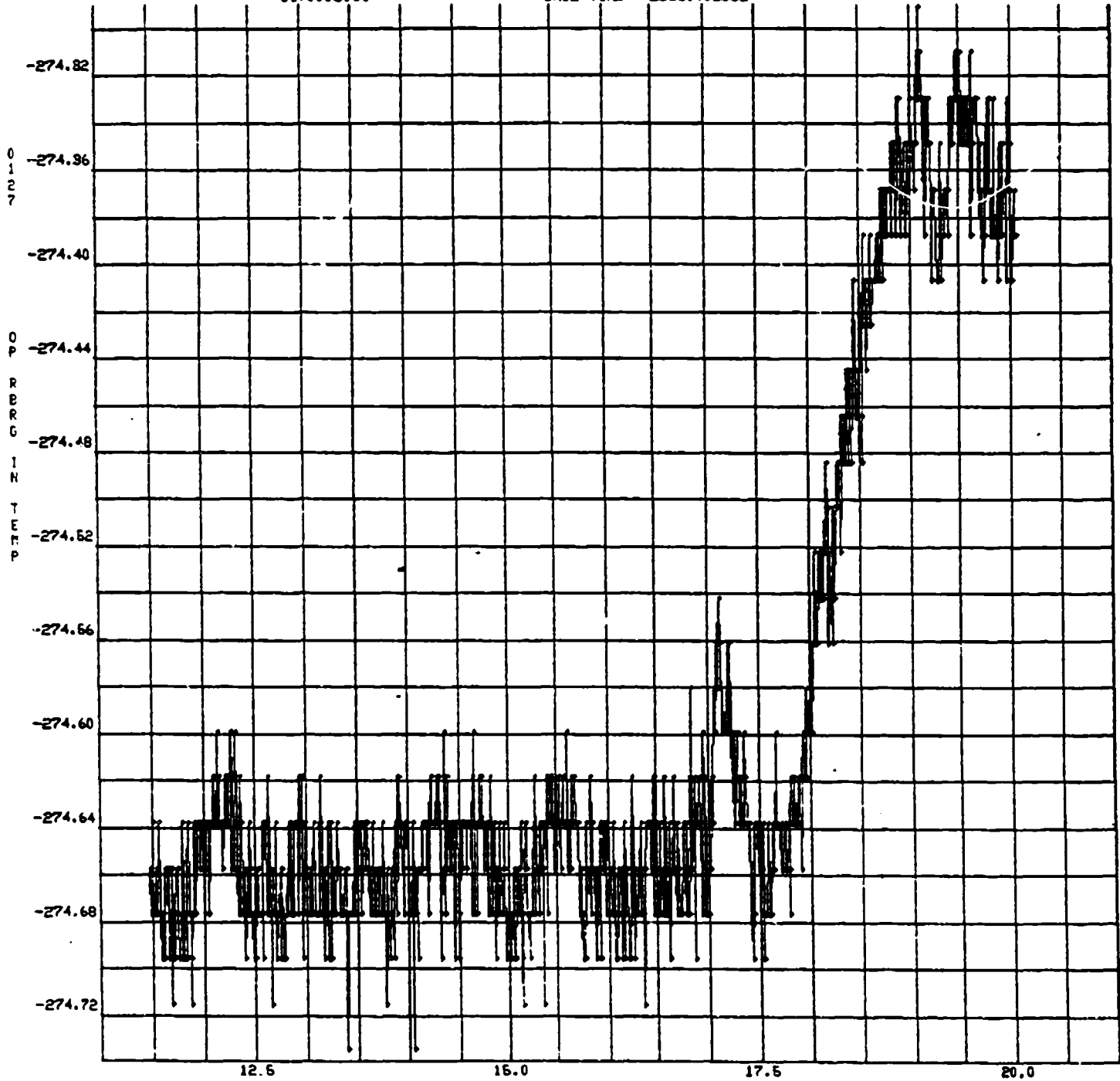

Appendix A: Test 87-017-005 Time Based Data Plots (1/28/87)

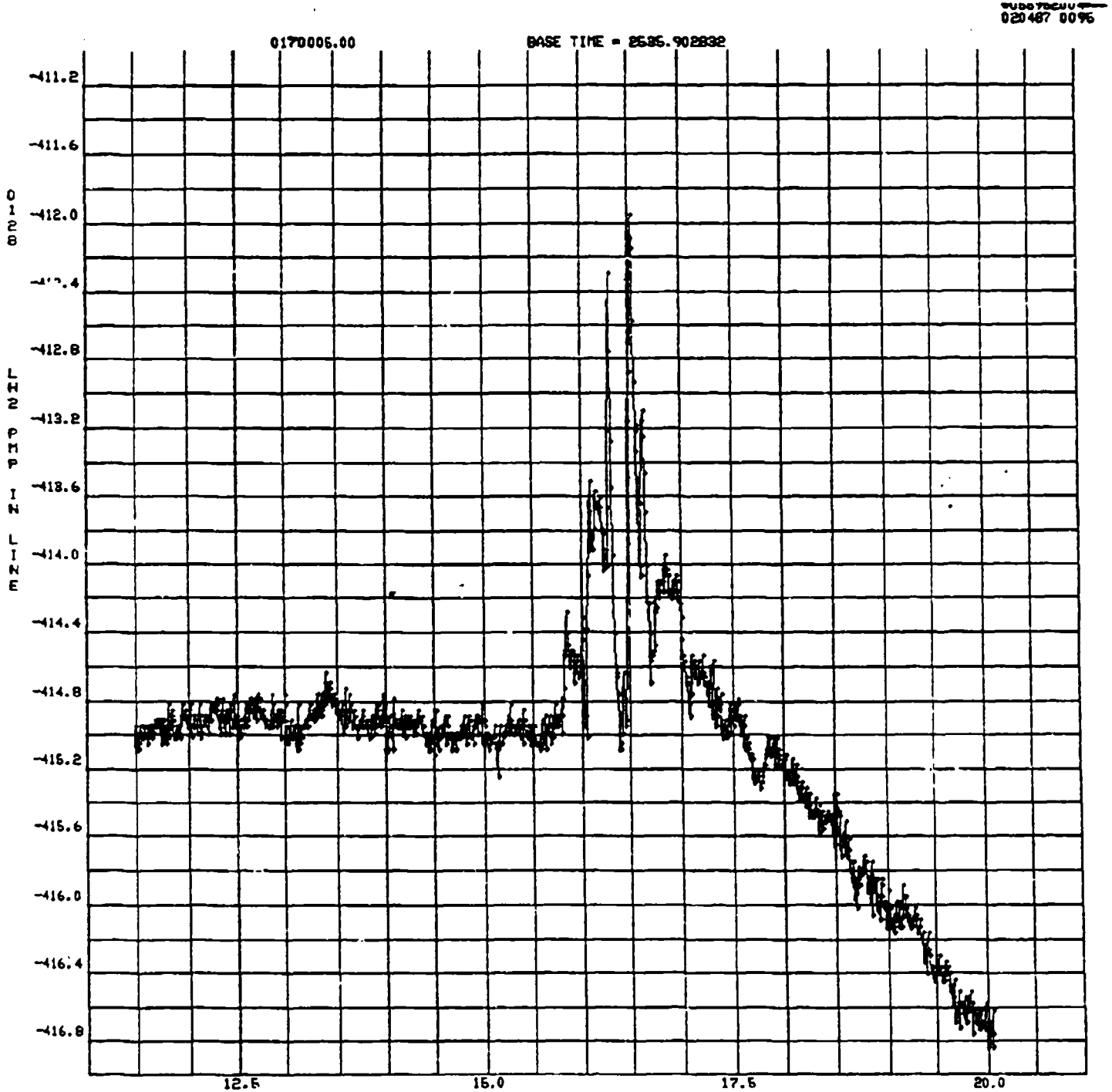

Appendix A: Test 87-017-005 Time Based Data Plots (1/28/87)

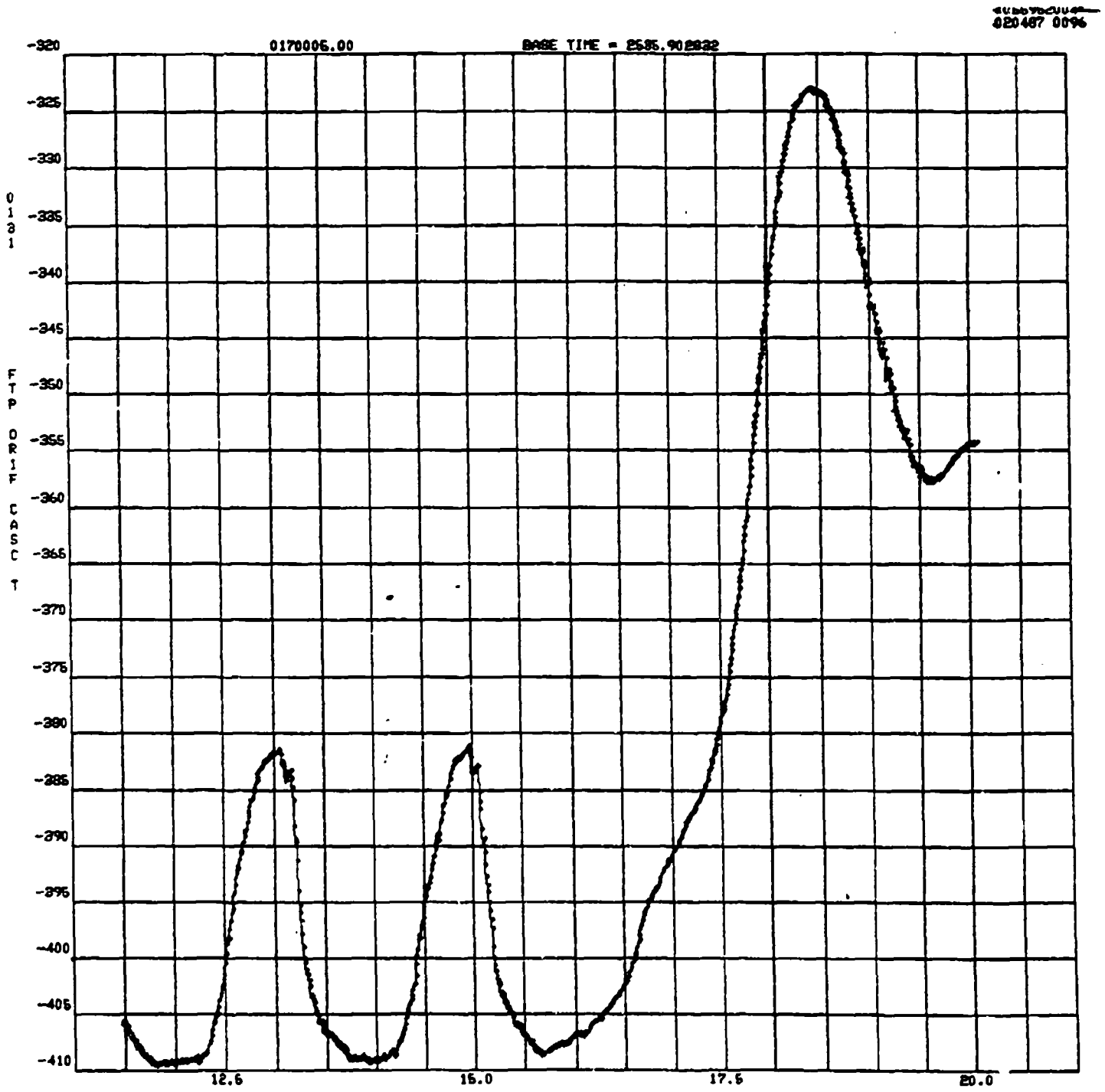

Appendix A: Test 87-017-005 Time Based Data Plots (1/28/87)

4066 96200 4
020457 0097

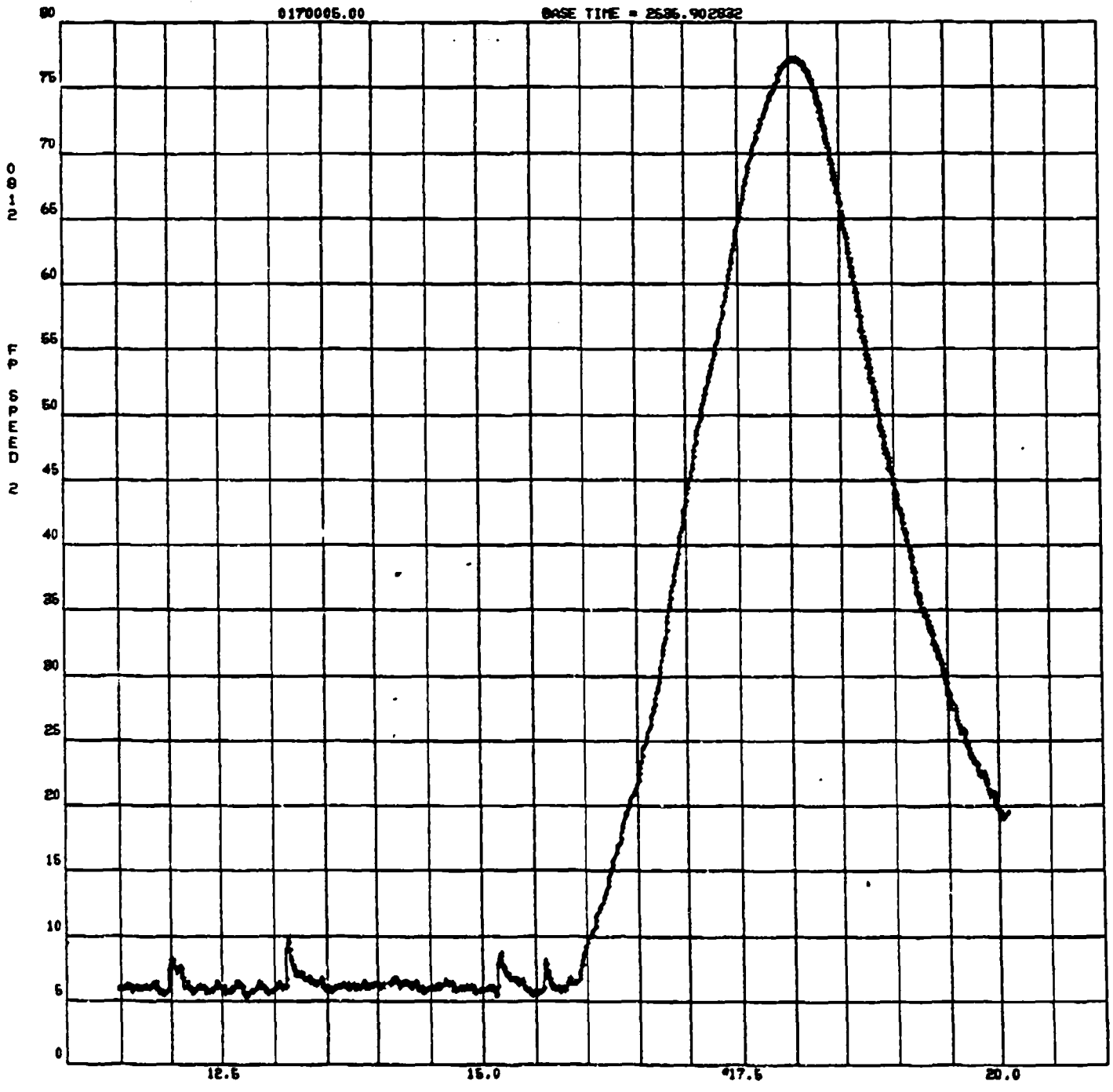

Appendix A:
Test 87-017-005 Time Based Data Plots (1/28/87)

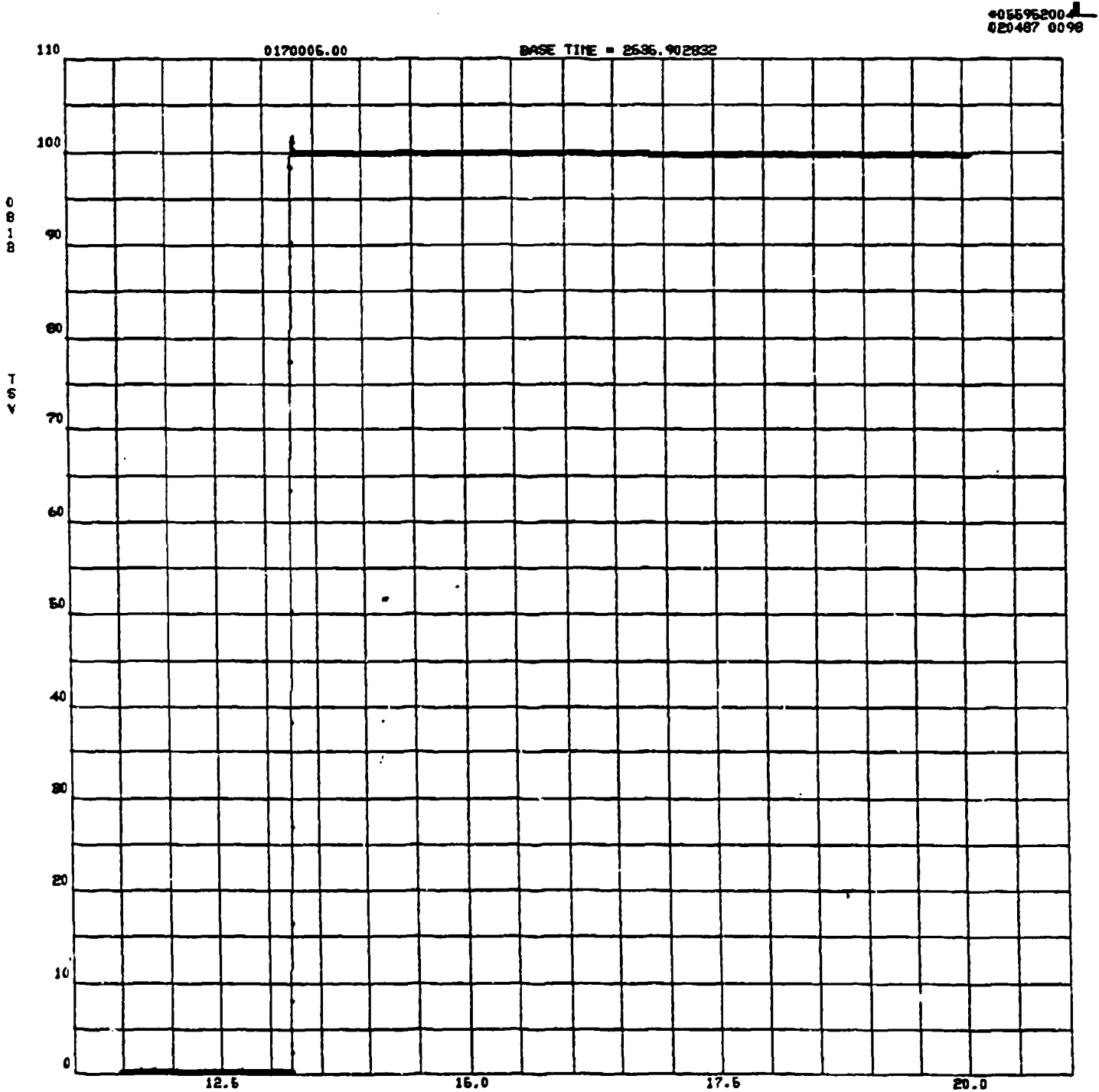

Appendix A: Test 87-017-005 Time Based Data Plots (1/28/87)

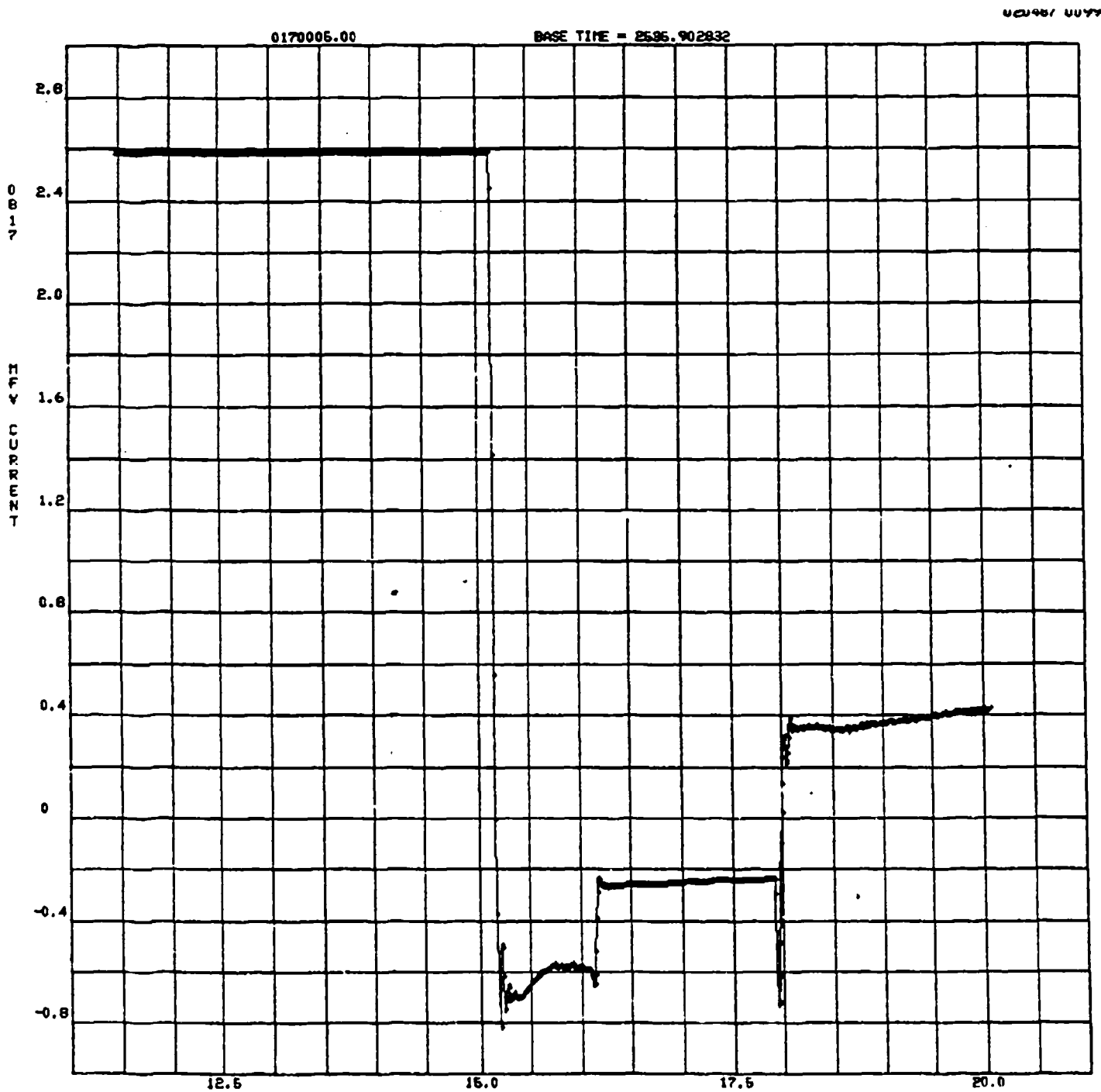

Appendix A: Test 87-017-005 Time Based Data Plots (1/28/87)

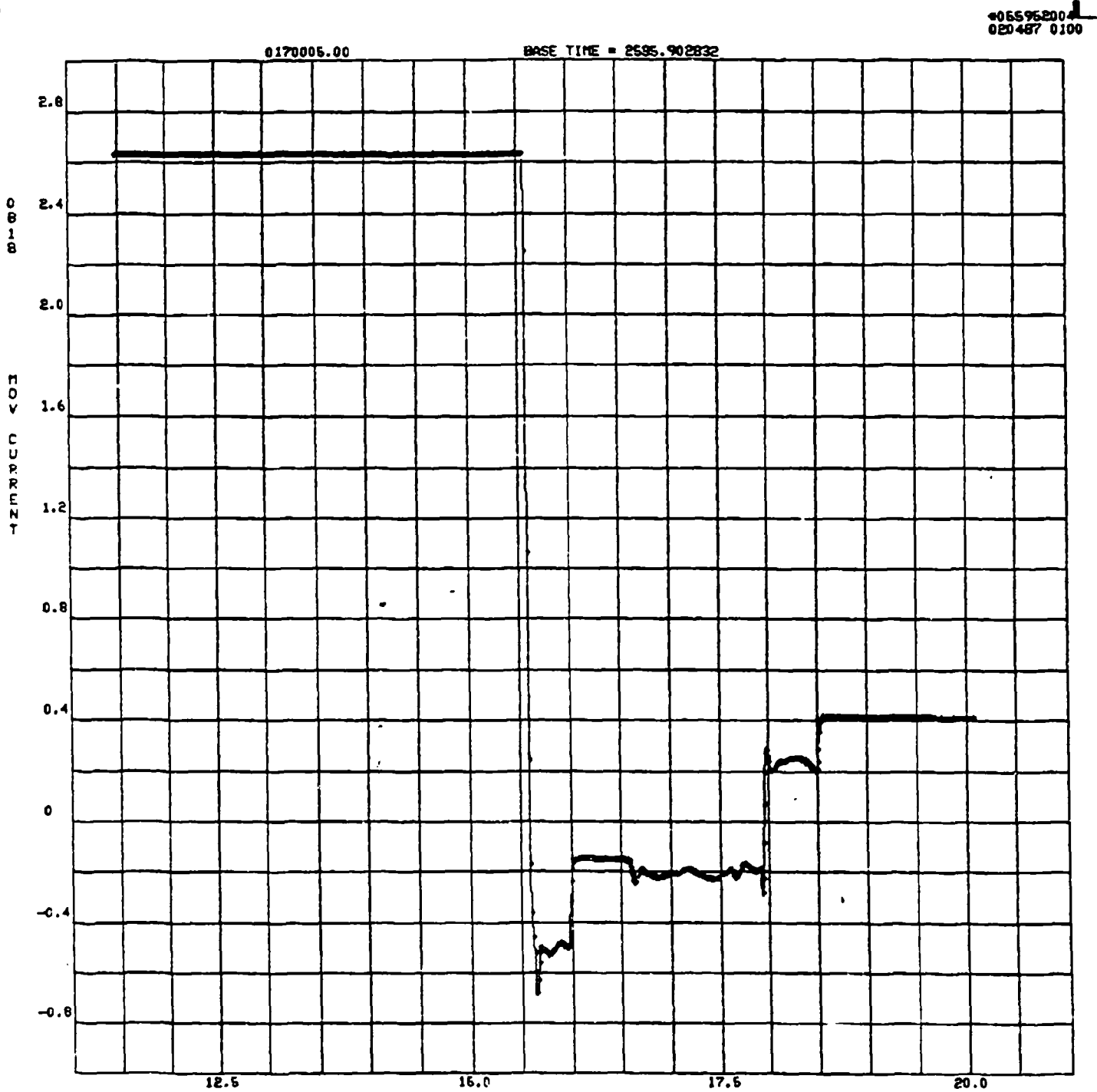

Appendix A: Test 87-017-005 Time Based Data Plots (1/28/87)

405595200
020487 0101



Appendix A: Test 87-017-005 Time Based Data Plots (1/28/87)

020487 0102

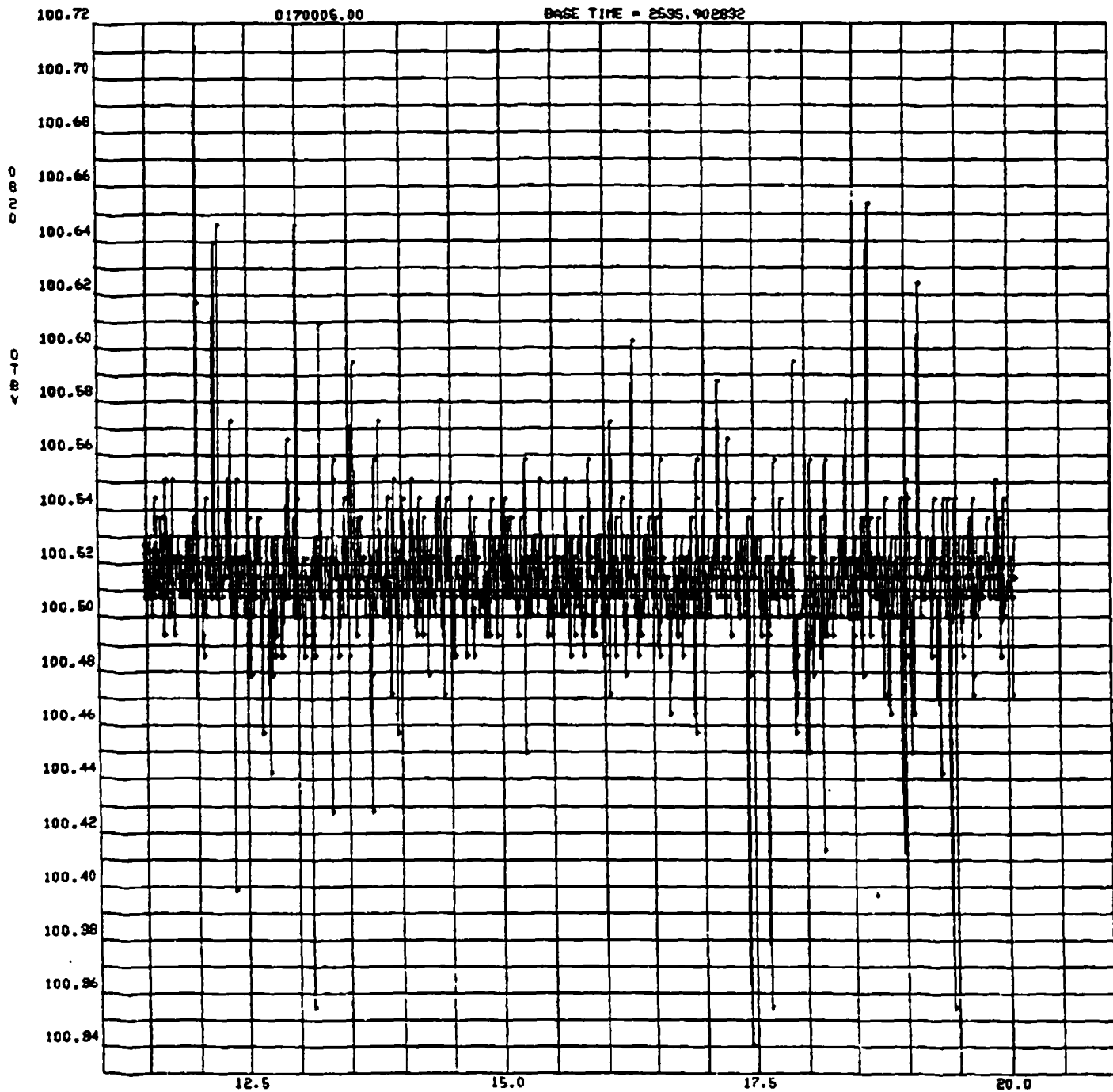

Appendix A:
Test 87-017-005 Time Based Data Plots (1/28/87)

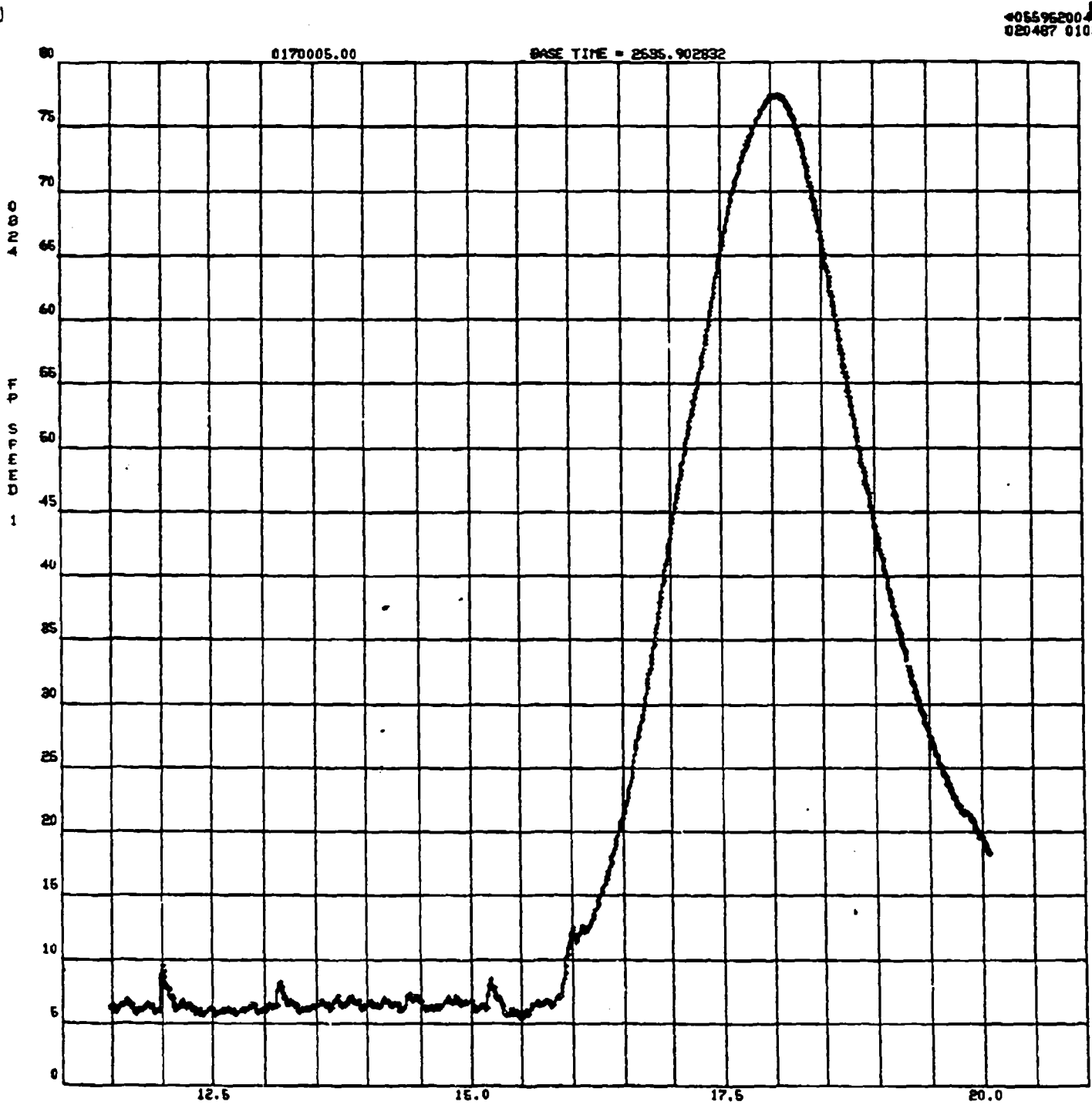

Appendix A: Test 87-017-005 Time Based Data Plots (1/28/87)

020487 0104

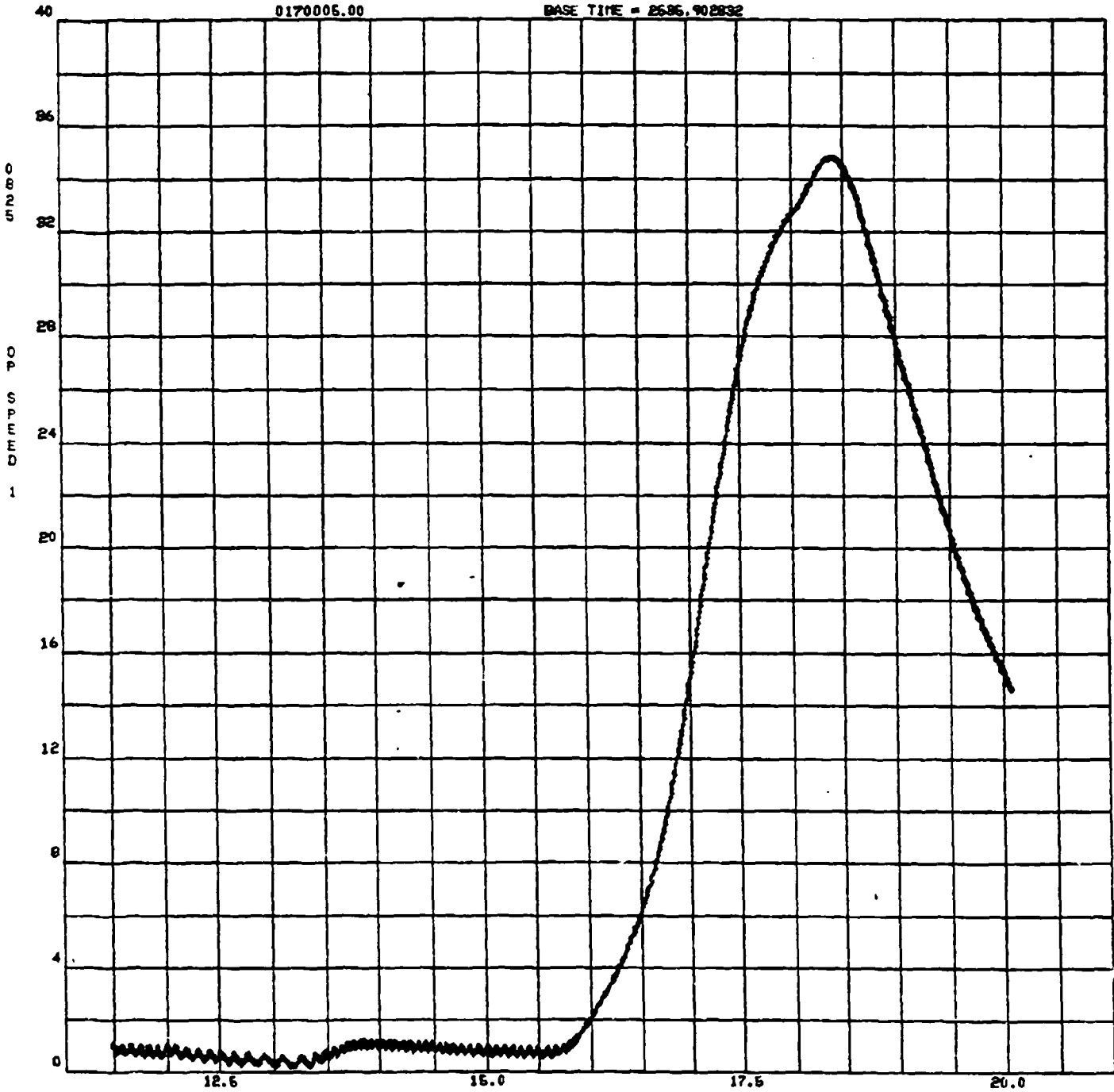

Appendix A:
Test 87-017-005 Time Based Data Plots (1/28/87)

06596200
020487 0105

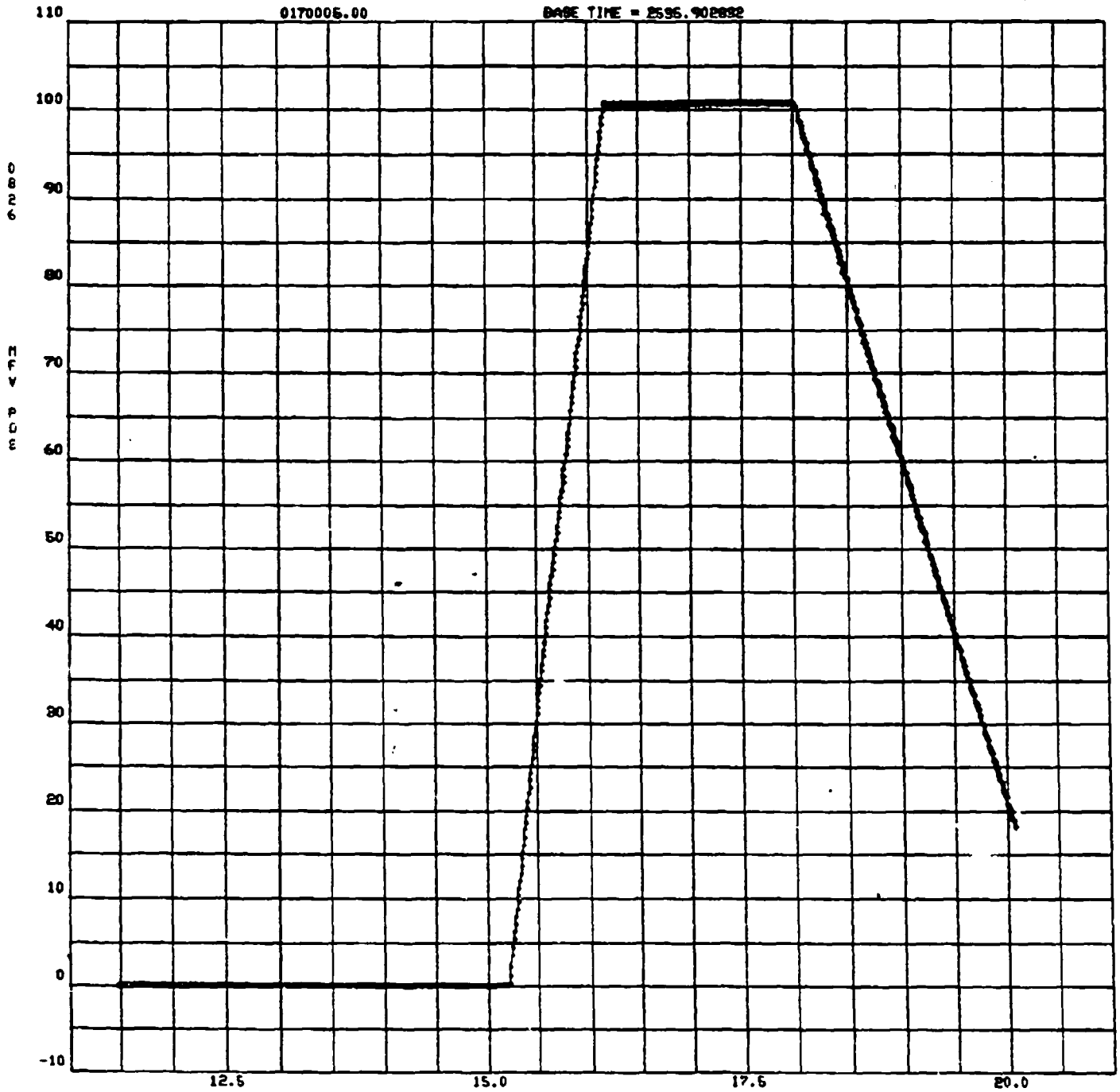

Appendix A: Test 87-017-005 Time Based Data Plots (1/28/87)

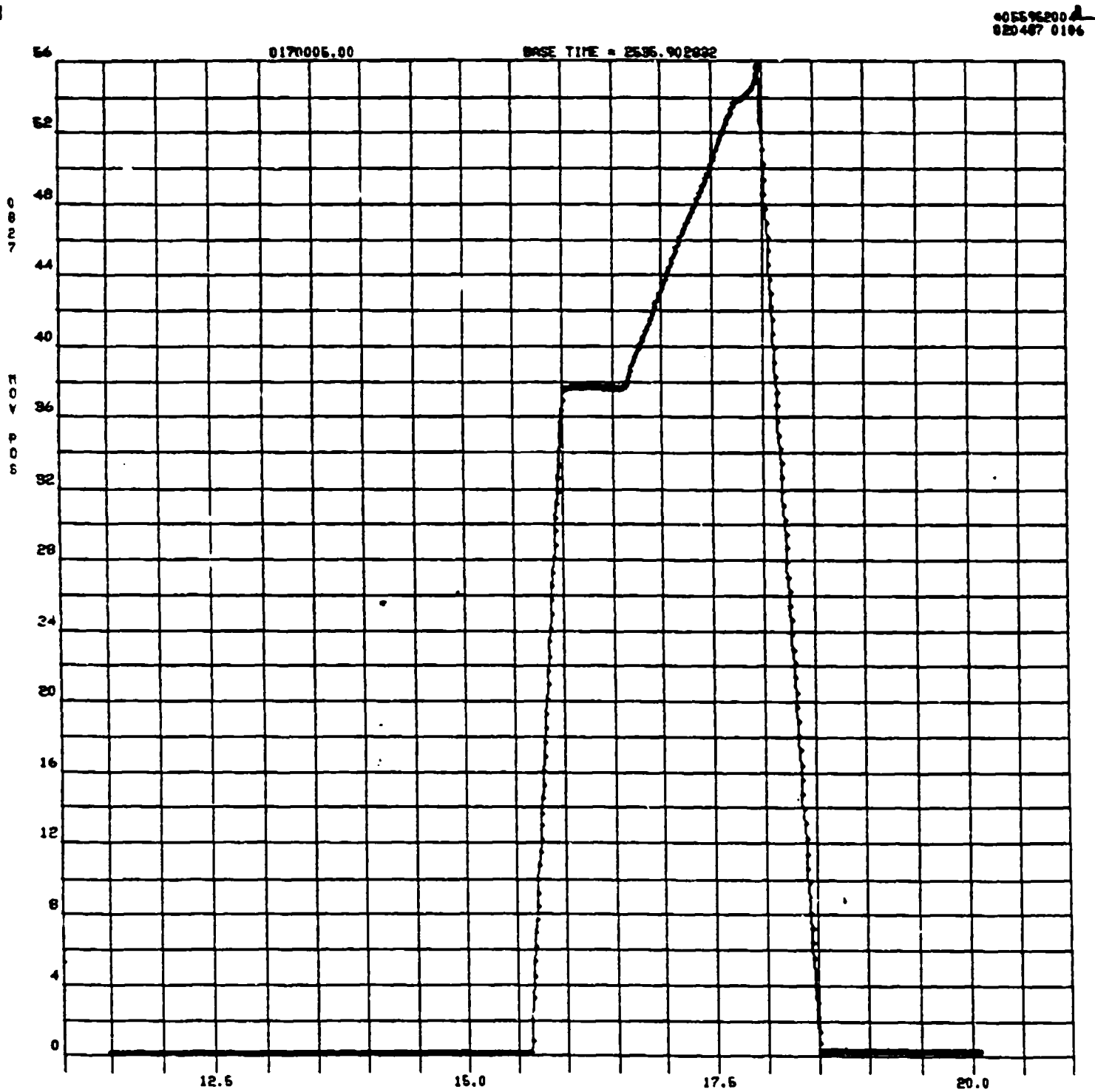

Appendix A: Test 87-017-005 Time Based Data Plots (1/28/87)

05596200
020487 0107

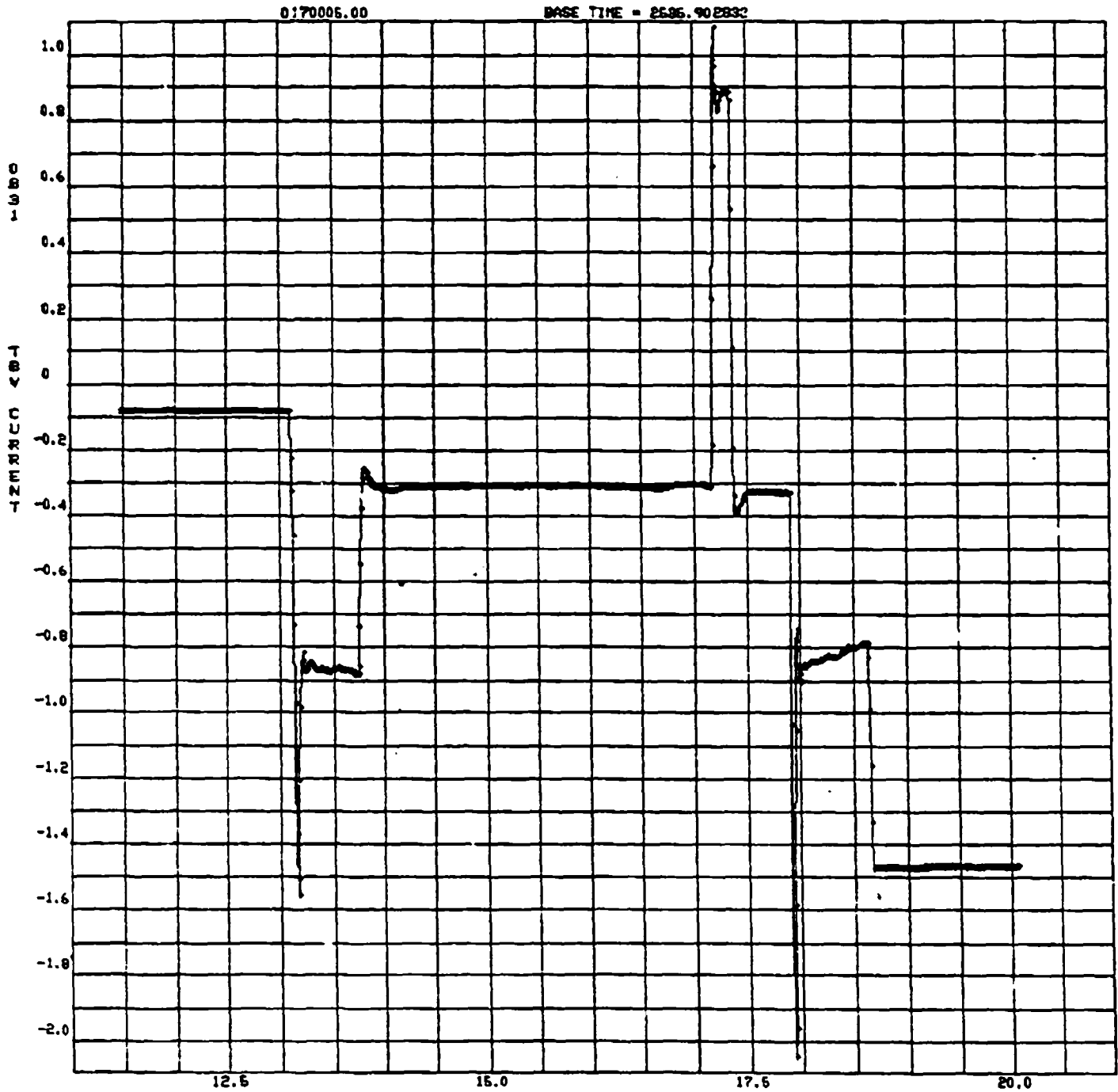

Appendix A: Test 87-017-005 Time Based Data Plots (1/28/87)

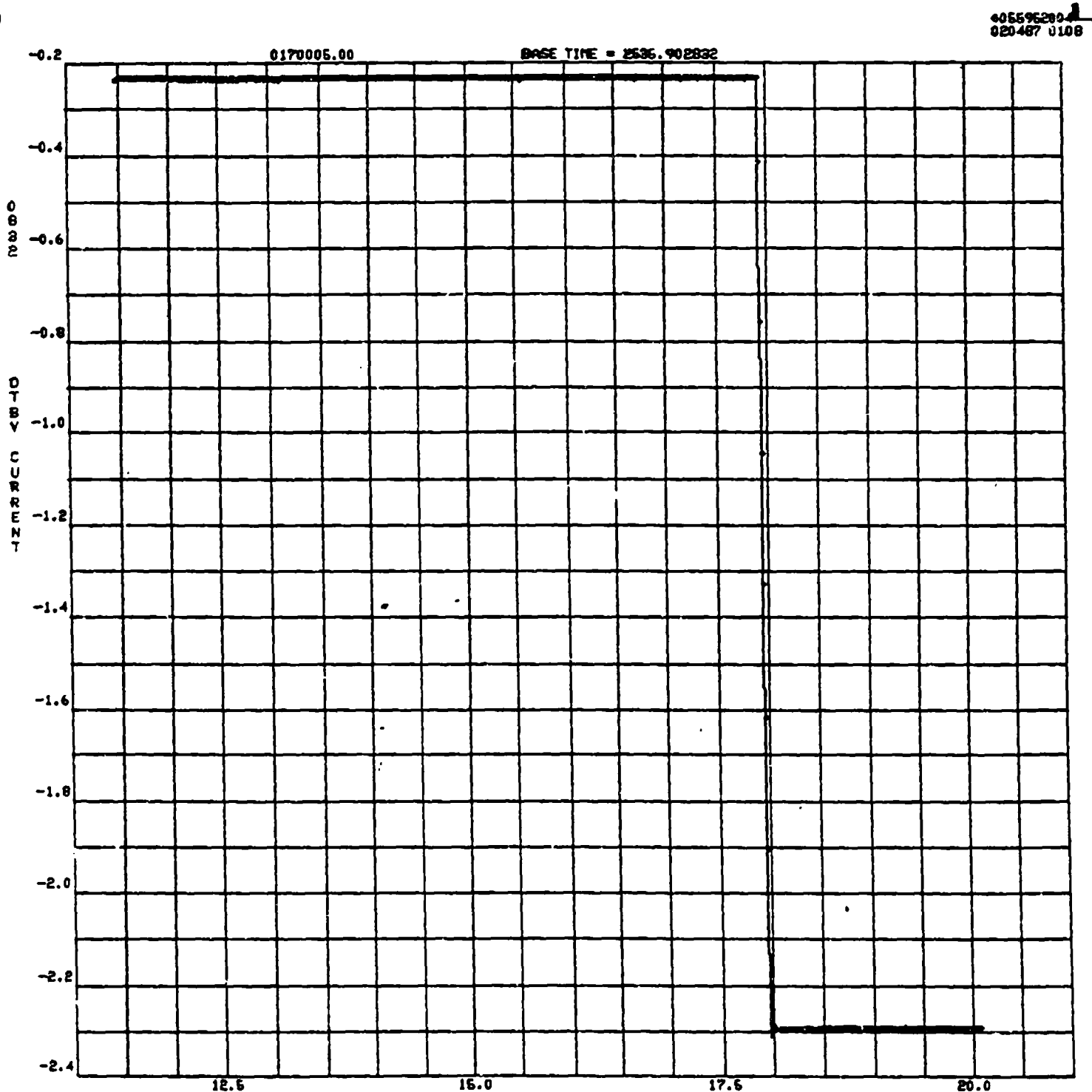

Appendix A: Test 87-017-005 Time Based Data Plots (1/28/87)

05595200
020487 0109

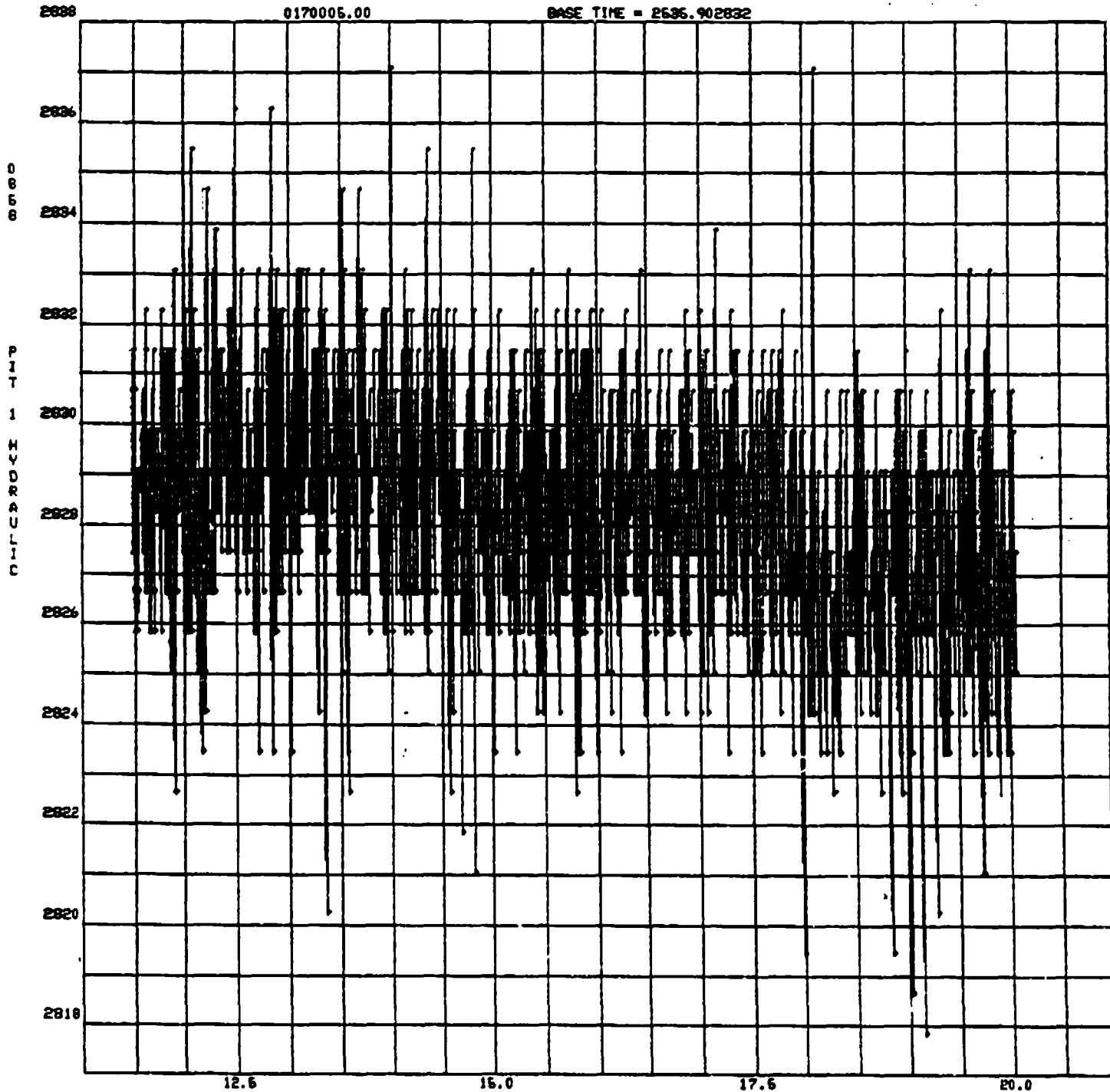

Appendix A: Test 87-017-005 Time Based Data Plots (1/28/87)

055962004
020487 0110

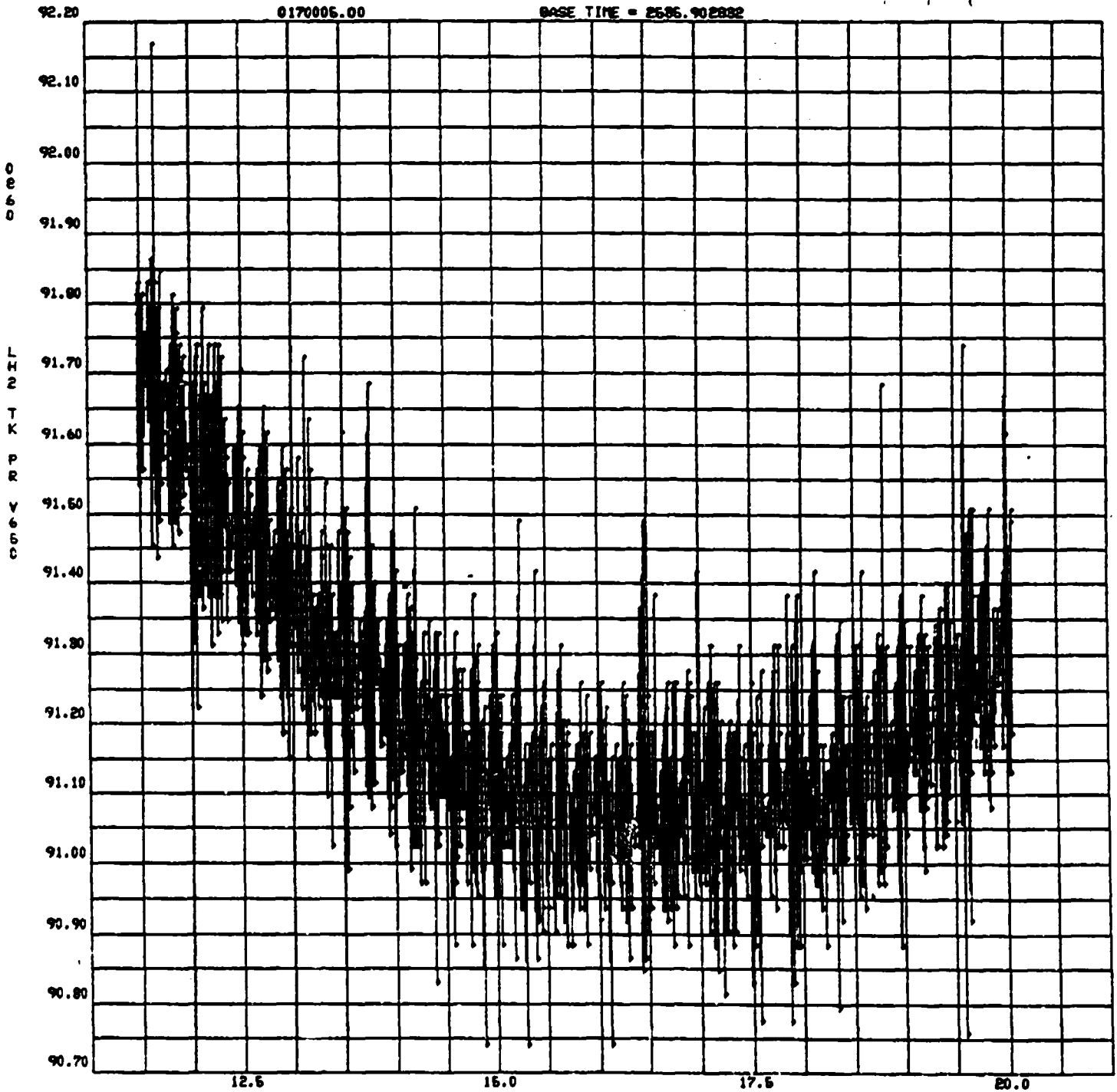

Appendix A: Test 87-017-005 Time Based Data Plots (1/28/87)

405595200
020487 0111

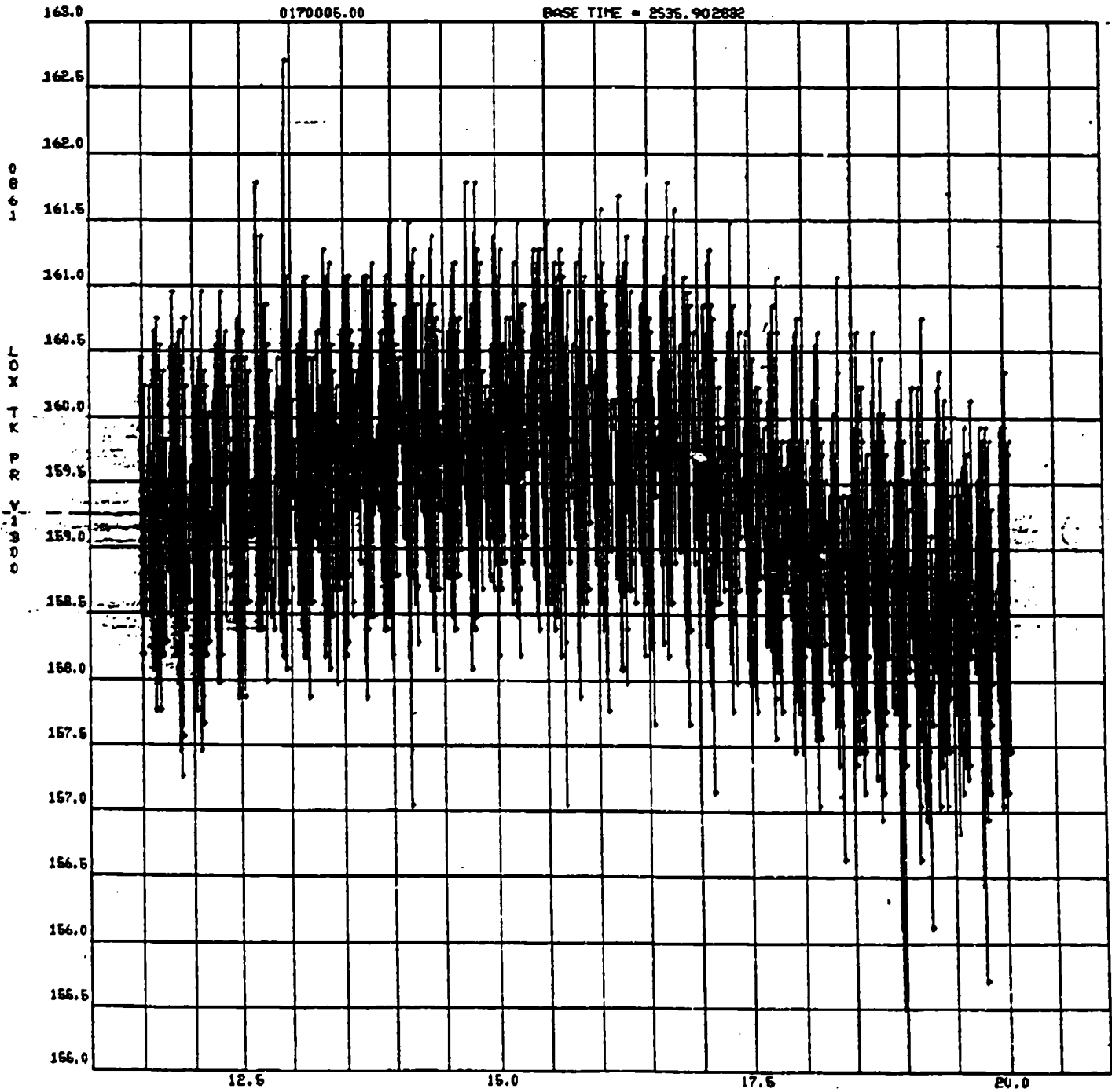

Appendix A:
Test 87-017-005 Time Based Data Plots (1/28/87)

005595200
020487 0039

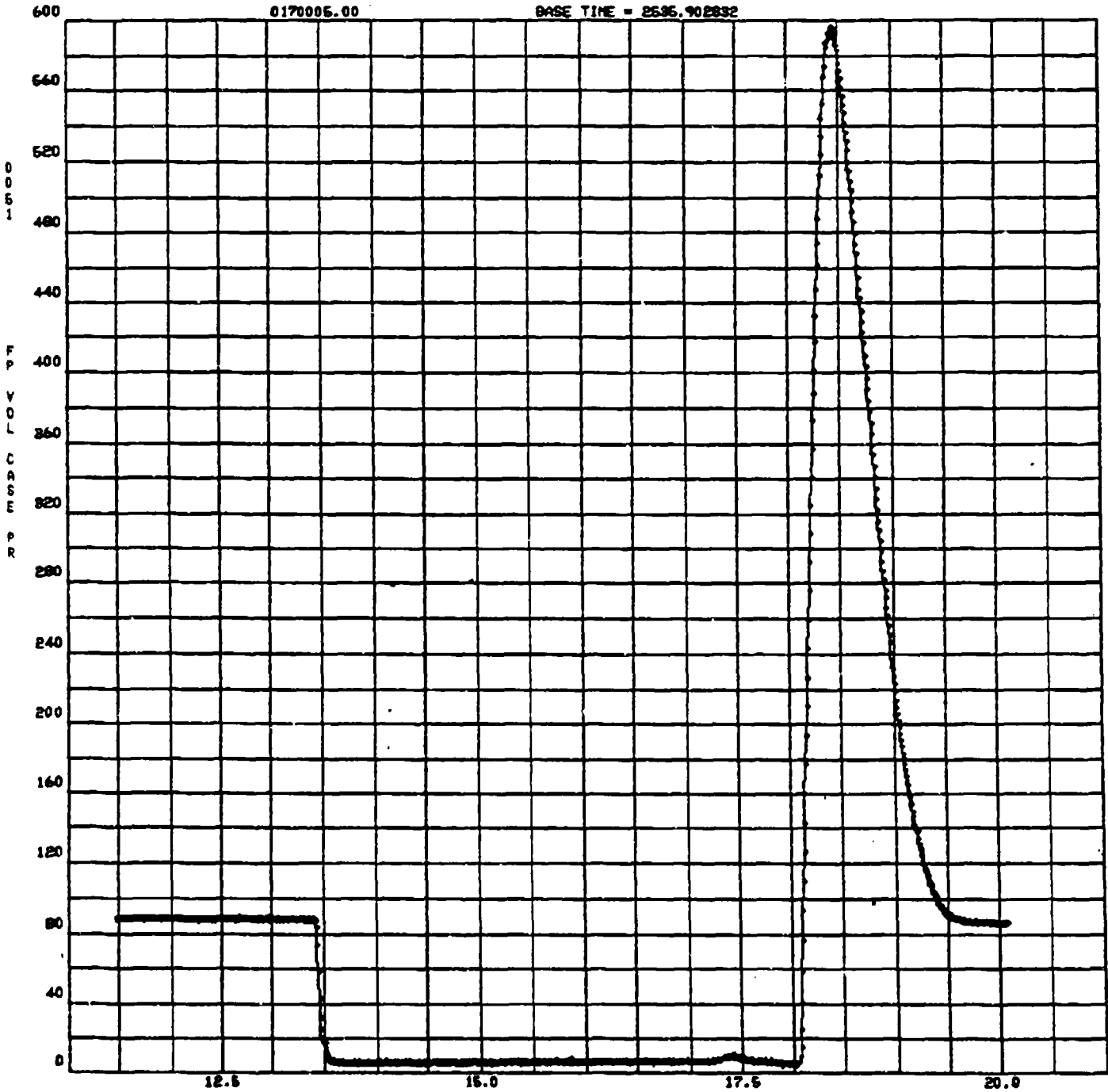

Appendix A: Test 87-017-005 Time Based Data Plots (1/28/87)

05596200
020487 0084

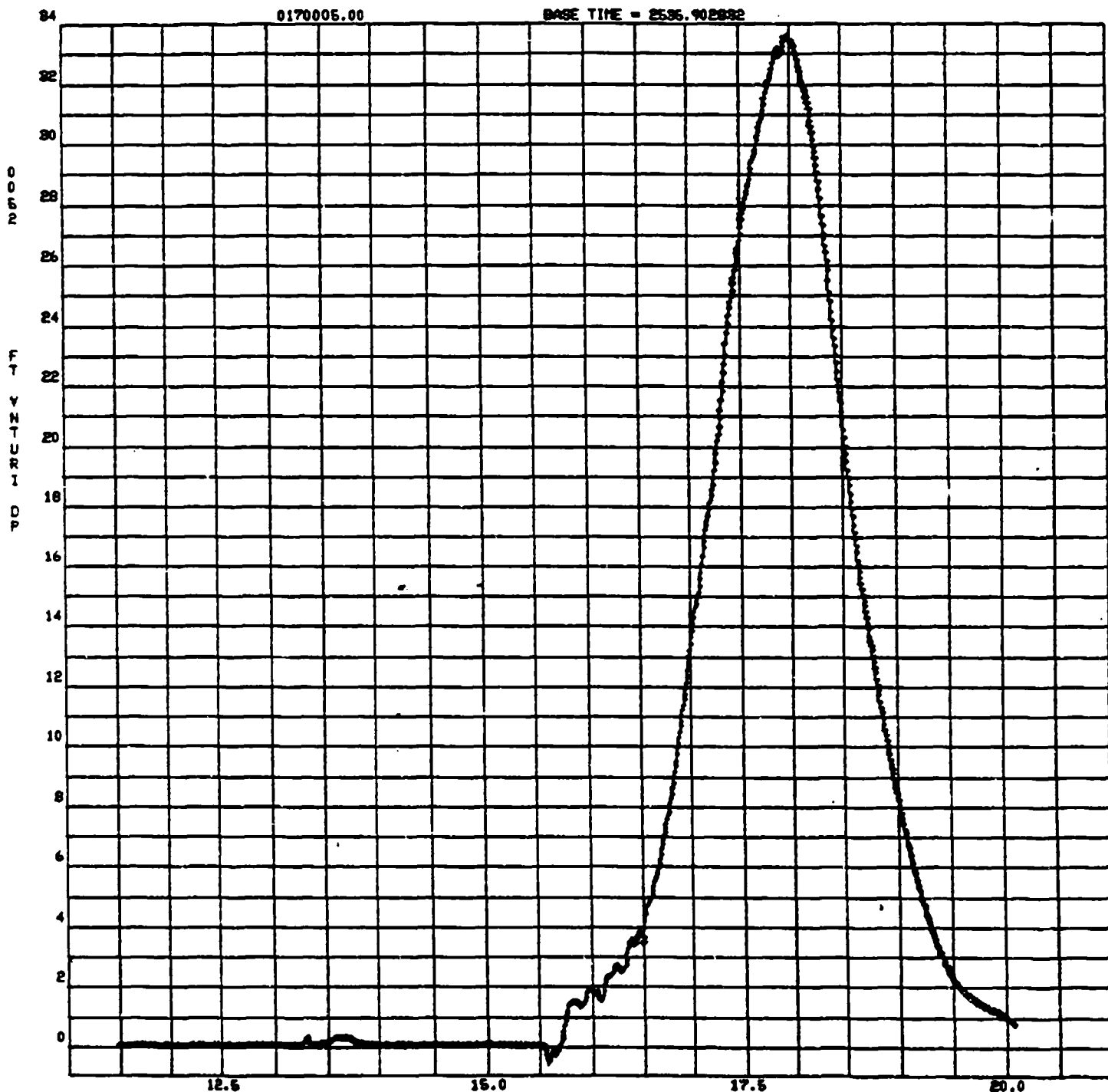

Appendix A:
Test 87-017-005 Time Based Data Plots (1/28/87)

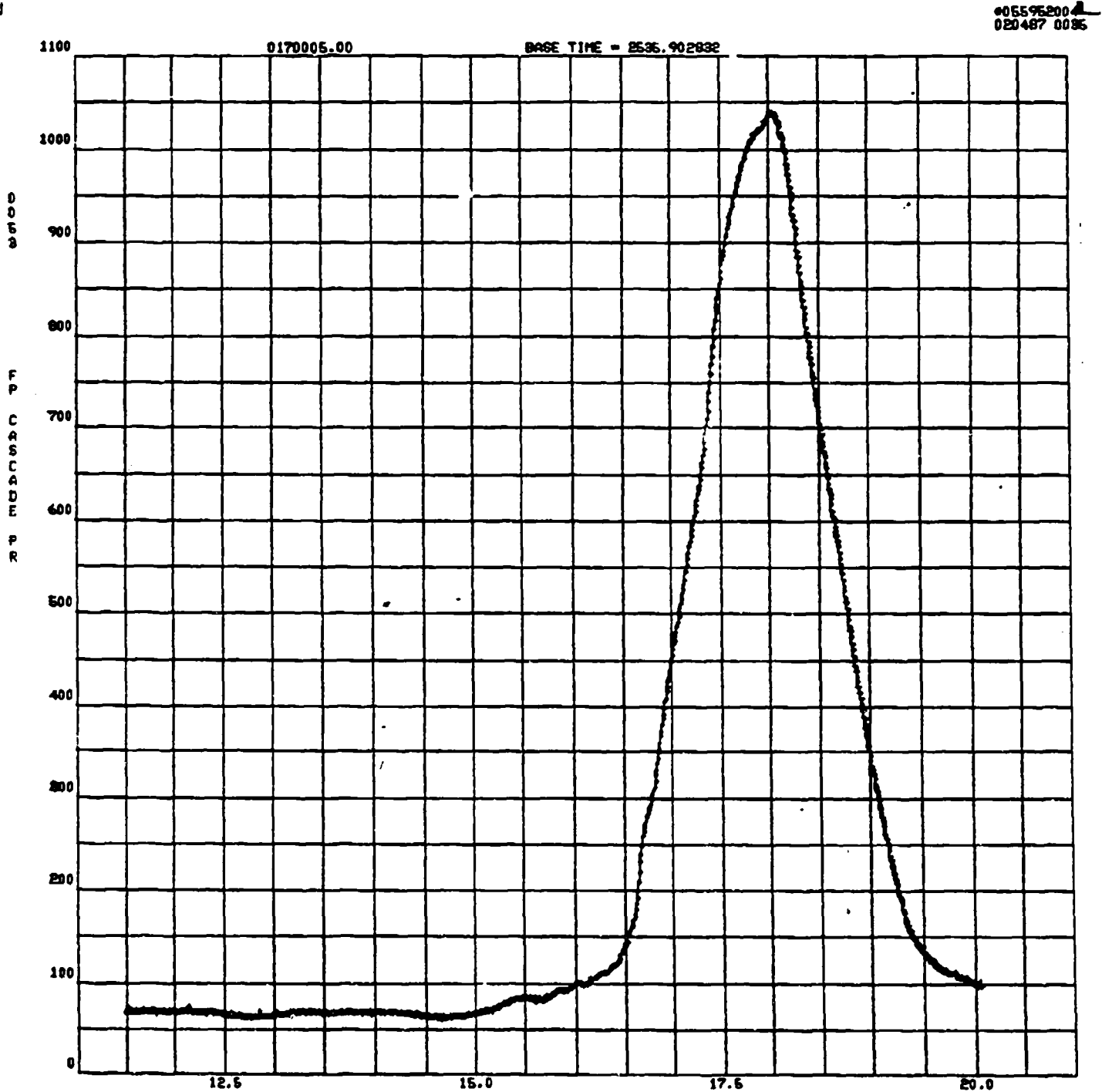

Appendix A: Test 87-017-005 Time Based Data Plots (1/28/87)

0170006.00
BASE TIME = 2536.902832

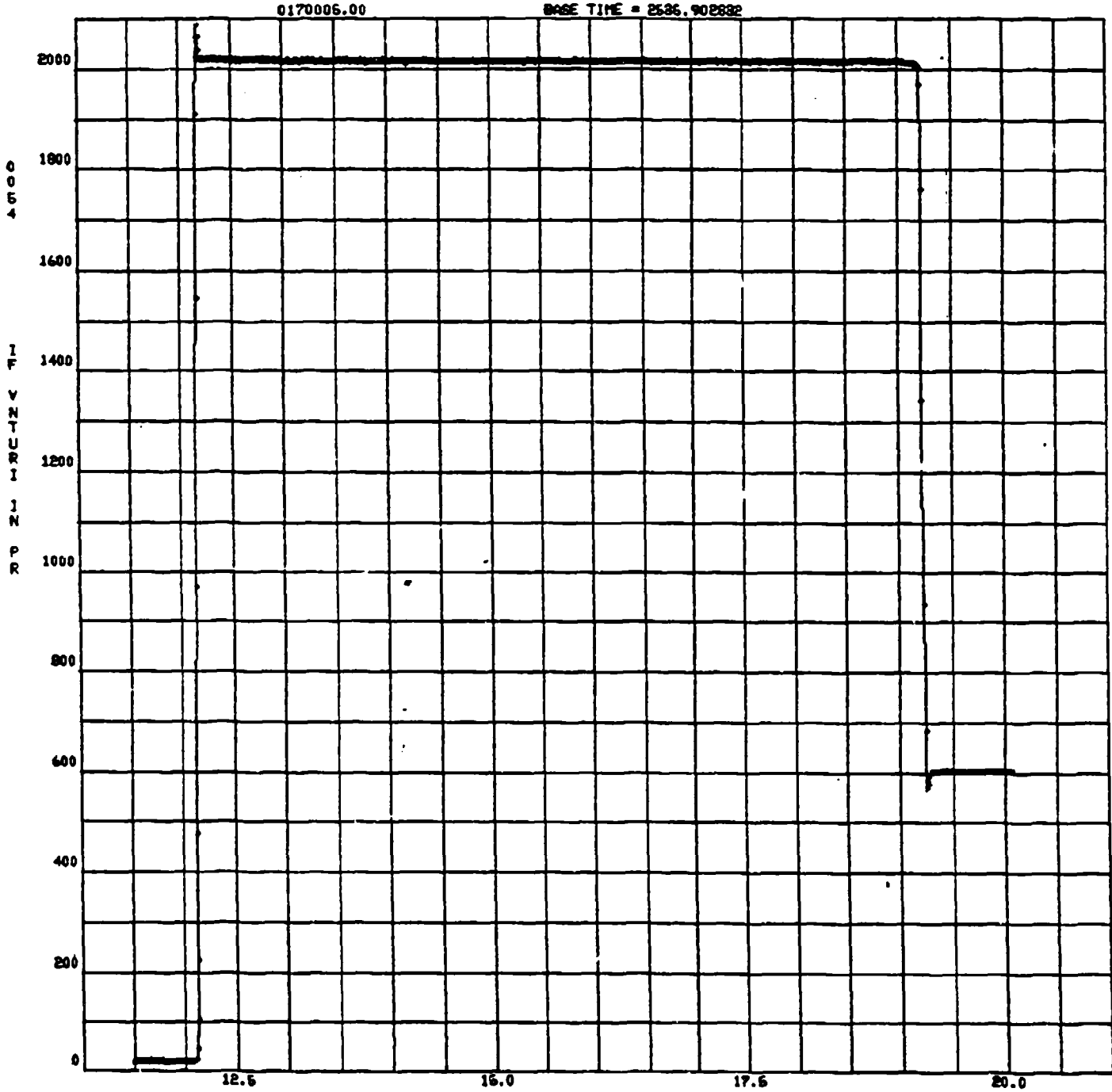

Appendix A: Test 87-017-005 Time Based Data Plots (1/28/87)

05595200
020487 0037

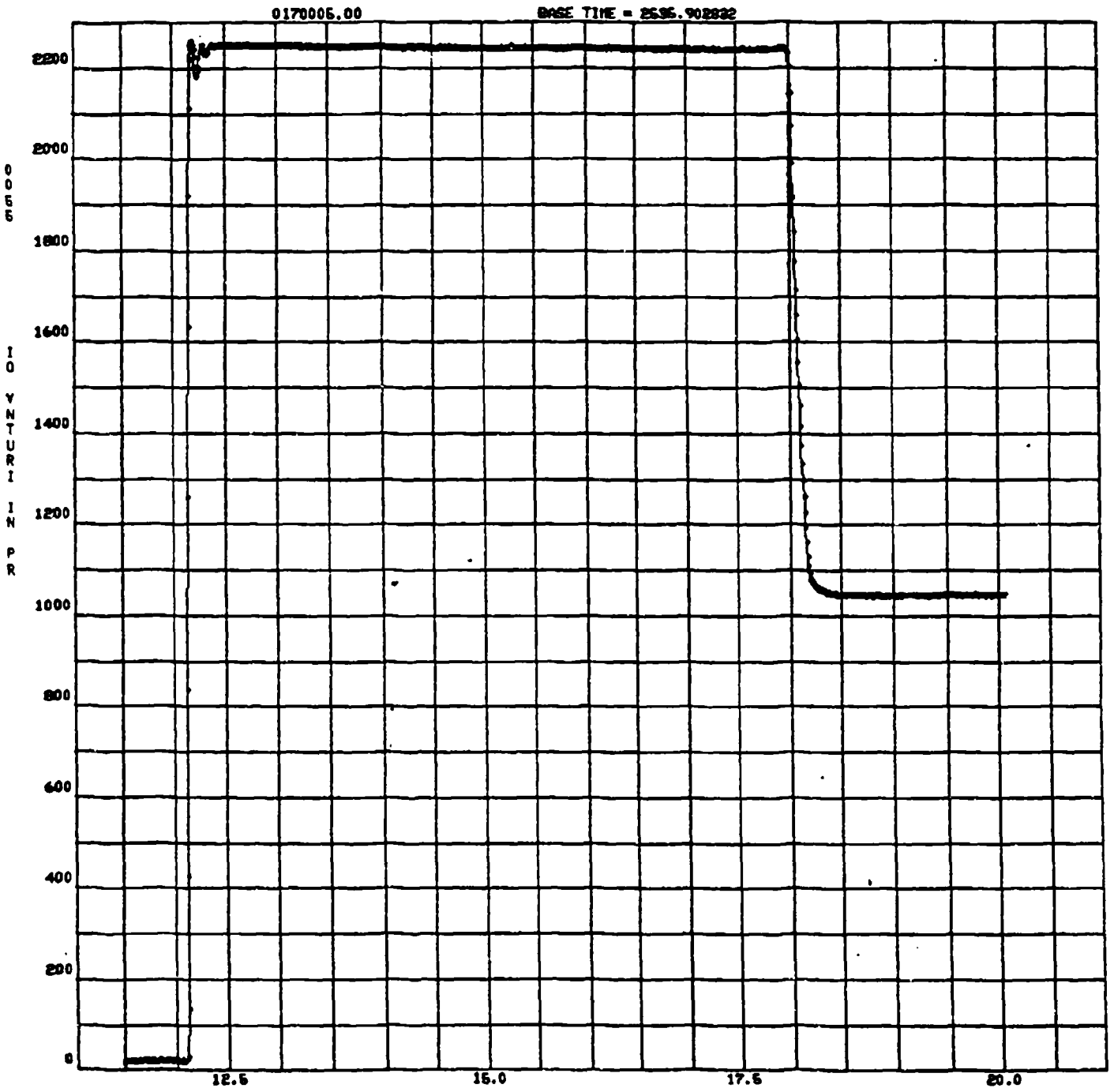

Appendix A: Test 87-017-005 Time Based Data Plots (1/28/87)

05596200
020487 0086

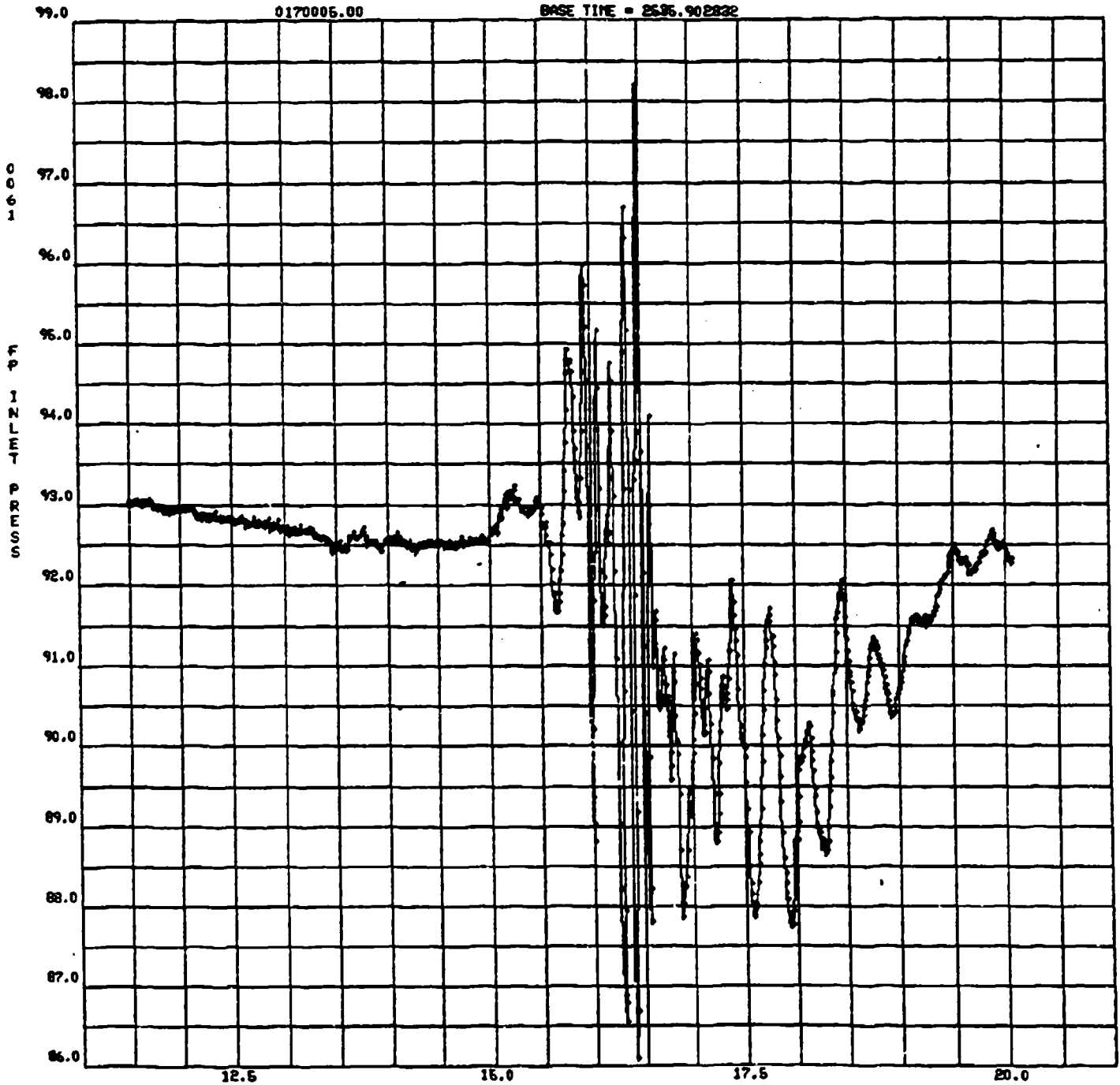

Appendix A: Test 87-017-005 Time Based Data Plots (1/28/87)

0170005.00
020487 0039

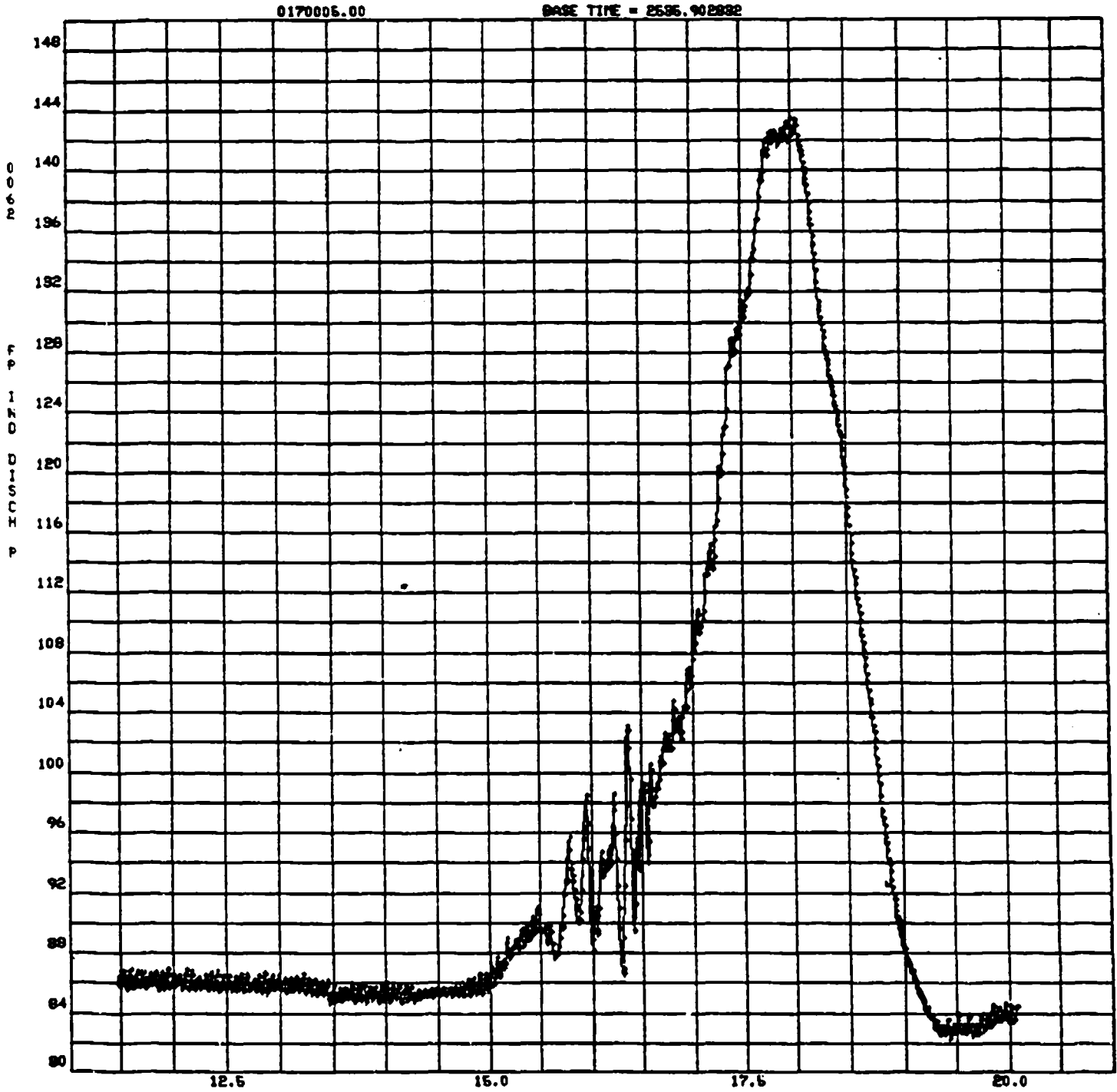

Appendix A: Test 87-017-005 Time Based Data Plots (1/28/87)

005595200
020487 0040

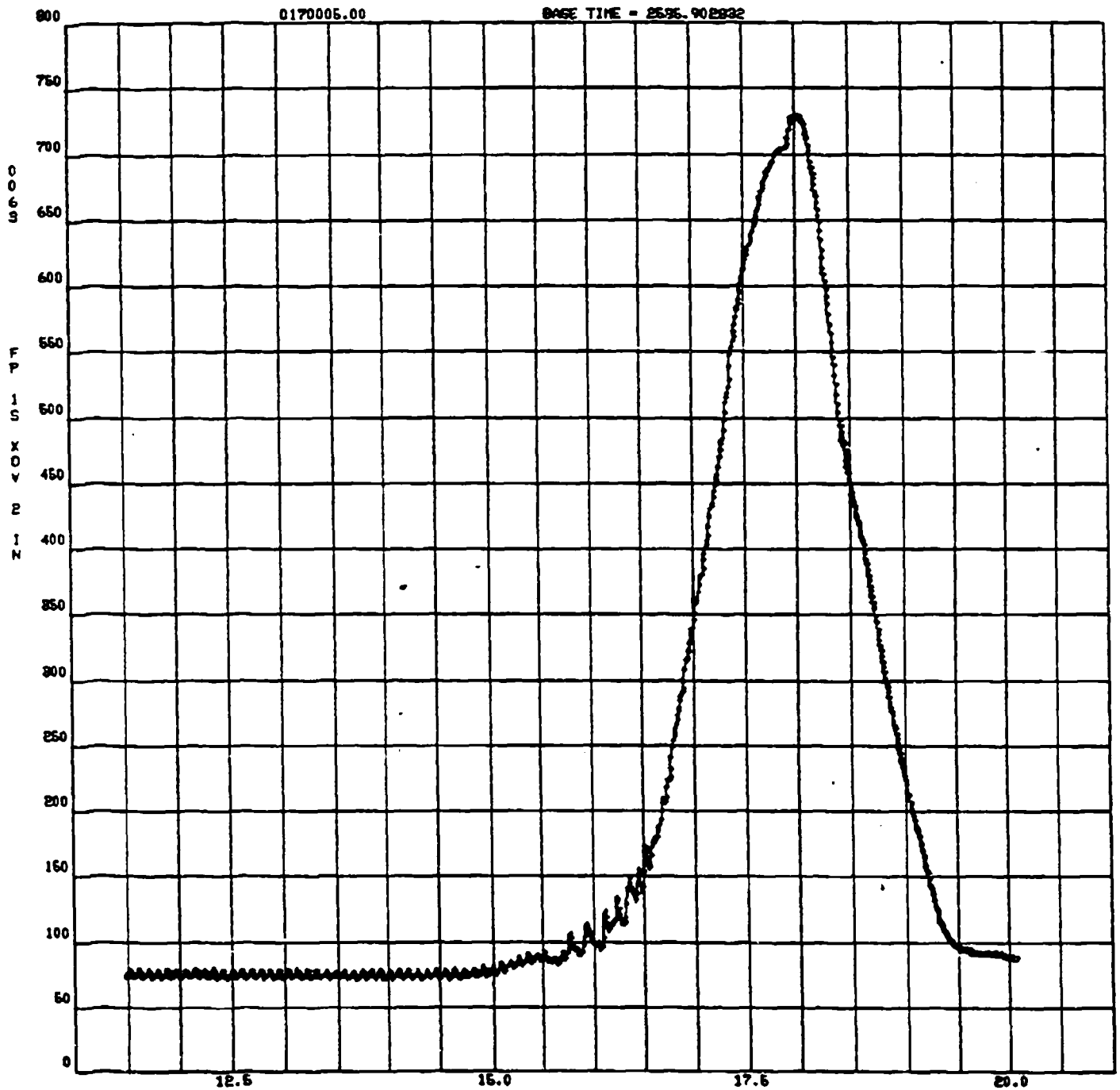

Appendix A:
Test 87-017-005 Time Based Data Plots (1/28/87)

005576200-
020487 00-41

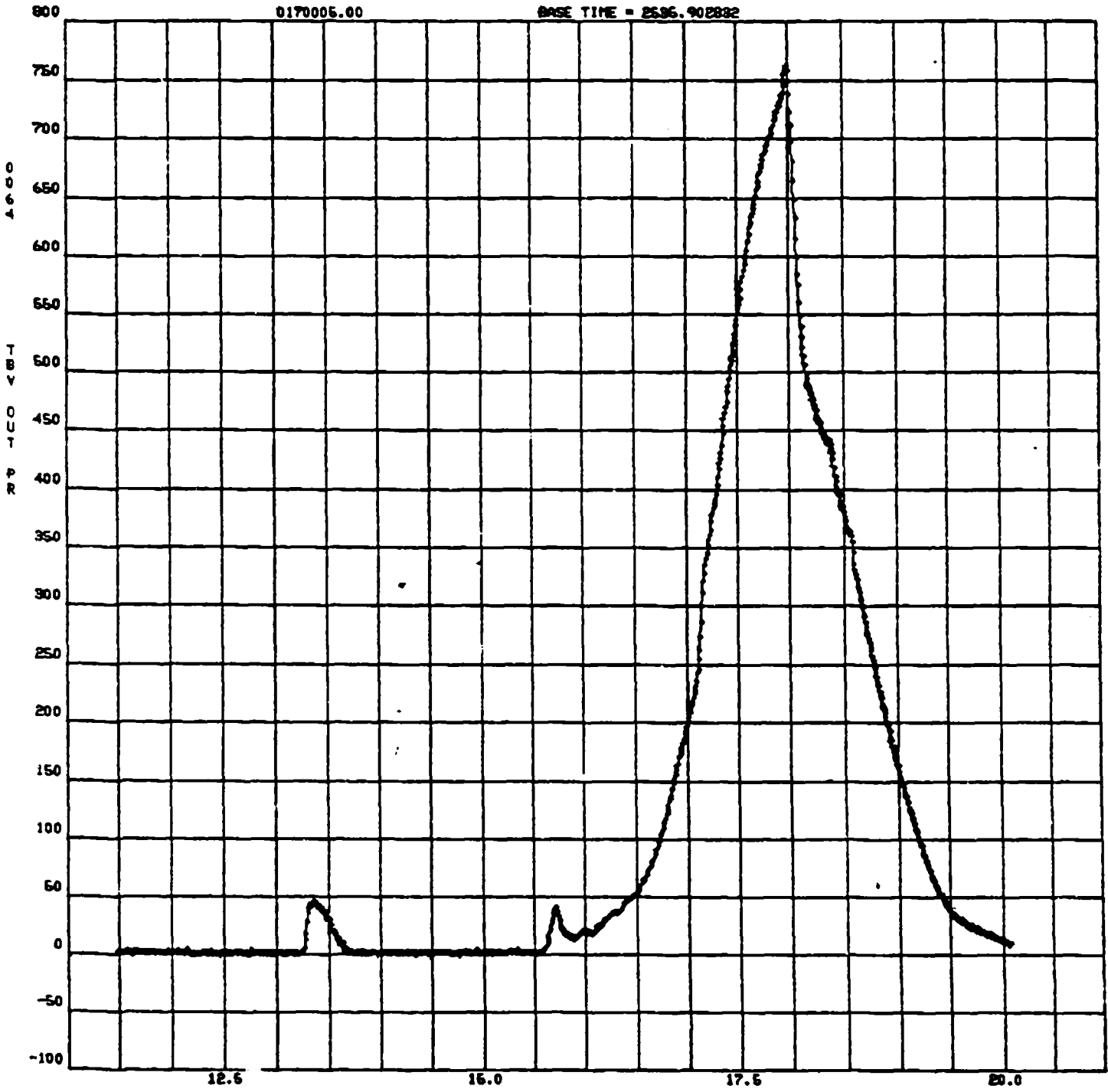

Appendix A: Test 87-017-005 Time Based Data Plots (1/28/87)

0155952004
020487 0042

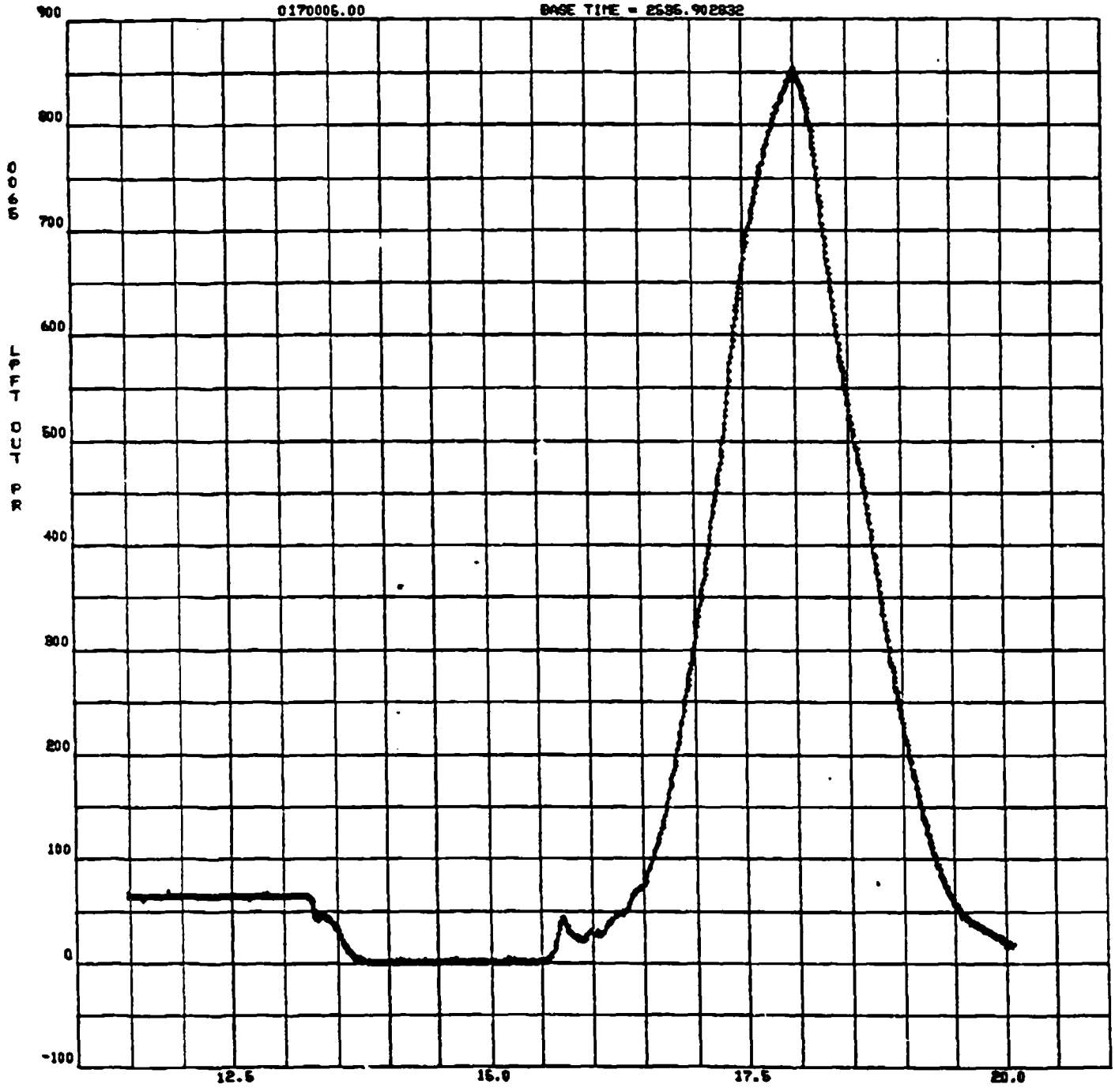

Appendix A: Test 87-017-005 Time Based Data Plots (1/28/87)

065595200
020487 0043

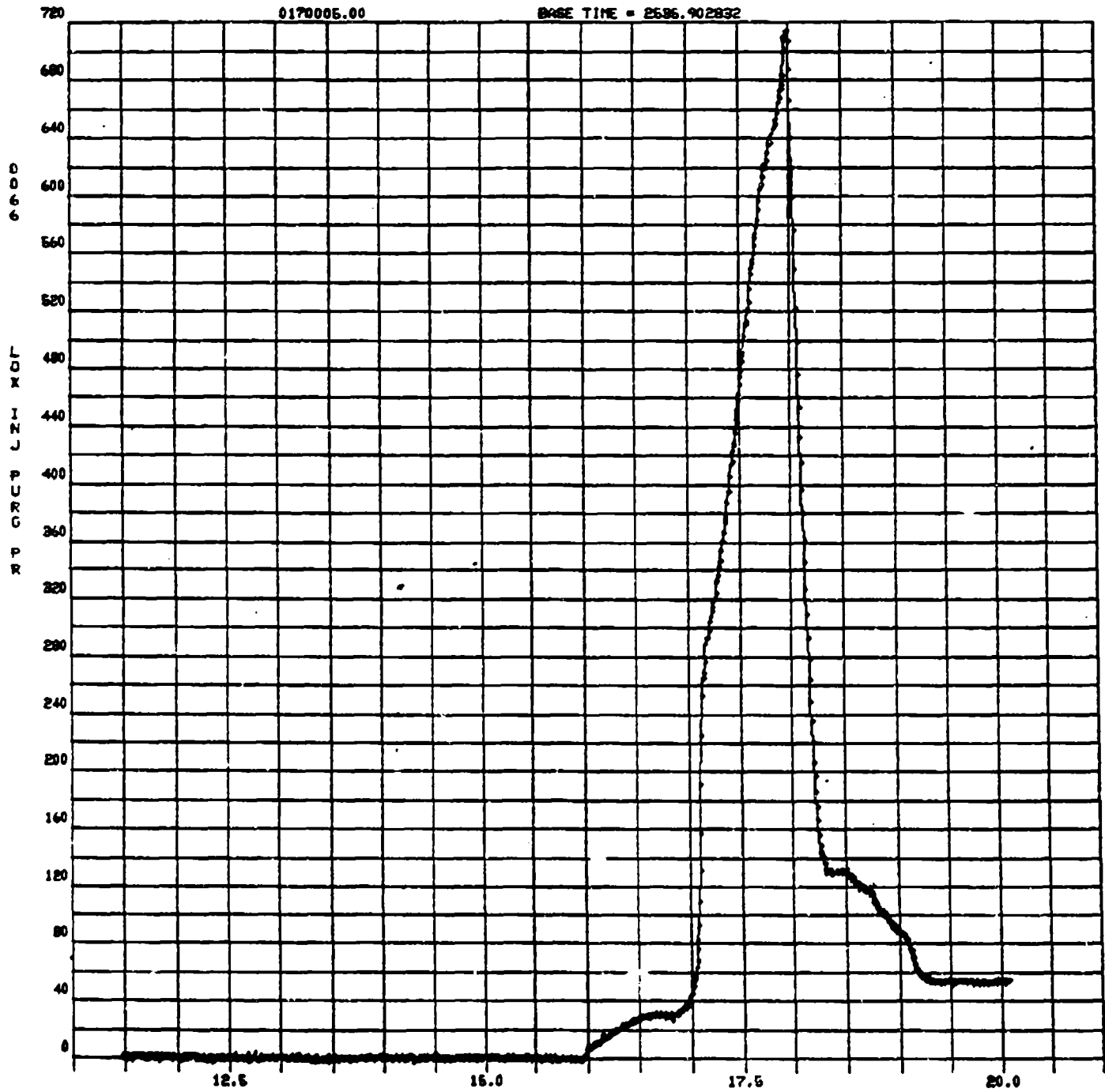

Appendix A: Test 87-017-005 Time Based Data Plots (1/28/87)

4055962004
020487 0044

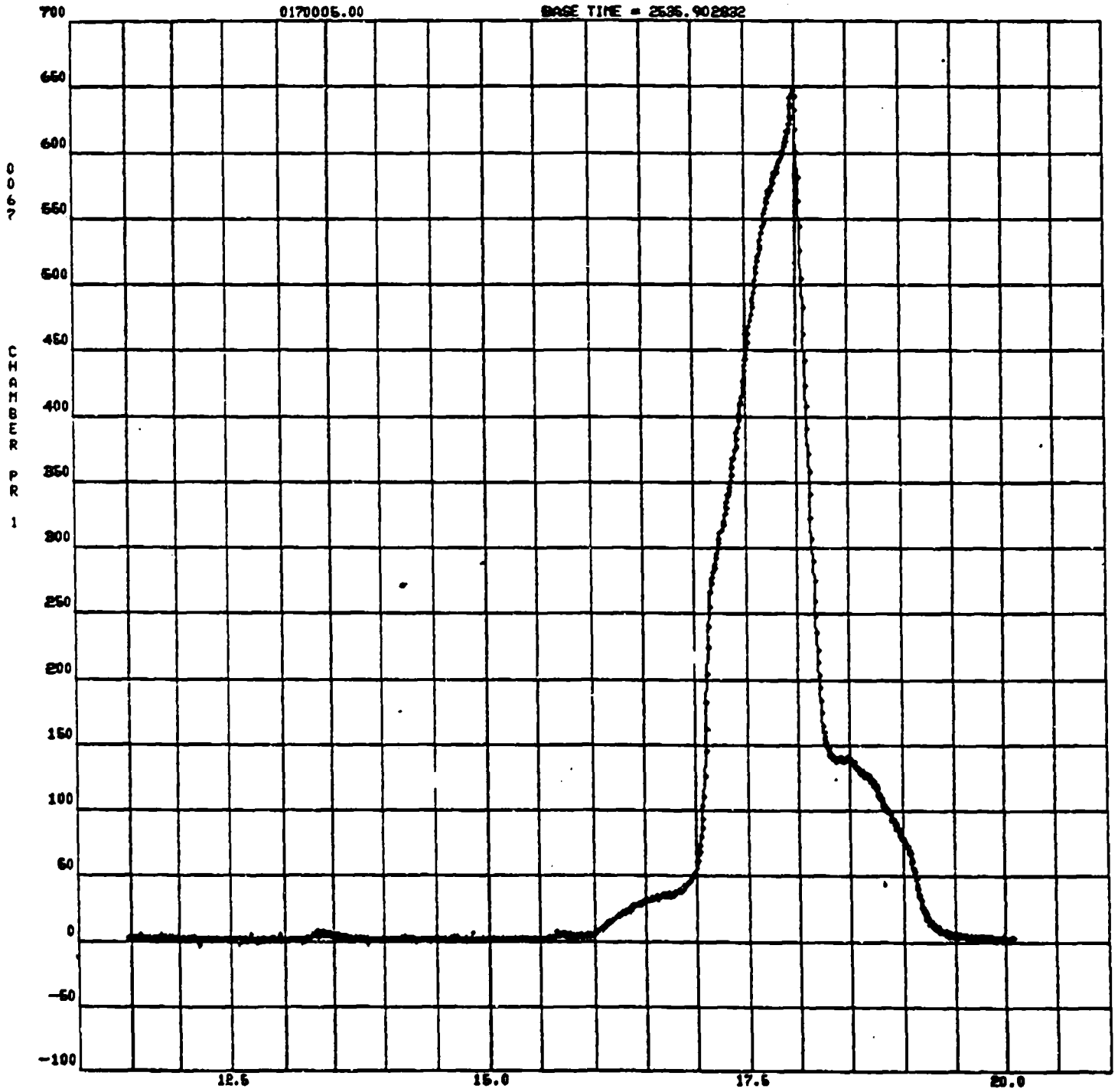

Appendix A: Test 87-017-005 Time Based Data Plots (1/28/87)

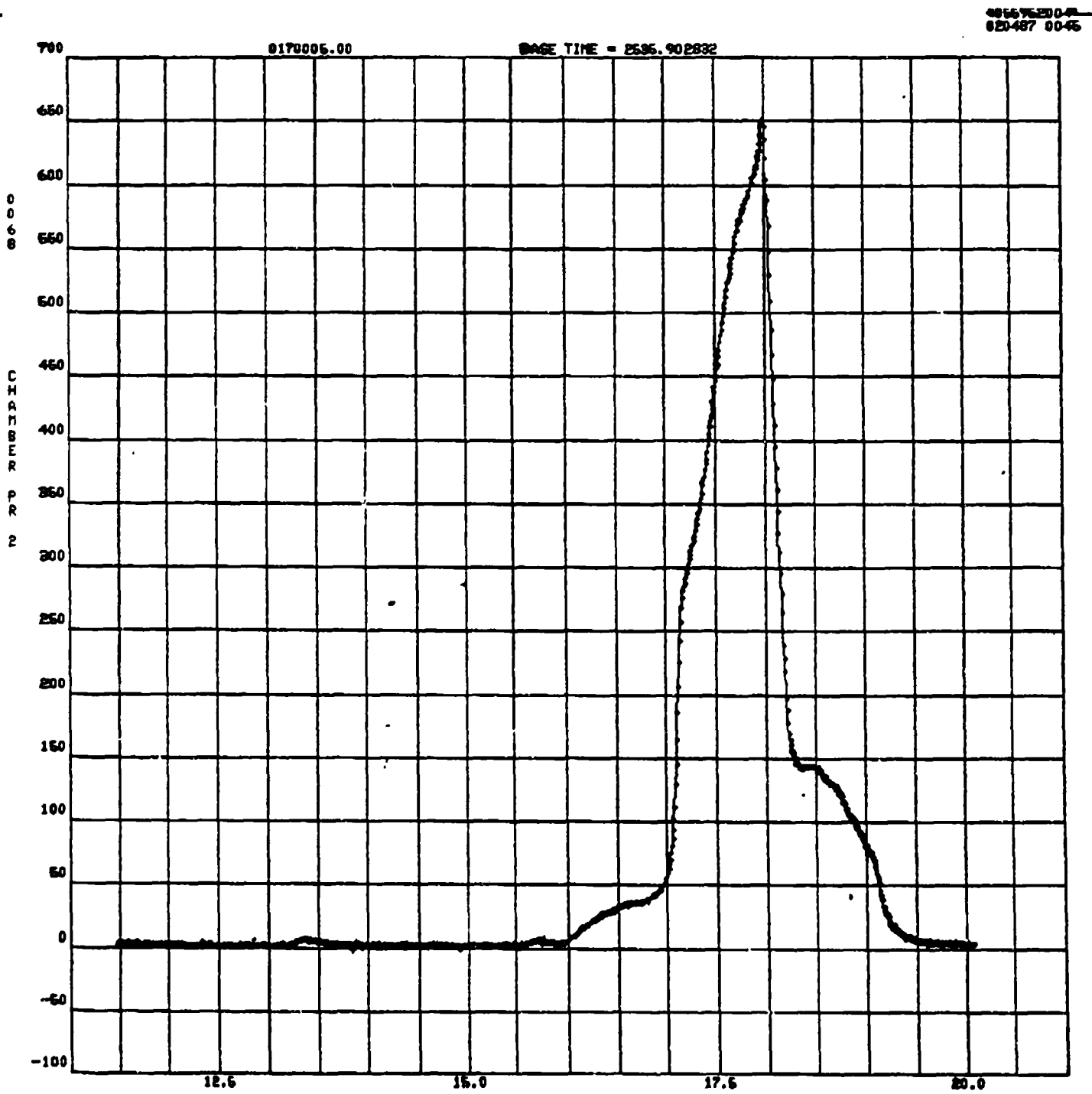

Appendix A: Test 87-017-005 Time Based Data Plots (1/28/87)

06595200-4
020487 0046

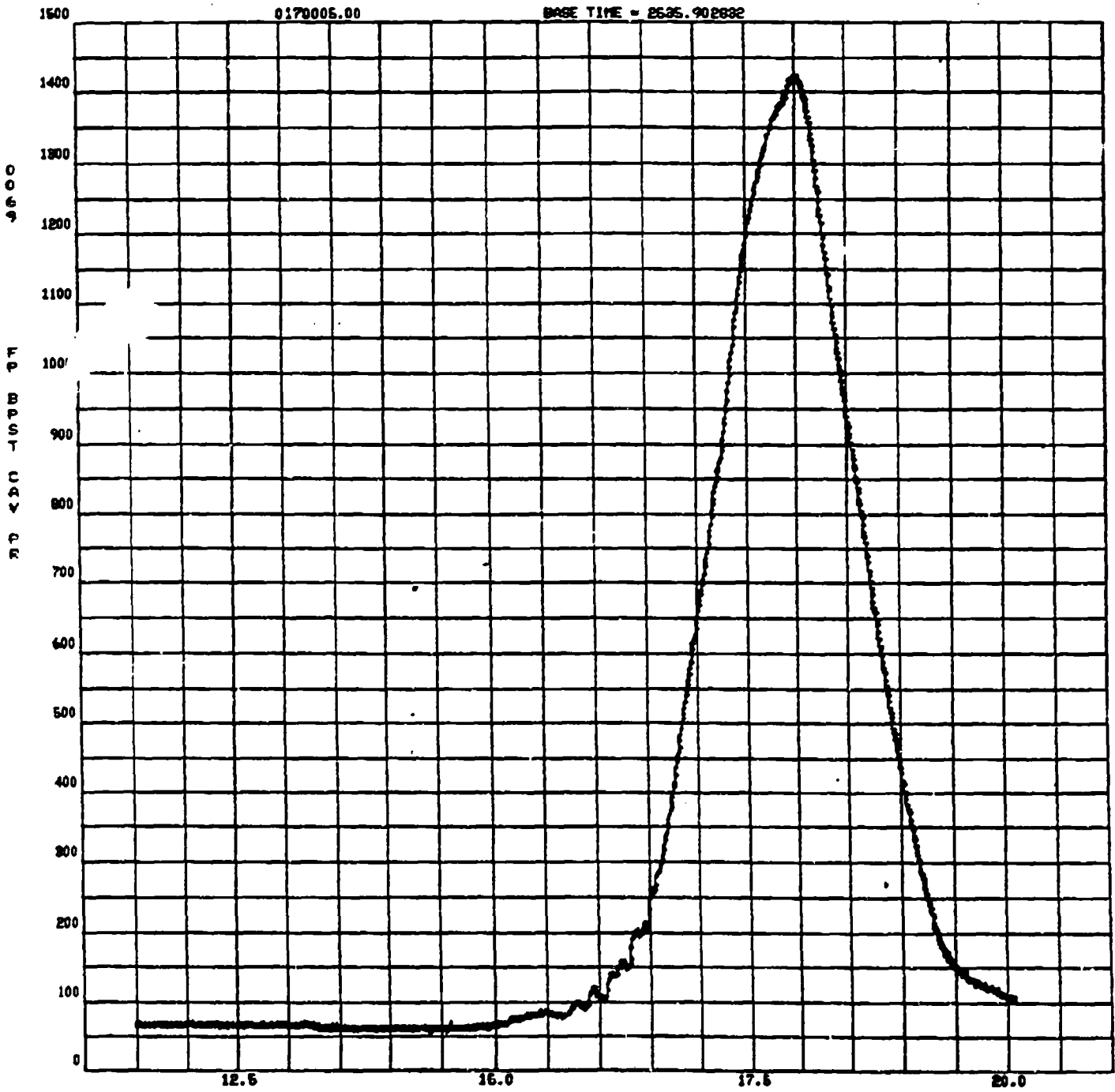

Appendix A:
Test 87-017-005 Time Based Data Plots (1/28/87)

015596200
020487 0047

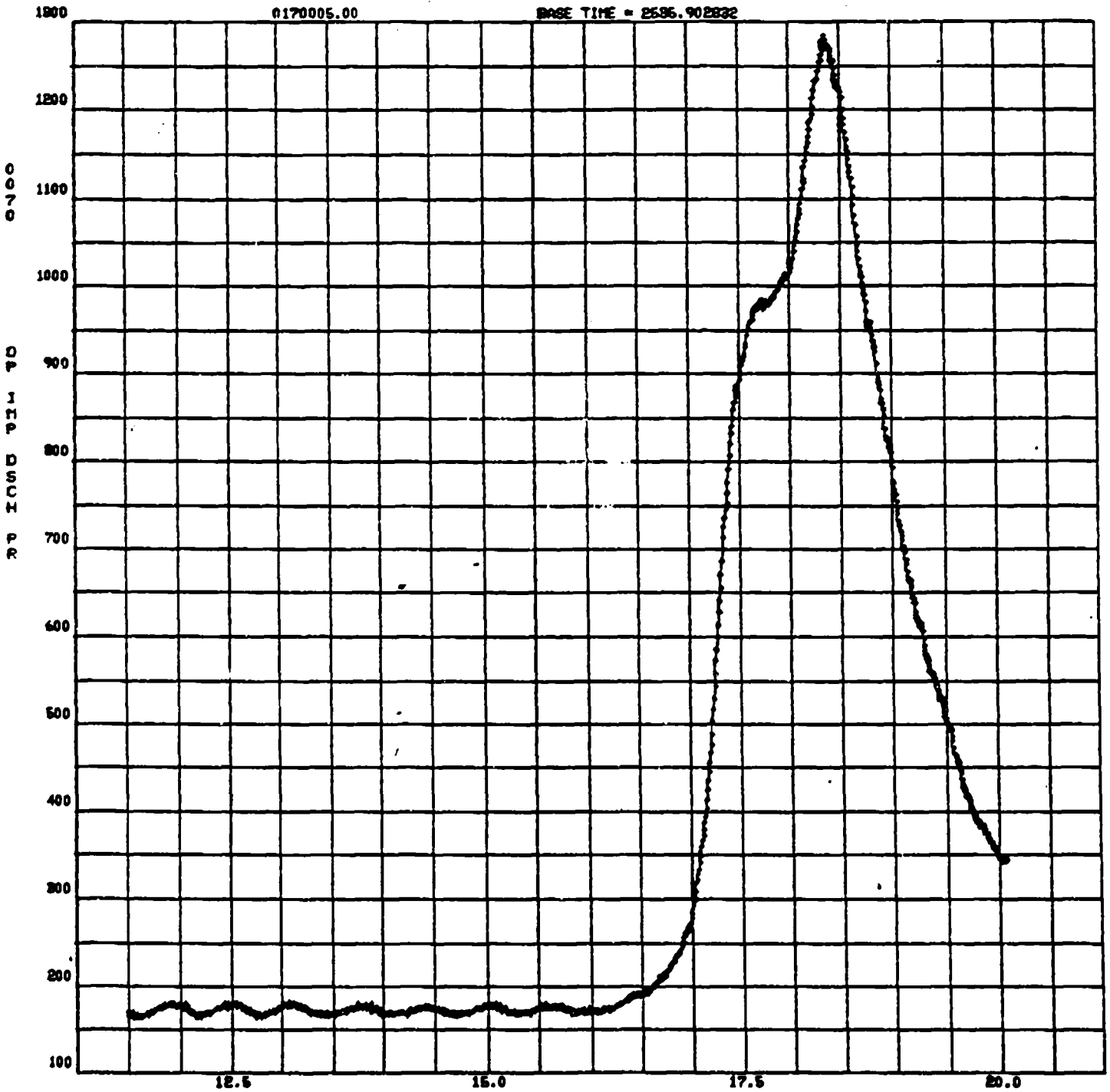

Appendix A: Test 87-017-005 Time Based Data Plots (1/28/87)

405595200
020467 0048

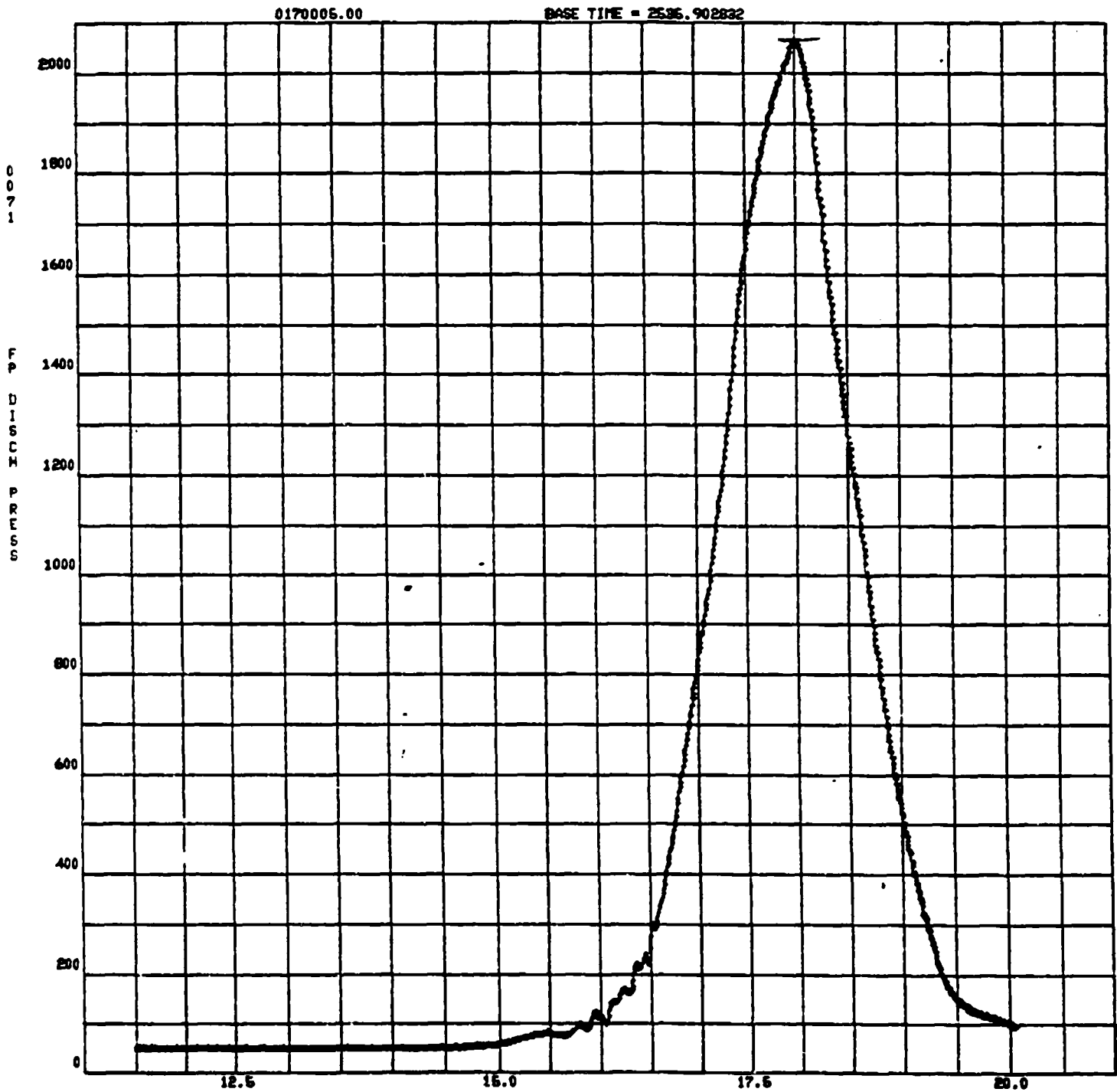

Appendix A: Test 87-017-005 Time Based Data Plots (1/28/87)

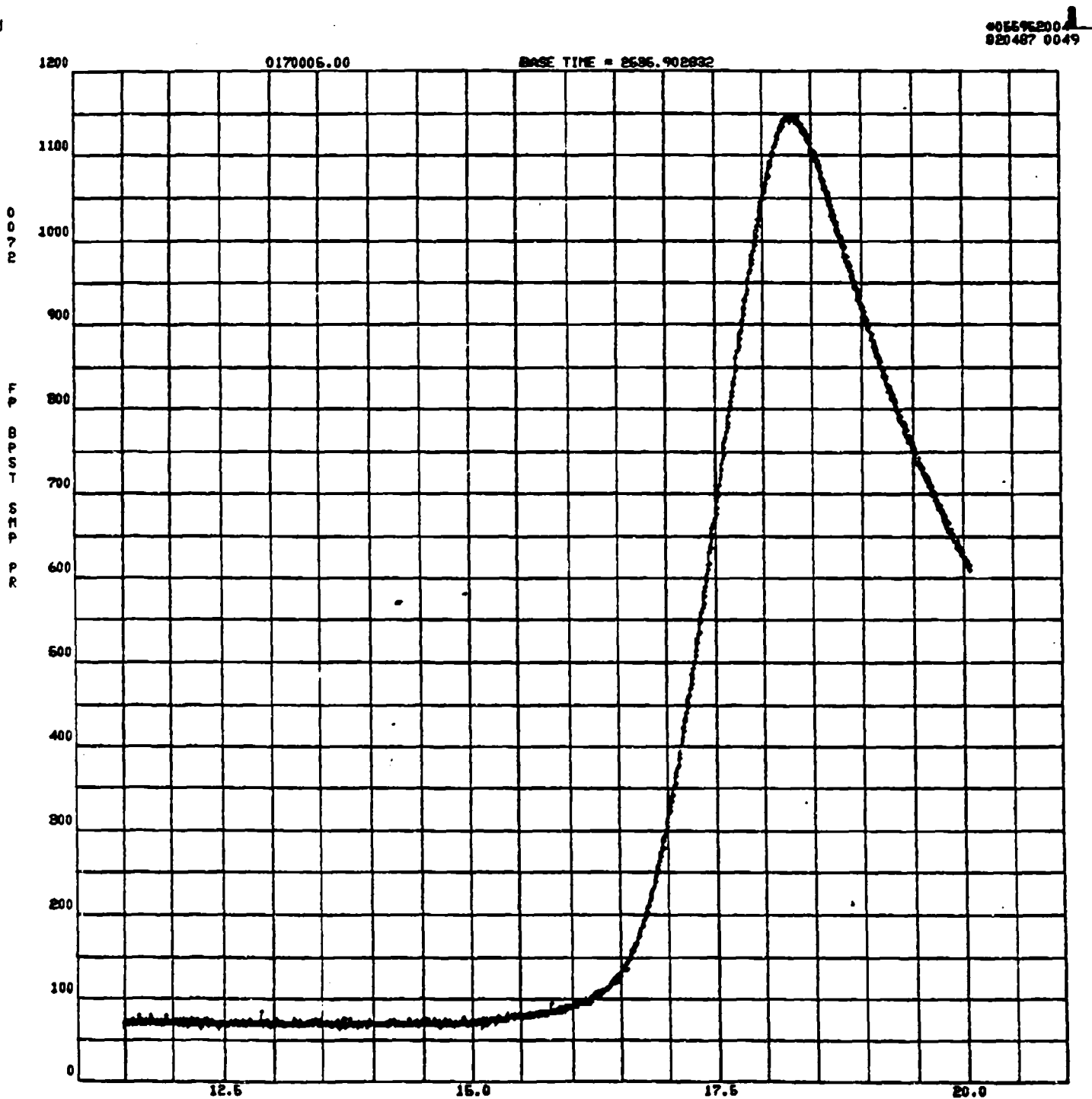

Appendix A: Test 87-017-005 Time Based Data Plots (1/28/87)

05595200
020487 0050

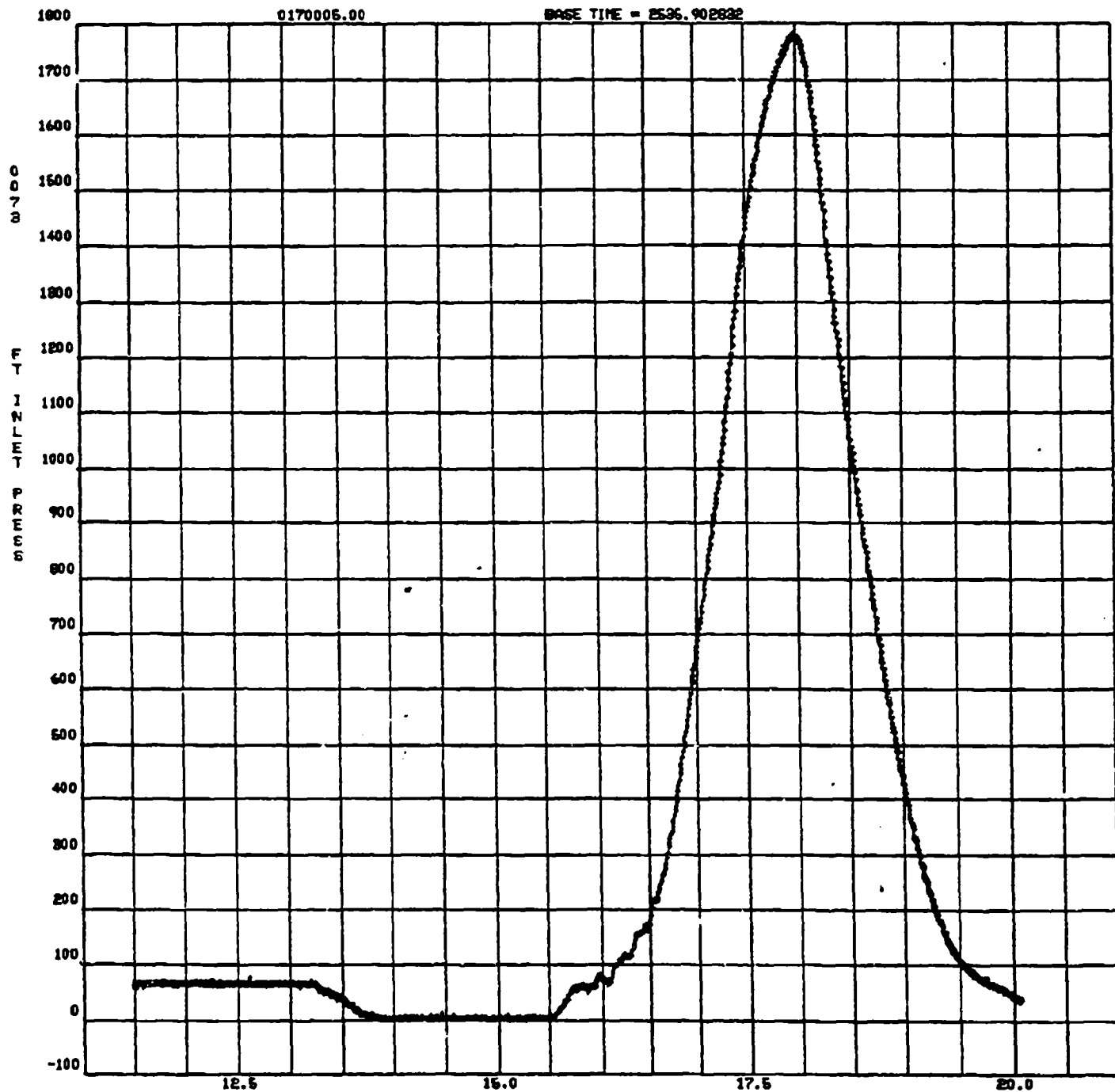

Appendix A: Test 87-017-005 Time Based Data Plots (1/28/87)

05595200.4
020487 0051

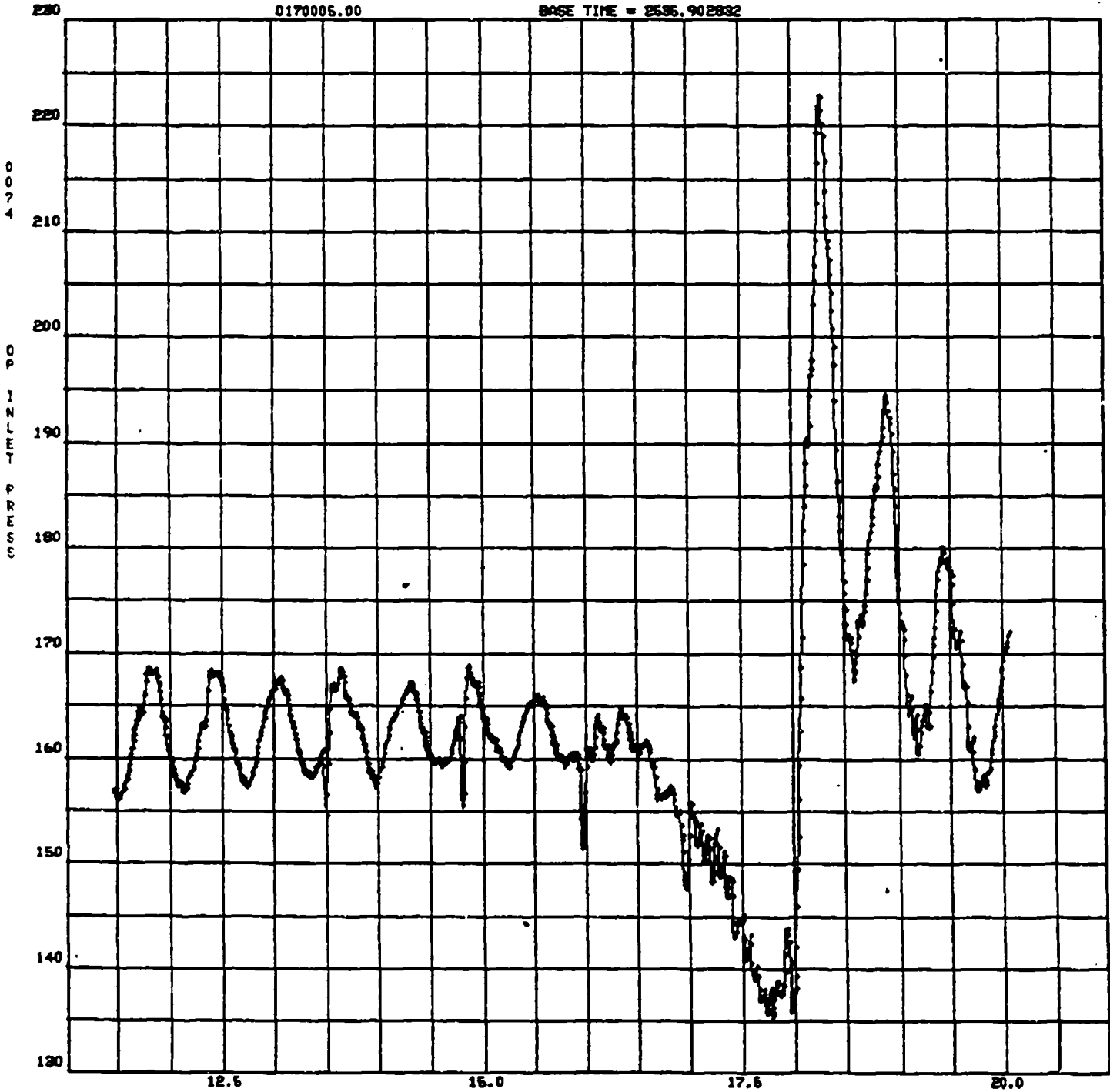

Appendix A: Test 87-017-005 Time Based Data Plots (1/28/87)

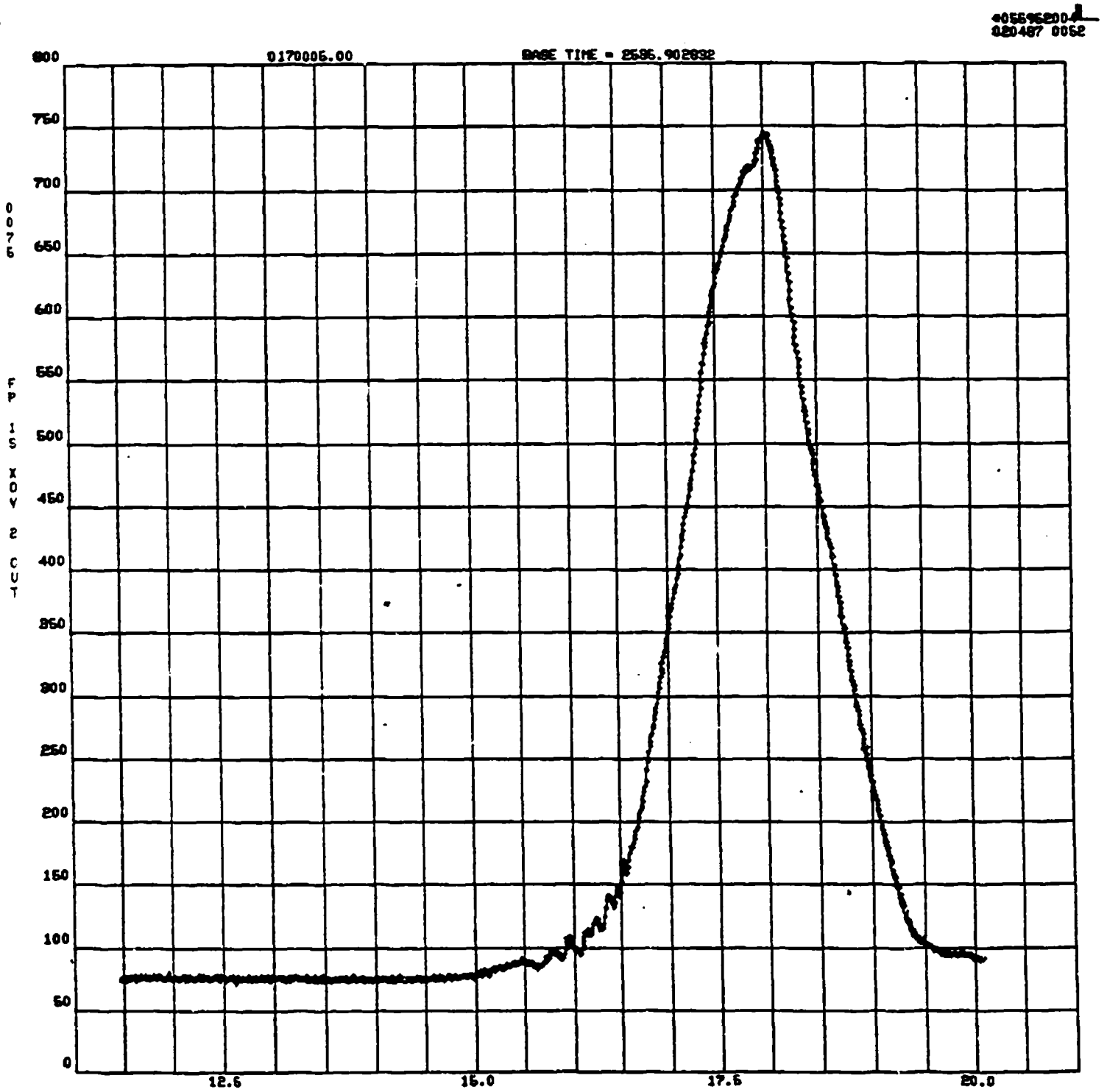

Appendix A: Test 87-017-005 Time Based Data Plots (1/28/87)

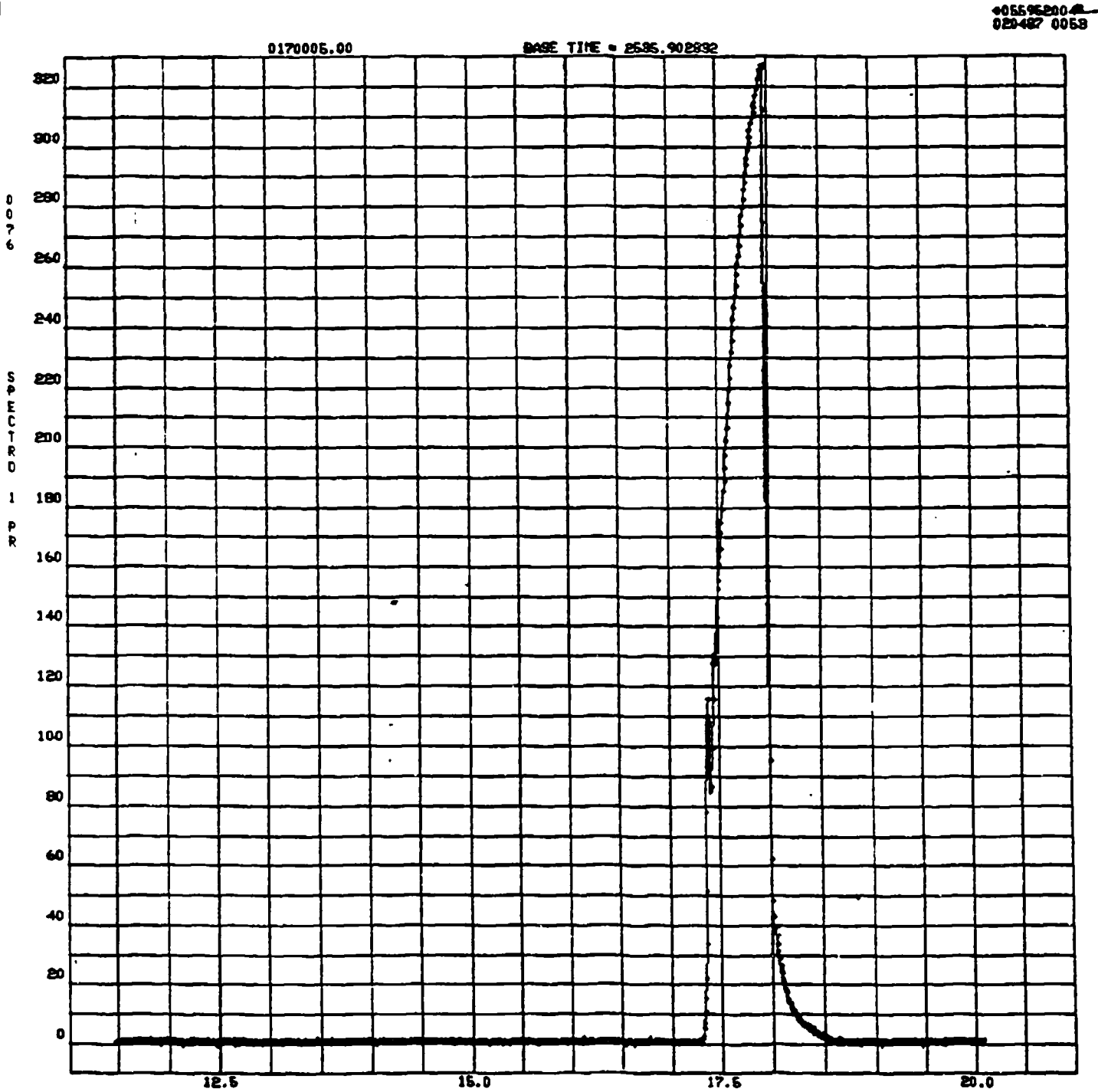

Appendix A: Test 87-017-005 Time Based Data Plots (1/28/87)

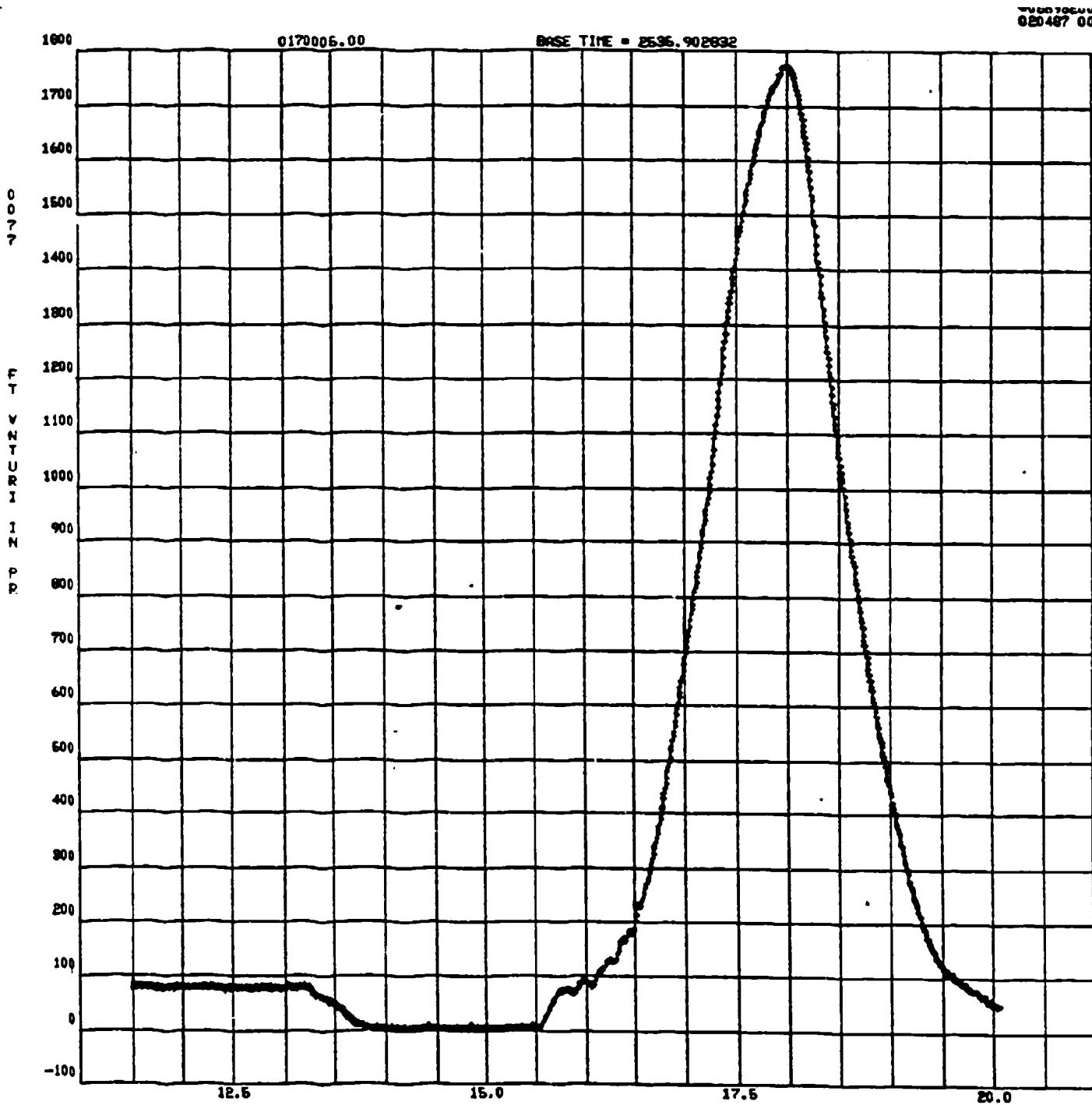

Appendix A:
Test 87-017-005 Time Based Data Plots (1/28/87)

00595200
020487 0055

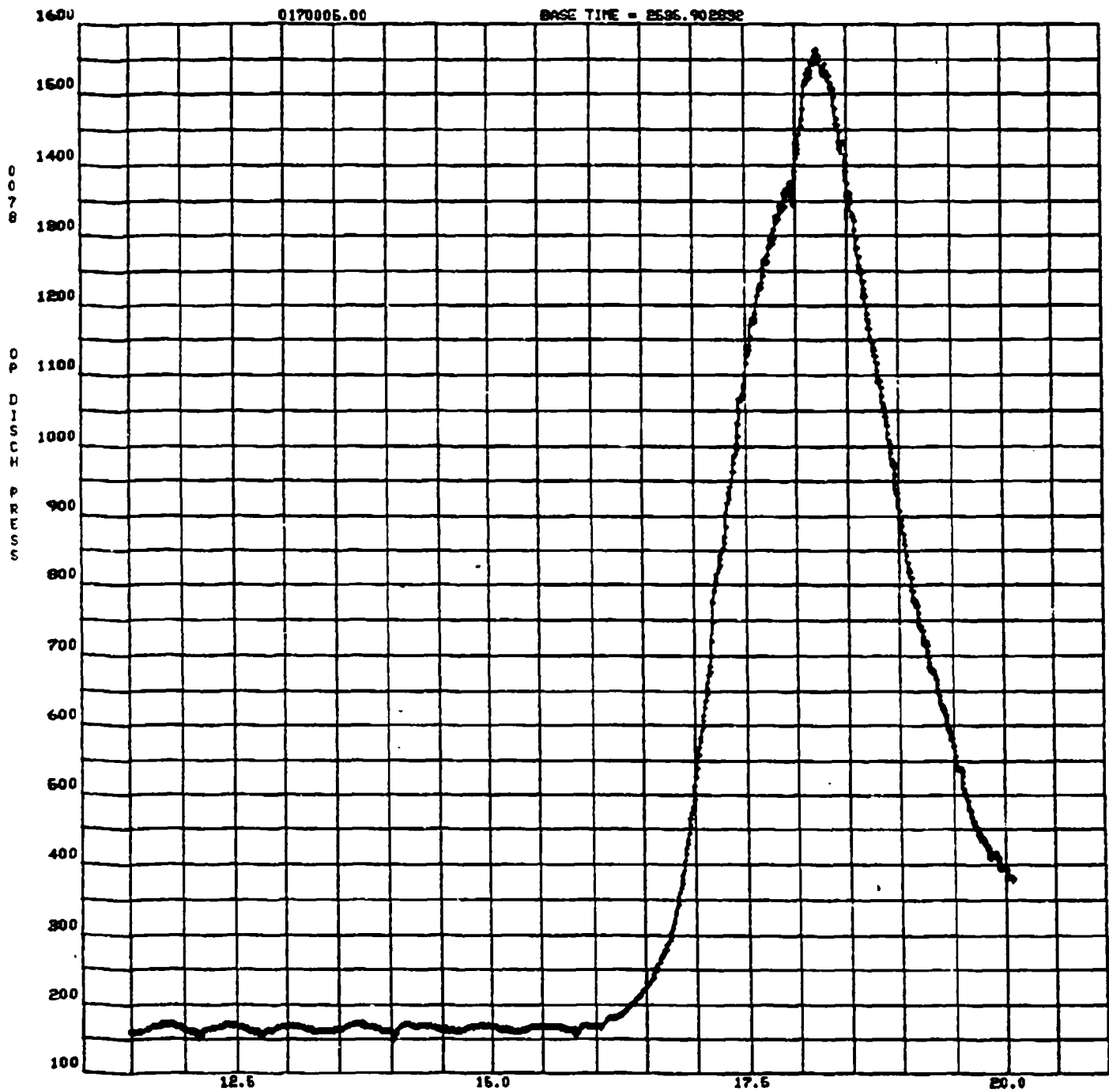

Appendix A: Test 87-017-005 Time Based Data Plots (1/28/87)

405595200-
020487 0056

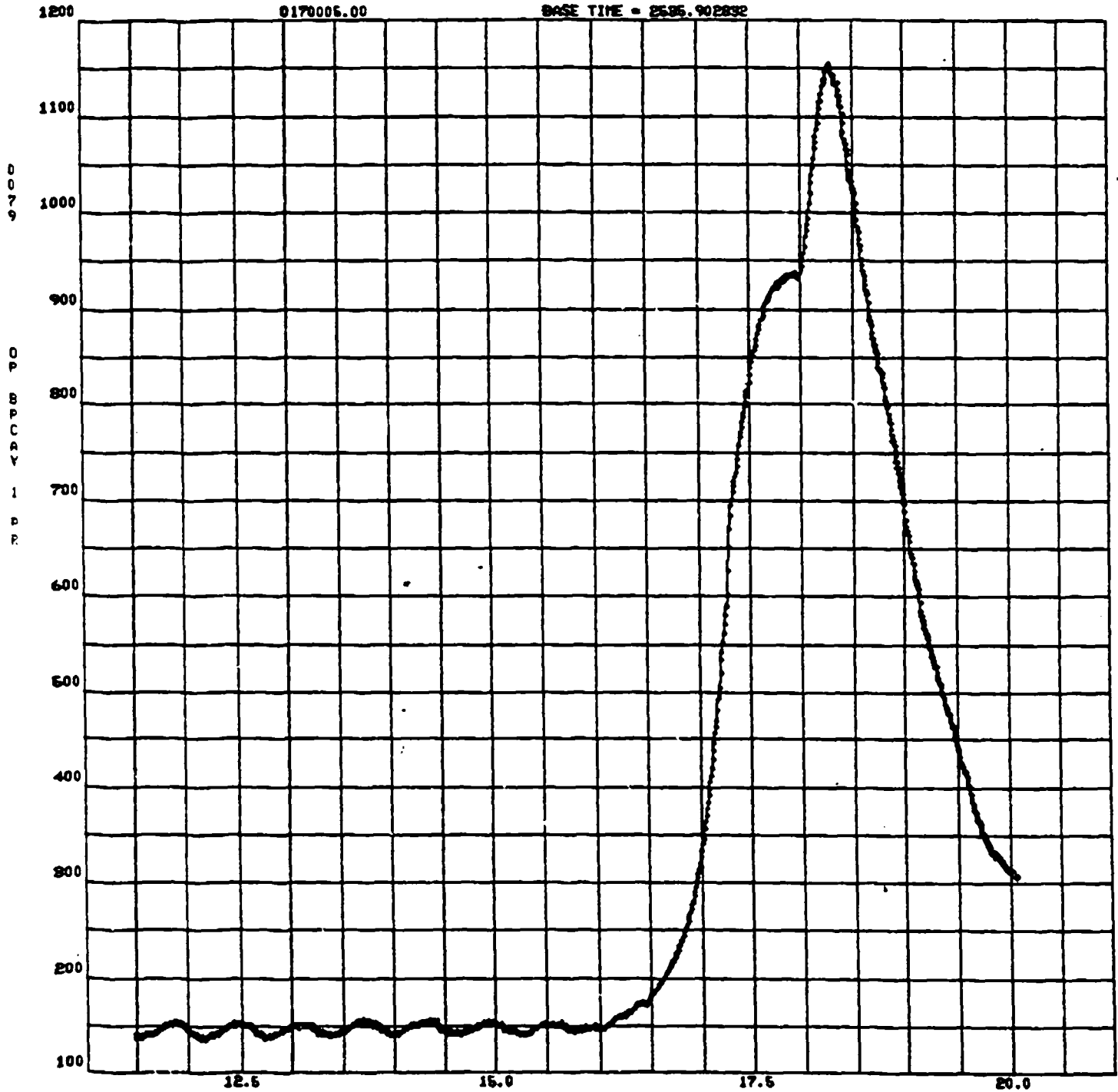

Appendix A:
Test 87-017-005 Time Based Data Plots (1/28/87)

005595200
020487 0057

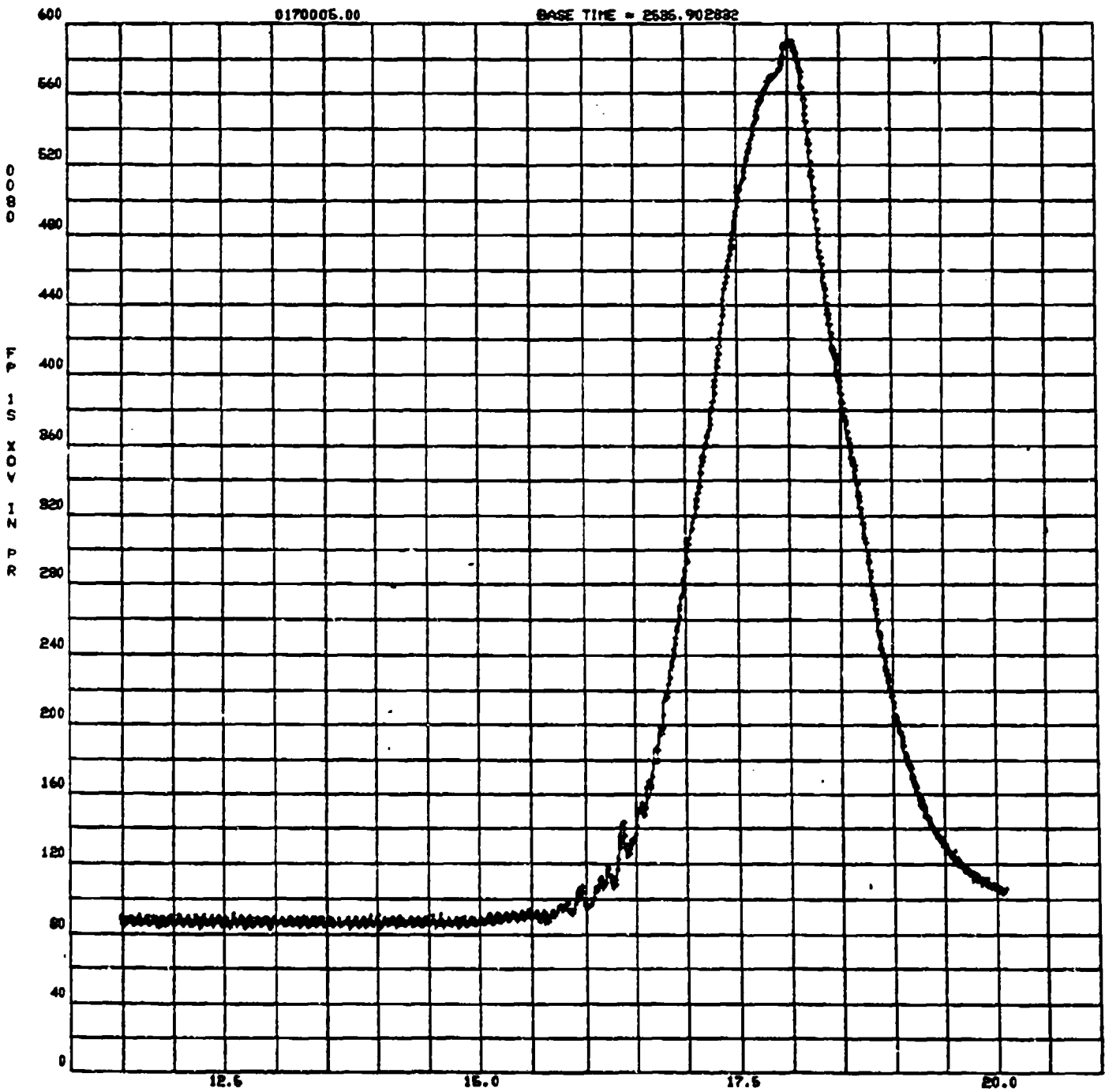

Appendix A: Test 87-017-005 Time Based Data Plots (1/28/87)

055952004
020467 0068

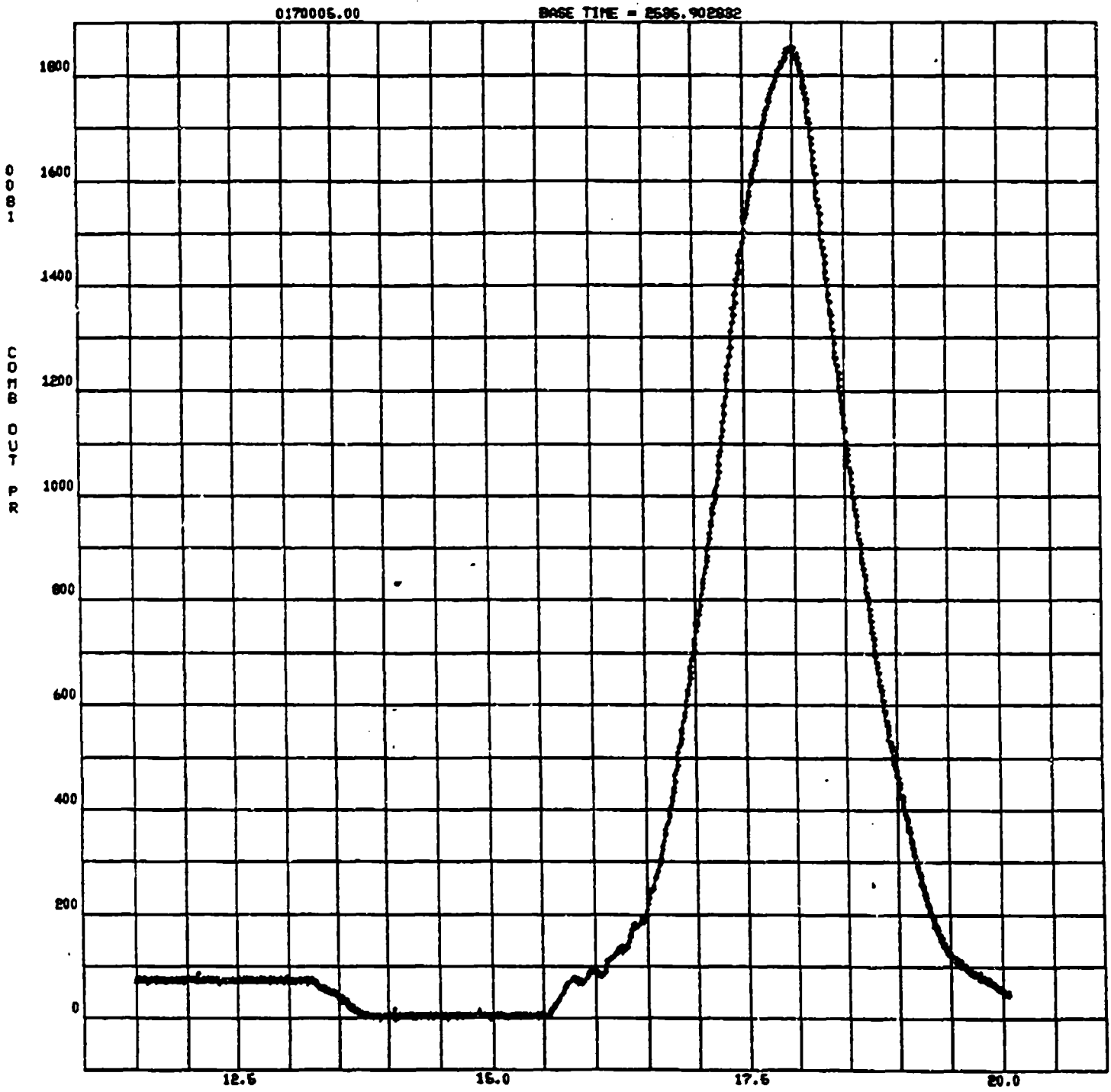

Appendix A: Test 87-017-005 Time Based Data Plots (1/28/87)

4055952004
020487 0059

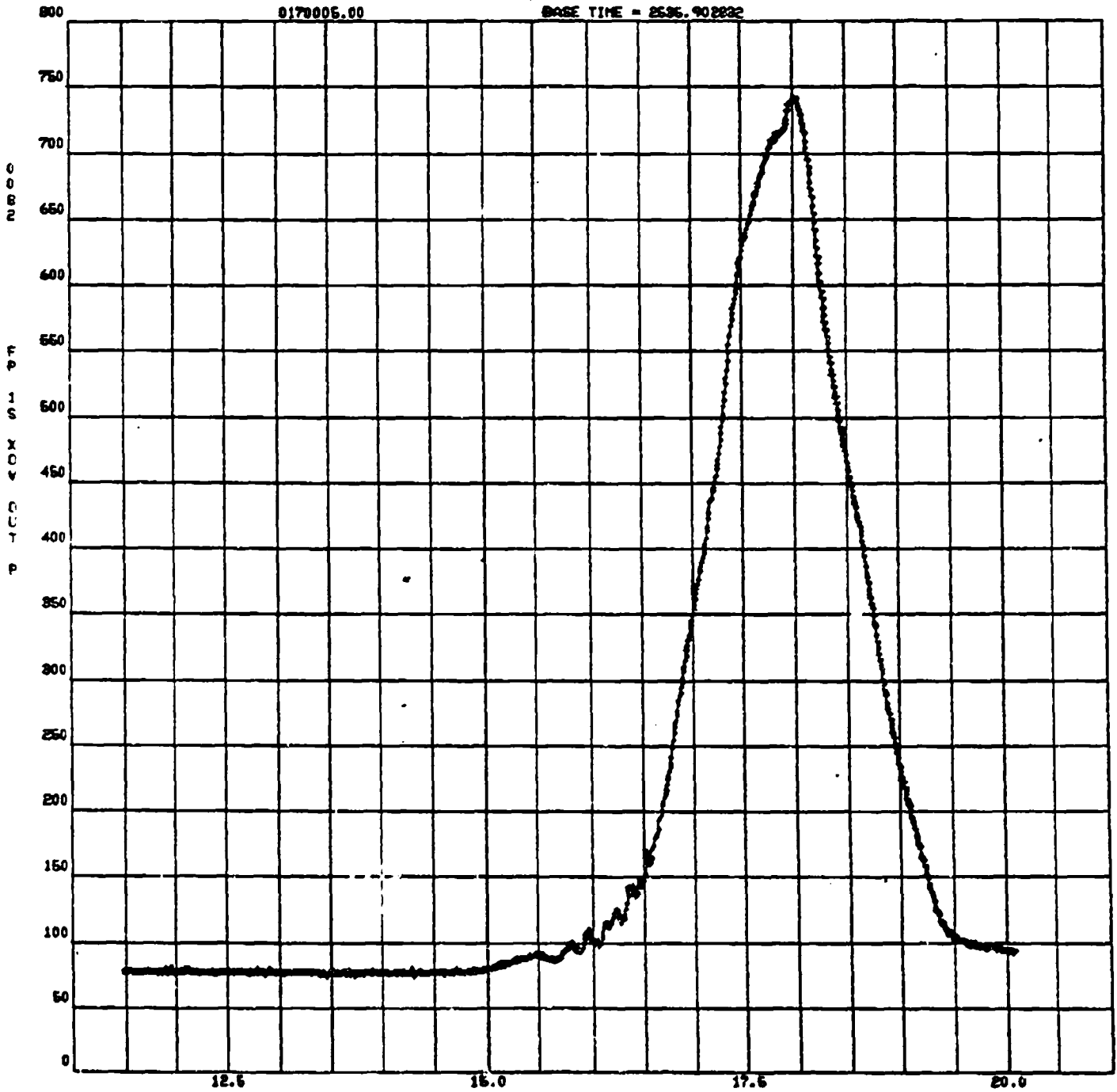

Appendix A: Test 87-017-005 Time Based Data Plots (1/28/87)

405595200
020467 0060

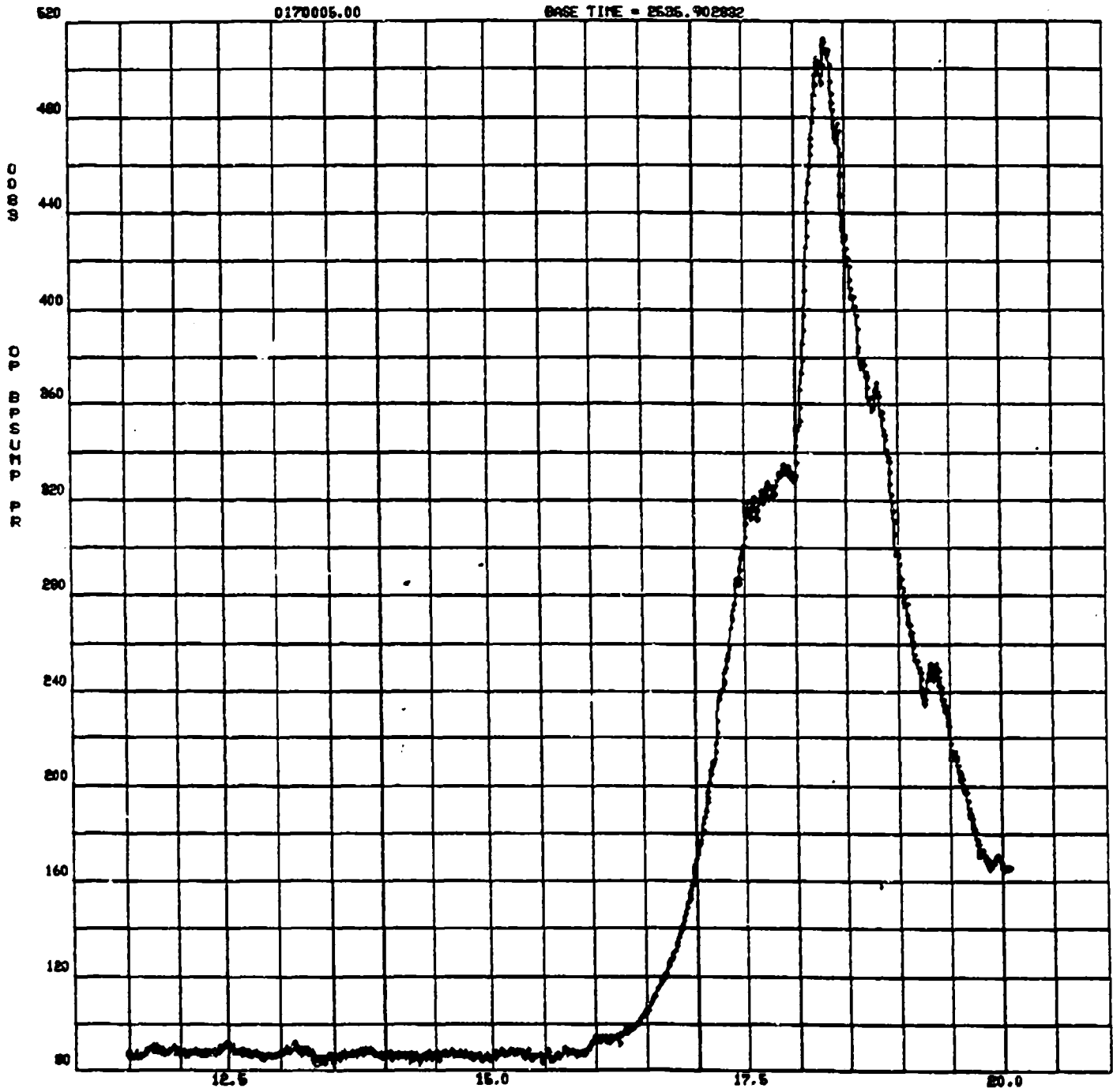

Appendix A: Test 87-017-005 Time Based Data Plots (1/28/87)

405596200
020487 0061

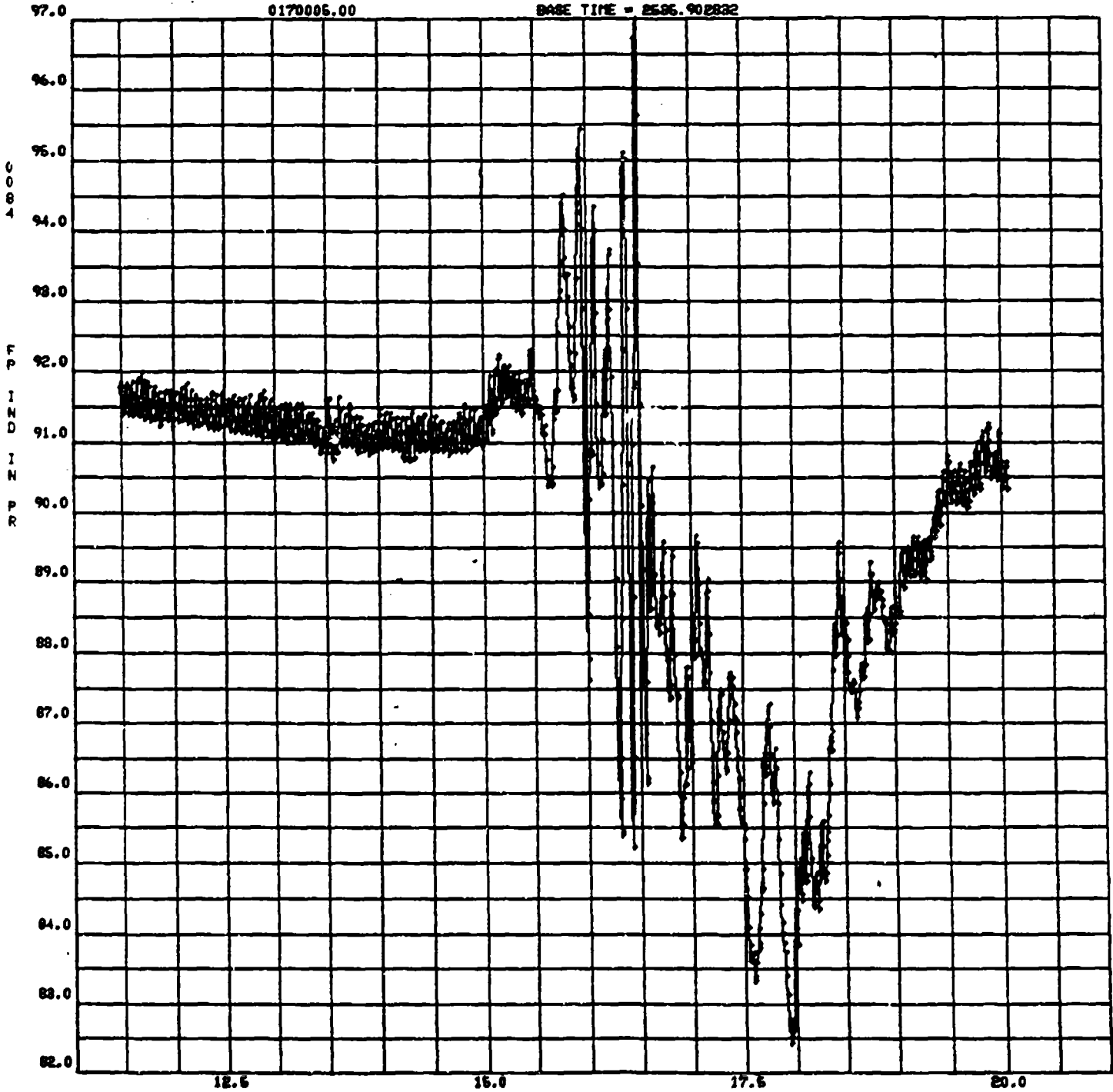

Appendix A: Test 87-017-005 Time Based Data Plots (1/28/87)

4055952004
020487 0062

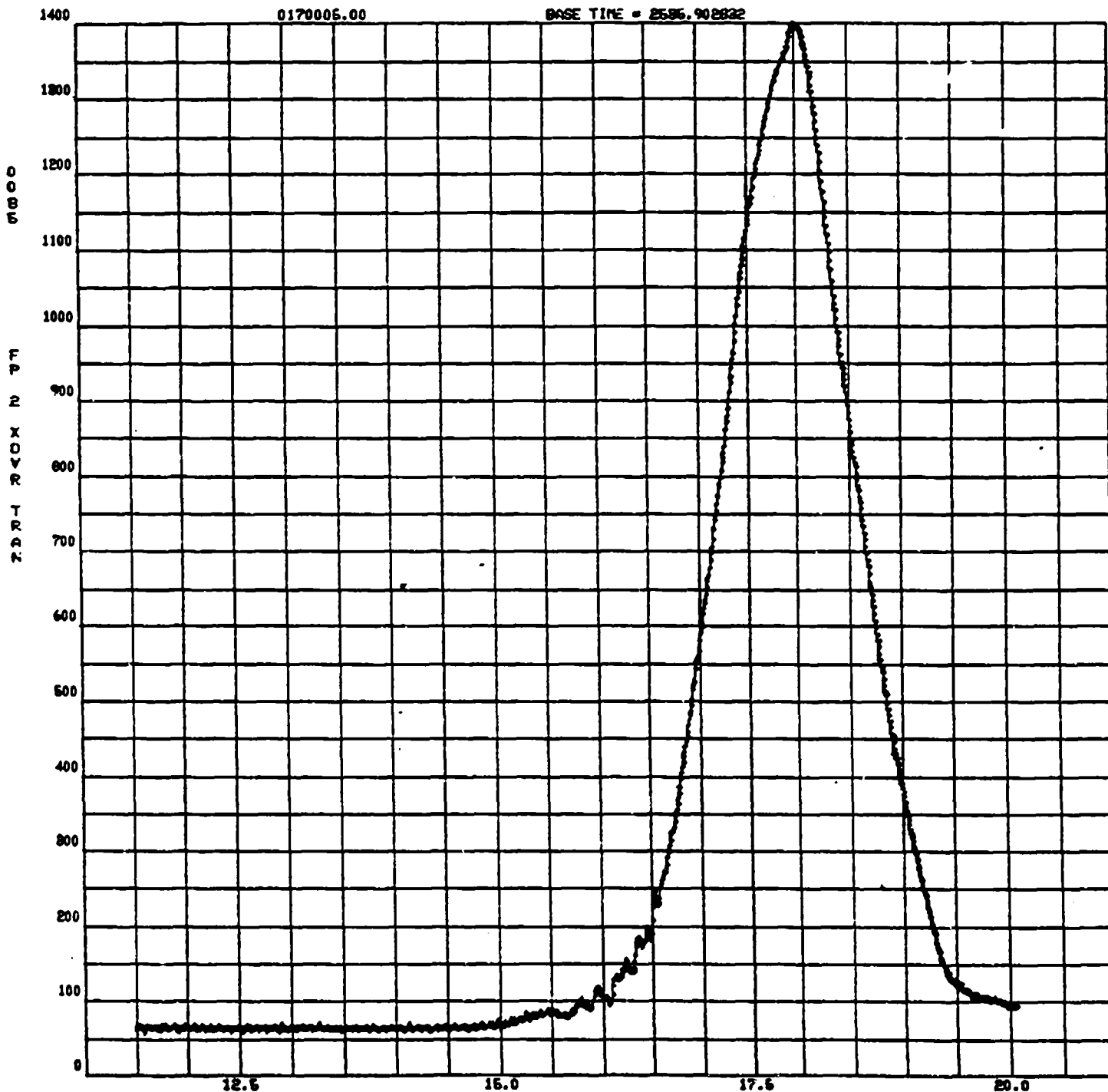

Appendix A: Test 87-017-005 Time Based Data Plots (1/28/87)

405595200
020487 0063

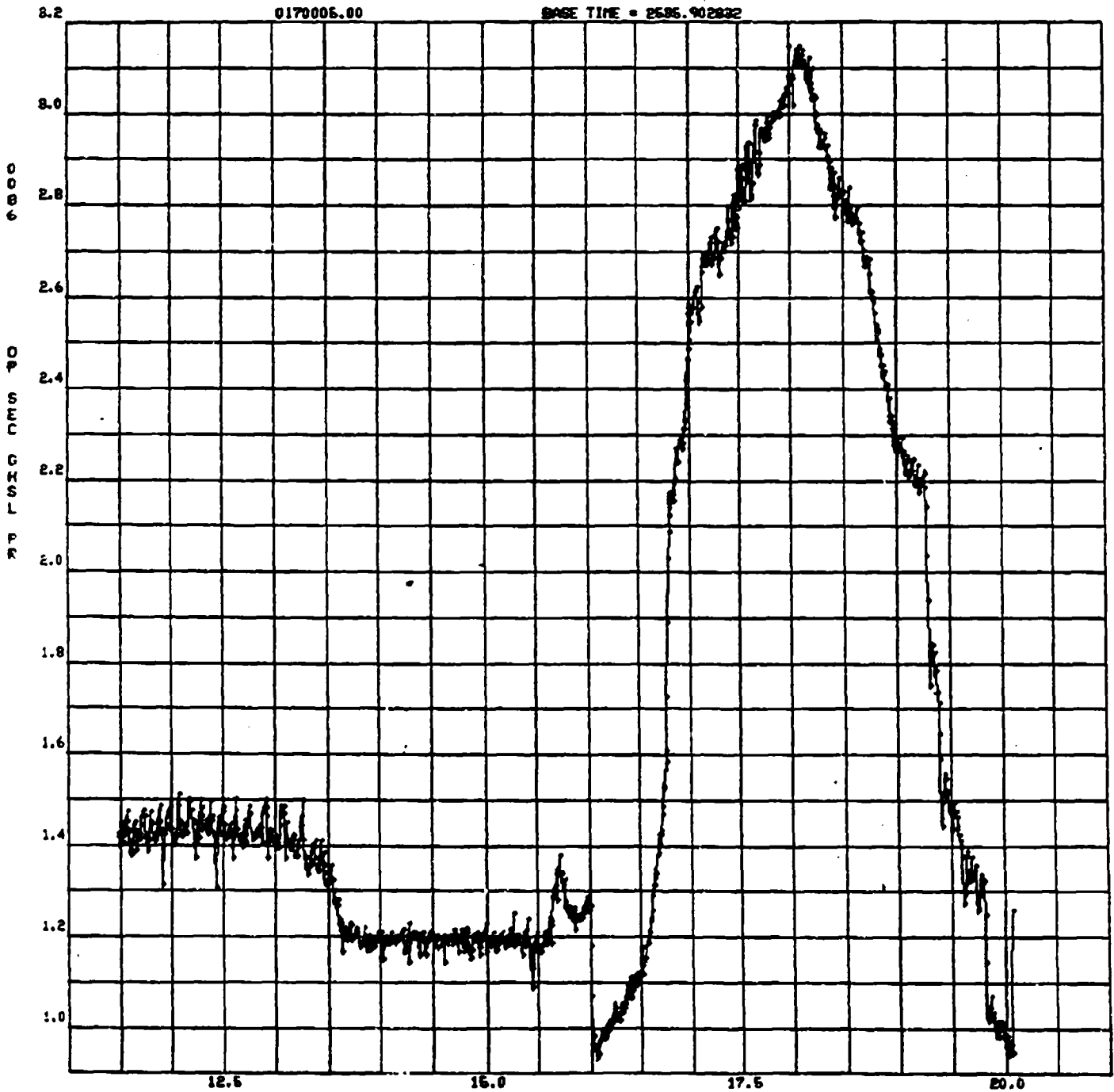

Appendix A: Test 87-017-005 Time Based Data Plots (1/28/87)

05595200
020487 0064

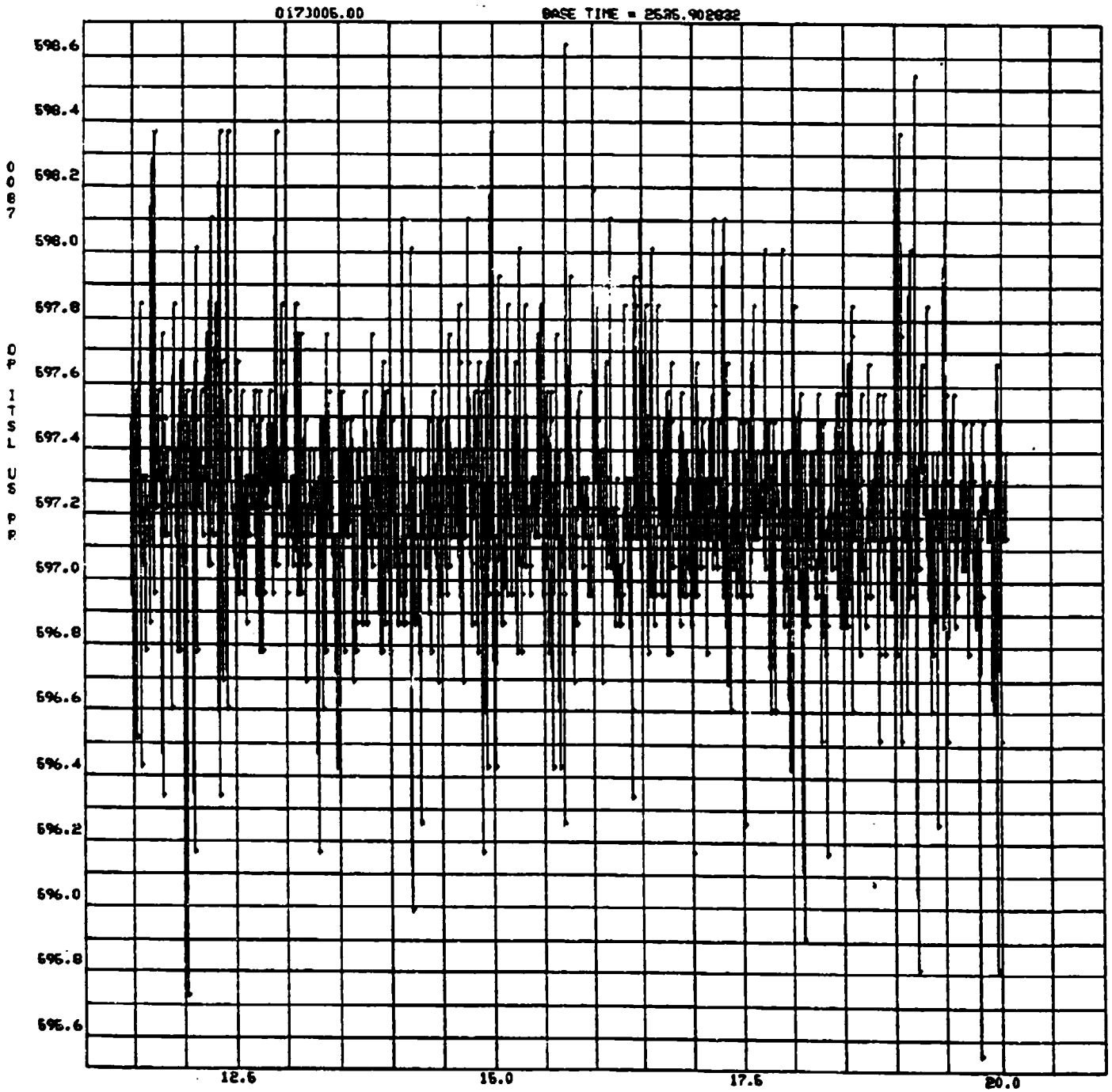

Appendix A: Test 87-017-005 Time Based Data Plots (1/28/87)

05596200
020487 0065

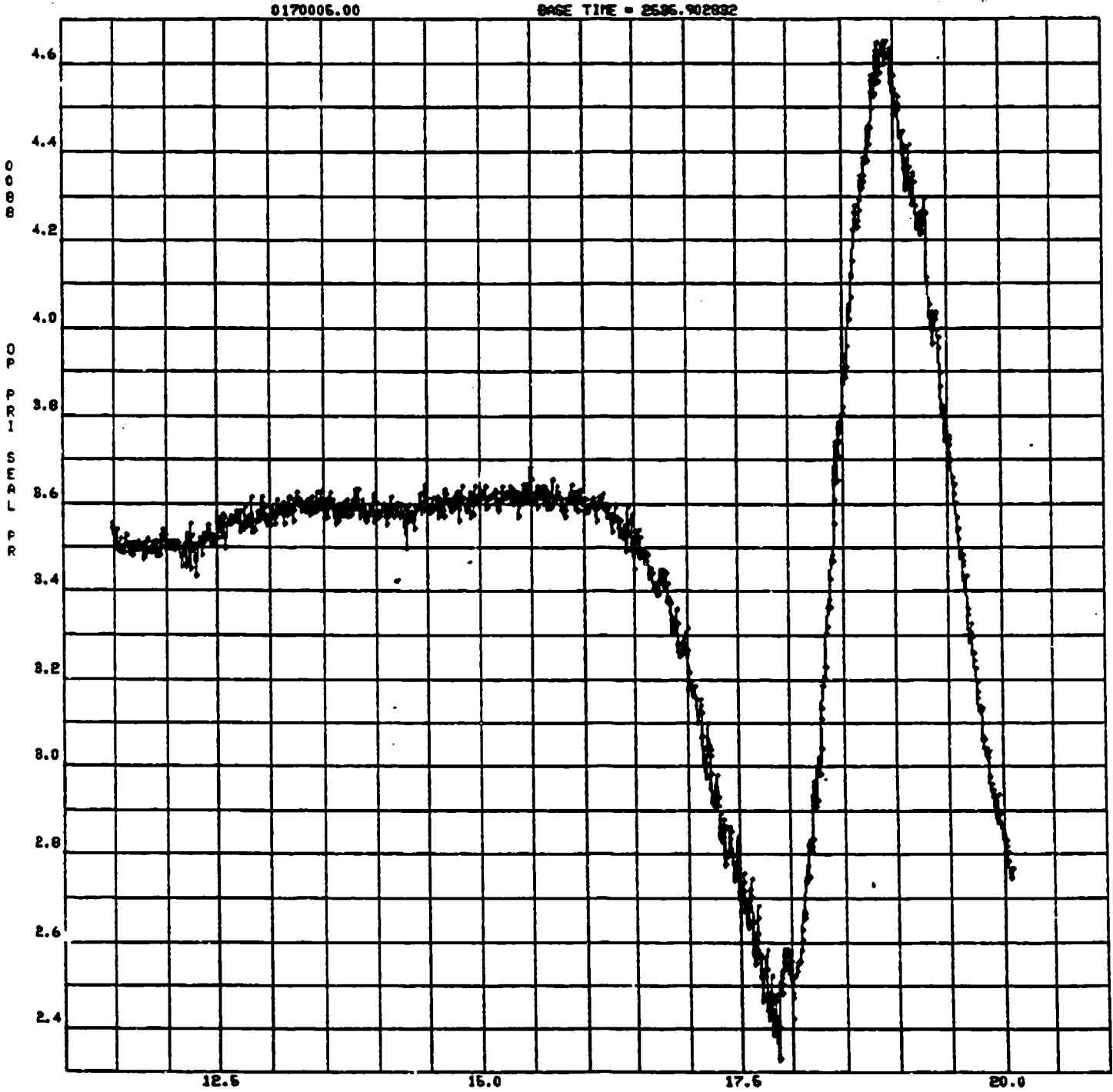

Appendix A: Test 87-017-005 Time Based Data Plots (1/28/87)

405595200
020487 0066

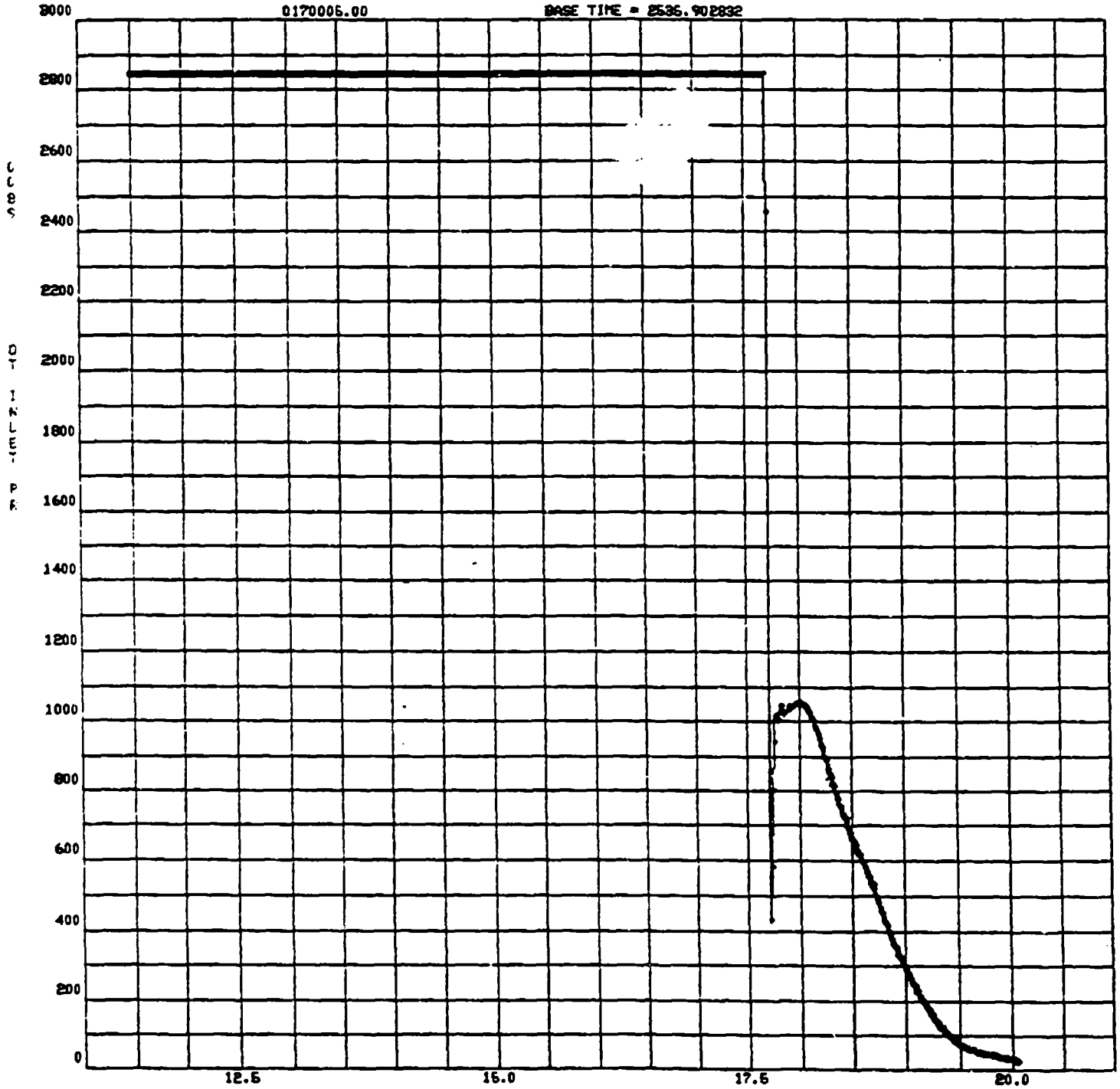

Appendix A: Test 87-017-005 Time Based Data Plots (1/28/87)

405596200
020487 0020

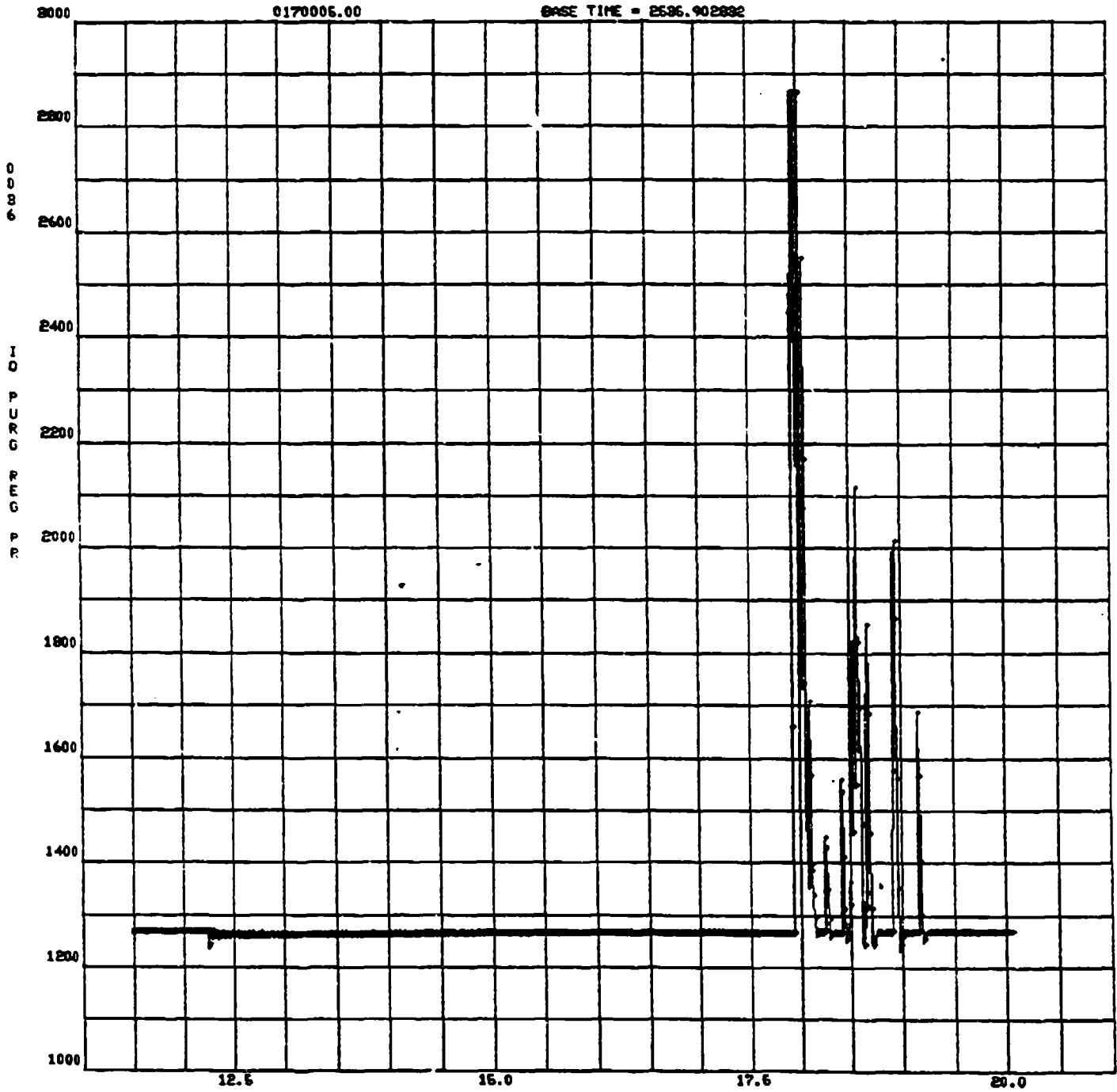

Appendix A: Test 87-017-005 Time Based Data Plots (1/28/87)

05595200
020487 0021

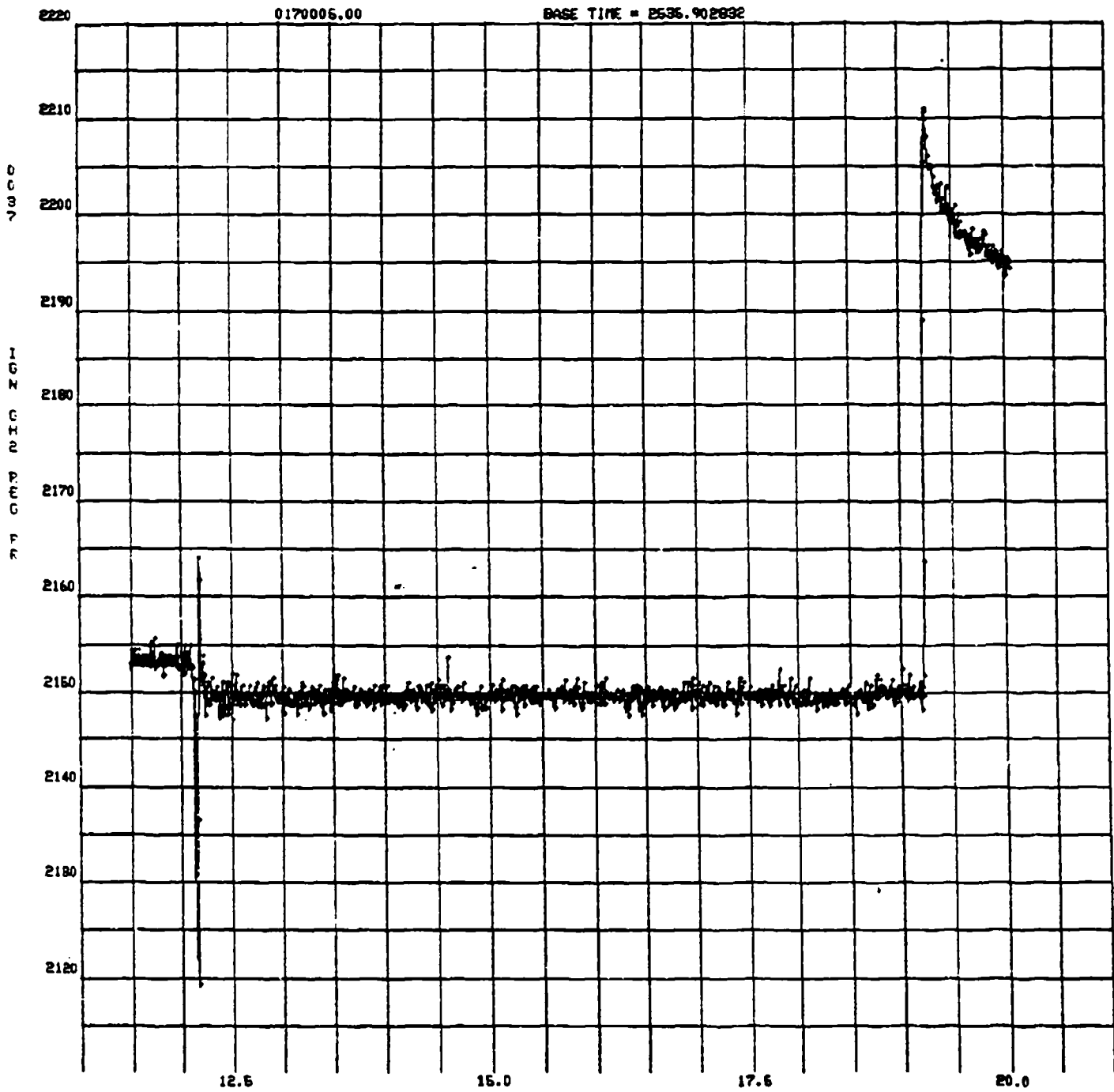

Appendix A:
Test 87-017-005 Time Based Data Plots (1/28/87)

005596200
020487 0022

0170006.00

BASE TIME = 2595.902832

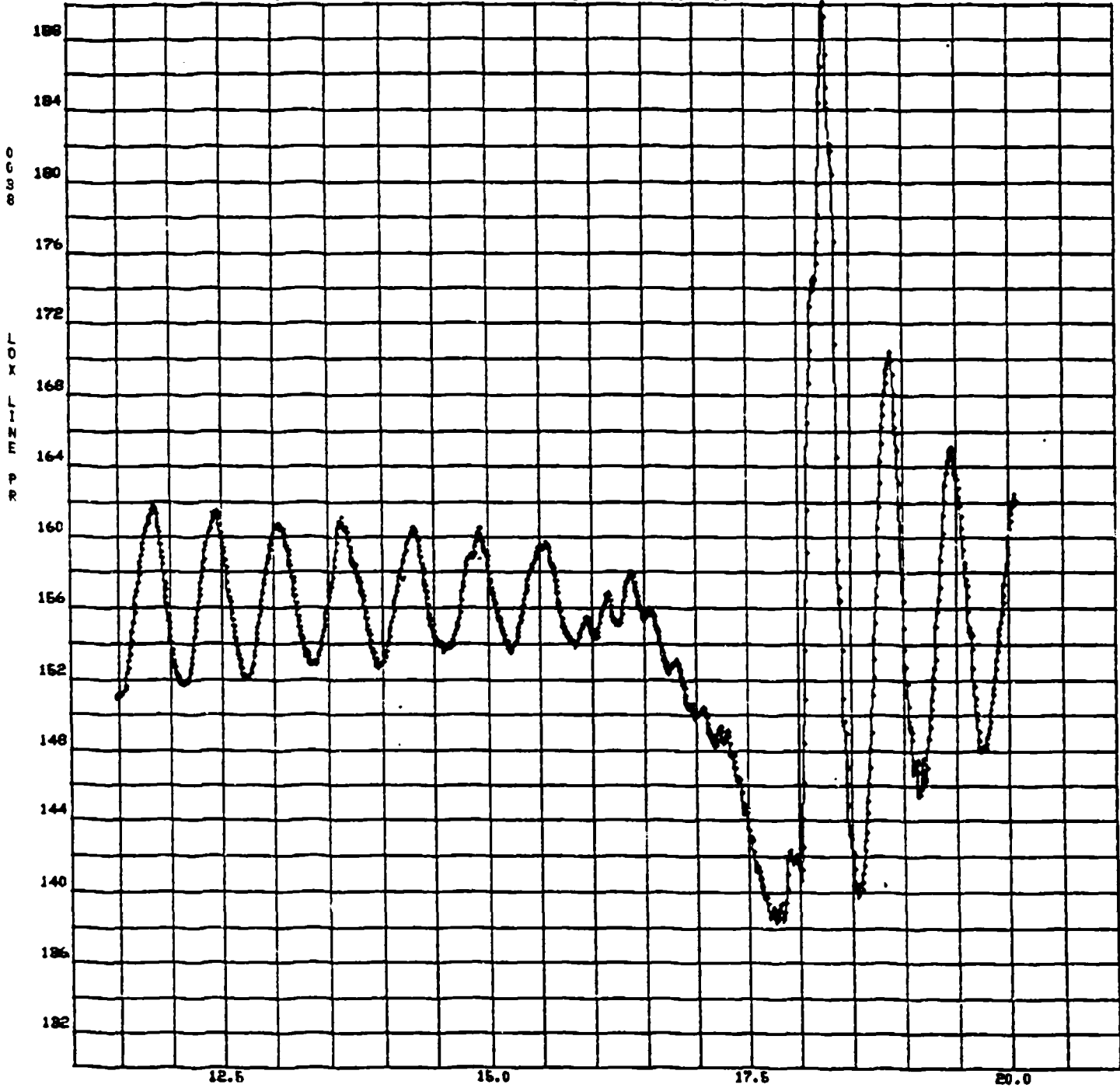

Appendix A: Test 87-017-005 Time Based Data Plots (1/28/87)

05596200
020487 0023

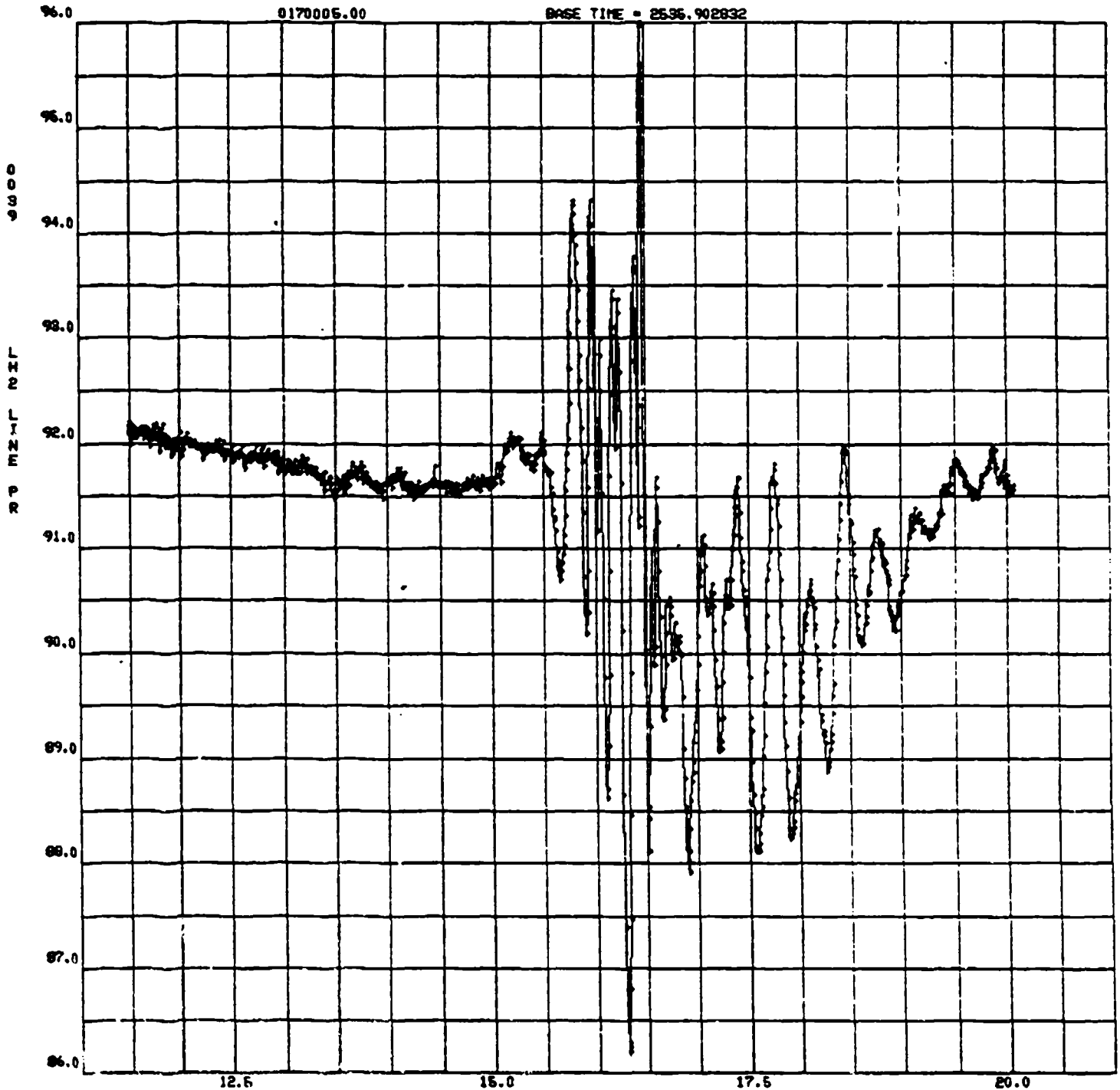

Appendix A: Test 87-017-005 Time Based Data Plots (1/28/87)

#05596200
020487 0024

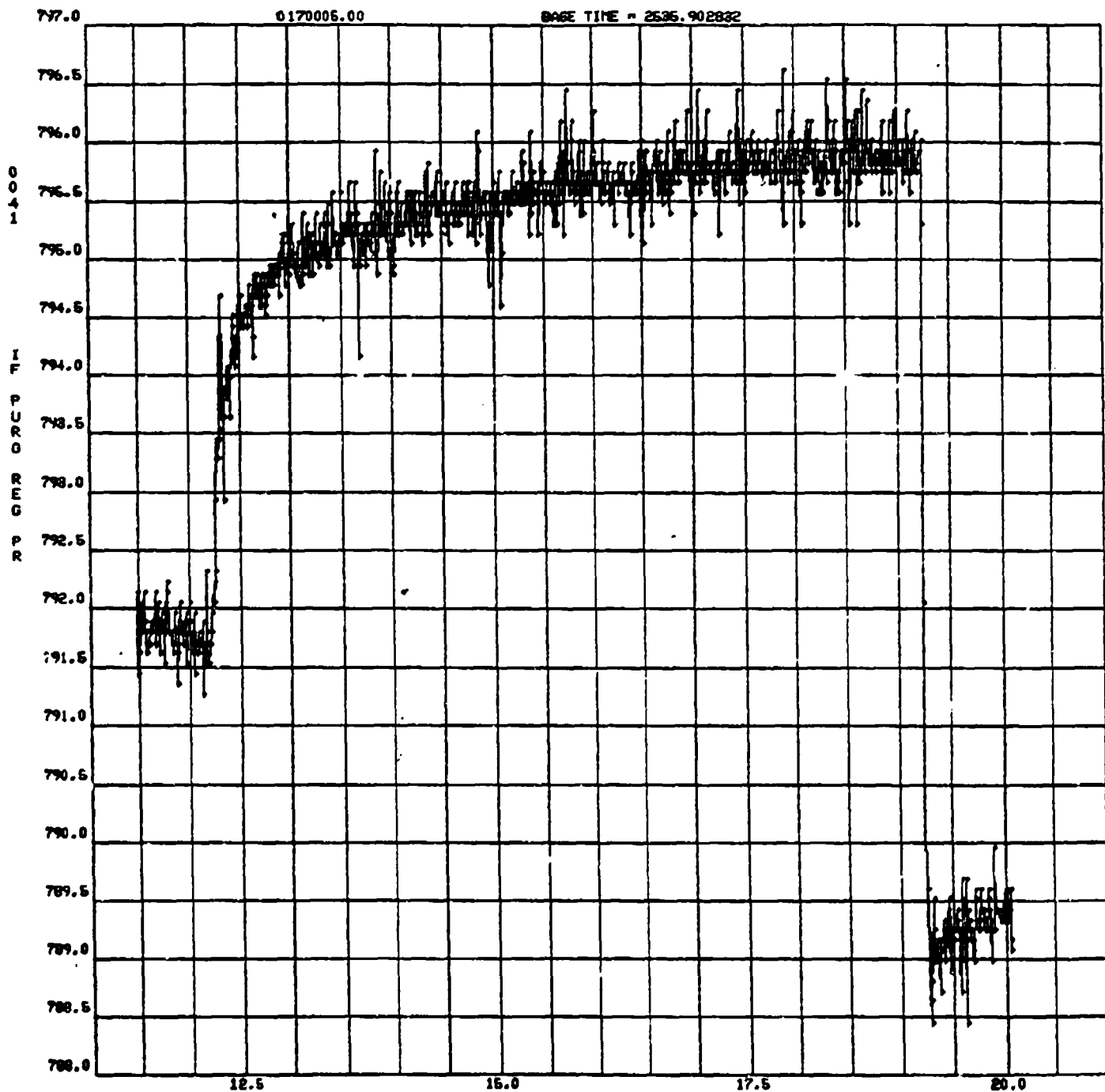

Appendix A: Test 87-017-005 Time Based Data Plots (1/28/87)

020487 0026

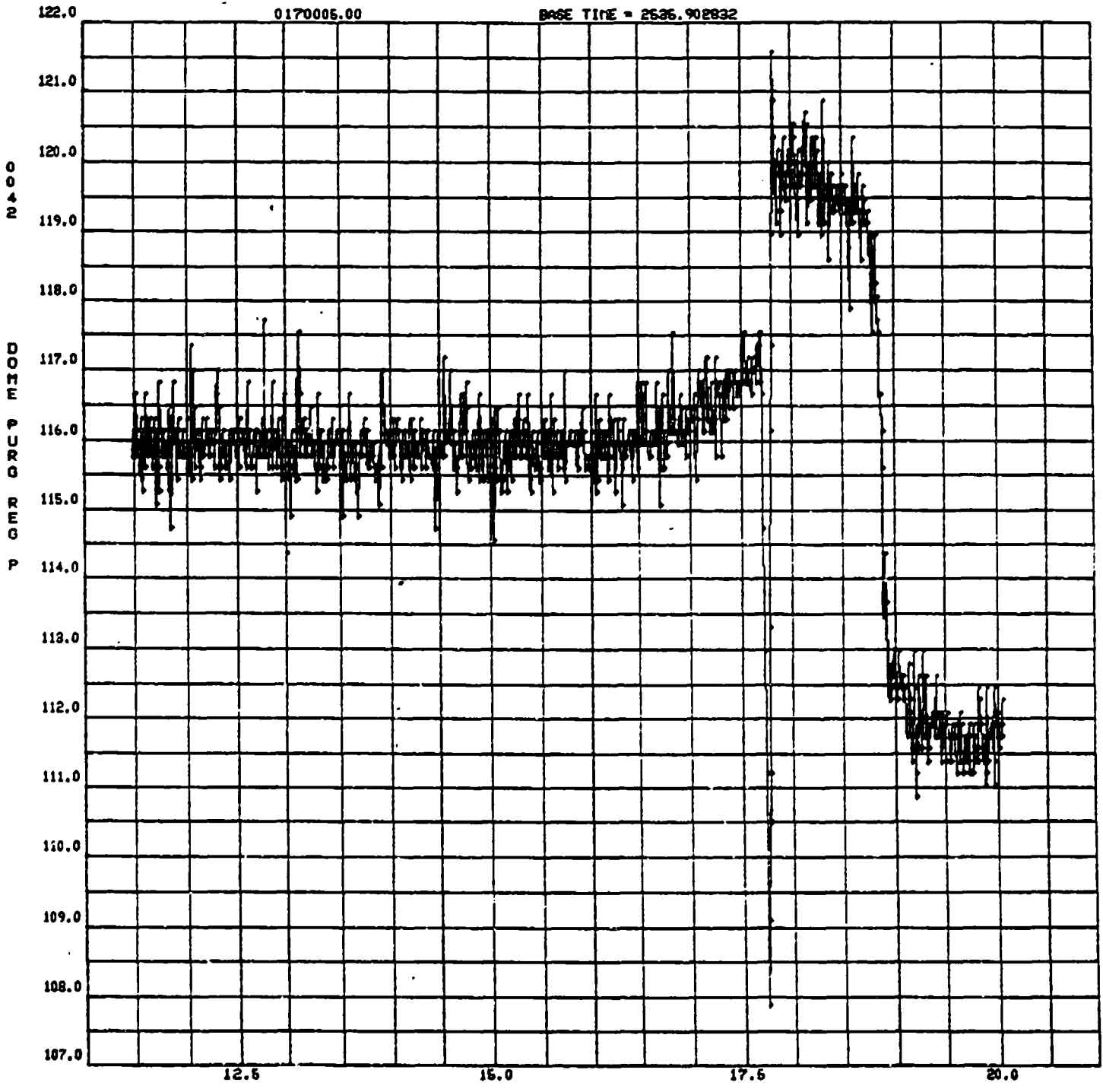

Appendix A: Test 87-017-005 Time Based Data Plots (1/28/87)

0170005.00
020487 6026

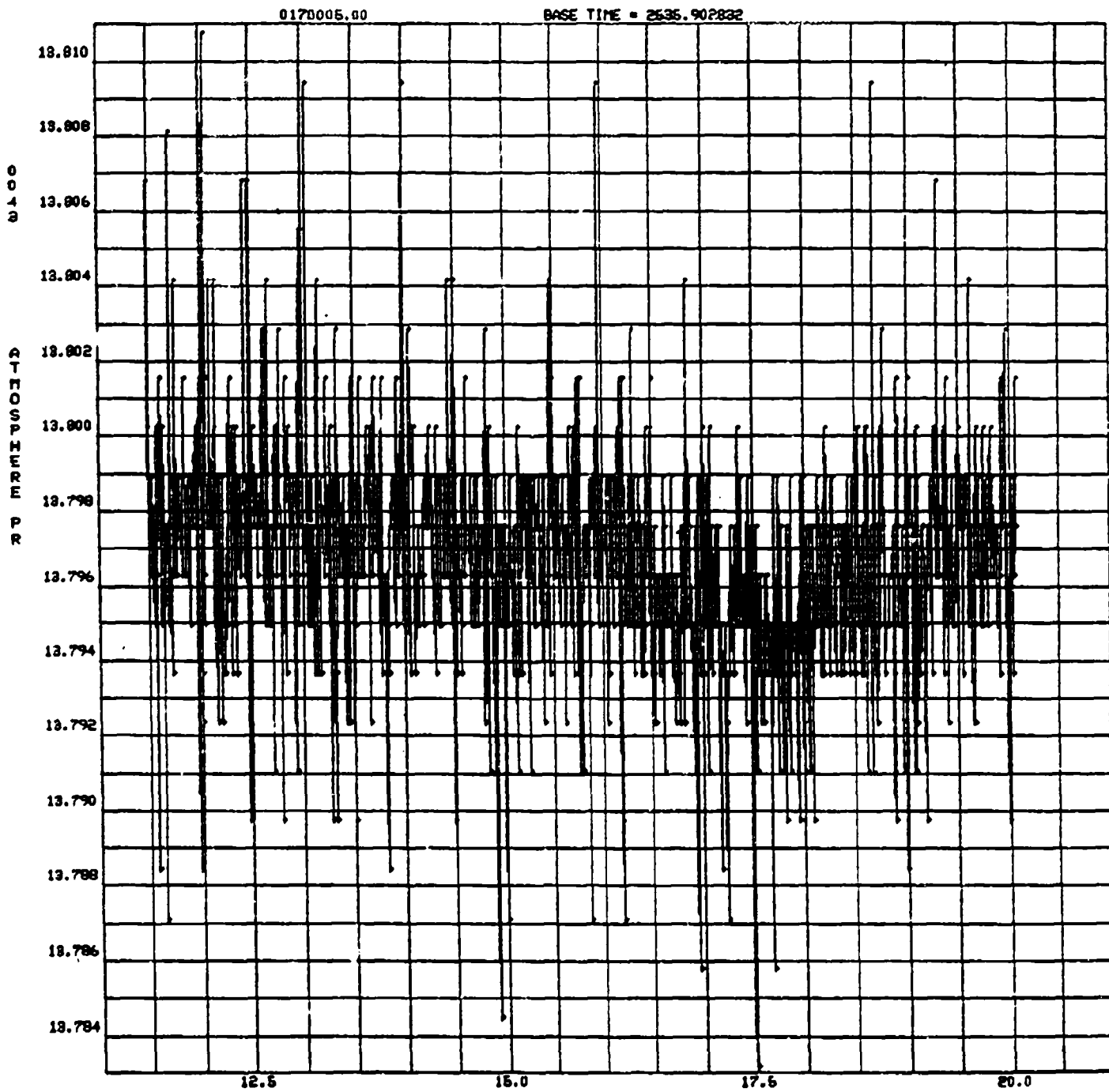

Appendix A:
Test 87-017-005 Time Based Data Plots (1/28/87)

05596200
020487 0027

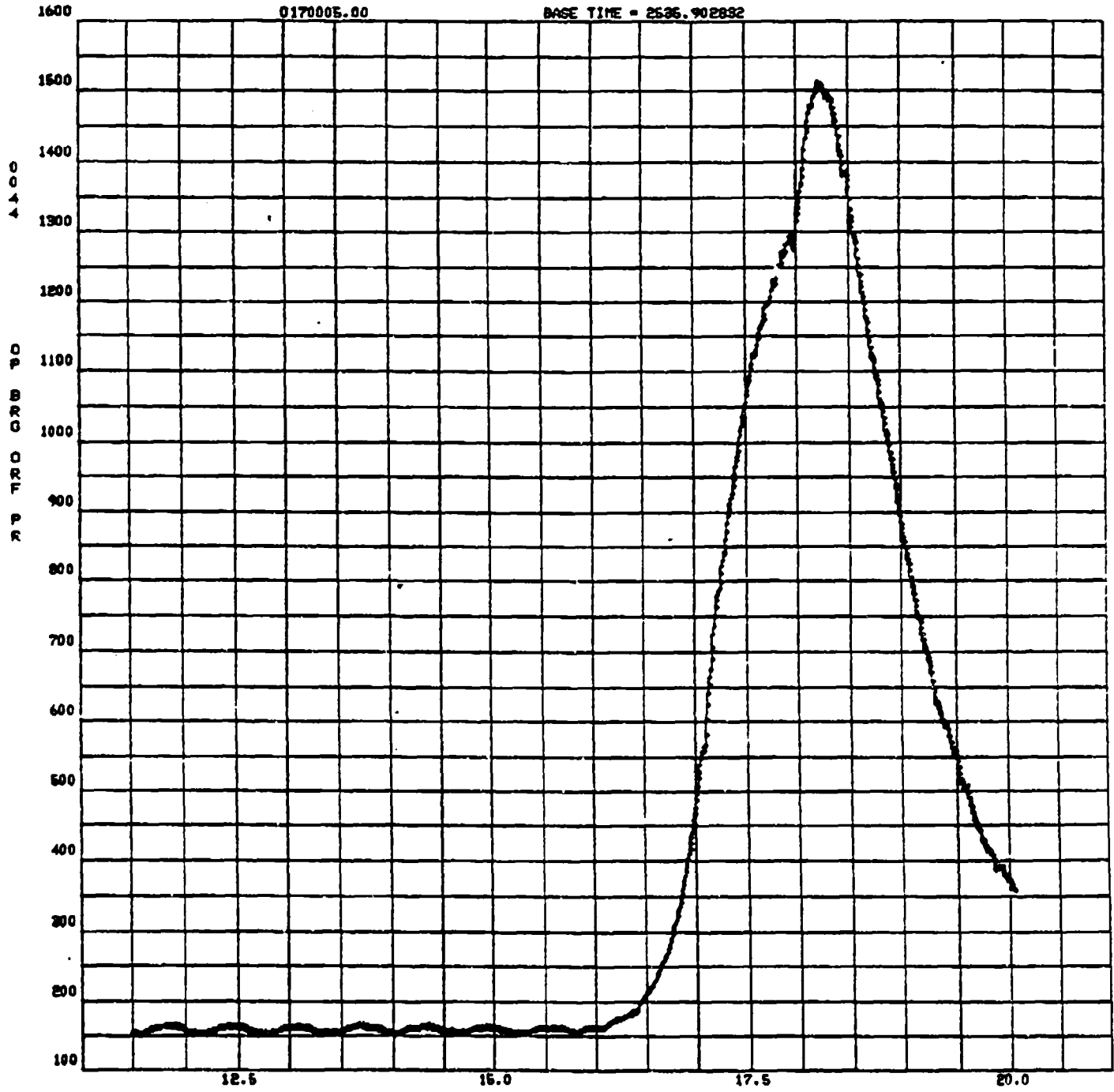

Appendix A: Test 87-017-005 Time Based Data Plots (1/28/87)

*055952004
020487 0029

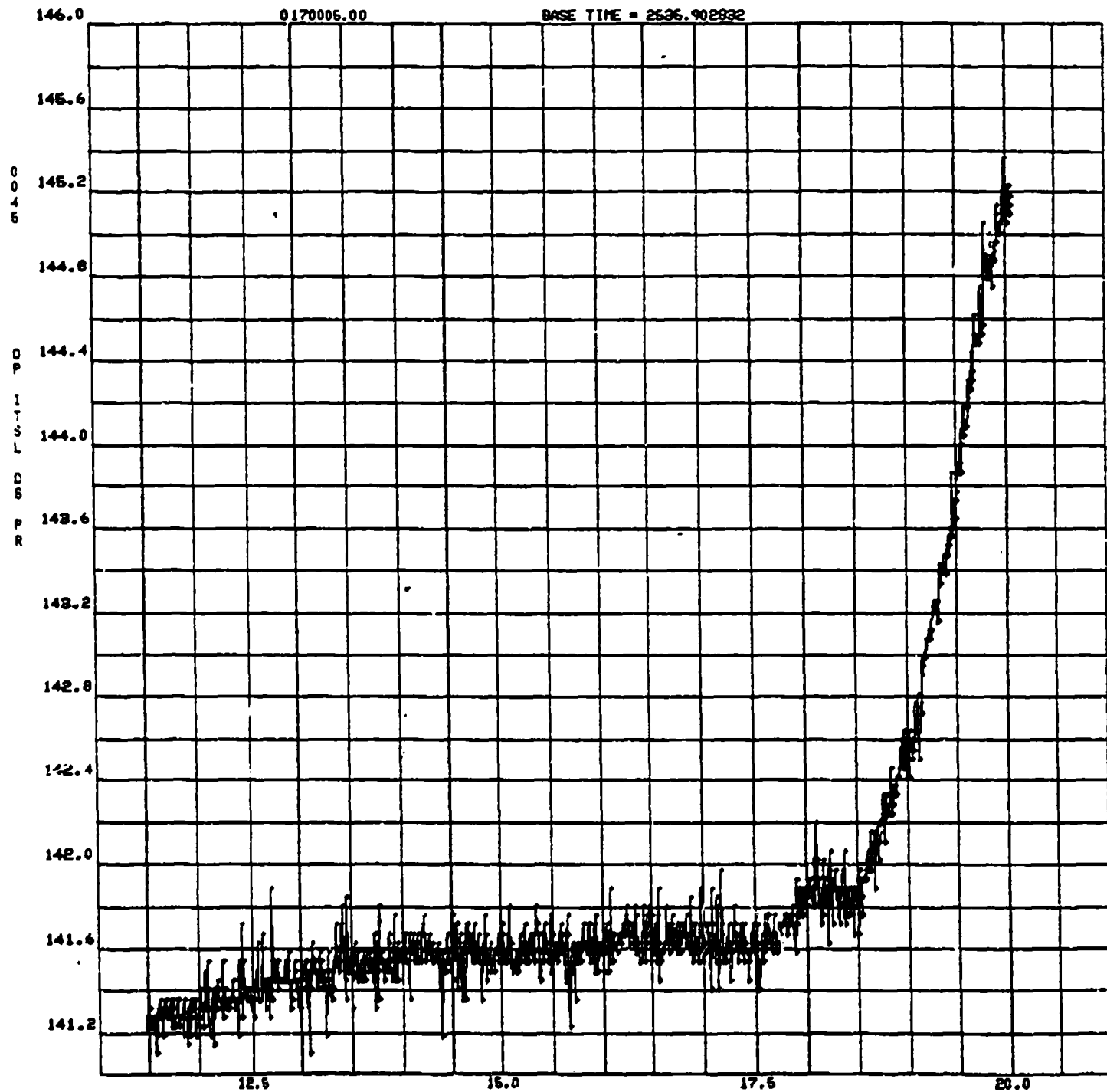

Appendix A: Test 87-017-005 Time Based Data Plots (1/28/87)

05595200
020467 0029

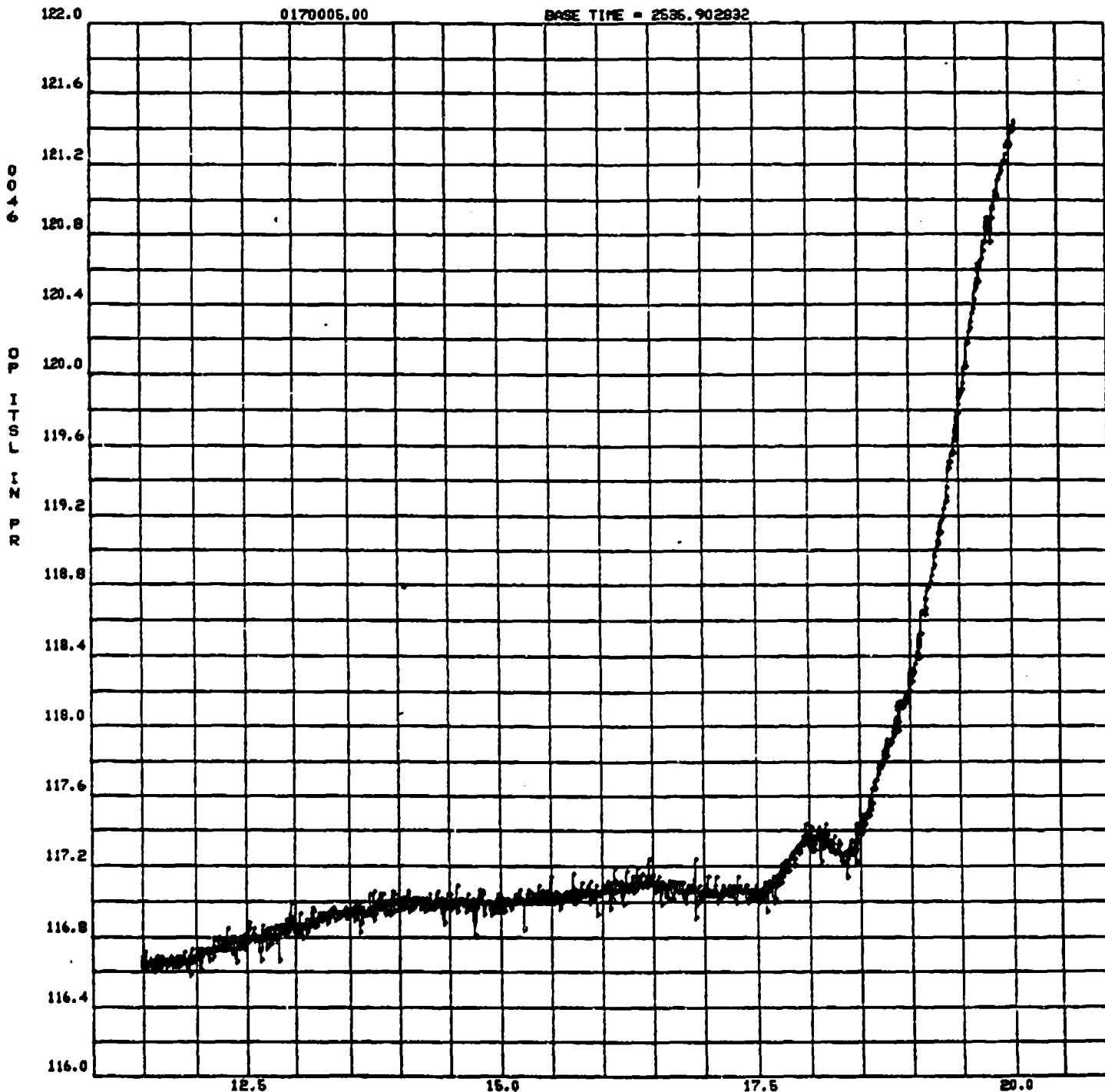

Appendix A: Test 87-017-005 Time Based Data Plots (1/28/87)

05595200
020487 0030

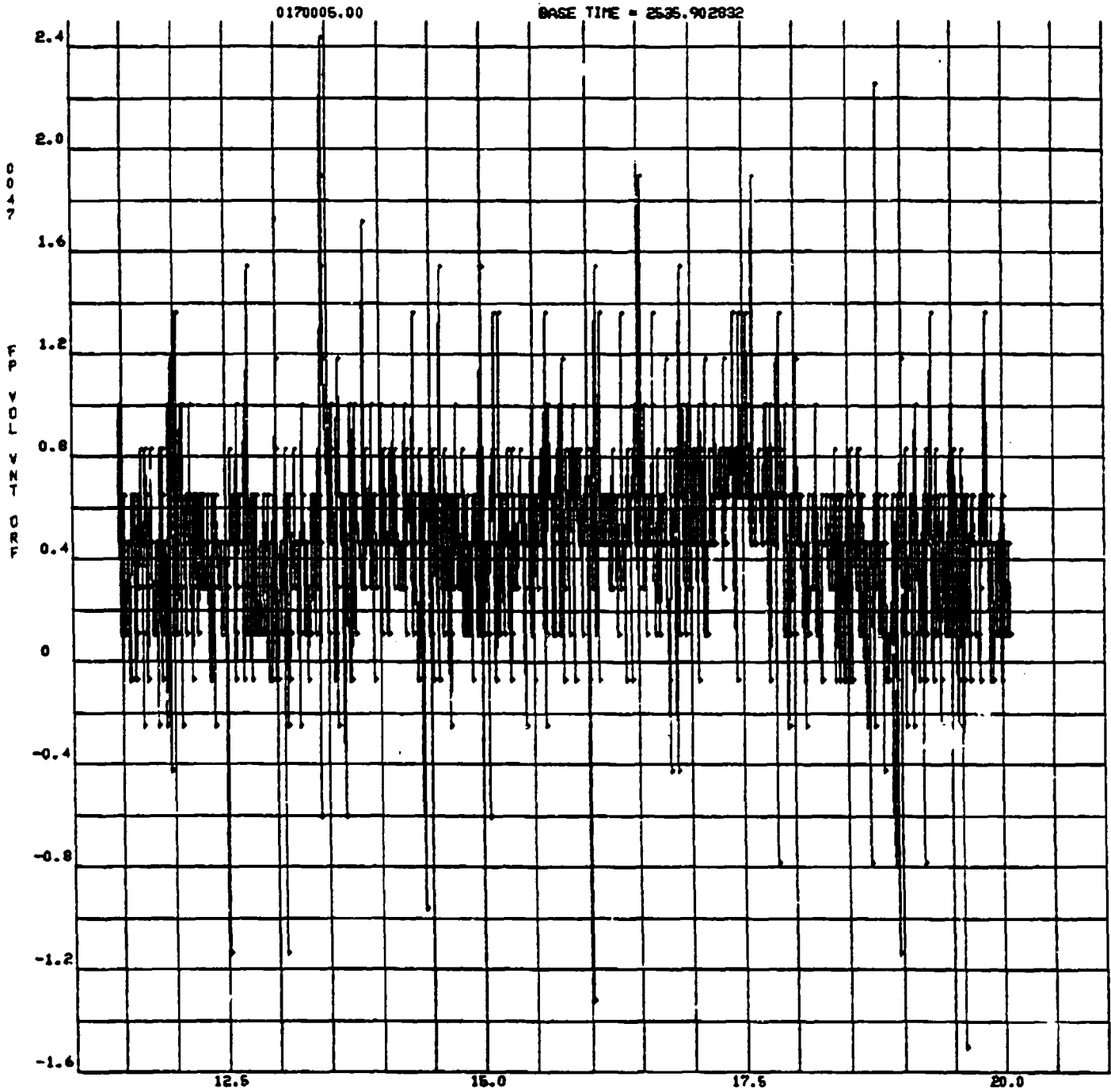

Appendix A: Test 87-017-005 Time Based Data Plots (1/28/87)

055962004
020467 0031

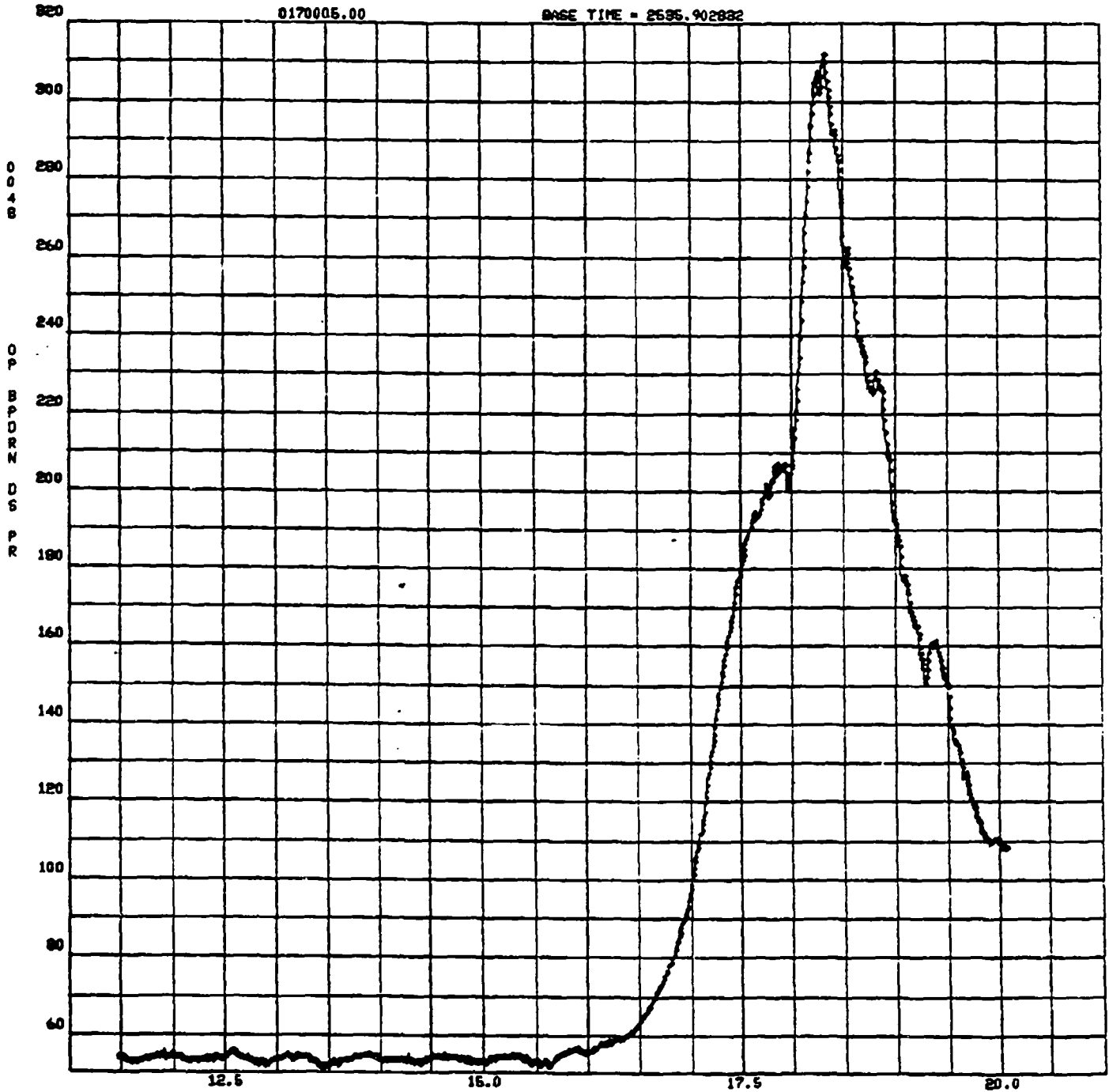

Appendix A: Test 87-017-005 Time Based Data Plots (1/28/87)

05596200
020487 0032

0170005.00

BASE TIME = 2535.902632

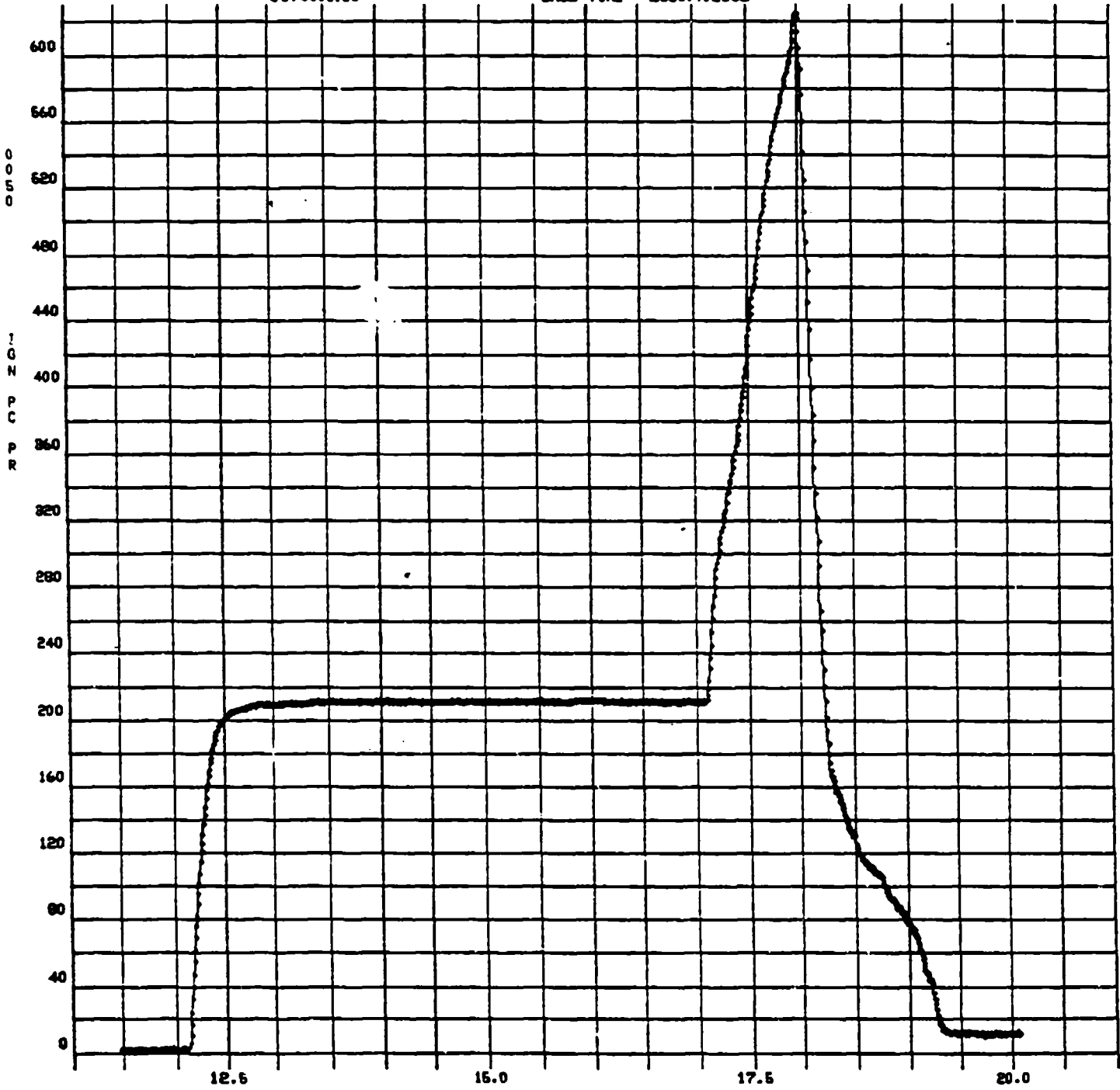

Appendix A: Test 87-017-005 Time Based Data Plots (1/28/87)

05596200
020487 0012

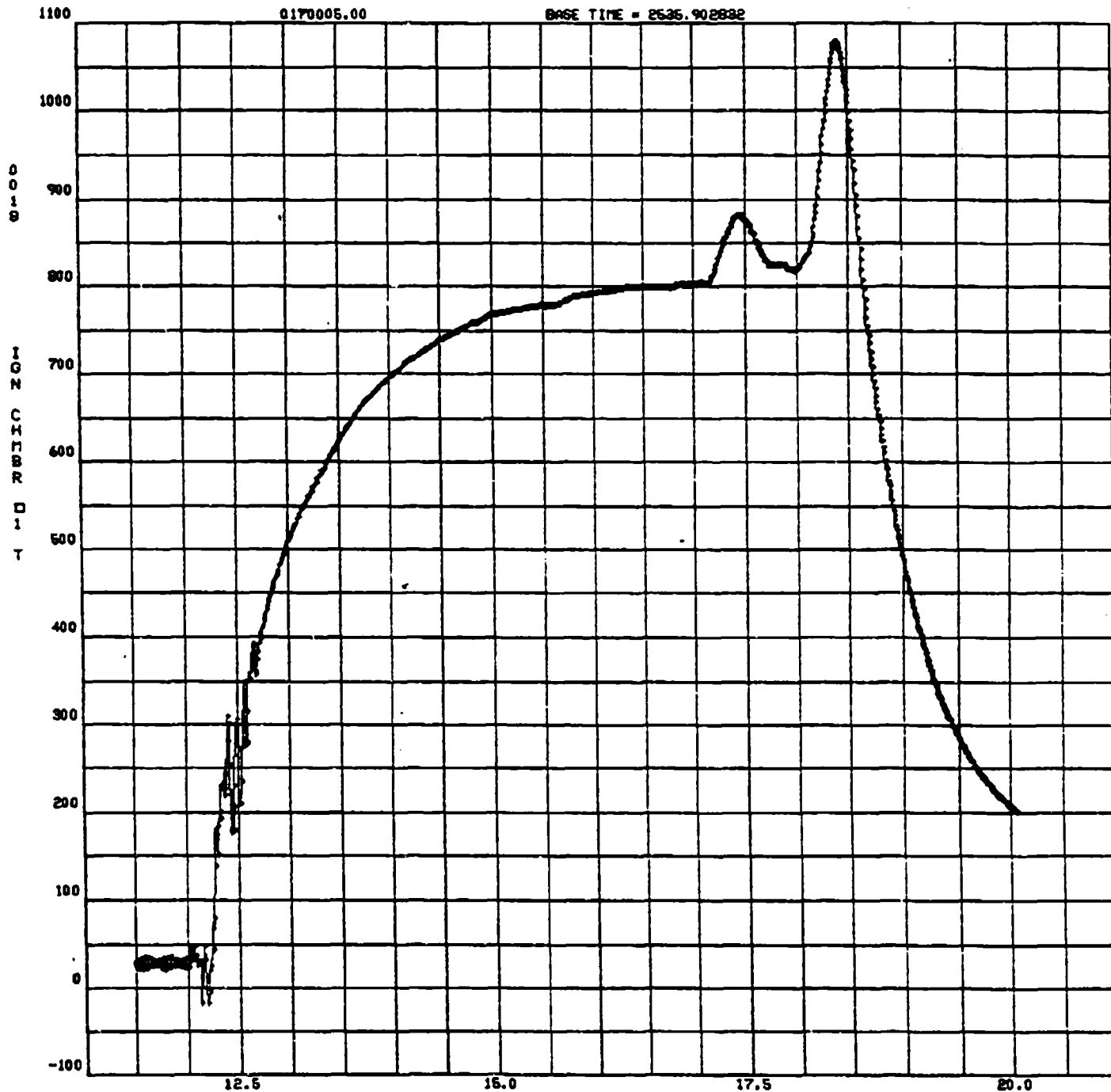

Appendix A: Test 87-017-005 Time Based Data Plots (1/28/87)

05596200
020487 0013

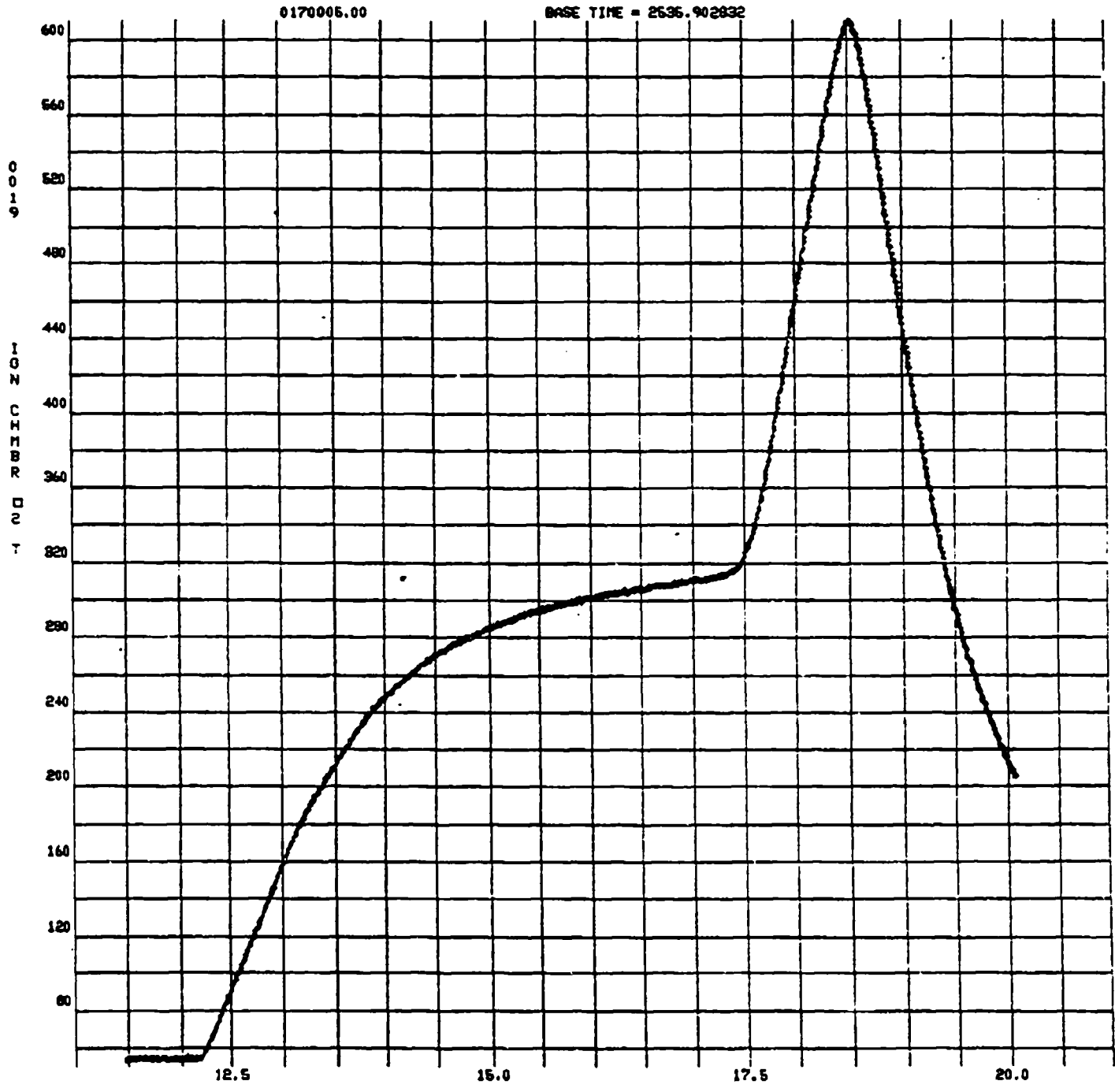

Appendix A: Test 87-017-005 Time Based Data Plots (1/28/87)

005596200
020487 0014

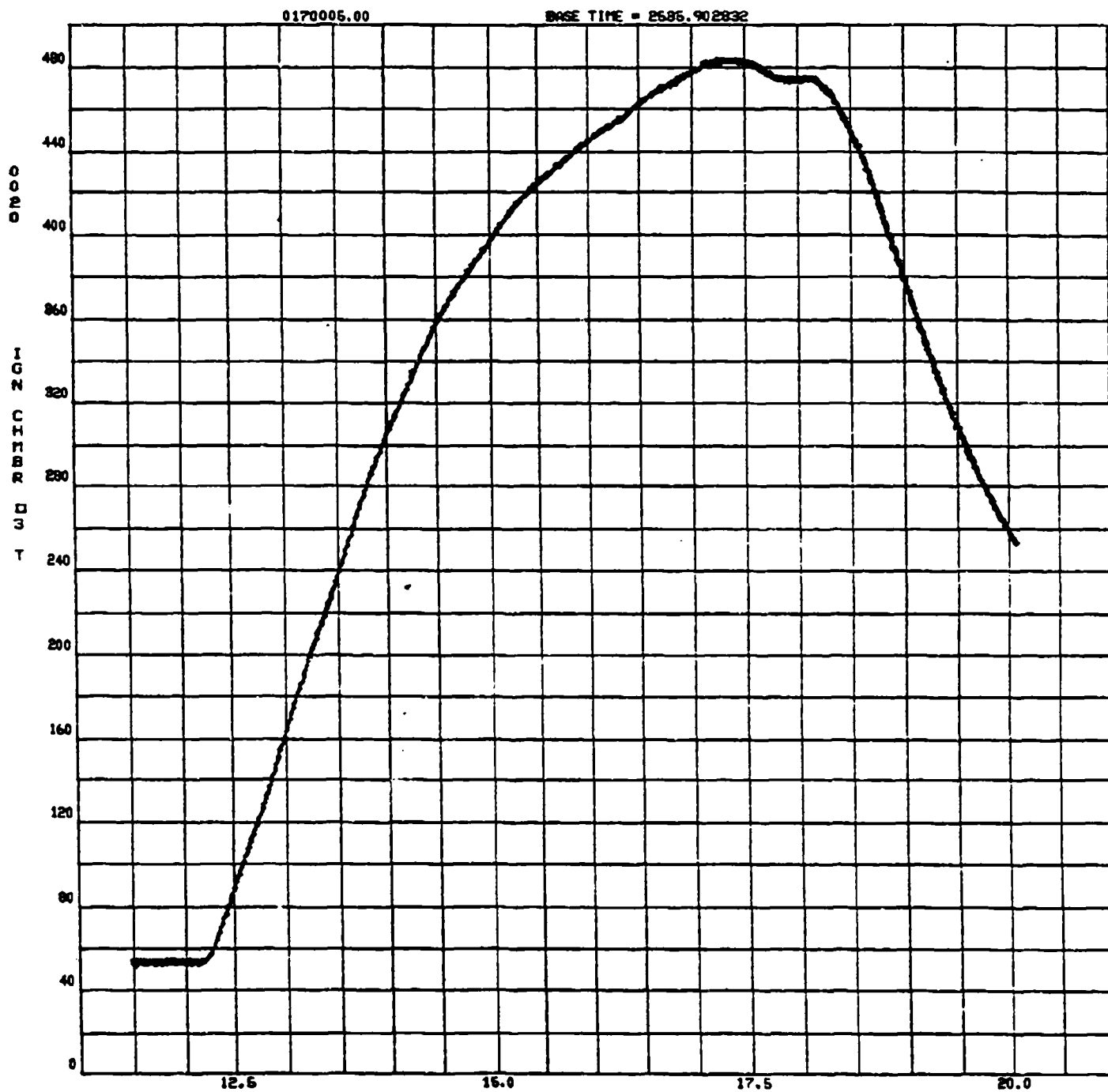

Appendix A: Test 87-017-005 Time Based Data Plots (1/28/87)

065952004
020487 0015

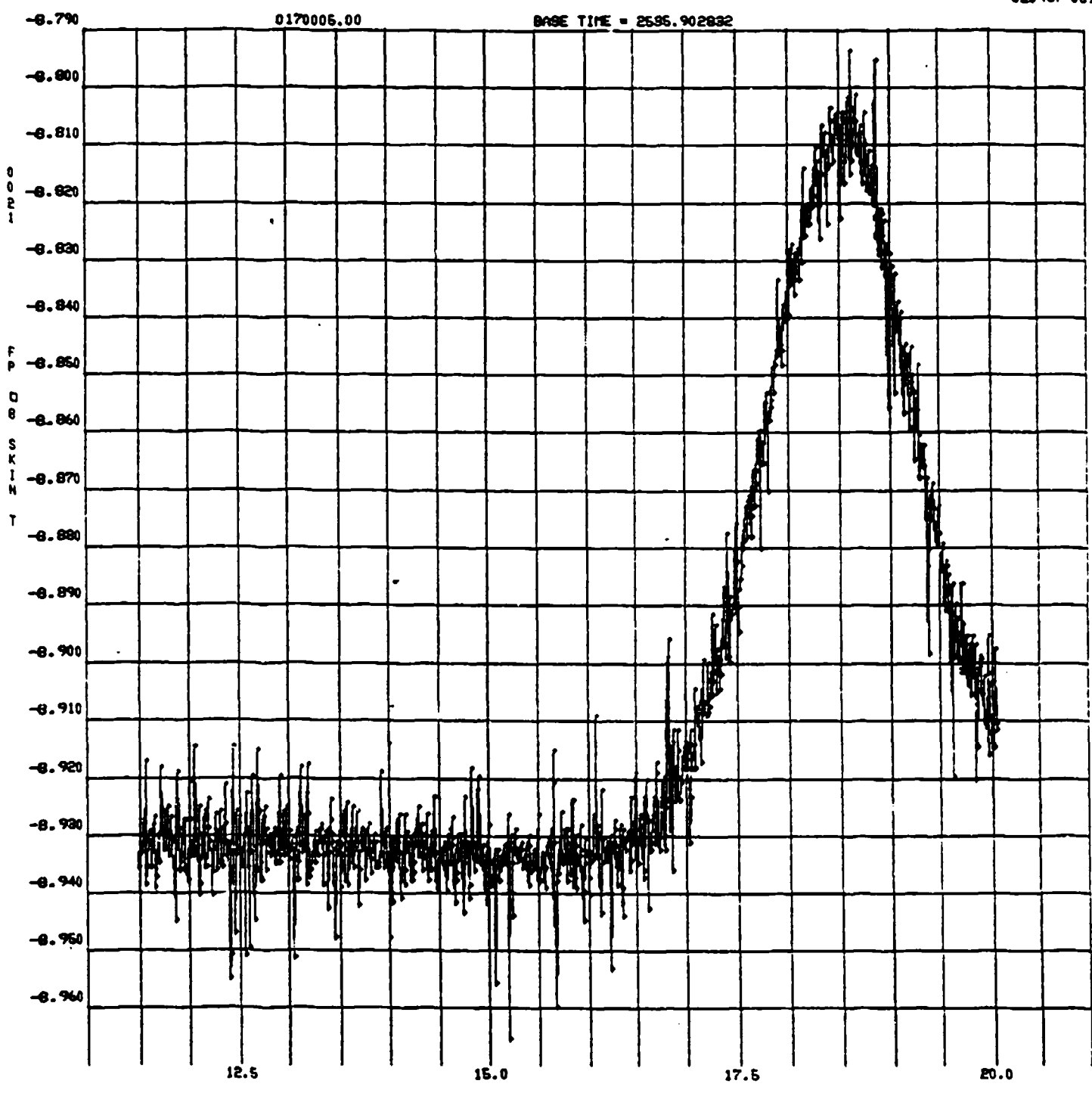

Appendix A: Test 87-017-005 Time Based Data Plots (1/28/87)

05595200
020487 0016

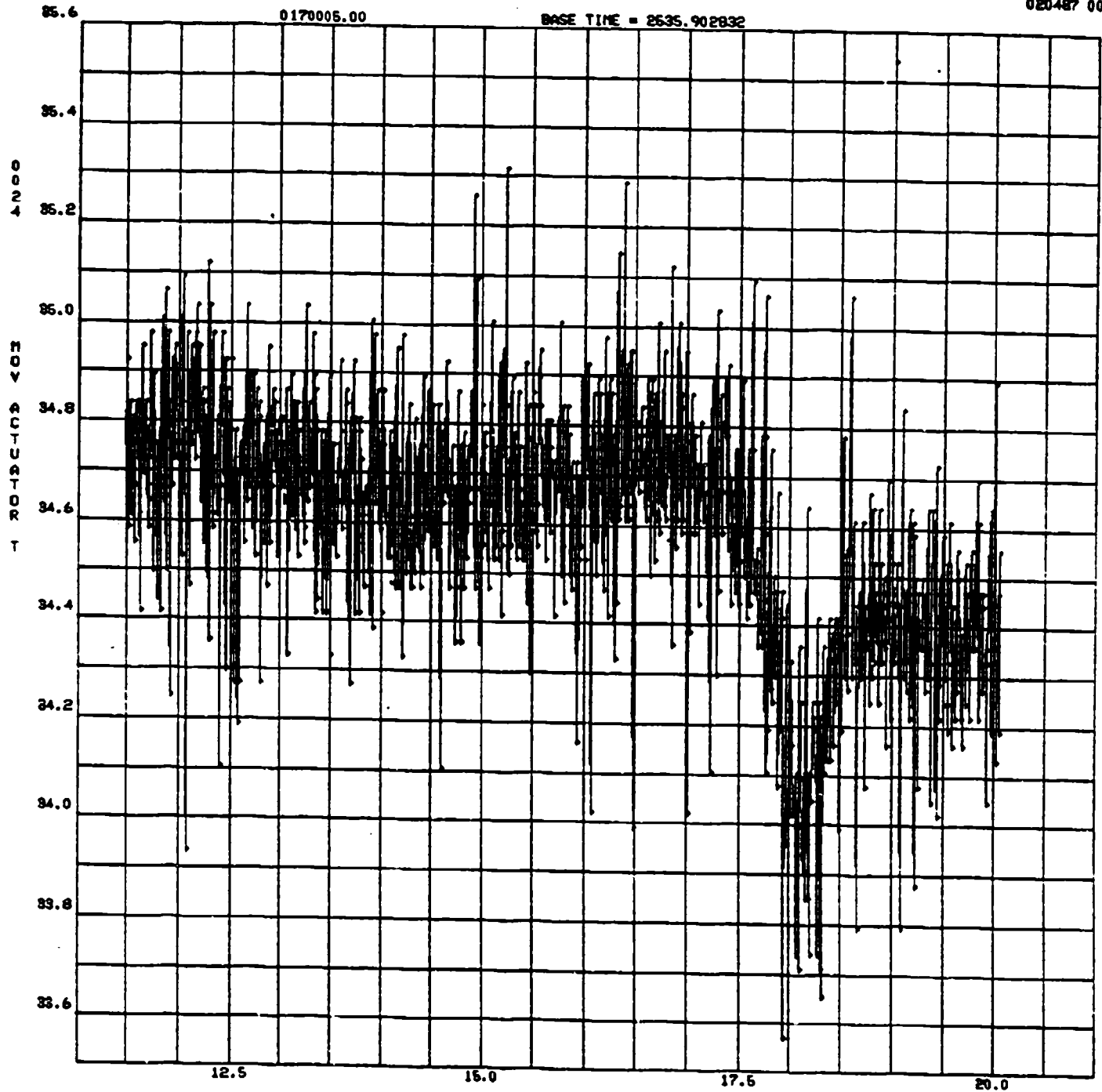

Appendix A: Test 87-017-005 Time Based Data Plots (1/28/87)

05595200
020487 0017

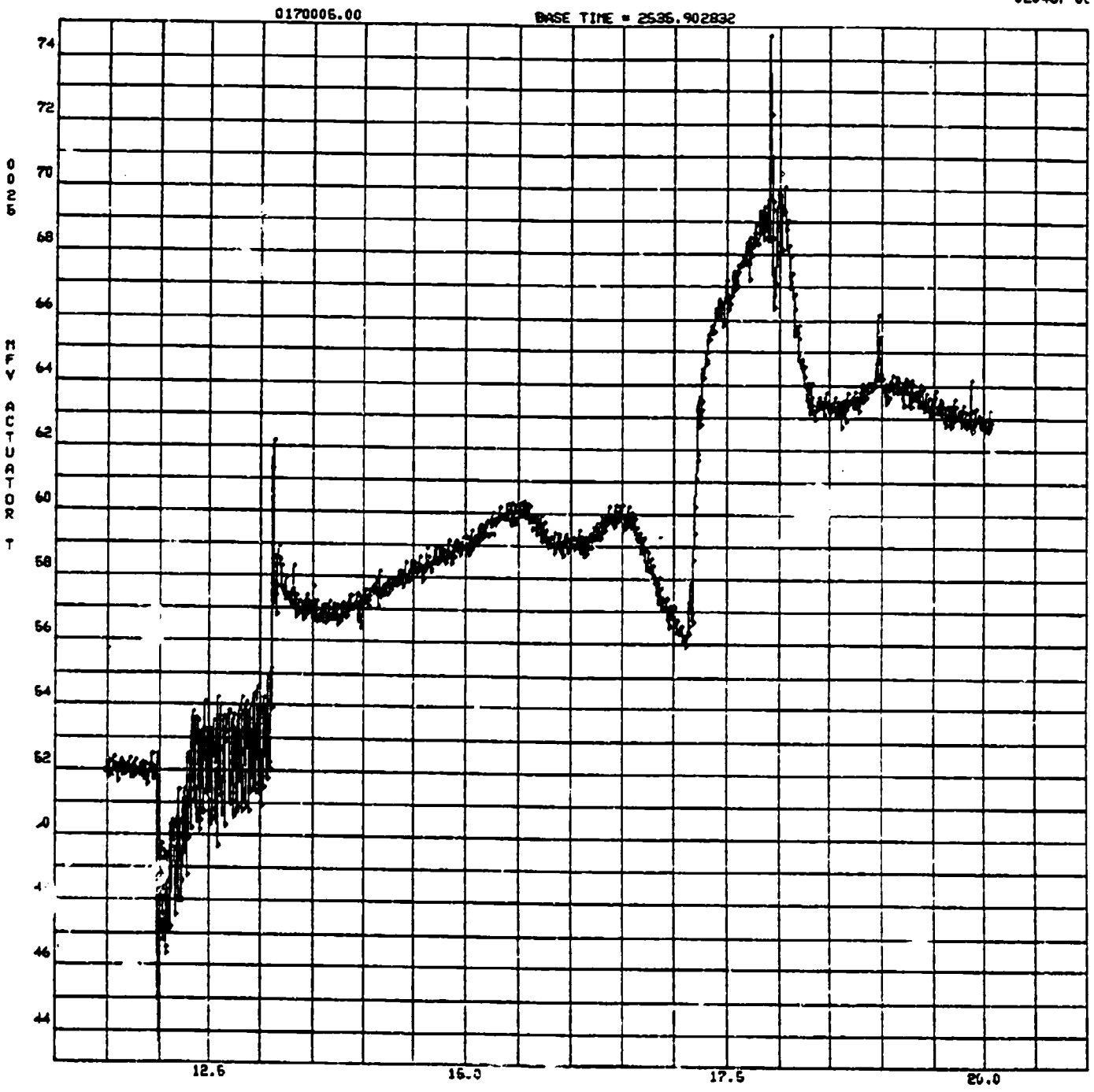

Appendix A: Test 87-017-005 Time Based Data Plots (1/28/87)

06596200
020487 0018

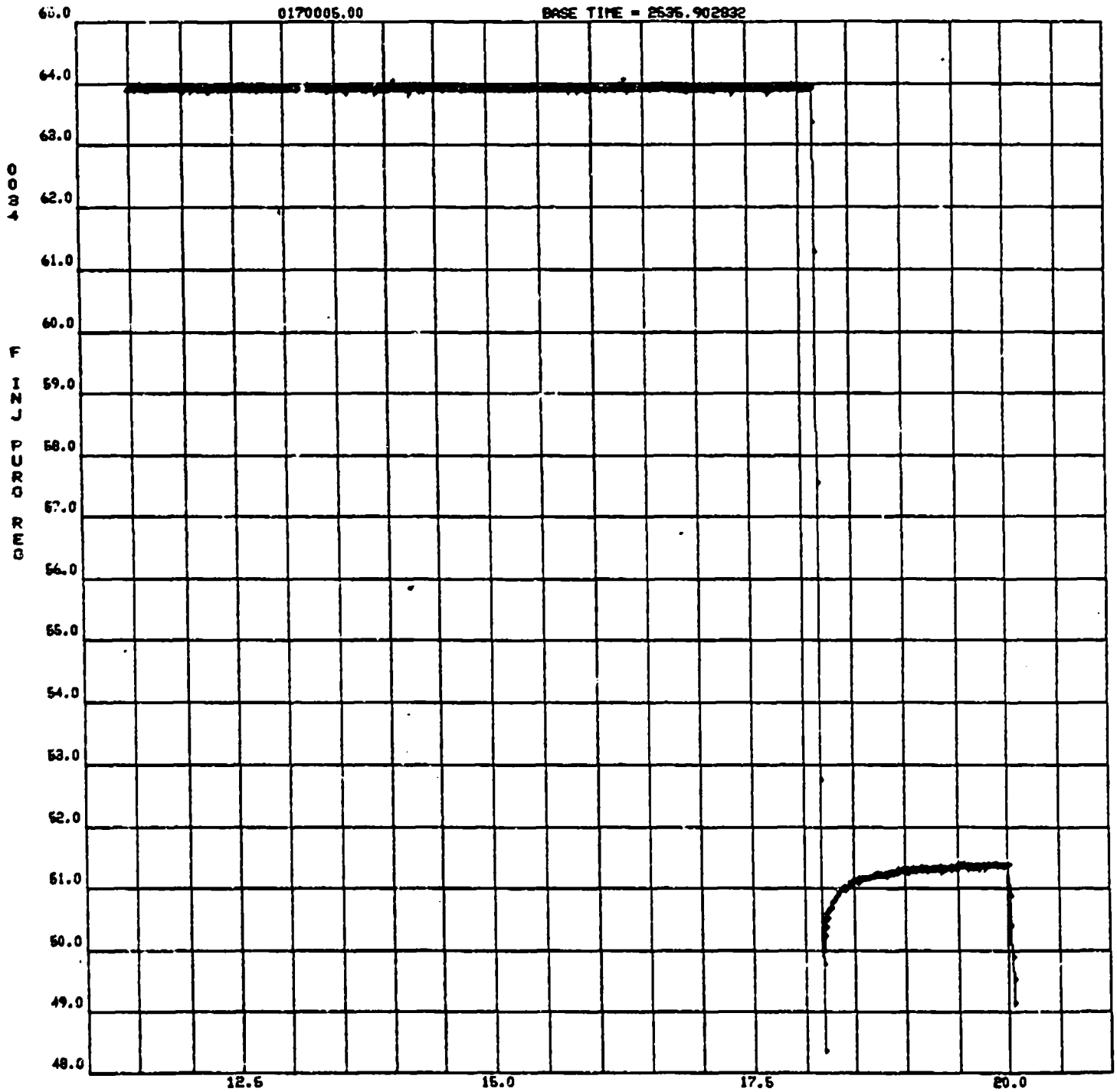

Appendix A: Test 87-017-005 Time Based Data Plots (1/28/87)

SUBSTCUU#
020487 0019

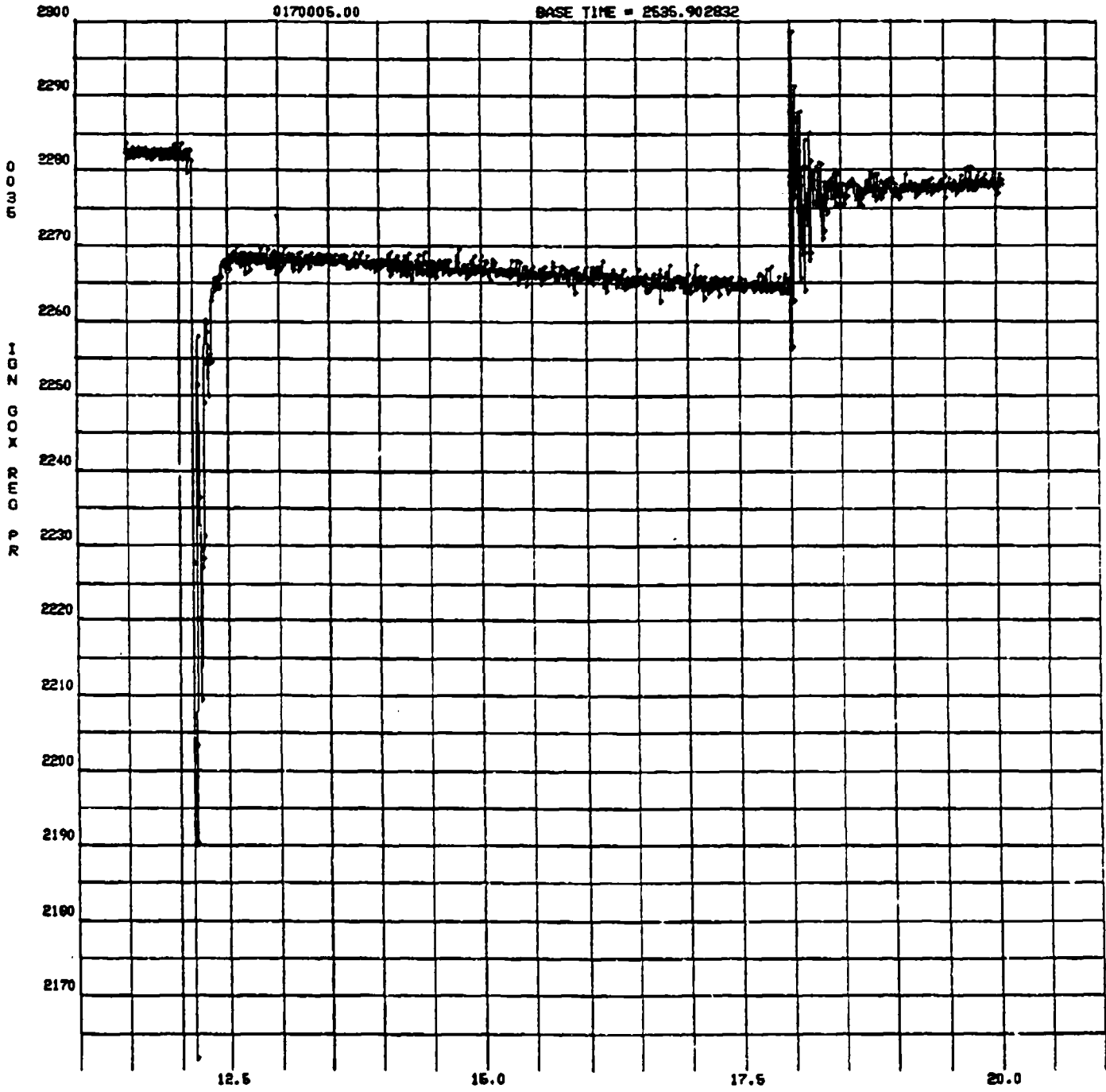

Appendix A: Test 87-017-005 Time Based Data Plots (1/28/87)

055962004
020487 0003

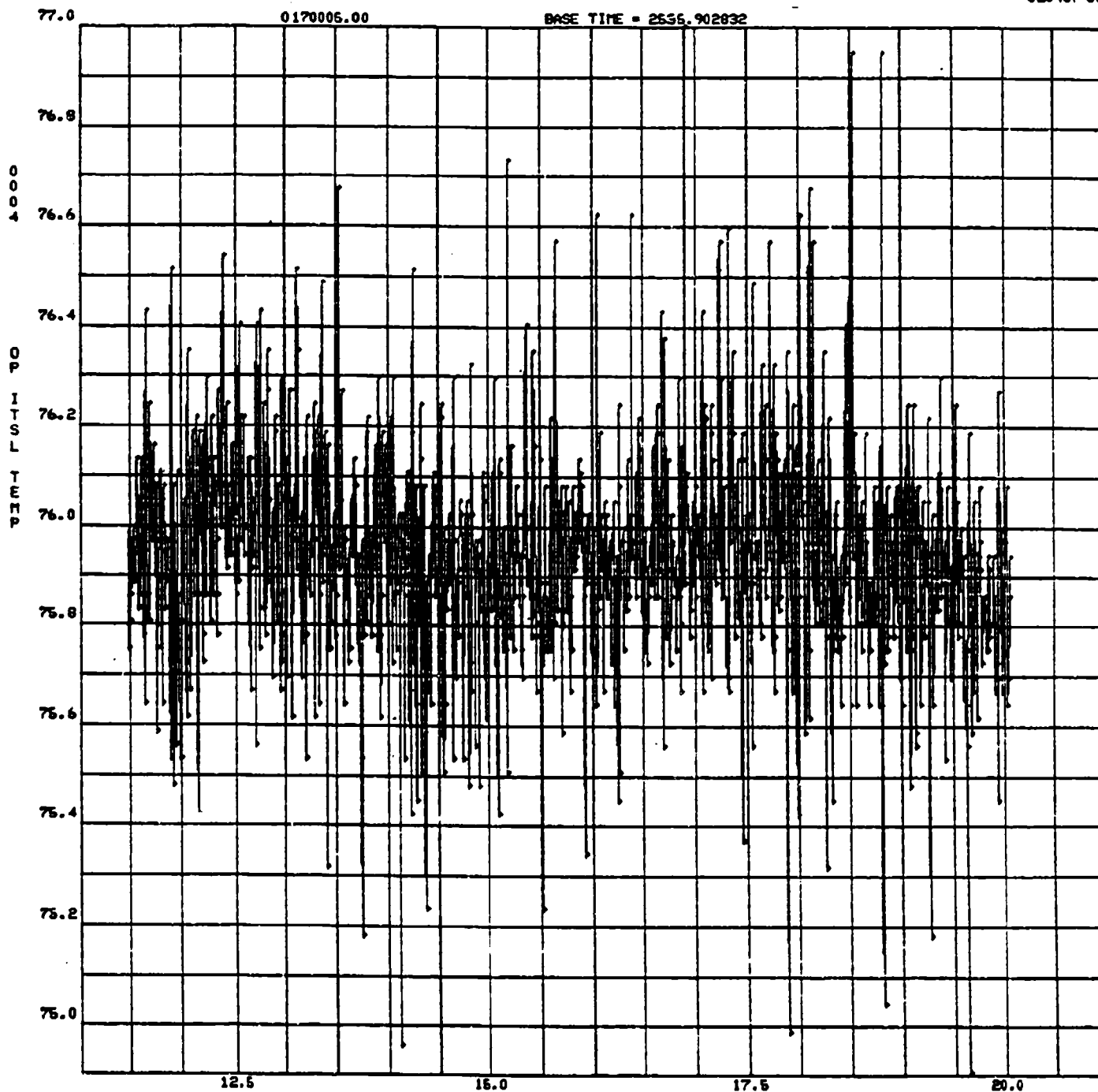

Appendix A: Test 87-017-005 Time Based Data Plots (1/28/87)

405595208
020487 0084

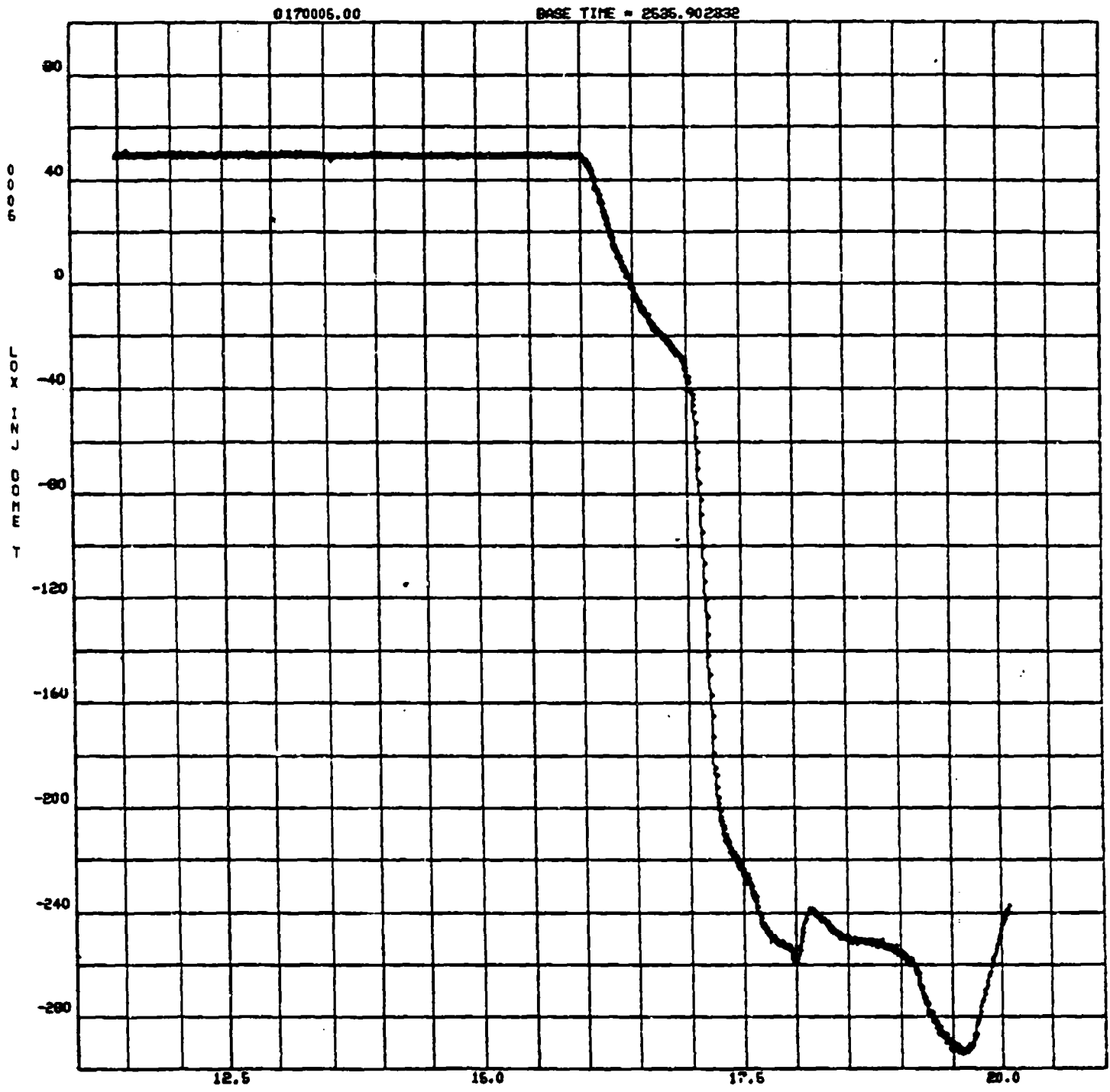

Appendix A: Test 87-017-005 Time Based Data Plots (1/28/87)

020487 0005

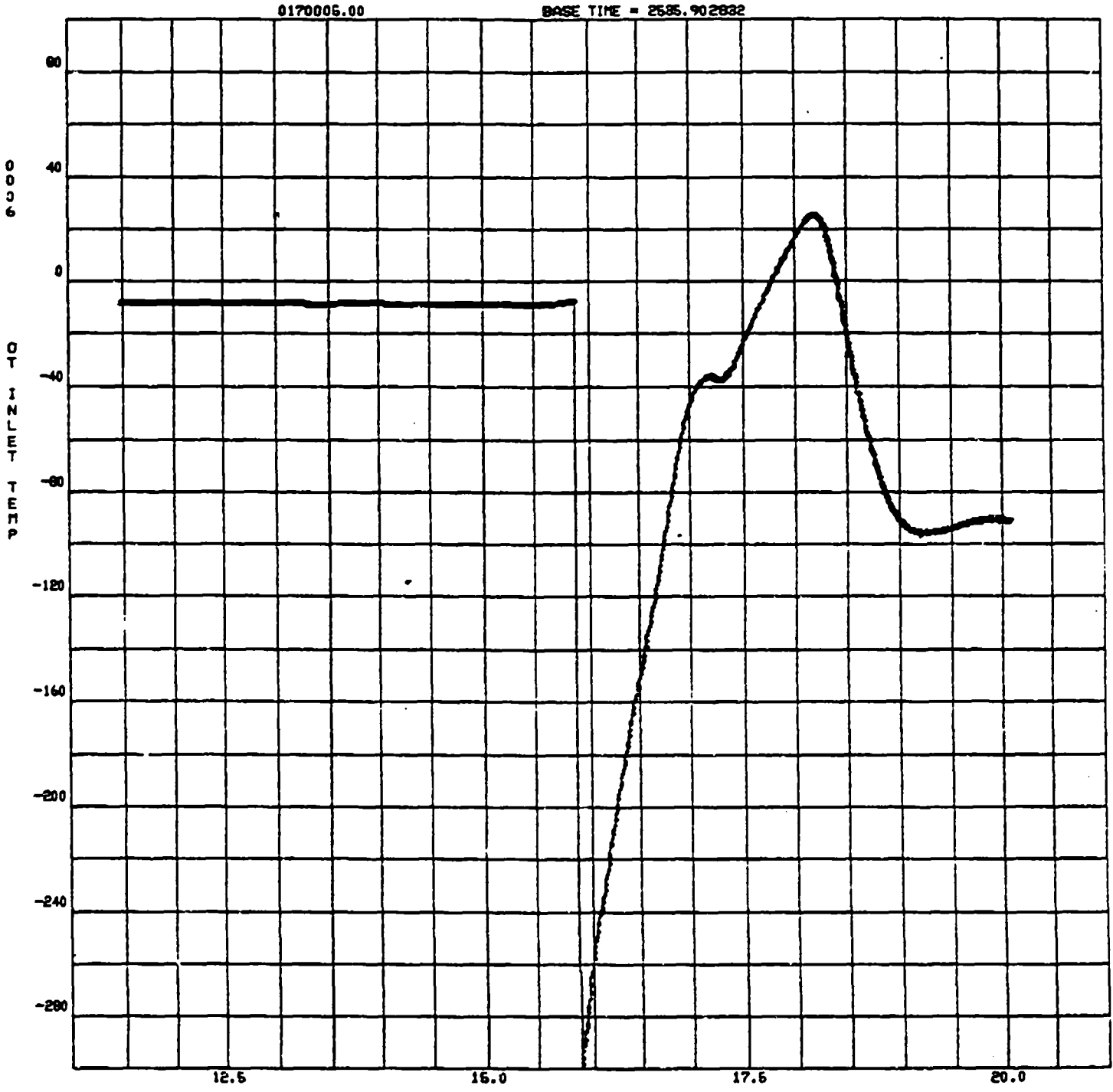

Appendix A: Test 87-017-005 Time Based Data Plots (1/28/87)

0155962004
020487 0006

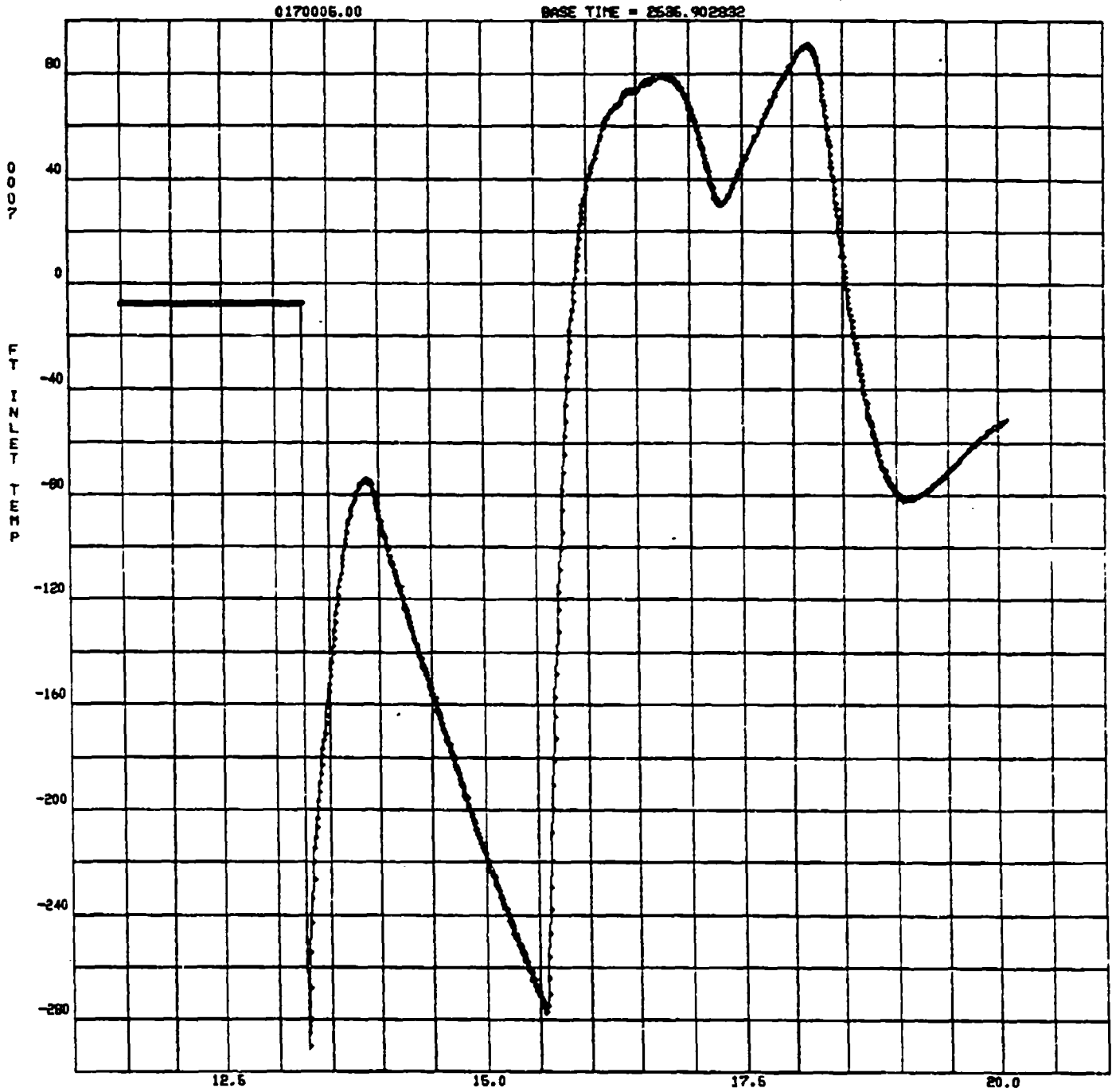

Appendix A: Test 87-017-005 Time Based Data Plots (1/28/87)

05596200
020487 0007

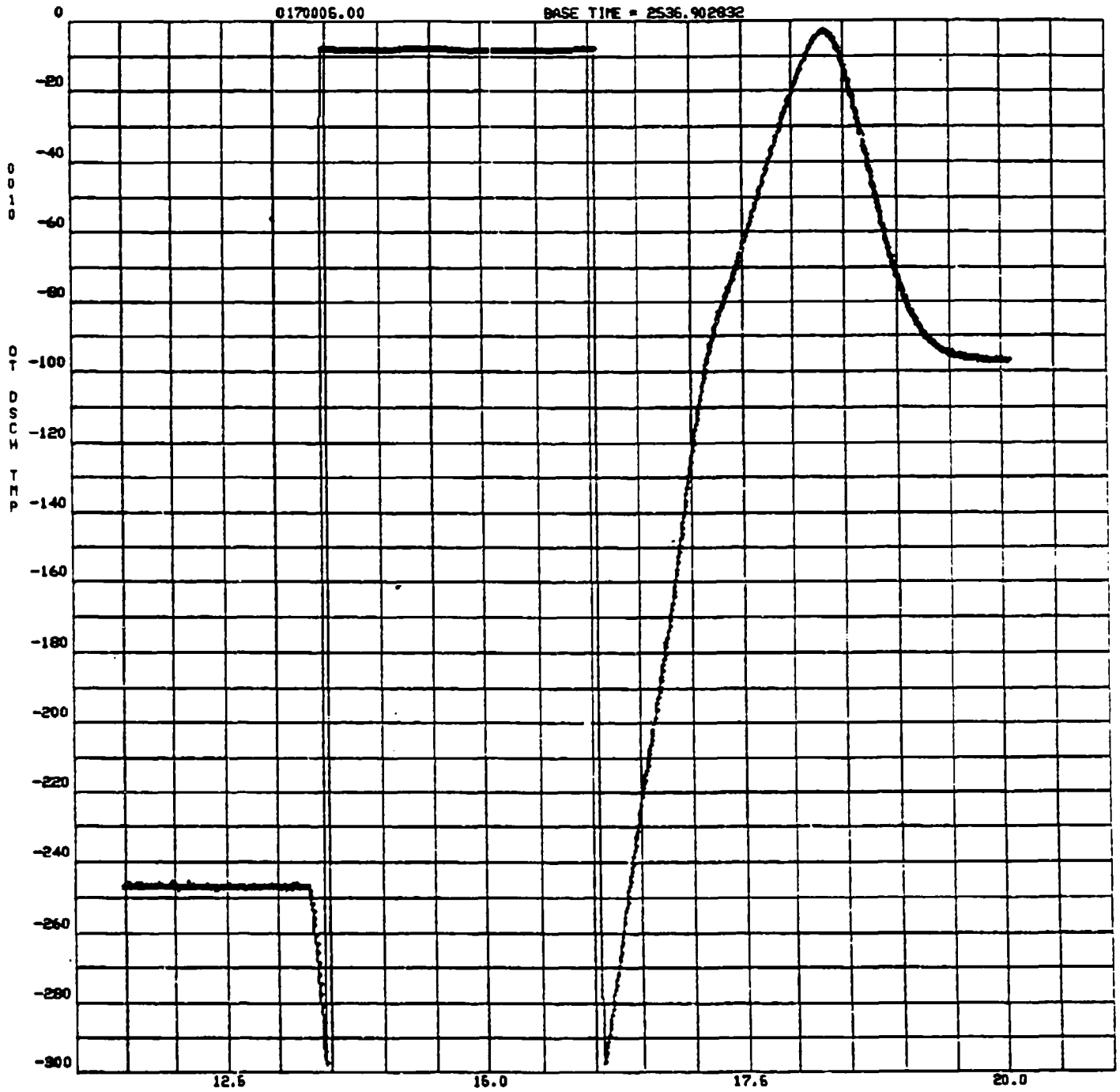

Appendix A: Test 87-017-005 Time Based Data Plots (1/28/87)

405595200
020487 0008

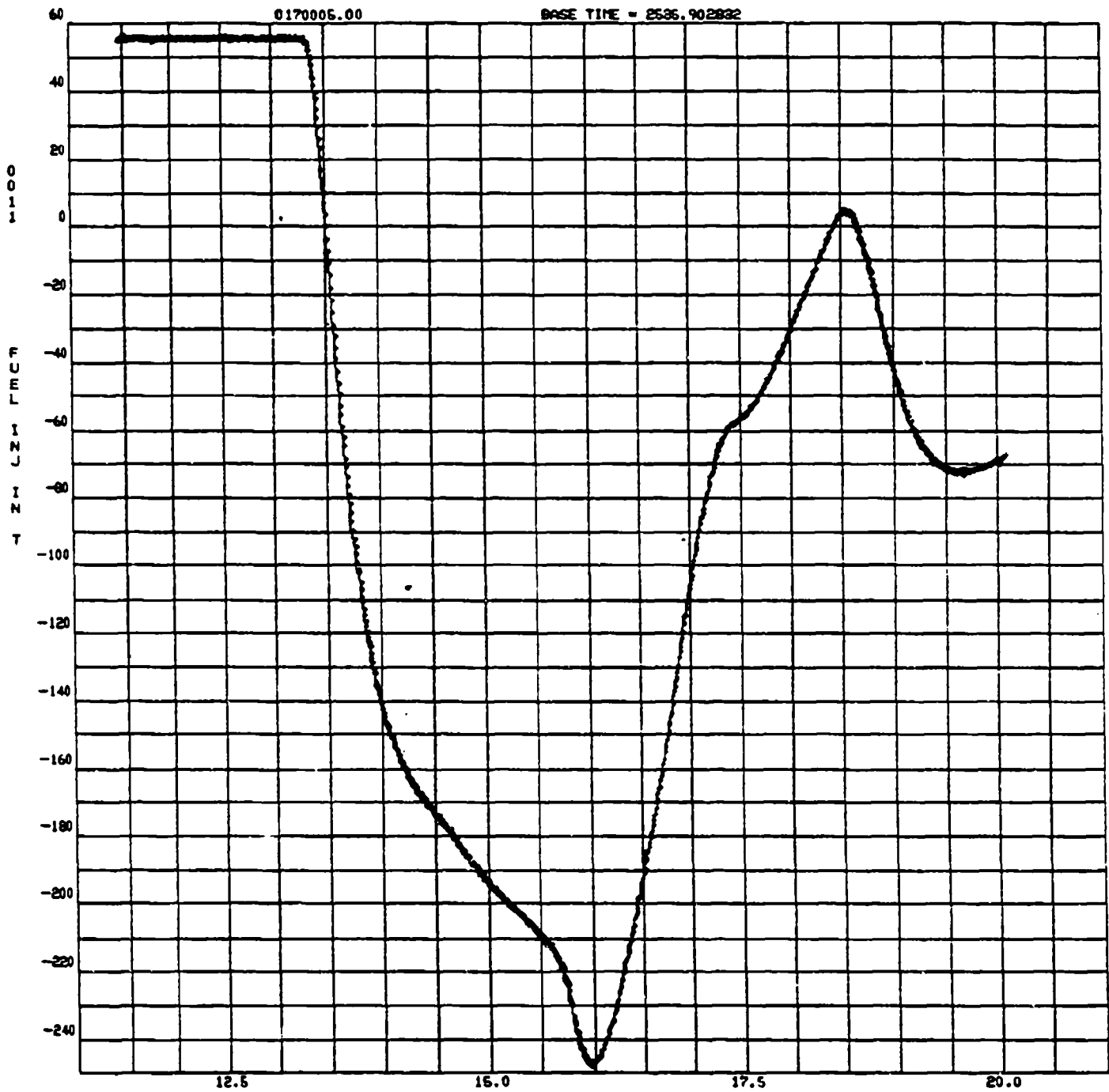

Appendix A: Test 87-017-005 Time Based Data Plots (1/28/87)

020487 0009

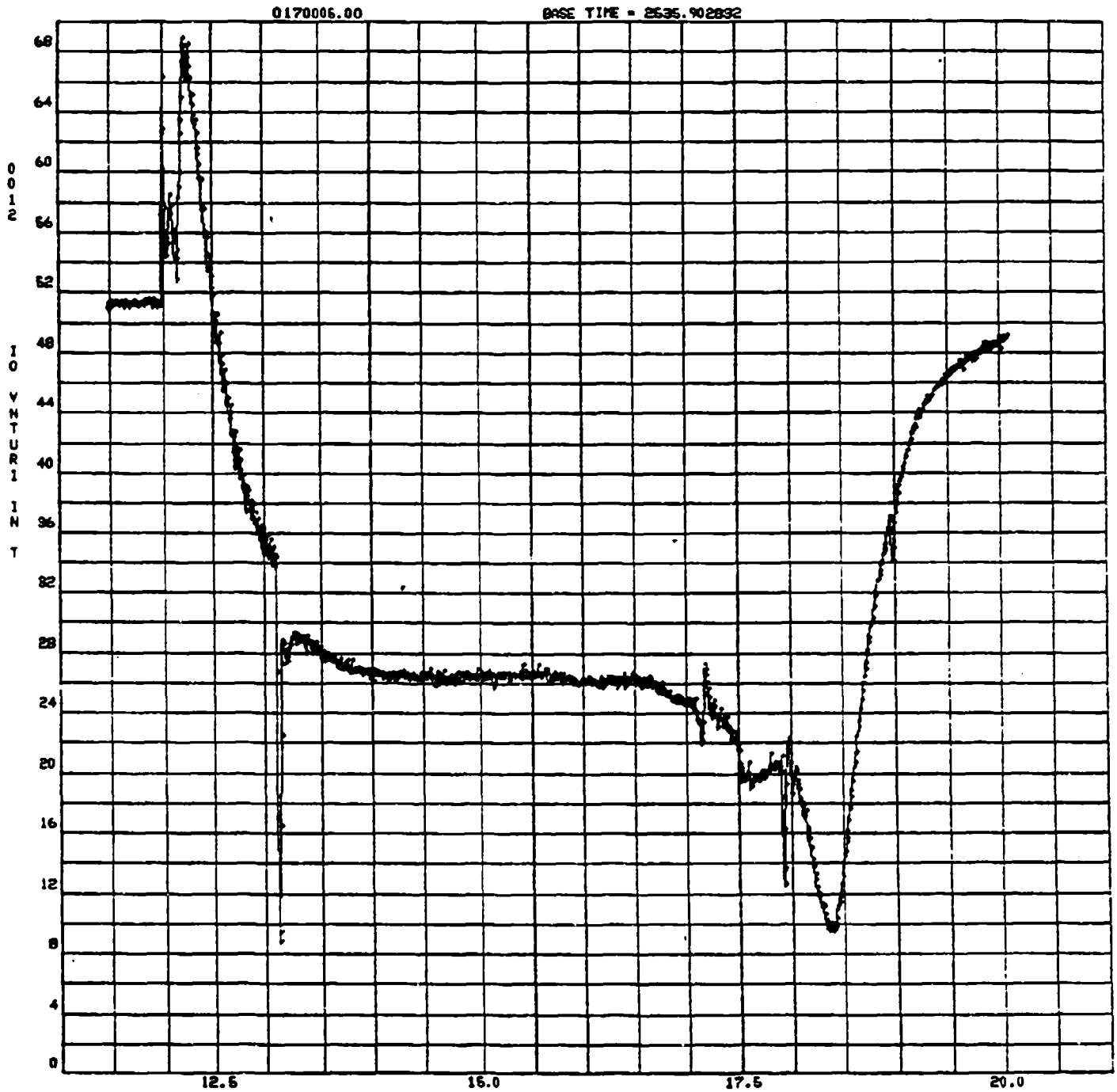

Appendix A:
Test 87-017-005 Time Based Data Plots (1/28/87)

*055952034
020487 0010

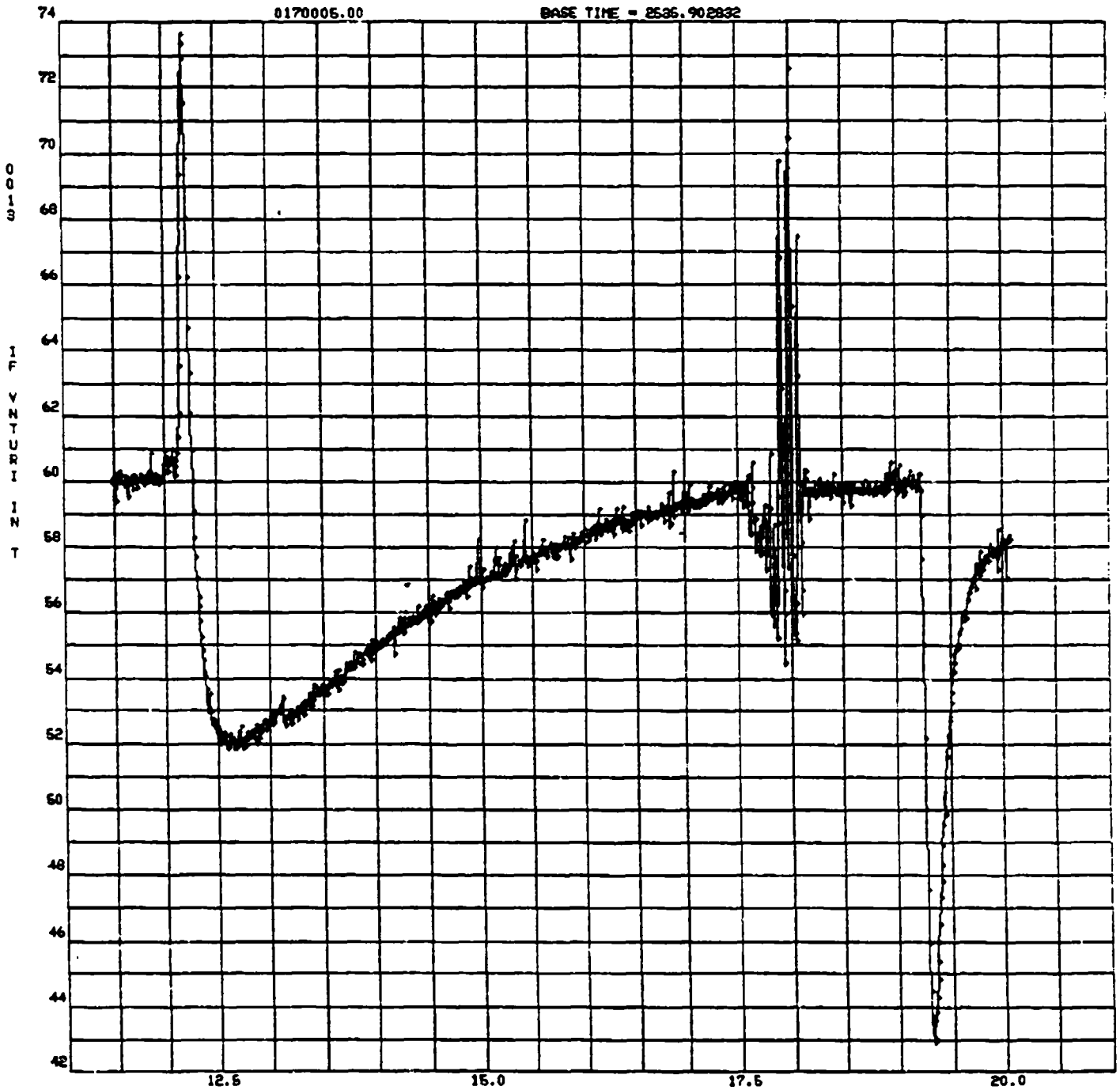

Appendix A: Test 87-017-005 Time Based Data Plots (1/28/87)

06595200
020487 0011



Appendix A: Test 87-017-005 Time Based Data Plots (1/28/87)

06595200
0204R7 0002

0170005.00

BASE TIME = 2535.902832

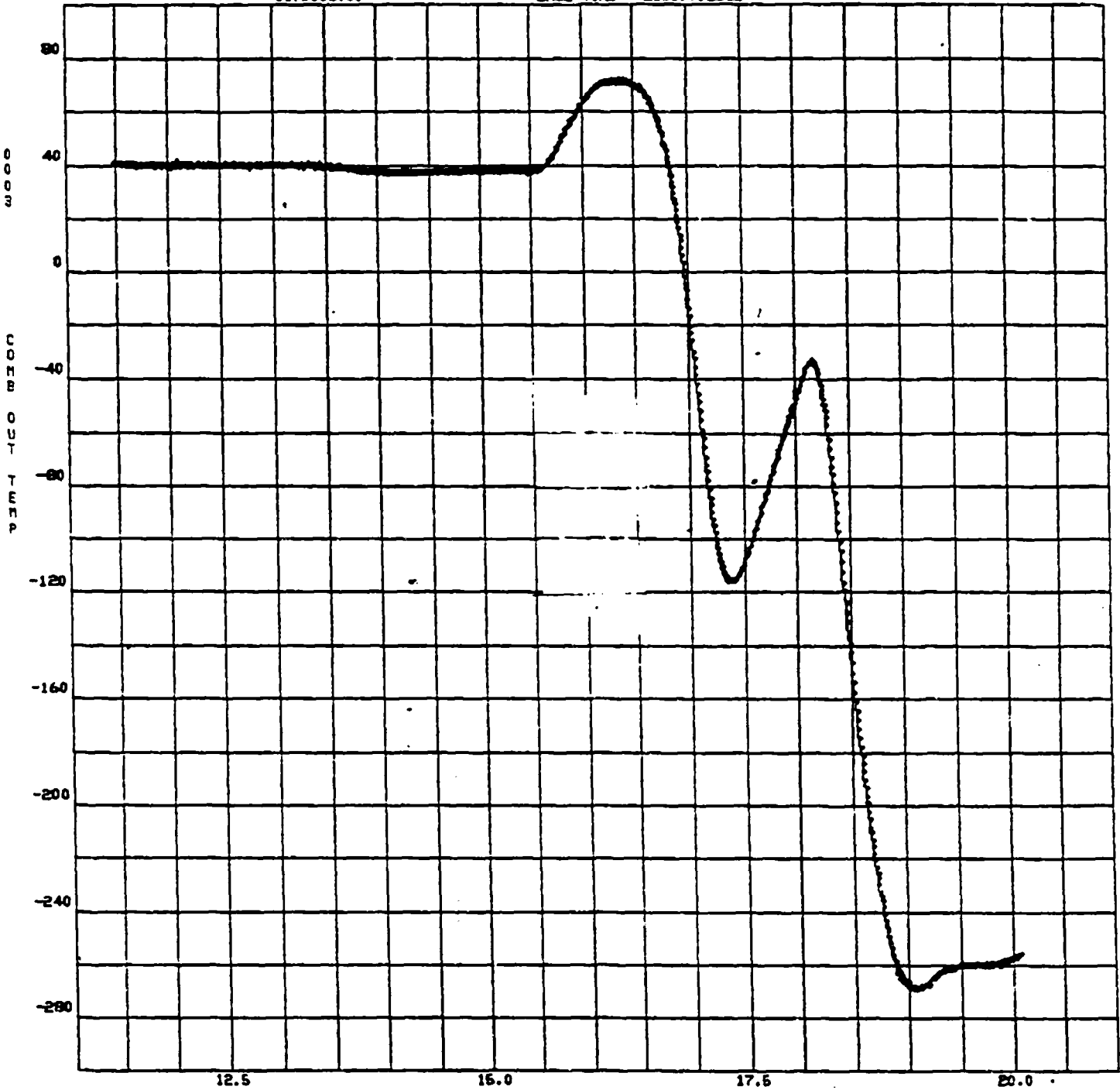

Appendix A: Test 87-017-005 Time Based Data Plots (1/28/87)

020487 0001

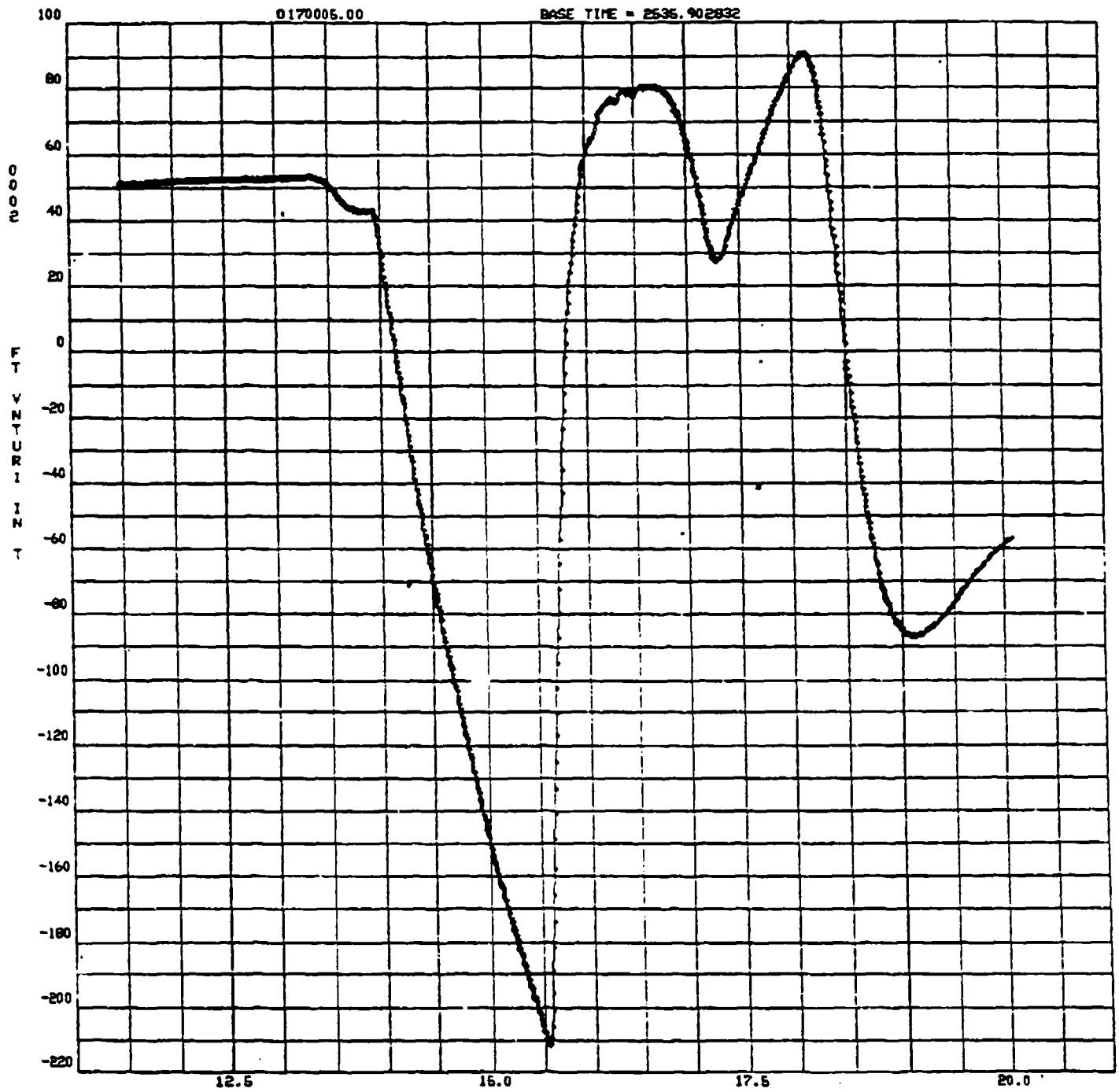

THIS PAGE INTENTIONALLY BLANK

Appendix B:

Test 87-017-006 Time Based Data Plots (1/28/87)

**Note: Units for the abscissa in all plots are seconds;
Units for ordinate parameters are given in Table 7-6**

Appendix B: Test 87-017-006 Time Based Data Plots (1/28/87)

4055952002
012987 0111

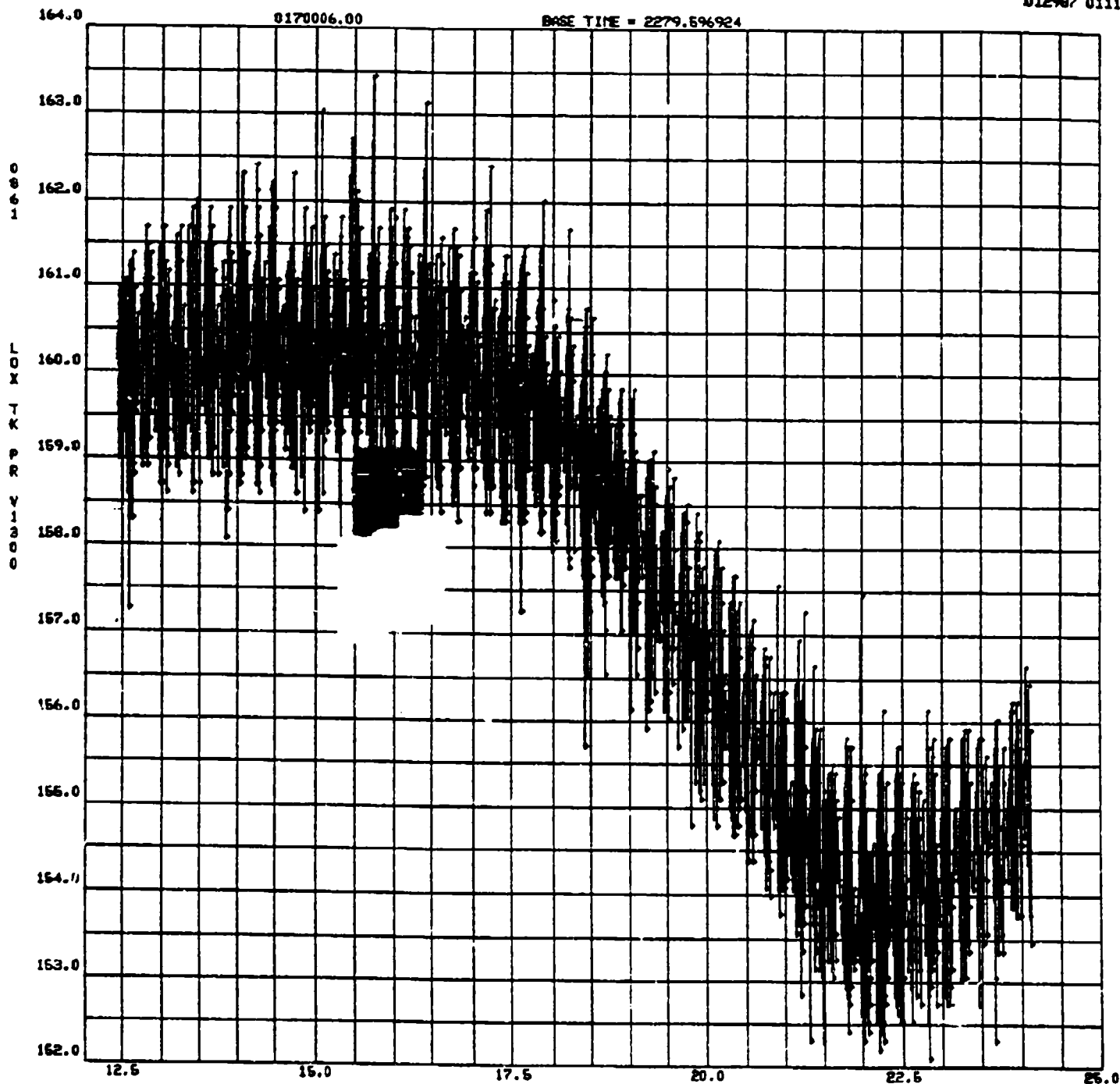

Appendix B: Test 87-017-006 Time Based Data Plots (1/28/87)

4055952008
012987 0110

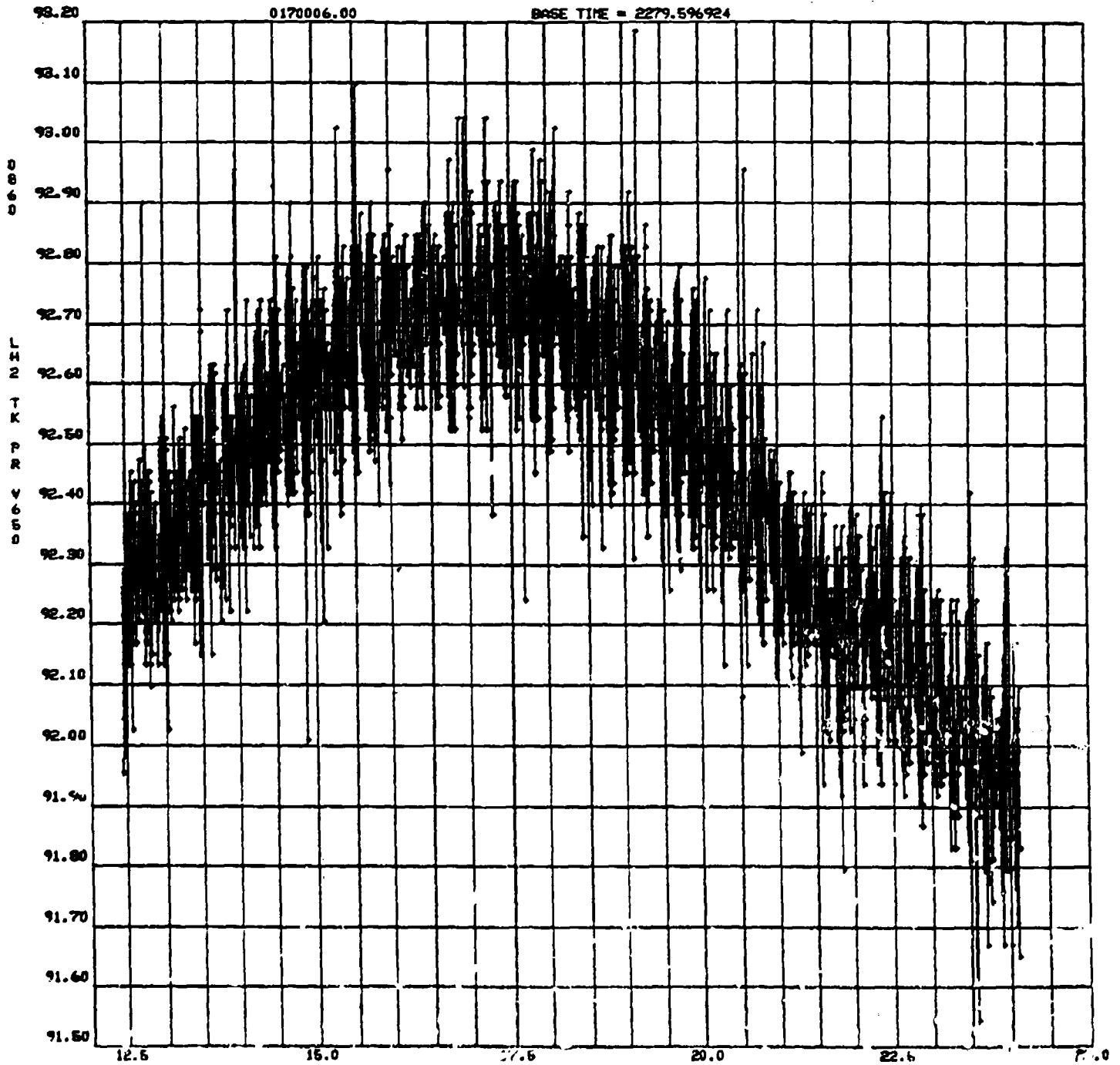

Appendix B: Test 87-017-006 Time Based Data Plots (1/28/87)

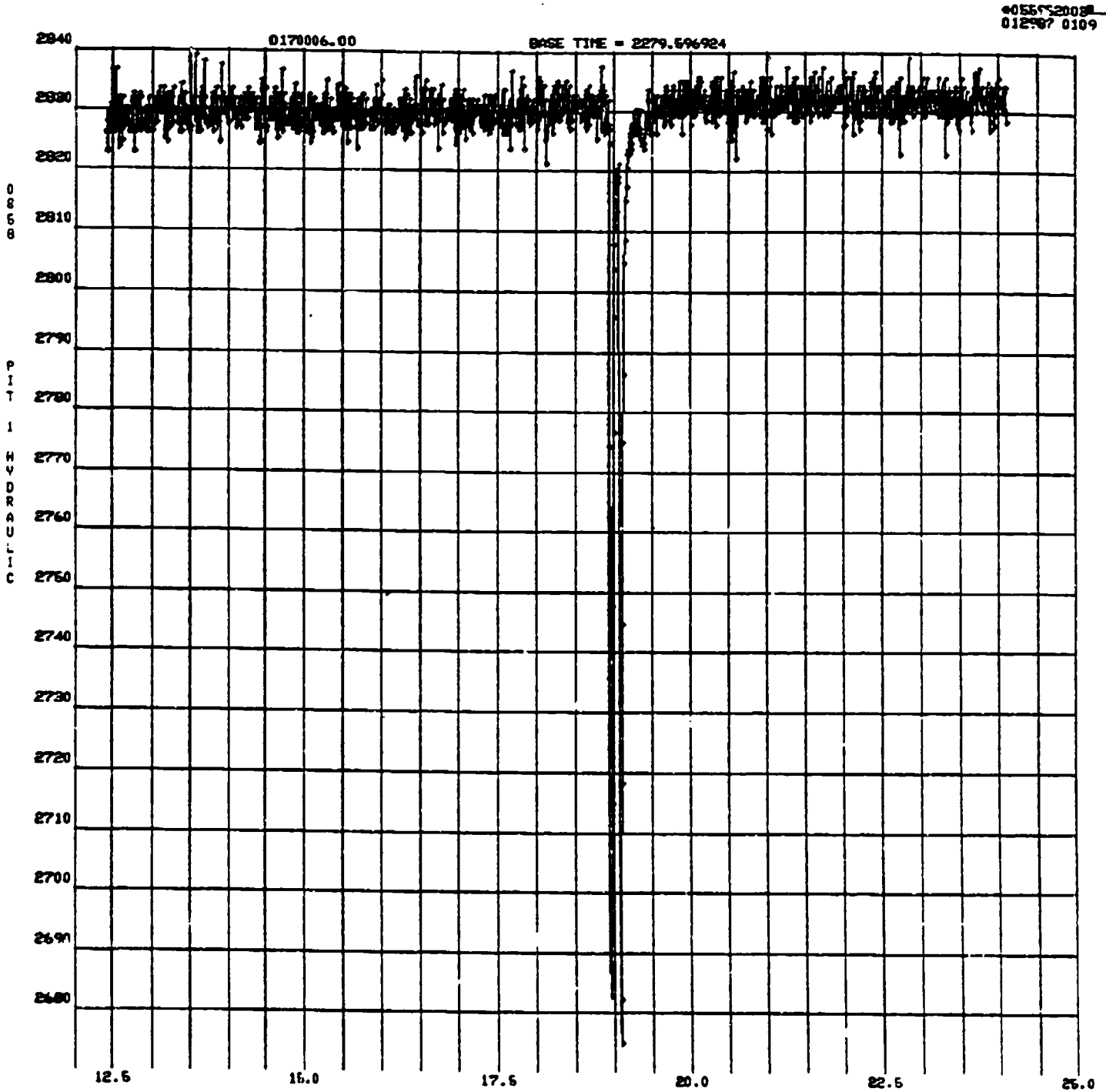

Appendix B: Test 87-017-006 Time Based Data Plots (1/28/87)

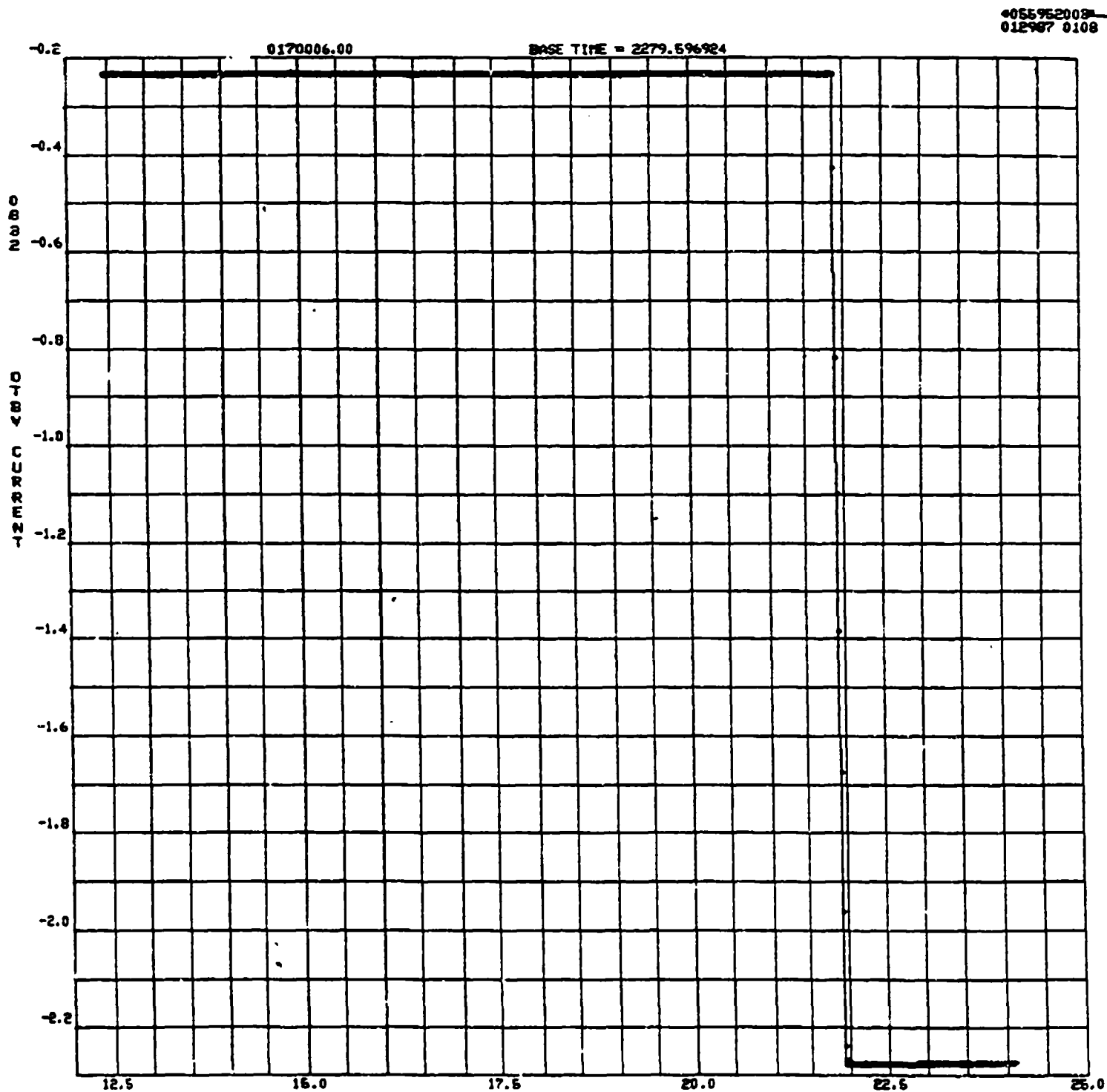

Appendix B: Test 87-017-006 Time Based Data Plots (1/28/87)

4055962003
012987 U107

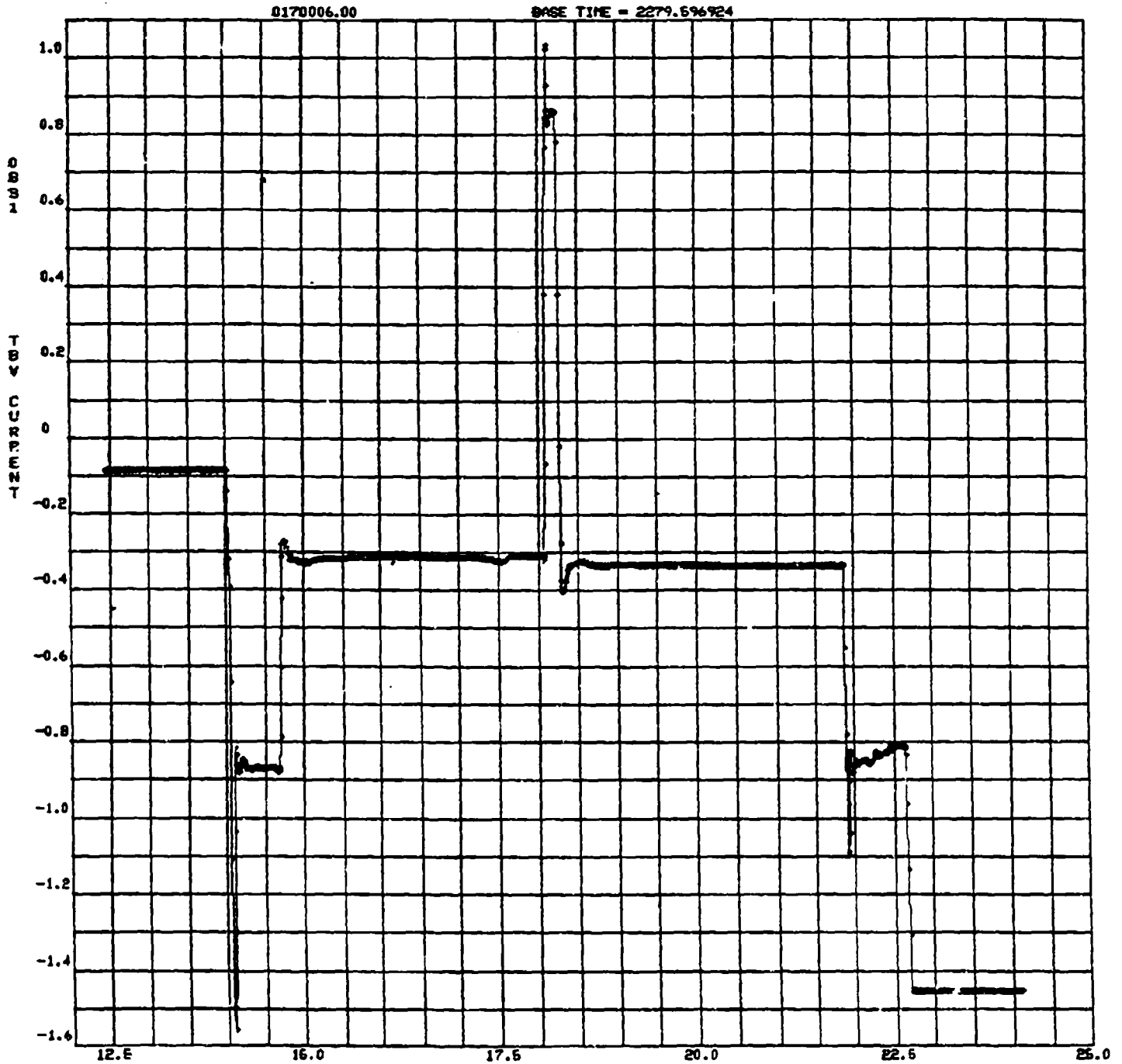

Appendix B: Test 87-017-006 Time Based Data Plots (1/28/87)

0155952005
012987 0106

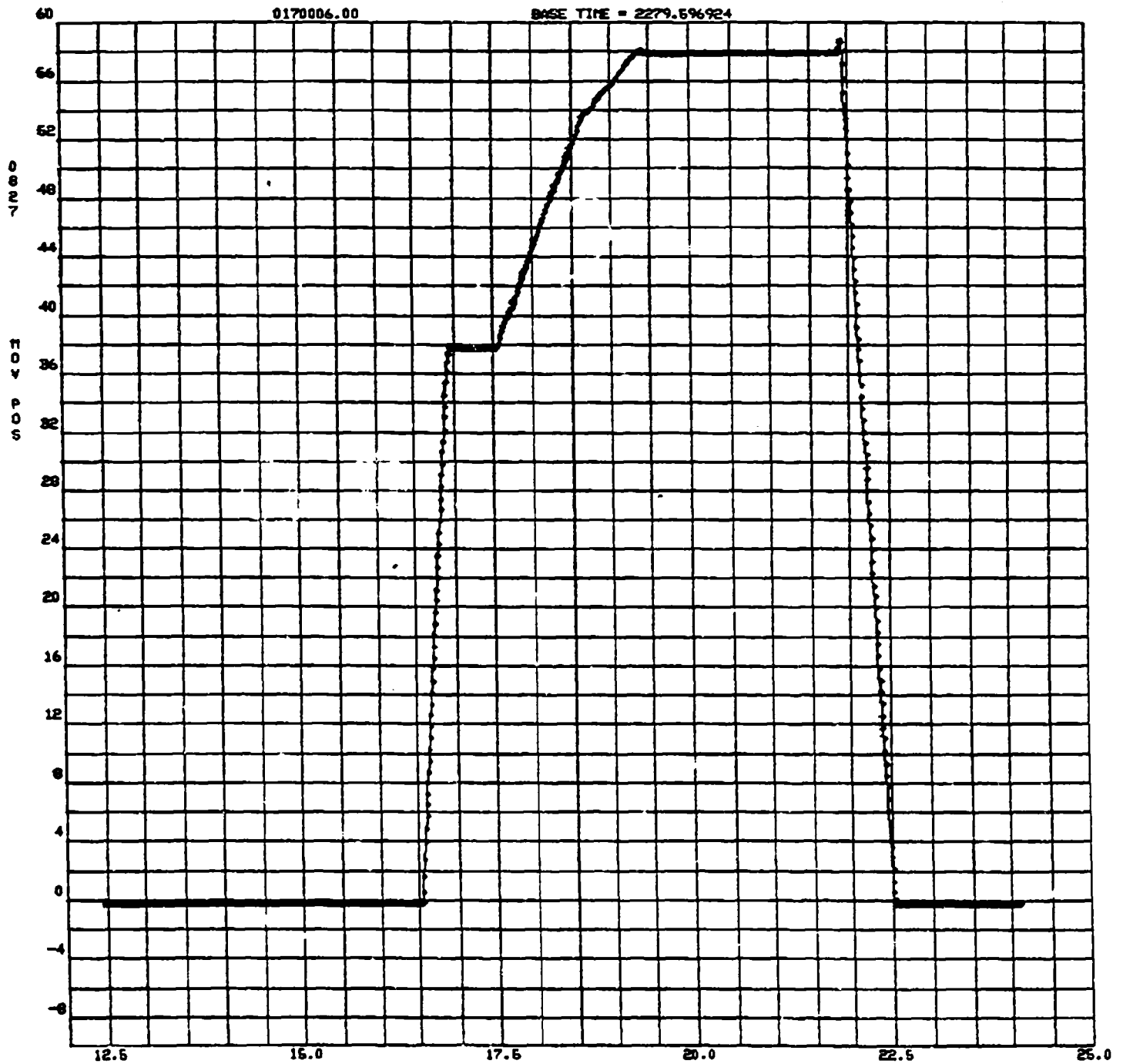

Appendix B:
Test 87-017-006 Time Based Data Plots (1/28/87)

4055962003
012987 0105

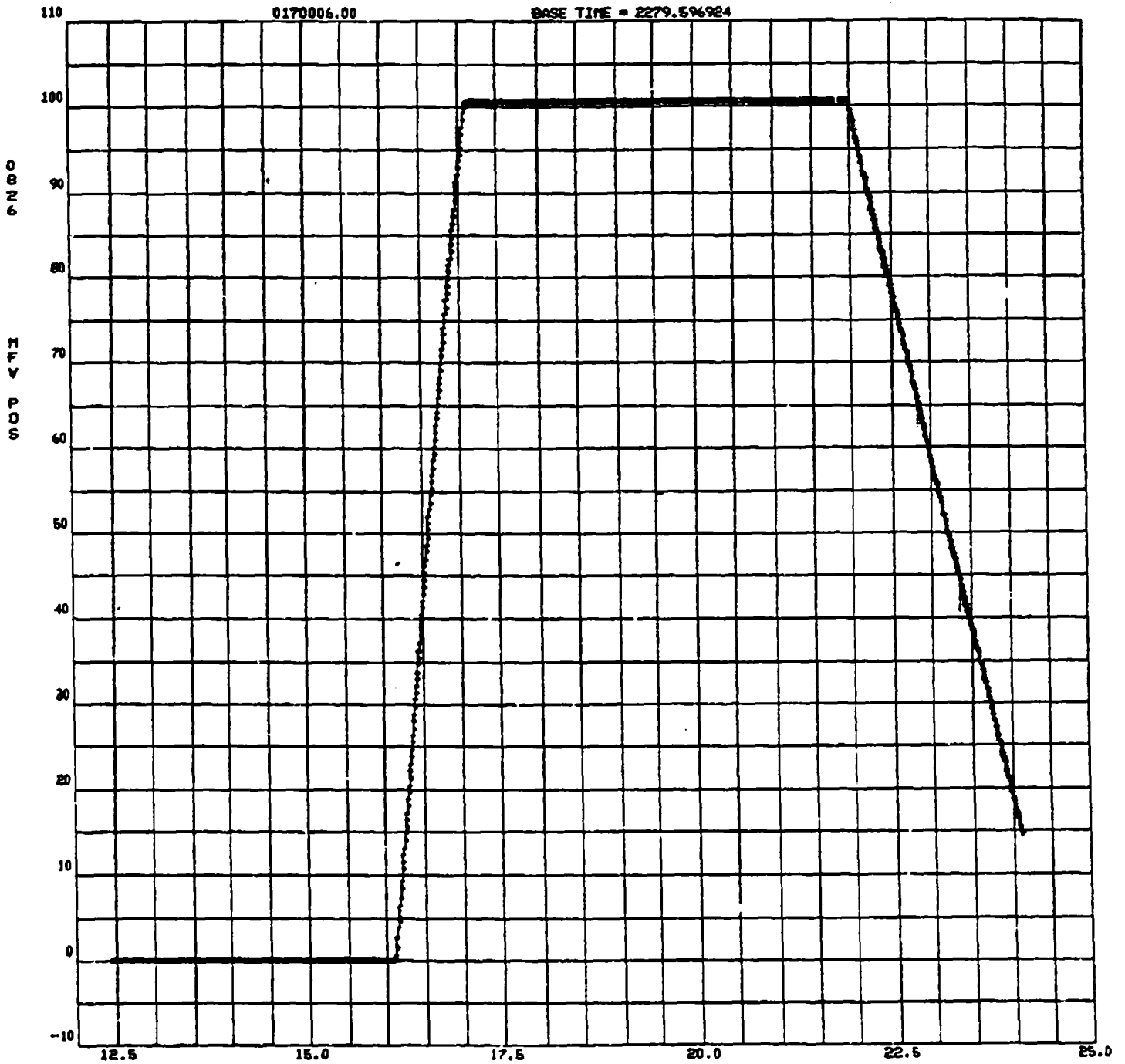

Appendix B: Test 87-017-006 Time Based Data Plots (1/28/87)

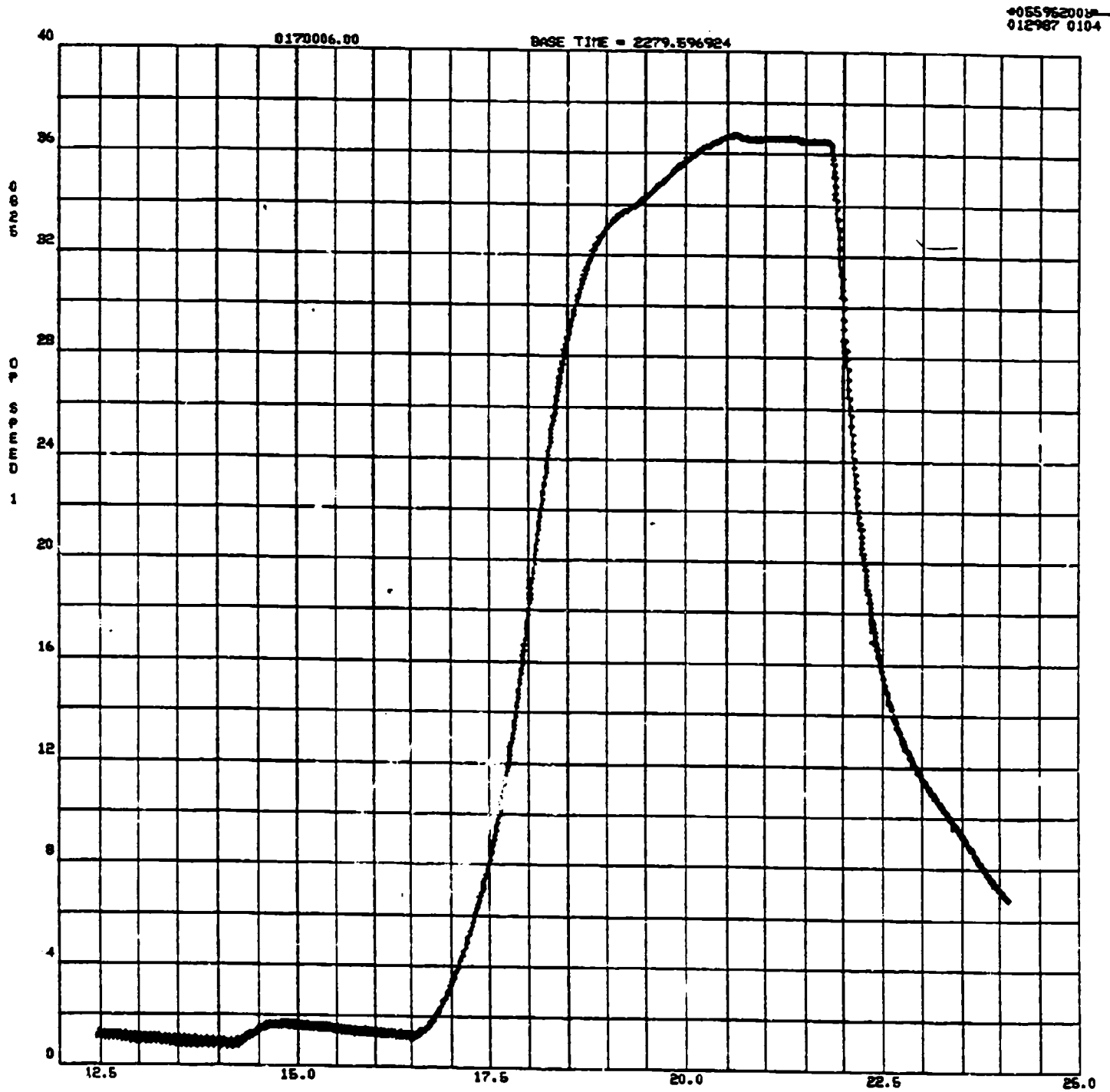

CR 194443

Appendix B: Test 87-017-006 Time Based Data Plots (1/28/87)

4055962005
012987 0103

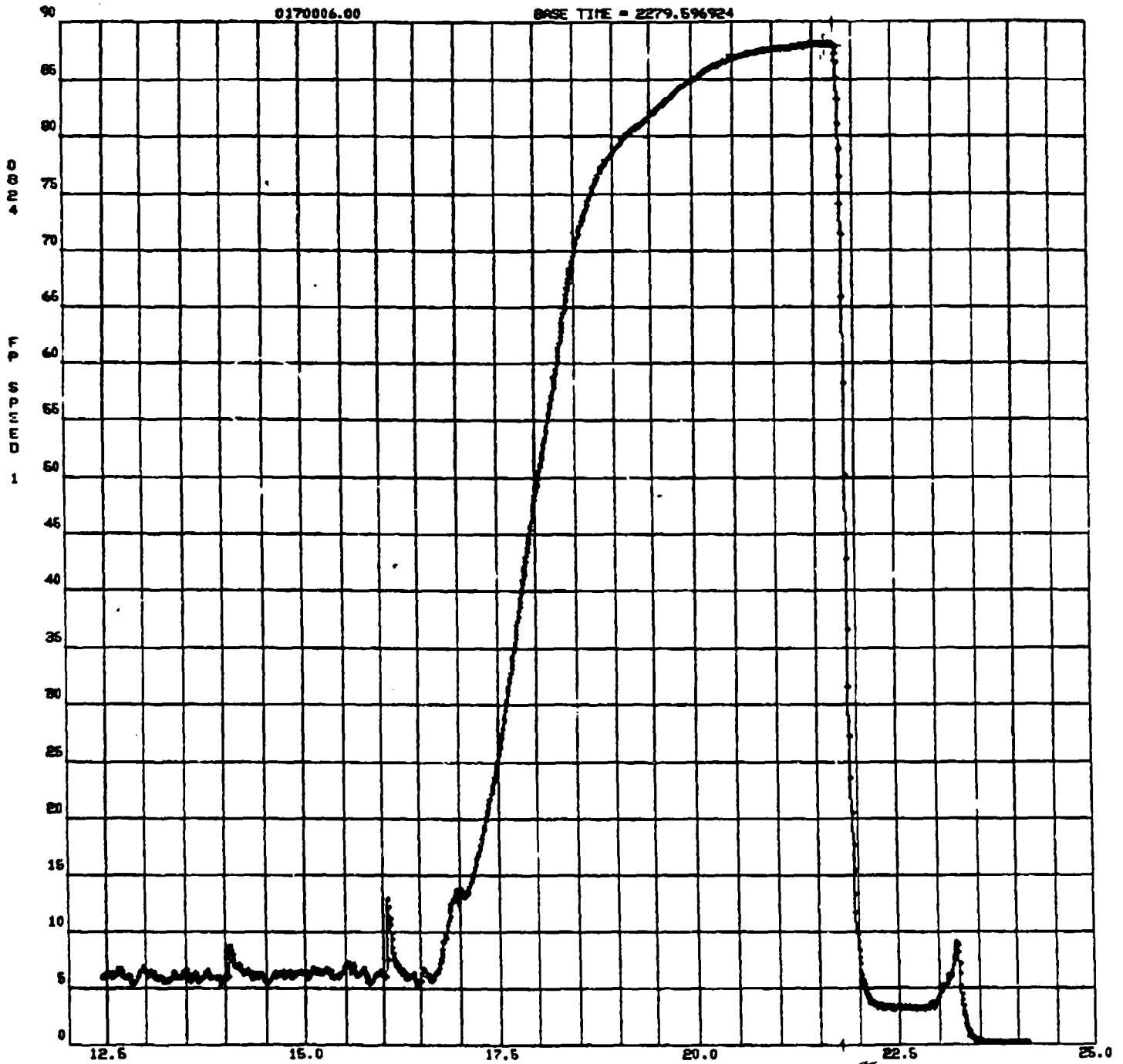

Appendix B: Test 87-017-006 Time Based Data Plots (1/28/87)

405596200.5
012967 0102

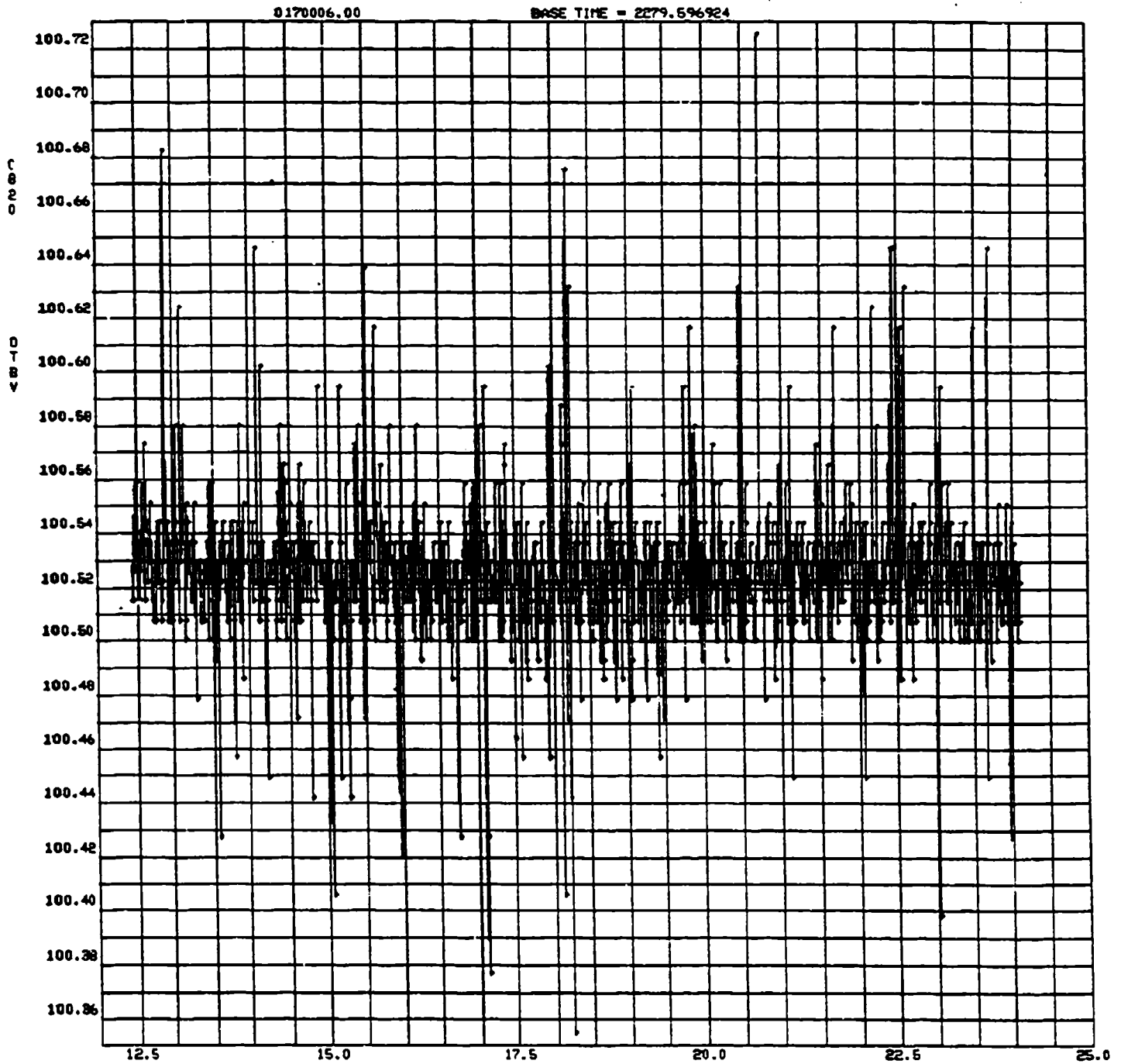

Appendix B: Test 87-017-006 Time Based Data Plots (1/28/87)



Appendix B: Test 87-017-006 Time Based Data Plots (1/28/87)

4055962003
012987 0100

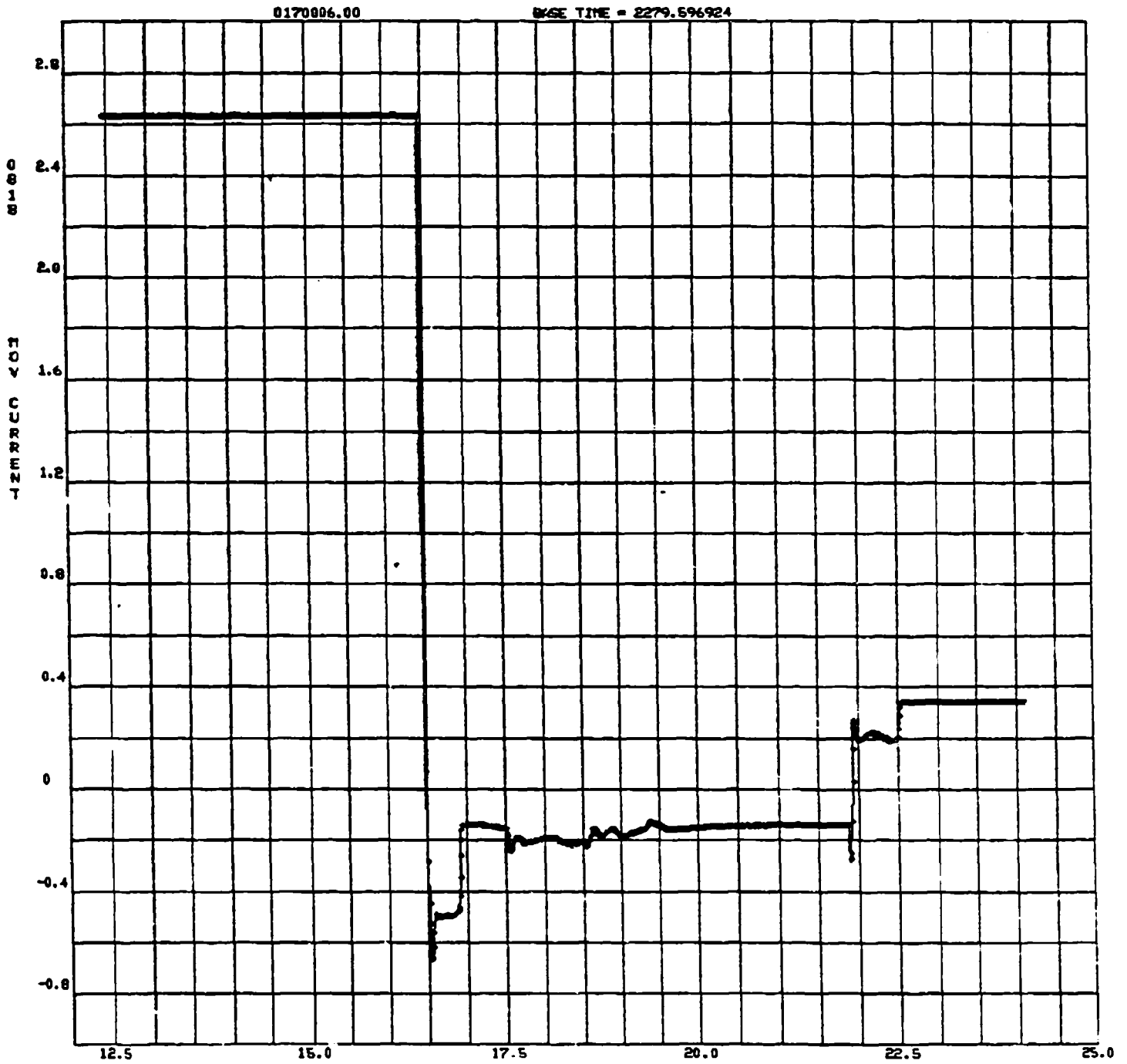

Appendix B: Test 87-017-006 Time Based Data Plots (1/28/87)

4055962009
012987 0099

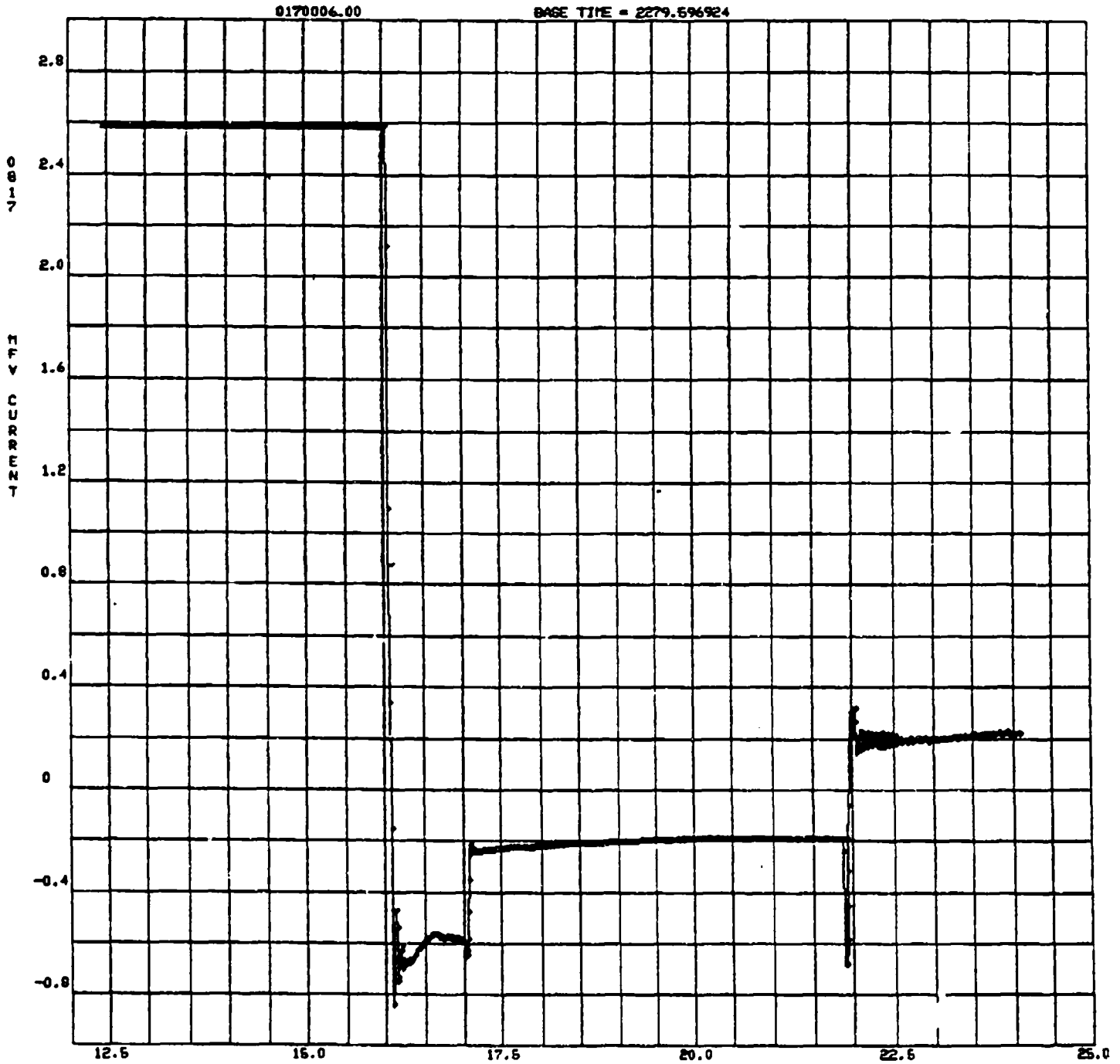

Appendix B: Test 87-017-006 Time Based Data Plots (1/28/87)

*055962002
012987 0098

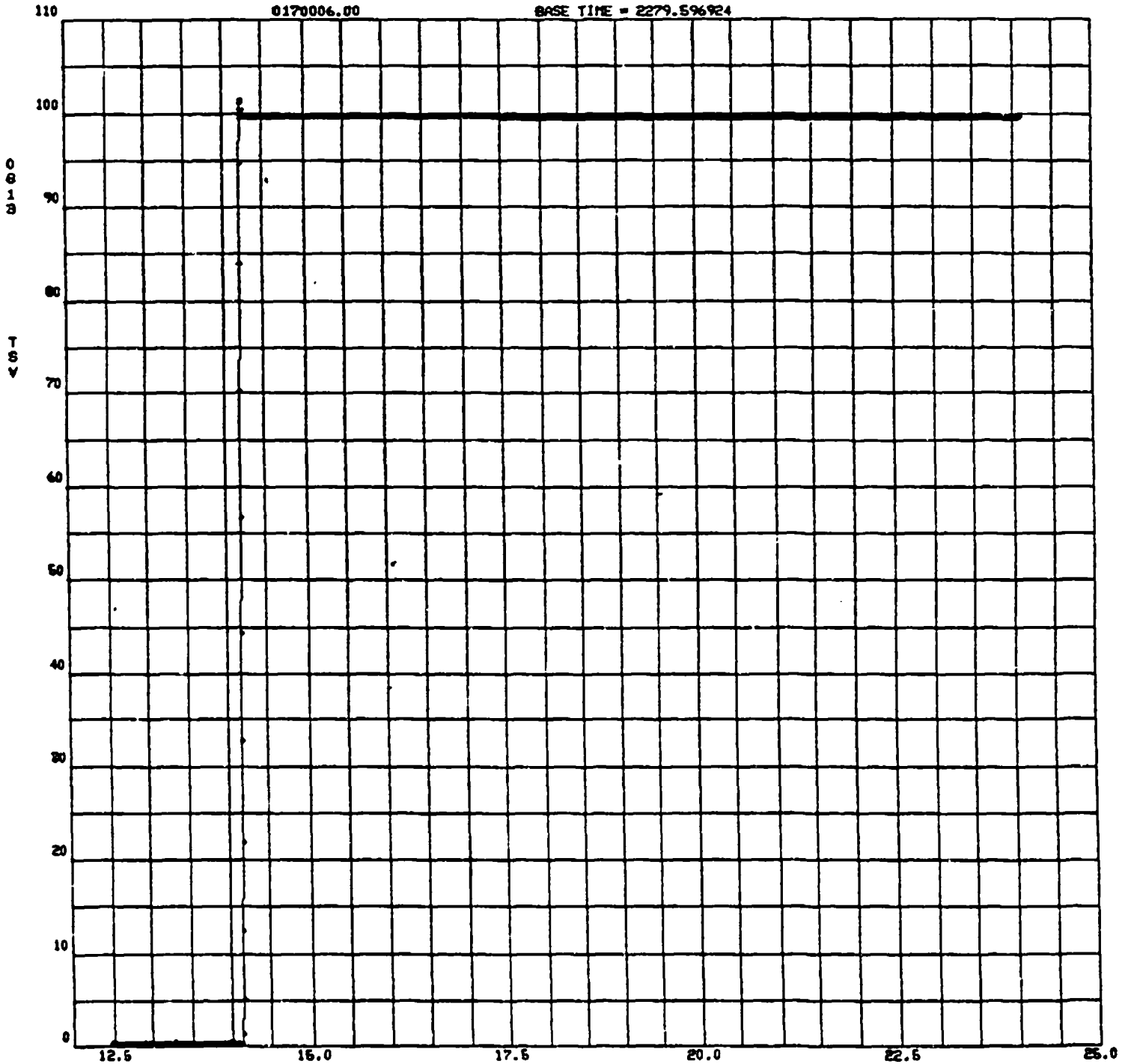

Appendix B: Test 87-017-006 Time Based Data Plots (1/28/87)

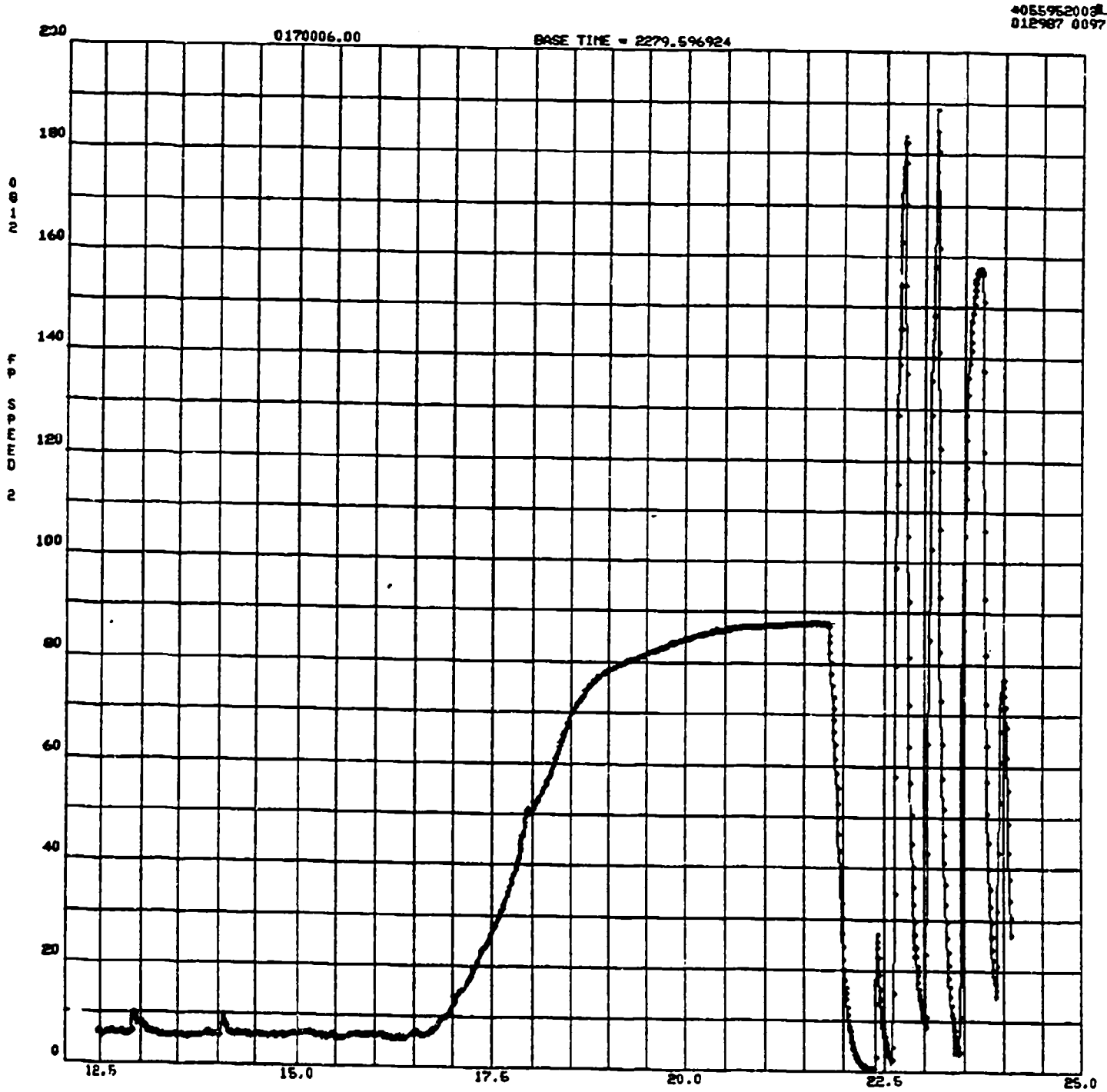

Appendix B: Test 87-017-006 Time Based Data Plots (1/28/87)

0155962002
012987 0096

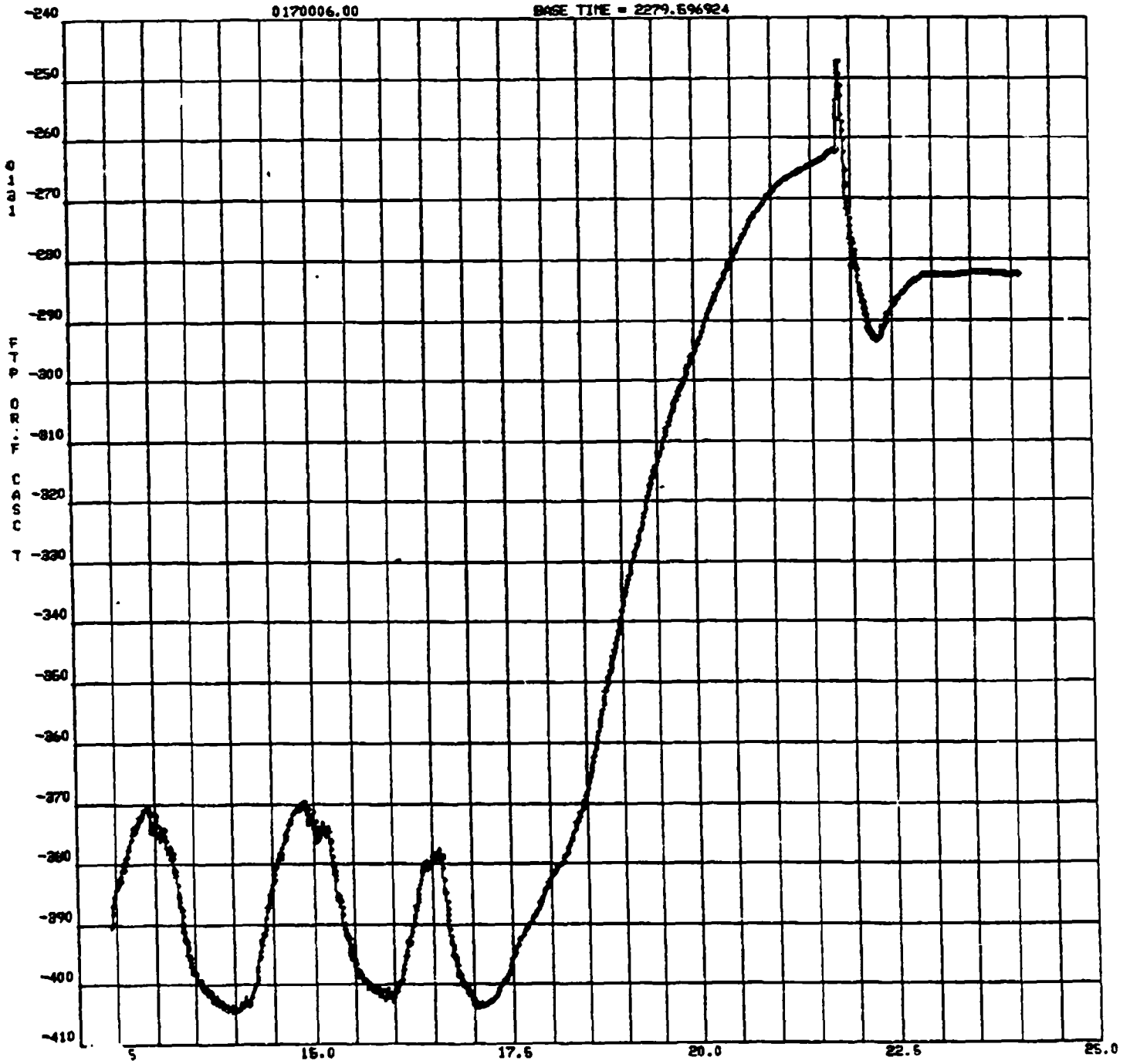

Appendix B:
Test 87-017-006 Time Based Data Plots (1/28/87)

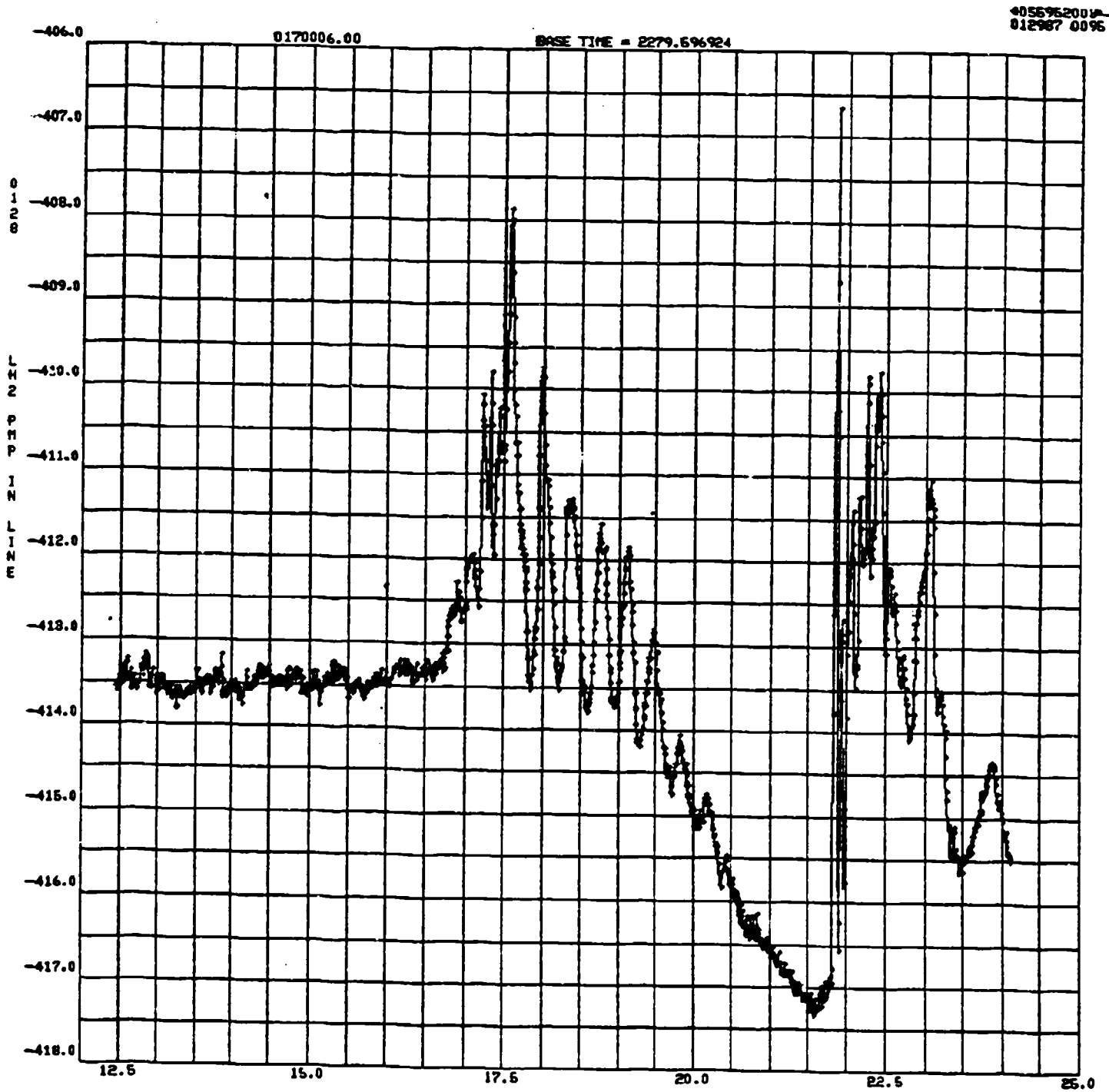

Appendix B: Test 87-017-006 Time Based Data Plots (1/28/87)

4055952008
012967 0094

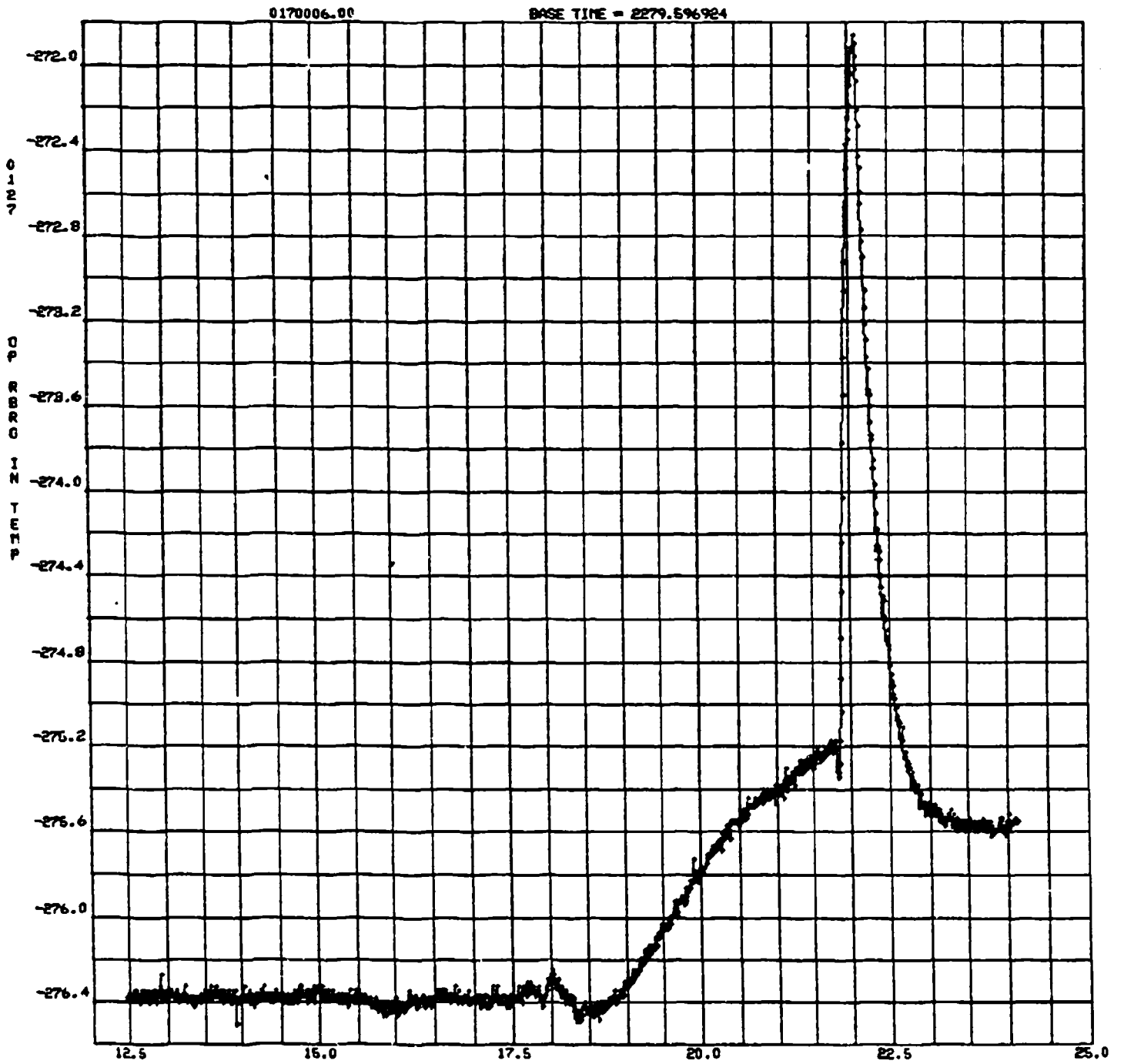

Appendix B: Test 87-017-006 Time Based Data Plots (1/28/87)

*05596203
012987 0093

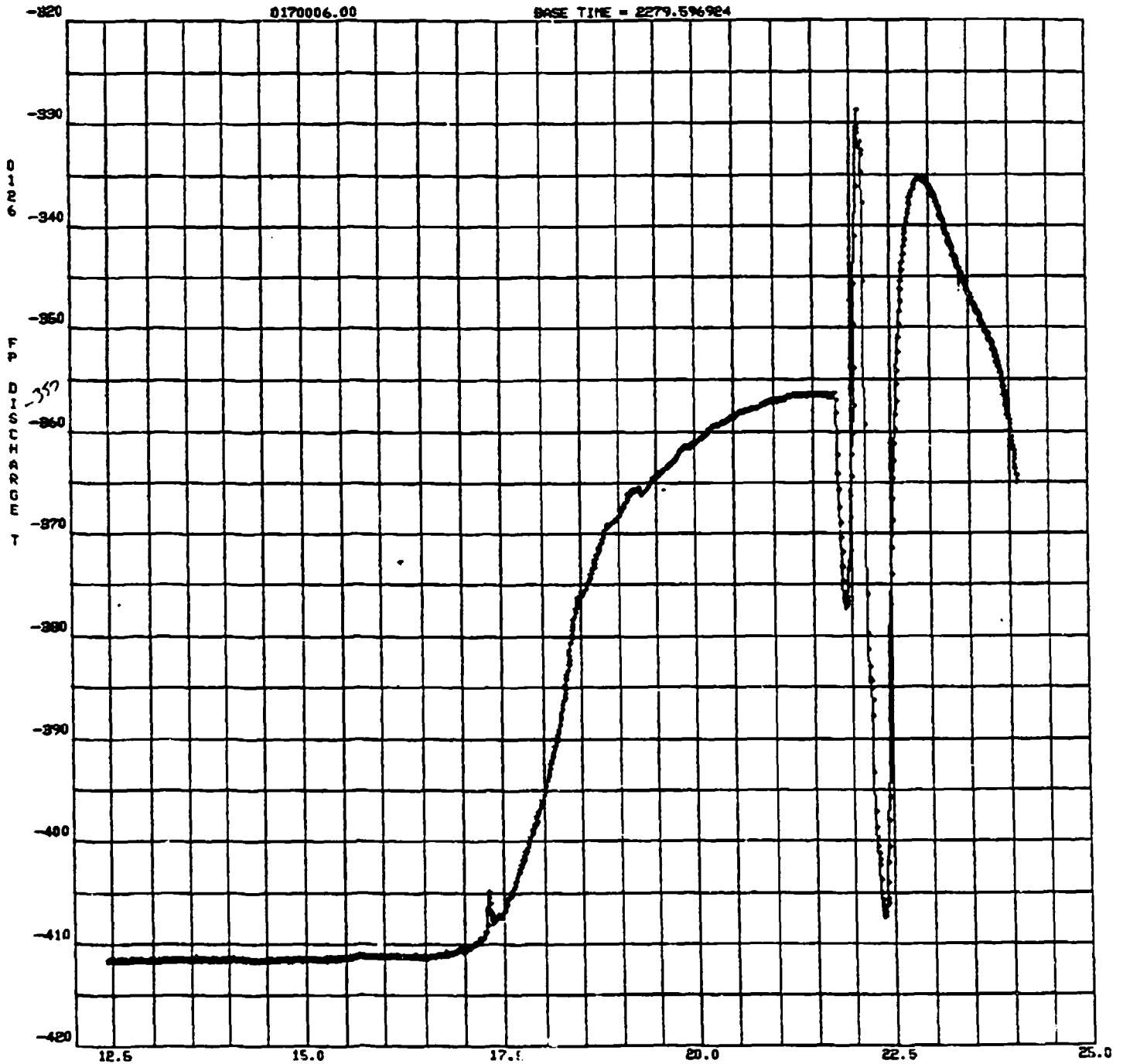

Appendix B: Test 87-017-006 Time Based Data Plots (1/28/87)

0055962003
012987 0092

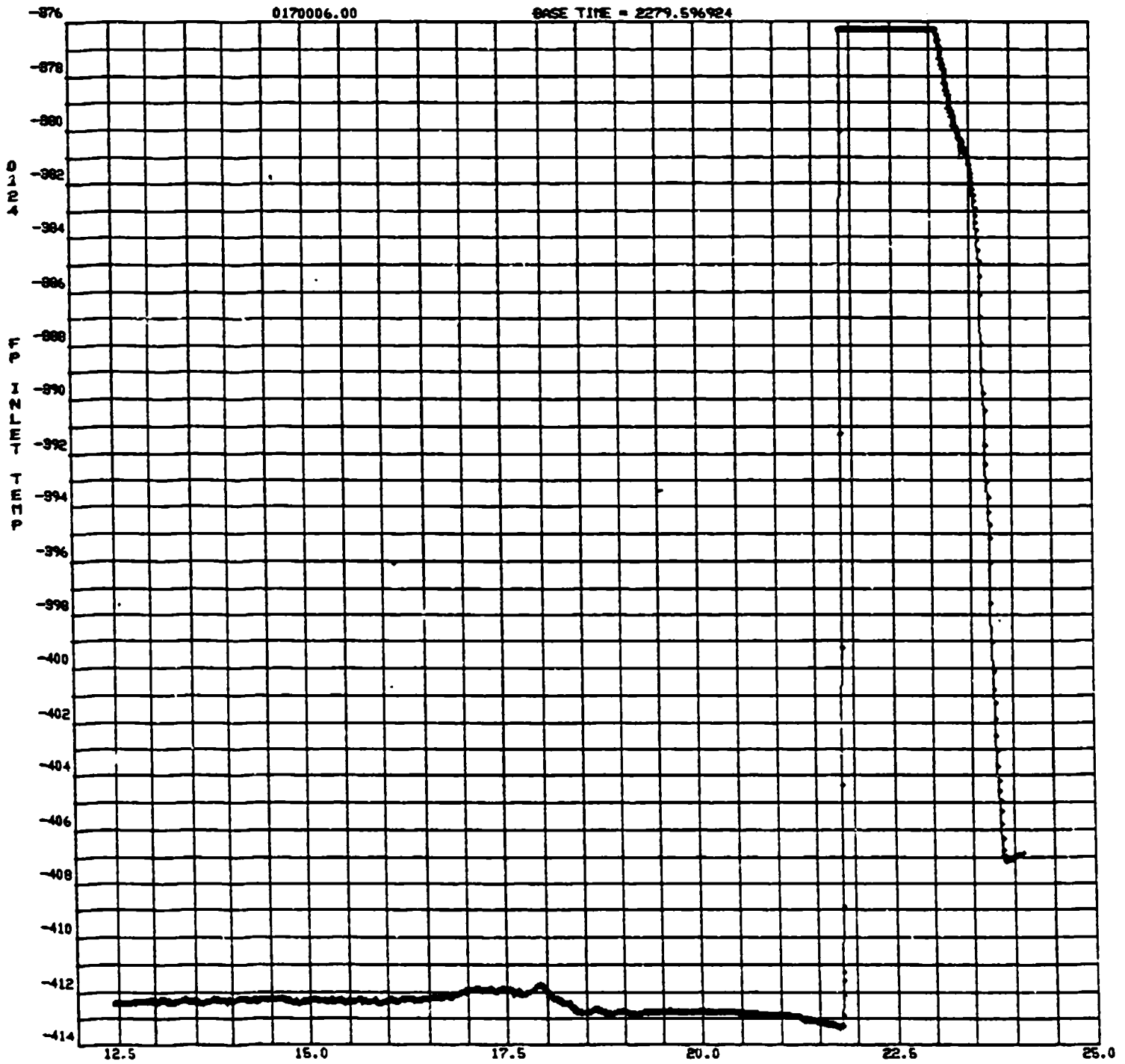

Appendix B: Test 87-017-006 Time Based Data Plots (1/28/87)

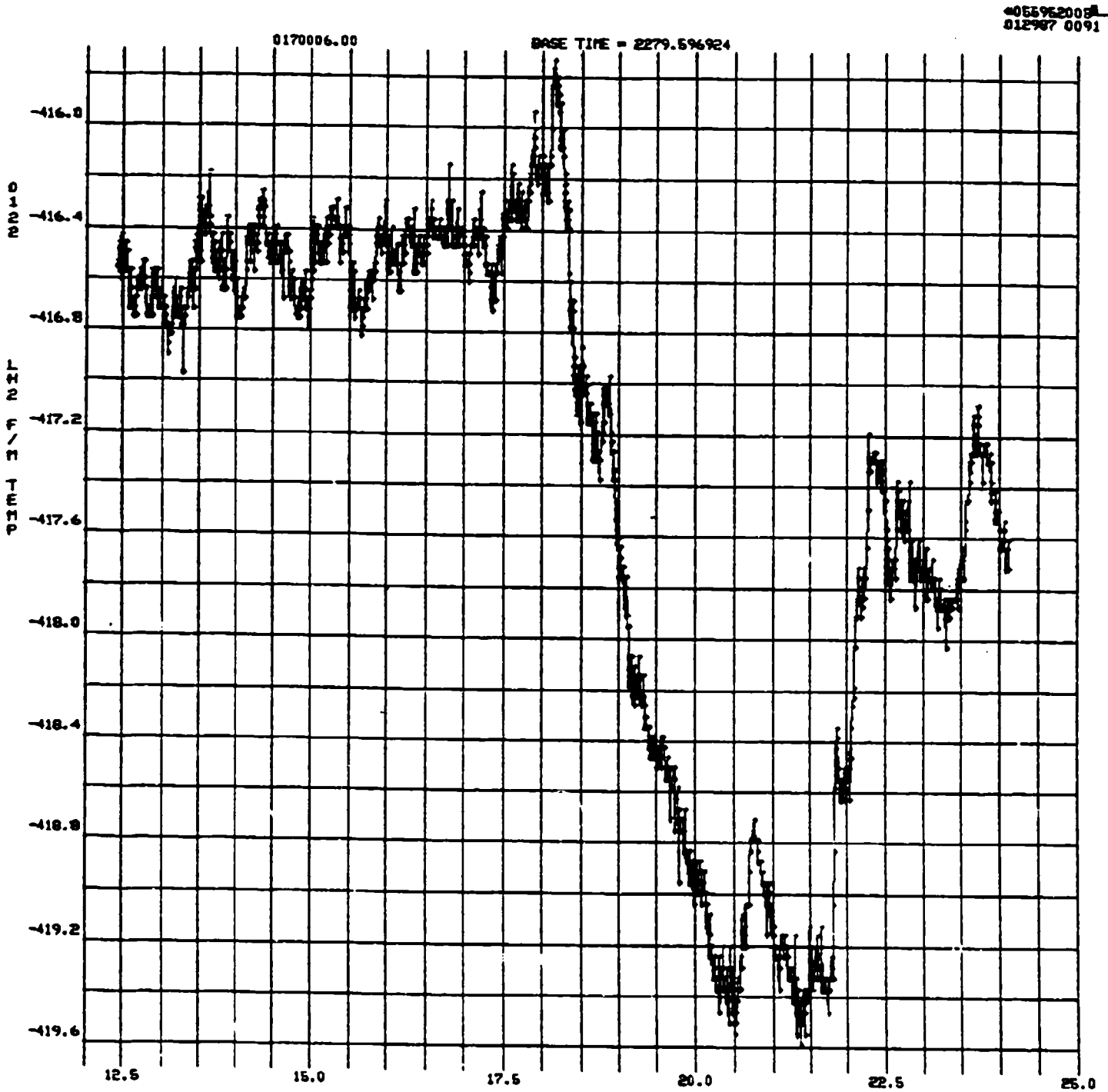

Appendix B: Test 87-017-006 Time Based Data Plots (1/28/87)

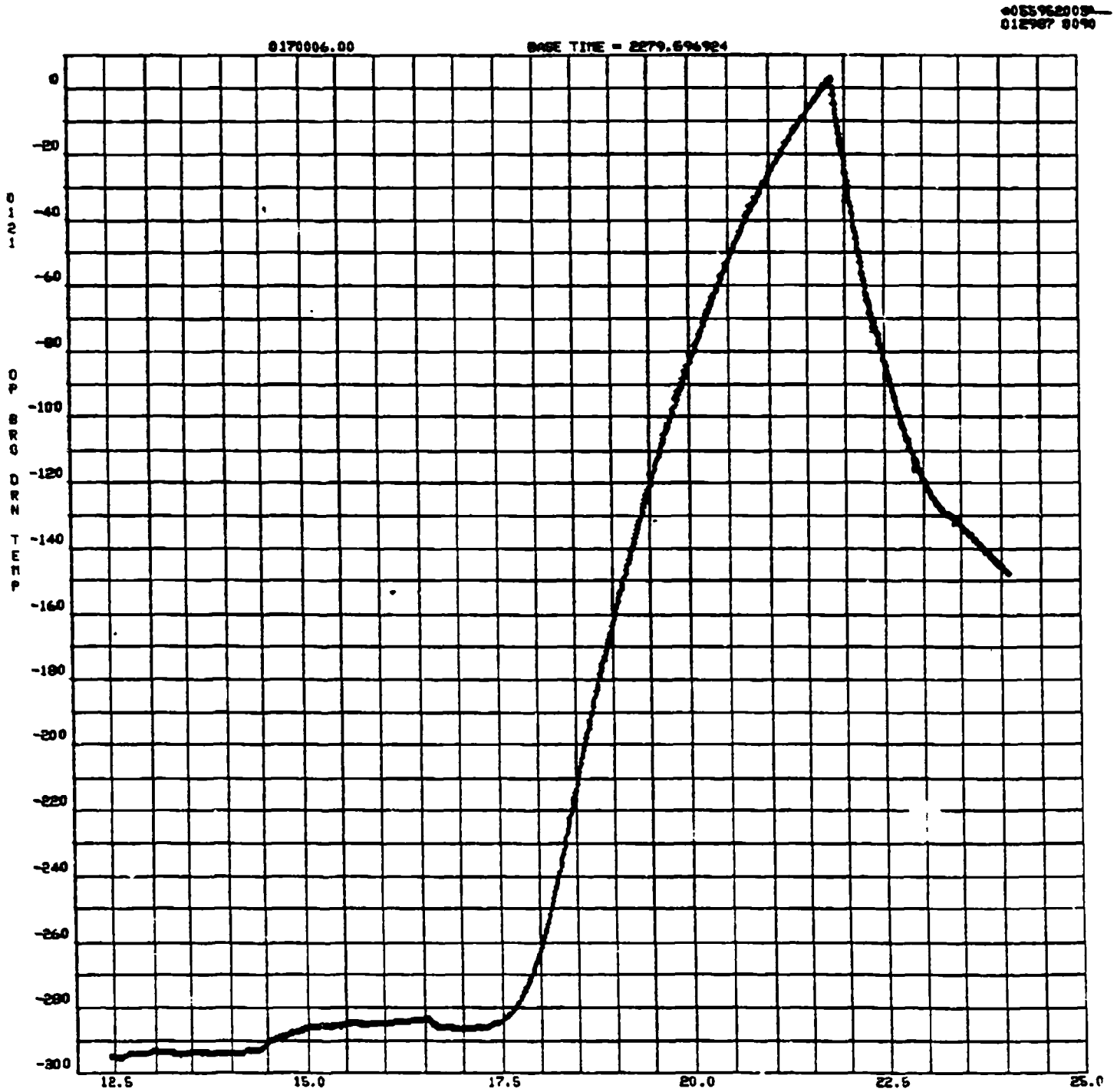

Appendix B: Test 87-017-006 Time Based Data Plots (1/28/87)

0155962003
012987 8089

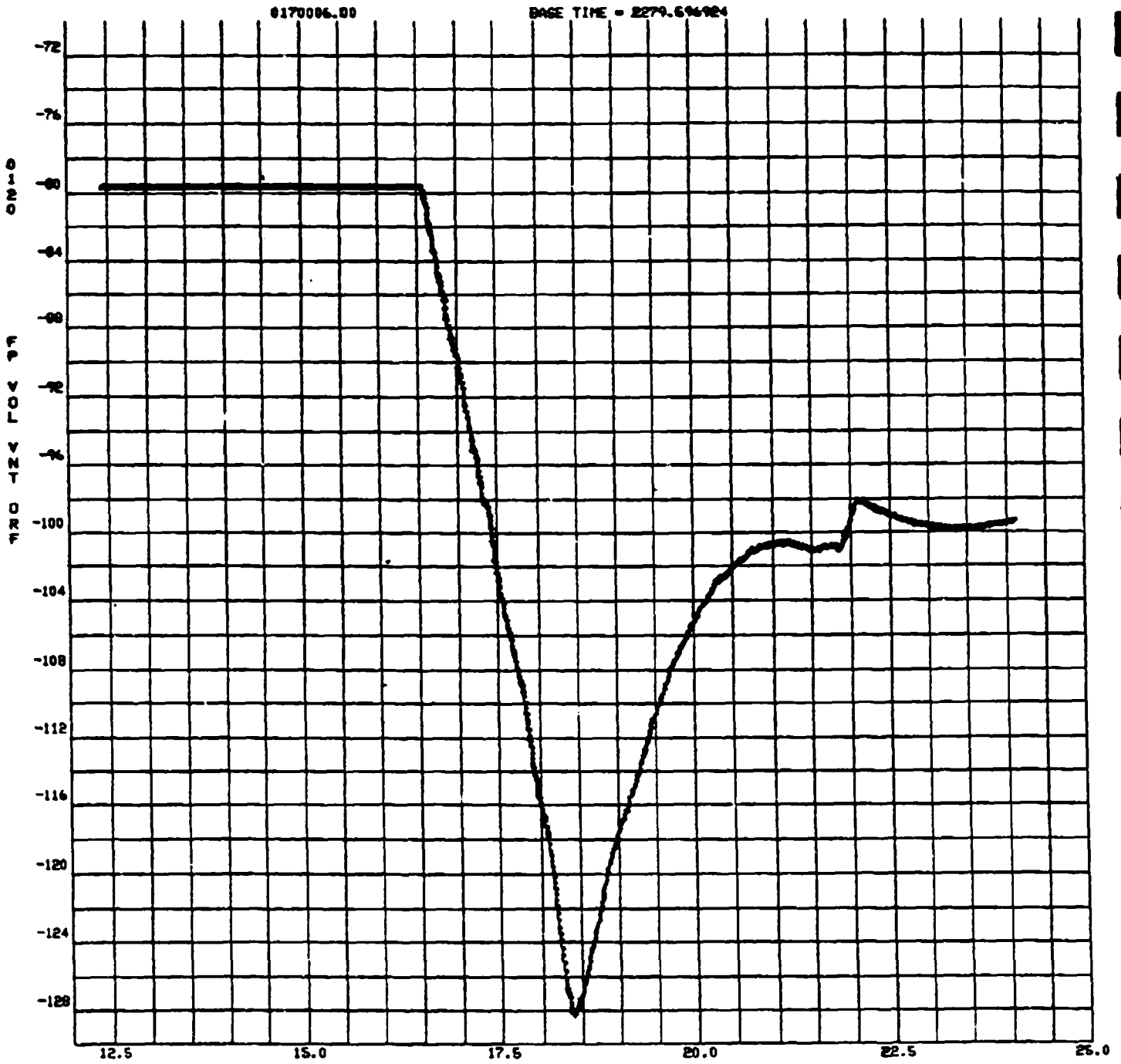

Appendix B: Test 87-017-006 Time Based Data Plots (1/28/87)

405596200
012967 001

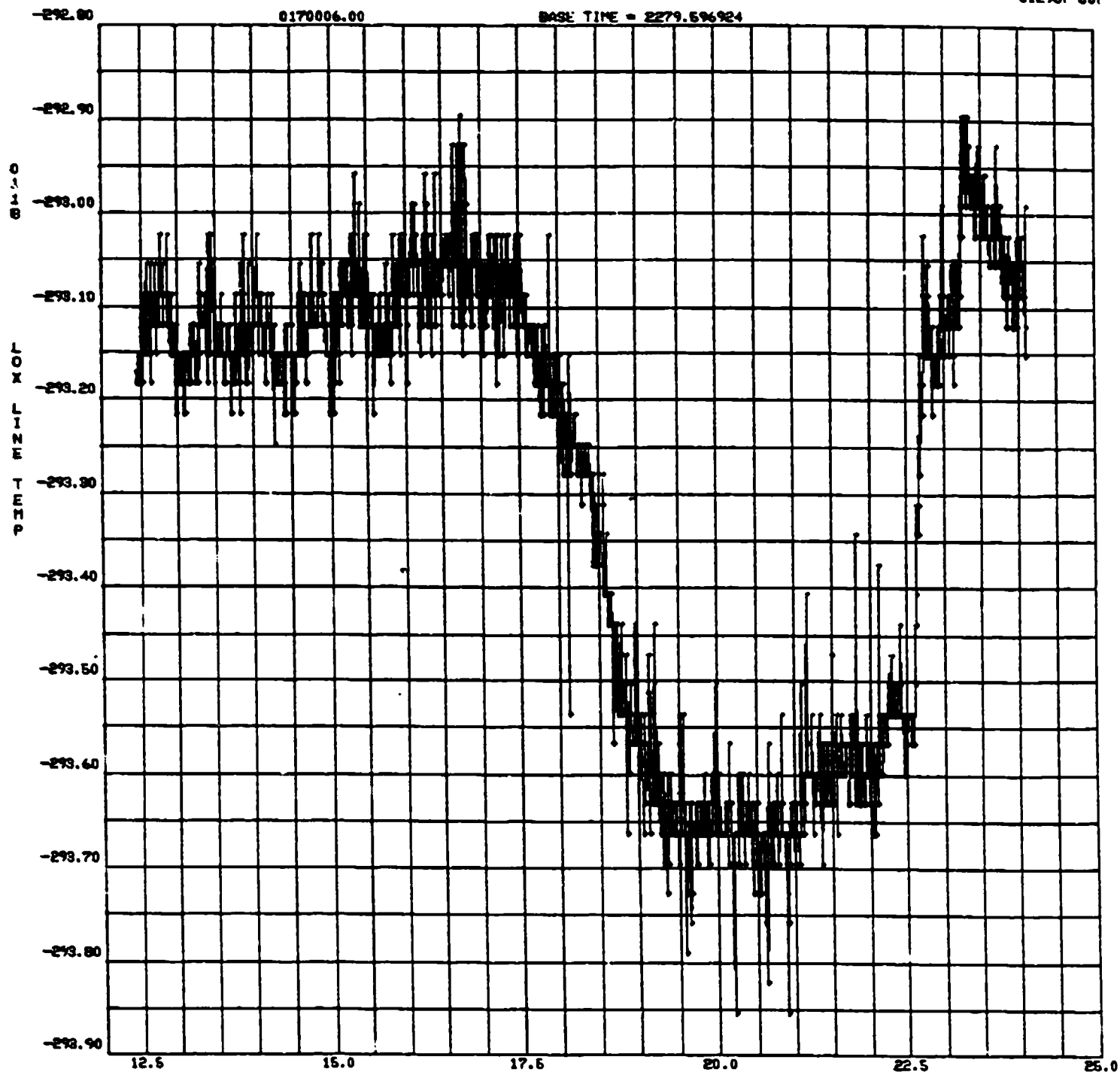

Appendix B: Test 87-017-006 Time Based Data Plots (1/28/87)

4055952005
812987 0087

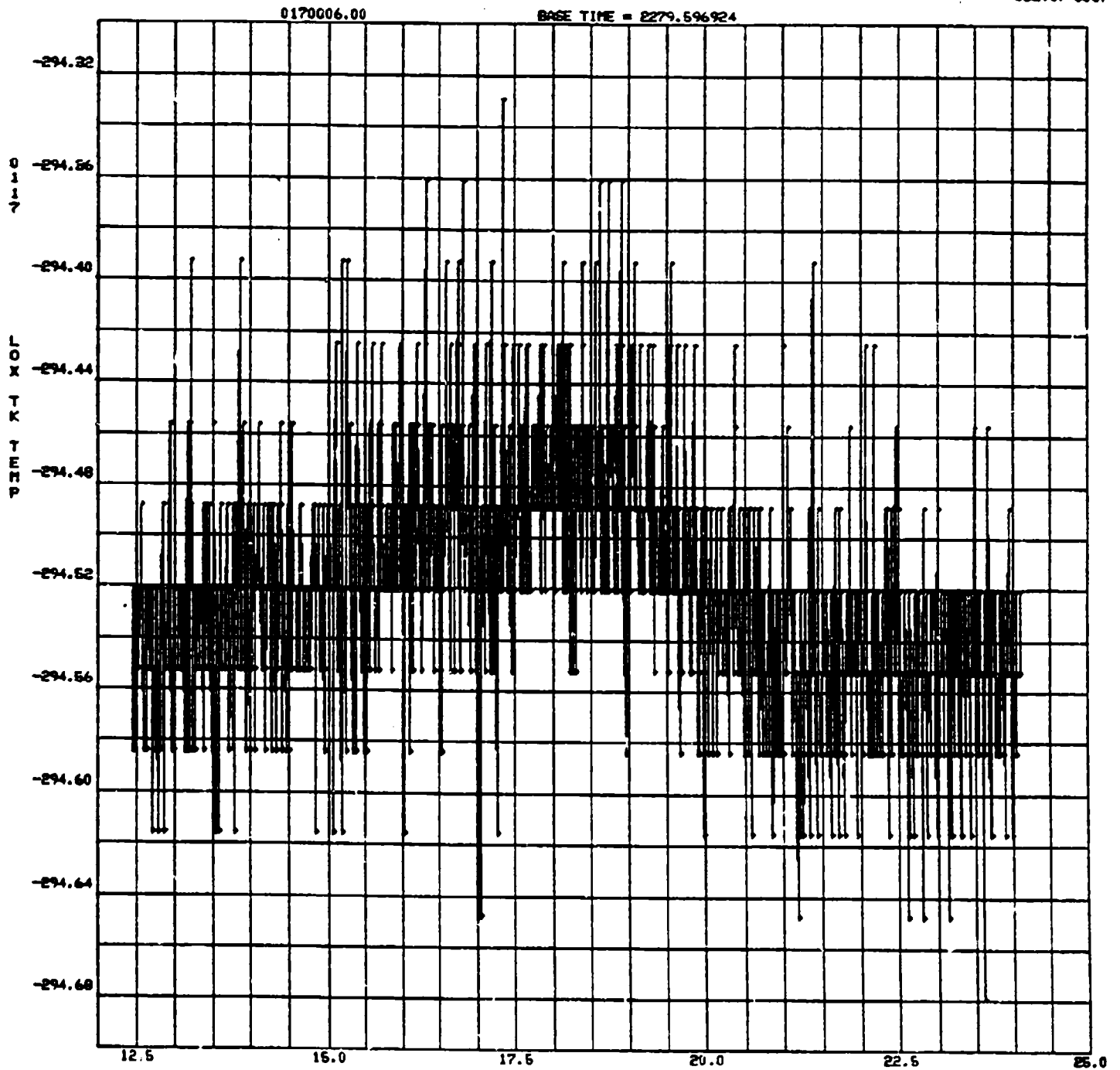

Appendix B: Test 87-017-006 Time Based Data Plots (1/28/87)

4055962009
012987 0086

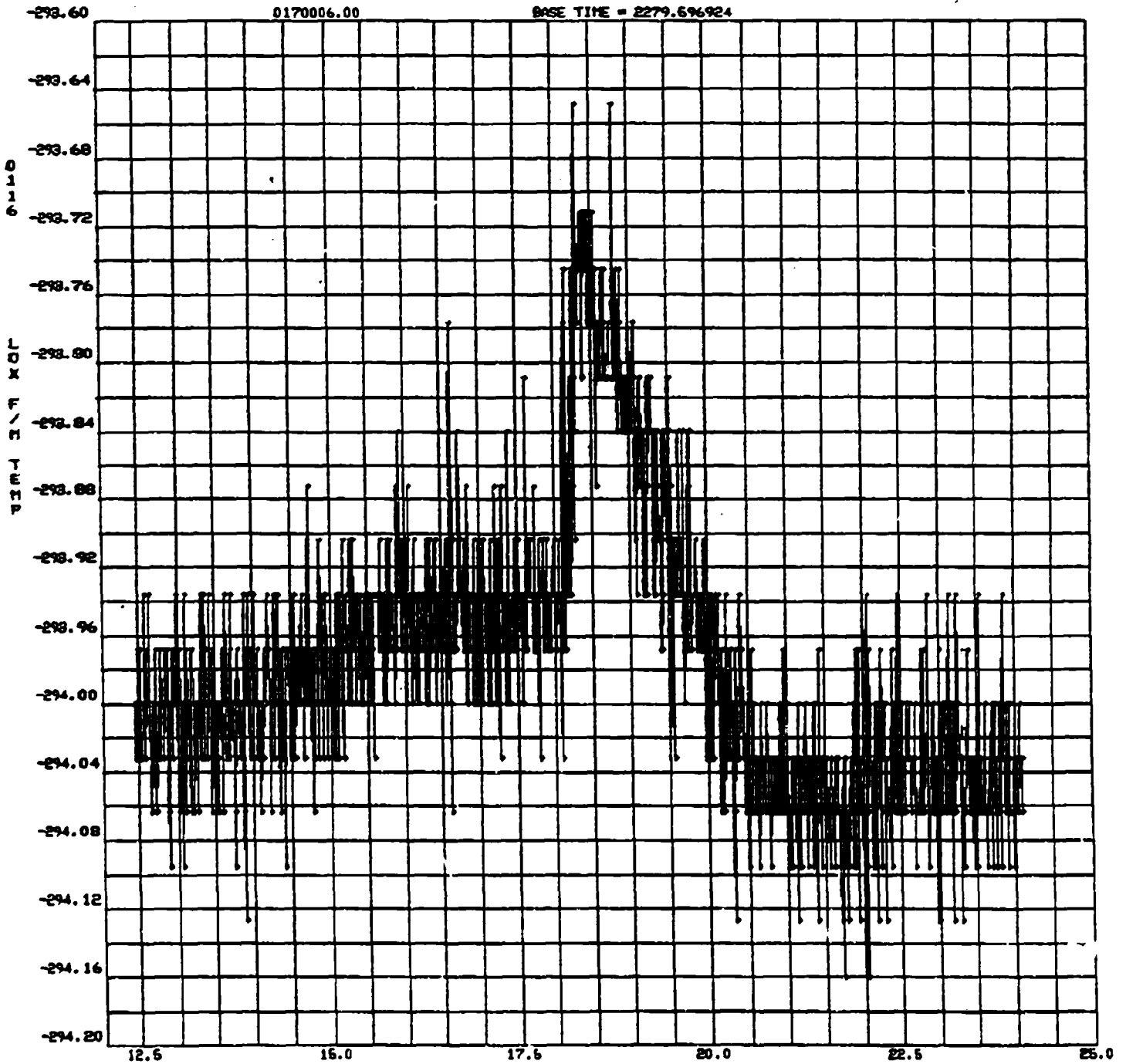

Appendix B: Test 87-017-006 Time Based Data Plots (1/28/87)

4056962003
012987 0086

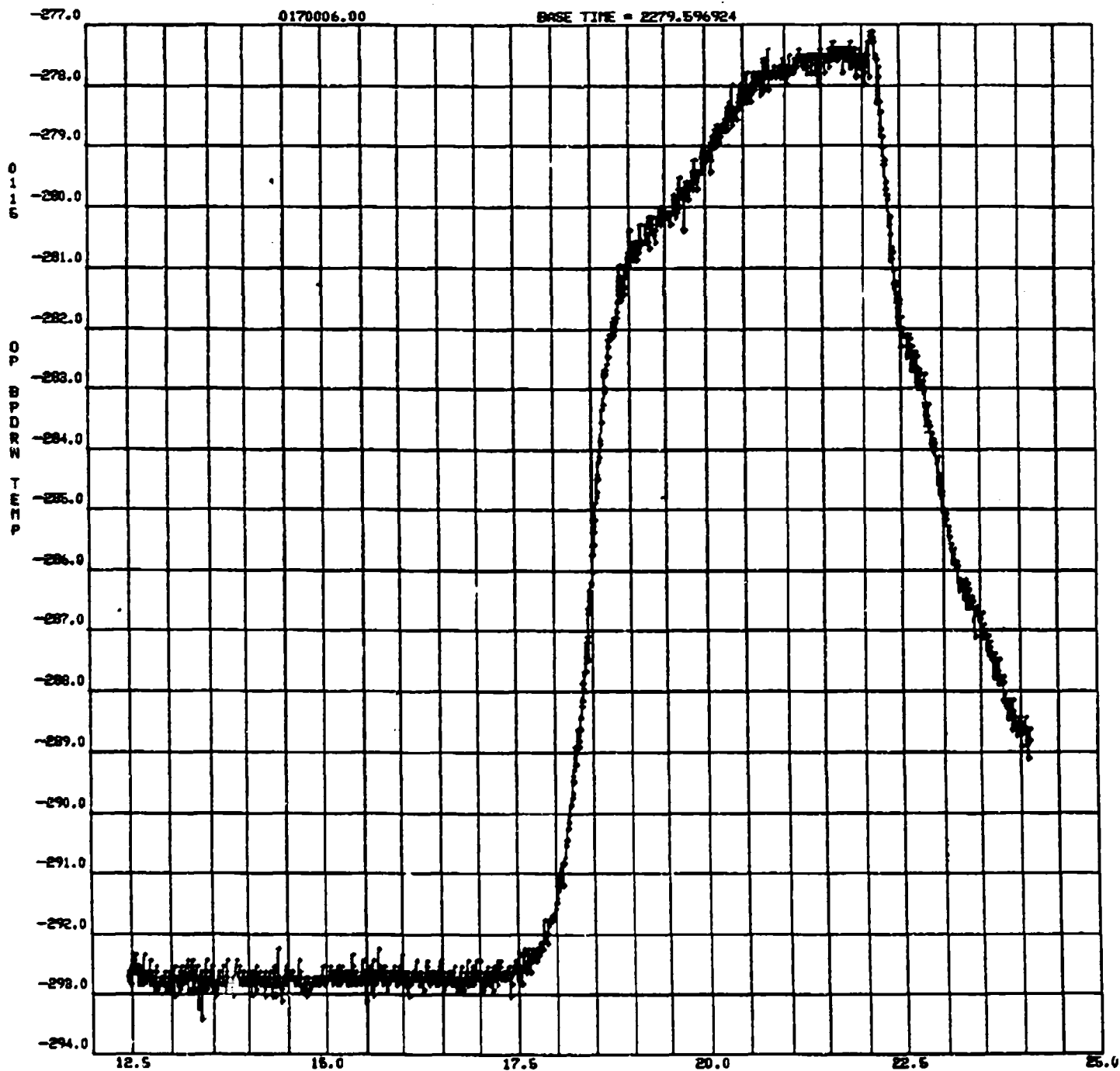

Appendix B: Test 87-017-006 Time Based Data Plots (1/28/87)

4055952003
012987 0084

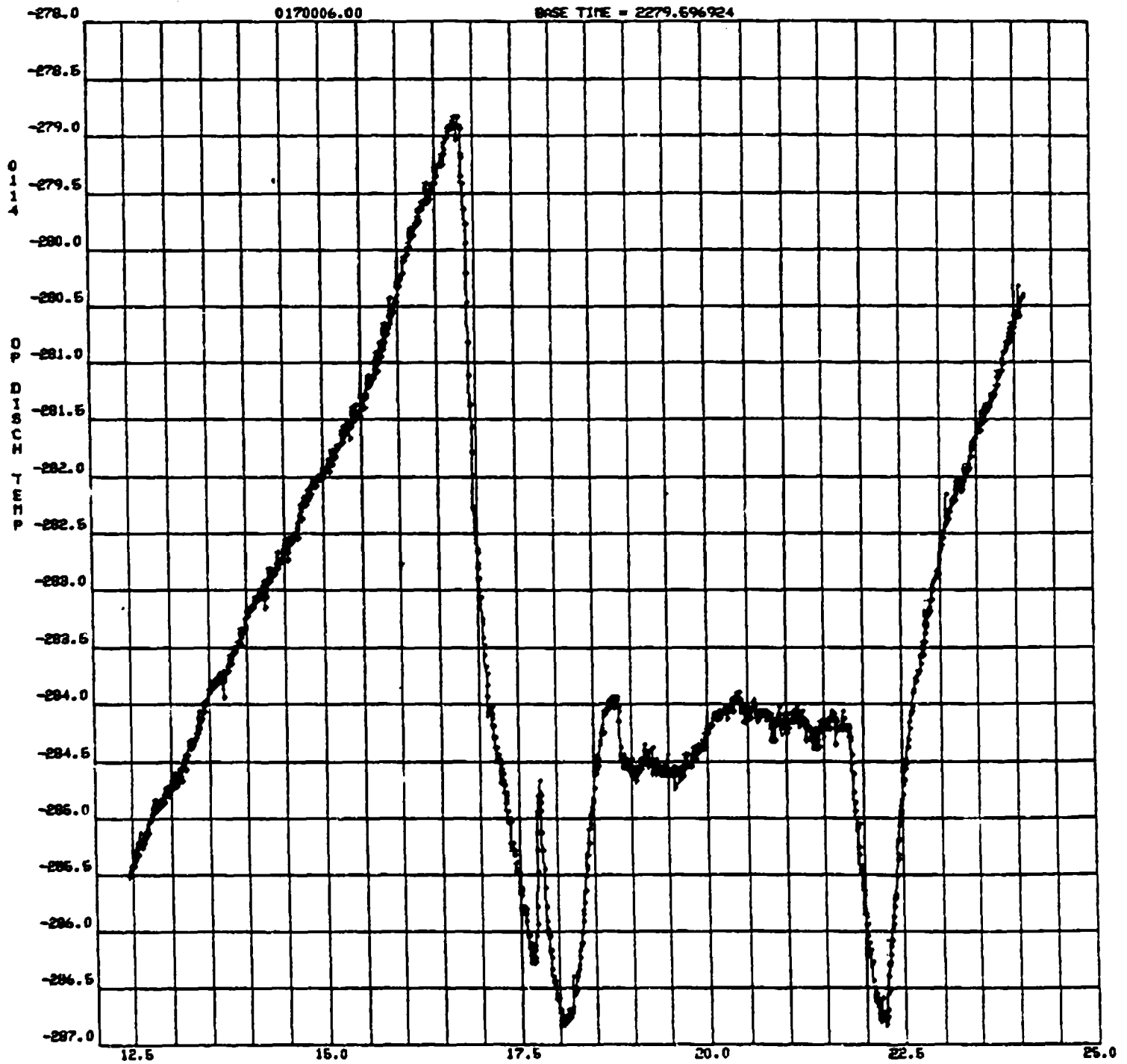

Appendix B:
Test 87-017-006 Time Based Data Plots (1/28/87)

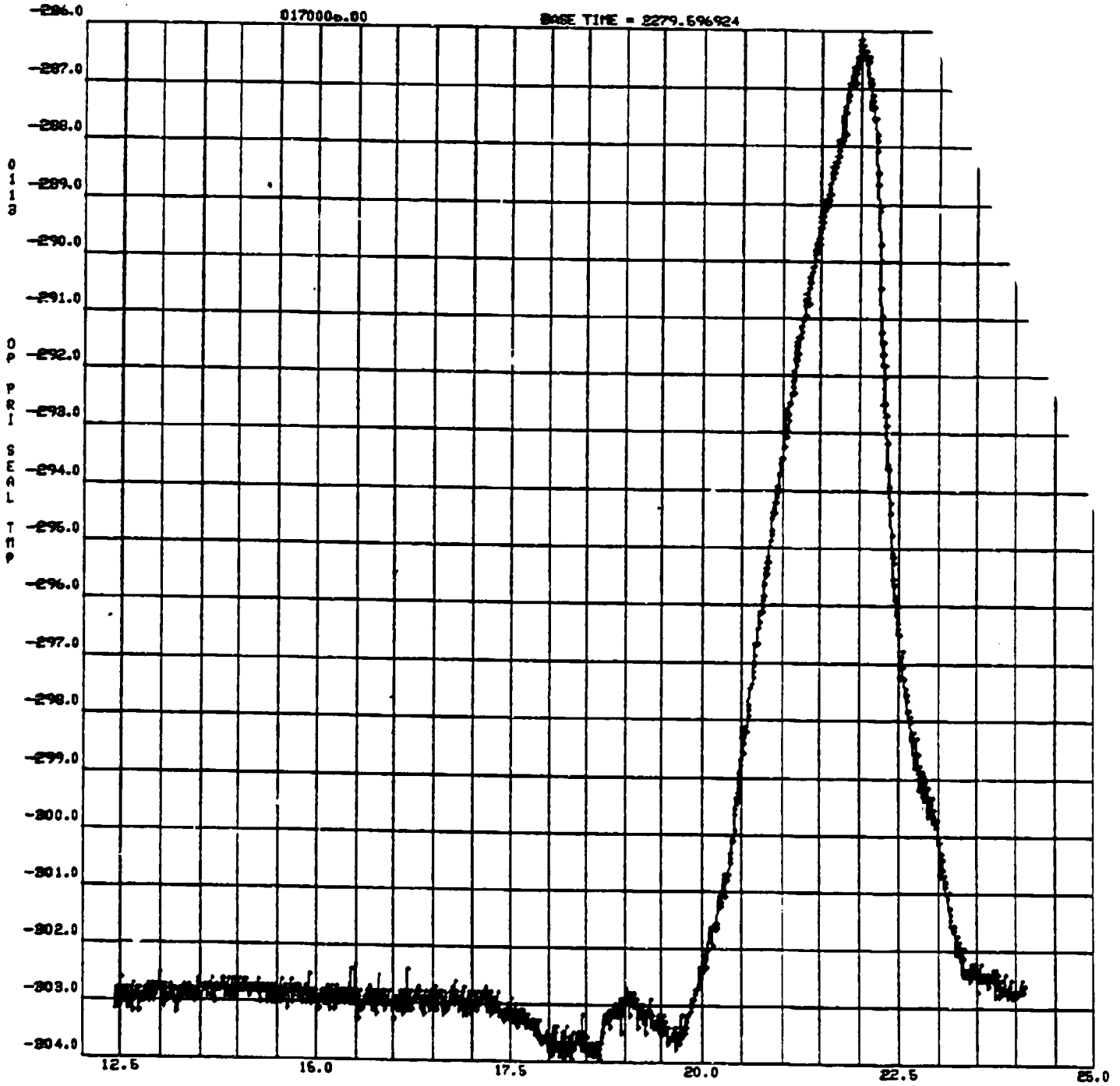

Appendix B: Test 87-017-006 Time Based Data Plots (1/28/87)

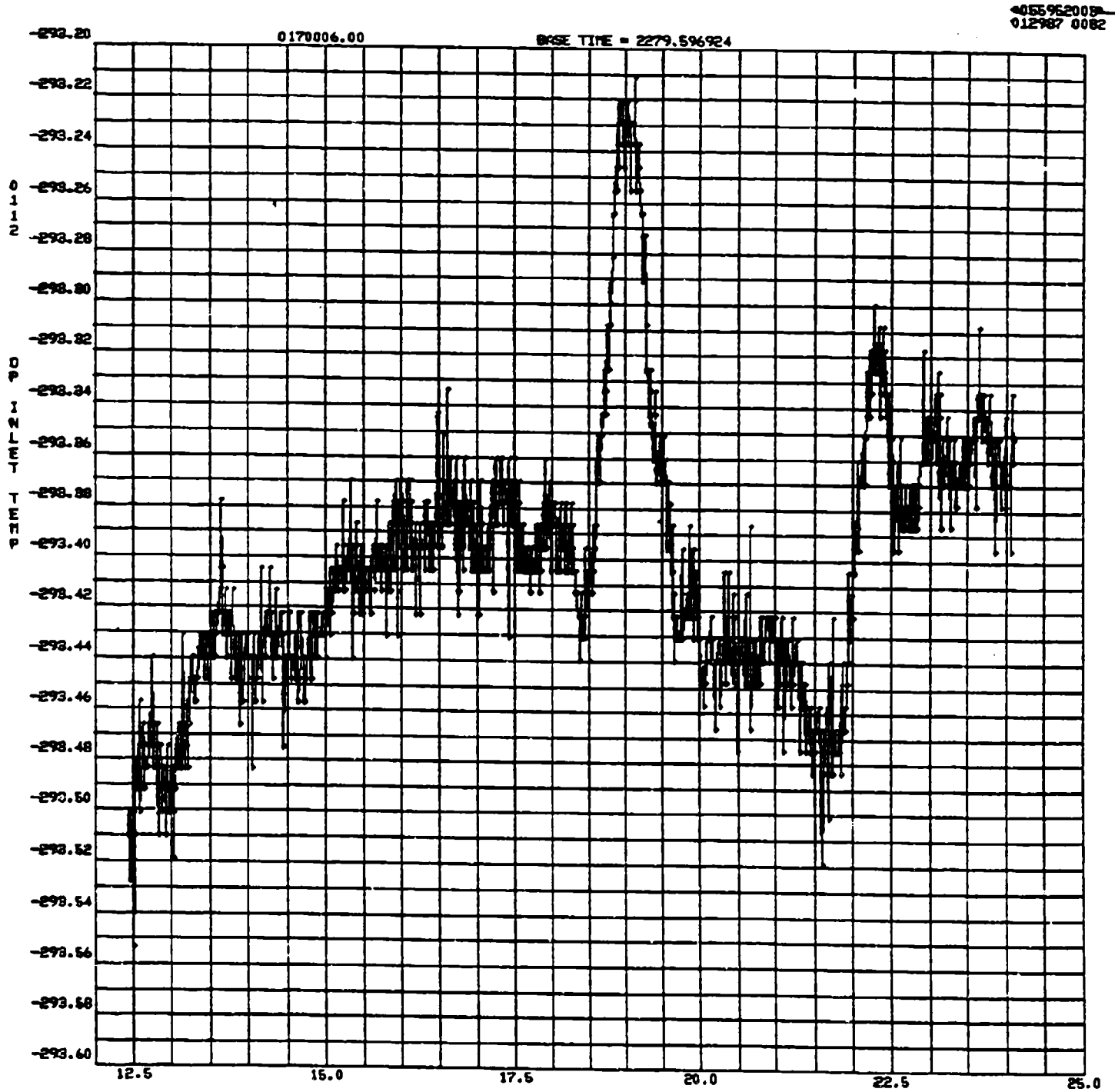

Appendix B: Test 87-017-006 Time Based Data Plots (1/28/87)

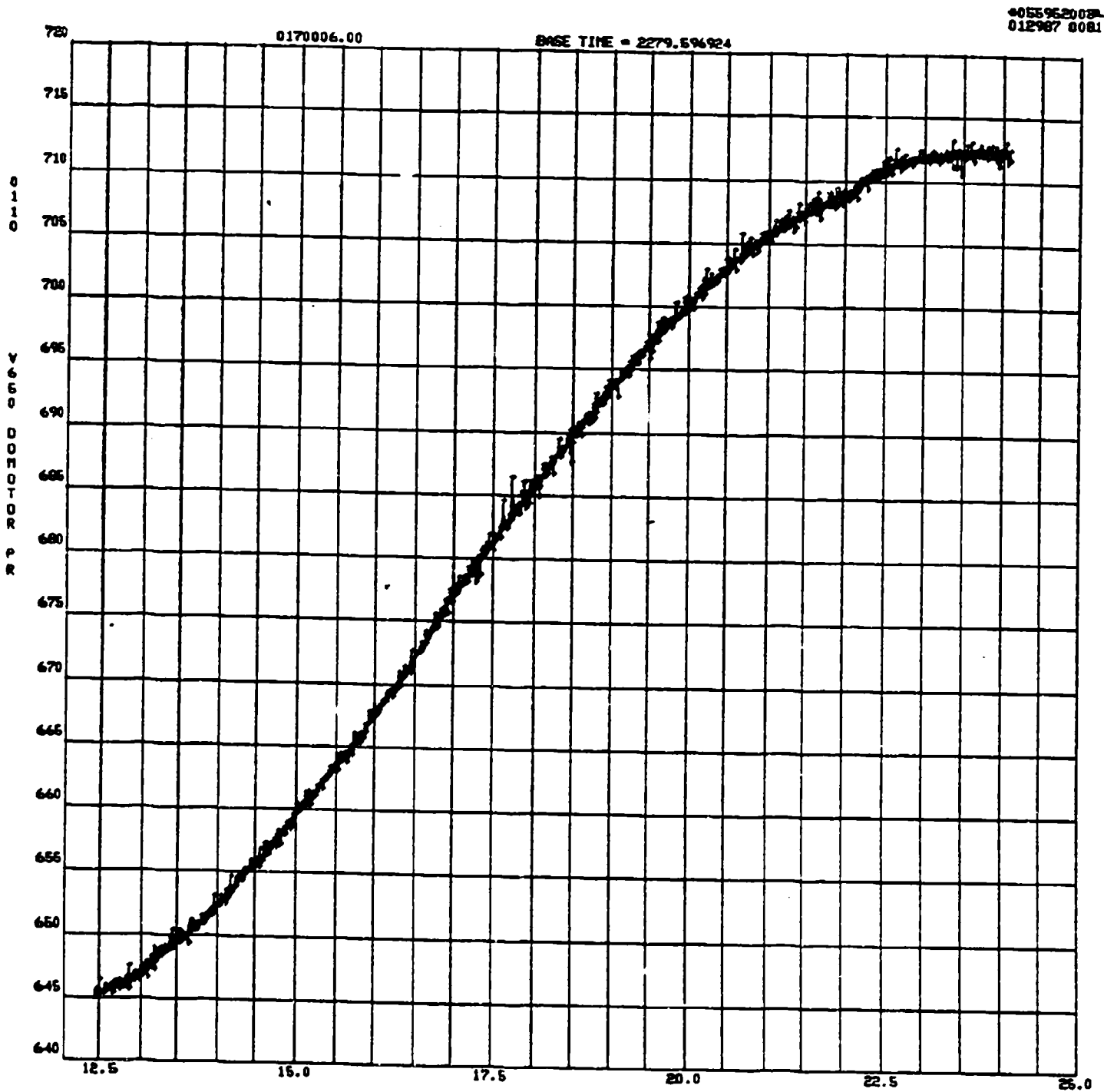

Appendix B: Test 87-017-006 Time Based Data Plots (1/28/87)

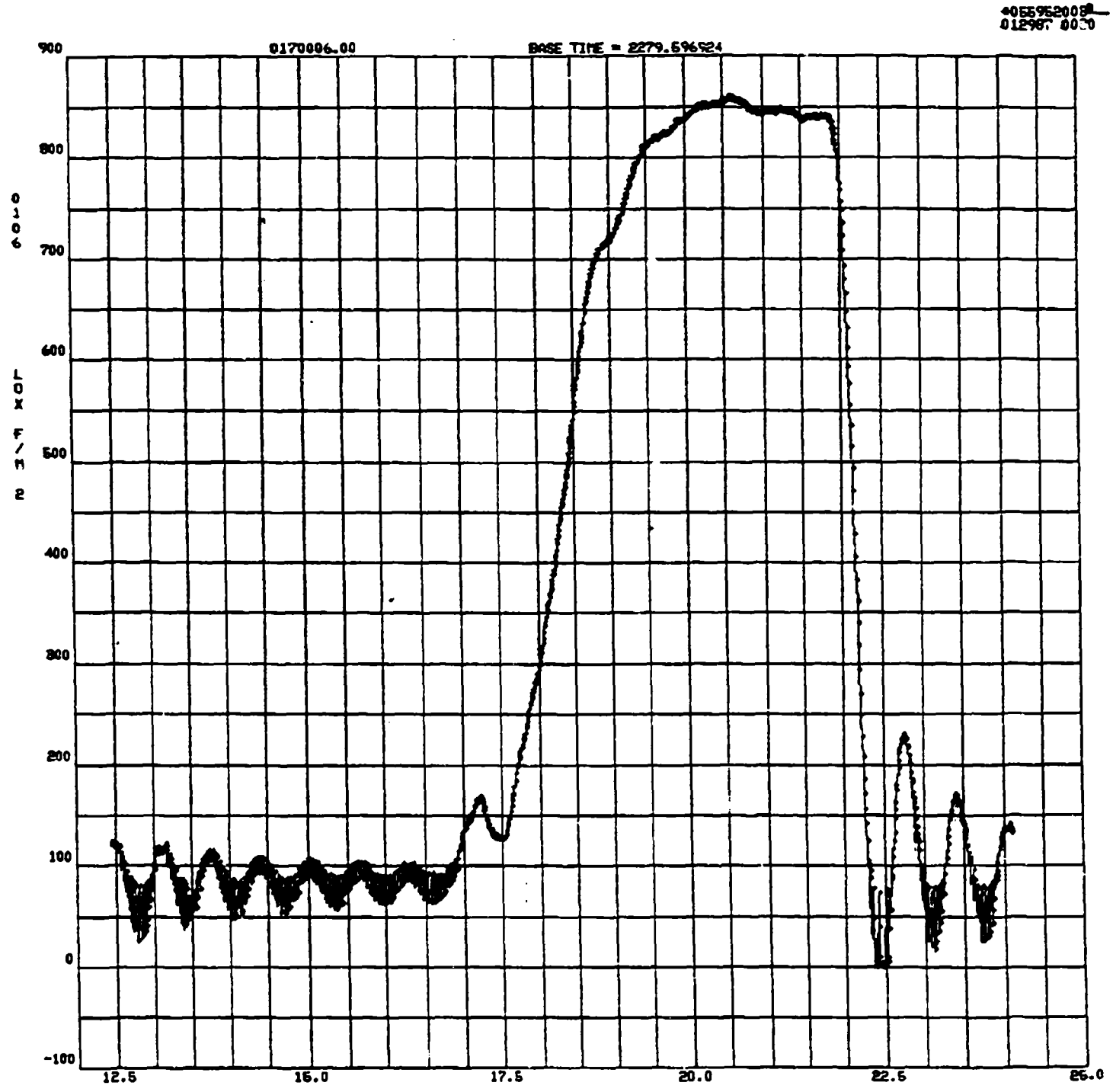

Appendix B: Test 87-017-006 Time Based Data Plots (1/28/87)

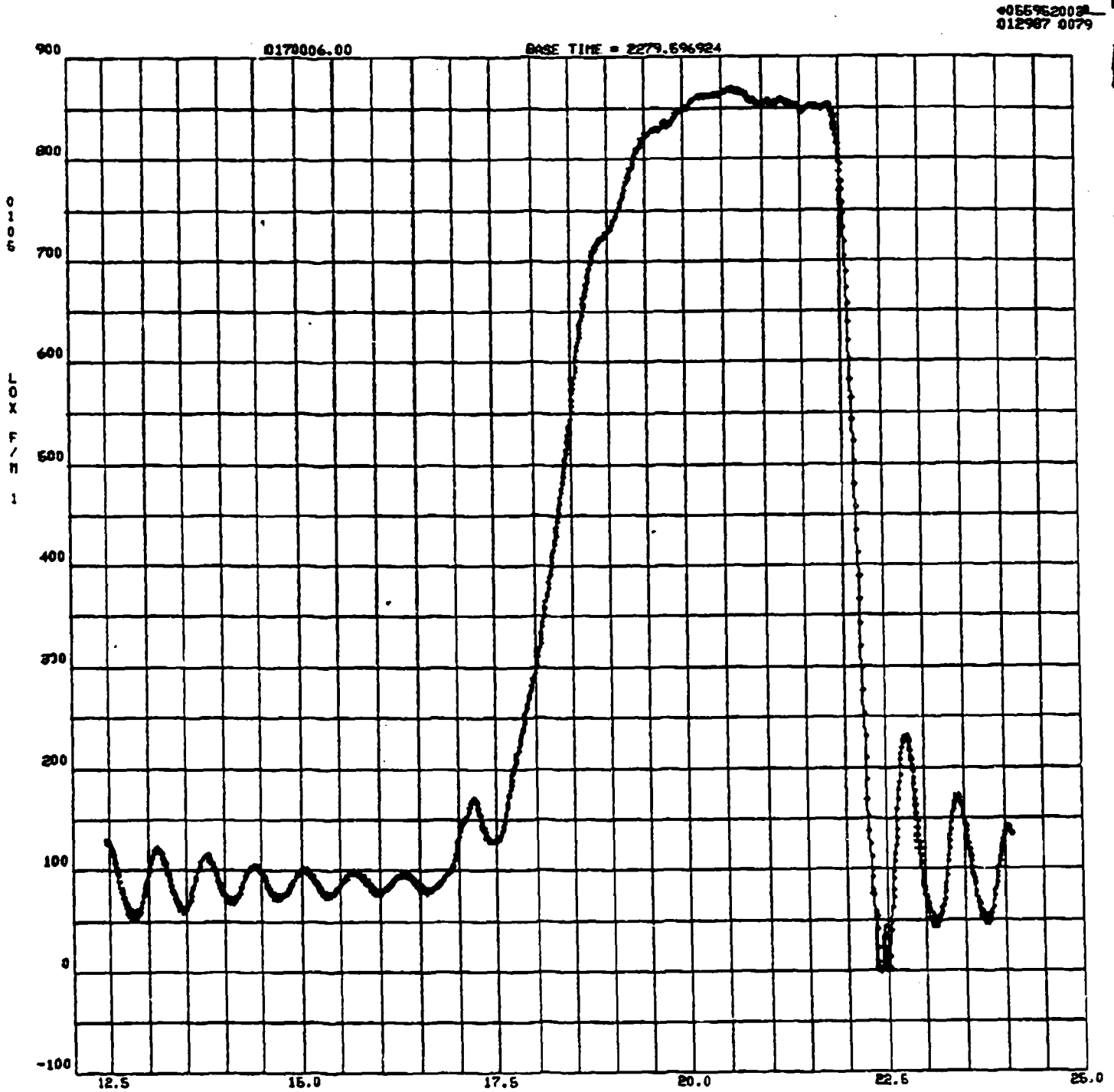

Appendix B: Test 87-017-006 Time Based Data Plots (1/28/87)

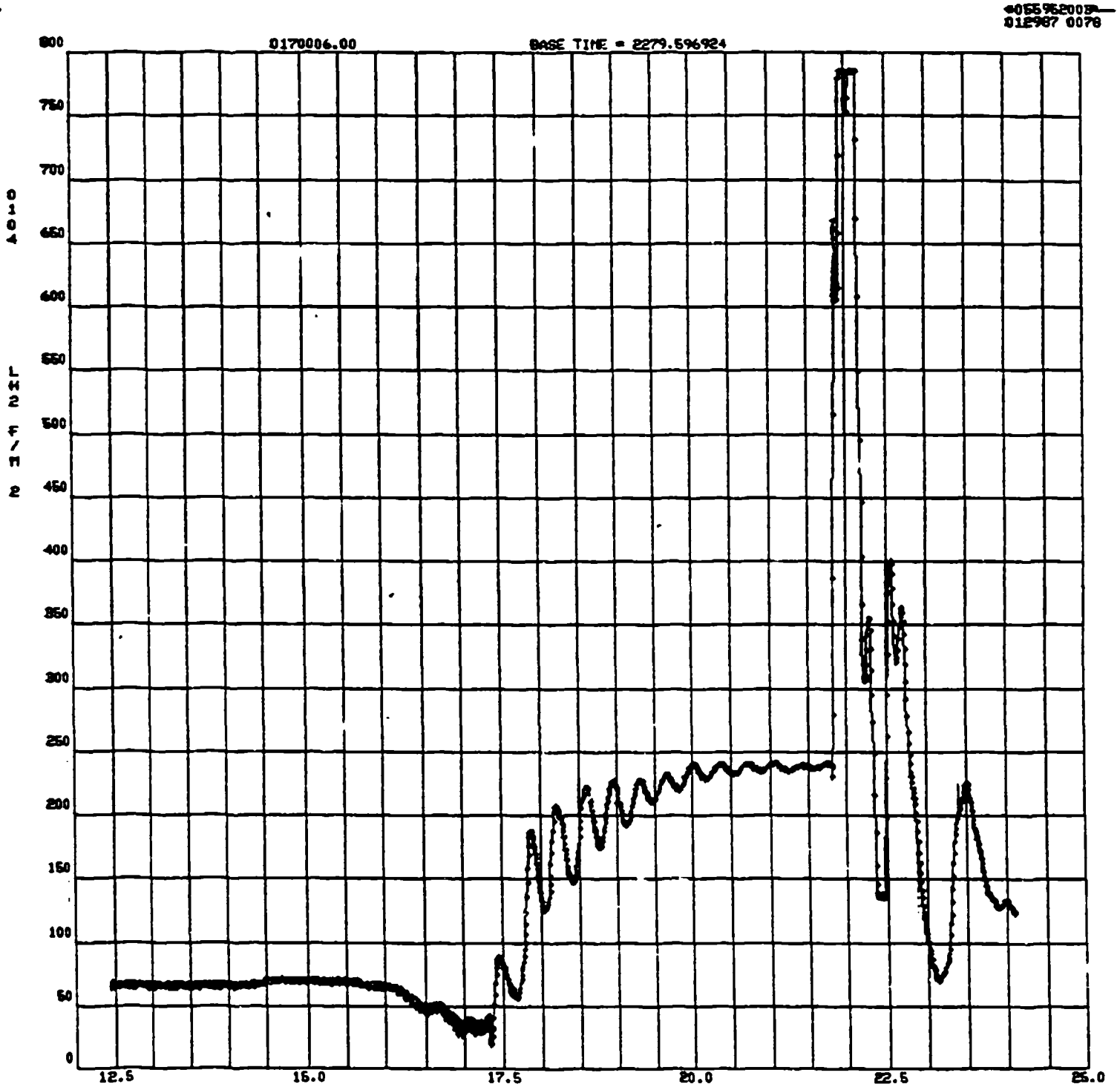

Appendix B: Test 87-017-006 Time Based Data Plots (1/28/87)

0155952008
012987 0077

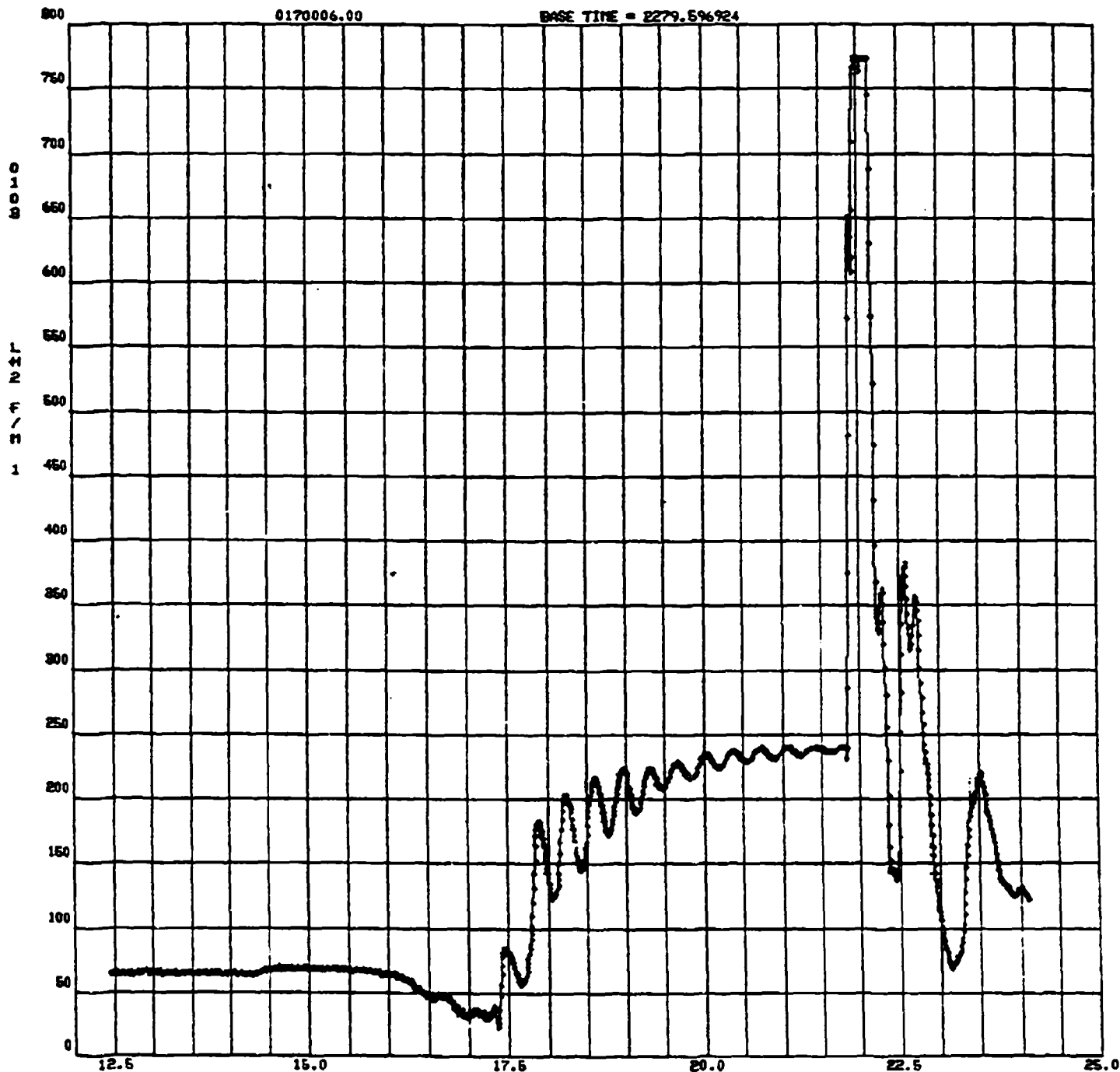

Appendix B: Test 87-017-006 Time Based Data Plots (1/28/87)



Appendix B: Test 87-017-006 Time Based Data Plots (1/28/87)

055952003
012967 0076

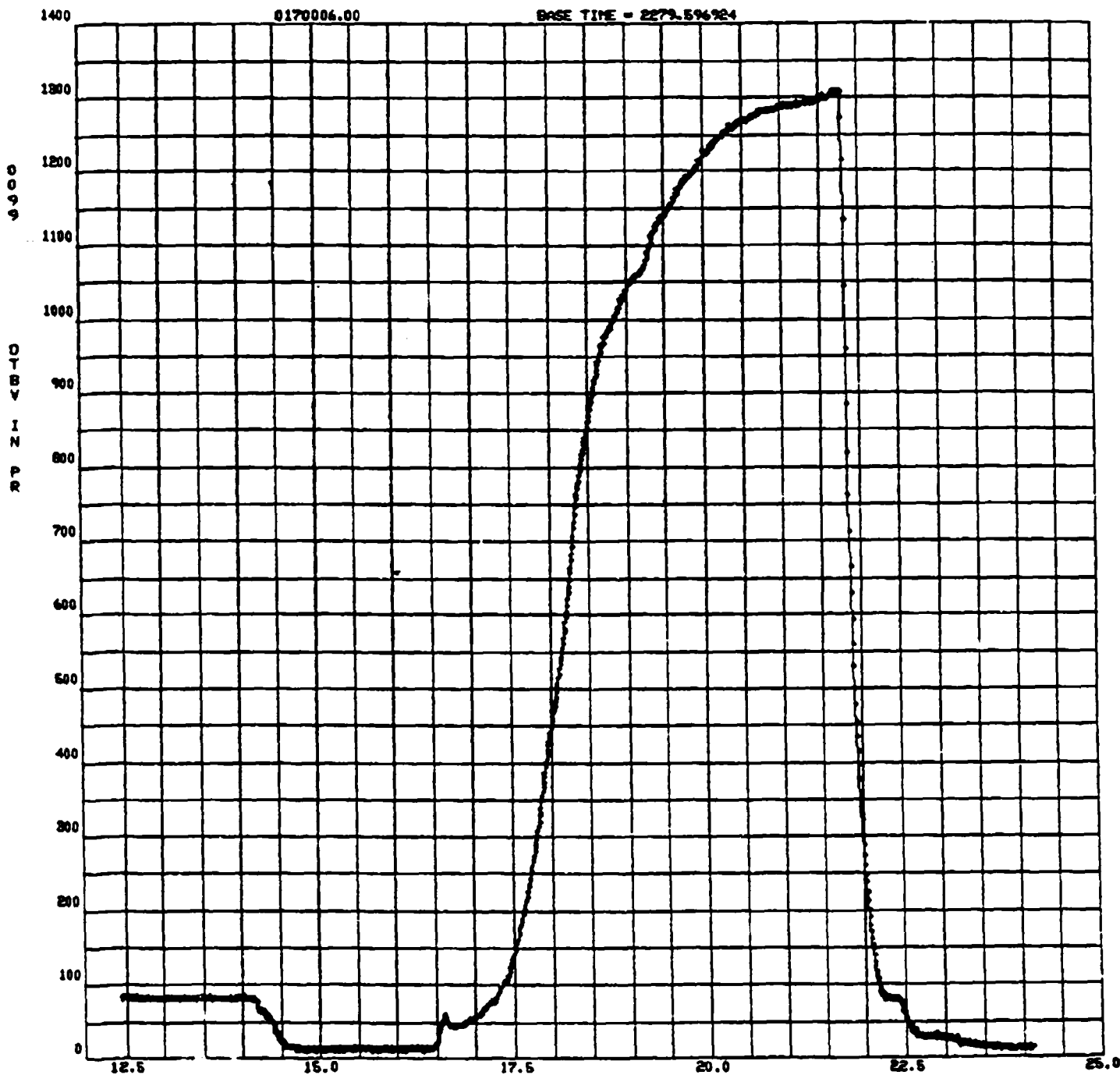

Appendix B: Test 87-017-006 Time Based Data Plots (1/28/87)

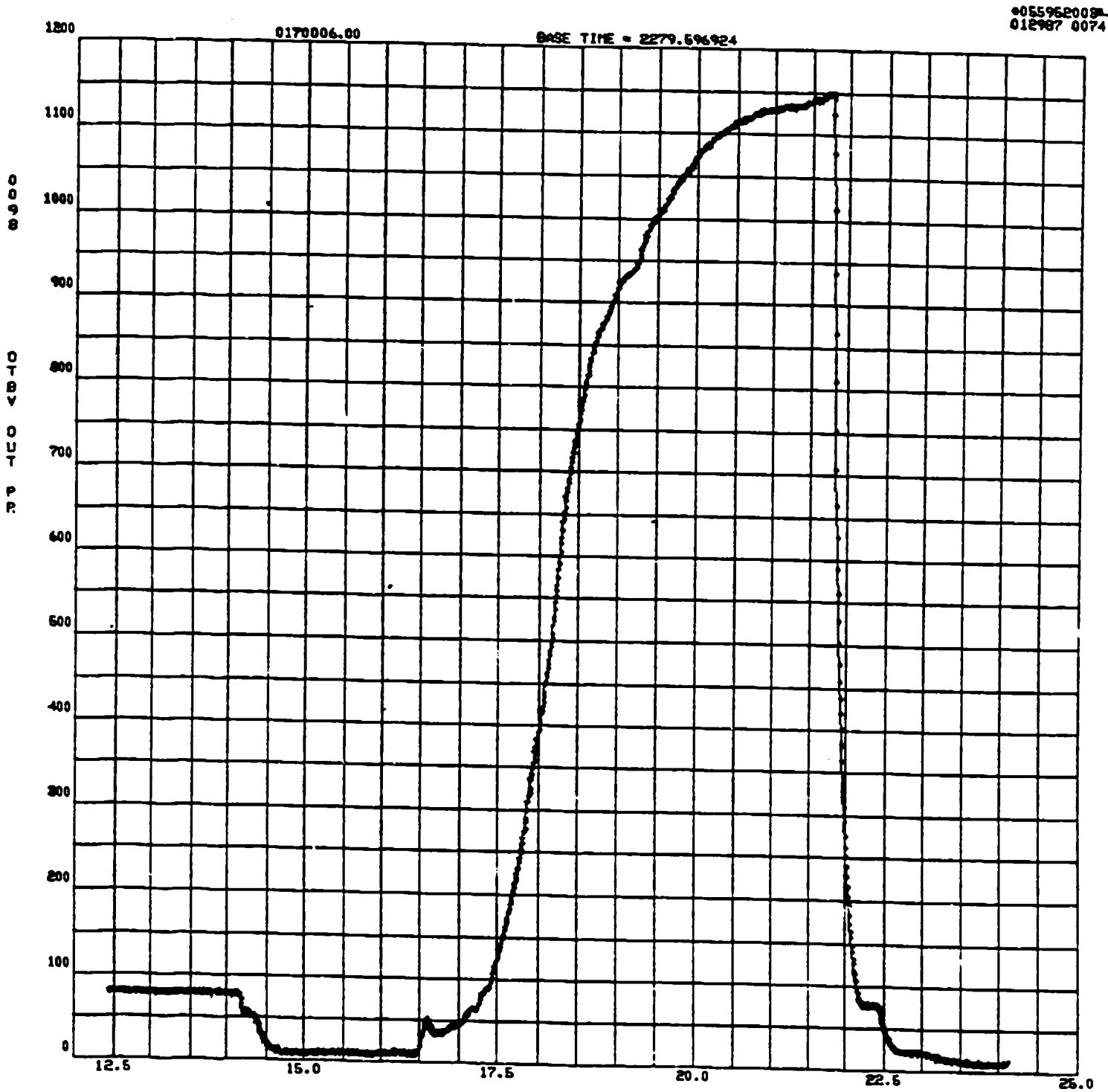

Appendix B: Test 87-017-006 Time Based Data Plots (1/28/87)

0155962003
012987 0078

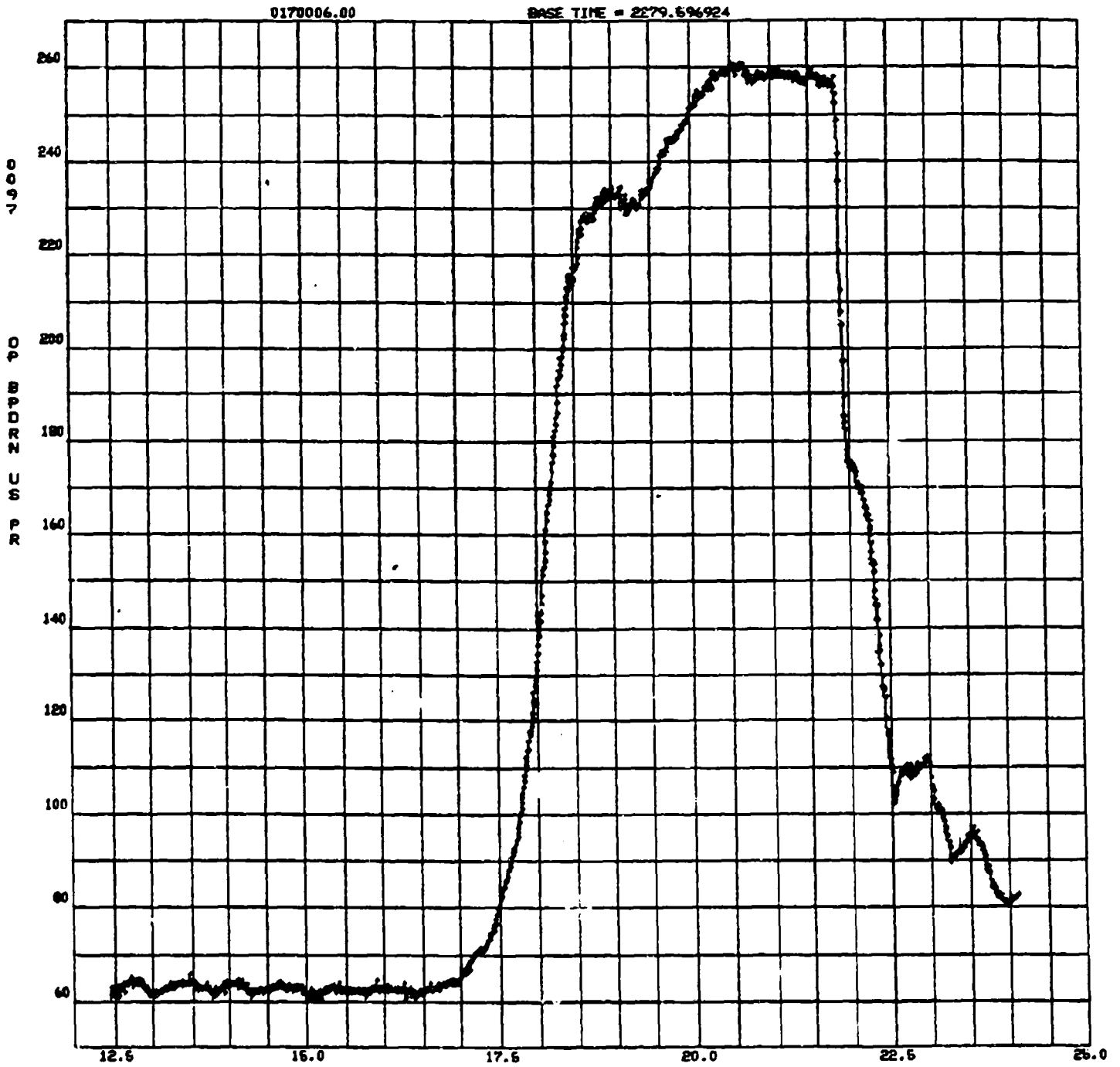

Appendix B: Test 87-017-006 Time Based Data Plots (1/28/87)

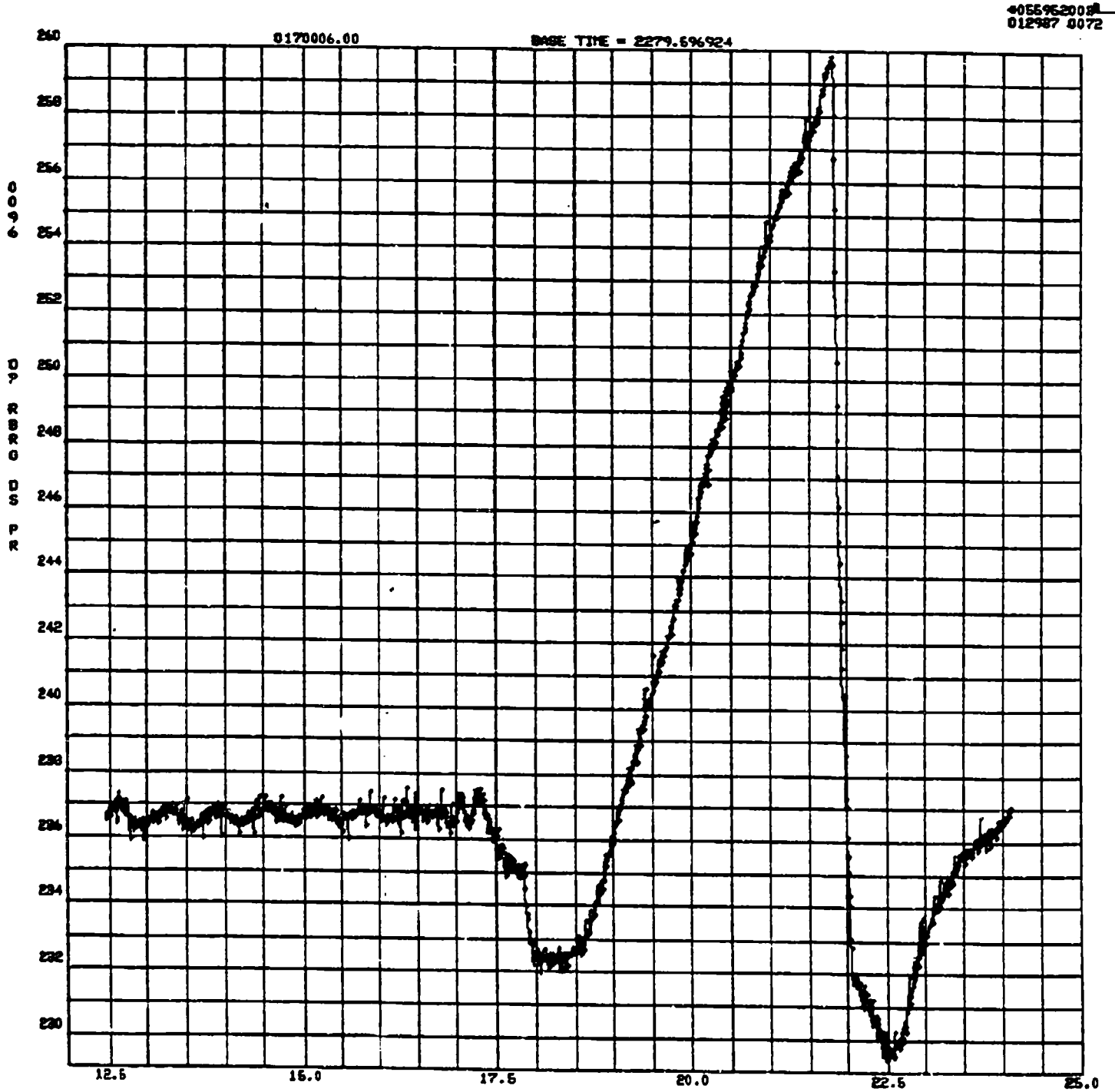

Appendix B: Test 87-017-006 Time Based Data Plots (1/28/87)

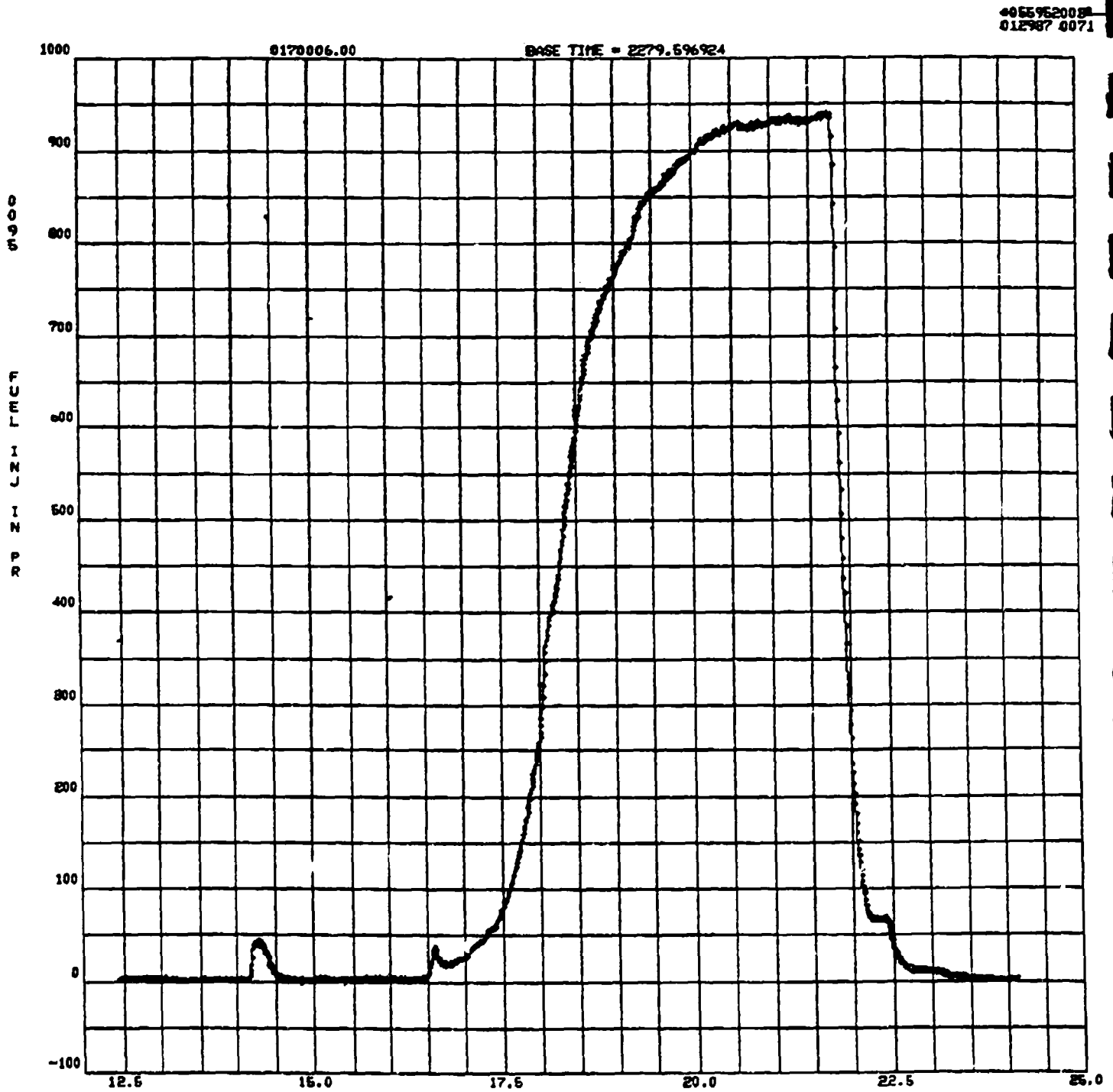

Appendix B: Test 87-017-006 Time Based Data Plots (1/28/87)

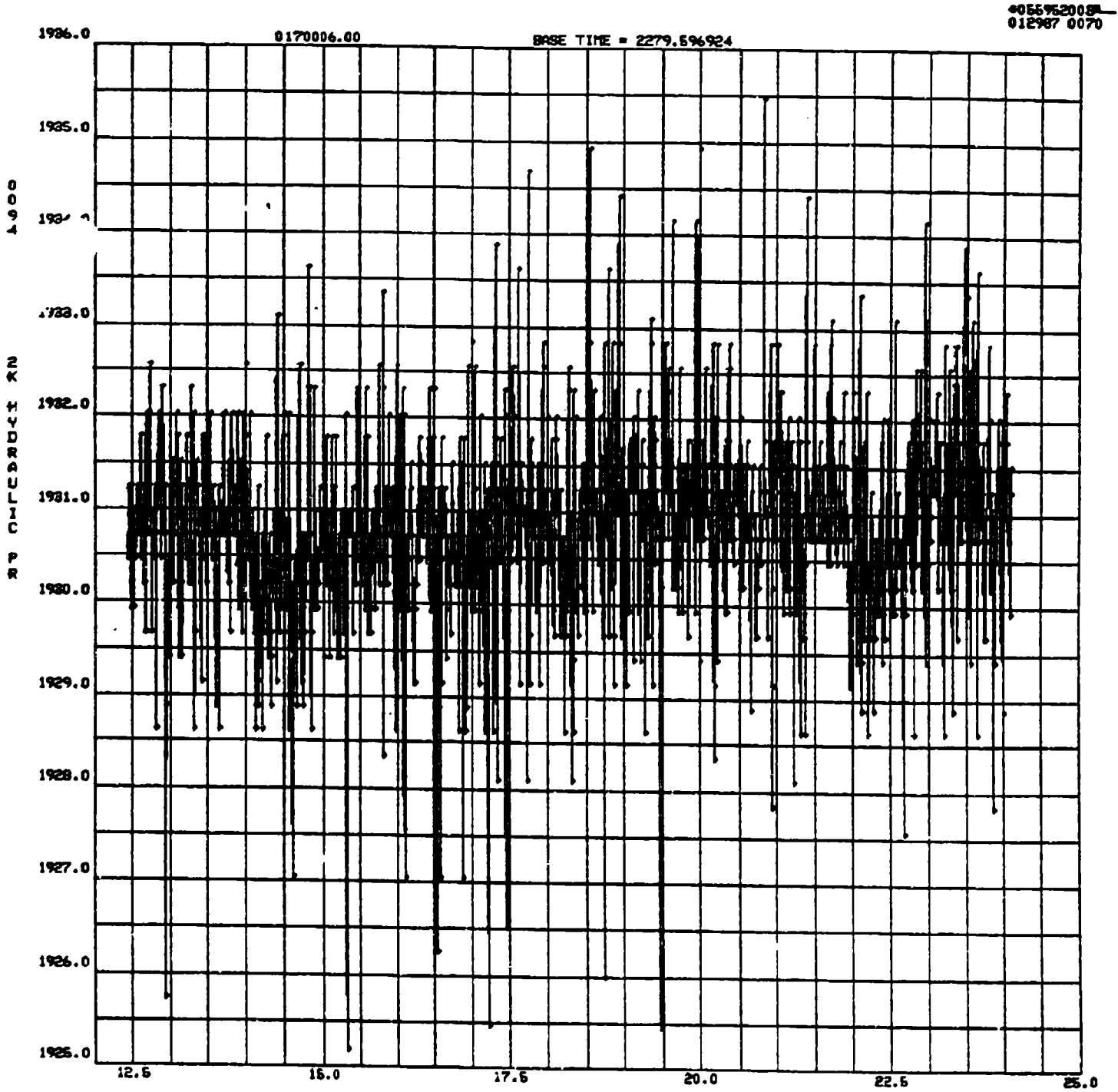

Appendix B: Test 87-017-006 Time Based Data Plots (1/28/87)

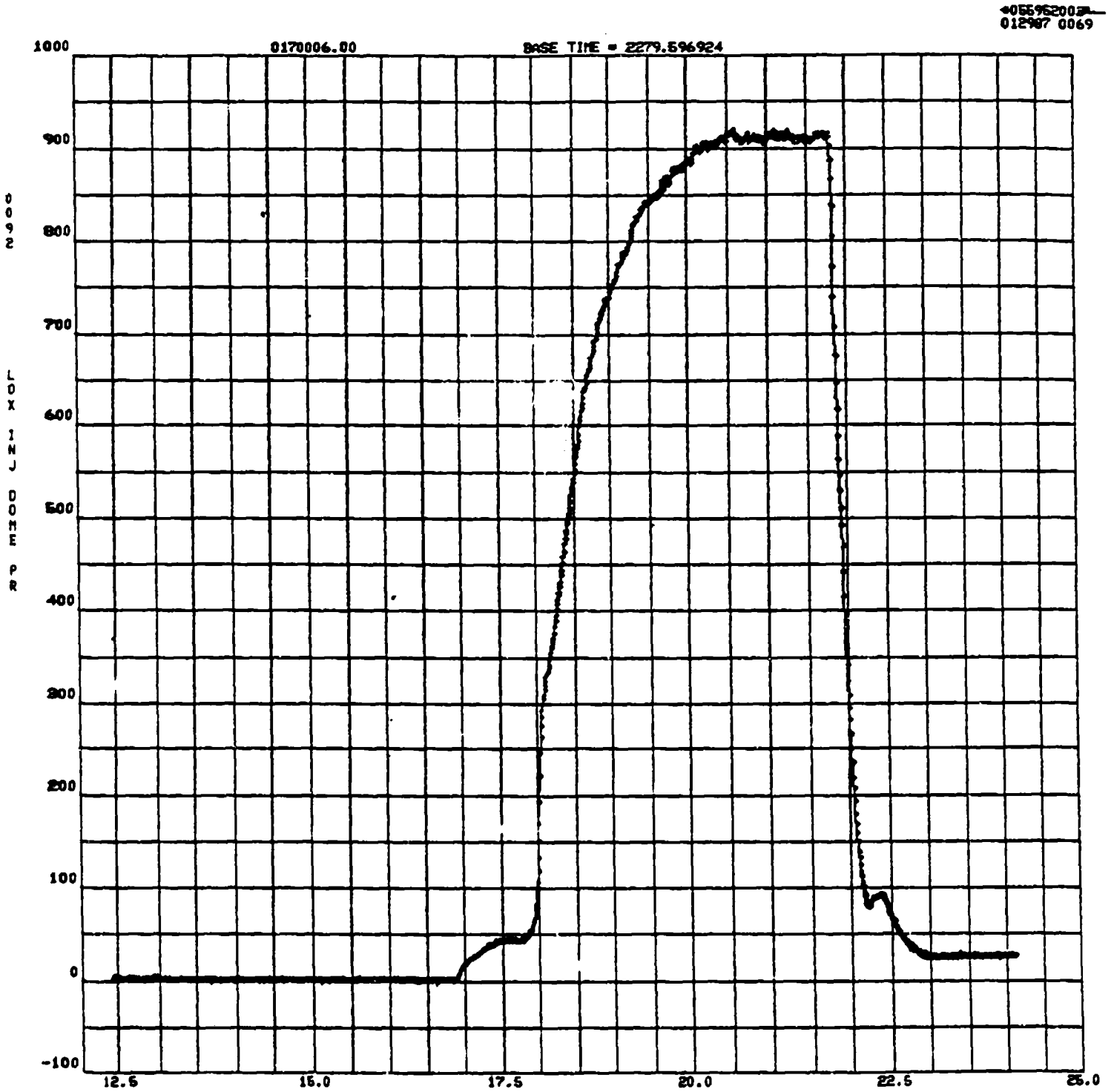

Appendix B: Test 87-017-006 Time Based Data Plots (1/28/87)

4055962003
012987 0060

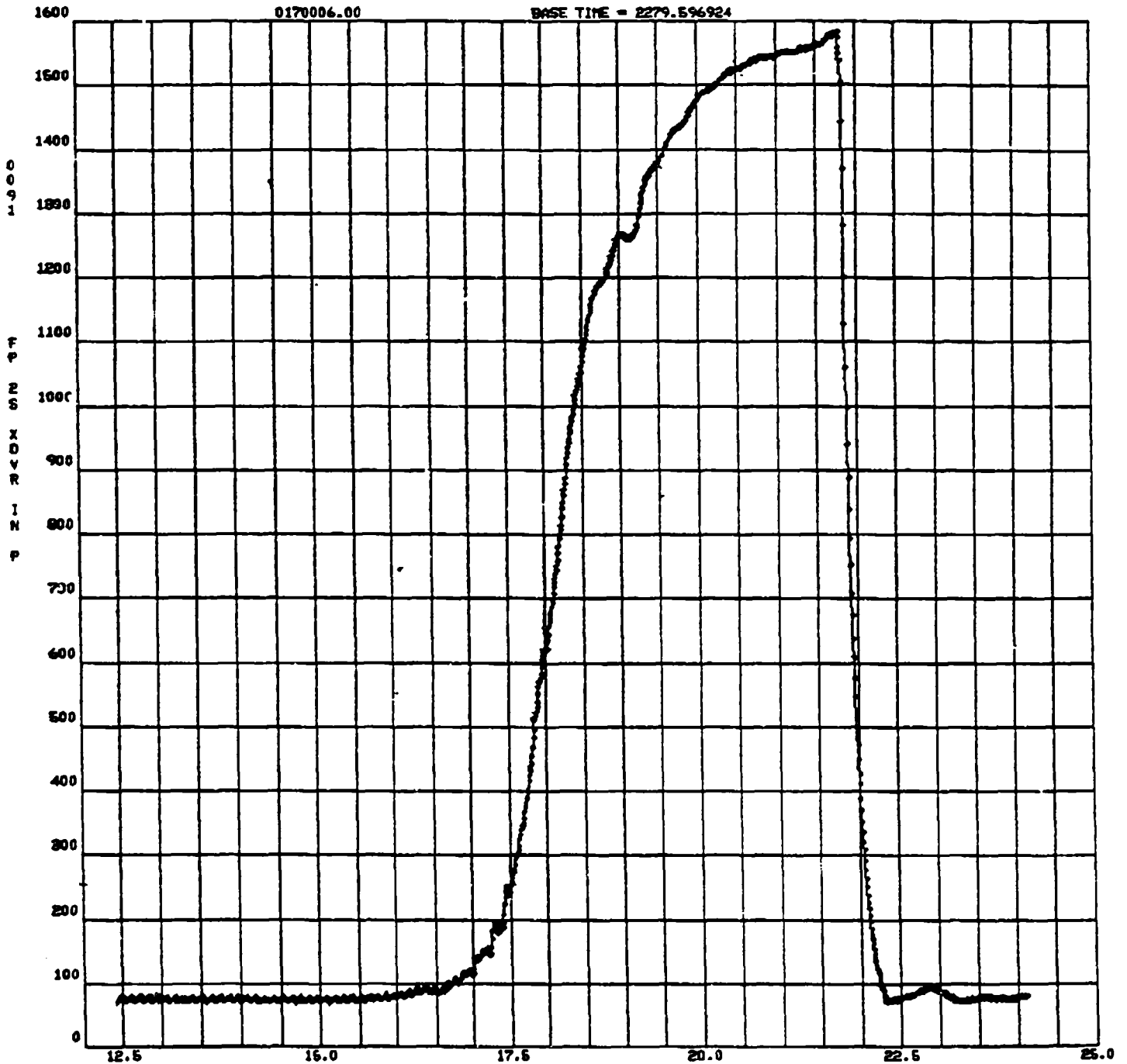

Appendix B: Test 87-017-006 Time Based Data Plots (1/28/87)

4055962009
012987 0067

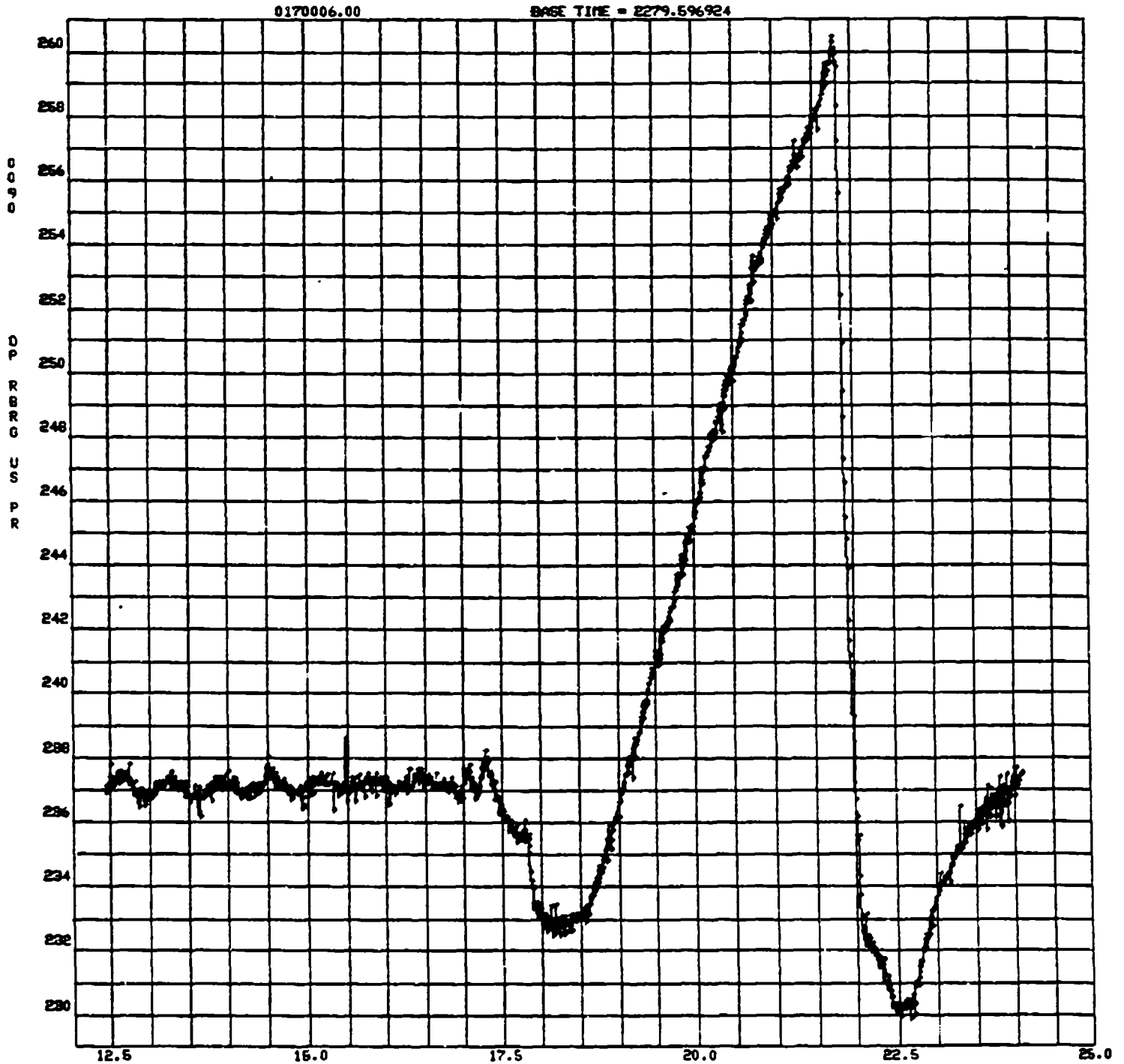

Appendix B: Test 87-017-006 Time Based Data Plots (1/28/87)

*055962003
012987 0066

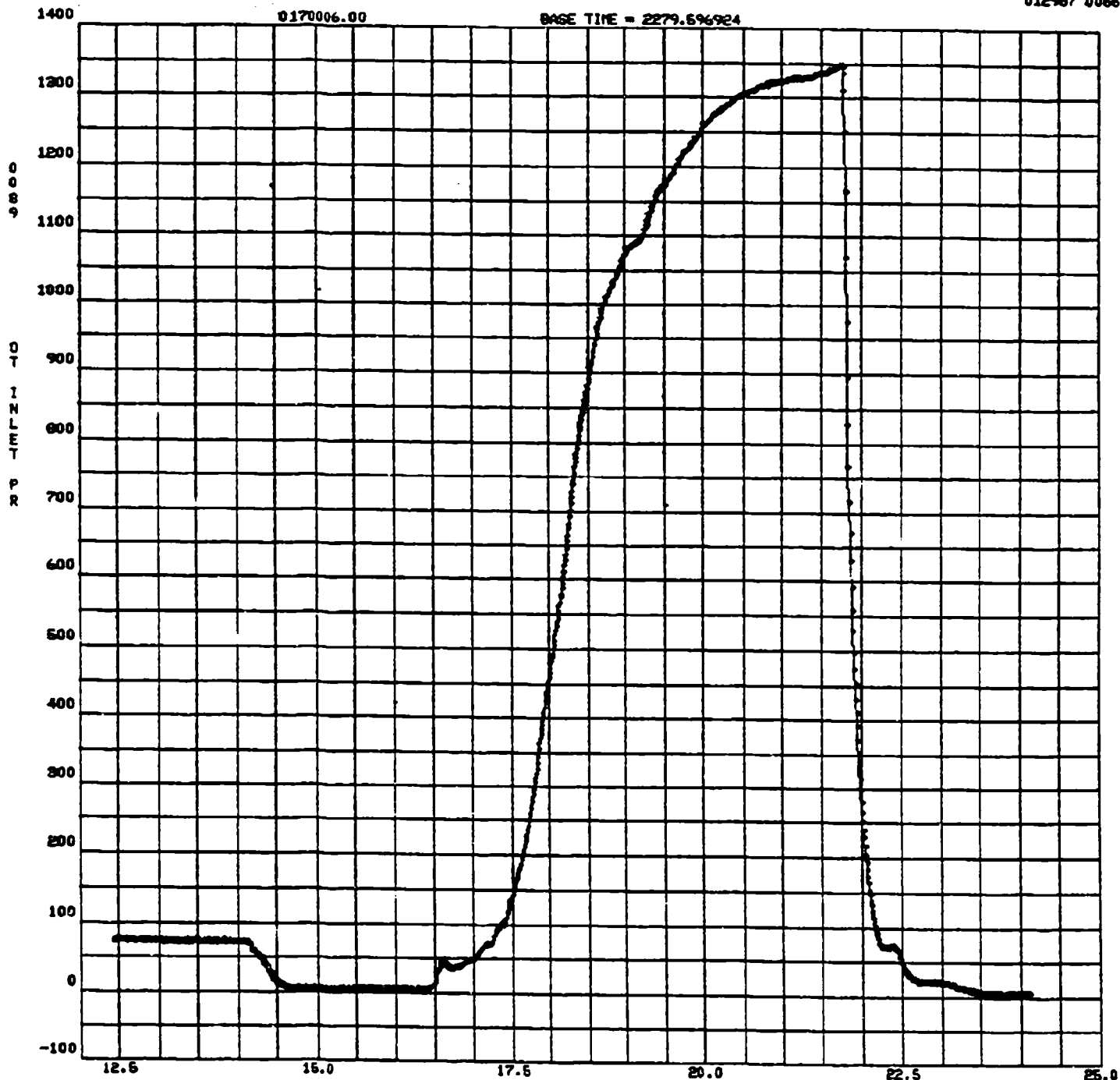

Appendix B: Test 87-017-006 Time Based Data Plots (1/28/87)

←055952009
012967 0065

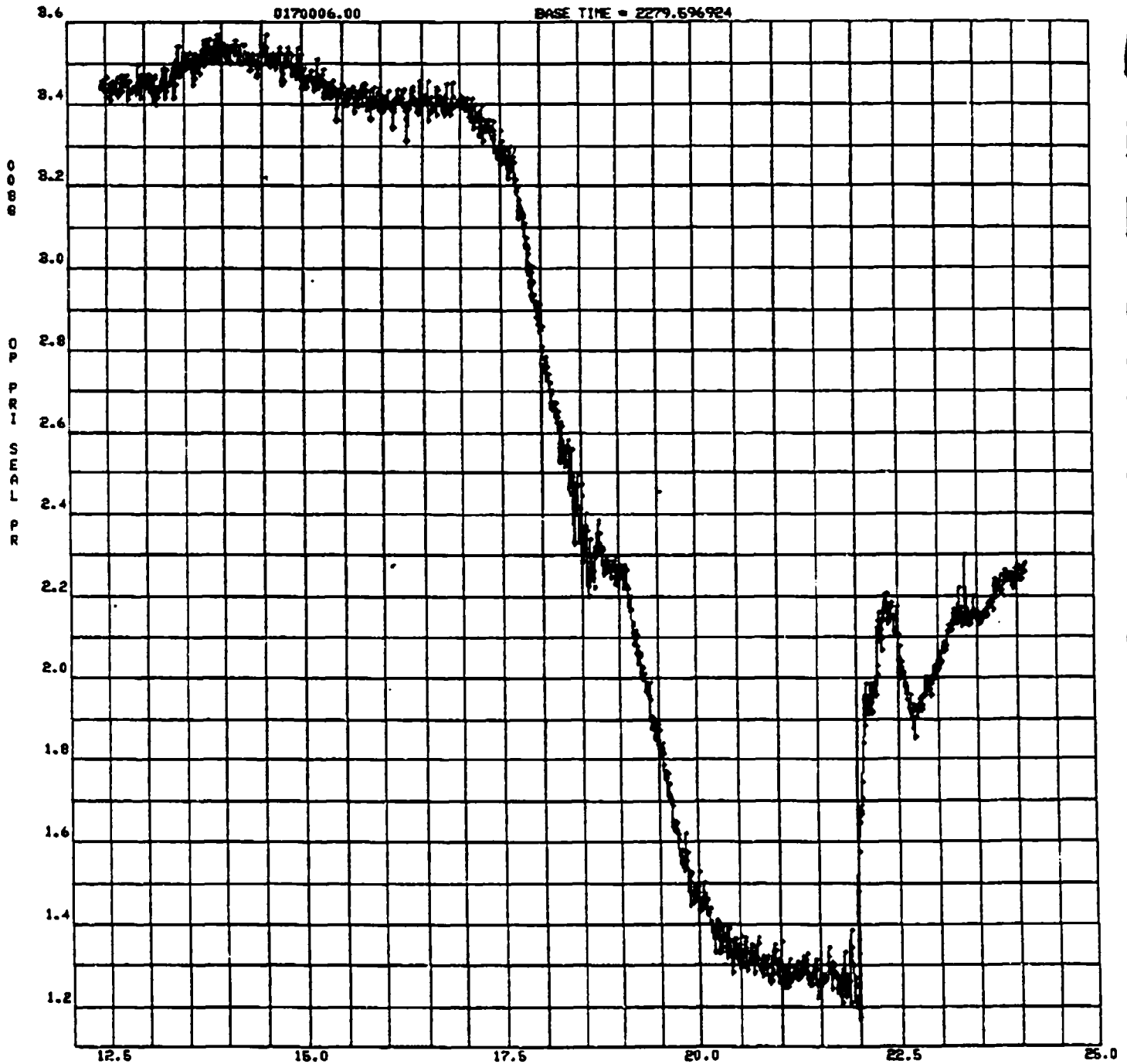

Appendix B: Test 87-017-006 Time Based Data Plots (1/28/87)

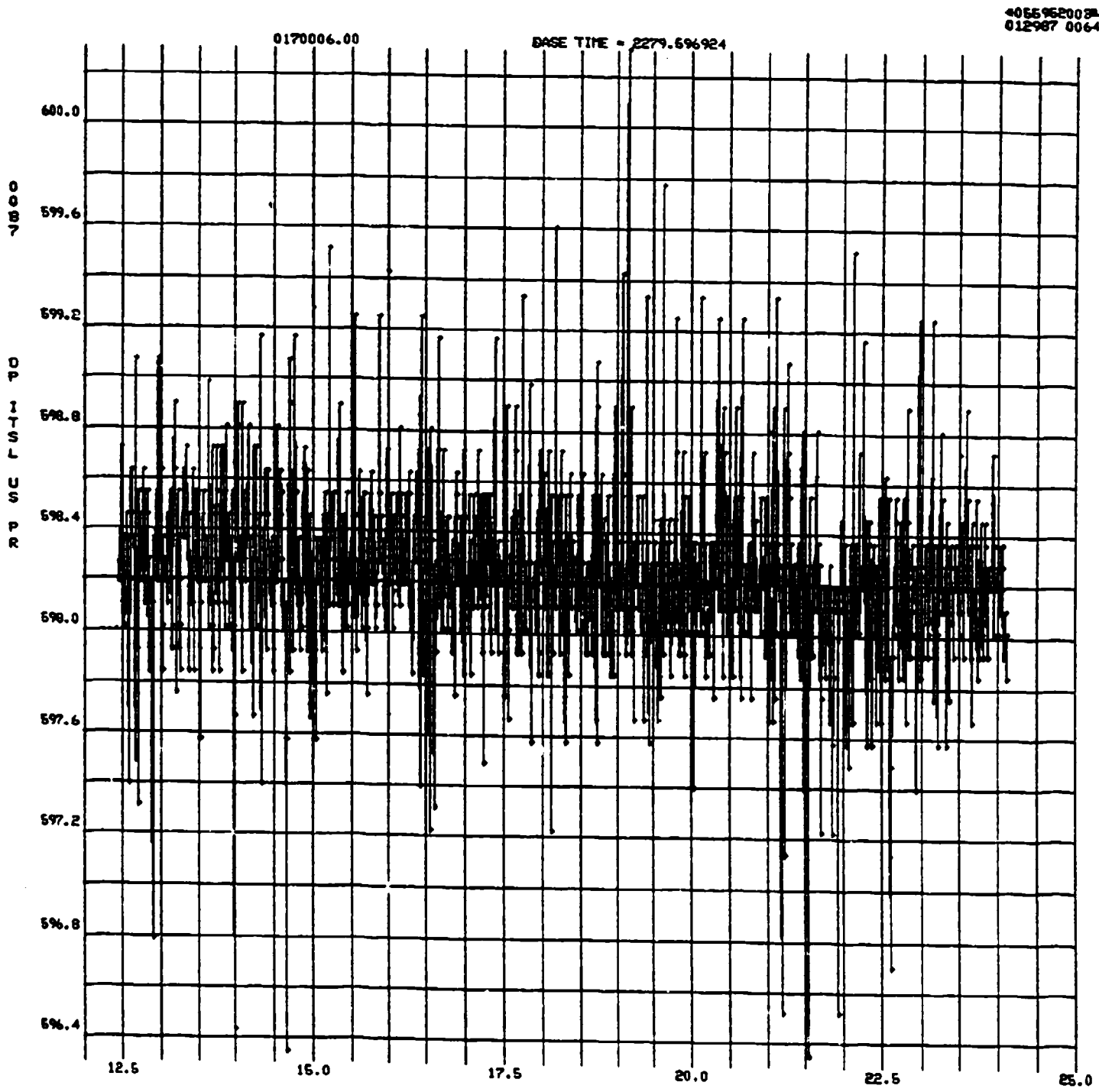

Appendix B: Test 87-017-006 Time Based Data Plots (1/28/87)

4055962009
012967 0063

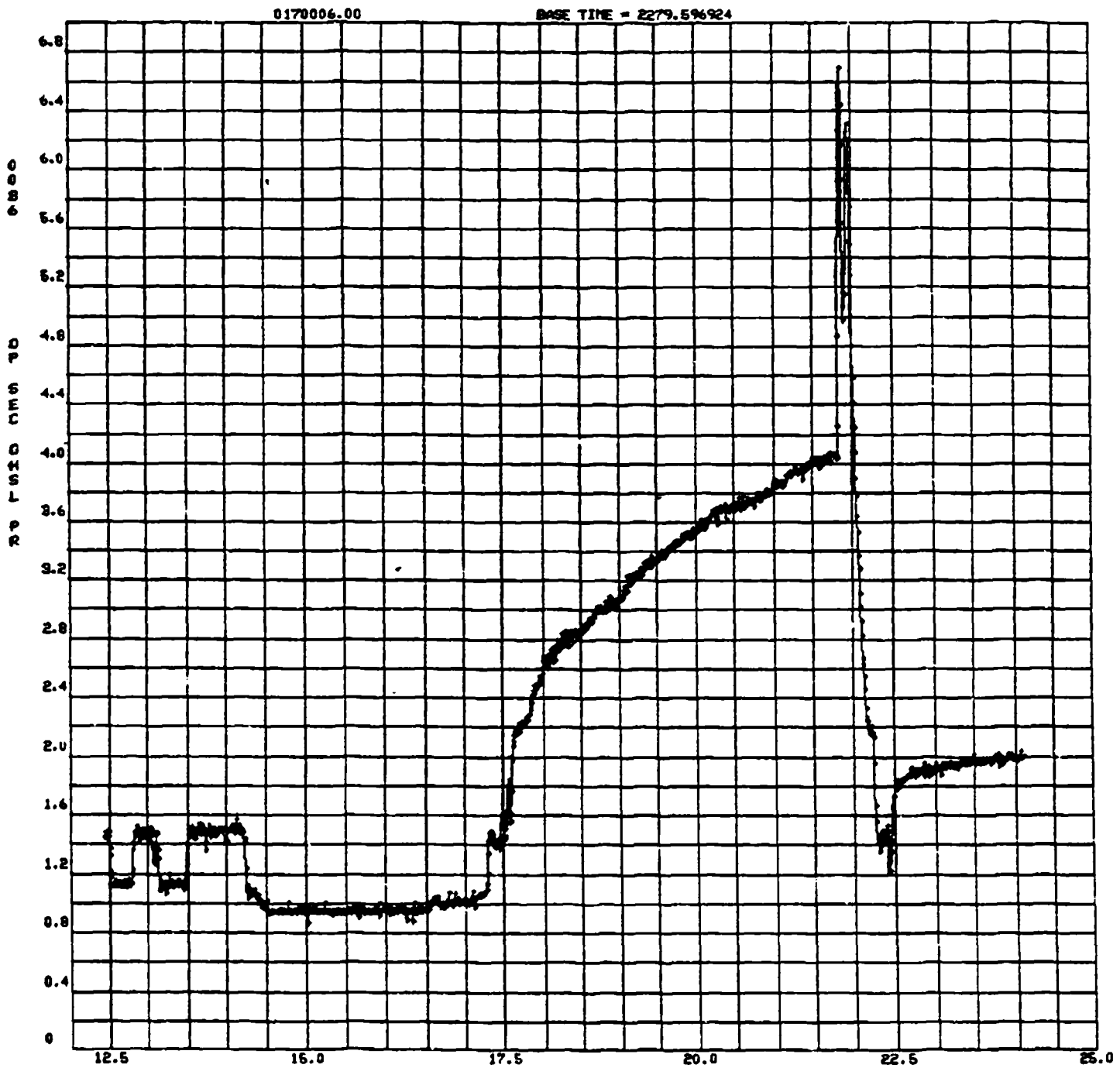

Appendix B: Test 87-017-006 Time Based Data Plots (1/28/87)

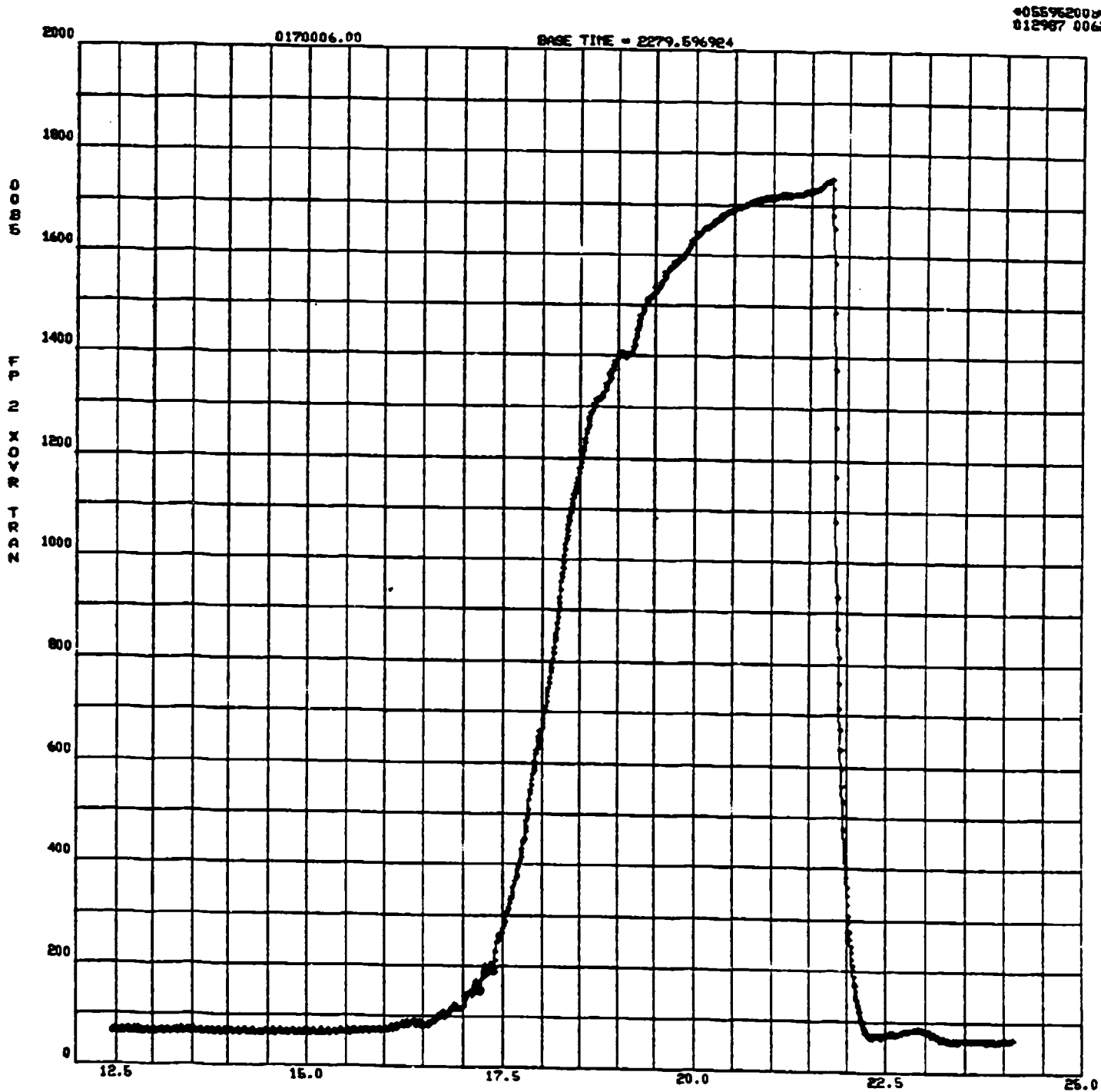

Appendix B: Test 87-017-006 Time Based Data Plots (1/28/87)

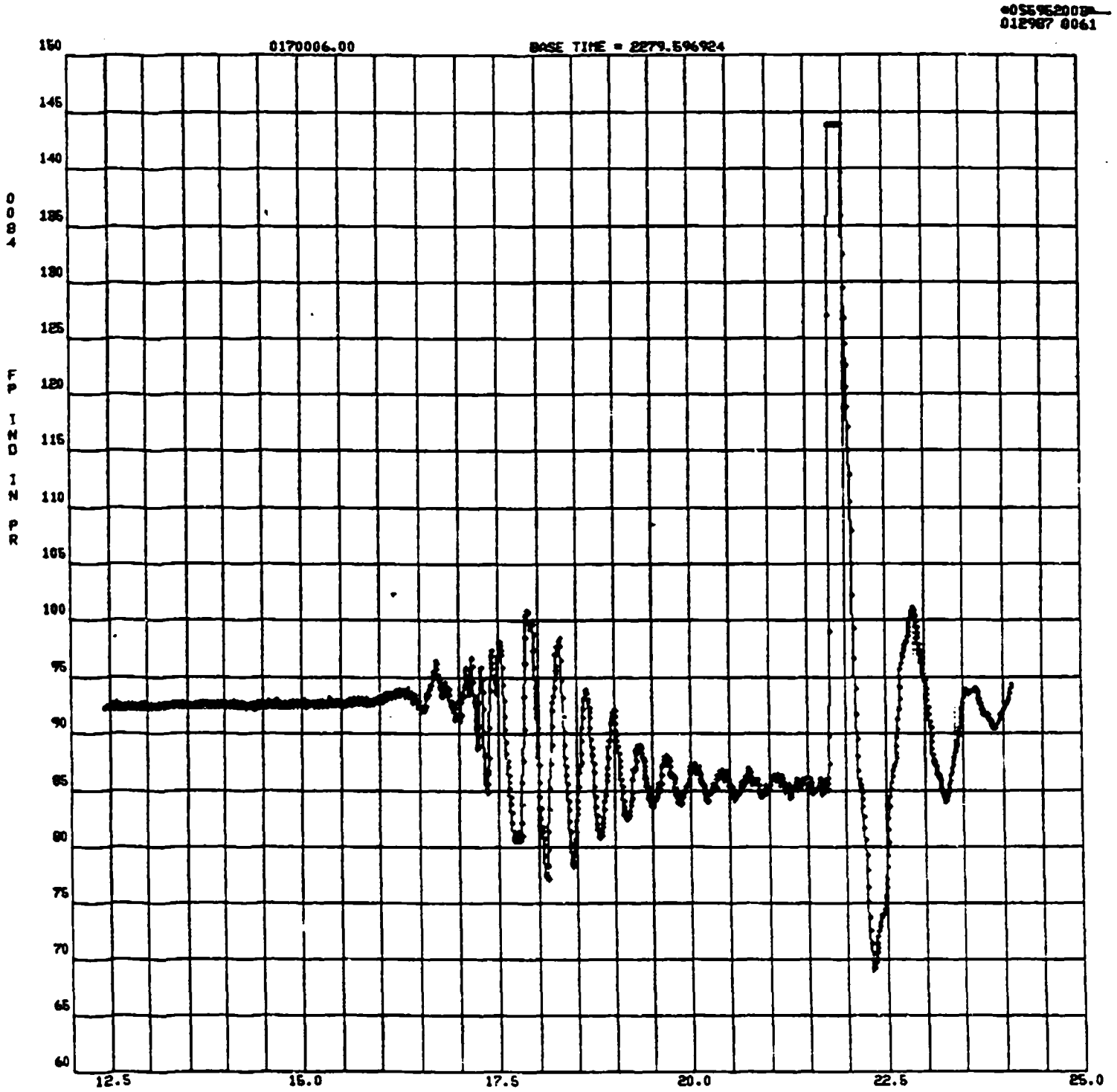

Appendix B: Test 87-017-006 Time Based Data Plots (1/28/87)

065962008
012987 0060

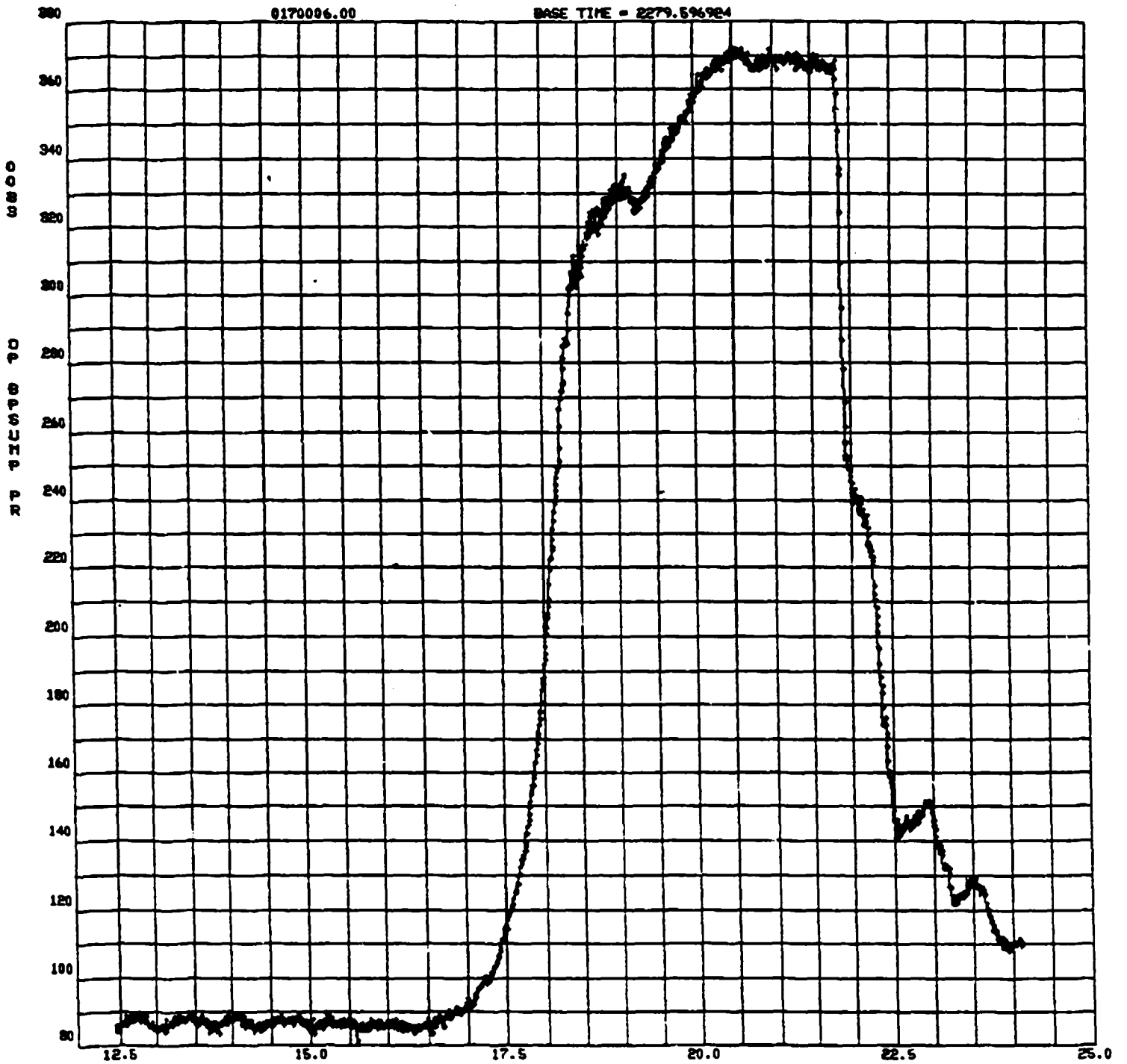

Appendix B:
Test 87-017-006 Time Based Data Plots (1/28/87)

4055962003
012987 0059

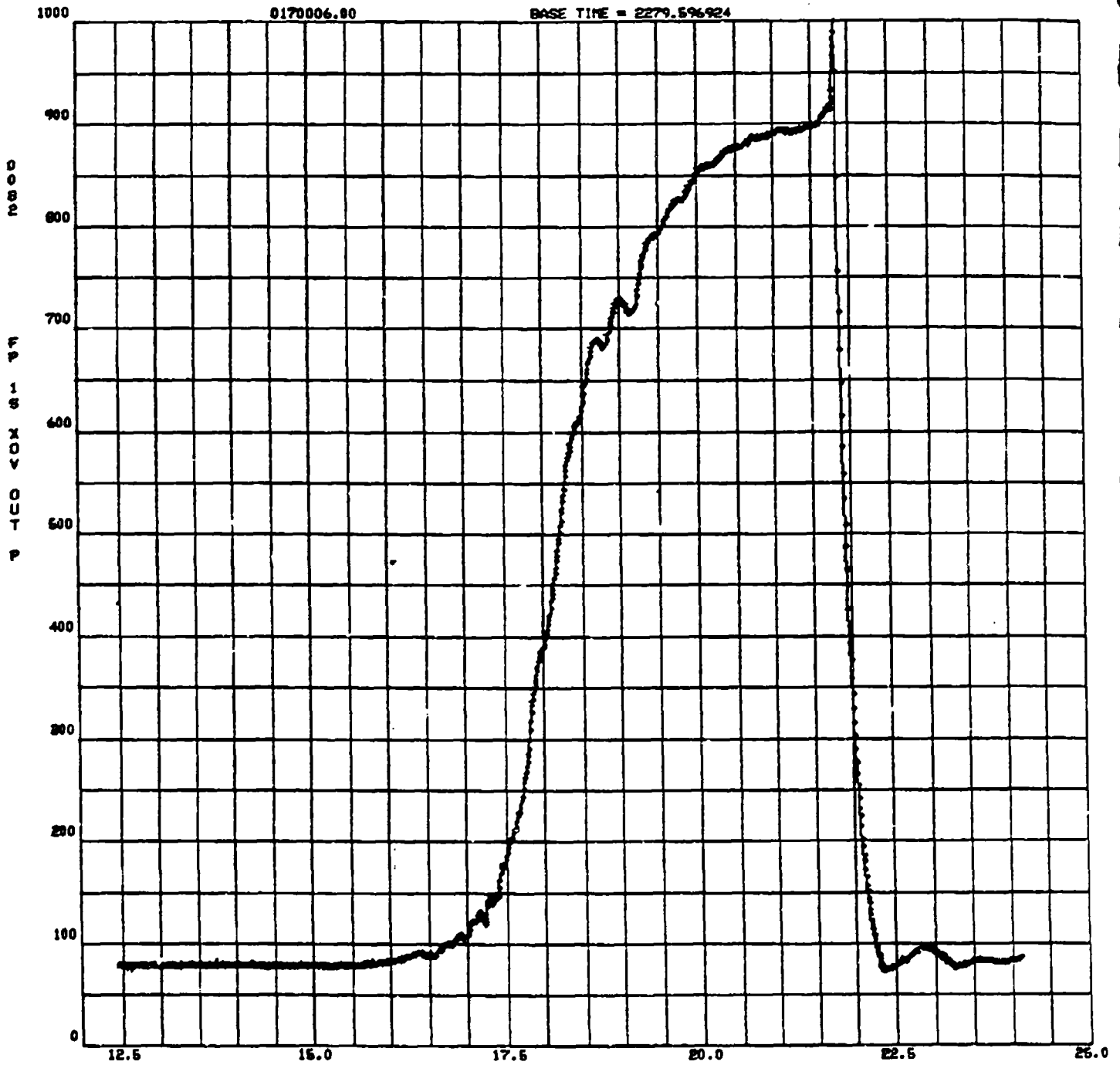

Appendix B: Test 87-017-006 Time Based Data Plots (1/28/87)

056962003
012987 0068

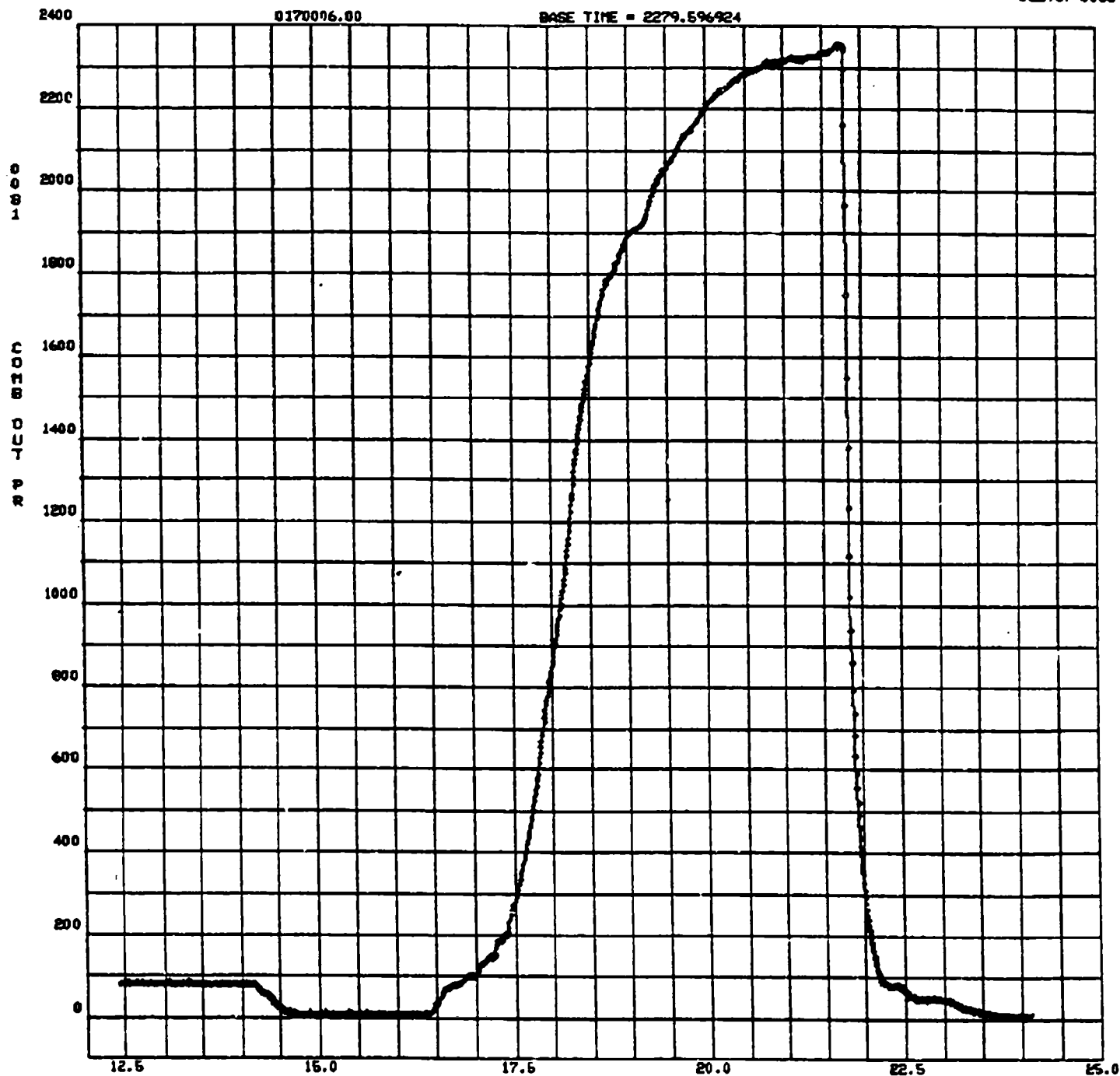

Appendix B: Test 87-017-006 Time Based Data Plots (1/28/87)

4055962008
012967 0057

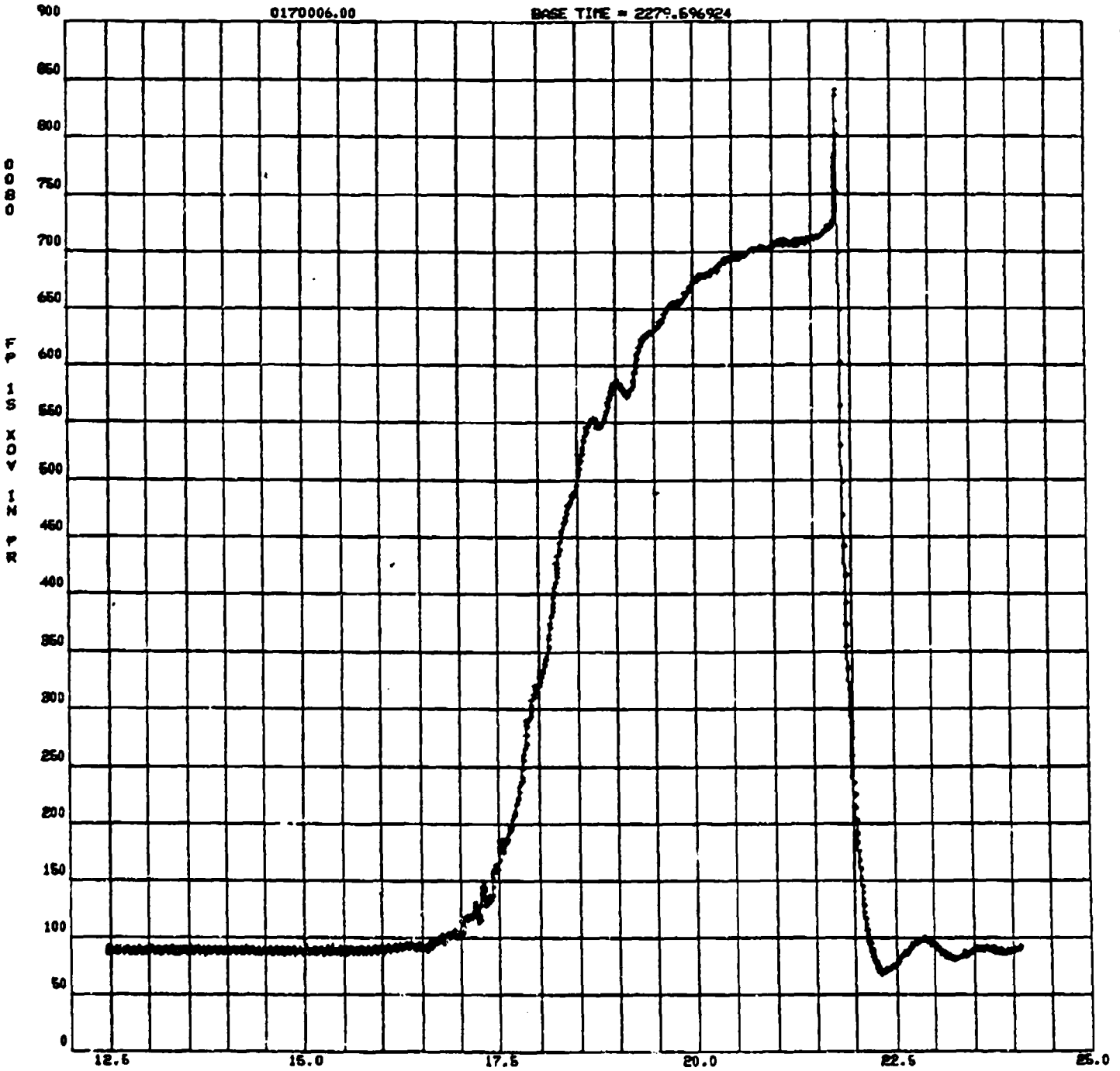

Appendix B: Test 87-017-006 Time Based Data Plots (1/28/87)

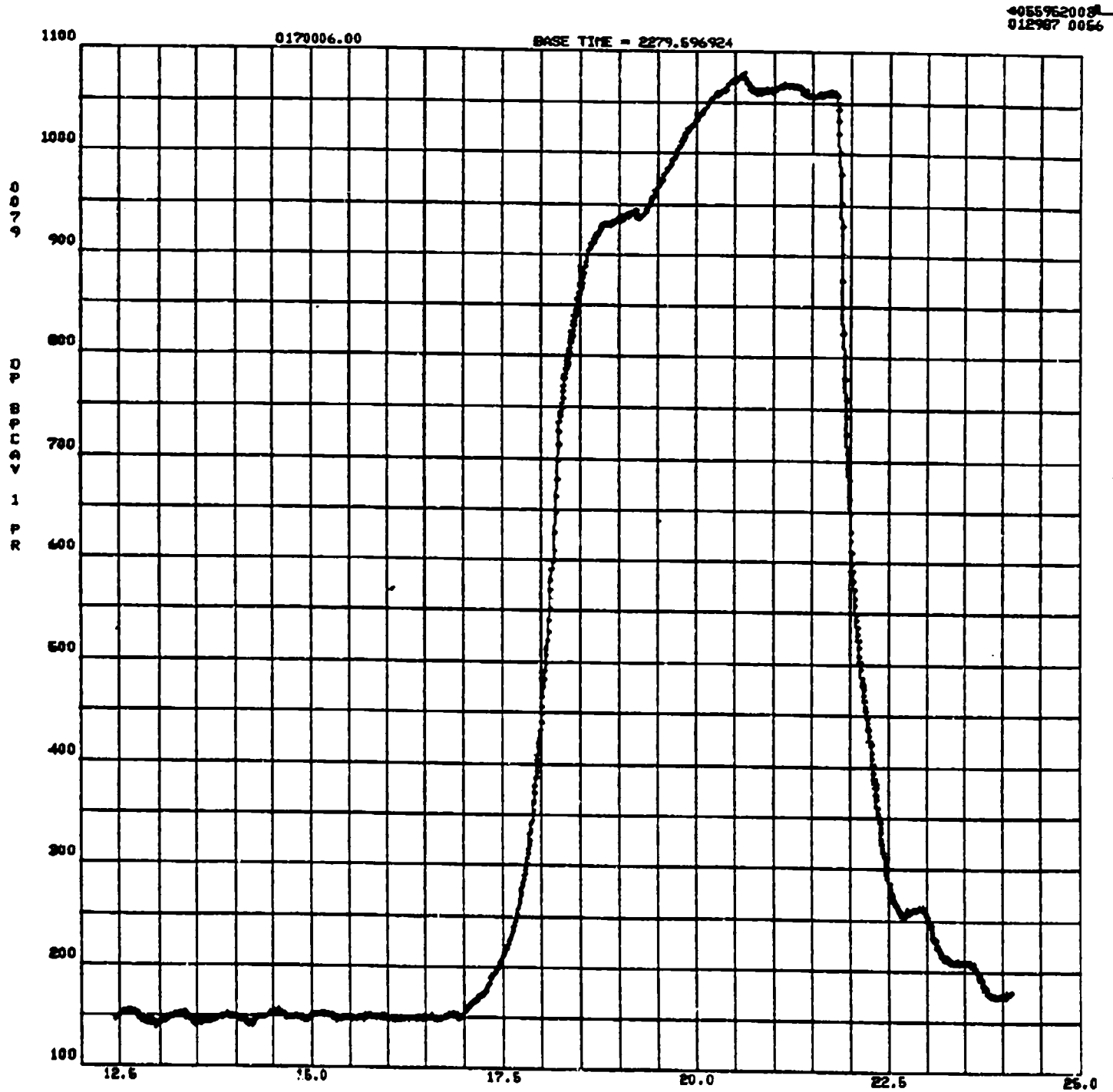

Appendix B: Test 87-017-006 Time Based Data Plots (1/28/87)

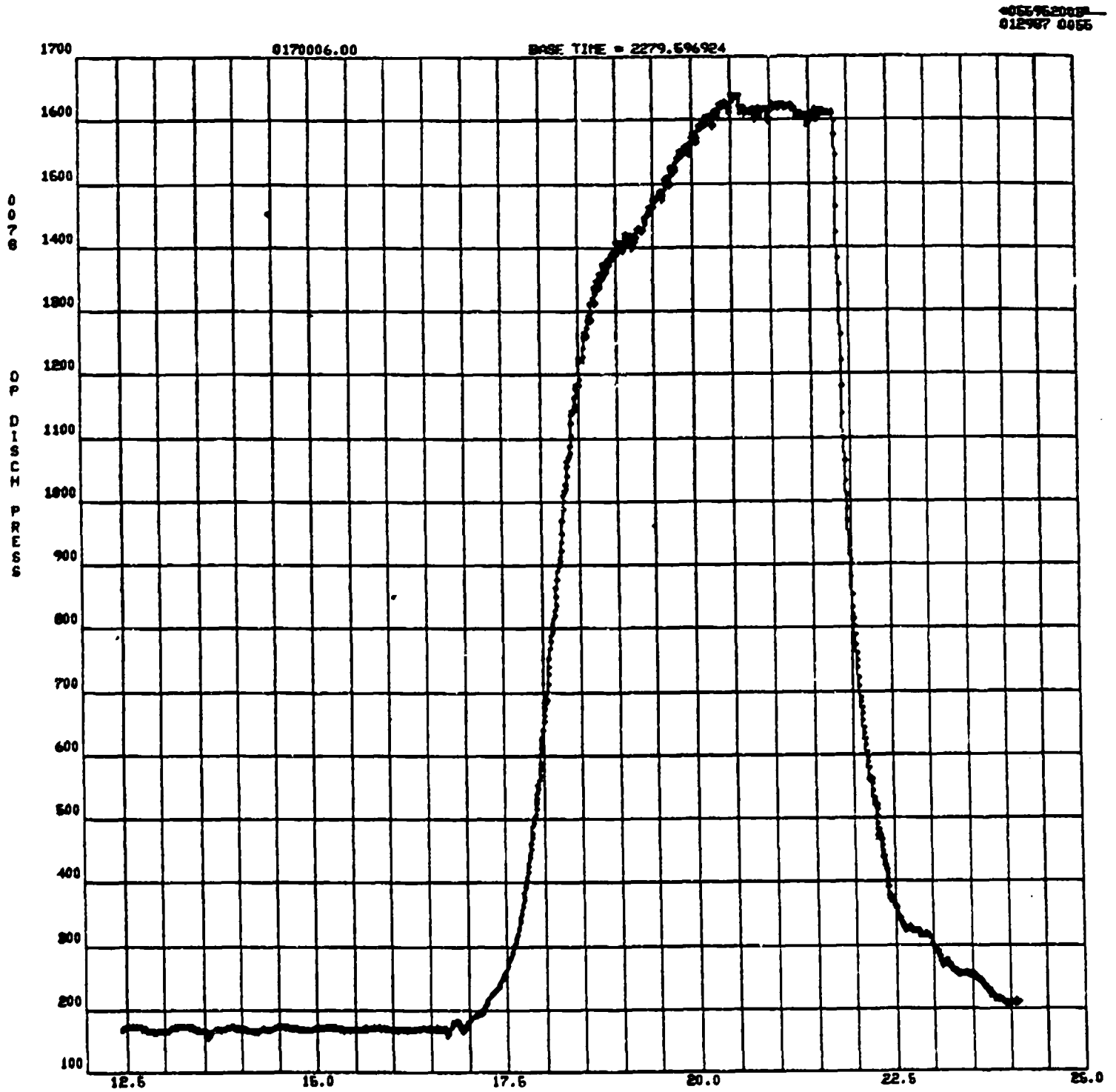

Appendix B: Test 87-017-006 Time Based Data Plots (1/28/87)

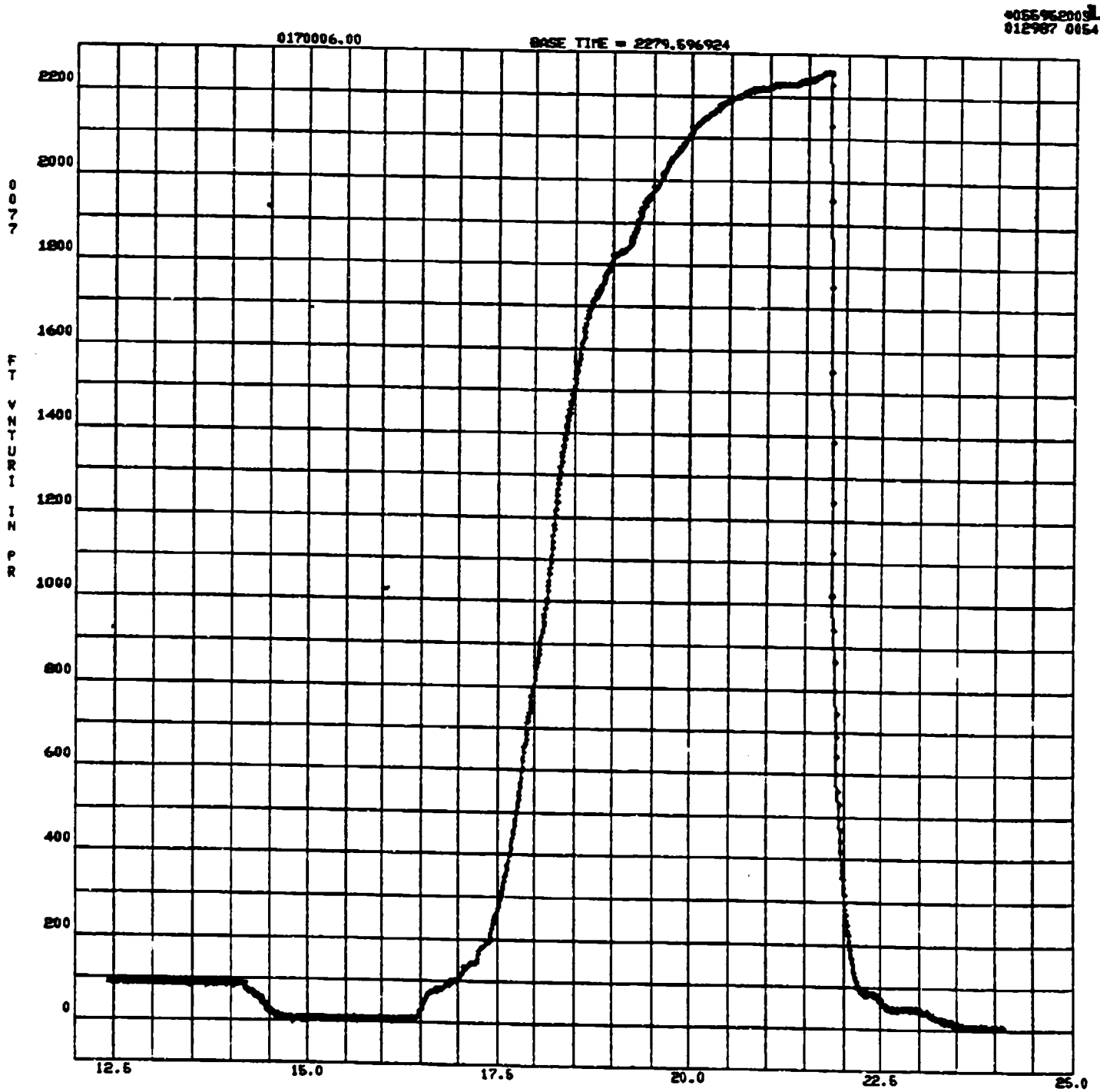

Appendix B:
Test 87-017-006 Time Based Data Plots (1/28/87)

4055962005
012907 0063

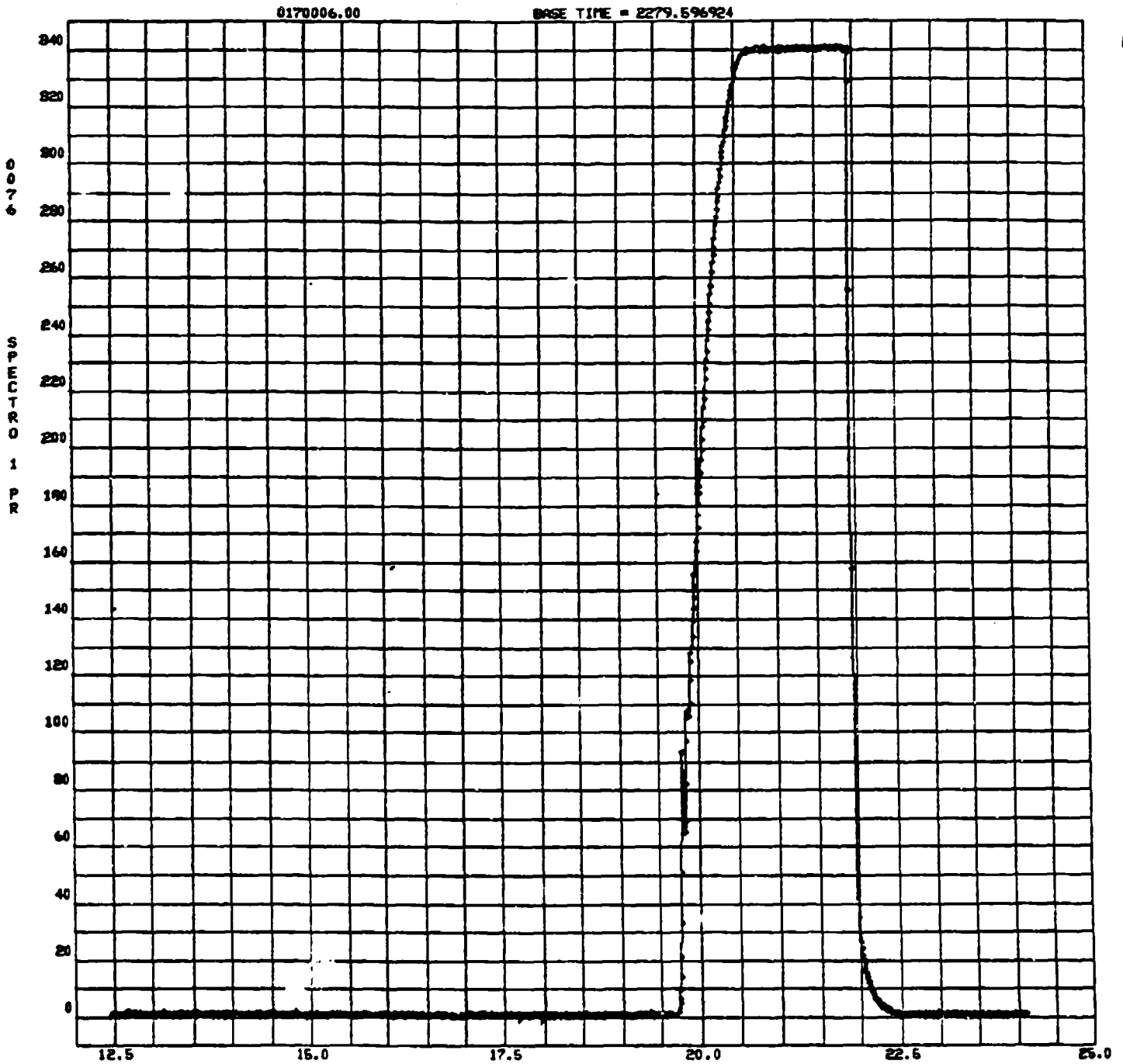

Appendix B: Test 87-017-006 Time Based Data Plots (1/28/87)

0055962003
012987 0052

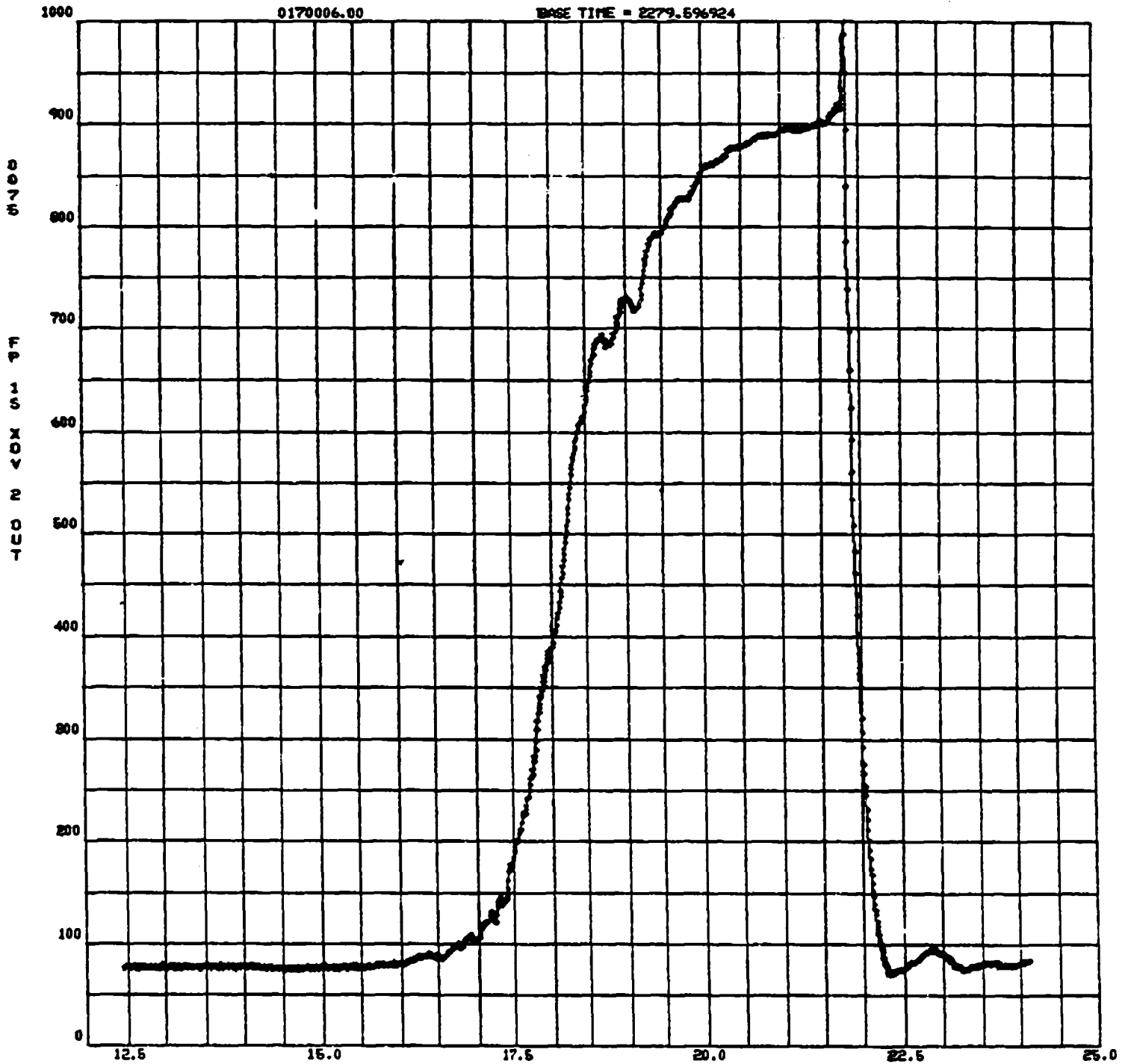

Appendix B: Test 87-017-006 Time Based Data Plots (1/28/87)

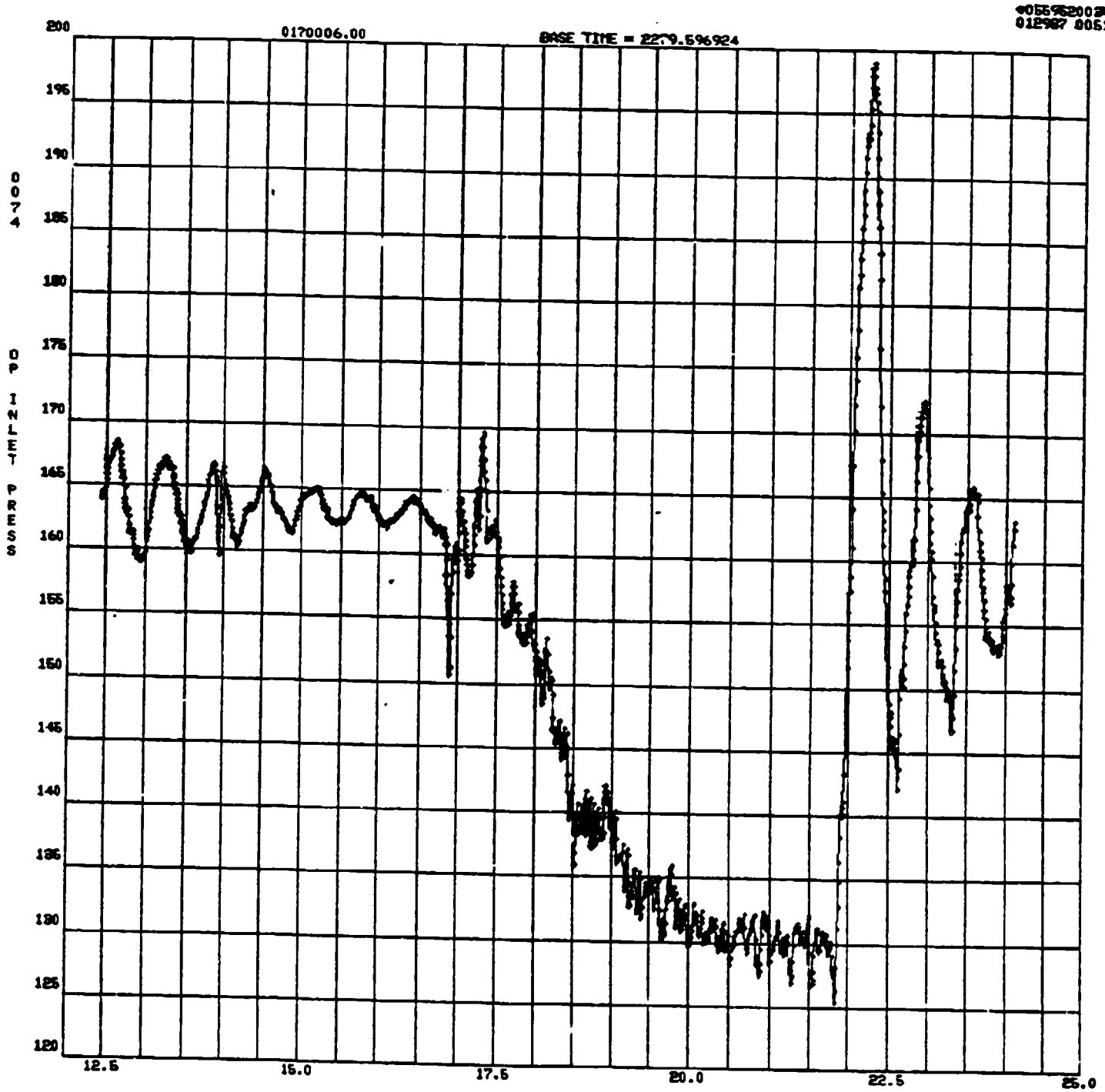

Appendix B: Test 87-017-006 Time Based Data Plots (1/28/87)

055962003
012987 0050

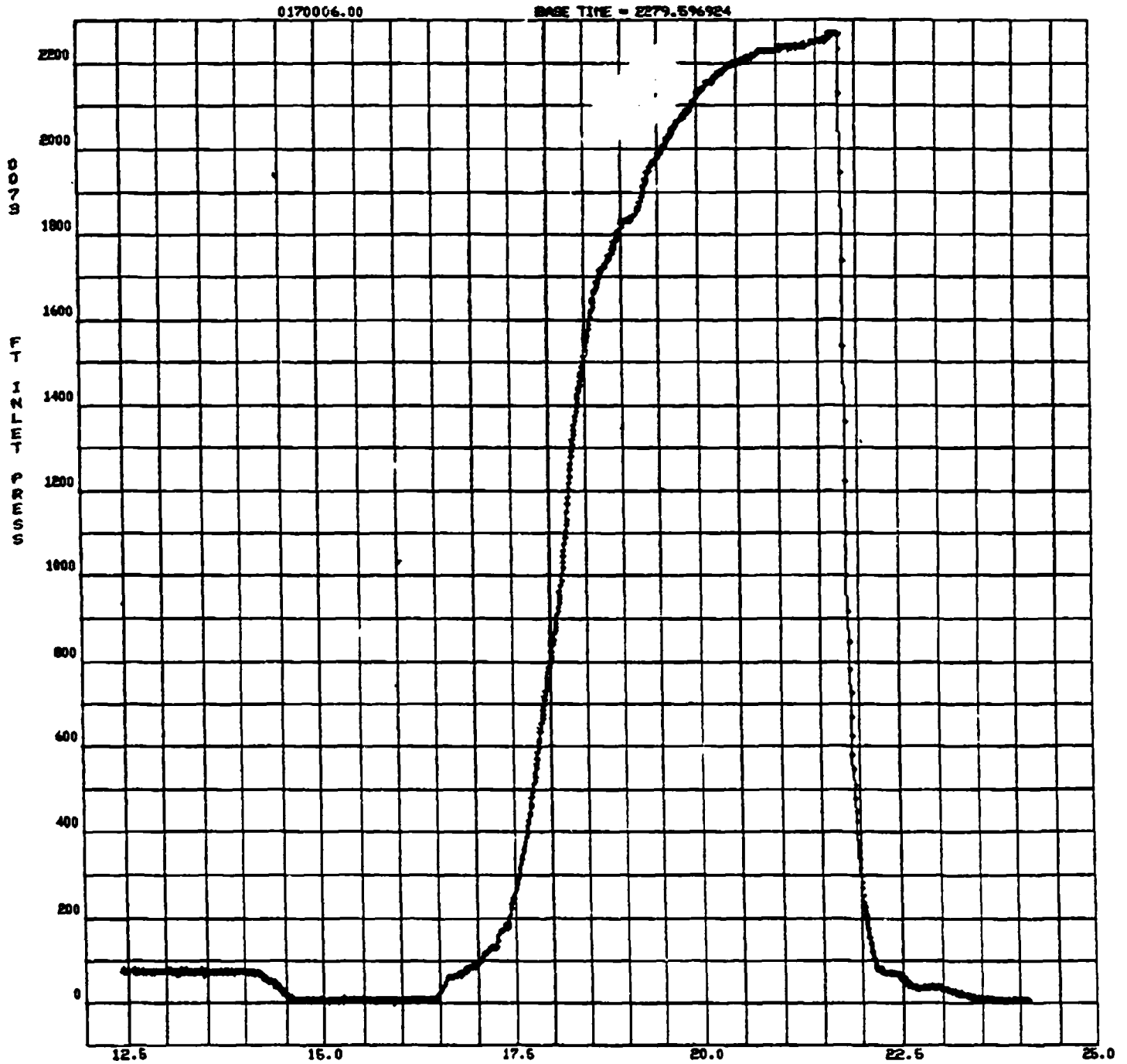

Appendix B: Test 87-017-006 Time Based Data Plots (1/28/87)

4055962003
012987 0049

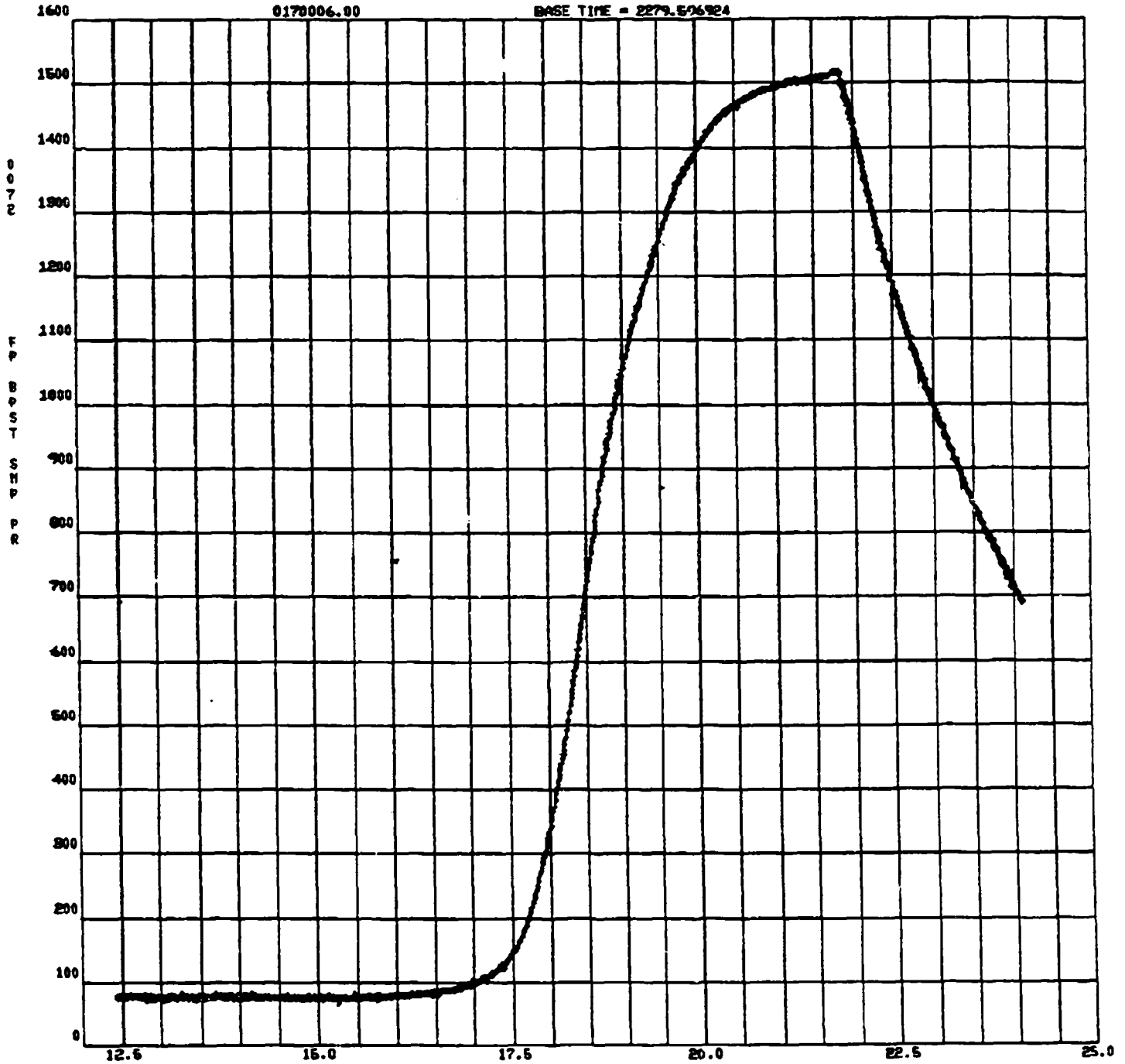

Appendix B: Test 87-017-006 Time Based Data Plots (1/28/87)

055962009
012907 6048

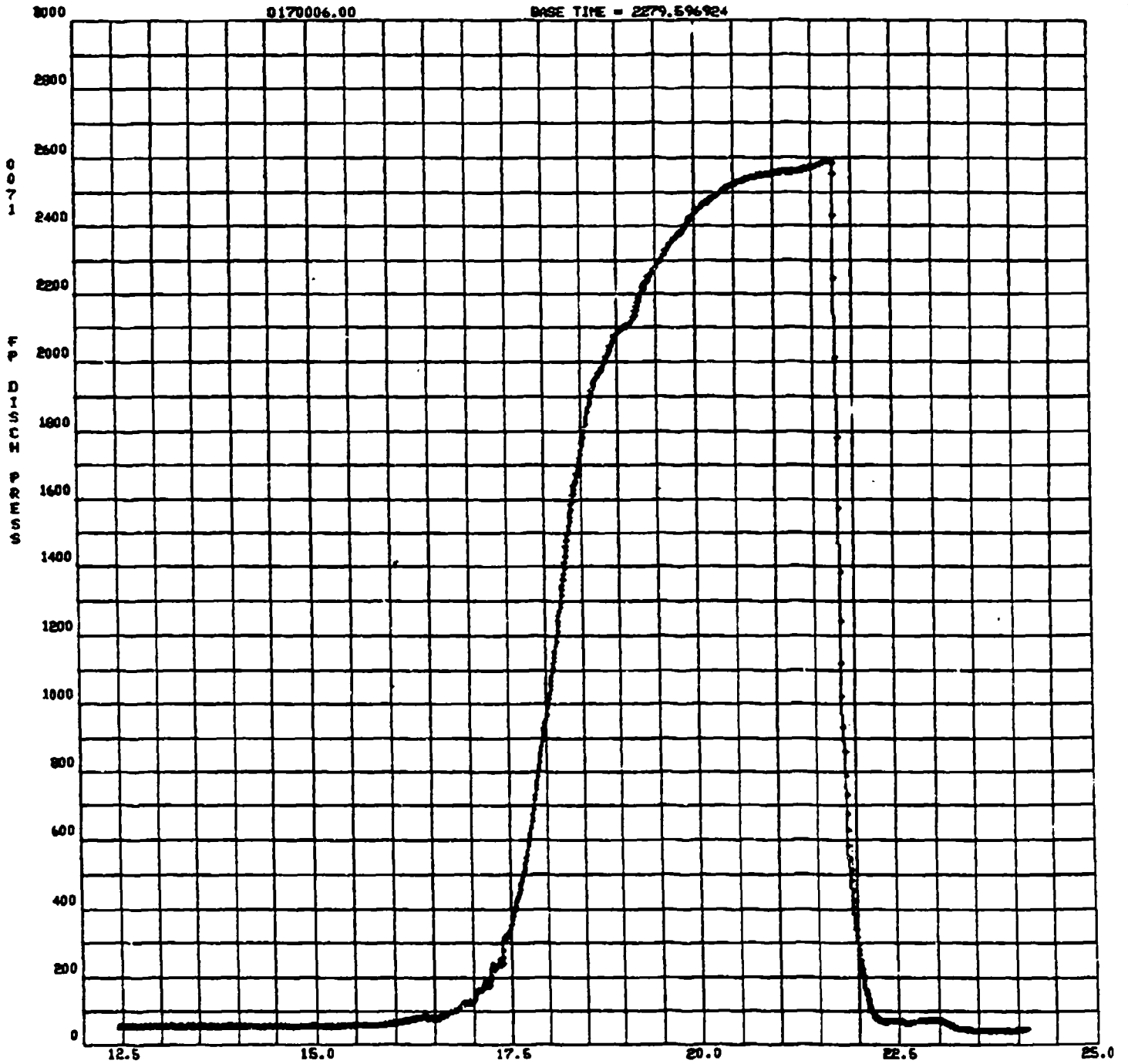

Appendix B:
Test 87-017-006 Time Based Data Plots (1/28/87)

4055962003
012987 0047

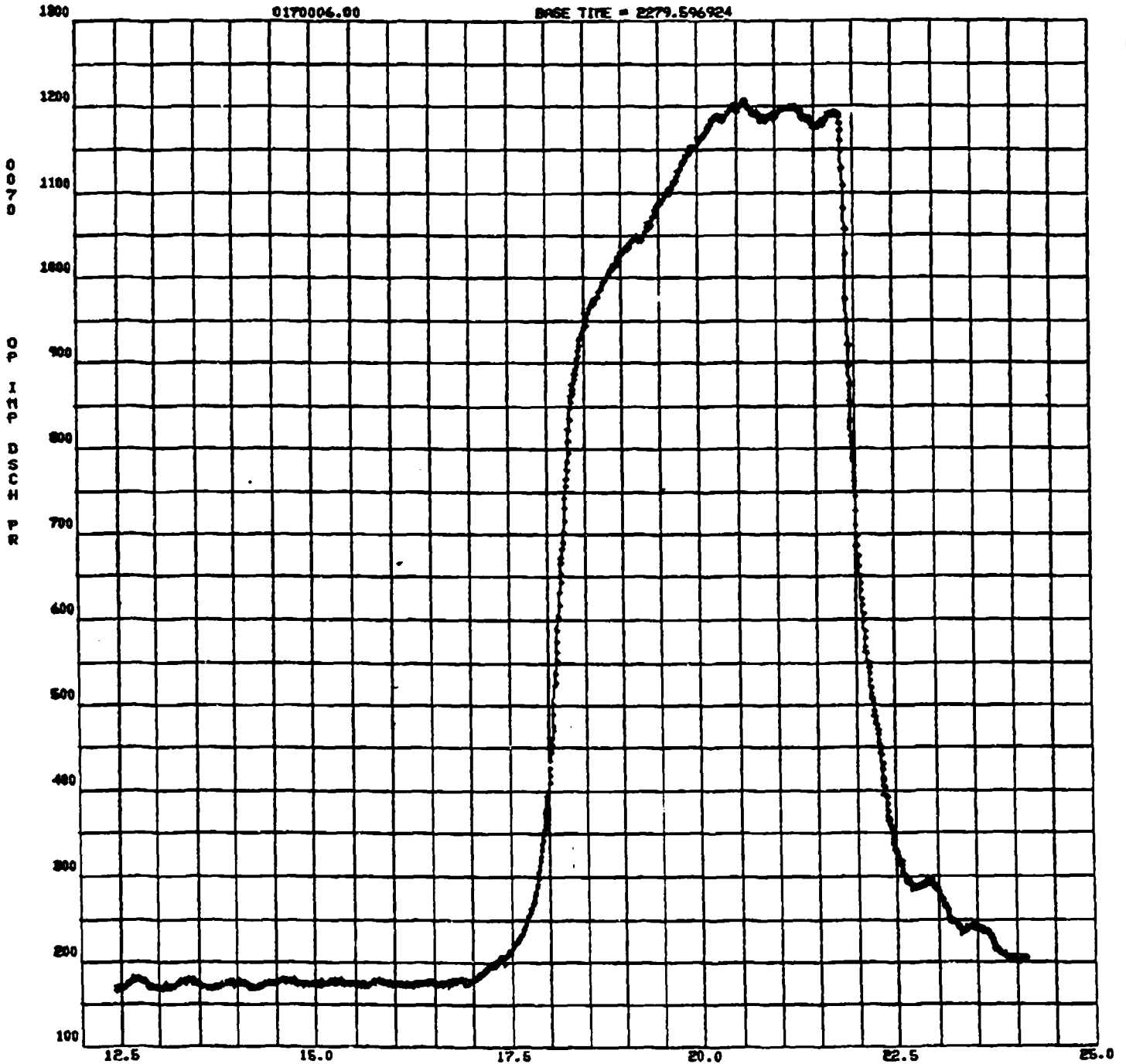

Appendix B: Test 87-017-006 Time Based Data Plots (1/28/87)

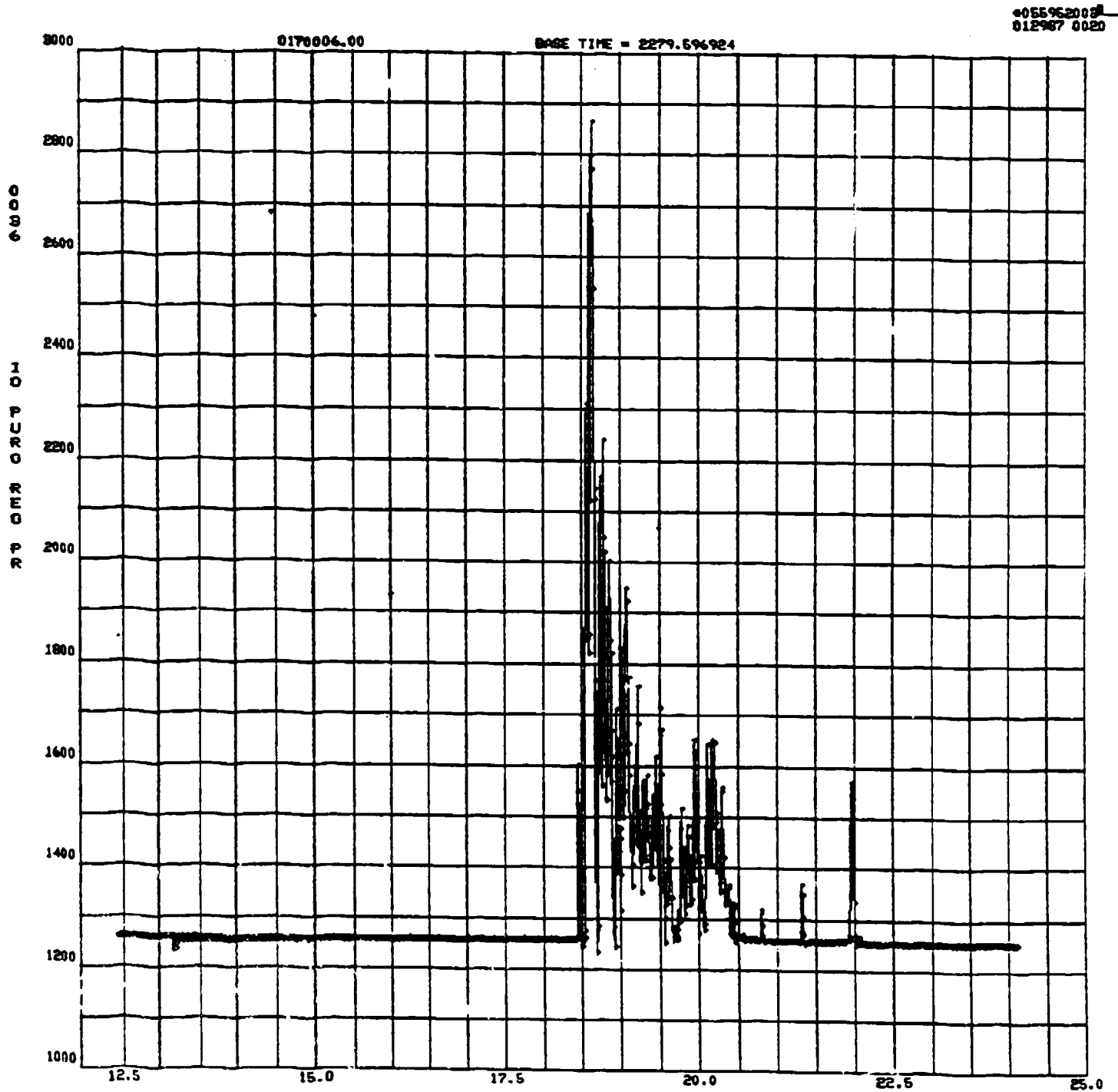

Appendix B: Test 87-017-006 Time Based Data Plots (1/28/87)

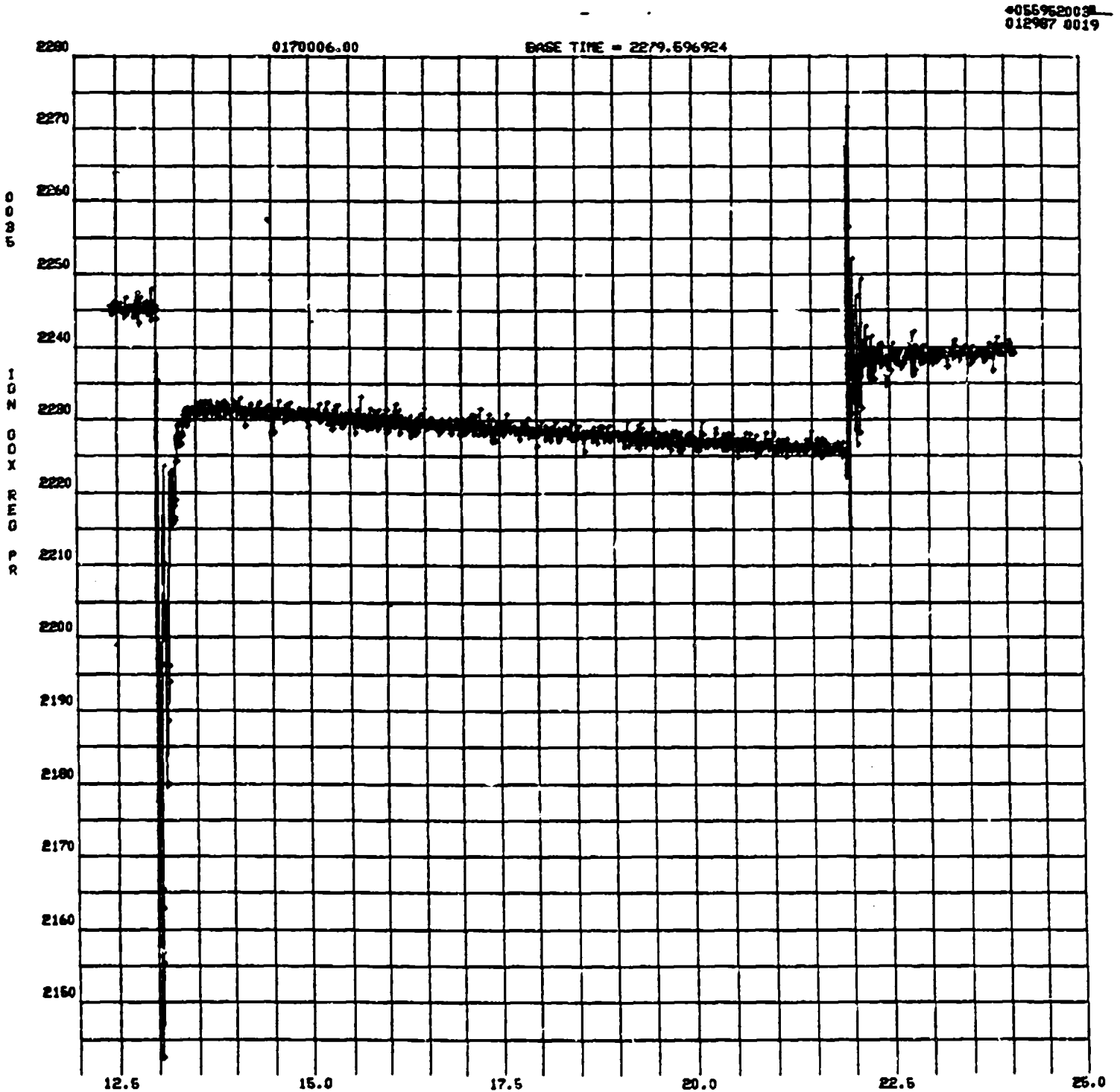

Appendix B: Test 87-017-006 Time Based Data Plots (1/28/87)

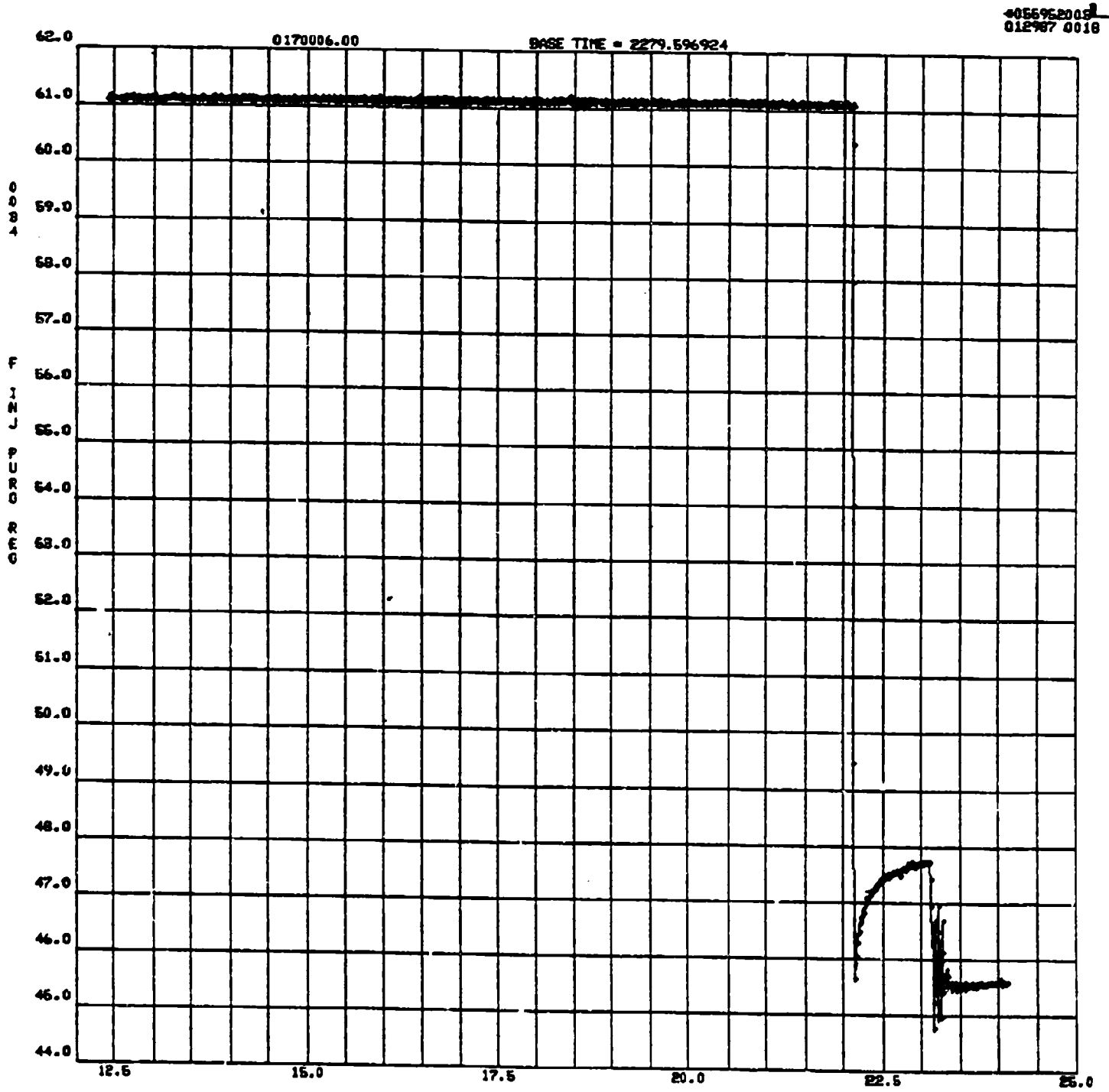

Appendix B: Test 87-017-006 Time Based Data Plots (1/28/87)

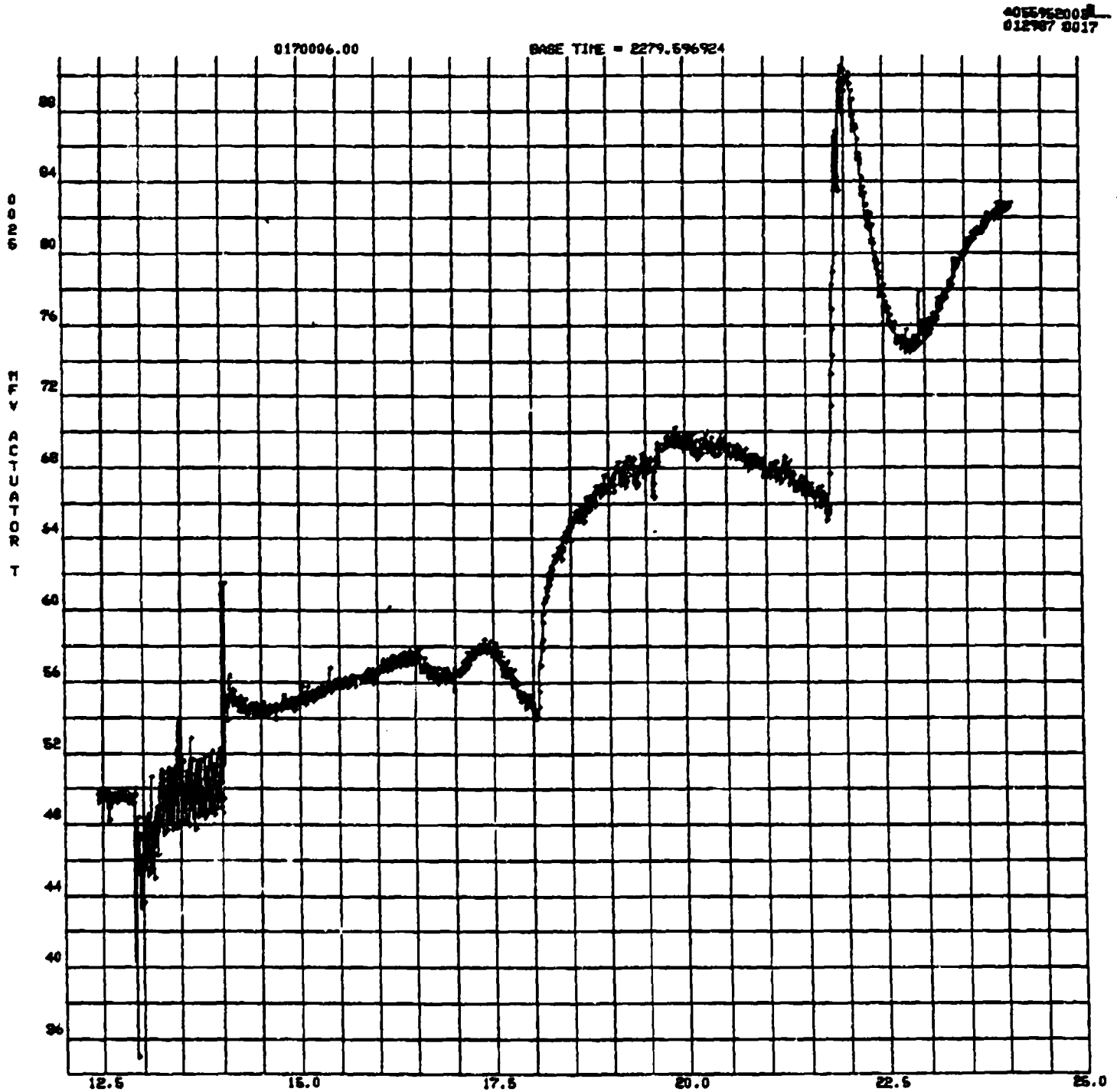

Appendix B: Test 87-017-006 Time Based Data Plots (1/23/87)

0055952009
012987 8016

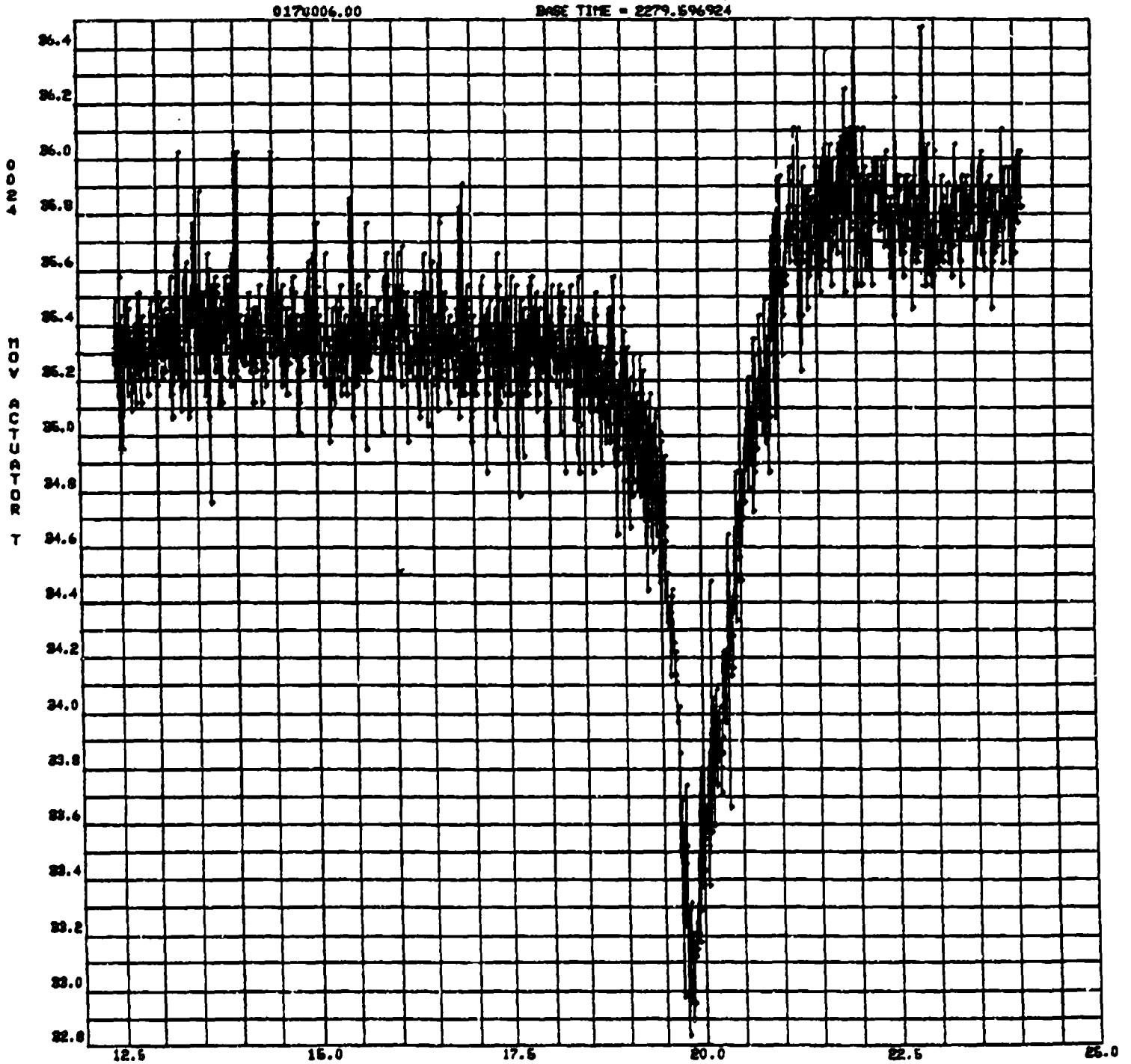

Appendix B: Test 87-017-006 Time Based Data Plots (1/28/87)

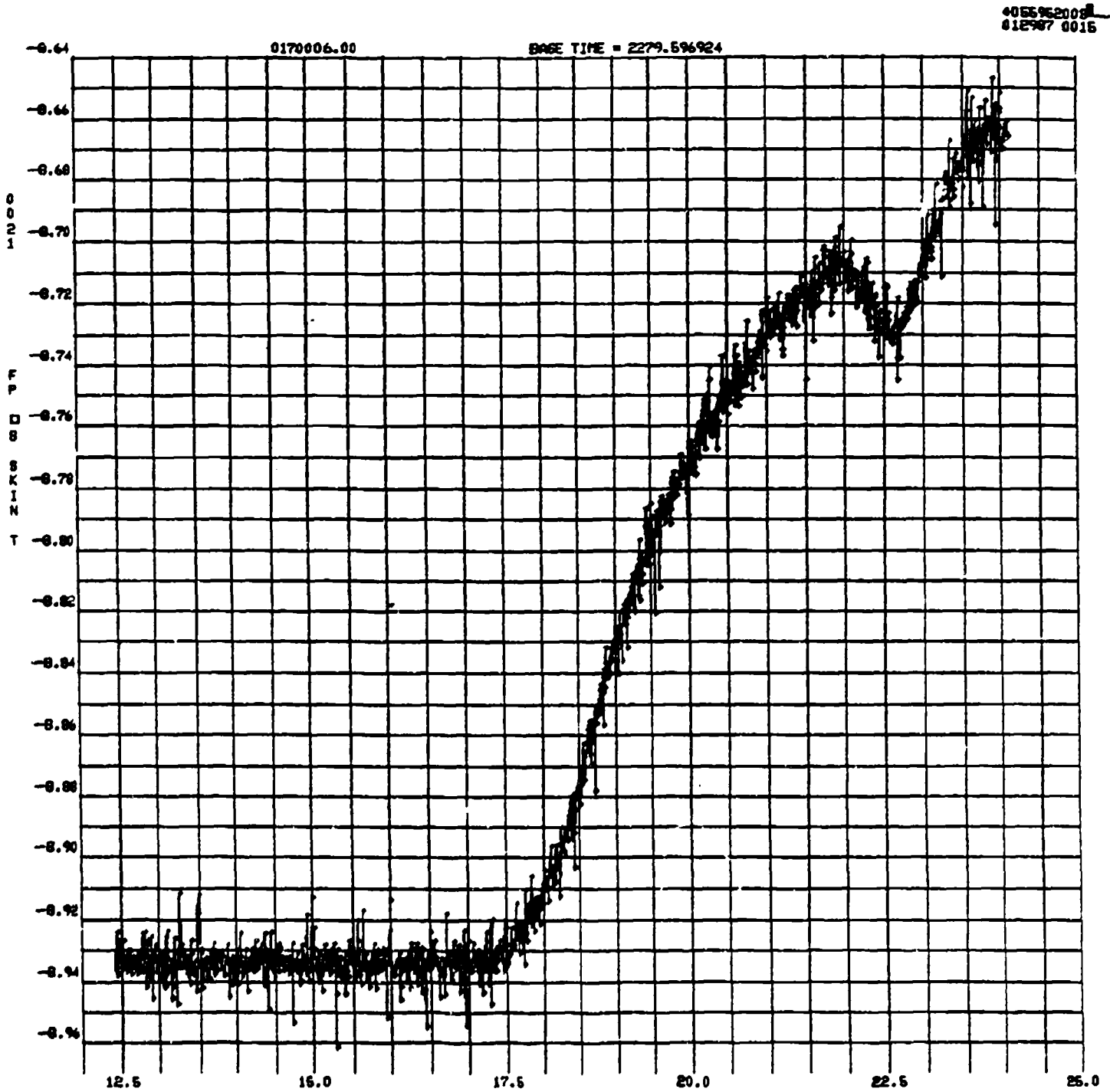

Appendix B: Test 87-017-006 Time Based Data Plots (1/28/87)

0055962009
012987 0014

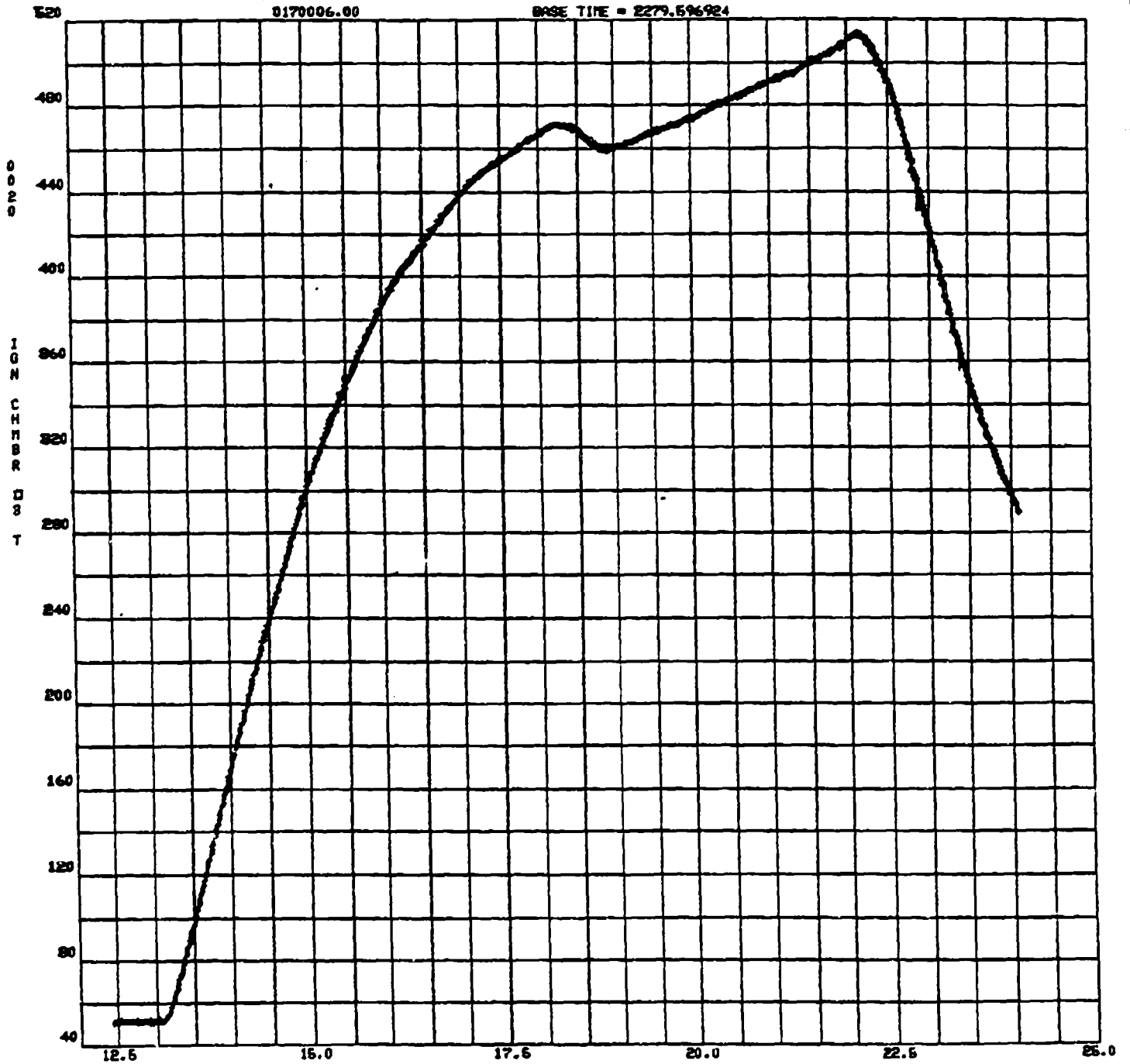

Appendix B: Test 87-017-006 Time Based Data Plots (1/28/87)

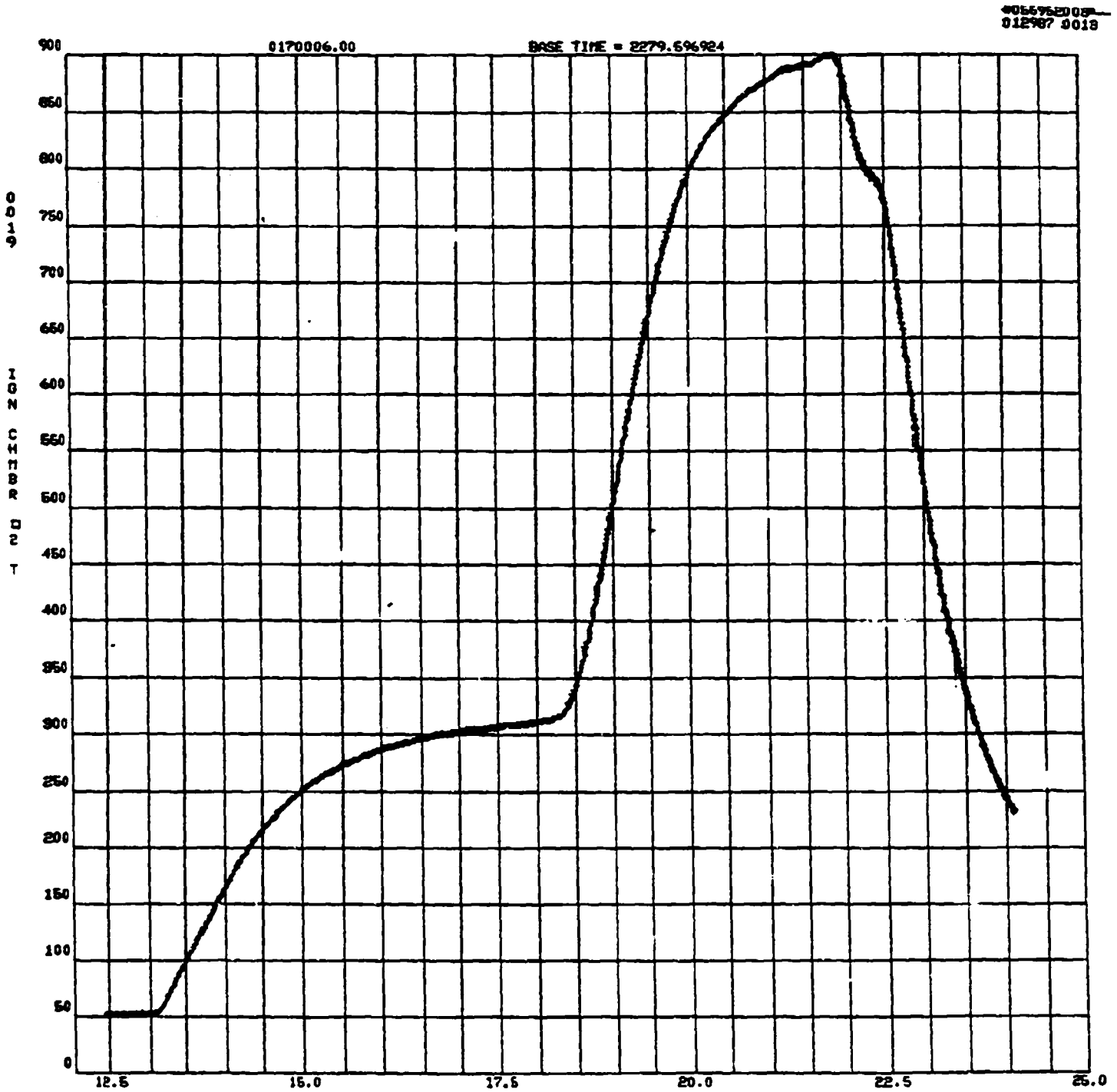

Appendix B: Test 87-017-006 Time Based Data Plots (1/28/87)

055962008
012967 0012

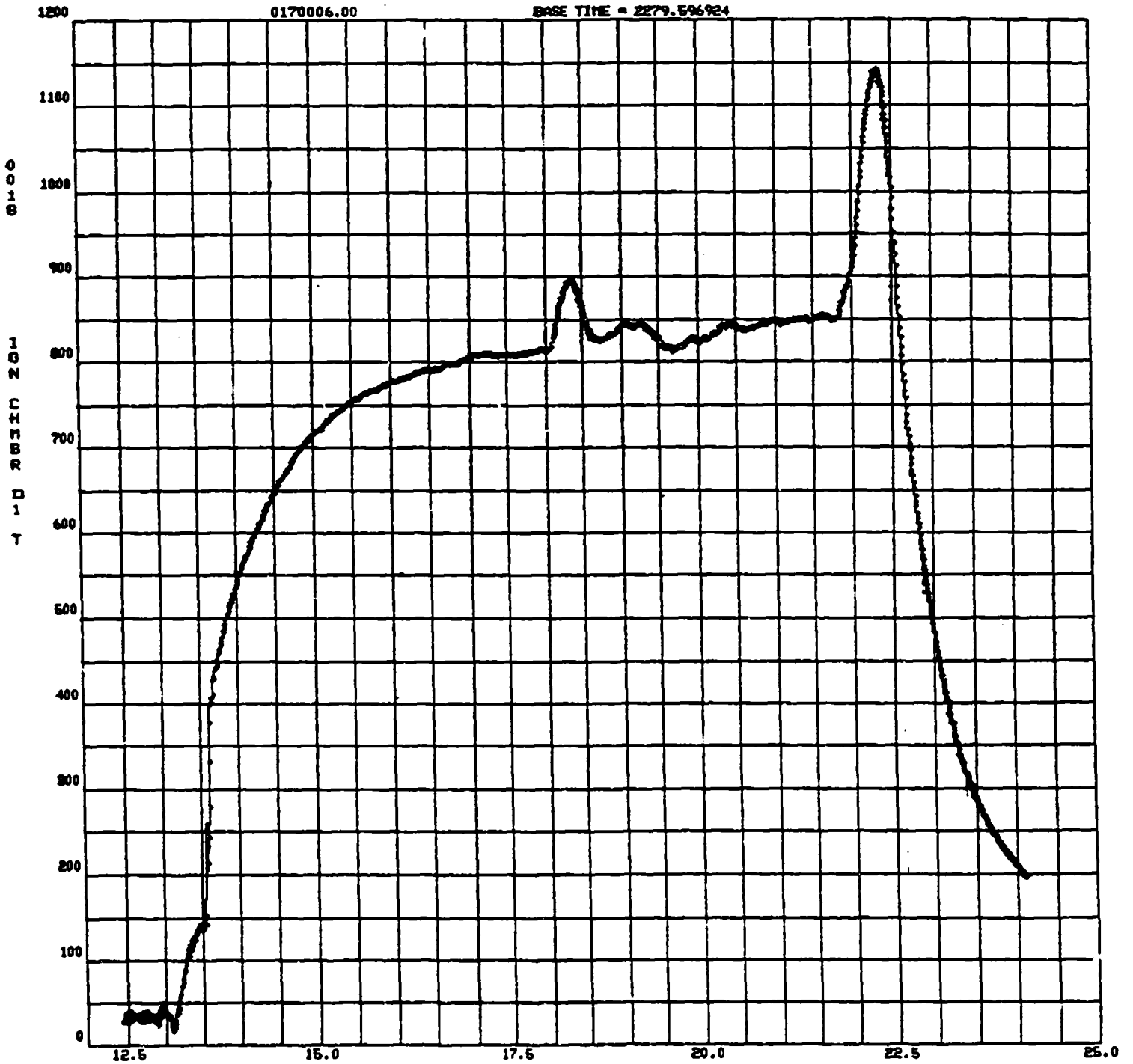

Appendix B: Test 87-017-006 Time Based Data Plots (1/28/87)

4055962009
012987 0011

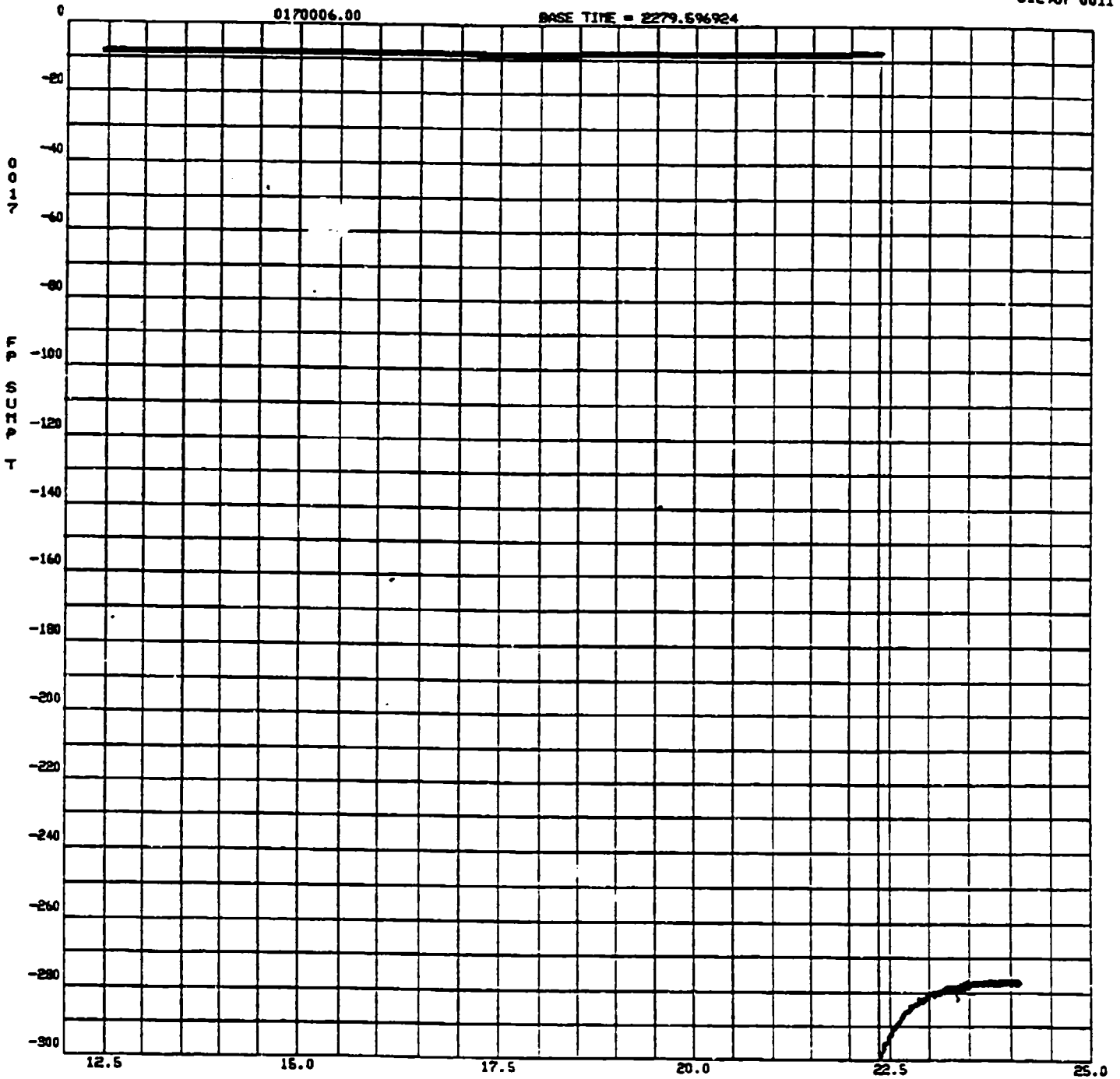

Appendix B: Test 87-017-006 Time Based Data Plots (1/28/87)

4055962009
012987 0010

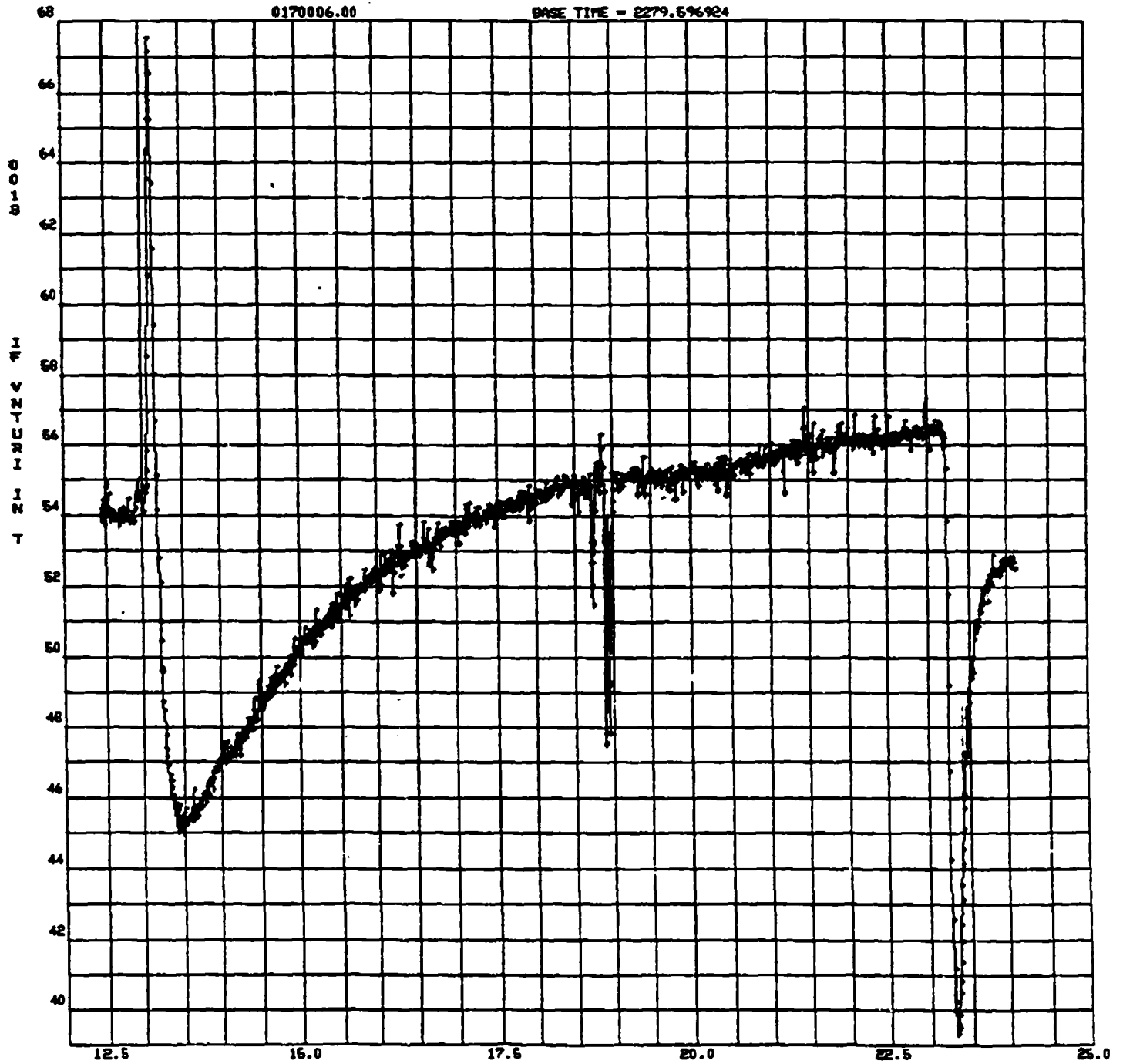

Appendix B: Test 87-017-006 Time Based Data Plots (1/28/87)

065962009
012987 0009

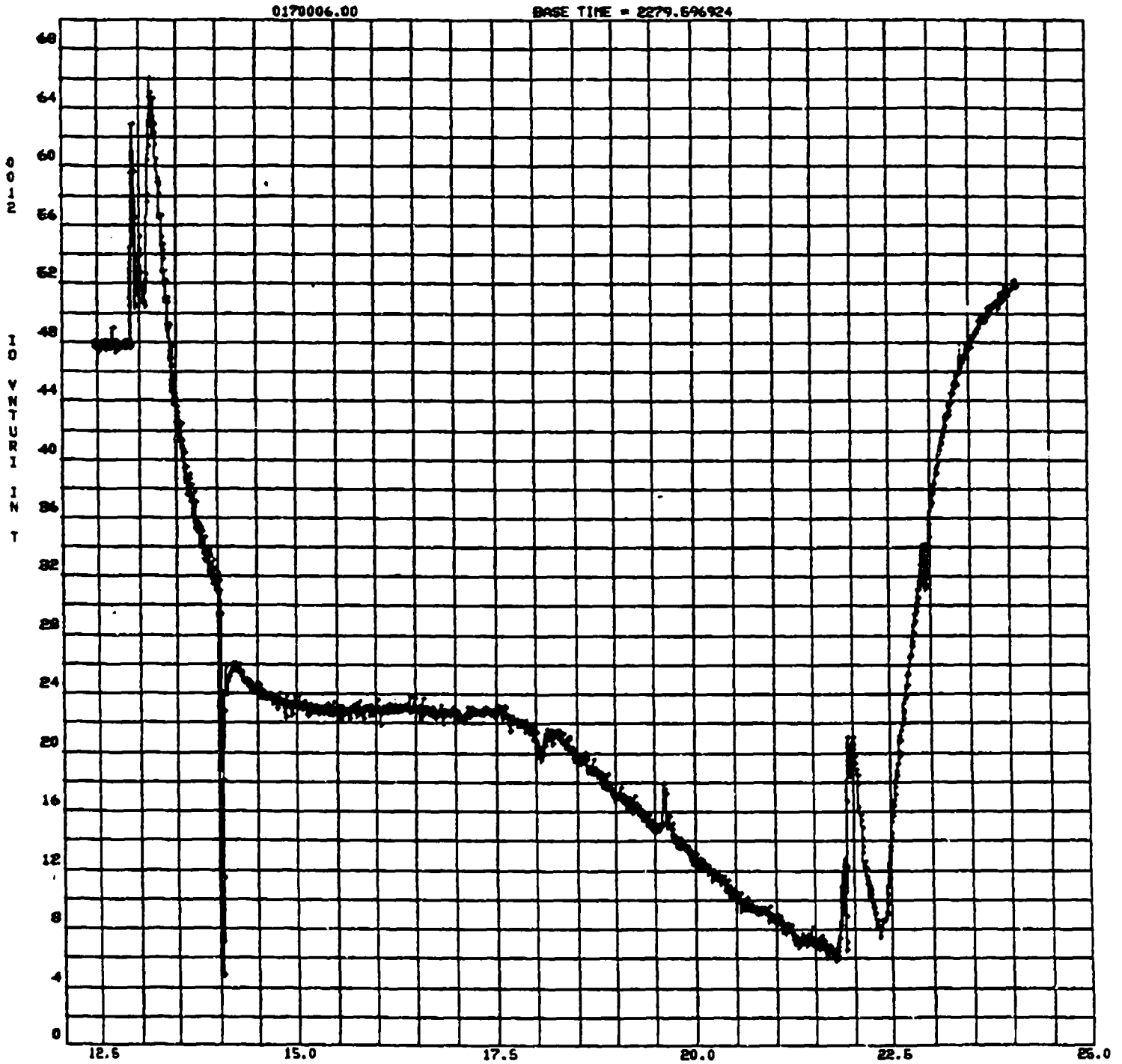

Appendix B: Test 87-017-006 Time Based Data Plots (1/28/87)

←055962009
012987 0808

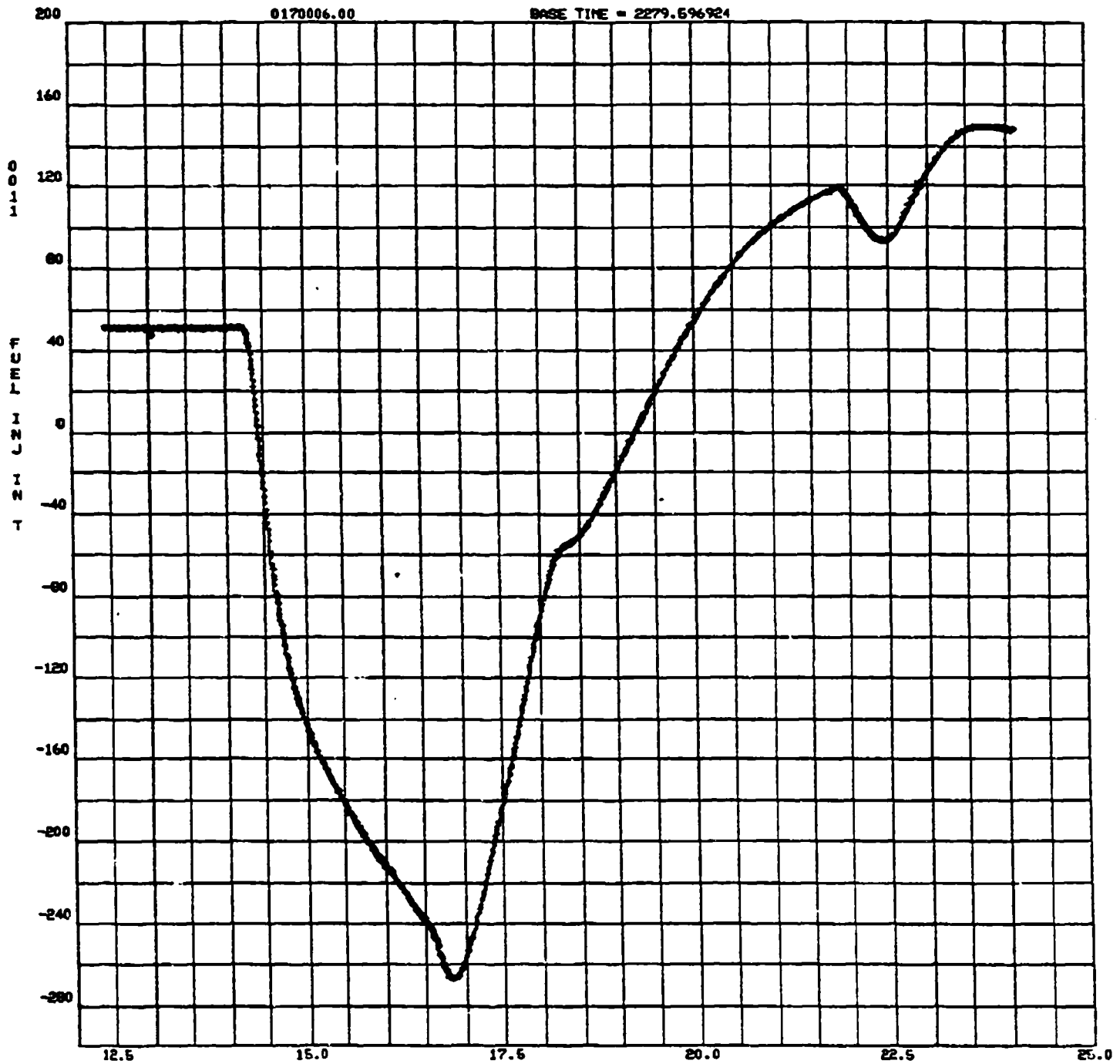

Appendix B:
Test 87-017-006 Time Based Data Plots (1/28/87)

055962005
012987 0007

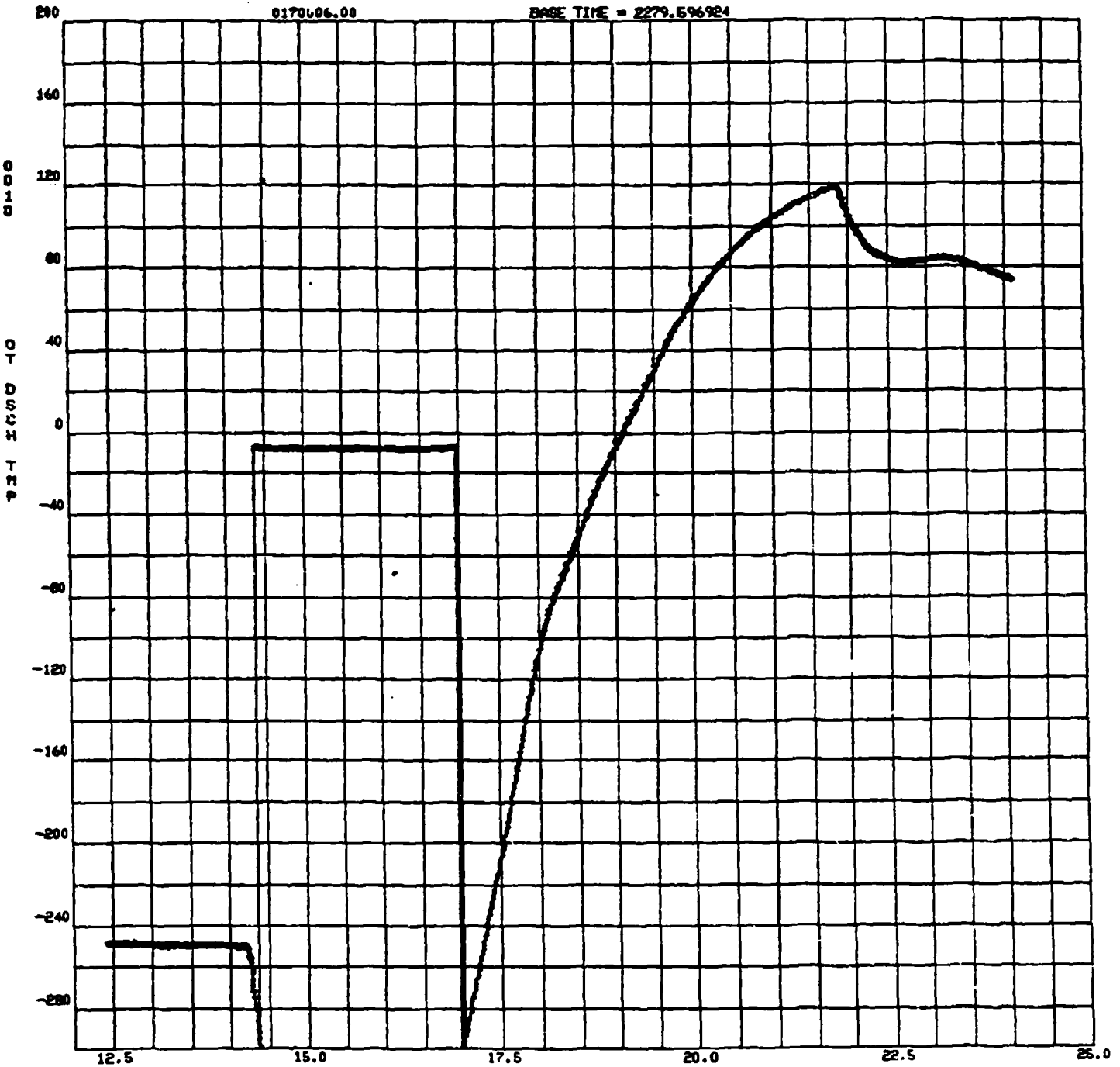

Appendix B: Test 87-017-006 Time Based Data Plots (1/28/87)

4055962003
012987 0006

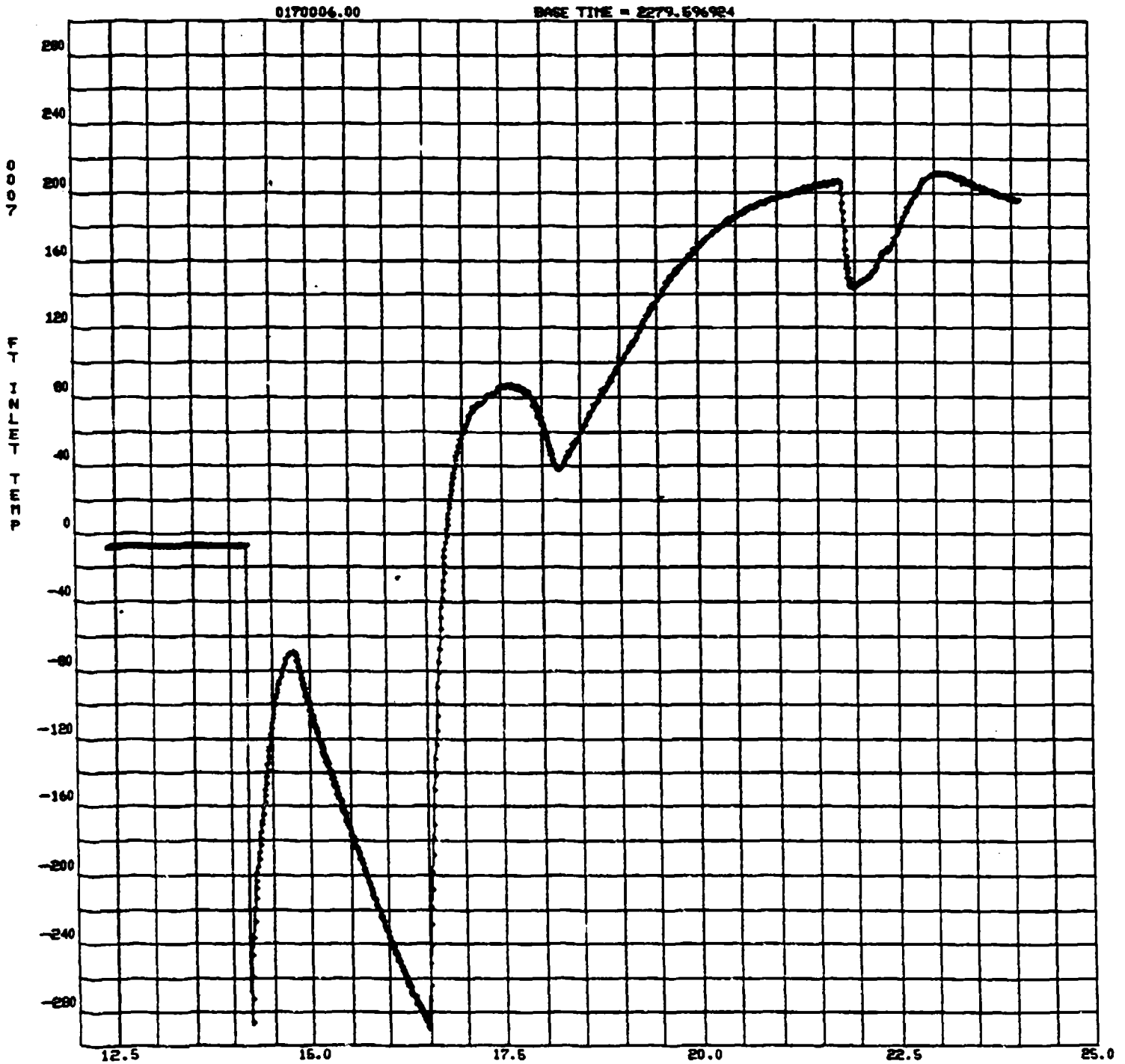

Appendix B: Test 87-017-006 Time Based Data Plots (1/28/87)



Appendix B: Test 87-017-006 Time Based Data Plots (1/28/87)

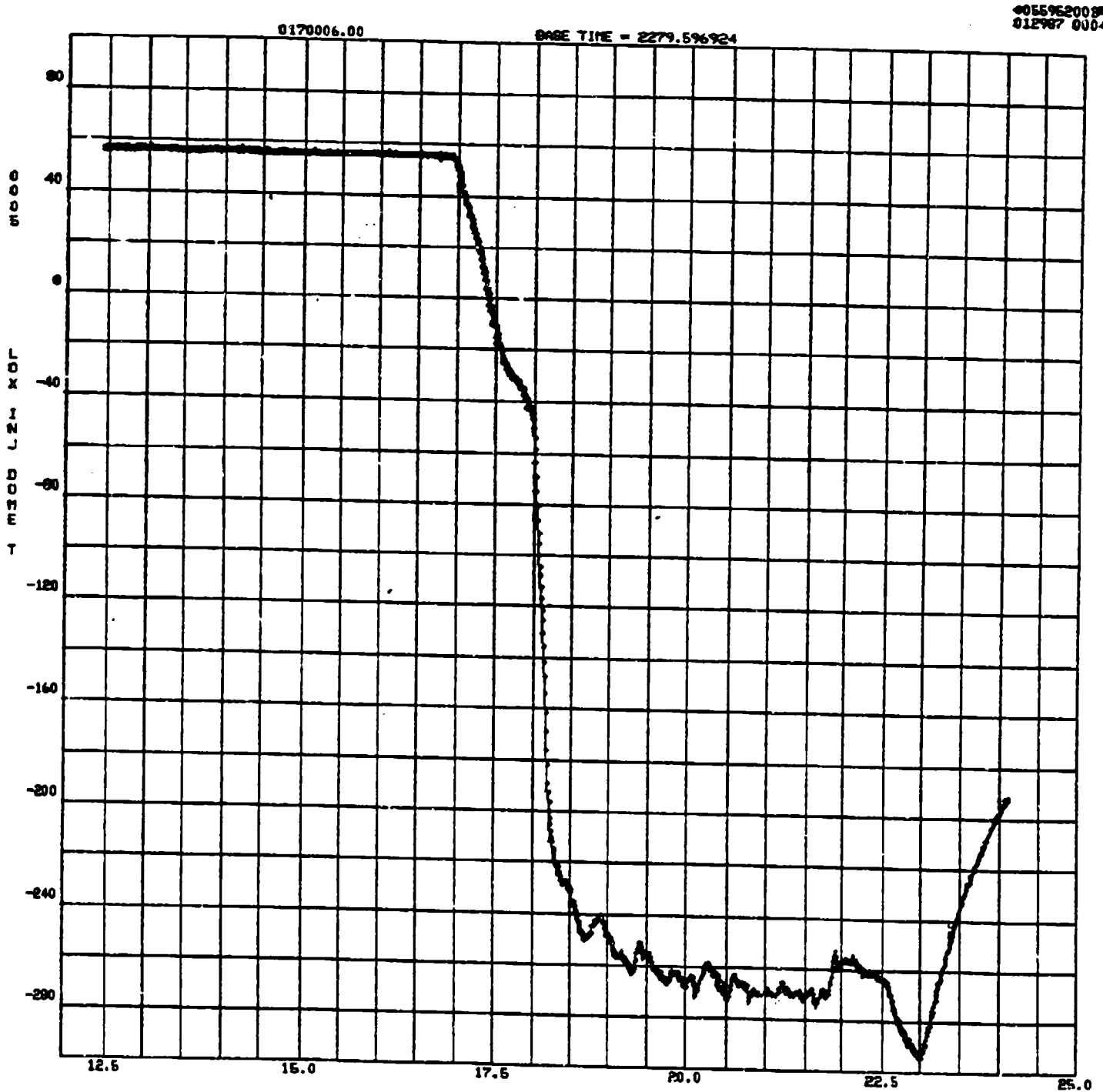

Appendix B: Test 87-017-006 Time Based Data Plots (1/28/87)

0170006.00
012987 0003

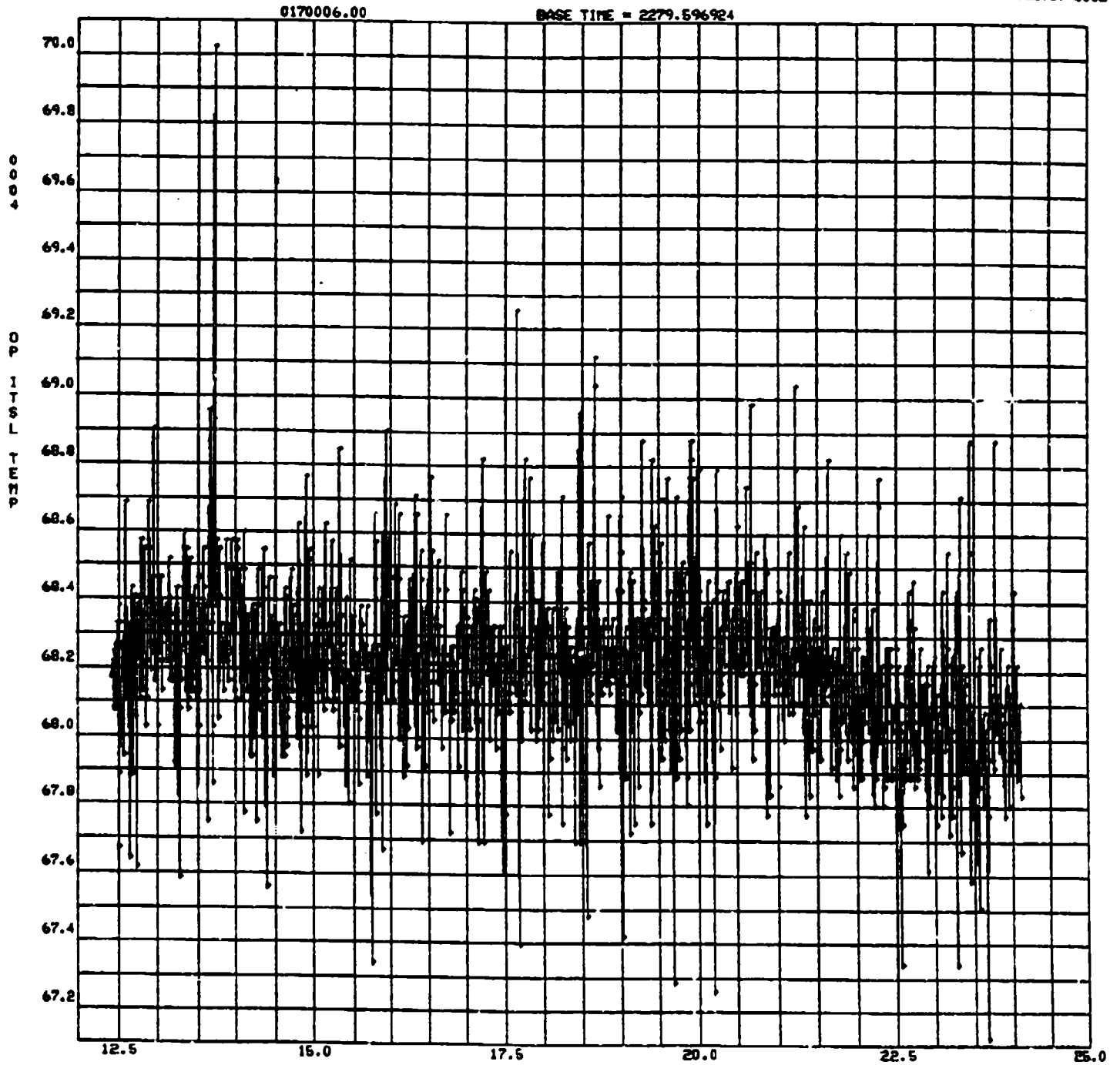

Appendix B: Test 87-017-006 Time Based Data Plots (1/28/87)

4055952008
012967 0002

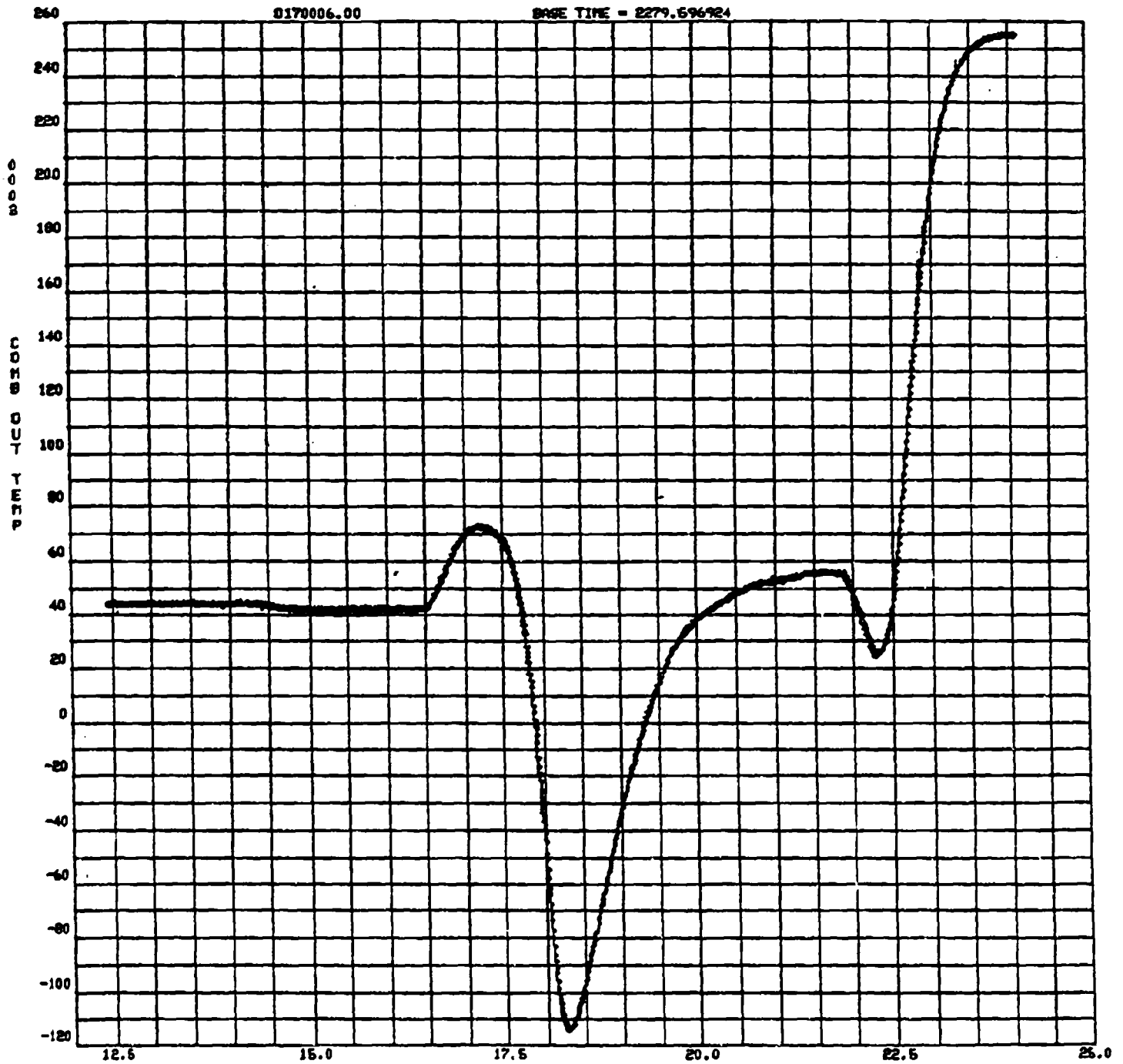

Appendix B: Test 87-017-006 Time Based Data Plots (1/28/87)



Appendix B: Test 87-017-006 Time Based Data Plots (1/28/87)

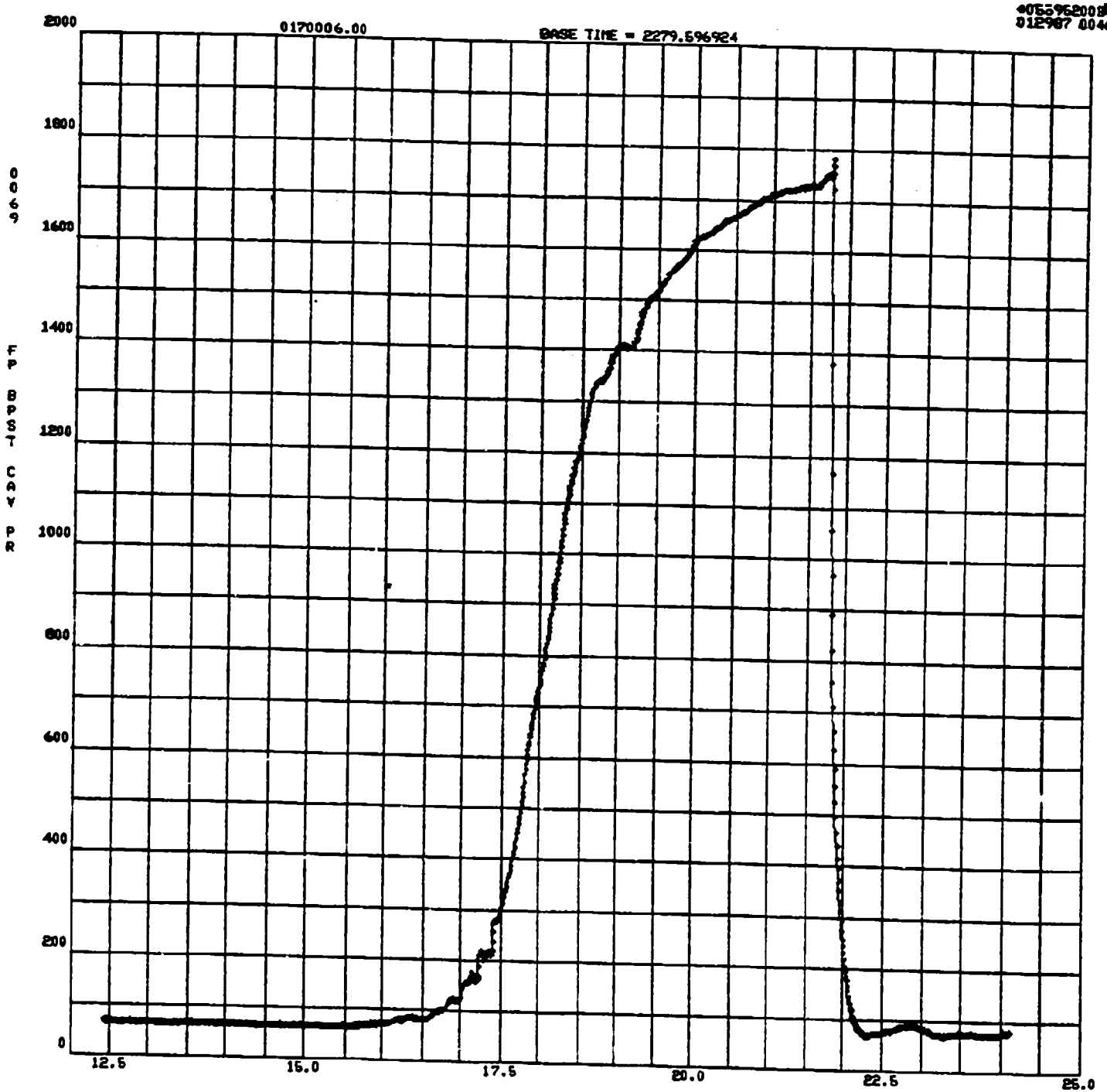

Appendix B:
Test 87-017-006 Time Based Data Plots (1/28/87)



Appendix B: Test 87-017-006 Time Based Data Plots (1/28/87)

065962002
012987 0044

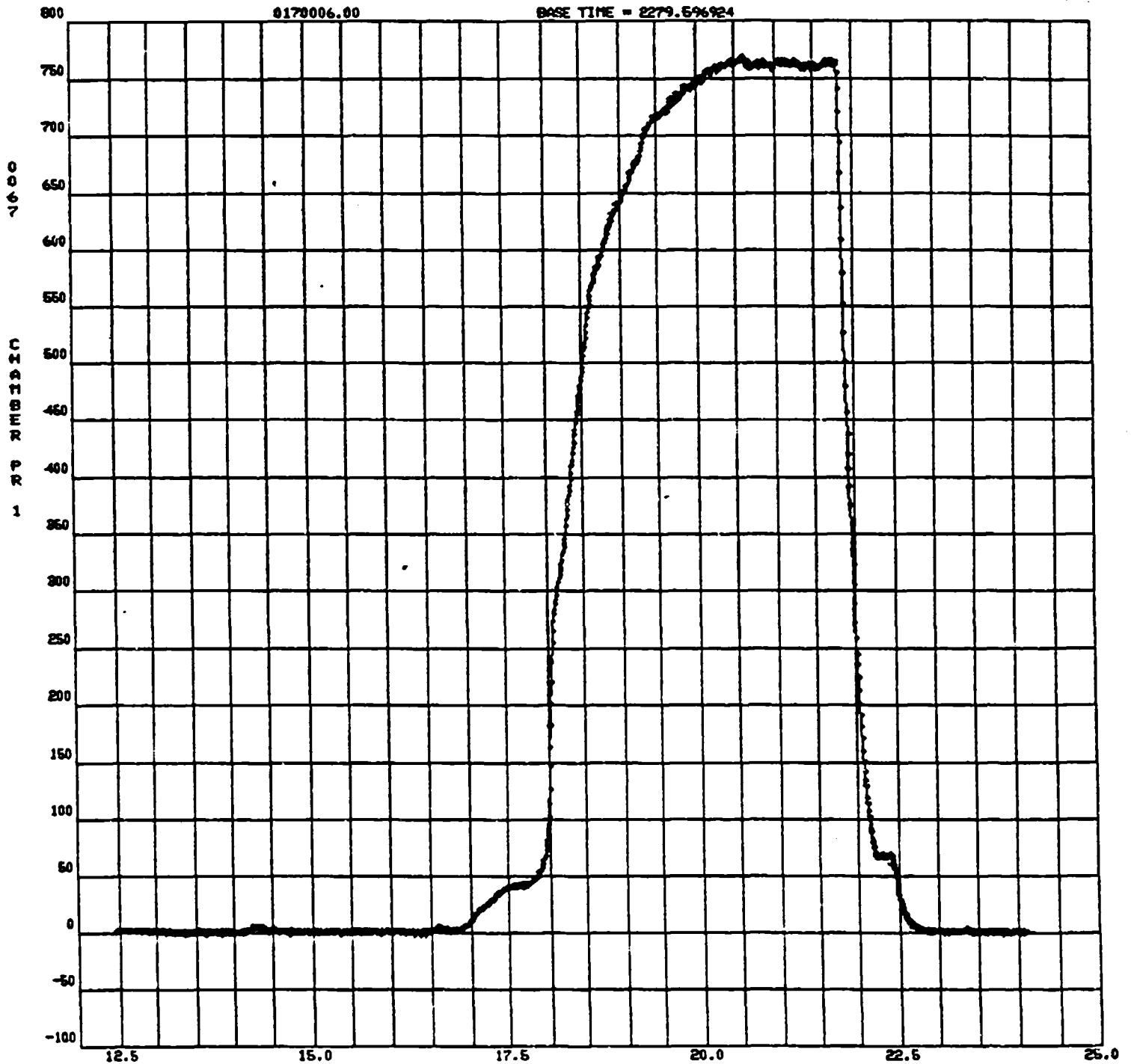

Appendix B: Test 87-017-006 Time Based Data Plots (1/28/87)

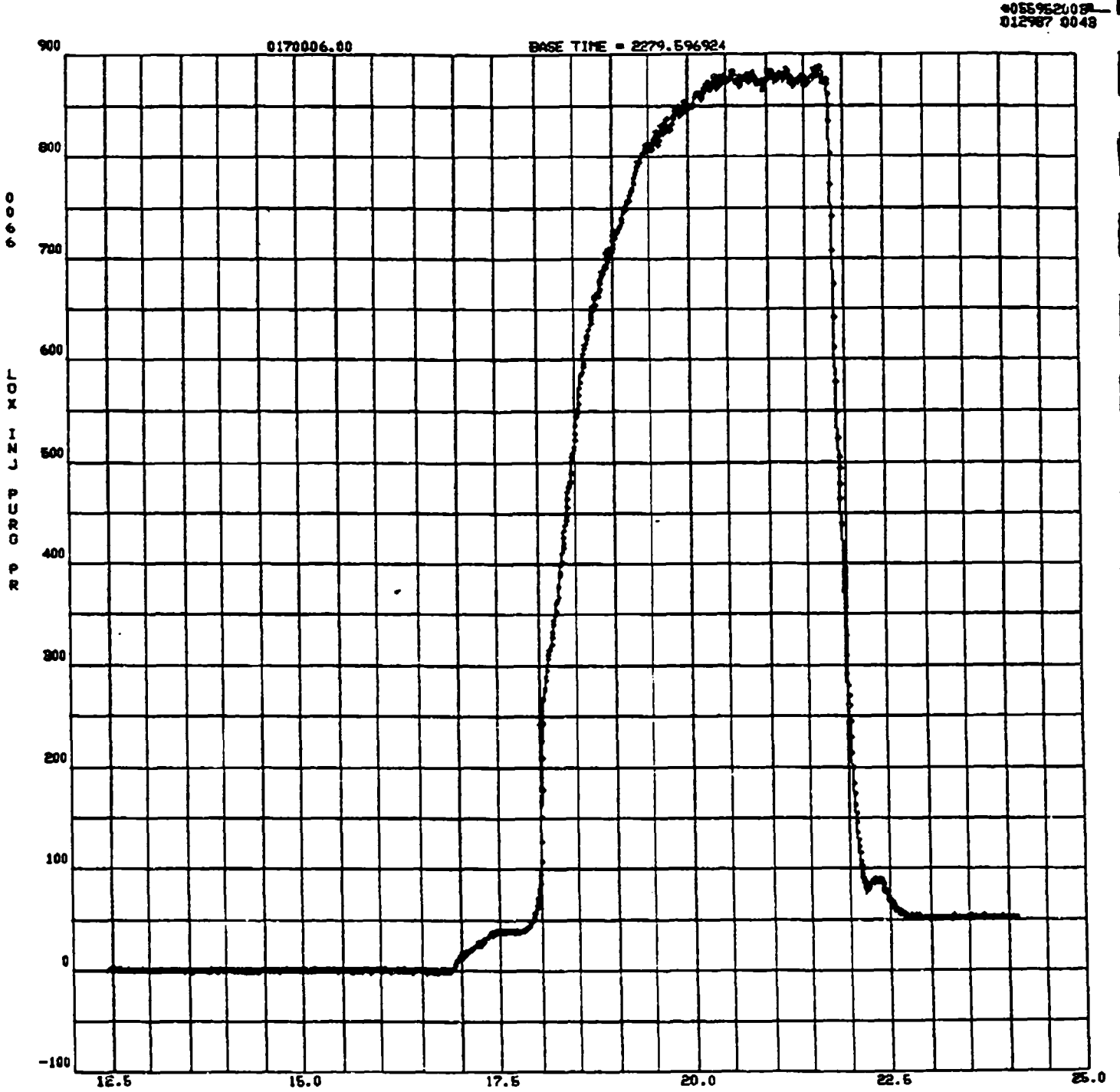

Appendix B:
Test 87-017-006 Time Based Data Plots (1/28/87)

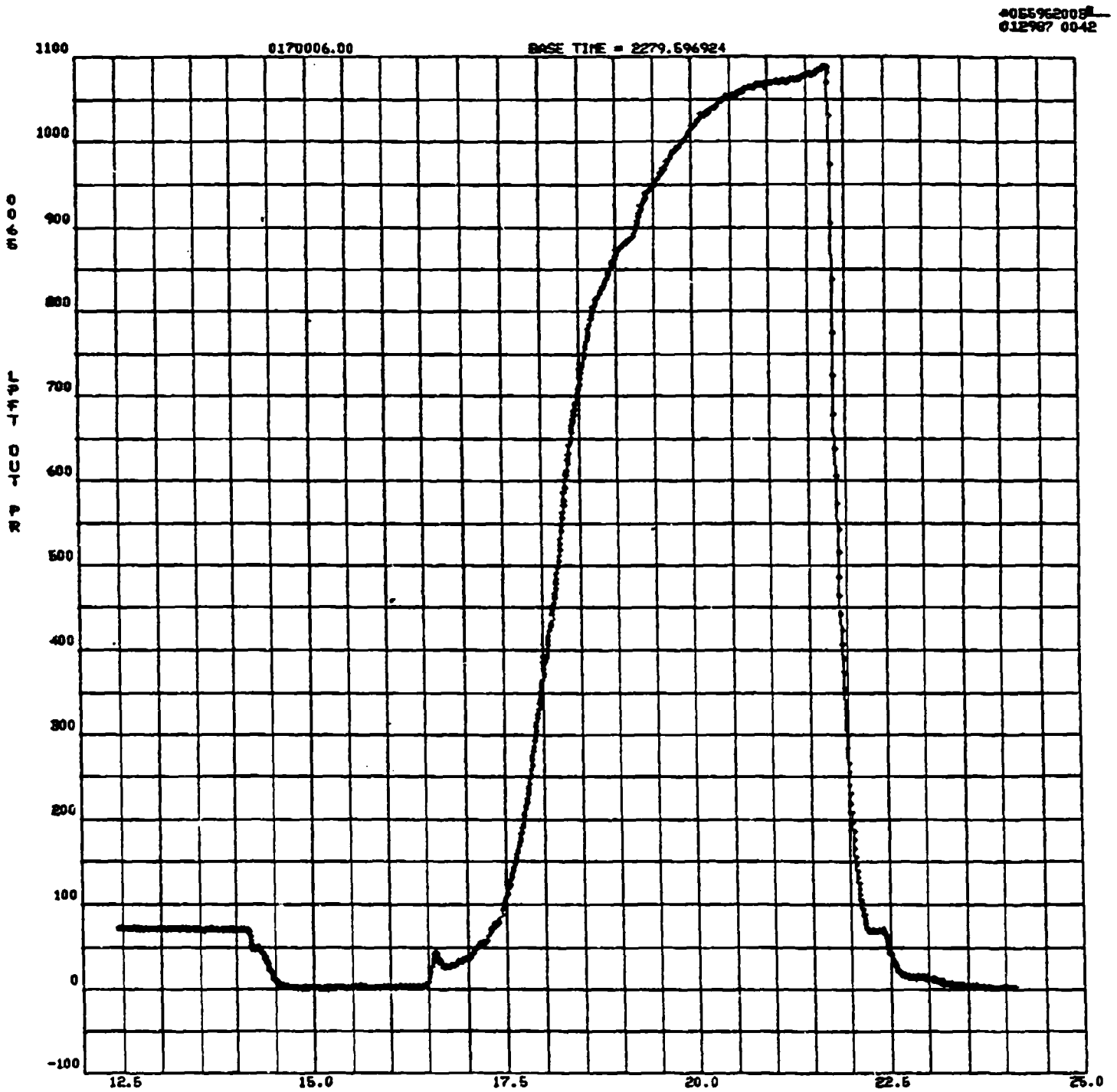

Appendix B: Test 87-017-006 Time Based Data Plots (1/28/87)

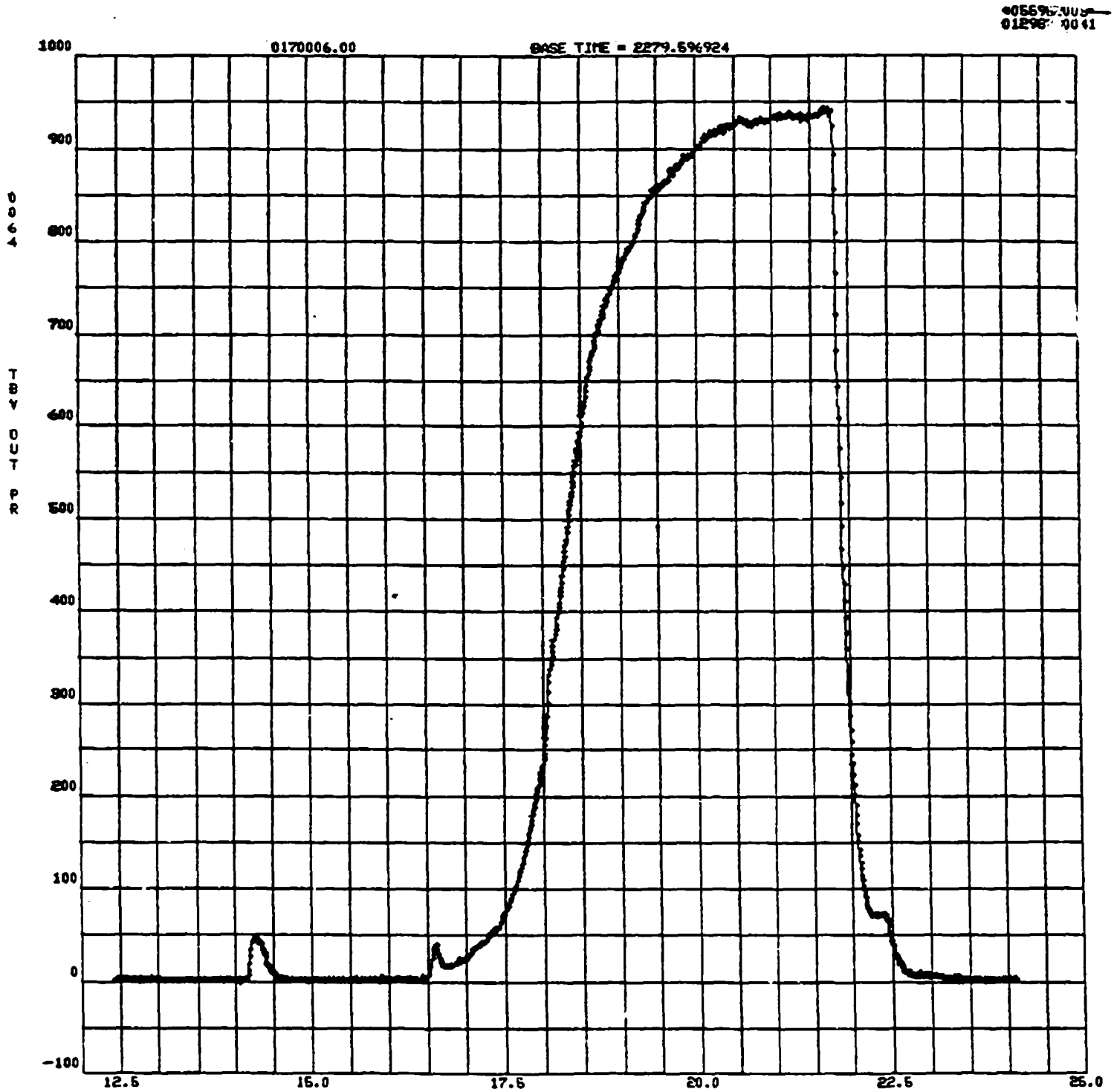

Appendix B: Test 87-017-006 Time Based Data Plots (1/28/87)

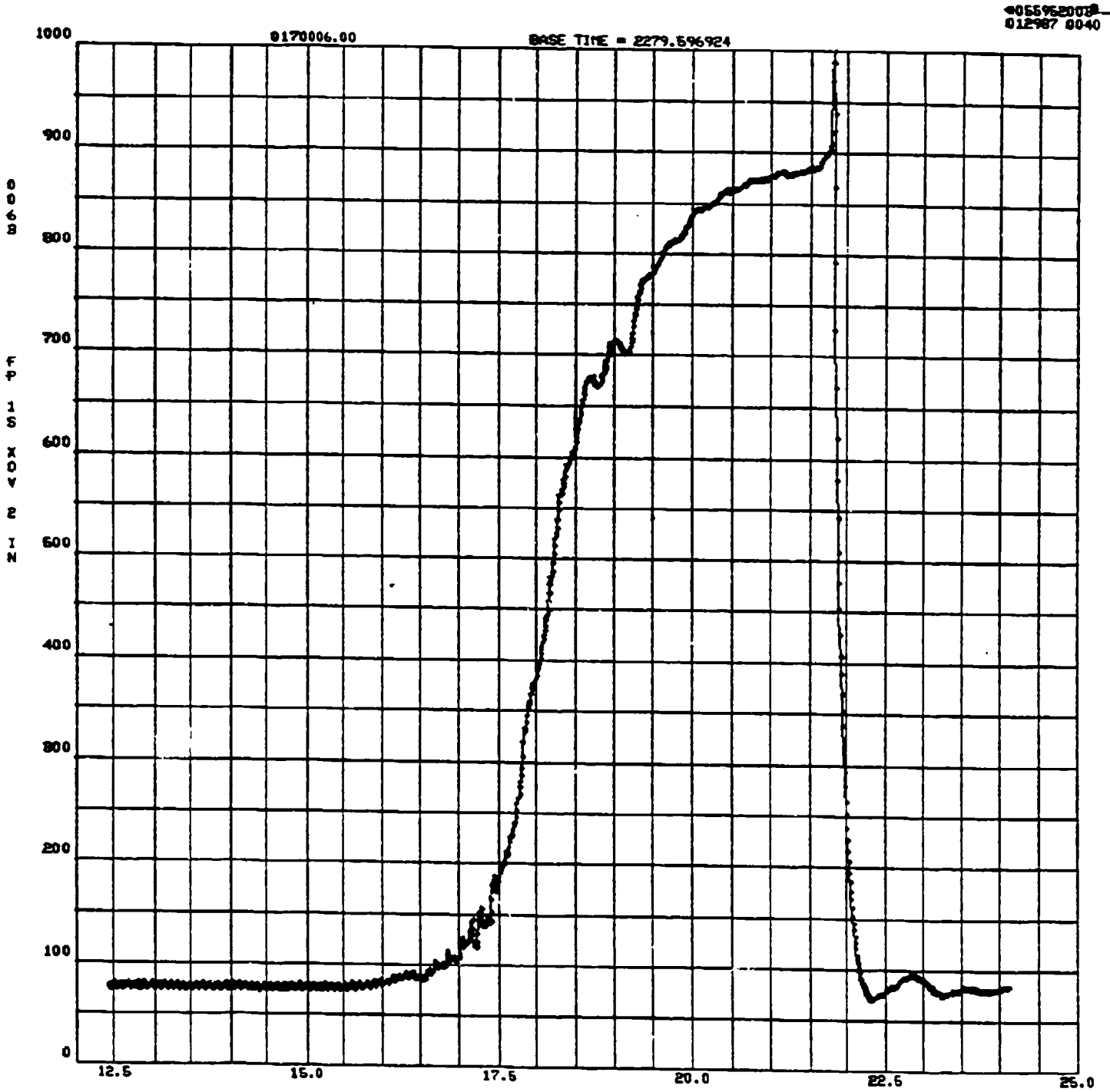

Appendix B: Test 87-017-006 Time Based Data Plots (1/28/87)

4055962008
012907 0089

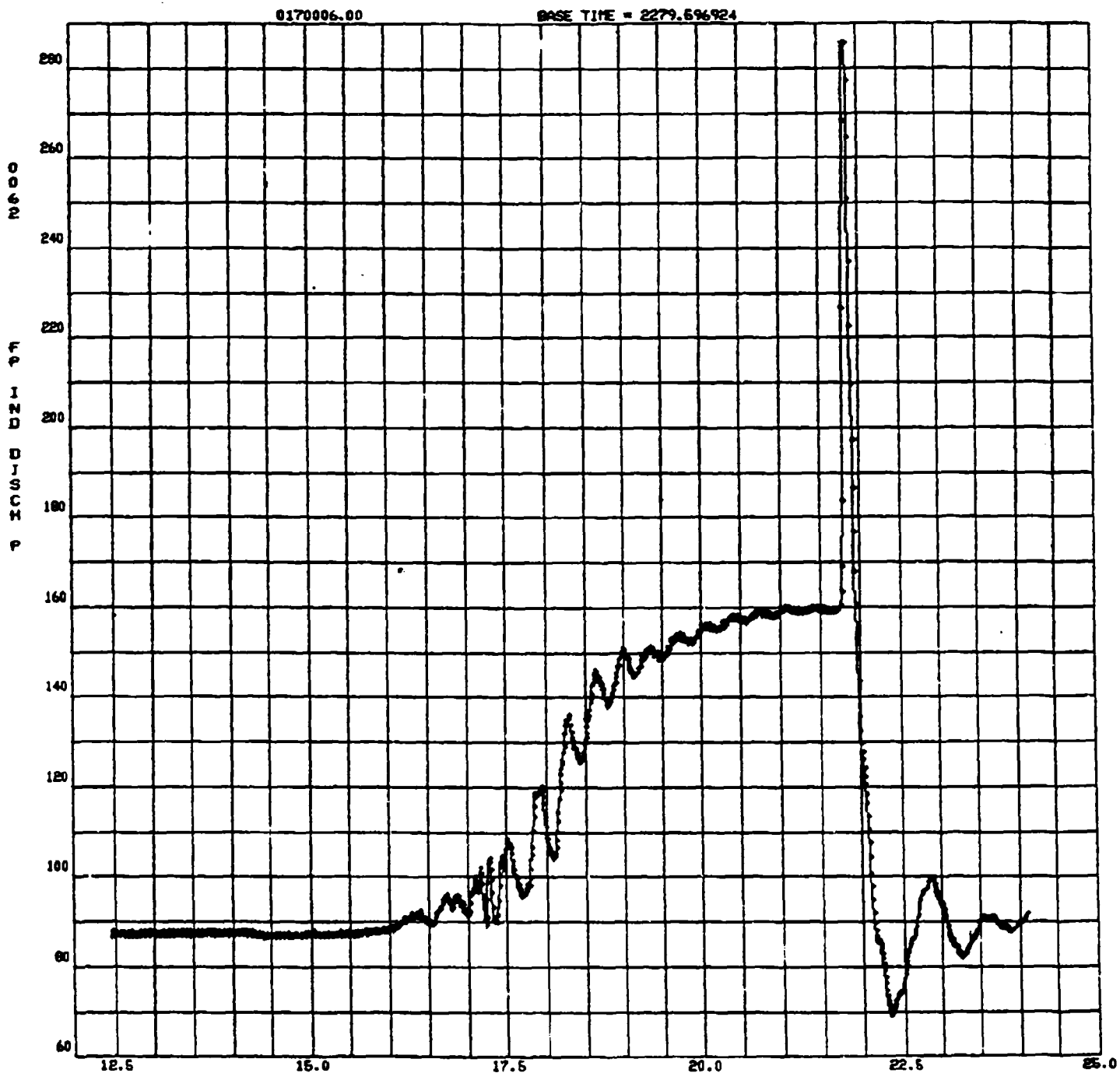

Appendix B: Test 87-017-006 Time Based Data Plots (1/28/87)

055952009
012987 0038

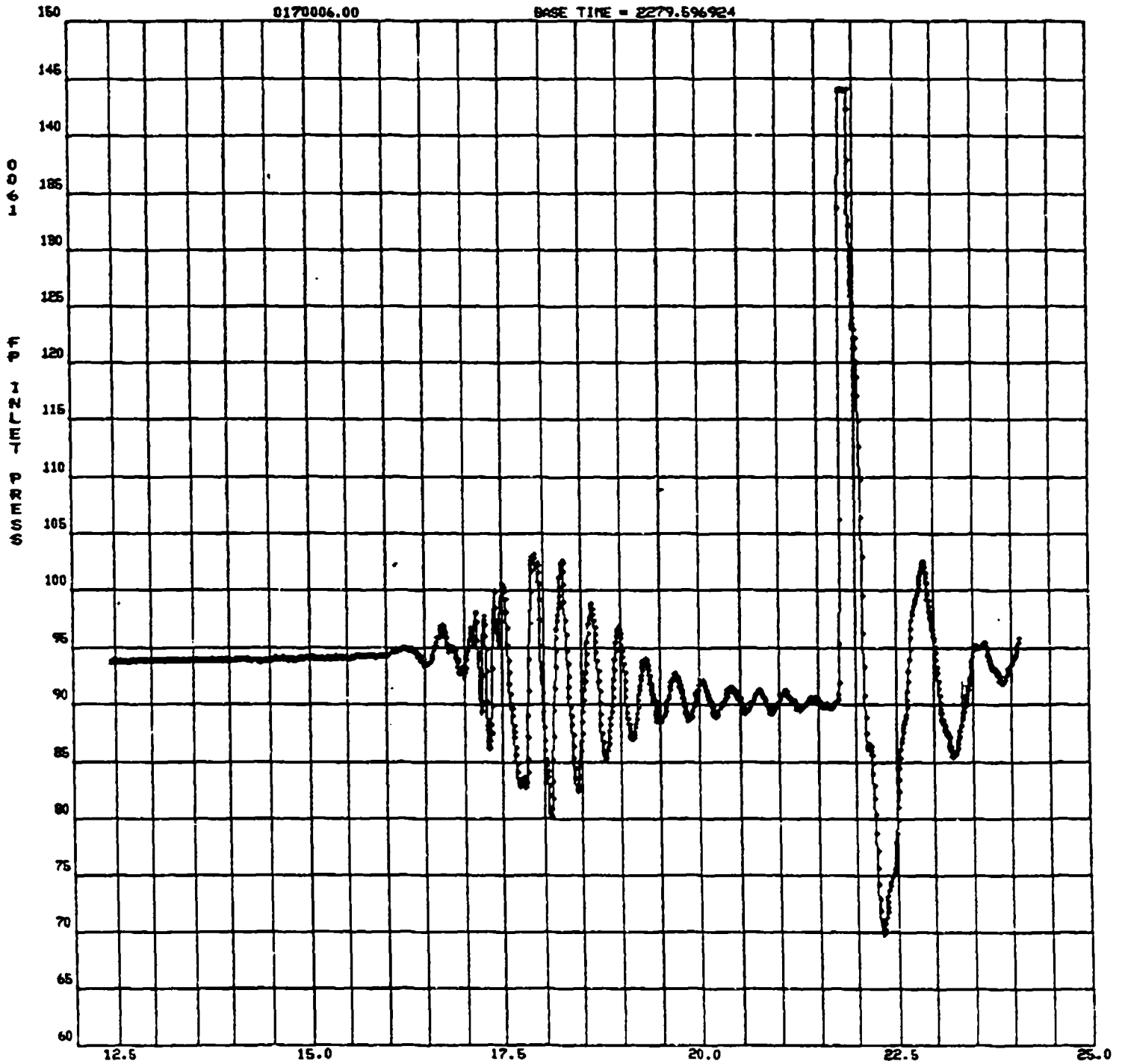

Appendix B: Test 87-017-006 Time Based Data Plots (1/28/87)

4055962002
012967 0037

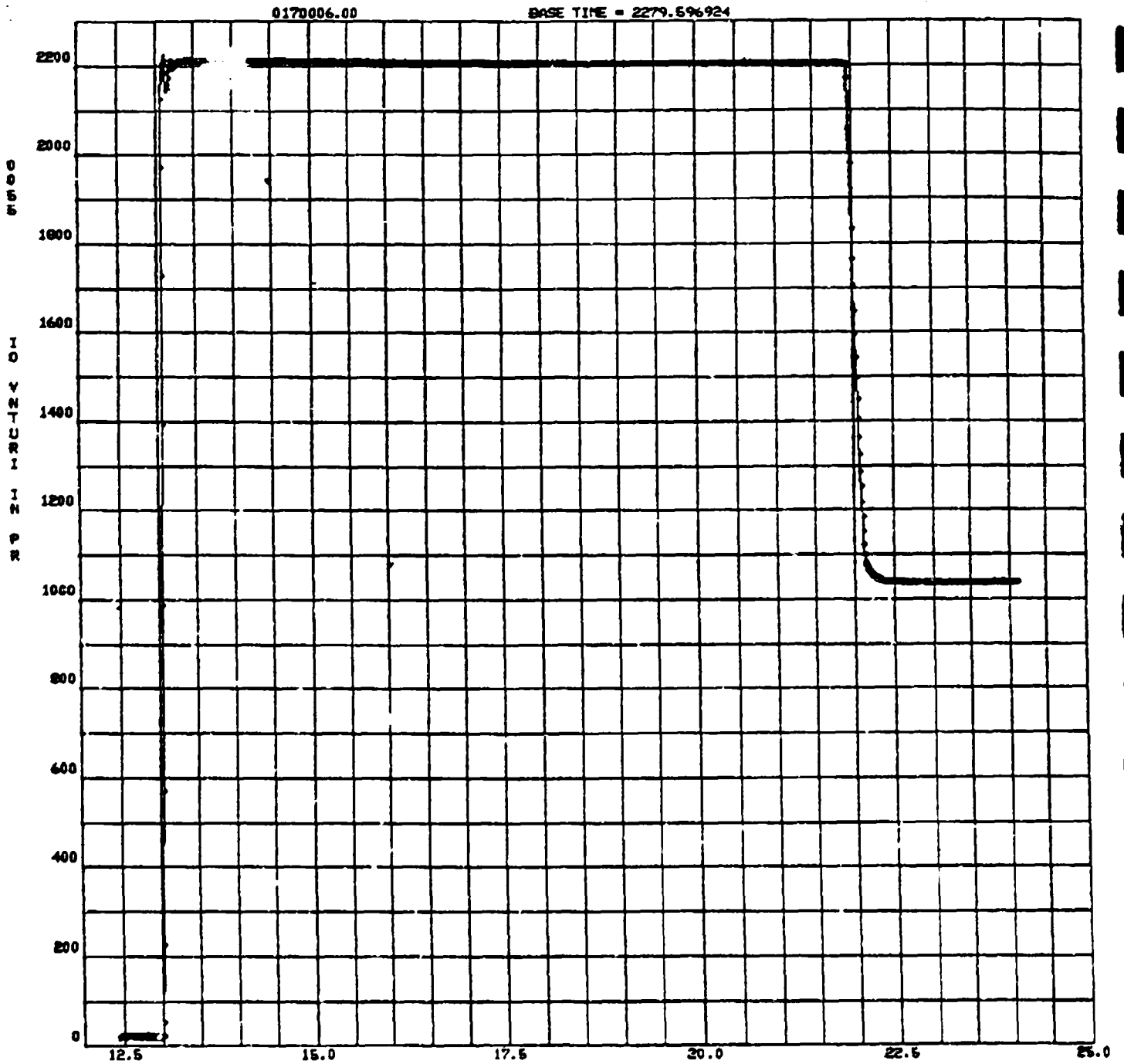

Appendix B:
Test 87-017-006 Time Based Data Plots (1/28/87)

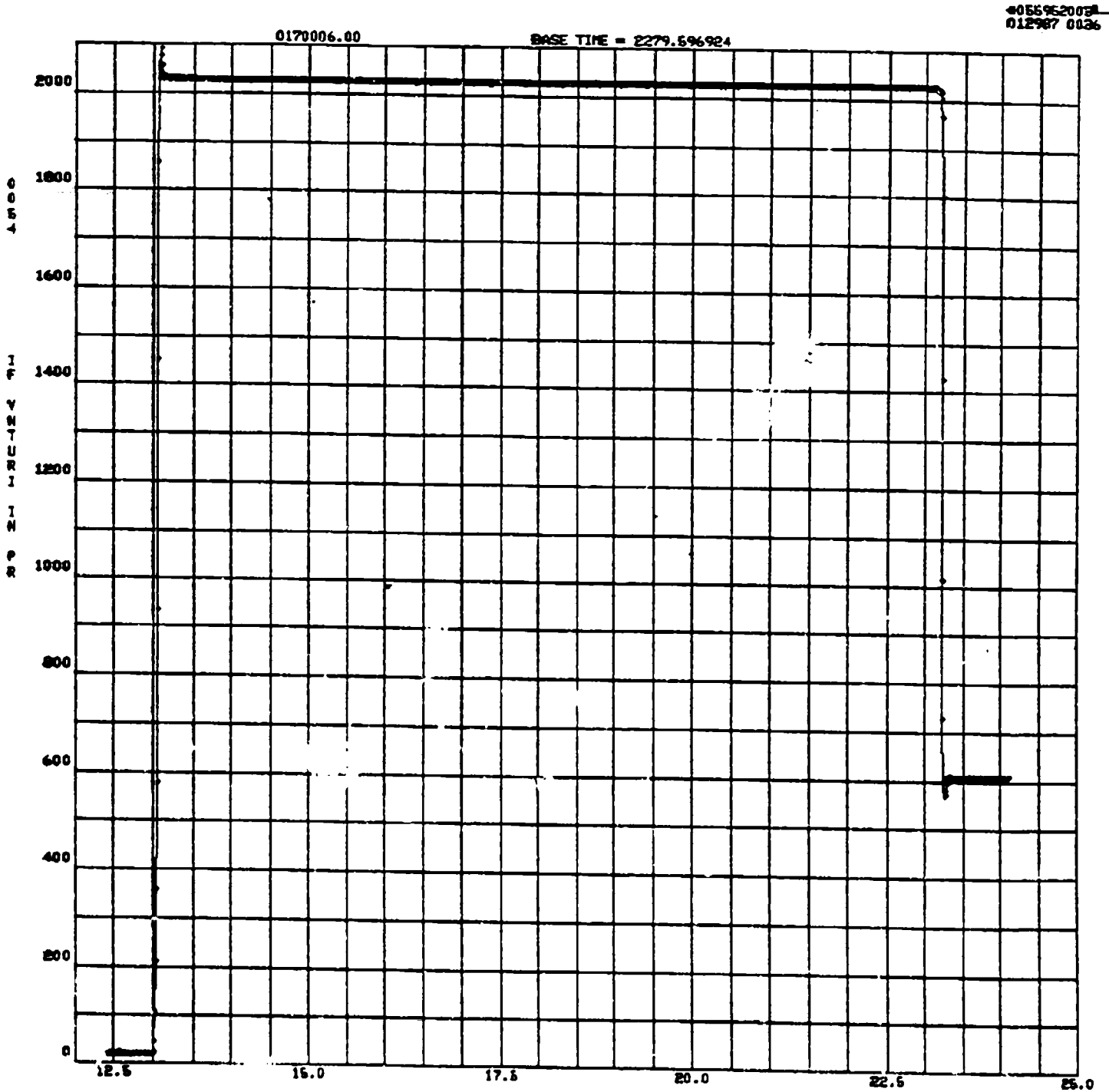

Appendix B: Test 87-017-006 Time Based Data Plots (1/28/87)

0170006.00
012987 0085

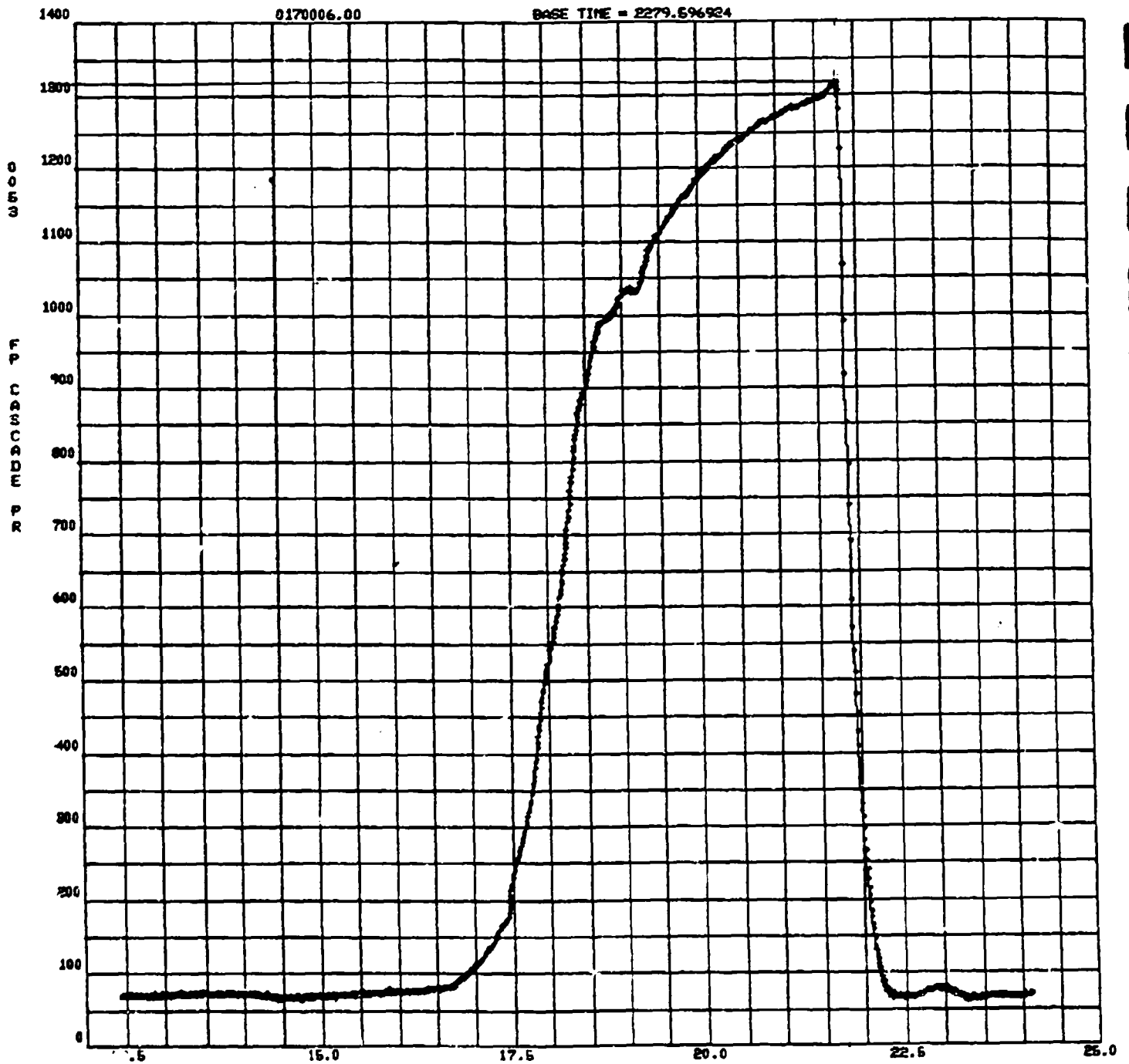

Appendix B: Test 87-017-006 Time Based Data Plots (1/28/87)

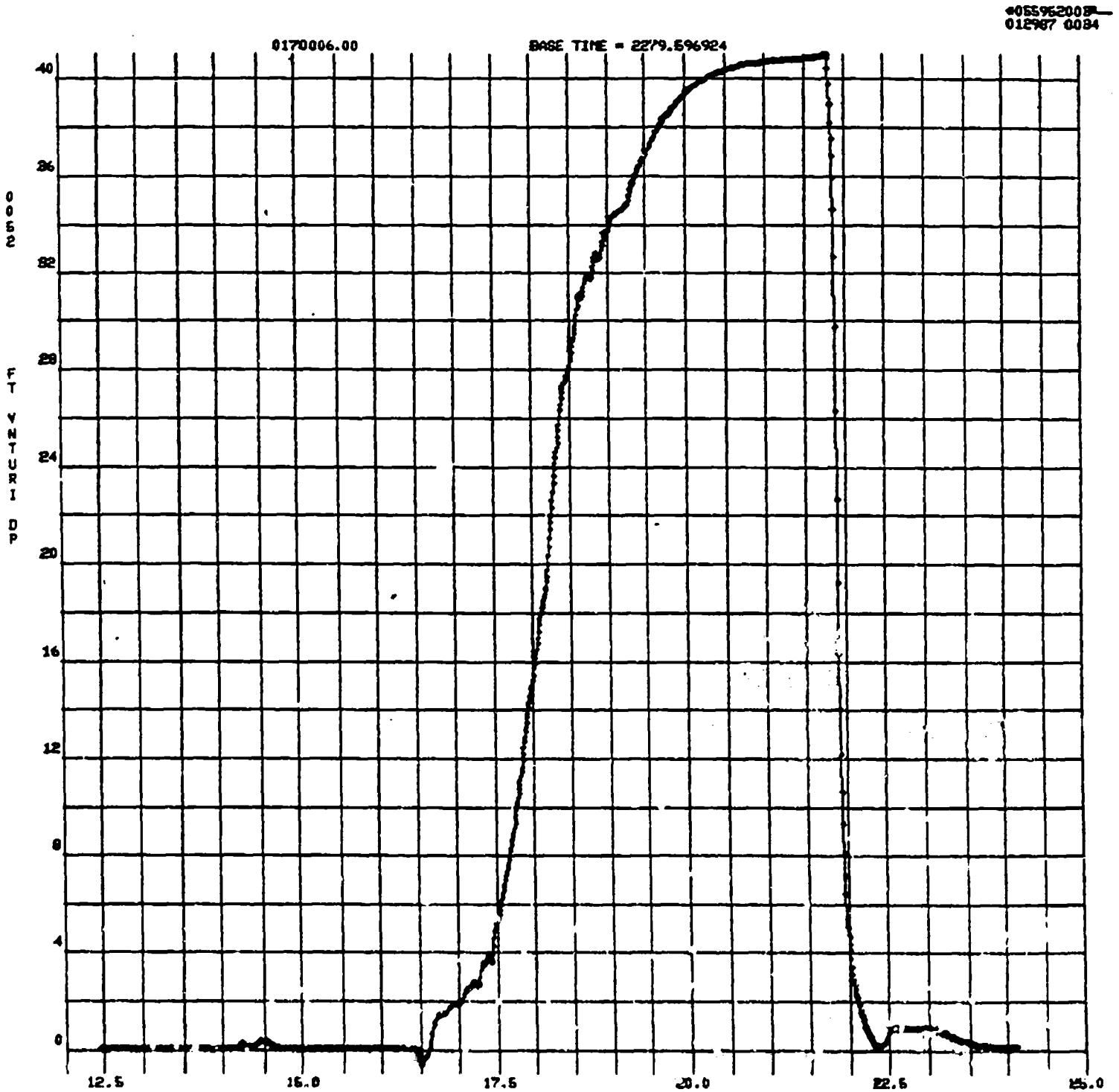

Appendix B: Test 87-017-006 Time Based Data Plots (1/28/87)



Appendix B: Test 87-017-006 Time Based Data Plots (1/28/87)



Appendix B: Test 87-017-006 Time Based Data Plots (1/28/87)

4055952008
012987 0031

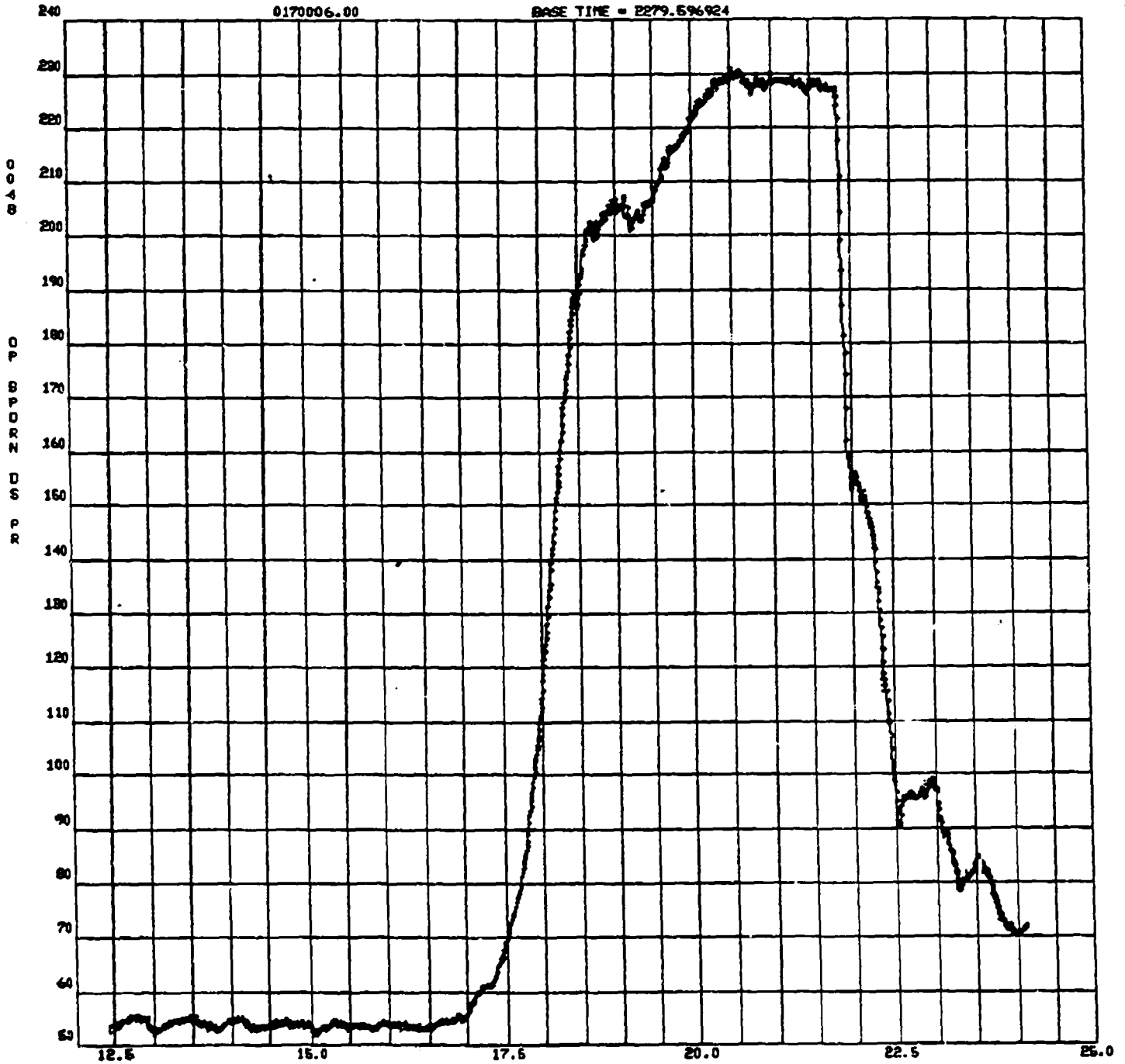

Appendix B: Test 87-017-006 Time Based Data Plots (1/28/87)

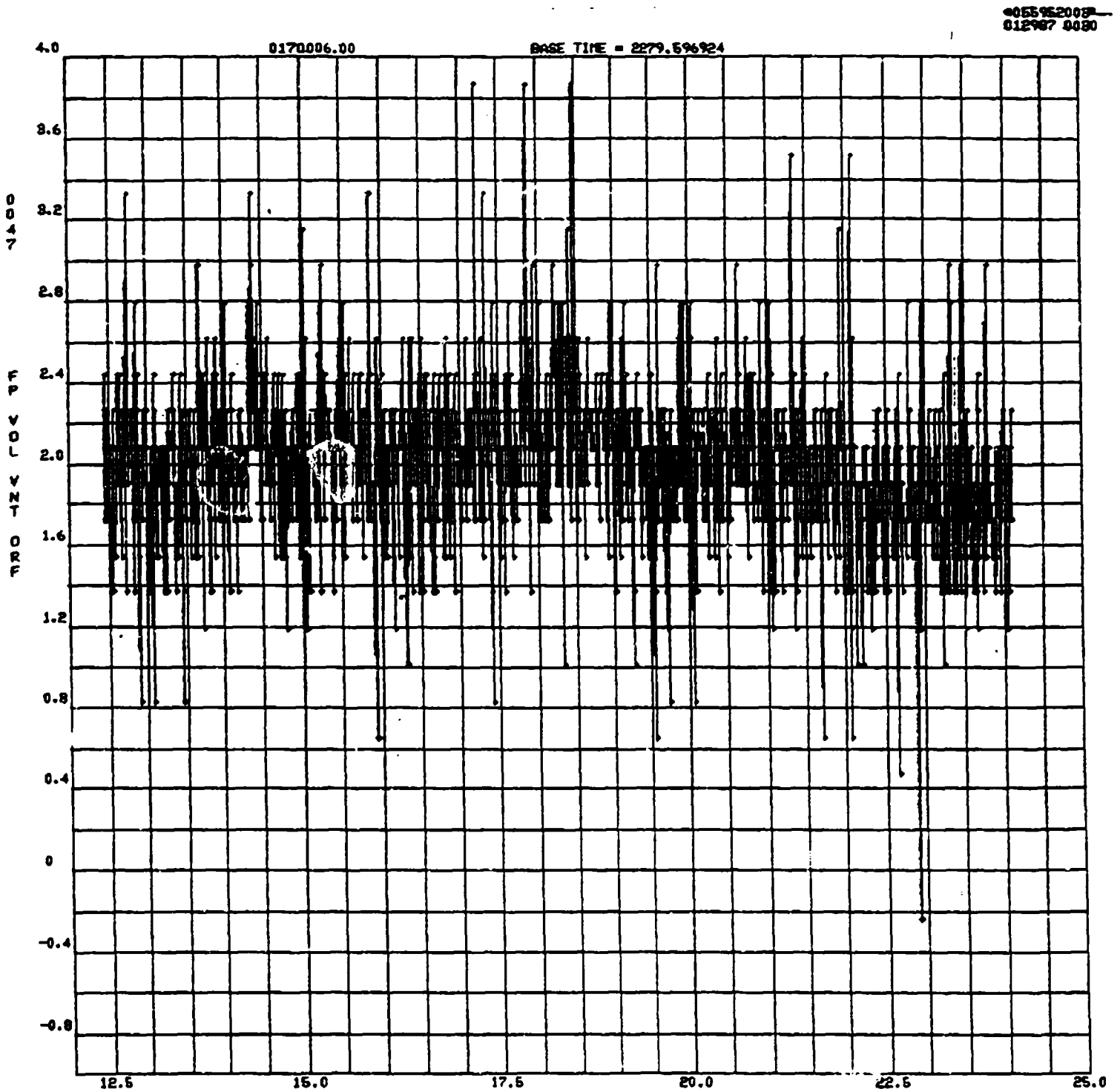

Appendix B: Test 87-017-006 Time Based Data Plots (1/28/87)

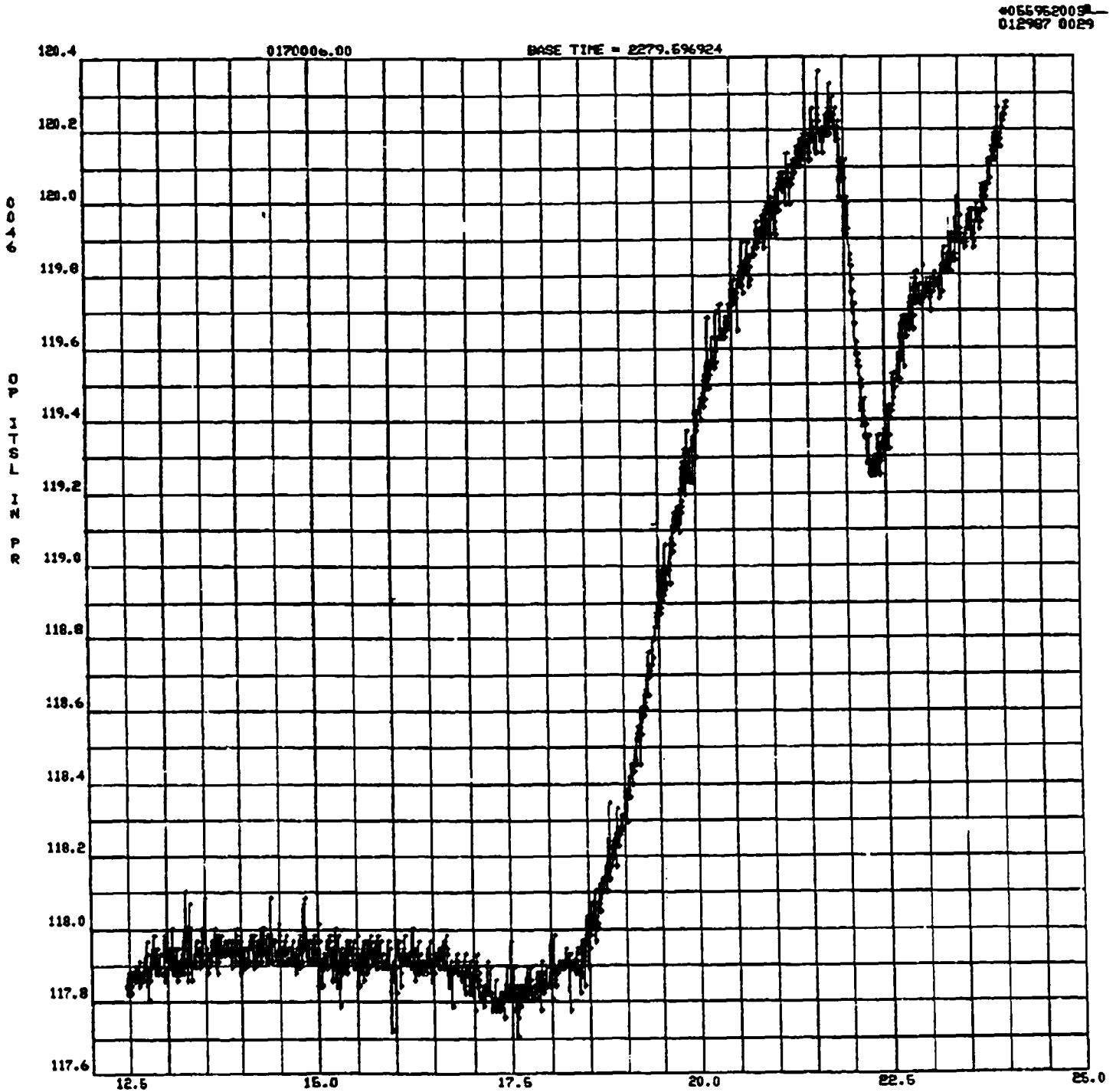

Appendix B: Test 87-017-006 Time Based Data Plots (1/28/87)

0055962008
012987 0028

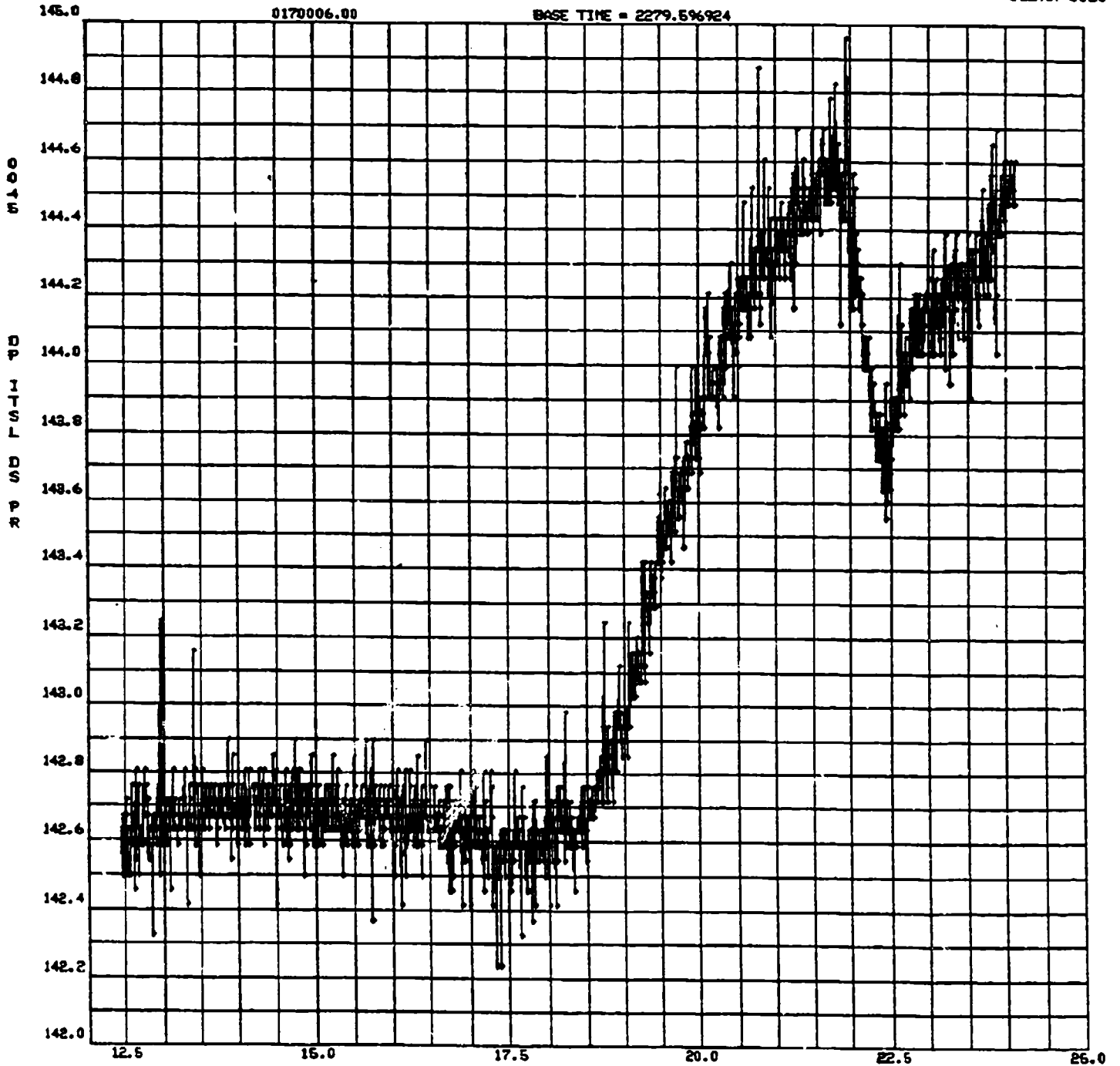

Appendix B: Test 87-017-006 Time Based Data Plots (1/28/87)

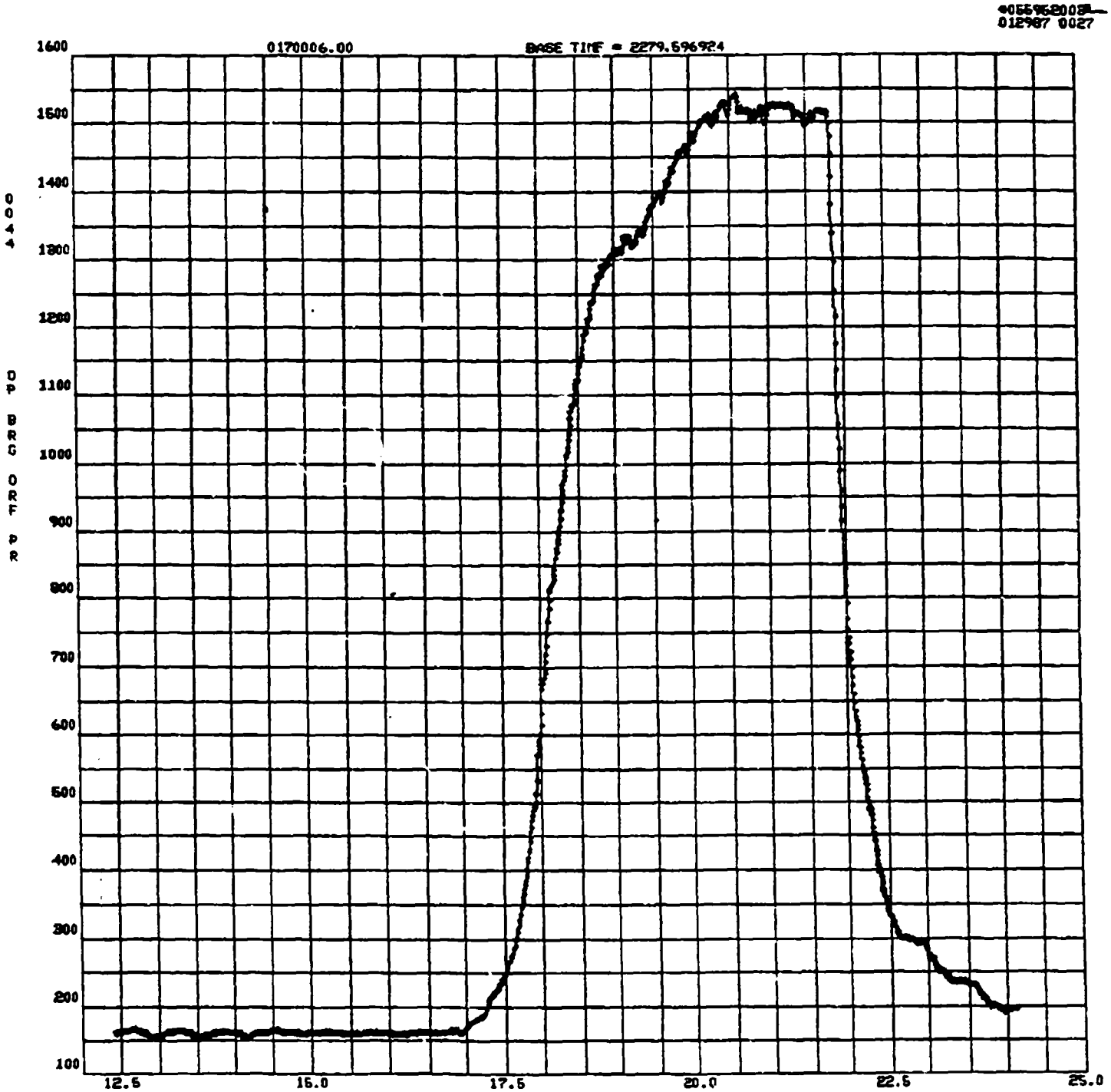

Appendix B: Test 87-017-006 Time Based Data Plots (1/28/87)

4055962008
012987 0026

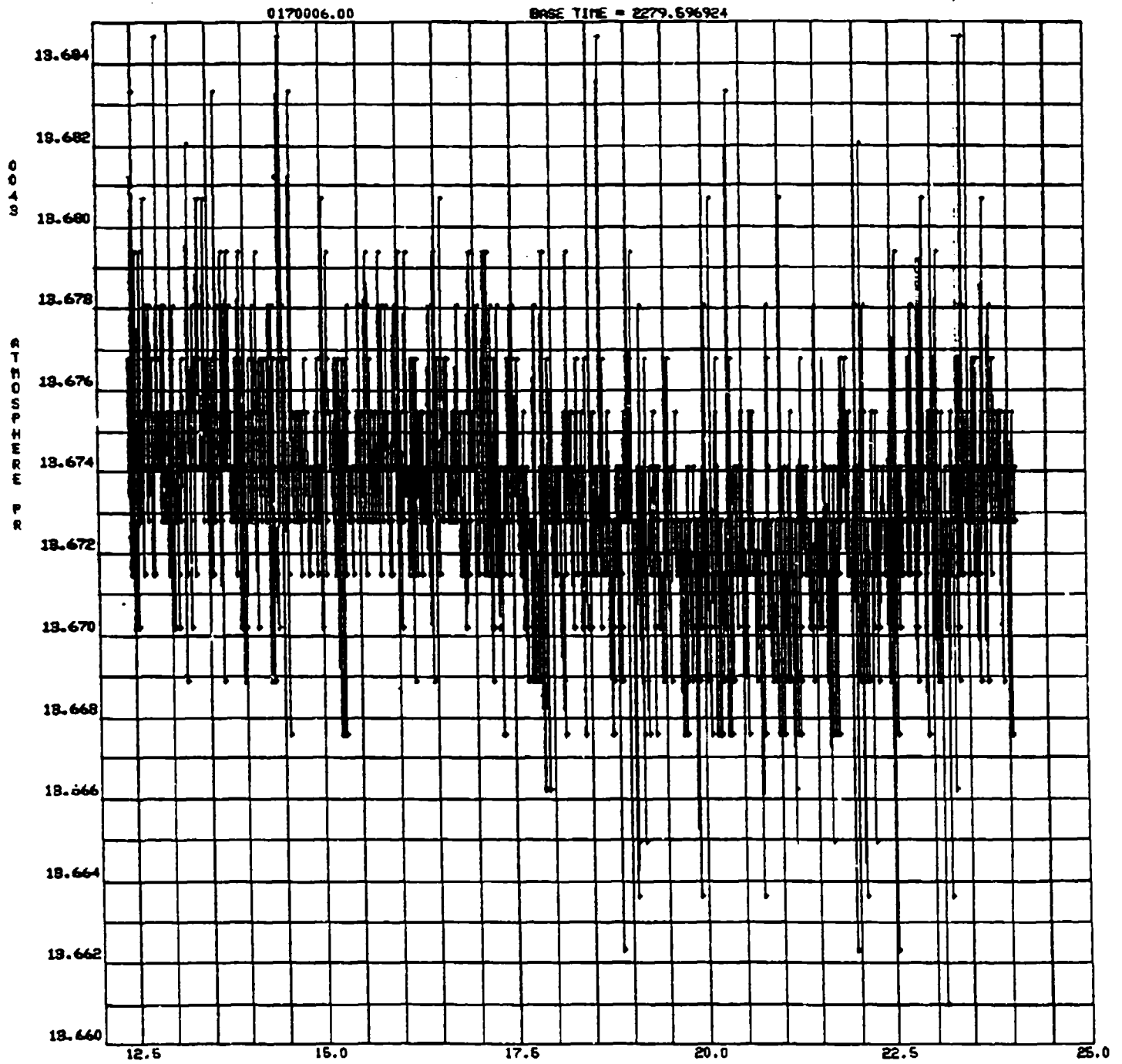

Appendix B: Test 87-017-006 Time Based Data Plots (1/28/87)

4055962009
012967 0025

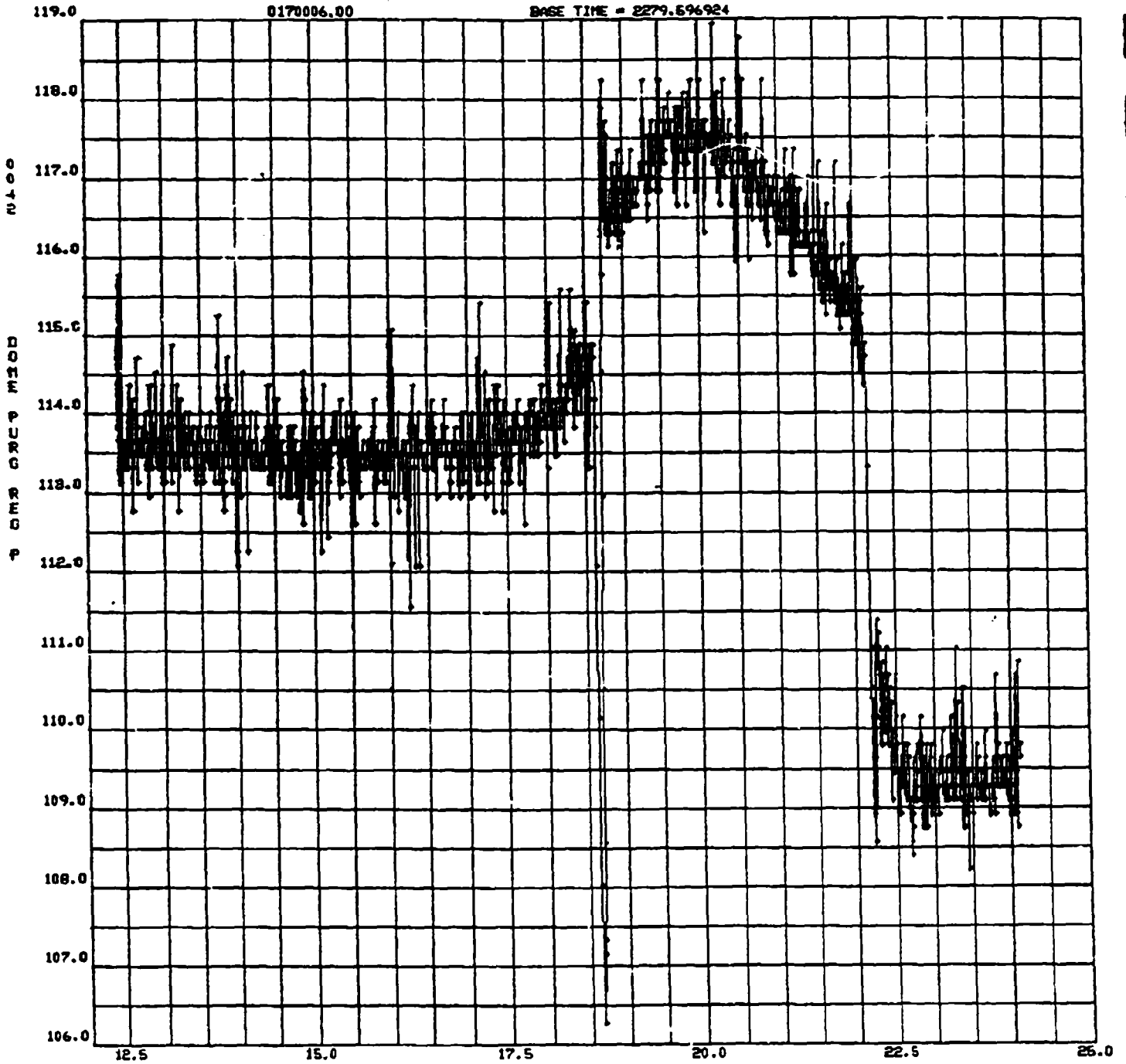

Appendix B: Test 87-017-006 Time Based Data Plots (1/28/87)

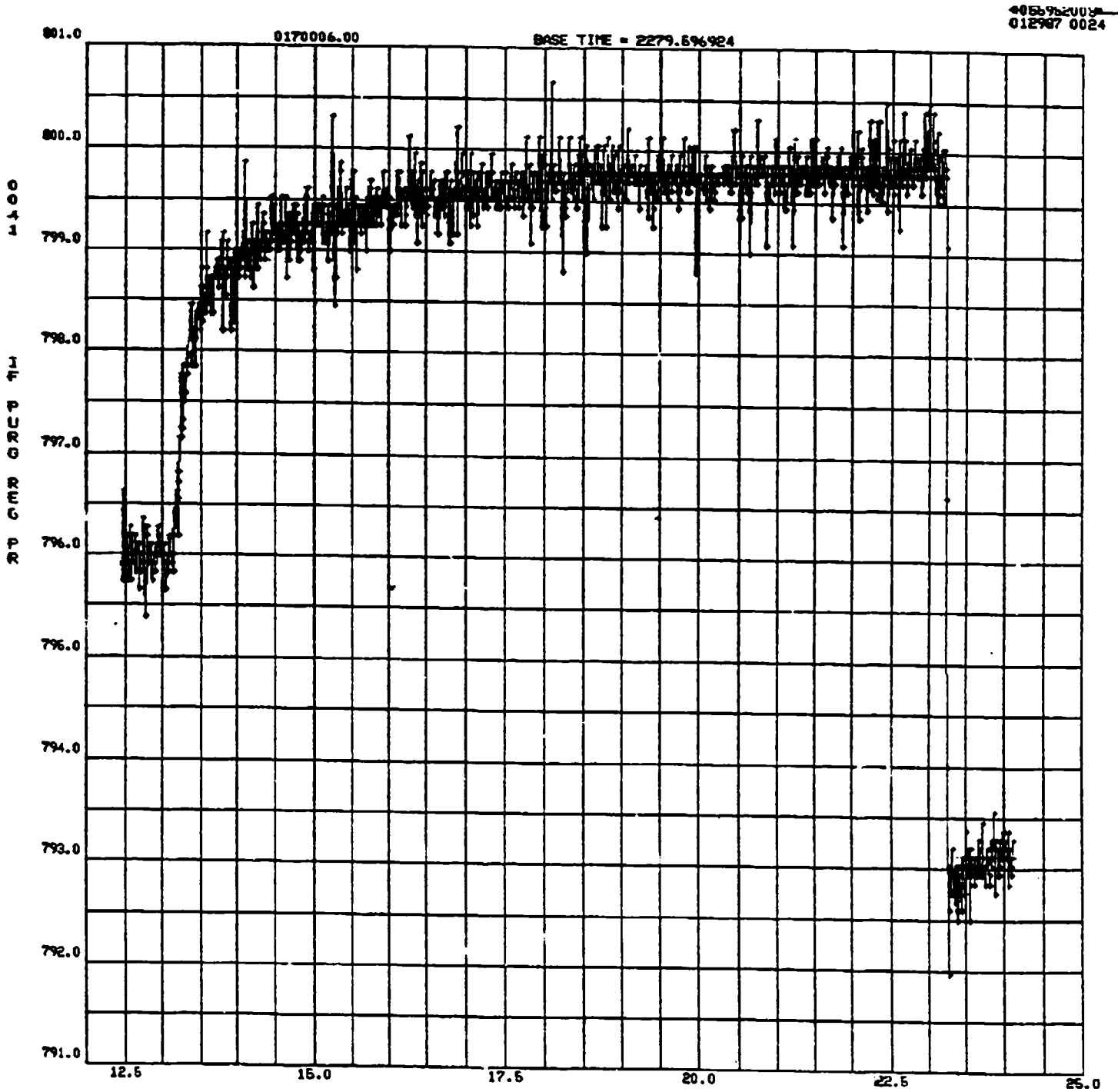

Appendix B:
Test 87-017-006 Time Based Data Plots (1/28/87)

4055962003
012987 0023

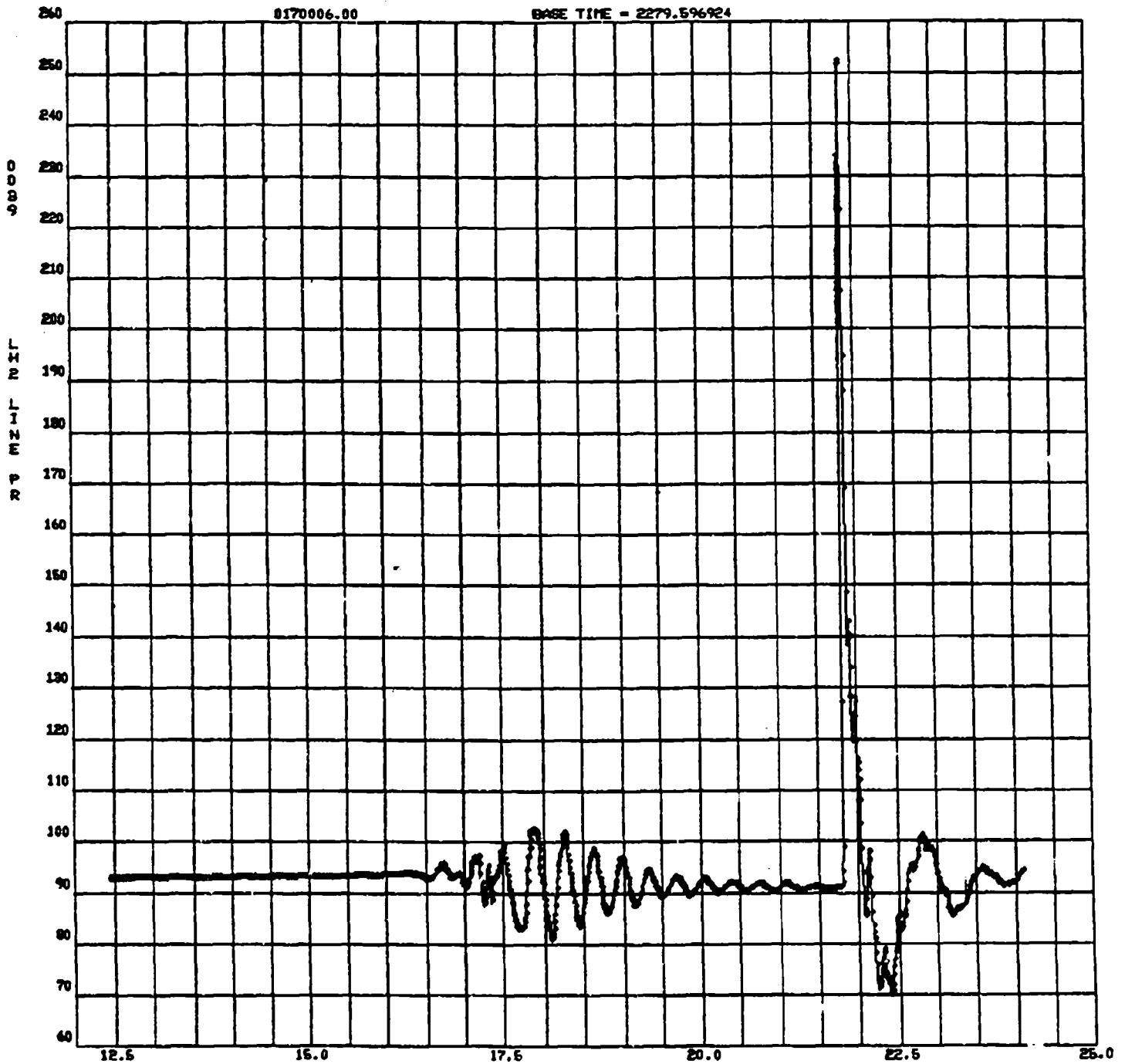

Appendix B:
Test 87-017-006 Time Based Data Plots (1/28/87)

00E962003
012987 0022

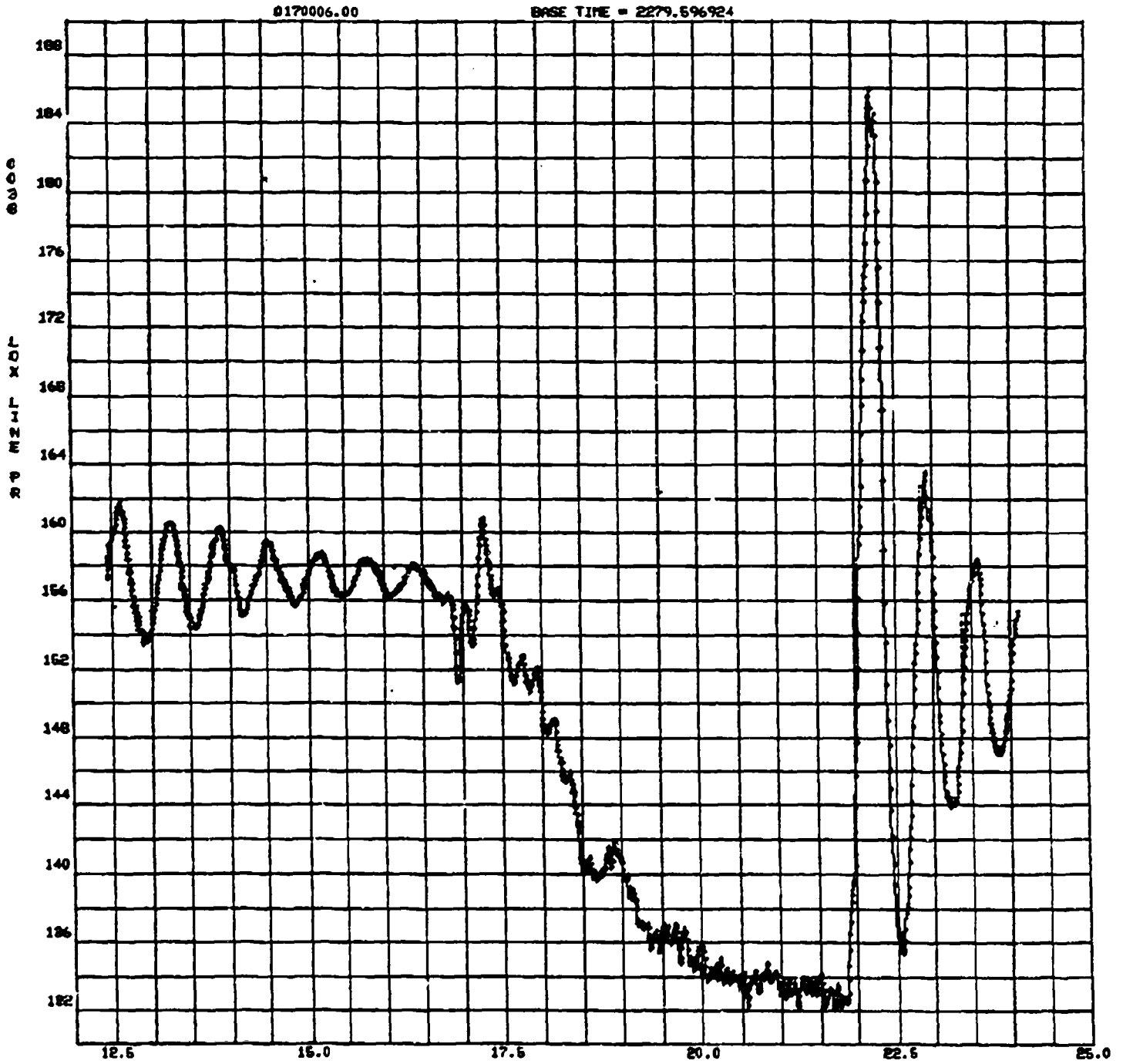

Appendix B: Test 87-017-006 Time Based Data Plots (1/28/87)

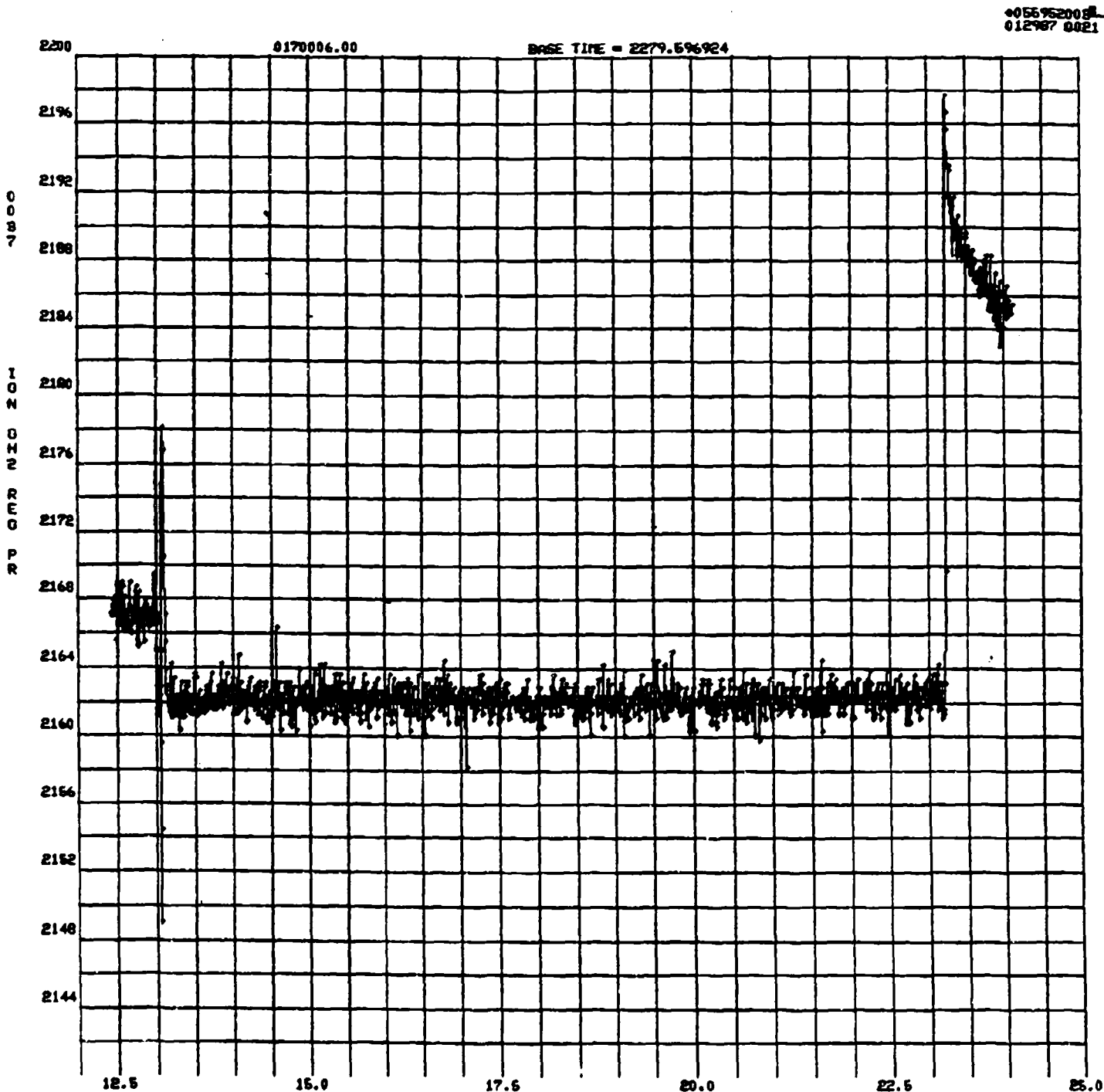



Report Documentation Page

1. Report No. NASA CR-194443	2. Government Accession No.	3. Recipient's Catalog No.	
4. Title and Subtitle Final Report Test Results of the RS-44 Integrated Component Evaluator Liquid Oxygen / Hydrogen Rocket Engine		5. Report Date 12 October 1993	6. Performing Organization Code
		8. Performing Organization Report No. R/RD92-127	
7. Author(s) R. F. Sutton and B. W. Lariviere		10. Work Unit No. TASK F.2 / F.4	11. Contract or Grant No. NAS 3-23773
		13. Type of Report and Period Covered Final Report; Apr 86 to Apr 87	
9. Performing Organization Name and Address ROCKWELL INTERNATIONAL Rocketdyne Division 6633 Canoga Avenue Canoga Park, California 91304		14. Sponsoring Agency Code	
15. Supplementary Notes Project Managers: G. Paul Richter, NASA Lewis Research Center, Cleveland, OH Dean D. Scheer, NASA Lewis Research Center, Cleveland, OH			
16. Abstract An advanced LOX/LH2 expander cycle rocket engine, producing 15,000 lbf thrust for Orbital Transfer Vehicle missions, was tested to determine ignition, transition, and main stage characteristics. Detail design and fabrication of the pump-fed RS44 integrated component evaluator (ICE) was accomplished using company discretionary resources and was tested under this contracted effort. Successful demonstrations were completed to about the 50% fuel turbopump power level (87,000 RPM), but during this last test, a high pressure fuel turbopump (HPFTP) bearing failed curtailing the test program. No other hardware were affected by the HPFTP premature shutdown. The ICE operations matched well with the predicted start transient simulations. The tests demonstrated the feasibility of a high performance advanced expander cycle engine. All engine components operated nominally, except for the HPFTP, during the engine hot-fire tests. A failure investigation was completed using company discretionary resources.			
17. Key Words (Suggested by Author(s)) Rocket Engine, Expander Cycle, Turbopump, Injector, Igniter - Combustion Chamber,		18. Distribution Statement Unclassified - Unlimited	
19. Security Classif. (of this report) Unclassified	20. Security Classif. (of this page) Unclassified	21. No. of Pages 372	22. Price