

AD-A276 696



2

PL-TR-94-2022

Environmental Research Papers, No. 1141

**PERFORMANCE STATISTICS BULLETIN
HIGH LATITUDE METEOR SCATTER PROPAGATION
JUNE, JULY, AUGUST, SEPTEMBER 1991**

**Alan D. Bailey
John M. Quinn
Patricia M. Bench
Wayne I. Klemetti**

**DTIC
ELECTE
FEB 24 1994
S B D**

1 February 1994

265 py **94-05988**

APPROVED FOR PUBLIC RELEASE; DISTRIBUTION UNLIMITED.



**PHILLIPS LABORATORY
Directorate of Geophysics
AIR FORCE MATERIEL COMMAND
HANSCOM AIR FORCE BASE, MA 01731-3010**

DTIC QUALITY INSPECTED &

9 4 2 23 217

"This technical report has been reviewed and is approved for publication"

EDWARD J. BERGHORN
Branch Chief

FOR THE COMMANDER

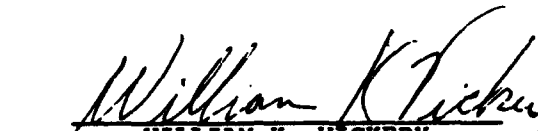
WILLIAM K. VICKERY
Division Director

This report has been reviewed by the ESC Public Affairs Office (PA) and is releasable to the National Technical Information Service (NTIS).

Qualified requestors may obtain additional copies from the Defense Technical Information Center. All others should apply to the National Technical Information Service.

If your address has changed, or if you wish to be removed from the mailing list, or if the addressee is no longer employed by your organization, please notify OLAA PL/TSI, Hanscom AFB, MA 01731-3010. This will assist us in maintaining a current mailing list.

Do not return copies of this report unless contractual obligations or notices on a specific document require that it be returned.

REPORT DOCUMENTATION PAGEForm Approved
OMB No. 0704-0188

Public reporting burden for this collection of information is estimated to average 1 hour per response, including the time for reviewing instructions, searching existing data sources, gathering and maintaining the data needed, and completing and reviewing the collection of information. Send comments regarding this burden estimate or any other aspect of this collection of information, including suggestions for reducing this burden, to Washington Headquarters Services, Directorate for Information Operations and Reports, 1215 Jefferson Davis Highway, Suite 1204, Arlington, VA 22202-4302, and to the Office of Management and Budget, Paperwork Reduction Project (0704-0188), Washington, DC 20503

1. AGENCY USE ONLY (Leave blank)		2. REPORT DATE 1 February 1994	3. REPORT TYPE AND DATES COVERED Scientific Interim	
4. TITLE AND SUBTITLE Performance Statistics Bulletin High Latitude Meteor Scatter Propagation June, July, August, September 1991			5. FUNDING NUMBERS PE 62101F PR 4643 TA 10 WU 08	
6. AUTHOR(S) A.D.Bailey, J.M.Quinn, P.M.Bench, W.I.Klemetti				
7. PERFORMING ORGANIZATION NAME(S) AND ADDRESS(ES) Phillips Laboratory (GPIA) 29 Randolph Road Hanscom AFB, MA 01731-3010			8. PERFORMING ORGANIZATION REPORT NUMBER PL-TR-94-2022 ERP, No. 1141	
9. SPONSORING / MONITORING AGENCY NAME(S) AND ADDRESS(ES)			10. SPONSORING / MONITORING AGENCY REPORT NUMBER	
11. SUPPLEMENTARY NOTES This report may be of special interest to: Advanced Research Projects Agency (ARPA), Naval Research Laboratory (NRL), and Naval Underwater Systems Center (NUSC)				
12a. DISTRIBUTION / AVAILABILITY STATEMENT Approved for Public Release; Distribution Unlimited			12b. DISTRIBUTION CODE	
13. ABSTRACT (Maximum 200 words) A representative sampling of meteor scatter propagation performance statistics is presented from the PL/GP High Latitude Meteor Scatter Test Bed. The data address questions of meteor scatter propagation under disturbed ionospheric conditions, as well as normal meteor scatter propagation in the polar region. The time and frequency variations of the propagation transfer function are characterized over the 35 to 147 MHz range, including the availability of useful meteor trails, the potential communication capacity associated with those trails, the occurrence and persistence of ionospheric scatter and sporadic E-layers, variations in the signal-to-noise ratios of each scatter return and the effects of auroral and polar cap absorption (PCA) events on meteor scatter propagation and communications. Statistics covering Arrival Rate, Duration, Duty Cycle, and Noise Temperature are presented. This bulletin is one of a series covering the test bed operation from February 1990 through September 1992.				
14. SUBJECT TERMS Meteor scatter Communications High latitude propagation Propagation			15. NUMBER OF PAGES 266	
			16. PRICE CODE	
17. SECURITY CLASSIFICATION OF REPORT UNCLASSIFIED	18. SECURITY CLASSIFICATION OF THIS PAGE UNCLASSIFIED	19. SECURITY CLASSIFICATION OF ABSTRACT UNCLASSIFIED	20. LIMITATION OF ABSTRACT SAR	

Contents

1.	INTRODUCTION	1
2.	HLMSTB SITE AND PATH DESCRIPTION	1
3.	HLMSTB SYSTEM DESCRIPTION	2
4.	DATA ACQUISITION	4
5.	DATA PROCESSING	4
6.	CLASSIFICATION	4
	6.1 Returns from Underdense Meteor Trails	5
	6.2 Returns from Overdense Meteor Trails	7
	6.3 Returns from Sporadic E-Layers	8
	6.4 Unidentified Propagation	8
7.	ANALYSIS OPTIONS	9
	7.1 Propagation Analysis	9
	7.2 Communication Analysis	9
8.	STATISTICAL DATA BASE	9
	8.1 Meteor Arrivals Data Base	9
	8.2 Distribution of Signal Durations Data Base	10
	8.3 Underdense Time Constants Data Base	10
	8.4 Duty-cycle Data Base	10
	8.5 Fading Data Base	11
	8.6 Link History Data Base	11
9.	DATA PRESENTATION AND FORMAT	11
	REFERENCES	19
	BIBLIOGRAPHY	21
	APPENDIX A: Statistics for June 1991	23
	APPENDIX B: Statistics for July 1991	83
	APPENDIX C: Statistics for August 1991	143
	APPENDIX D: Statistics for September 1991	202

Accession For	
NTIS GRA&I	<input checked="" type="checkbox"/>
DTIC TAB	<input type="checkbox"/>
Unannounced	<input type="checkbox"/>
Justification	
By _____	
Distribution _____	
Availability Codes	
Dist	Avail and/or Special
A-1	

Illustrations

Figure 1. The Geographical Location of the HLMSTB, Showing Typical Relationship to the Auroral Oval.	2
Figure 2. Block Diagrams of HLMSTB Instrumentation for the Sondrestrom AB-Thule AB Link.	3
Figure 3. Procedure for Analysis of Data from PL/GP High Latitude Meteor Scatter Test Bed. . .	4
Figure 4. Examples of Returns from Underdense Meteor Trails.	6
Figure 5. Examples of Returns from Underdense Trails with Fading from "Wind Distortion". . .	6
Figure 6. Examples of Returns from Overdense Trails.	7
Figure 7. Examples of Returns from Overdense Trails with Fading.	7
Figure 8. Examples of Returns from Sporadic E-layers.	8

Tables

Table 1. Geographical Parameters for the Sondrestrom AB to Thule AB path.	1
Table 2. Main Menu; Statistical Analysis Options.	5
Table 3. Outline of plot groups by Plot No., Showing Ordinate and Ascissa Data and the Group Screening Parameters.	17

Preface

The acquisition and processing of the data represented in this bulletin was a substantial and complex task, and the authors are indebted to the tireless and dedicated efforts of many people. Special appreciation is due Donald DeHart, Msgt Regina Burton, Dr. Jay Weitzen and Eric Li for their efforts in the area of data processing software, both in the field and at the laboratory. Also, we are greatly indebted to John Rasmussen, Jens Ostergaard, and Ssgt Carlton Curtis for the operations of the Greenland field facilities and the test equipment involved.

The meteor scatter performance statistics plots presented herein were selected as a representative sampling of the options available from the Phillips Laboratory (PL/GP) High Latitude Meteor Scatter Test Bed (HLMSTB) data processing and analysis resource. In addition to the performance information they present, they illustrate the sort of capabilities at PL/GP which can be made available to qualified researchers and system designers.

A minor weakness in the HLMSTB system was imprecise control of the transmitter power. However, transmissions were generally maintained within a variance of less than 1 dB. Equipment fatigue, vulnerability to unreliable power and intermittent non-availability of trained operators, were sources of difficulty. Maintenance and calibration visits by PL personnel were semiannual but irregularly scheduled, constrained by seasonal weather and remoteness of access. Power was automatically logged by the controlling computer and added to the database for reference.

During the period July 1989 through October 1990, PL/GP also operated an additional, trans-auroral Meteor Scatter Test Link between Sondrestrom Air Base and the Danish Meteorological Observatory in Narsarsuaq, Greenland. This link is indicated in Figure 1. of this bulletin. A data base created by that link is also available at PL/GP, Hanscom AFB; however bulletins will not be published for that link.

This series of meteor statistics from February 1990 through September 1992 does not include Section 10, Supplemental Information, which concerns ionospheric disturbances. The decision to close the PL High Latitude Link and conclude this program has led to a lack of manpower to fully investigate the disturbance data. The known periods of PCA events are as follows:

1990	1991	1992
11 Mar - 21 Mar	23 Mar - 31 Mar	7 Feb - 8 Feb
28 Apr - 29 Apr	3 Apr - 6 Apr	23 Feb - 25 Feb
21 May - 30 May	13 May - 14 May	9 May - 11 May
12 Jun - 14 Jun	31 May - 19 Jun	24 Jun - 29 Jun
1 Aug - 4 Aug	30 Jun - 3 Jul	29 Oct - 2 Nov
	7 Jul - 9 Jul	
	26 Aug - 28 Aug	
	30 Oct - 31 Oct	

In February, 1991, 147 MHz was removed from the testbed operation. It was replaced with 104 Mhz with high gain Yagi array antennas at both the transmitter and receiver sites. The array gain was

calculated to be 16 dB at the transmit site and 19 dB at the receive site. The plots labeled 147 Mhz from months beginning in March 1991 through September 1992 are labeled incorrectly, They should be labeled High Gain 104 MHz. The addition of the high gain arrays improves the performance to approximately the level of the 65 MHz frequency.

Qualified agencies may request additional data analyses or obtain limited access to the PL/GP resource. Please address your comments or requests to:

PL/GPIA, Attention: J.M.Quinn
29 Randolph Rd.
Hanscom AFB, MA 01731-3010.
or TeleFAX (617) 377-3550.

High Latitude Meteor Scatter Performance Statistics

1. INTRODUCTION

This bulletin presents a summary of results obtained from the Phillips Laboratory, Directorate of Geophysics (PL/GP) High Latitude Meteor Scatter Test Bed (HLMSTB) for the reporting period specified. The prime link, from which these data were derived, is approximately 1210 km long and located entirely within the polar cap in northern Greenland, between Sondrestrom and Thule Air Bases. See Figure 1 and Table 1. This link is an enhancement of the Rome Air Development Center (RADC) link described by Ostergaard et.al.¹

The PL/GP HLMSTB meteor scatter research links in Greenland are providing data to address a number of questions concerning meteor scatter propagation under normal and severely disturbed conditions as well as the potential performance of meteor burst communication systems in the polar region. The efforts under this measurement program are concentrated on characterizing the time and frequency variations of the transfer function, including:

- The availability of useful meteor trails,
 - The potential communication capacity associated with those trails,
 - The occurrence, persistence and effects of ionosscatter and sporadic E-layers,
 - Variations in the instantaneous polarization and signal-to-noise ratios of each return from a meteor trail, and
- The effects of aurora and polar cap absorption (PCA) events on meteor scatter propagation parameters and on the potential capacity of 35 to 147 MHz meteor scatter communication systems.

2. HLMSTB SITE AND PATH DESCRIPTION

The PL/GP meteor scatter test-bed main path is located entirely within the Polar Cap region with the transmitter at Sondrestrom Air Base (SAB) and the receiver at Thule Air Base (TAB), Greenland. Figure 1 shows the geographical location of the HLMSTB. Table 1 gives information on the geographical parameters of the sites and path features that influence the properties of the test-bed propagation path.

Table 1. Geographical Parameters for the Sondrestrom AB to Thule AB path.

	Receiver @ TAB	Transmitter @ SAB
LONGITUDE	68° 40'	50° 39'
LATITUDE	76° 33'	66° 59'
AZIMUTH	141.8°	337.8°
TERMINAL ELEVATION	240m	330m
HORIZON ELEVATION	1.1-1.7°	1.8-2.2°
MIDPATH ELEVATION for 100 Km ALTITUDE	6.5°	
GREAT CIRCLE DISTANCE	1210 km	

Received for Publication 25 January 1994

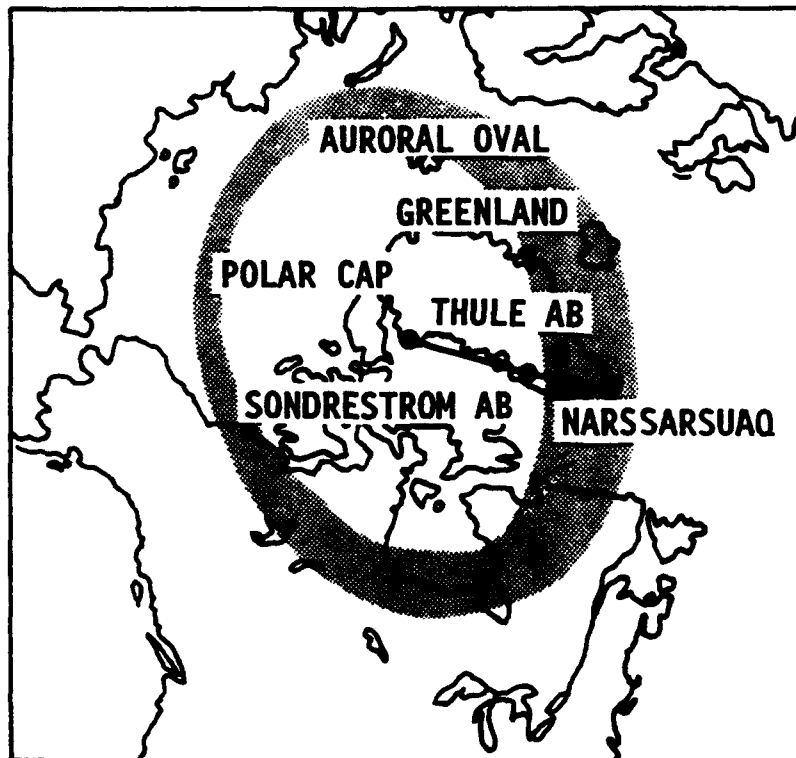
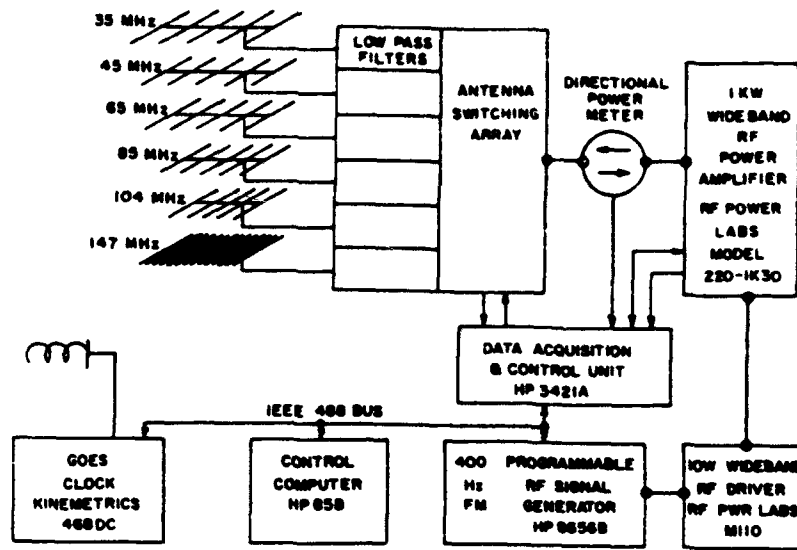

Figure 1. The Geographical Location of the HLMSTB, Showing Typical Relationship to the Auroral Oval.

3. HLMSTB SYSTEM DESCRIPTION

This Test Bed is designed to measure signal strength, polarization, and system noise at six frequencies, from 35 to 147 MHz.¹ The frequency coverage is chosen to examine absorption and depolarization from the very low end of the VHF frequency band, where meteor scatter links have maximum yield during undisturbed ionospheric conditions, to mid VHF where very little meteor scatter activity takes place but where absorption and depolarization are much less severe than at lower frequencies.

The transmitter at Sondrestrom Air Base and the receiver at Thule Air Base (Figure 2) are not conventional communication system components. Rather, they were developed to investigate features of meteor scatter from a propagation point of view, as well as from a communication viewpoint. The transmitter sequentially transmits a 400 Hz FM tone at 35, 45, 65, 85, 104, and 147 MHz. The receiver at Thule measures the characteristics of the meteor scatter returns as well as signals carried by other modes of propagation, originating from the Test Bed transmitter at Sondrestrom AB.



TRANSMITTER

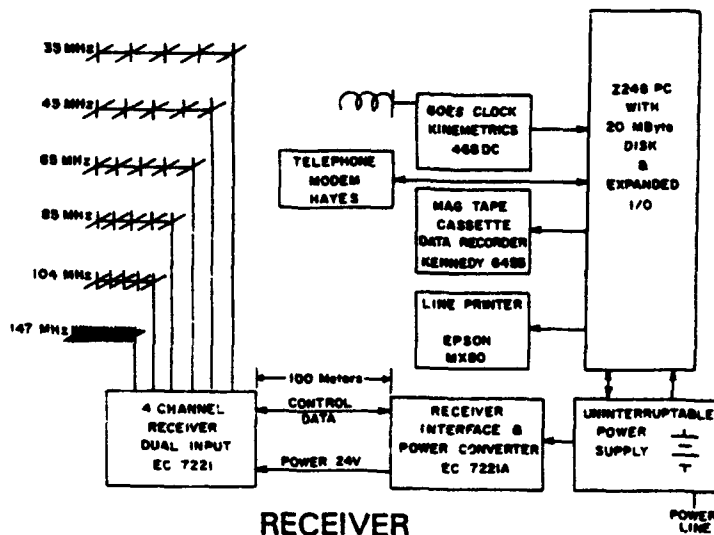

RECEIVER

Figure 2. Block Diagrams of HLMSTB Instrumentation for the Sondrestrom AB-Thule AB Link.

The horizontally polarized transmitting antennas are 5-element Yagis for 35 MHz to 104 MHz, positioned for optimal pattern illumination and gain consistency. A 12 element Yagi is used for 147 MHz. Matching receiver antennas are each composed of orthogonal, linearly polarized (Yagi) antenna pairs for measurement of the horizontal and vertical polarization components. The receiver Yagis are mounted on a common boom with separate lines feeding a dual channel, six frequency receiver with two identical channels at each frequency. Thus the amplitude for each polarization and phase difference between the signals received by the orthogonal antennas can be acquired and used to determine the polarization of the incident wave. The effective noise bandwidth of the receiver is 100 Hz.

4. DATA ACQUISITION

The horizontally and vertically polarized channels are sampled every 10 msec (100 samples/sec) and formatted into sequential 5-second records that include signal power of the polarized channels, the phase difference between the vertical and horizontal channels, and a flag indicating lock-on to a 400 Hz FM signature. Examples record displays are shown in Figures 4 through 8. Those records in which the 400 Hz signature is detected are transferred to a magnetic tape data storage unit and data tape cartridges are returned to the Phillips Laboratory for processing.

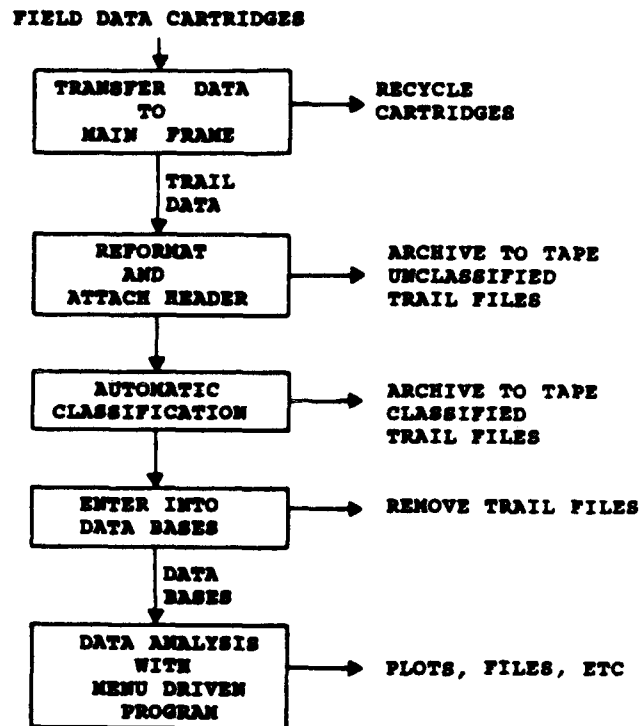

Figure 3. Procedure for Analysis of Data from PL/GP High Latitude Meteor Scatter Test Bed.

5. DATA PROCESSING²

The data processing procedure is shown in Figure 3. Data are transferred to the PL/GP VAX computer and the date, time, noise level, frequency, and other information are attached to each data record. The next step is classification, where the dominant propagation mechanism in each data record or sequence of records is identified. The final step of the processing procedure is statistical analysis of data in the data bases. These classified data bases can be processed in a number of different ways.³ The main menu of optional categories appears as Table 2. The principal purpose of this bulletin is to present a representative sample of analyzed data for the specified three month period.

6. CLASSIFICATION⁴

Several different propagation mechanisms are observed on the high latitude test bed. These different propagation mechanisms have different communication and propagation characteristics. In addition to underdense and overdense meteor trails, sporadic-E and low level ionospheric scatter propagation occur frequently. Auroral scatter is not generally observed on the Thule test link, since it is well north of the auroral zone.

Table 2. Main Menu; Statistical Analysis Options.

101	Number of arrivals exceeding a RSL threshold
102	Number of arrivals exceeding a SNR threshold
103	Distribution of time above a RSL threshold
104	Distribution of time above a SNR threshold
105	Noise level and link-up time history
106	Distribution of durations above RSL threshold
107	Distribution of durations above SNR threshold
108	Time constants
109	Fading Statistics
201	Throughput for idealized adaptive system (for all events)
202	Throughput for idealized adaptive system (for all frequencies)
203	Throughput for realistic adaptive rate system (all frequencies)
204	Throughput for realistic adaptive rate system (all events)
205	Throughput for realistic fixed rate system (for all frequencies)
206	Throughput for realistic fixed rate system (for all events)
207	Time required to transmit a message (for fixed rate system)

The classification system includes four categories of return: underdense meteor trails, overdense meteor trails, sporadic E-layers and unidentified propagation. Some of these classes contain waveforms that agree closely with the classical theory of meteor burst scattering as presented by Eshlemann⁵ and McKinley;⁶ however, most of the trails are distorted and often difficult to classify. The sporadic E-layer signals are distinctive as they are generally stronger and much longer lasting with slow fades. The remaining low level, fast fading signals are classified as unidentified propagation as they cannot be attached unambiguously to a specific physical propagation mechanism. Presently, unidentified signals are excluded from these bulletins.

6.1 Returns from Underdense Meteor Trails

The returns from underdense trails are characterized by a fast rising leading edge and a slower exponential decay. They account for by far the largest percentage of signals observed. Figure 4 shows a number of returns from underdense trails. The maximum amplitudes of the waveforms vary over a range of 40-45 dB and the durations vary from less than 0.1 second to several seconds. The occurrence of long duration trails is not well correlated with large maximum amplitudes as both returns with a long duration and a small maximum amplitude, and returns with a short duration and large amplitude are frequently observed.

Many underdense returns exhibit fading during their exponential decay phase. This phenomenon is observed on nearly all long lasting trails, and it is attributed to wind moving different portions of the trail to positions and attitudes that fulfill the geometric conditions for scattering between the transmitter and the receiver. These fades can be deep, occasionally reaching down to the receiver noise level; that is, a complete cancellation of the total received power by destructive interference between components of the received signal originating from different parts of the trail (Figure 5.)

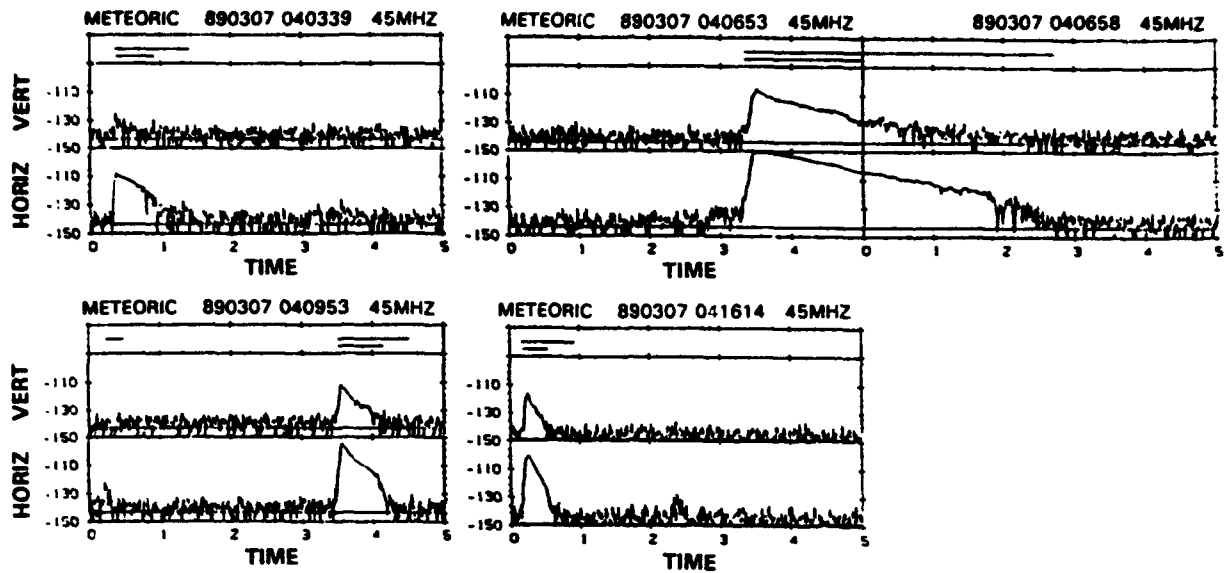

Figure 4. Examples of Returns from Underdense Meteor Trails.

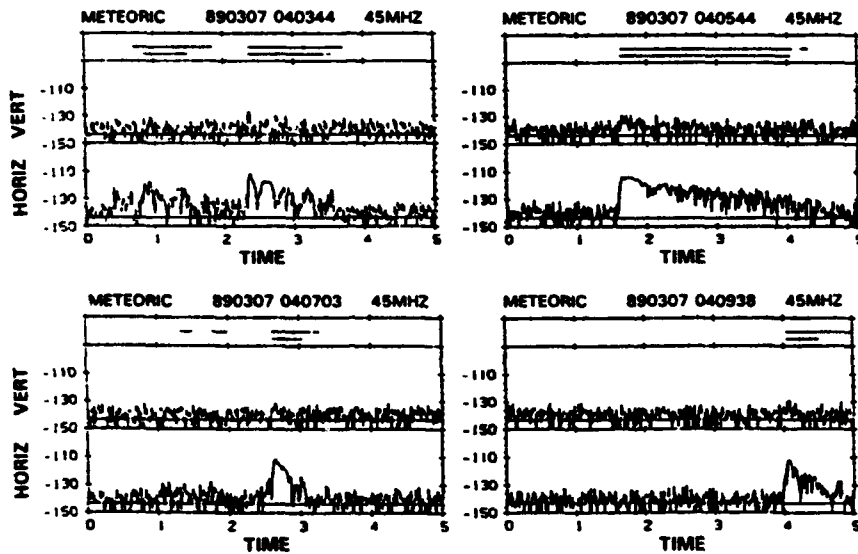

Figure 5. Examples of Returns from Underdense Trails with Fading from "Wind Distortion".

The time between the occurrence of successive meteor trails ranges from as little as a few milliseconds to several minutes. Trails often occur with separations of the order of one second or less. The multiple meteor trail returns can either be of approximately the same amplitude or of substantially different amplitudes, and it cannot at present be determined if the two signals came from portions of a fractured micrometeoroid, that is, have the same path through the scattering geometry, or if they are caused by two independent meteorites with entirely different paths.

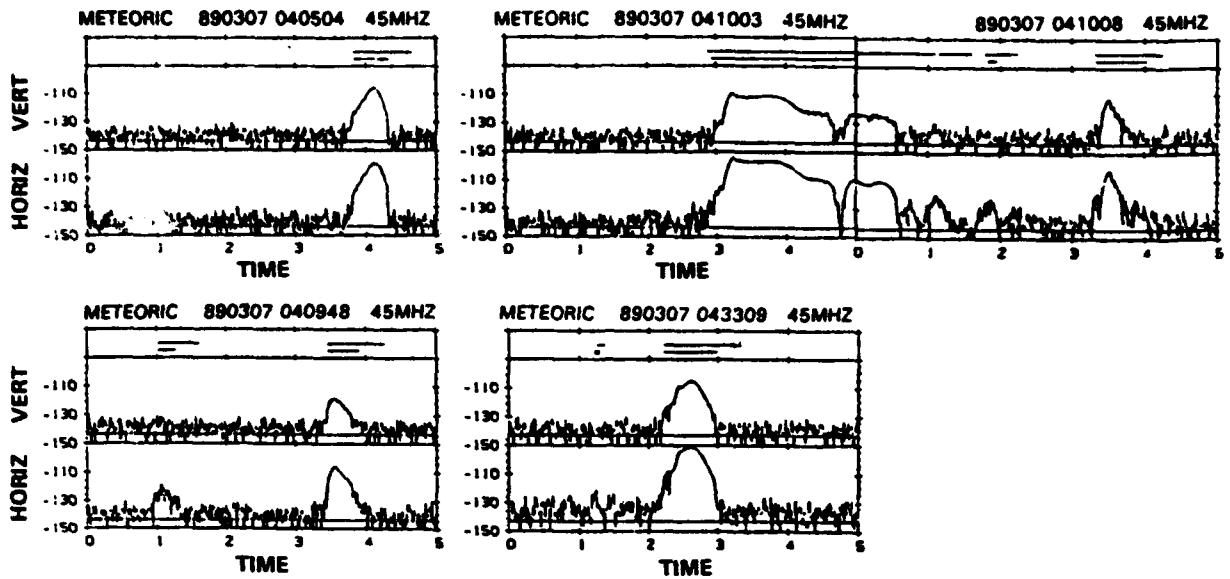

Figure 6. Examples of Returns from Overdense Trails.

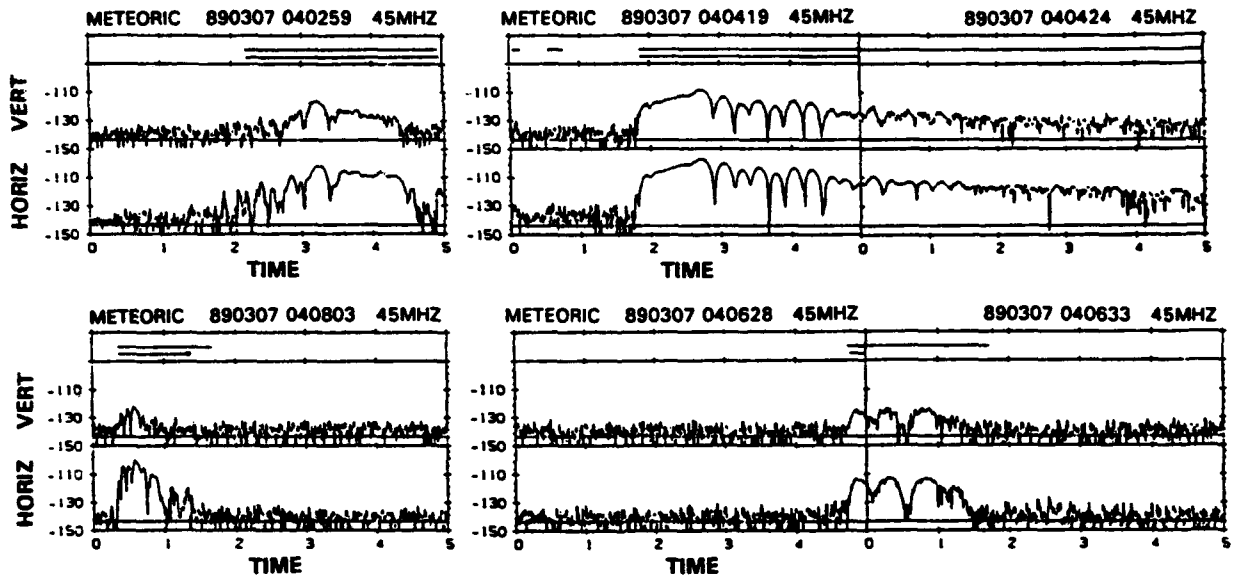

Figure 7. Examples of Returns from Overdense Trails with Fading.

6.2 Returns from Overdense Meteor Trails

The returns from overdense trails are characterized by a fast rising edge, often followed by an amplitude oscillation originating from the meteorite's movement through the scattering geometry during the formation of the trail. Unlike the returns from underdense meteor trails, however, the amplitude continues to increase after the trail is fully formed, and reaches a shallow maximum before decaying exponentially. Examples of returns from overdense meteor trails are shown in Figures 6 and 7.

The maximum amplitudes are frequently larger and the durations generally longer than those from underdense trails. The majority of the waveforms that last longer than 1 sec can be classified as returns from overdense trails. There are, however, a number of returns from overdense trails for which the maximum amplitude is comparable to the average maximum amplitude for returns from underdense trails, and which last considerably less than a second.

As the overdense trails and some underdense trails last longer than average, they are prone to wind distortion, which creates multipath propagation and large fluctuations in the received power. Some of the returns from these trails could be interpreted as either a return from a wind distorted trail, or as a return from a trail that did not originally fulfill the required scattering geometry, but has been repositioned by the wind after the trail was fully formed.

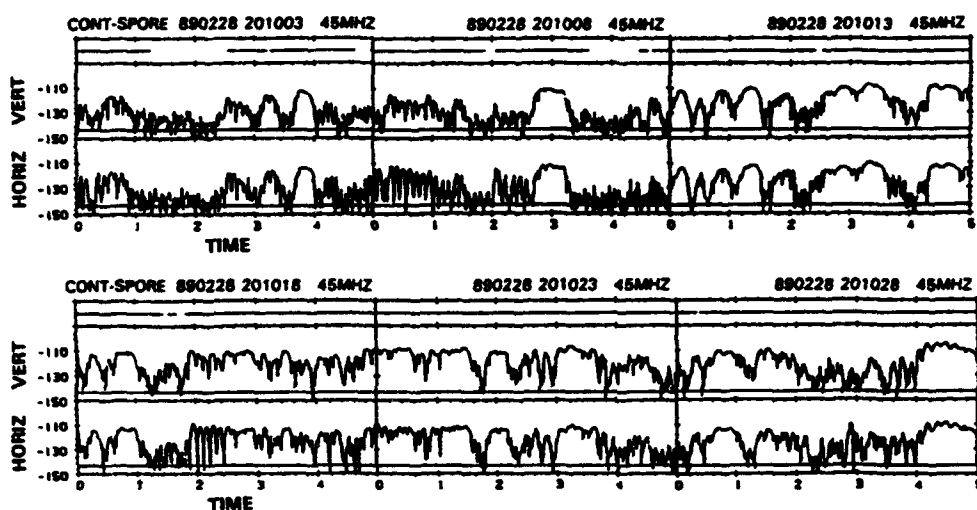

Figure 8. Examples of Returns from Sporadic E-layers.

6.3 Returns from Sporadic E-Layers

This classification is used to account for the occurrences of very strong (up to -75 dBm), enduring signal events, lasting from a few minutes to more than 25 minutes. The signals are observed primarily at the lower frequencies (35 and 45 MHz), but will appear above 100 MHz in extraordinary events. Examples of signals reflected from sporadic E-layers are shown in Figure 8.

These signals obviously do not originate from meteor trails, nor can they originate from the ionosphere's F-layer, as this does not reflect obliquely at VHF frequencies on a path as short as the Sondrestrom AB - Thule AB path. The logical explanation is that the signals originate from sporadic E-layers. These layers are known to occasionally have electron densities large enough to permit oblique reflections at frequencies in the lower VHF spectrum. The main characteristics of the signals, apart from their long duration, are the large amplitudes and the slow, deep fades. The fades generally exhibit a periodicity of 0.1 sec to 2 sec.

6.4 Unidentified Propagation

Occasionally, relatively weak, long lasting signals are received, characterized by rapid fading. These superficially fit the description of scattering from field aligned irregularities as

reported by Dyce.⁷ However, such scattering as a mode of propagation is not plausible for irregularities at F-layer heights and it is very unlikely, even for irregularities at E-layer heights, due to the geographical position of Sondrestrom AB and Thule AB relative to the nearly vertical inclination of the geomagnetic field. These signals often precede sporadic E events and they may in the future be reclassified as returns from weak sporadic E-layers. Unidentified signals are presently excluded from standard analysis options.

7. ANALYSIS OPTIONS

Information in the monthly data bases can be retrieved and processed using a menu-driven front end program that calls a subset of processing routines. The main menu is shown in Table 2. Each of the main options offers approximately ten sub-options, not listed, that allow the user to analyze the propagation and communication properties of the channel. Statistical analysis is divided into two general categories; propagation analysis (101-109) and communication analysis (201-207).

7.1 Propagation Analysis

Propagation statistics allow analysis of the arrival rate of trails, their duration, duty cycle and fading characteristics as a function of trail type, signal level, day, time of day, and frequency. These statistics can be used to examine the effect of disturbances, such as polar cap absorption or solar noise storms, as well as to calibrate physically based prediction models such as METPRED* or METEORLINK**.

7.2 Communication Analysis

Communications statistics are available, but are not included in this bulletin series. Communication statistics allow a user to define a system and infer its performance over the test link from actual data. Parameters that can be defined by the user are the data rate, modulation, error rate, packet structure, and signaling protocol. Users can specify either a fixed or an adaptive data rate system. Available statistics include time to deliver a message and throughput as a function of time of day, event type (underdense, overdense or sporadic-E), frequency, data rate, packet duration, error rate and packet structure. Output of the analysis program is presented in either table form or in files that can be plotted using a number of optional routines.

8. STATISTICAL DATA BASE

The following data base descriptions are included to provide the reader with introductory background to aid interpretation of the presentations of this report. Available data bases are:

- Meteor arrivals data
- Distribution of signal durations data
- Underdense time constants data
- Duty-cycle data
- Fading data
- Link history data

8.1 Meteor Arrivals Data Base

The number of meteors that exceed a signal threshold is determined for each time period as a function of signal threshold, frequency, time of day, trail type and polarization. Information in this data base can be used to observe the fluctuation in arrival rate during ionospheric disturbances

* METPRED is a proprietary Meteor Burst prediction model owned by Signatron Corporation.

** METEORLINK is a proprietary Meteor Burst prediction model owned by Scientific Applications International Corporation.

such as polar cap absorption (PCA) events, to determine the frequency dependence of the arrival rate as a function of time of day or season, to observe the relationship between received signal and number of trails, to observe and analyze the cross polarization dependence as a function of time of day and season, or to determine the percentage of trails that are underdense or overdense as a function of received signal level and frequency. Arrival rates of meteor trails (meteors per minute) that satisfy the user specified signal requirements are computed by dividing the number of meteors that satisfy the signal criteria by the time that the link was available to observe meteor trails. Available time takes into account the time the link was not observing meteors due to sporadic-E or ionospheric propagation, as well as link down time.

Data analysis routines can combine the received signal information in the arrival data base with noise level information in the link history data base to compute the arrival rate of meteors as a function of signal-to-noise ratio (SNR). This information can be used to predict the arrival rate of meteors useful for communication. In this and all other data bases, statistics are computed as a function of received signal level in increments of 2 dBm from -140 dBm to -90 dBm, covering the range of signals observed on the link.

8.2 Distribution of Signal Durations Data Base

The signal durations data base contains information on the durations of meteor and ionospheric signals above various received signal thresholds. Duration statistics are required to determine the average throughput and message delivery time of the channel, especially for realistic systems that transmit data in fixed length packets. For each signal event within a record or sequence of records, the times relative to the start of the record that the signal either exceeds or drops below the threshold is noted in a table. Since communication systems have some inherent capability to combat fades, the processing routines merge fades that are less than 40 ms in duration. Duration statistics are computed as a function of duration, received signal level, day, time of day, frequency, and propagation type (underdense trails, overdense trails or ionospheric).

Information stored in this data base as a function of received signal level can be transformed by the analysis routines to a function of signal to noise ratio by combining received signal information in this data base and noise information in the link history data base. Data in this data base can be used to optimize the design of communication protocols based upon the duration of meteor trails and to add to the understanding of the contribution of overdense and underdense trails to the performance of a channel.

8.3 Underdense Time Constants Data Base

Underdense meteor trails are observed to decay exponentially with a time constant that is a function of trail height, link distance, trail orientation, and frequency. In most work, the time constant of decay is assumed fixed for a given link, but in reality it is a random variable. Statistics of the duration and time constants are required for the generation of accurate meteor burst communication simulations. For each trail identified by the trail classifier as underdense, a minimum mean square error exponential fit to the trail is performed beginning at the maximum signal point to determine the decay constant. The statistics of the time constant are determined as a function of time of day and frequency, averaged over each month.

8.4 Duty-cycle Data Base

Duty cycle is the time the signal exists above a threshold divided by the total number of seconds the link was active (removing time that sporadic-E was dominant when analyzing meteor trails). This statistic is computed as a function of time of day, frequency, polarization, signal level and propagation mechanism (underdense trails, overdense trails, and ionospheric propagation). The relative contribution of the various mechanisms to the capacity of the channel can be evaluated.

For each meteor in a data record or sequence of data records, identified by the trail classifier, the number of seconds that the received signal level exceeds the threshold is computed and the appropriate duty cycle data slot is incremented. For records identified as ionospheric, the total duty cycle for the 5 second data record is computed and the appropriate data slot is incremented.

Information in this data base is combined with the noise information in the link history data base to determine the duty cycle as a function of signal-to-noise ratio, which is used to determine the capacity of the channel at a fixed bit error rate.

8.5 Fading Data Base

This data base provides information about the fading of the envelope of meteor trails and ionospheric propagation events. A fade is said to occur when the signal to noise ratio drops farther than 3 dB below 10 dB signal-to-noise ratio, relative to the specified bandwidth, and then goes back above the threshold during the life of a trail. The thresholds considered are 10 dB SNR relative to 100, 300, 600, 1200, 1600, 2400, 4800, 8000, 9600, 19200, 32000, 64000, and 128000 Hz bandwidth.

$$\text{Threshold above noise(dB)} = 10 \log(10^{(10 + 10 \log(BW/100)/10)} + 1).$$

(The 1 takes into consideration (S+N)/N.)

Fades per second are computed as the number of fades per event divided by the duration of the event. If the duration of the fade is greater than one second, we assume the beginning of a new event. For meteor trails, three statistics are computed; 1. fades per trail, 2. fades per second of event duration and 3. distribution of fade durations. For Sporadic-E, only the latter two statistics are available and meaningful.

8.6 Link History Data Base

The link history data base archives miscellaneous information about the link from each frequency period during the day. The data base contains information on the received noise level measured during the one minute preceding each frequency interval, the number of seconds during which ionospheric propagation (for example, Es) was the dominant mechanism, transmitter power recorded at the beginning of each frequency interval, and a flag indicating if no returns are received during the interval.

The noise information is combined with absolute signal level information in the other data bases to transform received signal level to signal-to-noise ratio (SNR) for communication analysis. The other information is used by the analysis program to determine meteor arrival rates accurately by evaluating the amount of time during each frequency interval that the system was actually available to observe meteors.

The transmitter power log database, although sometimes erratic or incomplete, is edited and then used to remove questionable intervals of data from the calculation of monthly average statistics. Editing is based on a review of the signal database, and verification that power deviates from the monthly norm by less than 1 dB. Intervals where power or reception is clearly and persistently below the monthly norm are rejected.

9. DATA PRESENTATION AND FORMAT

The appendices of statistics plots presented in this bulletin are only a sampling of the available propagation statistics options outlined in Table 2. Each appendix covers one month. The plots presented, in Appendices A through D, have been limited to those categorized as propagation

statistics, with attention focused on the "arrival rate" and "duty cycle" as functions of signal level, signal propagation mode and link frequency. Although communication statistics may be as readily obtained, they are omitted here because such data are highly system dependent, so that even a small "typical" sampling might overwhelm the function of this bulletin.

Table 3 is an outline of appendix plots, identified by plot number and arranged in groups that include a range of screening parameters, such as Time-of-Day, RSL-threshold, propagation-mode, or link-frequency. The ordinate and abscissa data are indicated as well as the compared parameters and the range of incremented screening parameters for each group. Table 3 is applicable to each monthly Appendix, A through D.

Those statistics plots presented as monthly averages are calculated excluding periods of sub-standard link performance and extraordinary events such as PCA's, and link outages. These periods are indicated in plots 115. Power information in plots 115, is edited to remove intervals of questionable performance and PCA events. Calculations of system throughput are based on an assumption of a 30 dBW transmitter feeding specific antennas as described in Section 3. However, average true power deviated from this by as much as 1 dB, depending on frequency and operating conditions, and in rare cases varied up to as much as 1 dB under stressed conditions. Intervals of high absorption (PCA's) are also removed from calculation of monthly averages, and are not displayed in plots 115. However, where valid, propagation data AR, DC, etc. are displayed against day-of-month (DOM) and time-of-day (TOD).

The format of plots 115 (Link Availability/Power) and 116 (Noise Temperature) are revisions of the congested displays presented in earlier Bulletin issues.* Plots 115 now display separate records of transmitter power for each frequency, during those data intervals which are included in the calculation of monthly average statistics. Disturbance (PCA's) and outage intervals are also removed from the calculation of monthly averages, and from the power display, plot 115.* Plots 116 now display separate records of noise temperature for each frequency, with a scale of the logarithm of noise temperature in degrees Kelvin.**

Arrival Rate (AR) has been defined as the number of classifiable meteor trail returns per minute exceeding a specified received signal (RSL) or signal-to-noise ratio (SNR). Duty cycle has been defined as the ratio of the accumulated time in which classifiable meteor trail returns exceed the specified RSL (or SNR) threshold, divided by the valid listening or acquisition window. Arrival Rates and Duty Cycle (DC) are presented in Plots vs Time, RSL and SNR. These plots are presented so as to compare either mode-classification or link-frequency. The majority of plots are presented vs Time-of-Day (TOD) as averaged over the month. Other plots showing distributions as a function of RSL or SNR are presented as 24 hour-whole month averages. However, selected hour intervals averaged over the month can be obtained.

Trail return "Duration" is also available as a function of all the parameters illustrated here. A small sampling of "Duration" data is included as Normal Distributions of Numbers of Returns vs Duration of Return.

*Earlier practice included no transmitter power information, but instead plotted link-up time for all frequencies as daily percentages, and on a common scale.

**Earlier practice displayed noise at all frequencies on a common linear scale, resulting in occasional confusion from overlapping records.

The plots presented here were generated by an automated batch process. Most plots are presented two-to-a-page. A notation at the lower right of each plot includes a menu identification and a batch plot number. The plot number is referred to by Table 3. The menu I.D. may be related to Table 2, but also includes submenu selections that are not treated here.

A "polarization = horizontal" notation appears with plots no. 1-66. All data presented in this bulletin are based on signals received on horizontally polarized receiving antennas. The PL/GP database and analysis software includes the option to present either horizontally or vertically polarized reception from the horizontally polarized transmissions.

A "maximum downtime due to sporadic-E = 240 secs." notation appears with plots no. 1-30. This refers to the default convention to delete from analysis that data acquired in any bi-hourly acquisition window which included more than 240 seconds of returns classified as sporadic-E. The reader may notice a significant impact on plots presenting data at 35 and 45 MHz. since E_s propagation may frequently dominate at polar cap latitudes, resulting in gaps in the data that are plotted versus Time of Day (TOD).

A "based on observed noise measurements = vertical" notation appears with plots 1-99 and 116. Several sources of noise measurement data are available. Noise measurements are made at each transmitting frequency transition from both horizontally and vertically polarized receiving antennas and, in addition, each trail record is processed to extract an apparent noise level which is averaged over the acquisition window. The default noise reference is measured from the vertically polarized receiving antennas.

A "effective system bandwidth = 100 Hz." notation appears with plots 28-30, 61-66, and 94-97. This is a trivial reference to the system effective noise bandwidth.

Plots 67-87, 94, 95, 100-106, and 108-114 are normalized distributions of trail return durations, or decay time-constants. The "normalizing factors" indicate the extent of data available for each mode.

Table 3. Outline of plot groups by Plot No., Showing Ordinate and Ascissa Data and the Group Screening Parameters.

PLOTS # 1-18

ARRIVAL RATE (M/min) vs. Time-Of-Day (UT)

Comparing propagation modes; Underdense, Overdense, and All Trails.

Screening parameters; RSL threshold -126, -116, -106 dBm and Link frequencies 35, 45, 65, 85, 104, and 147 MHz.

PLOTS # 19-24

ARRIVAL RATE (M/min) vs. Threshold RSL in dBm

Comparing propagation modes; Underdense, Overdense, and All Trails.

Screening parameters; Link frequencies 35, 45, 65, 85, 104, and 147 MHz. averaged over 24 hours.

PLOTS # 25-27

ARRIVAL RATE (M/min) vs. DAY/Time-Of-Day (UT)

Comparing link Frequencies; 45 and 104 MHz.

Screening parameters; RSL threshold -126, -116, -106 dBm

PLOT # 28

ARRIVAL RATE (M/min) vs. Time Of Day (UT)

Comparing link Frequencies; 35, 45, 65, 85, 104, and 147 MHz.

Screening parameters; All trails, 19 dB SNR threshold.

PLOT # 29

ARRIVAL RATE (M/min) vs. Threshold SNR in dB

Comparing link Frequencies; 35, 45, 65, 85, 104, and 147 MHz.

Screening parameters; All trails, 24 hour average.

PLOT # 30

ARRIVAL RATE (M/min) vs. DAY/Time Of Day (UT)

Comparing link Frequencies; 45 and 104 MHz.

Screening parameters; All trails, 19 dB SNR threshold.

PLOTS # 31-36

DUTY CYCLE ABOVE RSL (percent) vs. Threshold RSL in dBm

Comparing propagation modes; Underdense, Overdense, and All Trails, also Sporadic E and All Events.

Screening parameters; Link frequencies 35, 45, 65, 85, 104, and 147 MHz. averaged over 24 hours.

PLOTS # 37-54

DUTY CYCLE ABOVE RSL (percent) vs. Time-Of-Day (UT)

Comparing propagation modes; Underdense, Overdense, and All Trails, also Sporadic E and All Events.

Screening parameters; RSL threshold -126, -116, -106 dBm, and Link frequencies 35, 45, 65, 85, 104, and 147 MHz.

Table 3. Outline of plot groups; continued.

PLOTS # 55-57

DUTY CYCLE ABOVE RSL (percent) vs. DAY/Time-Of-Day (UT)

Comparing link Frequencies; 45 and 104 MHz.

Screening parameters; RSL threshold -126, -116, -106 dBm, for All Trails.

PLOTS # 58-60

DUTY CYCLE ABOVE RSL (percent) vs. DAY/Time-Of-Day (UT)

Comparing link Frequencies; 45 and 104 MHz.

Screening parameters; RSL threshold -126, -116, -106 dBm, for Sporadic E-layers only.

PLOTS # 61,62

DUTY CYCLE ABOVE SNR (percent) vs. SNR (dB)

Comparing link Frequencies; 35, 45, 65, 85, 104, and 147 MHz.

Screening parameters; All-Trails and All-Events including Sporadic E-layers, 24 hour average.

PLOTS # 63,64

DUTY CYCLE ABOVE SNR (percent) vs. Time-Of-Day (UT)

Comparing link Frequencies; 35, 45, 65, 85, 104, and 147 MHz.

Screening parameters; All Trails and All-Events including Sporadic E-layers, 19 dB SNR threshold.

PLOTS # 65,66

DUTY CYCLE ABOVE SNR (percent) vs. DAY/Time-Of-Day (UT)

Comparing link Frequencies; 45 and 104 MHz.

Screening parameters; All Trails and All-Events including Sporadic E-layers, 19 dB SNR threshold.

PLOTS # 67-84

NORMAL DISTRIBUTION vs. DURATION

Comparing propagation modes; Underdense, Overdense, and All Trails, also sporadic-E and All-Events.

Screening parameters; RSL threshold -126, -116, -106 dBm, and Link frequencies 35, 45, 65, 85, 104, and 147 MHz.

PLOTS # 85-87

NORMAL DISTRIBUTION vs. DURATION

Comparing link Frequencies; 35, 45, 65, 85, 104, and 147 MHz.

Screening parameters; RSL threshold -126, -116, -106 dBm, for All Trails.

PLOTS # 88-93

AVERAGE TRAIL DURATION vs. RSL

Comparing propagation modes; Underdense, Overdense, and All Trails, also Sporadic E and All Events.

Screening parameters; Link frequencies 35, 45, 65, 85, 104, and 147 MHz. averaged over 24 hours.

Table 3. Outline of plot groups; continued.

PLOTS # 94,95

NORMAL DISTRIBUTION vs. DURATION

Comparing link Frequencies; 35, 45, 65, 85, 104, and 147 MHz.

Screening parameters; 24 hour average, 19 dB SNR threshold, for All-Trails and All-Events including Sporadic E-layers.

PLOTS # 96,97

AVERAGE TRAIL DURATION vs. SNR

Comparing link Frequencies; 35, 45, 65, 85, 104, and 147 MHz.

Screening parameters; All trails, 24 hour average.

PLOT # 98

NORMAL DISTRIBUTION, UNDERDENSE DECAY CONSTANTS

Comparing link Frequencies; 35, 45, 65, 85, 104, and 147 MHz.

24 hour average.

PLOT # 99

AVERAGE UNDERDENSE DECAY CONSTANT vs. Time-Of-Day (UT)

Comparing link Frequencies; 35, 45, 65, 85, 104, and 147 MHz.

PLOT # 100

NORMAL DISTRIBUTION, FADES/SEC

Comparing link Frequencies; 35, 45, 65, 85, 104, and 147 MHz.

Screening parameters; All trails, 24 hour average.

PLOTS # 101-106

NORMAL DISTRIBUTION, FADES/SEC

Comparing propagation modes; Underdense, Overdense, and All Trails, also Sporadic E and All Events.

Screening parameters; Link frequencies 35, 45, 65, 85, 104, and 147 MHz. averaged over 24 hours.

PLOT # 107

AVERAGE FADES/SEC. vs. Time-Of-Day (UT)

Comparing link Frequencies; 35, 45, 65, 85, 104, and 147 MHz.

All trails.

PLOT # 108

NORMAL DISTRIBUTION, FADE DURATIONS

Comparing link Frequencies; 35, 45, 65, 85, 104, and 147 MHz.

Screening parameters; All trails, 24 hour average.

Table 3. Outline of plot groups; continued.

PLOTS # 109-114

NORMAL DISTRIBUTION, FADE DURATIONS

Comparing propagation modes; Underdense, Overdense, and All Trails, also Sporadic E and All Events.

Screening parameters; Link frequencies 35, 45, 65, 85, 104, and 147 MHz. averaged over 24 hours.

PLOT # 115

LINK-AVAILABILITY/POWER vs. DAY/Time-Of-Day (UT)

Indicating transmitter power during valid, benign, data periods.

Comparing link Frequencies; 35, 45, 65, 85, 104, and 147 MHz.

Periods of extraordinary disturbance (PCA's) are also blanked out.

PLOT # 116

NOISE-TEMPERATURE (Log of Kelvin Degrees) vs. DAY/Time-Of-Day (UT)

Comparing link Frequencies; 35, 45, 65, 85, 104, and 147 MHz.

PLOTS # 117-120

30 MHz RIOMETER DATA vs. DAY/Time-Of-Day

Two riometers are maintained at Thule AB. Direct riometer receiver outputs in volts, 117 and 119, show the diurnal variation in absorption throughout the month. Plots 118 and 120 display riometer absorption data in dB with the quiet day diurnal variation removed.

PLOTS # 121-123

3-AXIS MAGNETOMETER vs. DAY/Time-Of-Day. Data from a 3-axis fluxgate magnetometer at Thule AB. The X axis is aligned with magnetic-North pole.

References

1. Ostergaard, J.C., J.E. Rasmussen, M.S. Sowa, J.M. Quinn and P.A. Kossey, (1986) The RADC High Latitude Meteor Scatter Test-Bed. Rome Air Development Center, RADC-TR-86-74, ADA180550.
2. Weitzen, J.A., (1987) A data base approach to analysis of meteor burst data, Radio Science, Vol. 22, No. 1, pp 133-140.
3. Weitzen, J.A., (1989) USAF/GL Meteor Scatter Data Analysis Program, A Users Guide. GL Tech. Rep. GL-TR-89-0154, ADA214988.
4. Weitzen, J.A. and Tolman, S., (1986) A Technique for Automatic Classification of Meteor Trails and Other Propagation Mechanisms for the Air Force High Latitude Meteor Test Bed, Rome Air Development Center, RADC-TR-86-117, ADA173133.
5. Eshleman, V.R., (1955) Meteors and Radio Propagation, Part A. Meteor Ionization Trails: Their Formation and Radio Echoing Properties. RPL. Stanford University.
6. McKinley, D.W.R., (1961) Meteor Science and Engineering, McGraw-Hill.
7. Dyce, R., (1955) VHF auroral and sporadic E propagation from Cedar Rapids, Iowa to Ithaca, New York. IRE Trans. PGAP.
8. Bailey, A.D., Ostergaard, J.C., Bench, P.M., and Weitzen, J.A. (1991) Performance Statistics Bulletin, High Latitude Meteor Scatter Propagation, February, March, April 1989. PL/GP Tech. Rep. PL-TR-91-2122, Env.Res.Paper No. 1085, ADA253916.
9. Bailey, A.D., J.C.Ostergaard, R.M.Burton, C.H.Curtis, W.I.Klemetti, J.E.Rasmussen. (1992) Performance Statistics Bulletin, High Latitude Meteor Scatter Propagation, May, June, July 1989. PL/GP Tech. Rep. PL-TR-92-2222, Env.Res.Paper No. 1107. ADA264003.

Bibliography

Lovell A.C.B., (1954) Meteor Astronomy, Oxford University Press.

Ostergaard, J.C. (1989) Preliminary Investigation of Faraday Rotation Effects and Description of Polarization Measurements on the AFGL High Latitude Meteor Scatter Test Bed. Tech. Rep. GL-TR-89-0123, ADA211289.

Weitzen, J.A., Bouque, S., Horton, M., Bench, P.M., and Bailey, A.D. (1990) Distribution of Underdense Meteor Trail Amplitudes and its Application to Meteor Scatter Communication System Design. Phoenix Conference Proceedings.

Li, S.W., Weitzen, J.A., Ostergaard, J.C., Bailey, A.D., Bench, P.M., and Katan, J.R. (1990) Measuring the Effects of Auroral Absorption on High Latitude Meteor Burst Communications. IES Proceedings.

Weitzen, J.A., and Ostergaard, J.C. (1990) A Statistical Characterization of Fading on Meteor Communications Channels. GL Tech. Rep. GL-TR-90-0362, ADA235148.

Weitzen, J.A., Ostergaard, J.C., and Li, S.W. (1990) A High Resolution Statistical Characterization of Fading on Meteor Communications Channels. GL Tech. Rep. GL-TR-90-0329, ADA235548.

Ostergaard, J.C., Bailey, A.D., and Li, S.W. (1990) Investigation of Frequency Diversity Effects on Meteor Scatter Links in Greenland. PL/GP Tech. Rep. PL-TR-91-2026, ADA257771.

Bailey, A.D., Ostergaard, J.C., Bench, P.M., and Weitzen, J.A. (1991) Performance Statistics Bulletin, High Latitude Meteor Scatter Propagation, February, March, April 1989. PL/GP Tech. Rep. PL-TR-91-2122 Env. Res. Paper No. 1085, ADA253916.

Bailey, A.D., Ostergaard, J.C., Burton, R.M., Curtis, C.H., Klemetti, W.I. and Rasmussen, J.E. (1992) Performance Statistics Bulletin, High Latitude Meteor Scatter Propagation, May, June, July 1989. PL/GP Tech. Rep. PL-TR-92-2222 Env. Res. Paper No. 1107, ADA264003.

Bailey, A.D., Ostergaard, J.C., Burton, R.M., Curtis, C.H., Klemetti, W.I. and Rasmussen, J.E. (1993) Performance Statistics Bulletin, High Latitude Meteor Scatter Propagation, August, September, October 1989. PL/GP Tech. Rep. PL-TR-93-2196 Env. Res. Paper No. 1129, ADA274455

Bailey, A.D., Ostergaard, J.C., Burton, R.M., Curtis, C.H., Klemetti, W.I. and Rasmussen, J.E. (1993) Performance Statistics Bulletin, High Latitude Meteor Scatter Propagation, November, December 1989, January 1990. PL/GP Tech. Rep. PL-TR-93-2234, Env. Res. Paper No. 1133.

•
•

APPENDIX A

STATISTICS FOR JUNE 1991

GEOPHYSICS LAB METEOR SCATTER PROGRAM

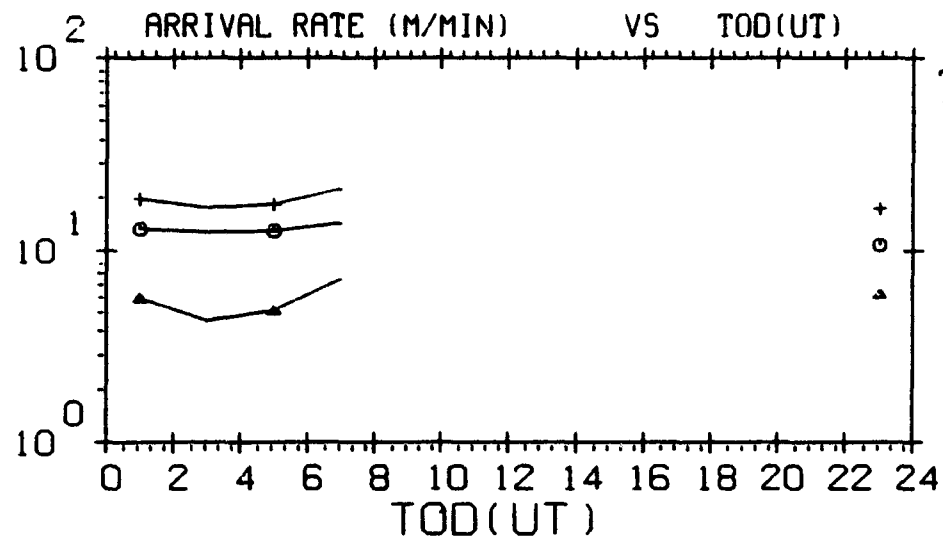

UNDERDENSE ○
 OVERDENSE △
 ALL TRAILS +

EXCEEDING -126.0 DBM RSL
 FREQUENCY - 35 MHZ
 POLARIZATION - HORIZONTAL
 MAXIMUM DOWN TIME DUE TO SPORADIC-E - 240 SECONDS
 BASED ON OBSERVED NOISE MEASUREMENTS - VERTICAL

MENU#101,05-2
 21-SEP-93
 PLOT# 1.00

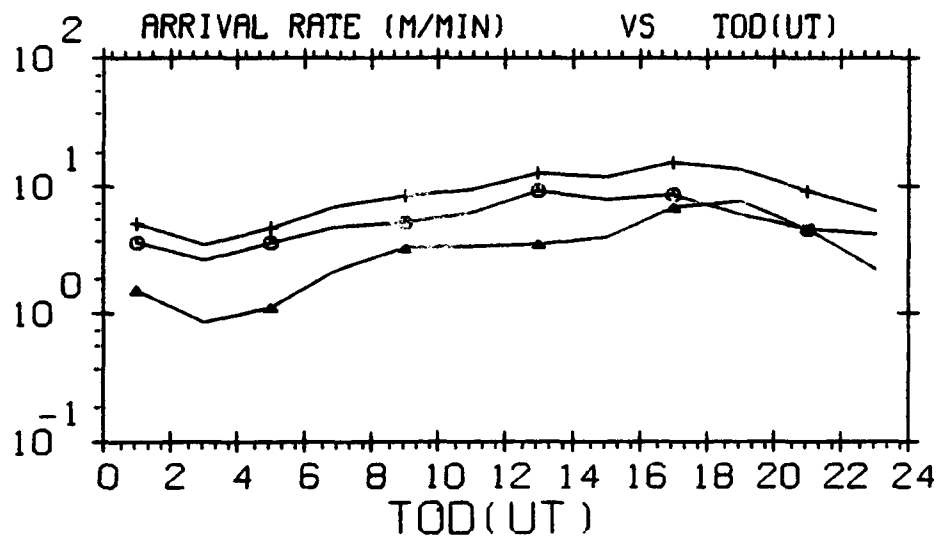

UNDERDENSE ○
 OVERDENSE △
 ALL TRAILS +

EXCEEDING -126.0 DBM RSL
 FREQUENCY - 45 MHZ
 POLARIZATION - HORIZONTAL
 MAXIMUM DOWN TIME DUE TO SPORADIC-E - 240 SECONDS
 BASED ON OBSERVED NOISE MEASUREMENTS - VERTICAL

MENU#101,05-2
 21-SEP-93
 PLOT# 1.00

GEOPHYSICS LAB METEOR SCATTER PROGRAM

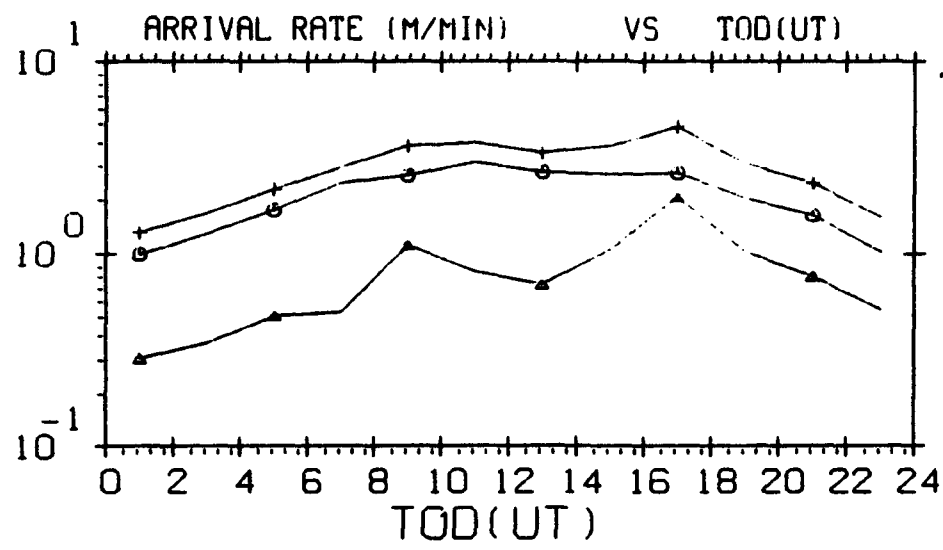

EXCEEDING -126.0 DBM RSL
 FREQUENCY - 65 MHZ
 POLARIZATION - HORIZONTAL
 MAXIMUM DOWN TIME DUE TO SPORADIC-E - 240 SECONDS
 BASED ON OBSERVED NOISE MEASUREMENTS - VERTICAL

MENU#101,05-2
 21-SEP-93
 PLOT# 3.00

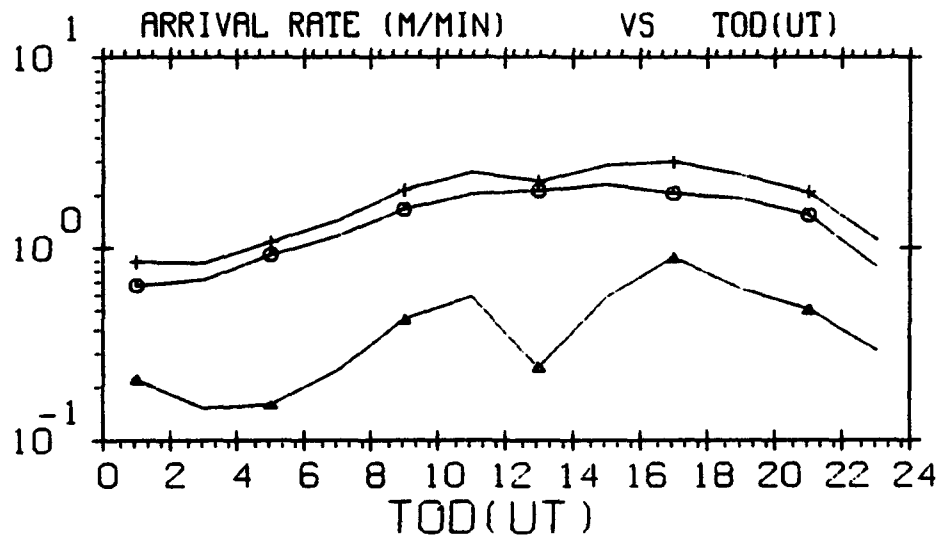

EXCEEDING -126.0 DBM RSL
 FREQUENCY - 85 MHZ
 POLARIZATION - HORIZONTAL
 MAXIMUM DOWN TIME DUE TO SPORADIC-E - 240 SECONDS
 BASED ON OBSERVED NOISE MEASUREMENTS - VERTICAL

MENU#101,05-2
 21-SEP-93
 PLOT# 4.00

GEOPHYSICS LAB METEOR SCATTER PROGRAM

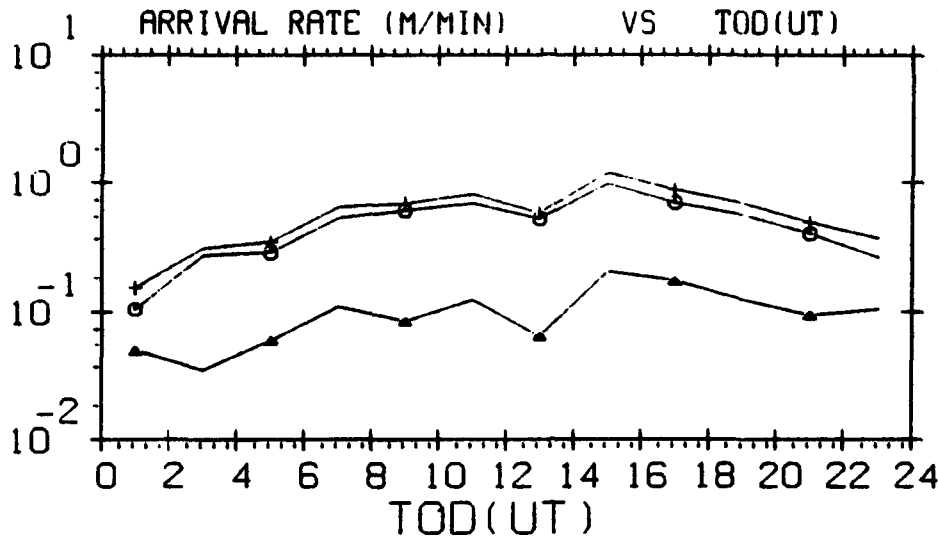

EXCEEDING -126.0 DBM RSL
 FREQUENCY - 104 MHZ
 POLARIZATION - HORIZONTAL
 MAXIMUM DOWN TIME DUE TO SPORADIC-E - 240 SECONDS
 BASED ON OBSERVED NOISE MEASUREMENTS - VERTICAL

MENU#101,05-2
 21-SEP-93
 PLOT# 5.00

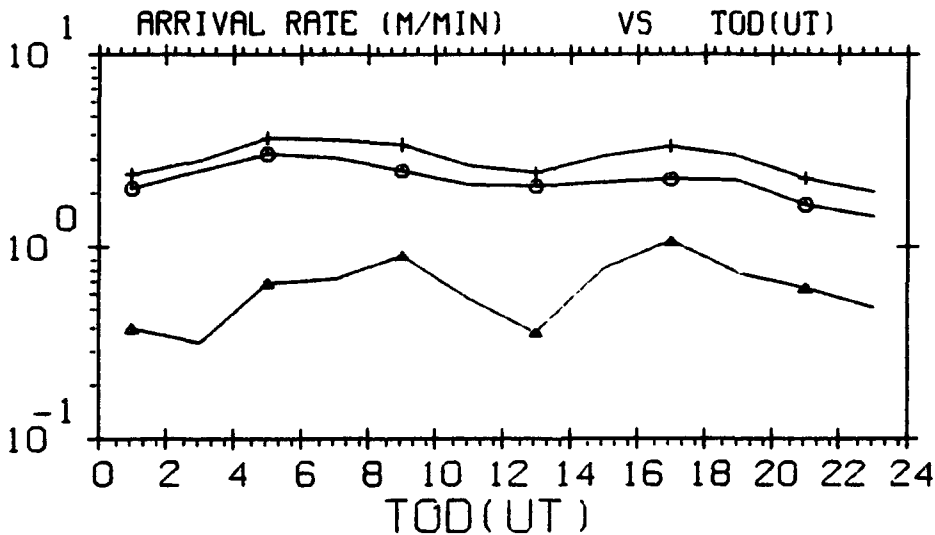

EXCEEDING -126.0 DBM RSL
 FREQUENCY - 147 MHZ
 POLARIZATION - HORIZONTAL
 MAXIMUM DOWN TIME DUE TO SPORADIC-E - 240 SECONDS
 BASED ON OBSERVED NOISE MEASUREMENTS - VERTICAL

MENU#101,05-2
 21-SEP-93
 PLOT# 6.00

GEOPHYSICS LAB METEOR SCATTER PROGRAM

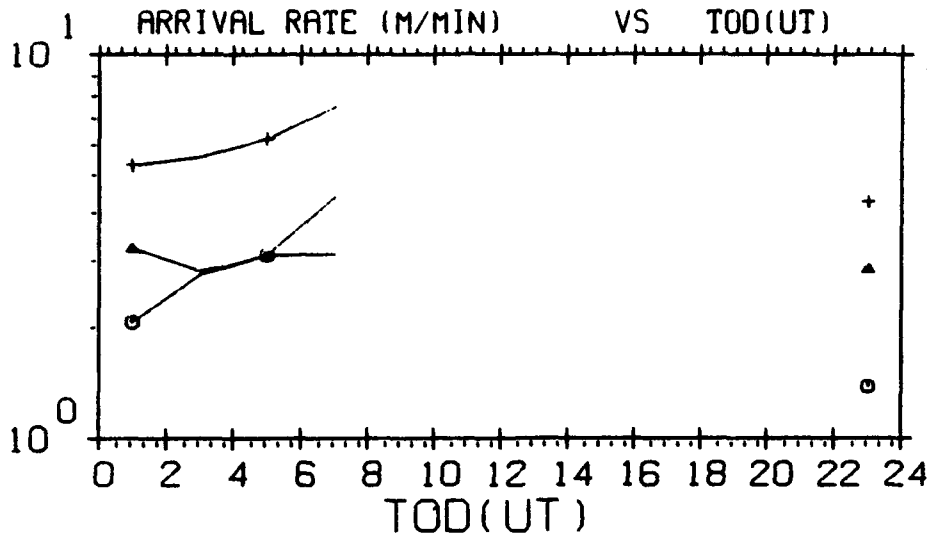

UNDERDENSE ○
 OVERDENSE △
 ALL TRAILS +

EXCEEDING -116.0 DBM RSL
 FREQUENCY - 35 MHZ
 POLARIZATION - HORIZONTAL
 MAXIMUM DOWN TIME DUE TO SPORADIC-E - 240 SECONDS
 BASED ON OBSERVED NOISE MEASUREMENTS - VERTICAL

MENU#101,05-2
 21-SEP-93
 PLOT# 7.00

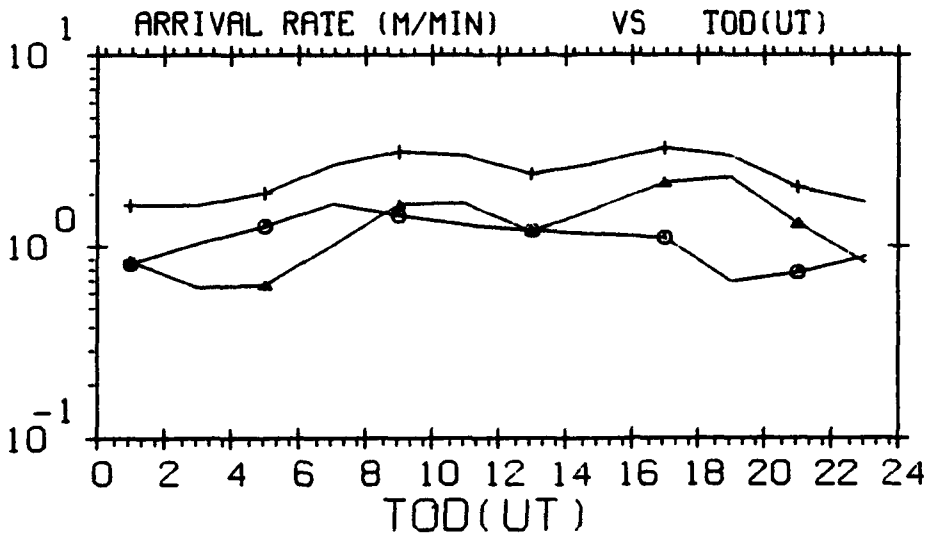

UNDERDENSE ○
 OVERDENSE △
 ALL TRAILS +

EXCEEDING -116.0 DBM RSL
 FREQUENCY - 45 MHZ
 POLARIZATION - HORIZONTAL
 MAXIMUM DOWN TIME DUE TO SPORADIC-E - 240 SECONDS
 BASED ON OBSERVED NOISE MEASUREMENTS - VERTICAL

MENU#101,05-2
 21-SEP-93
 PLOT# 8.00

GEOPHYSICS LAB METEOR SCATTER PROGRAM

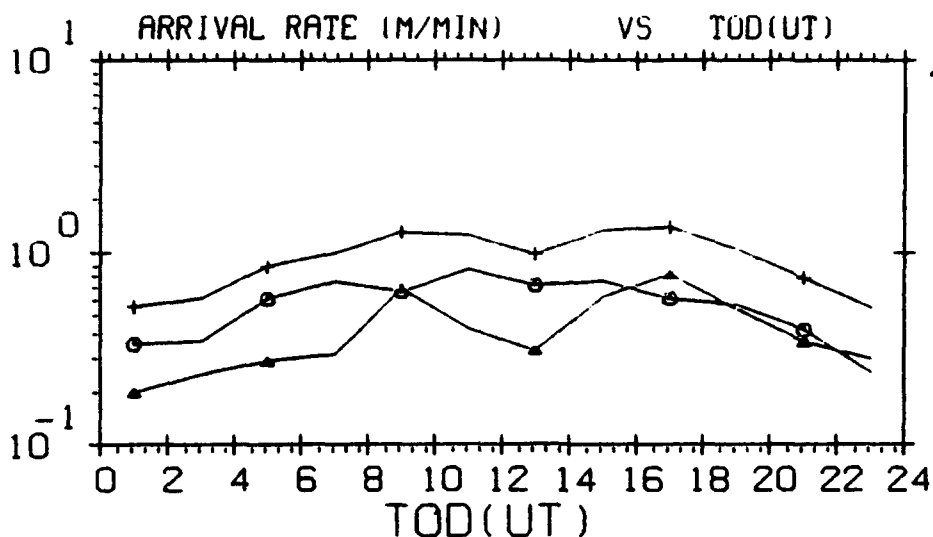

EXCEEDING -116.0 DBM RSL
 FREQUENCY - 65 MHZ
 POLARIZATION - HORIZONTAL
 MAXIMUM DOWN TIME DUE TO SPORADIC-E - 240 SECONDS
 BASED ON OBSERVED NOISE MEASUREMENTS - VERTICAL

MENU#101,05-2
 21-SEP-93
 PLOT# 9.00

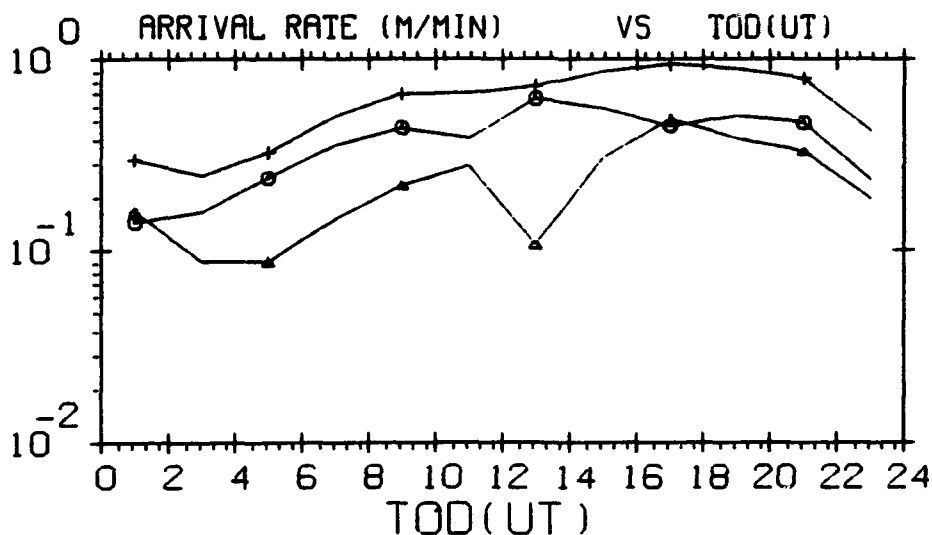

EXCEEDING -116.0 DBM RSL
 FREQUENCY - 85 MHZ
 POLARIZATION - HORIZONTAL
 MAXIMUM DOWN TIME DUE TO SPORADIC-E - 240 SECONDS
 BASED ON OBSERVED NOISE MEASUREMENTS - VERTICAL

MENU#101,05-2
 21-SEP-93
 PLOT# 10.00

GEOPHYSICS LAB METEOR SCATTER PROGRAM

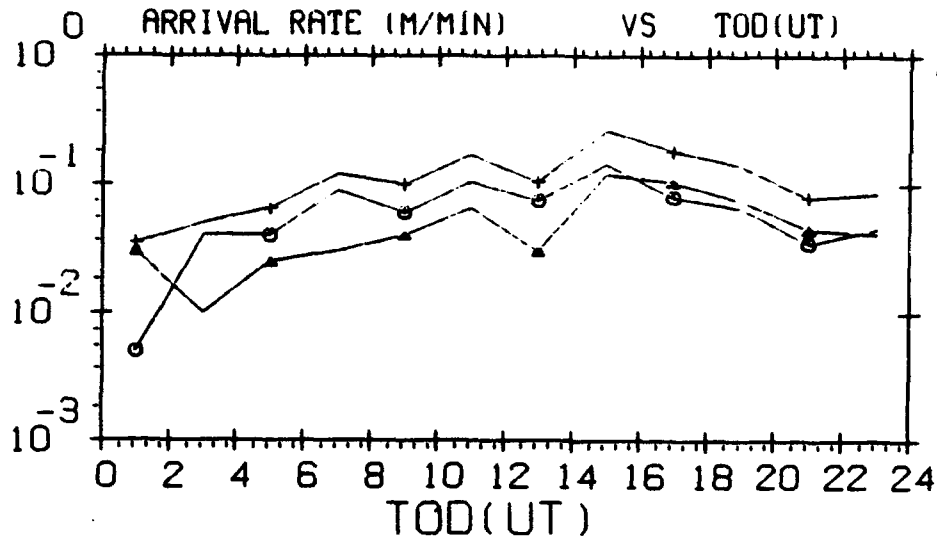

EXCEEDING -116.0 DBM RSL
 FREQUENCY - 104 MHZ
 POLARIZATION - HORIZONTAL
 MAXIMUM DOWN TIME DUE TO SPORADIC-E - 240 SECONDS
 BASED ON OBSERVED NOISE MEASUREMENTS - VERTICAL

MENU#101,05-2
 21-SEP-93
 PLOT# 11.00

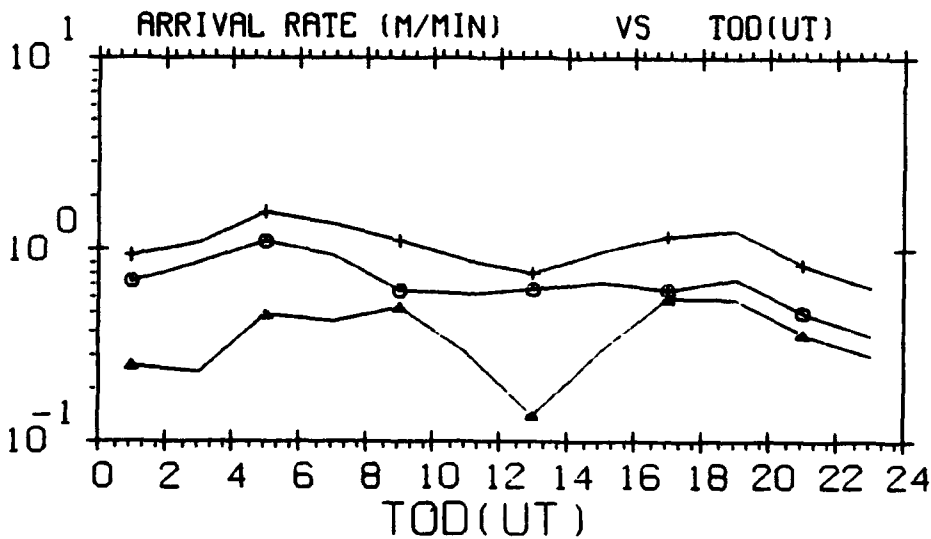

EXCEEDING -116.0 DBM RSL
 FREQUENCY - 147 MHZ
 POLARIZATION - HORIZONTAL
 MAXIMUM DOWN TIME DUE TO SPORADIC-E - 240 SECONDS
 BASED ON OBSERVED NOISE MEASUREMENTS - VERTICAL

MENU#101,05-2
 21-SEP-93
 PLOT# 12.00

GEOPHYSICS LAB METEOR SCATTER PROGRAM

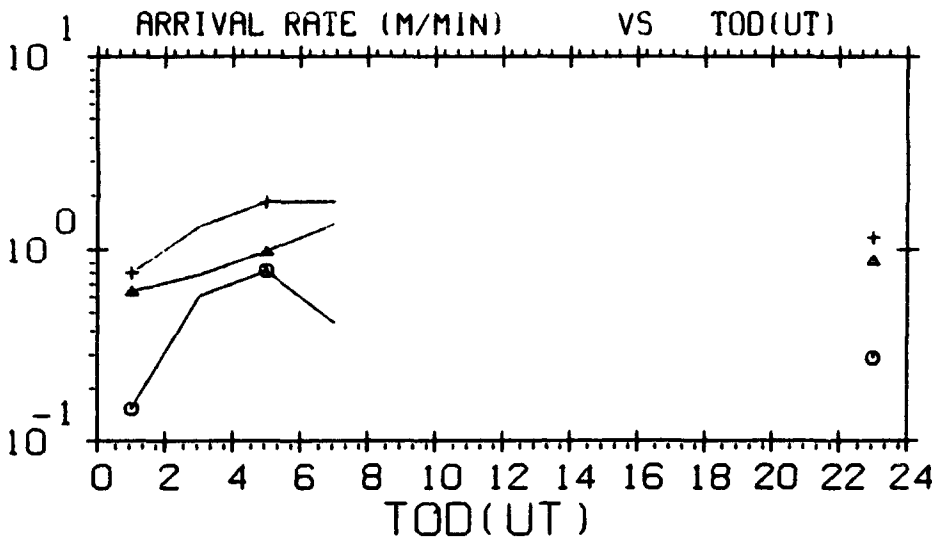

UNDERDENSE ○
 OVERDENSE △
 ALL TRAILS +

EXCEEDING -106.0 DBM RSL
 FREQUENCY - 35 MHZ
 POLARIZATION - HORIZONTAL
 MAXIMUM DOWN TIME DUE TO SPORADIC-E - 240 SECONDS
 BASED ON OBSERVED NOISE MEASUREMENTS - VERTICAL

MENU=101,05-2
 21-SEP-93
 PLOT= 13.00

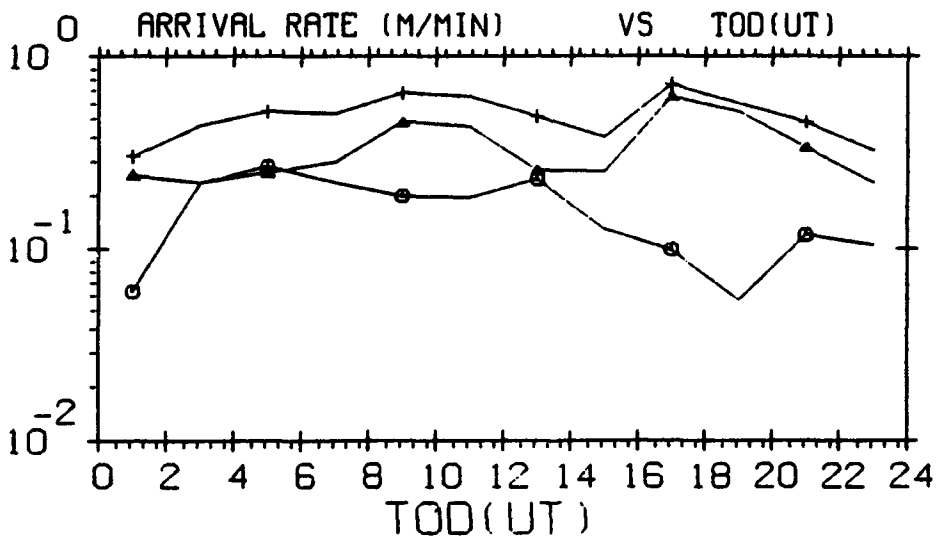

UNDERDENSE ○
 OVERDENSE △
 ALL TRAILS +

EXCEEDING -106.0 DBM RSL
 FREQUENCY - 45 MHZ
 POLARIZATION - HORIZONTAL
 MAXIMUM DOWN TIME DUE TO SPORADIC-E - 240 SECONDS
 BASED ON OBSERVED NOISE MEASUREMENTS - VERTICAL

MENU=101,05-2
 21-SEP-93
 PLOT= 14.00

GEOPHYSICS LAB METEOR SCATTER PROGRAM

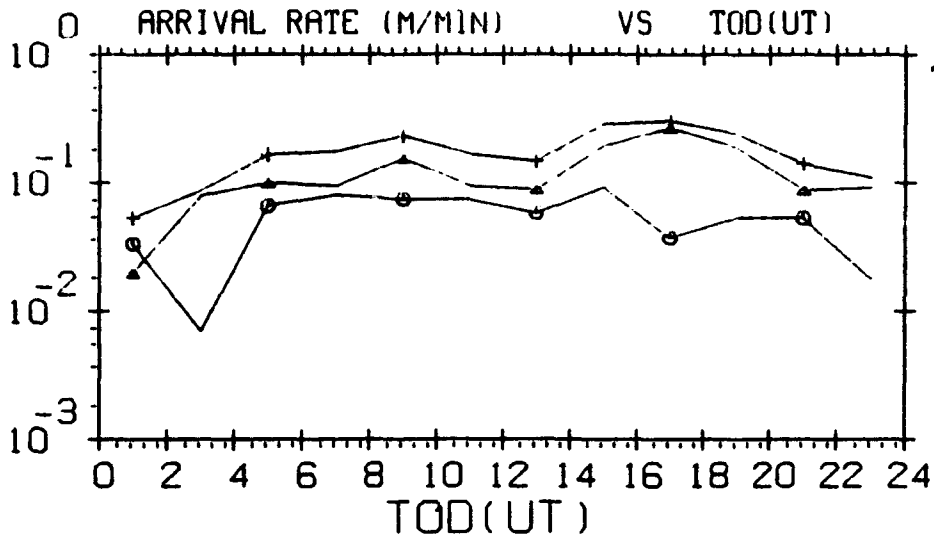

UNDERDENSE ○
 OVERDENSE △
 ALL TRAILS +

EXCEEDING -106.0 DBM RSL
 FREQUENCY - 65 MHZ
 POLARIZATION - HORIZONTAL
 MAXIMUM DOWN TIME DUE TO SPORADIC-E - 240 SECONDS
 BASED ON OBSERVED NOISE MEASUREMENTS - VERTICAL

MENU#101,05-2
 21-SEP-93
 PLOT# 15.00

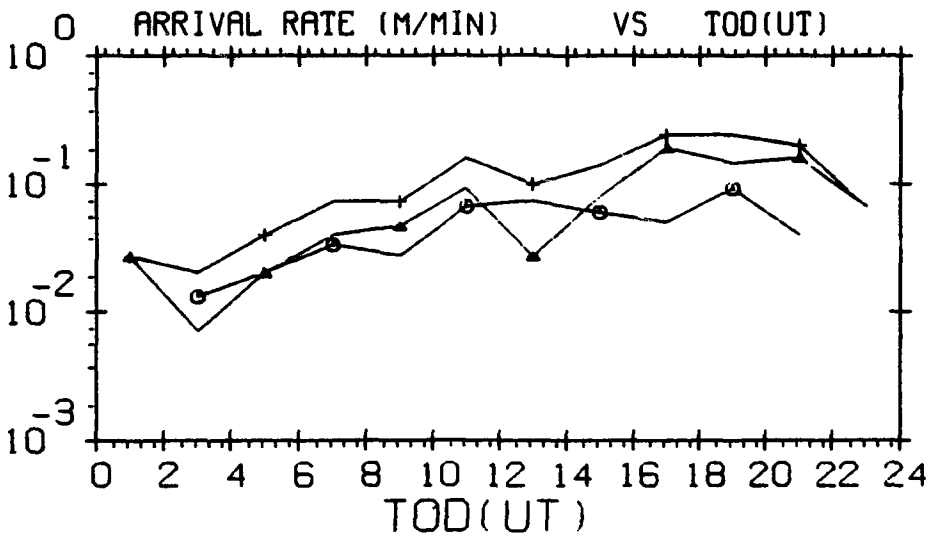

UNDERDENSE ○
 OVERDENSE △
 ALL TRAILS +

EXCEEDING -106.0 DBM RSL
 FREQUENCY - 85 MHZ
 POLARIZATION - HORIZONTAL
 MAXIMUM DOWN TIME DUE TO SPORADIC-E - 240 SECONDS
 BASED ON OBSERVED NOISE MEASUREMENTS - VERTICAL

MENU#101,05-2
 21-SEP-93
 PLOT# 16.00

GEOPHYSICS LAB METEOR SCATTER PROGRAM

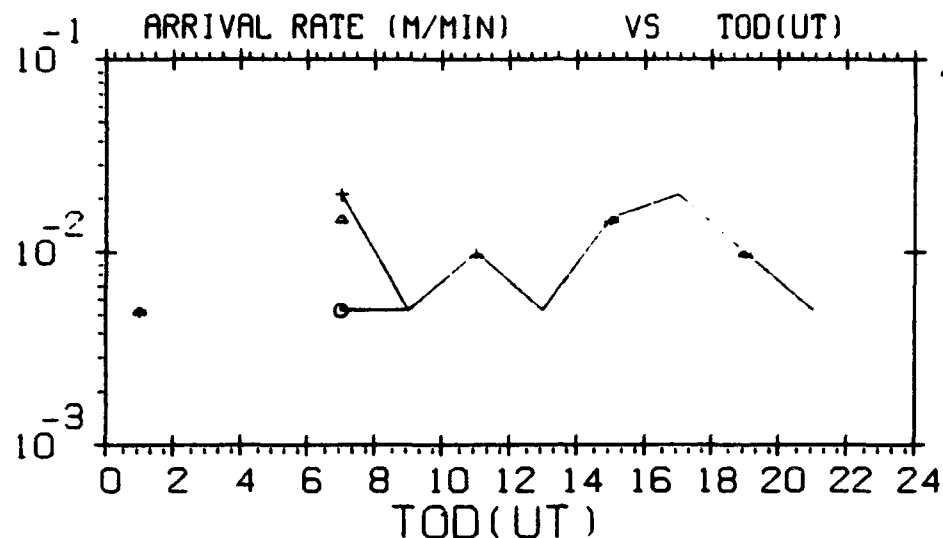

UNDERDENSE ○
OVERDENSE △
ALL TRAILS +

EXCEEDING -106.0 DBM RSL
 FREQUENCY - 104 MHZ
 POLARIZATION - HORIZONTAL
 MAXIMUM DOWN TIME DUE TO SPORADIC-E - 240 SECONDS
 BASED ON OBSERVED NOISE MEASUREMENTS - VERTICAL

MENU#101,05-2
 21-SEP-93
 PLOT# 17.00

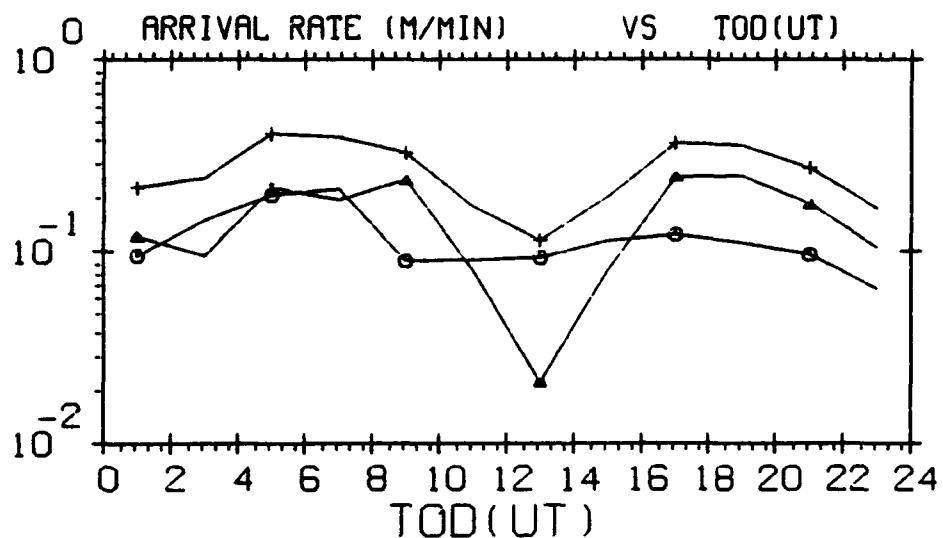

UNDERDENSE ○
OVERDENSE △
ALL TRAILS +

EXCEEDING -106.0 DBM RSL
 FREQUENCY - 147 MHZ
 POLARIZATION - HORIZONTAL
 MAXIMUM DOWN TIME DUE TO SPORADIC-E - 240 SECONDS
 BASED ON OBSERVED NOISE MEASUREMENTS - VERTICAL

MENU#101,05-2
 21-SEP-93
 PLOT# 18.00

GEOPHYSICS LAB METEOR SCATTER PROGRAM

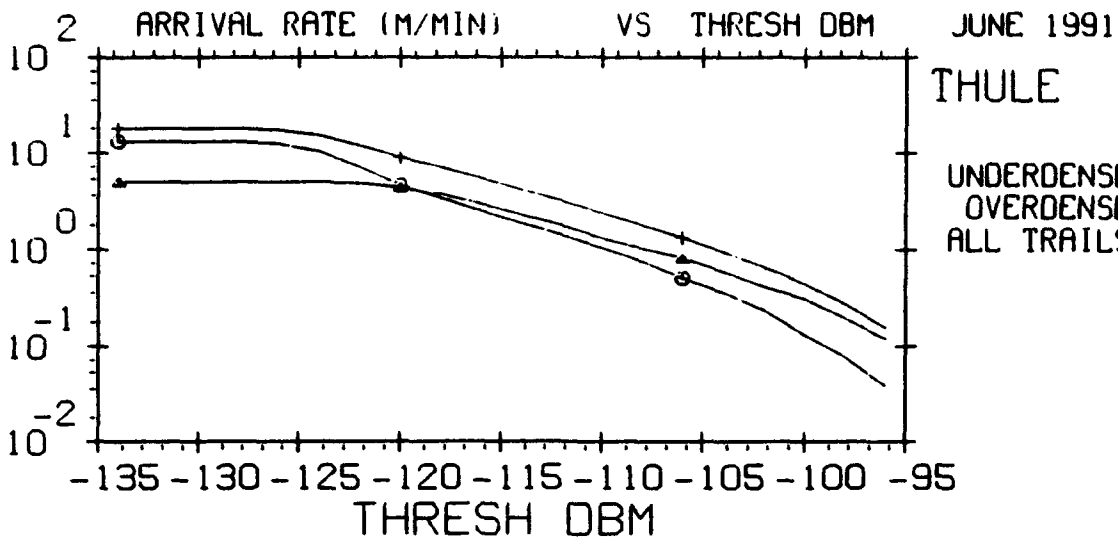

THE TIME OF DAY IS 0 : 24 HOURS U.T.
 FREQUENCY - 35 MHZ
 POLARIZATION - HORIZONTAL
 MAXIMUM DOWN TIME DUE TO SPORADIC-E - 240 SECONDS
 BASED ON OBSERVED NOISE MEASUREMENTS - VERTICAL

MENU=101,06-2
 21-SEP-93
 PLOT= 19.00

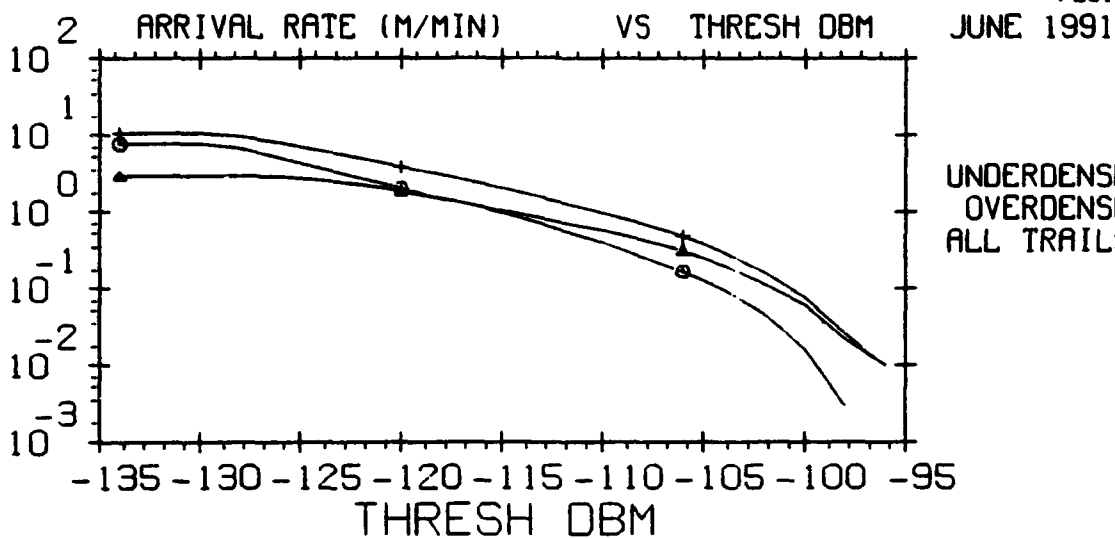

THE TIME OF DAY IS 0 : 24 HOURS U.T.
 FREQUENCY - 45 MHZ
 POLARIZATION - HORIZONTAL
 MAXIMUM DOWN TIME DUE TO SPORADIC-E - 240 SECONDS
 BASED ON OBSERVED NOISE MEASUREMENTS - VERTICAL

MENU=101,06-2
 21-SEP-93
 PLOT= 20.00

GEOPHYSICS LAB METEOR SCATTER PROGRAM

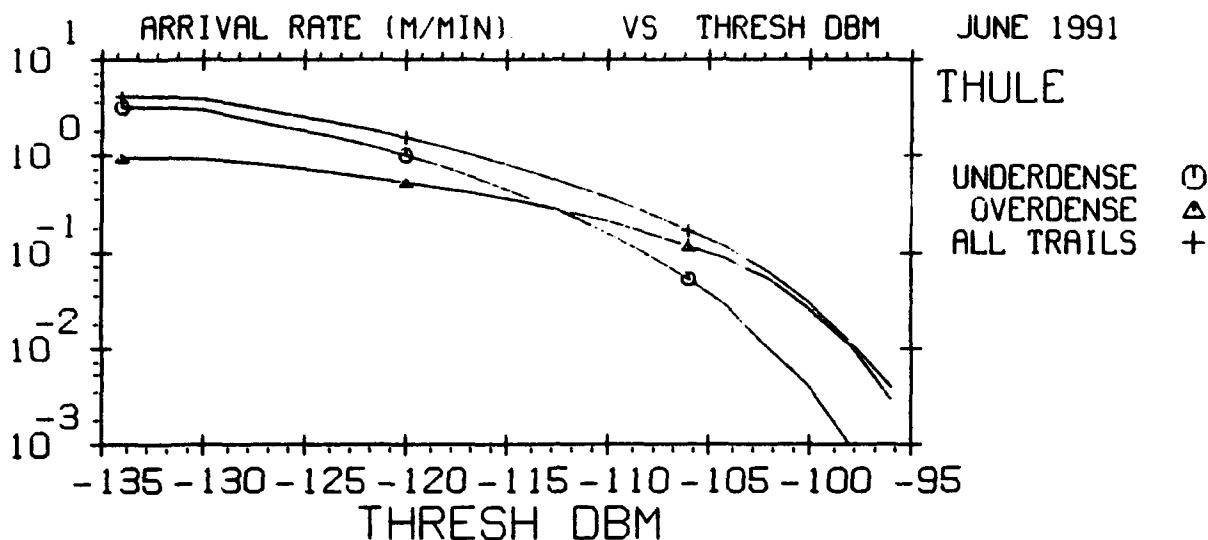

THE TIME OF DAY IS 0 : 24 HOURS U.T.
 FREQUENCY - 65 MHZ
 POLARIZATION - HORIZONTAL
 MAXIMUM DOWN TIME DUE TO SPORADIC-E - 240 SECONDS
 BASED ON OBSERVED NOISE MEASUREMENTS - VERTICAL

MENU#101,06-2
 21-SEP-93
 PLOT# 21.00

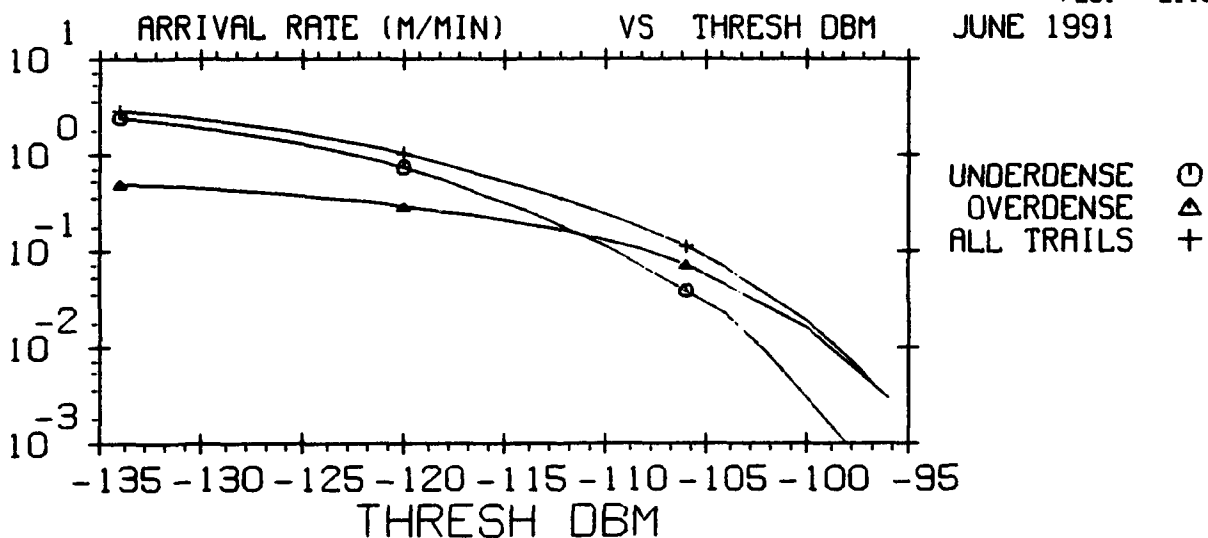

THE TIME OF DAY IS 0 : 24 HOURS U.T.
 FREQUENCY - 85 MHZ
 POLARIZATION - HORIZONTAL
 MAXIMUM DOWN TIME DUE TO SPORADIC-E - 240 SECONDS
 BASED ON OBSERVED NOISE MEASUREMENTS - VERTICAL

MENU#101,06-2
 21-SEP-93
 PLOT# 22.00

GEOPHYSICS LAB METEOR SCATTER PROGRAM

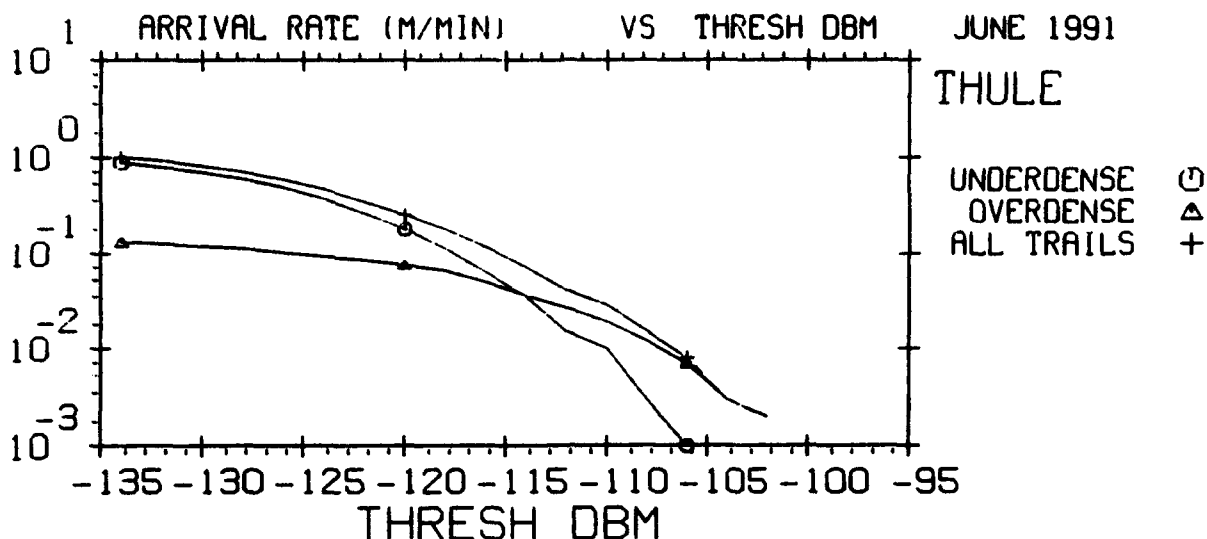

THE TIME OF DAY IS 0 : 24 HOURS U.T.
 FREQUENCY - 104 MHZ
 POLARIZATION - HORIZONTAL
 MAXIMUM DOWN TIME DUE TO SPORADIC-E - 240 SECONDS
 BASED ON OBSERVED NOISE MEASUREMENTS - VERTICAL

MENU#101,06-2
 21-SEP-93
 PLOT# 23.00

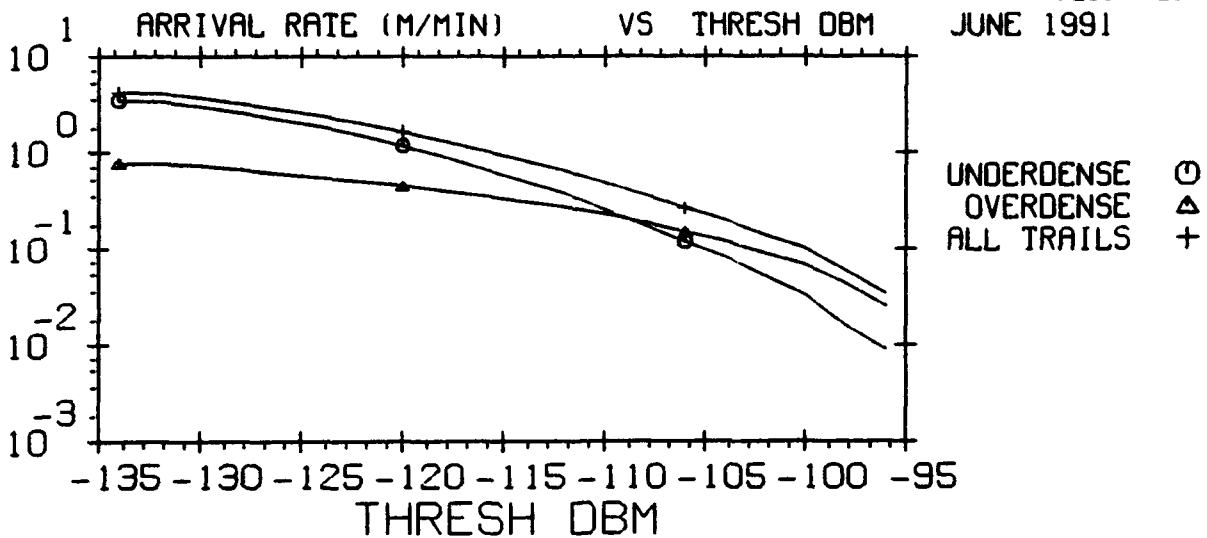

THE TIME OF DAY IS 0 : 24 HOURS U.T.
 FREQUENCY - 147 MHZ
 POLARIZATION - HORIZONTAL
 MAXIMUM DOWN TIME DUE TO SPORADIC-E - 240 SECONDS
 BASED ON OBSERVED NOISE MEASUREMENTS - VERTICAL

MENU#101,06-2
 21-SEP-93
 PLOT# 24.00

GEOPHYSICS LAB METEOR SCATTER PROGRAM

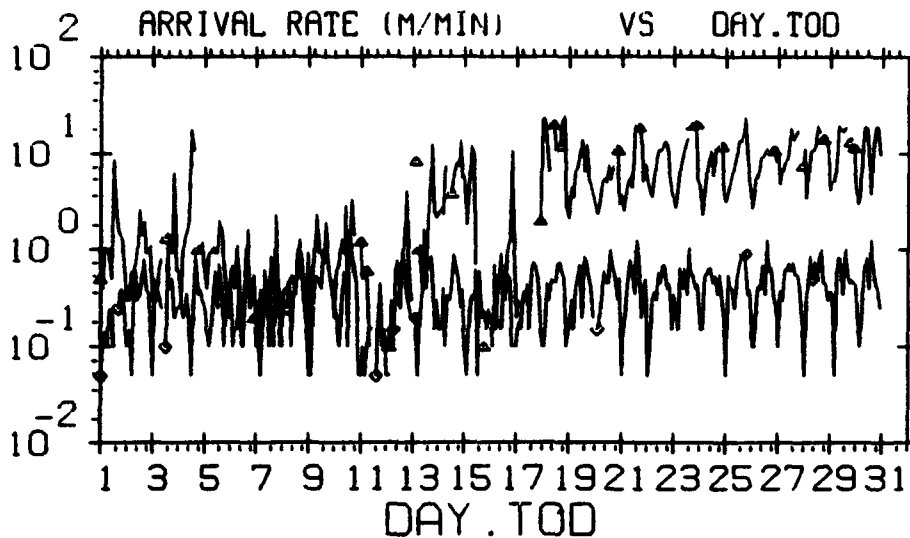

JUNE 1991

THULE

45 MHZ △
104 MHZ ◇

EXCEEDING -126.0 DBM RSL
TYPE OF METEOR TRAIL - UNDERDENSE AND OVERDENSE
POLARIZATION - HORIZONTAL
MAXIMUM DOWN TIME DUE TO SPORADIC-E - 240 SECONDS
BASED ON OBSERVED NOISE MEASUREMENTS - VERTICAL

MENU#101,03-2
21-SEP-93
PLOT# 25.00

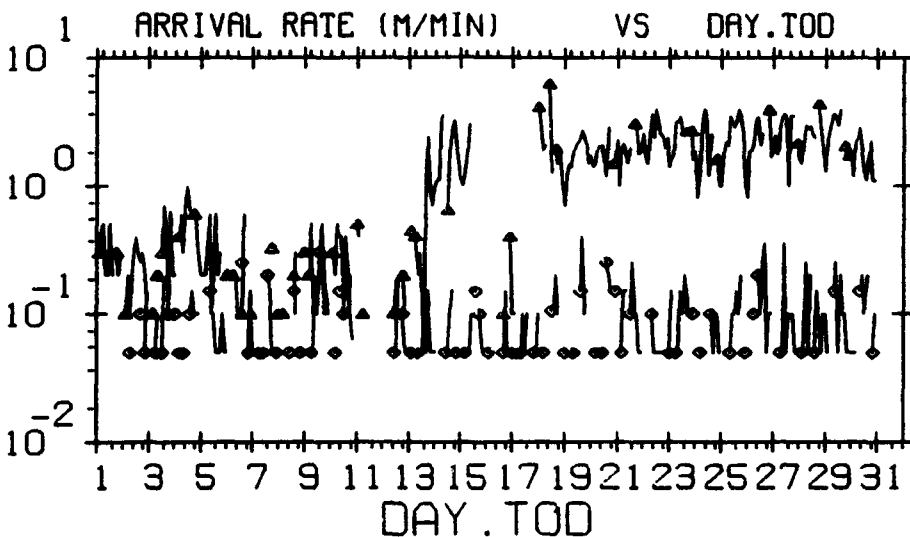

JUNE 1991

45 MHZ △
104 MHZ ◇

EXCEEDING -116.0 DBM RSL
TYPE OF METEOR TRAIL - UNDERDENSE AND OVERDENSE
POLARIZATION - HORIZONTAL
MAXIMUM DOWN TIME DUE TO SPORADIC-E - 240 SECONDS
BASED ON OBSERVED NOISE MEASUREMENTS - VERTICAL

MENU#101,03-2
21-SEP-93
PLOT# 26.00

GEOPHYSICS LAB METEOR SCATTER PROGRAM

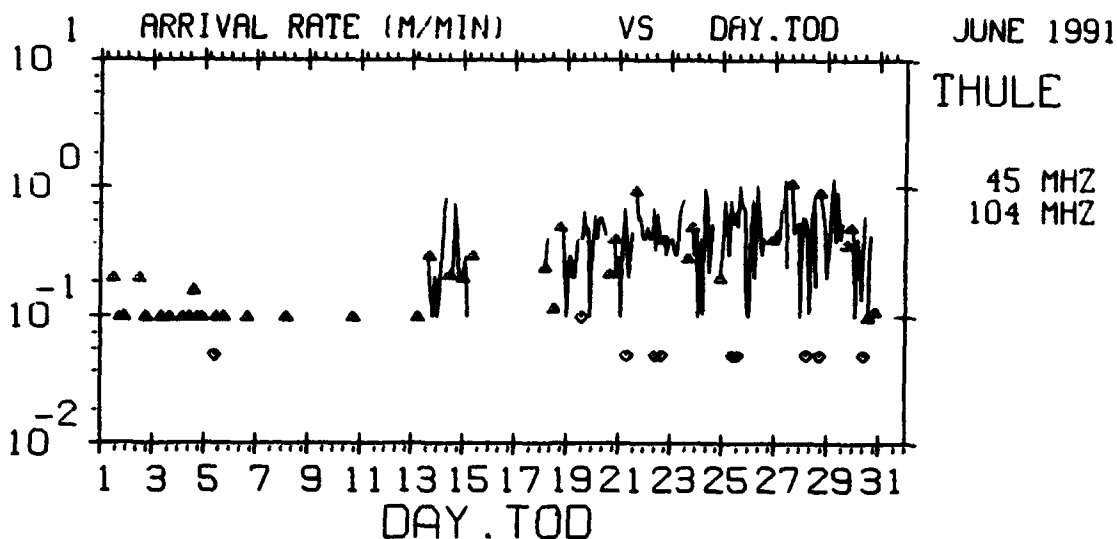

EXCEEDING -106.0 DBM RSL
 TYPE OF METEOR TRAIL - UNDERDENSE AND OVERDENSE
 POLARIZATION - HORIZONTAL
 MAXIMUM DOWN TIME DUE TO SPORADIC-E - 240 SECONDS
 BASED ON OBSERVED NOISE MEASUREMENTS - VERTICAL

MENU#101,03-2
 21-SEP-93
 PLOT# 27.00

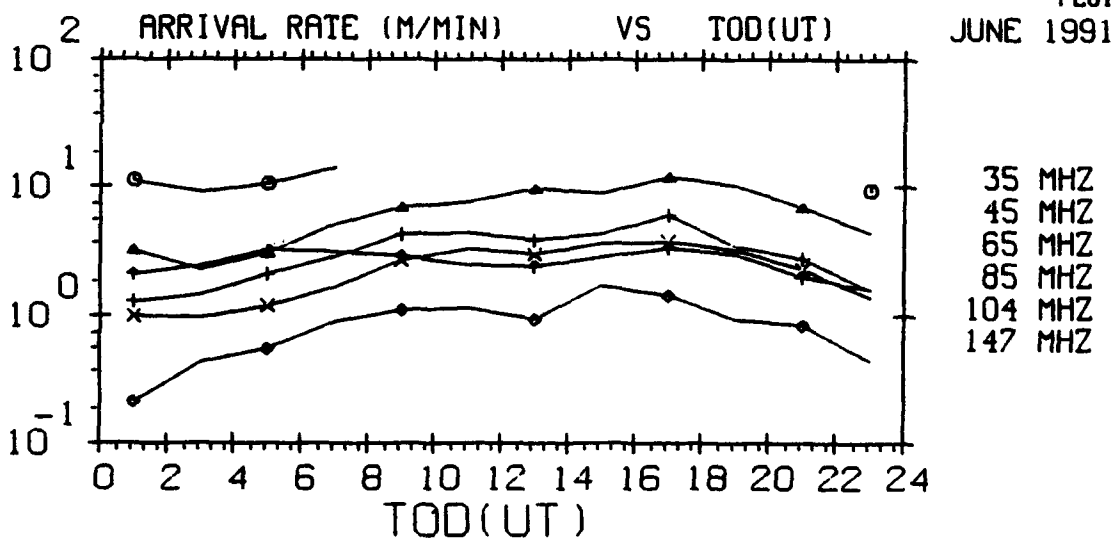

EXCEEDING 19.0 DB SNR
 TYPE OF METEOR TRAIL - UNDERDENSE AND OVERDENSE
 EFFECTIVE SYSTEM BANDWIDTH - 100.HZ
 POLARIZATION - HORIZONTAL
 MAXIMUM DOWN TIME DUE TO SPORADIC-E - 240 SECONDS
 BASED ON OBSERVED NOISE MEASUREMENTS - VERTICAL

MENU#102,01-2
 21-SEP-93
 PLOT# 28.00

GEOPHYSICS LAB METEOR SCATTER PROGRAM

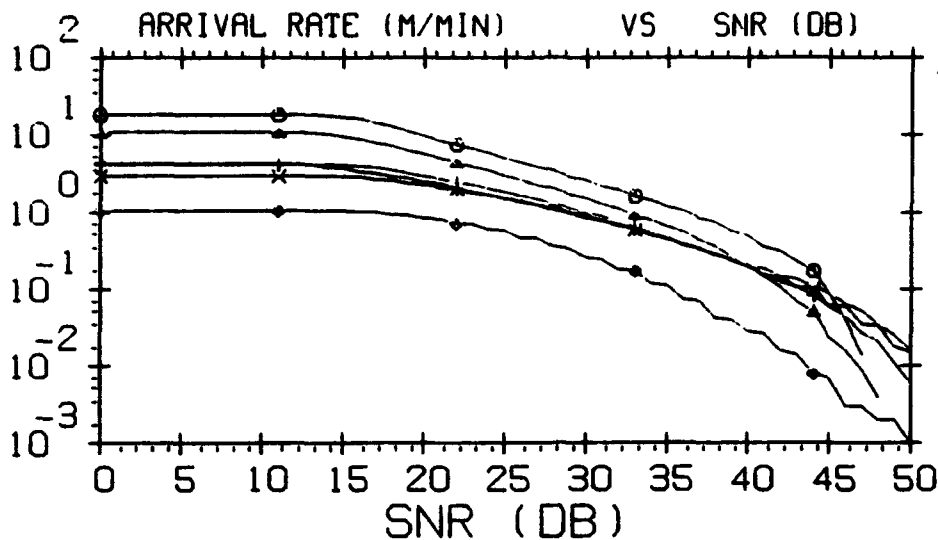

THE TIME OF DAY IS 0 : 24 HOURS U.T.
 TYPE OF METEOR TRAIL - UNDERDENSE AND OVERDENSE
 EFFECTIVE SYSTEM BANDWIDTH - 100.HZ
 POLARIZATION - HORIZONTAL
 MAXIMUM DOWN TIME DUE TO SPORADIC-E - 240 SECONDS
 BASED ON OBSERVED NOISE MEASUREMENTS - VERTICAL

MENU# 102,02-2
 21-SEP-93
 PLOT# 29.00

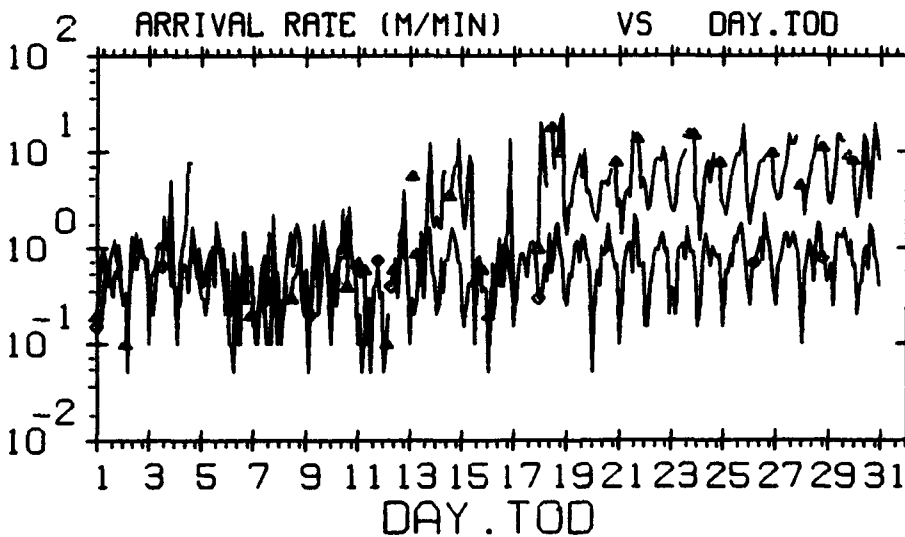

EXCEEDING 19.0 DB SNR
 TYPE OF METEOR TRAIL - UNDERDENSE AND OVERDENSE
 EFFECTIVE SYSTEM BANDWIDTH - 100.HZ
 POLARIZATION - HORIZONTAL
 MAXIMUM DOWN TIME DUE TO SPORADIC-E - 240 SECONDS
 BASED ON OBSERVED NOISE MEASUREMENTS - VERTICAL

MENU# 102,03-2
 21-SEP-93
 PLOT# 30.00

GEOPHYSICS LAB METEOR SCATTER PROGRAM

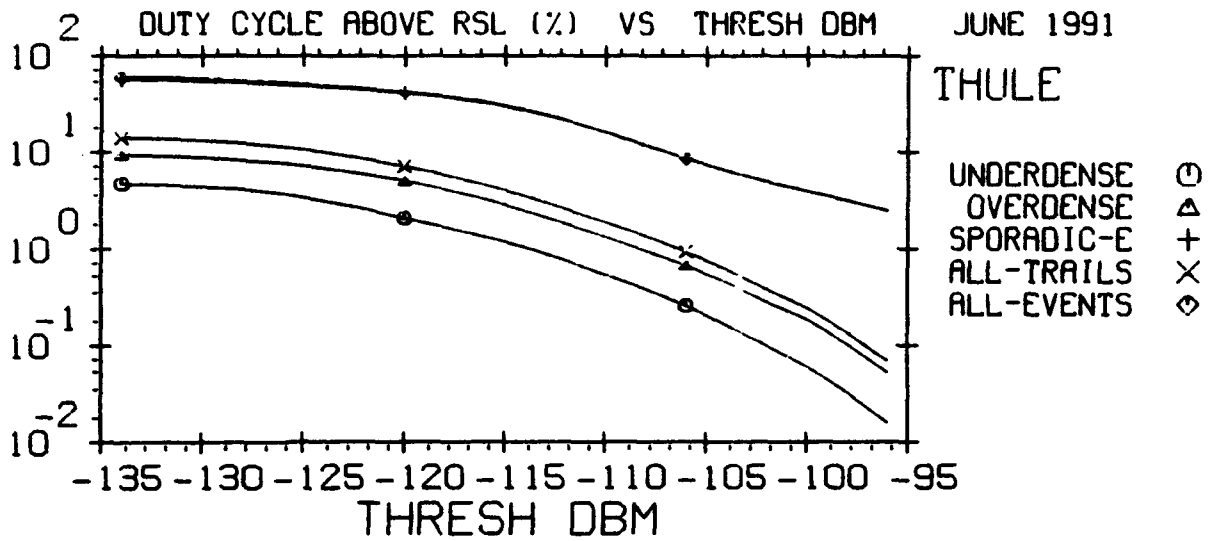

THE TIME OF DAY IS 0 : 24 HOURS U.T.
 FREQUENCY = 35 MHZ
 POLARIZATION - HORIZONTAL
 BASED ON OBSERVED NOISE MEASUREMENTS - VERTICAL

MENU=103,06-2
 21-SEP-93
 PLOT= 31.00

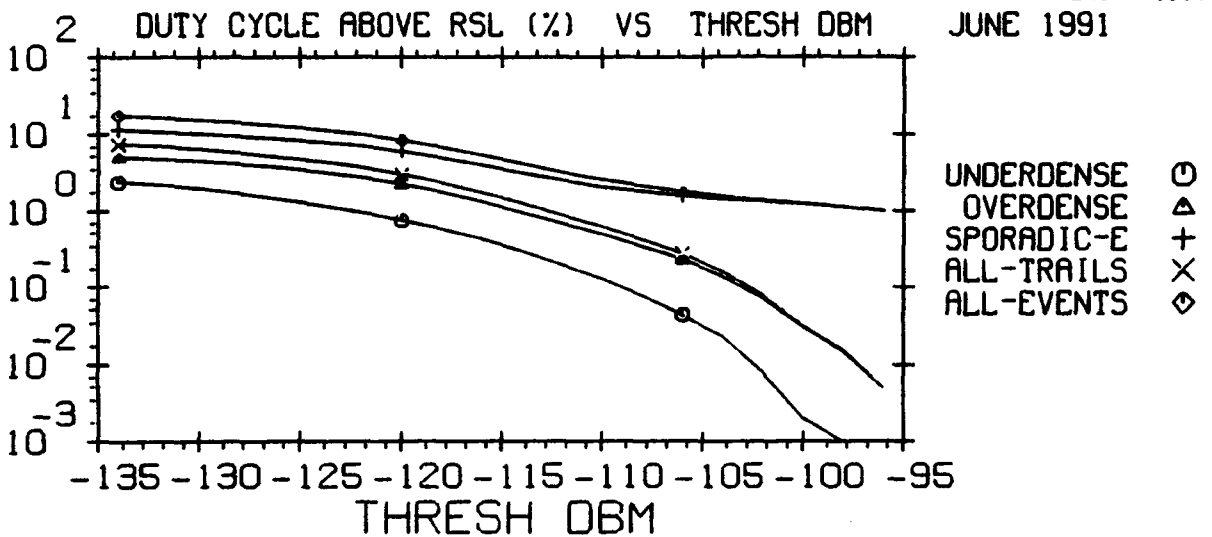

THE TIME OF DAY IS 0 : 24 HOURS U.T.
 FREQUENCY = 45 MHZ
 POLARIZATION - HORIZONTAL
 BASED ON OBSERVED NOISE MEASUREMENTS - VERTICAL

MENU=103,06-2
 21-SEP-93
 PLOT= 32.00

GEOPHYSICS LAB METEOR SCATTER PROGRAM

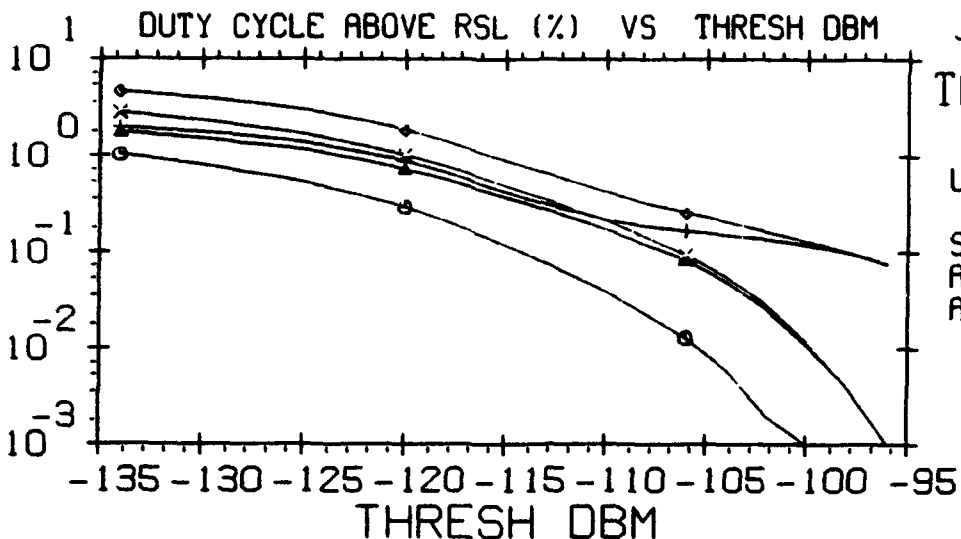

THE TIME OF DAY IS 0 : 24 HOURS U.T.
 FREQUENCY - 65 MHZ
 POLARIZATION - HORIZONTAL
 BASED ON OBSERVED NOISE MEASUREMENTS - VERTICAL

MENU=103,06-2
 21-SEP-93
 PLOT* 33.00

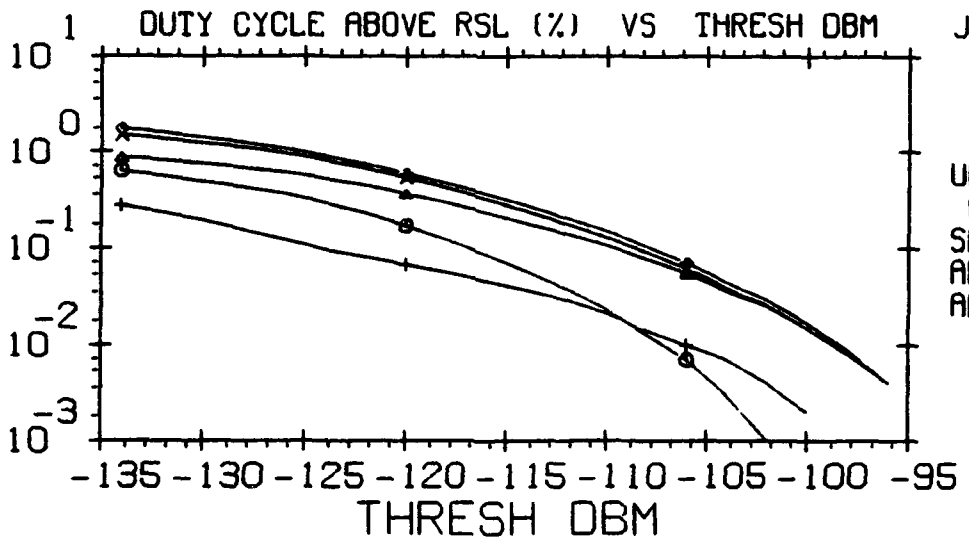

THE TIME OF DAY IS 0 : 24 HOURS U.T.
 FREQUENCY - 85 MHZ
 POLARIZATION - HORIZONTAL
 BASED ON OBSERVED NOISE MEASUREMENTS - VERTICAL

MENU=103,06-2
 21-SEP-93
 PLOT* 34.00

GEOPHYSICS LAB METEOR SCATTER PROGRAM

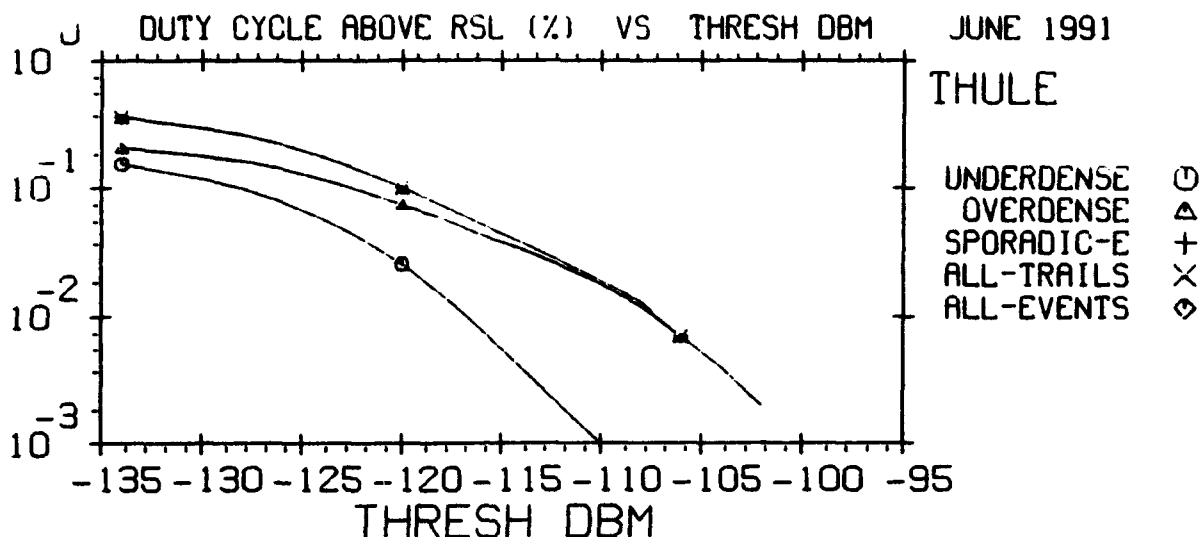

THE TIME OF DAY IS 0 : 24 HOURS U.T.
 FREQUENCY - 104 MHZ
 POLARIZATION - HORIZONTAL
 BASED ON OBSERVED NOISE MEASUREMENTS - VERTICAL

MENU=103,06-2
 21-SEP-93
 PLOT= 35.00

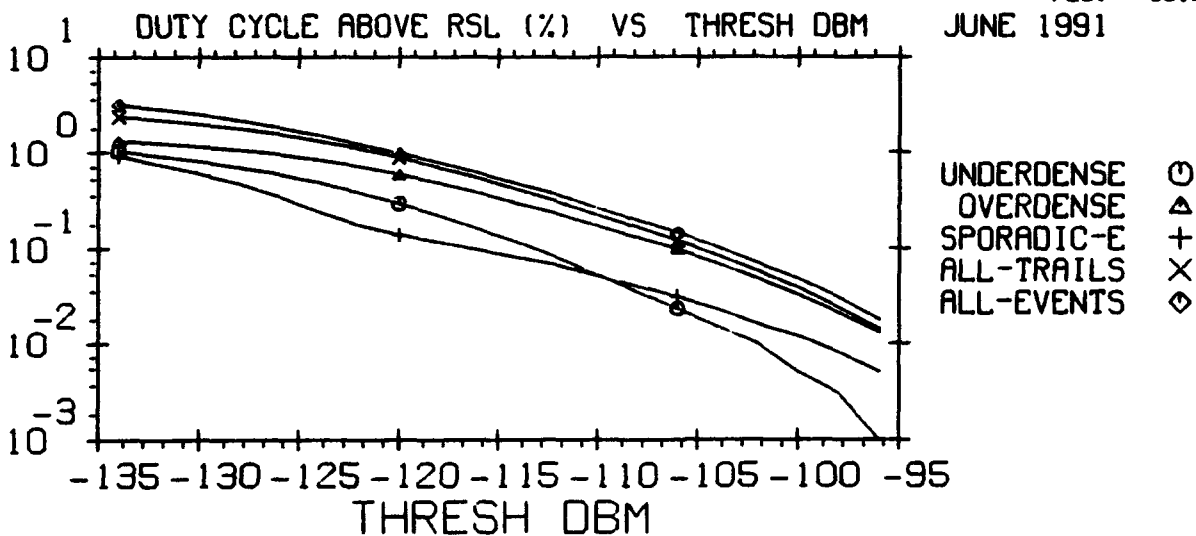

THE TIME OF DAY IS 0 : 24 HOURS U.T.
 FREQUENCY - 147 MHZ
 POLARIZATION - HORIZONTAL
 BASED ON OBSERVED NOISE MEASUREMENTS - VERTICAL

MENU=103,06-2
 21-SEP-93
 PLOT= 36.00

GEOPHYSICS LAB METEOR SCATTER PROGRAM

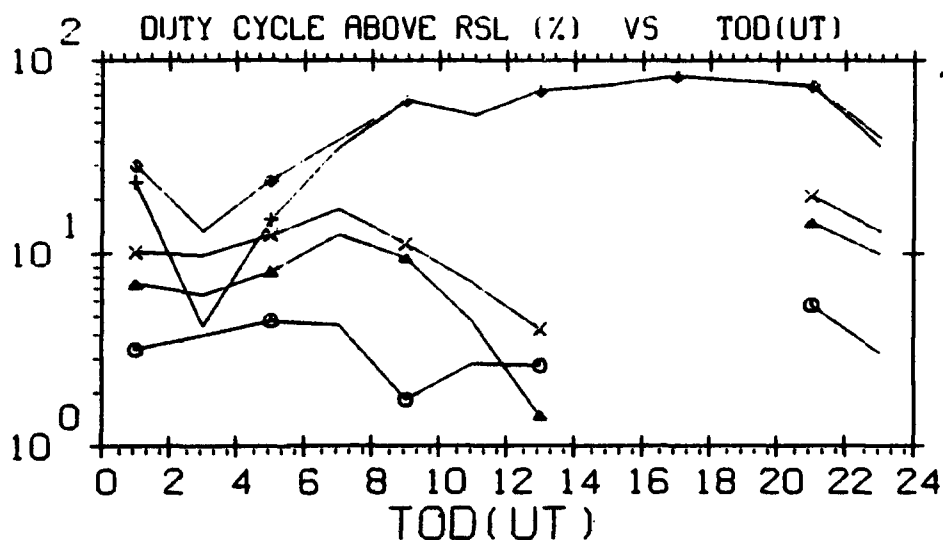

THRESHOLD - -126.0 DBM RSL
 FREQUENCY - 35 MHZ
 POLARIZATION - HORIZONTAL
 BASED ON OBSERVED NOISE MEASUREMENTS - VERTICAL

MENU#103,07-2
 21-SEP-93
 PLOT# 37.00

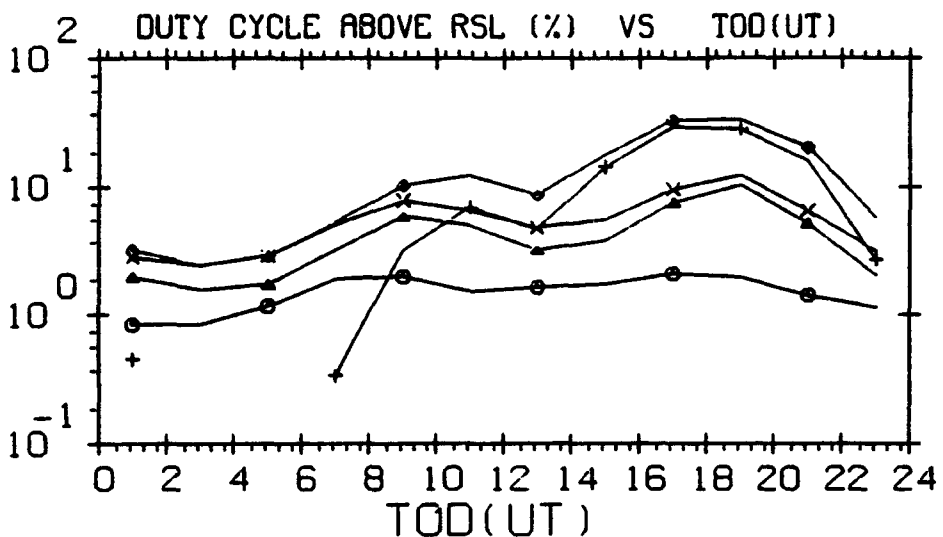

THRESHOLD - -126.0 DBM RSL
 FREQUENCY - 45 MHZ
 POLARIZATION - HORIZONTAL
 BASED ON OBSERVED NOISE MEASUREMENTS - VERTICAL

MENU#103,07-2
 21-SEP-93
 PLOT# 38.00

GEOPHYSICS LAB METEOR SCATTER PROGRAM

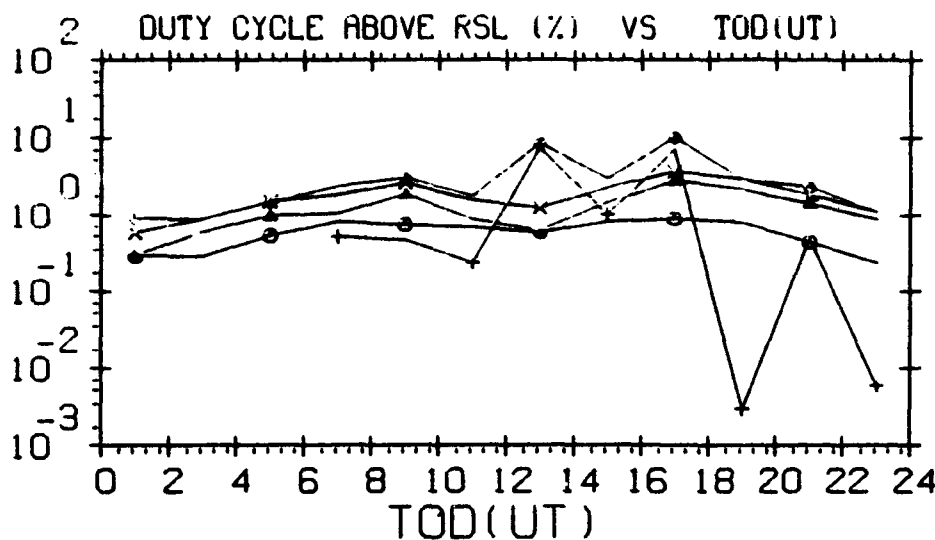

THRESHOLD - -126.0 DBM RSL
 FREQUENCY - 65 MHZ
 POLARIZATION - HORIZONTAL
 BASED ON OBSERVED NOISE MEASUREMENTS - VERTICAL

MENU#103,07-2
 21-SEP-93
 PLOT# 39.00

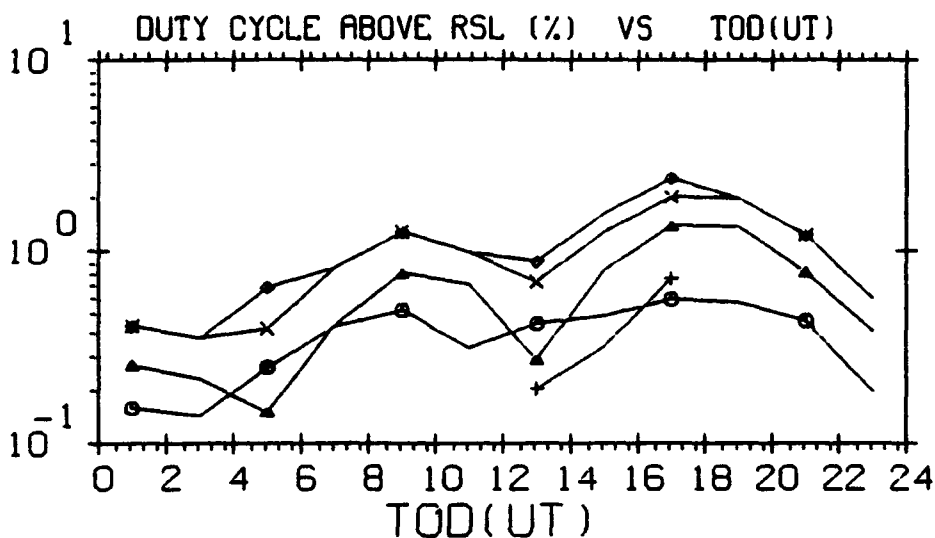

THRESHOLD - -126.0 DBM RSL
 FREQUENCY - 85 MHZ
 POLARIZATION - HORIZONTAL
 BASED ON OBSERVED NOISE MEASUREMENTS - VERTICAL

MENU#103,07-2
 21-SEP-93
 PLOT# 40.00

GEOPHYSICS LAB METEOR SCATTER PROGRAM

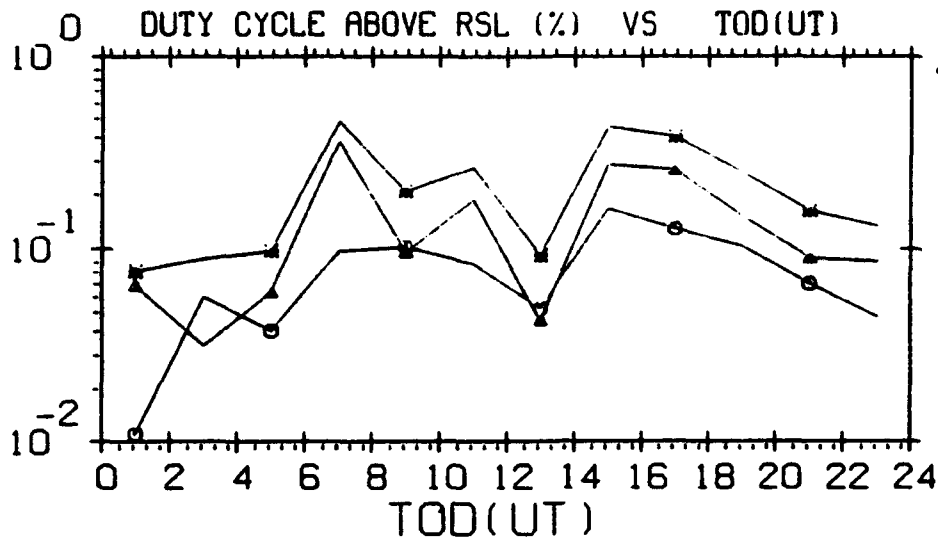

THRESHOLD - -126.0 DBM RSL
 FREQUENCY - 104 MHZ
 POLARIZATION - HORIZONTAL
 BASED ON OBSERVED NOISE MEASUREMENTS - VERTICAL

MENU=103,07-2
 21-SEP-93
 PLOT= 41.00

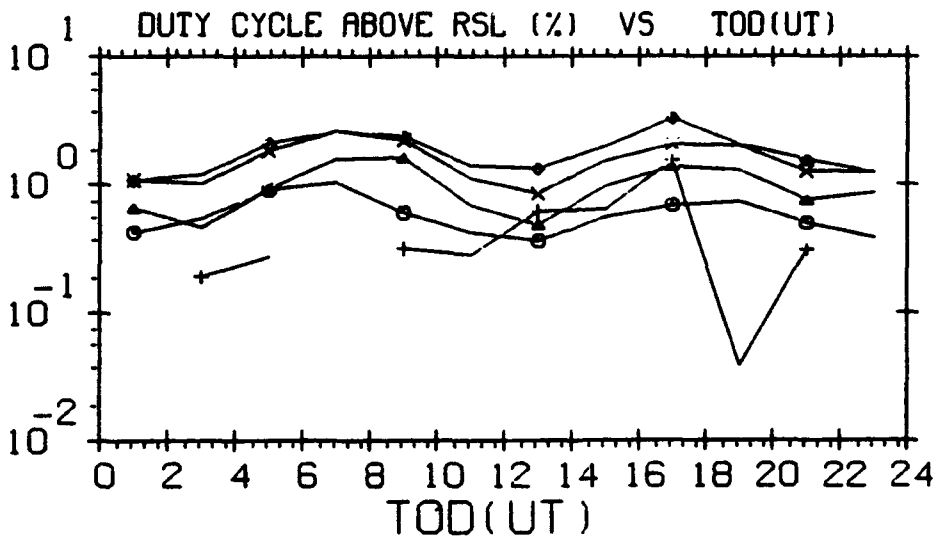

THRESHOLD - -126.0 DBM RSL
 FREQUENCY - 147 MHZ
 POLARIZATION - HORIZONTAL
 BASED ON OBSERVED NOISE MEASUREMENTS - VERTICAL

MENU=103,07-2
 21-SEP-93
 PLOT= 42.00

GEOPHYSICS LAB METEOR SCATTER PROGRAM

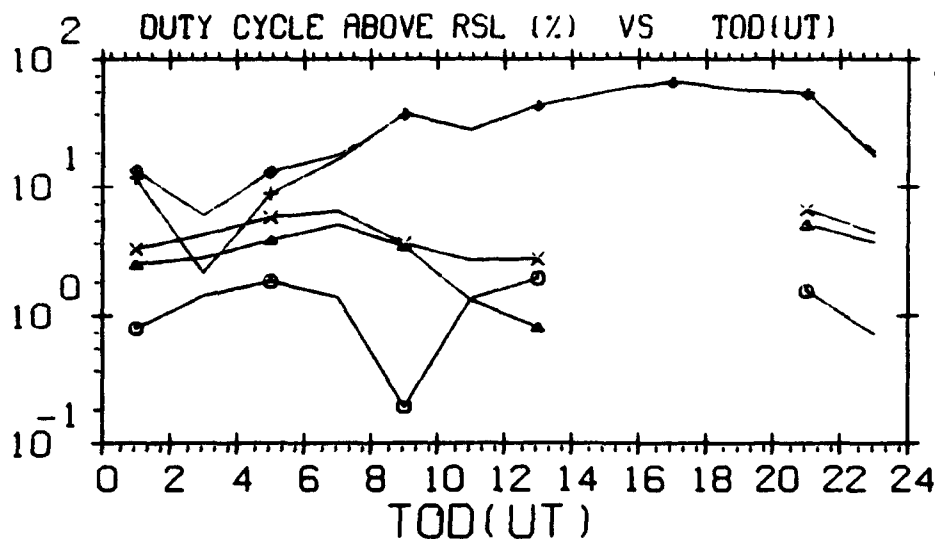

THRESHOLD - -116.0 DBM RSL
 FREQUENCY - 35 MHZ
 POLARIZATION - HORIZONTAL
 BASED ON OBSERVED NOISE MEASUREMENTS - VERTICAL

MENU=103,07-2
 21-SEP-93
 PLOT# 43.00

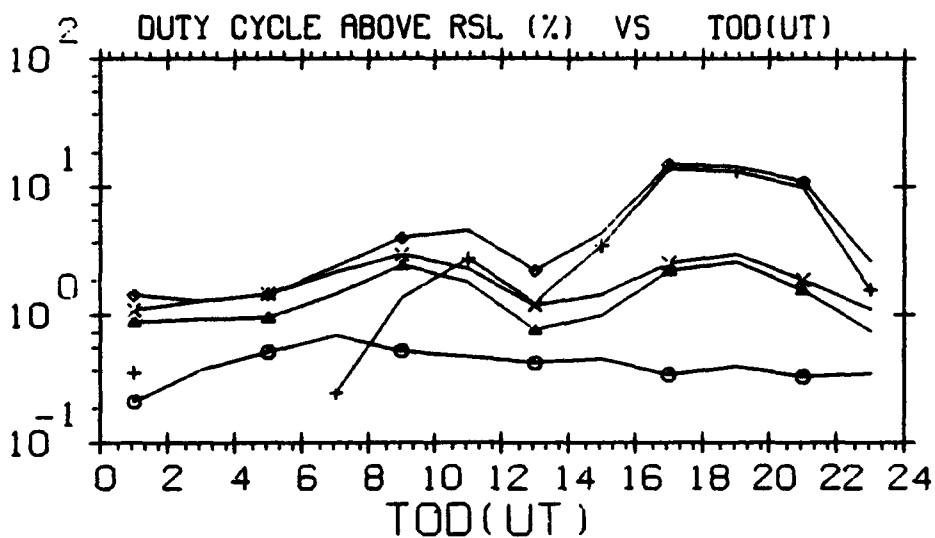

THRESHOLD - -116.0 DBM RSL
 FREQUENCY - 45 MHZ
 POLARIZATION - HORIZONTAL
 BASED ON OBSERVED NOISE MEASUREMENTS - VERTICAL

MENU=103,07-2
 21-SEP-93
 PLOT# 44.00

GEOPHYSICS LAB METEOR SCATTER PROGRAM

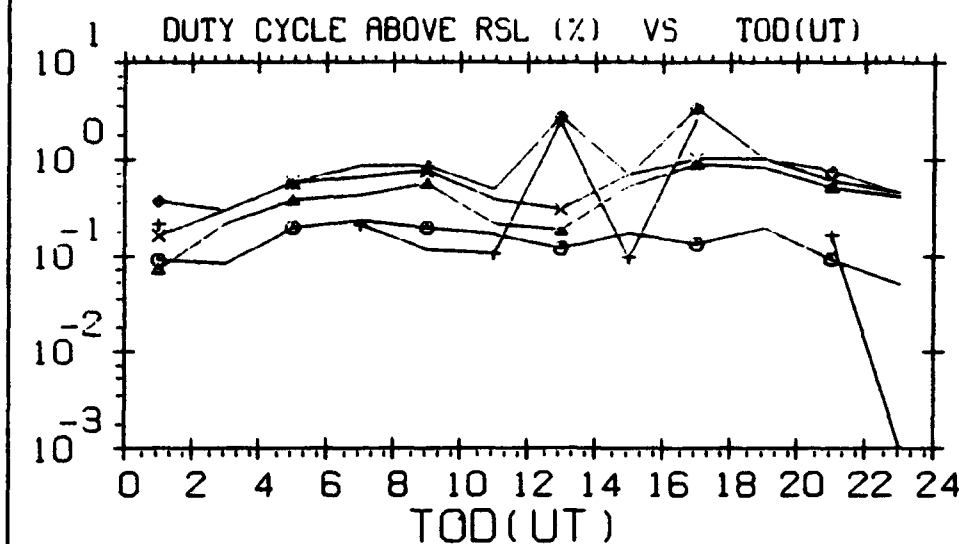

THRESHOLD - -116.0 DBM RSL
 FREQUENCY - 65 MHZ
 POLARIZATION - HORIZONTAL
 BASED ON OBSERVED NOISE MEASUREMENTS - VERTICAL

MENU#103,07-2
 21-SEP-93
 PLOT# 45.00

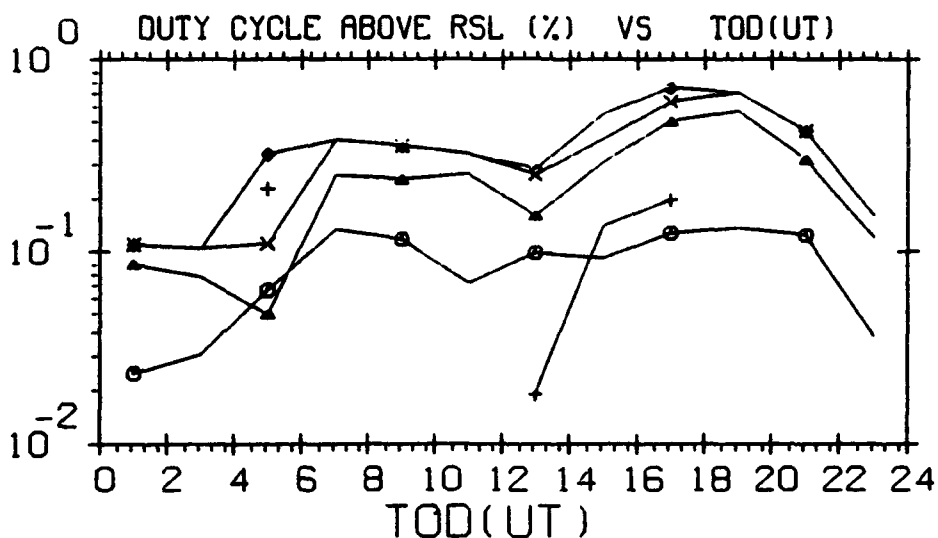

THRESHOLD - -116.0 DBM RSL
 FREQUENCY - 85 MHZ
 POLARIZATION - HORIZONTAL
 BASED ON OBSERVED NOISE MEASUREMENTS - VERTICAL

MENU#103,07-2
 21-SEP-93
 PLOT# 46.00

GEOPHYSICS LAB METEOR SCATTER PROGRAM

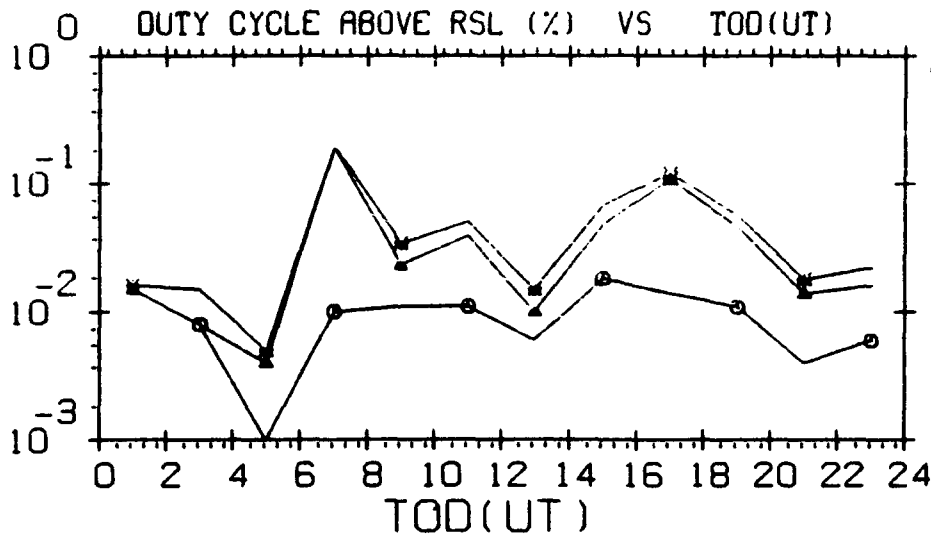

THRESHOLD - -116.0 DBM RSL
 FREQUENCY - 104 MHZ
 POLARIZATION - HORIZONTAL
 BASED ON OBSERVED NOISE MEASUREMENTS - VERTICAL

MENU#103,07-2
 21-SEP-93
 PLOT# 47.00

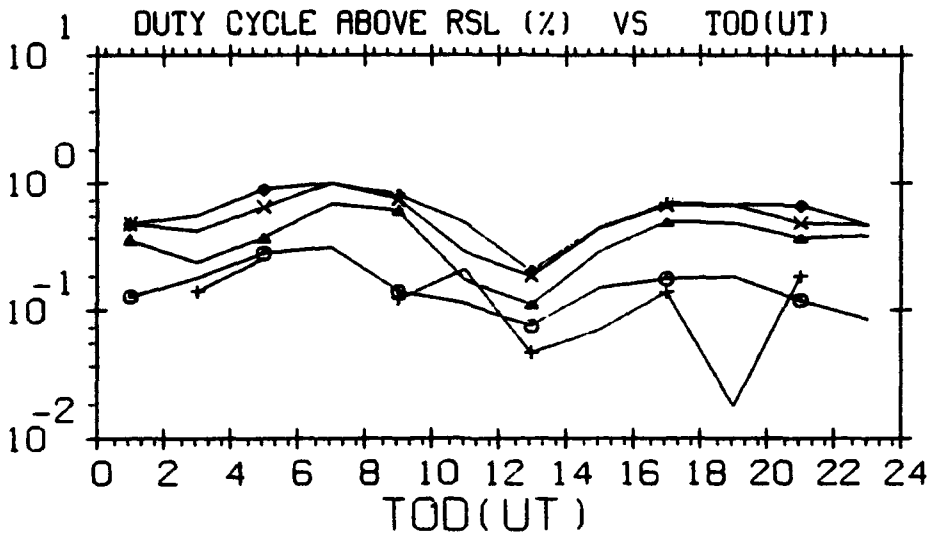

THRESHOLD - -116.0 DBM RSL
 FREQUENCY - 147 MHZ
 POLARIZATION - HORIZONTAL
 BASED ON OBSERVED NOISE MEASUREMENTS - VERTICAL

MENU#103,07-2
 21-SEP-93
 PLOT# 48.00

GEOPHYSICS LAB METEOR SCATTER PROGRAM

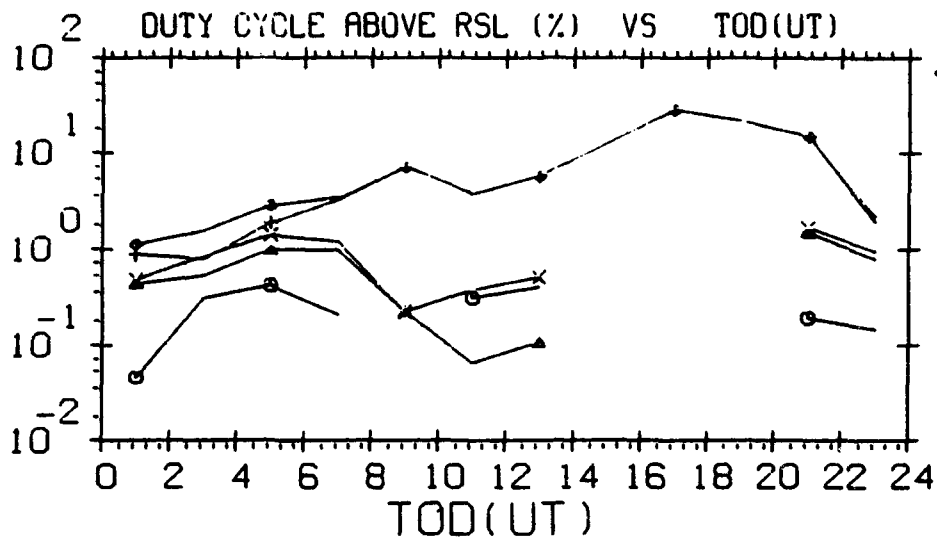

THRESHOLD - -106.0 DBM RSL
 FREQUENCY - 35 MHZ
 POLARIZATION - HORIZONTAL
 BASED ON OBSERVED NOISE MEASUREMENTS - VERTICAL

MENU#103,07-2
 21-SEP-93
 PLOT# 49.00

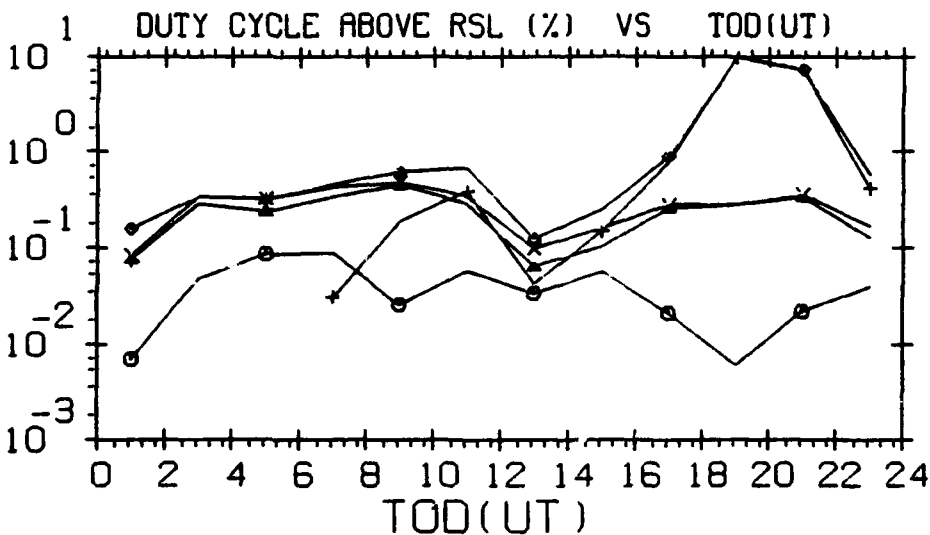

THRESHOLD - -106.0 DBM RSL
 FREQUENCY - 45 MHZ
 POLARIZATION - HORIZONTAL
 BASED ON OBSERVED NOISE MEASUREMENTS - VERTICAL

MENU#103,07-2
 21-SEP-93
 PLOT# 50.00

GEOPHYSICS LAB METEOR SCATTER PROGRAM

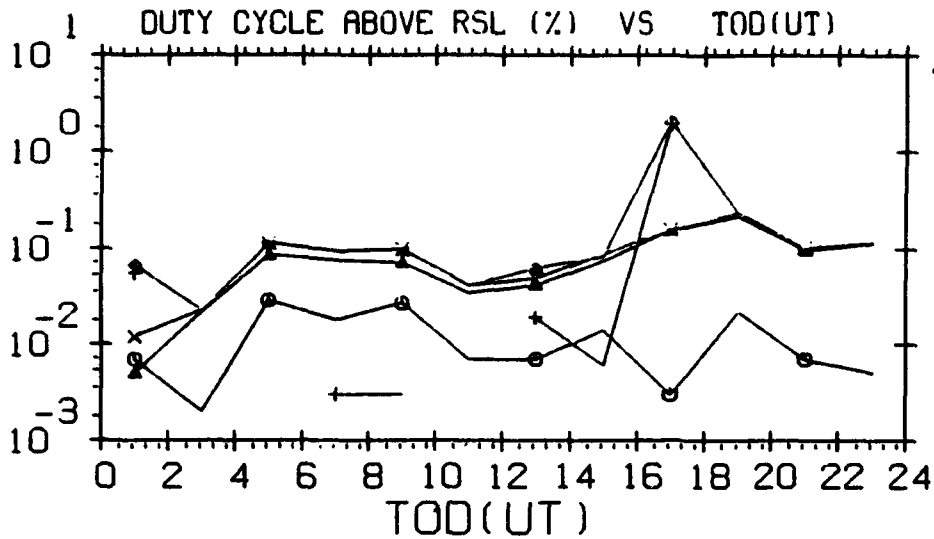

THRESHOLD - -106.0 DBM RSL
 FREQUENCY - 65 MHZ
 POLARIZATION - HORIZONTAL
 BASED ON OBSERVED NOISE MEASUREMENTS - VERTICAL

MENU#103,07-2
 21-SEP-93
 PLOT# 51.00

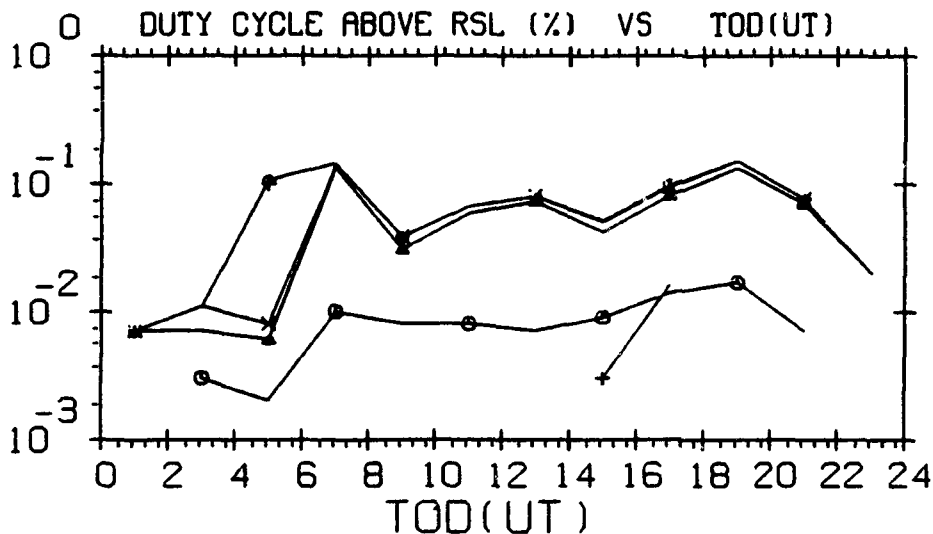

THRESHOLD - -106.0 DBM RSL
 FREQUENCY - 85 MHZ
 POLARIZATION - HORIZONTAL
 BASED ON OBSERVED NOISE MEASUREMENTS - VERTICAL

MENU#103,07-2
 21-SEP-93
 PLOT# 52.00

GEOPHYSICS LAB METEOR SCATTER PROGRAM

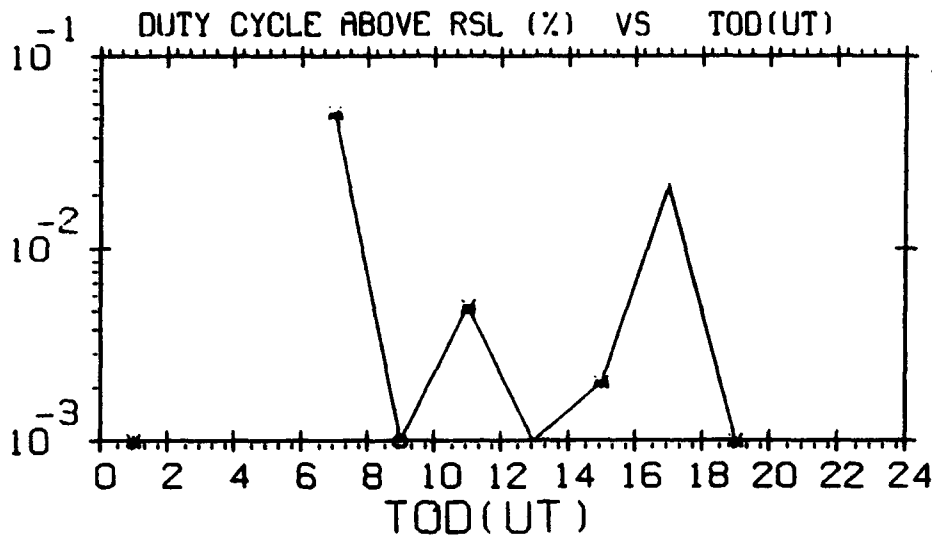

THRESHOLD - -106.0 DBM RSL
 FREQUENCY - 104 MHZ
 POLARIZATION - HORIZONTAL
 BASED ON OBSERVED NOISE MEASUREMENTS - VERTICAL

MENU#103,07-2
 21-SEP-93
 PLOT# 53.00

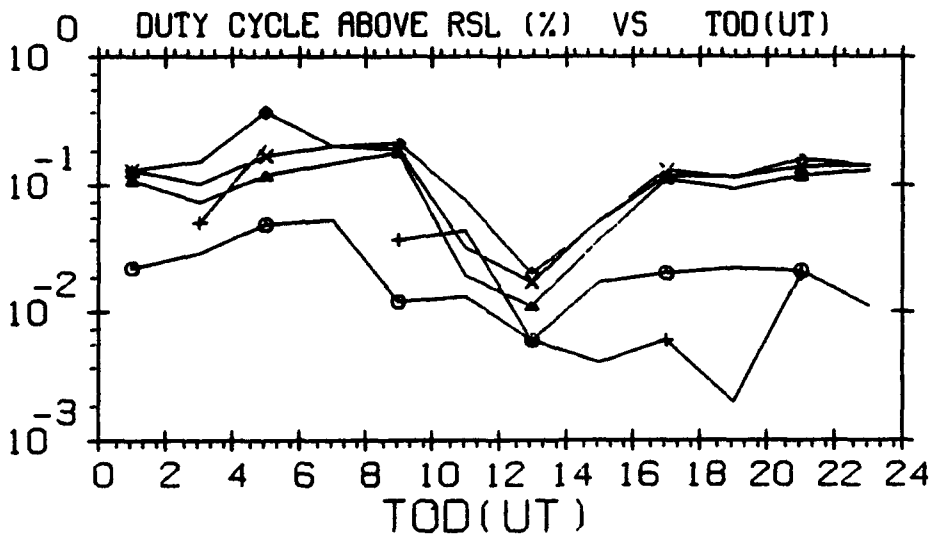

THRESHOLD - -106.0 DBM RSL
 FREQUENCY - 147 MHZ
 POLARIZATION - HORIZONTAL
 BASED ON OBSERVED NOISE MEASUREMENTS - VERTICAL

MENU#103,07-2
 21-SEP-93
 PLOT# 54.00

GEOPHYSICS LAB METEOR SCATTER PROGRAM

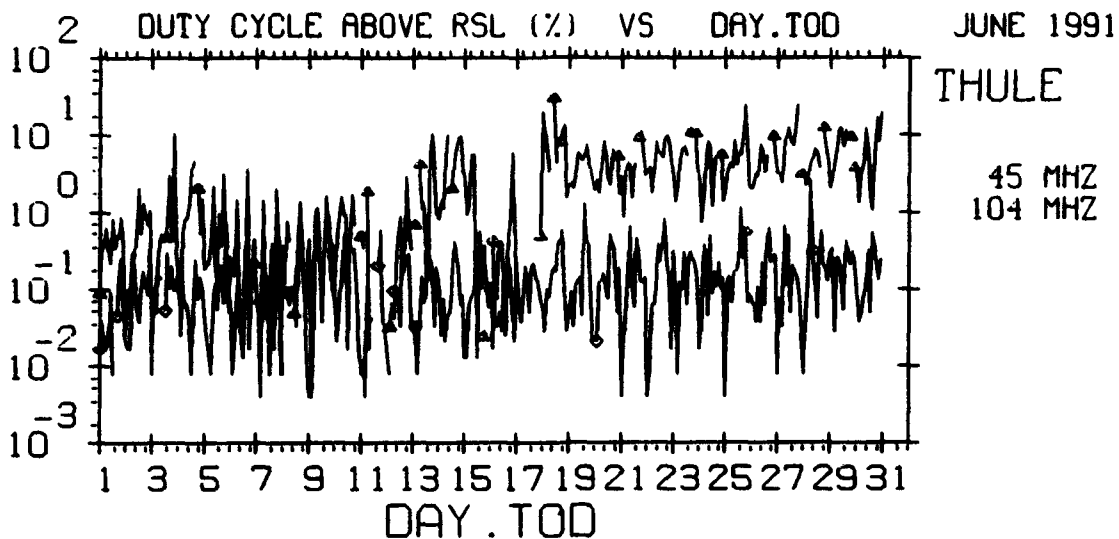

THRESHOLD - -126.0 DBM RSL
THE EVENT CLASS IS UNDERDENSE AND OVERDENSE TRAILS
POLARIZATION - HORIZONTAL
BASED ON OBSERVED NOISE MEASUREMENTS - VERTICAL

MENU#103,09-2
21-SEP-93
PLOT# 55.00

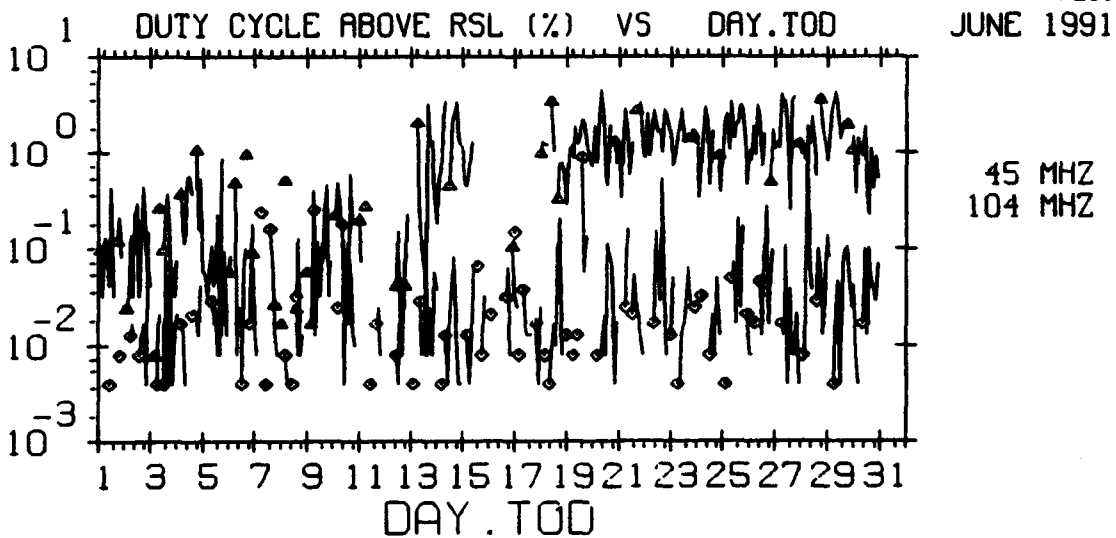

THRESHOLD - -116.0 DBM RSL
THE EVENT CLASS IS UNDERDENSE AND OVERDENSE TRAILS
POLARIZATION - HORIZONTAL
BASED ON OBSERVED NOISE MEASUREMENTS - VERTICAL

MENU#103,09-2
21-SEP-93
PLOT# 56.00

GEOPHYSICS LAB METEOR SCATTER PROGRAM

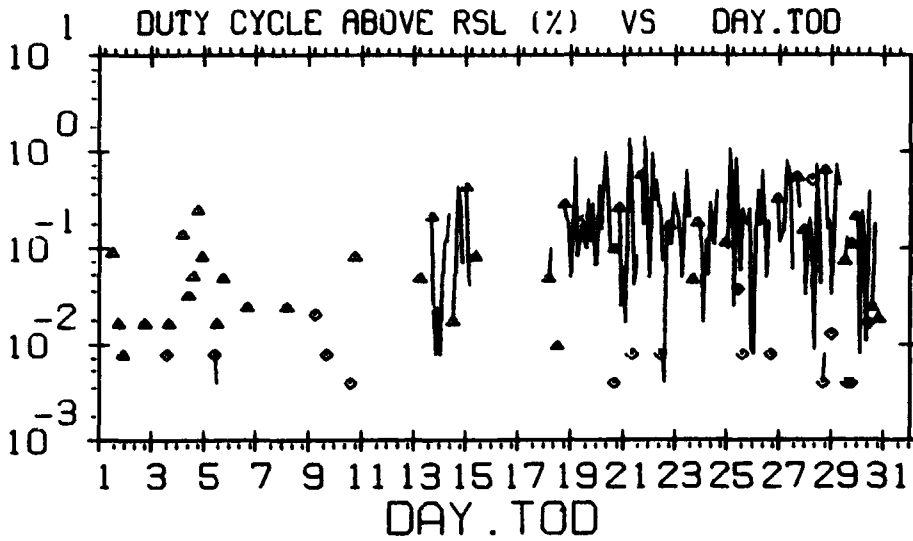

JUNE 1991
THULE

45 MHZ △
104 MHZ ◇

THRESHOLD - -106.0 DBM RSL
THE EVENT CLASS IS UNDERDENSE AND OVERDENSE TRAILS
POLARIZATION - HORIZONTAL
BASED ON OBSERVED NOISE MEASUREMENTS - VERTICAL

MENU=103.09-2
21-SEP-93
PLOT= 57.00

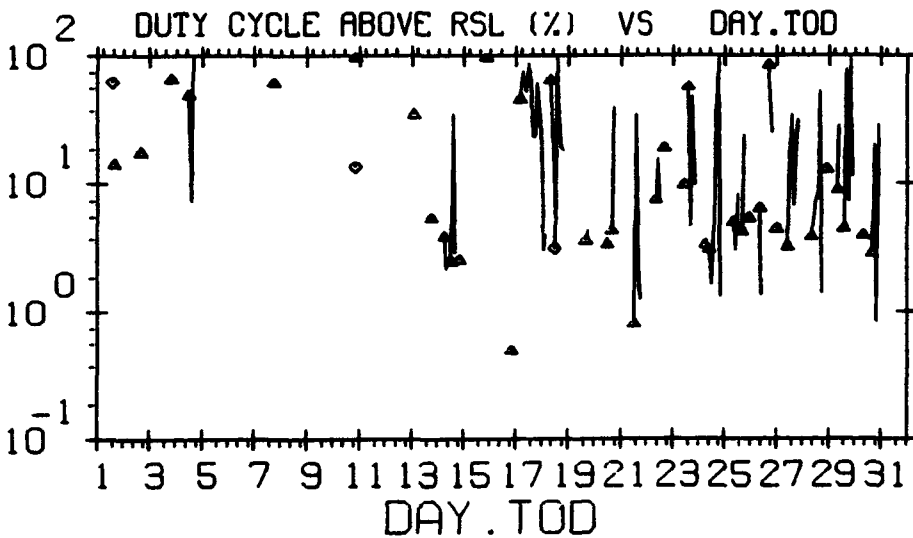

JUNE 1991

45 MHZ △
104 MHZ ◇

THRESHOLD - -126.0 DBM RSL
THE EVENT CLASS IS SPORADIC-E
POLARIZATION - HORIZONTAL
BASED ON OBSERVED NOISE MEASUREMENTS - VERTICAL

MENU=103.09-2
21-SEP-93
PLOT= 58.00

GEOPHYSICS LAB METEOR SCATTER PROGRAM

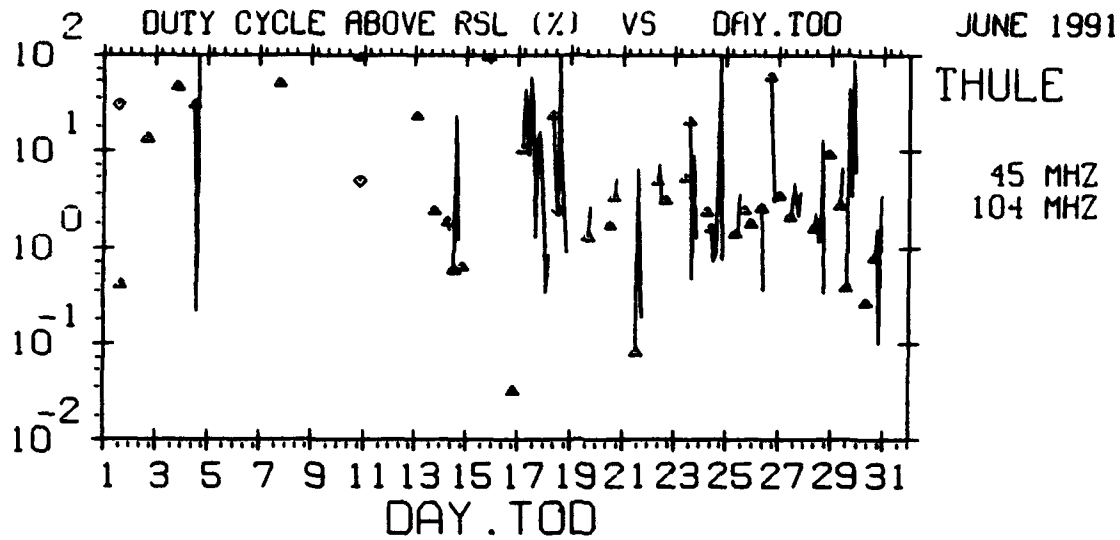

THRESHOLD - -116.0 DBM RSL
 THE EVENT CLASS IS SPORADIC-E
 POLARIZATION - HORIZONTAL
 BASED ON OBSERVED NOISE MEASUREMENTS - VERTICAL

MENU#103,09-2
 21-SEP-93
 PLOT# 59.00

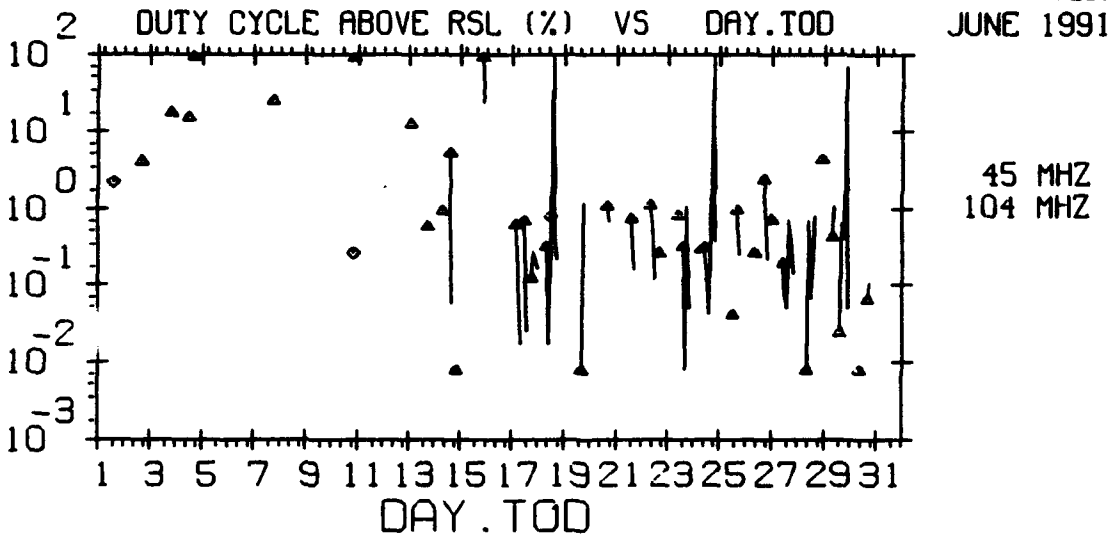

THRESHOLD - -106.0 DBM RSL
 THE EVENT CLASS IS SPORADIC-E
 POLARIZATION - HORIZONTAL
 BASED ON OBSERVED NOISE MEASUREMENTS - VERTICAL

MENU#103,09-2
 21-SEP-93
 PLOT# 60.00

GEOPHYSICS LAB METEOR SCATTER PROGRAM

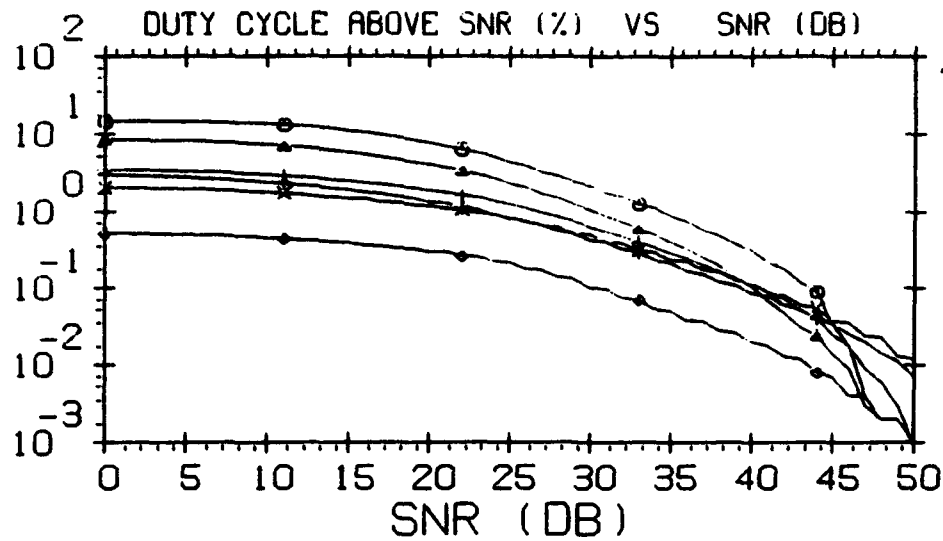

- 35 MHZ ○
- 45 MHZ △
- 65 MHZ +
- 85 MHZ ×
- 104 MHZ ◇
- 147 MHZ †

THE TIME OF DAY IS 0 : 24 HOURS U.T.
 THE EVENT CLASS IS UNDERDENSE AND OVERDENSE TRAILS
 EFFECTIVE SYSTEM BANDWIDTH - 100.HZ
 POLARIZATION - HORIZONTAL
 BASED ON OBSERVED NOISE MEASUREMENTS - VERTICAL

MENU#104,02-2
 21-SEP-93
 PLOT# 61.00

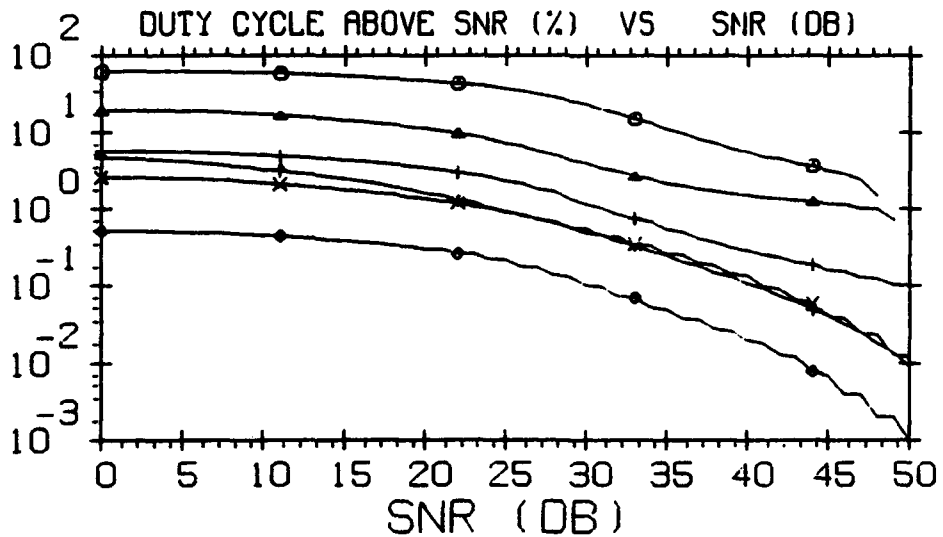

- 35 MHZ ○
- 45 MHZ △
- 65 MHZ +
- 85 MHZ ×
- 104 MHZ ◇
- 147 MHZ †

THE TIME OF DAY IS 0 : 24 HOURS U.T.
 THE EVENT CLASS IS SPORADIC-E AND METEOR TRAILS
 EFFECTIVE SYSTEM BANDWIDTH - 100.HZ
 POLARIZATION - HORIZONTAL
 BASED ON OBSERVED NOISE MEASUREMENTS - VERTICAL

MENU#104,02-2
 21-SEP-93
 PLOT# 62.00

GEOPHYSICS LAB METEOR SCATTER PROGRAM

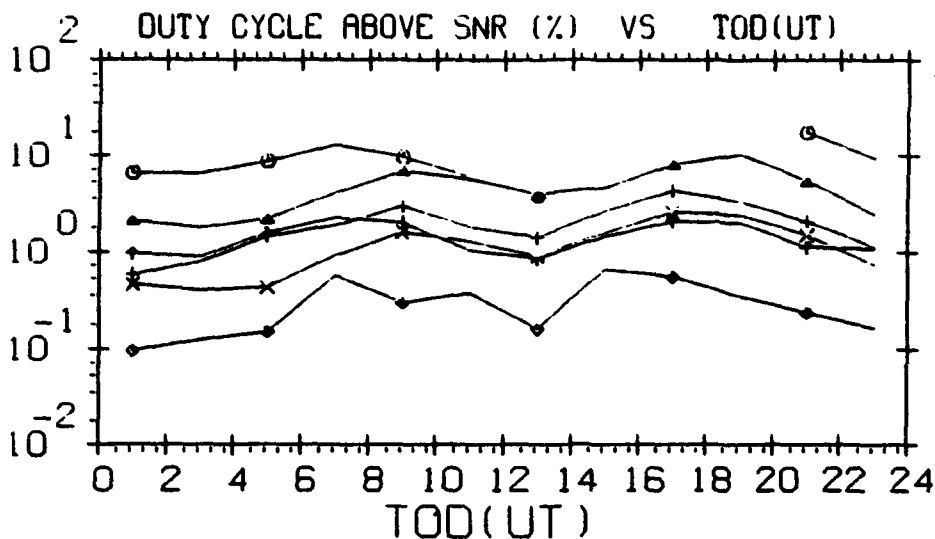

SIGNAL-TO-NOISE RATIO - 19.0 DB
 THE EVENT CLASS IS UNDERDENSE AND OVERDENSE TRAILS
 EFFECTIVE SYSTEM BANDWIDTH - 100.HZ
 POLARIZATION - HORIZONTAL
 BASED ON OBSERVED NOISE MEASUREMENTS - VERTICAL

MENU#104,03-2
 21-SEP-93
 PLOT# 63.00

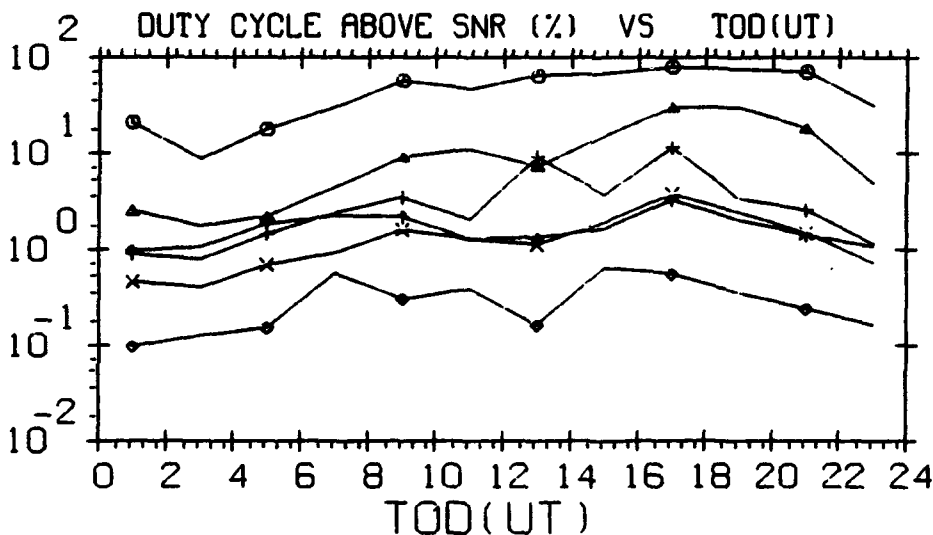

SIGNAL-TO-NOISE RATIO - 19.0 DB
 THE EVENT CLASS IS SPORADIC-E AND METEOR TRAILS
 EFFECTIVE SYSTEM BANDWIDTH - 100.HZ
 POLARIZATION - HORIZONTAL
 BASED ON OBSERVED NOISE MEASUREMENTS - VERTICAL

MENU#104,03-2
 21-SEP-93
 PLOT# 64.00

GEOPHYSICS LAB METEOR SCATTER PROGRAM

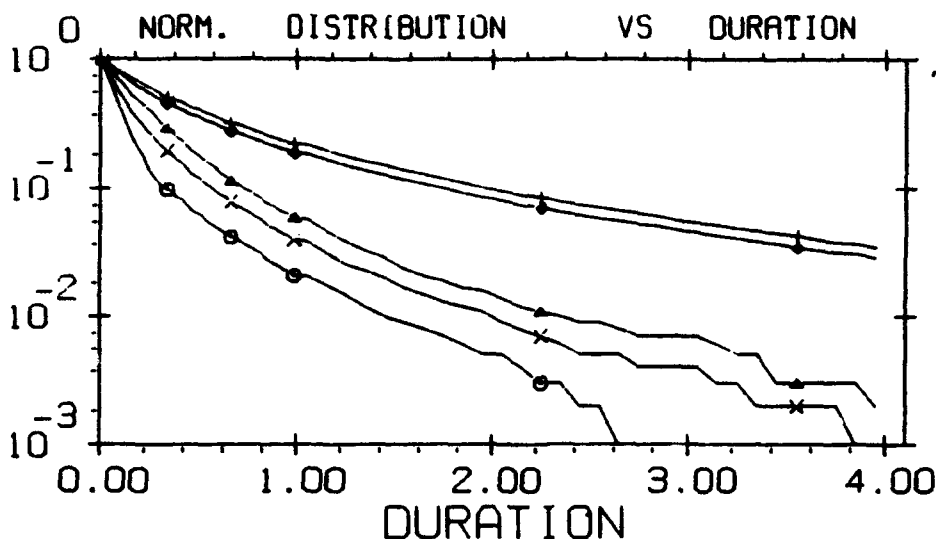

EXCEEDING -126.0 DBM RSL
 THE TIME OF DAY IS 0 : 24 HOURS U.T.
 FREQUENCY - 35 MHZ
 BASED ON OBSERVED NOISE MEASUREMENTS - VERTICAL
 NORMALIZING FACTORS:
 UNDER - 6098. OVER - 5960. SPOR-E - 55668.
 TRAILS - 12058. EVENTS - 67726.

MENU#106,02-4
 21-SEP-93
 PLOT# 67.00

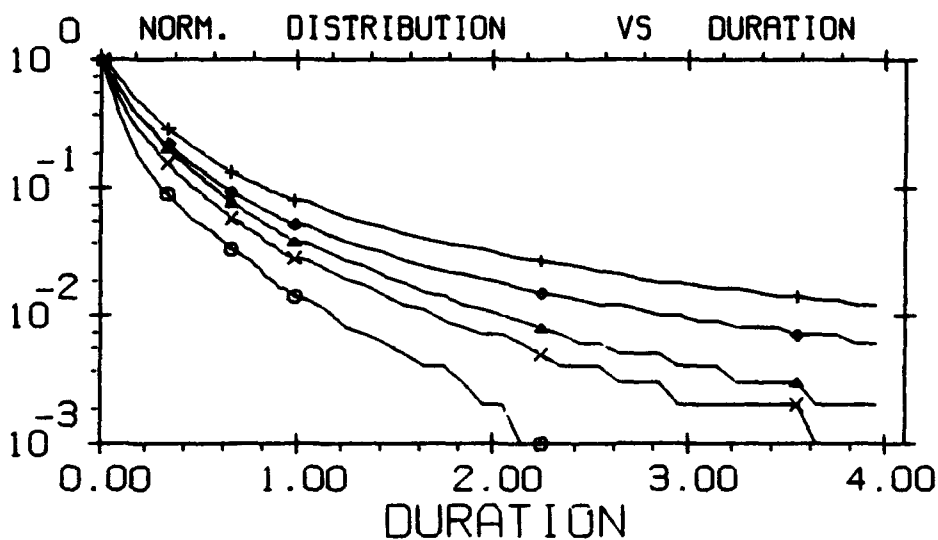

EXCEEDING -126.0 DBM RSL
 THE TIME OF DAY IS 0 : 24 HOURS U.T.
 FREQUENCY - 45 MHZ
 BASED ON OBSERVED NOISE MEASUREMENTS - VERTICAL
 NORMALIZING FACTORS:
 UNDER - 6987. OVER - 9223. SPOR-E - 14364.
 TRAILS - 16210. EVENTS - 30574.

MENU#106,02-4
 21-SEP-93
 PLOT# 68.00

GEOPHYSICS LAB METEOR SCATTER PROGRAM

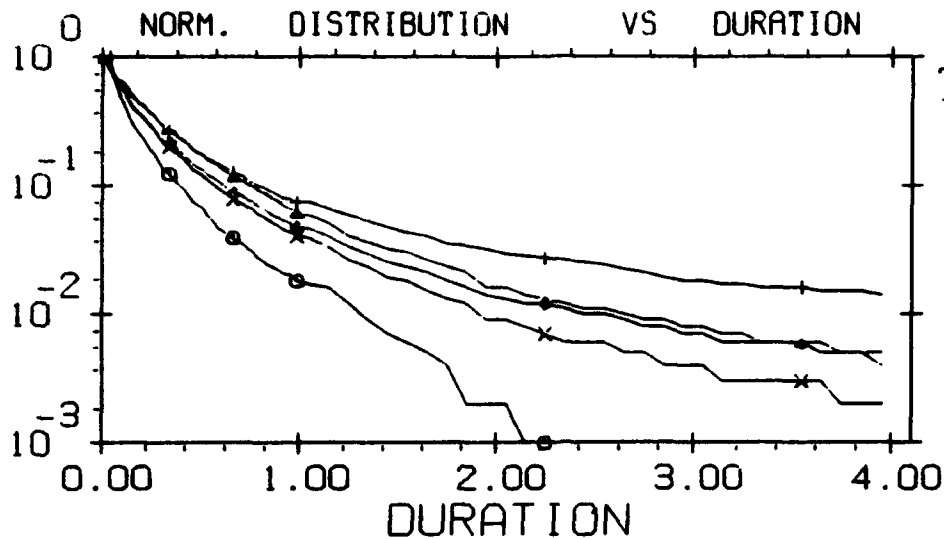

UNDERDENSE ⊙
 OVERDENSE △
 SPORADIC-E +
 ALL-TRAILS ×
 ALL-EVENTS ◇

EXCEEDING -126.0 DBM RSL
 THE TIME OF DAY IS 0 : 24 HOURS U.T.
 FREQUENCY - 65 MHZ
 BASED ON OBSERVED NOISE MEASUREMENTS - VERTICAL
 NORMALIZING FACTORS:
 UNDER - 4118. OVER - 4191. SPOR-E - 2327.
 TRAILS - 8309. EVENTS - 10636.

MENU=106,02-4
 21-SEP-93
 PLOT= 69.00

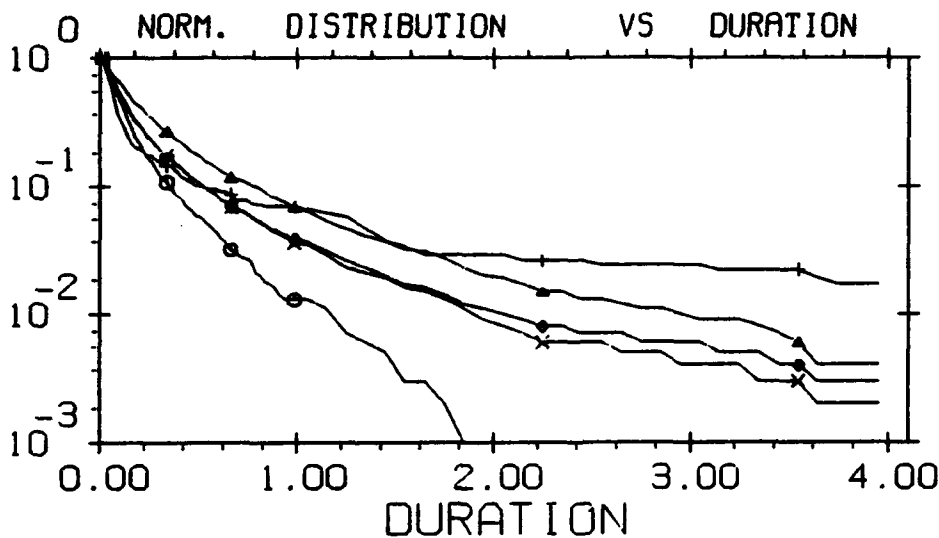

UNDERDENSE ⊙
 OVERDENSE △
 SPORADIC-E +
 ALL-TRAILS ×
 ALL-EVENTS ◇

EXCEEDING -126.0 DBM RSL
 THE TIME OF DAY IS 0 : 24 HOURS U.T.
 FREQUENCY - 85 MHZ
 BASED ON OBSERVED NOISE MEASUREMENTS - VERTICAL
 NORMALIZING FACTORS:
 UNDER - 2772. OVER - 2052. SPOR-E - 417.
 TRAILS - 4824. EVENTS - 5241.

MENU=106,02-4
 21-SEP-93
 PLOT= 70.00

GEOPHYSICS LAB METEOR SCATTER PROGRAM

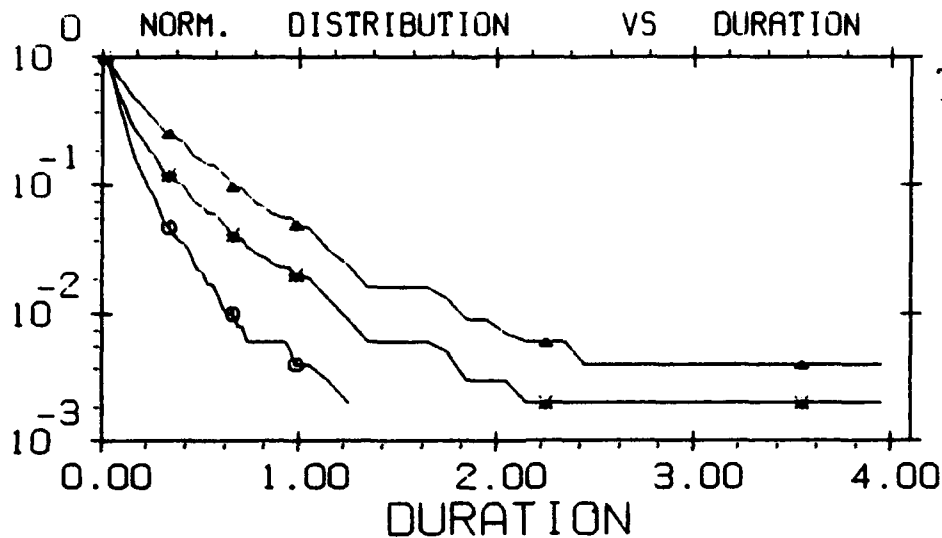

UNDERDENSE ⊙
 OVERDENSE △
 SPORADIC-E +
 ALL-TRAILS ×
 ALL-EVENTS ◇

EXCEEDING -126.0 DBM RSL
 THE TIME OF DAY IS 0 : 24 HOURS U.T.
 FREQUENCY - 104 MHZ
 BASED ON OBSERVED NOISE MEASUREMENTS - VERTICAL
 NORMALIZING FACTORS:
 UNDER - 1246. OVER - 678. SPOR-E - 0.
 TRAILS - 1924. EVENTS - 1924.

MENU#106,02-4
 21-SEP-93
 PLOT# 71.00

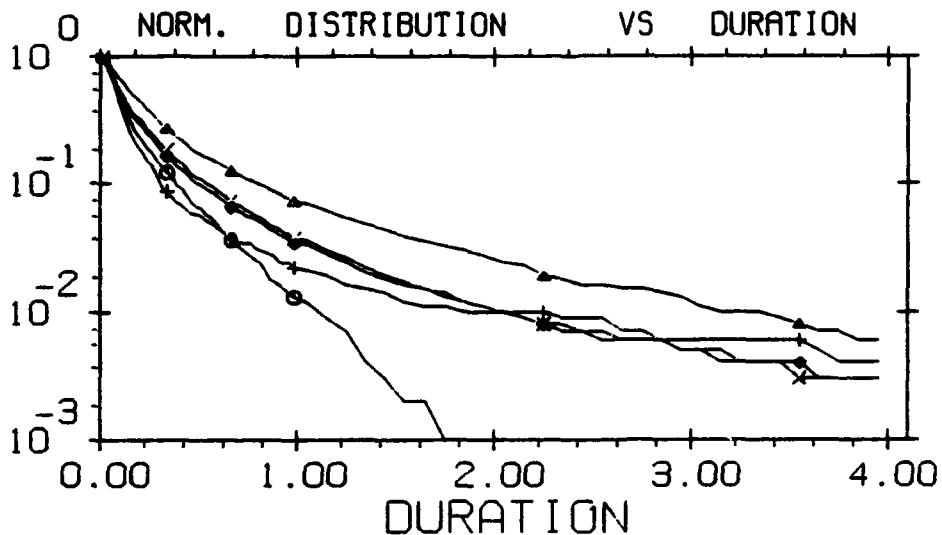

UNDERDENSE ⊙
 OVERDENSE △
 SPORADIC-E +
 ALL-TRAILS ×
 ALL-EVENTS ◇

EXCEEDING -126.0 DBM RSL
 THE TIME OF DAY IS 0 : 24 HOURS U.T.
 FREQUENCY - 147 MHZ
 BASED ON OBSERVED NOISE MEASUREMENTS - VERTICAL
 NORMALIZING FACTORS:
 UNDER - 5712. OVER - 3973. SPOR-E - 2326.
 TRAILS - 9685. EVENTS - 12011.

MENU#106,02-4
 21-SEP-93
 PLOT# 72.00

GEOPHYSICS LAB METEOR SCATTER PROGRAM

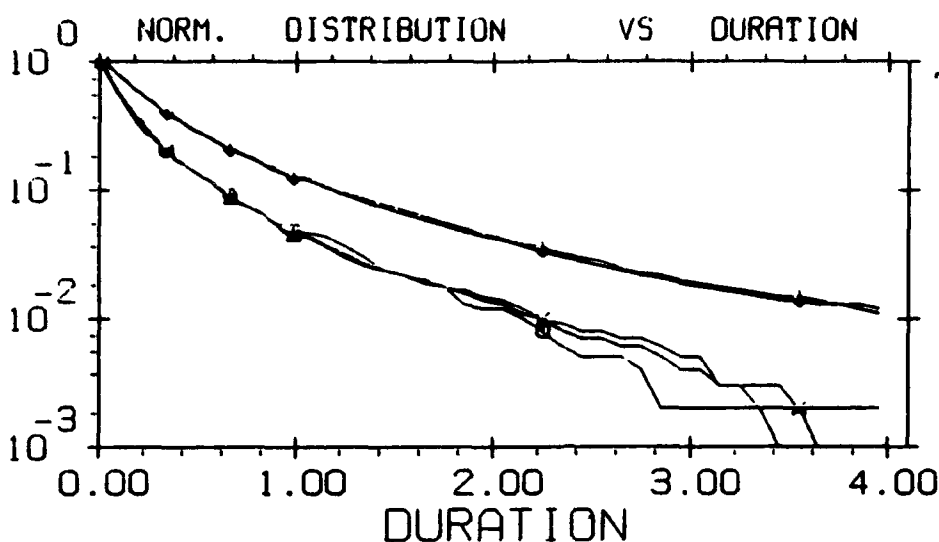

UNDERDENSE ○
 OVERDENSE △
 SPORADIC-E +
 ALL-TRAILS ×
 ALL-EVENTS ◇

EXCEEDING -116.0 DBM RSL
 THE TIME OF DAY IS 0 : 24 HOURS U.T.
 FREQUENCY - 35 MHZ
 BASED ON OBSERVED NOISE MEASUREMENTS - VERTICAL
 NORMALIZING FACTORS:
 UNDER - 1287. OVER - 2909. SPOR-E - 54604.
 TRAILS - 4196. EVENTS - 58800.

MENU#106,02-4
 21-SEP-93
 PLOT# 73.00

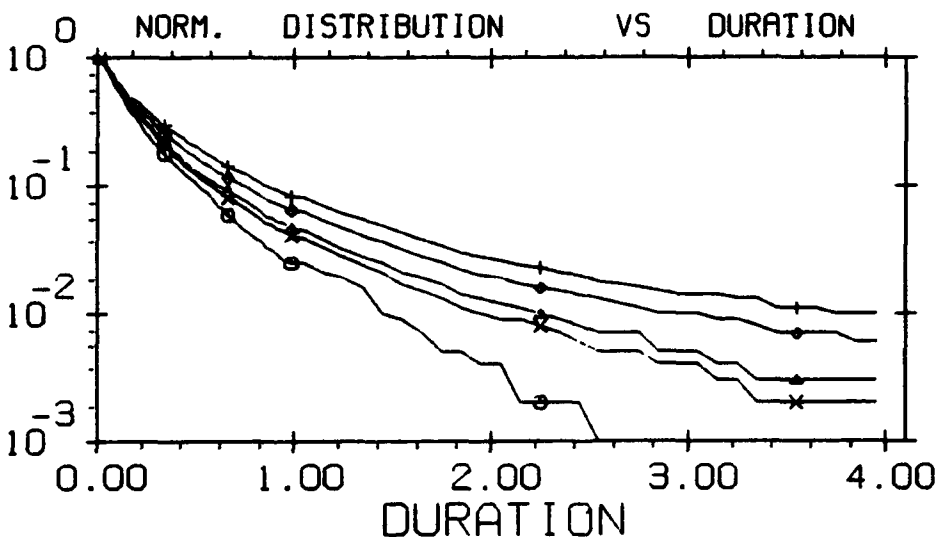

UNDERDENSE ○
 OVERDENSE △
 SPORADIC-E +
 ALL-TRAILS ×
 ALL-EVENTS ◇

EXCEEDING -116.0 DBM RSL
 THE TIME OF DAY IS 0 : 24 HOURS U.T.
 FREQUENCY - 45 MHZ
 BASED ON OBSERVED NOISE MEASUREMENTS - VERTICAL
 NORMALIZING FACTORS:
 UNDER - 1278. OVER - 2941. SPOR-E - 5520.
 TRAILS - 4219. EVENTS - 9739.

MENU#106,02-4
 21-SEP-93
 PLOT# 74.00

GEOPHYSICS LAB METEOR SCATTER PROGRAM

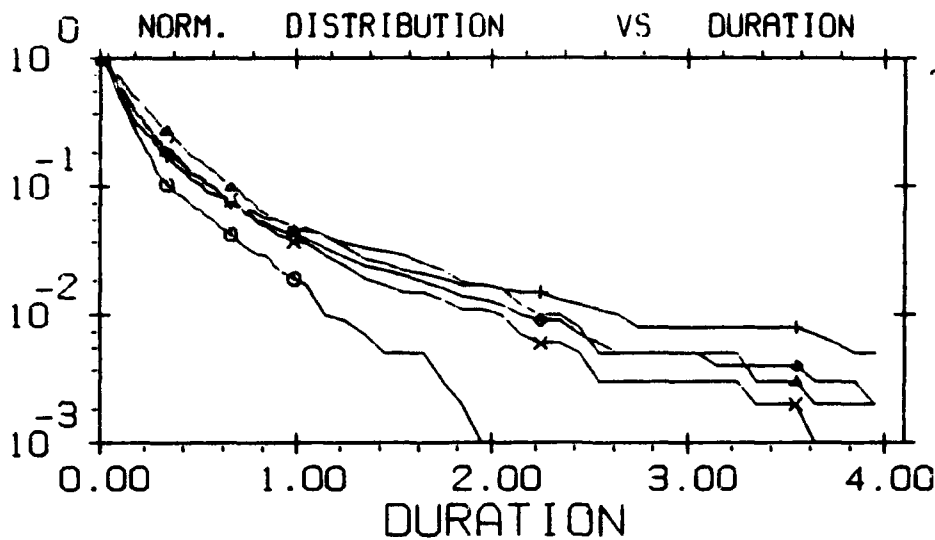

UNDERDENSE ⊙
 OVERDENSE ▲
 SPORADIC-E +
 ALL-TRAILS ×
 ALL-EVENTS ◇

EXCEEDING -116.0 DBM RSL
 THE TIME OF DAY IS 0 : 24 HOURS U.T.
 FREQUENCY - 65 MHZ
 BASED ON OBSERVED NOISE MEASUREMENTS - VERTICAL
 NORMALIZING FACTORS:
 UNDER - 1003. OVER - 1548. SPOR-E - 1295.
 TRAILS - 2551. EVENTS - 3846.

MENU#106,02-4
 21-SEP-93
 PLOT# 75.00

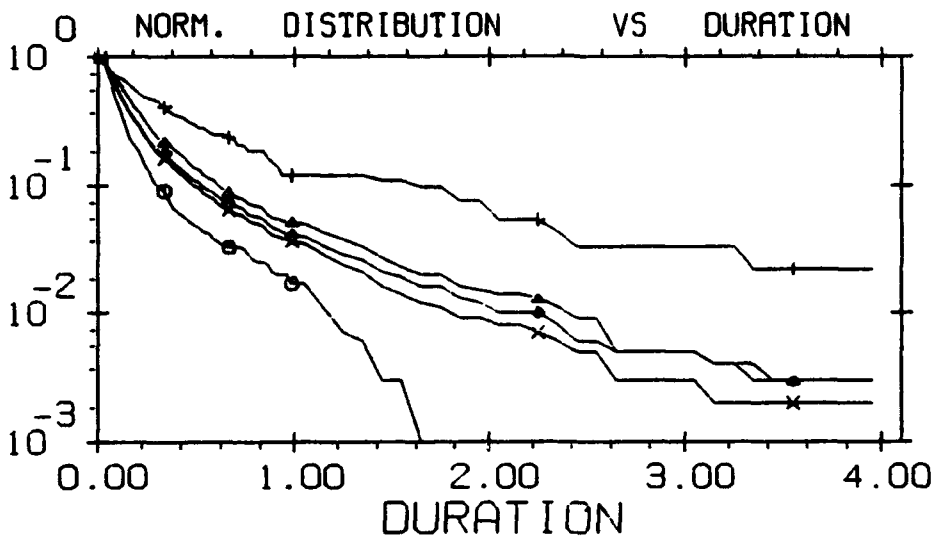

UNDERDENSE ⊙
 OVERDENSE ▲
 SPORADIC-E +
 ALL-TRAILS ×
 ALL-EVENTS ◇

EXCEEDING -116.0 DBM RSL
 THE TIME OF DAY IS 0 : 24 HOURS U.T.
 FREQUENCY - 85 MHZ
 BASED ON OBSERVED NOISE MEASUREMENTS - VERTICAL
 NORMALIZING FACTORS:
 UNDER - 717. OVER - 922. SPOR-E - 92.
 TRAILS - 1639. EVENTS - 1731.

MENU#106,02-4
 21-SEP-93
 PLOT# 76.00

GEOPHYSICS LAB METEOR SCATTER PROGRAM

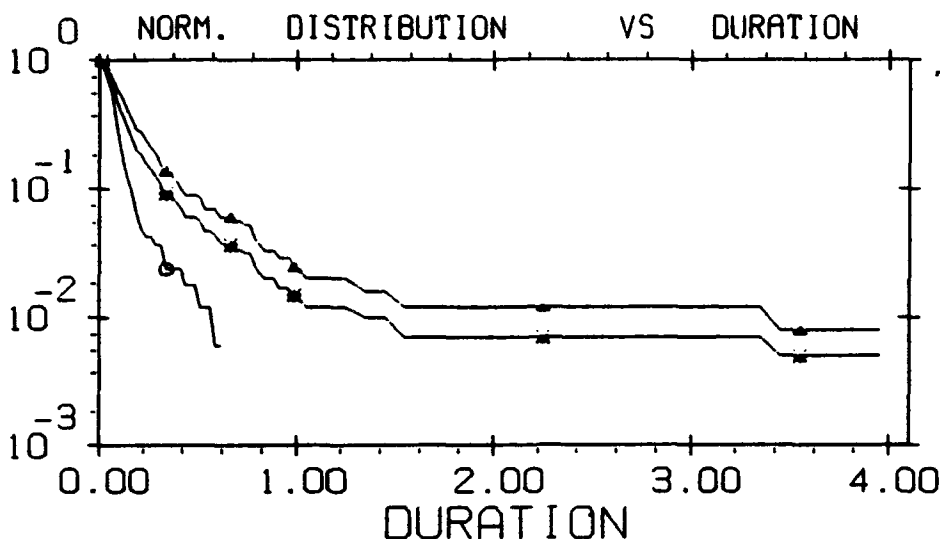

UNDERDENSE ⊙
 OVERDENSE △
 SPORADIC-E +
 ALL-TRAILS ×
 ALL-EVENTS ◇

EXCEEDING -116.0 DBM RSL
 THE TIME OF DAY IS 0 : 24 HOURS U.T.
 FREQUENCY - 104 MHZ
 BASED ON OBSERVED NOISE MEASUREMENTS - VERTICAL
 NORMALIZING FACTORS:
 UNDER - 164. OVER - 244. SPOR-E - 0.
 TRAILS - 408. EVENTS - 408.

MENU#106,02-4
 21-SEP-93
 PLOT# 77.00

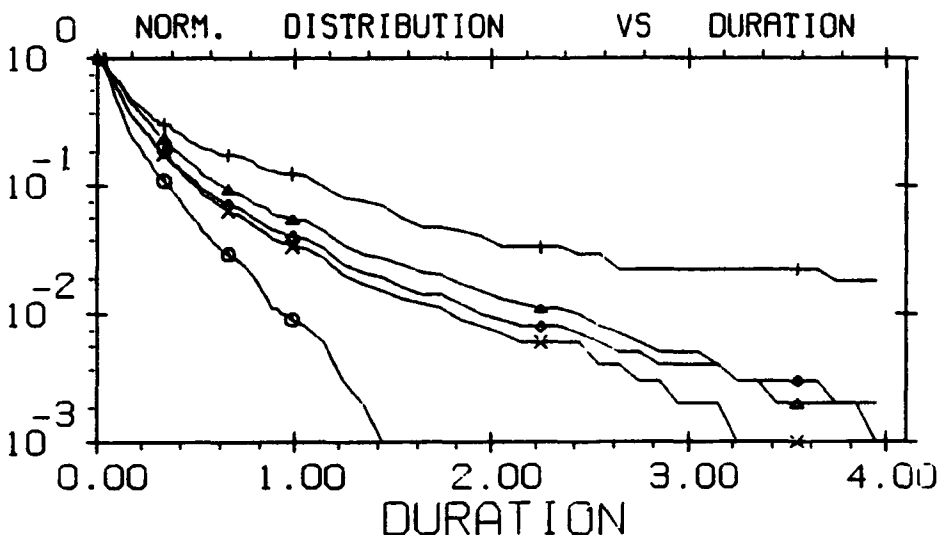

UNDERDENSE ⊙
 OVERDENSE △
 SPORADIC-E +
 ALL-TRAILS ×
 ALL-EVENTS ◇

EXCEEDING -116.0 DBM RSL
 THE TIME OF DAY IS 0 : 24 HOURS U.T.
 FREQUENCY - 147 MHZ
 BASED ON OBSERVED NOISE MEASUREMENTS - VERTICAL
 NORMALIZING FACTORS:
 UNDER - 1655. OVER - 1952. SPOR-E - 275.
 TRAILS - 3607. EVENTS - 3882.

MENU#106,02-4
 21-SEP-93
 PLOT# 78.00

GEOPHYSICS LAB METEOR SCATTER PROGRAM

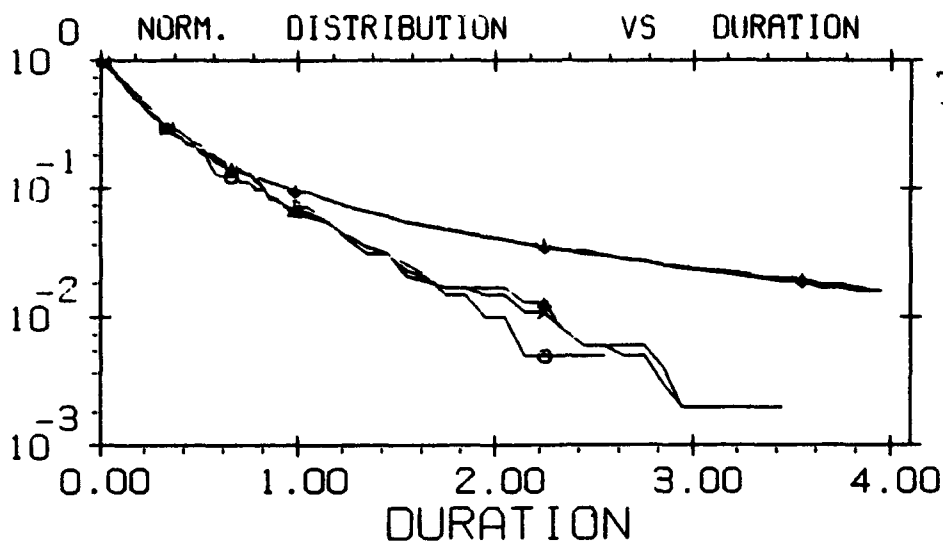

EXCEEDING -106.0 DBM RSL
 THE TIME OF DAY IS 0 : 24 HOURS U.T.
 FREQUENCY - 35 MHZ
 BASED ON OBSERVED NOISE MEASUREMENTS - VERTICAL
 NORMALIZING FACTORS:
 UNDER - 194. OVER - 472. SPOR-E - 13571.
 TRAILS - 666. EVENTS - 14237.

MENU#106,02-4
 21-SEP-93
 PLOT# 79.00

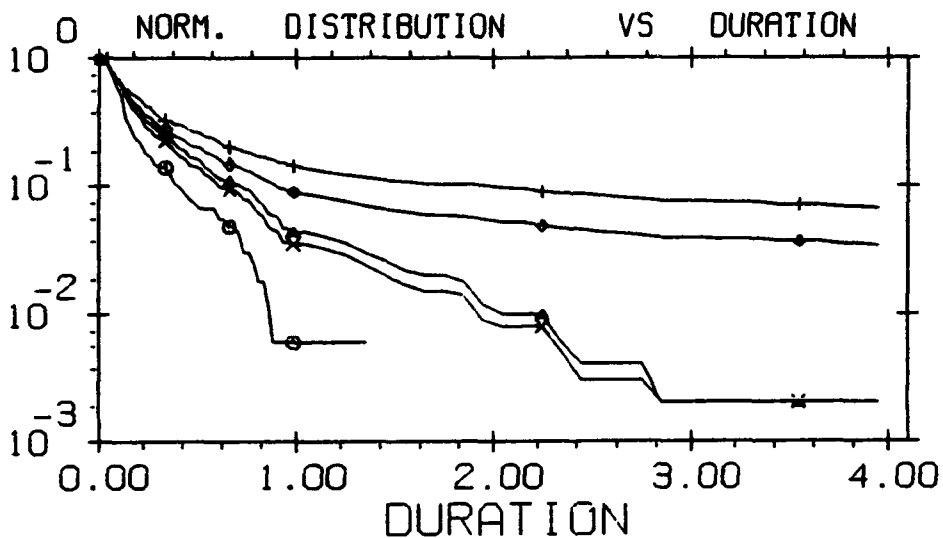

EXCEEDING -106.0 DBM RSL
 THE TIME OF DAY IS 0 : 24 HOURS U.T.
 FREQUENCY - 45 MHZ
 BASED ON OBSERVED NOISE MEASUREMENTS - VERTICAL
 NORMALIZING FACTORS:
 UNDER - 165. OVER - 495. SPOR-E - 675.
 TRAILS - 660. EVENTS - 1335.

MENU#106,02-4
 21-SEP-93
 PLOT# 80.00

GEOPHYSICS LAB METEOR SCATTER PROGRAM

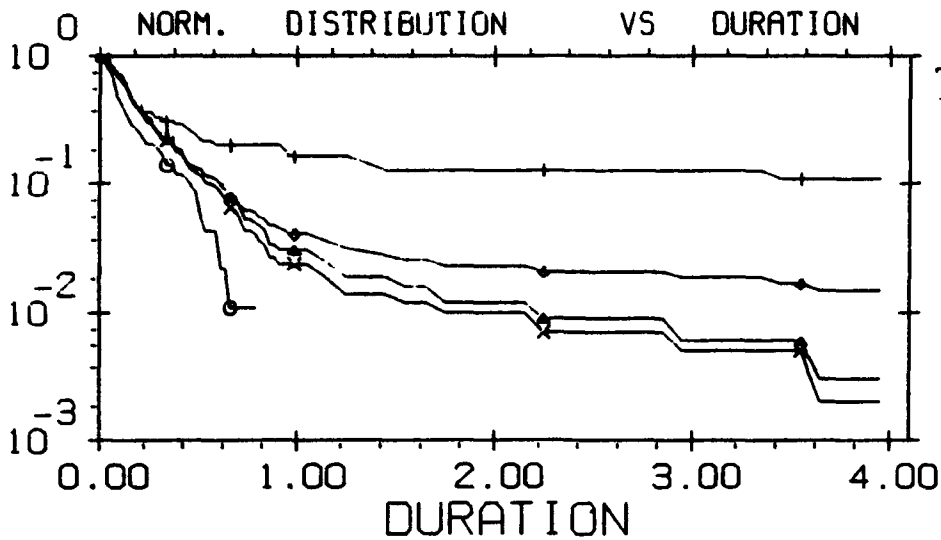

UNDERDENSE ⊙
 OVERDENSE △
 SPORADIC-E +
 ALL-TRAILS ×
 ALL-EVENTS ◇

EXCEEDING -106.0 DBM RSL
 THE TIME OF DAY IS 0 : 24 HOURS U.T.
 FREQUENCY - 65 MHZ
 BASED ON OBSERVED NOISE MEASUREMENTS - VERTICAL
 NORMALIZING FACTORS:
 UNDER - 93. OVER - 321. SPOR-E - 55.
 TRAILS - 414. EVENTS - 469.

MENU#106,02-4
 21-SEP-93
 PLOT# 81.00

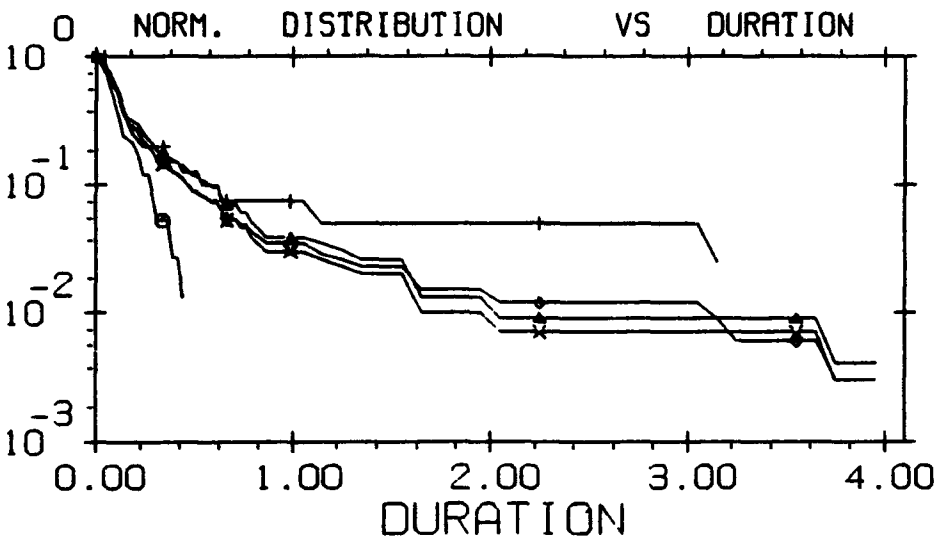

UNDERDENSE ⊙
 OVERDENSE △
 SPORADIC-E +
 ALL-TRAILS ×
 ALL-EVENTS ◇

EXCEEDING -106.0 DBM RSL
 THE TIME OF DAY IS 0 : 24 HOURS U.T.
 FREQUENCY - 85 MHZ
 BASED ON OBSERVED NOISE MEASUREMENTS - VERTICAL
 NORMALIZING FACTORS:
 UNDER - 75. OVER - 229. SPOR-E - 40.
 TRAILS - 304. EVENTS - 344.

MENU#106,02-4
 21-SEP-93
 PLOT# 82.00

GEOPHYSICS LAB METEOR SCATTER PROGRAM

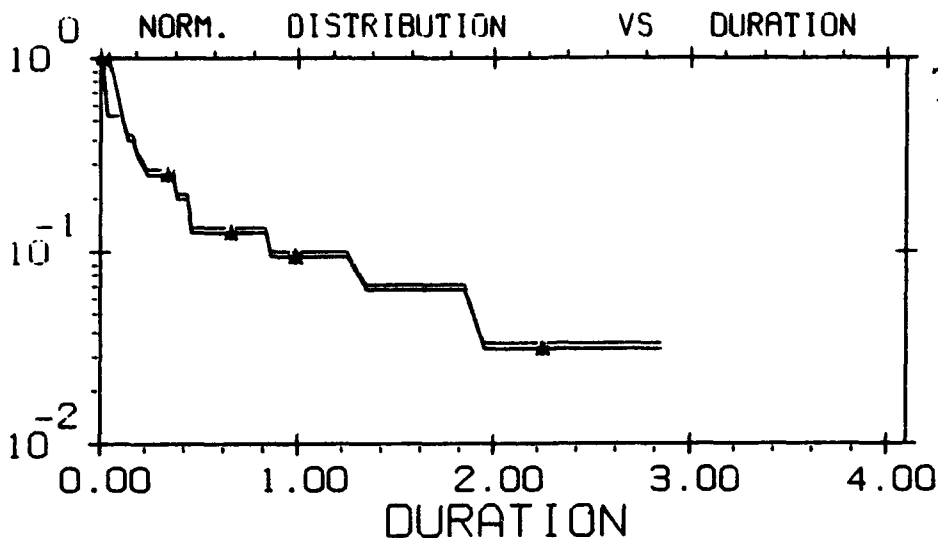

UNDERDENSE ⊙
 OVERDENSE △
 SPORADIC-E +
 ALL-TRAILS ×
 ALL-EVENTS ◇

EXCEEDING -106.0 DBM RSL
 THE TIME OF DAY IS 0 : 24 HOURS U.T.
 FREQUENCY - 104 MHZ
 BASED ON OBSERVED NOISE MEASUREMENTS - VERTICAL
 NORMALIZING FACTORS:
 UNDER - 2. OVER - 30. SPOR-E - 0.
 TRAILS - 32. EVENTS - 32.

MENU#106,02-4
 21-SEP-93
 PLOT# 83.00

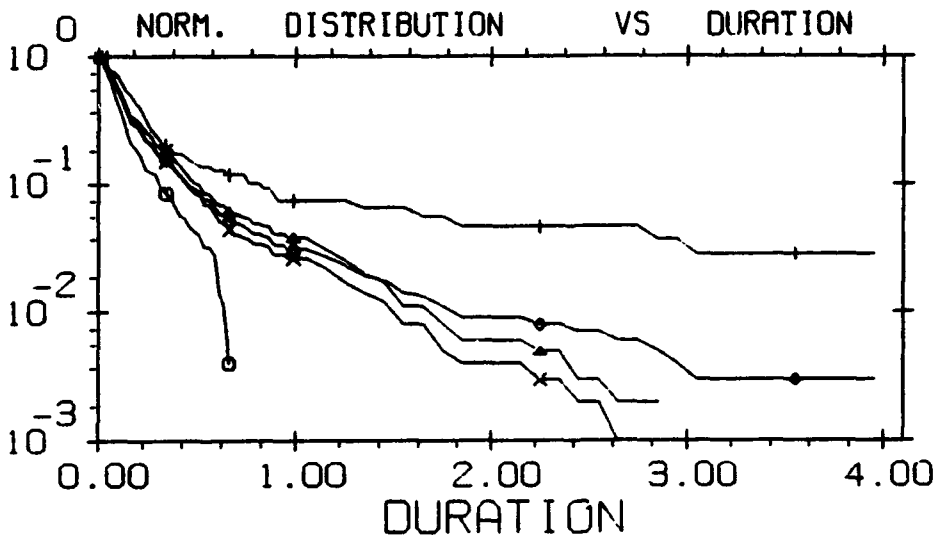

UNDERDENSE ⊙
 OVERDENSE △
 SPORADIC-E +
 ALL-TRAILS ×
 ALL-EVENTS ◇

EXCEEDING -106.0 DBM RSL
 THE TIME OF DAY IS 0 : 24 HOURS U.T.
 FREQUENCY - 147 MHZ
 BASED ON OBSERVED NOISE MEASUREMENTS - VERTICAL
 NORMALIZING FACTORS:
 UNDER - 283. OVER - 635. SPOR-E - 108.
 TRAILS - 918. EVENTS - 1026.

MENU#106,02-4
 21-SEP-93
 PLOT# 84.00

GEOPHYSICS LAB METEOR SCATTER PROGRAM

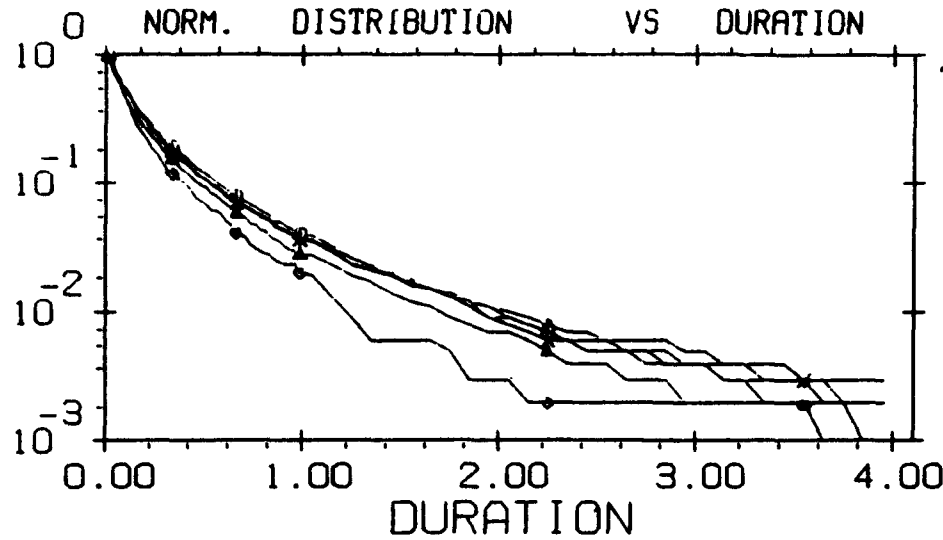

EXCEEDING -126.0 DBM RSL
 THE TIME OF DAY IS 0 : 24 HOURS U.T.
 THE EVENT CLASS IS UNDERDENSE AND OVERDENSE TRAILS
 BASED ON OBSERVED NOISE MEASUREMENTS - VERTICAL
 NORMALIZING FACTORS:
 35MHZ - 12058. 45MHZ - 16210. 65MHZ - 8309.
 85MHZ - 4824. 104MHZ - 1924. 147MHZ - 9685.

MENU=106,01-4
 21-SEP-93
 PLOT= 85.00

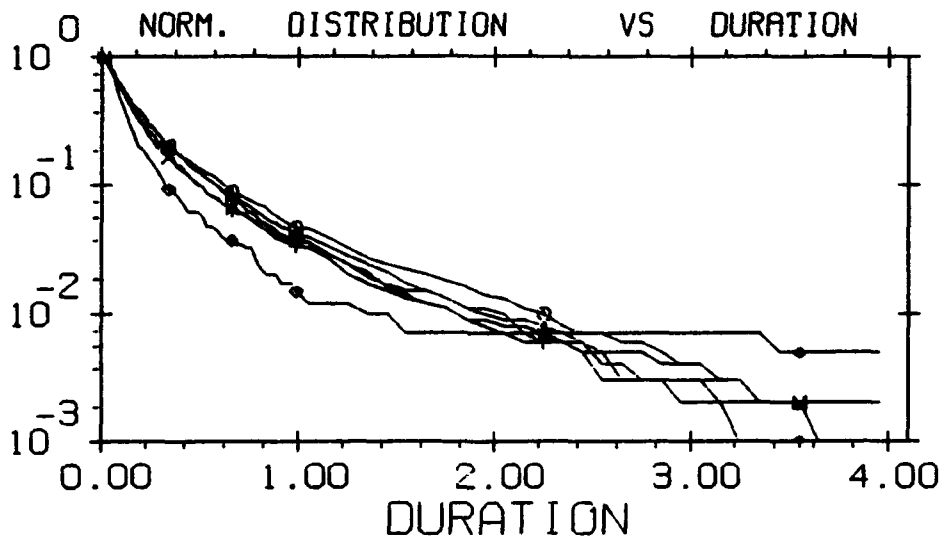

EXCEEDING -116.0 DBM RSL
 THE TIME OF DAY IS 0 : 24 HOURS U.T.
 THE EVENT CLASS IS UNDERDENSE AND OVERDENSE TRAILS
 BASED ON OBSERVED NOISE MEASUREMENTS - VERTICAL
 NORMALIZING FACTORS:
 35MHZ - 4196. 45MHZ - 4219. 65MHZ - 2551.
 85MHZ - 1639. 104MHZ - 408. 147MHZ - 3607.

MENU=106,01-4
 21-SEP-93
 PLOT= 86.00

GEOPHYSICS LAB METEOR SCATTER PROGRAM

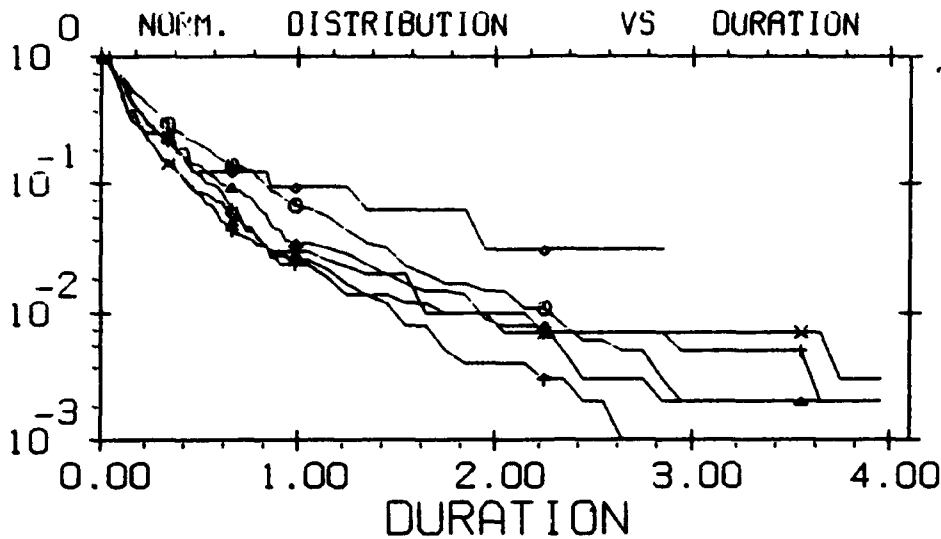

35 MHZ	⊙
45 MHZ	△
65 MHZ	+
85 MHZ	×
104 MHZ	◇
147 MHZ	*

EXCEEDING -106.0 DBM RSL
 THE TIME OF DAY IS 0 : 24 HOURS U.T.
 THE EVENT CLASS IS UNDERDENSE AND OVERDENSE TRAILS
 BASED ON OBSERVED NOISE MEASUREMENTS - VERTICAL
 NORMALIZING FACTORS:
 35MHZ - 666. 45MHZ - 660. 65MHZ - 414.
 85MHZ - 304. 104MHZ - 32. 147MHZ - 918.

MENU#106,01-4
 21-SEP-93
 PLOT# 87.00

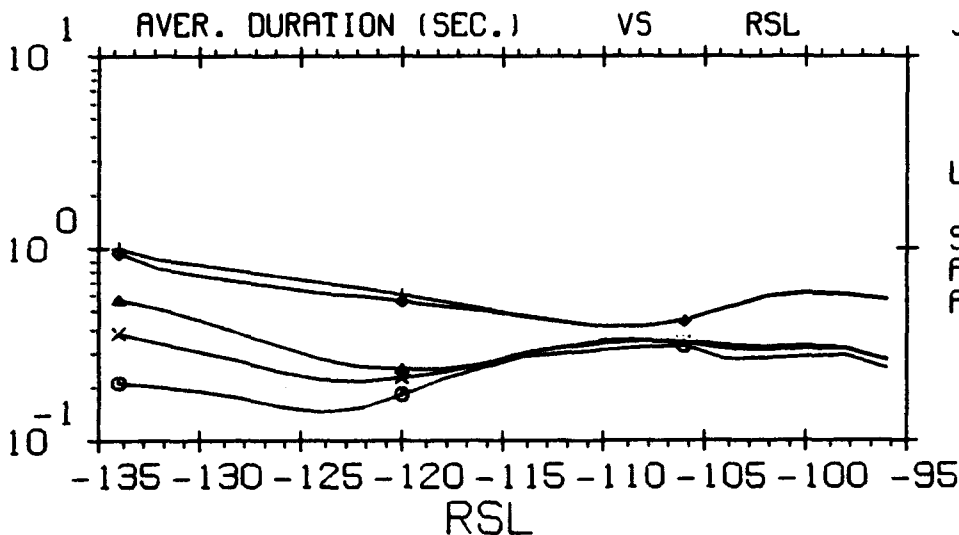

UNDERDENSE	⊙
OVERDENSE	△
SPORADIC-E	+
ALL-TRAILS	×
ALL-EVENTS	◇

THE TIME OF DAY IS 0 : 24 HOURS U.T.
 FREQUENCY - 35 MHZ
 BASED ON OBSERVED NOISE MEASUREMENTS - VERTICAL

MENU#106,06-1
 21-SEP-93
 PLOT# 88.00

GEOPHYSICS LAB METEOR SCATTER PROGRAM

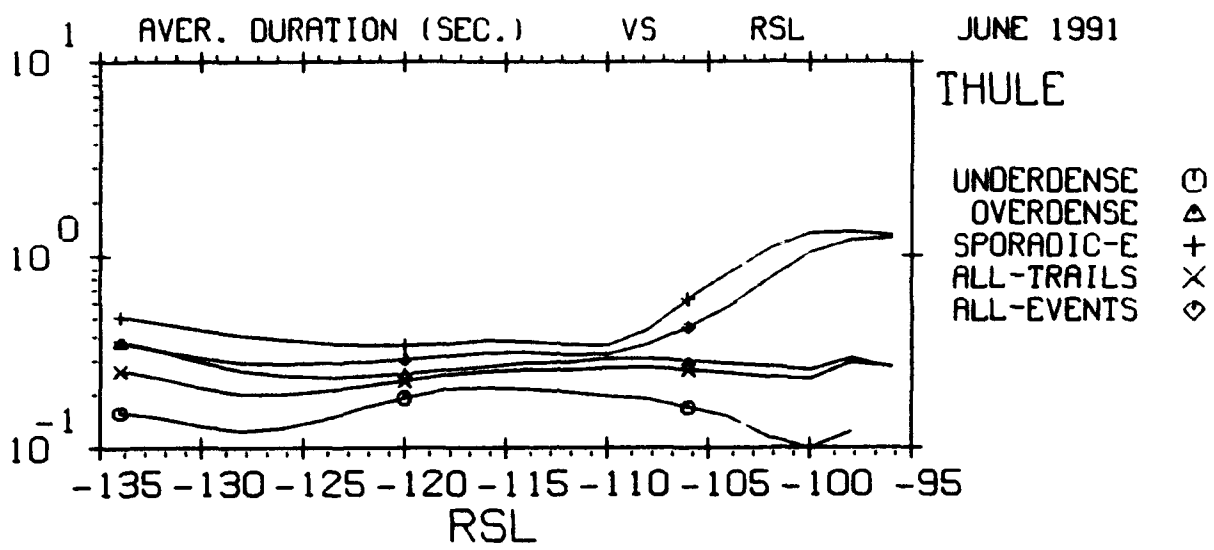

THE TIME OF DAY IS 0 : 24 HOURS U.T.
 FREQUENCY - 45 MHZ
 BASED ON OBSERVED NOISE MEASUREMENTS - VERTICAL

MENU#106,06-1
 21-SEP-93
 PLOT# 89.00

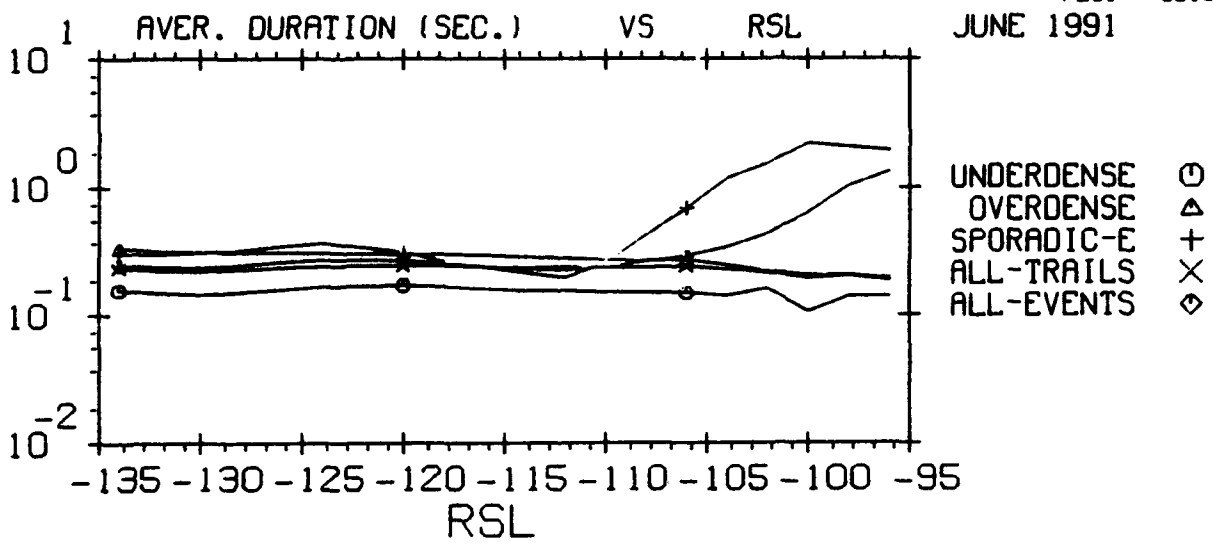

THE TIME OF DAY IS 0 : 24 HOURS U.T.
 FREQUENCY - 65 MHZ
 BASED ON OBSERVED NOISE MEASUREMENTS - VERTICAL

MENU#106,06-1
 21-SEP-93
 PLOT# 90.00

GEOPHYSICS LAB METEOR SCATTER PROGRAM

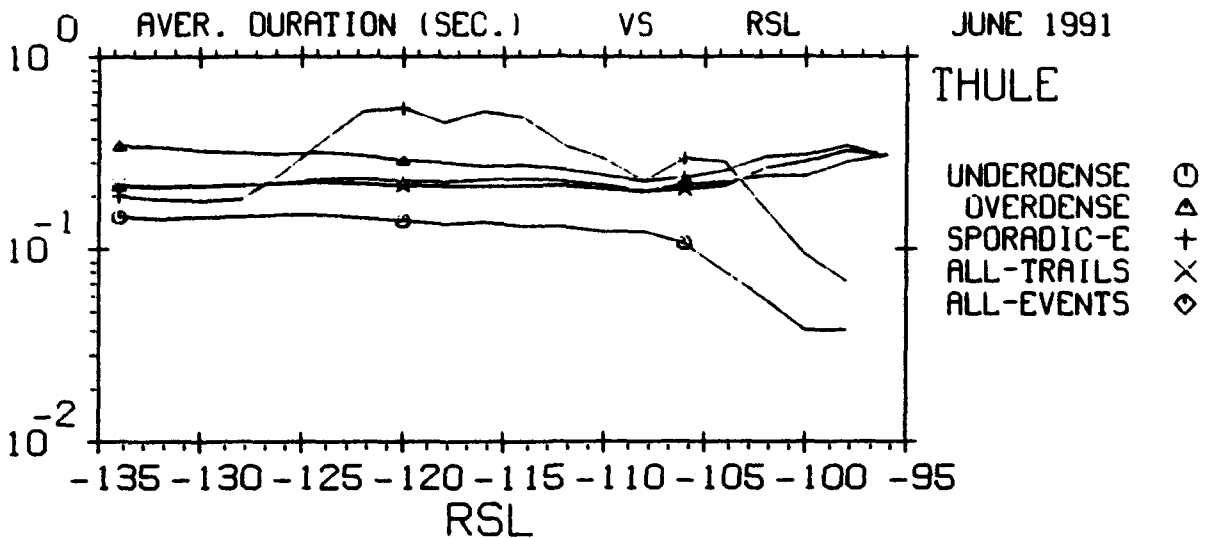

THE TIME OF DAY IS 0 : 24 HOURS U.T.
 FREQUENCY - 85 MHZ
 BASED ON OBSERVED NOISE MEASUREMENTS - VERTICAL

MENU#106,06-1
 21-SEP-93
 PLOT# 91.00

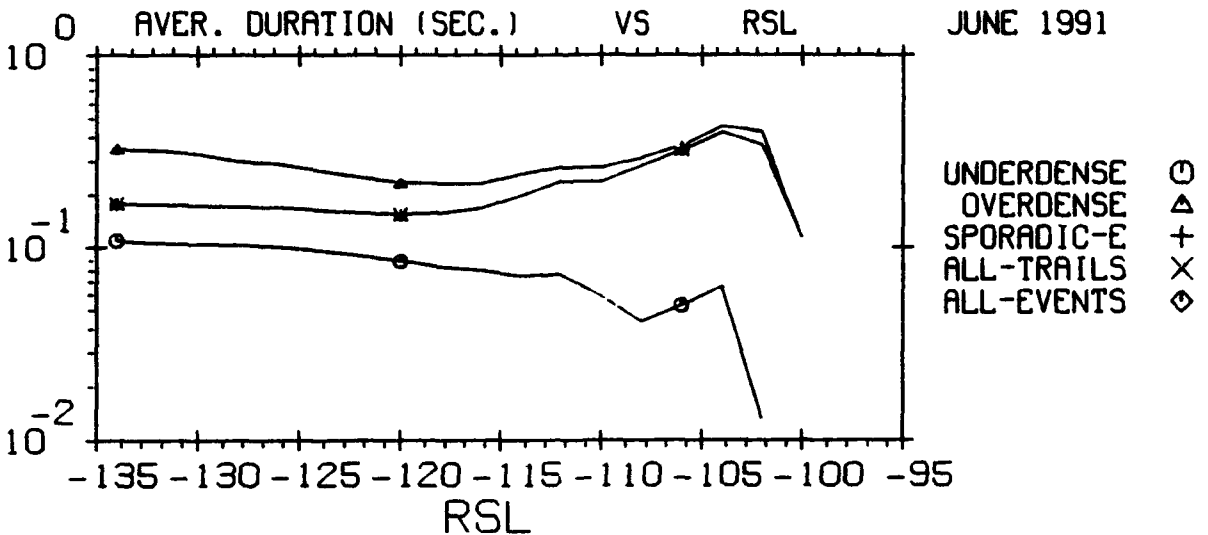

THE TIME OF DAY IS 0 : 24 HOURS U.T.
 FREQUENCY - 104 MHZ
 BASED ON OBSERVED NOISE MEASUREMENTS - VERTICAL

MENU#106,06-1
 21-SEP-93
 PLOT# 92.00

GEOPHYSICS LAB METEOR SCATTER PROGRAM

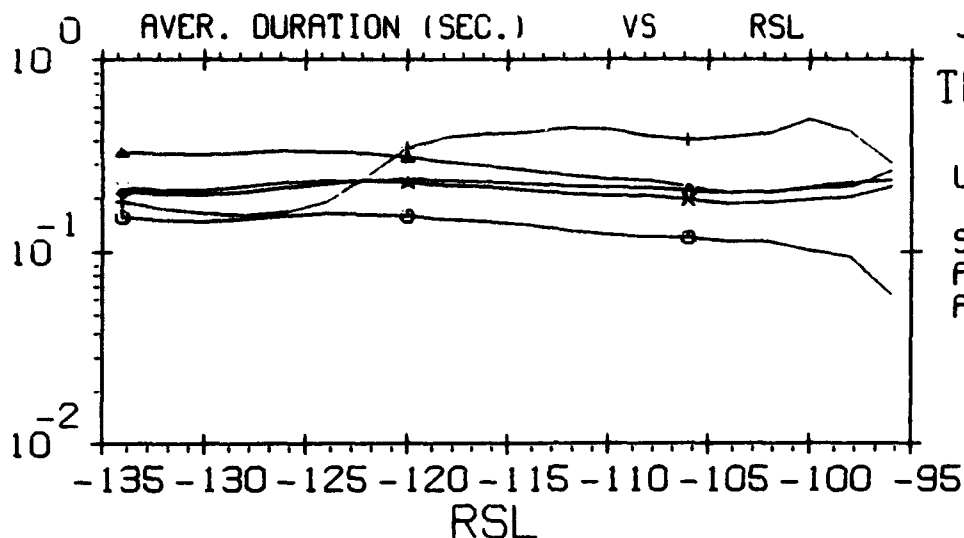

UNDERDENSE ⊙
 OVERDENSE △
 SPORADIC-E +
 ALL-TRAILS ×
 ALL-EVENTS ◇

THE TIME OF DAY IS 0 : 24 HOURS U.T.
 FREQUENCY = 147 MHZ
 BASED ON OBSERVED NOISE MEASUREMENTS - VERTICAL

MENU=106,06-1
 21-SEP-93
 PLOT= 93.00

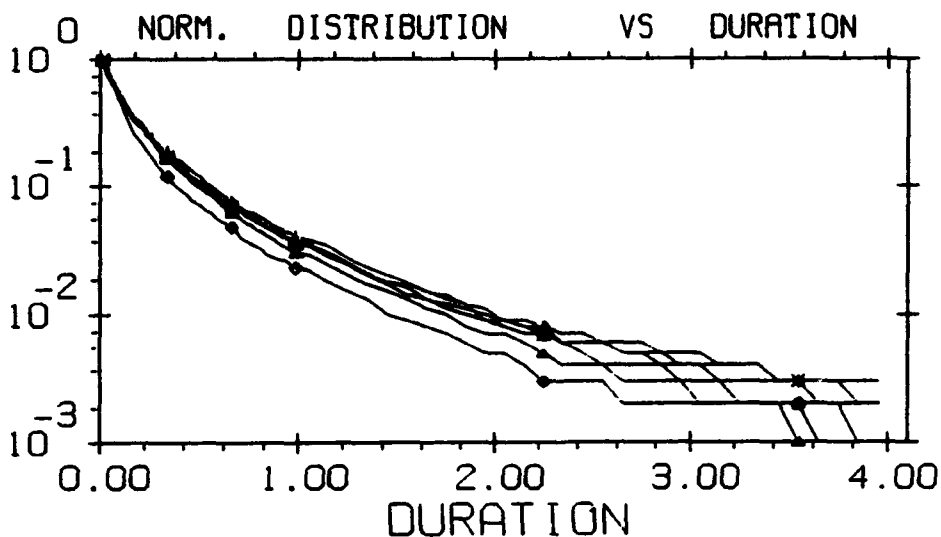

35 MHZ ⊙
 45 MHZ △
 65 MHZ +
 85 MHZ ×
 104 MHZ ◇
 147 MHZ ♣

EXCEEDING 19.0 DB SNR
 THE TIME OF DAY IS 0 : 24 HOURS U.T.
 THE EVENT CLASS IS UNDERDENSE AND OVERDENSE TRAILS
 EFFECTIVE SYSTEM BANDWIDTH = 100.HZ
 BASED ON OBSERVED NOISE MEASUREMENTS - VERTICAL
 NORMALIZING FACTORS:

35MHZ - 8873. 45MHZ - 12616. 65MHZ - 9391.
 85MHZ - 6214. 104MHZ - 2717. 147MHZ - 8873.

MENU=107,01-4
 21-SEP-93
 PLOT= 94.00

GEOPHYSICS LAB METEOR SCATTER PROGRAM

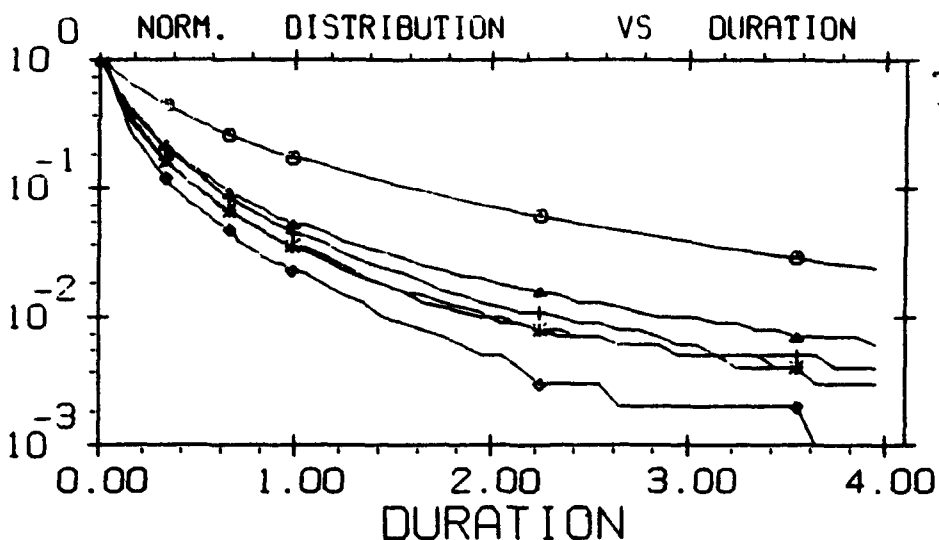

- 35 MHZ ○
- 45 MHZ △
- 65 MHZ +
- 85 MHZ ×
- 104 MHZ ◇
- 147 MHZ †

EXCEEDING 19.0 DB SNR
 THE TIME OF DAY IS 0 : 24 HOURS U.T.
 THE EVENT CLASS IS SPORADIC-E AND METEOR TRAILS
 EFFECTIVE SYSTEM BANDWIDTH - 100.HZ
 BASED ON OBSERVED NOISE MEASUREMENTS - VERTICAL
 NORMALIZING FACTORS:
 35MHZ - 65931. 45MHZ - 25953. 65MHZ - 11932.
 85MHZ - 7048. 104MHZ - 2717. 147MHZ - 10914.

MENU=107,01-4
 21-SEP-93
 PLOT= 95.00

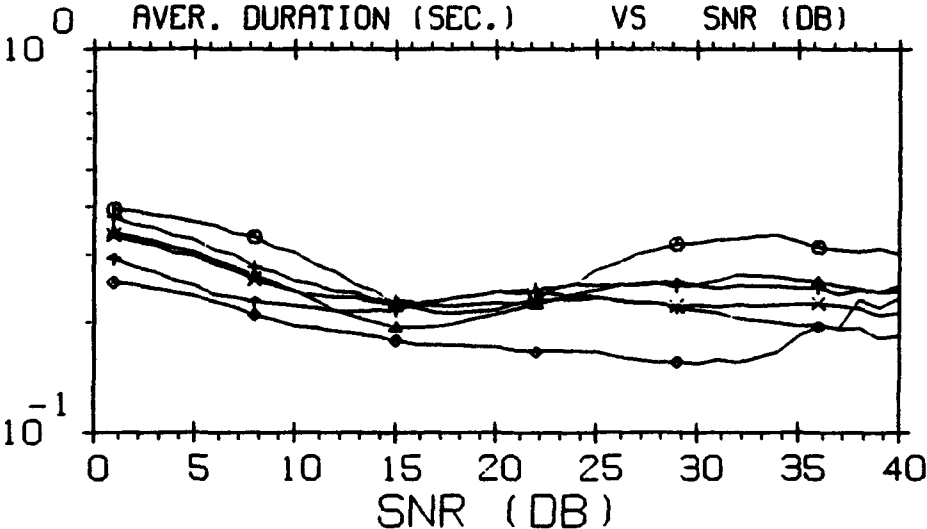

- 35 MHZ ○
- 45 MHZ △
- 65 MHZ +
- 85 MHZ ×
- 104 MHZ ◇
- 147 MHZ †

THE TIME OF DAY IS 0 : 24 HOURS U.T.
 THE EVENT CLASS IS UNDERDENSE AND OVERDENSE TRAILS
 EFFECTIVE SYSTEM BANDWIDTH - 100.HZ
 BASED ON OBSERVED NOISE MEASUREMENTS - VERTICAL

MENU=107,05-1
 21-SEP-93
 PLOT= 96.00

GEOPHYSICS LAB METEOR SCATTER PROGRAM

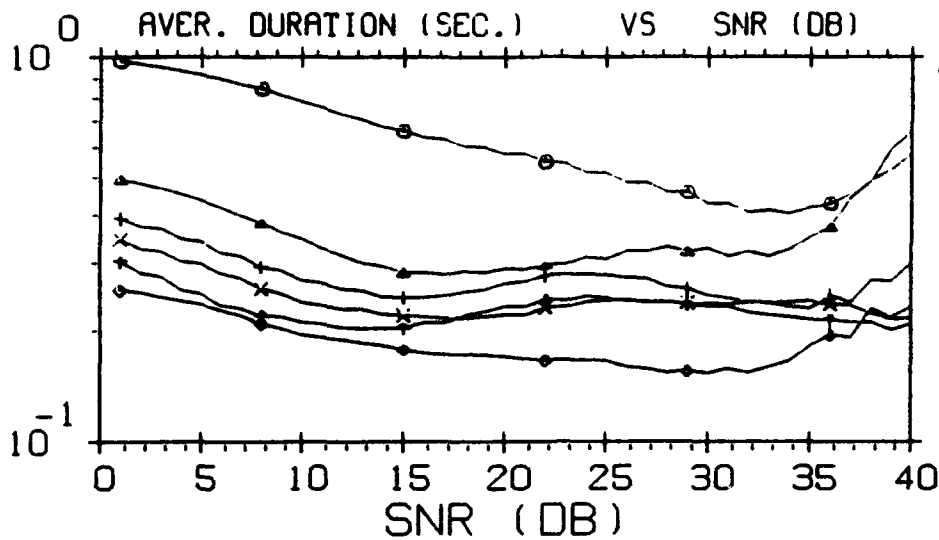

THE TIME OF DAY IS 0 : 24 HOURS U.T.
 THE EVENT CLASS IS SPORADIC-E AND METEOR TRAILS
 EFFECTIVE SYSTEM BANDWIDTH - 100.HZ
 BASED ON OBSERVED NOISE MEASUREMENTS - VERTICAL

MENU=107,05-1
 21-SEP-93
 PLOT= 97.00

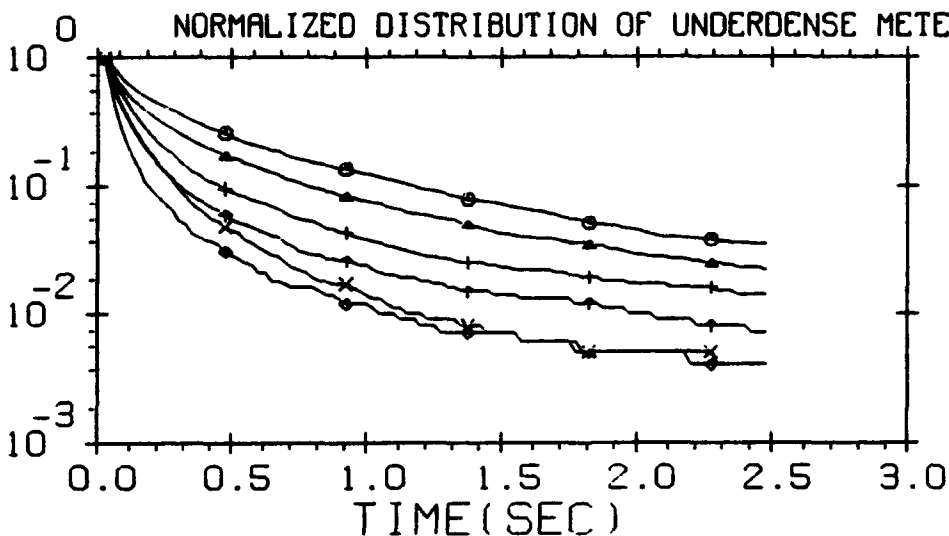

JUNE 1991
 THE TIME OF DAY IS 0 : 24 HOURS U.T.
 BASED ON OBSERVED NOISE MEASUREMENTS - VERTICAL
 NORMALIZING FACTORS:
 35MHZ - 2400. 45MHZ - 4309. 65MHZ - 4723.
 85MHZ - 3746. 104MHZ - 1910. 147MHZ - 7198.

MENU=108,01-4
 21-SEP-93
 PLOT= 98.00

GEOPHYSICS LAB METEOR SCATTER PROGRAM

AVERAGE UNDERDENSE TIME CONSTANT VS TIME FOR JUNE 1991

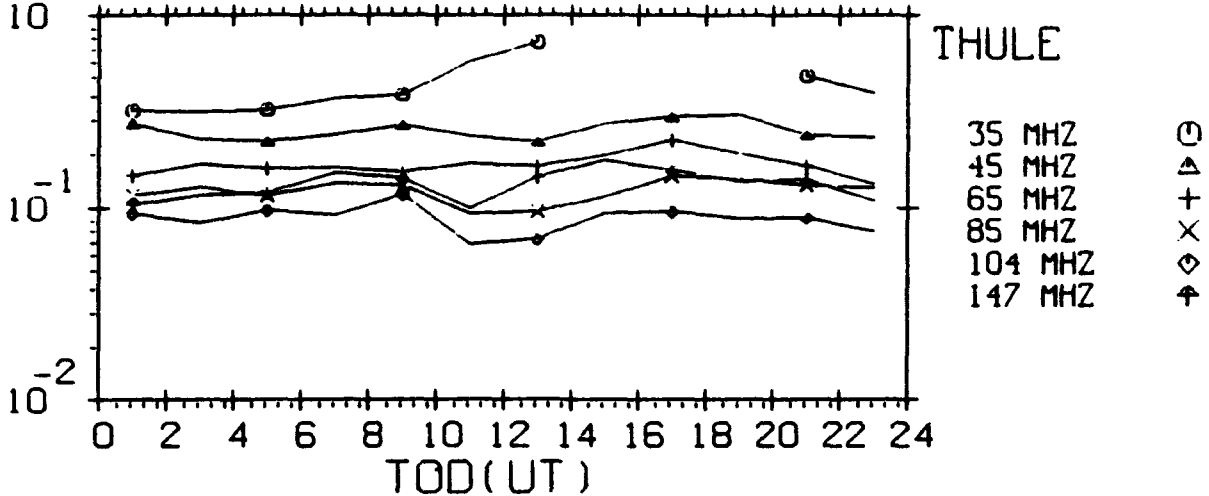

BASED ON OBSERVED NOISE MEASUREMENTS - VERTICAL
 THE 24 HOUR AVERAGE TIME CONSTANTS ARE
 0.338 0.252 0.174 0.123 0.089 0.135

MENU#108,02-1
 21-SEP-93
 PLOT# 99.00

NORMALIZED DISTRIBUTION OF FADES/SECOND FOR JUNE 1991

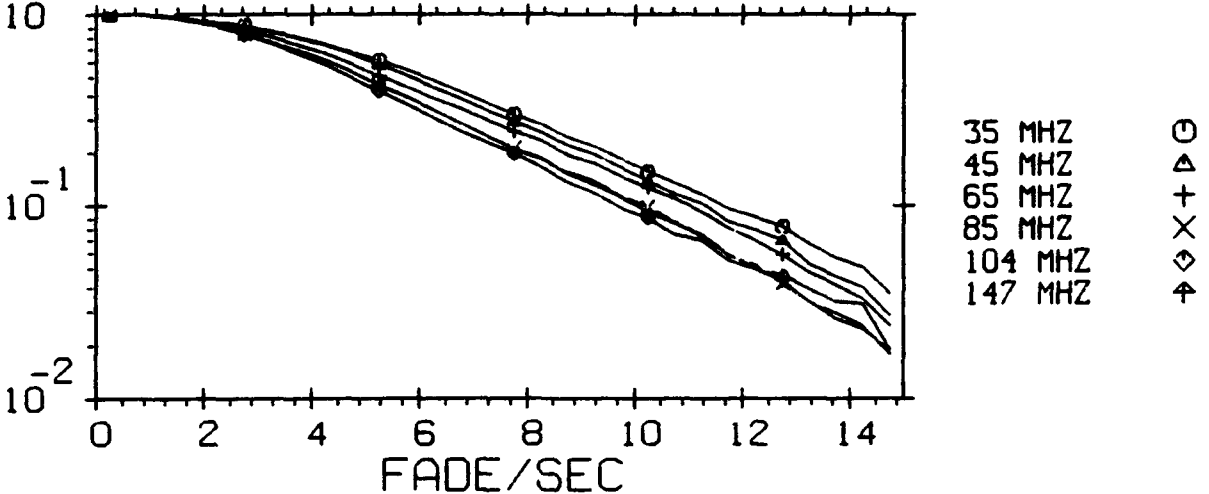

THE TIME OF DAY IS 0 : 24 HOURS U.T.
 THE EVENT CLASS IS UNDERDENSE AND OVERDENSE TRAILS
 NORMALIZING FACTORS:
 35MHZ - 9576. 45MHZ - 8425. 65MHZ - 9657.
 85MHZ - 5208. 104MHZ - 1365. 147MHZ - 10343.

MENU#109,01-4
 21-SEP-93
 PLOT# 100.00

GEOPHYSICS LAB METEOR SCATTER PROGRAM

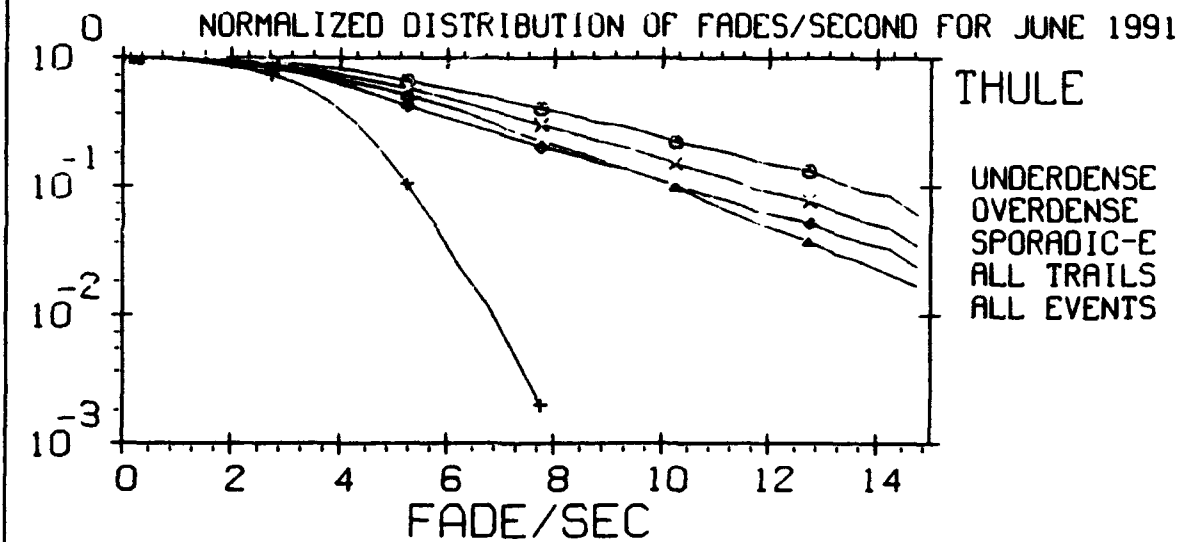

THE TIME OF DAY IS 0 : 24 HOURS U.T.
 FREQUENCY - 35 MHZ
 NORMALIZING FACTORS:
 UNDER - 3986. OVER - 5590. SPOR-E - 4503.
 TRAILS - 9576. EVENTS - 14079.

MENU# 109,02-4
 21-SEP-93
 PLOT# 101.00

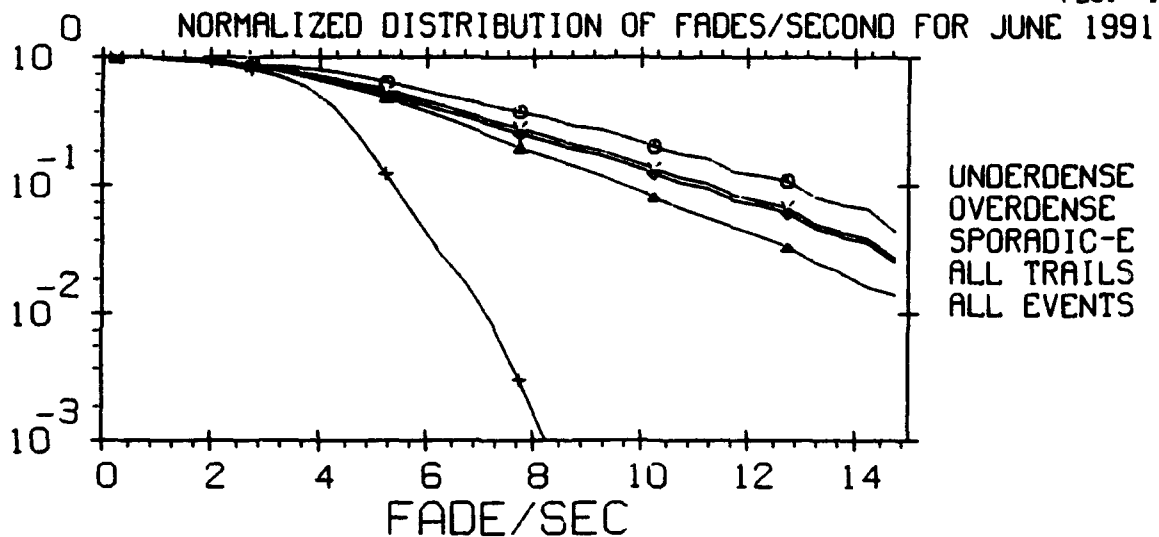

THE TIME OF DAY IS 0 : 24 HOURS U.T.
 FREQUENCY - 45 MHZ
 NORMALIZING FACTORS:
 UNDER - 3792. OVER - 4633. SPOR-E - 771.
 TRAILS - 8425. EVENTS - 9196.

MENU# 109,02-4
 21-SEP-93
 PLOT# 102.00

GEOPHYSICS LAB METEOR SCATTER PROGRAM

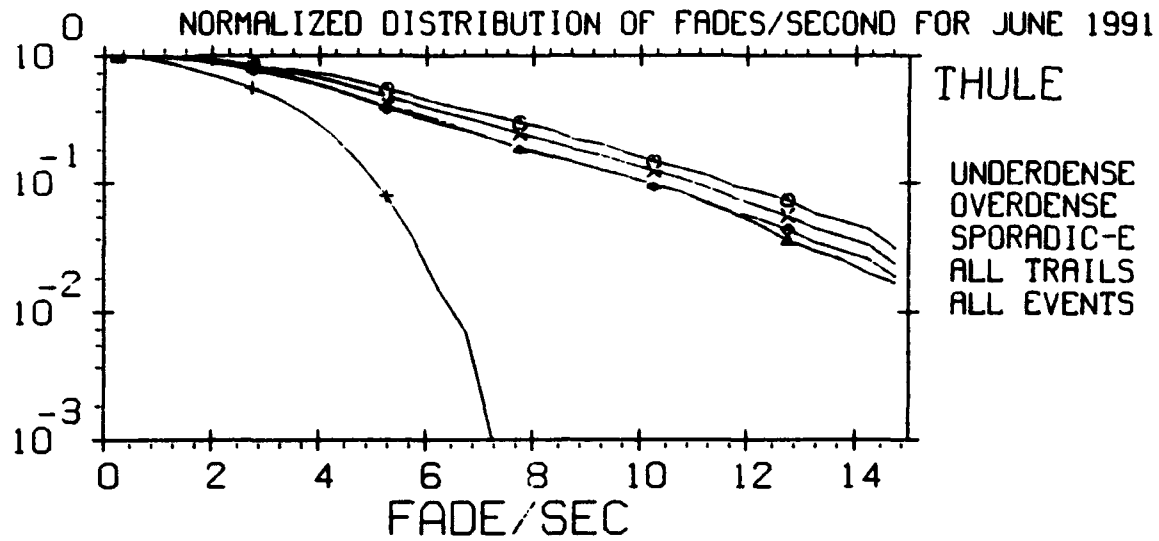

THE TIME OF DAY IS 0 : 24 HOURS U.T.
 FREQUENCY - 65 MHZ
 NORMALIZING FACTORS:
 UNDER - 4941. OVER - 4716. SPOR-E - 2603.
 TRAILS - 9657. EVENTS - 12260.

MENU#109,02-4
 21-SEP-93
 PLOT# 103.00

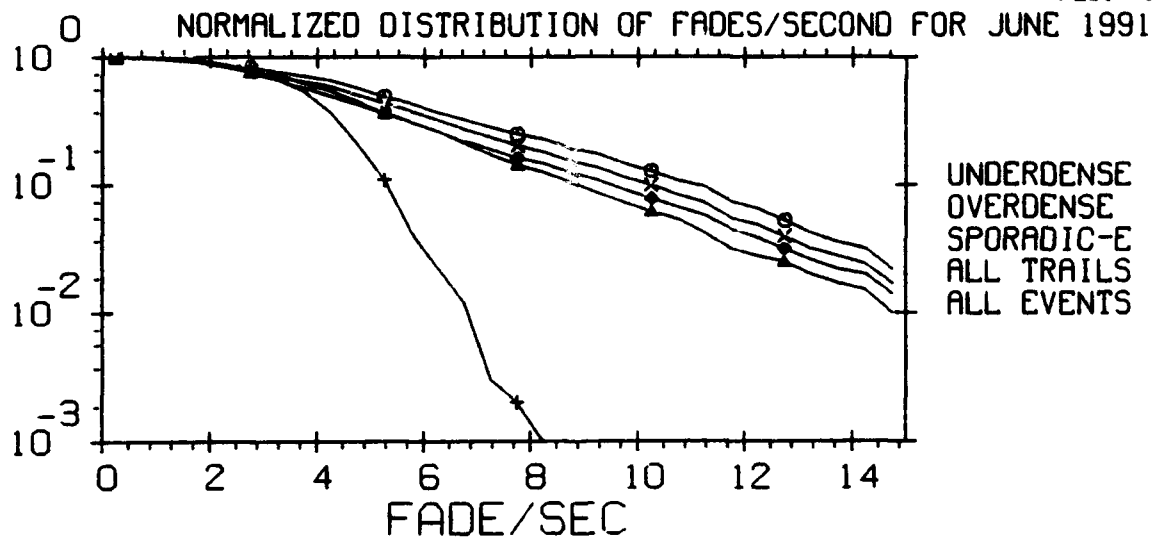

THE TIME OF DAY IS 0 : 24 HOURS U.T.
 FREQUENCY - 85 MHZ
 NORMALIZING FACTORS:
 UNDER - 2889. OVER - 2319. SPOR-E - 1282.
 TRAILS - 5208. EVENTS - 6490.

MENU#109,02-4
 21-SEP-93
 PLOT# 104.00

GEOPHYSICS LAB METEOR SCATTER PROGRAM

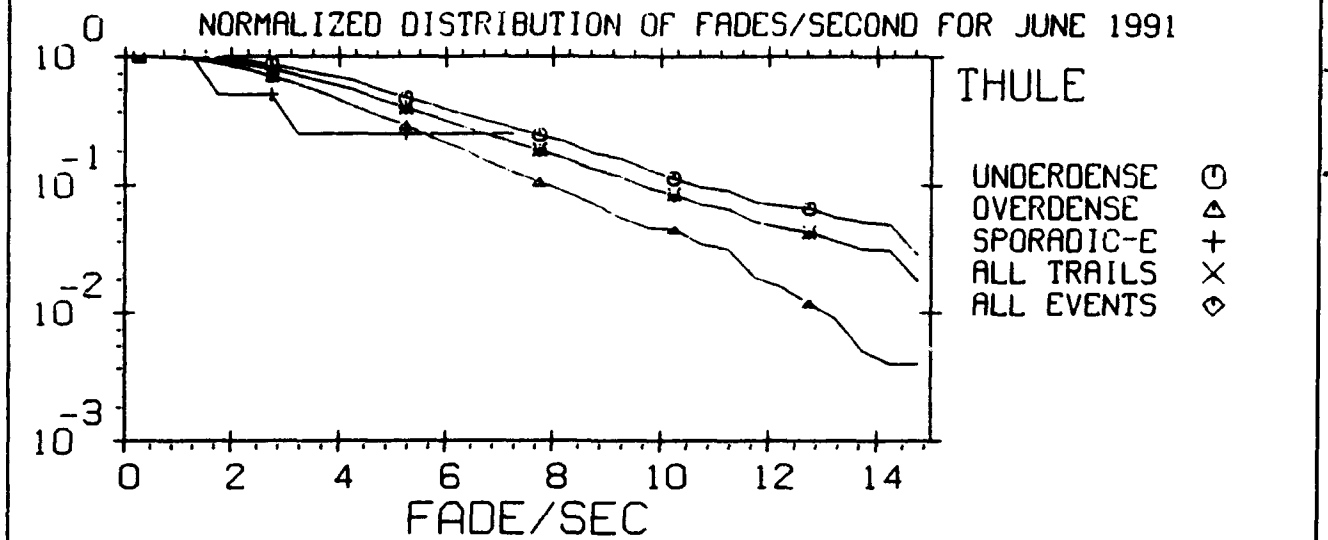

THE TIME OF DAY IS 0 : 24 HOURS U.T.
 FREQUENCY - 104 MHZ
 NORMALIZING FACTORS:
 UNDER - 795. OVER - 570. SPOR-E - 4.
 TRAILS - 1365. EVENTS - 1369.

MENU#109,02-4
 21-SEP-93
 PLOT# 105.00

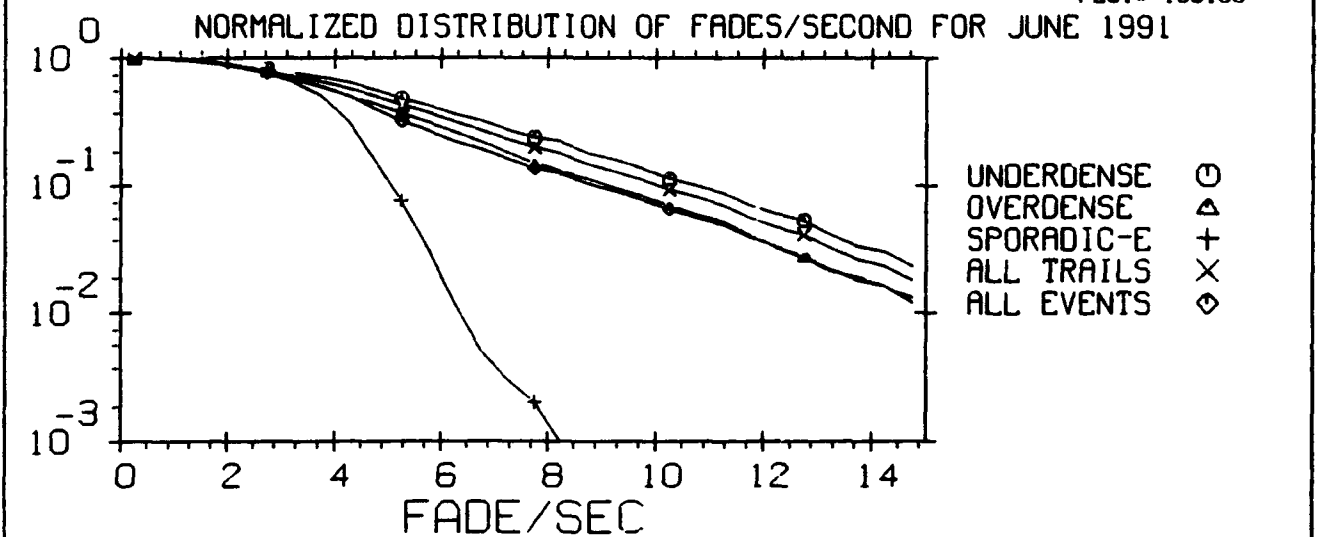

THE TIME OF DAY IS 0 : 24 HOURS U.T.
 FREQUENCY - 147 MHZ
 NORMALIZING FACTORS:
 UNDER - 5450. OVER - 4893. SPOR-E - 4526.
 TRAILS - 10343. EVENTS - 14869.

MENU#109,02-4
 21-SEP-93
 PLOT# 106.00

GEOPHYSICS LAB METEOR SCATTER PROGRAM

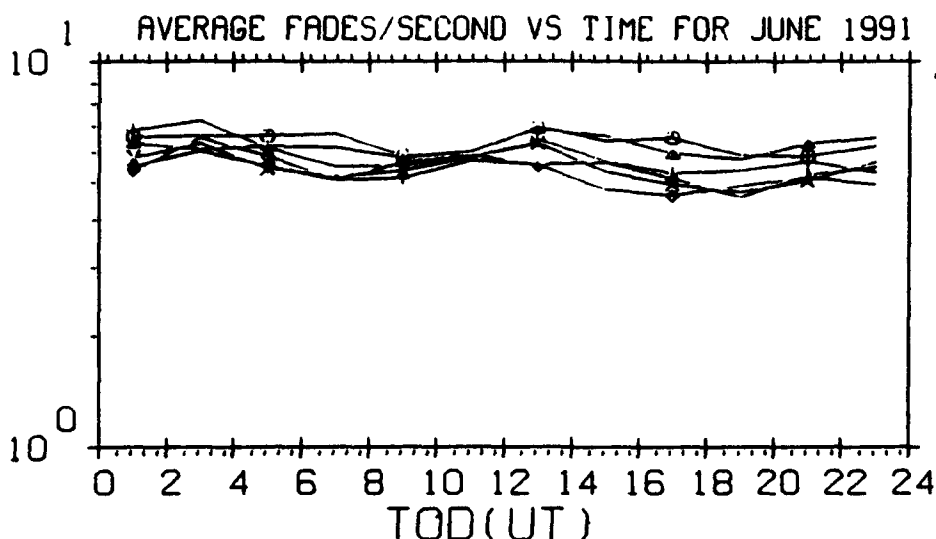

THULE

- 35 MHZ ○
- 45 MHZ △
- 65 MHZ +
- 85 MHZ ×
- 104 MHZ ◇
- 147 MHZ *

THE EVENT CLASS IS UNDERDENSE AND OVERDENSE TRAILS
 THE 24 HOUR FADES/SECOND AVERAGES ARE:
 6.261 6.034 5.650 5.231 5.029 5.219

MENU=109,07-1
 21-SEP-93
 PLOT= 107.00

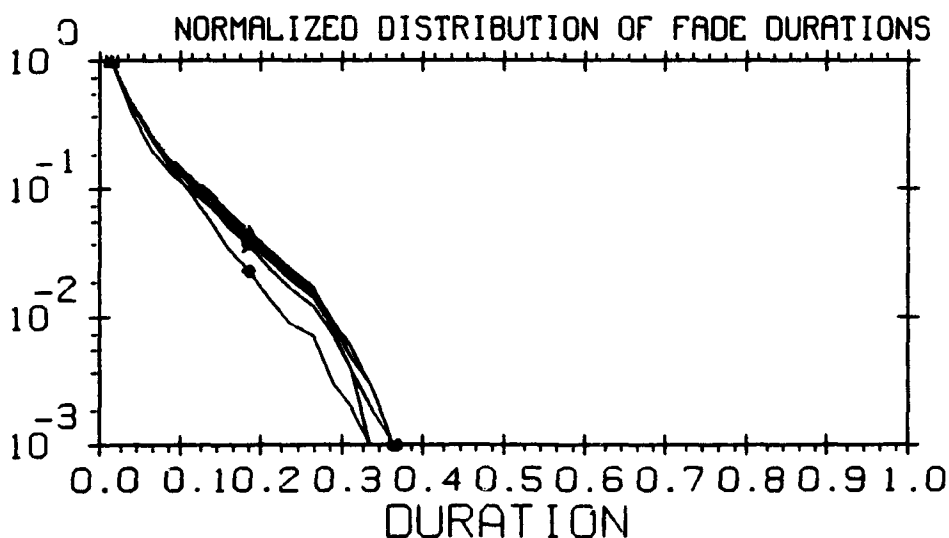

- 35 MHZ ○
- 45 MHZ △
- 65 MHZ +
- 85 MHZ ×
- 104 MHZ ◇
- 147 MHZ *

THE TIME OF DAY IS 0 : 24 HOURS U.T.
 THE EVENT CLASS IS UNDERDENSE AND OVERDENSE TRAILS
 NORMALIZING FACTORS:
 35MHZ - 44799. 45MHZ - 39232. 65MHZ - 39144.
 85MHZ - 18165. 104MHZ - 4854. 147MHZ - 36106.

MENU=109,05-4
 21-SEP-93
 PLOT= 108.00

GEOPHYSICS LAB METEOR SCATTER PROGRAM

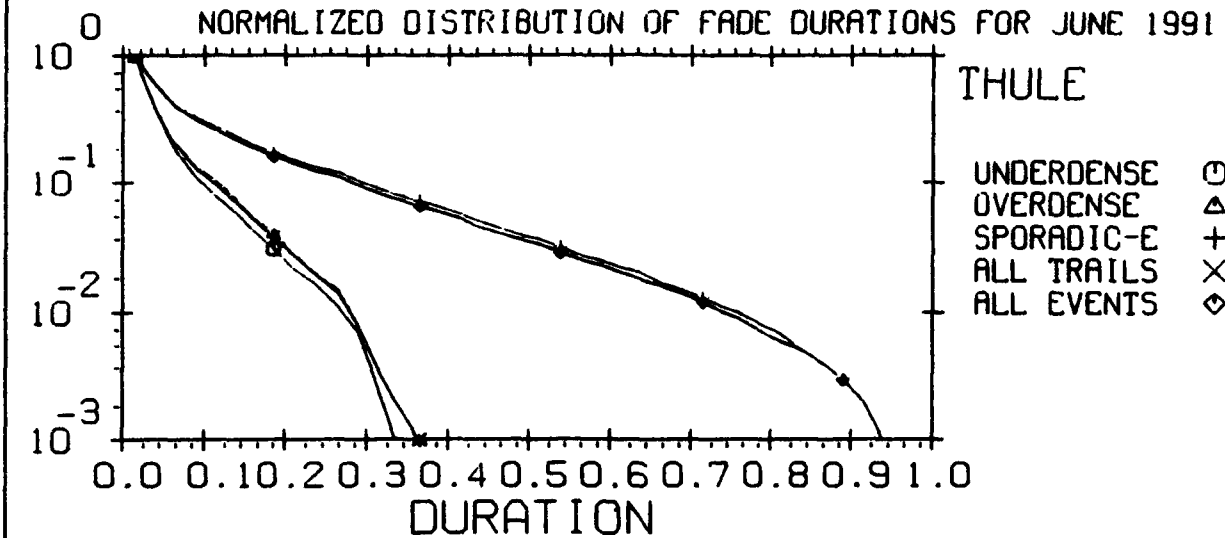

THE TIME OF DAY IS 0 : 24 HOURS U.T.
 FREQUENCY - 35 MHZ
 NORMALIZING FACTORS:
 UNDER - 11347. OVER - 33452. SPOR-E - 506826.
 TRAILS - 44799. EVENTS - 551625.

MENU#109.06-4
 21-SEP-93
 PLOT# 109.00

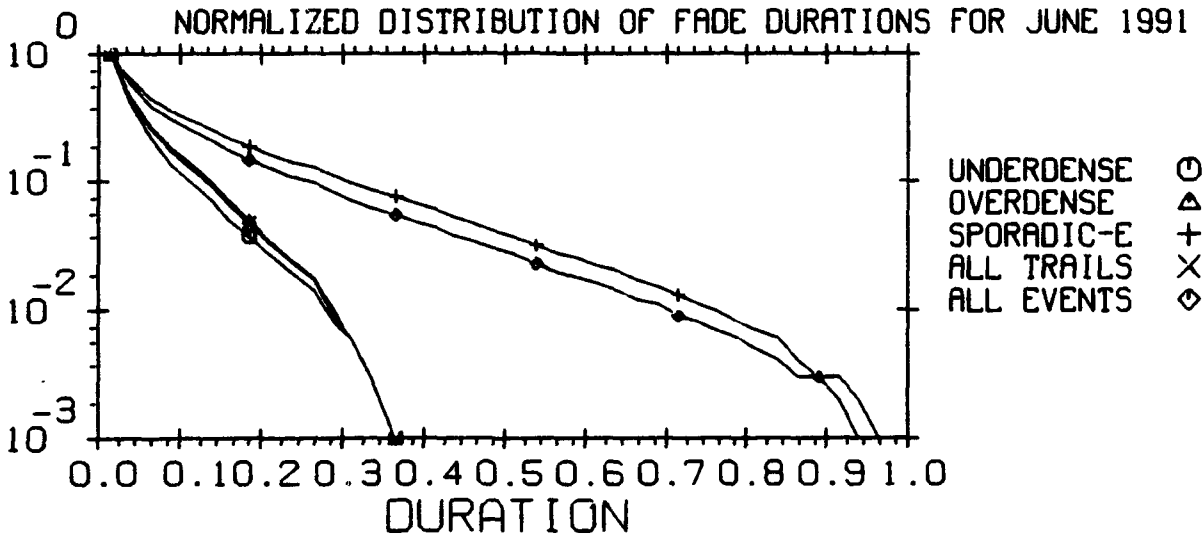

THE TIME OF DAY IS 0 : 24 HOURS U.T.
 FREQUENCY - 45 MHZ
 NORMALIZING FACTORS:
 UNDER - 9754. OVER - 29478. SPOR-E - 100640.
 TRAILS - 39232. EVENTS - 139872.

MENU#109.06-4
 21-SEP-93
 PLOT# 110.00

GEOPHYSICS LAB METEOR SCATTER PROGRAM

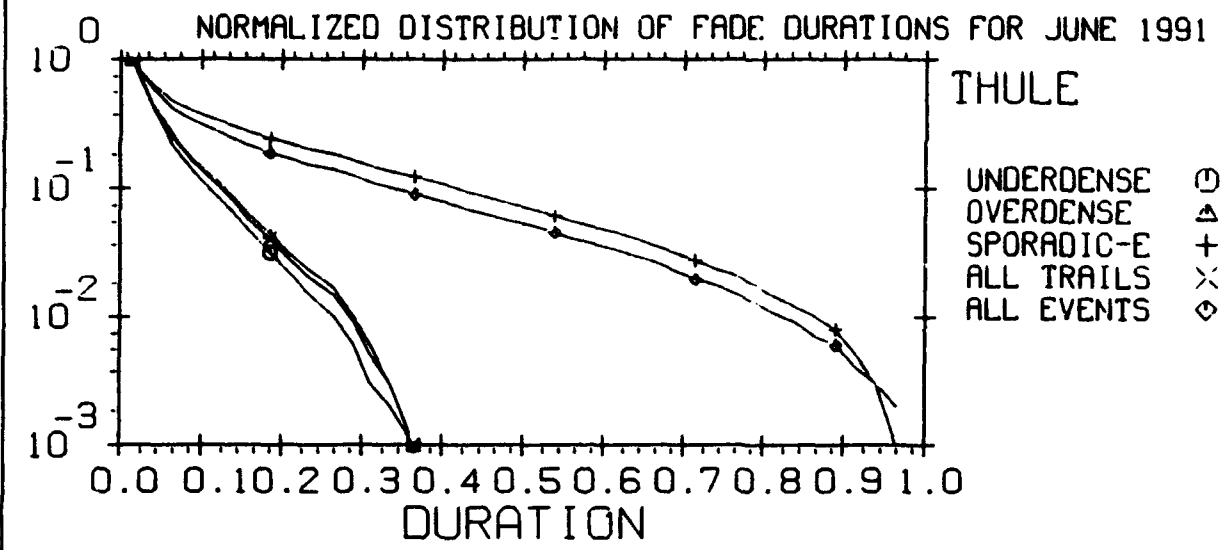

THE TIME OF DAY IS 0 : 24 HOURS U.T.
 FREQUENCY - 65 MHZ
 NORMALIZING FACTORS:
 UNDER - 11401. OVER - 27743. SPOR-E - 109940.
 TRAILS - 39144. EVENTS - 149084.

MENU#109,06-4
 21-SEP-93
 PLOT# 111.00

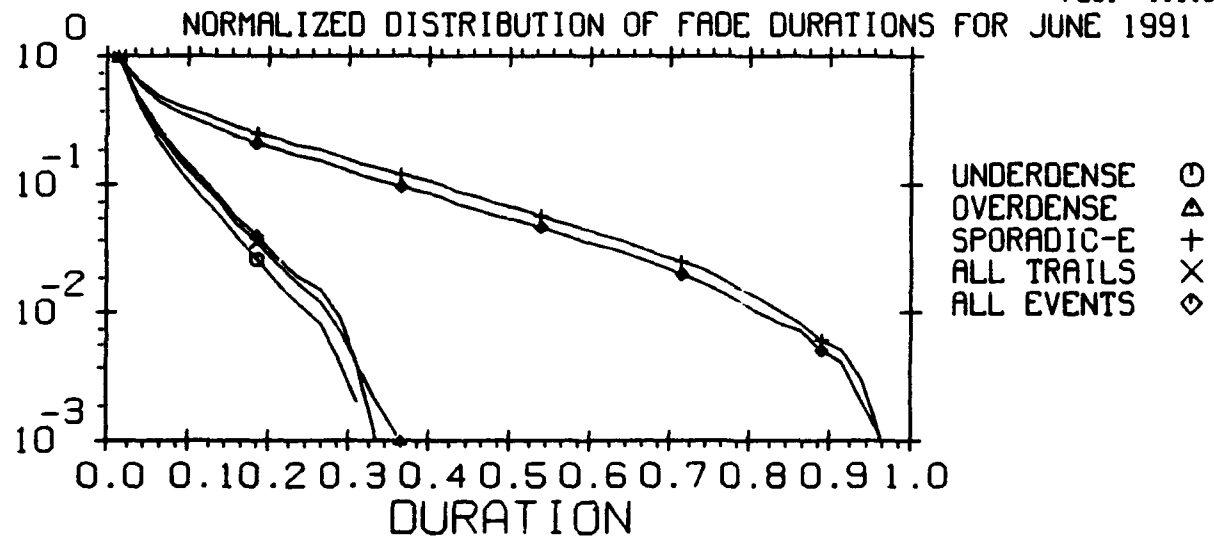

THE TIME OF DAY IS 0 : 24 HOURS U.T.
 FREQUENCY - 85 MHZ
 NORMALIZING FACTORS:
 UNDER - 6310. OVER - 11855. SPOR-E - 75307.
 TRAILS - 18165. EVENTS - 93472.

MENU#109,06-4
 21-SEP-93
 PLOT# 112.00

GEOPHYSICS LAB METEOR SCATTER PROGRAM

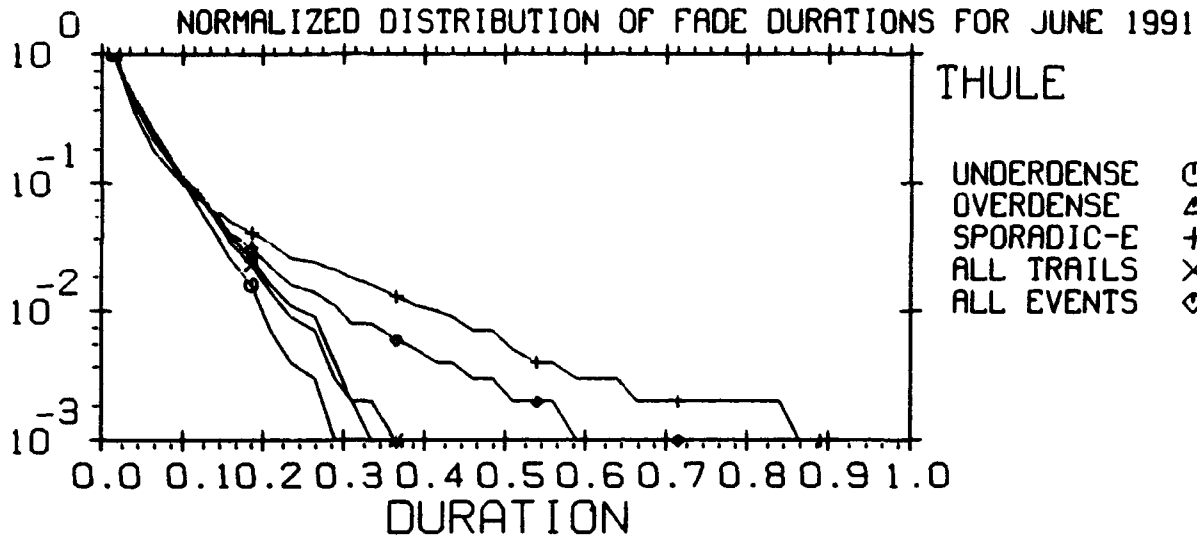

THE TIME OF DAY IS 0 : 24 HOURS U.T.
 FREQUENCY - 104 MHZ
 NORMALIZING FACTORS:
 UNDER - 1477. OVER - 3377. SPOR-E - 3641.
 TRAILS - 4854. EVENTS - 8495.

MENU#109,06-4
 21-SEP-93
 PLOT# 113.00

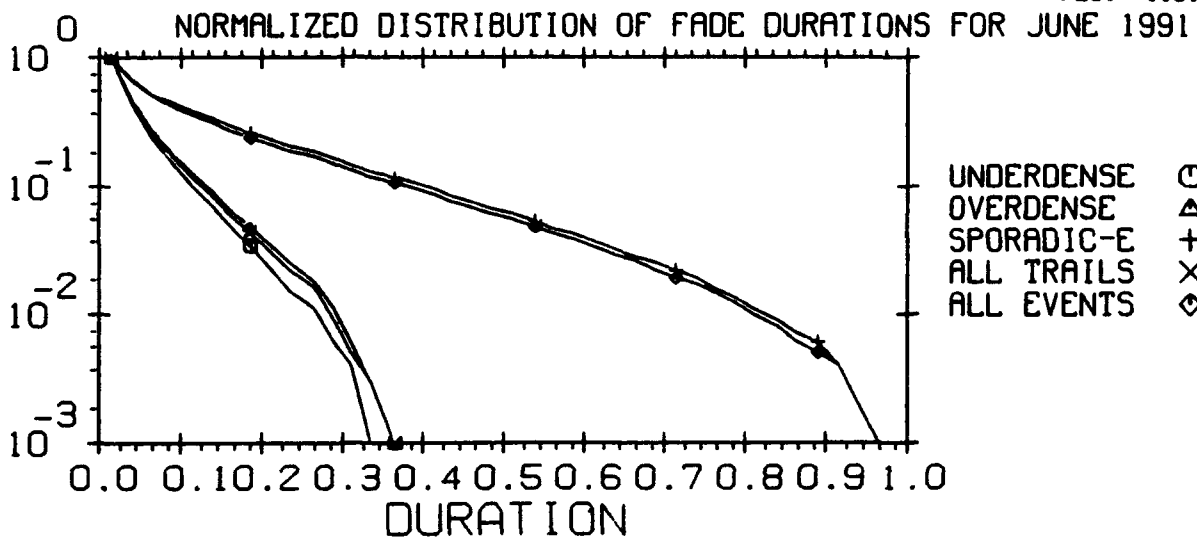

THE TIME OF DAY IS 0 : 24 HOURS U.T.
 FREQUENCY - 147 MHZ
 NORMALIZING FACTORS:
 UNDER - 12099. OVER - 24007. SPOR-E - 335426.
 TRAILS - 36106. EVENTS - 371532.

MENU#109,06-4
 21-SEP-93
 PLOT# 114.00

GEOPHYSICS LAB METEOR SCATTER PROGRAM

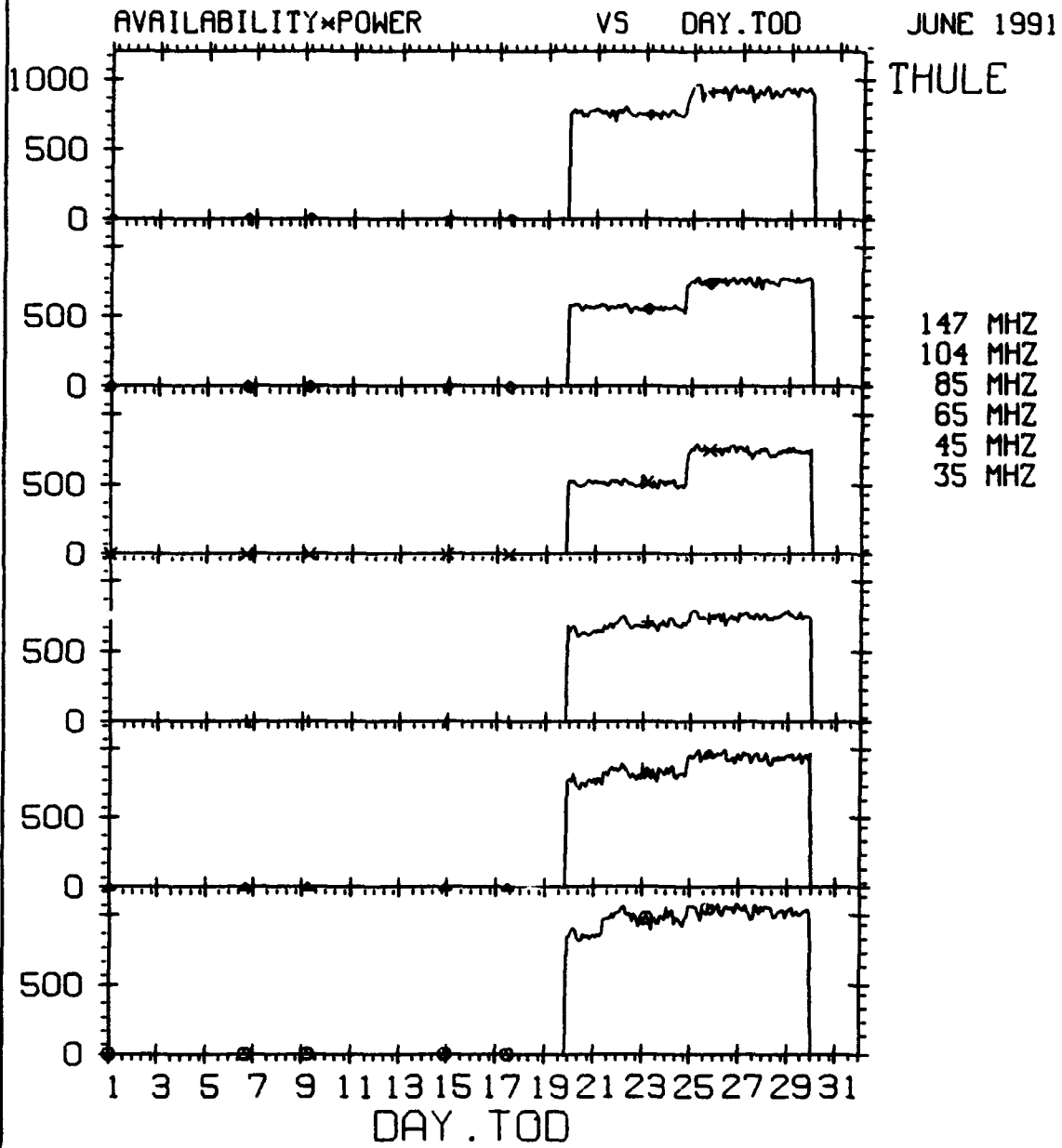

MENU#105,10-1
21-SEP-93
PLOT# 115.00

GEOPHYSICS LAB METEOR SCATTER PROGRAM

TEMP LOG-OF-KELVIN VS DAY.TOD JUNE 1991

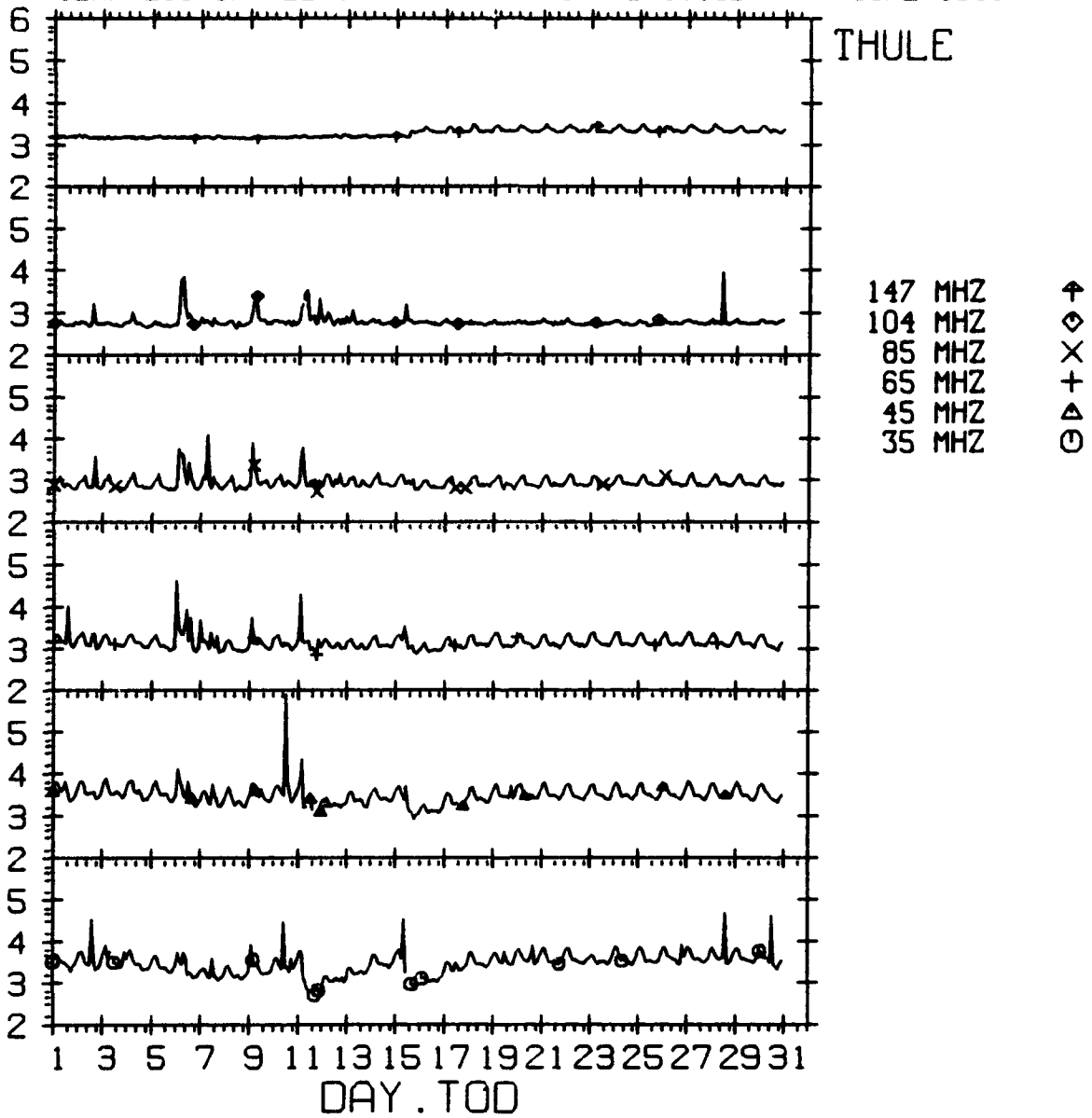

BASED ON OBSERVED NOISE MEASUREMENTS - VERTICAL

MENU=105,06-1
21-SEP-93
PLOT= 116.00

APPENDIX B

STATISTICS FOR JULY 1991

GEOPHYSICS LAB METEOR SCATTER PROGRAM

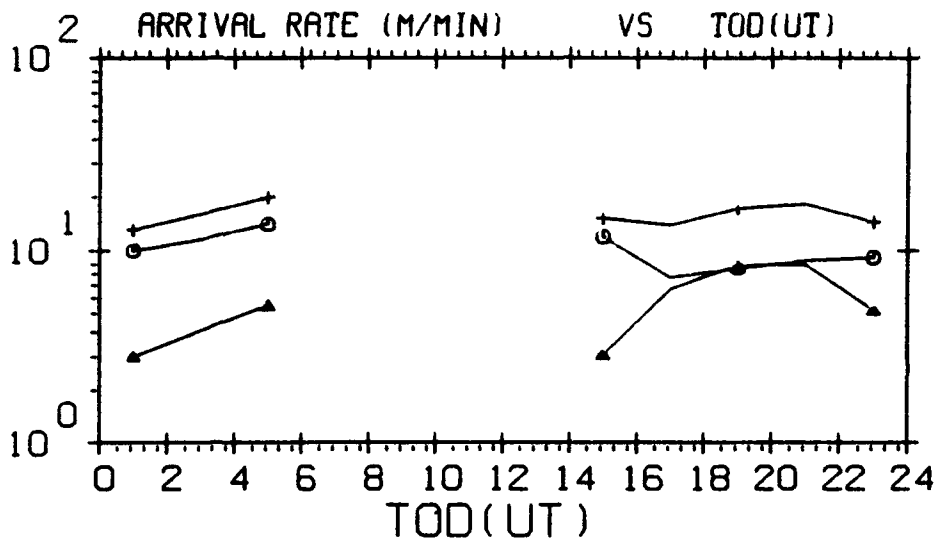

EXCEEDING -126.0 DBM RSL
 FREQUENCY - 35 MHZ
 POLARIZATION - HORIZONTAL
 MAXIMUM DOWN TIME DUE TO SPORADIC-E - 240 SECONDS
 BASED ON OBSERVED NOISE MEASUREMENTS - VERTICAL

MENU=101,05-2
 21-SEP-93
 PLOT= 1.00

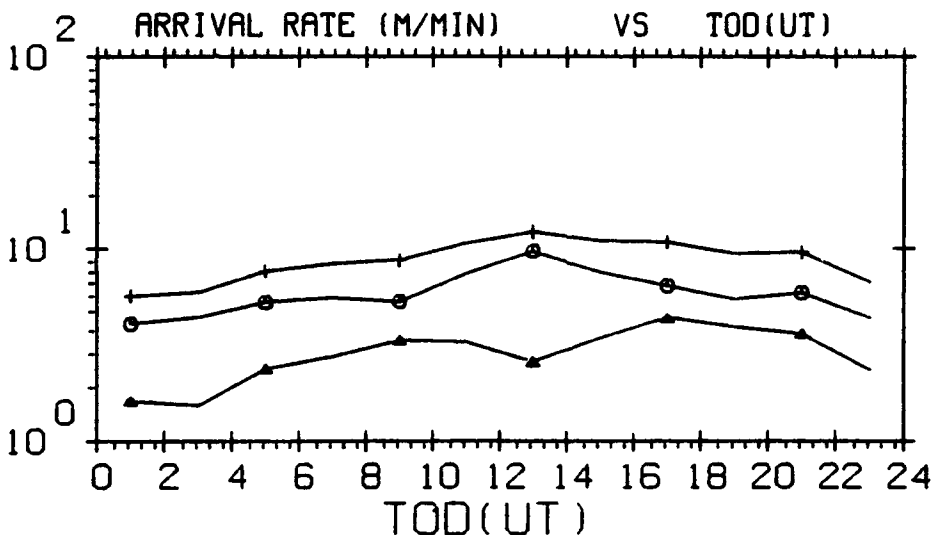

EXCEEDING -126.0 DBM RSL
 FREQUENCY - 45 MHZ
 POLARIZATION - HORIZONTAL
 MAXIMUM DOWN TIME DUE TO SPORADIC-E - 240 SECONDS
 BASED ON OBSERVED NOISE MEASUREMENTS - VERTICAL

MENU=101,05-2
 21-SEP-93
 PLOT= 2.00

GEOPHYSICS LAB METEOR SCATTER PROGRAM

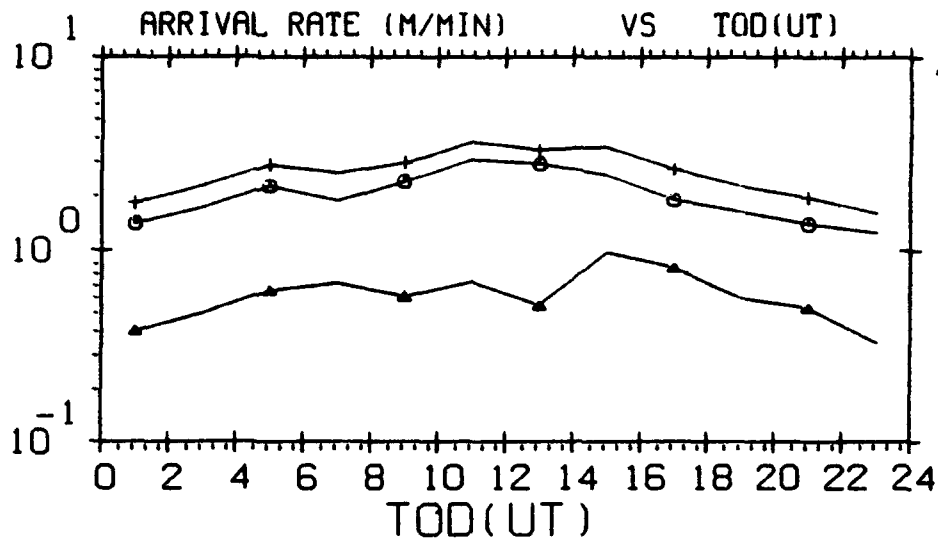

UNDERDENSE ○
 OVERDENSE ▲
 ALL TRAILS +

EXCEEDING -126.0 DBM RSL
 FREQUENCY - 65 MHZ
 POLARIZATION - HORIZONTAL
 MAXIMUM DOWN TIME DUE TO SPORADIC-E - 240 SECONDS
 BASED ON OBSERVED NOISE MEASUREMENTS - VERTICAL

MENU#101,05-2
 21-SEP-93
 PLOT# 3.00

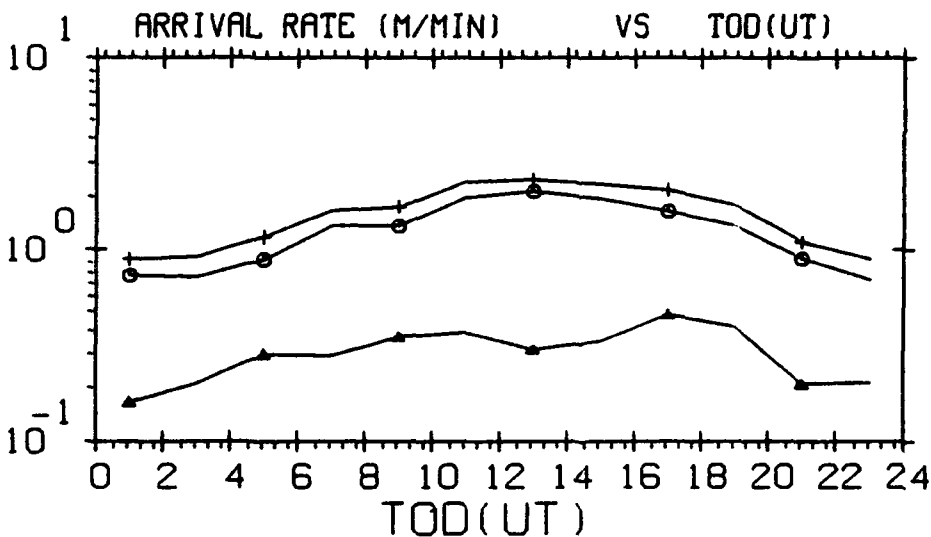

UNDERDENSE ○
 OVERDENSE ▲
 ALL TRAILS +

EXCEEDING -126.0 DBM RSL
 FREQUENCY - 85 MHZ
 POLARIZATION - HORIZONTAL
 MAXIMUM DOWN TIME DUE TO SPORADIC-E - 240 SECONDS
 BASED ON OBSERVED NOISE MEASUREMENTS - VERTICAL

MENU#101,05-2
 21-SEP-93
 PLOT# 4.00

GEOPHYSICS LAB METEOR SCATTER PROGRAM

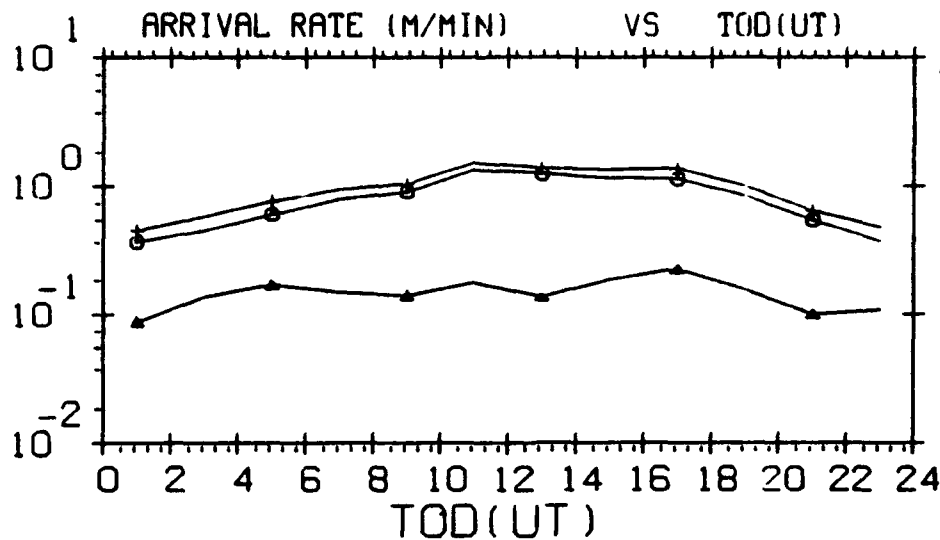

EXCEEDING -126.0 DBM RSL
 FREQUENCY - 104 MHZ
 POLARIZATION - HORIZONTAL
 MAXIMUM DOWN TIME DUE TO SPORADIC-E - 240 SECONDS
 BASED ON OBSERVED NOISE MEASUREMENTS - VERTICAL

MENU=101_05-2
 21-SEP-93
 PLOT= 5.00

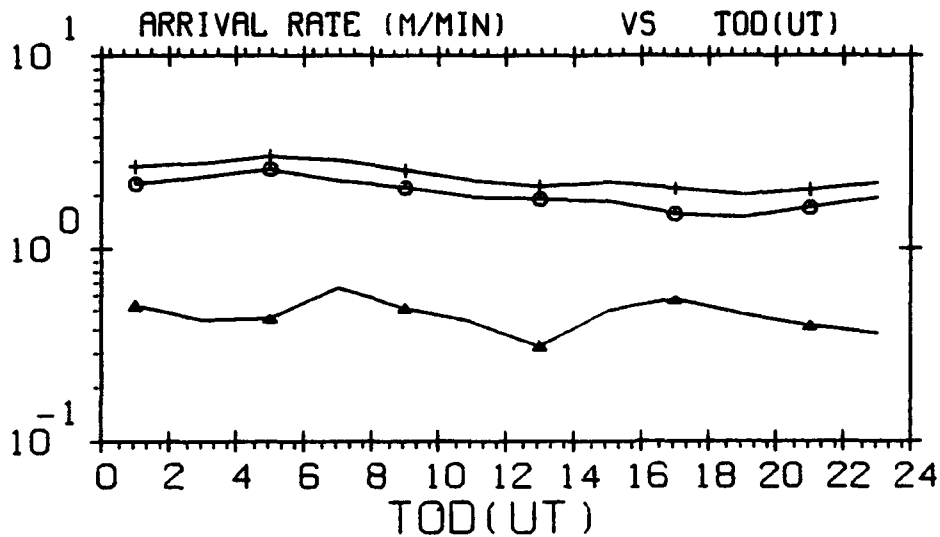

EXCEEDING -126.0 DBM RSL
 FREQUENCY - 147 MHZ
 POLARIZATION - HORIZONTAL
 MAXIMUM DOWN TIME DUE TO SPORADIC-E - 240 SECONDS
 BASED ON OBSERVED NOISE MEASUREMENTS - VERTICAL

MENU=101_05-2
 21-SEP-93
 PLOT= 6.00

GEOPHYSICS LAB METEOR SCATTER PROGRAM

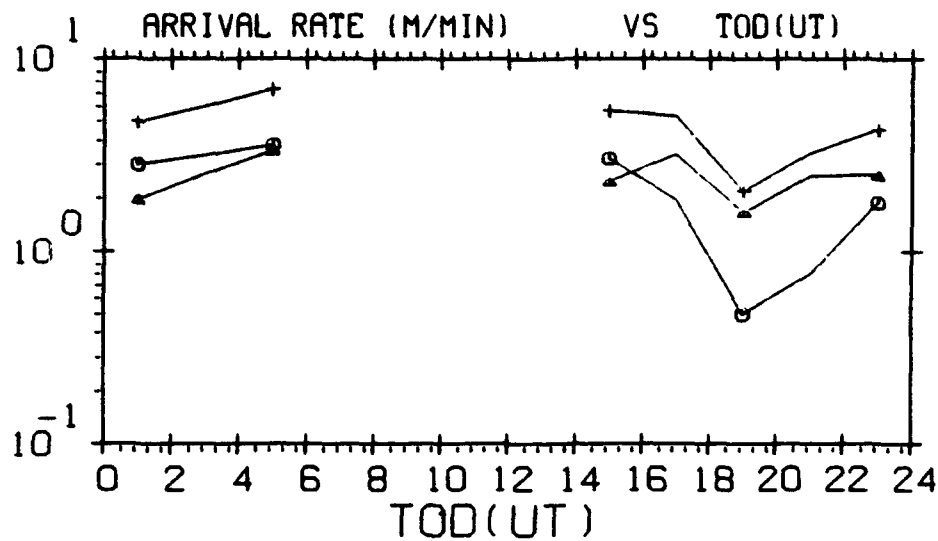

UNDERDENSE ○
 OVERDENSE △
 ALL TRAILS +

EXCEEDING -116.0 DBM RSL
 FREQUENCY - 35 MHZ
 POLARIZATION - HORIZONTAL
 MAXIMUM DOWN TIME DUE TO SPORADIC-E - 240 SECONDS
 BASED ON OBSERVED NOISE MEASUREMENTS - VERTICAL

MENU=101,05-2
 21-SEP-93
 PLOT= 7.00

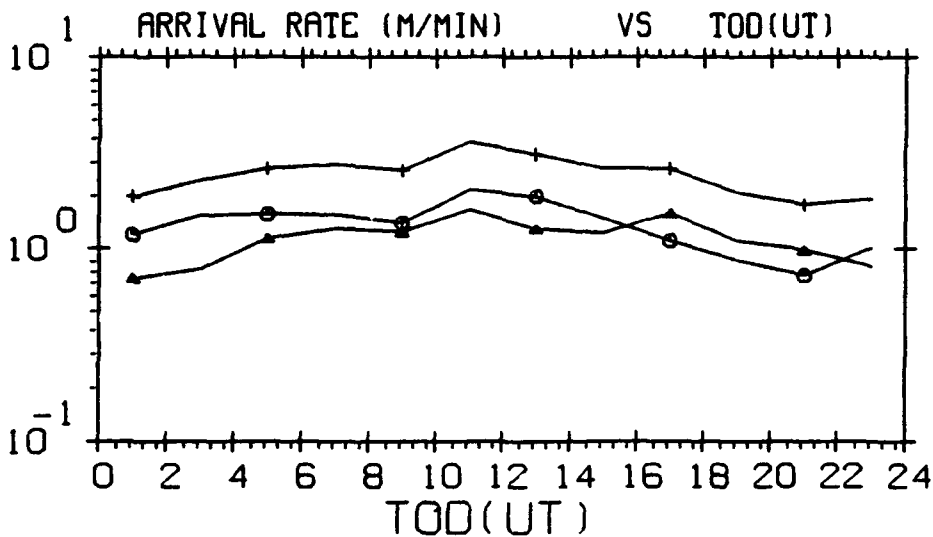

UNDERDENSE ○
 OVERDENSE △
 ALL TRAILS +

EXCEEDING -116.0 DBM RSL
 FREQUENCY - 45 MHZ
 POLARIZATION - HORIZONTAL
 MAXIMUM DOWN TIME DUE TO SPORADIC-E - 240 SECONDS
 BASED ON OBSERVED NOISE MEASUREMENTS - VERTICAL

MENU=101,05-2
 21-SEP-93
 PLOT= 8.00

GEOPHYSICS LAB METEOR SCATTER PROGRAM

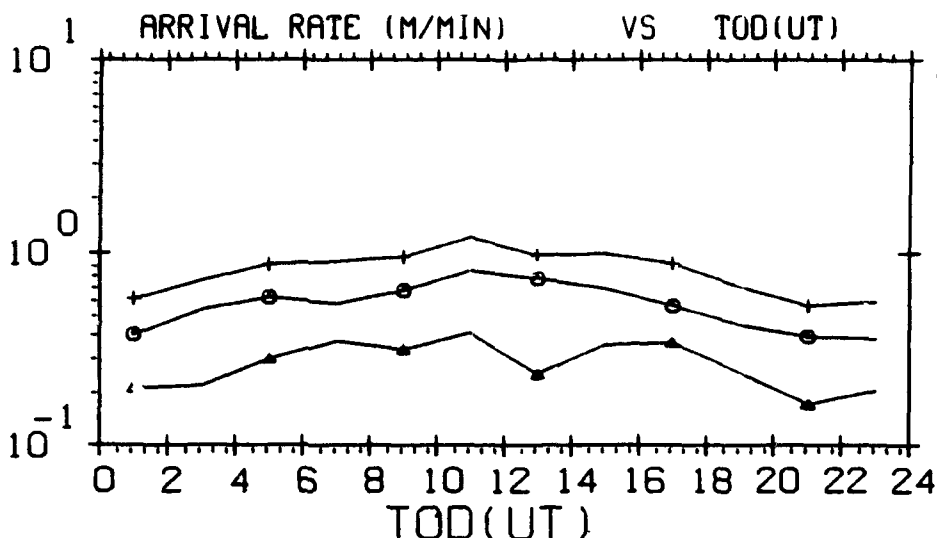

EXCEEDING -116.0 DBM RSL
 FREQUENCY - 65 MHZ
 POLARIZATION - HORIZONTAL
 MAXIMUM DOWN TIME DUE TO SPORADIC-E - 240 SECONDS
 BASED ON OBSERVED NOISE MEASUREMENTS - VERTICAL

MENU#101,05-2
 21-SEP-93
 PLOT# 9.00

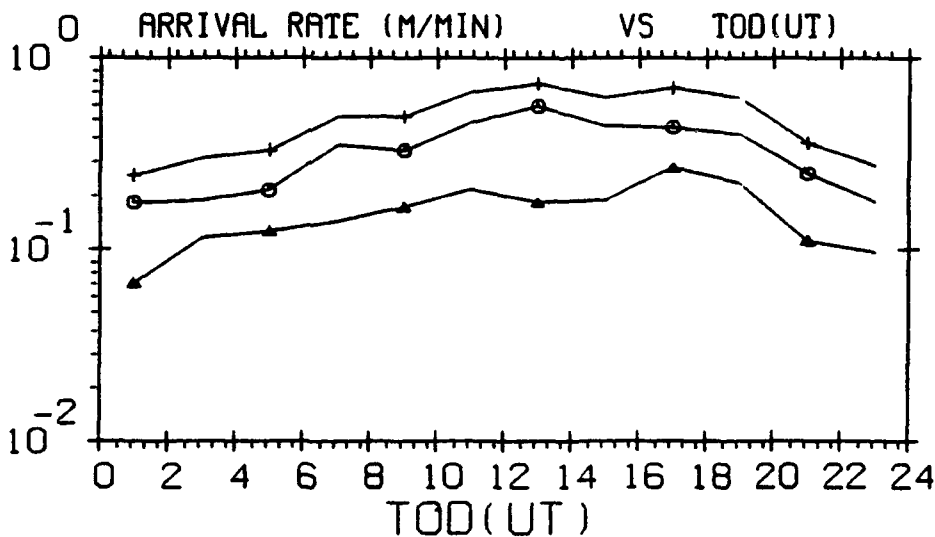

EXCEEDING -116.0 DBM RSL
 FREQUENCY - 85 MHZ
 POLARIZATION - HORIZONTAL
 MAXIMUM DOWN TIME DUE TO SPORADIC-E - 240 SECONDS
 BASED ON OBSERVED NOISE MEASUREMENTS - VERTICAL

MENU#101,05-2
 21-SEP-93
 PLOT# 10.00

GEOPHYSICS LAB METEOR SCATTER PROGRAM

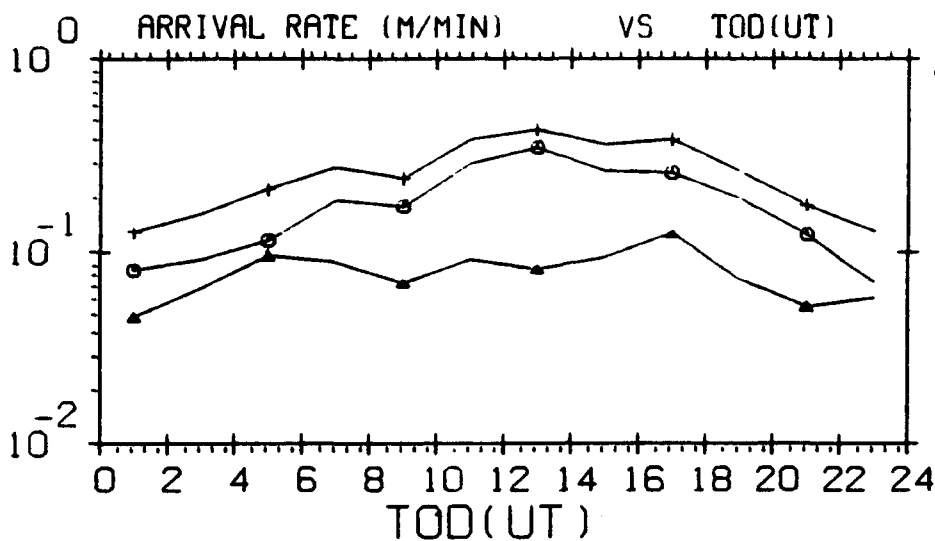

UNDERDENSE ○
 OVERDENSE △
 ALL TRAILS +

EXCEEDING -116.0 DBM RSL
 FREQUENCY - 104 MHZ
 POLARIZATION - HORIZONTAL
 MAXIMUM DOWN TIME DUE TO SPORADIC-E - 240 SECONDS
 BASED ON OBSERVED NOISE MEASUREMENTS - VERTICAL

MENU#101,05-2
 21-SEP-93
 PLOT# 11.00

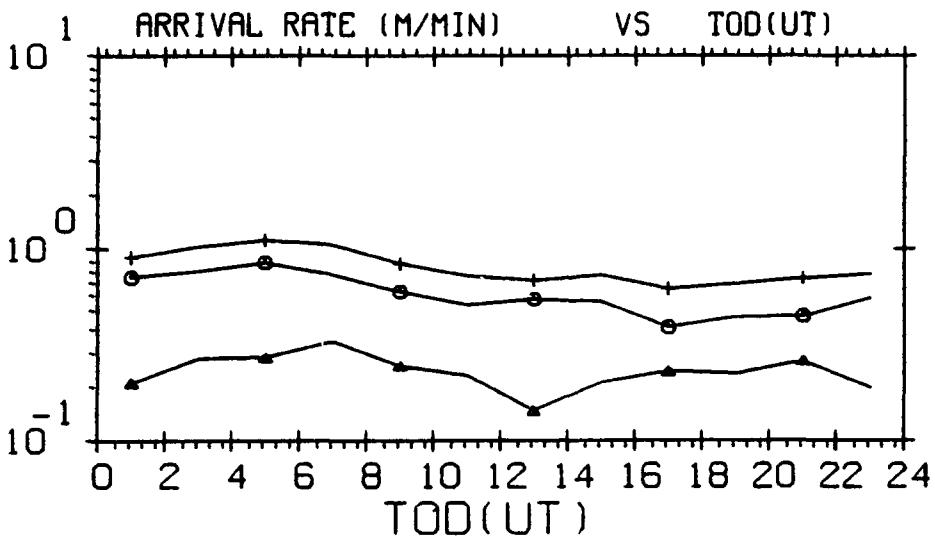

UNDERDENSE ○
 OVERDENSE △
 ALL TRAILS +

EXCEEDING -116.0 DBM RSL
 FREQUENCY - 147 MHZ
 POLARIZATION - HORIZONTAL
 MAXIMUM DOWN TIME DUE TO SPORADIC-E - 240 SECONDS
 BASED ON OBSERVED NOISE MEASUREMENTS - VERTICAL

MENU#101,05-2
 21-SEP-93
 PLOT# 12.00

GEOPHYSICS LAB METEOR SCATTER PROGRAM

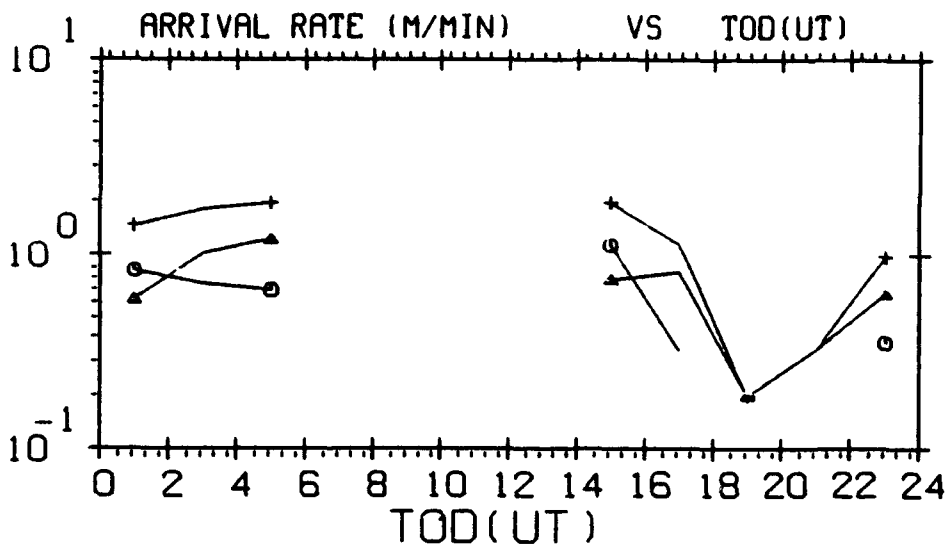

EXCEEDING -106.0 DBM RSL
 FREQUENCY - 35 MHZ
 POLARIZATION - HORIZONTAL
 MAXIMUM DOWN TIME DUE TO SPORADIC-E - 240 SECONDS
 BASED ON OBSERVED NOISE MEASUREMENTS - VERTICAL

MENU=101_05-2
 21-SEP-93
 PLOT= 13.00

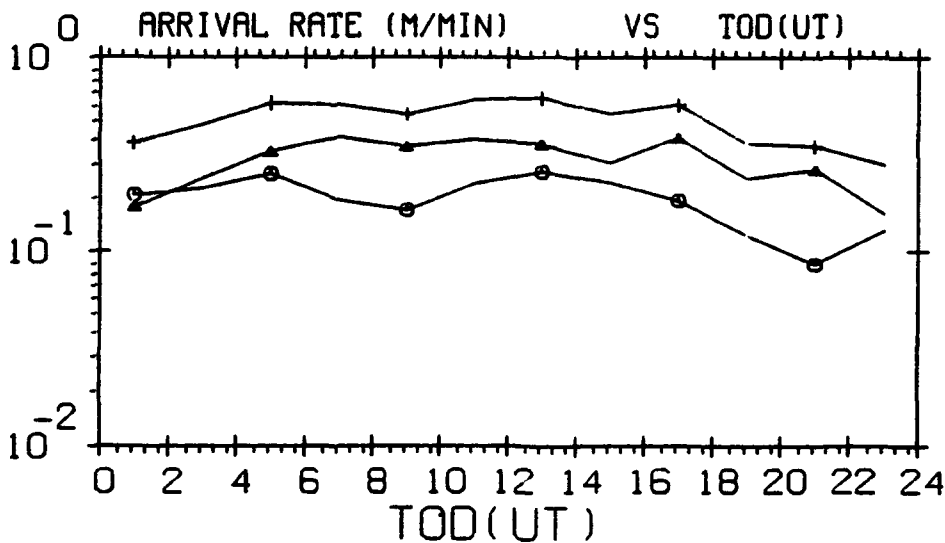

EXCEEDING -106.0 DBM RSL
 FREQUENCY - 45 MHZ
 POLARIZATION - HORIZONTAL
 MAXIMUM DOWN TIME DUE TO SPORADIC-E - 240 SECONDS
 BASED ON OBSERVED NOISE MEASUREMENTS - VERTICAL

MENU=101_05-2
 21-SEP-93
 PLOT= 14.00

GEOPHYSICS LAB METEOR SCATTER PROGRAM

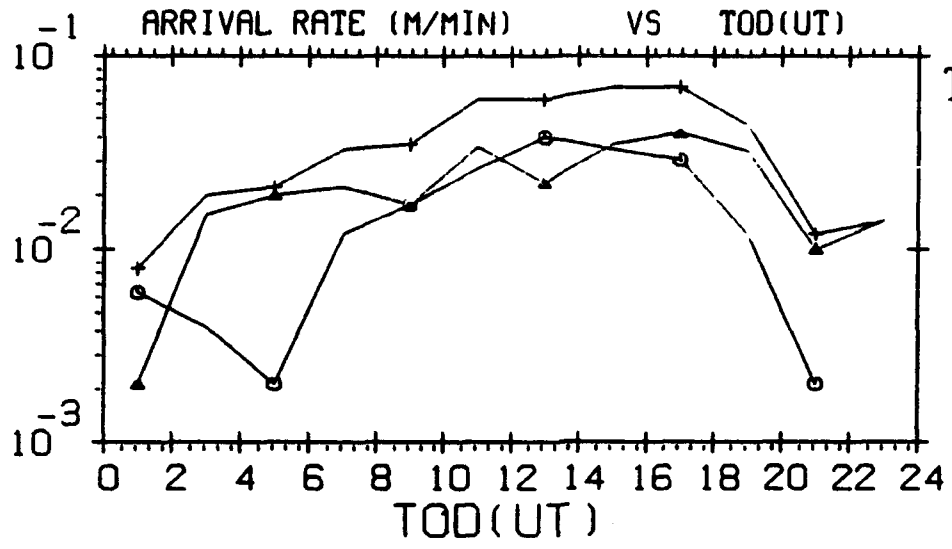

UNDERDENSE ○
 OVERDENSE △
 ALL TRAILS +

EXCEEDING -106.0 DBM RSL
 FREQUENCY - 104 MHZ
 POLARIZATION - HORIZONTAL
 MAXIMUM DOWN TIME DUE TO SPORADIC-E - 240 SECONDS
 BASED ON OBSERVED NOISE MEASUREMENTS - VERTICAL

MENU=101,05-2
 21-SEP-93
 PLOT= 17.00

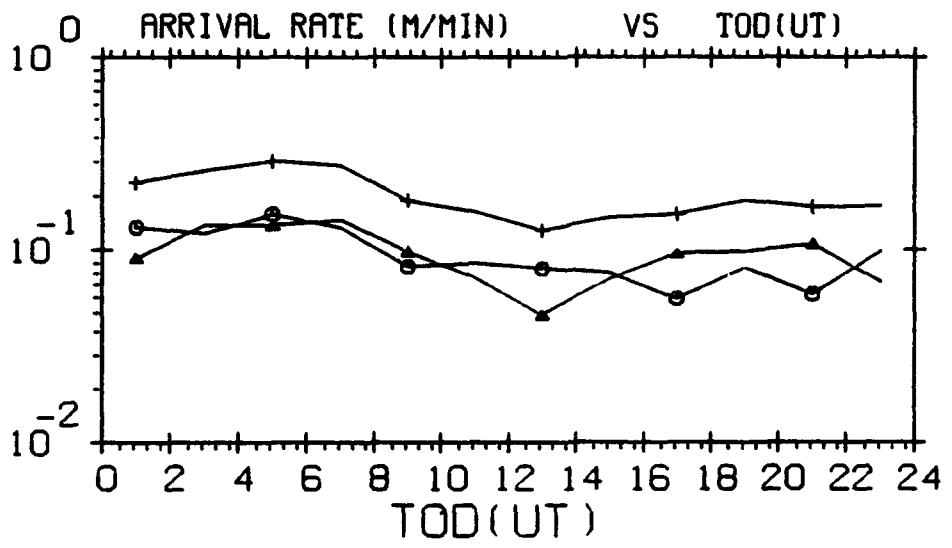

UNDERDENSE ○
 OVERDENSE △
 ALL TRAILS +

EXCEEDING -106.0 DBM RSL
 FREQUENCY - 147 MHZ
 POLARIZATION - HORIZONTAL
 MAXIMUM DOWN TIME DUE TO SPORADIC-E - 240 SECONDS
 BASED ON OBSERVED NOISE MEASUREMENTS - VERTICAL

MENU=101,05-2
 21-SEP-93
 PLOT= 18.00

GEOPHYSICS LAB METEOR SCATTER PROGRAM

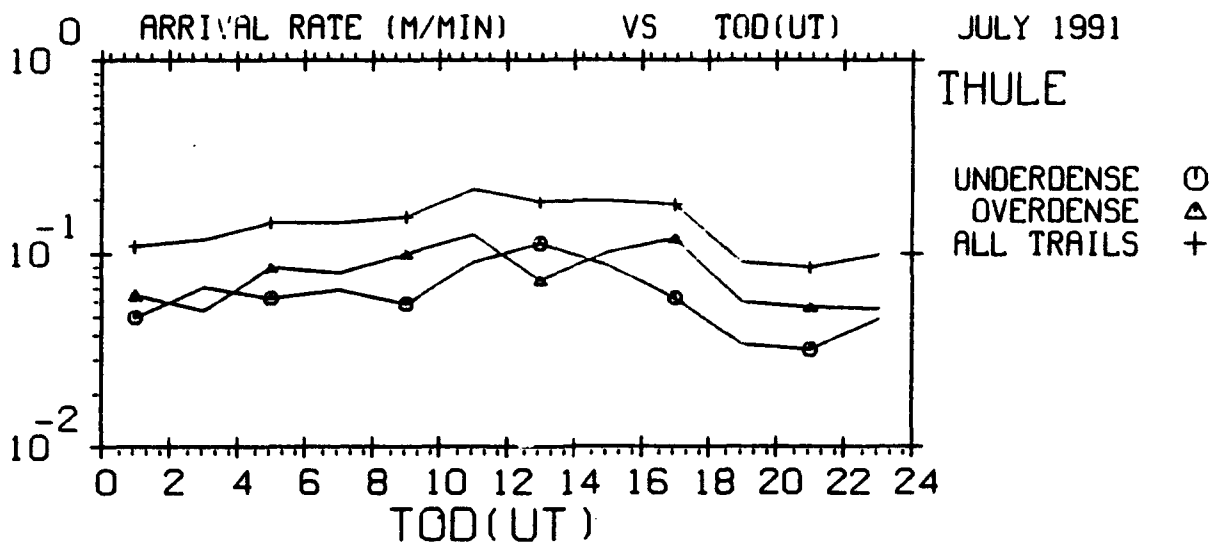

EXCEEDING -106.0 DBM RSL
 FREQUENCY - 65 MHZ
 POLARIZATION - HORIZONTAL
 MAXIMUM DOWN TIME DUE TO SPORADIC-E - 240 SECONDS
 BASED ON OBSERVED NOISE MEASUREMENTS - VERTICAL

MENU#101,05-2
 21-SEP-93
 PLOT# 15.00

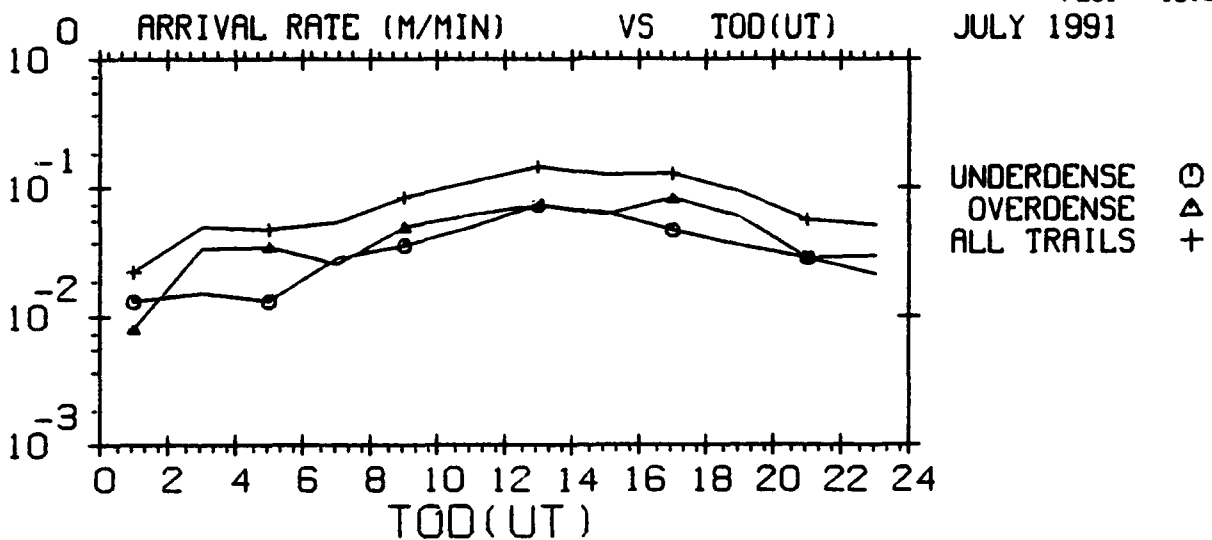

EXCEEDING -106.0 DBM RSL
 FREQUENCY - 85 MHZ
 POLARIZATION - HORIZONTAL
 MAXIMUM DOWN TIME DUE TO SPORADIC-E - 240 SECONDS
 BASED ON OBSERVED NOISE MEASUREMENTS - VERTICAL

MENU#101,05-2
 21-SEP-93
 PLOT# 16.00

GEOPHYSICS LAB METEOR SCATTER PROGRAM

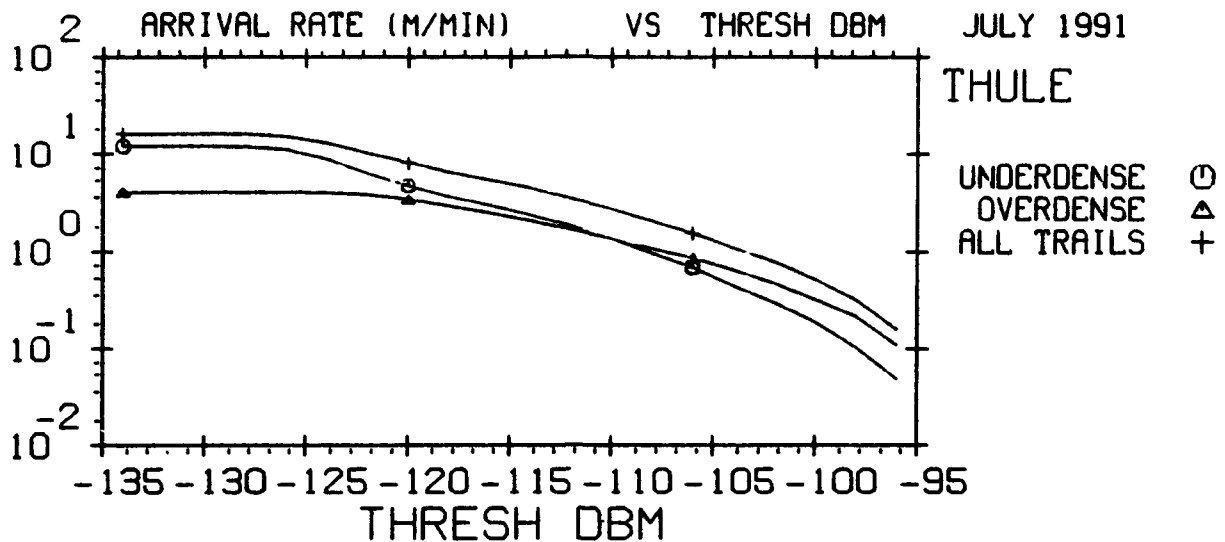

THE TIME OF DAY IS 0 : 24 HOURS U.T.
 FREQUENCY - 35 MHZ
 POLARIZATION - HORIZONTAL
 MAXIMUM DOWN TIME DUE TO SPORADIC-E - 240 SECONDS
 BASED ON OBSERVED NOISE MEASUREMENTS - VERTICAL

MENU=101,06-2
 21-SEP-93
 PLOT= 19.00

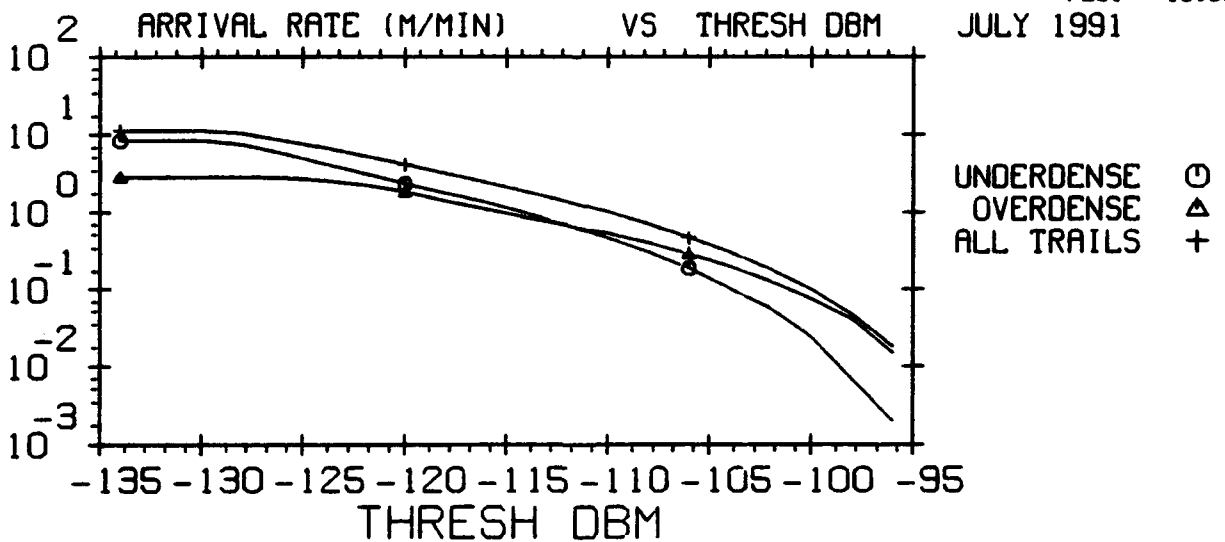

THE TIME OF DAY IS 0 : 24 HOURS U.T.
 FREQUENCY - 45 MHZ
 POLARIZATION - HORIZONTAL
 MAXIMUM DOWN TIME DUE TO SPORADIC-E - 240 SECONDS
 BASED ON OBSERVED NOISE MEASUREMENTS - VERTICAL

MENU=101,06-2
 21-SEP-93
 PLOT= 20.00

GEOPHYSICS LAB METEOR SCATTER PROGRAM

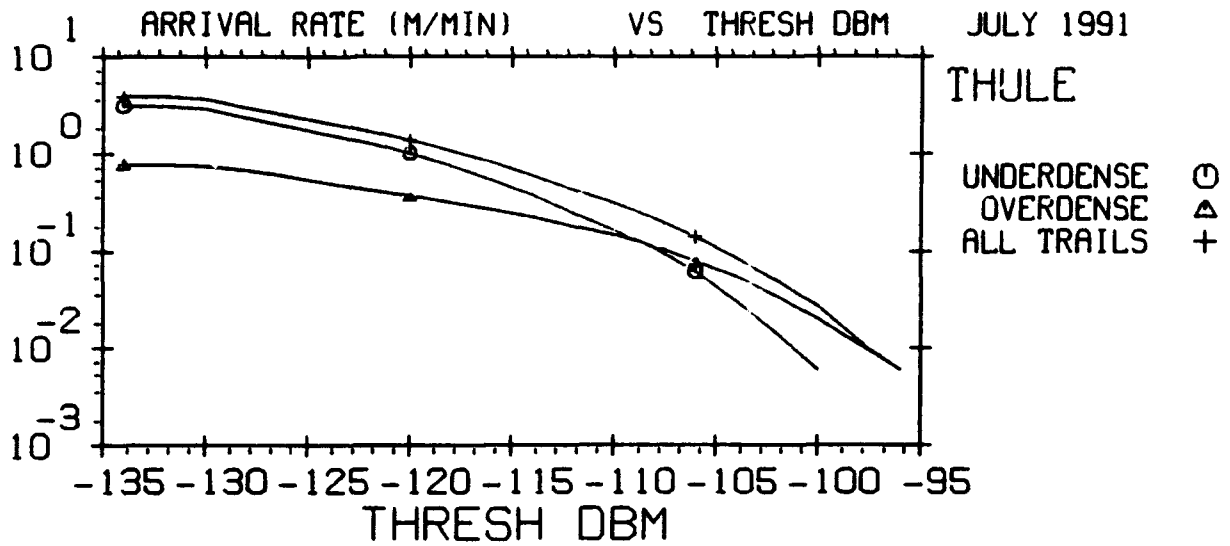

THE TIME OF DAY IS 0 : 24 HOURS U.T.
 FREQUENCY - 65 MHZ
 POLARIZATION - HORIZONTAL
 MAXIMUM DOWN TIME DUE TO SPORADIC-E - 240 SECONDS
 BASED ON OBSERVED NOISE MEASUREMENTS - VERTICAL

MENU=101,06-2
 21-SEP-93
 PLOT# 21.00

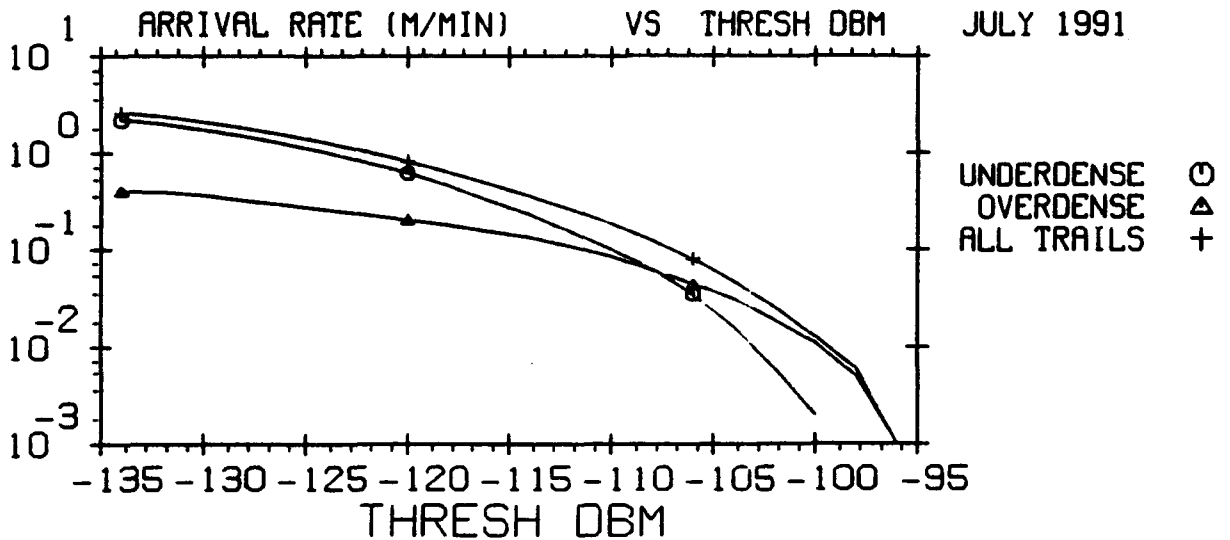

THE TIME OF DAY IS 0 : 24 HOURS U.T.
 FREQUENCY - 85 MHZ
 POLARIZATION - HORIZONTAL
 MAXIMUM DOWN TIME DUE TO SPORADIC-E - 240 SECONDS
 BASED ON OBSERVED NOISE MEASUREMENTS - VERTICAL

MENU=101,06-2
 21-SEP-93
 PLOT# 22.00

GEOPHYSICS LAB METEOR SCATTER PROGRAM

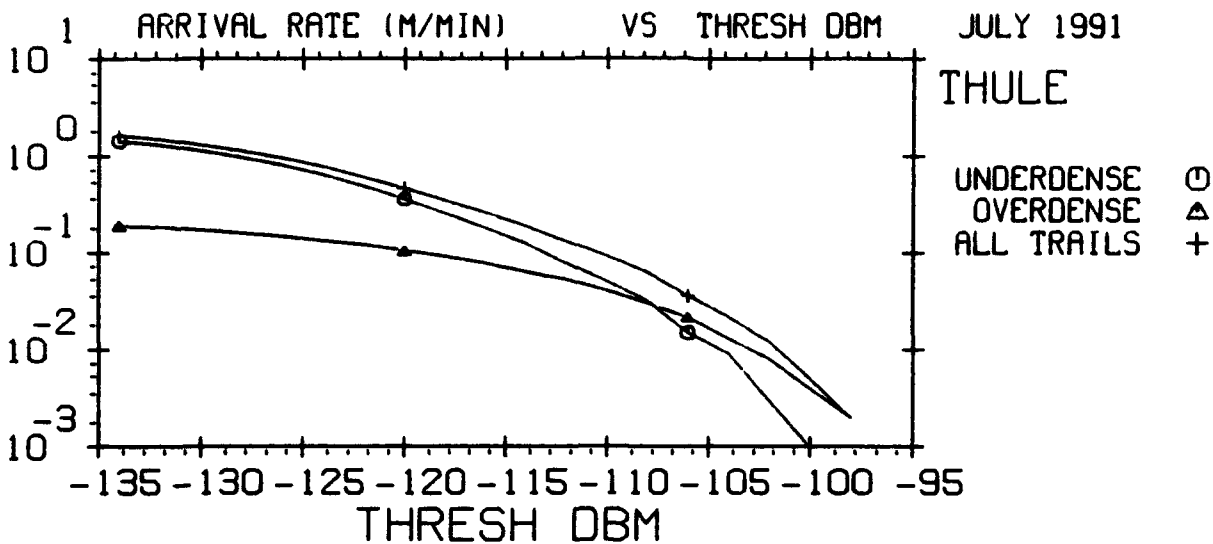

THE TIME OF DAY IS 0 : 24 HOURS U.T.
 FREQUENCY - 104 MHZ
 POLARIZATION - HORIZONTAL
 MAXIMUM DOWN TIME DUE TO SPORADIC-E - 240 SECONDS
 BASED ON OBSERVED NOISE MEASUREMENTS - VERTICAL

MENU*101,06-2
 21-SEP-93
 PLOT* 23.00

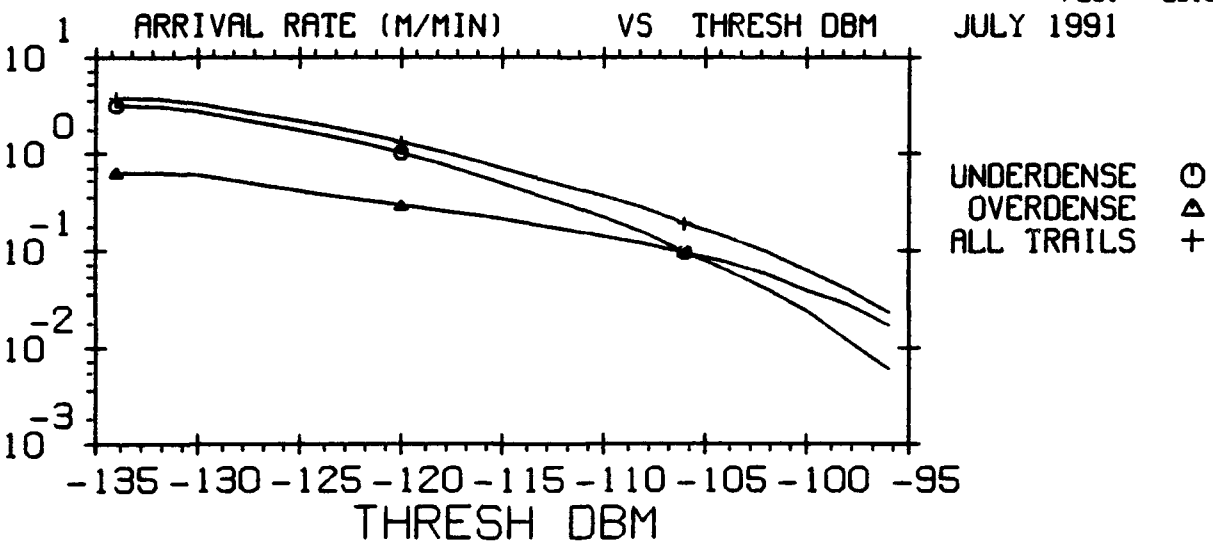

THE TIME OF DAY IS 0 : 24 HOURS U.T.
 FREQUENCY - 147 MHZ
 POLARIZATION - HORIZONTAL
 MAXIMUM DOWN TIME DUE TO SPORADIC-E - 240 SECONDS
 BASED ON OBSERVED NOISE MEASUREMENTS - VERTICAL

MENU*101,06-2
 21-SEP-93
 PLOT* 24.00

GEOPHYSICS LAB METEOR SCATTER PROGRAM

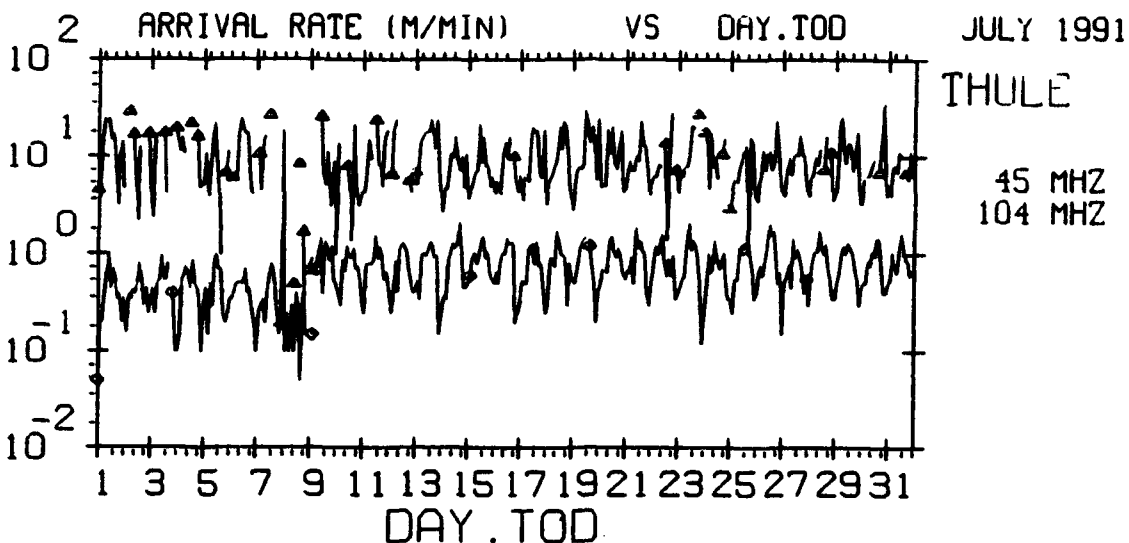

EXCEEDING -126.0 DBM RSL
 TYPE OF METEOR TRAIL - UNDERDENSE AND OVERDENSE
 POLARIZATION - HORIZONTAL
 MAXIMUM DOWN TIME DUE TO SPORADIC-E - 240 SECONDS
 BASED ON OBSERVED NOISE MEASUREMENTS - VERTICAL

MENU=101,03-2
 21-SEP-93
 PLOT* 25.00

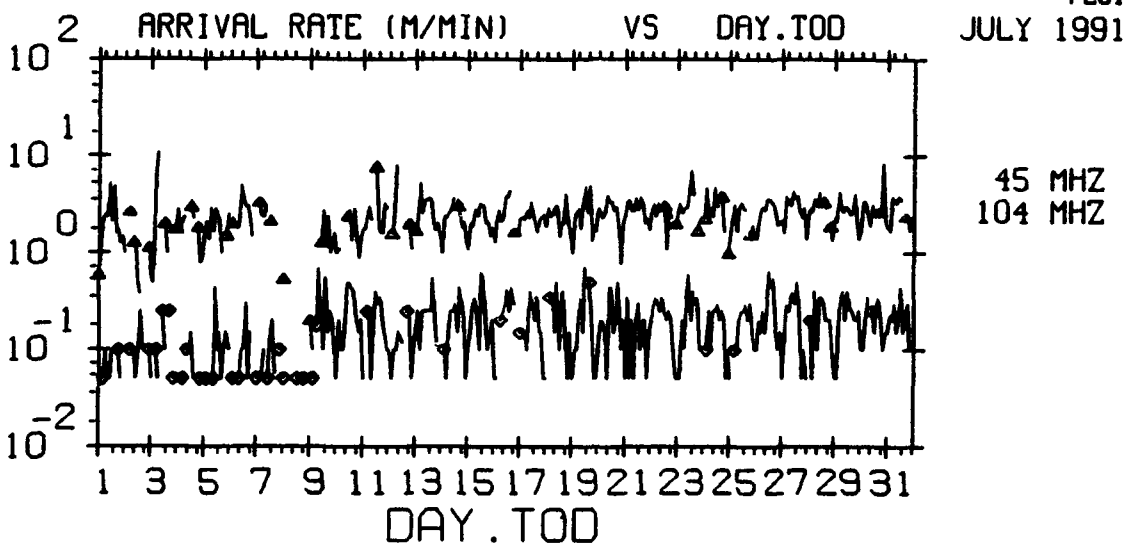

EXCEEDING -116.0 DBM RSL
 TYPE OF METEOR TRAIL - UNDERDENSE AND OVERDENSE
 POLARIZATION - HORIZONTAL
 MAXIMUM DOWN TIME DUE TO SPORADIC-E - 240 SECONDS
 BASED ON OBSERVED NOISE MEASUREMENTS - VERTICAL

MENU=101,03-2
 21-SEP-93
 PLOT* 26.00

GEOPHYSICS LAB METEOR SCATTER PROGRAM

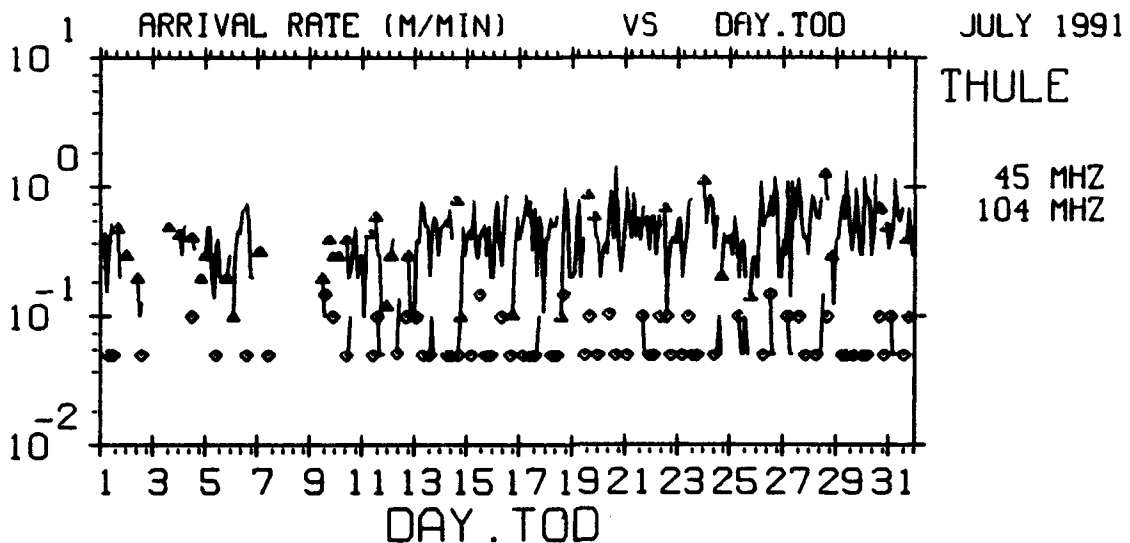

EXCEEDING -106.0 DBM RSL
 TYPE OF METEOR TRAIL - UNDERDENSE AND OVERDENSE
 POLARIZATION - HORIZONTAL
 MAXIMUM DOWN TIME DUE TO SPORADIC-E - 240 SECONDS
 BASED ON OBSERVED NOISE MEASUREMENTS - VERTICAL

MENU#101,03-2
 21-SEP-93
 PLOT# 27.00

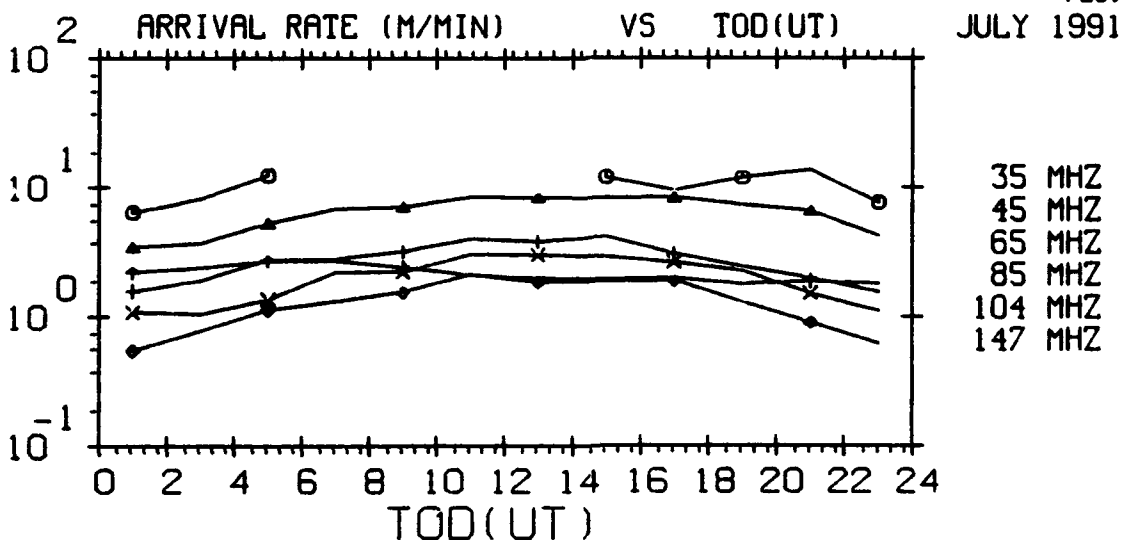

EXCEEDING 19.0 DB SNR
 TYPE OF METEOR TRAIL - UNDERDENSE AND OVERDENSE
 EFFECTIVE SYSTEM BANDWIDTH - 100.HZ
 POLARIZATION - HORIZONTAL
 MAXIMUM DOWN TIME DUE TO SPORADIC-E - 240 SECONDS
 BASED ON OBSERVED NOISE MEASUREMENTS - VERTICAL

MENU#102,01-2
 21-SEP-93
 PLOT# 28.00

GEOPHYSICS LAB METEOR SCATTER PROGRAM

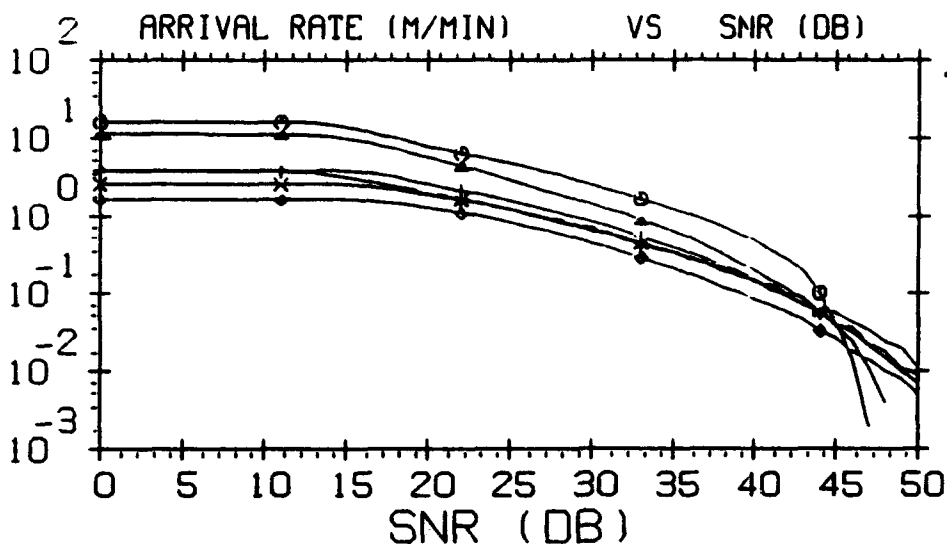

35 MHZ ○
 45 MHZ △
 65 MHZ +
 85 MHZ ×
 104 MHZ ◇
 147 MHZ ↑

THE TIME OF DAY IS 0 : 24 HOURS U.T.
 TYPE OF METEOR TRAIL - UNDERDENSE AND OVERDENSE
 EFFECTIVE SYSTEM BANDWIDTH - 100.HZ
 POLARIZATION - HORIZONTAL
 MAXIMUM DOWN TIME DUE TO SPORADIC-E - 240 SECONDS
 BASED ON OBSERVED NOISE MEASUREMENTS - VERTICAL

MENU#102,02-2
 21-SEP-93
 PLOT# 29.00

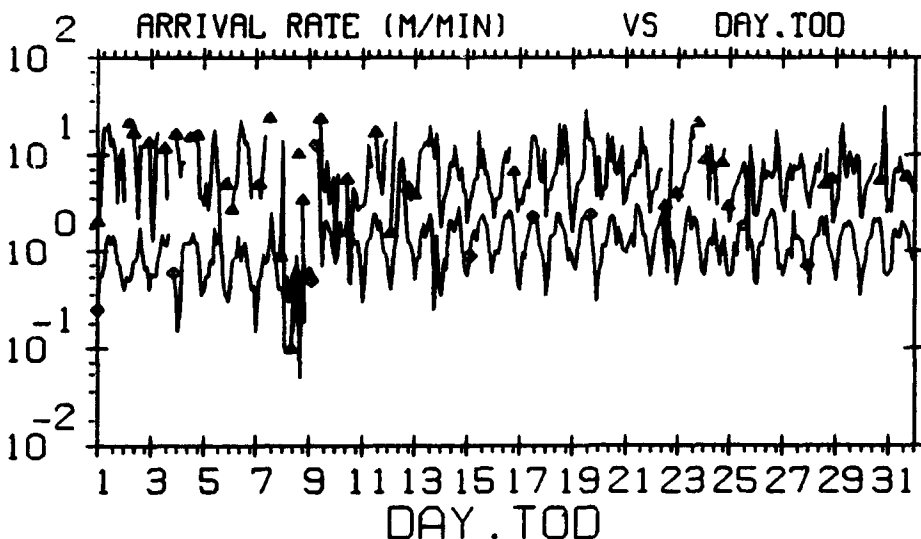

45 MHZ △
 104 MHZ ◇

EXCEEDING 19.0 DB SNR
 TYPE OF METEOR TRAIL - UNDERDENSE AND OVERDENSE
 EFFECTIVE SYSTEM BANDWIDTH - 100.HZ
 POLARIZATION - HORIZONTAL
 MAXIMUM DOWN TIME DUE TO SPORADIC-E - 240 SECONDS
 BASED ON OBSERVED NOISE MEASUREMENTS - VERTICAL

MENU#102,03-2
 21-SEP-93
 PLOT# 30.00

GEOPHYSICS LAB METEOR SCATTER PROGRAM

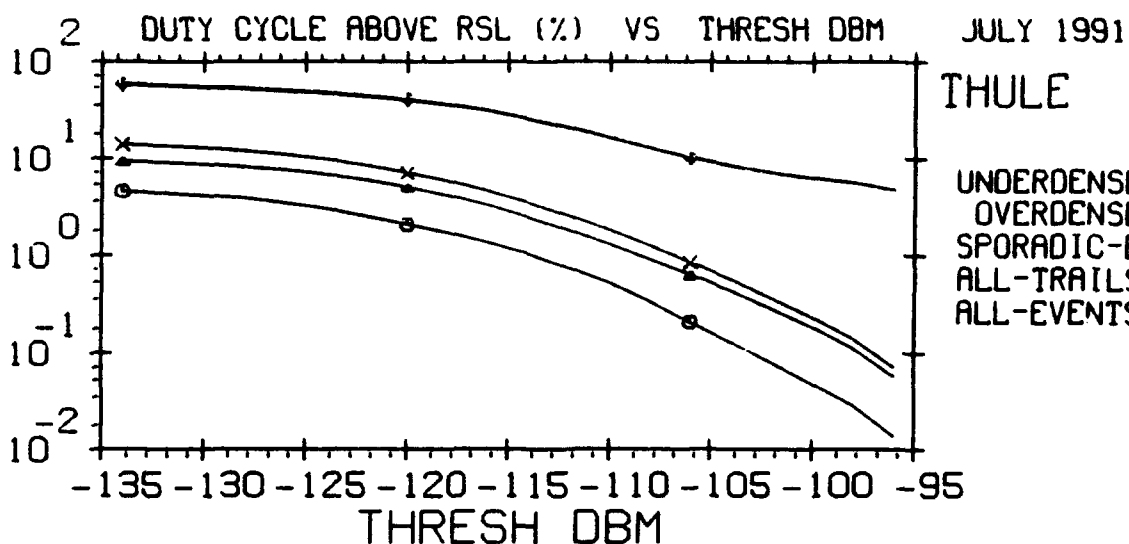

THE TIME OF DAY IS 0 : 24 HOURS U.T.
 FREQUENCY - 35 MHZ
 POLARIZATION - HORIZONTAL
 BASED ON OBSERVED NOISE MEASUREMENTS - VERTICAL

MENU#103,06-2
 21-SEP-93
 PLOT# 31.00

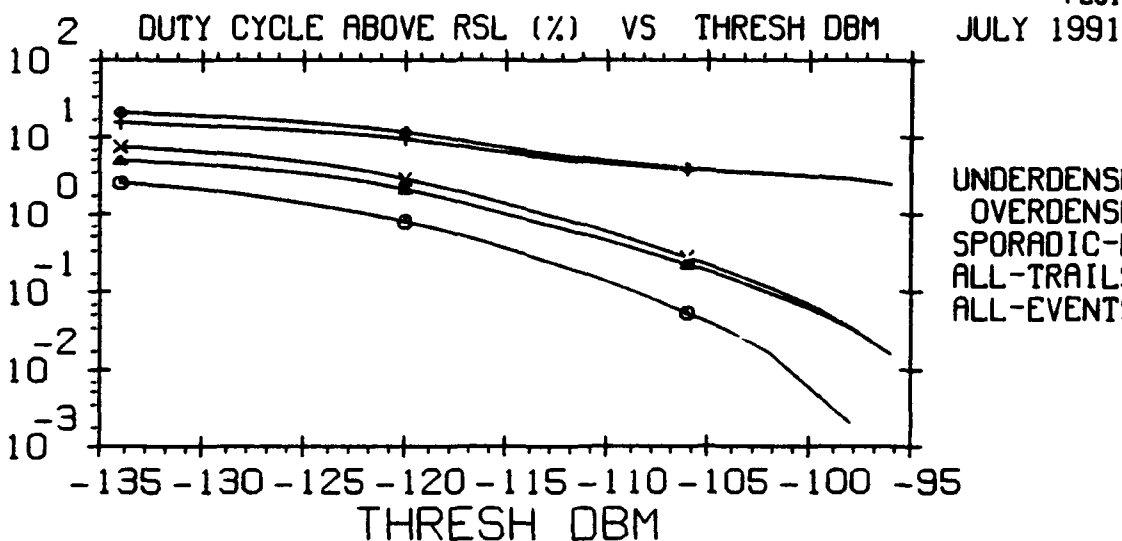

THE TIME OF DAY IS 0 : 24 HOURS U.T.
 FREQUENCY - 45 MHZ
 POLARIZATION - HORIZONTAL
 BASED ON OBSERVED NOISE MEASUREMENTS - VERTICAL

MENU#103,06-2
 21-SEP-93
 PLOT# 32.00

GEOPHYSICS LAB METEOR SCATTER PROGRAM

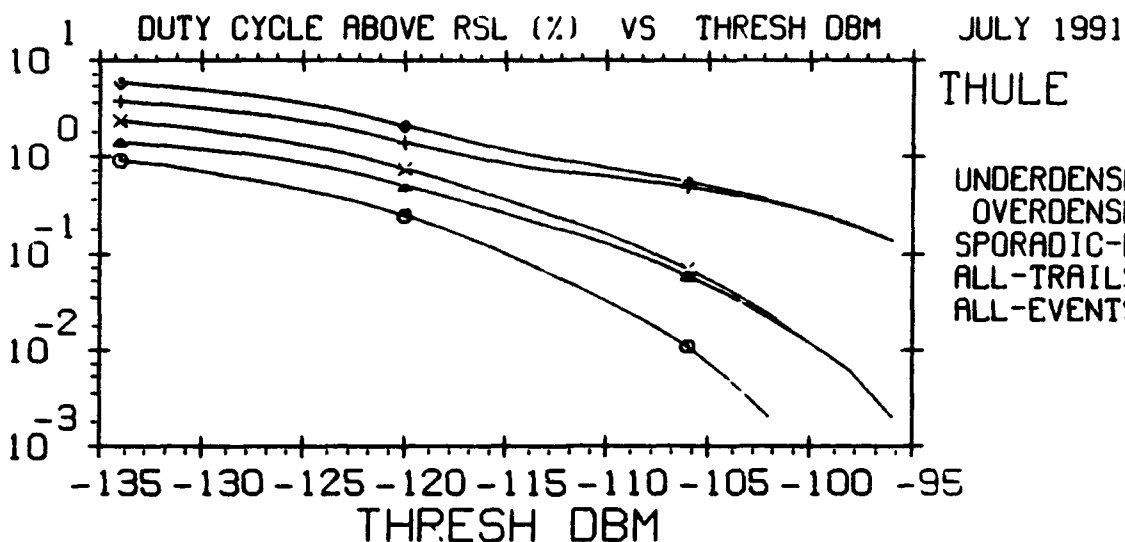

THE TIME OF DAY IS 0 : 24 HOURS U.T.
 FREQUENCY - 65 MHZ
 POLARIZATION - HORIZONTAL
 BASED ON OBSERVED NOISE MEASUREMENTS - VERTICAL

MENU=103,06-2
 21-SEP-93
 PLOT= 33.00

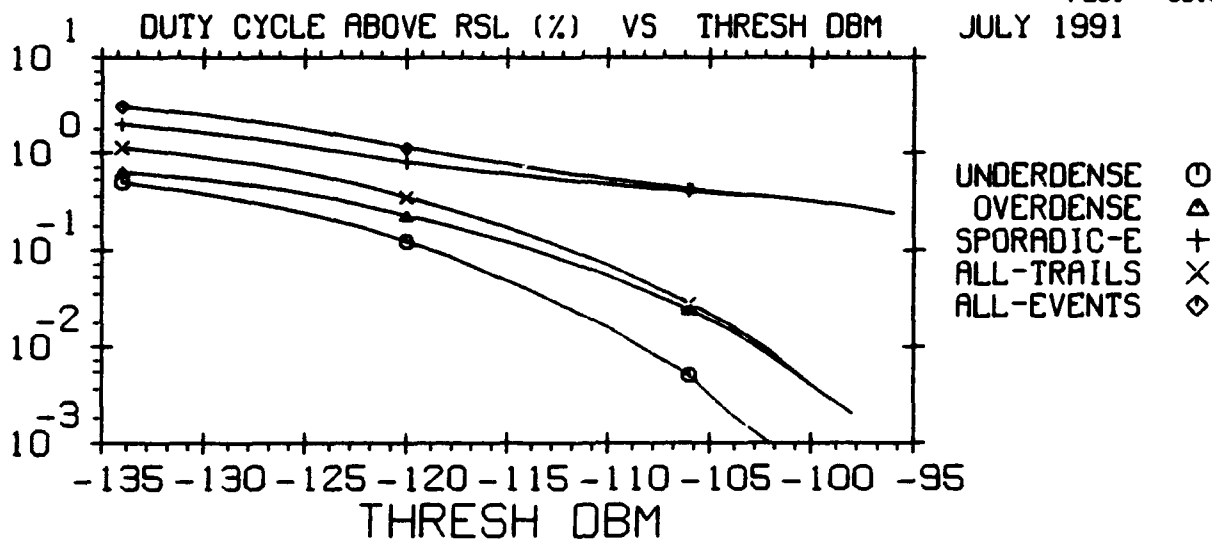

THE TIME OF DAY IS 0 : 24 HOURS U.T.
 FREQUENCY - 85 MHZ
 POLARIZATION - HORIZONTAL
 BASED ON OBSERVED NOISE MEASUREMENTS - VERTICAL

MENU=103,06-2
 21-SEP-93
 PLOT= 34.00

GEOPHYSICS LAB METEOR SCATTER PROGRAM

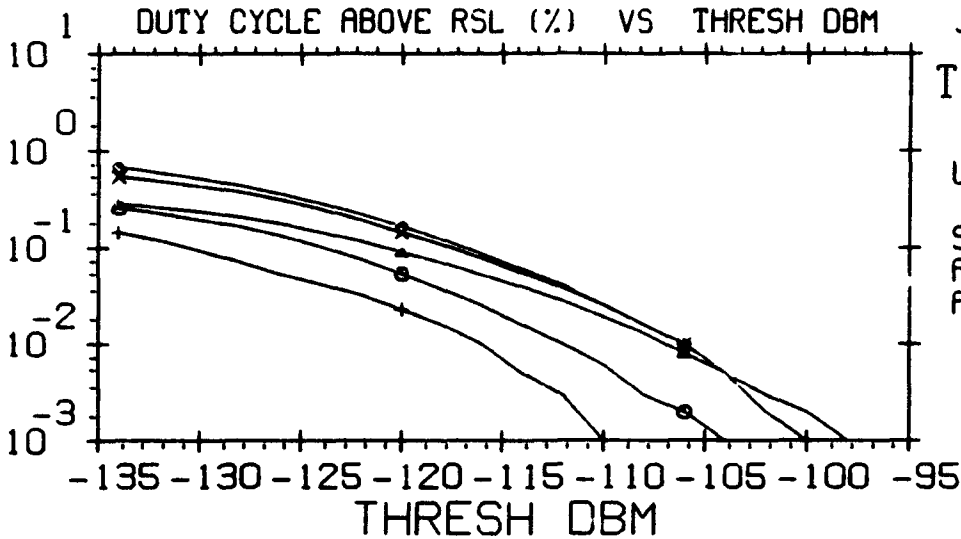

THE TIME OF DAY IS 0 : 24 HOURS U.T.
 FREQUENCY - 104 MHZ
 POLARIZATION - HORIZONTAL
 BASED ON OBSERVED NOISE MEASUREMENTS - VERTICAL

MENU#103,06-2
 21-SEP-93
 PLOT# 35.00

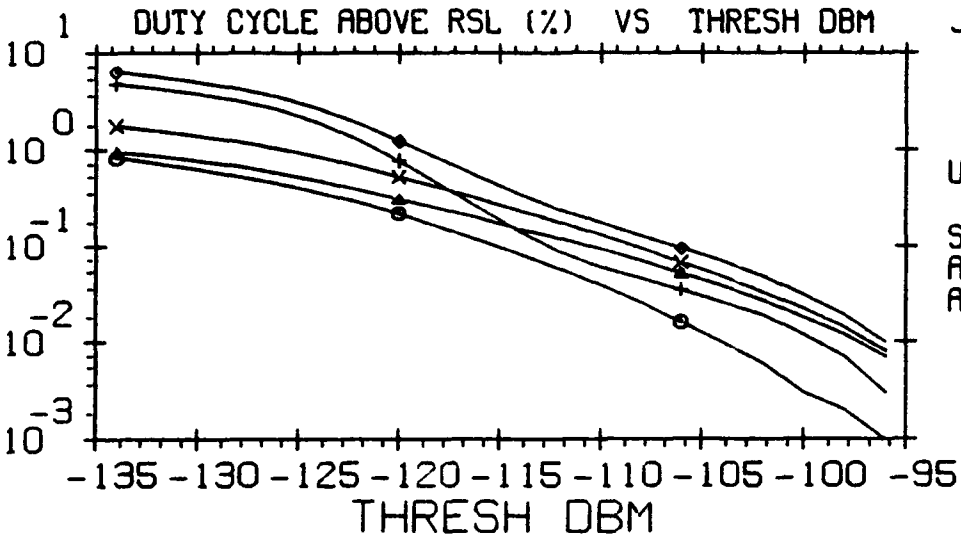

THE TIME OF DAY IS 0 : 24 HOURS U.T.
 FREQUENCY - 147 MHZ
 POLARIZATION - HORIZONTAL
 BASED ON OBSERVED NOISE MEASUREMENTS - VERTICAL

MENU#103,06-2
 21-SEP-93
 PLOT# 36.00

GEOPHYSICS LAB METEOR SCATTER PROGRAM

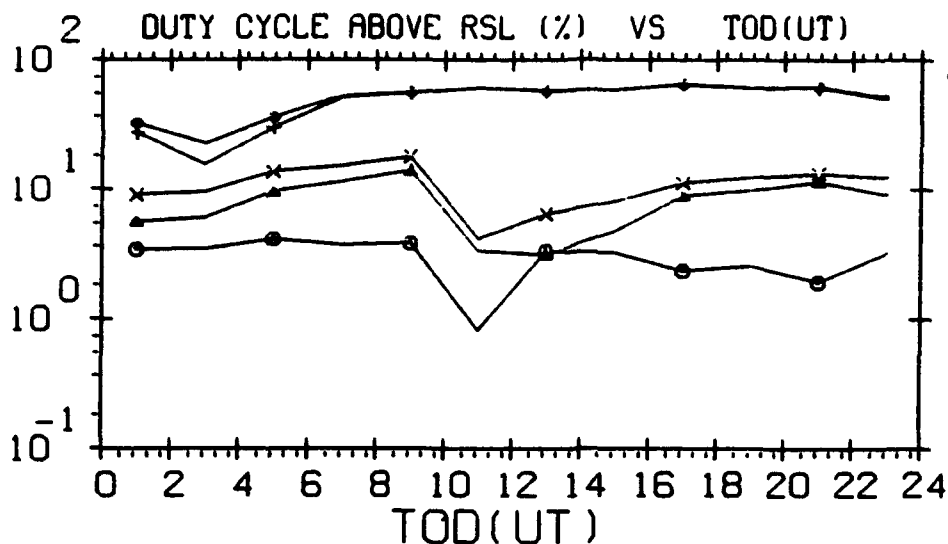

THRESHOLD - -126.0 DBM RSL
 FREQUENCY - 35 MHZ
 POLARIZATION - HORIZONTAL
 BASED ON OBSERVED NOISE MEASUREMENTS - VERTICAL

MENU=103,07-2
 21-SEP-93
 PLOT= 37.00

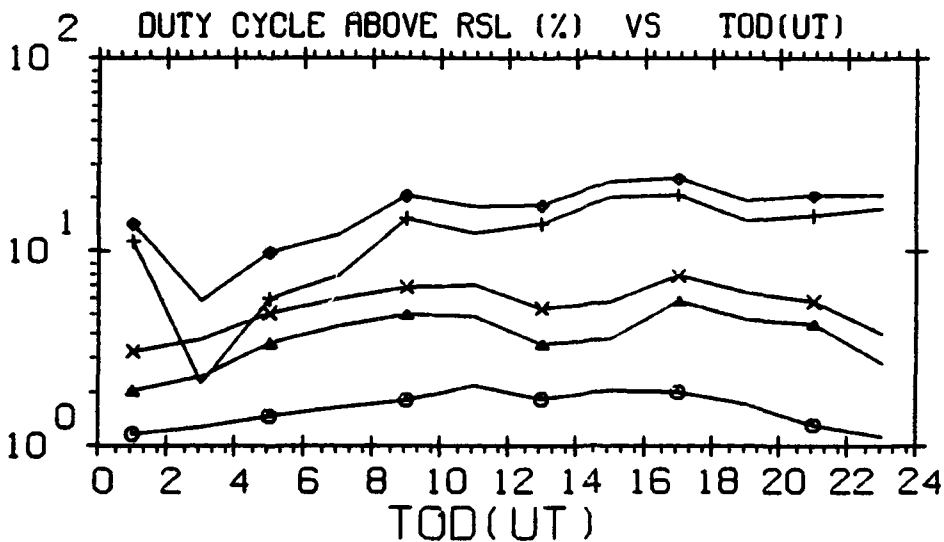

THRESHOLD - -126.0 DBM RSL
 FREQUENCY - 45 MHZ
 POLARIZATION - HORIZONTAL
 BASED ON OBSERVED NOISE MEASUREMENTS - VERTICAL

MENU=103,07-2
 21-SEP-93
 PLOT= 38.00

GEOPHYSICS LAB METEOR SCATTER PROGRAM

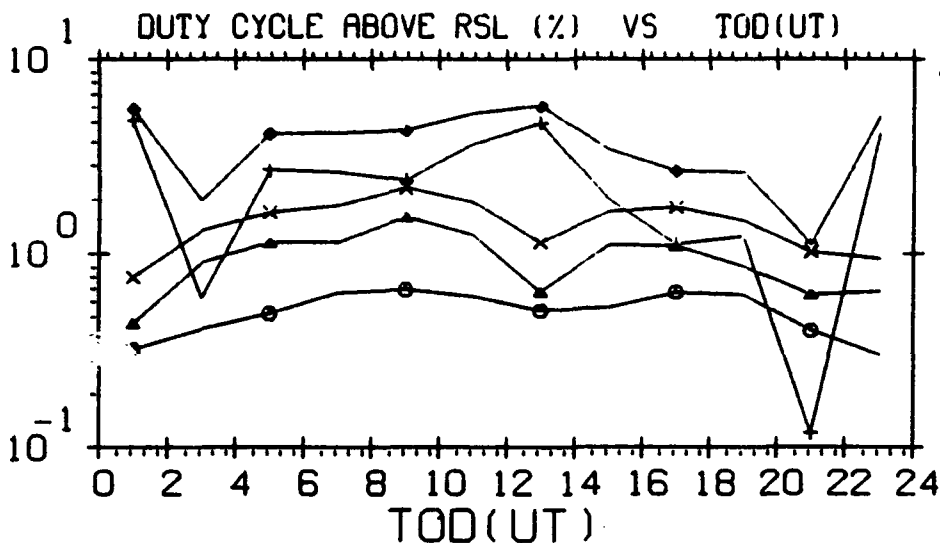

JULY 1991

THULE

UNDERDENSE ⊙
 OVERDENSE △
 SPORADIC-E +
 ALL-TRAILS ×
 ALL-EVENTS ◇

THRESHOLD - -126.0 DBM RSL
 FREQUENCY - 65 MHZ
 POLARIZATION - HORIZONTAL
 BASED ON OBSERVED NOISE MEASUREMENTS - VERTICAL

MENU# 103,07-2
 21-SEP-93
 PLOT# 39.00

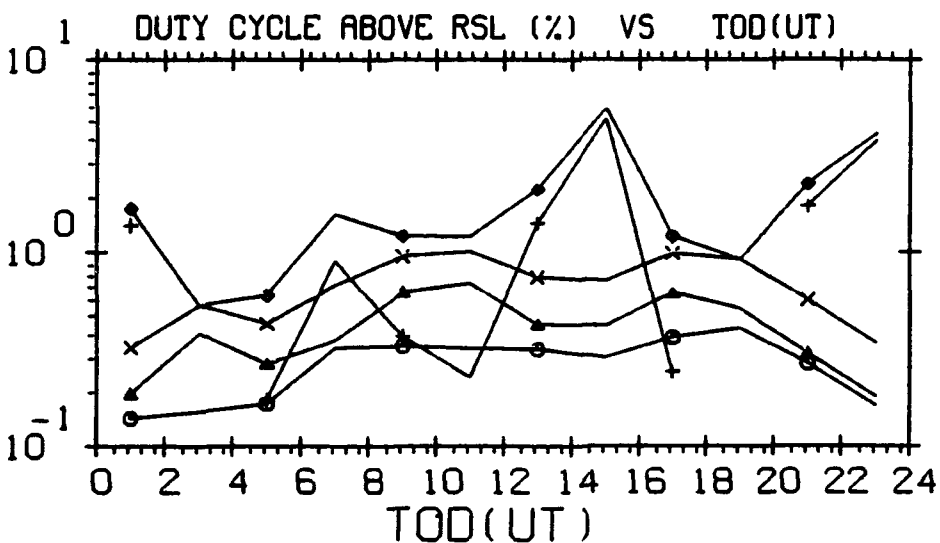

JULY 1991

UNDERDENSE ⊙
 OVERDENSE △
 SPORADIC-E +
 ALL-TRAILS ×
 ALL-EVENTS ◇

THRESHOLD - -126.0 DBM RSL
 FREQUENCY - 85 MHZ
 POLARIZATION - HORIZONTAL
 BASED ON OBSERVED NOISE MEASUREMENTS - VERTICAL

MENU# 103,07-2
 21-SEP-93
 PLOT# 40.00

GEOPHYSICS LAB METEOR SCATTER PROGRAM

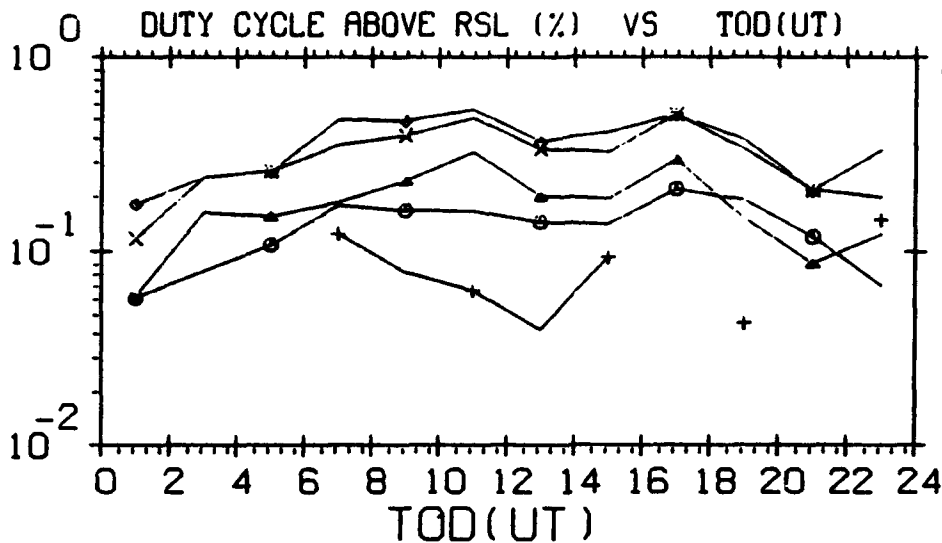

THRESHOLD - -126.0 DBM RSL
 FREQUENCY - 104 MHZ
 POLARIZATION - HORIZONTAL
 BASED ON OBSERVED NOISE MEASUREMENTS - VERTICAL

MENU=103,07-2
 21-SEP-93
 PLOT# 41.00

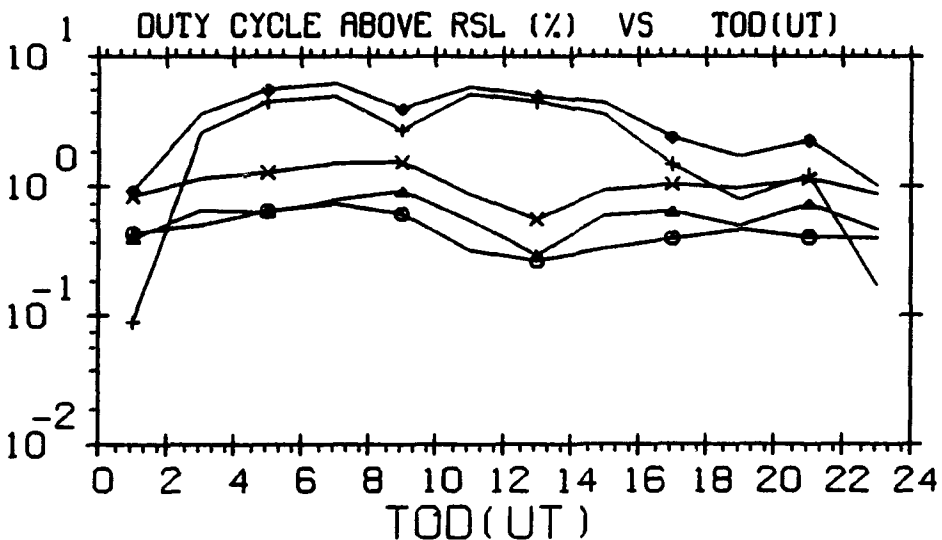

THRESHOLD - -126.0 DBM RSL
 FREQUENCY - 147 MHZ
 POLARIZATION - HORIZONTAL
 BASED ON OBSERVED NOISE MEASUREMENTS - VERTICAL

MENU=103,07-2
 21-SEP-93
 PLOT# 42.00

GEOPHYSICS LAB METEOR SCATTER PROGRAM

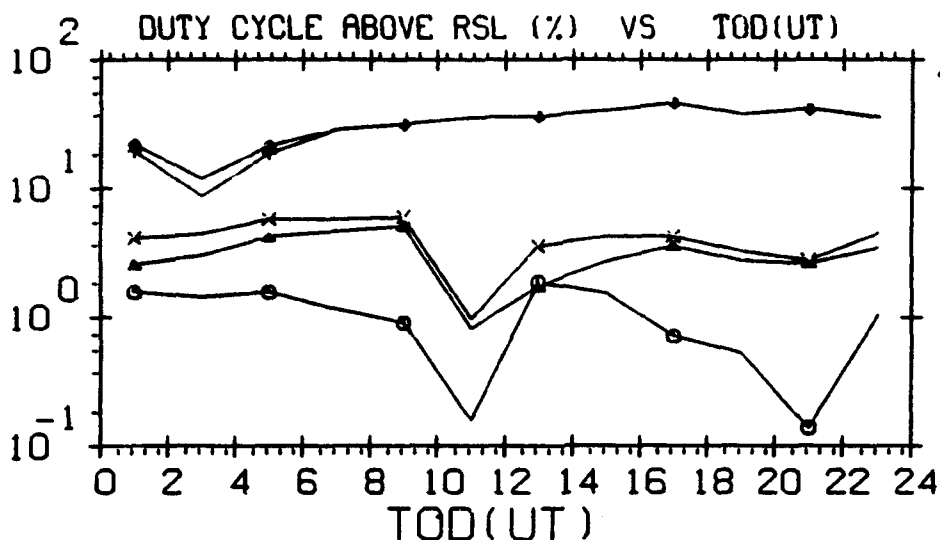

THRESHOLD - -116.0 DBM RSL
 FREQUENCY - 35 MHZ
 POLARIZATION - HORIZONTAL
 BASED ON OBSERVED NOISE MEASUREMENTS - VERTICAL

MENU=103,07-2
 21-SEP-93
 PLOT# 43.00

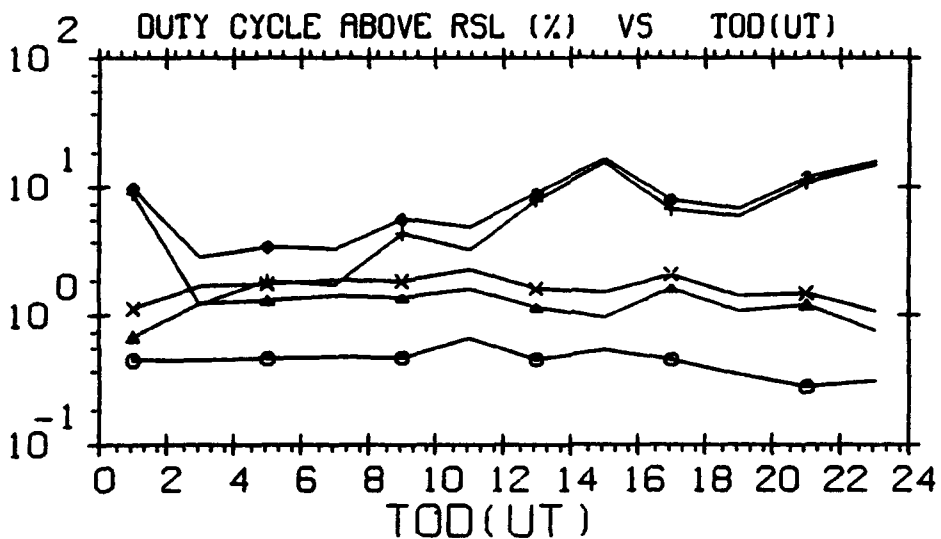

THRESHOLD - -116.0 DBM RSL
 FREQUENCY - 45 MHZ
 POLARIZATION - HORIZONTAL
 BASED ON OBSERVED NOISE MEASUREMENTS - VERTICAL

MENU=103,07-2
 21-SEP-93
 PLOT# 44.00

GEOPHYSICS LAB METEOR SCATTER PROGRAM

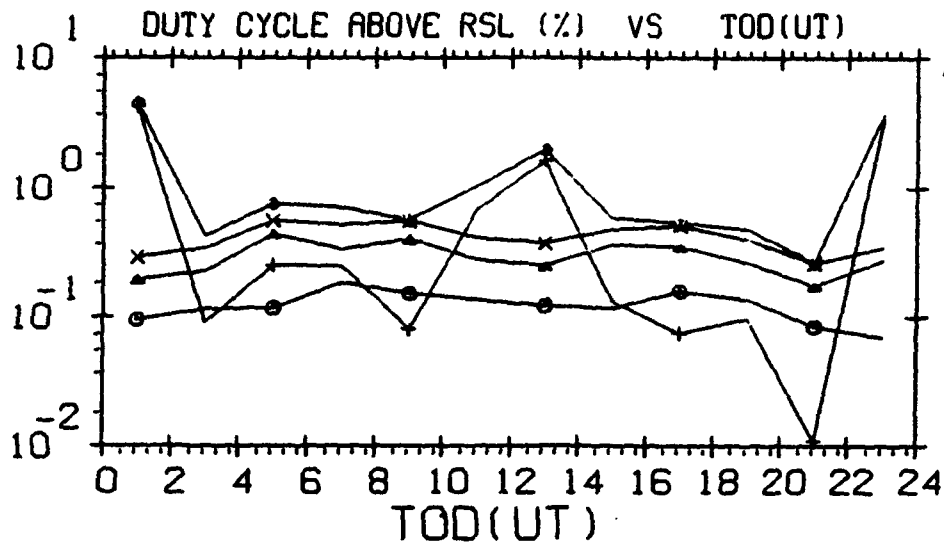

THRESHOLD - -116.0 DBM RSL
 FREQUENCY - 65 MHZ
 POLARIZATION - HORIZONTAL
 BASED ON OBSERVED NOISE MEASUREMENTS - VERTICAL

MENU#103,07-2
 21-SEP-93
 PLOT# 45.00

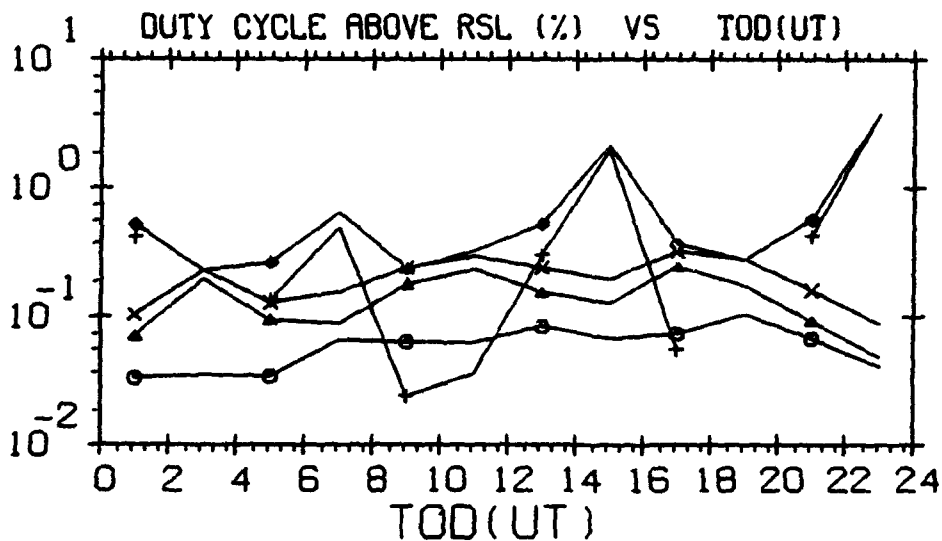

THRESHOLD - -116.0 DBM RSL
 FREQUENCY - 85 MHZ
 POLARIZATION - HORIZONTAL
 BASED ON OBSERVED NOISE MEASUREMENTS - VERTICAL

MENU#103,07-2
 21-SEP-93
 PLOT# 46.00

GEOPHYSICS LAB METEOR SCATTER PROGRAM

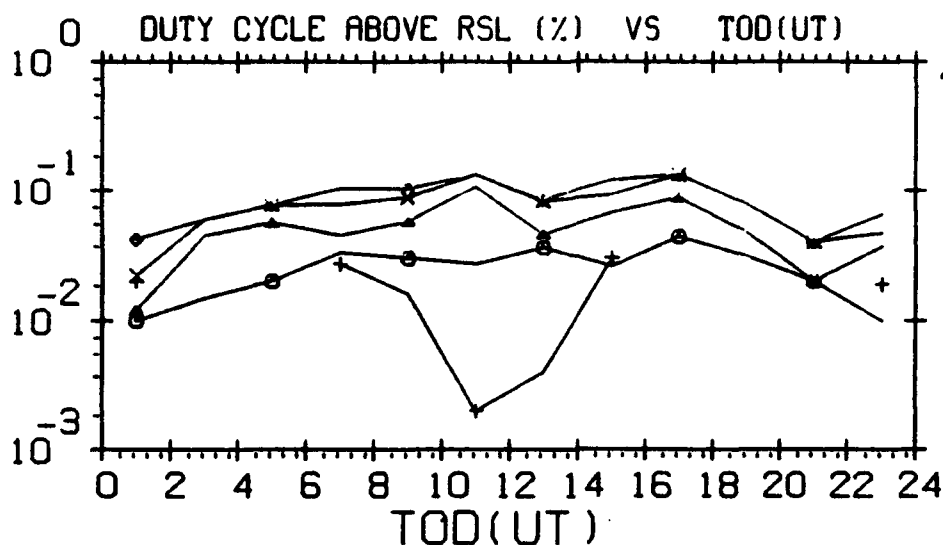

THRESHOLD - -116.0 DBM RSL
 FREQUENCY - 104 MHZ
 POLARIZATION - HORIZONTAL
 BASED ON OBSERVED NOISE MEASUREMENTS - VERTICAL

MENU=103,07-2
 21-SEP-93
 PLOT= 47.00

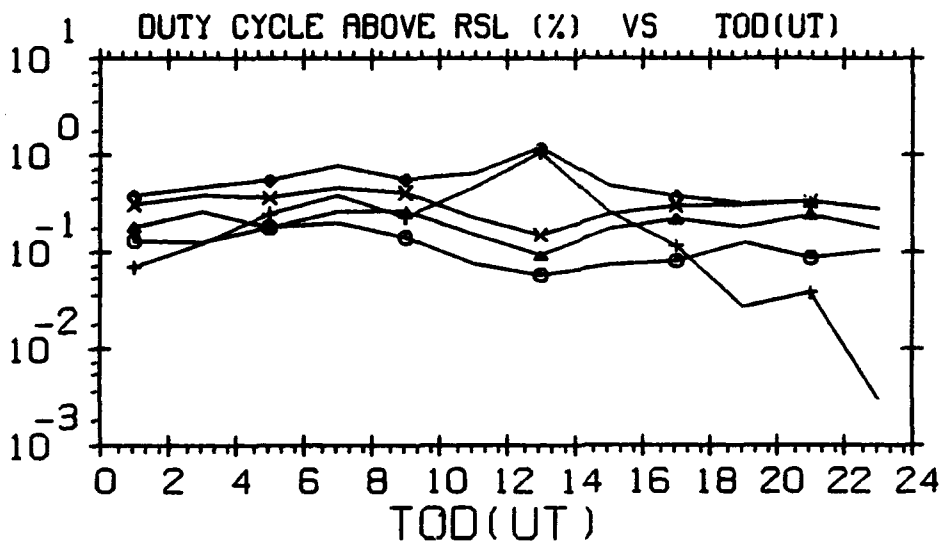

THRESHOLD - -116.0 DBM RSL
 FREQUENCY - 147 MHZ
 POLARIZATION - HORIZONTAL
 BASED ON OBSERVED NOISE MEASUREMENTS - VERTICAL

MENU=103,07-2
 21-SEP-93
 PLOT= 48.00

GEOPHYSICS LAB METEOR SCATTER PROGRAM

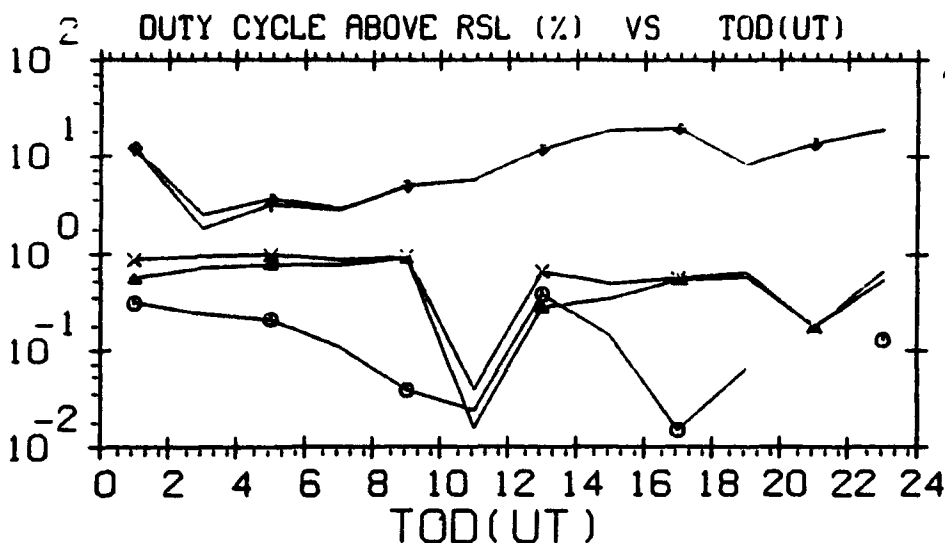

THRESHOLD - -106.0 DBM RSL
 FREQUENCY - 35 MHZ
 POLARIZATION - HORIZONTAL
 BASED ON OBSERVED NOISE MEASUREMENTS - VERTICAL

MENU#103,07-2
 21-SEP-93
 PLOT# 49.00

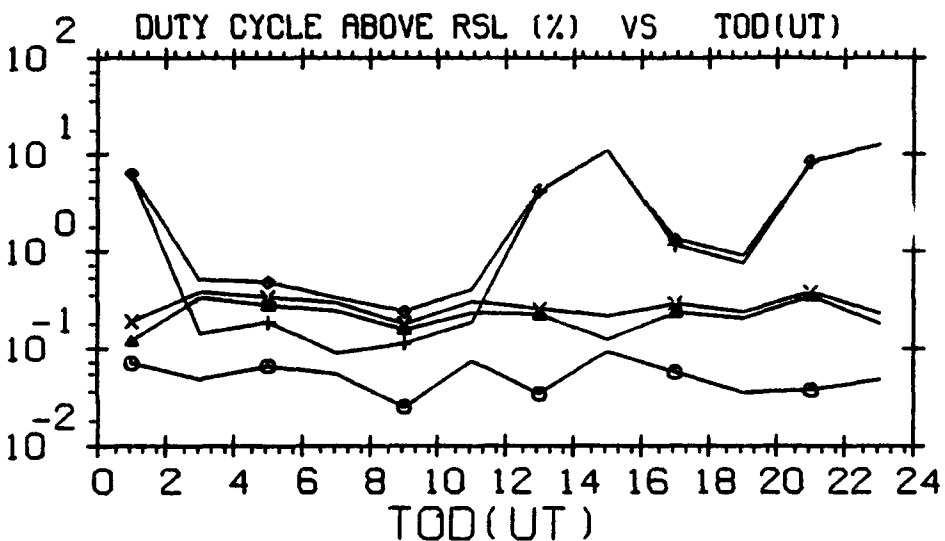

THRESHOLD - -106.0 DBM RSL
 FREQUENCY - 45 MHZ
 POLARIZATION - HORIZONTAL
 BASED ON OBSERVED NOISE MEASUREMENTS - VERTICAL

MENU#103,07-2
 21-SEP-93
 PLOT# 50.00

GEOPHYSICS LAB METEOR SCATTER PROGRAM

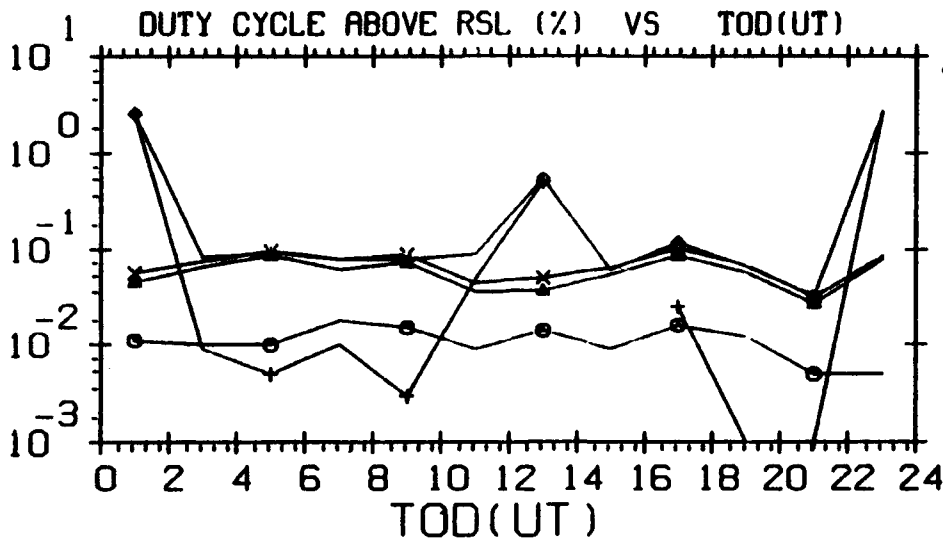

THRESHOLD - -106.0 DBM RSL
 FREQUENCY - 65 MHZ
 POLARIZATION - HORIZONTAL
 BASED ON OBSERVED NOISE MEASUREMENTS - VERTICAL

MENU#103,07-2
 21-SEP-93
 PLOT# 51.00

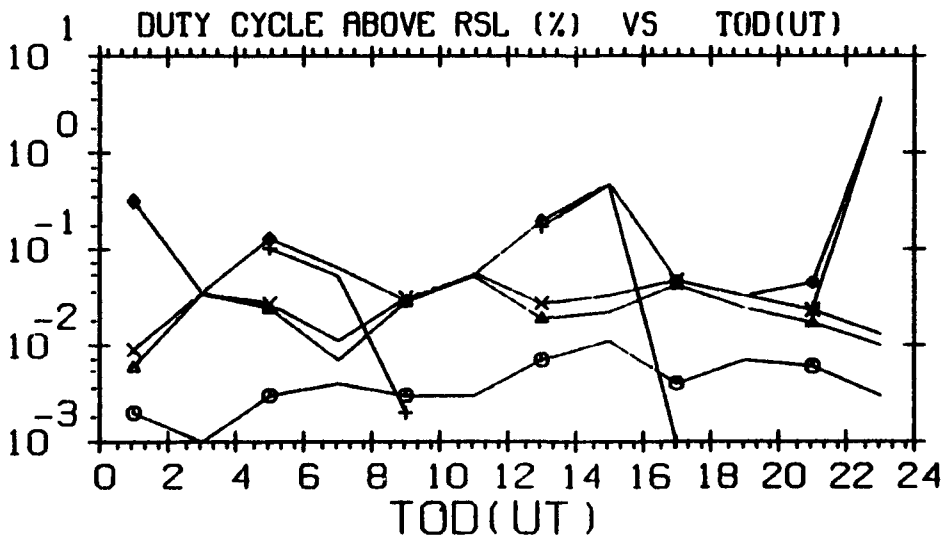

THRESHOLD - -106.0 DBM RSL
 FREQUENCY - 85 MHZ
 POLARIZATION - HORIZONTAL
 BASED ON OBSERVED NOISE MEASUREMENTS - VERTICAL

MENU#103,07-2
 21-SEP-93
 PLOT# 52.00

GEOPHYSICS LAB METEOR SCATTER PROGRAM

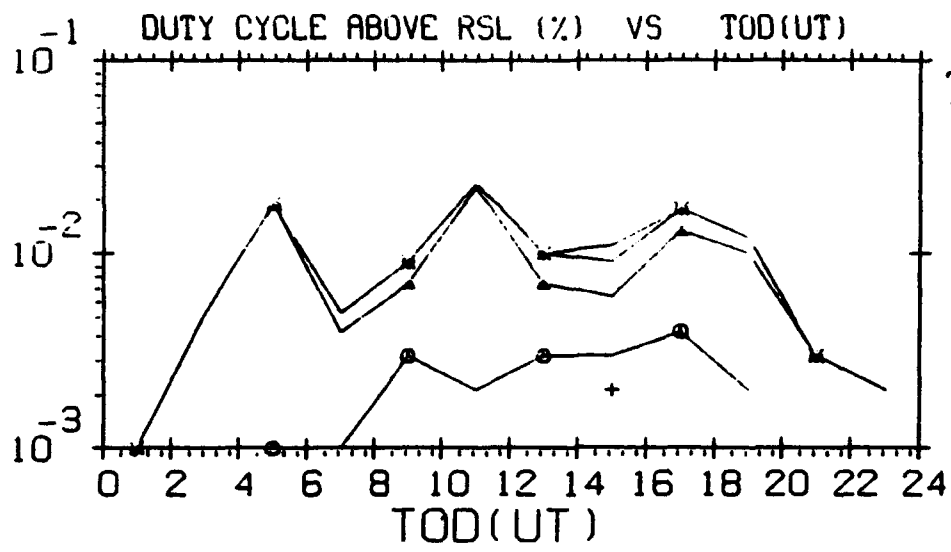

THRESHOLD - -106.0 DBM RSL
 FREQUENCY - 104 MHZ
 POLARIZATION - HORIZONTAL
 BASED ON OBSERVED NOISE MEASUREMENTS - VERTICAL

MENU# 103,07-2
 21-SEP-93
 PLOT# 53.00

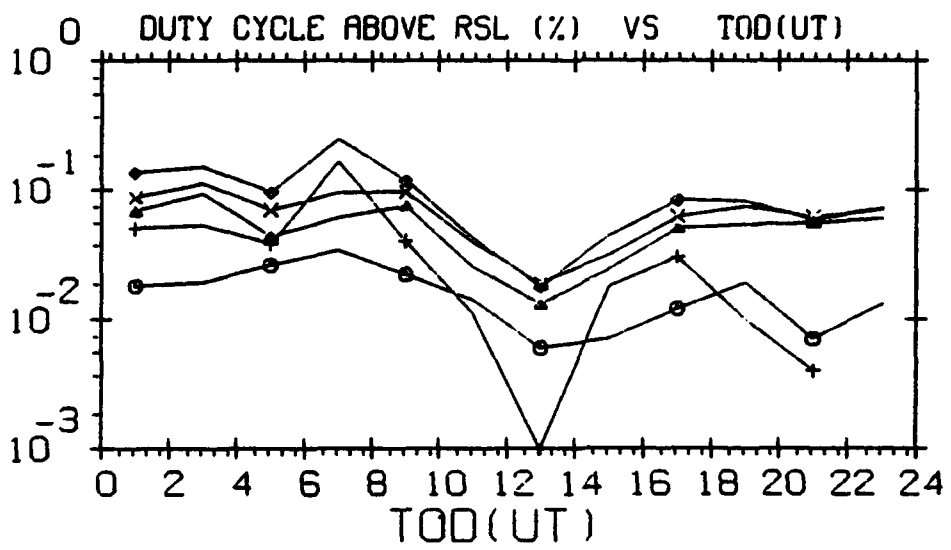

THRESHOLD - -106.0 DBM RSL
 FREQUENCY - 147 MHZ
 POLARIZATION - HORIZONTAL
 BASED ON OBSERVED NOISE MEASUREMENTS - VERTICAL

MENU# 103,07-2
 21-SEP-93
 PLOT# 54.00

GEOPHYSICS LAB METEOR SCATTER PROGRAM

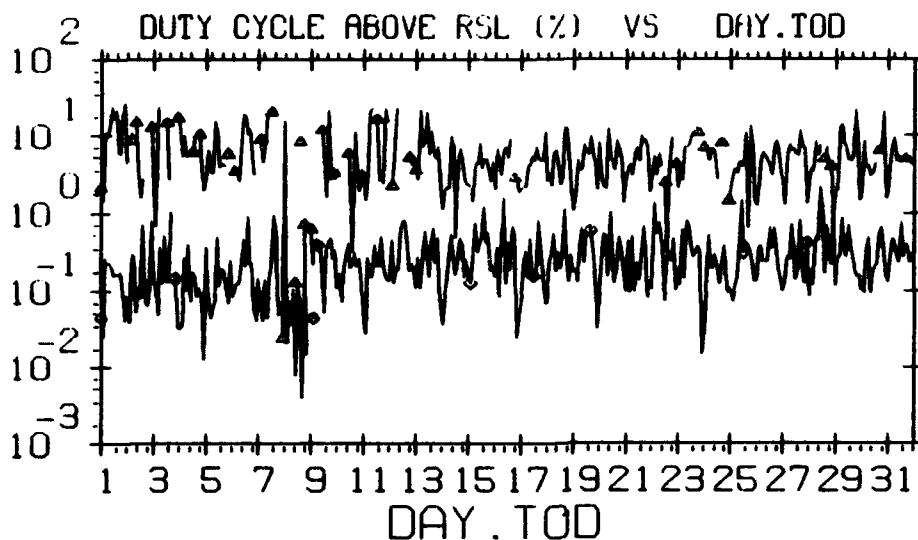

JULY 1991
THULE

45 MHZ △
104 MHZ ◇

THRESHOLD - -126.0 DBM RSL
THE EVENT CLASS IS UNDERDENSE AND OVERDENSE TRAILS
POLARIZATION - HORIZONTAL
BASED ON OBSERVED NOISE MEASUREMENTS - VERTICAL

MENU#103,09-2
21-SEP-93
PLOT# 55.00

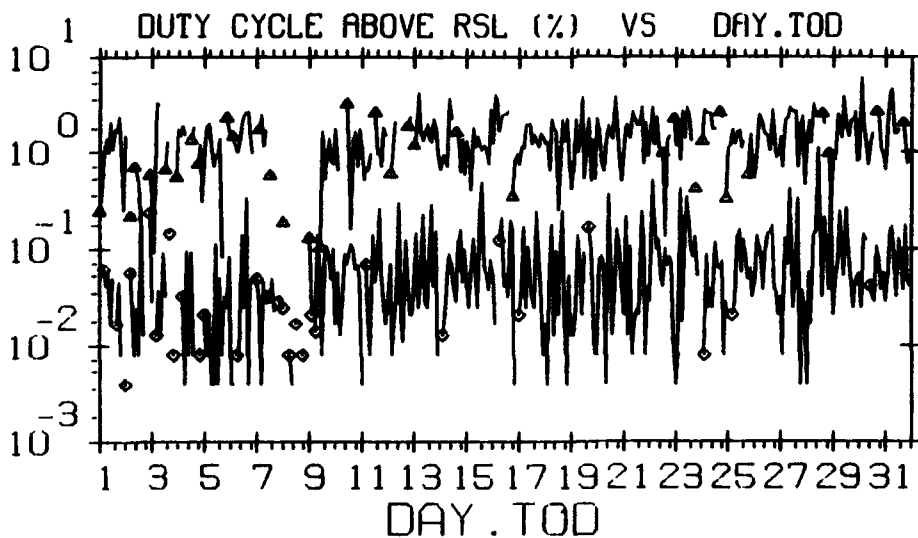

JULY 1991

45 MHZ △
104 MHZ ◇

THRESHOLD - -116.0 DBM RSL
THE EVENT CLASS IS UNDERDENSE AND OVERDENSE TRAILS
POLARIZATION - HORIZONTAL
BASED ON OBSERVED NOISE MEASUREMENTS - VERTICAL

MENU#103,09-2
21-SEP-93
PLOT# 56.00

GEOPHYSICS LAB METEOR SCATTER PROGRAM

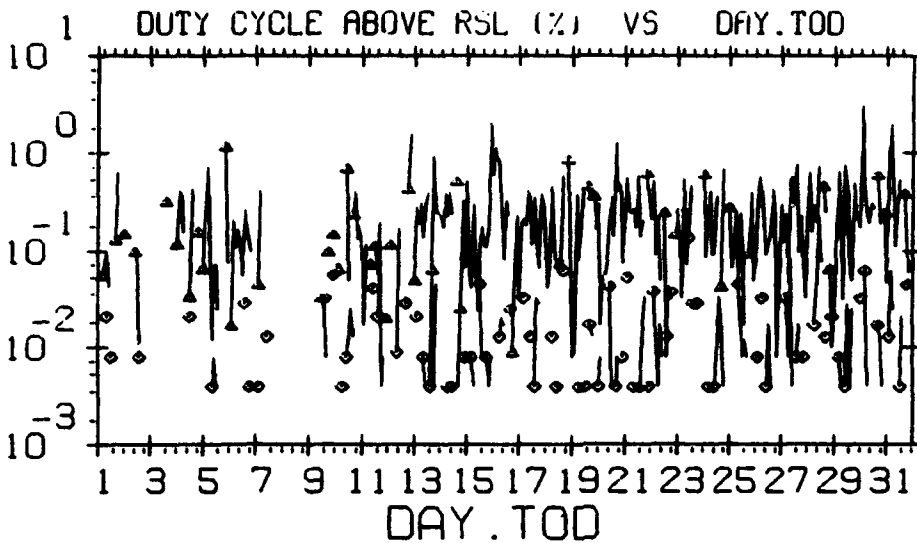

JULY 1991
THULE

45 MHZ ▲
104 MHZ ◆

THRESHOLD - -106.0 DBM RSL
THE EVENT CLASS IS UNDERDENSE AND OVERDENSE TRAILS
POLARIZATION - HORIZONTAL
BASED ON OBSERVED NOISE MEASUREMENTS - VERTICAL

MENU#103,09-2
21-SEP-93
PLOT# 57.00

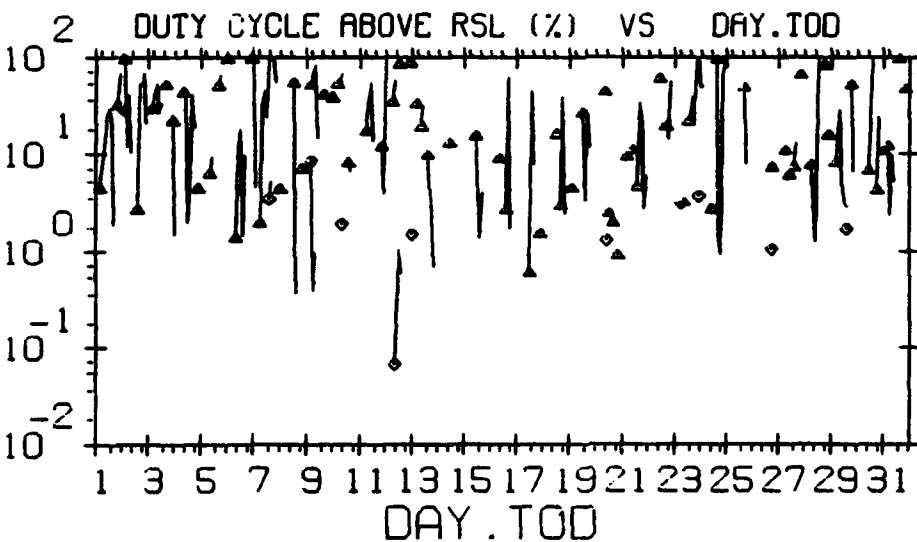

JULY 1991

45 MHZ ▲
104 MHZ ◆

THRESHOLD - -126.0 DBM RSL
THE EVENT CLASS IS SPORADIC-E
POLARIZATION - HORIZONTAL
BASED ON OBSERVED NOISE MEASUREMENTS - VERTICAL

MENU#103,09-2
21-SEP-93
PLOT# 58.00

GEOPHYSICS LAB METEOR SCATTER PROGRAM

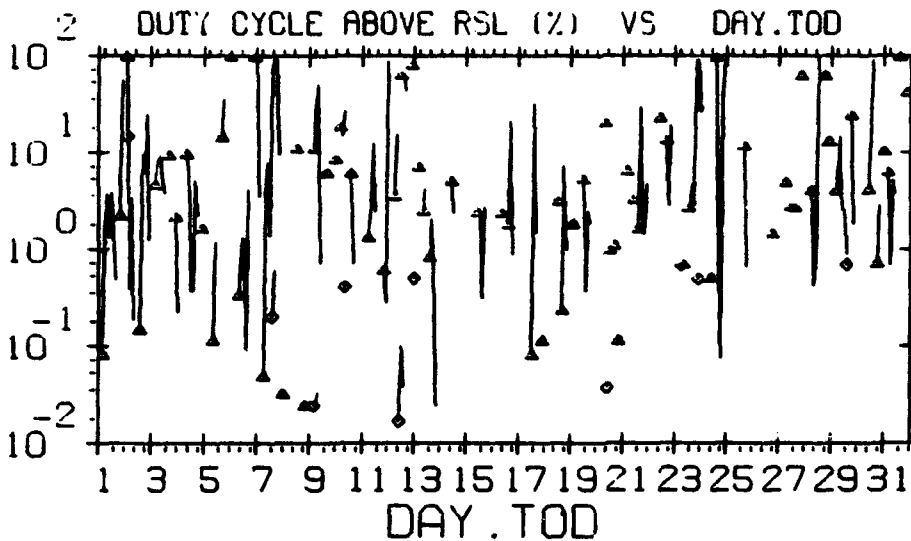

JULY 1991

THULE

45 MHZ \triangle
104 MHZ \diamond

THRESHOLD - -116.0 DBM RSL
THE EVENT CLASS IS SPORADIC-E
POLARIZATION - HORIZONTAL
BASED ON OBSERVED NOISE MEASUREMENTS - VERTICAL

MENU#103,09-2
21-SEP-93
PLOT# 59.00

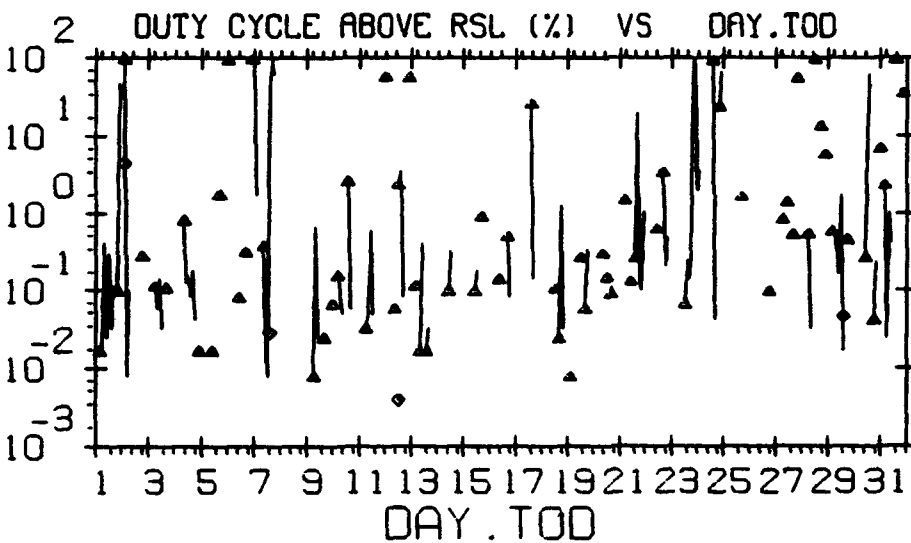

JULY 1991

45 MHZ \triangle
104 MHZ \diamond

THRESHOLD - -106.0 DBM RSL
THE EVENT CLASS IS SPORADIC-E
POLARIZATION - HORIZONTAL
BASED ON OBSERVED NOISE MEASUREMENTS - VERTICAL

MENU#103,09-2
21-SEP-93
PLOT# 60.00

GEOPHYSICS LAB METEOR SCATTER PROGRAM

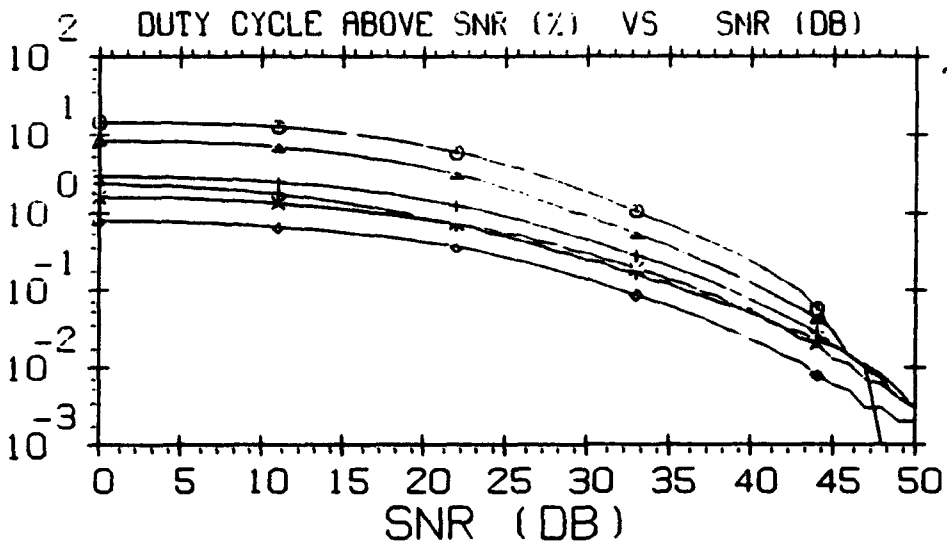

- 35 MHZ ○
- 45 MHZ △
- 65 MHZ +
- 85 MHZ ×
- 104 MHZ ◇
- 147 MHZ †

THE TIME OF DAY IS 0 : 24 HOURS U.T.
 THE EVENT CLASS IS UNDERDENSE AND OVERDENSE TRAILS
 EFFECTIVE SYSTEM BANDWIDTH - 100.HZ
 POLARIZATION - HORIZONTAL
 BASED ON OBSERVED NOISE MEASUREMENTS - VERTICAL

MENU=104,02-2
 21-SEP-93
 PLOT# 61.00

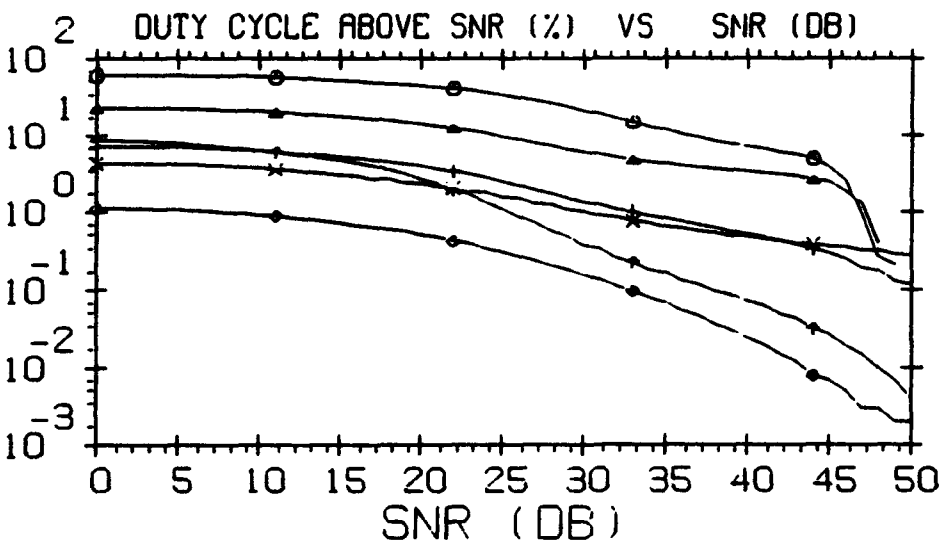

- 35 MHZ ○
- 45 MHZ △
- 65 MHZ +
- 85 MHZ ×
- 104 MHZ ◇
- 147 MHZ †

THE TIME OF DAY IS 0 : 24 HOURS U.T.
 THE EVENT CLASS IS SPORADIC-E AND METEOR TRAILS
 EFFECTIVE SYSTEM BANDWIDTH - 100.HZ
 POLARIZATION - HORIZONTAL
 BASED ON OBSERVED NOISE MEASUREMENTS - VERTICAL

MENU=104,02-2
 21-SEP-93
 PLOT# 62.00

GEOPHYSICS LAB METEOR SCATTER PROGRAM

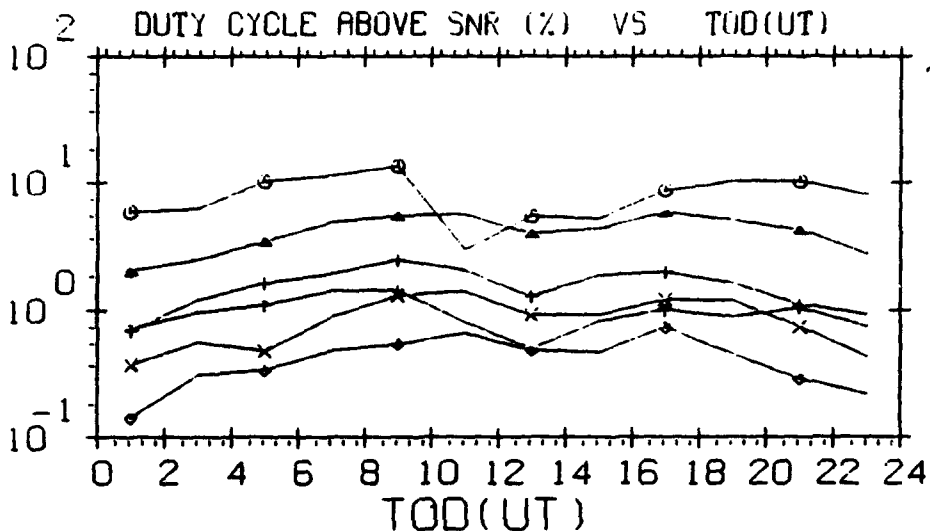

JULY 1991

THULE

35 MHZ	○
45 MHZ	△
65 MHZ	+
85 MHZ	×
104 MHZ	◇
147 MHZ	†

SIGNAL-TO-NOISE RATIO - 19.0 DB
 THE EVENT CLASS IS UNDERDENSE AND OVERDENSE TRAILS
 EFFECTIVE SYSTEM BANDWIDTH - 100.HZ
 POLARIZATION - HORIZONTAL
 BASED ON OBSERVED NOISE MEASUREMENTS - VERTICAL

MENU=104,03-2
 21-SEP-93
 PLOT# 63.00

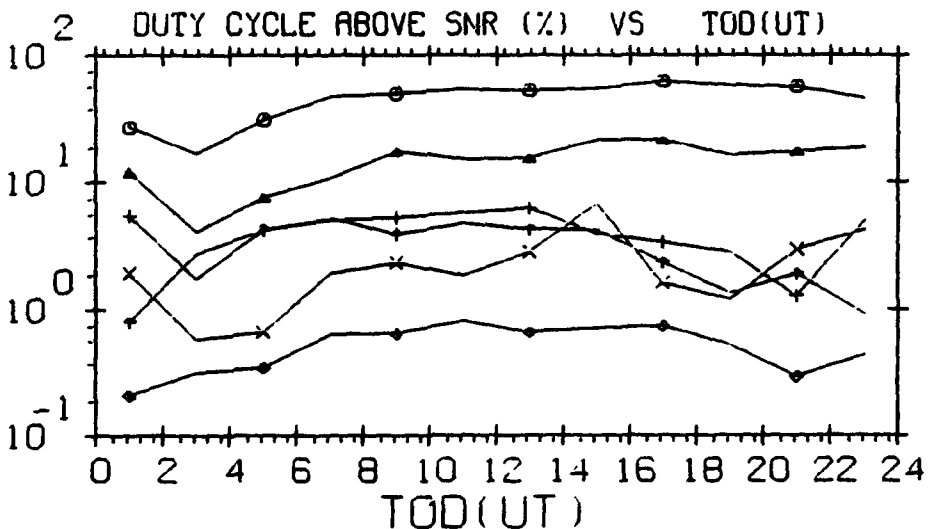

JULY 1991

35 MHZ	○
45 MHZ	△
65 MHZ	+
85 MHZ	×
104 MHZ	◇
147 MHZ	†

SIGNAL-TO-NOISE RATIO - 19.0 DB
 THE EVENT CLASS IS SPORADIC-E AND METEOR TRAILS
 EFFECTIVE SYSTEM BANDWIDTH - 100.HZ
 POLARIZATION - HORIZONTAL
 BASED ON OBSERVED NOISE MEASUREMENTS - VERTICAL

MENU=104,03-2
 21-SEP-93
 PLOT# 64.00

GEOPHYSICS LAB METEOR SCATTER PROGRAM

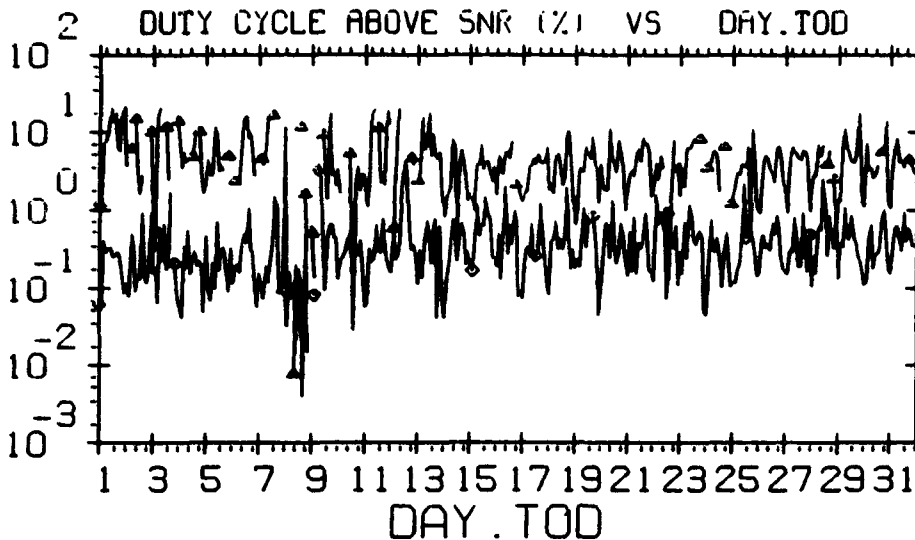

JULY 1991

THULE

45 MHZ △
104 MHZ ◇

SIGNAL-TO-NOISE RATIO - 19.0 DB
THE EVENT CLASS IS UNDERDENSE AND OVERDENSE TRAILS
EFFECTIVE SYSTEM BANDWIDTH - 100.HZ
POLARIZATION - HORIZONTAL
BASED ON OBSERVED NOISE MEASUREMENTS - VERTICAL

MENU#104,09-2
21-SEP-93
PLOT# 65.00

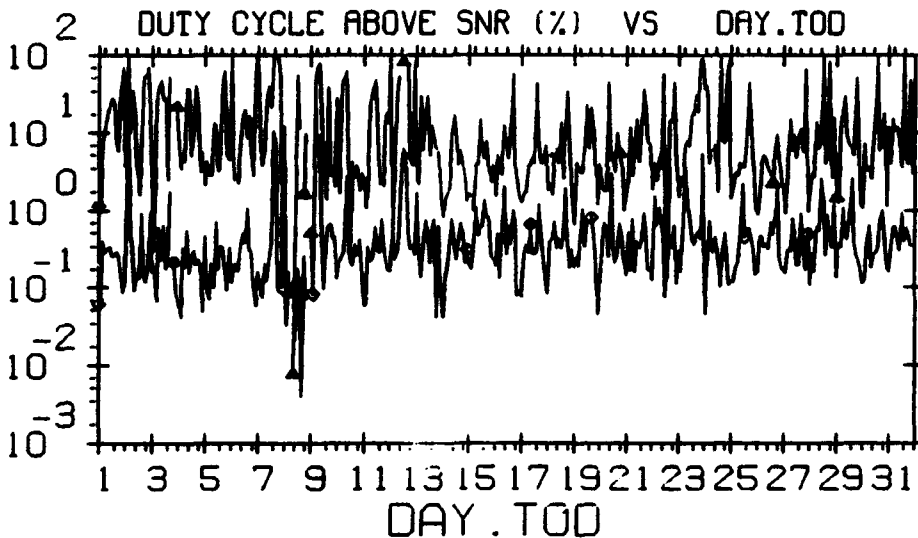

JULY 1991

45 MHZ △
104 MHZ ◇

SIGNAL-TO-NOISE RATIO - 19.0 DB
THE EVENT CLASS IS SPORADIC-E AND METEOR TRAILS
EFFECTIVE SYSTEM BANDWIDTH - 100.HZ
POLARIZATION - HORIZONTAL
BASED ON OBSERVED NOISE MEASUREMENTS - VERTICAL

MENU#104,09-2
21-SEP-93
PLOT# 66.00

GEOPHYSICS LAB METEOR SCATTER PROGRAM

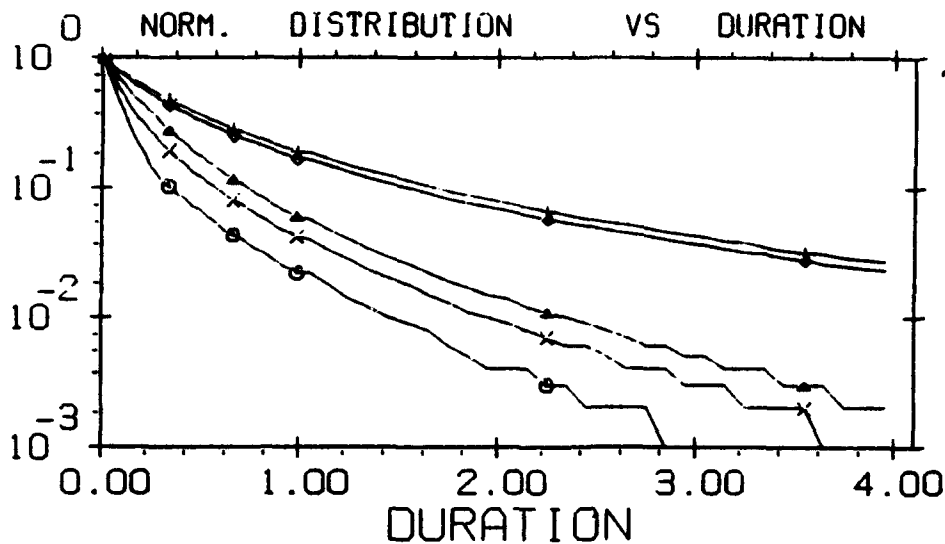

EXCEEDING -126.0 DBM RSL
 THE TIME OF DAY IS 0 : 24 HOURS U.T.
 FREQUENCY - 35 MHZ
 BASED ON OBSERVED NOISE MEASUREMENTS - VERTICAL
 NORMALIZING FACTORS:
 UNDER - 12690. OVER - 13393. SPOR-E - 153861.
 TRAILS - 26083. EVENTS - 179944.

MENU#106,02-4
 21-SEP-93
 PLOT# 67.00

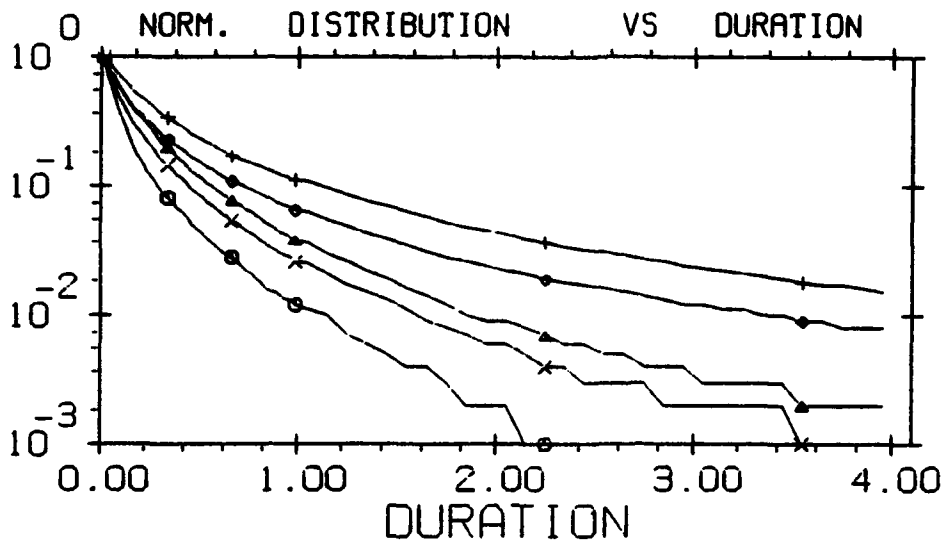

EXCEEDING -126.0 DBM RSL
 THE TIME OF DAY IS 0 : 24 HOURS U.T.
 FREQUENCY - 45 MHZ
 BASED ON OBSERVED NOISE MEASUREMENTS - VERTICAL
 NORMALIZING FACTORS:
 UNDER - 18933. OVER - 22510. SPOR-E - 35328.
 TRAILS - 41443. EVENTS - 76771.

MENU#106,02-4
 21-SEP-93
 PLOT# 68.00

GEOPHYSICS LAB METEOR SCATTER PROGRAM

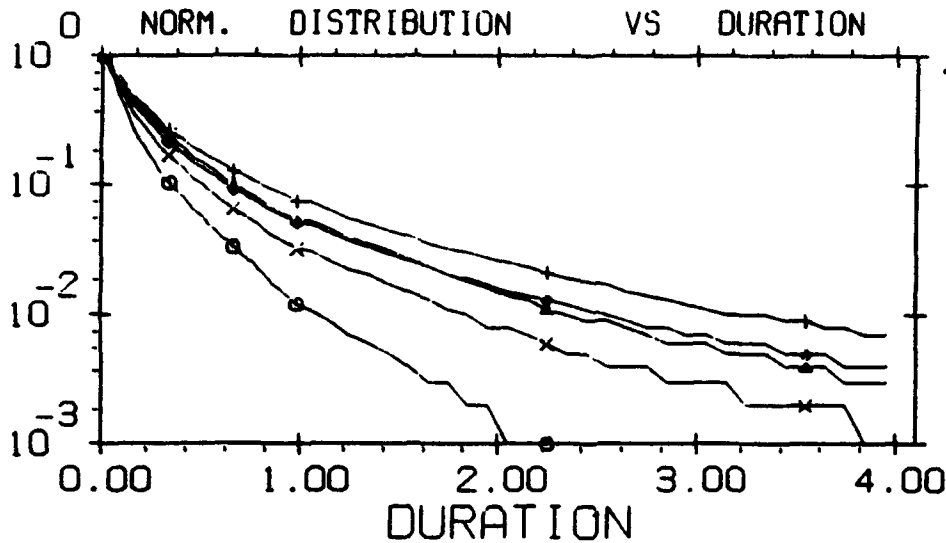

UNDERDENSE ⊙
 OVERDENSE △
 SPORADIC-E +
 ALL-TRAILS ×
 ALL-EVENTS ◇

EXCEEDING -126.0 DBM RSL
 THE TIME OF DAY IS 0 : 24 HOURS U.T.
 FREQUENCY - 65 MHZ
 BASED ON OBSERVED NOISE MEASUREMENTS - VERTICAL
 NORMALIZING FACTORS:
 UNDER - 9666. OVER - 8701. SPOR-E - 14926.
 TRAILS - 18367. EVENTS - 33293.

MENU=106,02-4
 21-SEP-93
 PLOT= 69.00

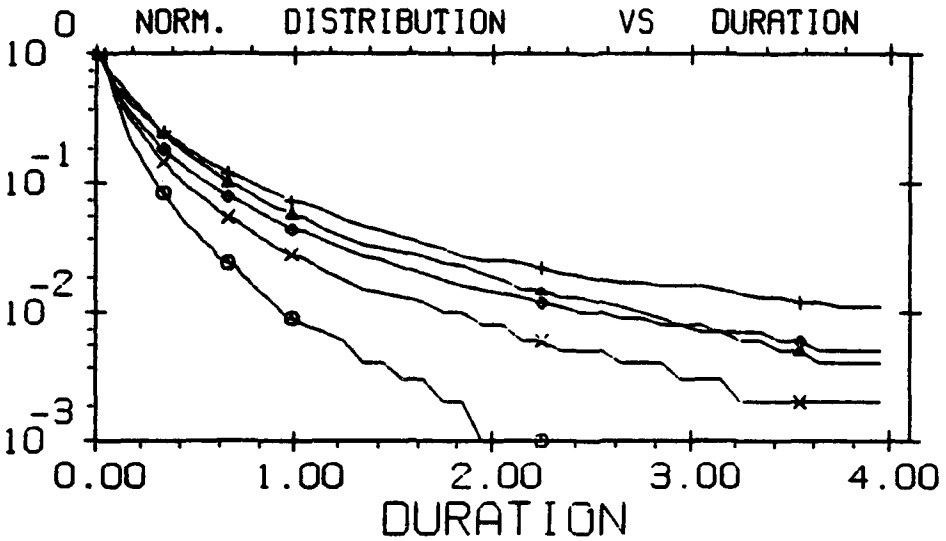

UNDERDENSE ⊙
 OVERDENSE △
 SPORADIC-E +
 ALL-TRAILS ×
 ALL-EVENTS ◇

EXCEEDING -126.0 DBM RSL
 THE TIME OF DAY IS 0 : 24 HOURS U.T.
 FREQUENCY - 85 MHZ
 BASED ON OBSERVED NOISE MEASUREMENTS - VERTICAL
 NORMALIZING FACTORS:
 UNDER - 5946. OVER - 3799. SPOR-E - 5790.
 TRAILS - 9745. EVENTS - 15535.

MENU=106,02-4
 21-SEP-93
 PLOT= 70.00

GEOPHYSICS LAB METEOR SCATTER PROGRAM

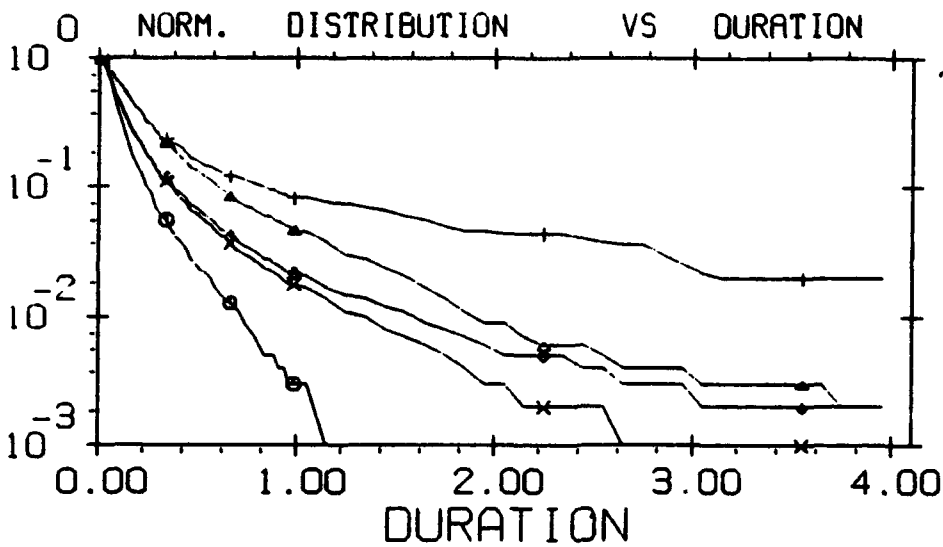

EXCEEDING -126.0 DBM RSL
 THE TIME OF DAY IS 0 : 24 HOURS U.T.
 FREQUENCY - 104 MHZ
 BASED ON OBSERVED NOISE MEASUREMENTS - VERTICAL
 NORMALIZING FACTORS:
 UNDER - 5077. OVER - 2567. SPOR-E - 497.
 TRAILS - 7644. EVENTS - 8141.

MENU#106,02-4
 21-SEP-93
 PLOT# 71.00

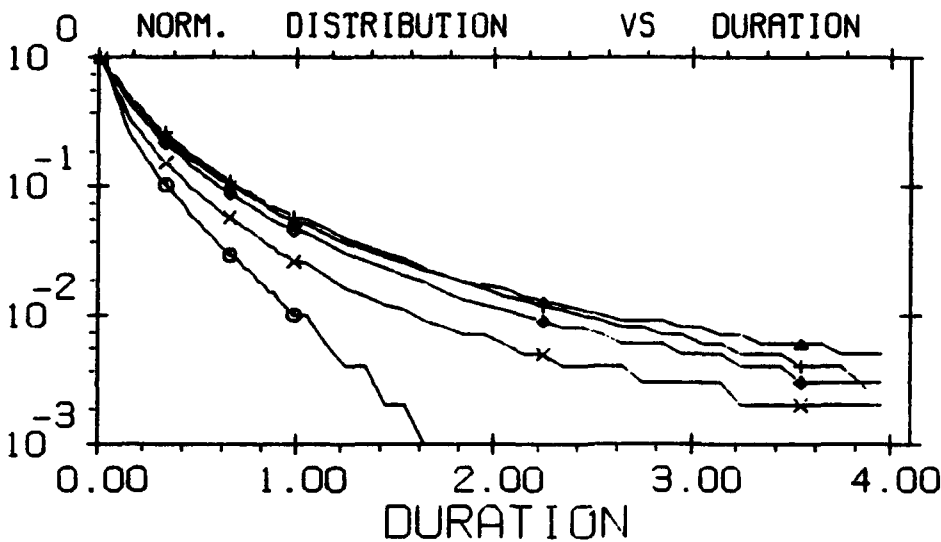

EXCEEDING -126.0 DBM RSL
 THE TIME OF DAY IS 0 : 24 HOURS U.T.
 FREQUENCY - 147 MHZ
 BASED ON OBSERVED NOISE MEASUREMENTS - VERTICAL
 NORMALIZING FACTORS:
 UNDER - 11357. OVER - 6692. SPOR-E - 26821.
 TRAILS - 18049. EVENTS - 44870.

MENU#106,02-4
 21-SEP-93
 PLOT# 72.00

GEOPHYSICS LAB METEOR SCATTER PROGRAM

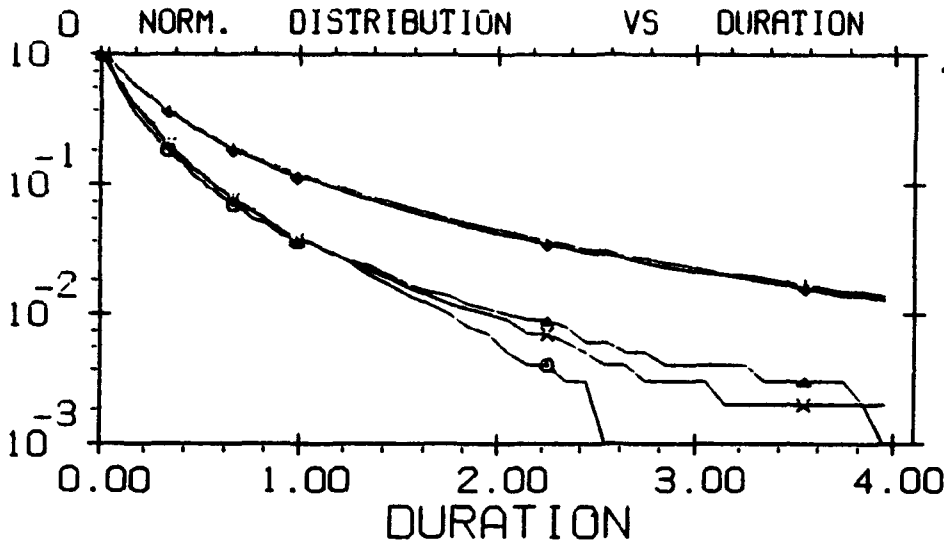

UNDERDENSE ○
 OVERDENSE △
 SPORADIC-E +
 ALL-TRAILS ×
 ALL-EVENTS ◇

EXCEEDING -116.0 DBM RSL
 THE TIME OF DAY IS 0 : 24 HOURS U.T.
 FREQUENCY - 35 MHZ
 BASED ON OBSERVED NOISE MEASUREMENTS - VERTICAL
 NORMALIZING FACTORS:
 UNDER - 3344. OVER - 6665. SPOR-E - 126445.
 TRAILS - 10009. EVENTS - 136454.

MENU#106,02-4
 21-SEP-93
 PLOT# 73.00

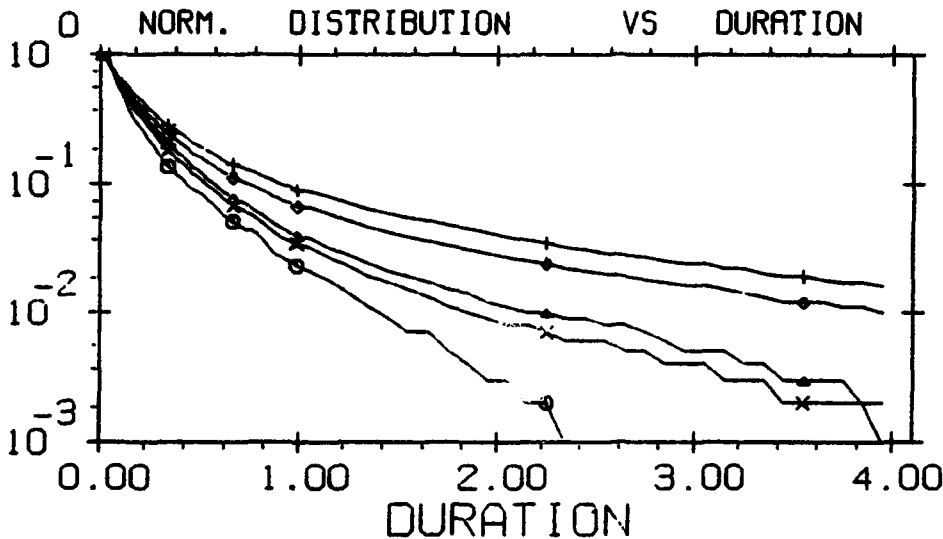

UNDERDENSE ○
 OVERDENSE △
 SPORADIC-E +
 ALL-TRAILS ×
 ALL-EVENTS ◇

EXCEEDING -116.0 DBM RSL
 THE TIME OF DAY IS 0 : 24 HOURS U.T.
 FREQUENCY - 45 MHZ
 BASED ON OBSERVED NOISE MEASUREMENTS - VERTICAL
 NORMALIZING FACTORS:
 UNDER - 3653. OVER - 6606. SPOR-E - 15312.
 TRAILS - 10259. EVENTS - 25571.

MENU#106,02-4
 21-SEP-93
 PLOT# 74.00

GEOPHYSICS LAB METEOR SCATTER PROGRAM

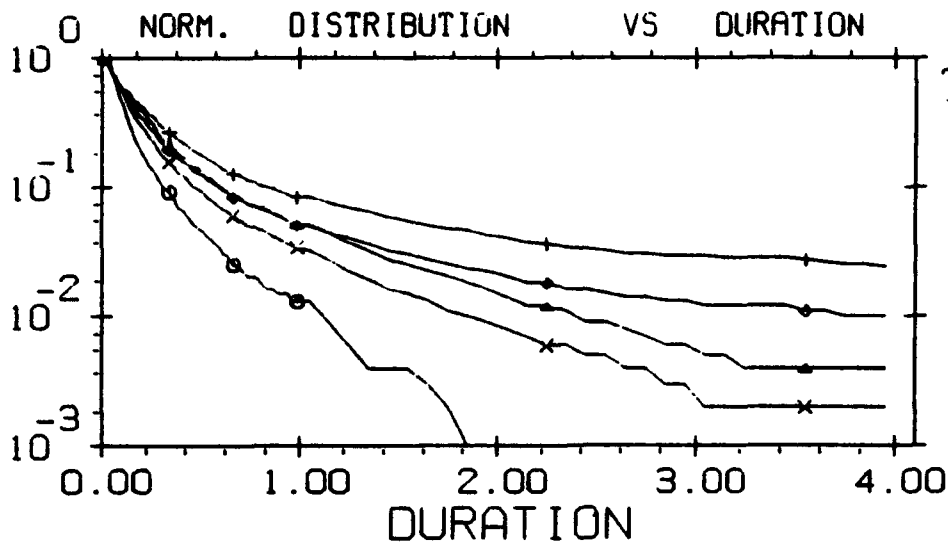

UNDERDENSE ⊙
 OVERDENSE △
 SPORADIC-E +
 ALL-TRAILS ×
 ALL-EVENTS ◇

EXCEEDING -116.0 DBM RSL
 THE TIME OF DAY IS 0 : 24 HOURS U.T.
 FREQUENCY - 65 MHZ
 BASED ON OBSERVED NOISE MEASUREMENTS - VERTICAL
 NORMALIZING FACTORS:
 UNDER - 2462. OVER - 2801. SPOR-E - 3125.
 TRAILS - 5263. EVENTS - 8388.

MENU#106,02-4
 21-SEP-93
 PLOT# 75.00

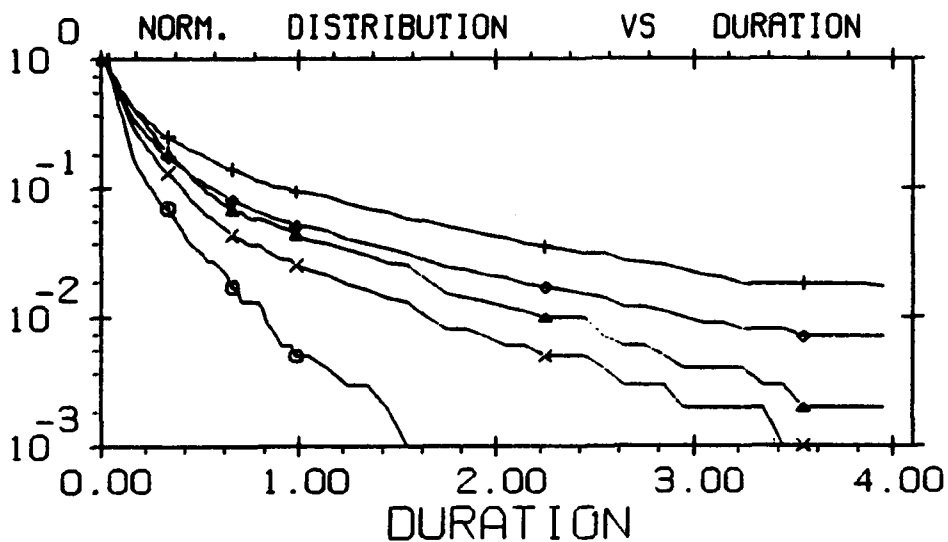

UNDERDENSE ⊙
 OVERDENSE △
 SPORADIC-E +
 ALL-TRAILS ×
 ALL-EVENTS ◇

EXCEEDING -116.0 DBM RSL
 THE TIME OF DAY IS 0 : 24 HOURS U.T.
 FREQUENCY - 85 MHZ
 BASED ON OBSERVED NOISE MEASUREMENTS - VERTICAL
 NORMALIZING FACTORS:
 UNDER - 1495. OVER - 1557. SPOR-E - 1916.
 TRAILS - 3052. EVENTS - 4968.

MENU#106,02-4
 21-SEP-93
 PLOT# 76.00

GEOPHYSICS LAB METEOR SCATTER PROGRAM

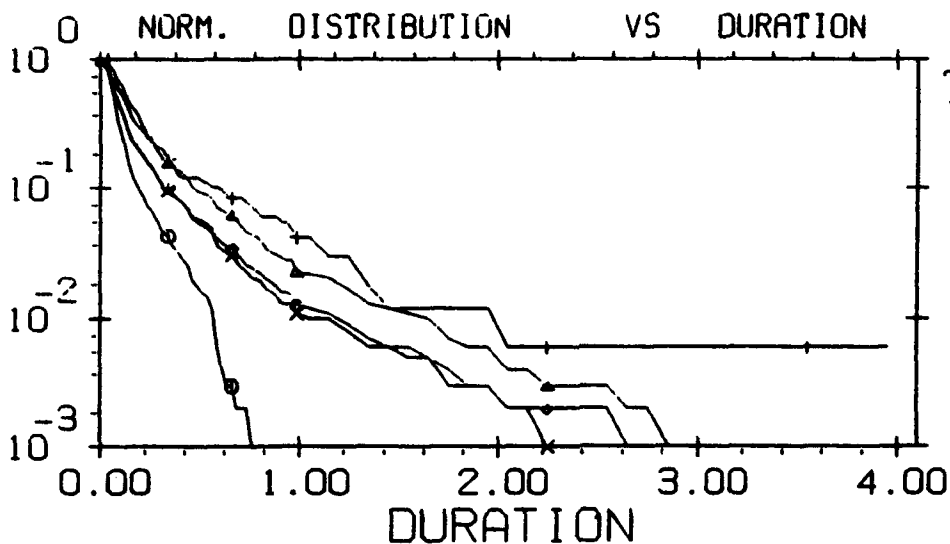

UNDERDENSE ◯
 OVERDENSE △
 SPORADIC-E +
 ALL-TRAILS ×
 ALL-EVENTS ◇

EXCEEDING -116.0 DBM RSL
 THE TIME OF DAY IS 0 : 24 HOURS U.T.
 FREQUENCY - 104 MHZ
 BASED ON OBSERVED NOISE MEASUREMENTS - VERTICAL
 NORMALIZING FACTORS:
 UNDER - 1159. OVER - 1016. SPOR-E - 167.
 TRAILS - 2175. EVENTS - 2342.

MENU#106,02-4
 21-SEP-93
 PLOT# 77.00

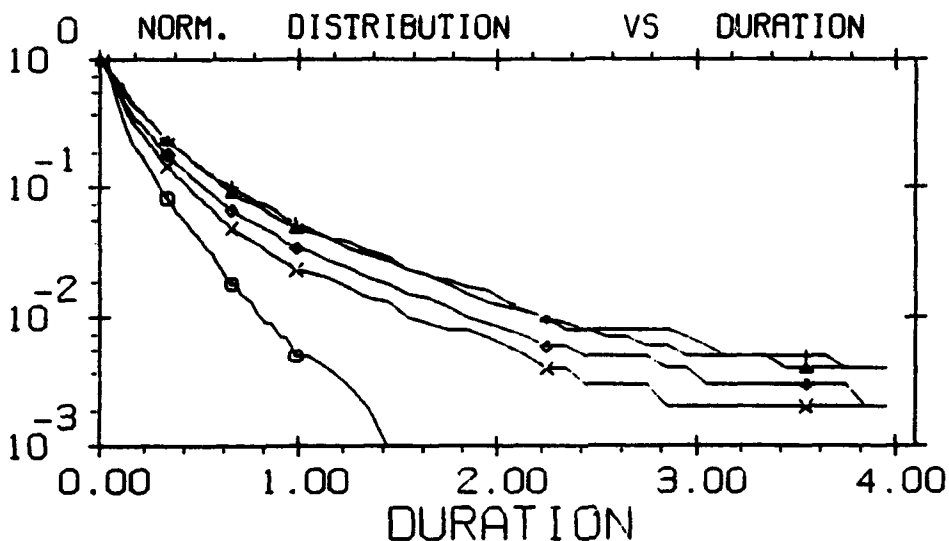

UNDERDENSE ◯
 OVERDENSE △
 SPORADIC-E +
 ALL-TRAILS ×
 ALL-EVENTS ◇

EXCEEDING -116.0 DBM RSL
 THE TIME OF DAY IS 0 : 24 HOURS U.T.
 FREQUENCY - 147 MHZ
 BASED ON OBSERVED NOISE MEASUREMENTS - VERTICAL
 NORMALIZING FACTORS:
 UNDER - 3273. OVER - 2312. SPOR-E - 3308.
 TRAILS - 5585. EVENTS - 8893.

MENU#106,02-4
 21-SEP-93
 PLOT# 78.00

GEOPHYSICS LAB METEOR SCATTER PROGRAM

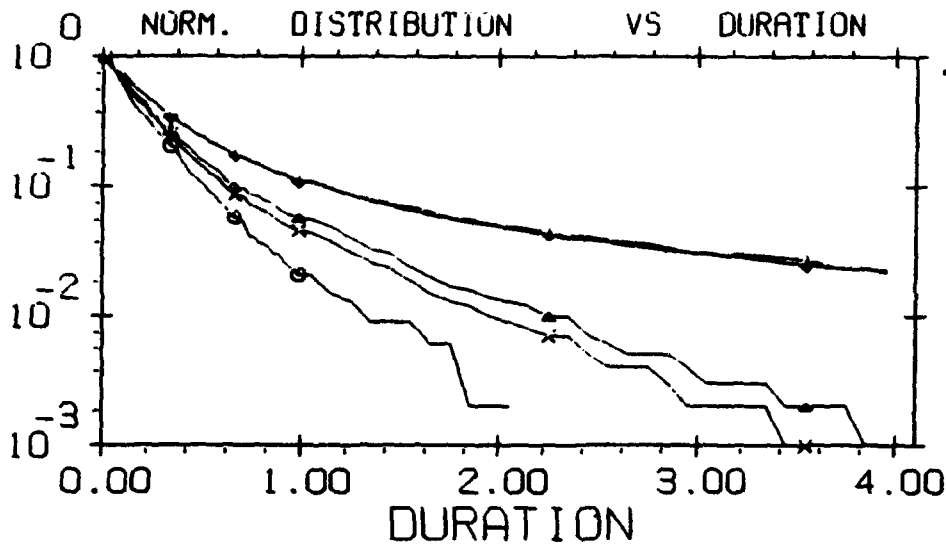

EXCEEDING -106.0 DBM RSL
 THE TIME OF DAY IS 0 : 24 HOURS U.T.
 FREQUENCY - 35 MHZ
 BASED ON OBSERVED NOISE MEASUREMENTS - VERTICAL
 NORMALIZING FACTORS:
 UNDER - 531. OVER - 1111. SPOR-E - 27277.
 TRAILS - 1642. EVENTS - 28919.

MENU=106,02-4
 21-SEP-93
 PLOT= 79.00

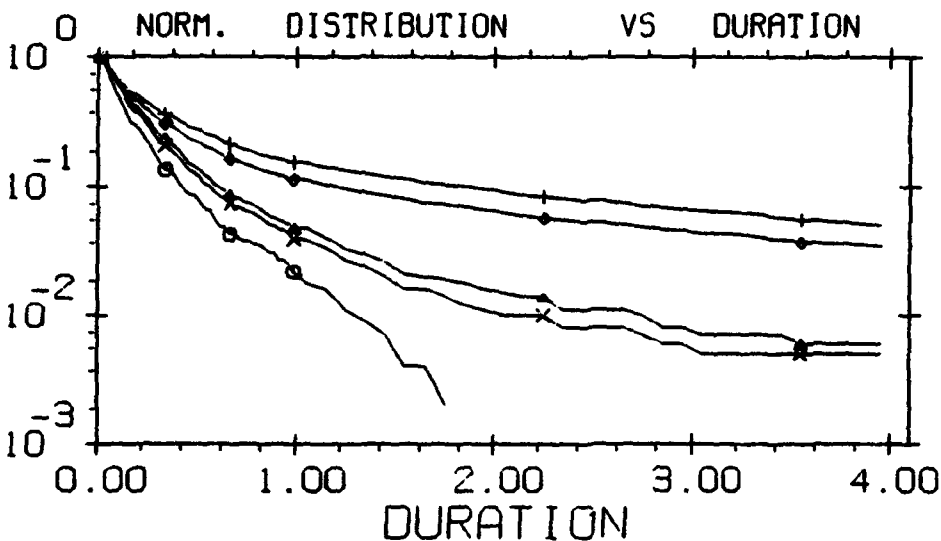

EXCEEDING -106.0 DBM RSL
 THE TIME OF DAY IS 0 : 24 HOURS U.T.
 FREQUENCY - 45 MHZ
 BASED ON OBSERVED NOISE MEASUREMENTS - VERTICAL
 NORMALIZING FACTORS:
 UNDER - 447. OVER - 1085. SPOR-E - 2858.
 TRAILS - 1532. EVENTS - 4390.

MENU=106,02-4
 21-SEP-93
 PLOT= 80.00

GEOPHYSICS LAB METEOR SCATTER PROGRAM

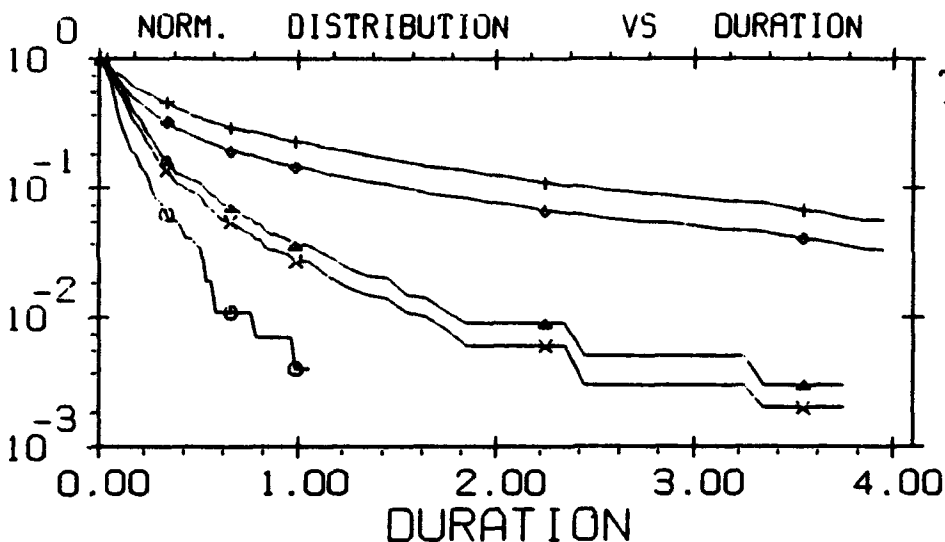

EXCEEDING -106.0 DBM RSL
 THE TIME OF DAY IS 0 : 24 HOURS U.T.
 FREQUENCY - 65 MHZ
 BASED ON OBSERVED NOISE MEASUREMENTS - VERTICAL
 NORMALIZING FACTORS:
 UNDER - 268. OVER - 665. SPOR-E - 1345.
 TRAILS - 933. EVENTS - 2278.

MENU#106,02-1
 21-SEP-93
 PLOT# 81.00

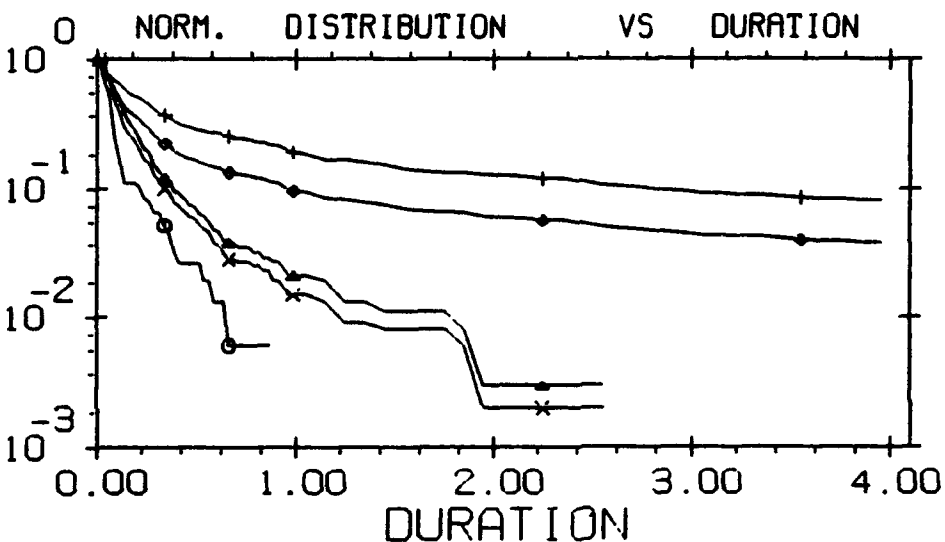

EXCEEDING -106.0 DBM RSL
 THE TIME OF DAY IS 0 : 24 HOURS U.T.
 FREQUENCY - 85 MHZ
 BASED ON OBSERVED NOISE MEASUREMENTS - VERTICAL
 NORMALIZING FACTORS:
 UNDER - 154. OVER - 373. SPOR-E - 459.
 TRAILS - 527. EVENTS - 986.

MENU#106,02-1
 21-SEP-93
 PLOT# 82.00

GEOPHYSICS LAB METEOR SCATTER PROGRAM

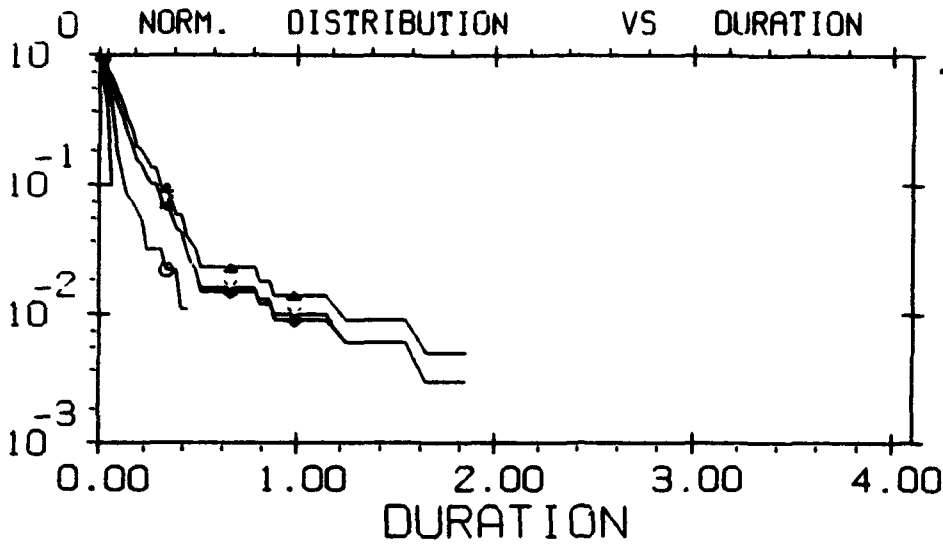

UNDERDENSE ⊙
 OVERDENSE △
 SPORADIC-E +
 ALL-TRAILS ×
 ALL-EVENTS ◇

EXCEEDING -106.0 DBM RSL
 THE TIME OF DAY IS 0 : 24 HOURS U.T.
 FREQUENCY - 104 MHZ
 BASED ON OBSERVED NOISE MEASUREMENTS - VERTICAL
 NORMALIZING FACTORS:
 UNDER - 93. OVER - 222. SPOR-E - 10.
 TRAILS - 315. EVENTS - 325.

MENU#106,02-4
 21-SEP-93
 PLOT# 83.00

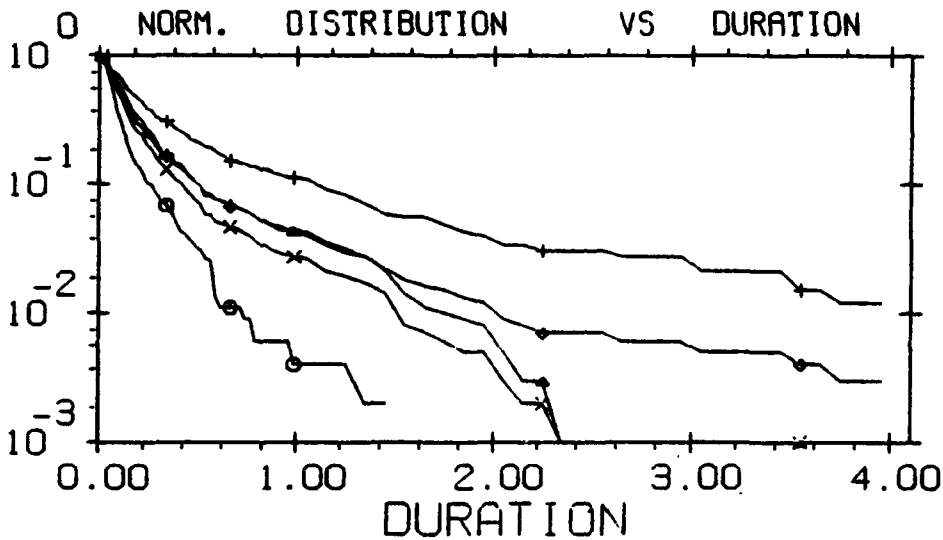

UNDERDENSE ⊙
 OVERDENSE △
 SPORADIC-E +
 ALL-TRAILS ×
 ALL-EVENTS ◇

EXCEEDING -106.0 DBM RSL
 THE TIME OF DAY IS 0 : 24 HOURS U.T.
 FREQUENCY - 147 MHZ
 BASED ON OBSERVED NOISE MEASUREMENTS - VERTICAL
 NORMALIZING FACTORS:
 UNDER - 530. OVER - 791. SPOR-E - 330.
 TRAILS - 1321. EVENTS - 1651.

MENU#106,02-4
 21-SEP-93
 PLOT# 84.00

GEOPHYSICS LAB METEOR SCATTER PROGRAM

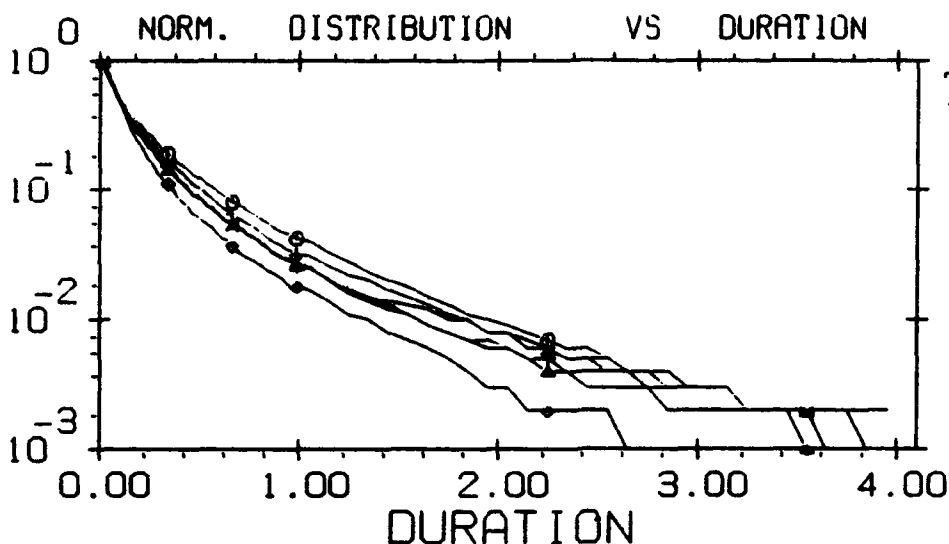

EXCEEDING -126.0 DBM RSL
 THE TIME OF DAY IS 0 : 24 HOURS U.T.
 THE EVENT CLASS IS UNDERDENSE AND OVERDENSE TRAILS
 BASED ON OBSERVED NOISE MEASUREMENTS - VERTICAL
 NORMALIZING FACTORS:
 35MHZ - 26083. 45MHZ - 41443. 65MHZ - 18367.
 85MHZ - 9745. 104MHZ - 7644. 147MHZ - 18049.

MENU#106,01-4
 21-SEP-93
 PLOT# 85.00

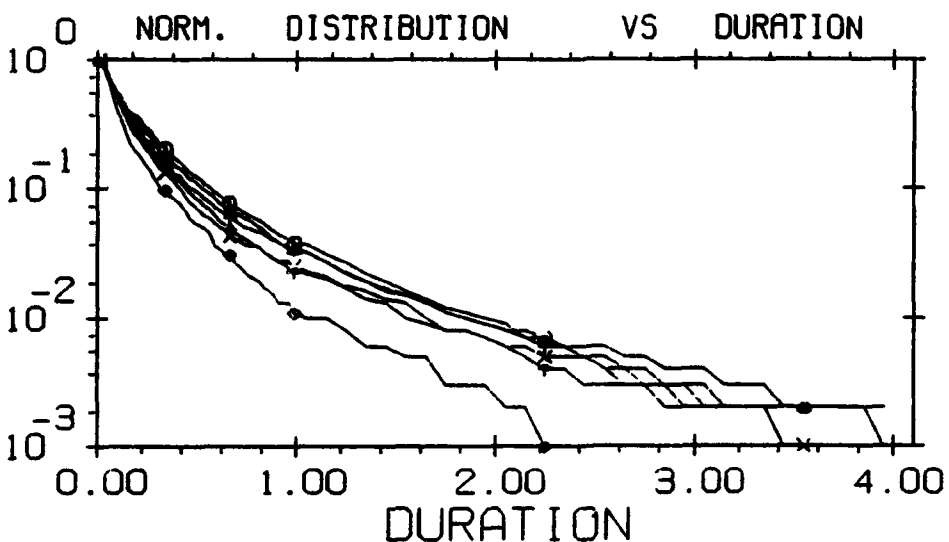

EXCEEDING -116.0 DBM RSL
 THE TIME OF DAY IS 0 : 24 HOURS U.T.
 THE EVENT CLASS IS UNDERDENSE AND OVERDENSE TRAILS
 BASED ON OBSERVED NOISE MEASUREMENTS - VERTICAL
 NORMALIZING FACTORS:
 35MHZ - 10009. 45MHZ - 10259. 65MHZ - 5263.
 85MHZ - 3052. 104MHZ - 2175. 147MHZ - 5585.

MENU#106,01-4
 21-SEP-93
 PLOT# 86.00

GEOPHYSICS LAB METEOR SCATTER PROGRAM

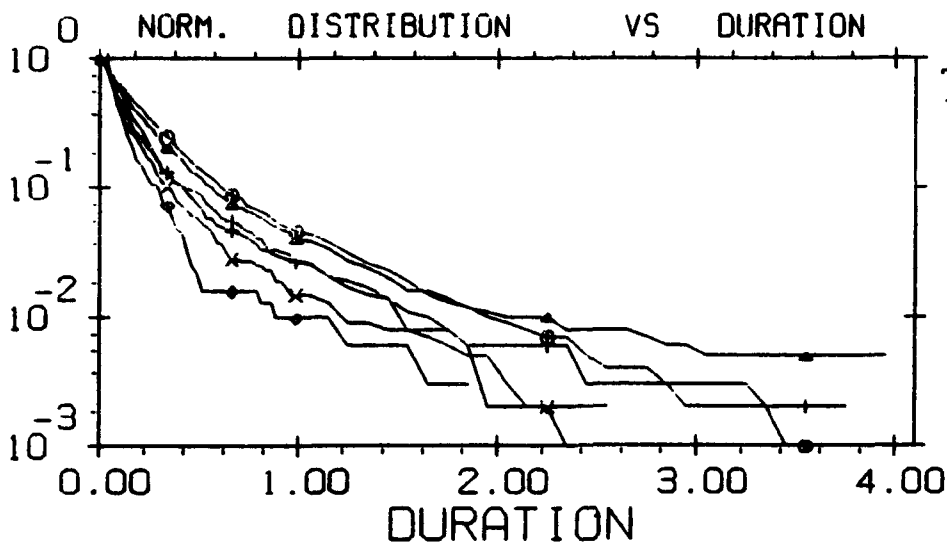

EXCEEDING -106.0 DBM RSL
 THE TIME OF DAY IS 0 : 24 HOURS U.T.
 THE EVENT CLASS IS UNDERDENSE AND OVERDENSE TRAILS
 BASED ON OBSERVED NOISE MEASUREMENTS - VERTICAL
 NORMALIZING FACTORS:
 35MHZ - 1642. 45MHZ - 1532. 65MHZ - 933.
 85MHZ - 527. 104MHZ - 315. 147MHZ - 1321.

MENU=106,01-1
 21-SEP-93
 PLOT= 87.00

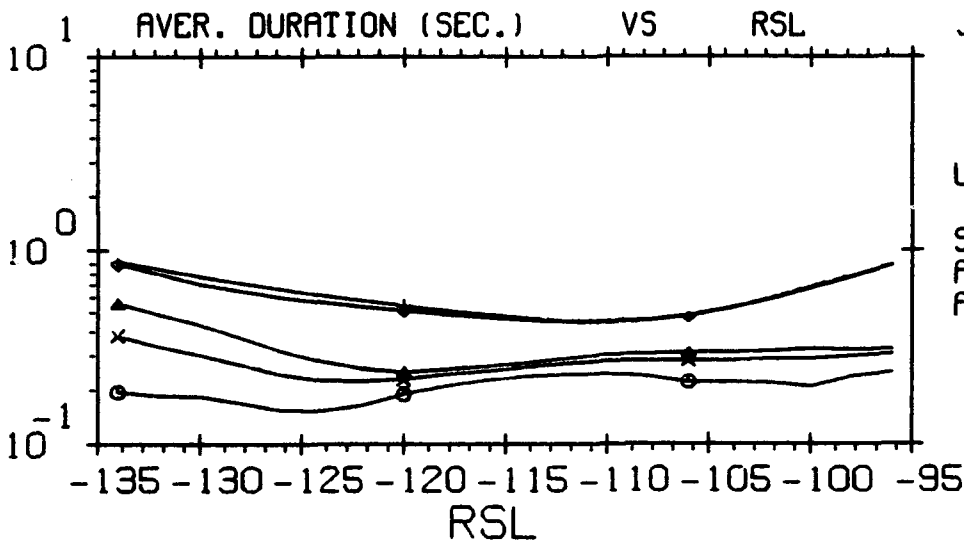

THE TIME OF DAY IS 0 : 24 HOURS U.T.
 FREQUENCY - 35 MHZ
 BASED ON OBSERVED NOISE MEASUREMENTS - VERTICAL

MENU=106,06-1
 21-SEP-93
 PLOT= 88.00

GEOPHYSICS LAB METEOR SCATTER PROGRAM

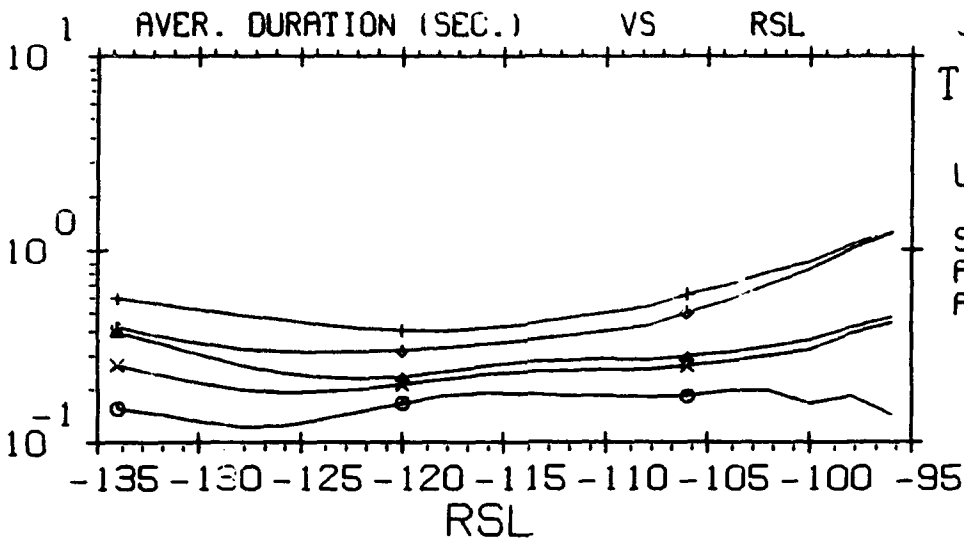

THE TIME OF DAY IS 0 : 24 HOURS U.T.
 FREQUENCY - 45 MHZ
 BASED ON OBSERVED NOISE MEASUREMENTS - VERTICAL

MENU*106,06-1
 21-SEP-93
 PLOT* 89.00

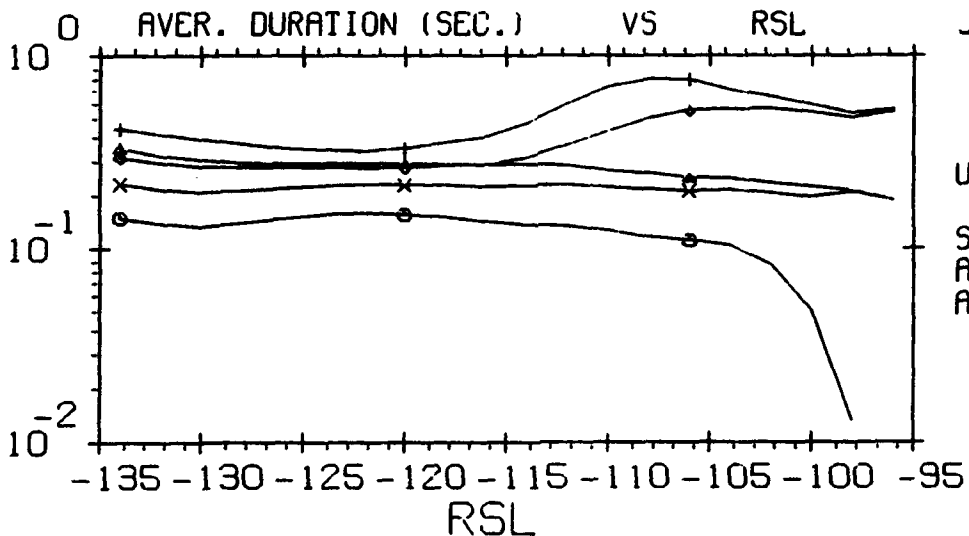

THE TIME OF DAY IS 0 : 24 HOURS U.T.
 FREQUENCY - 65 MHZ
 BASED ON OBSERVED NOISE MEASUREMENTS - VERTICAL

MENU*106,06-1
 21-SEP-93
 PLOT* 90.00

GEOPHYSICS LAB METEOR SCATTER PROGRAM

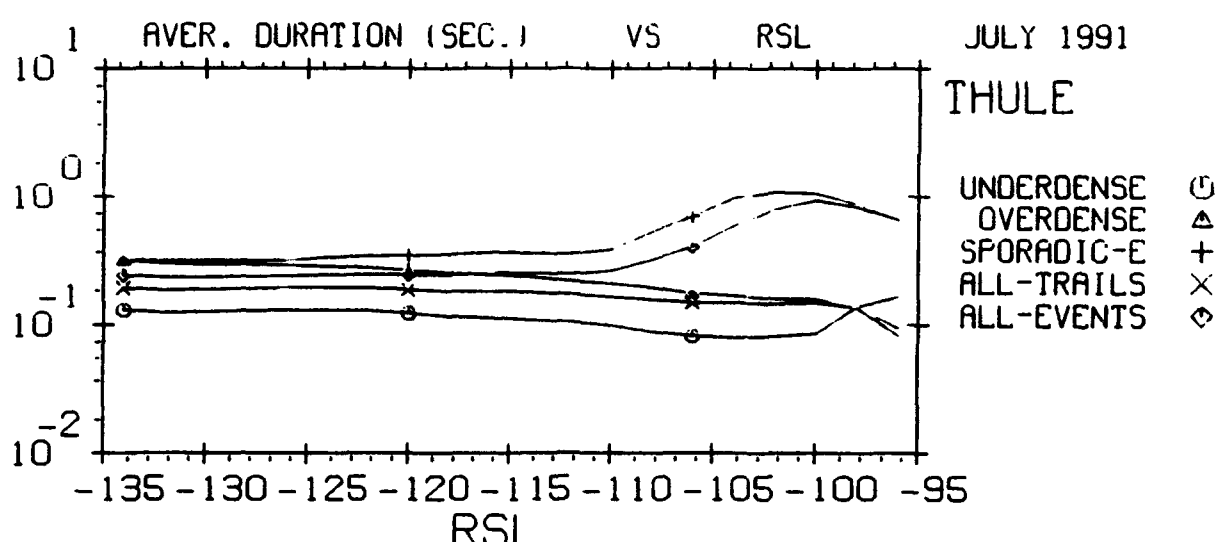

THE TIME OF DAY IS 0 : 24 HOURS U.T.
 FREQUENCY - 85 MHZ
 BASED ON OBSERVED NOISE MEASUREMENTS - VERTICAL

MENU#106,06-1
 21-SEP-93
 PLOT# 91.00

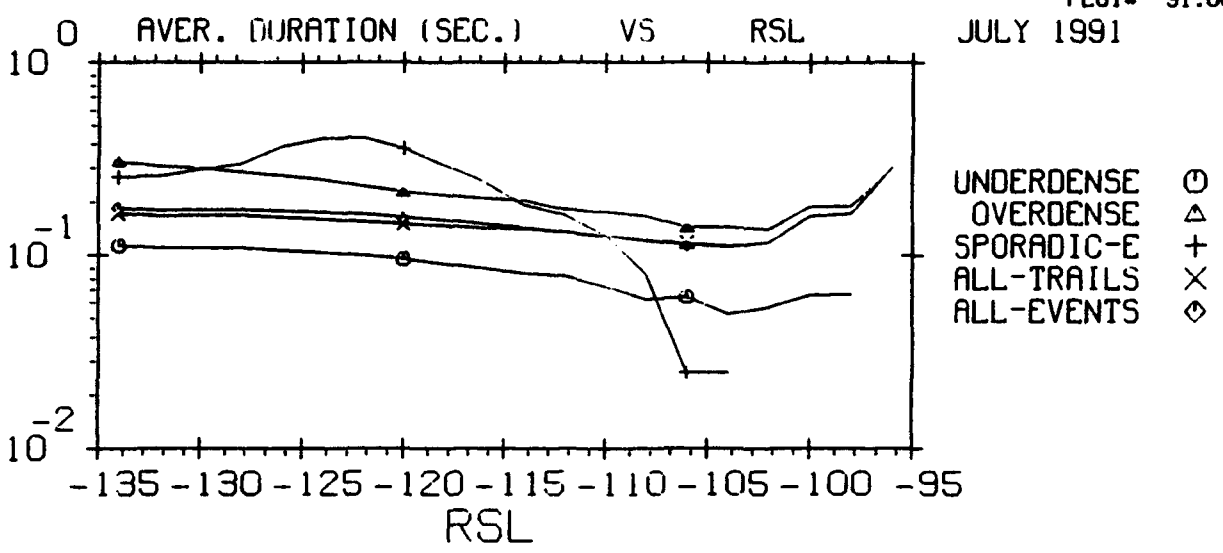

THE TIME OF DAY IS 0 : 24 HOURS U.T.
 FREQUENCY - 104 MHZ
 BASED ON OBSERVED NOISE MEASUREMENTS - VERTICAL

MENU#106,06-1
 21-SEP-93
 PLOT# 92.00

GEOPHYSICS LAB METEOR SCATTER PROGRAM

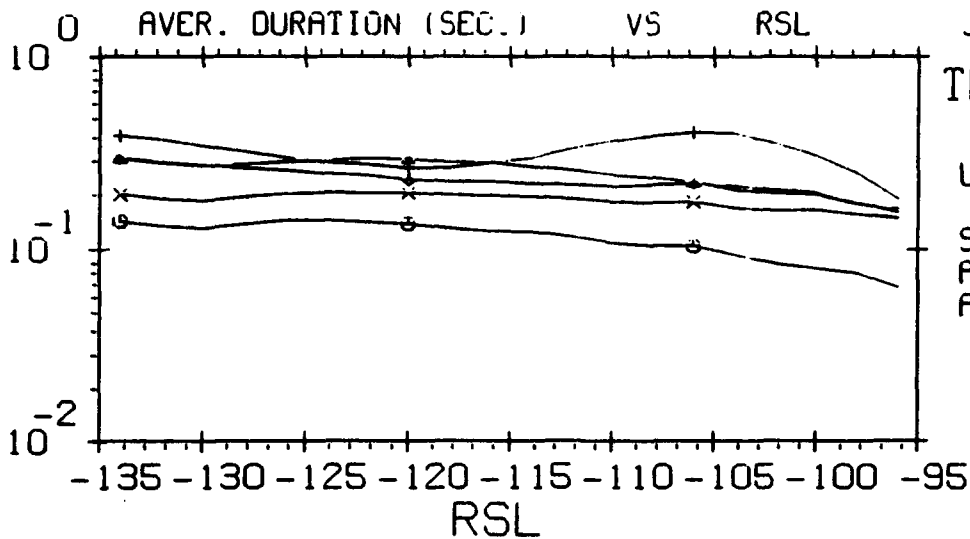

UNDERDENSE ⊙
 OVERDENSE △
 SPORADIC-E +
 ALL-TRAILS ×
 ALL-EVENTS ◇

THE TIME OF DAY IS 0 : 24 HOURS U.T.
 FREQUENCY = 147 MHZ
 BASED ON OBSERVED NOISE MEASUREMENTS - VERTICAL

MENU#106,06-1
 21-SEP-93
 PLOT# 93.00

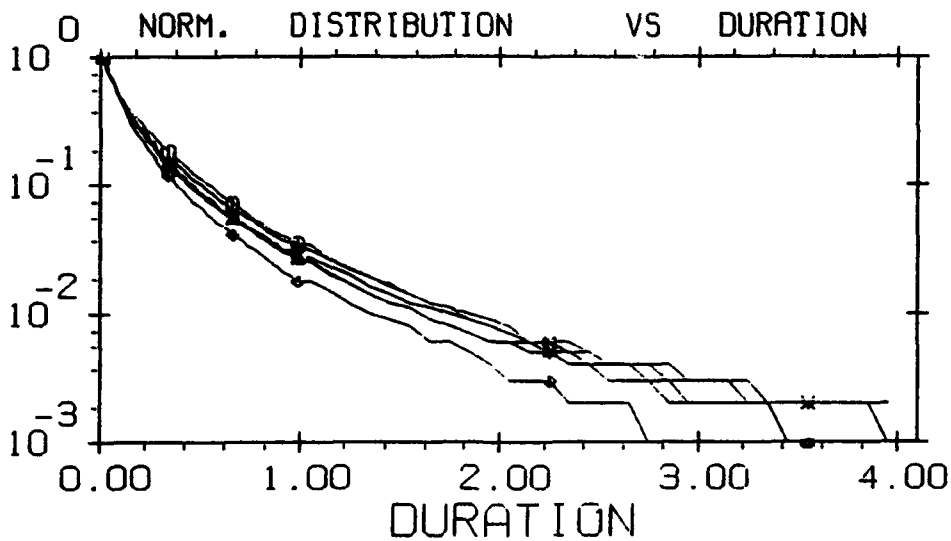

35 MHZ ⊙
 45 MHZ △
 65 MHZ +
 85 MHZ ×
 104 MHZ ◇
 147 MHZ ↑

EXCEEDING 19.0 DB SNR
 THE TIME OF DAY IS 0 : 24 HOURS U.T.
 THE EVENT CLASS IS UNDERDENSE AND OVERDENSE TRAILS
 EFFECTIVE SYSTEM BANDWIDTH = 100.HZ
 BASED ON OBSERVED NOISE MEASUREMENTS - VERTICAL
 NORMALIZING FACTORS:
 35MHZ - 18534. 45MHZ - 31471. 65MHZ - 20241.
 85MHZ - 12654. 104MHZ - 10303. 147MHZ - 16153.

MENU#107,01-4
 21-SEP-93
 PLOT# 94.00

GEOPHYSICS LAB METEOR SCATTER PROGRAM

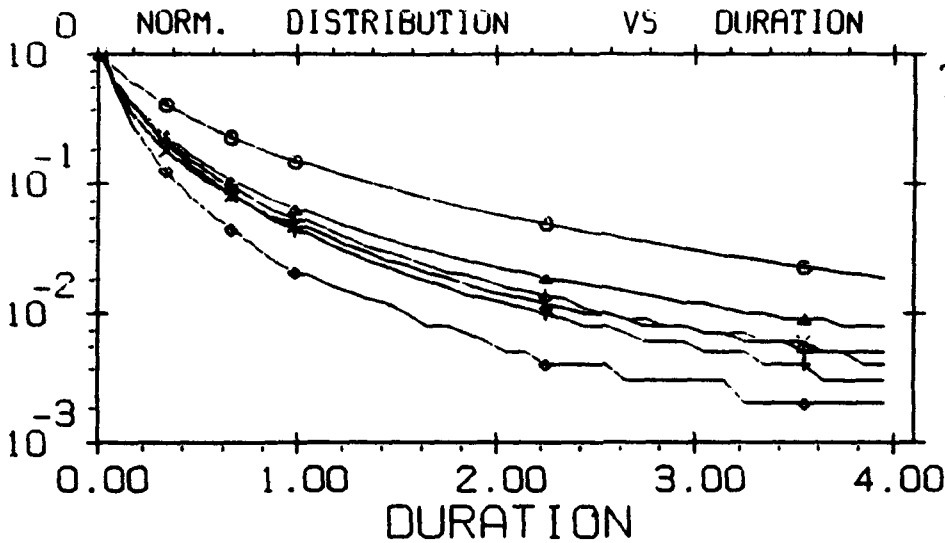

- 35 MHZ ○
- 45 MHZ △
- 65 MHZ +
- 85 MHZ ×
- 104 MHZ ◇
- 147 MHZ †

EXCEEDING 19.0 DB SNR
 THE TIME OF DAY IS 0 : 24 HOURS U.T.
 THE EVENT CLASS IS SPORADIC-E AND METEOR TRAILS
 EFFECTIVE SYSTEM BANDWIDTH - 100.HZ
 BASED ON OBSERVED NOISE MEASUREMENTS - VERTICAL
 NORMALIZING FACTORS:
 35MHZ - 169320. 45MHZ - 64584. 65MHZ - 36315.
 85MHZ - 20631. 104MHZ - 11366. 147MHZ - 39826.

MENU#107_01-4
 21-SEP-93
 PLOT# 95.00

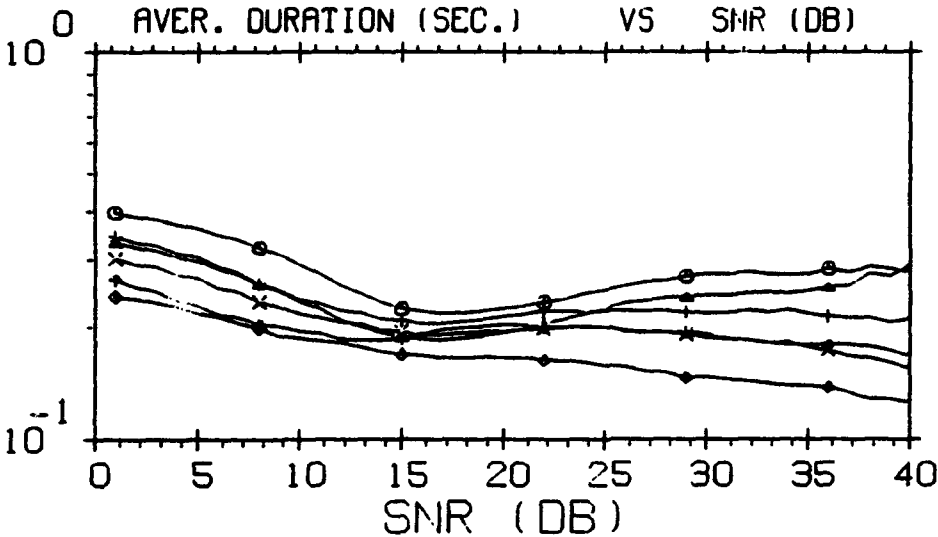

- 35 MHZ ○
- 45 MHZ △
- 65 MHZ +
- 85 MHZ ×
- 104 MHZ ◇
- 147 MHZ †

THE TIME OF DAY IS 0 : 24 HOURS U.T.
 THE EVENT CLASS IS UNDERDENSE AND OVERDENSE TRAILS
 EFFECTIVE SYSTEM BANDWIDTH - 100.HZ
 BASED ON OBSERVED NOISE MEASUREMENTS - VERTICAL

MENU#107_05-1
 21-SEP-93
 PLOT# 96.00

GEOPHYSICS LAB METEOR SCATTER PROGRAM

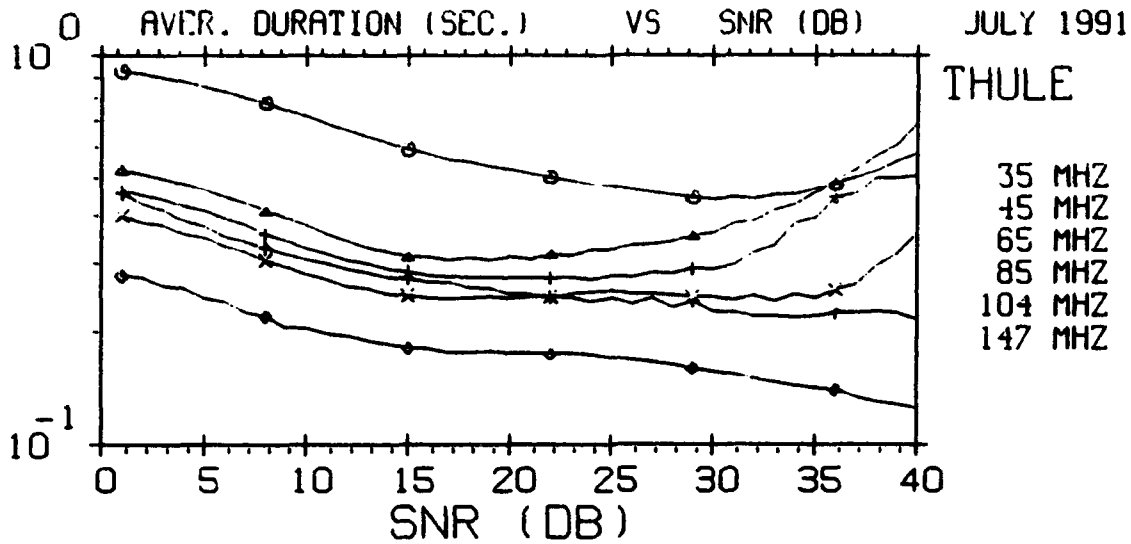

THE TIME OF DAY IS 0 : 24 HOURS U.T.
 THE EVENT CLASS IS SPORADIC-E AND METEOR TRAILS
 EFFECTIVE SYSTEM BANDWIDTH - 100.HZ
 BASED ON OBSERVED NOISE MEASUREMENTS - VERTICAL

MENU=107,05-1
 21-SEP-93
 PLOT= 97.00

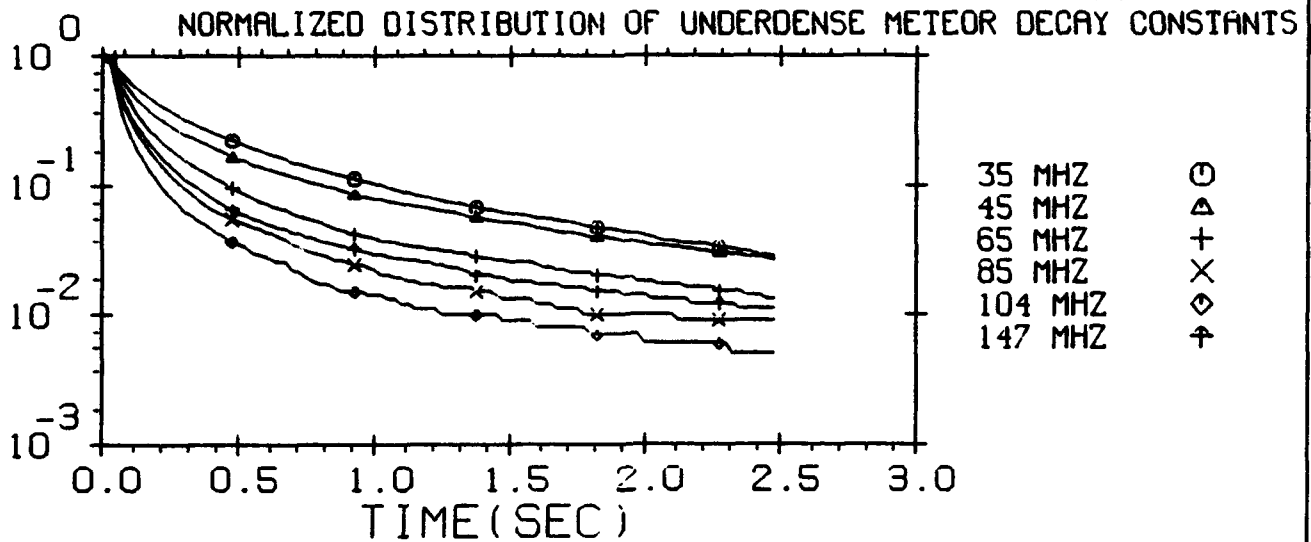

JULY 1991
 THE TIME OF DAY IS 0 : 24 HOURS U.T.
 BASED ON OBSERVED NOISE MEASUREMENTS - VERTICAL
 NORMALIZING FACTORS:
 35MHZ - 5193. 45MHZ - 11495. 65MHZ - 10929.
 85MHZ - 8309. 104MHZ - 7811. 147MHZ - 14978.

MENU=108,01-4
 21-SEP-93
 PLOT= 98.00

GEOPHYSICS LAB METEOR SCATTER PROGRAM

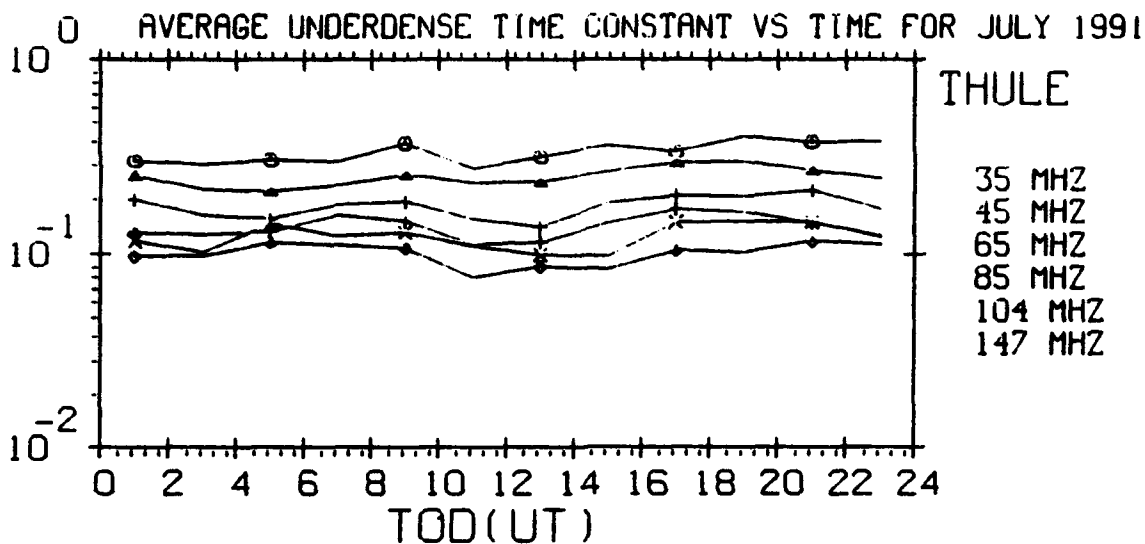

BASED ON OBSERVED NOISE MEASUREMENTS - VERTICAL

THE 24 HOUR AVERAGE TIME CONSTANTS ARE

0.313 0.249 0.173 0.122 0.098 0.138

MENU=106,02-1
21-SEP-93
PLOT= 99.00

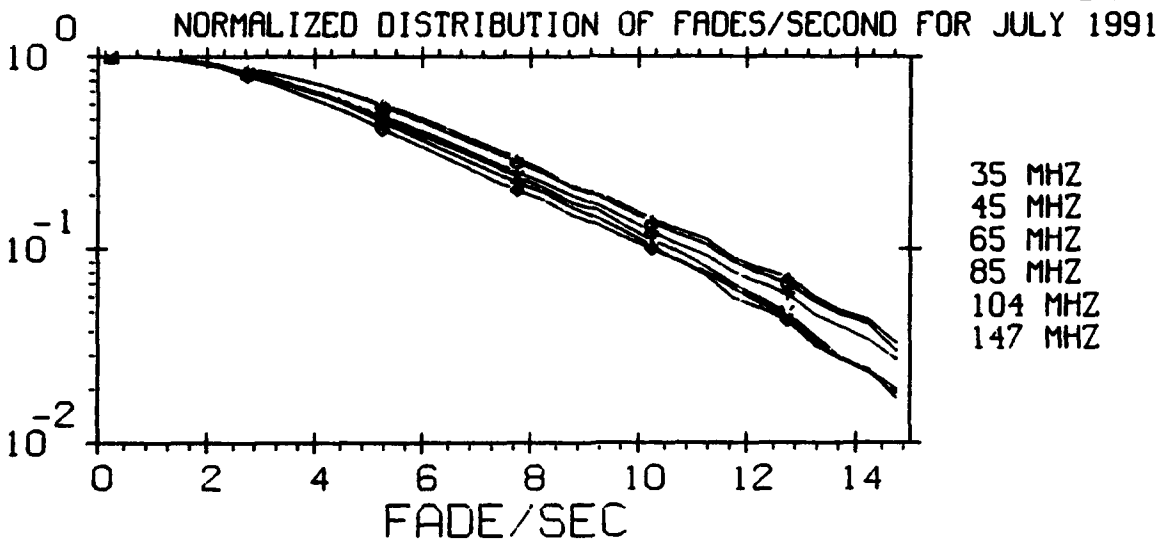

THE TIME OF DAY IS 0 : 24 HOURS U.T.

THE EVENT CLASS IS UNDERDENSE AND OVERDENSE TRAILS

NORMALIZING FACTORS:

35MHZ - 7905. 45MHZ - 14034. 65MHZ - 8819.
85MHZ - 4838. 104MHZ - 2768. 147MHZ - 9030.

MENU=109,01-4
21-SEP-93
PLOT= 100.00

GEOPHYSICS LAB METEOR SCATTER PROGRAM

NORMALIZED DISTRIBUTION OF FADES/SECOND FOR JULY 1991

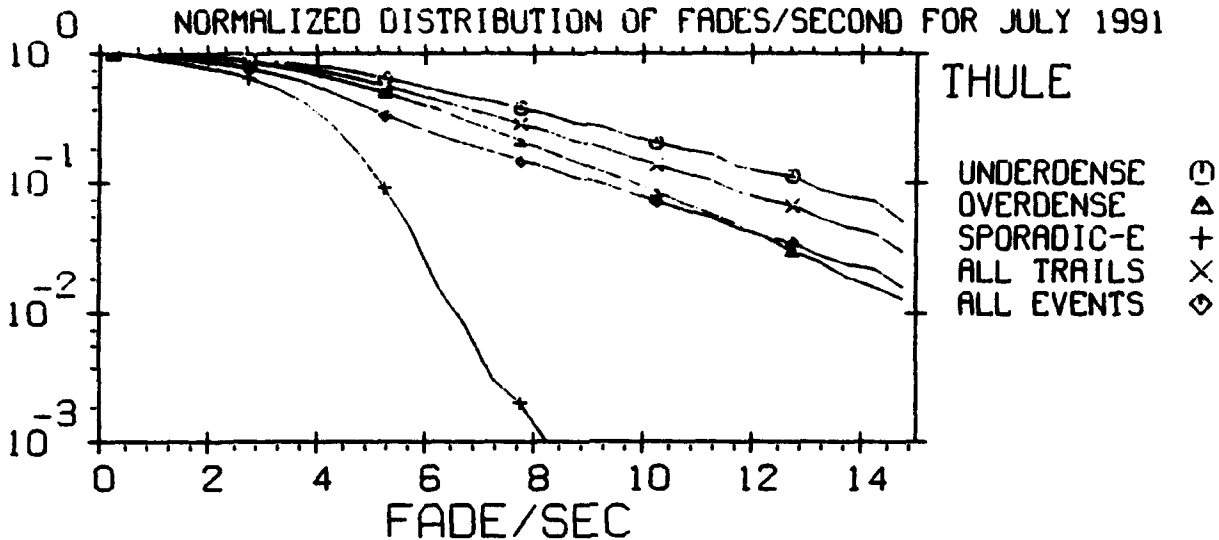

THE TIME OF DAY IS 0 : 24 HOURS U.T.

FREQUENCY - 35 MHZ

NORMALIZING FACTORS:

UNDER - 3503. OVER - 4402. SPOR-E - 7171.

TRAILS - 7905. EVENTS - 15076.

MENU#109,02-4
21-SEP-93
PLOT# 101.00

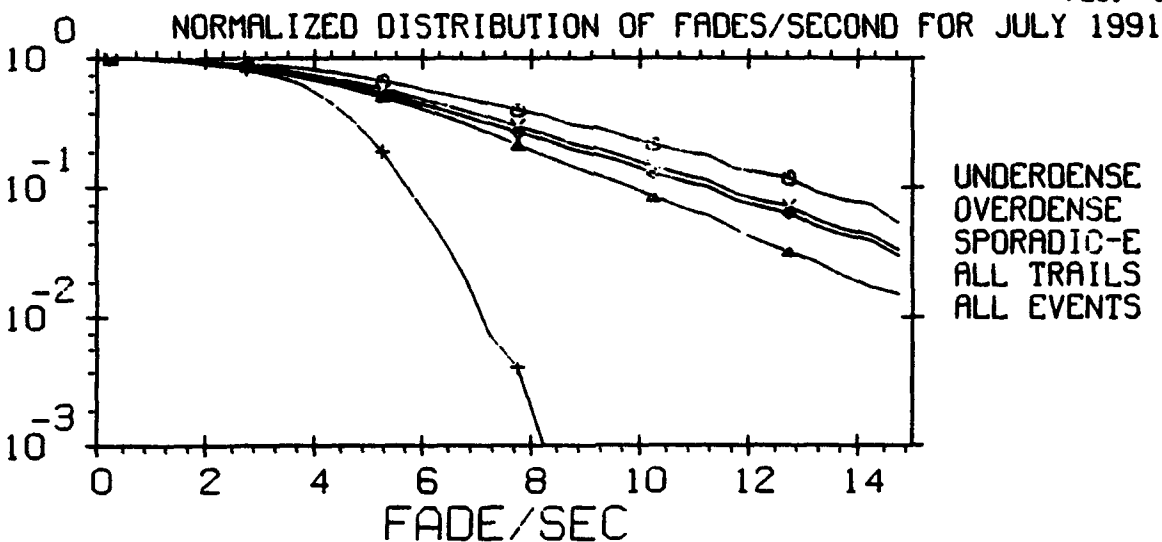

THE TIME OF DAY IS 0 : 24 HOURS U.T.

FREQUENCY - 45 MHZ

NORMALIZING FACTORS:

UNDER - 6499. OVER - 7535. SPOR-E - 1633.

TRAILS - 14034. EVENTS - 15667.

MENU#109,02-4
21-SEP-93
PLOT# 102.00

GEOPHYSICS LAB METEOR SCATTER PROGRAM

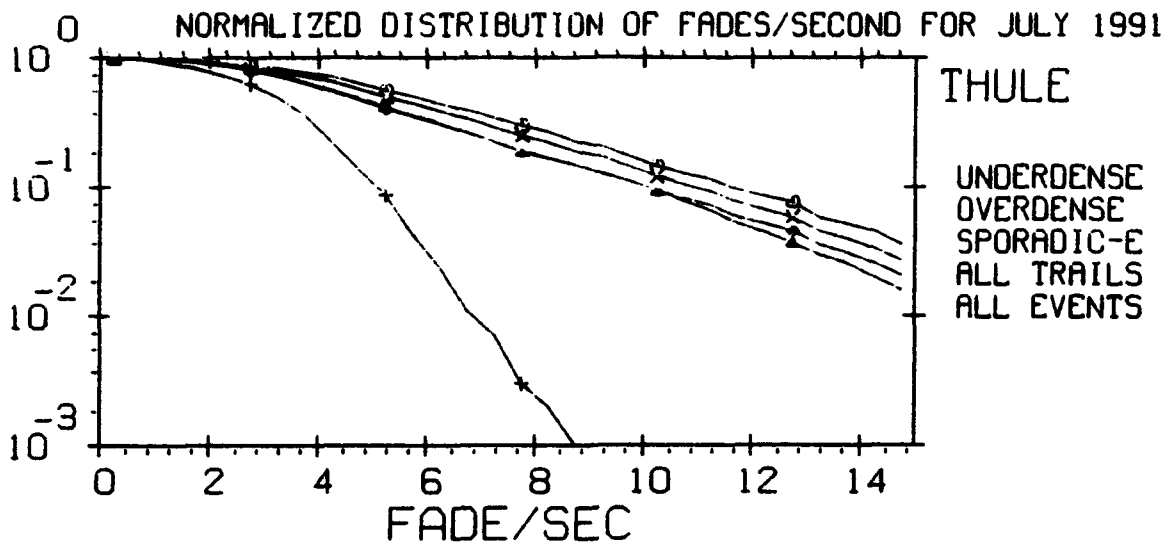

THE TIME OF DAY IS 0 : 24 HOURS U.T.
 FREQUENCY - 65 MHZ
 NORMALIZING FACTORS:
 UNDER - 4827. OVER - 3992. SPOR-E - 2586.
 TRAILS - 8819. EVENTS - 11405.

MENU=109,02-4
 21-SEP-93
 PLOT= 103.00

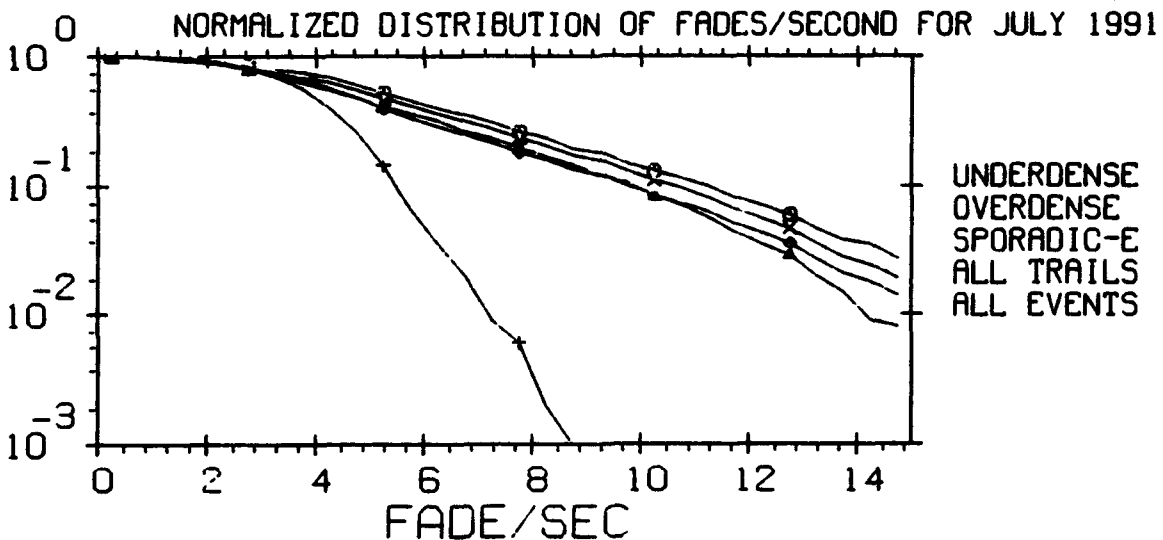

THE TIME OF DAY IS 0 : 24 HOURS U.T.
 FREQUENCY - 85 MHZ
 NORMALIZING FACTORS:
 UNDER - 2770. OVER - 2068. SPOR-E - 1439.
 TRAILS - 4838. EVENTS - 6277.

MENU=109,02-4
 21-SEP-93
 PLOT= 104.00

GEOPHYSICS LAB METEOR SCATTER PROGRAM

NORMALIZED DISTRIBUTION OF FADES/SECOND FOR JULY 1991

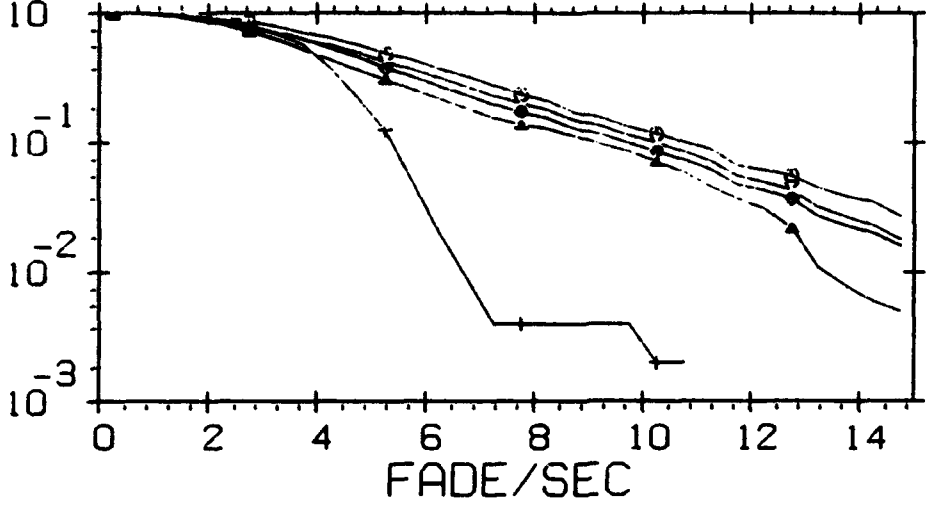

THULE

UNDERDENSE	○
OVERDENSE	△
SPORADIC-E	+
ALL TRAILS	×
ALL EVENTS	◇

THE TIME OF DAY IS 0 : 24 HOURS U.T.
 FREQUENCY - 104 MHZ
 NORMALIZING FACTORS:
 UNDER - 1707. OVER - 1081. SPOR-E - 452.
 TRAILS - 2768. EVENTS - 3220.

MENU#109,02-4
 21-SEP-93
 PLOT# 105.00

NORMALIZED DISTRIBUTION OF FADES/SECOND FOR JULY 1991

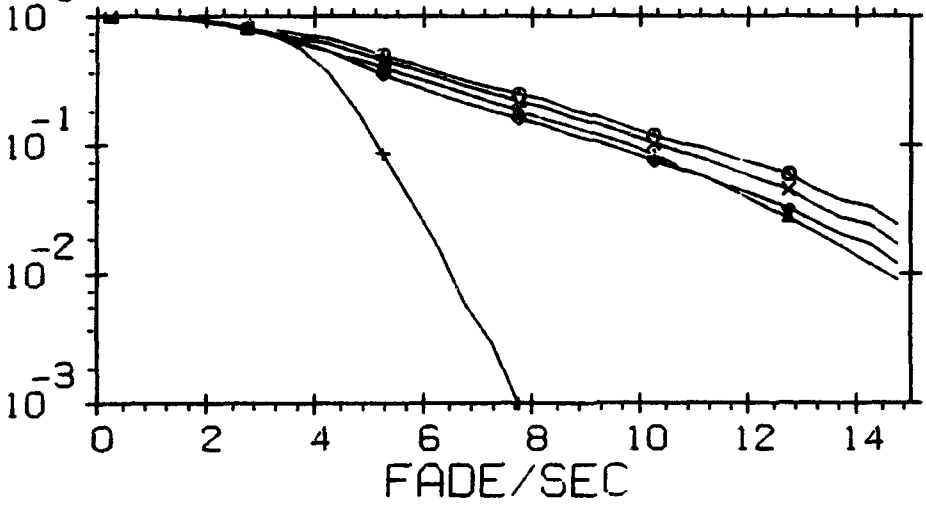

UNDERDENSE	○
OVERDENSE	△
SPORADIC-E	+
ALL TRAILS	×
ALL EVENTS	◇

THE TIME OF DAY IS 0 : 24 HOURS U.T.
 FREQUENCY - 147 MHZ
 NORMALIZING FACTORS:
 UNDER - 5009. OVER - 4021. SPOR-E - 3382.
 TRAILS - 9030. EVENTS - 12412.

MENU#109,02-4
 21-SEP-93
 PLOT# 106.00

GEOPHYSICS LAB METEOR SCATTER PROGRAM

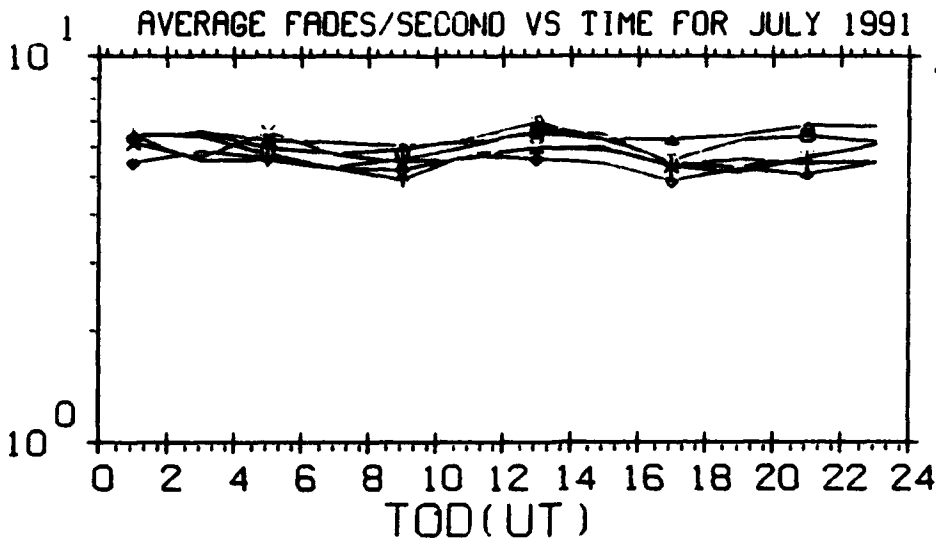

THULE

- 35 MHZ ⊙
- 45 MHZ △
- 65 MHZ +
- 85 MHZ ×
- 104 MHZ ◇
- 147 MHZ †

THE EVENT CLASS IS UNDERDENSE AND OVERDENSE TRAILS
 THE 24 HOUR FADES/SECOND AVERAGES ARE:

6.077 6.199 5.748 5.569 5.199 5.434

MENU#109,07-1
 21-SEP-93
 PLOT# 107.00

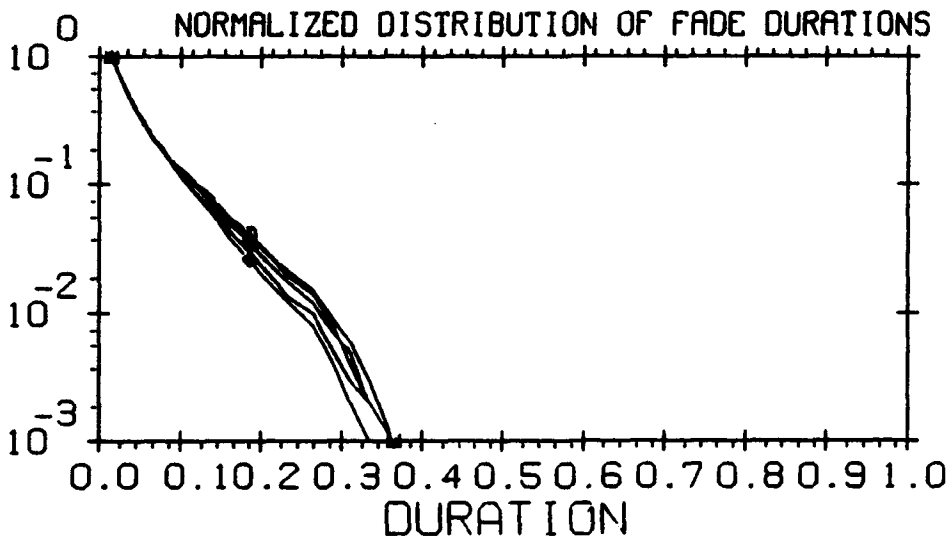

- 35 MHZ ⊙
- 45 MHZ △
- 65 MHZ +
- 85 MHZ ×
- 104 MHZ ◇
- 147 MHZ †

THE TIME OF DAY IS 0 : 24 HOURS U.T.
 THE EVENT CLASS IS UNDERDENSE AND OVERDENSE TRAILS
 NORMALIZING FACTORS:

35MHZ - 37113. 45MHZ - 64699. 65MHZ - 35364.
 85MHZ - 17455. 104MHZ - 9304. 147MHZ - 29020.

MENU#109,05-4
 21-SEP-93
 PLOT# 108.00

GEOPHYSICS LAB METEOR SCATTER PROGRAM

NORMALIZED DISTRIBUTION OF FADE DURATIONS FOR JULY 1991

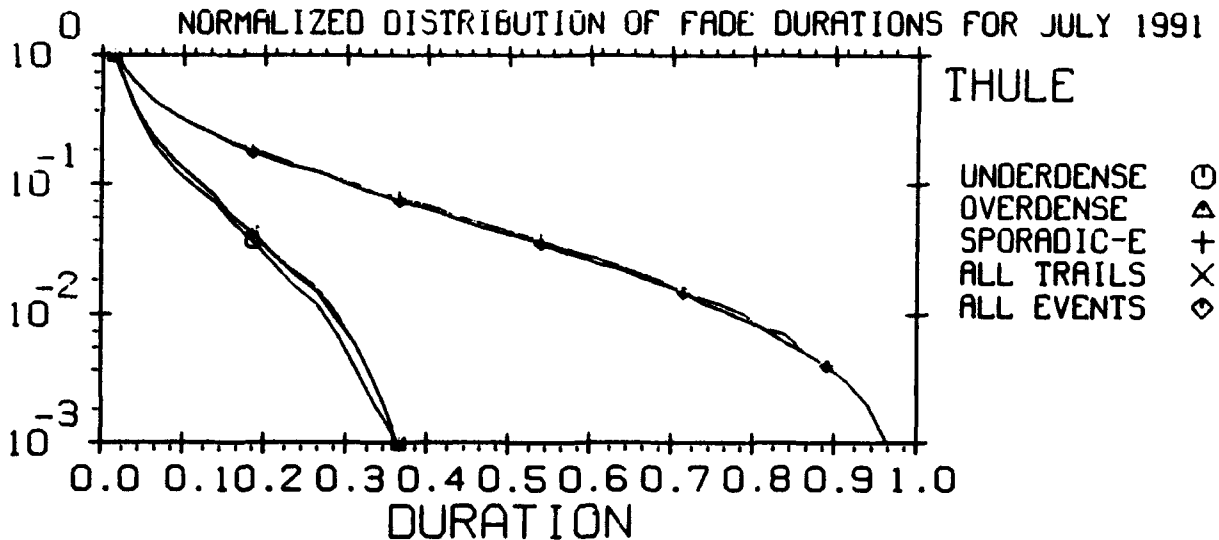

THE TIME OF DAY IS 0 : 24 HOURS U.T.

FREQUENCY - 35 MHZ

NORMALIZING FACTORS:

UNDER - 9780. OVER - 27333. SPOR-E - 634464.

TRAILS - 37113. EVENTS - 671577.

MENU=109,06-4

21-SEP-93

PLOT# 109.00

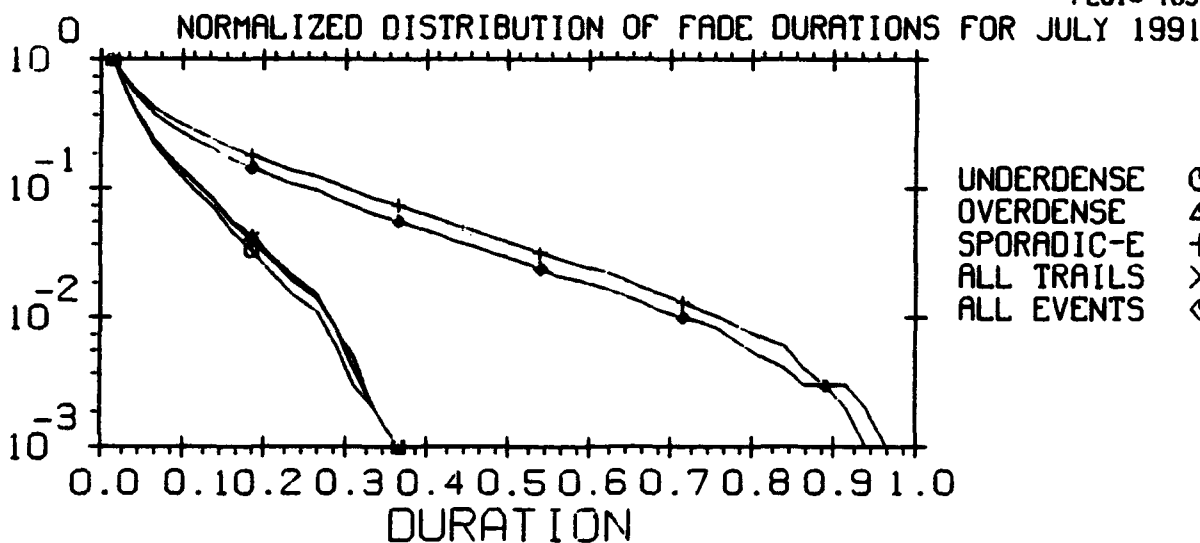

THE TIME OF DAY IS 0 : 24 HOURS U.T.

FREQUENCY - 45 MHZ

NORMALIZING FACTORS:

UNDER - 16973. OVER - 47726. SPOR-E - 197809.

TRAILS - 64699. EVENTS - 262508.

MENU=109,06-4

21-SEP-93

PLOT# 110.00

GEOPHYSICS LAB METEOR SCATTER PROGRAM

NORMALIZED DISTRIBUTION OF FADE DURATIONS FOR JULY 1991

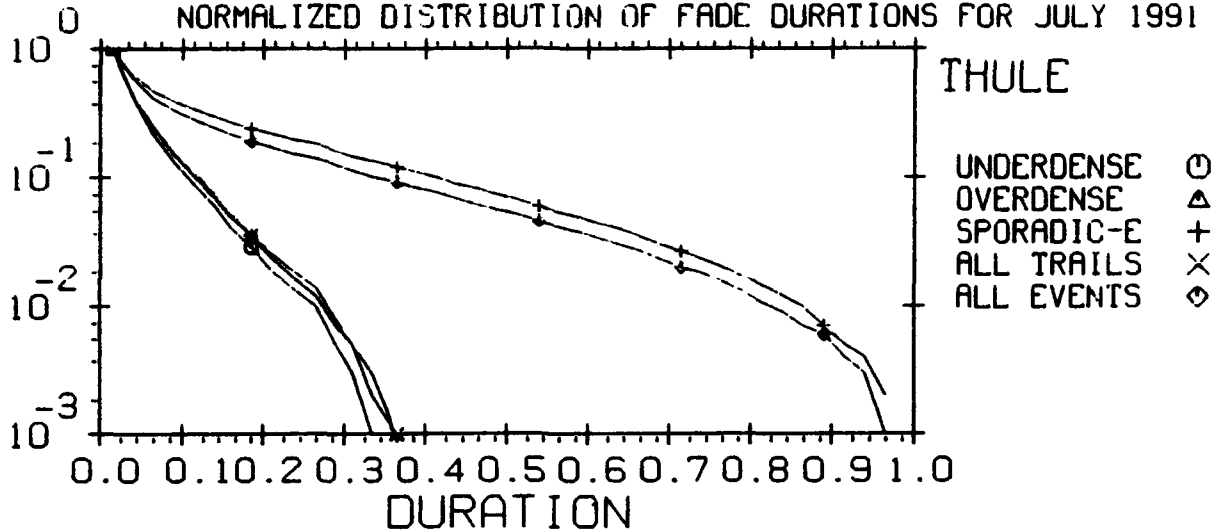

THE TIME OF DAY IS 0 : 24 HOURS U.T.

FREQUENCY - 65 MHZ

NORMALIZING FACTORS:

UNDER - 11135. OVER - 24229. SPOR-E - 113716.

TRAILS - 35364. EVENTS - 149080.

MENU#109,06-4
21-SEP-93
PLOT# 111.00

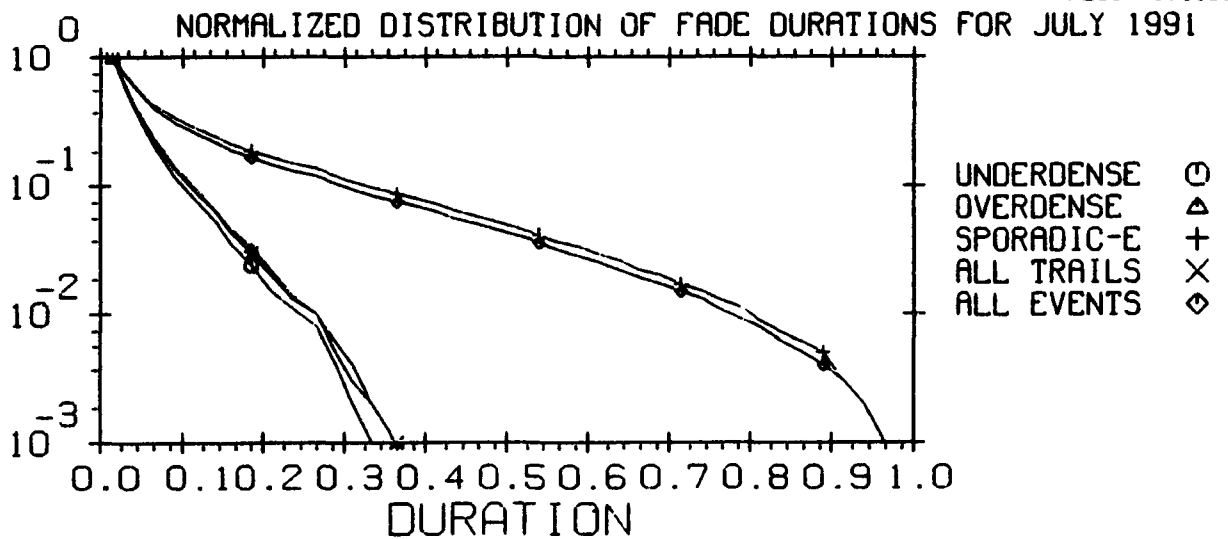

THE TIME OF DAY IS 0 : 24 HOURS U.T.

FREQUENCY - 85 MHZ

NORMALIZING FACTORS:

UNDER - 5920. OVER - 11535. SPOR-E - 109860.

TRAILS - 17455. EVENTS - 127315.

MENU#109,06-4
21-SEP-93
PLOT# 112.00

GEOPHYSICS LAB METEOR SCATTER PROGRAM

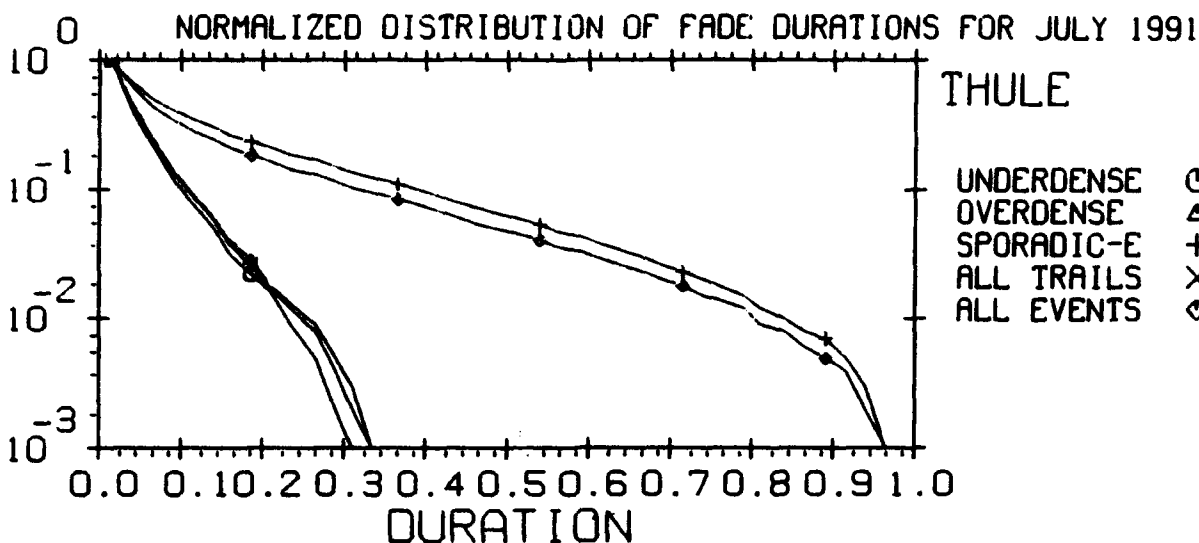

THE TIME OF DAY IS 0 : 24 HOURS U.T.
 FREQUENCY - 104 MHZ
 NORMALIZING FACTORS:
 UNDER - 3294. OVER - 6010. SPOR-E - 28988.
 TRAILS - 9304. EVENTS - 38292.

MENU=109,06-4
 21-SEP-93
 PLOT= 113.00

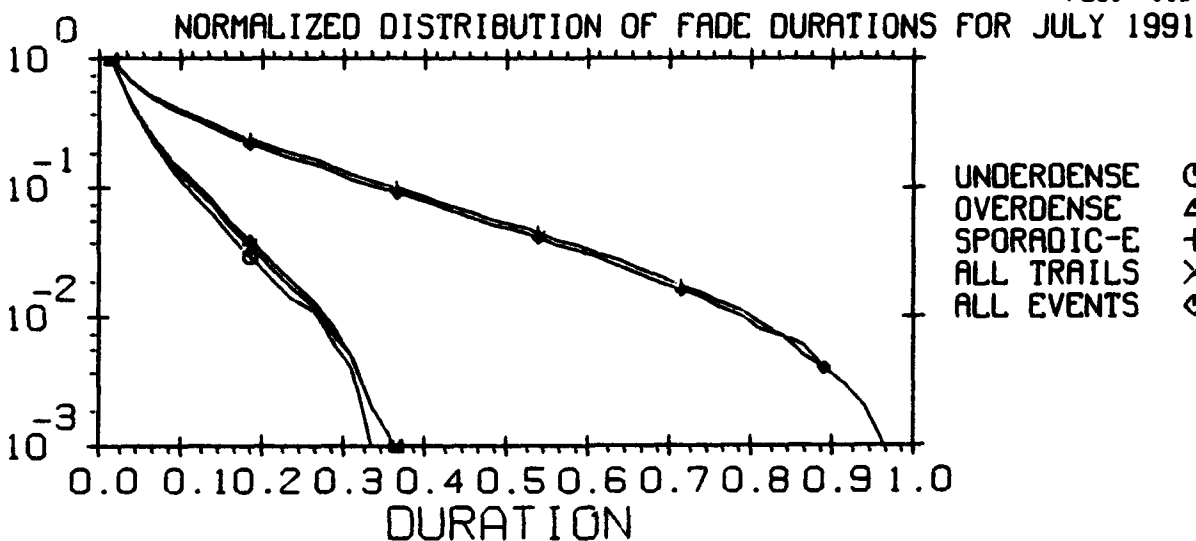

THE TIME OF DAY IS 0 : 24 HOURS U.T.
 FREQUENCY - 147 MHZ
 NORMALIZING FACTORS:
 UNDER - 10725. OVER - 18295. SPOR-E - 308686.
 TRAILS - 29020. EVENTS - 337706.

MENU=109,06-4
 21-SEP-93
 PLOT= 114.00

GEOPHYSICS LAB METEOR SCATTER PROGRAM

AVAILABILITY*POWER VS DAY.TOD JULY 1991

THULE

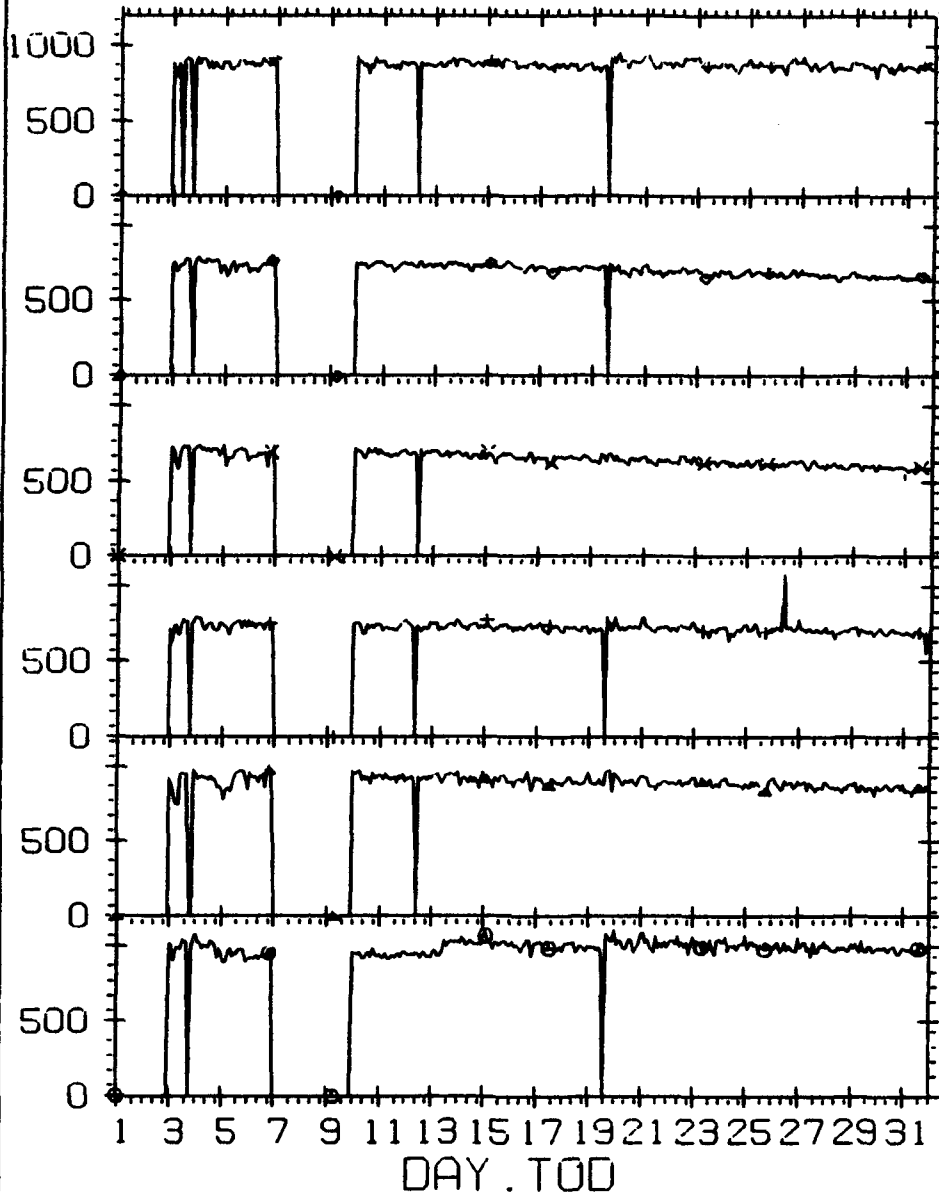

147 MHZ ↑
 104 MHZ ◇
 85 MHZ X
 65 MHZ +
 45 MHZ △
 35 MHZ ○

MENU*105,111-1
 21-SEP-93
 PLOT* 115.00

GEOPHYSICS LAB METEOR SCATTER PROGRAM

TEMP LOG-OF-KELVIN VS DAY.TOD JULY 1991

THULE

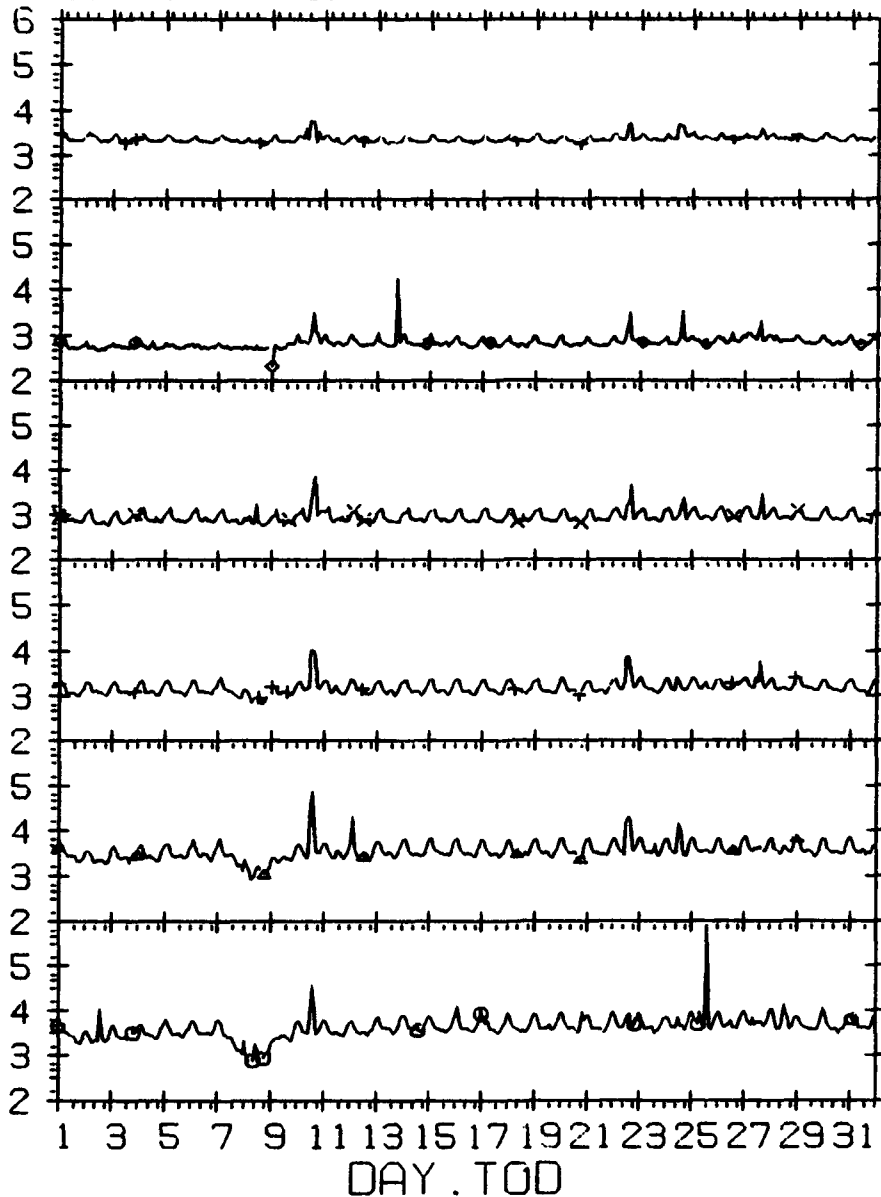

147 MHZ	↑
104 MHZ	◇
85 MHZ	X
65 MHZ	+
45 MHZ	▲
35 MHZ	○

BASED ON OBSERVED NOISE MEASUREMENTS - VERTICAL

MENU#105,06-1
21-SEP-93
PLOT# 116.00

APPENDIX C

STATISTICS FOR AUGUST 1991

GEOPHYSICS LAB METEOR SCATTER PROGRAM

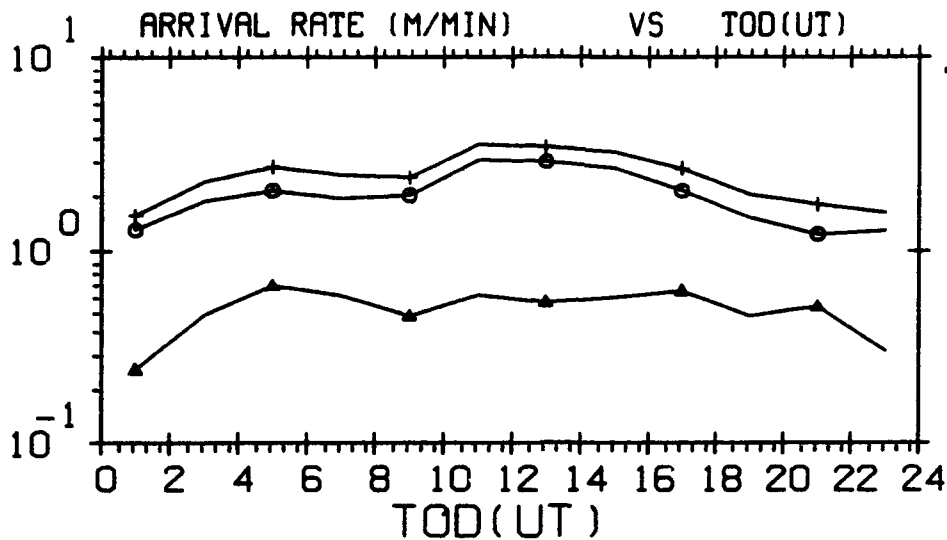

EXCEEDING -126.0 DBM RSL
 FREQUENCY - 65 MHZ
 POLARIZATION - HORIZONTAL
 MAXIMUM DOWN TIME DUE TO SPORADIC-E - 240 SECONDS
 BASED ON OBSERVED NOISE MEASUREMENTS - VERTICAL

MENU#101,05-2
 13-OCT-93
 PLOT# 3.00

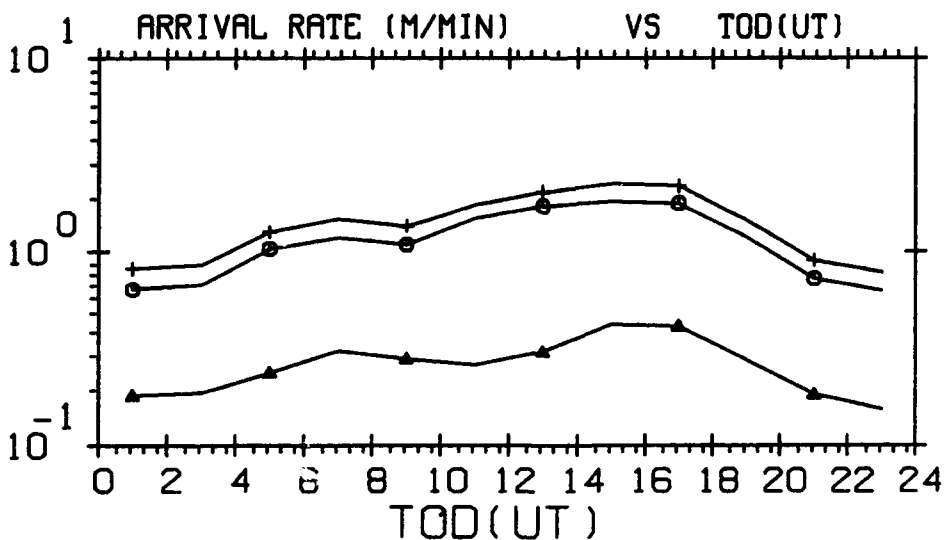

EXCEEDING -126.0 DBM RSL
 FREQUENCY - 85 MHZ
 POLARIZATION - HORIZONTAL
 MAXIMUM DOWN TIME DUE TO SPORADIC-E - 240 SECONDS
 BASED ON OBSERVED NOISE MEASUREMENTS - VERTICAL

MENU#101,05-2
 13-OCT-93
 PLOT# 4.00

GEOPHYSICS LAB METEOR SCATTER PROGRAM

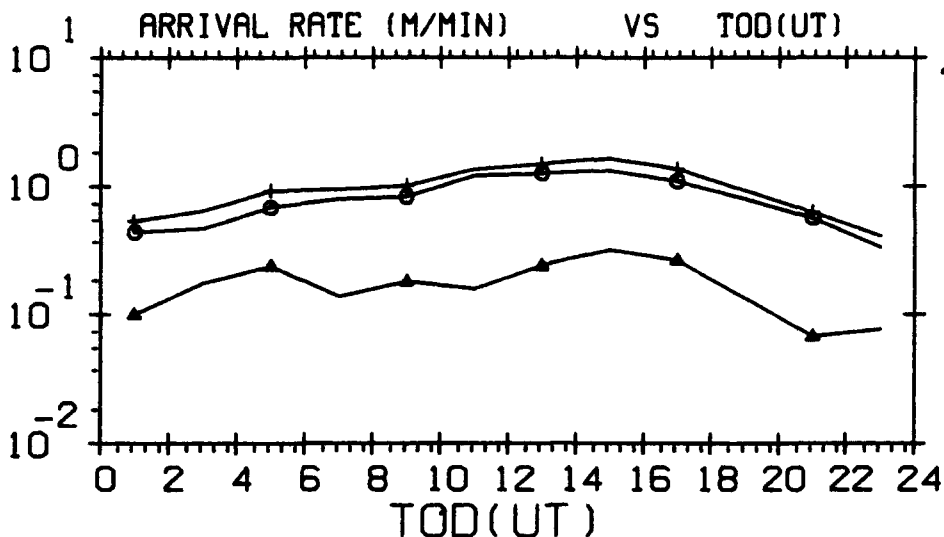

EXCEEDING -126.0 DBM RSL
 FREQUENCY - 104 MHZ
 POLARIZATION - HORIZONTAL
 MAXIMUM DOWN TIME DUE TO SPORADIC-E - 240 SECONDS
 BASED ON OBSERVED NOISE MEASUREMENTS - VERTICAL

MENU*101,05-2
 13-OCT-93
 PLOT* 5.00

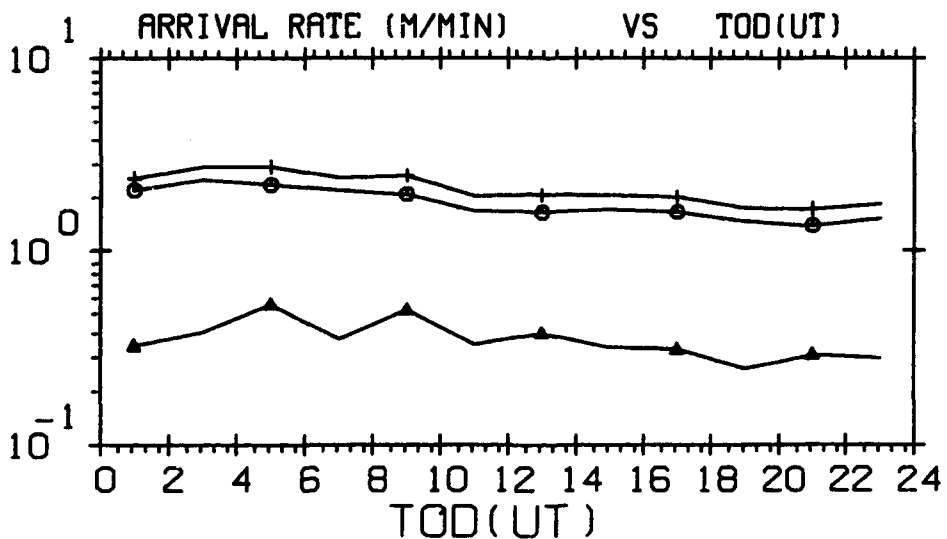

EXCEEDING -126.0 DBM RSL
 FREQUENCY - 147 MHZ
 POLARIZATION - HORIZONTAL
 MAXIMUM DOWN TIME DUE TO SPORADIC-E - 240 SECONDS
 BASED ON OBSERVED NOISE MEASUREMENTS - VERTICAL

MENU*101,05-2
 13-OCT-93
 PLOT* 6.00

GEOPHYSICS LAB METEOR SCATTER PROGRAM

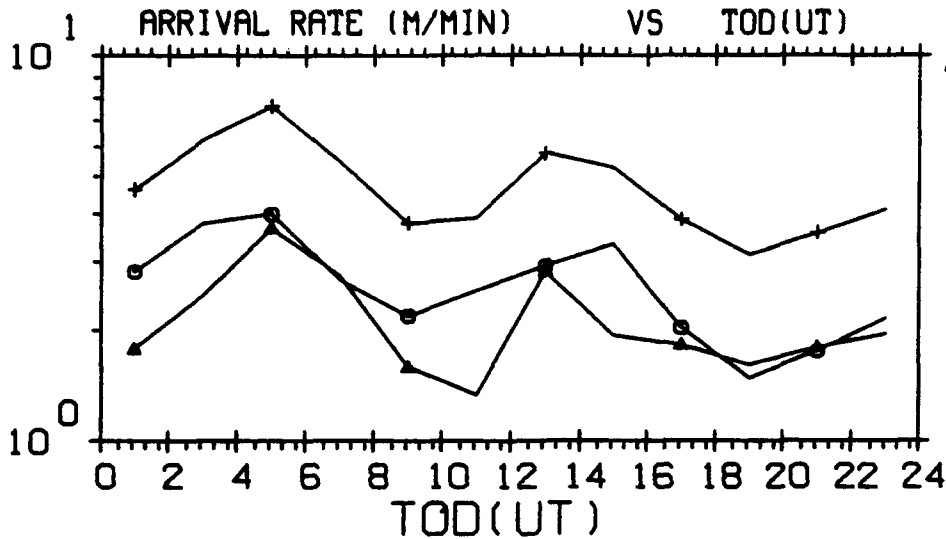

EXCEEDING -116.0 DBM RSL
 FREQUENCY - 35 MHZ
 POLARIZATION - HORIZONTAL
 MAXIMUM DOWN TIME DUE TO SPORADIC-E - 240 SECONDS
 BASED ON OBSERVED NOISE MEASUREMENTS - VERTICAL

MENU#101,05-2
 13-OCT-93
 PLOT# 7.00

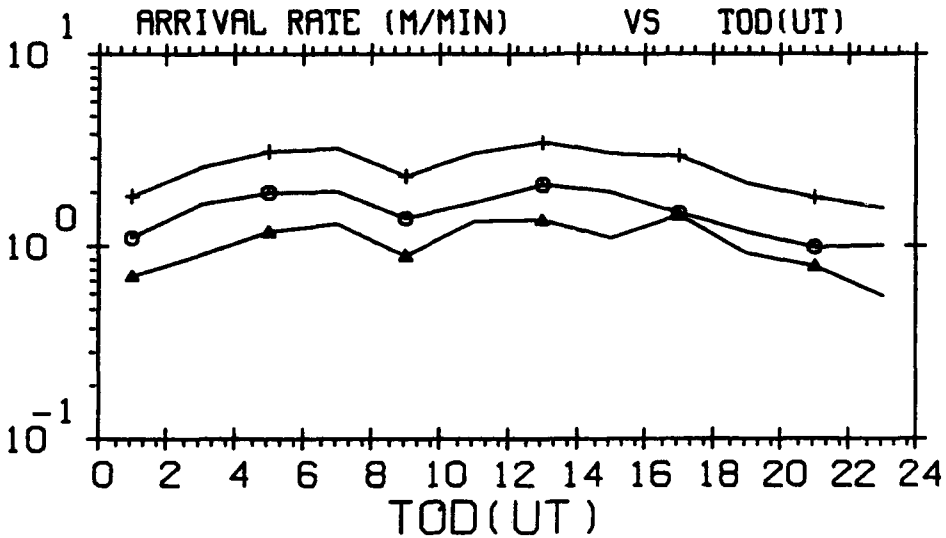

EXCEEDING -116.0 DBM RSL
 FREQUENCY - 45 MHZ
 POLARIZATION - HORIZONTAL
 MAXIMUM DOWN TIME DUE TO SPORADIC-E - 240 SECONDS
 BASED ON OBSERVED NOISE MEASUREMENTS - VERTICAL

MENU#101,05-2
 13-OCT-93
 PLOT# 8.00

GEOPHYSICS LAB METEOR SCATTER PROGRAM

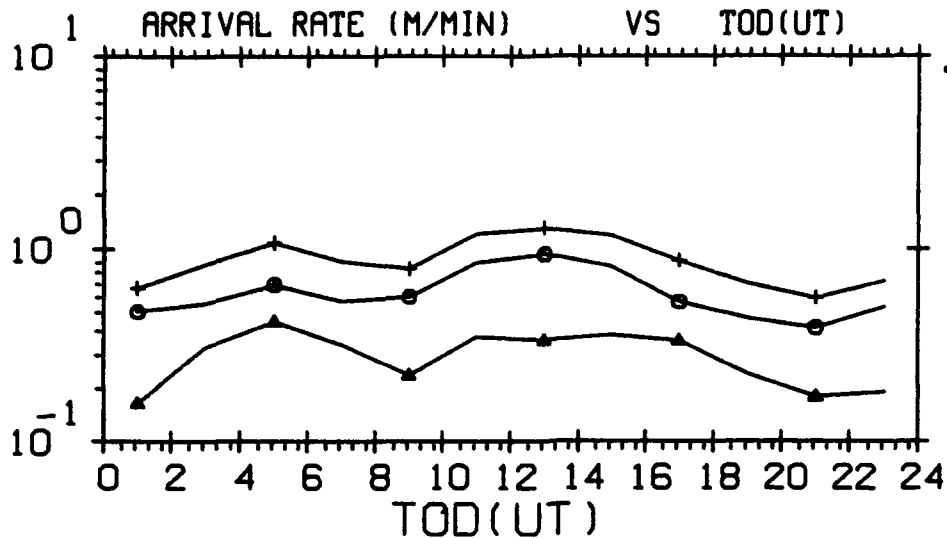

UNDERDENSE ○
OVERDENSE ▲
ALL TRAILS +

EXCEEDING -116.0 DBM RSL
 FREQUENCY - 65 MHZ
 POLARIZATION - HORIZONTAL
 MAXIMUM DOWN TIME DUE TO SPORADIC-E - 240 SECONDS
 BASED ON OBSERVED NOISE MEASUREMENTS - VERTICAL

MENU#101,05-2
 13-OCT-93
 PLOT# 9.00

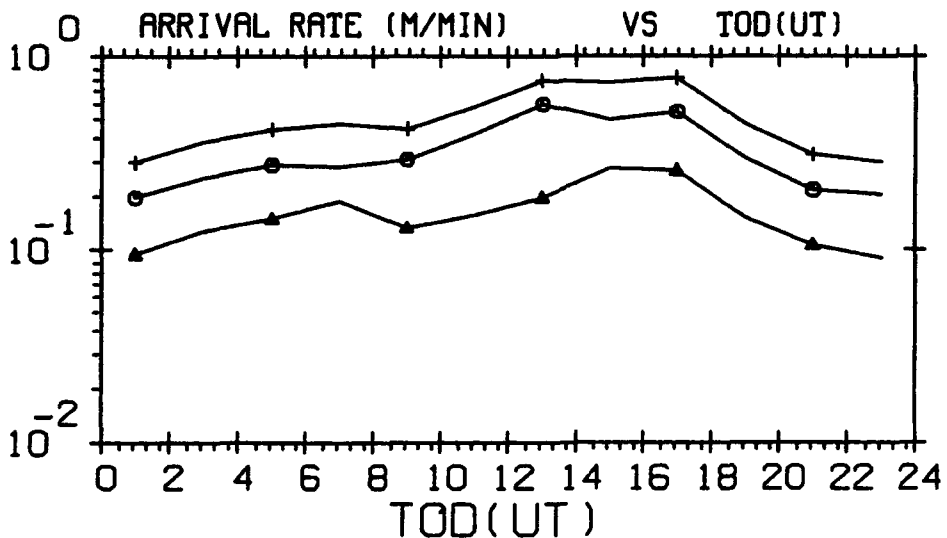

UNDERDENSE ○
OVERDENSE ▲
ALL TRAILS +

EXCEEDING -116.0 DBM RSL
 FREQUENCY - 85 MHZ
 POLARIZATION - HORIZONTAL
 MAXIMUM DOWN TIME DUE TO SPORADIC-E - 240 SECONDS
 BASED ON OBSERVED NOISE MEASUREMENTS - VERTICAL

MENU#101,05-2
 13-OCT-93
 PLOT# 10.00

GEOPHYSICS LAB METEOR SCATTER PROGRAM

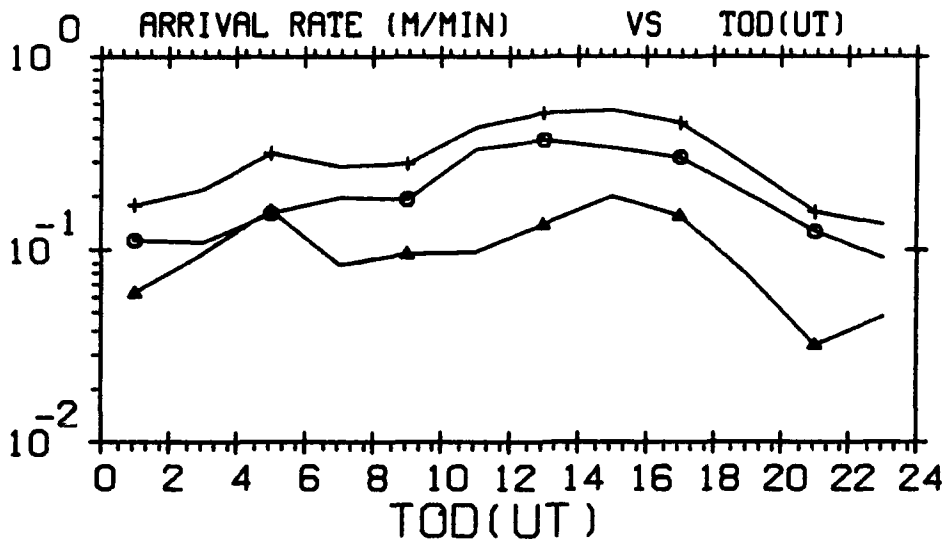

EXCEEDING -116.0 DBM RSL
 FREQUENCY - 104 MHZ
 POLARIZATION - HORIZONTAL
 MAXIMUM DOWN TIME DUE TO SPORADIC-E - 240 SECONDS
 BASED ON OBSERVED NOISE MEASUREMENTS - VERTICAL

MENU=101,05-2
 13-OCT-93
 PLOT= 11.00

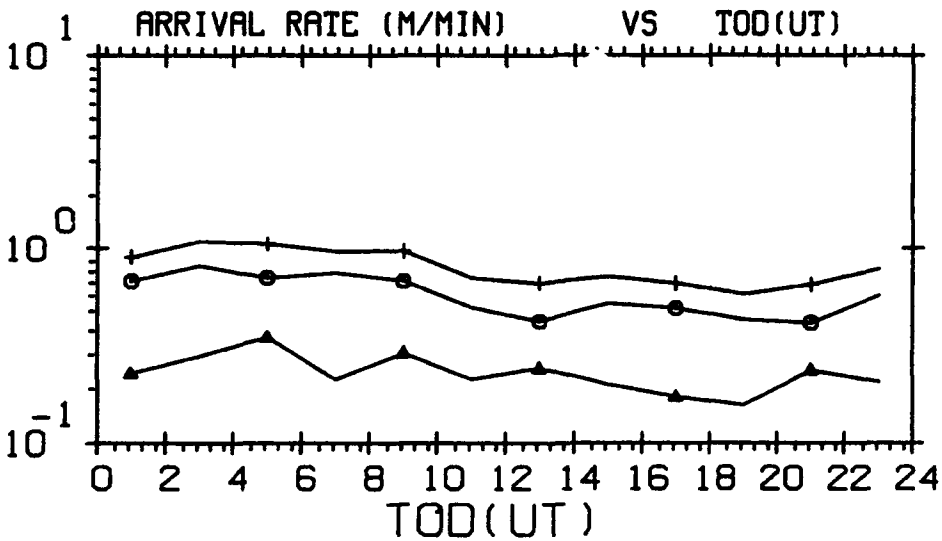

EXCEEDING -116.0 DBM RSL
 FREQUENCY - 147 MHZ
 POLARIZATION - HORIZONTAL
 MAXIMUM DOWN TIME DUE TO SPORADIC-E - 240 SECONDS
 BASED ON OBSERVED NOISE MEASUREMENTS - VERTICAL

MENU=101,05-2
 13-OCT-93
 PLOT= 12.00

GEOPHYSICS LAB METEOR SCATTER PROGRAM

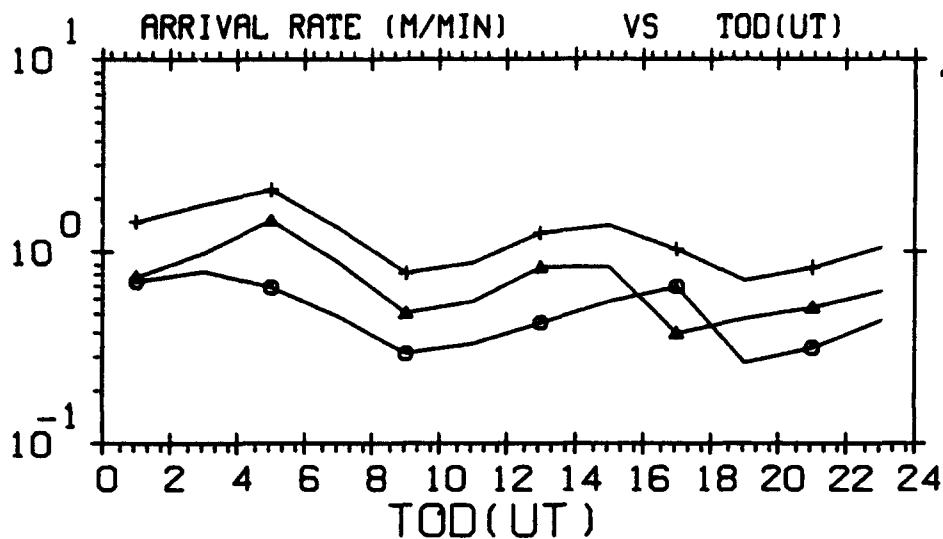

EXCEEDING -106.0 DBM RSL
 FREQUENCY - 35 MHZ
 POLARIZATION - HORIZONTAL
 MAXIMUM DOWN TIME DUE TO SPORADIC-E - 240 SECONDS
 BASED ON OBSERVED NOISE MEASUREMENTS - VERTICAL

MENU*101,05-2
 13-OCT-93
 PLOT* 13.00

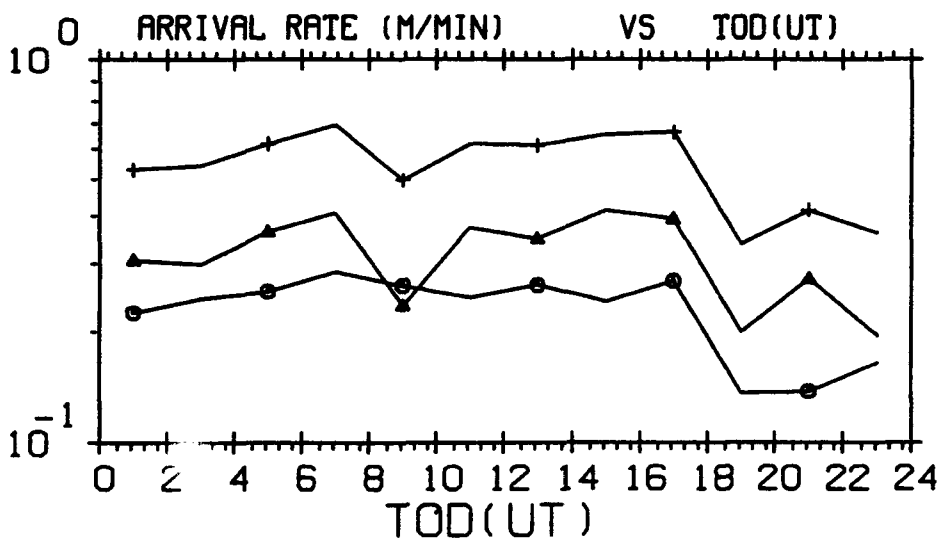

EXCEEDING -106.0 DBM RSL
 FREQUENCY - 45 MHZ
 POLARIZATION - HORIZONTAL
 MAXIMUM DOWN TIME DUE TO SPORADIC-E - 240 SECONDS
 BASED ON OBSERVED NOISE MEASUREMENTS - VERTICAL

MENU*101,05-2
 13-OCT-93
 PLOT* 14.00

GEOPHYSICS LAB METEOR SCATTER PROGRAM

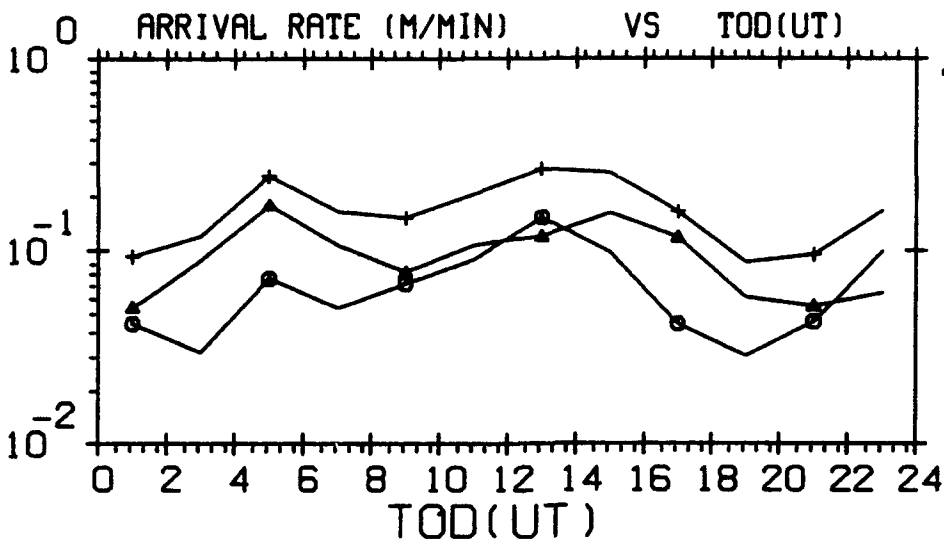

UNDERDENSE ○
 OVERDENSE △
 ALL TRAILS +

EXCEEDING -106.0 DBM RSL
 FREQUENCY - 65 MHZ
 POLARIZATION - HORIZONTAL
 MAXIMUM DOWN TIME DUE TO SPORADIC-E - 240 SECONDS
 BASED ON OBSERVED NOISE MEASUREMENTS - VERTICAL

MENU#101,05-2
 13-OCT-93
 PLOT# 15.00

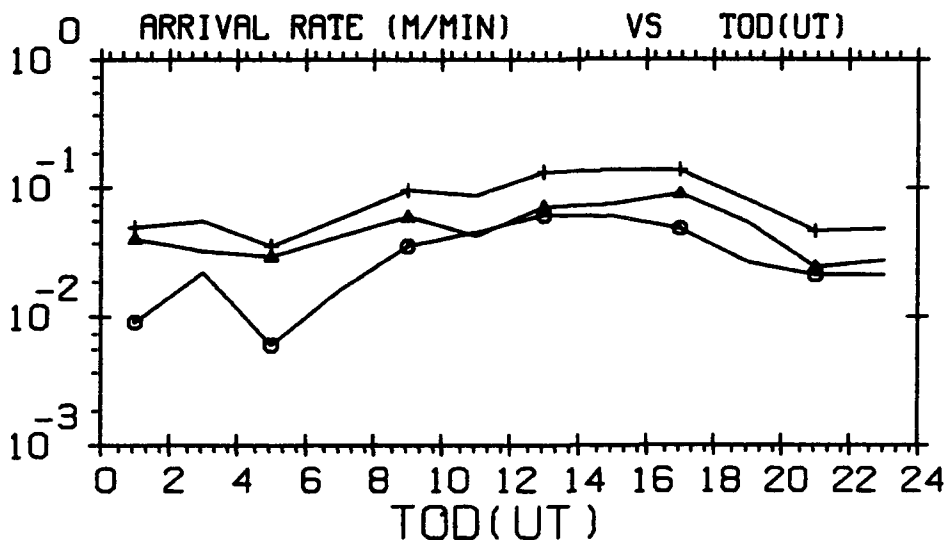

UNDERDENSE ○
 OVERDENSE △
 ALL TRAILS +

EXCEEDING -106.0 DBM RSL
 FREQUENCY - 85 MHZ
 POLARIZATION - HORIZONTAL
 MAXIMUM DOWN TIME DUE TO SPORADIC-E - 240 SECONDS
 BASED ON OBSERVED NOISE MEASUREMENTS - VERTICAL

MENU#101,05-2
 13-OCT-93
 PLOT# 16.00

GEOPHYSICS LAB METEOR SCATTER PROGRAM

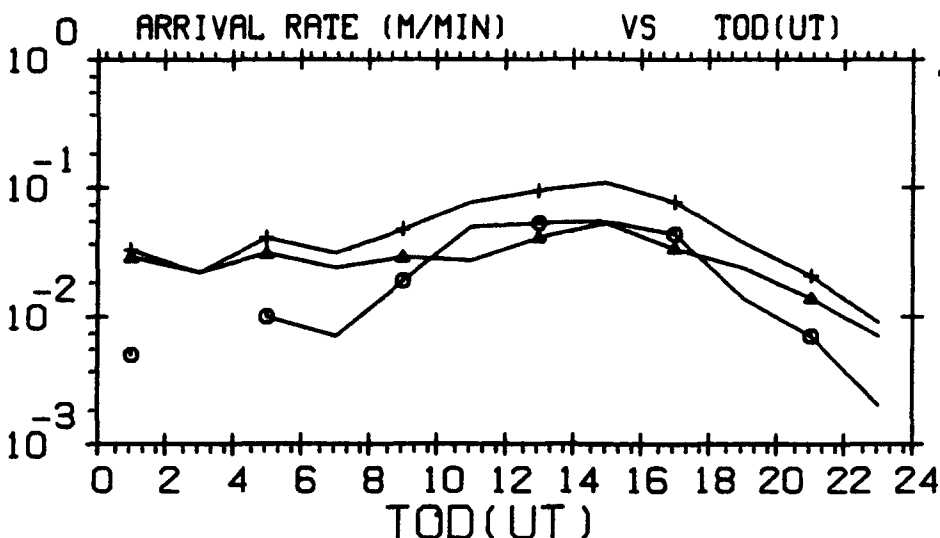

EXCEEDING -106.0 DBM RSL
 FREQUENCY - 104 MHZ
 POLARIZATION - HORIZONTAL
 MAXIMUM DOWN TIME DUE TO SPORADIC-E - 240 SECONDS
 BASED ON OBSERVED NOISE MEASUREMENTS - VERTICAL

MENU*101,05-2
 13-OCT-93
 PLOT* 17.00

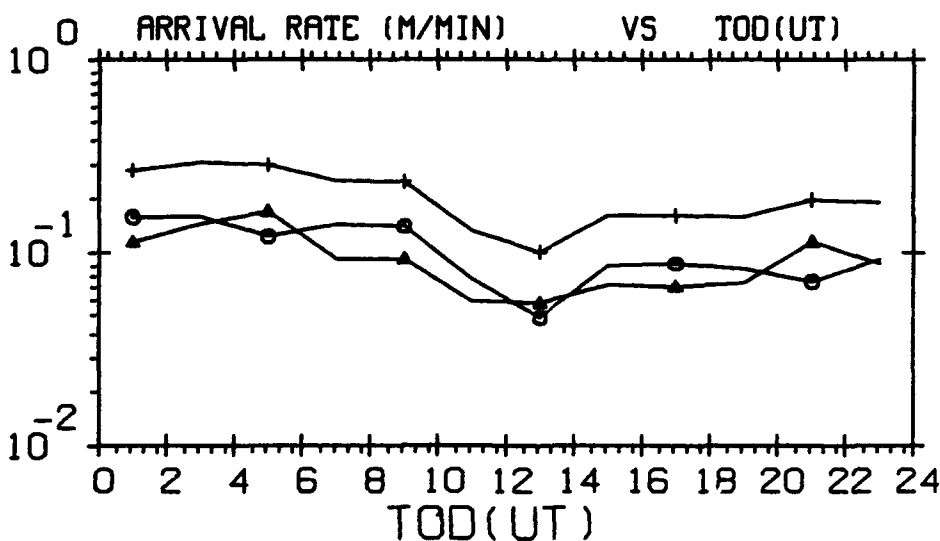

EXCEEDING -106.0 DBM RSL
 FREQUENCY - 147 MHZ
 POLARIZATION - HORIZONTAL
 MAXIMUM DOWN TIME DUE TO SPORADIC-E - 240 SECONDS
 BASED ON OBSERVED NOISE MEASUREMENTS - VERTICAL

MENU*101,05-2
 13-OCT-93
 PLOT* 18.00

GEOPHYSICS LAB METEOR SCATTER PROGRAM

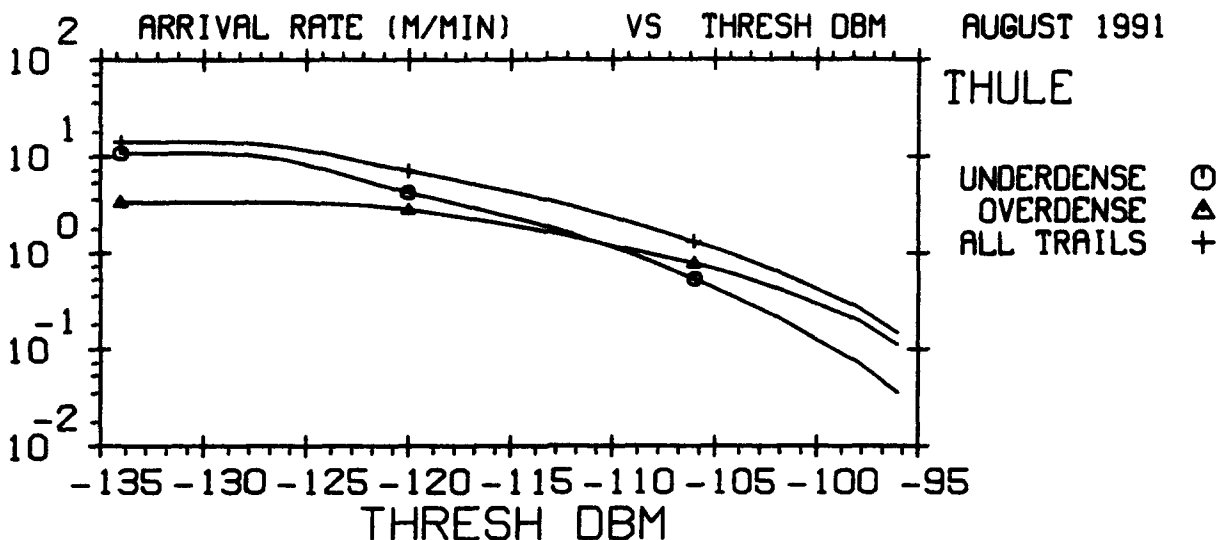

THE TIME OF DAY IS 0 : 24 HOURS U.T.
 FREQUENCY - 35 MHZ
 POLARIZATION - HORIZONTAL
 MAXIMUM DOWN TIME DUE TO SPORADIC-E - 240 SECONDS
 BASED ON OBSERVED NOISE MEASUREMENTS - VERTICAL

MENU*101,06-2
 13-OCT-93
 PLOT* 19.00

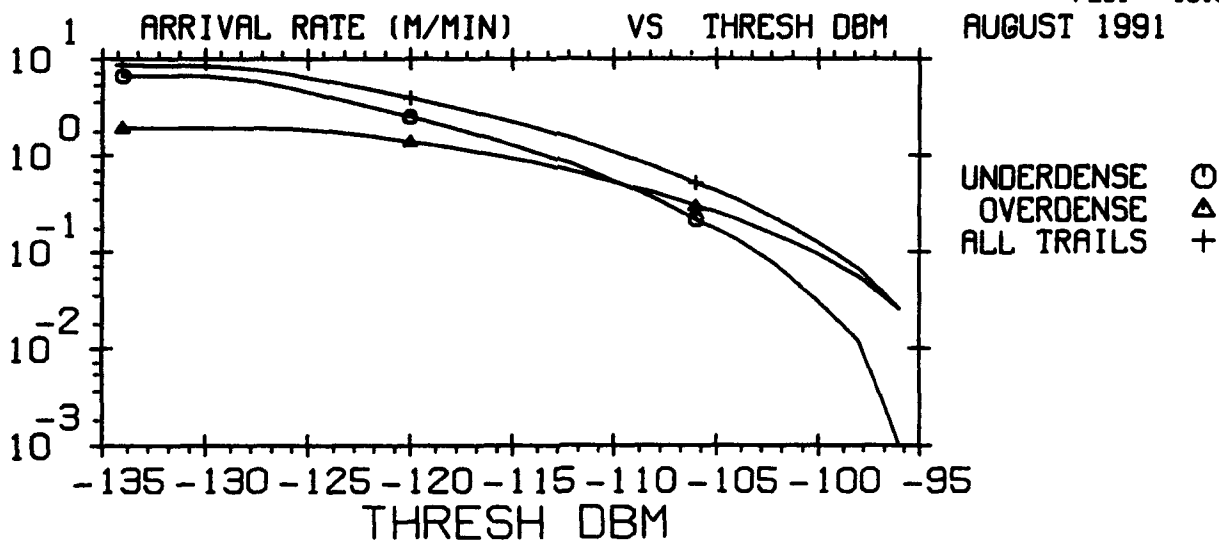

THE TIME OF DAY IS 0 : 24 HOURS U.T.
 FREQUENCY - 45 MHZ
 POLARIZATION - HORIZONTAL
 MAXIMUM DOWN TIME DUE TO SPORADIC-E - 240 SECONDS
 BASED ON OBSERVED NOISE MEASUREMENTS - VERTICAL

MENU*101,06-2
 13-OCT-93
 PLOT* 20.00

GEOPHYSICS LAB METEOR SCATTER PROGRAM

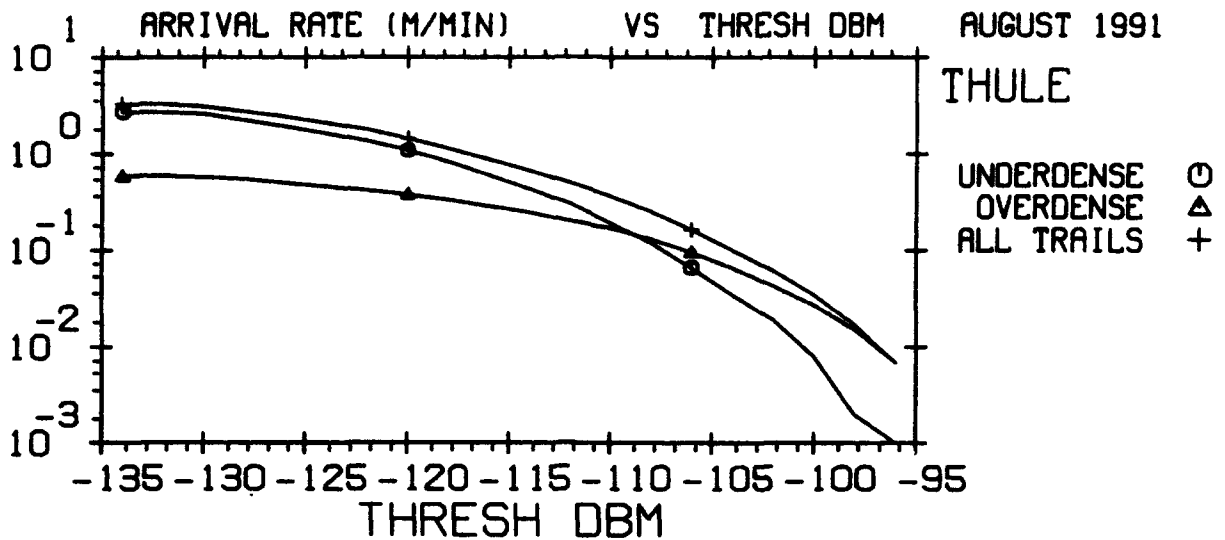

THE TIME OF DAY IS 0 : 24 HOURS U.T.
 FREQUENCY - 65 MHZ
 POLARIZATION - HORIZONTAL
 MAXIMUM DOWN TIME DUE TO SPORADIC-E - 240 SECONDS
 BASED ON OBSERVED NOISE MEASUREMENTS - VERTICAL

MENU#101,06-2
 13-OCT-93
 PLOT# 21.00

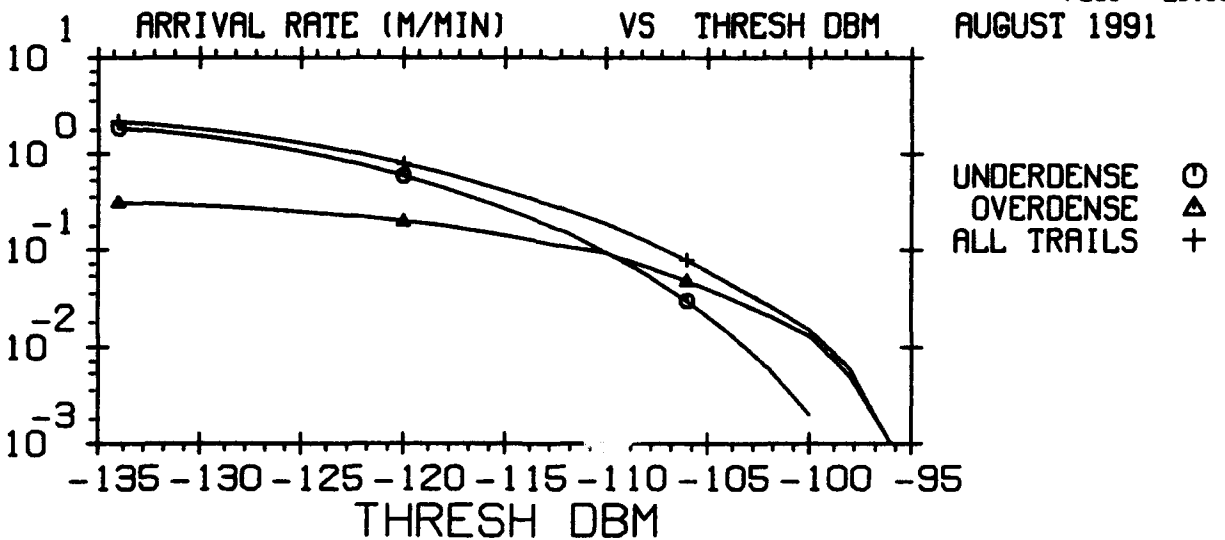

THE TIME OF DAY IS 0 : 24 HOURS U.T.
 FREQUENCY - 85 MHZ
 POLARIZATION - HORIZONTAL
 MAXIMUM DOWN TIME DUE TO SPORADIC-E - 240 SECONDS
 BASED ON OBSERVED NOISE MEASUREMENTS - VERTICAL

MENU#101,06-2
 13-OCT-93
 PLOT# 22.00

GEOPHYSICS LAB METEOR SCATTER PROGRAM

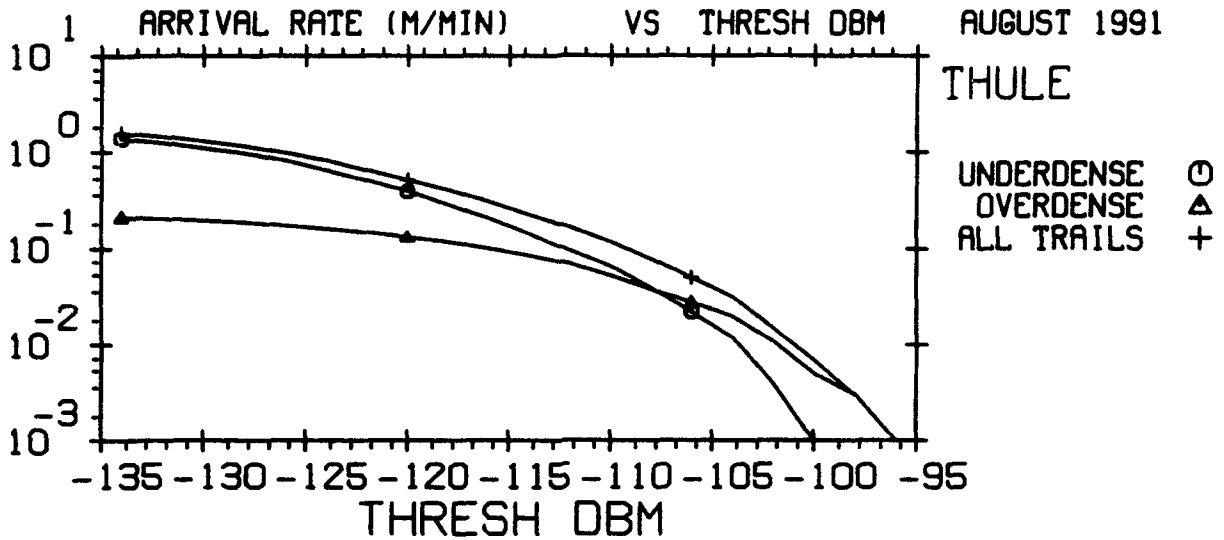

THE TIME OF DAY IS 0 : 24 HOURS U.T.
 FREQUENCY - 104 MHZ
 POLARIZATION - HORIZONTAL
 MAXIMUM DOWN TIME DUE TO SPORADIC-E - 240 SECONDS
 BASED ON OBSERVED NOISE MEASUREMENTS - VERTICAL

MENU*101,06-2
 13-OCT-93
 PLOT* 23.00

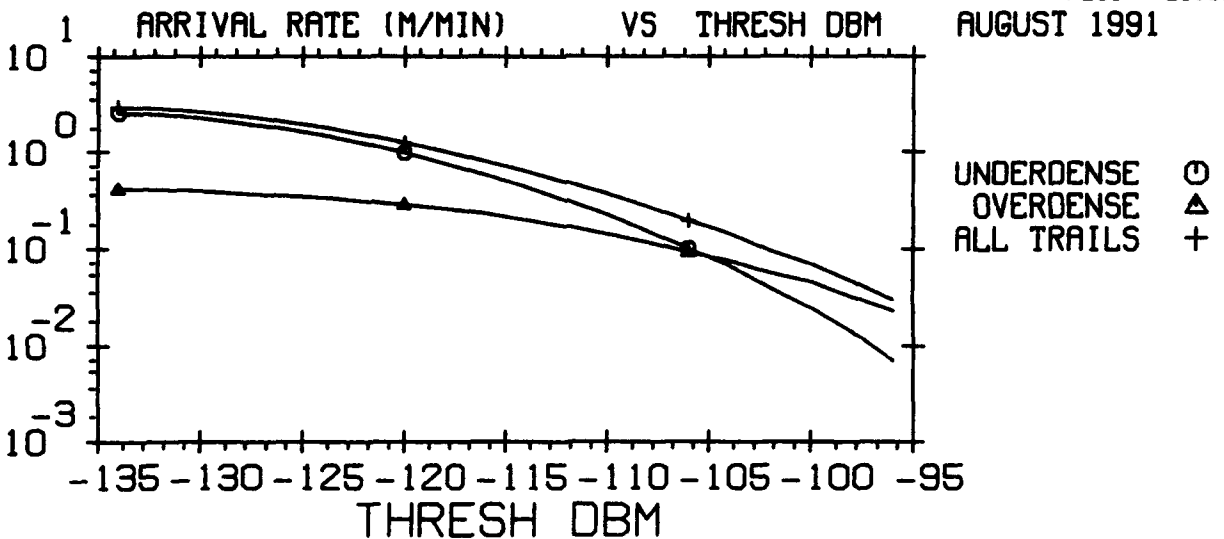

THE TIME OF DAY IS 0 : 24 HOURS U.T.
 FREQUENCY - 147 MHZ
 POLARIZATION - HORIZONTAL
 MAXIMUM DOWN TIME DUE TO SPORADIC-E - 240 SECONDS
 BASED ON OBSERVED NOISE MEASUREMENTS - VERTICAL

MENU*101,06-2
 13-OCT-93
 PLOT* 24.00

GEOPHYSICS LAB METEOR SCATTER PROGRAM

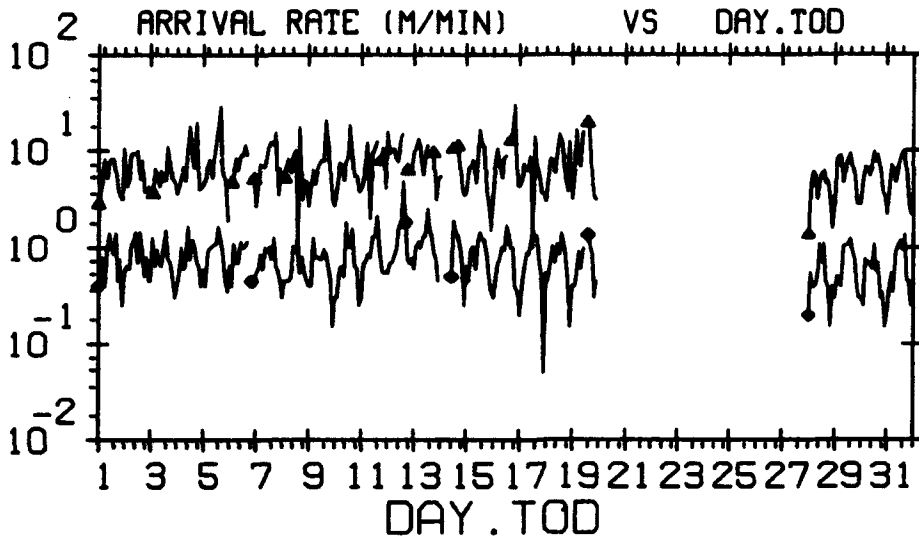

AUGUST 1991
 THULE
 45 MHZ △
 104 MHZ ◇

EXCEEDING -126.0 DBM RSL
 TYPE OF METEOR TRAIL - UNDERDENSE AND OVERDENSE
 POLARIZATION - HORIZONTAL
 MAXIMUM DOWN TIME DUE TO SPORADIC-E - 240 SECONDS
 BASED ON OBSERVED NOISE MEASUREMENTS - VERTICAL

MENU*101,03-2
 13-OCT-93
 PLOT* 25.00

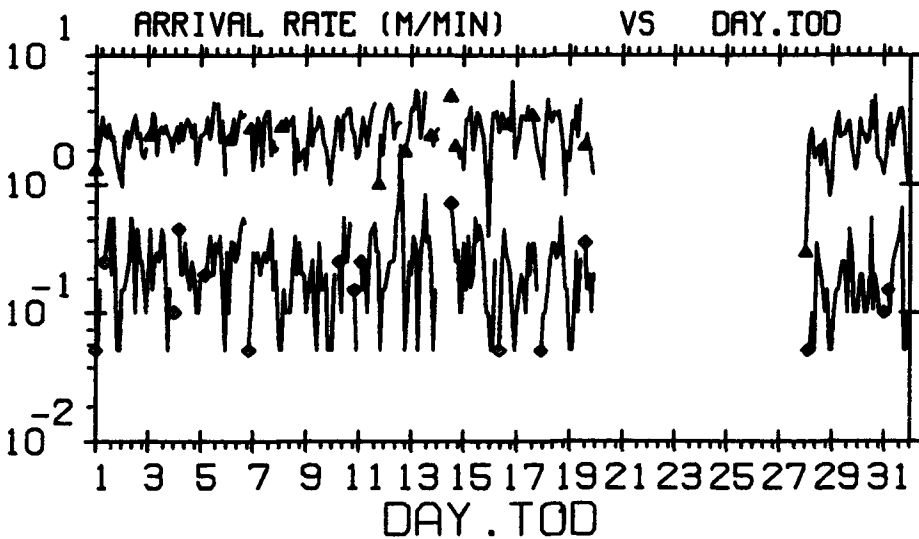

AUGUST 1991
 45 MHZ △
 104 MHZ ◇

EXCEEDING -116.0 DBM RSL
 TYPE OF METEOR TRAIL - UNDERDENSE AND OVERDENSE
 POLARIZATION - HORIZONTAL
 MAXIMUM DOWN TIME DUE TO SPORADIC-E - 240 SECONDS
 BASED ON OBSERVED NOISE MEASUREMENTS - VERTICAL

MENU*101,03-2
 13-OCT-93
 PLOT* 26.00

GEOPHYSICS LAB METEOR SCATTER PROGRAM

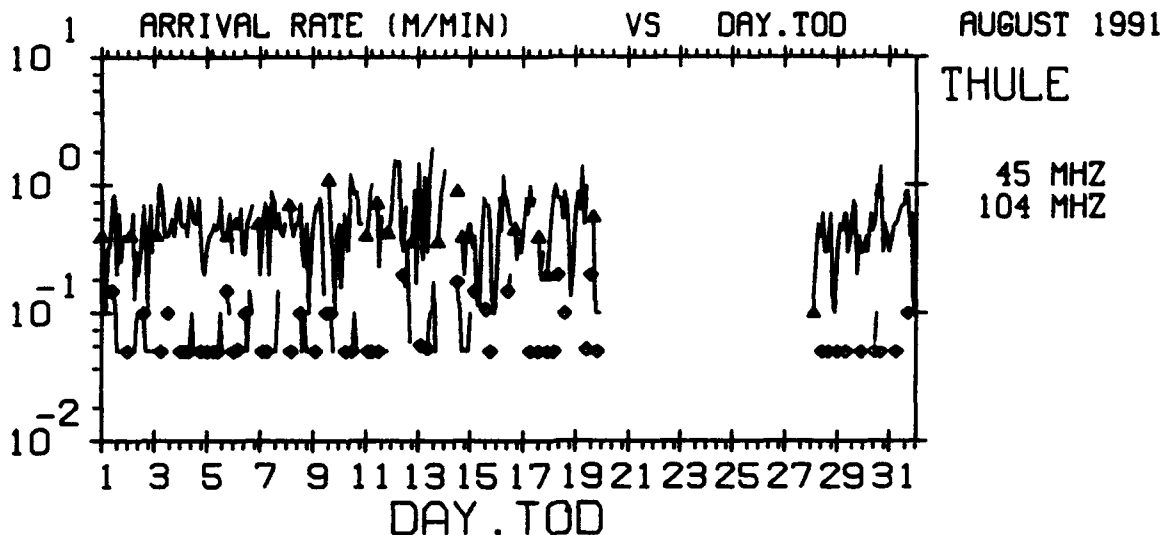

EXCEEDING -106.0 DBM RSL
 TYPE OF METEOR TRAIL - UNDERDENSE AND OVERDENSE
 POLARIZATION - HORIZONTAL
 MAXIMUM DOWN TIME DUE TO SPORADIC-E - 240 SECONDS
 BASED ON OBSERVED NOISE MEASUREMENTS - VERTICAL

MENU#101,03-2
 13-OCT-93
 PLOT# 27.00

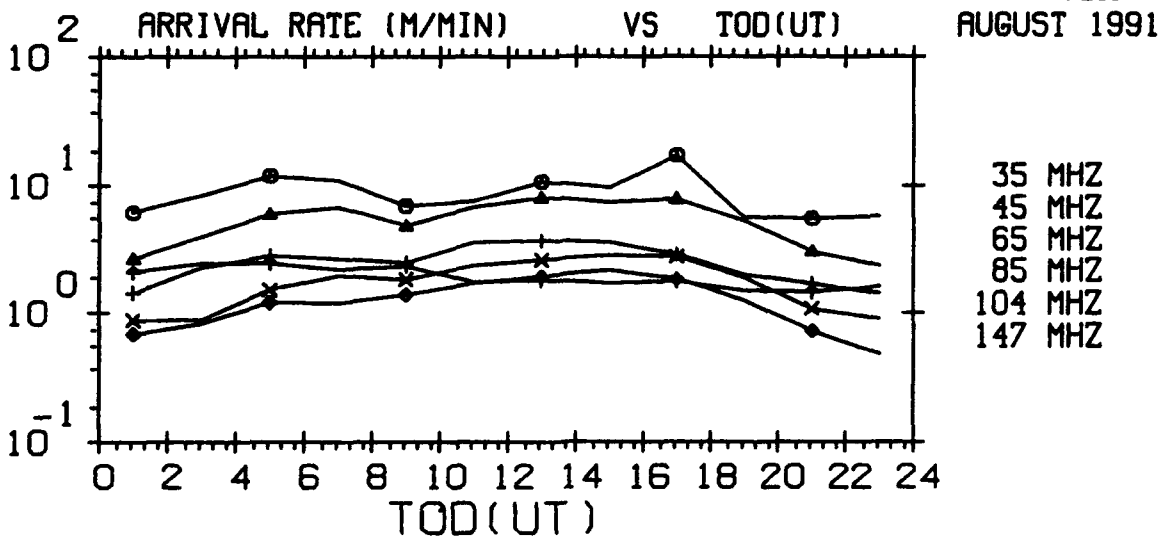

EXCEEDING 19.0 DB SNR
 TYPE OF METEOR TRAIL - UNDERDENSE AND OVERDENSE
 EFFECTIVE SYSTEM BANDWIDTH - 100.HZ
 POLARIZATION - HORIZONTAL
 MAXIMUM DOWN TIME DUE TO SPORADIC-E - 240 SECONDS
 BASED ON OBSERVED NOISE MEASUREMENTS - VERTICAL

MENU#102,01-2
 13-OCT-93
 PLOT# 28.00

GEOPHYSICS LAB METEOR SCATTER PROGRAM

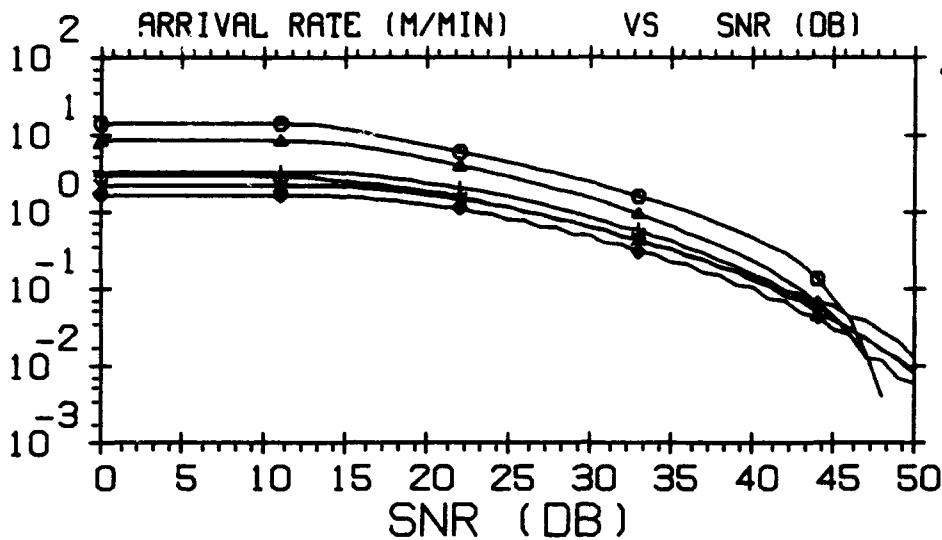

35 MHZ	○
45 MHZ	△
65 MHZ	+
85 MHZ	×
104 MHZ	◇
147 MHZ	↑

THE TIME OF DAY IS 0 : 24 HOURS U.T.
 TYPE OF METEOR TRAIL - UNDERDENSE AND OVERDENSE
 EFFECTIVE SYSTEM BANDWIDTH - 100.HZ
 POLARIZATION - HORIZONTAL
 MAXIMUM DOWN TIME DUE TO SPORADIC-E - 240 SECONDS
 BASED ON OBSERVED NOISE MEASUREMENTS - VERTICAL

MENU#102,02-2
 13-OCT-93
 PLOT# 29.00

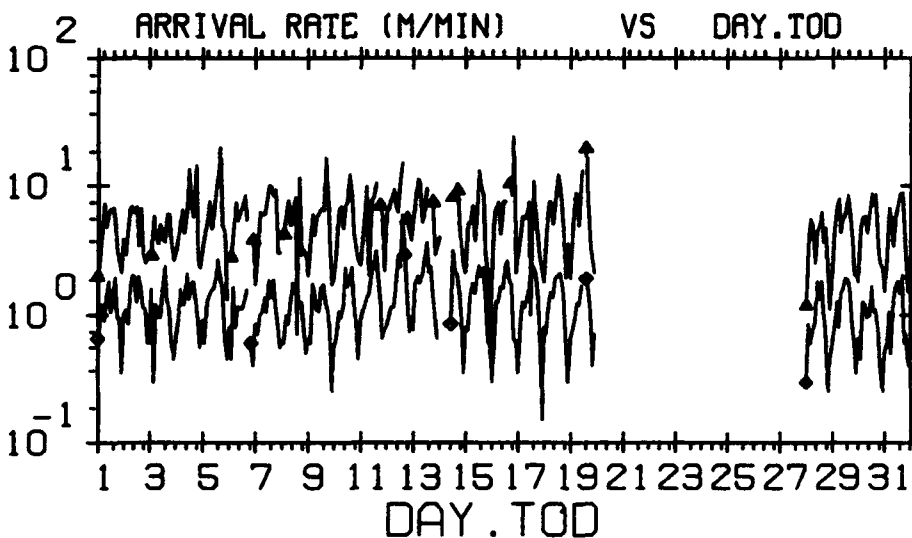

45 MHZ	△
104 MHZ	◇

EXCEEDING 19.0 DB SNR
 TYPE OF METEOR TRAIL - UNDERDENSE AND OVERDENSE
 EFFECTIVE SYSTEM BANDWIDTH - 100.HZ
 POLARIZATION - HORIZONTAL
 MAXIMUM DOWN TIME DUE TO SPORADIC-E - 240 SECONDS
 BASED ON OBSERVED NOISE MEASUREMENTS - VERTICAL

MENU#102,03-2
 13-OCT-93
 PLOT# 30.00

GEOPHYSICS LAB METEOR SCATTER PROGRAM

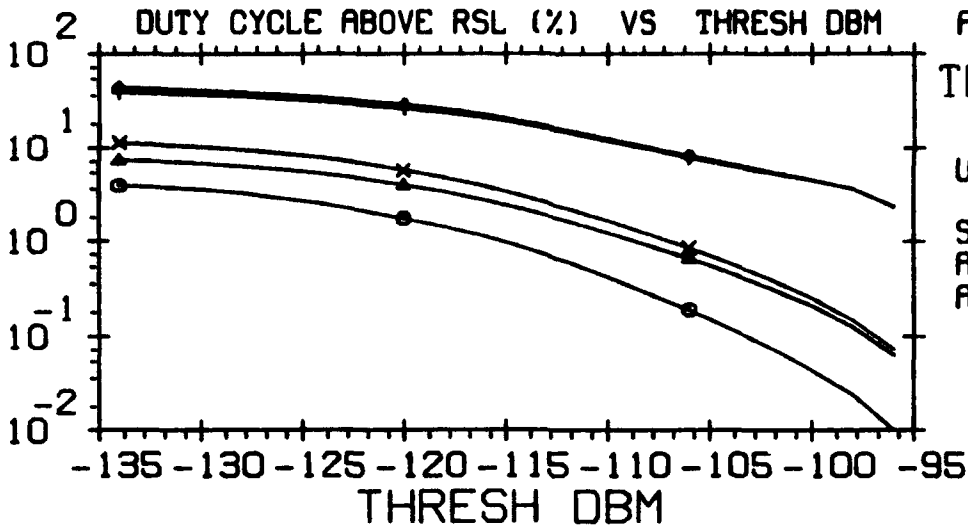

THE TIME OF DAY IS 0 : 24 HOURS U.T.
 FREQUENCY - 35 MHZ
 POLARIZATION - HORIZONTAL
 BASED ON OBSERVED NOISE MEASUREMENTS - VERTICAL

MENU#103,06-2
 13-OCT-93
 PLOT# 31.00

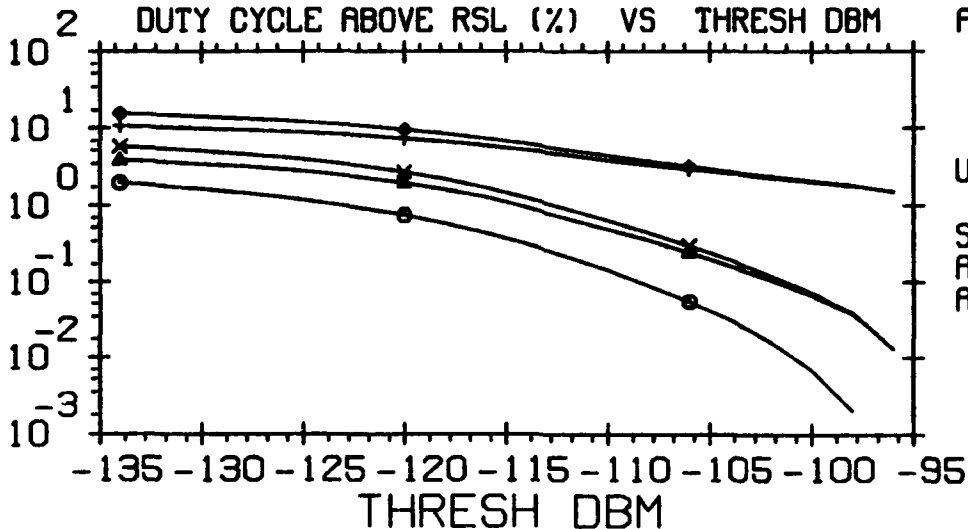

THE TIME OF DAY IS 0 : 24 HOURS U.T.
 FREQUENCY - 45 MHZ
 POLARIZATION - HORIZONTAL
 BASED ON OBSERVED NOISE MEASUREMENTS - VERTICAL

MENU#103,06-2
 13-OCT-93
 PLOT# 32.00

GEOPHYSICS LAB METEOR SCATTER PROGRAM

AUGUST 1991

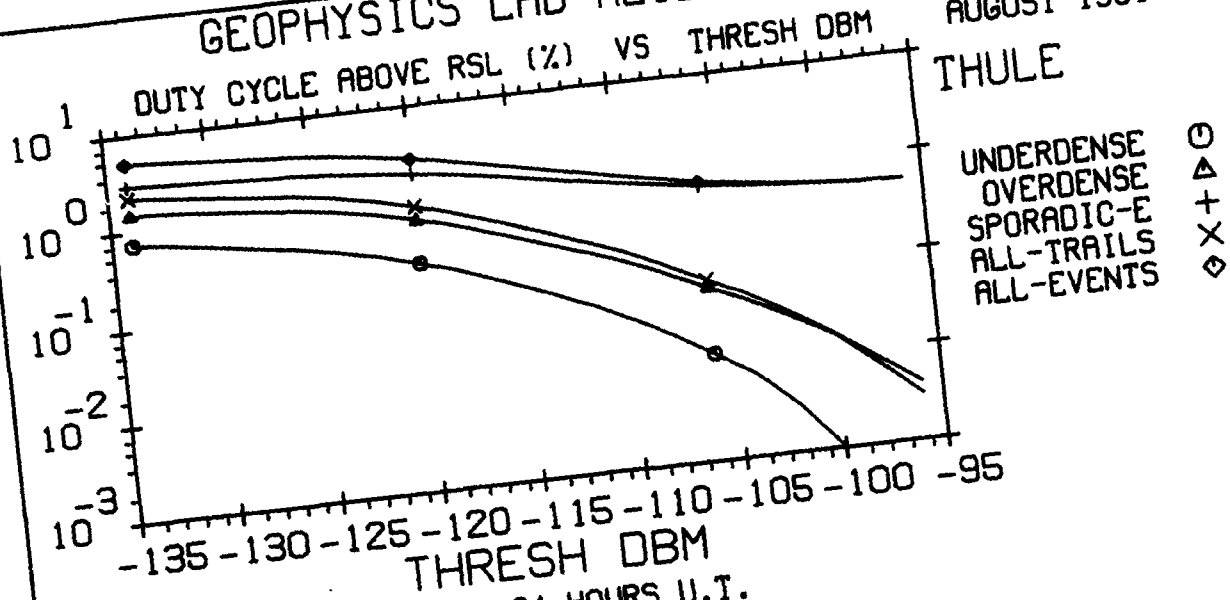

THE TIME OF DAY IS 0 : 24 HOURS U.T.
 FREQUENCY - 65 MHZ
 POLARIZATION - HORIZONTAL
 BASED ON OBSERVED NOISE MEASUREMENTS - VERTICAL

MENU#103,06-2
 13-OCT-93
 PLOT# 33.00

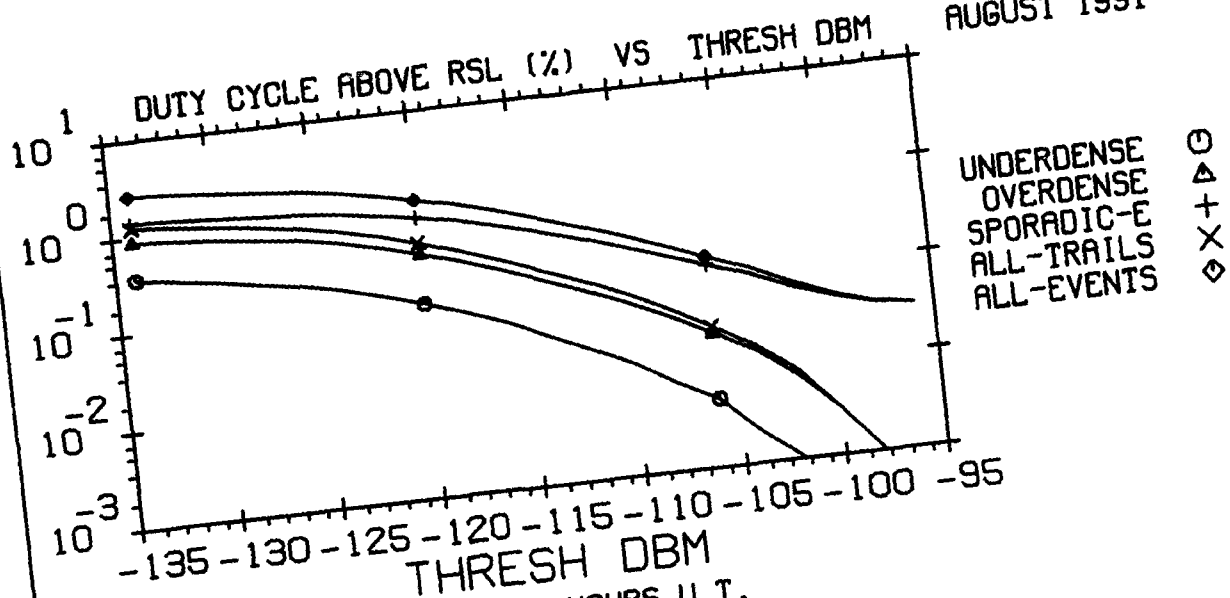

THE TIME OF DAY IS 0 : 24 HOURS U.T.
 FREQUENCY - 85 MHZ
 POLARIZATION - HORIZONTAL
 BASED ON OBSERVED NOISE MEASUREMENTS - VERTICAL

MENU#103,06-2
 13-OCT-93
 PLOT# 34.00

GEOPHYSICS LAB METEOR SCATTER PROGRAM

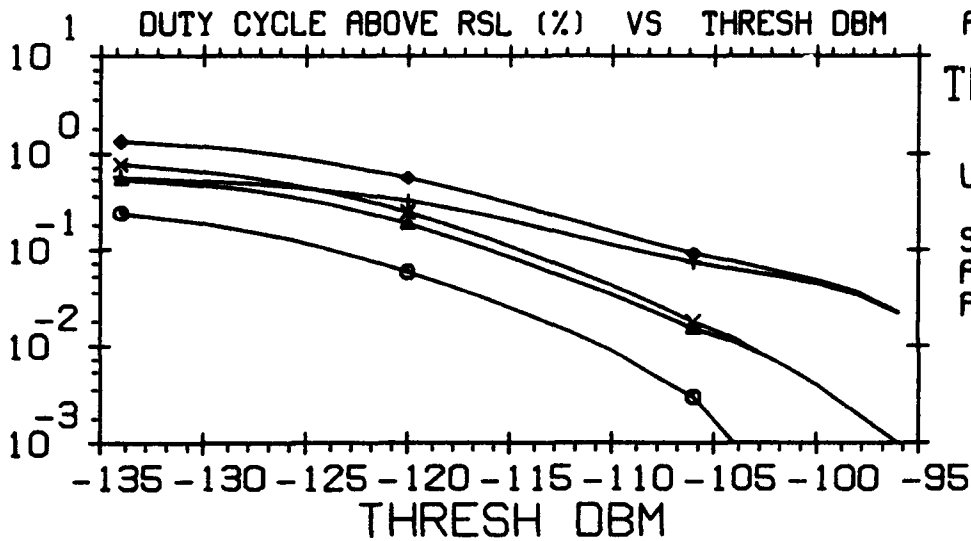

THE TIME OF DAY IS 0 : 24 HOURS U.T.
 FREQUENCY - 104 MHZ
 POLARIZATION - HORIZONTAL
 BASED ON OBSERVED NOISE MEASUREMENTS - VERTICAL

MENU*103,06-2
 13-OCT-93
 PLOT* 35.00

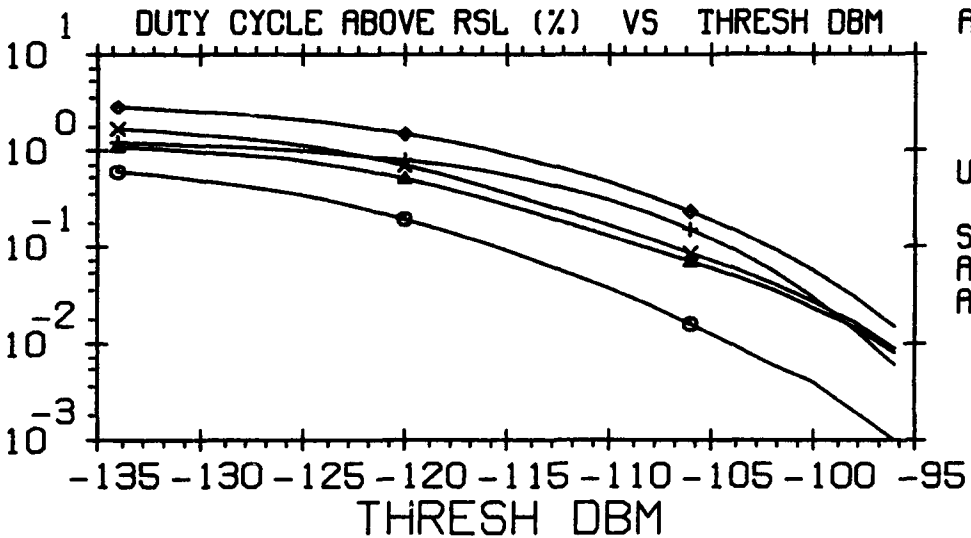

THE TIME OF DAY IS 0 : 24 HOURS U.T.
 FREQUENCY - 147 MHZ
 POLARIZATION - HORIZONTAL
 BASED ON OBSERVED NOISE MEASUREMENTS - VERTICAL

MENU*103,06-2
 13-OCT-93
 PLOT* 36.00

GEOPHYSICS LAB METEOR SCATTER PROGRAM

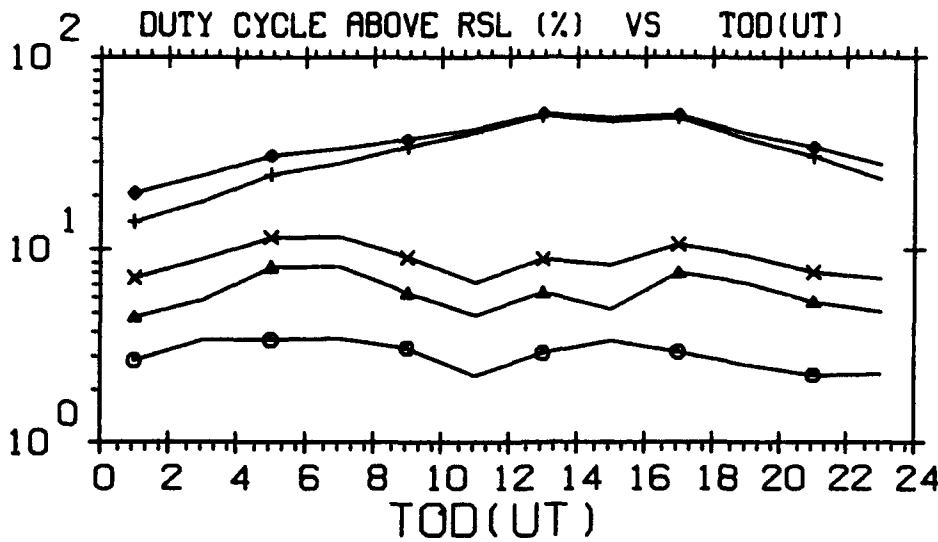

THRESHOLD - -126.0 DBM RSL
 FREQUENCY - 35 MHZ
 POLARIZATION - HORIZONTAL
 BASED ON OBSERVED NOISE MEASUREMENTS - VERTICAL

MENU*103,07-2
 13-OCT-93
 PLOT* 37.00

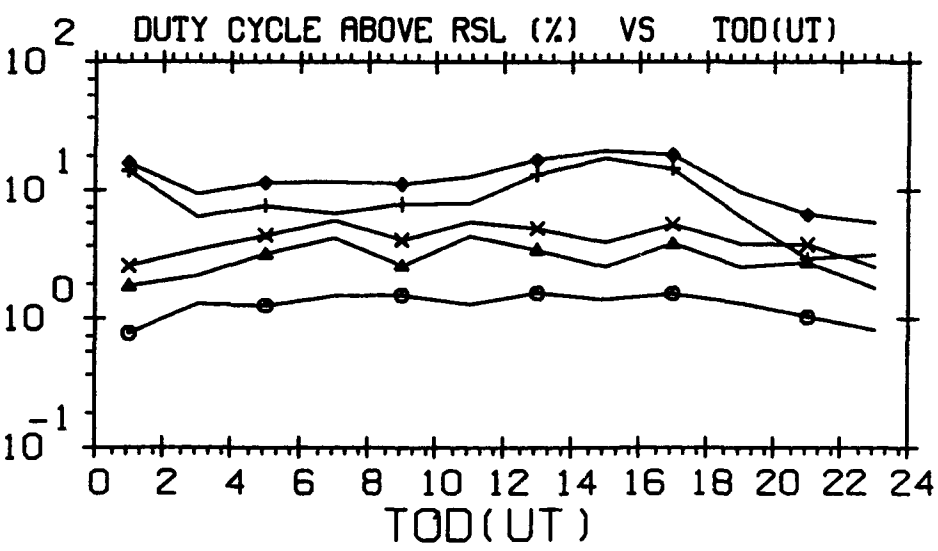

THRESHOLD - -126.0 DBM RSL
 FREQUENCY - 45 MHZ
 POLARIZATION - HORIZONTAL
 BASED ON OBSERVED NOISE MEASUREMENTS - VERTICAL

MENU*103,07-2
 13-OCT-93
 PLOT* 38.00

GEOPHYSICS LAB METEOR SCATTER PROGRAM

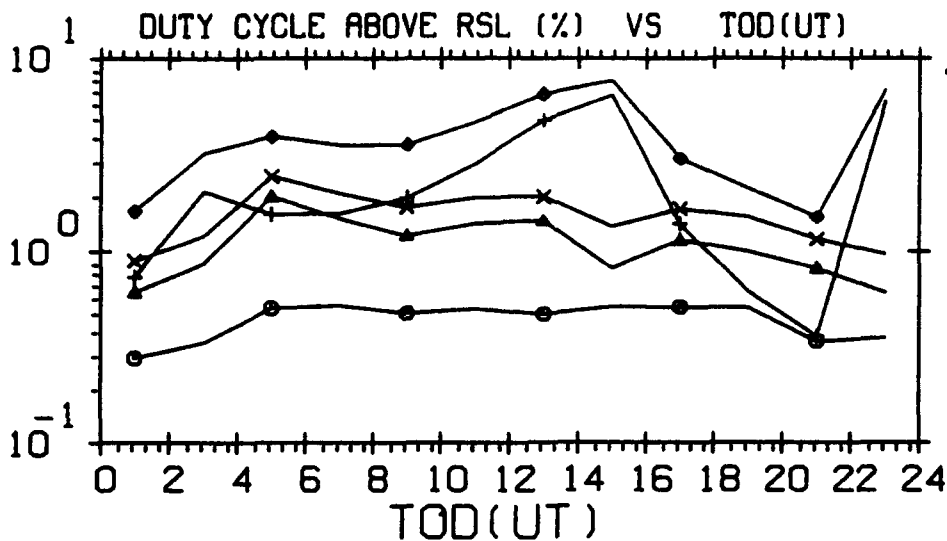

THRESHOLD - -126.0 DBM RSL
 FREQUENCY - 65 MHZ
 POLARIZATION - HORIZONTAL
 BASED ON OBSERVED NOISE MEASUREMENTS - VERTICAL

MENU*103,07-2
 13-OCT-93
 PLOT* 39.00

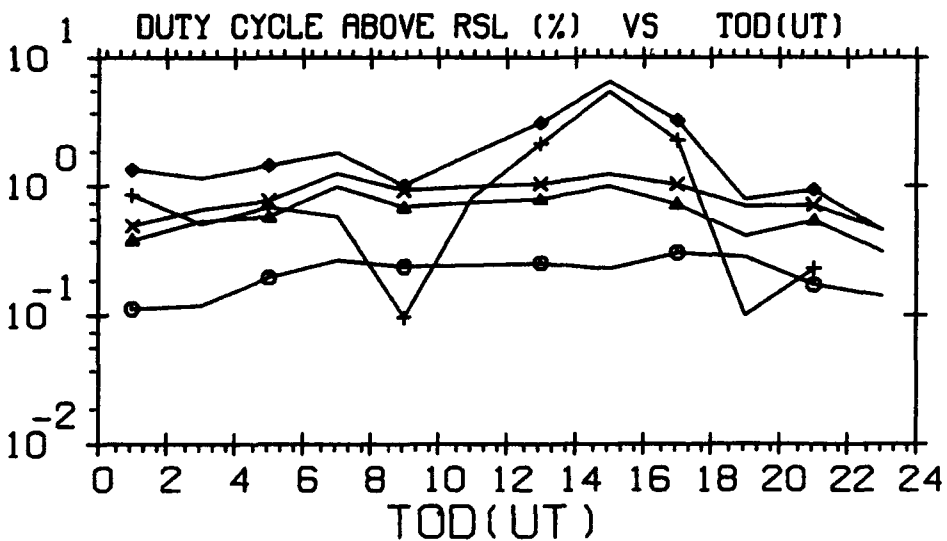

THRESHOLD - -126.0 DBM RSL
 FREQUENCY - 85 MHZ
 POLARIZATION - HORIZONTAL
 BASED ON OBSERVED NOISE MEASUREMENTS - VERTICAL

MENU*103,07-2
 13-OCT-93
 PLOT* 40.00

GEOPHYSICS LAB METEOR SCATTER PROGRAM

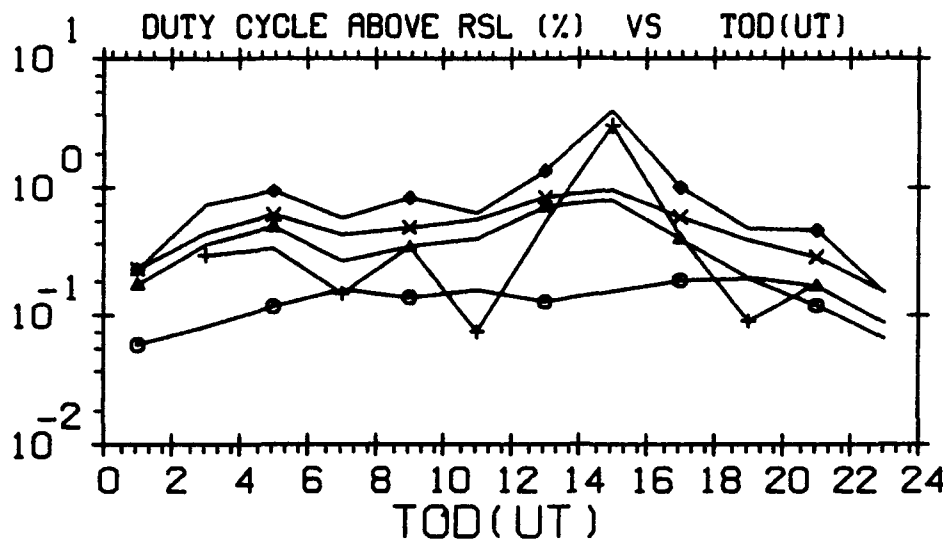

- UNDERDENSE ○
- OVERDENSE △
- SPORADIC-E +
- ALL-TRAILS ×
- ALL-EVENTS ◇

THRESHOLD - -126.0 DBM RSL
 FREQUENCY - 104 MHZ
 POLARIZATION - HORIZONTAL
 BASED ON OBSERVED NOISE MEASUREMENTS - VERTICAL

MENU*103,07-2
 13-OCT-93
 PLOT* 41.00

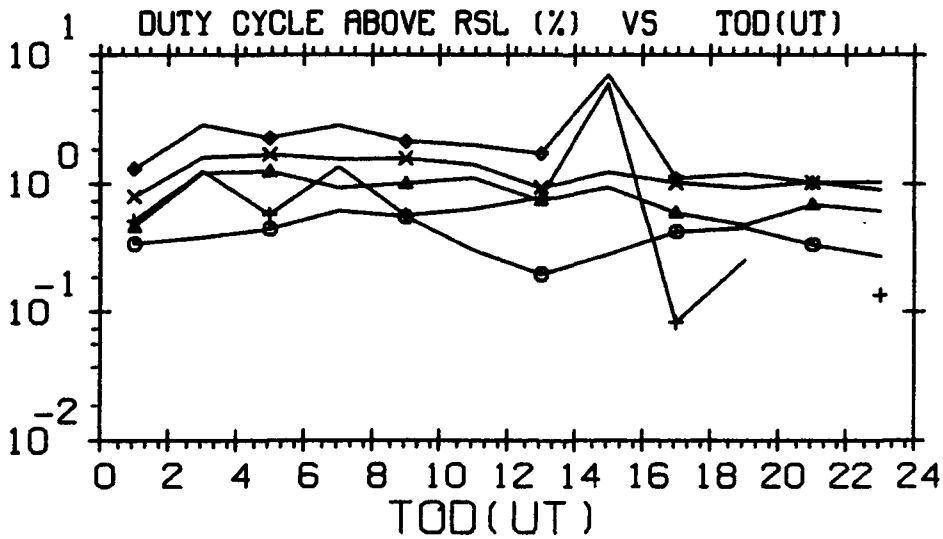

- UNDERDENSE ○
- OVERDENSE △
- SPORADIC-E +
- ALL-TRAILS ×
- ALL-EVENTS ◇

THRESHOLD - -126.0 DBM RSL
 FREQUENCY - 147 MHZ
 POLARIZATION - HORIZONTAL
 BASED ON OBSERVED NOISE MEASUREMENTS - VERTICAL

MENU*103,07-2
 13-OCT-93
 PLOT* 42.00

GEOPHYSICS LAB METEOR SCATTER PROGRAM

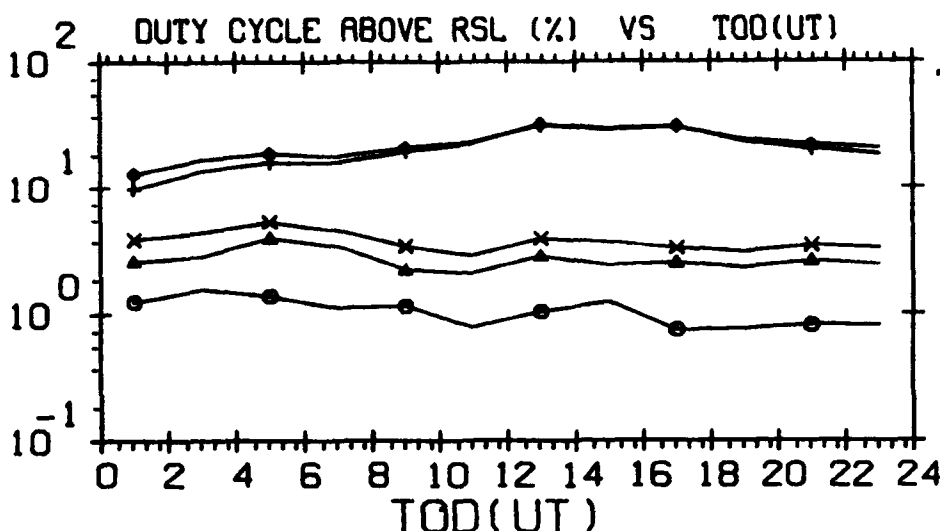

THRESHOLD - -116.0 DBM RSL
 FREQUENCY - 35 MHZ
 POLARIZATION - HORIZONTAL
 BASED ON OBSERVED NOISE MEASUREMENTS - VERTICAL

MENU#103,07-2
 13-OCT-93
 PLOT# 43.00

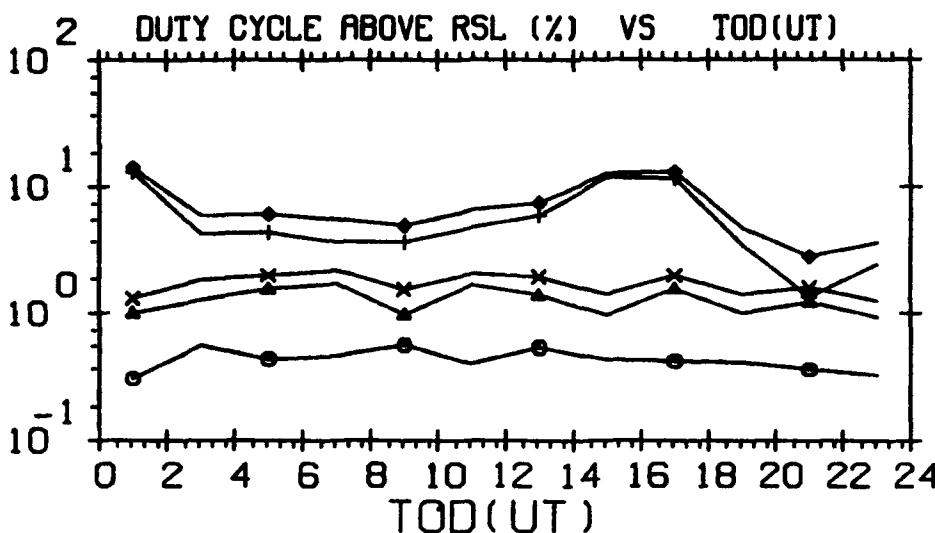

THRESHOLD - -116.0 DBM RSL
 FREQUENCY - 45 MHZ
 POLARIZATION - HORIZONTAL
 BASED ON OBSERVED NOISE MEASUREMENTS - VERTICAL

MENU#103,07-2
 13-OCT-93
 PLOT# 44.00

GEOPHYSICS LAB METEOR SCATTER PROGRAM

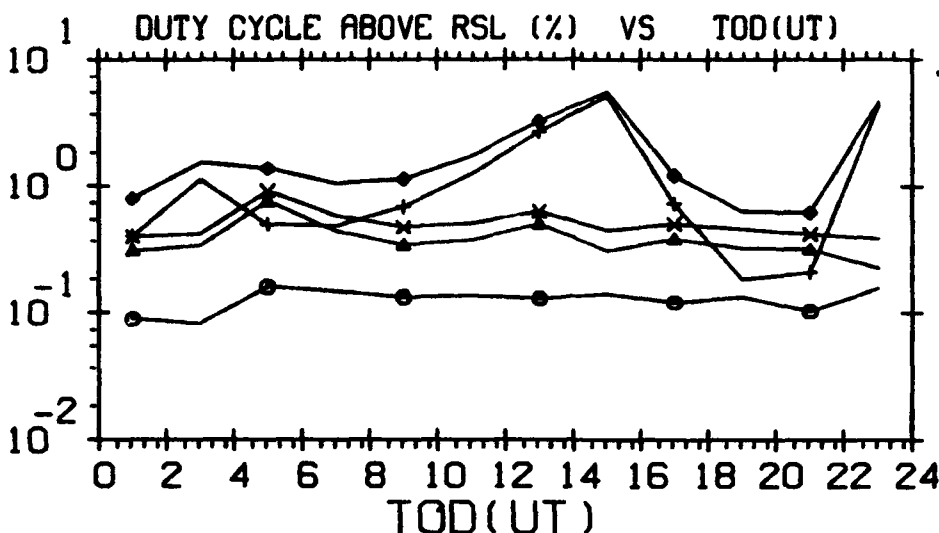

THRESHOLD - -116.0 DBM RSL
 FREQUENCY - 65 MHZ
 POLARIZATION - HORIZONTAL
 BASED ON OBSERVED NOISE MEASUREMENTS - VERTICAL

MENU#103,07-2
 13-OCT-93
 PLOT# 45.00

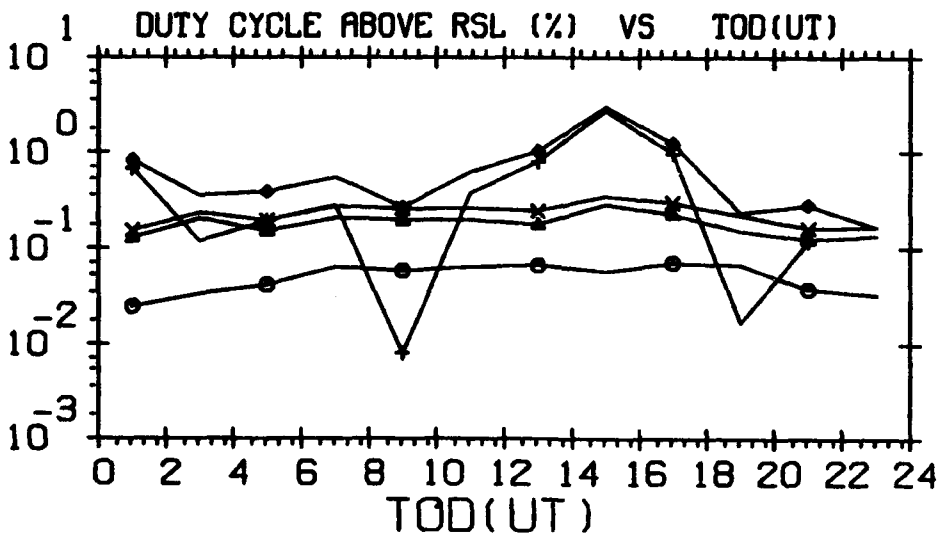

THRESHOLD - -116.0 DBM RSL
 FREQUENCY - 85 MHZ
 POLARIZATION - HORIZONTAL
 BASED ON OBSERVED NOISE MEASUREMENTS - VERTICAL

MENU#103,07-2
 13-OCT-93
 PLOT# 46.00

GEOPHYSICS LAB METEOR SCATTER PROGRAM

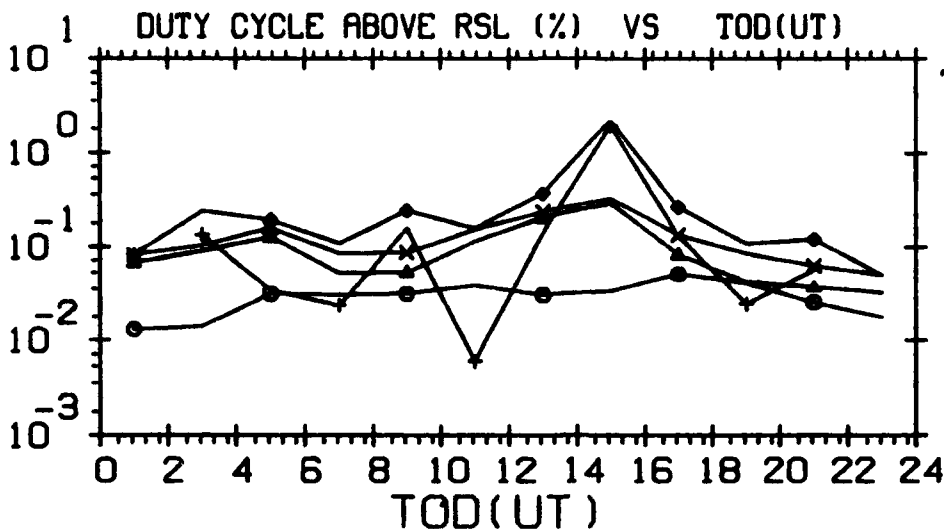

THRESHOLD - -116.0 DBM RSL
 FREQUENCY - 104 MHZ
 POLARIZATION - HORIZONTAL
 BASED ON OBSERVED NOISE MEASUREMENTS - VERTICAL

MENU#103,07-2
 13-OCT-93
 PLOT# 47.00

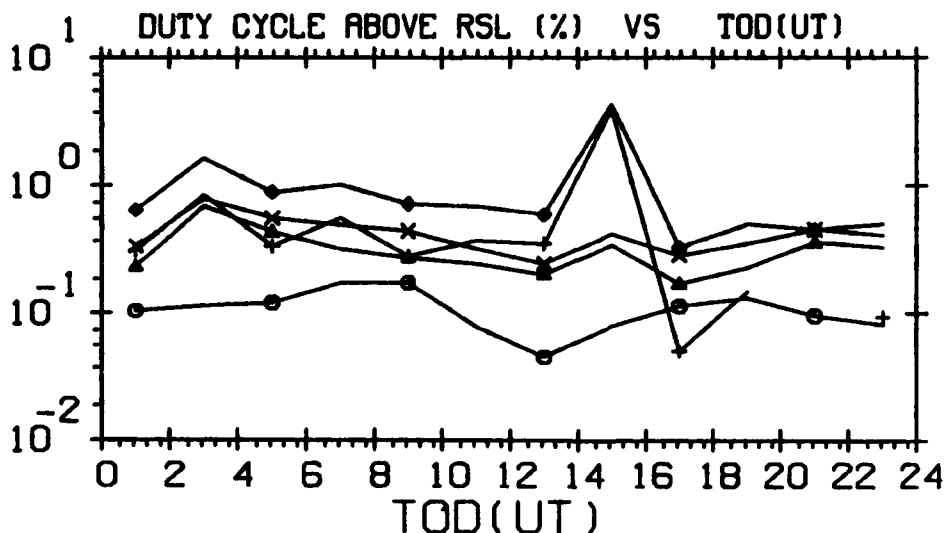

THRESHOLD - -116.0 DBM RSL
 FREQUENCY - 147 MHZ
 POLARIZATION - HORIZONTAL
 BASED ON OBSERVED NOISE MEASUREMENTS - VERTICAL

MENU#103,07-2
 13-OCT-93
 PLOT# 48.00

GEOPHYSICS LAB METEOR SCATTER PROGRAM

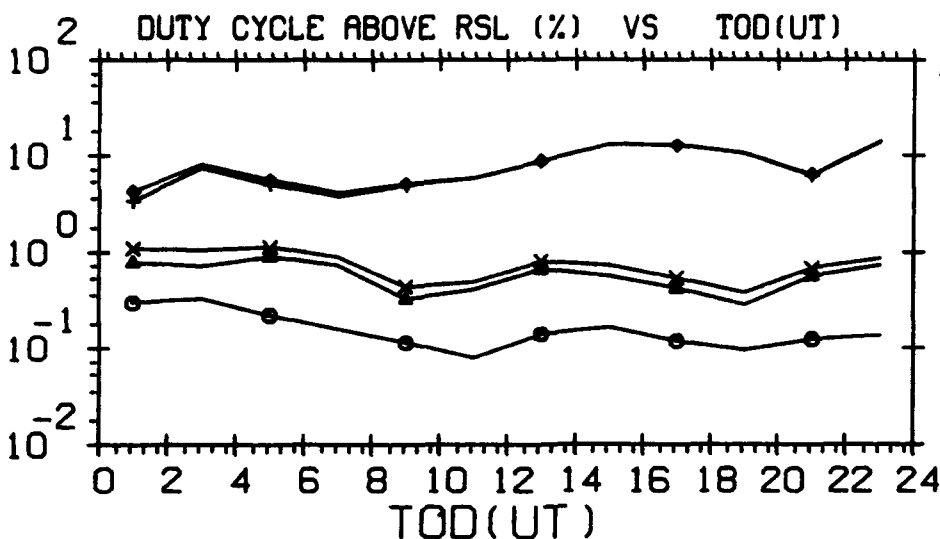

THRESHOLD - -106.0 DBM RSL
 FREQUENCY - 35 MHZ
 POLARIZATION - HORIZONTAL
 BASED ON OBSERVED NOISE MEASUREMENTS - VERTICAL

MENU#103,07-2
 13-OCT-93
 PLOT# 49.00

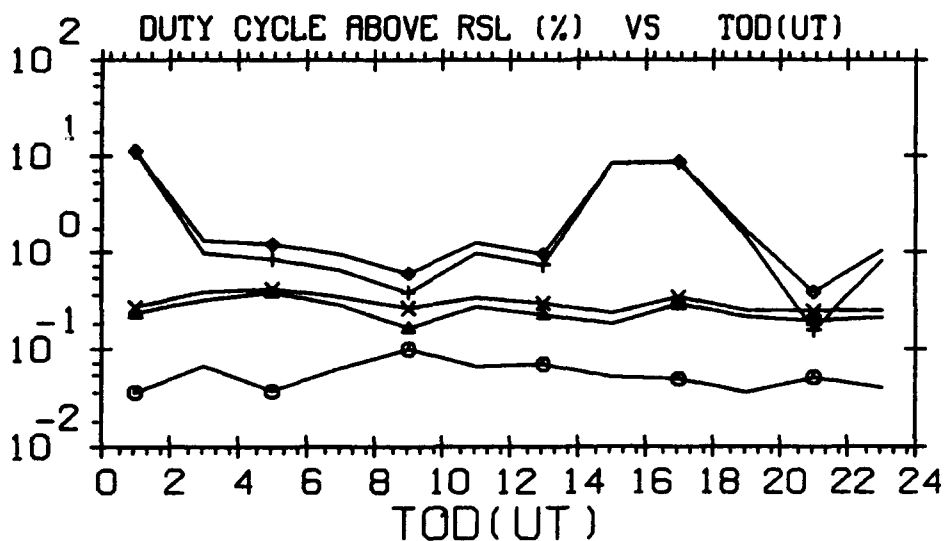

THRESHOLD - -106.0 DBM RSL
 FREQUENCY - 45 MHZ
 POLARIZATION - HORIZONTAL
 BASED ON OBSERVED NOISE MEASUREMENTS - VERTICAL

MENU#103,07-2
 13-OCT-93
 PLOT# 50.00

GEOPHYSICS LAB METEOR SCATTER PROGRAM

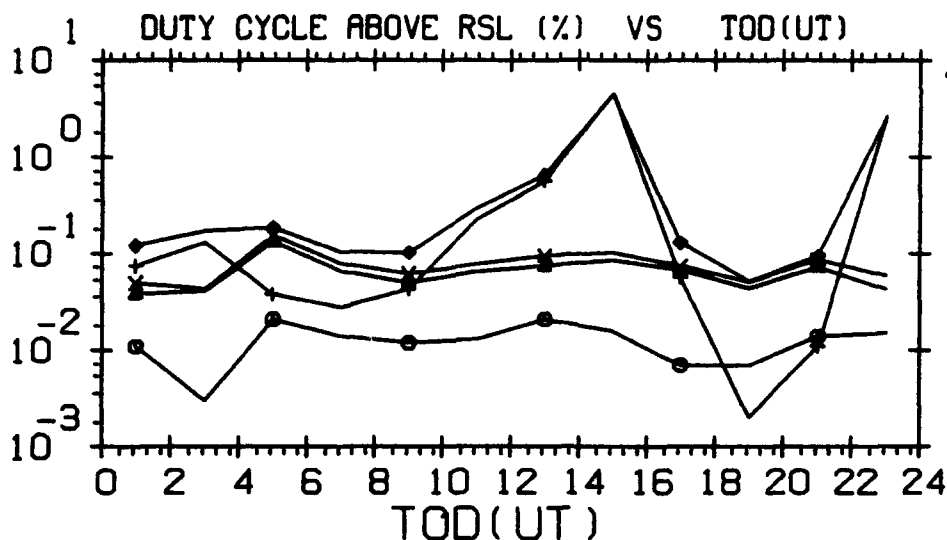

THRESHOLD - -106.0 DBM RSL
 FREQUENCY - 65 MHZ
 POLARIZATION - HORIZONTAL
 BASED ON OBSERVED NOISE MEASUREMENTS - VERTICAL

MENU#103,07-2
 13-OCT-93
 PLOT# 51.00

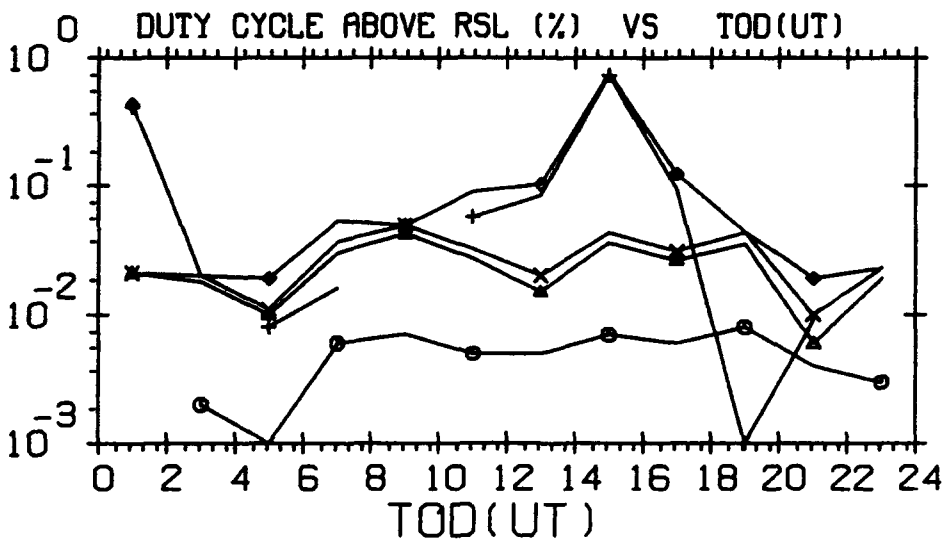

THRESHOLD - -106.0 DBM RSL
 FREQUENCY - 85 MHZ
 POLARIZATION - HORIZONTAL
 BASED ON OBSERVED NOISE MEASUREMENTS - VERTICAL

MENU#103,07-2
 13-OCT-93
 PLOT# 52.00

GEOPHYSICS LAB METEOR SCATTER PROGRAM

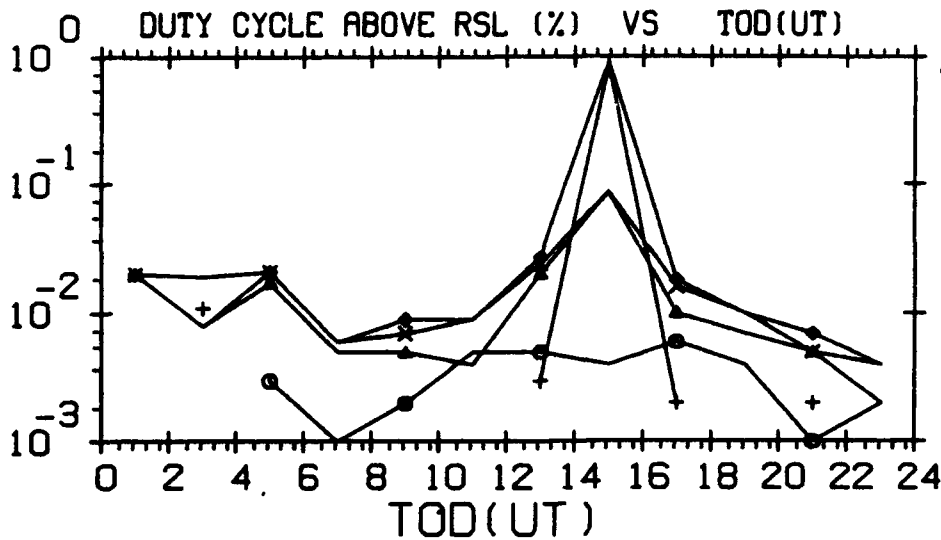

THRESHOLD - -106.0 DBM RSL
 FREQUENCY - 104 MHZ
 POLARIZATION - HORIZONTAL
 BASED ON OBSERVED NOISE MEASUREMENTS - VERTICAL

MENU#103,07-2
 13-OCT-93
 PLOT# 53.00

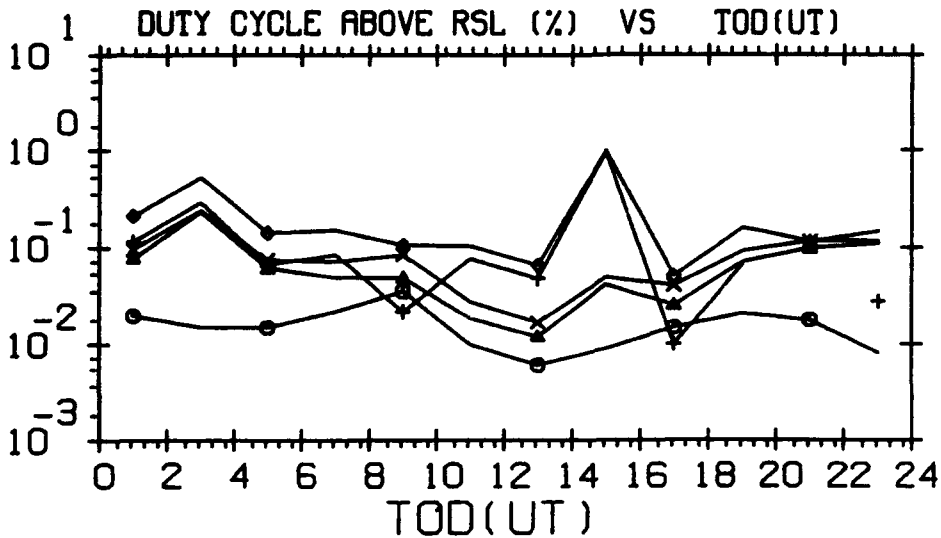

THRESHOLD - -106.0 DBM RSL
 FREQUENCY - 147 MHZ
 POLARIZATION - HORIZONTAL
 BASED ON OBSERVED NOISE MEASUREMENTS - VERTICAL

MENU#103,07-2
 13-OCT-93
 PLOT# 54.00

GEOPHYSICS LAB METEOR SCATTER PROGRAM

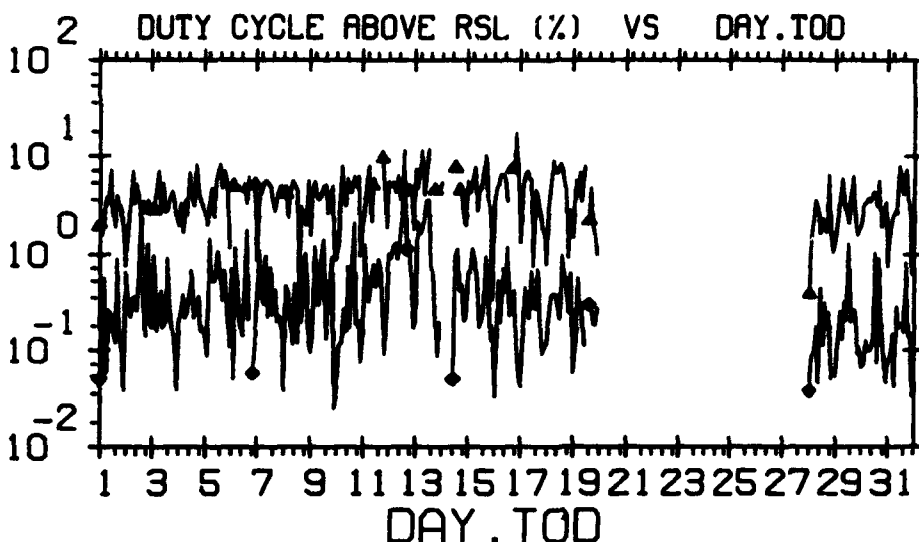

AUGUST 1991

THULE

45 MHZ ▲
104 MHZ ◆

THRESHOLD - -126.0 DBM RSL
THE EVENT CLASS IS UNDERDENSE AND OVERDENSE TRAILS
POLARIZATION - HORIZONTAL
BASED ON OBSERVED NOISE MEASUREMENTS - VERTICAL

MENU#103,09-2
13-OCT-93
PLOT# 55.00

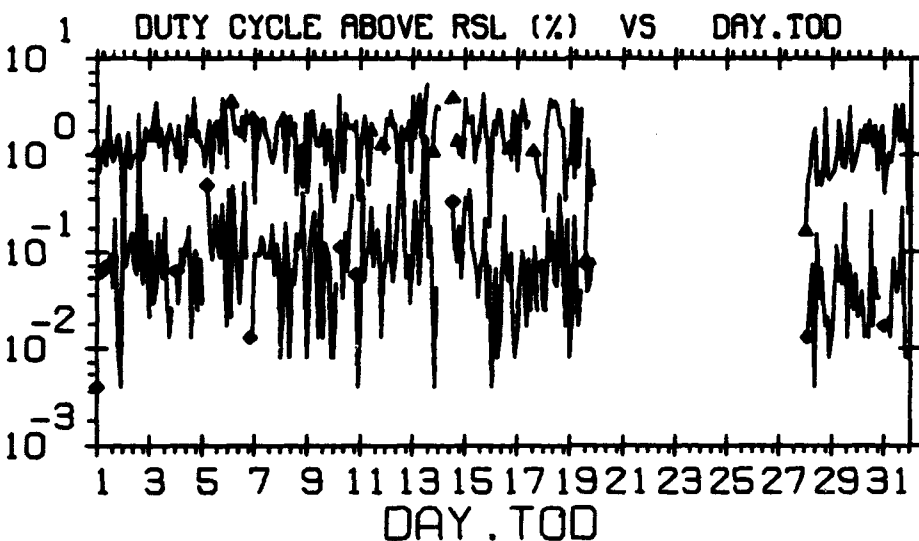

AUGUST 1991

45 MHZ ▲
104 MHZ ◆

THRESHOLD - -116.0 DBM RSL
THE EVENT CLASS IS UNDERDENSE AND OVERDENSE TRAILS
POLARIZATION - HORIZONTAL
BASED ON OBSERVED NOISE MEASUREMENTS - VERTICAL

MENU#103,09-2
13-OCT-93
PLOT# 56.00

GEOPHYSICS LAB METEOR SCATTER PROGRAM

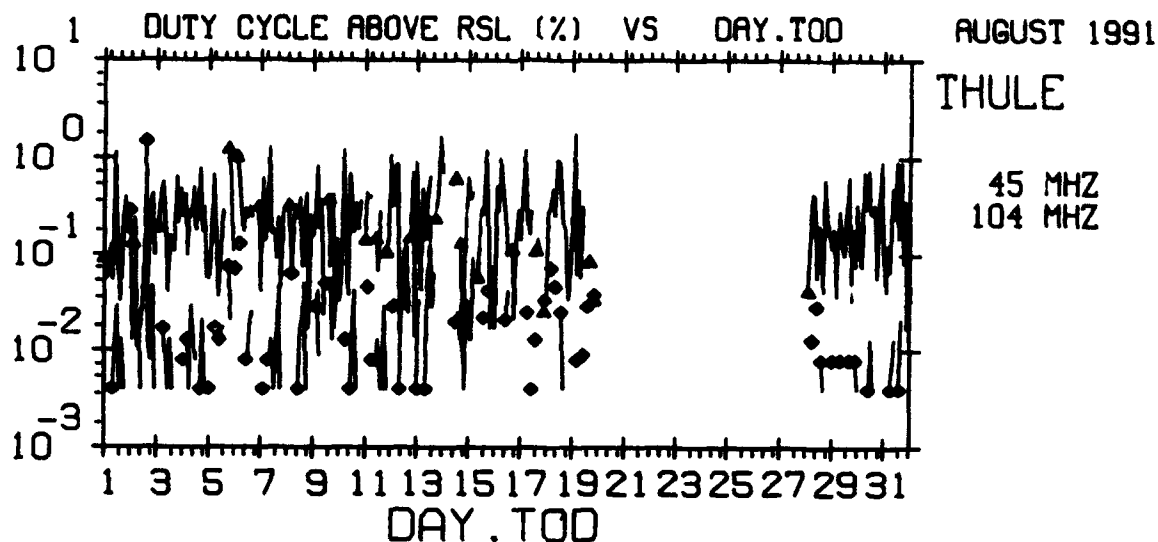

THRESHOLD - -106.0 DBM RSL
 THE EVENT CLASS IS UNDERDENSE AND OVERDENSE TRAILS
 POLARIZATION - HORIZONTAL
 BASED ON OBSERVED NOISE MEASUREMENTS - VERTICAL

MENU#103,09-2
 13-OCT-93
 PLOT# 57.00

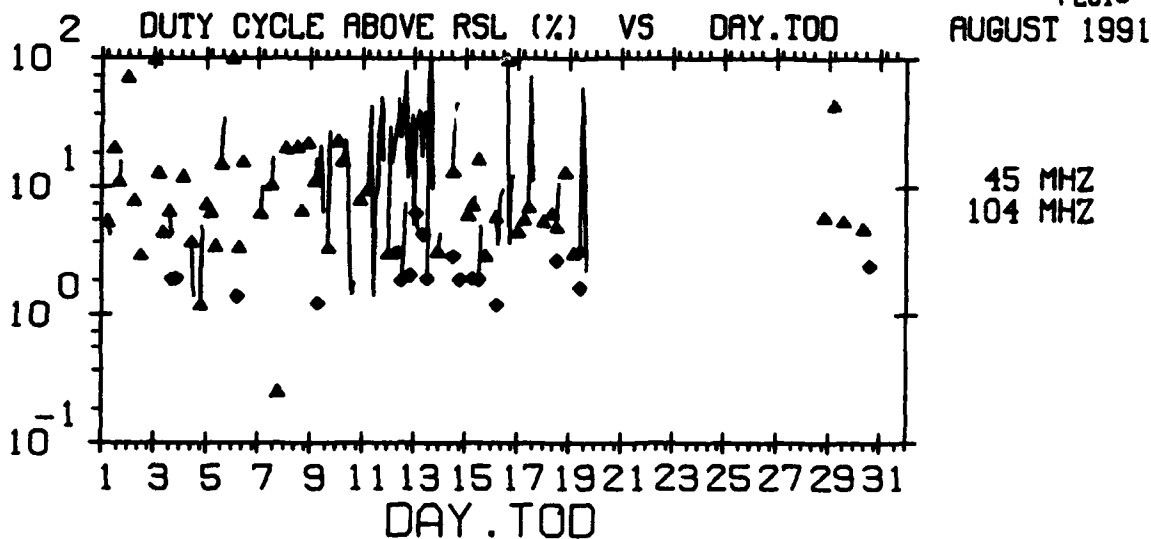

THRESHOLD - -126.0 DBM RSL
 THE EVENT CLASS IS SPORADIC-E
 POLARIZATION - HORIZONTAL
 BASED ON OBSERVED NOISE MEASUREMENTS - VERTICAL

MENU#103,09-2
 13-OCT-93
 PLOT# 58.00

GEOPHYSICS LAB METEOR SCATTER PROGRAM

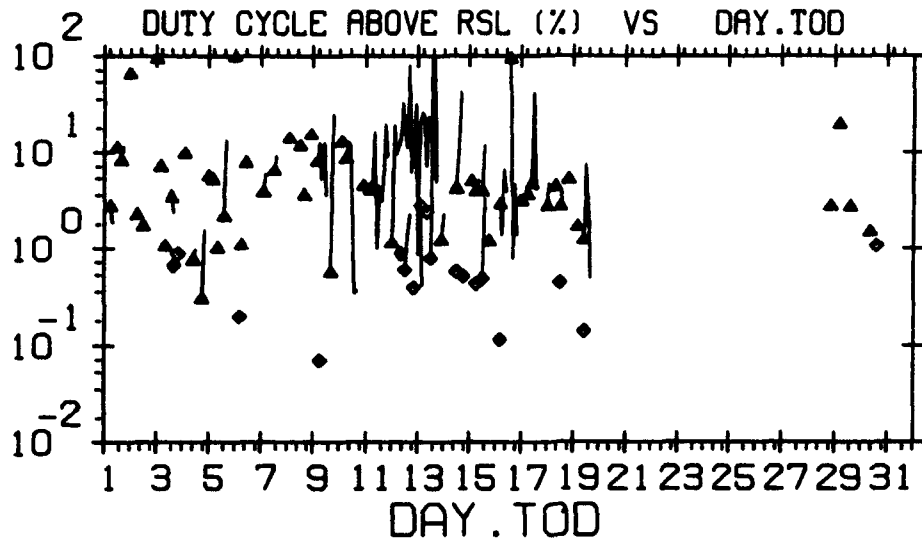

AUGUST 1991
THULE
45 MHZ ▲
104 MHZ ◆

THRESHOLD - -116.0 DBM RSL
THE EVENT CLASS IS SPORADIC-E
POLARIZATION - HORIZONTAL
BASED ON OBSERVED NOISE MEASUREMENTS - VERTICAL

MENU#103,09-2
13-OCT-93
PLOT# 59.00

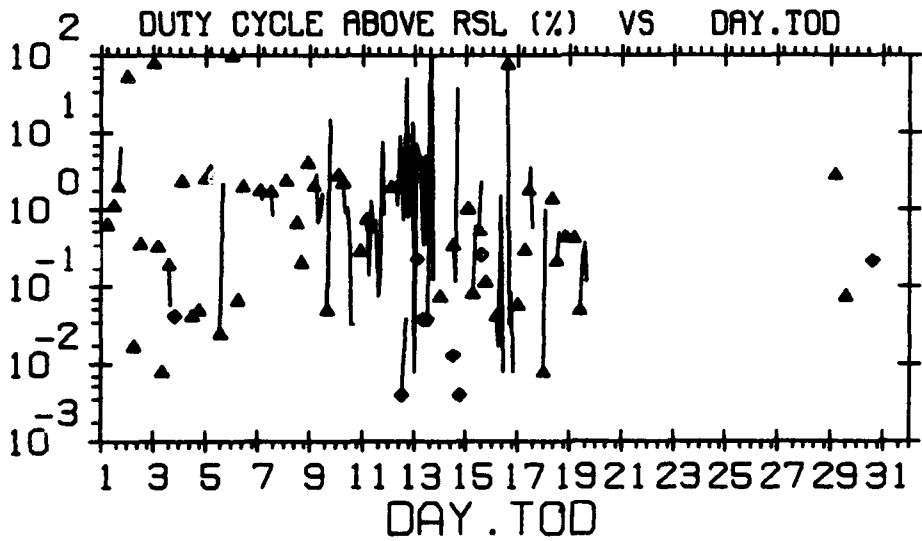

AUGUST 1991
45 MHZ ▲
104 MHZ ◆

THRESHOLD - -106.0 DBM RSL
THE EVENT CLASS IS SPORADIC-E
POLARIZATION - HORIZONTAL
BASED ON OBSERVED NOISE MEASUREMENTS - VERTICAL

MENU#103,09-2
13-OCT-93
PLOT# 60.00

GEOPHYSICS LAB METEOR SCATTER PROGRAM

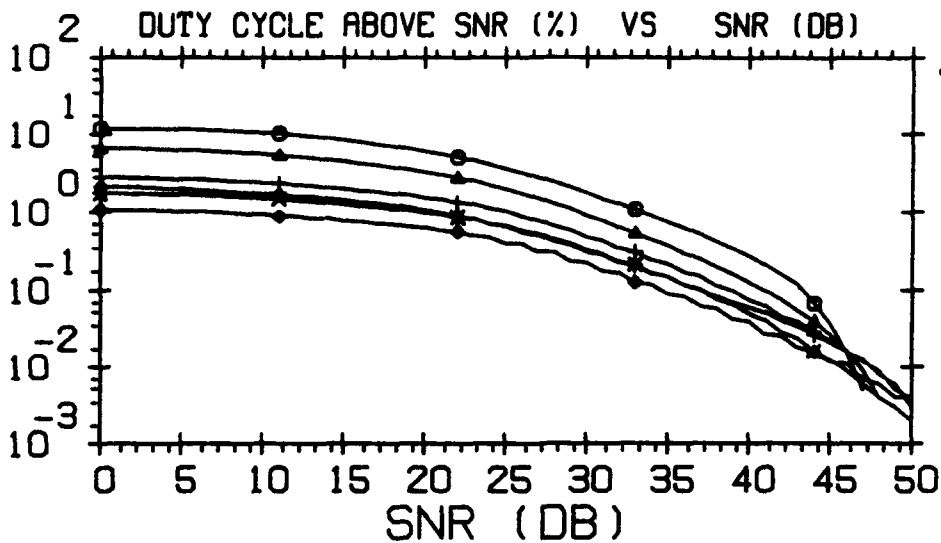

35 MHZ	○
45 MHZ	△
65 MHZ	+
85 MHZ	×
104 MHZ	◇
147 MHZ	↑

THE TIME OF DAY IS 0 : 24 HOURS U.T.
 THE EVENT CLASS IS UNDERDENSE AND OVERDENSE TRAILS
 EFFECTIVE SYSTEM BANDWIDTH - 100.HZ
 POLARIZATION - HORIZONTAL
 BASED ON OBSERVED NOISE MEASUREMENTS - VERTICAL

MENU#104,02-2
 13-OCT-93
 PLOT# 61.00

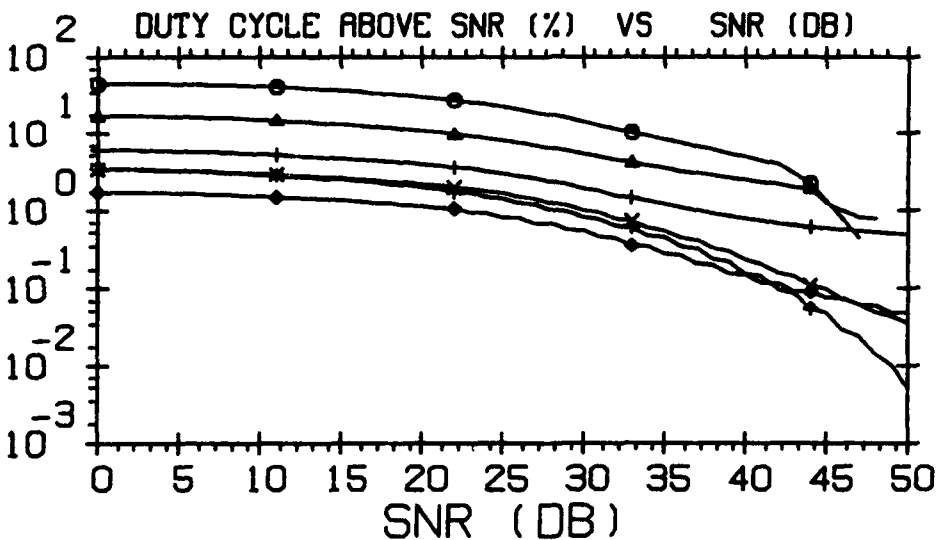

35 MHZ	○
45 MHZ	△
65 MHZ	+
85 MHZ	×
104 MHZ	◇
147 MHZ	↑

THE TIME OF DAY IS 0 : 24 HOURS U.T.
 THE EVENT CLASS IS SPORADIC-E AND METEOR TRAILS
 EFFECTIVE SYSTEM BANDWIDTH - 100.HZ
 POLARIZATION - HORIZONTAL
 BASED ON OBSERVED NOISE MEASUREMENTS - VERTICAL

MENU#104,02-2
 13-OCT-93
 PLOT# 62.00

GEOPHYSICS LAB METEOR SCATTER PROGRAM

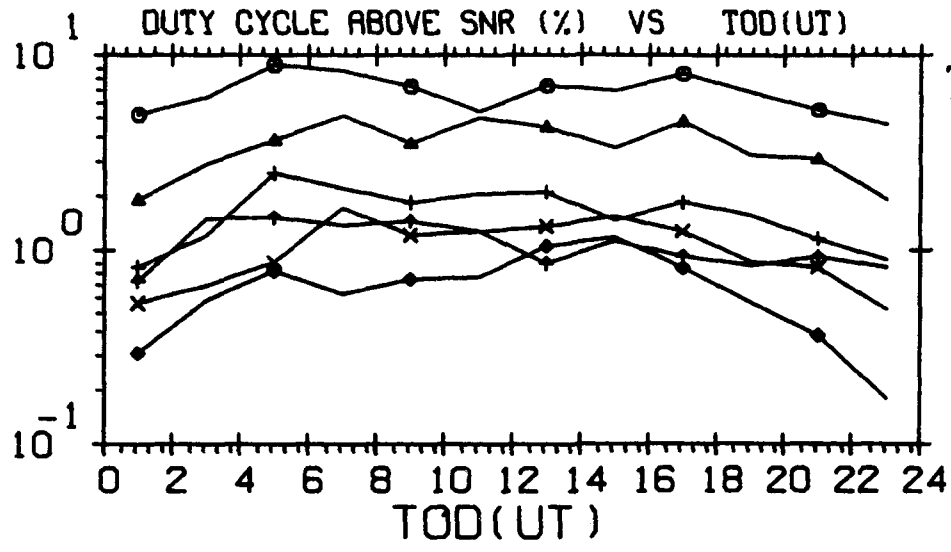

AUGUST 1991

THULE

- 35 MHZ ○
- 45 MHZ △
- 65 MHZ +
- 85 MHZ ×
- 104 MHZ ◇
- 147 MHZ †

SIGNAL-TO-NOISE RATIO - 19.0 DB
 THE EVENT CLASS IS UNDERDENSE AND OVERDENSE TRAILS
 EFFECTIVE SYSTEM BANDWIDTH - 100.HZ
 POLARIZATION - HORIZONTAL
 BASED ON OBSERVED NOISE MEASUREMENTS - VERTICAL

MENU=104,03-2
 13-OCT-93
 PLOT# 63.00

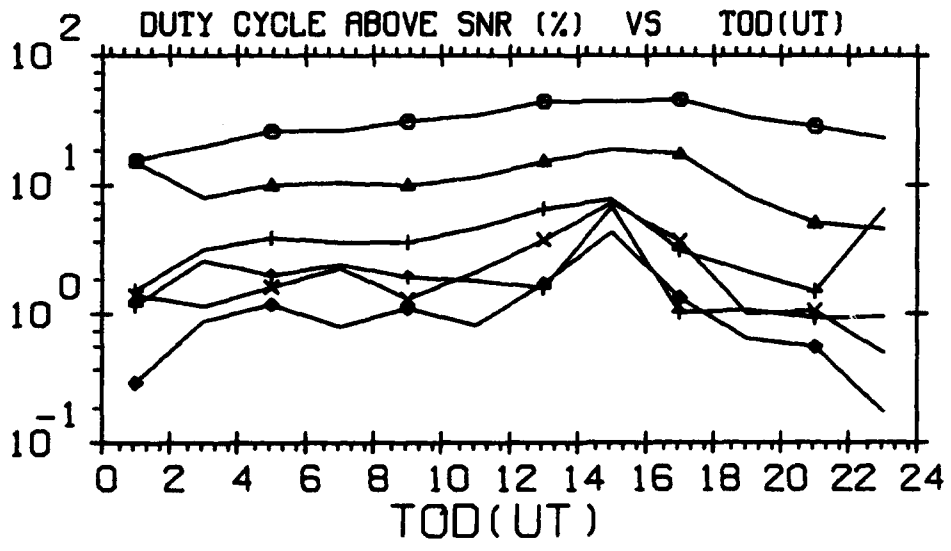

AUGUST 1991

- 35 MHZ ○
- 45 MHZ △
- 65 MHZ +
- 85 MHZ ×
- 104 MHZ ◇
- 147 MHZ †

SIGNAL-TO-NOISE RATIO - 19.0 DB
 THE EVENT CLASS IS SPORADIC-E AND METEOR TRAILS
 EFFECTIVE SYSTEM BANDWIDTH - 100.HZ
 POLARIZATION - HORIZONTAL
 BASED ON OBSERVED NOISE MEASUREMENTS - VERTICAL

MENU=104,03-2
 13-OCT-93
 PLOT# 64.00

GEOPHYSICS LAB METEOR SCATTER PROGRAM

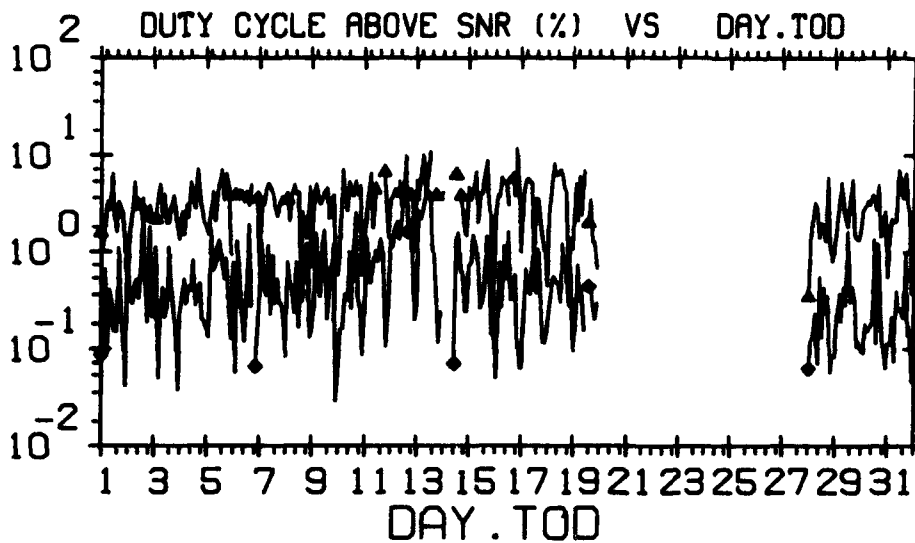

AUGUST 1991

THULE

45 MHZ ▲
104 MHZ ◆

SIGNAL-TO-NOISE RATIO - 19.0 DB
THE EVENT CLASS IS UNDERDENSE AND OVERDENSE TRAILS
EFFECTIVE SYSTEM BANDWIDTH - 100.HZ
POLARIZATION - HORIZONTAL
BASED ON OBSERVED NOISE MEASUREMENTS - VERTICAL

MENU*104,09-2
13-OCT-93
PLOT* 65.00

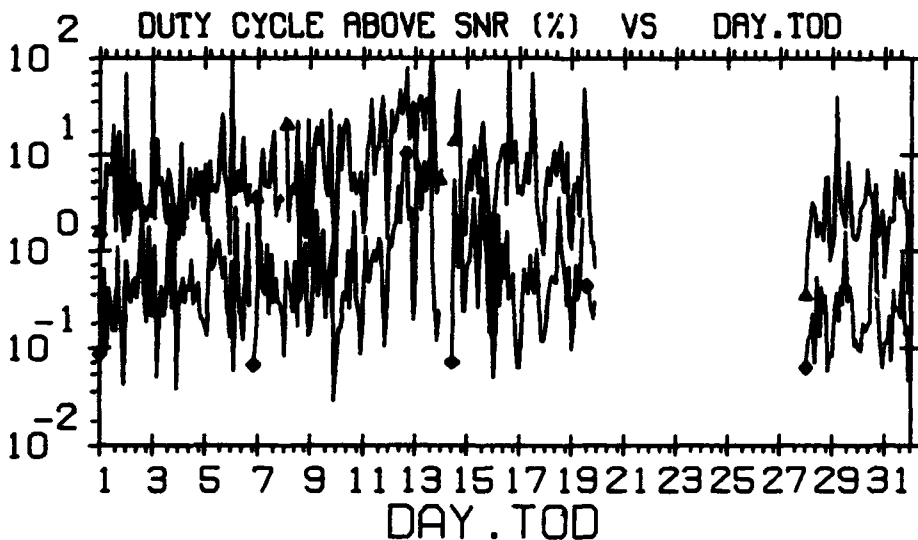

AUGUST 1991

45 MHZ ▲
104 MHZ ◆

SIGNAL-TO-NOISE RATIO - 19.0 DB
THE EVENT CLASS IS SPORADIC-E AND METEOR TRAILS
EFFECTIVE SYSTEM BANDWIDTH - 100.HZ
POLARIZATION - HORIZONTAL
BASED ON OBSERVED NOISE MEASUREMENTS - VERTICAL

MENU*104,09-2
13-OCT-93
PLOT* 66.00

GEOPHYSICS LAB METEOR SCATTER PROGRAM

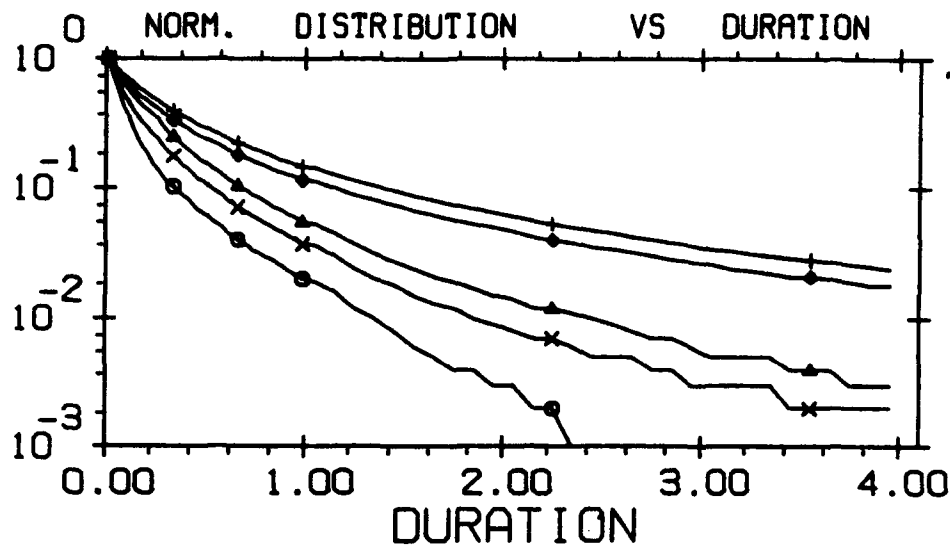

UNDERDENSE ⊙
 OVERDENSE △
 SPORADIC-E +
 ALL-TRAILS ×
 ALL-EVENTS ◇

EXCEEDING -126.0 DBM RSL
 THE TIME OF DAY IS 0 : 24 HOURS U.T.
 FREQUENCY - 35 MHZ
 BASED ON OBSERVED NOISE MEASUREMENTS - VERTICAL
 NORMALIZING FACTORS:
 UNDER - 18709. OVER - 18419. SPOR-E - 96662.
 TRAILS - 37128. EVENTS - 133790.

MENU=106,02-4
 13-OCT-93
 PLOT= 67.00

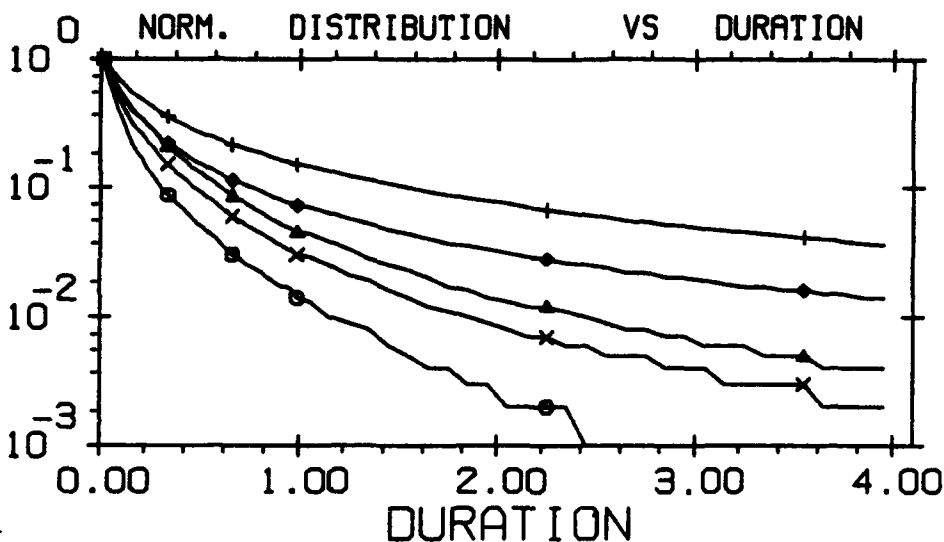

UNDERDENSE ⊙
 OVERDENSE △
 SPORADIC-E +
 ALL-TRAILS ×
 ALL-EVENTS ◇

EXCEEDING -126.0 DBM RSL
 THE TIME OF DAY IS 0 : 24 HOURS U.T.
 FREQUENCY - 45 MHZ
 BASED ON OBSERVED NOISE MEASUREMENTS - VERTICAL
 NORMALIZING FACTORS:
 UNDER - 13713. OVER - 15153. SPOR-E - 15324.
 TRAILS - 28866. EVENTS - 44190.

MENU=106,02-4
 13-OCT-93
 PLOT= 68.00

GEOPHYSICS LAB METEOR SCATTER PROGRAM

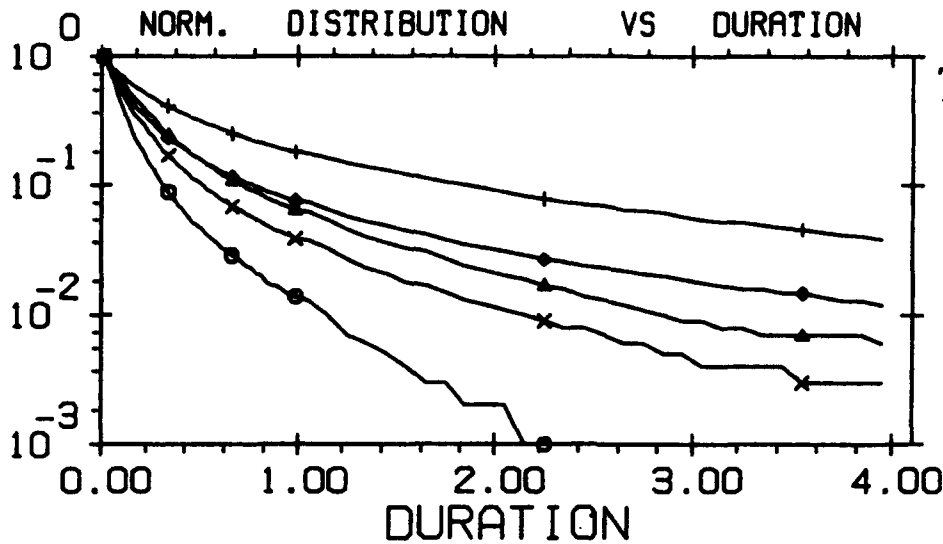

EXCEEDING -126.0 DBM RSL
 THE TIME OF DAY IS 0 : 24 HOURS U.T.
 FREQUENCY - 65 MHZ
 BASED ON OBSERVED NOISE MEASUREMENTS - VERTICAL
 NORMALIZING FACTORS:
 UNDER - 7808. OVER - 7930. SPOR-E - 5486.
 TRAILS - 15738. EVENTS - 21224.

MENU=106,02-4
 13-OCT-93
 PLOT= 69.00

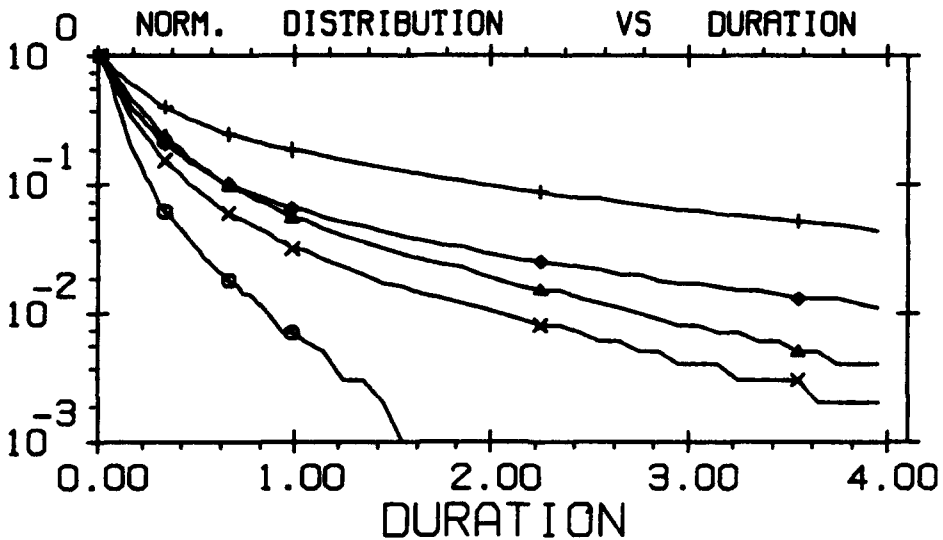

EXCEEDING -126.0 DBM RSL
 THE TIME OF DAY IS 0 : 24 HOURS U.T.
 FREQUENCY - 85 MHZ
 BASED ON OBSERVED NOISE MEASUREMENTS - VERTICAL
 NORMALIZING FACTORS:
 UNDER - 4579. OVER - 5058. SPOR-E - 2716.
 TRAILS - 9637. EVENTS - 12353.

MENU=106,02-4
 13-OCT-93
 PLOT= 70.00

GEOPHYSICS LAB METEOR SCATTER PROGRAM

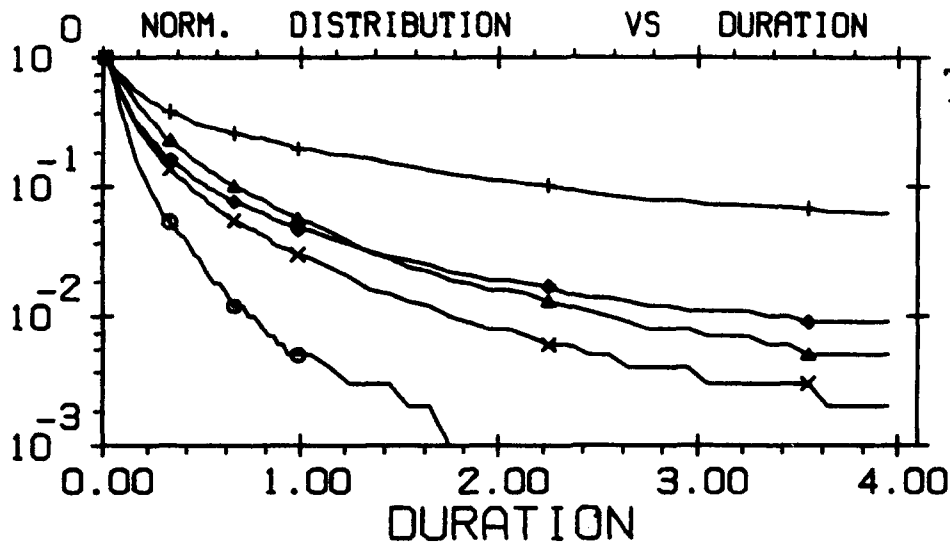

UNDERDENSE ○
 OVERDENSE ▲
 SPORADIC-E +
 ALL-TRAILS ×
 ALL-EVENTS ◇

EXCEEDING -126.0 DBM RSL
 THE TIME OF DAY IS 0 : 24 HOURS U.T.
 FREQUENCY - 104 MHZ
 BASED ON OBSERVED NOISE MEASUREMENTS - VERTICAL
 NORMALIZING FACTORS:
 UNDER - 4224. OVER - 3904. SPOR-E - 962.
 TRAILS - 8128. EVENTS - 9090.

MENU=106.02-4
 13-OCT-93
 PLOT# 71.00

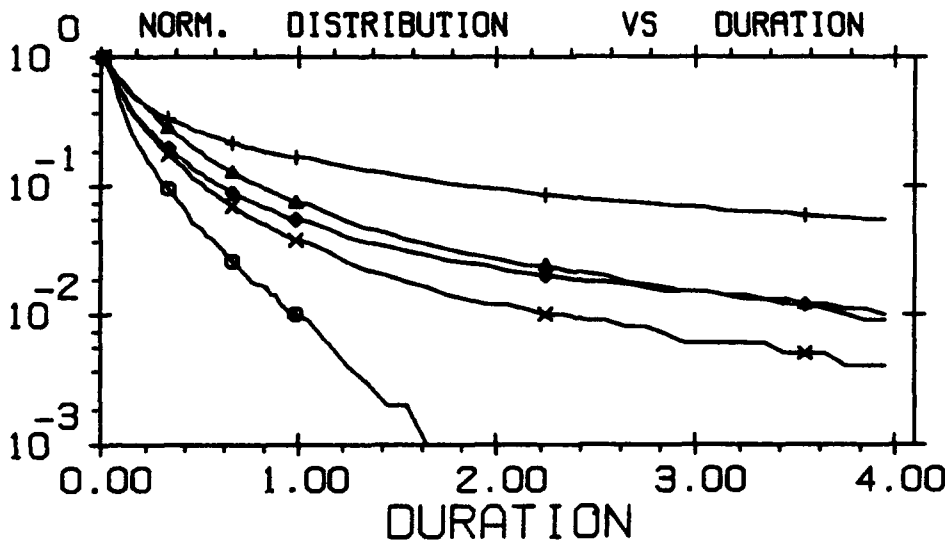

UNDERDENSE ○
 OVERDENSE ▲
 SPORADIC-E +
 ALL-TRAILS ×
 ALL-EVENTS ◇

EXCEEDING -126.0 DBM RSL
 THE TIME OF DAY IS 0 : 24 HOURS U.T.
 FREQUENCY - 147 MHZ
 BASED ON OBSERVED NOISE MEASUREMENTS - VERTICAL
 NORMALIZING FACTORS:
 UNDER - 8867. OVER - 6761. SPOR-E - 2380.
 TRAILS - 15628. EVENTS - 18008.

MENU=106.02-4
 13-OCT-93
 PLOT# 72.00

GEOPHYSICS LAB METEOR SCATTER PROGRAM

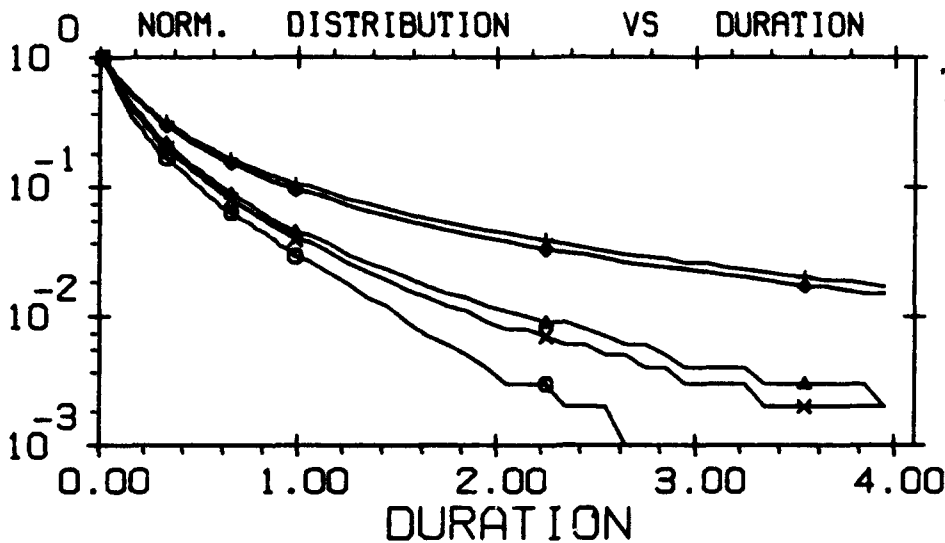

EXCEEDING -116.0 DBM RSL
 THE TIME OF DAY IS 0 : 24 HOURS U.T.
 FREQUENCY - 35 MHZ
 BASED ON OBSERVED NOISE MEASUREMENTS - VERTICAL
 NORMALIZING FACTORS:
 UNDER - 5069. OVER - 9164. SPOR-E - 72627.
 TRAILS - 14233. EVENTS - 86860.

MENU=106,02-4
 13-OCT-93
 PLOT= 73.00

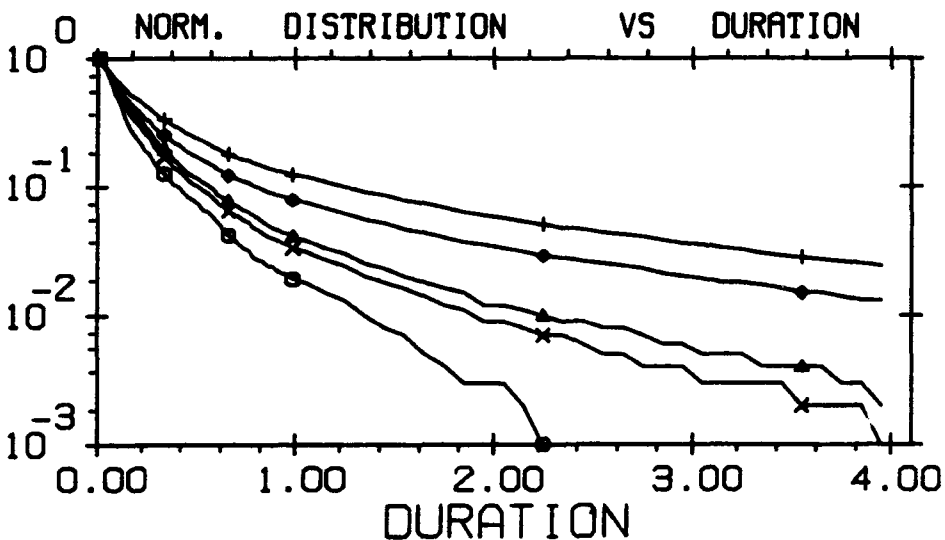

EXCEEDING -116.0 DBM RSL
 THE TIME OF DAY IS 0 : 24 HOURS U.T.
 FREQUENCY - 45 MHZ
 BASED ON OBSERVED NOISE MEASUREMENTS - VERTICAL
 NORMALIZING FACTORS:
 UNDER - 3680. OVER - 6770. SPOR-E - 10690.
 TRAILS - 10450. EVENTS - 21140.

MENU=106,02-4
 13-OCT-93
 PLOT= 74.00

GEOPHYSICS LAB METEOR SCATTER PROGRAM

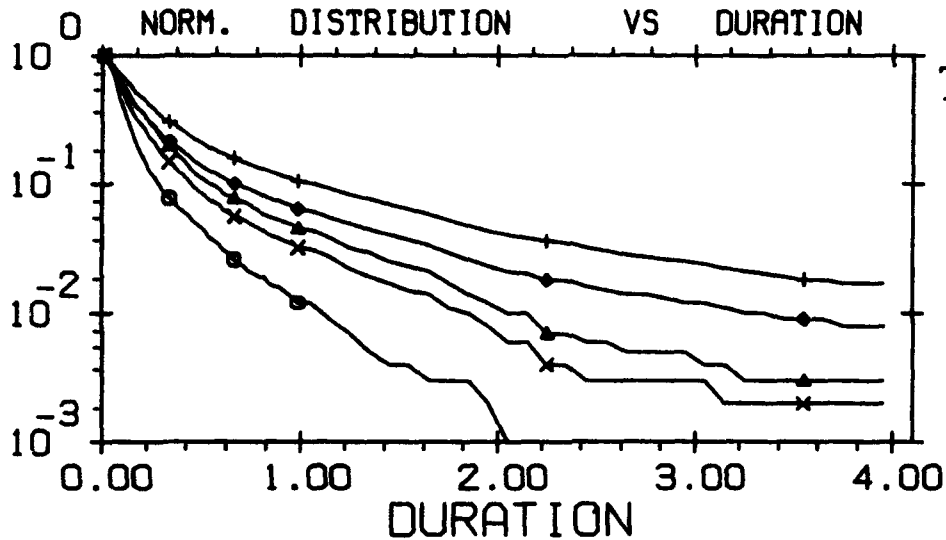

AUGUST 1991
THULE

UNDERDENSE ◯
 OVERDENSE △
 SPORADIC-E +
 ALL-TRAILS ×
 ALL-EVENTS ◇

EXCEEDING -116.0 DBM RSL
 THE TIME OF DAY IS 0 : 24 HOURS U.T.
 FREQUENCY - 65 MHZ
 BASED ON OBSERVED NOISE MEASUREMENTS - VERTICAL
 NORMALIZING FACTORS:
 UNDER - 2311. OVER - 3455. SPOR-E - 4523.
 TRAILS - 5766. EVENTS - 10289.

MENU=106,02-4
 13-OCT-93
 PLOT= 75.00

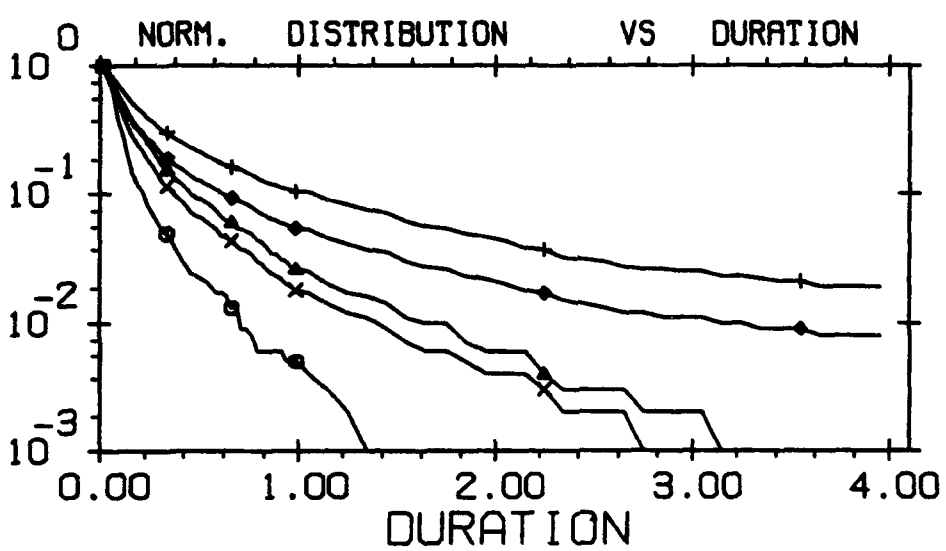

AUGUST 1991

UNDERDENSE ◯
 OVERDENSE △
 SPORADIC-E +
 ALL-TRAILS ×
 ALL-EVENTS ◇

EXCEEDING -116.0 DBM RSL
 THE TIME OF DAY IS 0 : 24 HOURS U.T.
 FREQUENCY - 85 MHZ
 BASED ON OBSERVED NOISE MEASUREMENTS - VERTICAL
 NORMALIZING FACTORS:
 UNDER - 1267. OVER - 2161. SPOR-E - 2467.
 TRAILS - 3428. EVENTS - 5895.

MENU=106,02-4
 13-OCT-93
 PLOT= 76.00

GEOPHYSICS LAB METEOR SCATTER PROGRAM

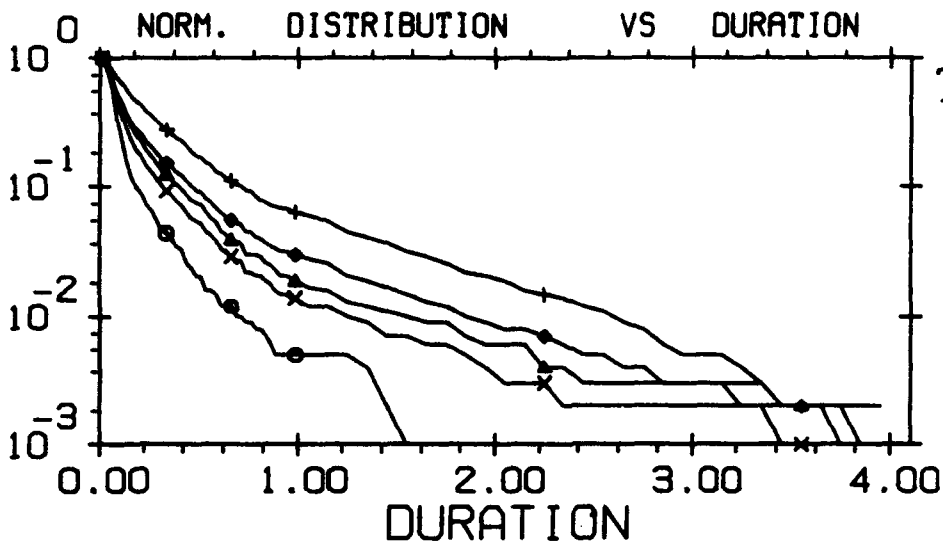

EXCEEDING -116.0 DBM RSL
 THE TIME OF DAY IS 0 : 24 HOURS U.T.
 FREQUENCY - 104 MHZ
 BASED ON OBSERVED NOISE MEASUREMENTS - VERTICAL
 NORMALIZING FACTORS:
 UNDER - 1098. OVER - 1786. SPOR-E - 1402.
 TRAILS - 2884. EVENTS - 4286.

MENU#106,02-4
 13-OCT-93
 PLOT# 77.00

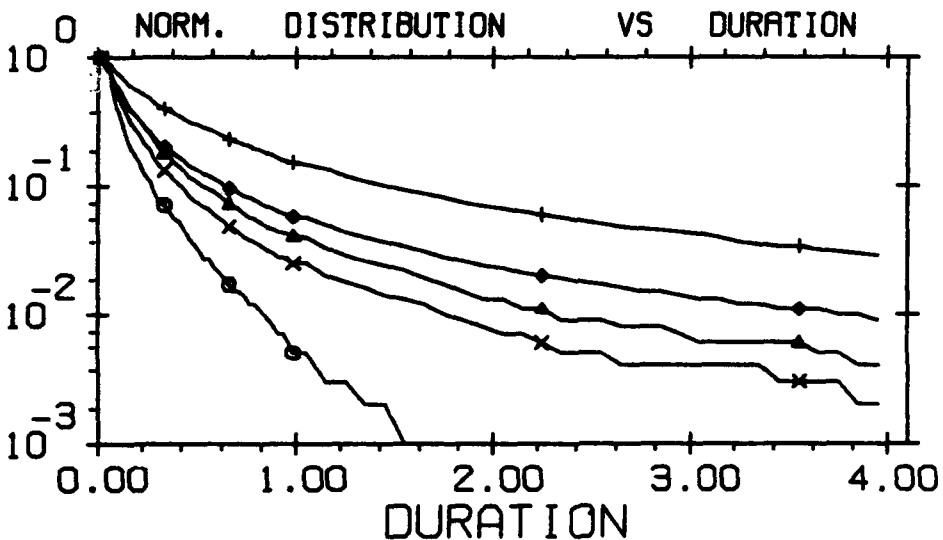

EXCEEDING -116.0 DBM RSL
 THE TIME OF DAY IS 0 : 24 HOURS U.T.
 FREQUENCY - 147 MHZ
 BASED ON OBSERVED NOISE MEASUREMENTS - VERTICAL
 NORMALIZING FACTORS:
 UNDER - 2883. OVER - 3801. SPOR-E - 2356.
 TRAILS - 6684. EVENTS - 9040.

MENU#106,02-4
 13-OCT-93
 PLOT# 78.00

GEOPHYSICS LAB METEOR SCATTER PROGRAM

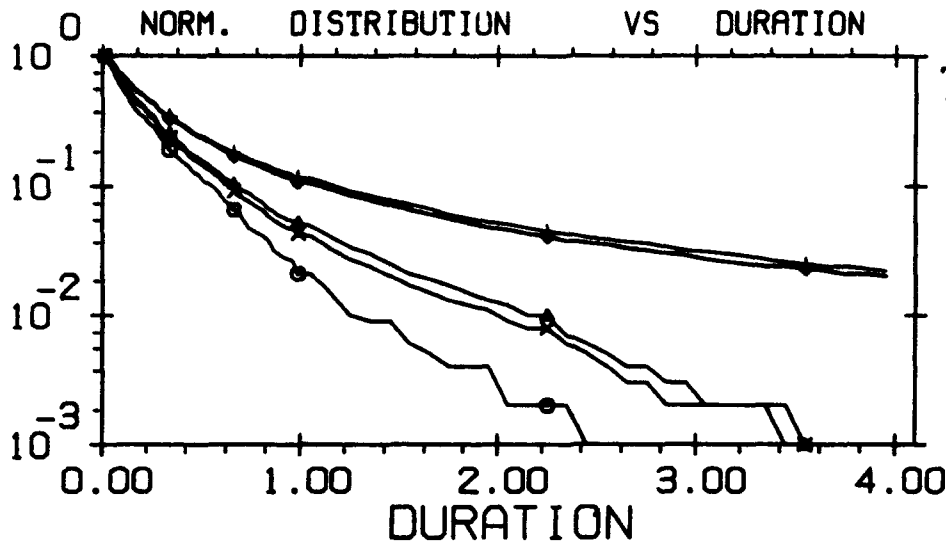

EXCEEDING -106.0 DBM RSL
 THE TIME OF DAY IS 0 : 24 HOURS U.T.
 FREQUENCY - 35 MHZ
 BASED ON OBSERVED NOISE MEASUREMENTS - VERTICAL
 NORMALIZING FACTORS:
 UNDER - 820. OVER - 2004. SPOR-E - 21564.
 TRAILS - 2824. EVENTS - 24388.

MENU=106,02-4
 13-OCT-93
 PLOT= 79.00

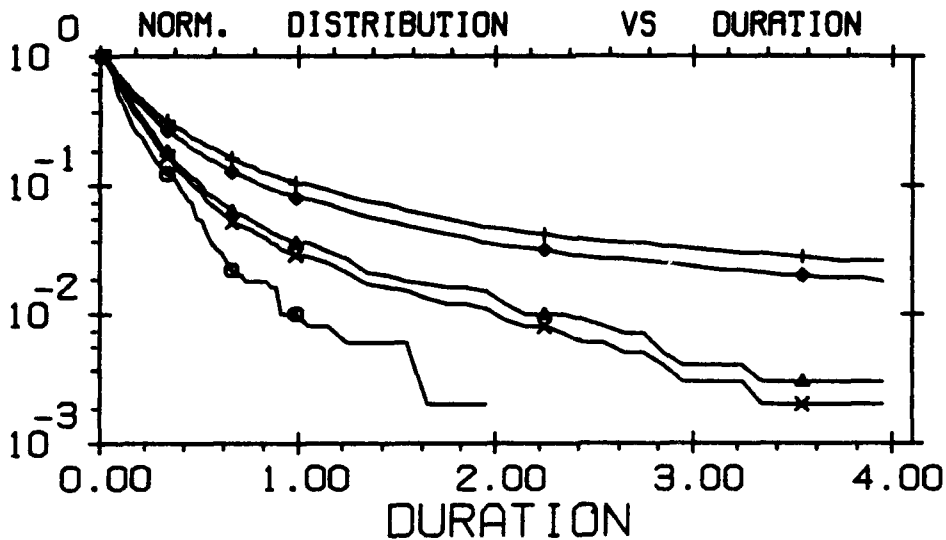

EXCEEDING -106.0 DBM RSL
 THE TIME OF DAY IS 0 : 24 HOURS U.T.
 FREQUENCY - 45 MHZ
 BASED ON OBSERVED NOISE MEASUREMENTS - VERTICAL
 NORMALIZING FACTORS:
 UNDER - 496. OVER - 1366. SPOR-E - 4136.
 TRAILS - 1862. EVENTS - 5998.

MENU=106,02-4
 13-OCT-93
 PLOT= 80.00

GEOPHYSICS LAB METEOR SCATTER PROGRAM

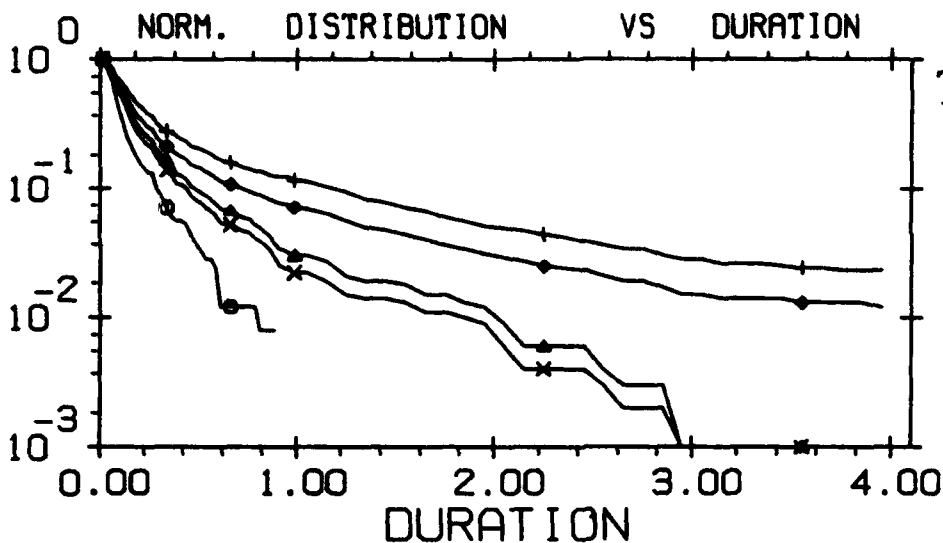

AUGUST 1991

THULE

UNDERDENSE	○
OVERDENSE	△
SPORADIC-E	+
ALL-TRAILS	×
ALL-EVENTS	◇

EXCEEDING -106.0 DBM RSL
 THE TIME OF DAY IS 0 : 24 HOURS U.T.
 FREQUENCY - 65 MHZ
 BASED ON OBSERVED NOISE MEASUREMENTS - VERTICAL
 NORMALIZING FACTORS:
 UNDER - 252. OVER - 674. SPOR-E - 1022.
 TRAILS - 926. EVENTS - 1948.

MENU=106,02-4
 13-OCT-93
 PLOT= 81.00

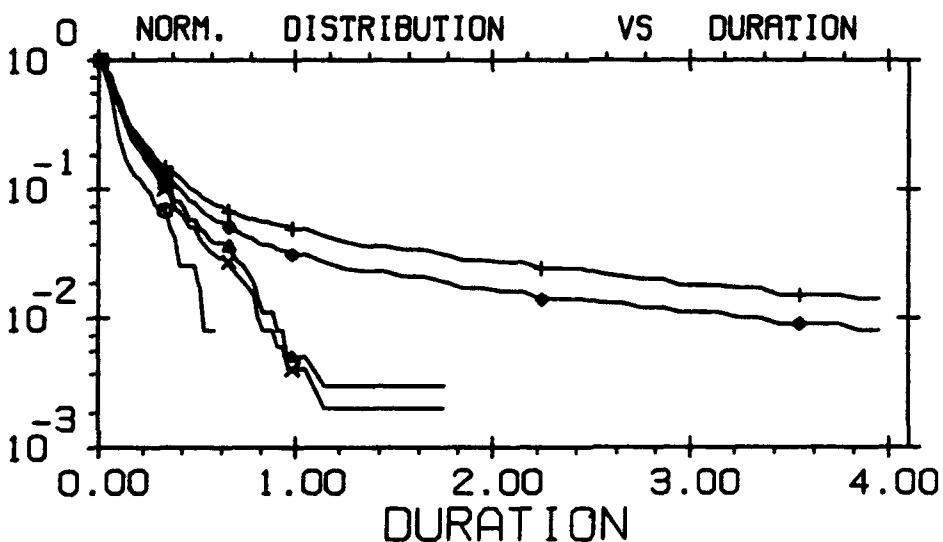

AUGUST 1991

UNDERDENSE	○
OVERDENSE	△
SPORADIC-E	+
ALL-TRAILS	×
ALL-EVENTS	◇

EXCEEDING -106.0 DBM RSL
 THE TIME OF DAY IS 0 : 24 HOURS U.T.
 FREQUENCY - 85 MHZ
 BASED ON OBSERVED NOISE MEASUREMENTS - VERTICAL
 NORMALIZING FACTORS:
 UNDER - 118. OVER - 364. SPOR-E - 716.
 TRAILS - 482. EVENTS - 1198.

MENU=106,02-4
 13-OCT-93
 PLOT= 82.00

GEOPHYSICS LAB METEOR SCATTER PROGRAM

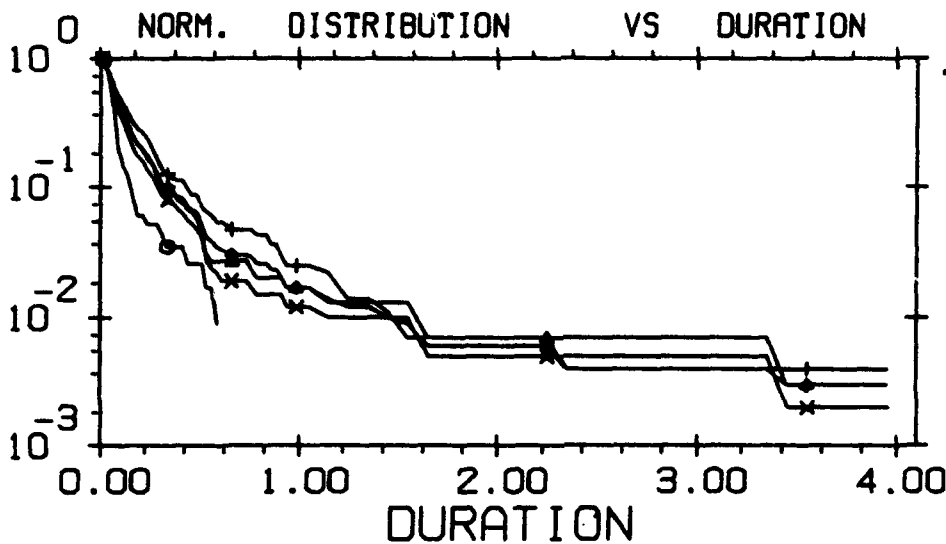

EXCEEDING -106.0 DBM RSL
 THE TIME OF DAY IS 0 : 24 HOURS U.T.
 FREQUENCY - 104 MHZ
 BASED ON OBSERVED NOISE MEASUREMENTS - VERTICAL
 NORMALIZING FACTORS:
 UNDER - 115. OVER - 298. SPOR-E - 277.
 TRAILS - 413. EVENTS - 690.

MENU#106,02-4
 13-OCT-93
 PLOT# 83.00

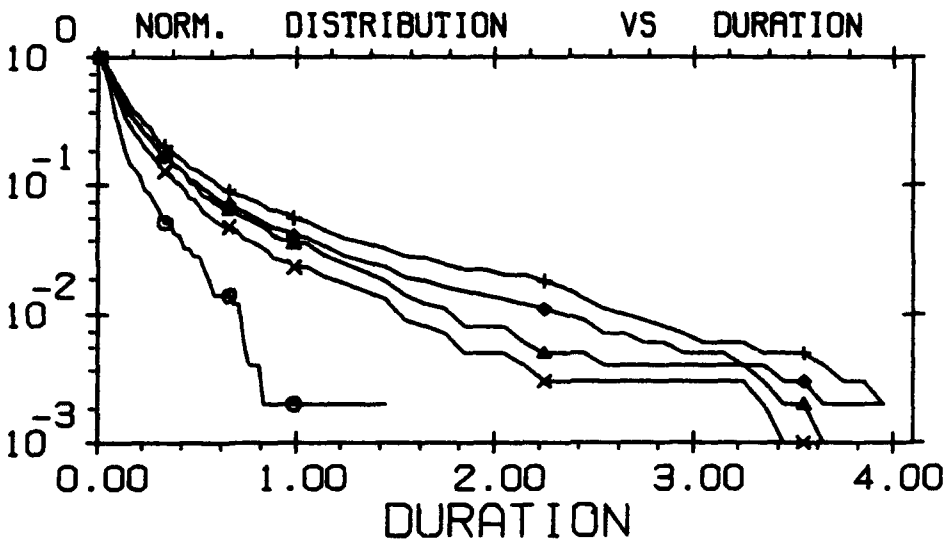

EXCEEDING -106.0 DBM RSL
 THE TIME OF DAY IS 0 : 24 HOURS U.T.
 FREQUENCY - 147 MHZ
 BASED ON OBSERVED NOISE MEASUREMENTS - VERTICAL
 NORMALIZING FACTORS:
 UNDER - 505. OVER - 985. SPOR-E - 1739.
 TRAILS - 1490. EVENTS - 3229.

MENU#106,02-4
 13-OCT-93
 PLOT# 84.00

GEOPHYSICS LAB METEOR SCATTER PROGRAM

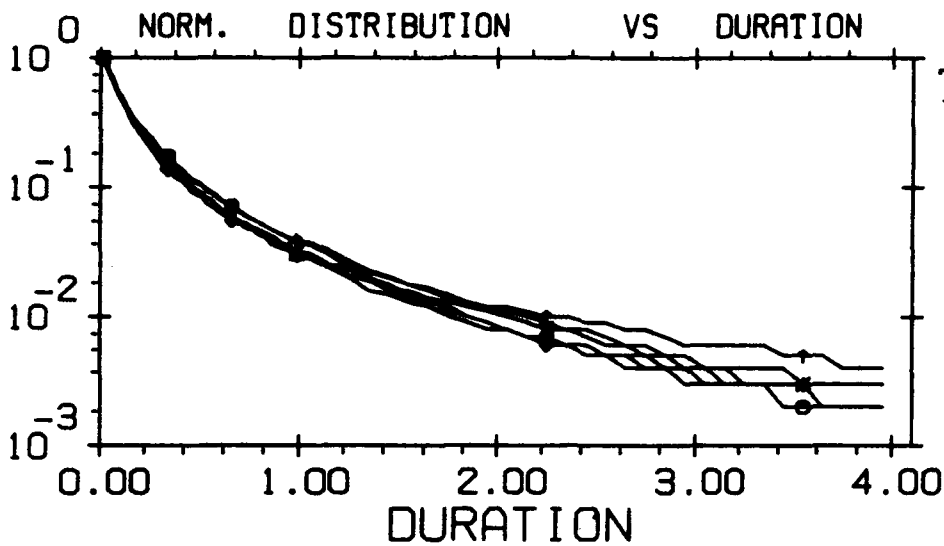

EXCEEDING -126.0 DBM RSL
 THE TIME OF DAY IS 0 : 24 HOURS U.T.
 THE EVENT CLASS IS UNDERDENSE AND OVERDENSE TRAILS
 BASED ON OBSERVED NOISE MEASUREMENTS - VERTICAL
 NORMALIZING FACTORS:
 35MHZ - 37128. 45MHZ - 28866. 65MHZ - 15738.
 85MHZ - 9637. 104MHZ - 8128. 147MHZ - 15628.

MENU#106,01-4
 13-OCT-93
 PLOT# 85.00

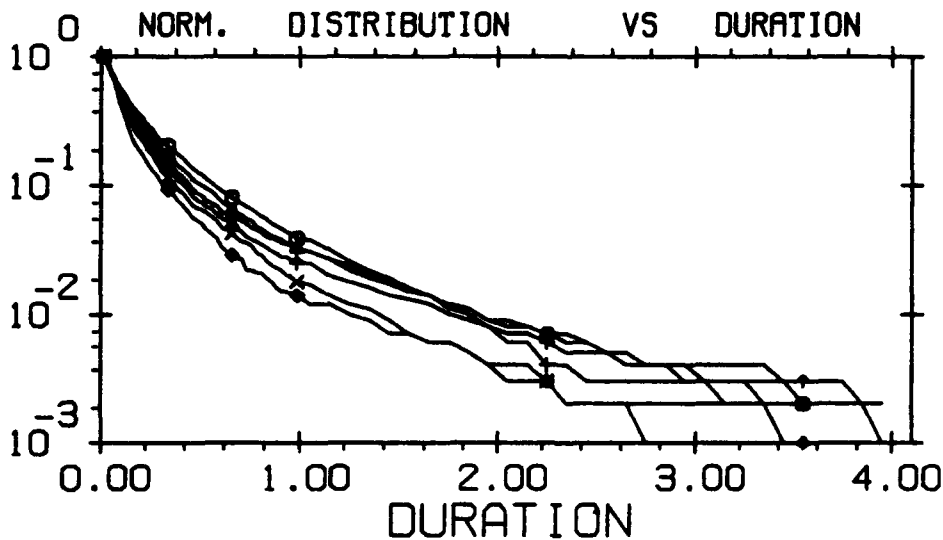

EXCEEDING -116.0 DBM RSL
 THE TIME OF DAY IS 0 : 24 HOURS U.T.
 THE EVENT CLASS IS UNDERDENSE AND OVERDENSE TRAILS
 BASED ON OBSERVED NOISE MEASUREMENTS - VERTICAL
 NORMALIZING FACTORS:
 35MHZ - 14233. 45MHZ - 10450. 65MHZ - 5766.
 85MHZ - 3428. 104MHZ - 2884. 147MHZ - 6684.

MENU#106,01-4
 13-OCT-93
 PLOT# 86.00

GEOPHYSICS LAB METEOR SCATTER PROGRAM

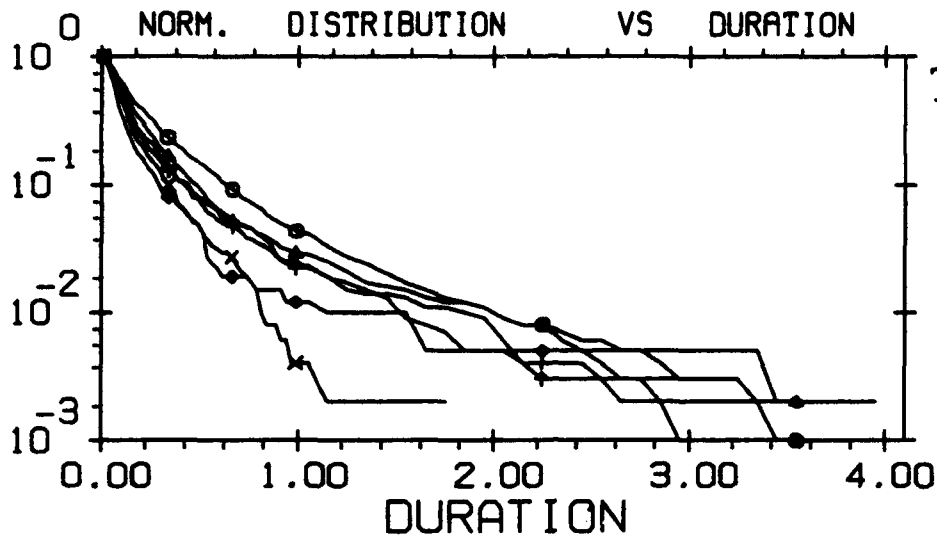

EXCEEDING -106.0 DBM RSL
 THE TIME OF DAY IS 0 : 24 HOURS U.T.
 THE EVENT CLASS IS UNDERDENSE AND OVERDENSE TRAILS
 BASED ON OBSERVED NOISE MEASUREMENTS - VERTICAL
 NORMALIZING FACTORS:
 35MHZ - 2824. 45MHZ - 1862. 65MHZ - 926.
 85MHZ - 482. 104MHZ - 413. 147MHZ - 1490.

MENU#106,01-4
 13-OCT-93
 PLOT# 87.00

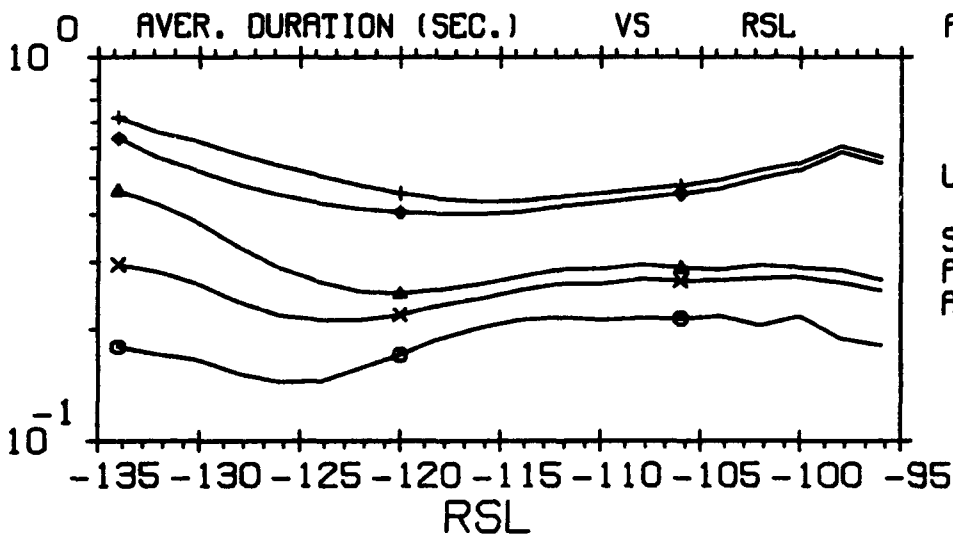

THE TIME OF DAY IS 0 : 24 HOURS U.T.
 FREQUENCY - 35 MHZ
 BASED ON OBSERVED NOISE MEASUREMENTS - VERTICAL

MENU#106,06-1
 13-OCT-93
 PLOT# 88.00

GEOPHYSICS LAB METEOR SCATTER PROGRAM

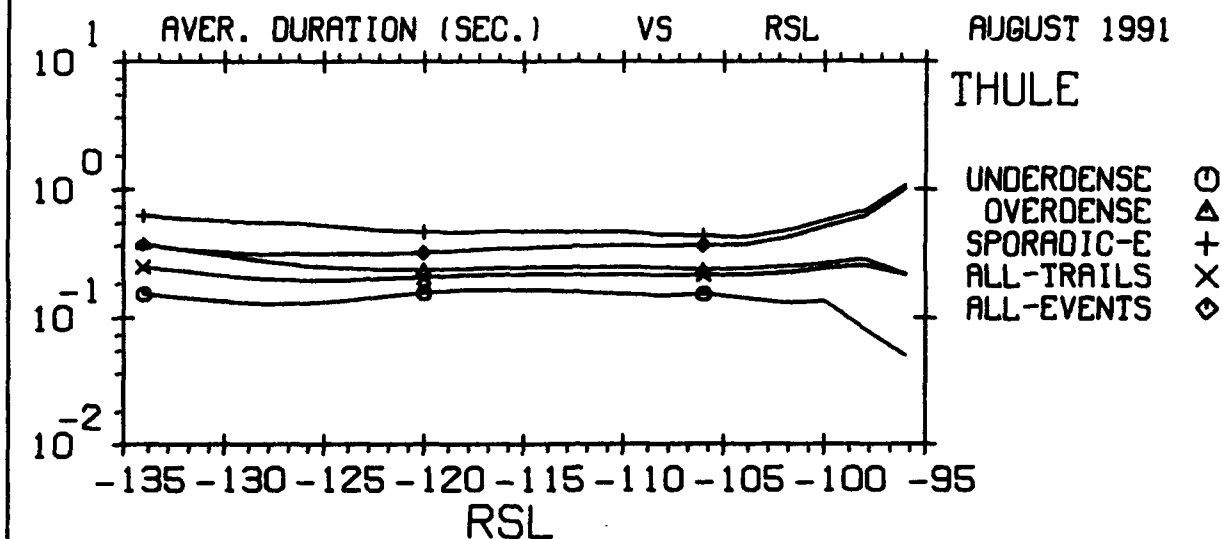

THE TIME OF DAY IS 0 : 24 HOURS U.T.
 FREQUENCY - 45 MHZ
 BASED ON OBSERVED NOISE MEASUREMENTS - VERTICAL

MENU=106,06-1
 13-OCT-93
 PLOT# 89.00

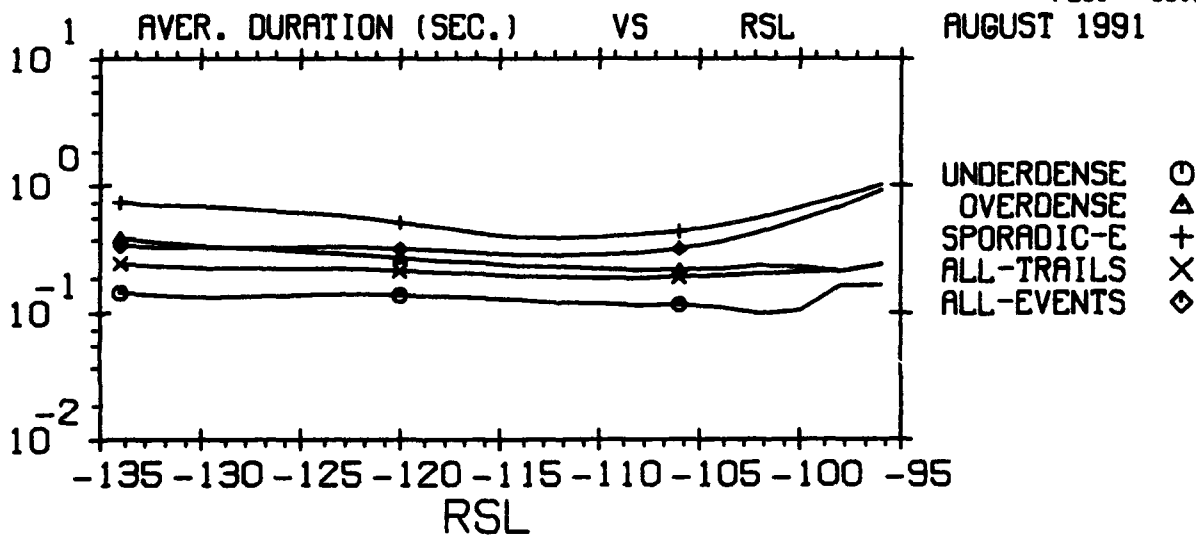

THE TIME OF DAY IS 0 : 24 HOURS U.T.
 FREQUENCY - 65 MHZ
 BASED ON OBSERVED NOISE MEASUREMENTS - VERTICAL

MENU=106,06-1
 13-OCT-93
 PLOT# 90.00

GEOPHYSICS LAB METEOR SCATTER PROGRAM

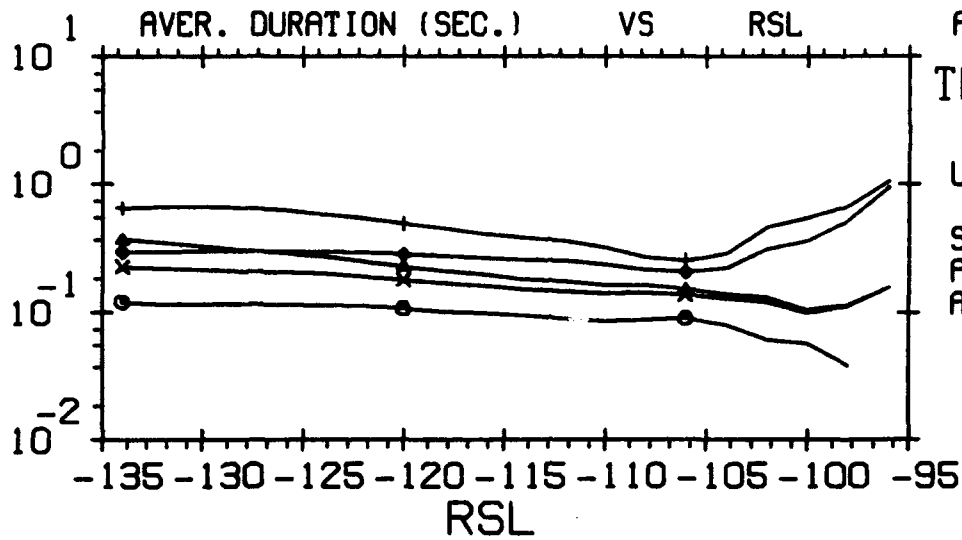

THE TIME OF DAY IS 0 : 24 HOURS U.T.
 FREQUENCY - 85 MHZ
 BASED ON OBSERVED NOISE MEASUREMENTS - VERTICAL

MENU#106,06-1
 13-OCT-93
 PLOT# 91.00

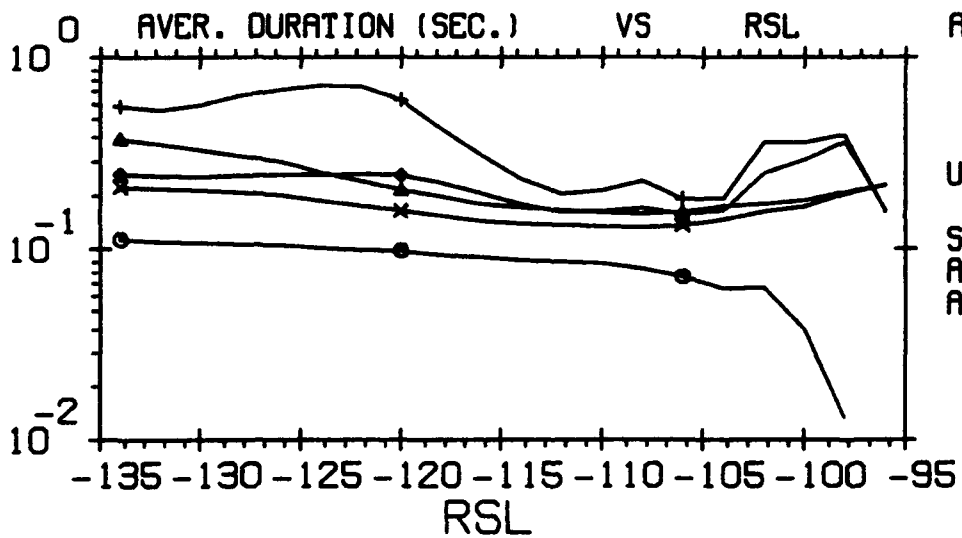

THE TIME OF DAY IS 0 : 24 HOURS U.T.
 FREQUENCY - 104 MHZ
 BASED ON OBSERVED NOISE MEASUREMENTS - VERTICAL

MENU#106,06-1
 13-OCT-93
 PLOT# 92.00

GEOPHYSICS LAB METEOR SCATTER PROGRAM

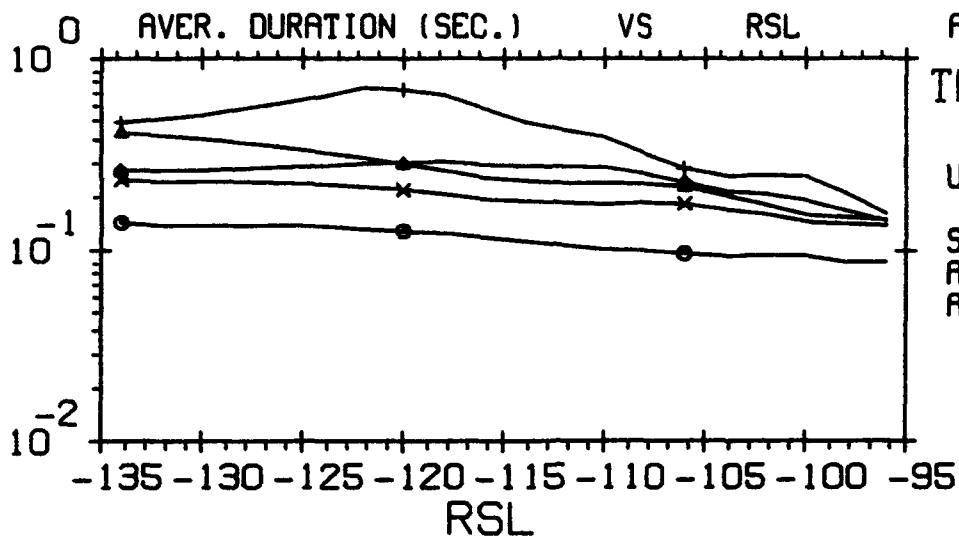

AUGUST 1991
THULE

UNDERDENSE ○
 OVERDENSE △
 SPORADIC-E +
 ALL-TRAILS ×
 ALL-EVENTS ◇

THE TIME OF DAY IS 0 : 24 HOURS U.T.
 FREQUENCY = 147 MHZ
 BASED ON OBSERVED NOISE MEASUREMENTS - VERTICAL

MENU#106,06-1
 13-OCT-93
 PLOT# 93.00

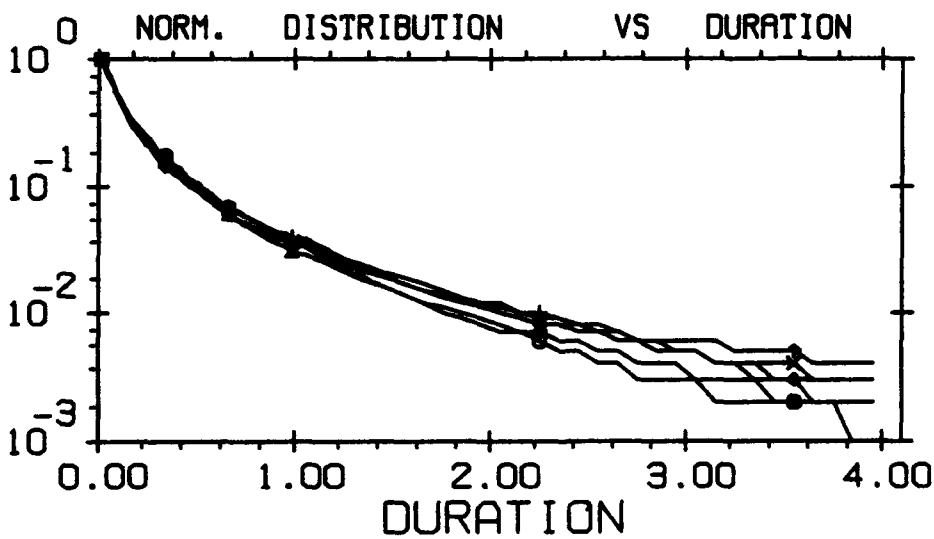

AUGUST 1991

35 MHZ ○
 45 MHZ △
 65 MHZ +
 85 MHZ ×
 104 MHZ ◇
 147 MHZ ↑

EXCEEDING 19.0 DB SNR
 THE TIME OF DAY IS 0 : 24 HOURS U.T.
 THE EVENT CLASS IS UNDERDENSE AND OVERDENSE TRAILS
 EFFECTIVE SYSTEM BANDWIDTH = 100.HZ
 BASED ON OBSERVED NOISE MEASUREMENTS - VERTICAL

NORMALIZING FACTORS:
 35MHZ - 26086. 45MHZ - 23253. 65MHZ - 16050.
 85MHZ - 11181. 104MHZ - 9809. 147MHZ - 14161.

MENU#107,01-4
 13-OCT-93
 PLOT# 94.00

GEOPHYSICS LAB METEOR SCATTER PROGRAM

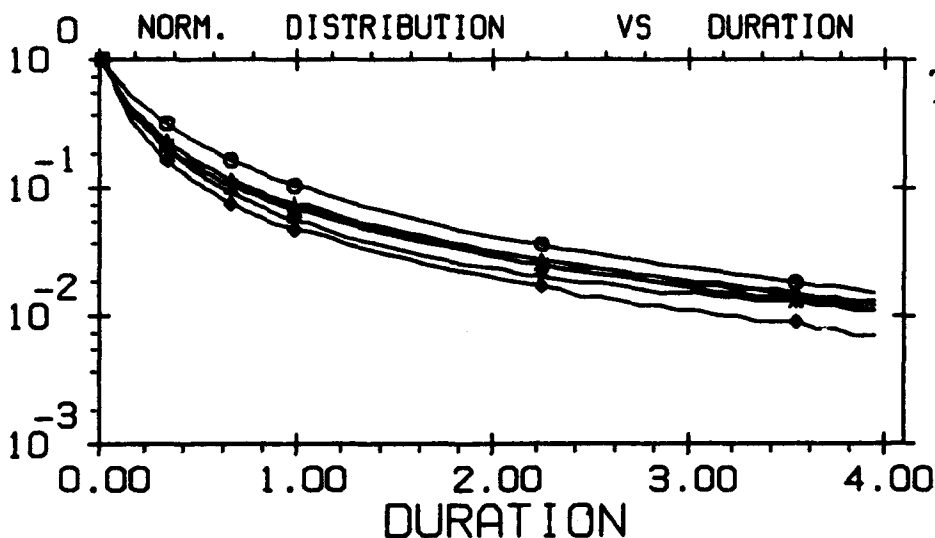

- 35 MHZ ○
- 45 MHZ △
- 65 MHZ +
- 85 MHZ ×
- 104 MHZ ◇
- 147 MHZ ↑

EXCEEDING 19.0 DB SNR
 THE TIME OF DAY IS 0 : 24 HOURS U.T.
 THE EVENT CLASS IS SPORADIC-E AND METEOR TRAILS
 EFFECTIVE SYSTEM BANDWIDTH - 100.HZ
 BASED ON OBSERVED NOISE MEASUREMENTS - VERTICAL
 NORMALIZING FACTORS:
 35MHZ - 118519. 45MHZ - 38826. 65MHZ - 21512.
 85MHZ - 13814. 104MHZ - 10963. 147MHZ - 16274.

MENU#107,01-4
 13-OCT-93
 PLOT# 95.00

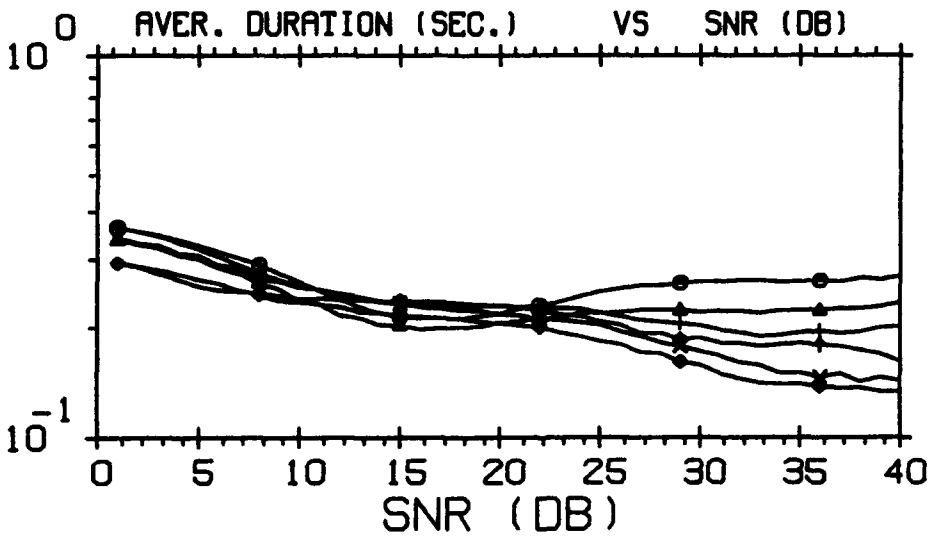

- 35 MHZ ○
- 45 MHZ △
- 65 MHZ +
- 85 MHZ ×
- 104 MHZ ◇
- 147 MHZ ↑

THE TIME OF DAY IS 0 : 24 HOURS U.T.
 THE EVENT CLASS IS UNDERDENSE AND OVERDENSE TRAILS
 EFFECTIVE SYSTEM BANDWIDTH - 100.HZ
 BASED ON OBSERVED NOISE MEASUREMENTS - VERTICAL

MENU#107,05-1
 13-OCT-93
 PLOT# 96.00

GEOPHYSICS LAB METEOR SCATTER PROGRAM

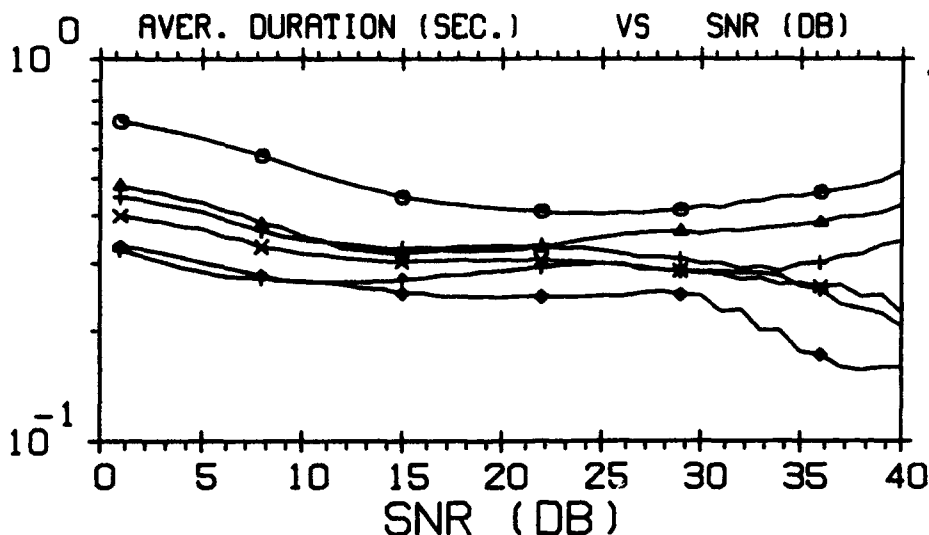

35 MHZ	○
45 MHZ	△
65 MHZ	+
85 MHZ	×
104 MHZ	◇
147 MHZ	↑

THE TIME OF DAY IS 0 : 24 HOURS U.T.
 THE EVENT CLASS IS SPORADIC-E AND METEOR TRAILS
 EFFECTIVE SYSTEM BANDWIDTH - 100.HZ
 BASED ON OBSERVED NOISE MEASUREMENTS - VERTICAL

MENU*107,05-1
 13-OCT-93
 PLOT* 97.00

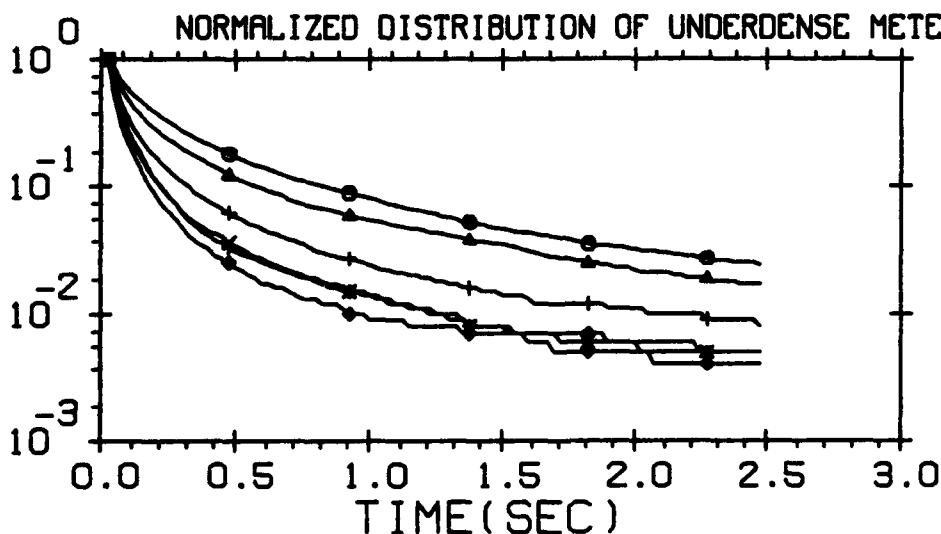

35 MHZ	○
45 MHZ	△
65 MHZ	+
85 MHZ	×
104 MHZ	◇
147 MHZ	↑

AUGUST 1991
 THE TIME OF DAY IS 0 : 24 HOURS U.T.
 BASED ON OBSERVED NOISE MEASUREMENTS - VERTICAL
 NORMALIZING FACTORS:
 35MHZ - 8466. 45MHZ - 8828. 65MHZ - 8401.
 85MHZ - 6060. 104MHZ - 5982. 147MHZ - 10703.

MENU*108,01-4
 13-OCT-93
 PLOT* 98.00

GEOPHYSICS LAB METEOR SCATTER PROGRAM

AVERAGE UNDERDENSE TIME CONSTANT VS TIME FOR AUGUST 1991

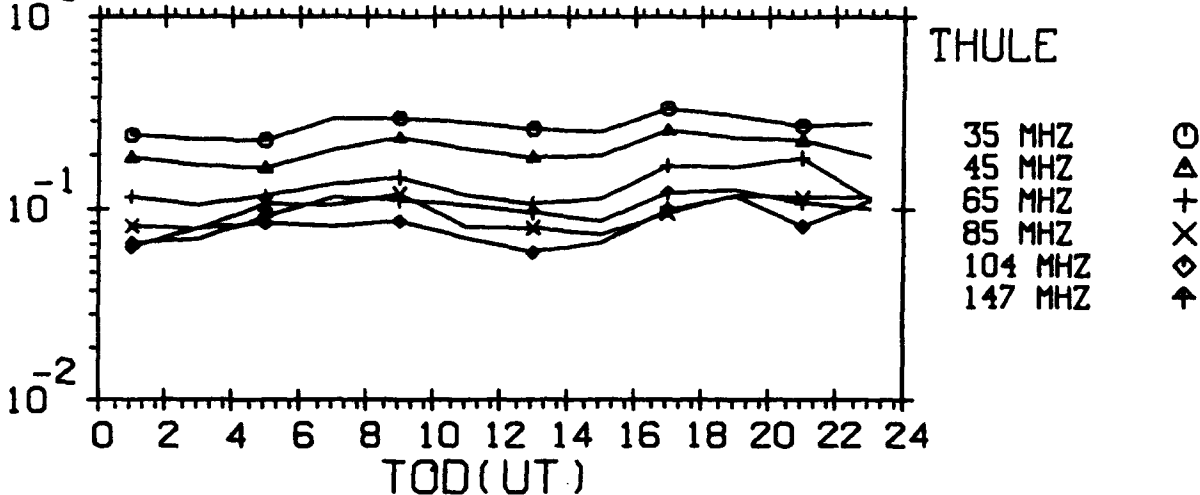

BASED ON OBSERVED NOISE MEASUREMENTS - VERTICAL
 THE 24 HOUR AVERAGE TIME CONSTANTS ARE

0.260	0.202	0.130	0.096	0.082	0.099
-------	-------	-------	-------	-------	-------

MENU=108,02-1
 13-OCT-93
 PLOT= 98.00

NORMALIZED DISTRIBUTION OF FADES/SECOND FOR AUGUST 1991

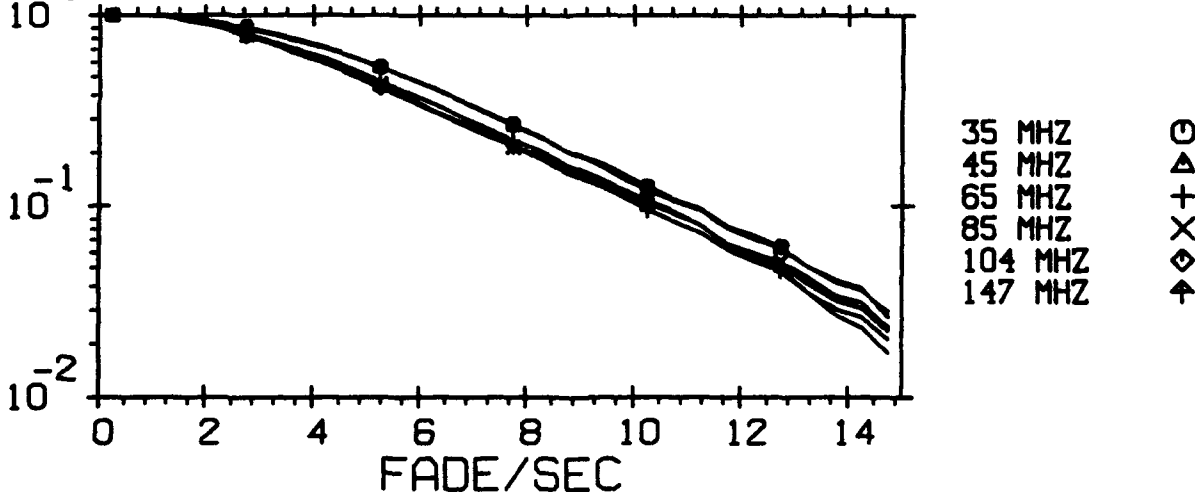

THE TIME OF DAY IS 0 : 24 HOURS U.T.
 THE EVENT CLASS IS UNDERDENSE AND OVERDENSE TRAILS
 NORMALIZING FACTORS:

35MHZ - 10518.	45MHZ - 8238.	65MHZ - 4673.
85MHZ - 2393.	104MHZ - 1961.	147MHZ - 4469.

MENU=109,01-4
 13-OCT-93
 PLOT= 100.00

GEOPHYSICS LAB METEOR SCATTER PROGRAM

NORMALIZED DISTRIBUTION OF FADES/SECOND FOR AUGUST 1991

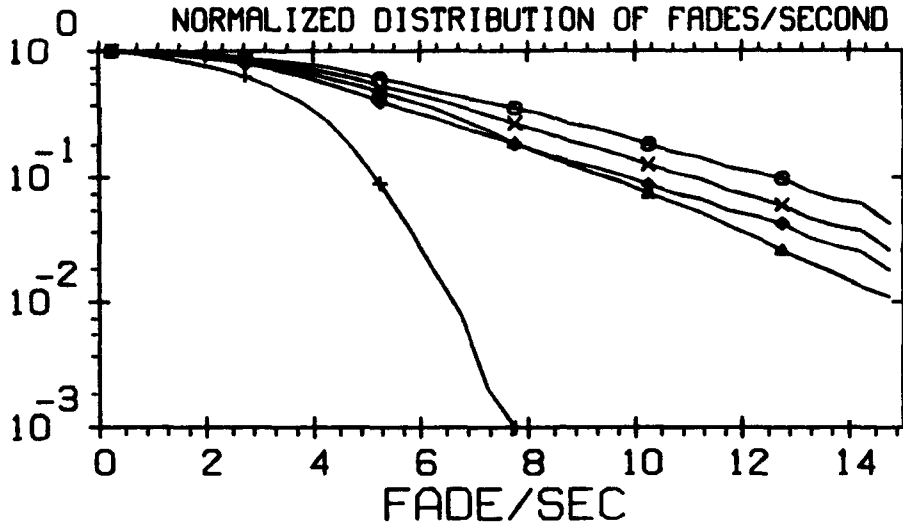

THULE

UNDERDENSE ○
 OVERDENSE △
 SPORADIC-E +
 ALL TRAILS ×
 ALL EVENTS ◇

THE TIME OF DAY IS 0 : 24 HOURS U.T.

FREQUENCY - 35 MHZ

NORMALIZING FACTORS:

UNDER - 5062. OVER - 5456. SPOR-E - 4636.

TRAILS - 10518. EVENTS - 15154.

MENU*109,02-4

13-OCT-93

PLOT* 101.00

NORMALIZED DISTRIBUTION OF FADES/SECOND FOR AUGUST 1991

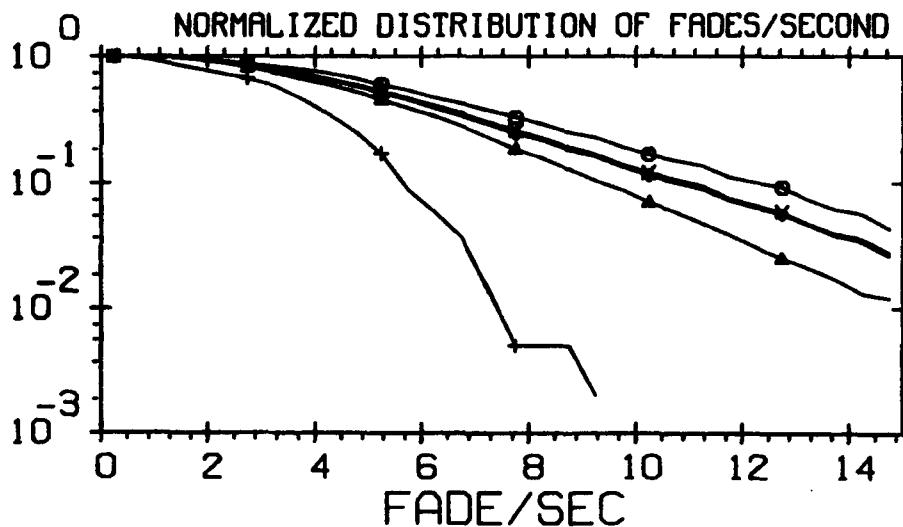

UNDERDENSE ○
 OVERDENSE △
 SPORADIC-E +
 ALL TRAILS ×
 ALL EVENTS ◇

THE TIME OF DAY IS 0 : 24 HOURS U.T.

FREQUENCY - 45 MHZ

NORMALIZING FACTORS:

UNDER - 4267. OVER - 3971. SPOR-E - 427.

TRAILS - 8238. EVENTS - 8665.

MENU*109,02-4

13-OCT-93

PLOT* 102.00

GEOPHYSICS LAB METEOR SCATTER PROGRAM

NORMALIZED DISTRIBUTION OF FADES/SECOND FOR AUGUST 1991

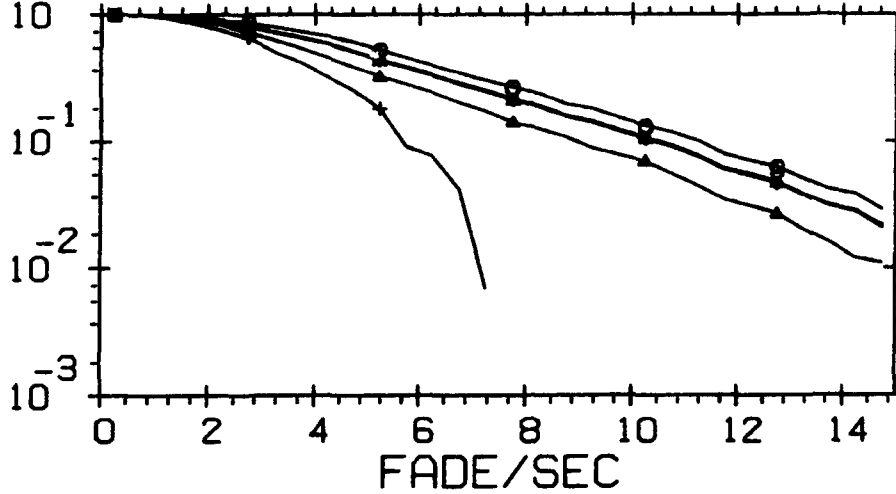

THULE

- UNDERDENSE ○
- OVERDENSE △
- SPORADIC-E +
- ALL TRAILS ×
- ALL EVENTS ◇

THE TIME OF DAY IS 0 : 24 HOURS U.T.
 FREQUENCY - 65 MHZ
 NORMALIZING FACTORS:
 UNDER - 2829. OVER - 1844. SPOR-E - 142.
 TRAILS - 4673. EVENTS - 4815.

MENU#109,02-4
 13-OCT-93
 PLOT# 103.00

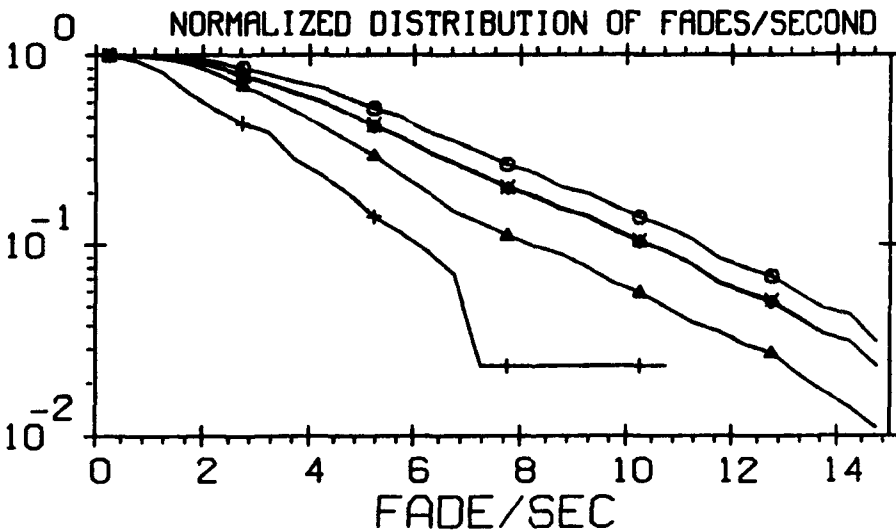

- UNDERDENSE ○
- OVERDENSE △
- SPORADIC-E +
- ALL TRAILS ×
- ALL EVENTS ◇

THE TIME OF DAY IS 0 : 24 HOURS U.T.
 FREQUENCY - 85 MHZ
 NORMALIZING FACTORS:
 UNDER - 1415. OVER - 978. SPOR-E - 43.
 TRAILS - 2393. EVENTS - 2436.

MENU#109,02-4
 13-OCT-93
 PLOT# 104.00

GEOPHYSICS LAB METEOR SCATTER PROGRAM

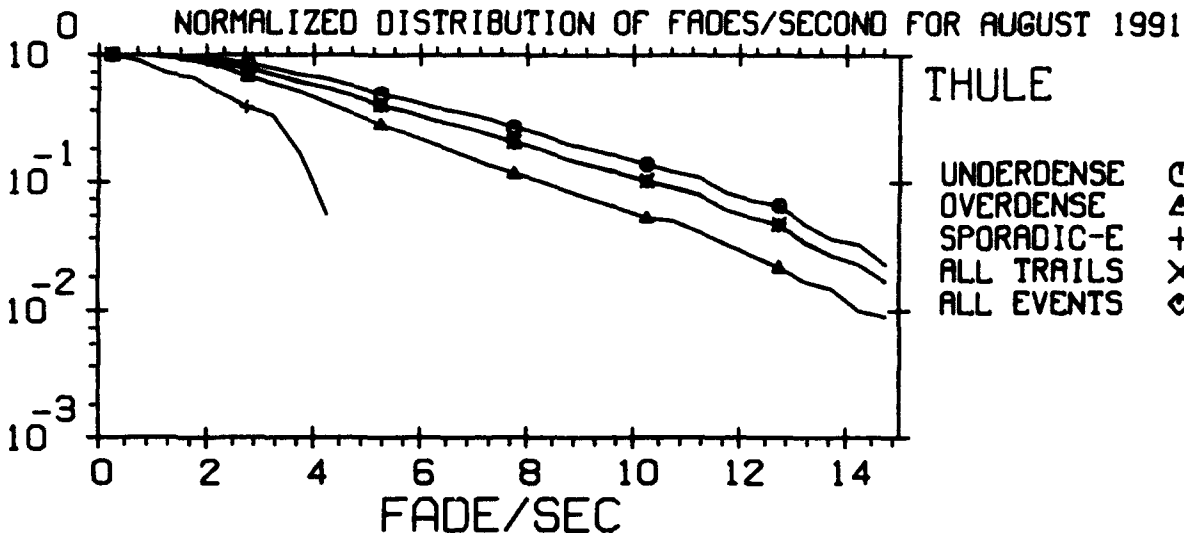

THE TIME OF DAY IS 0 : 24 HOURS U.T.
 FREQUENCY - 104 MHZ
 NORMALIZING FACTORS:
 UNDER - 1138. OVER - 823. SPOR-E - 18.
 TRAILS - 1961. EVENTS - 1979.

MENU=109,02-4
 13-OCT-93
 PLOT= 105.00

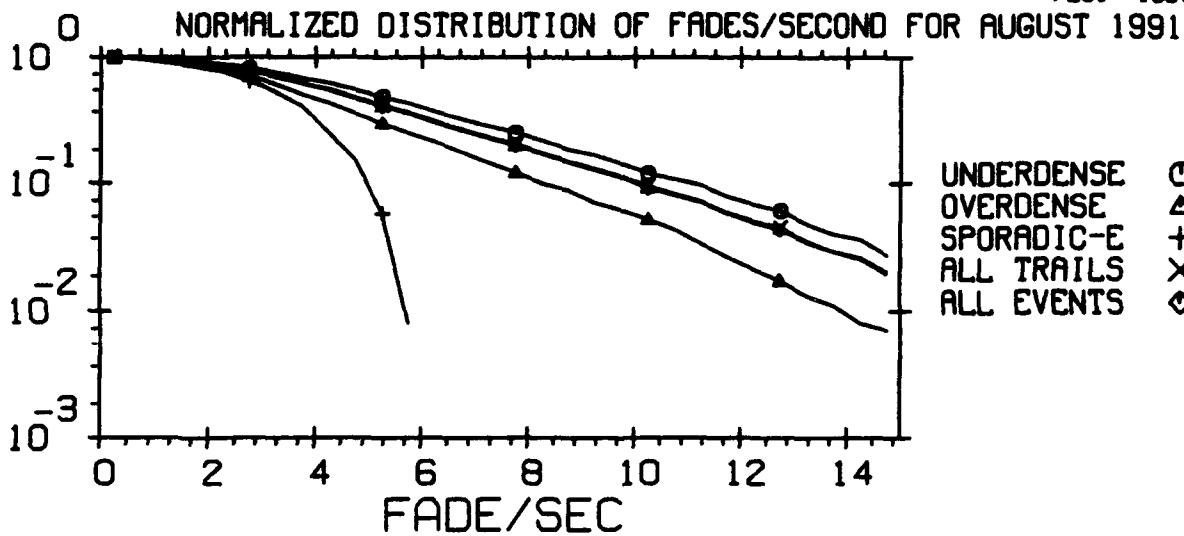

THE TIME OF DAY IS 0 : 24 HOURS U.T.
 FREQUENCY - 147 MHZ
 NORMALIZING FACTORS:
 UNDER - 2813. OVER - 1656. SPOR-E - 120.
 TRAILS - 4469. EVENTS - 4589.

MENU=109,02-4
 13-OCT-93
 PLOT= 106.00

GEOPHYSICS LAB METEOR SCATTER PROGRAM

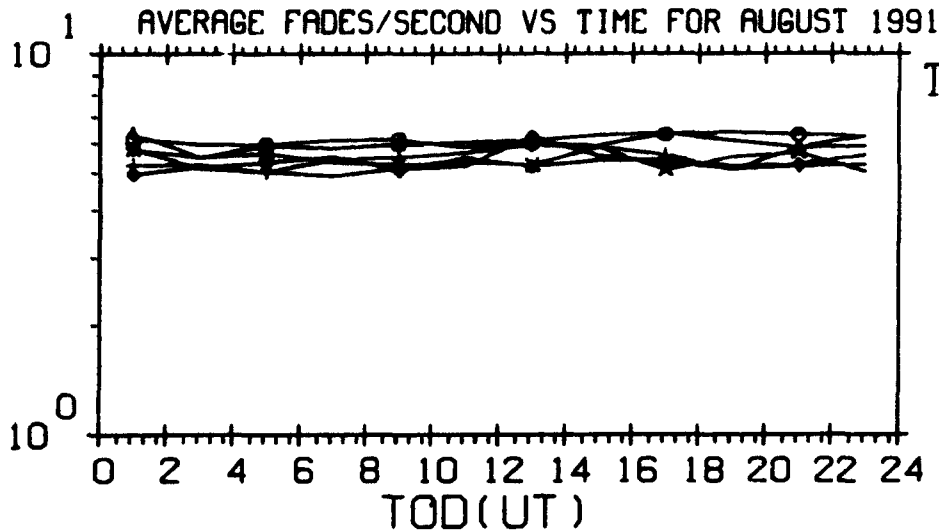

THULE

35 MHZ	○
45 MHZ	△
65 MHZ	+
85 MHZ	×
104 MHZ	◇
147 MHZ	↑

THE EVENT CLASS IS UNDERDENSE AND OVERDENSE TRAILS
 THE 24 HOUR FADES/SECOND AVERAGES ARE:

5.921	5.855	5.373	5.249	5.157	5.132
-------	-------	-------	-------	-------	-------

MENU#109,07-1
 13-OCT-93
 PLOT# 107.00

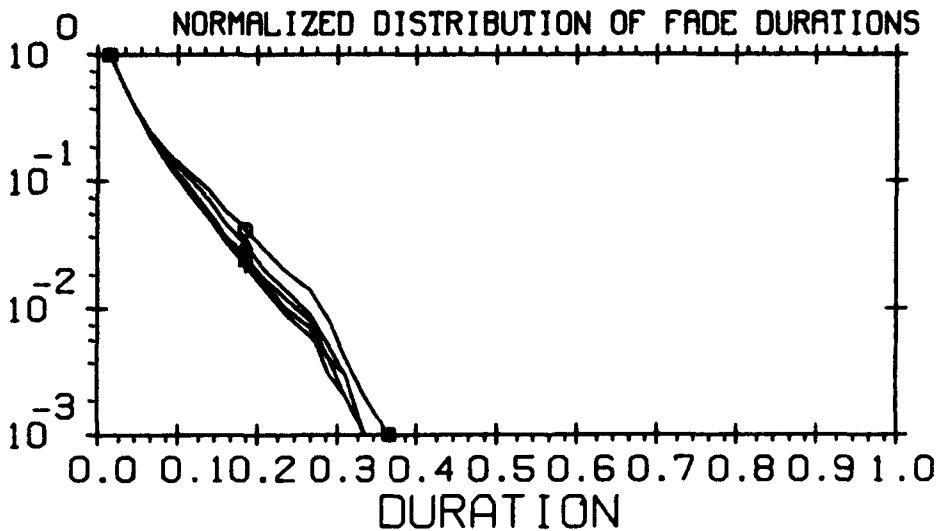

35 MHZ	○
45 MHZ	△
65 MHZ	+
85 MHZ	×
104 MHZ	◇
147 MHZ	↑

THE TIME OF DAY IS 0 : 24 HOURS U.T.
 THE EVENT CLASS IS UNDERDENSE AND OVERDENSE TRAILS
 NORMALIZING FACTORS:
 35MHZ - 48678. 45MHZ - 39110. 65MHZ - 24090.
 85MHZ - 14401. 104MHZ - 10850. 147MHZ - 20564.

MENU#109,05-4
 13-OCT-93
 PLOT# 108.00

GEOPHYSICS LAB METEOR SCATTER PROGRAM

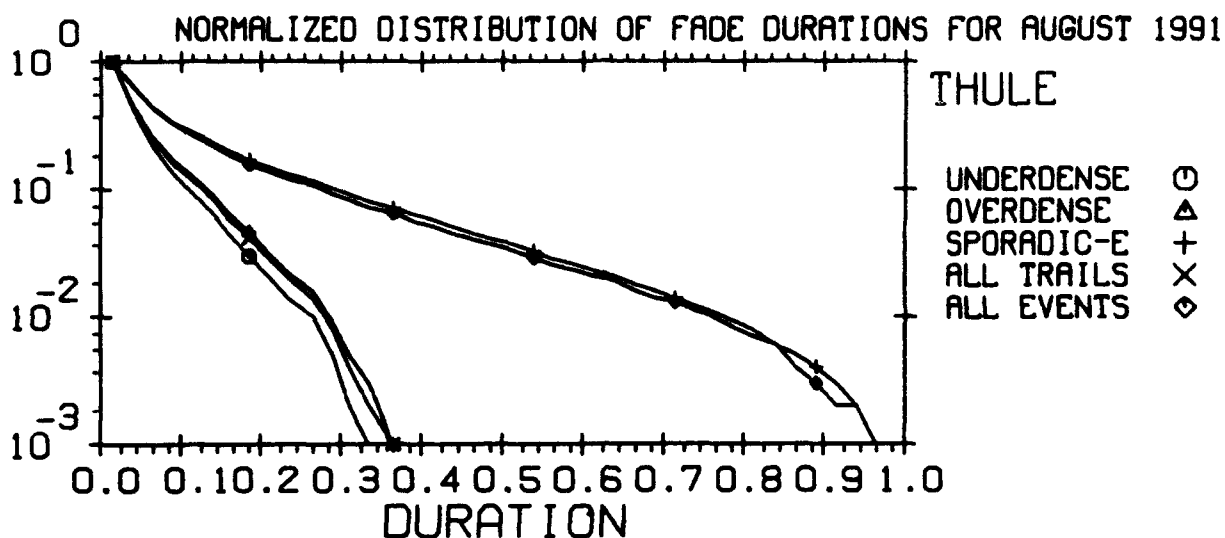

THE TIME OF DAY IS 0 : 24 HOURS U.T.
 FREQUENCY - 35 MHZ
 NORMALIZING FACTORS:
 UNDER - 14045. OVER - 34633. SPOR-E - 402943.
 TRAILS - 48678. EVENTS - 451621.

MENU=109,06-4
 13-OCT-93
 PLOT= 109.00

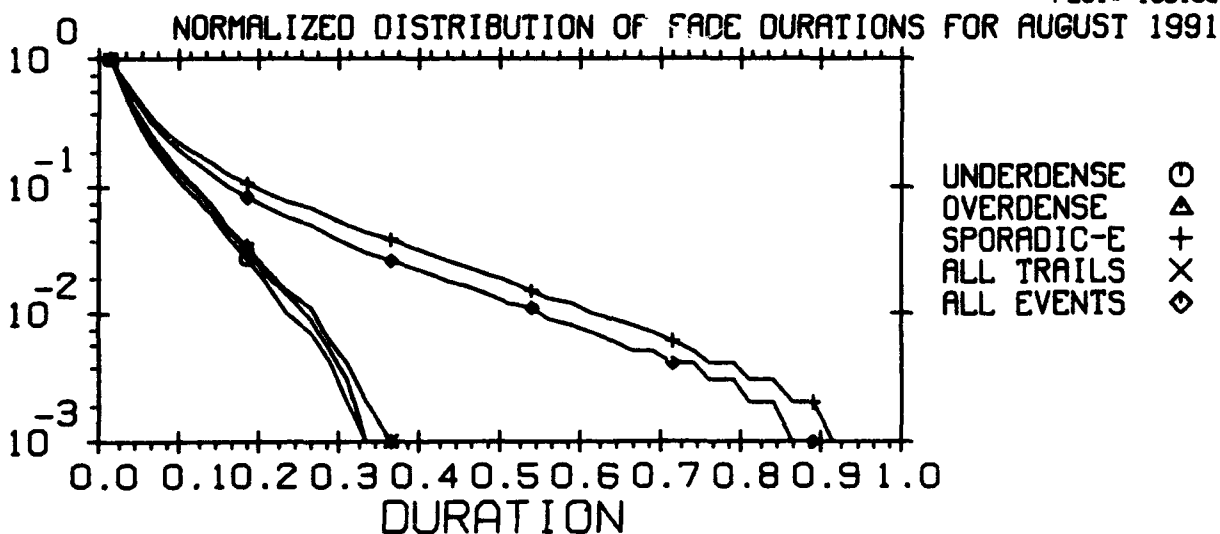

THE TIME OF DAY IS 0 : 24 HOURS U.T.
 FREQUENCY - 45 MHZ
 NORMALIZING FACTORS:
 UNDER - 10582. OVER - 28528. SPOR-E - 87020.
 TRAILS - 39110. EVENTS - 126130.

MENU=109,06-4
 13-OCT-93
 PLOT= 110.00

GEOPHYSICS LAB METEOR SCATTER PROGRAM

NORMALIZED DISTRIBUTION OF FADE DURATIONS FOR AUGUST 1991

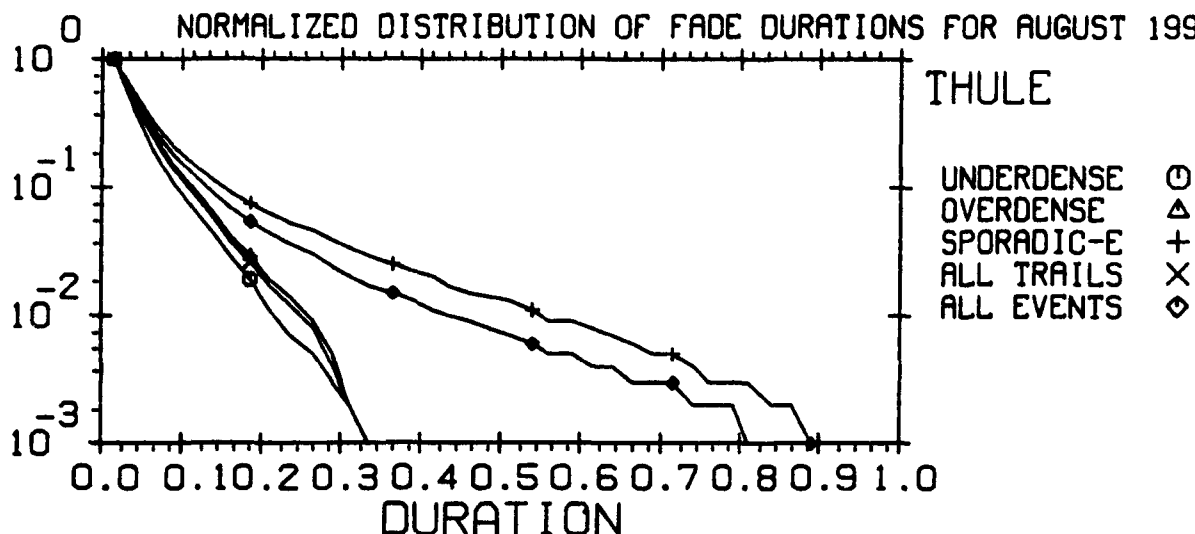

THE TIME OF DAY IS 0 : 24 HOURS U.T.

FREQUENCY - 65 MHZ

NORMALIZING FACTORS:

UNDER - 6430. OVER - 17660. SPOR-E - 32357.

TRAILS - 24090. EVENTS - 56447.

MENU*109,06-4

13-OCT-93

PLOT* 111.00

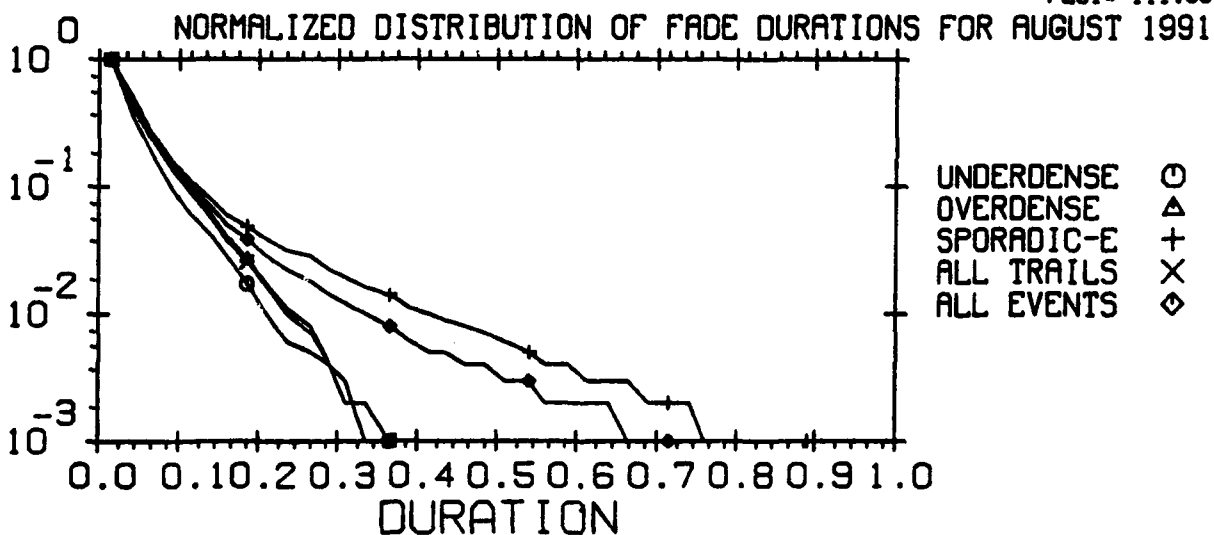

THE TIME OF DAY IS 0 : 24 HOURS U.T.

FREQUENCY - 85 MHZ

NORMALIZING FACTORS:

UNDER - 2969. OVER - 11432. SPOR-E - 17560.

TRAILS - 14401. EVENTS - 31961.

MENU*109,06-4

13-OCT-93

PLOT* 112.00

GEOPHYSICS LAB METEOR SCATTER PROGRAM

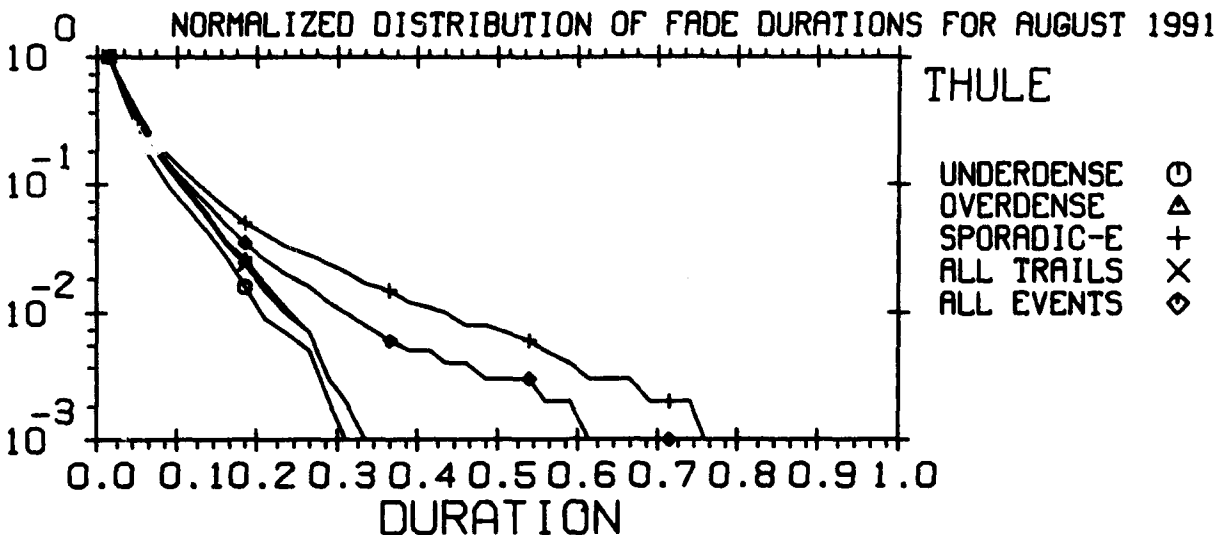

THE TIME OF DAY IS 0 : 24 HOURS U.T.
 FREQUENCY - 104 MHZ
 NORMALIZING FACTORS:
 UNDER - 2191. OVER - 8659. SPOR-E - 8245.
 TRAILS - 10850. EVENTS - 19095.

MENU=109,06-4
 13-OCT-93
 PLOT= 113.00

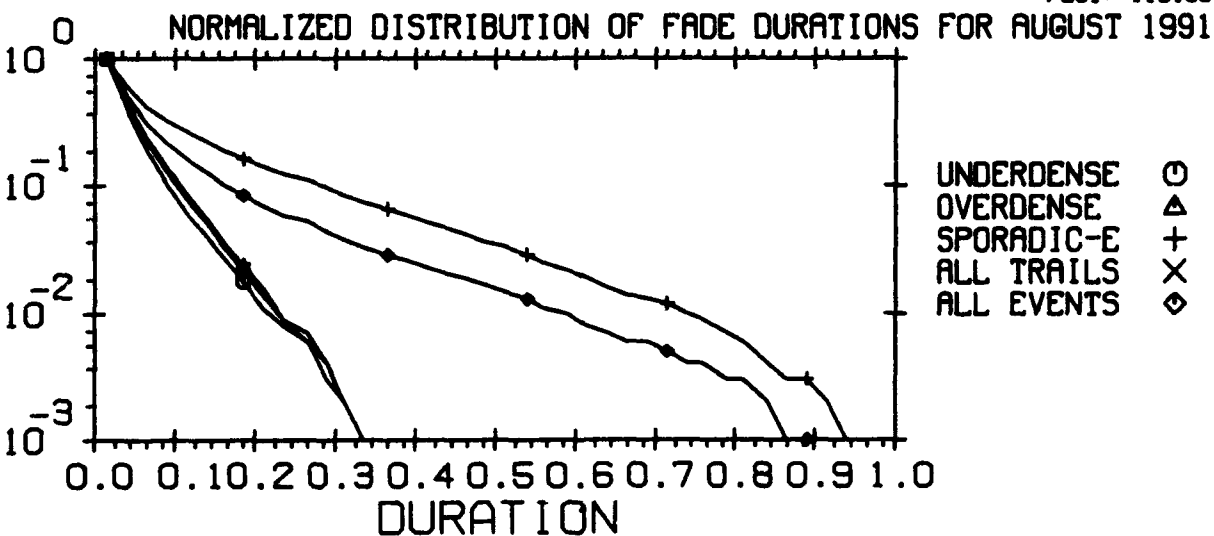

THE TIME OF DAY IS 0 : 24 HOURS U.T.
 FREQUENCY - 147 MHZ
 NORMALIZING FACTORS:
 UNDER - 5951. OVER - 14613. SPOR-E - 16204.
 TRAILS - 20564. EVENTS - 36768.

MENU=109,06-4
 13-OCT-93
 PLOT= 114.00

GEOPHYSICS LAB METEOR SCATTER PROGRAM

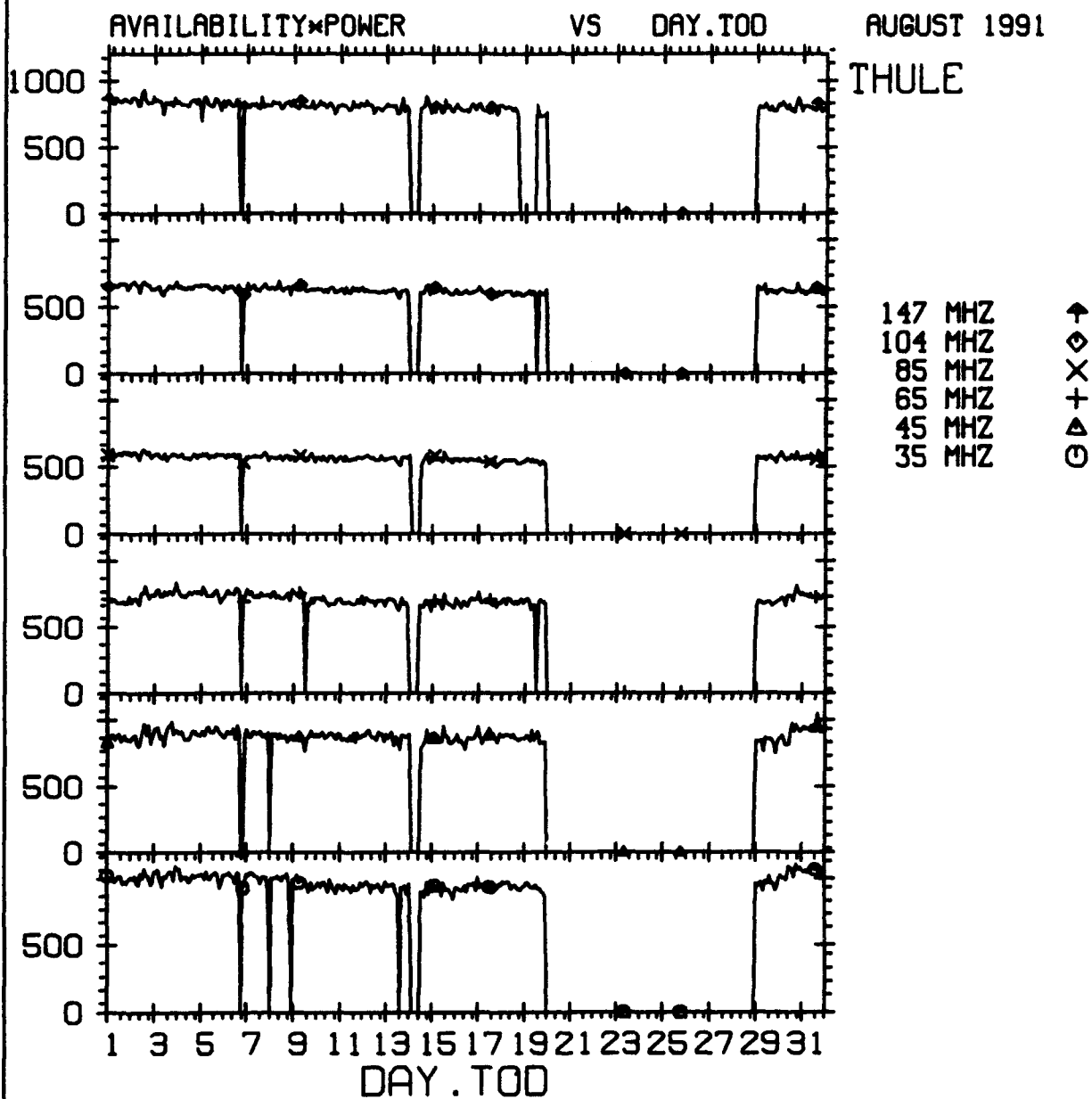

MENU=105,10-1
13-OCT-93
PLOT= 115.00

GEOPHYSICS LAB METEOR SCATTER PROGRAM

TEMP LOG-OF-KELVIN VS DAY.TOD AUGUST 1991

THULE

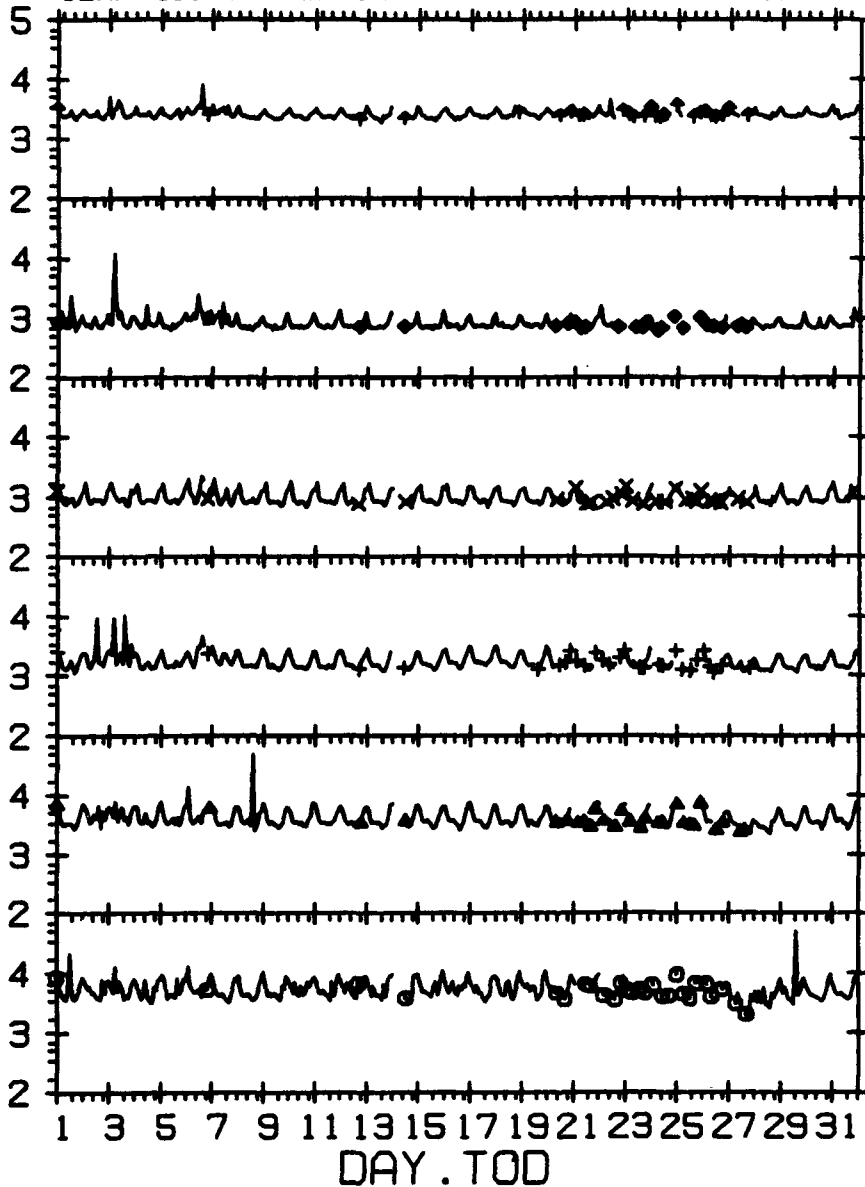

147 MHZ ↑
104 MHZ ◇
85 MHZ ×
65 MHZ +
45 MHZ △
35 MHZ ○

BASED ON OBSERVED NOISE MEASUREMENTS - VERTICAL

MENU#105,06-1
13-OCT-93
PLOT# 116.00

APPENDIX D

STATISTICS FOR SEPTEMBER 1991

GEOPHYSICS LAB METEOR SCATTER PROGRAM

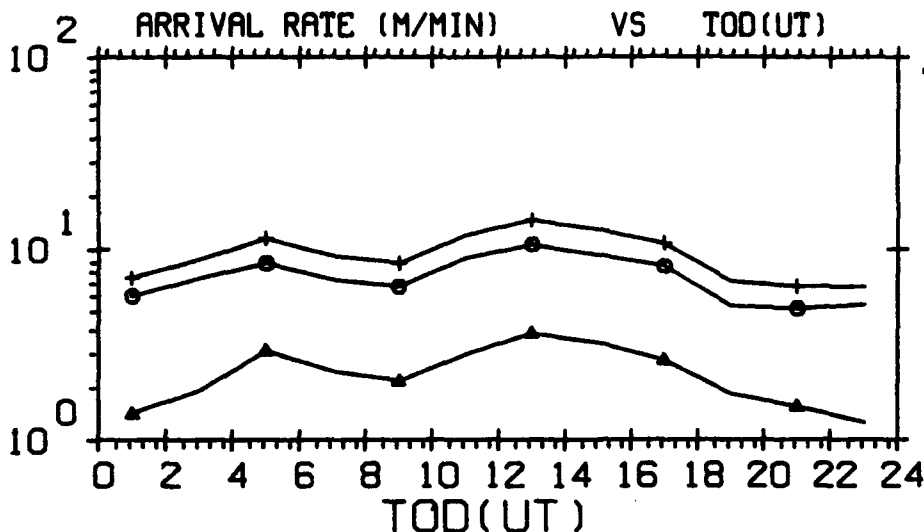

EXCEEDING -126.0 DBM RSL
 FREQUENCY - 35 MHZ
 POLARIZATION - HORIZONTAL
 MAXIMUM DOWN TIME DUE TO SPORADIC-E - 240 SECONDS
 BASED ON OBSERVED NOISE MEASUREMENTS - VERTICAL

MENU*101,05-2
 13-OCT-93
 PLOT* 1.00

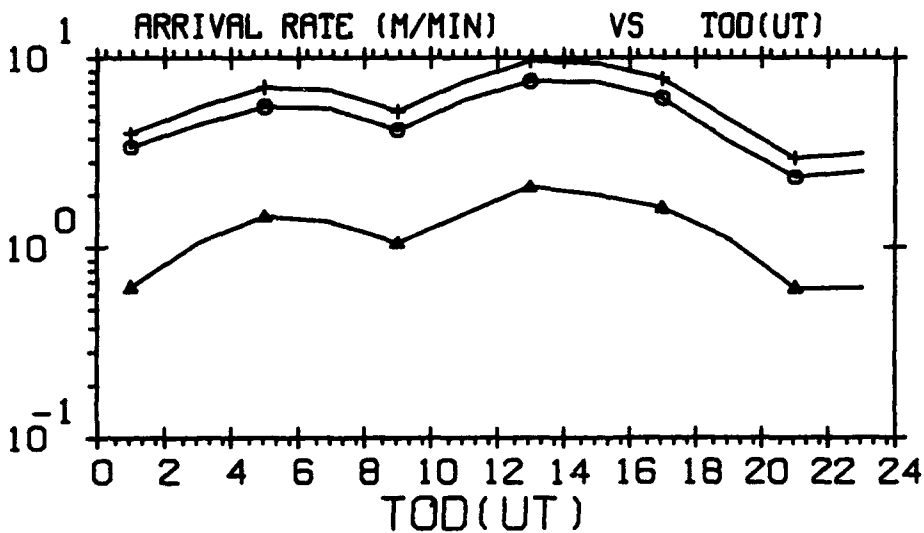

EXCEEDING -126.0 DBM RSL
 FREQUENCY - 45 MHZ
 POLARIZATION - HORIZONTAL
 MAXIMUM DOWN TIME DUE TO SPORADIC-E - 240 SECONDS
 BASED ON OBSERVED NOISE MEASUREMENTS - VERTICAL

MENU*101,05-2
 13-OCT-93
 PLOT* 2.00

GEOPHYSICS LAB METEOR SCATTER PROGRAM

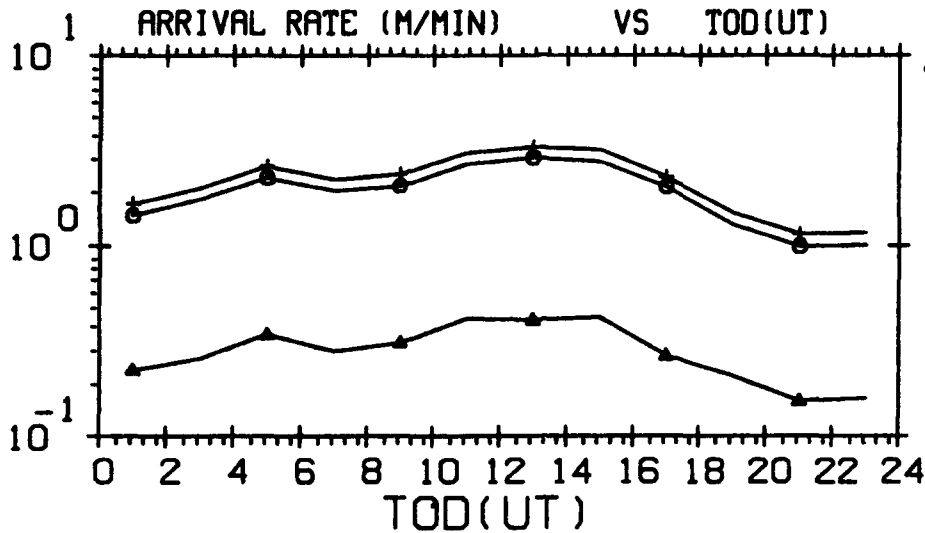

EXCEEDING -126.0 DBM RSL
 FREQUENCY - 65 MHZ
 POLARIZATION - HORIZONTAL
 MAXIMUM DOWN TIME DUE TO SPORADIC-E - 240 SECONDS
 BASED ON OBSERVED NOISE MEASUREMENTS - VERTICAL

MENU#101,05-2
 13-OCT-93
 PLOT# 3.00

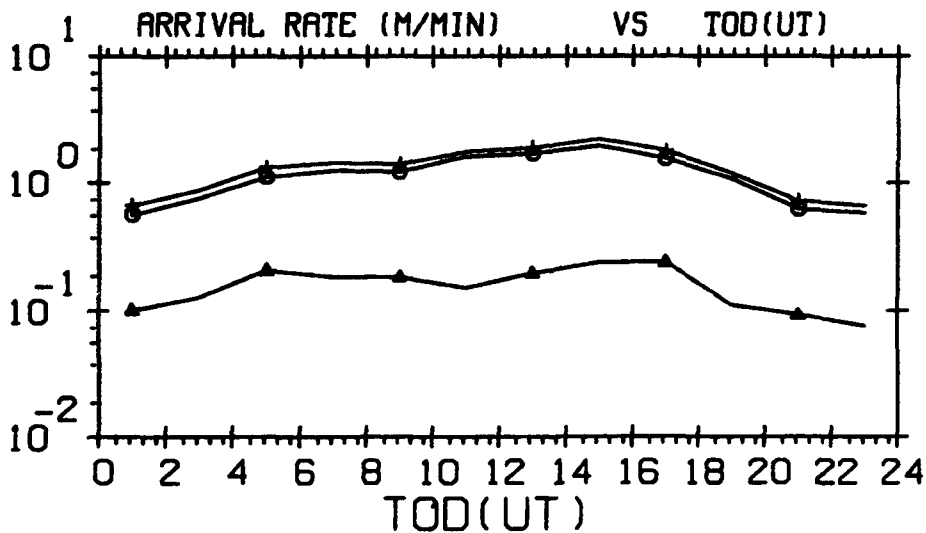

EXCEEDING -126.0 DBM RSL
 FREQUENCY - 85 MHZ
 POLARIZATION - HORIZONTAL
 MAXIMUM DOWN TIME DUE TO SPORADIC-E - 240 SECONDS
 BASED ON OBSERVED NOISE MEASUREMENTS - VERTICAL

MENU#101,05-2
 13-OCT-93
 PLOT# 4.00

GEOPHYSICS LAB METEOR SCATTER PROGRAM

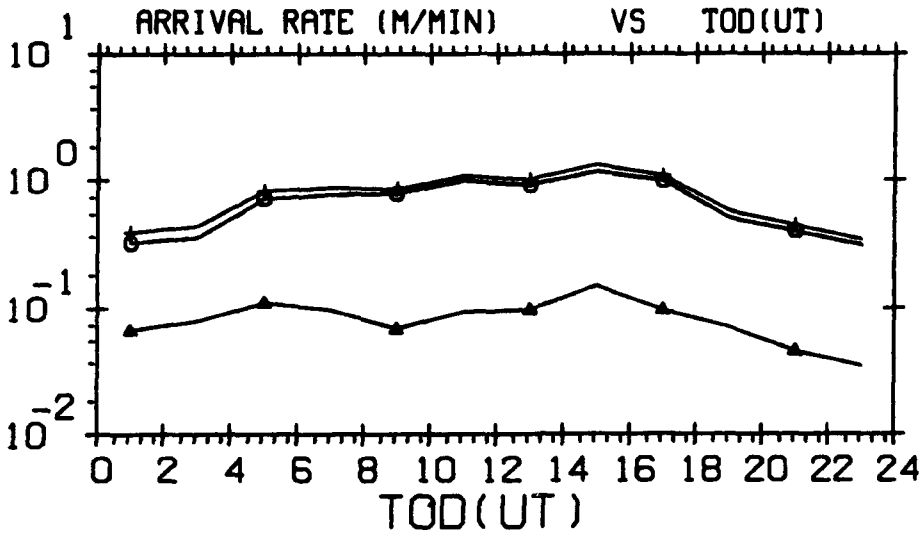

EXCEEDING -126.0 DBM RSL
 FREQUENCY - 104 MHZ
 POLARIZATION - HORIZONTAL
 MAXIMUM DOWN TIME DUE TO SPORADIC-E - 240 SECONDS
 BASED ON OBSERVED NOISE MEASUREMENTS - VERTICAL

MENU#101,05-2
 13-OCT-93
 PLOT# 5.00

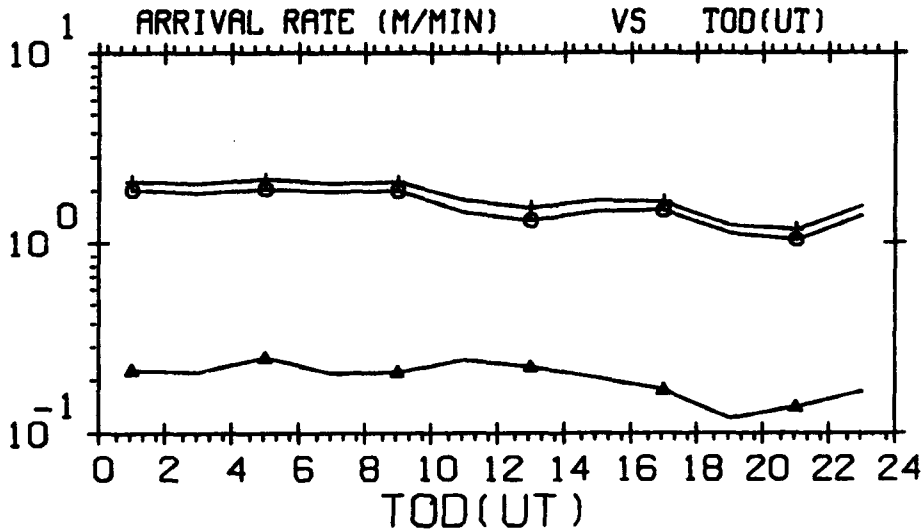

EXCEEDING -126.0 DBM RSL
 FREQUENCY - 147 MHZ
 POLARIZATION - HORIZONTAL
 MAXIMUM DOWN TIME DUE TO SPORADIC-E - 240 SECONDS
 BASED ON OBSERVED NOISE MEASUREMENTS - VERTICAL

MENU#101,05-2
 13-OCT-93
 PLOT# 6.00

GEOPHYSICS LAB METEOR SCATTER PROGRAM

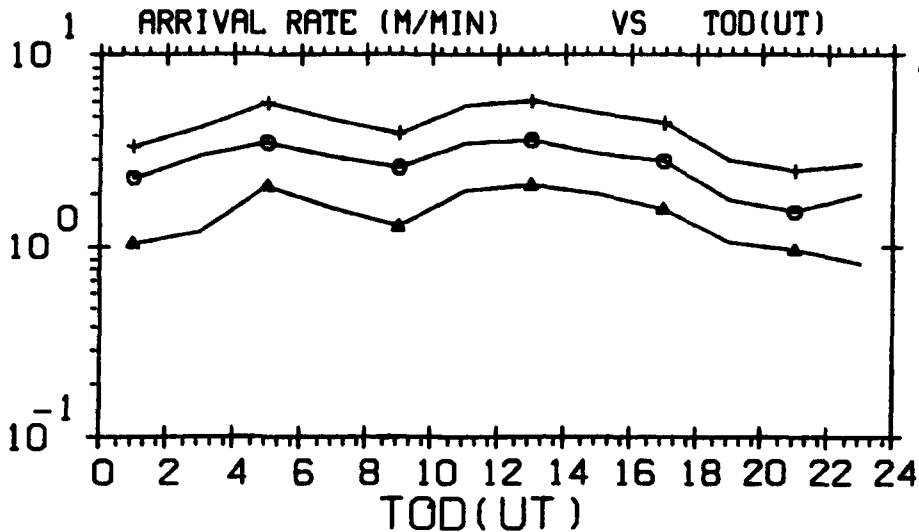

UNDERDENSE ○
 OVERDENSE △
 ALL TRAILS +

EXCEEDING -116.0 DBM RSL
 FREQUENCY - 35 MHZ
 POLARIZATION - HORIZONTAL
 MAXIMUM DOWN TIME DUE TO SPORADIC-E - 240 SECONDS
 BASED ON OBSERVED NOISE MEASUREMENTS - VERTICAL

MENU#101,05-2
 13-OCT-93
 PLOT# 7.00

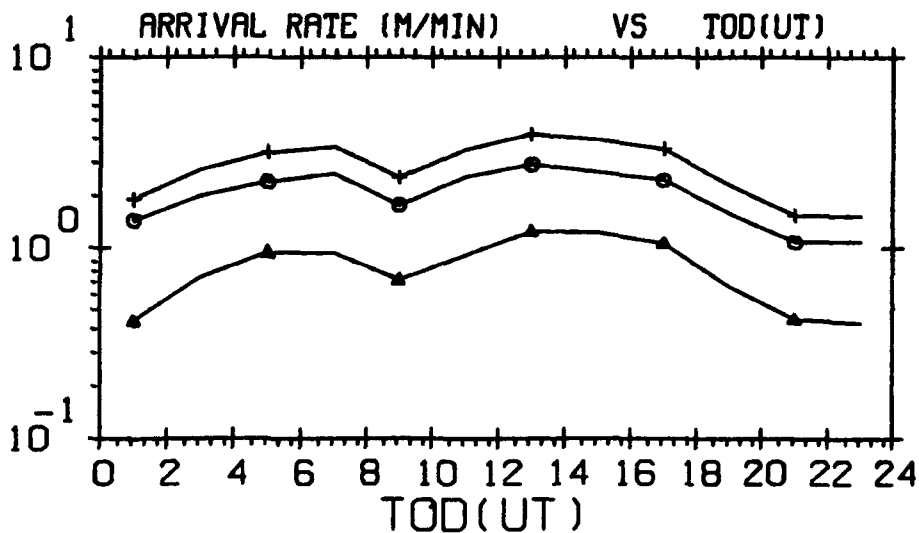

UNDERDENSE ○
 OVERDENSE △
 ALL TRAILS +

EXCEEDING -116.0 DBM RSL
 FREQUENCY - 45 MHZ
 POLARIZATION - HORIZONTAL
 MAXIMUM DOWN TIME DUE TO SPORADIC-E - 240 SECONDS
 BASED ON OBSERVED NOISE MEASUREMENTS - VERTICAL

MENU#101,05-2
 13-OCT-93
 PLOT# 8.00

GEOPHYSICS LAB METEOR SCATTER PROGRAM

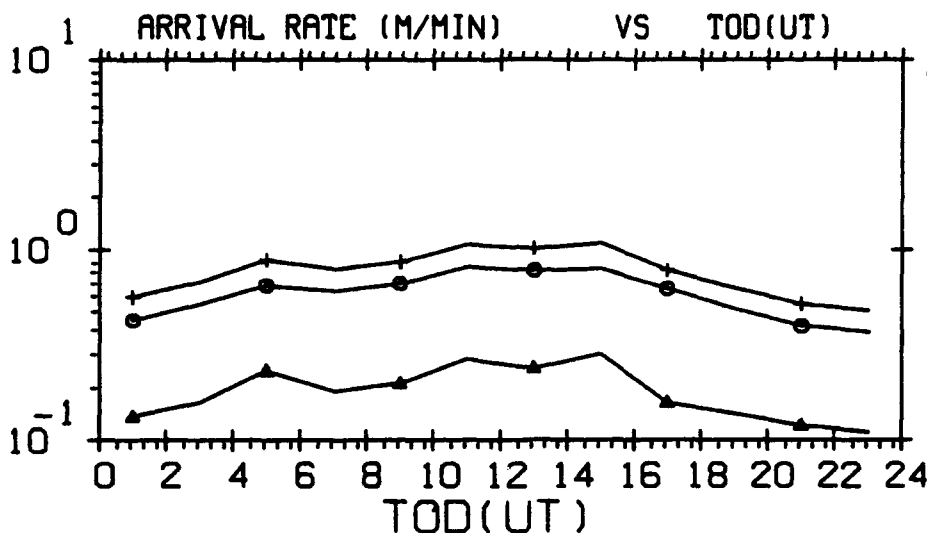

EXCEEDING -116.0 DBM RSL
 FREQUENCY - 65 MHZ
 POLARIZATION - HORIZONTAL
 MAXIMUM DOWN TIME DUE TO SPORADIC-E - 240 SECONDS
 BASED ON OBSERVED NOISE MEASUREMENTS - VERTICAL

MENU#101,05-2
 13-OCT-93
 PLOT# 9.00

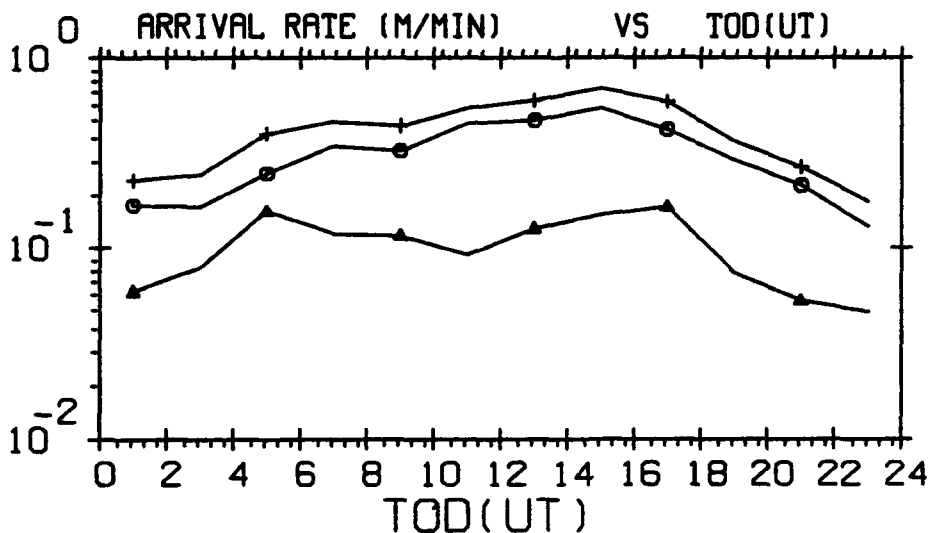

EXCEEDING -116.0 DBM RSL
 FREQUENCY - 85 MHZ
 POLARIZATION - HORIZONTAL
 MAXIMUM DOWN TIME DUE TO SPORADIC-E - 240 SECONDS
 BASED ON OBSERVED NOISE MEASUREMENTS - VERTICAL

MENU#101,05-2
 13-OCT-93
 PLOT# 10.00

GEOPHYSICS LAB METEOR SCATTER PROGRAM

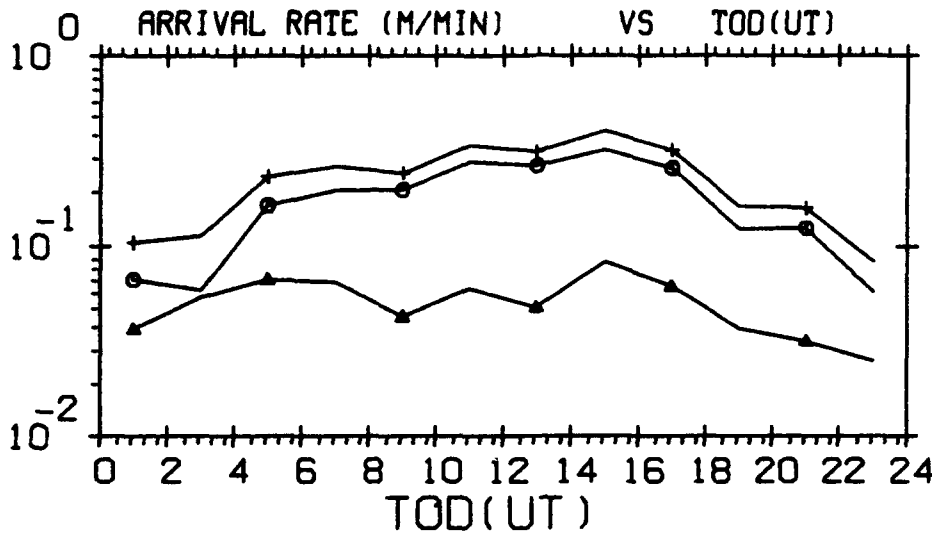

EXCEEDING -116.0 DBM RSL
 FREQUENCY - 104 MHZ
 POLARIZATION - HORIZONTAL
 MAXIMUM DOWN TIME DUE TO SPORADIC-E - 240 SECONDS
 BASED ON OBSERVED NOISE MEASUREMENTS - VERTICAL

MENU*101,05-2
 13-OCT-93
 PLOT* 11.00

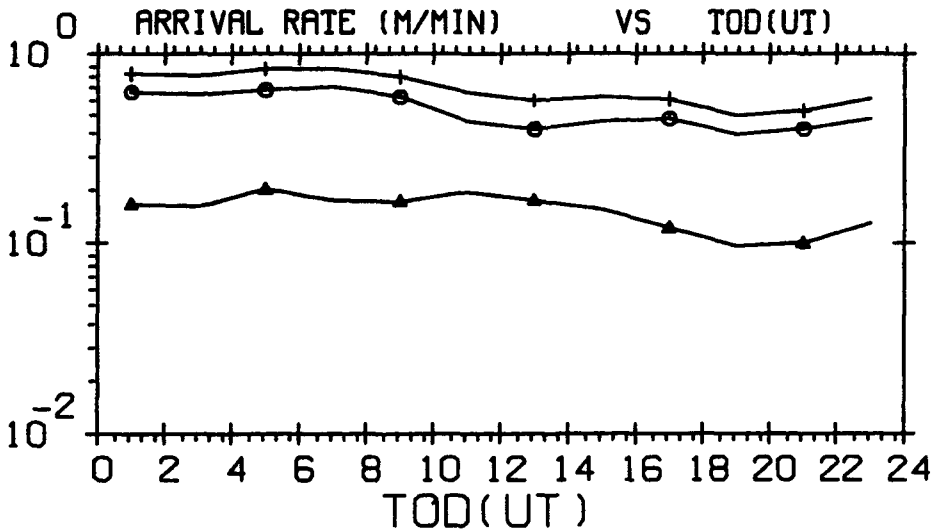

EXCEEDING -116.0 DBM RSL
 FREQUENCY - 147 MHZ
 POLARIZATION - HORIZONTAL
 MAXIMUM DOWN TIME DUE TO SPORADIC-E - 240 SECONDS
 BASED ON OBSERVED NOISE MEASUREMENTS - VERTICAL

MENU*101,05-2
 13-OCT-93
 PLOT* 12.00

GEOPHYSICS LAB METEOR SCATTER PROGRAM

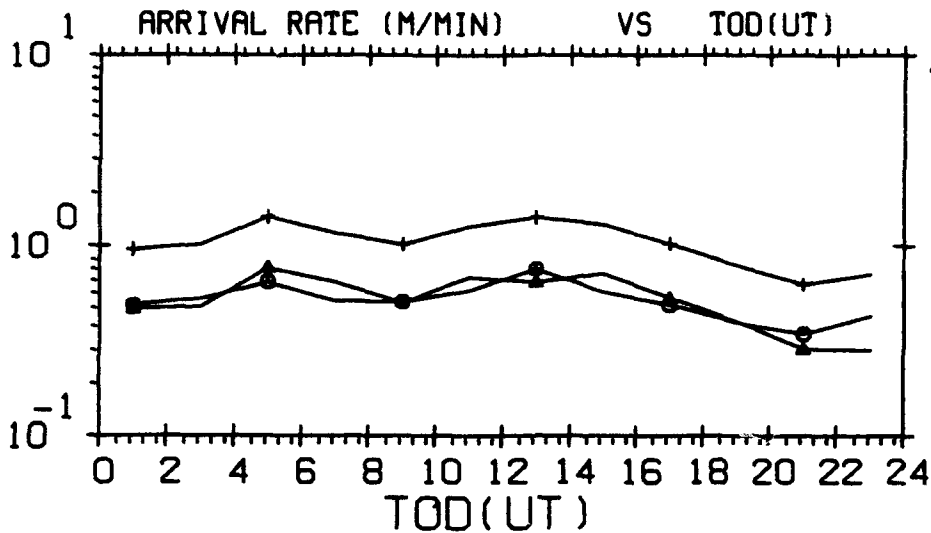

UNDERDENSE ○
 OVERDENSE △
 ALL TRAILS +

EXCEEDING -106.0 DBM RSL
 FREQUENCY - 35 MHZ
 POLARIZATION - HORIZONTAL
 MAXIMUM DOWN TIME DUE TO SPORADIC-E - 240 SECONDS
 BASED ON OBSERVED NOISE MEASUREMENTS - VERTICAL

MENU=101,05-2
 13-OCT-93
 PLOT= 13.00

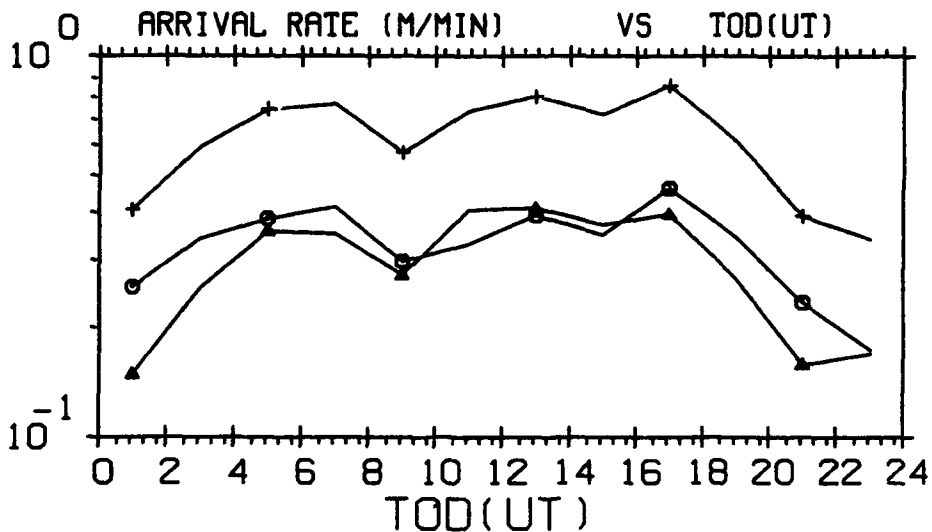

UNDERDENSE ○
 OVERDENSE △
 ALL TRAILS +

EXCEEDING -106.0 DBM RSL
 FREQUENCY - 45 MHZ
 POLARIZATION - HORIZONTAL
 MAXIMUM DOWN TIME DUE TO SPORADIC-E - 240 SECONDS
 BASED ON OBSERVED NOISE MEASUREMENTS - VERTICAL

MENU=101,C5-2
 13-OCT-93
 PLOT= 14.00

GEOPHYSICS LAB METEOR SCATTER PROGRAM

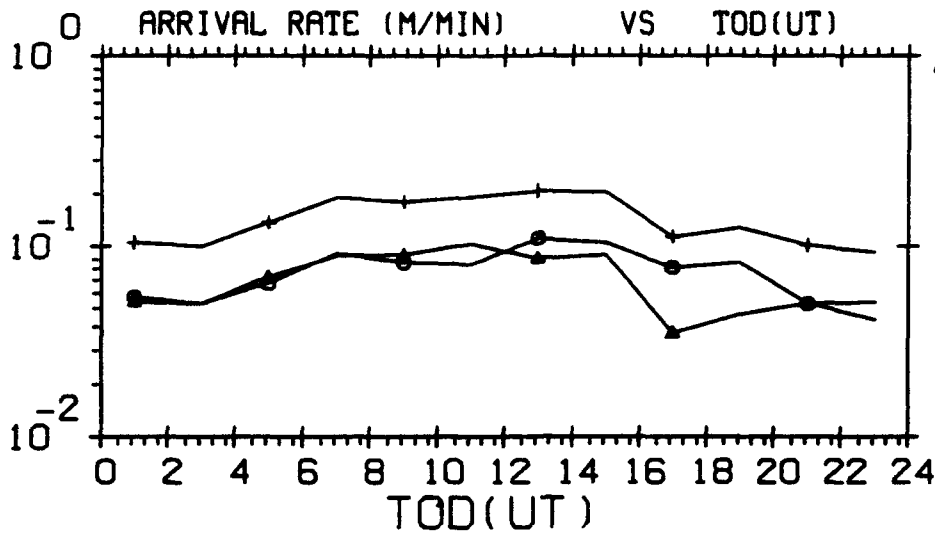

EXCEEDING -106.0 DBM RSL
 FREQUENCY - 65 MHZ
 POLARIZATION - HORIZONTAL
 MAXIMUM DOWN TIME DUE TO SPORADIC-E - 240 SECONDS
 BASED ON OBSERVED NOISE MEASUREMENTS - VERTICAL

MENU=101,05-2
 13-OCT-93
 PLOT= 15.00

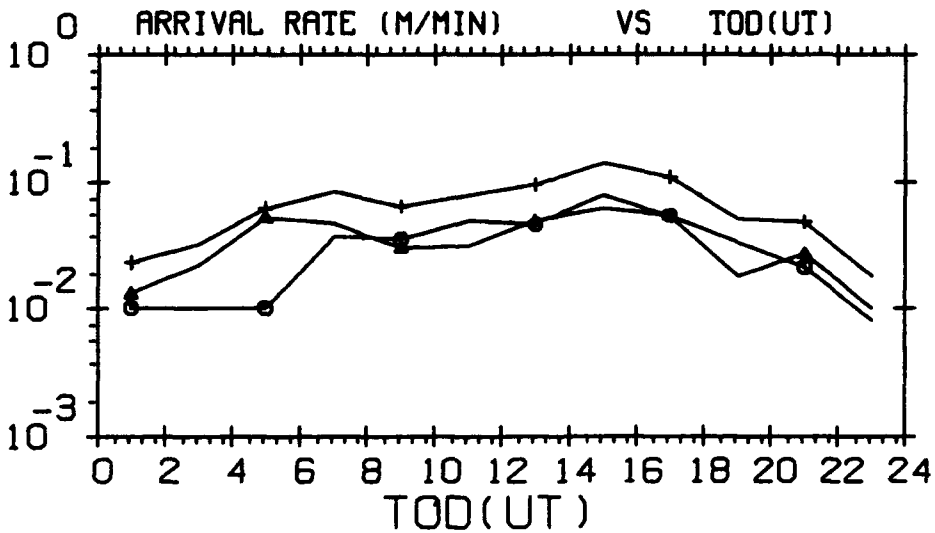

EXCEEDING -106.0 DBM RSL
 FREQUENCY - 85 MHZ
 POLARIZATION - HORIZONTAL
 MAXIMUM DOWN TIME DUE TO SPORADIC-E - 240 SECONDS
 BASED ON OBSERVED NOISE MEASUREMENTS - VERTICAL

MENU=101,05-2
 13-OCT-93
 PLOT= 16.00

GEOPHYSICS LAB METEOR SCATTER PROGRAM

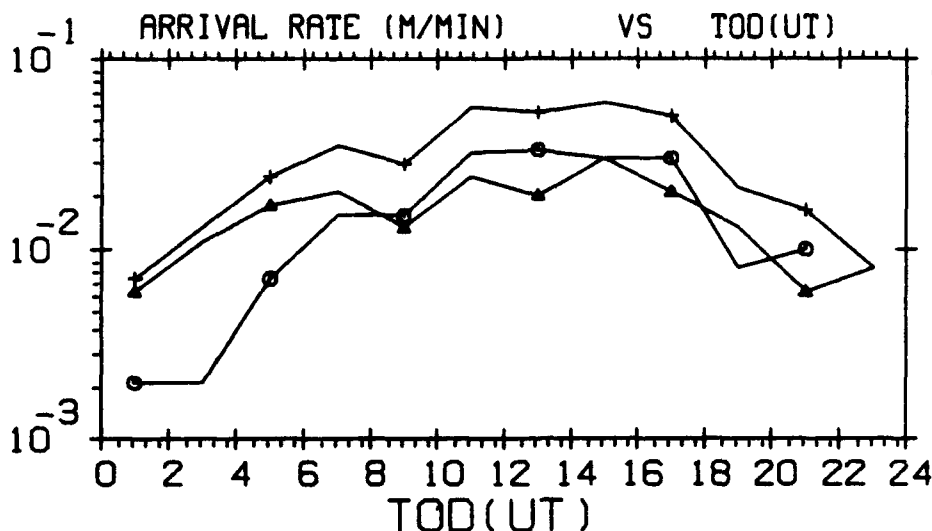

UNDERDENSE ○
 OVERDENSE ▲
 ALL TRAILS +

EXCEEDING -106.0 DBM RSL
 FREQUENCY - 104 MHZ
 POLARIZATION - HORIZONTAL
 MAXIMUM DOWN TIME DUE TO SPORADIC-E - 240 SECONDS
 BASED ON OBSERVED NOISE MEASUREMENTS - VERTICAL

MENU#101,05-2
 13-OCT-93
 PLOT# 17.00

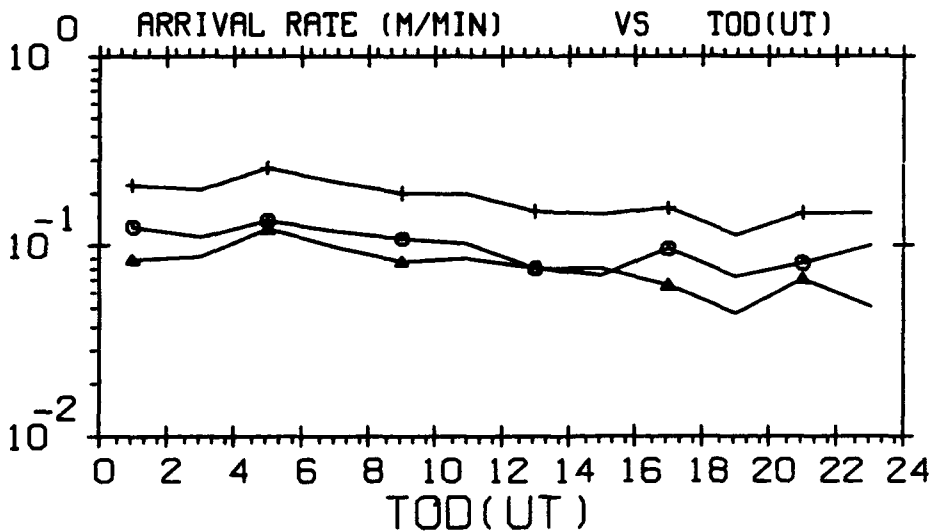

UNDERDENSE ○
 OVERDENSE ▲
 ALL TRAILS +

EXCEEDING -106.0 DBM RSL
 FREQUENCY - 147 MHZ
 POLARIZATION - HORIZONTAL
 MAXIMUM DOWN TIME DUE TO SPORADIC-E - 240 SECONDS
 BASED ON OBSERVED NOISE MEASUREMENTS - VERTICAL

MENU#101,05-2
 13-OCT-93
 PLOT# 18.00

GEOPHYSICS LAB METEOR SCATTER PROGRAM

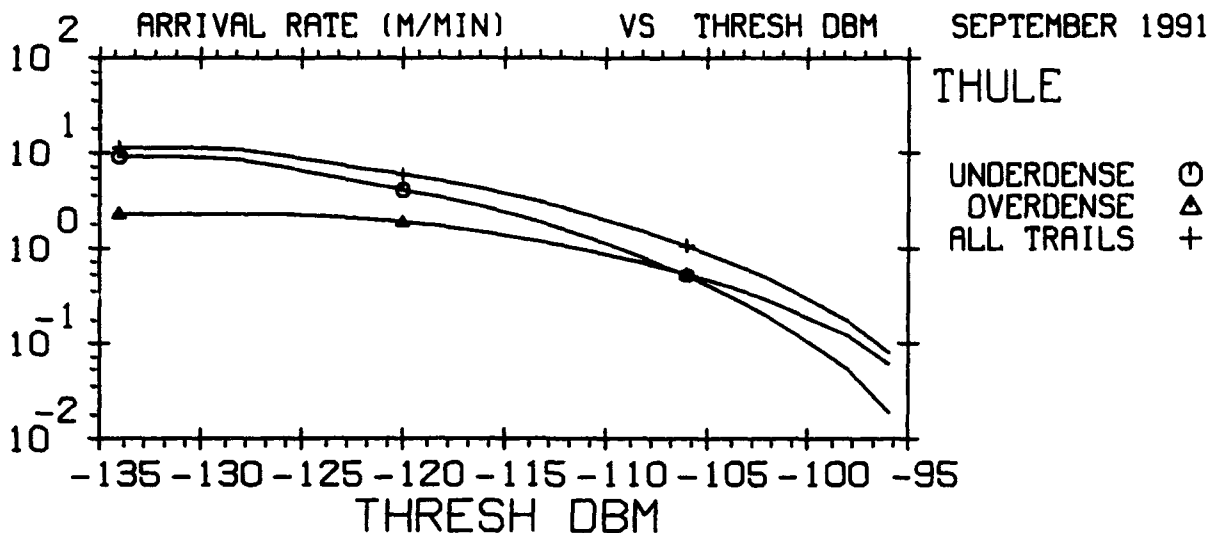

THE TIME OF DAY IS 0 : 24 HOURS U.T.
 FREQUENCY - 35 MHZ
 POLARIZATION - HORIZONTAL
 MAXIMUM DOWN TIME DUE TO SPORADIC-E - 240 SECONDS
 BASED ON OBSERVED NOISE MEASUREMENTS - VERTICAL

MENU*101,06-2
 13-OCT-93
 PLOT* 19.00

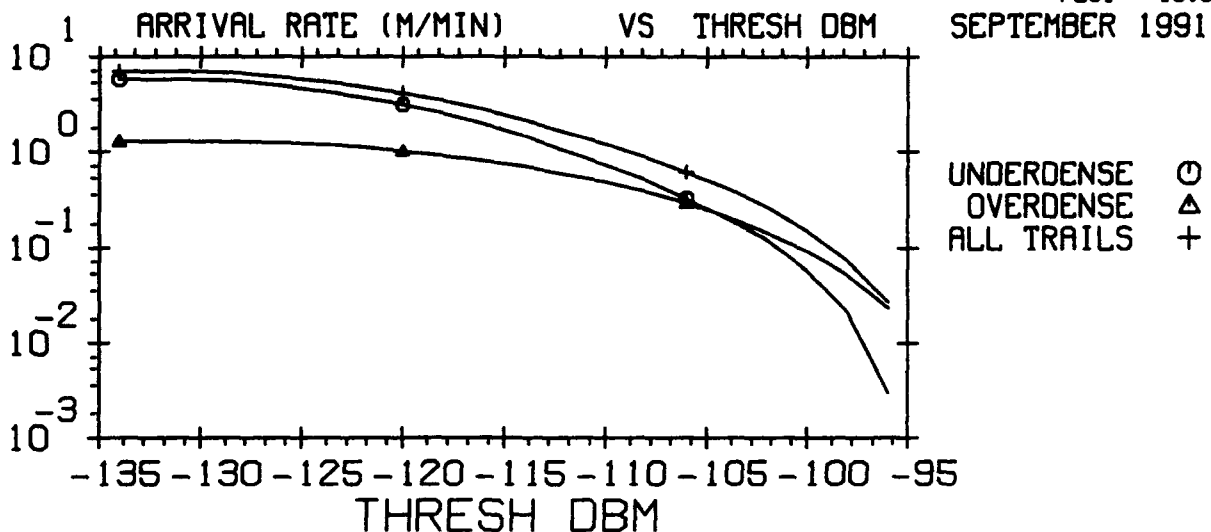

THE TIME OF DAY IS 0 : 24 HOURS U.T.
 FREQUENCY - 45 MHZ
 POLARIZATION - HORIZONTAL
 MAXIMUM DOWN TIME DUE TO SPORADIC-E - 240 SECONDS
 BASED ON OBSERVED NOISE MEASUREMENTS - VERTICAL

MENU*101,06-2
 13-OCT-93
 PLOT* 20.00

GEOPHYSICS LAB METEOR SCATTER PROGRAM

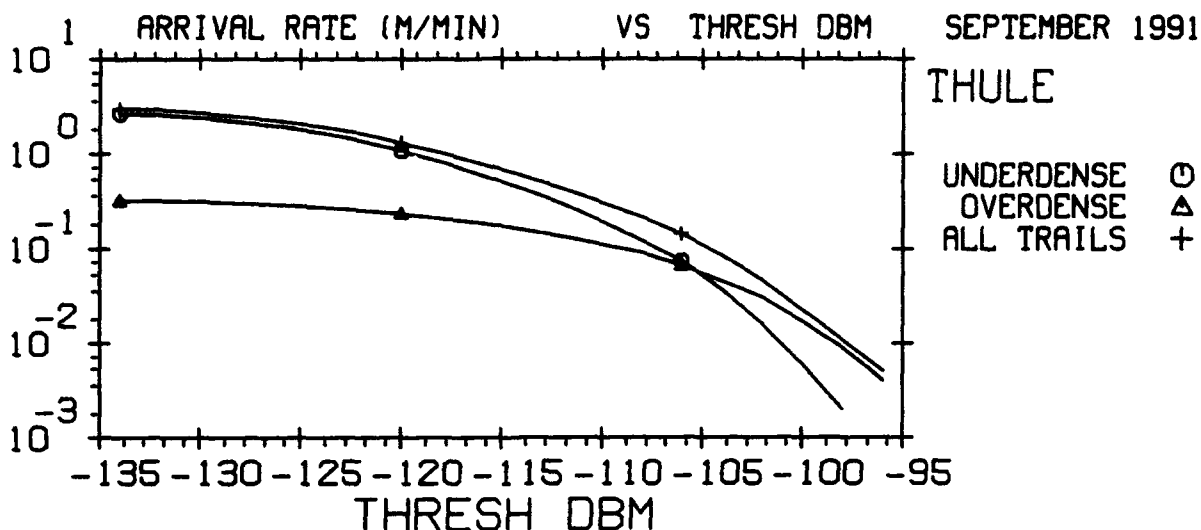

THE TIME OF DAY IS 0 : 24 HOURS U.T.
 FREQUENCY - 65 MHZ
 POLARIZATION - HORIZONTAL
 MAXIMUM DOWN TIME DUE TO SPORADIC-E - 240 SECONDS
 BASED ON OBSERVED NOISE MEASUREMENTS - VERTICAL

MENU*101,06-2
 13-OCT-93
 PLOT* 21.00

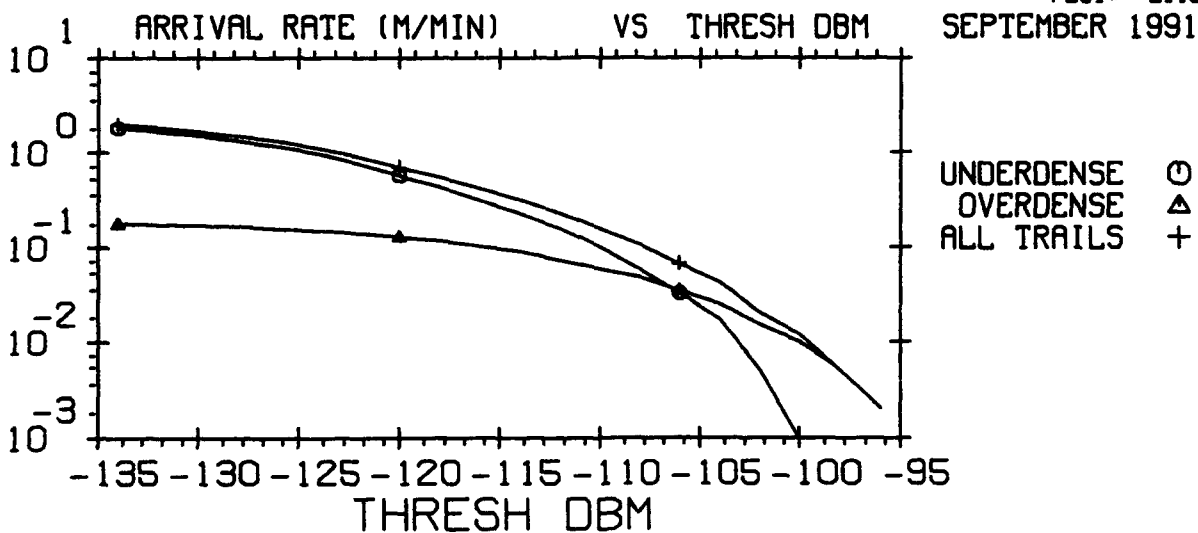

THE TIME OF DAY IS 0 : 24 HOURS U.T.
 FREQUENCY - 85 MHZ
 POLARIZATION - HORIZONTAL
 MAXIMUM DOWN TIME DUE TO SPORADIC-E - 240 SECONDS
 BASED ON OBSERVED NOISE MEASUREMENTS - VERTICAL

MENU*101,05-2
 13-OCT-93
 PLOT* 22.00

GEOPHYSICS LAB METEOR SCATTER PROGRAM

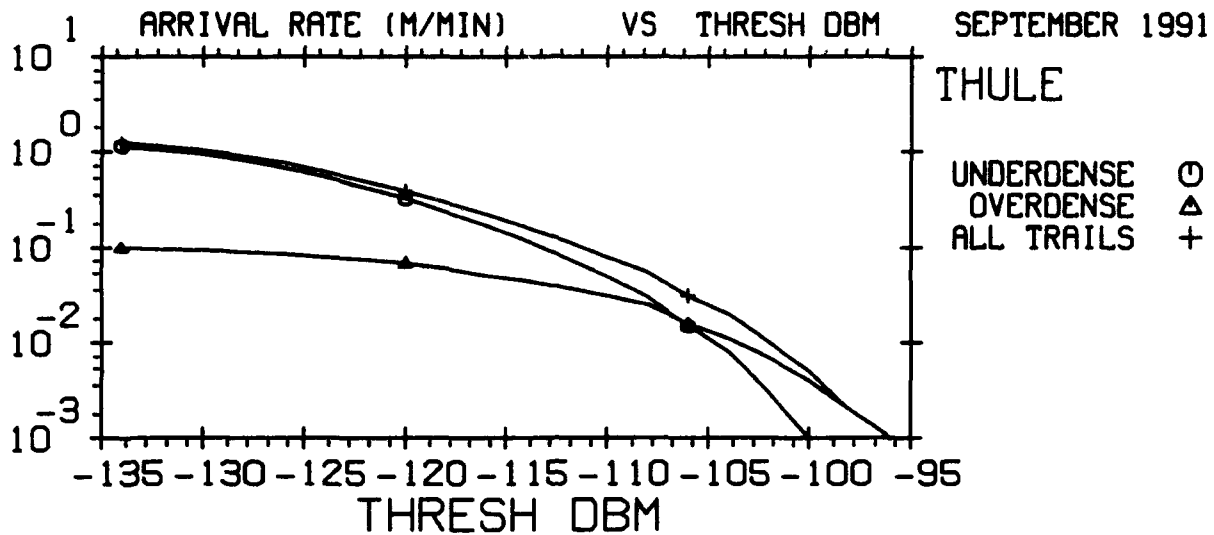

THE TIME OF DAY IS 0 : 24 HOURS U.T.
 FREQUENCY - 104 MHZ
 POLARIZATION - HORIZONTAL
 MAXIMUM DOWN TIME DUE TO SPORADIC-E - 240 SECONDS
 BASED ON OBSERVED NOISE MEASUREMENTS - VERTICAL

MENU*101,06-2
 13-OCT-93
 PLOT* 23.00

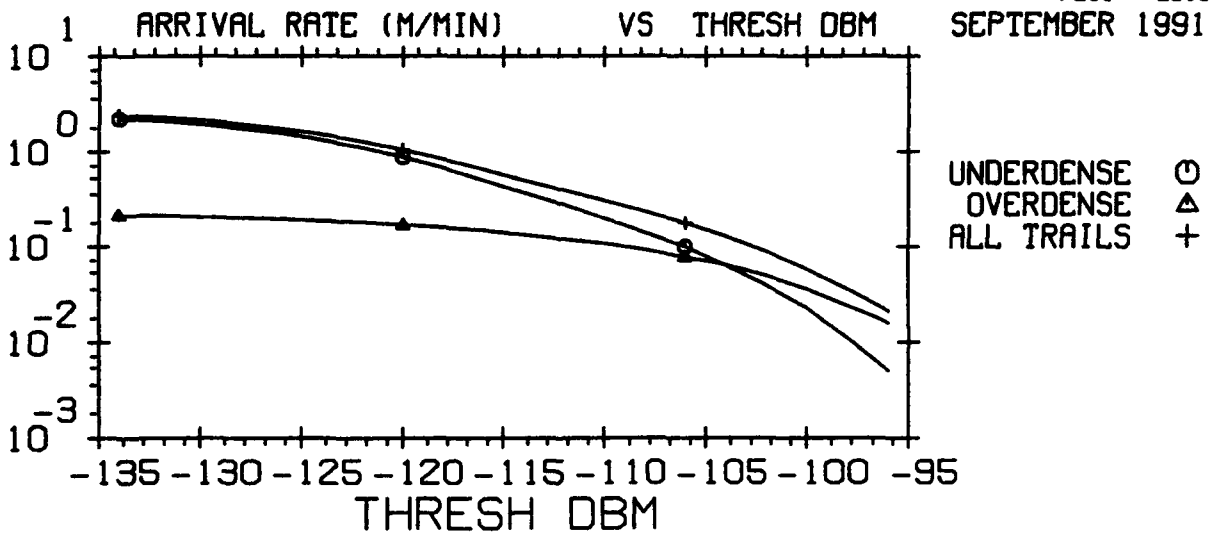

THE TIME OF DAY IS 0 : 24 HOURS U.T.
 FREQUENCY - 147 MHZ
 POLARIZATION - HORIZONTAL
 MAXIMUM DOWN TIME DUE TO SPORADIC-E - 240 SECONDS
 BASED ON OBSERVED NOISE MEASUREMENTS - VERTICAL

MENU*101,06-2
 13-OCT-93
 PLOT* 24.00

GEOPHYSICS LAB METEOR SCATTER PROGRAM

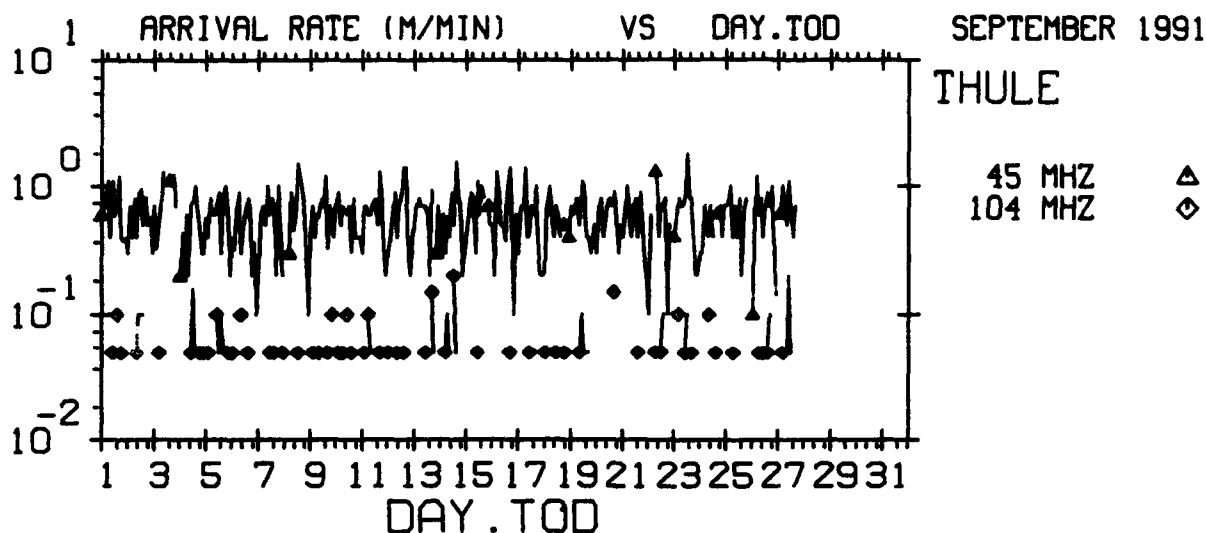

EXCEEDING -106.0 DBM RSL
 TYPE OF METEOR TRAIL - UNDERDENSE AND OVERDENSE
 POLARIZATION - HORIZONTAL
 MAXIMUM DOWN TIME DUE TO SPORADIC-E - 240 SECONDS
 BASED ON OBSERVED NOISE MEASUREMENTS - VERTICAL

MENU#101,03-2
 13-OCT-93
 PLOT# 27.00

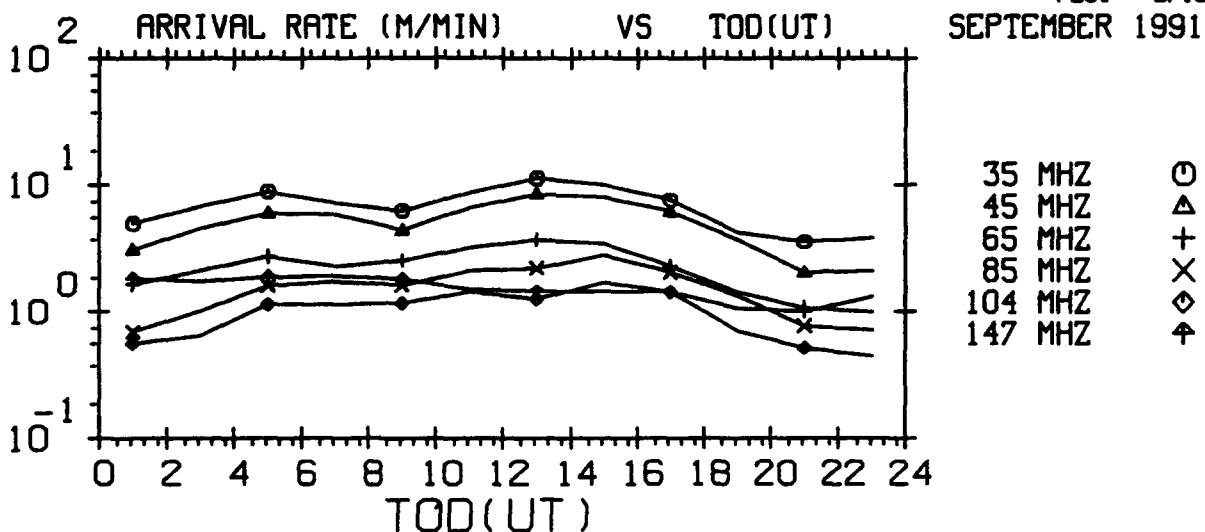

EXCEEDING 19.0 DB SNR
 TYPE OF METEOR TRAIL - UNDERDENSE AND OVERDENSE
 EFFECTIVE SYSTEM BANDWIDTH - 100.HZ
 POLARIZATION - HORIZONTAL
 MAXIMUM DOWN TIME DUE TO SPORADIC-E - 240 SECONDS
 BASED ON OBSERVED NOISE MEASUREMENTS - VERTICAL

MENU#102,01-2
 13-OCT-93
 PLOT# 28.00

GEOPHYSICS LAB METEOR SCATTER PROGRAM

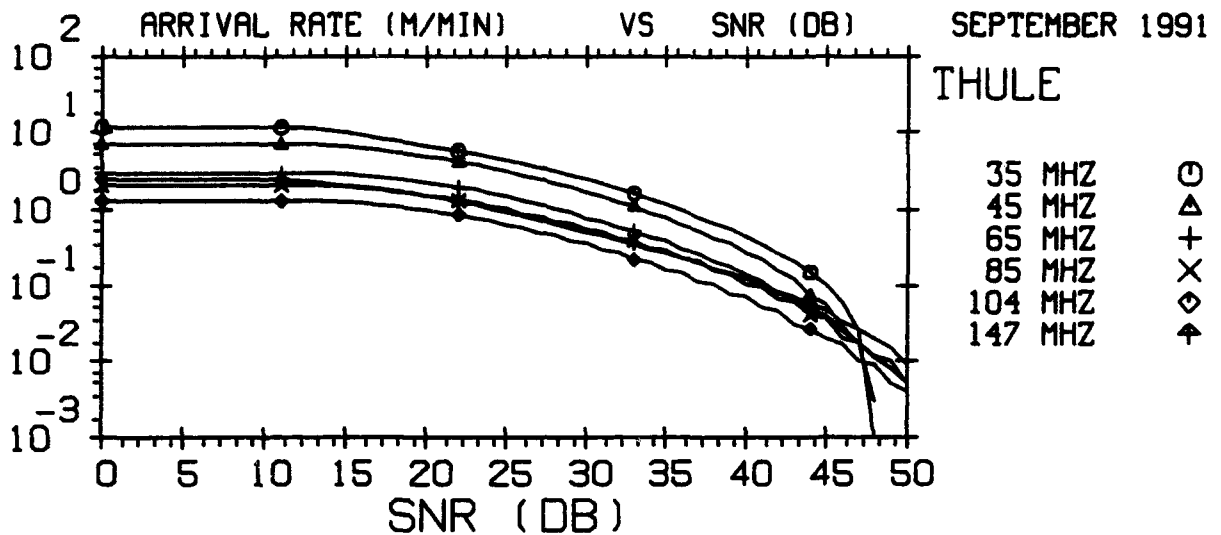

THE TIME OF DAY IS 0 : 24 HOURS U.T.
 TYPE OF METEOR TRAIL - UNDERDENSE AND OVERDENSE
 EFFECTIVE SYSTEM BANDWIDTH - 100.HZ
 POLARIZATION - HORIZONTAL
 MAXIMUM DOWN TIME DUE TO SPORADIC-E - 240 SECONDS
 BASED ON OBSERVED NOISE MEASUREMENTS - VERTICAL

MENU*102,02-2
 13-OCT-93
 PLOT* 29.00

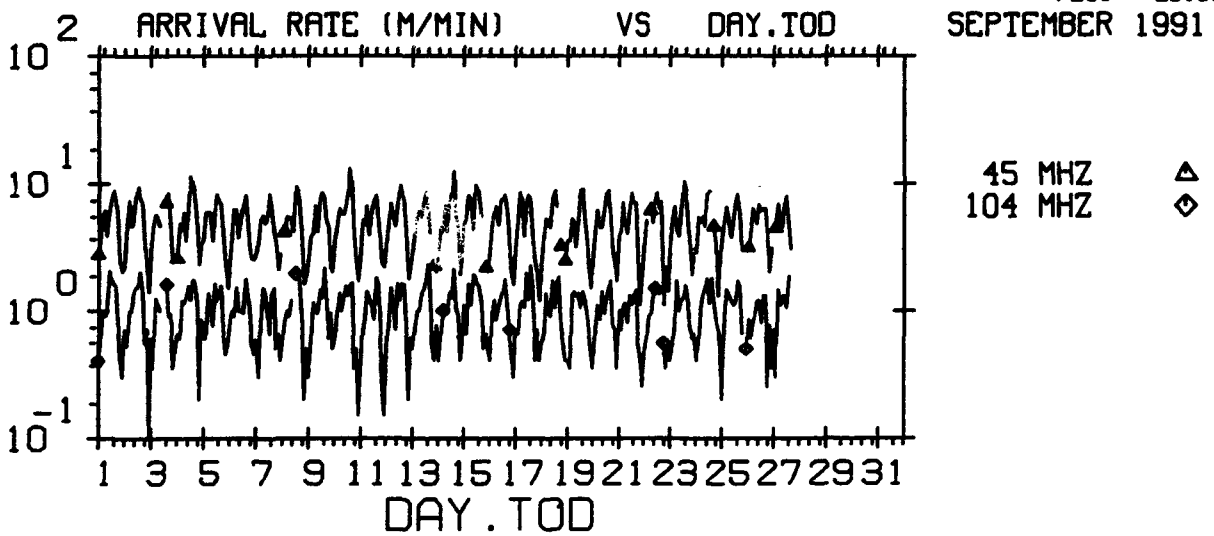

EXCEEDING 19.0 DB SNR
 TYPE OF METEOR TRAIL - UNDERDENSE AND OVERDENSE
 EFFECTIVE SYSTEM BANDWIDTH - 100.HZ
 POLARIZATION - HORIZONTAL
 MAXIMUM DOWN TIME DUE TO SPORADIC-E - 240 SECONDS
 BASED ON OBSERVED NOISE MEASUREMENTS - VERTICAL

MENU*102,03-2
 13-OCT-93
 PLOT* 30.00

GEOPHYSICS LAB METEOR SCATTER PROGRAM

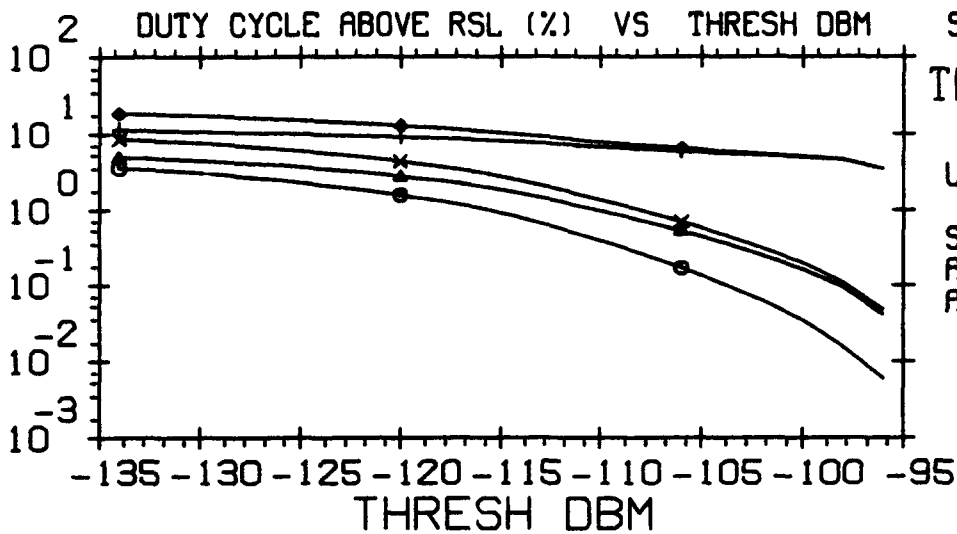

THE TIME OF DAY IS 0 : 24 HOURS U.T.
 FREQUENCY - 35 MHZ
 POLARIZATION - HORIZONTAL
 BASED ON OBSERVED NOISE MEASUREMENTS - VERTICAL

MENU#103,06-2
 13-OCT-93
 PLOT# 31.00

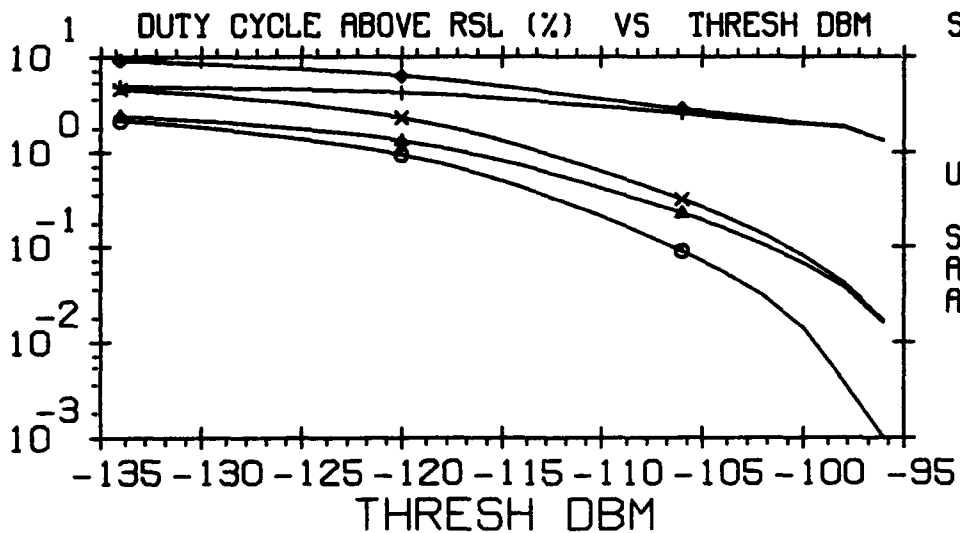

THE TIME OF DAY IS 0 : 24 HOURS U.T.
 FREQUENCY - 45 MHZ
 POLARIZATION - HORIZONTAL
 BASED ON OBSERVED NOISE MEASUREMENTS - VERTICAL

MENU#103,06-2
 13-OCT-93
 PLOT# 32.00

GEOPHYSICS LAB METEOR SCATTER PROGRAM

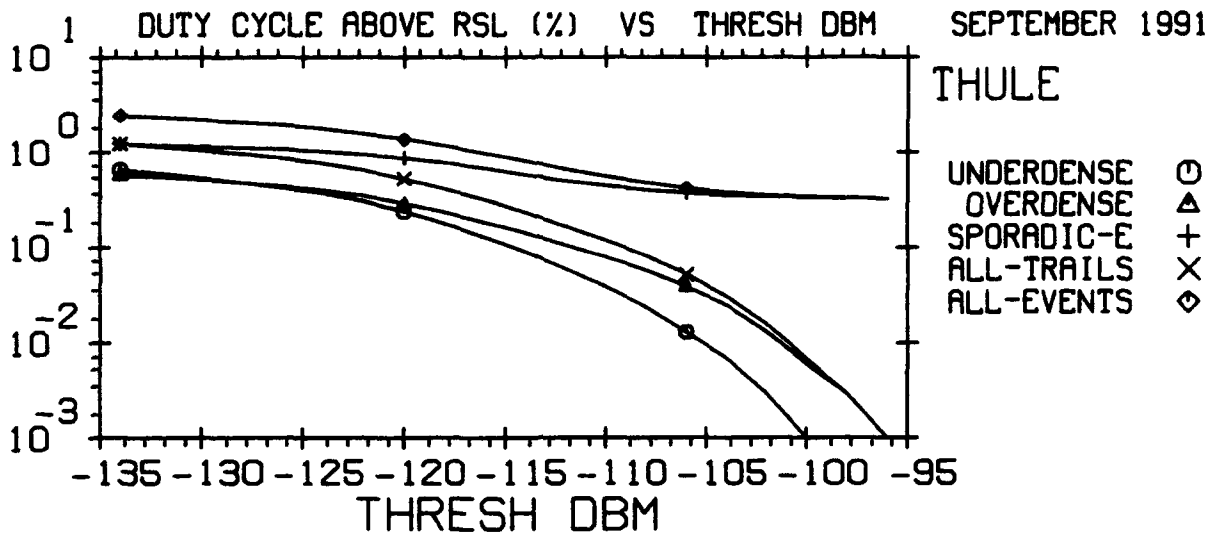

THE TIME OF DAY IS 0 : 24 HOURS U.T.
 FREQUENCY - 65 MHZ
 POLARIZATION - HORIZONTAL
 BASED ON OBSERVED NOISE MEASUREMENTS - VERTICAL

MENU#103,06-2
 13-OCT-93
 PLOT# 33.00

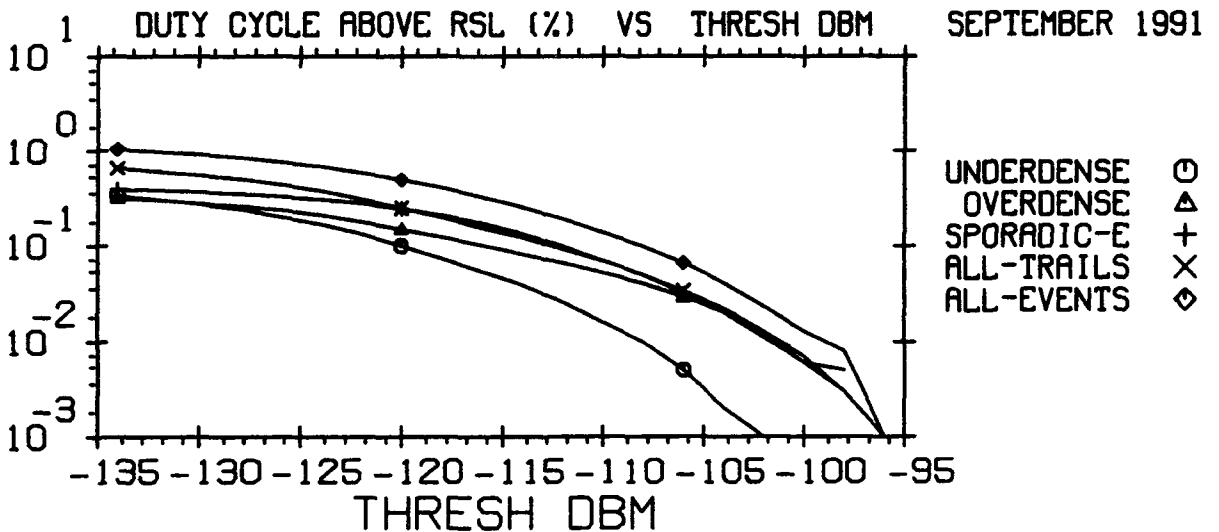

THE TIME OF DAY IS 0 : 24 HOURS U.T.
 FREQUENCY - 85 MHZ
 POLARIZATION - HORIZONTAL
 BASED ON OBSERVED NOISE MEASUREMENTS - VERTICAL

MENU#103,06-2
 13-OCT-93
 PLOT# 34.00

GEOPHYSICS LAB METEOR SCATTER PROGRAM

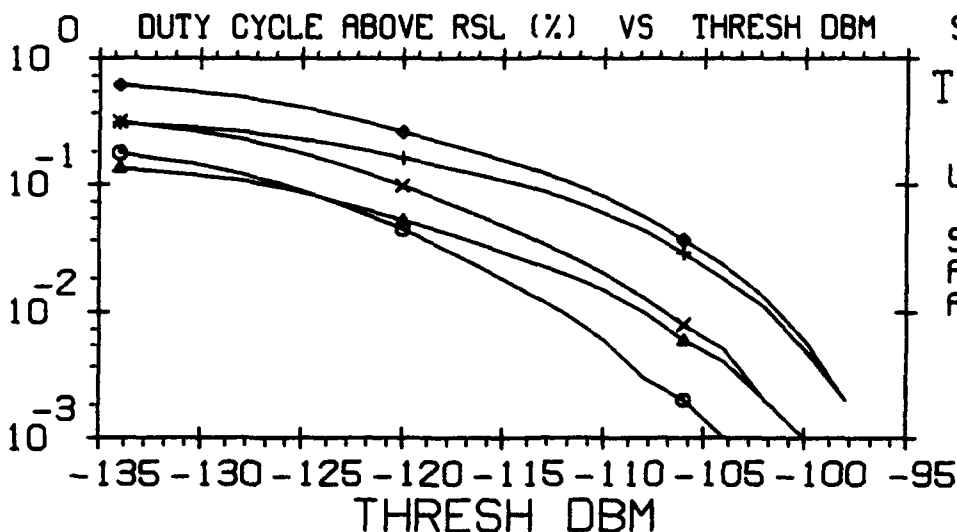

THE TIME OF DAY IS 0 : 24 HOURS U.T.
 FREQUENCY - 104 MHZ
 POLARIZATION - HORIZONTAL
 BASED ON OBSERVED NOISE MEASUREMENTS - VERTICAL

UNDERDENSE ○
 OVERDENSE △
 SPORADIC-E +
 ALL-TRAILS ×
 ALL-EVENTS ◇

MENU#103,06-2
 13-OCT-93
 PLOT# 35.00

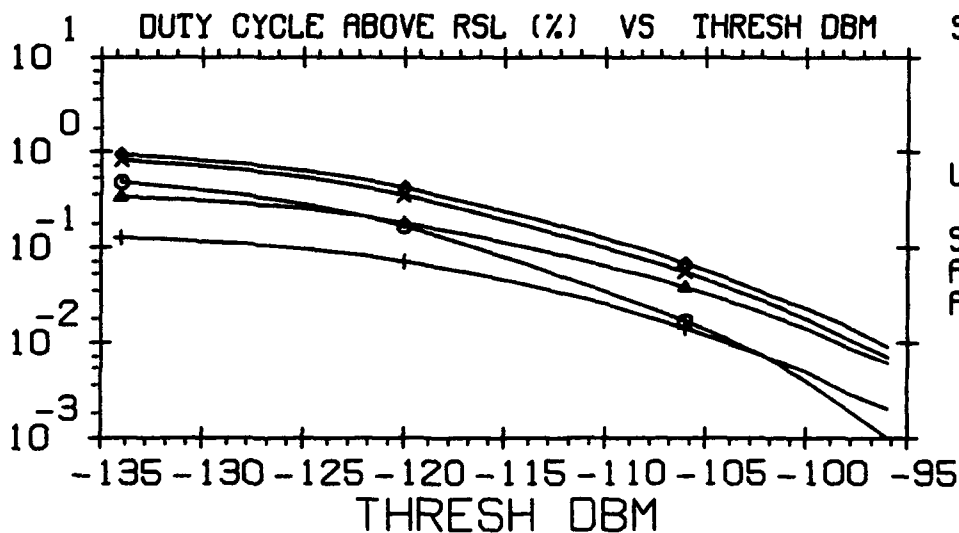

THE TIME OF DAY IS 0 : 24 HOURS U.T.
 FREQUENCY - 147 MHZ
 POLARIZATION - HORIZONTAL
 BASED ON OBSERVED NOISE MEASUREMENTS - VERTICAL

UNDERDENSE ○
 OVERDENSE △
 SPORADIC-E +
 ALL-TRAILS ×
 ALL-EVENTS ◇

MENU#103,06-2
 13-OCT-93
 PLOT# 36.00

GEOPHYSICS LAB METEOR SCATTER PROGRAM

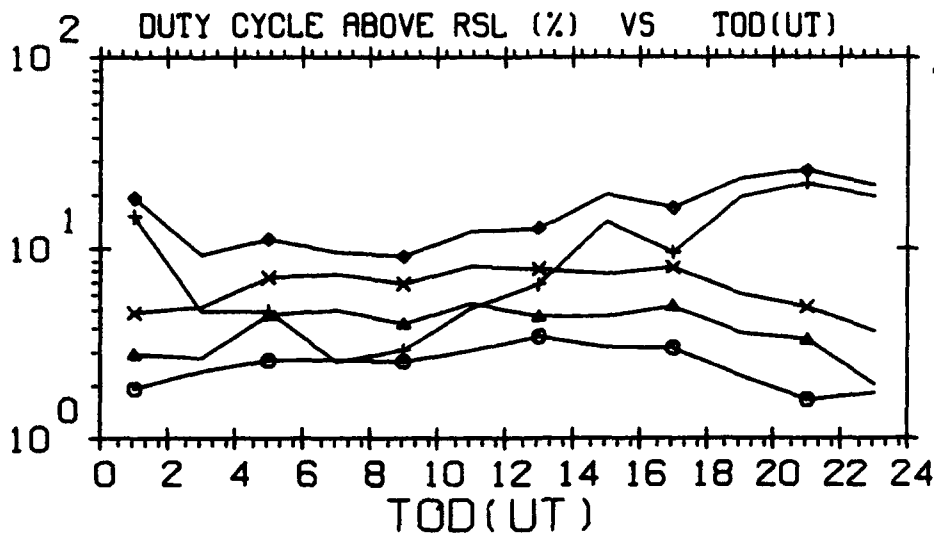

THRESHOLD - -126.0 DBM RSL
 FREQUENCY - 35 MHZ
 POLARIZATION - HORIZONTAL
 BASED ON OBSERVED NOISE MEASUREMENTS - VERTICAL

MENU#103,07-2
 13-OCT-93
 PLOT# 37.00

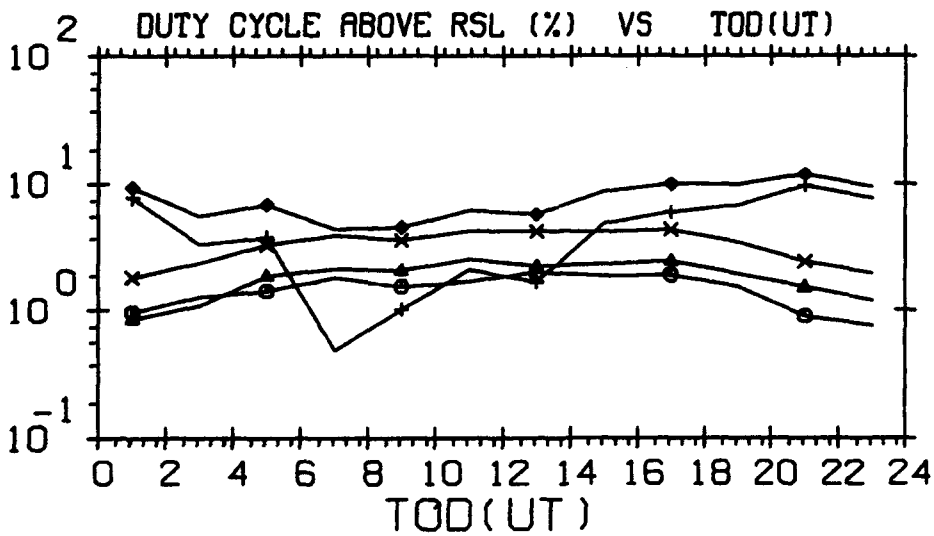

THRESHOLD - -126.0 DBM RSL
 FREQUENCY - 45 MHZ
 POLARIZATION - HORIZONTAL
 BASED ON OBSERVED NOISE MEASUREMENTS - VERTICAL

MENU#103,07-2
 13-OCT-93
 PLOT# 38.00

GEOPHYSICS LAB METEOR SCATTER PROGRAM

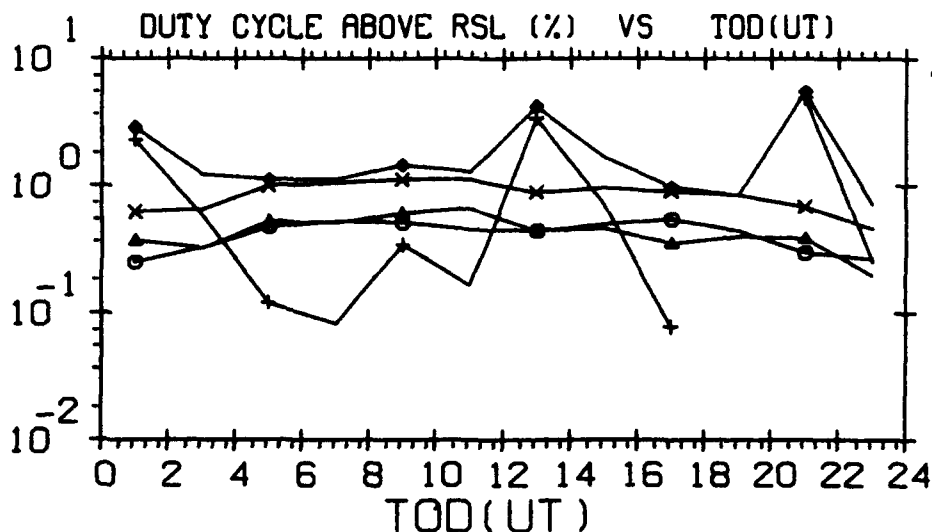

THRESHOLD - -126.0 DBM RSL
 FREQUENCY - 65 MHZ
 POLARIZATION - HORIZONTAL
 BASED ON OBSERVED NOISE MEASUREMENTS - VERTICAL

MENU#103,07-2
 13-OCT-93
 PLOT# 39.00

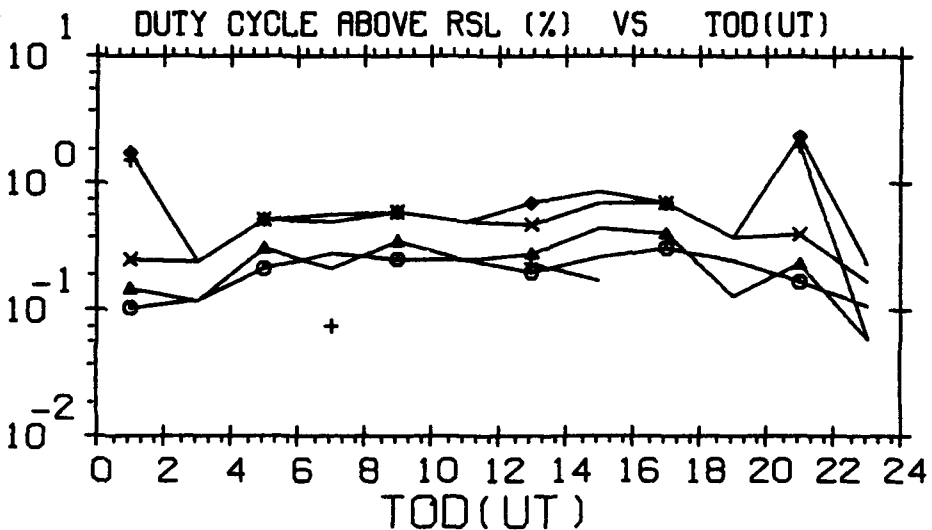

THRESHOLD - -126.0 DBM RSL
 FREQUENCY - 85 MHZ
 POLARIZATION - HORIZONTAL
 BASED ON OBSERVED NOISE MEASUREMENTS - VERTICAL

MENU#103,07-2
 13-OCT-93
 PLOT# 40.00

GEOPHYSICS LAB METEOR SCATTER PROGRAM

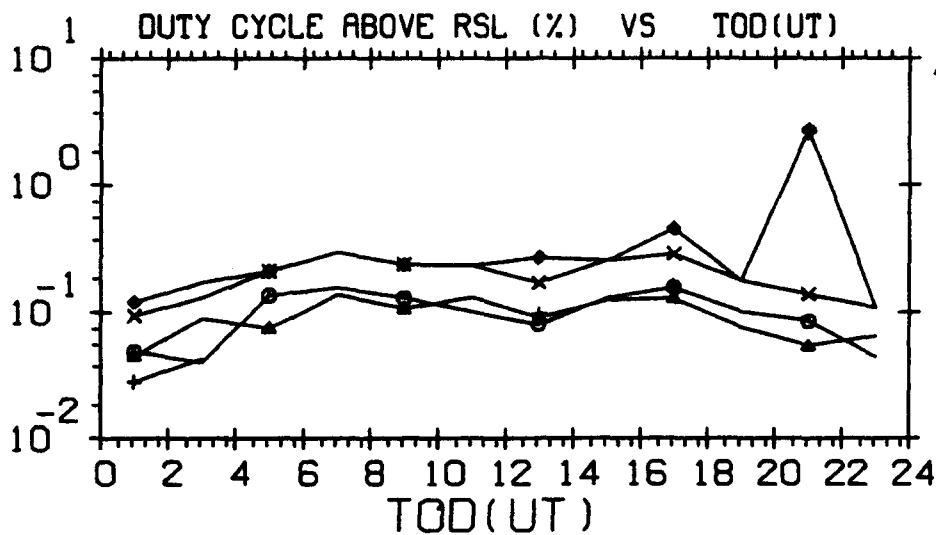

THRESHOLD - -126.0 DBM RSL
 FREQUENCY - 104 MHZ
 POLARIZATION - HORIZONTAL
 BASED ON OBSERVED NOISE MEASUREMENTS - VERTICAL

MENU#103,07-2
 13-OCT-93
 PLOT# 41.00

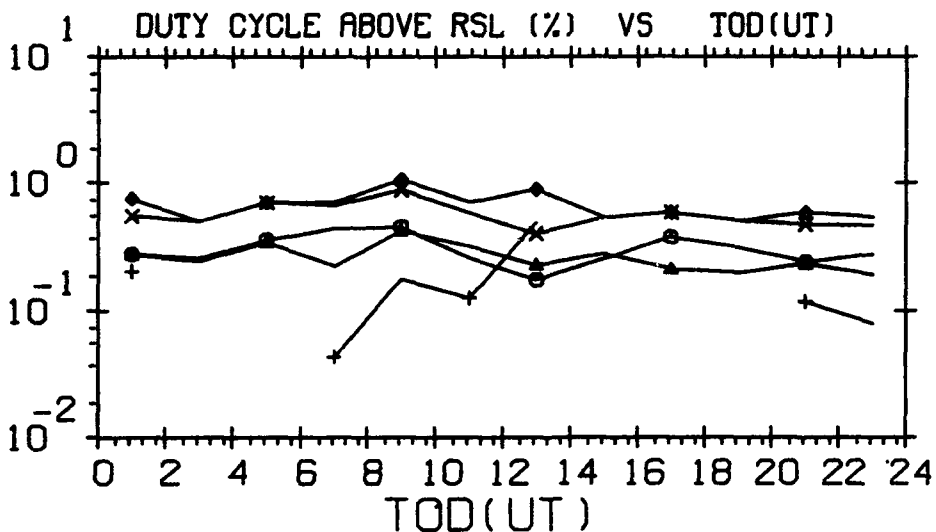

THRESHOLD - -126.0 DBM RSL
 FREQUENCY - 147 MHZ
 POLARIZATION - HORIZONTAL
 BASED ON OBSERVED NOISE MEASUREMENTS - VERTICAL

MENU#103,07-2
 13-OCT-93
 PLOT# 42.00

GEOPHYSICS LAB METEOR SCATTER PROGRAM

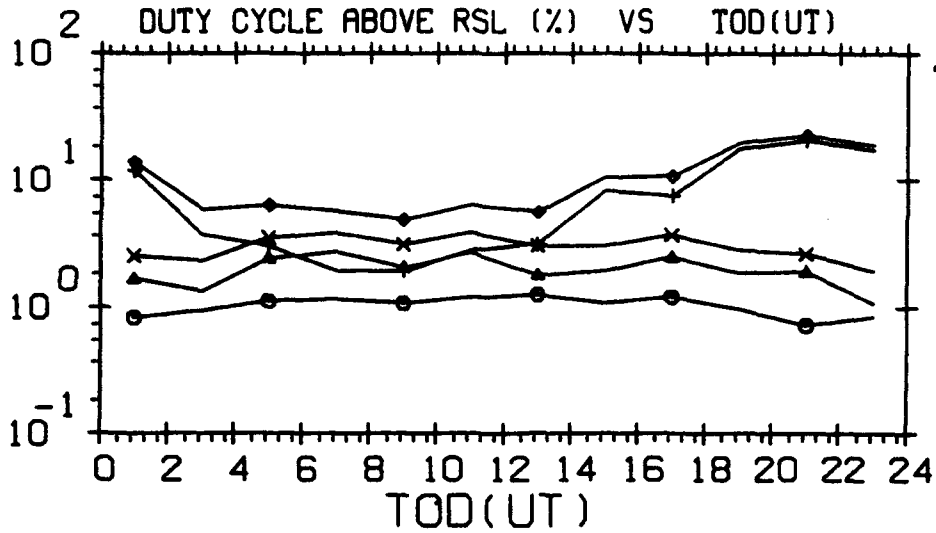

SEPTEMBER 1991

THULE

UNDERDENSE ○
 OVERDENSE △
 SPORADIC-E +
 ALL-TRAILS ×
 ALL-EVENTS ◇

THRESHOLD - -116.0 DBM RSL
 FREQUENCY - 35 MHZ
 POLARIZATION - HORIZONTAL
 BASED ON OBSERVED NOISE MEASUREMENTS - VERTICAL

MENU#103,07-2
 13-OCT-93
 PLOT# 43.00

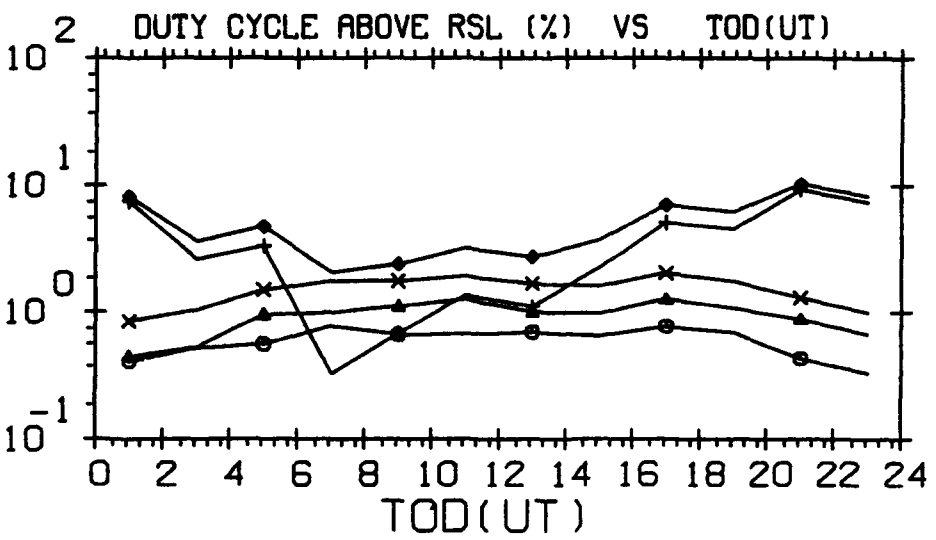

SEPTEMBER 1991

UNDERDENSE ○
 OVERDENSE △
 SPORADIC-E +
 ALL-TRAILS ×
 ALL-EVENTS ◇

THRESHOLD - -116.0 DBM RSL
 FREQUENCY - 45 MHZ
 POLARIZATION - HORIZONTAL
 BASED ON OBSERVED NOISE MEASUREMENTS - VERTICAL

MENU#103,07-2
 13-OCT-93
 PLOT# 44.00

GEOPHYSICS LAB METEOR SCATTER PROGRAM

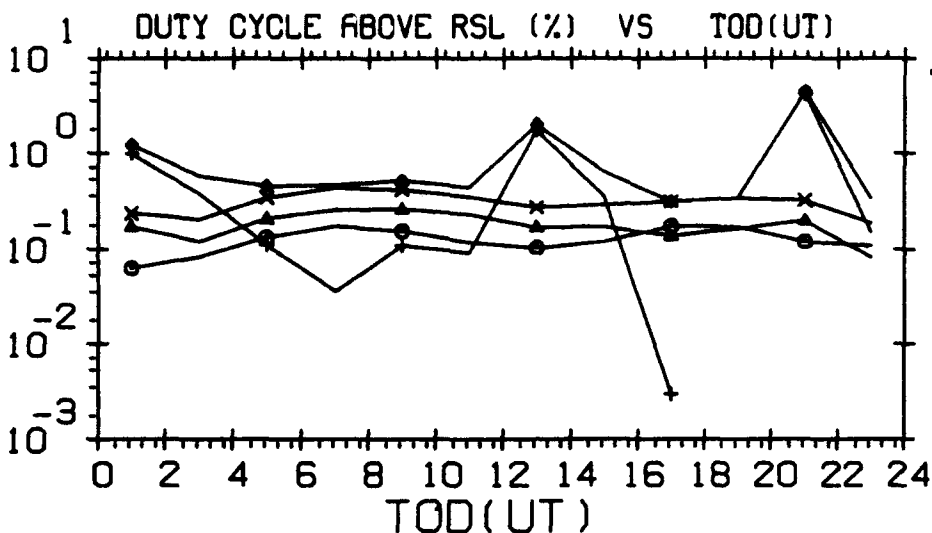

THRESHOLD - -116.0 DBM RSL
 FREQUENCY - 65 MHZ
 POLARIZATION - HORIZONTAL
 BASED ON OBSERVED NOISE MEASUREMENTS - VERTICAL

MENU#103,07-2
 13-OCT-93
 PLOT# 45.00

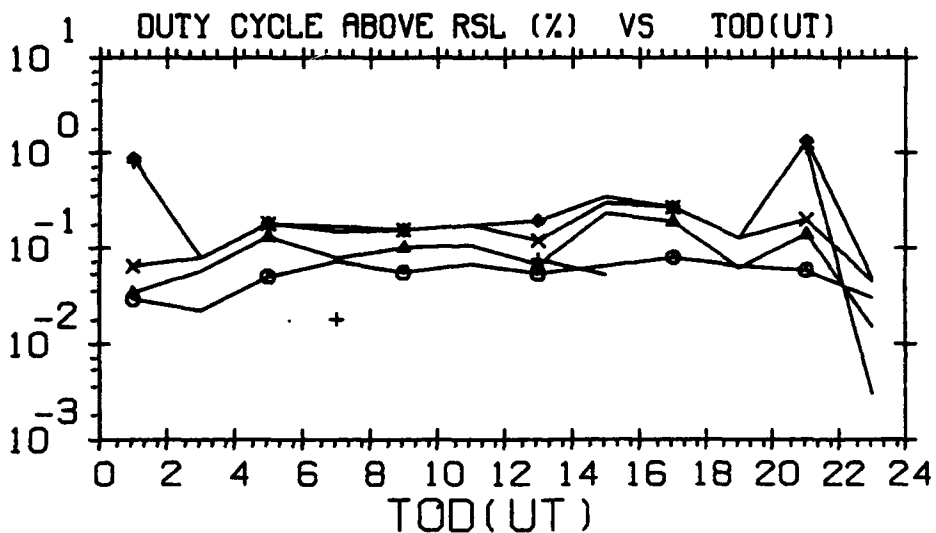

THRESHOLD - -116.0 DBM RSL
 FREQUENCY - 85 MHZ
 POLARIZATION - HORIZONTAL
 BASED ON OBSERVED NOISE MEASUREMENTS - VERTICAL

MENU#103,07-2
 13-OCT-93
 PLOT# 46.00

GEOPHYSICS LAB METEOR SCATTER PROGRAM

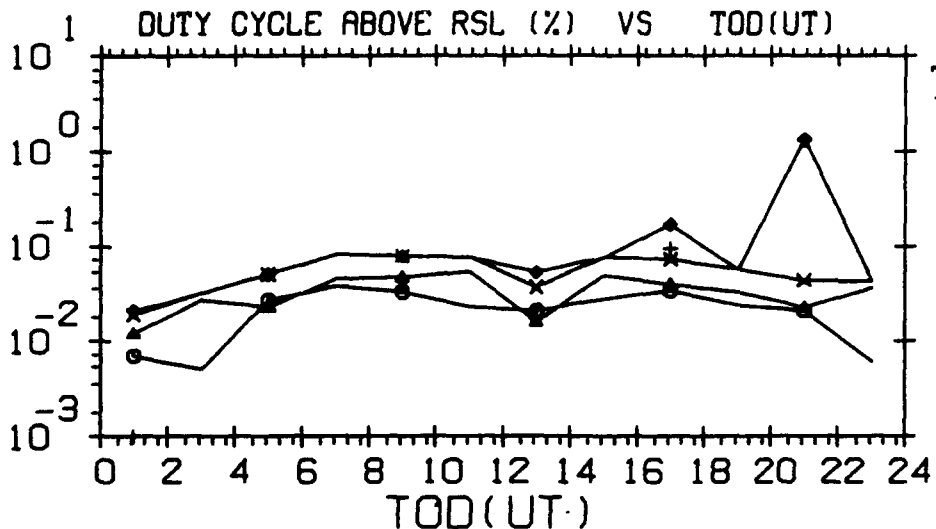

THRESHOLD - -116.0 DBM RSL
 FREQUENCY - 104 MHZ
 POLARIZATION - HORIZONTAL
 BASED ON OBSERVED NOISE MEASUREMENTS - VERTICAL

MENU=103,07-2
 13-OCT-93
 PLOT= 47.00

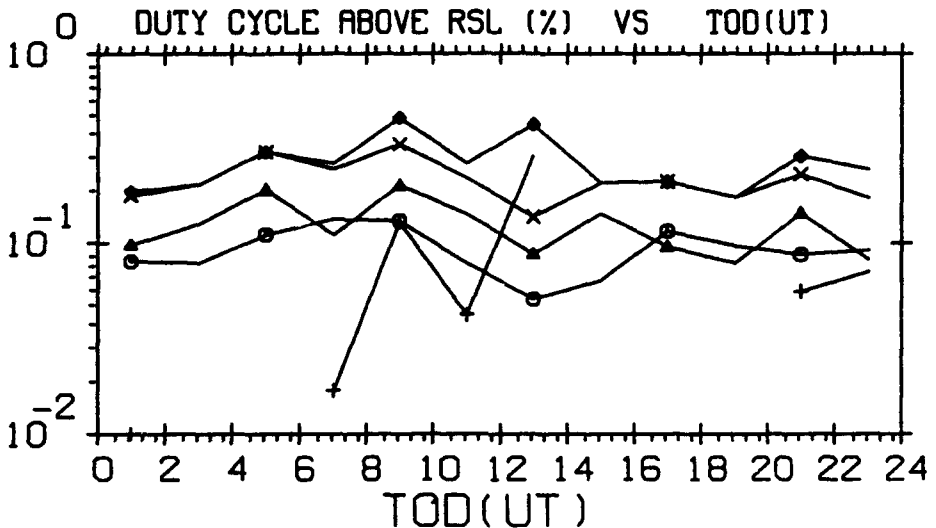

THRESHOLD - -116.0 DBM RSL
 FREQUENCY - 147 MHZ
 POLARIZATION - HORIZONTAL
 BASED ON OBSERVED NOISE MEASUREMENTS - VERTICAL

MENU=103,07-2
 13-OCT-93
 PLOT= 48.00

GEOPHYSICS LAB METEOR SCATTER PROGRAM

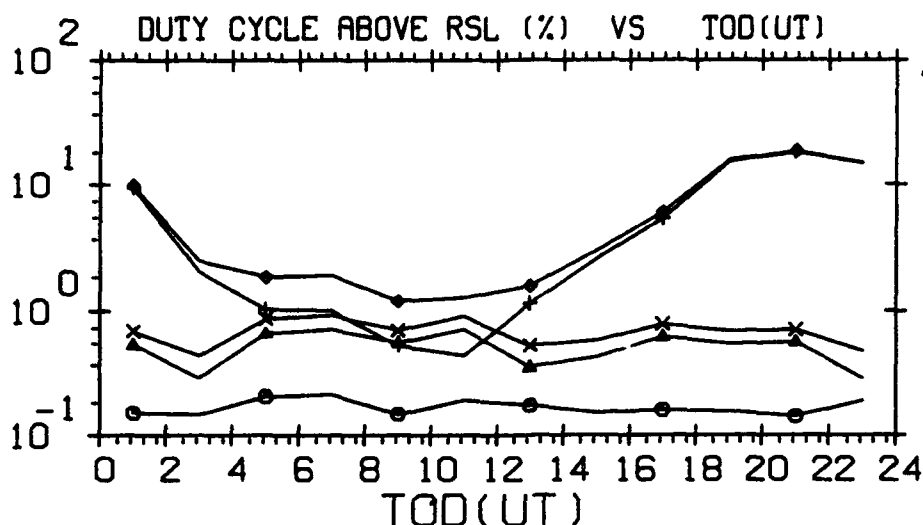

THRESHOLD - -106.0 DBM RSL
 FREQUENCY - 35 MHZ
 POLARIZATION - HORIZONTAL
 BASED ON OBSERVED NOISE MEASUREMENTS - VERTICAL

MENU# 103,07-2
 13-OCT-93
 PLOT# 49.00

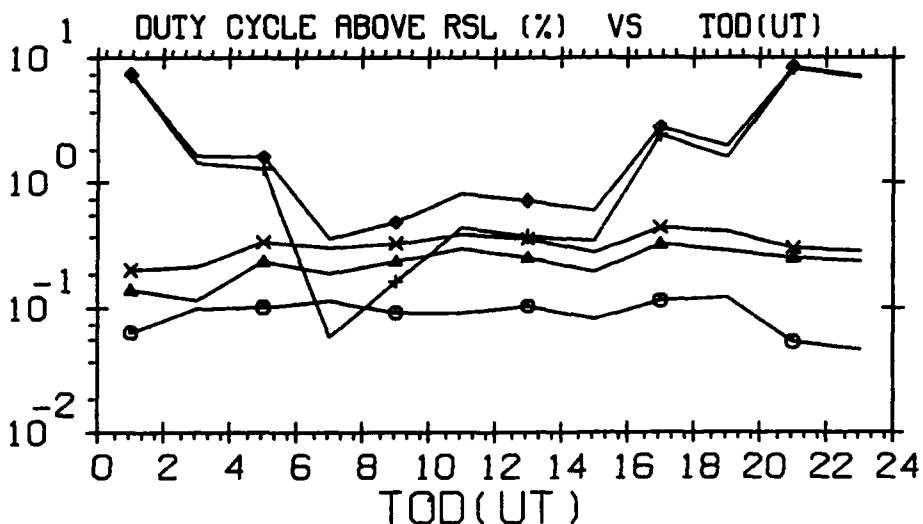

THRESHOLD - -106.0 DBM RSL
 FREQUENCY - 45 MHZ
 POLARIZATION - HORIZONTAL
 BASED ON OBSERVED NOISE MEASUREMENTS - VERTICAL

MENU# 103,07-2
 13-OCT-93
 PLOT# 50.00

GEOPHYSICS LAB METEOR SCATTER PROGRAM

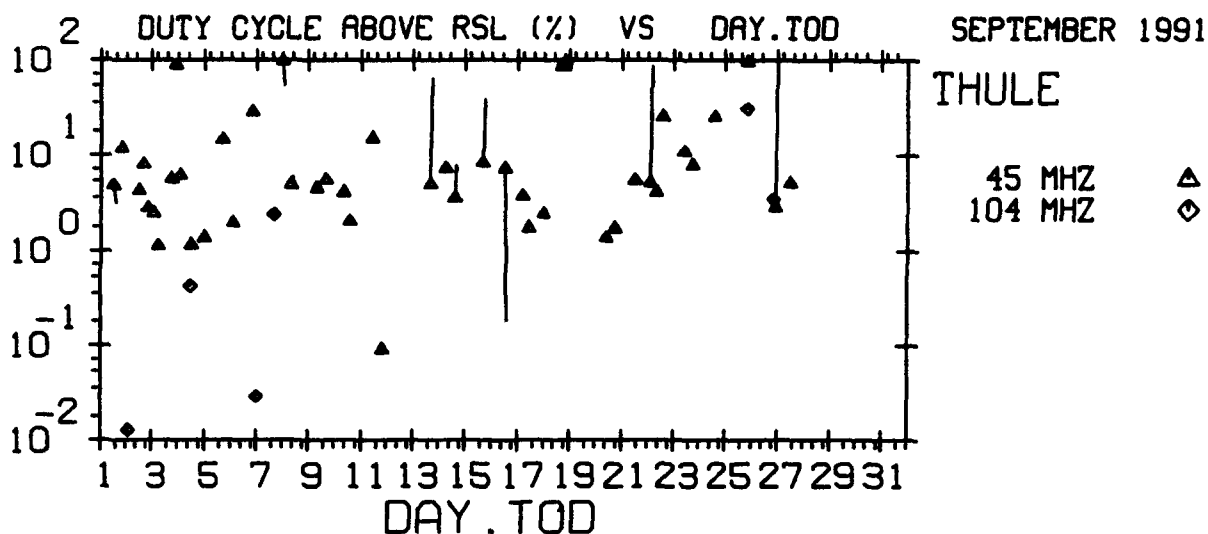

THRESHOLD - -116.0 DBM RSL
 THE EVENT CLASS IS SPORADIC-E
 POLARIZATION - HORIZONTAL
 BASED ON OBSERVED NOISE MEASUREMENTS - VERTICAL

MENU#103,09-2
 13-OCT-93
 PLOT# 59.00

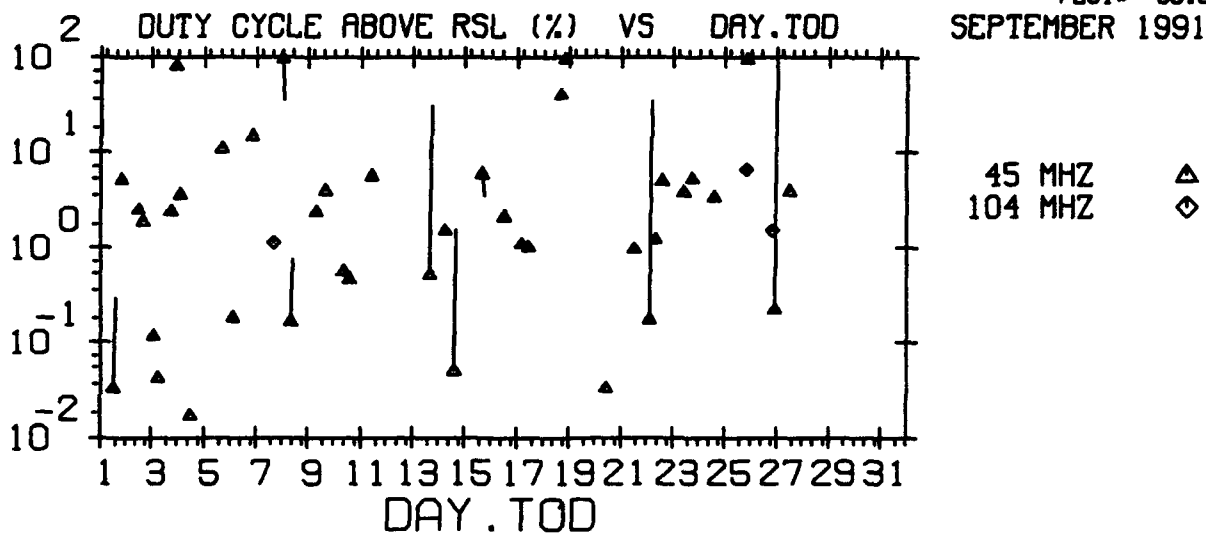

THRESHOLD - -106.0 DBM RSL
 THE EVENT CLASS IS SPORADIC-E
 POLARIZATION - HORIZONTAL
 BASED ON OBSERVED NOISE MEASUREMENTS - VERTICAL

MENU#103,09-2
 13-OCT-93
 PLOT# 60.00

GEOPHYSICS LAB METEOR SCATTER PROGRAM

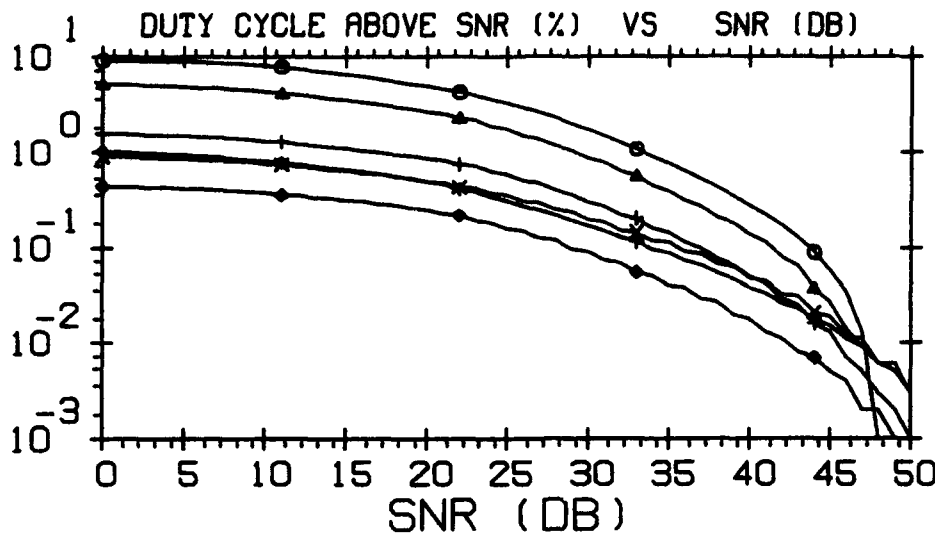

SEPTEMBER 1991
THULE

35 MHZ	○
45 MHZ	△
65 MHZ	+
85 MHZ	×
104 MHZ	◇
147 MHZ	↑

THE TIME OF DAY IS 0 : 24 HOURS U.T.
 THE EVENT CLASS IS UNDERDENSE AND OVERDENSE TRAILS
 EFFECTIVE SYSTEM BANDWIDTH - 100.HZ
 POLARIZATION - HORIZONTAL
 BASED ON OBSERVED NOISE MEASUREMENTS - VERTICAL

MENU#104,02-2
13-OCT-93
PLOT# 61.00

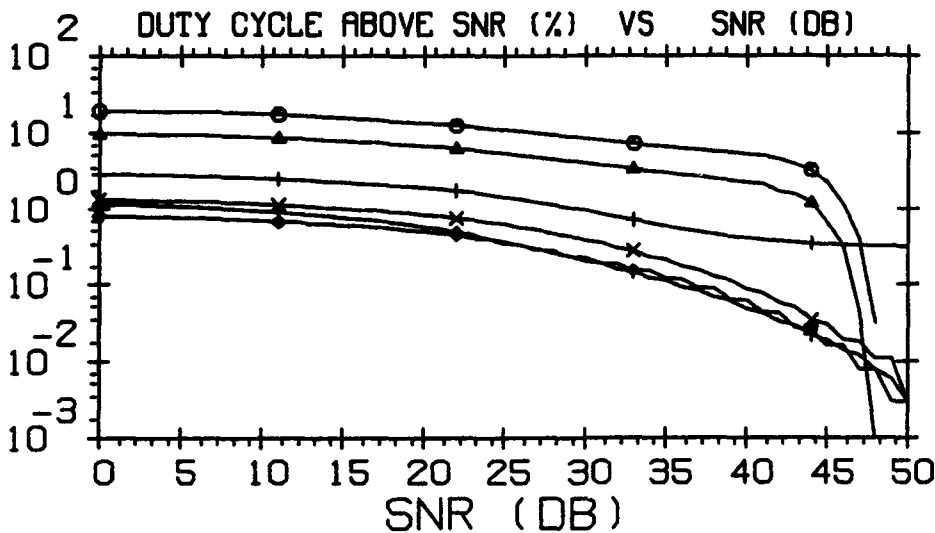

SEPTEMBER 1991

35 MHZ	○
45 MHZ	△
65 MHZ	+
85 MHZ	×
104 MHZ	◇
147 MHZ	↑

THE TIME OF DAY IS 0 : 24 HOURS U.T.
 THE EVENT CLASS IS SPORADIC-E AND METEOR TRAILS
 EFFECTIVE SYSTEM BANDWIDTH - 100.HZ
 POLARIZATION - HORIZONTAL
 BASED ON OBSERVED NOISE MEASUREMENTS - VERTICAL

MENU#104,02-2
13-OCT-93
PLOT# 62.00

GEOPHYSICS LAB METEOR SCATTER PROGRAM

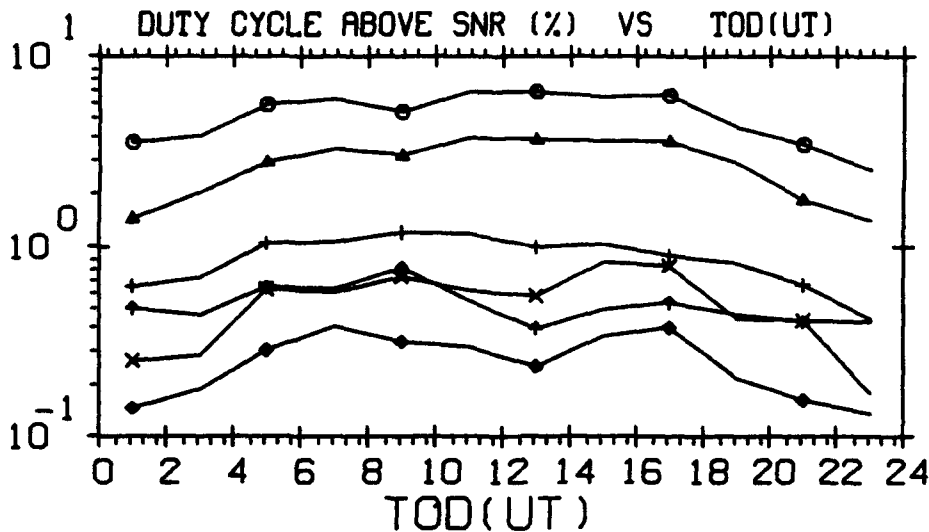

SEPTEMBER 1991

THULE

35 MHZ	○
45 MHZ	△
65 MHZ	+
85 MHZ	×
104 MHZ	◇
147 MHZ	↑

SIGNAL-TO-NOISE RATIO - 19.0 DB
 THE EVENT CLASS IS UNDERDENSE AND OVERDENSE TRAILS
 EFFECTIVE SYSTEM BANDWIDTH - 100.HZ
 POLARIZATION - HORIZONTAL
 BASED ON OBSERVED NOISE MEASUREMENTS - VERTICAL

MENU#104,03-2
 13-OCT-93
 PLOT# 63.00

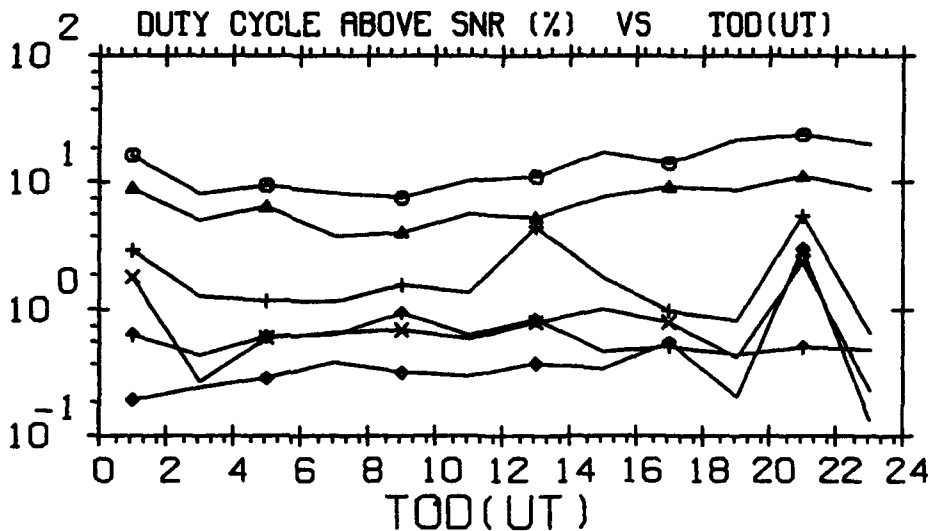

SEPTEMBER 1991

35 MHZ	○
45 MHZ	△
65 MHZ	+
85 MHZ	×
104 MHZ	◇
147 MHZ	↑

SIGNAL-TO-NOISE RATIO - 19.0 DB
 THE EVENT CLASS IS SPORADIC-E AND METEOR TRAILS
 EFFECTIVE SYSTEM BANDWIDTH - 100.HZ
 POLARIZATION - HORIZONTAL
 BASED ON OBSERVED NOISE MEASUREMENTS - VERTICAL

MENU#104,03-2
 13-OCT-93
 PLOT# 64.00

GEOPHYSICS LAB METEOR SCATTER PROGRAM

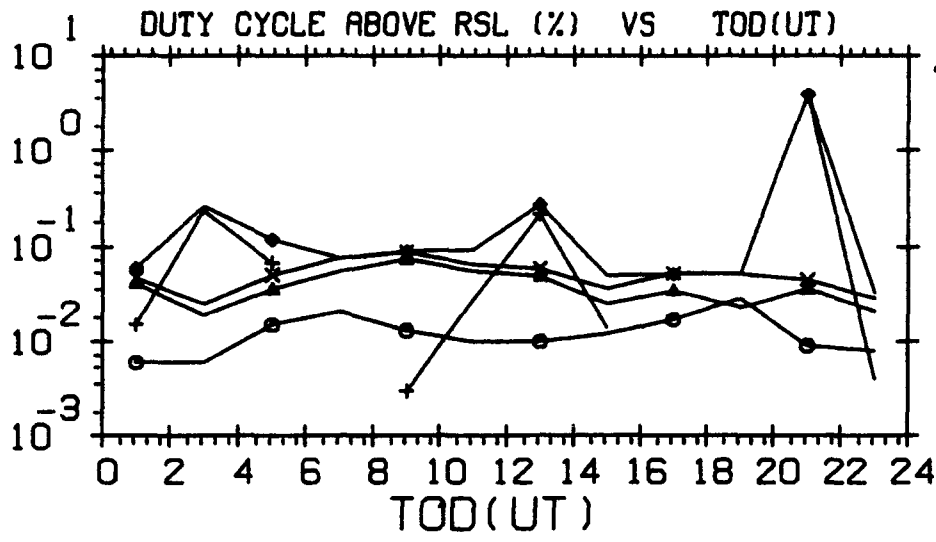

THRESHOLD - -106.0 DBM RSL
 FREQUENCY - 65 MHZ
 POLARIZATION - HORIZONTAL
 BASED ON OBSERVED NOISE MEASUREMENTS - VERTICAL

MENU*103,07-2
 13-OCT-93
 PLOT* 51.00

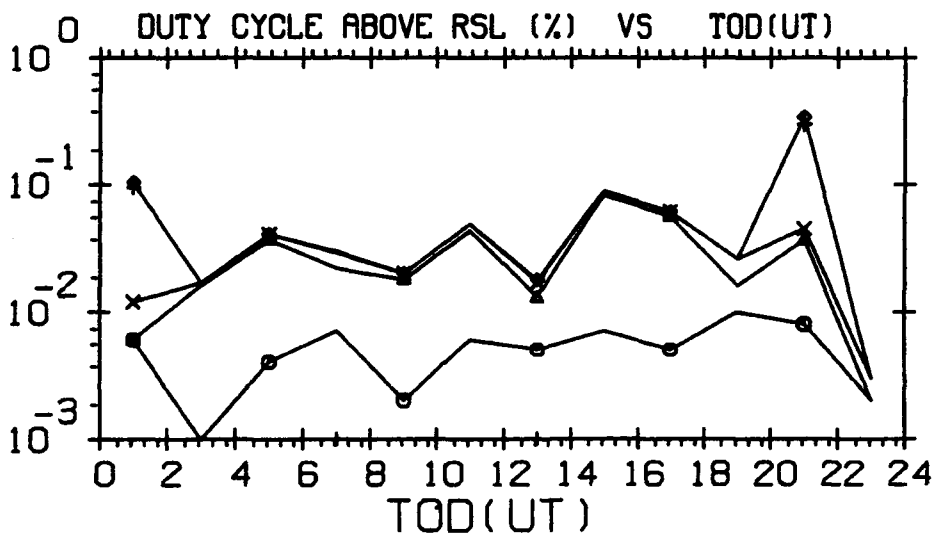

THRESHOLD - -106.0 DBM RSL
 FREQUENCY - 85 MHZ
 POLARIZATION - HORIZONTAL
 BASED ON OBSERVED NOISE MEASUREMENTS - VERTICAL

MENU*103,07-2
 13-OCT-93
 PLOT* 52.00

GEOPHYSICS LAB METEOR SCATTER PROGRAM

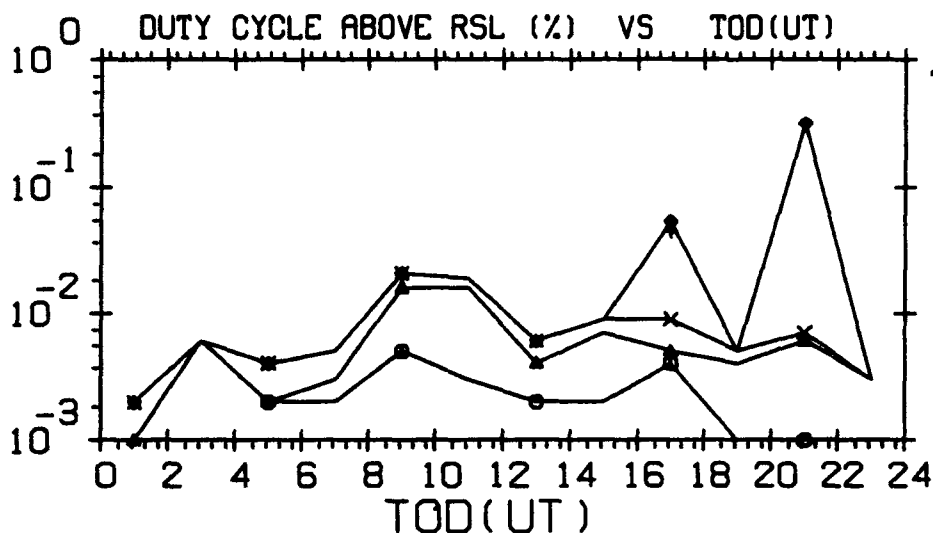

THRESHOLD - -106.0 DBM RSL
 FREQUENCY - 104 MHZ
 POLARIZATION - HORIZONTAL
 BASED ON OBSERVED NOISE MEASUREMENTS - VERTICAL

MENU#103,07-2
 13-OCT-93
 PLOT# 53.00

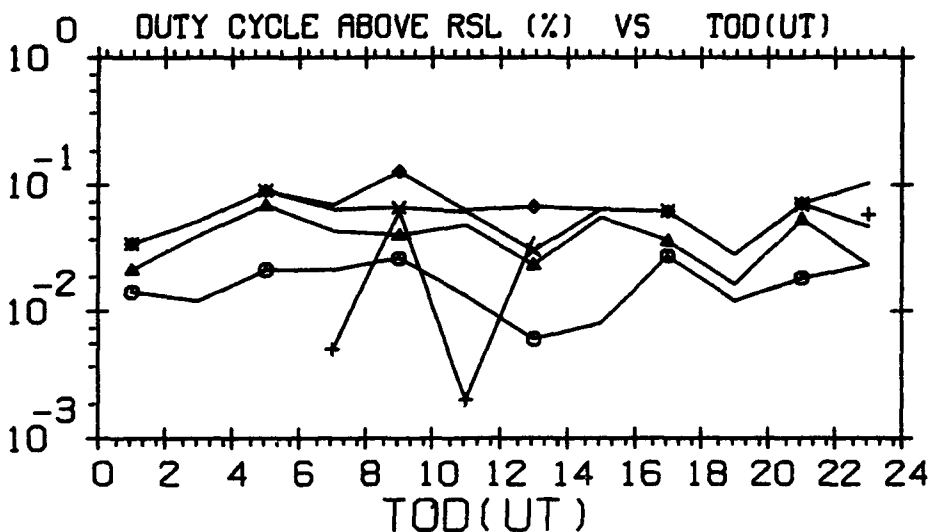

THRESHOLD - -106.0 DBM RSL
 FREQUENCY - 147 MHZ
 POLARIZATION - HORIZONTAL
 BASED ON OBSERVED NOISE MEASUREMENTS - VERTICAL

MENU#103,07-2
 13-OCT-93
 PLOT# 54.00

GEOPHYSICS LAB METEOR SCATTER PROGRAM

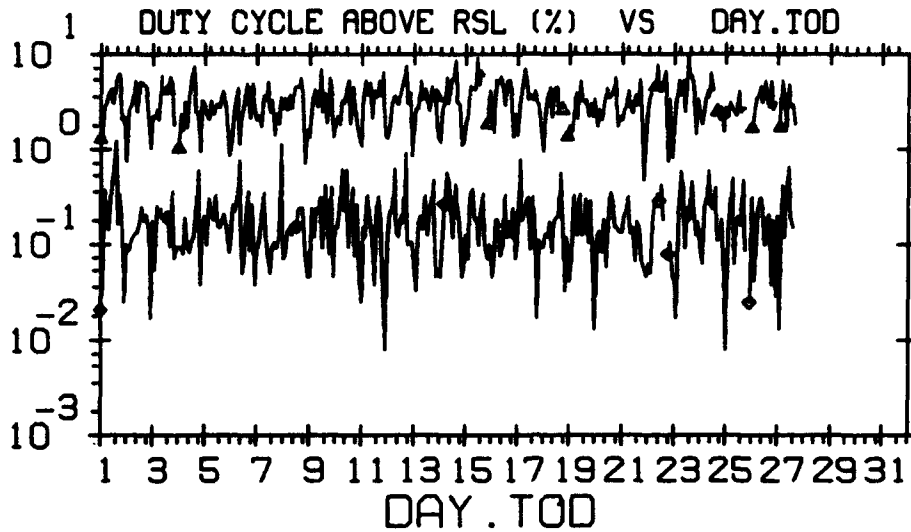

SEPTEMBER 1991

THULE

45 MHZ △
104 MHZ ◇

THRESHOLD - -126.0 DBM RSL
THE EVENT CLASS IS UNDERDENSE AND OVERDENSE TRAILS
POLARIZATION - HORIZONTAL
BASED ON OBSERVED NOISE MEASUREMENTS - VERTICAL

MENU#103,09-2
13-OCT-93
PLOT# 55.00

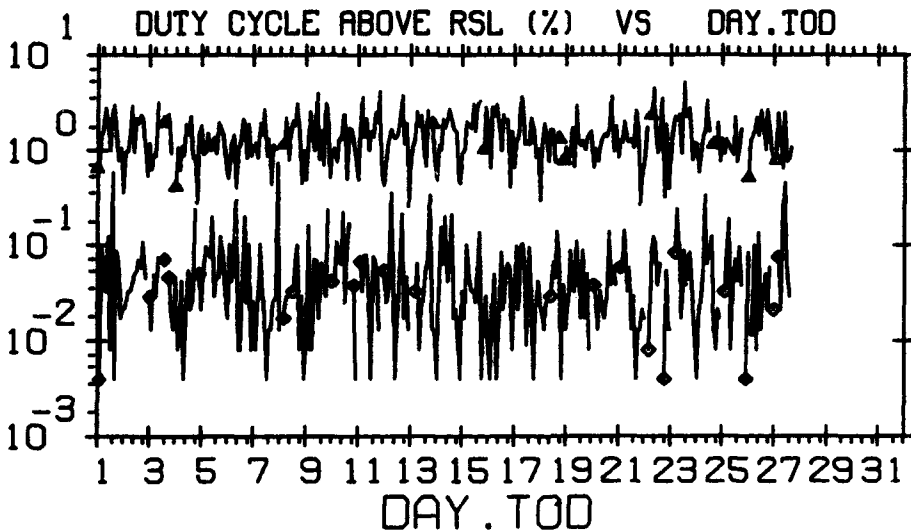

SEPTEMBER 1991

45 MHZ △
104 MHZ ◇

THRESHOLD - -116.0 DBM RSL
THE EVENT CLASS IS UNDERDENSE AND OVERDENSE TRAILS
POLARIZATION - HORIZONTAL
BASED ON OBSERVED NOISE MEASUREMENTS - VERTICAL

MENU#103,09-2
13-OCT-93
PLOT# 56.00

GEOPHYSICS LAB METEOR SCATTER PROGRAM

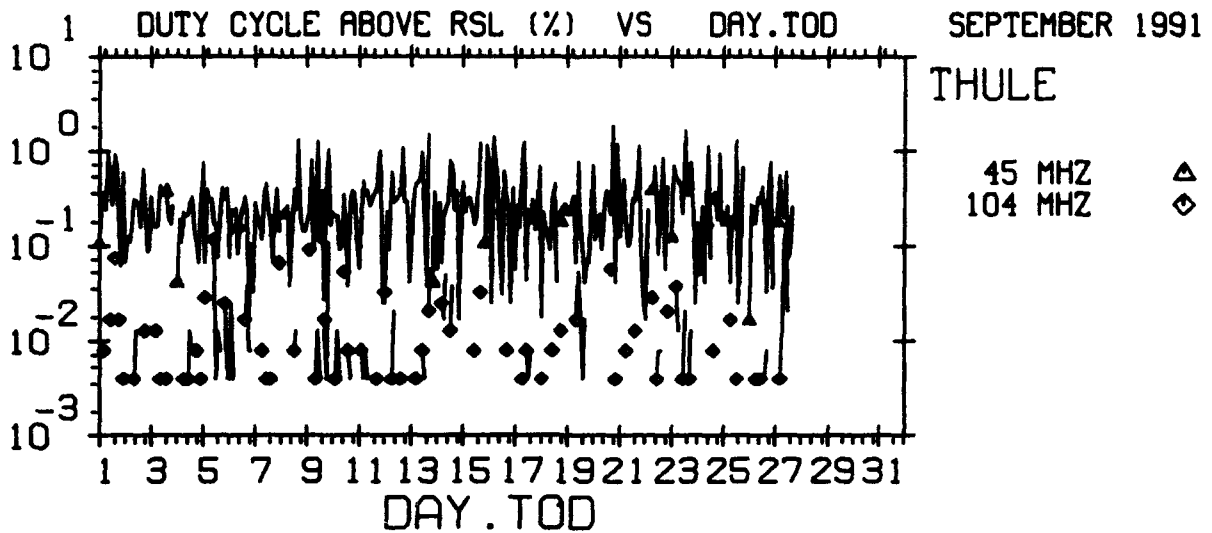

THRESHOLD = -106.0 DBM RSL
 THE EVENT CLASS IS UNDERDENSE AND OVERDENSE TRAILS
 POLARIZATION = HORIZONTAL
 BASED ON OBSERVED NOISE MEASUREMENTS - VERTICAL

MENU#103,09-2
 13-OCT-93
 PLOT# 57.00

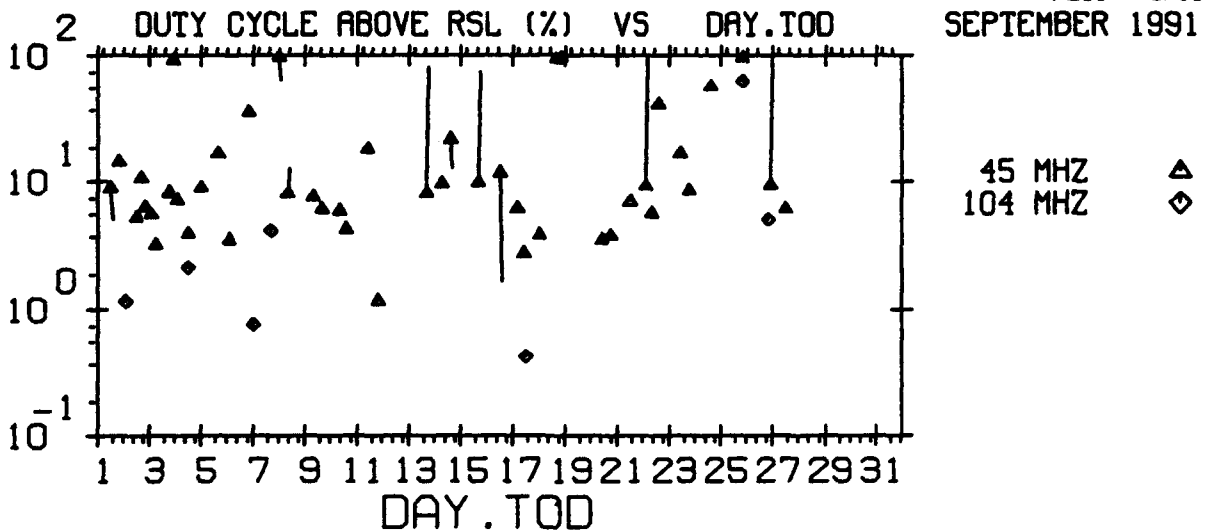

THRESHOLD = -126.0 DBM RSL
 THE EVENT CLASS IS SPORADIC-E
 POLARIZATION = HORIZONTAL
 BASED ON OBSERVED NOISE MEASUREMENTS - VERTICAL

MENU#103,09-2
 13-OCT-93
 PLOT# 58.00

GEOPHYSICS LAB METEOR SCATTER PROGRAM

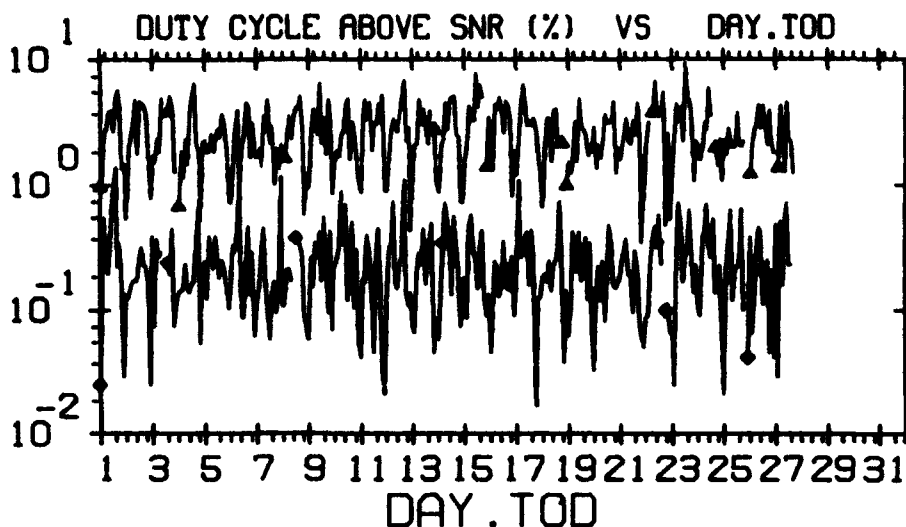

SEPTEMBER 1991

THULE

45 MHZ ▲
104 MHZ ◆

SIGNAL-TO-NOISE RATIO - 19.0 DB
THE EVENT CLASS IS UNDERDENSE AND OVERDENSE TRAILS
EFFECTIVE SYSTEM BANDWIDTH - 100.HZ
POLARIZATION - HORIZONTAL
BASED ON OBSERVED NOISE MEASUREMENTS - VERTICAL

MENU#104,09-2
13-OCT-93
PLOT# 65.00

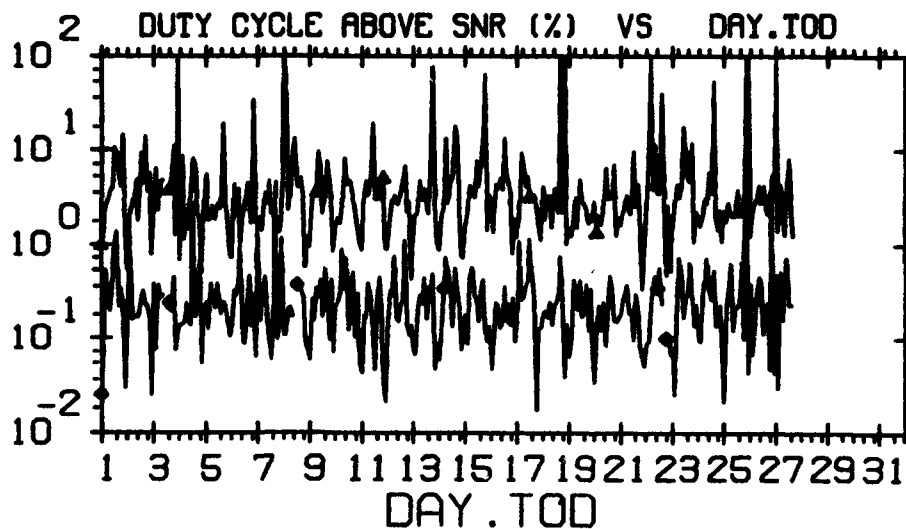

SEPTEMBER 1991

45 MHZ ▲
104 MHZ ◆

SIGNAL-TO-NOISE RATIO - 19.0 DB
THE EVENT CLASS IS SPORADIC-E AND METEOR TRAILS
EFFECTIVE SYSTEM BANDWIDTH - 100.HZ
POLARIZATION - HORIZONTAL
BASED ON OBSERVED NOISE MEASUREMENTS - VERTICAL

MENU#104,09-2
13-OCT-93
PLOT# 66.00

GEOPHYSICS LAB METEOR SCATTER PROGRAM

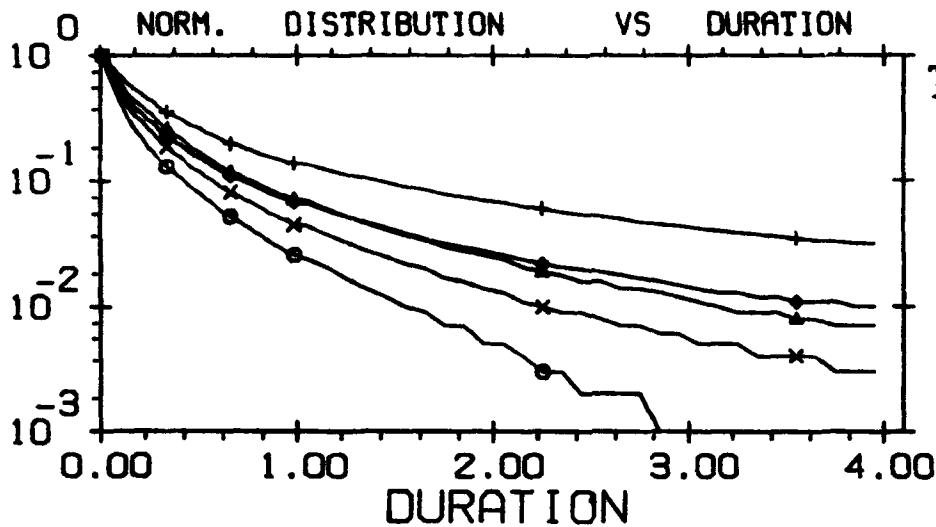

UNDERDENSE ○
 OVERDENSE △
 SPORADIC-E +
 ALL-TRAILS ×
 ALL-EVENTS ◇

EXCEEDING -126.0 DBM RSL
 THE TIME OF DAY IS 0 : 24 HOURS U.T.
 FREQUENCY - 35 MHZ
 BASED ON OBSERVED NOISE MEASUREMENTS - VERTICAL
 NORMALIZING FACTORS:
 UNDER - 33477. OVER - 25998. SPOR-E - 19116.
 TRAILS - 59475. EVENTS - 78591.

MENU#106,02-4
 13-OCT-93
 PLOT# 67.00

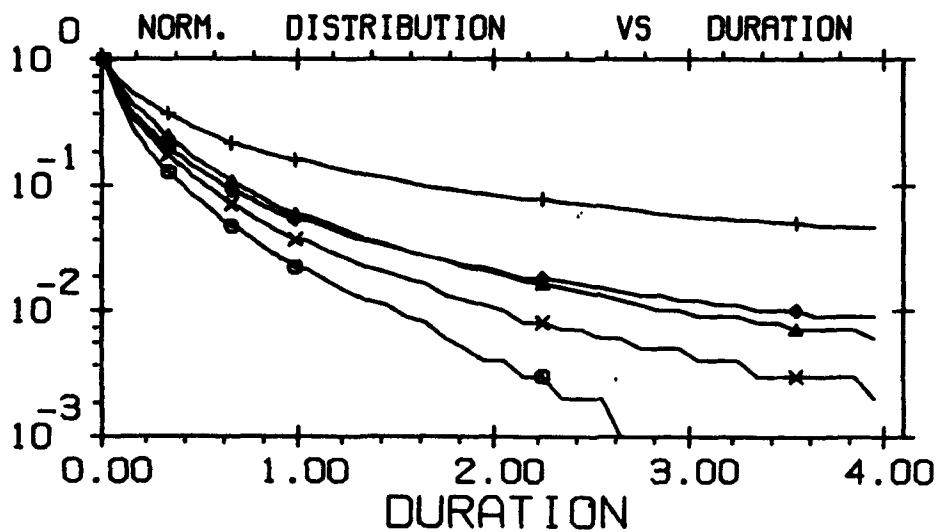

UNDERDENSE ○
 OVERDENSE △
 SPORADIC-E +
 ALL-TRAILS ×
 ALL-EVENTS ◇

EXCEEDING -126.0 DBM RSL
 THE TIME OF DAY IS 0 : 24 HOURS U.T.
 FREQUENCY - 45 MHZ
 BASED ON OBSERVED NOISE MEASUREMENTS - VERTICAL
 NORMALIZING FACTORS:
 UNDER - 16894. OVER - 11218. SPOR-E - 4622.
 TRAILS - 28112. EVENTS - 32734.

MENU#106,02-4
 13-OCT-93
 PLOT# 68.00

GEOPHYSICS LAB METEOR SCATTER PROGRAM

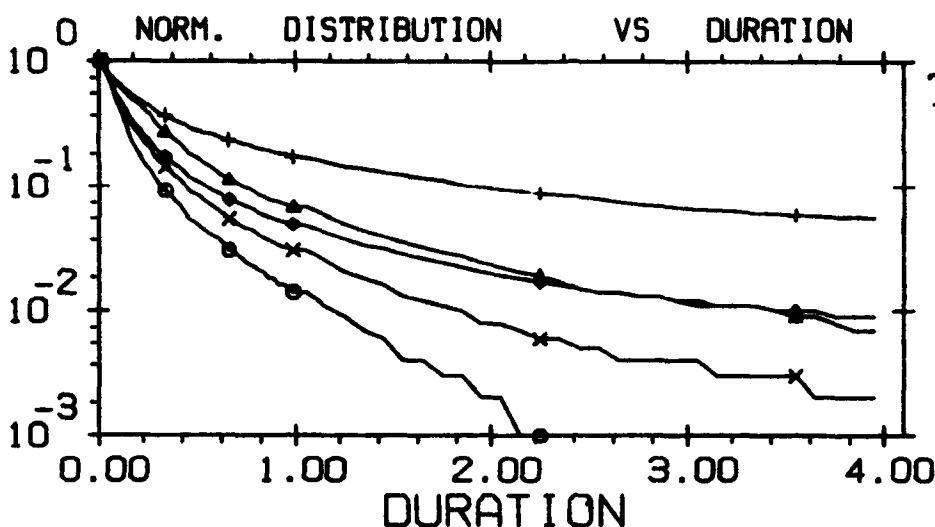

EXCEEDING -126.0 DBM RSL
 THE TIME OF DAY IS 0 : 24 HOURS U.T.
 FREQUENCY - 65 MHZ
 BASED ON OBSERVED NOISE MEASUREMENTS - VERTICAL
 NORMALIZING FACTORS:
 UNDER - 9243. OVER - 3759. SPOR-E - 1953.
 TRAILS - 13002. EVENTS - 14955.

MENU#106,02-4
 13-OCT-93
 PLOT# 69.00

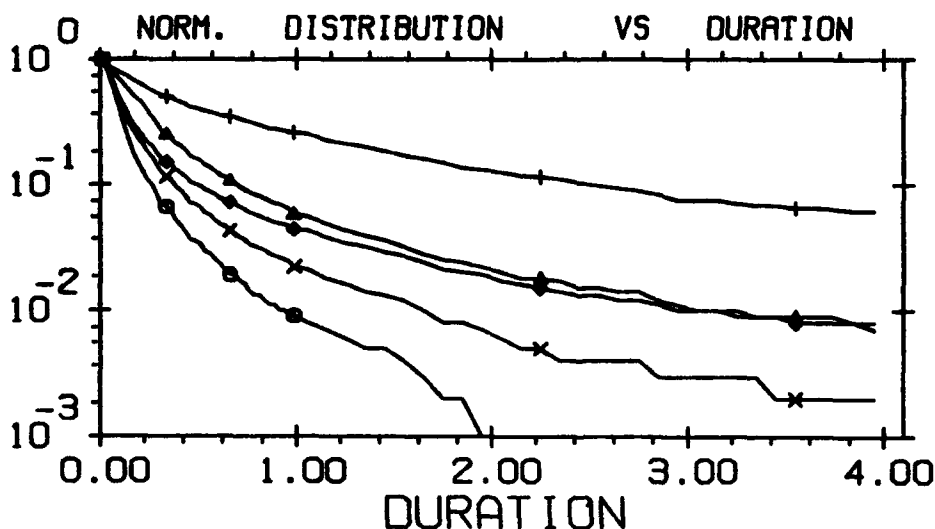

EXCEEDING -126.0 DBM RSL
 THE TIME OF DAY IS 0 : 24 HOURS U.T.
 FREQUENCY - 85 MHZ
 BASED ON OBSERVED NOISE MEASUREMENTS - VERTICAL
 NORMALIZING FACTORS:
 UNDER - 5547. OVER - 2013. SPOR-E - 785.
 TRAILS - 7560. EVENTS - 8345.

MENU#106,02-4
 13-OCT-93
 PLOT# 70.00

GEOPHYSICS LAB METEOR SCATTER PROGRAM

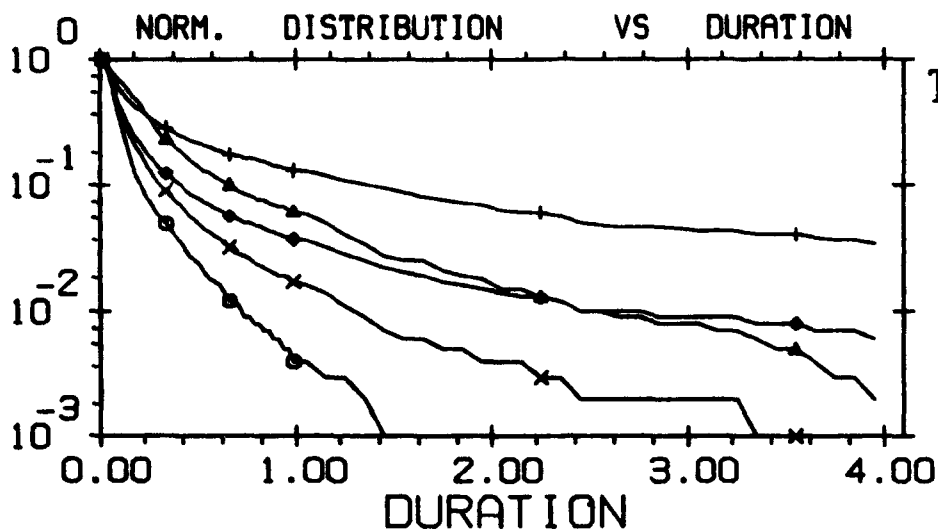

EXCEEDING -126.0 DBM RSL
 THE TIME OF DAY IS 0 : 24 HOURS U.T.
 FREQUENCY - 104 MHZ
 BASED ON OBSERVED NOISE MEASUREMENTS - VERTICAL
 NORMALIZING FACTORS:
 UNDER - 4241. OVER - 1216. SPOR-E - 1136.
 TRAILS - 5457. EVENTS - 6593.

MENU#106,02-4
 13-OCT-93
 PLOT# 71.00

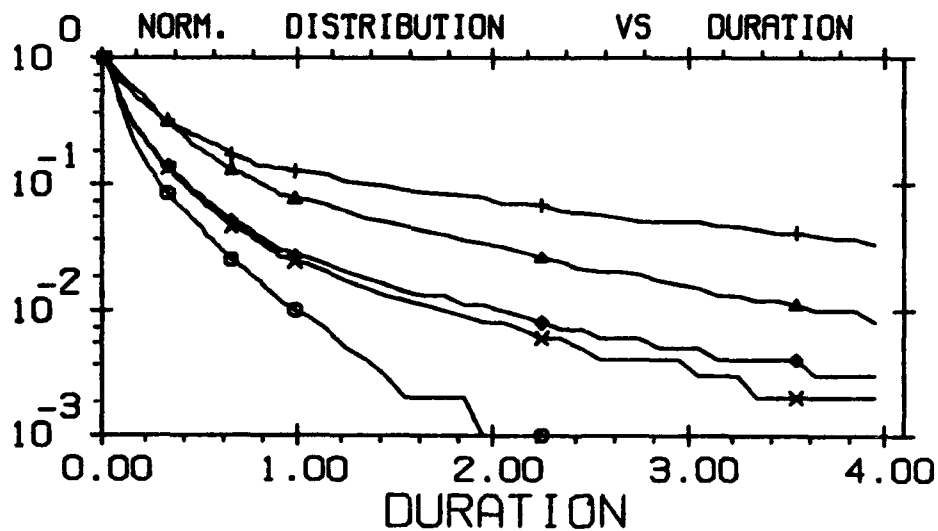

EXCEEDING -126.0 DBM RSL
 THE TIME OF DAY IS 0 : 24 HOURS U.T.
 FREQUENCY - 147 MHZ
 BASED ON OBSERVED NOISE MEASUREMENTS - VERTICAL
 NORMALIZING FACTORS:
 UNDER - 9859. OVER - 2618. SPOR-E - 459.
 TRAILS - 12477. EVENTS - 12936.

MENU#106,02-4
 13-OCT-93
 PLOT# 72.00

GEOPHYSICS LAB METEOR SCATTER PROGRAM

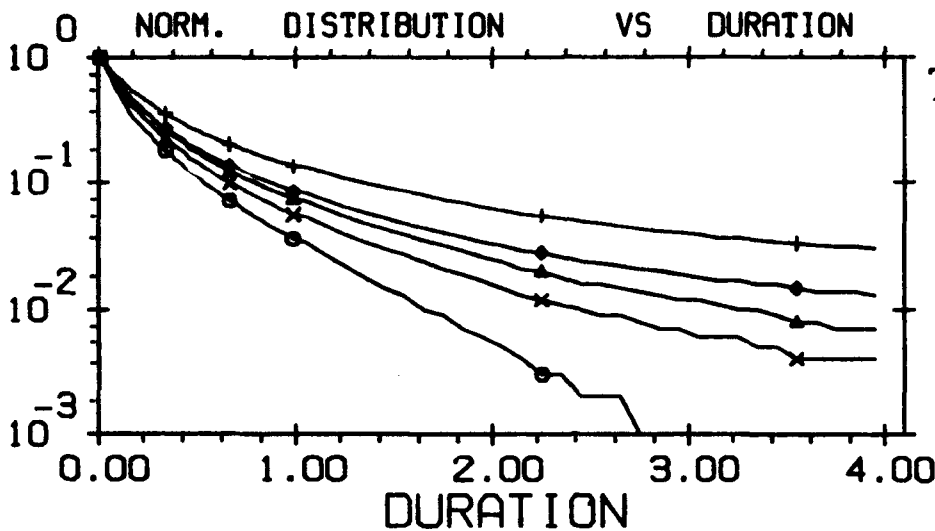

SEPTEMBER 1991

THULE

- UNDERDENSE ○
- OVERDENSE △
- SPORADIC-E +
- ALL-TRAILS ×
- ALL-EVENTS ◇

EXCEEDING -116.0 DBM RSL
 THE TIME OF DAY IS 0 : 24 HOURS U.T.
 FREQUENCY - 35 MHZ
 BASED ON OBSERVED NOISE MEASUREMENTS - VERTICAL
 NORMALIZING FACTORS:
 UNDER - 11089. OVER - 12831. SPOR-E - 13911.
 TRAILS - 23920. EVENTS - 37831.

MENU#106,02-4
 13-OCT-93
 PLOT# 73.00

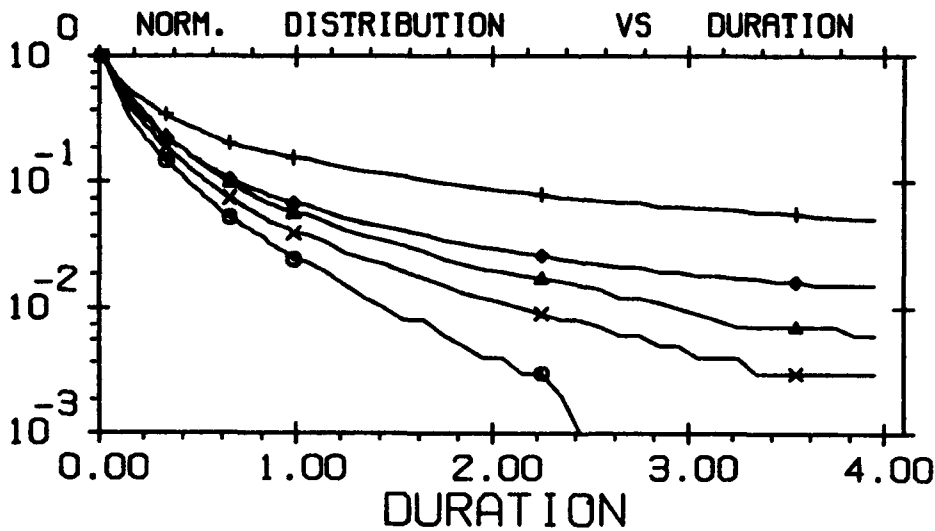

SEPTEMBER 1991

- UNDERDENSE ○
- OVERDENSE △
- SPORADIC-E +
- ALL-TRAILS ×
- ALL-EVENTS ◇

EXCEEDING -116.0 DBM RSL
 THE TIME OF DAY IS 0 : 24 HOURS U.T.
 FREQUENCY - 45 MHZ
 BASED ON OBSERVED NOISE MEASUREMENTS - VERTICAL
 NORMALIZING FACTORS:
 UNDER - 6252. OVER - 5658. SPOR-E - 3812.
 TRAILS - 11910. EVENTS - 15722.

MENU#106,02-4
 13-OCT-93
 PLOT# 74.00

GEOPHYSICS LAB METEOR SCATTER PROGRAM

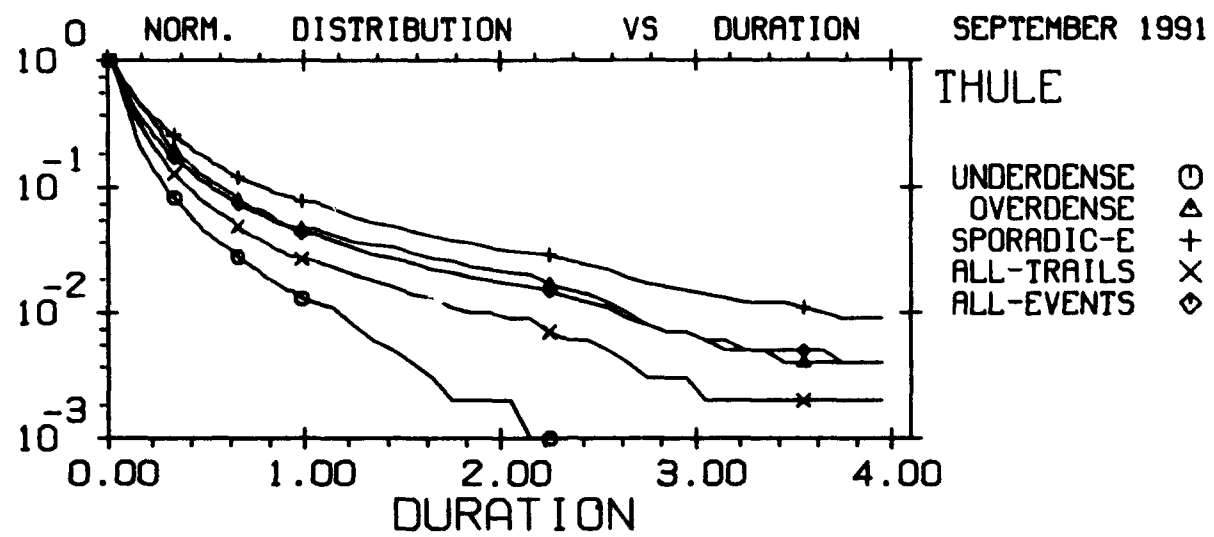

EXCEEDING -116.0 DBM RSL
 THE TIME OF DAY IS 0 : 24 HOURS U.T.
 FREQUENCY - 65 MHZ
 BASED ON OBSERVED NOISE MEASUREMENTS - VERTICAL
 NORMALIZING FACTORS:
 UNDER - 2886. OVER - 1894. SPOR-E - 2509.
 TRAILS - 4780. EVENTS - 7289.

MENU#106,02-4
 13-OCT-93
 PLOT# 75.00

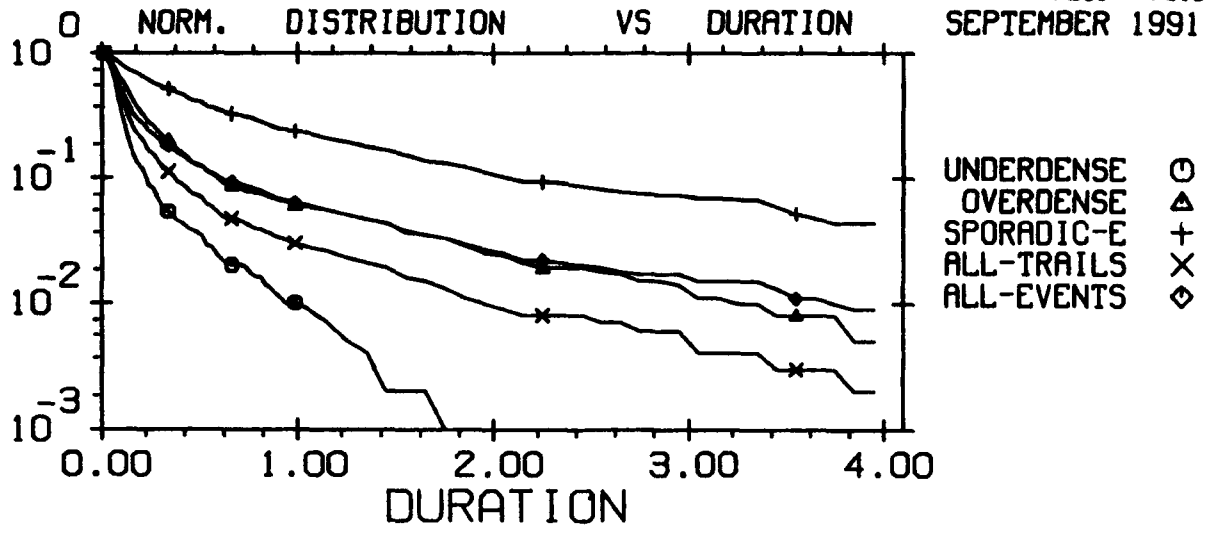

EXCEEDING -116.0 DBM RSL
 THE TIME OF DAY IS 0 : 24 HOURS U.T.
 FREQUENCY - 85 MHZ
 BASED ON OBSERVED NOISE MEASUREMENTS - VERTICAL
 NORMALIZING FACTORS:
 UNDER - 1528. OVER - 1004. SPOR-E - 498.
 TRAILS - 2532. EVENTS - 3030.

MENU#106,02-4
 13-OCT-93
 PLOT# 76.00

GEOPHYSICS LAB METEOR SCATTER PROGRAM

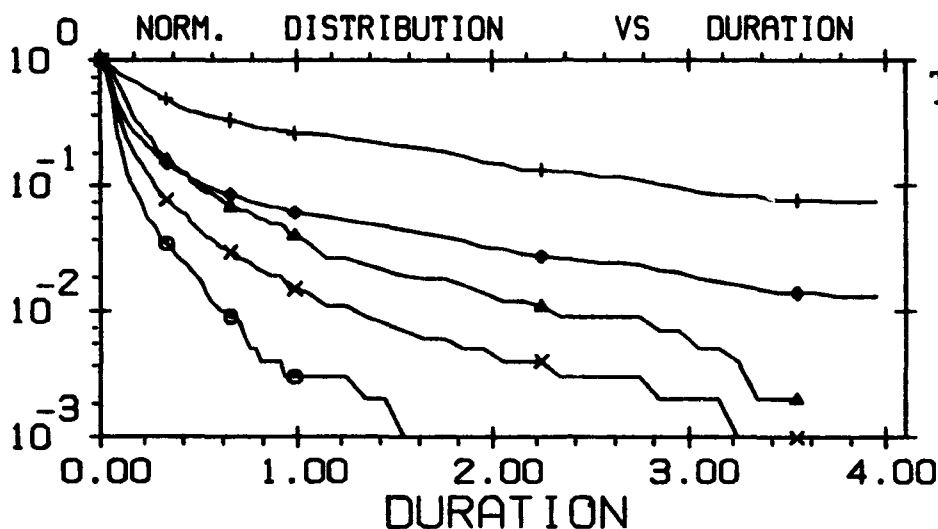

EXCEEDING -116.0 DBM RSL
 THE TIME OF DAY IS 0 : 24 HOURS U.T.
 FREQUENCY - 104 MHZ
 BASED ON OBSERVED NOISE MEASUREMENTS - VERTICAL
 NORMALIZING FACTORS:
 UNDER - 1131. OVER - 571. SPOR-E - 380.
 TRAILS - 1702. EVENTS - 2082.

MENU#106,02-4
 13-OCT-93
 PLOT# 77.00

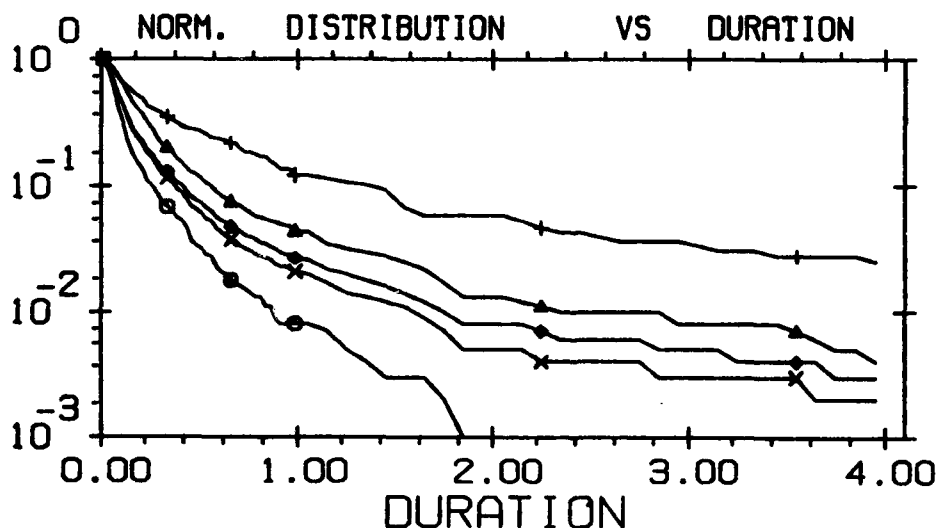

EXCEEDING -116.0 DBM RSL
 THE TIME OF DAY IS 0 : 24 HOURS U.T.
 FREQUENCY - 147 MHZ
 BASED ON OBSERVED NOISE MEASUREMENTS - VERTICAL
 NORMALIZING FACTORS:
 UNDER - 3326. OVER - 1779. SPOR-E - 322.
 TRAILS - 5105. EVENTS - 5427.

MENU#106,02-4
 13-OCT-93
 PLOT# 78.00

GEOPHYSICS LAB METEOR SCATTER PROGRAM

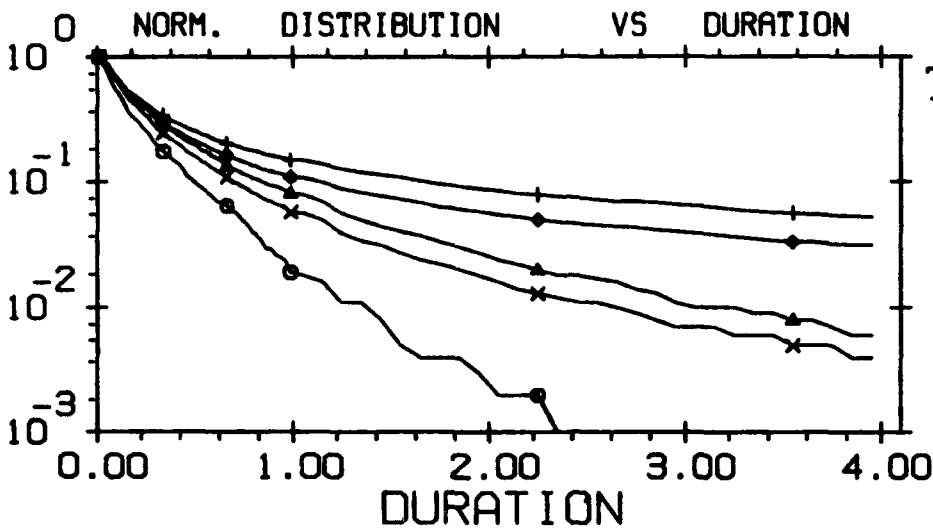

EXCEEDING -106.0 DBM RSL
 THE TIME OF DAY IS 0 : 24 HOURS U.T.
 FREQUENCY - 35 MHZ
 BASED ON OBSERVED NOISE MEASUREMENTS - VERTICAL
 NORMALIZING FACTORS:
 UNDER - 1903. OVER - 3165. SPOR-E - 6432.
 TRAILS - 5068. EVENTS - 11500.

MENU*106,02-4
 13-OCT-93
 PLOT* 79.00

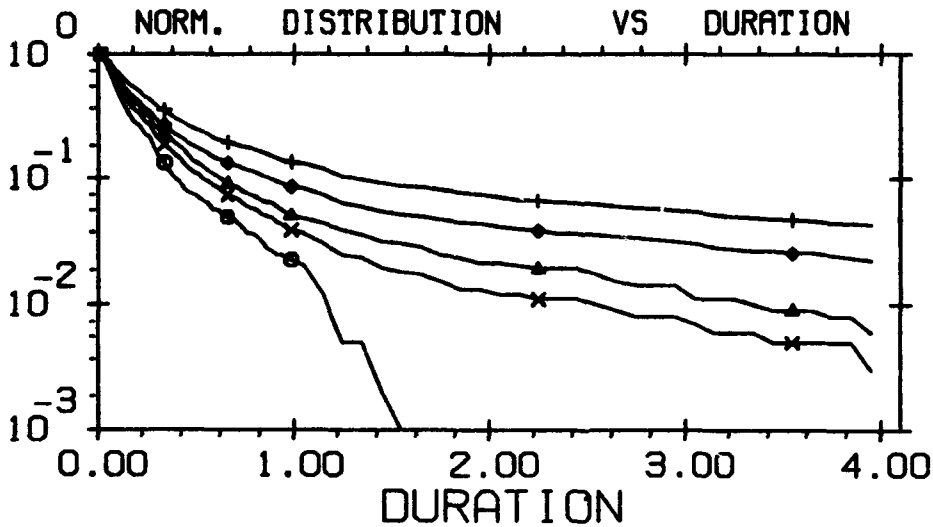

EXCEEDING -106.0 DBM RSL
 THE TIME OF DAY IS 0 : 24 HOURS U.T.
 FREQUENCY - 45 MHZ
 BASED ON OBSERVED NOISE MEASUREMENTS - VERTICAL
 NORMALIZING FACTORS:
 UNDER - 995. OVER - 1397. SPOR-E - 2266.
 TRAILS - 2392. EVENTS - 4658.

MENU*106,02-4
 13-OCT-93
 PLOT* 80.00

GEOPHYSICS LAB METEOR SCATTER PROGRAM

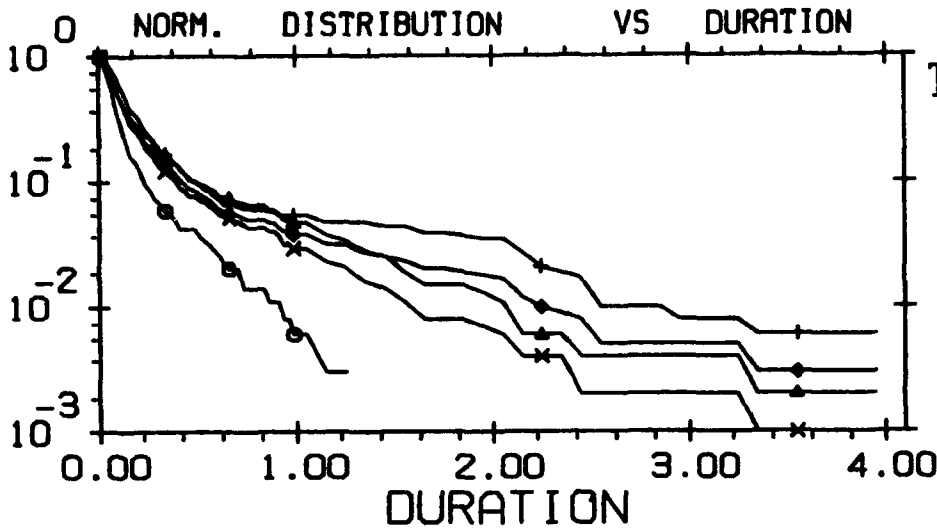

SEPTEMBER 1991

THULE

UNDERDENSE	○
OVERDENSE	△
SPORADIC-E	+
ALL-TRAILS	×
ALL-EVENTS	◇

EXCEEDING -106.0 DBM RSL
 THE TIME OF DAY IS 0 : 24 HOURS U.T.
 FREQUENCY - 65 MHZ
 BASED ON OBSERVED NOISE MEASUREMENTS - VERTICAL
 NORMALIZING FACTORS:
 UNDER - 357. OVER - 472. SPOR-E - 482.
 TRAILS - 829. EVENTS - 1311.

MENU#106,02-4
 13-OCT-93
 PLOT# 81.00

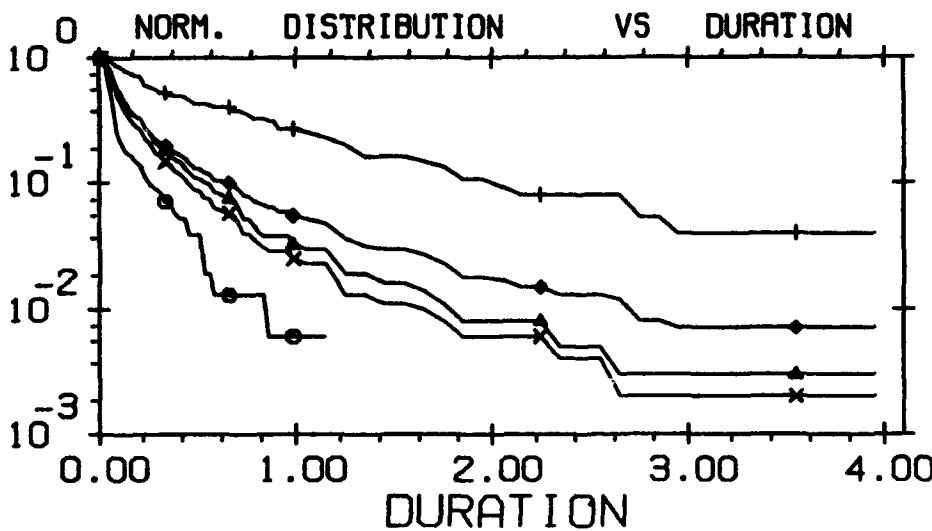

SEPTEMBER 1991

UNDERDENSE	○
OVERDENSE	△
SPORADIC-E	+
ALL-TRAILS	×
ALL-EVENTS	◇

EXCEEDING -106.0 DBM RSL
 THE TIME OF DAY IS 0 : 24 HOURS U.T.
 FREQUENCY - 85 MHZ
 BASED ON OBSERVED NOISE MEASUREMENTS - VERTICAL
 NORMALIZING FACTORS:
 UNDER - 155. OVER - 368. SPOR-E - 75.
 TRAILS - 523. EVENTS - 598.

MENU#106,02-4
 13-OCT-93
 PLOT# 82.00

GEOPHYSICS LAB METEOR SCATTER PROGRAM

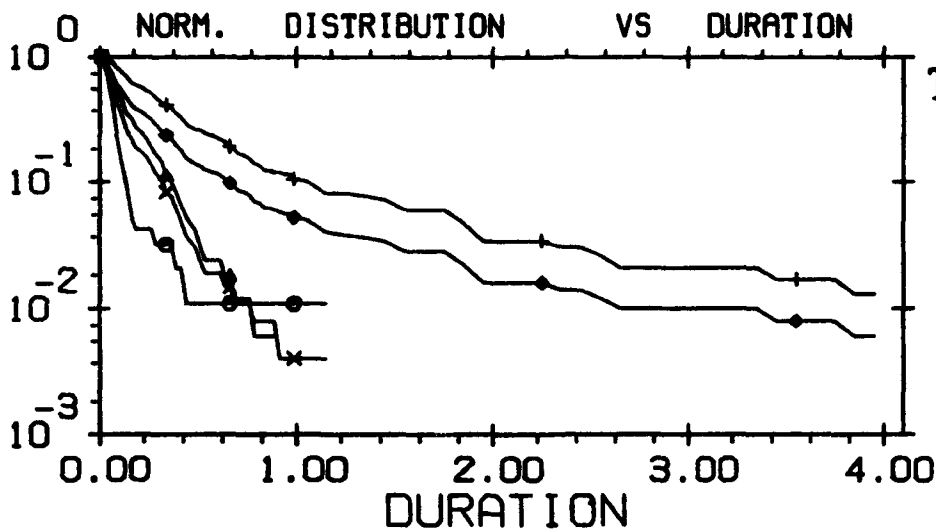

UNDERDENSE ⊙
 OVERDENSE △
 SPORADIC-E +
 ALL-TRAILS ×
 ALL-EVENTS ◇

EXCEEDING -106.0 DBM RSL
 THE TIME OF DAY IS 0 : 24 HOURS U.T.
 FREQUENCY - 104 MHZ
 BASED ON OBSERVED NOISE MEASUREMENTS - VERTICAL
 NORMALIZING FACTORS:
 UNDER - 95. OVER - 169. SPOR-E - 235.
 TRAILS - 264. EVENTS - 499.

MENU#106,02-4
 13-OCT-93
 PLOT# 83.00

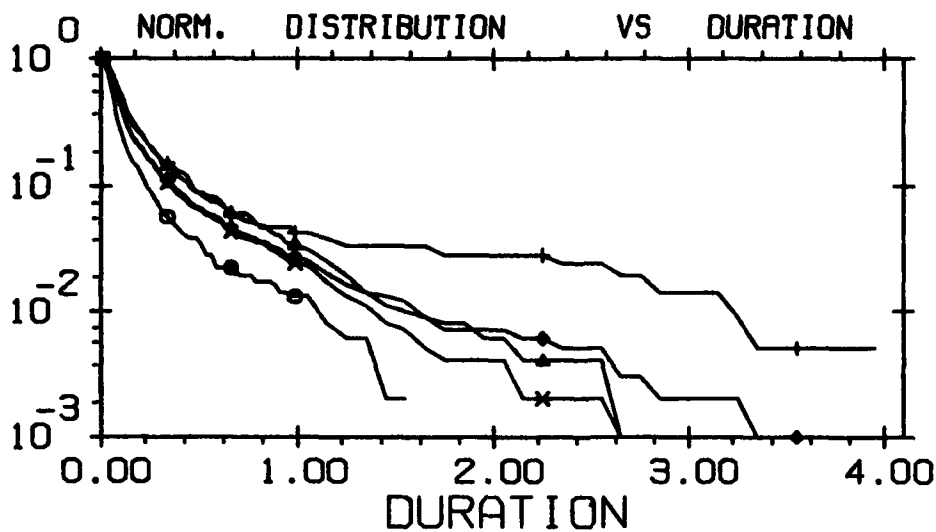

UNDERDENSE ⊙
 OVERDENSE △
 SPORADIC-E +
 ALL-TRAILS ×
 ALL-EVENTS ◇

EXCEEDING -106.0 DBM RSL
 THE TIME OF DAY IS 0 : 24 HOURS U.T.
 FREQUENCY - 147 MHZ
 BASED ON OBSERVED NOISE MEASUREMENTS - VERTICAL
 NORMALIZING FACTORS:
 UNDER - 636. OVER - 773. SPOR-E - 212.
 TRAILS - 1409. EVENTS - 1621.

MENU#106,02-4
 13-OCT-93
 PLOT# 84.00

GEOPHYSICS LAB METEOR SCATTER PROGRAM

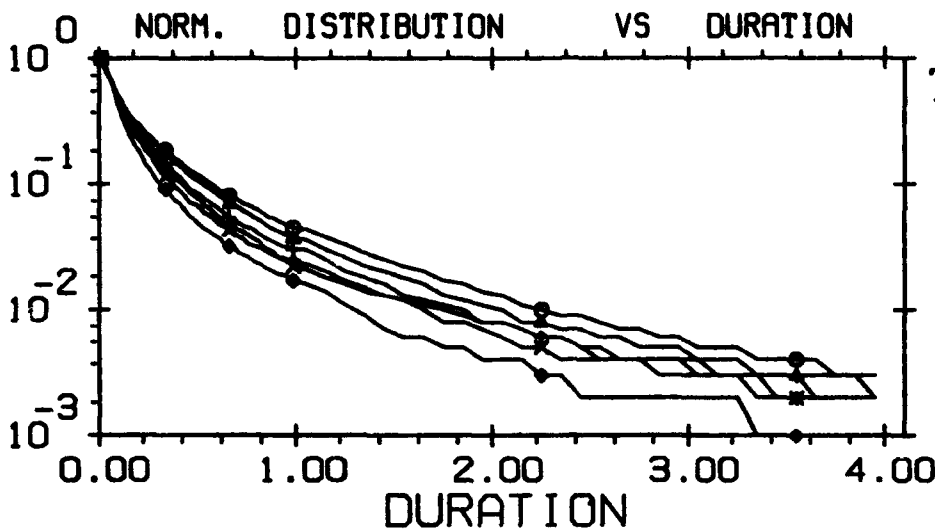

SEPTEMBER 1991

THULE

- 35 MHZ ○
- 45 MHZ △
- 65 MHZ +
- 85 MHZ ×
- 104 MHZ ◇
- 147 MHZ †

EXCEEDING -126.0 DBM RSL
 THE TIME OF DAY IS 0 : 24 HOURS U.T.
 THE EVENT CLASS IS UNDERDENSE AND OVERDENSE TRAILS
 BASED ON OBSERVED NOISE MEASUREMENTS - VERTICAL
 NORMALIZING FACTORS:
 35MHZ - 59475. 45MHZ - 28112. 65MHZ - 13002.
 85MHZ - 7560. 104MHZ - 5457. 147MHZ - 12477.

MENU#106,01-4
 13-OCT-93
 PLOT# 85.00

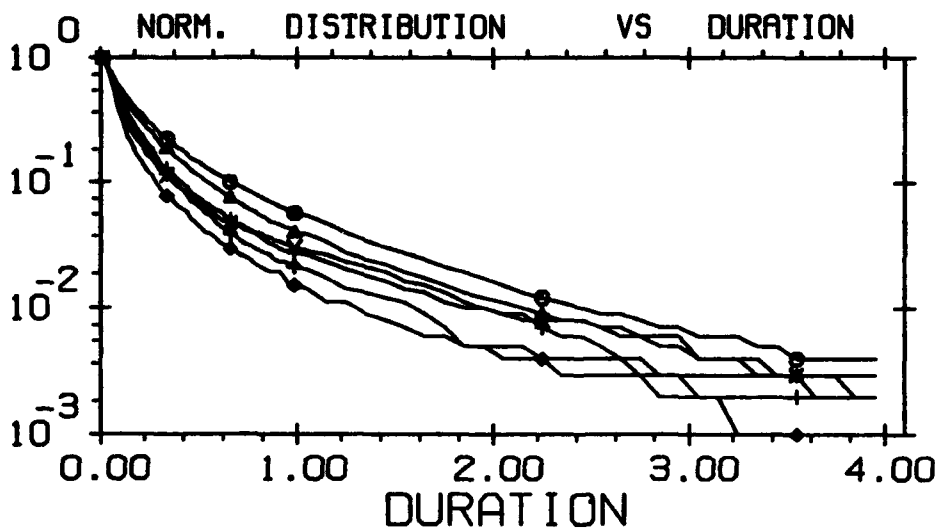

SEPTEMBER 1991

- 35 MHZ ○
- 45 MHZ △
- 65 MHZ +
- 85 MHZ ×
- 104 MHZ ◇
- 147 MHZ †

EXCEEDING -116.0 DBM RSL
 THE TIME OF DAY IS 0 : 24 HOURS U.T.
 THE EVENT CLASS IS UNDERDENSE AND OVERDENSE TRAILS
 BASED ON OBSERVED NOISE MEASUREMENTS - VERTICAL
 NORMALIZING FACTORS:
 35MHZ - 23920. 45MHZ - 11910. 65MHZ - 4780.
 85MHZ - 2532. 104MHZ - 1702. 147MHZ - 5105.

MENU#106,01-4
 13-OCT-93
 PLOT# 86.00

GEOPHYSICS LAB METEOR SCATTER PROGRAM

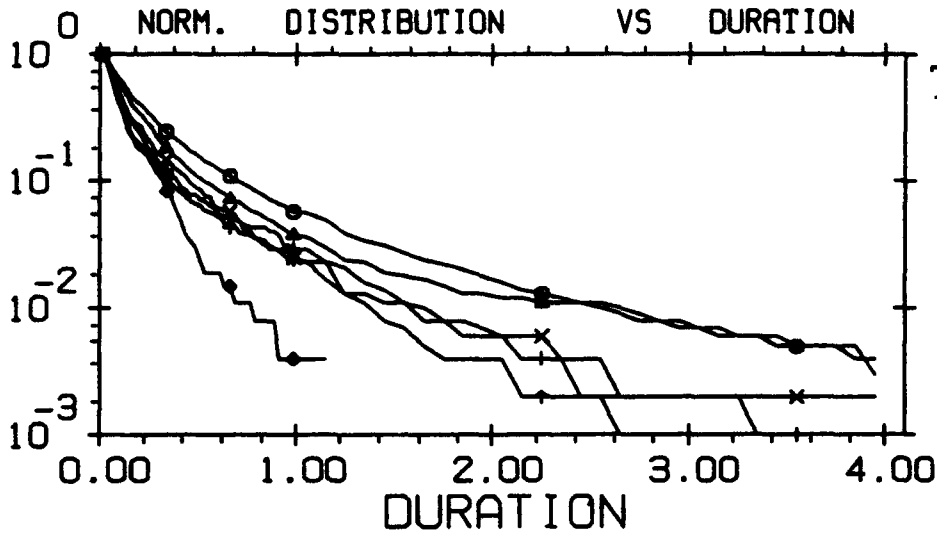

EXCEEDING -106.0 DBM RSL
 THE TIME OF DAY IS 0 : 24 HOURS U.T.
 THE EVENT CLASS IS UNDERDENSE AND OVERDENSE TRAILS
 BASED ON OBSERVED NOISE MEASUREMENTS - VERTICAL
 NORMALIZING FACTORS:
 35MHZ - 5068. 45MHZ - 2392. 65MHZ - 829.
 85MHZ - 523. 104MHZ - 264. 147MHZ - 1409.

MENU*106,01-4
 13-OCT-93
 PLOT* 87.00

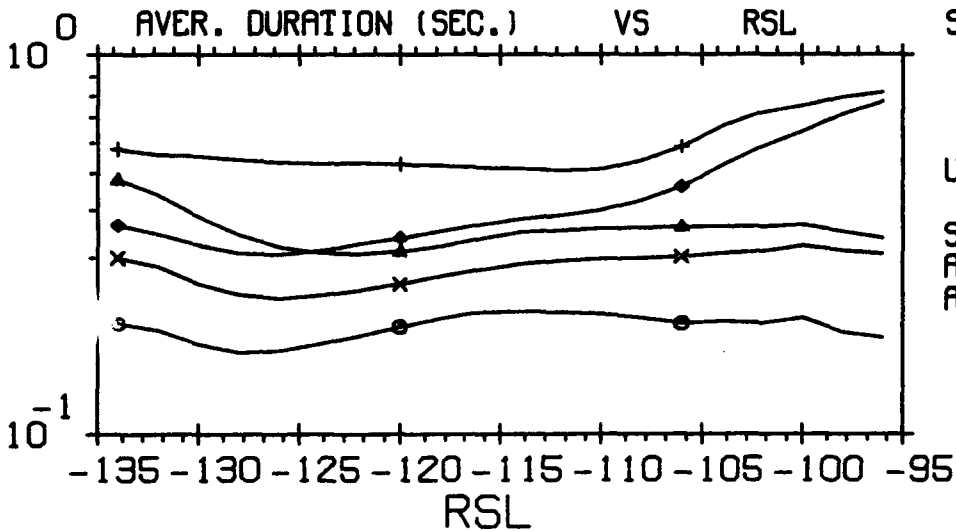

THE TIME OF DAY IS 0 : 24 HOURS U.T.
 FREQUENCY - 35 MHZ
 BASED ON OBSERVED NOISE MEASUREMENTS - VERTICAL

MENU*106,05-1
 13-OCT-93
 PLOT* 88.00

GEOPHYSICS LAB METEOR SCATTER PROGRAM

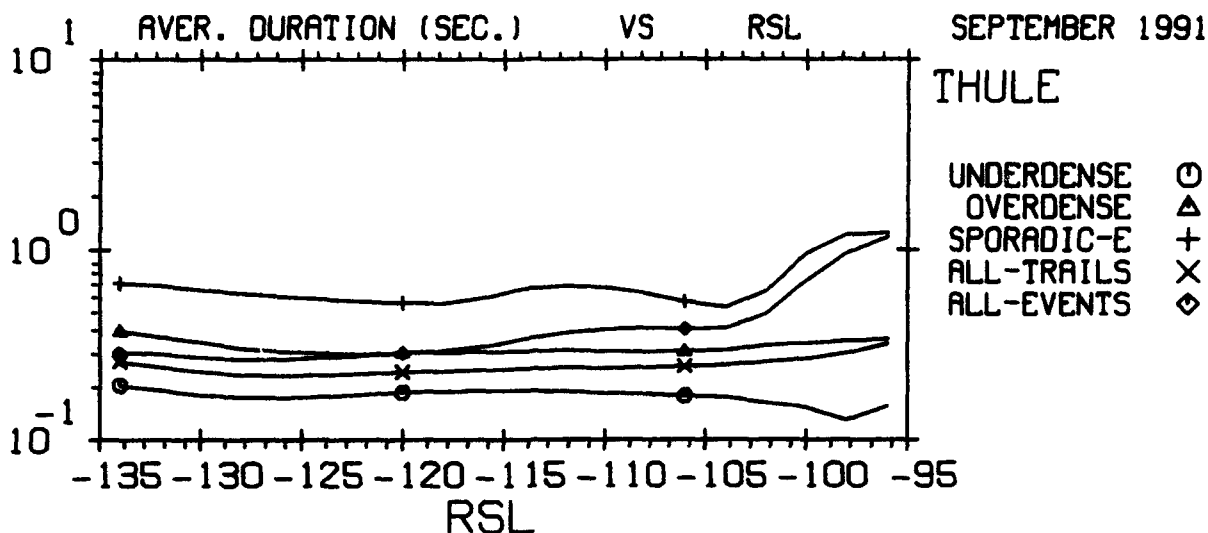

THE TIME OF DAY IS 0 : 24 HOURS U.T.
 FREQUENCY - 45 MHZ
 BASED ON OBSERVED NOISE MEASUREMENTS - VERTICAL

MENU*106,06-1
 13-OCT-93
 PLOT* 89.00

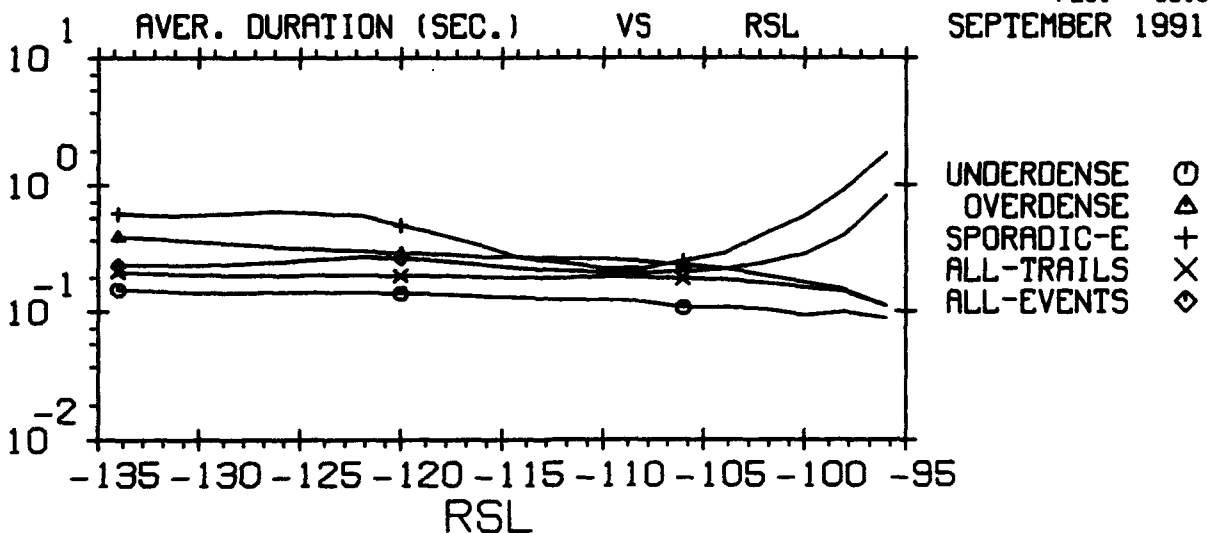

THE TIME OF DAY IS 0 : 24 HOURS U.T.
 FREQUENCY - 65 MHZ
 BASED ON OBSERVED NOISE MEASUREMENTS - VERTICAL

MENU*106,06-1
 13-OCT-93
 PLOT* 90.00

GEOPHYSICS LAB METEOR SCATTER PROGRAM

SEPTEMBER 1991

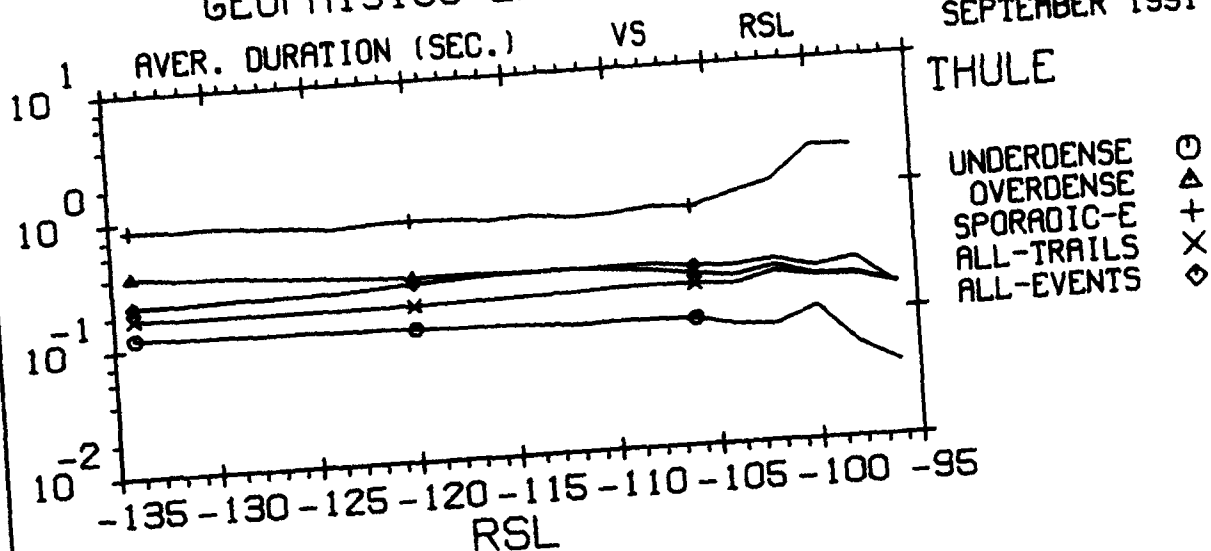

THE TIME OF DAY IS 0 : 24 HOURS U.T.
 FREQUENCY - 85 MHZ
 BASED ON OBSERVED NOISE MEASUREMENTS - VERTICAL

MENU#106,06-1
 13-OCT-93
 PLOT# 91.00

SEPTEMBER 1991

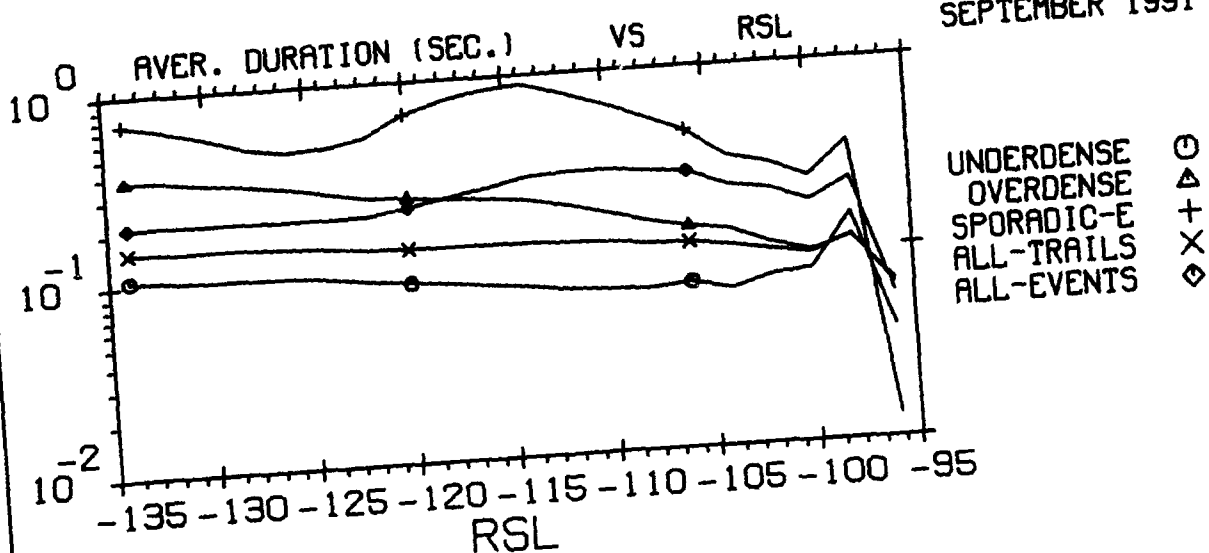

THE TIME OF DAY IS 0 : 24 HOURS U.T.
 FREQUENCY - 104 MHZ
 BASED ON OBSERVED NOISE MEASUREMENTS - VERTICAL

MENU#106,06-1
 13-OCT-93
 PLOT# 92.00

GEOPHYSICS LAB METEOR SCATTER PROGRAM

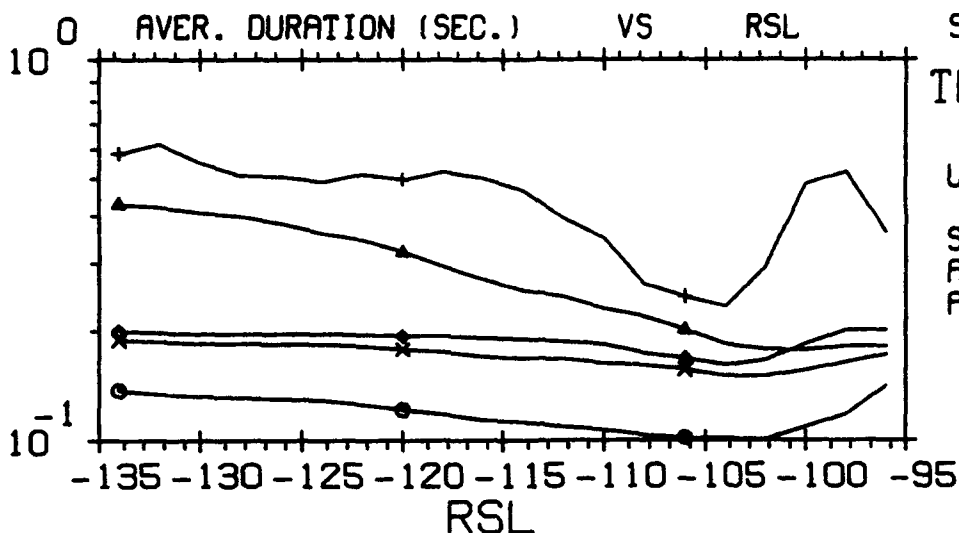

SEPTEMBER 1991

THULE

UNDERDENSE ○
 OVERDENSE ▲
 SPORADIC-E +
 ALL-TRAILS ×
 ALL-EVENTS ◇

THE TIME OF DAY IS 0 : 24 HOURS U.T.
 FREQUENCY - 147 MHZ
 BASED ON OBSERVED NOISE MEASUREMENTS - VERTICAL

MENU#106,06-1
 13-OCT-93
 PLOT# 93.00

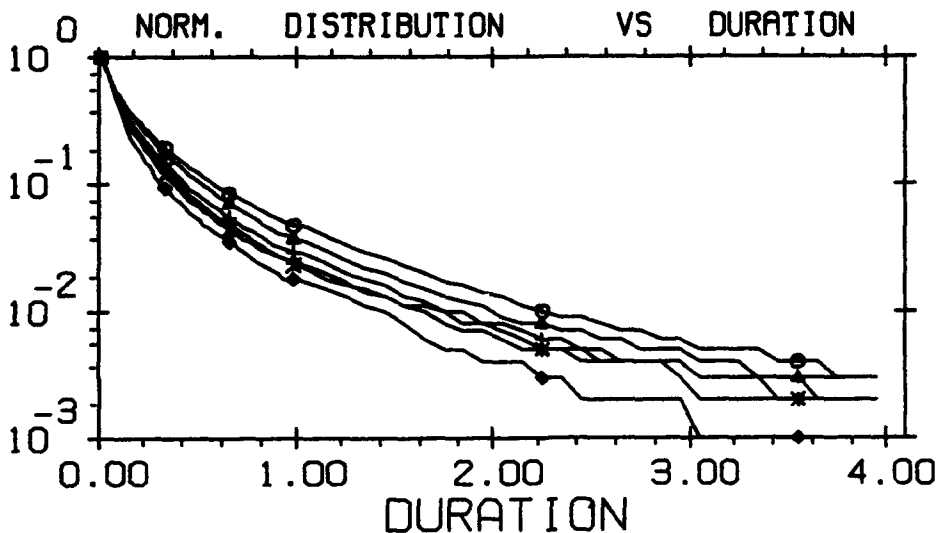

SEPTEMBER 1991

35 MHZ ○
 45 MHZ ▲
 65 MHZ +
 85 MHZ ×
 104 MHZ ◇
 147 MHZ ↑

EXCEEDING 19.0 DB SNR
 THE TIME OF DAY IS 0 : 24 HOURS U.T.
 THE EVENT CLASS IS UNDERDENSE AND OVERDENSE TRAILS
 EFFECTIVE SYSTEM BANDWIDTH - 100.HZ
 BASED ON OBSERVED NOISE MEASUREMENTS - VERTICAL
 NORMALIZING FACTORS:
 35MHZ - 44551. 45MHZ - 23240. 65MHZ - 13413.
 85MHZ - 8754. 104MHZ - 7036. 147MHZ - 11016.

MENU#107,01-4
 13-OCT-93
 PLOT# 94.00

GEOPHYSICS LAB METEOR SCATTER PROGRAM

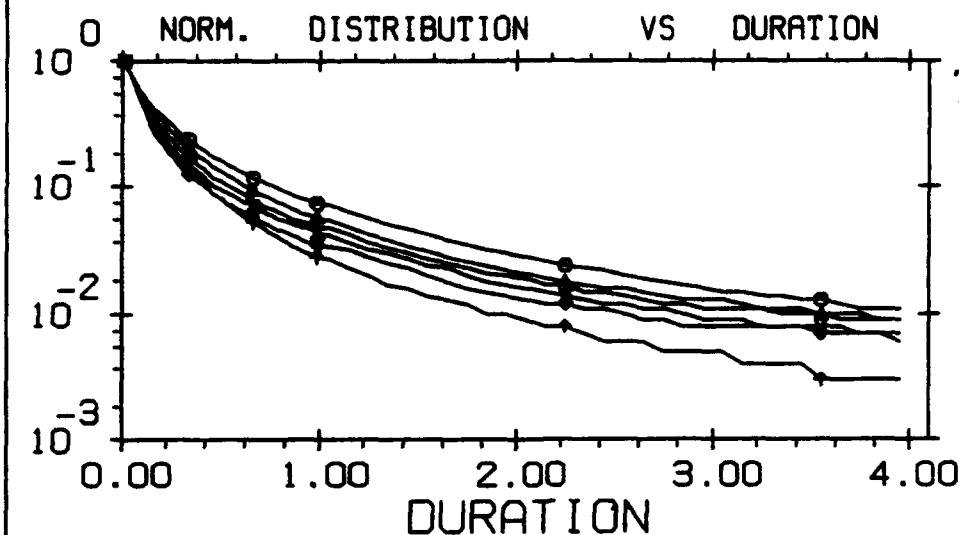

SEPTEMBER 1991

THULE

- 35 MHZ ○
- 45 MHZ △
- 65 MHZ +
- 85 MHZ ×
- 104 MHZ ◇
- 147 MHZ ↑

EXCEEDING 19.0 DB SNR
 THE TIME OF DAY IS 0 : 24 HOURS U.T.
 THE EVENT CLASS IS SPORADIC-E AND METEOR TRAILS
 EFFECTIVE SYSTEM BANDWIDTH - 100.HZ
 BASED ON OBSERVED NOISE MEASUREMENTS - VERTICAL
 NORMALIZING FACTORS:
 35MHZ - 62607. 45MHZ - 27893. 65MHZ - 15350.
 85MHZ - 9505. 104MHZ - 8249. 147MHZ - 11464.

MENU*107,01-4
 13-OCT-93
 PLOT* 95.00

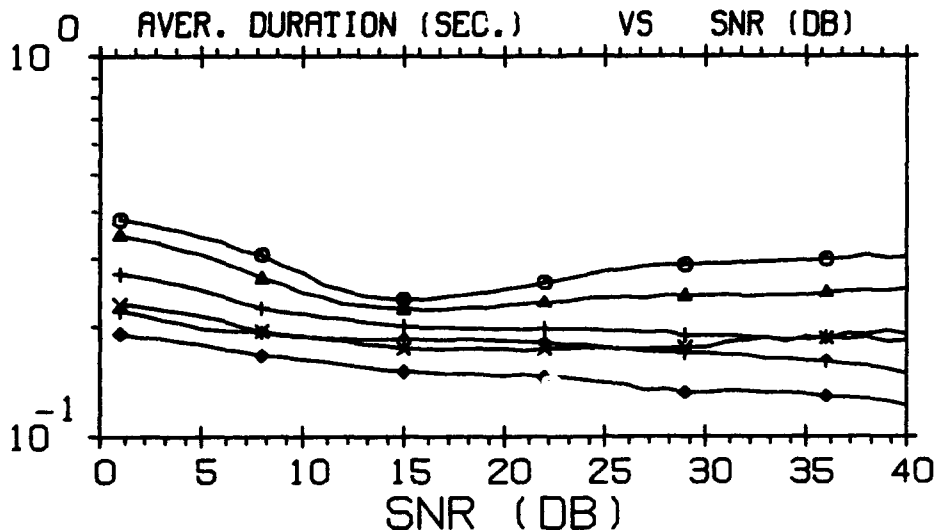

SEPTEMBER 1991

- 35 MHZ ○
- 45 MHZ △
- 65 MHZ +
- 85 MHZ ×
- 104 MHZ ◇
- 147 MHZ ↑

THE TIME OF DAY IS 0 : 24 HOURS U.T.
 THE EVENT CLASS IS UNDERDENSE AND OVERDENSE TRAILS
 EFFECTIVE SYSTEM BANDWIDTH - 100.HZ
 BASED ON OBSERVED NOISE MEASUREMENTS - VERTICAL

MENU*107,05-1
 13-OCT-93
 PLOT* 96.00

GEOPHYSICS LAB METEOR SCATTER PROGRAM

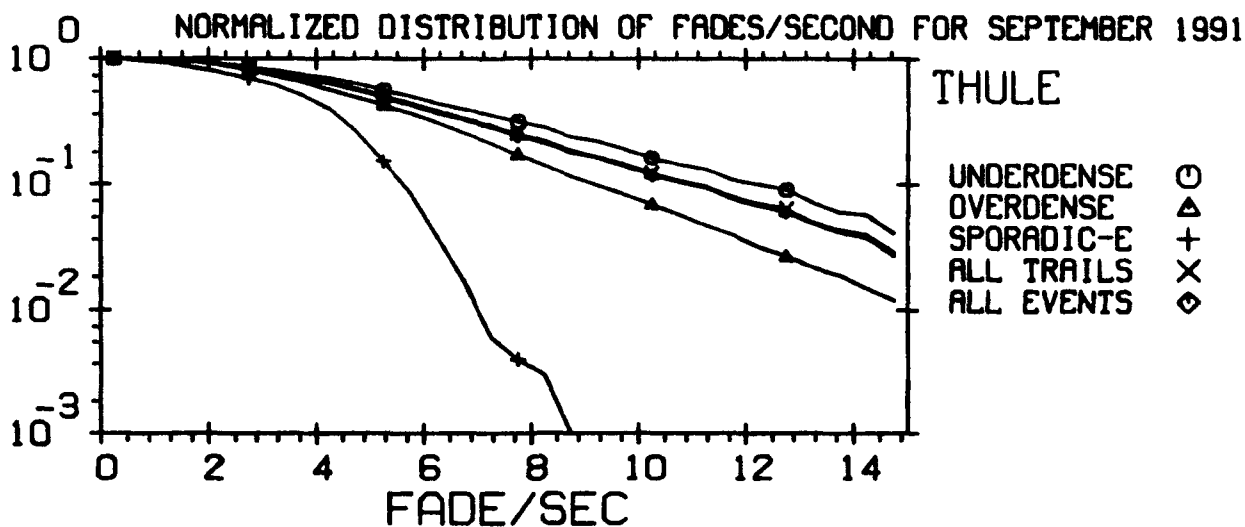

THE TIME OF DAY IS 0 : 24 HOURS U.T.
 FREQUENCY - 35 MHZ
 NORMALIZING FACTORS:
 UNDER - 9484. OVER - 6916. SPOR-E - 721.
 TRAILS - 16400. EVENTS - 17121.

MENU=109,02-4
 13-OCT-93
 PLOT= 101.00

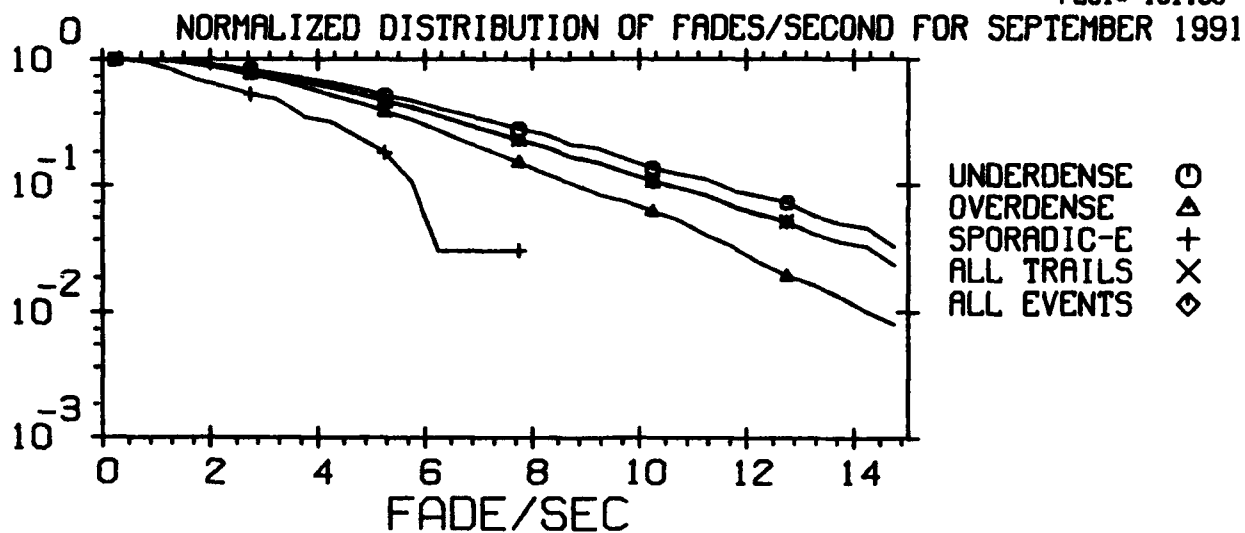

THE TIME OF DAY IS 0 : 24 HOURS U.T.
 FREQUENCY - 45 MHZ
 NORMALIZING FACTORS:
 UNDER - 4819. OVER - 3074. SPOR-E - 66.
 TRAILS - 7893. EVENTS - 7959.

MENU=109,02-4
 13-OCT-93
 PLOT= 102.00

GEOPHYSICS LAB METEOR SCATTER PROGRAM

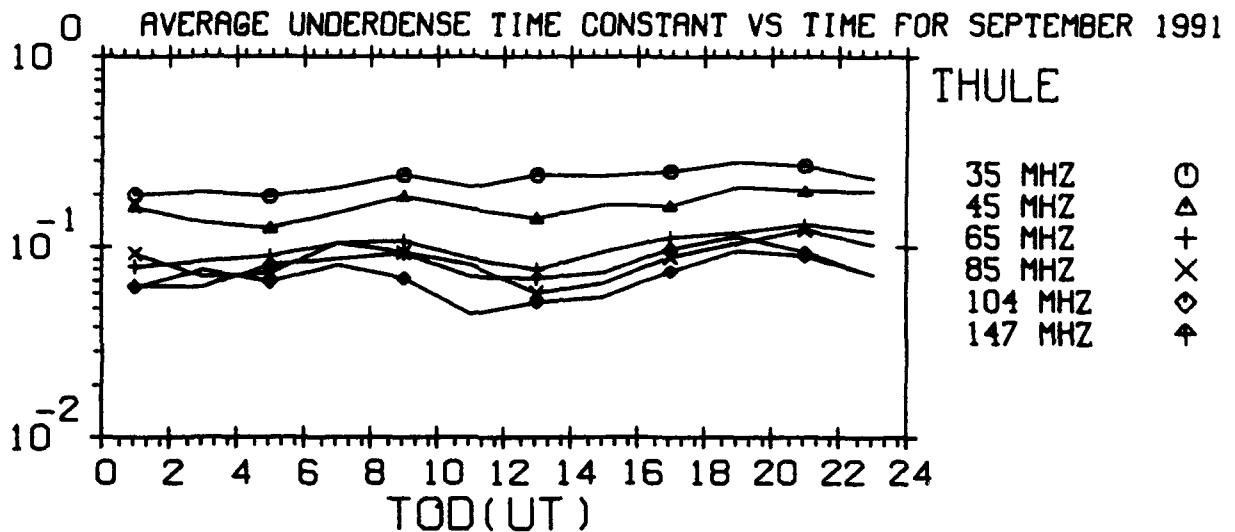

BASED ON OBSERVED NOISE MEASUREMENTS - VERTICAL
 THE 24 HOUR AVERAGE TIME CONSTANTS ARE

0.222	0.160	0.096	0.083	0.066	0.080
-------	-------	-------	-------	-------	-------

MENU#108,02-1
 13-OCT-93
 PLOT# 99.00

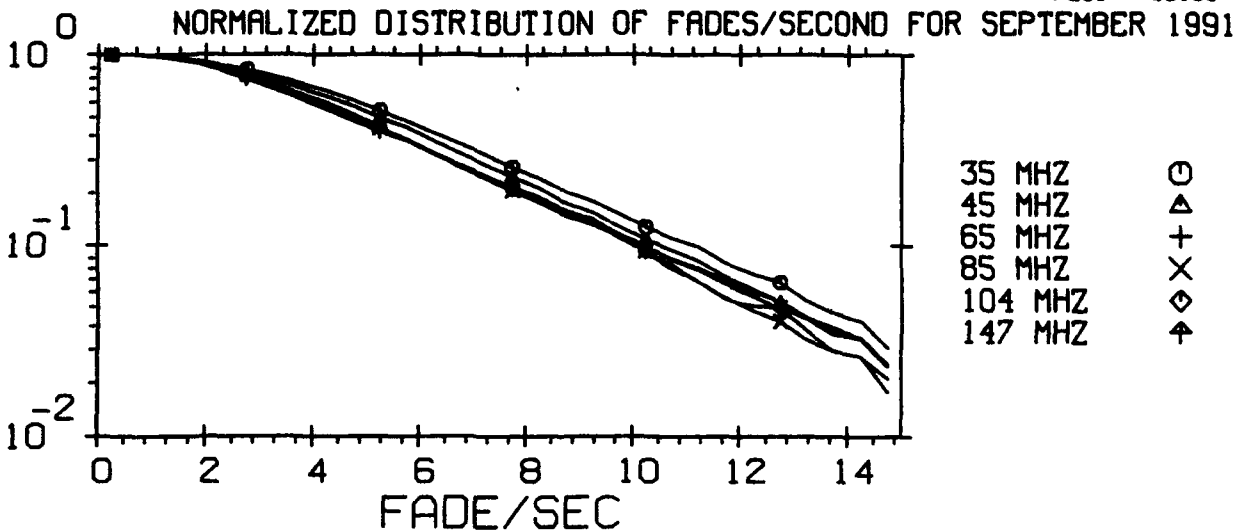

THE TIME OF DAY IS 0 : 24 HOURS U.T.
 THE EVENT CLASS IS UNDERDENSE AND OVERDENSE TRAILS
 NORMALIZING FACTORS:

35MHZ - 16400.	45MHZ - 7893.	65MHZ - 3232.
85MHZ - 1669.	104MHZ - 1073.	147MHZ - 2808.

MENU#109,01-4
 13-OCT-93
 PLOT# 100.00

GEOPHYSICS LAB METEOR SCATTER PROGRAM

NORMALIZED DISTRIBUTION OF FADES/SECOND FOR SEPTEMBER 1991

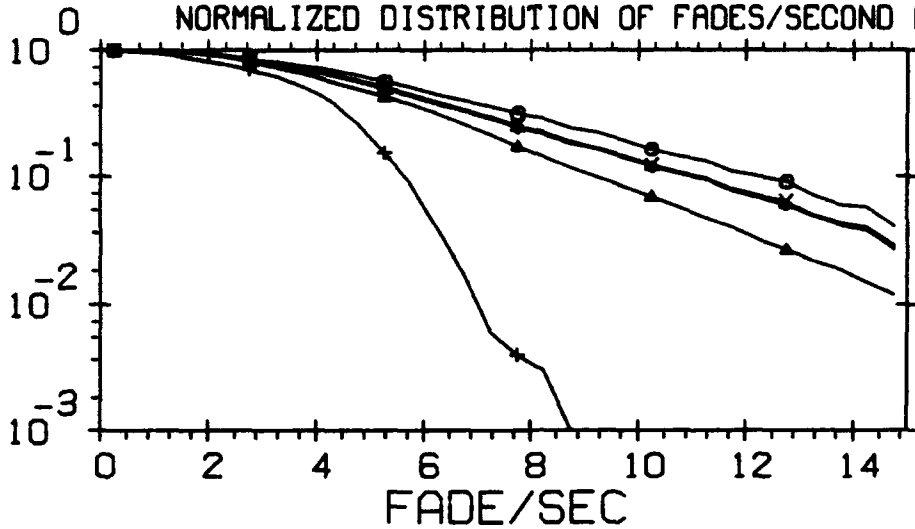

THE TIME OF DAY IS 0 : 24 HOURS U.T.

FREQUENCY - 35 MHZ

NORMALIZING FACTORS:

UNDER - 9484. OVER - 6916. SPOR-E - 721.

TRAILS - 16400. EVENTS - 17121.

MENU#109,02-4

13-OCT-93

PLOT# 101.00

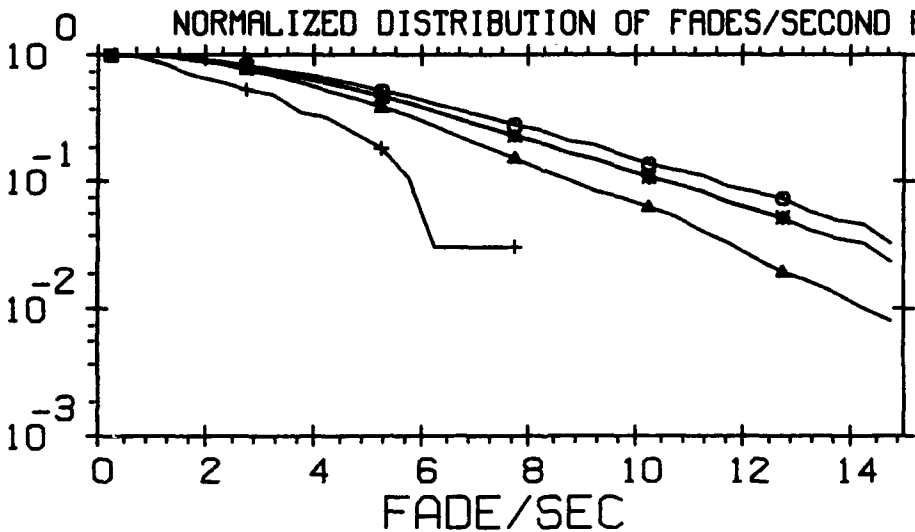

THE TIME OF DAY IS 0 : 24 HOURS U.T.

FREQUENCY - 45 MHZ

NORMALIZING FACTORS:

UNDER - 4819. OVER - 3074. SPOR-E - 66.

TRAILS - 7893. EVENTS - 7959.

MENU#109,02-4

13-OCT-93

PLOT# 102.00

GEOPHYSICS LAB METEOR SCATTER PROGRAM

NORMALIZED DISTRIBUTION OF FADES/SECOND FOR SEPTEMBER 1991

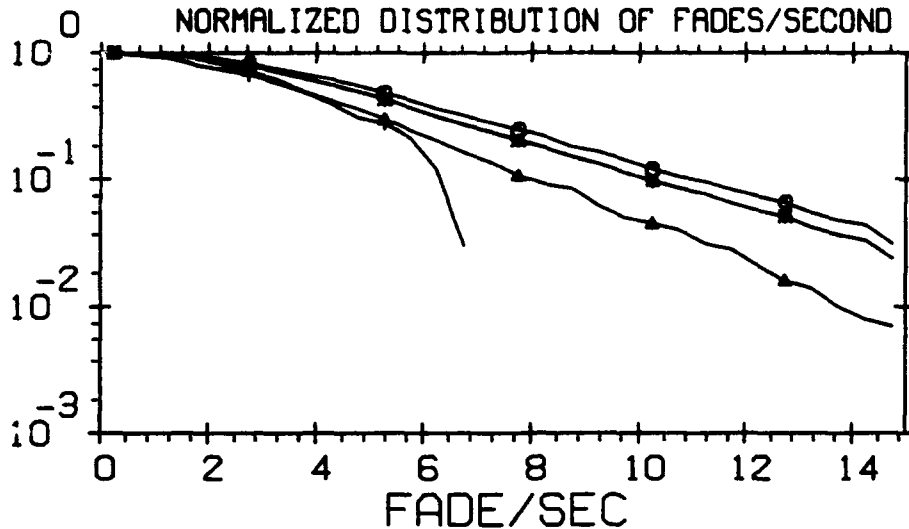

THULE

- UNDERDENSE ○
- OVERDENSE △
- SPORADIC-E +
- ALL TRAILS ×
- ALL EVENTS ◇

THE TIME OF DAY IS 0 : 24 HOURS U.T.

FREQUENCY - 65 MHZ

NORMALIZING FACTORS:

UNDER - 2255. OVER - 977. SPOR-E - 33.

TRAILS - 3232. EVENTS - 3265.

MENU*109,02-4

13-OCT-93

PLOT* 103.00

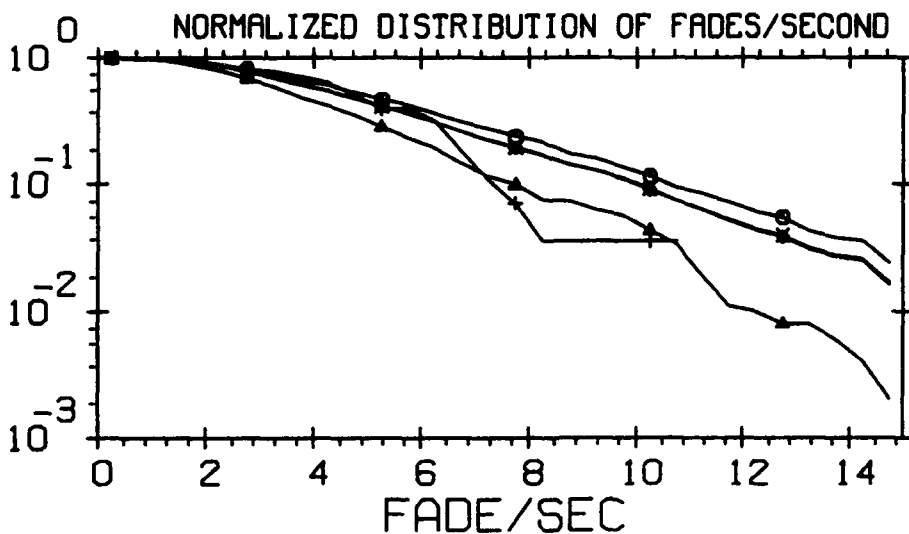

- UNDERDENSE ○
- OVERDENSE △
- SPORADIC-E +
- ALL TRAILS ×
- ALL EVENTS ◇

THE TIME OF DAY IS 0 : 24 HOURS U.T.

FREQUENCY - 85 MHZ

NORMALIZING FACTORS:

UNDER - 1143. OVER - 526. SPOR-E - 28.

TRAILS - 1669. EVENTS - 1697.

MENU*109,02-4

13-OCT-93

PLOT* 104.00

GEOPHYSICS LAB METEOR SCATTER PROGRAM

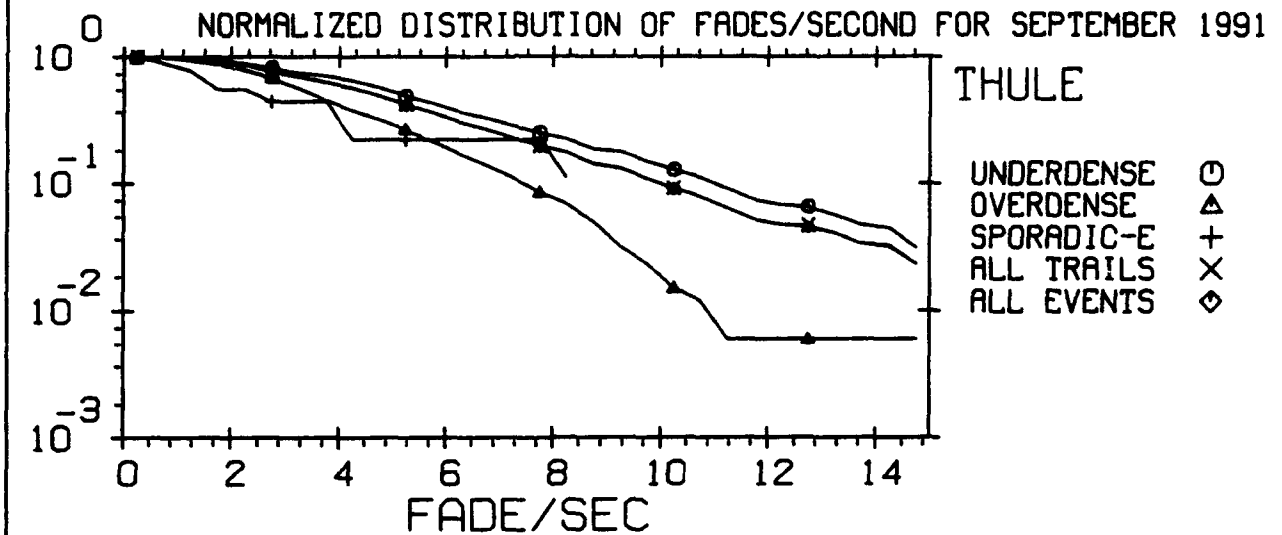

THE TIME OF DAY IS 0 : 24 HOURS U.T.

FREQUENCY - 104 MHZ

NORMALIZING FACTORS:

UNDER - 732. OVER - 341. SPOR-E - 9.

TRAILS - 1073. EVENTS - 1082.

MENU*109,02-4
13-OCT-93
PLOT* 105.00

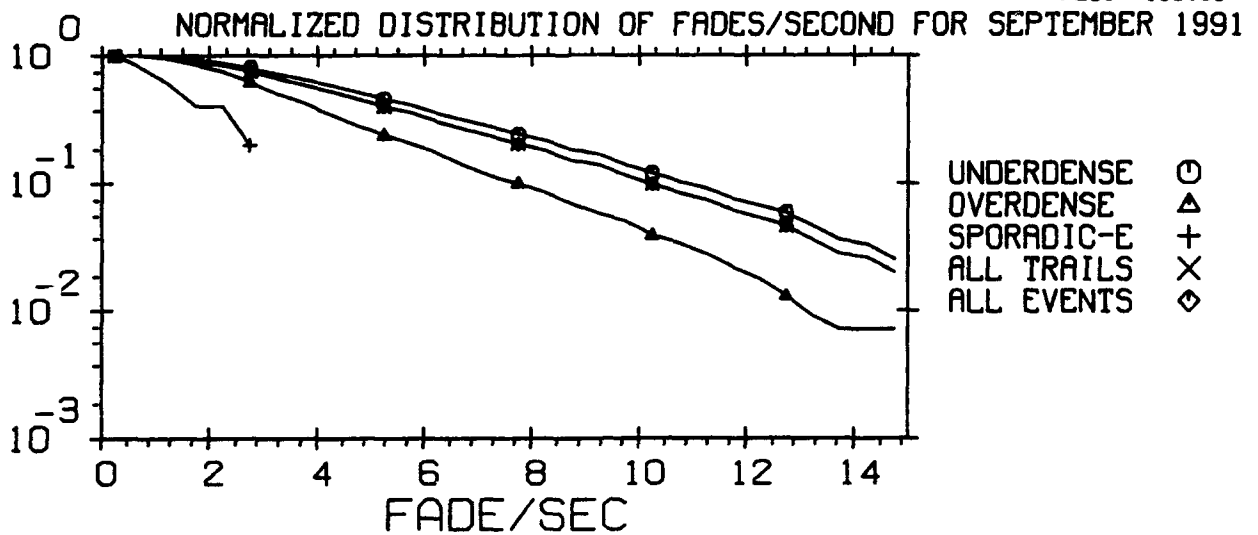

THE TIME OF DAY IS 0 : 24 HOURS U.T.

FREQUENCY - 147 MHZ

NORMALIZING FACTORS:

UNDER - 2045. OVER - 763. SPOR-E - 5.

TRAILS - 2808. EVENTS - 2813.

MENU*109,02-4
13-OCT-93
PLOT* 106.00

GEOPHYSICS LAB METEOR SCATTER PROGRAM

AVERAGE FADES/SECOND VS TIME FOR SEPTEMBER 1991

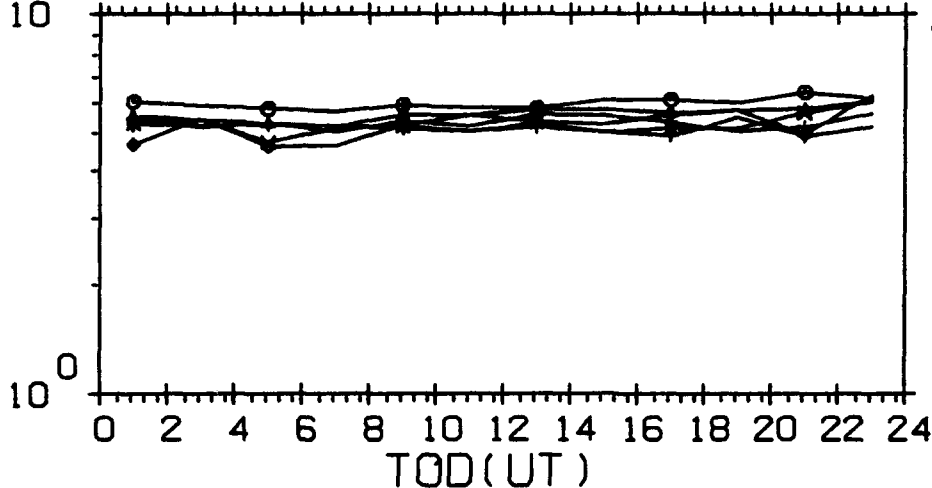

THULE

35 MHZ	○
45 MHZ	△
65 MHZ	+
85 MHZ	×
104 MHZ	◇
147 MHZ	⋈

THE EVENT CLASS IS UNDERDENSE AND OVERDENSE TRAILS
 THE 24 HOUR FADES/SECOND AVERAGES ARE:

5.784 5.455 5.192 5.065 5.119 5.024

MENU*109,07-1
 13-OCT-93
 PLOT* 107.00

NORMALIZED DISTRIBUTION OF FADE DURATIONS FOR SEPTEMBER 1991

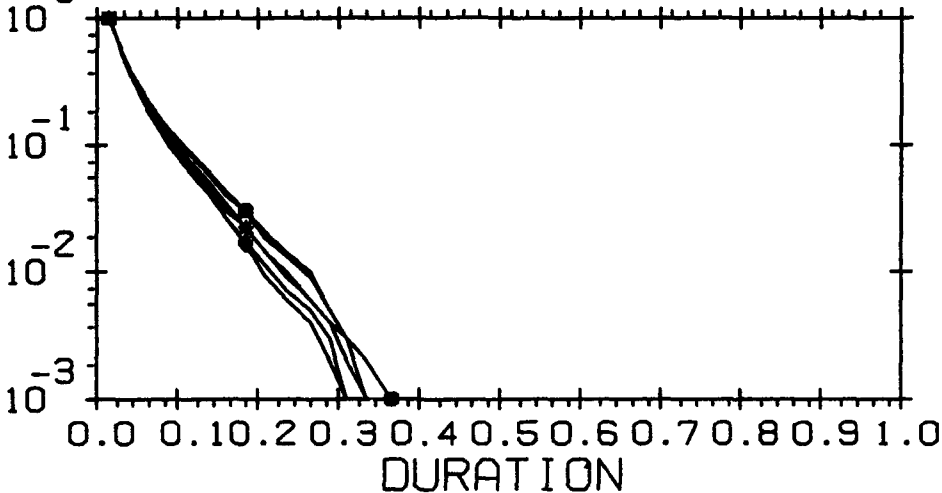

35 MHZ	○
45 MHZ	△
65 MHZ	+
85 MHZ	×
104 MHZ	◇
147 MHZ	⋈

THE TIME OF DAY IS 0 : 24 HOURS U.T.
 THE EVENT CLASS IS UNDERDENSE AND OVERDENSE TRAILS
 NORMALIZING FACTORS:

35MHZ - 75127. 45MHZ - 31781. 65MHZ - 11863.
 85MHZ - 5966. 104MHZ - 3248. 147MHZ - 8269.

MENU*109,05-4
 13-OCT-93
 PLOT* 108.00

GEOPHYSICS LAB METEOR SCATTER PROGRAM

NORMALIZED DISTRIBUTION OF FADE DURATIONS FOR SEPTEMBER 1991

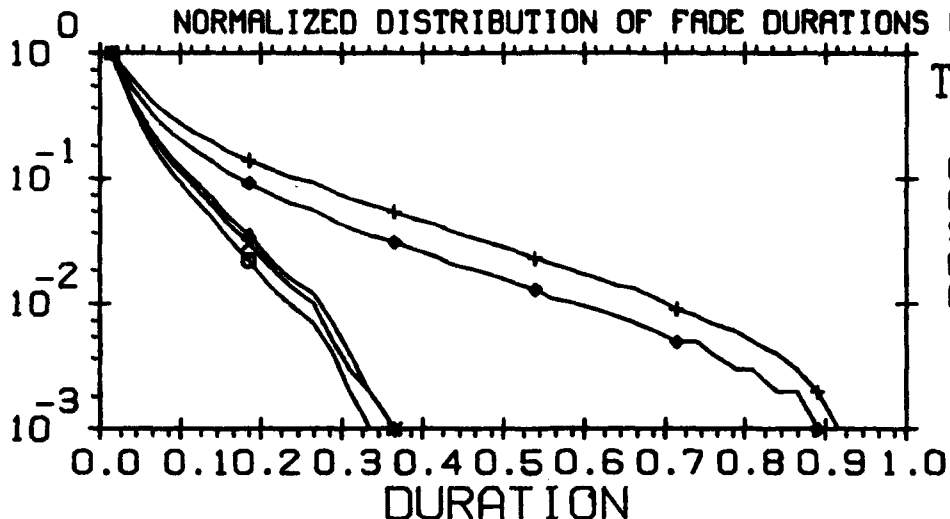

THULE

UNDERDENSE	○
OVERDENSE	△
SPORADIC-E	+
ALL TRAILS	×
ALL EVENTS	◇

THE TIME OF DAY IS 0 : 24 HOURS U.T.

FREQUENCY - 35 MHZ

NORMALIZING FACTORS:

UNDER - 27198. OVER - 47929. SPOR-E - 95254.

TRAILS - 75127. EVENTS - 170381.

MENU*109,06-4

13-OCT-93

PLOT* 109.00

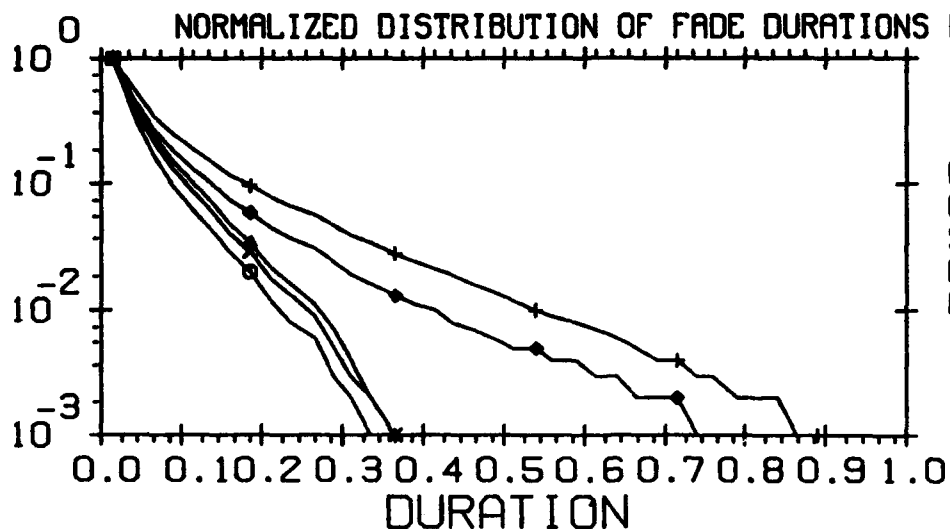

NORMALIZED DISTRIBUTION OF FADE DURATIONS FOR SEPTEMBER 1991

UNDERDENSE	○
OVERDENSE	△
SPORADIC-E	+
ALL TRAILS	×
ALL EVENTS	◇

THE TIME OF DAY IS 0 : 24 HOURS U.T.

FREQUENCY - 45 MHZ

NORMALIZING FACTORS:

UNDER - 12222. OVER - 19559. SPOR-E - 25802.

TRAILS - 31781. EVENTS - 57583.

MENU*109,06-4

13-OCT-93

PLOT* 110.00

GEOPHYSICS LAB METEOR SCATTER PROGRAM

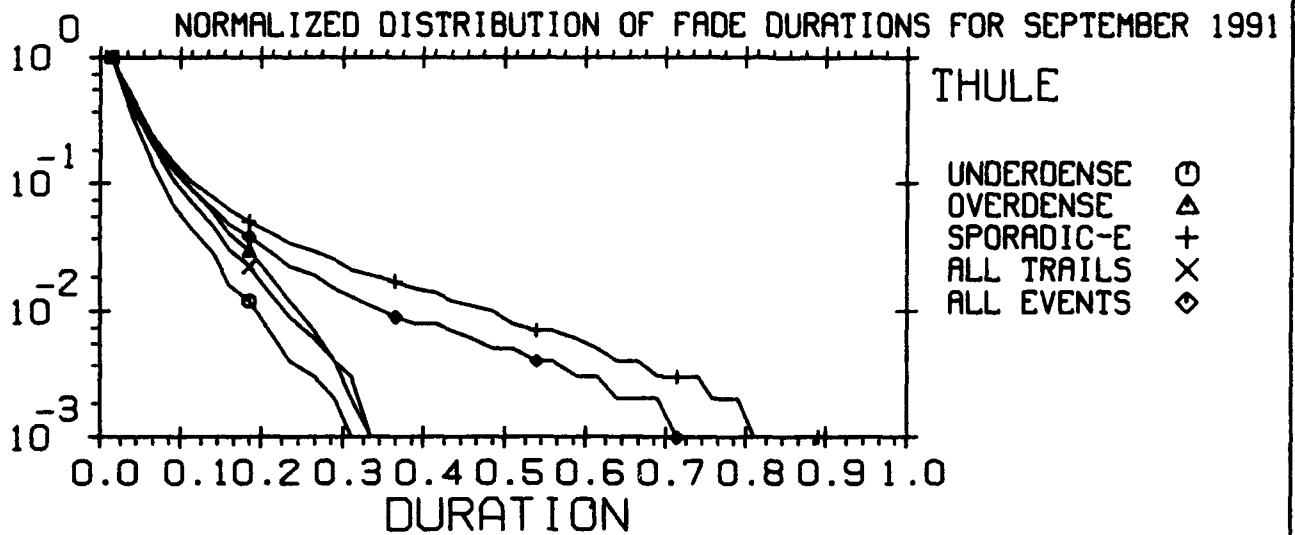

THE TIME OF DAY IS 0 : 24 HOURS U.T.
 FREQUENCY - 65 MHZ
 NORMALIZING FACTORS:
 UNDER - 5036. OVER - 6827. SPOR-E - 14559.
 TRAILS - 11863. EVENTS - 26422.

MENU#109,06-4
 13-OCT-93
 PLOT# 111.00

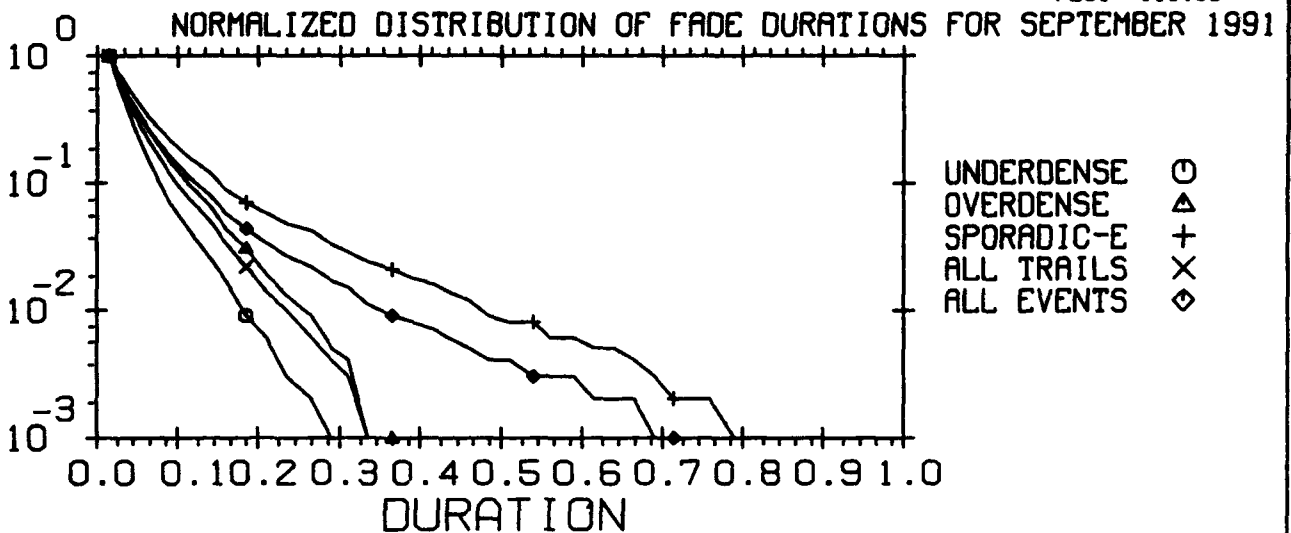

THE TIME OF DAY IS 0 : 24 HOURS U.T.
 FREQUENCY - 85 MHZ
 NORMALIZING FACTORS:
 UNDER - 2319. OVER - 3647. SPOR-E - 4787.
 TRAILS - 5966. EVENTS - 10753.

MENU#109,06-4
 13-OCT-93
 PLOT# 112.00

GEOPHYSICS LAB METEOR SCATTER PROGRAM

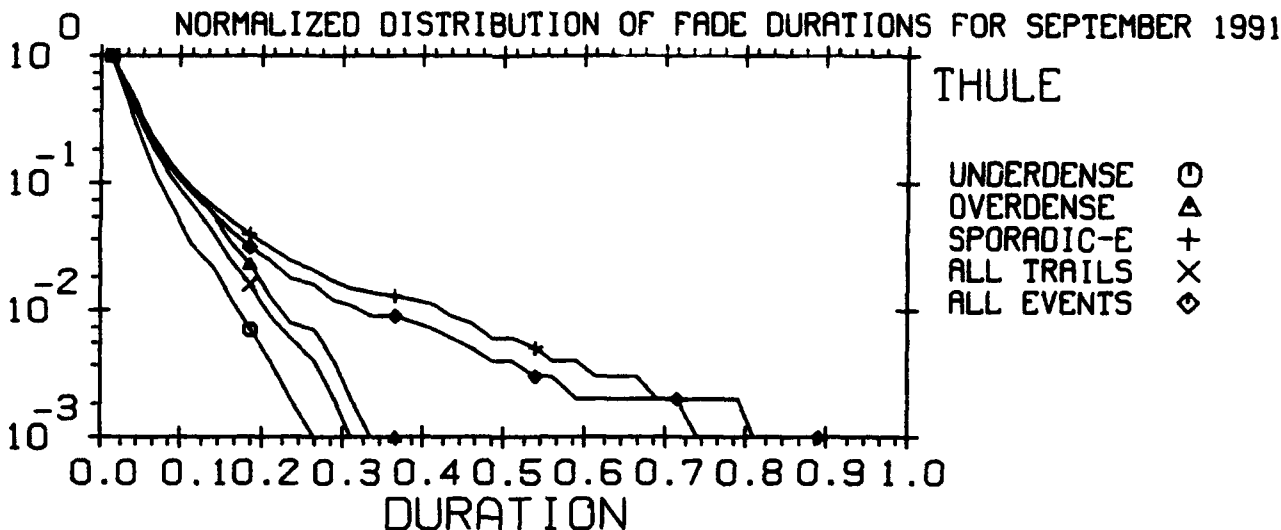

THE TIME OF DAY IS 0 : 24 HOURS U.T.
 FREQUENCY - 104 MHZ
 NORMALIZING FACTORS:
 UNDER - 1347. OVER - 1901. SPOR-E - 6503.
 TRAILS - 3248. EVENTS - 9751.

MENU=109,06-4
 13-OCT-93
 PLOT= 113.00

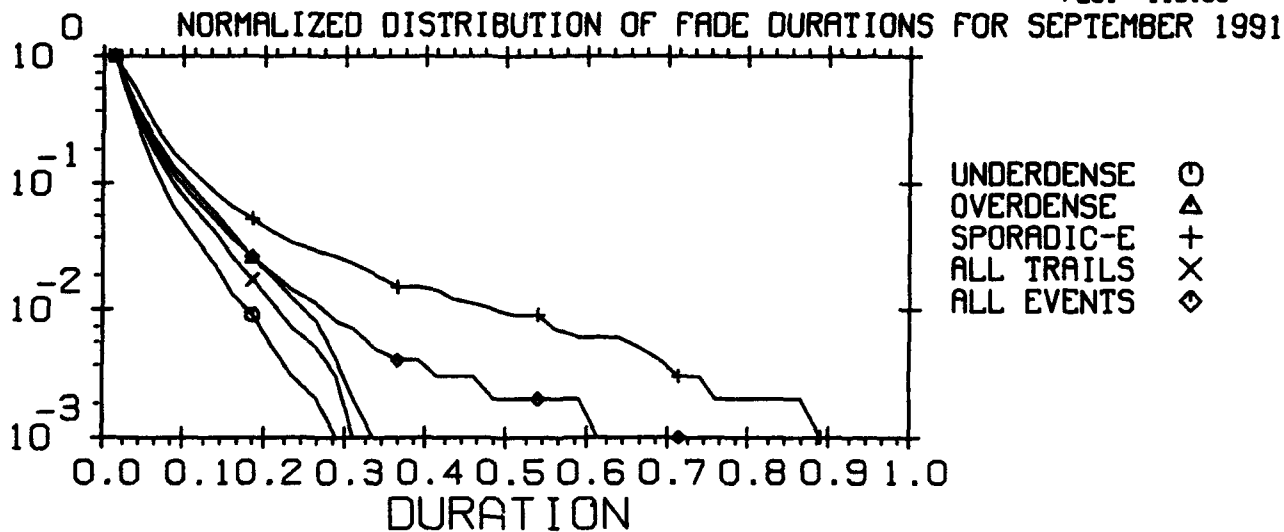

THE TIME OF DAY IS 0 : 24 HOURS U.T.
 FREQUENCY - 147 MHZ
 NORMALIZING FACTORS:
 UNDER - 4133. OVER - 4136. SPOR-E - 2739.
 TRAILS - 8269. EVENTS - 11008.

MENU=109,05-4
 13-OCT-93
 PLOT= 114.00

GEOPHYSICS LAB METEOR SCATTER PROGRAM

AVAILABILITY*POWER

VS DAY.TOD

SEPTEMBER 1991

THULE

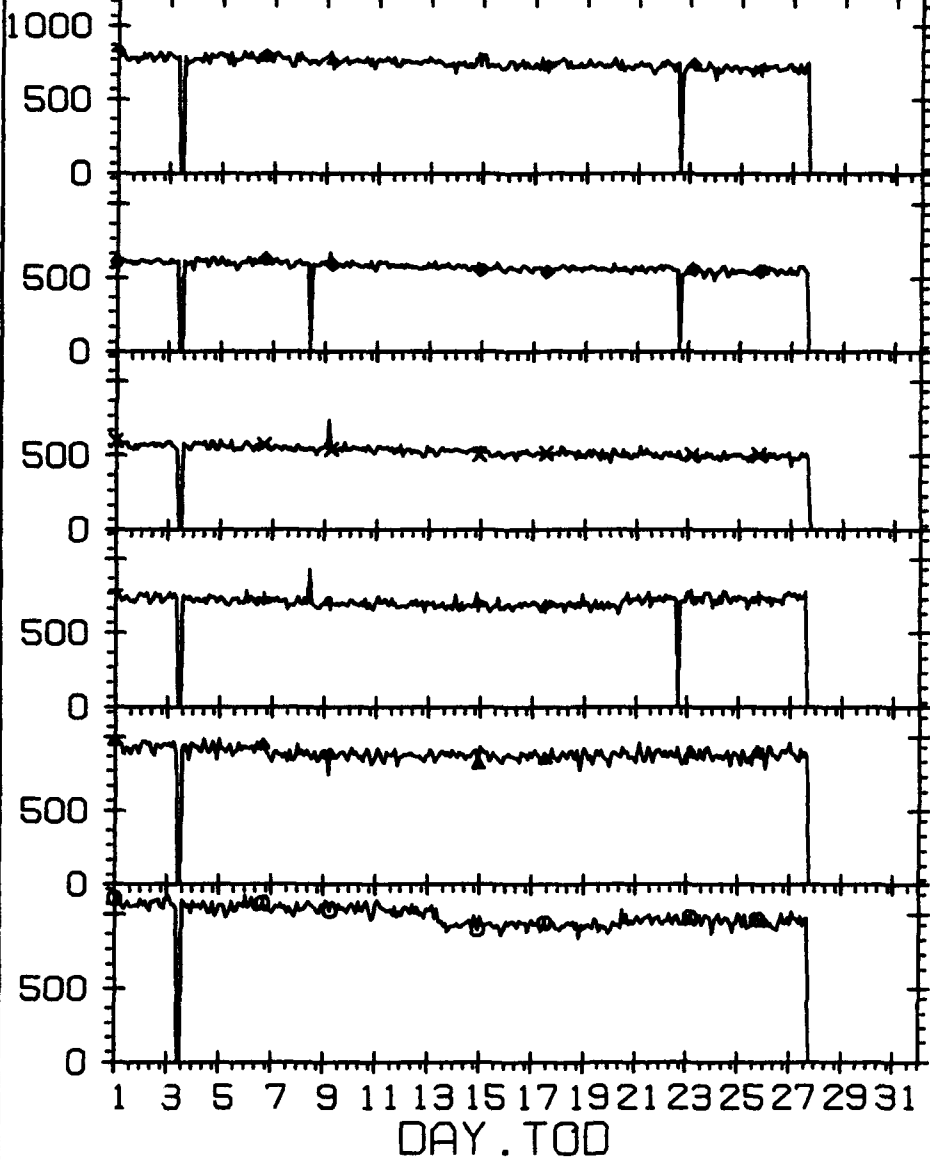

- 147 MHZ ↑
- 104 MHZ ◇
- 85 MHZ X
- 65 MHZ +
- 45 MHZ △
- 35 MHZ ⊙

MENU*105,10-1
13-OCT-93
PLOT* 115.00

GEOPHYSICS LAB METEOR SCATTER PROGRAM

TEMP LOG-OF-KELVIN

VS DAY.TOD

SEPTEMBER 1991

THULE

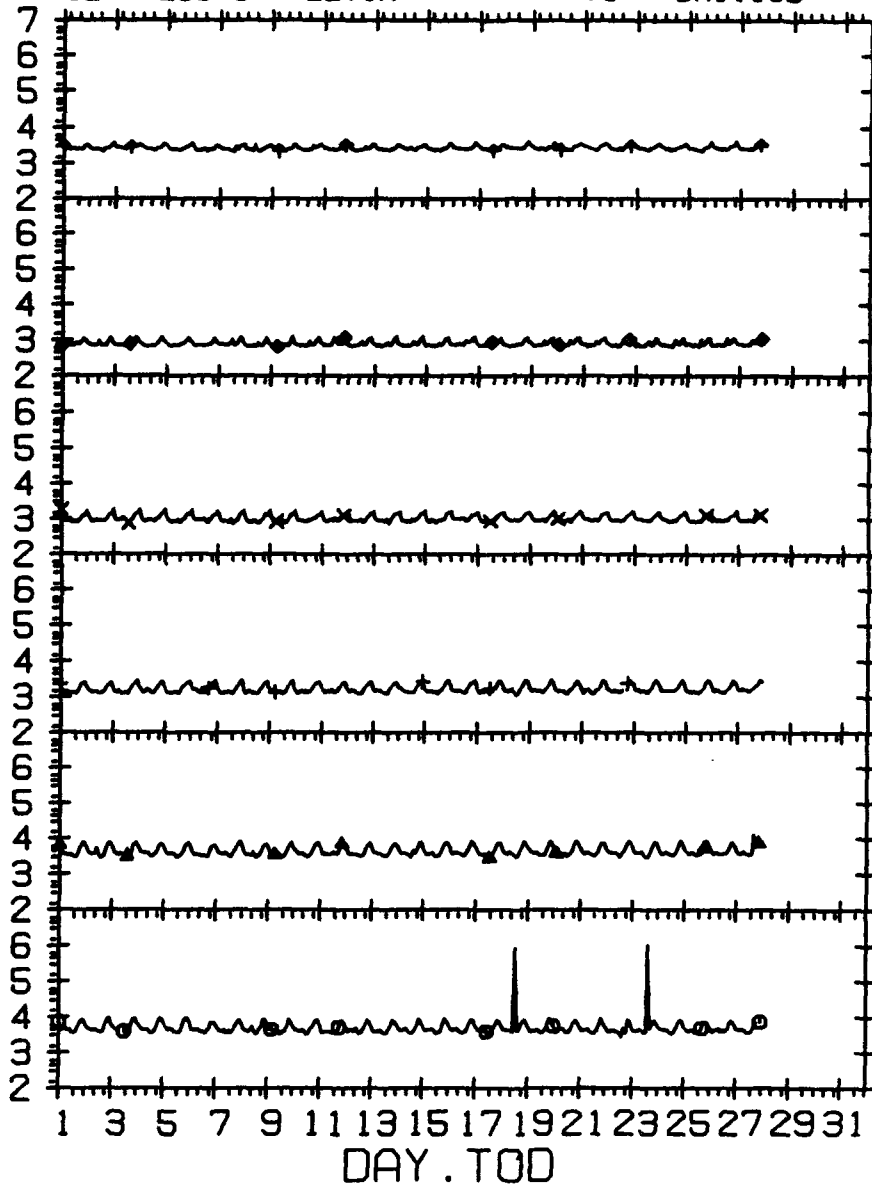

147	MHZ	↑
104	MHZ	◇
85	MHZ	×
65	MHZ	+
45	MHZ	△
35	MHZ	○

BASED ON OBSERVED NOISE MEASUREMENTS - VERTICAL

MENU*105,06-1
13-OCT-93
PLOT* 116.00