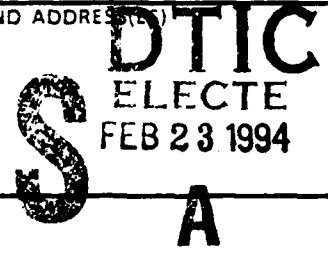

REPORT DOCUMENTATION PAGE

Form Approved
 OA No. 0704-0188

Public reporting burden for this collection of information is estimated to average 1 hour per response, including the time for reviewing instructions, searching existing data sources, gathering and maintaining the data needed, and completing and reviewing the collection of information. Send comments regarding this burden estimate or any other aspect of this collection of information, including suggestions for reducing this burden, to Washington Headquarters Services, Directorate for Information Operations and Reports, 1215 Jefferson Davis Highway, Suite 1204, Arlington, VA 22202-4302, and to the Office of Management and Budget, Paperwork Reduction Project (0704-0188), Washington, DC 20503.

1. AGENCY USE ONLY (Leave blank)		2. REPORT DATE 10/00/88		3. REPORT TYPE AND DATES COVERED	
4. TITLE AND SUBTITLE SITE PLAN SAFETY SUBMISSION FOR SAMPLING, MONITORING AND DECONTAMINATION OF MUSTARD AGENT, SOUTH PLANT, ROCKY MOUNTAIN ARSENAL				5. FUNDING NUMBERS AD-A276 155 	
6. AUTHOR(S)					
7. PERFORMING ORGANIZATION NAME(S) AND ADDRESS(ES) TENNESSEE VALLEY AUTHORITY				8. PERFORMING ORGANIZATION REPORT NUMBER 91036R01	
9. SPONSORING / MONITORING AGENCY NAME(S) AND ADDRESS(ES) ROCKY MOUNTAIN ARSENAL (CO.). PMRMA				10. SPONSORING / MONITORING AGENCY REPORT NUMBER	
					
11. SUPPLEMENTARY NOTES					
12a. DISTRIBUTION / AVAILABILITY STATEMENT APPROVED FOR PUBLIC RELEASE; DISTRIBUTION IS UNLIMITED				12b. DISTRIBUTION CODE	
13. ABSTRACT (Maximum 200 words) THE SCOPE OF THIS SITE PLAN SAFETY SUBMISSION (SPSS) INCLUDES: 1. SAMPLING PLAN TO DETERMINE IF H IS A CONTAMINANT IN EQUIPMENT AND PIPING USED IN THE 1970'S FOR THE H DEMIL PROGRAM 2. MONITORING PLAN FOR PERSONNEL INVOLVED IN THE SAMPLING EFFORT 3. DECON PLAN FOR PERSONNEL, EQUIPMENT, AND PIPING SHOULD CONTAMINATION BE IDENTIFIED. ADDITIONAL SECTIONS AND APPENDICES INCLUDE: 1. HISTORICAL USE OF BLD537 AND BLD538 2. CHEMICAL INFORMATION ON H, HD, AND HT 3. SAFETY REQUIREMENTS 4. MEDICAL REQUIREMENTS AND FIRST AID PROCEDURES 5. PIPING DRAWINGS 6. RMA SOP'S FOR SAMPLING, MONITORING, AND DECON.					
14. SUBJECT TERMS SOP, CHEMICAL, SAMPLING				15. NUMBER OF PAGES	
				16. PRICE CODE	
17. SECURITY CLASSIFICATION OF REPORT UNCLASSIFIED		18. SECURITY CLASSIFICATION OF THIS PAGE		19. SECURITY CLASSIFICATION OF ABSTRACT	
20. LIMITATION OF ABSTRACT					

**Best
Available
Copy**

VOLUME 1 OF 1

SITE PLAN SAFETY SUBMISSION
FOR
SAMPLING, MONITORING, AND DECONTAMINATION
OF MUSTARD AGENT - SOUTH PLANT
ROCKY MOUNTAIN ARSENAL

254 PPS

FOR
UNITED STATES DEPARTMENT OF THE ARMY
PROGRAM MANAGER
ROCKY MOUNTAIN ARSENAL
ABERDEEN PROVING GROUND, MARYLAND

94-05671

15/12/88

BY THE
TENNESSEE VALLEY AUTHORITY
NATIONAL FERTILIZER
DEVELOPMENT CENTER
MUSCLE SHOALS, ALABAMA

(PROJECT ORDER NO. PO 0188)

OCTOBER 1988



VOLUME 1 OF 1

SITE PLAN SAFETY SUBMISSION FOR
SAMPLING, MONITORING, AND DECONTAMINATION OF
MUSTARD AGENT - SOUTH PLANT
ROCKY MOUNTAIN ARSENAL

FOR

UNITED STATES DEPARTMENT OF THE ARMY
PROGRAM MANAGER
ROCKY MOUNTAIN ARSENAL
ABERDEEN PROVING GROUND, MARYLAND

Accession For	
NTIS CRA&I	✓ 1 2
DTIC TAB	
Unannounced Justification	
By _____ Distribution/	
Availability Codes	
Dist	Aval and/or Special
A-1	

Tennessee Valley Authority
National Fertilizer Development Center
Muscle Shoals, Alabama 35660

N O T I C E

This Site Plan/Safety Submission (SPSS) Plan was prepared by employees of the Tennessee Valley Authority (TVA) loaned to the U.S. Army Program Manager, Rocky Mountain Arsenal, Aberdeen Proving Ground, Maryland, pursuant to the provisions of TVA Contract No. TV-75178A and U.S. Army Project Order PO 0188 dated June 21, 1988.

Under that Project Order, TVA provided the services of mutually agreed upon TVA employees as loaned employees. In regard to the services provided by the TVA loaned employees, the Project Order states the following:

It is expressly understood that for all purposes of this Project Order the TVA employees will be acting as loaned employees and will be under the complete supervision and control of the Army at all times and that TVA shall not and cannot supervise or control such employees during the time they are providing services to the Army. It is further understood and agreed that neither TVA nor any of the loaned employees warrant or guarantee the advice and consultations given by such loaned employees under this agreement and that the Army is solely responsible for determining the suitability and acceptability of such advice and consultations for any purpose. Neither TVA, its agents and employees nor the loaned employees assume any liability or responsibility to the Army, its agents, employees, or contractors, or any third party for any costs, charges, damages (either direct or consequential), demands, claims, or causes of action for any personal injuries (including death) or damage to property, real or personal, or delays arising out of or resulting from any action or failures to act in connection with the efforts undertaken for this Project Order.

As provided above, this Site Plan/Safety Submission (SPSS) Plan was prepared by the TVA loaned employees under the direct supervision and control of the U.S. Army. The U.S. Army is solely responsible for its content and use and not TVA, its employees or agents. Wherever it appears in this report, the term "TVA" shall mean TVA loaned employees which are subject to the information quoted above.

ABBREVIATIONS

AMC	Army Materiel Command
AR	Army Regulation
CCL	Contamination Control Line
CG	Phosgene
CRA	Contamination Reduction Area
DOT	Department of Transportation
EMT	Emergency Medical Technician
FE	Facilities Engineer
GB	Sarin
GFCI	Ground Fault Circuit Interrupters
HD	Mustard
HTH	High Test Hypochlorite
IDLH	Immediately Dangerous to Life or Health
JSA	Job Safety Analysis
MSDS	Material Safety Data Sheet
OSHA	Occupational Safety and Health Act
PC&E	Protective Clothing and Equipment
PEL	Permissible Exposure Limits
PPE	Personal Protective Equipment
RMA	Rocky Mountain Arsenal
RM	Regulations Manual
SOP	Standing Operating Procedure
SPSS	Site Plan/Safety Submission
STB	Super Tropical Bleach
TAP	Toxicological Agent Protective
TLV	Threshold Limit Value
TM	Technical Manuals
TVA	Tennessee Valley Authority
TWA	Time Weighted Average

SITE PLAN/SAFETY SUBMISSION (SPSS) PLAN
SOUTH PLANT, ROCKY MOUNTAIN ARSENAL

TABLE OF CONTENTS

	Page
I. Purpose	1-1
1.0 General	1-1
II. Scope	2-1
2.0 General	2-1
III. Historical Use and Descriptions of Buildings	3-1
3.0 General	3-1
3.1 Building 537.	3-1
Figure 3-1 Location Map - RMA.	3-2
Figure 3-2 Plot Plan - South Plant Area.	3-3
Figure 3-3 Floor Plan - Building 537	3-4
3.2 Building 538.	3-6
Figure 3-4 Floor Plan - Building 538	3-7
IV. Potential Contamination	4-1
4.0 General	4-1
V. Chemical Information.	5-1
5.1 Classification	5-1
5.2 Description	5-1
5.3 Type of Hazard and Physiological Effects	5-2
5.4 Chemical and Physical Properties	5-3
5.5 Permissible Exposure Limits (PEL)	5-3
Table 5-1 - Chemical and Physical Properties of Mustard	5-4
VI. Sampling Plan.	6-1
6.0 General	6-1
6.1 Sampling Strategy	6-1
6.1.1 Sampling Assumptions	6-2
6.2 Sampling Procedure.	6-3
6.3 Quality Control	6-4
6.3.1 Laboratory.	6-4
6.3.2 Sampling.	6-4
6.4 Detection Methods and Equipment	6-4
6.4.1 Equipment	6-4
6.5 Laboratory Contingencies.	6-5
VII. Sampling Operations	7-1
7.0 General	7-1
7.1 Planning for Vessel/Pipe Disconnection.	7-1
7.2 Standing Operating Procedures (SOP)	7-3
7.3 Job Safety Analysis	7-3
7.4 Scaffolding	7-3
7.5 Electrical Power.	7-4
7.6 Equipment and Tools	7-4

VIII.	Monitoring Plan	8-1
	8.0 General	8-1
	8.1 Initial Pipe/Vessel Entry Monitoring	8-1
	8.2 Near-Real Time Monitoring	8-1
	8.3 Personnel Monitoring	8-2
	8.4 Pipe/Vessel Closure	8-2
	8.5 Ventilation Monitoring	8-2
IX.	Safety	9-1
	9.1 General	9-1
	9.2 Training	9-3
	9.3 Personal Protective Clothing and Equipment	9-3
	9.3.1 Levels of Protection	9-4
	9.3.2 Level of Protection Required for this Work	9-5
	9.3.3 Equipment for Levels of Protection	9-5
	9.3.4 Equipment Description	9-8
	9.3.5 Care of Protective Equipment	9-9
	9.3.6 Decontamination and Laundering of Protective Clothing	9-10
	9.3.7 Respiratory Protection	9-12
	9.4 Emergency SOP	9-14
	9.5 Ventilation	9-14
	9.6 Criteria for Containment	9-15
	9.7 Personnel Decontamination Contingencies	9-16
	Figure 9-1 Configuration of Personnel Decontamination Station Setup	9-18
	9.8 Safety Equipment/Decontamination/Change Facilities	9-19
	9.8.1 Equipment Required	9-19
	9.9 Personnel Protective Practices	9-20
	9.10 Heat Stress	9-21
	Table 9.1 - PC&E Maximum Wearing Time	9-22
	9.11 Emergency Preparedness	9-22
X.	Medical	10-1
	10.1 Medical Examination	10-1
	10.2 Key Medical Personnel	10-1
	10.3 Emergency Response Equipment	10-1
	10.4 Emergency Medical Identification	10-1
	10.5 First Aid Procedures	10-2
XI.	Hazard Zone Calculation	11-1
	11.0 General	11-1
XII.	Decontamination Plan	12-1
	12.0 General	12-1
	12.1 Decontamination of Buildings/Facilities/Equipment/ Piping/Vessels	12-2
	12.1.1 Levels	12-2
	12.1.2 Decontaminating Agents	12-2
	12.1.3 Specific Safety Precautions for Decontamination Operations	12-2
	12.1.4 Decontamination Operations	12-3
	12.2 Waste Disposal	12-4
	12.3 Decontamination Verification	12-4
	12.4 Records	12-4

XIII. Security 13-1
13.0 General 13-1

XIV. Equipment/Supplies Responsibilities 14-1
14.0 General 14-1
14.1 Equipment Supplied by TVA 14-1
14.2 Equipment Supplied by RMA 14-2

XV. References 15-1

Appendices

- A. Sample Point Summary for RMA's Mustard Facility
- B. Piping Isometric Drawings
- C. Agent Material Safety Data Sheet
- D. Portable Ventilation Unit
- E. MINICAM Near-Real Time Analyzer
- F. SMCRM-TOE-3, Bubbler Preparation
- G. SMCRM-TOE-16, Total Mustard (H, HN-1,HN-3) Emissions
- H. SOP Sampling and Personnel Monitoring
- I. SOP Personnel Contamination and Injury Emergencies
- J. SOP Piping/Equipment Decontamination
- K. RMA Standing Operation Procedure - Emergency Response

AMC-R 385-100 CHECKLIST FOR SPSS SUBMISSION

- X 1. Distances between the facility to be constructed or modified and other installation facilities; the installation boundaries; public traffic routes; and power transmission and utility lines.

NOTE: The distances may be listed in narrative form or reference may be made to the scaled drawing or facility map on which the specific distances are designated or clearly shown.

The shortest distance to an installation boundary is shown on the RMA General Site Map (Figure 3-1 of the SPSS) and is 8400 feet. The nearest occupied building is Building 728 which is 435 feet from the sampling sites. The nearest occupied contractor trailer is the Shell trailer which is located 325 feet southeast of the sample site.

- N/A 2. Identification and brief description of the mission of all facilities within inhabited building distance of the facilities to be constructed or modified.
- N/A 3. Identification and brief description of the mission of other facilities whose inhabited building distance arcs include the facilities to be constructed or modified.
- X 4. General description of the components, items, and hazardous materials to be handled or stored in the new or modified facilities, to include explosives limits and hazard classifications.

Analysis of the periodic bubbler sample records of the interior of Buildings 537 and 538 does not indicate mustard vapors above the detection limit of 0.003 mg/m³. The residual level of mustard contamination in piping and storage tanks is unknown but expected to be no more than trace amounts.

- X 5. Anticipated personnel limits for the facilities to be constructed or modified, by bays when appropriate.

A four-person team will perform all sampling and decontamination tasks. A radio control point will be established at the RMA Fire Department which is located approximately 1500 feet northwest of Building 537.

- N/A 6. Explosives limits and hazard classifications of ammunition, explosives, or other hazardous materials in facilities within inhabited building distance of the facility to be modified or constructed and facilities whose inhabited building distance arcs include the facilities to be modified or constructed.

- X 7. Construction details, types, arrangements, and test data pertaining to walls, roofs, shields, barricades, windows, exits, floors, explosives operating equipment, fire protection systems, lightning protection and static electricity grounding systems, electrical installations, ventilation systems and equipment, hazardous waste disposal systems, auxiliary support structures, chemical agent monitoring equipment, and General materials and construction.

Air bubblers and MINICAM near-real time analyzers will be used to monitor the air, the interior of piping, and the interior of storage tanks for mustard. Waste will be decontaminated with caustic and/or bleach solution and placed into pre-labeled 55-gallon drums for disposal. Portable ventilation units with local exhaust hoods will be placed adjacent to each pipe opening to contain any potential agent release. The exhausts of these portable ventilation units will flow through an activated charcoal filter. These units will provide a minimum of 100 linear feet per minute of air velocity at the point of potential agent release.

- N/A 8. Topographic map with appropriate contours when terrain features are considered to constitute natural barricading.

- N/A 9. A set of contract technical specifications if available.
- N/A 10. Explanation and rationale or justification for any deviations from the requirements of regulations, standards, or policy including information pertinent to approved or in-process waivers and exemptions that affect the project.
- N/A 11. Test results and other substantiating documentation supporting in-process hazard classifications.
- N/A 12. Test results and other substantiating documentation supporting conveyor spacing distances, operational shield designs, and proposed protective construction if not in accordance with Section 5-5 of this regulation and TM 5-1300.
- N/A 13. A copy of the restricted or controlled air space request, submitted in accordance with AR 95-50, must be enclosed on all demolition and firing, and test ranges where the maximum ordinate of fire will exceed 45 meters above ground level.

I. PURPOSE

1.0 General

The purpose of this Site Plan/Safety Submission (SPSS) is to describe procedures for:

- Sampling for the presence of the chemical agent, mustard (HD), as a contaminant in the south plant located at the Rocky Mountain Arsenal (RMA).
- Protection of workers and the environment during the sample preparation and sampling period for the presence of the agent.
- Decontamination should mustard agent be detected.

This plan is one of two prepared for the Department of the Army, Program Manager, Rocky Mountain Arsenal, Aberdeen Proving Ground, Maryland, for Support of the Chemical Agent Safety Program at Rocky Mountain Arsenal as part of Army Project Order No. PO 0188 and TVA Contract No. TV-75178A. Sampling of the mustard facility by TVA will run concurrently with sampling operations of the GB facility described in the other SPSS submitted.

Completion of the efforts described in this plan will ensure that potentially contaminated areas are identified and that, if necessary, mustard agent may be safely decontaminated in process equipment and piping in the south plant.

II. SCOPE

2.0 General

The scope of this SPSS includes the following:

- A sampling plan to determine if mustard agent is a contaminant in associated equipment and piping for the south plant that was used in the 1970s for the mustard and demil program.
- A monitoring plan for personnel involved in the sampling effort.
- A decontamination plan for personnel, equipment, and piping should agent contamination be identified.

Buildings with process equipment/piping with possible agent contamination covered by this SPSS are 537 and 538. Buildings 536, 539, and 540 were inspected and, based on the inspection and historical use, were determined to have no mustard agent contamination. Many of the original lines to Building 536 and some equipment were found missing. Existing equipment was open to the atmosphere and contained or was covered with considerable amounts of caustic. Based on this visual evidence, historical data, and building monitoring, Building 536 was judged to have no mustard contamination. The equipment in Buildings 539 and 540 was essentially all removed. Consequently, sampling of process equipment and piping is unnecessary for Buildings 536, 539, and 540.

Bubbler samples taken during the sampling period will be analyzed onsite by the U.S. Army personnel at RMA. Building ventilation ducts, open process vent lines, the mustard furnaces, and transfer booths will not be sampled.

III. HISTORICAL USE AND BUILDING DESCRIPTIONS

3.0 General

The mustard facility in relation to the other areas at RMA is shown in Figure 3-1. As discussed in Section 2.0, Buildings 536, 539, and 540 were inspected and, based on the inspection and historical use, were determined to have no mustard agent contamination. The historical use of Buildings 537 and 538 was obtained from discussions with RMA personnel and from research of available literature.

Primary historical data was obtained from three sources:

- Appendix A of draft Standing Operating Procedure (SOP), "SOP for Disposal of Contaminated Buildings," June 29, 1984; prepared for RMA by El Dorado Engineering, Inc., Salt Lake City, Utah.
- RMA Regulation Number 385-31, "SAFETY, Chemical Safety Program Requirements Control Procedures for Access to Agent Contaminated Buildings," dated January 4, 1988.
- An untitled report covering the demilitarization of excess stocks of toxic agent mustard at RMA between October 1969 and July 1974.

Building locations in the mustard facility are shown in Figure 3-2.

3.1 Building 537

Building 537 was built in 1945 (Figure 3-3). This building has been used for various operations throughout the years. These include:

- 1945-46 Mustard distillation operations
- 1947-49 Demilitarization of 75, 105, and 155 mm mustard filled projectiles
- 1960 Renovation of ton containers
- 1965 Demilitarization of Phosgene filled M78 and M79 bombs
- 1966 Demilitarization of 105 mm mustard filled projectiles
- 1968 Demilitarization of 105 mm WP filled projectiles
- 1969 Demilitarization of mustard (HD) ton containers
- 1971-74 Mustard demil operation
- 1976-81 Intermittent use for transfer of Phosgene (CG) from storage ton containers to shipping ton containers

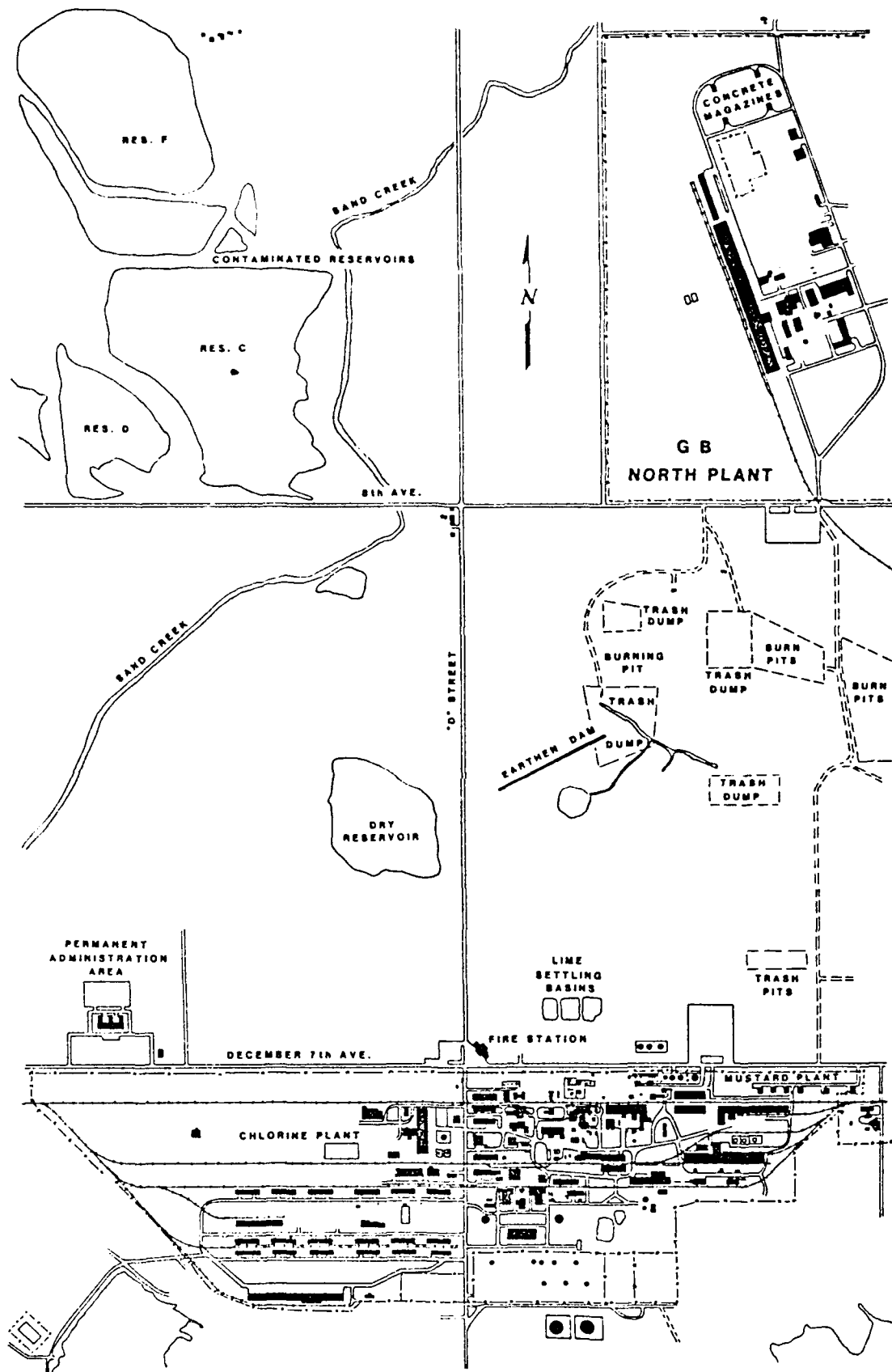
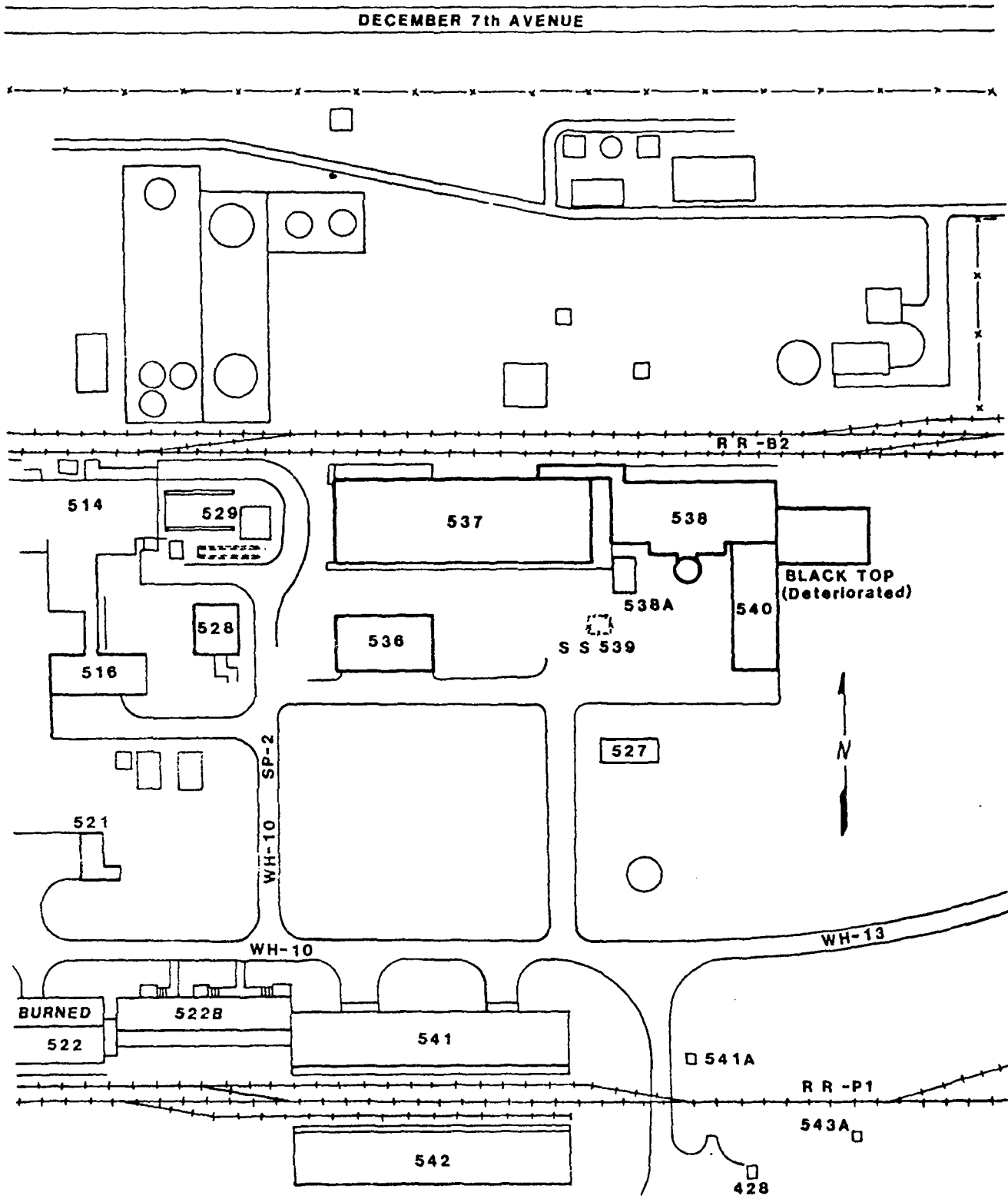

FIGURE 3-1
 LOCATION MAP
 R M A

FIGURE 3-2 PLOT PLAN SOUTH PLANT AREA (MUSTARD PLANT)



BLDG. 527
525
(SEE
FIG. 3-4)

221'-0"

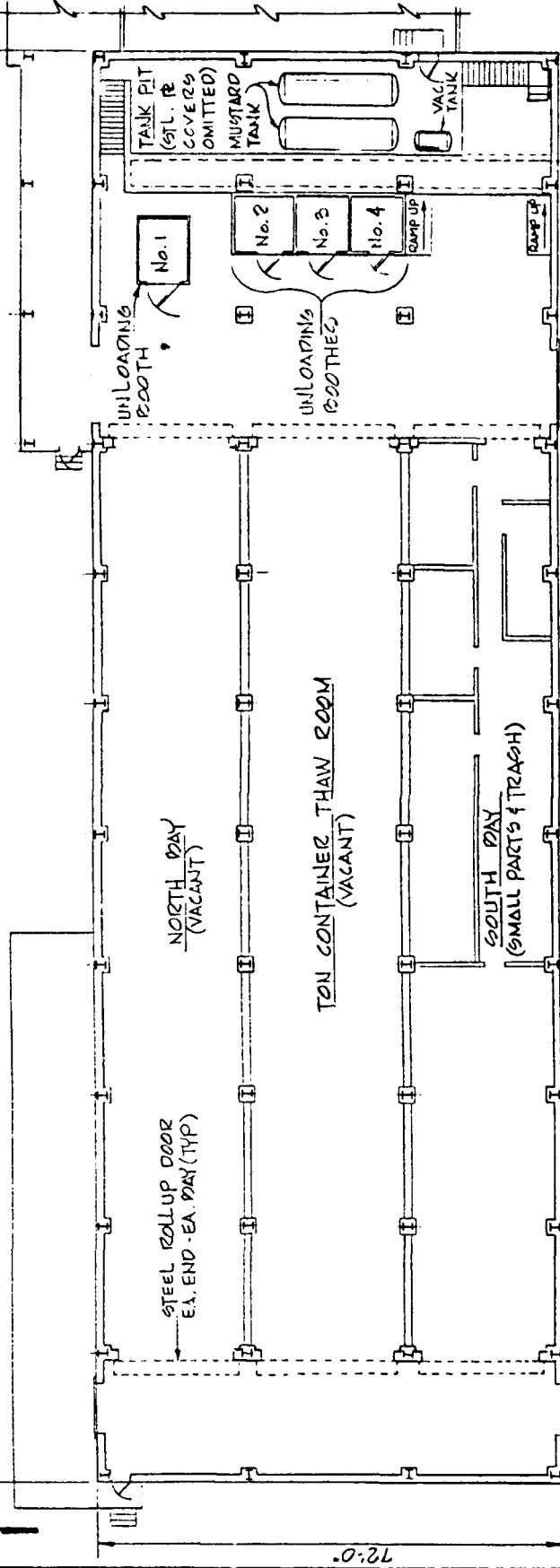

STACK



STACK

FLOOR PLAN
BUILDING No. 527
SCALE: 1/8" = 1'-0"

FIGURE 3-3

NATIONAL FERTILIZER DEVELOPMENT CENTER ENGINEERING AND SPECIAL PROJECTS MUSCLE SHOALS, ALABAMA	
RMA-SPSS	
BUILDING NO. 527 (SOUTH PLANT)	
SAMPLE NO. N/A	
DRAWN BY: BURCHAM	APPROVED: RUV
CHECKED BY: Williams	DATE: 8-16-55
	FIG. 3-3

During the demilitarization of the mustard ton containers, the containers were thawed in the west portion of the building; remotely unloaded in unloading booths located in the center portion of the building; pumped from the loading booths into holding tanks in the pit or eastern area of the building; and pumped to Building 538 for incineration. Trenches are located underneath the floor to contain any mustard from leaking containers in the thaw area. The potential for contamination is considered most probable in the pit area containing the holding tanks.

In accordance with RMA-R 385-31, this building has been decontaminated to a XXX level. Documentation was found related to this on page 10-1 of an untitled report covering the demilitarization of excess stocks of toxic agent mustard at RMA between October 1969 and July 1974. The report clearly stated that the following equipment was decontaminated:

1. Heat exchanger.
2. Quench tower and scrubber duct.
3. Brine storage tank Building 538.
4. Dryer system (Buildings 536 and 540).
5. Electrostatic precipitator.
6. Unload booths washed.

The report showed that the two mustard storage tanks were flushed with fuel oil and then flushed with a supertropical bleach and water mixture for approximately one week. The tanks were emptied and painted with Rustoleum. The report also stated that the mustard transfer lines which were flushed, removed, cut into small sections, and decontaminated by burning.

During TVA's field check, a jacketed line from above the pit area to the furnace was found to be in place. Some piping flanges had dry caustic around the edges, indicating some level of decontamination. The holding tanks appeared empty. The mustard storage tanks in the building basement appeared to be painted; however, an odor was evident that gave an indication that the area might be contaminated. For these reasons, sample points were identified in Building 537 even

though the documentation described above shows that the building and process equipment were decontaminated.

Building 537 is 22' x 71' in plan with a clear height of 16' -6". The building has concrete foundations and floors, with cinderblock walls, and a reinforced concrete roof supported by 16" square reinforced concrete columns. The floors are Grade A concrete and finished in sodium fluosilicate and Heresite. This building is connected to Building 538 by a covered passageway.

A 20' x 71' penthouse traverses the building near the middle. It is constructed with transite siding and with gypsum board sheated roof. The floors are reinforced concrete.

The building has three insulated rooms where mustard filled ton containers and 55-gallon drums were thawed. Hot air at about 150°F was circulated around the containers for about 8 hours. The mustard was then transferred from the containers to receiver tanks. A penthouse enclosed the steam heaters, controls, and air circulating equipment which circulated the hot air to the thaw rooms below. A concrete air circulation duct runs under the building floor. Lead lined floor gutters were provided to capture mustard spills and direct them toward sumps. Exhaust air was scrubbed in a separate building (immediately south of and considered a part of Building 537) before being released to the atmosphere. Above ground utilities to this building include steam, process and potable water, and electric power.

3.2 Building 538

This building was constructed in 1945 (Figure 3-4). The building was designed to contain disposal equipment (material handling, crusher, and three furnaces) for decontaminating 55-gallon drums which were drained of mustard in Building 537. In subsequent years, the building furnaces were used to decontaminate metal parts generated by the demilitarization operations in Building 537. In the 1970s, the furnaces were used to burn neat mustard.

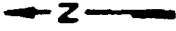

BLDG. 537 BLDG. 538
(SEE FIG. 3-3)

167'-0"

70'-0" approx.

BLDG. 540

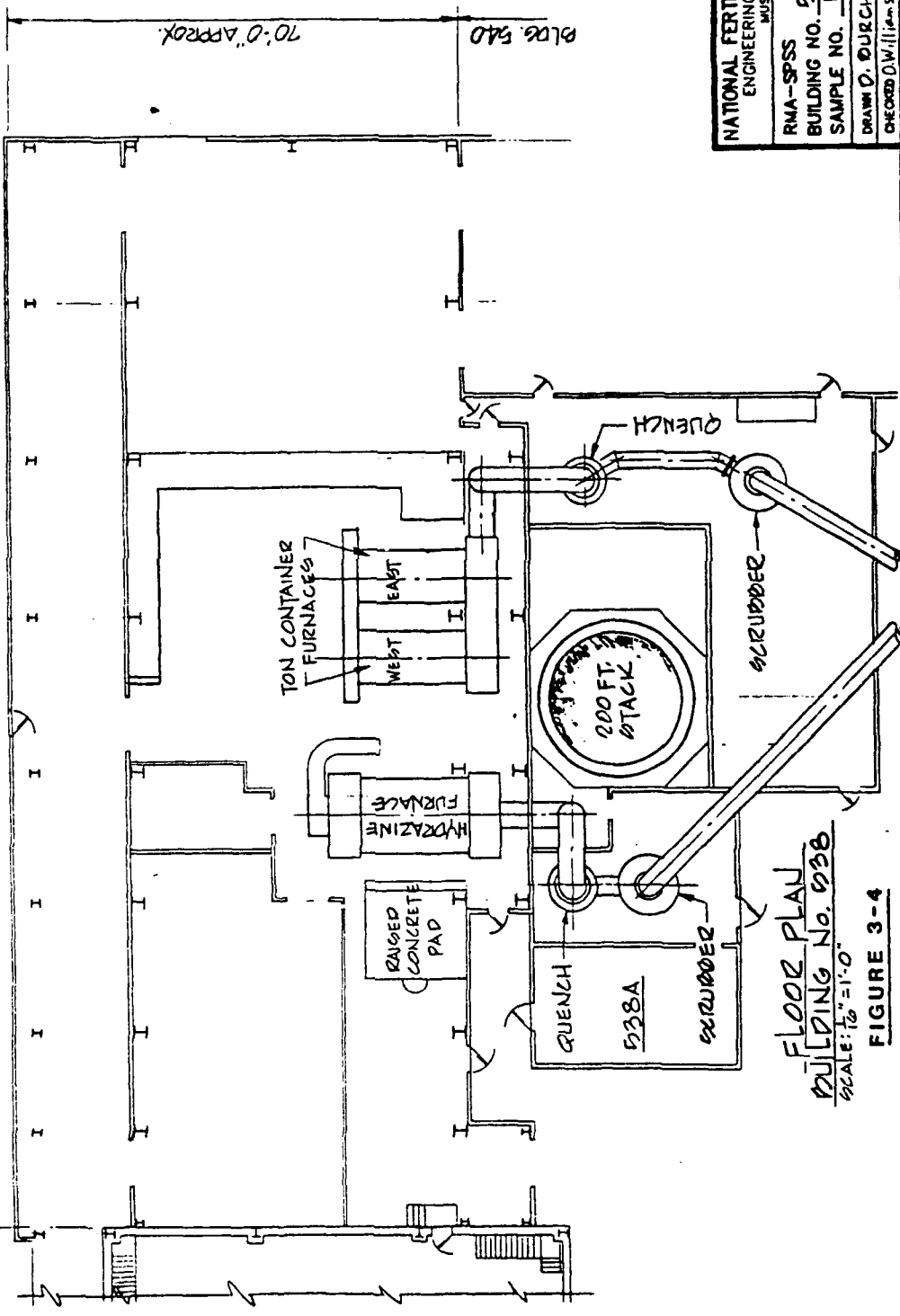

FLOOR PLAN
BUILDING No. 538
SCALE: 1/8" = 1'-0"

FIGURE 3-4

NATIONAL FERTILIZER DEVELOPMENT CENTER ENGINEERING AND SPECIAL PROJECTS MUSCLE SHOALS, ALABAMA	
RMA-SPSS	
BUILDING NO. 538 (SOUTH PLANT)	
SAMPLE NO. N/A	
DRAWN BY D. BURCHAM	APPROVED R.W.W.
CHECKED D.W. Williams	DATE 8-17-88 FIG. 3-4

The east and west furnaces exhaust through a scrubber and stack located immediately to the southeast of Building 538. The gas-fired hydrazine furnace, located immediately west of the above mentioned furnaces, also exhausts through a scrubber located immediately south of this furnace.

This building is 52' x 143' in plan with a ceiling height of 20'. It has a concrete foundation and floor, corrugated metal siding over steel framed walls, and a flat corrugated steel roof supported by steel columns. Extensions, 9' wide x 68' long, run along the north side, near the building midpoint. Immediately to the south and southeast are sheds (considered part of Building 538) containing exhaust ducts that run from the three furnaces to the scrubber and stack. Above ground utilities include steam, compressed air, potable water, and electric power lines.

IV. POTENTIAL CONTAMINATION

4.0 General

An onsite inspection was made by TVA personnel from July 22 through August 3, 1988, to identify potential areas of contamination for sampling, to determine the changes in process piping and equipment from original "as built" drawings, and to prepare piping isometric drawings showing the sample points. Sample points identified are described in detail in Appendix A. The piping isometric drawings, shown with the sample points, are in Appendix B.

Although documentation shows practically all the equipment to be decontaminated as described in Section 3.1, the following areas were identified from the survey as potential agent contaminated:

1. Holding tanks in the pit area of Building 537.
2. Associated piping between the ton transfer booths and the holding tanks and vacuum piping.
3. Transfer piping to the furnaces in Building 538.
4. An underground ventilation duct containing a 6-inch lead drain pipe located between the ton transfer booths and the pit area of Building 537.

The ventilation ducts of Building 537 that serve the thaw bays, the ton transfer booths from pick-up points to entry into the scrubber, and the exhaust ducts between the three furnaces in Building 538 and the exhaust scrubbers were originally selected for sampling based on a conservative approach. However, based on the onsite observations, a judgement was made not to sample these ducts. This judgement was based on the following factors:

1. The ducts were open to the atmosphere.
2. RMA records of building area samples indicated no presence of mustard (below 0.003 mg/m³).
3. The unlikely possibility of solid particles of mustard being deposited in the duct work.

V. CHEMICAL AGENT INFORMATION

5.1 Classification

The chemical agents commonly called "mustard" are given the military classification of H, HD, and HT. They are persistent blistering agents. These agents are further classified as class A poisons by the Department of Transportation (DOT) and as chemical Group A agents by AMC. Each belongs to Storage Compatibility Group K.

5.2 Description

For the agent mustard, H is used to identify the agent made by the Leivinstein process which contains up to 30-percent sulfur compounds as impurities. HD indicates agent which has been refined by distillation to remove impurities. HT is a mixture of 60-percent HD and 40-percent T. T is a sulfur and chlorine compound similar in chemical structure to HD.

Mustard gases all have similar chemical properties and action and produce related symptoms. They differ in production methods, physical properties, and blistering powers.

Distilled mustard is a light yellow, oily liquid purified by washing and vacuum distillation and, therefore, has less odor and good blistering power. Mustard exhibits a slight garlic-like odor. Skin absorption can cause death or incapacitation. Wet skin will absorb more mustard than dry; therefore, mustard has a lower lethal dosage in hot, humid weather. The eyes are very susceptible to low concentrations, but higher doses are necessary to produce incapacitation from skin absorption.

Mustard acts first as a cell irritant, eventually destroying the cells of the tissue affected. First symptoms appear within four to six hours; the higher the concentration, the quicker the symptoms appear. Injuries produced by HD heal slowly and are very susceptible to infection. The blood vessels are damaged preventing repair functions and the good medium for bacterial growth provided by the dead tissue further spreads the infection.

Type of Hazard and Physiological Effects

Mustard is an insidious vesicant or blistering agent and has been identified as carcinogenic, mutagenic, and teratogenic. The agent's garlic-like odor quickly becomes unnoticeable after the first detection because the agent causes the olfactory nerves to become insensitive. Another indication of the insidiousness is the possible absence of pain for a period of hours after vapor contact with the skin and for many minutes even after eye contact with the liquid. With regard to skin exposure, the presence of moisture of perspiration on the skin tends to increase the effect of exposure to agent.

Chronic exposures (10-20 years) to mustard agent are considered to be a health hazard; therefore, certain health minimums must be met if workers are exposed. Monitoring of work areas and medical surveillance must be carefully controlled and adequate records maintained. To protect the health and welfare of workers, no unprotected worker may be exposed to mustard agent vapor levels equal to or greater than 0.003 mg/m^3 . Mustard will produce physiological effects as a result of liquid or vapor contamination of the body. The severity of the effects is dependent on the degree of liquid contamination and on the vapor concentration and associated exposure time.

Hazards from mustard agents are through vapor contact with the eyes or respiratory tract and liquid contact with skin. The most common acute hazard is that of liquid contact with the skin. Mustard vapor may be absorbed readily through the respiratory tract and eyes and ingested through the gastrointestinal tract. The severity of the effects is dependent on the degree of liquid contamination and on the vapor concentration and associated exposure time. Mustard agents may persist on surfaces as liquid contamination for long periods because of their low volatilities. Mustard from contaminated surfaces can be transferred to personnel by contact. The effects of mustard exposure are described as follows:

1. Eye effect. The eye is most vulnerable to mustard either by liquid or vapor contact. Conjunctivitis (red eye) can occur following an exposure to a vapor concentration barely detectable by odor. Long exposures to low concentrations or exposures to high concentrations can result in permanent eye damage.
2. Skin effects. The initial effect after skin contact with either vapor or liquid is a reddening of the skin similar to sunburn; except with mild vapor burns, the reddening progresses to blistering and tissue destruction. The initial exposure is not accompanied by any sensation but as symptoms develop there may be an itching or burning sensation.
3. Respiratory effect. Inhalation of mustard vapor or aerosol causes damage to the mucous tissues of the upper respiratory tract. Damage develops slowly and may not reach maximum severity for several days following exposures. The symptoms are hoarseness, sore throat, and coughing. In cases of severe exposure, there is a predisposition to secondary infection such as bronchial pneumonia.
4. Cumulative effects. The rate of detoxification for mustard is very low. Very small repeated dosages are cumulative and even more serious because of the tendency toward sensitization. Exposure to vapors from spilled mustard may, in the first instance, cause only minor symptoms such as "red eye." Repeated exposures to such vapor may produce severe respiratory symptoms.

5.4 Chemical and Physical Properties

Table 5-1 shows the chemical and physical properties of H, HD, and HT with additional agent information found in FM 3-9 and in the Material Safety Data Sheet (MSDS), Appendix C of this SPSS.

5.5 Permissible Exposure Limits (PEL)

Personnel working without protection from inhalation of mustard vapors will not be exposed to concentrations exceeding the lowest measurable limit but not more than 0.003 mg/m³ for any period, even if the time weighted average (TWA) of 0.003 mg/m³ is not exceeded.

Table 5-1
Chemical and Physical Properties of Mustard

<u>Property</u>	<u>Agent - H, HD, HT</u>
Boiling Point	217° C (423°F)
Freezing Point	14.5° C (58°F) HD 0° C (32°F) HT
Flammability	Class III B Combustible Liquid
Color	Clear through amber to dark brown
Odor	Garlic
Vapor Pressure	0.072 mm Hg at 20°C (68°F)

Air-supplied respiratory protection is required at a level of 0.5 mg/m³ mustard which is the Immediately Dangerous to Life or Health (IDLH) level. For emergency operations, the M9A1 protective mask with Level A protective ensemble is authorized.

Nonrelated personnel, to include the General population, will not be exposed to a concentration of mustard greater than the detection limit for any time period. If a release occurs during the sampling and decontamination operations, containment and safety procedures outlined in this plan will be implemented to ensure that nonrelated personnel and the General population are protected within the above described limits.

The eyes are more sensitive to mustard vapor than either the skin or the respiratory tract. Totally incapacitating eye damage of several days duration can be produced by dosages which are insufficient to produce even partial incapacitation through the skin or respiratory route. Personnel involved in the sampling and decontamination activities of this plan will, as a precautionary measure, wear full face respiratory equipment that ensures protection of the eyes.

VI. SAMPLING PLAN

6.0 General

This section of the plan describes the overall sampling strategy procedures; detection equipment and methods; quality control of samples; and laboratory contingencies. Specific sampling points were identified by TVA personnel onsite during July-August 1988. These sampling points were selected based on several factors including piping arrangements, volume to be sampled, sampling equipment flow rates, and the flow rate necessary for effective sampling.

Therefore, each sampling point strategy and procedure was customized based on these factors. The individual specific sampling points are shown in Appendix A of this plan with a piping isometric of each sample point identified and the piping modification described necessary for sampling at each sample point in Appendix B.

Room and/or area sampling has been periodically performed on an annual basis by RMA. Records of these samples indicates no detection of mustard. Therefore, area/room bubbler samples will not be conducted under this plan. As discussed in Section 3.1, documentation of decontamination is recorded but TVA's field check created doubts in the documentation. Therefore, equipment/piping will be prepared in Building 537 for bubbler sampling. A portable ventilation system (Appendix D) will be used at each enclosure to be opened with activated carbon to prevent agent contamination to the area. The identified sample points will be treated as agent contaminated and sampled by a near-real time instrument immediately after breaking into the containment interior. Near-real time monitoring will continue as scheduled in the personnel monitoring section of this plan (Section 8.3).

6.1 Sampling Strategy

To assess the status of decontamination of the south plant, bubbler samples will be taken for mustard agent (HD) at representative locations in the process vessels and piping, where potential contamination may be expected. Sampling will be done according to standardized Army methodology, as delineated in the Sampling Procedure (Section 6.2). The temperature of the building should be

greater than 60°F for sampling. After the sample is taken, the vessel or piping will be reclosed until confirmation of no contamination by bubbler sample analysis. Bubbler samples will be analyzed by the RMA laboratory.

6.1.1 Sampling Assumptions

The analytical procedure is based on characteristics relating to the agent itself, the sampling environment (which includes the vessels, pipes, thermal environment, location, and any other aspects potentially affecting the sample), the sampling procedure, the analytical procedure, and the people performing the sampling. It is emphasized that this is a sampling plan and can be changed if the original assumptions are found to be invalid or as new facts become obvious.

The most basic assumptions are that the sampling and analytical methods are accurate and precise. These have been utilized and verified by the Army and others. If other parameters of the procedure needs adjustment, the sampling and analytical procedures should not be changed without assurance that the alternative procedure is equally accurate and precise.

The analytical procedure for mustard agent can detect 2.16 micrograms (μg). To collect 2.16 μg at the threshold limit value (TLV) ($.003 \text{ mg}/\text{m}^3$), a bubbler sampler will need to run for 2 hours at 6 liters per minute (0.72 m^3 of air sampled). For vessels having smaller volumes, the vessel will experience more than one air change. This is not a problem, however, since any non-gaseous agent in the vessel or line would continue to vaporize during sampling.

For vessels larger than 0.72 m^3 , a 2-hour sample is not adequate for a complete air change. In some cases, many days would be required to complete one air change. It is, however, not necessary for a complete air change, since any agent would be thoroughly dispersed within the vessel, and its vapors would be detected with a minimum amount of sample. Nevertheless, to ensure that even low levels of agent existing within large vessels are detected, the minimum sample time will be doubled to four hours for these large vessels.

Another assumption is that the ambient temperature will remain above 60°F during sampling. Obviously, if this not the case, sampling will be delayed until the temperature rises.

For each sample point identified, pipe and vessel volumes were calculated to determine sampling times, assuming unrestricted piping. If blockage or any restriction is encountered which loads the sampling pump excessively, alternative sampling must be considered. This may involve reducing the pipe length sampled or other adjustments, as necessary.

Duplicate sampling would increase the validity of sampling, yet it would also double the number of samples necessary and the duration of the sampling period. Consequently, both random duplicate and replicate sampling will be performed and analyzed (blindly) by the lab for validation. Additionally, the results from the near-real time analyzer (MINICAM, Appendix E) will be compared to those from the bubblers for further verification. With the known accuracy of the sampling and analytical methods, and with this duplicate/replicate sampling, further validating should not be required.

6.2 Sampling Procedure

The sampling will be done in accordance with Army Standing Operating Procedure SMCRM-TOE-3 (Appendix F), Index for Bubbler Preparation, and SMCRM-TOE-16, Total mustard (H, HN-1,HN-3) Emissions (Appendix G). Only trained industrial hygienists/chemists or industrial hygiene/chemist technicians operating under the direction of an industrial hygienist/ chemist will perform the sampling.

Before sampling, the lead industrial hygienist/chemist will review the sampling points with the sample preparation crew. All personnel entering the sampling area will have been previously instructed in emergency procedures; personnel protective equipment; decontamination procedures, signs and symptoms of exposure; and other safety precautions including heat stress prevention. The Job Safety Analysis and planning considerations are described in Section 7.

The sample preparation crew will proceed ahead of the sampling personnel, erecting scaffolds and otherwise preparing the sampling and makeup points. During sample preparation, all personnel in potentially contaminated areas will be monitored for exposure to mustard agent by a near-real time monitor with an alarm. This will be as described in the Monitoring Plan, Section 8.

The sampling device is described in Section 6.4, Detection Methods and Equipment. Equivalent equipment and methodology may be acceptable, with clearance from the RMA project manager.

6.3 Quality Control

6.3.1 Laboratory

Standard laboratory methodology for controlling accuracy and precision will be exercised and documented according to RMA sampling and Chemical Analysis Quality Assurance/Quality Control Plan (QA/QC Plan); prepared by USATHAMA and identified as SOP-TOE-19.

6.3.2 Sampling

Sample quality assurance will be maintained by requiring adherence to the sampling SOP and by taking random, duplicate samples, using sample blanks, and using blind sample analysis. Sample blanks will be treated and numbered as other samples.

6.4 Detection Methods and Equipment

The sampling or agent detection method will be according to RMA SOPs SMCRM-TOE-3 and SMCRM-TOE-16 (Appendices F & G). The various other detection methods are acceptable for ancillary purposes or supporting the primary sampling and personnel protection. These methods are also described in Appendices F & G.

6.4.1 Equipment

The bubbler sampling device will consist of an air pump capable of maintaining a flow of 6 liters per minute over the sampling period, a pressure gauge, a critical orifice, polyethylene tubing, a glass bubbler containing diethyl phthalate, and sufficient Teflon® tubing to connect the bubbler to the sampled vessel. The bubbler must be maintained at approximately 41°F (9°C) for the duration of the sample

time and until the sample is delivered to the laboratory for analysis by using a cooling bath. Further details of the sampling train and procedure is included in Appendix F.

After the sampling device is connected to the vessel and ready for sampling, the pump is started, the time recorded, and proper air flow assured. The air flow will be monitored each hour of sample time to assure proper flow. Any significant variance from the established sampling parameters will void the sample, unless accounted for and corrected.

Calibration of sampling pumps will be according to accepted, standard industrial hygiene procedures (NIOSH, etc.) using primary standard for volumetric flow.

6.5 Laboratory Contingencies

Analytical procedures for the mustard samples were specified in Sections 6.2, 6.3, and 6.4. Samples will be handled with utmost care. Equipment will be properly ventilated to prevent exposure to agent, agent by-products, or hazardous analytical chemicals.

Laboratory personnel will take special precautions to avoid exposure or contamination. Samples will only be transferred from bubblers to vials under laboratory hoods with ventilation functioning to assure 100 feet per minute linear velocity into the hood. Vials will be sealed before analysis. Bubblers and contaminated equipment will be submerged in one of the decontaminating agents (Section 12.2.2) immediately after removal of the sorbent. Waste sorbent and other sample wastes will be likewise neutralized before disposal. For equipment that is not decontaminated chemically, heating in an autoclave at 1000°F for ten minutes is necessary to decontaminate.

VII. SAMPLING OPERATIONS

7.0 General

All agent piping systems and holding tanks are essentially closed and will be treated as closed systems or containers. At least two openings, the actual sample point and the makeup air input points, will be required for sampling. Before any piping or vessel system is broken, a portable ventilation unit will be set up at the opening and operation of the portable ventilation unit with a charcoal filter will be assured. In most cases, opening the system will require breaking pipe flanges, removing blank flanges, removing vessel nozzle flanges, and in several cases, drilling openings and/or cutting pipe.

The sampling strategy requires isolating piping systems to identify and pinpoint contamination. In some cases where sample volumes are high, it may be necessary to break piping and make additional sample points. Lines or vessels determined to be free of mustard contamination after bubbler sample analysis will be labeled XXX. Lines with mustard contamination will remain closed and will be labeled X after bubbler sample analysis which will identify the line/vessel for decontamination. Drawings will likewise be marked to indicate the sample findings.

7.1 Planning for Vessel/Pipe Disconnection

Close daily coordination between the industrial hygienist/chemist collecting the sample and the personnel involved in preparing the piping and equipment for sampling is necessary. The following list of activities will be required to ensure a safe and efficient implementation of the sampling and monitoring procedure:

- Before initiating a sample activity, the industrial hygienist/chemist and the sample preparation crew will walk through the sampling area. This is necessary to reverify the sample and makeup points, sample volumes, pipe runs, drawing accuracy, necessary tools and equipment, the need for special scaffold or ladder access, sample tubing lengths, monitoring times, and unique hazards.

- A job safety analysis will be conducted (Section 7.3) to ensure safe operation.
- Operation of a portable ventilation system will be set up at each opening and its operation will be ensured before the system is opened.
- Proper protective clothing and equipment will be worn and proper equipment will be available.
- Initial sampling will be conducted by near-real time reading instruments immediately after the system is opened.
- Personnel monitoring equipment will be checked.
- All openings after sampling will be closed.
- A heat stress rest schedule will be set up and followed.
- The "buddy system" will be used. All sampling activities will occur using the "buddy system" of two or more personnel at all times.
- The individual as well as multiple sampling schedules will be established.
- Emergency procedures will be reviewed and/or modified. Emergency procedures will only be modified if the uniqueness of the sampling area requires it, such as a sample point requiring scaffolding access.
- Personal protective equipment and the operation of mechanical safety equipment such as the portable ventilation system, eye wash fountains, and safety showers will be checked.
- Radios and the emergency communication network will be checked. A local communications network will be established requiring the use of two-way portable radios with one to be carried at all times by each sampling crew.
- A contingency plan will be made on a daily basis to protect an employee who is injured while opening any piping/vessel which is damaged to the extent that it cannot be immediately closed. This contingency plan will ensure a method of rapidly resealing the enclosure until the opening can be closed.
- A catch pan containing a decontamination agent (Section 12.2.2) will be placed under each piece of equipment/piping to be disconnected to quickly decompose and decontaminate any liquid mustard, if present.

- Plastic sheets will be available to immediately cover any liquid spills that may occur after opening equipment/piping. These will be used in addition to the portable ventilation exhaust systems.
- The utmost care will be taken to prevent, contain, and limit any agent release.

7.2 Standing Operating Procedures (SOP)

SOPs for both the sampling and decontamination operations to include the considerations in Section 7.1 are included in Appendices H, I, & J. The SOP will include the appropriate safety considerations in Section 9.0, also. Special attention is given to breaking equipment/piping containment, such as disconnecting a pipe or opening a vessel so that any release of mustard is controlled and contained during both the sampling and/or decontamination operations.

7.3 Job Safety Analysis (JSA)

While the greatest personnel hazard in the agent sampling operations is exposure to the agent itself, other hazards exist. A primary example includes falls, such as from floor openings, and from work at elevations that will be required for pipe disconnections. Some pipes will have to be cut by saws for sample preparation. Heat stress while dressed in personal protective clothing and equipment will be a major concern.

To address these potential hazards, the sampling crew, as part of the daily sample planning activity described in section 7.1, will perform a Job Safety Analysis (JSA) for each activity. A formal JSA will not be required. However, the sampling crew, as a minimum, will determine for each sampling operation, the major activities to be completed, the tools and equipment necessary for each step, how each step will be completed, the hazards evident during each step, and necessary precautions required before starting the sampling activity. No sampling activity will begin until the JSA and all activities identified by the JSA have been addressed.

7.4 Scaffolding

One major concern is the identification of fall hazards from pipe work at elevated locations. Sampling at elevated locations will

require the erection of temporary scaffolding sections, scaffold flooring, and guard rails. Unique piping arrangements may require the use of custom-made scaffolding or work platforms. The use of portable ladders, except for work access, is discouraged. Some elevated work may also require the installation of life lines and the use of lanyards and safety belts.

No sampling activity at elevated locations will be performed without scaffold or temporary work platforms that provide safe access and work location. Special attention will be given to safe access, particularly if custom-made work platforms are required. All scaffolding, work platforms, and ladders will be constructed in accordance with applicable Army and OSHA requirements.

7.5 Electrical Power

Electrical power will be required for sampling operations. This requirement will necessitate restoring building lighting and outlets. Outlets are required for portable lighting that is needed for certain work locations; sample pump operations, portable ventilation units, and portable tools such as saws and drills are needed for pipe disconnections. Portable ground fault circuit interrupters (GFCI) will be used for 120 VAC power supplies.

7.6 Equipment and Tools

Portable equipment and hand tools used in the sampling and decontamination operations must be positively identified by a permanent marking system that cannot be removed through further use in agent operations, decontamination, or maintenance. These items should be stored and segregated from items that have not been used in agent operations.

Records will be maintained listing all equipment that has been used in agent operations and that has been placed in standby status, removed and saved for future operations, or is being converted to use in nonagent operations. Records will not be maintained for laboratory equipment unless contaminated with agent. Such records will identify the contaminating agent, the decontamination process

used, and the methods and results of analyses used to confirm the decontamination process. These items will continue to be controlled until decontamination is to 5X status, as described in Section 12 of this SPSS.

VIII. MONITORING PLAN

8.0 General

Monitoring of sampling activities will consist of near-real time sampling of the following activities:

- Initial pipe/vessel entry.
- Sampling personnel activities.
- Area or rooms during sampling activities.
- Portable ventilation system exhaust. This sampling is necessary to determine any agent release from containment and to protect personnel.

8.1 Initial Pipe/Vessel Entry Monitoring

Before opening a pipe/vessel the portable ventilation unit (Appendix D) will be set up and operating. Before pipe entry, a near-real time (Appendix E) sample will be taken of the room or area surrounding the piping and/or vessel. Immediately after opening a pipe or a vessel, a sample will be taken of the interior of the enclosure for presence of agent contamination using a near-real time reading instrument. The results of this reading will be recorded by the industrial hygienist/chemist for comparison with the area or room samples which will be taken periodically during the bubbler sampling operations.

After bubbler samples are obtained, the piping for the sample point will be closed. The bubbler sample analysis will determine if the section of piping/equipment sampled is contaminated.

If the samples identify agent contamination, the decontamination plan portion (Section 12) of the SPSS will be implemented. The monitoring just described will be repeated as part of the decontamination plan.

8.2 Near-Real Time Monitoring

Continuous, near-real time sampling devices with alarms will be used to assure that exposed personnel are informed of exposure as soon as possible. MINICAMS (Appendix E) will be used for the monitoring and will be calibrated on an actual mustard sample to ensure accuracy.

8.3 Personnel Monitoring

For personnel monitoring, samples with near-real time monitors and alarms will be taken in the breathing zone and in immediate areas of equipment/piping as they are opened. A near-real time device will determine the worst case exposure and will Generally sample within the breathing zone.

8.4 Pipe/Vessel Closure

Immediately after obtaining a bubbler sample from a pipe/vessel interior, a near-real time reading of the interior of the enclosure will be obtained for agent contamination before reclosing the interior. All vessels and pipes broken or opened for bubble sampling will be closed to provide containment in case contamination was identified. Immediately after pipe/vessel closure, another near-real time reading will be taken of the area/room surrounding the enclosure to determine if any agent release occurred.

8.5 Ventilation Monitoring

During all sampling operations, a portable ventilation system which includes a blower and charcoal filter (Appendix D) will be operated. The ventilation units will contain any agent release that may have occurred during the sampling operations. Near-real time readings will be taken on a periodic basis of the ventilation return ducts downstream of the carbon filter to ensure the air is not contaminated.

IX. SAFETY

9.1 General

Safety will be a primary consideration during sampling and preparation for sampling. All personnel will be protected and any potential release of the agent will be contained. The following elements make up the safety guidelines of this SPSS with each element described in more detail in later sections:

- Limited Potential Exposure: Personnel exposure will be limited to the minimum number of people for a minimum amount of time to a minimum amount of agent consistent with safe and efficient operations.
- Training: The key to a safe completion of this work are knowledge of the hazards associated with the agent; measures to control exposure, emergency procedures, and first aid; and medical procedures by sampling personnel. Training will include orientation to the Material Safety Data Sheet (MSDS) for mustard.
- Containment: Primary objectives of this SPSS are containment of potential agent release and control of a release should one occur. Containment measures include using catch-pans, bleach for decomposition and decontamination, and a portable ventilation unit.
- Contamination: All piping and vessels associated with previous mustard demil operations are treated as if they contained the mustard agent unless they are open to the atmosphere.
- Personal Protective Equipment (PPE): Because of the above information, all personnel when sampling will wear Protective Clothing and Equipment (PC&E) (Section 9.3.1) for all initial sampling operations including opening of piping/vessel enclosures. They will continue to utilize such equipment as long as the enclosures are open until bubbler sample analyses indicate the enclosure is free of agent contamination.

- Zones of Sampling/Control of Contamination: To further control the potential agent release, the volume of an enclosure (piping and vessels) will be limited for sampling. This zone of sampling, although determined based on sampling equipment limitations, provides a method of limiting any potential release of the agent. Such a zone methodology will also allow for isolation of any potential contamination. Immediately after completion of sampling, the enclosure will be resealed at both the sample point outlet and the air inlet or makeup point.
- Buddy System: A buddy system will be required for all sampling operations. This will require that two or more trained individuals always remain together while in a room or area where potential agent exposure exists.
- Monitoring. Personnel, area, room, and ventilation systems will be monitored during all sampling and decontamination operations.
- Ventilation: Sampling areas will be exhausted to activated carbon filters to contain any release of the agent during sampling and decontamination operations.
- Decontamination: Personnel decontamination equipment, facilities, and material will be provided in close proximity to all sampling and decontamination operations (Sections 9.7 and 9.8).
- Standing Operating Procedures (SOP's): SOP's are developed for all sampling, monitoring, and decontamination operations to ensure the safety and efficiency of these operations (Appendices H, I, & J).
- JSA's: JSA's will be conducted for all individual sampling and decontamination operations to ensure all potential hazards are identified and controlled (Section 7.3).

- Emergency Procedures: Emergency procedures are developed to ensure personnel protection in case of exposure to mustard and/or other injury/illness. These include a communications network, first aid facilities, and a rapid response of medical personnel and emergency medical technicians trained in agent exposure treatment.
- Compliance with Safety and Health Regulations and Standards: All sampling and decontamination operations will comply with existing, applicable U.S. Army regulations, standards and manuals; RMA regulations, standards, rules, and SOP's; and OSHA standards.

9.2 Training

Before initiating any operation, all sampling and decontamination personnel will receive training to include demonstrated proficiency in the following areas involving the chemical agent mustard:

- Operating procedures to include safety requirements.
- Hazard recognition involved in the operation.
- Signs and symptoms of agent exposure recognition.
- First aid and self aid administration and use of first aid equipment.
- Personnel decontaminating procedures.
- The execution of emergency procedures.
- Techniques of wearing, adjusting, inspecting, and caring for personal protective masks and clothing.
- Material Safety Data Sheets (MSDS).

TVA will provide orientation training for all of the above areas. Additional safety training by the safety office at RMA will be completed, including the MARK 1 Kit Chemical Agent and Emergency Response Training. No TVA personnel will be allowed to perform any operations in this SPSS without completing the above training.

9.3 Personal Protective Clothing and Equipment

The use of personal protective clothing and equipment (PC&E) is the most effective and efficient way of protecting personnel during

sampling and decontamination operations. The guidelines contained in the remainder of this section are taken from AMC-R 385-131, "Safety Regulation for Chemical Agents H, HD, HT, GB, and VX", October 9, 1987, U.S. Army Materiel Command.

9.3.1 Levels of Protection

There are six levels of PC&E protection designated by the U.S. Army, Levels A through F. The specific equipment required for each level is listed in Section 9.3.3. Each level of protection is described as follows:

Level A - Level A will be worn in areas of spilled agent or known liquid contamination and during decontamination operations. For these situations, the cuffs of the sleeves and legs of the M3 suit will be taped to the gloves and boots to reduce the amount of outside air drawn into the suit. Taping is not recommended for routine operations requiring Level A because of the residue left on the suit. Where a significant amount of liquid is present or the PEL is exceeded, time in the M3 suit will be limited to the extent operationally feasible and will not exceed one hour.

Air supplied or self-contained respiratory protection is required when airborne agent concentrations exceed the PEL levels (Section 5.5) or when in areas of potential but unknown airborne contamination. This requirement does not apply to emergency situations unless such protection is available and its use would not significantly impede the operation.

Level B - Level B will be worn when contact with suspect item is required and when performing operations which may result in release of agent vapors within the work area (e.g., air sampling inspection of stocks or inspection/repair of equipment), but there is no contact with liquid agent anticipated and no liquid agent is present.

Level B or equivalent commercial protective clothing, without impregnated underclothing, is required for decontaminating operations using Super Tropical Bleach (STB) or High Test Hypochlorite (HTH) in an atmosphere free of chemical agent contamination.

Level C - Level C will be worn by personnel who must be in agent areas where handling or contact with agent-filled items is involved and if low-level monitoring is not being performed.

Level D - Level D will be worn by personnel in clean areas where handling or contact with agent-filled items is involved and if low-level monitoring is being performed with negative results.

Level E - Level E will be worn by operating personnel who may be observing or supervising the operations and who would not likely contact an item or would only be exposed to agent in the event of an accident.

Laboratory personnel will use this level of protection in conjunction with approved gloves as required. A laboratory coat may be substituted for the coveralls. Masks will be located for readily available access instead of having to wear in the slung position.

Level F - Level F will be limited to casual or transient personnel who may be required to visit clean storage or operating areas.

9.3.2 Level Of Protection Required For This Work

The south plant was inspected by TVA personnel in July-August 1988. This inspection indicated no known liquid agent present in the buildings. There were visual indications of previous decontamination efforts, such as caustic deposits on some flanges of piping. However, most of the piping/equipment remain tightly closed. Based on these indications, a Level A protection will be required for the sampling operations until sampling indicates that no mustard contamination is present. Decontamination of minor levels of mustard will require Level A of PC&E.

9.3.3 Equipment For Levels Of Protection

Level A - M3 Toxicological Agent Protective (TAP) Ensemble - This ensemble is not a positive pressure system and thus some outside air will enter the suit through the sleeve, neck, and leg openings. Precautions to reduce the amount of outside air entering the suit are

contained within this and other sections of this regulation. For environments above the PEL, the air-supplied or self-contained suits are preferred. The following safety units are required for Level A protection:

- Suit - Coveralls, toxicological agent protective (TAP) (M3).
- Hood - Toxicologic agent protective (M3).
- Boots -- Butyl, safety toe, toxicological agent protective (M2A1).
- Gloves - Butyl, toxicological agent protective (M3, M4 gloveset).
GB/VX--Surgical or other equivalent nonstandard gloves will be worn underneath for protection when taking off TAP clothing.
Mustard--Surgical or other equivalent nonstandard gloves optional.
- Innerwear - GB/VX--Coveralls, fatigues, or similar (with drawers and undershirt) and socks. Alternative--long underwear and socks.
Mustard--Impregnated gloves, impregnated socks, and impregnated long underwear or impregnated protective liner to include shirt and trousers. Coveralls, fatigues, or unimpregnated underwear may be worn in addition.
- Mask - M9 series to be worn.

Air supplied or self-contained suits may be substituted for Level A protection when authorized by the Director, AMC Field Safety Activity ATTN: AMKOS-C, the Demilitarization Protective Ensemble (DPE) or the Toxicological Agent Protective Ensemble Self-Contained (TAPES). For operations involving mustard, only the 30 mil thick DPE for up to two hours is required.

Level B

- Apron - Toxicological agent protective (M2); extending below top of boots.
- Innerwear - GB/VX--Coveralls, fatigues, or similar (with drawers and undershirt) and socks.

Mustard--Impregnated gloves; impregnated socks; and impregnated protective liner to include shirt and trousers. Coveralls, fatigues, or unimpregnated underwear may be worn in addition.

- Hood - Toxicological agent protective (M3 and M9 mask or M6A2 for M17 mask).
- Boots - Butyl, safety toe, toxicological agent protective (M2A1).
- Gloves - Butyl, toxicological agent protective (M3, M4) gloveset. GB/VX--Surgical or other equivalent nonstandard gloves will be worn underneath for protection when taking off TAP clothing.
- Mask - M9 or M17 series to be worn.

Level C

- Boots - Butyl, safety toe, toxicological agent protective (M2A1).
- Gloves - Butyl, (M3, M4) gloveset.
- Apron - Toxicological agent protective (M2), extending below top of boots. Required only if job safety analysis (Section 7.3) determines that bodily contact with agent-filled items may occur.
- Clothing - Unimpregnated--coveralls or fatigues, socks, drawers, undershirt.
- Mask - M9 or M17 series to be worn.

Level D

- Boots - Butyl, safety toe, toxicological agent protective (M2A1).
- Gloves - Butyl (M3, M4) gloveset.
- Apron - Toxicological agent protective (M2); extending below top of boots. Required only if job safety analysis (Section 7.3) determines that bodily contact with agent-filled items may occur.
- Clothing - Unimpregnated--coveralls or fatigues, socks, drawers, undershirt.
- Mask - M9 or M17 series to be worn in slung position.

Level E

- Clothing - Unimpregnated--coveralls or fatigues, socks, drawers, undershirt.

Mask - M9 or M17 series to be worn in slung position. In laboratories, a lab coat may be substituted for coveralls or fatigue and the mask may be readily available at the work site instead of in the slung position. Gloves will be worn when required by Section 7.3.

Level F

Clothing - Street clothing.

Mask - M9 or M17 series to be worn in slung position.

9.3.4 Equipment Description

Protective boots - The butyl boots specified above will be safety toe type boots, M2A1, NSN 8430-00-820-7295/7306. Boot covers are optional additions to all levels of protective clothing.

Protective gloves - M3, M4, gloveset, and glovebox (made to MIL Spec MIL-G-12223) gloves are considered to be standard and may be used with any level of protective clothing.

Microclimate controls (cooling equipment) - Commercially available cooling vests or suits may be used under the M3 TAP ensemble or Level A clothing provided the integrity of the clothing is not degraded, the cooling equipment does not interfere with safe operations, a written SOP is prepared, training is provided, and a local hazard analysis verifying safe use is prepared. Cooling equipment inside a protective suit will not be reused if it becomes agent contaminated.

Emergency escape devices - Commercially available emergency escape devices may only be used by visitors who cannot be properly fitted with a regular protective mask and only for emergency escape purposes. These devices must have a self-contained air supply (typically 5-15 minute duration) and a hood and neck seal system that provides positive pressure clean air to the entire hood. The device must be NIOSH approved as an escape device. Visitors will be provided appropriate training in the use of the device and briefed on an evacuation plan that is consistent with the short duration of protection these devices provide.

Use of nonstandard type gloves - Nonstandard gloves may be used in lieu of standard gloves for agent activities requiring special handling consideration such as laboratory operations where good hand dexterity is essential or glovebox operations subject to the following requirements:

- The nonstandard glove selected will be limited to use in operations where standard gloves cannot be used because of safety or operational considerations. An example is the use of lightweight, tight fitting neoprene gloves in laboratory operations involving solvents incompatible with butyl rubber.
- Nonstandard gloves will be used only in a manner which prohibits intentional contact and has low potential for unintentional contact with liquid agent. If actual or suspect liquid contamination, the gloves will be decontaminated, removed, and disposed as soon as feasible.
- If no liquid contamination occurs, the gloves may be decontaminated, laundered, tested, and reused, except nonbutyl gloves will be destroyed.
- Nonstandard gloves will not be worn after liquid contamination or for more than one work shift.

9.3.5 Care of Protective Equipment

RMA will provide a separate area and facilities where protective clothing will be laundered, inspected, tested, and issued. Protective clothing and associated non-protective clothing may be laundered in the same facility. Associated non-protective clothing may also be laundered in other RMA laundry facilities. When the laundry is located in an area which allows access of nonrelated personnel, all protective clothing will be monitored before delivery to the laundry.

Butyl rubber impermeable protective clothing will burn and does not possess self-extinguishing properties. Therefore, contact with an

open flame or objects which would ignite the clothing must be avoided during laundering, inspection, testing, storage, and wearing. Smoking is prohibited in the vicinity of or while wearing butyl rubber protective items.

Clothing must be in a serviceable condition and properly fit the wearer. Unserviceable, damaged, or deteriorated clothing will not be issued or used. All protective clothing in active use must be sent to the laundry for inspection and testing quarterly. The M3 coveralls, M3/M4 gloveset gloves, and M2A1 boots will be leak tested:

- When newly removed from stock.
- After each laundering.
- Before use of these items if they have not been tested within the previous three-month period.
- Whenever there is evidence of deterioration or damage that might cause leakage.

The M3 coveralls, M3/M4 gloveset glove box gloves, and M2A1 boots will be leak tested using the procedures in TM 10-377. Because of the adhesive residue left on protective clothing, tape should not be used for sealing cuffs or marking suits. Each wearer is to assure serviceability of their PC&E by visual inspection before and after use. Serviceable protective clothing is not to be worn as a General utility item. Unserviceable protective items being used as General utility items, such as M2A1 boots, must be clearly marked so they cannot be mistaken for serviceable items.

9.3.6 Decontamination and Laundering of Protective Clothing

Requirements for decontamination and laundering of protective clothing will be as follows:

1. Protective clothing worn during first entry monitoring of enclosed agent facilities which is not subject to agent liquid or vapor contamination will be flushed with water and aerated for at least 12 hours prior to reuse. This protective clothing will be laundered once every three months as a minimum as outlined in Section 9.3.5 except that water temperatures may be reduced to 60°C (140°F).

2. Protective clothing worn in known agent vapor contaminated areas or which has minor liquid agent contamination will be decontaminated with a 10-percent HTH or STB slurry, thoroughly flushed with water, doffed, placed in a plastic bag, and sealed to prevent escape of agent vapors. During decontamination, particular attention should be given to the double cuff area on the sleeve and folds around leg and sleeve snaps on the M3 suit and cuffs of M2 apron. After at least four hours at a location providing a minimum temperature of approximately 21°C (70°F), the atmosphere inside the plastic bag will be tested for contamination with a low-level detector to verify that agent vapor concentrations do not exceed the PEL before the clothing may be removed from the bag and sent to the laundry facility. If agent concentrations above the permissible limits are detected, the clothing will be further decontaminated and tested.
3. Protective clothing subjected to any liquid contamination of mustard will be decontaminated and tested for thoroughness of decontamination as in paragraph 9.3.5. If no agent is detected by test, the clothing will be disposed.
4. Whenever the degree or type of contamination is questionable, the clothing will be treated as if it were subjected to liquid agent contamination.
5. Butyl rubber protection clothing contaminated with petroleum base products, including solvents or lubricants, will be disposed.

Protective clothing worn in contaminated areas will be decontaminated and monitored to assure that any agent vapors released do not exceed permissible limits and will not be reused until laundered. The laundry facility will thoroughly clean, inspect, and repair, if required. Laundering of impermeable protective clothing, excluding masks, will include soaking in hot soapy water with an alkalinity of a pH 8 to pH 9 at a temperature of 70° to 85°C (175° to 185°F) for at least one hour without agitation. Detergents are not to be used instead of soaps. The clothing will then be rinsed with fresh water,

air dried, and hung in a ventilated area for aeration for 24 hours. M3/M4 and gloveset gloves, M2A1 boots, and M3 coveralls will be leak tested after each laundering.

The wearing, care, maintenance, storage, handling, and decontamination of personal protective clothing and equipment must be in compliance with appropriate Technical Manuals (TMs), Regulation Manuals (RMs), Standing Operating Procedures (SOPs), etc.

9.3.7 Respiratory Protection

Respiratory protection will include the following essential elements:

A. Selection - The device which will give the best protection and which can be worn with the greatest degree of comfort under expected conditions of this operation will be selected using the following standards:

1. In an atmosphere which is oxygen deficient (less than 19.5 percent oxygen) or for operations other than field or emergency operations in which the toxic agent vapor concentration is considered to be immediately hazardous to the life and health of personnel, an air-supplied protective suit or pressure demand breathing apparatus will be used.
2. Canister or filter element-type masks can be used where oxygen deficiency is not a factor and concentrations do not exceed those considered to be immediately dangerous to life or health (IDLH). This category of protection includes the M9 and M17 series masks. All M17 series masks must be equipped with M13A2 filter elements having green filter element sleeves (NSN 4240-00-165-5026). M13 and M13A1 filter elements with black or gold filter element sleeves will not be used for protection against agent as these are training filters.
3. RMA will be responsible for providing the necessary respiratory protection equipment.

B. Wearer instructions - The wearer will be properly fitted and trained in the use and care of the respiratory device and the means by which it gives protection. The wearer's face will be clean shaven to the extent that there is no possible interference of any facial hair growth (beard, sideburns) with the sealing surfaces of the protective mask to assure that an effective seal will be maintained between the mask and the wearer's face. This restriction does not apply to the personnel provided with a self-contained emergency escape device or other approved devices not needing a mask-to-face seal. RMA will provide fit testing for all personnel required for the sampling and decontamination operations.

C. Individual care and use of Protective Masks

Initial fit

When a protective mask is issued or the filter element or canister is changed, it will be inspected for serviceability, fitted to the person, and tested for leaks.

A preventive maintenance program for protective masks used by individuals in their regular operational assignments must be established. The procedures prescribed in the operator's manual for the specific mask will be the minimum required except that filters or canisters are not to be removed as this invalidates the leak test. When masks are used daily, inspection and cleaning will be performed weekly to ensure serviceability. Supervisory personnel must check to assure that cleaning and inspection of masks are being performed by employees.

Wearing and Leak Checks

Personnel employed in operations where the mask is required for protection will check for fit and leakage whenever the mask is worn. Positive pressure air supplied masks are not subject to this provision but should be leak checked under the manufacturer's provisions.

Each individual is responsible for the condition of his own mask. This includes a detailed visual inspection. Defects will be immediately reported to the supervisor.

When the mask will be used only in emergency situations, the mask will be visually inspected and tested for fit and leakage at least every 6 months.

Contact lenses will not be worn by personnel involved in agent operations. An exception would be visitors who would only wear a mask only if evacuation is necessary.

The M11 canister will not be used for respiratory protection without the pad insert installed. The pad insert must be changed every eight hours of use. Wearing the mask for fitting and leak checking (isoamyl acetate test) is not to be considered use time. The pad inserts will be changed out daily for each shift. Mask is to be retested (M4 and M14 testers) after replacement of pad insert and M11 canister.

9.4 Emergency SOP

An emergency SOP has been developed for both the sampling, monitoring, and decontamination operations using (Appendices H, I, & J). As a basis, the RMA SOP SF-50-1 (Appendix K), "Emergency Response," dated April 25, 1988, was used.

9.5 Ventilation

Portable ventilation units will be used during the sampling and decontamination phases for Buildings 537 and 538. The existing building ventilation system is not available for use. Each portable ventilation unit (Appendix D) will include two hoses at each opening connected to a blower which is connected to an activated charcoal filter before being exhausted to the atmosphere. The minimum air velocity at each sample opening to each blower will be 100 linear feet per minute. The ventilation unit will be set up and operating before the enclosed pipe or vessel is opened. Operation of the ventilation unit will continue until the sampling is complete, until

all openings are closed, and until the analysis from the near-real time monitor confirms that no mustard is in the area.

9.6 Criteria for Containment

Appropriate containment is necessary for the protection of the employees performing the work, for the protection of other employees at the installation who are not associated with the work, and the General public.

There are two basic types of containment: total containment and vapor containment. With both types, the containment structure or facility will be equipped to entrap or detoxify the evaporated or aerosolized chemical agent by using filters, scrubbers, or other means. Total containment, as defined by the Army, addresses the contingency of an agent release from exploding ammunitions. Since there is no ammunition in the south plant and no known quantities of liquid mustard, this type of containment is not addressed in this SPSS.

Vapor containment is usually provided by building design and ventilation systems, but includes such things as hoods, glove boxes, cabinets, rooms, buildings, and double-walled pipes. Ventilation, as a containment measure for the south plant, was previously described in Section 9.5.

The primary principle for containment of potential mustard contamination in the south plant is to minimize the time a previously enclosed pipe or vessel is opened for sampling. A minimum of two openings will be required for sampling. These will be made just before sampling and will be closed or sealed immediately after sampling until the level of mustard contamination is determined from analysis of the bubbler sample. If decontamination is required, enclosures will only be re-opened just before initiating use of the decontaminant. Any spills of liquid or solids will be caught in a stainless steel pan containing a neutralizing chemical for immediate neutralizing and covered with a plastic sheet (Section 7.1).

Personnel Decontamination Contingencies

There are two primary routes of entry into the human body from exposure to mustard: the eyes or mucous membranes and the skin. Decontamination of these two routes of entry include the following:

- Eye and mucous membrane contamination - Speed in decontaminating the eyes is absolutely essential. The procedure is very effective for mustard in the first few seconds after exposure but is of very little value in preventing eye damage if the decontamination is delayed for one or two minutes after exposure. The person must be removed from the agent source and the eyes flushed immediately with water by tilting the head to the side, pulling the eyelids apart with the fingers, and pouring water slowly into the eyes. The eyes are not to be covered with bandages but, if necessary, the eyes are to be protected by dark or opaque goggles. The patient is then to be transferred to the medical facility.
- Skin contamination - The person is to be removed from agent source immediately. The victim will immediately be deluged with water at the portable safety shower. These showers will be placed in the nearby vicinity of the sampling activity. He will then be flushed with a five-percent sodium hypochlorite solution within a minute and analyzed by a near-real time monitor. If the near-real time monitor indicates no contamination, he will then be flushed with more water. The clothing should be cut and removed and the skin flushed with water and, if needed, a five-percent sodium hypochlorite solution. The skin should then be washed with soap and water. The victim should be washed again in the portable safety shower. If a thickened agent is involved, it should be removed by scraping with something dull such as a plasterer's trowel.

The RMA EMT's and the other TVA crews should be called immediately after contamination of personnel is determined. The TVA crew will bring the decontamination truck from the north plant complex. The victim will be transported to the designated hotline where TVA

personnel will further decontaminate, medical attention will be provided by the RMA EMT's, and the victim will be transferred to the Fitzsimmons Army Medical Center.

The personnel decontamination hotline will be located at the doorway just south of Building 537. The hotline procedure, as described in RMA SOP SF-50-1 is depicted graphically in Figure 9.1. The hotline will separate the hot or contaminated areas from the contaminated reduction area (CRA). The CRA will contain an equipment drop for tools and detection equipment, a decontamination station for equipment, step-in decontamination pans leading to the personnel decontamination station, a personnel decontamination station consisting of decontamination truck provided by RMA, a monitoring station for personnel and equipment, and an area for decontaminating, monitoring, and handling medical casualties. The contamination control line (CCL) will separate the CRA from the clean area.

Near-real time monitoring with the MINICAMS will be performed at specific sampling sites where opening of the process equipment is proceeding. If no mustard concentrations greater than 0.003 mg/m^3 are detected during the sampling, it will be assumed that neither personnel nor the sampling equipment was exposed to mustard during that operation.

If the MINICAMS register concentrations of mustard greater than the time weighted average (TWA) during the sampling operation, the sampler personnel will be considered contaminated. The hotline established becomes functional in this worst-case scenario and when sampling personnel are to leave the hot area, they will continue to wear their protective gear, cross the hotline into the CRA, and be decontaminated. The Level A gear will be placed in double plastic bags and monitored with the MINICAMS for mustard. If concentrations of mustard in the clothes are found greater than the TWA, the clothes will be decontaminated and sent to the laundry, and new Level A gear will be issued. If no mustard is found at concentrations greater than the TWA, the same protective clothing and respirator will be available to the sampler for the next round of operations.

EMERGENCY PERSONNEL DECONTAMINATION STATION (EPDS)

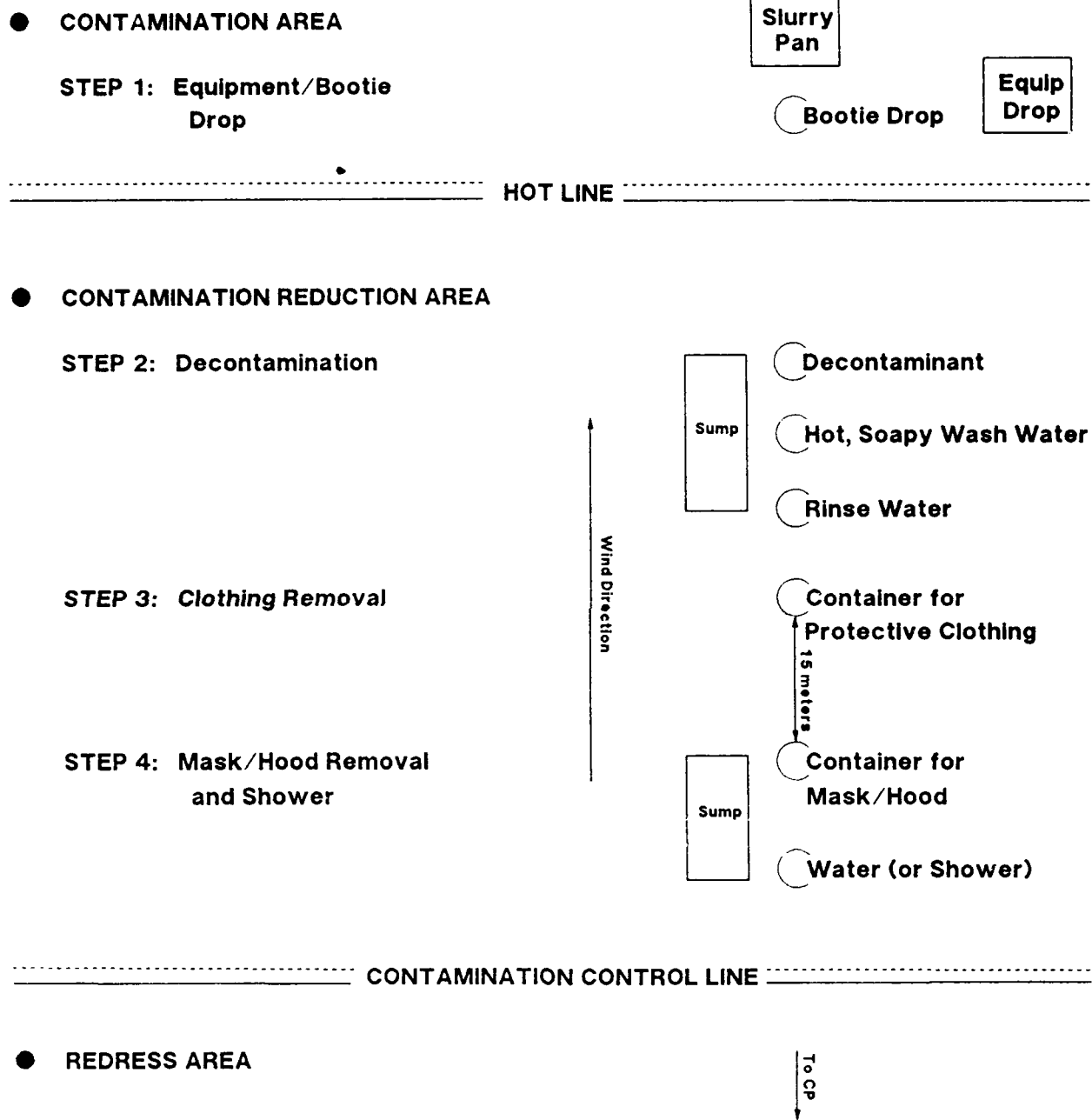

FIGURE 9-1 CONFIGURATION OF PERSONNEL DECONTAMINATION STATION SETUP, SOUTH PLANT, RMA (FROM RMA SOP SF-50-1)

Decontamination of personal protective clothing and equipment was previously described in Section 9.3.6.

9.8 Safety Equipment/Decontamination/Change Facilities

Daily change out of PC&E will occur at the portable trailer located just south of Building 1501 at the north plant. Employees will be transported by vehicle to and from the buildings of the south plant while dressed out in PC&E. This trailer will be equipped with showers and two separate sets of lockers, one for PC&E and one for personal clothing. The two locker sets will be separated by locating in separate rooms.

Utilities such as electrical power and an ample supply of clean water will be provided by RMA. TVA will provide the utility connections to the trailer. The wastewater will be diverted to the chemical sewer. TVA will provide this sewage hook-up.

Personnel monitors by near-real time MINICAMS will detect personnel and equipment contamination. Should accidental contamination occur, the contingencies and hotline procedures described in Section 9.7 will control contaminated PC&E and equipment. In this event provisions will be made for decontamination and removal of contaminated or potentially contaminated protective clothing at or adjacent to the south entrance to Building 537. Provisions for collecting such clothing for processing at the laundry facility will be provided as specified in Section 9.3.5 and 9.3.6.

TVA will provide portable, self-contained safety showers and separate, portable eyewash fountains. Hoses will be used to supply clean water to these two types of safety equipment. Wastewater will be collected in tanks supplied with these units. Two of each of these units will be placed in Building 537 near the sampling and/or decontamination operations.

9.8.1 Equipment Required

- A reliable source of clean water, available in quantities and under sufficient pressure for operation of eyewash fountains, safety showers and change house facilities.

- At least two portable, self-contained eyewash fountains and safety showers.
- First aid equipment and supplies to include dark or opaque goggles.
- An ample supply of five-percent sodium hypochlorite solution (commercial bleach) for personnel decontamination.
- An ample supply of caustic for decontamination of process equipment that is removed for sampling operations.
- Cloth, sponges, or gauze.
- A complete set of first aid instructions posted in the change-out trailer and in each building.
- An adequate, daily supply of soap and towels.

TVA will supply all of the above equipment, and RMA will provide the water, soap, and towels.

9.9 Personnel Protective Practices

The following precautionary measures will be observed by personnel who work in contaminated or suspected contaminated areas:

- A. All clothing, including shoes, will be changed at the beginning and ending of the work shift after arrival at the change-out trailer.
- B. Open sores or wounds will be evaluated by the local medical authorities at The Fitzsimmons Army Hospital and covered with impermeable dressing prior to admittance to the area.
- C. Each worker will shower thoroughly with special attention given to hair, face, neck, and hands, using plenty of soap before leaving at the end of the work day.
- D. Eating, drinking, chewing, and smoking within agent areas will not be permitted.
- E. Each worker will be inspected for signs of agent exposure before leaving the installation. The inspection will be made by the supervisor or his designee.

- F. The buddy system will be in effect for all activities in Buildings 537 and 538.

- G. A portable two-way radio will be carried by each crew when performing any activities within Buildings 537 and 538. The radio will be tuned to either the crew supervisor, other designated personnel located outside these two buildings, or with emergency personnel at the central RMA fire station. Radios are to be used to contact emergency personnel.

9.10 Heat Stress

Wearing either Level A or B protective clothing and equipment (PC&E) for extended periods of time will likely cause heat stress for the individual. The level of stress will be higher in the warm months of the year, when sampling operations for mustard are recommended. The degree of individual heat stress varies according to a number of physiological factors. Instead of addressing these individual factors, the supervisor of the sampling and decontamination crews will establish a schedule of work activity that allows a "cooling down" or rest period, where the PC&E can be temporarily removed. A place, separate from the suspected contaminated areas, will be established for this cooling period.

The work schedule should be determined on a daily basis in consultation with the industrial hygienist/chemist (Section 7.2) for efficient sampling operations. Table 9-1 below provides a suggested work schedule with PC&E. Rest periods between wearing times should allow for cooling down with more time required as the ambient temperature increases. A minimum cooling down period of three times the period the PC&E is worn should be allowed when the ambient temperature is over 90°F.

Table 9-1

PC&E Maximum Wearing Time

<u>Ambient Temperature</u>	<u>Maximum Wearing Time (hours)</u>
Above 90°F	1/4 hour
85-90°F	1/2 hour
80-84°F	1 hour
70-79°F	1 1/2 hour
60-69°F	2 hours
50-59°F	3 hours
30-49°F	5 hours
Below 30°F	8 hours

9.11 Emergency Preparedness

Following is a list of emergency preparedness provisions which will be followed in the implementation of this plan:

- A. A central control point that is informed of all operations with the agent will be established for coordination of emergencies. This control point is not required to be the center for chemical accident/incident control; however, the center may be used when it is more advantageous to the installation.
- B. The work area will be clearly defined and access limited to only authorized personnel who have received appropriate safety training or are accompanied by someone who has been trained.
- C. Work not necessary to the operations will not be performed in the areas of agent operations. Laboratories may have areas set aside for non-agent operations.
- D. Adequate operable detection equipment and materials will be maintained at all work areas. Wind direction indicators must be provided at all areas and located so they are readily visible to personnel in the areas.

- E. Telephones, radios, or other means of communication for advising the operational control point of emergencies will be available at the work sites.
- F. Decontamination and first aid equipment will be positioned at all agent operating sites. It is not necessary to man this type of equipment with non-operating personnel. Designated personnel will be trained to operate this equipment in the event of an emergency. A vehicle, suitable for use as an ambulance, will be readily available at the jobsite whenever operations are in progress.
- G. For field operations, each crew will have one individual designated as the safety person to perform such duties to ensure that the above equipment is available and properly positioned, monitor communications equipment, assist personnel in putting on protective clothing, and check for its proper fit, maintain records of entry/exit time, monitor stay times in PC&E, and ensure protective clothing is properly decontaminated and taken off.
- H. All TVA employees at RMA will be trained to be knowledgeable in agent exposure symptomatology, first aid, and treatment. A minimum of two trained people will be present during agent operations and will remain in visual contact with each other at all times or within the immediate access area when communication is provided and observation by operational control personnel is possible.
- I. All personnel working with agent will be given an off-duty hour telephone number (289-0190/0192) to report suspect exposures. This telephone number is the RMA fire department EMTs.
- J. Workers will report any illness to the supervisor before starting daily operations or before leaving the job if the illness occurs during working hours.

K. Any agent exposure, suspected exposure, agent spill or release, or other abnormal situation that may result in personnel injury must be reported to supervisory personnel immediately after necessary emergency action is taken. Personnel with possible agent exposures will report for medical evaluation as soon as possible.

X. MEDICAL

10.1 Medical Examination

All TVA personnel assigned to perform sampling and decontamination operations will have TVA administered medical examinations or have a current record of a TVA medical examination. This will include a determination of the fitness to use respiratory protection devices and personal protective clothing. The medical examinations will be coordinated with and the examination results forwarded to Fitzsimmons Army Hospital.

10.2 Key Medical Personnel

Key medical personnel necessary to support any emergencies to TVA personnel will be the Emergency Medical Technicians (EMT) provided by the RMA fire department. The Fitzsimmons Army Hospital will provide medical care for serious injuries or exposure to mustard.

10.3 Emergency Response Equipment

The RMA fire department will provide the following emergency response equipment necessary for conducting the sampling and decontamination operations:

- An ambulance.
- A communication system to summon aid.
- First aid equipment and supplies.
- A set of first aid instructions.

10.4 Emergency Medical Identification

TVA employees will be furnished a medical alert card by RMA personnel. Personnel will be requested to wear or have the identification card with them during off-duty hours.

The identification card will contain the following information: "FOR EMERGENCY MEDICAL INFORMATION CALL (INSTALLATION MEDICAL OFFICER TELEPHONE NUMBER). U.S. GOVERNMENT SERIAL NO. (PERSONNEL IDENTIFICATION NUMBER). This person works with and may have been

exposed to (type of agents by physiological action). Other special medical characteristics will include a list of allergies, special conditions, etc."

10.5 First Aid Procedures

Although a prime consideration in first aid for an individual who has been exposed to vesicant (mustard) agent is immediate removal to an uncontaminated area, the risk of leaving liquid vesicant in the eye is so much greater than the risk of exposure to vesicant vapors during the short period of decontamination, that eye decontamination must be done despite the presence of vapor. During handling and decontamination of casualty cases, personnel will give consideration to their own safety, take necessary precautions, and wear prescribed protective clothing and equipment to avoid becoming exposed to agent.

Section 9.7 of this plan contains procedures for personnel decontamination contingencies in case of exposure to mustard. Outside of these actions, TVA personnel will not attempt any first aid but will immediately call the EMTs at the RMA for emergency assistance.

XI. HAZARD ZONE CALCULATIONS

11.0 General

No explosives are involved in this sampling effort. Only environmental samples are to be collected, and no liquid mustard is anticipated to be present. Portable ventilation units with local exhaust hoods placed adjacent to each pipe/vessel broken for sampling will be used to collect any agent vapor release. Exhaust of the ventilation unit will be through activated charcoal filters.

Stainless steel catch pans filled with agent neutralizing chemicals will be placed under each pipe or vessel that is opened for sampling in the unlikely event liquid mustard is present and spilled. If such a release is detected, the pipe/vessel will be immediately reclosed. Plastic sheets will be placed near-by and immediately used to cover a spill as an added emergency containment measure. Personnel contaminated by a release will immediately proceed to emergency decontamination stations and showers. Tools accidentally contaminated will likewise be decontaminated by immediate washing in a neutralizing solution. All samples will be packaged immediately after collecting. No downwind hazard from the sampling and decontamination operations exists.

XII. DECONTAMINATION PLAN

12.0 General

Decontamination is defined by AMCCOMR 385-5 as: "The partial or complete removal or neutralization of a contaminant. The words 'decontamination' and 'decontaminated' should be used with other words such as 'degree of,' 'partial' or 'partially,' 'complete' or 'completely' to assure that the person receiving information does not assume contaminant has been completely removed when it may have been only partially removed."

There are four levels of decontamination specified by the Army.

These levels are defined as follows:

- (1) X - A single X indicates that the level of decontamination is unknown or that an item is contaminated to the extent that vapor concentrations from the equipment or within the facility exceed 0.003 mg/m^3 (for mustard agents.)
- (2) XXX - Three Xs indicate that the item has been surface decontaminated, which includes disassembled parts that are simply shaped (no crevices, threads, etc.), are made of essentially impervious materials (simple lab glassware, steel gears, etc.), and that appropriate tests or monitoring has verified that vapor concentrations above 0.003 mg/m^3 do not exist.
- (3) XXXXX - Five Xs indicate that the item is clean and may be released from government control without precautions or restrictions. 5X condition must be certified by the Commander's designated representative.
- (4) Clean conditional - When situations such as metallurgical investigations require testing at locations outside the installation, the item will be disassembled and exposed to moderately high temperatures long enough to decompose agent to compounds of lesser toxicity. A temperature of 177°C (350°F) for four hours is considered sufficient to decompose agent. Bubbler samples will be taken to assure vapor concentrations do not exceed 0.003 mg/m^3 for mustard agents. After test data is obtained, material will be decontaminated to 5X levels for release from government control or placed in approved storage as

X status. Such testing will be done only at government installations and under a standing operating procedure (SOP) concurred in by the installation responsible for the item.

12.1 Decontamination of Buildings/Facilities/Equipment/Piping/Vessels

12.1.1 Levels

All equipment, piping, and vessels in Buildings 537 and 538 identified as being contaminated from bubbler sampling results will be decontaminated to the XXX level. Such equipment identified by the sampling as being free of contamination will be declared decontaminated to the XXX level. After decontamination operations, decontamination will be verified by sampling.

12.1.2 Decontaminating Agents

Standard decontaminating agents that the Army considers acceptable for decontaminating equipment and spills (AMC-R 385-131, Section 5.1.d) include but are not limited to:

- Super Tropical Bleach (STB). STB must be used as a slurry. In the dry state, STB reacts violently with liquid mustard, producing toxic vapors and possibly sufficient heat to cause flame. STB should be immediately and thoroughly rinsed from surfaces after decontamination to preclude fire and limit corrosion.
- High Test Hypochlorite (HTH). HTH must be used as a solution. In the dry state, HTH reacts violently with liquid mustard, producing toxic vapors and possibly sufficient heat to cause flame.
- Commercial liquid bleach (nominal five percent solution of sodium hypochlorite).

The minimum acceptable chlorine content for STB is 10-percent, 30-percent for HTH, and three percent for sodium hypochlorite solution.

12.1.3 Specific Safety Precautions for Decontamination Operations

In addition to the hazards of mustard which are described elsewhere in this SPSS, there are additional hazards associated with the

decontamination chemicals as described in Section 12.1.2. In the dry state, both STB and HTH react violently with mustard creating two hazards, toxic vapors and an exothermic reaction that could cause a fire. The chlorine in all three of the previously described decontaminant chemicals is also hazardous to employees. It is corrosive to the skin and eyes and can cause serious burns and eye damage. It is toxic in its vapor form and toxic fumes are present even in the dry state of STB or HTH. Chlorine acts as an oxidizer and reacts explosively with or forms explosive compounds with many common chemicals, such as acetylene, turpentine, ether, ammonia gas, fuel gas, hydrocarbons, hydrogen, and finely divided metals.

Because of these potential hazards, the following safety and health precautions will be followed in decontamination operations:

- Level A protective clothing will be worn during actual decontamination operations because of the presence of mustard (Sections 9.3.1 and 9.3.3).
- For handling and mixing the decontamination chemicals, employees will wear respiratory and eye protection and protective clothing, including gloves. Level B PC&E will suffice for this protection.
- Decontamination chemicals will be stored in a cool place separate from any other chemical or material.
- Care will be taken to separate the decontamination chemicals from other chemicals and materials during the mixing operations.
- Mixing operations will be conducted in a well ventilated area, separate from Buildings 537 and 538, to preclude possible contact with mustard contaminant.
- Portable fire extinguishers or a source of water will be provided for potential fires.
- All decontamination equipment and tools will be flushed and cleaned with clear water after each period of use.

12.1.4 Decontamination Operations

Dry decontamination chemicals will be mixed with water to create a water bleach slurry just before initiating decontamination. Mixing will be conducted in a well ventilated area.

Where gravity can be used, the water-slurry will be poured at the elevated location and neutralized waste collected at the lowest elevation in drain pans or containers. Otherwise, a portable pump will be utilized to introduce the water-slurry mixture into the piping to be decontaminated and to transport it through the system. The waste will be routed to 55-gallon drums for collection.

Equipment and tools used in decontamination operations will be decontaminated by immersion and/or washing in one of the decontamination chemicals. Control and records of these tools are described in Section 7.6.

The neutralization process will be conducted in a ventilated area with a filtration system to remove traces of the mustard agent from the effluent air. Portable ventilation systems used in the sampling process (Section 9.5) will be utilized during decontamination operations.

12.2 Waste Disposal

Neutralized waste will be sampled and analyzed for the presence of any mustard. All waste will be collected in portable vessels for storage and future disposal. (Reference AMC-R 385-131, Section 5.2.a).

12.3 Decontamination Verification

The thoroughness of the neutralization process will be verified and documented by laboratory analyses to assure that agent concentrations are below emergency drinking water standards as defined in Army publications TB Med 577.

Lines and equipment will be resampled to verify complete decontamination for the sample periods as originally sampled.

12.4 Records

All sampling, decontamination, and resampling operations will be recorded to include piping/vessel identification, sampling results, method of sampling, method of decontamination, and dates. Records will be provided to RMA personnel for analysis and further use.

XIII. SECURITY

13.0 General

The facilities, equipment at the south plant as well as plans, methodologies, and literature contained in this SPSS are "unclassified" concerning national security. Security, as it relates to personnel allowed access to sampling and decontamination operations will be imposed to control personnel in the facilities. RMA security personnel control the public's General access to RMA. Further control will be imposed by barricading roadways accessing Buildings 537 and 538 and locking all entrances to the buildings.

RMA personnel will open and close the area each day. Coordination will be made with the RMA Facility Engineer (FE). The site manager will control access to the buildings in coordination with the RMA FE. Control of personnel will be by temporary badges issued by RMA security personnel. All security for these operations will be under the direct supervision of RMA security personnel in compliance with RMA security procedures and regulations.

XIV. EQUIPMENT/SUPPLIES RESPONSIBILITIES

14.0 General

The following lists define the responsibilities for providing equipment and supplies necessary for the sampling and decontamination operations at RMA.

14.1 Equipment Supplied by TVA

Sampling Equipment:

- Bubblers, glass.
- MINICAM near-real time samplers and monitors.
- Sampling pumps, 6 liters per minute.
- Grounding fault circuit interrupters, 120 volt (main power supplied by RMA).
- Calibrator, Gilian.
- Ice containers (ice supplied by RMA).
- Tubing, Teflon®
- Tubing, polyethylene.
- Thermometers.
- Parafilm.
- Data Sheets.

Ancilliary Equipment:

- Portable ventilation machines and carts.
- Sample set up tools, equipment, scaffolds, etc.
- Waste disposal equipment (drum w/lid, caustic, plastic bags, duct tape, labels).
- Portable change-out trailer.

Decontamination Equipment:

- 55-gallon drums of caustic/water solution.
- Caustic for mixing more solution, as needed.
- 5 gallons of bleach.
- Plastic bags, 30 gal.
- Labels and pens.
- Water.
- Plastic sheeting.
- Catch pans.

Emergency Equipment:

- Eyewash units.

- Portable showers.
- Bleach.
- First aid kits.

14.2 Equipment Supplied by RMA:

- Potable water.
- Electricity, 120 volts A.C.
- Decon truck and supplies.
- "Hotline" equipment and supplies.
- Laboratory services and analytical materials.
- CASARM (agent) material for calibration.
- Sanitary sewage and waste disposal connections or facilities.
- Personnel protective clothing and equipment (Section 9.3) for up to 30 people (includes mustard and GB plant) with spare equipment provided for contamination.
- Radios (dual channel, one being the RMA emergency channel).
- Laundry service for personal protective equipment.
- Wind indicators.

XV. REFERENCES

AMC-R 385-100, "Safety Manual," 1 August 1985.

AMC-R 385-131, "Safety Regulation for Chemical Agents H, HD, HT, GB, and VX,"
9 October 1987.

AMCCOMR-385-5, "Decontamination and Disposal of Facilities, Equipment, and
Material," 2 September 1987.

RMA Pamphlet 385-1, "Master Accident Prevention Safety Program," 2 May 1983.

RMA-385-31, "Chemical Safety Program Requirements-Control Procedures for
Access to Agent Contaminated Buildings," 4 January 1988.

AR-50-6, "Nuclear and Chemical Weapons and Material-Chemical Surety,"
12 December 1986.

TM 3-220, "Chemical, Biological, and Radiological (CBR) Decontamination," 22
November 1967.

RMA SOP SF-50-1, "Emergency Response Plan for Field Activity Discovered
Chemical Agents at Rocky Mountain Arsenal (RMA)," 25 April 1988.

Material Safety Data Sheet for H, HD, & HT, 5 January 1984.

"SOP for Disposal of Contaminated Buildings," prepared for Rocky Mountain
Arsenal by El Dorado Engineering, Inc., Salt Lake City, Utah, June 29, 1984.

"Sampling Plan for Field Survey of HD Contamination at Rocky Mountain Arsenal,
Colorado to U.S. Army Toxic and Hazardous Materials Agency," Novel Processes
Contract No. DAAA15-86-D-0001, Task No. 1, Subtask 4, Battelle, Denver,
Colorado, February 17, 1987.

Untitled Report Covering The Demilitarization of Excess Stocks of the Toxic
Agent Mustard at Rocky Mountain Arsenal Between October 1969 and July 1974.

APPENDIX A

SAMPLE POINT SUMMARY FOR
RMA's MUSTARD FACILITY

SAMPLE POINT SUMMARY FOR
RMA's MUSTARD FACILITY

During TVA's visit and survey of RMA's mustard facility, 26 sample points were initially identified (Table A-1). Piping isometrics were produced for each sample point identified and are shown in Appendix B.

After carefully reviewing each sample point and discussions with RMA personnel, fifteen of the original sample points were eliminated for various reasons. The primary reason for sample point elimination was that the enclosure to be sampled was open to the atmosphere. One sample point originally selected, 1-P-17, was a line used to transfer hydrazine to the hydrazine furnace.

A plywood enclosed area adjacent to the furnaces could not be surveyed during TVA's visit. However, after discussions with RMA personnel, this enclosed area contains process equipment that should be sampled. Although the area was not surveyed during TVA's visit to RMA, the area will be surveyed during the sampling phase; piping isometrics will be made showing the sample points, equipment, and piping modifications required; and the piping/equipment will be sampled to ensure all piping/equipment of the entire mustard facility is sampled.

TABLE A-1 SAMPLE POINT SUMMARY FOR RMA'S MUSTARD FACILITY

Sample Point No.	Outlet Sample Pt. Location		Description	Inlet Point Location		Openings in System	Estimated Volume (ft. ³)	Bubbler Sample Duration (hrs.)
	Bldg.	Floor Area Room		Qty.	Bldg. Floor Area			
[1-P-1]		Omit	Line Removed					
[1-P-2]	537	1 Thaw Area	36" Duct from thaw area to scrubber	1	537 Thaw Area	Duct open at end, open at take off points	423	4
[1-P-3]	537	1 Thaw Area	Unloading Booth #1 and duct	1	537 Thaw Area	Booth open; duct open	119	4
[1-P-4]	537	1 Unloading	Unload Booth #1 inside air	1	537 Unloading Area	Booth open in various places	1000	4
[1-P-5]	537	1 Unloading	Unload Booth #2 inside air	1	537 Unloading Area	Booth open in various places	1000	4
[1-P-6]	537	1 Unloading	Unload Booth #3	1	537 Unloading Area	Booth open in various places	1000	4
[1-P-7]	537	1 Unloading	Unload Booth #4	1	537 Unloading Area	Booth open in various places	1000	4
1-P-8	537/ 538	1 Mustard Storage	2" Mustard Transfer line to furnaces	1	537 Storage		0.479	2
1-P-9a	538	1 Hydrazine Furnace	44" exhaust duct from hydrazine furnace to quench tower	1	538 Outside		244	4
1-P-9b	538	1 Hydrazine Furnace	Air inside hydrazine furnace	1	538 Hydrazine Furnace		3000	4

[] = Sample point was eliminated due to open to atmosphere

Sample Point No.	Outlet Sample Pt. Location Bldg. Floor Area Room	Description	Inlet Point Location Qty. Bldg. Floor Area	Openings in System	Estimated Volume (ft. ³)	Bubbler Sample Duration (hrs.)
I-P-10	538 1 W. Ton Con- tainer furn. container furn.	Air inside west ton furn. container furnace	538 Furnace	Furnace is open to atmos.	3000	4
I-P-11	538 1 E. Ton Con- tainer furn. container furn.	Air inside east ton furn. container furnace	538 Furnace	Furnace is open to atmos.	3000	4
I-P-12	537 Tank Pit	West Mustard Tank	537 Tank Pit		3476	4
I-P-13	537 Tank Pit	East Mustard Tank	537 Tank Pit		3476	4
I-P-14	537 Tank Pit	2" drain line from Booth #1 to Mustard storage tanks	537 Unloading Area		1.7	2
I-P-14b	537 Tank Pit	2" unloading line from Mustard unloading booths No. 2,3,4	537 Unloading Area		2	2
I-P-15	537 Tank Pit	Mustard Tank Pit Area Sample	537 Basement	Open area	7385	4
I-P-16	538 1 Furnace Area	Flue gas duct from east furnace to scrubber	538 Furnace Area	Open to atmosphere	64	4
I-P-17	538 1 Furnace Area	1/4" line from Hydrazine furnace to underground piping	538 Furnace	Hydrazine line	1.1	2
I-P-18a	538 1 Outside	Ton container Flue duct to quench tower	538 Furnace Area	2 - Bell opening to furnaces	278	4
I-P-18b	538 1 Outside	24" duct from quench tower to scrubber	538 Outside	Open to atmosphere	240	4
I-P-19	538 1 Outside	20" Duct from west quench tower to west scrubber	538 Outside	Furnace is open	36.0	2

□ = Sample point was eliminated due to open to atmosphere

Sample Point No.	Outlet Sample Pt. Location		Description	Inlet Point Location		Openings in System	Estimated Volume (ft. ³)	Bubbler Sample Duration (hrs.)
	Bldg.	Floor Area Room		Qty.	Bldg. Floor Area			
I-P-20	537	Tank Pit	Vacuum Receiver Drum Mustard Storage Tank Pit	1	537 Tank Pit		6.6	2
I-P-21	537	1 Unloading Area	2" Vent lines from Booths to vacuum pumps, and 2" line from thaw area	3	537 Unloading Area		66	2
I-P-22	537	Tank Pit	Rectangular duct in basement of 537	1	537 Tank Pit		1430	4
I-P-23	537	Tank Pit	6" drain line in basement	1	537 Tank Pit		10	2

□ = Sample point was eliminated due to open to atmosphere

APPENDIX B
PIPING ISOMETRIC DRAWINGS

1

INTAKE STACK

FROM 20,000 GAL. BRINE STORAGE TANK

MIXER

BRINE STORAGE (1,000 GAL.)

PUMP, P-5

NATURAL GAS

DIST VENT

SALT SILO

SPRAY DRYER

VENTURI

FAN, F-3

SCREW CONVEYOR

SALT COMPACTOR

FLUID BED

HEATER

FAN, F-4

DRIED SALT

ROTARY AIR LOCK

FAN, F-6

ROT AIR

55 GAL. DRUM

ROTARY BLOWER

TAILOR SYSTEM

TO STORAGE/DISPOSAL

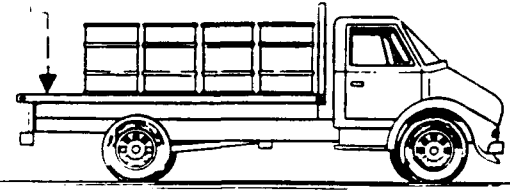

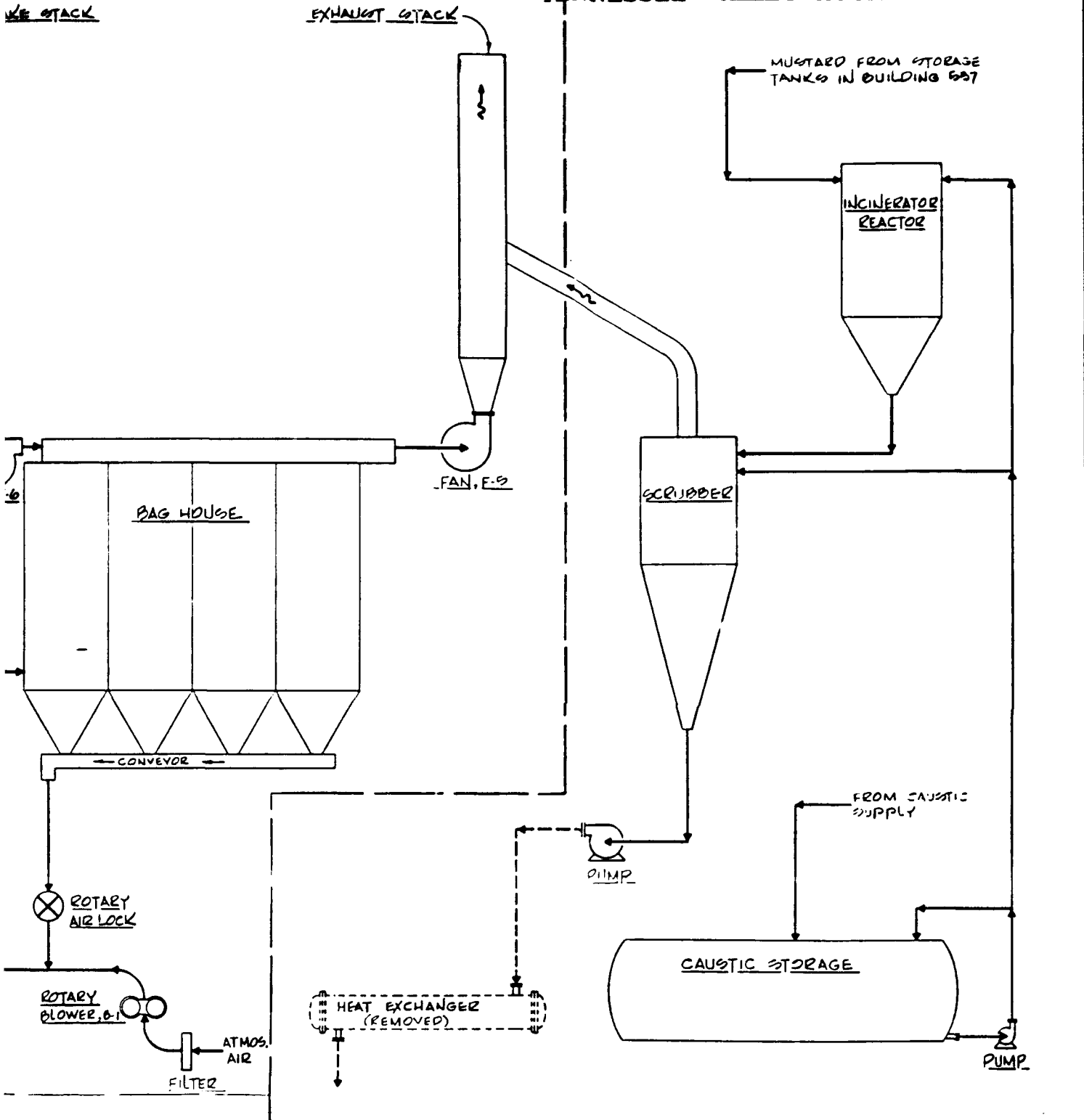

NATIONAL FERTILIZER DEVELOPMENT CENTER
 ENGINEERING AND SPECIAL PROJECTS
 MUSCLE SHOALS, ALABAMA

RMA-6966
 BLDG. 336
 PROCESS FLOW DIAGRAM
 NO SAMPLE POINTS

DRAWN: D. BURCHAM	APPROVED: <i>raw</i>
CHECKED: CWK	DATE: 9-22-88

312

①

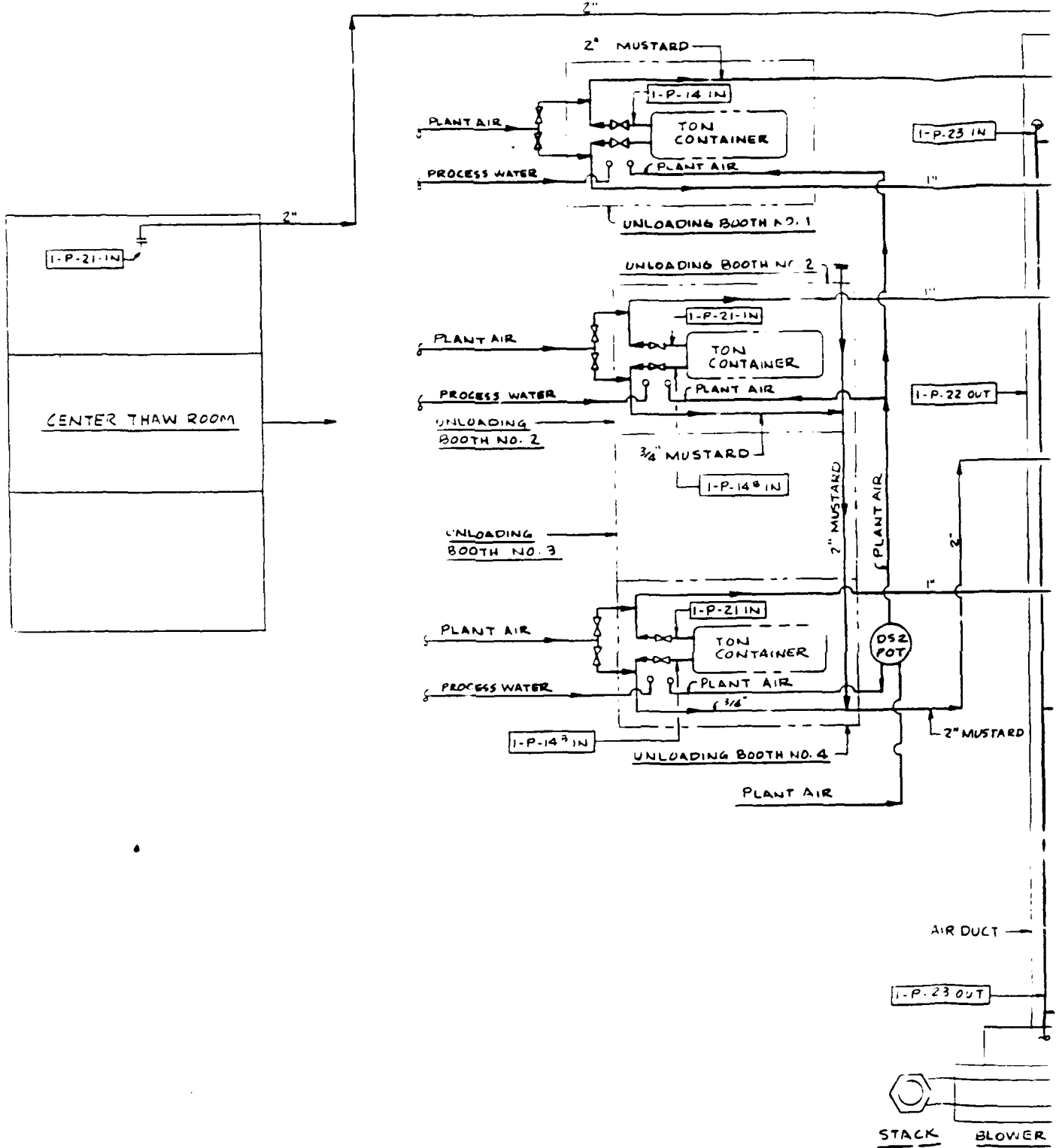

①

Relo
22 P
[Symbol]

10N CONTAINER THAW ROOM

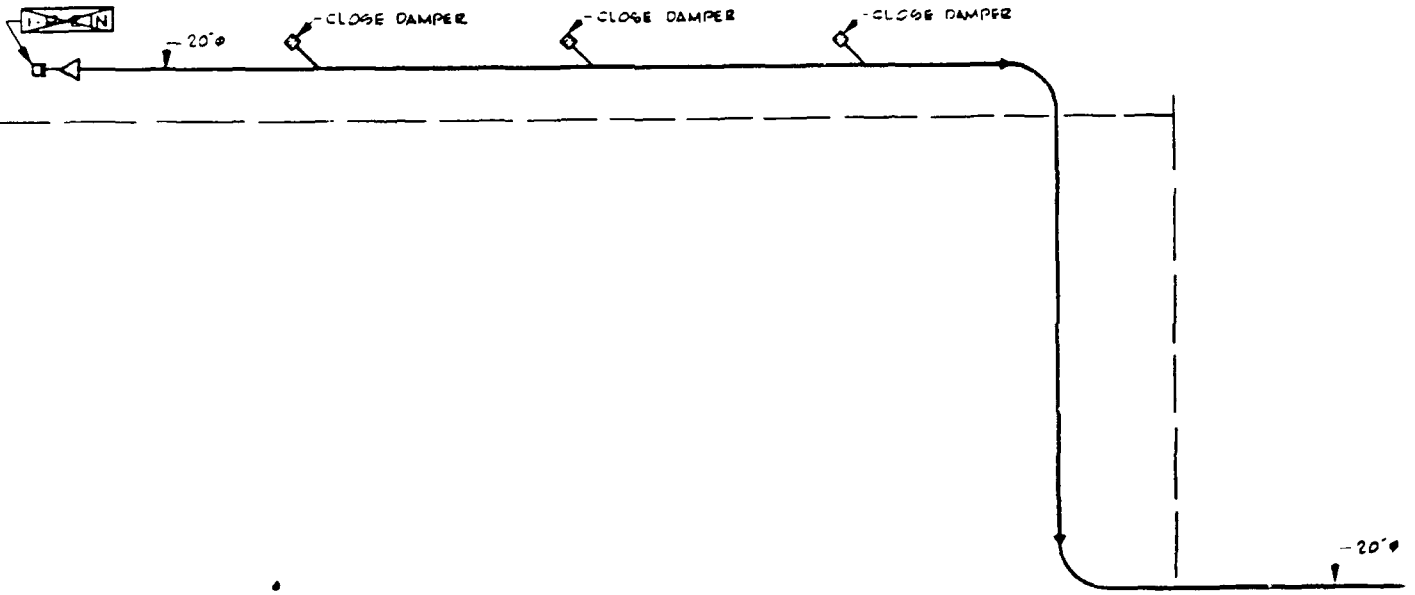

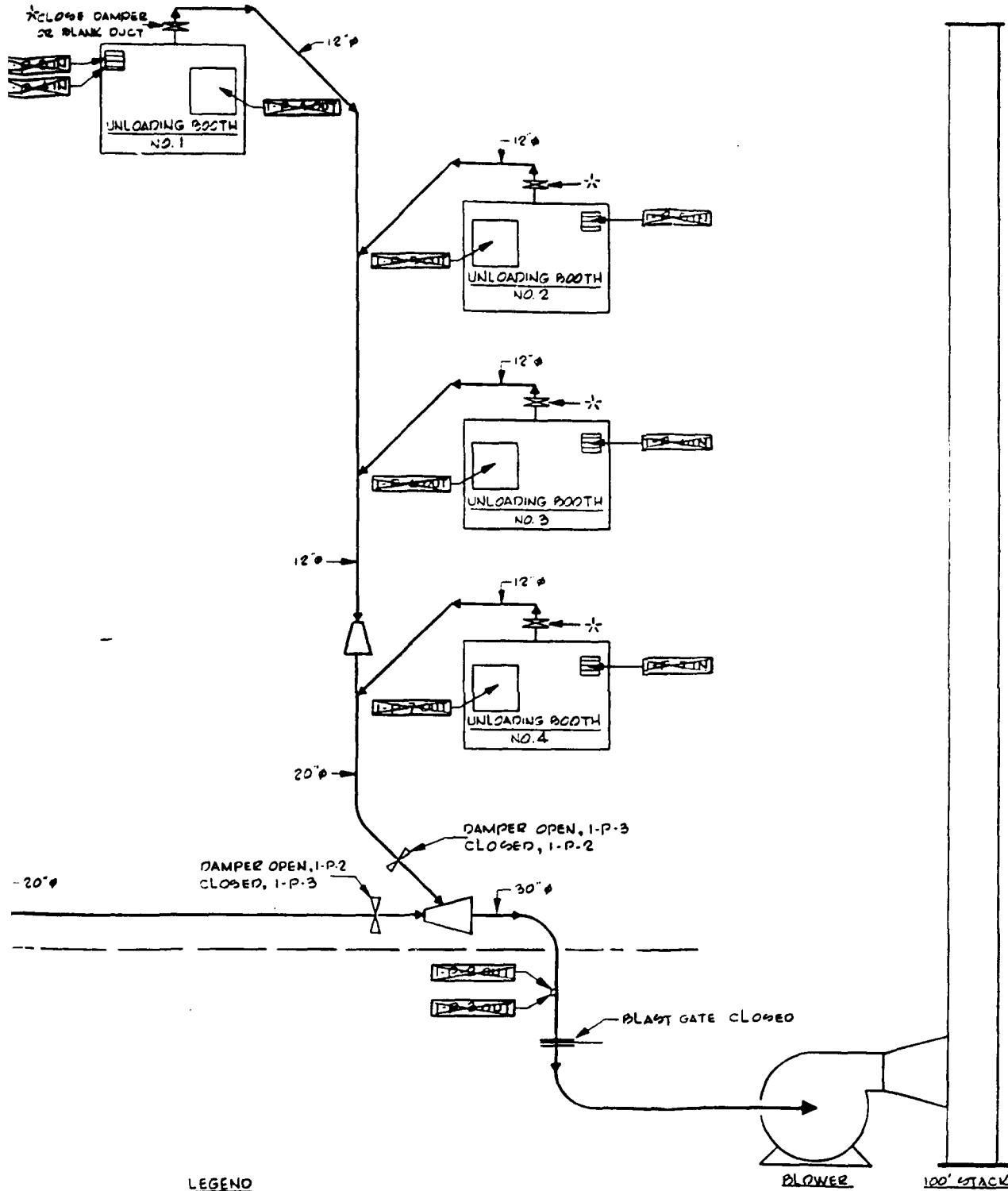

LEGEND

 THESE SAMPLES WILL NOT BE TAKEN

NATIONAL FERTILIZER DEVELOPMENT CENTER
 ENGINEERING AND SPECIAL PROJECTS
 MUSCLE SHOALS, ALABAMA

RMA-6P66
 BLOC. 537
 VENTILATION SYSTEM
 SAMPLE POINT DIAGRAM

DRAWN: D. BURCHAM	APPROVED: <i>[Signature]</i>
CHECKED: D. Williams	DATE: 9-29-88 314

(1)

1" MUSTARD LINE INSIDE 2" JACKET
FROM STORAGE TANKS IN BLDG. 597
(SEE DWG. NO. 313)

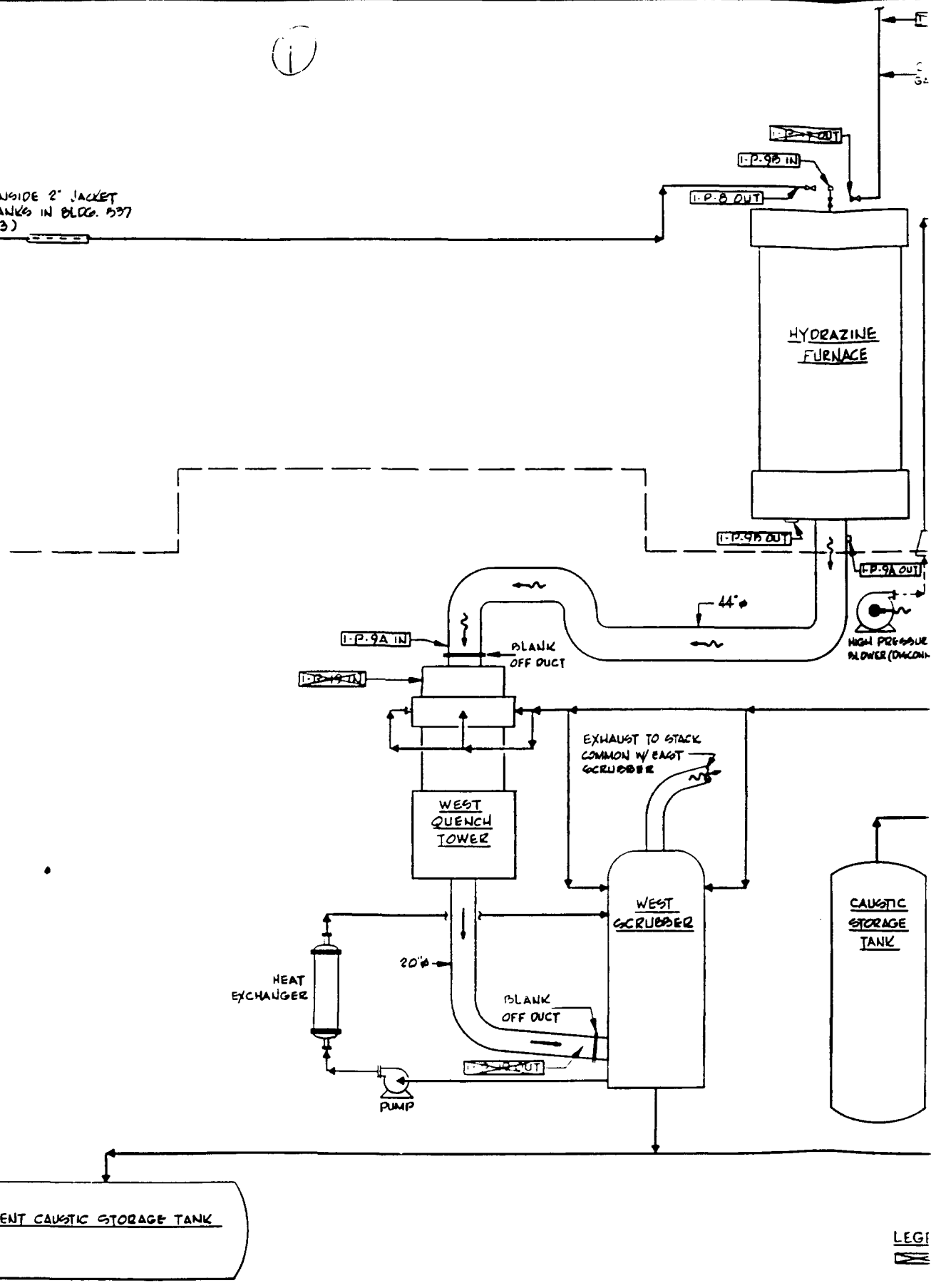
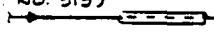

LEG
M

(2)

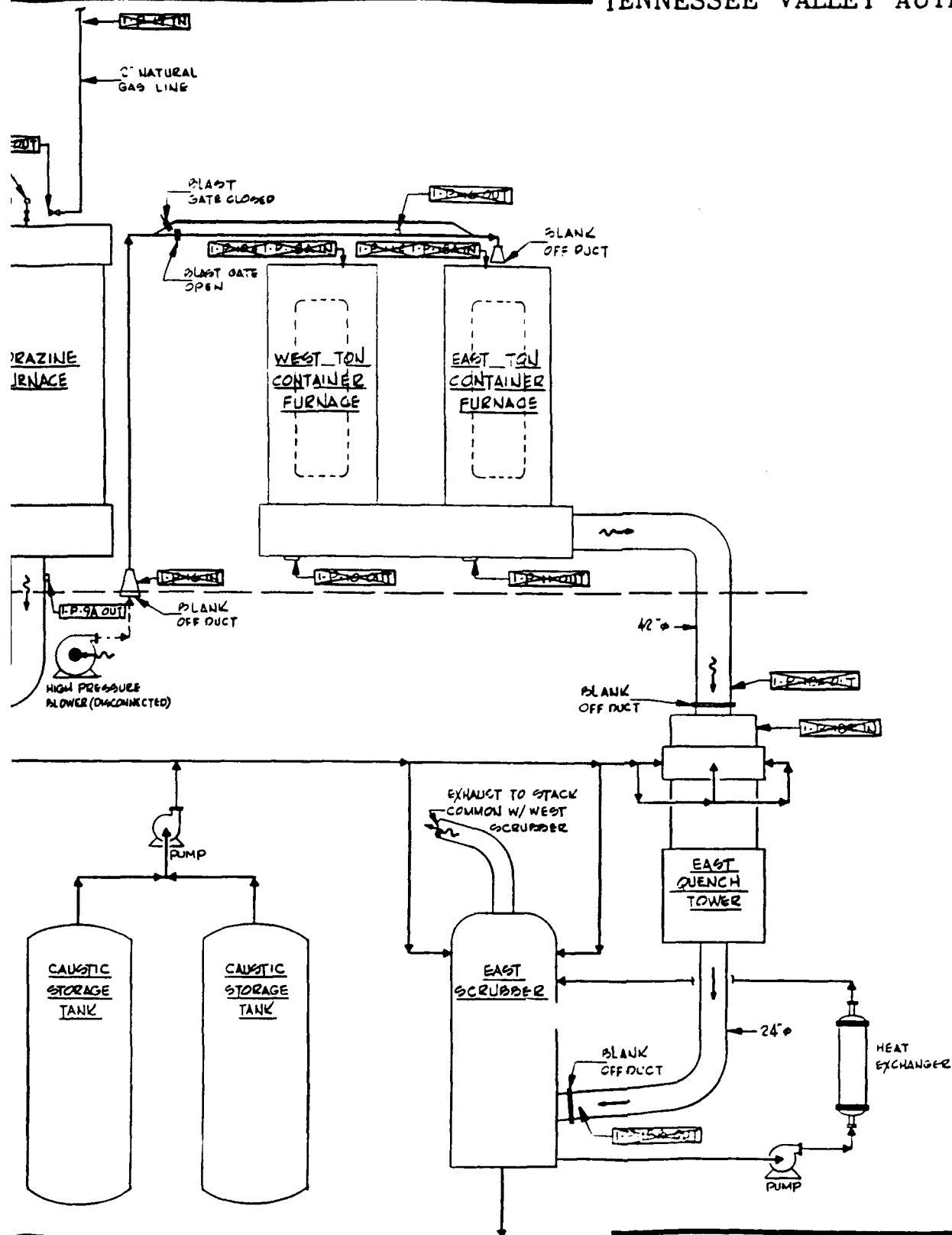

LEGEND

☐ THESE SAMPLES WILL NOT BE TAKEN

NATIONAL FERTILIZER DEVELOPMENT CENTER
ENGINEERING AND SPECIAL PROJECTS
MUSCLE SHOALS, ALABAMA

RMA-SPSS

BLOG. 538

SAMPLE POINT DIAGRAM

DRAWN: D. DURHAM

APPROVED: R.W.

CHECKED: CWK

DATE: 9-27-88

315

TENNESSEE VALLEY AUTHORITY
SCHEDULE FOR SAMPLES 12, 13 & 14

3. VALVE CLOSING SCHEDULE FOR SAMPLES 12, 13 & 14
- * THIS VALVE TO BE OPEN FOR SAMPLE 1-P-14
 - ** THIS VALVE TO BE OPEN FOR SAMPLES 1-P-12 & 1-P-13
 - *** THIS VALVE TO BE OPEN FOR SAMPLE 1-P-14
 - CLOSED FOR SAMPLES 1-P-12 & 1-P-14
 - CLOSED FOR SAMPLES 1-P-12 & 1-P-14
 - THIS VALVE TO BE OPEN FOR SAMPLE 1-P-12
 - CLOSED FOR SAMPLES 1-P-13 & 1-P-14
 - 4. SAMPLE 1-P-14-IN, WILL BE LOCATED AFTER SAMPLE 1-P-4 HAS BEEN COMPLETED.

- NOTES:
1. WHEN SAMPLING TANKS ALL OPENING EXCEPT INLET & OUTLETS WILL BE PLUGGED WITH STOPPERS.
 2. * NOTES WHEN VALVES SHOULD BE OPEN OR CLOSED.

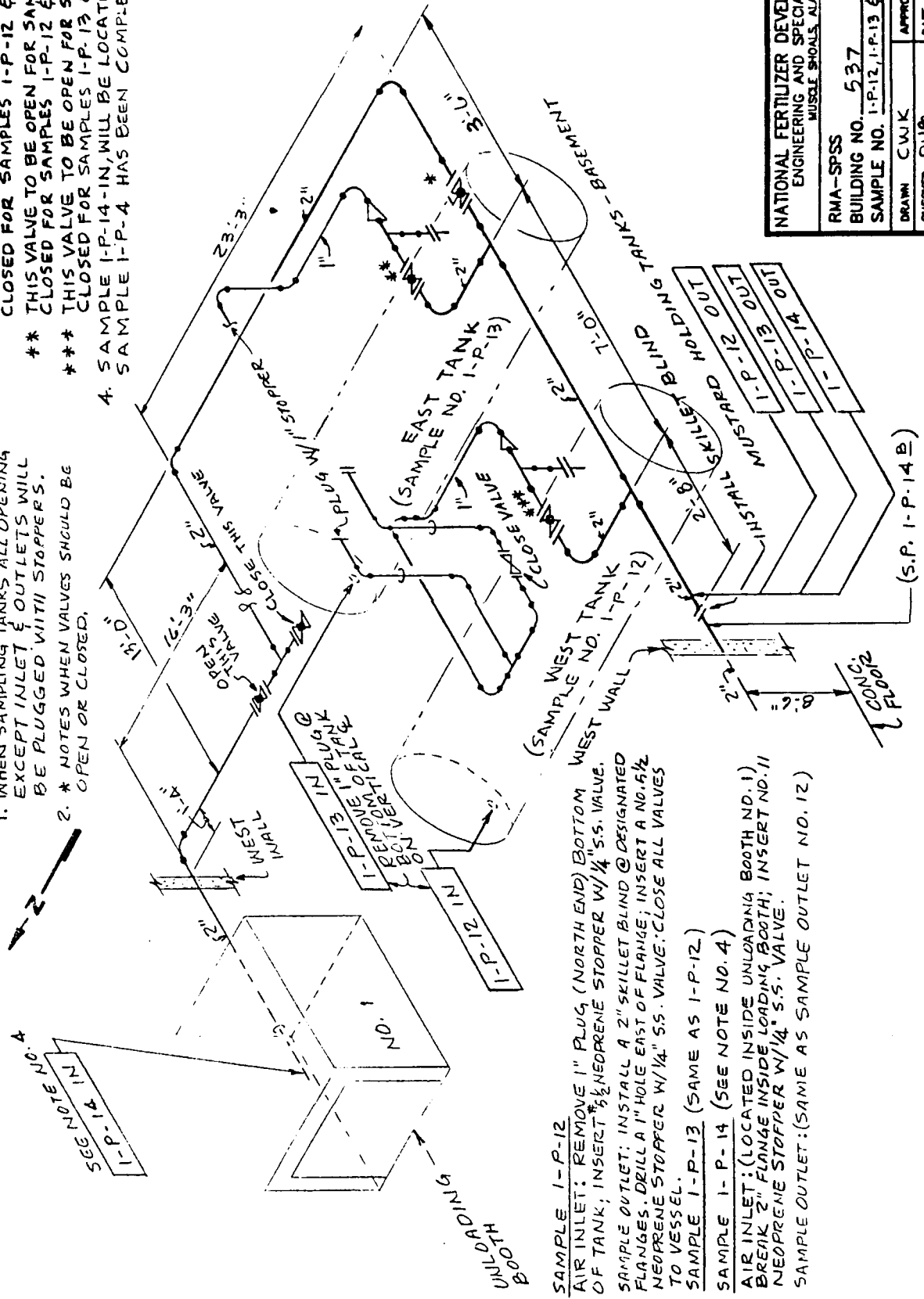

SAMPLE 1-P-12
 AIR INLET: REMOVE 1" PLUG (NORTH END) BOTTOM OF TANK; INSERT 3/4" NEOPRENE STOPPER W/ 1/4" S.S. VALVE.
 SAMPLE OUTLET: INSTALL A 2" SKILLET BLIND @ DESIGNATED FLANGES. DRILL A 1" HOLE EAST OF FLANGE; INSERT A NO. 4 1/2 NEOPRENE STOPPER W/ 1/4" S.S. VALVE; CLOSE ALL VALVES TO VESSEL.

SAMPLE 1-P-13 (SAME AS 1-P-12.)

SAMPLE 1-P-14 (SEE NOTE NO. 4)
 AIR INLET: (LOCATED INSIDE UNLOADING BOOTH NO. 1) BREAK 2" FLANGE INSIDE LOADING BOOTH; INSERT NO. 11 NEOPRENE STOPPER W/ 1/4" S.S. VALVE.
 SAMPLE OUTLET: (SAME AS SAMPLE OUTLET NO. 12.)

NATIONAL FERTILIZER DEVELOPMENT CENTER ENGINEERING AND SPECIAL PROJECTS MUSCLE SHOALS, ALABAMA	
RMA-SPSS	BUILDING NO. 537
DRAWN C.W.J.K.	APPROVED R.W.W.
CHECKED O.H.D.	DATE 9-30-61
	SAMPLE NO. 1-P-12, 1-P-13 & 1-P-14

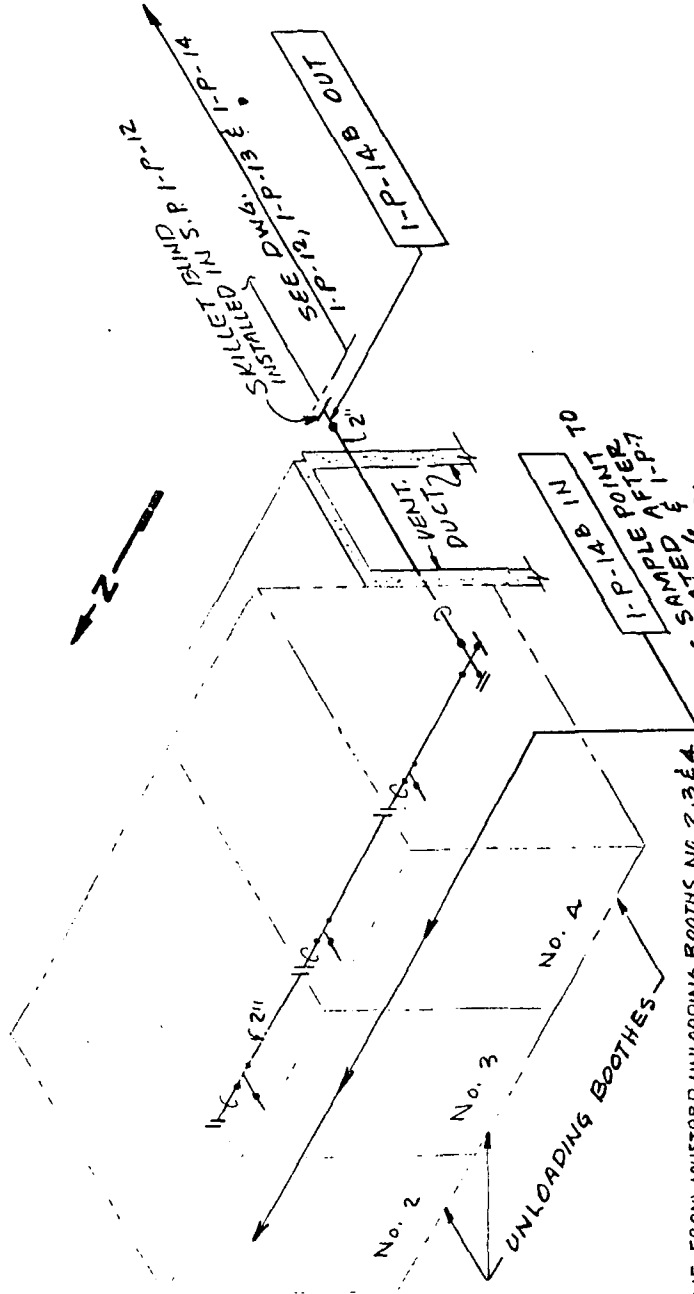

2" UNLOADING LINE FROM MUSTARD UNLOADING BOOTHS NO. 2, 3 & 4
 INLET AIR: INSTALL SKILLET BLANK; INSERT A
 NO. 11 STOPPER W/ 1/4" VALVE IN THE MUSTARD LINE INSIDE EACH
 BOOTH. INTERIOR OF THE BOOTHS UNACCESSIBLE AT THE TIME
 OF INITIAL INVESTIGATION, THE EXACT POINT OF INLET AIR
 WILL BE DETERMINED DURING SAMPLING. TAKE SAMPLE
 AT FLANGE NEXT TO 1-P-12, 13, & 14. SAMPLE OUTLET.
 SAMPLE OUTLET: DRILL A 1" HOLE & INSTALL NO. 5 1/2 NEOPRENE
 STOPPER W/ 1/4" S.S. TUBING AND VALVE FOR SAMPLING APPARATUS.

NOTE:
 1. THIS IS A 2" UNLOADING LINE (UNACCESSIBLE)
 CAN BE INSPECTED AFTER UNLOADING BOOTHS
 HAVE BEEN BUBBLED. 2" LINE MAY CONTINUE
 WEST TO 100 TON CONTAINERS IN TRAM ROOM.

NATIONAL FERTILIZER DEVELOPMENT CENTER ENGINEERING AND SPECIAL PROJECTS MUSCLE SHOALS, ALABAMA	
RMA-SPSS	BUILDING NO. 537
DRAWN C W K	SAMPLE NO. 1-P-14 B
CHECKED D H S	APPROVED R W W
	DATE 9-30-88 1-P-14 B

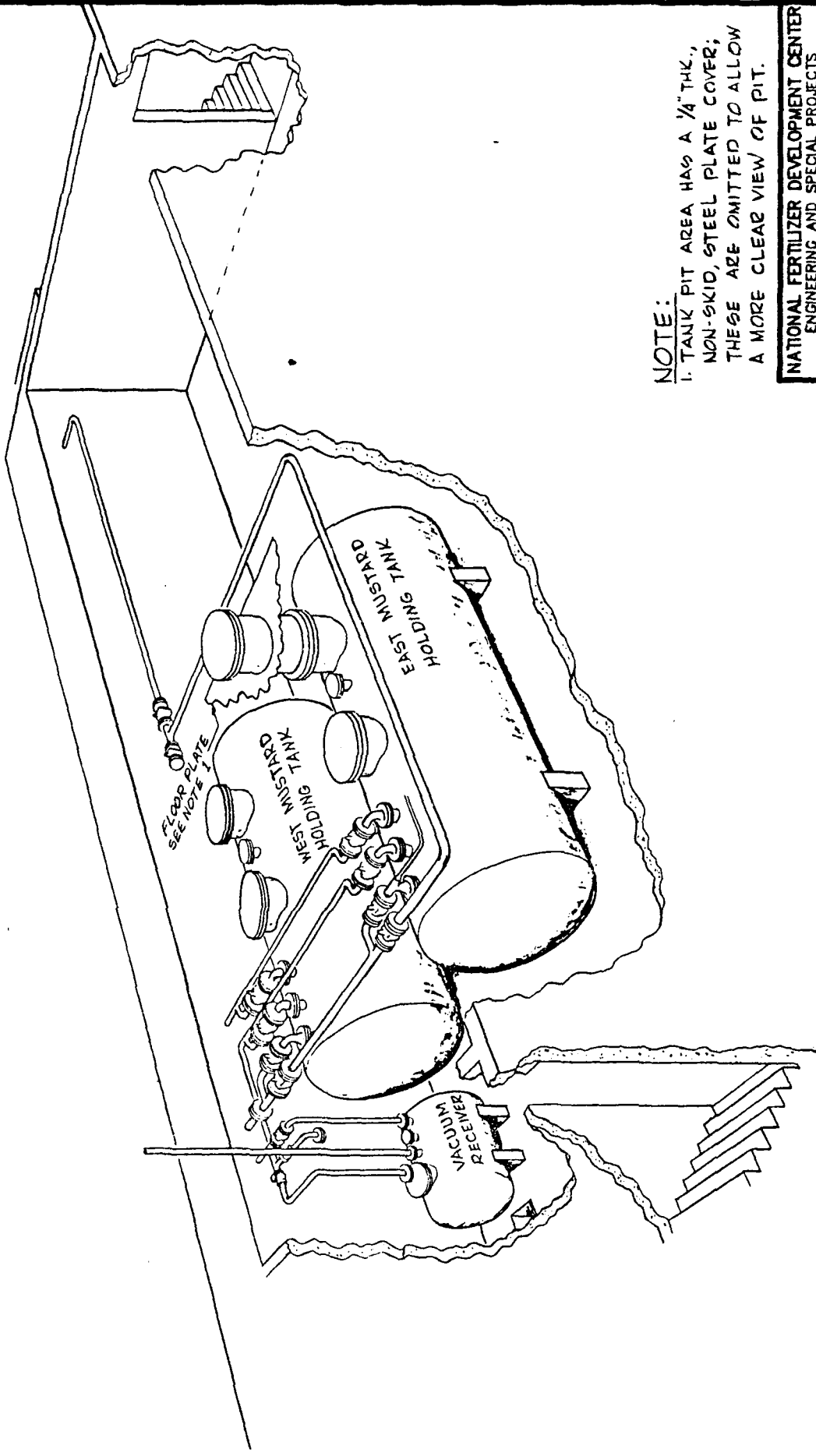

NOTE:

- 1. TANK PIT AREA HAS A 1/4" THK., NON-SKID, STEEL PLATE COVER; THESE ARE OMITTED TO ALLOW A MORE CLEAR VIEW OF PIT.

NATIONAL FERTILIZER DEVELOPMENT CENTER
 ENGINEERING AND SPECIAL PROJECTS
 MUSELE SHOALS, ALABAMA

RMA-SPSS

BUILDING NO. 537 (TANK PIT)

SAMPLE NO. 1-P-15

DRAWN D. BURCHAM

APPROVED T.W.W.

CHECKED

DATE 8/26/88

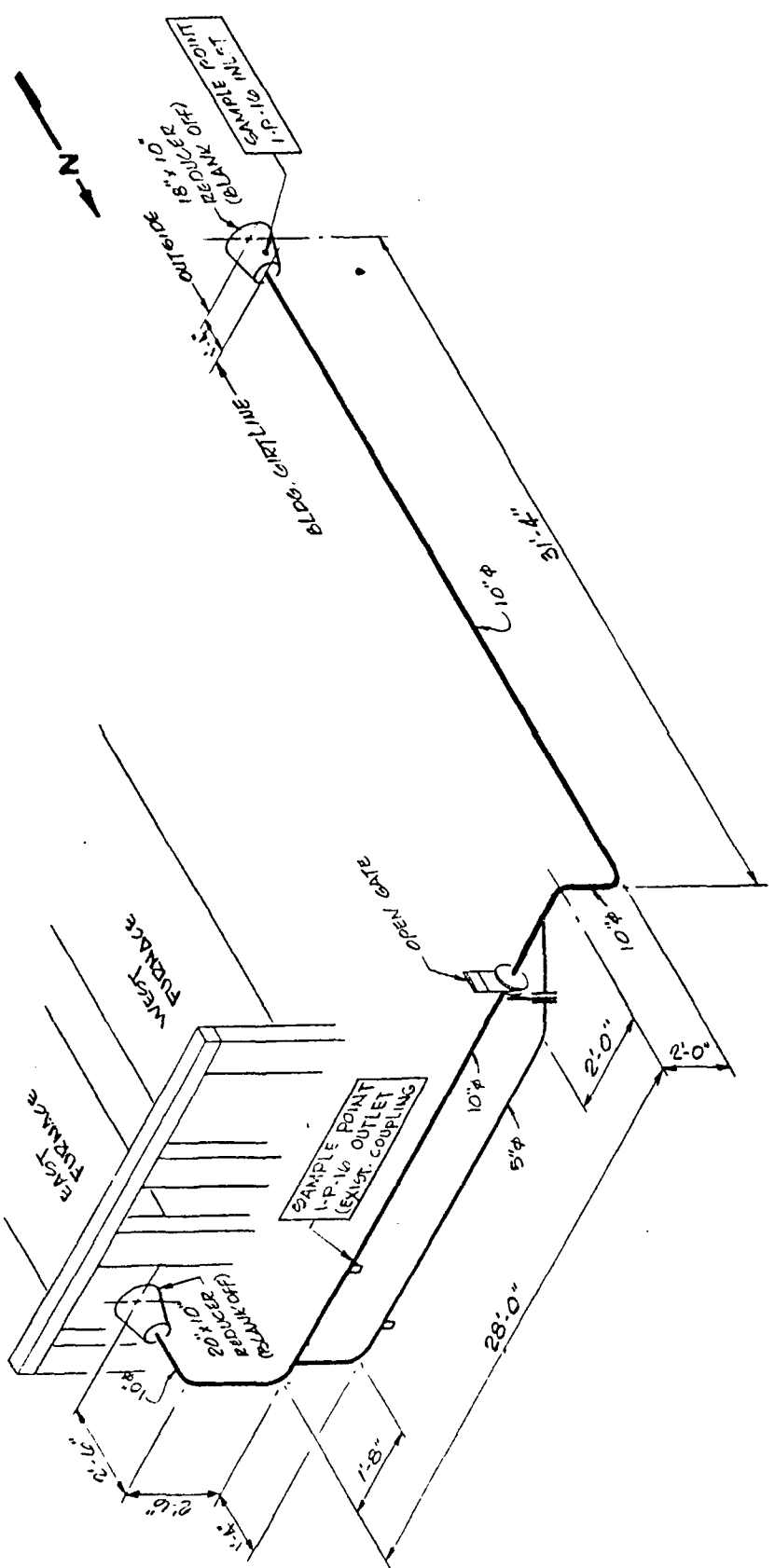

1-P.16
 DRAFT AIR DUCT FROM OUTSIDE TO EAST TON CONTAINER FURNACE.
 INSTALL BLIND ON OPEN END OF 18"x10" REDUCER AND DRILL
 1" HOLE FOR INLET AIR SUPPLY. INSERT #5 1/2 NEOPRENE STOPPER
 W/ 1/4" S.S. TUBING & VALVE. INSTALL BLIND ON OPEN END OF
 20"x10" REDUCER AT END OF EAST FURNACE. TAKE SAMPLE
 AT EXISTING COUPLING BY INSERTING NEOPRENE STOPPER
 W/ 1/4" S.S. TUBING & VALVE.

THIS DUCT WONT BE SAMPLED

NATIONAL FERTILIZER DEVELOPMENT CENTER ENGINEERING AND SPECIAL PROJECTS MUSCLE SHOALS, ALABAMA	
RMA-SPSS	BUILDING NO. 538
DRAMA D. DURCHAM	SAMPLE NO. 1-P.16
CHECKED C/K/K	APPROVED P.W.W.
	DATES: 18 85 1-PX6

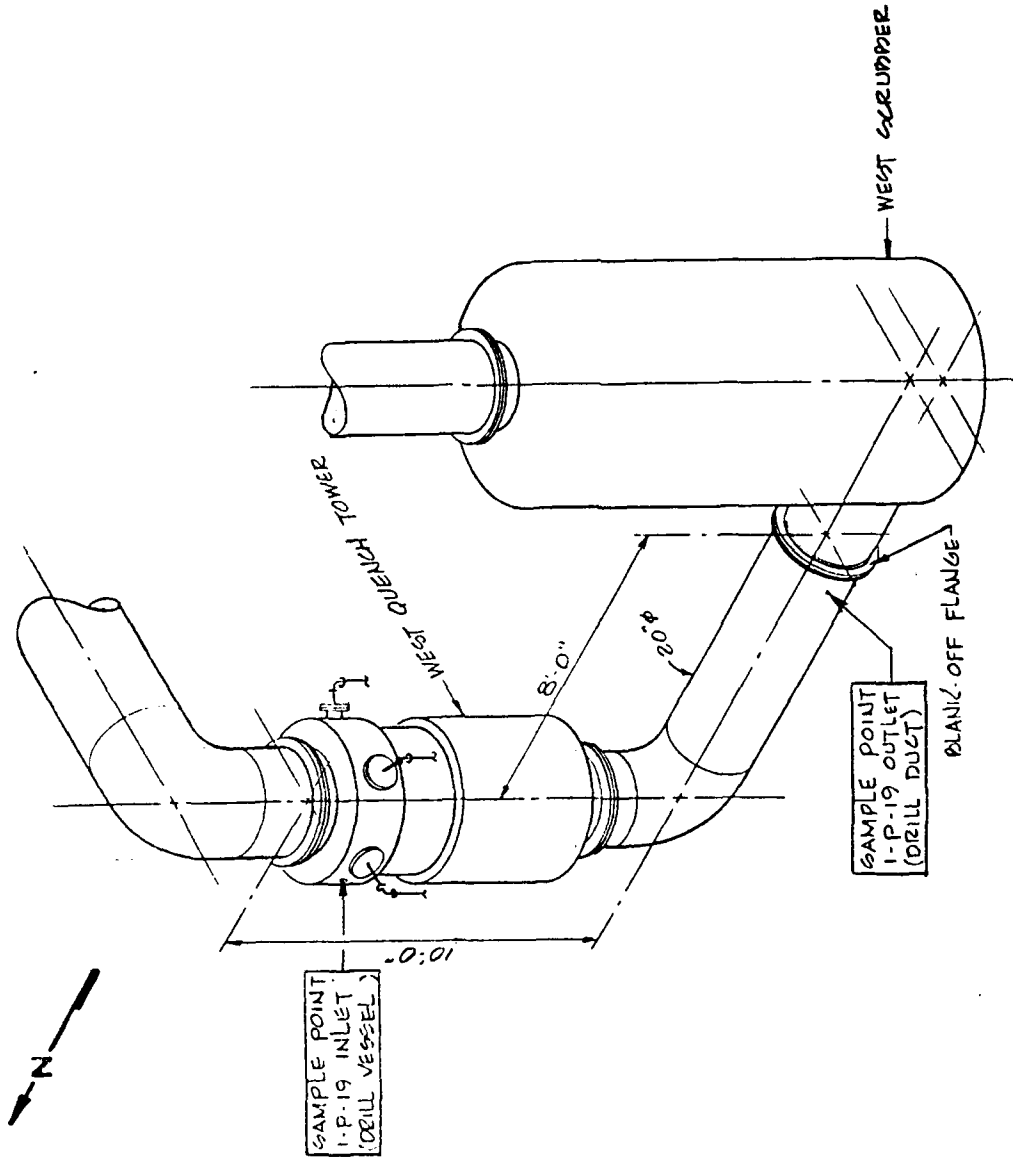

I-P-19
 DUCT FROM WEST QUENCH TOWER TO
 WEST SCRUBBER. INLET AIR SUPPLIED
 BY DRILLING 1" HOLE IN QUENCH
 TOWER AND INSERTING A #5/2
 NEOPRENE STOPPER W/1/4" S.S.
 TUBING & VALVE. PULL SAMPLE
 BY DRILLING 1" HOLE IN DUCT JUST
 AHEAD OF CONNECTION TO WEST
 SCRUBBER (BLANK OFF CONNECTION)
 AND INSERT A #5/2 NEOPRENE
 STOPPER W/1/4" S.S TUBING & VALVE.

THIS LINE WONT BE SAMPLED

NATIONAL FERTILIZER DEVELOPMENT CENTER ENGINEERING AND SPECIAL PROJECTS MUSCLE SHOALS, ALABAMA	
RMA-SPSS	
BUILDING NO. 528	
SAMPLE NO. I-P-19	
DRAWN D. DUECHAM	APPROVED H.W.K.
CHECKED C.W.K.	DATE 8.19.88
	1-2/19

VACUUM RECEIVER DRUM IN MUSTARD STORAGE TANK PIT. INLET AIR PROVIDED BY REMOVING BLIND FLANGE AT END OF 2" VENT LINE COMING FROM VACUUM DRUM, THROUGH FLOOR PLATE ON FIRST LEVEL AND INSERTING NO. 11 STEELER WITH 1/4" SS. VALVE CLOSE VALVE IN 2" LINE FROM VACUUM DRUM TO WEST WALL. TAKE SAMPLE BY REMOVING 1/4" CAP ON NIPPLE FROM 2" VENT LINE AT NORTH MOST END OF VACUUM DRUM. INSTALL A NO. 3 NEOPRENE STRIP 1/4" W/1/4" SS. VALVE & TUBING. ALSO CLOSE VALVES ON EAST & WEST STORAGE TANKS. 4 FT. SCAFFOLD REQ'D.

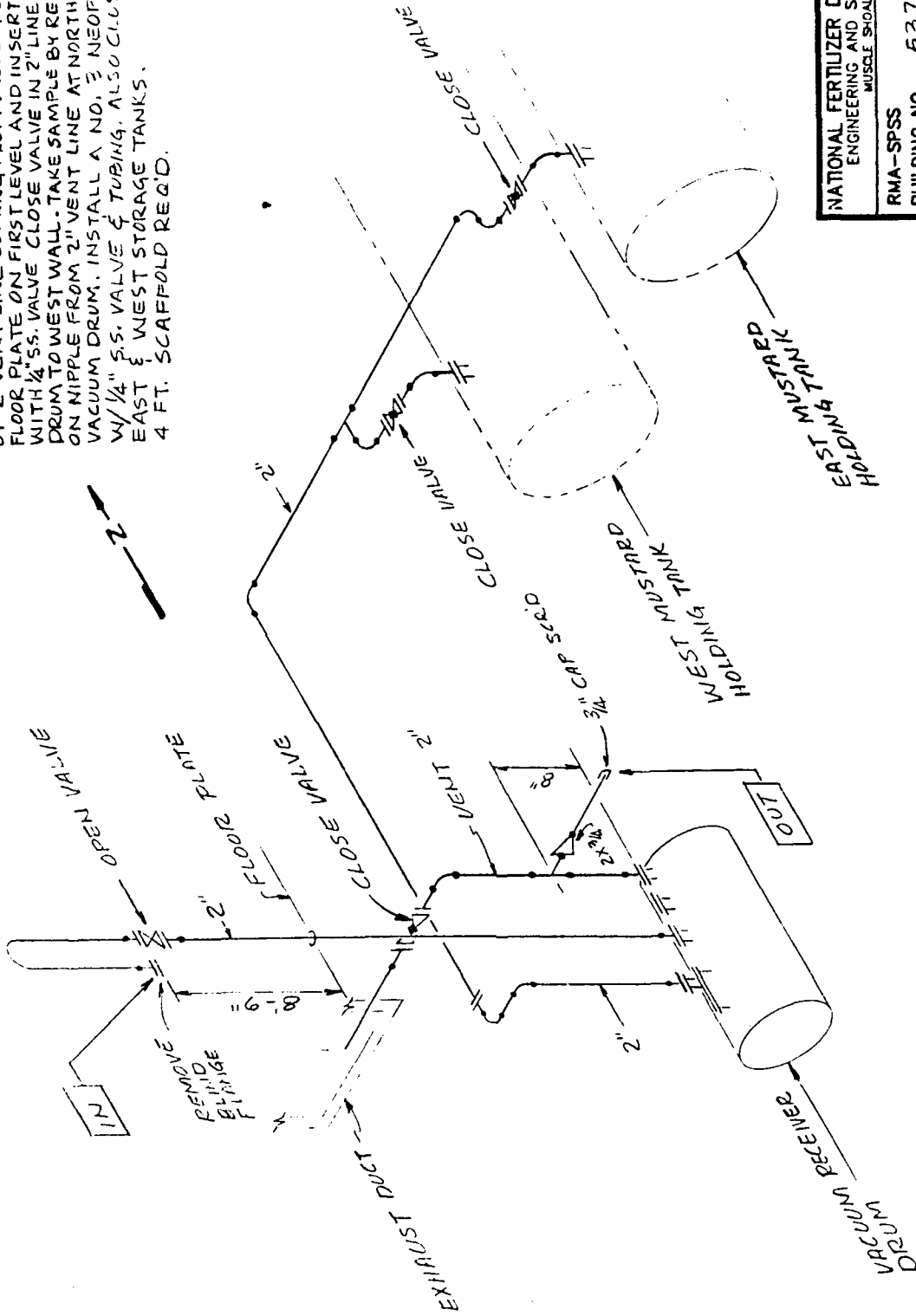

NATIONAL FERTILIZER DEVELOPMENT CENTER ENGINEERING AND SPECIAL PROJECTS MUSSELE SHOALS, ALABAMA	
RMA-SPSS	BUILDING NO. 537
DRAWN C.W.K.	SAMPLE NO. 1-P-20
CHECKED D.H.P.	APPROVED R.W.V.
	DATE 9/20/68
	1-P-20

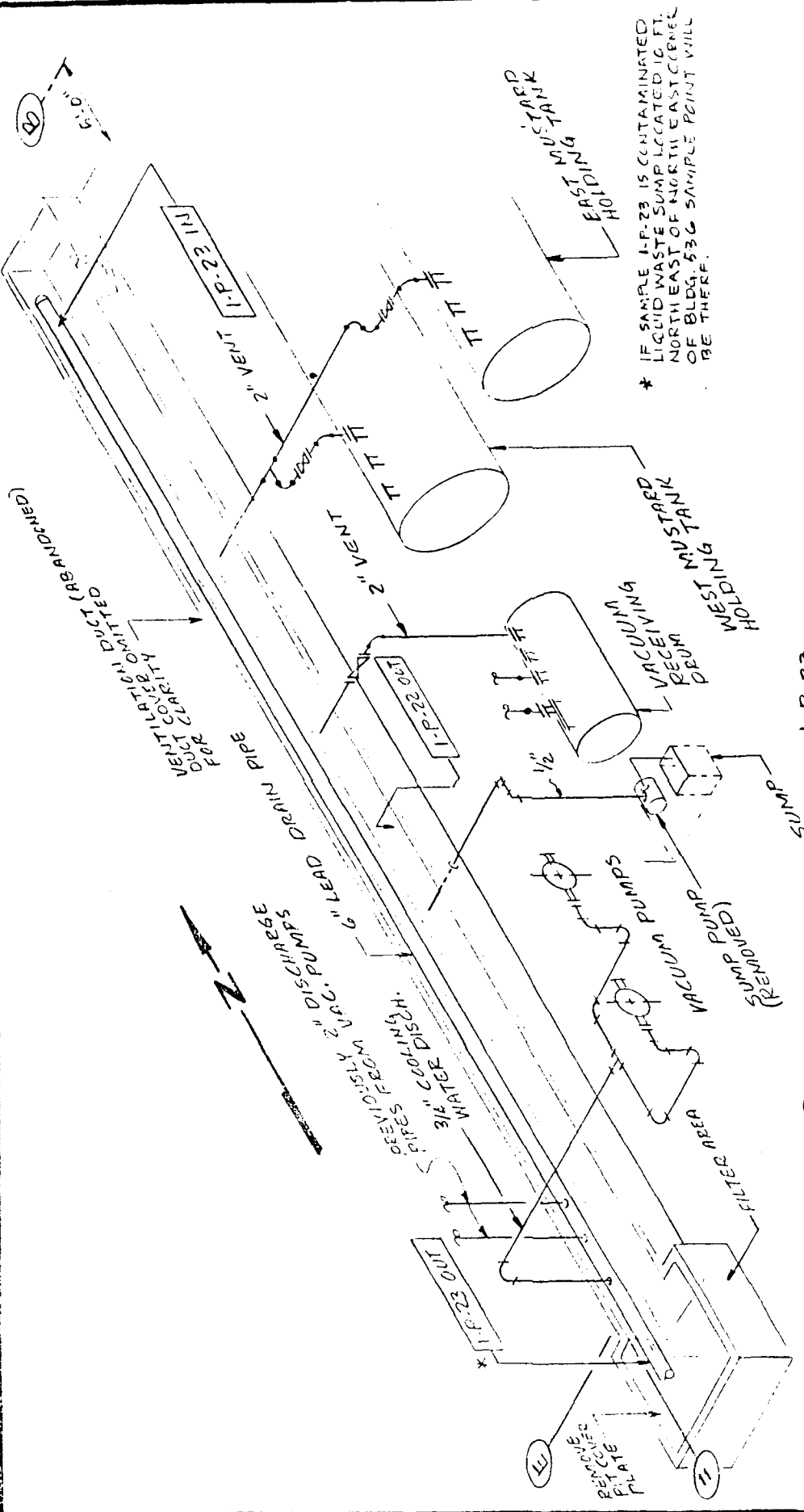

* IF SAMPLE I-P-23 IS CONTAMINATED LIQUID WASTE SUMP LOCATED 10 FT. NORTH EAST OF NORTH EAST CORNER OF BLDG. 536 SAMPLE POINT WILL BE THERE.

NATIONAL FERTILIZER DEVELOPMENT CENTER ENGINEERING AND SPECIAL PROJECTS MUSCOLE SHOALS, ALABAMA	
RMA-SPSS	BUILDING NO. 537
SAMPLE NO. J-I-P-22	1-P-22 & 1-P-23
DRAWN C/W/K	APPROVED P.W.W.
CHECKED D/H/P	DATE 9-30-77

1-P-23
6" DRAIN LINE IN BASEMENT OF BLDG. 537. REMOVE COVER ON TOP OF DUCT. DRILL HOLE THROUGH 6" LINE INSERT NO. 5/2 NEEPRENE STOPPER W/1/4" 5/8" VALVE. DRILL HOLE AT SOUTH END AND INSERT NO. 5/2 NEEPRENE STOPPER W/1/4" 5/8" VALVE AND TUBE FOR SAMPLING APPARATUS CONNECTION.

1-P-22
4" x 6" x 6" x 64"-0" DUCT IN BASEMENT OF BLDG 537. DRILL HOLE THROUGH TOP OF METAL COVER INTO DUCT IN ORDER TO INSTALL SAMPLING APPARATUS. SAMPLE SIMILAR TO ROOM AIR SAMPLES.

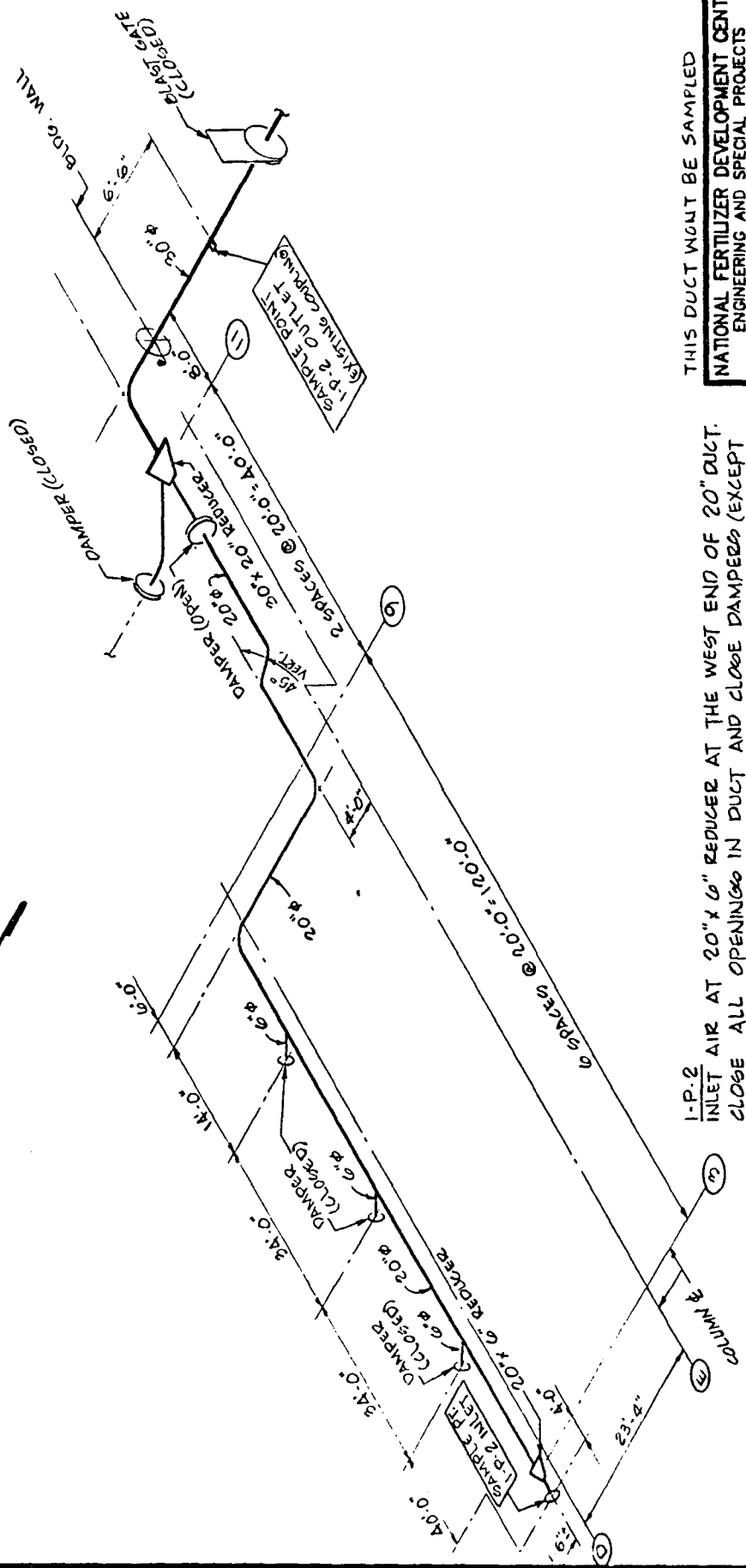

1-P.2
 INLET AIR AT 20" X 6" REDUCER AT THE WEST END OF 20" DUCT.
 CLOSE ALL OPENINGS IN DUCT AND CLOSE DAMPERS (EXCEPT
 THOSE SPECIFIED ON DRAWING). CLOSE PLAST GATE SOUTH
 OF EXISTING SAMPLE POINT COUPLING. PULL SAMPLE AT EXISTING
 COUPLING BY INSERTING A #5/2 NEOPRENE STOPPER W/1/4" 5/8" TURNING
 4 VALVE. SCAFFOLD REQ'D. APPROX. 8' HEIGHT.

THIS DUCT WONT BE SAMPLED

NATIONAL FERTILIZER DEVELOPMENT CENTER ENGINEERING AND SPECIAL PROJECTS MUSCLE SHOALS, ALABAMA	
RMA-SPSS	
BUILDING NO. 537	
SAMPLE NO. 1P-2	
DRAWN D. PULZHAM	APPROVED R.W.W.
CHECKED C.W.K.	DATE 8-9-88
	IP-2

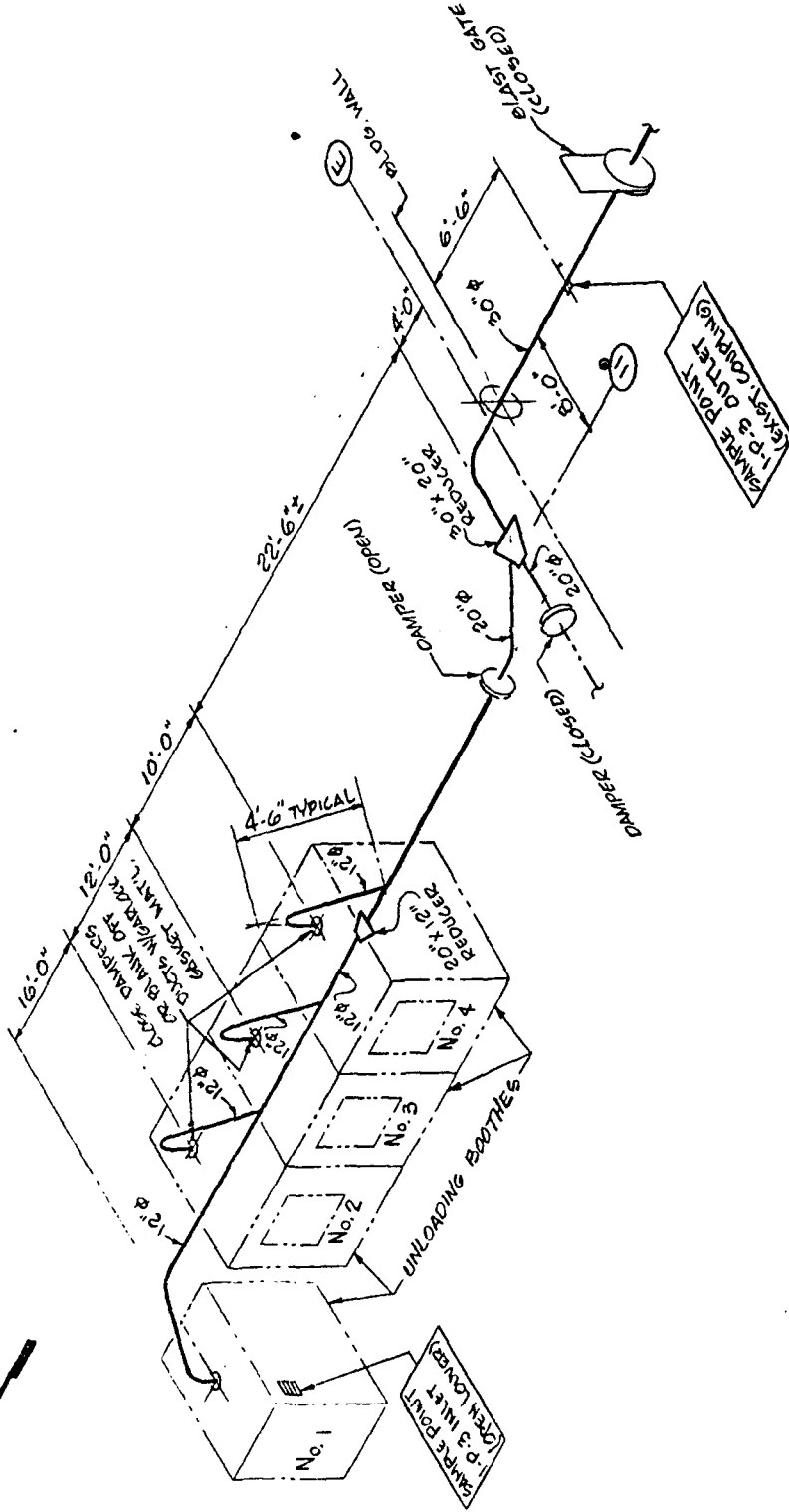
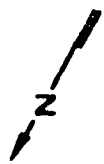

THIS DUCT WONT BE SAMPLED

NATIONAL FERTILIZER DEVELOPMENT CENTER
ENGINEERING AND SPECIAL PROJECTS
MUSSELE SHOALS, ALABAMA

RMA-SPSS
BUILDING NO. 527
SAMPLE NO. 1-P-3

DRAWN O. DUECHAM APPROVED R.W.W.K.
CHECKED C.W.K. DATE 8.9.88 1-P-3

1-P-3
CLOSE BLAST GATE SOUTH OF EXISTING SAMPLE POINT COUPLING. CLOSE DAMPER WEST OF 30" x 20" REDUCER, OPEN VENTILATION LOUVER FOR NO. 1 UNLOADING BOOTH FOR INLET AIR. CLOSE DAMPERS IN 12" Ø DUCT OR BLANK OFF DUCT FLANGE TO BOOTHS 2 THRU 4 (B' SCAFFOLD REQ'D). PULL SAMPLE AT EXISTING COUPLING BY INSERTING A #5 1/2 NEOPRENE STOPPER W/ 1/4" Ø. TUBING & VALVE.

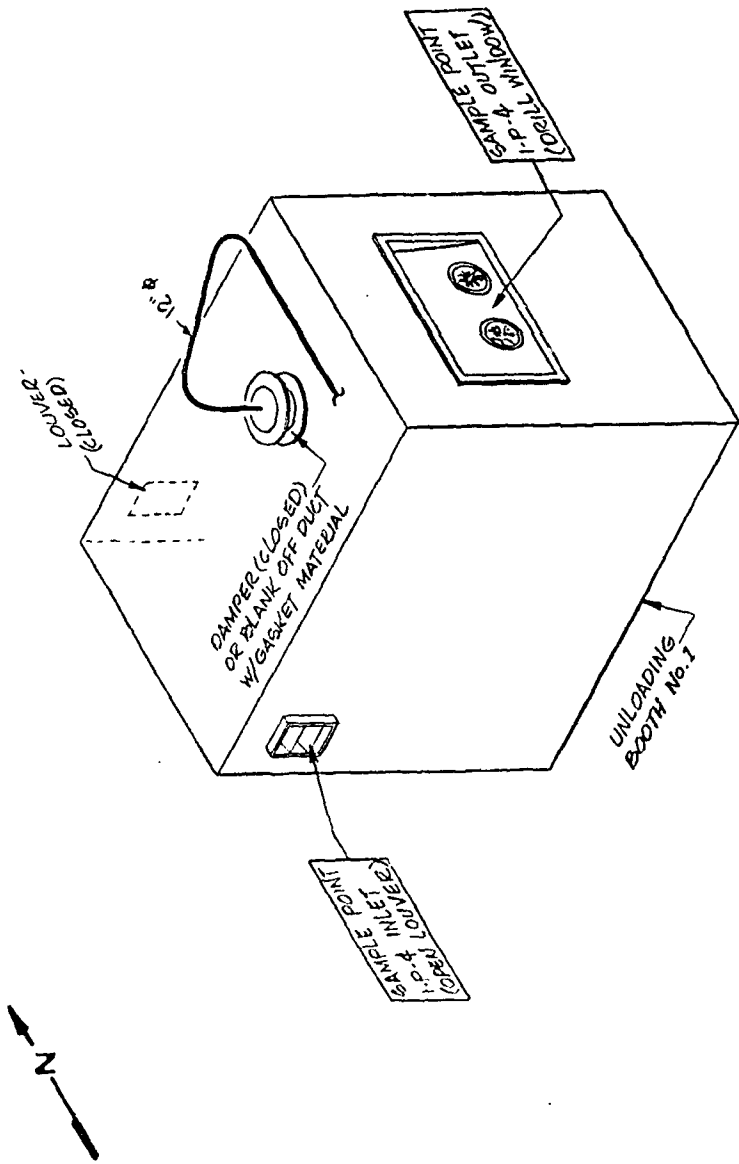

I-P-4
 INTAKE AIR CREATED BY OPENING LOUVER ON SOUTH WALL OF UNLOADING BOOTH. CLOSE DAMPER TO DUCT IN CEILING OF BOOTH OR BLANK OFF DUCT FLANGE. TAKE SAMPLE BY DRILLING A 1" HOLE IN PLASTIC WINDOW AND INSERTING A #5½ NEOPRENE STOPPER W/ ¼" O.S. TUBING & VALVE.

THIS AREA WONT BE SAMPLED

NATIONAL FERTILIZER DEVELOPMENT CENTER ENGINEERING AND SPECIAL PROJECTS MUSSE SHOALS, ALABAMA	
RMA-SPSS	
BUILDING NO. 537	
SAMPLE NO. I-P-4	
DRAWN BY DURCHAM	APPROVED BY [Signature]
CHECKED C W/K	DATE 8-10-88 1-24

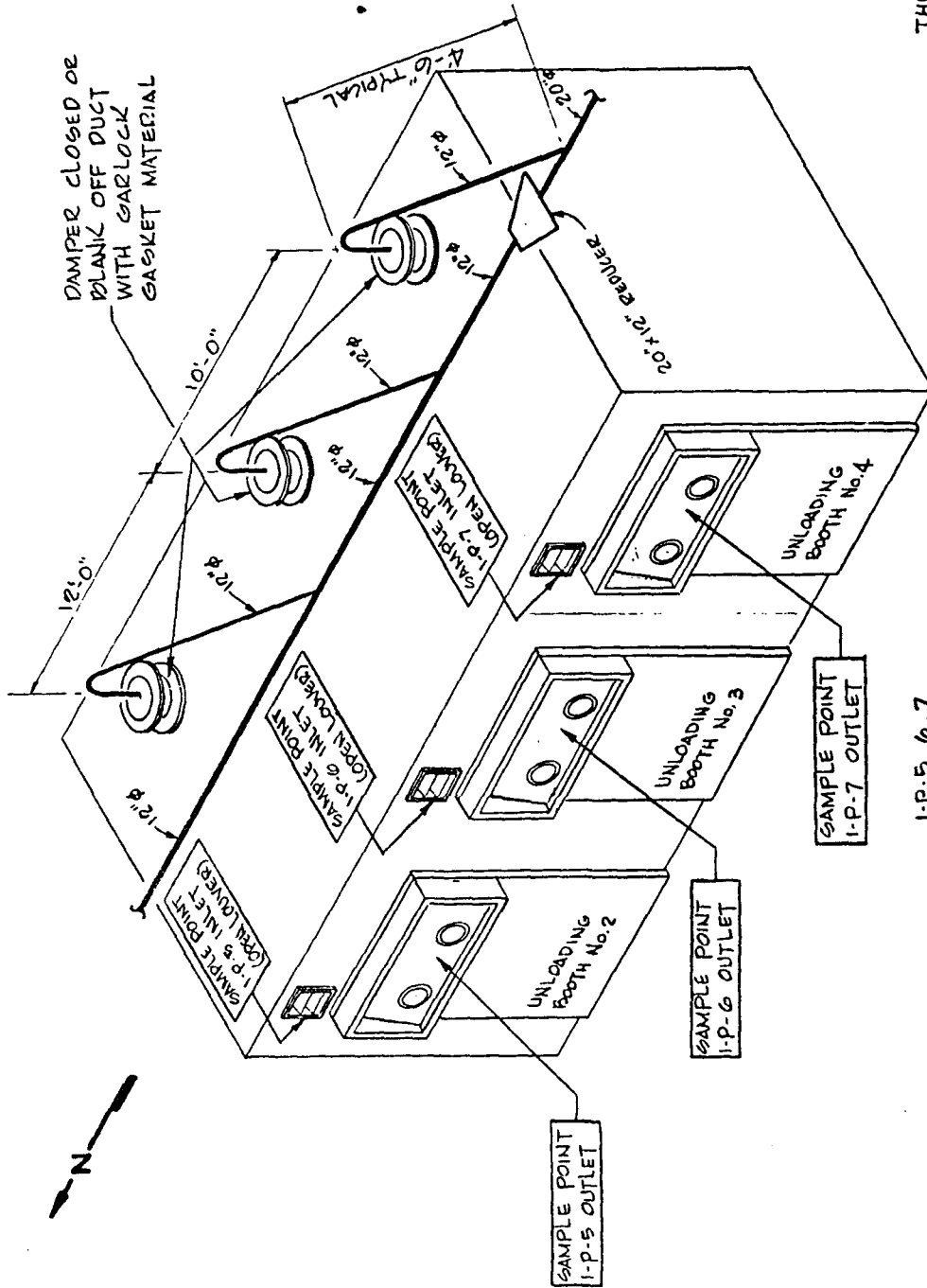

DAMPER CLOSED OR
BLANK OFF DUCT
WITH GARLOCK
GASKET MATERIAL

THIS AREA WONT BE SAMPLED

NATIONAL FERTILIZER DEVELOPMENT CENTER ENGINEERING AND SPECIAL PROJECTS MUSCLE SHOALS, ALABAMA	
RMA-SPSS	
BUILDING NO. 537	
SAMPLE NO. I-P-5, I-P-6, I-P-7	
DRAWN D. BURCHAM	APPROVED f.w.w.
CHECKED C.W.K	DATE 8-10-83
	I-P-5, 6, 7

I-P-5, 6, 7
INLET POINT IS THE LOUVER ON THE WEST END WALL
OF EACH BOOTH. CLOSE DAMPER OR BLANK OFF DUCT
TO CEILING OF BOOTH. PULL SAMPLE AT GLOVE PORT
BY DRILLING 1" HOLE IN PLASTIC WINDOW AND INSERTING A
#5½ NEOPRENE STOPPER w/¼" G.S. TUBING & VALVE.
(USE SAME PROCEDURE FOR ALL BOOTHS)
LOUVERS IN ALL THREE BOOTHS ARE NOT SEALED.

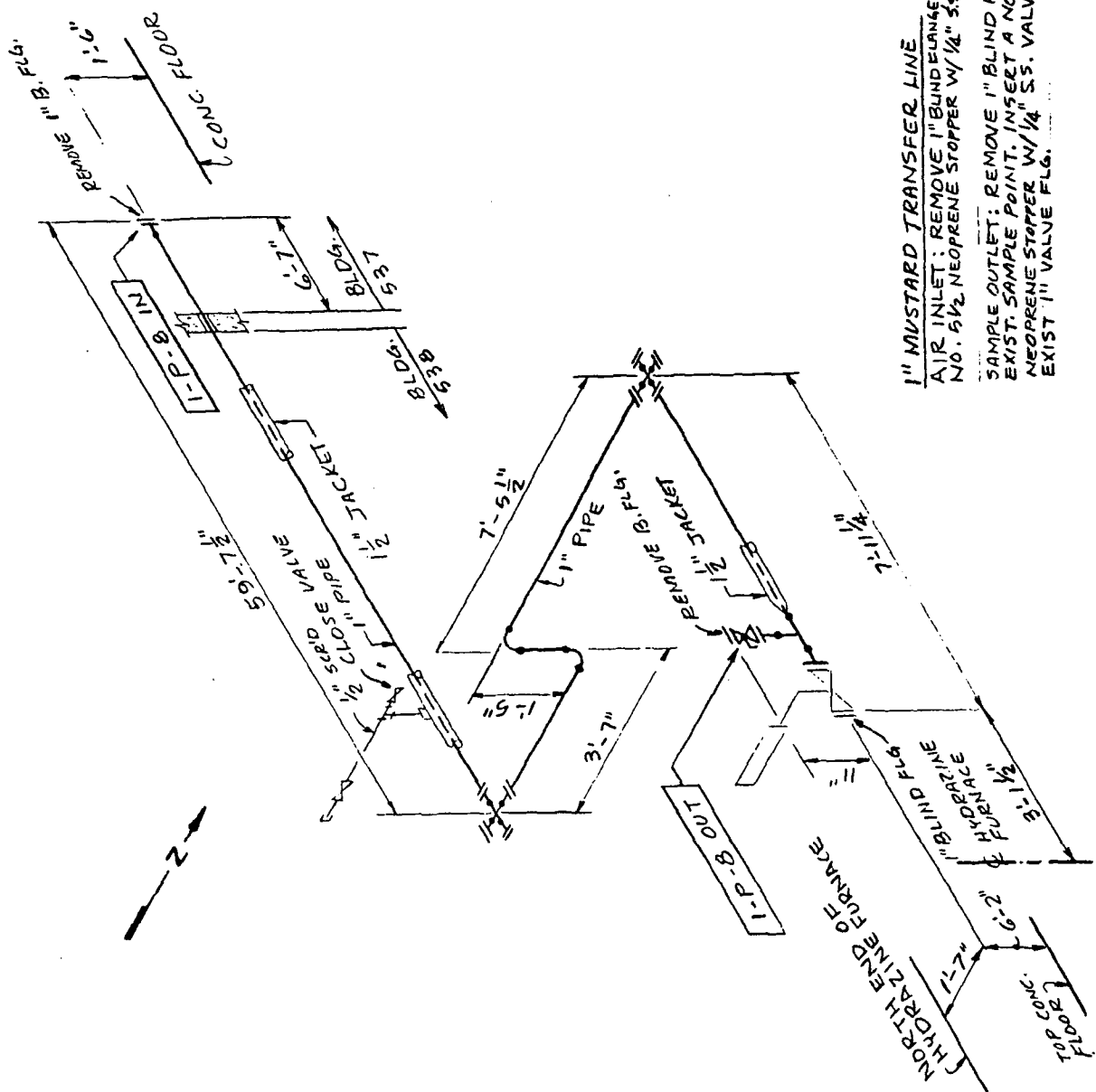

1" MUSTARD TRANSFER LINE
 AIR INLET: REMOVE 1" BLIND FLANGE INSERT A NO. 5/2 NEOPRENE STOPPER W/ 1/4" S.S. VALVE.
 SAMPLE OUTLET: REMOVE 1" BLIND FLANGE & EXIST. SAMPLE POINT. INSERT A NO. 5/2 NEOPRENE STOPPER W/ 1/4" S.S. VALVE INTO EXIST 1" VALVE FLG.

NATIONAL FERTILIZER DEVELOPMENT CENTER ENGINEERING AND SPECIAL PROJECTS MUSCLE SHOALS, ALABAMA	
RMA-SPSS	BUILDING NO. 537 & 538
DRAWN C W J K	SAMPLE NO. 1-P-8
CHECKED D H B	APPROVED R W W
	DATE 7-31-88 1-P-8

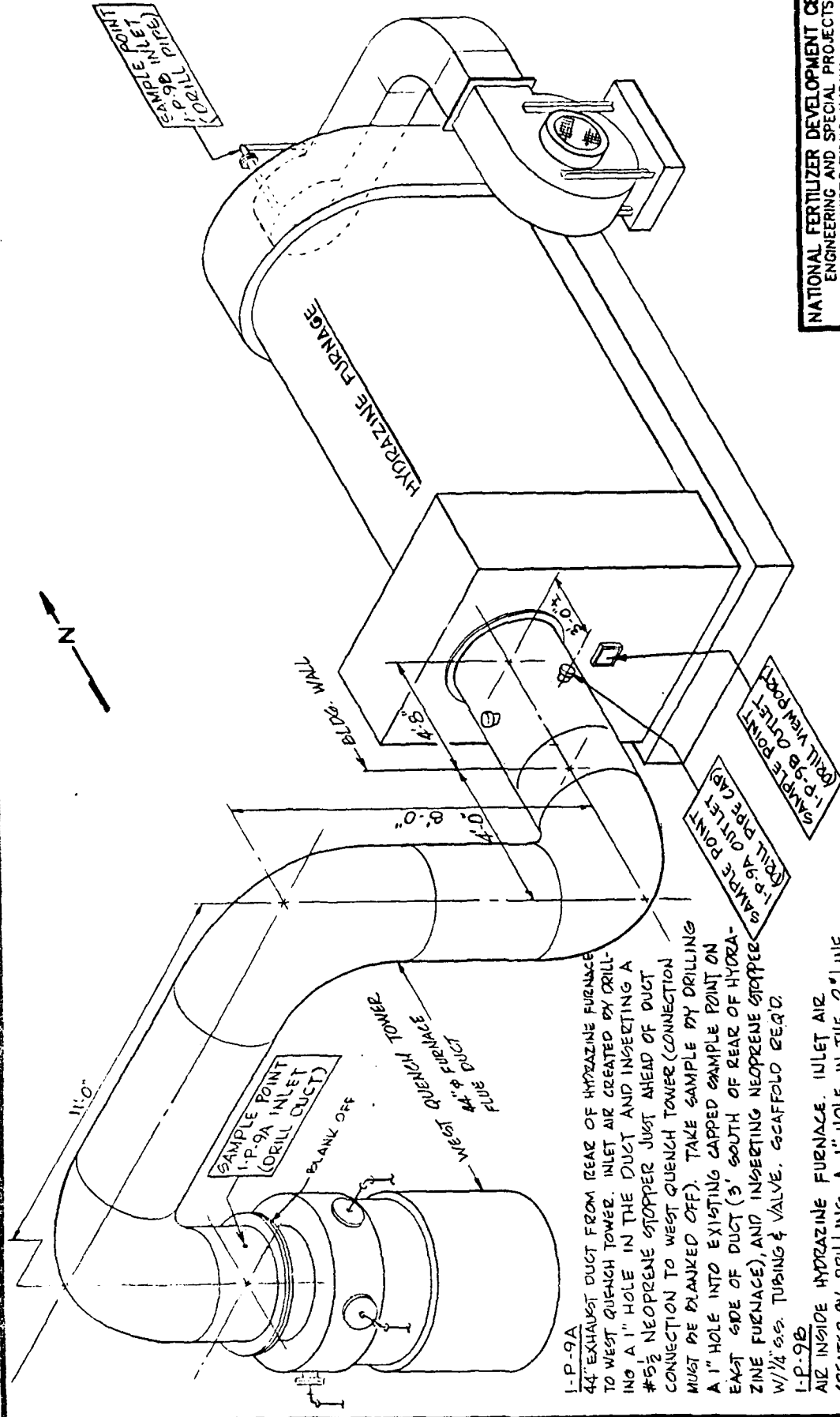

NATIONAL FERTILIZER DEVELOPMENT CENTER ENGINEERING AND SPECIAL PROJECTS MUSCLE SHOALS, ALABAMA	
RMA-SPSS	BUILDING NO. 538
DRAWN D. GUZZIHAM	SAMPLE NO. I-P-9A & I-P-9B
CHECKED C.W.I.C.	APPROVED F.W.L.
	DATE 8-15-88 I-P-9A, B

I-P-9A
 44" EXHAUST DUCT FROM REAR OF HYDRAZINE FURNACE TO WEST QUENCH TOWER. INLET AIR CREATED BY DRILLING A 1" HOLE IN THE DUCT AND INSERTING A #5 1/2 NEOPRENE STOPPER JUST AHEAD OF DUCT CONNECTION TO WEST QUENCH TOWER (CONNECTION MUST BE BLANKED OFF). TAKE SAMPLE BY DRILLING A 1" HOLE INTO EXISTING CAPPED SAMPLE POINT ON EAST SIDE OF DUCT (3' SOUTH OF REAR OF HYDRAZINE FURNACE), AND INSERTING NEOPRENE STOPPER W/ 1/4" S.S. TUBING & VALVE. SCAFFOLD REQ'D.

I-P-9B
 AIR INSIDE HYDRAZINE FURNACE. INLET AIR CREATED BY DRILLING A 1" HOLE IN THE 2" LINE (WHICH HAS A MITERED EL) AND INSERTING A #5 1/2 NEOPRENE STOPPER W/ 1/4" S.S. TUBING & VALVE. TAKE SAMPLE BY DRILLING A 1" HOLE IN OBSERVATION PORT AND INSERTING A #5 1/2 NEOPRENE STOPPER W/ 1/4" S.S. TUBING & VALVE. SCAFFOLD REQ'D.

WEST TON CONTAINER FURNACE. INLET AIR SUPPLY IS PROVIDED BY OPENING LOADING DOOR ON NORTH END. TAKE SAMPLE BY DRILLING 1" HOLE IN OBSERVATION PORT ON SOUTH END OF FURNACE AND INSERTING A #5/8 NEOPRENE STOPPER W/ 1/4" S.S. TUBING & VALVE.

1-P-11
EAST TON CONTAINER FURNACE SAME AS 1-P-10.



1-P-18A
FURNACE FLUE DUCT FROM TON CONTAINER FURNACES TO EAST QUENCH TOWER. INLET AIR SUPPLY IS THE LOADING DOOR OPENINGS ON THE NORTH END OF THE FURNACES. TAKE SAMPLE BY DRILLING 1" HOLE IN DUCT AHEAD OF BLANKED OFF CONNECTION TO TOP OF EAST QUENCH TOWER AND INSERTING A #5/8 NEOPRENE STOPPER W/ 1/4" S.S. TUBING & VALVE.

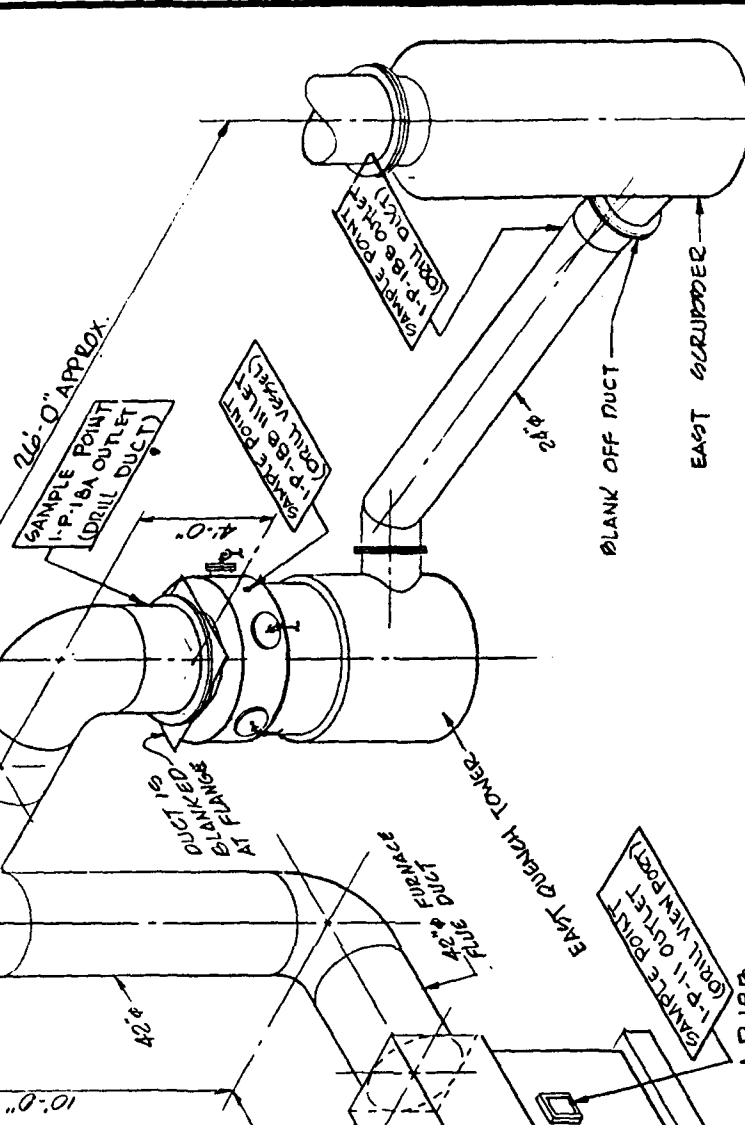

1-P-18B
DUCT FROM EAST QUENCH TOWER TO EAST SCRUBBER. INLET AIR SUPPLIED BY DRILLING A 1" HOLE IN THE QUENCH TOWER VESSEL AND INSERTING A #5/8 NEOPRENE STOPPER W/ 1/4" S.S. TUBING & VALVE TO REGULATE INLET AIR. TAKE SAMPLE AHEAD OF FLANGED CONNECTION TO EAST SCRUBBER BY DRILLING 1" HOLE IN DUCT AND INSERTING A #5/8 NEOPRENE STOPPER W/ 1/4" S.S. TUBING & VALVE.

THESE AREAS NOT TO BE SAMPLED

NATIONAL FERTILIZER DEVELOPMENT CENTER
ENGINEERING AND SPECIAL PROJECTS
MUSCLE SHOALS, ALABAMA

RMA-SPSS
BUILDING NO. 1-P-10, 11, 18A, 18B
SAMPLE NO. 1-P-10, 11, 18A, 18B

DRAWN BY BURZHAM
APPROVED R.W.V.

CHECKED C.W.K.
DATE 8-18-58 1-P-10/11/18

APPENDIX C

MATERIAL SAFETY DATA SHEET

AGENT: MUSTARD



DATE: 16 April 1988
HCSDS NO: 20058A

U.S. ARMY CHEMICAL
RESEARCH, DEVELOPMENT
AND ENGINEERING CENTER

Emergency Telephone #s:
CRDEC Safety Office
301-671-4411 0800-1630
EST After normal duty
hours: 301-278-5201
Ask for CRDEC Staff
Duty Officer

HD, AND THD (See Addendum A)

MATERIAL SAFETY DATA SHEET

SECTION I - GENERAL INFORMATION

MANUFACTURER'S NAME: Department of the Army

MANUFACTURER'S ADDRESS: U.S. ARMY ARMAMENT, MUNITIONS AND CHEMICAL COMMAND
CHEMICAL RESEARCH DEVELOPMENT AND ENGINEERING
CENTER
ATTN: SMCCR-SFS
ABERDEEN PROVING GROUND, MD 21010-5423

CAS REGISTRY NUMBER: 505-60-2, 39472-40-7, 68157-62-0

CHEMICAL NAME AND SYNONYMS:

Ethane, 1,1' -thiobis (2-chloro-)
Sulfide, bis (2-chloroethyl)
Bis(beta-chloroethyl)sulfide
Bis(2-chloroethyl)sulfide
1-chloro-2(beta-chloroethylthio)ethane
beta, beta'-dichlorodiethyl sulfide
2,2'-dichlorodiethyl sulfide
Di-2-chloroethyl sulfide
beta, beta'-dichloroethyl sulfide
2,2'-dichloroethyl sulfide

TRADE NAME AND SYNONYMS:

HD	Senfgas	H
Sulfur mustard	S-lost	HS
Iprit	Sulphur mustard gas	
Kampstoff "Lost"	S-yperite	
Lost	Yellow Cross Liquid	
Mustard Gas	Yperite	

CHEMICAL FAMILY: chlorinated sulfur compound

FORMULA/CHEMICAL STRUCTURE:

C4(H8)Cl2(S)

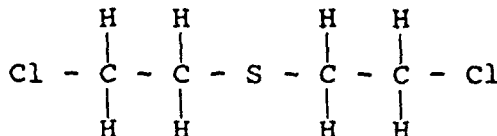

NFPA 704 SIGNAL: Health - 4
Flammability- 1
Reactivity- 1

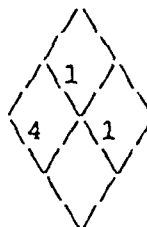

SECTION II - COMPOSITION

INGREDIENTS NAME	FORMULA	PERCENTAGE BY WEIGHT	RECOMMENDED EXPOSURE LIMIT
Sulfur Mustard	C ₄ (H ₈)Cl ₂ (S)	100	0.003 mg/m ³

SECTION III - PHYSICAL DATA

BOILING POINT DEG F (DEG C): 422 DEG F (217 DEG C)

VAPOR PRESSURE (mmHg): 0.072 mm Hg @ 20 DEG C (0.11 mm Hg @ 25 DEG C)

VAPOR DENSITY (AIR=1): 5.5

SOLUBILITY IN WATER: Negligible. Soluble in acetone, CH₃(Cl), tetrachloroethane ethylbenzoate, and ether.

SPECIFIC GRAVITY (H₂O=1): 1.27 @ 20 DEG C

VOLATILITY: 610 mg/m³ @ 20 DEG C
920 mg/m³ @ 25 DEG C

APPEARANCE AND ODOR: Water clear if pure. Normally pale yellow to black. Slight garlic type odor. The odor threshold for HD is 0.0006 mg/m³

SECTION IV - FIRE AND EXPLOSION DATA

FLASHPOINT (METHOD USED): 105 DEG C (ignited by large explosive charges)
122 DEG C (McCutchen-Young)

FLAMMABILITY LIMITS (% by volume): Unknown

EXTINGUISHING MEDIA: Water, fog, foam, CO₂. Avoid use of extinguishing methods that will splash or spread mustard.

SPECIAL FIRE FIGHTING PROCEDURES: Full protective clothing (see Section 8) and full respiratory protection must be worn when fighting fires inside buildings and areas where mustard agents are stored. Full protective clothing and canister or filter type masks can be worn where oxygen deficiency is not a problem. All persons not engaged in extinguishing the fire should be evacuated. Skin contact and inhalation of HD and its vapors must be avoided at all times. Although the fire may destroy most of the HD, care must be taken to assure that the HD does not contaminate uncontrolled areas and that the fire fighters are adequately protected from physical contact with the agent and agent fumes. Contact can be fatal.

SECTION V - HEALTH HAZARD DATA

RECOMMENDED EXPOSURE LIMIT(REL): Since HD is a carcinogen, airborne exposure should be controlled to the lowest feasible limit. No individual should be intentionally exposed to any direct skin or eye contact or any detectable airborne concentration. Presently, the detection limit is 0.003 mg/m³ as a 1-hour time-weighted average (TWA). As the analytical method improves, the REL will be lowered.

EFFECTS OF OVEREXPOSURE: HD is a vesicant (causing blisters) and alkylating

agent producing cytotoxic action on the hematopoietic (blood-forming) tissues which are especially sensitive. The rate of detoxification of HD in the body is very slow and repeated exposures produce a cumulative effect. Median doses of HD in man are:

LD50 (skin) = 100 mg/kg
Ict50 (skin) = 2000 mg-min/m³ at 70 - 80 DEG F (humid environment)
= 1000 mg-min/m³ at 90 DEG F (dry environment)
Ict50 (eyes) = 200 mg-min/m³
Ict50 (inhalation) = 1500 mg-min/m³ (Ct unchanged with time)
LD50 (oral) = 0.7 mg/kg

Maximum safe Ct for skin and eyes are 5 and 2 mg-min/m³, respectively.

ACUTE PHYSIOLOGICAL ACTION OF HD IS CLASSIFIED AS LOCAL AND SYSTEMIC.

LOCALLY, HD affects both the eyes and the skin. SKIN damage occurs after percutaneous resorption. Being lipid soluble, HD can be resorbed into all organs. Skin penetration is rapid without skin irritation. Swelling (blisters) and reddening (erythema) of the skin occurs after a latency period of 4-24 hours following the exposure, depending on degree of exposure and individual sensitivity. The skin healing process is very slow. Tender skin, mucous membrane and perspiration covered skin are more sensitive to the effects of HD. HD's effect on the skin, however, is less than on the eyes. Local action on the eyes produces severe necrotic damage and loss of eyesight. Exposure of eyes to HD vapor or aerosol produces lacrimation, photophobia, and inflammation of the conjunctiva and cornea.

SYSTEMIC ACTIONS occur primarily through inhalation and ingestion. The HD vapor or aerosol is less toxic to the skin or eyes than the liquid form. When inhaled, the upper respiratory tract (nose, throat, trachea) is inflamed after a few hours latency period, accompanied by sneezing, coughing, and bronchitis, loss of appetite, diarrhea, fever, and apathy. Exposure to nearly lethal dose of HD can produce injury to bone marrow, lymph nodes, and spleen as indicated by a drop in WBC count and, therefore, results in increased susceptibility to local and systemic infections. Ingestion of HD will produce severe stomach pains, vomiting, and bloody stools after a 15-20 minute latency period.

CHRONIC EXPOSURE to HD can cause sensitization, chronic lung impairment, (cough, shortness of breath, chest pain), and cancer of the mouth, throat, respiratory tract, skin, and leukemia. It may also cause birth defects.

EMERGENCY AND FIRST AID PROCEDURES:

INHALATION. Remove from the source IMMEDIATELY. If breathing has stopped, give artificial respiration. If breathing is difficult, administer oxygen. Seek medical attention IMMEDIATELY.

EYE CONTACT. IMMEDIATELY flush eyes with water for 10-15 minutes, pulling eyelids apart with fingers and pouring water into eyes. Do not cover eyes with bandages. Seek medical attention IMMEDIATELY.

SKIN CONTACT. Don respiratory protection mask and gloves; remove victims from source immediately and remove contaminated clothing. IMMEDIATELY decontaminate affected areas, flushing with 5 percent solution of sodium hypochlorite or liquid household bleach. After 3-4 minutes, wash off with soap and water to remove decontaminant and protect against erythema. Seek medical attention IMMEDIATELY.

INGESTION. Do not induce vomiting. Give victim milk to drink. Seek medical attention IMMEDIATELY.

SECTION VI - REACTIVITY DATA

STABILITY: Stable at ambient temperatures. Decomposition temperature is 149 DEG C to 177 DEG C. Mustard is a persistent agent depending on pH and moisture, and has been known to remain active for up to three years in soil.

INCOMPATIBILITY: Conditions to avoid. Rapidly corrosive to brass @ 65 DEG C. Will corrode steel at a rate of .0001" of steel per month @ 65 DEG C.

HAZARDOUS DECOMPOSITION: Mustard will hydrolyze to form HCl and thiodiglycol.

HAZARDOUS POLYMERIZATION: Will not occur.

SECTION VII - SPILL, LEAK, AND DISPOSAL PROCEDURES

STEPS TO BE TAKEN IN CASE MATERIAL IS RELEASED OR SPILLED: Only personnel in full protective clothing will be allowed in an area where mustard is spilled. The mustard should be contained using vermiculite, diatomaceous earth, clay or fine sand and neutralized as soon as possible using copious amounts of STB slurry or HTH solution. Never use dry STB or HTH since they will react violently with mustard and may burst into flames. Scoop up all contaminated material and place in approved DOT containers. Pour in STB slurry or HTH solution. Decontaminate the outside of the container, label in accordance with state, DOT and EPA regulations, and hold for disposal.

NOTE: Surfaces contaminated with HD and then rinse-decontaminated may evolve sufficient mustard vapor to produce a physiological response.

WASTE DISPOSAL METHOD: All decontaminated material should be collected, contained and chemically decontaminated or thermally decomposed in an EPA approved incinerator, which will filter or scrub toxic by-products from effluent air before discharge to the atmosphere. Any contaminated protective clothing should be decontaminated using HTH or bleach and analyzed to assure it is free of detectable contamination (3X) level. The clothing should then be sealed in plastic bags inside properly labeled drums and held for shipment back to the DA issue point. Decontamination of waste or excess material shall be accomplished in accordance with the following procedure:

(a) HD on laboratory glassware may be oxidized by its vigorous reaction with concentrated nitric acid.

(b) Chemical decontamination of HD may be accomplished by adding it to an excess of 60/40 slurry of STB or HTH solid bleach and water. HD has poor solubility in water. The HD-bleach slurry must be stirred frequently over 24 hours to assure that the HD has contacted and reacted with the bleach. After 24 hours, test for the presence of active chlorine in the decon slurry before discarding.

Alternately, decontaminated waste and/or HD can be held for pick-up by a Technical Escort Team.

SECTION VIII - SPECIAL PROTECTION INFORMATION

SPECIAL PROTECTION: For non-detectable airborne concentrations of HD suspected to be present (e.g. by odor or damaged container), wear full facepiece and:

- o Air-purifying chemical canister respirator, e.g., M9 gas mask with M11 canister, or M17 series gas mask with M-13A2 filter (for field use only)

- o Air-supplied respirator in positive pressure or continuous flow mode; or
- o An open circuit self-contained breathing apparatus (SCBA) in positive pressure mode.

For unknown concentrations of HD (e.g., direct contact with HD, maintenance of contaminated equipment, or cleaning up spills, etc.,) use open circuit, pressure demand, full facepiece SCBA, or continuous flow or pressure demand air-supplied, full facepiece respirator in combination with self-contained system. At or above detectable levels of HD (e.g., field or transfer operations), use a full facepiece, chemical canister, airpurifying protective mask with hood (M9 mask with M11 canister acceptable) or the 30 mil DPE (2 hour limit). Respirator and protective suit must be approved by AMC Field Safety Activity prior to use.

VENTILATION:

Local Exhaust. Mandatory. Must be filtered or scrubbed.

Special. Chemical laboratory hoods shall have an average inward face velocity of 100 linear feet per minute (1 fpm) plus or minus 10% with the velocity at any point not deviating from the average face velocity by more than 20%. Laboratory hoods shall be located such that cross drafts do not exceed 20% of the inward face velocity. A visual performance test utilizing smoke producing devices shall be performed in assessing the ability of the hood to contain agent HD.

Other. Recirculation of exhaust air from agent areas is prohibited. No connection between agent area and other areas through the ventilation system is permitted. Emergency backup power is necessary. Hoods should be tested semi-annually or after modification or maintenance operations. Operations should be performed 20 cm inside hoods.

PROTECTIVE GLOVES: MANDATORY. Can be chemical protective glove set gloves or butyl rubber M4 or M3, or other impervious gloves suitable for the specific operation.

EYE PROTECTION: As a minimum, chemical goggles will be worn. For splash hazard use goggles and face-shield.

OTHER PROTECTIVE EQUIPMENT: Full protective clothing will consist of the M3 butyl rubber suit with hood, M2A1 boots, M3 gloves, impregnated underwear, M9 series mask and coveralls (if desired), or the Demilitarization Protective Ensemble (DPE) if available or NIOSH approved equivalent. For general lab work, gloves and lab coat shall be worn with M9 or M17 mask readily available or NIOSH/OSHA approved respirator.

In addition, when handling contaminated lab animals, a daily clean smock, foot covers, and head covers are required.

SECTION IX - SPECIAL PRECAUTIONS

PRECAUTIONS TO BE TAKEN IN HANDLING AND STORING: Voluntary pregnancy testing shall be offered to women who may be exposed to HD above its PEL. During handling, the "buddy" (two-man) system will be used. Containers should be periodically inspected for leaks, either visually or using a detector kit, and prior to transferring the containers from storage to work areas. Stringent control over all personnel handling HD must be exercised. Chemical showers, eyewash stations, and personal cleanliness facilities must be provided. Wash hands before meals and at the end of the workday. No smoking, eating, or drinking is permitted at the work site. Decontamination equipment shall be conveniently located. Exits must be designed to permit rapid evacuation. HD should be stored in containers made

of glass for Research Development Test and Evaluation (RDTE) quantities or one-ton steel containers for large quantities. Agent shall be double-contained in liquid-tight containers when in storage.

OTHER PRECAUTIONS: See AMC-R 385-131, "Safety Regulations for Chemical Agents H, HD, HT, GB and VX", 9 Oct 1987, for additional information.

SECTION X - TRANSPORTATION DATA

PROPER SHIPPING NAME: Poisonous liquid, n.o.s.

DOT HAZARD CLASS: Poison A

DOT LABEL: Poison Gas

DOT MARKING: Poisonous liquid, n.o.s. (sulfur mustard) NA 1955

DOT PLACARD: Poison Gas

EMERGENCY ACCIDENT PRECAUTIONS AND PROCEDURES: See Sections IV and VIII.

PRECAUTIONS TO BE TAKEN IN TRANSPORTATION: Motor vehicles will be placarded regardless of quantity. Driver shall be given full and complete information regarding shipment and conditions in case of emergency. AR 50-6 deals specifically with the shipment of chemical agents. Shipment of agents will be escorted in accordance with AR 740-32.

While the Chemical Research Development and Engineering Center, Department of the Army believes that the data contained herein are factual and the opinions expressed are those of qualified experts regarding the results of the tests conducted, the data are not to be taken as a warranty or representation for which the Department of the Army or Chemical Research Development and Engineering Center assumes legal responsibility. They are offered solely for your consideration, investigation, and verification. Any use of these data and information must be determined by the user to be in accordance with applicable Federal, State, and local laws and regulations.

ADDENDUM A
ADDITIONAL INFORMATION FOR THICKENED HD

TRADE NAME AND SYNONYMS: Thickened HD, THD, HV

HAZARDOUS INGREDIENTS: None in liquid form. K125 (acryloid copolymer, 5%) is used to thicken HD. K125 is not known to be hazardous except in a finely-divided, powder form.

PHYSICAL DATA: Essentially the same as HD except for viscosity. The viscosity of HV is between 1000 and 1200 centistokes @ 25 DEG C.

FLAMMABLE AND EXPLOSION DATA: Same as HD.

HEALTH HAZARD DATA: Same as HD except for skin contact. For skin contact, use respiratory protective mask and remove contaminated clothing IMMEDIATELY. IMMEDIATELY scrape the HV from the skin surface, then wash the contaminated surface with acetone. Seek medical attention IMMEDIATELY.

SPELLING, LEAK, AND DISPOSAL PROCEDURES: If spills or leaks of HV occur,

follow the same procedures as those for HD, but dissolve the HV in acetone prior to introducing any decontaminating solution. Containment of HV is generally not necessary. Spilled HV can be carefully scraped off the contaminated surface and placed in a fully removable head drum with a high density, polyethylene lining. The HV can then be decontaminated, after it has been dissolved in acetone, using the same procedures used for HD. Contaminated surfaces should be treated with acetone, then decontaminated using the same procedures as those used for HD.

NOTE: Surfaces contaminated with HV or HD and then rins-decontaminated may evolve sufficient mustard vapor to produce a physiological response.

SPECIAL PROTECTION INFORMATION: Same as HD.

SPECIAL PROTECTION INFORMATION: Same as HD

SPECIAL PRECAUTIONS: Same as HD with the following addition. Handling the HV requires careful observation of the "stringers" (elastic, thread-like attachments) formed when the agents are transferred or dispensed. These stringers must be broken cleanly before moving the contaminating device or dispensing device to another location, or unwanted contamination of a working surface will result.

TRANSPORTATION DATA: Same as HD.

APPENDIX D
PORTABLE VENTILATION UNIT

Portable Ventilation Units

Portable ventilation units will be used for sampling and are available from two sources:

- (1) Commercial - Commercial units are available from Calgon, Inc. These units are capable of ventilating approximately 400 cfm at a total cost of \$5,125 (includes one carbon refill). The complete unit comes supplied with fan (blowers) damper, skid, casters, vent sorbent drum, connecting ductwork between drum and fan, and flange connections for both the fan inlet and drum outlet. Delivery of these units is about 6 to 8 weeks. (See Figure 1).
- (2) Department of the Army: The Army filter unit, gas-particulate, 300 cfm, ABC-M6A1 has been considered for this project. If available, the units could be loaned to RMA for the duration of the project. Using these units could cause logistic problems, however, because of the number needed and the problems encountered in obtaining the status of the equipment. The number needed may not be available for the sampling schedule.

Commercial portable ventilation units will be used for both the sampling and decontamination phases.

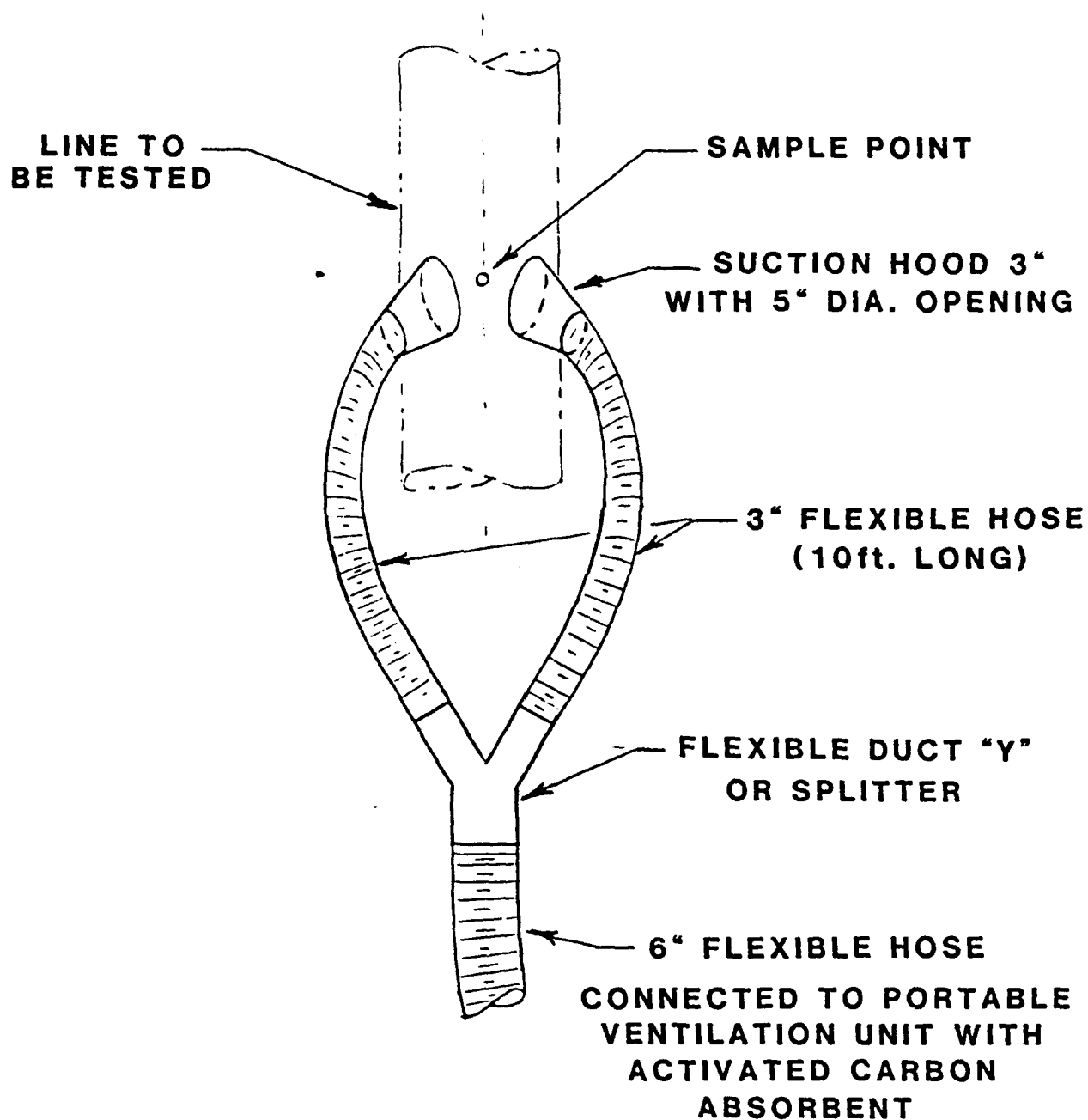
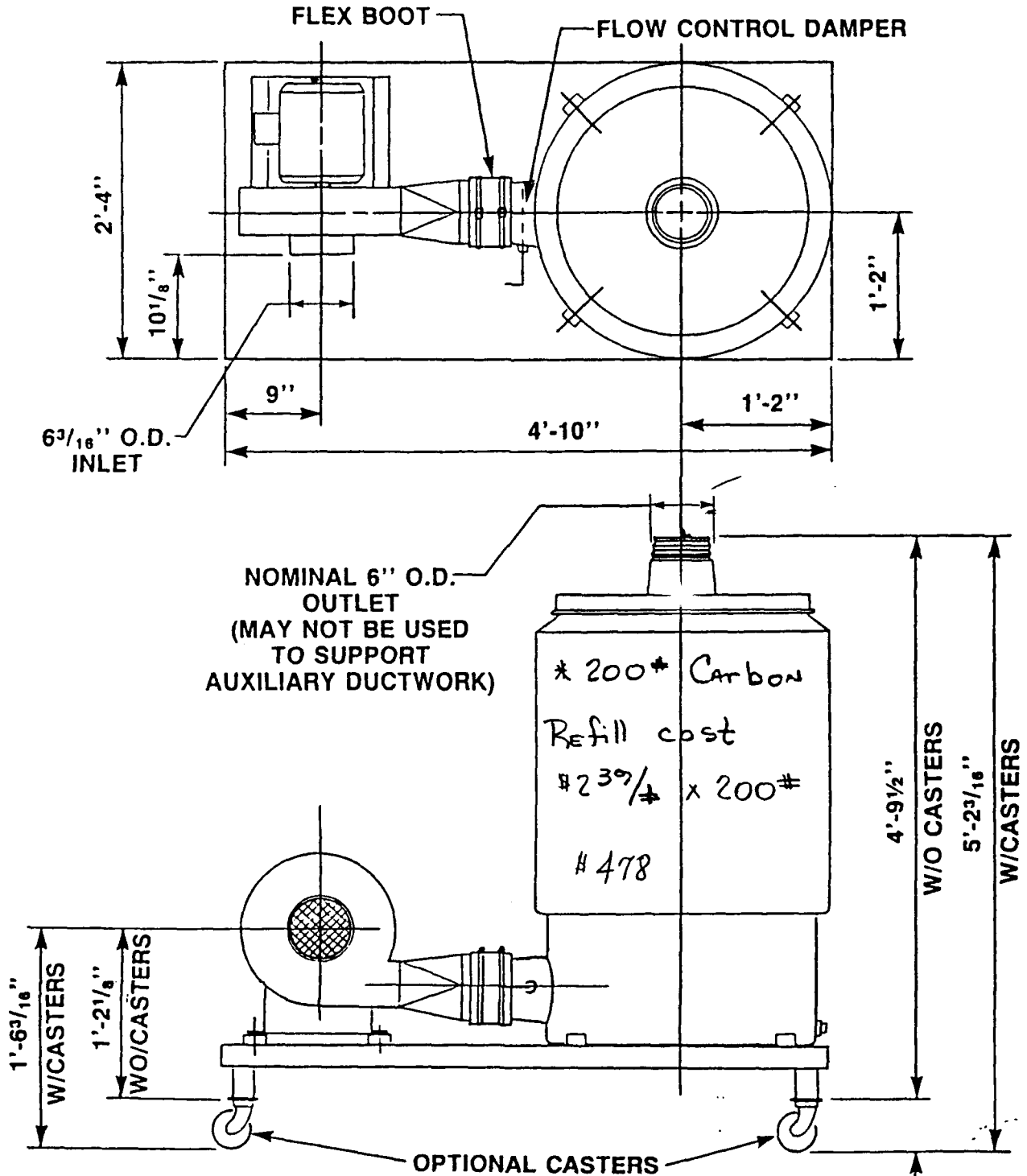

FIGURE 1
**PORTABLE SUCTION CONNECTION
FOR EACH SAMPLE OPENING**



28" HIGH FLOW VENTSORB WITH FAN



* Estimate changing Carbon on each unit ONCE for "South End"

SPECIFICATIONS

Blower:

Hartzell #07-11-II2, direct drive with 1.5 HP 3/60/460v TEFC 3500 RPM motor. Bottom horizontal discharge, CW rotation, discharge transition to 6" round and inlet guard. Entire blower to have black epoxy finish. Sound level estimated at 83.3 dBA at 5 feet under free field conditions.

Skid:

Carbon steel construction with Sherwin Williams Tile-Clad II finish or equal.

Canister:

Polyethylene with FRP, polypropylene and polyethylene internals.

Miscellaneous:

FLOW CONTROL DAMPER:

Polypropylene with 316 SS fasteners. Provides approximately 3 to 1 turndown.

FLEX-BOOT:

1/2" Neoprene with 316 SS band clamps.

Assembled Weight:

Empty: 285 Lbs.

With IVP Carbon: 510 Lbs.

With BPL Carbon: 485 Lbs.

AVAILABLE OPTIONS AND ADDITIONS

1. 1/60/115v TEFC motor in lieu of 3/60/460v TEFC motor.
2. 3/60/460v TEXP motor in lieu of 3/60/460v TEFC motor.
3. Flanged inlet on blower & flanged outlet on canister.
4. Heavy duty industrial casters (4" hard rubber).
5. Carbon may be one of the following:
 - 1 Drum of IVP 4 x 6
 - 1 Drum BPL 4 x 6
 - 1 Drum BPL 4 x 10

PERFORMANCE:

Carbon	Ext. SP (In. W.C.)	Approx. Flow (CFM)
IVP 4 x 6	0.0	400
225 Lbs.	3.5	300
17 1/2" Bed	6.0	200
	7.0	100
BPL 4 x 6	0.0	400
200 Lbs.	3.5	300
20 1/4" Bed	6.0	200
	7.0	100
BPL 4 x 10	0.0	325
200 Lbs.	1.0	300
19 1/2" Bed	5.0	200
	7.0	100

Note: Above performance based on average packed bed conditions. Actual conditions may be different resulting in increased or decreased flow.



CALGON CARBON CORPORATION

Lab Safety's Fume Extractor

Our low cost, high-efficiency fume extractor removes fumes, gases, vapors, particulates and odors no matter where they occur. Entirely polypropylene for cleanliness and chemical resistance, extractor conveniently mounts to workbench, wall or ceiling. Exhaust arm and base adjust to meet a variety of space and working requirements. Connect to an exhaust fan individually or to a centralized system where one fan services a number of extractors. A damper on each unit adjusts air volume. Fume extractor has a removable hood for exhausting at a point source. Total arm length: 52".

Individual models are described below. Model 103 can be combined with Model 101 or 102 since our No. 5540 Exhaust Fan can service two Fume Extractors.

Fume Extractor Model 101 — Fume Extractor with hood and light, exhaust fan with reducer, electrical control box and 10 feet of exhaust ducting.

C5753 1045.50

Fume Extractor Model 102 — Fume Extractor with hood and light, exhaust fan with reducer, transformer and 10 feet of exhaust ducting.

C5754 785.00

Fume Extractor Model 103 — Fume Extractor without hood.

C5755 189.00

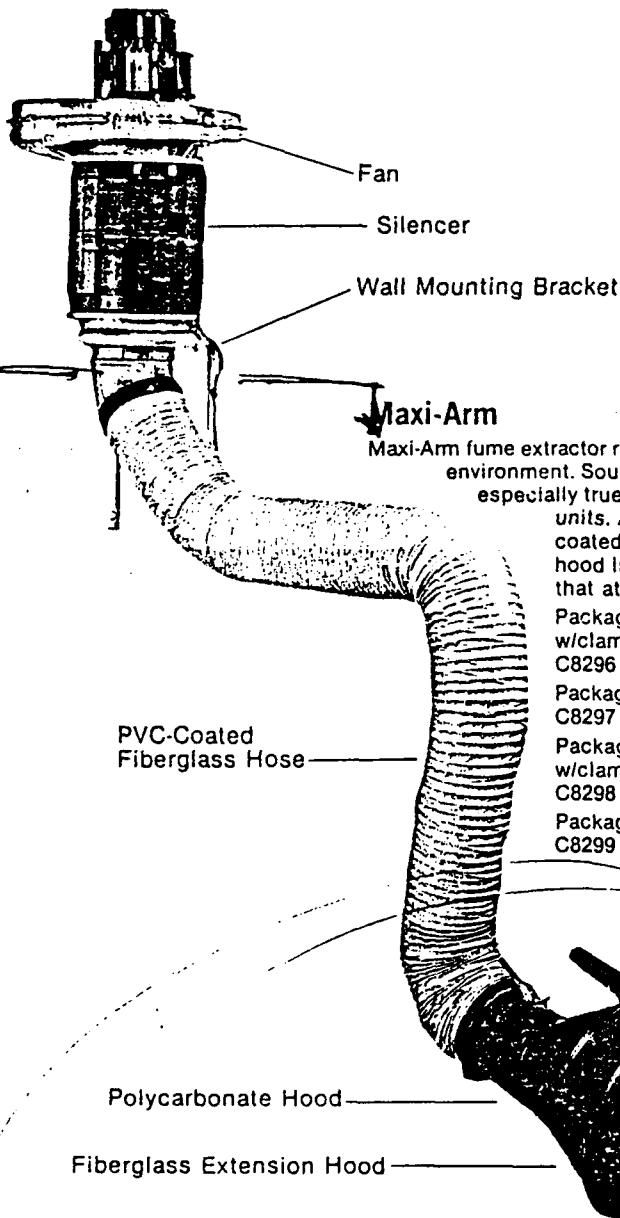
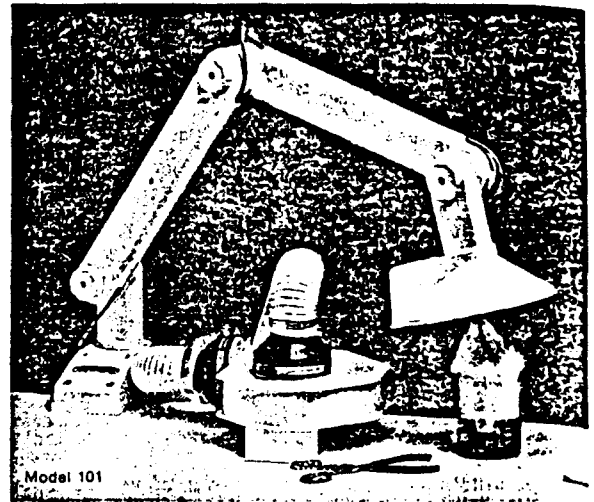

Accessories

No.	Description	Each
C5808	Hood without Light.	39.15
C5538	Hood with Light. Equipped with 24 Volt, 20 W. halogen lamp and switches for lamp and fan. Our No. 5542 Electrical Control Box must be purchased to operate the fan at this switch.	125.50
C5539	Transformer. For use with No. 5538 Hood with Light. Required if Electrical Control Box is not ordered.	101.45
C5542	Electrical Control Box. The power supply for lamp and fan. Permits operation of hood light and fan at switches.	366.25
C5541	Wall/Ceiling Bracket. Two are required for ceiling mounting.	26.45
C5541-2	Tabletop Bracket. For portable, temporary mounting of unit to tabletop.	37.50
C5540	Exhaust Fan. Used in combination with one or two Fume Extractors. Can be wall mounted. 175 cfm, 1/4 hp, 110 VAC. 5" inlet/outlet	285.00
C5767	Exhaust Duct. White PVC. 20 ft., 3" diameter.	89.00
C5751	Double Adapter. Needed when operating two units from one fan.	86.50
C5752	Reducer. For attaching 3" duct to 5" fan inlet.	36.00

Maxi-Arm

Maxi-Arm fume extractor removes contamination at the source for a cleaner and more comfortable work environment. Source extraction is more energy efficient than a central ventilation system. This is especially true with the new 7' Maxi-Arm, which covers a much larger area than most smaller units. Arm consists of aluminum supports for extra durability surrounded by a PVC-coated fiberglass hose. Polycarbonate hood includes a PVC damper. An aluminum hood is available for high temp use. Light package contains a 70 watt halogen bulb that attaches to the inside of the hood for low-visibility conditions.

Package 701 — Maxi-Arm and hood, single phase 1/2 hp fan, 12.5' PVC duct w/clamps, light package w/control box and wall mounting bracket.

C8296 1950.00

Package 702 — Maxi-Arm and hood, single phase 1/2 hp fan and wall mounting bracket.

C8297 1325.00

Package 703 — Maxi-Arm and hood, three phase 1/2 hp fan, 12.5' PVC duct w/clamps, light package w/control box and wall mounting bracket.

C8298 1837.00

Package 704 — Maxi-Arm and hood, three phase 1/2 hp fan and wall mounting bracket.

C8299 1211.00

Accessories

No.	Description	Each
C8285	Fiberglass Extension Hood	130.55
C8286	Aluminum Hood for High Temp Use	178.00
C8293	25' Ducting	264.35
C8295	12.5' Ducting	132.50
C8294	Ducting Clamp	4.40
C8287	T-Wall Bracket (for mounting 2 arms)	199.50
C8291	Silencer (reduces noise level by 1/3)	195.00
C8288	Transformers (provide 24V supply to light package)	2235.00
C5539	115V to 24V	101.95
C8289	230V to 24V	105.95
C8290	460V to 24V	120.50

APPENDIX E

MINICAM NEAR-REAL TIME ANALYZER

DESCRIPTION OF MINICAMS
AND THE
QUALIFICATIONS OF CMS RESEARCH CORPORATION

August 29, 1988

CMS RESEARCH CORPORATION
1075 South 13th Street, Suite 205
Birmingham, Alabama

TABLE OF CONTENTS

<u>Section</u>	<u>Page</u>
I. INTRODUCTION.	1
II. SUMMARY OF MINICAMS AND ACCESSORIES	1
III. SPECIFICATIONS FOR MINICAMS	2
IV. DESCRIPTION OF MINICAMS	3
A. Recent Improvements in MINICAMS.	3
B. Description of MINICAMS and Comparison with ACAMS.	4
C. Performance Characteristics of MINICAMS.	5
V. MANAGEMENT APPROACH	6
A. MINICAMS Production Management	7
B. Management of MINICAMS Service and Support	7
VI. BACKGROUND AND EXPERIENCE	8
A. Highlights	8
B. Biosketches of Key Staff	10
C. Contract Experience of Staff While at CMS Research.	14
D. General Experience	24
VII. FACILITIES AND EQUIPMENT.	24
A. XCSM Laboratory.	25
B. Other Facilities	25
C. Research Equipment	25
D. Other Equipment.	26
E. Facility Clearance	26
APPENDIX ARMY REGULATIONS REFERRING TO CW-AGENT MONITORING	

DESCRIPTION OF MINICAMS AND THE QUALIFICATIONS
OF CMS RESEARCH CORPORATION

I. INTRODUCTION

CMS Research Corporation has the necessary management expertise, personnel, facilities, and other resources to provide air monitoring systems and accessories for the determination of chemical-warfare (CW) agents at the Surgeon General's 8-hr time-weighted average (TWA) concentrations.

The following sections of this document include a brief description of monitoring equipment designed and manufactured by CMS Research, a discussion of the capabilities of the monitoring system, our management approach, and our technical background and experience in providing similar equipment and services. Also included is a brief description of CMS Research facilities relevant to the design, production, and testing of monitoring systems.

II. SUMMARY OF MINICAMS AND ACCESSORIES

CMS Research Corporation has developed a miniature automatic continuous air monitoring system (MINICAMS®), which is capable of detecting CW agents and simulants at concentrations that range from TWA limits to concentrations immediately dangerous to life and health (IDLH). This system and its accessories are:

- o MINICAMS, which includes a photomultiplier tube (PMT), phosphorus and sulfur optical filters, a single-channel electrometer, a sample pump, compressed gas regulators (one each for air, nitrogen, and hydrogen), a stand-alone, microprocessor-based controller, cables, a standard operation and maintenance manual, a stock of expendable supplies for approximately 90 days of normal operation, and two days of training for two staff at CMS Research prior to shipping the equipment.
- o A dual-pen, strip-chart recorder (Soltec Model 4202 or comparable) with fan-fold paper and felt-tipped pens.
- o A dot-matrix printer for hard-copy output.
- o A 12-port stream-selection system that allows the sequential sampling of multiple locations.

- o A PC-computer-based controller for laboratory applications.
- o Special software packages for permeation testing and other monitoring applications.

All MINICAMS hardware and accessories are shipped FOB destination within 90-120 days of the date of order.

III. SPECIFICATIONS FOR MINICAMS

CMS Research Corporation was founded about 2 years ago primarily to pursue research, development, and production of chemical-agent detection equipment. The key staff of CMS Research all have considerable experience in the automated detection of low levels of chemical agents as well as extensive training and experience in related disciplines, including the design and construction of electrical and mechanical components, circuit boards, and microprocessor-based instruments. As noted above, CMS Research has developed a miniature ACAMS (MINICAMS), which is capable of the detection of CW agents and simulants over several orders of magnitude. Some of the specifications for the monitoring system are:

- o MINICAMS uses the same analytical chemistry as the ACAMS, that is, sample preconcentration using solid sorbents, separation using gas chromatography, and detection with a flame-photometric detector.
- o It is designed to detect and report 8-hr, time-weighted average (TWA) concentrations of the chemical-warfare (CW) agents GB, VX, and HD in ambient air.
- o Agent concentration in TWA units is displayed on a liquid-crystal display (LCD) on the front panel of the controller.
- o A permanent record of the agent concentration is provided on a strip-chart recorder. An alarm is also displayed by the monitor when the agent concentration exceeds a preset limit (user selectable).
- o MINICAMS can detect TWA levels of GB and HD within 5 min and VX within 10 min.
- o MINICAMS is controlled by a dedicated, microprocessor-based, stand-alone controller as shown in Figure 1. The dimensions of the MINICAMS monitor are about 12 in. wide by 10 in. deep by 9 in. high, and the dimensions of the controller are approximately 12 in. wide by 12

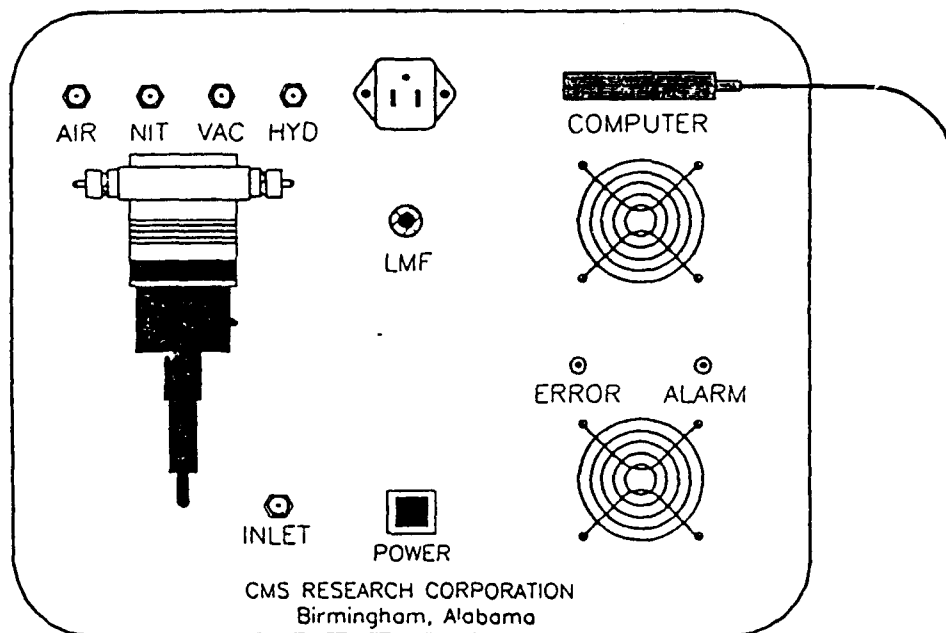

MINICAMS Monitor

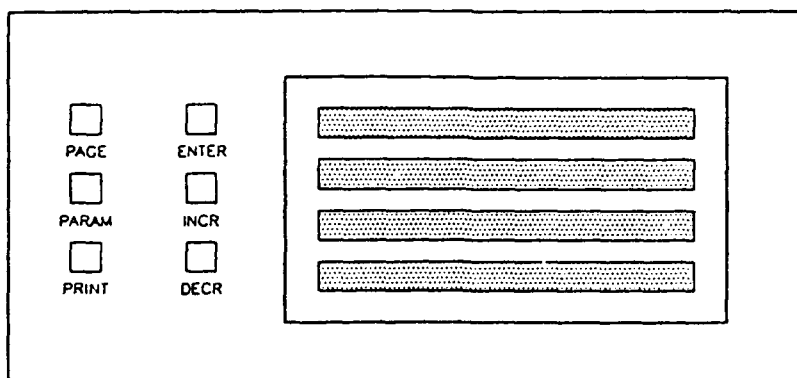

MINICAMS Controller

Figure 1. Diagram of MINICAMS with stand-alone controller.

MINICAMS PERMEATION/MONITORING SYSTEM

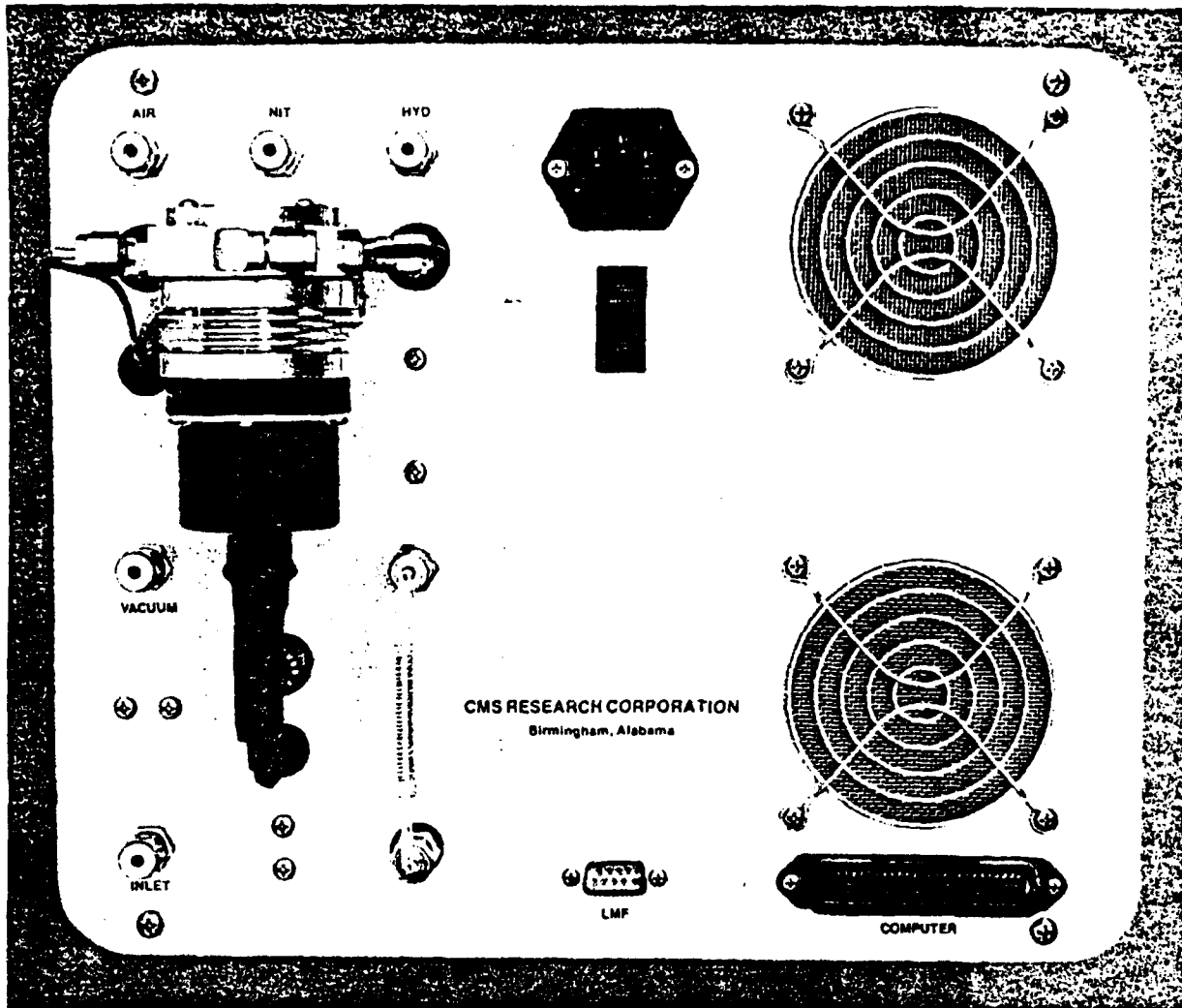

MINICAMS (miniature ACAMS) is an automated gas chromatograph designed for the quantitative detection of CW agents and simulants. It is based on proven technology enhanced by innovative ideas from the staff of CMS Research Corporation.

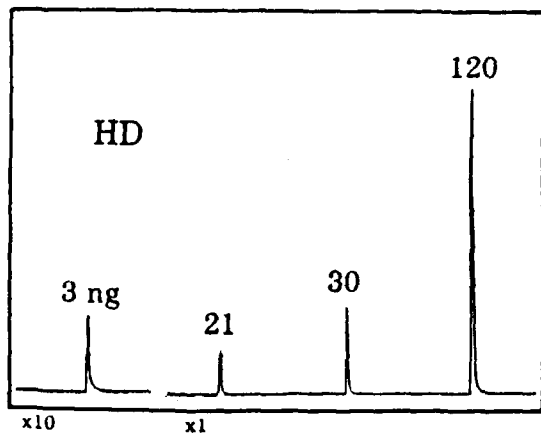
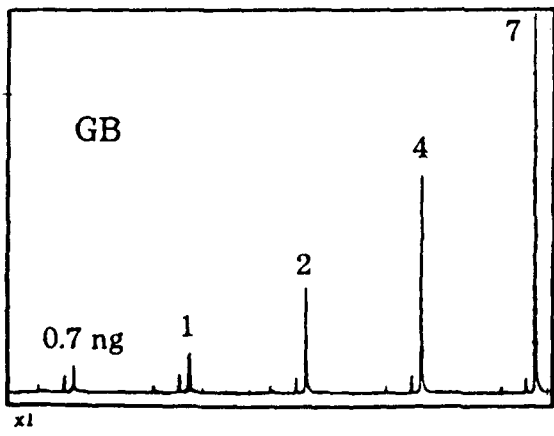

MINICAMS is a trademark of CMS Research Corporation.

MINICAMS MEANS PERFORMANCE

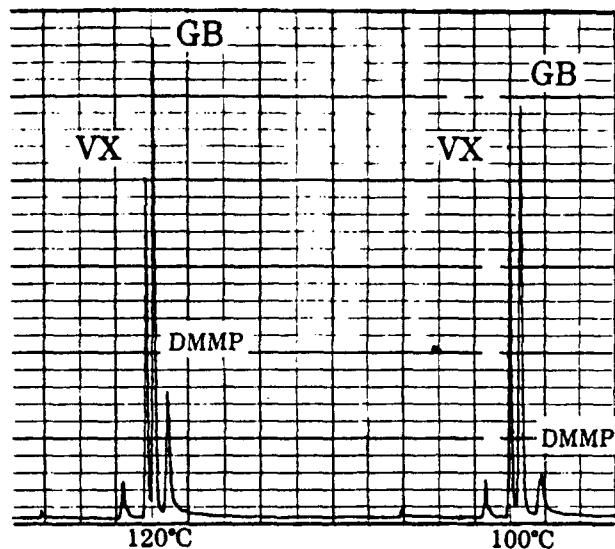

FEATURES

solid sorbents	fused-silica column
flame photometric detector	PC-based controller
mass data storage	user "programmable"
vapor or liquid samples	simple calibration
wide dynamic range	simple maintenance

ACCESSORIES

sample pump	recorder	dot-matrix printer
stack sampling apparatus		linear mass flowmeter
multiport sampler		custom software/hardware

APPLICATIONS

monitoring	Surgeon General's Limits (TWA)
	IDLH concentrations
	storage igloos
	charcoal filter banks
	incinerator and stack gas
	vapor generators
testing	permeation
	penetration
	decontamination
	vapor desorption
analysis	solutions and gases

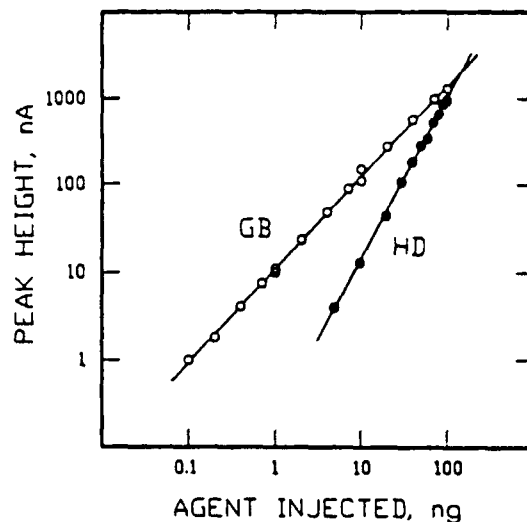

SPECIFICATIONS

15 pounds (monitor)	10 x 12 x 9 in. (monitor)
0.01 to 10,000 ng/L	0.00001 to 10 mg/m ³
50 to 1000 mL/min	2 to 60 min cycle
MDL < 0.1 ng of GB	MDL < 1 ng of HD
baseline resolution of GB and the G-analog of VX	

DETECTS

GB	GD	HD	VX	DFP
DIMP	DMHP	DMMP	CEES	DBS
other organosulfur and organophosphorus compounds				

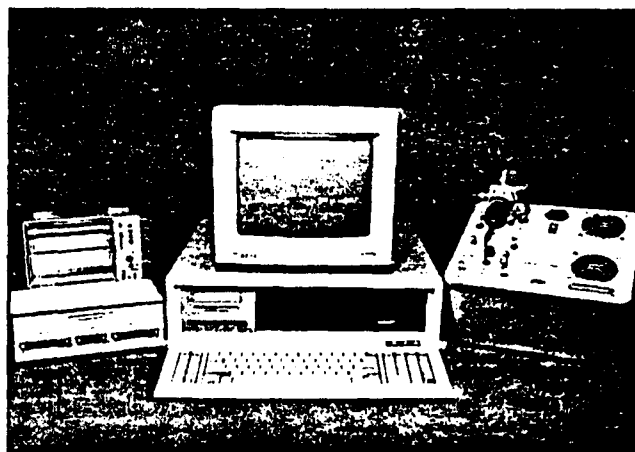

CMS
RESEARCH CORPORATION

For further information contact:
Dr. Gary D. Sides or Dr. Daniel R. Coleman
 CMS Research Corporation, 1075 South 13th Street
 Birmingham, Alabama 35255 • Telephone 205-934-9151

in. deep by 6 in. high. The monitor is normally located on top of the controller so that the counter space occupied by the MINICAMS is about 1 ft². The MINICAMS monitor and controller together weigh less than 20 pounds. The monitor and controller are connected by a 10-ft cable.

- o The strip-chart recorder is a Soltec Model 4202 dual-pen recorder. Its dimensions are approximately 5 in. high by 11 in. wide by 7 in. deep, and it weighs approximately 9 lbs. The chart speed ranges from 0.5 cm/hr to 16 cm/min including 16 cm/hr. The input ranges are 10 mV, 100 mV, and 10 V full scale.
- o The sample-pump assembly, based on the 0.1-hp Gast Model 1531-107B-G513X, is about 4 in. high by 9 in. long by 5 in. wide and weighs about 7 lbs.

Other features of MINICAMS are described briefly below.

IV. DESCRIPTION OF MINICAMS

A. Recent Improvements in MINICAMS

CMS Research is continuously improving MINICAMS to increase its reliability, make it easier to maintain and repair, and make it simpler to operate while retaining the excellent performance attainable using solid-sorbent preconcentration, capillary-column chromatography, and flame-photometric detection. Since installing the first two MINICAMS at Calspan Corporation and at Pine Bluff Arsenal, we have made the following improvements:

- o Reducing the number of custom circuit boards from six to two.
- o Greatly reducing the complexity of the wiring within the monitor.
- o Simplifying the plumbing of the sampling-and-analytical system.
- o Making the gas-chromatographic module easily removable for maintenance and repair.
- o Attaching the cover of the MINICAMS to the motherboard using standoffs so that the plumbing and electronics packages can be removed as a unit for maintenance and repair.

- o Improving the design and construction of the preconcentrator tube (PCT) heater.
- o Increasing the sensitivity of the monitoring system. (For example, the detection of less than 0.01 ng of GB has been demonstrated.)
- o Demonstrating the ability to detect 8-hr time-weighted-average (TWA) concentrations of GB and HD with a 5-min cycle and VX with a 10-min cycle without the use of external accessories such as a high-volume sampler.
- o Writing and debugging a more sophisticated software package that supports monitoring and special testing (for example, permeation testing).
- o Designing a stream-selection system that allows up to 12 different locations to be monitored by one MINICAMS sequentially.

As a result of the improvements listed above, we feel that the latest version of MINICAMS is superior to conventional monitoring approaches for CW agents.

B. Description of MINICAMS and Comparison with ACAMS

The chemical-agent monitoring system offered by CMS Research is the miniature ACAMS (automatic continuous air monitoring system) known as MINICAMS. This system is the latest version of ACAMS developed by Dr. Gary D. Sides, who has been responsible for the development and application of this technology to chemical-agent detection during the past eight years. MINICAMS is based on the same analytical chemistry that is in ACAMS and that is recognized for TWA-level monitoring in Army regulations AR 50-6 and AMC-R 385-131, portions of which are presented in the attached appendix. However, we have recently repackaged the ACAMS technology to reduce the size, weight, and cost of the monitoring system. Our work has resulted in the following advantages of MINICAMS compared to the conventional ACAMS:

- o Light weight--less than 20 pounds for the monitor (compared to 75 pounds for the ACAMS monitor).
- o Small size--a volume less than 1 ft³ for the monitor and a footprint of less than 1 ft² (compared to a volume of about 2 ft³ and a footprint of about 2 ft² for ACAMS).
- o Fused-silica capillary GC column for high resolution (versus the low resolution obtained with the packed column in ACAMS).

- o Direct communication and reporting to an IBM-PC-XT-compatible computer with mass storage capability for central data archiving and report generation.
- o Greater reliability and ease of service than for ACAMS.

C. Performance characteristics of MINICAMS

MINICAMS has been designed for the reliable detection of low levels of chemical agents. Some of the performance characteristics of MINICAMS are listed below:

- o The monitor is capable of determining TWA concentrations of the agents GB and HD automatically with response times less than 5 min and VX with response times less than 10 min without the use of external accessories such as a high-volume sampler. It can determine concentrations of nerve agent GB at or below 0.0001 mg/m³, nerve agent VX at or below 0.00001 mg/m³, and agents H or HD at or below 0.003 mg/m³. Examples of typical CW-agent chromatograms using MINICAMS are shown in Figures 2-5.
- o The collection of samples and the analysis and reporting of concentration data is entirely automatic. The stand-alone computer/controller is capable of sending data to a strip-chart recorder, to a dot-matrix printer, and to a serial RS232 I/O communications port.
- o Demonstrated absolute detection limits for the monitor are less than 0.1 ng of GB and VX; less than 3 ng of HD; and less than 1 ng of DMMP (a simulant that may be used during tests of the operation of the monitoring system by non-CPRP personnel).
- o The operation of the monitor does not involve the use or generation of liquids or liquid wastes that are classified as hazardous under the Resource Conservation and Recovery Act (RCRA).
- o The monitor is able to operate unattended 24 hours per day, 7 days per week, etc. Only periodic challenges of the monitor with RDTE dilute solutions need be conducted to ensure proper operation.
- o To facilitate maintenance and repair at a central location, the entire sampling-and-analytical system weighs less than 20 pounds, has a volume of about 1 ft³, and has a footprint of about 1 ft² (exclusive of compressed gases, sample pump, chart recorder, printer, and associated equipment used for computer communications).

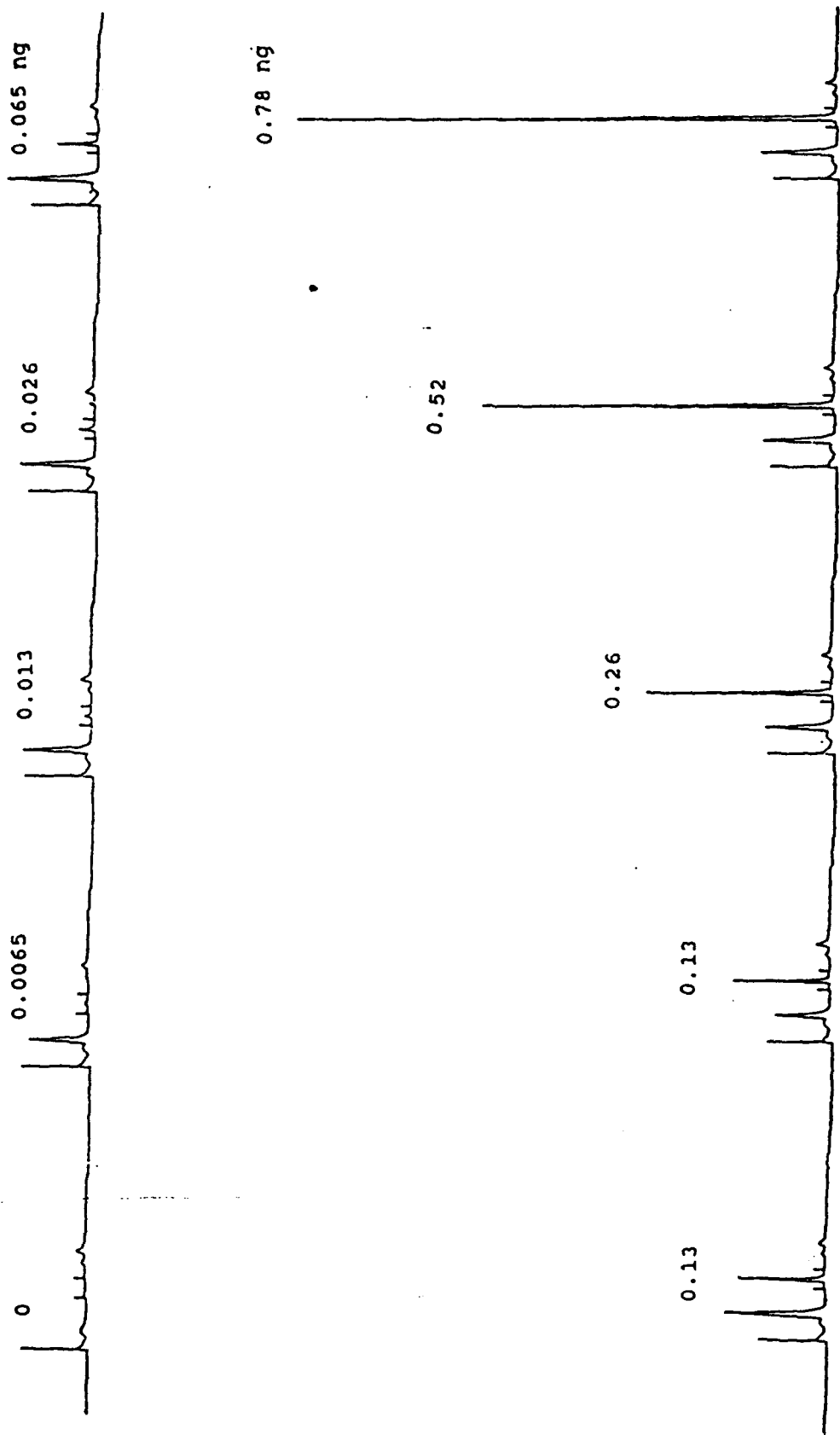

Figure 2. GB challenges of MINICAMS (5-min cycle).

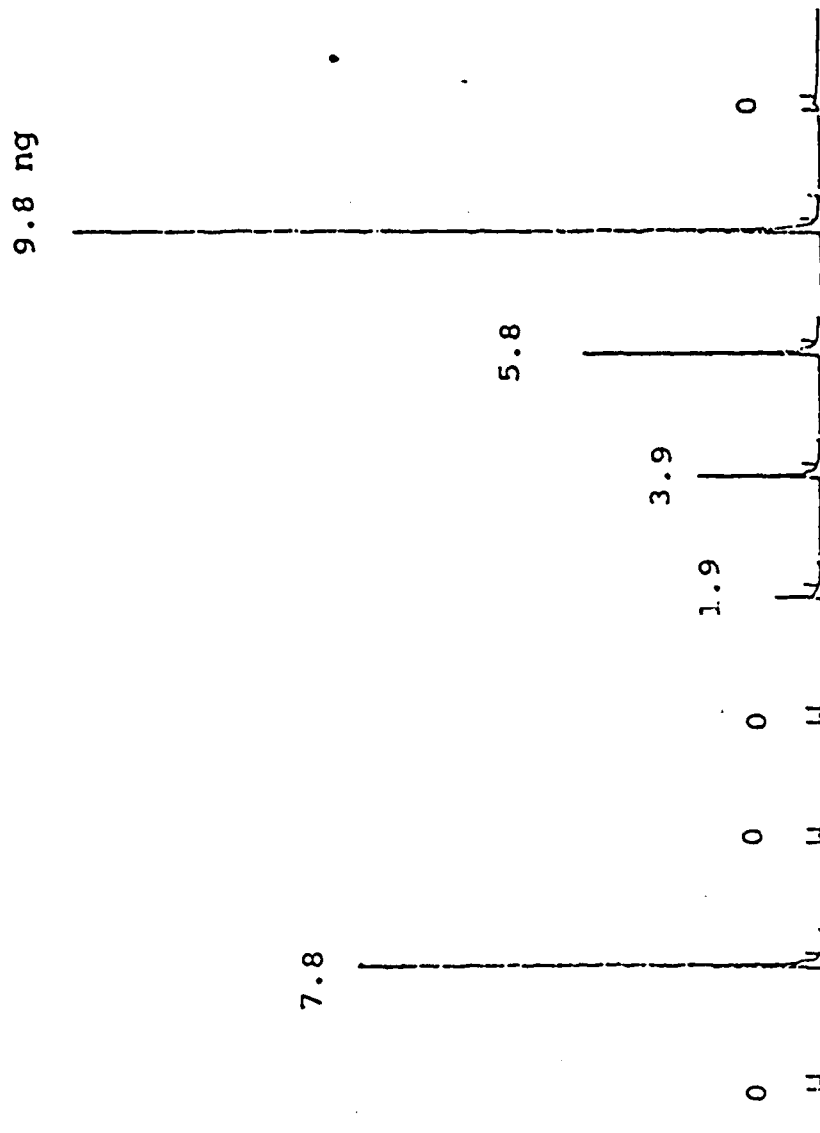

Figure 3. Typical MINICAMS chromatograms of HD (5-min cycle).

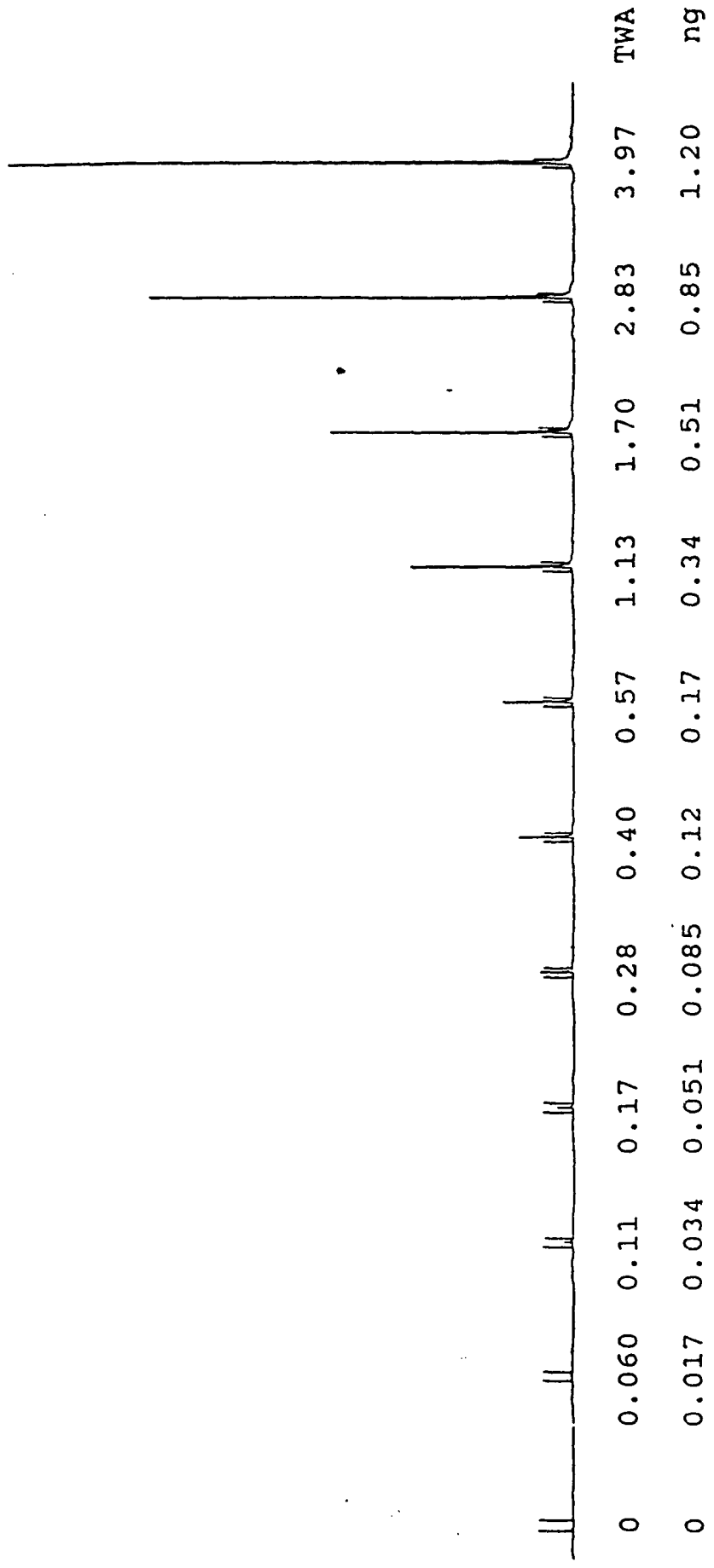

Figure 4. GB challenges of the Pine Bluff MINICAMS completed recently at CMS Research (5-min cycle).

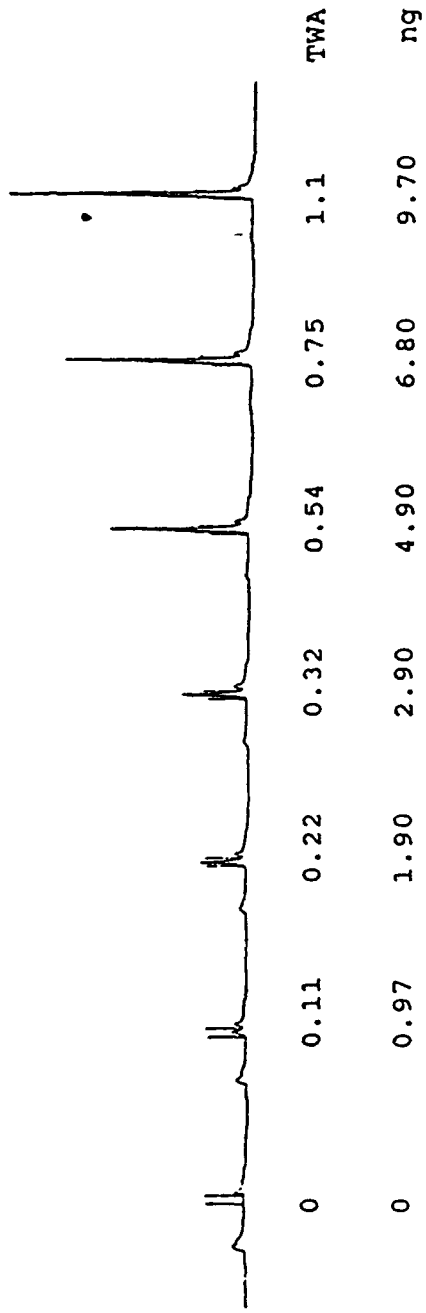

Figure 5. HD challenges of the Pine Bluff MINICAMS completed recently at CMS Research (5-min cycle).

- o As a demonstration of its ability to minimize interferences and to give false-positive responses, the monitoring system is able to distinguish between the agent GB (isopropyl methylphosphonofluoridate) and the G-analog of VX (ethyl methylphosphonofluoridate), which is not chemical surety materiel.
- o To ensure the collection of adequate sample for accurate analysis, the monitor is able to sample at a flow rate of greater than 1 L/min (without the use of a high-volume sampler).
- o Agent concentrations are detectable over a range of at least two orders of magnitude without modifying instrument operating parameters.
- o The monitoring system can be used away from fixed locations (for example, in mobile vans or trailers).
- o The monitor demonstrates a low incidence of false-negative responses because of its ability to indicate an instrument malfunction and to alert the user to this condition.

V. MANAGEMENT APPROACH

During the past year, the staff of CMS Research Corporation has doubled in size. Much of this growth has been the result of actual and anticipated business involving MINICAMS monitoring and permeation-testing systems. Key recent changes at CMS Research that are expected to benefit directly MINICAMS customers include:

- o Organizing MINICAMS into modules and submodules to simplify assembly, maintenance, and repair.
- o Improving the MINICAMS software package to facilitate monitoring and permeation-testing applications.
- o Establishing a computer-based system for the control of the MINICAMS parts inventory.
- o Preparing detailed MINICAMS assembly and testing procedures to ensure uniformity and quality.
- o Establishing assembly and testing work stations used exclusively for MINICAMS.
- o Hiring an assembly technician and an applications chemist committed to MINICAMS construction and testing.

- o Hiring an information specialist to archive reports and other documents including MINICAMS software packages.
- o Hiring a contracting officer to assist in negotiations and to ensure compliance with DOD procurement regulations.
- o Hiring a director of operations to ensure that customer specifications are met with each MINICAMS shipment.

A. MINICAMS Production Management

The primary goal of CMS Research is to provide reliable, high-quality monitoring equipment and services on schedule and at reasonable cost. To achieve this goal, we have assembled a team of professionals dedicated to efficient production of monitoring systems and accessories for the government market.

Dr. Gary D. Sides, President of CMS Research, oversees the production of monitoring equipment to ensure that efficiency and quality control standards are being attained. Ms. Carolyn U. Phillips, Director of Administration, is responsible for contract negotiations with the government and keeping the staff informed of any contract modifications that may have an impact on the production process. Dr. Daniel R. Coleman, Director of Operations, acts as the Project Engineer to ensure that the construction of the equipment is being completed on schedule and within budget. He is responsible for all aspects of the production process including purchasing, inventory control, construction, preliminary testing, final testing, and shipping to ensure that the final product the customer receives meets our rigid quality control standards.

B. Management of MINICAMS Service and Support

Because we are actively involved in designing monitoring equipment and improving MINICAMS, CMS Research has a team of specialists consisting of scientists and engineers that are experts in every aspect of MINICAMS. Listed below are the staff and their areas of expertise in CW-agent monitoring with MINICAMS. Biosketches of the key staff of CMS Research are included in Section VI.B. These staff are available to provide service and support either at the customer's site or by telephone:

Dr. Gary D. Sides	Systems and Applications
Mr. Marion H. Cates	Chromatography
Mr. J. Todd Brown	Computer Software

Mr. Thomas G. Thomas	Electronics and Computer System
Mr. Vincent L. Ray	Electronics Assembly and Testing
Ms. Teresa H. Roseberry	Applications Chemist
Mr. Raymond L. Hara	Custom and Modified Components
Ms. Janet H. Farris	Purchasing

Mr. Cates, Senior Chemist, along with Dr. Sides established the initial design criteria which formed the basis for the design of MINICAMS. Thus, they are both familiar with the entire system and can readily identify and correct problems in chromatographic performance. Mr. J. Todd Brown, Manager of Computer Support, designed and developed the software package that controls the operation of MINICAMS. Therefore, Mr. Brown can solve any problems that may arise with the software and can modify the package to meet specific needs of the customer.

Mr. Thomas, Manager of Engineering Support, designed the custom electronics of MINICAMS and the stand-alone computer so he can provide in depth support to solving problems associated with the electronics. Because Mr. Ray, Electronics Technician, performs the assembly of the electronic components of MINICAMS, he is well-suited to assist Mr. Thomas in troubleshooting the electronics components of the system.

VI. BACKGROUND AND EXPERIENCE

A. Highlights

CMS Research Corporation was founded more than two years ago primarily to pursue research, development, and production of CW-agent monitoring systems. The key staff of CMS Research all have considerable experience in the automated detection of low levels of CW agents as well as extensive training and experience in related disciplines, including the design and construction of electrical and mechanical components, circuit boards, and microprocessor-based instruments. For example, in addition to advancing ACAMS technology to its present level, the staff who now comprise CMS Research have provided monitoring support during approximately 400 man-days at CAMDS and other government sites over the last seven years.

The key staff of CMS Research Corporation are all experienced in the analysis of CW agents. Since 1981, Dr. Sides has directed or played a major role in about 85 contracts involving the design and contraction of CW-agent monitoring systems as well as other chemical defense work. Several of the

key staff (notably Dr. Sides, Mr. Cates, Mr. Brown, and Mr. Thomas) have considerable experience in the design and construction of monitoring systems, and they each have supported tests or the maintenance of such equipment at CAMDS, Anniston Army Depot, and the Chemical Research, Development and Engineering Center. In addition, they have experience in the evaluation of monitoring systems, in chemical decontamination, and the evaluation of protective clothing.

CMS Research staff have installed and supported CW-agent monitoring systems at eight sites in the United States and at one site outside the United States. Recently, they prepared the technical data package that was used to procure one such system (ACAMS) to be installed at CAMDS and JACADS. And they designed, constructed, and tested nine ACAMS for the Chemical Decontamination Training Facility at Ft. McClellan, Alabama. The experience of the staff at chemical demilitarization plants and at other agent-exclusion areas is summarized in Table 1. During the past 18 months, CMS Research staff have made 25 trips to 7 CW-agent exclusion areas to support monitoring involving ACAMS and MINICAMS.

CMS Research has extensive experience in the design, production, and support of the air monitoring systems specified in the RFQ. During the past 14 months, CMS Research has produced and delivered three MINICAMS. One system was installed at Calspan Corporation (Buffalo, NY) in July 1987 and since then has been used extensively for CW-agent safety monitoring at TWA levels. The other systems were installed at Pine Bluff Arsenal (Pine Bluff, AR) in September 1987 and at the Chemical Research, Development, and Engineering Center (CRDEC) (Aberdeen Proving Ground, MD) in March 1988.

Also, we are currently constructing 15 MINICAMS under government contracts or subcontracts. These units will be installed at the following locations:

1 each, MINICAMS for permeation testing	CRDEC
1 each, MINICAMS with FPD and FID capability for permeation testing	Army Materials Technology Laboratory
2 each, MINICAMS with stack sampling accessories	CRDEC
10 each, MINICAMS for TWA-level monitoring	CRDEC

TABLE 1. STAFF TRIPS INVOLVING WORK INSIDE US ARMY
AND OTHER CW-AGENT EXCLUSION AREAS
FOR MONITORING SUPPORT*

Exclusion Area	Number of trips
Army Materials Technology Laboratory	2
Anniston Army Depot	12
Battelle Columbus	2
Chemical Agent Munitions Disposal System	49
Calspan's Large-Scale Test Facility	1
Chemical Research, Development, and Engineering Center	12
Dugway Proving Ground	6
Geomet	1
Johnston Atoll	4
Midwest Research Institute	12
Medical Research Institute for Chemical Defense	1
Pine Bluff Arsenal	2
Pueblo Depot Activity	1
Rocky Mountain Arsenal	2
Southern Research Institute (20 years combined)	X
TOTAL:	
	107

*Three CMS Research staff have made trips to CW-agent exclusion areas outside the United States in support of CW-agent monitoring.

FACILITIES

CMS Research Corporation is located in the Center for the Advancement of Developing Industries on the campus of the University of Alabama at Birmingham. This modern center includes 36,000 sq. ft. of laboratories, offices, and conference and copy facilities and a professional support staff. CMS Research has office space, a production facility, and engineering and research laboratories, including a government-approved laboratory for working with low levels of toxic chemicals (for example, the U.S. Army's chemical-warfare agents). CMS Research equipment includes several microprocessor development systems, PC-based instrument controllers, a computer aided design system, an automated Hewlett-Packard gas chromatograph, automated monitoring systems, a chemical fume hood, and a chemical carcinogen glove box.

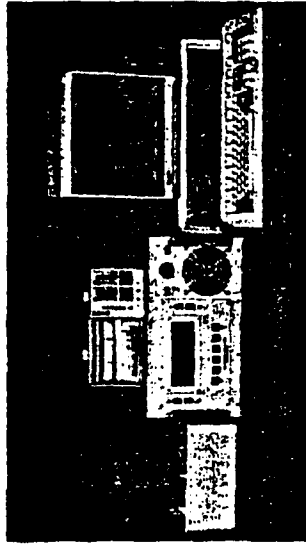
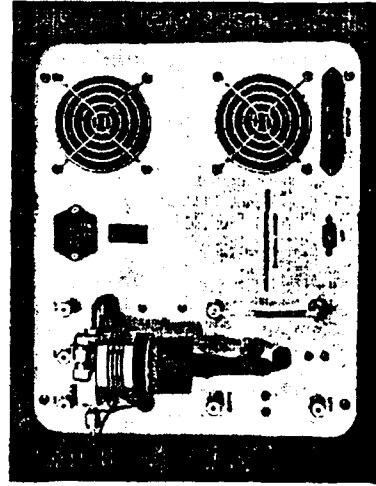

SENIOR STAFF

CMS Research is headed by Gary D. Sides, PhD, a physical chemist with over 16 years of experience in electronics, micro-computers, field service at remote chemical plants, and applied analytical chemistry. His work has included the development of automated monitoring systems based on gas chromatography (ACAMS and MINICAMS) as well as research and development involving permeation test methods, decon evaluation, modeling, and toxic chemicals.

Daniel R. Coleman, PhD, a biochemist with more than 10 years of experience in the detection, synthesis, and decontamination of toxic chemicals, is primarily responsible for business development. In addition, he manages testing and evaluation programs for the sampling and analysis of toxic chemicals. He has directed several research programs involving the application of biotechnology to the detection and decontamination of hazardous materials.

Marion H. Cates, BS, an analytical chemist with more than 13 years of experience, is responsible for research involving automated gas chromatographs for the detection of toxic chemicals. Prior to joining CMS, he worked for 8 years at Honeywell, where he was involved in the development of CW-agent monitors including the M43A1 and an ion mobility spectrometer (ACADA/SCM).



APPLIED RESEARCH

INSTRUMENTATION, TOXIC
CHEMICALS, MONITORING, TESTING,
COMPUTERS, ELECTRONICS

A corporate staff with more than 50 years of combined experience in providing government and industry with innovative solutions to high-technology problems.

1075 South 13th Street, Suite 205
Birmingham, AL 35205 Phone: 205-934-9151

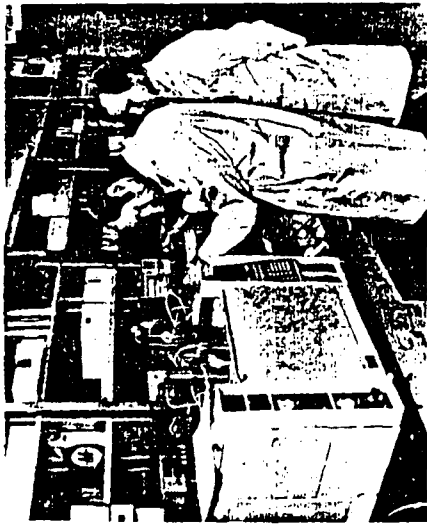

BACKGROUND

CMS Research Corporation is a small business located in Birmingham, Alabama (a labor surplus area). The corporation was founded primarily to pursue the development and production of chemical detection systems. The staff of CMS Research have training and experience in electrical engineering, chemistry, biology, biochemistry, computer science, and mechanical design. The strength of the staff of CMS Research is their ability to provide innovative solutions to high-technology problems in a timely and cost-effective manner. This ability is being exploited by industrial and government clients (including the Department of Defense) on several current research, development, and support projects.



EXPERIENCE

The experience of the staff of CMS Research includes the design and development of automated monitoring systems and accessories, the preparation of technical data packages and manuals, the installation and support of monitoring equipment and tests at remote sites, providing spare parts and supplies, the evaluation of monitoring equipment, and the preparation of training courses for operators and maintenance personnel. This experience also includes a total of about 100 trips to 16 CW-agent exclusion sites during the past 8 years to install or repair monitoring equipment or to support special tests involving monitoring. Thus, the staff of CMS Research are well-qualified to provide the following services:

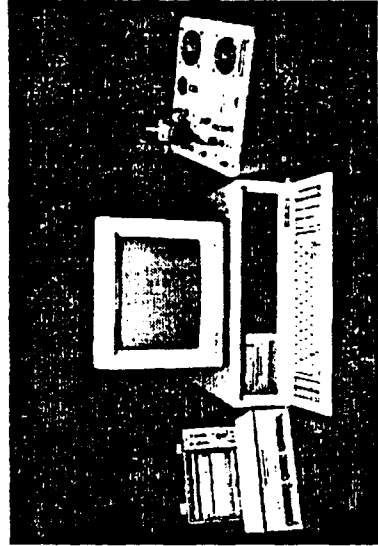

- **Chemical monitoring**
 - low levels of toxic chemicals
 - chemical detection systems
 - stack sampling
- **Product development**
 - process control devices
 - hardware design/fabrication
- **Field support**
 - spare parts and supplies
 - tests and training
 - maintenance
- **Analytical chemistry**
 - methods development
 - gas chromatography
- **Special applications**
 - instrument upgrade kits
 - existing hardware modifications
- **Testing**
 - product evaluation
 - permeation testing equipment
- **Computers**
 - microcomputer programming
 - interfacing to peripherals
 - computer communications
- **Electrical design**
 - custom circuit boards
- **Documentation**
 - training manuals and courses
 - technical data packages

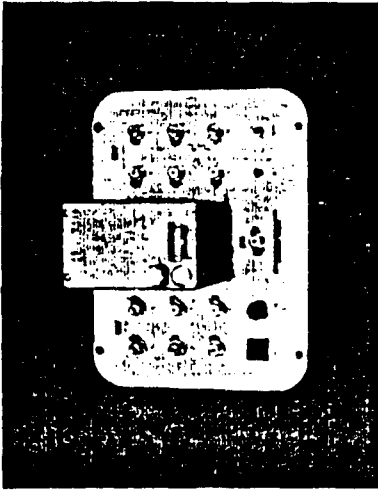

1 each, MINICAMS for HD
monitoring

Battelle Memorial
Institute (USATHAMA)

Further information about these efforts are presented in Section VI.C.

In addition to designing and producing MINICAMS during the past 18 months, the staff that now comprise CMS Research have designed, constructed, and supported ACAMS during the past eight years. Since founding CMS Research, we constructed and installed one ACAMS-based permeation-testing system at CRDEC and one ACAMS to support our internal research and development program. Prior to founding CMS Research, Dr. Gary D. Sides and several of the staff now with CMS Research completed numerous contracts for the Army to develop, construct, and install ACAMS at various government sites. This work was performed at Southern Research Institute (Birmingham, Alabama).

B. Biosketches of Key Staff

CMS Research Corporation is headed by Dr. Gary D. Sides, a physical chemist with extensive experience in electronics, microcomputers, field service at demil plants, and applied analytical chemistry. His work has included 20 trips to Tooele Army Depot (with about 110 days on-site at CAMDS) to test automated gas chromatographs known as ACAMS and to support CAMDS monitoring operations. Dr. Sides guided the development of ACAMS through some very difficult research and development and through tight production schedules. This work included the preparation of a technical data package for a Government procurement as well as the construction and testing of 11 ACAMS of this design under three different contracts. In addition, he guided the research and engineering effort under a recent contract that resulted in the development of an ACAMS-based permeation-testing system.

Dr. Sides' management skills are evident on examination of his record while at Southern Research Institute. He began his supervisory responsibilities at Southern with a staff of three as head of the Physical Chemistry Section. As of June 1986, his group had grown to a staff of nearly 30 people and was known as the Chemical Defense Division. This Division consisted of three Sections whose personnel worked in 39 offices and laboratory units within an area of about 7,000 square feet located in four different buildings. These laboratories included a toxic agent facility for working with chemical surety materiel (CSM), an SEM/X-Ray Laboratory, and instrument-development facilities. During 1985, his division completed about \$2,000,000 in business under about 20 different contracts. Under his direction, the instrument-development group within his division designed, constructed, installed, and supported the operation of about 40

automated gas chromatographs at eight sites in the United States and at one site outside the United States during a seven-year period.

Dr. Sides' success at Southern Research can be attributed to his persistence and determination to deliver quality research, products, and field support to his sponsors on schedule and within budget. While at Southern Research, he was responsible for not only about \$4,000,000 dollars in ACAMS research, production, and development but also for about \$3,000,000 in research and services involving permeation testing, modeling, hardware development, decontamination studies, and protective clothing evaluation. In addition, he contributed strongly to the success of about \$3,000,000 worth of research and development involving interdisciplinary efforts.

Dr. Sides' ability to manage complex work assignments and his schedule is reflected in the fact that he was a principal investigator or otherwise played a very strong role in the success of about 70 Government contracts for about 25 different organizations during his career at Southern (and he has supervised the work completed under 25 contracts and subcontracts during the first 18 months of operation at CMS Research). The technical staff supervised by Dr. Sides at Southern Research included three Section Heads (two of whom were PhDs), three other PhDs, and other technical staff including three secretaries, technicians, and staff with B.S. and M.S. degrees. The staff that worked together in his group included electrical engineers, computer scientists, analytical chemists, physical chemists, and an organic chemist. Dr. Sides has demonstrated extremely effective project management skills during the past few years, and he is determined to use those skills to ensure that CMS Research Corporation successfully completes the work described in this proposal.

Dr. Daniel R. Coleman, Director of Operations, joined CMS Research in 1987. He is responsible for the administrative direction all projects at CMS Research. He meets frequently with the technical staff to develop schedules and assist in allocating resources so that projects are completed on schedule and within budget.

Prior to joining CMS Research, Dr. Coleman served as head of the Biotechnology Division at Southern Research Institute. His work included conducting numerous chemical-defense contracts involving the development of decontamination formulations and processes, protective clothing, non-instrumental detection methods, and microencapsulation.

The staff of CMS Research are assisted in their administrative duties by Ms. Janet H. Farris, administrative assistant and secretary. Her duties include arranging travel, preparing cost

reports, accounts payable, and maintaining corporate files. She is also responsible for typing some of the documents prepared by the corporation.

Prior to joining CMS Research Corporation, Ms. Farris was the Senior Secretary in the Chemical Defense Division at Southern Research Institute. She was responsible for assisting the division head with the administrative functions for the division. Her varied responsibilities included composition of general correspondence, scheduling of reports and proposals to meet deadlines and ensuring their proper distribution, assisting in typing of technical documents, processing and expediting purchase orders for division personnel, maintaining division records, making travel reservations, and communicating with sponsors concerning the status of division projects. She also helped maintain the division database filing system.

Previously, Ms. Farris was employed as Office Coordinator for the Birmingham office of Quality Care Nursing Service and as a secretary in the Environmental Engineering Department, as a receptionist, and in the personnel and safety office at Southern Research Institute. She has experience in light bookkeeping, handling personnel files, insurance claims, and accident reports.

Ms. Carolyn U. Phillips, Director of Administration, is responsible for the negotiation and administration of all contracts as well as managing our accounting system, preparing invoices, and assisting in short- and long-range business planning.

Prior to joining CMS Research in 1988, Ms. Phillips served as the Senior Contracting Officer with Southern Research Institute where she directed a staff of eight involved with the preparation of cost proposals and the administration of contracts with the government, industry, and foundations.

Ms. Phillips received a B.S. degree with honors from the University of Alabama at Birmingham in 1977 and served as cost accountant with Vulcan Materials Company for two years.

Mr. Marion H. Cates, a senior scientist at CMS Research, is currently responsible for research involving automated gas chromatographs for the detection of CW agents at TWA levels. During the past two years, he has been responsible for the technical effort on a contract that has resulted in significant improvements in ACAMS and MINICAMS technology.

Prior to joining CMS, Mr. Cates worked for eight years at Honeywell, Inc., where he was involved in the development of CW-agent monitors including the M43A1 (M8A1) and an ion mobility spectrometer (ACADA/SCM). This experience included helping to set up production lines and quality assurance programs for the

M43A1 and the IDS. This experience was quite valuable because it involved moving detection technology from research and development into production. Mr. Cates has extensive experience in technical areas relative to the production and testing of monitoring systems. For example, he has approximately 12 months of experience working hands-on with chemical surety materiel at Midwest Research Institute, CRDEC, Battelle, and Geomet. He also supervised a laboratory at Stauffer Chemical for four years that was engaged in the analysis of organosulfur and organophosphorus fungicides, insecticides, and pesticides using gas chromatography and other analytical methods. Mr. Cates has a B.S. in chemistry.

Mr. Thomas G. Thomas has supervised work on contracts involving the construction of about 20 automated gas chromatographs (ACAMS) as well as research and development and field support during the past two years. He is the one individual within the CMS organization who has the most experience with the computer hardware, electronics, and analytical chemistry on which ACAMS and MINICAMS are based. Prior to joining CMS Research Corporation, Mr. Thomas was an assistant engineer for Southern Research Institute in Birmingham, Alabama. While at Southern Research, he was responsible for the supervision of an electrical engineer and two electronics technicians in the design and construction of automated gas chromatographs. In addition, he provided technical support for a wide range of contract research projects that included the construction and maintenance of permeation testing equipment, the design of control systems for the automated determination of grain volatiles, and the design of data-acquisition hardware. Mr. Thomas has a B.S. in chemistry and received a M.S. in electrical engineering in 1987.

Mr. J. Todd Brown has about eight years of experience with ACAMS and MINICAMS technology and is Manager of Computer Support at CMS Research. He has been responsible for the extensive development effort resulting in a user-friendly, yet powerful software package that controls the operation of MINICAMS. Mr. Brown was responsible for the development of all of the computer software for the TDP ACAMS under Contract DAAK11-84-C-0024. He has two years of experience in the use of Future Data microprocessor development systems to create and debug code for embedded microcomputers. (CMS owns three Future Data microcomputers of the same model used by Mr. Brown during the past two years.) Prior to joining CMS Research Corporation, Mr. Brown conducted contract research for ten years at Southern Research Institute, where he was involved not only with automated gas chromatographs but also with research on chemical decontamination, stack sampling in power plants, stack- or flue-gas conditioning agents, scanning electron microscopy (SEM), and the development of database, statistical-evaluation, and graphics software for personal computers and mainframe systems. Mr. Brown has a B.S. in chemistry and received a M.S. in computer and information science from the University of Alabama at Birmingham in 1987.

Mr. Raymond L. Hara has about two years of experience in the design, construction, and testing of automated gas chromatographs. His current responsibilities include the fabrication of custom mechanical and electronic components for MINICAMS and other products. His work has included making the detailed assembly notes and drawings that were used to prepare the technical data package for ACAMS under Contract DAAK11-85-C-0024. He also did much of the design work for the front panel of the ACAMS. In addition, he assisted in the assembly of ACAMS, High Volume Samplers, and Stack Sampling Apparatuses for the Chemical Decontamination Training Facility. Mr. Hara is especially experienced in digital electronics and computer-based simulations. He has also worked in aviation-related areas such as airframe and power-plant mechanics, avionics, and the design and construction of emergency-release systems. Mr. Hara has a B.S. in electrical engineering.

C. Contract Experience of the Staff While at CMS Research

During the past six years, the staff that now comprise CMS Research Corporation has been involved in about 72 contracts and subcontracts involving automated CW-agent monitoring systems that total about 6 million dollars. In addition, such technology has played a key role in about 32 other contracts that total more than 2.5 million dollars. Dr. Sides has served as the principal investigator or otherwise played a very strong role in all of these projects and has been very active in the application of automated gas chromatographs to research programs not directly related to monitoring. Brief summaries of monitoring projects completed or in progress during the past 24 months are presented below.

CONSULTING SUPPORT TO SOUTHERN RESEARCH INSTITUTE
Southern Research Institute
Consulting Agreement, 1986 (CMS Project 100)

Under this consulting agreement, Dr. Sides supervised the completion and demonstration of the TDP ACAMS under Contract DAAK11-85-C-0024 and the completion of 10 other ACAMS built according to the TDP under two other contracts (DAAA09-85-C-1329 and DAAA15-85-C-0067). He also worked with Mr. Hara to complete the technical data package.

TECHNICAL SUPPORT FOR THE OPERATION OF ACAMS
AT PUEBLO DEPOT ACTIVITY
Southern Research Institute (Tooele Army Depot)
Contract DAAC89-86-C-0023 (CMS Project 110)

CMS staff provided technical support for the installation and testing of two ACAMS at the Drill and Transfer System (DATS)

located at the Pueblo Depot Activity, Colorado. We used one ACAMS to sample the glove box and one to sample the stack during HD operations. We also trained Pueblo and Pine Bluff personnel in the operation and routine maintenance of ACAMS.

**MAINTENANCE AND REPAIR OF SIX ACAMS AND SIX
HIGH VOLUME SAMPLERS**

Southern Research Institute (Tooele Army Depot)
Contract DAAC89-86-C-0023 (CMS Project 111)

Under this subcontract, the CMS staff provided technical-support services at CAMDS. This work involved troubleshooting and repair of six ACAMS and the installation of six High Volume Samplers. Acceptance testing of the six ACAMS in the VX-TWA mode was also completed. Two different generations of ACAMS were serviced in this work.

**CONSTRUCTION OF 17 HIGH VOLUME SAMPLERS AND
6 STACK SAMPLING APPARATUSES**

Southern Research Institute (Tooele Army Depot)
DAAA09-86-C-0805 (CMS Project 120)

Under this subcontract, CMS Research constructed 17 High Volume Samplers and 6 Stack Sampling Apparatuses. The HVS units are more complex than those associated with the TDP ACAMS. They contain an electronics circuit board that controls the PCT heater, whereas the HVS included in the TDP has no circuit board. It is controlled entirely by the TDP ACAMS. The SSA units built were of the same design as those in the TDP.

**SUPPORT FOR THE OPERATION OF ACAMS AT CALSPAN'S
LARGE-SCALE TEST FACILITY**

GA Technologies, Inc. (USATHAMA)
Contract DAAK11-84-C-0028 (CMS Project 130)

Under this contract, the CMS staff refurbished a second-generation ACAMS provided by the Government. We then conducted challenges of the instrument that demonstrated its ability to determine quantities of the simulant DMMP (dimethyl methylphosphonate) over the range of 0.05 to 300 ng without readjustment. The ACAMS was then installed at Calspan's large-scale test facility where it was shown to perform equally as well using GB and HD.

CONSTRUCTION OF A PERMEATION TESTING SYSTEM
Battelle, Research Triangle Park Office (CRDEC)
Contract DAAG29-81-D-0100 (CMS Project 140)

Under this contract, we constructed an automated permeation-testing system for use by CRDEC in the evaluation of chemical-protective clothing. This work involved the construction of a TDP ACAMS and the design and construction of a stream-selection system that is a slave to the ACAMS. We installed the ACAMS and its associated stream-selection system and PC-compatible software at CRDEC during February 1987.

NEW CONCEPTS IN CHEMICAL AGENT MONITORING
US Army Toxic and Hazardous Materials Agency
Contract DAAA15-86-C-0108 (CMS Project 150)

Under this contract, we are conducting research to improve the chromatographic performance of ACAMS and to shorten its cycle of operation. We used a Hewlett-Packard gas chromatograph modified to function as an automated sampling-and-analytical system to test concepts generated under Phase I of this contract. During Phase II, we are modifying an ACAMS to incorporate the concepts demonstrated during Phase I.

PROVIDING SPARE PARTS AND SUPPLIES FOR ACAMS
Anniston Army Depot
Purchase Orders DAAC01-87-M-0056, -0318, and -0725
(CMS Projects 160, 170, and 200)

Under these purchase orders, we provided a variety of off-the-shelf and custom spare parts and supplies for automated gas chromatographs (ACAMS) located at Anniston Army Depot, Anniston, Alabama. The work conducted under these purchase orders included the procurement of parts, the modification of off-the-shelf parts, and quality-control tests. These parts and supplies were then shipped to Anniston to support the operation of ACAMS.

SUPPORT FOR THE OPERATION OF ACAMS
Anniston Army Depot
Purchase Order DAAC01-87-M-0363 (CMS Project 180)

Under this purchase order, we are providing field support for the operation of three ACAMS used to monitor during HD munitions download operations at Anniston Army Depot. We assisted in the installation and initial operation of this monitoring equipment and are providing maintenance support on an as-needed basis.

STACK MONITORING AT THE CHEMICAL AGENT MUNITIONS DISPOSAL SYSTEM (CAMDS), TOOELE ARMY DEPOT, UTAH
Southern Research Institute (Tooele Army Depot)
Contract DAAC89-86-C-0023 (CMS Project 190)

We recently supported tests of the sampling of VX in incinerator stack gas at CAMDS, Tooele Army Depot, Utah. This work included the preventive maintenance and repair of two automated gas chromatographs at CAMDS, the training of CAMDS personnel, and the preparation of a report that included recommended standard operating procedures for stack sampling at concentrations equal to three times the TWA level.

SUPPORT FOR THE CONSTRUCTION, TESTING, AND INSTALLATION OF 95 ACAMS FOR CAMDS AND JACADS
Combustion Engineering (USATHAMA)
Purchase Order 009123 (CMS Project 210)

Under this subcontract, we assisted Combustion Engineering in the construction, testing, and installation of 95 ACAMS at the Chemical Agent Munitions Disposal System (CAMDS), Tooele Army Depot, Utah, and at the Johnston Atoll Chemical Agent Disposal System (JACADS) in the Pacific Ocean. Our tasks also included the preparation of formal operators and maintenance training courses for technical personnel who will use the ACAMS.

CONSTRUCTION, TESTING, AND INSTALLATION OF A MINICAMS
Calspan Corporation
Purchase Order 86102 (CMS Project 230)

Under this purchase order, we constructed one MINICAMS for Calspan Corporation. This monitor represents the state-of-the-art in ACAMS technology. The monitor is based on advances made during research conducted under Contract DAAA15-86-C-0108 with USATHAMA and on recent internal research and development work at CMS Research.

A TRAINING COURSE FOR OPERATORS AND MAINTENANCE PERSONNEL
Tooele Army Depot
Purchase Order C3-7078-8273 (CMS Project 240)

This work involved the development and presentation of an introductory course on the latest ACAMS technology to key staff at the Chemical Agent Munitions Disposal System (CAMDS), Tooele Army Depot, Utah. The course included lectures, prepared handouts, and "laboratory" demonstrations. The course was presented on-site at CAMDS.

SPARE PARTS AND SUPPLIES FOR ACAMS

Dugway Proving Ground

Purchase Order DAAD09-87-M-0931 (CMS Project 250)

Under this purchase order, we provided modified off-the-shelf components as well as custom spare parts and supplies to support the operation of three ACAMS at Dugway Proving Ground, Utah.

MAINTENANCE AND REPAIR OF ACAMS

Dugway Proving Ground

Purchase Order DAAD09-87-M-1004 (CMS Project 260)

This work involved on-site repair and preventive maintenance for three ACAMS. Some spare parts and supplies were also provided under this purchase order.

MAINTENANCE OF MONITORING EQUIPMENT

Dugway Proving Ground

Purchase Order DAAD09-87-M-1205 (CMS Project 270)

This purchase order required two maintenance and repair visits to Dugway Proving Ground to support the operation of two ACAMS.

CONSTRUCTION OF A MINIATURE AUTOMATIC CONTINUOUS AIR MONITORING SYSTEM (MINICAMS)

Pine Bluff Arsenal

Contract DACA03-87-C-0028 (CMS Project 280)

We recently installed a MINICAMS at Pine Bluff Arsenal. The MINICAMS is considerably smaller and less expensive than the conventional ACAMS. It also has more features and is suitable for a wider range of applications.

MAINTENANCE AND REPAIR OF MONITORING EQUIPMENT

Chemical Research, Development and Engineering Center

Contract DAAD05-87-M-P039 (CMS Project 290)

Under this contract, we provided maintenance and repair support for one ACAMS in the CW-agent exclusion area at CRDEC.

SOLID SORBENT TUBES FOR USE IN ACAMS
National Institute for Occupational Safety
and Health
Purchase Order 87-12205 (CMS Project 310)

Under this purchase order, we constructed preconcentrator tubes containing solid sorbents for use in ACAMS and in High Volume Samplers.

ACAMS SPARE PARTS AND SUPPLIES
Chemical Research, Development and Engineering Center
Purchase Orders DAAC89-87-M-4058, DAAD05-87-M-7345,
and DAAD05-87-M-7337 (CMS Projects 330, 340 and 350)

Under these purchase orders, CMS Research supplied CRDEC with spare parts and supplies for ACAMS. These parts included custom components as well as off-the-shelf items modified by CMS.

SOFTWARE SUPPORT FOR THE AUTOMATIC CONTINUOUS AIR
MONITORING SYSTEM
Stearns-Roger Division
Contract 7046 8327999 (CMS Project 360)

Under this subcontract, we modified the ACAMS assembly language software package to eliminate bugs that have been discovered and to improve the operation of ACAMS by adding capabilities. Two sets of PROMs containing the new software were installed in two ACAMS at CAMDS for field testing. We then provided 95 sets of firmware for upgrading ACAMS at JACADS and CAMDS.

TRAINING FOR ACAMS OPERATORS AND MAINTENANCE PERSONNEL
CAMDS, Tooele Army Depot
Purchase Order C3-7223-8271 (CMS Project 370)

Under this purchase order, we prepared a training course for ACAMS operators and a training course for maintenance personnel. These courses were presented to about 30 technical staff at CAMDS.

CONSTRUCTION OF A MINIATURE AUTOMATIC CONTINUOUS AIR
MONITORING SYSTEM (MINICAMS)
Chemical Research, Development and Engineering Center
Purchase Order DAAD05-87-M-F530 (CMS Project 380)

Under this contract, we constructed a miniature automatic continuous air monitoring system (MINICAMS) for CRDEC. This equipment is used to monitor for TWA levels of HD, GB and VX and

to monitor vapor concentrations of agents in experimental apparatuses.

TECHNICAL SUPPORT FOR CHEMICAL AGENT MONITORING
AND ANALYSIS

Jacobs Engineering Group, Inc.
Subcontract 01-A001-S-87-0006
Delivery Order 0017 (CMS Project 390)

We conducted DAAMS tests for HD at CAMDS. These tests consisted of precision-and-accuracy studies to certify DAAMS for use at CAMDS. We also prepared test plans for evaluating bubbler methods at JACADS.

FABRICATION OF V-TO-G CONVERSION FILTERS FOR ACAMS

Dugway Proving Ground
Purchase Order DAAD09-88-M-0453 (CMS Project 410)

We constructed 1000 V-to-G conversion filters for use with ACAMS at Dugway Proving Ground.

CONSTRUCTION OF TWO HIGH VOLUME SAMPLERS

Dugway Proving Ground
Purchase Order DAAD09-88-M-0710 (CMS Project 420)

We fabricated two High Volume Samplers (HVS) for use with conventional ACAMS at Dugway Proving Ground.

DESIGN AND CONSTRUCTION OF A MINICAMS-BASED
PERMEATION TESTING SYSTEM

SRI International (Chemical Research, Development and
Engineering Center)
Purchase Order C 11976 (CMS Project 430)

We are currently designing a permeation-testing system based on MINICAMS technology for use during tests of fabrics with HD, GB, GD and VX. This system will include extensive software revisions to enable the storage of permeation data on disk and to print test data on a dot-matrix printer. The system will consist of a MINICAMS and a 24-port stream-selection system that is controlled by the MINICAMS.

CONSTRUCTION OF PRECONCENTRATOR TUBES FOR
HIGH VOLUME SAMPLERS

Tooele Army Depot

Purchase Order DAAC89-88-M-1750 (CMS Project 440)

This project involved the construction of 200 preconcentrator tubes (Chromosorb 106) for use with High Volume Samplers at the Chemical Agent Munitions Disposal System (CAMDS), Tooele Army Depot, Utah.

DESIGN AND CONSTRUCTION OF AN ACCESSORY TO ENABLE
ACAMS TO SAMPLE AGENT AT CONCENTRATIONS UP TO 100 mg/m³
Stearns-Roger Division (PEO-PM for Chemical Demil)
Subcontract 7046 8327999 (CMS Project 450)

Under this contract, we are modifying ACAMS software and hardware to extend the range of concentration that can be monitored. This work will also involve the design, construction, and testing of an accessory containing a sample loop with a known volume that will be used in place of the High Volume Sampler.

STREAM-SELECTION SYSTEM

US Army Materials Technology Laboratory

Contract DAAL04-88-M-0571 (CMS Project 460)

We are constructing a 12-port stream-selection system that will be controlled by the MINICAMS. The stream-selection system will allow sequential sampling from up to 12 individual compartments of a permeation test cell.

ON-CALL SUPPORT FOR ACAMS

Anniston Army Depot

Purchase Order DAAC01-88-M-2139 (CMS Project 470)

Under this contract, we provided on-call support for maintenance and repair of three ACAMS.

ACAMS TRAINING

Anniston Army Depot

Purchase Order May 23, 1988 (CMS Project 480)

We provided two weeks of on-site training in the operation and maintenance of ACAMS.

GLASS PCT HEATERS FOR ACAMS

Anniston Army Depot

Contract DAAC01-88-M-2620 (CMS Project 490)

We provided 6 glass preconcentrator tube heaters for ACAMS. These heaters are of a new low-mass design.

REPAIR OF ACAMS

Dugway Proving Ground

Contract DAAD09-88-M-1626 (CMS Project 500)

We provided extensive rebuilding and repair of three ACAMS.

ACAMS HIGH VOLUME SAMPLER TUBES

Tooele Army Depot

Contract DAAC89-88-M-2902 (CMS Project 510)

We constructed and supplied 200 each 6-mm-OD Chromosorb 106 high volume sampler tubes for use with ACAMS.

ON-SITE TESTING SUPPORT

General Atomics

Subcontract SC 104091 (CMS Project 520)

Under this contract, we provided two weeks of on-site testing to support the evaluation of the non-aqueous equipment decontamination system (NAEDS). We performed approximately 500 analyses of simulants for agents GB and HD using MINICAMS.

AUTOMATIC CHEMICAL-AGENT MONITORING SYSTEM

US Army Materials Technology Laboratory

Contract DAAL04-88-M-0687 (CMS Project 530)

Under this contract we are constructing a MINICAMS that will be used to support permeation-testing of protective clothing. The MINICAMS has both FPD and FID capability.

MINICAMS REPAIR

Pine Bluff Arsenal

Purchase Order DAAA03-88-M-2635 (CMS Project 540)

Under this purchase order, a MINICAMS was shipped to CMS Research. The monitor is being serviced, minor upgrades are being completed, and HD and GB challenges are being made.

MINIATURE ACAMS

Chemical Research, Development, and Engineering Center
Contract DAAD05-88-C-4150 (CMS Project 550)

Under this contract we are constructing and installing 12 MINICAMS. Two of these systems are supplied with stack-sampling apparatuses to enable reliable monitoring of an incinerator stack for both sulfur and phosphorus-containing agents. We are also providing spare parts, quarterly maintenance visits, and operator training.

ACAMS PRECONCENTRATOR TUBES

Tooele Army Depot
Purchase Order DAAC89-88-M-3053 (CMS Project 560)

We supplied 200 each 3-mm-OD Chromosorb 106 preconcentrator tubes for ACAMS.

ACAMS PRECONCENTRATOR TUBES

Dugway Proving Ground
Purchase Order DAAD09-88-M-1835 (CMS Project 570)

We supplied 100 each 3-mm-OD Chromosorb 106 and Tenax-GC preconcentrator tubes for ACAMS.

ON-CALL SUPPORT FOR ACAMS

Anniston Army Depot
Purchase Order DAAC01-88-P-5175 (CMS Project 580)

Under this contract, we are providing on-call support for maintenance and repair of three ACAMS.

SAMPLE-LOOP SELECTION SYSTEMS

Lockheed Engineering & Sciences Company
Subcontract D8377 (CMS Project 590)

Under this subcontract, we are designing, constructing, and installing eight sample-loop selection systems which will enable ACAMS to determine high levels of agent GB. This capability is needed to perform a full-scale evaluation of charcoal filter banks.

MINICAMS AND ACCESSORIES
Battelle Memorial Institute
Purchase Order R5594 (CMS Project 600)

We are constructing a MINICAMS and accessories to support hot-air decontamination studies to be conducted at Rocky Mountain Arsenal.

D. General Experience

It should be noted that the staff of CMS Research have been involved in the development of automated monitoring systems for CW agents at ASC, IDLH, and TWA concentrations for the past eight years. This work has included:

- o Developing analytical methods based on gas chromatography for the determination of the Surgeon General's TWA levels of the CW agents GD, GB, VX, and HD.
- o Designing automated gas chromatographs (ACAMS and MINICAMS) for use by relatively unskilled technical personnel at remote Army sites.
- o Constructing vapor generators for TWA levels of HD and GB to test the operation of monitoring equipment.
- o Participating actively in tests of the operation of monitoring equipment at several remote sites in the United States and at one site in Europe.
- o Preparing manuals and technical data packages for CW-agent monitoring systems.
- o Preparing and presenting training courses for operators and maintenance personnel.
- o Operating monitoring systems routinely for the detection of CW agents at concentration ranges over three orders of magnitude.

This general experience is certainly relevant to the design, production, and field testing of automated monitoring systems.

VII. FACILITIES AND EQUIPMENT

CMS Research Corporation is located in Birmingham, Alabama. We have all of the facilities and equipment needed to conduct the work involving automated monitoring systems for CW agents and simulants.

A. XCSM Laboratory

CMS Research recently established a laboratory for working with exempt chemical surety materiel (XCSM). This laboratory is required for testing a monitoring system being developed under Contract DAAA15-86-C-0108 with the Office of the Program Executive Officer-Program Manager for Chemical Demilitarization. The laboratory passed a preoperational inspection by safety and security personnel of the Chemical Research, Development and Engineering Center, (CRDEC). We received a shipment of dilute solutions of CW agents on June 4, 1987.

The XCSM Laboratory allows us to work with dilute solutions of the agents HD, GB and VX. Dilute solutions of these agents are sufficient to test the operation of monitoring systems. The laboratory includes a glove box with a charcoal filter on its exhaust and a chemical fume hood. All of the safety supplies necessary to work with CW agents are included in the laboratory.

All of the staff who work in the XCSM Laboratory are fully qualified in a formal Chemical Personnel Reliability Program (CPRP). This includes the analysis of blood samples by the Fitzsimons Army Medical Center to establish baseline cholinesterase levels.

B. Other Facilities

CMS Research has engineering facilities and equipment for the construction and testing of custom instrument systems. This equipment includes oscilloscopes, digital design consoles, power supplies, voltmeters, computer-based instrument-control systems, linear mass flowmeters, and simple tools for model preparation. We work with subcontractors as necessary for the fabrication of custom complex mechanical parts and circuit boards.

The facilities of CMS Research include laboratory space dedicated to the development, production, and testing of automated monitoring systems. Most of our work to date has involved the design and construction of instruments for the determination of CW agents at the Surgeon General's TWA concentrations and higher concentrations. Conference facilities and equipment for the reproduction of reports and other documentation are also available to the staff of CMS Research.

C. Research Equipment

CMS has the equipment needed to perform research in the development of chemical monitoring systems and to construct prototype systems. This equipment includes a Hewlett-Packard Model 5890 gas chromatograph equipped with a flame-ionization detector (FID), nitrogen-phosphorus detector (NPD), flame-

photometric detector (FPD), electronic flow sensors, an on-column capillary injection port, and a split-splitless capillary injection port. We recently interfaced this gas chromatograph to a personal computer for the control of breadboard systems mounted on the gas chromatograph. That is, the computer allows the chromatograph to be configured as an automated monitoring system so that new concepts can be evaluated easily.

CMS Research Corporation owns three Future Data Model 2300 microprocessor development systems. Each of these systems include 64 K of static RAM, a Z80 central processor unit (CPU), a Z80 emulator, a logic analyzer, a symbolic debugger, a dual disk drive, and parallel and serial I/O ports. A Future Data microprocessor development system has been used for all of the ACAMS (automated GC) software development during the past two years. We also have a Data I/O Series 22 PROM programmer for copying or downloading EPROMs and EEPROMs.

D. Other Equipment

The word processing and accounting needs of CMS are currently being met by a personal-computer based systems with Word Perfect word-processing software and with an SBT accounting package. This package includes general ledger, accounts payable, payroll, purchase order, and job costing modules. This system also includes a Toshiba P351 24-pin dot-matrix printer and a Hewlett-Packard Laserjet Series II printer.

Facsimile messages can be transmitted and received with a Sharp Model F-620 Fax Machine which is a fully automated Class 3 telecopier. Multiple copies of documents are made using the word processor or a high-quality copier. We prepare graphics using AutoCad running on a microcomputer with an XY plotter (Hewlett-Packard). Graphics capabilities beyond those of the staff of CMS Research are provided by local printing shops.

The staff of CMS Research Corporation also have seven IBM-compatible PC computers, each with an MS/DOS operating system, word processing, BASIC, 640 K memory, a floppy disk drive, a hard disk drive, and a dot-matrix printer. AutoCad software is available for generating graphics for documents and for generating mechanical drawings to document the design of hardware. Other software available includes RBASE 5000, FoxBase Plus, Lotus 1-2-3, Lotus Freelance, Turbo Pascal, and Microsoft C.

E. Facility Clearance

CMS Research was granted a facility clearance of SECRET in 1987 by the Defense Industrial Security Clearance Office, Columbus, Ohio. Most of the staff of CMS have SECRET security clearances as well. We are currently working on a contract with a security classification of CONFIDENTIAL.

APPENDIX

ARMY REGULATIONS REFERRING TO CW-AGENT MONITORING

APPENDIX F

SMCRM-TOE-3, BUBBLER PREPARATION

1. ROCKY MOUNTAIN ARSENAL
STANDING OPERATING PROCEDURE FOR:

2. ITEM: _____

3.a. OPERATION: Bubbler Preparation
 b. ESTIMATED DAILY PRODUCTION RATE: _____

4. ARSENAL ORGANIZATIONAL SYMBOL: SMCRM-TOE-A

5. SOP NO.: SMCRM-TOE-3 DATE: 27 Mar 79
 a. REV NO.: 2 DATE: 10 Jan 85
 b. CHANGE NO.: N/A DATE: N/A

6. AUTHORITY: N/A DATE: N/A

7. PREPARED BY: *Ernest F. Deines*
 ERNEST F. DEINES TITLE: Supervisory Physical Scientist
 TELEPHONE: 289-0198

8. REVIEWED BY: *H. Wicker* TITLE: Supervisory Chemist
 KIRVIEW W. WICKER

REVIEWED BY: *Elijah G. Jones* TITLE: Chief, Analytical Systems Branch
 ELIJAH G. JONES

9. SUBMITTED BY: *Elijah G. Jones* TITLE: Chief, Analytical Systems Branch
 ELIJAH G. JONES

10. CONCURRENCES:

<u>OFFICE</u>	<u>SIGNATURE</u>	<u>TITLE</u>
_____	_____	_____
_____	_____	_____
_____	_____	_____
<u>SMCRM-ISF</u>	<u><i>Tamara Rayburn</i></u>	<u>Environmental Coordinator</u>
<u>SMCRM-SR</u>	<u><i>Tamara Rayburn</i></u>	<u>Surety Officer</u>
<u>SMCRM-SF</u>	<u><i>Anna J. Harris</i></u>	<u>Safety Manager</u>

11. APPROVAL:

SMCRM-DC

Kristie L. Shady

CPT. OD. Dep Cmdr

12. QUARTERLY REVIEW:

13. SEMIANNUAL REVIEW:

14. BIENNIAL REVIEW:

SUPERVISOR'S STATEMENT

SOP NO: SMCRM-TOE-3 REV. NO: 2 CHANGE NO: N/A DATE: 2 Jan 85

OPERATION NO: _____

I have personally reviewed each of the operational steps of this SOP and have no question in my mind that the operation can be performed safely and efficiently. I have trained my operators in the details of their part of the operation and instructed them to follow the SOP without deviation.

SUPERVISOR/FOREMAN

DATE

BADGE NO

Amelia

15 Jan 1985

2133

X W. Welch

15 Jan 85

2379

SOP NO: SMURM-10E-3
REV NO: 1
REV NO: 2
CHANE NO: N/A

DATE: 27 April 1981
DATE: 2 Jan 1985
DATE:

INDEX FOR BUBBLER PREPARATION

	<u>Paragraph</u>
Purpose -----	1
Scope -----	2
Responsibilities -----	3
Plastic Bubblers -----	4
Glass Bubblers -----	5
Reference Table -----	Annex A

1. Purpose. The purpose of this SOP is to provide procedures for checking and filling of bubblers.

2. Scope. This SOP applies to all personnel assigned to the bubbler preparation.

3. Responsibilities. The bubbler preparation team is responsible for the correct checking, filling, marking and labeling of bubblers.

4. Plastic Bubblers.

4.1. Inspection:

4.1.1. Inspect each bubbler for obvious breaks around all seams, bottom, inlet and outlet sections, etc.

4.1.2. Check inlet and outlet flanges for burrs.

4.1.2.1. If any burrs are detected, scrape or sand them smooth.

4.1.2.2. Inspect seams for faults after deburring.

4.1.3. Leak test bubblers for unseen faults.

4.1.3.1. Check vacuum pump and lines for leaks.

4.1.3.1.1. Hook vacuum pump to rotometer with no bubbler; turn on pump then plug up end of vacuum line; rotometer ball should fall to zero.

4.1.3.1.2. If #1 above failed; fix and repeat.

4.1.3.2. Put bubbler in line and seal bubbler inlet flange; roto ball should fall to zero.

4.1.3.3. Bubbler can now be filled or placed in acceptable box. Bubblers that fail should be saved for return to manufacturer for credit.

REV NO: 1
REV NO: 2
CHANE NO: N/A

DATE: 27 April 1981
DATE: 2 Jan 1985
DATE:

4.2 Filling:

4.2.1. Check with lead chemist to see which test(s) will be run.

4.2.2. Fill bubbler with solutions listed below, mark a ring around spout and liquid level.

4.2.2.1. CN, Chloroacetophenone add 10 mls of propylene glycol with a red colored ring.

4.2.2.2. PS, Chloropicrin add 10 mls of hexylene glycol with a blue colored ring.

4.2.2.3. CK, Cyanogen chloride add 10 mls of *Reagent B with a black colored ring.

*Reagent B. Transfer 2.5 grams of 3-methyl-1-phenyl-2-pyrazolin-5-one (pyrazolone, Highest purity; melting point 127-128°C) into a 250 ml volumetric flask. Then add 50-ml of pyridine (99.9 percent minimum) and 25-ml of 3:1 volume ethyl alcohol: acetic acid. Dilute to the 250 ml mark with ethyl alcohol. Stopper the flask and shake to insure good mixing.

4.2.3. Fill out agent blocks on all 4-part label with agent identifier code.

4.2.4. Place control label in ziplock bag on bubbler.

4.2.5. Place bubbler into properly marked containers (CK is iced down and only good for 24 hours).

5. Glass Bubblers.

5.1. Inspections:

5.1.1. Look for any hairline cracks in bubblers.

5.1.2. Check to see if tube inside is intact.

5.1.3. Check to see that no bead is in inlet tube.

5.2. Cleaning:

5.2.1. For As:

5.2.1.1. Rinse with deionized water.

5.2.1.2. Fill with 5% HNO₃.

5.2.1.3. Let stand for 5 minutes.

SOV NO: SMOEM-100-3

DATE: 27 March 1981

REV NO: 1

DATE: 27 April 1981

REV NO: 2

DATE: 2 Jan 1985

CHANE NO: N/A

DATE:

5.2.1.4. Pour HNO_3 into container.

5.2.1.5. Rinse with deionized H_2O .

5.2.1.6. Dry completely.

5.2.2. For GB (high readings):

5.2.2.1. Add small amount of acetone.

5.2.2.2. Dump out contents; add solution of microcleaner.

5.2.2.3. Rinse several times with deionized H_2O .

5.2.2.4. Dry completely.

5.2.3. For GB bubblers not strong in GB:

5.2.3.1. Dump out contents.

5.2.3.2. Rinse several times with H_2O (deionized).

5.2.3.3. Dry completely.

5.3. Filling:

5.3.1. Check with Bldg lead chemist to see which test(s) will be run.

5.3.2. Fill bubblers with amount of solution stated below and ring top neck and solution level with appropriate tape:

5.3.2.1. As, Arsenic, add 10 mls of 2% NaOH with a white colored tape.

5.3.2.2. GB, Sarin, add 15 mls of 4.5 pH H_2SO_4 with a green colored tape.

5.3.2.3. H, Mustard, add 10 mls of diethylphthalate with a brown tape.

5.3.2.4. L, Lewisite, add 10 mls of 2% HCl with yellow tape.

5.3.3. Fill out agent blocks on all 4-part label with agent identification code.

5.3.4. Place control label in the lock on bubbler.

5.3.5. Place the bubbler into properly marked container.

REV NO: 1
REV NO: 2
CHANE NO: N/A

DATE: 27 April 1981
DATE: 2 Jan 1985
DATE:

ANNEX A

Reference Table

<u>Agent</u>	<u>Symbol</u>	<u>Type of Bubbler</u>	<u>Regent</u>	<u>#ml</u>	<u>Mark Around Spout and Liquid Liquid Level With</u>
Arsenic	As	Glass	2% NaOH	10	White Tape
Chloroacetophenone	CN	Plastic	Propylene	10	Red Ring
Chloropicrin	PS	Plastic	Hexylene Glycol	10	Blue Ring
Cyanogen Chloride	CK	Plastic	Reagent B	10	Black Ring
Lewisite	L	Glass	2% HCl	10	Yellow Tape
Mustard	H	Glass	Diethylphthalate (Mustard)	10	Brown Tape
Sarin	GB	Glass	4.5 pH H ₂ SO ₄	15	Green Tape

SAMPLING STATION LOCATIONS
FOR 1611 AREA

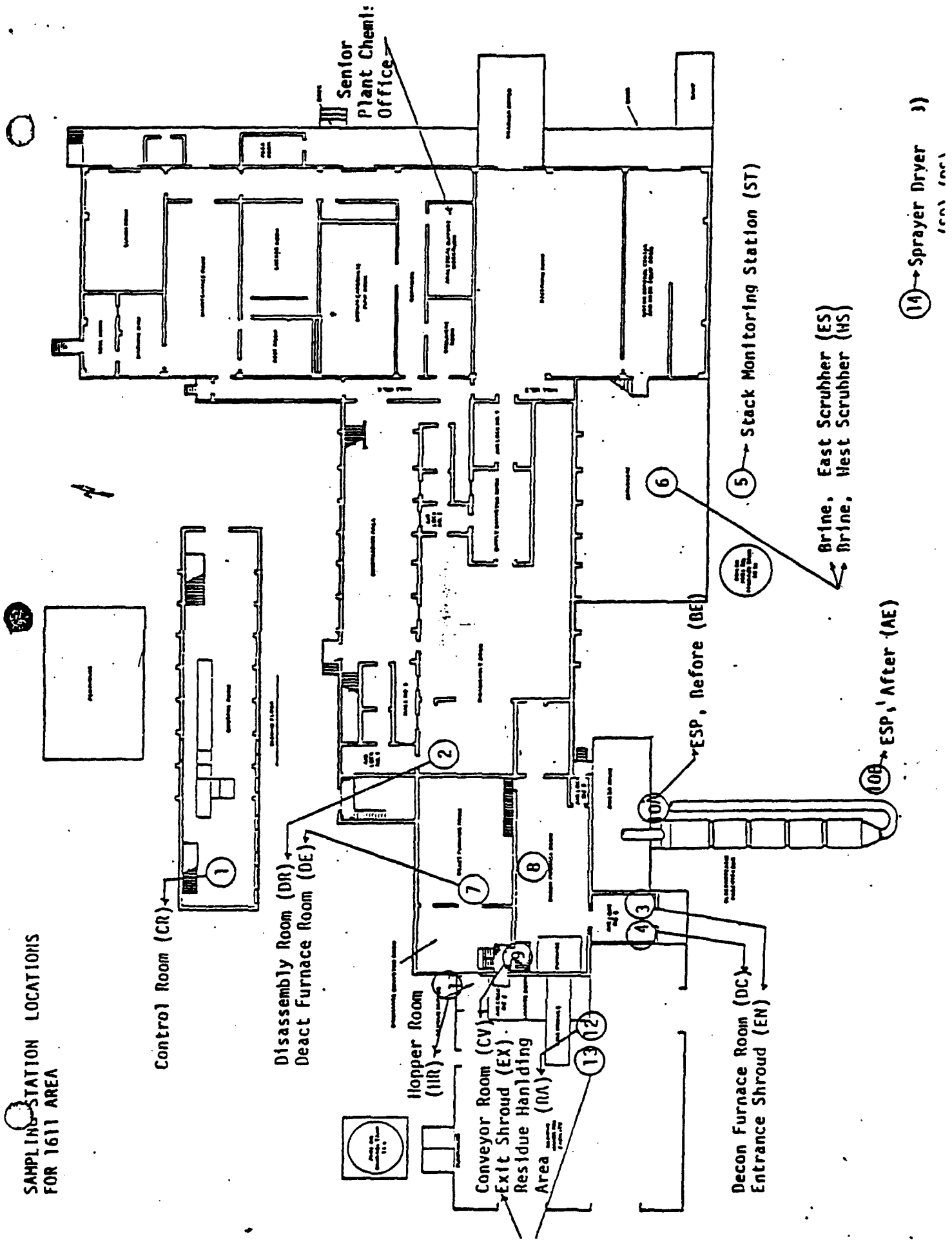

APPENDIX G

SMCRM-TOE-16, TOTAL MUSTARD (H, HN-1, HN-3) EMISSIONS

1. ROCKY MOUNTAIN ARSENAL
STANDING OPERATING PROCEDURE FOR:

2. ITEM: _____

3.a. OPERATION: Total Mustard (H,- HN-1, HN-3)
Emissions
 b. ESTIMATED DAILY PRODUCTION RATE: _____
 4. ARSENAL ORGANIZATIONAL SYMBOL: SMCRM-TOE-
 5. SOP NO.: SMCRM-TOE-16 DATE: 2 Aug 79
 a. REV NO.: 2 DATE: 10 Jan 85
 b. CHANGE NO.: N/A DATE: _____
 6. AUTHORITY: _____ DATE: _____

7. PREPARED BY: George B. Rogers TITLE: Chemist
 George Rogers TELEPHONE: X 201

8. REVIEWED BY: Kirvlew Wicker TITLE: Supervisory Chemist

REVIEWED BY: Elijah G. Jones TITLE: Chief, Analytical Systems Branch

9. SUBMITTED BY: Elijah G. Jones TITLE: Chief, Analytical Systems Branch

10. CONCURRENCES: Elijah G. Jones

<u>OFFICE</u>	<u>SIGNATURE</u>	<u>TITLE</u>
SMCRM-ISF	<u>[Signature]</u>	<u>Environmental Coordin</u>
SMCRM-SR	<u>Tamara J. Rayburn</u>	<u>Surety Officer</u>
SMCRM-SF	<u>Alma J. Harris</u>	<u>Safety Manager</u>

11. APPROVAL:

SMCRM-DC

Husted Shedy

CPT, OD, Dep Cmdr

12. QUARTERLY REVIEW:

13. SEMIANNUAL REVIEW:

14. BIENNIAL REVIEW:

2 May 1983

RMA Pam 385-1

SUPERVISOR'S STATEMENT

SOP NO: SMCRM-TOE- REV. NO: 2 CHANGE NO: 0 DATE: 10 Jan 85
16
OPERATION NO: _____

I have personally reviewed each of the operational steps of this SOP and have no question in my mind that the operation can be performed safely and efficiently. I have trained my operators in the details of their part of the operation and instructed them to follow the SOP without deviation.

SUPERVISOR/FOREMAN

DATE

BADGE NO

[Signature]

11/15/85

2379

10-7

Figure E-1

OPERATOR'S STATEMENT

SOP NO: SMCRM-TOE- REV. NO: 2 CHANGE NO: 0 DATE: 10 Jan 85
16

OPERATION NO: _____

I have read, or have had read to me, and understand the general and specific safety requirements necessary to accomplish my operation. I have been thoroughly trained in, and am familiar with, my part of the operation. I agree to abide by these instructions throughout my assignment.

<u>NAME</u>	<u>DATE</u>	<u>BADGE NO</u>
<u>Henry B. Poyen</u>	<u>15 Jan 85</u>	<u>2380</u>
<u>Mr. St. Linder</u>	<u>15 Jan '85</u>	<u>2376</u>
<u>John Bouts</u>	<u>15 JAN 85</u>	<u>2851</u>
<u>Tom Yager</u>	<u>16 Jan 85</u>	<u>2669</u>
<u>Tom Mack</u>	<u>16 Jan 85</u>	<u>2667</u>
_____	_____	_____

REV NO: 1
REV NO: 2
CHANGE NO: N/A

DATE: 27 April 1981
DATE: 10 January 1985
DATE:

INDEX FOR TOTAL MUSTARD (H, HN-1, HN-3) EMISSIONS

	<u>Paragraph</u>
Purpose -----	1
Scope -----	2
Responsibilities -----	3
 SECTION I AUTOMATED ANALYSIS	
Principle and Applicability -----	4
Apparatus -----	5
Reagents -----	6
Standards Preparation -----	7
Preliminary Instrument Procedure -----	8
Analytical Procedure -----	9
Instrument Shutdown Procedure -----	10
Calculations -----	11
 SECTION II GAS CHROMATOGRAPHIC DETERMINATION OF HD CONCENTRATIONS AS A TECHNICON VERIFICATION	
Principle and Applicability -----	12
Equipment and Reagents -----	13
Procedure -----	14
Technicon Diagram -----	Annex A
Criteria for Acceptable Daily Instrument Calibration Curve -----	Annex B
Safety -----	Annex C

1. Purpose. The purpose of this SOP is to provide procedures for the automated analysis of the quantity of mustard present in aerated environmental monitoring bubblers.
2. Scope. This SOP applies to all laboratory personnel assigned to the determination of mustard agent contamination in ambient air.
3. Responsibilities. The analyst assigned to the analysis of mustard is responsible for the determination of mustard content in the samples submitted.

SECTION I AUTOMATED ANALYSIS

4. Principle and Applicability.

4.1. Principle. A gas sample is aerated through a bubbler containing diethylphthalate (DEP) at a constant flow rate (6 lpm). Mustard added to 4-p-nitrobenzylpyridine in a basic solution gives a purple color which is determined on a colorimeter at 560 nm.

SOP NO: SMCRM-TOE-16 DATE: 2 August 1979 •
REV NO: 1 DATE: 27 April 1981
REV NO: 2 DATE: 10 January 1985
CHANGE NO: N/A DATE:

4.2. Applicability. This method is applicable for the determination of mustard (H, HN-1, and HN-3) emissions from stationary sources. HD optimum range is 0.15 ug/ml, minimum detectable limit is 0.04 ug/ml; HN-1 optimum range is 0.15 ug/ml, minimum detectable limit is 0.05 ug/ml; HN-3 optimum range is 0.15 ug/ml, minimum detectable limit is 0.01 ug/ml. Known interferences are caused by agents such as VX and CS and variations in PH.

5. Apparatus.

- 5.1. Volumetric Pipettes. 2 ml, 10 ml, 15 ml, 20 ml, 25 ml and 30 ml sizes.
- 5.2. Volumetric Syringe. 1 ml size with 1/100 ml increments.
- 5.3. Volumetric Flasks. 50 ml, 100 ml, 200 ml.
- 5.4. Test Tubes. 15 ml size.
- 5.5. Technicon Sampler. AA II or IV with 10 samples/Hr with A 2:5 ratio cam.
- 5.6. Technicon Pump. Proportioning pump III w/silicone tubing.
- 5.7. Baths. Two each Cartridge Kit Assembly AA II one w/mineral oil.
- 5.8. Colorimeter. AA II w/silicon tubing, and 560 nm filter.
- 5.9. Recorder. Adapted to AA II colorimeter.
- 5.10. Transmission Tubing. Silicone.
- 5.11. Coils and Fittings. See Annex A.
- 5.12. Sampler Cups. Polyethylene.

6. Reagents.

6.1. DB₃ Reagent (DB₃). To a 1 liter volumetric flask add 4.00 gm of DB₃ agent 4-(4 nitrobenzyl) pyridine and 56.00 gm of sodium perchlorate monohydrate. Fill the flask to 50-60 percent with 2-methoxyethanol (Ethylene Glycol Monomethyl Ether) and place the solution in sonic bath for about 15 minutes until all solids are in solution. Add 5 drops of glacial acetic acid, fill to mark with 2-methoxyethanol. Keep solution in a refrigerated box.

6.2. Diethylamine Reagent (DEA). Dilute reagent grade diethylamine with 2-methoxyethanol to a 1.3 (v/v) solution, (eg: 100 ml diethylamine in 300 ml 2-methoxyethanol). The solution should be clear to pale yellow in color. The reaction of diethylamine and 2-methoxyethanol is exothermic and slight cooling

SOP NO: SMCRM-TOE-16

DATE: 2 August 1979

REV NO: 1

DATE: 27 April 1981

REV NO: 2

DATE: 10 January 1985

CHANGE NO: N/A

DATE:

is necessary to avoid loss of the amine. Make up only the amount to be used each day (400 ml is usually sufficient for one full days run). Storing DEA Reagent longer than 24 hours will cause a loss in sensitivity.

6.3. Absorbent: Diethylphthalate (DEP). Use the same batch for the entire analysis.

6.4. Mustard.

6.5. HN-1.

6.6. HN-3.

7. Standards Preparation.

7.1. Prepare standards from approximately 1.5 to .04 ug/ml of mustard.

7.1.1. Place approximately 20 ml of diethylphthalate into a clean, dry 50 ml volumetric flask. (Care should be taken not to wet the inner walls of the ground glass joint and neck above the fill mark; if it becomes wetted, wipe clean with a tissue.) The flask is then stoppered and weighed to ± 0.0001 g to establish a tare weight.

7.1.2. After the flask is tared, add approximately 0.2 g of mustard to the tared flask. The flask is then stoppered and weighed, and the amount of agent is determined by the difference in weight. The flask is then made up to volume with diethylphthalate. This is Solution A (approximately 4000 ug/ml).

7.1.3. Using a clean, dry pipette, transfer 2 ml of Solution A into a 100 ml volumetric flask approximately one-half filled with diethylphthalate (DEP). Dilute to the 100 ml mark with DEP, and mix thoroughly. This is Solution B (approximately 80 ug/ml).

7.1.4. Using a clean, dry pipette, transfer 30 ml of Solution B into a 200 ml volumetric flask. Dilute to the 200 ml mark with DEP and mix thoroughly. This is Solution C (approximately 12 ug/ml).

7.1.5. Working standards are made in the same manner as discussed in 7.1.4.

Stock A		5393.4 ug/ml
Stock B	3 ml A in 200 ml	80.9 ug/ml
Stock C	15 ml B in 100 ml	12.14 ug/ml
Stock D	20 ml C in 100 ml	2.43 ug/ml
Standard E	10 ml C in 100 ml	1.21 ug/ml
Standard F	8 ml C in 100 ml	0.97 ug/ml
Standard G	5 ml C in 100 ml	0.61 ug/ml
Standard H	10 ml D in 100 ml	0.24 ug/ml
Standard I	20 ml H in 100 ml	0.04 ug/ml

SOP NO: SMCRM-TOE-16

DATE: 2 August 1979

REV NO: 1

DATE: 27 April 1981

REV NO: 2

DATE: 10 January 1985

CHANGE NO: N/A

DATE:

7.1.6. Each solution is made up to the mark with DEP, stoppered and inverted at least 30 times to ensure complete uniformity.

8. Preliminary Instrument Procedure.

8.1. The manifold should be set up as indicated in Annex A. The silicone tubing should be used exclusively except for the air line pump tube which may be Tygon.

8.2. Turn on heating baths, recorder and colorimeter. While the baths are stabilizing, pump DEP through the wash and sample tubes. Pump 2-methoxyethanol through the DB3 reagent and DEA reagent pump tubes. Allow to stabilize for at least 1/2 hour. (Note: After the initial startup, the heating baths are generally left on overnight).

8.3. After the temperature baths have stabilized, pump DB3 reagent and DEA reagent through the manifold for about 30 minutes.

8.4. After 30 minutes, ensure that the bubble pattern is fairly uniform throughout the system. Lift the colorimeter lid and check the flow cell for bubbles by pinching the light path pull-thru line and releasing.

8.5. Ensure that the toggle switch is in position "D". Close the colorimeter.

8.6. The baseline can now be set using the sample and reference apertures (coarse adjustment), and the baseline knobs (fine adjustment).

8.6.1. Should the baseline drift in any one direction at a constant velocity, the aperture controls (A and B) must be manipulated to correct the problem.

8.6.2. The baseline is usually set ten chart units from the edge of the zero or full scale of the chart.

8.6.3. The baseline may be wavy initially, but should quiet down and not vary more than 0.5 - 1.0 chart units.

9. Analytical Procedure.

9.1. Analysis of Standards.

9.1.1. From the series of standards in Section 7.1.5, duplicate aliquots of the high standard (Standard E) are placed on the tray followed by a single aliquot of each of the standards and as required by SOP No. 19, Annex J.

9.1.2. One of the higher standards may be placed after the quadruplicate Standards or samples to serve as a "marker", if desired.

SOP NO: SMCRM-TOE-16

DATE: 2 August 1979

REV NO: 1

DATE: 27 April 1981

REV NO: 2

DATE: 10 January 1985

CHANGE NO: N/A

DATE:

9.1.3. Approximately 30 minutes after a cup is sampled, the peak will appear on the recorder. The "Standard Cal" knob should be used when the first Standard "E" comes through. Standard "E" should be adjusted to give a units value of 80 chart units.

9.1.4. The standards curve is prepared by linear least squares regression of peak height vs. concentration.

9.1.5. See Annex B for criteria for acceptable daily instrumentation calibration curve.

9.2. Analysis of Samples.

9.2.1. Check the liquid level in each glass bubbler and record any changes. If the liquid level is low, dilute to the mark with DEP. (Note: Each bubbler will have a mark denoting the original level of the solvent.) A layer of water may also be on the top.

9.2.2. The entire solution in each bubbler is then transferred to individual test tubes. If water is present, it should be removed at this time.

9.2.2.1. Water may be excluded from the sample in one of two ways. 1) The bubbler solution is transferred to a test tube and the layers are allowed to separate. A disposable pipette is inserted below the aqueous layer and a sample portion removed. 2) The entire bubbler solution is poured through a sheet of fluted filter paper held by a glass funnel. The water is retained in the filter, the organic layer passes through.

9.2.3. Aliquots are taken from each test tube and transferred into separate sample cups. Place them on the Auto-Sampler tray. Place known standards as "markers" before and after the unknowns (and periodically among the unknown samples when many are being analyzed).

9.2.4. Start sampler, turn on recorder and set the baseline. Approximately 30 minutes after a "cup" is sampled, the peak will appear on the recorder.

9.2.5. If a bubbler concentration exceeds that of the high standard, a dilution with diethylphthalate must be done. Be sure to write down all sample dilutions for use in calculations.

10. Instrument Shutdown Procedure.

10.1. When an analysis is complete, turn off the recorder and colorimeter. Wash out the system by removing platen and hooking up vacuum pump to flow cell exit line. Place DB₃ reagent, DEA reagent, and sample lines into approximately 50 mls of (1) 20% nitric acid, then (2) water, then (3) 2-methoxyethanol, then (4) air. Replace platen, pump air through the three lines. Pump until the system is dry. Then shut off sample pump and remove platen.

10.2. Pump tubes should be replaced at the beginning of each day (except tygon air line).

SOP NO: SMCRM-TOE-16

DATE: 2 August 1979

REV NO: 1

DATE: 27 April 1981

REV NO: 2

DATE: 10 January 1985

CHANGE NO: N/A

DATE:

11. Calculations.

11.1. Dosage in bubblers. The dosage of mustard in the glass bubbler is calculated from the following equation:

$$D = A \times F \times V$$

Where A - absorbance reading at 560 nm (NAU)

F - factor from standard curve (ug/ml/NAU)

V - volume of bubbler solution including dilution factors (ml)

D - dosage of mustard in bubbler (ug)

Note: If the dosage exceeds the value 1.73 ug; the notification procedure specified in SOP #18, Sample and Data Flow for ID Sets, will be followed.

11.2. Concentration at sample source. Data will be entered on "Lab Data Coordinator Worksheet" as specified in SOP #18, Sample and Data Flow for ID Sets, according to the following equation:

$$C = \frac{D}{R \times T}$$

Where D - dosage of mustard in bubbler (ug)

R - sampling flow rate (li/min)

T - sampling time (min)

C - concentration of mustard (ug/li) @ sampling conditions

SECTION II GAS CHROMATOGRAPHIC DETERMINATION OF HD CONCENTRATION AS A TECHNICON VERIFICATION

12. Principle and Applicability.

12.1. Principle. Mustard emissions are sampled from the source by collection in bubblers containing diethylphthalate. An aliquot of the sample is directly injected into a gas chromatograph to determine the presence of HD.

12.2. Applicability: This method separates and detects the chemical agent HD from other material present in the bubbler solution which may interfere with the colorimetric analysis of HD by the technicon autoanalyzer.

13. Equipment and Reagents.

13.1. Tracor MT 220 gas chromatograph, or equivalent, equipped with a flame photometric detector in the sulfur mode and column switching valve.

13.2. GC column, 6 ft. x 4mm ID x 1/4" O.D., glass, packed with 10% QF-1 on 80/100 mesh Chromosorb W-HP.

13.3. GC column, 6 ft. x 1/4" O.D., unpacked.

13.4. Strip chart recorder.

13.5. Syringe, 10 microliter capacity.

13.6. Nitrogen, ultrapure-carrier grade, 210 cu. ft. cylinder.

SOP NO: SMCRM-TOE-16

DATE: 2 August 1979

REV NO: 1

DATE: 27 April 1981

REV NO: 2

DATE: 10 January 1985

CHANGE NO: N/A

DATE:

13.7. Hydrogen, zero grade, 210 cu. ft. cylinder.

13.8. Air, hospital grade, 210 cu. ft. cylinder.

13.9. Oxygen, hospital grade, 210 cu. ft. cylinder.

14. Procedure.

14.1. Install the packed and empty columns into the GC oven (the empty column provides make-up carrier gas to prevent baseline shift when the column switching valve is operated) and make the following adjustments on the instrument:

Inlet temperature	170°C (must be above oven temperature)
Oven temperature	165°C (isothermal)
FPD temperature	220°C
Nitrogen (carrier) flow:	50 cc/min each column
Hydrogen to FPD:	100 cc/min
Air to FPD:	60 cc/min
Oxygen to FPD:	20 cc/min

NOTE: Temperature $\pm 10^\circ\text{C}$, flows \pm cc/min.

(The air and oxygen flow may have to be lowered to ignite the FPD flame.)

14.2. Zero the electrometer and adjust the bucking current and signal attenuation as directed by the instrument's operating manual.

14.3. To analyze, for HD inject 8 microliters (the volume may be varied depending on the amount of HD present) into the packed column. The retention time for HD is about 2 minutes, and for diethylphthalate, 5 minutes.

14.4. Vent the diethylphthalate away from the detector using the column switching valve. The solvent may be purged from the column more quickly by programming the oven temperature to 220°C at 10 degrees/min.

14.5. The amount of HD present in a bubbler sample is then calculated as follows:

$$\text{ug HD in bubbler} = \frac{\text{peak ht (or area) of sample}}{\text{peak ht (or area) of standard}} \times \text{concentration of standard} \\ \times \frac{10 \text{ ml}}{\text{vol. of sample injected}}$$

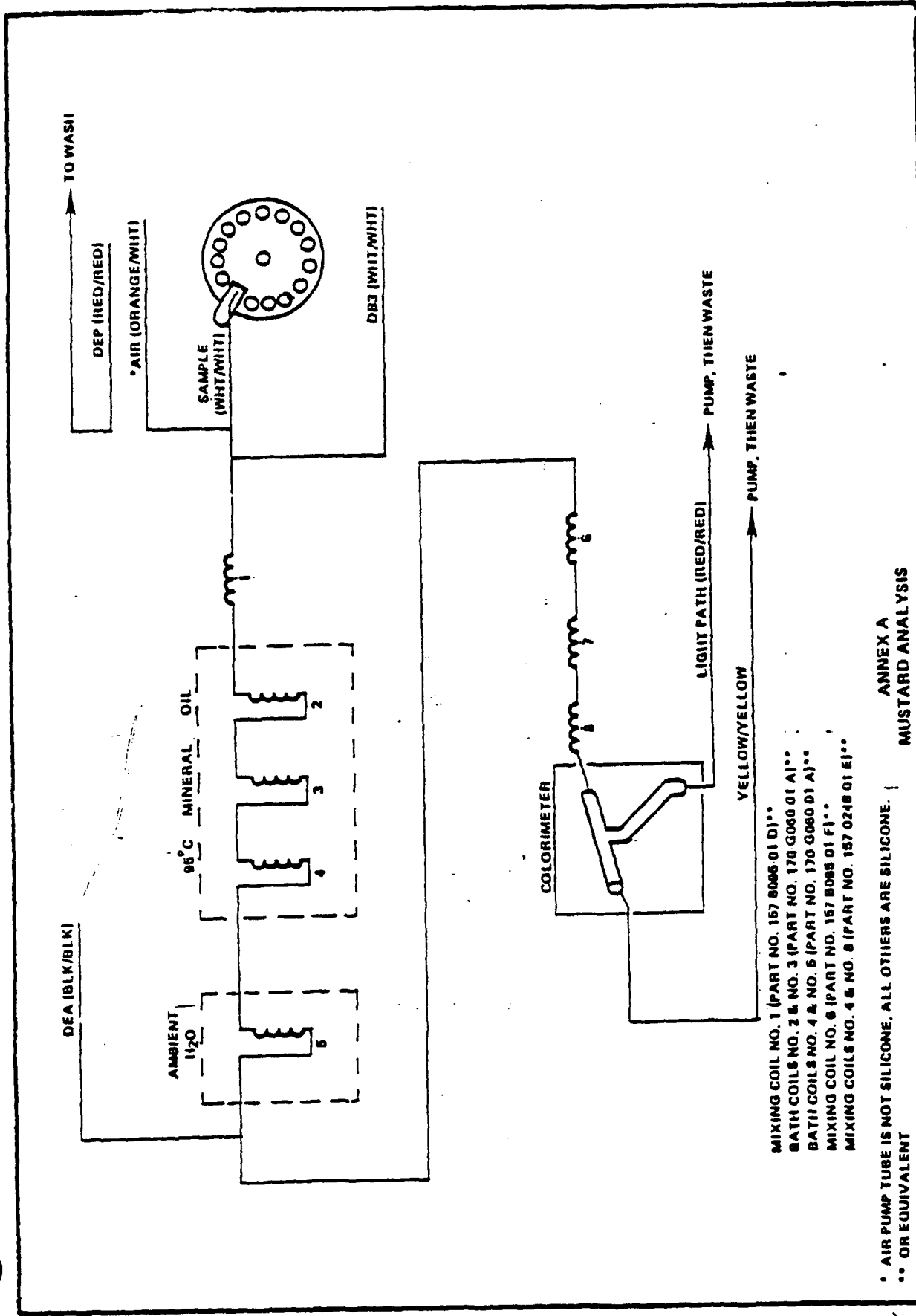

MIXING COIL NO. 1 (PART NO. 157 8085 01 D)**
 BATH COILS NO. 2 & NO. 3 (PART NO. 170 G060 01 A)**
 BATH COILS NO. 4 & NO. 5 (PART NO. 170 G060 01 A)**
 MIXING COIL NO. 6 (PART NO. 157 8085 01 F)**
 MIXING COILS NO. 4 & NO. 5 (PART NO. 157 0248 01 E)**

ANNEX A
 MUSTARD ANALYSIS

* AIR PUMP TUBE IS NOT SILICONE. ALL OTHERS ARE SILICONE.
 ** OR EQUIVALENT

SOP NO: SMCRM-TOE-16

DATE: 2 August 1979

NO: 1

DATE: 27 April 1981

NO: 2

DATE: 10 January 1985

CHANGE NO: N/A

DATE:

ANNEX B

CRITERION FOR ACCEPTABLE DAILY INSTRUMENT CALIBRATION CURVE

Mustard

The calibration procedure requires duplicate determination of five known standard solutions over a concentration range in DEP (per SOP SARRM-TOE-16). These ten instrument response-concentration points will be plotted to yield the calibration line. A least squares method will be utilized to determine the slope and the coefficient of variance of this line.

The acceptable limits for the slope are 66 ± 5 chart units/ μ g/ml and the coefficient of variance (determination of r-squared) will not be below 0.995. Failure to meet these requirements will require the analyst to redetermine the instrument response to those concentrations which plot the regression line and result in failure to meet the tolerances.

The calibration procedure will be conducted prior to analysis of any plant or QC samples each day.

SOP NO: SMCRM-TOE-16

DATE: 2 August 1979

REV NO: 1

DATE: 27 April 1981

REV NO: 2

DATE: 10 January 1985

CHANGE NO: N/A

DATE:

ANNEX C

Safety

1. Notification procedures as outlined in the applicable monitoring plan will be followed.
2. Always use a pipeting bulb or a mechanical pipet to transfer or to pipet liquid, never use your mouth.
3. All personnel working in Building 313 must have a protective mask and a pair of safety glasses available.
4. Diethylamine.
 - 4.1. DEA is extremely flammable and irritating to the skin, eyes and respiratory passages.
 - 4.2. Keep away from heat, sparks and open flame.
 - 4.3. Pour only in a hood while wearing gloves and eye protection.
 - 4.4. In case of contact with eyes, immediately flush eyes with copious amounts of water for 15 minutes. Get medical treatment. Flush skin or clothing with water.
5. Sodium Hydroxide.
 - 5.1. Concentrated sodium hydroxide will cause severe skin and eye burns.
 - 5.2. When handling concentrated sodium hydroxide, wear rubber gloves and eye protection. Dilute by pouring sodium hydroxide into water, never by adding water to concentrated base.
 - 5.3. Decontaminate from skin, eyes or clothing by flushing with copious amounts of water. If splashed in eyes, get medical treatment.
6. Sodium Perchlorate.
 - 6.1. Sodium perchlorate is a powerful oxidizing agent and a fire hazard. It will also cause skin and eye irritation.
 - 6.2. Store in small quantities in a cool, well ventilated place away from acute fire hazard and organic or other easily oxidizable materials.
 - 6.3. In case of contact with skin, eyes, or clothing, flush affected area with water for 15 minutes. Get medical treatment for eyes.
- 7.0 All waste will be placed in containers marked "Burn" in accordance with Standard Operating Procedures for Chemical Agent Identification Sets (CAIS), SOP No. SARRM-T-ID-78-101-6-4, dated 15 April 1981.

Army Regulation 50-6

Nuclear and Chemical Weapons and Materiel

Chemical Surety

**Headquarters
Department of the Army
Washington, DC
12 November 1986**

h. Wind direction or air flow will be determined before operations start and updated periodically during the work period. Personnel will be instructed to move to a designated clean area assembly point if agent is accidentally released.

i. Operational personnel must be familiar with the site accident and incident control plan and with their individual responsibilities for implementation.

j. Drinking, eating, and smoking in a limited area (see glossary) is prohibited unless approved by the MACOM. Locations for those activities will be in areas separated from the agent operating areas. Engineering controls and agent monitors will be used to assure that agent air concentrations will not exceed the permissible exposure limits for an unmasked worker as specified in table 5-1. Such designated areas will only be utilized by the individuals employed in the limited area. A single covered container of drinking water or other suitable liquid and disposable cups may be located not closer than 100 feet upwind from an outdoor operating site or in an exclusion area. Individual personal containers of water are not authorized. Conditions under which drinking, eating, or smoking may occur will be specified in the operations SOPs.

k. Decontamination, first aid, medical equipment, and support and emergency evacuation vehicles will be at the work site or group of work sites in close proximity during all operations.

l. All personnel will be given emergency off-duty telephone numbers to call and report illnesses. Each individual who has been working with nerve agents will be checked for symptoms of agent poisoning 30 minutes after leaving the work area and prior to leaving the installation.

m. Individuals assigned to chemical organizations, who are assigned chemical surety duties, may wear or carry a medical alert identification device at all times. Local procurement of medical alert identification items is authorized under the provisions of AR 385-32.

n. When a storage magazine containing Group A (storage and shipping classification) chemical surety materiel is opened, the person in charge of the working group will determine the hazard present in the structure. At least two qualified people (in keeping with the two-person concept) will monitor and inspect the magazine. Personnel who do the visual inspections or place detectors will wear appropriate levels of protective clothing. After inspection, the working group may be permitted to enter the structure wearing the level of protective clothing and equipment commensurate with the hazards and the job, as prescribed in the operations SOP. Automatic agent detector alarms will be used as much as possible when personnel are conducting operations in the vicinity of nerve agents.

o. Firefighter personnel should wear full firefighting protective clothing (without TAP clothing) during chemical agent

firefighting and fire rescue operations. Positive pressure, full facepiece, NIOSH approved, self-contained breathing apparatus (SCBA), shall be worn where there is danger of oxygen deficiency and when directed by the fire chief or CAI operations officer. The M9- or M17-series mask may be worn in place of SCBA when there is no danger of oxygen deficiency. If such clothing is contaminated, it will not be reused. When a fire involves chemical munitions that contain explosive components, all personnel must back-off upwind. If the fire is in the initial stages or does not involve energetic materiel, it may be fought at the discretion of the fire chief. Firefighting requirements for explosive fires are contained in DOD 6055.9-STD and AR 385-64. Also see AR 420-90 for other protective clothing requirements.

p. After a fire involving chemical munitions has been extinguished, when there is no longer any danger of an explosion, render-safe procedures may be accomplished, as necessary, and decontamination operations may be started.

q. Detonation of a munition resulting in a release of chemical surety materiel will create a downwind area that must be evacuated. The site of the explosion should be approached from upwind with appropriate protective clothing and equipment. If contaminated, all structures, objects, and the ground area immediately surrounding an explosion site must be decontaminated.

r. When work is to be performed at an outdoor site, the area will be monitored for the presence of chemical agent hazard before work is begun. Monitoring will include a visual leak check of each item (munitions or container) from the upwind side. Confirmatory tests will be performed, if necessary, to identify a substance suspected of being an agent. At least two qualified people (in keeping with the two-person concept) will monitor and inspect the area wearing the appropriate level of protective clothing and equipment. After the inspection, the work party may be permitted to work while carrying their protective mask in a slung position unless the specific task requires a higher level of protection. Casual personnel may enter with special permission provided they have an appropriate security clearance and have protective clothing and equipment commensurate with the hazard.

6-5. Monitoring of agent areas and operations

a. Before conducting any operation involving G-series agents or munitions, the operational site will be monitored for the presence of the agent by use of vapor detectors and by placing suitable alarms in selected areas.

(1) The area and the agent containers or munitions will be visually inspected. Personnel who place the alarms and do the visual inspection will wear appropriate levels of protective clothing.

(2) If the inspection of the site discloses a leaking agent container, the operational area

will be considered contaminated. The source of the leak will be identified and sealed and the area will be decontaminated.

(3) When inspection confirms that no hazard exists, personnel wearing appropriate protective clothing may enter the area to work.

b. Because of the low volatility of H-series and V-agents in bulk containers or munitions, air sampling is not reliable for determining the presence of these agents. Therefore, in addition to air sampling, first entry monitoring will include a thorough visual inspection of the containers or munitions and the surrounding area to determine agent presence.

c. First entry monitoring is not required—

(1) For storage areas when the operation to be performed would take less time than would first entry monitoring. Level A protection will be worn during these short-term operations.

(2) When a detector capable of monitoring below The Surgeon General limits (table 5-1) has been operating inside the location since last entry and shows no evidence of airborne contamination.

d. ABC M8-VGH detection paper or equivalent will be used as a confirmatory test for identifying GB, VX, and H-series agents in suspect liquids. This paper will not detect vapors or extremely small droplets of GB, VX, or H-series agents and may change color in the presence of certain decontaminants.

e. Chemical surety materiel operations areas will be monitored periodically to verify that workers are not exposed to agent levels greater than that allowed by The Surgeon General and that undesirable quantities of agent are not released to the atmosphere. If the existing detection equipment is inadequate, the best available equipment will be used together with other safeguards such as protective equipment to prevent exposure of personnel. Detection equipment that may be used to meet the above guidance include the Automatic Continuous Air Monitoring System (ACAMS), Real Time Monitor, M8/M10 alarms, liquid impingers (bubblers), and M256 or M18-series kits.

f. Monitoring will be supplemented by frequent visual observations of the operations area by trained personnel. GB, VX, and H-series agents act as solvents on most paints, causing the paint to peel, dissolve, or discolor, which may indicate leakage of these agents. When any of these conditions are detected on the painted surface of a container or munition, a confirmatory test will be conducted.

g. When a leaking container or munition is discovered during inspections, it will be decontaminated externally. Munitions will be encapsulated in liquid and vapor-tight containers. Bulk agent containers will have valves and plugs tightened or replaced as necessary to stop leakage. Anything contaminated by leaking materiel will be decontaminated. Encased munitions should be

DEPARTMENT OF THE ARMY
 HEADQUARTERS, US ARMY MATERIEL COMMAND
 5001 Eisenhower Ave., Alexandria, VA 22333-0001

AMC REGULATION
 No. 385-131

DRAFT: 4 Sep 1986

Safety

SAFETY REGULATIONS FOR CHEMICAL AGENTS H, HD, HT, GB and VX

This regulation may be supplemented by AMC major subordinate commands. One copy of each supplement will be furnished to the Director, AMC Field Safety Activity, ATTN: AMXOS-C, Charlestown, IN 47111-9669.

	Paragraph	Page
CHAPTER 1. GENERAL		
Purpose -----	1-1	1-1
Scope -----	1-2	1-1
Explanation of terms -----	1-3	1-1
Policy -----	1-4	1-2
Responsibilities -----	1-5	1-3
Deviation correction policy -----	1-6	1-3
2. AGENT INFORMATION		
Classification -----	2-1	2-1
Type of hazard -----	2-2	2-1
Physiological effects -----	2-3	2-1
Chemical and physical properties of Chemical Agents -----	2-4	2-3
Permissible exposure limits -----	2-5	2-3
3. AGENT MONITORING REQUIREMENTS		
Detection methods and equipment -----	3-1	3-1
Detection equipment capabilities -----	3-2	3-4
Monitoring support requirements -----	3-3	3-6
Quality control of monitoring methods -----	3-4	3-6
Detection requirements -----	3-5	3-6
Leaking containers or munition items -----	3-6	3-9
Maintenance of monitoring records -----	3-7	3-9
Detector/monitor tubing -----	3-8	3-9

* This regulation supersedes DARCOM-R 385-31, 20 April 1979 and DARCOM-R 385-102, 6 May 1982.

d. Absorption air sampling. An absorption air sampling system (commonly referred to as a "bubbler") provides a reliable method for detecting low level concentrations of agent vapors, however, this system has no capability for providing an alarm response when agent is present. The bubbler unit is usually a vessel packed with glass beads and filled with a scrubbing solution. The air sample is bubbled through the scrubbing solution which absorbs the chemical agent from the air sample. After sampling for a predetermined time and flow rate, the unit is removed and sent to a chemical laboratory for processing to determine the presence, type and quantity of agent in the sample. Utilizing the proper analytical techniques the system can detect average agent vapor concentrations of 0.003 mg/m^3 for mustard, 0.0001 mg/m^3 for GB, and 0.00001 mg/m^3 for VX. Lower average concentrations can be detected by increasing the sampling time and/or the rate of the sampled air. When bubblers are used in lieu of real time monitoring and to provide necessary feedback concerning conditions of the area monitored, samples should be analyzed as soon as possible after the sample is drawn. Where bubbler samples are not used as a substitute for real time monitoring and immediate analysis is not required, samples may be stored (or shipped if necessary; see paragraph 10-7 for transportation controls) provided that strict controls are present over temperatures and length of storage. Since samples are subject to agent degradation (i.e. hydrolysis) when subject to high temperatures or long periods of storage, bubbler samples should be aspirated and stored at controlled temperature conditions, 21°C (70°F) or less, right up to the time they are analyzed (within 36-48 hours). If the length of time between sampling and analysis will exceed 48 hours, temperatures should be maintained at or below 2°C (37°F) to minimize degradation. Water-based samples should not be subjected to freezing temperatures.

e. Depot Area Air Monitoring System (DAAMS). DAAMS is a portable air sampling unit which is designed to draw a controlled volume of air through a glass tube filled with a collection material (e.g. Tenex GC). As the air is passed through the solid sorbent tube agent is collected. After sampling for the predetermined period of time and flow rate, the tube is removed from the vacuum line and sent to a chemical laboratory for analysis to determine the presence, type, and quantity of agent collected in samples. This technique will sample down to the PEL and is to provide low-level detection capability.

f. Automated gas chromatographs. The automatic continuous air monitoring system (ACAMS) is a type of automated gas chromatographs that is currently available for real time agent detection and alarm capability at various levels. It has the capability to detect and alarm at the PELs.

g. Detector Ticket. The detector ticket is a stock item which will detect nerve agent vapor at concentrations as low as 0.02 mg/m^3 (GB) and 0.1 mg/m^3 (VX). It is included in the M18A2 kit (NSN 6665-00-903-4767) and the M30A1 refill kit (NSN 6665-00-909-3647). The sensitivity of the ticket decreases with lower temperature. Using a reagent (substrate), the square end of the ticket will turn blue in the absence of agent, and will turn light red-orange or have no color change in the presence of agent. The ticket will

discoloration of painted surfaces. All suspect liquids observed during the inspection should be tested with the M8 or M9 detector paper as a confirmatory measure. Agent leakage sometimes occurs at the juncture between the fuze or closing plug and projectile and then, due to chemical reaction and evaporation, self-sealing of the leak may result. Inspecting personnel should be aware of this condition and recognize that any built-up area between the fuze or closing plug and projectile or presence of a dry residue may be an indication of agent leakage.

m. **Olfactory.** The fact that mustard has a recognizable odor at low concentrations is useful to augment conventional monitoring methods. Personnel who detect the characteristic garlic odor of mustard must immediately mask and/or evacuate the area. Do not remain unprotected in the area after smelling mustard even if the odor disappears. Exposure to mustard vapors can impair the continued ability to smell its odor. Absence of odor shall never be relied upon alone to indicate absence of agent.

n. **Air Pumps.** Air pumps capable of being calibrated and achieving the required air flow to operate approved sampling tubes/media may be used during sampling operations, e.g., MSA Model G air pump. These air pumps must meet all other safety criteria for place of intended use.

o. **Chloroform Extraction.** Chloroform can be used as a solvent to remove potential surface contamination for laboratory analysis. It is not a substitute for air monitoring to establish a XXX level of decontamination.

p. **Other methods.** Detection methods other than those listed above may be used provided sensitivity and reliability have been demonstrated and documented. Approval of such detection methods by AMC Field Safety Activity (ATTN: AMXOS-C) is required.

3-2. Detection equipment capabilities.

a. **Capabilities, sensitivities, and response times for detector equipment** listed in paragraph 3-1 above, are shown in Table 3-1.

b. **Gross level detectors and alarms.** Gross level detectors are those detection devices that can provide a response within three minutes for agent concentrations at or below the IDLH level (see paragraph 2-5a(5)). Examples include blue band tubes, detector tickets, M8 alarms, etc. A gross level configured ACAMS can also provide rapid response; it would not also provide TWA sensitivity in this configuration.

c. **Low level detectors and/or alarm.** Low level detectors are those detection devices that can provide detection capability and/or alarm for concentrations of 0.003 mg/m^3 for mustard, 0.0001 mg/m^3 for GB and 0.00001 mg/m^3 for VX. Examples include the bubbler, DAAMS, ACAMS, and RTM's.

TABLE 3-1

Detector Sensitivity and Response/Processing Time*

Equipment	Sensitivity (mg/m ³)			Response Time	
	Mustard	GB	VX		
Detector Paper, M8/M9	Positive or Negative only			Immediately	
Detector Ticket	Not Capable	0.02 - 0.05	0.1	3	min
Blue Band Tube	0.5	0.2	Not Capable	3	min
White Band Tube	Not Capable	0.2	Not Capable	3	min
M256 Kit	1.0 - 3.0	0.02 - 0.05	0.05 - 0.15	12-15	min
				3-5	min
Bubbler	0.003	0.0001	0.00001	2-4	hrs
DAAMS	0.003	0.0001	0.00001	1	hr
ACAMS	0.003	0.0001	0.00001	10-20	min
RTM	Not Capable	0.0001	0.00001	8-12	min
DCAC	Not Capable	0.001		33	min
		0.2	0.4	2-3	min
M8	Not Capable	0.2	0.4	2-3	min
M8A1	Not Capable	0.1	0.1	1-2	min
M43A1	Not Capable	0.2	0.4	2	min
HYFED	0.003	0.001	0.001	1-2	min

* Processing time, if required, includes transport time from the site to the lab, set-up time, and analysis. Times are approximate and may vary from installation to installation.

3-3. Monitoring support requirements. Use of the air sampling devices described in paragraph 3-1 above, will require special training of personnel to operate and maintain those devices. A chemical laboratory is required for each installation which charges agent generators to provide known agent concentrations for quality control (QC) testing of monitors (para 3-4), and for performing timely processing of bubbler solutions or dry-type sampling tubes. Requests for detailed information on the use and maintenance of specific monitoring/air sampling equipment may be obtained from Director, AMC Field Safety Activity, ATTN: AMXOS-C, Charlestown, IN 47111-9669.

APPENDIX H
STANDING OPERATING PROCEDURE
SAMPLING AND PERSONNEL MONITORING

STANDING OPERATING PROCEDURE

SAMPLING AND PERSONNEL MONITORING

I. Purpose

- To establish procedures to be followed in sampling air from vessels, pipes, ducts, and areas for mustard agent, and for monitoring personnel exposure.

II. Scope

- This procedure applies to process air sampling in the South Plant. It is to be supplemented by specific sample site instructions in Appendices A and B this report.

III. Responsibilities

- Sampling teams are to follow this SOP, supplemented by the specific sampling instructions in Appendices A and B. Deviations require approval from the TVA project coordinator, who is responsible to the TVA project engineer. The project engineer is, in turn, responsible to the RMA project manager.
- Laboratory analyses are the responsibility of the RMA Environmental Laboratory. The team industrial hygienist/chemist will record and calculate personnel exposure data.
- Emergencies will be handled according to Sections 9.7, 10.3, and 10.5, the ultimate authority resting with the RMA Commander.

IV. Equipment supplied by TVA

Sampling Equipment:

- Bubblers, glass.
- MINICAM near-real time sampler.
- Sampling pumps, 6 liters per minute.
- Ground fault circuit interrupters, 120 volt (main power supplied by RMA).
- Calibrator, Gilian.
- Ice containers (ice supplied by RMA).
- Tubing, Teflon®.
- Tubing, polyethylene.
- Thermometers.
- Parafilm.
- Data sheets.

Ancilliary Equipment:

- Portable ventilation machines and carts.
- Sample set up tools, equipment, scaffolds, etc.
- Waste disposal equipment (drum w/lid, caustic, plastic bags, duct tape, labels).
- Portable change-out trailer.

Decontamination Equipment:

- 55-gallon drums of caustic/water solution.
- Caustic, for mixing more solution, as needed.
- 5 gallons of bleach.

- Plastic bags, 30 gal.
- Labels and pens.
- Water.
- Plastic sheeting.
- Catch pans.

Emergency Equipment:

- Eyewash units.
- Portable showers.
- Bleach.
- First aid kits.

V. Equipment Supplied by RMA

- Potable water.
- Electricity, 120 volts A.C.
- Decon truck and supplies.
- "Hotline" equipment and supplies, as per 9.7.
- Laboratory services and analytical materials.
- CASARM (agent) material for calibration.
- Sanitary sewage and waste disposal connections or facilities.
- Personal protective clothing & equipment (PC&E) (Section 9.3) for about 30 people with spares.
- Radios (dual channel, one being the RMA emergency channel).
- Laundry service for PC&E.
- Wind indicators.

VI. Preparation

1. The following should be performed for each sample point and each make-up (entry) point. Make-up points will be prepared first and closed until sampling begins.
2. Before entering the sample area, perform an informal JSA.
3. Don PC&E (Level F is acceptable until sample site preparation, Level A is mandatory when sampling or opening vessels).
4. Enter sampling area, as specified in JSA.
5. Set up emergency equipment (shower, water supply, eyewash, bleach containers, etc.).
6. Set up ancillary equipment (scaffold, electricity, decon equipment, ventilation machines).
7. Set up MINICAM, turn on, and warm up and calibrate.
8. Set up bubbler and pump.
9. Perform initial MINICAM sampling at sample site and record results (Attachment A).
10. Turn on ventilation machines and position intake near all openings for sample point.
11. Ensure spill containment is positioned (plastic or drip pans beneath the sample point, plastic covering material, and drum nearby).
12. Set up the sample site (open piping/vessels with extreme care--be prepared for a spill or pressurized release).
13. Obtain a MINICAM sample at the sample point immediately after opening each enclosure (Attachment A).
14. If necessary, close the sample point until the analysis from the MINICAM are known.
15. An alarm or positive reading on the MINICAM should be treated as an emergency. Close sample and make-up points. Leave MINICAM running. Leave ventilation machine running. Leave bubbler running,

if previously started, but remove from the (closed) sample point. Evacuate the area. Notify the RMA Fire Department by radio. (Section 9.7).

16. After site is prepared, close until ready to bubble.
17. Do a MINICAM sample in the ventilation exhausts and record results.
18. Mark the bubbler using only a number (to ensure "blind" analysis), and record the number against the actual sample number.

VII. Sampling

1. After preparing all inlet and outlet points for the sample with ventilation units operating at each opening and with MINICAM and all ancillary equipment functioning, open the make-up points, one at a time.
2. Connect the bubbler and open the sampling point outlet.
3. Start the bubbler pump, ensuring the proper pressure.
4. Monitor the sample point area with the MINICAM (record).
5. Sample the ventilation exhaust (record).
6. Sample the make-up points with the MINICAM (record).
7. Sample the make-up point ventilation exhaust (record).
8. Check the ice bath and pressure gauge every 15 minutes.

VIII. Post-Sampling

1. When sample duration is complete, record the final pressure.
2. Shut off the bubbler pump and record the time.
3. Seal the bubbler with Parafilm.
4. Obtain a MINICAM sample of the sample point and record.
5. Immediately close all openings for the sample.
6. Obtain a MINICAM sample of the makeup points.
7. Close the makeup points.
8. If MINICAM results show no evidence of mustard gas, shut off ventilation machine.
9. If positive MINICAM results, see Emergency above under "Preparation" (Step VI, 15).
10. Transport the bubbler sample to the laboratory using extreme care and maintaining in the ice bath.
11. For each ten samples, submit one "blank" bubbler (containing unexposed sorbent), numbered consecutively with other samples.
12. Move the MINICAM with extreme care to the next sample point, without de-energizing if possible. If power or hydrogen gas must be shut off for more than 15 minutes, recalibration is required after a 1-hour warm-up period. Therefore, it is advisable to try and maintain power continuously.
13. Dispose of any contaminated waste in the waste drum.
14. If a positive reading was obtained with the MINICAMS, purge the probe tube by sampling clean air for three sample cycles (about 15 minutes).

IX. Personnel Monitoring

1. Bubblers will not be used to evaluate personnel exposure.
2. Personnel exposures will be determined by assigning the MINICAM results to the personnel in a particular area for a specified period of time (do NOT use sample results from inside pipes and vessels as representative of personnel exposure).

3. The industrial hygienist/chemist will assign exposure times to each crew member, based upon the length of time he spent in a particular area.
4. The TWA exposure will be calculated from the sum of such times, multiplied by the corresponding MINICAM results for the appropriate operations, all divided by the total exposure time.
5. Exposures will be determined disregarding PPE.
6. TWA's will be "worst case" as the MINICAM will be sampling in the immediate areas of potential agent release.

X. Quality Assurance/Quality Control (QA/QC) Plan

1. RMA QA/QC procedure SMCRRM-TOE-19 will be followed.
2. This SOP will be followed unless deviations are approved by the TVA project manager.
3. Sample blanks and duplicates will not be known to the lab.
4. The industrial hygienist/chemist will maintain a "chain of custody" for all samples.

XI. Documentation

1. Each sample sheet will be initialed by the industrial hygienist/chemist.
2. Each sample sheet will be dated and completely filled out in ink.
3. The industrial hygienist/chemist will maintain custody of the sample sheets until turned over to the project manager.

XII. Emergency Procedures

- Sections 9.7, 10.3, and 10.5.

XIII. Hazardous Waste

- All potentially contaminated waste from sampling or ancillary operations will be neutralized or decontaminated and given to RMA for disposal.

ATTACHMENT A

SAMPLING - MUSTARD FACILITY - RMA

DAILY LOG SHEET

Date (dd/mm/yy): _____

Page ___ of ___

SAMPLE ID NUMBERS

DESCRIPTION

LOCATION

SAMPLE ID NUMBERS	DESCRIPTION	LOCATION
_____	_____	_____
_____	_____	_____
_____	_____	_____
_____	_____	_____
_____	_____	_____
_____	_____	_____
_____	_____	_____

FIELD OBSERVATIONS

HD Levels (MINICAMS)

Time

Sample Location

HD Levels (MINICAMS)	Time	Sample Location
_____	_____	_____
_____	_____	_____
_____	_____	_____
_____	_____	_____
_____	_____	_____
_____	_____	_____
_____	_____	_____
_____	_____	_____
_____	_____	_____
_____	_____	_____
_____	_____	_____
_____	_____	_____
_____	_____	_____
_____	_____	_____
_____	_____	_____
_____	_____	_____

NARRATIVE

APPENDIX I

STANDING OPERATING PROCEDURE
PERSONNEL CONTAMINATION AND INJURY EMERGENCIES

STANDING OPERATING PROCEDURE

PERSONNEL CONTAMINATION AND INJURY EMERGENCIES

I. Purpose

- To establish procedures for decontaminating personnel contaminated by agent, and procedures for dealing with non-agent related emergencies.

II. Scope

- This procedure applies to personnel accidentally contaminated by mustard agent in the sampling or equipment decontamination processes. It also applies to non-agent related accidents, injuries, and emergencies.

III. Responsibilities

- TVA personnel are responsible for immediately decontaminating themselves upon realization of contamination by agent. Team members are responsible for ceasing other activities per this plan in order to render immediate assistance to contaminated personnel (this will necessitate their own decontamination also).
- Any team experiencing an accident, or contaminated personnel will contact the TVA project coordinator immediately. The coordinator is responsible for notifying the RMA Fire Department EMTs and the TVA project engineer.
- The RMA Fire Department EMTs will attend the accident/contamination scene and transport the decontaminated personnel or otherwise injured personnel to Fitzsimmons Hospital for observation. The EMTs will also ensure that "Hotline" procedures are followed before transporting personnel.
- Through prior agreement with TVA, Fitzsimmons Hospital will provide treatment of injured personnel and observation of personnel exposed to agent.

IV. Equipment

- Emergency portable showers
- Bleach
- Caustic
- Water
- "Hotline" equipment (RMA supplied)
- Change-out room (trailer)
- Change of clothing
- Eyewash
- Radio
- Waste drum (disposed by RMA)

V. Procedures

Preliminary Decontamination

1. After any sign of gaseous/liquid release, or any other suspicion of personnel contamination (see Symptoms, Section 5.0), the project coordinator will be notified, routine operations shall cease, all other TVA employees will proceed to scene of contamination, and this plan shall be implemented.

2. Potentially exposed personnel will immediately proceed to the emergency shower and will deluge themselves with water.
3. The exposed person, if possible, will pour liquid bleach steadily and continuously over all contaminated body areas.
4. Other team members will assist in pouring the bleach and other decontamination procedures, being careful not to also become contaminated.
5. During contamination, one team member will radio the project coordinator, who will notify the RMA Fire Department EMTs.
6. After thoroughly deluging with bleach, the contaminated personnel shall rinse thoroughly in the shower.
7. Ventilation machines will be left running at sample and make-up points.
8. MINICAMS will be left running (to later assist in exposure verification).
9. Consistent with personnel safety, bubblers previously started will be left running, except that they shall be disconnected from the sample point, which will be closed.
10. Make-up points will be closed.
11. The entire team shall then proceed to the "Hotline" outside the building.

"Hotline"

1. Contaminated personnel, after preliminary decontamination shall enter the "Hotline", contaminated side, still fully clothed in Level A protection.
2. Contaminated personnel, stepping into the catch pan, shall be deluged with bleach.
3. Next, water will be used to thoroughly rinse the person.
4. A sample analysis using the MINICAM will be taken of the contaminated person to ensure that person or area is not contaminated.
5. The person will then step into the next catch pan and disrobe, except for his respirator.
6. The person will proceed to the change-out trailer shower.
7. After showering and removing respirator, the person will dress and exit the change room.
8. RMA Fire Department EMT personnel will immediately transport the decontaminated person(s) to Fitzsimmons Hospital where medical personnel will watch for symptoms and treat as necessary.

Non-contamination Emergencies

1. It will immediately be verified that contamination is not a factor in the injury or its treatment (otherwise, contamination must be suspected).
2. First aid will be rendered to the victim as soon as possible, without risking agent exposure or injury to those assisting.
3. A team member will immediately radio the project coordinator, who will notify the RMA Fire Department EMTs.
4. Team members will quickly transport the victim outside the building to the RMA ambulance.
5. The victim will be transported to Fitzsimmons Hospital, if necessary.

VI. Records

- All injuries (beyond first aid) and exposure accidents will be recorded and investigated by the project coordinator and the RMA safety staff.

APPENDIX J

STANDING OPERATING PROCEDURE
PIPING/EQUIPMENT DECONTAMINATION

STANDING OPERATING PROCEDURE

PIPING/EQUIPMENT DECONTAMINATION

I. Purpose

- This procedure outlines the decontamination process to be used for pipes or vessels found by the sampling process to contain agent contamination.

II. Scope

- This procedure applies to pipe and vessel contamination. Due to the uniqueness of the various process equipment, special adaptations or alterations to the procedure may be necessary in some cases. These shall be approved by the project engineer.

III. Responsibilities

- Decontamination teams are responsible for following this procedure, or for gaining written approval by the project engineer for deviations.
- Decontamination teams shall continuously monitor the operational areas for airborne agent, and for taking appropriate steps in the event of a spill or release.
- Decontamination operations will be taking place in areas found to contain agent, thus increasing the likelihood of personnel or environmental exposure. Extreme care must be taken to protect personnel and the environment.
- Emergencies will be handled according to Sections 9.7, 10.3, and 10.5 of the SPSS, the ultimate authority resting with RMA Commander.
- The project engineer will ensure that emergency procedures and equipment are in place before starting decontamination operations.

IV. Equipment

- Sodium hypochlorite
- Drums
- Liquid pump, 20 gal/min
- Mixer
- Pipefitting supplies
- Labels
- Ventilation machines
- MINICAM monitoring machines

V. Preparation

1. Perform an informal JSA to consider the potential hazards of the operation, or review from the sampling JSA.
2. Put on PC&E (Level A).
3. Enter the area of the decontamination operation.
4. Set up the emergency equipment (shower, etc.).
5. Set up the MINICAMS, turn on, and calibrate.
6. Position and turn on the ventilation machines (at sample and make-up points).
7. Mix the decontamination solution (NaClO).
8. Connect and ready the pump.
9. Position catch vessel under the sample point.

VI. Procedure

1. Open the sample point.
2. Open one make-up point.
3. Connect the decontamination hose from the pump to the make-up point.
4. Start the pump.
5. Run the pump until a steady stream exits the sample point. (The pump will have to be stopped and the catch drum at the sample point will have to be changed as it fills).
6. Turn off the pump and remove the hose from the make-up point.
7. Close the make-up point and move the hose to the next make-up point, if more than one exists.
8. Repeat the decon operation for each make-up point.
9. If the sample point location is higher than the inlet point, reverse the flow.

VII. Post-Decontamination

1. After all piping and vessels have been flushed with NaClO, follow-up sampling will be initiated in accordance with the Sampling SOP.
2. When sampling is completed, a negative response on the MINICAM will allow vessels and pipes to remain open.
3. A positive response will require secondary decontamination and re-sampling.

VIII. Hazardous Waste

- All waste from the decontamination operations or ancilliary operations will be disposed of according to RMA requirements.
- Waste will be tested to ensure complete neutralization to RMA-required levels.

IX. Documentation

- Records of all decontamination operations shall be maintained by RMA.
- TVA will record its verification of the XXX status of decontaminated vessels and piping.

X. Quality Assurance

- This SOP will be followed unless deviations are approved by the project engineer.
- After decontamination, follow-up sampling will be done in the same manner and for the same period originally performed when the vessels were found to be contaminated.

XI. Emergencies

- Sections 9.7, 10.3, and 10.5 of the SPSS.

APPENDIX K

RMA SOP SF-50-1, Emergency Response

1. ROCKY MOUNTAIN ARSENAL
STANDING OPERATING PROCEDURE FOR:

2. ITEM: EMERGENCY RESPONSE PLAN
FOR FIELD ACTIVITY
DISCOVERED CHEMICAL
AGENTS AT ROCKY MOUNTAIN
ARSENAL (RMA)

3.a. OPERATION: EMERGENCY RESPONSE

3.b. ESTIMATED DAILY PRODUCTION RATE: _____

4. ARSENAL ORGANIZATIONAL SYMBOL: SMCRM-SF

5. SOP NO.: SF-50-1 DATE: 25 APRIL 1988

5.a. REV NO.: 1 DATE: 25 APRIL 1988

5.b. CHANGE NO.: _____ DATE: _____

6. AUTHORITY: AMC-R 385-131 AP 50-6 DATE: 9 OCT 1987
12 NOV 1986

7. PREPARED BY: Alma T. Harris TITLE: SAFETY & OCCUPATIONAL HEALTH MANAGER
ALMA T. HARRIS TELEPHONE: 303-289-0338

8. REVIEWED BY: William Moloney TITLE: QUALITY ASSURANCE OFFICE
WILLIAM MOLONEY

REVIEWED BY: Martin L. Wittig TITLE: CHIEF, FIRE PREVENTION BRANCH
MARTIN L. WITTIG

9. SUBMITTED BY: Alma T. Harris TITLE: SAFETY & OCCUPATIONAL HEALTH MANAGER
ALMA T. HARRIS

10. CONCURRENCES:

OFFICE	SIGNATURE	TITLE
SMCRM-IS	<u>David L. Kim</u>	DIR, INSTALLATION SERVICES
SMCRM-IS	<u>Elijah G. Jones</u>	C, TECHNICAL SUPPORT OFFICE
SMCRM-SS	<u>Robert D. Howell</u>	C, SECURITY OFFICE
SMCRM-ISS	<u>Thomas B. Jones</u>	C, SYSTEMS OPERATIONS DIV
AMCRM-TO	<u>David L. Barber</u>	PM, TECHNICAL OPERATIONS
TECHNICAL ESCORT UNIT	<u>John R. Neal</u>	TEU COMMANDER
SMCRM-ISF	<u>Samuel T. Pratt</u>	ENVIRONMENTAL COORDINATOR
SMCRM-SF	<u>Alma T. Harris</u>	SAFETY MANAGER

11. APPROVAL:

<u>OFFICE</u>	<u>SIGNATURE AND DATE</u>	<u>TITLE</u>
SMCRM-CO	<i>Edward R. Ettner, Jr.</i> 17 June 88 EDWARD R. ETTNER, JR.	COMMANDER, RMA
_____	_____	_____
_____	_____	_____

12. QUARTERLY REVIEW:

<u>DATE</u>	<u>SIGNATURE</u>	<u>TITLE</u>
_____	_____	_____
_____	_____	_____
_____	_____	_____

13. SEMIANNUAL REVIEW:

<u>DATE</u>	<u>SIGNATURE</u>	<u>TITLE</u>
_____	_____	_____
_____	_____	_____
_____	_____	_____

14. BIENNIAL REVIEW:

<u>DATE</u>	<u>SIGNATURE</u>	<u>TITLE</u>
_____	_____	_____
_____	_____	_____
_____	_____	_____
_____	_____	_____

SUPERVISOR'S STATEMENT

SOP No. SF-50-1 REV No. _____ CHANGE No. _____ DATE _____

- 1. The Supervisor will sign this statement:
 - a. When first assigned as supervisor of the operation;
 - b. When an approved formal or interim change is made to the SOP;
 - c. At least once per quarter during simulation exercises;

2. I have personally reviewed each of the operational steps of this SOP and have no question in my mind that the operation can be performed safely, efficiently, and in an environmentally acceptable manner. I have trained the operators in the details of their part of the operation and have instructed them to follow the SOP without deviation.

SUPERVISOR:

(1)	_____	_____	_____
	ECC COMMANDER	DATE	SIGNATURE
(2)	_____	_____	_____
	TEU COMMANDER	DATE	SIGNATURE
(3)	_____	_____	_____
		DATE	SIGNATURE
(4)	_____	_____	_____
		DATE	SIGNATURE
(5)	_____	_____	_____
		DATE	SIGNATURE
(6)	_____	_____	_____
		DATE	SIGNATURE
(7)	_____	_____	_____
		DATE	SIGNATURE
(8)	_____	_____	_____
		DATE	SIGNATURE

OPERATOR'S STATEMENT

SOP No. SF-50-1 REV No. _____ CHANGE No. _____ DATE _____

- 1. The operator will sign this statement:
 - a. When first assigned to the operation;
 - b. When an approved formal or interim change is made to the SOP;
 - c. At least once per quarter during simulated exercises;

2. I have read or have had read to me and understand the general and specific safety and environmental requirements, personnel limits, work description, and inspection requirements necessary to accomplish my operation. I have been thoroughly trained in, and am familiar with, my part of the operation and I agree to abide by these instructions throughout my assignment to the operation.

OPERATOR:

(1) _____	DATE _____	SIGNATURE _____
(2) _____	DATE _____	SIGNATURE _____
(3) _____	DATE _____	SIGNATURE _____
(4) _____	DATE _____	SIGNATURE _____
(5) _____	DATE _____	SIGNATURE _____
(6) _____	DATE _____	SIGNATURE _____
(7) _____	DATE _____	SIGNATURE _____
(8) _____	DATE _____	SIGNATURE _____

EMERGENCY RESPONSE PLAN FOR
FIELD ACTIVITY DISCOVERED CHEMICAL AGENTS

TABLE OF CONTENTS

	<u>Page</u>
1. General Safety Requirements	6
2. Scope	7
3. Responsibilities	7
4. Hazardous Chemicals	11
5. Specific Safety Requirements	20
6. Index of Operations (Step-by-Step Operation Procedures) .	21
Appendix A. Procedures for Emergency Personnel Decontamination Station (EDPS)	34
Figure 1. EDP Station	36
Figure 2. Contractor Report of Suspected Chemical Agent .	37
Figure 3. RMA Field Reconnaissance and Monitoring for Suspected Chemical Agent	38
Figure 4. DA Form 285 with Instructions	39
Figure 5. Field Actions taken for Detection of Chemical Agents	41
Appendix B. Command Policy Letter on Control of Suspected Munition or Other Hazardous Material)	42
Appendix C. Emergency Response Personnel List	45
Appendix D. Industrial Chemicals List	47

This SOP supersedes SMCRM-DC, DC-R-50-1, 13 May 87.

1. GENERAL SAFETY REQUIREMENTS

- a. This SOP shall be available in the Emergency Control Center (ECC), Decontamination Truck, and other available places/areas as appropriate during this operation. All Emergency Response personnel shall maintain copies of this SOP and be responsible for carrying out its provisions.
- b. There will be no deviation or change to this SOP without prior approval of the Installation Commander or his designated representative.
- c. Care will be taken to limit exposure to a minimum number of personnel, for a minimum amount of time, to a minimum amount of hazardous material consistent with safe and efficient operations.
- d. Personnel lifting material will use proper, safe lifting procedures, avoid twisting when lifting or carrying, and avoid sharp objects.
- e. Protective Clothing and Equipment will be worn by all individuals as designated by their position of response.
- f. No smoking, eating, or drinking should occur during this emergency response. (There may be some areas excluded, i.e., ECC.)
- g. HEATSTROKE is a Medical Emergency. Immerse victim in cool water while waiting for the ambulance. Massage arms and legs to aid circulation. If unable to immerse victim, soak his clothing in water and rush him wet to a hospital. DO NOT TRY to give water to an unconscious victim.

NOTE: Prior designation of an Emergency Response Command Structure is highly recommended to avoid confusion and misdirection at the scene.

25 April 1988

SOP SF-50-1

2. SCOPE. This SOP outlines the responsibilities for the RMA Emergency Response Team to follow whenever a chemical accident/incident occurs at this installation. This SOP will be added as an Appendix to the contractor's Safety and Health Plans.

3. RESPONSIBILITIES:

a. The Commander (Cdr), RMA, will:

(1) Be in complete command and control of all personnel, equipment, and procedures within the operational site.

(2) Provide appropriate level protective clothing for all emergency response personnel. [The source of supply is the ISSA (Intra Service Support Agreement) with Pueblo Army Depot.]

(3) Designate a Chemical Accident/Incident Response Officer (CAIRO) to conduct actions in accordance with (IAW) this SOP. (When the Technical Escort Unit (TEU) are here, they will be the CAIRO.)

b. The CAIRO will:

(1) Initiate actions based upon this SOP to limit the spread of contamination and to prevent personnel becoming chemical casualties.

(2) Set up and control operations in and around the site from a mobile Command Post (CP) located upwind of the site at a safe distance based upon the particular circumstances of the accident/incident/occurrence.

(3) Determine the facts regarding the accident/incident/occurrence, and make appropriate recommendations as to response actions needed to the Cdr, RMA. Take actions as approved. In the absence of the Cdr, RMA, take actions considered necessary and appropriate.

(4) Advise and provide operational support to an AMC General Officer (On-Scene Commander) if one arrives at the Installation.

c. The Chief, Fire Department (Dept), RMA, will:

(1) Arrive on-site and assume full responsibility as the Assistant CAIRO (A/CAIRO) until arrival of CAIRO. Accomplish the immediate decontamination/treatment/evacuation of casualties from the site, and limit access onto the site to personnel needed for emergency response actions.

(2) Provide Emergency Medical Technician (EMT) and Firefighting/Rescue (FF/RS) teams to perform emergency response actions on site.

d. The Chief, Security Office, RMA, will provide security guards to establish Traffic Control Points (TCP) which will limit access of the site to persons needed for emergency response only.

e. The Chief, Technical Support Office (TSO), RMA, will:

(1) Provide chemical surety laboratory (lab) analysis on all suspect water and soil samples. Provide monitoring with bubblers for suspect contaminated equipment to determine if further decontamination is warranted prior to release.

(2) Provide results of analysis to the CAIRO for use at the operational site as soon as possible.

(3) Provide an individual to work with the Senior Quality Assurance personnel on the Downwind Hazard Monitoring Team.

(4) Provide a trained individual to operate the Downwind Vapor Hazard Distance (DWVHD) Calculator.

f. The Senior Quality Assurance (QA) personnel, RMA, will:

(1) Be the lead person for the Downwind Hazard Monitoring Team. (The other team members will be assigned at that time.)

(2) Provide training in the use of the M18A2 Chemical Detection Kit to members of the monitoring team.

g. The Director, Installation Services (DIS), RMA, will:

(1) Provide a two person monitoring team trained to monitor beyond the DWVHD downwind of an operational site.

(2) Provide downwind hazard monitoring outside the DWVHD downwind of an operational site.

(3) Provide on-site monitoring for chemical surety materials.

h. The Safety Manager, RMA, will report all accidents/incidents/occurrences to higher headquarters, i.e., PM as outlined in AR 50-6, and AR 385-40 to include appropriate supplements.

i. The Public Affairs Officer (PAO), RMA, will, if applicable, notify higher headquarters, i.e., PM as required by AR 360-5; and at the direction of the Cdr, RMA, will determine when to disclose information to the public.

j. The Chief, Systems Operations Division, will:

(1) Provide a trained and knowledgeable personnel decontamination team, comprised of other Arsenal elements, to respond to emergency situations in the event TEU is not available at RMA.

(2) Be the CAIRO when TEU is not available at RMA.

(3) Provide personal protective clothing and equipment to all RMA Emergency Response members.

k. The Contractor's On-Site Safety Officer (OSO) will:

(1) Provide the mini Decon and central shower system for his particular operations.

(2) Ensure that contractor personnel's Site Safety Procedures interface with this Emergency Response SOP.

(3) Ensure provisions are made for some (minimum 2) contractor personnel to remain on site at a predesignated location (at least 50 meters upwind) until RMA or Technical Escort Unit (TEU) emergency response team arrives so that information can be relayed to the emergency response teams.

(4) Ensure proper protective measures are utilized by contractor personnel on each operational site, to include protective clothing worn and removed properly for decontamination; chemical detection equipment and core sample heaters utilized correctly; and all equipment secured on site until site has been cleared by RMA emergency response actions in the event chemical contamination is suspected.

(5) Upon two consecutive positive readings with the M-18A2 during drilling or soil sampling operations, ensure all personnel within 150 feet of the drill/sample site and where the sample was tested move to a predetermined site upwind and thoroughly decontaminate their outer clothing. The RMA Fire Department will be called to initiate an emergency response.

(a) Have the crew immediately transported in a vehicle with a removable bed liner to the contractor support area where they will process through the hot line to the showers. Clothing and equipment will be double-bagged and held; wash water will be retained. Personnel will be observed throughout the process for symptoms of agent exposure.

(b) Return to the site if subsequent laboratory analysis of the suspect soil is negative. If the analysis is positive, the decontamination procedures of this SOP will apply. If the vehicle bed liner and contractor shower trailer are found to be contaminated, they will be decontaminated and retained under Army control.

(6) If contact with liquid or vapor agent is suspected, the contractor will move upwind to their mini-decon location, perform first-level decontamination and removal of outer clothing, and then be transported for further decontamination as appropriate. Rocky Mountain Arsenal personnel will control contaminated clothing until such time that laboratory analysis indicates negative results.

(7) After contractor personnel are transported to the central shower area, they will remain at a designated location for necessary observation for signs and symptoms of agent exposure. Observation by the supervisor or designated authority is necessary before allowing personnel to leave the installation, unless laboratory analysis of samples proves negative. In addition, the transport vehicle will be considered suspect contaminated until such time monitoring results prove negative. If positive readings are encountered, the transport vehicle will be decontaminated to the 3X level and appropriately marked in accordance with AMC-R 385-131. The transport vehicle must remain upwind of the operational site (at least 50 meters) to preclude the possibility of the vehicle becoming contaminated prior to its use.

1. The TEU/EOD Project Officer (OIC) will:

- (1) Serve as the CAIRO of RMA when on Post.
- (2) Obtain overall guidance from the Commander, TEU, Aberdeen Proving Ground, Maryland.
- (3) Provide a summary of operations conducted to the Program Manager (PM), the Cdr, RMA, and the contractor involved.
- (4) Have operational command and control over all personnel directly involved in the operations downrange.
- (5) Be responsible for the execution of all TEU operations.
- (6) Conduct a briefing for all personnel involved in downrange operations and reemphasize safety precautions to be taken.
- (7) Ensure a copy of this SOP and other applicable publications are readily available in a conspicuous place at the command post.
- (8) Coordinate with TEU S4, PM, and RMA for acquisition of necessary military unique supplies to complete operations.

(9) Ensure radio/telephone contact with CAIRO on site is maintained during all operations.

(10) Ensure that the required personnel, equipment, and decontaminants are on-hand before starting operations.

(11) Be responsible for establishing the hotline.

(12) Ensure that a log (DD Form 1594) of operations is kept.

m. The Decon Team Hot Line Supervisor (TEU NCOIC when on post) will:

(1) Ensure that all personnel are prepared and ready for work upon arrival at the work site at the time designated by the OIC.

(2) Ensure that each individual has been briefed on the hazards of the operations and that the SOP has been read, understood, and signed by all personnel concerned.

(3) Ensure that substitutes for the operational teams are available when required.

(4) Ensure that all operational personnel have received a daily safety briefing before they are involved in any operations.

(5) Ensure that all equipment will be operated by licensed personnel.

(6) Ensure that all downrange personnel have had their protective masks fit checked with amyl acetate (banana oil).

(7) Ensure the CAIRO has TEU radio net and RMA Charlie net, as necessary.

n. The TEU personnel will perform procedures as directed by the OIC.

o. The individual workers will:

(1) Follow protective measures outlined in this SOP and any other applicable SOPs in order to prevent the spread of contamination and to prevent becoming a chemical casualty.

(2) Inform supervisor of any change in health status, particularly during and after operations occur.

4. HAZARDOUS CHEMICALS. In all cases, the RMA Fire Prevention Branch will, after initial decontamination, evacuate the victim immediately to the Fitzsimons Army Medical Center (FAMC) Emergency Room (ER). They will ensure the FAMC ER is notified of the incoming casualty by the most expeditious communication method available.

a. HTH (Calcium Hypochlorite).

(1) HTH is a bleaching material available as a stable, water-soluble material in a granular form. The compound contains between 70% and 30% available chlorine and is very corrosive. HTH is satisfactory for the decontamination of V and H agents. Do not use pure HTH on H, since a toxic vapor and/or a fire can be produced.

(2) HTH will destroy clothing, has a toxic vapor, and will burn the skin. A protective mask and rubber gloves are the minimum protective equipment for handling HTH. If HTH comes in contact with the skin or clothing, the area should be flushed with large amounts of water.

(3) HTH bleaches out the enzyme detector ticket. To confirm decontamination, use M8 detector paper for VX and the Blue Band Tube/Green Top Bottle for G series agents. Use Blue Band Tube/Blue Top Bottle for H series agents.

(4) Transport the casualty immediately to the FAMC ER. Notify the ER of the incoming casualty.

b. STB (Super Tropical Bleach).

(1) STB is a bleaching material available as a stable, water-soluble material in a powder form. The compound contains between 35% and 10% available chlorine and is very corrosive. STB is used primarily in slurry pans. Do not use pure STB on H, since a toxic vapor and/or a fire will be produced.

(2) STB will destroy clothing, has a toxic vapor, and will burn the skin. A protective mask and rubber gloves are the minimum protective equipment for handling STB. If STB comes in contact with the skin or clothing, the area should be flushed with large amounts of water.

(3) STB bleaches out the enzyme detector ticket. To confirm decontamination, use M8 detector paper for VX and the Blue Band Tube/Green Top Bottle for G series agents. Use Blue Band Tube/Blue Top Bottle for H series agents.

(4) Transport the casualty immediately to the FAMC ER. Notify the ER of the incoming casualty.

c. Soda Ash (Sodium Carbonate - Washing Soda).

(1) Soda Ash is a white powder having alkaline properties.

(2) Soda Ash is used for decontamination purposes at the personnel decontamination station (PDS) and is an effective decontaminant for G agents.

(3) Transport the casualty immediately to the FAMC ER. Notify the ER of the incoming casualty, if necessary.

d. Caustic Soda (Sodium Hydroxide).

(1) Caustic Soda is the primary decontaminant for G series agents.

(2) Caustic Soda should be mixed in an iron or steel container, never in an aluminum one.

(3) Add Caustic Soda to water to prevent boiling and spattering due to the excessive heat emitted.

(4) Caustic Soda can cause skin burns.

(5) Transport the casualty immediately to the FAMC ER. Notify the ER of the incoming casualty.

NOTE: Caustic Soda is not in the list of required materials. Use Soda Ash instead.

e. Nerve Agents (GB, GD, GA, VX).

(1) GB, GD, and GA are colorless liquids with a high boiling point and a very low freezing point. They are considered non-persistent, lethal chemical agents.

(2) VX is a straw-colored liquid with an extremely high boiling point and a very low vapor pressure. It is considered a persistent, lethal chemical agent.

(3) Nerve agents are rapid-acting, lethal chemical agents. The action of the agent within the body is the inactivation or inhibition of cholinesterase. The hazards from nerve agents are that of vapor absorption through the respiratory tract, absorption through any part of the skin, through the eyes, and through the gastrointestinal tract by ingestion.

(4) Accidental skin contact with the liquid agent or inhalation of agent aerosol or vapor are the most common causes of casualties. The agent absorption rate is accelerated through cuts or abrasions in the skin.

(5) Symptoms - Initial:

(a) Pinpointing of pupils (myosis) and dimness of vision.

(b) Running nose.

(c) Tightness of chest.

(d) Difficulty in breathing.

(e) Liquid contact produces, in addition to the above symptoms, localized sweating and twitching in the muscles beneath the exposed area.

(6) Symptoms - Advanced.

(a) Nausea and possible vomiting.

(b) Cramps and involuntary urination and/or defecation.

(c) Headache or drowsiness.

(d) Coma.

(e) Convulsions.

(f) Cessation of breathing.

(7) The casualty will be decontaminated. After decontamination of the eyes by immediately flushing with water and decontaminating the face, the victim will be masked. Contaminated clothing will be removed. Contaminated areas (except eyes) will be washed with commercial liquid household bleach (Sodium Hypochlorite - nominal 5% solution) and flushed immediately with water. Decontamination will be completed, if possible.

(8) If there is no apparent breathing, CPR will be started immediately. Mechanical resuscitation will be used by the EMTs if facial contamination is present.

(9) One (1) Nerve Agent Antidote Kit (NAAK), MARK 1, will be given immediately by intramuscular injection to an individual upon onset of symptoms or signs of agent exposure.

NOTE: Although myosis (pupil contraction) is a sign of nerve agent exposure, the MARK 1 kit will not be given when this is the only symptom present (IAW DARCOM Reg 385-102).

(10) One MARK 1 injector dose may be repeated at 10-15 minute intervals if indicated by the continuation of nerve agent symptoms. No more than three (3) doses will be given without the advice and approval of a physician. A record of the doses will be kept with the casualty.

(11) Transport the casualty immediately to the FAMC ER. Notify the ER of the incoming casualty.

f. Mustard (H, HD, HT - Blister Agents).

(1) Mustards are oily liquids ranging from colorless to dark brown in color. They have a characteristic odor similar to garlic or horseradish. Mustards freeze at approximately 58 degrees Fahrenheit, are stable in storage to 252 degrees Fahrenheit, and have no action on metals.

(2) Mustards are delayed-action, persistent, toxic chemical agents that burn and blister the skin or injure the internal parts of the body. Main portals of entry into the body are by inhalation of the vapors, by liquid contact with the skin, or through any body opening.

(3) Persistence of the hazard from mustard is dependent upon the concentration of the agent and the temperature. It will persist two to five times longer in the winter than in the summer.

(4) Mustard has a cumulative effect even in small repeated exposures and may produce a sensitization in some individuals. If this occurs, the individual will exhibit allergic symptoms and will react to even small doses.

(5) Symptoms.

(a) Little or no pain occurs upon exposure to mustards. The first symptoms appear 4 to 6 hours later.

(b) Eyes are extremely sensitive to low concentrations of mustard and become inflamed, causing "red eye" and a sensation of grit in the eyes.

(c) When exposed to heavy concentrations, the nose and throat become inflamed, causing the sensation of having a head cold.

(d) The skin reddens and water blisters may develop if the individual contacts liquid mustard.

(6) After exposure to a mustard agent (H, HD, HT, or L), flush eyes and face with copious amounts of fresh water. Blot contamination from the skin - DO NOT RUB OR SCRUB!

(7) Remove the person from the source of the contamination and flush the skin and clothes with a 5% Sodium Hypochlorite solution within one (1) minute of exposure. Remove the contaminated clothing. Flush the skin again with a 5% Sodium Hypochlorite solution. Wash contaminated skin with soap and water. If showering facilities are not immediately available, use the skin decontamination pads found in the M258A1 Decontamination Kit.

(8) For gross contamination of the skin, the contaminated area should be flushed immediately with clear, cool water, avoiding rubbing the affected area. As soon as possible, the individual should shower.

(9) Transport the casualty immediately to the FAMC ER. Notify the ER of the incoming casualty.

g. Lewisite (L - Blister Agent).

(1) Lewisite is an oily liquid ranging from colorless to violet in color. It has a characteristic odor similar to that of geraniums. Lewisite freezes at 0 degrees Fahrenheit, and has no action on metals if it is dry.

(2) Lewisite is a rapid-acting, non-persistent, toxic chemical agent that burns and blisters the skin or injures the internal parts of the body. Main portals of entry into the body are by inhalation of the vapors, by liquid contact with the skin, or through any body opening.

(3) The persistence of the hazards from Lewisite is dependent on the concentration of the agent and the temperature. It decomposes rapidly in hot, humid weather.

(4) Lewisite has a cumulative effect on the body and acts as a systemic poison.

(5) Symptoms:

(a) Lewisite produces an immediate, strong, stinging sensation to the skin. Reddening of the skin is evident within thirty (30) minutes.

(b) Eyes are extremely sensitive to liquid Lewisite and sight loss will occur if they are not decontaminated within one (1) minute.

(c) High concentrations of Lewisite cause pulmonary edema, diarrhea, subnormal temperature, and low blood pressure.

(6) Transport the casualty immediately to the FAMC ER. Notify the ER of the incoming casualty.

NOTE: Decontamination and treatment of Lewisite casualties is IAW paragraph 3f(7) - (9) above.

h. Hydrogen Cyanide, Cyanogen Chloride (AC, CK - Blood Agents).

(1) Blood agents are absorbed into the body primarily by breathing. They affect the bodily functions through action on the enzyme cytochromeoxidase, thus preventing the normal transfer of oxygen from the blood to the body tissues.

(2) Blood agents are rapid acting casualty-producing agents which have a short duration of effectiveness due to the high volatility of the agents.

(3) CK has the additional capability of breaking down the filter elements of the protective mask.

(4) Symptoms:

(a) Increased breathing rate. (AC) Rapid or shallow breathing, depending on type.

(b) Decreased breathing rate. (CK).

(c) Increased pulse rate and pounding heart.

(d) Lips and skin will flush pink to red because of the excessive oxygen in the blood.

(5) After exposure to a blood agent, evacuate the casualty immediately to the FAMC ER.

(6) Artificial respiration may be needed if breathing becomes difficult.

(7) Decontamination procedures for AC and CK is to wash with copious amounts of water. However, the agent has a rapid evaporation factor making field decon ineffective.

(8) Transport the casualty immediately to the FAMC ER. Notify the ER of the incoming casualty.

i. Adamsite (DM - Vomiting Agent).

(1) DM is a greenish--yellow powder to black solid with no apparent odor.

(2) DM has a very high rate of action and requires only about one (1) minute to incapacitate an individual.

(3) Symptoms:

(a) Irritation to the eyes and mucous membranes.

(b) Runny nose.

- (c) Sneezing.
- (d) Coughing.
- (e) Severe headaches and acute pain.
- (f) Tightness in the chest.

(g) Nausea and vomiting. The effects may last up to three (3) hours.

(4) After exposure to a vomiting agent, vigorous activity will lessen the duration of the effects of this agent.

(5) Decontamination procedures -- remove victim to fresh air. A 5% sodium hypochlorite and water solution (bicarbonate of soda) should be used to wash away any detectable DM.

(6) Transport the casualty to the FAMC ER immediately. Notify the ER of the incoming casualty.

j. Phosgene (CG - Choking Agent).

(1) CG is a delayed-action chemical agent which is absorbed by the lung air sacs and then hydrolyzed. This irritation damages the capillaries and causes blood plasma to fill the lungs causing "dry land drowning".

WARNING: CG can defeat the protective mask in a short period of time.

(2) Symptoms:

(a) Initial - May vary from none to severe (coughing, nausea, or headache).

(b) Advanced - Tightness in the chest, painful shallow breathing, and coughing up a frothy sputum.

(3) After exposure to a choking agent, keep the casualty calm and warm.

(4) Aeration is the primary decontamination; however, the area of the face/mask may be washed with copious amounts of water. Caustic solution may be used to decon liquid CG. (Ammonia hydroxide mist may be used for leak detection.)

(5) Transport the casualty immediately to the FAMC ER. Notify the ER of the incoming casualty.

k. BZ.

(1) BZ is a slow-acting incapacitating agent. Action of the agent within the body is the depression of the central nervous system. The hazards of BZ are from inhalation or ingestion.

(2) Symptoms: (after 1 to 4 hours).

- (a) Restlessness.
- (b) Dizziness.
- (c) Confusion.
- (d) Vomiting.
- (e) Dryness of the mouth.
- (f) High temperature (sometimes above 102° F *, p. 6)
- (g) Flushing of the skin.
- (h) Blurred vision.
- (i) Dilation of the pupils.
- (j) Slurred speech.

(3) After exposure to an incapacitating agent, keep the casualty calm, restrained; may need cooling as for heat stroke*.

(4) Decontamination of personnel can be accomplished by washing contaminated parts with soap and water. Flush eyes with clear water only. Clothing and individual equipment should be shaken or brushed and thoroughly washed. Hypochlorite or alcohol caustic solutions are suitable for decontamination.

(5) Transport the casualty immediately to the FAMC ER. Notify the ER of the incoming casualty.

1. White Phosphorous (WP) and Red Phosphorous (RP).

(1) WP and RP are bursting smokes which ignite spontaneously when they come in contact with air. The vapors of WP and RP are poisonous, and exposure causes bone decay. (No vapors are found in smoke.)

(2) WP and RP should be moved and stored under water to prevent spontaneous combustion.

(3) Symptom: Severe burns which could take a long time to heal.

(4) After exposure to WP or RP, keep the casualty calm and keep the affected area under water.

(5) Transport the casualty immediately to the FAMC ER. Notify the ER of the incoming casualty.

5. SPECIFIC SAFETY REQUIREMENTS.

a. Before being assigned to emergency response operations, RMA personnel will be given a medical examination IAW AMC Reg 385-131, DA PAM 40-8, and OSHA standards. The preassignment medical examination will include blood cholinesterase tests IAW current policy to establish a baseline level. Each person who is assigned to hazardous operations will be given a medical examination at least annually and at any other occasion when the medical authority deems it advisable.

b. Other personnel and visitors who have a need to monitor or inspect RMA emergency response operations will have established a baseline cholinesterase level and have a record of it on file at the FAMC, or other medical monitoring program. This will be completed prior to visiting the operational area.

c. In cases of agent exposure, cholinesterase determinations will be made to measure the degree of anticholinesterase activity. Follow-up examinations of plasma and RBC cholinesterase content will be performed at the discretion of the medical officer.

d. Prior to assignment to operations at RMA contractor sites, the contractor personnel will be thoroughly briefed in the signs and symptoms of agent/contaminant exposure, by their Safety and Health personnel, as well as being instructed in first aid and self-aid techniques for exposure to the various agents/contaminants that they will be working with.

e. All personnel involved in operations at RMA suspect hazardous sites will be given an off-duty telephone number (289-0190/0192) to which suspect exposures can be reported to the RMA Fire Dept EMTs.

f. Any illness or sickness will be reported by the individual to the supervisor prior to the start of daily operations or before leaving the job, if the illness occurs during working hours.

g. Individuals requiring entrance to the suspect sites at RMA and having any cuts or abrasions on their person will inform his/her supervisor. These individuals will be referred to qualified medical personnel, prior to being permitted in the hazardous waste site, for assurance the cuts or abrasions are properly covered for the type of work to be accomplished.

h. All protective clothing worn by individuals or used during the operation will be serviceable and wear dated.

i. Protective masks will be serviceable and fit checked prior to use during operations.

j. Training exercises will be conducted utilizing procedures for personnel decontamination (See Appendix A and Figure 1).

SOP No.	<u>SF-50-1</u>	DATE	<u>25 Apr 88</u>
Rev No.	<u>1</u>	DATE	<u>25 Apr 88</u>
CHANGE	<u> </u>	DATE	<u> </u>

6. INDEX OF OPERATIONS

<u>OPERATION NUMBER</u>	<u>BLDG. NO. OR SITE</u>	<u>DESCRIPTION OF OPERATION</u>	<u>PAGE</u>
1	Field	Step-by-Step Operation Procedures (Sampling and/or Area Sweeps)	23
N/A	Field	Field Actions Taken for Detection of Chemical Agents	41

REMARKS:

a. This SOP prescribes policies and procedures for emergency response actions to be taken at Rocky Mountain Arsenal (RMA). These emergency response actions will support drilling and sampling operations conducted by government and contractor personnel; liquid sampling and area clearance operations conducted by Technical Escort/Explosive Ordinance Detachment (TEU/EOD) personnel; and any other future operations conducted at RMA in which potential for exposure to a chemical surety material exists.

b. The majority of contractors physically working on RMA are supporting the Remedial Investigation (RI) being conducted by the Program Manager for Contamination Cleanup, RMA. The two primary contractors are EBASCO and ESE. Both contractors are involved in drilling soil samples and pulling water samples from the thousands of wells located on RMA.

(1) Morrison-Knudsen Engineers is one of the contractors conducting an RI of contamination on RMA for Shell Chemical Company. This firm does its own collection of soil and water samples, as well as receiving splits of samples taken on RMA by EBASCO and ESE.

(2) Each contractor has numerous subcontractors who fulfill some portion of their contracts on RMA. The contractors, as well as their subcontractors, are responsible for adhering to the procedures outlined in this SOP for the health and safety of all concerned.

c. The Program Manager is responsible for the overall health and safety of contractors working for them. Any changes made by contractors which may affect the health and safety of their employees should be coordinated with the Program Manager and the RMA Safety Manager.

d. Appendix B identifies the procedures to be used should a suspected munition or other hazardous material be found on this installation/post.

e. Appendix D identifies a list of industrial chemicals found on RMA that the contractors are likely to become involved with.

REFERENCES:

AMC-R 385-100

AMC-R 700-107

AR 50-6

RMA-R 385-1

A. STANDING OPERATING PROCEDURE FOR
Emergency Response by
Rocky Mountain Arsenal (RMA)
Personnel and TEU/EOD Personnel
(when on post)

B. OPERATION 1
C. LOCATION RMA
D. SOP No. RM-SF-50-1
DATE 25 Apr 88
E. REV No. 1 DATE 25 Apr 88
F. CHANGE No. DATE

G. OPERATION: Sampling and/or Area Sweeps

H. EXPLOSIVES LIMITS: N/A

I. PERSONNEL LIMITS: Available Personnel on the current TDA

J. STEP NO./DESCRIPTION	SPECIFIC INSTRUCTIONS (Safety (S), Operational (O), Quality Checks (QC))
1. Pre-Operation & During Operation. The supervisor of each operational site will ensure actions are IAW approved SOPs and Safety Plans.	<p>1 (O). OSO/OIC will designate the location of the CP at least 50 meters upwind of the operational site, and will relocate the CP as needed.</p> <p>2 (O). OSO/OIC will establish and maintain telephone and/or radio communications with the RMA Fire Dept.</p> <p>3 (QC). OSO/OIC will appoint a CP recorder who will maintain a daily log of all operations to be given to the CAIRO if emergency response actions become necessary.</p> <p>4 (S). Personnel should know the proper protective equipment to be worn, the proper decontamination techniques to be performed, the methods to limit the spread of potential contamination, and the actions to be taken upon finding a positive test for chemical surety material.</p>

NOTE: Personal Protective Clothing & Equipment (PPC&E) can be found in paragraphs K and L. Levels of PPC&E can be found in AMC-R 385-1, Chapter 4.

J. STEP NO./DESCRIPTION	Specific Instructions (Safety(S), Operational(O), Quality Checks(QC))
<p>2. Termination of Operation.</p> <p>Upon finding a positive test for chemical surety material, operations will cease on site, and emergency notification will begin. [See Figure 1]</p>	<p>1 (O). Upon finding a positive reading for chemical surety material with OV/HNU/M8/M18A2 detectors, all operations stop.</p> <p>2 (O). OSO/OIC will verify the positive reading with an M18A2 Chemical Agent Detector Kit. If test is negative, resume operations. If test is positive, begin the emergency response by calling the RMA Fire Dept., Ext.223.</p> <p>3 (O). OSO/OIC will direct on-site personnel to decontaminate their clothing, and proceed to the Contractor's Support Area for processing through the hot line IAW paragraph 2k, page 10.</p> <p>4 (S). OSO/OIC will observe personnel closely in a shaded area for signs/symptoms of chemical agent exposure and/or heat prostration.</p> <p>5 (O). All individuals will take appropriate first aid measures for either chemical agent or heat casualties.</p> <p>6 (O). OSO/OIC will direct all equipment, soil and water samples are to remain on-site.</p> <p>7 (O). Soil samples found to contain surety material after being placed inside the core heater will not be distributed. These will be monitored by RMA QA personnel; and if positive, will be transported by them directly to the RMA Lab for chemical surety analysis.</p>
<p>3. Limited Emergency Response Actions.</p> <p>a. These actions will be performed by RMA employees in response to notification of a positive reading for chemical surety material.</p>	<p>1 (O). Upon notification of a positive test, the RMA Fire Dept. will notify the Command Office, QA Office and TEU (if on post) of the positive test and the location of the contractor.</p> <p>2 (O). The Fire Dept Chief, or the Senior Fire Officer, will proceed to</p>

J. STEP NO./DESCRIPTION	Specific Instructions (Safety(S), Operational(O), Quality Checks(QC))
<p>b. These actions will be a combined RMA-TEU response to any notification of a positive reading for chemical surety material.</p>	<p>the CP at the operational site to initiate measures to limit access to the area to authorized personnel only and to assume duties as the A/CAIRO.</p>
<p>4. When TEU/EOD are on post they will contain hazards and establish a hot-line and PDS. They will also take samples for the Lab test.</p>	<p>3 (S). Until appropriate monitoring with an M18A2 kit has proven the initial test negative, all personnel will assume that the chemical agent is present and dress/perform accordingly.</p>
	<p>4 (O). Upon arrival on-site, the QA monitoring team will coordinate with the A/CAIRO and the On-Site Safety Officer (OSO) to gather information before proceeding along with the A/CAIRO in appropriate level Protective Clothing onto the site to perform monitoring of samples, equipment, and bore holes. After providing the necessary information [Figure 3], and answering any additional questions, the OSO and any other contractor personnel will process off the site IAW paragraph 2k, page 10. Individuals will be observed closely for signs/symptoms of chemical agent exposure for at least 30 minutes after coming off-site prior to departing RMA for the day.</p>
	<p>5 (O). If M18A2 tests by the Monitoring Team prove to be negative, the Monitoring Team will notify the A/CAIRO who will give the OSO permission to resume operations.</p>
	<p>6 (O). If the M18A2 kit tests prove to be positive for a chemical surety agent, the Monitoring Team will notify the A/CAIRO of the results and the agent present. The A/CAIRO will direct the personnel decontamination team to set up a PDS, notify the OSO of the positive test results for that particular chemical surety agent.</p>

J. STEP NO./DESCRIPTION	Specific Instructions (Safety(S), Operational(O), Quality Checks (QC))
-------------------------	--

7 (O). Depending on the amount of equipment on-site and the number of casualties (if any), the A/CAIRO will direct members of the EMT/FF/RS teams to assist the Monitoring Team in decontaminating equipment on-site, double-bagging all items, and sealing the bore hole with plastic to prevent further vapor hazard in open air. The A/CAIRO through the Fire Prevention Branch will notify the Laboratory.

8 (O). Once the equipment has been double-bagged, and a sample has been taken to the RMA Lab for chemical surety analysis, the Monitoring Team will pass the double-bagged equipment through the PDS for transportation by truck to Building 882, seal with plastic any sample bore sites in the operational area, place appropriate markers on-site, and then process through the PDS off-site.

9 (O). The Safety Manager and the PAO, RMA, will make the necessary reports (if applicable) up the chain of command within the prescribed time limits delineating the events which occurred.

5. Extensive Emergency Response Actions and RED PHONE ALERT

1 (O). The A/CAIRO will determine any additional response needed based upon the Monitoring Team recommendations. The A/CAIRO will notify the Security Desk Sergeant who will initiate a RED PHONE ALERT message requesting specified personnel comply with these actions.

2 (O). When RED PHONE ALERT message comes through, the Emergency Response Team members will proceed to the Laundry for Masking, after which all personnel will take their assigned positions. (See Appendix C for Emergency Response Personnel List.)

J. STEP NO./DESCRIPTION	Specific Instructions (Safety(S), Operational(O), Quality Checks (QC))
3 (O). The ECC members will proceed to the ECC to assume duties as assigned.	
4 (O). The CAIRO will proceed to the site with the ambulance and driver/EMT.	
5 (O). The ECC will notify the Lab of possible incoming surety samples, and will notify members of the personnel decontamination team to respond IAW this SOP. He will notify the Downwind Vapor Hazard Calculator to proceed to the (ECC) to begin calculating the DWVHD for the chemical agent identified on site.	
6 (O). The Chief, Security Office, will dispatch a TCP Security Team to the operational site based upon the route of ingress onto the site provided by the A/CAIRO. The A/CAIRO will brief the TCP Security Team upon arrival on-site, and will direct the placement of the TCP based upon wind direction, suspected agent, and routes into and out of the operational area. The Chief, Security Office, then proceeds to the ECC to coordinate security operations on post.	
7 (O). The A/CAIRO will direct the required response level of EMT and FF/RS teams based upon circumstances on-site.	
8 (S). Once on-site, all Emergency Response personnel will remain at the CP designated, unless specifically directed to accomplish emergency rescue procedures downrange either while wearing Level A Protective Clothing or appropriate firefighting protective clothing and respiratory apparatus.	

J. STEP NO./DESCRIPTION	Specific Instructions (Safety(S), Operational(O), Quality Checks(QC))
	<p>9 (O). After receiving the DWVHD from the ECC, the CAIRO will dispatch the monitoring team in Level B Protective Clothing with mask worn to monitor areas just beyond the DWVHD to ensure no vapor hazards exist outside the DWVHD. The ECC must ensure no unprotected personnel are allowed to remain within the area covered by the DWVHD. The team should radio results and locations to the ECC, where these will be plotted to ensure no additional persons need to be evacuated.</p>
	<p>10 (O). The EMT rescue team remaining at the CP will observe contractor and RMA personnel in the CP, and treat any injuries which may occur.</p>
	<p>11 (O). Once the site has been cleared, and all personnel proceeding from the hot area are processed through the PDS, the CAIRO will determine if the TCP Security Team(s) can be released based upon the location of the site, and the safety factors involved.</p>
	<p>12 (O). The CAIRO will complete the initial report of the accident/incident/occurrence (Figure 3), and provide it to the Cdr, RMA.</p>
	<p>13 (O). The Safety Manager and the Public Affairs Officer (PAO), RMA, will make the necessary reports up the chain of command within the prescribed time limits delineating the events which occurred.</p>
	<p>14 (O). All on-site personnel involved in the emergency response will be observed by EMTs, and if found to exhibit symptoms of chemical agent exposure, will be treated and transported immediately to the FAMC ER for follow-up treatment. Notify the FAMC ER of the incoming casualty, the chemical agent to which the patient was</p>

J. STEP NO./DESCRIPTION	Specific Instructions (Safety(S), Operational(O), Quality Checks(QC))
6. Follow-Up Requirements	<p>exposed, and the decontaminants used, by the most expeditious communications method available.</p> <p>15 (O). Once the site has been properly marked and all double-bagged protective clothing, contaminated soil, and equipment have been removed, the CAIRO will cancel the emergency response and allow all personnel to return to normal duties.</p> <p>1 (O). The Monitoring Team will monitor the double-bagged equipment with a minimum of one (1) each 2 to 3 hour lab bubbler to determine if contamination is present.</p> <p>2 (O). If the analyses show the equipment is no longer contaminated, it can be released to contractor personnel for use <u>on RMA only</u> since it will have been decontaminated to 3X level only. If the analyses show the equipment is still contaminated, the monitoring team will attempt to decontaminate and bubble the equipment again. If the equipment is still contaminated, the equipment will be held on RMA for future thermal decontamination.</p> <p>3 (O). Once the analyses of the samples are completed, the RMA Lab will furnish results to QA, Cdr, RMA, TEU (when on post), PM, and the contractor involved. If there are no detectable levels of chemical surety material present in the sample, it can be released to the contractor, and from the contractor to all other appropriate contractors/subcontractors. If there are detectable levels of chemical surety material present within the sample, the sample will not be released, and will remain in Building 882 until final disposal after approved decontamination.</p>

J. STEP NO./DESCRIPTION	Specific Instructions (Safety(S), Operational(O), Quality Checks(QC))
	<p>4 (O). All personnel, including contractor, RMA, and TEU employees, should monitor their health and watch carefully for any signs or symptoms of chemical agent exposure which may not appear until after normal duty hours. If symptoms seem to appear, the individual employee should telephone the EMTs at the RMA Fire Dept to report the symptoms to them (289-0190/0192). They will recommend that the individual proceed immediately to the FAMC ER for treatment. The EMTs will telephone the FAMC ER to report that an individual with specific symptoms is proceeding to their location for treatment.</p>
	<p>5 (O). The final report will be compiled, prepared, and distributed to the Cdr, RMA, the Contractor OSO, the TEU (if on post), and Program Manager, by the CAIRO. It should include: Contractor Report of Suspected Chemical Agent; DA Form 285 (see Figure 4); Lab results (if agent is detected); and CAIR After-Action Report.</p>

K. SPECIAL REQUIREMENTS:

1. Equipment will be added or deleted as dictated by the situation and/or weather conditions at the discretion of the OIC/NCOIC/CAIRO.

2. First Aid Equipment: (located in the ambulance provided by RMA):

a. Stretcher	2 ea
b. Blanket, Wool	4 ea
c. Water	5 gal
d. Kit, First Aid, General	2 ea
e. NAAK, Mark 1	6 ea

L. EQUIPMENT, TOOLS, GAGES, AND SUPPLIES:

<u>ITEM</u>	<u>QTY</u>
1. MATERIALS:	
a. HTH (Calcium Hypochlorite)	350 lbs.
b. Soda Ash (Sodium Carbonate - Washing Soda)	350 lbs.
c. Potable Water	20 gals.
d. Household Bleach (Sodium Hypochlorite -5% Solution)	5 gals.
e. STB	50 lbs.
2. TOOLS/EQUIPMENT PER INDIVIDUAL:	
a. Mask, Protective, M17A2	1 ea
b. Mask, Protective, M9A1	1 ea
c. Boots, Safety or TAP	1 pr
d. Field Jacket or Parka, Cold Weather	1 ea
e. Gloves, Butyl Rubber	1 pr
f. Coveralls, Explosive Handler	1 ea
g. Headgear	1 ea

25 April 1988

- h. Wet Weather Parka and Trousers 1 ea
 - i. Kit, Nerve Agent Antidote (Mark 1) 3 ea
3. VEHICLES:
- a. Truck, 4-Wheel Drive, 1/2 ton 2 ea
 - b. Truck, Cargo, 2 1/2 ton Tactical w/Power Driven Decontamination Apparatus (PDDA) 1 ea
 - c. Ambulance (provided by the RMA Fire Dept) 1 ea
4. CHEMICAL EMERGENCY KIT:
- a. Gloves, TAP 5 pr
 - b. Boots, TAP 5 pr
 - c. Footwear, TAP (Booties) 5 pr
 - d. Hood, TAP, M3 3 ea
 - e. Mask, M9 w/Filter 3 ea
 - f. Undergarment, Impregnated 3 sets
 - g. Gloves, Surgical 9 pr
 - h. Coveralls, TAP 3 ea
 - i. Coveralls, Explosive Handler 3 ea
 - j. Apron, TAP 2 ea
 - k. M6A2 Hood 2 ea
 - l. Kit, Detector, M18A2 3 ea
 - m. Water, 5 gallon Can 3 ea
 - n. Bucket, 1 gallon 3 ea
 - o. Tape, Masking 4 rls
 - p. Bags, Plastic, Large & Small, 6 mil Thick 20 ea
 - q. HTH 5 lbs
 - r. Soda Ash 5 lbs

25 April 1988

SOP SF-50-1

s.	Kit, Decontamination, Personal, M258A1	2 ea
t.	Brush, Toilet	2 ea
u.	Magic Markers	4 ea
v.	POP (Plaster of Paris)	10 rls
5.	MISCELLANEOUS:	
a.	Radio, Portable	6 ea
b.	Megaphone	2 ea
c.	Air Horn	2 ea
d.	Tape, Surveyors, Plastic	8 rls
e.	Stakes (2" x 1" x 4')	100 ea
f.	Hammer	2 ea
g.	Kit, Detector, M18A2	3 ea
h.	Probes, Non-Metallic	2 ea
i.	EOD Response Kit	1 ea
j.	Sand Bags (Prefilled)	20 ea
k.	.50 Cal Carts, Electric	10 ea
l.	Film, Color 5 x 7	10 pkg
m.	Camera, Polaroid	1 ea
n.	Prop Charge Cans Assorted Sizes (1-8" Prop Charge Can)	
o.	Fluorescent Orange Plastic Strips 1" x 6"	100 ea
p.	Chemical Agent Contamination Markers	50 ea

APPENDIX A

PROCEDURES FOR AN EMERGENCY PERSONNEL DECONTAMINATION STATION (EPDS)

STEP 1. Equipment Drop.

Equipment: Any material which prevents the contaminated equipment from contacting the ground, such as plastic bags or oilcloth; container with plastic bag liner for booties.

Action: Place all equipment used at the accident or incident site on the protective material. All movement across the hot line is through the slurry pan, if used. Remove booties, one at a time, and place booties in the container. Step across hot line on the grate over the sump.

STEP 2. Decontamination.

Equipment: Containers, preferably sprayers, for: decontaminant; hot, soapy water; and rinse water; decontaminant in sump, ABC M18A2 Detector Kit; first aid for agent(s) detected by Initial Entry Party (IEP) or Work Party (WP).

Action: Stand on grate over sump. Spray, pour, or brush each person's impermeable protective clothing with decontaminant. Spray, pour, or brush individual with hot, soapy water. Spray or pour rinse water on individual.

STEP 3. Clothing Removal.

Equipment: Plastic-lined container for protective clothing.

Action: Remove all clothing, except protective mask and hood, and place in the container. Continue to Step 4 which is at least 15 meters away.

STEP 4. Mask and Hood Removal and Shower.

Equipment: Plastic-lined container for protective mask and hood; container such as a 5-gallon can for wash water; grate for sump; towels.

Action: Step onto grate, take deep breath, and remove mask and hood and place in a container. Rinse head and upper body, then resume breathing. Pour water over body and wash with soap. Rinse body. Proceed across contamination control line to redress area.

Appendix A (continued)

STEP 5. First Aid and Redress.

Equipment: Extra clothing for personnel who are processed through the emergency PDS. First aid equipment to handle the emergency situation.

Action: Personnel have any injuries treated, dry off, and get dressed. They then go to the CP to wait for equipment and articles left at the PDS.

The IEP and WP should decontaminate as much of its own personal protection items and mission essential equipment as it can. Leave the area and the nonessential equipment to be decontaminated by support personnel.

The EPDS area is marked as contaminated, if required, until it is decontaminated by support elements.

FIGURE 1

EMERGENCY PERSONNEL DECONTAMINATION STATION (EPDS)

CONTAMINATION AREA

STEP 1. Equipment/Bootie Drop.

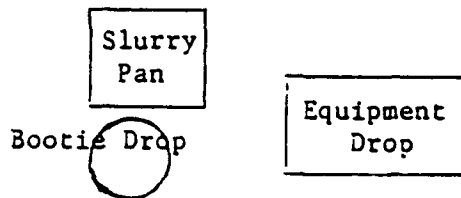

CONTAMINATION REDUCTION AREA

STEP 2. Decontamination.

STEP 3. Clothing Removal.

STEP 4. Mask/Hood Removal and Shower.

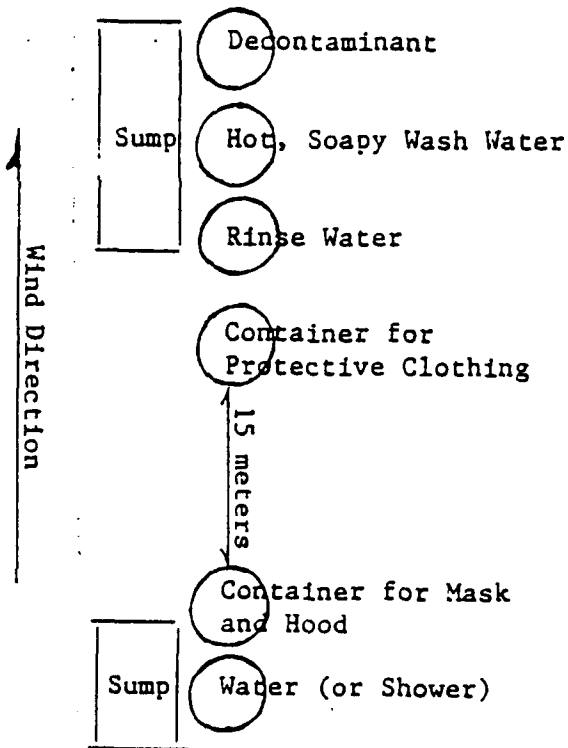

REDRESS AREA



FIGURE 2

CONTRACTOR REPORT OF SUSPECTED CHEMICAL AGENT

DATE & TIME _____

Site Safety Supervisor: _____

Location: _____

Describe Activities in Progress: _____

Personnel Present: _____

Notification to Fire Dept _____ hrs _____ / _____ / _____

METHOD OF DETECTION

____ Physiological Symptoms (describe): _____

____ Smell/Odor (describe): _____

____ M18A2 Detector Kit: Color of Tube Band _____

Number of Drops from which Bottle _____

Detector Ticket _____

Color Response of Tube or Ticket _____

____ M8 Alarm

____ M8 Detector Paper (color) _____

____ HNU Photoionization Analyzer Model PI-101 (_____ ppm) _____

____ Foxboro OVA Model 128 (_____ ppm)

____ Other _____

SAMPLE REPORT FOR CONTRACTORS

FIGURE 3

RMA FIELD RECONNAISSANCE AND MONITORING
FOR SUSPECTED CHEMICAL AGENT

Date & Time of Investigation: _____

Date & Time of Detection by Contractor: _____

RMA Personnel Conducting Field Investigation: _____

Describe Activities, Protective Clothing, Instruments, and Equipment: _____

Describe Monitoring Performed at Site: _____

Describe Observations and Action Taken: _____

Conclusion:

- _____ No Agent Found, Resume Operations.
- _____ Agent Found, Decontaminated, Resume Operations.
- _____ Agent Found, Area Isolated, No Further Operations.

Signature of TEU-OIC _____

Signature of Contractor OSO _____

Signature of CAIRO/A/CAIRO _____

INSTRUCTIONS FOR DA FORM 285

GENERAL. The unit having the accident must investigate it and complete this report. Complete only shaded items for nonfatal off-duty accidents not involving Army operations or materiel. For all other accidents, complete all items, except those for safety staff or Safety Center use only. Type or print the report. Items may be continued on an attached sheet. Items not in the instructions are self-explanatory.

- 1a. Enter the six-part unit identification code (UIC) of the unit having the accident.
- 1b. Enter the description of the unit. For example, enter HMC 2/34 Inf, 184 CAV, Yuma PG.
2. If unknown, estimate.
3. Dawn is between first light and official sunrise. Dusk is between official sunset and night.
4. "On Post" means the accident happened on property under Department of Defense control.
5. Enter facts needed to locate the accident scene. As needed, enter building number or direction and distance from closest landmark; enter street or highway name or number; enter city or military installation; enter state and country.

SECTION A - PERSONNEL INVOLVED

Complete this section for each person involved in the accident. "Involved" means a person who was injured or who caused or contributed to the accident. If more than one person was involved, use more forms and complete only this section on them. Witnesses and injured passengers are not considered involved. Be sure to also complete this section on each supervisor who caused or contributed to the accident. Give the supervisory error in item 30. In case of damage to property with no personnel involved (e.g., fire, return disaster), report only items 6, 7 and 8 for the property custodian or the hand-releasable holder.

7. Give official address for all Government personnel. Leave out for all others. Include the unit UIC if different from the UIC in item 1.
8. Complete for all Government personnel. Leave out for all others.
9. Enter pay grade for all Government personnel including foreign national employees. For example, enter SS, O4, NGB, GS-12, C-3A. Leave out for all others.
- 10-13. Complete for Government personnel only. Leave out for all others.
14. "On Duty" means (a) person was at duty station during duty hours; or (b) person was away from duty station during duty hours out on official business. Leave out for non-Government personnel.
- 15-16. Complete for Government personnel only. Leave out for all others.
18. Enter this person's activity or task. For example, enter firing rifle, lifting box, walking across street, driving truck.
- 19-21. Leave out if activity (item 18) was not required for training. For example, exclude horseplay, chow run, stand down.
22. Pick the term below that best describes the overall mission of the activity or task in item 18.

Administrative: office	Medical
Maintenance; repair, services	Physical training;
Transportation; supply, disposal	recreation
Production; construction	Food Services
Research; development; testing	Other operation
Emergency services; law enforcement	Personal; domestic
	Off duty

23. The following definitions apply:
 3. Permanent total disability means person can never again do similar work.
 - c. Permanent partial disability means person loses or can never again use a body part.
 - d. Lost workday case - days away from work means person misses one or more days of work.
 - e. Lost workday case - restricted work activity means person is temporarily unable to perform regular duties.
 - f. Nonfatal case without lost workday means person (1) was permanently transferred or terminated, (2) received treatment greater than first aid, (3) lost consciousness, or (4) had an occupational illness that did not result in fatality or lost workday.
 - g. First aid only means one-time treatment of minor injuries.
24. Estimate the number of workdays this person will lose. Do not update this estimate unless this person dies.
25. Estimate the number of workdays this person cannot perform all regular duties after going back to work.
26. Describe this person's injury or occupational illness. For example, enter third-degree chemical burn, first-degree thermal burn, compound fracture, dermatitis, neuritis, concussion.
27. For the injury or illness shown in item 26, give the body part involved. For example, enter left knee, lungs, right thumb, nose.
28. Pick from the list below the event that resulted in the injury or illness. Then give the thing that produced it. For example, enter struck against door; bodily reaction due to U/B; overexertion due to lifting box; exposure to noise.

Struck against ...	Bodily reaction due to ...
Struck by ...	Overexertion ...
Fell from elevation onto ...	Exposure to ...
Fell from same level onto ...	External contact with ...
Caught in/under/between ...	Ingested ...
Ruined/abused by ...	Inhaled ...

DA FORM 285, Aug 80

30. For each mistake this person made, pick one error from the list below. Use error in a sentence that includes the result of the error. For example, due to inadequate attention, SGT Jones did not yield the right of way to the other vehicle; PFC Smith made an improper decision to drive while under the influence of alcohol; Mr. English failed to follow procedures (SOP) and began spot welding without his safety goggles in place; due to inadequate planning by the company commander (CPT Wright), there was no unit CS and snow removal program. As a result, PFC Carr broke his arm by falling on the icy steps.

Inadequate inspection	Failed to comply with general rules/principles
Improper attention	Improper simple physical action
Failed to recognize	(lift, hold, drop, hit, push, pull, sit, stand, reach for, open, close, connect, disconnect, etc.)
Misjudged clearance	Improper complex physical action
Speed/weight/size	(walk, run, crawl, climb, carry, jump, sign, adjust, steer, brake, etc.)
Misinterpreted	Inadequate communication
Failed to anticipate	(ask, answer, signal, inform, etc.)
Inadequate planning	
Improper decision	
Inadequate supervising	
Troubleshooting/	
problem solving	
Failed to follow procedures/	
orders/laws	

SECTION B - PROPERTY AND/OR MATERIEL INVOLVED

- 31a. List all property involved in the accident whether damaged or not. For example, enter Tank, M60A1. "Property involved" means materiel which is damaged or whose use or misuse contributed to the accident.
- 31b. Give ownership for each item listed. For example, enter Army, Air Force, Army National Guard, contractor, or private.
- 31c. If accident involved Army operations enter estimated total cost of damage. Total will include costs of parts and labor.
32. For each materiel failure or malfunction, pick one type from the list below. Use the type in a sentence to tell how the materiel failed. Include nomenclature of materiel as in item 31. For example, M60A1 fuel line connector vibrated loose and sprayed fuel over engine causing fire; F1500M road grader fuel brake master cylinder rubber piston seal decayed and failed, causing loss of fluid and brake failure.

Overheated/burned/melted	Pulled/stretched
Frost (temperature)	Twisted/torqued
Obstructed/pinned/clogged	Compressed/hit/punctured
Vibrated	Bent/warped
Rubbed/worn/frayed	Sheared/cut
Corroded/rusted/dirted	Decayed/decomposed
Overpressured/burst	Electric current action
	(short, arc, surge, etc.)

33. TM 28-750 requires a Category 1 EIR for materiel failures or malfunctions that cause or contribute to accidents.

SECTION C - ENVIRONMENTAL CONDITIONS INVOLVED

34. For each environmental condition, pick one type from the list below. Use the type in a sentence that describes its role in the accident. For example, driver's vision was restricted by fog; air breathed was contaminated by toxic fumes; heat exhaustion resulted from high temperature; seaman slipped and fell on floor made slippery by wax; illumination (dark, glare, etc.); Radiation (sunlight, x-ray, LASER, etc.); Precipitation (rain, fog, ice, snow, etc.); Work surface (slippery floor, cluttered walkway, steep rough road, etc.); Contaminants (fumes, dust, chemicals, FOD, etc.); Noise; Air pressure (explosion, decompression, altitude effects, etc.); Temperature/humidity; Wind/turbulence; Vibration; Elect. city lightning, arc, surge, short, shock, etc.); Acceleration/deceleration

SECTION D - DESCRIPTION AND CORRECTIVE ACTION

35. Give the sequence of events that describes what happened leading up to and including the accident. In describing the factors be sure to (a) name personnel making errors; (b) tell how involved personnel are related to materiel listed in item 31, e.g., commander in M151A2 or lighting immersion heater; and (c) tell how environmental conditions affected personnel or materiel. Continue on an attached sheet if necessary.
37. This item is to be completed by the commander or his representative.
38. Command review as locally required.

SAFETY STAFF USE ONLY

- GENERAL.** The safety staff will complete this section on all accidents. The safety staff will investigate all accidents requiring a DA Form 285-1 and will attach it to this report.
39. When change is checked, items 1, 2, 6 and 8 must be completed plus any changes.
 40. Enter MACOM of the unit shown in item 1. For example, enter FORSCOM, TRADOC, USAREUR, NGB, or CDE.
 42. From the list below, select the type that best describes this accident. Types are listed in order of precedence to help pick one when more than one applies.
- | | |
|-------------------------|--------------------------|
| Army mater vehicle | Fire |
| Army combat vehicle | Chemical |
| Army operating vehicle | Explosive |
| Privately owned vehicle | Missile |
| Marine diving | Radiation |
| Marine underway | Nuclear |
| Marine not underway | Personnel injury - other |
| Other Army vehicle | Property damage - other |
43. Describe the type of vehicle collision. For example, ran off road and overturned, head-on collision, back-to-back, or vehicle struck pedestrian.

UNITED STATES ARMY ACCIDENT INVESTIGATION REPORT <small>For use of this form, see AF 285-82. The government agency is OCSJ/OL.</small>						APPROPRIATE CONTROL SYMBOLS CSGAS - MTRAM
NOTE: SPACES BELOW, DENIED BY HEAVY LINES ARE FOR "SAFETY CENTER USE ONLY."						
1. UNIT IDENTIFICATION		2. TIME AND DATE OF ACCIDENT			3. TIME OF DAY (Check one)	
a. VIC	b. DESCRIPTION	a. YEAR	b. MONTH	c. DAY	d. HOUR	<input type="checkbox"/> a. DAWN <input type="checkbox"/> b. DAY <input type="checkbox"/> c. DUSK <input type="checkbox"/> d. NIGHT
4. LOCATION <input type="checkbox"/> a. ON POST <input type="checkbox"/> b. OFF POST						
5. BRAGAT LOCATION OF ACCIDENT						
SECTION A - PERSONNEL INVOLVED						
6. NAME (Last - First - MI)		7. ADDRESS (Use official address for all Government personnel)			8. SOCIAL SECURITY NUMBER	
9. GRADE	10. AGE	11. SEX <input type="checkbox"/> a. MALE <input type="checkbox"/> b. FEMALE	12. MOB OR CIVILIAN JOB SERIES	13. FLIGHT STATUS <input type="checkbox"/> a. YES <input type="checkbox"/> b. NO	14. DUTY STATUS <input type="checkbox"/> a. ON DUTY <input type="checkbox"/> b. OFF DUTY	15. NO. OF HOURS ON CONTINUOUS DUTY BEFORE ACCIDENT
16. NO. OF HOURS SLEPT IN LAST 24 HOURS (If more on duty than sleep at)						
17. CLASSIFICATION AT TIME OF ACCIDENT (Check appropriate box)						
<input type="checkbox"/> a. ACTIVE ARMY <input type="checkbox"/> c. OTHER U.S. MILITARY <input type="checkbox"/> b. ARMY CIVILIAN <input type="checkbox"/> d. ROTC <input type="checkbox"/> e. ARMY CONTRACTOR <input type="checkbox"/> f. DEPENDENT <input type="checkbox"/> g. NONAPPROPRIATED FUND		NATIONAL GUARD <input type="checkbox"/> h. TECH <input type="checkbox"/> i. ROT-1 <input type="checkbox"/> j. AT <input type="checkbox"/> k. PTFD <input type="checkbox"/> l. PTFE <input type="checkbox"/> m. AOT ARMY RESERVE <input type="checkbox"/> n. ROT <input type="checkbox"/> o. AT <input type="checkbox"/> p. AOT <input type="checkbox"/> q. PTFE FOREIGN NATIONAL <input type="checkbox"/> r. DIRECT HIRE <input type="checkbox"/> s. CONTRACT HIRE <input type="checkbox"/> t. CASUALTY <input type="checkbox"/> u. OTHER / Specify				
18. THIS PERSON'S ACTIVITY/TASK AT TIME OF ACCIDENT				19. IF THIS PERSON'S ACTIVITY WAS NECESSARY PART OF TRAINING, GIVE TYPE		
				<input type="checkbox"/> a. BASIC / School <input type="checkbox"/> b. ADVANCED / School <input type="checkbox"/> c. OUT / Unit <input type="checkbox"/> d. PROFICIENCY / Unit <input type="checkbox"/> e. OTHER / Specify		
20. WAS THIS PERSON'S ACTIVITY PART OF FIELD EXERCISE?		21. WAS THIS PERSON'S ACTIVITY PART OF TACTICAL TRAINING?		22. OPERATIONAL CATEGORY (Inventory operational category and also inventory and essential mission at time of accident.)		
<input type="checkbox"/> a. YES <input type="checkbox"/> b. NO		<input type="checkbox"/> a. YES <input type="checkbox"/> b. NO				
23. SEVERITY OF INJURY TO THIS PERSON (Check one box)						
<input type="checkbox"/> a. FATAL <input type="checkbox"/> b. PERMANENT TOTAL DISABILITY <input type="checkbox"/> c. PERMANENT PARTIAL DISABILITY <input type="checkbox"/> d. LOST WORKDAY CASE - DAYS AWAY FROM WORK <input type="checkbox"/> e. LOST WORKDAY CASE - RESTRICTED WORK ACTIVITY <input type="checkbox"/> f. NON-FATAL CASE WITHOUT LOST WORKDAYS <input type="checkbox"/> g. FIRST AID ONLY <input type="checkbox"/> h. NO INJURY <input type="checkbox"/> i. MISSING AND PRESUMED DEAD						
24. HOLIDAYS LOST (Specify)	25. HOLIDAYS RESTRICTED (Specify)	26. TYPE/NA TURE OF INJURY/OCCUPATIONAL ILLNESS		27. BODY PART AFFECTED		
28. CAUSE OF INJURY/OCCUPATIONAL ILLNESS				29. VEHICLE RESTRAINT SYSTEM		
				<input type="checkbox"/> a. USED <input type="checkbox"/> b. NOT AVAILABLE <input type="checkbox"/> c. NOT APPLICABLE <input type="checkbox"/> d. AVAILABLE BUT NOT USED		
30. THIS PERSON'S ERRORS WHICH CAUSED OR CONTRIBUTED TO THE ACCIDENT (Describe each error and the result)						
SECTION B - PROPERTY AND/OR MATERIAL INVOLVED						
31. LIST ALL PROPERTY INVOLVED IN THE ACCIDENT WHETHER DAMAGED OR NOT IF ACCIDENT INVOLVED ARMY OPERATIONS, SHOW COST OF ANY DAMAGE.						
NO.	a.	NAME OF ITEM (Company, Manufacturer, L.S., Model, Year, Model)	b.	OWNERSHIP	c.	AMOUNT OF DAMAGE
1						
2						
3						
32. MATERIAL FAILURE(S) MALFUNCTION(S) WHICH CAUSED OR CONTRIBUTED TO THE ACCIDENT (If serial number and item # report)						
33. CONTROL NUMBER FOR THE BR COVERING EACH FAILURE/MALFUNCTION (Refer to SF 285)						
SECTION C - ENVIRONMENTAL CONDITIONS INVOLVED						
34. ENVIRONMENTAL CONDITIONS WHICH CAUSED OR CONTRIBUTED TO THE ACCIDENT						
SECTION D - DESCRIPTION AND CORRECTIVE ACTION						
35. FULLY DESCRIBE THE ACCIDENT (Where available a sketch or map is preferred, all major personnel assignments and references to A.I.)						
36. ACTION TAKEN, ANTICIPATED, OR RECOMMENDED TO CORRECT THE CAUSE(S) OF THIS ACCIDENT						
37. SIGNATURE OF COMMAND REPRESENTATIVE				38. COMMAND REVIEW		
SAFETY STAFF USE ONLY						
39. REPORT SUBMISSION <input type="checkbox"/> a. INITIAL <input type="checkbox"/> b. CHANGE		40. MACOM	41. LOCAL REPORT NUMBER	42. ACCIDENT TYPE	43. TYPE OF VEHICLE COLLISION	
44. SAFETY STAFF POINT OF CONTACT (Include position, name and phone)			45. SPECIAL REMARKS		46. DATE REPORT COMPLETED (YY - MM - DD)	

FIGURE 5

FIELD ACTIONS TAKEN FOR DETECTION OF CHEMICAL AGENTS

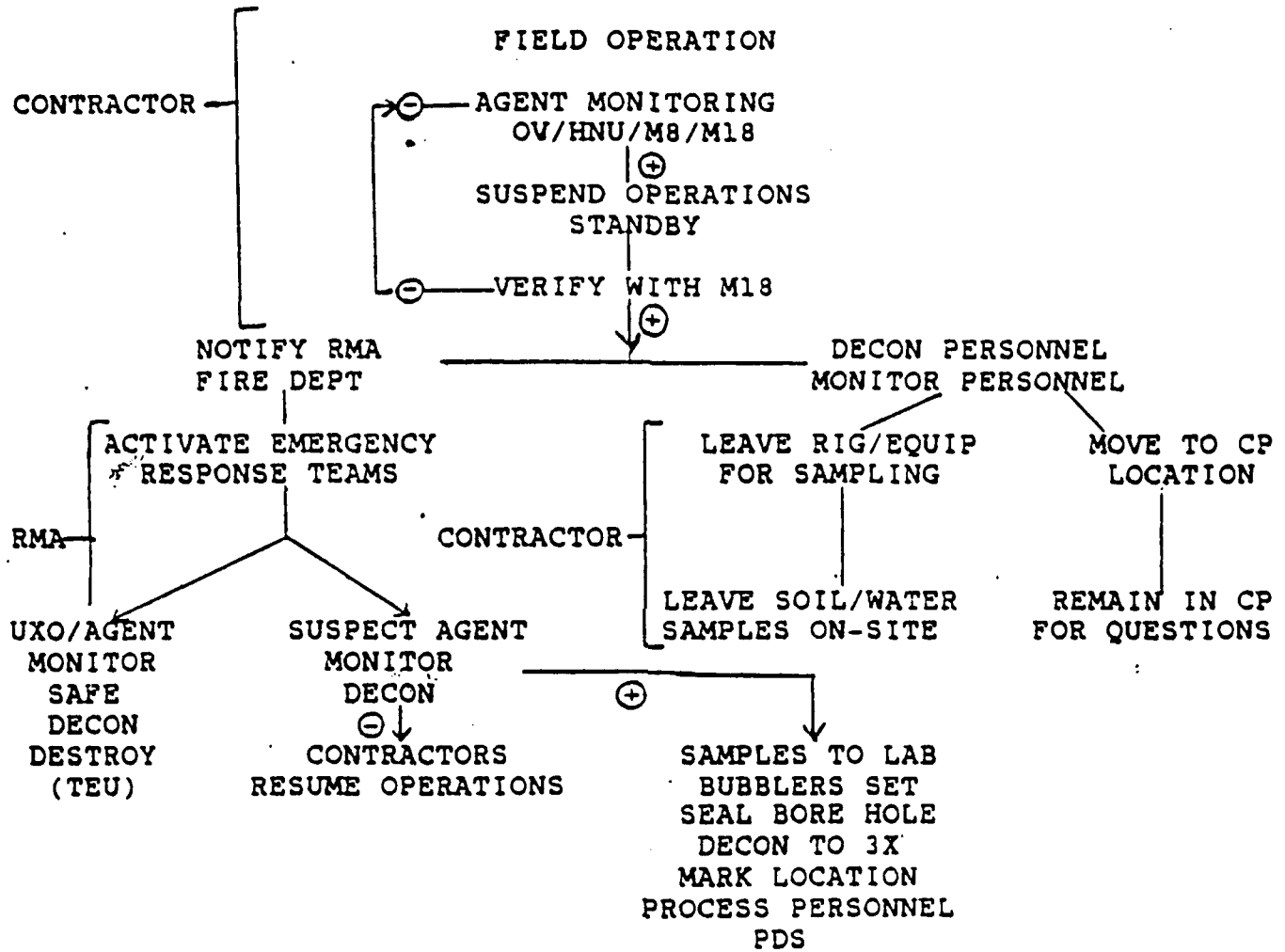

APPENDIX B

REPLY TO
ATTENTION OF:

DEPARTMENT OF THE ARMY

ROCKY MOUNTAIN ARSENAL
COMMERCE CITY, COLORADO 80022-2180

SMCRM-SF

18 May 1988

SUBJECT: Command Policy Letter: Control of Suspected Munitions or
Other Hazardous Material Found on Post

SEE DISTRIBUTION

1. All potentially hazardous munitions, munition components, and sensitive or hazardous materials will be controlled from the time of discovery on the Installation until their final disposition. Accountability will be maintained by the Director of Installation Services. Quantities issued to other activities will be controlled by the appropriate responsible officer, who will maintain adequate records to show disposition at all times. All such material will be stored in accordance with current regulations.

2. Any suspected munition or hazardous material found on the Installation will not be moved or handled by the person(s) discovering the suspect item. The location will be noted and the finder's supervisor or foreman will be advised immediately. The following information will be provided:

- a. Name of individual discovering item.
- b. Location and telephone number of supervisor (foreman) calling.
- c. Description of munition or hazardous material found.
- d. Specific location of the item(s).
- e. Brief description of how the munition or hazardous material was located.

3. Responsibilities:

- a. Supervisor (of the individual finding the suspect item) will:
 - (1) Immediately notify the Chief, Security Office, Extension 367/Fire Prevention Branch, Extension 192, of the finding.
 - (2) Fill in the initial information (Section A) of the DA Form 3265-R (sample attached) and give to EOD personnel for completion of Section B (or C, Fire Prevention Branch, if EOD is not called in).

This letter supersedes letter, SMCRM-SF, 11 March 1986.

EXPLOSIVE ORDNANCE INCIDENT REPORT

For use of this form, see FM 9-13 and 9-16; the presoning agency is U.S. Continental Army Command.

1. UNIT NUMBER
SMCRM-

2. CONTROL NUMBER

3. UNUSUAL
4. ROUTINE

SECTION A: INITIAL INFORMATION

5. DATE/TIME REPORTED 10 Jan 86, 0930 hrs	9. INCIDENT LOCATION In back of Bldg 109 North side	11. ITEM(S) REPORTED Green ton container appears to be bent in in the middle
6. REPORTED BY U. R. Safe	10. WHO TO CONTACT Security Police, X-369 Fire Prev Br, X-192	
7. PHONE NUMBER 289-0001	8. ADDRESS Rocky Mountain Arsenal	

SECTION B: ACTION BY ECO

12. PERSONNEL DISPATCHED	13. DATE/TIME	14. TRAVEL DATA	15. MAN-HOURS
	A. DEPT	A. AIR-FLYING TIME	A. TRAVEL
	B. ARR	B. VEH-MILEAGE	B. INCIDENT
	C. COMPL		

16. CONFIRMED IDENTIFICATION	17. DISPOSITION
------------------------------	-----------------

18. INCIDENT NARRATIVE (INCLUDE ALL SIGNIFICANT DETAILS AND PROBLEMS)

AUTHENTICATION

A. TYPED NAME, GRADE OF UNIT COMMANDER	B. TELEPHONE NO.	C. DATE
--	------------------	---------

SMCRM-SF

18 May 1988

SUBJECT: Command Policy Letter: Control of Suspected Munitions or Other Hazardous Material Found on Post

b. Chief, Fire Prevention Branch, will:

(1) Make a preliminary inspection, designate/mark the area of the item, and notify the Commander, or his designee, who will make the determination if support from the 94th EOD is necessary. (If Tech Escort Detachment is on post, they will be notified in lieu of the 94th EOD.)

(2) After investigating and verifying the report, immediately notify the Safety Manager of the reported finding.

(3) If munitions or toxic chemicals are involved, notify security for an access control team.

(4) Complete DA Form 3265-R if EOD is not called in. Copies of the report will be forwarded that day to Chief, Supply division; Facilities Engineer; Chief, Quality Assurance; and Director, Contamination Control.

c. Chief, Security Office, will:

(1) Control access onto and off the site.

(2) Provide escort for the EOD team in moving the munition or hazardous material to an appropriate storage location as determined in coordination with the Chief, Supply Division.

(3) Report appropriate items on DA Form 3056 in accordance with the provisions of AR 190-11 and/or AR 190-40.

d. Chief, Supply Division, will:

(1) Research found items to determine if the reported commodity is on record. If not on record, the commodity will be recorded and reported to the appropriate National Inventory control Point (NICP).

(2) Notify the security and Safety Offices immediately for action under Serious Incident Reporting Procedures.

e. Safety Manager will: Incorporate this information in the safety indoctrination given to all new employees.

f. Directors and Office Chiefs will: Ensure that all personnel are informed of the procedures directed in paragraphs 1 and 2 above.

Encl

EDWARD R. ETTNER, JR.
MAJ, CmlC
Commanding

DISTRIBUTION B

APPENDIX C

EMERGENCY RESPONSE PERSONNEL LIST

ECC Commander	David L. Heim, Ext. 115
RMA Commander	Edward R. Ettner, Jr., MAJ, Ext. 141
Program Manager, Technical Operations	David S. Strang, X 118
Chemical Accident/Incident Response Officer (CAIRO)	Susan Neary, CPT, Ext. 424 (when on post)
Chemical Accident/Incident Response Officer (CAIRO) Assistant CAIRO (A/CAIRO)	Tom James, Ext. 264 Martin Wittig, 192
Director, Installation Services Laboratory	David L. Heim, 115 Elijah G. Jones, Ext. 194
Chief, Technical Support Office	Elijah G. Jones, Ext. 194
Quality Assurance	William Moloney, Ext. 112
Monitoring Team	William Moloney, Ext. 112
DIS Monitoring Team	To Be Designated, Ext. 115
Chief, Security Office	William Dowell, Ext. 367
Security Desk	Desk Sergeant, Ext. 369
Safety Manager	Alma T. Harris, Ext. 338
Public Affairs Officer	William R. Thomas, Ext. 441
Contractor On-Site Safety Officer	To Be Designated
Personal Protective Clothing	Thomas James, Ext. 264
Chief, Systems Operation Division	Thomas James, Ext. 264
Hot Line Team	System Operation Personnel, Ext. 351

Emergency Response Personnel List (continued)

Decon Team	TEU/EOD Personnel when on post), Ext. 424
TEU/EOD Project Officer	Susan Neary, CPT, Ext. 424
TEU NCOIC, Aberdeen, MD	AV 584-4383
94th EOD, Fort Carson, CO	AV 691-4242
Surety Officer, AMCCOM, (MAJ Calvin Austin)	AV 793-4815
Alternate Surety Officer, AMCCOM (Betty Peterson)	AV 793-3193

APPENDIX D

INDUSTRIAL CHEMICALS LIST

1. Lead (Pb).

(a) Lead, inorganic lead, includes lead oxides, metallic lead, lead salts, and organic salts; but excludes lead arsenate and organic lead compounds. Lead is a blue-gray metal which is soft and malleable. Lead is slightly soluble in water in the presence of nitrates, ammonium salts and carbon dioxide.

(b) The routes of entry are inhalation and ingestion. Lead can cause anemia and hemopoetic system disturbances, kidney damage, central nervous system damage, and reproductive problems (decreased sperm production and teratogenesis).

(c) Symptoms: Early Effects:

- (1) Fatigue.
- (2) Sleep disturbance.
- (3) Headache.
- (4) Nausea.
- (5) Aching bones and muscles.
- (6) Constipation.
- (7) Abdominal pains.
- (8) Decreased appetite.
- (9) Irritability.

(d) Symptoms: Long Term Effects:

- (1) Anemia.
- (2) Pallor.
- (3) Lead line on gums.
- (4) Decreased hand-grip strength.
- (5) Wrist or foot drop.

(e) After exposure to lead, irrigate eyes with water.

(f) Flush skin with soap and water.

(g) If exposure is respiratory, move the exposed person to fresh air at once and perform artificial respiration.

(h) If the chemical has been swallowed, give large quantities of water and induce vomiting. WARNING: DO NOT MAKE AN UNCONSCIOUS PERSON VOMIT.

(i) Transport the casualty immediately to the FAMC ER. Notify the ER of the incoming casualty.

2. Mercury (Hg).

(a) Mercury is a silvery, mobile, odorless liquid. It boils at 356 - 357 degrees Centigrade. Its vapor pressure at 20 degrees Centigrade is 0.0012 mmHg.

(b) The routes of exposure are inhalation of mercury vapor, skin absorption, and skin and eye contact. Mercury exposure can cause skin and eye irritation. Mercury exposure can also cause pneumonitis and bronchitis. Exposure also can cause central nervous system damage and kidney damage.

(c) Symptoms:

- (1) Weakness.
- (2) Fatigue.
- (3) Loss of appetite.
- (4) Insomnia.
- (5) Loss of weight.
- (6) Indigestion.
- (7) Diarrhea.
- (8) Metallic taste in mouth.
- (9) Increased salivation.
- (10) Inflammation of gums.

- (11) Black line on gums.
- (12) Loosening of teeth.
- (13) Irritability.
- (14) Loss of memory.
- (15) Excitability.
- (16) Anxiety.
- (17) Delirium w/hallucinations.
- (18) Melancholia.
- (19) Manic depressive psychosis.

(d) If mercury contacts the eyes, irrigate immediately.

(e) If mercury contacts the skin, wash with soap and water promptly.

(f) If exposure is respiratory, move the exposed person to fresh air at once and perform artificial respiration.

(g) If mercury is swallowed, give large quantities of water and induce vomiting. WARNING: DO NOT MAKE AN UNCONSCIOUS PERSON VOMIT.

(h) Transport the casualty immediately to the FAMC ER. Notify the ER of the incoming casualty.

3. Arsenic (As).

(a) Arsenic is a semi-metallic element. The poisonous, whitish, or steel-grey powder of white oxide of arsenic is insoluble in water. Arsenic is present as an impurity in many metal ores and is generally produced as arsenic trioxide as a by-product in smelting of these ores, particularly copper.

(b) The primary routes of entry into the body are skin absorption and ingestion.

(c) Symptoms:

- (1) Conjunctivitis.
- (2) Visual disturbances.

(3) Peripheral neuropathy (loss of feeling in extremities).

(4) Hyperpigmentations of the skin (increased discoloration).

(5) Palmer and plantar (skin of the hands) hyperpigmentation of the skin.

(6) Palmer and plantar hyperkeratosis (thicker callouses on hands).

(7) Dermatitis.

(8) Skin cancer.

(d) After exposure to arsenic, irrigate eyes with water.

(e) Wash contaminated areas of the body with soap and water.

(f) Transport the casualty immediately to the FAMC ER. Notify the ER of the incoming casualty.

4. Dibromochloropropane (DBCP).

(a) DBCP is an amber to brown liquid with a pungent odor. It boils at 199 degrees Centigrade under a pressure of 760 mmHg. DBCP has been supplied to the agricultural industry since 1955 in the form of liquid concentrate, emulsifiable concentrate, powder, granules, and solid material.

(b) NIOSH recommends that exposure be limited to no greater than 10 parts per billion as a TWA concentration for 10 hour work-shifts for a forty-hour week.

(c) The primary route of entry into the body is inhalation of vapors.

(d) Ingestion may result in forms of cancer, but cancer has not been proven to be caused by inhalation of DBCP vapors. Target organs of DBCP exposure include the kidneys, liver, and reproductive system.

(e) Symptoms: Chronic Exposure:

(1) Sterility.

(2) Diminished renal functions.

(3) Degeneration and cirrhosis of the liver.

(f) After inhalation of DBCP vapors, move the exposed person into fresh air at once.

(g) After ingestion of DBCP, give large quantities of water and induce vomiting. WARNING: DO NOT MAKE AN UNCONSCIOUS PERSON VOMIT.

(h) Transport the casualty immediately to the FAMC ER. Notify the ER of the incoming casualty.

5. Chlorinated Pesticides (e.g., Dieldrin and Aldrin).

(a) Chlorinated Pesticides are colorless to light-tan solids with a mild chemical odor, melting at from 175 degrees to 176 degrees Centigrade. These are man-made compounds belonging to the group of cyclodiene insecticides and a subgroup of the chlorinated cyclic hydrocarbine insecticides, including DDT, BHC, etc.

(b) These chemicals are persistent in the environment due to low volatility and low solubility in water. They are extremely apolar, resulting in a high affinity for fat leading to a progressive accumulation in the food chain.

(c) The Federal limit of exposure is 0.25 mg/m³. The STEL value is 0.75 mg/m³, and the IDLH level is 450 mg/m³.

(d) The main routes of entry into the body include inhalation, ingestion, skin absorption, eye and skin contact. The target organs are the central nervous system, liver, kidney, and skin.

(e) Symptoms:

- (1) Headaches.
- (2) Dizziness.
- (3) Nausea.
- (4) Vomiting.
- (5) Malaise.
- (6) Sweating.
- (7) Myclonic limjerks (voluntary muscle twitching).
- (8) Clonic or tonic convulsions (involuntary muscle).
- (9) Coma.

(f) After exposure to chlorinated pesticides, irrigate eyes immediately with water.

(g) Wash skin with soap and water promptly.

(h) If the exposure is respiratory, move the casualty into fresh air at once and perform artificial respiration.

(i) If exposure is by ingestion, give large amounts of water and induce vomiting. WARNING: DO NOT MAKE AN UNCONSCIOUS PERSON VOMIT.

(j) Transport the casualty immediately to the FAMC ER. Notify the ER of the incoming casualty.

6. Benzene (C₆H₆).

(a) Benzene is a clear, volatile, colorless, highly flammable liquid with a characteristic odor. It is used as a constituent in motor fuels, as a solvent, as a chemical intermediate, and in the manufacture of detergents and explosives.

(b) Benzene enters the body by inhalation of vapors, through cuts, ingestion, and eye contact. Entry through intact skin is possible, but is less direct. Benzene attacks the blood, central nervous system, skin, bone marrow, eyes, and the respiratory system.

(c) Symptoms: Local:

(1) Irritation of skin, eyes, and upper respiratory tract.

(2) Pulmonary edema and hemorrhage.

(3) Dry scaly dermatitis.

(d) Symptoms: Systemic:

(1) Central nervous system depression.

(2) Anemia.

(3) Hypo- or hyperactive bone marrow (increase or decrease in red blood cell production).

(4) Leukemia.

(5) Chromosomal aberrations.

(e) After exposure to Benzene, irrigate the eyes immediately with water.

(f) Wash skin with soap and water promptly.

(g) If exposure is respiratory, move the casualty into fresh air at once and perform artificial respiration.

(h) If exposure is by ingestion, get medical attention.
WARNING: DO NOT INDUCE VOMITING.

(i) Transport the casualty immediately to the FAMC ER.
Notify the ER of the incoming casualty.

7. Unexploded Ordnance (UXO).

(a) The operational area may contain UXOs filled with high explosives and/or chemical agents.

(b) UXOs will be disposed of only by qualified FOD personnel IAW paragraph 7f, SOP TEU-RMA 50-11.