



2

TECHNICAL REPORT

Naval Facilities Engineering Service Center, Port Hueneme, CA 93043-4328

HORIZONTAL DRILLING SYSTEM (HDS) FIELD TEST REPORT - FY91

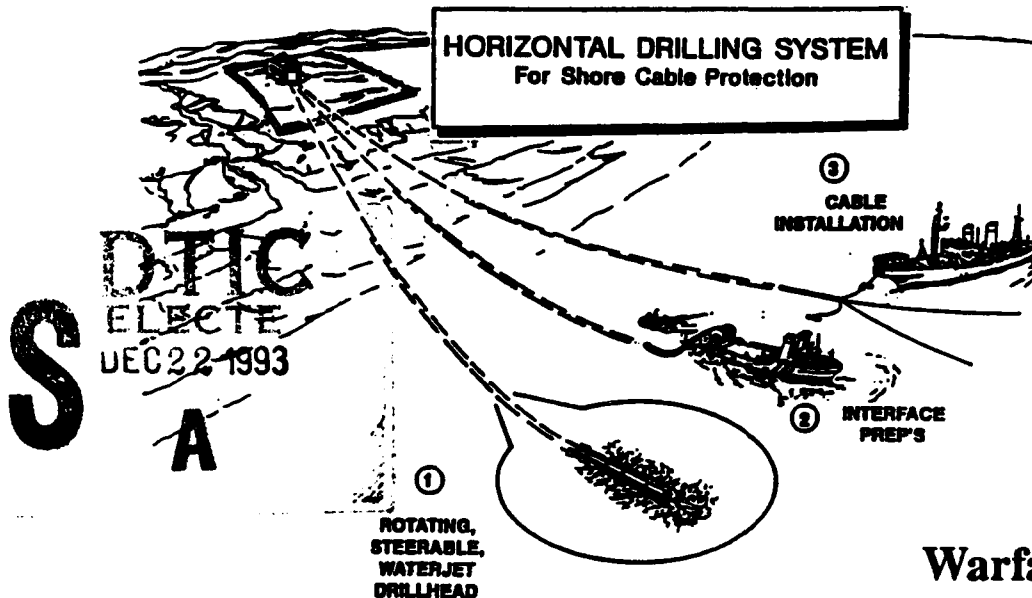

TR-2002-OCN

October 1993

By B. Cable

Sponsored by
Space and Naval
Warfare Systems Command

This document has been approved
for public release and sale; its
distribution is unlimited.

A series of horizontal drilling tests were conducted by the Naval Civil Engineering Laboratory (NCEL) at the Naval Weapons Center (NWC) China Lake, California, and at NCEL, Port Hueneme, California, under the sponsorship of the Space and Naval Warfare Systems Command (SPAWAR). The purpose of these tests was to demonstrate the operational capability of a horizontal drilling system (HDS) - a prototype system using high-pressure water as the drilling medium. Test results have provided preliminary confirmation of drill string steerability and drill string friction criteria under limited conditions. This report documents HDS FY91 tests at NWC China Lake and NCEL, and provides a discussion regarding test results.

93-30806



Approved for public release; di

93 12 21 148

**Best
Available
Copy**

METRIC CONVERSION FACTORS

Approximate Conversions to Metric Measures		Approximate Conversions from Metric Measures	
When You Know	To Find	When You Know	To Find
Symbol	Symbol	Symbol	Symbol
LENGTH			
inches	centimeters	millimeters	inches
feet	centimeters	centimeters	inches
yards	meters	meters	feet
miles	kilometers	kilometers	yards
AREA			
square inches	square centimeters	square centimeters	square inches
square feet	square meters	square meters	square yards
square yards	square meters	square kilometers	square miles
square miles	square kilometers	hectares (10,000 m ²)	square miles
acres	hectares		acres
MASS (weight)			
ounces	grams	grams	ounces
pounds	kilograms	kilograms	pounds
short tons (2,000 lb)	tonnes	tonnes (1,000 kg)	short tons
VOLUME			
teaspoons	milliliters	milliliters	fluid ounces
tablespoons	milliliters	liters	pints
fluid ounces	milliliters	liters	quarts
cups	liters	cubic meters	gallons
pints	liters	cubic meters	cubic feet
quarts	liters	cubic meters	cubic yards
gallons	liters		
cubic feet	cubic meters		
cubic yards	cubic meters		
TEMPERATURE (exact)			
Fahrenheit temperature	Celsius temperature	Celsius temperature	Fahrenheit temperature
	subtracting 32)	9/5 (then add 32)	

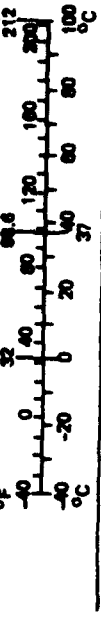

*1 in = 2.54 (exactly). For other exact conversions and more detailed tables, see NBS Misc. Publ. 288, Units of Weights and Measures, Price \$2.26, SD Catalog No. C13.10-288.

PREFACE

On 1 October 1993, the Naval Civil Engineering Laboratory (NCEL) was consolidated with five other Naval Facilities Engineering Command (NAVFAC) components into the Naval Facilities Engineering Service Center (NFESC). Due to publishing timeframes, this document may have references to NCEL instead of NFESC.

Accession For	
NTIS CRA&I	<input checked="" type="checkbox"/>
DTIC TAB	<input type="checkbox"/>
Unannounced	<input type="checkbox"/>
Justification	
By	
Distribution /	
Availability Codes	
Dist	Avail and/or Special
A-1	

DTIC QUALITY INSPECTED 3

REPORT DOCUMENTATION PAGE			Form Approved OMB No. 0704-018	
Public reporting burden for this collection of information is estimated to average 1 hour per response, including the time for reviewing instructions, searching existing data sources, gathering and maintaining the data needed, and completing and reviewing the collection of information. Send comments regarding this burden estimate or any other aspect of this collection information, including suggestions for reducing this burden, to Washington Headquarters Services, Directorate for Information and Reports, 1215 Jefferson Davis Highway, Suite 1204, Arlington, VA 22202-4302, and to the Office of Management and Budget, Paperwork Reduction Project (0704-0188), Washington, DC 20503.				
1. AGENCY USE ONLY (Leave blank)		2. REPORT DATE October 1993		3. REPORT TYPE AND DATES COVERED Final: Dec 1985 through May 1993
4. TITLE AND SUBTITLE HORIZONTAL DRILLING SYSTEM (HDS) FIELD TEST REPORT - FY91			5. FUNDING NUMBERS PR - 43-142 WU - DN669028	
6. AUTHOR(s) B. Cable				
7. PERFORMING ORGANIZATION NAME(s) AND ADDRESS(es) Naval Facilities Engineering Service Center 560 Center Drive Port Hueneme, CA 93043-4328			8. PERFORMING ORGANIZATION REPORT NUMBER TR-2002-OCN	
9. SPONSORING/MONITORING AGENCY NAME(s) AND ADDRESS(es) Space and Naval Warfare Systems Command Arlington, VA 22245-5200			10. SPONSORING/MONITORING AGENCY REPORT NUMBER	
11. SUPPLEMENTARY NOTES				
12a. DISTRIBUTION/AVAILABILITY STATEMENT Approved for public release; distribution unlimited.			12b. DISTRIBUTION CODE	
13. ABSTRACT (Maximum 200 words) A series of horizontal drilling tests were conducted by the Naval Civil Engineering Laboratory (NCEL) at the Naval Weapons Center (NWC) China Lake, California, and at NCEL, Port Hueneme, California, under the sponsorship of the Space and Naval Warfare Systems Command (SPA WAR). The purpose of these tests was to demonstrate the operational capability of a horizontal drilling system (HDS) - a prototype system using high-pressure water as the drilling medium. Test results have provided preliminary confirmation of drill string steerability and drill string friction criteria under limited conditions. This report documents HDS FY91 tests at NWC China Lake and NCEL, and provides a discussion regarding test results.				
14. SUBJECT TERMS Cable survivability, cable protection, cable shore landings, ice scour, horizontal drilling, waterjet cutting, well logging, pipe joints			15. NUMBER OF PAGES 55	
			16. PRICE CODE	
17. SECURITY CLASSIFICATION OF REPORT Unclassified	18. SECURITY CLASSIFICATION OF THIS PAGE Unclassified	19. SECURITY CLASSIFICATION OF ABSTRACT Unclassified	20. LIMITATION OF ABSTRACT UL	

CONTENTS

	Page
1.0 INTRODUCTION	1
1.1 Background	1
1.2 Purpose	1
1.3 Approach	1
1.4 Test Support	2
1.5 Test Article Description	2
2.0 TEST OBJECTIVES	6
2.1 Introduction	6
2.2 Test Objectives Versus System Capability	6
2.3 Summary	8
3.0 ROCKSITE B TEST GEOMETRY AND GENERAL ARRANGEMENT ...	8
3.1 Rocksite B	8
3.2 Launcher Foundation	8
3.3 Water Storage and Distribution System	10
3.4 Drilling Trajectories	10
3.5 Site Geology	12
3.6 Environmental Issues	20
4.0 TEST OPERATIONS AND SCHEDULE	21
4.1 Mobilization	21
4.2 Test Operations	21
4.3 Demobilization	32
5.0 DISCUSSION OF TEST RESULTS	32
5.1 Pipe Friction Measurements	32
5.2 Steerability	37
5.3 Accuracy: Logging Test	39
5.4 Personnel Training	39
5.5 System Performance	41
5.6 Cable Pull Test	44
5.7 Wet Interface Test	46
6.0 CONCLUSIONS	46
6.1 Objectives	46
6.2 Steerability Objective	47
6.3 Overall Objectives	47

	Page
7.0 RECOMMENDATIONS	48
8.0 REFERENCES	48

1.0 INTRODUCTION

1.1 Background

A series of horizontal drilling tests were conducted by the Naval Civil Engineering Laboratory (NCEL) at the Naval Weapons Center (NWC) China Lake, California, and at NCEL, Port Hueneme, California, under the sponsorship of the Space and Naval Warfare Systems Command (SPAWAR). The purpose of these tests was to demonstrate the operational capability of a horizontal drilling system (HDS) - a prototype system using high-pressure water as the drilling medium. Test results have provided preliminary confirmation of drill string steerability and drill string friction criteria under limited conditions. This report documents HDS FY91 tests at NWC China Lake and NCEL, and provides a discussion regarding test results.

1.2 Purpose

The HDS program was established to extend existing commercial horizontal drilling technology to a (horizontal) distance of 25,000 feet for the purpose of enhancing shore landing cable protection. Present horizontal drilling limits are less than 5,000 feet. In order to provide a 25,000-foot horizontal drilling capability, several special hardware components were developed as part of the HDS program. Included in the development effort were three key developmental components: a steerable drillhead, a rotating logging tool, and a high-torque capacity pipe joint. Development of each of these components was essential in order to meet the required distance objective. No similar capability exists within industry today regarding these three key developmental subsystems. Therefore, completion of HDS development efforts focused on the successful design and testing of the steerable drillhead, logging tool, and high-torque pipe joint. Although the development of other specialized drilling equipment was necessary in the program, the success or failure of HDS capability hinges on validating the operational capability of these three key subsystems.

1.3 Approach

The field test program for FY91 focused primarily on the drilling operations at Rocksite B, NWC, China Lake, California (see Section 3.1). However, there were also two other supporting field tests conducted: (1) the cable pull test, and (2) the wet interface test.

1.3.1 Cable Pull Test. Baseline plans included two pull (cable installation) tests: one at Southwest Research Institute (SWRI) and one at Rocksite B. The SWRI test was conducted and involved a pull test through 5,000 feet of pipe using two cables of "similar" size and weight as system cables. The Rocksite B pull test was to be longer (10,000 to 22,100 feet, depending on length of longest drilling test) and would install the same type and quantity of cables to be used in an actual HDS installation. Only the SWRI pull test was actually conducted, as the program was curtailed before a long-distance drilling test and subsequent pull test could be conducted at Rocksite B.

1.3.2 Wet Interface Test. Wet interface tests were to be conducted both at NCEL and at sea to demonstrate the installation of the wet interface hardware: flex pipe and pipe flange. Only the NCEL tank tests were conducted before program termination.

1.3.3 Rocksite B Test. The initial goal for the NWC Rocksite B field test was to drill three short (500-foot) test holes and a single long test hole to 22,100 feet. The long hole was later reduced to 10,000 feet due to funding limitations identified prior to starting field test activities. As a result of continued problems in identifying available funding at the contractor's level, testing was terminated after completing three short test holes. The long test was not conducted. Drill string torque values were measured for two test holes in an effort to validate drill string friction values. The third short test hole was a drill string steering test. This test provided positive results regarding steering capability for the system.

1.4 Test Support

HDS development and test support was provided to the Navy by Western Instrument Corporation (WIC) of Ventura, California. Additional technical support was provided by Battelle Memorial Institute (BMI) and SWRI via subcontracts from WIC.

1.5 Test Article Description

The HDS is composed of the equipment described in the following paragraphs (Figure 1).

1.5.1 Launcher. The launcher is a hydraulic machine that provides rotation (0 to 9.2 rpm), torque (55,000 ft-lb), and push/pull forces (280/320 kip) to the drill string during drilling operations.

1.5.2 Drill Pipe. The drill pipe is a high-strength drill pipe made from 4145 steel alloy with a 4.75-inch OD and 3.5-inch ID. The drill pipe includes a specially designed flush joint with a high-torque capacity at 15,000 psi internal pressure.

1.5.3 Steerable Drillhead (SDH). The steerable drillhead provides steering control to the drill string. This unit is battery operated and can be instructed to cut/steer in any one of the four quadrants - up, down, right, or left (Figure 2).

1.5.4 Logging Subsystem. The logging subsystem provides real-time location information for the drill string. The logging subsystem includes a logging tool, logging winch, logging cable, and logging data acquisition system.

1.5.5 Information Control Center. The Information Control Center (ICC) records system parameters (flow, pressure, torque, and forces) during drilling operations. It also contains system control circuits to protect the drill string from failures due to exceeding the limits on one or a combination of various parameters: pressure, torque, and push forces.

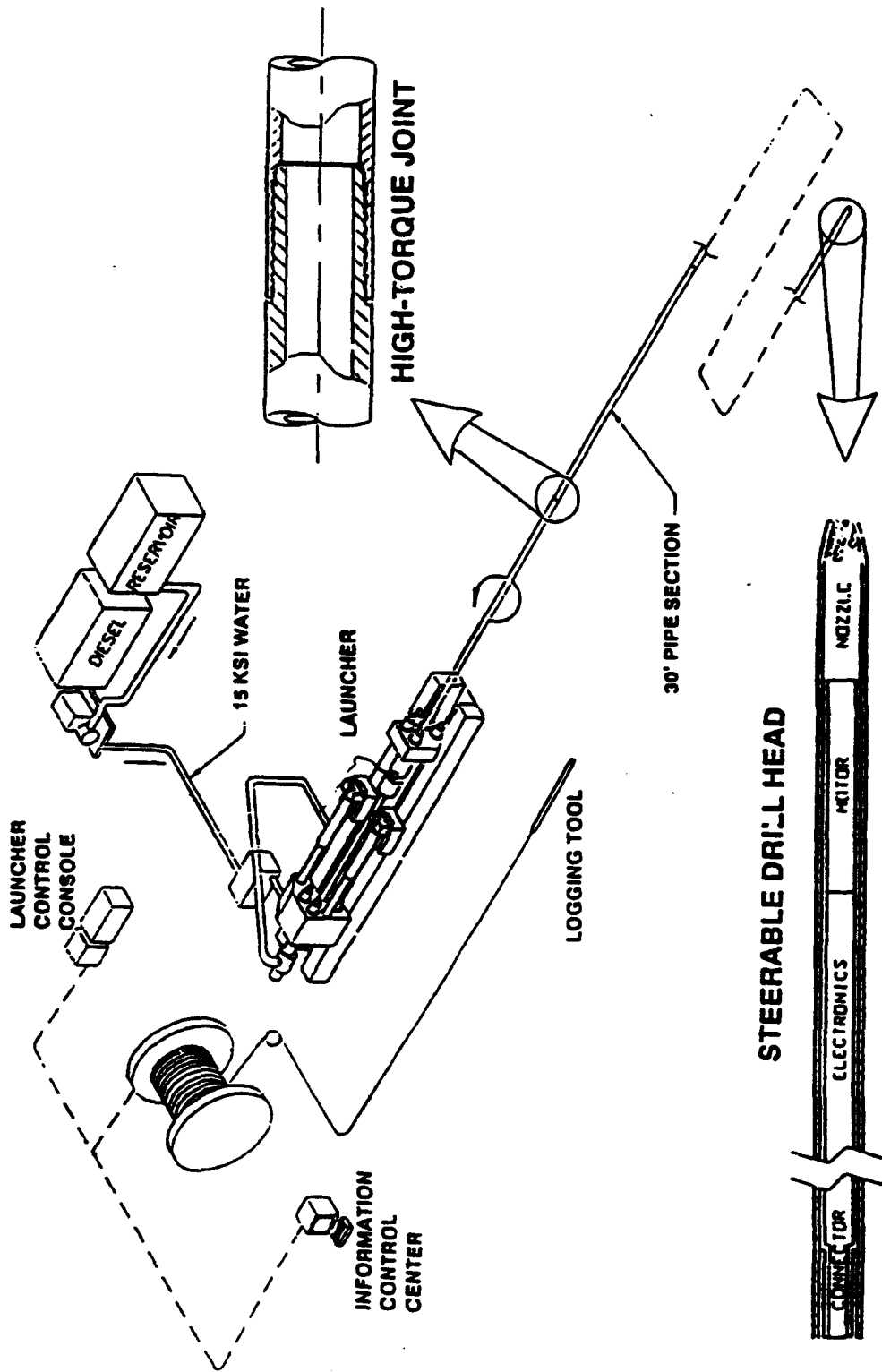

Figure 1
Key technical features.

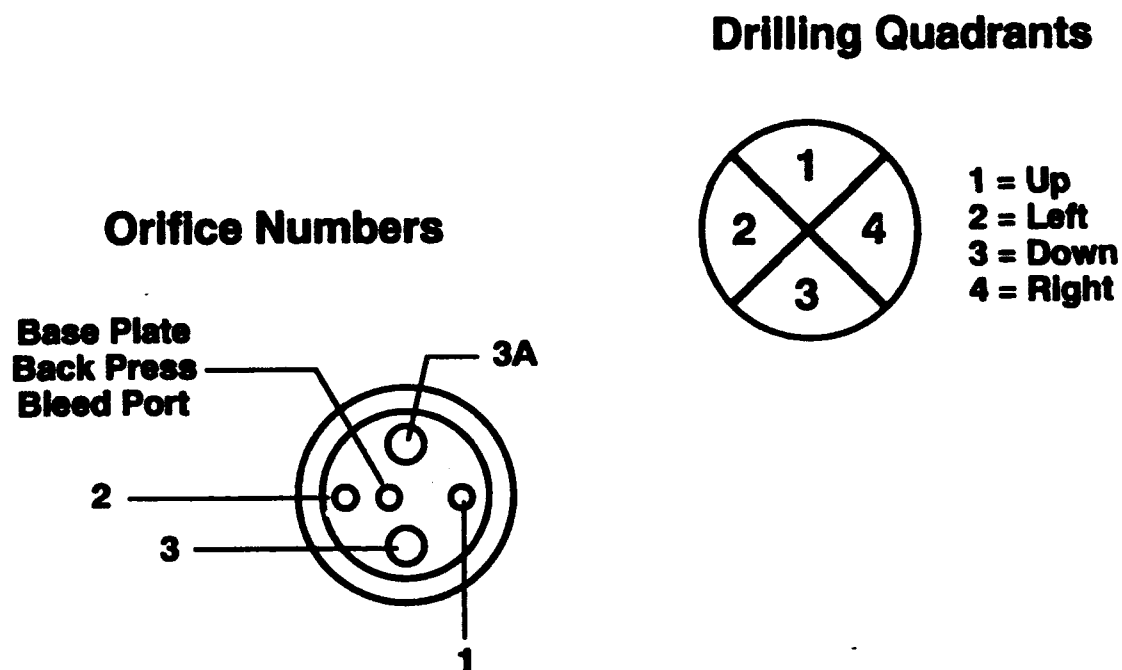

Figure 2
SDH drilling quadrants.

1.5.6 High-Pressure Pump Assembly. The high-pressure pump assembly consists of two 1,000-horsepower diesel pump assemblies, each of which provides up to 15,000-psi water pressure to the drillhead. The second diesel pump unit is a backup unit.

1.5.7 Low-Pressure Pump and Filtration Subsystem. The boost pump subsystem provides boost pressure to the high-pressure pump assemblies. It also filters the water before it reaches the high-pressure pump.

1.5.8 Pigging Subsystem. The final cable installation into the drill pipe is accomplished by using water pressure to pig the cables into the pipe. The pigging subsystem consists of a pig assembly, cable seal assembly, and pressure hoses and fittings (the cable pig is shown in Figure 3).

1.5.9 Wet Interface Subsystem. The wet interface subsystem makes the transition between the rigid pipe and the connecting cable assemblies offshore. The wet interface hardware includes a special pipe termination (pipe flange) and up to 1,000 feet of flexible pipe. This hardware is deployed and installed from an intermediate sized work platform (work boat) using divers (Figure 3).

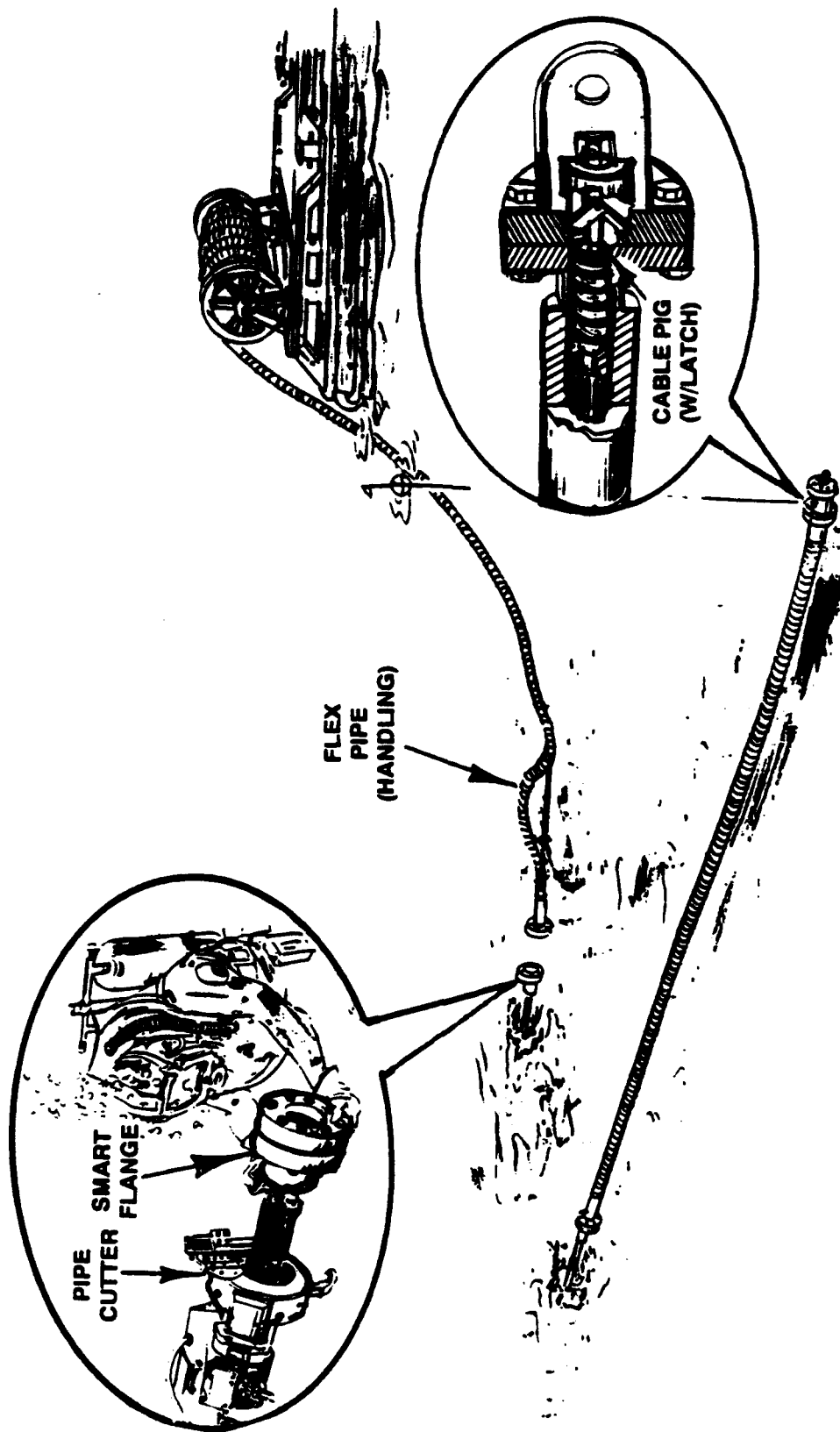

Figure 3
Flexipipe deployment.

2.0 TEST OBJECTIVES

2.1 Introduction

In order to demonstrate overall system capability, the following test objectives were established at the outset of the FY91 HDS test program:

- A. Demonstrate distance, 10,000 feet (formerly 22,100 feet).
- B. Demonstrate steerability with accuracy.
- C. Conduct cable pull test.
- D. Conduct wet interface test.
- E. Provide personnel training.
- F. Validate system operation.

2.2 Test Objectives Versus System Capability

The importance of each of these objectives, and how/why it relates to system capability and performance are discussed in the following paragraphs.

2.2.1 Objective A: Demonstrate Distance. One of the questions that will remain unresolved until physically demonstrated is the system's drilling capability in terms of distance. In one regard, one might assume that demonstrating system distance is only a necessary "formality," especially since the system was "designed" to meet the required goal. In many technical arenas, it would be a trivial exercise to validate a system's designed capability. Unfortunately, this is not the case here. Oil field production drilling (a close analogy) and more specifically, long distance horizontal drilling, is not a well defined technology. And, until system drilling distance has been demonstrated, this capability issue cannot be confirmed.

Pipe friction and formation geology are not always known quantities. Independent of prior survey information describing formation geology (core samples, seismology, etc.), certain assumptions are made at the outset of drilling operations relating to expected conditions "downhole." One never knows the total impact of downhole geology (material physical properties and formation geometry) on drilling operations.

However, based on previous drilling operations, both commercial and HDS project experience, the circumferential and axial dynamic pipe friction coefficient is approximately 0.33. It will undoubtedly be higher under certain conditions and lower in others for any one drilling operation, but a 0.33 friction coefficient represents an average over the length of the drill string. This parameter is important because the relationship between drill string friction and drilling distance is linear. If the friction coefficient is 10 percent higher, the maximum obtainable drilling distance is reduced by a proportional amount. The exact relationship is discussed further in subsequent paragraphs. The important fundamental here is to realize that drill string friction determines maximum obtainable drilling distance and is a function of downhole geology and drill

string geometry. Validating typical drill string friction values is therefore of paramount importance in determining HDS distance capability.

2.2.2 Objective B: Demonstrate Steerability With Accuracy. Hitting a predetermined target area is critical to the success of the HDS. In a typical HDS application, the drill string wet end will interface with complex offshore cable systems where wet end placement is generally confined by operational and physical parameters (e.g., water depth, bottom geology/profile, etc.). Because wet end location will be based on a variety of fixed conditions, the final target window is defined as the ideal or preferred area. Generally, areas outside the target window are less desirable and could impose additional unnecessary hardships and/or interface operations.

With this in mind, and realizing that hitting a predetermined target can only be achieved with steering control while drilling, steerable drillhead and logging subsystems were developed. Drill string steering and logging field tests were identified as a means to validate the required level of drill string steering and logging accuracy capabilities.

2.2.3 Objective C: Conduct Cable Pull Test. The requirement to demonstrate a cable installation during field tests was postponed due to funding limitations. It must be noted, however, that a full-length pull test was not considered paramount to the success of the field test and that a cable pull test "denio" has always been considered a low technical risk. There was never a question regarding the feasibility of pigging optical-mechanical cables through the full length of drill pipe. All calculations, theoretical and otherwise, indicate acceptable levels of cable stress for all possible HDS pigging conditions. In fact, a 5,000-foot pull test was successfully conducted at SWRI in FY90 that demonstrated cable installation capability and verified acceptable levels of cable tension during pigging operations to 5,000 feet.

Additional testing will provide an opportunity to conduct a full-length pull test and verify the cable installation technique.

2.2.4 Objective D: Conduct Wet Interface Test. The wet interface test was also postponed due to funding limitations. This is another test that was considered a low technical risk and its outcome would not impact the success/failure of the HDS to a great extent. The deployment and connection of interface hardware involves surface and subsurface coordination efforts. Although a pipe flange installation technique has been developed and demonstrated at NCEL, special wet end deployment procedures need to be demonstrated. But again, this wet end deployment test does not represent a high technical risk and has therefore been postponed until project funding will allow its execution.

2.2.5 Objective E: Provide Personnel Training. Familiarity and understanding of system equipment is integral to successful operation of any system. With the HDS, several major subsystems are required to work together in concert during drilling and logging operations. Coordination between key operators is critical, and understanding the limits of the equipment and of the system as a whole is also very important. Several key positions were identified and personnel were trained in these positions. This is not to say that only those persons presently trained are uniquely qualified to operate HDS equipment, or are capable of conducting a drilling operation. On the contrary, the focus of the training objective was to identify key operational positions and provide supportive documentation (O&M manual, assembly drawings) for assembly and operation of HDS equipment. The field test provided the opportunity to validate the documentation with hands-on experience.

The level of training and supportive documentation achieved are discussed in Section 5.0, DISCUSSION OF TEST RESULTS.

2.2.6 Objective F: Validate System Operation. System operation relates to the ability of the equipment to function as designed. The HDS is a prototype system. It is important to demonstrate and validate operation on every level: system, subsystem, and individual component levels. This is required in order to identify where design modifications are necessary or where incorrect component assembly/operation exists. The launcher hydraulic circuit is an example where many opportunities for incorrect assembly and/or component failure exist. A thorough inspection/test of the hydraulic system is always necessary after assembly.

Several major subsystems are integral to HDS operation and capability (i.e., the steerable drillhead, logging subsystem, pipe joints, high-pressure pump assemblies, etc.). The HDS field test provided an opportunity to evaluate each subsystem function, operation, and reliability.

2.3 Summary

It is important to note that not all of the objectives were met at the conclusion of the FY91 test program. However, several key objectives were met and, as a result, subsystem validation has been demonstrated to the Navy for several important components of the horizontal drilling system. Although distance and steering accuracy have not been demonstrated to date, significant progress has been made. A discussion regarding test objectives versus test results is presented in Section 5.0, DISCUSSION OF TEST RESULTS.

3.0 ROCKSITE B TEST GEOMETRY AND GENERAL ARRANGEMENT

3.1 Rocksite B (Figures 4, 5, and 6)

A portion of NWC China Lake was set aside as a test area for the horizontal drilling system. This area was located inside NWC ECHO Range boundaries, approximately 1 mile inside the ECHO Range guard gate and approximately 1/4 mile south of the Randsburg Wash access road (see Figure 6). The test area was excavated with two levels - upper and lower, and labeled "Rocksite B." The site general arrangement is shown in Figure 4. Two temporary fabric shelters were erected to house the launcher and diesel units.

3.2 Launcher Foundation (Figure 7)

Construction of a concrete pad at the upper level of Rocksite B was required to support drilling loads transferred from the drill string to the launcher foundation. The foundation was designed to support the weight of the launcher and ancillary equipment (60 kip), the horizontal loads (500 kip), and machine torque (55K ft-lb) at the pipe axis. The launcher foundation design is discussed in Reference 1.

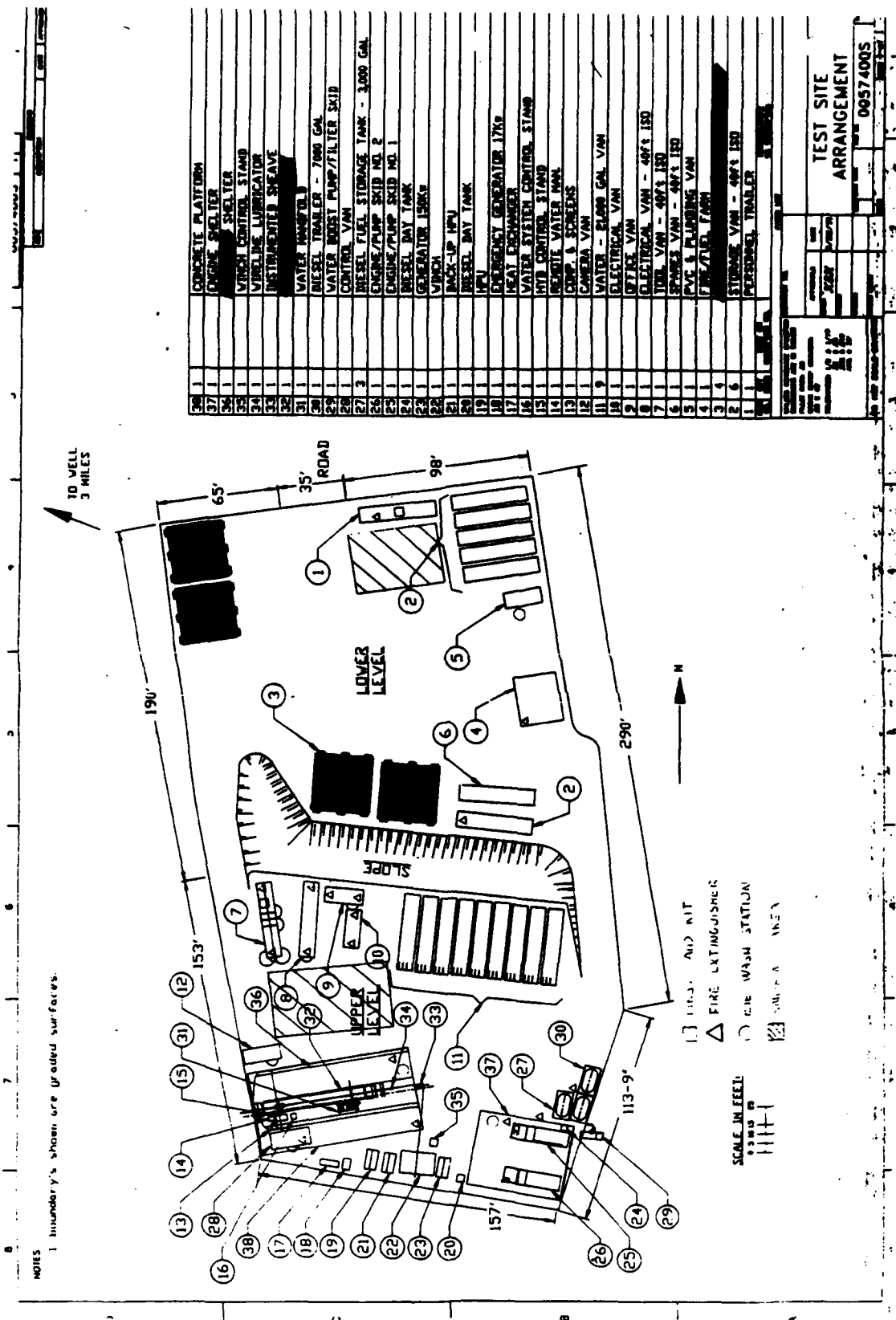

Figure 4
Rocksite B test site geometry.



Figure 5
Rocksite B.

3.3 Water Storage and Distribution System (Figures 8 and 9)

The water distribution system included a well (drilled to a depth of 750 feet) located approximately 2.5 miles from Rocksite B as a means of providing drilling fluid (water) to the test site. An analysis of the water showed the water had approximately 10,000 ppm salt content. This was not considered a problem since the HDS was designed to operate with seawater (33,000 ppm salt). A total of eleven 21,000-gallon storage tanks were utilized as part of the water system. Two of the eleven storage tanks were located at the well. Water usage rates were expected to be from 50,000 to 150,000 gallons per day. A geophysical survey of the proposed well area is described in Reference 2.

3.4 Drilling Trajectories (Figure 6)

The area west of Rocksite B was surveyed and approved for construction of three short test trajectories out to a maximum of 500 feet (Tests A, B, and C) and one long test trajectory out to a maximum of 10,000 feet (formerly 22,100 feet) (Test D).

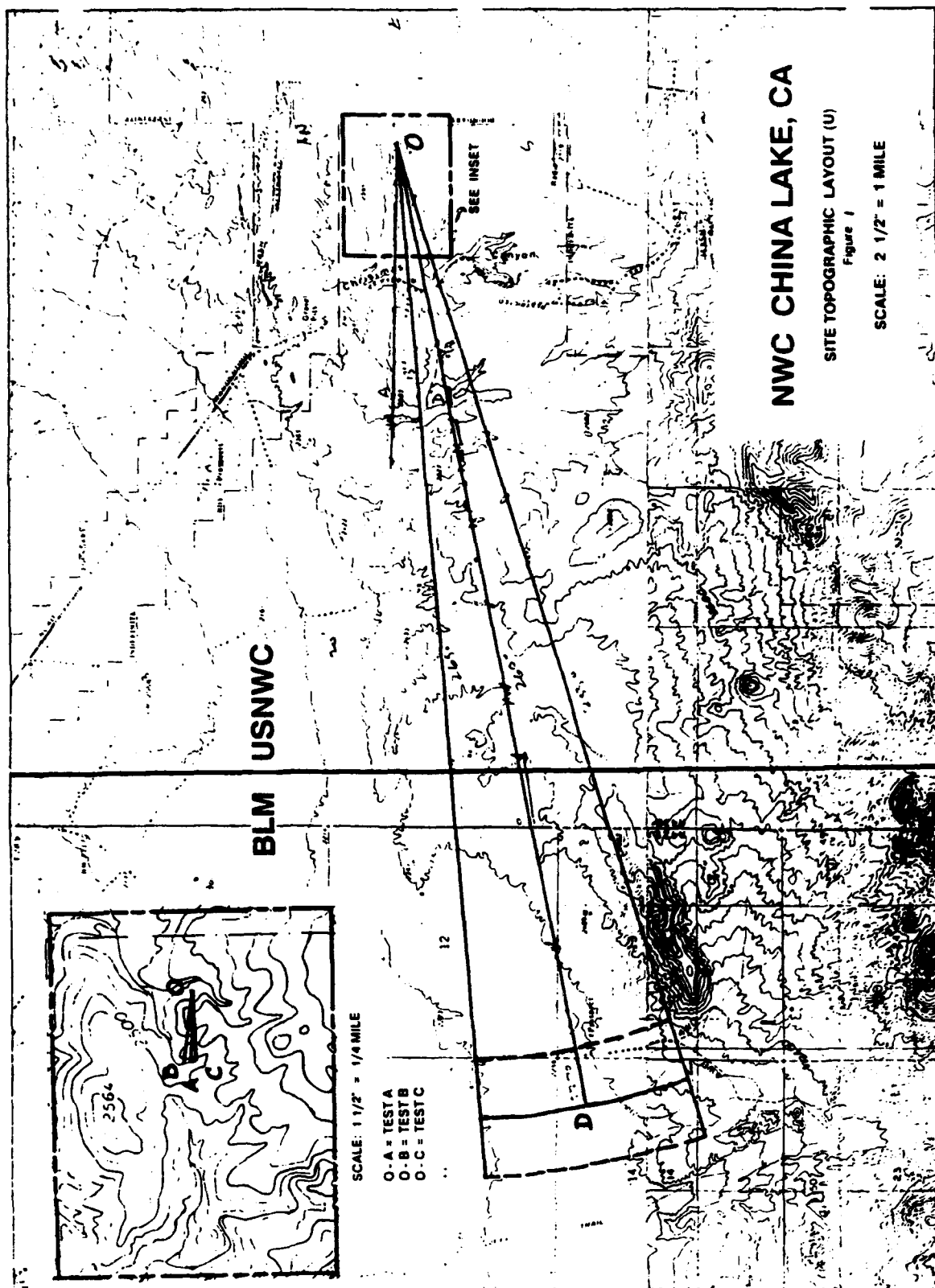

Figure 6
Test trajectories.

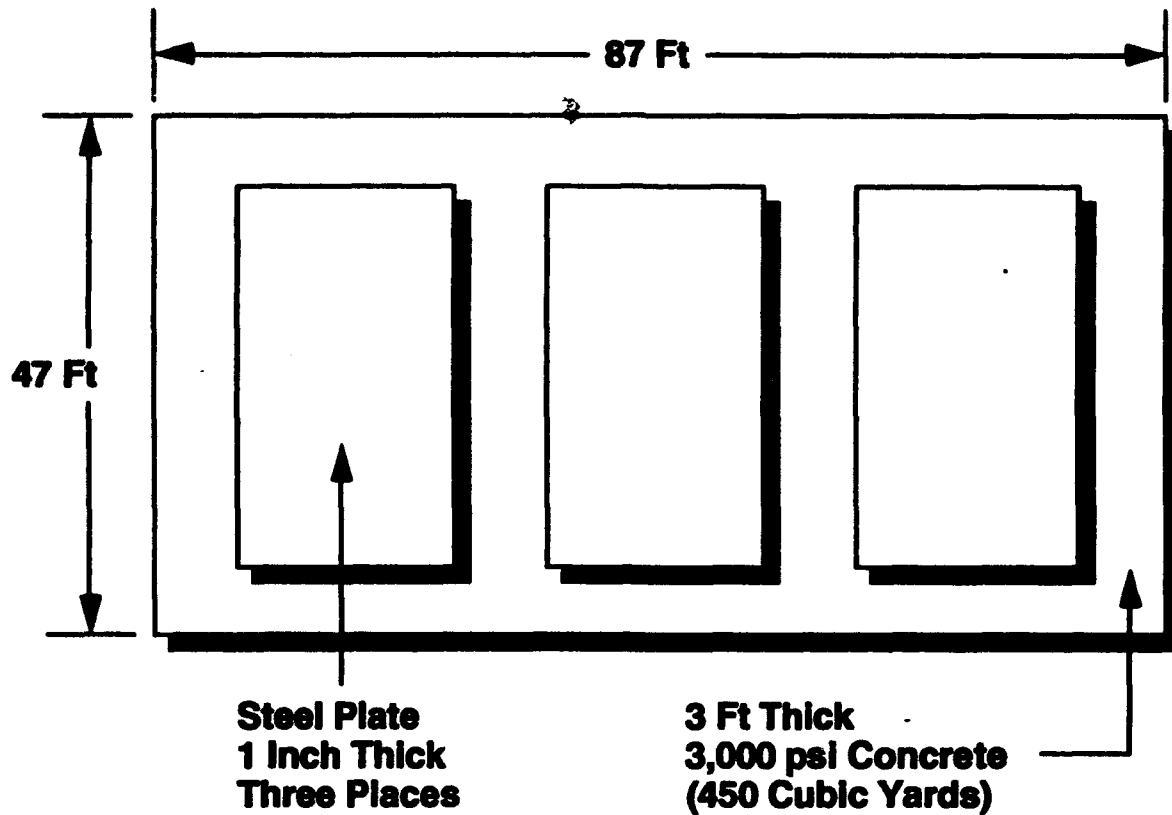

Figure 7
BL foundation.

As part of the overall test objective, the three 500-foot tests and the 10,000-foot test were established to demonstrate the following system parameters: (1) Test A - the amount of "natural" steering (deviation) the drill string exhibits from its straight line trajectory; (2) Tests B and C - the amount of deviation from the straight line trajectory due to a controlled steering command to the steerable drillhead; and (3) Test D - the accuracy and distance capability of the horizontal drilling system to a distance of 10,000 feet. In all tests where an exit event was experienced, a calibration of the logging tool was planned.

3.5 Site Geology (Figures 10 and 11)

Test site location/selection was almost entirely dependent on geology. The goal during the field test was to duplicate a specific geology type (contorted limestone) found at a potential HDS installation location. Geophysical analysis of core samples from the potential installation location was used as the basis for selecting the field test site. The Christmas Canyon area (Rocksites B) of NWC, China Lake offered geology that was remarkably close to matching the target geology. The test area was composed of local tight folds of cherty and shaley limestone. The material strength of the limestone was measured at 25,000 psi, with a bulk strength of 5,000 to 10,000 psi. Typical surface geology is described in Figures 10 and 11, and Reference 3 documents the geology of Rocksites B.



Figure 8
Test well.



Figure 9
Storage tank configuration.

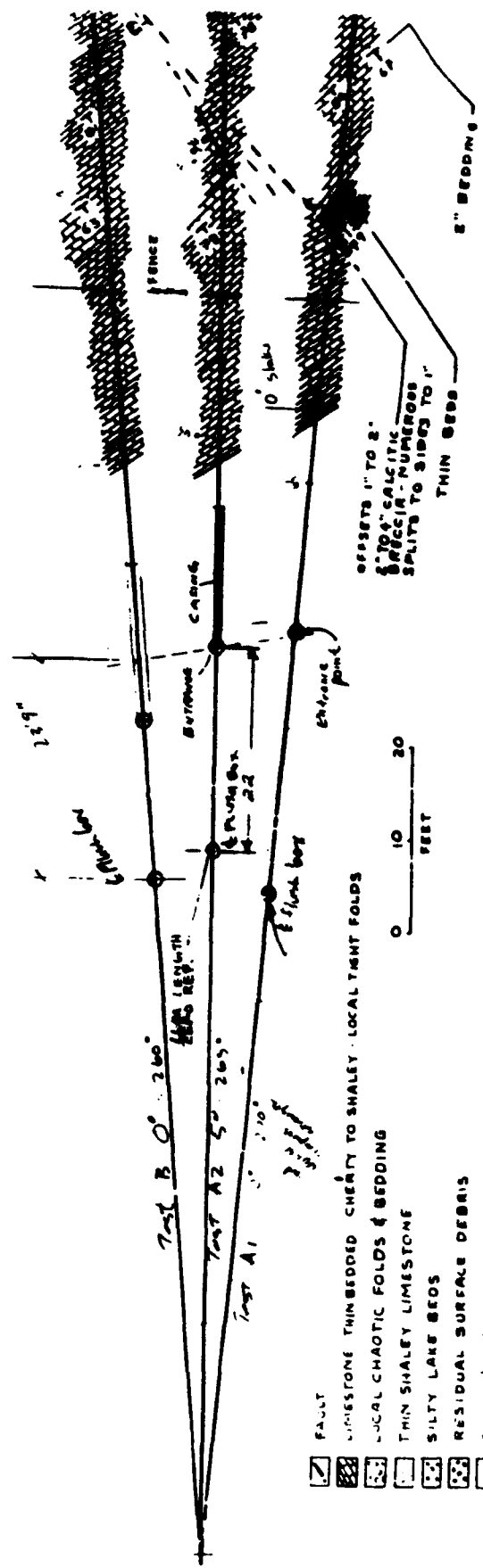

SHEET 1

Figure 10a
Site geology and trajectories plan view.

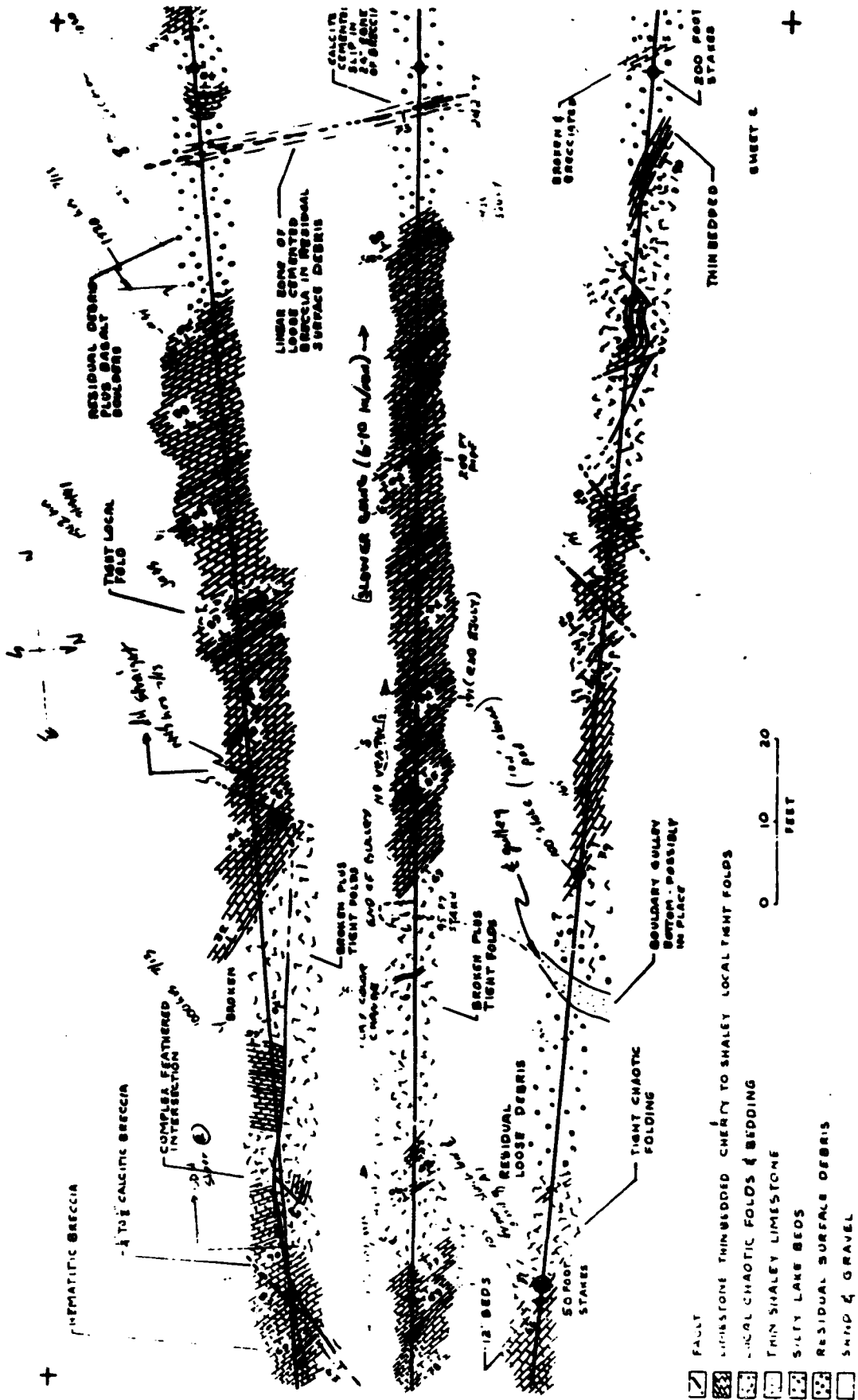

Figure 10b
Site geology and trajectories plan view.

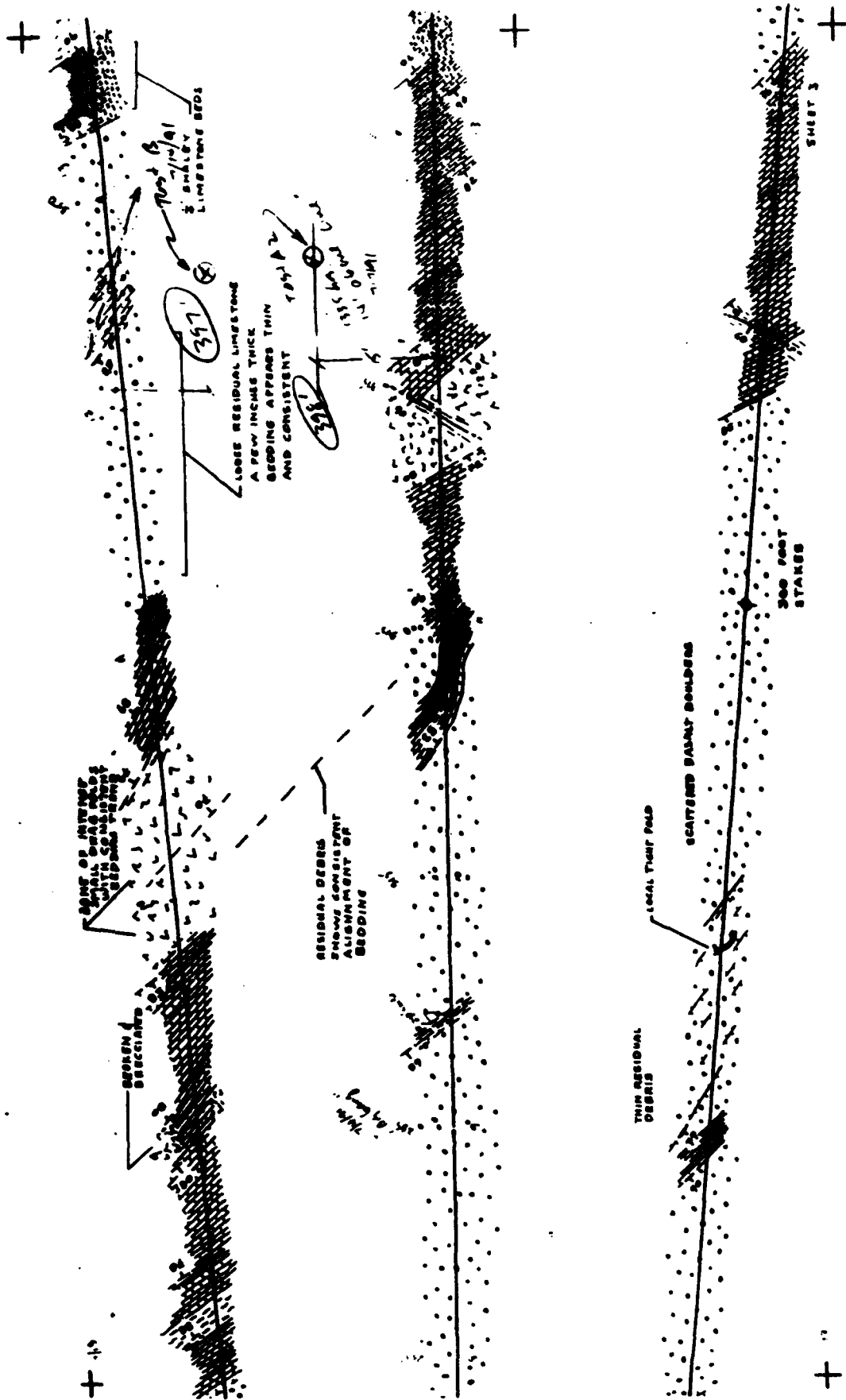

Figure 10c
Site geology and trajectories plan view.

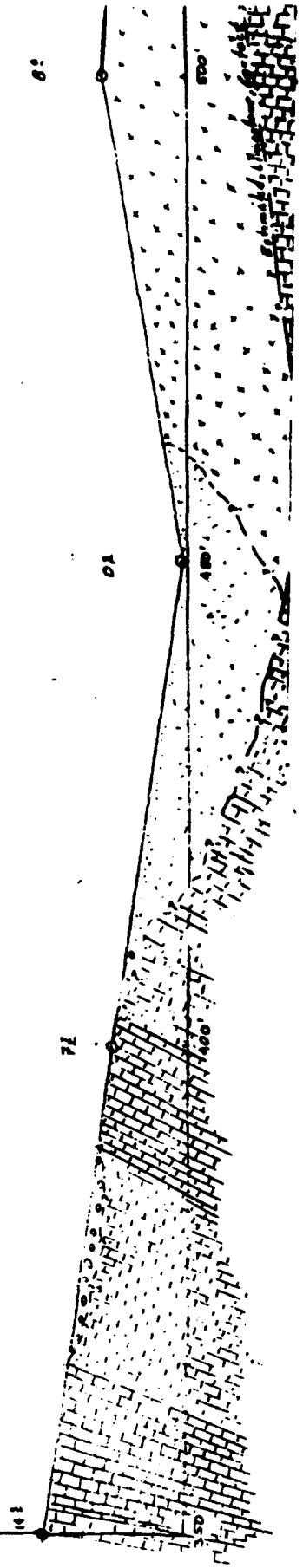
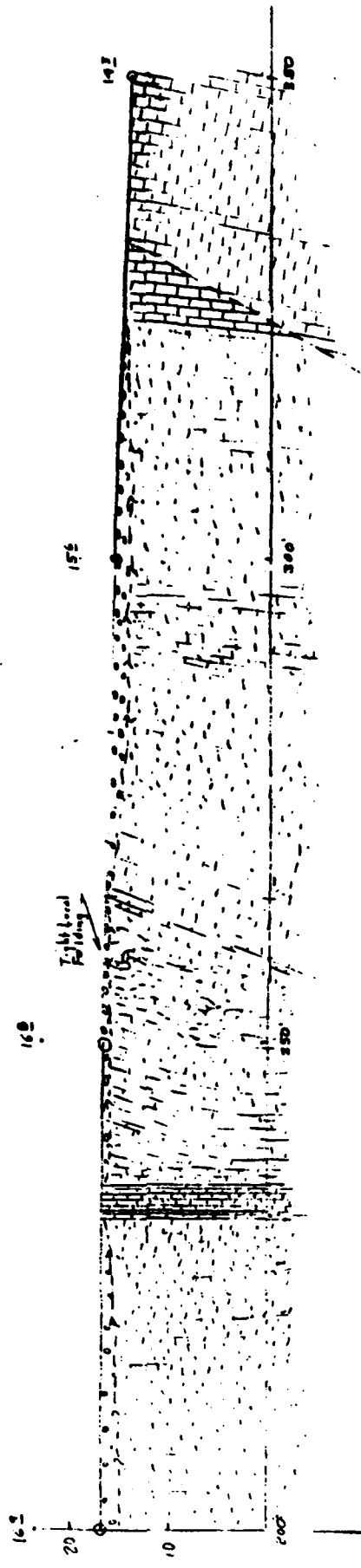
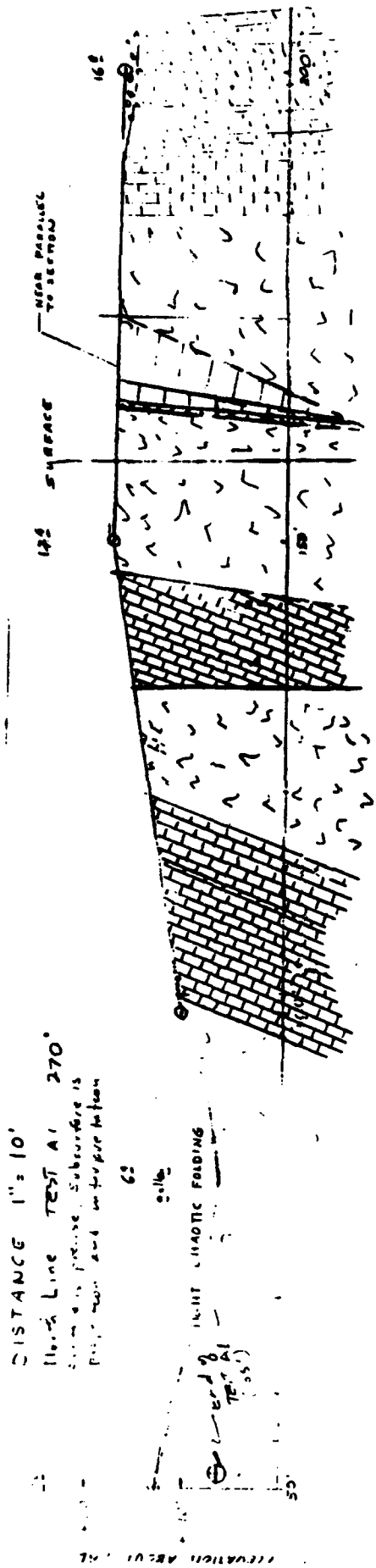
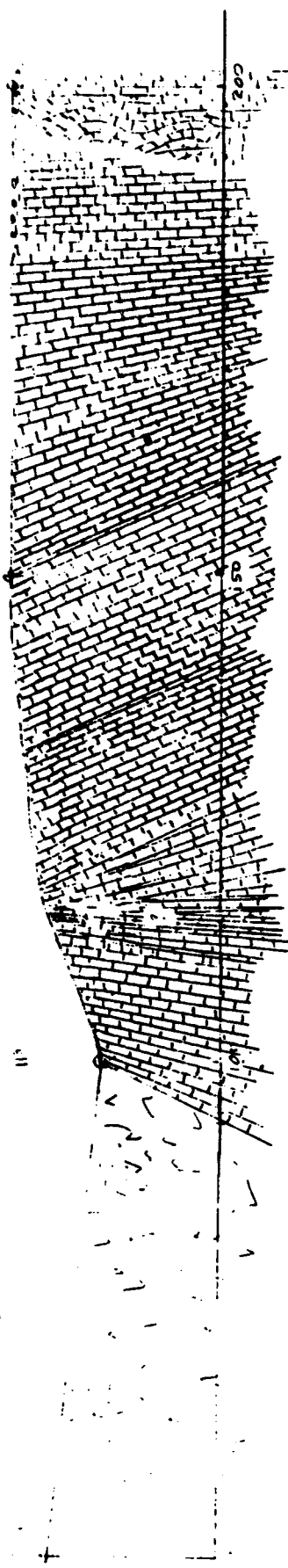

Figure 11a
Site geology and trajectories elevation view.

SCALE 1" = 10'
 SECTION 11
 20°



Folded -
 Bedding orthogonal
 and parallel to
 section

Bl 8 (100)

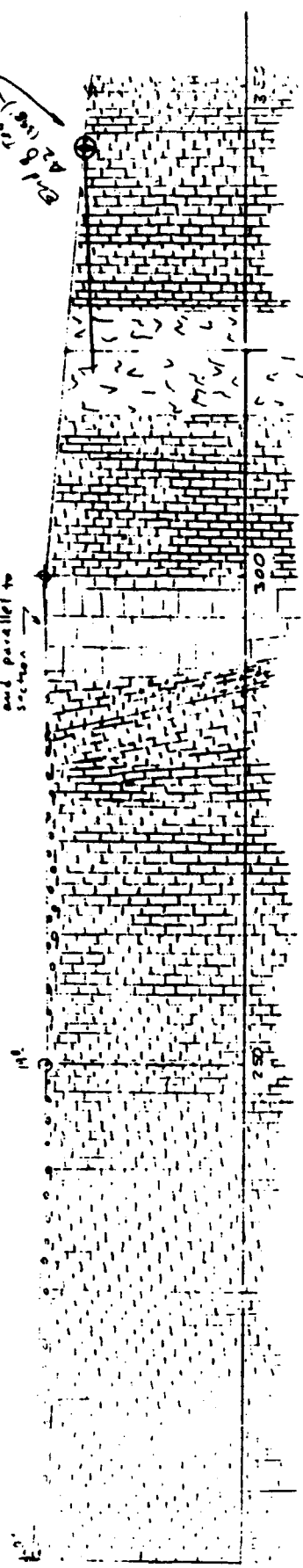

102

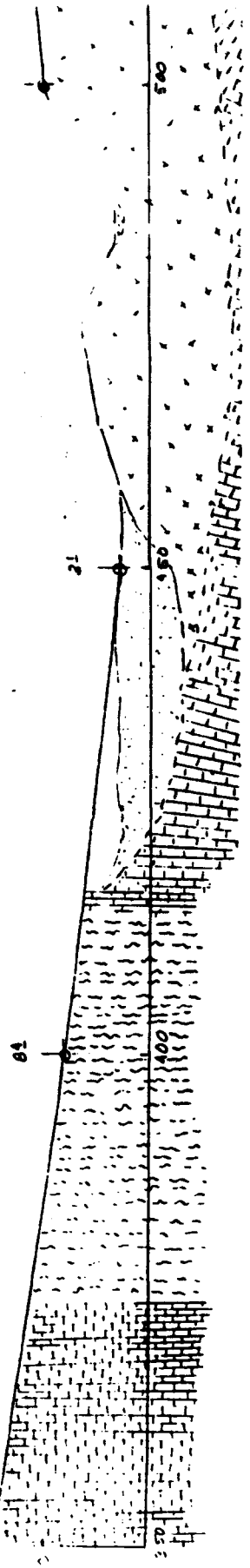

Figure 11b
 Site geology and trajectories elevation view.

3.6 Environmental Issues

Permission to conduct the field test involved a rather extensive environmental approval process. Several agencies were involved in obtaining final permission to construct and operate equipment at Rocksite B.

3.6.1 Site Approval. An access permit for Rocksite B was required from NWC environmental codes. The test area and test trajectory paths were surveyed by NWC environmentalists prior to site construction. The environmentalists were primarily looking for endangered species and/or archaeological remains that would be disturbed due to test operations. None were found.

3.6.2 Water Injection. A concern regarding water injection into the existing aquifer was raised during the site selection process. Once the site was selected, NWC Command was briefed into the HDS project so they could fully understand the details surrounding the planned test and how they relate to water injection. Approval to conduct the tests at Rocksite B was based on knowledge of the geological conditions at the test area. Permission to test was given by NWC, provided drilling operations stayed within the following operating parameters: (1) use either fresh water or water taken from a local well as the drilling fluid, (2) use drilling fluid that does not contain any additives, and (3) do not drill more than 150 feet below the initial entrance point level.

3.6.3 Water Discharge. Water surface runoff was also considered to have a negative environmental impact. Any modification to surface conditions, regardless of how seemingly minor, could have a negative impact on indigenous plant/animal species. Careful consideration as to the location of water runoff was given prior to starting operations. Permission to operate was given by NWC, provided water runoff used existing natural drainage paths and the runoff did not extend beyond the immediate area of testing. If the water runoff was visible from the main Echo Range access road, operations would be put on hold until the condition could be rectified.

3.6.4 Diesel Emissions. Operation of the two diesel engines required permits from the San Bernardino County Air Pollution Control District (APCD). Permission to operate was given by the APCD contingent upon several conditions, including: (1) conduct an emissions test on one of the diesel engines to determine the level of NOX and other pollutants being generated during test operations, and (2) diesel (i.e., testing) operations could not exceed 90 days. Permission to operate was granted in April. The diesel operating permit (Authority to Construct), Emissions Test Results report, and supporting documents are presented in References 4 and 5.

4.0 TEST OPERATIONS AND SCHEDULE

4.1 Mobilization

Site preparations were initiated by NCEL at Rocksite B in March 1991. Site mobilization efforts at Rocksite B were initiated by Western Instrument Corporation on 20 May 1991. The contractor's mobilization schedule is provided as Figure 12.

4.2 Test Operations

The contractor commenced test operations on 20 June 1991 (Figure 13). Figures 10 and 11 show the final test trajectories, lengths, and typical formation geology. The Test Plan and Test Program System Safety Plan are presented in References 6 and 7.

The following tests were conducted.

4.2.1 Test A1 (No Steering) - 20 Through 24 June, 110 Feet (Figures 14 and 15). Test A was conducted to determine the natural tendency for the drill string to deviate. The straight drillhead was used throughout this test. The initial trajectory was 270 degrees, true.

This first test provided several lessons that helped identify "standard" start/entry procedures. The initial technique used to start the hole involved low pressure and low flow to "wash" into the formation. Minimum pressure and flow were used. Although there was concern about creating a large entrance hole and therefore increasing the length of unsupported pipe between the forward rotator and the hillside, there was also a need to minimize return water (environmental impact). Sandbags were used at the entrance area to minimize water return (runoff) in this area.

After drilling 110 feet, the drill string was deviating severely. It was backed out and restarted three times in an attempt to straighten the trajectory. The drill string had a tendency to climb sharply (approximately 0.16-inch raise per 12-inch advance); this was causing higher than acceptable levels of drill string torque. The torque was being measured at the launcher aft rotator. The high measured value was primarily due to two conditions: (1) additional reactive loads were present at the points of contact between the drill string and the curved hole, and (2) the drill pipe was rubbing the inside of the forward rotator due to the severe (large) exit angle at the forward rotator. During the second attempt to straighten the trajectory, the drill string was backed out and restarted at a slower advance rate. Unfortunately, the pipe followed the original hole. On the third restart, high pressure and flow was used at the outset. The net effect was to essentially erase the original hole and create a new drilling path. Figure 15 shows the result of using high pressure and flow at the entrance area. The net effect was to wash away the surrounding material and excavate a cavity into the hillside. This was a very undesirable condition both environmentally and in terms of increased suspended pipe length.

EQUIPMENT MOBILIZATION SCHEDULE

X=1 DAY

MAR. 15, 1991

RESP | 3/18-3/24 | 3/25-3/31 | 4/1-4/7 | 4/8-4/14 | 4/15-4/21 | 4/22-4/28 | 4/29-5/5 | 5/6-5/12 | 5/13-5/19

	RESP	3/18-3/24	3/25-3/31	4/1-4/7	4/8-4/14	4/15-4/21	4/22-4/28	4/29-5/5	5/6-5/12	5/13-5/19
5 VANS @ SRB	BL	X								
MECH VAN COMP	BL	X								
MECH VAN PACK	BR	XX	XX							
MECH VAN SHIP	BR			X						
ELEC VAN COMP	BL		X							
ELEC VAN PACK	DF		XX	XXXX						
ELEC VAN SHIP	DF					X				
SPARES VAN COMP	BL					X				
SPARES VAN PACK	RP						XXXXXX			
SPARES VAN SHIP	RP					X				
PACK SKIDS	BR		XX							
SHIP SKIDS	BR		X							
SET SKIDS	BR		X			X				
PACK FRAME	RP		XX	X						
SHIP FRAME	RP			XX						
PACK CLAM 2	JB			XX						
PACK CLAM 1	JB			XX						
SHIP CLAMS	JB			X						
SETUP CLAM 2	JB					XXX				
SETUP CLAM 1	JB					XXX				
HYD SYS MOD	JA		XXX							
HYD SYS PACK	JA		XXXX	XXX						
WATER SYS PACK	RP		XXXXX							
DATA SYS TO MARKET	DL		X							
PACK ELEC SYS	DF			XXXXX						
SHIP HYD SY	BR			X						
SHIP ELEC SYS	BR					X				
SHIP WATER SYS	BR		X							
SHIP OFFICE VAN	BR			X						
SHIP CONTROL VAN	BR					X				
SHIP PERS VAN	RM			X						
PAD COMPLETE	RC			X						
SITE SURVEY			X							
EMISSIONS										
WATER TANKS ARRIVE	JB					XXX				
INSTALL TRENCHES						XX				
ASSEMBLE WATER SYS	RP					XXXXXXXX				
GENERATORS ARR.				X						
SITE ELECT. INST.	SA					XXXXX				
SETUP FRAME	BR			XX	XXXXXXXX	XXXXXXXX				
SETUP HYD	JA					XXXXX				
SETUP ELEC.	DF					XXXXX				
INTERIM WINCH SETUP	BL					XXXXX				
FINAL WINCH SETUP	BL								XXXXXX	
SHIP DATA SYS	DL							X		
SHIP FUEL SYS	RM		X			X				
SEABEES ARRIVE				1		2		2		
SANITATION HOOKUP										
PHONE HOOKUP										
COMMENCE TEST									5	

June 1991

ROCKSITE B TEST SCHEDULE

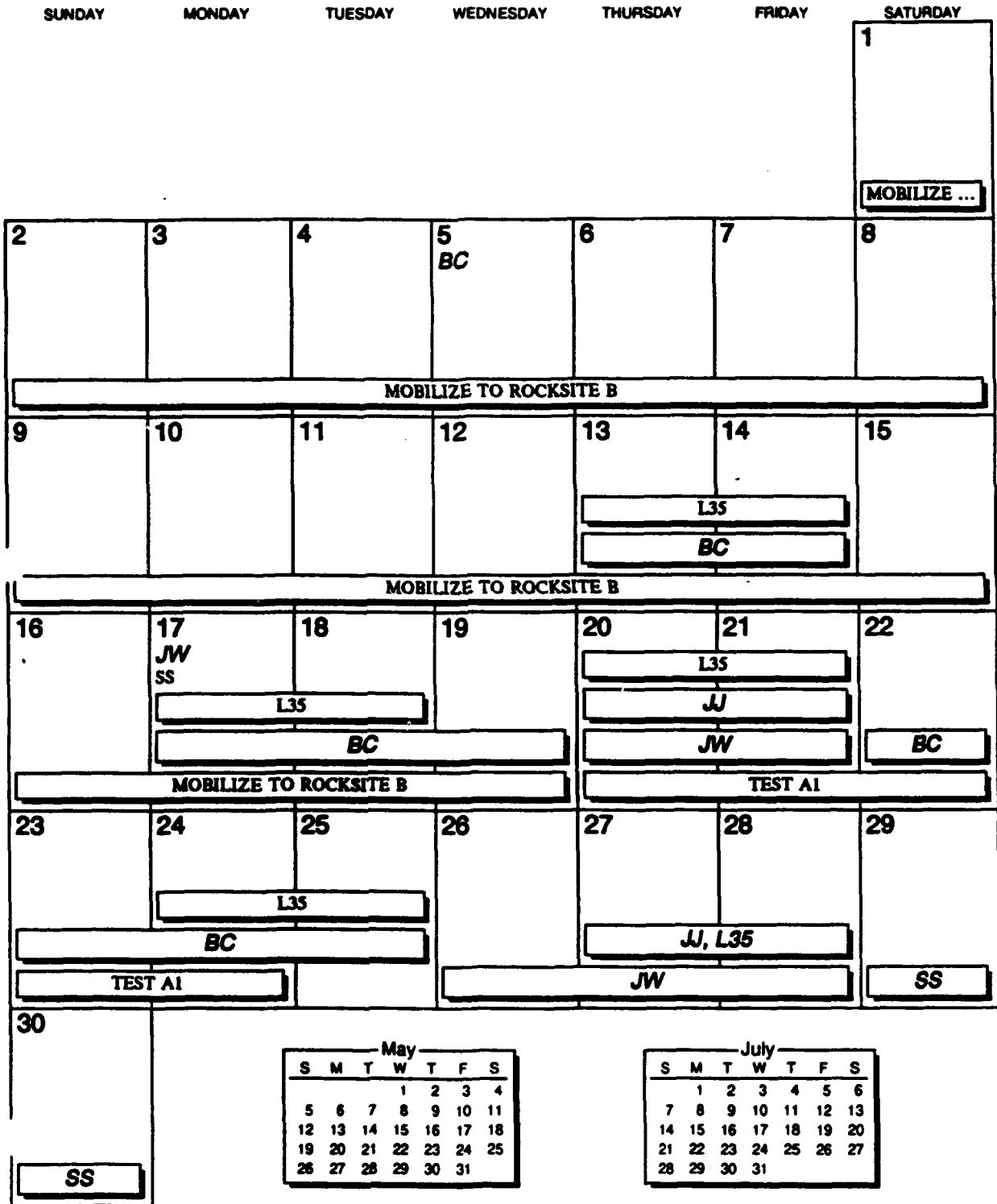

Figure 13a
Test schedule.

July 1991

ROCKSITE B TEST SCHEDULE

SUNDAY	MONDAY	TUESDAY	WEDNESDAY	THURSDAY	FRIDAY	SATURDAY
	1	2	3	4	5	6
				BC		
	TEST A2					
	L35					
	JW					
7	8	9	10	11	12	13
	BC			TEST B		
	TEST A2	SS				
		BC				JW
14	15	16	17	18	19	20
	LOG TEST					
	JW			DEMOBILIZE		
	TEST B					
21	22	23	24	25	26	27
DEMOBILIZE						
28	29	30	31			
DEMOBILIZE						

June

S	M	T	W	T	F	S
						1
2	3	4	5	6	7	8
9	10	11	12	13	14	15
16	17	18	19	20	21	22
23	24	25	26	27	28	29
30						

August

S	M	T	W	T	F	S
				1	2	3
4	5	6	7	8	9	10
11	12	13	14	15	16	17
18	19	20	21	22	23	24
25	26	27	28	29	30	31



Figure 14
Entrance test A1, initial.



Figure 15
Entrance test A1, final.

Test A1 was terminated at 110 feet for two reasons:

(1) After several reentries, the entrance opening (hole diameter) had been enlarged to approximately 7 feet and collapse of the hillside was imminent if operations continued at this location.

(2) The volume of return water was becoming an environmental issue.

Due to the size of the opening, sealing off the opening was not possible and virtually all of the water was being returned from the entrance. Natural absorption of the surrounding soil could not keep up with the return water volume. (Due to environmental and security related restrictions, operations were to be stopped if water runoff was visible from the main road, approximately 1/4 mile away.)

Test A1 typical average water pressure, flow, nozzle configurations, and drilling rates are provided Table 1.

Table 1. Test A1 Test Data

Event	Distance (ft)	Water Pressure (kpsi)	Flow (gpm)	Drill Rate (ipm/rpm)	Nozzle Configuration (Figures 16 & 17)
Initial Start	0-5	0.45-1.8	80	6-12/5	A1-1
Transition	5-15	2-3.4	80-90	16/5	A1-2
Straight Drilling	15-65	5.6-9.7	100-120	15-17/5	A1-2
Straight Drilling	65-70	14	150	20/5	A1-2
Straight Drilling	70-110	14-14.5	150	30/5	A1-3

4.2.2 Test A2 (No Steering) - 2 Through 7 July, 398 Feet (Figures 18, 19, and 20). Test A2 was a continuation of the Test A1 philosophy, where the main objective was to determine natural deviation without controlled steering. Again, the straight drillhead was used throughout. The launcher assembly was moved to a new trajectory of 265 degrees, true.

Based on the results of Test A1, it was decided to provide a pipe casing at the entrance point (Figure 20). An 8-inch-diameter by 16-foot-long schedule 40 steel pipe was prepared and installed around the drill string during the initial entrance process. This added component proved to be beneficial for the following reasons: (1) it stabilized the entrance hole size, minimizing return flow; (2) it provided additional bearing support to the drill string at a critical area; and (3) it helped to guide the drill string if/when reentry was necessary.

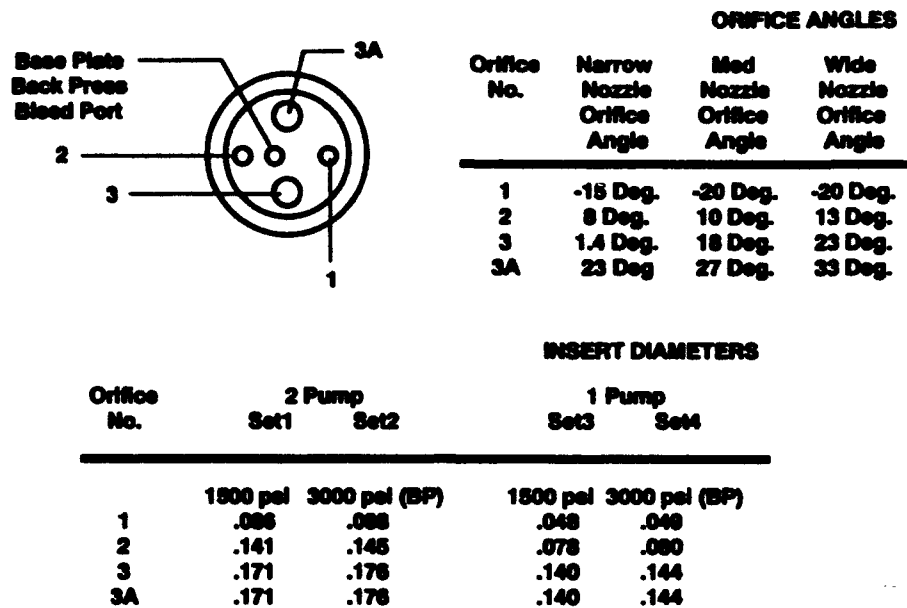

Figure 16
Nozzle geometry.

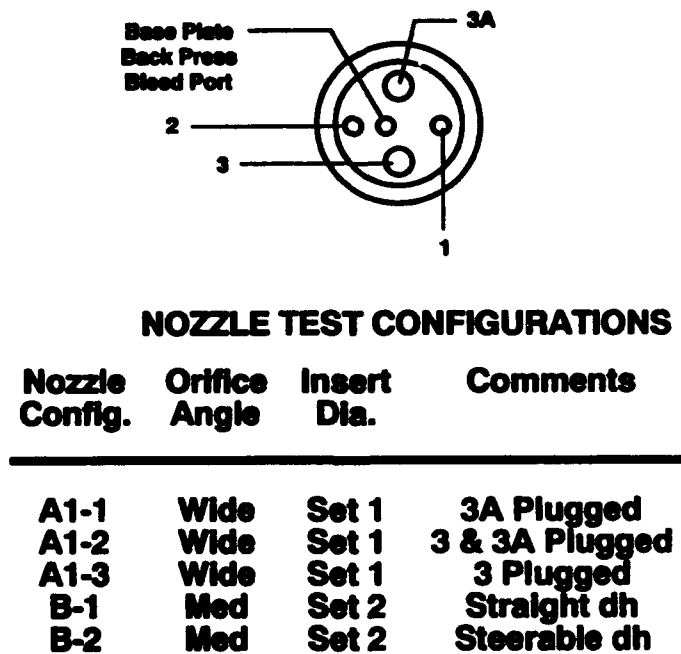

Figure 17
Nozzle configuration.

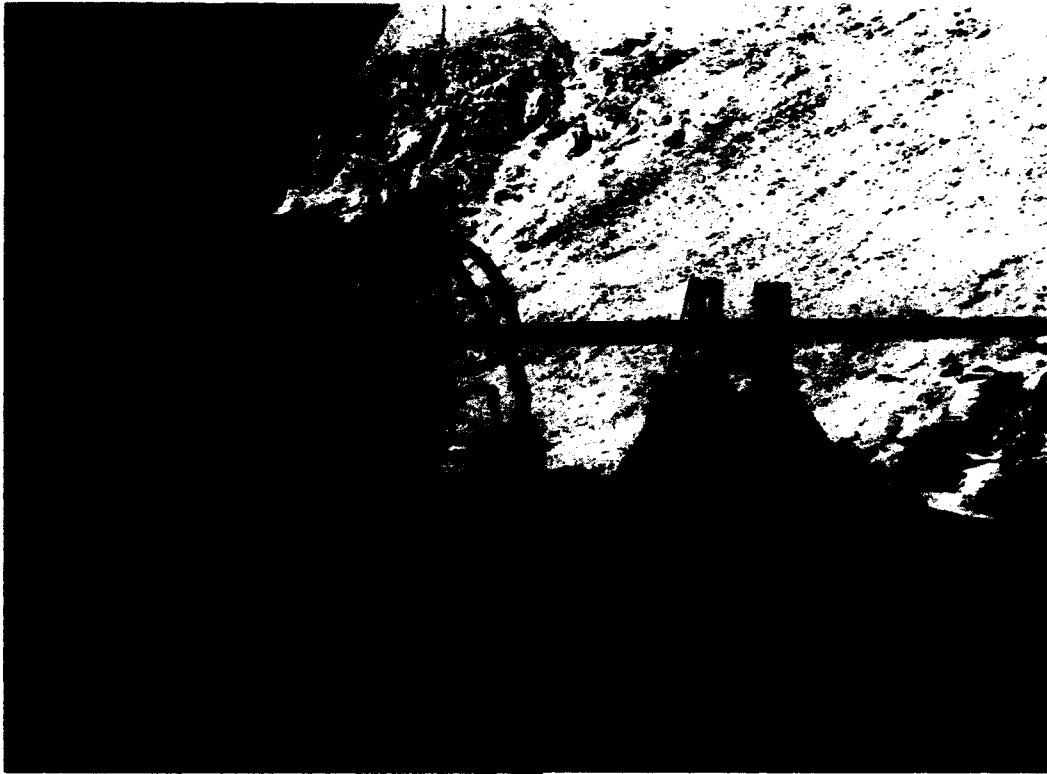

Figure 18
Entrance of test A2.

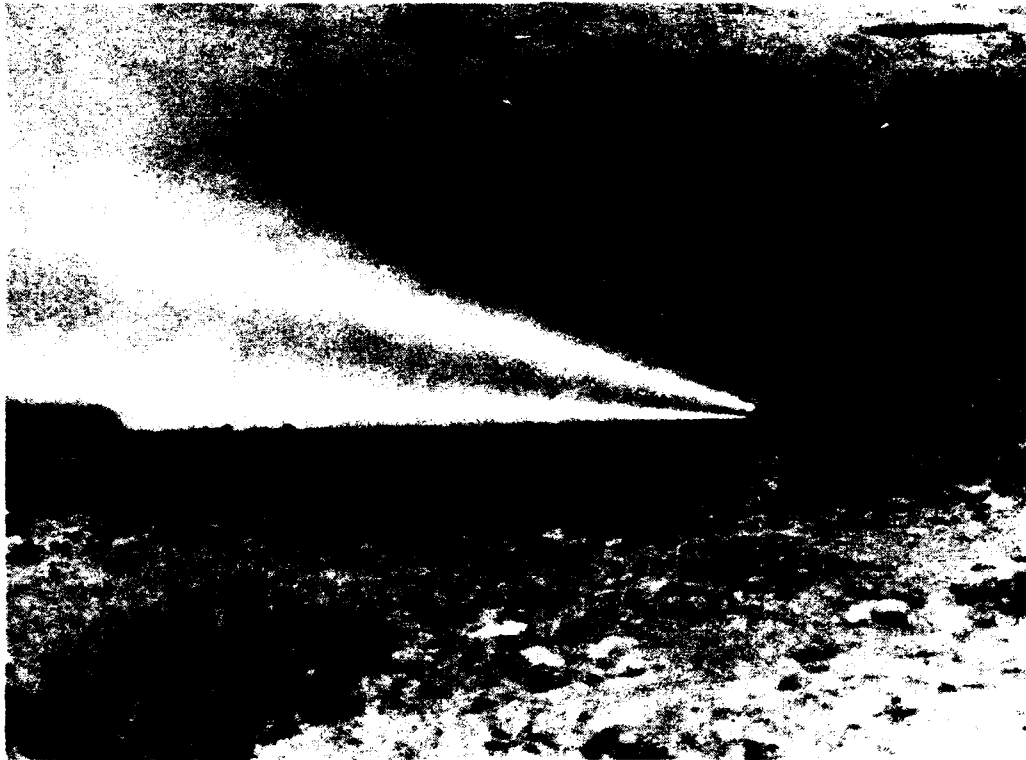
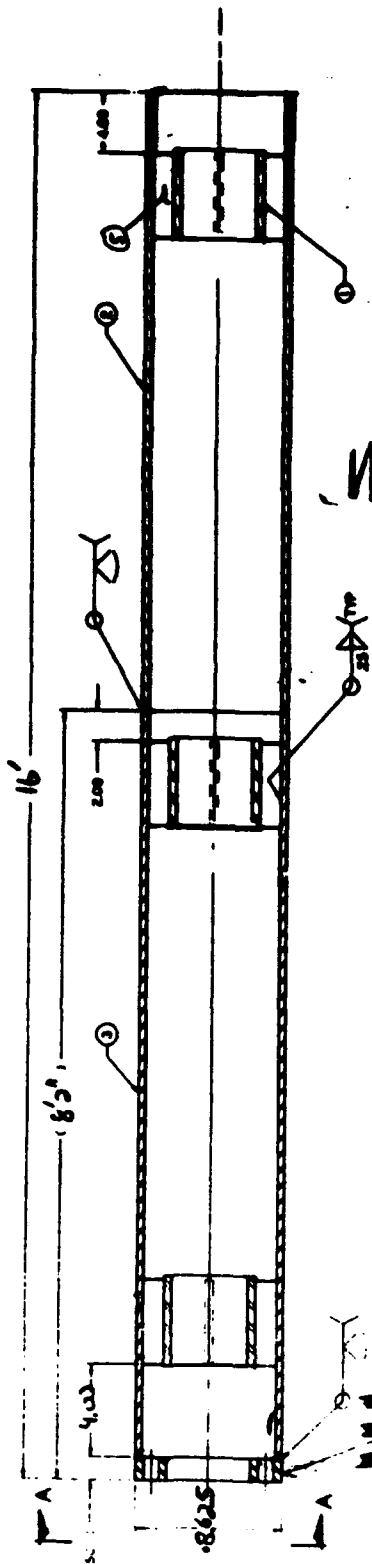

Figure 19
Exit of test A2.



WORKING PAPERS

- ⑤ 1/2" plate 1.2 x 6.0
- ④ 1.5" thick A-36 p
- ③ 8" sch 40 x 8' 3" LMB 1018
- ② 8" sch 40 x 7' 0" LMB 1018
- ① 5" sch 40 x 6" LMB 1018

230

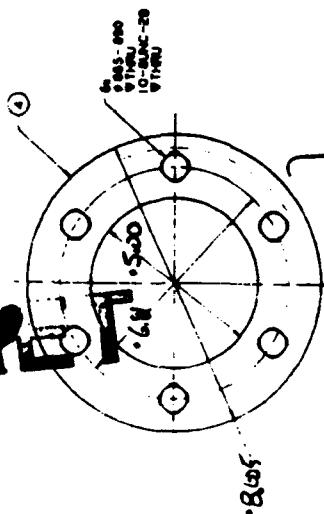

Also require 1 mending piece
w/ 4.87 I.D. and 1/8" thru
holes.

VIEW A-A
SCALE 1/2"

0084/91
29E 388



Figure 20
Pipe casing.

There was minimal return water from the entrance hole after approximately 30 feet of drilling. The water was being injected into the formation. As drilling continued, some water reached the surface above the trajectory, but not enough to pose an environmental problem.

The test was terminated after the drill string exited the surface at a point 398 feet from the launcher. The final exit point was determined by surface survey to be 15 feet to the left and 14 feet above the initial trajectory. This translates to a deviation of 2.16 degrees in the horizontal plane and 2.02 degrees in the vertical plane over a distance of 398 feet.

Test A2 typical water pressure, flow, and drilling rates are provided in Table 2.

Table 2. Test A2 Test Data

Event	Distance (ft)	Water Pressure (kpsi)	Flow (gpm)	Drill Rate (ipm/rpm)	Nozzle Configuration (Figures 16 & 17)
Initial Start	0-11	2.3-3.1	80-100	4-6/4.5	A1-3
Transition	11-16	11.2	100-120	12/5	A1-3
Straight Drilling	16-200	11.5-14	100-150	10-30/5	A1-3
Straight Drilling	200-294	11.5-13	100-150	5-11/5	A1-3
Straight Drilling	294-398	11-13	100-150	15-30/5	A1-3

4.2.3 Test B (Controlled Steering) - 11 Through 14 July, 397 Feet (Figure 21). The purpose of this test was to demonstrate the capability to deviate the drill string (steer) in a controlled manner. The steerable drillhead (SDH) was used to initiate a deviation at a selected position downhole. The initial trajectory was 260 degrees, true. A drill string casing was installed using methods developed during Test A2.

After drilling "straight" for approximately 130 feet, the SDH was installed and programmed to deviate to the right once a drill string rotation of 5 rpm was reached. The initial plan was to perform the steering event for one to two pipe sections (30 to 60 feet) and then return to straight drilling. As it turned out, the SDH unit functioned for approximately 40 feet and then steering control became intermittent for the next 10 to 20 feet due to a combination of failures within the SDH unit. The details of these failures are discussed in paragraph 5.5.3 of Section 5.0. A steering event was performed over a distance of approximately 40 feet and was considered sufficient to produce a measurable deviation based on the initial steering objectives.

Test B was terminated as a result of an exit event measuring 397 feet from the launcher assembly. Surveyed results showed a 10-foot vertical deviation and an 11-foot horizontal deviation to the right.

Figure 12
Mobilization schedule.



Figure 21
Test B exit.

Test B typical water pressure, flow, and drilling rates are provided in Table 3.

Table 3. Test B Test Data

Event	Distance (ft)	Water Pressure (kpsi)	Flow (gpm)	Drill Rate (ipm/rpm)	Nozzle Configuration (Figures 16 & 17)
Initial Start	0-16	2.5-11	80-100	6-12/4.5	B-1
Straight Drilling	16-130	11-13	100-150	10-14/5	B-1
Steering Event	130-170	9.8-12	100-150	15-20/6	B-2
Straight Drilling	170-397	11.5-13	100-150	15-25/5	B-1

4.2.4 Logging Test - 15 Through 17 July. A logging test was conducted at the conclusion of drilling operations. However, due to a variety of internal electrical failures, the logging tool was unable to record horizontal position data.

Several attempts to repair the logging unit were made in the field. Unfortunately, the extent of the problem was beyond the capability present at the test site. Additional efforts will be made to repair the system and conduct follow-on data collection tests at Rocksite B.

4.3 Demobilization

Rocksite B demobilization efforts commenced on 17 July 1991 and were completed on 31 July 1991.

5.0 DISCUSSION OF TEST RESULTS

5.1 Pipe Friction Measurements

Pipe friction during drilling operations translates to torque and push force requirements for the system. System capability in terms of distance is directly related to drill string friction, pipe joint efficiency, and the ability of the pipe joint to transfer the required torque and longitudinal loads from one pipe section to the next. Therefore, validation and comparison of theoretical versus empirical pipe friction data were an important part of testing.

For straight, level drilling, drill string torque is a linear function of pipe weight and diameter and can be expressed by the following relationship (Refs 8 and 9):

$$T = w_g \times r \times \mu \times L \quad (1)$$

where: T = drill string torque for a given pipe length (ft-lb)

w_g = weight per foot of pipe and internal components (lb/ft)

r = pipe radius (ft)

μ = friction coefficient (dimensionless)

L = length of pipe (ft)

Published data indicate dynamic and static friction coefficients of 0.33 and 0.48, respectively. Friction data from industry agree with earlier field test results from HDS testing at Kern River (circa 1985). As can be seen from the friction values, there is a significant difference between dynamic and static friction coefficients. Generally, a static condition exists when pipe rpm is below 4 to 5 rpm and dynamic conditions exist at rpm (velocities) above that range.

Using Equation 1, 0.33 as the dynamic friction coefficient and a distance of 25,000 feet, the theoretical maximum torque requirement can be calculated as follows:

$$T = 31.82 \text{ lb/ft} \times 4.75/24 \text{ ft} \times 0.33 \times 25,000 \text{ ft}$$

$$= 51,960 \text{ ft-lb}$$

The drill string torque was measured for Test A2 and Test B by rotating the drill string with a pipe wrench and measuring the force at the end of the moment arm (pipe wrench) during rotation. This method of torque measurement is considered "static" because the rotation velocity (rpm) was very low. The following torque values were measured for Test A2 (398-foot long) and Test B (397-foot long) drill strings under static conditions:

$$\text{Test A2} = 1,000 \text{ ft-lb}$$

$$\text{Test B} = 1,200 \text{ ft-lb}$$

Using Equation 1 above, in rearranged form, these data translate to calculated static friction factors of 0.46 for Test A2 and 0.55 for Test B. If one assumes "straight" trajectories, these values can be calculated as follows:

For Test A2,

$$\mu_A = \frac{T}{r \times w_g \times L}$$

$$= \frac{1000}{4.75/24 \times 27.53 \times 398}$$

$$= 0.46$$

and for Test B,

$$\mu_B = \frac{T}{r \times w_g \times L}$$

$$= \frac{1200}{4.75/24 \times 27.53 \times 397}$$

$$= 0.55$$

Although the measured torque value from Test A2 is within the expected range for static conditions, the value for Test B was higher than expected. This variance can be attributed to one or more conditions. For both Tests A2 and B, the pipe had been at rest for a period of several days and would have experienced additional "set" due to material (cuttings) being allowed to settle around the drill string during a nonrotational (static) condition. Although additional

adhesion (resistance) is expected (given sufficient time for the water to drain and allow material to settle around the pipe), the high torque value from Test B cannot be totally attributed to this.

In addition to the static condition, an equally significant "event" occurred in Test B: the drill string deviated from its straight line trajectory as a result of a forced steering command. Due to this steering event, additional contributing (antirotation) forces were created: (1) the normal forces (reactive loads) at the points of contact between the hole ID and the pipe along the deviation event were greater than the weight of the pipe alone, and (2) to a lesser extent, pipe bending stresses were created which required additional torque (energy) from the system.

For the most part, the above explanations apply only to Test B. Test A2 was a "natural" steering event and did not require high reactive loads during the steering event to steer the drill string (i.e., Test A2 deviation was based on the natural tendency for the drill string to deviate). However, Test B was considered a more radical condition and created a more acute angle of deviation.

It can be demonstrated that a forced steering event produces greater antirotational forces. Existing theories predict additional reactive loads caused by bending the pipe due to steering (both with and without internal pressure). The bending forces as a result of steering events are created by an increase in the normal reaction force at the points of contact between the pipe and the inside surface of the hole as the pipe is "forced" to one side of the hole during steering. This additional force can be treated as additional effective pipe weight.

An additional term in Equation 1 is required to express the increased forces as a result of steering events:

$$T = (W_S + W_D) \times r \times \mu$$

where: W_S = pipe weight along straight section (lb)

W_D = effective pipe weight along deviation section (lb)

For a steering event such as that shown in Figure 22, the torque due to steering can be calculated as follows:

$$T = [w_{SL}l_{SL} + w_{DL}l_{DL}] \times r \times \mu \quad (2)$$

where: w_{SL} = weight per foot, straight length
= 27.53 lb/ft

w_{DL} = weight per foot, deviation length (lb/ft)

l_{SL} = straight length (ft)

l_{DL} = deviation length (ft)

and as before,

μ = friction coefficient

r = pipe radius (ft)

Pipe Friction Calculations, Test B:

W = Added wt/ft Due to Deviation

$$= \frac{24 EI\theta}{l^3}$$

IF, $E = 30,000$ psi
 $I = 17.62$ in⁴
 $l = 40$ ft
 $\mu = 0.48$ (Static)
 $\theta = y/l = 0.024$

Then, $W_{DL} = 43$ lb/ft
 and $T = wl \mu r$
 $= (W_{SL} \cdot l_{SL} + (W_{DL} \cdot l_{DL})) \mu r$
 $= 1097$ lb-ft

$l_{DL} = 40$ ft, $l_{SL} = 357$ ft

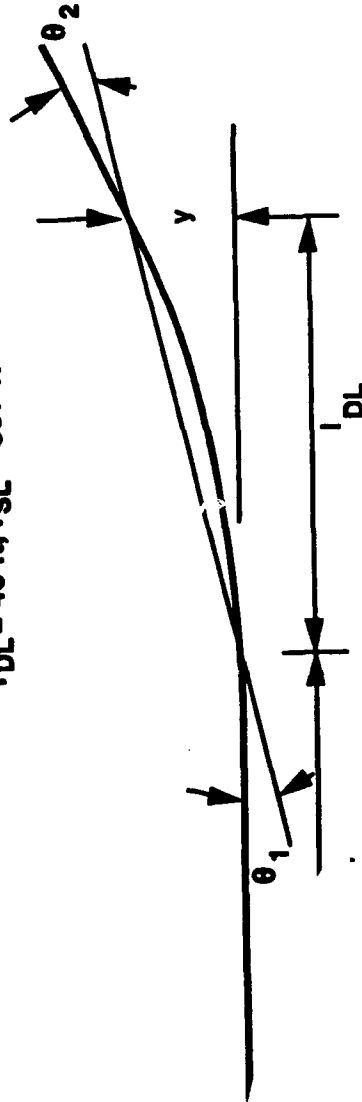

92

Figure 22
Steering event.

Using a deviation event of 40 feet for Test B, the total effective added weight per foot along the deviation can be calculated as follows (Ref 10):

$$w_{DL} = \frac{(24 \times E \times I) (\theta)}{(l_{DL})^3} \quad (3)$$

where: E = pipe modulus
= 30×10^6 (psi)

I = pipe moment of inertia
= 17.62 (in.⁴)

θ = slope at end of deviation event
= 0.024 (from Test B data)

l_{DL} = length of deviation event
= 40 feet
= 480 inches

Therefore,

$$w_{DL} = \frac{(24 \times 30 \times 10^6 \times 17.62 \times 0.024)}{480^3} \times 12$$

$$= 33 \text{ lb/ft}$$

The total weight per foot along the 40-foot deviation length equals 43 lb/ft and is a vector sum of [33 and 27.53] lb/ft. That is:

$$w_{DL} = (33^2 + 27.53^2)^{1/2}$$

$$w_{DL} = 43 \text{ lb/ft}$$

Using Equation 2 above in rearranged form, the calculated static friction coefficient for Test B is 0.48, as:

$$\mu = \frac{T}{(w_{SL} l_{SL} + w_{DL} l_{DL}) \times r}$$

$$= \frac{1200}{[(27.53 \times 357) + (43 \times 40)] \times 4.75/24}$$

$$= 0.53$$

The precision of ± 50 ft-lb in the torque measurement puts the calculated friction coefficient in the range of 0.46 to 0.53, which agrees with published data. It must be realized that increased accuracy would be obtained with increased drill string length.

Furthermore, using Equation 2 and a static friction value of 0.48, the total torque is calculated for Test B as follows:

$$\begin{aligned} T &= [(27.53 \times 357) + (43 \times 40)] \times 0.48 \times 4.75/24 \\ &= 1,097 \text{ ft-lb} \end{aligned}$$

In summary, these data suggest an acceptable degree of correlation between existing friction data for a drill string subjected to static conditions. We have shown that static friction coefficients measured at Rocksite B are reasonable.

5.1.1 Effective Pipe Weight. This additional effective pipe weight per foot (w_{DL}) can be minimized by limiting the amount of steering and maximizing the radius of curvature during drilling operations to only that amount required to reach the target and make the drill string surface at the completion of drilling operations.

Because of pipe joint strength limits, it is important to minimize steering requirements during drilling operations. This implies that in order to achieve maximum drilling distance, the drill string radius of curvature during controlled steering events must be maximized. Based on the amount of steerability demonstrated at Rocksite B, a controlled radius of curvature appears to be possible.

The results of Tests A2 and B logging runs will be used to determine if the measured results and steering maneuvers are compatible with the theory presented here. Final analysis must wait until the test holes are logged and actual steering parameters are measured.

5.1.2 Effects of Geology on Drill String Friction. Several factors affect drill string friction levels. Although geological conditions have an impact - some materials are known to exhibit especially high frictional resistance - this report does not investigate this phenomena nor does it attempt to correlate formation types with friction properties. On the other hand, there are two obvious drilling parameters that minimize friction levels during drilling operations, namely drill string lubrication and velocity (tangential and axial). Lubrication is provided by the cutting process (high-pressure water), and the system normally is operated with continuous rotation (tangential velocity) and forward advancement (axial velocity).

Static versus dynamic friction coefficients are discussed in Reference 11 and in paragraph 5.1. Regarding lubrication, an additional option is available to further reduce drill string friction. This involves additives to the drilling fluid. A friction coefficient of 0.15 to 0.20 is not uncommon in the drilling community using drilling fluid additives (Ref 11). Again, this report does not address use of drilling fluid additives beyond identifying their existence as a possible option. Obviously, environmental concerns will come into play if/when this option is considered.

5.2 Steerability

The ability to control the drill string is of paramount importance. Although torque limits the system in terms of distance, steering control relates to the ability to "hit" a predetermined target AND achieve maximum obtainable distance. We have learned from tests at Rocksite B

that steering control provides the capability to continue drilling operations without exiting the surface prematurely. That is, without steering control, the natural tendency is for the system to "steer" up. Although "steerability" is a function of geology (formation type) and other parameters (drill string geometry, rate of advance, initial angle), testing to date has indicated that without steering control, maximum obtainable distances may be relatively short.

5.2.1 Drill String Deviation. Again, the conditions of Test A were set up to explore the natural tendency for the drill string to deviate (drift) while drilling "straight." The results of Test A2 show deviation up (14 feet) and to the left (15 feet), similar to what was experienced during earlier tests (Figure 23). There are a variety of theories that attempt to explain why the drill string deviates from its original trajectory, most of which suggest an upward deviation. One possible explanation involves the placement of cuttings inside the hole. Because pipe rotation is clockwise, the sweeping action of the nozzle jets combine with pipe rotation and gravity to carry a majority of the cuttings to the lower right side of the hole. This produces a reaction force in the cutting bed directed up and to the left as the pipe advances over the cuttings. The Test A2 exit point was 14 feet higher than the entrance point elevation over a total horizontal distance of 398 feet. Test B had similar vertical deviation. The exit point was approximately 10 feet above entrance point elevation over a distance of 397 feet. This implies that in order to reach drilling distances beyond 400 to 500 feet, one must be able to control the drill string by steering straight, and in some extreme cases, steer down. Otherwise, premature surfacing may occur.

5.2.2 SDH Operation. Although the SDH unit experienced mechanical and electrical problems during testing operations, continuous steering in the "right" quadrant was accomplished over a drilling distance slightly more than one pipe section (40 feet) during Test B. This resulted in an exit point 11 feet to the right of the original straight-line trajectory. Based on physical observations, the SDH appears to have demonstrated the ability to control the drill string trajectory using SDH steering commands. Also, the amount of steerability demonstrated in Test B is greater than what would be required for long distances. In fact, it will be important to selectively limit the amount of steering required during extended drilling operations. Otherwise, maximum torque limits could be exceeded and pipe failure could occur. (This is discussed above as additional torque due to steering.)

It will be increasingly important to determine what steering corrections are required to "neutralize" the natural drift so drilling will be straight. If the logging system functions as designed, this "drill straight" procedure can be identified with minimal effort during follow-on system tests.

5.2.3 Effects of Geology on Steering. One important difference between conventional drilling technology and water jet drilling is that in jet drilling, the drilling nozzle (bit) does not make contact with the formation during drilling operations. The cutting occurs several inches ahead of the nozzle. Conversely, in conventional drilling, the bit is in constant contact with the formation. In general, this makes conventional drilling more sensitive to variations in the formation. In conventional drilling the bit will tend to deviate or turn into layered formations, in jet drilling it does not. This implies that under certain conditions, conventional drilling may produce a greater "natural" deviation than jet drilling.

SYSTEM "NATURAL" DEVIATION:

TEST	LENGTH	DEVIATION	
		Horizontal	Vertical
Kern River	470-ft	29-ft L	44-ft Up
SRB Granite	40-ft	3-in L	2.75-in Dwn
NWC Test A2	398-ft	14-ft L	15-ft Up
NWC Test B	397-ft	11-ft R	10-ft Up

- **Possible Explanation for Up & Left Deviation:**
 - **Rotation CW Transfers Majority of Cuttings to R Side of Hole**
 - **Gravity Allows Cuttings to Flow to Bottom of Hole**

Figure 23
Test history.

5.3 Accuracy: Logging Test

Several days were spent at Rocksite B troubleshooting electrical problems on the logging tool. Personnel from Battelle were present at the site, along with WIC electrical engineers, working on a variety of logging tool problems. Unfortunately, logging efforts and therefore drill string location measurement efforts had to be terminated due to funding limits before a complete logging operation for Test A2 or Test B could be executed.

A single logging run recording vertical information on Test B drill string was accomplished. No horizontal position data were obtained during this logging run. It is evident that additional electrical/mechanical modifications and testing will be required before the logging system is considered functional. The details concerning what problems were found and what efforts were expended on the logging tool are provided in Battelle's final test report (Ref 12).

5.4 Personnel Training

A key ingredient integral to the success of the horizontal drilling system is the ability of the operating crew to "operate" the system and for the "system" to function as designed. It must be realized that many concurrent operating parameters (forward rate, pressure, rpm) cannot be simulated or tested simultaneously in the laboratory. Therefore, input and experience to control these parameters and drilling procedures had to be developed during actual drilling operations (i.e., hands-on training). This is primarily due to the different conditions associated with

continuously changing parameters during drilling operations (equipment operating levels/limitations, variations in geological formation, pipe loading/recycle events, etc.). A "cookbook" approach to operating the launcher during actual drilling operations is not possible at this point. Operating levels must be constantly monitored and varied during drilling.

As an example, drilling rate (and how this parameter is affected by pressure and drill string rpm for a given geology) can only be explored during actual operations and is somewhat unique to specific types of geology. The drilling supervisor and launcher operator must be constantly aware of operating levels and interpret feedback from measured data (water pressure, hydraulic pressure, rpm, etc.) to determine what changes, if any, are necessary to maximize drilling rates, but not overstress the system. Drilling rates at Port Hueneme in granite were slow (2 in./min), but they were consistent. Drilling rates at Rocksite B were as high as 35 in./min and generally varied over a range from 5 in./min to 25 in./min, 15 to 20 in./min was common. In order to maximize the drilling rate, the system must be kept close to but not above its physical limits. Again, the necessary operational technique can only be gained through experience.

5.4.1 Key Positions. The following key positions were identified and personnel were trained in these positions:

Drilling Supervisor. Overall supervisor of drilling operations. Makes decisions regarding selection of drillhead type and application of SDH unit. Two persons were trained.

Launcher Operator. Controls the launcher assembly. Makes adjustments to pressure, rpm, and forward rate to obtain optimum drilling rate. Four persons were trained.

Drill Crewman. Provides support to load pipe and maintains high-pressure lines, launcher assembly, and hydraulic systems. Operates logging winch. Four persons were trained.

SDH Operator. Provides instructions to SDH unit based on direction from Drilling Supervisor. Provides electrical/mechanical maintenance for SDH. Two persons were trained.

Diesel Operator. Maintains diesel engines and high-pressure pump assemblies. Two persons were trained.

Logging Engineer. Operates logging tool console and provides maintenance to logging subsystem as required. One person was partially trained.

Information Control Officer. Maintains Information Control Center electronics. Provides input to Drilling Supervisor regarding operating levels for recorded system parameters. Two persons were trained.

The following staffing profile has been identified as the minimum required per operating shift:

<u>Quantity</u> <u>Per Shift</u>	<u>Position Title</u>
1	Drilling Supervisor
1	Launcher Operator
2	Drill Crewman
1	Diesel Operator
1	SDH Engineer
1	Logging Engineer
1	Information Control Center Operator

5.5 System Performance

5.5.1 Launcher Assembly Operation. The launcher assembly functioned as designed. However, with some minor modifications, efficiency of operation for this assembly could be improved. Otherwise, the launcher assembly functioned well.

It was noted that pipe loading efficiency could be increased considerably. It is possible to reduce the time to load a section of pipe from the existing 30 minutes to 10 minutes with minor changes to the unit. When pipe loading and recycling of the aft rotator is factored into drilling rates, the overall average rate is reduced by as much as 50 percent. In general, with pipe loading included, a 9- to 15-in./min average was obtainable at Rocksite B, or about 30 minutes to drill one pipe section and 30 minutes to load the next pipe section - an acceptable rate but could be easily improved.

An improved method to measure drill string torque is also required. When drilling short distances, certainly less than 500 feet, the existing torque measurement method is inadequate. The existing system measures the hydraulic pressure across one of the aft rotator hydraulic motors at a point where normal fluctuations in hydraulic pressure and the low levels of pressure being measured make it difficult to obtain meaningful data. Pressure modulation (dampening) or gage relocation would improve measurement accuracy.

In addition, the aft rotator and fluid swivel IDs could be enlarged to allow passage of the logging tool and SDH from the aft rotator area. This would increase the efficiency of logging and SDH operations considerably. The existing method employs loading the logging and SDH units between pipe sections forward of the saver-sub and is very labor intensive.

5.5.2 Drill Pipe Performance. The drill pipe and high-torque joint/washer/seal assembly functioned as designed. The pipe specification is presented in Reference 13. Pipe material is heat treated 4145 steel alloy with a minimum yield strength of 135,000 psi.

Two adapter configurations were available for testing. One design had tungsten inserts (studs) circumferentially located at its bitter end. The other design did not. Both adapter configurations had weld overlays applied for wear resistance.

One studded adapter unit experienced a failure during Test A2: material failure (cracks) allowed the end to open up and release (eject) the drillhead. Preliminary analysis indicates failure due to incorrect mounting of the studs (insufficient edge distance and mounting holes too deep) and poor welding procedures for the weld overlay. A metallurgical analysis of the failed adapter is presented in Reference 14.

A plasma spray hard coating 6 mils thick was applied to the 15-foot pipe section, just aft of the adapter. The hardfacing provided wear resistance at this critical area. Although measurable wear was never obtained on any of the pipe, hardfacing appears to be capable of protecting the pipe from wear as intended. Hardness values were greater than KHN 970. Reference 14 documents the microstructure and corresponding material hardness for the 15-foot section.

The present torque capacity for the pipe joint is approximately 50,000 ft-lb at zero internal pressure (Figure 24). The joint torque capacity decreases with increasing internal pressure. Reference 15 contains details of joint development and test program results. With the present joint design, system distance capability can be considered limited to 25,000 feet at less than 15-kpsi internal pressure. This may be adequate; however, water pressure for drilling and joint safety factors at 25,000 feet are marginal at best. Possible ways to increase the operating safety factor (joint strength) and therefore allow higher water pressures to improve performance in the 20,000- to 25,000-foot range are: (1) improve the existing joint design, or (2) use higher strength pipe material during high-torque demand phases (20,000 to 25,000 feet).

A requirement to install a pipe casing at the entrance point has been identified as an efficient means of controlling initial starting conditions. It is important to control initial water backflow and provide formation stability at the entrance area. Otherwise, cuttings will be washed away and the entrance hole becomes oversized. This creates an undesirable buckling condition due to an increase in unsupported length of pipe in this area. It can also contribute to unwanted deviations for the drill string.

5.5.3 Steerable Drillhead (SDH) Performance. Although the SDH unit functioned long enough to demonstrate some steering capability, failures occurred during use. Reliability of the SDH assembly did not meet desired levels. Electrical and mechanical failures were experienced. Mechanical portions of the unit are very sensitive to contamination. One of the integrated circuit chips failed due to high ambient temperatures. However, with some very minor modifications, an acceptable level of SDH reliability is expected.

The first problem was identified during an initial check-out of the SDH unit. The SDH was installed into the drill pipe at the conclusion of Test A2 as a means to verify SDH operation. At the conclusion of Test A2, the drill pipe end was exposed at the 398-foot point. The unit was programmed to cut in the first quadrant (up deviation) once pipe rotation reached 5 rpm. The exposed end allowed physical observation of SDH operation. Once the SDH was in place, it was quickly realized that full water pressure was not obtainable. The system could only generate approximately 7,000 psi instead of the expected 15,000 psi. The problem was attributed to an imbalance of pressure across the SDH piston and base plate assemblies. The resultant effect was excessive internal leakage, and therefore full pressure could not be obtained. After experimenting with various orifice diameters at the nozzle bleed port (Figure 16), the correct orifice size was installed and testing resumed at full pressure.

Once the SDH was installed into the Test B drill pipe, a second failure occurred. The unit failed due to ingestion of debris (small rocks and foreign particles) causing the SDH internal motor to overload and shut down. The unit was disassembled and cleaned. Additional care was exercised during subsequent SDH pigging operations to minimize introducing foreign matter during SDH installation.

A third failure occurred during Test B SDH operations. The unit shut off prematurely. It had been instructed to steer in the fourth quadrant (right deviation) when pipe rotation reached 5 rpm. After approximately 40 feet of SDH operation, the unit stopped shifting and was

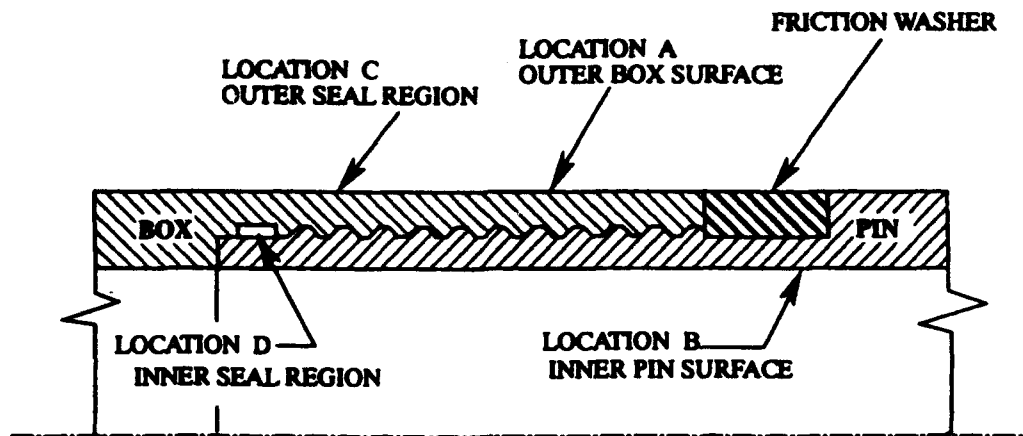

Figure 24
High-torque pipe joint.

subsequently removed from the drill pipe. The remainder of Test B was completed using the straight drillhead. After disassembly, the failure was attributed to sensitivity to high internal water temperature (120°F plus): an integrated circuit component had failed due to heat. Upon cooling down, the faulty component became operational. The obvious solution here is to conduct additional temperature testing on electronic components and remove/replace heat sensitive components with less sensitive components.

A follow-on effort is proposed where the SDH subsystem design would be evaluated for possible reduction in complexity. The present feeling is that some of the design features may not be required and simplification would increase SDH reliability during operation.

5.5.4 Straight Drillhead Performance. A straight drillhead assembly was also tested. This unit is essentially a "dumb" drillhead that provides a straight drill pattern. The unit was used for 95 percent of all drilling at Rocksite B and functioned as designed.

5.5.5 Logging Subsystem Performance. As mentioned above, the logging tool experienced serious electrical failures and after several attempts could not be repaired in the field. The need for the present logging tool design complexity is questionable. Major design modifications and tests, both electrical and mechanical, may be necessary before this subsystem is considered functional.

A follow-on effort to repair the logging tool and conduct a data run at Rocksite B is planned at NWC.

5.5.6 Information Control Center (ICC) Performance. Only marginal success was achieved in recording drilling data using the Information Control Center. The majority of data recorded during test operations was done manually. The majority of the problems encountered in using the ICC stemmed from lack of preparation and testing prior to starting operations at Rocksite B. The ICC was never fully functional prior to or during testing. Unexpected electrical problems plagued the system from the outset. Without the necessary protection

devices, over voltage and current conditions caused damage to circuit boards on several occasions.

The present ICC uses off-the-shelf software and is considered adequate for its intended use. The majority of problems stemmed from a signal (millivolts/milliampere) mismatch between the analog, digital, sender, and receiver components. These problems can be corrected with minor modifications to the electrical circuits involved.

The ICC subsystem is not considered functional at present and needs additional minor configuration modifications prior to future calibration and check-out tests.

5.5.7 High-Pressure Pump Performance. The units functioned as designed. However, on certain occasions maximum engine rpm could not be maintained due to high ambient temperatures at Rocksite B (115°F plus). Fortunately, this anomaly did not affect test operations.

5.6 Cable Pull Test

The full-length pull test was canceled due to funding limitations and imposition of higher priority efforts to demonstrate other system capabilities. This test was considered a low technical risk and was not integral to demonstrating horizontal drilling capabilities. However, a 5,000-foot cable installation test was successfully conducted at SWRI in FY90. For discussion of cable pull test results, see Reference 16.

5.6.1 Cable Tension. In summary, theoretical cable tension during a single cable installation can be calculated using the following equations (Ref 17):

For straight runs,

$$P = w \times l \times f \quad (4)$$

where: P = cable tension (lb)

w = cable weight per foot (lb/ft)

l = cable length (ft)

f = friction coefficient

And for horizontal bends,

$$\frac{P_2}{P_1} = \frac{w \times r}{P_1} \left[\sinh(f \times \theta + \sinh^{-1} \frac{P_1}{w \times r}) \right] \quad (5)$$

where: P_1 = tension at start of bend (lb)

P_2 = tension at end of bend (lb)

θ = included angle of curvature along bend (Radians)

Proof for these equations and a list of applicable equations for vertical bends are provided in Reference 17.

For Test B, the theoretical maximum cable tension can be calculated using Equations 4 and 5 assuming no vertical bends as follows (see Figure 22):

For straight section, from point 1 to point 2,

$$P = w \times l \times f$$

$$f = 0.30$$

$$w = 0.305 \text{ lb/ft (dry)}$$

$$l = 130 \text{ ft}$$

$$\begin{aligned} P &= 0.305 \times 130 \times 0.30 \\ &= 11.9 \text{ lb} \end{aligned}$$

For horizontal bend, from point 2 to point 3,

$$\frac{P_3}{P_2} = \frac{w \times r}{P_2} \left[\sinh(f \times \theta + \sinh^{-1} \frac{P_2}{w \times r}) \right]$$

$$\theta = 5.11^\circ, 0.89 \text{ RAD (from Test B data)}$$

$$r = 447.5 \text{ ft (from Test B data)}$$

Therefore,

$$\frac{P_3}{P_2} = \frac{0.305 \times 447.5}{11.9} \left[\sinh(0.3 \times 0.89 + \sinh^{-1} \frac{11.9}{0.305 \times 447.5}) \right]$$

$$\frac{P_3}{P_2} = 4.15$$

$$P_3 = 49.4 \text{ lb}$$

For the straight section, from point 3 to point 4,

$$P = w \times l \times f$$

$$f = 0.30$$

$$w = 0.305 \text{ lb/ft (dry)}$$

$$l = 227 \text{ ft}$$

$$\begin{aligned} P &= 0.305 \times 227 \times 0.30 \\ &= 20.8 \text{ lb} \end{aligned}$$

The total tension at the pig would be the sum of the above tension values,

$$\begin{aligned} P_{\text{total}} &= 11.9 + 49.4 + 20.8 \\ &= 82.1 \text{ lb} \end{aligned}$$

The maximum expected cable tension for a typical cable installation of 0.525-diameter cable for 25,000 feet is less than 1,500 pounds, well below the allowable working load for these types of cables.

5.7 Wet Interface Test

The wet interface test was cancelled due to funding limitations and imposition of higher priority efforts to demonstrate other system capabilities. However, as part of the wet interface installation demonstration, a pipe flange installation test was conducted at NCEL.

5.7.1 Pipe Flange Installation Test. NCEL team divers demonstrated the operation of the Wachs pipe cutter as it would be used during interface operations. Diver procedures for using the Wachs pipe cutter and installation of the interface Smart Flange were successfully demonstrated and documented on video.

6.0 CONCLUSIONS

6.1 Objectives

Not all test objectives have been met to date. However, significant accomplishments have been achieved as a result of testing at Rocksite B. Obviously, our "Distance" objective was not met. Our longest test hole was A2 at 398 feet. Pipe friction data were measured for each test and correlate favorably with expected values for static conditions with and without a steering event. A summary of objectives and test results is provided in Table 4.

Table 4. Summary of Test Results

Initial Test Objective	Modifications to Test Objective	Objective Met/Not Met
A. Distance 22,100 feet	10,000 feet	Objective not met.
B. Steerability Accuracy, +/- 25-ft vert +/- 1,320-ft horiz	No change	Limited success.
C. Cable Pull Test 22,100 feet	Test postponed	Objective not met.
D. Wet Interface Test	Test postponed	Objective not met.
E. Personnel Training	No change	Objective met except for logging operations.
F. System Operation 1. Launcher 2. Steerable drillhead 3. Logging unit 4. Drill pipe 5. Information Control Center 6. Diesel/pump	No change No change No change No change No change No change	Objective met. SDH reliability not met. Objective not met. Objective met. Limited success. Objective met.

6.2 Steerability Objective

The fact that a programmed deviation was achieved is considered the most significant accomplishment to date. Preliminary observations show some validation of steering ability. However, additional information must be obtained to record the details of the steering event. Namely, Test B drill string should be logged. Only in this way can the duration and amount of deviation achieved be validated.

6.3 Overall Objectives

Except for the logging and Information Control Center subsystems, the horizontal drilling system components functioned as designed during Rocksites B test operations. System requirements for personnel training for launcher, steerable drillhead, and related ancillary support equipment were met.

7.0 RECOMMENDATIONS

1. The results of Test A and Test B cannot be fully evaluated until both drill strings have been logged. Each end of each pipe was left accessible with a single 3/8-inch diameter line installed in each pipe to assist with future logging operations.

2. Additional distance testing is also recommended. We need to demonstrate the system's distance capability - 10,000 to 12,000 feet would be sufficient to obtain credible friction data and demonstrate controlled steering capability. A follow-on test to 10,000 feet is recommended, preferably at Rocksite B, since this would have minimal impact in terms of effort and cost.

3. Serious problems exist with the existing logging subsystem. Several deficiencies have been identified in the present design. Modifications and improvements will be required before the HDS has a logging capability. A more detailed analysis of the logging subsystem failures are presented in Reference 12. Although the logging subsystem is considered salvageable, additional efforts to simplify the system are recommended. A separate design evaluation is needed to determine if the existing suite of logging functions is necessary.

8.0 REFERENCES

1. Naval Civil Engineering Laboratory. Contract Report 230-KCK: Machine foundation. Tucker and Associates, Ridgecrest, CA, Jan 1991.
2. Naval Weapons Center. Geophysical survey - Groundwater exploration using Schlumberger soundings along the eastern portion of the Randsburg Wash Road and within Christmas Canyon, by A.M. Katzenstein, D.M. Meade, and J.R. Neffew. China Lake, CA, Dec 1990.
3. COMARCO, WSD. Geology of the Christmas Canyon Test Site, by C.F. Austin and C.C. Pierce. China Lake, CA, 1991.
4. Air Pollution Control District. Diesel operating permit "permit to construct." Victorville, CA, 1991.
5. Naval Energy and Environmental Support Activity. NEESA 2-184: Emission test results, temporary diesel engines rocksite "B", China Lake Naval Weapons Center, China Lake, California, by K.J. McCallister. Port Hueneme, CA, 1991.
6. Naval Civil Engineering Laboratory. Contract Report WIC-230-0033/91: Field test plan. Western Instrument Corporation, Ventura, CA, Apr 1991.
7. Naval Civil Engineering Laboratory. Contract Report WIC-230-0067/91: System safety analysis. Western Instrument Corporation, Ventura, CA, Jun 1991.
8. Naval Civil Engineering Laboratory. Contract Report 230-0107/91: Horizontal drilling project report. Radialphysics Limited, San Francisco, CA, Feb 1986.

9. Naval Civil Engineering Laboratory. Technical Note N-1863: Horizontal drilling system (HDS) operations theory report, by J.V. Wilson. Port Hueneme, CA, Jul 1993.
10. M.F. Spotts. Design of machine elements. Englewood Cliffs, NJ, Prentice-Hall, Inc., 5th Edition, 1978, p 23.
11. Callin Kerr. "Design criteria help plan, North Sea horizontal wells," Ocean Industry, Oct 1991, p 37.
12. Naval Civil Engineering Laboratory. Contract Report 230-BCL-0036: Final report on fabrication and testing of a steerable drillhead and horizontal logging instrument. Battelle Memorial Institute, Columbus, OH, Aug 1991.
13. Southwest Research Institute. SWRI Specification No. 3087009: Specification for special pipe joints. San Antonio, TX, 1991.
14. Naval Civil Engineering Laboratory. Memorandum: Analysis of tube failure, by J. Jenkins. Port Hueneme, CA, 1991.
15. Naval Civil Engineering Laboratory. Contract Report SRI-008/91: Task 007/010 Joint development final report. Southwest Research Institute, San Antonio, TX, Sep 1991.
16. Naval Civil Engineering Laboratory. Contract Report WIC-230-0030/90: Final report, cable pull test. Western Instrument Corporation, Ventura, CA, Jul 1990.
17. F.H. Buller. "Pulling tension during cable installation in duets or pipes," General Electric Review, Aug 1949, p 21.