

2



US Army Corps
of Engineers
Construction Engineering
Research Laboratory

AD-A272 573



USACERL Technical Report FM-93/11
April 1993
Roofing Maintenance Management System

ROOFER: Membrane and Flashing Condition Indexes for Single-Ply Membrane Roofs—Inspection and Distress Manual

by
David M. Bailey
Donald E. Brotherson
Wayne Tobiasson
Stuart D. Foltz
Al Knehans

Because no procedures exist to inspect and evaluate the condition of single-ply membrane roofing systems within the ROOFER program, the U.S. Army Construction Engineering Research Laboratories (USACERL) has developed this inspection and distress manual for these roofing systems. Included is the standardized information needed to conduct the visual inspection survey, including names, descriptions, severity levels, measurement criteria, causes and photographs of membrane and flashing distresses. Procedures for distress density calculations are also provided. Roof inspectors can use this information to objectively determine the indexes that reflect the (1) ability of the membrane and flashing to perform their functions, (2) needed level of maintenance, and (3) waterproof integrity.

DTIC
SELECTED
NOV 12 1993
S B D

93-27490



Approved for public release; distribution is unlimited.

93 11 8 166

The contents of this report are not to be used for advertising, publication, or promotional purposes. Citation of trade names does not constitute an official endorsement or approval of the use of such commercial products. The findings of this report are not to be construed as an official Department of the Army position, unless so designated by other authorized documents.

DESTROY THIS REPORT WHEN IT IS NO LONGER NEEDED

DO NOT RETURN IT TO THE ORIGINATOR

DISCLAIMER NOTICE

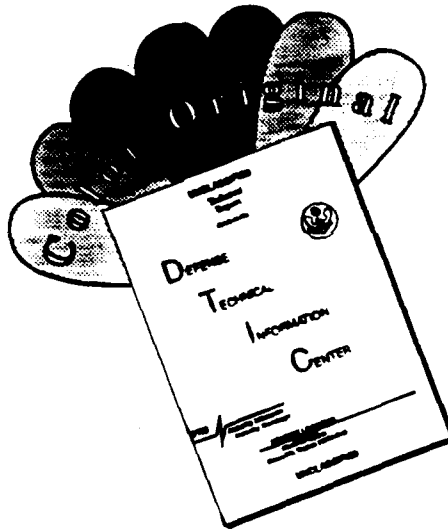

THIS DOCUMENT IS BEST QUALITY AVAILABLE. THE COPY FURNISHED TO DTIC CONTAINED A SIGNIFICANT NUMBER OF COLOR PAGES WHICH DO NOT REPRODUCE LEGIBLY ON BLACK AND WHITE MICROFICHE.

USER EVALUATION OF REPORT

REFERENCE: USACERL Technical Report FM-93/11, *ROOFER: Membrane and Flashing Condition Indexes for Single-Ply Membrane Roofs—Inspection and Distress Manual*

Please take a few minutes to answer the questions below, tear out this sheet, and return it to USACERL. As user of this report, your customer comments will provide USACERL with information essential for improving future reports.

1. Does this report satisfy a need? (Comment on purpose, related project, or other area of interest for which report will be used.)

2. How, specifically, is the report being used? (Information source, design data or procedure, management procedure, source of ideas, etc.)

3. Has the information in this report led to any quantitative savings as far as manhours/contract dollars saved, operating costs avoided, efficiencies achieved, etc.? If so, please elaborate.

4. What is your evaluation of this report in the following areas?

a. Presentation: _____

b. Completeness: _____

c. Easy to Understand: _____

d. Easy to Implement: _____

e. Adequate Reference Material: _____

f. Relates to Area of Interest: _____

g. Did the report meet your expectations? _____

h. Does the report raise unanswered questions? _____

i. General Comments. (Indicate what you think should be changed to make this report and future reports of this type more responsive to your needs, more usable, improve readability, etc.)

5. If you would like to be contacted by the personnel who prepared this report to raise specific questions or discuss the topic, please fill in the following information.

Name: _____

Telephone Number: _____

Organization Address: _____

6. Please mail the completed form to:

Department of the Army
CONSTRUCTION ENGINEERING RESEARCH LABORATORIES
ATTN: CECER-IMT
P.O. Box 9005
Champaign, IL 61826-9005

REPORT DOCUMENTATION PAGE

Form Approved
OMB No. 0704-0188

Public reporting burden for this collection of information is estimated to average 1 hour per response, including the time for reviewing instructions, searching existing data sources, gathering and maintaining the data needed, and completing and reviewing the collection of information. Send comments regarding this burden estimate or any other aspect of this collection of information, including suggestions for reducing this burden, to Washington Headquarters Services, Directorate for Information Operations and Reports, 1215 Jefferson Davis Highway, Suite 1204, Arlington, VA 22202-4302, and to the Office of Management and Budget, Paperwork Reduction Project (0704-0188), Washington, DC 20503

1. AGENCY USE ONLY (Leave Blank)	2. REPORT DATE April 1993	3. REPORT TYPE AND DATES COVERED Final	
4. TITLE AND SUBTITLE ROOFER: Membrane and Flashing Condition Indexes for Single-Ply Membrane Roofs—Inspection and Distress Manual		5. FUNDING NUMBERS 4A162784 AT41 MB-D92	
6. AUTHOR(S) David M. Bailey, Donald E. Brotherson, Wayne Tobiasson, Stuart D. Foltz, and Al Knehans		8. PERFORMING ORGANIZATION REPORT NUMBER TR-FM-93/11	
7. PERFORMING ORGANIZATION NAME(S) AND ADDRESS(ES) U.S. Army Construction Engineering Research Laboratories (USACERL) P.O. Box 9005 Champaign, IL 61826-9005		10. SPONSORING/MONITORING AGENCY REPORT NUMBER	
9. SPONSORING/MONITORING AGENCY NAME(S) AND ADDRESS(ES) Headquarters, U.S. Army Corps of Engineers (HQUSACE) ATTN: CEHSC-FB-S 20 Massachusetts Avenue, NW Washington, DC 20314-1000		11. SUPPLEMENTARY NOTES Copies are available from the National Technical Information Service, 5285 Port Royal Road, Springfield, VA 22161.	
12a. DISTRIBUTION/AVAILABILITY STATEMENT Approved for public release; distribution is unlimited.		12b. DISTRIBUTION CODE	
13. ABSTRACT (Maximum 200 words) Because no procedures exist to inspect and evaluate the condition of single-ply membrane roofing systems within the ROOFER program, the U.S. Army Construction Engineering Research Laboratories (USACERL) has developed this inspection and distress manual for these roofing systems. Included is the standardized information needed to conduct the visual inspection survey, including names, descriptions, severity levels, measurement criteria, causes and photographs of membrane and flashing distresses. Procedures for distress density calculations are also provided. Roof inspectors can use this information to objectively determine the indexes that reflect the (1) ability of the membrane and flashing to perform their functions, (2) needed level of maintenance, and (3) waterproof integrity.			
14. SUBJECT TERMS ROOFER single-ply membrane membrane condition index (MCI)		15. NUMBER OF PAGES 100	
		16. PRICE CODE	
17. SECURITY CLASSIFICATION OF REPORT Unclassified		18. SECURITY CLASSIFICATION OF THIS PAGE Unclassified	19. SECURITY CLASSIFICATION OF ABSTRACT Unclassified
		20. LIMITATION OF ABSTRACT SAR	

FOREWORD

This research was conducted for the Directorate of Military Programs, Headquarters, U.S. Army Corps of Engineers (HQUSACE) under Project 4A162784AT41, "Military Facilities Engineering Technology"; Task MB; Work Unit D92, "Roofing Maintenance Management System." The technical monitor was Al Knehans, CEHSC-FB-S.

The work was performed by the Engineering and Materials Division (FM), of the Infrastructure Laboratory (FL), U.S. Army Construction Engineering Research Laboratories (USACERL). David M. Bailey is the principal investigator. Dr. Paul Howdysshell is Chief, CECER-FM and Dr. Michael J. O'Connor is Chief, CECER-FL. The USACERL technical editor was Gloria J. Wienke, Information Management Office.

Donald E. Brotherson is Director of the Building Research Council, University of Illinois. Wayne Tobiasson is a Research Civil Engineer in the Experimental Engineering Division at the U.S. Army Cold Regions Research and Engineering Laboratory (USACRREL).

Special acknowledgement is due to the following who participated as members of the development/field validation team: Dr. Robert Alumbaugh, Naval Civil Engineering Laboratory (NCEL), John Bradford, roofing contractor; Dwight Jennings, roofing consultant; Mark de Ogburn, U.S. Navy, Southern Naval Facilities Engineering Command (SOUTHNAVFACENGCOM); and Tom Wallace, U.S. Navy, Northern Naval Facilities Engineering Command (NORTHNAVFACENGCOM).

COL Daniel Waldo, Jr., is Commander and Director of USACERL and Dr. L.R. Shaffer is Technical Director.

DTIC QUALITY INSPECTION

Accession For	
NTIS GRA&I	<input checked="" type="checkbox"/>
DTIC TAB	<input type="checkbox"/>
Unannounced	<input type="checkbox"/>
Justification	
By _____	
Distribution/	
Availability Codes	
Dist	Avail and/or Special
A-1	

CONTENTS

	Page
SF298	1
FOREWORD	2
LIST OF FIGURES AND TABLE	5
1 INTRODUCTION	7
Background	7
Objective	7
Approach	7
Using the Manual	8
Mode of Technology Transfer	8
2 PROCEDURES FOR ROOF INSPECTION AND CALCULATION OF INDEXES	10
Roof Sections	10
Roof Plans	10
Inspection Procedure	14
Inspection Guidelines	16
MCI and FCI Calculations	17
3 FLASHING DISTRESSES	22
Index	22
Base Flashing, Membrane Material (BF)	23
Base Flashing, Coated Metal (BC)	28
Metal Cap Flashing (MC)	31
Embedded Edge Metal (EM)	35
Flashed Penetrations (FP)	39
Pitch Pans (PP)	42
Interior Drains and Roof Level Scuppers (DR)	45
4 MEMBRANE DISTRESSES	49
Index	49
Splits (SP)	50
Ridges (RG)	52
Holes, Cuts, and Abrasions (HL)	54
Defective Seams (DS)	57
Surface Coating Deterioration (SC)	61
Membrane Deterioration (MD)	63
System Securement Deficiencies (SS)	65
Membrane Support Deficiencies (MS)	69
Patching (PA)	71
Debris and Vegetation (DV)	73
Improper Equipment Supports (EQ)	76
Ponding (PD)	78
METRIC CONVERSION TABLE	80
REFERENCES	80
APPENDIX A: Deduct Value Curves	81

CONTENTS (Cont'd)

Page

APPENDIX B: Inspection and Rating Forms

93

DISTRIBUTION

FIGURES

Number		Page
1	Membrane and Flashing Condition Indexes (MCI and FCI) and Ratings	9
2	Six-Step Rating Procedure	11
3	Roof Inspection Worksheet Showing Example Roof Plan	12
4	Standard Symbols for the Roof Section Plans	13
5	Completed Roof Inspection Worksheet	15
6	Reverse Side of Roof Inspection Worksheet	18
7	Roof Section Rating Form	19

TABLE

1	Deduct Values in Descending Order	21
---	-----------------------------------	----

ROOFER: MEMBRANE AND FLASHING CONDITION INDEXES FOR SINGLE-PLY MEMBRANE ROOFS INSPECTION AND DISTRESS MANUAL

I INTRODUCTION

Background

The U.S. Army has over 300 million square feet of low-slope roofing, the largest portion of this being bituminous built-up membranes. Army installations spend a large portion of their infrastructure maintenance dollars repairing and replacing these low-slope roofs. Historically, Army Directorates of Engineering and Housing (DEHs), like other facility managers, have lacked systematic procedures for evaluating and managing their inventory of roofs to make the best use of limited maintenance funds.

The U.S. Army Construction Engineering Research Laboratories (USACERL), with the assistance of the U.S. Army Cold Regions Research and Engineering Laboratory (USACRREL) and the U.S. Army Engineering and Housing Support Center (USAEHSC), developed ROOFER, an Engineered Management System initially for bituminous built-up roofs (Bailey et al. 1989; Bailey, Brotherson, and Tobiasson 1989). The ROOFER procedures with a microcomputer application (Bailey et al. 1990) provide building managers with a decision support tool for assessing roof condition, selecting repair strategies, and establishing planning and budgeting needs for accomplishing this work.

Since the early 1980s, the amount of single-ply membranes being used for roofing at Army installations has been steadily increasing. DEHs, Directorates of Public Works (DPWs), and other building managers need to be able to use the ROOFER program to evaluate single-ply roofing systems.

Objective

The objective of this work was to develop condition index procedures based on visual inspection of the flashing and membrane components of single-ply roofs as part of the program to extend ROOFER to other types of roofing systems. This report provides roof inspectors with a standard reference for conducting inspections and calculating the membrane condition index (MCI) and flashing condition index (FCI).

Approach

The concepts and theory behind the condition index methodology and the process used to develop and field validate the distress definitions and deduct value curves are described elsewhere (Shahin, Bailey, and Brotherson 1987a). The procedures for determining membrane and flashing condition indexes for built-up roofs (BUR) as described elsewhere (Shahin, Bailey, and Brotherson 1987b) provide the basis for this work. The same developmental process involving a rating team of experts and field tests at six sites (military and nonmilitary) was used for this effort.

*A metric conversion table is on page 80.

Single-ply flashing distresses are categorized by flashing type, as was done for BUR. Some single-ply membrane distresses are comparable to BUR distresses. For these similar flashing and membrane distresses, the corresponding BUR deduct value curves were determined by field ratings to be valid for single-ply roofing. Several distresses, different from those encountered by BUR, were identified for the single-ply membrane component. For those distresses, new defects were defined and deduct value curves were developed, field tested, and verified.

Using the Manual

Chapter 2 contains the inspection procedures. Distresses for flashings and membranes are presented in Chapters 3 and 4, respectively. These two chapters include descriptions of distresses, severity levels, defect definitions, photographs, measurement criteria, and causes. Inspectors should study this manual and carry a copy for reference during inspections.

Results of roof inspections are to be used in conjunction with the calculation procedures in Chapter 2 to determine the MCI and FCI and their respective ratings (Figure 1). Deduct Value Curves are in Appendix A and samples of roof inspection sheets are in Appendix B. These membrane and flashing component condition indexes, combined with an insulation condition index (ICI) for insulated roofs, are used to determine a roof condition index (RCI) and provide an overall assessment of a roof. The methods for calculating the single-ply ICI and combining it with the MCI and FCI are the same as for BUR and are documented in USACERL Technical Report M-90/04, *ROOFER: An Engineered Management System for Bituminous Built-Up Roofs*.

Mode of Technology Transfer

This report serves as the ROOFER inspection manual for single-ply roofs. The capabilities for performing automated calculations and storing collected information will be incorporated into the Micro ROOFER software program. USAEHSC is the support agency that has the responsibility for assisting in implementing the ROOFER program at Army installations.

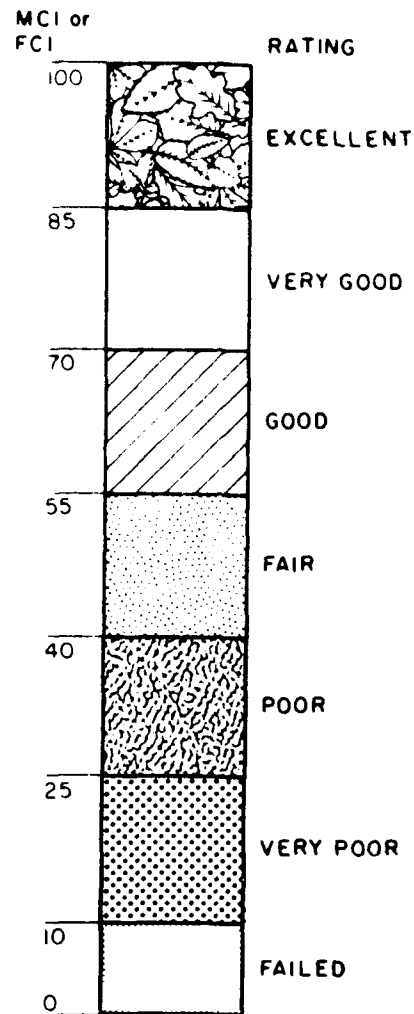

Figure 1. Membrane and Flashing Condition Indexes (MCI and FCI) and Ratings.

2 PROCEDURES FOR ROOF INSPECTION AND CALCULATION OF INDEXES

As defined by the concepts and theories in previous RCI research reports (Shahin, Bailey, and Brotherson 1987a, 1987b), the condition indexes reflect the (1) ability of the membrane and flashing to perform their functions, (2) needed level of maintenance and, (3) waterproof integrity. Determining the MCI and FCI requires measurement of all existing membrane and flashing distresses. A thorough visual inspection must be conducted to determine the distress type, severity, and amount of each defect present. A distress type (e.g., defective seams) may have several different defects (e.g., missing lap sealant, wrinkled seam) for a given severity level. The inspection must be carefully organized and planned to provide the necessary information for determining the membrane and flashing conditions.

This chapter presents the overall process for visually inspecting single-ply membrane roofs and computing membrane and flashing condition indexes as shown in Figure 2.

Roof Sections

The inspector should divide each building's roof into sections and rate each section independently to determine maintenance, repair, and replacement (MRR) needs. Using this approach, a roof section in poor condition does not detract from the assessment of a roof section on the same building that is performing well. Also it may be possible to replace only those sections that are not performing well.

Roof sections are assigned letter designations (A,B,C, and so on) and are generally delineated by:

- perimeter details such as firewalls, expansion joints, or area dividers,
- different roof levels,
- areas having different roofing systems, different amounts of rooftop equipment, or significantly different conditions below the roof, or
- areas that were constructed at different times.

If a roof is physically divided into many small areas, it may be possible to combine several similar areas (e.g., canopies over entrances) into one section, provided the areas of similar age and construction. However, if areas have different structural systems or different environments below the roof, they should be treated as individual sections. Large areas without obvious delineations should be arbitrarily divided into areas of 25,000 to 40,000 sq ft.

Roof Plans

Each roof section should have a roof plan drawn to a scale that fits on the Roof Inspection Worksheet (Figure 3). A blank version of the worksheet is provided in Appendix B. The plan should show all physical roof features, including perimeter conditions (e.g., roof edge, expansion joint, parapet wall), rooftop equipment, projections through the roof, roof drains, walkways, sign supports, piping, and other features. The standard symbols shown in Figure 4 should be used to identify these items.

STEP 1: Divide Building Roof Into Sections and Develop Roof Plans.

STEP 2: Inspect Roof Section. Determine Distress Types, Severity Levels, and Defects & Measure Quantities.

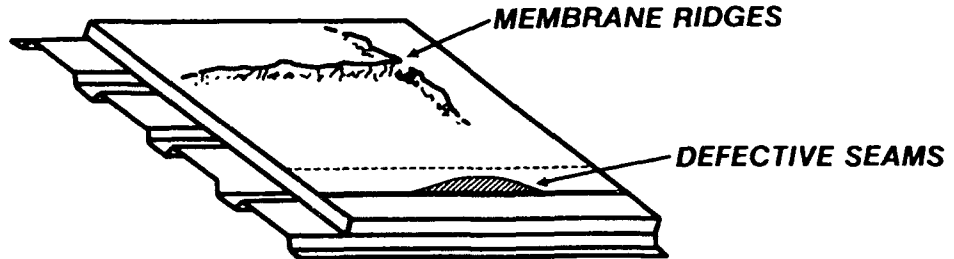

STEP 3: Determine Deduct Values.

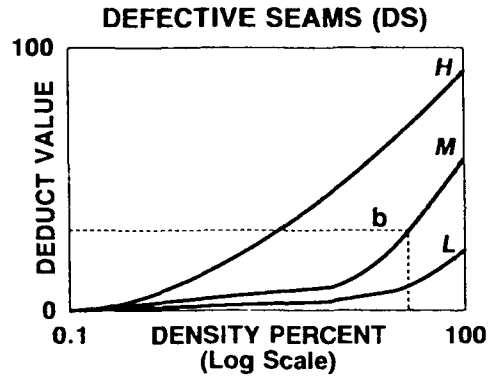
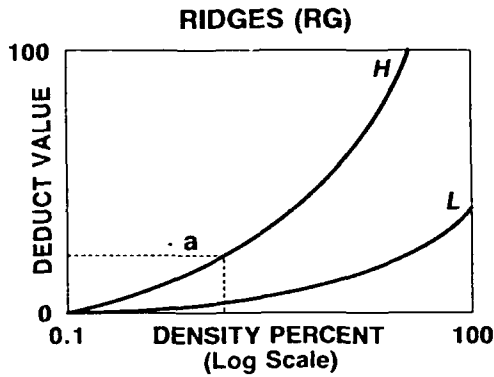

STEP 4: Determine Corrected Deduct Values.

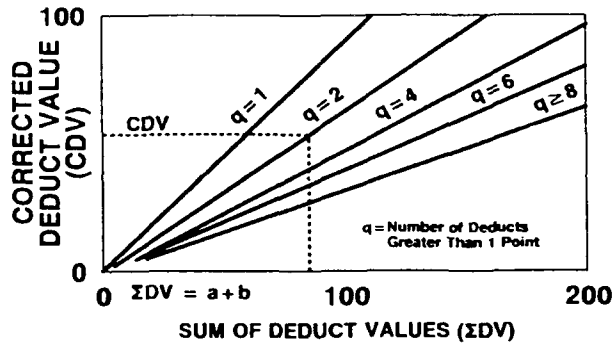

STEP 6: Determine Membrane and Flashing Condition Ratings.

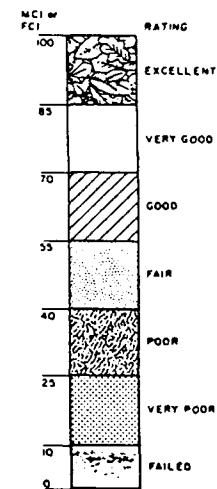

STEP 5: Compute Membrane and Flashing Condition Indexes.

Figure 2. Six-Step Rating Procedure.

ROOF INSPECTION WORKSHEET		AGENCY/INST.: <i>FORT XXX</i>						
BUILDING <u>97</u>	PER. FLASHING _____ LF	DATE _____						
SECTION <u>B</u>	CURB FLASHING _____ LF	NAME _____						
BF-BASE FL-MEM BC-BASE FL-METAL MC-METAL CAP EM-EMBEDDED MET FP-FLASHED PEN	PP-PITCH PAN DR-DRAIN & SC SP-SPLITS RG-RIDGES HL-HOLES	DS-DEF SEAMS SC-SURF COAT MD-MEM DET SS-SYSTEM SEC MS-MEM SUPPORT	PA-PATCHING DV-DEB & VEG EQ-EQ SUPPORT PD-PONDING	ID #	DIS S	SE V	DE F	QT Y
SCALE: $\frac{1}{16}'' = 1'-0''$								

(This form has been reduced in size.)

Figure 3. Roof Inspection Worksheet Showing Example Roof Plan.









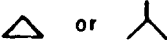

	H = HATCH E = EQUIPMENT P = PENTHOUSE S = SKYLIGHT SC = SOLAR COLLECTOR T = TRANSFORMER V = VENTILATOR
	ANTENNA
	CORE SAMPLE WITH SAMPLE IDENTIFIER
	VENT PIPE
	DRAIN OR DOWNSPOUT
	LADDER
	SCUPPER
	CHIMNEY OR FLUE
	PITCH PAN
	FLASHED PIPE
	LIGHTNING ROD
	ROOF EDGE
	PARAPET WALL OR ADJACENT BLDG
	EXPANSION JOINT OR ROOF DIVIDER

Figure 4. Standard Symbols for the Roof Section Plans.

Inspection Procedure

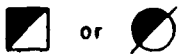
Survey Team

The roof inspection should be performed by a team of at least two people: an inspector and a recorder. The inspector surveys the roof, identifying distresses and determining appropriate severity levels, defects, and quantities. The recorder enters the data on the Roof Inspection Worksheet and assists in measuring distress quantities. The recorder also serves as the safety observer for the team.

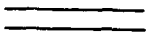
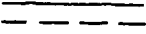
Supplies

The following supplies are required to perform the inspection and can be carried in a satchel when on the rooftop:

- Inspection and Distress Manual (this document)
- Pencil and clipboard
- Single-ply Roof Inspection Worksheets
- Small, 3-in. pointing trowel
- Can of spray paint
- Stiff bristle whisk broom
- Pocket knife
- Measuring tapes (12-ft and 100-ft recommended)
- Large plastic bag (for collecting rooftop debris).

Survey Preparation

It may be necessary for the survey team to contact the building superintendent or custodian for assistance in gaining access to the roof. Once on the rooftop, the roof section plan should be developed (or verified, if a plan already exists). Before the survey begins, locate all penetrations, projections, rooftop equipment, and perimeter conditions on the plan. Measure and record dimensions on the roof plan. Measure and record the total perimeter flashing length (in lineal ft) in the appropriate space in the heading of the Roof Inspection Worksheet. Also determine and record on the worksheet the length of the base flashing on all curbed penetrations.

Distress Survey

Inspectors must be able to identify the various distresses and defects accurately and follow the inspection procedure closely to obtain meaningful, consistent, and repeatable results.

When performing the inspection, identify each distress as it is encountered; determine its severity level, the specific defect present, and measure its quantity using the criteria defined in Chapters 3 and 4. Enter this information in the columns on the right side of the Roof Inspection Worksheet. Each distress encountered is assigned an identification number, starting with 1 (ID # in column 1) and numbering consecutively. Record the location of each distress on the roof plan using the identification number as shown in Figure 5. If, during the inspection, the Roof Inspection Worksheet becomes filled, continue recording on a second worksheet. (Appendix B contains an abbreviated list of identifiers for all the distresses/defects, which is designed to assist inspectors in rapidly identifying defects. A copy of the list can be attached to the bottom of a long [8 in. x 14 in.] clipboard, so it is exposed below the Roof Inspection Worksheet, as a ready reference during inspections.)

Perform the distress survey on each roof section using the following steps:

1. Inspect the perimeter flashing. Establish a starting point at one corner of the roof section. Walk the perimeter, examining the base flashing, embedded edge metal flashing, and metal cap flashing. Fill in the worksheet as the inspection proceeds.
2. After inspecting the perimeter, walk the roof area, using an established pattern, inspecting all other flashings. This includes curbed penetrations, flashed penetrations, pitch pans, drains, etc.
3. Inspect the roof membrane. Establish a starting point at one corner of the roof section. Using 10- to 15-ft wide strips, walk back and forth across the roof section surveying the entire membrane.

Inspection Guidelines

Proper inspection requires surveying the entire roof section. However, if defects occur uniformly over a large area or if the roof is covered with ballast, use sampling procedures.

Representative Sampling Technique

When specific defects occur uniformly on a large area of the membrane or a long run of flashing, the following representative sampling technique can be used.

Select a portion of the roof (e.g., 1000 sq ft of membrane or 100 ft of flashing) and measure the distress in the sample area. Then, by extrapolation, estimate the quantity of that distress for the total portion of the membrane or flashing affected. Record the distress information as a single entry with one identification number on the Roof Inspection Worksheet. The boundaries of the overall area or length should be shown on the roof section plan.

Embedded Edge Metal Joints on Ballasted Roofs

As a method of sampling the embedded edge metal joints for ballasted systems, determine the number of joints by dividing the total length of embedded edge metal flashing by the length of the edge metal sections (often 10 ft). Move the gravel at every fourth joint to inspect for splits in the stripping material. Count the number of inspected joints having a specific defect and multiply by four to determine the total length of the defect. Replace ballast after completing inspection.

Defective Seams on Ballasted Roofs

For ballasted roofs, check field seams at five different locations on each roof section. Clear the ballast from a 5-ft length of the seam at each location and clean the exposed seam with a whisk broom. If all checked seams are without defects, assume the remaining field seams are satisfactory. If any defects are found, use the following sampling technique:

1. For roof sections with sheet widths of 10 ft or less, inspect 2 percent of the total length of field seams (2 ft every 100 ft of seam). For roof sections having sheet widths greater than 10 ft, inspect 4 percent of the total length of field seams (2 ft every 50 ft of seam). Measure length of each specific seam defect found.
2. Extrapolate to determine the total length of seam defects for the entire roof section from the total length of defect found. When 2 percent of the seams are inspected, multiply the actual

defect length by 50 to compute total length of defect. When 4 percent of the seams are inspected, multiply the actual defect length by 25 to compute the total length of defect.

3. Replace ballast after completing inspections.

General Guidelines

The following is a list of general guidelines for the roof inspection:

- When on the rooftop, be careful not to damage the roof. Do not step on unsupported flashing or membrane.
- If snow or a large area of ponding exist on the roof, postpone the inspection until the roof is clear.
- Wherever possible, measure lengths and areas to determine distress quantities. Estimating, instead of measuring, compromises the rating accuracy. Pacing to find lengths, or some other numerical estimating method, is preferable to "eyeball" estimates.
- If more than one severity level of a distress exists in a localized area, count the entire area at the highest severity level present.
- Note existing problems that are not included in the lists of flashing and membrane distresses in Section C (Evaluation of Rooftop Conditions) or in Section D (Remarks) on the reverse side of the Roof Inspection Worksheet (Figure 6). A blank copy of this sheet is provided in Appendix B.
- Walk the interior of the building and examine the ceiling for water marks or other evidence of problems. Note rusting or other signs of water penetration in Section A (Evaluation of Interior Conditions) on the reverse side of the Roof Inspection Worksheet. Occupants can often provide valuable information.
- Walk the outside of the building and look for water stains, efflorescence, missing mortar, spalled brick, and gutter and drainage problems. Note any findings in Section B (Evaluation of Exterior Conditions) on the reverse side of the Roof Inspection Worksheet.

MCI and FCI Calculations

The MCI and FCI of a roof section are determined from the information recorded on the Roof Inspection Worksheet. The calculations are completed on the Roof Section Rating Form (Figure 7) using the following procedure. A blank copy of the Roof Section Rating Form is provided in Appendix B.

Determine Deduct Values

Use information from the Roof Inspection Worksheet to complete the heading section of the Roof Section Rating Form. Transfer the quantities for each combination of distress type and severity level to the Roof Section Rating Form. Flashing distresses are tabulated on the left side of the page and membrane distresses on the right. Total the quantities for each severity of each distress, calculate each density using the equations in Chapters 3 and 4, and determine deduct values (DV) from the Deduct Value Curves in Appendix A.

ROOF INSPECTION WORKSHEET - COMMENTS

INSTRUCTIONS: Circle response, i.e., Y = yes, N = no or U = unknown or not observed. If Y (yes), circle the type of problem.

A. EVALUATION OF INTERIOR CONDITIONS

1. Does the roof leak? Describe: Yes, (Y) N U
Room 124, exterior wall

2. Are there water stains on: (Y) N U

a. walls	c. deck	e. structural elements
(b) ceilings	d. floor	f. other: _____

3. Do structural elements show any of the following: Y (N) U

a. cracks	d. alteration	g. physical damage
b. splits	e. rotting	h. insect damage
c. spalling	f. settlement	i. other: _____

4. Does the underside of the deck show any of the following: Y N (U)

a. rusting	c. spalling	e. sagging
b. rotting	d. cracks	f. other: _____

B. EVALUATION OF EXTERIOR CONDITIONS

1. Do the exterior walls show any of the following: (Y) N

a. cracks	c. spalling	(e) water stains
b. rusting	d. movement	f. other: _____

2. Does the fascia or soffit show any of the following: Y (N)

a. cracks	c. spalling	e. water stains
b. rusting	d. peeling	f. other: _____

3. Do the gutters or downspouts show any of the following: (Y) N

a. loose	c. missing	e. clogged
(b) damaged	d. disconnected	f. other: _____

C. EVALUATION OF ROOFTOP CONDITIONS

1. Is there any unauthorized, unnecessary, or improperly installed equipment on the roof? Y (N)

a. equipment	c. antennas	e. cables
b. signs	d. platforms	f. other: _____

2. Do adjacent parapet walls show any of the following: (Y) N

a. cracks	c. cap cracked	e. sealant flaws
b. spalling	(d) cap missing	f. other: _____

D. REMARKS: _____

Figure 6. Reverse Side of Roof Inspection Worksheet.

ROOF SECTION RATING FORM											
BUILDING <u>97</u>		SECTION <u>B</u>		DATE <u>27 JUL 92</u>		CALC. BY <u>RWB</u>					
PER. FLASHING <u>271 FT</u>		FLASHING		AREA <u>3462 SQFT</u>		CHKD. BY <u>C.S.</u>					
CURB FLASHING <u>70 FT</u>		TOTAL <u>341 FT</u>									
FLASHING				MEMBRANE							
BF - BASE FL - MEM BC - BASE FL - METAL MC - METAL CAP EM - EMBEDDED MET FP - FLASHED PEN PP - PITCH PAN				DR - DRAIN & SC SP - SPLITS RG - RIDGES HL - HOLES DS - DEF SEAMS SC - SURF COAT MD - MEM DET			SS - SYSTEM SEC MS - MEM SUPPORT PA - PATCHING DV - DEB & VEG EQ - EQ SUPPORT PD - PONDING				
TYP	SV	QUANTITIES	TOT	DEN	DV	TYP	SV	QUANTITIES	TOT	DEN	DV
BC	H	20	20	5.9	22	PD	L	40	40	1.2	4
EM	H	1+1+1+1	4	1.2	11	SS	H	50	50	1.4	23
EM	M	1+1	2	.59	6	DS	M	10	10	.29	5
BF	M	2	2	.59	4	DS	H	15	15	.43	32
MC	H	1	1	.29	7						
DR	H	1	1	.29	28						
PP	L	4	4	1.2	4						
CORRECTED DEDUCT VALUE (CDV)										33	
FCI = 100 - CDV = <u>67</u>											
FLASHING RATING = <u>GOOD</u>											
CORRECTED DEDUCT VALUE (CDV)										38	
MCI = 100 - CDV = <u>62</u>											
MEMBRANE RATING = <u>GOOD</u>											

Figure 7. Roof Section Rating Form.

Determine Corrected Deduct Values

Tabulate flashing deduct values in descending order as shown in Table 1. Determine the sums of flashing deduct values (ΣDV) and the number of distresses with deduct values greater than 1 (q), then use these two values and the appropriate graph in Appendix A to determine corrected deduct values (CDV) for the flashing distresses. Circle the maximum value of CDV as shown in Table 1.

Repeat this process using the appropriate graph in Appendix A to determine the maximum corrected deduct for the membrane.

Compute Membrane and Flashing Condition Indexes

Calculate flashing and membrane condition indexes using the following equations:

$$FCI = 100 - \text{Max. } CDV_{\text{flashing}}$$

$$MCI = 100 - \text{Max. } CDV_{\text{membrane}}$$

Determine Membrane and Flashing Condition Ratings

Determine the corresponding descriptive condition ratings from Figure 1 for both indexes.

Table 1
Deduct Values in Descending Order
Flashing

(Distress data from the completed Roof Section Rating Form, Figure 7)

DV	ΣDV	q	CDV _{flashing}
28	28	1	28
22	50	2	32
11	61	3	33
7	68	4	33
6	74	5	32
4	78	6	32
4	82	7	29

Maximum CDV_{flashing} = 33

Membrane

(Distress data from the completed Roof Section Rating Form, Figure 7)

DV	ΣDV	q	CDV _{membrane}
32	32	1	32
23	55	2	38
5	60	3	37
4	64	4	34

Maximum CDV_{membrane} = 38

3 FLASHING DISTRESSES

Index

<u>Distress</u>	<u>Page</u>
Base Flashing - Membrane Material	23
Base Flashing - Coated Metal	28
Metal Cap Flashing	31
Embedded Edge Metal	35
Flashed Penetrations	39
Pitch Pans	42
Interior Drains and Roof Level Scuppers	45

BASE FLASHING, MEMBRANE MATERIAL (BF)

Description: Base flashing is composed of membrane material or other flexible material. The base flashing extends from the roof surface upward above the plane of the membrane to provide a watertight termination of the membrane.

Severity Levels:

Low: Any of the following defects:

1. Light crazing or eroding of the base flashing.
2. Top of base flashing is less than 6 in. above the membrane.
3. Nailing strip or flashing batten with exposed fasteners is less than 6 in. above the roof surface.
4. Seam or side lap is open less than 1/2 in.
5. Flashing has repairs made with compatible materials.

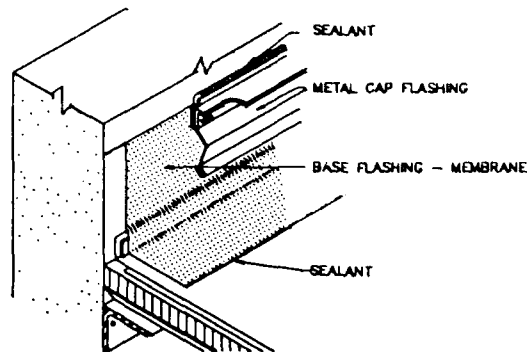

Medium: Any of the following defects:

1. Crazing or eroding of the base flashing that has worn through to a reinforcement or scrim sheet or down to another layer of different color, or has resulted in obvious loss of sheet thickness.
2. Slippage, wrinkling, blistering, pulling, unbonding, or bridging of base flashing material that does not allow water to penetrate.
3. The presence of solvents, oil, or other chemicals with deterioration of the base flashing but does not allow water to penetrate.
4. Flashing has repairs made with dissimilar materials.
5. Seam or side lap is open more than 1/2 in. but does not allow water to penetrate the flashing.
6. Loose or missing termination bar where no counterflashing is used.
7. Loose or missing nailing strip.

High: Any of the following defects:

1. Crazing or eroding of the base flashing that has worn through the flashing allowing water to penetrate.
2. Holes, splits, or tears in base flashing, allowing water to penetrate.
3. Exposed gaps at top of the base flashing.
4. Seam or side lap is open through its entire width, allowing water to penetrate the flashing.
5. Holes through the base flashing caused by solvents, oil, or other chemicals.

Measurement: Measure length (ft) of base flashing having the above conditions. Holes, open side laps, and seams count as 1 ft each.

BASE FLASHING, MEMBRANE MATERIAL (BF)

Density:

$$\frac{A}{B} \times 100 = \text{Problem Density}$$

where A = length of base flashing defects (ft)
B = total length of flashing on roof section being rated (including perimeter flashings and flashings for penthouses, courtyards, and curbed projections).

Note: A problem density is calculated for each existing severity level.

Causes:

1. Flashing splits or tears can result from construction defects, mechanical damage, material shrinkage, unattached membrane pulling the flashing, or differential movement between the wall and the deck.
2. Slippage, wrinkling, or pulling of base flashing may result from weak or no attachment between the flashing and the substrate. This can result from any of the following conditions:
 - adhesive or flashing material was improperly applied or substrate was not properly prepared.
 - adhesive used was improper type or poor quality, or
 - fasteners were improper or too few to hold flashing to the substrate.

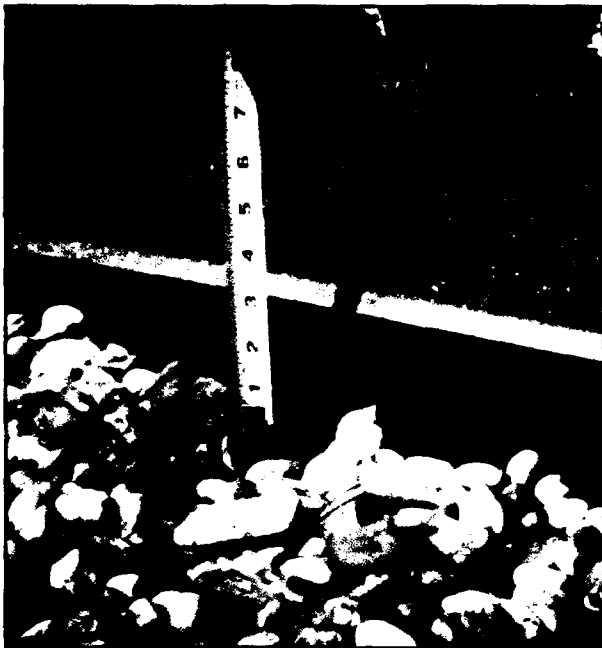

BFL2
<Low Severity>
Top of base flashing is less than 6 in. above the membrane



BFL3
<Low Severity>
Nailing strip with exposed fasteners is less than 6 in. above the roof surface

BASE FLASHING, MEMBRANE MATERIAL (BF)

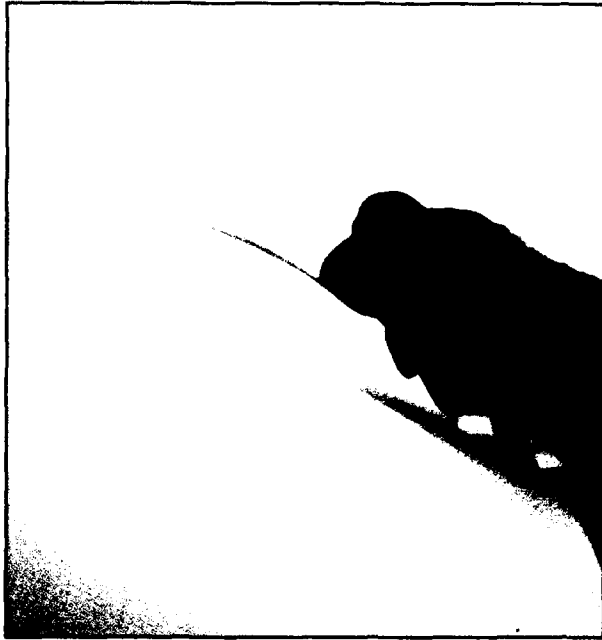

BFL4
<Low Severity>
Seam is open less than 1/2 in.

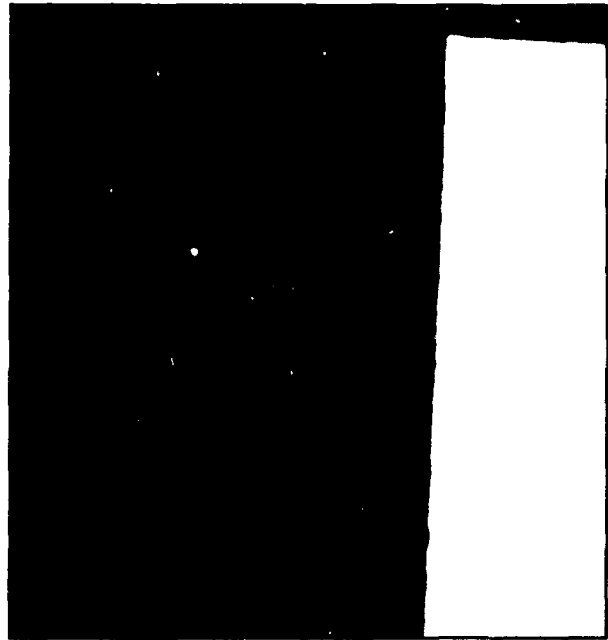

BFM1
<Low Severity>
Crazing or eroding of base flashing through to another layer



BFM2
<Medium Severity>
Wrinkling of base flashing



BFM2
<Medium Severity>
Blistering of base flashing

BASE FLASHING, MEMBRANE MATERIAL (BF)



BFM5
<Medium Severity>
Side lap is open more than 1/2 in. but is not allowing water to penetrate



BFM6
<Medium Severity>
Loose termination bar where no counterflashing is used



BFH1
<High Severity>
Eroding of base flashing that allows water to penetrate



BFH2
<High Severity>
Splits in the base flashing

BASE FLASHING, MEMBRANE MATERIAL (BF)



BFH2
<High Severity>
Tears in the base flashing



BFH3
<High Severity>
Exposed gap at the top of base flashing



BFH3
<High Severity>
Exposed gap at top of base flashing on ballasted roof

BASE FLASHING, MEMBRANE MATERIAL (BF)

BASE FLASHING, COATED METAL (BC)

Description: Base flashing material is composed of membrane-coated metal. The metal extends from the roof surface upwards above the plane of the membrane providing a watertight termination of the membrane.

Severity Levels:

Low: Any of the following defects:

1. Loss of protective coating or light corrosion.
2. Distortion of joint covers.
3. Top of flashing is less than 6 in. above the roof surface.
4. Exposed fasteners.

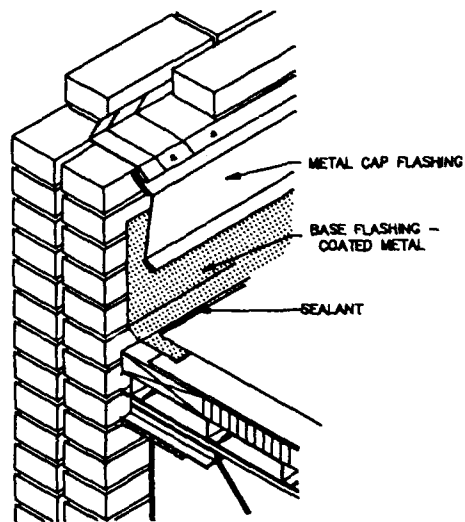

Medium: Any of the following defects:

1. Joint cover is unbonded to metal base flashing, but does not allow water to penetrate.
2. Coated metal base flashing fasteners are loose.
3. Coated metal base flashing has pulled away from the wall or curb or has lifted up but top termination is watertight.
4. Cracking or eroding of the joint cover material that has not worn through and does not allow water to penetrate.
5. Coated metal base flashing has repairs made with dissimilar materials.

High: Any of the following defects:

1. Holes in metal base flashing.
2. Hole in joint cover or unbonding of joint cover from metal base flashing, allowing water to penetrate.
3. Exposed gaps at top termination of the base flashing.
4. Coated metal base flashing has pulled away from the wall or curb or has lifted up, allowing water to penetrate (rate full section of metal, normally a 10-ft length).

Measurement: Measure length (ft) of base flashing having the above conditions. Holes, open side laps, and seams count as 1 ft each. Each joint cover having a hole is counted as 1 ft. As a method of sampling the joint covers for ballasted systems, determine the total number of existing joints by dividing the total length of coated metal base flashing by the length of the metal sections (usually 10 ft). Every fourth joint should be inspected for defects in the cover strip. Count the number of inspected joints having a specific defect and multiply by 4 to determine the total length of the defect.

BASE FLASHING, COATED METAL (BC)

Density:

$$\frac{A}{B} \times 100 = \text{Problem Density}$$

where A = length of base flashing defects (ft)
B = total length of flashing on roof section being rated (including perimeter flashings and for penthouses, courtyards, and curbed projections).

Note: A problem density is calculated for each existing severity level.



BCL1
<Low Severity>
Loss of protective coating

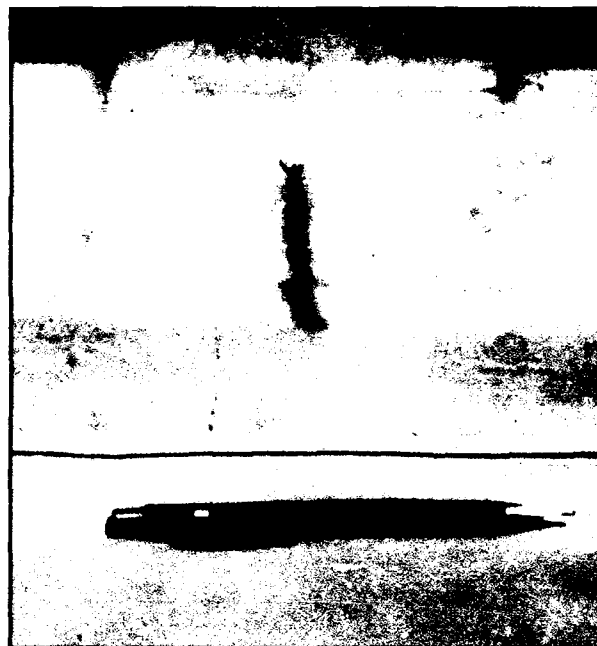

BCH2
<High Severity>
Split in joint cover allowing water to penetrate

BASE FLASHING, COATED METAL (BC)



BCH4

<High Severity>

**Base flashing has pulled away from curb,
allowing water to penetrate**

BASE FLASHING, COATED METAL (BC)

METAL CAP FLASHING (MC)

Description: Metal cap flashing includes any sheet metal that serves to counterflash or cover a detail such as a parapet, firewall, roof area divider, equipment curb, raised roof edge, or an expansion joint, protecting the top termination of the base flashing and shedding water away from it. The metal cap flashing should be free to expand and contract.

Note: Not all single plys are installed with counterflashing to protect the top of the base flashing.

Severity Levels:

Low: Any of the following defects:

1. Loss of protective coating or corrosion without holes.
2. Top of counterflashing or metal coping is deformed and allows water to pond on the top.
3. Metal cap flashing is deformed but still performing its function.
4. Metal cap flashing has been sealed to base flashing.

Medium: Any of the following defects:

1. Corrosion has caused holes in the metal on a sloping or vertical surface.
2. Metal cap flashing has loose fasteners, failure of soldered or sealed joints, or loss of attachment.
3. Metal cap flashing has rough edges that are in contact with base flashing.

High: Any of the following defects:

1. Metal cap flashing is missing or displaced from its original position.
2. Corrosion has caused holes in the metal on a horizontal surface.
3. Metal cap flashing has open joints or missing joint covers where covers were originally installed.
4. Sealant at reglet or top of counterflashing is missing or no longer functional, allowing water to channel behind it.
5. Counterflashing is loose at the top allowing water to channel behind it.
6. Metal cap flashing does not extend over top of base flashing.

Measurement: Measure length (ft) of metal cap flashing having the above conditions. Individual defects (i.e., joints, holes) count as 1 ft minimum.

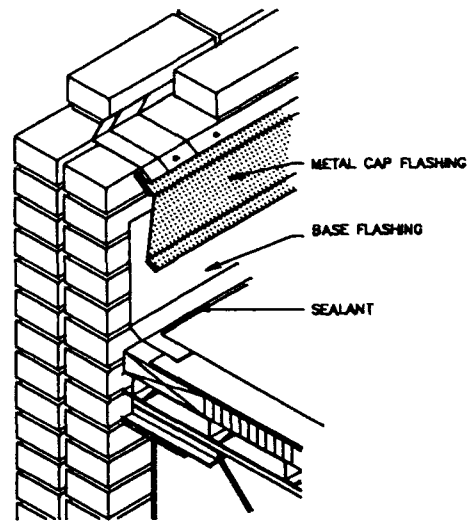

METAL CAP FLASHING (MC)

Density:

$$\frac{A}{B} \times 100 = \text{Problem Density}$$

where A = length of metal cap flashing defects (ft)
B = total length of flashing on roof section being rated (including perimeter flashings and flashings for penthouses, courtyards, and curbed projections).

Note: A problem density is calculated for each existing severity level.



MCL1
<Low Severity>
Corrosion without holes



MCL1
<Low Severity>
Loss of protective coating

METAL CAP FLASHING (MC)



MCL3
 <Low Severity>
 Metal cap flashing is deformed



MCM2
 <Medium Severity>
 Metal cap flashing has loose fasteners

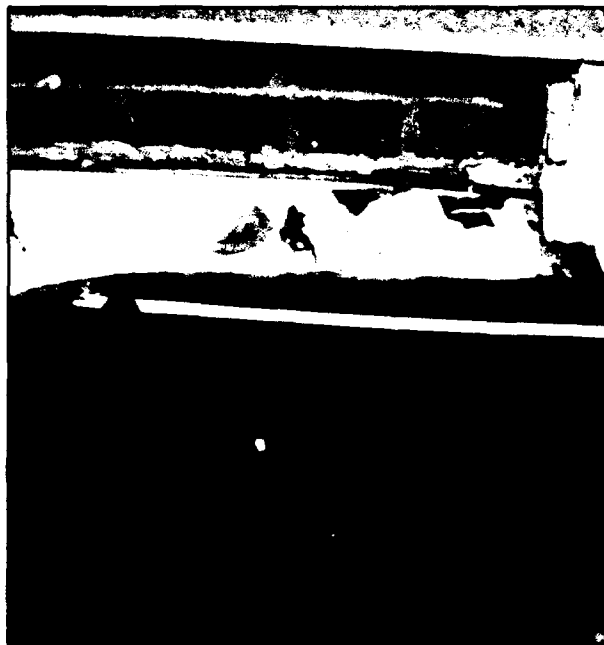

MCM3
 <Medium Severity>
 Metal cap flashing has rough edges that are in contact with the base flashing



MCH2
 <High Severity>
 Corrosion holes have occurred through the metal on a horizontal surface

METAL CAP FLASHING (MC)



MCH3
<High Severity>
Metal cap flashing has missing joint cover

METAL CAP FLASHING (MC)

EMBEDDED EDGE METAL (EM)

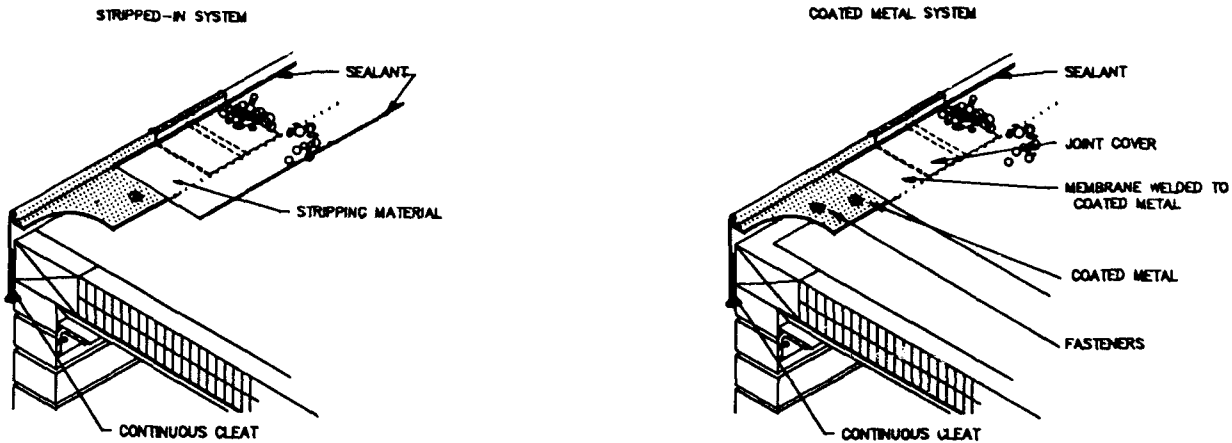

Description: Embedded edge metal is a formed strip of metal at the edge of the roof that continues down the vertical part of the wall to form a fascia or drip edge. This stripped-in flashing provides a finished termination for the roofing membrane. On all but coated-metal flashing systems, the metal is placed on top of the membrane and fastened to the deck through it. To make that area watertight, the metal is covered with membrane or flashing material (i.e., it is stripped in). Coated metal systems have their edge metal placed before the membrane. The membrane is adhered to the top of the coated metal, thereby eliminating the need to have it stripped in. A formed vertical projection (gravel stop) may be incorporated to prevent ballast from rolling or washing off the roof. Exterior and interior gutters, which are embedded in the membrane, are considered embedded edge metal. (An interior gutter is a built-in trough of metal or other material that collects water from the roof and carries it to a drain or downspout.)

Severity Levels:

Low: Any of the following defects:

1. Loss of protective coating or light corrosion.
2. Termination battens have exposed fasteners.
3. Stripping material is open less than 1/2 in.
4. Distortion of joint covers.
5. For coated metal edge flashings that are not stripped in, membrane is open less than 1/2 in.

Medium: Any of the following defects:

1. Joint cover is unbonded to embedded edge metal, but does not allow water to penetrate.
2. Nails under stripping material are backing out.
3. Stripping material is crazing, checked, or cracked.
4. Stripping material is open more than 1/2 in., but edge metal fasteners are not exposed.
5. Loose or lifted metal with deterioration of the stripping material.

EMBEDDED EDGE METAL (EM)

6. Embrittled joint stripping material.
7. The entire length of interior gutter is rated medium as a minimum due to the potential for leak damage.
8. For coated metal edge flashings that are not stripped in, membrane is open more than 1/2 in. but does not allow water to penetrate.

High: Any of the following defects:

1. The stripping material is missing or open and edge metal fasteners are exposed, or stripping material has holes, cuts or tears, allowing water to penetrate.
2. Hole in joint cover or unbonding of joint cover from embedded edge metal, allowing water to penetrate.
3. Holes through the metal.
4. Holes associated with loose or lifted embedded edge metal.
5. Holes in the interior gutter.
6. For coated metal edge flashings that are not stripped in, membrane is open allowing water to penetrate.

Measurement: Each split above a joint is counted as 1 ft. As a method of sampling the embedded edge metal joints for ballasted systems, determine the number of joints by dividing the total length of embedded edge metal flashing by the length of the edge metal sections (often 10 ft). Gravel should be moved at every fourth joint and the stripping material inspected for splits. Count the number of inspected joints having a specific defect and multiply by four to determine the total length of the defect.

Density:

$$\frac{A}{B} \times 100 = \text{Problem Density}$$

where A = length of embedded edge metal flashing defects (ft)
 B = total length of flashing on roof section being rated (including perimeter flashings and flashings for penthouses, courtyards, and curbed projections).

Note: A problem density is calculated for each existing severity level.

Causes:

1. Splits in the stripping material and loose stripping material are caused by:
 - insufficient or improper nailing of the metal, allowing it to move,
 - insufficient bonding of the stripping material to the embedded metal, or
 - embrittlement or hardening of stripping material.
2. Exposed metal flanges can result from stripping material deterioration or the flange may have never been stripped-in.
3. Loose or lifted metal edge is caused by insufficient fastening, rotting or lack of a wood perimeter nailer, membrane shrinkage, or high winds.

EMBEDDED EDGE METAL (EM)



EML4
<Low Severity>
Distortion of joint cover

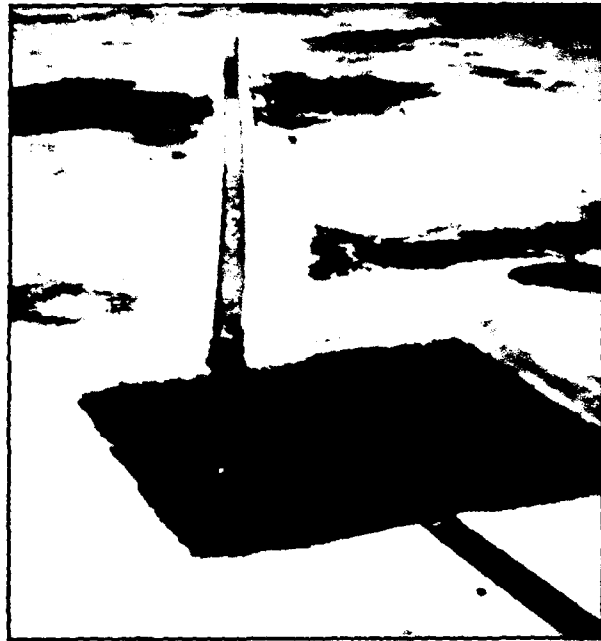

EMM7
<Medium Severity>
Interior gutter



EMH1
<High Severity>
Stripping material is open

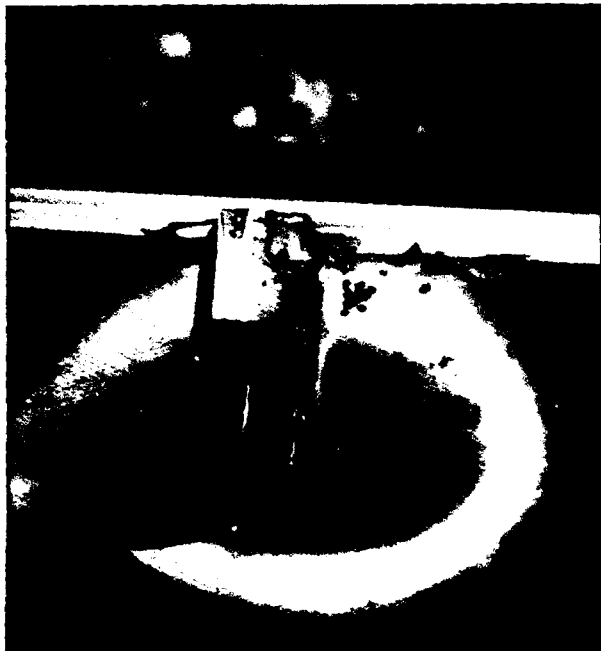

EMH1
<High Severity>
Stripping material is torn

EMBEDDED EDGE METAL (EM)



EMH2
<High Severity>
Hole in joint cover

EMBEDDED EDGE METAL (EM)

FLASHED PENETRATIONS (FP)

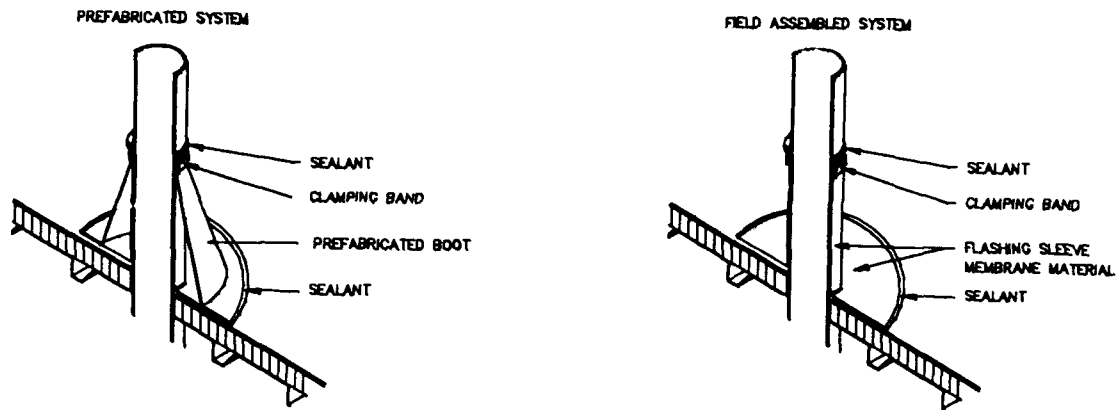

Description: This category includes pipes, plumbing vent stacks, flues, ducts, conduits, guy wires, drain sumps, and other penetrations through the roof membrane (excluding pitch pans but including metal curbing for hatches and ventilators, where the metal flange is stripped into the membrane or, in the case of some coated metal flashing systems, the membrane is adhered to the top of the coated metal flange, thereby eliminating the need to have it stripped in).

Severity Levels:

Low: Any of the following defects:

1. Flashing sleeve is deformed.
2. Stripping material, boot, or membrane (for coated metal flashing sleeves) is open less than 1/2 in.
3. Top of flashing is less than 6 in. above the membrane.

Medium: Any of the following defects:

1. Stripping material is crazing, checked, or cracked.
2. Stripping material, boot, or membrane (for coated metal flashing sleeves) is open more than 1/2 in. but does not allow water to penetrate the flashing.
3. Top of flashing sleeve or boot is not sealed or is not rolled down into the existing plumbing vent stack.
4. Clamping band is loose or missing (where required).
5. Umbrella is open or no umbrella is present (where required).
6. Corrosion of metal or delamination of coating.

High: Any of the following defects:

1. Stripping material has holes, cuts, or tears.
2. Stripping material, boot, or membrane (for coated metal flashing sleeves) is open, allowing water to penetrate.

FLASHED PENETRATIONS (FP)

3. Holes, cuts, or tears in flashing sleeve or metal curb.
4. No flashing sleeve present.
5. Incompatible flashing material has been used.

Measurement: Count each small distressed flashed penetration as 1 ft at the highest severity level present. For metal curbs and ducts with more than 1 ft of perimeter, measure the length (in ft) of the distressed perimeter.

Density:

$$\frac{A}{B} \times 100 = \text{Problem Density}$$

where A = length of distressed flashed penetrations (ft)
 B = total length of flashing on roof section being rated (including perimeter flashings and flashings for penthouses, courtyards, and curbed projections).

Note: A problem density is calculated for each existing severity level.

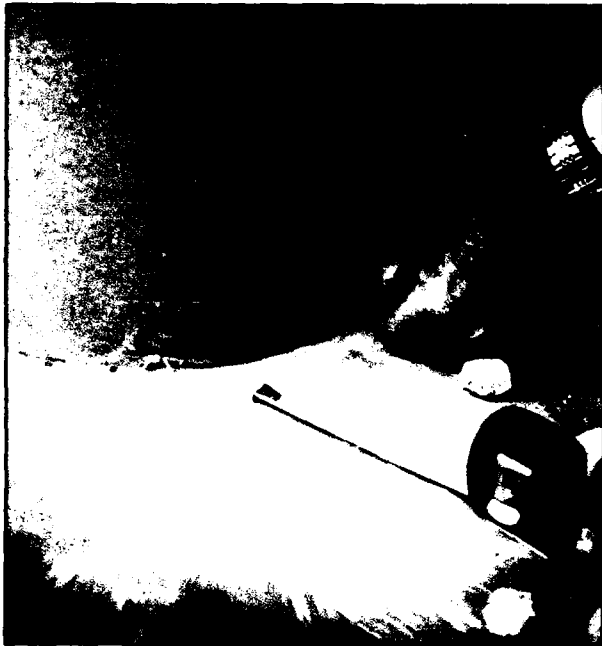

FPL2
 <Low Severity>
 Stripping material is open less than 1/2 in.



FPL3
 <Low Severity>
 Top of flashing is less than 6 in. above the ballasted roof surface

FLASHED PENETRATIONS (FP)

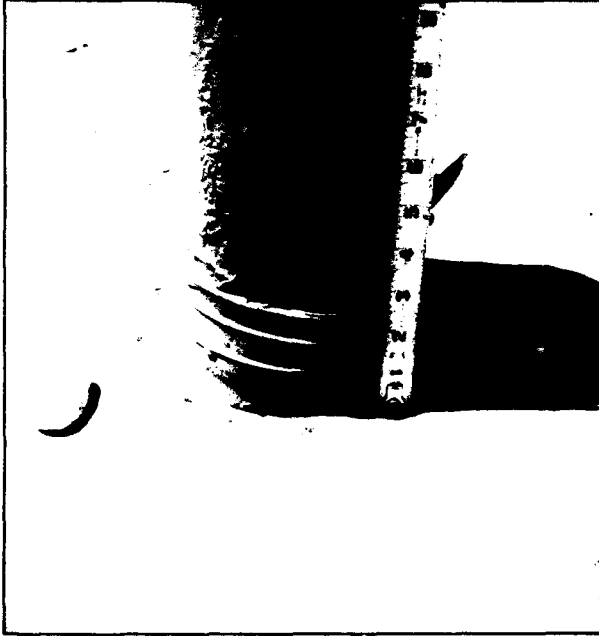

FPL3
<Low Severity>
Top of flashing is less than 6 in. above the membrane



FPH2
<High Severity>
Stripping material is open



FPH4
<High Severity>
No flashing sleeve present

FLASHED PENETRATIONS (FP)

PITCH PANS (PP)

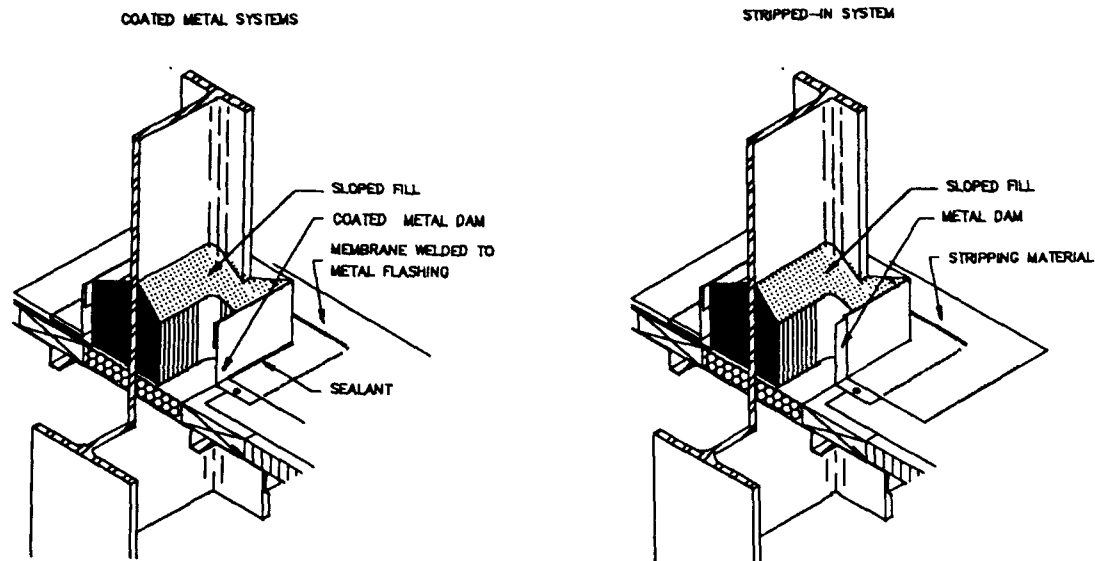

Description: A pitch pan is a flanged metal sleeve placed around a roof-penetration element and filled with a sealer. For pitch pans on ethylene-propylene-diene monomer (EPDM) and Hypalon roofing systems, stripping material should cover the sides of the metal pan and terminate within the pan below the sealer.

Severity Levels:

Low:

1. All pitch pans are low severity at a minimum due to the maintenance requirements.

Medium: Any of the following defects:

1. Stripping material is crazing, checked, or cracked.
2. Stripping material or membrane (on coated metal pitch pans) is open more than 1/2 in. but does not allow water to penetrate the flashing.
3. Loss of protective coating or corrosion of metal.
4. For EPDM and Hypalon, stripping material is not covering the top of the metal pan or does not terminate below the sealer.

High: Any of the following defects:

1. Stripping material has holes, cuts, or tears, allowing water to penetrate through.
2. Edge of stripping material or membrane (on coated metal pitch pans) is open, allowing water to penetrate.
3. Sealer is below the metal rim, allowing ponding in the pan.
4. Sealer has cracked or separated from the pan or penetration.
5. Corrosion through the metal pan.

PITCH PANS (PP)

Measurement: Each distressed pitch pan should be counted once at the highest severity level present.

Density:

$$\frac{A}{B} \times 100 = \text{Problem Density}$$

where A = number of distressed pitch pans (ea)
B = total length of flashing on roof section being rated (including perimeter flashings and flashings for penthouses, courtyards, and curbed projections).

Note: A problem density is calculated for each existing severity level.

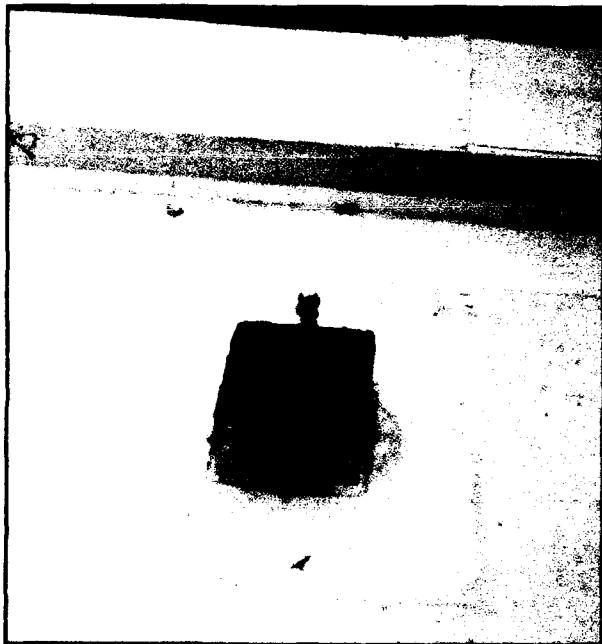

PPL1
<Low Severity>
Pitch pan installed and maintained correctly



PPM3
<Medium Severity>
Loss of protective coating

PITCH PANS (PP)

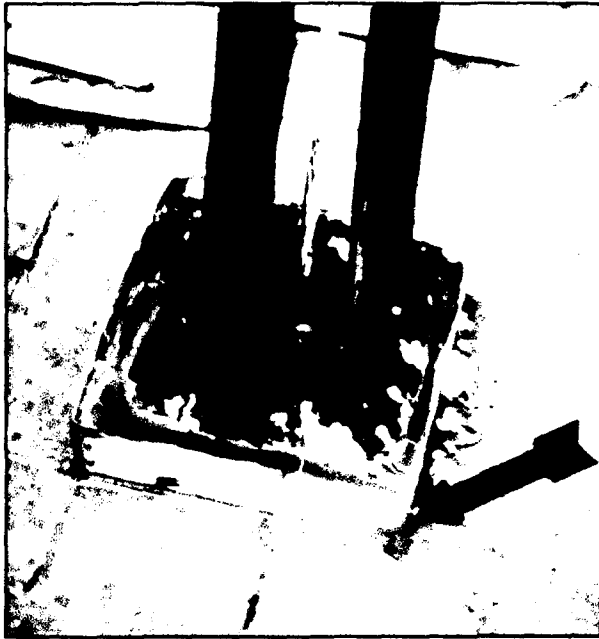

PPM4
<Medium Severity>
Stripping material is not covering metal pan on
an EPDM system



PPH3
<High Severity>
Sealer is below metal rim

PITCH PANS (PP)

INTERIOR DRAINS AND ROOF LEVEL SCUPPERS (DR)

Description: A drain is a penetration of the roof membrane that allows water to flow into a piped drainage system. The drain fixture at the roof has a flange and/or clamping arrangement to which the roofing membrane is attached. Stripping material may also be present at the drain. A scupper is a channel through a parapet or raised roof edge that is designed to drain the roof. Roof-level scuppers are for primary drainage. Elevated (overflow) scuppers are for emergency drainage.

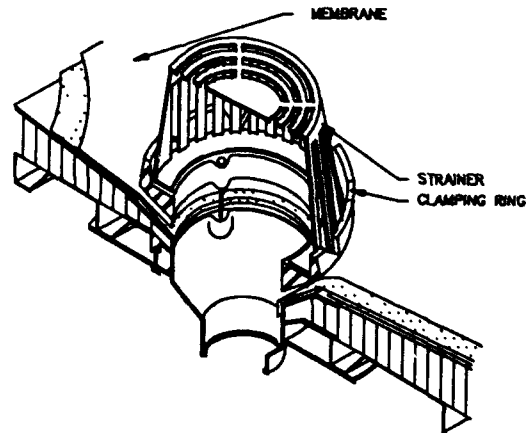

Note: Most single-ply roofing systems do not require stripping material around the drain.

Severity Levels:

Low: Any of the following defects:

1. Field seam within 1 ft of a drain or roof-level scupper.
2. Stripping material or membrane is open less than 1/2 in.

Medium: Any of the following defects:

1. Stripping material is crazing, checked, or cracked.
2. Stripping material or membrane is open 1/2 in. or more, but does not allow water to penetrate.
3. Strainer is broken or missing.
4. Scupper shows loss of protective coating or start of metal corrosion.
5. Drain has a field seam in the clamping ring.

High: Any of the following defects:

1. Stripping material has holes, cuts, or tears, allowing water to penetrate.
2. Stripping material or membrane is open, allowing water to penetrate.
3. Clamping ring is loose or missing from drain or bolts are missing.
4. Drain is clogged.
5. Scupper is broken or contains holes.
6. Holes, cuts, tears, or abrasions through the membrane within 2 ft of the drain or scupper.

Measurement: Each distressed drain and scupper should be counted once at the highest severity level present.

INTERIOR DRAINS AND ROOF LEVEL SCUPPERS (DR)

Density:

$$\frac{A}{B} \times 100 = \text{Problem Density}$$

where A = number of distressed interior drains and roof level scuppers
B = total length of flashing on roof section being rated (including perimeter flashings and flashings for penthouses, courtyards, and curbed projections).

Note: A problem density is calculated for each existing severity level.

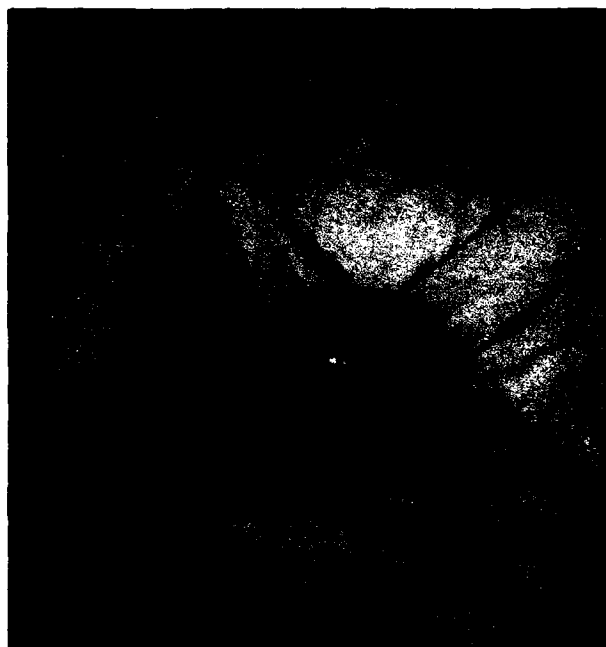

DRL1
<Low Severity>
Field seam is within 1 ft of a drain

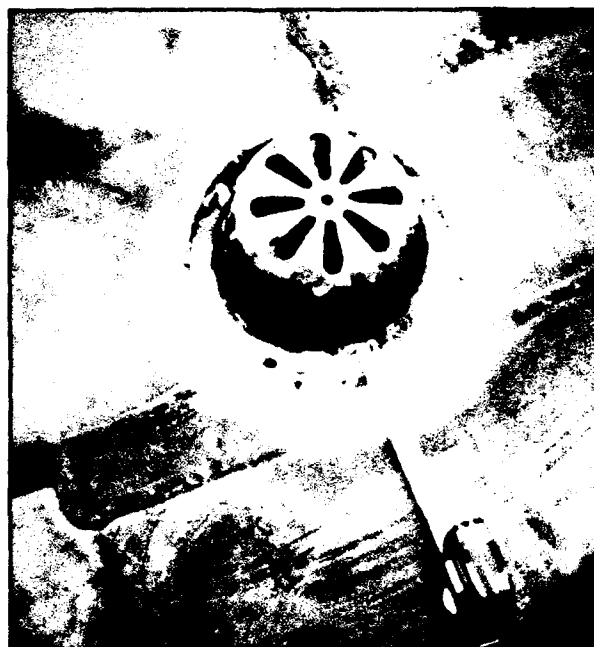

DRM5
<Medium Severity>
Drain has a field seam in the clamping ring

INTERIOR DRAINS AND ROOF LEVEL SCUPPERS (DR)

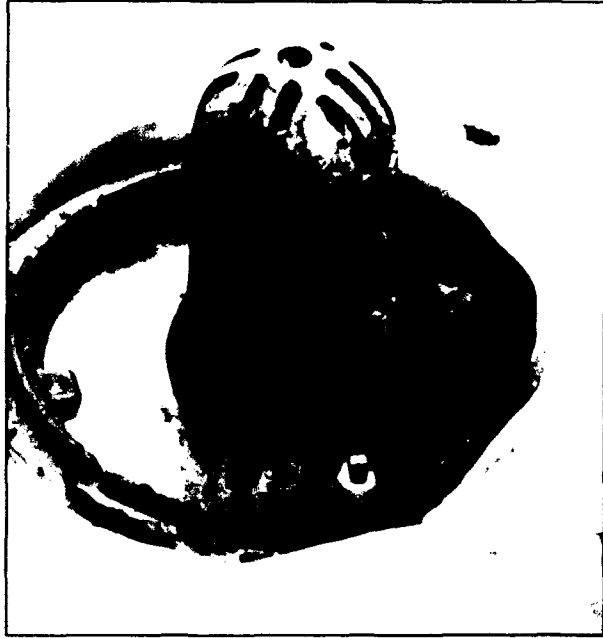

DRH2
 <High Severity>
 Membrane is not clamped, allowing water to penetrate

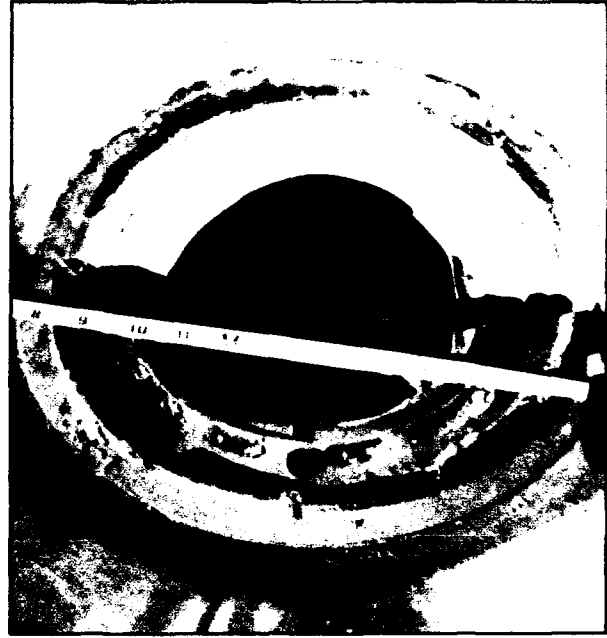

DRH3
 <High Severity>
 Clamping ring is broken



DRH3
 <High Severity>
 Bolts are missing from clamping ring



DRH4
 <High Severity>
 Drain is clogged

INTERIOR DRAINS AND ROOF LEVEL SCUPPERS (DR)



DRH6
<High Severity>
Membrane tear within 2 ft of drain

INTERIOR DRAINS AND ROOF LEVEL SCUPPERS (DR)

4 MEMBRANE DISTRESSES

Index

<u>Distress</u>	<u>Page</u>
Splits	50
Ridges	52
Holes, Cuts, and Abrasions	54
Defective Seams	57
Surface Coating Deterioration	61
Membrane Deterioration	63
System Securement Deficiencies	65
Membrane Support Deficiencies	69
Patching	71
Debris and Vegetation	73
Improper Equipment Supports	76
Ponding	78

SPLITS (SP)

Description: Splits are cracks or tears that extend through the membrane. They vary in length from a few inches to the length of the roof and in width from hair-line to more than 1 in.

Note: Cuts are rated as Holes, Cuts, and Abrasions (HL) distresses.

Severity Levels:

High:

1. All splits in the membrane are considered high severity due to their leak potential.

Measurement: Measure length of split.

Density:

$$\frac{A}{B} \times 100 = \text{Problem Density}$$

where A = total length of membrane splits (ft)
B = total area of roof section being rated (sq ft).

Causes:

1. Membrane shrinkage or embrittlement.
2. Movement of the substrate.
3. Warping of insulation boards.
4. Thermal contraction of the membrane.

SPLITS (SP)



SPH1
<High Severity>
Membrane split



SPH1
<High Severity>
Membrane split on ballasted roof

SPLITS (SP)

RIDGES (RG)

Description: Ridges are long, narrow (usually less than 3 in.), raised portions of the roof membrane. Usually ridges occur directly above the insulation board joints.

Note: Wrinkles in the membrane are not rated as ridges. Wrinkles that block drainage and cause ponding are rated as Ponding (PD). Wrinkles occurring on fully-adhered systems are rated as System Securement Deficiencies (SS).

Severity Levels:

Low:

1. All ridges are rated low severity as a minimum.

High:

1. Open breaks have developed in the ridge allowing water to penetrate.

Measurement: Measure length of ridges running in all directions. When many ridges are present, the representative sampling technique may be used.

Density:

$$\frac{A}{B} \times 100 = \text{Problem Density}$$

where A = total length of membrane ridges (ft)
B = total area of roof section being rated (sq ft).

Note: A problem density is calculated for each existing severity level.

Causes: Ridging can result from internally generated moisture collecting at insulation joints and affecting the membrane or from movement of the substrate.

RIDGES (RG)



RGL1
<Low Severity>
Watertight ridges having no open breaks



RGH1
<High Severity>
Open breaks have developed in the ridge

RIDGES (RG)

HOLES, CUTS, AND ABRASIONS (HL)

Description: Holes and cuts are membrane distresses caused by physical abuse from tools, traffic, debris, gravel, wind, etc., or manufacturing defects such as pinholes. Holes and cuts can be of various shapes and sizes. Abrasion is physical damage that has roughened or worn the membrane surface.

Severity Levels:

Low:

1. Surface scratches or abrasions with no significant loss of membrane thickness.

Medium:

1. Cuts, gouges, or abrasions with loss of membrane thickness but not fully penetrating the membrane.

High: Any of the following defects:

1. Holes, cuts, gouges, or abrasions that penetrate the membrane.
2. Holes through the membrane caused by underlying mechanical fasteners.

Measurement:

1. Count the total number of scratches, gouges, holes, and cuts in the membrane. If the distance between distresses is less than 1 ft, count the distresses as one. If the distress is longer than 1 ft, measure the length. Measure area of abrasion in square feet.
2. When large quantities of this problem are present, the representative sampling technique may be used.

Density:

$$\frac{A}{B} \times 100 = \text{Problem Density}$$

where A = total number and/or length of membrane scratches, gouges, holes and cuts (ft) or total area of abrasion (sq ft)
B = total area of roof section being rated (sq ft).

Note: A problem density is calculated for each existing severity level.

Causes:

1. Roof traffic.
2. Debris.
3. Broken or sharp ballast, especially at wrinkled areas.
4. Manufacturing defects such as pinholes.
5. Mechanical fasteners.
6. Wind-borne objects.

HOLES, CUTS, AND ABRASIONS (HL)

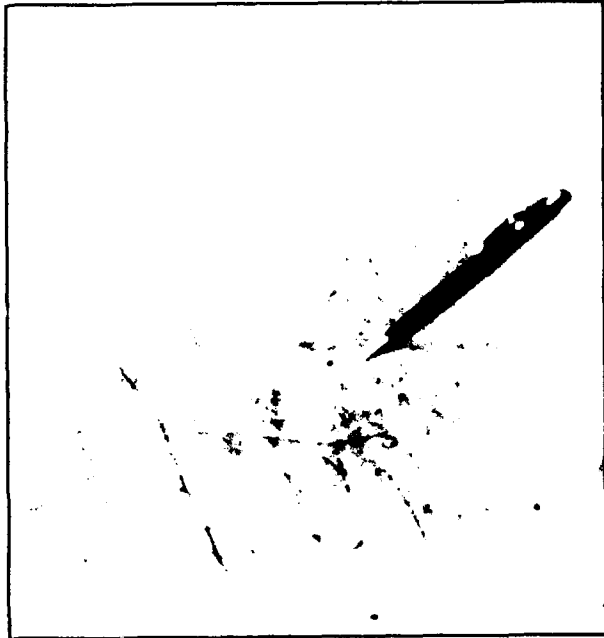

HLL1
<Low Severity>
Surface scratches and abrasions

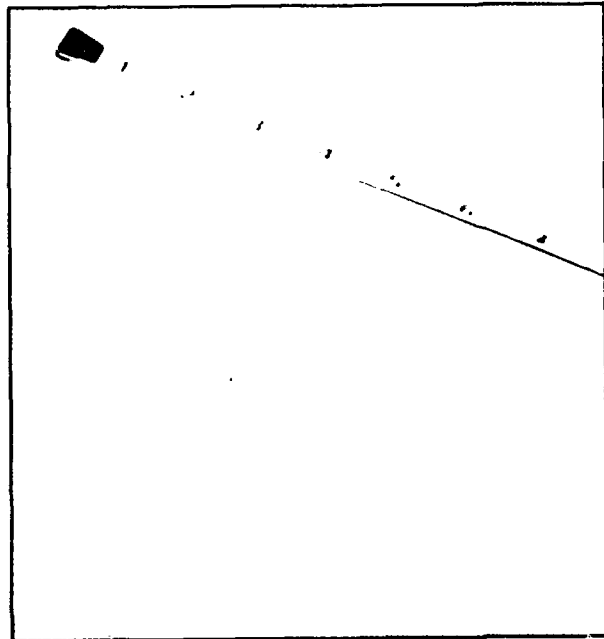

HLM1
<Medium Severity>
Gouges not penetrating the membrane

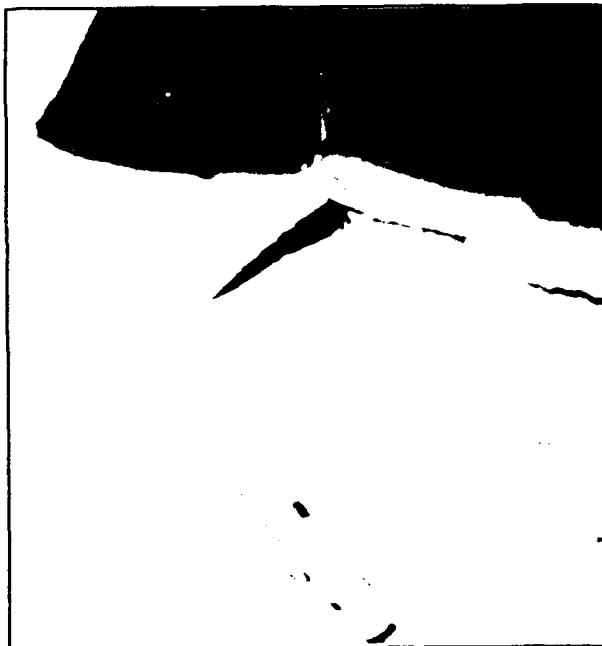

HLH1
<High Severity>
Cut penetrating the membrane

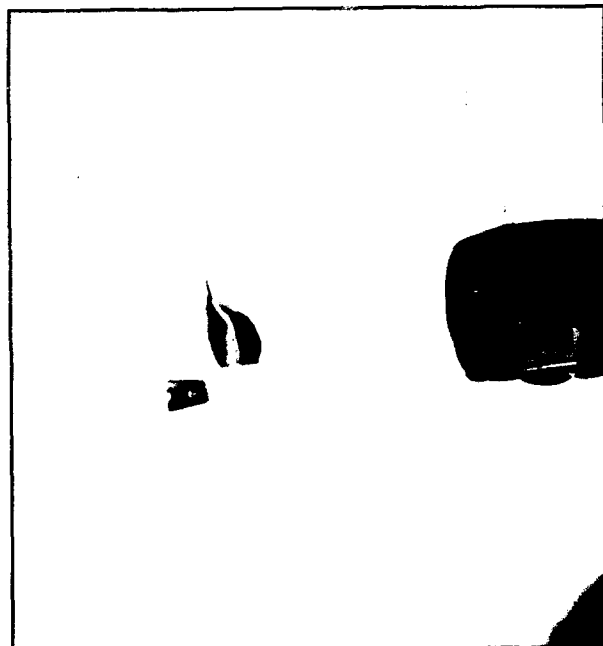

HLH1
<High Severity>
Membrane hole

HOLES, CUTS, AND ABRASIONS (HL)

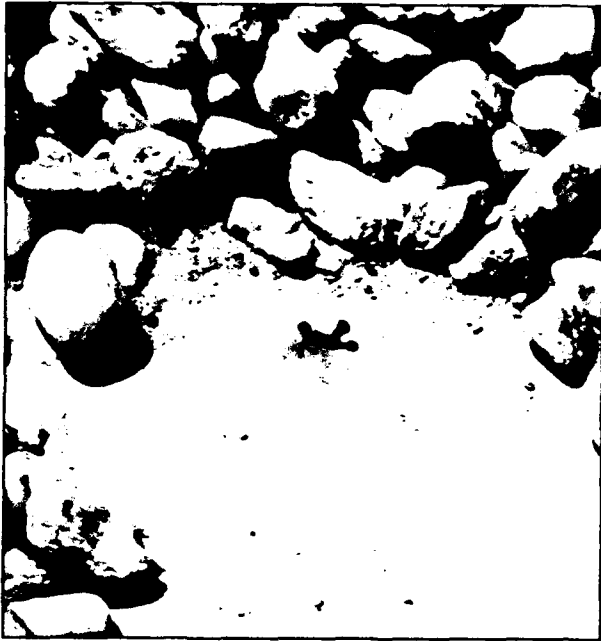

HLH2
<High Severity>
Nail protruding through membrane



HLH2
<High Severity>
Screw backing out through membrane

HOLES, CUTS, AND ABRASIONS (HL)

DEFECTIVE SEAMS (DS)

Description: Defective seams include incomplete, damaged, or weak seams that join two sheets of a membrane.

Note: For EPDM and polyvinyl chloride (PVC) membranes, all field seams should have lap sealant at the edges. All other membranes should have lap sealant at cut edges of seams that have exposed reinforcement material.

Severity Levels:

Low: Any of the following defects:

1. Missing lap sealant at field seam (EPDM and PVC membranes only).
2. Missing lap sealant at field seam which has exposed reinforcement material at seam edge (usually at end laps and field-cut edges of sheets).
3. Seam is open less than 1/2 in.
4. Wrinkling at seam that is watertight.
5. Seam intersections (e.g., T-joints) on EPDM that do not have a patch covering them.
6. Blisters within the seam.

Medium: Any of the following defects:

1. Seam is open 1/2 in. or more, but does not allow water to penetrate the membrane.
2. Pinch wrinkle at seam.

High: Any of the following defects:

1. Seam is open through its entire depth, allowing water to penetrate.
2. Fishmouths, wrinkles, or bunches at the seam that allow water to penetrate.

Measurement: For exposed membranes (no overlying ballast), inspect all seams visually.

For ballasted roofs, check field seams at five different locations on the roof section. Clear ballast from 5 ft of the seam at each location then clean the exposed seam with a whisk broom. If all checked seams are without defects, assume the remaining field seams are satisfactory. If any defects are found, use the following sampling technique:

1. For roof sections with sheet widths of 10 ft or less, inspect 2 percent of the total length of field seams (2 ft every 100 ft of seam). For roof sections having sheet widths greater than 10 ft, inspect 4 percent of the total length of field seams (2 ft every 50 ft of seam). Measure length of each specific seam defect found.
2. Extrapolate to determine the total length of seam defects for the entire roof section from the total length of defect found. When 2 percent of the seams are inspected, multiply the actual defect length by 50 to compute total length of defect. When 4 percent of the seams are inspected, multiply actual defect length by 25 to compute total length of defect.

DEFECTIVE SEAMS (DS)

Density:

$$\frac{A}{B} \times 100 = \text{Problem Density}$$

where A = total length of defective seams (ft)
B = total area of roof section being rated (sq ft).

Note: A problem density is calculated for each existing severity level.

Causes:

1. Seams improperly made.
2. Seams damaged in use.
3. Wrinkles in the membrane at the seam.



DSL1
<Low Severity>
Missing lap sealant



DSL2
<Low Severity>
Missing lap sealant with exposed reinforcement material

DEFECTIVE SEAMS (DS)



DSL3
<Low Severity>
Seam is open less than 1/2 in.



DSL4
<Low Severity>
Wrinkling at seam



DSL5
<Low Severity>
EPDM seam intersection does not have a patch



DSL6
<Low Severity>
Blisters within seam

DEFECTIVE SEAMS (DS)



DSM1
<Medium Severity>
Seam is open more than 1/2 in.



DSM2
<Medium Severity>
Pinch wrinkle at the seam



DSH1
<High Severity>
Seam is open through its entire depth

DEFECTIVE SEAMS (DS)

SURFACE COATING DETERIORATION (SC)

Description: Surface coating deterioration includes wear, blistering, or peeling of any surface coating applied for fire protection (such as adhesive coating and sand on an EPDM membrane) or solar reflectivity, but not waterproofing.

Severity Levels:

Low:

1. Color of underlying membrane can be seen through the coating or membrane has lost coating protection (for membrane with coating protection that does not have sand or mineral matter embedded).

Medium:

1. Membrane area has lost the sand or mineral matter portion of the coating protection (for membrane with coating protection that has sand or mineral matter embedded).

Measurement:

1. Measure the square feet of each affected area and rate at the highest severity level present.
2. When large quantities of this problem are present, the representative sampling technique may be used.

Density:

$$\frac{A}{B} \times 100 = \text{Problem Density}$$

where A = total area of surface coating deterioration (sq ft).
B = total area of roof section being rated (sq ft).

Note: A problem density is calculated for each existing severity level.

Causes:

1. Weathering.
2. Roof traffic.
3. Poor adherence of coating to membrane due to material or application problems.

SURFACE COATING DETERIORATION (SC)

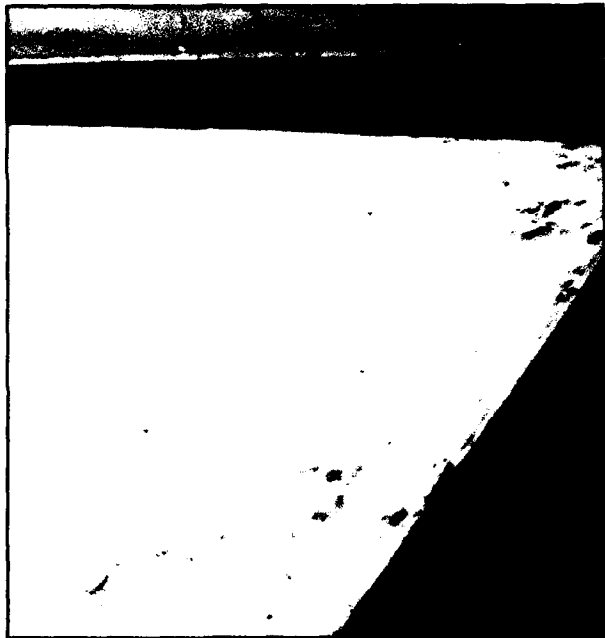

SCL1
<Low Severity>
Loss of protective coating

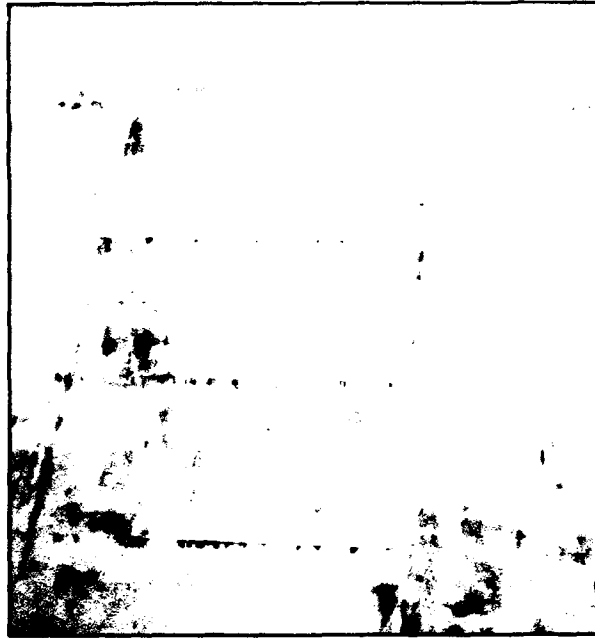

SCM1
<Medium Severity>
Loss of protective sand coating

SURFACE COATING DETERIORATION (SC)

MEMBRANE DETERIORATION (MD)

Description: This category includes erosion or crazing of the membrane. Erosion is the wearing away of the membrane surface creating a rough texture. Crazing is hairline cracking of the membrane.

Severity Levels:

Low:

1. Light crazing of the membrane surface.

Medium:

1. Crazing or eroding of the membrane surface that has worn through to a reinforcement or scrim sheet or down to another layer of different color, or has resulted in obvious loss of sheet thickness.

High:

1. Crazing or eroding of the membrane surface that has worn through the membrane allowing water to penetrate.

Measurement:

1. Measure the square feet of each affected area and rate at the highest severity level present.
2. When large quantities of this problem are present, the representative sampling technique may be used.

Density:

$$\frac{A}{B} \times 100 = \text{Problem Density}$$

where A = total area of the membrane deterioration (sq ft)
B = total area of roof section being rated (sq ft).

Note: A problem density is calculated for each existing severity level.

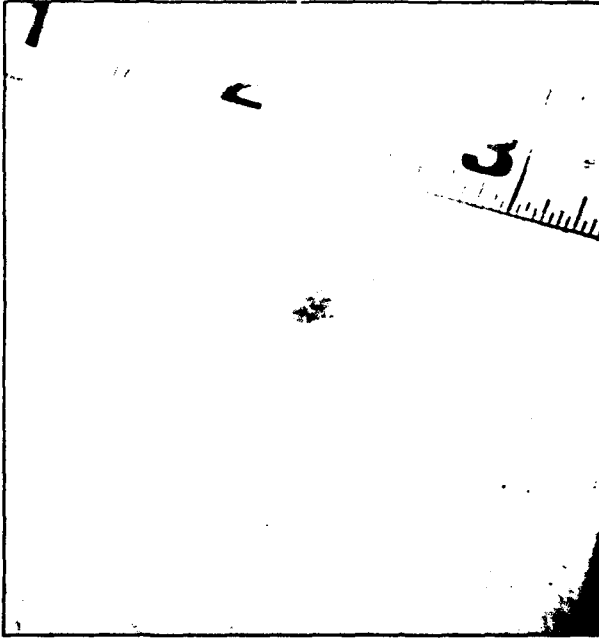

MDL1
<Low Severity>
Light crazing of membrane surface

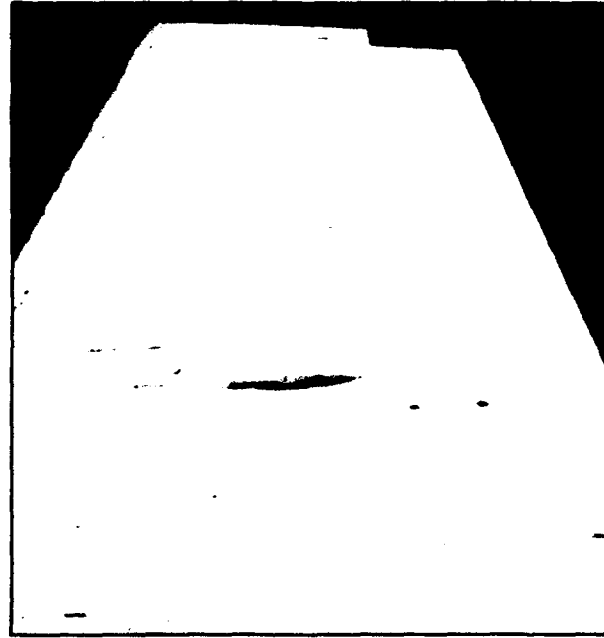

MDL1
<Low Severity>
Light crazing of membrane shown by color change

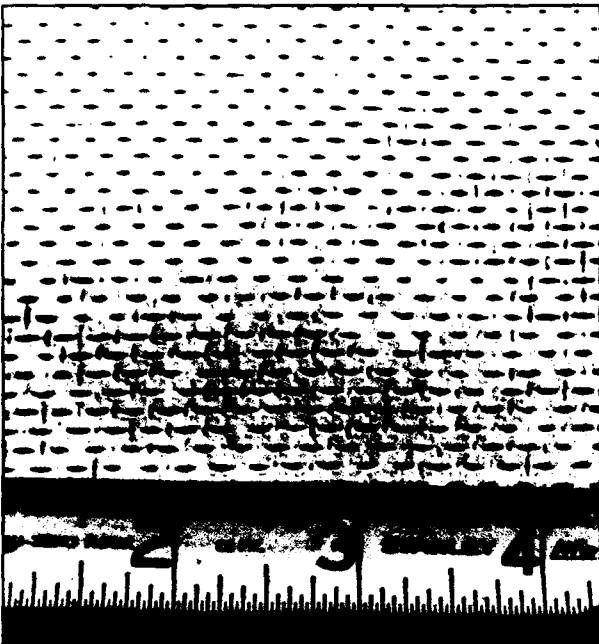

MDM1
<Medium Severity>
Eroding of membrane with exposed scrim



MDH1
<High Severity>
Scrim completely exposed

MEMBRANE DETERIORATION (MD)

SYSTEM SECUREMENT DEFICIENCIES (SS)

Description: For fully adhered membranes, system securement deficiencies include membrane areas (including blisters) that are unattached to the substrate. For mechanically attached membranes, this category includes failed mechanical fasteners. For partially adhered membranes, the category includes membrane that is not adhered at points of attachment. For ballasted membranes, the membrane has areas where ballast is missing or displaced.

Note: Holes in the membrane caused by mechanical fasteners are rated as Holes (HL).

Note: If ballast is redistributed by the inspector to cover bare areas, these areas should not be counted as defects.

Note: For defect definitions, "building perimeter" is the area within 10 ft of a roof edge. These areas experience high wind uplift pressures.

Severity Levels:

Low: Any of the following defects:

1. For fully adhered systems, an area of unattached membrane or substrate of 2 sq ft or less.
2. For ballasted systems, a bare area of 4 sq ft or less.

Medium: Any of the following defects:

1. For fully adhered systems, an area of unattached membrane or substrate of greater than 2 sq ft but less than 100 sq ft (less than 25 sq ft at building perimeter).
2. For mechanically attached systems, an isolated mechanical fastener that has lost its attachment capability or backed out causing bridging of the membrane.
3. For partially adhered systems, an isolated point of attachment that has lost adherence.
4. For ballasted systems, a bare area of greater than 4 but less than 100 sq ft (less than 25 sq ft at building perimeter).

High: Any of the following defects:

1. For fully adhered systems, an area of unattached membrane or substrate 100 sq ft or greater (25 sq ft at building perimeter).
2. For mechanically attached systems, adjacent mechanical fasteners that have lost their attachment capability or backed out causing bridging of the membrane.
3. For partially adhered systems, adjacent points of attachment that have lost adherence.
4. For ballasted systems, a bare area of 100 sq ft or greater (25 sq ft at building perimeter).

Measurement:

1. Measure square feet of membrane having the above conditions. For mechanically fastened and partially adhered systems, count the effective area of unattached membrane.
2. When large quantities of this problem are present, the representative sampling technique may be used.

SYSTEM SECUREMENT DEFICIENCIES (SS)

Density:

$$\frac{A}{B} \times 100 = \text{Problem Density}$$

where A = total area of attachment defects (sq ft)
B = total area of roof section being rated (sq ft).

Note: A problem density is calculated for each existing severity level.

Causes:

1. Overdriven, underdriven, or crooked placement of fasteners.
2. Membrane was adhered before the solvent had flashed off from the contact adhesive.
3. Wind damage.
4. Traffic damage.
5. Moisture within the system.

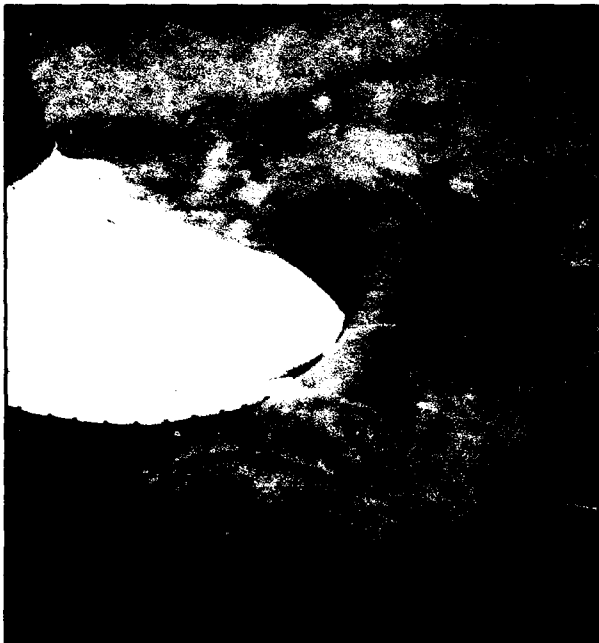

SSL1
<Low Severity>
Unattached membrane of less than 2 sq ft

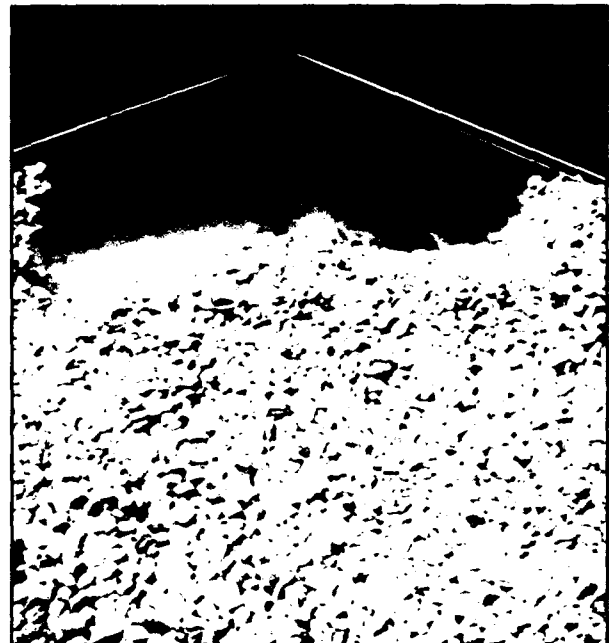

SSL2
<Low Severity>
Ballasted system, bare area of less than 4 sq ft

SYSTEM SECUREMENT DEFICIENCIES (SS)



SSM1
<Medium Severity>
Unattached membrane of more than 2 sq ft but less than 100 sq ft



SSM2
<Medium Severity>
Unattached mechanical fastener



SSM4
<Medium Severity>
Ballasted system, bare area of less than 25 sq ft at building perimeter

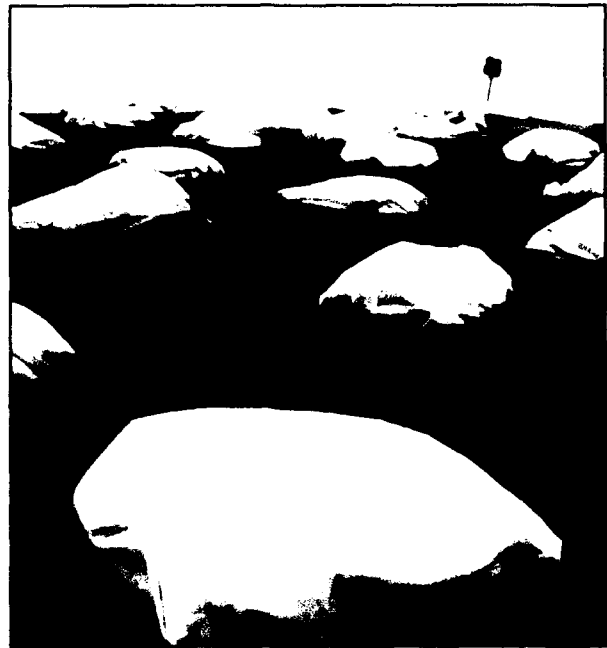

SSH1
<High Severity>
Unattached membrane greater than 100 sq ft

SYSTEM SECUREMENT DEFICIENCIES (SS)



SSH2
<High Severity>
Adjacent mechanical fasteners have lost their attachment capability



SSH4
<High Severity>
Ballasted system, bare area more than 100 sq ft

SYSTEM SECUREMENT DEFICIENCIES (SS)

MEMBRANE SUPPORT DEFICIENCIES (MS)

Description: The surface on which the membrane rests may not be smooth and continuous. For fully adhered membranes, partially adhered membranes, and mechanically attached membranes, this category includes warping, bowing, or shrinkage of insulation boards. For ballasted membranes, it includes displaced insulation boards. Localized absence of membrane support may be due to missing components below.

Note: Mechanical fastener defects and loose insulation boards are rated as System Securement Deficiencies (SS).

Severity Levels:

Low: Any of the following defects:

1. Membrane tension caused by warping or bowing of substrate.
2. Uneven joints or gaps more than 1/2 in. wide, but less than 2 in. between insulation boards.

Medium: Any of the following defects:

1. Uneven joints or gaps more than 2 in. wide between insulation boards or absence of substrate support for width of 2 in. or more.
2. For ballasted systems, insulation boards have been displaced.
3. Lumps indicating presence of foreign material between membrane and substrate.

Measurement:

1. Measure square feet of membrane area having the above conditions.
2. When many of these deficiencies are present, the representative sampling technique may be used.

Density:

$$\frac{A}{B} \times 100 = \text{Problem Density}$$

where A = total area of membrane support distress (sq ft)
B = total area of roof section being rated (sq ft).

Note: A problem density is calculated for each existing severity level.

Causes:

1. Poor attachment of substrate.
2. Dimensional instability of insulation, decking, or other support materials.
3. Wind displacement of insulation boards.
4. Construction debris.

MEMBRANE SUPPORT DEFICIENCIES (MS)



MSL1
<Low Severity>
Membrane tension caused by warping or bowing of the substrate

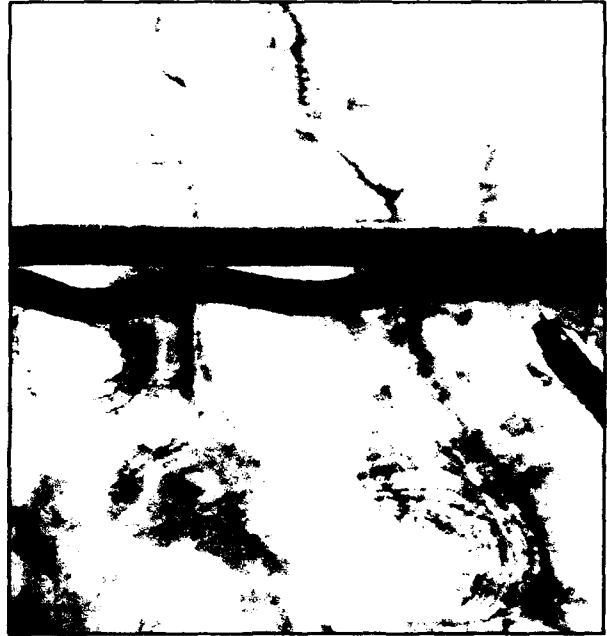

MSM1
<Medium Severity>
Uneven support more than 2 in. wide



MSM2
<Medium Severity>
Insulation boards have been displaced



MSM3
<Medium Severity>
Lumps indicating foreign material

MEMBRANE SUPPORT DEFICIENCIES (MS)

PATCHING (PA)

Description: Patching is a localized temporary or permanent repair of the membrane using dissimilar materials. Repairs made with similar materials are not counted as patches; distresses associated with these repairs should be recorded in the appropriate category (often defective seams) and not as patching distresses.

Severity Levels:

Low:

1. All patches that are not made with similar materials as that of the original construction are rated as low severity as a minimum.

Medium:

1. All patches made with temporary materials (i.e., duct tape, caulking, and sealants) are rated medium severity as a minimum.

High:

1. Other distresses of high severity are present within the patched area (count as patching distress only).

Measurement:

1. Measure square feet of each patch having the above conditions.
2. When large quantities of this problem are present, the representative sampling technique may be used.

Density:

$$\frac{A}{B} \times 100 = \text{Problem Density}$$

where A = total area of patching (sq ft)
B = total area of roof section being rated (sq ft).

Note: A problem density is calculated for each existing severity level.

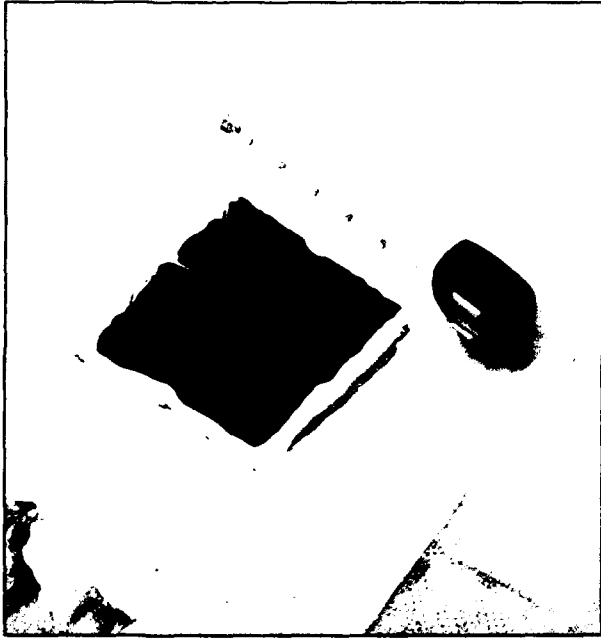

PAL1
<Low Severity>
Patch made with dissimilar material

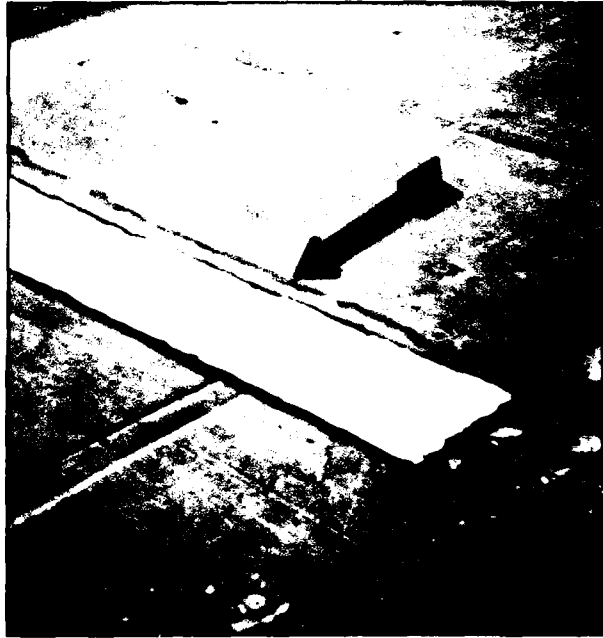

PAH1
<High Severity>
Other distresses (i.e., fishmouths) along edge of patch

PATCHING (PA)

DEBRIS AND VEGETATION (DV)

Description: Debris and vegetation includes the presence of foreign objects, vegetation, fungal growth, solvents, oils, or other chemicals that could damage, puncture, or degrade the membrane.

Note: Accumulation of oils and grease can present a significant fire hazard and should be reported immediately.

Note: Do not rip out vegetation that is growing into the waterproofing system, as that may allow water to penetrate.

Severity Levels:

Medium: Any of the following defects:

1. Vegetation that has not penetrated the membrane.
2. Degradation of the membrane caused by solvents, oil, or other chemicals.
3. Foreign materials that are not removed from the roof during the inspection.

High: Any of the following defects:

1. Vegetation that has penetrated the membrane.
2. Degradation of the membrane caused by solvents, oil, or other chemicals allowing water to penetrate.

Measurement: Measure square feet of debris and vegetation having the above conditions.

Density:

$$\frac{A}{B} \times 100 = \text{Problem Density}$$

where A = total area of debris and vegetation (sq ft)
 B = total area of roof section being rated (sq ft).

Note: A problem density is calculated for each existing severity level.

Causes: Lack of preventative maintenance.

DEBRIS AND VEGETATION (DV)



DVM1
<Medium Severity>
Vegetation that has not penetrated the membrane



DVM2
<Medium Severity>
Degradation of membrane caused by solvents or oil



DVM3
<Medium Severity>
Foreign materials that were not removed during inspection



DVH1
<High Severity>
Vegetation that has penetrated the membrane

DEBRIS AND VEGETATION (DV)



DVH2

<High Severity>

Degradation of membrane by oils has caused a hole, allowing water to penetrate

DEBRIS AND VEGETATION (DV)

IMPROPER EQUIPMENT SUPPORTS (EQ)

Description: Improper equipment supports or pipes, conduits, and mechanical equipment supports (wood sleepers, channels, etc.) that are placed directly on the membrane with no protective pad or are not placed high enough to allow for maintenance of the membrane below the equipment. Repairing this distress may require replacing the surrounding insulation and membrane.

Note: Terminations for guy wires are rated as Flashed Penetration (FP) distresses.

Severity Levels:

Low:

1. All improper equipment supports are rated low severity as a minimum due to the maintenance problems associated with them.

Medium:

 Any of the following defects:

1. Movement of the support has displaced the membrane but has not cut or punctured it.
2. Equipment is bolted through the membrane but the membrane is sealed and watertight.

High:

 Any of the following defects:

1. Movement of support has cut or punctured the roof membrane.
2. The equipment is bolted through the membrane and the membrane is not sealed, allowing water to penetrate.

Measurement: Measure square feet of each improper equipment support. The minimum dimensions for length and width of a support shall be 1 ft.

Density:

$$\frac{A}{B} \times 100 = \text{Problem Density}$$

where A = total area of improper equipment supports (sq ft)
B = total area of roof section being rated (sq ft).

Note: A problem density is calculated for each existing severity level.

Causes:

1. Inadequate design.
2. Poor construction.

IMPROPER EQUIPMENT SUPPORTS (EQ)



EQL1
<Low Severity>
Equipment stand supported by wood blocking



EQL1
<Low Severity>
Pipe supported by wood blocks

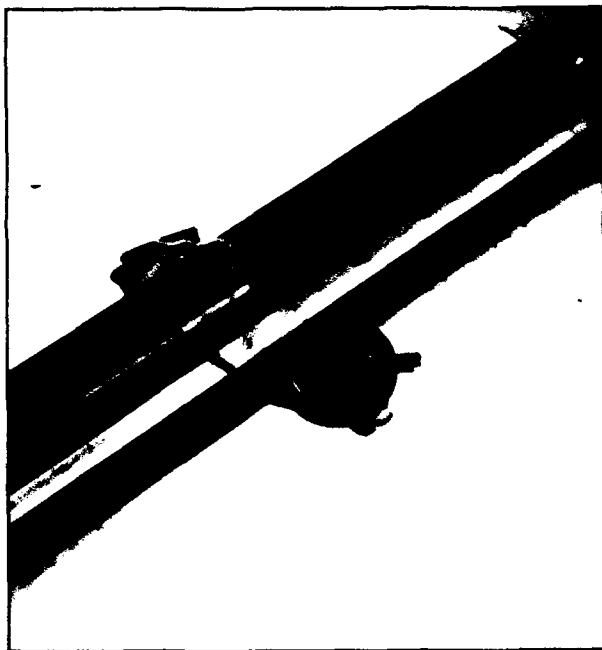

EQL1
<Low Severity>
Improper equipment supports



EQH1
<High Severity>
Movement of support has cut the membrane

IMPROPER EQUIPMENT SUPPORTS (EQ)

PONDING (PD)

Description: Ponding includes standing water or evidence of standing water by the presence of staining or accumulation of debris. Water that remains longer than 48 hr is considered ponded water.

Severity Levels:

Low:

1. General ponding is rated low severity.

Medium: Any of the following defects:

1. Ponding caused by wrinkles or folds in the membrane that block drainage.
2. Ponding caused by warping or bowing of the substrate beneath the membrane.

Measurement: Measure square feet of affected area.

Density:

$$\frac{A}{B} \times 100 = \text{Problem Density}$$

where A = total area of ponding (sq ft)
B = total area of roof section being rated (sq ft).

Note: A problem density is calculated for each existing severity level.

Causes:

1. Improper design or construction.
2. Irregularities of membrane surface.
3. Clogged roof drains or scuppers.
4. Deck deflection.

PONDING (PD)



PDL1
<Low Severity>
General ponding

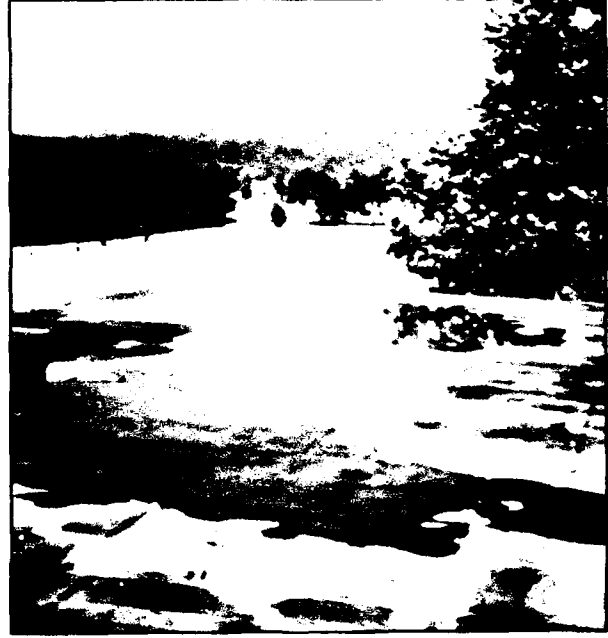

PDL1
<Low Severity>
General ponding in field of roof



PDM1
<Medium Severity>
Ponding caused by wrinkles or folds in the
membrane

PONDING (PD)

METRIC CONVERSION TABLE

1 ft = 0.305 m
1 sq ft = 0.0929 m²
1 in. = 25.4 mm

REFERENCES

- Bailey, D. M., D. Brotherson, and W. Tobiasson, *ROOFER: A Management Tool for Maintaining Built-up Roofs*, USACERL Technical Manuscript M-90/02/ADA214032 (USACERL, October 1989).
- Bailey, D. M., D. Brotherson, W. Tobiasson, and A. Knehans, *ROOFER: An Engineered Management System (EMS) For Bituminous Built-Up Roofs*, USACERL Technical Report M-90/04/ADA218529 (U.S. Army Construction Engineering Research Laboratory [USACERL], December 1989).
- Bailey, D. M., B. Young, S. Hansen, and J. Elston, *Micro ROOFER User's Guide*, USACERL ADP Report M-90/12 (USACERL, April 1990).
- Shahin, M. Y., D. Bailey, and D. Brotherson, *Membrane and Flashing Condition Indexes for Built-Up Roofs Volume I: Development of the Procedure*, Technical Report M-87/13/ADA190367 (USACERL, September 1987a).
- Shahin, M. Y., D. Bailey, and D. Brotherson, *Membrane and Flashing Condition Indexes for Built-Up Roofs Volume II: Inspection and Distress Manual*, Technical Report M-87/13/ADA190368 (USACERL, September 1987b).

APPENDIX A: Deduct Value Curves

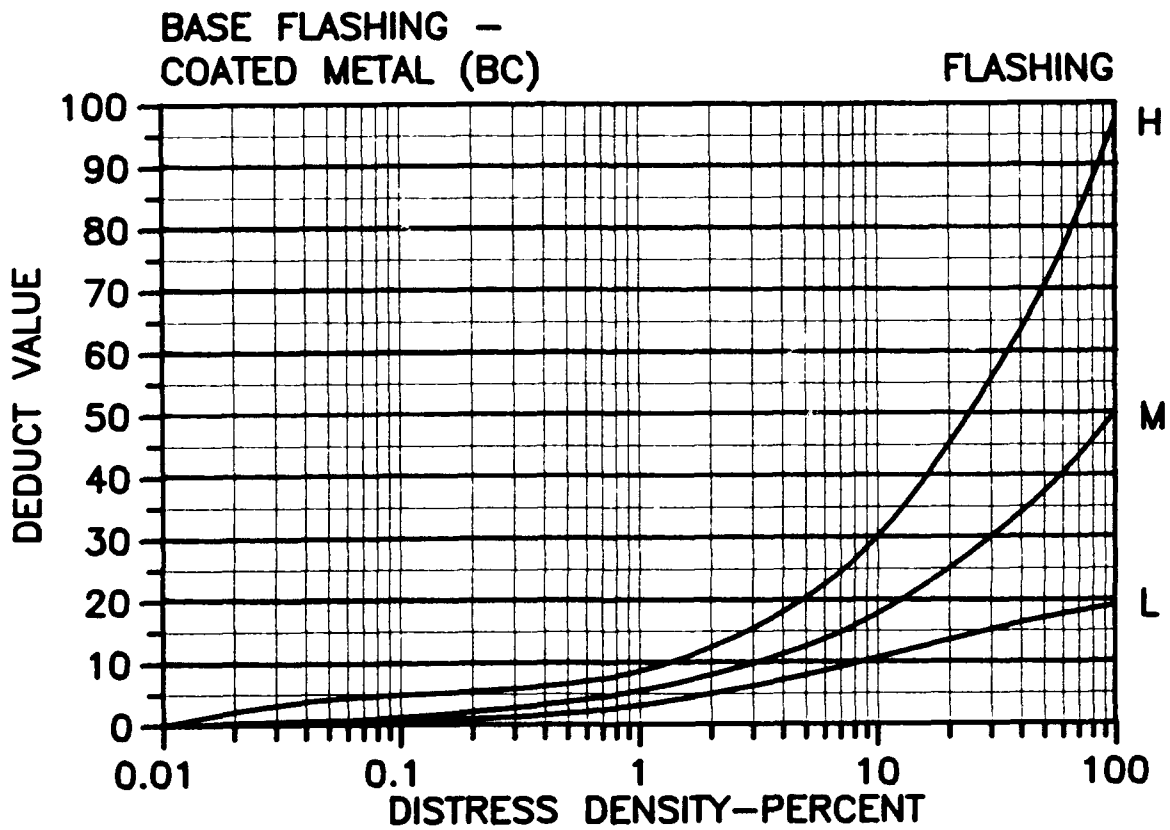
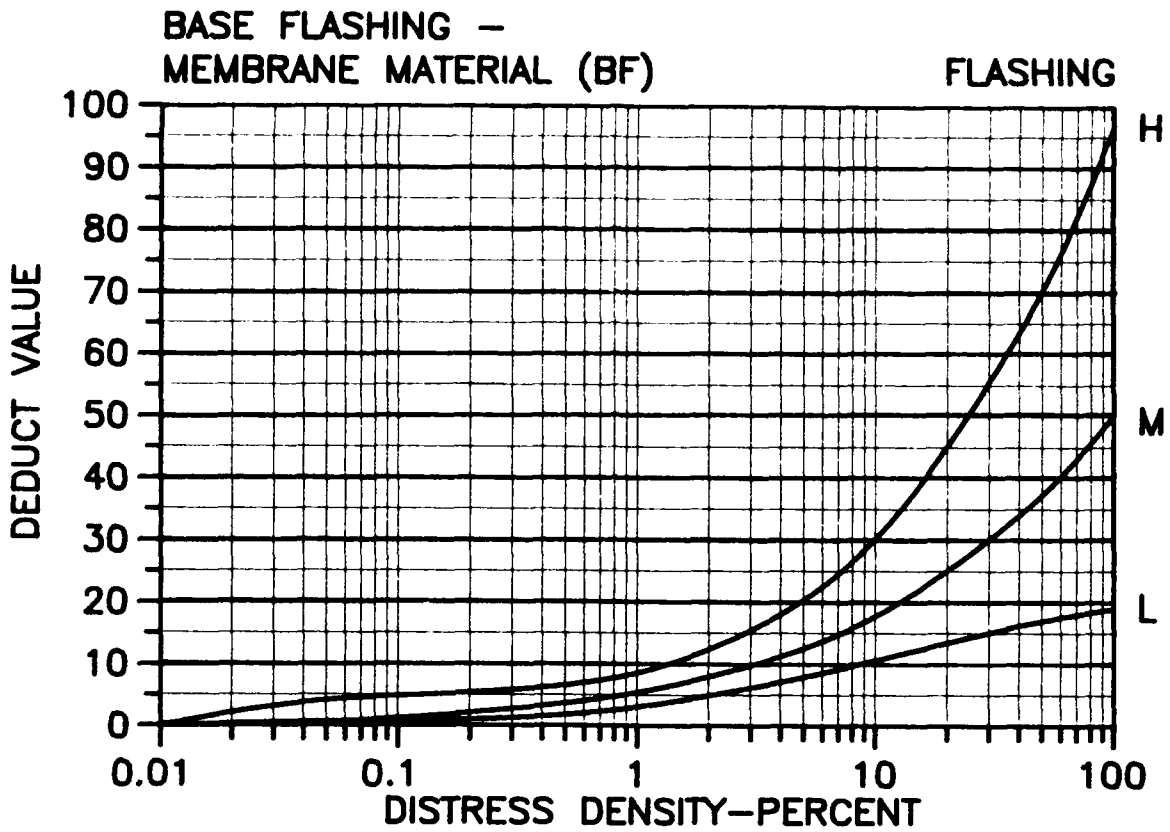

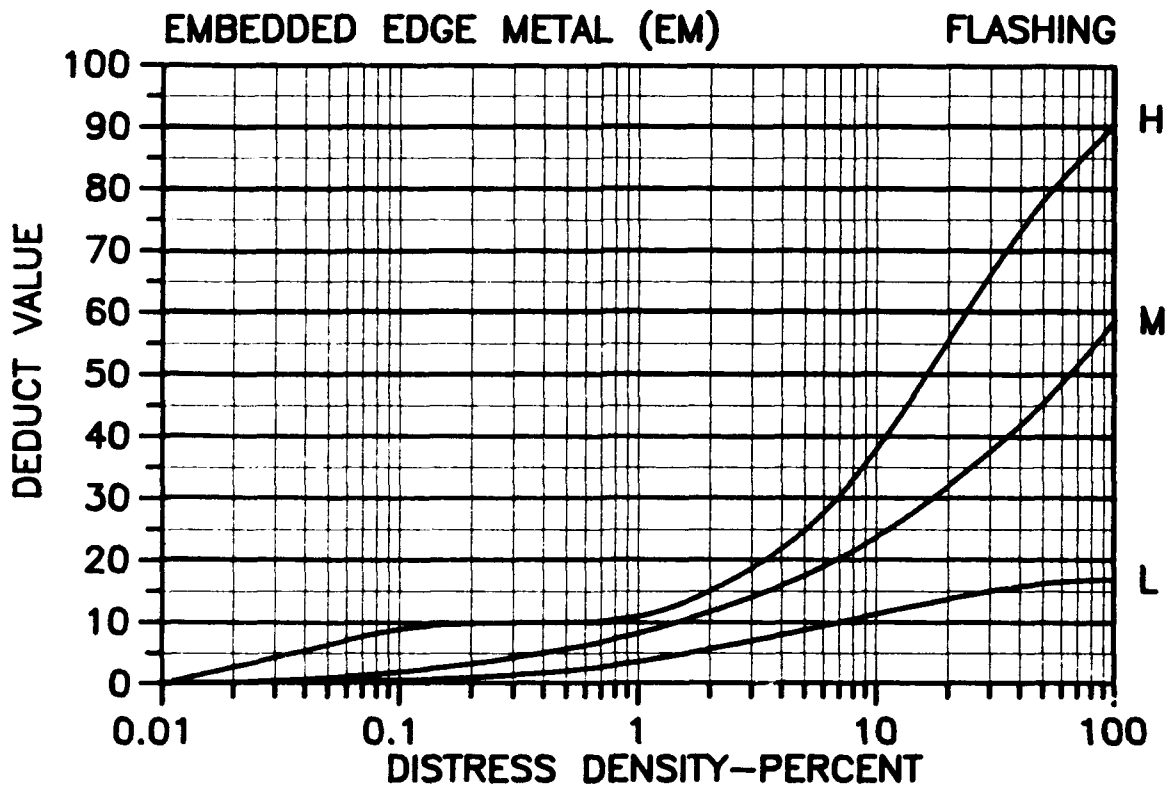
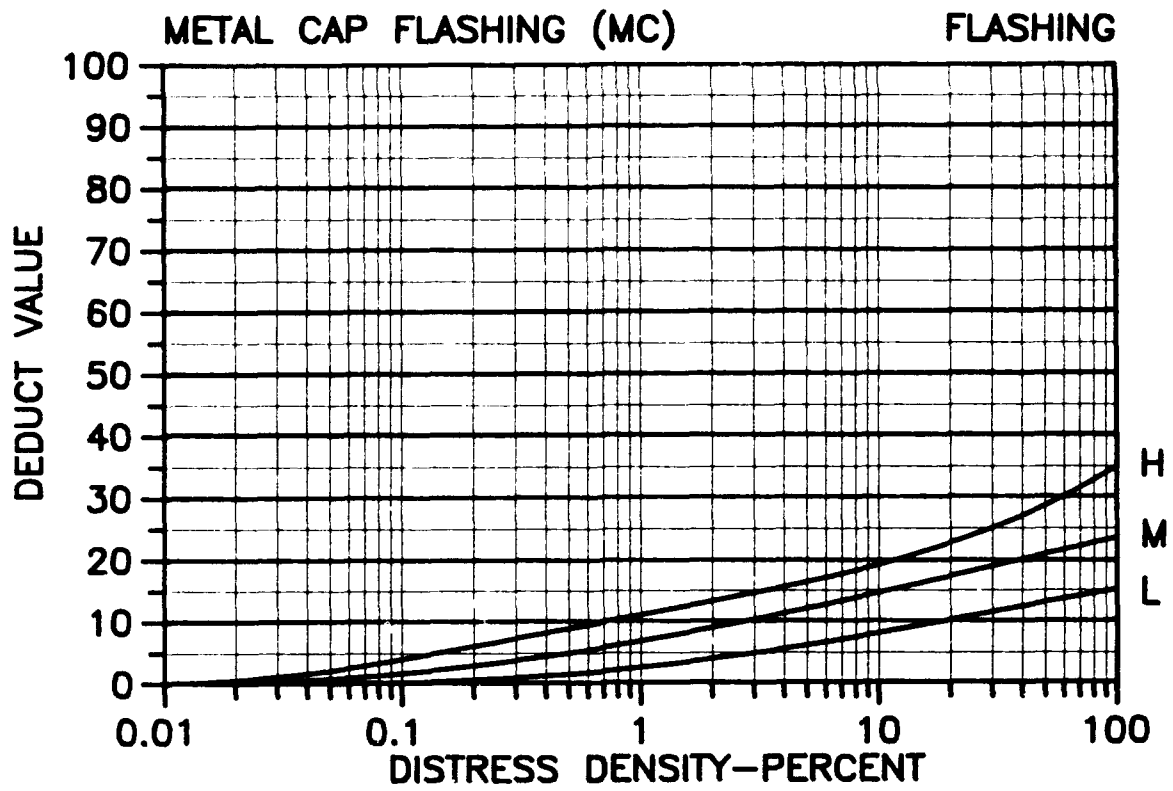

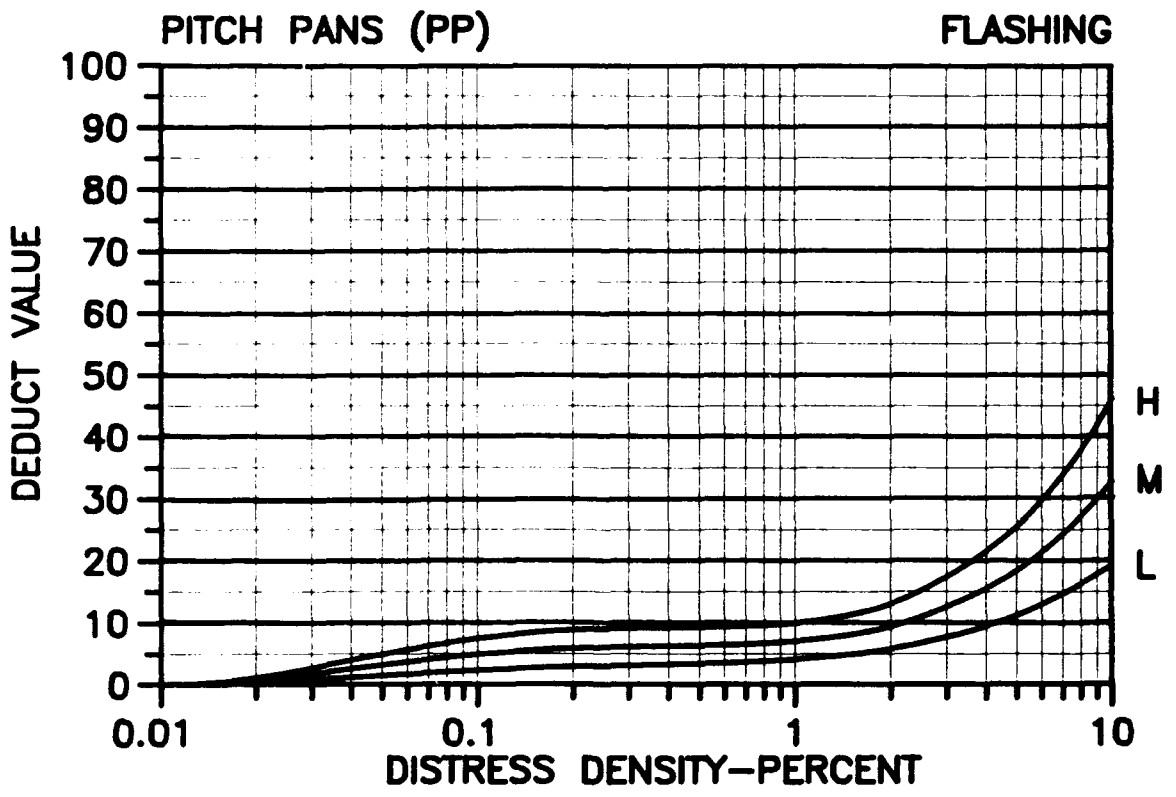
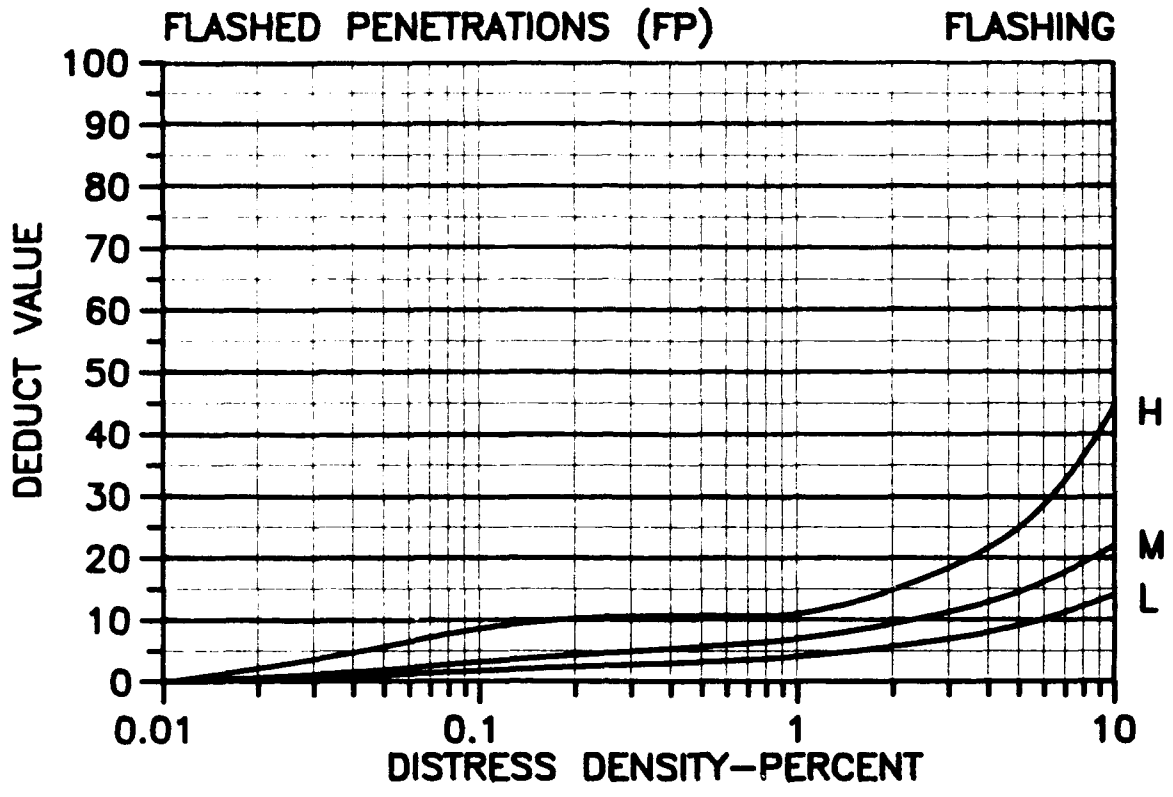

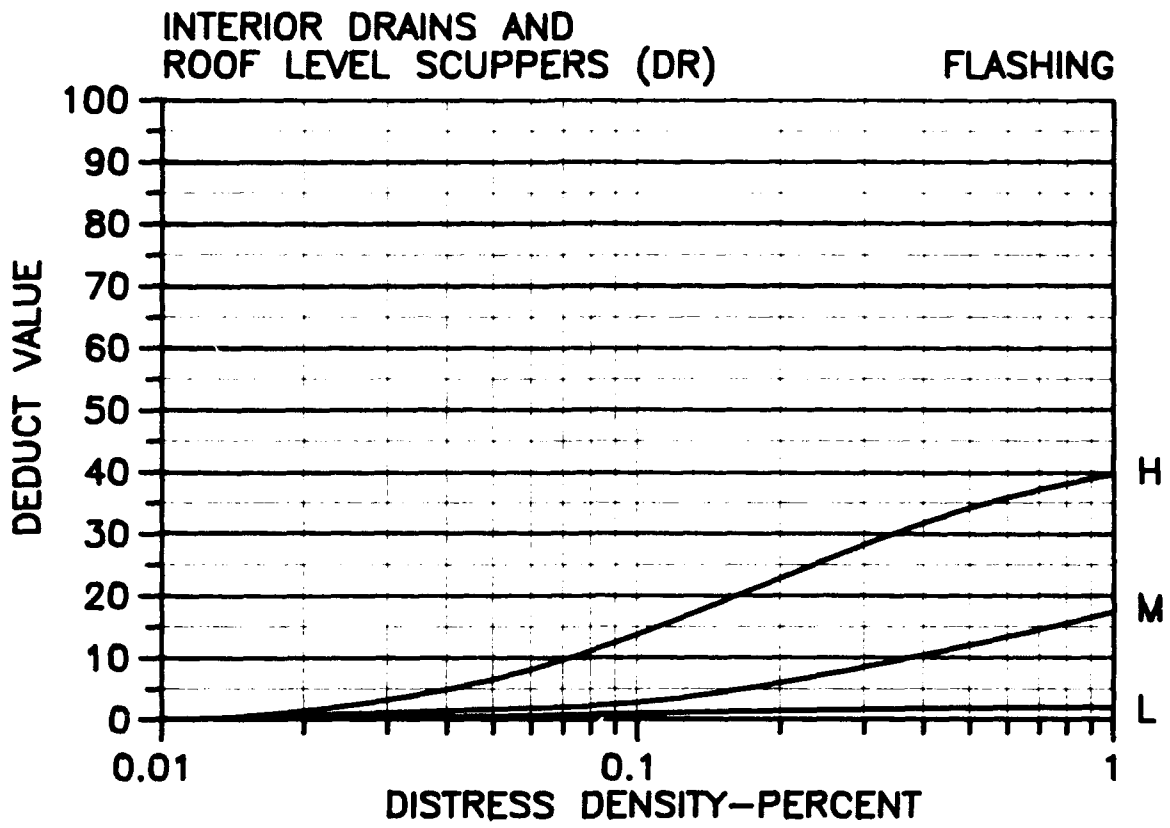

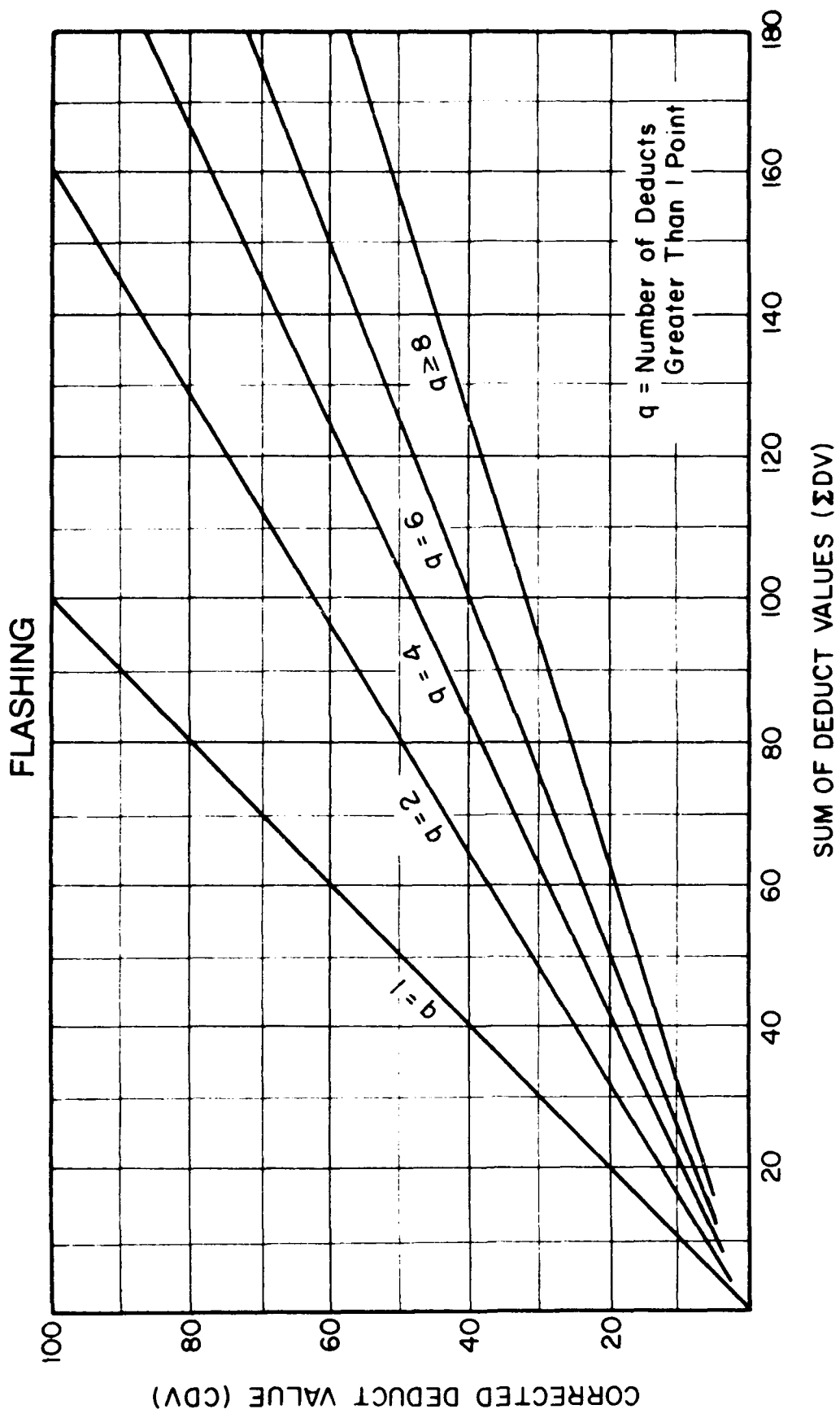

Corrected deduct values for flashing.

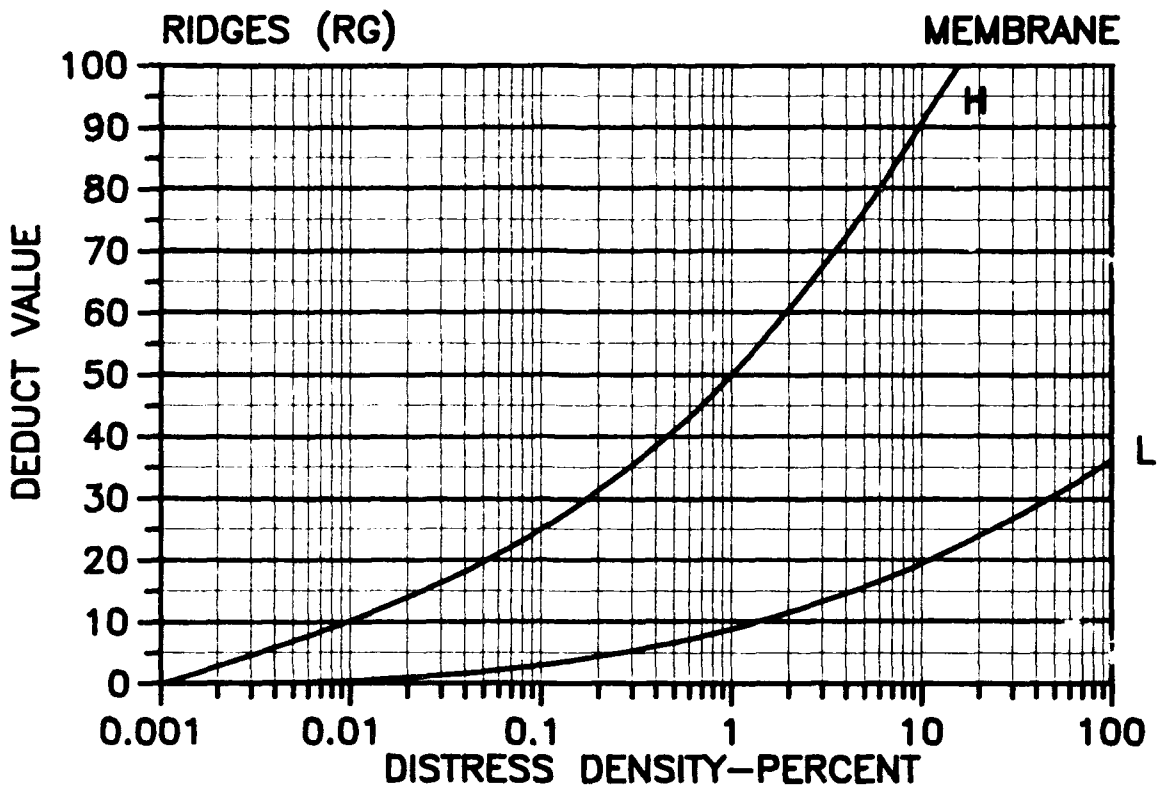
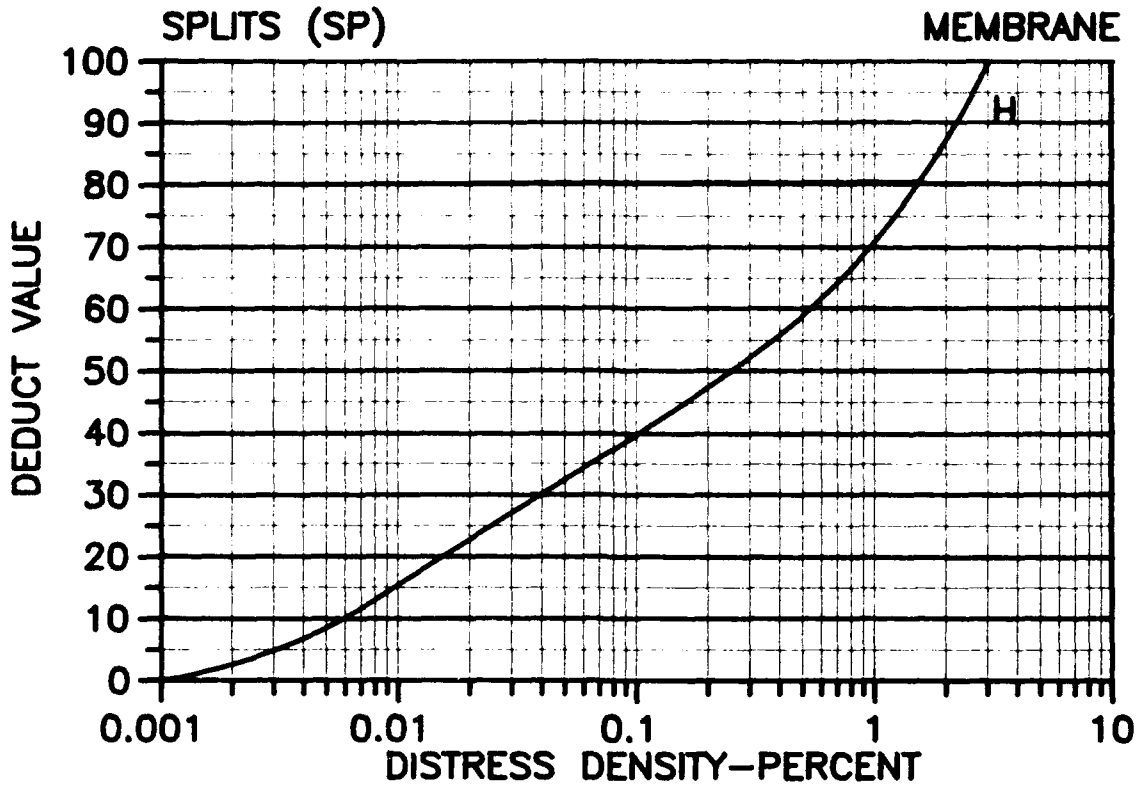

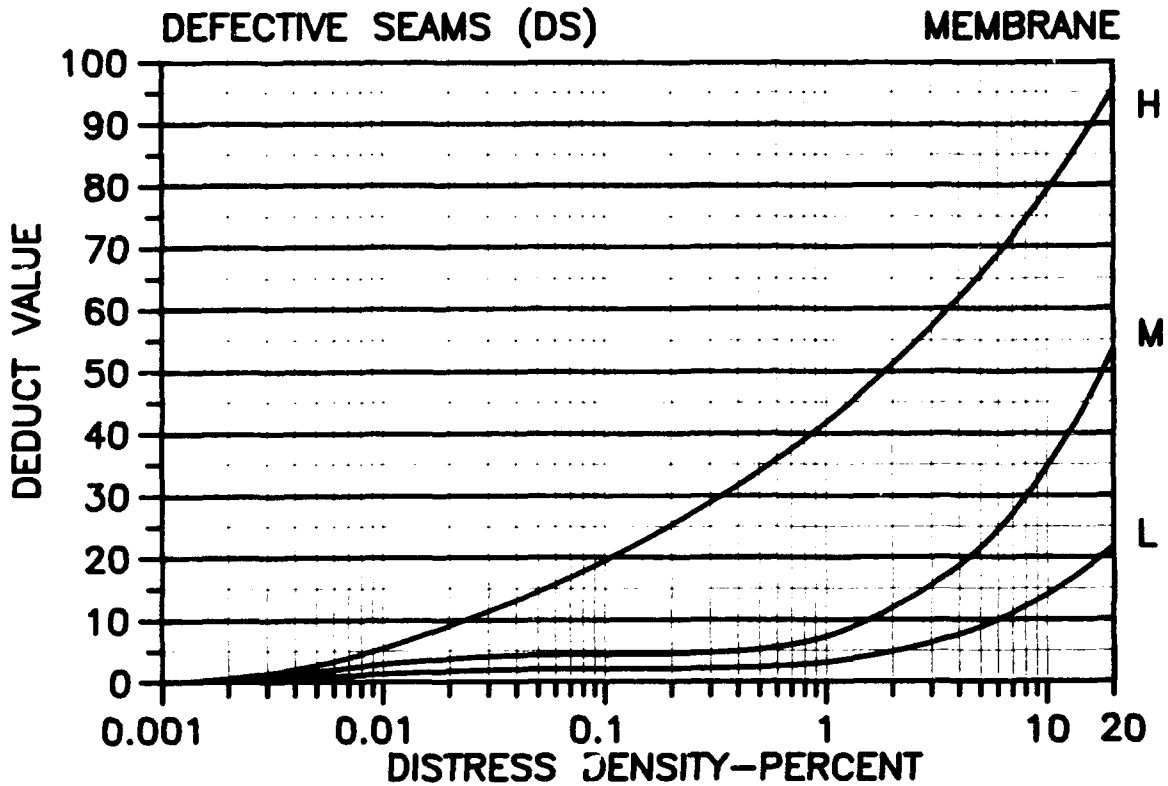
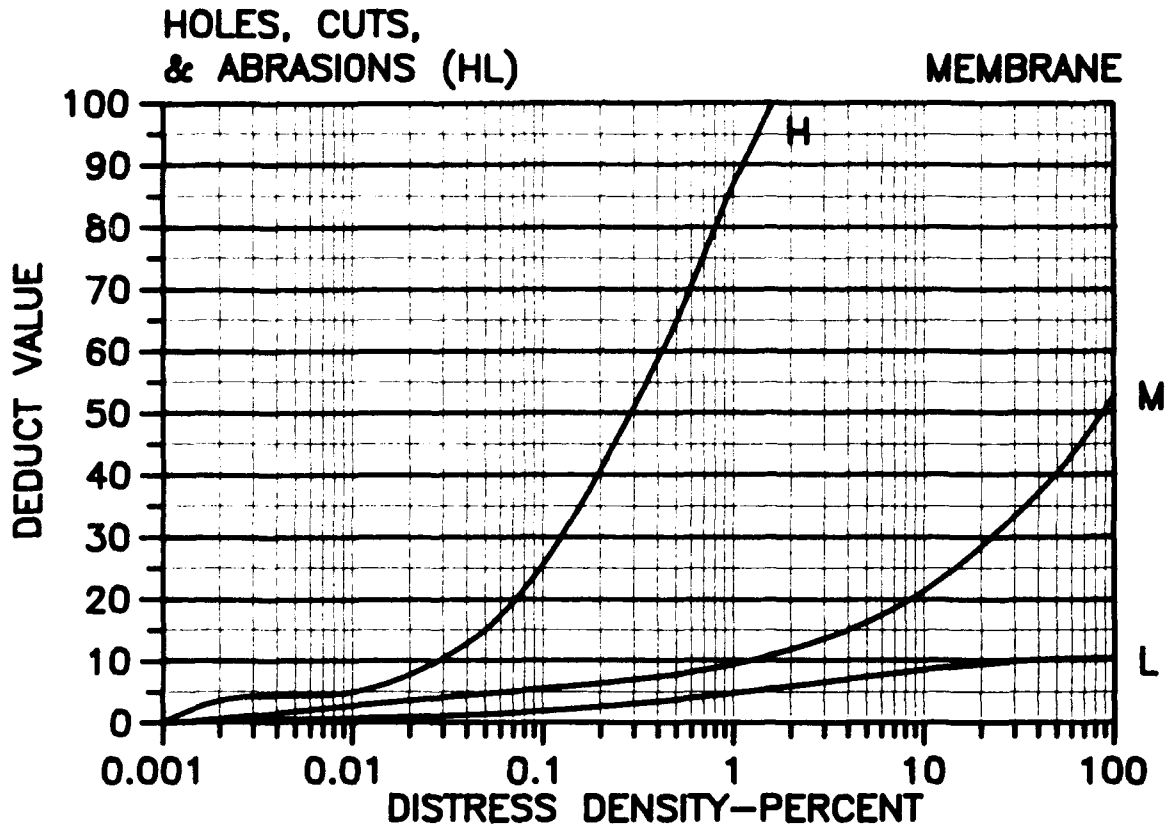

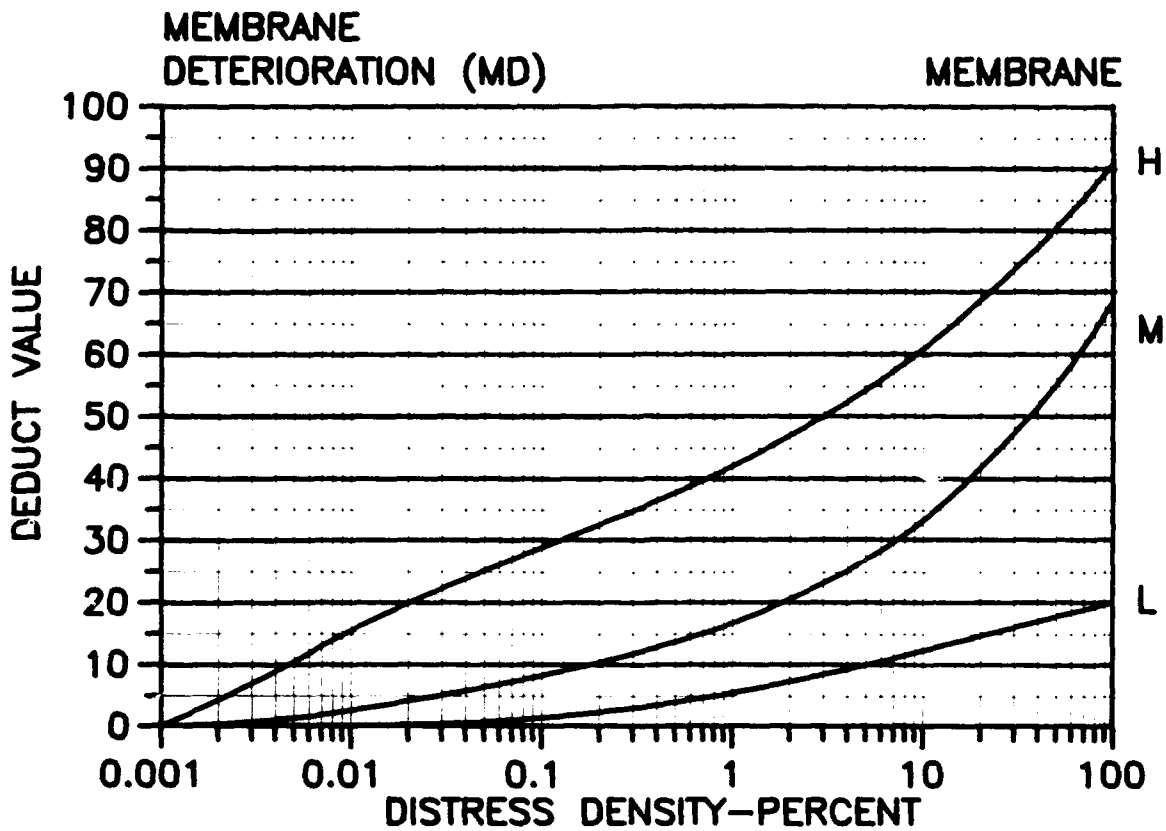
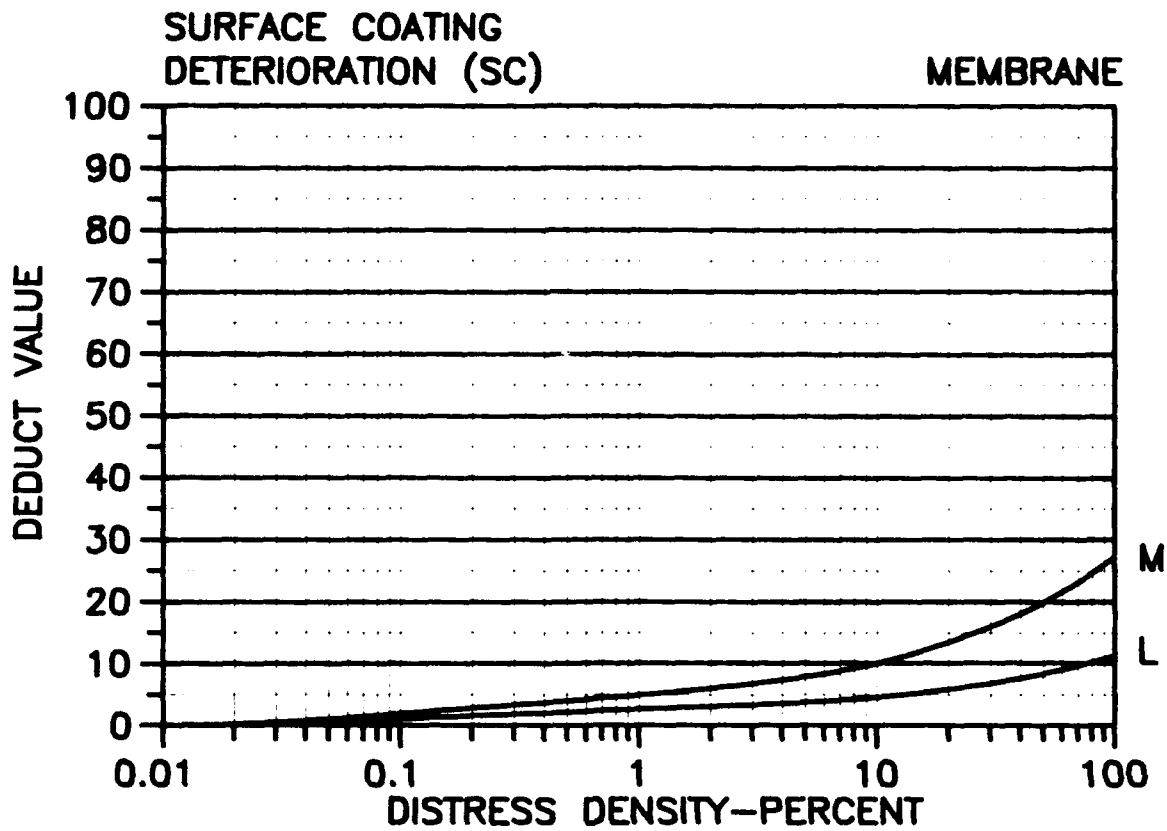

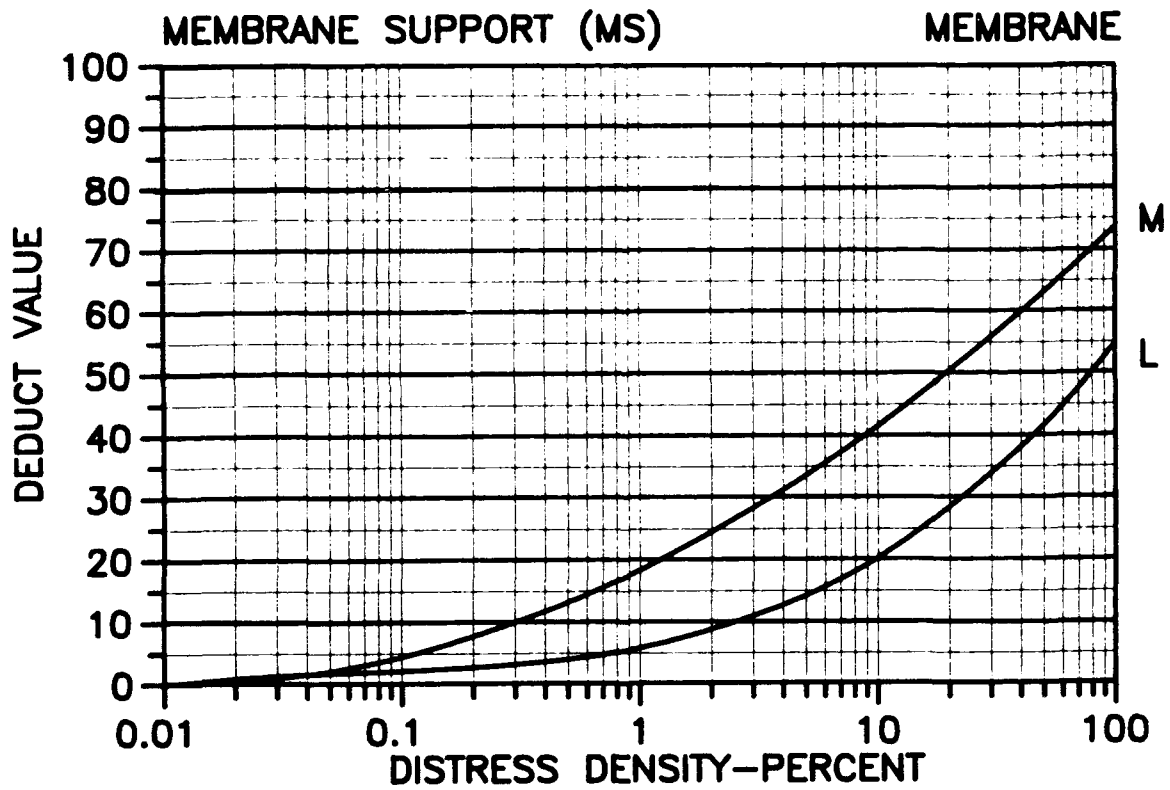
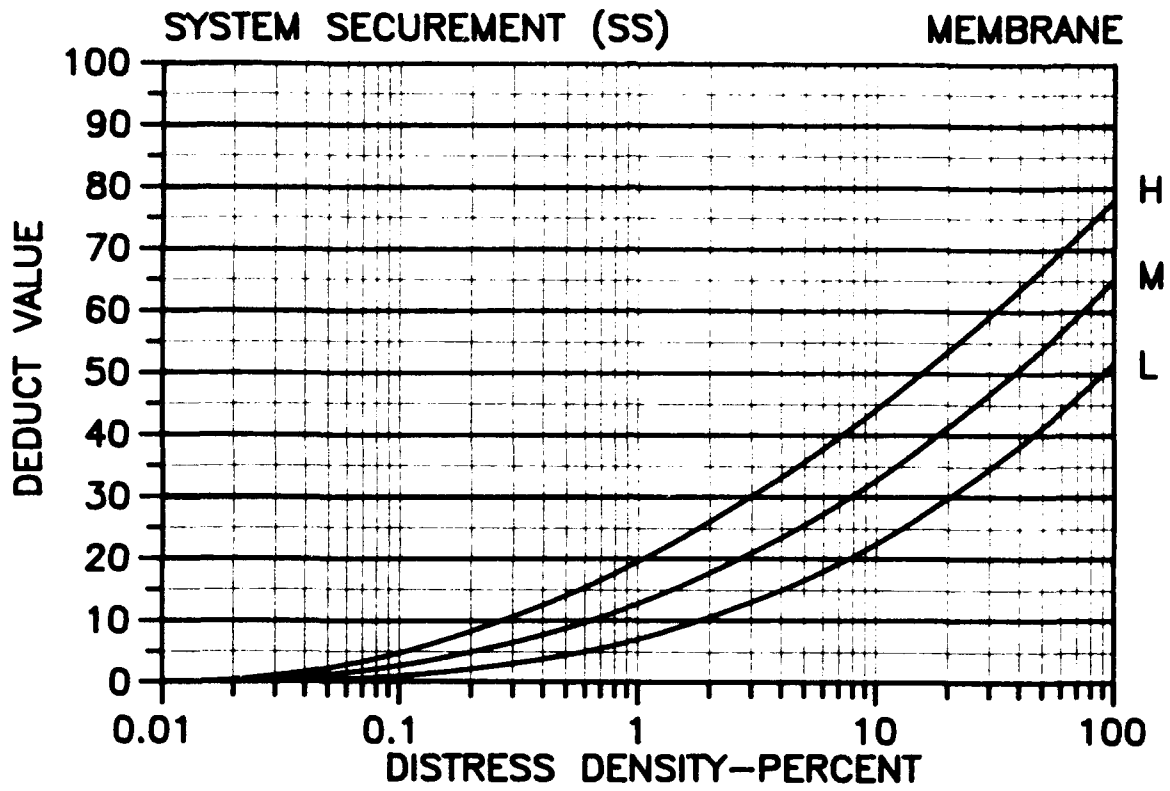

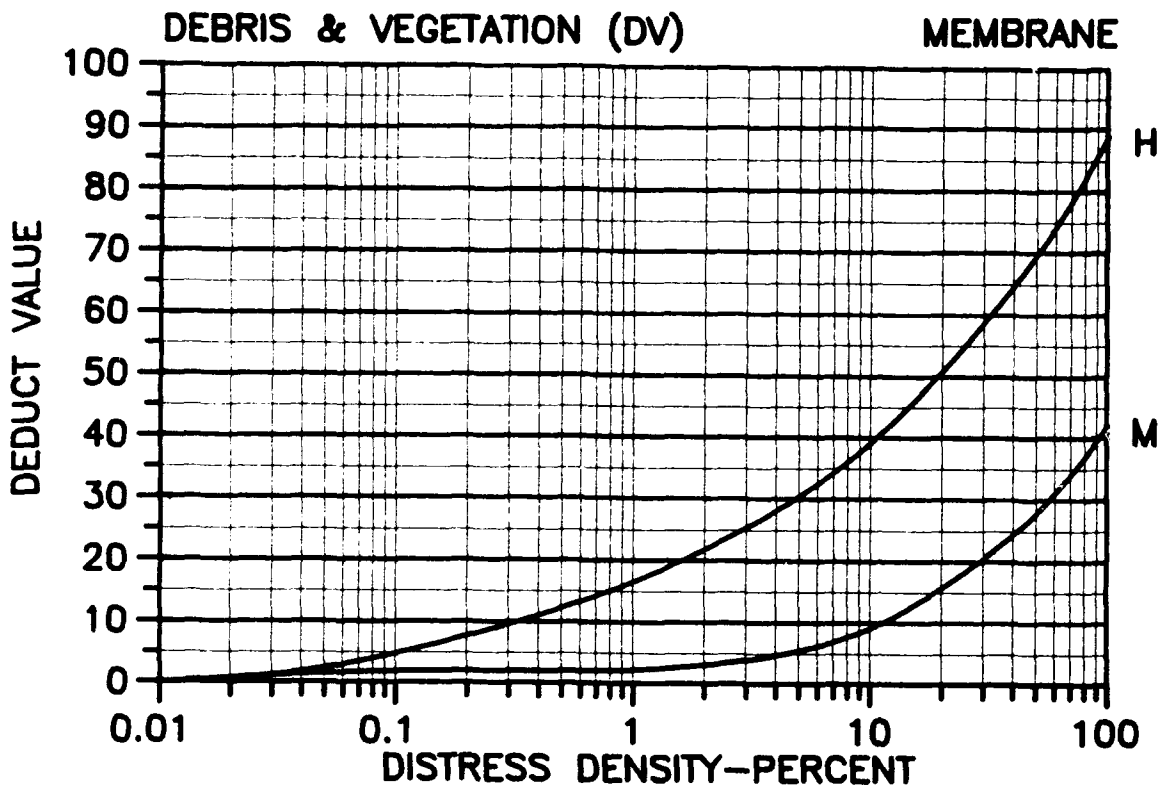
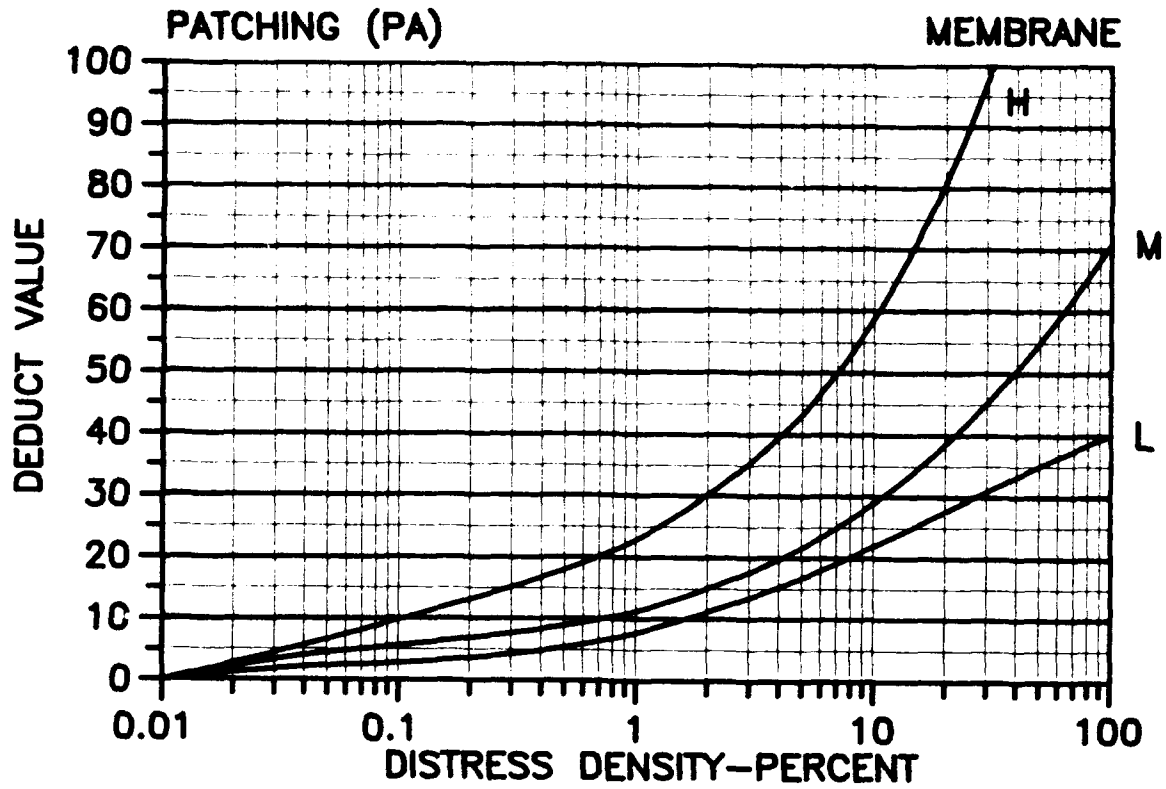

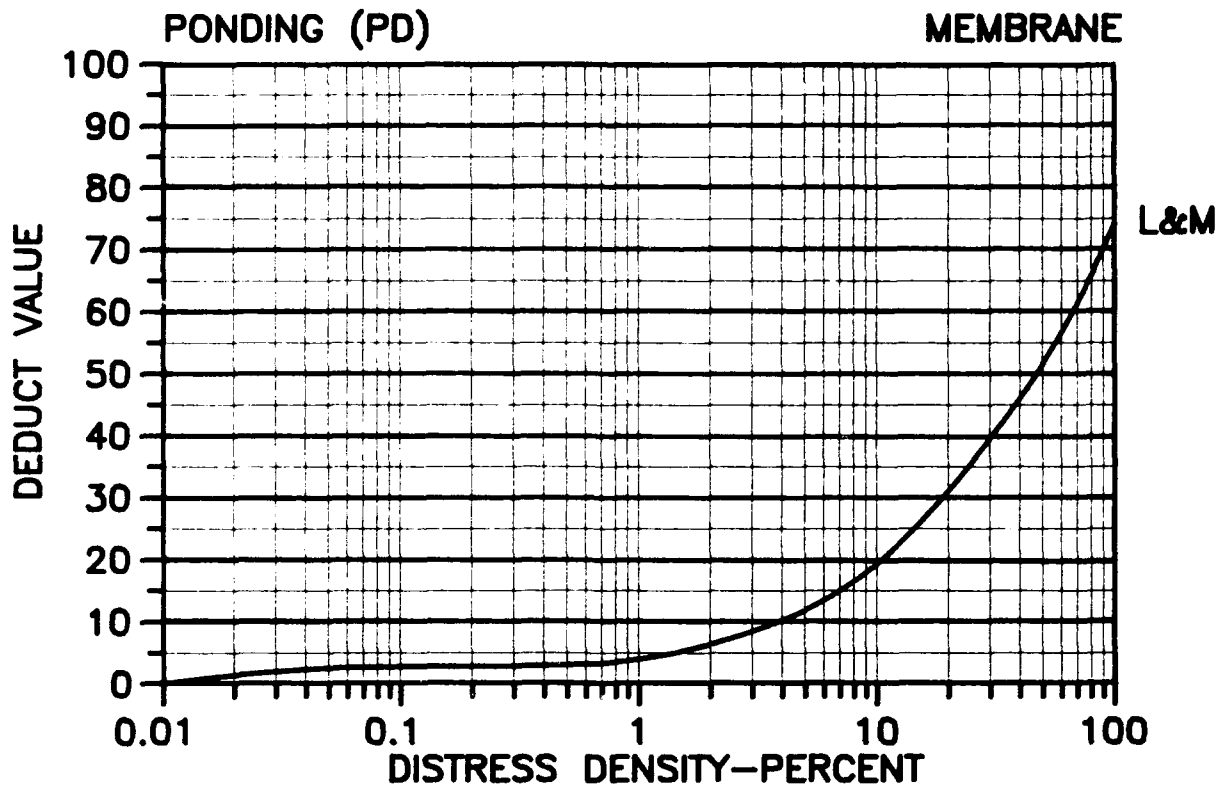
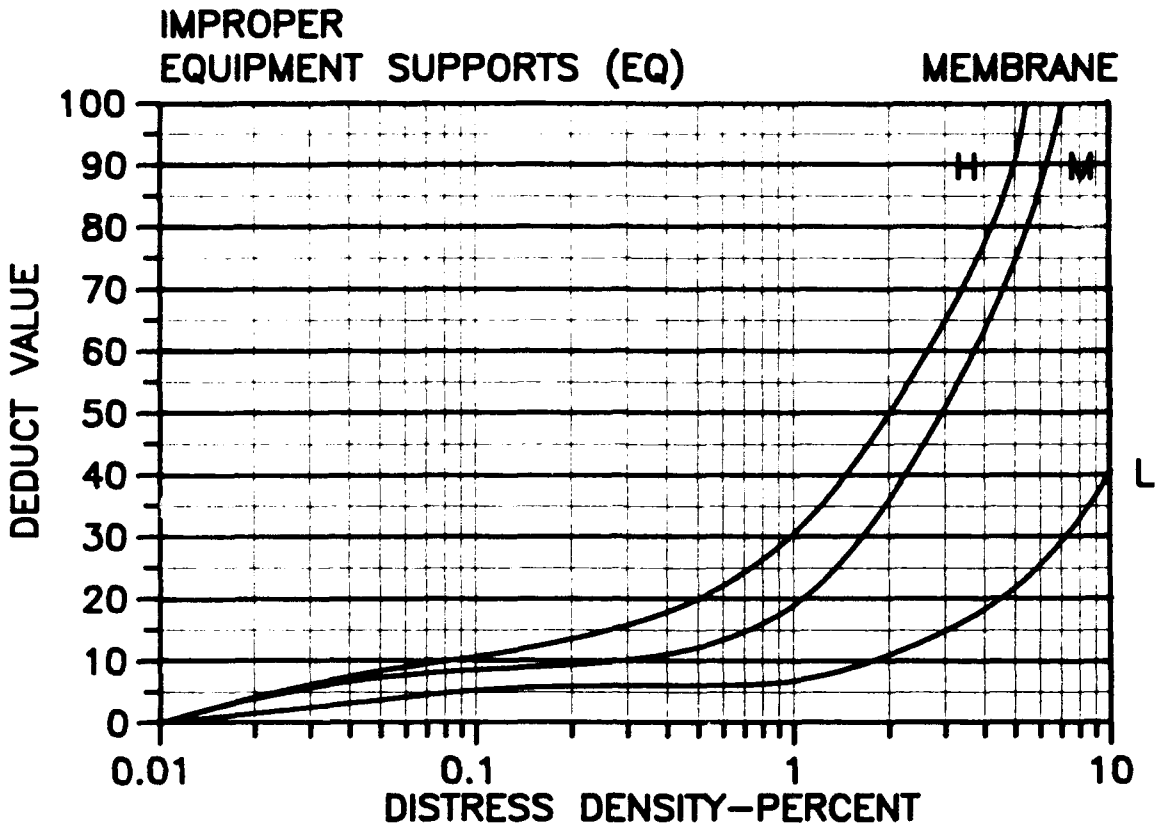

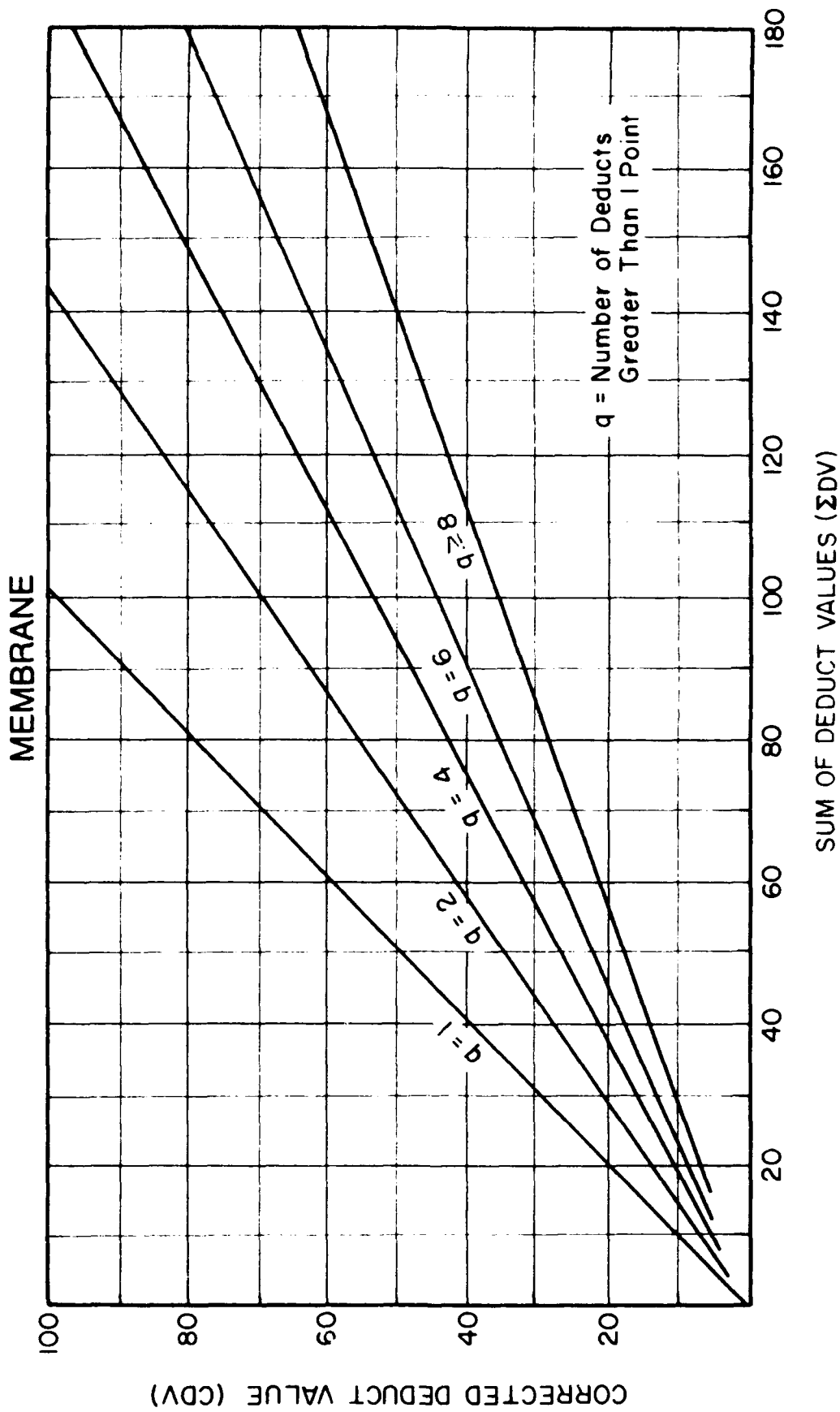

Corrected deduct values for membrane.

APPENDIX B: Inspection and Rating Forms

On the following pages are a Roof Inspection Worksheet (front and back) and a Roof Section Rating Form that may be photocopied for use. Also included is an abbreviated list of single-ply distresses, severity levels, and defects for attachment to inspection clipboard.

ROOF INSPECTION WORKSHEET		AGENCY/INST.:						
BUILDING _____	PER. FLASHING _____	LF _____	DATE _____					
SECTION _____	CURB FLASHING _____	LF _____	NAME _____					
BF-BASE FL-MEM BC-BASE FL-METAL MC-METAL CAP EM-EMBEDDED MET FP-FLASHED PEN	PP-PITCH PAN DR-DRAIN & SC SP-SPLITS RG-RIDGES HL-HOLES	DS-DEF SEAMS SC-SURF COAT MD-MEM DET SS-SYSTEM SEC MS-MEM SUPPORT	PA-PATCHING DV-DEB & VEG EQ-EQ SUPPORT PD-PONDING	I D #	D I S	S E V	D E F	Q T Y
SCALE: _____							NORTH	

ROOF INSPECTION WORKSHEET - COMMENTS

INSTRUCTIONS: Circle response, i.e., Y = yes, N = no or U = unknown or not observed. If Y (yes), circle the type of problem.

A. EVALUATION OF INTERIOR CONDITIONS

- | | |
|---|-------|
| 1. Does the roof leak? Describe: _____
_____ | Y N U |
| 2. Are there water stains on:
a. walls c. deck e. structural elements
b. ceilings d. floor f. other: _____ | Y N U |
| 3. Do structural elements show any of the following:
a. cracks d. alteration g. physical damage
b. splits e. rotting h. insect damage
c. spalling f. settlement i. other: _____ | Y N U |
| 4. Does the underside of the deck show any of the following:
a. rusting c. spalling e. sagging
b. rotting d. cracks f. other: _____ | Y N U |

B. EVALUATION OF EXTERIOR CONDITIONS

- | | |
|---|-----|
| 1. Do the exterior walls show any of the following:
a. cracks c. spalling e. water stains
b. rusting d. movement f. other: _____ | Y N |
| 2. Does the fascia or soffit show any of the following:
a. cracks c. spalling e. water stains
b. rusting d. peeling f. other: _____ | Y N |
| 3. Do the gutters or downspouts show any of the following:
a. loose c. missing e. clogged
b. damaged d. disconnected f. other: _____ | Y N |

C. EVALUATION OF ROOFTOP CONDITIONS

- | | |
|--|-----|
| 1. Is there any unauthorized, unnecessary, or improperly installed equipment on the roof?
a. equipment c. antennas e. cables
b. signs d. platforms f. other: _____ | Y N |
| 2. Do adjacent parapet walls show any of the following:
a. cracks c. cap cracked e. sealant flaws
b. spalling d. cap missing f. other: _____ | Y N |

D. REMARKS: _____

ROOF SECTION RATING FORM

BUILDING _____		SECTION _____		DATE _____		CALC. BY _____
PER. FLASHING _____ FT		FLASHING _____		AREA _____ SQFT		CHKD. BY _____
CURB FLASHING _____ FT		TOTAL _____ FT				

FLASHING

BF - BASE FL - MEM
 BC - BASE FL - METAL
 MC - METAL CAP
 EM - EMBEDDED MET
 FP - FLASHED PEN
 PP - PITCH PAN

DR-DRAIN & SC

TYP	SV	QUANTITIES	TOT	DEN	DV
		CORRECTED DEDUCT VALUE (CDV)			
FCI = 100 - CDV = _____		FLASHING RATING = _____			

MEMBRANE

SP - SPLITS
 RG - RIDGES
 HL - HOLES
 DS - DEF SEAMS
 SC - SURF COAT
 MD - MEM DET

SS - SYSTEM SEC
 MS - MEM SUPPORT
 PA - PATCHING
 DV - DEB & VEG
 EQ - EQ SUPPORT
 PD - PONDING

TYP	SV	QUANTITIES	TOT	DEN	DV
		CORRECTED DEDUCT VALUE (CDV)			
MCI = 100 - CDV = _____		MEMBRANE RATING = _____			

R O O F E R (S P M)

LIST OF DISTRESSES, SEVERITY LEVELS, AND DEFECTS FOR SINGLE-PLY MEMBRANE (SPM) ROOFS

FLASHING DISTRESSES (SPM)				MEMBRANE DISTRESSES (SPM)			
BF-LOW (LF) 1. Light crazing 2. Low, <4" High 3. Low nail strip, <4" 4. Seam/gap, open, <1/2" 5. Repair, compact mat BF-MED 1. Cracking thru relief 2. Unbonded, not open 3. Schv/oli, no det 4. Repair, dissim mat 5. Seam open, >1/2" 6. Loose term bar 7. Loose nail strip BF-HIGH 1. Cracking thru flash 2. HL/SP, pene 3. Exposed gap at top 4. Seam open, pene 5. Schv/oli, de/holes	BC-HIGH 1. Holes 2. Hole in ft corr, pene 3. Exposed gap at top 4. FL pulled, pene MC-LOW (LF) 1. Loss of coat, ft corr 2. Top of CF is delerm 3. Metal cap is delerm 4. MC sealed to BF MC-MED 1. HL on vert surface 2. Fast loose, killed ft 3. Rough edges at BF MC-HIGH 1. Metal cap FL missing 2. HL on horiz surface 3. MC missing ft corr 4. Seal at top miss 5. CF loose, pene 6. Does not cover BF	EM-MED 1. Joint corr unbond 2. Nails backing out 3. Strip crazed 4. Strip open, >1/2" 5. Loose mat, det mat 6. Embrit ft strip mat 7. Interior gutter 8. Coat EM open, >1/2" EM-HIGH 1. Strip open 2. HL on ft corr, open 3. HL in metal 4. HL by loose EM 5. HL in interior gutter 6. Coat EM, open, pene FP-LOW (LF) 1. Seam delaminated 2. Strip open, <1/2" 3. Low, <4" FP-MED 1. Strip mat crazed 2. Strip open, no pene 3. Strainer/brominates 4. Clamp loose/miss 5. Umbrella e. miss/miss 6. Meats corroding FP-HIGH 1. HL in strip mat 2. Seam FP open, pene 3. HL in FP or curb 4. No seams 5. Incomplete mat used	PP-LOW (EA) 1. All PP-MED 1. Strip mat crazed 2. Strip open, no pene 3. Loss of protect coat 4. Strip not cover pan PP-HIGH 1. HL in strip mat 2. Strip open, pene 3. Sealer low 4. Sealer crazed 5. Corrosion thru pan DR-LOW (EA) 1. Seam <1/2" from DR 2. Strip open, <1/2" DR-MED 1. Strip mat crazed 2. Strip open, no pene 3. Strainer/brominates 4. Scupper/loss of coat 5. Field seam in ring DR-HIGH 1. Holes in strip mat 2. Strip, open, pene 3. Ring loose/miss 4. Drain clogged 5. Scupper/bromin/HL 6. Holes, <2" from DR	SP-HIGH (LF) 1. All RG-LOW (LF) 1. All, no breaks RG-HIGH 1. Open breaks HL-LOW (SF) 1. Sirt scratched HL-MED 1. Not penetrating HL-HIGH 1. Penetrating 2. By mesh fastener DS-LOW (LF) 1. No lap seal (E-P) 2. No lap seal (relief) 3. Seam open, <1/2" 4. Wrinkle seam, sealed 5. No relief at "T" 6. Blister in seam DS-MED 1. Seam open, >1/2" 2. Wrinkle in seam (E)	SC-LOW (SF) 1. Loss of coating SC-MED 1. Loss of sand coat MD-LOW (SF) 1. Light crazing MD-MED 1. Cracking to relief MD-HIGH 1. Eroded thru mem, pene SS-LOW (SF) 1. FA, <2 SF 2. BS, <4 SF SS-MED 1. FA, >2 or <100 SF 2. MA, isolated fast 3. PA, isolated fast 4. BS, >4 or <100 SF SS-HIGH 1. FA, >100 SF/75 per 2. MA, ad fast loose 3. PA, ad fast loose 4. BS, >100 SF/75 per	MS-LOW (SF) 1. Jt width, by wrapping 2. Jt width, 1/2" - 2" MS-MED 1. Jt width > 2" 2. BS, local displaced 3. Lumps by mat PA-LOW (SF) 1. All w/compact mat PA-MED 1. All w/incompact mat PA-HIGH 1. With HIGH Distress DV-MED (SF) 1. Veg, no pene 2. Schv/oli, no pene 3. Foreign mat DV-HIGH 1. Veg pene mem 2. Schv/oli, thru mem EO-LOW (SF) 1. All, improper attach EO-MED 1. Move, no puncture 2. Bolt, wastelight EO-HIGH 1. Move, puncture 2. Bolt, water penetrat PD-LOW (SF) 1. All, after 48 hrs PD-MED 1. By wrinkles 2. Warp of substrate	
				INSULATION DISTRESS: IH-HIGH (SF) 1. Wet insulation			

USACERL DISTRIBUTION

Chief of Engineers
 ATTN: CEHEC IM LH (2)
 ATTN: CEHEC IM-LP (2)
 ATTN: CECG
 ATTN: CERD M
 ATTN: CBCC P
 ATTN: CERD L
 ATTN: CECW P
 ATTN: CECW PR
 ATTN: CEMP E
 ATTN: CEMP C
 ATTN: CECW O
 ATTN: CECW
 ATTN: CERM
 ATTN: CEMP
 ATTN: CERD C
 ATTN: CEMP M
 ATTN: CEMP R
 ATTN: CERD ZA
 ATTN: DAEN ZCM
 ATTN: DAEN ZCE
 ATTN: DAEN ZCI

CEHSC
 ATTN: CEHSC F 22060
 ATTN: CEHSC TT 22060
 ATTN: CEHSC ZC 22060
 ATTN: DET III 79906

US Army Engr District
 ATTN: Library (40)

US Army Engr Division
 ATTN: Library (13)

US Army Europe
 ATTN: AEAEN EH 09014
 ATTN: AEAEN ODCS 09014

V Corps
 ATTN: DEH (8)

VII Corps
 ATTN: DEH (11)

29th Area Support Group
 ATTN: AERAS FA 09054

100th Support Group
 ATTN: AETT EN DEH 09114

222d Base Battalion
 ATTN: AETV BHR E 09034

235th Base Support Battalion
 ATTN: Unit 28614 Ansbach 09177

293d Base Support Battalion
 ATTN: AEU5G-MA-AST-WO E 09086

409th Support Battalion (Base)
 ATTN: AETT G DEH 09114

412th Base Support Battalion 09630
 ATTN: Unit 31401

Frankfurt Base Support Battalion
 ATTN: Unit 25727 09242

CMTC Hohenfels 09173
 ATTN: AETT H DEH

Mainz Germany 09185
 ATTN: BSB MZ E

21st Support Command
 ATTN: DEH (10)

US Army Berlin
 ATTN: AEBA EH 09235
 ATTN: AEBA EN 09235

SETAF
 ATTN: AESE EN-D 09613
 ATTN: AESE EN 09630

Supreme Allied Command
 ATTN: ACSGEB 09703
 ATTN: SHHBB/ENGR 09705

INSCOM
 ATTN: LALOG I 22060
 ATTN: LAV-DEH 22186

USA TACOM 48397
 ATTN: AMSTA XE

Defense Distribution Region East
 ATTN: DDRE-WI 17070

HQ XVIII Airborne Corps 28307
 ATTN: AFZA-DEH EE

4th Infantry Div (MECH)
 ATTN: APZC FE 80913

Fort Pickens 23824
 ATTN: AFZA FP E

Tobyhanna Army Depot 18466
 ATTN: SDSTO EH

US Army Materiel Command (AMC)
 Redstone Arsenal 35809
 ATTN: DESMI KLF
 Jefferson Proving Ground 47250
 ATTN: STEJP LD F/DEH
 Letterkenny Army Depot
 ATTN: SDSLE CNN 17201
 Pueblo Army Depot 81008
 ATTN: SDSTE-PU1 F
 Dugway Proving Ground 84022
 ATTN: STEDP EN
 Tooele Army Depot 84074
 ATTN: SDSTE-ELF
 Yuma Proving Ground 85365
 ATTN: STEYP EH E
 Tobyhanna Army Depot 18466
 ATTN: SDSTO EH

Seneca Army Depot 14541
 ATTN: SDSSE HE
 Aberdeen Proving Ground
 ATTN: STEAP DEH 21005
 Sharpe Army Depot 95331
 ATTN: SDSSH E
 Fort Monmouth 07703
 ATTN: SELPM EH E
 Savanna Army Depot 61074
 ATTN: SDSLE-VAE
 Rock Island Arsenal
 ATTN: SMCRI EH
 ATTN: SMCRI-TL
 Watervliet Arsenal 12189
 ATTN: SMCWV-EH
 Red River Army Depot 76102
 ATTN: SDSRR-G
 Harry Diamond Lab
 ATTN: Library 20783
 White Sands Missile Range 88002
 ATTN: Library
 Corpus Christi Army Depot
 ATTN: SDSCC-ECD 78419

FORSCOM
 ATTN: Facilities Engr (12)
 Fort Bragg 28307
 ATTN: AFZA-DE
 Fort Campbell 42223
 ATTN: AFZB-DEH
 Fort McCoy 54656
 ATTN: APZR-DE
 Fort Stewart 31314
 ATTN: APZP-DEF
 Ft Buchanan 00934
 ATTN: Envr Office
 Ft Devens 01433
 ATTN: APZD-DE
 Fort Drum 13602
 ATTN: APZS-EH-E
 Fort Irwin 92310
 ATTN: APZJ-EH
 Fort Hood 76544
 ATTN: APZF-DE-ABS Engr
 Fort Meade 20755
 ATTN: AFKA-ZI-EH-A

6th Infantry Division (Light)
 ATTN: APVR DE 99505
 ATTN: APVR-WF-DE 99703

National Guard Bureau 20310-2500
 ATTN: NGB-ARI

Fort Belvoir 22060
 ATTN: CETEC-IM T
 ATTN: CECC-R 22060
 ATTN: Engr Strategic Studies Ctr
 ATTN: Australian Liaison Office

USA Natick RD&E Center 01760
 ATTN: STRNC-DT
 ATTN: DRDNA-F

TRADOC
 ATTN: DEH (13)
 Fort Monroe 23651
 ATTN: ATBO-G
 Carlisle Barracks 17013
 ATTN: ATZB-DIS

Fort Eustis 23604
 ATTN: DEH
 Fort Chalfee 72905
 ATTN: ATZR ZF
 Fort Sill 73503
 ATTN: ATZR E

US Army Materiel Tech Lab
 ATTN: SLCMT DEH 02172

WESTCOM 96858
 ATTN: DEH
 ATTN: APEN A

SHAPE 09705
 ATTN: Infrastructure Branch LANDA

Area Engineer, AEDC Area Office
 Arnold Air Force Station, TN 37389

HQ USEUCOM 09128
 ATTN: EC14-LIE

AMMRC 02172
 ATTN: DRXMR AF
 ATTN: DRXMR WE

CEWES 39180
 ATTN: Library

CBICRL 03755
 ATTN: Library

USA AMCOM
 ATTN: Facilities Engr 21719
 ATTN: AMSMC-IR 61299
 ATTN: Facilities Engr (3) 85613

USAARMC 40121
 ATTN: ATZIC-EHA

Military Traffic Mgmt Command
 ATTN: MTEA-GB-EHP 07002
 ATTN: MT-LOF 20315
 ATTN: MTE-SU-FE 28461
 ATTN: MTW-IE 94626

Fort Leonard Wood 65473
 ATTN: ATSE-DAC-LB (3)
 ATTN: ATZA-TE-SW
 ATTN: ATSE-CFLO
 ATTN: ATSE-DAC-PL

Military Dist of WASH
 Fort McNair
 ATTN: ANEN 20319

USA Engr Activity, Capital Area
 ATTN: Library 22211

Norton AFB 92409
 ATTN: Library

US Army ARDEC 07806
 ATTN: SMCAR-ISE

Charles E Kelly Spt Activity
 Fort Meade 20755
 ATTN: DEH 15071

Engr Societies Library
 ATTN: Acquisitions 10017

Defense Nuclear Agency
 ATTN: NADS 20305

Defense Logistics Agency
 ATTN: DLA-WI 22304

Walter Reed Army Medical Ctr 20307

US Military Academy 10996
 ATTN: MAEN-A
 ATTN: Facilities Engineer
 ATTN: Geography & Envr Engrg

416th Engineer Command 60623
 ATTN: Gibson USAR Ctr

USA Japan (USARJ)
 ATTN: APAJ EN-ES 96343
 ATTN: HONSHU 96343
 ATTN: DEH-Okinawa 96376

Naval Facilities Engr Command
 ATTN: Facilities Engr Command (8)
 ATTN: Division Offices (11)
 ATTN: Public Works Center (8)
 ATTN: Naval Constr Battalion Ctr 93043
 ATTN: Naval Civil Engr Laboratory (3) 93043

8th US Army Korea
 ATTN: DEH (12)

US Army HSC
 Fort Sam Houston 78234
 ATTN: HSLO F
 Fitzsimons Army Medical Ctr
 ATTN: HSHG-DEH 80045

Tyndall AFB 32403
 ATTN: AFESC Program Ofc
 ATTN: Engrg & Svc Lab

USA TSARCOM 63120
 ATTN: STSAS-F

American Public Works Assoc 64104 1806

US Army Envr Hygiene Agency
 ATTN: HSHB-ME 21010

US Gov't Printing Office 20401
 ATTN: Rec Sec/Deposit Sec (2)

Nat'l Institute of Standards & Tech
 ATTN: Library 20899

Defense Tech Info Center 22304
 ATTN: DTIC-FAB (2)

Fort Drum, APZS-EH-P 13602
 ATTN: DEH/Construction

NAVFACENGCOM Atlantic Division 23511
 ATTN: Code 406

U.S. Bureau of Reclamation 80225

Tyndall AFB 32403
 ATTN: AFESC-DEMDM

Williams AFB 85224
 ATTN: 82 AEG/DB

NAVFACENGCOM 22332
 ATTN: Code 461C

Federal Aviation Administration 60018
 ATTN: AGL-436

USA Natick R&D Laboratories 01760
 ATTN: STRNC-D

Norfolk Naval Shipyard 23709
 ATTN: Code 440

US Army Engr District
 New York 01731
 ATTN: Mail Stop 5
 Baltimore 21203

US Army Engr Division, Huntsville 35805

Cold Regions Research Laboratory 03755
 ATTN: CEICRL

Wright Patterson AFB 45433
 ATTN: HQ-AFLC/DEEC

Naval Air Development Center 18974
 ATTN: Public Works Office

NCEB 93043
 ATTN: Code L53

U.S. Department of Energy 97208
 Code: ENOA

Veterans Administration 20420
 ATTN: Arch Spec Div

320
 +60
 04/93