

AD-A267 033



3

AGARD-CP-520

AGARD-CP-520

AGARD



ADVISORY GROUP FOR AEROSPACE RESEARCH & DEVELOPMENT

7 RUE ANCELLE 92200 NEUILLY SUR SEINE FRANCE

AGARD CONFERENCE PROCEEDINGS 520

Combat Automation for Airborne Weapon Systems: Man/Machine Interface Trends and Technologies

(L'Automatisation du Combat Aérien:
Tendances et Technologies
pour l'Interface Homme/Machine)

DTIC
ELECTE
JUL 14 1993
S A D

*Copies of papers presented at the joint Flight Mechanics Panel and
Guidance and Control Panel Symposium, held in
Edinburgh, Scotland, United Kingdom from 19th—22nd October 1992.*

This document has been approved
for public release and sale; its
distribution is unlimited.



NORTH ATLANTIC TREATY ORGANIZATION

Published April 1993

Distribution and Availability on Back Cover

DISCLAIMER NOTICE

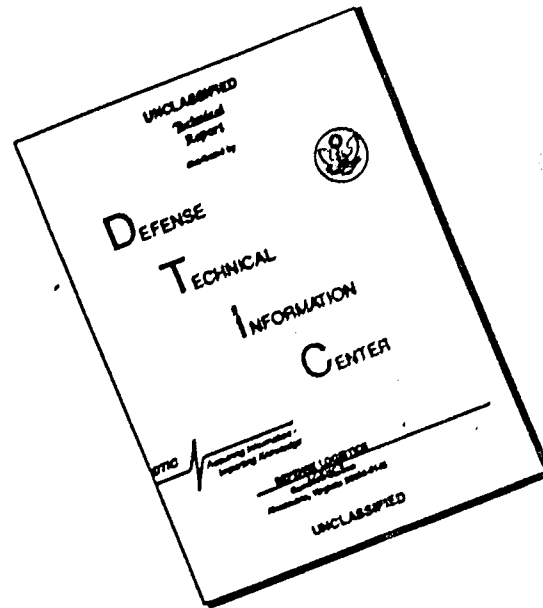

THIS DOCUMENT IS BEST QUALITY AVAILABLE. THE COPY FURNISHED TO DTIC CONTAINED A SIGNIFICANT NUMBER OF PAGES WHICH DO NOT REPRODUCE LEGIBLY.

AGARD

ADVISORY GROUP FOR AEROSPACE RESEARCH & DEVELOPMENT

7 RUE ANCELLE 92200 NEUILLY SUR SEINE FRANCE

DTIC QUALITY INSPECTED 5

AGARD CONFERENCE PROCEEDINGS 520

Combat Automation for Airborne Weapon Systems: Man/Machine Interface Trends and Technologies

(L'Automatisation du Combat Aérien:
Tendances et Technologies
pour l'Interface Homme/Machine)

Accession For	
NTIS CRA&I	<input checked="" type="checkbox"/>
DTIC TAB	<input type="checkbox"/>
Unannounced	<input type="checkbox"/>
Justification	
By	
Distribution /	
Availability Codes	
Dist	Avail and/or Specialist
A-1	

Copies of papers presented at the joint Flight Mechanics Panel and Guidance and Control Panel Symposium, held in Edinburgh, Scotland, United Kingdom from 19th—22nd October 1992.



North Atlantic Treaty Organization
Organisation du Traité de l'Atlantique Nord

93-15917

053

The Mission of AGARD

According to its Charter, the mission of AGARD is to bring together the leading personalities of the NATO nations in the fields of science and technology relating to aerospace for the following purposes:

- Recommending effective ways for the member nations to use their research and development capabilities for the common benefit of the NATO community;
- Providing scientific and technical advice and assistance to the Military Committee in the field of aerospace research and development (with particular regard to its military application);
- Continuously stimulating advances in the aerospace sciences relevant to strengthening the common defence posture;
- Improving the co-operation among member nations in aerospace research and development;
- Exchange of scientific and technical information;
- Providing assistance to member nations for the purpose of increasing their scientific and technical potential;
- Rendering scientific and technical assistance, as requested, to other NATO bodies and to member nations in connection with research and development problems in the aerospace field.

The highest authority within AGARD is the National Delegates Board consisting of officially appointed senior representatives from each member nation. The mission of AGARD is carried out through the Panels which are composed of experts appointed by the National Delegates, the Consultant and Exchange Programme and the Aerospace Applications Studies Programme. The results of AGARD work are reported to the member nations and the NATO Authorities through the AGARD series of publications of which this is one.

Participation in AGARD activities is by invitation only and is normally limited to citizens of the NATO nations.

The content of this publication has been reproduced directly from material supplied by AGARD or the authors.

Published April 1993

Copyright © AGARD 1993
All Rights Reserved

ISBN 92-835-0706-1



Printed by Specialised Printing Services Limited
40 Chigwell Lane, Loughton, Essex IG10 3TZ

Preface

Recent advances in combat automation technologies offer significant potential for improving overall mission effectiveness. Development of advanced situational awareness display concepts, parallel distributed computer architecture and tactical information fusion techniques have paved the way for new operational capabilities and weapon system employment tactics. Harnessing these innovative technologies is critically dependent upon establishing an effective and intuitive pilot vehicle interface.

Presentation of accurate situational data at the right time in an appropriate format remains a significant challenge. Effective combat systems must employ anticipatory control laws, data management and display techniques. Consequential trend information based on both current decisions and alternative courses of action is essential. A well integrated system must reconcile multiple and potential conflicting data sources relative to the current and projected tactical situation and aircraft state. Future manned fighter systems must be capable of providing automated command guidance and signal limiting when appropriate, e.g. ground collision avoidance cues, AOA/g limiting, etc. Additionally, future systems must also correctly harmonize the automatic functions consistent with the pilot's intention and total tactical situation.

It was decided by both the Flight Mechanics Panel and Guidance and Control Panel of AGARD that a jointly sponsored Symposium on these topics would be both timely and effective.

The Symposium addressed changing and possible future operational scenarios, advanced technology concepts, application issues and experimental development efforts and included sessions on: combat mission application, tactical decision aiding and information fusion, situation awareness, human capabilities and limitations, and design and evaluation of integrated systems. It closed with a Round Table Discussion on the prospects and limitations for combat automation.

Préface

Les progrès considérables réalisés récemment dans le domaine des technologies d'automatisation du combat laissent prévoir une amélioration de l'efficacité globale de la mission. Le développement de concepts avancés de perception de la situation, l'architecture informatique répartie en parallèle et les techniques de fusionnement des informations tactiques ont ouvert la voie à de nouvelles capacités opérationnelles et à de nouvelles tactiques de déploiement des systèmes d'armes. L'exploitation de ces technologies novatrices passe obligatoirement par l'élaboration d'une interface intuitive pilote-véhicule.

La présentation de données fiables sur la situation tactique au moment opportun et au format approprié est un défi appréciable qui reste à relever. Pour être efficaces, les systèmes de combat doivent faire appel à des lois de pilotage à anticipation et à des techniques de gestion et de visualisation de données. Il est essentiel de disposer d'informations conséquentes sur l'évolution de la situation, basées à la fois sur les décisions en cours et les possibilités d'action alternatives. Un système bien intégré doit concilier de multiples sources de données, potentiellement contradictoires, relatives aux situations tactiques courantes et projetées, ainsi qu'à l'état de l'aéronef. Les systèmes intégrés des futurs avions de combat pilotés devront être en mesure d'assurer le guidage par télécommande automatisé et la limitation du signal le cas échéant, pour l'évitement d'obstacles par exemple, ou pour la limitation de l'AOA/g etc. En outre, ces systèmes devront pouvoir coordonner les différentes fonctions automatiques en conformité avec les intentions du pilote et la situation tactique globale.

Les Panels AGARD de la mécanique du vol et du guidage et du pilotage ont considéré qu'il était opportun et profitable d'organiser conjointement un symposium sur ces sujets.

Ce symposium a examiné l'évolution des scénarios opérationnels et les scénarios futurs, les concepts technologiques avancés, les applications et les programmes de développement expérimentaux. Les différentes sessions ont porté sur: les applications aux missions de combat, le fusionnement des données et les aides à la décision tactique, la perception de la situation, les capacités et les limitations humaines et la conception et l'évaluation des systèmes intégrés. Le symposium s'est terminé par une table ronde sur les perspectives et les limitations de l'automatisation du combat aérien.

Panel Officers

Flight Mechanics Panel

Chairman: ICA J.-M. Duc
Directeur
Affaires Internationales
ONERA
29, Avenue de la Division Leclerc
92322 Châtillon-sous-Bagneux
France

Deputy Chairman: Prof. L.M.B. da Costa Campos
Pavilhão de Maquinas
Instituto Superior Tecnico
1096 Lisboa Codex
Portugal

Panel Executive: Mr M.K. Foster

Mail from Europe	Mail from US and Canada:
AGARD—OTAN	AGARD—NATO
Attn: FMP Executive	Attn: FMP Executive
7, rue Ancelle	Unit 21551
92200 Neuilly-sur-Seine	APO AE 09777
France	
Tel: 33(1) 47 38 57 70	
Telex: 610176 (France)	
Telefax: 33(1) 47 38 57 99	

Guidance and Control Panel

Chairman: Mr S. Leek
British Aerospace
Defence (Dynamics) Ltd
PO Box 19
Six Hills Way, Stevenage
Herts SG1 2DA
United Kingdom

Deputy Chairman: Mr J.K. Ramage
Chief, Flight Control
Advanced Development Branch
Wright Laboratory
Wright-Patterson AFB,
OH 45433
United States

Panel Executive: Commandant M. Mouhamad, FAF

Mail from Europe:	Mail from US and Canada
AGARD—OTAN	AGARD—NATO
Attn: GCP Executive	Attn: GCP Executive
7, rue Ancelle	Unit 21551
92200 Neuilly-sur-Seine	APO AE 09777
France	
Tel: 33(1) 47 38 57 80	
Telex: 610176 (France)	
Telefax: 33(1) 47 38 57 99	

TECHNICAL PROGRAMME COMMITTEE

Co-Chairmen

Mr J.K. Ramage Chief, Flight Control Advanced Development Branch Wright Laboratory Wright-Patterson Air Force Base OH 45433 United States	Dipl.-Ing. H. Wuennenberg Head of Flight Mechanics Dornier GmbH Postfach 1301 7990 Friedrichshafen Germany
---	---

HOST NATION COORDINATOR

Mrs S. Martin
DRA Aerospace Division
Room G09, Building Q101
RAE Farnborough
Hants GU14 6TD
United Kingdom

ACKNOWLEDGEMENT

The Flight Mechanics Panel and Guidance and Control Panel wish to express thanks to the National Authorities of The United Kingdom for the invitation to hold this meeting in Edinburgh, and for the facilities and personnel which made the meeting possible.

Les Panels du Mécanique du Vol et du Guidage et Contrôle tiennent à remercier les Autorités Nationales du Royaume Uni pour leur invitation à tenir cette réunion à Edinbourg, ainsi que des installations et du personnel mis à sa disposition.

Contents

	Page
Preface/Préface	iii
Panel Officers	iv
	Reference
Technical Evaluation Report by I.C. Statler	T
Keynote Address — Combat Automation for Airborne Weapon Systems: Man/Machine Interface Trends and Technologies by I. Macfadyen	K
Guidance and Control for Low Level Penetration and Attack by V. Baglio	1*
X31 Demonstration of Integrated Flight and Propulsion Control for Effective Combat at Extreme Angles of Attack by M.S. Francis, E. DeVere Henderson, E. Kunz, S. Powers and H. Richter	2
Paper 3 withdrawn	
Integrated Tactical Aircraft Control by J.K. Ramage	4†
Planning for Air to Air Combat by I.D. Gray	5
Pilot Decision Aiding for Weapon Delivery — A Novel Approach to Fire Control Cueing Using Parallel Computing by A.R. Buffett and R.M. Wimbush	6
Aide à la Décision Tactique en Combat Rapproché (Tactical Decision Aiding and Information Fusion) par A. Seguin et A. Gilles	7*
A New Class of Mission Support for Combat Air-Crew by H.J. Pipe	8
Pilot Intent and Error Recognition as Part of a Knowledge Based Cockpit Assistant by T. Wittig and R. Onken	9
A Retrospective on Pilot Associates by J.K. Ramage	10
The Design and Development of the New RAF Standard HUD Format by J.R. Hall	11
Symbology for Head Up and Head Down Applications for Highly Agile Fighter Aircraft — To Improve Spatial Awareness, Trajectory Control and Unusual Attitude Recovery by G. Fischer and W. Fuchs (Part I), H. Phillipp (Part II)	12

	Reference
Virtual Interface Applications for Airborne Weapons Systems by E. Howard	13
Paper 14 withdrawn	
Head-Steered Sensor Flight Test Results and Implications by L.N. Lydick	15
The Quest for an Integrated Flying Helmet by A. Karavis and D.N. Jarrett	16
The Physiological Limitations of Man in the High G Environment – Implications for Cockpit Design by N.D.C. Green	17
Oculo-Motor Responses and Virtual Image Displays by G.K. Edgar, C. Neary, I. Craig and J.C.D. Pope	18
Human Capabilities and Limitations in Situation Awareness by M.R. Endsley and C.A. Bolstad	19
Operator and Automation Capability Analysis: Picking the Right Team by R.M. Taylor and S.J. Selcon	20
Cognitive Interface Considerations for Intelligent Cockpits by R.G. Eggleston	21
Ergonomic Development of Digital Map Displays by A. Martel and G.A. Ward	22
System Automation and Pilot-Vehicle-Interface for Unconstrained Low-Altitude Night Attack by T.O. Church and W.S. Bennett II	23
Evaluation Automatique de Combats Aériens Fondée sur les Intervalles Caractéristiques (Computer Assisted Evaluation for Air Close Combat Based on Time Interval Characterisation) par P. Poutignat et H. de Fontenilles	24
Evaluation on the Flight Simulator of an Experimental System to Support the Pilot during Air-to-Air Engagements by C. Asperti	25*
Air Assign and Forget Weapon System for Helicopters by E. Eckert and A. Mattisek	26*
Intégration de l'Équipage dans les Modes de Tir du Tigre et du Gerfaut (Integration of the Crew in Tiger and Gerfaut Firing Modes) par D. Destelle	27*
Flight Evaluation of a Computer Aided Low-Altitude Helicopter Flight Guidance System by H.N. Swenson, R.D. Jones and R. Clark	28
Requirements for Pilot Assistance in a Thrust-Vectoring Combat Aircraft by E. Howard and R.E. Bitten	29

Reference

Design Considerations for a Night, Air to Surface Attack Capability on a Dual Role Fighter

30

by R.A. Hale, J.J. Chino, L.L. Niemyer, J.R. Jadik and B.E. Lightner

Overview of Cockpit Technology Research and Development Programs for Improvement of the Man/Machine Interface: Review of the AGARD AVP Symposium held in Madrid, May 1992

31

by P.J.M. Urlings and E.W. Pijpers

Technical Evaluation Report

Irving C. Statler
 Chief, Aerospace Human Factors Research Division
 MS 262-1 NASA Ames Research Center
 Moffett Field, CA 94035-1000
 U.S.A.

This is a report of the symposium on "Combat Automation for Airborne Weapon Systems: Man/Machine Interface Trends and Technologies" sponsored by the Flight Mechanics and the Guidance

and Control Panels that included a session sponsored by the Aerospace Medical Panel and a review of another recent relevant symposium from the Avionics Panel.

CLASSIFICATION

This symposium was classified NATO-SECRET by the Technical Program Committee to enable total freedom in the presentations and in the ensuing discussions of this critical problem area. In fact, only four of the presentations were classified; three NATO-

CONFIDENTIAL and one NATO-RESTRICTED. This Technical Evaluation Report is UNCLASSIFIED because no reference is made to any of the classified information presented or discussed during the meeting.

FOREWORD

My evaluation of this symposium and of the presentations and discussions is considerably biased by my personal perceptions of the issues confronting the designers of the machines with which humans will be required to interact, particularly when those machines have certain attributes that might be considered as "intelligent." Therefore, it is probably well that the reader be aware of these biases prior to considering my evaluations.

Our experiences with automation in aviation give us adequate cause to question whether the current design philosophy based on allocation of functions and reliance on human adaptability will suffice for designing the systems of the future civil and military aerospace missions. We continue to discover that new technologies invariably introduce new problems because the systematic consideration of human cognitive capabilities and limitations is not typically a part of the design of the aircrew station. Human error among highly skilled, strongly motivated individuals such as aircrew is only rarely explained by carelessness and more commonly is a product of systems and procedures mismatched to the mechanisms of human information processing. Technically complex systems continue to be designed assuming the operator will provide all the adaptive control and integration required for effective operation. We are finding that such systems frequently only work in the most benign environments, and that training does not compensate for bad design.

Consequently, I am biased toward the need for adopting a philosophy of "human-centered" design for

automation, and for evaluating human-factors issues in the earliest stages of every major system development. In a human-centered design, the human role is treated as central and the machine is used to assist the human in achieving his goals rather than to supplant him. In most applications to aviation, the problem area is not that of automation, but, rather, of partial automation in which the human is expected to make the decision, but must rely on computer-mediated data from sensor hardware for a portion of the information that is necessary for him to make that decision, and must share the responsibilities for control with the machine. Therefore, I become concerned with any new offering of automation in which the designer has not obviously asked the question "In this situation, what is it that we expect the human to be able to do?", followed by the question "What information and what control must he have in order to do it?"

Another of my biases is that I do not accept the connotation of intelligence when applied to machines. As we have not yet found a universally acceptable definition and objective metric for human intelligence, I hardly think we are in any position to claim that we are able to measure machine intelligence. Behaviors of animals, robots, or even simple machines may be perceived as "intelligent" by the naive observer when they entail none of the perceptual and cognitive processes associated with human intelligence. All automation might be viewed (by an observer of its operation) as appearing to exhibit some aspect of intelligence, but artificial or machine "intelligence" is

quite different from human intelligence, and it serves no useful purpose to try to relate one to the other.

Also, I am biased against the declaration of data by the display designer as "information." When the human and the machine must share information to achieve a mutually agreed upon decision, the process entails an interaction that is comparable with communication among members of a human team. The display interface corresponds to the "language" of communication, but understanding requires more than a common language. In stating the purpose of this

symposium, the Technical Program Committee said "*Presentation of accurate situational data at the right time in an appropriate format remains a significant challenge.*" I totally agree with this statement. However, displays present data (not information), and their timing and format alone do not ensure that the operator has sufficient information to make the correct decision.

Having now been warned of my biases, the reader is left to his/her own perceptions of how fairly I have treated the evaluations of the presentations at this symposium.

SYMPOSIUM THEME

The Technical Program Committee stated that the theme of this meeting was the following:

"Recent advances in combat automation technologies offer significant potential for improving overall mission effectiveness. Development of advanced situational awareness display concepts, parallel distributed computer architecture, and tactical information fusion techniques have paved the way for new operational capabilities and weapon system employment tactics. Harnessing these innovative technologies is critically dependent upon establishing an effective and intuitive pilot-vehicle interface.

The human operator's information-processing bandwidth is limited and must be augmented if the manned fighter is going to be effective in the projected high-threat environment of the late 1990's. Tactical decision aiding vis-a-vis knowledge-based system technology smoothes the transition between multiple, short-time-line, event-driven critical combat decisions. During times of intense high mental workload, where the pilot's

attention is exclusively devoted to high priority tasks, the off-line automated combat functions continue processing input sensor data for storage and later presentation to the pilot.

Presentation of accurate situational data at the right time in an appropriate format remains a significant challenge. Effective combat systems must employ anticipatory control laws, data-management and display techniques. Consequential trend information based on both current decisions and alternative courses of action is essential. A well integrated system must reconcile multiple and potential conflicting data sources relative to the current and projected tactical situation and aircraft state. Future manned-fighter systems must be capable of providing automated command guidance and signal limiting when appropriate, e.g. ground-collision-avoidance cues, AOA/g limiting, etc. Additionally, future systems must also correctly harmonize the automatic functions consistent with the pilot's intention and total tactical situation."

PREVIOUS AGARD ACTIVITIES

The AGARD Technical Panels have shown a long history of concern about the man-machine interface. The very first meeting of the Guidance and Control Panel (GCP) in September 1966 was on "The Human Operator in Aircraft and Spacecraft Control." The Avionics Panel (AVP) sponsored a conference on "Artificial Intelligence" in 1971, and one on "Automation in Aerospace Systems" in 1972.

In 1981, the GCP sponsored a symposium titled "Impact of New Guidance and Control Systems on Military Aircraft Cockpit Design" at which there was strong caution expressed against accepting a new technology until it is established that it actually reduces crew workload.

The Symposium sponsored by the AVP in 1982 titled "Advanced Avionics and the Military Aircraft: Man/Machine Interface" (Ref. 1) was another reflection of this concern. The theme of that meeting stated "*To obtain the maximum benefit from advanced avionics requires that the most careful consideration be given to the interface between avionics systems and aircrews.*" Many of the papers presented at this conference addressed the human factors of new avionic systems, and, in his

Technical Evaluation Report on that meeting, R.A. Chorley said "*It is pointless to build aircraft with superb performance, and to man them with highly intelligent, highly trained pilots, if restrictions on the rate of flow of information from the machine to the man, and on the rate at which the man can make inputs to the machine, are the limiting factors in the performance of the overall man/machine systems.*" The wisdom of this admonishment may be reflected in the fact that few of the advanced display technologies described at that conference have yet to be incorporated into cockpits ten years later. We are still not certain on how to use color and voice to improve human-machine communication.

In 1985, the GCP convened a Working Group to address the recommendations that had been made in 1981 as a consequence of a study on "Automation in Combat Aircraft" sponsored by the U.S. National Academy of Sciences. (Ref. 2) The AGARD Advisory Report No. 228 of that GCP Working Group, published in 1986, noted that, despite the multi-disciplinary composition of the Group, the unifying theme that evolved was a concern for the "*provision of a facilitative environment in which the control and cognitive capabilities of the human can be combined and optimized.*"

The Aerospace Medical Panel (AMP) sponsored a symposium in 1986 titled "Information Management and Decision Making in Advanced Airborne Weapon Systems" at which Lieutenant General P.D. Manson said in his welcoming address "The very systems that so capably digest, transform, and present combat information to the crew of an aircraft can themselves add to the increasing complexity and information burden which these humans must bear." (Ref. 3) In his TER of that meeting, Dr. Robert J. Wherry, Jr. said "The complex problems surrounding man-machine information transfer and information management in modern airborne weapon systems have already reached the critical stage.....The enormity of the human factors

problems to be solved must be clearly and carefully enunciated."

These few examples from the history of AGARD activities, and the support of this symposium by four of the nine Technical Panels of AGARD indicates the importance and the cross-cutting nature of problems associated with human-machine interactions. AGARD, has recognized that the ability of the aerospace community to make full use of developments in automation is critically dependent upon establishing an effective and intuitive pilot-vehicle interface. At this symposium, AGARD, once again, convened an exceptional group of experts to address this continuing and complex problem.

INTRODUCTION

For the foreseeable future, there will be very few activities or missions in aerospace that will be accomplished entirely by autonomous systems without human involvement. Human intelligence and the ability it confers to exercise judgment and, thus, to deal with unexpected situations will warrant the services of the human member in future systems. All of the future missions will be performed by a composition of integrated technical, human-biological, and human-social subsystems with shared responsibilities among crew members and machines in flight and on the ground. We will rely on the human subsystems for all critical decisions to ensure safe, reliable, and effective performance of the missions even in totally unexpected situations. The human's role in our complex aerospace systems appears to be secure for a number of decades to come. Consequently, the psychological needs, as well as the physical capabilities and limitations, of the human must be considered as fixed constraints in the total system design.

The classical situation of human factors has been that some machine has been developed to do some task, and the human-operator aspects of controlling this machine and of being trained to do so have been dealt with in due course. The human in between the displays and controls has been used as an adaptive mapper relating his interpretation of the displays into control actions. Human factors considerations have gone unidentified until with their eventual discovery they cause expensive redesign or jeopardize mission success. Until recently, machines and missions were sufficiently simple and there remained sufficient margin to the human operator's capability that he was able to adapt to the needs of the machine or unexpected situations and still perform the mission. We could take advantage of each new technology as long as the human perceptual capabilities were sufficient to provide all the information he needed to operate the system reliably. Unfortunately, this concept has been carried over into the designs of advanced automated systems in which the demands on human adaptability for robust operation has exceeded human capability. There has been a tendency to exploit that which is technologically feasible, leaving to the human pilot those remaining tasks which have escaped

automation, together with the new tasks which are invariably generated.

We now have systems and devices on board our modern aircraft that permit virtually full automatic flight from shortly after takeoff through landing rollout, with increased precision and decreased flight crew workload. These high levels of automation and the "glass cockpits" have been well received by the piloting community. Pilots believe that automation on flight decks is a good thing, and the majority enjoy flying automated aircraft. However, we have not yet accumulated sufficient experience to praise or condemn with assurance. These new aircraft are designed to work best "hands off" during nominal operations, and they are excellent in this mode. It is only when the pilot must intervene in an off-nominal situation that human factors issues ever come to light; but, these systems are designed to very high standards of reliability. Off-nominal situations due to system failures or situations outside design limits are rare, and most pilots have not yet encountered one.

Nevertheless, several accidents, and a large number of incidents reported to the NASA/FAA confidential Aviation Safety Reporting System, have been associated with, and in some cases appear to have been caused by, the interaction between automation and the operators of the aircraft. While automation conveys very significant benefits, the aviation community clearly perceives in automation a potential threat to air safety. Anecdotal reports of problems with automated systems are abundant, and mostly these have not been the results of failure in machine reliability, but rather of failure of information management and communication between the machine and the human operator. We have learned from these reports that the introduction of automation has had unanticipated effects on human performance and has introduced new kinds of system faults. We have learned that automation is not an easy way to remove human error from the system. Our experience with automation indicates that its introduction usually relocates and changes the nature and consequences of human error, rather than removing it. We now know that the new errors created through automation can, in fact, be worse than the types of errors alleviated through automating.

Flight crews have ignored (or have been unaware of) important instrument readings such as fuel levels, have failed to hear warning devices, have deviated from basic operational procedures, have shut down the wrong engine or thrown the wrong switch, have failed to coordinate crew activities, have apparently become totally disoriented, and have continued to rely on the autopilot when it clearly was not operating properly. Automation has acted in ways not expected or desired by the pilots. In some cases, automated warning devices have failed or been rendered inoperative and flight-crew procedures have failed to detect, by independent means, an unsafe configuration. In other cases, automation has operated in accordance with its design specifications, but in a mode incompatible with safe flight under particular circumstances. We have also received reports of incidents from commercial aviation that have been identified with too little workload in some phases of flight to the point of complacency, lack of vigilance, and boredom. Others have been associated with too much workload in off-nominal situations, particularly when the automated systems call for increased head-down operations during these times. In still others, automation has not warned, or flight crews have not detected, that the automation was operating beyond its design limits or unreliably.

Intervention by the aircrew is further complicated by inadequate feedback to the operator about system status for timely diagnosis should an off-nominal situation occur. The causes of some failures may not even be available to the crew in flight. For example, a few pilots have been led to believe they had jammed throttles when angle-of-attack-envelope protection was autonomous and not easily overridden. The AGARD Advisory Report No. 228 stated *"If an integrated automatic emergency system suddenly alerts the pilot to a potentially hazardous situation which has been building up for some time, and which involves the combination of a number of factors, the fact that the man has not been a party to the development of the situation may result in considerable and unacceptable time costs while he reorients himself. There are a number of questions raised by this problem which have*

less to do with automation per se, but rather with the way in which information is presented to aircrew."

The evidence of problems of human interactions with advanced cockpits has become so pervasive that the new U.S. National Plan for Aviation Human Factors (Ref. 4) assigns highest priority to encouraging the development of procedures for evaluating human factors issues as part of every major system development.

We do not know how to design a complex, automated machine in such a way that it will fit naturally into a human organization. We have little appreciation of either the potential or the limitations of partnerships between humans and automated or advisory machines, or of how these interactions affect relations with other crew members or total crew performance. A lack of understanding of and appreciation for the characteristics, needs, and limitations of human performance and behavior manifests itself today as mistakes in the designs of flight-deck displays and controls, unrealistic procedures, excessive training costs, and a challenge to human adaptability. For certain, our experiences with automation in aviation give us cause to question whether the current design philosophy based on allocation of functions and reliance on human adaptability will suffice for designing the systems of the future aerospace missions.

It was against this background of experience and concerns, that the four AGARD Technical Panels, AMP, AVP, FMP, and GCP, joined in producing this symposium. It is against this same background also (together with the personal biases of which the reader was forewarned) that I offer my comments on the presentations and discussions over the three days of meetings. These comments constitute my personal evaluations of and observations on the content of each presentation. In no sense are they intended to summarize the extensive research and the significant findings that are represented by these papers. The reader can expect to understand my comments only if he has read the complete paper provided in this publication of the Conference Proceedings.

THE PROGRAM

Keynote Address

Air Vice-Marshal Ian MacFadyen, Assistant Chief of the U.K. Defense Staff Operational Requirements (Air Systems) presented the Keynote Address and was an eloquent spokesman for, as he put it, the "Man" in this symposium's "Man-Machine" interface. He pointed out that the systems in aircraft have not only been increasing in number, but also in complexity. Automation has been pursued as the solution to helping the pilot cope with this problem, but it has been applied randomly and not as an integral component of the man-machine system.

Sophisticated technologies that appear to offer significant potential improvements have, in fact, saturated the crew with data when what is needed is

information. Air Marshal MacFadyen attributed some of the current difficulties to the fact that cockpit designers have ignored the philosophy of Paul Fitts in allocating tasks between man and machine according to their capabilities. In view of the fact that the work of Fitts was referred to several times during the course of the symposium, I will offer most of my comments on the subject here, up front.

In 1951, Fitts, in a landmark paper, (Ref. 5) developed a list comparing the functions for which man is superior to machines to the functions for which the machine is superior to man. Ever since then, this list (or variations of it) has been used as a basis for comparing man to machine and choosing the one that fits best to perform a required function: but it does not work. While strides have been made in reducing the probability of some kinds of pilot error, the design philosophy based on

allocation of functions between men and machines has not been successful in coping with the increasing complexity of modern aviation systems. All attempts to build and expand upon this concept have led to difficulties and contradictions. The facts of the Fitts list are correct, and yet the concept has failed to produce reliable systems. Final designs seldom looked like the initial allocations based on the list, and efforts to rebuild the tables based on actual allocations were abandoned because the lack of fit was obvious. The problem is that men and machines are not comparable, they are complementary and must not be treated as competitors for assignments.

The Working Group that produced the AGARD Advisory Report No. 228 made the same mistake by basing their review of the man-machine interface problem on the means for the allocating aircrew functions to human or machine agents, and by making the first principle of their design guidance "*An appreciation of what can be automated from the technological viewpoint.*" In fact, most of their report is devoted to what can be automated, and very little to what should.

It is worth recalling the guidelines suggested by Wiener and Cary in their 1980 landmark paper titled "Flight Deck Automation: promises and problems" (Ref. 6) as they foresaw many of these issues. They pointed out, even then, that the question was "*not whether a function can be automated, but whether it should, due to the various human factor questions that are raised.*" Their caution to designers to be aware of possible behavioral effects of automation is still valid, and is supported by recent evidence, a decade later.

Air Marshal MacFadyen says correctly that we must find ways to assist the pilot's "*natural instinctive and intuitive qualities of being unpredictable.*" He pointed out that while the machine obeys laws and can be explained by formulae, man follows few laws and is highly unpredictable. This makes it exceedingly difficult to harmonize the human and the machine components of a system. He noted appropriately that "*aircrew error*" is a "*convenient catch-all for accidents caused by inadequate training, ill-defined operating procedures, or even bad design of the cockpit interface which itself only exacerbates the problem during a high-stress situation.*" Not only do I agree with this statement, but I would express it even more strongly. All too often, we have blamed the symptom of a mistake by the aircrew when the underlying cause was a display, a control, a procedure, or even a training that induced the error because it was not a human-centered design for the situation encountered.

However, the solutions to the problems posed by Air Marshal MacFadyen are not to be found in the rote application of Fitts' principles. As he said "*Only by understanding man's capabilities and limitations will it be possible to design integrated avionics systems which match man's requirements and result in effective man-machine combination.*"

Session I - Combat Mission Application

There is no argument with the claim that the crews of our modern military aircraft need help, and the representative mission scenarios analyzed in the three presentations of the first session provided ample supporting evidence of this claim. Not only have the missions become more complex and demanding of the crew-aircraft systems, but each system is expected to have multi-mission capabilities. Low-level penetration and attack, combat at extreme angles of attack, and the effective utilization of combined manned and unmanned air vehicles addressed by the authors of the three papers presented in the first session are compelling examples of the current dilemma. The crews need help, there are technologies which appear to be able to come to their aid, but we are not certain that we know how to implement the total human-machine system with assurance that it can cope with any unexpected situation.

In the scenarios described in these three papers, and in many others today, both in and out of aerospace, we are trying to design for shared command and control of highly dynamic events among dispersed agents some of which are human, and each of which (whether human or not) has its own intentions, knowledge base, and perception of the state of the world. The combat situations described in the three papers of this first session represent a small subset of this broader problem.

1. Guidance and Control for Low-level Penetration and Attack (NATO CONFIDENTIAL paper - UNCLASSIFIED Title) BAGLIO, V. (U.S.)

Low-level penetration for a ground attack in the lethal environment of today's surface-to-air capabilities is a particularly difficult mission for which the pilot needs all the help he can get just to stay alive, much less hit his target. Mr. Baglio clearly showed that there are technologies that could help the pilot to navigate over unknown terrain to a target while staying very close to the ground, avoiding obstacles and detection, and selecting the best choice of target from among several possibilities in real time. Although this capability has been demonstrated in flight as well as in man-in-the-loop simulations, I too must ask the question that was put by a member of the audience: In an aggressive, low-level flight trajectory involving rapid avoidance maneuvers that are commanded by sensor inputs, and an automatically controlled curvilinear bombing run during which the aircraft may never be aimed directly at the target, how can the pilot maintain sufficient awareness of the situation to accomplish his purpose for being aboard; namely, to provide the flexibility to cope with the unexpected? The author replied that this had not appeared as a problem during the evaluations. In this scenario, many unpredictable things can happen to place the situation outside of the nominal for which the system was designed. It then falls upon the pilot's flexibility and adaptability to compensate. All too often, validation experiments are performed solely to demonstrate that the technology can do its job when they should determine also whether, if required, the pilot could perform his job.

2. X-31A Demonstration of Integrated Flight and Propulsion Control for Effective Combat at Extreme Angles of Attack FRANCIS, M.S., POWERS, S.A. (U.S.), KUNZ, E., (GE), & DE VERE HENDERSON, H. (U.S.)

The development of the X-31A was predicated on the admirable concept that a fighter aircraft would have a significant advantage in close-in combat if it could maneuver controllably beyond the stall boundary. It was found that thrust vectoring combined with this capability offered additional potential benefits in enhanced maneuverability. The authors stated that it was essential to an assessment of the benefits of this enhanced maneuverability to design a vehicle with a "...highly integrated 'pilot friendly' aerodynamic and propulsion flight control system...". Their interpretation of user friendly was that the complex control interactions had to be transparent to the pilot. However, making these control interactions transparent to the pilot means he does not know which of a multitude of combinations and permutations of vectored thrust and aerodynamic controls are being used in a very complex flight-control-law system. This is unacceptable unless the machine has absolute fail-safe reliability under all circumstances; otherwise the pilot will find it extremely difficult to diagnose problems and take proper corrective action. For example, he is expected to select a different switch position depending on whether the loss of data on angle of attack and yaw is due to a failure of the inertial measurement system or of the signals from the vanes. Can we be certain that the pilot will be capable of recovering from a failure in time when the cause has been obfuscated?

This is an extreme example of a common fault of new aircraft systems in which the computers introduced between the aircraft's state sensors and the displays and between the pilot's inputs and the highly automated control surfaces of the aircraft serve to obscure the pilot's image of his aircraft. Previously, displays and controls were both directly coupled to the aircraft so that the pilot was able to construct the mental image of the aircraft state directly from displayed responses to his control inputs. Today, engineers can easily incorporate logic into the airplane itself; but the computers introduce (by design or otherwise) dynamic mappings of their own so that the pilot is no longer able to relate the displays directly to the aircraft state or his control inputs to the aircraft's responses. Arbitrary delays, spatial separation of cause and effect, and discrete, discontinuous subsystems tend to obscure cause-effect relationships. The pilot is insulated from the aircraft and develops a completely different image of the system he is operating than he would if the computers were not there. Consequently, any failure of the computers (either due to electro-mechanical failure or an unexpected situation) requires the pilot to intervene in a system with which he is not currently familiar.

The authors of this presentation recognized that even the extensive simulator work has not provided an adequate understanding of the problem of ensuring the pilot's awareness of his situation at all times during maneuvers at very high angles of attack. This is due, in large part,

to the complex maneuver sequences that cause disorientation. They have proposed a new head-down display for the post-stall regime which could be useful only as a training tool as the pilot would need to be looking out of the cockpit in combat.

This is another example in which the system's control feedback has been inadequate for the pilot to maintain effective control. The hysteretic behavior of lift and moment discovered during dynamic pitching maneuvers is also likely to make the pilot's life interesting. I strongly support the authors' summary statement that "*The key challenge to effective control is a compatible and properly tuned pilot-vehicle combination.*" In a human-centered design approach, this challenge might have been confronted first.

3. Integrated Tactical Aircraft Control RAMAGE, J.K. (U.S.)

Although the original paper that had been scheduled was canceled, Mr. Ramage discussed aspects of the benefits and problems of coupling manned and unmanned air vehicles that were to have been addressed. He spoke of the interest in developing the capability for an internetted, pilot-supervised team of manned and unmanned air vehicles that could exploit human ingenuity to increase the effectiveness of both during air-to-surface and air-to-air missions. In support of these ideas, Mr. Ramage reviewed some of the lessons learned from Desert Storm as seen by a sub-group of the GCP. Pilot-aided weapons had great success, while autonomous weapons were less successful in a clear demonstration of the advantage of human adaptability in the unpredictable battle over autonomous weapons with limited flexibility. There appear to be significant payoffs to enabling integrated pilot control over manned and unmanned vehicles, but there are many critical issues. The pilot is already overworked performing his own mission. How, then, can he be expected to maintain effective control of multiple UAVs considering the issues of safety and the integrity of system-wide management? This concept poses a formidable challenge to developing the proper level and reliability of automation, situation awareness, and communication for sharing command and control among the pilot, the ground, the unmanned vehicles, and other manned aircraft in the area. For certain a pilot could not cope with this responsibility using current technology.

Session II - Tactical Decision Aiding and Information Fusion

The second session was primarily concerned with advisory systems rather than automation per se, and the particular systems described by the authors of the six papers in this session appear to be susceptible to the same problems that have traditionally plagued advisory systems.

Many of the initial expert systems, that were called consultant or advisory systems, possessed very little capability for supporting cooperative interaction with human operators. People learning to use advisory devices bring with them prior assumptions about the state of the world, and about cause-effect and goal-action

relations based on past personal experiences and training. They use these assumptions in trying to understand the instructions, in devising a plan of what to do, and then in trying to understand why the machine did not do what they had expected. Interference with understanding and, hence, collaboration results when the human and the advisory system do not have the same representations of the state of the world (or of each other or of the system that both are monitoring). People have difficulty accepting advice that appears to be inconsistent with their prior assumptions about the actual and potential states of the situation. Current advisory systems usually use question-and-answer dialogs as the mechanism for achieving common understanding through explanation. It has been demonstrated, in a variety of applications of advisory systems, that these dialogs are not conducive to cooperative interaction because they must be structured to fit the machine's model of the world which may not coincide with that of its human partner. The human has no possibility of conveying to the machine his own perceptions of the state of the world which may be influenced by factors that have no meaning to the machine. For instance, it seems inevitable that experts will sometimes disagree and, yet, there has never been a provision for an expert user to register that he does not agree with what the system is doing, and to compare reasons for his disagreement with the rationale of the system. There is no possibility for the man and the machine to discover how much each knows or what each knows nothing about.

The problem is that, in the current state of advisory-system design, the machine and the human are not sharing information and perceptions about the state of the world in a manner that will enable the system to arrive at a consensus decision, and take an agreed-upon coordinated action. The solution to the problem of designing cooperative human-machine systems is not in better interface designs or better explanations. The problem and its solution reside elsewhere.

In the keynote address to the 1987 AMP conference on "Information Management and Decision Making in Advanced Airborne Weapon Systems," (Ref. 3) Dr. Richard Malcolm (in his paper titled *The Challenge of the Transparent Interface*) said *"We are forced to the conclusion that the mind and the computer work very differently from one another, and to try to force one to do the other's job is folly."*

This dilemma is emphasized in the presentations of this session because they all considered systems to assist the pilot in real time during highly dynamic situations when the pilot does not have time to evaluate carefully the advice offered. If the pilot and his advisor do not have precisely the same perception of the situation, and the pilot does not have the time to clarify the differences, he must arbitrarily select one or the other when either or both may be wrong.

5. Planning for Air-to-Air Combat GRAY, I.D. (U.K.)

Mr. Gray introduced this session with a particularly good example of the complexities inherent in developing effective real-time advisory systems. He

tackled the formidable problem of providing timely tactical advice in air-to-air combat and the challenges these pose to development of needed technologies. He points out that the air combat environment is *"very dynamic, involves intelligent adversaries, implicit group operations, and has very incomplete information available within it."* Mr. Gray states that group operations and ad hoc cooperative tactics have proven difficult to formulate on a rational basis. However, he fails to recognize fully the implications of the facts that air-to-air combat is highly unpredictable and entails adversaries who, while intelligent, do not always engage in acts that appear rational to an observer. Mr. Gray's proposed solutions are based on implementing procedures based on formal logic. But these are not at all the way a human analyzes a problem and arrives at a decision. Mr. Gray says his process can account for actions taken by the adversary that are suboptimal or unexpected, but can it take account of an irrational move? For example, limits of the V-N diagram used in constructing this logic may mean nothing to the desperate adversary in air combat. The situation is similar to the problem of machine chess. The masters have frequently defeated the machine by making illogical moves. Even if Mr. Gray succeeds in finding ways to prune his search/planning tree to reasonable size in order to produce a plan in time for the pilot to peruse and consider it, do we have any assurance that the pilot will find the plan acceptable---or even understandable? The search tree for coplanar engagements limited to conventional moves is already too large. In all likelihood, it will become necessary to introduce heuristic pruning, but heuristics have never proven successful in any comparable application of expert systems. Of course, there are the tremendous benefits to be realized from timely advice to the pilot engaged in air-to-air combat noted by Mr. Gray, but we do not yet know how to do it with any assurance that the advice will be correct and acceptable to the pilot under all circumstances.

Certainly, mission planning prior to execution of the mission is a candidate for an advisory system, and a great deal of work has gone into developing such systems. However, this too should be designed for maximum interaction with the aircrew because planning is an essential part of training for the mission. It gives the crew the opportunity to think through the mission and prepare for contingencies. We need to understand the entire process of mission planning. With proper design, a computerized mission-planning advisor can be used to reinforce this essential process. On the other hand, I have great reservations about the use of automated re-planning in real time (i.e., in flight) because of the importance of the crew involvement in the planning process.

I am not certain that totally automated in-flight mission planning is a desirable capability for most military missions. However, an advisory system could be useful when we learn how to design it for effective communication with the human responsible for the mission planning and for its execution.

6. Pilot Decision Aiding for Weapon Delivery: A novel approach to fire control cueing using parallel computing BUFFETT, A.R. & WIMBUSH, R.M. (U.K.)

Messers Buffett and Wimbush undertook another challenge nearly as formidable as that of Mr. Gray. They tried to provide the pilot with decision aiding, in the form of firing cues, for the use of air-to-air missiles. Without a doubt, the scenario described by the authors is yet another in which the pilot desperately needs help. The nature of the challenges for fire-control cueing are identical with those for advice in air-to-air combat; namely, complex calculations over an extensive search/planning tree must be carried out sufficiently rapidly for the pilot to consider the advice prior to taking an action, and the advice must be acceptable to and quickly understood by the pilot. Once again, as in the case of Mr. Gray's advisory system, the process is based on formal logic even though the adversary cannot be expected to be logical.

The authors stated that "*The detailed 'end-game' of a missile fly-out is statistical in nature and probably cannot be modeled 'correctly'....*" This being the case, of what value will the advice be to the pilot? What reliability is the pilot expected to attach to any advice, and does making such judgments under the stress of the battle-field engagement add to his already excessive cognitive workload? Are we, once again, introducing worse problems with the fix than existed before?

7. Aide à la décision tactique en combat rapproché (Aiding Tactical Decisions in Close Combat) SEGUIN, A. & GILLES, A. (FR)

This was another attempt to develop an advisor for tactical decisions which is susceptible to all of the same concerns I expressed with regard to the previous two papers of this session. A questioner from the audience asked how the system coped with uncertainties, to which the authors replied they had not yet looked at the problem from this point of view. But is this not a fundamental issue? This is an advisor to the pilot, whose primary purpose for being aboard the aircraft is to cope with uncertainties and the unexpected. Is it not appropriate to ask how well the advisor will perform in assisting the pilot to perform this job?

8. A New Class of Mission Support for Combat Aircrew PIPE, H.J. (U.K.)

The problem addressed by Mr. Pipe was quite similar to those considered by Mr. Gray, Mr. Buffett and Mr. Wimbush. Again, I have no argument with the statement that the problem exists, and that the pilot needs help. I do have a problem with the proposal that we know how to build an acceptable solution, and, even more, with the implication that we know how to validate our solution.

According to the authors, the Mission Management Aid (MMA) was designed to "...*behave sensibly within the bounds of Mission constraints....*" but, as I have said already several times, sensible behavior may not be

consistent with human behavior in air combat, nor may it be a winning strategy.

The authors recognized that the assistance must be provided without adding to the cognitive workload during critical situations. Is this possible? The pilot continuously formulates his own predictions and plans in this dynamic environment. It appears to me that the need to compare his plans to the proposals from the MMA does not reduce his cognitive workload, but rather can significantly increase it particularly if they are based on different perceptions of the situation and different interpretations of sensory inputs.

The MMA incorporates pilot interaction into the situation assessment and planning, but the authors did not seem to appreciate how difficult it is to enable the necessary dialog. I described some of the difficulty in my introductory comments to this session.

The MMA establishes information priorities based on its presumptions of what the pilot needs to know and when he needs to know it. This concept has been attempted in the past with little success. How can we be certain what data are important to the pilot and when in a sudden change of situation? After the unexpected event, it is too late to discover that certain data should have been displayed.

9. Pilot Intent and Error Recognition as Part of a Knowledge-based Cockpit Assistant WITTIG, T. & ONKEN, R.C. (GE)

This presentation reported on a well-intentioned and appropriate study in which it was recognized that a knowledge-based cockpit assistant needs to be able to distinguish between intentional, albeit unexpected, behavior and pilot error in assessing the situation. Nevertheless, I have several concerns about the particular solution proposed. It might have application to the commercial transport as presented by the authors, but I caution against considering it for the unconstrained environment typical of, say, air combat. It is based on determining relevant pilot scripts based on expected behavior and comparing the pilot's activities with expected ones. In the highly disciplined environment of the commercial air transport governed by well defined operational rules and procedures, the basis of "expected behavior" may be reasonable. But this is probably not a valid basis for judgments of actions taken by the pilot engaged in air battle. Further, the authors claim that pilot behavior can be represented by a set of rules, but this is unfounded except, possibly, in nominal operations of commercial aircraft. Even in this case, this approach would have no value in a totally unexpected situation. In this instance, when the pilot is already hard at work, the system would only add to his workload by signaling a false alarm of an error. The potential for excessive false alarms leads to distrust.

I also am concerned about the validity of applying probabilistic reasoning and Bayesian analysis to classifying pilot intent. The claim that this is "*well established knowledge on human cognitive processing*" is currently in question. The experiments performed at Stanford on medical diagnosis produced opposite results

when they were replicated with only slightly different instructions to the subjects.

Finally, while the machine needs to understand the human, it is equally true that the human must understand the machine. The fundamental need is for effective support for communication and common understanding. The pilot must also be able to determine whether confusing advice is intentional or in error.

10. A Retrospective on Pilot's Associate RAMAGE, J.K. (U.S.)

The ambitious concept of the Pilot's Associate program when it started over 16 years ago was to assist the pilot with correct and acceptable advice and support in a timely manner on assessing his situation, planning his mission and tactics (both prior to and during the mission), and managing his systems during air-to-air combat. This was an example of an advisory system that failed largely because insufficient attention was paid to determining what would be needed to make it acceptable to the user. An advisor is only as valuable as the extent to which his advice is accepted. Although tests showed that the advance-mission planner and the error detector were generally useful, the pilots' comments on the tactical planner were uniformly negative. The speculation is that pilots do not readily accept advice concerning high-level tasks, but that contradicts the evidence of experienced human-team performance in critical situations. I maintain that a pilot will (and does) accept advice even in an emergency provided that he understands and trusts the source and is certain that the advisor has the same perception of the situation as he. This is a valuable lesson to be learned from the PA program as we undertake to develop advisory systems to operate in even more complex and unpredictable environments.

Session III - Situation Awareness

"Situation Awareness refers to the ability to rapidly bring to consciousness those characteristics that evolve during a flight." (Ref. 7) In most of the presentations of this session, the implication was that the machine knew the situation precisely, and that the only problem was to get this information to the pilot. As a consequence of this misperception, the question of why the pilot was there was often raised during this session. However, we have recognized that there are certain invaluable qualities in coping with the unpredictable that the human brings to the system performance that cannot (yet) be emulated by a machine. Consequently, it is essential that the engineer recognize the communication necessary for situational awareness is bi-directional; in some circumstances, the pilot is likely to have useful information to contribute to the correct perception of the state of the world.

Another misperception evident in several of the presentations was that the pilot was merely a "monitor." The pilot must be kept aware of the situation so that he will be able to take over full control in the event of an unforeseen circumstance for which the system was not designed. His is not a totally passive operation as the developers of AI and automated systems would imply;

he must feel as though he is constantly in the control loop if he is to take over control quickly and effectively.

Furthermore, it is inappropriate for the designer of a display to declare that his display produces "Situational Awareness." Awareness of the situation is subjectively determined by the user of the data presented in the display, and is influenced by the sum total of the user's knowledge of the current state of his world, how it got there, his role in it, and his look into the future. Displays present data, not information. It is a major problem for research psychologists to measure reliably the degree of situational awareness. Situational awareness has important consequences for the potential of a behavior to succeed or fail, but it cannot be directly observed in that behavior. Developers of devices to assist the pilot in being aware of his situation are encouraged to consider carefully the numerous cautions in the papers presented during Session IV, and, in particular, the one by Endsley and Bolstad titled "Human Capabilities and Limitations in Situation Awareness."

The format or symbology of the display on a HUD, the use of a virtual display, head-steered sensors, and integrated helmets described in this session do not, in and of themselves, ensure that the data they present will be gracefully integrated and interpreted into the information that enables the pilot to ascertain his situation correctly and rapidly. Can we be certain that the data presented, whatever the display, do not overwhelm his perceptual and cognitive capabilities at a moment of high stress, and do not interfere with his decision-making responsibilities? On the other hand, if the system is designed to filter the data, how can we be certain that we have not eliminated information essential to his coping with the unexpected? How can we ensure situational awareness when the unexpected occurs, and just when the pilot needs help the most? Current systems also typically suffer from inadequate feedback to enable the operator to understand the situation and take an appropriate action when there is a time pressure. Moreover, they frequently merely present the situational data of the moment, whereas the operator needs to know the events of the recent past to make predictions of the future.

The problem of human-computer interaction and, in particular, of situation awareness is often considered to be merely one of proper interface design, and this misconception was reflected in several of the papers presented during this session. However, when the human and the machine must each contribute a share of the information needed to define the true state of the world, this viewpoint is not appropriate. A well-executed interface design is a necessary, but not a sufficient, condition for communication and cooperation. The objective of interface design is simply to put the data in the mode (i.e., visual, auditory, tactile, etc.) and the format (i.e., alphanumeric, iconic, clock dials, thermometer tapes, color, font, size, location, etc.) to maximize the likelihood that the human can translate the data displayed into information. Unless the user can effectively integrate and decode the data representations to extract relevant information (as defined individually by the user), the display design will fail to support the user.

We have found that the electronic display systems we provide to aid the pilot sometimes were not helping at all, and were actually complicating his job. The pilot is frequently being confronted with too much data in formats that are not conducive to rapid interpretation and integration, and whose access imposed a memory load. Some applications of computer interface technology resulted in increased demands on the slow, deliberative, capacity-limited human cognitive processes rather than in engaging parallel, automatic, perceptual-recognition-based processes. The pilot is often drowning in data much of which may be essential to his survival, but is starved for information.

Without a doubt, improperly designed interfaces will interfere with communication, but even the most elegantly designed interface will not assure mutual understanding under all circumstances. While interface design is an important element of the integrated human-system design, the interactions must be well understood before undertaking an interface design. To focus on the human-computer interface as the area of principal concern is not enough. The solution to the problem of designing cooperative human-machine systems is not solely in better interface design which is merely the language of communication. As stated in the TER of the 1982 GCP conference *"Modern aircraft have intelligent systems which can communicate with each other, but although machine-to-machine communications are now easy, as those from man to man have always been, man-to-machine communication still poses problems."*

Procedures and measures are needed to assess objectively the pilot's awareness of his situation as a consequence of system concepts as well as alternative displays.

11. The Design and Development of the New RAF Standard HUD Format HALL, J.R. (U.K.)

The author described a 15-year effort to develop a display design for intuitive spatial awareness with minimum potential for misinterpretation in all flight situations. He claimed that the Fast-jet HUD Format (FJF) has been shown to minimize spatial disorientation even in extreme flight conditions. In answer to a question from the audience, the author admitted that this format may not be the "last word," at least, for use in an HMD. However, he certainly implied that this was the last word for HUDs and pointed out that a STANAG was in preparation. Unfortunately, another word (and position) was presented by the authors of the next paper.

12. Symbology for Head-up and Head-down Applications for Highly Agile Fighter Aircraft - to improve spatial awareness, trajectory control, and unusual attitude recovery FUCHS, W.H., FISCHER, G., PHILIPP, H. (GE)

The authors of this paper offered an alternative HUD format, called the Arc Segment Attitude Reference (ASAR), to the pitch-ladder display proposed by Mr. Hall in the previous paper. The ASAR is vastly different from the display described by Mr. Hall and, yet, according to the authors, pilots found both to be great improvements in spatial awareness in simulations and

in flight to current displays. What does this mean? The optimum display design is not unique? Which is the most logical and intuitive? Should the ASAR replace the pitch bars as the standard format or is there yet another even more ingenious display waiting to be devised? The authors claim that flight tests demonstrated pilots were able to recover from unusual (and unexpected) attitudes without failures using the ASAR, while, with the pitch-ladder display, they often hesitated before taking corrective action or took incorrect actions initially. I consider that a display that enables a pilot to invariably and immediately take the correct action to recover from an unexpected attitude is a very compelling demonstration of its effectiveness in providing spatial awareness.

13. Virtual Interface Applications for Airborne Weapon Systems HOWARD, E. (U.S.)

The author used Virtual Interface (VI) technology to refer to *"head-coupled displays and controls, perspective and stereoscopic displays, electronic associates, etc."* and the term VI to *"establish the notion that the PVI design is intended to be natural, seamless, and intuitive."* She noted that VI technology offers several unique advantages for displaying data, but that its current capabilities limit its applicability to fighter cockpits.

I should like to point out that VI technology is certainly not new. It is so mature that you can buy it from Nintendo. The supercockpit that the U.S. Air Force spent many years developing over a decade ago, was based on a virtual helmet-mounted display. It failed mostly because we were unable to determine exactly what to put in that display not because of any foreseen fundamental limitations on the technology itself. The issue is not whether the technology can be developed, but rather of how and where to use it; at the moment, it is a solution looking for a problem. The author proposed a problem in the form of a "novel display concept" called the All-aspect Head Aiming (AHA) display for use in an "embedded simulation."

I have two difficulties with the author's proposal. For one, it is not obvious to me that the particular display concept makes use of advantages of VI that the author articulated so well, other than possibly a wide field of view, which I do not consider to be an advantage unique to VI. I even failed to appreciate how this display demonstrated fully the exploitation of the particular characteristics of human peripheral vision. For the other, I must have misunderstood the author's use of the term "embedded simulation." I understand the expression to mean the provision of capabilities within the system design with which the actual system can be used as a simulator (usually for training) by linking it to a computer that simulates the rest of the world during a mission. Certainly, there is great potential for use of VI in an embedded simulation when it is part of the actual system. We seem to be far from that state. On the other hand, VI has application to, and is being used in, ground-based, man-in-the-loop simulators exploiting many of its unique advantages.

I would have preferred to hear more discussion by the author on how to use the advantages of VI and on the potential it offers for enhancing situational awareness.

15. Head-steered Sensor Flight Test Results and Implications LYDICK, L. (U.S.)

This was an excellent presentation on a program to develop and evaluate head-steered FLIR/HMD night-attack system integrated with fire control, navigation, communication and display system for the close-air-support mission. In my opinion, this was a very successful engineering accomplishment that demonstrated some valuable lessons for the future similar displays that will be developed. For one, we learned that monocular display produces binocular rivalry; something the Apache pilots have known for some time, but have been reluctant to admit. For another, I was surprised to hear that a 20 ms delay in the head-driven visual system was just barely acceptable when most man-in-the-loop simulators are content to accept up to 50 ms. It is also interesting, albeit not so surprising, to note the several occurrences of vertigo, particularly on first flights, the reports of high levels of fatigue, and the indications of anxiety. From a human factors perspective, it would be extremely interesting to understand the apparent orienting influence of the system and the failure of the pilots to admit to any sensation of detachment as reported by the author. Both of these could be important to future similar systems such as, for example, the enhanced/synthetic vision systems contemplated for future commercial transports.

16. The Quest for an Integrated Flying Helmet KARAVIS, A. & JARRETT, D.N. (U.K.)

I am concerned that this quest is driven by a desire to explore the limits of available technologies rather than by a well-defined and human-centered design requirement. The authors state that the helmet must incorporate, from the initial design stage, functionally integrated protection, life support, communication facilities, vision enhancement, weapon aiming, and flight-display functions provided that *"these are shown to be necessary and operationally useful."* I find no fault with this opinion except to encourage consideration first of the necessity and utility of each element from the user's perspective.

The authors say *"It remains for the helmet designer to be constrained by the physical limitations of the human frame. He must be aware of new concerns such as active noise reduction, NBC and automatic mask tensioning. His design must take into account supportability, maintainability and reliability. Paramount are the safety considerations of the design."*

These are all fine, but I wish that the authors had also recognized the need for the helmet designer to consider the perceptual and cognitive limitations of the pilot, particularly if they should find it useful to incorporate communication facilities, vision enhancement, weapon aiming, and flight-display functions. The authors point out that the addition of extra components compromises basic ergonomic qualities. I point out that attractive features such as vision enhancement, display and control

functions will invariably compromise basic psychological qualities.

The authors say *"Genuine integration is VITAL,"* and I wholeheartedly agree provided they include human perceptual and cognitive limitations in the integration. The authors are encouraged to review the considerations expressed in paper #18 of the next session titled *"Oculomotor Responses and Virtual Image Displays."*

Session IV - Human Capabilities and Limitations

I was particularly pleased with the AMP's participation in arranging this session.

The authors of the papers in this session addressed some of the concerns that I have already expressed above. The problem remains that much of the understanding about human psychological and psychophysiological capabilities and limitations described by these authors has not yet found its way into the designs of the technology-driven systems described in the other sessions.

17. The Physiological Limitations of Man in the High-G Environment: Implications for Cockpit Design GREEN, N.D.C. (U.K.)

This was a paper with which I have absolutely no argument. It represents the proper approach to considering human limitations in aircraft design, and presents it in an admirable fashion. In this case, the author addresses the implications of the physiological limitations of the pilot to high accelerations on an aircraft's maneuverability--certainly a fundamental consideration of fighter aircraft performance. I would like the developers and designers of the systems we heard about at this meeting to take note and learn a lesson from this, because the same approach needs to be taken with regard to the implications of psychological limitations on displays and controls, automation, and advisory systems. Some of these concepts, such as helmet-mounted displays, will also encounter physiological limitations. For example, acceleration effects on peripheral vision could negate one of the benefits of the helmet-mounted display even if the pilot does not lose consciousness. Of course, the added weight of the helmet is a prime concern. Pressure breathing with G loads will interfere with voice communication systems that have been proposed. At least, the designers need to take account of the understandings provided in this and the next three papers and to cooperate closely with the human factors community.

18. Oculomotor Responses and Virtual Image Displays EDGAR, NEARY, CPAIG (U.K.)

This was an excellent presentation on some the basic physiological and psychological characteristics of the human visual system that have important implications for virtual-image displays such as are commonly used on HUDs and HMDs with regard to safety as well as effectiveness. For example, it may be easier for the user to eye track a target if it lies in a different depth plane

from the background. This means that it may be beneficial to alter the disparity between the images of the target and the background presented to each eye on an HMD. This characteristic might also reduce tracking performance with a monocular HMD, especially during air-to-ground operations.

HUDs and HMDs, as currently designed, may have adverse effect on the pilot's ability to maintain accommodation appropriately. Virtual imagery can precipitate lapses of accommodation; the outside world could appear further away than it is and could become blurred with consequent serious operational safety implications. Inappropriate accommodation can also influence depth perception.

The potential effects are sufficiently serious and robust to give designers ample cause to consider them in designing virtual-image devices, including those being considered for enhanced vision systems for commercial transports.

19. Human Capabilities and Limitations in Situation Awareness ENDSLEY, M.R. & BOLSTAD, C.A. (U.S.)

This is another of my highly recommended readings for cockpit designers. The authors presented an excellent exposition of many of the concerns about human cognitive capabilities and limitations that must be considered when designing systems that are intended to help the human user. Whereas the previous two papers of this session were concerned with things that are largely physiological, this paper was concerned with things that are cognitive and their implications for situational awareness (SA). For example, humans have a limited pool of attention, their perceptions are influenced by the expectations, their attention span narrows under high workload and stress, and they tend to focus on those things that they believe to be the most important even though they could be wrong.

The authors reported the results of an experiment that showed significant individual differences among experienced pilots in their abilities to maintain situational awareness. They postulated that these differences could be correlated with six basic skills; namely, spatial abilities, attention abilities, memory, perception, logical/analytical skills, and personality. Their tests of this hypothesis produced inconclusive and somewhat confusing results. They blame this on the limited sample size using only experienced pilots, the constraint to a single type of mission, and examination of only a single component of SA. I suggest that there may be a more fundamental explanation for the results. Many of the skills or qualities that make one pilot more expert at maintaining SA than another are not available to introspection, and, consequently, extremely difficult to identify and to evaluate. Experts cannot tell you why they are experts, and psychologists have written many books on the subject of what makes an expert without arriving at consensus.

One of the cautions from the authors to system designers is to make certain that "key pieces of information have not been inadvertently eliminated." Of

course, I agree with this excellent advice, but I want to carry this a bit further. Mostly, the pilot is there to cope with the unexpected. How can we know, in advance, which piece of data will contribute to the key information he will need, and whether he should have been kept aware of that all along? Also, as the authors correctly state "The pilot needs to be able to respond to not only the immediate crisis, but to look ahead to what is coming up---to possible situations that are forming." What information (or what data) does he need to be able to do this?

20. Operator and Automation Capability Analysis - Picking the right team TAYLOR, R. (U.K.)

In my opinion, this was certainly among the best papers presented at this symposium from the aspect of technical content. The author presented what I consider to be the right perspective on this entire problem area with the statement "The notion of man and machine working as an intelligent, co-operative team is considered by many as being central to the application of AI technology. The introduction of team concepts provides a broader framework for thinking about human-machine cooperation."

I agree that the coordinated activity when a team of individuals is required to perform a complex task is the appropriate model on which to base a design philosophy for human-machine collaboration. I suggest that we might structure such a philosophy on the bases of the relevant empirical work on human-to-human interaction during cooperative problem solving, and to relate the characteristics required of effective and valued human members of the team to the design requirements of the non-human member. While this is the proper philosophy, it appeared that the author failed to understand the full implication of his statement.

The domain of applications of automation being considered covers the range of human involvement with machines between systems that are operated entirely under direct manual control and those that are completely automatic and are transparent to the user. All such systems require humans and machines to interact dynamically in a complementary manner because the human and the machine must each contribute a share of the information needed to define the true state of the world; and/or the human and the machine must each contribute a portion of the actions needed to achieve the mutually desired state of the world.

As suggested by the author of this paper, designers of such systems must think in terms of the performance of a total system (a team) composed of human and non-human entities. The mutual influences among these entities constitute interactions. The system performance is concerned with optimizing the interactions; not the individual behaviors of the components. The machine-design philosophy must be based on a concept of building a human-complementary, human-interactive system. Human-centered design is not solely for the purpose of preserving the flexibility and authority of the human as suggested by the author. It is to provide a total system design that takes into account the human's capabilities and limitations so that he is enabled to

contribute his share, whatever that may be, to fulfilling the objectives and coping with every situation. In this philosophy of sharing, the competition for, and the allocation of, tasks between men and machines become meaningless. "*Human-centered design*" and "*Function allocation*" are contradictory concepts.

Moreover, so long as the human is assigned responsibility for all the critical decisions, the system hardware must not make it difficult for the human to assume these responsibilities. In this case, the objectives of a human-centered design should be to support humans to achieve the operational objectives for which they are responsible. The human role must be treated as central and the machine must be used to assist the human in achieving his goals rather than to supplant him.

The problem that interferes with the communication of information and understanding fundamental to this team concept is analogous to that of establishing communication between two persons of different cultures. Humans come from a "*culture*" that is totally different from that of the non-human "*intelligence*." Differences in the processes of problem solving and decision making are deeply rooted in the respective traditions and cultures of humans and machines. Machines do not sense data, process it, solve problems, make decisions, learn from experience, or take actions the way humans do. Machine logic is not the same as human logic. In fact, not everything that humans do is completely logical. It is easy to accept that a non-human "*intelligence*" cannot be expected to understand a human. It is equally true, even if not so obvious, that a human cannot be expected to understand a non-human "*intelligence*." A team of humans becomes effective in a particular domain only after they have shared common knowledge and experience about the state of the world and meaningful activities in the context of that domain. A partnership between the human and the machine must be built on mutual understanding and trust. The machine must have the ability to anticipate its human-partner's actions. The human must be able to anticipate and understand these machine anticipations in order to work cooperatively. Furthermore, if the human has an incorrect image of the machine's model of the world, he may not be able to fit correctly any conclusions of the machine into his image regardless of the degree of sophistication of explanations. The human may need to be able to ask the machine "*Did you know about this when you suggested that?*" in order to decide whether to accept or reject a proposal. Similarly, the machine may need to be able to ask the human this same sort of question, and interpret the response correctly in the context of its own perceptions. The arrows on the block diagram that the author presented for the system authority concepts of co-operative functioning should aim in both directions. Bi-directionality of communication has been shown to be a very strong influence for effective human-human teamwork.

The author called for systems that the user can trust to act autonomously. I maintain that the user must also be able to trust the machine's advice and information and to trust it to share appropriately in executing agreed

upon decisions for action, just as he might another human member of his team.

21. Cognitive Interface Considerations for Intelligent Cockpits EGGLESTONE, R. (U.S.)

In many respects, this presentation complemented the previous one. It was a rather philosophical discussion of the cockpit architecture appropriate to the notion of an intelligent cockpit.

If the cockpit has cognitive capabilities as proposed by the author then a human-machine joint cognitive system implies a productive relationship between the knowledge of the machine and that of the human in which the different points of view are integrated in the decision process. Regrettably, the profound consequences of this implication on the system architecture were not discussed by the author.

Of course, a system in which human users can override the machine partner, as currently required, compromises the goal of developing truly cooperative human-machine systems. The human may not always be the most competent decision maker, and the correct perception of the state of the world may only reside with the machine member of the team. Someday, we may consider the case when the human is no longer the sole supplier of the initiative, the direction, the integration, and the standards. We may accept that the safest and most efficient system is one that incorporates considerable duplication or interchangeability of functions among its human and non-human crew members and thus benefits from the strengths of both.

In the meantime, current delegations of authority to the human member of the team do not change the requirement for true and effective dialog during the decision-making process, and the author indeed recognized this in his cognitive design requirement calling for effective cognitive-level transactions with the user. However, I believe that this means there must be commonality of the cognitive processes in the two members. Significantly, the author noted the difficulties of dealing with the ambiguities of anaphoric references and elliptical expressions something which seldom causes problems of understanding between members of an experienced human team with common cultural backgrounds.

In the author's architecture, the intelligent cockpit totally obscures the system from the user by interposing its own interpretation of events prior to their display and by interposing its own interpretations of the pilot's response prior to their implementation. The philosophy of the intelligent cockpit may have some value to the engineer as a construct, but I fear it obfuscates the true intention of human-centered design.

22. Ergonomic Development of Digital Map Displays MARTEL, A.P., VASSIE, C.K., & WARD, G.A. (U.K.)

This presentation was largely concerned with design of the display format; i.e., with things like choices of icons, color, font, size, the use of luminance or chrominance contrast, shape, and edges. (Things that

might be treated best by commercial artists.) Such features can be very important to recognition, but may have very little to do with understanding and with the efficiency of transfer of information. Recognition of, say, a letter is not a cognitive skill (at least, beyond the age of about 5), it is a psychomotor skill. The understanding of the letter (or more properly groups of letters) is the cognitive part of the process, and, whereas recognition may be very fast, interpretation, assimilation with other display components, and understanding are the time-consuming parts of the process and the concerns for cognitive workload. This paper was an interesting, but certainly not the most important consideration of digital-map-display design from a human factors perspective.

Session V - Design and Evaluation of Integrated Systems

In most cases of the systems described at this symposium, the evaluations of their integrated designs must be determined by the effectiveness of the cooperation among the human elements and the machine elements in arriving at a decision and in taking the appropriate action in all possible situations.

The power of an integrated human-machine system resides in the system design that makes the most effective integration of the characteristics of all of its components. Automated systems must be designed with an awareness of, and as complements to, the cognitive and motivational inclinations of the human users. Just as in a team composed entirely of human performers, proficiency of the individual entities of a human-machine system does not assure proficient and effective team or system performance. Cooperation entails information transfer which is inherently an interactive process. We will never achieve effective cooperation between human and machine as long as we continue to design the machine without integrating the perceptual and cognitive limitations and capabilities of the human. In an analogy with the artificial heart program, the introduction of machine intelligence in a given system can fail (and has failed) because we do not understand the rejection mechanisms of the human.

In my opinion, the presentations in this session did not address the fundamental aspect of evaluating adequately the potential for human factors problems in the designs or in their evaluation procedures. Does the system support the human in fulfilling his responsibilities under even totally unexpected situations when he is likely to be required to act with ingenuity under extreme stress? Is the system able to continue to help the pilot if he chooses to act unpredictably (which may be the winning strategy)?

23. System Automation and Pilot Vehicle Interface for Unconstrained Low-altitude Night Attack CHURCH, T.O. & BENNETT, W.S. (U.S.)

This was a demonstration of the absolutely marvelous capabilities that are achievable with competent engineering and integration of available technologies. My concern with this presentation was the absence of any consideration for what the pilot is expected to do (or

be able to do) should he encounter an unexpected situation or a system failure or an incomprehensible display while engaged in a low-altitude, night attack. I have no doubt that this marvelous system will indeed work as advertised in all the nominal scenarios for which it was designed. But, in the highly disorganized and unpredictable environment of the battle-field engagement, it is very likely to encounter a set of inconceivable circumstances. What then?

24. Evaluation Automatique de Combats Aériens Fondée sur les Intervalles Caractéristiques (Computer Assisted Evaluation for Air Close Combat Based on Time Interval Characteristics) POUTIGNAT, Ph. & FONTENILLES, H. de (FR)

The authors described an interesting concept for a training tool whose value to training has yet to be demonstrated. It is intended to help instructors and pilots in training for air combat by providing them with an interactive simulation. The use of time-interval characteristics simply enables the computer to provide fast diagnosis of errors from a tactics rule base or of alternative maneuvers that stay within the prescribed performance criteria. The rules and criteria are based, in part, on interrogation of experts and, in part, on analyses of expert performance in an air combat man-in-the-loop simulator. It is not possible to predict whether this concept will enhance pilot training, although there is some limited evidence that the use of well-designed video games have benefited pilot training. The idea is worth a controlled study of its value.

25. Evaluation on the Flight Simulator of an Experimental System to Support the Pilot During Air-to-air Engagements (NATO CONFIDENTIAL paper -UNCLASSIFIED Title) ASPERTI, C. (IT)

The author presented some very interesting results of an evaluation of an autopilot to assist a pilot with a gun attack on an adversary aircraft. This is another example of a mission in which the pilot needs help. It is extremely difficult, requiring the pilot's full attention, to bring the piper on the target and to stabilize it long enough for effective gun fire. The autopilot design met its requirements and, apparently, did its job very well--- certainly much better than the pilot was able to do on his own (although, in fairness to the pilot, the author admitted that the piper was not well designed for manual tracking). The interesting point was that the autopilot plus pilot had less aim-point error in elevation and better firing possibilities than did the autopilot alone even though the added control inputs by the pilot were quite small. The author said he thought this was because the pilot was able to predict better than the autopilot when the target maneuvered in an unpredictable manner. Also significant was the comment from the pilot that he felt he was controlling the attack. I believe this a very important feature of a well-designed man-machine system. If the human is assigned ultimate authority and responsibility, then he must feel that he is in control at all times. He cannot simply be taken along for the ride.

26. An Assign-and-Forget Weapon System for Helicopters (NATO CONFIDENTIAL paper -UNCLASSIFIED Title) ECKERT, E. & MATTISEK, A. (GE)

At the present time, there are many problems with the guns mounted on helicopters for air combat that interfere with their effective use and impact safety of flight. A part of the solution to an assign-and-forget weapon system for helicopters is a new recoil-free, turret-mounted gun.

It seems to me that this subsystem fits within the requirements that permit total autonomy. When the task environment is satisfactorily predictable and a priori controllable, when the machine has acceptable reliability, and when the activities necessary for the task are iterative and demand consistent performance, a machine can, and should, perform the task without continuous human involvement. The nominal operation of such subsystems can be made transparent to the human. Subsystems that fall into this category, for example, are the automated yaw damper on all commercial aircraft, and the automatic choke in the automobile. These systems are nearly completely automatic, except that they must be designed to allow graceful intervention by the human operator in the rare emergencies, (for example, in this case, suppose the pilot suddenly discovers the target is a friend and not a foe) and for maintenance. (An important area for human factors engineering research that has been neglected is how to design a complex automatic system to facilitate its being backed up manually.)

It seems to me that, once the target is detected and assigned, the pilot/gunner would be quite content to leave the task to the automated weapon. Even I have difficulty finding a potential human factors problem with this concept, except, possibly, the one mentioned by a member of the audience; namely, a potential momentary confusion to the gunner after lockon when the FLIR tracker decouples from the helmet sight.

27. Intégration de l'équipage dans les modes de tir du Tigre et du Gerfaut (Integration of the Crew in Tiger and Gerfaut Flying Modes) (NATO RESTRICTED paper - UNCLASSIFIED Title) DESTELLE, D. (FR)

The author described an architecture for multi-mission capabilities. As far as I could ascertain from the presentation, the only consideration for human factors was that pilots were members of the Cockpit Working Group which, the author said, was a body for making high-level decisions of design concepts and of budget; hardly what I would consider a terribly loud voice for the man in the man-machine system. It was also difficult for me to determine from the paper the validity of the evaluation process by which the man-machine interface was "optimized."

28. Flight Evaluation of a Computer Aided Low-altitude Helicopter Flight Guidance System SWENSON, H.N., JONES, R.D. & CLARK, R. (U.S.)

A computer develops a tree structure of possible paths, logically prunes the tree, and then presents the best trajectory to the pilot as a "pathway in the sky" (not notably different from the "tunnel in the sky" display proposed several years ago). An interesting idea was the display of a phantom aircraft that helps the pilot follow the path by pursuit tracking; probably a good way to help the pilot visualize his future flight path.

In this system, as in many of the others, I cannot evaluate how easy it is for the pilot to act unpredictably and continue to get the help he needs. It could be a problem for him to look down into the cockpit to reset the system for a new pathway while maintaining close clearance above rough terrain. Such problems may be exacerbated by the monocular display that is currently being used (see paper #18).

An interesting point that was made in this presentation was in answer to a question from the audience as to whether the author perceived differences between the ground-based simulation and flight. The speaker stated that the performance limitations the pilot will accept in the simulator are much greater than those that are acceptable in flight---a point to be noted well by those who rely too heavily on simulation for validating concepts. This poses a dilemma because, mostly, we are concerned with performance limitations at the fringes of the flight envelope where we tend to do our explorations in the simulator rather than in flight. The author also noted that the vibration levels in flight were significantly worse than in the simulator and, when combined with the helmet-mounted display, were very fatiguing.

29. Requirements for Pilot Assistance in a Thrust-vectoring Combat Aircraft HOWARD, E. & BITTEN, R.E. (U.S.)

Thrust vectoring combined with post-stall maneuver capability offers a significant potential edge in agility over conventional fighter aircraft. (See also paper #3.) This has been indicated in both man-in-the-loop simulation and in flight. However, comparison between man-in-the-loop simulations and digitally controlled simulations reported by the author appear to show that man is not capable of exploiting this edge to the fullest, or, at least, as well as the computer. The question then was why the difference between the human and the digital pilots, and what can we do to help the human utilize better the capabilities offered by this new aircraft? The author suggested that this difference was due to the digital pilot being more proficient, being able to apply what it knows consistently, and having better awareness of the situation because it has instantaneous access to all of the needed data so that it can make optimal use of even the briefest opportunities to initiate and execute an attack. The author, therefore, proposed to improve the human pilot's proficiency through better training, and to provide new displays for improved spatial and tactical situation awareness. I suggest that a subset of these proposals should include the recognition that the digital pilot was designed to use the data as it was generated to produce the information it needed. On the other hand, we have no control over the human design, and the data display format, while it is compatible with the

capabilities of the digital pilot, may not be compatible with the human needs for extracting information expeditiously. This situation bears some similarity to the comment made by the author of paper #25 in which he admitted that the pilot may have been penalized by having a pipper that (while good for autopilot operation) had not been designed for manual tracking. If we understood the capabilities of the human pilot as well as we do the digital pilot, we should be able to design data inputs to be compatible with the requirements of each.

An interesting comment offered by the author was that she believed the human with proper help will eventually be superior to the digital pilot. Although I believe this is true, I do not understand why the author would say this when she claimed that the digital pilot was able to consistently and perfectly use the full advantage offered by the aircraft's maneuverability. Could it be that the human might have an edge if he were able to exploit the available capabilities not only as well but with ingenuity, when the opportunity presented itself?

The author also commented that pilots are notably inconsistent in what they say they want in data display and format. If so, how were all those other authors able to claim the "optimum pilot-vehicle interface"?

30. Design Considerations for Night, Air-to-Surface Attack Capability on a Dual Role Fighter HALE, R.A., CHINO, J.J., NIEMYER, L.L., JADIK, J.R. & LIGHTNER, B.E. (U.S.)

This presentation described a very well-done engineering effort to produce an affordable integration and retrofit of available technologies; but, it had little, if anything, to do with assuring a good man-machine interface.

31. Overview of Cockpit Technology Development and Research Programs for Improvement of the Man-Machine Interface (Review of the AGARD AVP Symposium Madrid May 1992) PIJERS, E.W., TIMMERS, H.A.T. & URLINGS, P.J.M. (NE)

I understood the presenter to say that the sub-title of this AVP symposium was "Advanced Aircraft Interfaces: the Machine Side of the Man-machine interface." It was intended that that meeting should not conflict with the present symposium, but the presenter said this was an artificial separation, and it is always necessary to consider both sides in areas such as assisting situation awareness.

I have few comments on this excellent review of the AVP symposium except to note a couple of interesting points that the presenter made. He said there was some consensus that the cockpit of the year 2020 would be a self-contained, encapsulated spheroid embedded in the aircraft or elsewhere. If you remove pilot, where does he go? Can he exploit opportunities and exercise ingenuity from that position? How can he use his own perception of the situation if his only source of data is through the machine? Why should we believe that the machine will consistently perceive every situation perfectly?

Once again we heard a plea to make use of Fitts' list of comparative attributes of man and machine, and the need

to allocate responsibilities in accordance with those attributes. I can only repeat the opinion I have already stated several times. Allocation of functions has never succeeded as a design philosophy, it is inconsistent with human-centered design, teamwork, and dynamic interaction to share command and control as needed.

Round Table - Combat Automation: Prospects and Limitations

One of the two chairpersons from each of the five sessions convened in a round-table discussion in which each presented a statement summarizing key points of each session (except Session I) and expressed some personal opinions on the issues raised. (The following are my personal interpretations of what was said, and my own comments appear parenthetically.)

SESSION II: Professor Onken said that his comments would overlap into presentations made in other session. He felt that the main messages that came from the presentation in Session II were 1) that the capability to provide aid in real time has now been demonstrated, and 2) that the needs exist for aiding the pilot in all aspects of his job. He believed that there remained the most fundamental need to understand the requirements of and to provide appropriate support for the management of dialogue between man and machine.

Professor Onken said that, in providing support to the pilot, the easiest part was in assisting the execution of a decided action. (Like the assign-and-forget weapon system). He felt that planning is a bit more difficult but doable. (Certainly, this is true of advance mission planning, but I am not certain that automated re-planning during the course of a mission is, and, if it is, I am not certain that it is advisable.)

Professor Onken stated (and I certainly agree) that the crucial difficulty is assisting the pilot to be completely and correctly aware of his situation at all times. He raised another aspect of this problem that had not been addressed during the meeting; namely that the pilot himself (i.e., his physical and mental condition, his behavioral characteristics, his intentions, etc.) is part of the current state of the world. (How do we measure these and factor them into the machine's perception of the situation?)

Although the machine exceeds human capabilities in many respects, it still lacks human perceptual capability (which may be an important contribution to establishing the true situation). It may, therefore, be necessary to arrive at consensus on the situation, and this will require dialogue and efficient information flow between man and machine (things we do not yet know how to do).

SESSION III: Mr. Agneesens pointed out the two main themes of Session III: 1) descriptions of developments of new display concepts that may be new approaches but have yet to demonstrate acceptance, and 2) papers describing engineering activities of integrating available technologies. (Mostly, I agree with this perception, and find, regrettably, that in this area of situation awareness, which Professor Onken pointed out to be the most critical and difficult, the presentations were to a large

extent, technology driven with only rare indications of concerns for harmonizing system designs with human capabilities.)

SESSION IV: Dr. Davies summarized the papers in Session IV. She noted, particularly, the importance of appreciating the potential visual problems with HUDs and HMDs described in paper #12. Although HUDs and HMDs have been around for along time, it is a bit disturbing to discover potentially critical problems at this late date.

She reminded the audience of the important message in paper #13 that use of known human-factors principles in designs could possibly lead to improvements of system performance without relying on more automation. She felt that paper #22 demonstrated the merit of this message, and showed the danger of not considering the system as a whole, including the human.

Dr. Davies believed that paper #20 presented a very powerful message by pointing out the differences in trust among members of an experienced human-human team and a human-machine system, and the importance of considering teaming between human and machine. Paper #21 supported paper #20 by pointing out the need to understand the cognitive interface and account for human adaptive behavior

A member of the audience wondered if the concept of paper #21 might be used to give some insight into crew sizing. He suggested that there needs to be research on the allocation of functions between man and man as well as between man and machine.

Another member of the audience said there needed to be more information on the human physiological systems for, say, developing integrated helmets that are ejection safe.

A member of the audience noted that paper #17 was concerned with physiological limitations of men, and wondered about the data base for women with respect to tolerance to g-loads. Dr. Davies noted that while women are known to be somewhat less tolerant to a given gradient, the gradients are less because women tend to be shorter and lighter.

Dr. Davies also stated the need to find a way to make the pilot more comfortable in his cockpit even under

high-g loads, and that, in general, there needs to be more attention paid to basic comfort.

(These were good comments made by Dr. Davies and by members of the audience, and worthy of further consideration by both researchers and system developers.)

SESSION V: Dr. van den Broek expressed the opinion that the objective should be to automate as much as possible. He felt that this approach could have significant affect on the data that need to be displayed. It would then be possible to reduce the data to the pilot to only those essential to his monitoring the automatic system. Dr. van den Broek suggested that the pilot needs only to monitor just to "make sure that everything is going right" and, if anything goes wrong, he can intervene. (When a user monitors the operation of a machine, it is so that the user may take over full control efficiently, effectively, and correctly if required. In order to be able to do that, the user must know not only what the situation is at the moment he takes control, but also how the machine got itself into that condition so that he is able to diagnose the problem, predict the potential future states, make the appropriate decision, and take the correct action. Considering that we are attempting to cope with a situation which was never taken into account in the design of the machine, what information will the user need, and what data must be presented for him to extract that information in time? Notice in this scenario, I have not included the special case of the battle-field engagement in which the human's life may depend upon his ability to grasp a momentary opportunity presented by his adversary and take advantage of a totally unexpected maneuver to win the day. What automated system with only the human monitor aboard can do that? Until the potential lethality becomes totally unacceptable, the military will never give up the edge that spontaneous human ingenuity can produce.)

The Program Co-Chair, Dr. Ramage closed the round table with the summary statement that technologies to automate higher levels of responsibility are being developed, the function of the pilot in the military aircraft will continue to change with these increasing capabilities to automate, and it will continue to be essential harmonize the pilot-vehicle interactions.

OVERALL EVALUATION AND CONCLUSIONS

This symposium program offered an excellent cross-section of laboratory and field research and technology development on several of the most important aspects of the problem of designing advanced systems with assurance of the robust performance of the man-machine system. It is apparent from this and other recent conferences that a substantial number of people, in a large number of places, are deeply concerned about the effective integration of humans and complex systems. The problem of designing for shared command and control among dispersed agents some of which may be human pervades many areas and is not limited to aerospace systems. I was particularly pleased with the inclusion in this symposium of Session IV on Human

Capabilities and Limitations, which, very likely, represents the first time that human factors have been considered at the early stages of concept development. I was, however, a bit disappointed in the balance between the voices representing the man and those representing the machine. Even though most of the authors professed to having a human-centered design, or the optimum man-machine interface, few had any solid evidence to support their contention. Proving that the system performs what it was designed to do is not enough. Ensuring that the man-machine system can still perform safely and effectively in a totally unpredicted and unpredictable situation is essential. Human factors problems are encountered in the off-

nominal operations; never in the nominal situations for which the system was designed.

One day, the intelligence of a computer may rival that of the human brain. One day, we may learn how to couple human brains and computing machines in truly cooperative partnerships. For the foreseeable future, however, we must continue to rely on human intelligence, judgment, flexibility, creativity, and imagination in dealing with unexpected events, while complementing these with machine capabilities for logic, speed, persistence, consistency, and exactitude.

We will need to learn how to integrate humans with machines to an extent far beyond our current understandings. Our experience with automation in aviation convinces me that current design philosophies based, largely, on allocation of functions and on the assumption of human adaptability will not produce the machines required to perform the future missions with assurance of safe and reliable system performance. We will need to adopt a philosophy of design that views the performance of the total system composed of human as well as non-human entities. We need to be able to address human factors issues during the conceptual design stages of missions and systems; well before the problems are discovered during man-in-the-loop simulation, flight test, or operations when the consequences and their repair can be terribly costly.

We have only just begun to develop the human-performance models we need in order to identify potential human-factors problems during conceptual design. Much research remains to understand the

perceptual and cognitive functions, informational requirements, and the mechanisms of communication adequately to model human interaction with highly automated subsystems. Research is needed that transcends the boundaries between the physical, psychological, and social sciences.

Dr. Malcolm, in his address to the AGARD Conference on "Information Management and Decision Making in Advanced Airborne Weapon Systems" titled "The Challenge of the Transparent Interface" (Ref. 3) expressed well the objective of research on man-machine systems in the following statement: *"To achieve the goal of the appropriate division of labour, we must set out to systematically discover what are the components of mindware that allow us to make such decisions. We must also discover how the establishment of mindset makes use of those components to produce a trained mind. As the inter-relationships between mindware and mindset become apparent, the method for providing the most efficient training will emerge. At the same time the presentation formats of the hardware will have to present its information in formats which are analogous to the symbols used in the mind for perception and cognition. In parallel with this, new methods for permitting the aircrew to control the vehicle and present it with their decisions will start to emerge.....The result of such an integration of mindware, hardware, and mindset will be an interface between man and machine which appears to be 'transparent'. The interaction between the two will be so intimate that they will be functionally connected and, to an observer, it will be very difficult to discern where one leaves off and the other begins."*

RECOMMENDATIONS

Our inadequate understanding of the complex problems associated with the design of human-centered, partial automation in modern airborne weapon systems and in commercial and military transports has reached a critical stage. It is limiting our ability to make full and effective use of new technological capabilities.

AGARD, and, in particular, the four Technical Panels sponsoring this meeting, are urged to continue to carry this message to the aerospace community by convening conferences such as this that bring together representatives of the human operator as well as of the aircraft design, its guidance and control, and its displays. The enormity of the human factors problems to be solved must be clearly and carefully enunciated—a role for which AGARD is particularly well suited. TI conference was an important step toward developing a common agreement on our goal.

Our current situation cries out for cooperative research as there does not exist in any one nation sufficient resources in either expertise or money to solve these problems in a reasonable time. Unfortunately, I see, as yet, little evidence of any coordinated effort in this direction. I feel a sense of urgency, because while we are still struggling with the science to understand the underlying problems, the engineering community is spending a great deal of money building solutions.

The following specific recommendations for research are not significantly different from those made by the Committee on Human Factors of the National Research Council already in 1987. (Ref. 7) Six years later and there is still no significant move in any of our nations to support these proposals.

RECOMMENDATION 1: Design and support an aggressive program leading to the understanding of human crew functioning and interactions, teamwork skills, cooperative problem solving, cooperative decision making, and productivity under stressful conditions, including continual and intermittent exposures to multiple physiological and psychological stressors. An understanding of "teamwork" is not only important to developing the proper techniques for selection, training, and organization of human crews, but is also essential to development of design guidelines for complex, automated (and, possibly, learning) systems with which humans will need to cooperate.

RECOMMENDATION 2: Design and support an aggressive research program leading to the eventual development of human-performance engineering models that are able to incorporate results of the research conducted in response to Recommendation 1 above.

It has become quite clear that there is great potential value to having human performance models of sufficient validity to use for relative evaluations during preliminary and conceptual design. We need to be able to have some indication early in the design process of potential human factors problems. For this, we will rely on simulations using human-performance models to examine the contributions of the human and the machine to total system performance.

Simulation is the most promising approach for investigating the behavior of complex systems during conceptual and preliminary design. However, to make effective use of simulation during conceptual design of human-machine systems, we need a model of the human

activities, a model of the tasks to be accomplished and of the role that the human plays in accomplishing those tasks, and a model of the human capabilities, limitations, and needs to play that role.

The capability to model, structure, and analyze the human components of complex and interactive man-machine systems, has not kept pace with the current capability to develop advanced technology systems with which the human must interact. Computational modeling of human perception and cognition will enable us to describe the complementary contributions of human and machine to a system in order to be able to address human factors issues during the conceptual design stages of missions and systems.

REFERENCES

1. AGARD Conference Proceedings No. 329, "Advanced Avionics and the Military Aircraft: Man/Machine Interface" held in Blackpool, U.K., 26-29 April, 1982
2. Committee on Automation in Combat Aircraft. "Automation in Combat Aircraft" Air Force Studies Board, Assembly of Engineering, National Research Council, U.S. National Academy of Sciences, Washington, D.C. 1982
3. AGARD Conference Proceedings No. 414, "Information Management and Decision Making in Advanced Airborne Weapon Systems," held in Toronto, Canada, February 1987
4. The National Plan for Aviation Human Factors Washington, DC, 10 Jan. 1991
5. Fitts, P.M. (ed.) Human Engineering for an Effective Air Navigation and Traffic Control System Washington, D.C.: National Research Council 1951
6. Wiener, E.L. and Curry, R.E. Flight -Deck Automation: promises and problems. Moffett Field, CA: NASA TM 81206, June 1980
7. Wickens, C.D. "Workload and Situation Awareness: An Analogy of History and Implications" INSIGHT (The Visual Performance Technical Group Newsletter of the Human Factors Society), Vol. 14, No. 4, December 1992.
8. Sheridan, T.B., Kruser, D.S., and Deutsch, S. (eds.) Symposium Proceedings: Human Factors in Automated and Robotic Space Systems, Committee on Human Factors, Commission on Behavioral and Social Sciences and Education, National Research Council. Washington, D.C.: National Academy Press. 1987

KEYNOTE ADDRESS

COMBAT AUTOMATION FOR AIRBORNE WEAPON SYSTEMS: MAN/MACHINE INTERFACE TRENDS AND TECHNOLOGIES

by

Air Vice Marshal I. MacFadyen, RAF
ACDS OR (Air)
Main Building -- Room 3212
Whitehall
London SW1 2HB
United Kingdom

I would like to thank the Chairman, Commandant Mouhamad (FAF) (Moo-ham-add), for the opportunity to give this keynote address to the AGARD Joint Flight Mechanics and Guidance and Control Panels symposium and to start off your week's deliberations. May I say that it gives me an enormous satisfaction to play a small part in an organisation which provides a unique structure for international cooperation in aerospace research and development. Indeed, as the oldest scientific and technical organisation within NATO, you have a record to be proud of in your goal to disseminate aerospace technology within the NATO alliance. On that score, I was very pleased to note that at the recent AGARD Avionics panel in Madrid, one of my staff Squadron Leader Tim Southam gave a joint presentation with the DRA at Farnborough on the RAF's Integrated Helmet Technology Demonstrator Programme.

What I would like to try and do, in the few minutes that I have available, is to try and point your minds to some of the operational drivers that must be properly addressed if the "end-user" - in other words the aircrew - are to do their job in an efficient and effective way. I am the 'Man' in your 'Man Machine' interface.

The primary aim of all aircrew is to put weapons on the target and reduce the degree of air vehicle management. This applies to the air to air or ground attack environments. The pilot in the loop is more flexible and tactical in a rapidly changing scenario but his limitations are dependant upon his ability to look out of the cockpit. We must explore ways in which we might assist his natural instinctive and intuitive qualities of being unpredictable, and provide ways of maintaining his Situational Awareness in a fast changing battle scenario. His job is invariably part of a co-operative team relying on external data to prosecute an attack.

There is a strange contradiction in our man-machine combination. One part - the machine - obeys laws and can be explained by formulae. The other part - man - follows few such laws, indeed he can be most unpredictable. He is sometimes illogical full of prejudices, likes and dislikes; they come in different shapes and sizes and their performance defies reliable measurement. If God did indeed create man, in his own image, then he was certainly not a qualified engineer.

I would like to spend a few moments highlighting the theme of the symposium. A well integrated aircraft system must reconcile multiple, and potentially conflicting, data sources relative to the tactical situation and aircraft state. Raw sensor inputs would be enough to swamp our inadequate human operator. The information may have to be processed and fed to him in 'Brain sized' chunks of digestible information to provide the pilot with the information he needs, when he needs it. Future manned fighter systems must also be capable of providing automated command guidance and when appropriate ground collision avoidance cues, AOA/G limiting cues, etc. Additionally future systems must also correctly harmonize the automatic functions consistent with the pilot's intention and tactical situation.

In trying to come to some conclusions on these thoughts, this symposium will address changing and possible future operational scenarios, advanced technology concepts and this application, and the experimental work which we hope will lead to an effective Man Machine Interface (MMI) for future combat aircraft.

With all the recent dramatic changes in the world order, it is now even more difficult than ever to predict the scenario of the next conflict which, in any case is becoming increasingly difficult to define. We now talk about risks and

the operational environment; the risk to NATO interests in any particular scenario. A key part of future operations, as in the Gulf War, will be the gaining of air superiority and supremacy over the battlefield; without that supremacy, other operations will always be vulnerable and we are likely to suffer unacceptable casualties. All the studies that we have done on future fighter aircraft indicate that the demands on the next generation of such machines will require unprecedented levels of agility, performance and lethality, combined with flexibility and adaptability. I say that because we now have, at our fingertips, sophisticated technologies from the electronics industries of both East and West combined in a new open marketplace. Things are not quite as simple as under the old "Cold War" scenarios where we were hopeful of having superior sophisticated weaponry.

Recent advances in the technology of automating the rate of data transfer between aircraft has offered significant potential for improving overall SA and thus mission effectiveness. The development of advanced cockpit displays, combined with the fusion of tactical information, have paved the way for new operational capabilities and weapon employment tactics. Harnessing these innovative technologies is critically dependent upon establishing an effective and intuitive MMI.

So how are we to manage the avionic data in a modern cockpit?

The rapid developments in avionics and the associated processing power now available in aircraft have produced cockpit systems which can quickly saturate the crew with information. As successive new combat aircraft have been introduced into service, so the quantity and complexity of avionics systems has progressively increased. On the other hand, man's information processing capacity has remained constant at a few bits of information per second. This must be augmented if the manned fighter is going to be effective in the high threat environment of the late 1990's. Only by understanding man's capabilities and limitations will it be possible to design integrated avionics systems which match man's requirements and result in an effective man-machine combination.

Today's combat aircraft systems direct many channels of information into the cockpit but the pilot remains the same single channel device that he has always been. It is now essential to "manage" the flow of information to the pilot to enable him to be provided with the relevant data,

in a readily understandable form, at the appropriate time. It has not yet proven possible to automate the decision making and combat capabilities of the man in the cockpit. Therefore the requirement to manage data to the pilot is driven by the need to support that man. In this context, the presentation of accurate situational data at the right time in an appropriate format is a significant challenge.

Future aircrew aids, such as the UK's mission management aid, will only be viable if the information flow between the avionics systems and the aircrew can be suitably managed. This will involve close analysis of the pilot's task and the identification of those tasks which can be carried out better by man or machine. Human factors, as well as the careful study of feedback mechanisms, must be carefully embodied in both directions across the MMI to achieve satisfactory results. Further these problems need to be validated by simulation prior to any flight trials if we are to obtain optimum results.

I have elaborated these because, in the past, attempts to solve these problems in front-line aircraft have too often adopted a piecemeal approach, and the result has been limited success. Consequently, aircrew themselves have been forced to make up for the shortcomings of avionic integration. Lessons from the Gulf War have re-emphasised that this approach can lead to the failure of the man/machine interface, or the failure of missions, with sometimes fatal consequences.

Thus, by paying great attention to the management of the information flow between aircrew and their avionic systems, it will be possible to optimise the ability of aircrew to do their job effectively in future combat aircraft.

What then are the main areas that need attention?

Not only has the number of systems in aircraft been rising over the years but the complexity of individual systems has also been increasing. To offset this trend and to attempt to reduce the correspondingly high crew workloads, increasing use has been made of automation.

However, most systems have been developed separately and integrated at too late a stage in the development cycle. Thus it often appears that the application of automation has been applied in a random way and not as an integral component of the man-machine system. Rarely are the relative merits of the man and the

machine compared in order to indicate which tasks should be allocated to the man and which to the machine. Fitts, an eminent American psychologist, as long ago as 1950, listed a number of qualities which are performed best by man and best by machine, yet little of his philosophy appears thus far to have been implemented in military cockpits.

Man's evolutionary process has resulted in him having a transmission rates of only a few bits/second. Whereas there is almost no limit to the information transmission rate for which a machine can be designed. Thus, where man has a usable channel capacity of between 2 and 25 bits/second, modern machines possess transmission rates in excess of 500 Megabits/second. There is therefore clearly a huge mismatch between man, and the handling capacities of modern cockpit information systems.

Although man can be considered as a multi-sensor device, the link between his sensors and central processor, his brain, is such that it can generally only accept one sensor at a time by time-sharing. Further emotion rather than logic will often dictate the order in which responses are made. Some form of mission management aid will be required to filter the information and to schedule it in a timely and appropriate way. This, together with man's limited transmission capacity, merely reinforces the maxim that too much information degrades crew performance. Only by carefully matching the information sources to man's processing and channel capacities can the optimum man-machine system be produced.

A word on safety - important not only because aircraft are very expensive these days, but also because aircrew are often irreplaceable - certainly in the short term. Thus whilst the design of a fighter aircraft must be optimised for war-time performance, the issue of aircraft safety must also be of prime consideration. There are complex trade-offs to be performed in achieving acceptable levels of both parameters, recognising that enhancement of one may compromise the other.

A relatively high proportion (typically 40%) of combat aircraft losses are attributed to "aircrew error". This sometimes appears to be a convenient catch-all for accidents caused by inadequate training, ill-defined operating procedures, or even bad design of the cockpit interface which itself only exacerbates the problem during a high-stress situation. The insidious nature of system induced aircrew error is worthy of closer examination.

I suggest that the issue of safety within the cockpit is therefore much more than mere consideration of the physical aspects of the MMI, where well established procedures already exist for analysis of the hazards of both hardware and software. More needs to be done than a review of the likelihood of aircrew error, although this is difficult enough in itself. There is, however, an overlap between these two areas where the interaction of the man with the machine is more important than the interface itself. It may be unrealistic to hope for this interaction as being error-free; but it is important that the required interaction is as error-tolerant as can be made possible. Safety assessments of this nature are their in infancy with no widely available methods or procedures for carrying them out, but in EFA we have adopted a robust approach to the development of an efficient MMI, and I would now like to turn to this in more detail.

The concept of human-electronic co-operation in the cockpit is synonymous with that of a team. Whether or not the team members interact effectively will rely largely upon the pilot's acceptance of his electronic team-mate. Many pilots look towards the future of such co-operation with some concerns.

A particular area of concern is the issue of pilot trust and acceptance of his electronic team-mate. A strategy of automating nearly all a pilot's tasks, which it is technically feasible, will compromise a pilot's ability to decisively influence events and is consequently unlikely to provide a design acceptable to aircrew. A first defence against this can be achieved by developing a closer liaison between aircrew and the system designer. There is one real problem here - and that is opinion. If you ask 12 pilots a question, you are quite likely to get 12 answers, such is the complexity of the problem. Thus, aircrew opinion will need to be backed up by actual trials in the air, or in simulators and the like.

The division of tasks and the level of interaction chosen will be dependent on the task being performed. The development of a team approach, as well as a knowledge of what each part of the team is doing is critical to maintain SA. Most aircrew would agree that the quality of the MMI of automated systems is critical to aircrew acceptance of such systems. It is frequently an aircrew complaint that there is already too much information displayed in the cockpit during periods of high workload, particularly in single-seat aircraft. The proliferation of sensor and weapon aiming systems will only serve to exacerbate this problem.

Certainly, the mission and prioritisation of the information in single-seat aircraft such as EFA is a task that cannot be exclusively carried out by the pilot.

During such periods of high workload, it would therefore be most advantageous if an automated system could prioritise information but it must only present the essential information that is flight critical. Since the pilot has only a single-channel decision centre, there is no point in presenting him with the need for decisions on more than one action at a time. At the same time, pilots will want the assurance that all is well with the information that is not being presented to him. It is better to have, as in EFA, 3 screens that can be compartmentalised and managed successfully, than a large wrap around screen that becomes unmanageable.

Let me now try and draw together a few thoughts and conclusions. It will come as no surprise to you that man is relatively poor at handling information and is easily overloaded. Information from systems and sensors needs increasingly to be processed, filtered and presented to aircrew only at the appropriate time. Some form of mission management aid that automates the functions that man is poor at doing is vital. However, despite man's limitations, he has attributes which cannot yet be reproduced by artificial intelligence. It is essential, therefore to allocate the various component mission functions to either the man or machine, the decision depending upon which can do the job best at the time.

EFA will benefit greatly as a potent weapon system from the structured approach taken to both cockpit and system design. By virtue of this approach and the harnessing of appropriate human factors expertise, methods and tools, the EFA cockpit promises to be a flexible workplace that allows efficient, reliable and safe human operation with a manageable pilot workload.

In the light of the current EFA experience, the following conclusions can perhaps be drawn:

Optimisation of the weapon system design can only be realised if a common approach is

taken to the interpretation and implementation of the customer requirement in all design areas. This is nowhere more important than at the design stage of the integration of system and cockpit functions.

A structured approach is therefore required to the design of a modern combat aircraft that considers the hardware, software and human together. This is vital if we are to obtain enhanced weapon system performance whilst containing the overall aircrew workload.

Structured system design methods, and mission and task analysis, must therefore be a cohesive part of an integrated set of aircrew tools. The RAF is committed to the development of an integrated design process that allows all the attendant benefits to be realised.

Overall, there is no question that automation which relieves aircrew of tasks during critical periods of high workload, as well as help in carrying out mundane and routine tasks, would be greatly welcomed by all aircrew. Whilst there is a degree of mistrust and scepticism concerning the integrity and reliability of automated systems, the development of such systems is enthusiastically supported as they are seen as the only means by which single-seat pilots especially will be able to cope with the likely workload of future aircraft systems.

The ultimate acceptance of such highly automated systems will only be achieved when the 'folklore' of trustworthiness generated by reliable systems is passed on to a generation of pilots who have no previous experience of such systems.

Finally, I think I should stress that pilot opinions are just that - they may be wrong! They always differ and their opinions will probably change. However, do remember that ultimately pilot opinion will determine whether or not the human and electronic team members together really do enhance the operational capability of our aircraft, no matter how well you scientists think it works in the laboratory.

I look forward to a most interesting symposium and would now like to hand over to the first session chairmen. Thank you.

<u>QUALITY</u>	<u>MACHINE</u>	<u>MAN</u>
Computation.	Accurate, fast. Poor error correction.	Slow, Inaccurate but good error correction.
Intelligence.	limited at present.	Can deal with the unpredicted and can anticipate.
Overload.	Sudden breakdown.	"Graceful degradation".
Sensor Input.	Wide range. some outside human senses.	Wide energy range and variety dealt with by one sensor.

Fitts' list

Fig.1.

X-31 DEMONSTRATION OF INTEGRATED FLIGHT AND PROPULSION CONTROL FOR EFFECTIVE COMBAT AT EXTREME ANGLES OF ATTACK

Lt Col Michael S. Francis
DARPA/ASTO
3701 North Fairfax Drive
Arlington, Virginia 22203

E. DeVere Henderson, SRS Technologies
Erwin Kunz, Messerschmitt-Bolkow-Blohm (MBB)
Sid Powers, Rockwell International, North American Aircraft
Helmut Richter, German Ministry of Defense (GMOD)

INTRODUCTION

From its inception, the X-31 Enhanced Fighter Maneuverability (EFM) Program has been both countercultural and controversial in its approach to modern air combat. Predicated on the notion that an agile maneuvering capability beyond the "stall boundary" would give a modern fighter a significant advantage in close-in combat, the program's fundamental basis seemed to ignore two major tenets of aerial warfare as it evolved in the 1980's. First, the basic premise appeared to violate the widely accepted 'sustained energy maneuverability' philosophy which emanated from the post Vietnam era. Second, the program's fundamental presumption of a close-in combat arena was inconsistent with the vision of a legion of stealth advocates - a vision which emphasized beyond-visual-range (BVR) combat employing long range weapons almost exclusively. Despite this departure from the prevailing view, the continuing march of vehicle and weapons technologies, coupled with the increasingly diverse yet still capable threat suggest that the capabilities being pioneered in the X-31 Program might yet prove significant for future generations of combat aircraft.

To appreciate the importance of the X-31 program and its results, it is helpful to understand its origins as well as its role in the post cold war era. The EFM Program was born at the height of East-West tensions during the late 1970's and early 1980's. The west European defense scenario prevalent throughout those years assumed a numerically superior and technologically formidable enemy operating in a relatively compressed theatre of operations. The need for visual identification of the threat coupled with revolutionary advances in electronic warfare technology seemed to ensure that the air battle would ultimately collapse to close-in conditions.

At the same time, newly emerging weapons capabilities suggested a significant change to the tactics employed in air combat. Weapons such as the all aspect missile and fuselage-aimed, high performance gun would dictate that the traditional tailchase form of dogfight might be replaced by a much shorter duration encounter where the aircraft with the first shot would likely win the engagement.

Prompted by these concerns and with West German government encouragement, Messerschmitt-Bolkow-Blohm began investigating ways to cope with this threat. As their studies progressed, the concept of dynamic, post stall maneuvering evolved as a promising technique to defeat a 'conventional' adversary in close-in air combat. The hypothesized capability proved extremely effective as verified by the results of literally thousands of

simulations - both digital and manned. In fact, these early combat simulation results were key in providing the motivation to conduct the program. (See References 1 - 5). The statistical results have been replicated on numerous occasions in other simulation exercises which employed various configurations. (Reference 6).

Although the development of these revolutionary tactics represented a significant accomplishment, the development of an air vehicle which could actually achieve this form of dynamic, post stall flight provided a challenge of a much greater magnitude. Although the once impenetrable stall boundary had been occasionally breached by modern high performance aircraft, it still represented a major obstacle in combat operational capability. If an aircraft were to routinely exploit this unforgiving regime of flight, several new technologies would have to be merged to provide the measure of control effectiveness and responsiveness required for this demanding new application. The advent of thrust vectoring technology for airbreathing engine systems, coupled with the ability to integrate aerodynamic and propulsion controls would provide the necessary stimuli to consider the possibility of flight in this regime, free from the negative consequences of instability and departure normally associated with this arena.

Further studies of the benefits of thrust vectoring coupled with a high angle-of-attack (AoA) capability uncovered some additional potential benefits to be expected for such an aircraft. These include:

- Post Stall Maneuvering
- Enhanced Agility
- Roll Coupled Fuselage Aiming
- Steep Descents
- Enhanced Deceleration
- Enhanced Negative g Capability

This set of enhancements was given the collective name of Enhanced Fighter Maneuverability, or EFM.

After several years of conceptual and operationally-oriented studies and the formation of the Rockwell International-MBB team, the X-31 Enhanced Fighter Maneuverability Program was formally initiated in late 1985. It was challenged with four major goals which have not changed over time:

- 1) Provide a rapid demonstration of the high agility maneuvering concepts derived from post stall related technologies;

- 2) Investigate the tactical benefits of these technologies, especially in the close-in air-to-air combat arena;
- 3) Develop design requirements and a data base for future applications; and,
- 4) Validate a low cost international prototyping concept.

The focus of the X-31 Program is as appropriate today as it was at its inception over a decade ago. Despite the gains made in low observables technology, the evolving balance in that technology suggests that close-in combat will again emerge as a significant factor in determining the outcome of the air war in future conflicts. Moreover, the X-31's unique technologies afford an even greater opportunity for improving flight performance and efficiency. Viewed as an alternative to conventional aerodynamically-driven force and moment generation, thrust vectoring capability of the type employed in the X-31 may prove useful in the stabilization and trim of vehicles at much higher speeds. The exploitation of vectoring in this manner offers the promise of significantly smaller ancillary aerodynamic surfaces, along with concomitant reductions in weight and aerodynamic drag.

DESIGN EVOLUTION

With a solid basis and rationale provided by the numerous combat simulations, the program's architects understood the characteristics which their hypothesized vehicle would have to possess. The program's philosophy called for a demonstrator design which could not only perform controlled flight and dynamic maneuvers at high angles of attack, but one which could also be employed to assess the tactical benefits of the embedded technologies, i.e., a true operational surrogate. In that regard, the vehicle must possess a highly integrated 'pilot friendly' aerodynamic and propulsion flight control system in which complex control interactions would be transparent to the pilot. It must be able to fly into and out of the post stall regime with impunity, and it must have high thrust-to-weight to provide the necessary deceleration and acceleration capability to get in and out of post stall rapidly. Thrust vectoring itself would be implemented by means of several "paddles" positioned about the circumference of the nozzle exhaust region and deflected into the exhaust plume to vector the thrust.

The flight vehicle concept evolved from early Rockwell and MBB studies which led to a new aircraft design which made extensive use of existing subsystems. Early configuration experiments in the NASA-Langley Research Center wind tunnels demonstrated controlled flight at angles of attack up to 88 degrees.

The basic design of the airframe was generated on the Rockwell Computer-Aided Design (CAD) system. Fabrication was aided by using Computer-Aided Manufacturing (CAM) integrated in an experimental, 'skunk works' environment. This approach, advanced for its time, led to better 'fit' and fewer problems than with any prior program on which the team members had worked.

It was recognized at the outset that producing a new low cost airframe in order to demonstrate the EFM tactical advantages was a significant challenge. During Phases I and II the design and fabrication philosophy was worked out among the decision makers in Rockwell, MBB and the two governments. While there were no secret methods of reducing costs, the program adopted a

set of approaches and rigidly held to them. The first principle was to focus the effort on just what was important. Under this philosophy, it was decided to provide the X-31A with only modest supersonic capability, since the principal focus of the program was the subsonic maneuvering arena. A maximum Mach number of approximately 1.3 was deemed sufficient to prove that the aircraft could fly and maneuver supersonically.

A major decision was to instrument the aircraft only for proof of load carrying capability and for defining the tactical maneuvering environment. Many sensors normally incorporated into experimental and operational aircraft were deleted. This approach turned out to be sufficient for opening the conventional flight envelope and for defining the state of the maneuvering aircraft. However, it was not sufficient as an engineering tool for investigating other anomalies such as, for example, vertical tail buffet. (Vertical tail buffet has not been a problem so far in this flight test program.)

The extensive use of existing proven subsystems removed many of the requirements for their flight qualification. As a result, a smaller engineering staff was required than that normally employed on a new design. However, this approach involved the acceptance of some weight penalties.

In the design process, the approach was to "do it once." Eliminating many design iteration loops resulted in shortened development time and decreased costs, but this came at the expense of some undefined weight growth and a less than optimum structure. However, the resulting aircraft is fully capable of performing its intended tasks. In parallel with the single pass approach, generous design and safety margins were used in order to reduce the requirement for additional models and tests. For example, in collaboration with the Rockwell flutter group, the flutter "q" margin was increased from the standard 32% to 44%. As a result, no flutter model test was required. In addition to being a cost driver, such model tests are frequently pacing items in the development cycle. Flight test results to date show that the structure is sufficiently stiff and that there is no concern about wing or tail flutter.

The results of several early studies indicated that some 2,200 pounds of fuel were required for the X-31 to fly its primary mission profile - a short flyout and return, coupled with several air-to-air engagements, of which five minutes total time would be spent under full afterburner conditions. An additional 1,100 pounds of fuel allowed the aircraft to fly out 100 nautical miles to conduct the air-to-air combat and return. This was chosen as the design fuel load. As the X-31A design matured and a better estimate of the actual weight became available, an empty equipment bay immediately forward of the single fuel tank was incorporated into the tank. The result was a total fuel load of approximately 4,000 pounds, an amount slightly more than that available on the X-29. Additional information regarding the design and development of the X-31 may be found in References 7 - 11.

THE X-31 AIRCRAFT

The X-31A is a single seat, single engine, high performance flight demonstrator (Figure 1). The aircraft consists of a slender fuselage containing an F404 turbofan engine fed by a belly-mounted inlet, a cambered and twisted wing mounted on the

bottom of the fuselage, a small and aerodynamically decoupled canard forward of the cockpit, a single vertical tail, and its most distinguishing feature - three externally supported thrust vectoring paddles mounted on the aftmost bulkhead. The aircraft has a wing span of 23.8 feet and a length of 43.2 feet. The maximum takeoff gross weight is 16,200 lb., of which approximately 4,000 pounds are fuel.

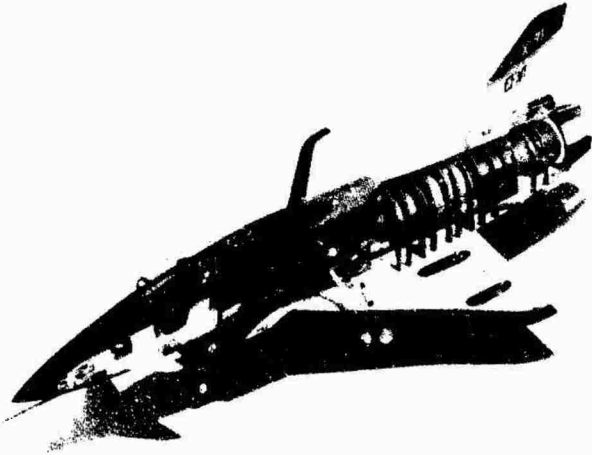

Figure 1. The X-31 Aircraft

The fuselage contains the flight test instrumentation, the cockpit, the engine inlet and duct, the single cell fuel tank, the F404 engine, the hydraulic and electrical systems, the airframe mounted accessory drive (AMAD), the flight control computers, and the landing gear. The air data boom is mounted on the underside of the aircraft to counteract effects of this appendage on the lateral-directional characteristics of the aircraft in the post stall regime. Two separate angle-of-attack sensing vanes are fitted to the nose boom. Only one yaw vane is employed, but it drives two separate transducers. Both the angle of attack and angle of yaw are primary inputs to the flight control system. The inlet leading edge is deflectable to 26 degrees down in order to minimize airflow distortion at high angles of attack.

The wing is fabricated from aluminum substructure and graphite composite upper and lower skins. No fuel is carried in the wing. Only hydraulic lines and electric leads are passed through the wing. The wing has two-section leading and trailing edge flaps. The leading edge flaps are deployed as a function of angle of attack to improve lateral directional stability at high values of alpha. The inner and outer section deflections are synchronized through a rotary gear train, and are driven by a rotary hydraulic actuator located at the base of the wing root. Each of the trailing edge flaps is driven by separate electro-hydraulic actuators. The inner and outer flaps are synchronized through the flight control software. Maximum trailing edge flap deflection is 30 degrees.

The canard consists of left and right panels mounted on a common shaft. Two electro-hydraulic actuators, synchronized by the flight control system, are used to deflect the canard panels. Canard deflection angles range from -70 degrees (leading edge down) to +20 degrees.

The rudder mounted at the trailing edge of the single vertical tail is driven by two actuators mounted at its base. A spin recover parachute mortar is located within a housing at the base of the vertical tail. A foam plastic panel is used to close out the spin recovery parachute compartment. To operate, the mortar fires the parachute packet directly through this foam panel.

The landing gear is basically that of an F-16, with slightly modified oleopneumatic shock absorber. The main landing gear wheels are from a Cessna Citation, with tires from a Vought A-7 nose gear. Anti-skid brakes from an F-16 are mated with the Citation wheels. The nose gear is a stock F-16 nose landing gear.

The thrust vectoring system consists of three carbon-carbon vanes attached to the aft fuselage structure, each coated with silicon carbide in high temperature regions. These vanes are positioned symmetrically about the engine circumference with vane #1 located just below the vertical tail in the symmetry plane. Each vane is driven by a separate actuator. The three actuators are connected to a single hydraulic system (hydraulic simplex), but driven by two flight control computers (electrical duplex). In the event of hydraulic or electrical failure, all three vanes are deactivated and go into a free floating mode. The maximum deflection of all three vanes is 26 degrees into the jet plume. Vanes #2 and #3 located on the lower half of the fuselage are usable as speed brakes with a maximum outward deflection of 60 degrees. Vane #1 is limited 7 degrees outward deflection due to its proximity to the spin chute release path.

The X-31A cockpit is entirely conventional, with many principal elements taken from the F-18, including a standard F-18 canopy and windscreen which the X-31 structure was designed to accommodate. This resulted in a simple yet effective cockpit layout which does not require a significant amount of training for military pilots.

An actual F-18 instrument panel structure was used in the aircraft (Figure 2). Some modifications were made to accept a small amount of specialized equipment. The panel is dominated by the HUD in its upper center. A digital data panel mounted on the left side of the panel was acquired from an F-18. Control buttons, not all of which were activated on the X-31, surround this panel. The right panel contains a standby airspeed indicator, an analog altimeter and a sensitive angle-of-attack indicator. Slightly below this panel is an electrically driven turn and bank indicator.

Mounted on a panel just beneath the HUD are the controls for the flight control system. A two pole switch is used to switch in the spin recovery logic should the aircraft depart. Push buttons on the same line provide means of calling in the takeoff and landing settings for the flight controls and to enable/disable the thrust vectoring vanes.

Below this are the selection buttons for the various modes of the flight control systems. BASIC is the normal mode. R1 is a reversionary mode used when the inertial measurement unit (IMU) fails to provide the angle of attack and angle of yaw values. Another mode, R2, is called up when the data from the angle of attack and yaw vanes are lost. A third mode, R3 provides a fixed gain setting to allow successful recovery of the aircraft should both the IMU and aerodynamic data be lost. Just above this set of

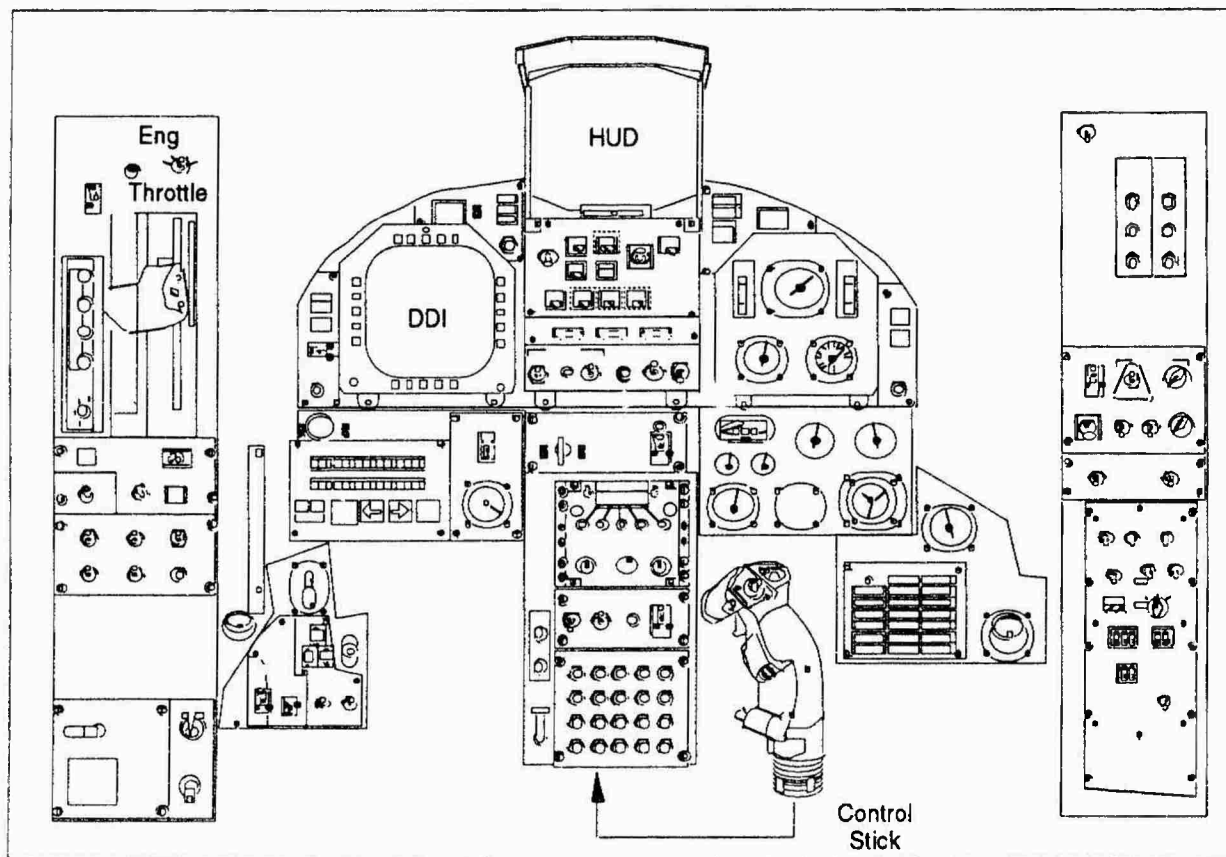

Figure 2. X-31 Instrument Panel

push buttons is a R3 gain control button. High gains are needed for landing; low for high speed flight. These are pilot-selectable.

The HUD display provides the pilot with the necessary heading, attitude, speed, altitude and angle-of-attack information. Mach number, altitude, airspeed, and rate of climb are presented digitally also. Ladders are used to show the current angles of attack and aircraft load factor in addition to the standard aircraft pitch attitude ladder.

The stick in the X-31 was mounted on a conventional two axis support system. The F-18 control stick was used but was fitted with an AV-8 stick grip. This stick grip was a slight modification of the F-18 grip but with additional control buttons more appropriate to the X-31. Because the X-31 is a fly-by-wire aircraft, no natural mechanical feedback loops were available for the pilot's controls. Accordingly, the stick was fitted with longitudinal and lateral "bungee" cords to provide necessary feedback.

It should also be noted that a 26% scale, unpowered drop model of the X-31 configuration which is dynamically faithful to the full scale vehicle was also constructed. Built by NASA-Langley researchers under DARPA sponsorship, this research platform was designed to replicate all aerodynamic control combinations and ascertain the purely aerodynamic stability characteristics of the configuration at high angles of attack. This subscale aircraft continues to serve as a "pathfinder" for the manned flight test program.

INTEGRATED FLIGHT PROPULSION CONTROL SYSTEM

Vehicle control of the X-31 aircraft is achieved through pilot "commanded," computer-implemented flight control laws which select the appropriate mix of control effectors to match the desired flight condition. This mix may involve any of a multitude of combinations of aerodynamic surfaces, i.e., wing leading and trailing edge flaps (inboard or outboard) and canard, as well as the position of the three thrust vector vanes. Engine throttle control is maintained as a separate, independent pilot selectable function. The system is automated to the extent that the control effector combination commanded is generally transparent to the pilot.

After assessing several flight control system options, a digital fly-by-wire multivariable feedback system was chosen because it afforded the greatest flexibility for configurational change in an experimental aircraft such as the X-31. Although a classical quadruplex hardware concept was proposed early in design, budget and schedule constraints dictated a somewhat different approach based on three dedicated flight control computers and a fourth computer to serve as a so-called "tie breaker". Figure 3 illustrates the concept and ancillary components. This new FCS hardware architecture required the development of a complex redundancy management concept. In order to fulfill the "fail-safe" requirements, some of the redundancy management logic functions had to be integrated into the control law structure, increasing the control law design effort considerably. Loss of essential feedback signals could only be compensated by

reconfiguration of the basic control mode, which led to the implementation of degraded (reversionary) control modes described previously.

Control Law Structure

The architecture of the X-31A flight control laws is based on a linear feedback matrix K and the nonlinear forward paths f_u and f_y (See Figure 4). The main characteristic of this architecture is the difference equation between the feedback signals and the command value for all feedback signals. For all feedback signals an associated command signal must be calculated from the pilot input. Thus the actuator command vector u is the sum of the steady state command vector (trimmed surface deflections) and the feedback difference vector multiplied by the feedback gain matrix (K). This u was determined using a linearized aircraft model divided into longitudinal and lateral segments. The resulting formulation yields fourth order difference equation models.

The feedback matrix was mathematically calculated using optimal control theory. The principal task for the designer was the definition of the weighting matrices which, in turn, influences optimization of the feedback matrix K . Stability and handling analyses were then carried out with the full high order system. When this check showed unsatisfactory results, the weighting matrices were modified and the whole procedure repeated.

This simplified model could lead to a higher order system with reduced stability and/or degraded handling qualities. Therefore, to improve flying qualities and stability further, additional elements were integrated into the forward command paths and feedback loops, the control architecture's two major components. These elements include inertia coupling compensation, gyroscopic coupling compensation, gravity effect compensation, feedback error integration, washout filters, command scaling algorithms, command filters, phase advance filters, and rate limiters. Notch filters were also installed in some of the signal paths to preclude structural coupling effects.

In the flight path (wind) axes reference system, the forces in y- and z-direction consist just of the centripetal force and gravity. These forces are used to calculate the flight path rate command signals. The body axes commands are transformed into flight path axes. With the dependency of these rates on gravity, additional moments due to aerodynamic damping appear in the exact equation. The compensation of these moments was neglected. The time differential of the gravity components leads to angular accelerations. These moments are compensated by feedforward commands.

Gyroscopic moments are dependent on the square of the angular rates and are, therefore, not considered in the linearized model. At

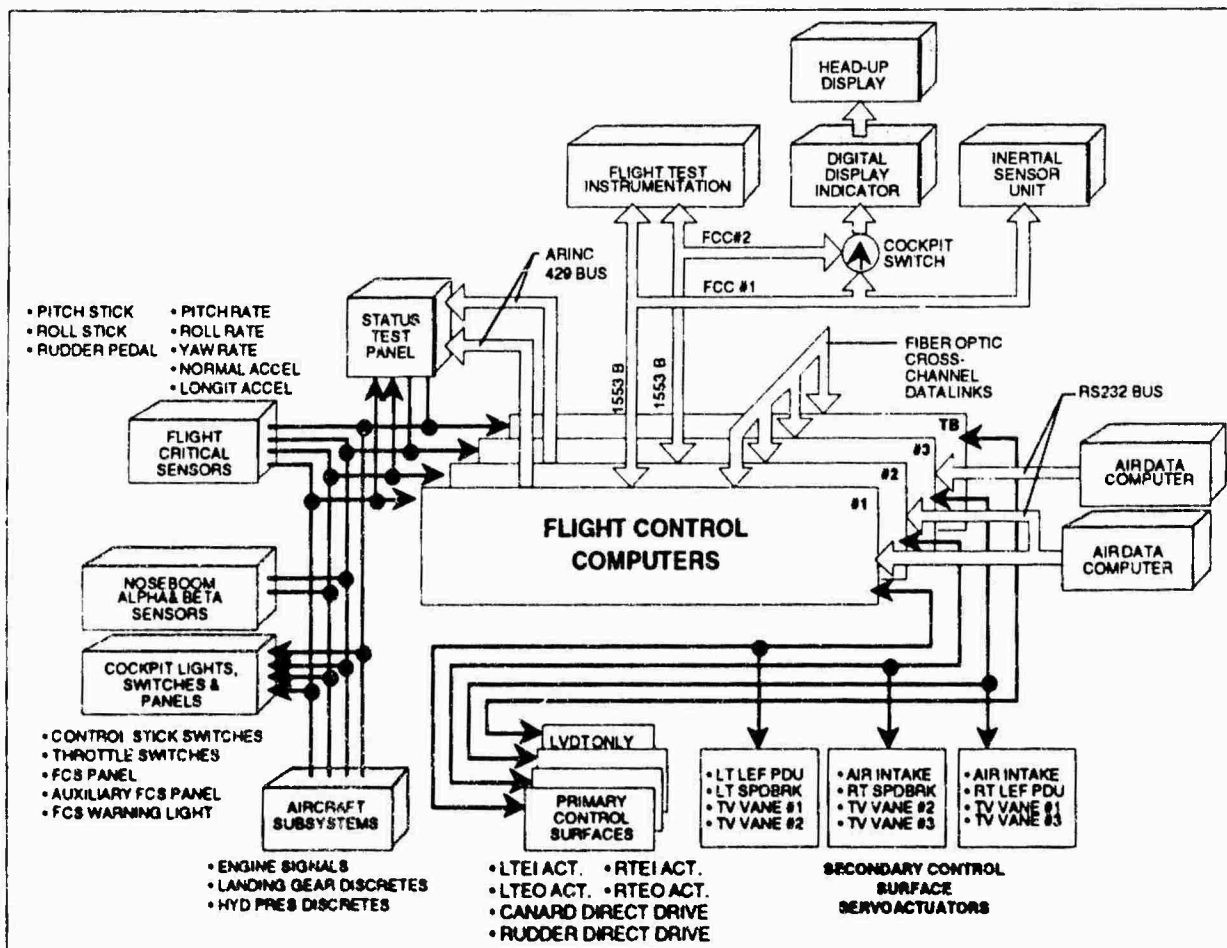

Figure 3. Flight Control System Architecture

high angular rates, these moments cannot be neglected. Without compensation, these moments would lead to unacceptably large deviations, and the aircraft reaction would lag its actual dynamic behavior. Introduction of integral feedback was observed to help, but it also introduced overshoot. An improved solution was a feedforward compensation acting instantly (just lagged by sensors and actuation dynamics) against the disturbances. The small remaining deviations due to model uncertainties are now controlled by feedback loops.

The principal source of control implementation by the pilot is through the center-mounted stick. In fact, in the post-stall flight regime, the rudder pedal function is disabled so that the stick provides the only means of pilot feedback to the aircraft control system. Figure 5 shows the longitudinal stick force as a function of stick deflection. Note the break in the force curve. A detent at this position provides the pilot with a tactile cue to indicate that he has reached the end of the conventional control stick movement. Additional stick deflection requires enabling of the post stall maneuvering portion of the control laws. In order to enter post stall flight, a post-stall enable button must be depressed by the pilot, and all the other post stall requirements must be met. The paddle switch on the front of the control stick provides an immediate method for returning to the basic (or conventional) flight control mode.

At low dynamic pressures, each pitch stick position commands a specific angle of attack, whereas at high dynamic pressure a specific load factor is commanded. The switchover between these two command systems is at the flight condition where 30° angle of

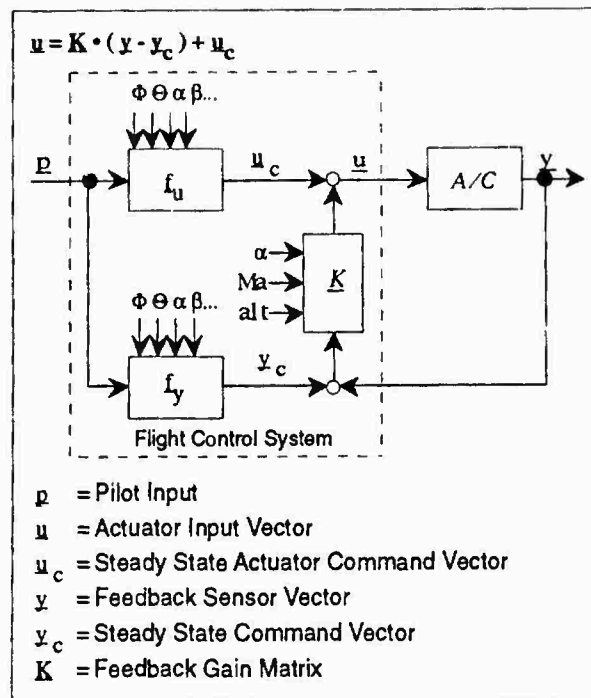

Figure 4. Flight Control Law Architecture

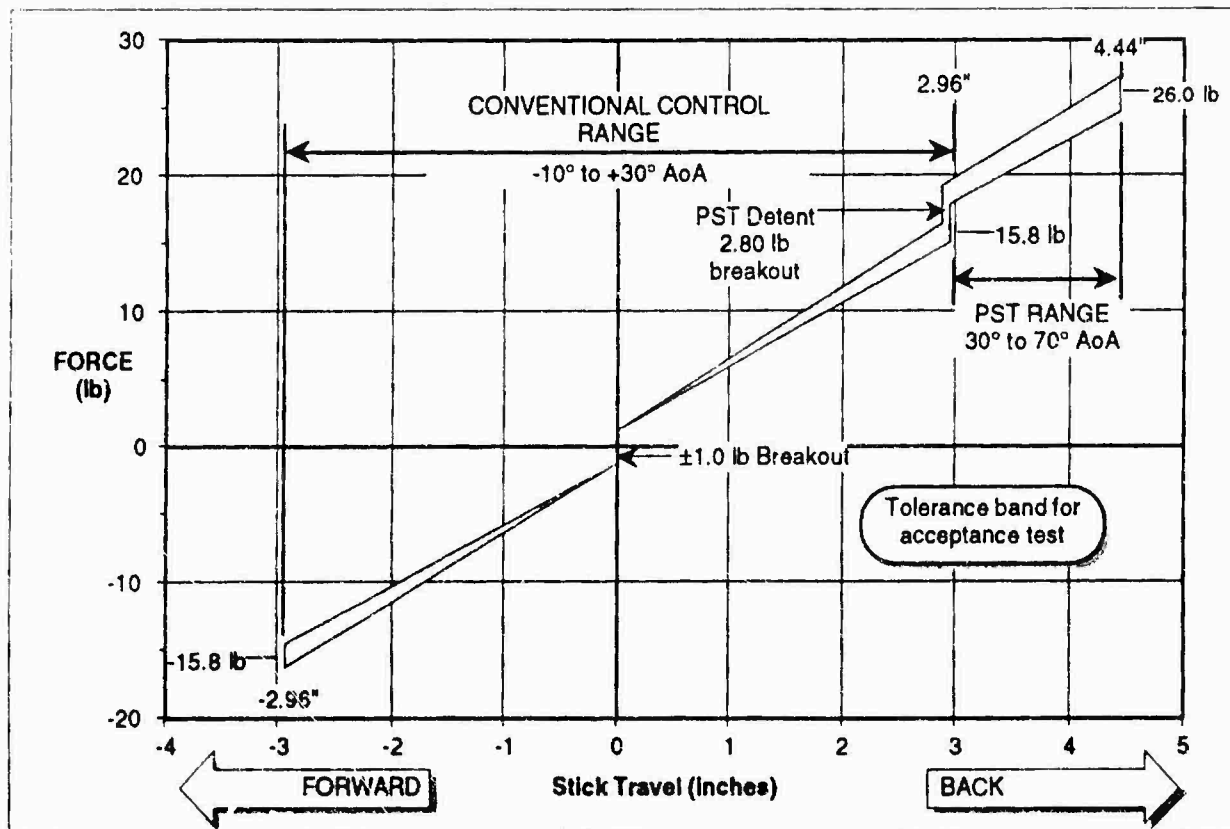

Figure 5. Stick Force Characteristics

attack results in the maximum load factor (7.2 g's). This occurs at approximately 380 pounds per square foot (psf), or approximately 320 KCAS. This command characteristic was employed at low dynamic pressures because of the desire to precisely control angle of attack within the post-stall envelope. An integration of error of the commanded signal forces the aircraft to the commanded value. Post stall flight is only possible if the aircraft is in the low dynamic pressure angle-of-attack command regime. The maximum angle of attack is currently limited to 70 degrees.

The angle of attack commanded by the stick movement is displayed in Figure 6a. The maximum pitch stick deflection range is 4.5 inch aft and 3 inch forward. With full forward stick, an angle of attack between -5 degrees and -8 degrees (depending on flight condition) is commanded at low dynamic pressure, while the same position commands -2.4 g's at high dynamic pressure. Three inch aft stick position corresponds to +30 degrees AoA and +7.2 g's, at and above corner speed. The maximum stabilized angle of attack, +70 degrees, is commanded with full aft stick (4.5 inch).

Roll stick deflection results in a roll rate command around the velocity vector (see Figure 6b). A quadratic characteristic is used to get low sensitivity around the neutral stick position and sufficient roll rate for full command. The maximum roll rate is scaled with flight condition such that the available control power will be used as much as possible for steady state roll, with enough left for stabilization and departure prevention. Additionally, a roll command acceleration limit is included to prevent actuator rate saturation. This limit is a function of dynamic pressure for low angle of attack and a function of thrust at post stall flight conditions.

The maximum roll rate command values were calculated considering aileron and rudder effectiveness, thrust vectoring capabilities and structural load limits. They are stored in the flight control computers as functions of Mach number, altitude and angle of attack. To avoid surface rate saturation during rapid stick inputs, the roll rate command is rate limited depending on flight condition and power setting.

In the directional axis, the sideslip command characteristic is designed to improve lateral directional control, to minimize uncommanded steady-state sideslip angle, and to improve turn coordination. The scaling of the sideslip command characteristic is dependent on true airspeed, AoA and roll stick deflection. Yaw pedal deflection results in a sideslip command, which varies between 12° at low dynamic pressure and 5° at high dynamic pressure. At higher angles of attack, the yaw ("beta") command is blended out, so that all available control power can be used for rolling (roll priority).

Trim capabilities have been implemented about all three axes. The trim values are added to the forward command signals. In the longitudinal axis, the direct link path defines the steady state canard and trailing edge flap positions dependent on the commanded angle of attack. Since two control surfaces are available (canard and trailing edge flaps), pitching moments generated by trailing edge flap deflections can be compensated by canard deflections. Two trim schedules, one for "take off and landing" and one for "cruise", have been implemented. The "cruise" trim schedule is optimized for minimum drag at low angle of attack and lateral/directional stability at high angle of attack. The trim schedule for take off and landing is optimized for lift to reduce take off and landing speed. In the longitudinal axis, thrust vectoring is not used for trim since sufficient aerodynamic control power is available.

In the lateral/directional axes, direct links are provided from both the roll rate command, and the sideslip command to the trailing edge flaps (differential), rudder and thrust vectoring actuators. The direct link commands correspond to the deflections calculated for steady state flight conditions. The direct-link yawing moment is fed to the aerodynamic rudder at angle of attack up to 30°. At higher angles, the rudder becomes ineffective. Therefore the direct-link is designed to blend in thrust vectoring so that it provides the full authority in yaw at angles of attack above 45 degrees.

System stability and dynamic characteristics are determined by the feedback loops. In the X-31's multi-variable feedback sys-

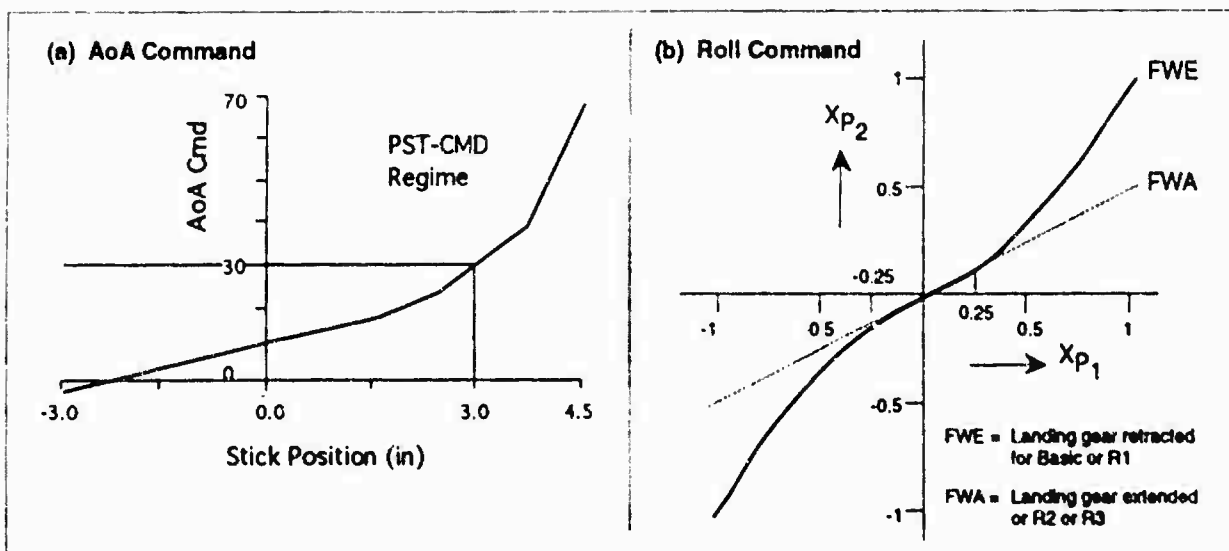

Figure 6. Stick Command Characteristics

tem, each feedback error signal, i.e. difference between sensed and commanded signal, is multiplied by individual gains corresponding to the control effectors integrated in the control loop. In the longitudinal axis, angle of attack and pitch rate are feedback signals. The corresponding error signals are fed to canard, trailing edge flaps (symmetrical) and thrust vectoring actuators. In the lateral/directional axes, sideslip angle (β), roll rate and yaw rate are feedback signals. The corresponding error signals are fed to aileron (differential trailing edge flaps), rudder, and thrust vectoring. The gains are dependent on Mach number, altitude and, where necessary, on angle of attack.

Thrust Vectoring Command Distribution

The longitudinal and lateral/directional flight control systems command effective thrust deflections in the pitch and yaw directions respectively. These have to be transformed into the associated vane actuator commands. Stored thrust vectoring tables (based on full scale and model tests) are used to calculate the vane deflections in two steps. First the plume boundary vane position is calculated, then the thrust deflection vane commands are superimposed. Flight control software limits vane deflection toward the exhaust jet to 26 degrees to preclude mechanical interference between the vanes. When thrust vectoring is switched off, vane 2 and vane 3 may be used as speedbrakes. The thrust vector command distribution matrix is graphically depicted in Figure 7.

The thrust vectoring system can be switched on and off by pilot selection. In case of a failure, thrust vectoring is automatically "blended" out. This blending is implemented in the flight control software in a way that permits the aerodynamic surfaces to receive additional commands which produce the same overall moments as with thrust vectoring.

As long as sufficient aerodynamic control power is available, there is no difference in the moments generated with and without thrust vectoring. This occurs over the whole conventional flight envelope and is also true for the pitch axis even in the post stall regime. In all cases, the linear handling qualities are nearly unchanged with thrust vectoring on or off.

In case of a thrust vector system failure in post stall flight, the available aerodynamic yawing moment is insufficient. To keep sideslip as low as possible, the rudder as well as the differential flap command are blended out during recovery to low angle of attack. Due to the reduced control power, the roll performance is also reduced with thrust vectoring off. The lower overall control power and the reduced relative actuator moment rate significantly reduce vehicle agility in this condition.

The control law structure does not change with the introduction of the post stall (or PST) mode. Only the breakpoints in gain tables and angle-of-attack dependent scaling are extended to the larger angle-of-attack range. Flying into the post stall regime is only possible if all of the PST prerequisites are fulfilled, namely,

- BASIC mode in operation,
- Thrust vectoring selected,
- Within the PST flight envelope,
- Engine RPM at or above Mil Power (89%),
- Altitude greater than 10,000 feet, and
- No FCS failure detected.

To prevent the pilot from unintentional PST entries, the detent mentioned earlier was introduced. Similarly, if one or more of the prerequisites is not fulfilled or in case of a failure, the angle of attack is automatically reduced to 30 degrees, the upper limit of the conventional flight conditions envelope.

FLIGHT TEST PROGRAM

The three major segments of the flight test program are: 1) conventional envelope definition; 2) post-stall envelope expansion; 3) tactical evaluation.

The first of these segments was conducted with two objectives in mind. First, since the X-31 was a new design, it was important to demonstrate its performance, reliability and overall flight worthiness. Second, a comprehensive examination of the conventional (below stall) flight regime was necessary to permit the mock combat exercises to be flown as part of the tactical evaluation. This first flight test segment was essentially completed in the fall of 1991.

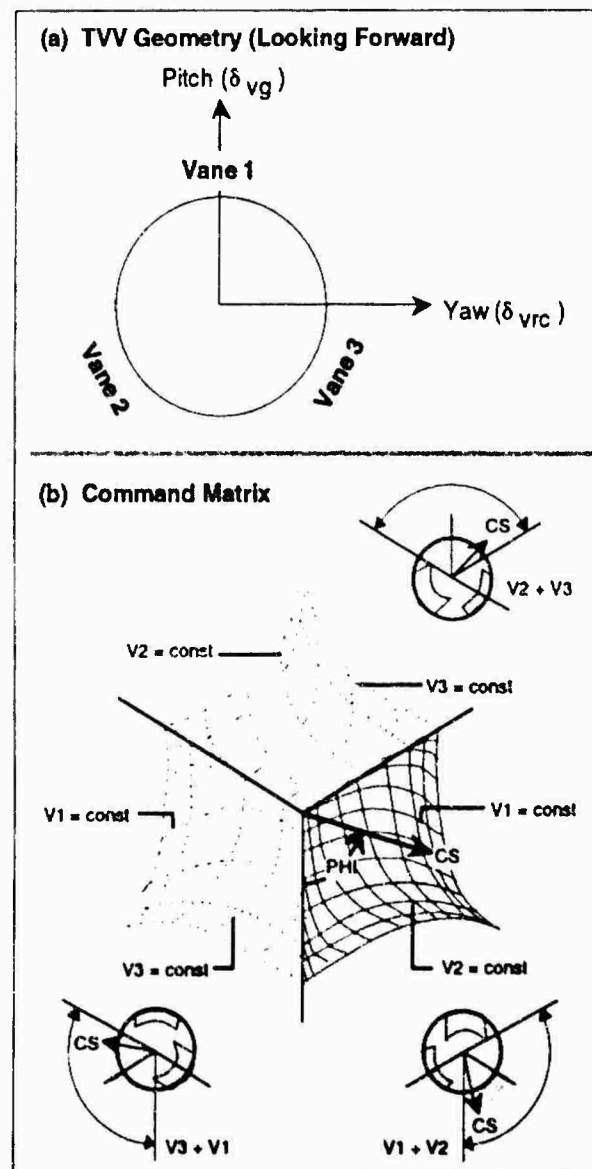

Figure 7. Thrust Vectoring Command Distribution

The post-stall regime is defined as any flight condition in which the angle of attack exceeds 30 degrees. The post-stall envelope expansion segment, however, involves significantly more than reaching limiting values in this parameter. The X-31 is designed to fly aggressively into and out of the post stall arena to facilitate extremely rapid turning and pointing. The coupling of high agility within the high angle-of-attack regime necessitates a broader view of the envelope expansion process. For this reason, the core of this flight test segment is based on four "maneuver milestones," designed to stress sequentially the aircraft's performance further in demonstrating dynamic post stall flight. These milestones include:

- 1) Trimmed, stable flight at a maximum angle of attack of 70 degrees;
- 2) Full deflection, 1g, velocity vector rolls at 70 degrees AoA;
- 3) Dynamic, level turn entry to post stall conditions from corner speed with maximum AoA less than or equal to 70 degrees; and
- 4) Turn optimized, gravity assisted post stall maneuver with a 180 degree heading change at minimum radius and maximum rate.

The first three are graphically depicted in Figure 8. The fourth maneuver (Figure 9) is sometimes referred to the "clinical maneuver," or Herbst maneuver, after the concept's originator. This maneuver is analogous to a classic wingover, but it incorporates the vehicle agility and high AoA characteristics embedded in the X-31 philosophy, i.e. high entry speed, rapid deceleration to deep post stall conditions, rapid roll around the velocity vector at high AoA, and subsequent rapid acceleration back to high speed conditions with concomitant return to low (conventional) AoA.

In addition to accomplishing the maneuver milestones, other assessments to be made during this flight test segment include: elevated and negative-g performance, departure resistance, vertical stall dynamics, and pointing agility. Throughout this segment, the control system will be tuned and modified, if necessary, to improve the aircraft's handling characteristics.

The final segment of the flight test program, tactical evaluation, will focus on assessing the combat advantages of employing the EFM technologies in a quasi-operational environment. Current plans call for initiating this segment concurrently with the latter stages of post stall maneuver development. During this period, basic fighter maneuvers predicated on earlier simulation results and expected to be used in air-to-air combat engagements will be developed and flown. Following this stage and at the completion of the second segment, 1-vs-1 air combat engagements with an adversary aircraft are planned to be flown. Candidate adversary aircraft include both the F-18 and the second X-31 aircraft (without benefit of thrust vectoring), as well as several other current fighter aircraft. Results of these tests should provide some confirmation of simulation-derived tactical exchange ratios. Perhaps more significantly, these flights should provide the greatest insight yet into the pilot-vehicle interface issues associated with this unique type of flying. Unlike the domed simulators employed to date which provide only limited visual cues to the pilot, the in-air tests should enhance our understanding of the other physiological constraints imposed in this dynamic environment.

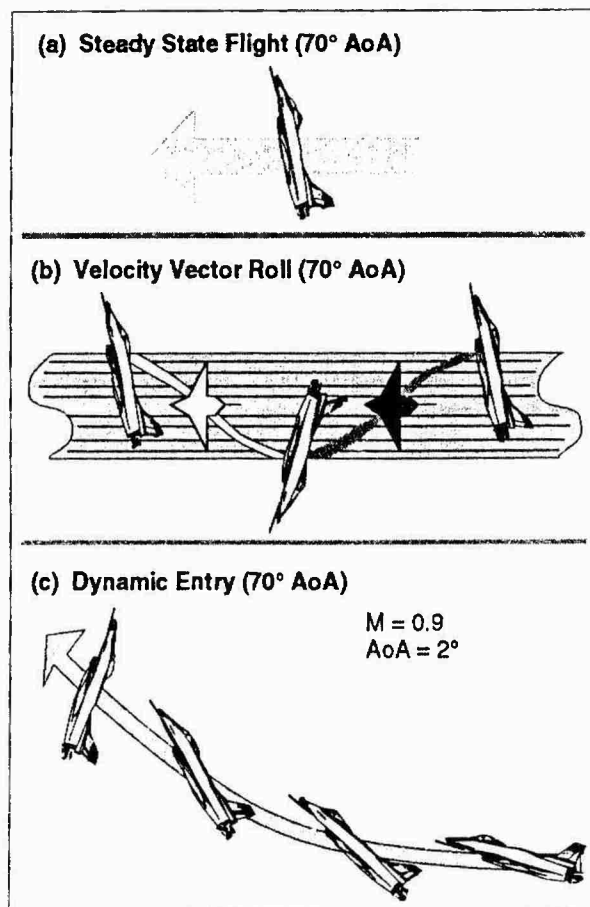

Figure 8. Maneuver Milestones

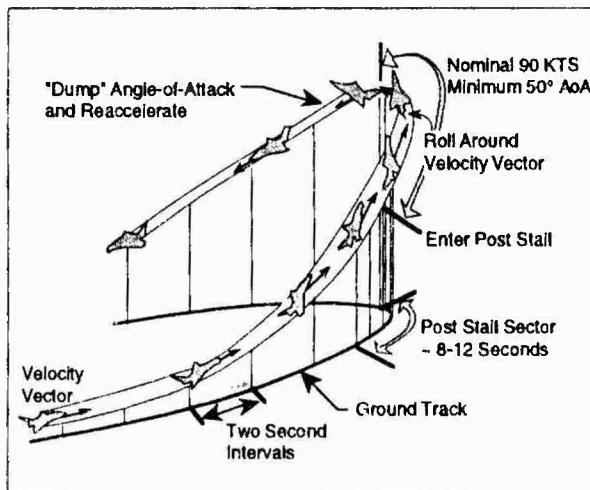

Figure 9. Clinical Post Stall Maneuver

Although the tactical evaluation is currently focused on close-in air-to-air combat issues, additional plans are being made to assess the versatility of the EFM technologies in the air-to-ground environment. In this demonstration, a simulation will be employed to calculate the optimized flight path to be flown by a suitably equipped X-31 vehicle through an hypothesized, multi-faceted ground-to-air threat. Then, in a replication of this "shooting gallery" scenario, the real X-31 would fly an identical trajectory employing its conventional agility and post stall capabilities.

FLIGHT TEST RESULTS

Flight Control System - Conventional Envelope

During the initial 14 months of the program, most of the flight test activity focused upon definition of the conventional envelope, with the aircraft having been flown to several of its performance limits, including maximum positive load factor (7.2 g's) and altitude (40,000 feet). Although it did not exceed sonic velocity, the aircraft did reach Mach number equal to 0.92, entirely adequate for the close-in engagements being planned for tactical testing. In all, 102 flights were flown in the conventional regime, where the vehicle's handling qualities, structural loads, flutter characteristics and flight control system behavior were assessed. A summary of conditions flown in the conventional envelope is depicted in Figure 10.

Formation flight and other tasks in the conventional mode which require precise flying have been accomplished without difficulty. However, it must be noted that the pilots agree that the aircraft is rather sluggish in pitch, apparently due to the angle-of-attack rate limit programmed into the flight control laws. This rate is currently restricted to 25 degrees per second. One pilot commented that he had sensation more of "plowing" through the air than of "slicing" through it. Both the n_z demand in the conventional mode and the angle-of-attack demand in the post stall mode are limited in rate.

Velocity vector rolls within the conventional envelope were found to be easily accomplished, with yaw angle remaining below 5 degrees during full deflection inputs. However, roll onset and maximum roll rates were found to be higher than desired above 300 knots (IAS). The roll mode time constant has been measured at 0.1, a value well below the military specification of 0.25. Full lateral stick inputs were found to generate a roll rate of 280 degrees per second, with a very high roll onset rate. This level of "agility" made it difficult to achieve precise roll capture, although the system was highly responsive to rapid stick inputs. These handling qualities were termed "lateral untidiness" by the Rockwell Chief Test Pilot after the X-31's maiden flight. Though one of the test pilots favors the current very quick response in the roll axis, the majority of the pilots believe that the aircraft's roll response is a little too abrupt and that not all of the lateral quickness would be useful in combat. As a result of these observations, flight control software was modified to improve the roll characteristics. The current maximum commanded roll rate is 240 degrees per second.

Early in the flight test program, a roll asymmetry of 300 degrees per second to the left and 240 degrees to the right was detected. This was traced to a lateral trim mechanization anomaly which was corrected in the next software revision.

The thrust vectoring system was initially calibrated in the conventional flight mode. Its operation in flight has been verified as being transparent to the pilot. Identical flying qualities are evident with thrust vectoring on or off (as designed). A compilation of thrust vectoring calibration test points accumulated over the conventional envelope is depicted in Figure 11.

Over the range of conditions examined, angle of attack and "g" control were found to be satisfactory. At high dynamic pressures, stick force per "g" was found to be light (3-4 lb), but acceptable. Prior to first flight, the test pilot community was concerned over

the lack of damping in the stick assembly. As a result, the stick in the second aircraft was installed with tighter tolerances and, therefore, more friction. This installation was deemed more satisfactory by the pilots.

One of the most prominent early concerns with the flight control system was the sharp difference in aircraft response in each axis with nominally equal control stick or rudder displacement. A one inch lateral stick displacement requires less force yet produces much more rapid aircraft response than a one inch longitudinal stick displacement. This lack of harmony is apparent in both the conventional and post stall mode but is readily accommodated by the experienced test pilots involved in the flight test program.

In the mechanization of the flight control system, an undamped stick with only bungee feedback has been combined with low values of stick force per g, resulting in moderate control sensitivity. Initially the stick was configured in the pitch axis with bungees rated at seven pounds per inch of travel. The pilots anticipated that stick forces with this configuration would be excessive. Flight test results verified their concern and the bungees subsequently replaced with a set rated at 5.5 pounds per inch, as mentioned earlier. In the longitudinal axis, the last 1.5 inches (out of 4.5 inches) is unavailable in the conventional mode. This is considered a minor irritant, though it does impact the ability to effect precise control when the stick is in the vicinity of the detent. The roll axis control stick bungees are rated at 4 pounds per inch. The allowable stick travel in this case is three inches left and right.

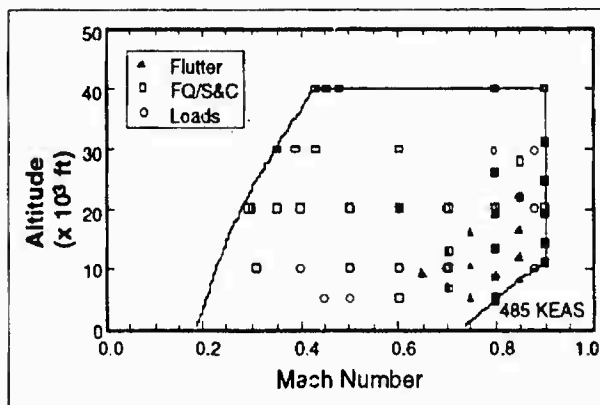

Figure 10. Conventional Flight Test Conditions

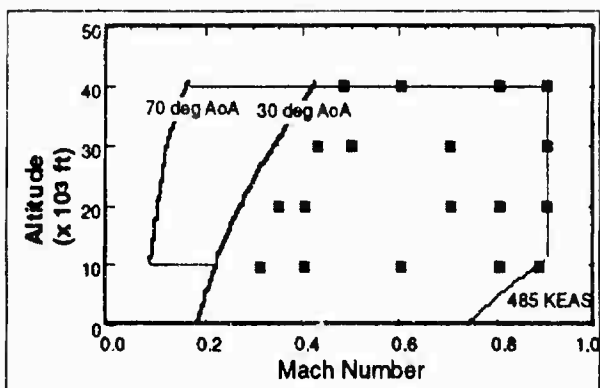

Figure 11. Thrust Vectoring Vane Calibration Points

The F-16 rudder pedals used in the X-31 are small and the maximum displacement of the pedals is approximately one inch. The aircraft is essentially mechanized to provide "feet-on-the-floor" operation and the pilots find this arrangement gives good handling qualities. The pedals command rudder displacement during conventional flight (angles of attack less than 30 degrees). Above 30 degrees angles of attack, the flight control system blends elevon, flap, rudder and thrust vectoring vane deflections to roll the aircraft around the velocity vector with minimum sideslip. The maximum yaw angle excursions in flight are on the order of a few degrees.

A light to moderate buffet was observed beginning at 10-12° AoA. This is typical of wing stall. The buffeting increased slightly up to angles of attack of about 15 degrees but remained constant beyond that. No significant aircraft motion has resulted from this buffeting. The pilot feels this as a slight "shaking."

During one flight the aircraft was inadvertently flown to 0.92M which was in excess of the then imposed 0.9M limitation. At this condition, the aircraft experienced a sharp pitch-up to 7.2 g's. Examination of the aero database after the flight showed that the pitching moment curves in this Mach region do exhibit a pitch up tendency. Furthermore, the flight control laws had not been developed to permit flight beyond 0.9M, although this capability is both feasible and under consideration for a future modification.

In general, the aircraft replicates its simulations throughout the conventional envelope.

Flight Control System - Post Stall Envelope

As of this writing, twenty-nine flights into the post-stall regime have been made. Post stall testing has been conducted from 30 deg to 70 deg AoA during gentle decelerations (1g). Full stick input bank-to-bank and 360 degree rolls have been completed at 50 degrees AoA and have shown good A/C response and handling. During full deflection rolls at 30° AoA, the sideslip build-up was 2° or less with thrust vectoring engaged. This is a significant accomplishment attributable to the effectiveness of the flight control system.

In the post stall mode with vectored thrust enabled, the X-31 has continuously demonstrated adequate pitch-up authority and a repeatable, authoritative response to control input. However, the aircraft has exhibited less of a nose down pitching moment than predicted. This was found to be due to changes in the external lines of the aircraft. The original X-31 configuration featured external structural booms to hold the thrust vectoring paddles in place. These were later incorporated into the structure so that the aft end of the fuselage presented a smooth, unbroken contour. The aero database used for control system development was based on the original configuration with the exposed booms. No significant difference between the predicted and the experienced aerodynamics was noted until angles of attack of 52 degrees was reached.

The trailing edge flap position at this angle of attack was observed to be 8 degrees (trailing edge down) as compared to 2 degrees (up) during simulation. As the left roll/yaw developed and three-quarters right stick was applied, the left trailing edge flaps reached full 30 degrees down. The maneuver was terminated as the left roll asymmetry slowly increased. Yaw angle remained at two

degrees or less during the maneuver. Recovery to below post stall conditions from this unusual condition was acceptable. Though the aircraft was not responding adequately to lateral stick inputs, the maneuver was rather stable and predictable.

Study of the problem led to the conclusion that this deflection difference was due to a difference in C_{mo} at large angles of attack. To reduce the required control deflection and thereby provide for more control authority in roll at high angle of attack, small, aft-mounted strakes were installed on the aircraft. Drop model tests conducted with the strakes installed indicate that C_{mo} will be close to the values derived from the original configuration and flight tests show performance as originally expected. Additional post stall flights will provide more data on both the pitch moment and roll/yaw asymmetry.

The handling qualities in the post stall regime have been sub-optimal due to the substantial pitch stick forces required for control. Pilot concentration is required to stabilize at exact test conditions, due to stick forces ranging from 15 to 22 1/2 pounds in the PST mode and the stick travel/alpha demand schedule in which one millimeter of stick travel is nominally equivalent to one degree angle of attack. Loads of this magnitude and demand sensitivity require both hands on the stick. Constant angle of attack rolls are even more difficult. Despite the forces and other aspects of the pitch axis system, the pilots unanimously believe that the system will be satisfactory when performing the maneuvers anticipated during the tactical evaluation phase of the flight test program.

In contrast to the conventional mode, the roll response in the post stall mode is rather sluggish. However, the roll rate in this condition is much better than almost any other current aircraft. (Full stick rolls under post stall conditions in most modern aircraft are likely to result in a departure.) Furthermore, large stick displacements at high angles of attack are difficult to accomplish due to pitch stick forces and the large lateral stick movements. These lateral displacements are also difficult to effect due to resulting stick contact with the pilots' legs and the strength limitations incurred by the ergonomics which necessitate the "two-handed" approach.

From a pilot-vehicle interface perspective, the flight control system, as designed and constructed, is satisfactory to meet the test objectives of the X-31 flight test program. Further into the high-angle-of-attack envelope expansion, software changes and, possibly, flight control law modifications which further optimize aircraft operation may be expected. It is less likely that aircraft hardware will change. In general, predicted aerodynamic instabilities suggested by wind tunnel data have been overcome by the control authority provided by the thrust vectoring system.

Cockpit Displays

In the X-31 heads-up-display, a digital data indicator provides a menu of selections available to the pilot, along with a complement of standard analog instruments. Pilots find the instrumentation and displays generally satisfactory for satisfying the flight test objectives in the conventional flight mode. However, several pilots have expressed a requirement for a larger angle-of-attack indicator as well as a yaw rate instrument. All agree that some additional capability could enhance the post stall flight regime testing.

Early in the program, it was argued that decoupling the aircraft reference line from the flight path velocity vector, as occurs in the high angle of attack regime, would present challenges to the pilot in terms of spatial disorientation and energy management. However, the magnitude of the challenge and how best to assist the pilot in maintaining good situational awareness was not well understood. Even today, after many hours of simulation, protracted discussions on the issue, and with some experience in the post stall regime, there is no clear cut consensus as to the level of assistance the pilot needs, nor how best to provide that assistance. However, there seems to be general agreement that the state of one's own velocity vector, and, for air combat applications, the state of the adversary must be known. The most recent flights involving high AoA 360 degree rolls have confirmed initial opinions that more information on the state of the velocity vector is required. The problem is further complicated with multiple adversaries. Some pilots believe conventional out-the-window cues in ACM will be adequate; others do not. As of this date, there is no consensus as to how much of such assistance should be "heads up" and how much can be "heads down".

The F-18 HUD used on the X-31 was modified to enable the pilot to freeze either the aircraft reference line symbol (the "W") or the velocity vector symbol (the "O") at the center of the display. These two modes enable the pilot to determine either his pitch attitude or the direction of the vehicle velocity vector. Although this arrangement is better than the option of having the pilot mentally integrate information from the Attitude Directional Indicator(ADI), the Horizontal Situation Indicator(HDI), the altimeter, the Vertical Velocity Indicator(VVI), and the airspeed indicator, the current HUD display has substantial shortcomings.

The primary deficiency is limited field of view - only 10 to 15 degrees. This makes it difficult to maintain precise control of dynamic pitch rate. When, for example, in a high-angle-of-attack maneuver the "O" is frozen at the center of the HUD, the pilot can readily determine the orientation of his velocity vector. However, due to the narrow field of view of the HUD, the "W" will be fully displaced to the edge of the HUD and will not give an accurate picture of the aircraft attitude. In order to determine the pitch attitude of the aircraft the pilot must refer to another instrument or to outside references. He can also of course, change modes on the HUD to place the "W" at the center.

To assess the value and utility of aircraft orientation and dynamic information fed back to the pilot during post stall maneuvers, the X-31 Program supported the development of a special instrument for this purpose. Developed by prime contractor, Messerschmitt-Bolkow-Blohm, a spherical image icon was configured to relate vehicle orientation at high alpha with the velocity vector (See Figure 12). Incorporated in a heads-down-display (HDD) cockpit panel instrument, the device has proven useful in teaching situational awareness to pilots learning to fly the clinical Herbst maneuver and other post stall maneuvers. The display, as configured, has been most useful as an instructional tool, but many pilots have serious doubts about its usefulness in the tactical environment. A variation of the display for use in a HUD format was also designed by MBB. However, due to the limited field of view and the fact that the pilot will be looking away from the HUD during much of the time in a tactical engagement, there is solid consensus

within the pilot and engineering communities that a helmet mounted display (HMD) is the best solution. The X-31 Program is exploring options in this area.

The X-31 is not equipped with sensors to track adversary aircraft. Therefore, the pilot must perform this function. One of the goals of a series of past intensive simulation campaigns was to help calibrate the pilots' eyes. During two separate three week periods, pilots flew the X-31 against various adversaries, including a variant of the F-18, and first developed and later validated a set of "rules of thumb" to help estimate firing ranges and other pertinent parameters. The X-31 simulation model was "equipped" with sensor and fire control system capabilities to teach the pilots what the "correct picture" looked like. The pilots then flew the simulators with and without the benefit of the sensors. The results showed that the missile firing results with and without the additional sensors were comparable. The results from the gun firings showed that the guns were slightly less effective without the sensor information.

To help compensate for the absence of adversary sensors on the aircraft, the X-31 Program is exploring options to provide adversary information to the pilot via other means. One approach which is being examined is the use of the aerial combat maneuvering instrumentation (ACMI), employing range assets and an aircraft mounted pod as a two-way communication device. As a receiver, the pod will supply information received from the ACMI computer to the aircraft data bus for display. It can transmit data from which the aircraft state vector can be derived for display to the pilot in the domed simulator.

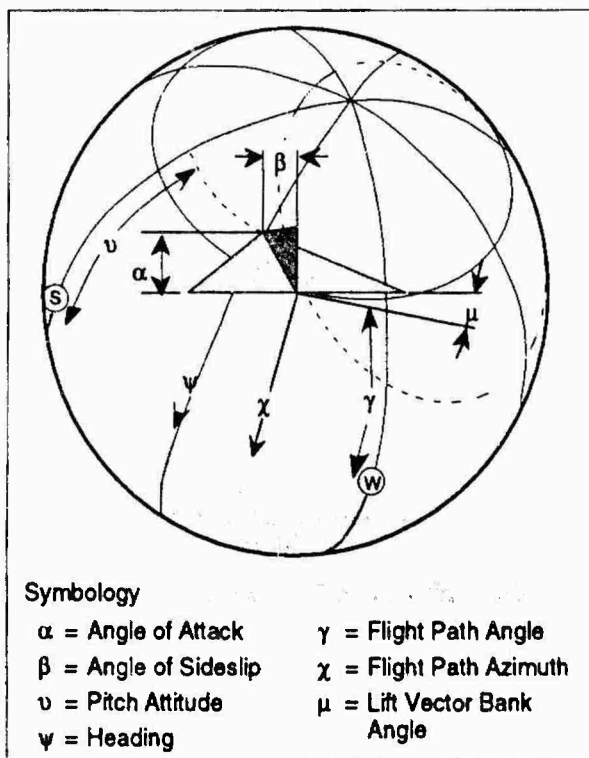

Figure 12. Post Stall Display Symbology

The X-31 program is also investigating the feasibility and potential options to network the X-31 aircraft with various combinations of manned domed and computer driven simulators on the ground. Using such a network will enable the program to minimize the risk of losing both aircraft while conducting evaluations in similar aircraft (with and without thrust vectoring for example). This capability would also facilitate the validation of previous simulations involving multiple combatants (m-versus-n) which were accomplished only with ground-based simulators.

Cockpit Layout

The X-31 design provides excellent visibility for the pilot in all quadrants, including over the side. The pilots are generally satisfied with the seat height and seat adjustments, with one exception. (One of the pilots, who is approximately 5'8" tall, prefers to fly with his head up next to the top of the canopy.) Other aspects, including the glare shield, windscreen and canopy are very satisfactory.

Cockpit switchology is straightforward and satisfactory for this experimental aircraft, with one exception. The airplane is equipped with a Status Test Panel which presents system fault codes for analysis and action. To read the fault codes the pilot must scroll through the menu and this takes time. Furthermore, the codes are presented in the inverse order in which they occurred. If the last code up (the most recent occurrence) cannot be reset, then it is not possible to reset the others. This arrangement is workable, but, in some cases, may have forced operation in less desirable flight modes resulting in mission aborts under conditions that otherwise might have been preventable.

FUTURE CHALLENGES

Although much has already been discovered in flying the X-31 into the post stall regime, the most significant challenges have yet to be faced. The dynamic maneuvers yet to be performed will stress both man and vehicle as the realities of this demanding regime unfold. The situational awareness issues facing the pilot cannot be fully appreciated, even from the extensive fixed-base simulator work accomplished to date. The potentially complex maneuver sequences which occur in air combat (high-g accelerations, both positive and negative, sequentially occurring with multi-axis disorienting rotational accelerations) can be expected to provide a significant amount of insight into the problem. If current simulator experience is an indicator, even precision, pre-defined classical maneuvers can be expected to challenge the best pilots early in the learning process.

Vehicle control during rapid transitions involving angular rotation onset and termination (capture) can be expected to be less than perfect given the vehicle's inertia characteristics and inherent control authority, coupled with the pilot's own reaction limits. Transients in which the desired alpha and beta limits are exceeded should be expected. Eventually, this transient behavior must be mastered by the pilots and the engineering community which 'tunes' the aircraft. Stabilizing and trimming the vehicle at high AoA provide confidence in the aircraft's departure resistance. The execution of precise maneuvers during which 'equilibrium' is fully maintained will illustrate that necessary control authority is available. But the ability of the pilot-vehicle combination to go

beyond this limit, to achieve temporary non-equilibrium conditions, "skidding" through the stall region and using these same characteristics for recovery are at least part of the stressing prescription for post stall agility.

The system's control feedback necessary for the pilot to be effective has already surfaced as a significant issue. Stick forces required to control the vehicle in post stall have been the subject of several studies and a flight control system modification. But this area of investigation and concern is by no means completed. The stick forces required to provide reactive response to the pilot to dynamic onset and termination in maneuvers are, in some sense, at odds with requirements for accurate, precision pointing at high angle-of-attack conditions. Whether a single stick-based control scheme like that employed on the X-31 is adequate to the task has yet to be determined.

Finally, an area expected to provide major surprises is the vehicle aerodynamic behavior during dynamic, high AoA maneuvers. Based on several wind tunnel studies and other data (References 12 - 15), a dynamic lift increment can be expected to occur on the X-31 during moderate and high rate excursions into the post-stall regime. This rate-and-amplitude driven phenomenon which commonly exhibits a hysteretic behavior in lift and moment during dynamic pitching maneuvers, has been associated with unsteady vortex formation and burst characteristics on both two- and three-dimensional lifting surfaces. Some preliminary data for the X-31 configuration are provided in Figure 13. While most maneuvers expected to be experienced by the X-31 are dynamic in character, very few will actually remain in the symmetry plane. Very little is known about the potential for control system or control authority issues resulting from dynamic lift and related phenomena. Similar flow phenomena can be expected to occur at the inlet to the engine. The effect of these transient vortices on engine performance can only be crudely estimated since this unique form of distortion has never been the subject of engine qualification testing. In these areas, the X-31 is expected to be a pioneer. Preliminary calculations indicate that while the effects of dynamic lift will be measurable, they should not provide 'showstopper' impact to the flight test program as currently conceived.

SUMMARY

The X-31 Program is providing new options for conducting and winning close-in air combat in the future. Through the exploitation of the key EFM technologies - high thrust-to-weight ratio, multi-axis thrust vectoring, integrated flight-propulsion controls coupled with a 'pilot friendly' vehicle interface - the X-31 is pioneering dynamic post stall flight for a variety of combat applications. The key challenge to effective control in this arena is a compatible and properly tuned pilot-vehicle combination. The program's emphasis on control simplicity, care free handling, and situational awareness issues should help assure that its key objectives will be met.

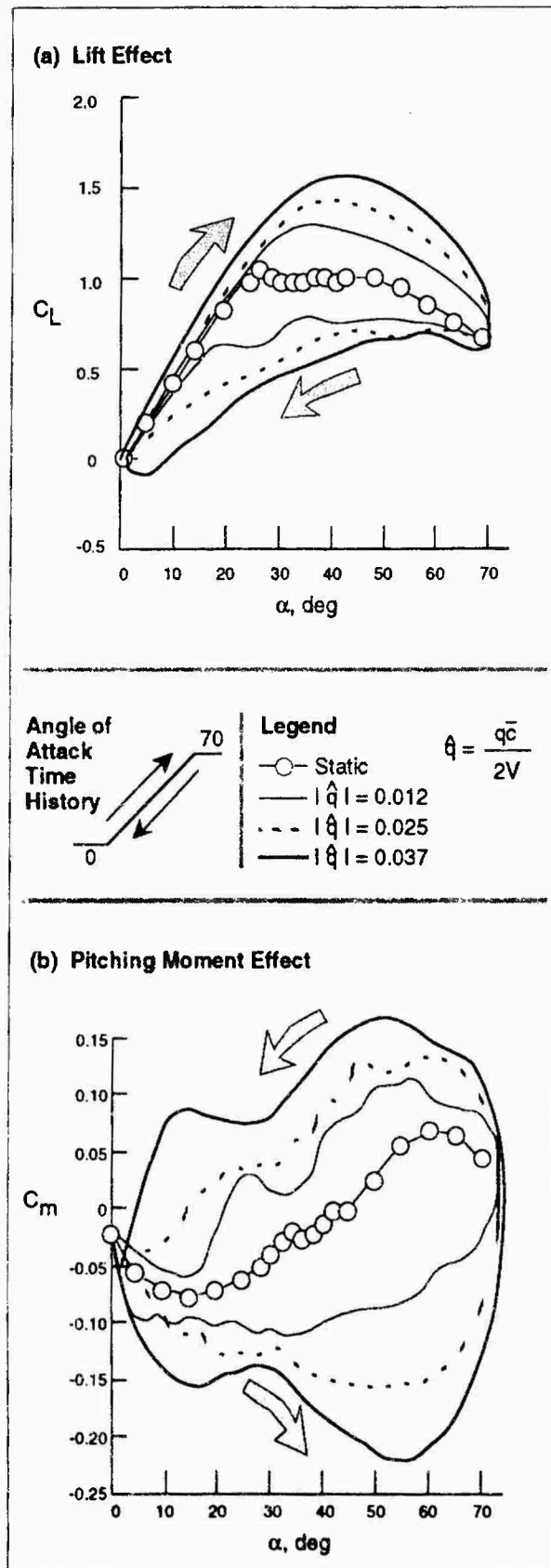

Figure 13. Dynamic Lift Effects on X-31 Configuration

REFERENCES

1. Herbst, W.B., *Dynamics of Air Combat*, *Journal of Aircraft*, Volume 20, July 1983.
2. Ross, H., *Taktische Auswertung von PST - Manover im Luftkampf*, MBB Report ETL 1977, 1.SS-1.
3. Haiplik, R., Eberle, *Bemannte Simulation - 1979*, MBB Report TKF/STY/0071.
4. Herbst, W.B., *Future Fighter Technologies*, *Journal of Aircraft*, Volume 17, August 1980.
5. Herbst, W.B., *Supermaneuverability*, Joint Automatic Control Conference, University of Virginia, Charlottesville, June 17-19, 1981.
6. Doave, P.M., Gay, C.H., Fligg, J.A., et al., *Multi-System Integrated Control (MuSIC Program)*, McDonnell Aircraft Company, June 1990, WRDC Technical Report 90-6001, Restricted by Arms Export Control Act.
7. Powers, S. and Schellenger, H., *The X-31: High Performance at Low Cost*, AIAA-89-2122, Presented at the AIAA/AHS/ASCE Aircraft Design, Systems, and Operations Conference, Seattle, WA, July 31 - August 2, 1989.
8. Powers, S.A., *The Design and Manufacturing Approach to the X-31A*, AIAA 91-3150, Presented at the AIAA Aircraft Design, Systems, and Operations Meeting, Baltimore, MD, September 23-25, 1991.
9. Robinson, M.R., and Herbst, Dr. W.B., *The X-31A and (sic) Advanced Highly Maneuverable Aircraft*, ICAS-90-04, Presented at the ICAS meeting in Stockholm, Sweden, September 9-14, 1990.
10. Hoerter, G.J., Powers, S.A., and Robinson, M.R., *The Development and Progress of Enhanced Fighter Maneuverability on the X-31*, SAE-90-91, presented at the SAE Atlantic Meeting, Dayton, OH April 22-26, 1991.
11. Bayati, J.E., and Lum, E.L., *Control Design for the X-31 Aircraft*, Presented at the 1991 American Control Conference, Chicago, IL, June 24, 1992.
12. Lang, J.D. and Francis, M.S., *Unsteady Aerodynamics and Dynamic Aircraft Maneuverability*, *Unsteady Aerodynamics - Fundamentals and Applications to Aircraft Dynamics*, AGARD-CP-386, April 1985.
13. Ashley, H., Katz, J., Jarrah, M.A., and Vanech, T., *Survey of Research on Unsteady Aerodynamic Loading of Delta Wings*, *Journal of Fluids and Structures*, Volume 5, pp. 363-390, 1991, Academic Press, Ltd.
14. Jarrah, M.A.M., *Low-Speed Wind-Tunnel Investigation of Flow About Delta Wings, Oscillating in Pitch to Very High Angle of Attack*, AIAA-89-0295. AIAA 87th Aerospace Sciences Meeting, January 9-12, 1989, Reno, Nevada.
15. Goman, M.G., Stolyarov, G.I., et al., *Description of the Longitudinal Aerodynamic Characteristics of Aircraft at the High Angles of Attack Accounting for the Dynamic Effects of Detached Flow*, "Report of Central Aerohydrodynamic Institute, Zhukovsky, Russia (1990) (In Russian).

Planning for Air to Air Combat

I. D. Gray
 Radar Systems Division
 GEC Ferranti Defence Systems Limited
 Crewe Toll
 Ferry Road
 Edinburgh, EH5 2XS, UK

Summary

Air combat planning has always proven very difficult because of the dynamic environment, intelligent adversaries, group operations and the incomplete nature of any information. Two approaches, those of "expert systems" and classical adversary search are presented and compared. Searching is then described and developed in detail. The implications of such an approach are considered for the future of air combat.

1 Introduction

The air combat environment has always been considered very difficult to perform tactical planning within for a variety of reasons.

i - It is a very dynamic environment where the relative positions and attitudes are subject to very rapid rates of change.

ii - The adversaries must be considered intelligent and to have objectives and a plan of their own.

iii - Air to air combat implicitly involves group operations and cooperative tactics for which it has proven difficult to formulate a rational basis.

1.1 The Intelligent Opponent

There are two solution methods currently considered against intelligent adversaries. These are:-

i - expert systems - attempting to encapsulate expert knowledge applied to a range of example situations and then to extrapolate this knowledge to new situations.

ii - classical adversary search - using knowledge of the moves physically possible for each side's aircraft to search through move/counter-move trees for the optimal next move.

The expert system approach involves embodying expert knowledge into a rule base which is then used to drive an inference engine, which makes a tactical plan based on which rules "fire" (are true) in a given situation.

The major problems with expert systems are twofold:-

i - the solutions are limited by the experts in that it is difficult to get a consensus of opinion on a given situation amongst a group of experts, and it can be difficult to extract the essential features of a situation from an expert.

ii - group operations extracted from expert opinion are at best ad hoc and are not based on "force multiplier" criteria. These "rule of thumb" tactics have basically remained the same as the World War 1 "Dicta Boelke".

For these reasons an alternative approach, that of classical adversary search, is presented.

1.2 Search Strategy

Search algorithms generally act to return a maximal (in some sense) value from a set of end positions, the major difference when dealing with intelligent adversaries is realising that they have opposed objectives involving minimising the gains that the other is trying to maximise. This is dealt with by constructing a search tree in which alternate layers represent the options available to the maximiser and minimiser respectively. The search strategy then becomes a minimax search involving three major stages:-

- i - plausible move generation
- ii - search
- iii - static evaluation

Although the above three functions tend to be intertwined in operation, search proceeds by generating moves and evaluating them, they can still be separated and their calling sequence and result interpretation left to the selection of the individual search strategy. An additional advantage of such an approach is that the costing/evaluation function is clearly differentiated allowing it to be "fine tuned" without affecting the overall operation of the search strategy. The above three elements and their application to air to air planning and

assessment are detailed in the following three sections.

This search is limited only by the physics controlling the aircraft's motion and not by the experience of the experts consulted. It is a straightforward matter to generalise the tree structure to allow for multi-ship engagements, this giving a natural extension of the method to encompass group operations through co-operative tactics.

The paper will concentrate on adversary search methods, their inherent problems and methods of dealing with these, and extensions of the techniques to deal with larger and more realistic engagements. A range of specific scenarios will be introduced to compare and contrast the difference between engagements controlled by "experts", and those involving search routines driven by mathematically derived evaluation functions and involving variable degrees of lookahead. Finally the paper will discuss the impact of such an approach on future air combat.

2 Plausible Move Generation

This is the procedure which grows the search/planning tree by developing the moves and countermoves which are possible from the current situation. The order in which the moves are developed depends on the particular search strategy employed.

2.1 Reference Frames

There are two major geometrical reference frames (right handed orthogonal bases) used for move generation:-

i - aircraft body axes - this is the most natural frame for describing the manoeuvre decisions from the user's (i.e. pilot's) viewpoint, and fits well into the search tree.

ii - inertial axes - used for all the underlying aerodynamic calculations resulting from the above "decision" manoeuvres e.g. aircraft turning moments.

Aircraft body axes are referenced to the "forward", "starboard" and "down" axes as lowercase x-y-z in figure 2.1. Roll, pitch and yaw angles in the positive directions are shown (p, q and r degrees per second respectively).

The inertial axis system is referenced to a North-East-Down frame where the fixed reference is indicated by uppercase X-Y-Z in figure 2.2 (aircraft body axes are in lowercase). In this diagram the aircraft is shown in straight and level flight on a heading ψ . The positive direction of subsequent elevation θ and then bank ϕ angles is indicated. ψ , θ and ϕ are known as Euler angles.

These are described further in reference 5.

2.2 Aerodynamic Constraints

The performance of an aircraft can best be described in a set of performance envelopes relating factors such as air speed (true and indicated), radial g, height, energy and specific excess power (see appendix to reference 4). These are then used as limiting constraints by the plausible move generator.

As an example the V-n diagram in figure 2.3 illustrates a typical aerodynamic template used to constrain the generation of plausible moves. It indicates the maximum (and minimum) g values that can be pulled (or pushed) at different velocities. The critical velocities are:-

i - V_s - level flight stall speed

ii - V_c - corner velocity, when the rate of turn is maximised for minimal radius of turn

iii - V_d - dive velocity, maximum safe dive

3 Search

This is the procedure which scans the generated tree looking for the "best" plan to follow in the light of the situation resulting from pursuing this plan. The strategy may comprise a series of moves and countermoves in the case of a two player adversary search against intelligent opponents. Here again the order of scanning the tree is determined by the particular search strategy employed.

3.1 Basic Minimax Search

The search proceeds by constructing a basic game tree (fig 3.1) in which alternative levels represent the choices of moves available to the player and his opponent respectively. In the example there are two responses ("move right" or "move left") available for each move. After a predetermined even number of levels, to allow each player the same number of "simultaneous" moves, a static evaluation function is used to assign a value (to the player) of the situation existing at each of the terminal leaves of the tree. In the example there are four levels, two each to the player and his opponent, with the player "moving" first, and there are sixteen terminal leaves evaluated. Earlier nodes (decision points) in the tree are labelled according to whether it is the player (maximising) or his opponent (minimising) moving at that level. The tree is then scanned from the leaves back by copying back the minimum or maximum value (depending on the level) attached to the node, repeating the process until the root of the tree is reached.

In the example leaves "2" and "15" pass back "2", leaves "14" and "15" pass back "14", both of these at a minimising level, and then "14" is passed back to the maximising level.

The end result is that the value passed back to the root, a maximising level as it represents the player's first "move", is a lower bound on the value to the player based on optimal play by his opponent. This counters arguments about whether the opponent will fool the plan by not choosing his "best" response, because in this case the player will extract a larger value from the play.

In the example the player can ensure a value of "9" by moving along the bold path, if however his opponent takes the non-bold path at his first (min) node the player can guarantee a value of a least "14".

There are two problems to this whole procedure. First the potential explosion in the number of terminal leaves to be evaluated, and second the critical nature of the evaluation function. The former will be addressed in section 3.2, and 3.3 the latter in sections 4 and 5.

3.2 Applying Alpha Beta Cutoffs

Basic minimax search is simple to implement and understand, but it does have the problem of requiring the whole tree to be generated and then all the leaves evaluated. This can be very expensive both in terms of processing and of storage requirements. A lot of information about the best move so far is generated during the minimax search. This can be used to selectively prune branches leading to worse situations without the need to generate all the intervening moves or evaluate all the leaves.

While searching the tree a current lower bound (alpha), and upper bound (beta), are maintained for this branch. If at any time alpha exceeds beta the remainder of the branch can be pruned without being generated or evaluated. Alpha and beta are initially set to minus and plus infinity, and then updated at maximising and minimising levels respectively. The final value of alpha at the root gives a lower bound for the value of the game to the player. A fuller description and analysis of the algorithm can be found in reference 1.

The example (figure 3.2) shows this pruning process in action with the conclusions drawn on each step listed on the right. Steps 1 to 23 proceed exactly as the basic minimax search already described as no cutoffs occur. This establishes an initial lower bound (alpha) of "9" at the root before the alternative branch is explored. Steps 24 and 25 give an upper bound (beta) of "4" which is less than the current lower bound of "9" so the remaining processing at this node can be pruned. This establishes "4" as the value for this node (at step 29) which is passed back to establish a new upper bound of "4" at step 30. As this beta is less than the current alpha of "9" no further processing need be done below this node. Step 31 establishes "9" as the value of the game to the player. This is the same result as with the full minimax search

but has involved nine fewer move generations and six fewer evaluations, a significant saving in storage and processing time.

Alpha Beta pruning is guaranteed to return the same value as minimax but can allow search to proceed almost twice as far into the tree in the same time. It may however, because of an unfortunate ordering of the leaves, not prune out any branches as shown by the upper sub-tree in the example.

3.3 The Combinatorial Explosion

In order to illustrate the explosive nature of the number of alternative planning options to be considered, even in relatively small scale scenarios, two examples were constructed (figure 3.3). These were both limited air to air engagements but in a similar manner small scale engagements could have been constructed for an air to ground scenario with SAM sites employing C³I.

The first five columns are the search statistics for a one versus one, planar, equi-speed engagement where the participants can control their radial g (turn) from 1g to 3g in discrete steps, left or right, changing by at most one step each move. This choice reflects a setting of the control surfaces and on reaching the 3g "limit" can either stay there or move back to 2g. The "level" is the number of half-moves to each participant i.e. level 4 is 2 moves or time steps for each. "Degree" is the average number of choices available at each node. This reduces because of the limits put on radial g, extending this limit results in the degree staying at its maximum value for a greater number of levels into the search tree. The "number of leaves" is how many terminal positions would require evaluation of performing a pure minimax search. "Minimum scan" is the theoretical minimum terminal positions that would require evaluation using alpha beta cutoffs if the search tree were perfectly ordered. Assuming a random distribution of the terminal branches the "branching factor" indicates the average number of branches alpha beta had to search at each node resulting in the "expected scan" for the number of terminal evaluations required. The last column is for a two versus two engagement with each participant controlling turn and climb dive in a similar manner. The derivation of these quantities is described in reference 3.

The examples clearly illustrate how rapidly the number of positions explodes with increasing level, control choices and number of participants. This a many on many engagement with control over turn, climb and throttle would become quite unmanageable. Alpha beta can be seen to postpone but not prevent this combinatorial explosion.

3.4 Search Optimisation and Heuristic Alternatives

The basic alpha-beta minimax search can be improved significantly by the addition

of one or more of the following optimisation techniques.

- i - Successor ordering.
- ii - Lookahead/iterative deepening.
- iii - "Killer" heuristic.
- iv - Non-speculative pruning.

All of these rely on the existence of a "well behaved" (smoothly varying) evaluation function for maximum effect and applicability. The "all-aspect-missile" evaluator of section 4.1 is of this class. These techniques lead naturally into heuristic based searches of which B* is an example. Note however that heuristic searches can no longer guarantee to find the globally optimal solution, unlike alpha beta, but only a locally optimal one.

3.4.1 Successor ordering

When the plausible moves generated from a given node can be reordered on an optimal basis for the player "on the move" at a given level then considerable search savings can be made. The pruning can then be maximised under any given node thereby extending the search depth possible, or reducing the search time. Such reordering can be achieved through an analysis of a range of potential encounter configurations, with optimal orderings then held in look-up table form to minimise computation time during an actual search.

3.4.2 Lookahead/iterative deepening

If an "end" position in the tree search is particularly dynamic or volatile the search for the "best" move benefits from an extension of volatile nodes for sufficient extra nodes for the situation to become quiescent. This has the effect of countering the "horizon" effect (failure to consider the moves that are beyond the lookahead depth "horizon") thus leading to more reliable move decisions.

3.4.3 "Killer" heuristic

The "best" move from the corresponding previous level of the tree (the "killer") should always be tried first if it is still valid. This can lead to very rapid reduction in the size of the tree through pruning of less promising continuations.

3.4.4 Non-speculative forward pruning

As absolute upper and lower limits can be placed on the evaluation function in a given time interval they can be assigned to any node to indicate the limits of its (short term) future behaviour. These behavioural limits can then be used to forward prune branches of the tree which cannot possibly affect the outcome thus reducing still further the search time, the number of evaluation required, and the number of moves generated.

3.4.5 B* Search

Berliner's B* search algorithm (reference 2) is a best first proving search applicable to classical adversary search situations involving minimaxing. It uses optimistic and pessimistic heuristic functions to bound the evaluations achievable on any given branch of the search tree, and so functions like a heuristic analogue of non-speculative forward pruning discussed earlier. The search involves proving one of two hypotheses about the current "best" possible move, these are:-

- i - Prove best - attempt to raise the pessimistic bound of the current best move so that it is no worse than the optimistic bounds of the alternative moves.
- ii - Disprove rest - attempt to lower the optimistic bounds of the alternative moves so that they are no better than the pessimistic bound of the current "best" move.

and when one proves true to select as the "best" move. This search strategy does not suffer from the horizon effect as its depth is not truncated artificially, but is driven by the evaluation heuristics.

4 Static Evaluation

This is the procedure which performs the "dynamic" part of situation assessment by considering the situation resulting from the application of the plan, and returns plan related values. Whether such values are produced purely at the end of each plan or are assessed throughout the generation of the plan is determined by the particular search strategy employed.

4.1 One on One Engagements

The evaluation function developed to date is based around a one on one, coplanar, equispeed engagement using all aspect missiles taking into account the following factors:-

- i - Range,
- ii - Relative aspect,
- iii - Relative bearing,
- iv - Mission role - one of Fighter, Escort or Bomber.

with the basic engagement geometry being that illustrated in figure 4.1. The function combines values for the attack effectiveness, vulnerability to attack, willingness to engage and range dependent parameters to provide an assessed value for the engagement which is positive if the player (blue) has an advantage, and negative if his opponent has the advantage.

Rate parameters, whether range or accelerations, are deliberately excluded from the static evaluation function because its task is to provide an instantaneous

"snapshot" of a situation as it develops. Any time dependent factors are wrapped up in the generation of the plausible moves and the subsequent search through the tree of moves.

4.2 Assessed Surface Plots

The five surface plots of figure 4.2 (b-f) illustrate the changes in the assessed value of a one on one engagement, where the blue and red aircraft take on the various roles of "fighter", "escort" and "bomber". Changes of heading are plotted for the blue and red aircraft over the range $[-180^\circ, 180^\circ]$ with the red aircraft positioned due North of the blue one, i.e. at a bearing of 0° .

Two examples will serve to illustrate:-

i - Fighter versus Escort (figure 4.2c) - in the "tail on" situation the peak at $(0^\circ, 0^\circ)$ indicates that the fighter should carry through the attack. It has an "attack opportunity window" of $[-123.7^\circ, 56.3^\circ]$, and an "optimal" attack trajectory of -33.7° .

ii - Bomber versus Fighter (figure 4.2f) - in the "tail on" situation the saddle-point at $(0^\circ, 0^\circ)$ indicates that the bomber should turn away and evade. It has an "attack opportunity window" of $(-153.4^\circ, 26.6^\circ)$, and an "optimal" attack trajectory of -63.4° .

As this can be seen there is sufficient overall behavioural information built in to the evaluation using the mission roles, and "optimal" trajectories can be extracted balancing the pursuit and evasion drivers within the overall behaviour. The orientation of the peaks in the surface also gives clues as to direction of turn for the blue aircraft:-

i - Escort versus Fighter, Fighter versus Bomber (d and e) - turn in same direction as red aircraft.

ii - Fighter versus Escort, Bomber versus Fighter (c and f) - turn in opposite direction to the red aircraft.

4.3 Example Group Engagement

Figure 4.3 illustrates a four versus four group engagement in which two pairs of blue fighters (B2 to B4) on combat air patrol are attacking the leading aircraft in a red interdiction, comprising two escorts (R1 and R2) and two bombers (R3 and R4). Values for each possible one on one engagement are tabulated and summation of these indicates a very favourable situation for blue. Further incorporating resource allocation is then required to resolve the multiple engagement satisfactorily.

5 Conclusions

5.1 Current Status

The current status of the engagement model and planner is:-

i - It offers a coplanar equispeed engagement model for small scale (up to two versus) air combat.

ii - It encompasses realistic pursuit and evasion behaviour which is mission role dependent.

iii - Conventional tactics are generated from single move lookahead searches, which also give singleton and group situation assessment.

iv - Planned tactics are catered for in multi-move lookahead searches, and lead to the possibility of earlier disengagement from unfavourable situations.

v - Basic group operations are made possible through the assessment of the group situation and the construction of a generalised search tree.

5.2 Future Development

Within the three search functions the following extensions will be added:-

i - plausible move generation - extend to three dimensions, add variable aircraft velocities and realistic aircraft performance envelopes.

ii - search - add enhancements and heuristic mechanisms of section 3.4, and construct a meta-planner for full resource allocation in group operations.

iii - static evaluation - cater for other weapon fits, extend assessment to three dimensions, incorporate "energy" variables and develop optimistic and pessimistic evaluators for the B*.

5.3 Impact on Air Combat

Reliable air combat plans and advice can have several major impacts on current operational practice:-

i - enhanced "force multiplier" results from effective group operations.

ii - earlier assessment of deteriorating situations can lead to earlier and more successful break off from an engagement.

iii - generation and maintenance of group fused and assessed world views will provide an almost "spherical" sensor cover-

age leading to much improved situation awareness.

This last should also act as a driver for future communication and sensor systems which together with sensor fusion techniques will give the information basis for the formation of air combat plans.

6 References

1 - Knuth, D E and Moore, R N, "An analysis of alpha-beta pruning", *Artificial Intelligence*, 6, pp. 293 - 326, North Holland, 1975.

2 - Berliner, H J, "The B* tree search: A best-first proof procedure", *Artificial Intelligence*, 12, pp. 23 - 40, North Holland, 1979.

3 - Pearl J, "Game-searching theory: Survey of recent results", in Bramer, M A (ed.), "Computer game playing. Theory and practice", pp. 276 - 284, Ellis Horwood, 1983.

4 - Shaw, R L, "Fighter Combat: Tactics and maneuvering", US Naval Institute, Md., 1986.

5 - "Definitions of aircraft attitude and heading angles", Air Publication 112A-0001-1, 1967

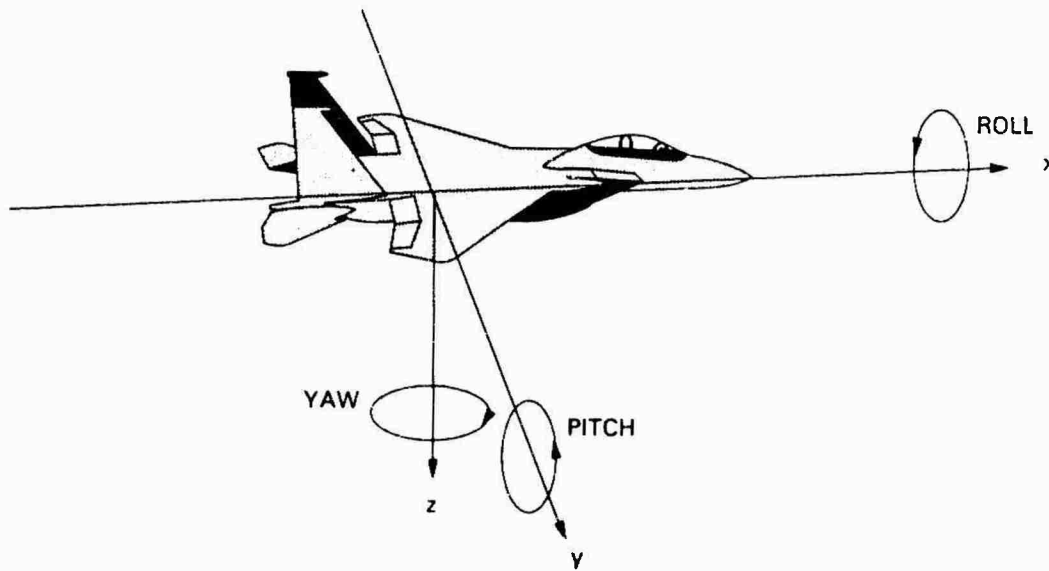

Aircraft Body Axes

Figure 2.1

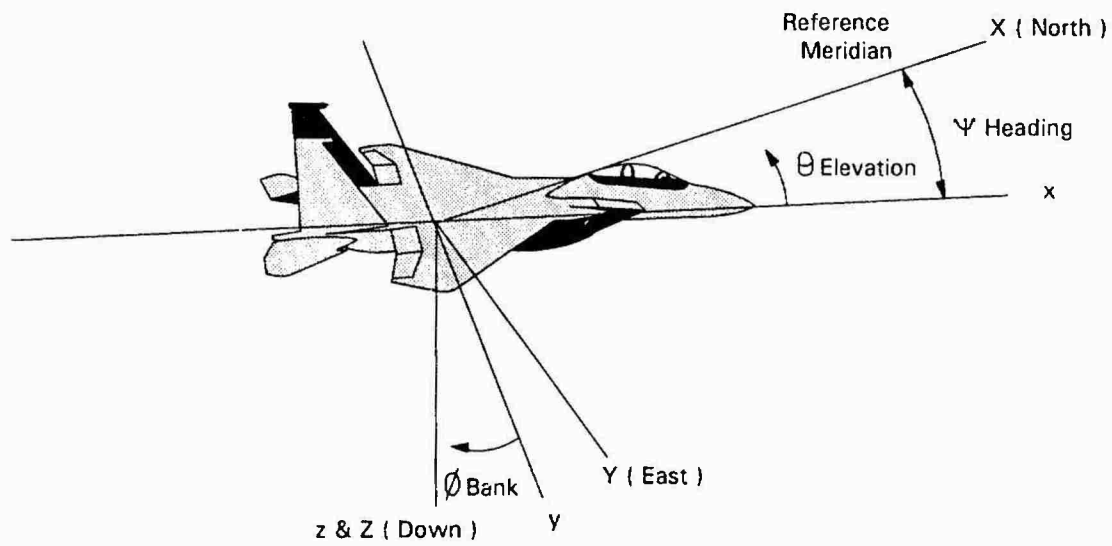

Inertial Axes and Euler Angles

Figure 2.2

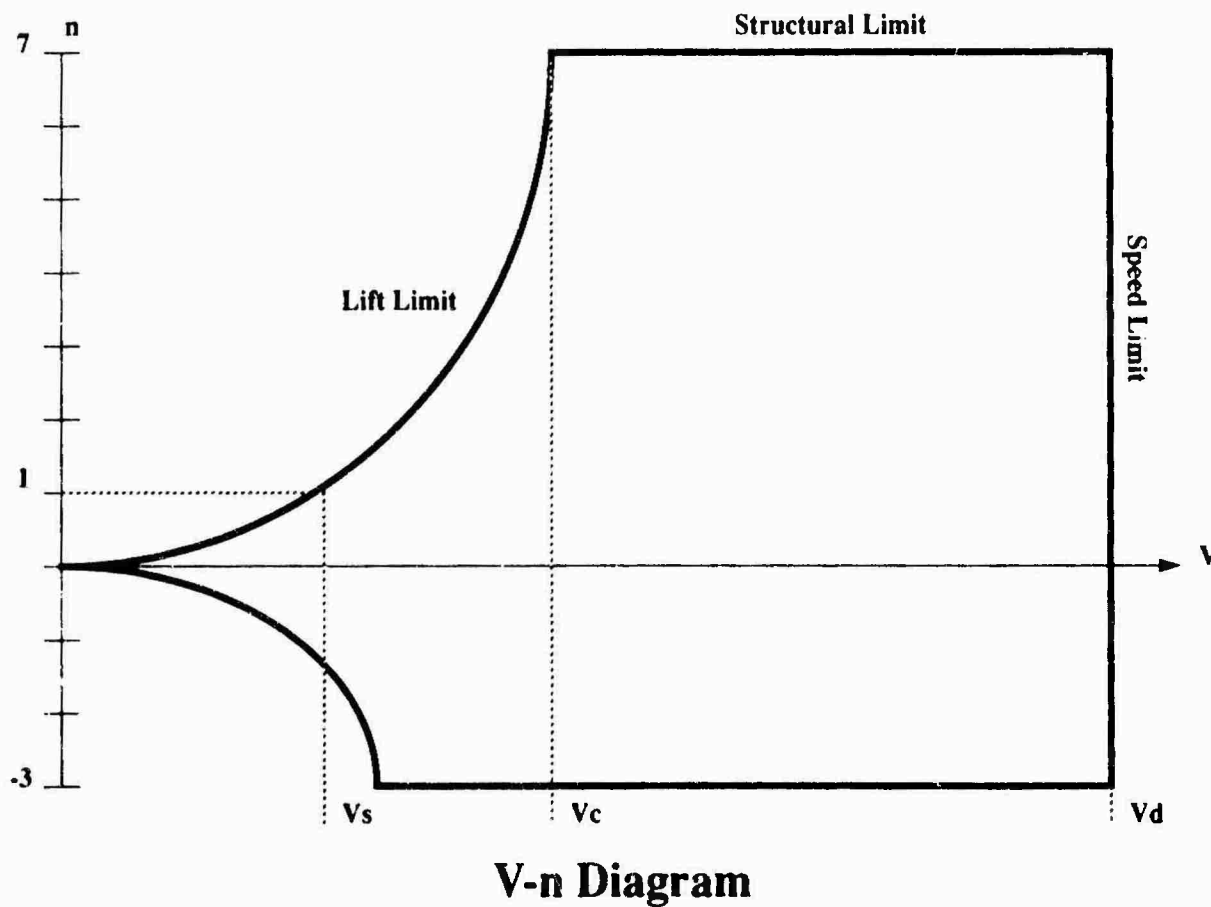
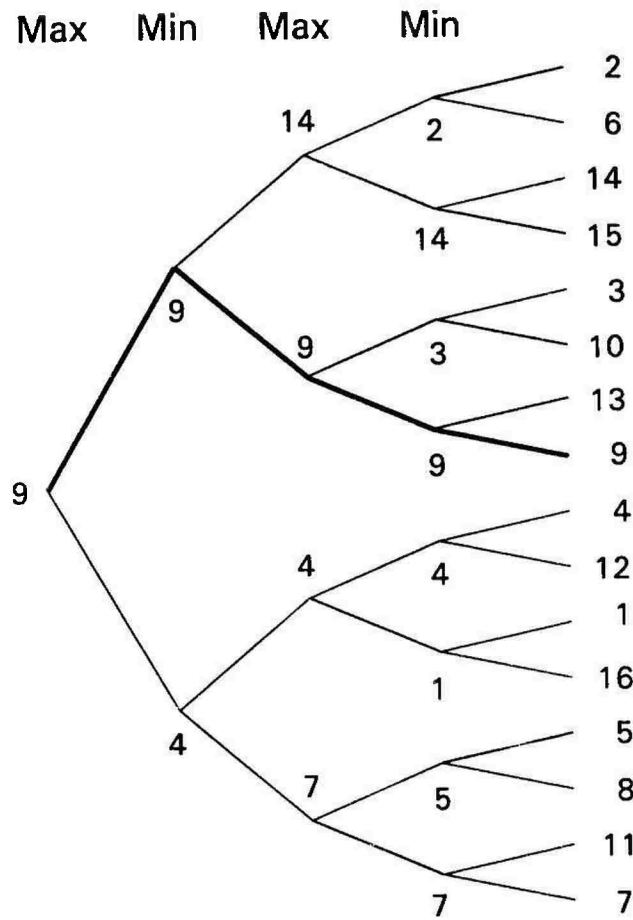
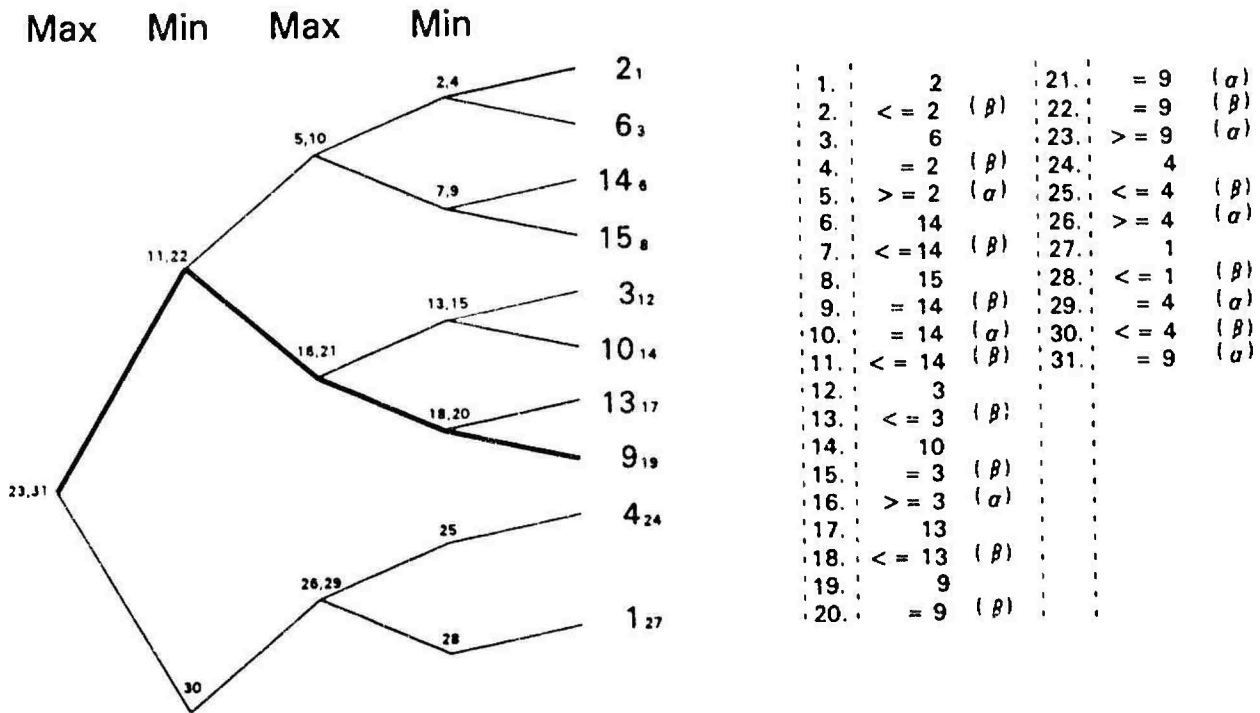

Figure 2.3



Minimax Search

Figure 3.1



Alpha Beta Cutoffs

Figure 3.2

level	4	6	8	10	12	4
degree	3.000	2.924	2.882	2.853	2.833	81.000
number of leaves	81	625	4761	35721	267289	43046721
minimum scan	17	49	137	377	1033	13121
branching factor	2.148	2.110	2.088	2.074	2.063	24.510
expected scan	21	88	362	1469	5956	360912

Search Statistics

Figure 3.3

Position : (x,y) (x',y')
 Range : r
 Heading : θ θ'
 Aspect : a a'
 Bearing : β β'
 Relative Bearing : ρ ρ'

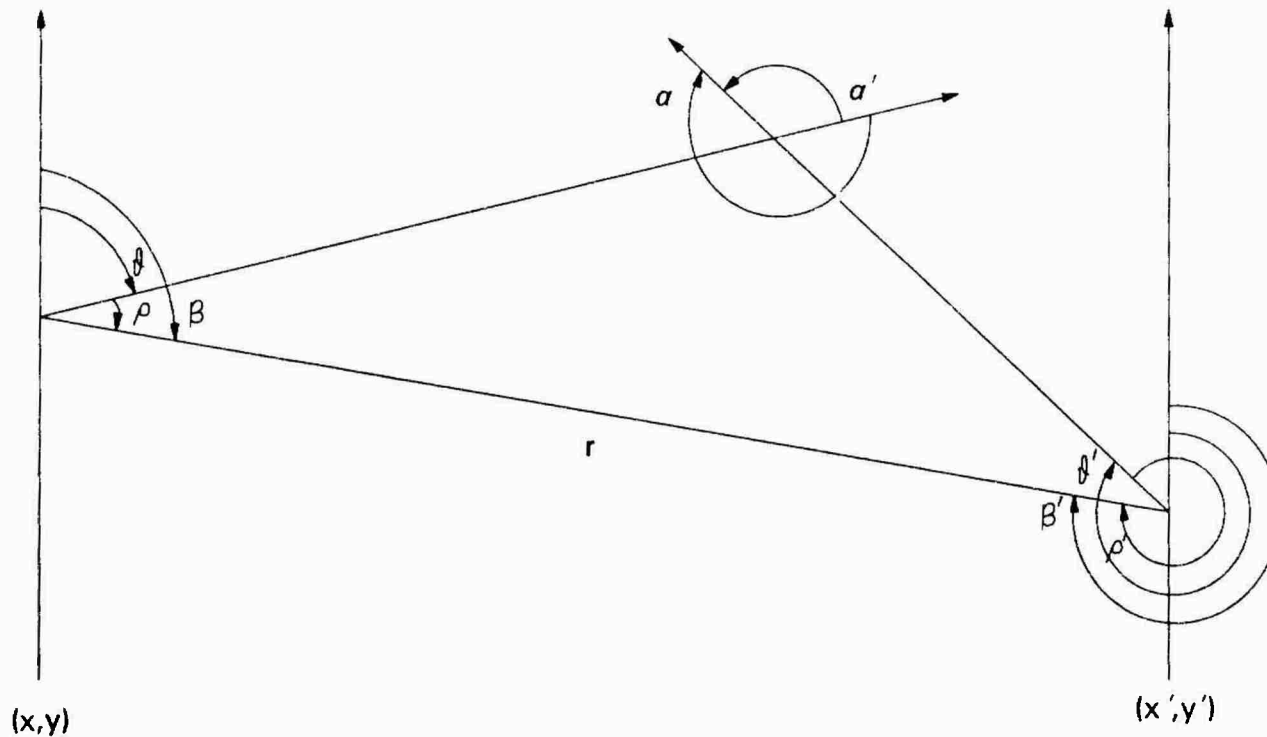

Figure 4.1 One on One Engagement

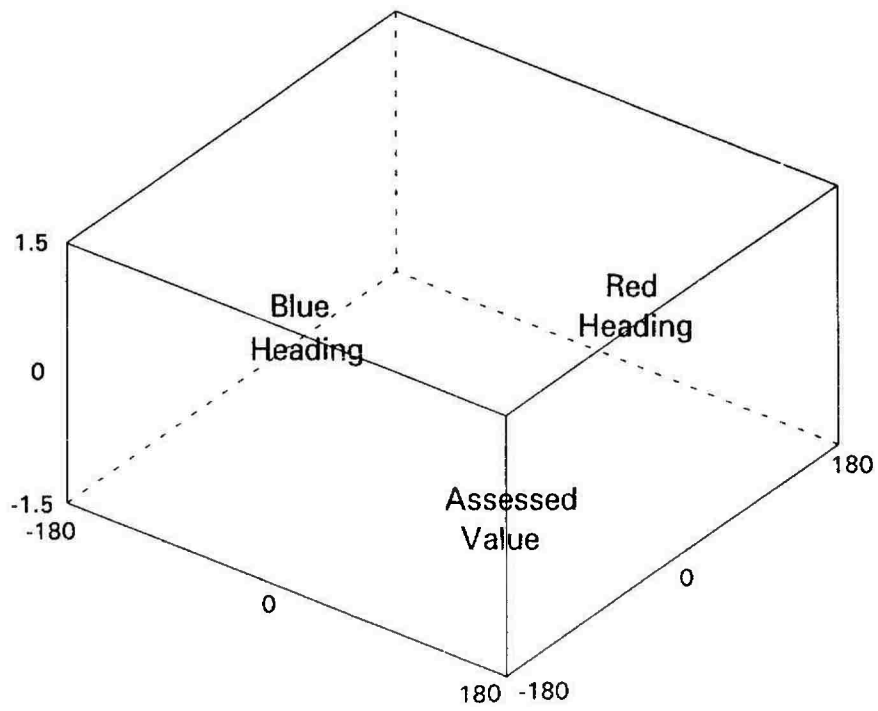

Figure 4.2a Key to Graphs

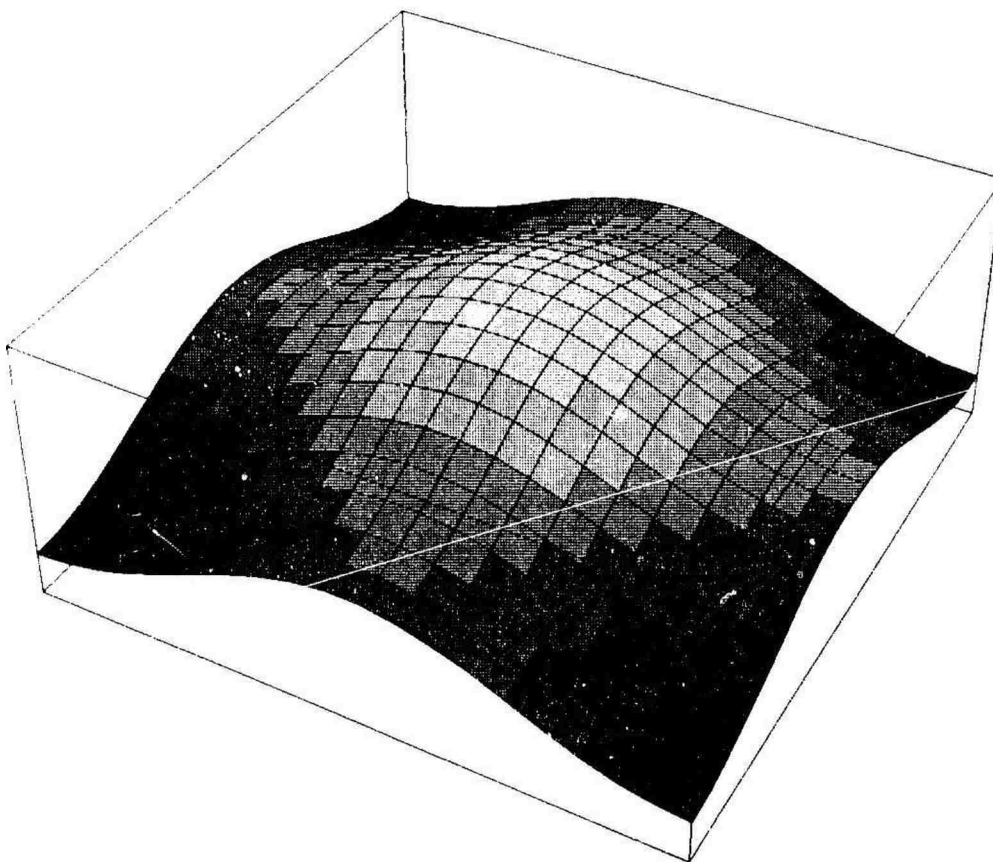

Figure 4.2b Fighter vs. Fighter

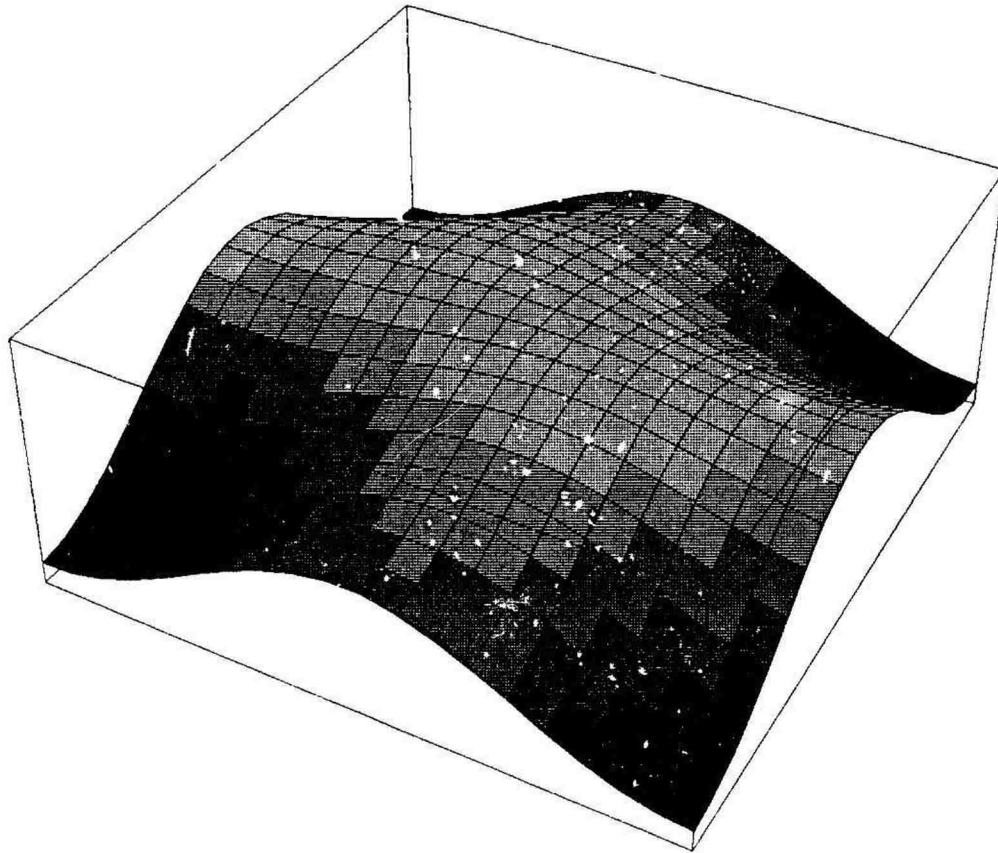

Figure 4.2c Fighter vs. Escort

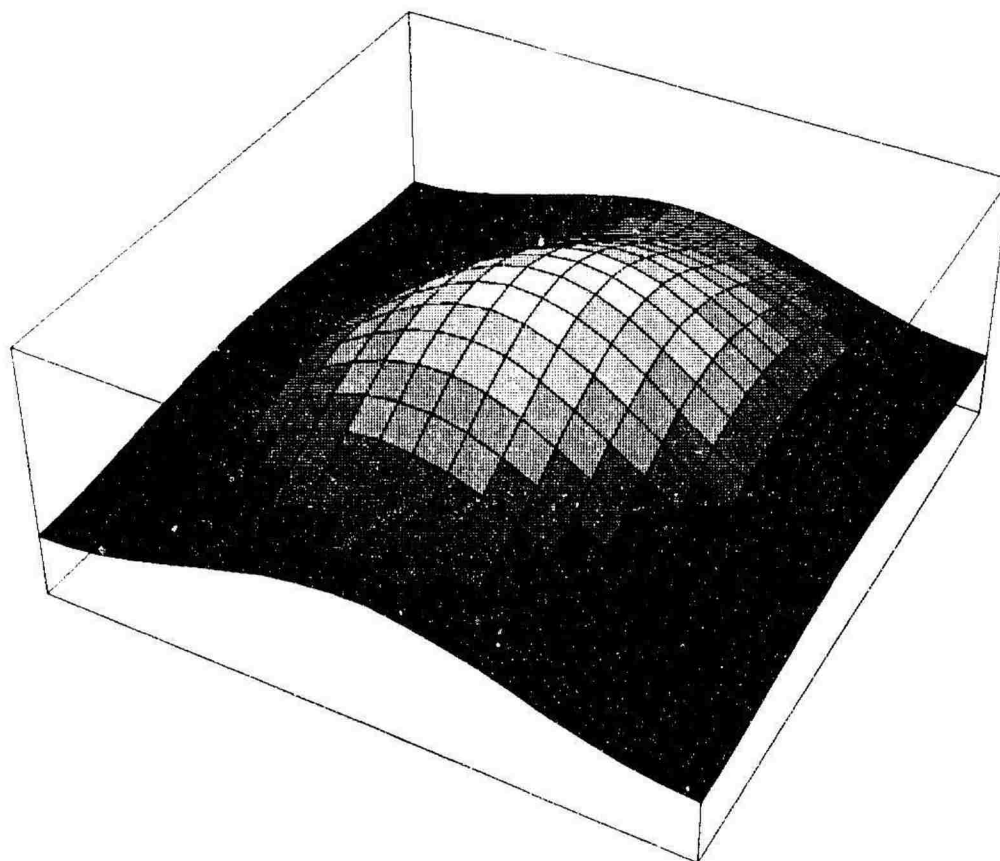

Figure 4.2d Escort vs. Fighter

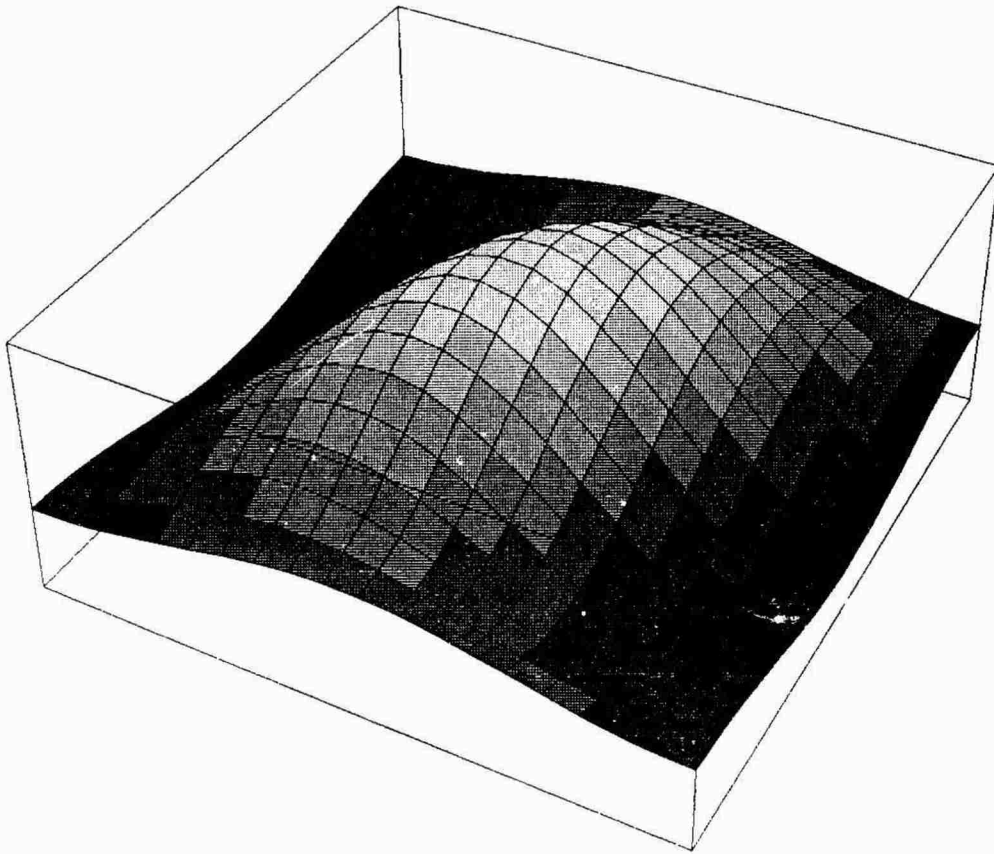

Figure 4.2e Fighter vs. Bomber

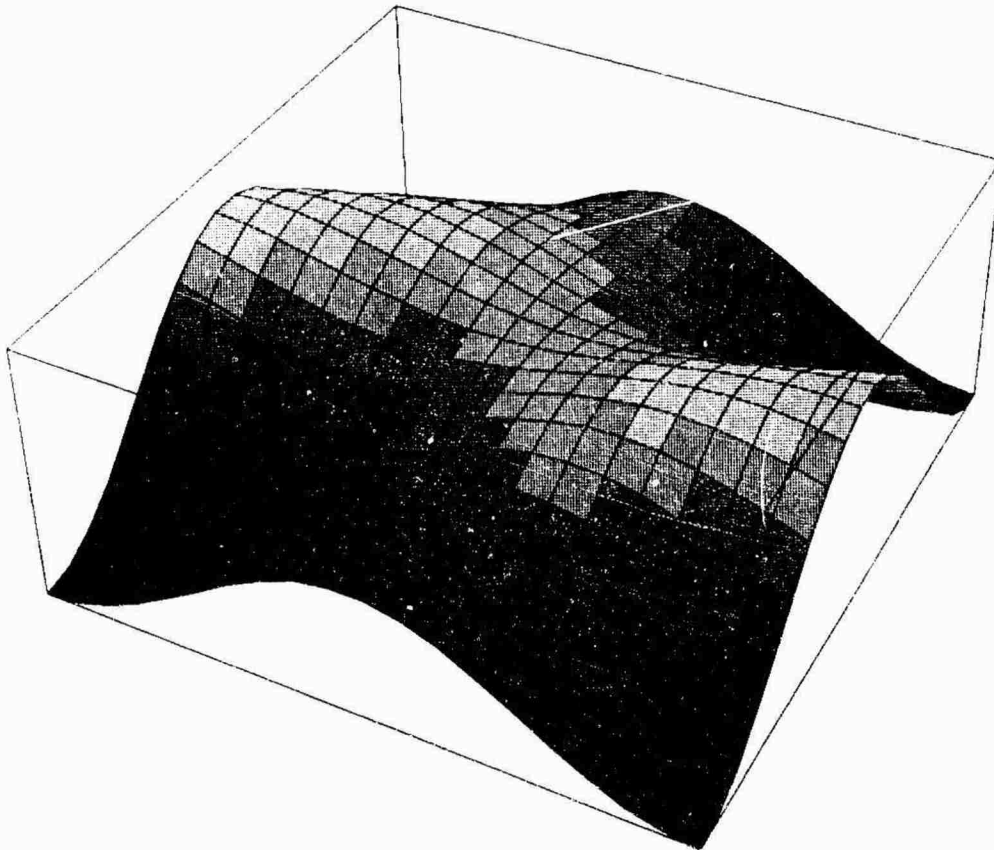
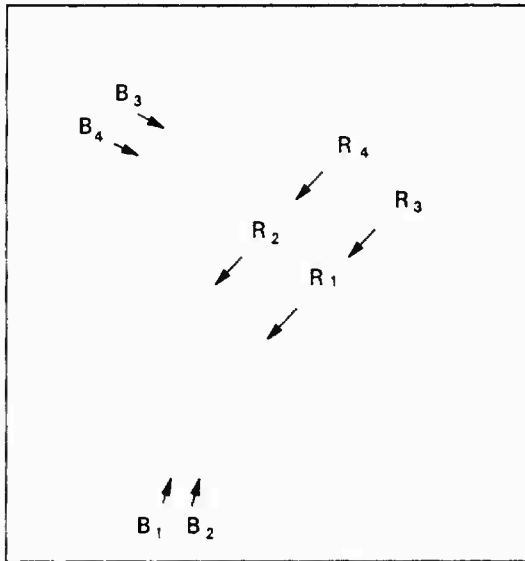

Figure 4.2f Bomber vs. Fighter



B_1, B_2, B_3, B_4 = Fighter

R_1, R_2 = Escort

R_3, R_4 = Bomber

Figure 4.3

	R_1	R_2	R_3	R_4	Total
B_1	-0.004	0.105	0.016	0.043	0.159
B_2	0.033	0.156	0.029	0.046	0.265
B_3	1.012	1.509	1.070	1.310	4.900
B_4	0.836	1.144	0.923	1.012	3.916
					9.239

Example Group Engagement

**PILOT DECISION AIDING FOR WEAPON DELIVERY -
A NOVEL APPROACH TO FIRE CONTROL CUEING USING PARALLEL COMPUTING**

A.R. Buffett and R.M. Wimbush
Aerospace Systems Division
EASAMS Limited
Lyon Way, Frimley Rd,
Camberley, Surrey,
GU16 5EX, UK.

SUMMARY

This paper describes the application of advanced technology, both hardware and software, to provide improved pilot Man-machine Interface (MMI) automation for the central function of an airborne weapon system, namely weapon release. The specific scenario addressed is that of providing the pilot with decision aiding, in the form of firing cues, for the use of air-to-air missiles.

The paper gives an overview of the need for automation/decision aiding in air-to-air missile fire control, by illustrating the way in which missile performance can vary greatly with the changes of engagement parameters which occur rapidly in an air-to-air combat scenario. The high pilot workload in this type of scenario, and the future requirement for multiple simultaneous missile firings, further support the need for automation to provide pilots with simple, processed, predictive data on which to base their firing decisions.

Current methods of generating and displaying fire control cueing information to the pilot are described. Their limitations, in terms of lack of flexibility, approximation in calculation, and serial rather than parallel execution, are discussed. A novel future approach - the use of an on-board missile fly-out simulation - which offers a potential solution to such limitations, is presented. This relies upon the development of a simple, but sufficiently accurate, missile fly-out model, and the use of parallel processing to achieve the required 'faster-than-real-time' operation and multiple simultaneous cueing.

The development of such a model, and its potential to provide an efficient and intuitive MMI for fire control cueing for future missiles and combat scenarios, is described.

1. THE REQUIREMENT FOR FIRE CONTROL CUEING

One of the most important, if not *the* most important, aspect of any combat mission is the successful achievement of weapon delivery. This is also an area where, due to the limitations of human information processing capabilities, a need exists for efficient

automated support to weapons useage and for a flexible and unambiguous MMI. This will be especially true if weapon delivery performance, and hence mission effectiveness, is to be maintained in future multi-target, multi-threat environments with associated high operator workload.

A most challenging area of weapon delivery, for both the supporting technology and the operator MMI, is the provision of 'Fire Control Cueing', i.e. information on when a firing opportunity is available, to a military aircraft pilot. This is particularly true in relation to the use of air-to-air missiles against opponent aircraft. In this highly dynamic scenario, there exists a complex interaction of rapidly changing factors which define when the launch of any given type of missile from a moving aircraft will be successful in intercepting its moving target.

The air-to-air launch scenario is illustrated in Fig. 1. The main variables which determine whether a missile firing will achieve a successful intercept are:

- a. Launch aircraft parameters (e.g. speed, height, heading and climb angle).
- b. Target aircraft parameters (e.g. speed, height, heading and sightline relative to launch aircraft).
- c. Missile parameters (e.g. maximum time of flight, guidance method, maximum turn rate).
- d. Error boundaries on the above parameters (e.g. due to sensor accuracy in detecting b., or design/manufacturing tolerances in c.).
- e. Post-launch target manoeuvre (e.g. evasive changes of heading/attitude once a missile launch has been detected).

In an air-to-air combat engagement, opportunities for missile firing, with varying probabilities of success (based on the values of the above parameters at the time) will appear and disappear throughout the combat. Accurate estimation of the occasions when a missile launch would be successful is therefore clearly beyond the capabilities of an unaided pilot, especially given the high workload imposed by other aspects of such a scenario.

The pilot, who for the foreseeable future will retain control of weapon release, therefore requires to be continually advised of the occurrence and success probability of each firing opportunity, as a decision aid to assist his tactical manoeuvring and use of his limited missile load. Fire control cueing achieves this by the rapid calculation of missile flightpath and hence intercept success, from the complex interactions of the above parameters, in order to advise the launch aircraft pilot when to fire. This is achievable assuming that values of parameters a. and c. are known, parameter b. information is available from sensors (e.g. Air Intercept Radar on-board the launch aircraft - see Fig. 1), and parameters d. and e. are estimated.

With recent improvements in missile technology (providing increased effective range, 'all aspect' launch and multiple firing capabilities), and future high threat/multi-target environments, the challenge for fire control cueing in future will be:

- i. To carry out the necessary calculations sufficiently rapidly and accurately for a wider range of missile types and scenarios, and simultaneously for multiple firings.
- ii. To display such additional information to the pilot in a way which he will easily and quickly understand.

Before discussing the capability of current and proposed future fire control cueing systems to meet these needs, the concept of a Launch Success Zone (LSZ) and its variation with changes of engagement parameter values, must be understood.

2. THE LAUNCH SUCCESS ZONE

The LSZ is a means of representing the output of fire control cueing calculations. It will allow the method of conducting the calculations, the relative effects of engagement parameter variations, and the nature of the information available to the pilot, to be understood.

The LSZ is a volume of space around a target from within which a missile fired from a launch aircraft will, for given conditions, hit the target. The LSZ is described by a maximum and minimum range boundary, defining the area of three-dimensional space around the target which the launch aircraft must enter to achieve a successful missile firing. Figure 2 shows a two-dimensional plot of an LSZ.

2.1 LSZ Calculations

The LSZ is generated by conducting fire control calculations, i.e. detailed modelling of missile fly-outs, for a given engagement scenario, for different launch/target aircraft geometries. Specifically,

sequential fly-outs from different ranges along radial aspect lines are conducted (see Fig. 2), to identify the change from misses to hits (i.e. the maximum range at which hits occur) and then the change from hits to misses (i.e. the minimum range at which hits occur). These points are called the maximum and minimum range boundaries and their specific values are found by a process of incremental refinement of fly-out range known as the 'boundary search' procedure.

The maximum and minimum range boundary limits are defined by different factors (e.g. missile maximum flight time or sightline spin rate) depending upon the launch scenario.

2.2 Variations in Launch Success Zones

The LSZ for any given situation will depend upon the values of parameters a. to e. listed in Section 1. Thus, for a given missile type/capability, the LSZ will vary according to the engagement parameters, error boundaries on such parameters and post-launch target behaviour. Some examples are discussed below.

Figure 3 shows the LSZ of a nominal scenario case where the launch aircraft and target aircraft have the same speed and same altitude, (often referred to as the co-speed, co-altitude case). A generic air-to-air missile type is assumed, and subsequent figures will show the effects of other parameter changes.

Figure 4 shows the effect of increasing the target speed. It can be seen that the LSZ gets longer and thinner with a region of no capability around the beam where the sightline spin rate becomes high.

Figure 5 shows the effect of a 'Steering Error' at launch. (A Steering Error is an azimuth angle between the missile body axis and the target sightline at the time of launch.) The maximum range boundary becomes slightly smaller and the minimum range further out, indicating an overall reduction in missile coverage.

Figure 6 shows the effect of 'Snap Angle Error' at launch. Snap Angle is the angle the launch aircraft needs to adopt in elevation in order for the missile body axis to be pointing down the target sightline. The maximum range boundary is much smaller, but the minimum is hardly affected.

Figure 7 shows the effect of parameter error boundaries, specifically total motor impulse variation as might result from manufacturing tolerances (although the extent of the variation illustrated is not necessarily typical). The maximum range boundary, defined to a large extent by the maximum flight time of the missile, is correspondingly affected. Other parameter error variations e.g. in the detection of target aircraft data, will also affect the LSZ to varying degrees.

It can be seen that the LSZ can change in size and shape appreciably with changes in the launch geometry (and, to a lesser extent, error boundaries), but even bigger changes can result from target behaviour after the missile is launched.

If the relative geometry and target/launch aircraft parameters are known and the target behaviour during the missile flight is known, then it is possible to calculate the nominal missile capability against that target. Unfortunately this is rarely, if ever, the situation. Although the launch aircraft parameters should be well known, the target aircraft parameters will always be slightly out of date and the future target motion, though bounded by specific manoeuvre capabilities, cannot be accurately predicted. The magnitude of uncertainty due to inaccurate assumptions about the target motion will obviously be a function of target reaction and missile flight time (the longer the missile is in flight the more likely a previous estimate of the target post-launch behaviour is to be in error).

Consider three cases of differing post-launch behaviour as shown in Fig. 8:

1. The target is assumed to fly straight and level, then the typical maximum range boundary is elongated in the front and shortened round the back.
2. The target performs a high-g break manoeuvre so as to turn away from the missile, which considerably reduces the maximum range boundary from the front.
3. The target turns at a sustained 'g' level, then the effect on the maximum range boundary is to twist it round in the direction of turn.

For an all-aspect infra-red or a radar-guided missile, where large front hemisphere ranges are realistic for acquisition, then it can be appreciated (from the changes in the LSZ) that the assumption about future target behaviour is very important to the reliability of the indications given by the fire control system.

Depending on the type of missile e.g. short or long range, lock-before-launch or command-aided mid-course followed by autonomous terminal homing, the LSZ variations and hence fire control uncertainties will be different, but in all cases post-launch target behaviour (and variability of parameters due to error boundaries) will make the task of the fire control system more difficult.

2.3 Display of Fire Control/LSZ Information to the Pilot

The display of fire control cueing information to the pilot will not involve the whole of the LSZ, but will be restricted to the range boundaries on the particular radial

aspect line that corresponds to the angle of approach of his aircraft to the target.

Current means of presenting this information to the pilot will be described in Section 3. However, the capabilities of modern missiles and the demands of future scenarios will require the development of novel presentation formats to handle the increasing amount of information which will need to be available to the pilot. Section 4 will describe the fire control cueing system proposed to generate the extra information required, and will discuss some approaches to its display.

3. CURRENT METHODS OF FIRE CONTROL CUEING

3.1 Calculation

Traditionally the calculation of missile capability has been carried out by doing thousands of runs of a 5 or 6 degrees-of-freedom 'Reference Standard' missile fly-out model in order to generate LSZs for an appropriate range of possible scenario parameter variations. This requires a lot of computer time and also considerable effort from skilled analysts' in guiding 'boundary searches' and interpreting the results. There is a statement in one document from the Naval Weapons Center, China Lake, USA proclaiming that 'Generating LSZs is more of an art than a science'.

The use of digital computers on board combat aircraft has moved the fire control cueing solution from being one of the aircrew memorising a book of LSZs or rules of thumb (resulting from the above Reference Model runs), to the current situation of the real-time display in the cockpit of missile performance data. However, this current solution still relies upon the interpretation of data from LSZs previously generated by Reference Model runs. To achieve this, the information on missile capability is either stored as a database of LSZs which can be interpolated for the current conditions, or as an algorithm which has been produced by carrying out regression fits on a database of such zones.

In either case, the database required is large and hence expensive to generate in time and computer resources. As mentioned earlier, assumptions need to be made in conducting individual calculations, for example, about target behaviour during the missile flight. Each parameter which is thus varied multiplies the number of zones required in the database to give adequate coverage for interpolation to be acceptable. Also the range of each parameter is missile and launch/target aircraft dependent e.g. launch aircraft and target aircraft minimum and maximum Mach numbers determine the speed coverage required.

By virtue of all the work being done 'off-line' on ground-based computers, the computing resources

needed on the aircraft for the current standard of fire control cueing solution are relatively small, and methods such as the use of algorithms ensure real-time fire control cueing.

However, the drawbacks of the current fire control cueing solution are:

- The requirement for a large LSZ database.
- The approximation of results derived from interpolation or algorithm generation.
- The inflexibility of the solution, requiring large numbers of reference model runs should, for example, missile parameters change, or new target manoeuvre assumptions be required.

In addition, current solutions, as implemented on-board the aircraft, are typically limited to the calculation of fire control cueing for one target at a time.

3.2 Display

Display systems currently used for fire control cueing are typically of the form shown in Fig. 9. The left side of this figure shows the reduced LSZ situation where, as discussed in Section 2.3, a given launch aircraft approach geometry represents a single radial aspect line. The information of interest to the pilot is the maximum and minimum range boundaries in relation to his present range, for the particular combination of speed, height and other parameters which exists at the time. In the case shown, the current launch aircraft position/range is between the maximum and minimum range boundaries. The maximum range boundary for a post-launch constant high 'g' turn by the target is also shown, as current fire control systems are often designed to present such an additional range boundary. This is of great value to the pilot, as it represents a more realistic estimate of maximum range capability.

The right side of Figure 9 shows a typical Head-up Display (HUD) format illustrating the presentation to the pilot of the fire control cueing appropriate to the LSZ situation discussed above. The display has two parts - the LSZ (on the right) and the Allowable Steering Error (ASE) on the left. The LSZ scale shows the current range (between the launch and target aircraft) against the maximum range boundaries for the two target manoeuvre assumptions and the minimum range boundary. This indicates that the launch aircraft is within firing range for a non-maneuvring target, but outside firing range if the target conducts a constant high 'g' turn (of an assumed 'g' value) after firing. Depending upon other factors, the pilot will normally try to wait until he is within the second maximum range boundary before firing, but must do so before his current range reaches the minimum range point. Also shown is an Aim Dot and ASE Circle, superimposed on

the HUD aircraft attitude display. These indicate, respectively, the sightline to the target and the maximum allowable sightline angle error (between the launch aircraft and the target) permissible at launch for a successful intercept under the current engagement parameters. The ASE circle only appears when a potential firing solution exists, and the pilot must manoeuvre the launch aircraft to satisfy both the LSZ (range) and ASE (angular) requirements in order to achieve the firing solution. The displayed ASE circle and LSZ range boundary points will frequently change size/position with change of launch/target aircraft parameters and relative geometries during the course of the combat.

The requirement for more complex fire control cueing information in future multi-threat, multi-target scenarios thus presents a challenge not only to the calculation of such information, but also to the development of new methods/formats for its display.

4. A FUTURE METHOD OF FIRE CONTROL CUEING - ON-BOARD SIMULATION

4.1 Description

As discussed above, current fire control cueing methods generally rely on a large database of LSZs being available from ground-based reference model runs. A novel, alternative approach would be to install a simpler missile fly-out model in an on-board computer and generate the results directly as required (see Fig. 10). While this would have a number of significant advantages over the current methods, it also presents a number of potential problems of implementation. Examples of each are listed below.

Advantages:

1. A single, simpler 'generic' model could be used for all missiles.
2. Changes in aircraft or weapon capabilities, or in the type of fire control information generated and displayed to the pilot (see below), could be more easily accommodated simply by updating the on-board model.
3. Range boundaries could be calculated specifically for the 'known current' engagement parameters instead of interpolation from the LSZ data.
4. The one program could be used to supply a wide variety of fire control information e.g. on the effects of different post-launch target behaviour, or cueing for different types of missiles carried.

5. A programmable target behaviour representation could be included to allow this to be varied as required.
6. The types of boundary search could be varied or changed as the need arises, for example, 'expert systems' may, in future, offer improved boundary search performance.
7. Updated intercept predictions could be made for the current missile in flight, to aid decisions on the need to launch another missile at the same target.
8. Assessments could be made (using the same on-board model 'in reverse') of one's own vulnerability to missiles launched by the target.
9. Multi-target cueing and prioritisation based on, for example, target 'g' needed to escape could be carried out.

Potential Problems:

- a. The run speed of the model would need to be fast enough to provide the required pilot display update rate, for all of the fire control cueing information. This would necessitate a model capable of running a fly-out simulation much faster than real-time.
- b. Boundary searches would have to be achieved automatically (without a reference model analyst to guide them), therefore a unique boundary needs to exist (which is not true in certain circumstances) or the search algorithm be clever enough to find the required boundary.
- c. The model would need to be sufficiently accurate to give predictions in keeping with the quality of data on the scenario.
- d. The model predictions of missile minimum (as well as maximum) range performance would need to be understood.

Overall therefore, the on-board simulation approach offers enhanced flexibility and cost-effectiveness in fire control cueing, but solutions to the problems of accuracy and computational speed would need to be found.

4.2 Feasibility and Development Approach

The feasibility of developing a missile fly-out model for use as an on-board simulation to provide fire control cueing has been studied. The critical issues relating to both the software techniques and hardware technology aspects of such a development have been identified. These are discussed below, in the context of defining EASAMS' approach to the development of such a system.

4.2.1 Software Approach

The key to providing a software model which could achieve the required performance for on-board use lies in the complexity of the simulation and the efficiency of the computing techniques employed.

4.2.1.1 Model Complexity

There seems to be some debate on the level of complexity required in a missile model to make its predictions useful. However, bearing in mind the effects of perturbations in launch/target aircraft and missile parameters and of parameter error boundaries, it is suggested that for fire control cueing applications (as opposed to detailed missile performance analysis) a simpler model could provide sufficiently accurate data. Some justification for this statement is given below:

- A simple 'trimmed aerodynamics' model representing motion in three dimensions can be shown, for most conditions, to give predictions within the spread from a 6 degrees-of-freedom model when manufacturing tolerances and statistical effects are taken into account.
- If the missile of interest is roll controlled then it is a reasonable assumption to make that the roll control system achieves its purpose and therefore a 5 degrees-of-freedom model with the appropriate fixed roll assumption could suffice.
- If the missile is freely rolling then it is unlikely that each production missile will behave in an identical manner, hence even a 'complex' model will not be correct. So there is little point in trying to represent roll behaviour and therefore a 5 degrees-of-freedom model with an appropriate fixed roll assumption could suffice.
- The detailed 'end-game' of a missile fly-out is statistical in nature and probably cannot be modelled 'correctly', so for the purpose of generating launch boundaries, a simple miss-distance against a point target could be adequate.

4.2.1.2 Computing Techniques

Given the above statements on model complexity, the approach to computing techniques has been to a simplified fly-out model design which, while providing sufficient accuracy, would require less computing power per second of simulated flight and hence become feasible for real-time operation.

Some simplifications that can be made in a missile model are:

1. Use of look-up tables relating normal force coefficient and angle of incidence.
2. Use of low order numerical integration scheme.
3. Use of low order transfer function relating demanded and achieved lateral acceleration.

In addition, the fewer time steps calculated per missile flight and the fewer flights per boundary search, the faster the predictions can be made. These imply:

4. Use of a variable time-step algorithm in the numerical integrations.
5. Use of an efficient boundary search algorithm.

The critical modelling speed factor is the time taken to generate a new set of numbers for the fire control cueing display. If several range boundaries are being computed corresponding to different assumptions then clearly these could be calculated in parallel. This implies:

6. Use of a multi-processor array e.g. transputers, where each boundary point is calculated on a different transputer and if some further information is needed then, in principle, all that is required is another transputer to provide the enhanced functionality with no degradation in update rate.

The flexibility of the system will to some extent be governed by its architecture. This implies:

7. The architecture needs to be generic to cope with different missiles and designed such that additional processors can be added as more calculations are required. This could also allow 'graceful' degradation of system performance to occur if any of the processors fail.

4.2.2 Hardware Approach

For the standard of model required in this application (as described above) individual processors of 1-2 Megaflops capability are needed. A processor of this power is capable of carrying out the necessary calculations to update a boundary point. The transputer falls into this category and is ideally suited to this application.

As developments continue in miniaturisation and computation speed, then undoubtedly other processors will become available. However the transputer has various attractions including the ability to 'flood-fill' a large number of processors with the same program, and the ease with which more processors can be added and the array reconfigured. Such features are essential to the flexibility of the on-board fly-out simulation approach, allowing fire control cueing information to be

generated in parallel (for example for multiple targets or the assessment of different post-launch target manoeuvre effects), and the number of simultaneous calculations to be increased if required.

EASAMS' hardware approach has therefore been to explore the use of a fly-out model on a transputer system.

4.3 Implementation

Based on the feasibility study, and the software and hardware approaches outlined above, a simplified fast fly-out missile model has been developed which is generic, has trimmed aerodynamics, a variable time-step and automatic boundary searches. Initial results from the model have been validated against a reference model.

A proof-of-principle demonstrator using a multiple transputer board in a PC has been produced. This has shown the simultaneous, real-time generation of fire control cueing of a form similar to that of current operational systems i.e. two maximum range boundaries, one minimum range boundary and an ASE circle.

A second demonstrator has been produced using a multi-transputer array installed in a graphics workstation. This shows the generation of multiple target fire control cueing in a more complex engagement scenario. Future work will examine the calculation of other, more novel, forms of cueing information which are possible using the same generic missile fly-out model.

4.4 Display

While the demonstrations to date have used the same form of display as current fire control systems (see Fig. 9), work is underway to investigate new, more effective display formats to match the enhanced capabilities of the transputer-based fly-out model.

Initial studies will investigate ways of displaying basic fire control information in a multi-target scenario, where simply having multiples of the current fire control formats (one for each target) would not provide an acceptable MMI. A possible solution could involve the coding of ASE/LSZ information into different shape and/or colour symbols presented in the HUD at an appropriate position to represent the sightline to each target (see Fig. 11). This should be easier and faster to interpret and provide a much less cluttered display. Additionally, different types of range boundary information may be of value in the basic fire control display. For example, a 'no escape' boundary (where the probability of intercepting the target is calculated as 100%, regardless of feasible target post-launch manoeuvre) may be useful. Alternatively, a display of the level of 'g' at which a target would be required to

turn, during post-launch manoeuvre, in order to defeat the missile, may be of value. Such display possibilities, and others, will need to be investigated to establish the most effective way of presenting pilots with a simple 'Missile Intercept Confidence Factor'.

Further studies will be needed to address the more novel display possibilities which on-board fly-out simulation could supply, such as updated intercept predictions for current missiles in flight, or the threat posed to the launch aircraft by the target's missiles.

4.5 Applications

The transputer-based fly-out model has been developed with the aim of providing improved fire control cueing, by means of on-board simulation, for future air combat aircraft. However, the potential applications of this novel system encompass other roles and other domains.

Initial use of the new model has been in the area of weapon system assessment and design for the UK MOD. Here, the speed with which the fly-out simulation can be run has allowed studies involving many repetitions of fly-outs under different circumstances to be conducted within a more realistic timescale, to provide essential data on future missile design/performance. In this context, the model has been used stand-alone and as a submodel within a larger 'battle' model. In its real-time application, the fly-out model could also potentially be used as a weapon firing training aid, or as part of a full mission simulator, as well as its ultimate on-board aircraft use.

Although developed to meet an air-to-air fire control requirement, the model can equally be applied to other scenarios/domains such as surface-to-air or surface-to-surface, for ship or land-based weapon systems. This only requires the appropriate characteristics of the missiles (e.g. aerodynamics, thrust, guidance) and of the launch and target platforms, to be input in place of those existing in the model.

An additional application in the Naval or Army domains could be for Threat Evaluation and Weapon Assignment (TEWA), where a central command and control function links a number of dispersed weapons platforms.

Figure 12 illustrates this scenario, representing perhaps a group of ships or a battlefield air defence system. If appropriate in this situation, the model could be used as part of the central command function, to provide a rapid assessment of the firing opportunities of each weapons unit against a given target, enabling firing commands to those units to be more selective and hence their limited weapons resources to be used more effectively.

5. CONCLUSIONS

Improvements in the calculation, and display to the pilot, of fire control cueing information will be necessary to ensure the effectiveness of air-to-air missile useage for future combat scenarios and advances in weapons technologies.

On-board missile fly-out simulation is a novel approach to meeting this requirement, and offers several potential advantages in terms of flexibility of use and cost-effectiveness of generation over current methods.

Advances in computing technology, in particular in the field of parallel processing and transputers, have created the possibility of implementing such calculation intensive applications in real-time on-board combat aircraft.

EASAMS has developed a simple, efficient, yet suitably accurate, fly-out model designed for transputer implementation as an on-board simulation. A PC/transputer demonstrator has been used for performance assessment and validation, and a second, workstation/transputer, demonstrator is currently being used to examine various types of novel MMI display formats to represent the additional fire control information which the model is capable of generating.

The efficiency of the model in conducting fly-out simulations has application in missile design/performance assessment studies and training simulators, as well as its use for on-board fire control cueing to support weapon release decisions. It can be applied to missile firings from airborne, land-based, or naval weapons platforms, involving different missile types and engagement scenarios.

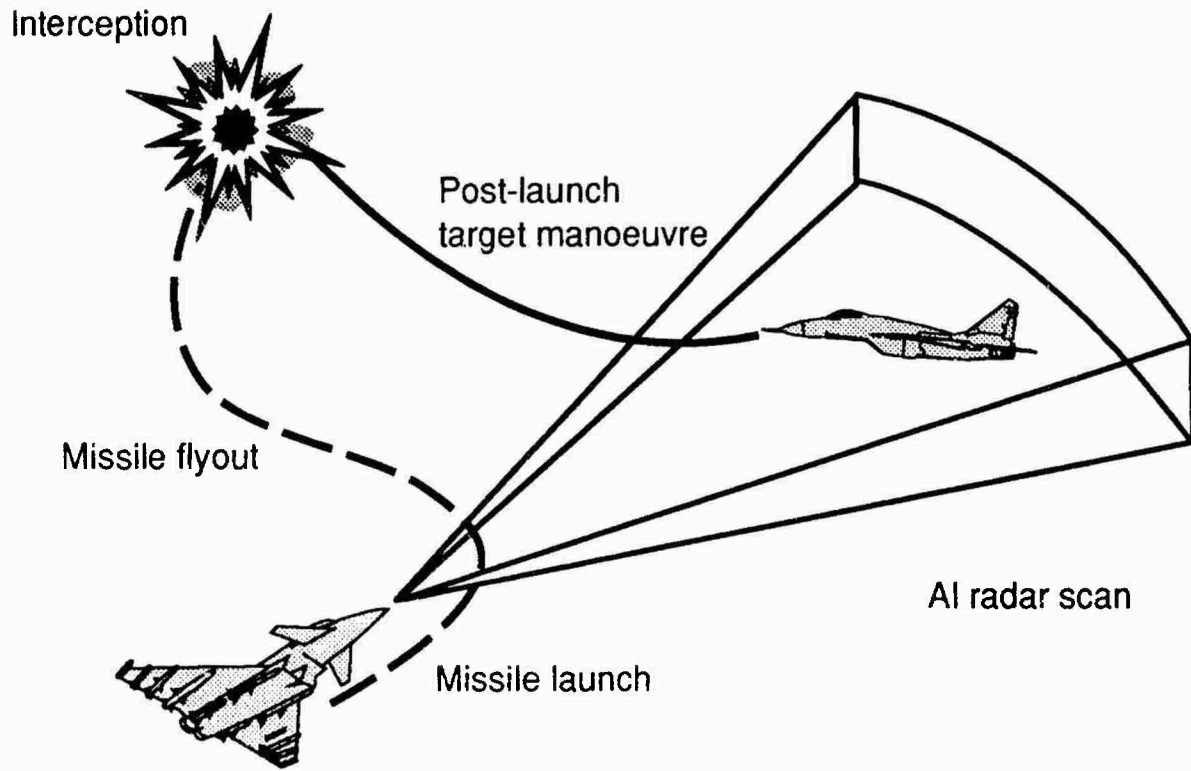

Fig. 1 LAUNCH SCENARIO

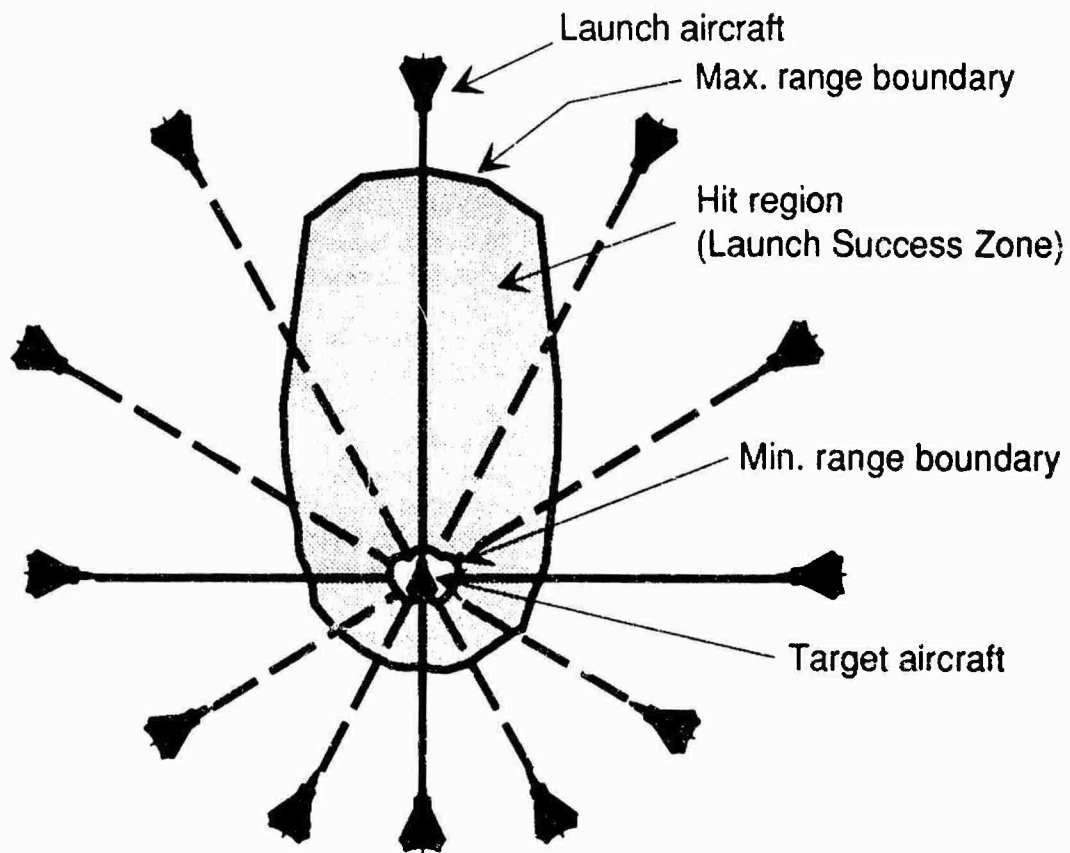

Fig. 2 A LAUNCH SUCCESS ZONE

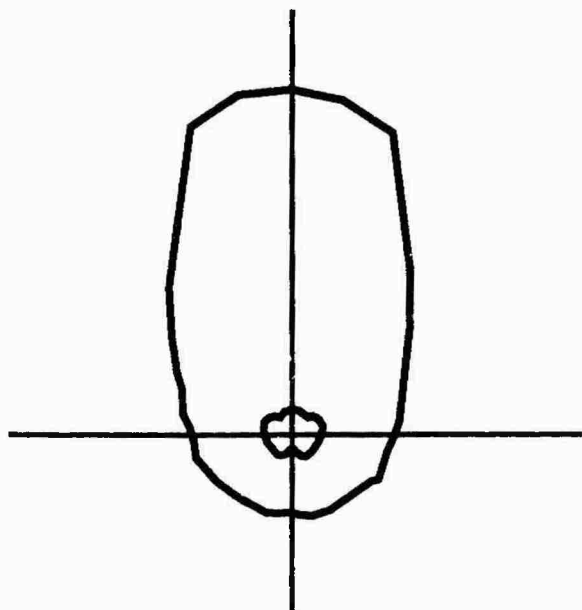

Fig. 3 NOMINAL (CO-SPEED, CO-ALTITUDE) LSZ

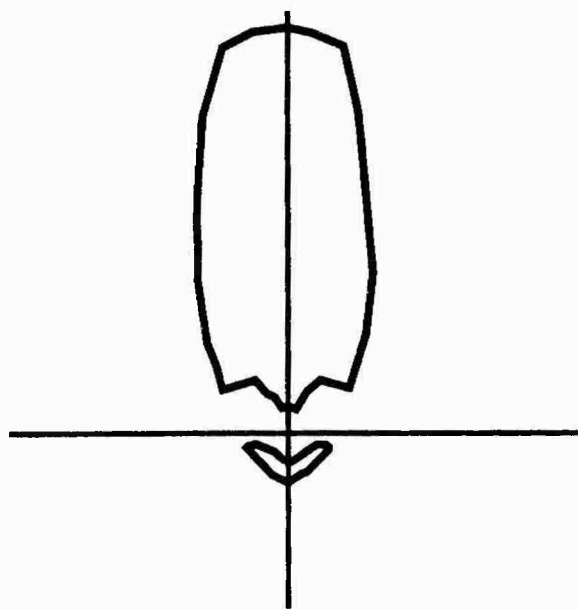

Fig. 4 TARGET SPEED INCREASED

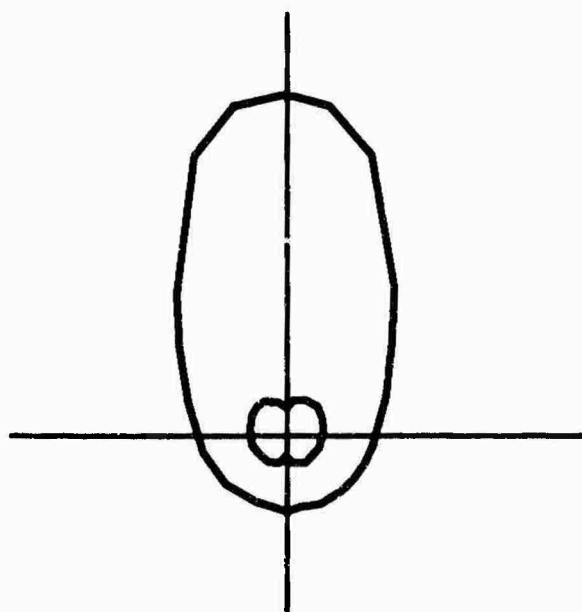

Fig. 5 STEERING ERROR AT LAUNCH

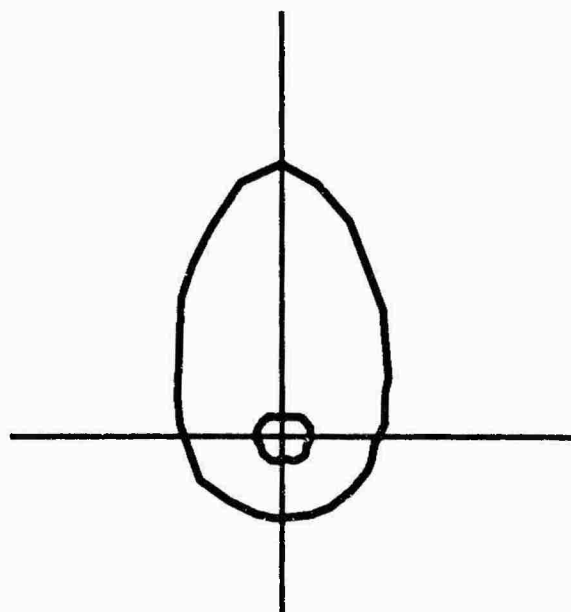

Fig. 6 SNAP ANGLE AT LAUNCH

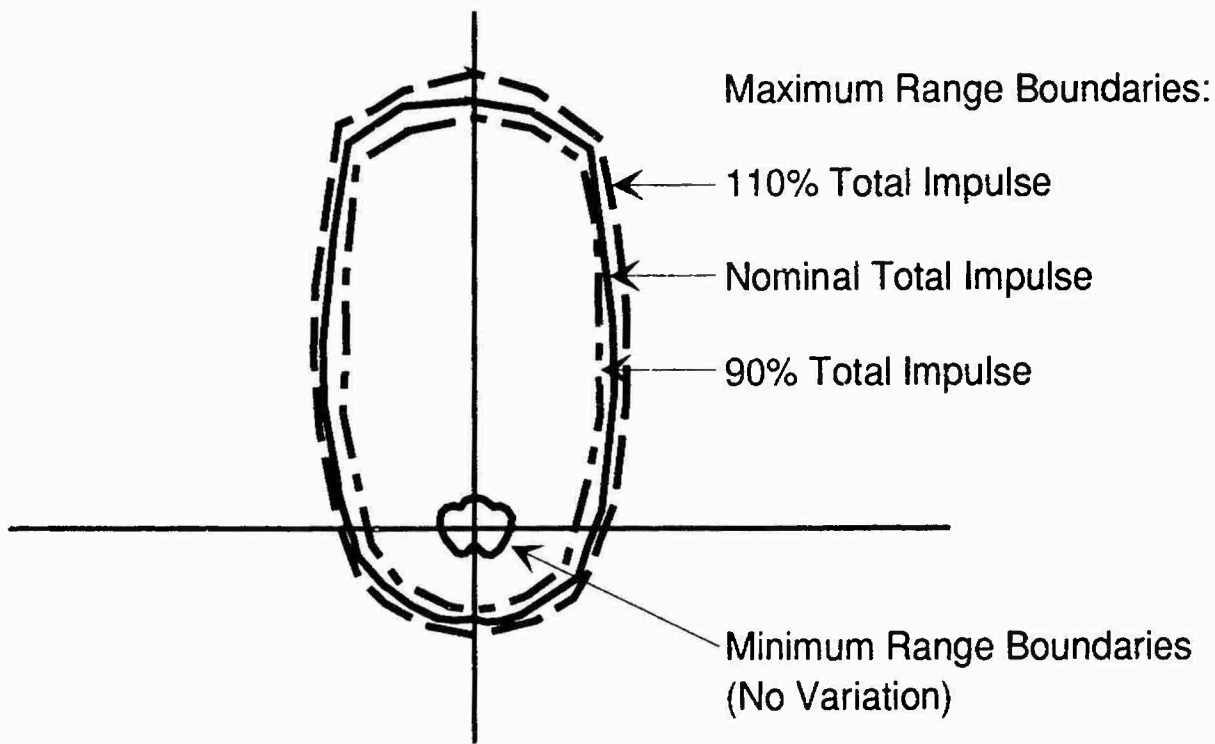

Fig. 7 TOTAL MOTOR IMPULSE VARIATION

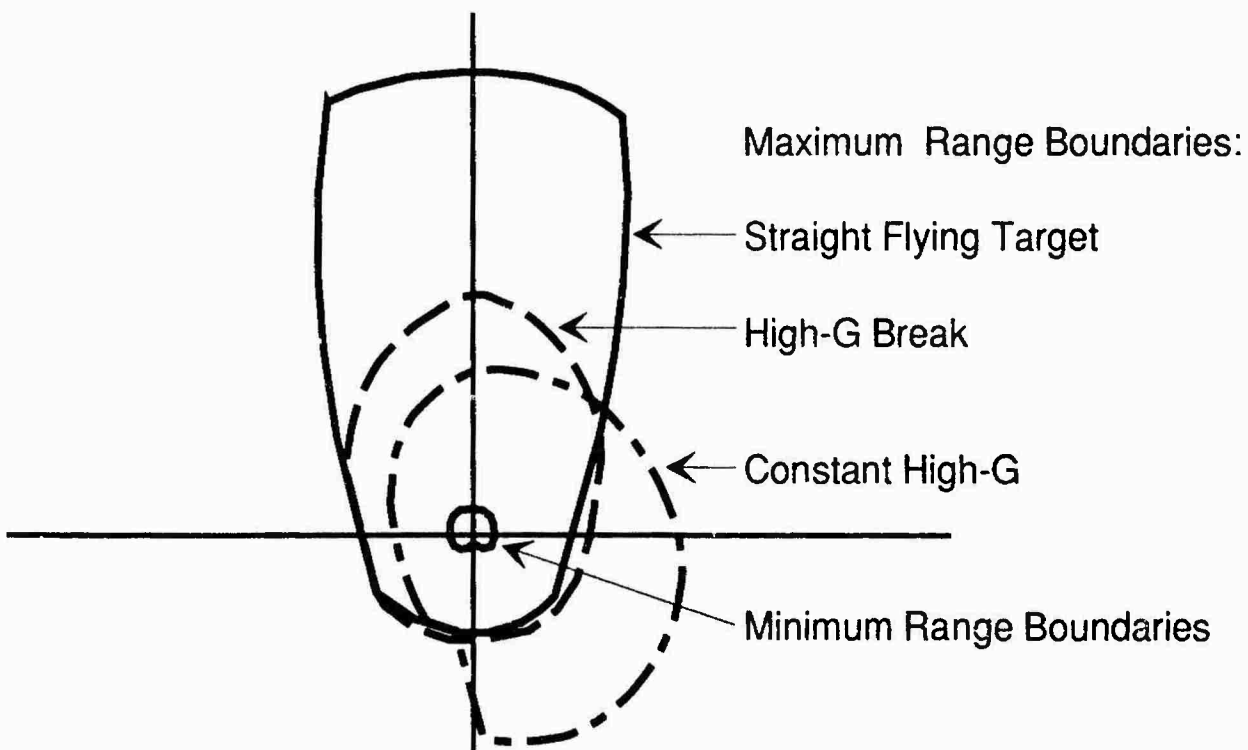

Fig. 8 POST-LAUNCH TARGET MANOEUVRE

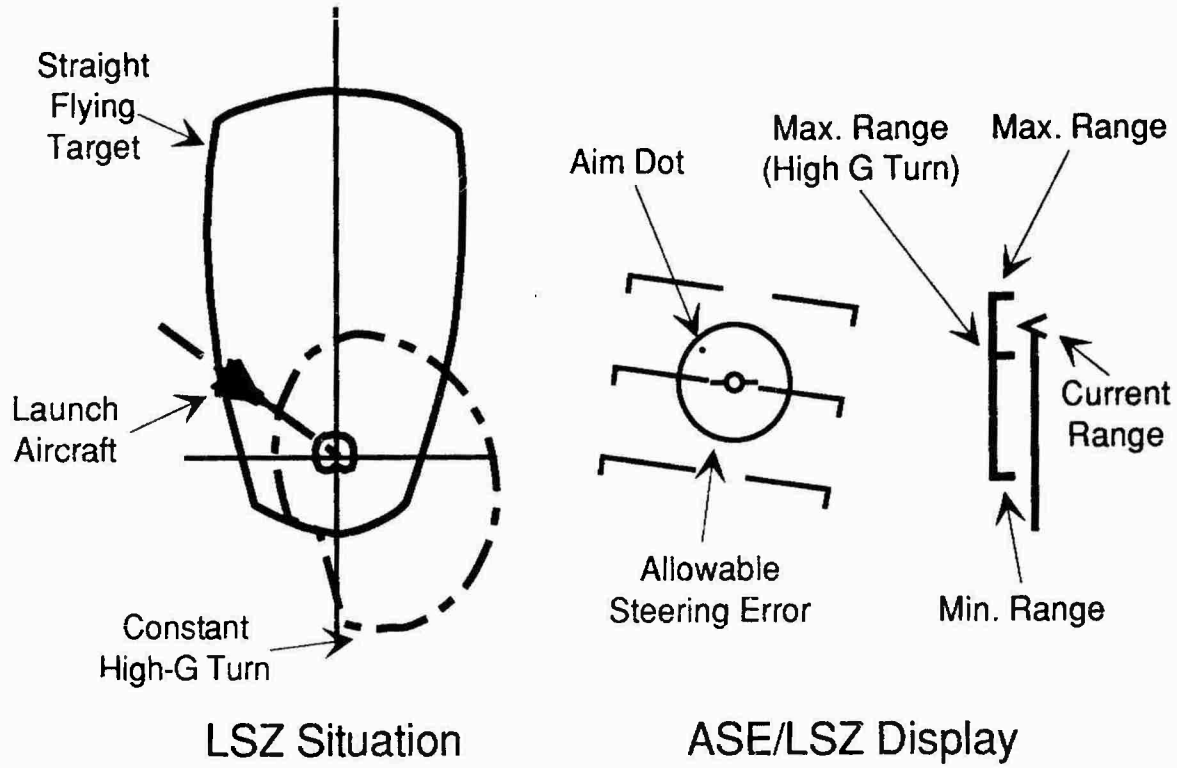

Fig. 9 DISPLAY OF FIRE CONTROL CUEING

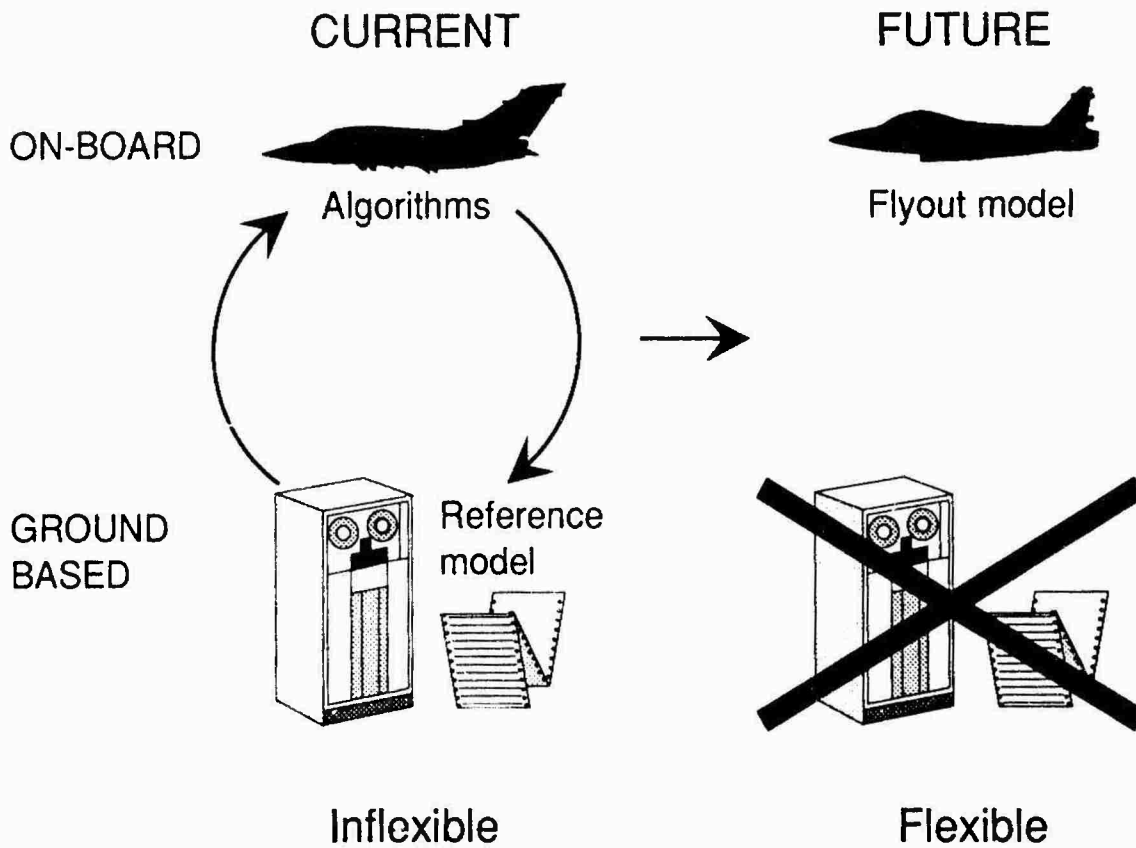

Fig. 10 THE ON-BOARD SIMULATION SOLUTION

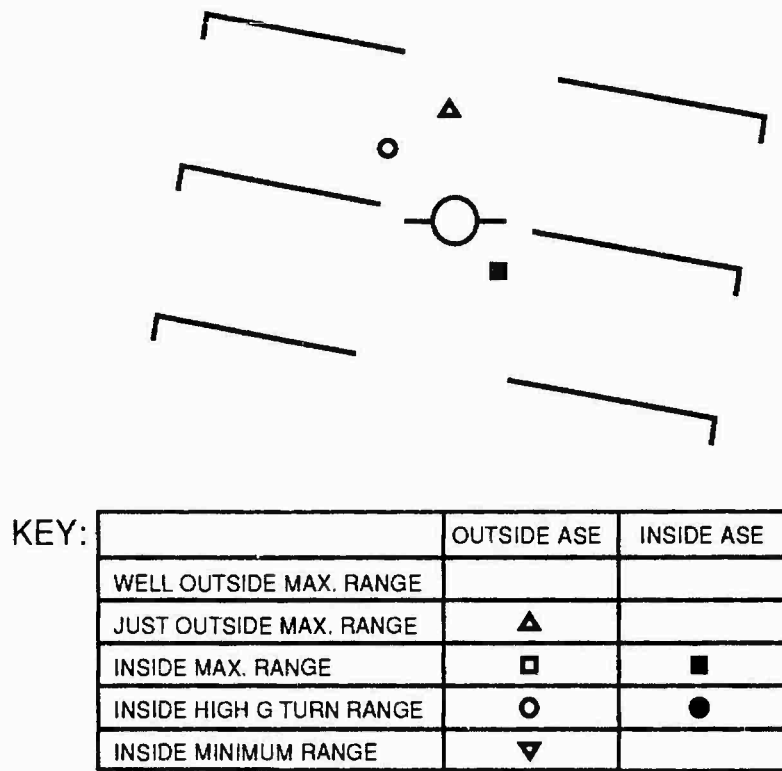

Fig. 11 POSSIBLE MULTI-TARGET ASE/LSZ DISPLAY

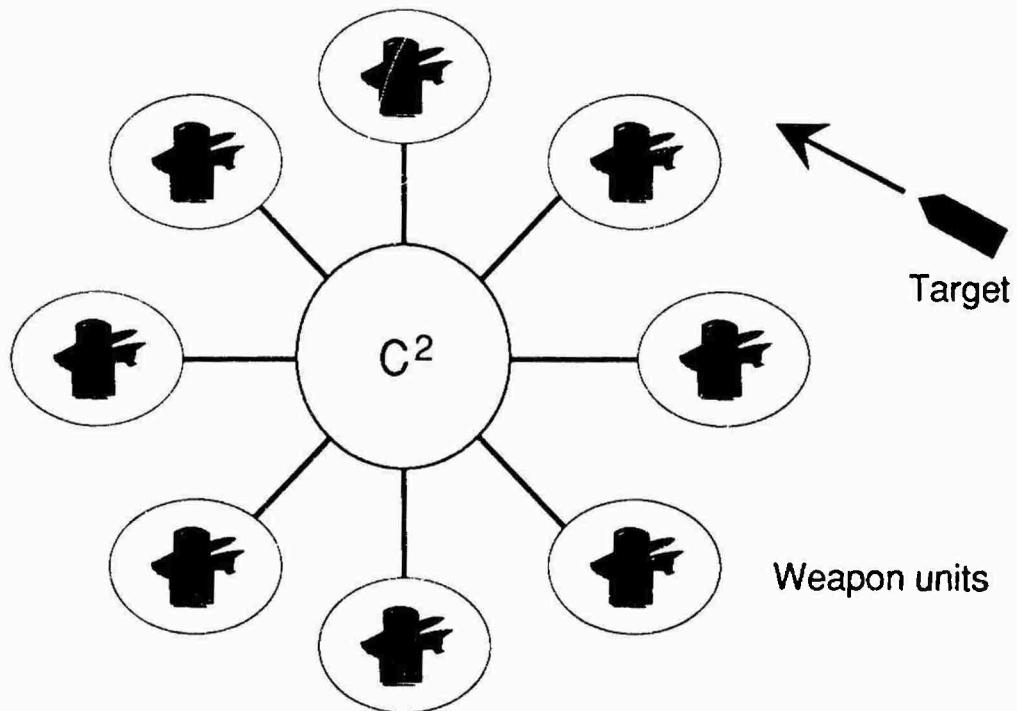

Fig. 12 THREAT EVALUATION AND WEAPON ASSIGNMENT

A NEW CLASS OF MISSION SUPPORT FOR COMBAT AIR-CREW

by

Harvey J Pipe
GEC Sensors
Basildon, Essex
SS14 3EL
United Kingdom

SUMMARY

In the next century, combat aircraft will be even more complex than those planned as current replacements; this is to counter increasingly competent aggressors, who may operate anywhere in the world.

While the traditional scenario of NATO versus Warsaw Pact forces is well understood, out-of-area battlefields are relatively poorly documented and, when conflicts flare-up quickly, fresh intelligence will have to be gathered as situations develop, and databases updated during flight. This raises the problems of dynamic planning (both strategic and tactical) while missions are in progress, and highlights the need for interoperability with other nations. Also, if there is only a single crew member, then work overload is likely, to the detriment of the mission and possible safety of the aircraft. In these circumstances some form of computerised assistance is required.

To tackle the need for a new class of mission support, UK Industry and the Ministry of Defence set up the Mission Management Aid (MMA) Project. By rapid prototyping of software, the functional requirements of the MMA, and also the real-time symbiosis between man and intelligent machine, are being investigated.

This paper covers the integration of an MMA into future combat aircraft, its operation, the core topics of Sensor Fusion, Situation Assessment (including Dynamic Threat Assessment), Planning and Tactical Routeing (with Defence/Attack Options Management).

Evaluation of the MMA is showing that better situation awareness is obtained, increasing mission effectiveness and survivability, and that overall the MMA is a vital integral system for future aviation.

1 INTRODUCTION

There is no doubt that the future roles and operational requirements of military aviation are changing, as the traditional scenario between NATO and Warsaw Pact forces is overtaken by conflicts elsewhere in the world. The capabilities of emergent enemies are increasing, and, by contrast with Europe, databases of other regions are immature - thus aircraft may need to be updated with fresh information during their mission. The need for rapid deployment of forces from cooperating nations also points to the importance of interoperability.

In this challenging environment, avionics equipment is becoming more sophisticated and multifunctional, and there is a trend towards forming complex integrated systems. These may have to be managed by only a single crew

member in future, and during intense combat this could lead to work overload and ultimately to mission failure - despite being supported by advanced facilities.

To address the concept of a new class of support for a pilot, the Mission Management Aid Project was set up in the late eighties. This research programme depends on the collaboration of British Aerospace, GEC Avionics, GEC Ferranti, GEC Sensors, Smiths Industries, and the Ministry of Defence, and draws on the expertise of staff seconded to form a multi-disciplined team located on the Defence Research Agency site at Farnborough, where work is supported by the DRA.

The Project is investigating the feasibility of a Mission Management Aid (MMA), that will be installed in a combat aircraft. Currently it is the aircrew who have thoroughly to understand the mission, its routes and hazards, and try to make sense of all information, from whatever source, resolve ambiguities, and judge the best tactical response in any situation. The MMA, by collating all information, is being designed to provide advanced tactical assistance, and control - if the pilot wishes - so that he can achieve an enhanced situation awareness and maintain this benefit when events change faster than human recognition. This will improve mission effectiveness and promote survivability.

By simulating the concept, on a network of computers, its functionality is being developed. This software prototyping environment allows rapid system investigations, and functional optimisation. Experimental man-machine interface work is helping to define Pilots' requirements in an MMA fitted aircraft. The current phase, Proof of Concept Simulation, should lead naturally into trials in real time using a pilot flown aircraft simulator.

2 MMA INTEGRATION IN COMBAT AIRCRAFT

In generic terms, the *basic* architecture of a future combat aircraft could be represented by Fig. 1.

The Pilot interacts with his machine by Controls and Displays that, via an Interface Manager, access management functions associated with each subsystem of the aircraft:-

Aircraft:

Propulsion & Flight Control System, Air-data, Utilities,

Defence:

Missile Approach Warner, Jammers, Electronic Support Measures, IFF,

Attack:

Laser Ranger & Target Marker, Infra Red Search & Track,

Weapons:

Stores, Chaff, Flares, Decoys,

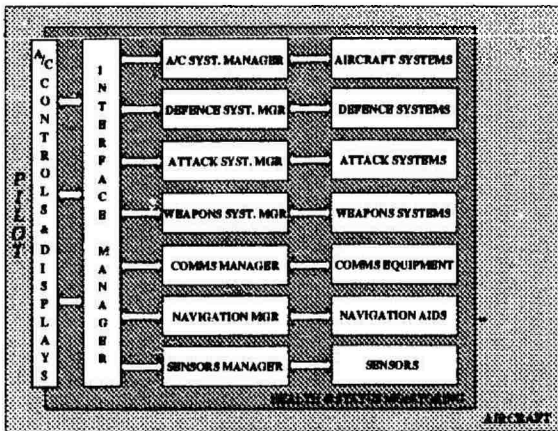

Fig. 1 BASIC AIRCRAFT ARCHITECTURE

Communications:

Multi-band facilities including JTIDS/MDS, Wide Area Covert System, Data Handling & Processing,

Navigation:

Inertial, Terrain Referenced, Radar Altimeter,

Sensors:

Radar Warning Receiver, Laser Warning Receiver, Forward Looking Infra Red,

Note these are notional functional groupings of facilities and could be re-organised to suit specific Avionics' Architectures as appropriate.

When integrating a Mission Management Aid within such an Aircraft Architecture, that aircraft will see the MMA in a dominant role, not above the Pilot's control or authority, but certainly higher than the management functions of the aircraft's subsystems; as shown in Fig. 2.

As a system, the MMA is likely to have three main parts: an Executive, a Resources Manager, and the Core Functions. The Executive acts as a computer operating system, using Mission information and control knowledge to task the Resources Manager with directing and supervising the Core - where functional processing is performed.

In parallel, individual Executives for each subsystem would interface with, and be coordinated by, the MMA Executive; the Interface Manager is also expanded intelligently to handle inter-subsystem cooperation via the Executives. This forms the intelligence of the MMA. In addition to an underlying Health & Status Monitoring system, a Reflex function (such as automatic initiation of defence/attack actions) could sensibly be interfaced here with the basic facilities.

The reason for choosing this style of executive management is to ensure intelligent operation of the total system, by:-

- * coordinating and controlling activities of subsystems
- * appropriately handling data exchange between subsystems
- * maintaining a central database (including aircraft state, and subsystems' states) :
- covering all levels from raw data to entire mission plans

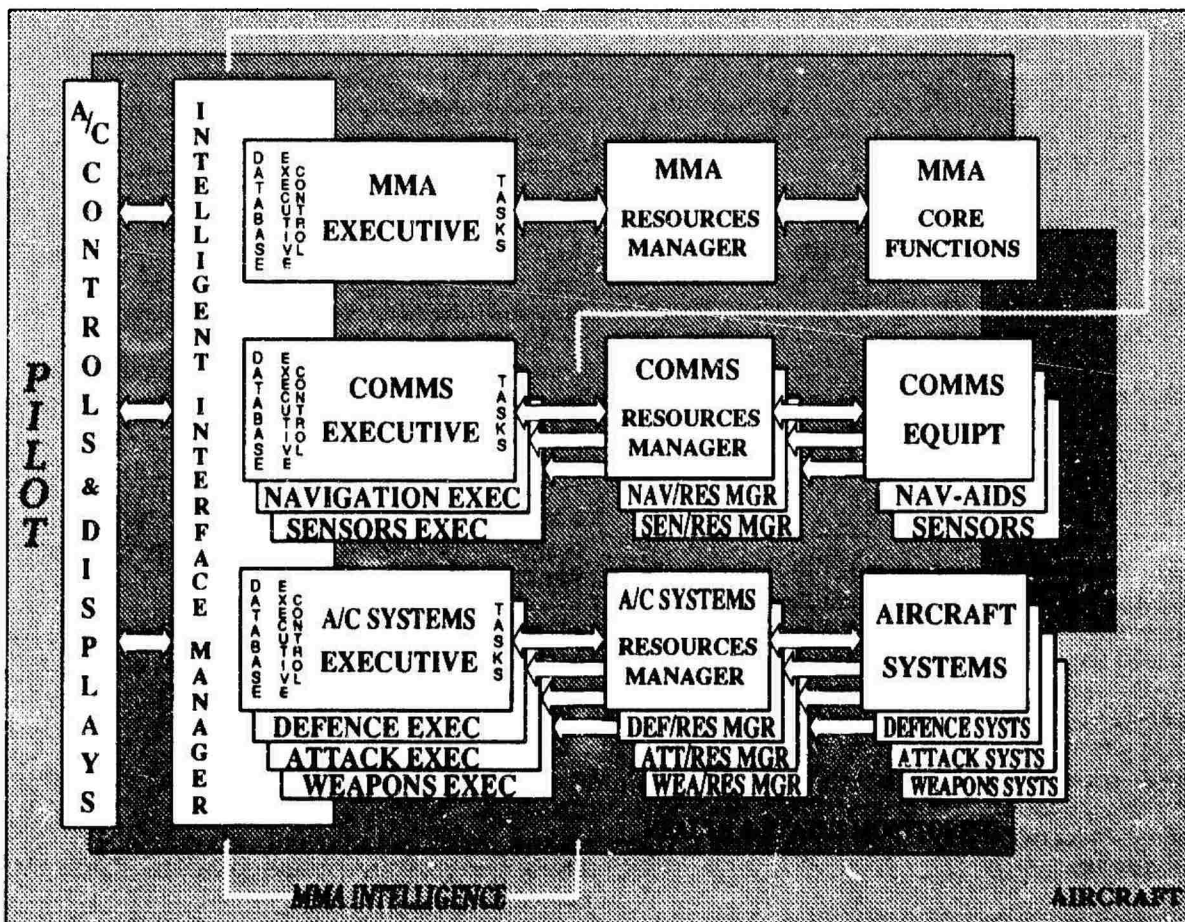

Fig. 2 MMA INTEGRATION WITH BASIC AIRCRAFT ARCHITECTURE

- up-dating information, and handling its staleness
- assessing information validity, & avoiding inconsistencies
- * arbitrating between any conflicting actions that may arise
- * providing appropriate information for the Pilot interface
- * reasoning about response time of activities, based on priority and urgency of the goal; and thus incidently contributing to status monitoring.

For the MMA aircraft, the virtue of this type of implementation is that its subsystems can be autonomous (and therefore engineered for optimal operation, performance, and response time, taking advantage of independent technology upgrades) and yet are integrated into a total operating system that behaves intelligently and which can also be controlled, or modified, by the Pilot. The key to a natural man-machine symbiosis is for the Pilot to be able to tailor the aircraft to his own preferences when he climbs aboard, and for the MMA intelligence to anticipate the pilot's intentions.

In overview, the MMA aircraft could be regarded as a flying computer-aided system. As described, it is data driven, but structured so as to behave sensibly within the bounds of Mission constraints then applying, thus avoiding erroneous action and possible "latch-ups".

By virtue of redundancy and local reconfiguration, system faults or failures can be accommodated, but if any of this intelligence suffered catastrophically - for example by enemy inflicted damage - the Pilot should be able to revert to direct control of remaining subsystem equipment and facilities.

3 OPERATION OF THE MMA

The MMA is conceived to have two over-lapping phases of operation. Firstly, before take-off, the MMA is primed with Mission details and data so that a proposed route plan and activities can be ratified - or alternatives computed. At the same time, the subsystems' executives will formulate their own schedules for Mission activity (e.g. the Navigation Executive translates the *planned route* into a 4-dimensional *flight profile* for controlling the aircraft).

Secondly, during flight the aircraft continually assesses its environment and, as threats react to its presence, the MMA dynamically replans actions to suit, keeping calculated risks to a minimum while maintaining Mission objectives, and advising the Pilot appropriately with pertinent messages.

In concert, the Executives within the MMA's Intelligence coordinate and issue tasks to their respective Resources Managers in the subsystems. For example, the Communications Manager automatically sets-up and controls the required radio channels for information exchange with other participants at the appropriate time and place. Concurrently, the Communications Executive reiterates calculations pertinent to route variations (taking account of enemy locations, terrain screening, and electronic warfare activity), updates the communications schedule and, at the same time, controls all electromagnetic radiation from the aircraft - to an extent such that essential friendly operations are not impaired but yet covertness is maximised.

The system also copes with housekeeping chores, and will be able to reconfigure facilities to bypass equipment faults. By using parallel processing, and redundancy, all MMA functions work simultaneously and systems can survive battle

damage.

Freed of such tasks the aircrew can then make full use of the situational advantage given by the MMA, and augment it with his own cognitive abilities. Thus, by flying with a Mission Management Aid, pilot and aircraft form a very effective combination.

4 MMA CORE FUNCTIONS

As described earlier, the MMA is likely to assume a top-level role, to augment the pilot.

In overview, the MMA Core Functions interact with the aircraft Base Systems (shown at the bottom of Fig. 3); and provide advice to the pilot, via the Intelligent Interface Manager, and/or direct control of the aircraft systems if and when required by him - he remains the ultimate decision maker and can delegate tasks to the MMA as appropriate. As a safety feature, and in the event of a catastrophic computer failure, fallback to reversionary systems is always possible.

The Core Functions are conceived to perform Sensor Fusion, Situation Assessment, Planning and Tactical Routeing.

4.1 Sensor Fusion

Within the Core, Sensor Fusion is logically first. It handles observations of world objects by aligning data from various sources (sensors, communications, navigation) - which may have different accuracies, temporal and spatial reference frames - and resolves this information to provide correlated object tracks.

Using geographical knowledge from an onboard terrain database, and mission data loaded before take-off, with signature information obtained during flight, (from Radar and Infra-Red devices), the object tracks are then attributed with possible identities and probable modes of operation. This correlated view of the scenario is known as the Alpha Scene, a widespread view of all objects - including friendly forces.

4.2 Situation Assessment

This function takes the Alpha Scene and, with on-board intelligence about threat characteristics and behaviour, identifies objects and their hostility towards the aircraft. If the pilot believes he has superior knowledge, he can interact with Situation Assessment to resolve ambiguities that might arise from the hypotheses generated, or to direct attention to a particular threat. This is the Beta Scene, local to the aircraft; a version of Alpha, that has been filtered to prioritise threat capability and intention, and also indicate friendly disposition.

4.3 The Planner

The Planner examines mission objectives against this scenario, proposes the best flight path and also gives tactical assistance in response to the dynamically changing local Beta Scene. The resulting options (Gammas) are available to the pilot, with the selected one, Gamma*, ready for automatic implementation.

In generating plans, account is taken of the current situation and available resources, such as weapons, fuel, counter-measures, and supporting aircraft.

In determining the route, various search strategies are used. The range and density of threats is of prime importance, and

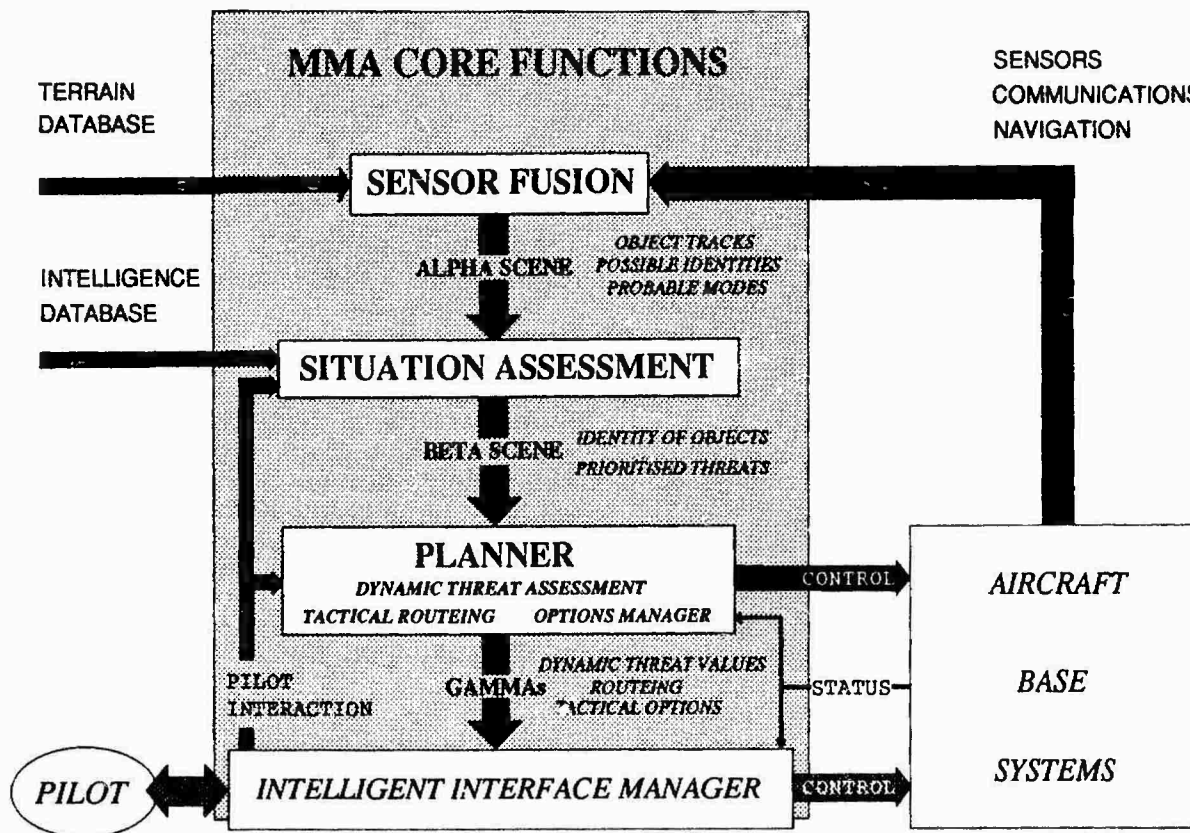

Fig. 3 MMA CORE FUNCTIONS

terrain screening from them - by flying low - is highlighted. Alternative routes are automatically evaluated against expected threat activity, fuel and time estimates, while keeping to waypoint restrictions and other mission constraints, for example the time-on-target.

Within the Planner, three main functions exist:-

4.3.1 Tactical Routeing provides an optimum course by looking ahead through the local environment, taking account of the aircraft's performance, fuel and time constraints, as well as terrain-masked threats.

Path deviations are continually being evaluated against threat posture, in the context of the planned route, and refinements are achieved by balancing off-route costs against risks involved. Navigational instructions are generated automatically, and can control the flight.

4.3.2 Dynamic Threat Assessment postulates the actions of hostile systems. Based on their "known" operational characteristics, the number and frequency of possible firings against the aircraft are calculated. Conceptually, for each threat, a profile of *activity level* against *time* is constructed and, for any route, a cumulative profile of all probable threat activities is developed.

As an example, the results of these computations, for ground-based threats, are shown in Fig. 4. The steps in the threat profiles indicate the expected system mode changes: from a baseline level of *surveillance*, via *acquisition*, and *tracking*, through to *illumination* when missile launches are imminent.

In predicting hostile responses, Dynamic Threat Assessment takes into account the reaction time of each system, the time required in each mode to achieve a firing solution, and the effects of terrain screening. Currently, as a pessimistic view is taken of enemy activities, the Planner dynamically minimises costs in a worst-case scenario.

4.3.3 The Options Manager examines tactics against enemy actions, and recommends suitable responses.

For example against a missile attack, triggered by the warning of missile launch or approach, the Options Manager uses information from Situation Assessment about the appropriate hostile system and, with knowledge of the MMA aircraft's performance and resources, calculates the necessary *escape envelope*. This would take account of the kill zone of the threat, possible aircraft manoeuvres to break missile lock, use of countermeasures (chaff, flares, or electronic methods for example) or simply terrain screening.

These recommendations could be coupled into the aircraft's systems, to set-up automatic sequences and relieve the pilot of time-critical, split-second, actions. In an emergency situation, this is where a Reflex function is appropriate; this should improve survivability.

5 MAN-MACHINE INTERFACE

It should be remembered that the MMA is intended to aid the aircrew, by primarily improving situation awareness, and relieving them of onerous tasks - permitting them to carry out their preferred work, and that which it is impractical to automate. However, in achieving these aims a balance must

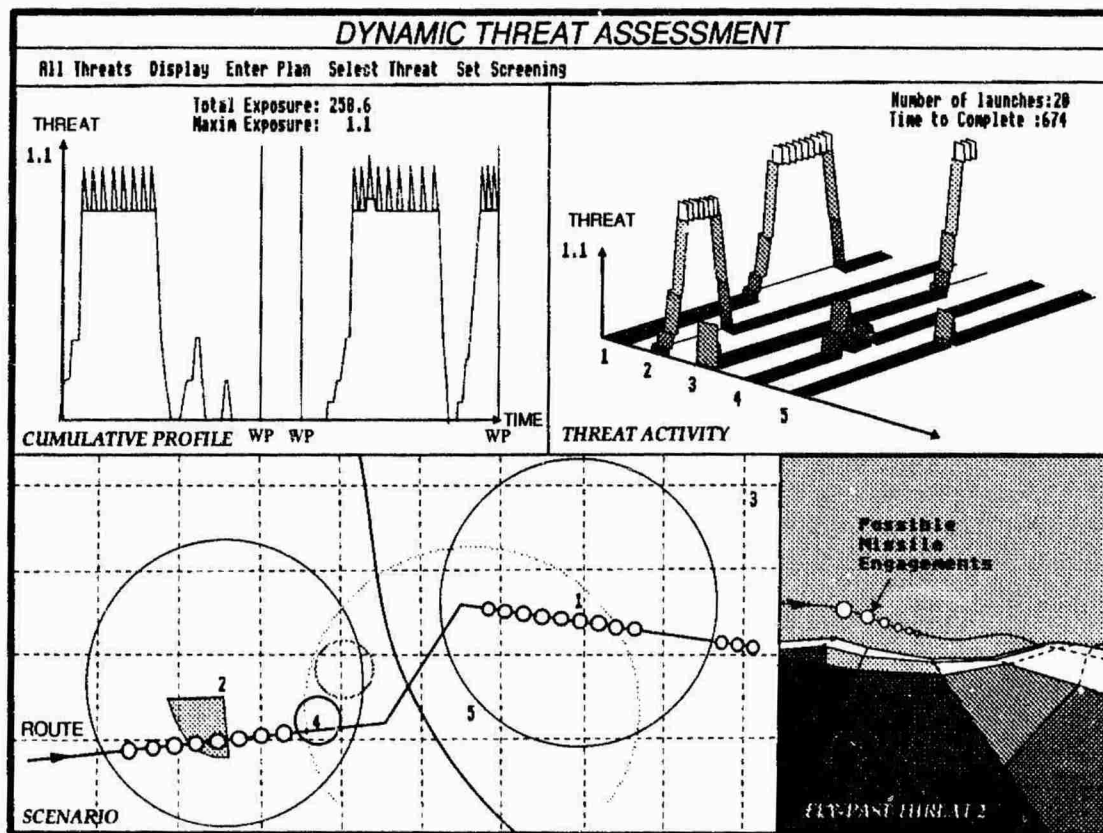

Fig. 4 DYNAMIC THREAT ASSESSMENT - an engineering display

be struck between introducing ever more complex systems and optimising the pilot's performance with such equipment.

The MMA will affect all the major avionic systems of future aircraft, as well as the pilot, and the relative level of authority between the pilot and the MMA (or its components) is of fundamental importance in the design of the overall system. MMA design must not fall into the trap of striving to *reduce* mission workload, but yet at the same time *increasing* the pilot's effort in controlling and monitoring not only the MMA, but also the status of the Pilot / MMA partnership.

Clearly, the Pilot / MMA interaction is potentially very complex, and for effective use it must be designed carefully so as to be intuitive. The sharing of tasks with the MMA should be able to be tailored to pilot preferences, but is likely to be dynamically variable during flight. Also, the aircrew must be provided with the required information at the relevant time, but must not be overwhelmed; equally, they ought to have the opportunity to interrogate any function as far back as raw sensor data - for there will be occasions when the MMA puts value judgements on data at its disposal (e.g. dynamic threat assessment) when the pilot is unsure of the system's reasoning. However, as the MMA evolves and aircrew confidence in it grows, this should become unnecessary.

As an integral part of the Project, these interface aspects are being investigated both in the laboratory and in cockpit simulations.

6 MMA EVALUATION

Successful integration of an intelligent system such as the MMA requires the acceptance and confidence of the user.

At the present stage of the Project the MMI work is being combined with the prototype MMA functions in a Proof-of-Concept Simulation (PCS); this is implemented on Symbolics and Silicon Graphics computers, using LISP and C, and runs in real time.

To exercise and assess the emerging MMA, a scenario test-harness is used that simulates all necessary aircraft systems and emulates complete missions. Within a programme of iterative software prototyping & development both trials and demonstrations are run, when evaluation of the MMA is carried out by aircrew, scientists, engineers, and "customers".

There are two broad levels at which performance of the MMA may be measured, the functional level, and the operational level.

The *functional level* of evaluation is concerned with assessing the degree to which the MMA software produces a "correct" and high-integrity response to any particular set of conditions. In those cases that are deterministic (e.g. cockpit moding), the "correct" solution will be self-evident, but where a value judgement has to be made by the MMA (e.g. threat hostility) then "believable" answers or options for the pilot should be presented.

At the *operational level* it is important to evaluate the overall system. The basic objectives are to establish that the MMA is doing something useful, that an MMA-equipped aircraft is more mission-effective, and that the man-machine interaction is optimal.

Figure 5 is an example of an engineering display, on the PCS

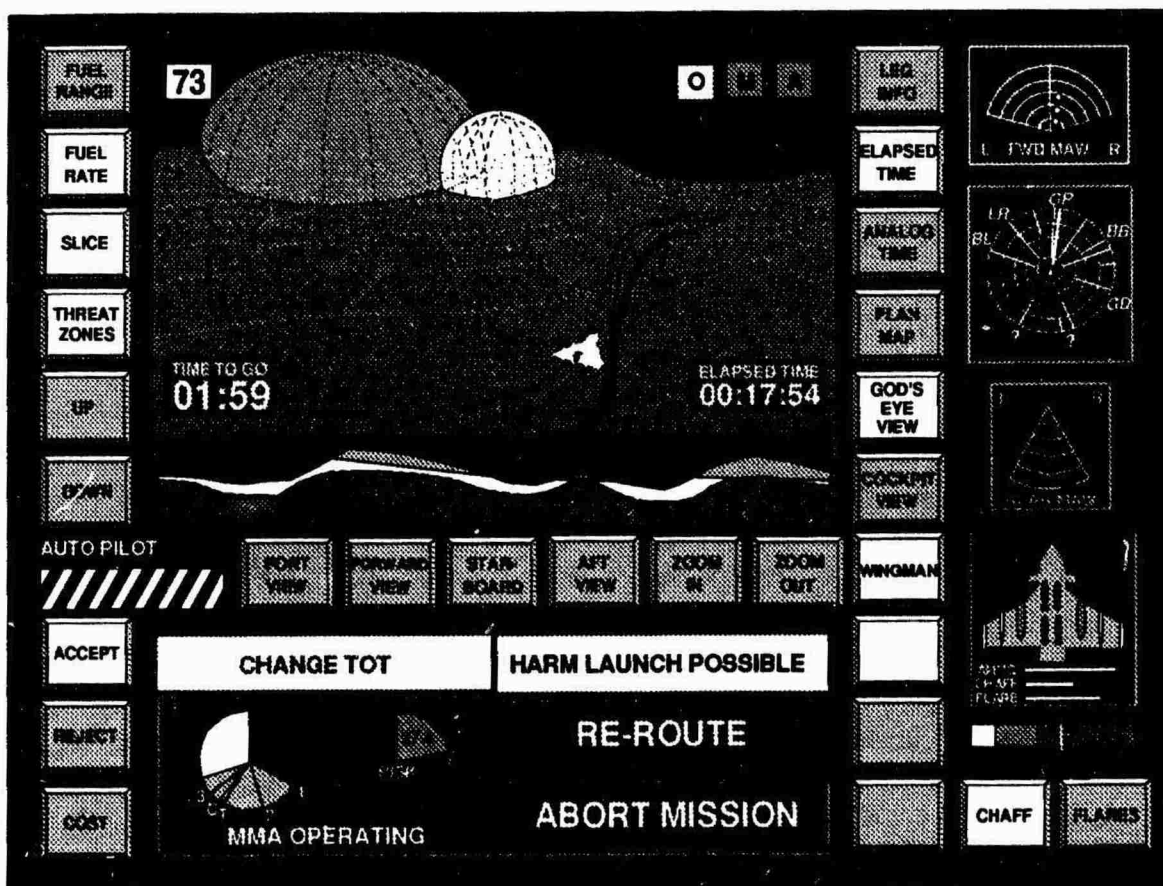

Fig. 5 PROOF of CONCEPT SIMULATION - engineering display

rig, during one such evaluation run.

But only by exploring other forms of presentation (e.g. helmet mounted displays) and carrying out further trials on a pilot flown combat simulator - examining the MMA's behaviour in all circumstances and optimising its performance - will the confidence of pilots be truly earned.

7 CONCLUDING REMARKS

Through this Project the concept of a Mission Management Aid is being developed and, by rapid-prototyping, its functional requirements generated. These can be used to develop a real-time pilot-flown mission simulation, to prove the effectiveness of the MMA, and within which the full extent of man-machine interaction will be explored.

Research is covering the MMA's need to assess all situations, to advise and decide on actions and reactions, and to controlling aircraft functions automatically if and when necessary, thus helping the pilot to complete a successful mission.

The Mission Management Aid brings together all avionics equipment into a total aircraft system. By being tailored dynamically in sympathy with human activities throughout a flight, it truly augments crew ability, giving much better situational awareness, better response, and increased effectiveness and survivability.

The Mission Management Aid thus is becoming a vital integral system for future aviation.

BIBLIOGRAPHY

Catford, J.R., and Gray, I.D., "Research into a Mission Management Aid", in AGARD 49th Symposium of the Guidance & Control Panel, 10-13th October 1989, Toulouse.

Gibson, C.P., and Ms Garrett, A.J., "Towards a Future Cockpit - the Prototyping and Pilot Integration of the Mission Management Aid", in "Situational Awareness in Aerospace Operations", AGARD Conference, 2-6th October 1989, Copenhagen.

Lovesey, E.J., and Davis, R.I., "Integrating Machine Intelligence into the Cockpit to aid the Pilot", in "Machine Intelligence for Aerospace Electronic Systems", AGARD Conference, 13-16th May 1991, Lisbon.

Lovesey, E.J., "Management of Avionics Data in the Cockpit" Working Paper FS638/92, March 1992, Defence Research Agency (Aerospace Division), RAE Farnborough.

Pipe, H.J., "The UK Mission Management Aid Project", paper T4-4 in "Automatic Control in Aerospace - Aerospace Control '92", 12th IFAC Symposium, 7-11th September 1992, Otobrunn, Germany.

**PILOT INTENT AND ERROR RECOGNITION
AS PART OF A KNOWLEDGE BASED COCKPIT ASSISTANT**

T. Wittig, R. Onken
Universität der Bundeswehr München
Institut für Systemdynamik und Flugmechanik
Werner-Heisenberg-Weg 39
D-8014 Neubiberg
Germany

SUMMARY

A Pilot Intent and Error Recognition module as part of a knowledge based Cockpit Assistant System is presented, which is being developed at the University of the Armed Forces in Munich in cooperation with the Dornier company and implemented in a flight simulator. The system mainly supports the pilot crew with regard to the monitoring and planning task and provides assistance for a number of plan execution functions for the civil flight operation under Instrument Flight Rules.

During the whole flight the Pilot Intent and Error Recognition module monitors pilot activities and the flight status in order to detect deviations from the actual flight plan immediately. In this case, the current flight situation is evaluated, the pilot behaviour is analysed over a certain time period and by use of both pilot intent or error is recognized. Pilot errors lead to warning messages, recognized pilot intent to a modification of the flight plan.

In this paper a short survey is given of the concept and the function of the Cockpit Assistant System. After that the structure of the Pilot Intent and Error Recognition will be described in detail. At the end, the integration of this module into the Cockpit Assistant System and the evaluation in a flight simulator are presented.

1. INTRODUCTION

Civil air transportation of today is characterized by flights under Instrument Flight Rules (IFR), since this kind of flight operation guarantees flight execution with almost full independence of the weather conditions. However, among other factors lacking visual references as well as increased automation and complexity of cockpit instrumentation can result in overcharges of the pilot crew. It is a fact that by far the majority of accidents is caused by human errors [1,2].

Statistical data of aircraft accidents and their causes can be correlated with findings on the cognitive behaviour

of humans [3]. From this it became evident that electronic pilot assistance has a good chance of becoming effective for:

- situation assessment
- planning and decision making and
- plan execution.

This requires a system design complementing human capabilities and not replacing human control functions generally by automatic ones.

On the basis of this formal knowledge of the user needs a cockpit assistant for IFR operation is being developed at the University of the German Armed Forces in Munich and implemented in a flight simulator. This research, when started in 1988, was aimed at assisting the pilot in SPIFR (Single Pilot IFR) operations and led to a first prototype, called ASPIO (Assistant for Single Pilot IFR Operation) [4]. Since 1991 a similar advanced Cockpit Assistant System (CASSY) for the two man crew is developed in cooperation with the Dornier company [5].

To achieve the assisting functions CASSY is structured into several modules and integrated into the air traffic system with interfaces to the aircraft, the pilot and the Air Traffic Control (ATC). The major modules and the information flow within this system are described in chapter 2.

Hereby, the Pilot Intent and Error Recognition (PIER) module comprises an important task of the situation assessment. In this module, pilot activities are compared with the expected ones generated in a separate CASSY module with regard to the actual flight plan. In case of deviations, a classification process is started aiming at recognizing possible crew intentions. The concept and the structure of the PIER will be described in chapter 3, before in chapter 4 a brief survey is given of the integration of the module into CASSY and the evaluation in a flight simulator.

2. STRUCTURE OF CASSY

As mentioned before, the requirements for the cockpit assistant made it necessary to structure the system into several task specific modules [5]. The system consists of the following main components:

- Dialogue Manager (DM)
- Automatic Flight Planner (AFP)
- Piloting Expert (PE)
- Pilot Intent and Error Recognition (PIER)

Those main modules of CASSY together with the information flow are shown in figure 2.1 and will be briefly described in the following.

The Dialogue Manager (DM) comprises all components for the information transfer between CASSY and the pilot crew, including the management of information flow to the pilot crew.

Extensive use is made of speech communication in either direction. Speech input is used for acknowledgement and rejection of system recommendations and as a communication medium for instructions to the executional aids of CASSY. For this purpose a speaker dependent speech recognition system is used based on

the phraseology of civil aviation. Synthetic speech is used for speech output, with different voices for different categories of assistant messages. More complex information like comprehensive flight plan recommendations is presented visually using one of the multifunctional displays.

Hereby, the Dialogue Manager controls the syntax of the speech input, the priority and category of each speech output message and information to be visually presented to the pilot crew.

For every flight, a flight plan must be issued before takeoff. This flight plan can be worked out by the Automatic Flight Planner (AFP) or can be prepared by means of other facilities and then fed into the system as part of the initial conditions [6].

During the flight the AFP is activated when significant deviations from the flight plan occur because of such events as new ATC instructions not in accordance with the flight plan, adverse weather conditions or system failures.

An evaluation of the current situation and its future projection might pinpoint where conflicts with the original flight plan arise. This can result in a problem solving algorithm for the selection of an alternate destination and corresponding generation of a new flight plan. Hereby, route and trajectory planning is performed by the AFP under consideration of aircraft system state and performance limitations. It includes tactical and strategical planning.

The AFP planning results are presented to the pilots as recommendations. If not corrected by the pilots, agreement for the new flight plan is achieved.

On the basis of the flight plan as generated by the AFP and acknowledged by the pilots, the Piloting Expert (PE) performs the automatic management of flight plan execution [7].

This is carried out by following the instructions of ATC, information about system failures or bad environmental conditions, messages considering the flight progress and regulations for piloting. Hereby, the Piloting Expert is construed as a model of the pilot crew taking into account the standard pilot activities as well as the individual behaviour and the danger boundary. In this way the module determines the expected actions the pilot crew is supposed to carry out during the various flight segments. The modelling is essentially rule-based on the basis of the extensively elaborated and published piloting regulations.

Those expected pilot actions serve as an input into the Pilot Intent and Error Recognition (PIER), which now draws the comparison between the actual and the expected pilot behaviour. In case of deviations from the actual flight plan warnings, hints or the recognized crew intent are transferred to the crew by use of the Dialogue Manager.

Further information considering the PIER module are given in the following chapter.

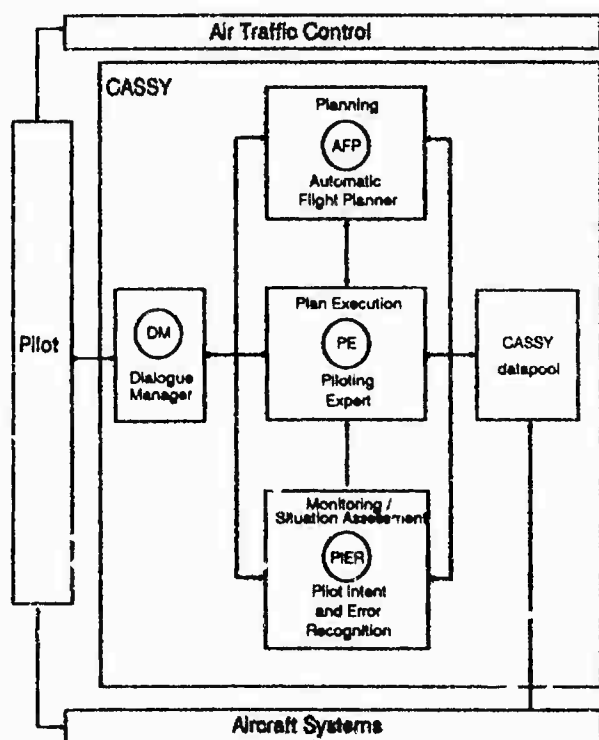

Fig. 2.1: Structure and information flow of CASSY

3. STRUCTURE OF THE PIER

3.1. General view

The basic task of the Pilot Intent and Error Recognition comprises monitoring of the pilot crew activities and the resulting flight status. Hereby, the comparison is drawn with the expectations made by the Piloting Expert. In case of discrepancies, the main task of the PIER consists of the recognition of pilot intent or error. This is aimed at detecting the possibly new unknown flight plan changed by the pilots. Only the following situations are possible:

- flight in a conflict area (thunderstorm, turbulence) and return to the original flight plan afterwards
- flight around a conflict area (thunderstorm, collision) and return to the original flight plan afterwards
- selection of a new waypoint (thunderstorm) and no return to the original flight-plan afterwards
- reaction because of system failure (low pressure)
- break-off of take-off or final approach

The intent recognition is started upon detection of pilot actions deviating from the flight plan.

Hereby, it is thinkable that the crew carries out the actions for leaving the actual flight plan before informing ATC about their intention.

Further, flight plan recommendations made by CASSY can be disregarded by the pilots without informing the system.

The intent recognition is mainly performed by use of an inference algorithm based on known intent hypotheses. That means that, at first, apriori probabilities for possible hypotheses for the crew intent are determined with regard to the actual flight situation and secondly those probabilities are modified with respect to the actual pilot actions. The most probable hypothesis is selected.

These tasks of the PIER make it necessary to choose a modular approach with the following priorities:

- situation representation
- interpretation of pilot behaviour and of the flight situation
- determination of pilot action sequences

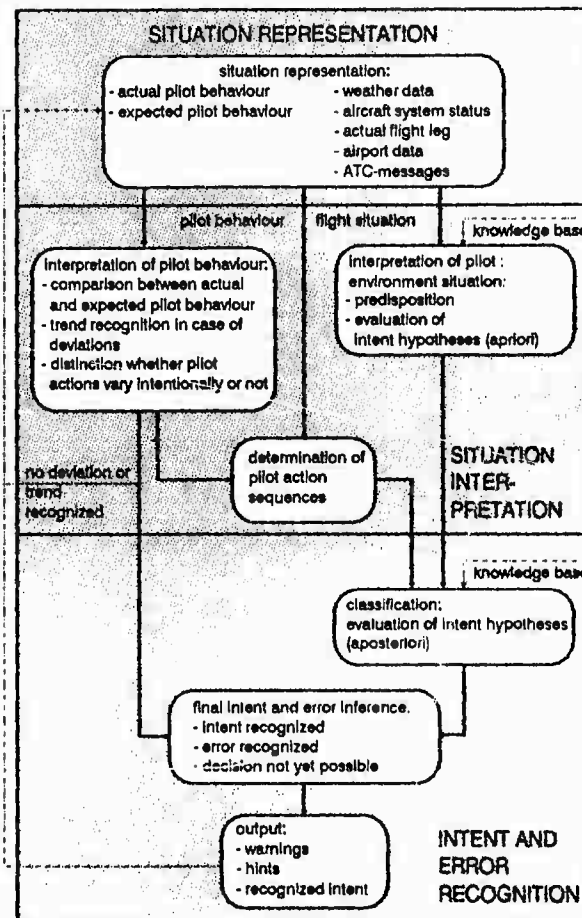

Fig. 3.1: Structure of the PIER

- classification of the crew intent
- final intent and error inference

The structure of the PIER resulting from this is shown in Figure 3.1 and will be described in the following.

3.2. Situation representation

The continuous representation of the situational status is the basis of the PIER. All available information considering the flight situation is read and summarized in a representation of the overall situation. As shown in figure 3.2, the inputs thereby come from the PE module and the dynamic CASSY datapool which contains all available data about the aircraft, the environment, ATC instructions and clearances and the flight plan.

This representation includes the following components:

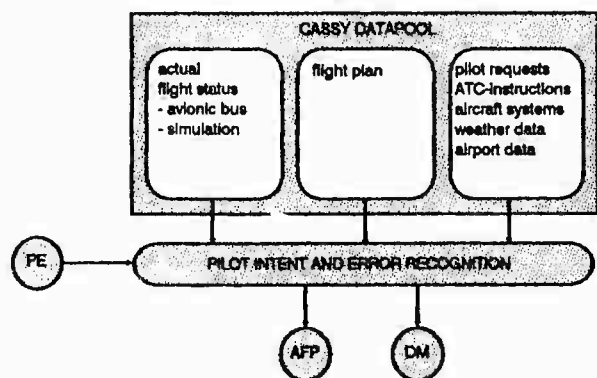

Fig. 3.2: Communication partners of the PIER

- expected pilot behaviour (PE)
- actual flight status (datapool)
- actual flight leg (datapool)
- weather information (datapool)
- pilot requests (datapool)
- ATC - messages (datapool)
- messages about onboard systems (datapool)
- airport data (datapool)

By use of this information a representation of the situation can be realised and can be made available to all other PIER components.

The CASSY modules DM and AFP are working on the output of the PIER. This will be further described in chapter 3.7.

3.3. Interpretation of pilot behaviour

For the situation interpretation, which follows the situation representation, a distinction is made between pilot behaviour and the pilot environment situation.

The interpretation of the pilot behaviour comprises the following components:

- monitoring of pilot actions and comparison between actual and expected pilot behaviour
- trend recognition

- distinction whether pilot behaviour varies intentionally or not

At this point it has to be noted that the interpretation of pilot behaviour also includes the actual flight status. For instance, considering the interpretation of situational elements influenced by the pilot, like the pilot actions for altitude control, only an evaluation of the actual altitude takes place. Other tasks such as monitoring of the flap or frequency setting on the other side can be related directly to an evaluation of pilot actions.

Considering at first the monitoring of pilot actions the comparison is drawn between the expected and the actual activities of the crew. It is the goal to find out violations of the tolerances for individual behaviour, the standard behaviour and the danger boundary. Pilot activities can be extracted from the actual aircraft status fed in by the avionic bus of the aircraft or a flight simulation. In particular, the monitoring process comprises the time histories of altitude, speed and course as well as flap, gear, speedbrake and frequency settings.

In case of deviations from the expected actions a trend recognition is performed considering continuous parameters such as the time histories of the altitude, the airspeed or the course. This results in the statement whether the pilot actions tend to reduce the deviations or not. Considering the time history of the altitude this is done by use of the rate of the altitude change and of the rate of climb or descend. If no deviation can be detected or if the tendency for the reduction of the deviations can be stated, then the intent recognition is stopped at this point. Otherwise the distinction has to be made whether a flight plan change has been carried out intentionally or not. It has to be made clear, at this point, that this does not mean that also the kind of intent, if intention is detected, is identified.

To find out whether the deviation from the flight plan was intentionally or not the following strategy is used:

- alerting the crew when leaving the actual flight plan
- monitoring of the crew reaction over a certain time period
- recognition of intentional behaviour in case of missing crew reaction within this time period

In this way intentional behaviour can be detected almost unambiguously. This evaluation is performed for all pilot actions varying from the actual flight plan and the result is transferred to the final intent and error inference (see chapter 3.7.).

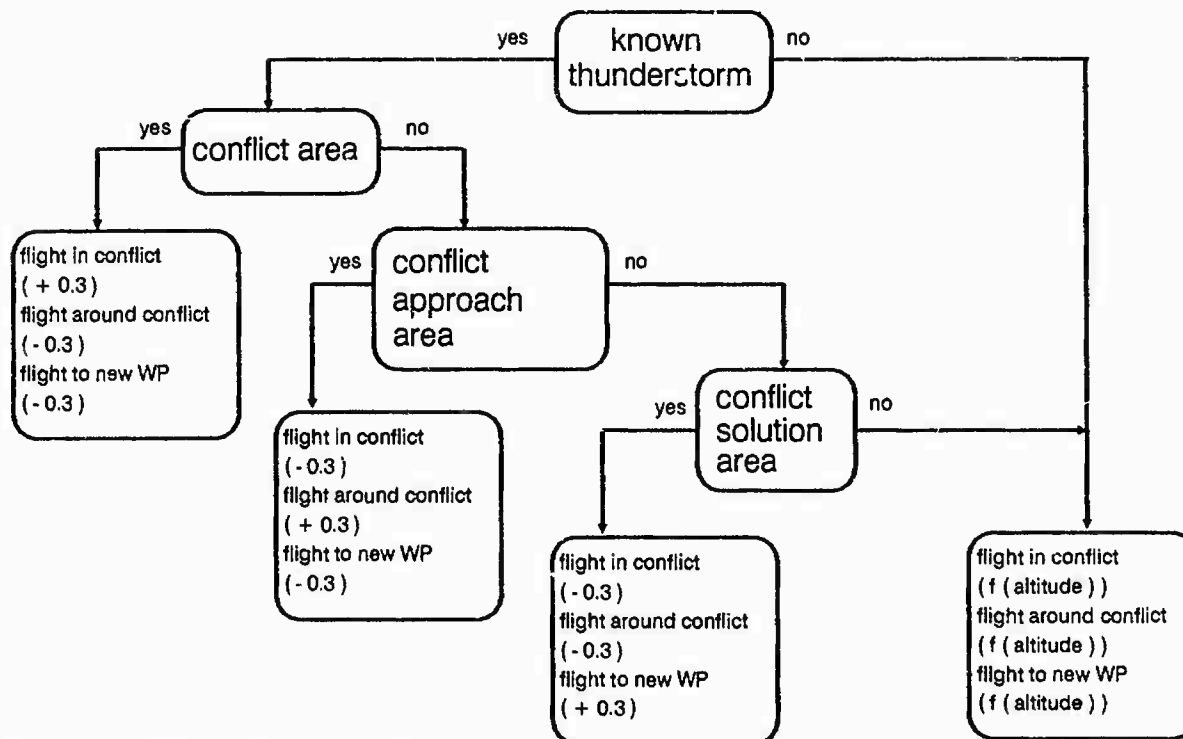

Fig. 3.3: Decision tree for bad weather area

3.4. Interpretation of the pilot environment situation

In addition to the pilot behaviour the pilot environment situation is evaluated. This includes all situation components not influenced by the pilots, such as:

- actual flight leg
- ATC messages
- bad weather areas
- airport data
- aircraft systems

This information can be taken from the CASSY datapool as shown in figure 3.2.

It is the goal of the interpretation of the pilot environment situation to check the necessity for changes of the actual flight plan independent from the actual pilot behaviour. At this point the Pilot Intent and Error Recognition is already able to expect an intentional deviation from the flight plan on the basis of these parameters. In this way possible hypotheses for the crew intentions can be generated and evaluated with respect to the situation.

The knowledge needed for this purpose is implemented in decision trees for all situation elements. In figure 3.3 such a decision tree is shown for a bad weather area.

In case of a known bad weather area with thunderstorm for instance the pilot reaction depends on the distance to this conflict area. From figure 3.3 the following classification of the distance is evident:

- conflict solution area: conflict is situated in the following flight leg
- conflict approach area: conflict area is situated in the actual flight leg in front of the aircraft
- conflict area: conflict area is already reached

This information concerning the distance to a conflict area and the classification can be taken from the CASSY datapool.

For the shown case the following hypotheses for the crew intent are concerned:

- flight in bad weather (can lead to speed reduction because of turbulence)
- flight around bad weather area (course change)
- flight to a new waypoint (course change)

These hypotheses are associated with so called certainty factors (value 0.3 in figure 3.3.). This theory is explained in chapter 3.6.

In this way all situation elements are checked and the hypotheses concerned are evaluated. These hypotheses are the basis for the classification of pilot intent.

3.5. Determination of pilot action sequences

The determination of the actual pilot action sequences is a further condition for the classification. Through the determination of those action sequences actually valid hypotheses criteria are derived. In the following the time history of the course is used as an example for this determination.

As shown in figure 3.4 a course deviation from the actual track is caused for instance by a bad weather area in front of the aircraft. Different types of conflicts (compare with danger of collision) will cause different characteristics of course changes.

To take all possible evading maneuvers (for example with respect to course deviations) into consideration this knowledge has to be represented in event trees. In figure 3.5 an event tree is shown for all possible course changes. In this figure each block represents a criterion. The relation of these criteria can be interpreted as OR connections in the horizontal axis and as AND connections in the vertical one. The vertical axis represents the time elapsed. This representation is hereby equivalent to that of a finite automata.

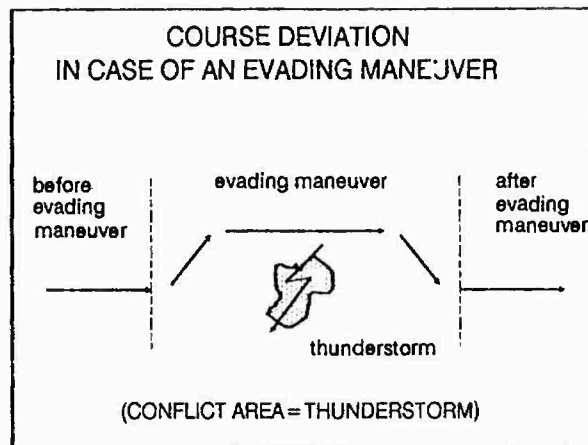

Fig 3.4: Course deviation because of thunderstorm

By monitoring of the actual course deviation over a certain time period the verified criteria are stated. In this way the evading maneuver of figure 3.4 is described through the criteria hatched in figure 3.5.

This analysis of pilot behaviour is done for all parameters in case of deviations and is the basis for the following classification.

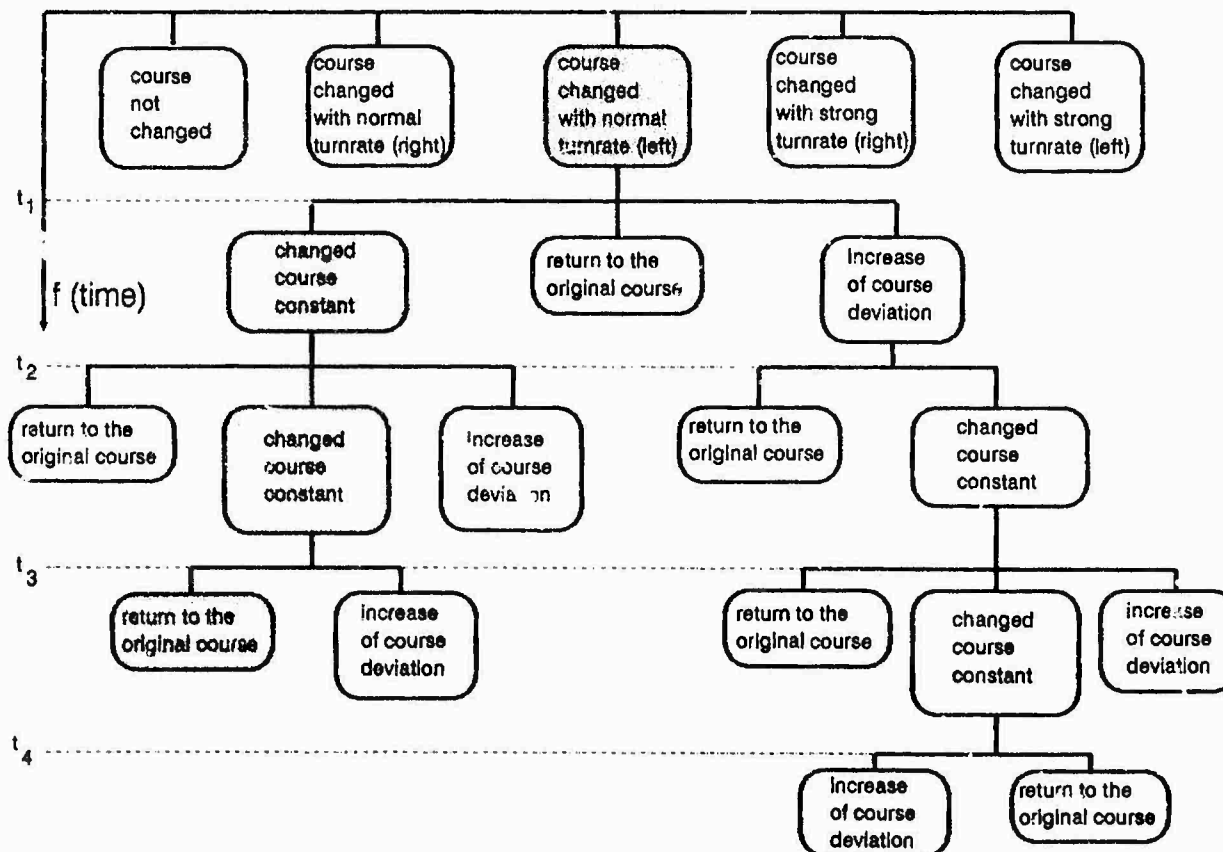

Fig 3.5: Event tree for the course history

3.6. Classification of the crew intent

Some people claim, the concept of determining intent is a source of confusion and controversy. In spite of this, realistic methods exist in order to detect the intent of human operators under certain conditions [8,9].

The main approach is that of probabilistic reasoning whose basis exists in the evaluation of all statements with a probability representing the level of uncertainty. These uncertainties can be derived from representative statistics by expert estimations.

The basis of probabilistic reasoning is the Bayes' Theorem. By use of that the most probable diagnosis is selected under consideration of a given number of symptoms. Essentials for that are the independence of the symptoms, the completeness of all diagnoses, the mutual exclusion of diagnoses and a sufficient number of cases for each diagnosis. Since those essentials are normally not fulfilled, a lot of variants have been developed based on the Bayes' Theorem. They all, however, use the same algorithm for the evaluation of diagnoses:

- start with the apriori probabilities of all diagnoses
- modification of the probabilities for all diagnoses for each symptom with respect to the symptom-diagnosis-probabilities
- selection of the most probable diagnosis

That means with respect to the Pilot Intent and Error Recognition module that all hypotheses (= diagnoses) are evaluated by use of apriori probabilities, that the verified criteria (= symptoms) are stated and that aposteriori probabilities of the hypotheses are calculated (= classification).

Having examined different variants of the Bayes' Theorem an approach was selected already used for the development of MYCIN, a computer-based system designed at Stanford University to assist physicians with clinical decision-making. In this case no probabilities in the statistical sense exist, but a measure of belief and a measure of disbelief are computed and added to so called certainty factors [10,11].

A certainty factor (CF) is a number between -1 and +1 that reflects the degree of belief in a hypothesis [11]. Positive CF's indicate that there is evidence that the hypothesis is valid. When $CF = 1$, the hypothesis is known to be correct. On the other hand, negative CF's indicate that the weight of evidence suggests that the hypothesis is false. $CF = -1$ means that the hypothesis has been effectively rejected. As shown in figure 3.6, a transition area is defined in which there is virtually no reasonable hypothesis currently known because of the small values of CF's.

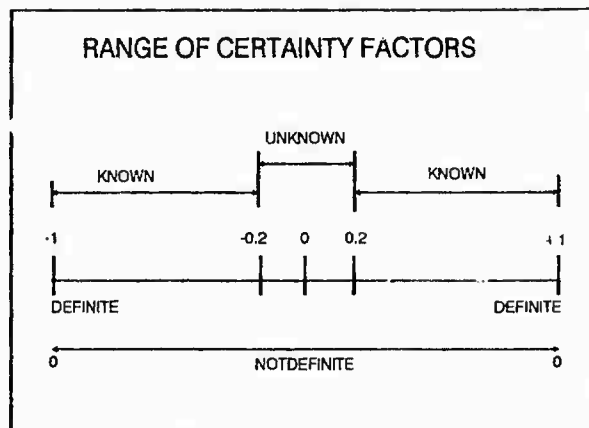

Fig. 3.6: Range of certainty factors [11]

It is the advantage of this approach that combinations of criteria (see chapter 3.5.) can be represented by rules leading to a very descriptive and flexible knowledge base.

The criteria for example shown in figure 3.5 can be represented by the following rule:

If

1. course not changed or ($CF = 0.0$)
2. course left with strong turnrate or ($CF = -0.2$)
3. course left with normal turnrate ($CF = 0.8$)

and

1. changed course constant or ($CF = 0.8$)
2. return to the original course or ($CF = -0.8$)
3. increase of course deviation ($CF = 0.5$)

then

an evading maneuver is the pilot intent
with a certainty factor CF_{new}

This rule, of course representing only one part of the event tree, has to be applied for all hypotheses. That means that all conditional parts of the rules have to be imposed upon certainty factors dependent on the actual hypothesis. Considering the evading maneuver shown in figure 3.4 the named CF's are used. The certainty factor of the overall rule CF_{new} is determined by calculating the mean value of the CF's of the proved criteria. This has to be performed for all rules. It has to be noted that the certainty factors have to be normalized, since otherwise behaviour based on these rules would be irrational.

Finally, the CF_{new} values of all rules are combined one after another with the old CF of each hypothesis by use of the following equation:

$$CF_{old} \text{ and } CF_{new} > 0 : \\ CF = CF_{old} + (1 - CF_{old}) * CF_{new} ;$$

CF_{old} or $CF_{new} < 0$:

$$CF = \frac{CF_{old} + CF_{new}}{1 - \min(CF_{old}, CF_{new})};$$

CF_{old} and $CF_{new} < 0$:

$$CF = -(-CF_{old} - (1 + CF_{old}) * CF_{new});$$

When the first rule is used CF_{old} becomes equal to the a priori probabilities of the hypotheses from the interpretation of the flight situation. After the last one has been used CF represents the final certainty of each hypothesis.

3.7. Final intent and error inference

The distinction whether the crew acts intentionally or not on one side and the certainties of all possible hypotheses for the crew intent on the other side lead to a final intent and error inference. It is the goal to take a decision on pilot intent or pilot error by comparing the most probable hypotheses and by the selection of the best alternative.

The crew behaviour is classified as mistaking only in case of no meaningful intention was discovered or if the danger boundary is exceeded. In those cases warning messages are transferred to the crew by use of the DM module. For this purpose, the nature and the priority of warnings are fixed in the PIER module with respect to the dimension of the deviation.

If intentional behaviour has become evident but the intention itself is not completely uncovered a short hint is given to the crew and the module carries on trying to

find out the crew intent. If no hypothesis can be proven within a certain time period the conclusion is drawn that the deviation from the flight plan represents a pilot error. The system carries on warning the crew.

Having recognized intentional behaviour as well as a proven hypothesis this information is transferred to the DM and further to the pilots. At this place the pilots have the chance to comment the recognized intent. If not, a successful intent recognition is assumed. In this case the AFP is informed, since changes of the actual flight plan could be necessary.

4. EXPERIMENTAL TESTING

As it is done for all CASSY components the Pilot Intent and Error Recognition is being implemented as a single process on a UNIX workstation coded in the programming language C. The communication with the other modules is realised by UNIX standard functions for the interprocess communication (message buffer and shared memory).

The flight simulator facility at the University of the Armed Forces in Munich used for the integration of CASSY is shown in figure 4.1.

The experimental setup around a fixed base cockpit consists of a number of components. The central computer of the experimental setting is a UNIX IRIS 4D / 140 GTXB Graphics workstation with four central processor units. Aircraft dynamics (6-degrees of freedom model of the HFB 320), autopilot, radio navigation systems and wind characteristics are simulated and a high performance head down instrumentation display is generated. The workstation is also used to run all

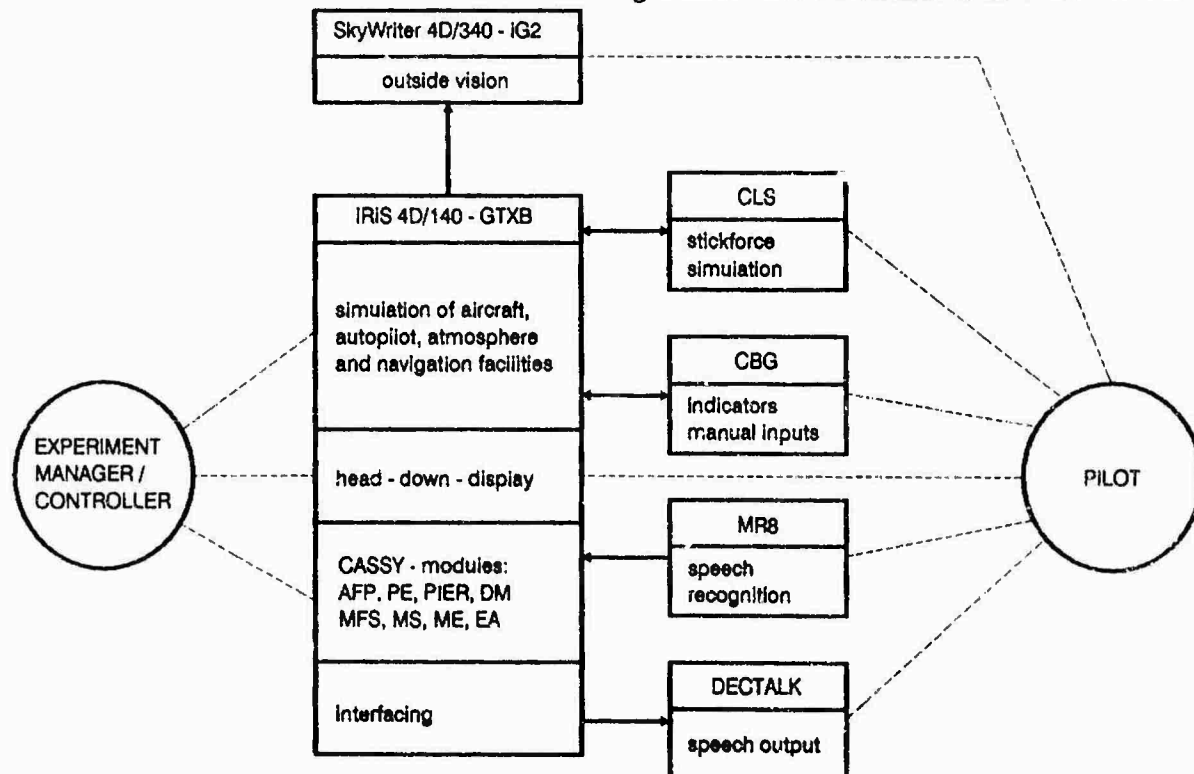

Fig. 4.1: Experimental setup

CASSY modules and to perform the interfacing with speech input and speech output, the stick force simulation unit and a control and display panel. The image outside vision is generated by an additional SkyWriter workstation. Also a radar display for use as a combined ATC controller / instructor workstation is installed.

Considering the actual implementation of the PIER module in the flight simulator it can be stated that a first version was successfully installed. This includes the communication with the other CASSY modules, the monitoring of the pilot behaviour, the trend recognition and some examples of the intent recognition.

In first low scale experiments the Pilot Intent and Error Recognition module was tested in the flight segments enroute and final approach. Intentional pilot behaviour thereby could be unambiguously detected.

Considering the enroute segment an area with heavy thunderstorm was reported by ATC. Once this conflict area was situated in the next flight leg ahead, once in the actual flight leg. In the first case the actual track was left by the pilot and a new waypoint was selected without informing ATC or CASSY. This new waypoint could be detected by the PIER module and the pilot intent was transferred to the AFP for changing the flight plan. The thunderstorm area situated in the actual flight leg in front of the aircraft led to an evading maneuver with a return to the original track afterwards. This intent also could be detected by the PIER.

In the final approach the recognition of the go-around maneuver is the most important task of the PIER, especially since in this case the crew normally does not inform ATC about it. The test runs showed that this intent could be recognized quickly and reliably.

It can be stated that in all cases the certainty factor of the recognized hypothesis was near 1.

In 1993 an intensive testing of CASSY will take place. The Pilot Intent and Error Recognition then will have the chance to prove its performance under conditions as realistic as possible.

5. CONCLUSION AND FUTURE WORK

The human pilot's intrinsic limits of capability and behavioural characteristics of mismatching lead to certain categories of errors and resulting accidents. Therefore, the knowledge about human debits can be exploited for the specification of automatic cockpit aids. Electronic pilot assistants can offer great benefits in monitoring, planning and decision-making for complex situations. These systems can rapidly derive recommendations to the pilot without getting "tired" or losing information.

The presented cockpit assistant system for IFR operation is able to understand the situation on the basis of knowledge about facts and procedures of the piloting task environment and the actual data about the flight status and pilot actions. The situation can be evaluated

with regard to conflicts concerning the actual flight plan. If necessary, the system derives a revised flight plan as a recommendation to the pilot or can also serve the pilot for plan execution tasks.

One important task of CASSY is the recognition of pilot intent and error. For this purpose, the PIER module is developed. As presented in this paper, this module is monitoring the pilot actions and the actual flight status in order to detect deviations from the actual flight plan. In case of deviations pilot intent or error are recognized. This is realised by use of a classification process, consisting of the interpretation of the flight situation and the determination of pilot action sequences while deviations from the actual flight plan are observed. Thereby uncertainties are evaluated by use of certainty factors. First test runs showed that this concept is able to fulfill the expectations made for the PIER. For the future it is intended to extend the knowledge base of the PIER, especially considering the event trees used for the determination of pilot action sequences. It is expected that the PIER module will be comprehensively tested in 1993.

6. REFERENCES

- [1] Rügger, B.
Human error in the cockpit.
Swiss Reinsurance Company,
Aviation Department, 1990.
- [2] Chambers, A.B., Nagel, D.C.
Pilots of the Future: Human or Computers.
Communications of the ACM, Vol. 28,
No. 11., 1985.
- [3] Rasmussen, J.
*Skills, Rules and Knowledge;
Signals, Signs and Symbols, and other Distinctions
in Human Performance Models.*
IEEE-SMC-13, No. 3., 1983.
- [4] Dudek, H.-L.
*Wissensbasierte Pilotenunterstützung im
Ein-Mann-Cockpit bei Instrumentenflug.*
Universität der Bundeswehr München,
Dissertation, 1990.
- [5] Wittig, T., Onken, R.
*Knowledge-Based Cockpit Assistant for
Controlled Airspace Flight Operation.*
5th IFAC Symposium on Analysis, Design and
Evaluation of Man-Machine Systems,
The Hague, 1992.

- [6] Prevot, T., Onken, R., Dudek, H.-L.
*Knowledge-Based Planning for Controlled
Airspace Flight Operation as Part of a
Cockpit Assistant.*
AGARD GCP Symposium, Amsterdam, 1991.
- [7] Ruckdeschel, W.; Dudek, H.-L.
*Modellbasierte Fehlererkennung in der
Flugzeugführung.*
VDI-Tagung, München, 1992.
- [8] Riley, V.A.; Yadrick, R.M.; Judge, C.L.A.
*Decision Support and Adaptive Aiding for
a Battlefield Interdiction Mission.*
Proceedings of the 2nd Joint GAF/RAF/USAF
Workshop on Human-Electronic Crew
Teamwork, Ingolstadt, 1990.
- [9] Hoshtrasser, B.; Geddes, N.D.
*Operator Intent Inferencing for Intelligent
Operator Support Systems.*
IJCAI-Workshop on Integrated Human-Machine
Intelligence in Aerospace Systems, Detroit, 1989.
- [10] Buchanan, B.; Shortliffe, E.
Rule-Based Systems - the MYCIN Experiments.
Addison - Wesley, 1984.
- [11] Shortliffe, E.
Computer-Based Medical Consultations - MYCIN.
American Elsevier Publishing Company,
New York, 1976.

THE DESIGN AND DEVELOPMENT OF THE NEW RAF STANDARD HUD FORMAT

J R Hall

Control & Simulation
Flight Dynamics & Simulation Division
Defence Research Agency
Bedford MK41 6AE, UK

SUMMARY

In poor weather and on instruments the safe piloting of an aircraft requires the display of basic flight information to the pilot in a manner that is instinctive, immediate and unambiguous. Head-up display formats have singularly failed in this regard over the years and are known to be a contributing factor in many incidents involving lack of spatial awareness by the pilot.

This paper describes the theory, experimental development and flight proving of the DRA Fast-jet HUD Format (FJF). This format has been designed to keep the pilot spatially aware under the most dynamic of flight manoeuvres whilst retaining the flight-path information so necessary for mission effectiveness during normal tactical manoeuvring and steady flight conditions. These include low level night operations with FLIR and NVGs and highly dynamic, hard manoeuvring flight in poor weather or on instruments either at low level or in the air-to-air role.

The FJF offers increased mission effectiveness and reduced pilot workload. This is achieved by reducing the attention the pilot needs to give to assimilate the information he requires to do the task, by reducing the possibility of spatial disorientation, and by reducing the time to acquire weapon solutions that require rapid and accurate control of flight-path.

The FJF has been accepted by the UK Air Force Department as the standard for the RAF fast-jet fleet and by all 4 nations for EFA, and is currently under evaluation by the US Flight Symbology Working Group. A STANAG is in preparation.

This paper was sponsored by DDOR8(Air) RAF under research package tasking F07C22XX.

1. INTRODUCTION

The pilot in a modern, high performance, agile fighter could not operate effectively without having mission (ie navigation, weapon, target, threat etc) and flight information overlaid in its correct position on his forward outside world visual scene.

Careful design of the displayed information, to match the pilot's requirements for the task in hand and to match the handling characteristics of the vehicle, is essential if high pilot workload and reduced mission effectiveness is not to result. The fact that head-up display formats are known to be a contributing factor in many incidents involving lack of spatial awareness¹, and that pilots revert head-down to recover spatial awareness on current head-up display formats, indicates there is room for improvement. Correctly designed, the display

should promote spatial awareness and minimise the attention the pilot needs to give to assimilate the information he requires under all flight conditions, including highly dynamic, hard manoeuvring flight when there are few or no external visual cues. Specifically, the pilot's assimilation of the displayed information should be instinctive, immediate and unambiguous under all flight conditions.

The DRA fast-jet HUD format (FJF)^{2,6} addresses the display of basic flight information for use by operational squadron pilots and has been designed so that mission related information may be added as required. It has been shown to meet the above requirements and has been flight proven in many operational conditions including night operations with Forward Looking Infra-Red (FLIR) and Night Vision Goggles (NVGs).

The DRA FJF was developed^{2,3} on the piloted flight handling simulators at DRA Bedford with parallel flight validation taking place using the Bedford T4 Harrier aircraft XW175. Whilst paper designs and desk top simulations have an important role to play in the understanding of the human factors issues involved in display formats, the application of this knowledge to the design and development of operational displays clearly has to be undertaken in a dynamic and representative flight environment. The piloted flight simulator and the T4 Harrier at DRA Bedford are both fitted with the same programmable head-up display hardware, and this permitted display development on the simulator and flight validation in the Harrier to proceed in parallel, often on the same day. The FJF has been extensively validated in flight in a range of aircraft, including Harriers, Jaguars, Buccaneer and an HS748 as shown in table 1. It has been tested and approved during development by a large number of service pilots and has been flight proven with a number of all weather systems including FLIR and NVGs.

Aircraft	Trial Objective
Harrier XW175	Simulation validation, Bedford
BAe Jaguar	Formal testing for Jaguar
Nightbird Harrier Nightbird Buccaneer	Suitability for night low-level with FLIR and NVGs
HS748	Velocity vector based approaches

Table 1. Major FJF Validation Aircraft

The FJF was adopted by the UK Air Force Department as the standard for the RAF fast-jet fleet in 1988 and by all 4 nations for EFA in 1990. It is currently under evaluation by the US Flight Symbology Working Group and a STANAG is in preparation.

Sections 2 and 3 of this paper describe the development history and design requirements of the FJF. Section 4 describes its design features and section 5 presents a selection of simulation and flight results.

2. DEVELOPMENT HISTORY

The importance of display design was well illustrated during DRA's work to develop the recovery package for the Sea Harrier in reduced visibility in the late 1970s²⁴. An approach speed on instruments of around 120 knots was dictated by handling considerations on the one hand and the need to decelerate safely to the hover in the range available on the other. Flying straight and level in partially jet-borne flight at 120 knots in the simulator resulted in a moderate pilot workload and a handling qualities rating (HQR) using the Cooper-Harper rating scale²⁵ of 3.8 based on the mean of 9 pilots (Fig 1).

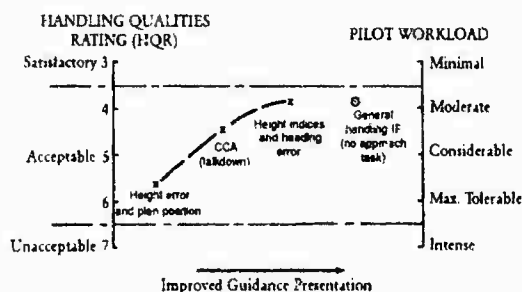

Fig 1. Effect of Guidance Presentation on Handling Qualities and Pilot workload

Adding an approach task, in the form of a talkdown by a carrier based controller (CCA), resulted in an increase in pilot workload and a mean HQR of 4.4. The original proposal was to add guidance symbology in the HUD in the form of height error and a plan position display written about the aircraft symbol. This resulted in a much higher pilot workload and increased the mean HQR to 5.6. Following a development study on the DRA Bedford piloted flight simulator, the method of presenting guidance information recommended for Sea Harrier consisted of an index around the counter-pointer altimeter, which traced out the desired height approach profile, and an index on the heading scale giving track error. Pilots found this a very natural display to fly. It was never misinterpreted, required little or no learning, gave both height and height rate information and gave the pilot great flexibility of operation. It reduced the pilot workload and handling to the same as flying the aircraft at 120 knots on instruments (HQR = 3.8): ie an approach task had been added with no increase in pilot workload or degradation in handling qualities - clearly a highly satisfactory result. It was better than a CCA because the pilot could work in his own time and could assess the results of his corrective actions without waiting for the controller to come back with the necessary information.

This work on the recovery package for Sea Harrier in poor weather established many of the ground rules for the design of HUD formats and many of the features which were subsequently included in the FJF. These include the importance of presenting rate information for many tasks, the design and use of counter-pointer displays for height and speed, thermometer scales for VSI and AoA, rolling digits for rpm and QNH and a power margin display. Also established was the value, on 1:1 geared pitch ladders, of horizon pointing legs as a recovery aid and of numerals on the left hand side only when in erect

flight for promoting spatial orientation.

DRA, then RAE, Bedford was first tasked to develop a common display for the RAF fast-jet fleet in 1980. Initial work addressed the Jaguar and the air-to-ground role as this was the first aircraft planned to be fitted with the new display. Initial simulation and flight trials in 1981 at DRA Bedford were followed by evaluations by 82 front line Jaguar pilots on their training simulators at Lossiemouth, Coltishall and Wildenrath in late 1982. 79 of these pilots recommended immediate adoption of the FJF in the Jaguar. Potential disorientation problems with the change from the existing 5:1 to a 1:1 geared pitch ladder were identified by 2 pilots, and these problems were resolved to the satisfaction of all pilots during further trials in 1983/4.

Date	Milestone	No of pilots
1977	Sea Harrier recovery symbology	9
1980	*Formal tasking from OR52c to develop the FJF	
1981	Initial trials: 2 simulation trials flight validation in Harrier XW175	33 20
1982	Evaluation on Jaguar training sims *Adopted by the RAF for the Jaguar	82
1983-4	Display refinements: 4 sim trials	19
1984-8	Pitch ladder dev: 2 sim trials 2 flight trials	22 21
1988	*Adopted as UK RAF standard HUD format	
1989	Nightbird Harrier trial with FLIR and NVGs *Strongly recommended for the GR7	6
1989	Presented to the US FSWG *Accepted for evaluation by the US FSWG	
1990	Evaluation of pitch ladders for EFA *FJF adopted in full for RAF and EFA	19
1990	US FSWG simulator evaluation of HUD formats *Many FJF features adopted	
1991	Pitch ladder and drive law refinements: simulation trial	5
1992	*STANAG in preparation	

Table 2. FJF Development History - Major Milestones and *Highlights

The studies were then extended to ensure that the display is satisfactory for other roles, including low level operations at night or in poor weather with FLIR and NVGs, and highly dynamic, hard manoeuvring flight in poor weather and on instruments in both the air-to-ground and the air-to-air roles. This has resulted in refinements both to the drive laws of the aircraft symbol and to the design of the pitch ladder. Trials have also been run to support various projects including the GR5, GR7, EFA and the work of the US Flight Symbology

Working Group (FSWG).

The FJF was adopted as the standard for the UK fast-jet fleet in 1988, for EFA in 1990 and is currently being evaluated by the US FSWG. A STANAG is currently in preparation.

3. DESIGN REQUIREMENTS AND OBJECTIVES

The requirement was to develop and recommend a single presentation of basic flight information for use head-up by all RAF HUD-equipped fast-jet aircraft and for all flying except the VSTOL mode in the Harrier (for which a derivative of the FJF has been developed). The only conditions were that horizon correlation should exist when required, that mission related (navigation, weapon, threat etc) information could be added as required and that the symbology would be suitable for use on existing pilot display units (PDUs) with narrow fields-of-view (FOV).

Any symbology written in the pilot's line of sight represents clutter and restricts his ability to see out. Further, basic flight information represents a small part of the information required by the pilot in a fast-jet. Additional aims were thus to minimise the amount of green writing by ensuring that the information is presented as efficiently as possible and to keep the centre of the display as clear as practical for the presentation of mission related information.

The objectives of the FJF design were thus to:-

1. Increase mission effectiveness and safety.
2. Promote spatial awareness and eliminate spatial disorientation.
3. Reduce pilot workload by minimising the attention the pilot needs to give to his displayed information.
4. Minimise clutter, especially near the centre of the display.

This was achieved by tailoring the information presented to the pilot to the requirements of the task, so that the attention he needs to give to the display to assimilate the information he requires to perform the task is minimised: ie the interpretation of the display is instinctive, immediate and unambiguous.

4. THE DESIGN FEATURES OF THE FJF

The FJF comprises 3 major elements:-

1. The Display Reference
2. The Pitch Ladder
3. The Peripheral Scales

and these will be considered in turn in the following sections.

4.1 Display Reference

The choice and positioning of the display reference, or aircraft symbol, in the display is at the heart of any display design. The design aim was to:

- o Provide a well behaved display reference for the rest of the display symbology which promotes spatial awareness under

the most dynamic of flight manoeuvres whilst retaining the flight-path information so necessary for mission effectiveness during normal tactical manoeuvring and steady flight conditions.

The available options include:-

1. Pitch Attitude
2. Full Velocity Vector (VV)
3. Climb-Dive Angle (CDA)

and various combinations of the above such as locked or relative VV. Each has its advantages and disadvantages.

The velocity vector (VV) shows the aircraft's flight-path and is displaced from the attitude symbol, or waterline reference, by angle-of-attack (AoA), sideslip and the resolved components of the vertical and horizontal winds. The climb-dive angle (CDA) is the vertical component of the velocity vector (VV).

An attitude based aircraft symbol provides a well behaved display reference and a crisp response and is the ideal display reference when attitude is the parameter the pilot wishes to control, eg catapult take-offs or Harrier style VSTOL operations. Operational considerations have long dictated the replacement of attitude by velocity vector (VV) or climb-dive angle (CDA) as the basic display reference in military fast-jet aircraft, because in most phases of flight there are major advantages in knowing where the aircraft is going, rather than where it is pointing. Unfortunately, for all aircraft that manoeuvre using wing lift, a VV based display reference brings with it major disadvantages in manoeuvring, especially highly dynamic hard manoeuvring, flight. Firstly, the VV aircraft symbol is highly active in the pilot's field-of-view (FOV), as it reacts directly to every change in angle-of-attack and sideslip, and this can lead directly to a loss of spatial awareness and pilot disorientation. Further, the generation of sideslip is incidental to a manoeuvre and not a parameter over which the pilot wishes to exercise direct control during a manoeuvre. Its display is thus unwanted and unnecessary. Secondly, cross winds can lead to large lateral displacements of the aircraft symbol in the display, which can result in FOV problems and an apparently asymmetrical roll response. This is because the aircraft is rolling in air axes whilst the display is referenced to ground axes. Finally, flight-path response is delayed compared with attitude, which leads to a sluggish display response when read against the outside world or pitch ladder. This prevents the pilot exercising crisp control over the flight-path of his vehicle, especially at lower speeds.

A CDA based display eliminates the lateral problems associated with a VV symbol. It retains the vertical problems, however, namely over-active in the display and a sluggish response. Further, a VV display is still essential for most air-to-ground operations. Various limiting systems, ghost aircraft symbols and pilot selectable 'locked' modes are thus to be found in current fast-jets to provide the necessary range of acceptable displays to cover the roles of the aircraft.

Predictably, the initial trial established that what pilots really want is a display which shows where the aircraft is going when in trimmed flight but is well behaved when manoeuvring; ie, an amalgam of the best features of the attitude and VV based displays in one format.

The DRA FJF achieves this by using the 'achievable' or 'quickened' climb-dive angle (ACDA) as the display reference and presenting 'achievable' VV as a separate symbol which is of such a size that it can be used or ignored by the pilot as required. ACDA is the vertical component of VV with an estimate of the component of AoA which leads to a change in the vertical flight-path angle removed.

'Quickener' is a generic term covering a wide range of possible solutions to the problem, of which 'achievable' is a specific solution directly related to the physics of flight-path control. The FJF solution was dubbed 'quickened' CDA during the early trials and the name has stuck. This is too general a descriptor and could, falsely, suggest a corrected or even false display reference not directly related to the velocity vector of the aircraft, whereas the 'quickener' of the FJF is designed specifically to provide an estimate of the manoeuvre AoA and thus removes the lag between the generation of AoA and a change in flight-path angle inherent in the flight dynamics of fixed-wing aircraft. The name 'achievable' CDA (ACDA) will thus be used here to indicate a specific solution directly related to the physics of flight-path control.

To appreciate the significance of ACDA it is necessary to consider the flight-path control of a fixed-wing aircraft. It must be stressed here that we are only considering that class of aircraft that generate lift by rotating the whole vehicle. The problems of aircraft using direct lift are different.

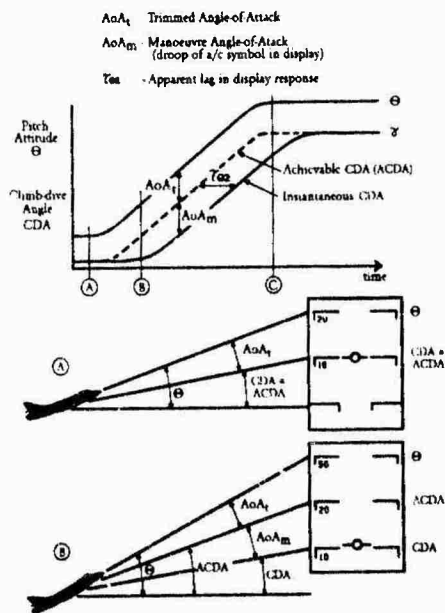

Fig 2. Response Behaviour of CDA based displays

Fig 2 shows the variation with time of pitch attitude (θ) CDA and ACDA (dotted line) during a simple manoeuvre to change the vertical flight-path angle of an aircraft in wings level flight. It demonstrates how the ACDA symbol behaves in a crisp fashion similar to pitch attitude (θ) whilst the CDA symbol presents a sluggish response, is highly active in the display and requires considerable pilot anticipation to avoid overshooting the desired flight-path angle. At point 'A' the pilot elects to change the vertical flight-path angle from 10° to some higher value. At point 'B', some small time later, θ and ACDA have changed but, due to the mass of the aircraft and the need to rotate the aircraft in order to generate an AoA and thereby a normal force to change the flight-path, the CDA remains close to its initial value. At point 'C' the new θ and ACDA have

been achieved, but the CDA continues to change until the AoA generated to manoeuvre the aircraft has returned to zero. Looked at another way, the CDA at any point in the manoeuvre is transient and can only be achieved by the pilot reversing his control demand.

Consider this response as viewed by the pilot in the HUD assuming the pitch ladder and outside world move as one. Point 'A' again shows the steady state condition in the climb immediately before the pilot elects to change the flight-path angle. At point 'B' the pitch attitude and ACDA symbols, if drawn, have remained fixed in the display and have thus responded directly to the pilot commanded input by moving with respect to the pitch ladder and outside world to show a 10° increase in flight-path. In contrast, the CDA symbol has moved down the display in synchrony with the pitch ladder and outside world and is only just beginning to show a small increase in flight-path when read against the pitch ladder or outside world. This is because the whole aircraft needs to be rotated to generate an AoA. It will not be until some small time later, as the AoA and normal force result in a change in flight-path, that the CDA symbol will move with respect to the pitch ladder at the same rate as θ and ACDA. This delay appears to the pilot as a sluggish response. The CDA will remain displaced down the display by an angle AoA_m during the manoeuvre and will move back up the display to overlay the ACDA symbol only after the new θ and ACDA have been achieved. The CDA displayed during a manoeuvre is thus transient and can only be achieved by the pilot reversing his commanded input.

In practice, some small movement of the ACDA symbol in the display is acceptable provided it is in the direction normally expected. A gain of less than unity is thus normally used to accommodate errors in the estimate of AoA_m .

When operating close to the ground an accurate ground referenced 'achievable' velocity vector symbol is required. This is provided in the FJF by a small diamond displayed at all times and which is of such a size that it can be readily used by the pilot but is not distracting when not required. The use of 'achievable' VV to position the VV diamond in the display reduces pilot workload in low-level flight and dramatically reduces the time required to place a conventional bomb-fall line through a target¹³.

The major advantages of adopting this display reference are:-

- o The aircraft symbol responds crisply to pilot inputs when read against the pitch ladder or the outside world scene.
- o The large and rapid vertical movements of conventional CDA and VV symbols in the display whilst manoeuvring hard are largely eliminated.
- o The aircraft reference symbol shows the 'achievable' CDA of the aircraft, ie the CDA at which the aircraft will settle out once the pilot stops manoeuvring, not the instantaneous CDA or where the aircraft is pointing.
- o The large and rapid lateral movements of VV reference displays whilst rolling, especially at high incidence, due to contamination by uncommanded sideslip are eliminated.
- o The large lateral offset of a VV reference display when flying in a crosswind is eliminated.

- o The perceived apparent asymmetry in aircraft roll response that can occur with a VV referenced display when rolling in a crosswind is eliminated.
- o Because the aircraft symbol now only moves slowly and smoothly in the pilot's field-of-view and is fixed to the centre-line of the pilot's PDU, all peripheral scales can be drawn in a fixed position relative to this aircraft symbol to give the pilot a constant scan pattern.
- o The small quickened velocity vector diamond provides a continuous display of 'achievable' VV, for use when a definitive ground reference is required, and is of a size that can be readily used by the pilot but is not distracting when not required.

It remains to define the split between 'trimmed' and 'manoeuvre' AoA in other than wings level flight. The AoA generated to hold level turning flight must be used to position the aircraft symbol if its movement in the display is to be minimised for all bank angles. This, however, would result in a false indication of CDA if the horizon continued to be written overlaying the outside world horizon. Pilots were adamant that the display of 'achievable' CDA, obtained from the relative positions of the aircraft symbol and horizon bar, must always be correct (display integrity) whereas the position of the 'achievable' VV diamond must always be correct when read against the outside world (outside world integrity). In level turning flight, therefore, the horizon bar must be drawn through the aircraft symbol and this results in a loss of horizon correlation at high bank angles. Thus the designer must position the horizon bar with respect to the aircraft symbol and the VV diamond with respect to the outside world and in both cases he must use a quickener based only on any AoA leading to a change in the vertical flight-path angle, which is zero in level flight. This is known as the air-to-ground quickener and is derived from aircraft pitch attitude rate. When positioning the aircraft symbol, however, he has a choice between a quickener based on total manoeuvre AoA, which will minimise display movement under all flight conditions and bank angles and is known as the air combat quickener, or the air-to-ground quickener which will retain horizon correlation but result in an over-active display at large bank angles. The air combat quickener is derived from body pitch rate. The air combat quickener must be used for all flying which may involve hard manoeuvring at bank angles in excess of 60° or 70° if display movement and the possibility of spatial disorientation is to be minimised. The loss of horizon correlation when using the air combat quickener has been judged to be of no consequence in all tasks flown to date, with the possible exception of the landing approach, and is recommended for all tasks unless specific task considerations dictate otherwise.

Though display movement is dramatically reduced in manoeuvring flight using 'achievable' CDA, the aircraft can still reach the limit of the pilot's available FGV under high AoA, steady flight conditions, eg on the approach. When the ACDA symbol approaches the edge of the FOV it limits, shows a line and horizon correlation is lost whereas the VV diamond is unlimited and can go outside the FOV of the PDU.

4.2 Pitch Ladder

The display of flight information must be designed to enable the pilot to execute certain mission tasks. A fighter pilot at night, IFR, flying a high speed, high g, diving intercept to low level is primarily interested in killing the target. He must also maintain three dimensional orientation and does not want

to be forced to recover from an unusual position because his concentration has been on tactical rather than flight information. The pitch ladder is there to provide this orientation and must be designed to prevent him becoming spatially unaware. The priority throughout the design of the pitch ladder has thus been to promote spatial awareness/orientation at all times, even when the pilot's primary concentration is on tactical or mission, rather than flight, information whilst also providing a satisfactory recovery aid in the event of the pilot becoming disorientated or entering an unusual position. This should become a much rarer event if the first goal is achieved. Further, the aim was to provide the recovery aid without adding symbology because of the problem of deciding when to add the recovery symbology to cover the requirements of all pilots without distracting, or reducing the mission effectiveness of, those pilots most resistant to spatial disorientation.

The design aims for the pitch ladder were thus to:-

1. Promote spatial orientation at all times, even when the pilot's primary concentration is on tactical or mission, rather than flight, information.
2. Provide a recovery aid in the, now much rarer, event of the pilot becoming disorientated or entering an usual position.

The problem of providing a well behaved and crisply responding display of the aircraft symbol when read against the pitch ladder or outside world, whilst also presenting velocity vector based information, was resolved by presenting 'achievable' CDA (see section 4.1).

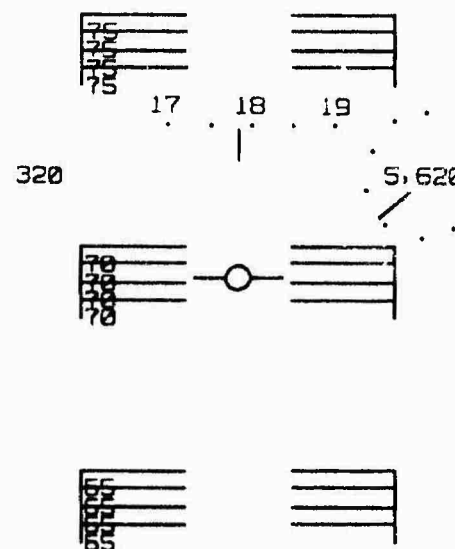

Fig 3. The Ladder Effect

The adoption of unity gain pitch ladders, to be conformal with the outside world especially for low level air-to-ground operation, brought with it similar problems to the change from attitude to VV based displays. At pitch attitude rates well within the capability of modern aircraft, 1:1 geared pitch ladders suffer from the ladder effect (Fig 3), the ladder becomes unreadable and spatial orientation, especially in the vertical, is lost. Recent experiments on both sides of the Atlantic^{20,25} have shown that the solution adopted in many modern aircraft, the bendy bar pitch ladder, is prone to misinterpretation and can, for example, lead to the pilot

rolling inverted and pulling through the downward vertical when recovering from a nose down unusual attitude.

Fig 3 shows a rather clinical representation of the ladder effect. In real life, rapid scrolling and the apparent multiple writing of the pitch bars makes the digits unreadable and the pilot loses awareness of his pitch orientation. To reduce the ladder effect the gearing must be reduced, but this can only be done when the horizon is not in the FOV if the low-level mission requirements of horizon correlation, i.e. a 1:1 geared pitch ladder, are to be satisfied. The FJF solution is a ladder with a gearing varying linearly with flight-path angle from 1:1 around the horizon to 4.4:1 at the zenith and nadir (Fig 4).

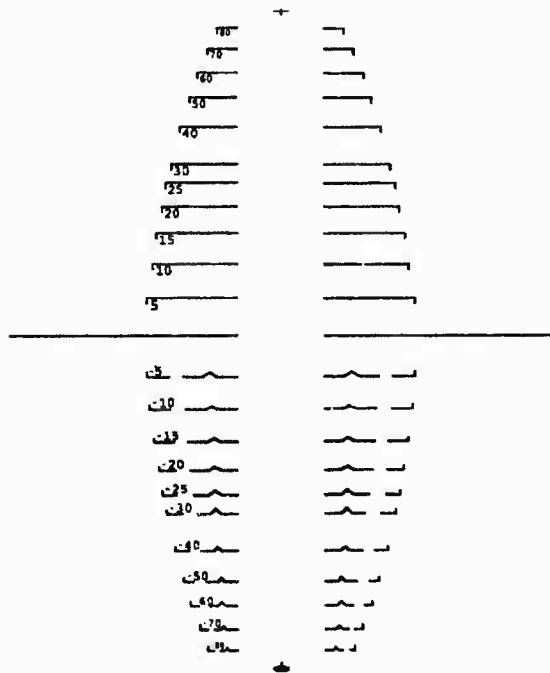

Fig 4. The FJF 4.4:1 Variable Gain, Straight Tapered, Pitch Ladder (Schematic)

To reduce clutter only the 10° pitch bars are drawn above ±30° and the entire ladder is written within a window 15° high, i.e. only 3 or 4 pitch bars are normally drawn at any one time.

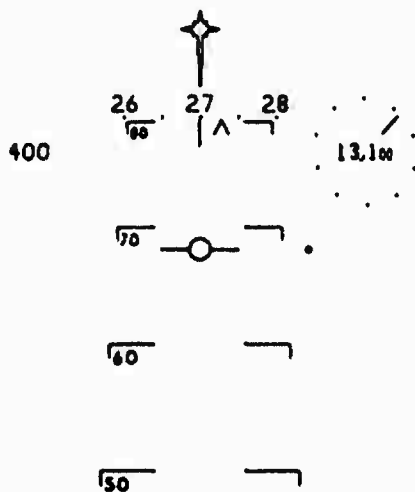

Fig 5. The Basic Fast-Jet HUD Format (FJF) showing a high nose-up CDA.

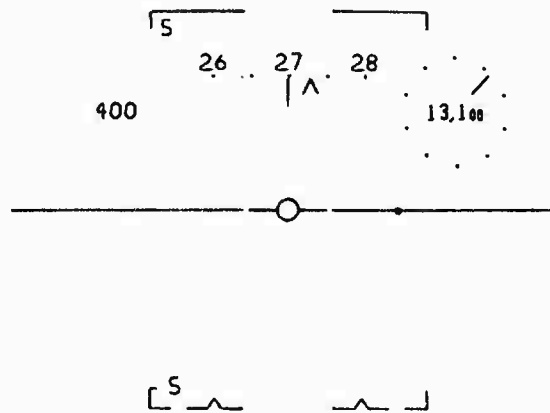

Fig 6. The Basic FJF in level flight and a 20 knot crosswind

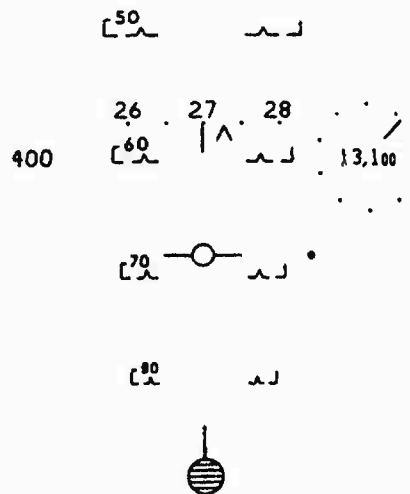

Fig 7. The Basic FJF showing a large nose-low CDA

For many phases of flight, eg when concentrating on the primary mission task, the pilot may only require a general awareness of his orientation. This is provided by the following design features as illustrated in Figs 5, 6 and 7:-

1. The ladder is tapered to provide a coarse analogue presentation of pitch attitude. The taper ratio is 4:1 on the pitch bars and 1.5:1 on the numerals.
2. The pitch bars are straight to provide instinctive roll attitude information.
3. The pitch angle numbers are written on the left hand side only when in erect flight to provide gross erect/inverted information.
4. The climb bars are solid and the dive bars dashed (three dashes and a dash to gap ratio of 1.5 was found to be the optimum). The dive bars include a horizon pointing chevron to provide the strong differentiation between climb and dive required during some highly dynamic manoeuvres.
5. Horizon pointing legs as a recovery aid from unusual positions. These are positioned on the outboard ends of all pitch bars, to de-clutter the centre of the display, and are horizon pointing because the pilot then only has to 'form the bucket and pull' and does not first have to

determine whether he is climbing or diving.

6. A long unique horizon line.
7. New unique zenith and nadir symbols.

The design of the pitch ladder provided the only occasion when the simulation results differed from flight. Pilots expressed concern in the simulator that a variable gain pitch ladder did not provide ideal pitch rate cues. For a steady pitch rate the ladder results in a variable crossing rate of the pitch bars due to both the variable gain and the omission of the 5° bars above $\pm 30^\circ$. In flight, with all the additional pitch rate cues available, no such reservations were expressed and the ladder was evaluated as satisfactory. This aspect of the ladder has since been extensively evaluated in flight, covering many mission tasks, without adverse comment. This highlights the importance of parallel flight validation during developments of this kind.

The design aims for the pitch ladder were considered to have been achieved when pilots said that they no longer felt the need to revert head-down to regain spatial awareness or to recover from unusual positions.

4.3 Peripheral Scales

The design aims for the peripheral scales were to provide:-

1. The information the pilot requires to do his task, presented in the form most easily assimilated by the pilot.
2. A constant scan pattern.
3. A clear and uncluttered presentation.

During the design of the FJF it was repeatedly proved that where the pilot requires rate and trend information to perform the task then the time to perform the task and pilot workload is dramatically reduced if this information is presented in a form that is readily assimilated by the pilot. This is not achieved by digitally displayed information. It can be achieved in various ways, depending upon the priority of the information and the resolution and range required. Examples include: counter-pointer displays where good resolution and long range are required, tape displays where good resolution is required over a limited range and rolling digits, a highly effective way of presenting rate and trend information with minimal additional writing overheads which dramatically reduces the time required to set such parameters as engine rpm and QNH.

The FJF with a basic set of peripheral scales is shown in Figs 5, 6 and 7.

All peripheral scales are drawn with respect to the aircraft symbol, and hence move up and down the pilot's display unit with the aircraft symbol, to give the pilot a constant scan pattern. Height or altitude information is presented as a counter-pointer display at top right and speed as digits top left. Heading and/or track is presented as a conventional tape display at top centre.

Extensive testing in many aircraft, including the Nightbird Harrier, has shown that a counter-pointer presentation of height is essential for night operations and flight in poor weather or on instruments when considerations of flight safety, mission effectiveness and pilot workload are taken into account. Radar altitude may be presented and would be preceded by an

'R'. Counter-pointer speed was rated as highly desirable for many of the tasks evaluated and it is recommended that this be added on a moding basis when required by the task.

The design of counter-pointer displays, in particular, is critical if rate information is to be rapidly and readily assimilated by the pilot. In particular:-

- o The digits must be legible. Minimum digit size will vary with the quality of the display, and is likely to be greater on raster than cursive displays. The space occupied by the digits can be minimised by reducing the resolution of digital height displayed above 9999 ft to 100 ft and drawing the last two zeros in the space normally occupied by a single digit (see Figs 5, 6 and 7). A 0.5 sec update rate on the digits only is used to improve legibility.
- o The needle must clear the digits at all angles and subtend an angle of at least 0.64 deg at the pilot's eye. Rapid assimilation of height data appears to rely heavily on the orientation of a needle of finite size (at least 0.64 deg). When a short needle or index was used pilot considered the display to be little better than a pure digital presentation.
- o Small dots, not dashes, are preferred to mark the circumference in order to minimise clutter. A difference in diameter was considered to be sufficient to distinguish unequivocally between the height and speed counter-pointer presentations.

The use of counter-pointer displays for height and speed was found to be far superior to tape presentations and was adopted after extensive development and evaluation had shown that tapes scales failed to provide the pilot with a satisfactory presentation of rate and trend information, especially of height.

An external index to the height (or speed) counter-pointer has been shown to be a very effective method of presenting an optimum or desired height (or speed) to the pilot (see Fig 9). It has large range and resolution and allows the pilot considerable flexibility of operation²⁰.

Pilots strongly recommended positioning the heading scale at the top for ground attack missions and for any manoeuvre which involves rolling out onto a given heading or track. They also strongly recommended the display of track as well as, or in place of, heading and an open index may be used to show track or demanded heading/track.

4.4 Additional Symbolology

Further symbolology may be added as the mission dictates. Fig 8 shows the FJF with the addition of conventional ground attack weapon symbolology (bomb-fall line and continuously computed impact point (CCIP)) and Fig 9 with additional peripheral scales.

In Fig 9, AoA is shown as a linear thermometer scale on the left, the double dots at 8° AoA representing an important operational AoA for the Harrier. Vertical speed is presented as a non-linear thermometer scale on the right, the equally spaced lines representing 0, ± 500 , ± 1000 , ± 2000 and ± 4000 ft/min. Pilots preferred inward facing arrows on both scales and dissimilar scales to eliminate the rare occurrence of a misinterpretation. Ideally, where operational and field-of-view considerations permit, the nominal operational AoA, the aircraft symbol and zero VSI should be on the same

level on the PDU. g and rpm are shown as rolling digits.

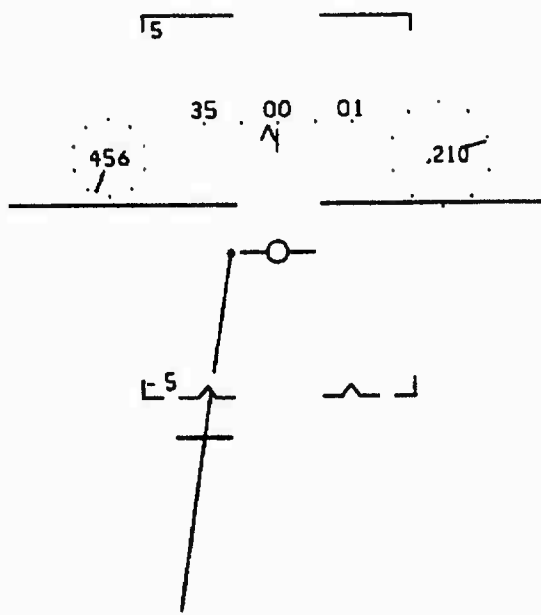

Fig 8. Example of the FJF with Ground Attack Symbology (Bomb-Fall Line and CCIP Marker)

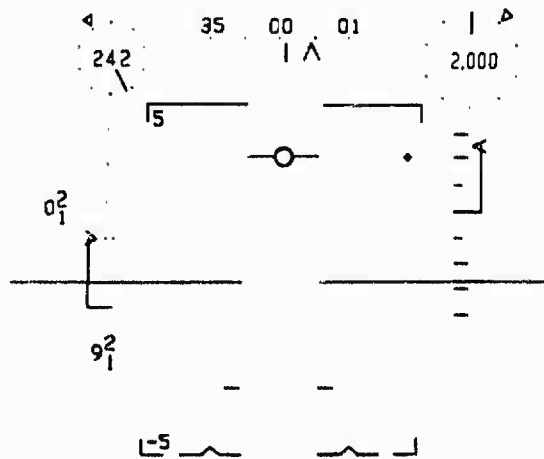

Fig 9. FJF with additional peripheral scales .

To some extent, the design of these peripheral scales is not critical provided that the system chosen provides the information clearly, unambiguously and with a minimum of clutter. Care should be taken when deciding what additional information is required for a task to ensure that it is really necessary given the flight characteristics and display integrity of the given vehicle. For example, are displays of AoA and g required on a vehicle with carefree handling, or VSI necessary if the display of ACDA is of high integrity?

5. SIMULATION AND FLIGHT RESULTS

The following results are taken from two of the many simulation and flight trials carried out during the design, development and flight proving of the FJF. The first example directly compares the FJF with one of the best display formats in current service but, because it concentrated on low level operations it addressed only the display reference and peripheral scales. The second example is thus chosen to address the pitch ladder.

5.1 Comparison of the FJF with the GR5 HUD formats

In 1989 the opportunity arose to evaluate and validate the FJF in the Nightbird Harrier and to compare the FJF directly with the GR5 HUD formats¹⁹. The NAV modes of the FJF and GR5 are similar in many respects. Both aircraft symbols represent CDA, and are constrained to move on or close to the vertical centre-line of the PDU, and both present velocity vector as a secondary symbol. Both displays have thus removed one of the major causes of spatial disorientation, namely uncommanded lateral movements of the display due to the generation of sideslip whilst manoeuvring hard on instruments.

The major differences between the FJF and GR5 display formats in NAV mode were:-

1. Use of 'Achievable' or 'Quickened' CDA and VV symbols in the FJF.
2. Counter-pointer displays of height and speed in the FJF compared with digits in the GR5.
3. A fixed scan pattern in the FJF, because the peripheral scales were written with respect to the aircraft symbol, compared with a variable scan pattern in the GR5 because the peripheral scales were written fixed in the PDU.
4. Velocity vector presented at all times by a small diamond in the FJF and in the GR5 by a ghost aircraft symbol the same size as the aircraft symbol when the drift angle exceeded 2 deg.

The operational roles examined were low level night operations using FLIR and NVGs. Flying in NAV mode included hard manoeuvring at low level and weapon attacks. In VSTOL mode it included transitions to and from the hover with both rolling and vertical landings.

The pilots emphasised the reliance placed on the HUD for night operations when the available visual cues are reduced and there is a significant increase in pilot workload. They rated the FJF the same or better, often much better, for all tasks. The FJF was rated satisfactory for all flight regimes and the ratings given showed little spread. In contrast, the ratings for the GR5 displays showed a greater variation, from satisfactory to unacceptable, with most ratings being acceptable (4 through 6). The overall ratings given by the 4 pilots are given in the following table, where 2 is good and 5 is deficient and needs improvement.

Pilot	1	2	3	4
FJF	2	2	2.5	2
GR5	5	4 to 5	4	3

Table 3. Overall Pilot Ratings for the Fast-Jet and GR5 Hud Formats

The FJF was considered significantly superior for night operations as illustrated by the following typical pilots comments:-

- o 'The GR5 format takes a lot of practice to fly well - the fast-jet format came naturally which frankly says it all'.
- o 'Quickened CDA comes into its own in cloud and at night'.

- o 'Analogue height needed for rapid assimilation of height data and for rate information, especially in poor visibility, at night and at low level'.
- o 'Fixed scan pattern preferred: the pilot knows instantly where to look to find height, speed, etc'.
- o 'VV diamond preferred to the large GR5 ghost symbol which is confusing and clutters the display'.

5.2 Straight Tapered versus Bendy Bar Pitch Ladders

There has long been considerable debate on the best design of pitch ladder, and in 1990 a side-by-side comparison of the straight tapered ladder of the FJF and the equivalent bendy bar ladder was carried out on the piloted flight simulator at DRA Bedford to determine the pitch ladder for EFA²⁰. To guarantee impartiality, this trial was coordinated and controlled by OR52c(Air). The emphasis was on the retention of spatial orientation during hard manoeuvring flight on instruments, especially when distracted by or concentrating on other tasks, and on the recovery from unusual positions. The 19 subject pilots were drawn from the UK, Germany, Italy and Spain and included operational squadron pilots, test pilots and pilots currently serving with the UK Ministry of Defence. All were familiar with bendy bars but many had not previously seen the straight tapered ladder. All considered that the straight tapered ladder gave much improved spatial orientation and markedly reduced the possibility of spatial disorientation whilst also providing a satisfactory recovery aid from unusual positions. All preferred the straight tapered ladder, some strongly, as illustrated by the following pilot comments.

Straight Tapered Ladder

- o 'The straight bars give a clear bank reference (being parallel to the horizon) and a discrete, accurate, easily interpreted pitch reference'.
- o 'It is easier to determine bank angles at a glance particularly at large positive or negative pitch angles'.
- o 'This display gave me the ability and the confidence to fly without thinking of a head-down display to check results'.

Bendy Bar Pitch Ladder

- o 'At steep attitudes and bank angles greater than 10 deg, the uncertainty about bank, which was severe, causes a knock on effect to give a strong feeling of uncertainty about the pitch attitude'.
- o 'The bendy bars give a very powerful indication of the nearest horizon, almost to the point of distraction ... and to the detriment of roll and pitch information'.
- o 'The bent bars and the [inboard] horizon indicators give a cluttered picture making it difficult to assess the bank angle'.

The ratings given for the straight tapered ladder range from 1 through 5 compared with 3 through 9 for the bendy bar ladder as shown in the following histograms.

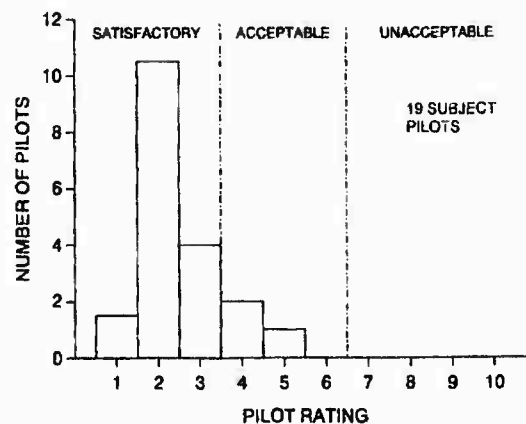

(a) Straight Tapered Pitch Ladder (FJF)

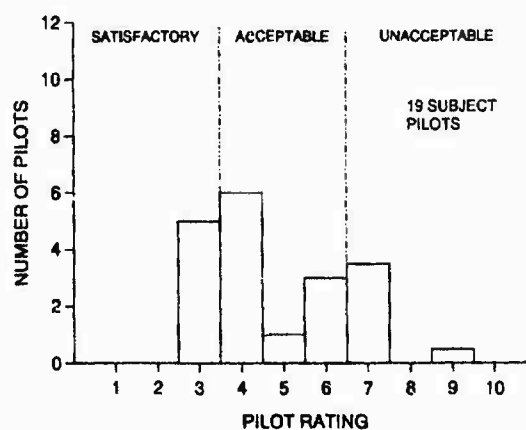

(b) Bendy Bar Pitch Ladder

Fig 10. Histograms of Pilot Ratings for the FJF Straight and Bendy Bar Ladders

The pilots made just 3 serious errors out of 190 manoeuvres flown. These all occurred with the bendy bar ladder and involved three different pilots pulling through the downward vertical when recovering from a nose low and inverted unusual attitude. This result was perhaps surprising given the pilots favourable comments regarding the indication of the nearest horizon with the bendy bar ladder.

An analysis of task performance showed little significant difference between the two formats once the major errors had been removed²¹. This would indicate that task performance is not an appropriate metric when measuring pilot workload and spatial awareness.

The fact that 3 serious errors were made with the bendy bars, a concept very familiar to the pilots, whereas none were made with the straight tapered ladder suggests that the straight tapered ladder provides a more intuitive and unambiguous presentation.

A subsequent study in the US has confirmed these results²⁶. This study found that 'articulated [bendy] lines in the bottom half of the HUD are detrimental to a pilot's ability to recover from nose-down unusual attitudes' and that 'in seven cases with the articulated lines on the bottom, subjects appeared unable to determine that they were inverted and rolled in the wrong direction or applied back pressure before achieving a bank angle of less than 90 degrees--which either delayed their recovery or steepened their dive angle,

thereby worsening the situation.' The study 'recommends using parallel lines in the bottom half of the standardized HUD to provide more consistent and accurate bank information.'

6. CONCLUSIONS

The DRA fast-jet HUD format (FJF) has been shown to meet all its design objectives following extensive development and refinement in the Bedford piloted flight simulator and flight proving in a number of fast-jet aircraft. In particular, it promotes spatial awareness and largely eliminates spatial disorientation during all phases of flight, including hard dynamic manoeuvring flight in poor weather and on instruments and when the pilot's primary attention is on tactical or mission, not flight, information. At the same time, it retains the flight-path information so necessary for mission effectiveness during normal tactical manoeuvring and steady flight conditions, and provides a satisfactory recovery aid in the event of the pilot becoming disorientated or entering an unusual position. Mission, threat and navigation information may be added as required and the use of 'achievable' VV dramatically reduces the time to achieve weapon solutions that require fast and accurate control of the flight-path of the vehicle.

Specifically, the DRA fast-jet HUD format (FJF) provides:

An aircraft symbol which:-

- o Is well behaved in the pilot's field-of-view and provides a sound basis for the rest of the display.
- o Approximates to 'achievable' CDA when read against the outside world.

A small 'achievable' velocity vector diamond which:-

- o Presents 'achievable' VV when read against the outside world.
- o Provides a much improved datum for weapon aiming symbology which requires the fast and accurate control of the flight-path of the vehicle.
- o Is of such a size that it can be readily used by the pilot but is not distracting when not required.

A pitch ladder which:-

- o Presents 'achievable' CDA when read against the aircraft symbol.
- o Responds crisply to pilot control demands and is well harmonised with the longitudinal response of the aircraft.
- o Promotes spatial awareness, in conjunction with the aircraft symbol, under all flying conditions including hard manoeuvring flight in reduced visibility and on instruments and when the pilot's primary concentration is on tactical or mission, not flight, information.
- o Provides a satisfactory aid for the recovery of spatial awareness and from unusual positions.

Peripheral scales which:-

- o Provide a constant scan pattern with the aircraft symbol.

- o Are designed to present the information required by the pilot for a given task in a manner which is easy to assimilate. In particular, they are designed to provide rate and trend information when this is required by the pilot to perform the task.

The design of the FJF has resulted in a number of improvements in the display of basic flight information head-up. Taken together these improvements result in a display which is a significant improvement on those in current use in terms of promoting total situational awareness, thereby increasing both safety and mission effectiveness.

Mission related symbology may be added as required and the use of 'achievable' VV as a datum for ground operations has been shown to markedly reduce the time to achieve weapon solutions which require fast and accurate control of the flight-path of the vehicle.

The FJF has been accepted as the standard for the RAF fast-jet fleet and for EFA and is currently the subject of a STANAG in preparation.

ACKNOWLEDGEMENTS

The author would like to acknowledge the major contribution made by John Penwill, who retired recently, in the design and development of the FJF. He was responsible for the majority of the simulation and flight trials and for the design and development of the pitch ladder. The author would also like to acknowledge the invaluable contributions made by numerous pilots, scientists and engineers who have contributed to the development of the FJF over the years, notably Sqn Ldr P J Bennett (ret), Wng Cdr J M Henson and Mr C D Wills.

REFERENCES

- | No | Author | Title |
|----|---|--|
| 1. | A Kuipers, MD, A Kappers, Lt Col, C R van Holten, Maj, J H W van Bergen, Sgt, Prof Dr W J Oosterveld. | Spatial disorientation incidents in the RNLA F16 and F5 aircraft and suggestions for prevention. AGARD conference on 'Situational Awareness in Aerospace Operations', Copenhagen 1989. AGARD-CP-478, paper OV-E, Oct 1989. |
| 2. | J R Hall, Sqn Ldr C M Stephens, J C Penwill. | A review of the design and development of the RAE fast-jet head-up display format. RAE Working Paper FM WP(89)034, July 1989. |
| 3. | J R Hall, J C Penwill | RAE fast-jet HUD format - specification issue 2. (Display tailored for T4 Harrier XW175). RAE Working Paper FM WP(89)064, September 1989. Amendment list 1 issued 18 October 1990. Amendment list 2 issued 15 April 1991. |
| 4. | Sqn Ldr P J Collins. | The RAE fast-jet format head-up display. Paper presented to SETP European Symposium, Aries, France, April 1990. |
| 5. | Flt Lt B J Singer. | The RAE fast-jet HUD format. Paper presented at an evening lecture on 'Future Aircraft Displays' at the Royal Aeronautical Society on 11 April 1991. |

6. Sqn Ldr J M Henson. A review of the development of the Fast Jet Head-Up Display drive laws and symbology suite. RAE Tech Memo FS(F)657, 1987.
7. J C Penwill, C D Wills. A simulator and flight trial assessment of several head-up display formats with unity pitch attitude scaling. RAE Tech Memo FS(B)476, 1982.
8. J R Hall, J C Maberley, C D Wills, Sqn Ldr D Stangroom. NATC/McDonnell Douglas Aircraft Co visit to RAE Bedford in July 1982 to discuss AV-8B Head-Up Display formats. RAE Tech Memo FS(B)490, 1982.
9. J R Hall. The development of Drive Laws for a Quickened CDA Referenced Head-Up Display. Unpublished RAE Report.
10. J C Penwill. A flight simulator assessment of a 1:1 head-up display format for the Jaguar aircraft. RAE Tech Memo FS(B)497, 1982.
11. J C Penwill, Sqn Ldr J M Henson. Flight simulator assessments of a 1:1 head-up display format for the Jaguar. (Addendum to Tech Memo FS(B)497). RAE Tech Memo FS(B)520, 1983.
12. J C Penwill. The presentation of pitch bars in head-up displays - A flight simulation study. RAE Tech Report TR 87024, 1987.
13. J C Penwill, J R Hall. The RAE Fast Jet Head-Up display format optimised for the RAF Jaguar. RAE Tech Report TR 88006, 1988.
14. J C Penwill, C D Wills. A flight evaluation of HUD pitch ladders suitable for high pitch rates. RAE Tech Report TR 88014, 1988.
15. J C Penwill. Zenith and nadir symbols for the pitch ladder of the RAE Fast-Jet Head-Up Display Format. RAE Tech Report TR 89020, 1989.
16. Sqn Ldr C Stephens, J C Penwill. RAE Bedford technical evaluation of the variable geared ladder. RAE Working Paper FM WP(88)007.
17. Sqn Ldr P J Bennett. The display of raster and cursive flight symbols in a Harrier aircraft fitted with electro-optic sensors and a Ferranti HUD. RAE Tech Report 84092, 1984.
18. Sqn Ldr P J Bennett. The integrated navigation, sensor and display system in the RAE Nighthawk Harrier T4. RAE Tech Memo FS(B)639, 1986.
19. J C Penwill. Harrier Night Trial to Evaluate the GR5 and DRA Fast-jet Head-Up Display Formats. DRA report in preparation.
20. J C Penwill, J R Hall. A four nation comparative evaluation of the two pitch ladder designs proposed for EFA. DRA report in preparation.
21. P R E Jameson, J C Penwill. Analysis of data from a comparative evaluation of two HUD pitch ladder formats. DRA report in preparation.
22. J C Penwill, J R Hall. A refinement to the pitch ladder and an evaluation of the quickeners of the DRA fast-jet head-up display format. DRA report in preparation.
23. Flt Lt P J Bennett. The Head-Up Display of Power Margin in Harrier and AV-8B Aircraft. RAE Tech Memo FS 439, 1981.
24. G Harrison, J R Hall, et al. Recovery of the Sea Harrier in poor visibility. RAE Tech Memo FS 204, September 1978.
25. G E Cooper, R P Harper Jr. The use of Pilot Rating in the evaluation of handling qualities. Agard Rpt 567, April 1969.
26. Lisa F Weinstein, W R Ercolino. The effect of variations in head-up display climb/dive ladder configuration on recovery from unusual attitudes. USAF Armstrong Laboratory, USA 1991.

© Controller, Her Majesty's Stationary Office London 1992

SYMBOLGY FOR HEAD UP AND HEAD DOWN APPLICATIONS
FOR HIGHLY AGILE FIGHTER AIRCRAFT - TO IMPROVE
SPATIAL AWARENESS, TRAJECTORY CONTROL AND
UNUSUAL ATTITUDE RECOVERY

Part I by

G. Fischer and W. Fuchs
Dornier Luftfahrt GmbH
Flight Simulation Department,
P.O. Box 13 03
D-7990 Friedrichshafen 1
Germany

SUMMARY

The progressively increasing agility of modern fighter aircraft (a/c) with high onset and high sustained pitch and roll rates makes spatial orientation and awareness an even more demanding task for the operator. Pilots already complain about fast moving and twisting pitch bars in the HUD and the necessity to concentrate almost their entire attention on maintaining spatial orientation.

Scaled and geared pitch bars relieved the problem to some extent but didn't solve it, at least according to our opinion.

The above mentioned problems are aggravated with the introduction of advanced fighter a/c capable of even higher onset and angular rates, and flying at higher angles of attack (AoA) or even in the post-stall regime, where the actual flight path in space and the a/c attitude may deviate to a great extent.

In order to overcome the problems mentioned above, a more stationary and easier interpretable reference symbology, a circular arc segment, is used to indicate pitch (θ) or flight path angle (γ), whereas the roll angle (ϕ) is given by the angular relation between a/c reference symbol and the center of the arc segment, Fig. 1.

Fig. 1

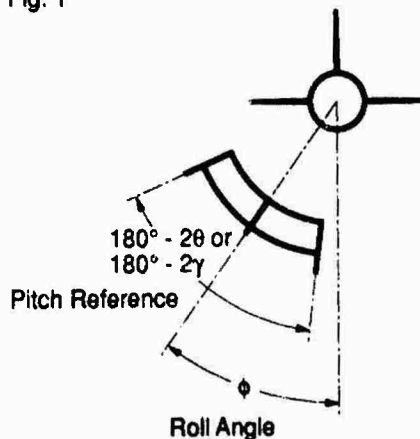

1 SIMULATOR AND IN-FLIGHT EXPERIENCE

Symbology expressed in short terms:

Horizontal flight or attitude is indicated by a 180° arc segment underneath the centered a/c symbol. Pointing or flying 90° down or up is indicated either by a complete circle or no segment at all, with only the gap marks maintained. The arc segment dimension is defined by $180^\circ - 2\theta$ or $180^\circ - 2\gamma$ respectively, Fig. 2.

Fig. 2

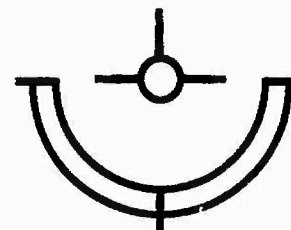

Horizontal
Flight



Straight
up

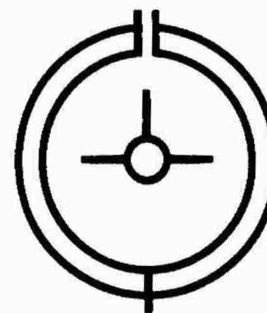

Straight
down

Looking at the first version of the symbology it is pretty obvious why operators used to call it ORANGE PEEL Display, but the symbology has changed.

1.1 Simulator Trials

The arc segment attitude reference (ASAR) symbology was demonstrated to a number of flight test and operational pilots during flight handling simulator trials in 1987. The reaction of the operators was positive and in-flight simulations were recommended.

In 1989, 60 flights with a total of 16 flight test and GAF pilots involved, were performed using the first symbology version. Flight test a/c was an Alpha Jet with a safety pilot in the 2nd seat.

These assessments were also positive with a number of recommendations and change requests to be incorporated before the next in-flight simulations.

During a simulator trial at the Dornier flight simulator in July 1990, the modified symbology was further refined and tested against the standard pitch ladder display with 3 flight test and 6 GAF pilots involved. There was also unanimous agreement that the arc segment was superior for air to air (A/A) combat, coarse manoeuvring and unusual attitude recovery, but needed further refinement and in-flight testing for low level (L/L), air-to-ground (A/G) and instrument flight applications.

Fig. 3 shows various examples of the agreed 2nd version prepared for in-flight validation which started in spring 1992.

Pitch References:

Dots and gaps have been introduced to mark attitude angles at zero, ± 30 and ± 60 degrees. The dots for the lower segment portion remain displayed for angles above the horizon to improve location identification of the semi-circular shape.

Roll Reference:

An additional roll reference marker is displayed at the segment as a foot point of the aircraft reference symbol.

Horizon Reference:

The ASAR symbology has one weak point which you may have realized already. It is the precise pitch reference near horizontal flight. For this reason a well extended line representing the true horizon with just a gap for the a/c reference symbol was added and, in addition to the horizon line, pitch reference marks from $+10$ to -40 degrees with 5 degree intervals.

2 FURTHER APPLICATIONS

2.1 Combinations with Other Symbology

Based on the common request that the basic flight attitude reference symbology should be identical for all phases of flight, we tested the ASAR symbology in combination with A/A, A/G and flight director guidance symbology. The combinations work well with ratings better or at least equivalent to present standards.

Up to this point, the a/c reference symbol as the center of the arc display was oriented to the actual flight path in space, which means, the position on the HUD was subject to angle of attack (AoA) and yaw angle changes which causes undesirable dynamics in combination with all sorts of artificialities, like damping, scaling, gearing, FOV limiting, etc.

We found that flight path orientation of the a/c reference symbol is favourable for phases of flight requiring low a/c dynamics but high angular flight path resolution for example, for take-off, approach, landing, enroute cruise or L/L portions.

2.2 Guidance Symbology for Highly Dynamic Manoeuvring

In view of the advancing capabilities of aircraft which are controllable to much higher AoA, where actual flight path and a/c attitude may differ to a great extent and the growing capacities of airborne computers which allow for computations of optimized 3-dimensional air combat trajectories, we did some changes and additions to the ASAR symbology.

2.3 ASAR for Combat Manoeuvring

The a/c reference symbol is changed, shaped in relation to AoA and displayed at a fixed position. This allows the indication of e.g. optimum and maximum AoA as well as intermediate situations in combination with flight path and attitude references without the need to cross-check other symbols or displays, Fig. 4.

Precomputed high performance combat profiles which will - in most cases - be near the envelope boundaries require rapid and aggressive control inputs. Regardless of whether manual or automatic steering is selected, the indications must be simple, instinctive and unambiguous, and available in combination with attitude and AoA indications.

A straight line and a marker is introduced to command roll angles and load factors (G) in combination with the previously mentioned symbols.

The pilot rolls the a/c to align the vertical fin of the reference symbol with the straight bar and applies stick pressure to place the G marker in a defined position, e.g. the end of the line, Fig. 5.

3 CONCLUSION

Pilots involved with the ASAR display either in simulator or in-flight trials think that this symbology solves all deficiencies of the symbology currently in use, for all phases of flight. A/c attitude awareness can be maintained at lower levels of attention thus leaving additional capacities to monitor and handle other tasks.

Fig. 3 Present ASAR Symbology

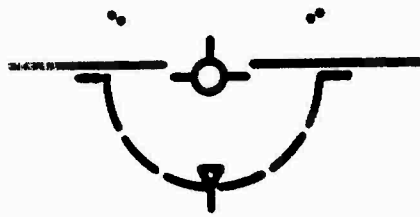

Nearly Level Flight
 $\gamma \leq 0^\circ, \theta = 0^\circ$

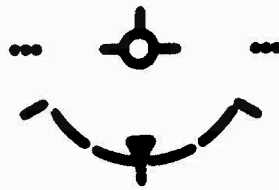

Climbing
 $\gamma = 30^\circ, \theta = 0^\circ$

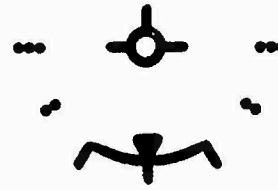

Climbing
 $\gamma = 60^\circ, \theta = 0^\circ$

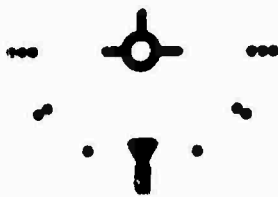

Straight Up
 $\gamma = 90^\circ, \theta = 0^\circ$

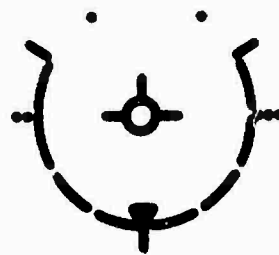

Descending
 $\gamma = -30^\circ, \theta = 0^\circ$

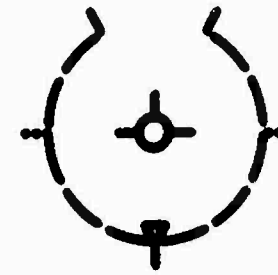

Descending
 $\gamma = -60^\circ, \theta = 0^\circ$

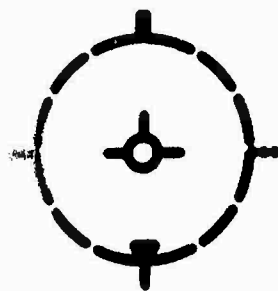

Straight Down
 $\gamma = -90^\circ, \theta = 0^\circ$

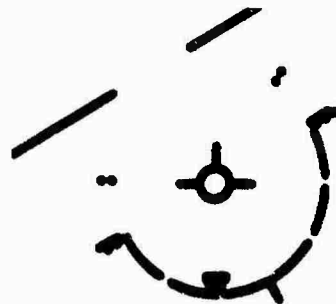

$\gamma = -2^\circ, \theta = 35^\circ$

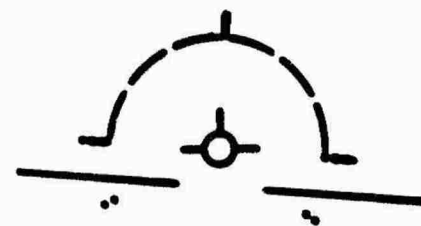

$\gamma = -1^\circ, \theta = 170^\circ$

Fig. 4 AOA Indication

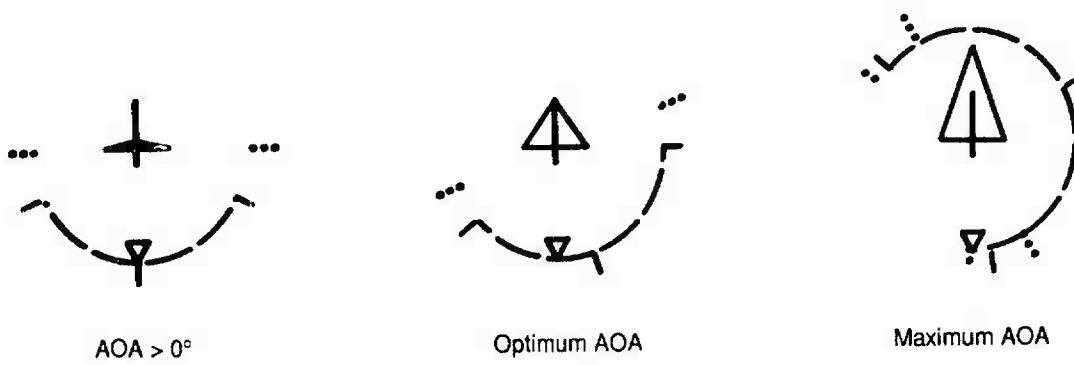
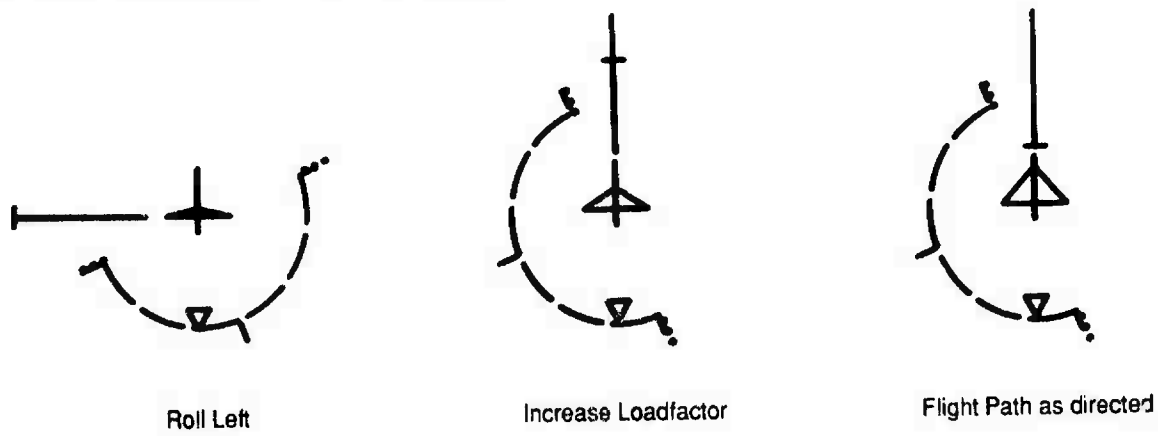

Fig. 5 Flight Path Command Steering



Part II by

H. Phillipp, Test Pilot
 German Armed Forces Flight Test Center
 WTD61, Flugplatz
 D-8072 Manching
 Germany

1 BACKGROUND

In the late 80's an extension of the tactical role of the German Alpha Jet light attack fighter required improvement of HUD attitude display to serve as primary instrument for day/night operation.

The required improvement had to provide:

1. immediate unmistakable differentiation of upper and lower hemisphere,
2. easy readability of pitch and roll attitude at static and maximum dynamic flight conditions.

There were two possibilities for achieving the required improvements:

- modernizing the original pitch ladder type attitude display, or
- integrating a new type of attitude display, the segmented horizon.

The segmented horizon was in fact introduced by Dornier during ground based simulation for modernizing the original pitch ladder display. Functioning entirely different, it seemed to avoid some problems involved with the pitch ladder type displays. It was decided to investigate and develop both displays as potential alternatives.

2 PITCH BAR TYPE ATTITUDE SYMBOLOGY

The original Alpha Jet HUD contains a monochromatic displayed pitch ladder attitude symbology. This type of attitude symbology originates from the HDD artificial horizon. Compared to the HDD, it has two remarkable deficiencies:

2.1 There is no coloured underlay, which is vitally important for safe differentiation of the upper and lower hemisphere.

2.2 Unlike the sphere of the artificial horizon, which is totally visible to the pilot, the pitch bars are visible only, when they are within or when passing through the FOV. The vertical limitation of the FOV of the HUD (max. 20°) creates a port-hole effect which makes orientation difficult at high angular rates.

The original software was modified to minimize the effects of these deficiencies.

The missing colour underlay of the pitch bars was compensated for by different shaping of the pitch bars above or below the horizon (solid/dashed lines).

To avoid disorientation due to the porthole effect

- a recovery aid pointing the nearest way to the horizon was developed. It was achieved by inclining the pitch bars which progressively increase with increasing pitch angles.
- the speed of pitch bars moving through the field of view was reduced. It was achieved by changing the equidistant scaling of the pitch bars at high pitch angles.

During the definition process, when reshaping the original pitch bars for better discrimination, an entirely new problem arose.

It was caused by the decision to show solid pitch bars below and dashed pitch bars above the horizon line. The so formed attitude symbology was identical to other western HUD displays, except for the fact that it was 180° inverse to all other HUD attitude symbology used in the western aviation community. Convinced that the newly formed attitude symbology was the more logical one, interrogations of individual and groups of pilots were conducted. They were asked to state which display represents the most logical, unmistakable, intuitively correct assignment of the pitch bars. The voting of what symbol should represent the lower hemisphere (the ground) showed, that

- a majority (about one half) preferred solid pitch bars,
- a minority (about one quarter) preferred dashed pitch bars,
- another minority had problems to decide at all.

Regardless of the decisions in the past, which caused the present assignment of pitch bars, it is evident that a monochromatic pitch bar attitude display contains inherent ambiguity.

This ambiguity can be eliminated only by colouring the pitch bars - like the coloured underlay of the artificial horizon. Whether this has been tested is unknown.

3 SEGMENTED HORIZON

The segmented horizon is characterized by a concentric display of all pitch and roll information close to the main steering cue, the velocity vector. There is no need for coloured underlay to distinguish between right-side up and upside down and there is no porthole effect. The concentrated display provides situation awareness cues at similar low display dynamics like the artificial horizon. In order to minimize clutter, the number of symbols is kept at a minimum. A negative aspect is the pitch resolution provided by the circle. The achievable precision is insufficient at small pitch angles, but is compensated by auxiliary pitch bars (+10°, -40°).

4 TEST PROGRAM

The German armed forces test center is presently conducting an in-flight evaluation of both attitude displays in parallel, using the Alpha Jet as testbed. The evaluation of the navigation mode is currently under way, the weapon modes (A/A and A/G) will follow.

The evaluation is conducted on a qualitative basis, using defined, repeatable manoeuvres as rating criteria.

- Precise instrument type manoeuvring
- Coarse manoeuvring to predetermined parameters
- Unusual attitude recovery

The HDD is covered, a safety pilot controls the program from the rear seat.

Until now five pilots have been involved, two from the test center, three from different squadrons of the Luftwaffe (F4, Tornado, Alpha Jet) with multiple, single or no HUD experience.

5 PRELIMINARY TEST RESULTS

The adaptation to both attitude display systems, the inclined pitch bars and the segmented horizon was no factor.

Precise instrument type flying (static manoeuvres, ±20° Pitch, ±60° Roll) was possible, there was no remarkable difference between both displays.

Flying high dynamic manoeuvres, orientation was possible with both displays, but the pitch bar display needed a high level of attention, thus increasing workload. It therefore received negative comments.

The segmented horizon was rated positive for good situation awareness at both low and high manoeuvring rates, for low non-cluttering segment dynamics, and good correlation of display with outside reality. A negative aspect was the inability to quickly stabilize a predetermined pitch angle with

a precision of better than ±3° when using the segment only.

Recovering from unusual attitudes after loss of orientation shows a remarkable difference between both attitude displays with respect to the time required to regain orientation.

Flying the segmented horizon, the recovery action was always without hesitation into the correct direction.

Flying the pitch bar attitude display, hesitation and initially incorrect bank inputs were observed.

To simplify the recovery to the nearest horizon it was briefed to pull

- into the funnel formed by the inclined pitch bars,
- through the open gap formed by the circle (critical nose low recovery).

With the segmented horizon, this recovery advice worked without any failure. The pilots rated the display close to fool-proof.

With the pitch bar attitude display, the above mentioned recovery also worked, but needed more attention. During one recovery test the funnel was ignored and the recovery initiated to the critical side. At low altitude, this recovery would have been unsuccessful.

6 CONCLUSION

The preliminary results, based on one out of three HUD operation modes to be investigated, allow the conclusions:

- Both attitude displays, the inclined pitch bar and the segmented horizon are superior to the original straight pitch ladder type display.
- The segmented horizon attitude display has proven superior to the inclined pitch bar attitude display and seems to fulfil the stated requirements.
- The ambiguity of the pitch bar attitude display should raise concern and support further investigations.
- The final recommendation of whether the segmented horizon display should replace the pitch bar should be made after further investigations with a representative number of participants.

VIRTUAL INTERFACE APPLICATIONS FOR AIRBORNE WEAPONS SYSTEMS

Emily Howard, Ph.D.
Rockwell International, North American Aircraft
P.O. Box 92098; Mail Code 011-GB01
Los Angeles, CA 90009 U.S.A.

ABSTRACT

This paper addresses a class of controls and displays technology that shall be referred to collectively as Virtual Interface (VI) technology. The contents of this paper are presented in three parts. Part I will describe what is meant by a "virtual interface," a suite of control and display technology being developed for future implementation in operational aircraft systems. The problem that will be discussed is how the transition process between development and operational status is particularly difficult for VI technology, given current applications. Part II will describe some new applications of VI technology, based upon several programs that utilize embedded simulation for operational test and evaluation and training purposes. A review of the benefits of VI technology shows promise for accelerating the transition process at least toward these operational activities. Part III then will describe a new display concept, based on virtual interface technology, that was designed for one of these embedded simulation applications and conclude with a discussion of plans for future development.

PART I - WHAT IS A VIRTUAL INTERFACE?

The notion of a "virtual interface" refers to a general class of pilot-vehicle interface technology that is being targeted for transition into future aircraft cockpits.¹ The development of these products derives primarily from requirements to enhance overall system performance, based upon the pilot's inherent abilities. The use of this term is intended to capture one of the overriding objectives of this technology: to enable the pilot to interact with his vehicle in a way that is natural, intuitive, and seamless. Hence, a "virtual" interface.

In another context, virtual interface technology might be considered as just another title for advanced cockpit controls and displays. Table 1 lists a few of the specific examples of emerging controls and displays technology that can be considered as part of the VI family. All of these devices are concerned with improving the information transfer between the pilot and his airborne weapons system, given only the opportunity to re-design the cockpit, not the pilot. Descriptions and evaluations of each of these individual entries are the subject of numerous other papers, both within these proceedings and elsewhere, so I will not elaborate on any one specifically. What I am concerned with is trying to determine how this family of technology as a whole may fit into future airborne weapons systems.

Table 1. Examples of VI technology

Virtual Interface Displays:
Helmet-mounted displays Large flat panel displays Voice displays Cockpit projection displays Perspective imagery Stereoscopic imagery Three-dimensional audio Tactile displays Volumetric displays
Virtual Interface Controls:
Touch screens Body position trackers: head, hand, eye Pilot-aiding systems Voice recognition

So far as can be determined, nearly everyone within the industry (myself included), seems to agree that VI technology promises to part of the next generation of cockpit designs. If we follow the trends from past and current designs, VI technology may simply be viewed as the next logical phase of cockpit evolution. Some of these trends are presented in Table 2. Early examples of cockpit interface systems emphasized segregated, single function displays that depicted simple alphanumeric and abstract characters, and required that the pilot look "heads-down." Current designs incorporate integrated, multi-function displays that utilize two-dimensional representative symbols, and enable the pilot to remain more "heads-up." Some of the next generation concepts that have been proposed incorporate panoramic, all-purpose displays that depict three-dimensional, virtual-world images and support the pilot even as he looks "heads-out."

Table 2. Evolutionary Trends In Cockpit Design

Past	Current	Next?
Segregated, single function displays	Integrated, multi-function displays	Global, panoramic displays
Alphanumeric characters	Representative symbols	Virtual-world images
Heads-down displays	Heads-up displays	Heads-out displays

Thus, given general agreement on where VI technology is going, the real question is, how do we get there? Most cockpit design studies focus on applications whereby new technology is proposed to improve overall system performance by producing measurable improvements in pilot performance. These efforts typically strive to show how improved mission effectiveness (i.e., increased survivability and/or lethality) can be achieved through reduced pilot workload, enhanced situation awareness, etc. Rapid development in cockpit controls and displays capabilities, however, has significantly out-paced the development of essential new knowledge about how human performance is affected by these capabilities. Without this knowledge, then, design engineers cannot easily (nor, at times, even successfully) integrate and validate designs utilizing VI components. The result is a painstakingly slow transition process between cockpit technology development and operational use—ranging from ten to even twenty years.

The challenge for successful technology transition can be understood from another perspective by adopting a simple definition: "Transition can only occur where technology 'pull' equals or exceeds technology 'push.'" By this definition, one may argue that VI technology has thus far shown only limited transition potential because of insufficient "pull." This deficiency is attributable to poorly understood or incomplete requirements for enhancing human performance (i.e., the lag in available

knowledge noted above), coupled with certain risks that may directly inhibit "pull" (i.e., costs and schedule).

To tackle the challenge for VI technology transition, then, two solutions become immediately apparent. First, more applications need to be studied in order to identify all potential requirements for utilizing VI technology. Second, new technology integration approaches need to be developed in order to insure that the capabilities and benefits of *existing* systems are fully realized. The next sections describe some work that has adopted these strategies for achieving VI technology transition.

PART II - NEW APPLICATIONS FOR VIRTUAL INTERFACE TECHNOLOGY

Rockwell is currently involved in several programs that are investigating the use of *embedded simulation* to support a variety of applications. These applications largely address the operational test, evaluation and training aspects of airborne weapons systems deployment. Figure 1 depicts a conceptual representation of how embedded simulation functions within these applications, incorporating both real and simulated weapons systems that are linked together electronically for conducting combat exercises. In such exercises, the synthetic elements may be generated via airborne (including onboard) or ground-based simulation systems, using a variety of networking approaches. The predominant "pull" for this development is the increased flexibility and safety of performing these exercises at significantly reduced costs.

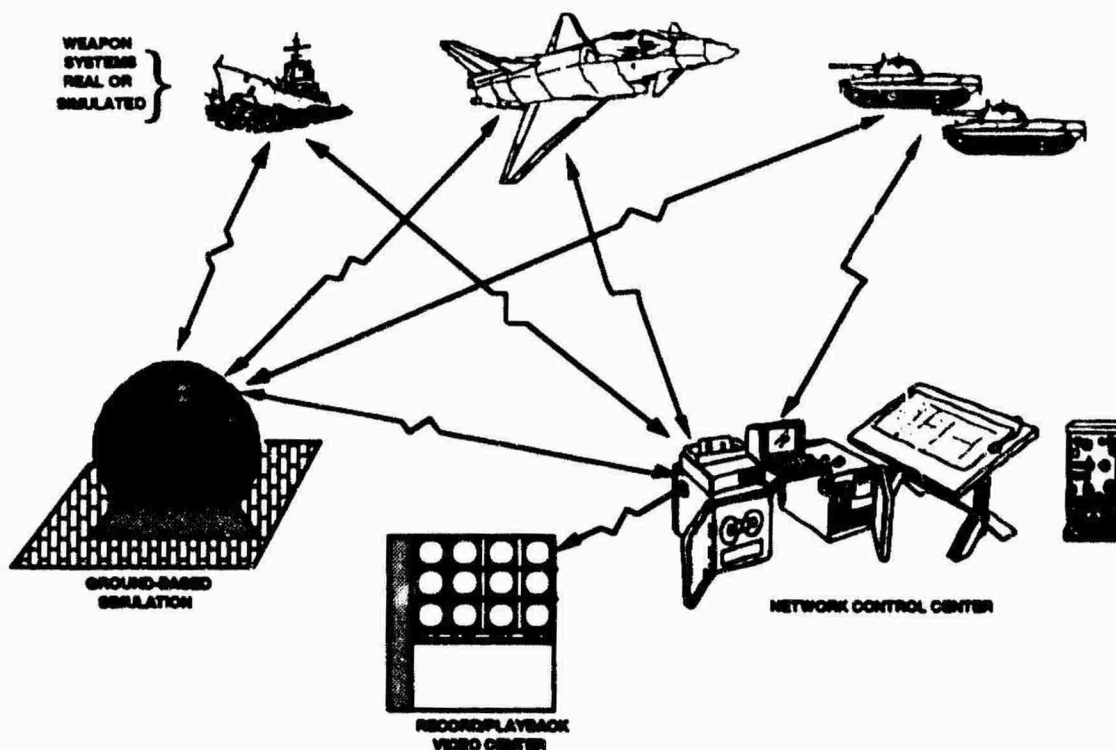

Figure 1. Embedded Simulation Concepts Offer New Applications for Virtual Interface Technology

One particular application we are investigating utilizes a two-way datalink and range telemetry system to match a pilot in flight against a pilot in a dome simulator on the ground to conduct close-in combat exercises. This work is being performed in support of our X-31 Enhanced Fighter Maneuverability contract. The key drivers for this application are not only the benefits in exercise safety and cost-effectiveness, but the new tactical evaluation opportunities that are enabled as well. For instance, fighting against a simulated opponent should reduce some of the safety limitations imposed when such exercises involve an airborne opponent, offering the pilot more options with which to exploit the full potential of his aircraft's tactical envelope.

One of the design challenges associated with this particular application, however, is how to support pilot awareness with the sufficient resolution and "feel" of live close-in combat. To this end, VI technology offers a number of advantages for stimulating pilot awareness relative to conventional (currently operational) cockpit interface technology. A few of these are listed below. Note that this description is not intended to be an exhaustive review of all of the capabilities of VI technology.

Advantages of Virtual Interface Technology

When compared with current cockpit technology, VI components can generally offer much wider fields-of-view, as defined in both instantaneous and total display coverage. This fundamentally provides more usable area in which to convey information. Second, VI systems support three-dimensional representations of information. This capability enables the pilot to acquire more accurate assessments of critical spatial relationships within his tactical situation through cues like perspective, stereopsis, motion parallax, proprioception, and viewpoint manipulation (analyzing the same information from potentially many different eye points). Further, VI technology generally offers a more flexible means of representing information, so that the display formats can be more appropriately tailored to meet the pilot's exact needs.

Finally, VI supports what can be potentially described as "correlated perception," receiving complementary inputs about the environment simultaneously through multiple perceptual channels. An example of this feature is found within helmet-mounted displays that provide spatially-localized information about the environment, e.g., target position. These systems couple the pilot's vestibular perception of where he is looking with his visual perception of the environment displayed within the HMD to create a compelling, and intuitive representation of the required information. While the functional basis underlying "correlated perception" is not well understood, two advantages can be proposed. One advantage is from sheer information redundancy. VI systems may allow pilots to perceive information acquired concurrently across multiple channels more accurately by minimizing the

impact of perceptual limitations occurring within any one channel. The other advantage is based on the theory that a good deal of information that we extract from our environment is done so unconsciously, and that the mechanisms underlying these so-called unconscious or "ambient" processes are heavily dependent on correlated perception.² Consequently, VI systems may support pilot awareness in ways that do not require conscious effort, significantly lowering the pilot's mental workload.

Given the features just described, VI technology has clear advantages over conventional cockpit technology for meeting pilot awareness requirements during in-flight combat exercises against a simulated airborne opponent. In our assessment of technology feasibility, then, recalling the definition of successful transition, our strategy has been to capitalize on the requirements for pilot awareness during CIC (i.e., maximize "pull"), while avoiding the risks associated with "cutting-edge" developments (i.e., minimize "push"). This forced us to consider only those systems that have already been, or are in the process of becoming, flight-qualified. Limited thus to these "low-risk" technologies, the real challenge becomes: Can we provide sufficient and appropriate cues to the airborne pilot to represent his opponent adequately during close-in combat?

Much of the information that a pilot needs during CIC is obtained by tracking his opponent's position visually. Using this technique, the pilot can most effectively analyze his opponent's relative geometry, energy, and probable tactics that will determine his own course of action. Ideally, then, systems for stimulating pilot awareness should exactly duplicate the pilot's visual experience during close-in combat, implicating helmet-mounted displays (HMD's) or canopy projection techniques as leading candidates. Given only today's "off-the-shelf" technologies to choose from, however, this ideal system is clearly not available. The width of the human visual field spans over 200°, which is well beyond the capacity of most contemporary prototype HMD's, let alone those that are currently flight-rated. And canopy projection systems, given their limited application to a real mission environment, are even considerably less mature in their development than HMD's.

This situation prompted us to deal with the pilot awareness problem from a slightly different approach—one that attempts to maximize the utility of existing, flight-qualified technology capabilities. Our strategy led us thus to develop concepts that could be implemented within integrated, head-coupled systems comprised of moderate (30°) field-of-view, helmet-mounted displays, stroke- or stroke/raster-capable (monochrome) image generators, magnetic or ultrasonic head-trackers, and (possibly) a single source, three-dimensional audio localizer. The next section describes the a novel display concept that was developed for capitalizing on these systems.

PART III - A NEW VIRTUAL INTERFACE DISPLAY CONCEPT

Using the technology listed above, our goal was to design an integrated display concept for simulating an airborne opponent within the cockpit to conduct CIC exercises in flight. The purpose of this display concept is to emulate the pilot's visual tracking tasks that dominate such engagements. As part of this effort, we have developed an innovative display format to provide off-boresight cues indicating to the pilot where he should aim his head in order to retain a visual track on his opponent. The display format has been named the All-aspect Head Aiming (AHA) display (patent pending).³

The rationale underlying the AHA display concept is schematized in Figure 2. In this figure, the three-dimensional airspace of interest to the pilot has been depicted as a sphere centered on the pilot's ownship aircraft. This sphere may be viewed as representing the total CIC arena; an opponent aircraft may be located anywhere within this sphere. Also shown is a cylinder, which remains centered on the pilot's head, with its longitudinal axis aligned with his current head position (the helmet's boresight). Within the sphere, the cylinder's orientation will thus depend upon both the pilot's aircraft attitude and head position. The cylinder is also constructed to be slightly conical in shape, so that the forward cylinder face is narrower in diameter than the aft face. In current implementations of the AHA display format, the forward face of the cylinder subtends 20° of visual angle, while the aft face is 30° in diameter.

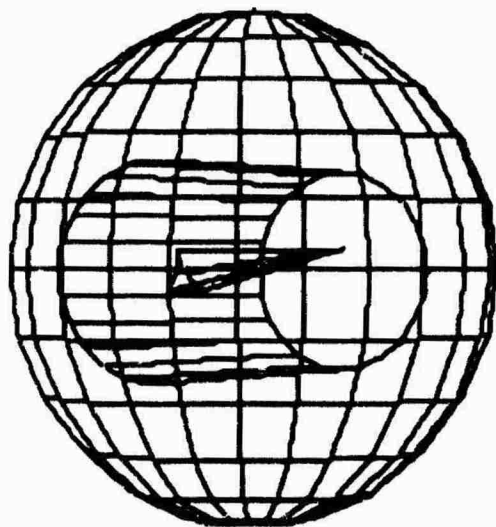

Figure 2. Schematic Representation of The All-Aspect Head Aiming (AHA) Display Concept Rationale

The AHA display segregates the three-dimensional world into two hemispheres: one forward and one aft of the pilot's current head position. Each hemisphere is then mathematically "flattened" into two dimensions, using graphical mapping techniques. The "mapped" position of

any aircraft within that hemisphere is then projected (along a polar vector) onto the perimeter of the applicable cylinder face (forward or aft), represented now as a ring within each hemispheric mapping. These symbols thus provide a cue to the pilot that references the location of other aircraft, whether forward or aft, relative to his helmet's current boresight.

Because the forward and aft cylinder faces have different diameters, the two rings representing each hemisphere can be superimposed concentrically into a single visual image. These two rings thus comprise the format of the AHA display, shown integrated with conventional flight symbology in Figure 3. To interpret the AHA display format, the pilot monitors the location of his opponent by tracking the symbology that appears along these rings. If the opponent is located within 90° (in any direction) of his helmet's boresight (i.e., forward), a symbol will appear along the inner (smaller diameter) ring of the display. If the opponent is located more than 90° from his helmet's boresight (i.e., aft), a symbol will appear along the outer ring. If the pilot then points his head in the direction indicated by the symbol, he will eventually acquire his opponent's position visually. Note also that, as illustrated in Figure 3, this display format is not solely restricted to one-versus-one engagements, and may be used within a many-versus-many scenario via different symbology for friendly and opponent aircraft. Figure 3, in fact, depicts a two-versus-two scenario with the two opponents each within 90° on either side of where the pilot's head is currently aimed, and with his wing man greater than 90° from his head position, below and to the right.

Within the AHA display, the off-boresight cues will appear only when the target aircraft positions are outside of the field-of-view of the pilot's HMD. During the air combat exercise, the positions and attitudes of all aircraft (real and simulated), as well as the pilot's head orientation will be monitored. Whenever the pilot's display "window" (i.e., the field-of-view of his HMD) intersects with the opponent's location, a higher fidelity image of the opponent aircraft is presented. If the opponent's position moves outside of the display window, the opponent aircraft image is then replaced with the AHA symbol to help the pilot re-acquire the image visually once more.

In this way, the information provided by the AHA display approximates the pilot's pattern of perception within live close-in combat. During a live engagement, while he is tracking his opponent's position visually, the pilot's central vision is also gathering detailed information about his opponent's attitude, relative geometry, etc. Whenever he breaks track, such as when his opponent moves behind him, he will use his peripheral vision to help guide his head back toward re-acquiring the track within central vision once again. Unlike central vision, however, peripheral vision cannot process detailed features. During the time when the target is moving through his peripheral

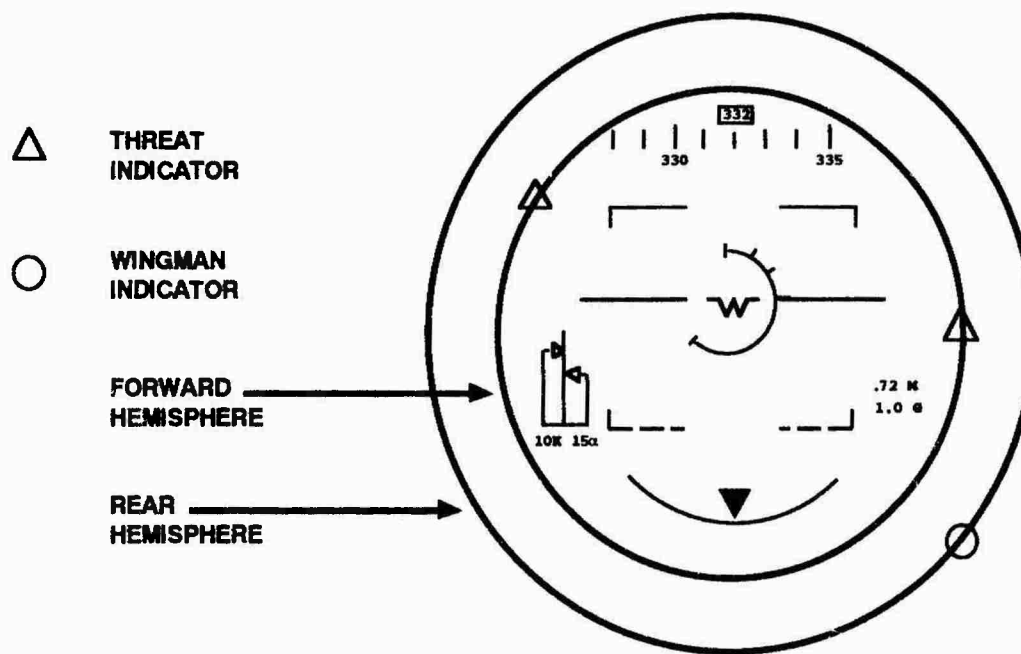

Figure 3. The AHA Display Format Integrated With Conventional Display Symbology

vision, the pilot will obtain little information concerning his opponent's actions.

On the other hand, the human peripheral visual system does seem to be useful for processing spatial orientation information, helping a pilot keep track of his whereabouts in relation to the environment.^{2,4} In recent studies, other display concepts have incorporated peripheral vision to enhance pilot spatial orientation for attitude awareness.³⁻⁷ The AHA display capitalizes on this capability for supporting the pilot's sense of spatial orientation in relation to an opponent. The off-boresight cues depicted within a 30° field-of-view HMD should thus provide much of the same information that a pilot would naturally acquire from his much larger peripheral visual field during live CIC exercises.

In addition to complementing the capabilities of peripheral vision, three other desired features are also incorporated within the design of the display. First, the off-boresight cues (or the target image) remain in view at all times, even as the opponent aircraft passes behind or beneath the view of the pilot. Second, obstruction of the central field-of-view is minimized, especially when multiple aircraft are engaged. Third, as shown in Figure 3, the AHA display format can be easily integrated with other conventional display formats (pitch ladders, weapons status, airspeed and altitude indicators, etc.) that traditionally occupy the pilot's central field-of-view. These three features are important in that they support the pilot's sense of tactical orientation continuously without interfering with other tasks (such as weapons and energy management) that may require the central portion of his vision.

Evaluation and Future Plans

The AHA display concept was simulated dynamically on a Silicon Graphics Personal Iris workstation using Rockwell's proprietary version of the AASPEM (Advanced Aircraft Systems Performance Evaluation Model) combat evaluation tool (see also paper 29 in these proceedings). Pilots' head movements were simulated by manipulating the look angle within the simulation interactively from the keyboard. Using pilots and human factors experts as subjects, this baseline evaluation revealed that the AHA display shows good promise for supporting pilot awareness in-flight against a simulated CIC opponent. Subjects were able to track their opponent quite easily by following the cues provided by the AHA display. At the conclusion of the evaluation, several modifications of the original display concept were recommended. These included incorporating symbol size as a coarse index of target range and enhancing the representation of azimuth among the off-boresight cues.

Effort in the near future will focus on more detailed evaluation and refinement of the AHA display. We will begin by incorporating some of the proposed suggestions for improving our original concept. In particular, we intend to augment the representation of azimuth by integrating the AHA display concept with a three-dimensional (3-D) audio display system.⁸ Like the AHA display concept, a 3-D audio display also provides spatial cues relative to the pilot's current head position. The 3-D audio display presents these cues by convolving a single auditory input into a stereo output that "appears" to emanate from the target position. As the pilot moves his head, the sound source alters the displayed auditory

HEAD-STEERED SENSOR FLIGHT TEST RESULTS AND IMPLICATIONS

L. N. Lydick
General Dynamics
Fort Worth Division
P. O. Box 748
Fort Worth, Texas 76101
USA

1.0 SUMMARY AND INTRODUCTION

A comprehensive flight test program of a head-steered FLIR/HMD night attack system was conducted by General Dynamics between August 1987 and January 1990. Seventy-five development and demonstration F-16B flights were flown. Approximately 90% of the flights were conducted in night visual meteorological conditions. The remainder were conducted in daytime with the pilot's vision obscured by an opaque visor cover to simulate night and to study laser eye protection.

Because the new FLIR/HMD systems were fully integrated with the F-16B fire control, navigation, communication, and display system, it was possible to achieve a considerable degree of tactical relevance in the tests, Figure 1. The night attack portion of the testing was a subset of a broader series of tests to explore advanced techniques for close air support (CAS). The work was industry sponsored by a number of corporations in a cooperative effort of about thirty million dollars. The tests and demonstrations culminated in operational test by (then) Tactical Air Command pilots at Nellis Air Force Base, Nevada, and Fort Hood, Texas. The night CAS systems evaluations were quite favorable, and were planned for production until the remarkable end of the cold war reoriented (or perhaps gave pause to) planned introduction of the concepts to the fleet.

In this paper, the author provides a summary overview of the mission, a description of the systems, the lessons learned, and some thoughts about future system requirements.

2.0 THE CLOSE AIR SUPPORT MISSION

Before presenting a detailed system description for the Falcon Eye FLIR, helmet displays, and other equipment, it is advantageous to discuss the operational theater, Figure 2. Shown are (1) the necessary communications with a Forward Air Controller (FAC) beginning at eight to twenty miles range, (2) the pilot's visual survey of the battle and target area, and (3) a weapons delivery phase. Two insets in the figure show the variations caused by weapons selection. For ballistic weapons, a lateral offset and shallow pop-up was often chosen for the CCIP delivery, while an essentially straight run-in typifies the stand-off delivery of boosted weapons such as AGM-65 Maverick.



Figure 1. F-16B Night Attack CAS Demonstrator

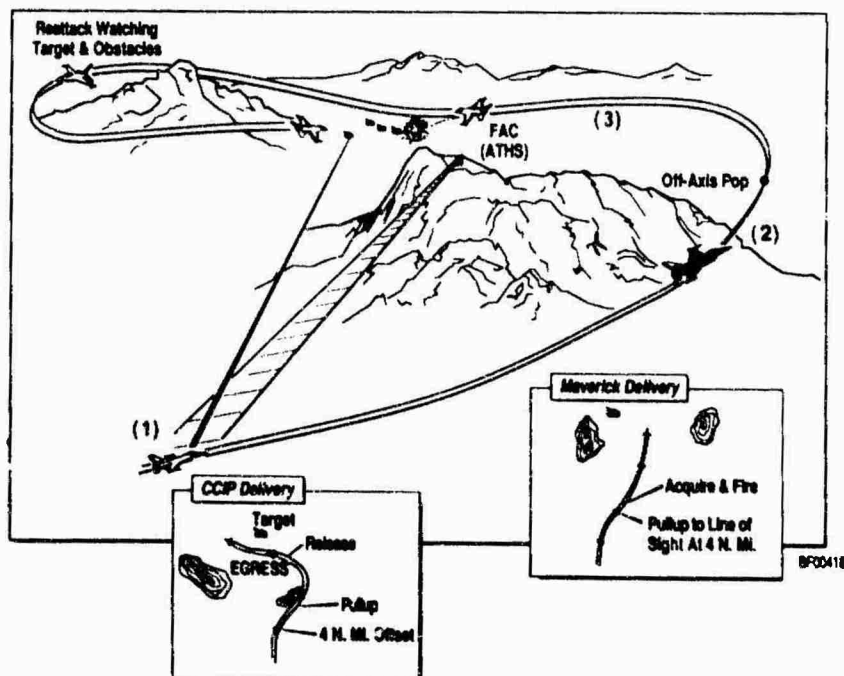

Figure 2. CAS Mission from Low Altitude Ingress

In understanding the system requirements for the close air support mission, it is fundamentally important to recall that the target is initially detected, recognized, and identified by the person on the ground, the FAC. This critical fact tells us a defining characteristic of the airplane sensor suite: it does not have to recognize (tank vs. hot rock, etc.) the target.

3.0 SYSTEM DESCRIPTION

As a part of a rather broad flight test program conducted by General Dynamics in the Fort Worth, Texas area, an F-16B was fitted in 1987 with equipment specialized for the night CAS role, Figure 3. With the head-steered FLIR it was possible for the F-16 pilot to fly night CAS profiles virtually identical to those flown in the daytime. The other equipment listed in Figure 3 provided a dramatic enhancement to both the day and night CAS capabilities.

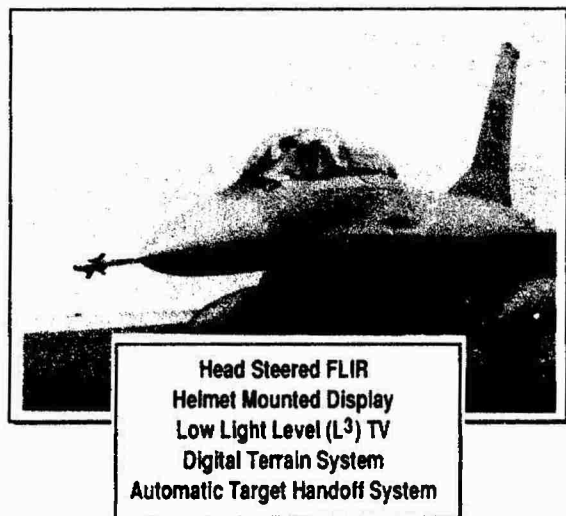

Figure 3. Systems for Night Close Air Support

ATHS and DTS

A major step was taken in that the target data were radioed by the FAC directly to the F-16's fire control computer (and, therefore, helmet mounted display) via a Collins Avionics Automatic Target Handoff System (ATHS) - - - essentially a VHF/UHF modum. Because the aircraft maintained a continuous INS update via a B.A.e. digital terrain system (DTS) called TERPROM, the FAC could direct the pilot's eye to the target location (HMD coordinates) with accuracy consistently in the fifty meter range. Further, the DTS provided a manual terrain following feature with a pitch steering cue and ground collision warnings in the HMD. These exquisite implementations were the heart of the CAS night attack demonstrations.

FLIR

The Falcon Eye head-steered FLIR, Figure 4, was built by Texas Instruments, and essentially with their corporate funding. It was designed specifically for the F-16 and for the CAS requirements. It offers two fields-of-view (FOV) 30 degrees and 5.3 degrees which allow 1:1 wide field-of-view (WFOV) registration in the HMD and 5.65X narrow field of view (NFOV) magnification for close up detection and examination of targets. Both features were exceptionally popular with the pilots. There was no requirement for long range target recognition capability. The FLIR was mechanized in head coordinates (azimuth and elevation) with a derotation feature to automatically adjust when the pilot tilted his head (helmet) in roll. Thus the pilots' virtual image in the HMD was stabilized to exactly overlay the real world. Night spacial

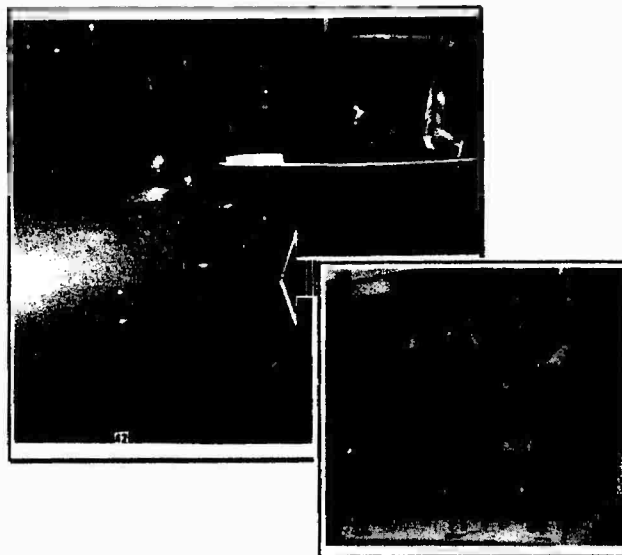

Figure 4. Falcon Eye FLIR Installation

disorientation was nil once the pilot accepted the "virtual world" as the real world, and the confidence factor was exceptional. The FLIR narrow field-of-view provided resolution similar to (about one half) the pilots daytime foveal vision. Thus, by switching back and forth between the wide and narrow fields the pilot could expect to see most of the objects at night that he could normally see in the daytime.

The FLIR was DC restored, had advanced gimbal control loops built by GEC Avionics (formerly Singer Kearfoot), and operates in the 8-12 μ M band where earth pastoral, scene irradiance is relatively large. The FLIR was designed to reside in the forward equipment bay of the F-16 with the turret extending above the mold lines sufficient for an unobstructed view similar to that of the pilot, Figure 5.

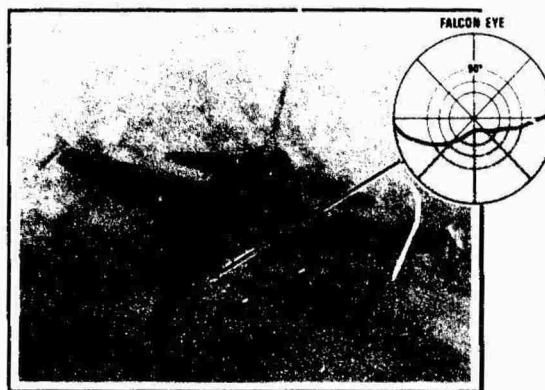

Figure 5. Falcon Eye Field of Regard Similar to Pilots

HMD's

Two night capable helmet displays were developed and tested, Figure 6. Both had full stroke/raster capability and were matched in field-of-view to the FLIR WFOV. One system built by GEC Avionics was biocular (one CRT servicing two eyes) and helmet-mounted. The other, built by Honeywell, was monocular and mounted on the oxygen mask.

The helmet systems were wind blast tested to assure helmet visor retention and nil effects on the ACES II pitot system. Both were compatible with an HMD electronics unit supplied by GEC. In order to study operability in a laser threat environment, an opaque cloth visor cover was provided. It was extensive in nature, blocking all of the pilot's visual cues except for the HMD display.

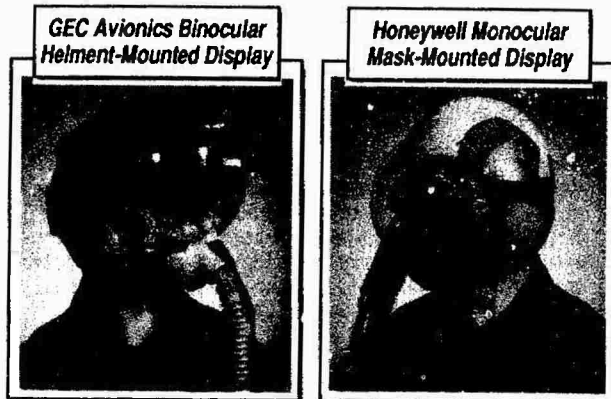

Figure 6. Biocular and Monocular HMDs were Tested

BF00416

L³TV

To try to capture a synergistic effect between the visual and IR bands, the F-16 B demonstrator aircraft was fitted with a low light level TV (L³TV), Figure 7. This image intensified camera was mounted in front of the HUD combiner in the location of the HUD camera. Its image was displayed in the HUD and was 1:1 registered with the external scene. Cameras from five different vendors were tested. The idea of this effort was that the L³TV would provide an image better than that of the FLIR on nights of high absolute humidity. Since the HMD carried the head-steered FLIR imagery, it was necessary to switch off the HMD image as the pilot's line-of-sight approached straight forward. This was inherently possible because the Honeywell magnetic helmet position sensor was benched to the HMD infinity-focused, line-of-sight (LOS). A very considerable effort was expended in understanding the correct switching techniques, the relationship of the HUD symbology to the HMD symbology, the L³TV, performance, and the dynamics of the head tracker stabilization.

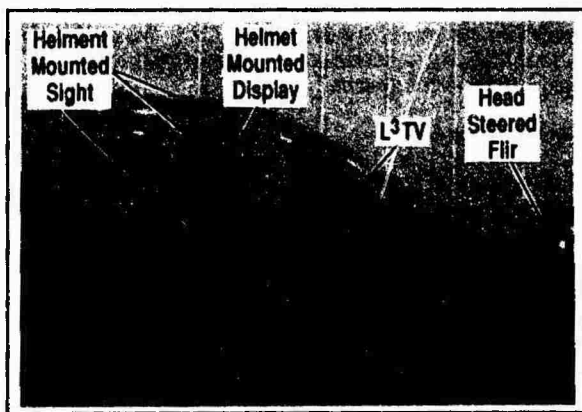

Figure 7. Low Light Level Television Supplemented the IR System

Electronic Architecture

The entire system suite was fully integrated electronically as is shown in Figure 8. A special ARINC bus was used to pass the Honeywell magnetic head tracker line-of-sight to the GEC HMD electronics unit and the FLIR. This was necessary in order to prevent significant bus lag that would have occurred had the LOS been routed through the 1553 protocol bus. As implemented, the average signal delay was about twenty milliseconds. Although this amount of delay was visible in the stabilized HMD symbology, it was acceptable to the pilots. After considerable informal appraisal, the author believes twenty milliseconds to be about the most delay that would be acceptable.

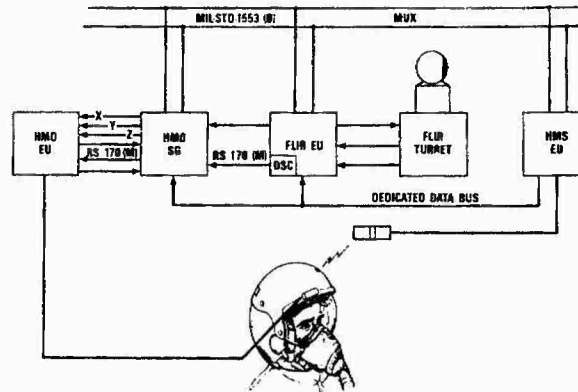

Figure 8. Electronic System Architecture

4.0 LESSONS LEARNED

The systems worked very well, given their developmental status. The test and guest pilots adapted to the concept quickly. Usually one flight was adequate for the guest pilot to understand and accept the "virtual world" created by the FLIR/HMD. Successful CAS profiles could be flown on the second or third attempts, and after three or four flights the pilots could demonstrate considerable consistency in (1) low level flight using the FLIR/HMD and terrain data base TF symbology, (2) target acquisition via ATHIS/HMD, and (3) maneuvering CCIP weapon delivery.

Pilot Acceptance

An important objective of the head-steered FLIR testing was to determine for the high speed aircraft, its acceptability from the physiological and psychological points of view. Certainly its acceptability for rotary wing aircraft had been encouraging. Would the pilot stay spatially oriented or not? Would he be encouraged towards vertigo? Eye fatigue? Anxiety? Would the helmet fit be adequate to hold the display exit pupil over the eye at elevated g., etc.

Perhaps a summary listing will provide an efficient way to communicate the results from the flights. As the reader studies the list, it is important to distinguish the (few) daytime simulation flights with the obscuring visor cover from the actual night missions.

- Vertigo:** Several mild occurrences among the experienced, but non-current pilots. No complaints from F-16 current pilots.
- Fatigue:** Full missions, including take-off and landing with the opaque visor cover were very tiresome. Vertigo and mild nausea were reported by one experienced pilot under the bag.
- Anxiety:** There were several manifestations. Most guest pilots taking their first flights in a fighter experienced some nausea. Several experienced pilots could not bring their "comfort level" below 600 feet (180 meters) on the first ride.
- Helmet:** The GEC biocular helmet weighs 2.0 kg (4.4 pounds). It required considerable effort to achieve proper fit, but received no complaints for total weight, and maintained exit pupil to 4g's once properly fitted.

By far, the most interesting and unexpected events involved two of the most experienced and trained pilots. These individuals were current in the F-16, were military line pilots and were exceptionally proficient. Neither had experience with virtual world (infinity focused) FLIR imagery.

For one of the pilots, the step into the virtual world was clearly difficult. He expressed anxiety after the first two rides, then displayed remarkable adaptation and confidence on the third.

The other pilot, equally experienced, adapted to the imagery during taxi to the runway on the first flight. Then, after peeking under the HMD combiners at 400k and 300 feet AGL and seeing absolutely nothing (desert location), reported, I will never "peek" again, and flew more conservatively. Both individuals clearly experienced cognition of the safety implications of not remaining aware of the real world.

Certainly, there is no significant evidence that individuals have become, or may become detached from their finitude while flying in the virtual world. On inquiry, the two General Dynamics project pilots reported no difficulty staying in touch with the danger present in low level flight. Less comforting was the fact that they tied this to their continual awareness of visual objects outside their HMD combiner glass such as, cockpit, canopy, internal and external lights, moonlit terrain and stars. The concern would be when none such is present. The author strongly encourages the systems designers to liberally incorporate break X, aural warnings, Ground Collision Avoidance Systems (GCAS), manual TF, and other features with the "virtual world" system designs. Further, the author would encourage some research to look for euphoric, hypnotic, or detachment effects of "virtual world" flying.

Typically, (1) the experienced pilots were not fully comfortable on the first flight, (2) were very comfortable on subsequent flights, and (3) could perform, with some confidence, most of the maneuvers at night with which they were proficient in the daytime, including take-off and landing (dark runway). All of the experienced pilots expressed belief that the head-steered FLIR system provides an orienting, rather than a disorienting effect. After about ten flights each, the two project pilots were exploring the boundaries of the system capabilities. Examples are: (1) delayed pop-ups resulting in target line-of-sight angles of forty-five degrees, four g pull-ups and three to four seconds maximum on final, (2) pop-ups to 5000 feet (1500M) AGL with inverted pull-downs (360 degree rolls) for bomb delivery, and (3) routine ridge crossing at 200-300 feet (60-100M) AGL.

MONOCULAR and BIOCULAR HMD's

At the time that the Falcon Eye program was conceived there was much controversy as to the acceptability of a monocular HMD. Since a monocular system was potentially lighter and less expensive, it was decided to build and test a monocular system. There were a few problems associated with the mounting of the system on the oxygen mask, the main one of which was preventing the mask from slipping downward while pulling g's. This problem was greatly reduced by anchoring the mask to the helmet brim via a thin nylon thread, Figure 6. The thread terminated on its upper end with a small velcro patch which allowed easy mask removal.

Unfortunately, many problems surfaced for the monocular display early in the testing. These difficulties included rivalry and adaptation differences between the eyes. Therefore, the concept was abandoned after about ten flights.

The GEC Biocular HMD was fully satisfactory for the test program. It was relatively lightweight and offered video performance only slightly inferior to the GEC HUD. Its modulation transfer function was steadily improved during the test program, and benefitted from the simplicity of the optical design.

Actual gravity bomb drops were performed using the HMD. Little or no degradation in accuracy was experienced.

FLIR Performance and FOV

The head-steered FLIR was designed specifically for the F-16 and the unique requirements of visual coupling with the HMD. It consistently produced tank target detections at four nautical miles on low humidity nights. A larger aperture had been suggested by Texas Instruments at program inception, but was declined in favor of a smaller overall turret diameter (current aperture is 2.6 inches (6.6 cm average). The FLIR offered such a large field-of-regard that the pilots never commented

that they could not see in the desired direction. Advanced FLIR algorithms were developed and refined which prevented the heat of the F-16 nose image from disrupting the automatic gain control. This pioneering work by Texas Instruments was exceptional.

The narrow field-of-view was fundamentally important. It gave the pilots the opportunity to see targets and scenes with a clarity well beyond that of a navigation FLIR. The narrow field was selected with a hands-on switch of the momentary type. All weapon delivery symbology was properly scaled for the narrow field; however, the pilots preferred to use the 1:1 registered wide field-of-view for CCIP weapon release.

Advanced techniques were explored for target designation using the HMD alone, without cursor controls. These efforts were quite successful and accurate designations in narrow field-of-view of a few milliradians were typical.

5.0 WHERE TO FROM HERE

It is important to realize that USAF decided in 1991 not to produce a CAS night attack system for the F-16-- and that after much deliberation. The reason stated was that this is a role for the Army. Presumably the concerns have been with fratricide and communication. One would assume that as advanced target hand-off systems, GPS, and terrain data based navigation become commonplace, the Air Force will, once again, turn its attention to night CAS and the head-steered FLIR. So what is next? Or, of more relevance, what shall we do while we wait for this technology to come off the shelf?

Customer Needs

Foremost, it is important to realize that air forces of various nations will be needing advanced night attack systems. Certainly, the emphasis on signature reduction will favor small and integrated systems.

At this time, USAF only admits to a need to operate at night in enemy territory beyond the CAS perimeter. OK, then we in the U.S. can discuss and work on systems for interdiction and strategic attack. Certainly, all of the features of the low cost Falcon Eye systems are needed, and are as desirable for Battlefield Air Interdiction (BAI) as for CAS. We need to look beyond CAS, but capitalize on the system it validated - the head-steered vision system.

Behind Enemy Lines

If one accepts the notion that the night theater for the attack airplane is a bit further into enemy territory, perhaps it starts only a few kilometers beyond the Forward Air Controllers' perimeter, we enter a vastly more difficult and expensive design arena. An arena where the pilot may still be cued to mobile targets by off-board systems, but will need on-board systems to recognize the target (tanks versus trucks, or SKUDS versus transports).

IN BAI, THE FAC'S CRITICAL SERVICE OF RECOGNIZING THE TARGET IS MISSING.

Returning to Figure 2, notice in the inset drawings that four nautical miles range is shown as a significant point for both the conventional weapon CCIP attack, and the stand-off weapon attack. Here the pilot makes his commitment to fate. With gravity weapons, it is at about four miles that the pilot must decide if the target is real, and then fly into the more lethal defense zones. With stand-off weapons, it is at four miles that the pilot must get the weapon in the air. Why? Because if he delays any longer it isn't a stand-off weapon. And finally, with laser guided ballistic bombs the possibility for weapon loft (if low) or release (if high) begins at about four miles.

Clearly, the most significant advancement relative to the low cost Falcon Eye system would be to develop a supplemental capability to RECOGNIZE (tank vs truck vs SKUD vs hot rock vs tree vs cow vs house vs, etc.) tactically relevant targets at four nautical miles. With such a supplemental capability,

the Falcon Eye concept could extend its remarkable success from the CAS perimeter deep into the enemies backyard.

Target Recognition Problems

As the reader probably already knows, four nautical mile recognition range is a big technical challenge. Further, the author wishes to assert that the capability is not worth developing unless it meets some severe tests:

- (1) Very high recognition probabilities are required. Perhaps 95%, i.e., a certainty. Please consider eight line pairs for positive recognition rather than four.
- (2) Poor atmospheric conditions are the design point. Perhaps 18 gm/M^3 would be the least moisture to even consider for system design.
- (3) For a small, multirole fighter, the system should not exceed about ten inches (25cm) diameter, or it should be retractable, or integrated into the airframe.

Each of these requirements needs to be defended.

First, from the FLIR systems designers point of view there seems to be some advantage to defining recognition as occurring when four raster line pairs receive a certain level of video modulation. From the integrating contractors view point, the recognition range definition must contain a supplemental and pragmatic element -- It is the distance from the target when the pilot says he can tell what the target is. This distinction becomes very troublesome during system definition and contract award activities. The four line pair criterion is optimistic; and the use of a probability criterion, (e.g., the probability of recognition is 60%), allows the most innocent of recognition range questions from the user group to always be answered in the affirmative. Pilot: "Will system X recognize a tank at four nautical miles"? Respondent, "Yes, the probability will be 60%". Pilot, "Oh" - - - - .

The author strongly encourages a more realistic viewpoint about target recognition. When a pilot cross checks the various instruments on his cockpit displays he looks at them very briefly and moves his eyes to the next display. With each glance, he expects to receive a certain bit of needed data. He

glances at the attitude ladder in the HUD and notices a slight bank; he glances at the fuel gauge and has less fuel than anticipated, etc. The concept of "probability that the attitude indicator or fuel gauge will be there" would seem ridiculous yet, we have been willing to treat the problem of displaying a recognizable picture of the target in just such a fashion. What the integrating contractor needs to know is the range at which the target image can be recognized, not the probability of recognition at a certain range.

Requirement (1) above is stated to assert that at four nautical miles the target must be recognizable - period. Requirement (2) is really a part of requirement (1). It says: at four nautical miles the target must be recognizable - even though the war isn't being fought on a desert test range. If the reader would redirect his or her attention to Figure 1, please note that the rear cockpit is "fogged in". We must design FLIR's for the atmospheric condition that exists on typical nights in typical climates. Requirement (3) attempts to provide a realistic specification for the physicals of a system that will have to meet severe signature, cost, and volumetric constraints.

A Recognition FLIR

Now the question is, is it even possible to build a small system that can recognize a tank from a range of four miles when the atmospheric conditions are as poor as stated above? Certainly, some basic physics should be examined at the outset. If an optical system is chosen, then well known defining equations exist. The front aperture is sized by its diffraction of the received energy. The governing relationship is Rayleigh's equation.

$$\theta = 1.22 \frac{\lambda}{D}$$

Where θ is the angular subtense of a resolvable element, λ is the wavelength of the radiation, and D is the diameter of the optical element receiving the radiation. Figure 9 shows the geometry of the recognition problem. Notice in the figure that eight horizontal resolution lines are shown within the height of the vehicle. Much research has shown that a pilot MAY be able to recognize (tank vs truck) based on this criterion. As a point of departure, the author is looking for criteria that makes it a CERTAINTY that the pilot will be able to recognize the target.

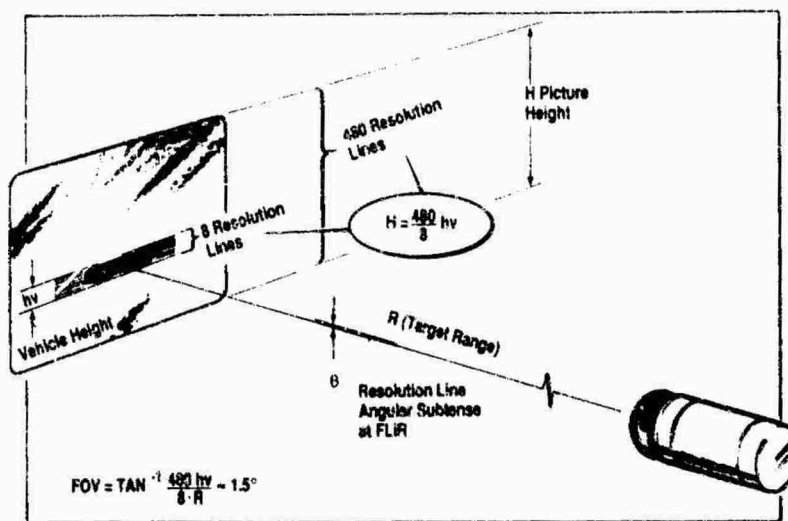

Figure 9. Target Recognition at Long Range Requires Very Narrow Field-of-View

Figure 10 shows a representation of a SKUD missile/transporter. The representations are a mosaic of eight, and of sixteen pixels per transporter height. That is, four and eight line pairs respectively. Only four shades of grey are shown, representing a FLIR imager operating at the threshold of its sensitivity. Are eight lines adequate for a pilot to do vehicle recognition with a one or two second glance, and with certainty? SKUD? Fuel transporter?

THE AUTHOR ASSERTS THAT WE NEED A RECOGNITION SYSTEM CAPABLE OF DISCRIMINATING AMONG CATEGORIES OF VEHICLES, AMONG A CLUTTER OF OBJECTS, AND AT FOUR NAUTICAL MILES RANGE.

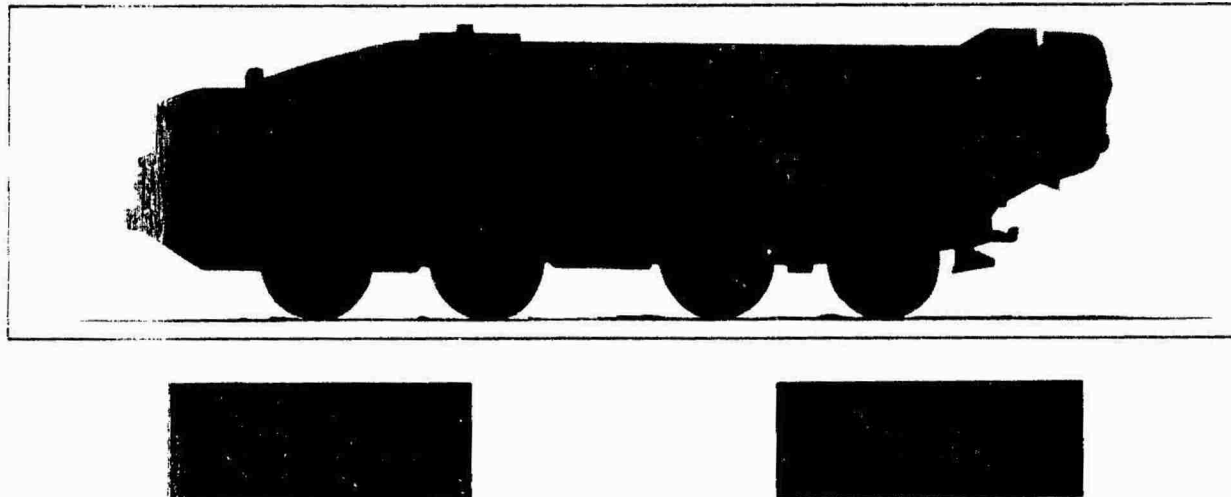

Figure 10. SKUD Missile/Transporter Recognition Problem

Figure 11 shows Rayleigh's relationship for relevant wavelengths, aperture size, and video lines of resolution. Every experience and conversation of the author on this subject over the last ten years suggest that only the largest of the 8-12 μM FLIRs, PAVE TAC with 10 inch (25cm aperture), even approaches the four nautical mile, 95% probable, recognition range criterion set forth by mission needs. It is time to move to a short or medium wave length, and a sixteen line recognition criterion.

Assuming that system cost will be a major driver in our thinking about next steps, please refer to Figure 12. Shown is the clear slope in the imager cost as we increase wavelength. Also shown is the non-linear nature of optics cost versus

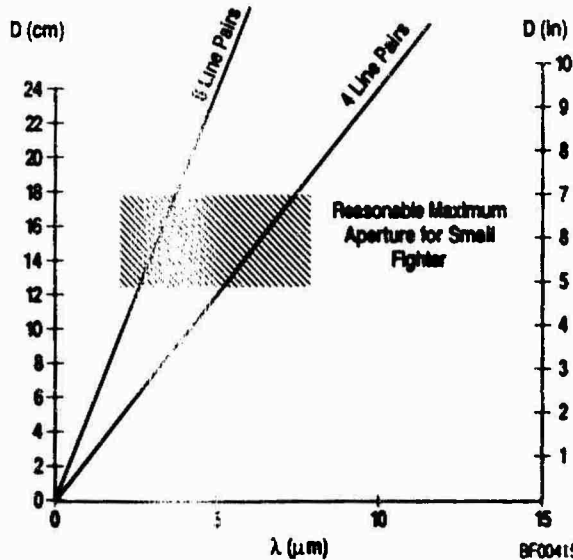

Figure 11. Recognition with a Small Aperture Favors Shorter Wavelengths

system aperture. The strong implication is that a short to medium wavelength recognition system offers the possibility for lower cost, smaller aperture, and a high recognition probability. Surely there must be some difficulties with this argument. There are.

Years of research have shown the 8-12 μM band to be better for target FLIRs. The major factor has been that earth pastoral scene irradiance is an order of magnitude greater in the 8-12 μM band, than in the 3-5 μM band. But the author is not suggesting that the next step beyond Falcon Eye is development of a next generation target FLIR. The author is suggesting a break from the tradition of designing the recognition feature into the target FLIR.

THE IDEA IS THE DEVELOPMENT OF AN OPTIMIZED "RECOGNITION FLIR".

Advantages for a separate recognition FLIR would include:

- Freedom from consideration of pastoral scene irradiance as a driving factor
- Better atmospheric transmission at 18 gm/M^3 if a shorter wave length is selected
- Relatively small aperture for better integration with the aircraft
- Lower focal plane array cost, including the probability of a staring array rather than a scanned array.

Further, if the recognition feature is stripped out of the target FLIR, then it too would benefit dramatically.

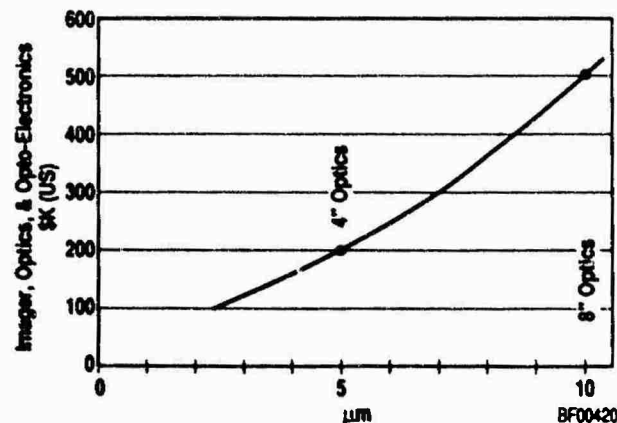

Figure 12. Optics and Imager Cost for $2 \cdot 10^5$ Pixels

THE QUEST FOR AN INTEGRATED FLYING HELMET

by

A. Karavis and D.N. Jarrett
 Defence Research Agency
 Flight Systems Department
 RAE Farnborough
 Hants GU14 6TD
 United Kingdom

1. SUMMARY

The addition of vision enhancement, display and control functions to aviator's headgear is operationally attractive. Fast jets and helicopters currently under development call for headgear with a combination of these novel facilities.

This paper reviews the recent history of such helmet systems, which demonstrate admirably the inventiveness of the design teams. However, there are attendant perceptual and operational concerns and the addition of extra components invariably compromises basic ergonomic qualities.

A new design philosophy, which emphasises functional integration rather than the incorporation of compatible sub-systems, is emerging. This will be assisted significantly when key optical and electro-optical technologies become mature.

2. INTRODUCTION

The modern aviator's headgear has developed over the years in parallel with the continuing expansion of military aircraft's flight envelope and the increasing demands of the physical environment in which he is required to operate. Initially the hazards were totally environmental; he needed to keep his ears warm and the wind out of his eyes. As operating heights increased he required oxygen to survive and so the breathing mask was added. Similarly, the advent of radio added earphones and a microphone. Jet aircraft with increased operating speeds and heights dictated the requirement for an ejection seat and hence the need for better head and face protection for the pilot, resulting in the present configuration of a hard helmet shell complete with a suspension system to give good comfort and impact protection, with integral earphones and sound attenuating earcups. A dual visor mechanism may be employed for bird strike and blast protection and to attenuate bright sunlight.

Fig.1 illustrates a typical modern helmet, the RAF Mk 10, which incorporates all the above functions. In addition, this helmet has been made to fit over the AR5 NBC headgear and allows the use of corrective spectacles. The parameters considered in the design include protection, comfort, pilot's field of regard, mass, c of g, compatibility with the rest of the aircrew equipment assembly, the cockpit and cockpit systems, and safety. The helmet is relatively cheap compared with other equipment surrounding the pilot.

However, it is fair to say that a new era in helmet design has dawned and designers are faced with unprecedented complexities and trade-offs. The helmet is seen as being a suitable platform for mounting a variety of devices which improve vision and increase mission effectiveness by easing the interaction between the pilot and his aircraft. However, after almost two decades of development, the additions still tend to be fairly bulky and cumbersome appendages.

This paper reviews the reasoning behind the requirement for an integrated approach to helmet design by enumerating some of the significant developments in helmet mounted equipment over the years. It discusses their uses and evolution, identifying the technological areas which are likely to provide the desired capabilities at much reduced weight, size and power requirements.

With this as a background, it is argued that, not only is integration vital for successful and acceptable schemes, but the development of key technologies is essential to resolve the present conflict of concerns between the avionic fraternity's aspirations for enhanced mission effectiveness and the aeromedical interests in the pilot's well-being.

3. BACKGROUND AND TERMINOLOGY

In order to make this presentation more understandable it is worthwhile explaining our terminology.

A helmet-mounted sight HMS is a simple optical device which makes an aiming mark visible to the helmet wearer, enabling him to point his helmet and designate the direction of an object. Used with a helmet position sensor HPS, this direction can be measured relative to the airframe.

A helmet-mounted display HMD is a more complex optical device which may present dynamic symbols and/or pictures. A monocular HMD supplies an image to one eye, whereas a binocular HMD supplies the same image to both eyes. Only a binocular HMD can supply different images to each eye.

A visually-coupled system VCS uses the signals from a HPS to drive a steerable imaging sensor, such as a gimballed camera, the output from which is presented on the HMD. The field of view FoV of the display is the solid angle of the image presented to both eyes. The field of regard FoR is the angular envelope over which the display or sensor can be slaved.

Most of the helmet-mounted optical systems collect light from an emissive source and direct it into the helmet-wearer's eye so that he sees a distant virtual image superimposed on the external scene. Usually, a collimating combiner is placed in front of the eye to form the distant image (collimation) and superimpose it upon the natural forward view (combination), but an additional optical relay lens is interposed to transform the source image and relay it to the focal plane of the collimating combiner. Each eyepiece is therefore composed of a relay and a collimating combiner.

Most arrangements use the principle of a partially reflecting spherical mirror as the collimating element. This forms a good image from a point source placed at the focus of the sphere, so long as the light is collected by a small eye pupil on the optical axis. Aberrations increase dramatically the larger the image subtense, eye pupil or off-axis angle, making it necessary to incorporate compensating corrections in the relay design. There are two basic optical configurations, on-axis and off-axis, illustrated in Fig.2.

For a given optical design there is

always a trade-off between the weight and complexity of the corrective relay and the degree of correction attained. On-axis designs can be corrected relatively easily, especially for monochromatic light but, since they require separate collimating and combining elements, two semi-reflecting surfaces are normally placed between the eye and the external world. Off-axis configurations seem to meet the packaging constraints imposed by the helmet, but aberration correction invariably entails using lens elements which are inclined to and de-centred from the optic axis, and which are therefore more difficult to construct.

The pupil of the viewer's eye is not clamped to the optical axis of the collimating combiner, since it moves as he looks over the displayed FoV, or whenever the helmet shifts on his head. The eyepiece exit pupil, the range of positions in which the eye's pupil can be placed without affecting the quality of the perceived image, must be considerably larger than the largest eye pupil, especially if it has no positional adjustments which accommodate users with different interpupillary separations. The eye relief is the separation between the surface of the cornea and the nearest optical component.

4. NOVEL USES OF AVIATOR'S HEADGEAR

Table 1 summarises helmet mounted vision enhancement, control and display devices in a near chronological order. For each application, the combination of sub-systems is boxed to show the emergence of a particular capability. Examples of internationally manufactured systems are given together with an indication of their current status. It should be noted that the Table is merely illustrative and not intended to be a complete compendium of products. Annex A summarises the characteristics of these devices.

4.1 Vision Enhancement

One of the first devices to reach regular service use were Night Vision Goggles (NVGs) which provide the wearer with an intensified view of a dark scene by means of Image Intensifier (I²) Tubes (see Table 1 column D). The scene is focused onto an intensifier tube by an objective lens. The I² tube has a photo-cathode which is sensitive to light in the visible spectrum, and has a gain of several orders of magnitude. It produces an intensified image on a monochromatic (green)

phosphor screen which the pilot sees at unity magnification through an optical eye-piece.

Usually configured binocularly, the added mass is approximately 800 gm. Fig.3 illustrates a typical NVG configuration where the viewer sees the intensified scene as if through a pair of field glasses. In an alternative arrangement the image from the phosphor is projected onto a semi-reflecting element in front of the viewer which combines the intensified image with the direct view, as illustrated in Fig.4, showing the GEC Avionics Cats Eyes.

There are advantages and disadvantages to both configurations. For example, the non-combiner type protrudes more, which is critical in a small cockpit, and the pilot can see nothing but the I² image in his forward view, and cockpit instruments and controls must be viewed by peering beneath the obstructing goggles. However, the Cats Eyes arrangement, in allowing the pilot to see through the I² image, can result in perceptual difficulties when the pilot is looking at a Head up Display (HUD) and attempting to fuse the disparate virtual images. A facility for turning the goggles off when they are pointing towards the HUD can be incorporated.

Use of NVGs in fast-jets also introduces other problems. The additional mass, and its distribution, is a routine burden exacerbated by the higher g loads on the pilot's head. Ejection requires a safe system for separating the goggles from the helmet automatically, and the pilot must be provided with face protection against blast and bird strikes. One solution adopted in the UK for the Nite-Op goggle has been to extend the oxygen mask upwards to include a close-fitting face protective clear visor.

In recognition of the difficulties of operating with NVGs in fast-jets, various endeavours at integrating NVGs with the helmet have been undertaken. Fig.5 shows the Kaiser Strike-eye helmet in which the I² tubes are mounted directly on each side of the helmet at brow level, and Fig.6 shows the Night Vision Corporation Eagle Eye which is configured to fit into the helmet front with little forward protrusion.

In all applications it is necessary for all sources of light in the cockpit to be made compatible with the red and near infra-red sensitive NVGs. Cockpit lights are filtered to the blue-green

end of the spectrum to prevent overloading the I² tubes.

4.2 Information Display and Control

During operational flying the pilot of a military aircraft has not only to prosecute the mission but maintain situational awareness and perform the aircraft house-keeping tasks such as fuel management and system monitoring. When he is in a hostile environment it behoves the pilot to spend the majority of his time "head up". It is therefore beneficial for vital information to be available to him without the need to go "head down" and run the risk of losing his target, missing a firing opportunity or colliding with the ground. The HUD presents basic flying and weapon aiming information over a limited forward field, reducing time spent head down. However, the modern pilot has to contend with a much more complex scenario with sophisticated surface to air missile systems, complex electronic warfare and their countermeasures. We therefore need to supply an extension to these head-out facilities for easy, accurate and reliable means of interacting with the aircraft and the outside world.

4.2.1 Helmet Mounted Sights

The simplest form of helmet mounted display is the helmet mounted sight (HMS), which usually consists of a light source such as LEDs which illuminate various elements of a fixed reticle. Alternatively, the LEDs can be configured as a matrix, various elements of which may be activated to form symbols or alpha- numerics. The quality of the image in this case is limited by the spatial resolution of the matrix which tends to result in fairly simple formats. For instance, in the HMMD (column A of Table 1), the pilot views the projected image monocularly via a reflective patch on the visor. This acts as an off-axis collimating combiner, using a deposited dichroic film optimised to reflect the red imagery and minimise the colouration of the direct view through the visor.

When used in conjunction with a HPS it is possible for the pilot to steer a weapon seeker or direct his radar towards a target. In this manner the firing opportunities can be increased. An early example is the Honeywell Visual Target Acquisition System (VTAS) which was used in conjunction with Sparrow and Sidewinder missiles and the Air Interception radar in some variants of the F4 Phantom in the early 70s.

The VTAS helmet is shown at Fig.7.

A more modern variant of the HMS is the Alpha Helmet Mounted Sight (AHMS), illustrated in Fig.8. Developed under contract for RAE, this equipment is being used to support experimental flight trials. Based on the Mk 10 Alpha Helmet, it is noteworthy that the HMS has only added 100 gms to the weight of the helmet. The collimated image of the LED reticle is viewed on a dichroic patch on the standard polycarbonate visor.

The use of the oxygen mask as an alternative mount for a sight was investigated at RAE, as shown in Fig.9. The image is formed in a similar manner to the AHMS, the major difference being that the combining element has no optical power. This concept has been flown successfully and could provide a cheap retrofit solution.

The FoV requirements for a HMS are less demanding than other devices which will be discussed later. In essence, the display shows an aiming mark and, provided the designated target is within the slaved sensor's FoV, lock-on will be achieved. It follows that the sight FoV need only be of the same order of magnitude, typically 6 - 10°, thus keeping the weight of the optical elements low. The requirements for a reasonably large exit pupil still pertain so that the whole sight image can be seen if the helmet position changes on the pilot's head.

4.2.2 Helmet Mounted Displays

In a HMD the imagery and symbol overlay are dynamic and the optics must be designed to display the whole sensor FoV and maintain 1:1 registration with the direct view. The maintenance of good eye relief and exit pupil, coupled with the FoV requirements all conspire to promote large and heavy optical elements. A HMD within a VCS enables the pilot to view the images generated from multiple waveband sensors - visible as well as IR. Although his FoV is limited by the HMD or the sensor, his FoR is limited only by the gimbal limits of the platform, the capability of the HPS or his own capability as a contortionist. Such a system is fitted to the US Army Apache helicopter. The IHADSS (Integrated Helmet and Display Sighting System) provides an image from a steerable infra-red sensor to the crew using the Honeywell monocular HMD illustrated in Fig.10.

A similar capability, designed with

fast-jet use in mind, is the biocular Falcon-Eye HMD which provides cursive symbols together with an image derived from a head slaved FLIR sensor in an experimental F16.

A binocular HMD (BHMD) has been developed for RAE Farnborough by GEC Avionics to support the Flight Systems Department Lynx helicopter flying programme. This centres on developing techniques of using helmet mounted devices to explore VCS and dynamic symbolic overlays with various sensors under a variety of flight conditions. Miniature 1" CRTs are employed, one each side of the helmet above the ears as shown in Fig.11. The imagery is displayed on 40° diameter, fully overlapped oculars and makes use of see-through on-axis collimating combiners.

4.3 Perceptual Factors

Experience has shown that a large number of disconcerting perceptual phenomena arise during flight when operating with helmet mounted devices. Some are intrinsic to the task and others are attributable to the characteristic of specific helmet mounted devices. Fig.12 is an attempt to summarise the relationship between causes and these largely unwanted effects.

Although a monocular HMS is acceptable for intermittent daytime use, because the pilot is mainly concentrating on the external world, night flying experience where the pilot relies on intensified imagery to see obstacles over enduring periods has shown that binocular imagery is essential. A number of factors contribute to this conclusion.

When the eyes have markedly different stimulation the resulting binocular rivalry can cause eye strain, discomfort, fatigue and even disorientation. Furthermore, even with identical stimuli, the alignment of the images with each other is critical to the acceptability of these devices. Although the centre directions of the two images may be stable and register accurately with the external world, small and subtle differences between the perceived shape or size of the left and right images may be a concern. Such binocular differences may either cause eye fatigue or the inability to fuse the images, particularly if they are displaced vertically, while small horizontal disparities can give rise to false depth impressions.

It should be noted that the possibility of presenting stereoscopic three-dimensional images using stereoscopic pairs fed to the separate channels of a binocular HMD has not been explored sufficiently to understand the real benefits and drawbacks. Systems devised to exploit such images will require more stringent control over binocular differences.

Not only must each ocular be geometrically aligned, adjustments must be provided to ensure that the pilot's eye is as near as possible to the centres of the exit pupils. Since it is more difficult to obtain satisfactory correction for off-axis designs across the full exit pupil, and the image errors which remain are largely symmetrical about the off-axis direction (the direction from which the relay feeds light into the collimating combiner), unaligned off-axis designs are most likely to have binocular differential aberrations. Rapid head movements, causing helmet shifts and displacement of the eyes within the exit pupils, may make the image move in depth and swim across the projection plane.

Where the pilot can see the direct view through the combiners as well as the 'artificial' scene, problems can arise when the pilot transfers his attention between the near cockpit and the far scene. Due to natural convergence of the eyes when focused on a near scene, on looking up and out at the display he will be very conscious of transient double imaging before he attains fusion.

In order to increase the horizontal FoV of a binocular system, it is possible to splay the oculars so that the FoVs only partially overlap, giving binocular imagery in the overlap but monocular in the remaining area. However, experience with splayed NVGs indicates that the benefit of this increase is outweighed by the annoyance of the brightness discontinuities.

The experience of binocular NVGs, which have the advantage of saving the weight of an I² tube and objective lens, can lead to the appearance of 'fixed pattern noise', or strongly correlated noise patterns, which causes distractions out of proportion to the objectively assessed noise content of the image. With independent channels the uncorrelated noise averages to a significantly lower level.

5. THE INTEGRATED HELMET

5.1 The requirement

Up to this point we have discussed what may be considered to be current technology helmet mounted equipment, each designed to meet a particular operational requirement, some of which are in service almost in spite of their acknowledged deficiencies. These deficiencies may be physical restrictions, such as reduced mobility, or flight restrictions imposed by safety considerations. The tendency has been to produce an addition to an existing 'standard' helmet to fulfil a particular requirement.

Table 1. summarises the uses of helmet mounted systems for vision enhancement, display and control. Columns A to F are uses which have been proposed and studied previously and, of these, B, D and E have entered service with various operators.

Column G summarises the suggested uses and constituents of the next generation of active headgear in such aircraft as EFA, ATF and Rafale fighters and the Tiger helicopter. The tendency here is to combine the need for bright images for weapon aiming and cueing in daylight with the need for intensified external imagery, superimposed on a head-slaved thermal sensor image and flight symbols, at night. As this effectively encompasses all applications from A to F, it certainly stretches the ingenuity of equipment designers and forces the need for the concept of the Integrated Helmet (IH). The number of interpretations of what constitutes an IH is legion, but to meet the likely operational requirements the conceptual design should provide the combined functions of vision enhancement and the display of weapon aiming and flight information which can be overlaid on a stabilised image derived from a sensor. It goes without saying the helmet must retain its full protective and life support attributes, be compatible with the rest of the pilot's personal equipment and incorporate a helmet position sensor.

The problems associated with aggregating these demanding requirements revolve mainly about achieving a design which,

- satisfies all the optical requirements
- is configured to give a satisfactory weight distribution
- is within an envelope consistent with use in a cockpit
- has a tolerable mass.

The conflicting requirements of day and night operations rebel against a single version of the headgear for both rôles, but that is a desirable aim on logistical grounds if for no other reason. An alternative approach would use a pair of interchangeable modules optimised, respectively, for day and night conditions. For both cases, weight can be reduced as the head only bears the weight of equipment required at the time. Unfortunately, there has to be a down side as it does not cover day-through-to-night and night-through-to-day missions unless the other module is stowed within the cockpit. Not only must stowage space be provided, but the in-flight changeover, however well designed the latching mechanism, presents potential difficulties to the pilot which under certain circumstances could be hazardous.

Typical of the approaches which attempt to meet these requirements is the Kaiser Strike Eye Helmet Integrated Display shown at Fig.5. The basic helmet can be fitted with a selection of brow-mounted modules, one for instance contains two I² tubes and provides binocular night scene intensification, and another has two I² tubes plus two miniature (1") CRTs giving a selectable stroke/raster display that may overlay the night vision scene. The latter may also be used as a display in daylight operations. The optical design is common to all modules, giving 30° circular binocular FoV with 100% overlap, and the collimating combiner blocks may be rotated upwards to provide unrestricted vision, during carrier landings for example. Designed for high performance tactical aircraft, it has an all up weight of just over 2 kg with the full complement of devices. Even with an optimised c of g, it has to be said that this mass is likely to be a noticeable encumbrance to the fast-jet operator entering an engagement after a few hours combat air patrol.

5.2 The UK MOD Demonstrator Programme

The Procurement Executive of the UK Ministry of Defence has initiated a competitive contract for an Advanced Integrated Avionics Helmet for use in a Technology Demonstration Programme. The specification was intentionally made very demanding. It called for a 30° x 40° FoV, with dual I² and displays, packaged into a compact light-weight stable helmet which would not compromise the pilot's safety should he have to eject. Such fast jet operations as strike attack, air defence, close air and offensive support missions are the

primary applications, but the implications of operating the helmet in a helicopter were also part of the requirement. The AIAH will be assessed and demonstrated in the RAE Tornado Integrated Avionics Research Aircraft (TIARA).

The Invitation to Tender was issued to over twenty firms internationally, and responses were received from four. The proposal from GEC-Avionics was selected. It is very similar to that shown schematically in Fig.13 in that it is fully binocular, uses optical image combination and like Strike Eye has block combiners. It is due to be delivered for flight trials in mid-93. The short timescale of the procurement was set in the knowledge that 'state of the art' technology would be offered. Although the delivered equipment may not represent the optimum longer-term technical solution to the problem, this programme will provide practical experience for drawing up future helmet mounted equipment requirements.

5.3 Image Combination

5.3.1 Optical Superimposition

A simplified generic schematic of equipment and supporting electronics such as that of the Kaiser Strike Eye and the GEC Avionics TDP design is shown in Fig.13. Here, each eye's optical system is arranged to combine the dim light emitted from the phosphor of the image intensifier with that from the phosphor of the brighter CRT using a combiner mirror biased to reflect more of the I² output. This optical combination retains the size, shape, quality and colour of the two sources. However, this inevitably loses most light from the CRT.

5.3.2 Electronic Mixing

The alternative technique electronically mixes the video signal from a miniature helmet-mounted low-light TV camera into the video signal normally displayed on the CRT as illustrated in Fig.14. This obviates brightness losses incurred in the optical combiner, it allows great flexibility for correcting and matching the component images, and it gives the designer more freedom over the siting of the helmet-mounted sensors. Such I²-CCD sensors, using a channel-plate Image Intensifier and a Charge-Coupled Device with either photon or electron coupling, are under development.

The high spatial resolution of the intensifier cannot, unfortunately, be carried through the limited bandwidth

video/raster system, and the advantage of a night vision aid with an independent battery power source is lost.

If such an electronic image combination technique becomes tenable the headgear designer's job is eased a little. He need only design a display system and provide a plug-in mount for one or two I²-CCD sensors, with cabling and connections to transfer the signals from the helmet to the display generation electronics. The system designer could then offer a very versatile night vision enhancement facility using the I²-CCD sensors or, to save head-borne weight in an aircraft with a head-slaved gimballed sensor, just use the display as part of a VCS. Given modular construction, the choice of either, or both, could be left to operational preference.

6. Enabling Technologies

Although the miniature 1" faceplate CRT has become the accepted standard image source for a flightworthy display, it can only supply an adequately bright well-resolved image if it is monochromatic. Alternative devices which can match its quality and produce fully coloured images, or have other weight or safety benefits, would appeal to both the designers and users.

Active matrix liquid-crystal displays used in commercial HMDs are as yet too large, with individual cells about five times the size of a CRT spot, but development could easily halve this value. Being transmissive, the image brightness of these devices depends on the back illumination, and improved miniature fluorescent lamps or flood-gun CRTs are possible. We will certainly see future flightworthy systems incorporating such improvements in order to obtain the colour range, robustness, lightness and low power/voltage operation inherent in these devices. Other "flat panel" technologies, such as light-emitting diode junctions, electroluminescence and plasma-discharge effects, although in principle amenable to appropriate miniaturisation, have subtle limitations and are less likely to receive the costly investment.

The laser is another potentially attractive image source. Each eye channel could be constructed from a RGB triad, with individual brightness modulators, mounted somewhere in the cockpit. The beams could be brought to a common axis and focussed onto the end of a single optical fibre leading to a helmet-mounted line-frame scanner and a

collimating combiner. This would place the least mass, power and complexity on the pilot's head. It is very important that failure of the scanner or its excitation should not leave the pilot looking at an intense stationary spot. Currently, scanning techniques cannot provide the required resolution but technologies are developing rapidly. The picture is much dimmer than that provided by the miniature CRT. Fortunately, as the size of off-helmet components is less crucial, the laser power can be boosted to compensate.

The CRT is also capable of considerable refinement. Further miniaturisation could reduce the mass from about 150 grams to about 50 grams, for a ½" device, while colour imagery is possible using layered phosphors, as in a penetron CRT, or using a sequentially switched RGB shutter with a white phosphor. For the latter, three-state liquid-crystal cells are available but their efficiency must be raised from the current value of about 5%.

All the HMDs discussed above use conventional refractive optics to produce the collimated virtual image and rely upon a partially reflective coating on the combining element, such as the visor or a prismatic eyepiece. There are several methods of forming partially reflective layers on surfaces. The simplest is a thin metal film, which is insensitive to the colour of the light but absorbs a significant proportion. Multi-layer dielectric films reflect selected wavelengths very efficiently at particular angles, by constructive interference from the parallel boundaries, and they are very suitable for handling the narrow band emitted from the CRTs.

Conformal holograms are very similar in function to such dielectric stacks, but the layers or fringes are formed within a thicker photo-sensitive coating exposed to the microscopic standing wave pattern caused by a suitable pair of interfering beams from an intense source, usually a laser.

Non-conformal holograms, in which the fringes are not parallel to the substrate and therefore break into the coating surfaces, can be formed by other constructional geometries. They can act as a wavelength- and angle-selective concave mirror, having a shorter focal length than the curved substrate and a different optical axis. They give the designer more flexibility

over the shape of the substrate. However, diffraction spectra may be formed by the microscopic undulations where fringes intersect the surface. The design must not allow light, particularly direct sunlight, which satisfies such diffraction conditions to enter the eye and give rise to strong 'rainbows' across the display image.

Most commercial holograms are formed in dichromated gelatin (DCG) which is hygroscopic and must be sealed between stout impermeable layers, such as the glass sandwich construction developed for HUD combiner glasses. Stable photo-polymers suitable for coating plastic substrates are under development, but they have not, as yet, shown the same processing qualities, clarity or efficiency as DCG. Their use for visor-mounted holograms is a topic for current research.

The principal developments in helmet-mounted optics are likely to be in the design and fabrication of holographic elements. However, a range of other optical engineering topics, including studies of the overall optical configurations, the design and manufacture of off-axis de-centred optics, aspherics and coatings, may have a significant impact on the practical form of future devices.

A similar technically eclectic approach is necessary to advance the art of helmet position sensing. Established electro-magnetic systems are capable of further refinement, mainly to compensate for field distortions when installed in a cockpit and to increase the measurement frequency and head excursion envelope. A variety of techniques utilising, for instance, multi-receiver triangulation, helmet pattern recognition, interferometry or direct angle sensing, are at various stages of development.

7. Design Constraints

The total headgear must conform to a number of practical criteria which, stated with artless simplicity, require it to be safe, protective, well fitting, comfortable, unrestrictive, secure, easily doffed and donned, maintainable and affordable. However, each of these facets is invariably translated into a quantitative specification for a particular application. For instance it would be reasonable to describe an adequately comfortable helmet for use in a fast jet as having a mass less than 2Kg, a centre of gravity between that of the head and the neck point of rotation,

of allowing an internal cooling airflow and applying a uniformly low pressure to the scalp. The designer therefore carries the burden of fulfilling all of these details while attempting to build in the additional functional attributes.

It is also of note that new protective requirements and techniques are evolving. For instance, passive acoustic protection by the helmet shell and the enveloping earcups is now being augmented by active noise reduction (ANR) which feeds an out-of-phase signal to each earphone. This reduces low frequency noise significantly, complementing the passive techniques which work well at higher frequencies, but it adds complexity to the headgear.

The military pilot is faced with a variety of hostile threats against which he must be protected. Modern non-conventional weapons can inflict varying degrees of damage to the pilot without necessarily causing him or his aircraft sudden catastrophic destruction. In some instances temporary visual incapacity may be caused, in other cases longer term or even permanent eye damage may result. Inevitably, a balance between protection, cost, weight, and the penalties of compromising the pilot's effectiveness has to be carefully considered. The designer must approach the problem in a systematic manner and produce a scheme which is compatible with the other requirements since there is no point in producing the ultimate protection which denies the pilot visibility of his helmet displays or his cockpit controls. It may be preferable to provide protection only while the threat exists, for instance, by rapid detection and activation of the shielding device. PZLT goggles, which shield against nuclear flash, embody this principle. It would, however, be very difficult to design a helmet-mounted display which also incorporates such a device.

Development of protection against loss-of-consciousness under g (G-LOC) has resulted in the extension of the g-trousers to include a torso harness. This applies an external pressure to the chest needed to counter a beneficial excess pressure of breathing air fed into the mask. Unfortunately, to prevent leakage and maintain pressure within the mask, it is simultaneously necessary to increase the tension in the mask retaining

straps, perhaps using another inflating bladder in the nape of the helmet. This again adds mass, increases the number of connections, needs adjustments to suit the individual and is very likely to move the helmet on the head.

The logistics of providing the headgear must always be borne in mind by the designer. There is considerable variation between the size and shape of pilots' heads, but the equipment must be supplied in such a form that at least one variant fits each individual and functions properly. Too many variants or bespoke tailoring are costly, both in production and spares holding. A good knowledge of cranial and facial anthropometry is essential.

Modular construction could enable the designer to argue that lightness may be most easily achieved by wearing the minimum and having additional modules stowed in cubby-holes in the cockpit. For instance, a dark visor could be removed at night or a miniature intensifier camera could be removed in daylight. Maintenance should then be a simple matter of replacing modules, which could avoid complex jigs or alignment aids. However, it is necessary to ensure that in-flight change-over can be done single-handedly under stress in the cockpit confines with absolute certainty. Also, the provision of interfaces and break-points between modules would necessarily add mass or introduce structural weakness. It is broadly inconsistent with the need for functional integration.

8. FUNCTIONAL INTEGRATION

As suggested earlier, aviator's headgear has developed like an onion, growing layers to meet new requirements and ensuring compatibility by not interfering with the established form. It is suggested that this process cannot be stretched to include the active visual enhancement, display and control functions which are now sought. Further layers will make the burden too heavy, too restrictive and too uncomfortable, and the wearer will be more aware of the deficiencies than the extra facilities.

Each component should be designed and built to fulfil as many functions as possible. For instance, the shell must be a load spreading, energy absorbing protective carapace, as always, but it should attenuate sound and act as an optical bench. The visor must deflect windblast and debris, attenuate glare, act as a collimating combiner, and seal against the shell to prevent ingress of

MDC and NBC agents. Components must reinforce each other mechanically and not interfere electrically or optically. Functional integration demands re-thinking the traditional construction of the overall headgear while accepting the lessons accumulated in the evolution of existing components.

This presents a new challenge to the designers, who should be teamed to include optical and electronic specialists as well as ergonomists, aero-medical and mechanical engineers. In turn, they need good research data to assess objectively the alternative approaches and detailed optimisations that constitute the inventive design process.

The DRA (Aerospace Div) has a comprehensive research programme which, as well as supporting crucial technological developments, seeks to establish the genuine requirements of the equipment by simulator and flight evaluations.

The instigation of such endeavours as the Integrated Helmet TDP, in conjunction with MOD (PE), is central to this programme.

9. CONCLUSIONS

1. The addition of vision enhancement, display and control functions to aviator's headgear is operationally attractive. Fast jets and helicopters currently under development call for headgear with a combination of these facilities. Satisfactory implementation, and subsequently successful operational experience, may induce the designers of future aircraft to base the man-machine interface on helmet-mounted systems.

2. The recent history of the development of helmet-mounted devices demonstrates admirably the inventiveness of the design teams. However, it also shows that the addition of extra components invariably compromises basic ergonomic qualities.

3. A new design philosophy, which emphasises functional integration rather than the incorporation of compatible sub-systems, has become essential. This will be assisted significantly when key optical and electro-optical technologies become mature.

4. A mixture of operational, technological and human questions must be addressed by well aimed research.

Acknowledgements

The major portion of this paper was presented at the Institute of Mechanical Engineers Seminar on "The Man-Machine Interface in Civil and Military Aircraft" held in London, October 1991.

The authors wish to thank the following firms for their valuable assistance in providing information and illustrative material used in this paper.

GEC Ferranti, Kaiser Electronics, Hadland Photonics, CAE, MBM Technology, Hughes Aircraft Company, Elbit Computers Ltd, GEC Avionics.

This work has been carried out with the support of the Procurement Executive Ministry of Defence.

APPLICATION	A	B	C	D	E	F	G	H	J
H-M DEVICE									
Helmet position sensor									
Symbolic display									
Image intensifiers									
One-eye pictorial display									
Two-eye pictorial display									
Eye direction sensor									
CONDITIONS	Day	Day	Day	Night	Night Poor vis.	Night	Day Night Poor vis.	Day	Day Night Poor vis. Enclosure
VEHICLE	Fast jet	Fast jet	Fast jet	Helicopter Transport Fast jet	Helicopter Fast jet	Helicopter	Helicopter Fast jet	Fast jet	Helicopter Fast jet
CURRENT STATUS	Tried	In service	Developed	In service	In service	In service?	Prototypes available	Ground simulation	Ground simulation
EXAMPLES	HMMD	VTAS OMMS AHMS IHSS	DASH IHS/DS HADAS Agile Eye	ANVIS Cats Eyes Eagle Eye NITE-Op NITEBIRD Merlin	HOPS/HELPS IHADSS HMD/LOSL Falcon Eye WFOV BHMD HMD	NVG-HUD	INVS INVHS/DS Strike Eye Knighthelm Wide Eye	HMOS	FOHMD VCASS VEIL BHMD+ PEPS

Table 1 SUMMARY OF THE USES FOR H-M VISION ENHANCEMENT, CONTROL AND DISPLAY DEVICES



Figure 1 Current Headgear: Mk 10 Helmet and Oxygen-mask

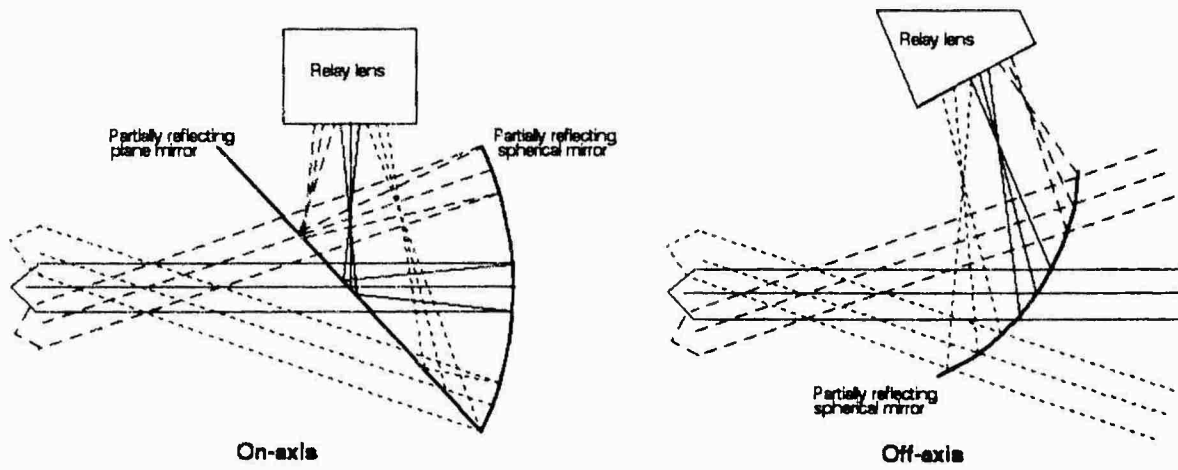

Figure 2 On-axis and Off-axis Optical Configurations

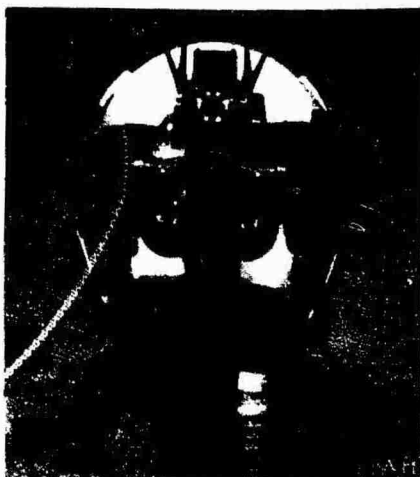

Figure 3 GEC-Ferranti Nite-Op NVG



Figure 4 GEC-Avionics Cats-Eyes NVG



**Fig 5 Kaiser Electronics Strike Eye
Helmet Integrated Display**



**Fig 6 Night Vision Corporation
Eagle Eye NVG**



**Fig 7 Honeywell Visual Target Acquisition
System Helmet**



**Fig 8 GEC-TSRL Alpha Helmet-
Mounted Sight**



**Fig 9 DRA(AD) Oxygen-mask Mounted
Sight**



**Fig 10 Honeywell IHADSS Monocular
Helmet-Mounted Display**



Fig 11 GEC-TSRL Binocular Helmet-Mounted Display

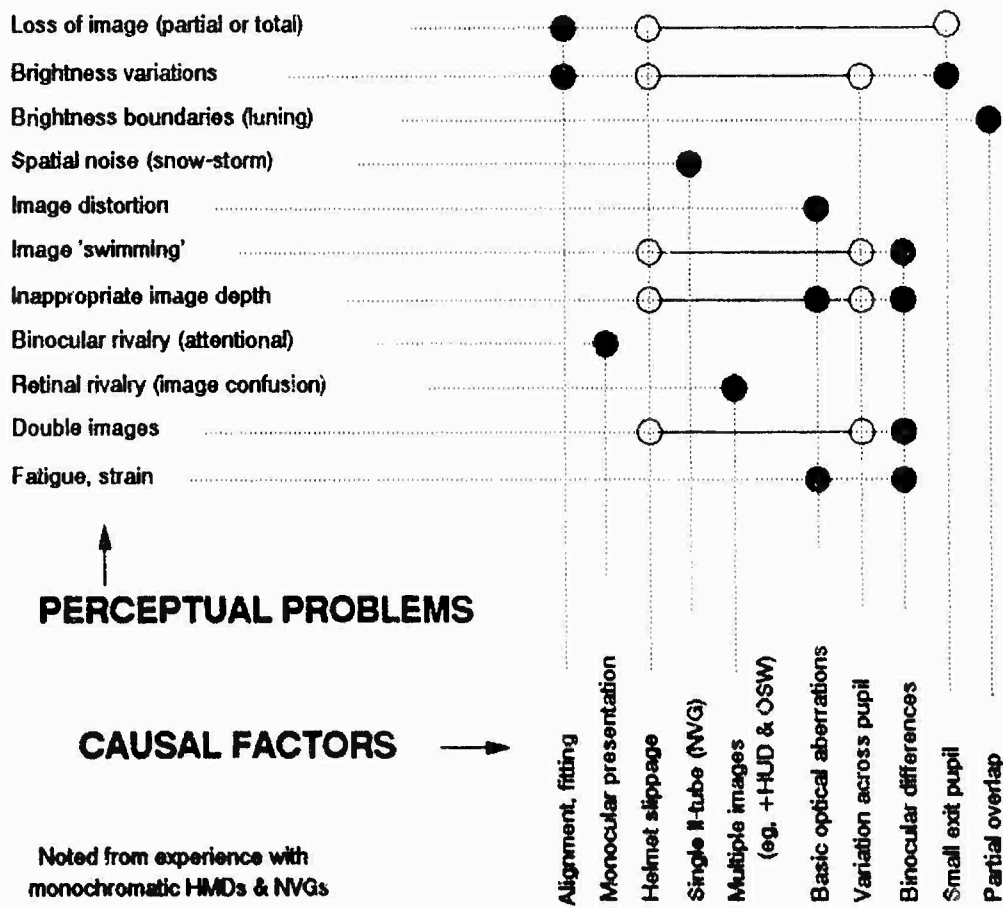

Fig.12 Summary of perceptual problems.

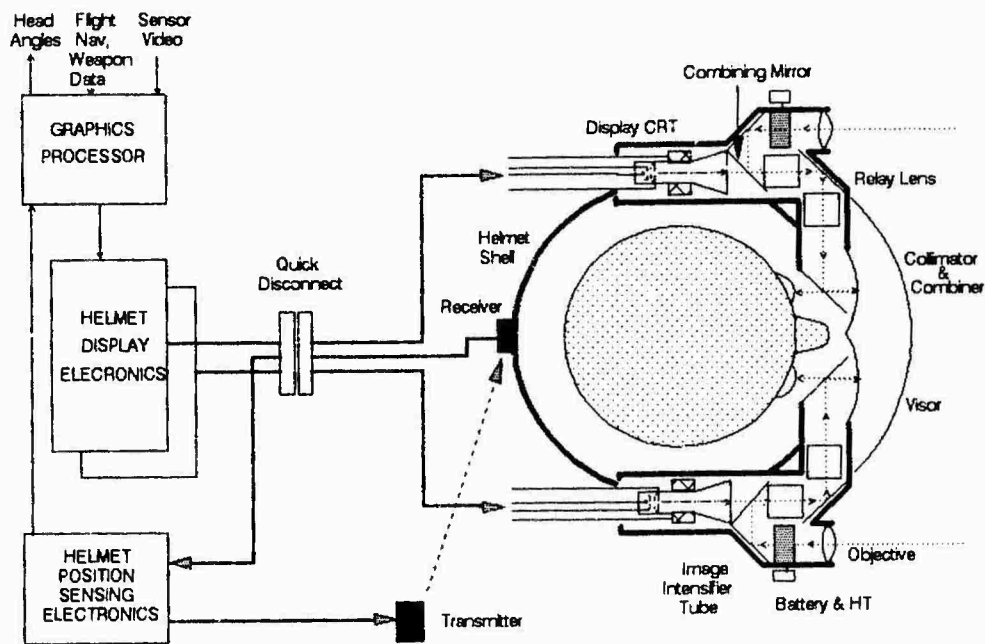

Fig.13 Schematic for an Integrated Helmet system: Optical image superimposition.

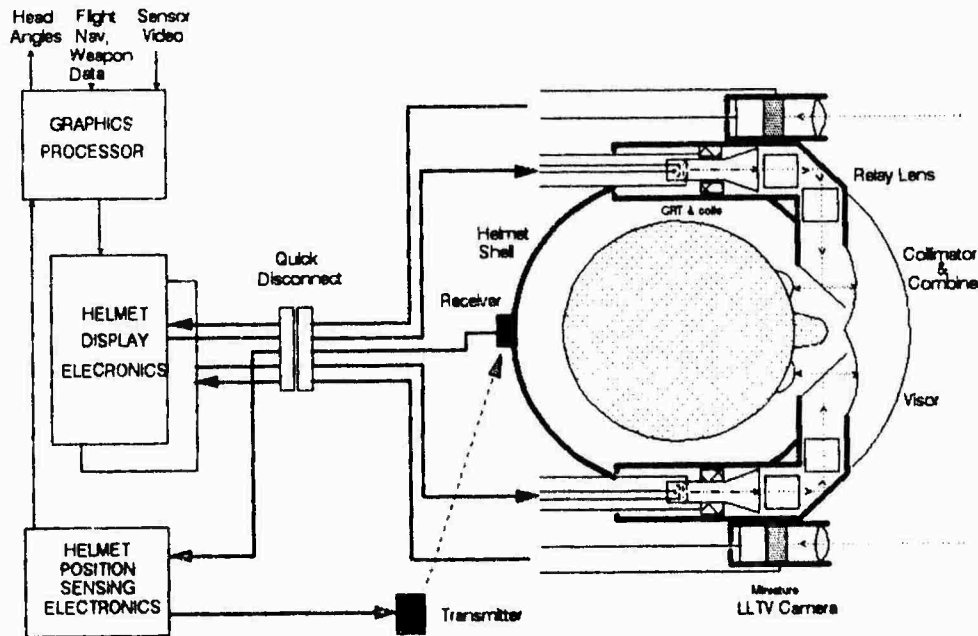



















Fig.14 Schematic for an Integrated Helmet system: Electronic image mixing.

DEVICE	MANUFACTURER	APPLICATION	OPTICAL ARRANGEMENT	FIELD OF VIEW (degrees)	EXIT PUPIL (mm)	EYE RELIEF (mm)	COMBINER TRANSMISSION	BRIGHTNESS (n Lamberts)	MASS (kg)	NOTES
HMMD Helmet Mounted Matrix Display	Morcon Avionics	A	Off axis	10	16	On visor	78%	400	0.5 D	Programmable 32x32 LED display
VITAS Visual Target Acquisition Set	Honeywell	B	Off axis	6	15	On visor	15%	?	?	Illuminated reticle Parabolic visor
OMMS Oxygen Mask Mounted Sight	DRM(AD)	B	On axis	4.5	?	Outside visor	80%	2000	0.1 D	Illuminated reticle
AMMS ALPHA Helmet- Mounted Sight	GEC Avionics	B	Off axis	3.5	16	47.5	80%	2000	1.4 DH	Fixed format LED display
IMSS Integrated Helmet Sight System	Sentant Avionique	B	Off axis	6	?	?	High	?	1.3 DH	Stroke
DASH Display and Sight Helmet	EBM Computer	C	Off axis	22	12x18	50	High	3000	1.2 DH	Includes flight data Electro-magnetic weapon aiming
IHS/DS Integrated Helmet Sight/Display System	Sentant Avionique	C	?	20	?	?	High	?	1.6 DH	
HMOAS Helmet Airborne Display and Sight	EL-OP	C	?	30x22	?	25	15%	3000	0.4 D	Sensor + overlay
				20	17	80%	2000	1.3 DH	Day Night	Day visor/stroke Stroke or Raster/stroke Night visor/raster
Agile Eye	Kaiser Electronics	C	Off axis	20	17	48	10%	2000	1.3 DH	







Annex A: Summary of helmet-mounted device characteristics

DEVICE	MANUFACTURER	APPLICATION	OPTICAL ARRANGEMENT	FIELD OF VIEW (degrees)	EXT PUPIL (mm)	EYE RELIEF (mm)	COMBINER TRANSMISSION	BRIGHTNESS (n Lamberts)	MASS (kg)	NOTES
ANVIS	Hughes ME ITT	D	On axis 	40	10	15 25	-	-	0.81 D	Several variants
Cats Eye	GEC Avionics	D	Off axis 	30	10	25	30%	-	0.8 D	
Eagle Eye	Hodland Photonics SRL	D	? 	40	?	15	?	?	0.56 D	Optional sensor/symbology imager
NITE-OP	GEC Ferranti	D	On axis 	45	10	30	-	-	0.75 D	Helicopter No see-through - rotates upwards Variant (NVC-HUD) injects CRT imagery
NITEBIRD	GEC Ferranti	D	On axis 	45	10	30	-	-	0.81 D	Fixed wing No see-through - rotates upwards Has auto-detach mechanism
Merlin	ITT	D	Off axis 	35	10	20	40%	-	0.5 D	New image intensifier tubes
HOPS/HELPS Helmet-mounted optical Projection System/Helmet Position Sighting System	Autonetics	E	On axis 	20	?	25	50%	50	0.45 D	Very early HMD
IMOSS Integrated Helmet and Display Sight System	Honeywell	E	On axis 	30x40	10	49	75%	400	1.8 DH	Sensor plus overlay Includes 5 degree sight at 2000 ft Variant (HMIS) includes image intensifier
HMD/LSL Helmet Mounted Display with Line of Sight Locator	AEG	E	? 	40x40	8	17	?	?	0.3 D	Hybrid and stroke modes Off-helmet CRT with 300x300 fibre optic bundle

Annex A (continued)

DEVICE	MANUFACTURER	APPLICATION	OPTICAL ARRANGEMENT	FIELD OF VIEW (degrees)	EXT PUPIL (mm)	EYE RELIEF (mm)	COMBINER TRANSMISSION	BRIGHTNESS (ft Lamberts)	MASS (kg)	NOTES
HMD Hughes Visor Display	Hughes	E	Off axis 	30x40	10x15	95	70%	100	?	EI-ocular Raster/Stroke 30x80 degree binocular simulator version with 40 degree overlap
Falcon Eye	GEC Avionics	E	Off axis 	30	10	25	30%	250 1000	1.9 DHM	EI-ocular Raster/stroke
WFOV Wide Field of View	Honeywell	E	Off axis 	60	?	?	?	?	?	40 degree overlap Total field of view is 60x80
BHMD Experimental Binocular Helmet- Mounted Display	GEC Avionics	E	On axis 	30x40	14	35	35% 5%	100	0.9 D	Night visor Values for raster: Stroke is 300 fL Day visor
HMD Helmet-Mounted Display	MBDA Technology	E	Off axis 	55x60 per eye	10	45	70%	1000+	2.0+	Variable overlap Monochrome version, on-helmet CRTs Colour version, fibre optic link to helmet
INVS Integrated Night Vision System	Honeywell	G	Off axis 	?	?	?	?	?	?	
INMMS/DS Integrated Night Vision Helmet Sight / Display System	Serfont Avionique	G	Off axis 	30x40	?	?	?	?	2.2 DH	Raster sensor Stroke symbology Integrated light intensifiers
Sofite Eye	Kaiser	G	On axis 	30	12	25	40% 10%	2000 230	1.86 to 2.2 DH	Night visor Raster/stroke Image intensifiers, CRTs or both Stowable combiners Modular 30x40 degree option with 50% overlap Day visor
KnightVision	GEC Avionics	G	Off axis 	35	12	25	40%	180 3000	2.0 DHM	Raster Stroke

Annex A (continued)

DEVICE	MANUFACTURER	APPLICATION	OPTICAL ARRANGEMENT	FIELD OF VIEW (degrees)	EXT PUPIL (mm)	EYE RELIEF (mm)	COUPLER TRANSMISSION	BRIGHTNESS (n Lamberts)	MASS (kg)	NOTES
Wide Eye	Kaiser	G	On axis 	36-52	12	25	30% 8.5%	2000 115	1.8 DH	Day stroke Roster/Stroke/Hybrid Modular Night raster
HMOS Helmet Mounted Oculometer System	Honeywell	H	Off axis 	?	?	?	?	?	?	
FOHMED Fibre Optic Helmet Mounted Display	CAE Electronics	J	On axis 	65x125 60x120	15	36	10%	50 10	2.4 DH	4 light valves 36 deg overlap with hi-res insert Full colour 4 CRTs
VCASS Visually-Coupled Airborne Systems Simulator	Ferrand	J	On axis 	80x80 per eye	15	30	5%	10	3.5 DH	Variable overlap
VEL Virtual Environment Integration Laboratory	DRA(AD)	J	On axis 	80	20	25	20%	50	2.0 DH	Target specification Variable overlap Full colour Eye sensor
BHMD-PEPS Binocular Helmet- Mounted Display and Flare Eye Position Sensor	OEC Avionics	J	On axis 	50	12	30	25%	50	2.5 DH	Values for raster mode 80 fL in stroke mode Eye sensor

Notes for Annex A

Application letters refer to classes in Table 1

Optical arrangement: On and off axis refer to collimating optics

Field of view is either total (vertical x horizontal) or circular per eye

Mass codes: D = additional head-mounted device

H = helmet

M = oxygen mask

ALL FIGURES SHOULD BE TAKEN AS ESTIMATES

Annex A (final)

THE PHYSIOLOGICAL LIMITATIONS OF MAN IN THE HIGH G ENVIRONMENT

Implications for Cockpit Design

N D C Green
Biodynamics Division
RAF Institute of Aviation Medicine
Farnborough, Hants GU14 6SZ, UK

Summary

The physiological limitations imposed upon man by the high G environment are discussed, with particular reference to the cardiovascular, respiratory and musculo-skeletal systems. Anti-G technology has been developed specifically for agile fighter aircraft, but it is apparent that if man is to have the capacity to tolerate any further increases in aircraft agility, a radically different approach to G protection is required. The most effective physiological solution is to change the orientation of the pilot such that his long axis is no longer in the plane of greatest acceleration, entailing major cockpit redesign. This and other solutions are examined, and their acceptability to aviators is considered.

Introduction

Aircraft design has now advanced to such an extent that, in a number of areas, aircraft performance exceeds the physiological capability of the pilot. This is particularly true of the accelerative forces produced by agile fighter aircraft, such as the F-16 and the European Fighter Aircraft (EFA). There are 2 key areas of performance improvement that are relevant: not only can agile aircraft sustain high G levels for considerably longer than existing aircraft, but the rate of onset of G can be much greater (in excess of $10G\text{s}^{-1}$). These improvements pose a challenge to the aviation physiologist and pilot alike, and the resulting problems and their possible solutions will be explored further in this paper. Specifically, the physiological limitations imposed by the high G environment upon the cardiovascular, respiratory and musculoskeletal systems will be explained. The mode of operation of current anti-G protection will be examined, together with the proposed anti-G protection for next generation agile aircraft. Finally, the implications for cockpit design should man need to be protected against the effects of further increases in aircraft agility will be discussed.

The High G Environment

The acceleration vectors to which man is subjected in flight are described by a three axis co-ordinate system (X, Y and Z). The standard AGARD aeromedical terminology for describing the direction of these vectors can be seen in figure

1. It should be noted that the applied acceleration and the resultant inertial vector by definition act in opposite directions. It is the direction of the acceleration that determines whether the term 'G' is positive or negative. For example, the forward acceleration of an aircraft on take-off will produce an inertial force that pushes the body backwards into the seat (termed +Gx). It is also important to note that this classification refers to the man and his orientation only, and cannot be used to describe the direction of forces acting upon the aircraft. All accelerations described herein are assumed to be of long duration (that is, greater than one second).

When man is seated conventionally in a fast jet aircraft, the largest accelerative forces produced are in his long (head-foot) axis, usually as the aircraft banks in a turn or recovers from a dive. This is unfortunate, because man is most susceptible to the effects of long duration acceleration in the Gz axis. Large +Gx accelerations (in the order of 3-4G) are sometimes encountered upon aircraft carrier launches, but these are rarely of sufficient magnitude to have significant physiological effect. At present, aircraft do not normally produce any significant acceleration in the Gy axis, although this may change if future agile aircraft adopt advanced thrust vectoring techniques.

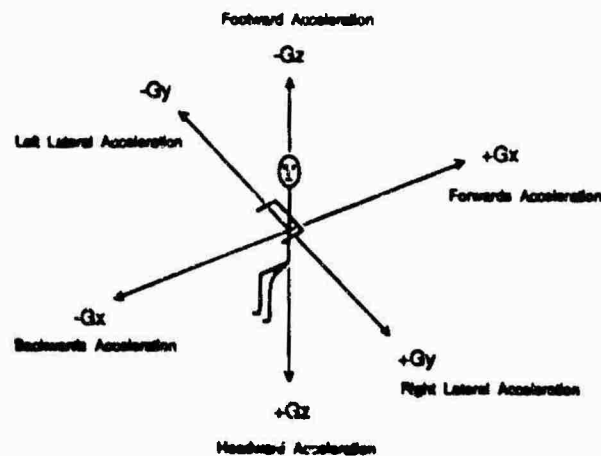

Figure 1. Standard AGARD aeromedical terminology for describing the direction of acceleration and inertial forces. The arrows show the direction of the inertial vector (i.e. the force apparent to the pilot).

Musculoskeletal Effects

The most apparent effects of increased +Gz acceleration are those on the limbs and soft tissues, even at low levels of +Gz. Beyond +2Gz there is distinctive sagging of the soft tissues of the face, and limbs feel very heavy on movement. At between +2.5 and 3Gz it becomes impossible to rise from the seated position and thus escape from an aircraft is impossible without assistance. At greater than +6Gz, limb movement of any form becomes difficult. In one study (Ref. 1) it was found that it took twice as long to reach the face blind handle of the ejection seat (located above and behind the head) at +6Gz than it did when at 1Gz. No limb movement is possible at +8Gz and above.

Gross limb movements are rarely required under high +Gz, however. Fine movements by fingers and hands are relatively unaffected by high +Gz (Ref. 2), and thus it is possible for the pilot to operate correctly situated controls with no impairment. To this end, HOTAS (Hands On Throttle And Stick) technology is currently employed in a number of agile aircraft.

Head movement also becomes increasingly difficult under G. If the head is allowed to slump forward, it becomes very difficult to raise it again to the vertical position. Without a helmet, it is impossible to raise the head at accelerations of greater than +8Gz. If a helmet is worn, this figure may be as low as +4Gz. The cockpit should therefore be designed such that, under high Gz, minimum head movement is required to see the necessary instrumentation. More importantly, the current drive towards helmet mounted display systems must be balanced against the penalty imposed by heavier helmets. A system of helmet support, which bears some of the weight of the helmet under high +Gz, may be required. Such a system must not interfere with head mobility, specifically the pilot's ability to 'check six'; this makes design difficult and as yet no operational system exists.

Cardiovascular Effects

The most significant problems for man under high +Gz are due to the effects on his cardiovascular system. As +Gz increases, there is increasing loss of vision, followed by loss of consciousness. The problem is not a new one and is not limited to current agile aircraft; loss of vision was reported by pilots when making turns during the Schneider Trophy races of the 1920s. To appreciate the cause of this problem, it is necessary to understand the underlying physiology.

A column of fluid exerts a pressure that is dependant on the height of that column, the density of the fluid and the acceleration to which it is exposed:

$$p = h\rho g$$

where p is the pressure exerted, h is the height of the column, ρ is the density of the fluid and g is the acceleration. Therefore, due to gravity, a hydrostatic gradient exists in the column of blood contained in the blood vessels

between the head and heart when in an upright position. In an average man the head-heart distance is approximately 30cm; thus at 1G the pressure exerted by this column of blood will be:

$$p = 0.30 \times 1.06 \times 10^3 \times 9.81 \\ = 3119.6 \text{ Pa or } 23.4 \text{ mmHg}$$

where the density of blood is $1.06 \times 10^3 \text{ Kg m}^{-3}$, and acceleration due to gravity is 9.81 ms^{-2} . This means that if the peak (systolic) blood pressure generated at heart level is 120 mmHg, the pressure at the level of the brain will be approximately 100 mmHg, at 1G. Considering the same situation, when the man is exposed to +5Gz:

$$p = 0.30 \times 1.06 \times 10^3 \times (9.81 \times 5) \\ = 15597.9 \text{ Pa or } 117.0 \text{ mmHg}$$

so the peak blood pressure at brain level will be approximately 3 mmHg at +5Gz. At approximately this pressure (i.e. 0 mmHg), blood flow and hence oxygen transport to the brain will cease. Consciousness is lost 4-5 seconds after blood flow to the brain ceases, as there is a small 'reserve' of oxygen within the brain itself. The pilot will only regain consciousness when Gz is reduced to such a level that blood flow to the brain resumes. This period of unconsciousness is termed the period of absolute incapacitation. A period of relative incapacitation follows, when the pilot is disoriented and unable to fly the aircraft; studies show that some even consider ejection. The period of relative incapacitation lasts 15-30 seconds, and so in total the pilot may be incapable of flying the aircraft for 45-60 seconds. A fast jet may travel a distance of 6 miles in this time.

Figure 2 shows the changes in blood pressure due to the hydrostatic pressure gradient in blood vessels at different levels of the body, for a man at 1G and at +5G. Not only does hydrostatic pressure decrease above heart level under +Gz, but it increases below heart level. Because veins are elastic walled and thus distensible, at high venous pressures they will expand in diameter to hold a greater volume of blood. This means blood will tend to pool in the lower limbs at high +Gz and return of blood to the heart will be reduced. This directly decreases the amount of blood available for the heart to pump, and so blood pressure is reduced. Two distinct mechanisms, which both tend to reduce arterial blood pressure at head level under increased +Gz, can therefore be seen. The pressure drop caused by the hydrostatic gradient is compounded by the fall in blood pressure caused by blood pooling in the legs.

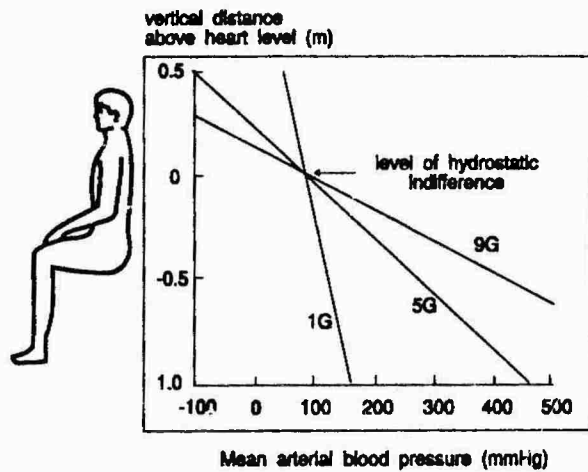

Figure 2. Regional variation in blood pressure due to hydrostatic gradient measured at +1Gz and at +5Gz.

Although man lives the majority of his life in a more or less 1G environment, he is equipped with mechanisms to adjust blood pressure. If this were not the case, he would not survive the pressure changes incurred by simply getting out of bed in the morning, and would collapse unconscious due to blood pooling in the legs. Pressure sensors exist in the arteries near the heart and in the neck, and pressure changes detected are relayed to the brainstem. From here signals are sent both to the heart and to the arteries to adjust blood pressure appropriately, by changing the force and rate of heart contraction, and by constricting or dilating small arteries (called arterioles). Constriction of arterioles increases the resistance of the arterial system and thus increases arterial blood pressure. This mechanism is termed the baroreceptor reflex. Figure 3 shows arterial blood pressure measured at head level in a subject exposed to + on a human centrifuge. Blood pressure drops as G is applied, but at point A, blood pressure increases again by the mechanism described above.

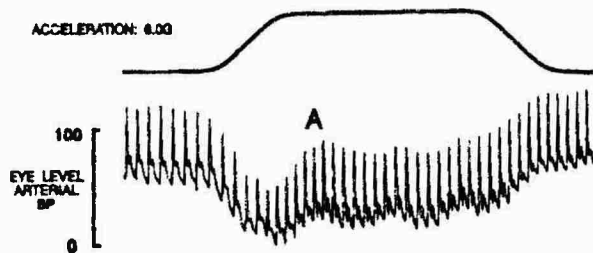

Figure 3. Trace recorded on RAF human centrifuge demonstrating changes in eye level arterial blood pressure at +6Gz. Point A indicates rise in blood pressure due to baroreceptor reflex.

As a pilot pulls G, he is not aware of these cardiovascular changes. However, if the acceleration is sufficient, a 'greying-out' or loss of peripheral vision occurs. As G is increased, more and more peripheral vision is lost until eventually a state may be reached where the pilot loses all vision and only blackness remains. However, he remains fully conscious and able to hear and speak normally. The reason for this apparent discrepancy is that the eyeball has an internal pressure of

approximately 20mmHg; thus blood flow to the retina will stop at a pressure 20mmHg lower than that required to sustain flow to the brain. The pattern of visual loss, from centre to periphery, is thought to be due to branching of the retinal vessels; the pressure within these vessels is decreased peripherally, as the total cross sectional area of blood vessel increases.

Visual loss is commonly used by aircrew to gauge their tolerance to G. Decreasing peripheral vision is a cue to unload G before unconsciousness occurs. Figure 4 shows the effect of G onset rate on this pattern. Line A represents the process just described, with a period of visual loss preceding unconsciousness. If, however, the G onset rate is much higher (Line B) then there is no preceding period of visual loss and the pilot becomes unconscious with no warning. It is precisely this mechanism that has given rise to the increased incidence of G induced loss of consciousness (G-LOC) seen with the introduction of agile aircraft such as the F-16. In a survey of USAF aircrew in 1984, Pluta (Ref. 3) found that 12% of all aircrew admitted to being unconscious at some time whilst flying on active duty. More significantly, he found that 30% of all F-16 aircrew admitted to suffering G-LOC at some time during flight. To date there have been 18 crashes directly attributable to G-LOC in the United States forces. G-LOC is most likely to occur during air combat manoeuvring, for example in the initial break when evading an aggressor in the six o'clock position: if G-LOC occurs during such a manoeuvre, the unconscious pilot will slacken his grip on the controls and the aircraft will tend to come out of the turn. The attacking aircraft will then easily be able to manoeuvre into a position to take the winning shot.

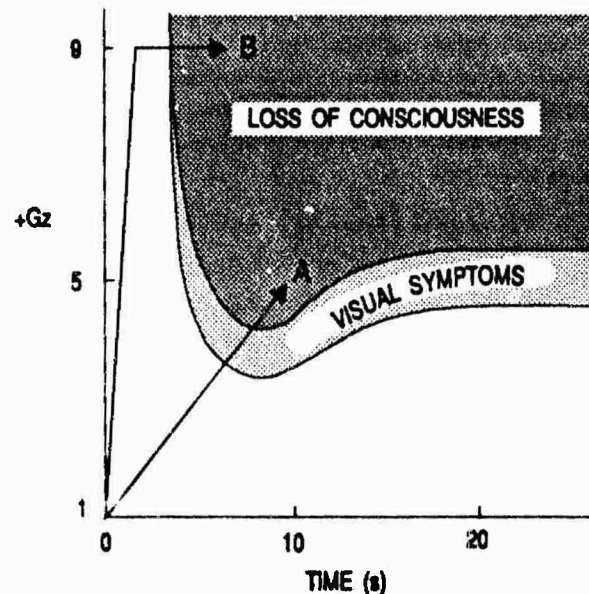

Figure 4. Tolerance to +Gz and effect of onset rate. Line A indicates a moderate G onset rate (1G/s), with loss of consciousness being preceded by greyout and blackout. Line B represents a rapid G onset rate (10 G/s) where loss of consciousness occurs without visual warning.

Respiratory System

When high Gz is sustained, the pattern of gas exchange in the lungs is altered. This may be of sufficient degree to lower the

amount of oxygen carried in the blood, to an extent that function of the brain is adversely affected.

A hydrostatic gradient exists in the blood vessels of the lung, in the same way as in the general circulation. At high +Gz very little (if any) blood flow occurs at the top of the lung due to this gradient, and so any inspired oxygen in this region cannot be transported to the circulation. The increased weight of the lung tissue under +Gz distorts its physical structure, and this can cause airways in the lower part of the lung to close. The balance between ventilation of the lung with gas and perfusion of the lung with blood is therefore different (and less favourable) than that at 1G. In this way the amount of oxygen transferred to the blood may be greatly reduced under high +Gz. Any decrease in arterial oxygen saturation will occur slowly however, and so this mechanism will only cause a significant problem if Gz is sustained for a period of minutes rather than seconds. This situation is becoming more likely as agile aircraft develop greater endurance at high +Gz.

In summary, a normal man is able to tolerate up to about +4Gz with clear vision, by virtue of his physiological blood pressure control. Above this level there is increasing loss of vision until blackout and then unconsciousness occurs. Gross movements of any sort are severely restricted above +6Gz although fine movement is preserved. Prolonged exposure to accelerations of greater than +4-5Gz lead to a fall in the oxygen saturation of arterial blood, which will adversely affect the function of the brain.

Current Anti-G Protection

In current fighter aircraft, the techniques employed to increase aircrew tolerance to +Gz can be divided into 2 groups: the Anti-G Straining Manoeuvre (AGSM) and the conventional anti-G suit. The aim of any anti-G protective system is to:

- increase blood pressure to the brain under +Gz and thus overcome the hydrostatic pressure drop
- reduce pooling of blood in the lower limbs and so encourage more blood to return to the heart.

Anti-G Straining Manoeuvre

Prior to World War II it was noticed that the greying out of vision observed during high +Gz turns could be diminished if the pilot gave a loud shout or grunt during the turn. It was also noticed that tensing of the leg muscles or pushing down on the rudder pedals could similarly improve G tolerance. These actions have since been refined into the Anti-G Straining Manoeuvre. This comprises of a co-ordinated series of muscle tensing and forced expiration whilst the throat is closed (analogous to straining at stool), in a 3-4 second cycle.

The effect of the AGSM on the circulation is twofold. Tensing of the muscles, particularly in the lower limbs,

increases the pressure in the tissues and acts directly on the arterioles to reduce their diameter. When the diameter of these vessels is decreased, the total resistance of the circulation is increased, which in turn elevates the systemic arterial pressure. The increased tissue pressure generated also prevents veins from distending, so blood is less able to pool, and return of blood to the heart is encouraged.

When forced expiration is made against a closed throat such that no air is allowed to escape, the pressure inside the chest cavity increases. This pressure is transmitted directly to the heart and great vessels, and so the arterial pressure of blood contained within these vessels is increased.

Anti-G Trousers

Anti-G trousers were first developed in World War II, when greyout became a problem in the agile fighter aircraft of the day. One of the earliest suits, the Franks Flying Suit, consisted of water filled bladders which covered the lower half of the body from abdomen to ankle. The pilot sat on a reservoir of water connected to the suit by a hose; as +Gz increased and the pilot was forced into his seat, water was displaced from the reservoir and filled the suit, to effectively compress the lower limbs and abdomen. This suit was found to be bulky and cumbersome, and gave an unpleasant sensation akin to floating when filled under G. Consequently, suits inflated by compressed gas were employed instead. The original design has not altered greatly since the 1940s. Most suits are of a 5 bladder design, with 2 calf bladders, 2 thigh bladders and an abdominal bladder (see Figure 5). This allows a fair degree of mobility in the garment, whilst retaining an effective increase in G tolerance.

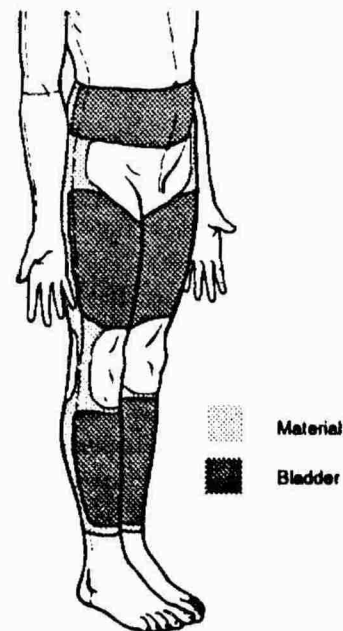

Figure 5. Standard 5 bladder anti-G trouser. Note that bladders are present over anterior surface of limbs and abdomen only (i.e. not circumferential).

Anti-G trousers have a similar physiological action to muscle tensing. The trousers inflate to a given pressure as +Gz is applied, and so compress the tissues of the lower limbs. This causes an increase in peripheral vascular resistance, by constriction of arterioles, and blood pressure is therefore increased. Pooling of blood in the veins is also reduced, as the increased tissue pressure limits distension of the veins. The function of the abdominal bladder is principally to support the heart. Under +Gz the heart may descend in the chest by up to 5cm, thus increasing the head - heart distance and increasing the hydrostatic gradient. The abdominal bladder splints the diaphragm and so prevents this movement of the heart.

Anti-G trouser inflation is governed by the anti-G valve, a Gz sensitive device that supplies a given pressure at a given level of +Gz. The valve usually cuts in at around +2.0G, and must have sufficient flow rate to allow the anti-G trousers to reach 90% of full inflation within 1-2 seconds. Figure 6 shows a typical anti-G valve schedule.

Anti-G valve
outlet pressure
(psi)

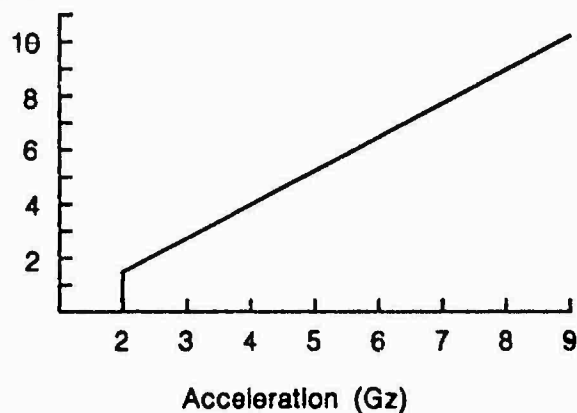

Figure 6. Typical Anti-G valve operating schedule.

Anti-G trousers typically increase G tolerance by about 1.0-1.5G, and in combination with the AGSM, clear vision should be maintained at +8.0G for at least 30 seconds. To this end, centrifuged based high G training, where correct AGSM technique is taught and practised, is employed by many air forces to ensure that aircrew reach this standard.

Advanced Anti-G Protection

The introduction of aircraft with high G onset rates has prompted the development of an improvement on G protective systems which have remained largely unchanged since the 1940s. The new anti-G systems provide protection not only to an increased level of +Gz, but also against the increased G onset rate. They also provide greater endurance for the pilot at high +Gz, to match the improved endurance of agile aircraft at high +Gz. Such systems will be employed in EFA, and are also being retrofitted to F-16 aircraft in the United States Air Force.

Full Coverage Anti-G Trousers

Full coverage anti-G trousers (FAGTs) return to the original anti-G trouser designs of the 1940s which provided cover from abdomen to ankle. G tolerance is increased because a larger surface area of the body is constricted by anti-G trousers, and thus more of the circulation is supported. Figure 7 shows the typical design of FAGTs. Because the lower limbs are entirely surrounded by impermeable bladders, mobility in the garment is impaired compared with current anti-G trousers. Likewise, the area available for heat loss by sweating is reduced, and so aircrew may become uncomfortably hot in the garment. Work is currently in progress to refine FAGTs to reduce these problems. At present, G tolerance is improved by 2.0-2.5G in this type of garment (Ref. 4).

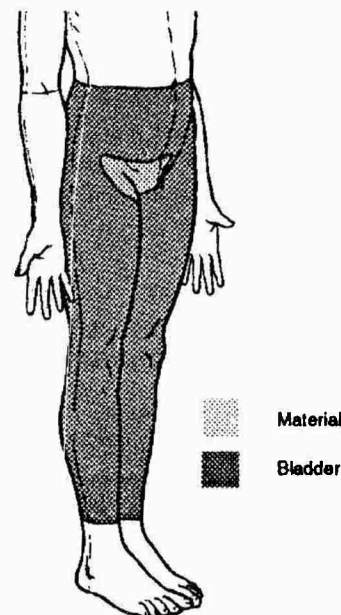

Figure 7. Full coverage anti-G trousers, with circumferential bladders.

Positive Pressure Breathing for G Protection

Positive pressure breathing, the breathing of gas at an increased pressure to that of ambient, has been used for a number of years since the introduction of high altitude flight. Positive pressure breathing has, however, only recently been used for G protection. A specially modified breathing regulator, that is driven from the anti-G valve, is used to supply breathing gas at an increased pressure when +Gz is increased. In a typical schedule, pressure breathing would cut in at +2.0G and then increase at 11mmHg per G to a plateau of 55mmHg. Figure 8 shows such a pressure breathing schedule.

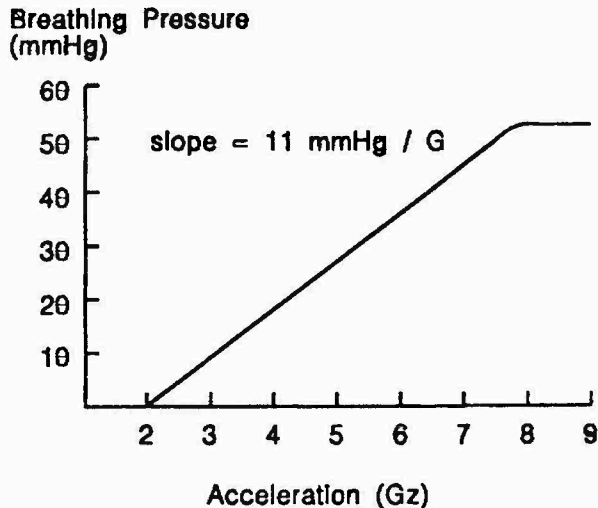

Figure 8. Typical schedule delivered by pressure breathing regulator.

Positive pressure breathing for G protection (PBG) has a similar physiological action to the straining performed in the AGSM. Increased pressure is generated in the chest, and this pressure acts directly upon the heart and great vessels. The pressures are additive, and thus arterial blood pressure is raised by approximately the pressure of the breathing gas supplied. In practice, pressure breathing under +Gz is almost transparent to the user, and is far more tolerable than pressure breathing at 1G. At high breathing pressures, encountered above about +7Gz, speech may become difficult or even unintelligible. This has implications for the operation of direct voice input (DVI) systems, as speech at high +Gz may not be recognised.

In combination with FAGTs, PBG will enable the pilot to tolerate +9G with clear vision. However, unlike the conventional system, little or no straining should be required by the majority of aircrew. This means that endurance at high G should be greatly increased, as the rapidly tiring AGSM is no longer required. Further, the onset of PBG is automatic (unlike the AGSM) and so at high G onset rates, the absence of visual straining clues to the pilot is unimportant. G protection will therefore be supplied automatically: not only will the workload of the pilot be reduced, but the number of G-LOC related accidents should be greatly diminished.

Future G Protection

It has become apparent that the G protection afforded by FAGTs and PBG approaches the maximum possible by such techniques. This is because no further increase in G trouser coverage or inflation pressure is possible. The pressures employed by PBG cannot be increased much further than those already used, as there is a safety margin beyond which damage to lung tissues may result. If protection against higher levels of +Gz is required, an entirely new approach to G protection is required.

The G tolerance of a relaxed man in the seated position is +4.0 - 5.0Gz, as previously explained, due to the hydrostatic

pressure gradient between head and heart. If, however, man is in the fully recumbent position, then his G tolerance is in the order of +8Gx (without any form of G protection). This is because there is no hydrostatic gradient, and blood flow to the brain can continue. In fact the +8Gx limit is imposed by the inability to breathe at higher G levels due to the weight of the chest wall. If PBG is used, then +12-15 Gx can be tolerated. Any effective method of improving G tolerance further therefore relies on moving the long axis of man out of the plane of greatest acceleration (Gz).

It has been shown that reclining the seat by a small degree is not sufficient to improve G tolerance. A seatback angle of greater than 65° is required before a significant improvement in G tolerance is seen. At this angle, the pilot's visibility, particularly rearwards, will be reduced unless the cockpit is sufficiently redesigned; as yet the investment required for this is unacceptable.

In 1954 a Gloster Meteor was adapted by Armstrong Whitworth Ltd to accommodate a prone pilot in the nose of the aircraft. 99 sorties were made over the next two years from the RAF Institute of Aviation Medicine at Farnborough. Figure 9 illustrates the control system of the aircraft: the pilot lies prone, and thus visibility to the rear was almost non-existent. A window in the floor aided landing and take off. Most pilots who flew the Prone Meteor found it not unpleasant to fly in the prone position; the main criticisms were of chest discomfort when lying down under G, and the lack of visibility.

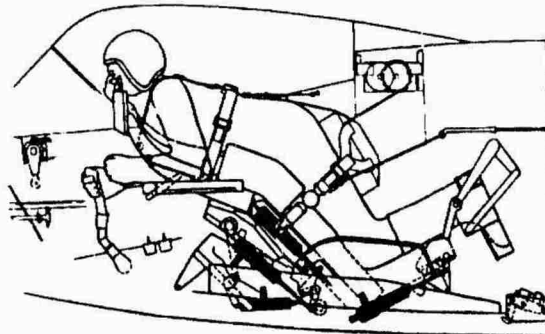

Figure 9. Schematic diagram of Prone Meteor cockpit.

An alternative solution that retains the pilot's visibility from the cockpit, except when pulling +Gz, is the rotating seat. In such a system, the pilot's seat rotates as acceleration is applied such that the resultant force acts in the +Gx, not +Gz plane. Figure 10 demonstrates this principle. Rotation has the advantage that the pilot's orientation is 'normal' for take off and landing, and vision is unrestricted. Further, continuous supine position causes discomfort, and does not protect against Gx forces such as carrier launches. Such a rotating system was proposed as long ago as 1939 (Ref. 6), and various seats have been developed and tested since then. Such seats have never fully met the essential criteria (Ref. 7) which are:

- unimpaired visibility in the direction of the flight path in upright and supinated position, as well as unimpaired vision of the displays
- location of all necessary controls on easily operable hand grips
- reliable means of escape from the aircraft.

Rotating seats have never been employed in production aircraft, because the disadvantages of cost, weight and complexity have outweighed the benefits in terms of improved G tolerance. Soon this may no longer be the case, as current technology enables many of the earlier design problems of these systems to be solved; the use of helmet mounted displays and virtual reality would be of key importance in any future tilting aircraft seat. If further increases in aircraft agility are required, there will be no option but to reconsider cockpit redesign, or the pilot will be unable to fly the aircraft to its full performance envelope.

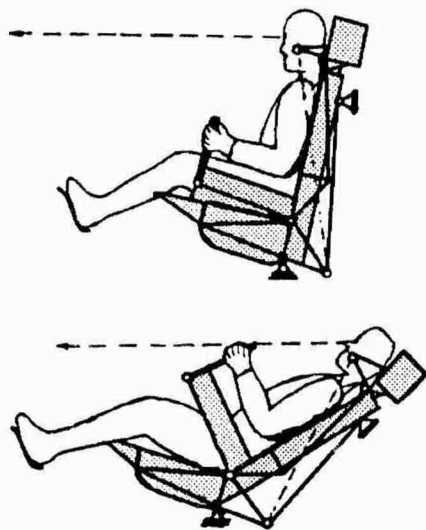

Figure 10. Principle of rotating seat. Note position of sidestick controls maintained; eye level remains at the same height.

Other solutions currently being pursued involve G-LOC detecting devices, which constantly measure various physiological parameters of the pilot to determine his state of consciousness. The attitude of the aircraft in flight is also taken into account, and the software may then assess the likelihood of the pilot being unconscious at any given time. A warning is then given prior to automatic recovery of the aircraft. A number of prototype systems exist, but no NATO air force currently uses such a system. From the aviation physiologist's standpoint, this is the wrong approach - it would be better to prevent G-LOC rather than detect it after the event.

The 'world record' for G tolerance goes to the unicellular organism *Euglena Gracilis*: 50% of a colony immersed in fluid culture survived 212,000G for 4 hours (Ref. 8). Far in the future, it has been suggested that the best way to protect man against the high G environment (including space travel) may be to immerse him entirely in fluid, such that hydrostatic effects will be negated by the counterpressure of the fluid in which he is immersed. Unfortunately, this would also require filling the lungs with fluid to overcome the problems caused by the different density of gas and tissue. Certain fluorocarbon compounds may be suitable for use as a 'breathing liquid', because they combine low viscosity and non-toxicity with high oxygen solubility. A combination of fluid immersion and liquid breathing might offer protection up to at least +30Gz, but aircrew acceptance of this system might be in doubt!

Summary

If there is a perceived role for an agile aircraft which can achieve and sustain greater than +10-12G, consciousness will not be supported with the pilot in conventional (seated) orientation, despite the use of advanced anti-G systems such as full coverage anti-G trousers and positive pressure breathing. Thus design of any such aircraft must, from the outset, involve radically different cockpit orientation to accommodate a prone or supine pilot, or at the very least some form of tilting aircraft seat. The technology to achieve this exists; to produce a practical end product relies on close co-operation between engineers, pilots and aeromedical specialists alike.

References

1. Howard, P., "The physiology of positive acceleration", in *A Textbook of Aviation Physiology* (ed. J. A. Gillies), Pergamon Press, London, UK, 1965, pp 655.
2. Fletcher, D. E., Collins, C. C., Brown, J. L., (1958) Report NADC-MA-5807, U. S. Naval Air Development Center, Pa.
3. Pluta, J. C. LOC survey. *Flying Safety* 1984; 25-8.
4. Prior A R. J. Centrifuge assessment of the +Gz acceleration protection afforded by full coverage anti-G trousers. RAF IAM Aircrew Equipment Report No 572. Sep 1988.
5. Crossley, R. J. and Glaister, D. H., "Effect of Posture on Tolerance to Positive (+Gz) Acceleration", in "Adaptation and Acclimatisation in Aerospace Medicine", AGARD CP 82-71, 1971, pp 6-1 to 6-6.
6. Robertson, D., "Scheme for obviating blacking-out of the pilot in modern high speed aircraft", RAF Flying Personnel Research Committee Report No. 77, Dec 1939.

7. von Beckh, H. J., "Positioning of Aircrews - Ultima Ratio of G Protection?", *Aerospace Med.* 43 (7), July 1972, pp 743-754.
8. Morris, D. P., Beischer, D. B., Zariello, J. J., (1958) Research Report NM-19-00-01 Subtask 1, Report No. 2, U. S. School of Aviation Medicine, Fa.

© British Crown Copyright 1952 MOD

Published with the permission of the Controller of Her Britannic Majesty's Stationary Office

Oculo-Motor Responses and Virtual Image Displays

G.K. Edgar, C. Neary, I. Craig and J.C.D. Pope

Sowerby Research Centre, British Aerospace plc
FPC 267, PO Box 5, Filton, Bristol,
BS12 7QW.
UK

Summary

Virtual image displays are likely to become more prominent in the cockpit, the most common examples being the head-up display (HUD) and, more recently, the helmet-mounted display (HMD). This paper describes a series of experiments highlighting some of the advantages and disadvantages of displays of this type. The first experiments demonstrate that introducing perceived depth differences into displays may improve eye-tracking performance. The second series of experiments illustrates some of the problems with virtual image displays; namely that the eyes may be inappropriately accommodated (focused) when using virtual image displays. The possible consequences of these problems are discussed.

Introduction

A virtual image is defined as, 'an optical image formed by the *apparent* divergence of rays from a point, rather than their *actual* divergence from a point'. What this means is that, although it may be possible to view an object through a lens system and although that object may *appear* to be at a particular distance from the viewer, there is no real object at that distance. Many widely-used instruments such as telescopes, microscopes and binoculars present a virtual image to the user.

Devices which present the user with a virtual image are now used widely in aircraft, the most common of these being the head-up display (HUD). The HUD is used to present symbols or imagery (such as forward-looking infra-red (FLIR)) to the pilot by reflecting images off a combiner glass placed in the pilots line-of-sight. The imagery is usually collimated so that it

appears to lie at, or near, infinity. Thus, in principle, the images presented on the HUD should appear to overlay, and be in the same plane as, the outside world. Obviously the image presented via the HUD must be a virtual image as, although the image appears to be at infinity, the display providing the images is only about a metre away from the pilot.

The advantages of presenting imagery on a HUD are obvious. Important information can be displayed to the pilot without the pilot having to look down into the cockpit (something which is clearly undesirable in, for instance, fast low-level flight). Also, the pilots view of the outside world can be enhanced by projecting, for instance, FLIR imagery onto the HUD. One disadvantage of the HUD is that if the pilot looks away from the combiner, he can, of course, no longer see the information presented on it. One solution to this problem is to head- (or helmet-) mount the combiner so that the information remains in the pilots line-of-sight as the head moves. This has led to the current interest in helmet-mounted displays (HMDs) in military aviation.

Unfortunately, there are some disadvantages to using virtual image displays such as HUDs and HMDs in the cockpit. One disadvantage is that to present the images to the pilot a combiner has to be placed in the line-of-sight. Although the combiner should be almost completely transparent it may still cause problems, and some of these problems will be considered in this paper.

Another problem with HUDs and HMDs results from attempting to present all the information the pilot might need on the display. This may

lead to the display becoming rather cluttered. There are various ways in which a virtual image display could be 'decluttered'. One possibility, given that the apparent distance of the image can be changed is to use depth cues and to have different parts of the image presented at different depths. This may be particularly useful if the user is attempting to track an item on the display - when having the item to be tracked at a different depth to the 'background items' may make tracking easier. An investigation into the eye-tracking of images will also be described in this paper.

Eye-tracking of targets in the same or different depth-plane to the background.

Smooth pursuit eye movements are important for optimal visual performance; they allow one to observe targets moving at slow to moderate velocities. When, for example, a small target begins to move smoothly across one's field of view, in order to continue to see the target clearly a smooth pursuit eye movement must be made i.e., a slow eye movement of approximately the same angular velocity as the target. The accuracy of a pursuit eye movement is usually expressed in terms of the 'gain' (measured as eye velocity/target velocity) of the smooth pursuit eye movement. If the eye tracks the target perfectly then the gain is 1.0. If the eye movement lags behind the target being tracked then the gain is less than 1.0. A stationary contour rich background lying in the same depth plane as a pursuit target is generally found to decrease the gain of smooth pursuit eye movements^{1,2,3,4,5}. This decrease in pursuit gain is usually attributed to conflicting activity within the pursuit and optokinetic (OKN) systems arising from the motion of the background on the retina in the opposite direction to the eye movement. Little, however, is known about the effect on pursuit of a background lying in a different depth plane. Two studies^{6,7} have reported that OKN gain decreases when binocular fixation is not in the plane of field motion. This suggests

that pursuit/OKN conflict may be reduced (and hence pursuit gain increased) when a target and background field lie in different depth planes.

The implications of these findings for HUDs and HMDs is that it may be easier for the user to eye-track a target if it lies in a different depth plane to the background. A series of experiments were conducted to see if this might be the case. There are two ways in which the apparent relative depth of the target and background could be altered. The first and most straight forward way would be to physically move the target or background so that they are separated in 'real' depth. In this case, both the focus (accommodation) of the eyes and also their vergence (the angle at which the eyes are 'turned in' to view a near target) would alter as fixation was changed from the background to the target). Another way of changing the apparent relative depth of the target and background (and this would probably be the easiest method when using a display such as a HMD) would be to alter the disparity between the images of the target and background presented to each eye. This would have the effect of making the target and background appear to be at different depths, although the eyes vergence and accommodation would remain unchanged.

The effects of both these methods was investigated. As the results were similar for both conditions, only the second experiment (changing the apparent relative depth of the target and background by changing disparity) will be described.

Methods

Four subjects with normal binocular vision tracked a small (0.25 deg) sinusoidally oscillating target while the disparity of a dichoptically presented background, optically positioned at the distance of the target, was varied. Identical stationary backgrounds were displayed on laterally placed screens and were viewed through two beam splitters, as in a Wheatstone

stereoscope. Each background consisted of a vertical 0.2 c/deg grating, 20 deg wide x 15 deg high, with a central 2 deg black band within which the target moved. Horizontal disparity of the background was produced by displacing the background displays to the left or right. Several background disparities were used (-2, -1, 0, +1, +2 deg). The optical distance of the target and background screens was fixed at 1 dioptre. Target motion (0.2 Hz; 15 deg peak-to-peak), produced using servomotor controlled mirrors, was viewed binocularly through the beam splitters. The subject's task was to track the horizontal motion of the target as accurately as possible. Binocular eye movements were recorded with a differential IR system. Head position was stabilized by way of a mouthbite.

Mean smooth pursuit gain (the ratio of peak velocity of smooth eye movement to peak velocity of target motion) was determined from the eye velocity records.

Results

The mean smooth pursuit gain as a function of the binocular disparity of the stationary background is shown across subjects in Fig. 1. The figure shows that the smooth pursuit gain had a minimum value (0.75) when the disparity of the background was zero and that for both crossed (+) and uncrossed (-) disparities the pursuit gain increased (up to about 0.9) with the degree of binocular disparity in the background.

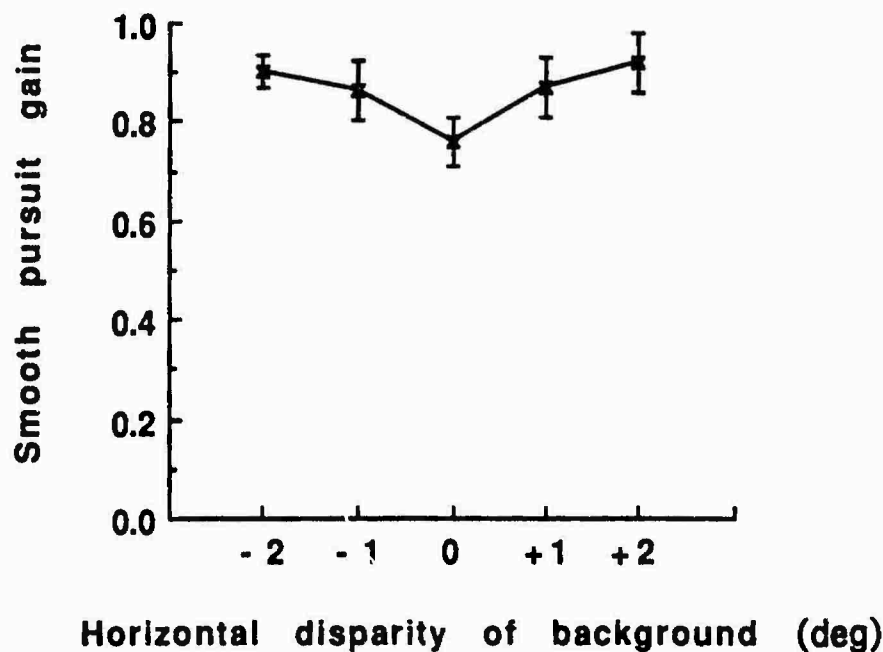

Fig. 1. Mean gain of smooth pursuit eye movements across subjects as a function of the binocular disparity of the stationary background. Target motion: sine-wave, 15 deg peak-to-peak at 0.2 Hz. Target vergence = background vergence = 1 D. Error bars represent ± 1 SD.

Discussion

These results indicate that the relative depth of a background can affect the smooth pursuit eye movement

response. For all subjects, pursuit gain increased with the apparent distance of the background from the target. Thus, the greater the difference in depth between the target and the background, the easier it was for subjects to track the

moving target. Although, more work is needed to examine, for instance, the effect of different types of background, these results suggest that presenting information at different depths may have some benefits.

As already mentioned, similar results were found when the apparent differences in target and background depths were "real". However, this was not the case when the viewing conditions were monocular. Under monocular conditions, physically changing the distance of the target from the background had little or no effect on pursuit gain. This suggests that when binocular cues (disparity) to depth are absent, as in monocular HMDs, target tracking performance may be reduced, especially during air-to-ground operations.

Accommodation and virtual-image displays

When viewing an object at a particular distance the eyes will tend to focus (accommodate) to bring the image into sharp focus. Accommodation is traditionally expressed in dioptres (D) which is the reciprocal of the focusing distance (in metres). There are four main factors (and many subsidiary ones) that may affect the accommodation response. The four main factors are:

Reflex accommodation. The change in accommodation driven by stimulus blur.

Tonic accommodation. In darkness, or when viewing an empty field (such as a clear sky), accommodation lapses to a resting position, typically at a distance of 0.5 - 2.0 m.

Convergence accommodation. If the vergence of the eyes changes, then the accommodation response will also tend to change (and vice versa).

Proximal or Psychic accommodation. The knowledge that there is an object close to the eye may be sufficient to affect accommodation.

If the accommodation level is inappropriate to the distance of the object, then the object will appear blurred and, if it is of low contrast, may be more difficult to detect. It is obviously important, therefore, that a pilot is able to maintain accommodation appropriately. There is some evidence, however, that some of the newer technologies introduced into the cockpit are actually making this more difficult. In particular, virtual-image displays, such as HUDs and HMDs may have an adverse effect on accommodation^{8,9}. HUD imagery is usually collimated so as to appear to lie at, or near, infinity. Theoretically, it should be possible for the pilot to view the HUD imagery and the outside world and for both of them to appear to be in focus. However, considering the factors that influence accommodation (described above) it seems possible that introducing a combiner into the line-of-sight (as is the case in HUDs and HMDs) may have an adverse effect on accommodation.

A series of experiments were conducted to examine some of the factors that may affect accommodation with virtual-image displays.

Visual accommodation to virtual imagery presented in darkness

Perhaps the worse situation for a pilot attempting to maintain accommodation is when there is nothing for the pilot to focus on. This may occur at night or when viewing a clear sky. In this case there is a tendency for accommodation to lapse towards the resting focus. This is usually referred to as night, or empty-field, myopia¹⁰.

When viewing through a HUD, however, there is always some imagery, even though there may be nothing in the 'outside world' for the pilot to focus on. This first experiment examined whether viewing virtual imagery presented against a dark background would provide a sufficient stimulus to maintain accommodation at infinity. Also examined was the effect of a subject actually having to process part of the image, as there have been

some studies suggesting that mental effort may affect accommodation¹¹.

Methods

Accommodation was measured using a laser optometer¹². Eight subjects (4 male, 4 female) were tested. The mean age of the subjects was 30.25 years (range 21 - 36 years). All subjects had acuities of, or better than, 6/6 (with normal correction). Virtual images were presented to the subjects via a beam splitter placed directly in front of the eye. Viewing was monocular.

Three experiments were run in darkness. These were:

1. The subject's dark focus was measured. The subjects' accommodation was measured while they sat in complete darkness and no imagery was presented.

2. Subjects viewed a virtual image (an array of hashes) that had been collimated so as to appear to lie at infinity. This stimulus was chosen because an array of hashes provides a lot of clear, fine, detail which should provide an excellent stimulus to accommodation. In this condition subjects were simply asked to try and keep the hashes in focus while their accommodation was measured. The pattern of hashes was square and subtended 23.4 deg of visual angle. Each symbol subtended 0.95 deg.

3. Words were presented in the centre of the array of hashes at a rate of one every second. The subjects were asked to read the words aloud while their accommodation was measured.

Results

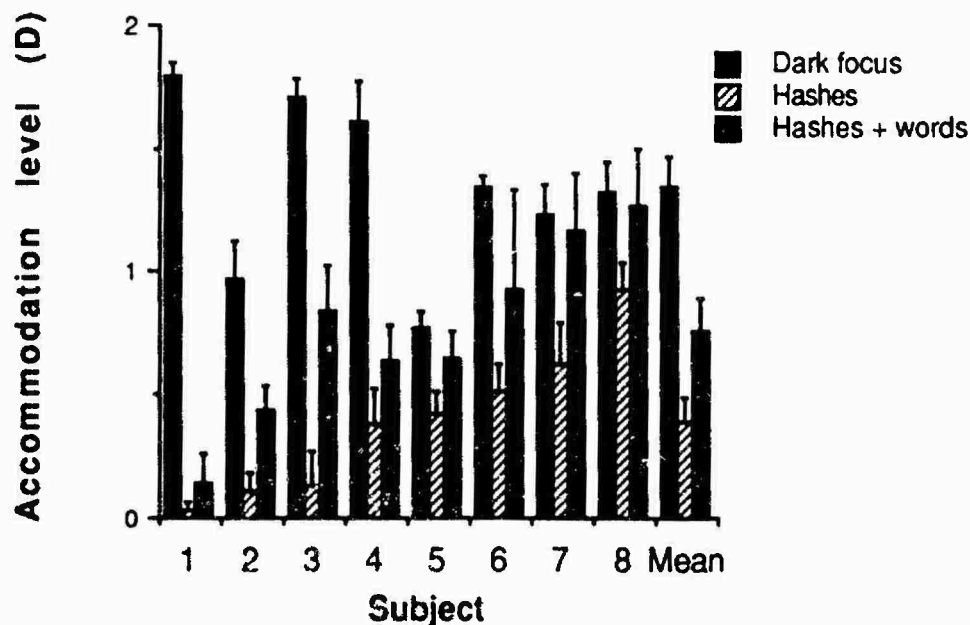

Fig. 2. Accommodation levels for eight subjects: a) In darkness (filled bars) b) Viewing an array of hashes collimated so as to appear to lie at infinity (cross-hatched bars) c) Reading words presented backwards in the array of hashes (shaded bars). A value of zero indicates that the subject was focused at infinity. A value of 2.0 indicates that the subject was focused at 0.5 m. The value for each subject is the mean of four trials. Error bars indicate 1 SD.

The accommodation responses for the eight subjects in each of the three conditions are shown in Fig. 2. The dark focus for almost all subjects was

between one and two dioptres (0.5 - 1 m). When viewing the array of hashes (collimated to infinity) only three out of eight subjects were able to maintain

accommodation at, or near, infinity. Interestingly, when the subjects were asked to process part of the image (by reading words that were presented backwards) all eight subjects showed shifts in accommodation *away* from infinity; i.e. the subjects were all focusing at a closer distance than was appropriate for the stimulus.

Visual accommodation to virtual imagery superimposed on the 'real world'

The previous experiment looked at levels of accommodation when performing different tasks in darkness. Perhaps the most interesting result was the lapse in accommodation away from infinity when the subjects were asked to process the virtual image. However, in the experiment above, the virtual image was the only stimulus to accommodation. The next experiment examined whether similar effects are obtained when the virtual imagery is superimposed on the 'real world'

Methods

Twelve subjects (7 male, 5 female) were tested in this experiment. The mean age of the subjects was 30.4 years (range 24 - 36 years). Accommodation was measured in the same way as described above. In this experiment, however, rather than being tested in darkness the subjects were seated looking out of an open window (the window was open to avoid the possibility of subjects focusing on the actual window). The view from the window was of a brick wall and bushes situated 28 m (which would require an accommodative level of 0.036 D) away from the subject. The wall and bushes should provide a good stimulus for

accommodation, and there was a light fitting on the wall which subjects were asked to use as a fixation point. Three conditions were run. These were the same as those in the first experiment except that the virtual imagery was now superimposed on the outside world. Viewing was monocular. Thus the three conditions were:

1. The subjects were asked view the scene and to try and keep the wall and the light fitting in focus.
2. The array of hashes was superimposed on the outside world view using a beamsplitter. The virtual image was collimated so as to appear at the same optical distance as the wall. Subjects were asked to try and keep the hashes and the wall in focus while their accommodation was measured.
3. Reversed words were presented in the array of hashes at a rate of one a second. Subjects (as in the previous experiment) were asked to read the words aloud.

Results

The accommodation responses for the twelve subjects in each of the three conditions are shown in Fig. 3. In the first two conditions, although some subjects were unable to maintain focus on the wall (one subject focusing at a distance of a little over 1m) most of the subjects were able to maintain accommodation at, or near, infinity (with some subjects even showing a slightly negative accommodation response). However, once again, when subjects were required to process the virtual image (by reading the words) every subject showed an inward lapse of accommodation.

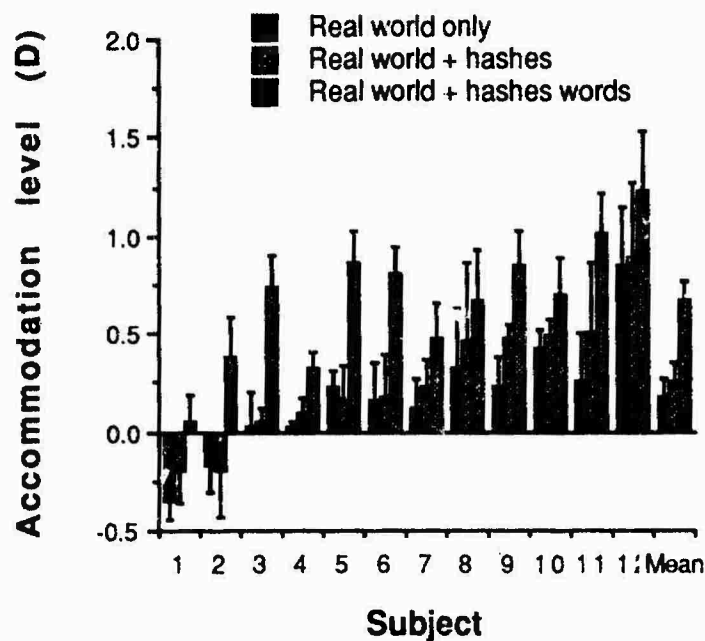

Fig. 3. Accommodation levels for 12 subjects: a) Viewing an outside world scene (filled bars) b) Viewing an array of hashes superimposed on the outside world view (cross-hatched bars) c) Reading words presented backwards in the array of hashes (shaded bars). A value of zero indicates that the subject was focused at infinity. A value of 2.0 indicates that the subject was focused at 0.5 m. The value for each subject is the mean of four trials. Error bars indicate 1 SD.

Discussion

These data indicate that, even if a subject has a good accommodative stimulus to focus on, the level of accommodation may still be inappropriate to that distance. Perhaps more important is the finding that, if subjects are required to actually process a virtual image, then accommodation shows a strong tendency to lapse towards the subject. This happens in darkness and even when the imagery is superimposed on a real world scene that should provide an excellent stimulus to accommodation. The implications of these results for HUD and HMD use are clear. A large amount of information is usually presented on the display - and it is clearly going to be information that the pilot may need to attend to and process (there would be little point presenting it otherwise!).

An important question, therefore, is whether these accommodation problems are likely to cause problems in a 'real life' situation. Available evidence suggests that they may. If a pilot is misaccommodated, then distant objects

in the real world will appear blurred and, if they are of low contrast, may be difficult or impossible to see. A graphic example of an object in the outside world being 'missed' is provided by an incident which occurred in 1976. On a clear, sunny morning a DC-9 collided with a Trident 3 over Yugoslavia. All 176 passengers and crew aboard both aircraft were killed. The Trident was leaving an 11 km long contrail against a bright blue sky - but the crew of the DC-9 gave no indication of having seen the Trident. A subsequent investigation¹³ suggested that a contributory factor may have been that the crew were misaccommodating due to the presence of large window posts in the DC-9 - which were acting to pull accommodation away from infinity.

A loss of sensitivity, however, is not the only undesirable consequence of misaccommodation. Roscoe states that the apparent size of objects is correlated ($r > 0.9$) with the distance at which the eyes are focused¹⁴. Thus, if the eyes are misaccommodated then the perceived size (and distance away) of

objects may be incorrect. This may lead to hard, flat landings and possibly may be a factor in what have been euphemistically described as 'controlled flights into terrain'. Roscoe suggests that such biased judgements may partially account for the fact that one of the most common accidents for helicopter pilots flying with imaging displays is collision with trees - and also the fact that between 1980 and 1985 the USAF lost 73 airplanes in clear weather due to pilot misorientation resulting in controlled flight into terrain (54) or disorientation resulting in loss of control (19) while flying by reference to HUDs.

Thus, it can be seen from these data that there are some important safety issues that need to be considered in the design of virtual image displays such as HUDs and HMDs. Although these displays are undoubtedly an extremely useful aid and allow the pilot to monitor much useful information without the need to look down into the cockpit, it is important that both the potential benefits (such as the possibility of presenting information at different depths) and the potential problems (such as misaccommodation) should be examined if these displays are to realise their full potential.

References

1. Hood (1975) *J. Oto-rhino-lar.* **37**, 65-73.
2. Yee *et al.* (1983) *Invest. Ophthalm. & Vis. Sci.* **24**, 1115-1122.
3. Collewijn & Tamminga (1984) *J. Physiol. (Lond.)* **351**, 217-250.
4. Barnes & Crombie (1985) *Exp. Brain Res.* **59**, 548-558.
5. Keller & Khan (1986) *Vis. Res.* **26**, 943-955.
6. Howard & Gonzalez (1987) *Vis. Res.* **27**, 1807-1816.
7. Howard & Simpson (1989) *Exp. Brain Res.* **78**, 309-314.
8. Roscoe (1987) *Bul. Hum. Fac. Soc.* **30**, 1-3.
9. Iavecchia *et al.* (1988) *Hum. Fac.* **30**, 698-702.
10. Knoll (1952) *Am. J. Optom.* **29**, 69-81.
11. Winn *et al.* (1991) *Ophthalm. Physiol. Opt.* **11**, 335-339.
12. Hennessy & Leibowitz (1972) *Behav. Res. Meth. and Instru.* **4**, 237-239.
13. Roscoe & Hull (1982) *Hum. Fac.* **24**, 659-672.
14. Hull, Gill & Roscoe (1982) *Hum. Fac.* **24**, 311-319.

HUMAN CAPABILITIES AND LIMITATIONS IN SITUATION AWARENESS

Mica R. Endsley, Ph.D., P.E.
 Department of Industrial Engineering
 Texas Tech University
 Lubbock, TX 79409 USA

and

Cheryl A. Bolstad
 Monterey Technologies, Inc.
 Cary, NC 27511 USA

SUMMARY

Achieving high situation awareness (SA) is a major goal in the design of aircraft systems. Efforts are currently underway by a number of individuals who are attempting to address this need through improvements in avionics system design, automation, and the pilot-vehicle interface (PVI). These efforts can be greatly enhanced through an understanding of human capabilities and limitations in achieving SA. This paper presents an identification of those factors which underlie basic human SA capabilities, including key information processing mechanisms, critical human skills, and a discussion of external factors which act to hamper SA. The implications of each of these issues for the design of systems, including PVI and automation efforts, are discussed.

BASIC LIMITATIONS IN ACHIEVING SA

Situation awareness (SA) will be defined here as "*the perception of the elements in the environment within a volume of time and space, the comprehension of their meaning, and the projection of their status in the near future*" [1, 2]. Three major factors — attention, working memory and long term memory — are believed to be critical limits of SA at each of its three levels: perception, comprehension and projection.

The first level of SA involves simply perceiving the needed information. In complex environments, such as the fighter cockpit, this can be quite challenging in and of itself. Attention limitations seriously restrict how much information can be processed simultaneously. Therefore, pilots typically employ a process of information sampling to circumvent this limit by attending to information in rapid sequence following a pattern dictated by long-term memory stores concerning relative priorities and the frequency with which information changes. Working memory also plays an important role in this process, allowing the pilot to modify attention deployment on the basis of other information perceived or active goals. For example, in a study of pilot SA, Fracker [3] showed that a limited

supply of attention was allocated to environmental elements on the basis of their ability to contribute to task success.

Unfortunately, people do not always sample information optimally. Typical failings include: 1) forming non-optimal strategies based on a misperception of the statistical properties of elements in the environment, 2) visual dominance — attending more to visual elements than information coming through competing aural channels, and 3) limitations of human memory, leading to inaccuracy in remembering statistical properties to guide sampling [4]. In addition, in the presence of information overload, a frequent occurrence, pilots may feel that the process of information sampling is either *not sufficient* or *not efficient*, in which case the pilot may choose to attend to certain information, to the neglect of other information. If the pilot is correct in his selection, all is well. However, in many instances this is not the case.

As a highly visible example, reports of controlled descent into the terrain by high performance fighter aircraft are numerous [5]. While various factors can be implicated in these incidents, channelized attention (31%), distraction by irrelevant stimuli (22%), task saturation (18%) and preoccupation with one task (17%) have all been indicated as significant causal factors [6]. Some 56% of respondents in the same study indicated a lack of attention for primary flight instruments (the single highest factor) and having too much attention directed towards the target plane during combat (28%) as major causes. Clearly, this demonstrates the negative consequences of both intentional and unintentional disruptions of scan patterns. In the case of intentional attention shifts, it is assumed that attention was probably directed to other factors that the pilot erroneously felt to be more important, because his SA was either *outdated* or *incorrectly perceived* in the first place. This leads to a very important point. In order to know which information to focus attention on and which information can be temporarily ignored, the pilot must have at some level an understanding about all of it — i.e. "the big picture". This issue will be discussed in more detail later.

The occurrence of perception itself is also affected by the contents of both working memory and long-term memory stores. Advanced knowledge of the characteristics, form, and location of information, for instance, can significantly facilitate the perception of information [7, 8, 9, 10, 11, 12]. This type of knowledge is typically gained through experience, training or pre-mission briefings. Long-term memory stores also play a significant role in classifying perceived information into known categories or mental representations [13], an almost immediate act in the perception process [14].

In simple environments, the perception of even very novel data can be accommodated within the limits of human attention and working memory. In complex environments, however, as both attention and working memory are, in essence, limited systems, the perception of the elements in the environment, the first level of SA, is ultimately dependent on the presence of long-term memory stores indicating which information to attend to and providing for the classification of information into understood concepts and operationally relevant categories for decision making. Without these, the limitations of attention and working memory will seriously compromise SA.

The second level of SA involves comprehending the meaning of the data that is perceived. Comprehension of the situation goes beyond simply being aware of the elements which are present, to include a gestalt type synthesis of disjointed Level 1 elements and an understanding of their significance in light of pertinent operational goals. In the absence of other mechanisms, this process must occur by actively processing the information in working memory. New information must be combined with existing knowledge and a composite picture of the situation developed. Achieving the desired integration and comprehension in this fashion is a very taxing proposition that can seriously overload the pilot's limited working memory and will draw even further on his limited attention, leaving even less capacity to direct towards the process of acquiring new information.

Similarly, projections of future status (the third level of SA) and subsequent decisions as to appropriate courses of action will draw upon working memory as well. Wickens [4] has stated that the prediction of future states imposes a strong load on working memory by requiring the maintenance of present conditions, future conditions, rules used to generate the latter from the former, and actions that are appropriate to the future conditions. A heavy load will be imposed on working memory if it is taxed with achieving the higher levels of situation awareness in addition to formulating and selecting responses and carrying out subsequent actions.

In actual practice, however, long term memory structures developed through experience and training can be used to circumvent the limitations of working memory. For novices, or those dealing with novel situations, decision making in the dynamic flight environment is an arduous task, requiring detailed mental calculations based on rules

or heuristics which place a heavy burden on working memory and attention. Where experience has provided the development of long-term memory structures, most likely in the form of schema and mental models, pattern matching between the perceived elements in the environment and those long term memory stores can occur on the basis of pertinent cues. These long term memory structures can provide the required comprehension and future projection required for the higher levels of SA almost automatically, thus off-loading working memory and attention requirements substantially. A major advantage of these long-term stores is that a great deal of information can be called upon very rapidly, using only a very small amount of attention [15]. When scripts have been developed, tied to these schema, the entire decision making process will be greatly simplified, and working memory will be off-loaded even further.

In summary, then, situation awareness can be achieved by drawing upon a number of mechanisms. Due to limitations of attention and working memory, long-term memory stores may be more heavily relied upon to achieve SA in highly demanding environments. The degree to which these structures can be developed and effectively used in the flight environment (through triggering by salient cues) will ultimately determine the quality of a pilot's SA.

SA SKILLS

Although experience is one vehicle which may allow pilots to overcome the limitations of various processing mechanisms, there is at least anecdotal evidence that a great deal of difference in SA abilities exists between pilots who for all intents and purposes have had the same training and years of experience. Are there then overriding abilities which may lead some to be better at acquiring and processing information, deploying attention or generating good mental models?

To answer this question, a study was instigated by the authors to determine whether any general attributes could be determined that would explain potential individual differences in SA abilities [16]. The study utilized data obtained on twenty-five experienced military fighter pilots. Data was collected in a real-time, high-fidelity man-in-the-loop simulator. The subjects were randomly divided into five teams with four subjects serving on the red side and two subjects serving on the blue side in each team. Each team participated in 24 trials of an air-to-air fighter sweep mission. SA data obtained using the Situation Awareness Global Assessment Technique (SAGAT) [1, 17, 18] was collected from each subject 36 times over the 24 trials.

First, the study sought to determine whether there really are any consistently reliable differences between pilots in achieving SA. For each subject an average SA score was obtained across the 36 SAGAT measurements, based on the accuracy of their knowledge of where enemy aircraft were located. The average SA score varied from .038 to .330 across individuals (with 1.0 representing a perfect

score). An ANOVA performed on this data revealed that neither the specific team the subject was assigned to ($F=.842$, $df=4$) nor the side (red vs. blue) ($F=.071$, $df=1$) were significantly related to the SA score at the $\alpha = .05$ level of significance. This indicates that individual SA scores were relatively independent of these two factors. Individuals did not appear to have better SA if they were assigned to a particular side (even though the blue aircraft had better avionics and capabilities) or if they were assigned to a particular team where some members of that team may have had higher SA. While it is difficult to prove the null hypothesis, the low F values obtained in the ANOVA are rather convincing.

A second analysis was performed to determine whether SA scores were stable within a given individual. While some variance from trial to trial should be expected, particularly when using a random stop procedure such as SAGAT, it was questioned whether, on average, some subjects would do consistently better. To investigate this, the data for three individuals who participated in the study twice (once on each of two teams) and one individual who participated in the study three times (once on each of three teams) were examined. Test-retest reliability scores calculated for each individual subject were .99, .92, .98 and .98 respectively, indicating a high level of stability for SA within subjects. The results of these two analyses support the hypothesis that there are fairly consistent individual differences in SA.

In the second part of this study, a battery of tests was administered to the pilots to determine whether there were any skills that could be related to the individual differences demonstrated. The tests represented abilities that could be measured in each of six primary areas identified as potentially important for SA [19]. These included:

- 1.) Spatial abilities, the degree to which an individual can mentally visualize and manipulate objects spatially and visualize one's own orientation relative to those objects,
- 2.) Attention abilities, specifically attention sharing as needed to achieve SA in a complex environment,
- 3.) Memory, including working memory capacity and the quality and quantity of long-term memory stores,
- 4.) Perception, the ability to rapidly perceive and assimilate new information,
- 5.) Logical/analytical skills which may be useful in searching out information and piecing it together, and
- 6.) Personality, including various factors which have been found to be related to success in pilot training and in problem solving and workload management.

A detailed description of this test battery is reported by Bolstad [20, 21]. In all, 18 tests were administered to the 21 subjects from the above study that were available for further participation. As some tests consisted of more than one subtest or had more than one measure of

success, 31 resultant variables were examined for their relation to SA abilities. The SA scores for each subject were correlated with scores on each variable using a Pearson pairwise correlation matrix. The results are summarized in Table 1.

In this study, three of the four spatial tests showed a moderate correlation with SA ($R = .317$, $.353$, and $-.354$), providing good evidence for the relationship between SA and spatial skills. Of the perceptual tests, reaction time on the most difficult perceptual speed test ($R = -.448$), number of errors on the perceptual speed test ($R = .366$), and reaction time on the most difficult level of the encoding test ($R = -.547$) were all correlated with SA. It is likely that the easier levels of these two tests may not have been sufficiently demanding to provide any discrimination between subjects.

While the correlation between the Raven's Matrices and the SA measure was somewhat low ($R = .243$), two other tests, the Minnesota Form Board test and the Group Embedded Figures Test (GEFT), had moderate correlations with SA ($R = .317$ and $.385$). This is worth mentioning as these three tests were all highly intercorrelated ($R = .576$, $.533$, and $.576$). Although each alleges to measure something different, all appear to tap into the subjects' pattern matching skills, indicating at least some support for the importance of pattern matching.

The attention sharing test provided confusing results. The reaction time data on the two secondary tasks showed very low correlations with SA ($R = -.138$ and $-.250$), however the level of difficulty reached in the primary tracking task was highly correlated with SA ($R = .717$). It would seem most likely that those pilots who possess exceptional tracking skills would be able to devote more of their attention towards the assessment of the situation instead of towards manually flying the aircraft. If this is the case, however, it would be expected that this spare capacity would be reflected in the secondary task scores, which was not the case. Our hypothesis is that perhaps the digit cancellation secondary tasks used were too simple to provide the level of sensitivity needed. More data will be needed to draw any firm conclusions in this regard.

None of the measures of short-term or long-term memory revealed very high correlations with SA. This is not too surprising in the case of long-term memory, as it is doubtful that any of these measures are capable of reflecting either the quality or quantity of long-term stores developed by the experienced subjects in this sample. It may also be that alternate measures of short-term memory, such as memory span, may be more appropriate.

In addition, neither measure of logical/analytical abilities was found to be correlated with the measure of SA used in this analysis. It is likely that such abilities are far more important to the higher levels of SA (comprehension and projection of future scenarios) than they are to knowledge of enemy aircraft location which comprised the SA score used in this study. Further

	VARIABLE	N	MEAN	STD. DEV.	PEARSON'S R
SPATIAL	Revised Minnesota Form Board Test				
	number correct	21	42.76	9.42	.317
	Cube Comparison Task				
	number correct	19	12.90	4.51	.353
	Aerial Orientation Test				
number correct	20	65.15	3.44	.150	
	Maze Task				
	average test time	20	105.12	44.66	-.354
ATTENTION	Time Sharing				
	2-digit cancelation - RT	15	1.36	0.26	-.138
	8-digit cancelation - RT	15	1.43	0.16	-.250
	tracking only - difficulty level	15	4.29	0.75	.717
MEMORY	Immediate/Delayed Memory				
	total test - RT	13	1.05	0.45	.389
	total errors	13	2.73	2.63	-.071
	Biographical				
	age	21	44.28	9.18	-.225
	experience - years	21	16.90	6.26	-.233
	experience - flight hours	21	3619.28	1551.28	-.304
	experience - combat	21	0.52	0.51	-.164
PERCEPTION	Perceptual Speed				
	subtest 1 - RT	14	1.18	0.18	-.041
	subtest 2 - RT	14	1.07	0.17	-.167
	subtest 3 - RT	14	1.07	0.15	-.007
	subtest 4 - RT	14	0.98	0.12	.066
	subtest 5 - RT	14	0.94	0.13	-.448
	total errors	14	9.43	1.56	.366
	total test - RT	14	1.05	0.14	-.128
	Encoding Speed				
	physical subtest - RT	14	0.93	0.17	-.074
	name subtest - RT	14	0.99	0.18	-.295
	categorical subtest - RT	14	1.53	0.32	-.547
	total errors	14	2.57	1.60	-.264
	Perceptual Vigilance				
	RT	18	2.92	3.47	.041
Raven's Advanced Progressive Matrices					
number correct	20	22.15	4.82	.243	
LOGIC/ ANALYTIC	Analytic Test - GRE				
	number correct	21	14.05	4.11	.073
	Risk Taking				
	predominant attitude	20	-	-	-
	Internal Timing				
	average absolute error	14	62.99	22.68	-.074
PERSONALITY	This I Believe	21	4.00	0.00	-
	O'Conner Abstractness Orientation Scale	21	4.00	0.00	-
	Aviator Locus of Control (Rotter)	21	-	-	-
	Group Embedded Figures Test (GEFT)				
	number correct	21	15.76	3.46	.385
	Dot Estimation				
	total test time	17	591.06	322.03	-.418
RT	17	11.06	5.82	-.382	
	number correct	17	45.94	8.99	-.415

Table 1
Correlation Between Individual Attributes and Situation Awareness

research is needed to draw any conclusions on this subject.

Of the personality measures, neither of the measures of cognitive complexity nor locus of control provided sufficient variation for analysis. The GEFT, reportedly measuring field independence, did show a moderate correlation with SA ($R = .385$), however, due to its high correlation with other tests (Raven's matrices and the Minnesota Form Board as discussed above), it is difficult to say just which ability is being tapped. The dot estimation test, reportedly a measure of compulsiveness/decisiveness, was correlated with both SA ($R = -.382$ for RT and $-.415$ for number correct) and the perceptual speed task ($R = .459$ for RT and $-.492$ for number correct). Similarly, it is difficult to say just what the operant attribute is.

Taken as a whole, the study is limited in both its restricted sample size and in the fact that it only examined experienced pilots, thus a great deal of self selection and attrition have probably influenced the range of individual capabilities considered. In addition, it should be noted that some skills might be important to SA in other missions that may not be in the fighter sweep mission examined in this study. Furthermore, only a single component of SA was examined — knowledge of aircraft location. Clearly, much more data based on a broader study is needed to draw any firm conclusions about these skills.

This study does, however, represent the first attempt to determine whether SA truly is an ability at which some people are better than others and to determine which specific skills might lead to these differences. Results point to several skills which appear to be important and which may be improved in the pilot population through either training, selection or design concepts which alleviate the need for superior abilities on these dimensions.

OPERATIONAL CHALLENGES TO SA

Numerous external factors act to constantly challenge the pilot who is seeking to acquire and maintain SA. As discussed previously, the sheer complexity of the environment is not to be underestimated. Over the past 50 years, there has been a dramatic growth in complexity resulting from: 1) increased aircraft speeds and weapons capabilities leading to more rapid dynamics in the rate of change of information and reduced processing and decision time, 2) an explosion of electronics, avionics and weapons systems, each more complex than the last in its functioning and each providing more detailed information than ever before, and 3) a more numerous and capable enemy, greatly increasing the number of external elements to deal with. There are simply more things to attend to, more complexity involved with understanding those things, and less time in which to accomplish all of this.

Associated with the improvements in avionics capabilities is a dramatic increase in the sheer quantity of

information available. Sorting through this data to derive the desired information and achieve a good picture of the overall situation may be no small challenge, depending on how the pilot-vehicle interface is designed to present the information available.

Stressors, such as high workload, noise, and anxiety, that may be encountered in combat situations can act as a challenge to SA as well. The first, and probably most widespread, finding is that under various forms of stress, people tend to narrow their field of attention to include only a limited number of central aspects [22, 23, 24, 25, 26, 27, 28]. A decrease in attention is generally observed for peripheral information — those aspects which attract less attentional focus — under perceived danger [22, 29]. Broadbent [30] found that there was an increased tendency to sample dominant or probable sources of information. Sheridan [31] has termed this effect "cognitive tunnel vision". This is a critical problem for situation awareness, leading to the neglect of certain features in favor of others. In many cases, such as in emergency conditions, it is those factors outside the pilot's perceived "central task" that prove to be lethal.

It has also been found that under stress people will attend to less information [32] [33], particularly through premature closure, arriving at a decision without exploring all information available [32, 34, 35]. Wright [33] furthermore found that subjects under time pressure attended more to negative information. In addition, several authors have found that scanning of stimuli under stress is scattered and poorly organized [34, 35, 36]. Complex tasks with multiple input sources are particularly sensitive to the effects of stressors [37, 38, 39]. It would seem then that stressors significantly effect the early stage of the decision making process that is involved in the recognition and assessment of the situation (SA) by: 1) disrupting scan patterns, 2) adversely influencing *which* elements are attended to, and 3) reducing the *number* of elements attended to.

A second way in which stressors may impact SA is through working memory. Working memory is in high demand during many phases of the decision making process, when novel stimuli must be interpreted and comprehended, a prediction of future states determined, and appropriate actions generated [4]. Many authors have found significant decrements in working memory capacity and retrieval during noise stress and anxiety [40, 41]. The consequences of this effect on working memory will be varied, however. In decision tasks with a high working memory load, such as those requiring a piecing together of information to form the higher levels of SA, a significant impact would be expected. As a great deal of expert decision making and SA may utilize long-term memory structures in a pattern-matching process, however, the effect may be minimal in those cases.

Finally, the technologies employed in the aircraft must be considered. The various improved avionics systems that have been incorporated into the cockpit across the years have all been added with the express desire of improving the quantity and quality of data provided to the

pilot, and thus his SA. Unfortunately an unintended result of this has been the data explosion and information overload currently being dealt with as a bummer to SA.

In characteristic form, engineers and designers are currently trying to rectify this problem with new technological fixes. Suggestions along these lines range from better data integration, to improved display technologies, to new display formats, to automated systems for filtering the data displayed to the pilot in a prioritized manner, to automated systems for reducing pilot workload thus improving SA. In order to guide these efforts into profitable avenues it is worth examining just how the pilot's SA needs relate to each of these endeavors.

DESIGN IMPLICATIONS

PVI Displays - Probably the first thing that can be done to help pilots achieve SA in a demanding environment is to improve the PVI so that the required information can be gleaned with a minimum amount of workload. Unnecessary workload may be typically required to: 1) find needed information somewhere in the maze of screens available, 2) acquire information from a given display format, filtering out unneeded competing information, and 3) integrate low level data or interpolate data to derive the SA information that is needed in the form it is needed in, for decision making.

Design initiatives that seek to minimize such steps should have an immediate pay-off in helping pilots achieve SA in complex environments by reducing demands on the pilots' limited working memories and attentional capacities. In some cases this may involve whole new ways of presenting information, but in many cases this simply involves doing a better job of applying known human factors guidelines. To be successful, design efforts need to focus on presenting the SA information that is needed (as opposed to raw data), particularly at the higher levels of SA — thus minimizing processing requirements, especially for less skilled pilots. Whatever the design approach, at least two major pitfalls need to be avoided.

1.) New system designs need to be examined carefully to insure that certain key pieces of information used as cues for activating relevant long-term memory stores have not been inadvertently eliminated. For example, spatial disorientation in the F-16 has been attributed, in part, to a loss of sensation of movement, as compared to older aircraft [6]. This type of subtle information can be important to SA. This concern may be particularly applicable to efforts involving data integration. Currently pilots draw very important information regarding the reliability of data or what others are likely to know, for instance, from where a piece of data comes from. This qualitative aspect may become obscured by data integration. Care needs to be taken that these sometimes subtle aspects of information are not lost in new designs.

2.) Sometimes design efforts which seek to improve SA of some elements may inadvertently lower SA on other elements. For instance, in a study investigating a three-dimensional display concept, it was found that while SA increased on one dimension (altitude), it simultaneously decreased on two other dimensions (range and azimuth), when compared to SA using a traditional two-dimensional display [42]. In this particular study, the shift was most likely due to a change in the visual orientation provided by the display, making it more difficult to fix reference points in three dimensional space. In many other cases, however, a shift in SA from some elements to others may occur due to changes in attention deployment brought on by the characteristics of the displays. In either case, it is particularly important that such design efforts be systematically and objectively evaluated for their effect on the pilot's overall SA — including both obviously relevant elements and other, seemingly peripheral, elements which might also be affected.

Intelligent Systems - In addition to the use of new displays, the use of artificial intelligence (AI) or expert systems is being investigated as a means of improving SA. Two primary avenues are being explored for this. The first proposes to off-load the overburdened pilot by performing certain functions automatically. Thus, the pilot would theoretically have more resources to apply towards achieving SA and dealing with novel aspects of the situation. This method aims at the workload problem, impacting SA indirectly.

The assumption of certain tasks by automated systems has a long history, thus some data exists on the costs and benefits associated with this approach. Unfortunately, automation of various kinds has been found to produce a whole new set of human problems in the numerous settings in which it has been implemented so far. These problems include:

1.) Increased monitoring load - The automation of functions will leave the pilot with fewer functions to carry out, but with a more complex system to monitor — a function which people do not excel at [43].

2.) Out-of-the-loop performance problems - Numerous studies have shown that humans are slower and less accurate at failure detection when they become passive rather than active decision makers as a result of the automation of functions [44, 45, 46]. It has been suggested that situation awareness is one of the primary factors underlying out-of-the-loop performance problems [47]. As the pilot becomes a passive decision maker, it is hypothesized that situation awareness suffers.

3.) Loss of skills - In relation to the out-of-the-loop syndrome, a loss of skills may also result, rendering pilots less able to perform functions when they do take over manually following an automation failure [48].

4.) Over-trust (complacency) and under-trust - Pilots may possess either too much trust in automated systems, leading to a false sense of complacency and lack of proper monitoring, or a complete lack of trust,

characterized by complete disuse of the system, even when it might be beneficial [48, 49]. This results in suboptimal performance, high workload and a waste of the dollars that went into providing the system.

5.) Increased system complexity - The addition of automation tends to increase system complexity, as not only is the initial system present, but also the new system that automates some function. This means more components to monitor and more systems for the pilot to try to understand - of which automated systems tend to be inherently more complex. Furthermore, there is an increased probability of system failure associated with the increased number of systems, all adding to the complexity of the pilot's job [43].

Each of these factors can act to reduce the effectiveness of newly automated systems, and may even totally negate any advantages. Many problems with fielded systems can be readily traced to a lack of consideration for the humans who operate, maintain and otherwise interact with these systems. Increases in monitoring loads, system complexity, and passive decision making will all tax the pilot's ability to achieve and maintain good SA. It is proposed that the best means of circumventing these challenges to SA is by:

1.) Establishing an optimal *level* of automation or control — The effects of various levels of automation on workload, situation awareness, and overall human performance must be clearly established. Artificial intelligence is not an all or nothing proposition. The level of control and interaction provided the pilot may largely affect his situation awareness, as it impacts the degree to which the pilot is involved in the decision process, and thus performance in detecting system breakdowns and assuming control.

2.) Providing for flexible function allocation — Interface designs should support the need for flexible function allocation. No longer are certain tasks to be assigned to the pilot and others to the system in perpetuity. A more likely occurrence is that such allocations will be fluid over time, with certain functions being passed back and forth as circumstances demand. New interfaces must be designed that will provide the SA needed to adequately support this transition. These interfaces also should support the pilot's need to detect and handle problems encountered at the boundaries of the system when circumstances go beyond the system's programming.

3.) Ensuring proper feedback — Finally, fundamental changes in the amount and type of feedback provided by automated systems have been noted to be crucial [50]. Better methods are needed for determining the exact information (and its preferred format) which needs to be conveyed to the pilot - particularly as some of this information may typically be quite subtle and therefore may be missed in early system design efforts.

The successful implementation of AI will depend on many issues — the need for very different types of skills, the retention of less frequently used skills, and a fundamental change in the type of workload. As intrinsic

features, the increased complexity of these systems and the fundamental changes they induce in the pilot's degree of involvement in decision making (from active to passive) necessitate that SA will need to be directly considered in developing an effective future cockpit.

The second major approach in applying AI to the cockpit attempts to make the pilot's interface with the aircraft more intelligent. This is a relatively new concept made possible by the advancement of AI related techniques. This approach promises to deal with problems — such as experiencing high workloads in sifting through superfluous information or attending to the wrong information — by presenting only the high priority information. It proposes the automatic filtering of data by presenting to the pilot only that which he needs at a particular point in time based on a hierarchy of events and goals and a prioritization of information in relation to these. This method thus aims at the information overload problem, impacting SA directly. To determine how to best implement an information filtering scheme, it is worthwhile to examine what the pilot really needs.

First, the pilot's temporal transition from goal to goal (or task to task) within the timeline of a mission must be considered. Each goal will have certain SA requirements, dictating which information is most important to that goal. Typically, information received will trigger which goals are currently most important. During the course of a mission, the pilot may switch between goals rapidly and frequently, as circumstances dictate (e.g. from find enemies, to evade missile, to assess malfunction, to attack target, to evade missiles, etc..). Information filtering, by definition, seeks to insure that at any point in time, the information is shown that is needed for the pilot's current goals and tasks and "extraneous" information is suppressed so as not to distract the pilot or overload him [51, 52].

What must be recognized is that switching between goals may occur very rapidly, with an almost immediate response required. Pilots do not instantly have SA simply by looking at instantaneously presented information. It takes a certain amount of time to orient oneself to a situation, to ascertain the players and their critical features. Furthermore, SA is developed across a period of time by observation of system dynamics. Things like the tactical intentions of an aircraft, or whether it has seen one's aircraft or not, are not immediately apparent upon looking at a display, but rather are generated by observing the movements of aircraft over time in relation to ownship and other aircraft.

If a filtering concept changes displays and displayed information with the expectation that the pilot should have full SA and be immediately able to react to the situation, there may be problems. Not only will the build up of higher level SA over time be denied, but he will also have to orient himself quickly to a new situation. This is something that will probably require more attention than if he had been allowed to assimilate the same information gradually over time. In addition, if the PVI takes on a mind of its own, changing at will for

the pilot to assimilate and respond to, it may inadvertently require that more attention be directed toward attaining SA in order to keep up with display changes. (What is it doing? Why did it do that? What happened to my display? Where am I in the system?)

Secondly, the pilot needs to be able to respond to not only immediate crises, but to look ahead to what is coming up — to possible situations that are forming (level 3 SA). This allows the prudent pilot to plan ahead to avoid unwanted situations, to develop a tactical strategy for dealing with possibilities, or to prime himself for possible actions thus minimizing reaction time. This is only possible if the pilot can look ahead to develop this higher level of SA. Care must be taken that information filtering schemes do not deny the pilot this highly important information. Filtering out "unimportant" information on the basis of temporal significance can easily lead into this trap.

Thirdly, individual pilot differences must be considered with respect to the formation of information filtering schemes. Individual pilots may need and use different types of information to form their SA [53]. These differences may not only occur between individual pilots, but also across different goals and tasks for the same pilot. It may be that a more experienced pilot relies on not only high priority information to form his SA, but also on less important or highly temporal information which may act as a cue for retrieving schema from long term memory. A less experienced pilot may not have acquired this ability.

Do these arguments indicate that information filtering is inherently a bad idea? Certainly not. They merely point towards all too easy pitfalls which must be avoided. The pilot can best reap the benefits of information filtering if certain principles are incorporated into information filtering schemes.

1.) Keep the pilot informed of the "big picture". Allow him to have a global understanding of the total situation as it develops, in order that he can make better decisions about the parts of it he is currently dealing with. (For example, completely different decisions may be made about an attack by a solitary aircraft than about the same attack if it is known that a whole flight of aircraft are presently bearing down to support that aircraft.) This big picture need not depict great levels of detail, but rather high level information about a broad range of elements, with the capability provided for the pilot to focus in on more detail upon demand. The big picture will also serve as a good backdrop for rapid switches between parts of the picture. This approach should minimize orientation time as pressing parts are brought up by the system to be dealt with.

2.) Secondly, ways of incorporating the pilot effectively into the control loop must be found. The system needs to do certain things *for* the pilot, not *to* him. If he can be incorporated into system decisions — to switch between displays, to block certain things, to show others — his "system awareness" (a subset of SA) will be much better and additional workload involved in tracking

the behavior of an autonomous display system minimized.

3.) Insure that when information gets filtered, those cues which are critical to the pilot for triggering long term memory stores do not get filtered out. If much of SA depends on these stores for comprehension and projection, it would be highly imprudent to block any features which will call up the relevant information from memory. Furthermore, individual pilot differences must be considered. It may be that more experienced pilots will require one type of filtering scheme and less experienced pilots another in certain situations, with global filtering schemes appropriate at other times. The trick here, of course, is in being able to identify *a priori* just what the key features are. Unfortunately, sometimes this may not be apparent without detailed testing.

4.) Lastly, information filtering should not be employed as a magic wand that will cure all information overload problems. Sometimes simpler, although not as sensational, solutions may be better. For instance, a tremendous amount can be accomplished by simplifying and better integrating information and getting it into the format that is needed. Make sure the information presented is "SA oriented" — what the pilot needs to see — instead of "technology oriented" — what the black box readily outputs. Better PVI's can also be employed to deal with known perceptual problems. For instance, if stressors and workload destroy scan patterns and information input, minimize the effects by providing integrated displays. Make the really important things obvious and attention grabbing.

Many of the solutions to current problems can be met by simply doing a better job of applying known human factors guidelines or by using new technologies to get around attention limitations (e.g. speech systems, helmet mounted displays, sound localization, etc...). Only after the simple things have been accomplished should more complex solutions such as AI be implemented. Not only does this make fiscal sense (in terms of dollars and manpower), but it is also safer. The difficulties discussed in this paper may be serious ones. It is probably best to avoid the risk of running foul of them unless necessary, and, even then, do not expect a panacea. Information filtering strategies, if implemented with caution, may however provide a useful mechanism for aiding the pilot when more conventional means fall short.

REFERENCES

1. Endsley, M. R. (1987). SAGAT: A methodology for the measurement of situation awareness (NOR DOC 87-83). Hawthorne, CA: Northrop Corporation.
2. Endsley, M. (1988). Situation Awareness Global Assessment Technique (SAGAT). Proceedings of the National Aerospace and Electronics Conference (NAECON). New York: IEEE.

3. Fracker, M. L. (1989). Attention gradients in situation awareness. In Situation Awareness in Aerospace Operations (pp. 6/1-1/10). Copenhagen, Denmark: NATO - AGARD.
4. Wickens, C. S. (1984). Engineering psychology and human performance. Columbus, Ohio: Charles E. Merrill Publishing Co.
5. McCarthy, G. W. (1988). Human factors in F16 mishaps. Flying Safety, May, 17-21.
6. Kuipers, A., Kappers, A., van Holten, C. R., van Bergen, J. H. W., and Oosterveld, W. J. (1989). Spatial disorientation incidents in the R.N.L.A.F. F16 and F5 aircraft and suggestions for prevention. In Situational Awareness in Aerospace Operations (pp. OV-E-1 - OV-E-16). Copenhagen, Denmark: NATO - AGARD.
7. Posner, M. I., Nissen, J. M., and Ogden, W. C. (1978). Attended and unattended processing modes: The role of set for spatial location. In H. L. Pick and E. J. Saltzman (Eds.), Modes of Perceiving and Processing (pp. 137-157). Hillsdale, NJ: Erlbaum Associates.
8. Barber, P. J., and Folkard, S. (1972). Reaction time under stimulus uncertainty with response certainty. Journal of Experimental Psychology, 93, 138-142.
9. Davis, E. T., Kramer, P., and Graham, N. (1983). Uncertainty about spatial frequency, spatial position, or contrast of visual patterns. Perception and Psychophysics, 5, 341-346.
10. Humphreys, G. W. (1981). Flexibility of attention between stimulus dimensions. Perception and Psychophysics, 30, 291-302.
11. Palmer, S. E. (1975). The effects of contextual scenes on the identification of objects. Memory and Cognition, 3, 519-526.
12. Biederman, I., Mezzanotte, R. J., Rabinowitz, J. C., Franolin, C. M., and Plude, D. (1981). Detecting the unexpected in photo interpretation. Human Factors, 23, 153-163.
13. Ashby, F. G., and Gott, R. E. (1988). Decision rules in the perception and categorization of multidimensional stimuli. Journal of Experimental Psychology: Learning, Memory and Cognition, 14(1), 33-53.
14. Hinsley, D., Hayes, J. R., and Simon, H. A. (1977). From words to equations. In P. Carpenter and M. Just (Eds.), Cognitive processes in comprehension Hillsdale, N.J.: Erlbaum.
15. Logan, G. D. (1988). Automaticity, resources and memory: Theoretical controversies and practical implications. Human Factors, 30(5), 583-598.
16. Endsley, M. R., and Bolstad, C. A. (1992). Individual differences in pilot situation awareness. Manuscript submitted for publication.
17. Endsley, M. R. (1989). A methodology for the objective measurement of situation awareness. In Situational Awareness in Aerospace Operations (pp. 1/1 - 1/9). Copenhagen, Denmark: NATO - AGARD.
18. Endsley, M. R. (1990). Situation awareness in dynamic human decision making: Theory and measurement (NOR DOC 90-49). Hawthorne, CA: Northrop Corporation.
19. Endsley, M. R. (1988). A construct and its measurement: The functioning and evaluation of pilot situation awareness (NOR DOC 88-30). Hawthorne, CA: Northrop Corporation.
20. Bolstad, C. A., and Rodriguez, S. L. (1991). Evaluation of Pilot Attribute Measures (NOR DOC 90-01). Hawthorne, CA: Northrop Corporation.
21. Bolstad, C. A. (1991). Individual pilot differences related to situation awareness. Proceedings of the Human Factors Society 35th Annual Meeting (pp. 52-56). Santa Monica, CA: Human Factors Society.
22. Bacon, S. J. (1974). Arousal and the range of cue utilization. Journal of Experimental Psychology, 102, 81-87.
23. Baddeley, A. D. (1972). Selective attention and performance in dangerous environments. British Journal of Psychology, 63, 537-546.
24. Bartlett, F. C. (1943). Fatigue following highly skilled work. Proceedings of the Royal Society (B), 131, 147-257.
25. Callaway, E., III, and Dembo, D. (1958). Narrowed attention: A psychological phenomenon that accompanies a certain physiological change. AMA Archives of Neurology and Psychiatry, 79, 74-90.
26. Davis, D. R. (1948). Pilot error. London: HMSO.
27. Eysenck, M. W. (1982). Attention and arousal: cognition and performance. Berlin: Springer-Verlag.
28. Hockey, G. J. R. (1970). Effect of loud noise on attentional selectivity. Quarterly Journal of Experimental Psychology, 22, 28-36.

29. Weltman, G., Smith, J. E., and Egstrom, G. H. (1971). Perceptual narrowing during simulated pressure-chamber exposure. Human Factors, 13, 99-107.
30. Broadbent, D. E. (1971). Decision and stress. London: Academic Press.
31. Sheridan, T. (1981). Understanding human error and aiding human diagnostic behavior in nuclear power plants. In J. Rasmussen and W. B. Rouse (Eds.), Human detection and diagnosis of system failures. New York: Plenum Press.
32. Janis, I. L. (1982). Decision making under stress. In L. Goldberger and S. Breznitz (Eds.), Handbook of stress: Theoretical and clinical aspects (pp. 69-87). New York: The Free Press.
33. Wright, P. (1974). The harassed decision maker: Time pressures, distractions, and the use of evidence. Journal of Applied Psychology, 59(5), 555-561.
34. Keinan, G., and Friedland, N. (1987). Decision making under stress: Scanning of alternatives under physical threat. Acta Psychologica, 64, 219-228.
35. Keinan, G. (1987). Decision making under stress: Scanning of alternatives under controllable and uncontrollable threats. Journal of Personality and Social Psychology, 52(3), 639-644.
36. Wachtel, P. L. (1967). Conceptions of broad and narrow attention. Psychological Bulletin, 68, 417-429.
37. Jerison, H. J. (1957). Performance on a simple vigilance task in noise and quiet. Journal of the Acoustical Society of America, 29, 1163-1165.
38. Jerison, H. J. (1959). Effects of noise on human performance. Journal of Applied Psychology, 43, 96-101.
39. Broadbent, D. E. (1954). Some effects of noise on visual performance. Quarterly Journal of Experimental Psychology, 6, 1-5.
40. Mandler, G. (1979). Thought processes, consciousness and stress. In V. Hamilton and D. M. Warburton (Eds.), Human stress and cognition: An information-processing approach. Chichester: Wiley and Sons.
41. Hockey, G. R. J. (1986). Changes in operator efficiency as a function of environmental stress, fatigue and circadian rhythms. In K. Boff, L. Kaufman, and J. Thomas (Eds.), Handbook of perception and performance (pp. 44/1- 44/49). New York: John Wiley.
42. Endsley, M. R. (1989). Tactical simulation 3 test report: Addendum 1 situation awareness evaluations (81203033R). Hawthorne, CA: Northrop Corporation.
43. Wickens, C. D. (1992). Engineering Psychology and Human Performance (2nd ed.). New York: Harper Collins.
44. Wickens, C. D., and Kessel, C. (1979). The effect of participatory mode and task workload on the detection of dynamic system failures. IEEE Transactions on Systems, Man and Cybernetics, 13, 21-31.
45. Wickens, C. D., and Kessel, C. (1980). The processing resource demands of failure detection in dynamic systems. Journal of Experimental Psychology: Human Perception and Performance, 6, 564-577.
46. Young, L. R. A. (1969). On adaptive manual control. Ergonomics, 12, 635-657.
47. Endsley, M. (1987). The application of human factors to the development of expert systems for advanced cockpits. Proceedings of the Human Factors Society 31st Annual Meeting (pp. 1388-1392). Santa Monica, CA: Human Factors Society.
48. Wiener, E. L., and Curry, R. E. (1980). Flight deck automation: Promises and problems. Ergonomics, 23, 995-1011.
49. Danaher, J. W. (1980). Human error in ATC system operations. Human Factors, 22(5), 535-545.
50. Norman, D. A. (1989). The problem of automation: Inappropriate feedback and interaction not overautomation (ICS Report 8904). La Jolla, CA: Institute for Cognitive Science, U. C. San Diego.
51. O'Shannon, D. (1986). Expert systems in EW. DS & E March, 19-25.
52. Morishige, R. I., and Retelle, J. (1985). Air combat and artificial intelligence. Air Force Magazine, October, 91-93.
53. Sullivan, C., and Blackman, H. S. (1991). Insights into pilot situation awareness using verbal protocol analysis. Proceedings of the Human Factors Society 35th Annual Meeting (pp. 57-61). Santa Monica, CA: Human Factors Society.

OPERATOR AND AUTOMATION CAPABILITY ANALYSIS: PICKING THE RIGHT TEAM

R.M. Taylor
S.J. Selcon

RAF Institute of Aviation Medicine
Farnborough, Hants. GU14 6SZ, UK

1. SUMMARY

This paper provides a review of the role of operator and automation capability analysis in aircrew systems design. We chart the changing perceptions of human and machine functionality with increasing machine capability, from early pilot-in-the-loop control, through to the division and sharing of responsibilities for systems management and mission problem solving. Concepts for the integration of human and machine resources in the performance of physical and cognitive tasks, including decision-making, are discussed in the context of developments in machine intelligence. Operator capability and task analysis, and the modelling of human performance, are seen to have developed from providing tools for system design, to giving critical support for real-time dynamic function allocation in advanced adaptive systems. A model of cooperative teamwork, with the machine conceived of as an electronic-crew teaming resource, is proposed as broad framework for thinking about future adaptive systems requirements. We report the results of a recent study of human-electronic crew teamwork with RAF Harrier and Tornado aircrew. The results provide evidence for the validity of the teamwork model, and indicate directions for extending the capability for cooperative functioning in future aircrew adaptive systems.

2. INTRODUCTION

2.1. Human Engineering in Initial Systems Design

Standard procedures for the application of human engineering to advanced aircrew systems design, now documented in NATO STANAG 3994 AI (1), and in equivalent National defence standards, require the following as part of initial system analysis:

- (1) Identification of the functions to be performed by the system in order to meet mission requirements.
- (2) A review of the potential capabilities of the human system and equipment components.
- (3) Allocation of each system function to human, hardware, or software system components, or combinations thereof.

Logically, the capability of the system components should determine the functions assigned to them for performance. Analysis of operator capability includes measurement of aptitude, training and human

engineering parameters. In conducting an analysis of potential operator capability, special emphasis is required to be placed on identifying capabilities which are unique to humans, i.e. capabilities which can not be achieved by machines. In conducting subsequent function allocation, particular attention needs to be paid to those functions which may be performed by either humans, hardware or software. Decisions resulting from these analyses ultimately lead to the definition of the tasks to be performed by the operator, the task loading, and the task information and control requirements. Thus, identification of areas of both unique and shared human and machine capabilities are key elements of the early system design process.

2.2. Potential Operator Capability Analysis

Prediction and specification of potential operator capability is a relatively immature and imprecise science. This makes operator capability analysis a potential weak link in the human-systems design process. Designers of aircrew systems traditionally have had to rely on the judgement of operator representatives, such as test aircrew, who have the difficult task of predicting the capability of the "average pilot or navigator". This approach is untenable when designing new systems for an unspecified operator or target audience. A more comprehensive analysis would involve formal, systematic consideration of the trade-offs between aptitude, training and human engineering variables (e.g. level of automation/aiding). The aim is to reduce costs and increase benefits for mission performance. The problem is that human performance data is often inaccessible, insufficient and not in a form that readily supports system design decision-making. Also, aptitude and training analyses have traditionally been conducted independently, and not as an integrated part of the system design process, along with human engineering considerations. Considerable effort has been expended recently to address these problems through systems procurement initiatives, such as the Army MANPRINT programme (2), the USAF IMPACTS and US Navy HARDMAN programmes (3), and the creation of improved human performance data bases and associated designers aids (4).

In a perfect system, the supply of human resources, maximised by aptitude and training parameters and facilitated by human engineering, is matched to the mission performance task demands, which are controlled by human engineering, at minimum cost and optimal

value. The relationship between the quality of performance and the quantity of human resources invested in a task needs to be understood, with particular attention to the effects of task difficulty (demand) and automaticity with skill development. Human engineering can assist when performance is limited by the provision of data (data-limited performance). Aptitude and training are relevant when performance is restricted by the supply of resources (resource-limited performance).

2.3. Task Analysis and Workload Prediction

Human-engineering methods are available for decomposing tasks in order to predict and control attentional demands, resolve task conflicts and avoid operator overload. These human engineering task analysis methods use relatively simple models of operator performance-resource functions, with levels of representativeness necessary and sufficient for human-engineering purposes (e.g. VACP), but more elaborate models are available, with associated increased computational complexity e.g. TOSS/TAWL, MHP/GOMS, HOSS, WINDEX (5). CREWCUT is probably the most advanced model of this kind. It is based on the multiple resource theory of attention and generates prediction of workload with automation (6). Increased complexity will be needed to account for aptitude and training parameters such as processing ability, practice, automaticity and knowledge acquisition variables. A common performance-resource model and associated taxonomy is required, with a broader task-description language for systematically linking human resource capabilities to mission-performance task demands, incorporating all the features required for human-engineering analysis, with the addition of aptitude and training parameters.

2.4. Increasing Automation Capability

Developments in machine capability through advances in computers, have extended the boundaries of shared capability between humans and machines to include previously uniquely human functions, such as pattern recognition and cognitive reasoning or "thinking". In advanced systems, capability analysis and function allocation will require performance modelling and a task description language that is common to both human and machine system components at increasingly higher cognitive levels. A review of the development of function allocation with advancing machine capability can give some insights into the nature of this changed requirement, and also can serve to highlight areas of uncertainty and provide some pointers for the direction of future research.

3. TRANSFER OF TASKS: MANUAL TO AUTOMATIC CONTROL

3.1. Manual Control

Aircraft control traditionally has been the most pressing problem for aeronautical systems design. Consequently,

control of aircraft systems has been the principal paradigm governing the design of the pilot-aircraft interface (7). In early aircraft, manual control was the only option for achieving safe take-off and landing, and for maintaining stable directional flight. The design of the pilot interface was primarily a problem of providing a closed-loop negative feedback control system with the pilot as the adaptive element.

3.2. Automatic Control

Subsequent increases in aircraft capability, systems complexity and the number of sub-system control tasks have necessitated that many aircraft operations be carried out under automatic control in order to avoid unacceptable aircrew workload. In addition to the need to contain pilot workload, transferring tasks and functions from humans to machines was the logical result of exercising the division of labour in human-machine systems on the basis of the relative advantages of humans and machines. Tasks and functions would be allocated to machines if machines were able to perform them better and more cost effectively. Technology advances made it possible for many operations, previously controlled manually by humans, to be controlled by machines, with the human relegated to the role of monitoring task performance, or as a back-up in case of equipment malfunction or failure.

3.3. Performance-Based Function Allocation

One of the first attempts to describe human-machine differences for the purposes of function allocation was made by Fitts (8). Fitts provided listings of functions that humans were relatively good at, and what therefore should be reserved for human manual control, and listed functions that machines were more capable of performing, and what therefore were candidates for automation with human monitoring. The following are examples of Fitts' principles.

Humans surpass machines:

1. Ability to detect small amounts of visual or acoustic energy.
2. Ability to perceive patterns of light or sound.
3. Ability to improvise and use flexible procedures.
4. Ability to store very large amounts of information for long periods of time and recall relevant facts at the appropriate time.
5. Ability to reason inductively.
6. Ability to exercise judgement.

Machines surpass humans:

1. Ability to respond quickly to control signals, and to apply great force smoothly and precisely.
2. Ability to perform repetitive, routine tasks.
3. Ability to store information briefly and then erase it completely.
4. Ability to reason deductively including computational ability.

5. Ability to handle complex operations, e.g. do many different things at once.

Fitts also advised that in general, human tasks should provide activity and should be intrinsically interesting. Furthermore, he recommended that machines should monitor humans rather than the converse, because humans are not reliable at monitoring.

3.4. Limitations

Advances in machine capability, particularly through the development of computers, soon invalidated these early comparisons. But the "Fitts Lists" approach to allocation of function was limited from the outset. This was because it relied on comparing differences in abilities which could be quantified. The important distinctions between humans and machines are qualitative and not comparable (9). Furthermore, human performance data are rarely in a form to support decisions on human-machine function allocation. Where there is a real choice between human and machine implementation of functions, design decisions are based on analyses of the cost-benefits of human and machine performance, including considerations of operator skill level, training and workload, and on equipment development, installation and maintenance costs, and not on relatively simplistic notions of which agent performs a particular task or function the best.

4. CHANGE OF FOCUS

4.1. Preserving Flexibility

In practice, humans and machines are complementary rather than competitive. The principal advantages of humans are that they are flexible and adaptive. These characteristics can not be described numerically.

In 1974, Singleton (10) maintained that the real difference between human and machine performance is what is generally called intelligence: "the machine has none and the human always has some". What constitutes intelligence is debatable. However, intelligent behaviour is now no longer regarded as necessarily a uniquely human characteristic. With advances in computer technology, machine or artificial intelligence has become a recognised form of automation technology. Notwithstanding, key aspects of intelligent behaviour which enable humans to deal with the unpredictable, such as versatility, flexibility and adaptability, are difficult to achieve with machines. Machines are characteristically more reliable and consistent. Only in exactly specified and predictable tasks will the consistency of machines point clearly to a machine-only solution.

4.2. Preserving Authority

Singleton also argued that certain functions, such as goal-setting, goal-switching and strategy switching, necessarily should be reserved for humans to preserve

the basic human-machine relationship. Responsibility for generating goals provides top-level control of systems functioning, it determines who is in charge and it dictates the form of the human-machine "trans-cockpit authority gradient". Generation of goals may be eventually the only uniquely human function of human-machine systems.

4.3. Human-Centred Design

One solution to function allocation is to let machines perform all that can be done, at reasonable cost, leaving human versatility to fill in the functional gaps. But this approach does not make full use of human advantages for flexibility and adaptability that can be valuable in the operation of complex, dynamic systems. The highly dynamic nature of the flight environment requires an approach to system design best described as human-centred, which recognises the human operator as the essential adaptive element. A better solution for highly dynamic systems is one where the human operates as the functional "elastic glue" that holds the system together, where the human carries out or delegates functions to the machine as necessary, in accordance with the demands of the task situation. The supervisory control paradigm goes some way towards achieving these objectives.

5. DELEGATION OF FUNCTIONS: SUPERVISORY CONTROL

5.1. Outside the Loop

The concept of supervisory control describes a solution to man-machine system design where the primary tasks of humans are to monitor the functioning of the system, and to detect, diagnose and correct system malfunctions. The human is normally outside the active control loop, leaving normal routine system control to automatic processes, whilst retaining the power to intervene with manual control, if necessary. The human is elevated to the status of system manager, with the flexibility to determine function allocation and to delegate tasks for autonomous machine operation (11).

5.2. Applications for Supervisory Control

The supervisory control model was originally presented as a solution to the problems of designing interfaces for long distance robotic teleoperations (12). It has been proposed since to guide the design of other systems usually with long system response times, such as nuclear power plants. More pertinently, it has been used to characterise recent approaches to civil flight-deck interface design in which the commercial pilot has become increasingly cast in the role of system monitor and system supervisor.

5.2. General Model

One general model for supervisory control distinguishes four hierarchical levels of functioning (13). These four levels are as follows:

- (1) The actual tasks to be performed.
- (2) "Dumb" controlled elements.
- (3) An "intelligent" computer-controlled element interfacing with the human
- (4) The human operator who monitors the system mostly affects tasks indirectly, and sets system goals.

Cognitive and computational tasks are broadly allocated to the three higher levels according to knowledge-based (level 4), rule-based (level 2), and skill-based (level 3) behaviour requirements.

5.2. Decision Taxonomy

A taxonomy for the allocation of decision functions between humans and computer, based on a general model of supervisory control is described by Sheridan & Verplanck (14). This taxonomy divides human-computer decision-making into ten levels of automation, ranging from the human making and actioning all the decisions, to where the computer does the same and only informs the human if it chooses to do so. The levels in between are characterised in terms of human or computer responsibility for six behavioural elements or functions (requests, gets, selects, approves, starts and tells options and actions). As the computer assumes more responsibility and carries out more of the behavioural elements, its role changes from merely a "tool" or decision aid that predicts the consequences of decisions (levels 2,3), to that of an "assistant" or decision-support system (levels 4 to 6), to a full associate of the human (levels 7,8), and finally to the role of autonomous agent (levels 9,10).

5.3. Standard Allocation

In the supervisory control model, goal definition and decision evaluation are usually reserved for humans, whilst other high level cognitive and computational functions are shared (e.g. situation assessment, resource and action assessment). This "standard allocation" may change according to factors such as human-computer system reliability, uncertainty about characteristics (goals, knowledge, action options and outcomes, desirability of outcomes) of decision situations ranging from calculations to problems, dilemmas, nightmares (15), and the cognitive capabilities of the human and computer.

5.4. Limitations

The problem with the supervisory control paradigm for the cockpit interface in military aircraft is that the human is still largely in a monitoring role. Wiener and Curry (16) highlighted the inappropriateness of placing the pilot in a monitoring role when evidence clearly points to the fact that humans are particularly poor at monitoring and detecting failures. Egglestone (7) identified three interface design problems with the supervisory control model that present problems for the

aircraft pilot. Firstly, humans are not reliable monitors and experience difficulty maintaining alertness and vigilance over time without active involvement in the system's operation. Secondly, faults and malfunctions, and their causes, are difficult to communicate to a supervisor outside the active control loop. Thirdly, rapid human intervention in an emergency is difficult to achieve when normally outside the control loop because the pilot will have a poorly developed mental model of system functioning. The military flight environment requires rapid decisions and short response times. The supervisory control model is not optimised for operating in highly dynamic environments.

6. CO-OPERATIVE FUNCTIONING: MISSION PROBLEM SOLVING

6.1. Machine Intelligence

Advances in computer technology have increased the ability of machines to emulate human cognitive functioning. Whereas human cognitive capabilities are relatively fixed, computers are rapidly increasing in capabilities such as pattern recognition and reasoning. Significant developments have occurred in machine or artificial intelligence (MI/AI), in particular expert systems and knowledge-based systems. These use symbolic methods, heuristic reasoning and neural networks rather than algorithmic, deterministic and stochastic computational procedures. These developments have provided machines with the capability to perform complex routine tasks autonomously, such as target recognition and sensor fusion, and more importantly, to assist the pilot in the solution of problems external to the system i.e. mission problems, such as route planning and navigation. Machine intelligence can now be expected to offer support in making decisions, as well as off-loading tasks from aircrew in order to reduce operator workload.

6.2. Electronic Crewmember

In the concept of "distributed intelligence"(17), goal-directed cooperative work is achieved by the computer operating as an intelligent partner or co-worker, functioning as a full associate of the human. The Electronic Crewmember or EC, introduced by Moss et al (18), conceives of the computer and avionics equipment as a mechanistic pilot associate operating across all systems. They argued that in a "blended" configuration, the human-machine system could allow the pilot to operate at a rule-based level, with the EC handling skill-based behaviour and formulating problems and proposing solutions to problems that would otherwise require knowledge-based behaviour, each of which present difficulties for the pilot alone.

6.3. Virtual Symbiosis

These developments in machine cognitive reasoning capability have the potential to go a long way towards achieving perhaps the ideal human-machine relationship,

namely a cooperative partnership, with symbiotic and synergistic coupling in performing intellectual operations. In a recent review of human-robot systems, Granda et al (19) describe "virtual symbiosis" as the final stage in the development of human-robot relationships. In a symbiotic relationship, the combination of components produces a composite performance which is dependent on the interaction between the individual elements. Neither component alone can complete all the functions necessary for optimum system performance.

6.4. Embedded Goals

To achieve cooperative goal-directed activity, the computer must have embedded in its functioning some knowledge of system and sub-system goals, sufficient for it to provide appropriate support for decisions during mission problem-solving. Thus, the capability of the machine can be seen to have been extended from performing tasks and accepting functions, to involvement in the maintenance and achievement of mission goals. Note that in this conceptualisation, the generation of goals remains a uniquely human function, maintaining the human in charge at the highest level of system control.

6.4. Trust

Difficulties in gaining pilot acceptance and trust for machine involvement in mission-critical decision making, necessitate that the machine support be configured to aid the pilot in making decisions, rather than as a substitute for pilot decision-making. Achieving the required level of pilot trust and confidence may require the aid to be more proficient at the task than the pilot (20). In a recent review of decision-support systems (DSS), Selcon & Taylor (21) conclude that a problem with any DSS, whatever its architecture, is its effectiveness once operating within its applied context. Caution needs to be exercised in the design and implementation of such systems. The implementation of imperfect DSS's requires feedback to the operator if he/she is not to be drawn, through over-reliance on the system, into unacceptably high error rates. An alternative is to ensure that a suitable degree of transparency exists in the system thus allowing concurrent checking of system performance. In other words, the operator has a requirement to know where uncertainty exists so that he/she can treat that information accordingly. Failure to inform the operator of uncertainty will not only lead to errors but also a loss in his situational awareness since awareness that uncertainty exists is crucial to an accurate understanding of the decision problem space. This in turn is also likely to diminish trust in the system, as error rates increase, due to the perceived inaccuracy of the system. Naturalistic or "real-world" decision makers e.g. legal judges, use pre-digested information summaries from others as advice or decision support. The analogy in aviation is for the EC to fuse the large amounts of

incoming data/information into a cognitively compatible form, which the operator can use as the basis of his decision, thereby reducing his decision workload whilst still allowing him to maintain his knowledge of relevant uncertainty. Thus the DSS should be set up to form a decision making team with the operator i.e. to help him make a decision without removing him from the decision loop.

6.5. Dynamic Function Allocation

Aiming to provide decision-support systems for pilot aiding which reduce pilot workload and increase situational awareness is not necessarily sufficient. The key objective should be to use machine intelligence to improve the matching or integration of machine and human resources for optimum mission performance. One approach to improving the integration of human and machine resources is to provide adaptive aiding or adaptive function allocation that is responsive to changing demands of dynamic situations. Dynamic function or task allocation has the potential to use human-computer system resources more effectively in a dynamic environment than can be achieved by a static, fixed allocation. Essentially, the task is assigned to the agent who has the time to attend to the task. Thus, the workload is shared in real-time during the mission. Tasks are shared by the pilot actively or explicitly authorising the computer to carry out the task, or by automatic task shedding with implied consent through the pilot pre-setting permissible pilot workload levels, or through common knowledge of the mission objectives and overall governing rules of operation (22, 23).

6.6. Levels of Autonomy

The provision of flexible automation categories, where the pilot has the freedom to choose the level of automation for each function, and to vary this choice as the tactical situation changes, is widely recognised as essential to avoid too rigid automation being imposed by the designer (24). The need for a discrete set of operational modes or autonomy modes, as a means of reducing confusion about responsibilities with dynamic function allocation and system autonomy, is discussed by Yadrick et al (25). Within each level, the EC's authority would be well defined and bounded, facilitating predictability, and rules would define the conditions and methods for changing levels. The pilot would be able to select any level, at any time. If the computer has difficulty performing at the selected level, it would inform the pilot and assume the highest level that it can. The current level of autonomy would be displayed at all times to the pilot. The number of levels, and the functionality within each level needs to be determined. As an example, they suggest five possible levels similar to Sheridan's decision taxonomy (14). The levels are:

- (1) Inactive. The system maintains functions, but takes no actions and initiates no pilot communications.

- (2) Standby. The system could initiate communication when some pilot-defined condition is satisfied.
- (3) Advisor. The system would provide information, but take no actions.
- (4) Assistant. The system would maintain advisory functions and assume responsibility for tasks explicitly allocated to it by the pilot.
- (5) Associate. Under full dynamic function allocation, the system would maintain advisory functions and be responsible for pilot-allocated tasks, but in addition it would take over tasks as needed in accordance with events, current plans, situation assessments, pilot task demands, task priorities and pilot preferences.

6.7. Operational Relationships

In addressing task allocation with an EC, Krobusek et al (26) propose levels of autonomy (LOA) to define the degree of automation at which functions are performed. LOA'S are set according to the pilot interaction or Operational Relationship (OR) desired for a particular EC sub-function, similar to Sheridan's behavioural elements. OR's range from where the pilot must perform the activity, to automatic performance by EC with or without pilot consent, or when various conditions are met, with and without pilot notification. In other OR's, EC may remind or prompt the pilot to perform an action either autonomously or only with pilot authorisation. From this, pilot-selectable levels of EC autonomy are generated with specified OR's for each particular task and task cluster. Within an LOA, some clusters of functions will be more autonomous than others according to what is the most appropriate human-computer relationship and task allocation. Tailoring by the pilot of LOA functional clusterings and dynamic task allocation are proposed to provide flexibility in responding to the changing temporal and loading demands of the dynamic mission environment.

6.8. Pilot Authority and Intent

The EC has been described as enabling the pilot to operate at the level of intentions; communicating with the aircraft what is needed to be done, without being concerned with how it is accomplished (27). Egglestone (7) discusses a number of teaming arrangements between humans and intelligent machines that increase cooperation while preserving the pilot's authority. Cooperation can be achieved with horizontal and vertical organisations of relationships. All assume that the EC has some ability to understand the problem situation and predict the pilot's intentions through knowledge of mission goals. On the question of who is in charge, Egglestone points out that authority comprises of both forming and executing directives, expressed at different levels of specificity. Authority can be exercised at a high level of specificity, by setting only the policy and problem focus, without identifying the specific commands for actions to be taken. When this occurs,

such as with the pilot operating at the level of intention, then a relatively high degree of active cooperation, implicit communication, mutual understanding and trust is required between the pilot and EC to achieve successful performance.

6.9. Manual, Supervisory and Cooperative Functioning

In Figure 1, we have attempted to summarise the essential differences between cooperative functioning and the concepts of manual and supervisory control. This illustration is based on the method used by Egglestone (7) to represent human-machine teaming arrangements. The diagrams in Figure 1 show schematic representations of the authority relationships between the human and machine components under the three systems concepts. Arrows drawn between the human (H) and machine (M) components indicate the direction in which authority is exercised. The location of the Pilot Vehicle Interface (PVI) is indicated as having changed from being concerned with the performance of tasks, to the delegation and monitoring of functions, and then finally to the communication and setting of goals. The changing allocation of responsibilities is shown for goals, functions and tasks. Under manual control, the human is responsible for both goals and functions. Under supervisory control, functions have been delegated to the machine. Under cooperative functioning, goals are assigned to the machine and some functions and tasks are shared under dynamic allocation, as shown by the composite symbols.

7. ADAPTIVE AIDING: AN EXAMPLE

7.1. PA Pilot-Vehicle Interface

The USAF/DARPA Pilot's Associate programme aimed at developing a single-seat fighter pilot decision aiding system for real-time piloted simulation (28). This programme proposes a multi-function EC to assist the pilot, with a functional component called the Pilot Vehicle Interface (PVI) which manages the pilot-EC interface to conform with the pilot's intentions. The PVI comprises an operator model, error monitor, adaptive aiding module, and an interface manager.

7.2. Functional Overview

Adaptive aiding is a key concept of the PVI for matching and integrating pilot and machine resources. Adaptive aiding aims to provide assistance to the pilot efficiently and unobtrusively, while allowing the pilot to remain at the top of the system control hierarchy i.e. to stay in charge (29). This is achieved by incorporating a model of human decision-making and control abilities into the system control automation, and by unobtrusively monitoring the operator's performance and by setting-up expectations and predictions of pilot behaviour. The PVI adaptive aiding concept provides various levels of control. The aid can transform a task, making it easier to perform for an overloaded operator.

(a) MANUAL CONTROL

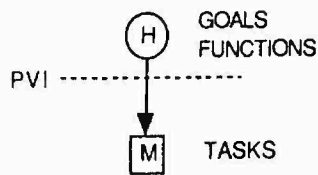

(b) SUPERVISORY CONTROL

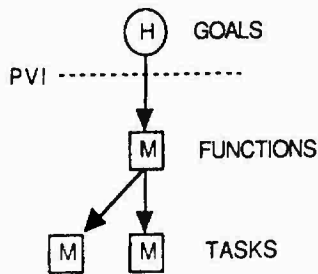

(c) CO-OPERATIVE FUNCTIONING

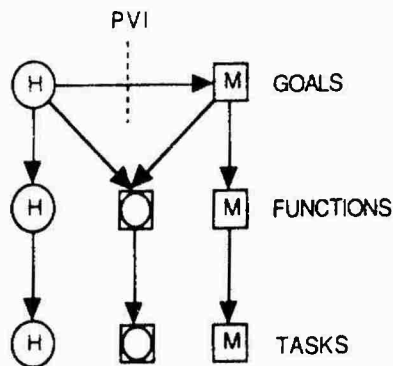

KEY : H = HUMAN M = MACHINE
PVI = PILOT VEHICLE INTERFACE

FIGURE 1 - Systems Authority Concepts

Alternatively, it can partition a task so that the sub-goals are divided between the pilot and the computer. Partitioning involves maximum cooperation to prevent confusion. Finally, the aid can allocate the task to automatic performance, with pilot notification, if the necessary machine capability exists to execute the task effectively (30).

7.3. Machine Cognitive Capabilities

The PVI has a number of important cognitive reasoning capabilities. A PVI intent inferencing capability is provided by monitoring pilot actions which are identified in terms of scripts, plans and goals present in the system knowledge base, leading to activation of the corresponding script, plan or goal. Unidentified actions are classified with reference to a cognitive model of human error, leading to remedial recommendations and predictions of consequences for communication to the pilot. A PVI operator modelling capability is provided by estimating demanded and available resources, derived from the list of active scripts and a profile of the currently displayed information, with reference to a Multiple Resources Theory conceptualisation of the operator. This analysis guides the selection of presentation modality and formatting of displayed information. A PVI human performance prediction capability is provided by a matrix of human performance models, including signal detection probability, choice selection reaction time, choice selection speed-accuracy trade-off, and reach/touch reaction time.

7.4. Embedded HPM

Incorporation of a human performance model (HPM) into the aircraft system represents a major advance. Traditionally, such models have been used only as design tools to predict the performance of alternative human-machine system configurations with specific, known tasks. In human-to-human shared tasks, performance is enhanced by the ability of the participants to model dynamically the behaviour and set up expectations of the other agent (26). To achieve an equivalent capability, an embedded HPM goes beyond the design tool application, and sets out to predict pilot performance, requirements and intentions in real-time dynamic situations (31). Such an embedded model must comprise both human and situational variables. These additional variables include system demands (e.g. system dynamics, malfunctions, environmental factors, situation contingencies, mission status); cognitive situation assessment (e.g. reprioritising demands, planning elimination of demands or focusing on high priorities); decision making or task selection; and task/procedure execution.

8. HUMAN-ELECTRONIC CREW TEAMWORK

8.1. Cooperative Teamwork

The notion of man and machine working as an intelligent, co-operative team is considered by many as being central to the application of AI technology (32, 33). The introduction of team concepts provides a broader framework for thinking about human-machine cooperation. Consideration of the machine as a teaming resource raises a number of issues. Foremost among these must be considerations of trust between team members, functionality of team members,

communication within the team, and where authority should be vested within the team

8.2. Teamwork Model

A model of such teamwork was described by Selcon & Taylor (34). Taylor & Selcon (35), derived from the social psychology of small group dynamics (36, 37). This model is shown in Figure 2. Teams are considered to differ from small groups in the greater emphasis placed in teams on clear definition of goals, roles and structure.

Teams have three distinctive characteristics:

- (1) Co-ordination of activity, aimed at performing certain tasks and at achieving specific, agreed goals. Such co-ordination is dependent on trust between team members to be successful, since trust is the mechanism which allows co-ordination of effort to take place.
- (2) Well-defined organisation and structure, with members occupying specific roles with associated power, authority and status, whilst exhibiting conformity and commitment to team norms and goals. Such organisation will define the allocation of functions and the locus of authority within the team.
- (3) Communication and interaction between team members. These are referred to as team processes.

The system of relationships between the components of teamwork can be understood in terms of the team's goals, resources, and their effects on individual team members, team development and team performance. Such a model provides the framework for considering the implementation of adaptive aiding and DSS so as to produce an effective team capable of best achieving the operational aims for which it was designed.

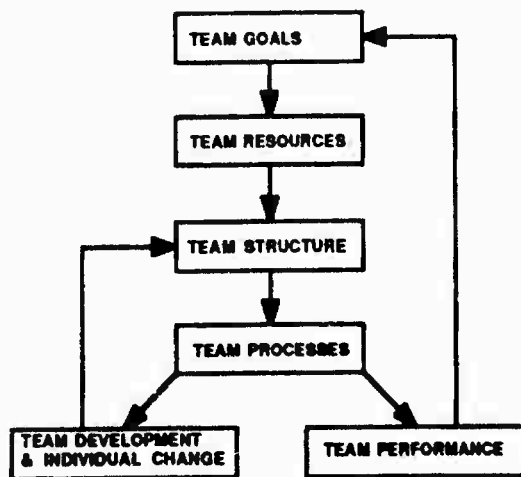

FIGURE 2 - Teamwork Model

8.3. Teamwork audit

8.3.1. Audit Method

In a preliminary test of the validity of the teamwork model, the teamwork characteristics of eight aircrew systems were evaluated by aircrew with a high level of familiarity with the candidate systems (35). The evaluation took the form of a teamwork maturity audit. Technically immature and mature aircrew systems were compared using a teamwork audit tool. The audit tool comprised a listing of twenty teamwork constructs, selected from the literature on human-electronic crew teamwork, and linked to the principal teamwork model components, as shown in Table 1.

Five system experts (test pilots, specialist consultants, project leaders) provided ratings of the teamwork audit constructs on examples of "immature" and "mature" crew-systems technology within their respective operational roles. The following operational roles were considered: Civil transport (Piper Apache PA28/7 v A320 Airbus); Air defence (BAe Hawk v General Dynamics F16C Fighting Falcon); Strike/attack (Panavia Tornado GR1 v UK MOD/Industry Joint Venture Mission Management Aid); and Ground planning (Jaguar Mk 1 Aircraft Ferranti Autoplan v Harrier GR Mk7 Aircraft Advanced Mission Planning Aid). In each case, the system experts were required to decide whether each audit construct was a primary feature, a minor feature, or not represented in the system.

8.3.2. Audit Results

The results of this study are illustrated graphically in Figure 3. Insufficient data were obtained to support statistically justifiable conclusions. However, the results provided broad evidence that the teamwork model was at least sensitive to the substantial developments in crew-systems technologies that have occurred since the early 1970's. In general, the mature candidates scored higher and exhibited more of the teamwork characteristics than the immature systems. The two-crew GR1 Tornado received an unusually high assessment of team processes, largely due to successful pilot-navigator communication. But with the exception of the Tornado/MMA comparison, the data supported for the general notion that there has been improvements in the embodiment of teamwork goals, resources and structure requirements, but that little progress has been made in the development of teamwork processes. In other words, human-machine interface developments seem to be lagging behind progress in mission-system capability.

9. OPERATIONAL AIRCREW VALIDATION STUDY

9.1 Study Objectives

In order to provide a statistically testable validation of the teamwork model, a further study was undertaken

MATURITY CONSTRUCTS	DEFINITIONS
<p><u>TEAM GOAL</u> Clarity Common Structure Tracking Impact Achievement</p> <p><u>TEAM RESOURCES</u> Sufficiency Availability Heterogeneity Compatibility Enhancement Capability</p> <p><u>TEAM STRUCTURE</u> Goal Driven Resource Accessibility Cohesiveness Dynamic Function Allocation Levels of Autonomy</p> <p><u>TEAM PROCESSES</u> Wide Bandwidth Bidirectionality Shared Initiative Common Knowledge Base Trust</p>	<p>Clearly defined performance objectives. Shared understanding of meta/sub goals. Awareness of changing objectives. Critical for mission success. High probability of success.</p> <p>Enough expertise/ability/competence. Readiness for application to task. Variability/uniqueness of expertise. Ability to combine/integrate/match. Ability to add to expertise.</p> <p>Governed by performance objectives. Facilitates access to resources. Attracts conformity to team norms. Real-time role-task distribution. Degrees of independent functioning.</p> <p>Multiple modalities for communication. Two-way flow of information/feedback. Leadership turn taking. Shared understanding of situations. Willing to accept others' judgments.</p>

TABLE 1. Teamwork Audit Constructs

based on the operational experience of RAF aircrew on the GR1 Tornado and GR5/7 Harrier aircraft. The aim was to contrast examples of good and bad teamwork, and to use these examples to determine the sensitivity and diagnostic power of the teamwork model, and associated constructs, to different qualities of teamwork.

9.2. Scenarios.

Descriptions of four ground-attack tactical scenarios, common to both Harrier and Tornado operations, were obtained from MOD(Air) Operational Requirements staff. Each scenario described a familiar tactical problem in which interaction between the aircrew and the aircraft systems contributes significantly to mission success or failure. The four scenarios obtained from the OR staff are as follows:

9.2.1. *Bounced SAP.*

On a pairs Simulated Attack Profile (SAP), low-level, day, with good VMC, you are bounced by a single, head-on radar threat. You counter, forcing you off track. The adversary manoeuvres into a visual stern attack. Again you counter until the threat is lost. You then attempt to regain your original track and time-on-target.

9.2.2. *Low-level weather abort.*

On a four-ship, low-level training mission over hilly terrain in marginal weather. You encounter worsening weather and initially try to avoid it by going off-track. You are then forced into a low-level abort into cloud, on instruments. You then attempt to regain your original track and low-level formation.

9.2.3. *Multiple missile threat.*

On a daytime Spade-Adam mission (i.e. a complex ECM environment) in good weather, two miles from attacking

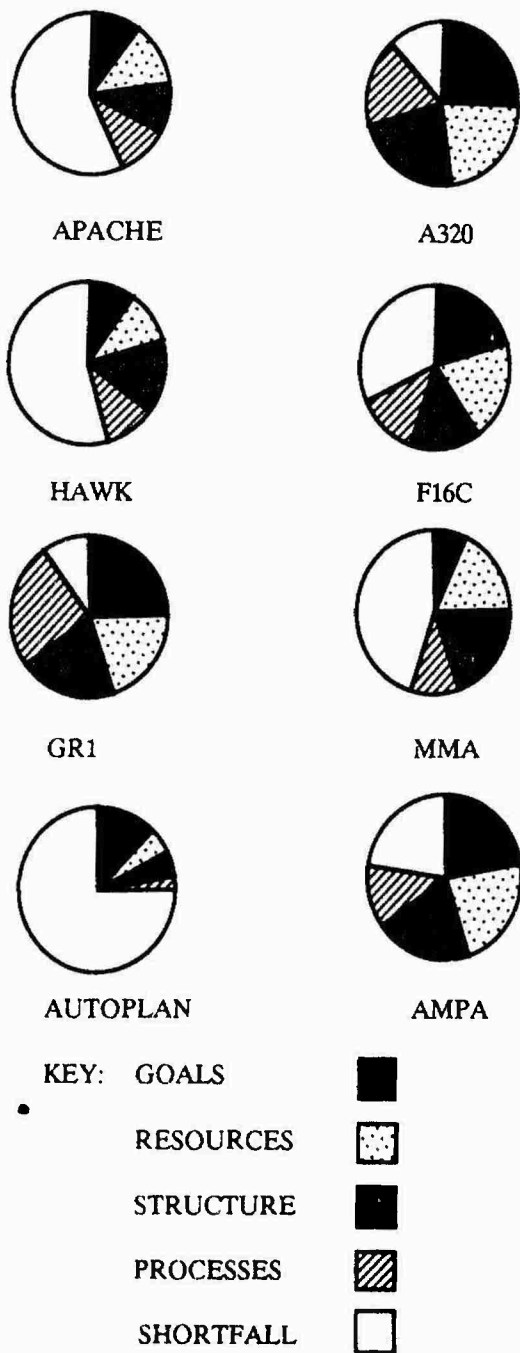

FIGURE 3 - Audit Component Proportions

the airfield you get an indication of a SAM 8 target tracker from your 1 o'clock position. This is followed by a SAM 6 launch from an unknown location. You have to prioritise the threat and complete the airfield attack.

9.2.4. GATE.

On a 4-ship attack, flying No.2, using 1000lb bombs, you have planned for a forty second split over target. You have to avoid a ground threat on the run-in and therefore cannot make your planned time-on-target. You then attempt to go for your alternative time-on-target (GATE) to complete the attack.

9.3. Aircraft

9.3.1. Tornado GRI

Late 1970's, variable geometry (swing wing) two-seat tandem, multi-role jet, employed in the overland strike/attack and reconnaissance roles, with all-weather, night automatic Terrain Following, Inertial and Doppler navigation radar; with pilot E-scope and moving-map display, automatic laser/radar or laser/HUD weapon aiming and delivery, and ECM radar warning; and with navigator combined Radar and Projected Map Display, Electronic digital TV tabular displays for mission computer monitoring and planning, and with mission plan pre-loading facility.

9.3.2. Harrier GR7

1980's, single-seat VSTOL ground attack aircraft, equipped with FLIR and NVG for night attack operations; inertial navigation and angle rate bombing system; simple auto-pilot system; wide field-of-view HUD used to display night FLIR superimposed on the outside world; 2 multi-purpose colour displays with digital colour map, horizontal situation display, or weapons management system formats; fully integrated internal ECM suite giving automatic counter measures to threats; audio/voice warning system; data insertion facility for loading pre-planned sortie data.

9.4. Methods

The four scenarios were presented to twenty RAF Germany Tornado and Harrier aircrew during a structured interview on teamwork. In the interview, the aircrew were provided first with an introduction to the concept of human-electronic crew teamwork, a brief description of the teamwork model, and an explanation of the teamwork audit constructs. They were then asked to consider each scenario in turn, and to think about an example, preferably from their own experience where good teamwork helped successful recovery or where poor teamwork made recovery difficult. Harrier aircrew (8 pilots) were directed to think of teamwork between themselves and their cockpit systems. Tornado aircrew (5 pilots, 7 navigators) were instructed to think about teamwork between themselves and the other crew member, and their respective cockpit systems. The scenarios were identified for consideration as examples of either good or bad teamwork, in an order balanced across the aircrew subjects. Each subject was required to consider two good and two bad teamwork scenarios. Having imagined an appropriate example as directed, the aircrew were then required to rate the example on the teamwork dimensions using a seven-point Likert-type rating scale of 1(low) to 7(high).

	TEAMWORK QUALITY				AIRCRAFT TYPE			
	Mean Rating		ANOVA		Mean Rating		ANOVA	
TEAMWORK MATURITY CONSTRUCTS	Poor team work	Good team work	F df:1,16	Sig.	Tornado Aircraft	Harrier Aircraft	F df:1,12	Sig.
GOALS								
Clarity	4.15	5.86	10.32	0.01	5.10	4.87	0.24	NS
Common Structure	3.70	5.49	10.79	0.01	4.70	4.43	0.23	NS
Tracking	3.97	5.44	7.96	0.05	4.75	4.65	0.04	NS
Impact	3.77	5.32	6.42	0.05	4.37	4.81	0.27	NS
Achievement	3.36	5.38	10.16	0.01	4.20	4.62	0.27	NS
RESOURCES								
Sufficiency	4.18	5.56	10.32	0.01	5.00	4.68	0.33	NS
Availability	4.42	5.15	4.74	0.05	4.72	4.65	0.01	NS
Heterogeneity	4.16	5.05	2.62	NS	4.62	4.59	0.00	NS
Compatibility	3.82	5.60	11.57	0.01	4.79	4.59	0.14	NS
Enhancement	4.05	5.19	3.01	NS	4.81	4.34	0.79	NS
STRUCTURE								
Goal Driven	4.26	5.18	3.06	NS	4.79	4.62	0.12	NS
Accessibility	3.95	5.09	6.56	0.05	4.45	4.62	0.18	NS
Cohesiveness	4.01	5.13	5.96	0.05	4.56	4.59	0.00	NS
DFA	3.49	5.15	9.85	0.01	4.39	4.21	0.20	NS
LOA	3.54	4.65	3.95	NS	4.12	4.06	0.01	NS
PROCESSES								
Wide Bandwidth	3.69	4.50	1.80	NS	4.02	4.21	0.09	NS
Bidirectionality	3.35	5.49	14.89	0.01	4.83	3.81	4.76	0.05
Shared Initiative	3.22	4.87	7.58	0.05	4.85	2.84	19.35	0.001
Common Knowledge	3.37	5.42	13.79	0.01	4.83	3.75	5.29	0.05
Trust	4.10	5.92	9.66	0.01	5.54	4.10	11.92	0.01

TABLE 2 Mean Teamwork Ratings

9.5. Results

9.5.1. ANOVA

Analysis of variance was performed on the ratings for each teamwork dimension, to test for differences between teamwork quality (good/bad), aircraft (Harrier/Tornado), and scenarios (SAP / Abort / ECM / GATE). The results are summarised in Table 2.

9.5.2. Dimensions Sensitivity

The results show that good teamwork was associated with higher mean ratings on all 20 of the model dimensions. Statistically significant differences in ratings were obtained on 15 of the 20 model dimensions. The 5 dimensions in which the difference in mean ratings (dx) failed to reach significance were Heterogeneity and Enhancement (Resources), Goal Driven and Levels of Autonomy (Structure), and Wide Bandwidth (Processes). Ratings on all 5 Goals

dimensions showed a significant association with improved teamwork. The strongest associations between ratings and teamwork quality ($p < 0.01$) were in the following dimensions: Bidirectionality (dx = 2.14), Common Knowledge (dx = 2.04), Achievement (dx = 2.02), Trust (dx = 1.82), Common Structure (dx = 1.79), Compatibility (dx = 1.78), Goal Clarity (dx = 1.70), Dynamic Function Allocation (dx = 1.65) and Resources Sufficiency (dx = 1.37).

9.5.3. Principal Domains

The mean ratings of the major model domains associated with good and poor teamwork are shown graphically in Figure 4. Summarising across the individual dimensions, within the principal model domains, the increases in mean ratings (dx) with improved teamwork were as follows: Goals, dx = 1.70; Resources, dx = 1.18; Structure, dx = 1.18; Processes, dx = 1.69.

9.5.4. Aircraft Types

The mean ratings of the major model domains associated with the two aircraft types are shown graphically in Figure 5. Significant differences between the ratings for the two aircraft types were obtained on only 4 of the audited dimensions, all in the Processes domain, namely; Shared Initiative ($dx=2.01, p<0.001$); Trust ($dx=1.44, p<0.01$); Bidirectionality ($dx=1.02, p<0.05$); Common Knowledge ($dx=1.08, p<0.05$). The Tornado aircrew gave higher ratings than the Harrier pilots irrespective of scenario type and teamwork quality on all four of these teamwork processes dimensions.

9.5.5. Scenarios

There were no significant interactions between scenarios, aircraft type and teamwork quality. A small effect of scenario type was found on the ratings of Resource Accessibility, where the SAP scenario produced significantly lower ratings than the other three scenarios ($F=3.989, df=3,16, p<0.05$).

9.5.6. Principal Components Analysis

Principal components analysis was performed on the data in order to identify any underlying factors. The results are shown in Table 3. This showed evidence of only 2 factors. The first component, which accounted for 55.82% of the variance, loaded on all the model dimensions except Goal Achievement (-0.25) and Goal Impact (-0.24). Conversely, the second component loaded only on Goal Achievement (0.83) and Goal Impact (0.90). This second component accounted for a further 20.61% of the variance.

9.6.1. Scenarios

The broad objectives of the study seem to have been met. The study successfully contrasted examples of good and bad teamwork and provided statistical data on the validity of the teamwork model. The method of contrasting examples of good and bad teamwork relied almost entirely on the imagination of the aircrew. With

few exceptions, the aircrew reported little or no difficulty in thinking of suitable examples. This was partly due to the familiarity of the four scenarios. All the aircrew reported frequent and recent experience with the scenarios. No record was made during the interviews of the specific incidences of teamwork within the scenarios which were envisaged by the aircrew when providing their ratings. Consequently, there is no way of checking what the ratings are based on, or of verifying that they were true examples of good and bad teamwork. On the other hand, we have no reason to doubt that the aircrew understood the task and carried it out according to the instructions. Uncertainty over the exact teamwork scenarios could have been reduced by providing specific examples of good and bad teamwork for rating. However, it was decided that this approach would have drawn less directly upon the individual's personal experience and knowledge. A provided example probably would have been more difficult to think about and visualise than an example drawn from their own personal experience.

9.6. Discussion

9.6.1. Understanding the Dimensions

The ability of the aircrew to understand and apply the teamwork dimensions provided more difficulty than the aircrew having to recall an appropriate scenario. Certain model dimensions seemed difficult to grasp because the descriptions used theoretical constructs and unfamiliar words e.g. heterogeneity and bandwidth. Further explanation and practical examples often had to be provided. In future work with aircrew, understanding probably could be improved by providing additional practical examples based on flying experience. This might improve the sensitivity of some of the more difficult dimensions. Notwithstanding, the data seem to suggest that there was sufficient understanding of most of the dimensions to enable consistently different ratings to be given for good and poor teamwork.

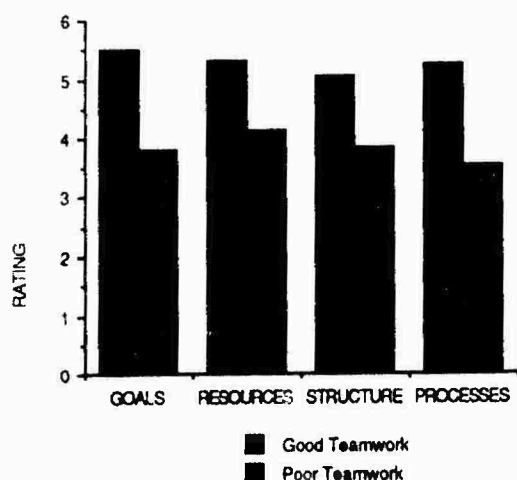

FIGURE 4 - Mean Ratings for Model Domains for Good and Poor Teamwork

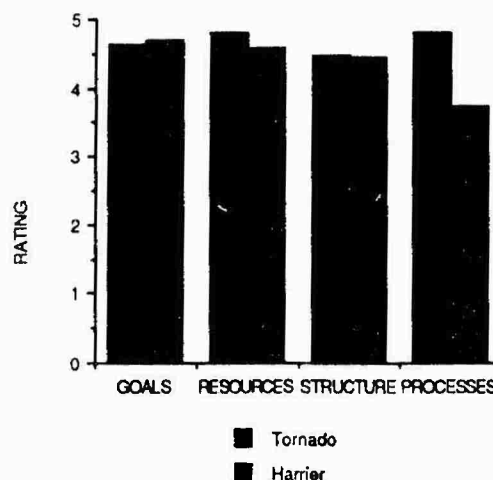

FIGURE 5 - Mean Ratings for Model Domains for Tornado and Harrier Aircraft

	PRINCIPAL CO-ORDINATES	
	FACTOR 1	FACTOR 2
TEAMWORK MATURITY CONSTRUCTS	Value: 11.16 Percent: 55.82	Value: 4.12 Percent: 76.43
GOALS		
Clarity	-0.83	0.37
Common Structure	-0.80	0.40
Tracking	-0.81	0.37
Impact	-0.24	0.90
Achievement	-0.25	0.88
RESOURCES		
Sufficiency	-0.78	0.44
Availability	-0.75	0.44
Heterogeneity	-0.72	0.46
Compatibility	-0.80	0.43
Enhancement	-0.60	0.34
STRUCTURE		
Goal Driven	-0.72	0.40
Accessibility	-0.80	0.39
Cohesiveness	-0.79	0.42
DFA	-0.87	0.24
LOA	-0.71	0.42
PROCESSES		
Wide Bandwidth	-0.64	0.51
Bidirectionality	-0.84	0.22
Shared Initiative	-0.82	0.19
Common Knowledge	-0.82	0.20
Trust	-0.83	0.17

TABLE 3 - Principal Components Analysis

9.6.2. Validity of Ratings

A fundamental uncertainty with this method is the extent to which different ratings represent true differences in teamwork quality, or whether the differences are automatically ascribed because understanding of the model suggests that there should be a difference. A more sophisticated rating scale, using questionnaire design techniques to check and balance for response bias (e.g. multiple descriptions of dimensions, reversals of dimensional polarity, non-teamwork dimensions) might improve the validity of future work. Objective measurement of teamwork performance would provide a more basis for comparisons.

9.6.3. Principal Domains

The analysis suggests that all four of the principal model domains are relevant to teamwork quality. Differences in team goals and team processes contributed slightly more towards improved teamwork quality than differences in team resources and structure. However, the data indicate that the degree of influence

of each domain was more or less equivalent in the present study. This finding may be an artefact of the study method. It seems likely that the relative contributions of the domains to teamwork will be task and situation specific. Principal components analysis suggests that there is a single strong underlying component to the model. It seems reasonable to assume that this is principal component is teamwork. A second component was evident from the ratings of two of the Goals dimensions. Although all five Goals dimensions were associated with improved teamwork, this finding suggests that certain aspects of goals, namely achievement and impact, may operate differently, and perhaps independently, from the other model dimensions. This finding might be a statistical artefact. Further data is needed to check this interpretation.

9.6.4. Teamwork Sensitivity Weighting

The differences between the mean ratings for good and poor teamwork, supported by the results of the ANOVA, provide broad evidence of the relative sensitivity of the model dimensions. Table 4 provides a summary of the relative sensitivity or impact of the model dimensions. The dimensions are divided into three categories of High, Medium or Low Sensitivity. This classification is based on the relative magnitude, within each domain, of the mean rating differences between good and poor teamwork. Increasing mean differences are associated with increasing sensitivity and impact. The one exception is Resource Availability which obtained a relatively small but statistically significant difference in mean ratings. Thus, Resource Availability is classified as having medium rather than low impact. Further evidence will be required to test the generality of these findings. However, this simple categorisation provides an initial basis for weighting the individual dimension ratings, or for their elimination or replacement, in future work on the model.

Dynamic Function Allocation (DFA) is considered to have high sensitivity to teamwork quality, whereas Levels of Autonomy (LOA), intended to support DFA, do not appear to be important for good teamwork. It may be that LOA are relatively difficult to conceptualise or recognise in Harrier and Tornado teamwork, or that they are just not present. LOA are proposed for future systems in order to structure the delegation of authority and allow the building of trust and confidence, particularly when co-operating with a mechanical associate through a restricted communication channel. In this sense, LOA may be considered to affect teamwork only indirectly, through Dynamic Function Allocation. LOA may be an engineering necessity and not a common feature of natural, mature teamwork. It may be that in a mature relationship, the levels need to be transparent, providing a smooth transitioning of authority, rather than a rigid series of fixed, switchable steps. The ideal requirement for good quality teamwork may be more like the flexible functional clustering and

IMPACT	GOALS	RESOURCES	STRUCTURE	PROCESSES
HIGH	Achievement Comm. Structure Clarity	Compatibility Sufficiency	DFA	Bidirectionality Comm. Knowledge Trust
MEDIUM	Impact Tracking	Availability	Accessibility Cohesiveness	Shared Initiative
LOW		Enhancement Heterogeneity	LOA Goal Driven	Wide Bandwidth

TABLE 4- Relative Impact of Teamwork Dimensions

operational relationships (OR's) proposed by Krobusek et al (26), rather than the well-defined, bounded levels suggested by Yadrick et al (25).

The insensitivity of Enhancement is probably due to the difficulty of adding expertise in real-time dynamic situations. Wide Bandwidth is seen to have low sensitivity, even in distinguishing between Harrier and Tornado teamwork, where the latter offers the option of speech communication. As with Heterogeneity and Goal-Driven Structure, this finding may be due at least in part to difficulty in understanding or recognising the constructs. Further data is needed to confirm these results. Nevertheless, it seems likely that these are relatively unimportant teamwork dimensions.

9.6.5. Sensitivity to Scenarios

There were no significant differences in the ratings between the four tactical scenarios. This does not necessarily mean that the model is not sensitive to scenario differences. It is possible that the requirement to rate different personal examples of the scenarios masked any effects due to the specified tactical situations. Nevertheless, the results seem to suggest that the factors governing teamwork quality may be relatively independent of the demands of the tactical scenario. The implication is that the model is generalizable across tactical situations.

9.6.6. Sensitivity to Aircraft Types

The study provided an opportunity to compare teamwork in a single-seat and a two-seat aircraft performing the same task. Perhaps surprisingly, for two substantially different aircraft, the results show no consistent differences between the Tornado and Harrier with regard to teamwork Goals, Resources and Team Structure. None of the dimensions in these three domains showed any effect of aircraft type. Even Resource Sufficiency, a dimension on which one reasonably might have expected

a difference between a single and two-crew cockpit, the difference in ratings ($dx = 0.31$) failed to reach significance at the 5% level. A larger sample of aircrew on each aircraft type might conceivably produce a different picture. However, on the basis of the present data, one has to conclude that the two aircraft seem to have more or less equal provision with regard to teamwork goals, resources and structure.

9.6.7. Pilot Interface Development

Whilst the navigator, considered as a teamwork resource, does not seem to be missed, at least by Harrier aircrew, the ratings on Teamwork Processes indicate that the second crew-member has value in being able to share initiatives and knowledge, in providing bi-directional dialogue and communication, and in generating trust for autonomous action. The data suggest that on these dimensions of teamwork, the Tornado is probably substantially stronger than the Harrier. Once again, as in the crew-systems audit reported earlier (35), the pilot interface developments incorporated in more technically advanced systems, in this case Harrier, show little evidence of matching the teamwork processes in Tornado. Advances in the Harrier mission system capability do not seem to be matched by improvements in the pilot interface design.

10. CONCLUSIONS

On the basis of this review and from our recent work on human-electronic teamwork, we are able to draw the following conclusions about the requirements for capability analysis and function allocation in advanced aircrew system:

- a. Potential operator capability analysis is a key element of early human-systems design. The current lack of proven formal procedures means that it is a potential weak link in the aircrew system design

process, particularly when procuring new systems for an unknown target audience.

- b. Human-engineering methods for workload prediction incorporate relatively simple models of human performance. These models provide a useful starting point for understanding the needs for operator capability specification in systems design.
- c. Developments in machine capability will require development of a common cognitive performance-resource model for human and automation capability analysis and function allocation.
- d. Transfer of functions to automation in systems design solely on the basis of performance is not the best way to exploit human versatility and flexibility, nor to preserve human capability and responsibility for changing system goals.
- e. Creating a supervisory role for the operator presents problems when working in a highly dynamic environment that make it unsuitable for most military aircrew systems.
- f. Advances in computer technology now make it possible for the machine to assist in making decisions and solving problems external to the system.
- g. In future systems, automation technology will be able to function as a co-operative partner or associate to the pilot, responding adaptively to changing demands.
- h. Achieving pilot confidence and trust for levels of autonomous machine functioning in solving external mission problems will require careful engineering of the pilot interface.
- i. There will need to be a clear understanding of the rules governing function allocation and levels of autonomy, whilst maintaining the flexibility needed in a dynamic environment.
- j. In order to co-operate adaptively, the computer will need to be given knowledge of the mission goals, and to be able to anticipate the pilot's requirements.
- k. Incorporation of a human performance and error model within the aircraft system is necessary to predict operator capability and provide adaptive aiding.
- l. The concept of co-operative teamwork, with the machine viewed as a teaming resource, provides a useful broad framework for thinking about future adaptive system requirements.
- m. The results of the recent teamwork study indicate the relative contributions of different aspects of teamwork to teamwork performance.
- n. Whereas dynamic function allocation (DFA) seems to be an important characteristic of good teamwork,

the value of levels of autonomy, a concept associated with DFA, seems less clear.

- o. A smooth, flexible transitioning of autonomy, rather than a fixed series of discrete steps, may be more characteristic of mature teamwork.
- p. Comparisons between a single-seat and two crew aircraft indicate that the second crew member provides a valuable support for teamwork communication processes, not matched by the design of the pilot-machine interface in the more advanced single-seat aircraft.
- q. The design of the pilot interface seems likely to be the principal restriction on human-electronic crew teamwork capability in the foreseeable future.
- r. Improved pilot interface technology is needed to exploit the full potential of human-electronic crew teamwork.

11. ACKNOWLEDGEMENTS

The authors wish to acknowledge the assistance given by Sqn. Ldr. T. Southam, MOD OR 52c (Air) and Sqn. Ldr. R. Marsden, MOD OR 83a (Air) in the generation of the tactical scenarios, and the co-operation of members of No. 3 (F) Squadron, RAF Gutersloh, and No. 9 Squadron, RAF Bruggen in providing the teamwork ratings.

© British Crown Copyright 1992

Published with the permission of the Controller
of Her Britannic Majesty's Stationery Office

12. REFERENCES

1. NATO STANAG 3994 AI. The Application of Human Engineering to Advanced Aircrew System Design
2. Booher, R. "MANPRINT: An Approach to Systems Integration". Van Nostrand Reinhold, 1990.
3. Boff, K.R. 1990. Integrated Ergonomics into System Design. CSERIAC Gateway, Vol. 1, No. 2, pp 1-3.
4. Boff, K.R. and Lincoln, J.E. 1988. Engineering Data Compendium: Human Perception and Performance. AAMRL Wright-Patterson AFB, Ohio.
5. McMillan, G.R., Beevis, D., Salas, E., Strub, M.H., Sutton, R., and Van Breda. Eds. 1989. Applications of Human Performance Modelling to Systems Design. New York: Plenum.

6. Plocher, T., Lockett, J.F., Kovack, P. and Powers, J. 1991. CREWCUT: A new tool for predicting human performance in conceptual systems. *Proceedings of the Human Factors Society 35th Meeting*, Vol. 2: 1206-1209.
7. Eggiestone, R. E. 1988 Machine Intelligence and Crew-Vehicle Interfaces. In: E. Herr and H. Lumin, Eds. "Machine Intelligence and Autonomy for Aerospace Systems". AIAA
8. Fitts, P. M. 1951. (Ed.) Human Engineering for an Effective Air Navigation and Air Traffic Control System. Washington, D. C.: National Research Council Committee on Aviation Psychology.
9. Jordan, N. "Allocation of Functions Between Man and Machine in Automated Systems", *Journal of Applied Psychology*, Vol. 47, pp161-5, 1963
10. Singleton, W.T. "Man - Machine Systems". London, UK, Penguin, 1974
11. Sheridan T B. "Supervisory control of teleoperators". In Bernotat R K and Gartner K P (Eds) *Displays and Context*. Swets & Zeitlinger. 1972
12. Sheridan T. B. and Ferrell, W. R. "Supervisory Control and Manipulation". *Proceedings of the 3rd Annual Conference on Manual Control*. NASA-SP-1441967, 1967.
13. Sheridan T B, Fischhoff B., Posner, M., & Pew, R. W. "Supervisory Control Systems. in Committee on Human Factors (Eds), in: "Research needs for human factors". Washington DC, USA, National Academy Press. 1983
14. Sheridan T B and Verplanck W L "Human computer control of under-sea teleoperators". Technical Report. MIT Man-Machine Laboratory, Cambridge, MA, USA. DTIC No. ADA057655. 1978
15. Zachary W., Wherry, R., Glenn, F., & Hopson, J". *Human Factors in Computer Systems Conference*, Gathersburg, MD, USA, National Bureau of Standards, 1982.
16. Wiener, E. L. and Curry R. E. "Flight deck automation: Promises and problems". *Ergonomics*, 23; 1980, pp 955-1011.
17. Goodson J., Zachary, W., Weiland, W., & Hopson J. "Distributed Intelligence Systems: AI Approaches to Cooperative Man-machine Problem Solving" in C3I. AIAA Computers in Aerospace Conference. Hartford CT, USA, AIAA-83-2316, 1983
18. Moss, R., Riesing J., and Hudson N. "Automation in the cockpit: Who's in charge?" *Proceedings of the 3rd SAE Aerospace Engineering Technology Conference*, Long Beach, CA. 1984
19. Granda T. M., Kirkpatrick M. and Peterson L. A. "The Evolutionary Role of Humans in the Human-Robot System" in "Proceedings of the Seminar on the Robotics in the Battlefield", NATO DRG, AC/243-TP/3 Vol. C, 1992, ppC1.1to7.
20. Rouse, W. B. and Morris, N. M. "Conceptual design of a human error tolerant interface for complex engineering systems", *Automatica*, 23, 1987, pp 231-235.
21. Selcon S.J. and Taylor, R.M. "A Review of Decision Support Systems (DSS) and their Applications". RAF IAM Report No. 714, May, 1992.
22. Emerson T J, Reising J M, and Britten-Austin H G. "Workload and Situational Awareness in Future Aircraft", in "Recent Advances in Cockpit Aids for Military Operations", Royal Aeronautical Society Proceedings, London, 1987
23. Boys R. and Palko K. "Automation and Dynamic Allocation: Engineering Issues and Approaches". in *NAECON Proceedings*, 1988.
24. Hollister, W., Ed., "Improved Guidance and Control at the Man-Machine Interface", AGARD-AR-228., 1986
25. Yadrick, R.M., Judge, C.L., and Ritey, V.A. "Decision Support and Adaptive Aiding for a Battlefield Interdiction Mission", in "The Human-Electronic Crew: Is The Team Maturing?" RAF Institute of Aviation Medicine, PD-DR-P5, April 1991.
26. Krobusek R. D., Boys R. M., and Palko, K. D. "Levels of Autonomy in a Tactical Electronic Crewmember", in "The Human-Electronic Crew: Can They Work Together?", RAF Institute of Aviation Medicine, BSD-DR-G4, December 1988. (WRDC-TR-89-7008, 1989).
27. Reising, J. R. and Emerson, T. J. "The cockpit of the year 2000: How big a step?" in "Human Factors Considerations in High Performance Aircraft", AGARD-CP-371, November 1984, Paper 15.
28. Lizza C. S., Rouse D. M., Small R. L., and Zenyuh J. P. "Pilot's Associate: An Evolving Philosophy", in "The Human-Electronic Crew: Is The Team Maturing?", RAF Institute of Aviation Medicine, PD-DR-P5, April 1991.
29. Andes, R. C. "Adaptive aiding in complex systems: An implementation", in "Proceedings of the IEEE 1987 Conference on Systems, Man and Cybernetics", 1987.
30. Rouse, W. B., Geddes, N. D. and Curry, R. E. "An architecture for intelligent interfaces: Outline of an

- approach to supporting operators of complex systems". *Human-Computer Interaction*, 3, 2, 1987
31. McCoy, M. and Boys, R. "Human Performance Models Applied to Intelligent Decision Support Systems" in "Proceedings of the IEEE National Aerospace Conference", 1987.
 32. Emerson, T.J., Rienecke, M., Riesing, J.R. and Taylor, R.M (Eds). "The Human-Electronic Crew: Can They Work Together?" . RAF Institute of Aviation Medicine ,BSD-DR-C4, December 1988, (WRDC-TR-89-7008, 1989).
 33. Emerson, T.J., Rienecke, M., Riesing, J.R. and Taylor, R.M. (Eds). "The Human-Electronic Crew: Is the Team Maturing?" . RAF Institute of Aviation Medicine, PD-DR-P5, April 1991.
 34. Selcon, S.J. and Taylor, R.M., "Psychological Principles for Human-Electronic Crew Teamwork", in "The Human-Electronic Crew: Is the Team Maturing?" . RAF Institute of Aviation Medicine, PD-DR-P5, April 1991.
 35. Taylor, R. M. and Selcon, S. J. "A Teamwork Model of Pilot Aiding: Psychological Principles for Mission Management System Design". AGARD-CP-504, March 1992, Paper 9.
 36. McGrath, J.E., "Social Psychology: A Brief introduction", New York, Holt, Rinehart & Winston, 1964.
 37. Larson, C.E. and DeFasto, F.M.J., "Teamwork. What Must Go Right/What Can Go Wrong", London: Sage, 1989.

Cognitive Interface Considerations for Intelligent Cockpits

Robert G. Eggleston
Human Engineering Division
Armstrong Laboratory
AL/CFHP

Wright-Patterson Air Force Base, OH 45433-6573
USA

SUMMARY

This paper presents the concept of an Intelligent Cockpit as a knowledge-based aiding system. It argues that, in order to maximally support the air crew, user aiding in two areas is required: mission task aiding and interface useability aiding. These areas of aiding are discussed in relation to four different forms of an intelligent cockpit. The central purpose of the paper, however, is to introduce the concept of a cognitive design requirement for aiding systems, and to suggest its importance to design solutions expected to achieve crew aiding in both the mission task and interface useability areas. Two arguments are made: 1) A deeper knowledge of human capabilities and limitations is needed to generate effective cognitive design requirements for an aiding system; and 2) more cognitive design requirements are needed for an intelligent cockpit in comparison with a conventional one. Illustrations of possible cognitive design requirements are presented in support of these arguments. Special attention is given to requirements that derive from human capabilities and limitations. Based on the general discussion, it is also concluded that an intelligent cockpit should be a separate module from the traditional systems avionics, since it requires a unique process architecture.

INTRODUCTION

Advances in computer technology have had a profound effect on all forms of modern military weapon systems. In the case of the crew station for military aircraft, an example of this effect can be seen in the displays, controls, and other avionic devices that populate a modern cockpit. With rare exception, computer technology is involved in the signal processing requirements to generate display formats and the transmission of signals to and from control devices and the remaining avionic components. Military aircraft continue to move toward an "all glass" instrument panel and a multi-mode "fly-by-wire" control system that depends heavily on computer technology for its behavior. While these advances are impressive, and will no doubt continue into the future, the crew station as we know it today is on the threshold of an even more profound change, one that is dependent on advances being made in the sub-area of Computer Science known as Artificial Intelligence (AI).

AI gives a computer-based system the ability to use abstract, human-like knowledge and reasoning methods to control system behavior. When this is applied to a crew station, the AI system can apply knowledge and logic to understand any or all of the following: (1) the abstract goals of a mission;

(2) the immediate and long range mission plans of the aircrew; (3) the state of system assets and its implication for mission performance; (4) what system, environment, and mission information the aircrew needs and how to best present it; and (5) identification of when the crew makes any procedural errors in mission execution, and the ability to intercede. Capabilities like these fundamentally change the very nature of the crew station. It is no longer adequate to regard the cockpit as merely a display and control center, where information is delivered to the crew and crew commands are registered by the system. With AI, an intelligent cockpit takes on an agent-like quality and the expanded role of explicitly aiding the crew in mission performance. *An intelligent cockpit, therefore, is an aiding system that delivers information, engages in dialogue with the crew, implicitly and explicitly, while assisting in mission execution.*

Given its expanded role, design requirements for an intelligent cockpit will also be expanded. The interface as a complete avionic subsystem will have a processing architecture that sits behind present-day symbol generators and graphics processors. While many design requirements for this type of system are similar in nature to those of other avionic subsystems, a knowledge-base module raises new cognitive understanding and interaction requirements that do not have to be addressed in the design of a conventional cockpit.

The purpose of this paper is to illustrate, in a general way, the notion of an intelligent cockpit¹, and to suggest the type of cognitive considerations that need to be addressed during system design. Because of these considerations and for other reasons, it is argued that an intelligent cockpit needs to be regarded as a single, integrated avionic subsystem that requires functional and process design attention throughout system development. The paper contains a brief presentation of possible conceptual architectures for an intelligent cockpit. This discussion is needed to clarify the relations between the concepts of an intelligent cockpit and other forms of knowledge-based aiding systems such as an electronic crew member ("Pilot's

¹The terms *crew station* and *cockpit* will be used interchangeably throughout this paper. While a cockpit can consist of many subsystems, such as the crew capsule, transparencies, ejection system, controls and displays, etc., when used here we are referring to the interface among the crew, mission avionics, and communications systems. Accordingly, the terms *interface*, *pilot interface*, *crew interface*, or *user interface* are also used to mean the cockpit or crew station.

DOMAINS FOR AIDING ASSISTANCE

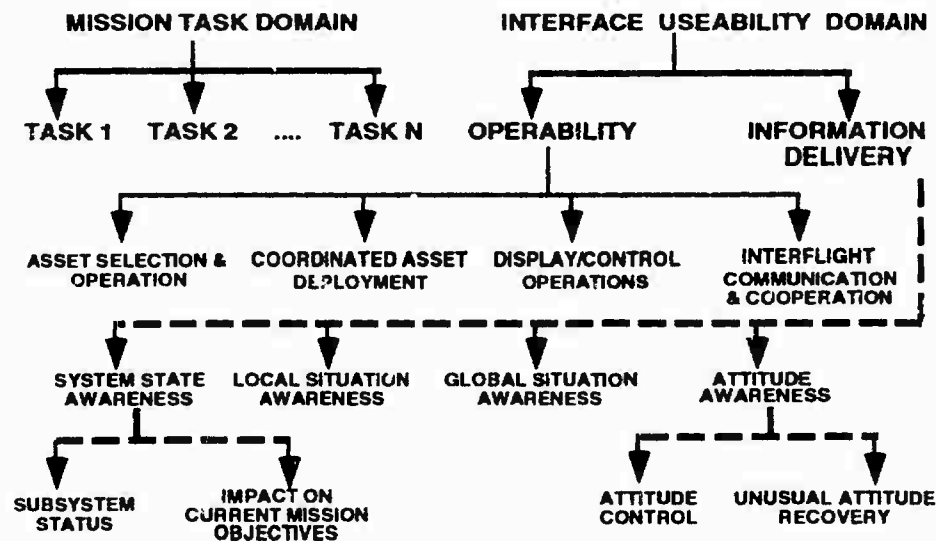

Figure 1. Possible domains or areas where an Intelligent Cockpit might provide knowledge-based aiding to the crew.

Associate") or single-task aid like a route planner. Cognitive considerations are then reviewed in terms of those derived from a task aiding role versus those derived from a useability aiding role. Human capabilities and limitations are at the root of several cognitive considerations. Since it is crucial that a user-centered stance be taken when forming cognitive requirements for an intelligent cockpit, additional attention is given to those factors derived from human capabilities and limitations.

AN INTELLIGENT COCKPIT AS AN AIDING SYSTEM

An intelligent cockpit is a knowledge-based system. As such, it can be designed to contain knowledge about one or more domains of interest. It may use this knowledge to reason about activity in any of these knowledge domains. Based on resident knowledge and reasoning, aiding can be offered in terms of planning, diagnosis, or task execution to assist a human partner or colleague. At a general level, therefore, all knowledge-based systems are similar. What distinguishes an intelligent cockpit from another knowledge-based aiding system is the domains of knowledge it contains and the forms of reasoning performed.

The goal of a crew station, conventional or intelligent, is to provide a means for the user to operate the system and use its assets to accomplish a military objective. This suggests at least three broad domains in which an intelligent cockpit can aid the system user in meeting mission objectives. It could assist the pilot in performing one or more mission tasks. It could assist the pilot in using system assets, including the interface subsystem itself. And, finally, it could assist in delivering information used for task planning and for forming and maintaining a mission-oriented awareness of the situation.

Fig 1 depicts a course decomposition of these three domains of aiding. Mission task aiding could include things like assistance in realtime replanning of a mission route to meet new circumstances or objectives, or assistance with target location and identification. Essentially, any mission task an air crew might perform could qualify for assistance. As military systems add new avionic capabilities there is a strong tendency for the cockpit to grow in complexity. This often results in the cockpit interface itself getting in the way of mission performance, and potentially useful avionic features end up not being used or being used in a sub-optimal manner. As a result of this trend, one area for an intelligent cockpit to provide aiding is to assist in its own useability by the aircrew, including what information it delivers, and in what form, to improve user situation awareness. A limited decomposition of knowledge-based aiding domains in these areas is also shown in Fig 1.

It could be argued that some of the entries under Interface Useability and Interface Information Delivery in Fig 1 define mission task domains. Entries like Coordinated Asset Deployment, Interflight Communication and Coordination, and Assessing System State or Current Mission Objective have an obvious mission focus and could easily be regarded as Mission Task Domains. Moreover, one might question if it is appropriate to consider direct assistance with mission tasks as capabilities of an intelligent cockpit. An aiding technology or subsystem such as a realtime route planner may be regarded as a new avionic device, or a collection of such devices, if properly integrated, could define a "Pilot's Associate." The demarcation among what defines an intelligent cockpit, an intelligent associate, or a single aiding technology, therefore, is not sharp. Clearly, what aiding functions one wishes to ascribe to an intelligent cockpit are somewhat arbitrary.

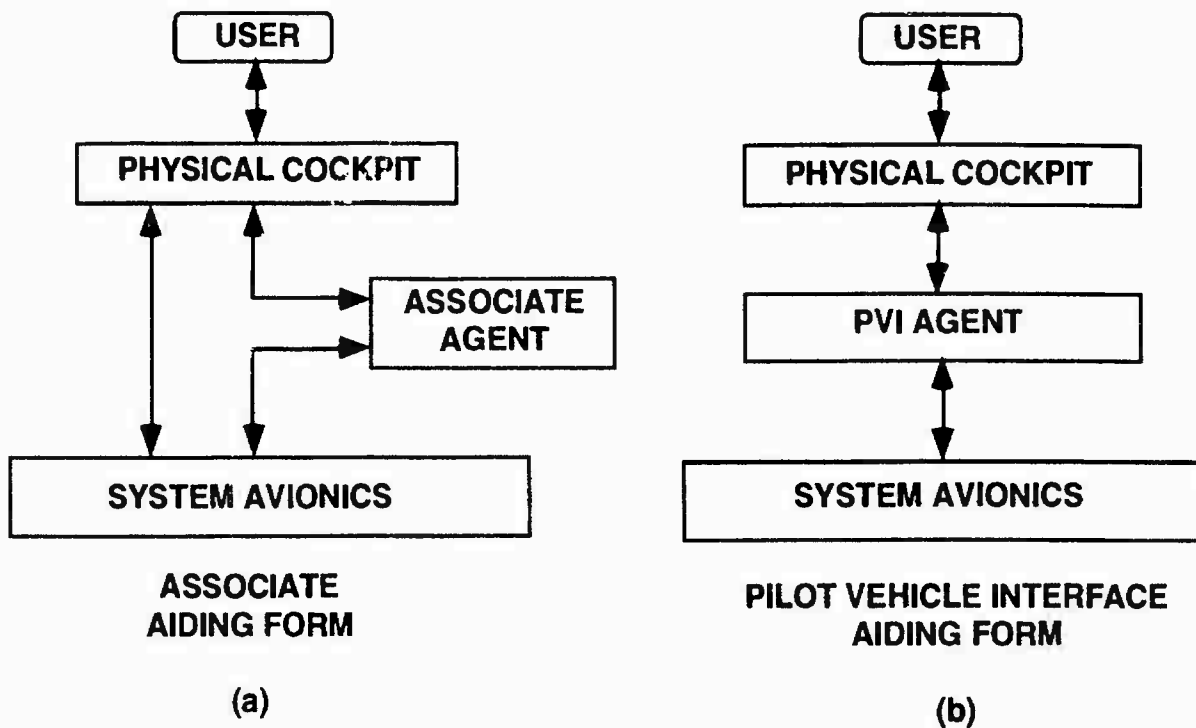

Figure 2. Panel (a) depicts a conceptual architecture for an intelligent cockpit in the form of an associate agent. Panel (b) shows how the architecture might look when an intelligent cockpit is regarded to be a Pilot-Vehicle Interface (PVI) agent.

The distinction between task aiding and useability aiding provides a useful partitioning for the purpose of identifying cognitive requirements, and thus will be used here. But, before turning to a review of requirements, it will be valuable to examine the cockpit aiding technology issue in greater detail.

Whether aiding is best thought of as an associate, a discrete task aid, or an intelligent cockpit depends on the form of the aiding system architecture. A top level view of the

conceptual architecture for an "associate" aiding system is shown in Fig 2a. The associate is a knowledge-based agent that sits between conventional system avionics and the physical cockpit (Ref 1). If it contains a "pilot-vehicle interface" (PVI) that can reason about what information to present and how to present it, given the current context, or how to assist the pilot in ways that make task execution easier, then, in principle, the associate agent could accomplish all of the functions implied by the domains of aiding mentioned earlier (See Fig 1.) (Ref 2). According to

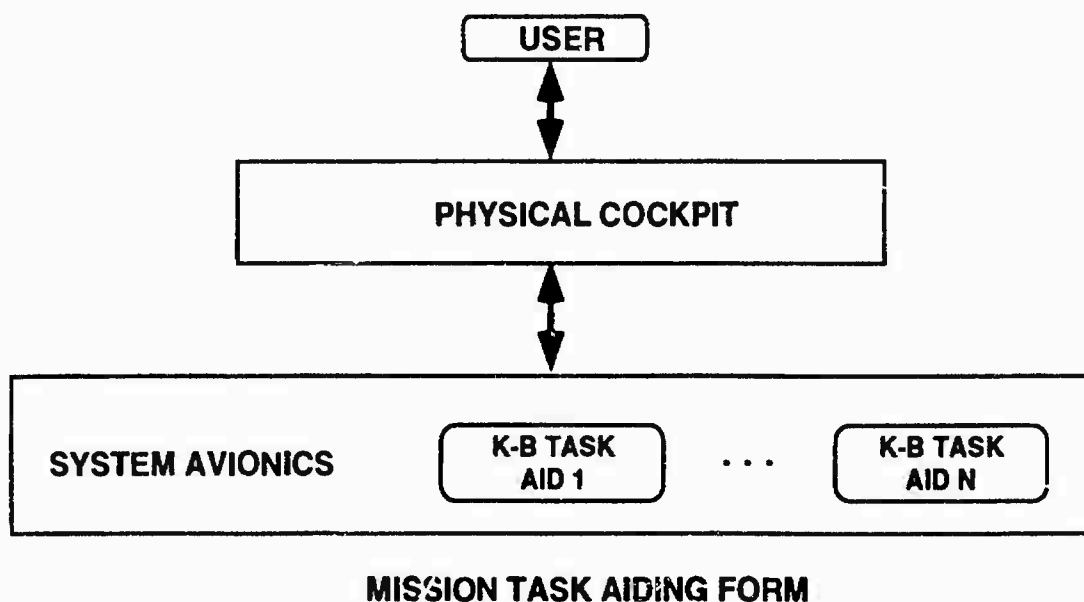
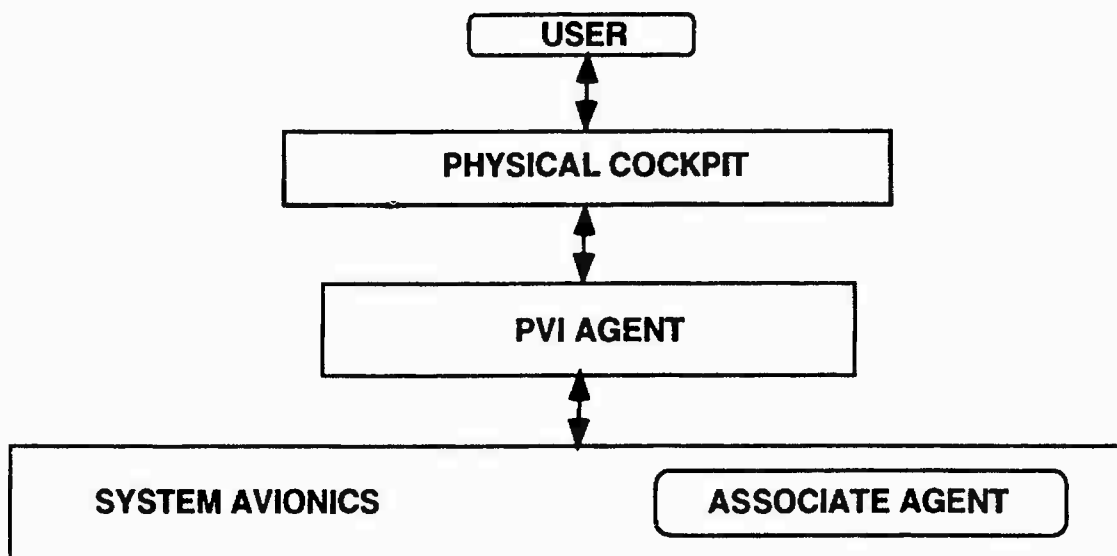

Figure 3. This illustrates a conceptual architecture for an intelligent cockpit in the form of one to N mission task aids. Each aiding system is a module within the system's avionics architecture.



DUO AGENT AIDING FORM

Figure 4. This depicts the conceptual architecture for an intelligent cockpit in the form of two interacting, knowledge-based agents: an Associate agent as a module in the system avionics, and a second Pilot-Vehicle Interface (PVI) agent with a separate process architecture. The intelligent cockpit consists of the two agents and the physical instrument panels, displays, and controls.

this architecture, therefore, there is an equivalence between the concepts of an intelligent cockpit and an associate agent. Given the breadth and depth of knowledge required and the range of aiding required to meet these goals, the associate label seems more appropriate.

Another conceptual architecture is shown in Fig 2b. According to this design, the PVI agent sits between the system avionics and the physical cockpit. The PVI agent is concerned with information management and participating in all transactions with the pilot in a manner expected to yield improved mission performance. All interactions with the system avionics are managed by the PVI, giving it the opportunity to assist in mission performance and make the interface less intrusive and easier to use in the process. The intelligent cockpit, in this view, may be regarded as the physical crew station interface as the front end and the PVI agent as the back plane, or deep structure of the system (Ref 3).

These two architectures, the associate agent form and the PVI agent form, converge if some avionic outputs are passed through the PVI agent to the crew without additional processing, and if the previously mentioned aiding functions are accomplished. Thus, process architecture differences by themselves may not be sufficient to justify one label over another (e.g., intelligent cockpit vs. associate).

Fig 3 shows an architecture for separate knowledge-based mission task aids. Each functional aid is treated as a separate avionic subsystem that makes its capabilities available in the crew station. If one or a small number of mission aiding technologies are provided, this architecture could be regarded

as a weak form of an intelligent cockpit. It is a weak form because, even though knowledge-based methods are employed (hence, in some sense, making the subsystem intelligent), the existence of the capability in the crew station could result in adding more complexity for the crew to handle. The value of the aiding, therefore, depends on whether or not its mission impact exceeds the cost of using it (e.g., the cost of invoking the aid, following operating procedures, coordinating its use with other task-critical activities). This points out that a truly intelligent cockpit not only needs to help the crew with mission-specific tasks, but must do so in a manner that makes the interface easier to use and minimizes or eliminates the intrusiveness of the crew station itself.

A duo agency concept for an aiding system is shown in Fig 4. Both a PVI agent and associate agent are defined. The associate agent is regarded as a multi-dimensional aiding system that can accomplish a wide range of specific mission aiding tasks. It may be treated as a uniquely identifiable avionic subsystem, as shown. The PVI agent is responsible for managing all user-system transactions in a mission sensitive manner. In this way, it minimizes the intrusiveness of the interface itself in the course of mission aiding and facilitates ease of use of the system by the crew. The full extent of mission aiding is dependent upon both the associate and the PVI agent. While both of these functions can be accomplished by the conceptual architectures shown in Fig 2, the duo agency arrangement shows that two separate knowledge-based modules can cooperate to make a more flexible intelligent system.

Both the associate and PVI agent must have a combination of task domain knowledge, system capabilities knowledge,

and user capabilities knowledge. Knowledge in these areas may be shared through a common architecture. The basic difference between the associate and PVI agent is focus. The associate focuses on providing specific task aids. The PVI agent focuses on the ease of use of those aids and all other system assets. As a result of this focus difference, it seems more natural to equate the PVI agent with an intelligent cockpit label and to treat the associate as an intelligent avionic subsystem, but this is really a matter of preference. For the purpose of this paper, an intelligent cockpit is simply regarded as an aiding system. Any of the suggested conceptual architectures could apply to the term. Any finer definition of an intelligent cockpit is left for the designer to decide.

COGNITIVE CONSIDERATIONS

In the previous section, I attempted to clarify the meaning of an intelligent cockpit and to suggest its relationship to other aiding system concepts such as an associate agent and mission task aid. The range of cognitive requirements for an intelligent cockpit, of course, will change, depending on which of the presented conceptual architectures are used to define the crew station. In this section, I propose cognitive design requirements for a *generalized intelligent cockpit* and compare them with design requirements for a conventional crew station. It is important to understand the difference between these two types of cockpits, since the underlying designs may vary greatly even though overt behavioral differences may not be readily apparent. To make this last point clear, I shall begin with schematic depictions of a conventional and a notional intelligent cockpit. This is followed by a discussion of cognitive design considerations.

Conventional Cockpit

A highly simplified representation of a military weapon system is shown in Fig 5. The conventional viewpoint is that the cockpit serves as a means of linking the user with the system. We know that this view is incomplete, since the modern crew station clearly also links the user with the external environment and mission, particularly at night, in adverse weather, or when engagements are beyond visual range. Nevertheless, the diagram presents a schematic or conceptual framework that has generally guided interface design. Fig 5 conveys the notion that the crew station acts essentially as a cable to connect the pilot to the system avionics assets and control system of the air vehicle. This is its principal function. The power of the system is considered to reside in the avionic capabilities (and the human), not in the controls and displays.

Panel b. of Fig 5 shows how a conventional crew station deals with a possible engine fire event. An engine sensor detects the problem and this information is delivered to the cockpit where an engine fire warning light is lit. The pilot attempts to verify the problem by cross checking engine performance parameters and decides to shut down the engine since he will still have enough power to return to base. The switch closure commands the system avionics to shut down the troublesome engine. This illustration shows the basic display-control flavor of the crew station. It simply presents a signal to the crew and receives a response from the user. The avionics accomplish all actions. The interface serves as just a connector between the crew and the avionics.

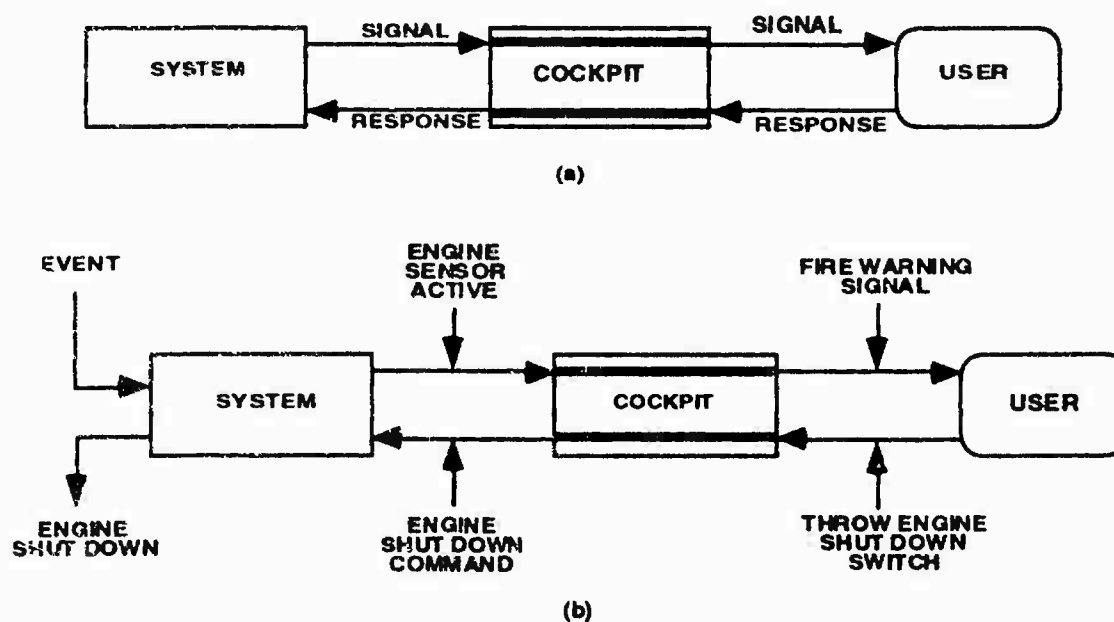

Figure 5. Panel (a) shows a model of a cockpit from the conventional viewpoint: as a display/control center. It acts like a cable that links the user to signals from the system and sends user inputs to the system for action. Panel (b) illustrates how such a cockpit might behave to an engine fire event.

Table 1. A Comparison of a Conventional and an Intelligent Cockpit.

CONVENTIONAL COCKPIT	INTELLIGENT COCKPIT
<ul style="list-style-type: none"> • Display & Control Center (physical) • Information Delivery & Control System (conceptual) • Major Design Requirements <ul style="list-style-type: none"> - layout design - display dial design - format and symbology design - display operational procedure design - control operation design - task-based operational sequence design • Imbedded Cognitive Requirements (basis) <ul style="list-style-type: none"> - mission analysis - task analysis - information analysis - workload analysis 	<ul style="list-style-type: none"> • Inter-agent Transaction Center (physical) • Knowledge-based Aiding System (conceptual) <ul style="list-style-type: none"> - mission task aiding - useability aiding • Human-Like Agent <ul style="list-style-type: none"> - conceptual understanding - conceptual level communication - mixed initiative dialogue • Conventional Cockpit Design Requirements • Additional Cognitive Design Requirements (process architecture) <ul style="list-style-type: none"> - knowledge base design - reasoning process design

Intelligent Cockpit

A notional intelligent cockpit is shown in Fig 6. It is an aiding system that uses knowledge and reasoning processes to: (1) intelligently respond to user commands and requests, (2) provide knowledge-based state assessments, (3) provide execution assistance when authorized, and (4) make the interface itself more usable and non-intrusive. As the diagram indicates, interactions with the pilot are transactional, which implies a dialogue form of communication. Some dialogues may be implicit and depend on action coupled with knowledge level understanding by the user. When this path is used, the interface seems almost transparent (i.e., the intelligent aiding is invisible).

Fig 7. illustrates the potential value added by an intelligent cockpit when an engine fire event occurs. After an engine sensor is activated, a signal is delivered to the intelligent cockpit. Based on resident knowledge, it reasons about the problem, seeks additional data, and considers mission implications. It then determines what notification to deliver to the pilot, how to present it, and how to interpret pilot inputs in response.

It should be clear that an intelligent cockpit is engaged in a great deal of cognitive level internal processing. Under some circumstances, however, on the surface, it may appear no different to the pilot than a conventional cockpit. If, for

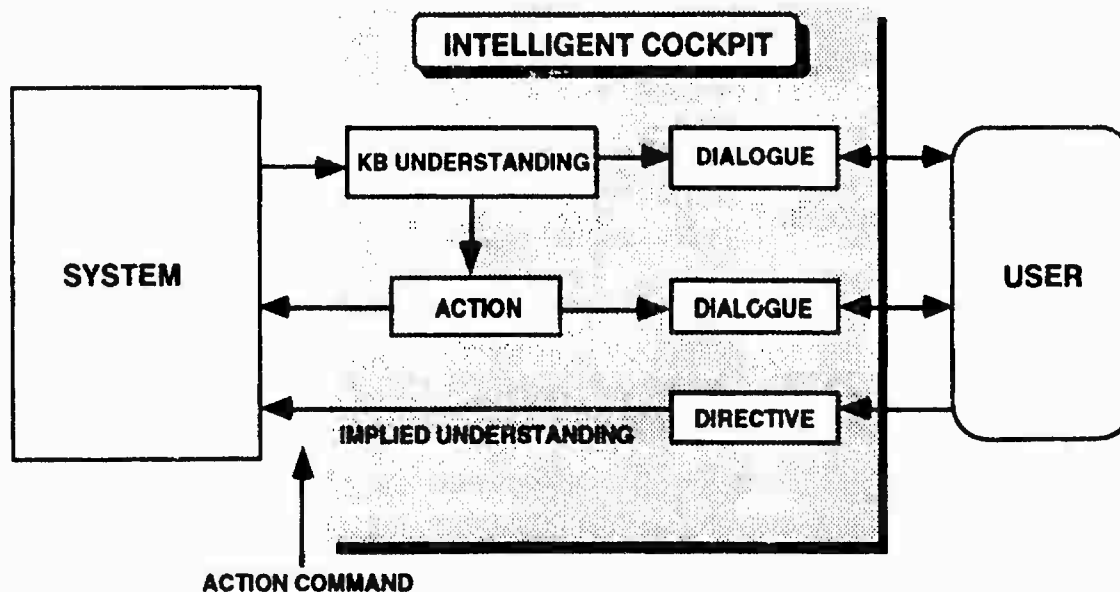

Figure 6. Top level view of an intelligent cockpit as a knowledge-based agent.

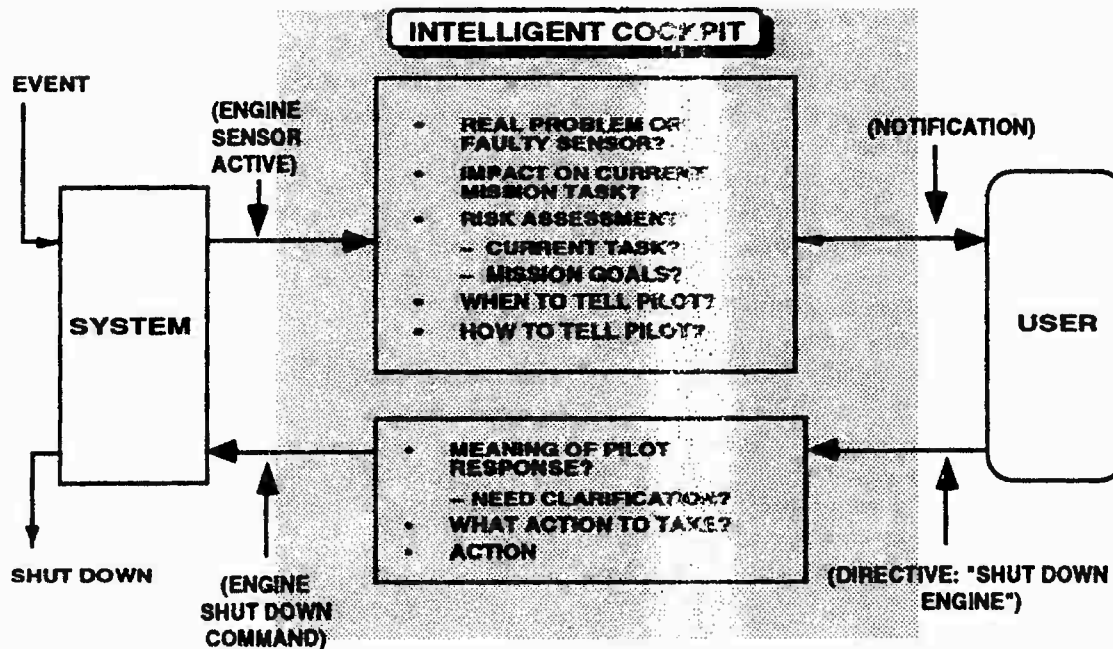

Figure 7. An illustration of some of the knowledge-based reasoning, dialogue activities, and system actions an intelligent cockpit might accomplish in response to a possible engine fire event.

instance, a clearly disabling and dangerous engine fire event occurs, both types of crew station might express the warning in the same terms. If pre-authorized, the intelligent cockpit could begin shut down procedures without an explicit command from the pilot, but it would be a relatively simple thing to add this capability to a conventional cockpit to maintain apparent equivalency. Yet the two types of systems would internally remain vastly different. *The intelligent cockpit would be much more flexible and adaptive in handling these and many other events. The power of the intelligent cockpit comes from its ability to consider a wide range of data and issues that allow it to exhibit adaptive behavior.*

COGNITIVE DESIGN REQUIREMENTS

The function of the pilot-vehicle interface for a conventional cockpit is generally deemed to be self-evident. Its purpose is to deliver system and mission information and to provide a means for the pilot to operate the system. For this type of system, cognitive level functional and informational design requirements are essentially contained in the traditional Human Factors Engineering activities associated with crew station design (See Table 1). They are reflected in the decisions that are made for what information to present, where to place it, etc. The decision to depict Rmax1 and Rmax2 on an offensive system display, the selection of conditions under which a shoot cue will be presented, the decision to announce bingo and joker fuel states, and the design of various threat warning messages are examples where cognitive factors are considered. Cognitive requirements can also be seen in design decisions for declutter modes, panel and format layout configurations, operating procedures, and many other human factors

decisions. In general, these and all other cognitive requirements derive from four sources:

- Mission types and conditions under which the system is expected to perform
- System asset capabilities and the form in which they are made available to the crew
- Human capabilities and limitations
- Physical environmental factors

These sources are explicitly considered using the typical design and analysis tools listed in the Conventional Cockpit column of Table 1. Requirement refinement is generally achieved through a variety of empirical investigations under part task, task, and mission test conditions. The most important point for this discussion is that the cognitive requirements generated by these analyses are essentially *implicitly* contained in the eventual cockpit design. Since a conventional crew station does not contain a process architecture, except for symbol generation, format selection, and control signal processing, a design engineer may not even be aware of the existence of cognitive requirements and how they are fulfilled; they are simply provided by the task analysis and human factors specialist. As a result, they may not be well integrated with other avionic design requirements needed to insure an efficient cockpit design.

By now, it is clear that an intelligent cockpit requires a sophisticated process architecture and can be regarded in terms of a range of aiding functions that it can provide to the system. Table 1 shows the current view of an intelligent

cockpit based on the preceding discussion. It also shows, in distinction to a conventional crew station, that cognitive requirements are contained explicitly in the knowledge bases and reasoning logic used internally by the system to make aiding decisions. *These requirements are in addition to the conventional ones derived from human factors analyses.* The design task for this type of cockpit, therefore, is more like that for the development of any avionic subsystem, but because of the intimate connection the aiding system has with the aircrew, considerable attention must be given to human adaptability, information processing capabilities and limitations, and skilled psychomotor capabilities.

Up to this point, I have treated the meaning of a cognitive design requirement as generally understood by the reader on the basis of prior knowledge and the foregoing discussion. To my knowledge, there is no widely accepted definition of this construct. In an effort to be as clear as possible about the meaning of this term, the following definition is offered:

A cognitive design requirement includes all system factors that are essential for it to behave at a conceptual (symbolic and abstract) level of understanding and engage in a knowledge level discourse with a system user.

The definition contains two parts, both of which are important for the design of an intelligent cockpit, or any other aiding system. First, to qualify as a cognitive design requirement, accomplishment of planned system behavior must depend on the use of a knowledge base, a representation of information at a symbolic level of meaning and understanding. The second part states that only systems behavior which requires or is involved in generating knowledge level discourse with the user qualifies as a cognitive design requirement. The definition purposely excludes the use of knowledge-based technologies for exclusively internal consumption by the system, such as when they are used in an autonomous, fully automatic subsystem. An automatic controller that uses fuzzy logic, for example, would not generate cognitive design requirements according to the definition.

It should not be concluded that this definition pertains only to the design of systems that contain an explicit knowledge-based representation. It is intended to cover cognitive design requirements for any system that depends on the use of abstract knowledge, however represented, to control system behavior and communicate with the user. This includes, for example, any connectionist or parallel distributed process design approach where knowledge is implicitly coded into the network architecture on the basis of designer-determined training (e.g., Ref 4, 5).

It was indicated earlier that cognitive design requirements for an intelligent cockpit derive from four sources: the mission, external environment, system assets (capabilities and limitations), and human user capabilities and limitations. These are the major domains of knowledge that have to be

exploited by a designer to develop an aiding system. In general terms, the designer needs to answer two questions: What abstract information and reasoning ability is needed for the proposed aid to operate (behave) at a cognitive level? What abstract understanding about human cognitive and psychomotor processing must the aiding system achieve in order to interact with the user at a cognitive level of discourse? It follows from these questions that cognitive design requirements for an aiding system may exist in four broad areas:

- knowledge content selection for knowledge-based representation
- knowledge content to support reasoning needed to derive abstract context-sensitive understanding
- knowledge content selection about how to maintain an effective cognitive-based transaction with a human user
- knowledge content selection about the influence of structural and process constraints imposed by system assets and the user on system performance

Knowledge can be regarded as the raw data contained in a knowledge base resident inside an aiding system. The designer must derive what data to include, the levels of abstraction to be used, and the interconnections and dynamic states between data items that are required to efficiently capture symbolic meaning. This task is usually accomplished by knowledge engineers who use various tools to extract pertinent knowledge from so-called domain experts (Ref 6).

Additional raw data is generally needed to support inference-based reasoning. The significance of an object/event or the ability to classify an object/event may depend upon the representation of key attributes in the knowledge base. A detected body moving in the sky, for example, may be classified as an aircraft or a missile depending on its detected velocity and electronic emission profile. Once classified as an aircraft, additional data may be needed to determine its type and its threat significance to one's mission. As the detected aircraft maneuvers over time, when realtime sensor data is lost and then re-acquired, additional knowledge could be used to infer if it is the same aircraft and not a new threat source. Many knowledge sources may need to be consulted by the knowledge engineer to acquire this type of additional information to support the inferencing process.

Earlier, I suggested that a generalized intelligent cockpit could be viewed as a system that provides two types of aiding to the air crew: direct mission task aiding and aiding to make the crew station easier to use by the crew (i.e., useability aiding). It is this second type of aiding that drives the need for cognitive design requirements that focus on transactions of the aiding system with the user. It would be a mistake, however, to conclude that knowledge about

cognitive-based transactions and user capabilities and limitations are not needed if an intelligent cockpit is limited in form to only direct mission task aiding. As indicated previously, an aid's cost of use may exceed its potential benefit unless an efficient context sensitive transaction can be established with the user.

A very general view of cognitive requirements for useability aiding is shown in Fig 8. The requirements are divided into two areas: (1) those related to the selection of knowledge for internal representation and (2) those required to directly support reasoning needed to determine user goals and intentions, and to support cognitive-based transactions. The items in Fig 8 should not be taken as an exhaustive or even comprehensive list of cognitive design requirements. The items are a list of some major areas where more detailed cognitive requirements will be needed to guide the design of an aiding system. It is beyond the scope of this paper, however, to present a detailed listing of cognitive design requirements to support a specific system development program. My purpose here is mainly to raise awareness of the types of requirements that need to be established.

The example entries under Dialogue Knowledge Representation deserve additional comment. Dialogues can range from very simple forms to sophisticated and cognitively complex forms. The range of dialogue knowledge represented in an aiding system places limits on the level of discourse that is possible between the aiding system and the user. The two example cognitive requirements shown in Fig 8 address the knowledge needed to handle natural level dialogue with its inherent ambiguities. Anaphoric expressions are ones where a key reference is only implied from context and not stated explicitly. (It may

have been stated earlier in the conversation.) A pilot might say, "You got it." to pass his control authority of the aircraft. An aiding system might be given this authority, within some defined boundaries. A simple system might only be able to hold heading and airspeed (i.e., a conventional autopilot). A more complex system might fly the stored mission route, or hold the current attitude. A more intelligent cockpit might be able to determine which of these or several other alternatives is implied by the vague anaphoric expression, "You got it," based on its reasoning about important aspects of the context. It should also be noted that this expression need not be conveyed verbally. Given available technology, the pilot could shake his hand or make some other gesture to convey this intention. Nonverbal interactions like this are included under the term 'dialogue' as it is used here. Elliptical expressions are another form of indirect communication an aiding system may have to reason about, and hence, needs knowledge about, in order to make the interface natural and non-intrusive.

It is important to understand that the capabilities and limitations of the human user are a principal feature in defining cognitive requirements for an intelligent cockpit. While it is not explicitly shown in Fig 8, knowledge of this type is interactive with Dialogue and Information Portrayal knowledge requirements when forming cognitive level transactions. It is obvious, for example, that a notification will be unsuccessful if it is delivered in a way that cannot be perceived by a pilot. Therefore, an effective dialogue will insure: (1) the input message is above sensory threshold; (2) signal-to-noise ratio is adequate; (3) cognitive attention is directed to the notice; etc.

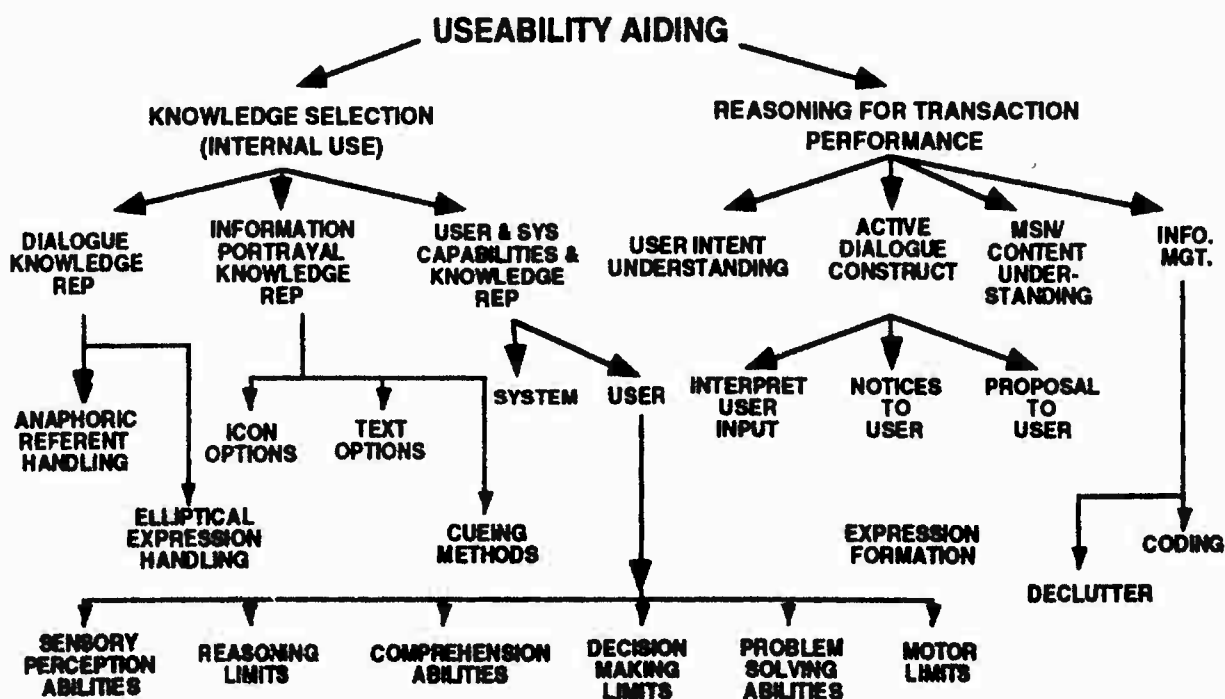

Figure 8. A partial decomposition of cognitive design requirements derived from a useability task aiding role of an intelligent cockpit.

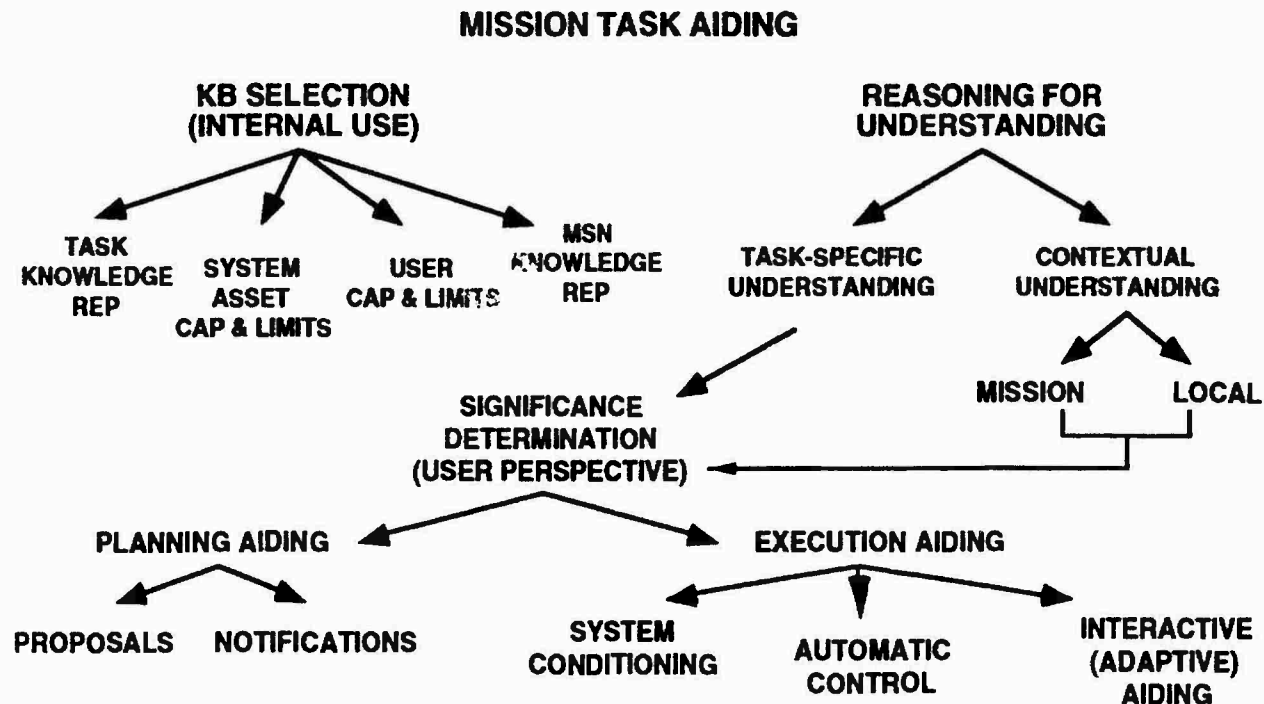

Figure 9. A partial decomposition of cognitive design requirements derived from a mission task aiding role of an intelligent cockpit.

The understanding of human capabilities and limitations is no less important in establishing cognitive design requirements from the mission task aiding perspective. This knowledge is needed for the aiding system to determine when and how to deliver proposals and notifications, and how to offer execution aiding. In short, any mission aiding is nested under the interface as a means of making its effects available to the crew. Therefore, knowledge of user capabilities and limitations apply for the same reason they do from the usability aiding perspective. A highly sophisticated task aid may also depend on knowledge in this area, however, to support reasoning used to determine the likely significance (to the user) of events/states and their implications for possible planning and execution aiding (See Fig 9.).

The evolution of the cockpit from a display and control center to an intelligent aiding system requires the crew station designer to have a deeper understanding of human abilities than ever before. While this topic is broad and its study is well beyond the scope of this paper, it is appropriate to suggest some cognitive design requirements based on human capabilities that probably are not considered during the design of conventional systems. These are requirements where an aiding system can perhaps compensate for human limitations or idiosyncrasies. This topic is covered in the next section.

THE USER AND COGNITIVE DESIGN REQUIREMENTS

Model of Human Performance

There are several ways to model the human in an effort to illuminate fundamental capabilities and limitations. All

have their uses, but no existing model is adequate for every purpose. The current state of knowledge in the science of psychology does not allow us to provide a well-formed, highly integrated model of human behavior at a fine level of resolution. Rather, we have available as design tools: 1) integrated performance models and model-building systems that consider task behavior in fairly gross time and resource terms and 2) information processing models that identify different human abilities and constraints related to single- and multi-task performance (Ref 7, 8, 9). At the other end of the spectrum are detailed models for stages in individual sensory systems, classes of perceptual phenomenon, and some cognitive tasks (Ref 10, 11). All of these models can be put to good use in system design. However, the major challenge is how to adequately account for and predict the form of adaptive behavior that a person will exhibit in a given task context. Most models are very weak in this area. Thus, like most other engineering disciplines, it is risky to base design decisions solely on the basis of analytic findings without verifying and supplementing them with empirical studies that contain relevant mission features.

For the purpose of discussion of cognitive design requirements, I shall treat human performance in terms of a successive set of understand-act cycles. This may be regarded, at least loosely, as a cognitive analog to the Perception-Action cycle model advanced by Neisser (Ref 12). The essential idea is that a person uses sensory, perceptual, and cognitive resources to formulate an understanding of the present situation and bases one's actions in the environment on this state of awareness. As the situation changes, one's understanding changes which, in turn, influences actions and a new understand-act cycle is completed. The notion of understanding is used as a

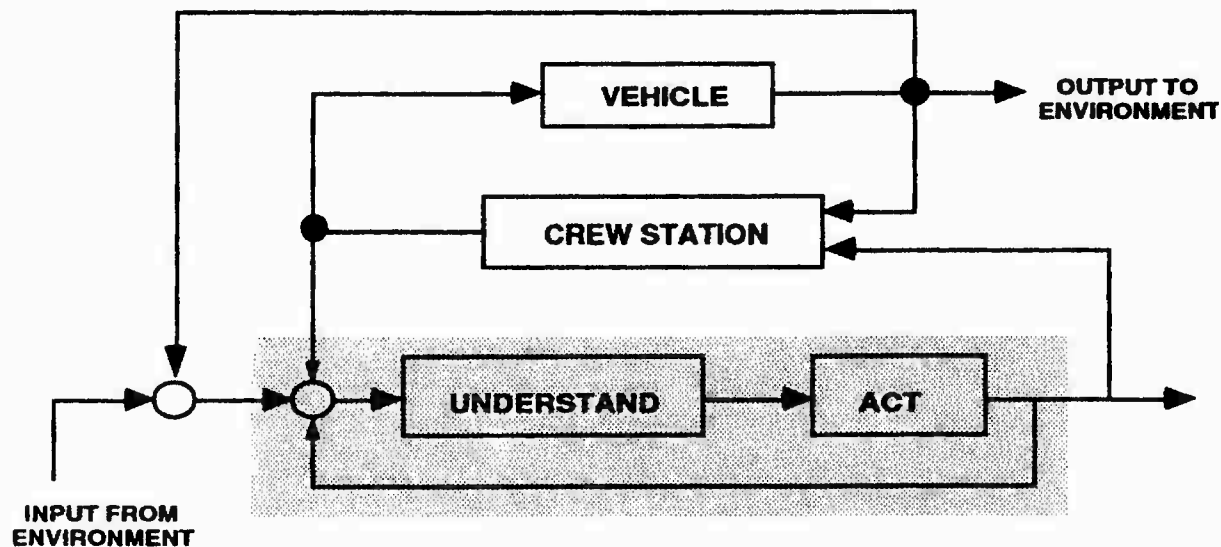

Figure 10. A representation of human understand-act performance in the context of a vehicle.

cognitive construct. It specifies a state of awareness that is relative to the active goals and intentions of the actor regardless of the basis for their induction (i.e., whether they were formed in response to environment states and events or were motivated through self-driven thinking). Action connects the entity back to the physical environment where energy and kinematic constraints are placed on behavior. Through a succession of understand-act cycles, a person accomplishes the goals and tasks needed to complete a job (e.g., a military mission).

In the context of work in a weapon system, a crew station serves as the physical, local job site that is embedded in the external environment where the mission is to be completed. The crew receives information and data from both of these sources, as well as from pre-mission sources, that stimulates understand-act activity. Actions are propagated through the resources made available in the crew station. This simplified model, in the context of a user-machine system, is shown in Fig 10.

Execution of the understand-act process places demands on the human machinery. These demands may be separated into areas according to different types of human resources, as shown in Fig 11. The capture and processing of current input from the work environment (crew station and external world) depends on the performance of the sensory-perceptual subsystem. Characteristics of this system constrain the precepts that can be produced from these signals. The demand on the system can be understood in terms of how aspects of the stream of incoming signals interact with these processing characteristics. A limitation is said to exist when some aspect of the impressed signal matrix potentially important for human performance is in some way lost, corrupted, or retarded in time. If, for example, the ambient light changes by several orders of magnitude, the vision system can become energy saturated or deprived so that informational aspects of the signal are lost, temporarily, until the eye adjusts to the new light level. This is the common phenomenon of light or dark adaptation, depending

on the direction of energy change. As a result of the process architecture of the visual system, at least two performance limitations result under these conditions. Real time sensory data providing anticipatory or feedback information actively being used to guide action-taking is temporarily lost and thus human performance degrades (perhaps to the point of stopping). Second, no new visual percept of any kind can be formed for some period of time after exposure to this type of environmental event. Hence, any potentially useful information (e.g., cognitive content), such as alerting signals or state changes, are not available either and performance will degrade accordingly. In a similar way, limitations on human performance result from the interaction of signal matrices with the long term memory, working memory, and motor systems.

In very general terms, the study of human cognitive behavior is often separated into four areas: reasoning, comprehension, decision making, and problem solving. This partitioning does not necessarily imply a commitment to separate systems for these areas. Most researchers would probably agree that there is considerable overlap among them at the process level. But, for the purpose of illustrating how human processing limitations can lead to cognitive design requirements for an intelligent cockpit, they may be used to organize the discussion.

Fig 11 depicts these areas of cognition as components of the understand-act process. Also shown is a skilled-movement component needed to tie in motor limitations. Sensory-perceptual factors have been suppressed at the process level of representation. Based on a broad range of research in each of these content areas, some processing characteristics of a person who is actively seeking to understand and act in the environment are well known. This knowledge of human cognition and motor skill performance can be used potentially in two ways to guide the formulation of necessary cognitive design requirements. First, as already mentioned, to insure user compatibility with the design of a specific mission task aid, it must interact with the user in a

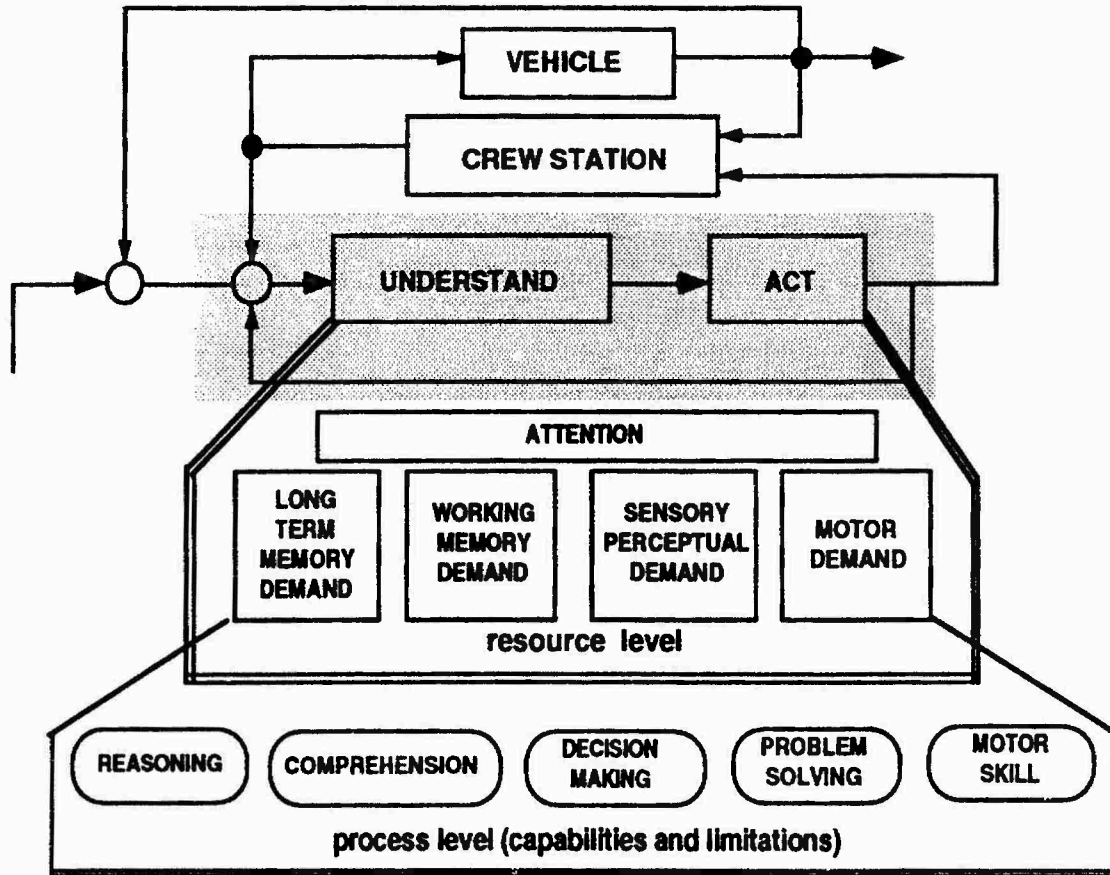

Figure 11. This diagram decomposes the human understand-act system into areas of processing capabilities and limitations. Task-activated, understand-act processing requirements place demands on human resources to achieve desired mission performance.

form that is bounded by the human constraints (i.e., can be achieved given the constraint). A second way knowledge gleaned from Cognitive and Engineering Psychology can be used in cockpit design is to pattern machine functions and processes after known characteristics of the human. A few examples of both types will be used to illustrate the point.

A consistent finding in the study of reasoning and decision making is that humans seek evidence to confirm a hypothesis. This attitude for seeking only confirmatory evidence has been called a confirmation bias. It can lead to errors in judgment when the sampled cases all agree with the hypothesis (but it is wrong) and the evidence from them is consistent with this view (Ref 13). An error may occur because of undersampling a large space (and negative instances have not been selected) or because the hypothesis is a special case of the true underlying situation. These problems can be eliminated, or at least minimized, if some disconfirming tests are made.

Knowledge of the human confirmation bias (constraint) suggests a possible cognitive design requirement for an aiding system. The system could be given knowledge of this human foible and use it to make "test" suggestions to a user who, say, might be exploring hypotheses to diagnose a tactical situation or to troubleshoot a system malfunction.

Humans are good at resolving anaphorical and elliptical expressions contained in a dialogue. If an aiding system also had this capability, then a more natural language discourse could be maintained. This would reduce memory load demand on the user for specific syntactic and semantic structure of a less flexible discourse; hence, without this ability of the intelligent cockpit, the interface probably would not be as easy to use. Based on studies of language development by Kintsch and his colleagues, it has been proposed that four cognitive models are used to resolve ambiguities like those of anaphoric reference. These models, therefore, might serve as useful cognitive design requirements for an aiding system. (For details, see Ref 14, 15, 16, 17.)

Working memory and attention are also identified in the expanded understand-act model shown in Fig 11. Everyone is well aware that it is difficult, if not impossible, to attend to several things simultaneously, and that it is often hard to mentally manipulate (i.e., operate on) many items without the use of an external aid like a pad of paper. There is a vast psychological literature that attempts to elucidate human attention and memory limitations (Ref 18, 19).

When these limitations impede human information processing, they are properly regarded as cognitive constraints. A general finding is that working memory limits is approximately 7 ± 2 items (Ref 20). A complicating factor for scientists and engineers alike, is that what constitutes an effective item can change through learning and experience. This is an example of the amazing adaptive abilities of the human. Indeed, with practice, it has been shown that while the typical adult can memorize ± 7 digits for immediate recall, some can far exceed this limit. Ericsson et al (Ref 21) trained one individual to recall a string of over 80 visually presented digits. This feat was achieved apparently by chunking the digits and associating them with general knowledge about finishing times in races. (The subject in this study was a runner.) All humans learn to chunk from elemental units like letters to progressively larger units like words, propositions and concepts, even if they normally do not achieve the level shown by Ericsson's et al subject (Ref 22).

Two types of cognitive design requirements are suggested to address this human limitation and adaptability. One, of course, is to track demand on thinking (i.e., reasoning, decision making, and some forms of problem solving), infer available chunk size, and limit items presented to stay within the magical number. A second possible design requirement might be to determine the way to package information so that the user can process it efficiently using the largest available (from learning and experience) chunk size (i.e., facilitate human generation of a larger chunk size).

Attention can be focused (like a spotlight), divided between two areas of interest, and directed (oriented) to a place of importance. A rich body of data indicates some of the factors that can facilitate attention dividing or focusing. This is obviously an important area for cognitive design requirements (see Ref 19).

Research from a problem solving orientation has been largely responsible for illustrating how humans use heuristics to reduce cognitive workloads. Simon, for example, has highlighted how a person will employ a qualitative "rule-of-thumb" that generally yields "good enough" performance though it often does not lead to optimal performance. Simon has called this a "satisficing" strategy (Ref 23, 24). This finding was central to much of the research that underlies the emergence of AI as an area of Computer Science, and the formulation of a new discipline called Cognitive Science. Work on human problem solving, therefore, may have great influence on cognitive requirements for knowledge representation and inference processing.

An understand-act model of human performance is just that -- only a model of behavior. Often, it may be difficult to cleanly separate behavior into these two aspects, and generally people are themselves aware of their own performance only at an integrated, holistic level that

obscures the understand-act division. Even though cognitive issues in general tend to address the understand side of the cycle, the act side must still be considered.

A classic example of a psychomotor design requirement addresses so-called stimulus-response compatibility (Ref 25). The stimulus side may at times require considerable mental processing before a response (physical action) is initiated. By considering the modality of the input, the internal code required to achieve understanding, and the output channel required for a physical response, a designer may be able to arrange things to optimize psychomotor compatibility for the user (see Ref 9).

These illustrations have shown a range of possible cognitive requirements for an intelligent cockpit. Some of these address aspects of aiding that are likely to contribute directly to mission performance aiding. Others may contribute most often by improving the useability of the interface itself. A knowledge of human capabilities and limitations is clearly important to the design of an intelligent interface.

LIMITATIONS AND CAPABILITIES ON THE SYSTEM SIDE

Any physical device always has limits on how it achieves its intended functions. A radar system, for example, has limits on acquisition range and resolution. In addition to processing limits, the physical form of a device constrains how a person gains access to its functional capabilities. Thus, while it makes important capabilities available, utilization of its functional abilities places demands on the user. If the user cannot meet these demands in a given situation, then, of course, total user-machine performance is degraded. This is the classic problem of human factors engineering for conventional cockpits. For an intelligent cockpit, however, this type of issue takes on a new dimension that has implications for the design of device features with which the user does not directly interact. An aiding system needs adequate degrees of freedom on the machine side to allow implementation of cognitive-level aiding methods.

An intelligent cockpit gains some of its power based on an ability to adaptively construct a cognitive-level dialogue in a context-sensitive manner. For example, the intelligent machine agent may propose a single-side offset tactical attack by delivering a simple text message to the aircrew. It might also present the same message through a voice synthesizer. And it might be able to vary the detail of the message content, including using features of the current environment in the proposal. In addition to these strictly language-based manipulations, the dialogue could occur based on graphical inputs to the crew and interpretation of crew-induced vehicle actions. Thus, for instance, a flight trajectory symbolizing a single-side offset could be displayed on a tactical situation display. The point of this discussion is that the intelligent agent needs to be able to

Issue: announce a state, condition, or event

Standard Design Approach

Abstraction Level: concrete =
implementation method

Implementation Logic:

IF: <state>

THEN: activate preselected
implementation method

Options: Blink, Color, Reverse
Video, Sound, Voice

Cognitive Engineering Design Approach

Abstraction Level: conceptual =
invitation concept

Implementation Logic:

Knowledge-based, context sensitive
implementation

IF: <context condition>

THEN: select <implementation method>
AND activate <selected method>

Options: Blink, Color, Reverse
Video, Sound, Voice

Figure 12. An example of cognitive-based design for an intelligent cockpit shown in contrast with the standard interface design approach.

express itself in many different ways to have an effective dialogue as task conditions change. This will also allow the intelligent cockpit to minimize its own intrusiveness on crew workload.

To achieve this dynamic range of cognitive abilities, an intelligent cockpit must have access to low level features of individual avionic devices. In addition, a cognitive architecture must be formulated for the intelligent system, otherwise the designer will not know what device features must be made available to support abstract user-machine dialogue. A simple example of what I am advocating can be seen by examining an annunciation system. The functional goal of an annunciation system is to alert the user about a state or event expected to have importance to mission performance. Conceptually, an announcement consists of two parts. It contains an alerting component that invites the user to notice something of importance. The second component, of course, is the content of the message itself. These two components may either be tightly or loosely coupled. A blinking light, for example, may be used to draw attention to a dialogue box that contains a text message (loose coupling), or the blinking light itself may contain the message by a color-coded code (e.g. blinking light means a fuel flow problem). Memory load can be removed from the tightly coupled form by blinking a text message, as with a shoot cue that blinks the word "shoot" in a conventional cockpit, both components of an annunciation system are fixed during design. That is, a single form of implementation is established for each alert. An intelligent cockpit has the possibility of holding constant an annunciation function at a higher level of abstraction. It could hold in memory, for example, the concept of an annunciation defined by inviting and message components. The method of implementation could be separated from this knowledge-level understanding.

The result is a cognitive architecture for an intelligent announcing system that has the freedom to choose a suitable implementation method based on the situation at the moment. For example, if a display contains many red symbols, and an announcement needs to be made, presenting another red symbol may fail to accomplish the alerting or inviting function. An intelligent interface could infer this based on its knowledge and select a different implementation strategy such as blinking. This contrast between an intelligent and conventional aiding system is shown in Fig 11². It is important to note, however, that this intelligent aiding could not be achieved unless the hardware design of the interface allows the aiding system to have access to and manipulation authority over the available implementation methods. System designers must be sensitive to this type of cognitive design requirement to enable an intelligent cockpit to reach its full potential.

CONCLUSIONS

The concept of an intelligent cockpit and the need for detailed cognitive design requirements are outgrowths of the use of AI technology in a military system. An intelligent cockpit can mean several different things. I have taken the position here that it is best thought of as a knowledge-based aiding system. The aiding may come in different forms and in different areas, all of which may be regarded to be in some sense an instance of an intelligent cockpit. In general, an intelligent crew station may offer aiding in two areas: mission task aiding and interface useability aiding. Knowledge-based mission aiding may also be defined as an

2 The notion of a knowledge-based, context sensitive annunciation system has not been thoroughly developed, nor has it been tested. There are many issues that need to be resolved before its value can be determined. Its use, therefore, should be approached with due caution.

Crew Interface Subsystem Evolution

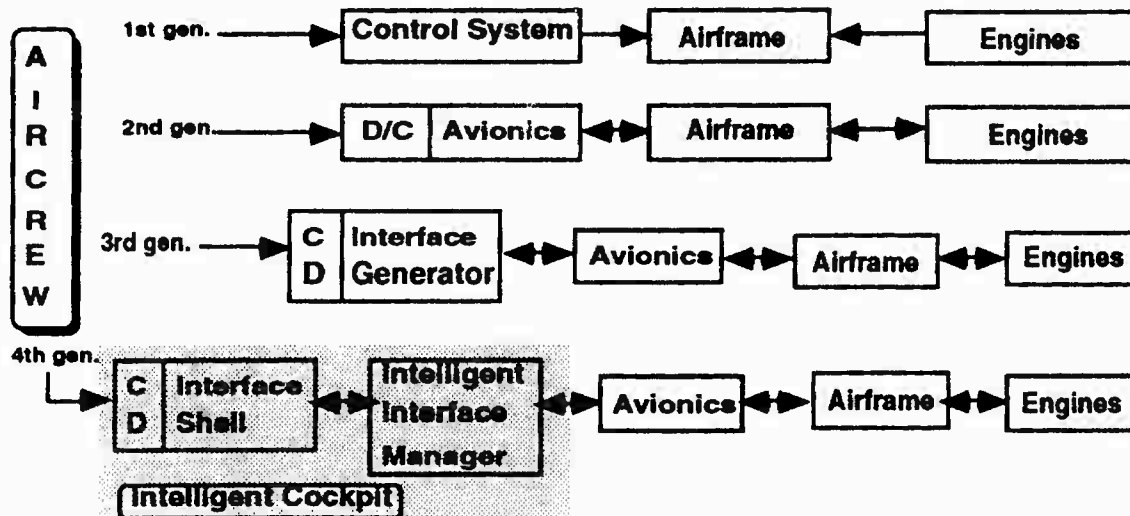

Figure 13. A schematic depiction of the evolution of the airplane cockpit from a simple set of controls to an intelligent cockpit as an aiding system.

electronic associate or as a stand alone intelligent task aid. These different viewpoints can add further confusion over the term intelligent cockpit. I suggested here that the most appropriate term to use (e.g., associate, task aid, or intelligent cockpit) may depend on the form of the process architecture used for the aiding system. Four possible conceptual architectures were presented and associated with these different terms for aiding systems.

A definition was offered for a cognitive design requirement that emphasized the system's ability to behave on the basis of knowledge, and to converse with the user at this level. The selection of knowledge for representation to define task states, events, and their significance was identified as a source of cognitive requirements, as was knowledge used to support the inferencing process. Another important source of cognitive requirements stems from the cognitive processing capabilities and limitations of the human user of the system. I argued that a deeper or more complete understanding of human abilities is needed for the design of an intelligent cockpit as an aiding system than that required for a conventional system. This additional insight is needed in part to support intelligent selection of human ability/knowledge for representation in the aiding system, and in part to be sure dialogue expressions are formed to make the interface easy to use and non-intrusive.

An understand-act model of behavior was presented to relate human performance to major areas of cognitive research in psychology. The basis for several possible cognitive design requirements that emerge from human abilities were illustrated. These included factors associated with attention, working memory limits, and an analysis (reasoning and decision making) bias known as a confirmation bias. The human ability to learn and adapt offer special challenges to the system designer, and an example of this was presented.

It is clear that an intelligent interface serves more roles than a conventional one. Since the beginning of aviation, there has been a progressive advance in the roles of the crew station as the uses and demands on airplanes as military weapon systems have increased. (See Ref 3 for a discussion of this point.) Generally, the interface has grown in complexity as new roles are assumed and more and more avionic devices have been added to the system. An intelligent interface represents an important departure from this historic development. While it again expands the role of the crew station, it is also a development that is intended to reduce, not add to, the complexity of use of the interface. To achieve this goal, the aiding system has its own knowledge base and internal process architecture. As a result, it is entirely appropriate, if not essential, to treat an intelligent interface as a major and separate avionic subsystem. In order to produce good intelligent interface designs, it will be necessary to devote more attention to the interface than ever before. It will also be necessary to have a clear understanding of how each avionic device and subsystem is distinct from the aiding system and how these abilities are made available for it. This is needed to allow the interface aiding system to form and manage the interface in a way that can make it easier for the operator to use. A view of the evolution of the crew vehicle interface toward this state as an aiding system is depicted in Fig 13.

A cockpit as a knowledge-based aiding system holds enormous potential as a means to improve user performance through various methods to aid situation awareness, effectively managing user workload, as well as by providing direct task aiding. To turn this potential into reality, however, the designer must successfully meet a new assortment of challenges. Some of the most difficult ones will no doubt stem from the cognitive nature of the to-be-designed artifact. New tools and methods will be needed. The ability to produce well-formed cognitive design

requirements will be an essential step in the emerging development process. Hopefully, this paper can be used to point the designer in the correct direction.

ACKNOWLEDGMENT

I am grateful to Laura Mulford for her splendid assistance in the preparation of this manuscript under difficult circumstances.

REFERENCES

- 1 Banks, S.B. and Lizza, C.S., (1991) Pilot's Associate: A cooperative, knowledge-based system application. IEEE ALMagazine, 6(3).
- 2 Rouse, W.B., Geddes, N.D., and Curry, R.E. (1988) An architecture for intelligent interfaces: Outline of an approach to supporting operators of complex systems. Human-Computer Interaction, Vol. 3, 87-122.
- 3 Eggleston, R.G. (1988) Machine intelligence and crew-vehicle interfaces. In E. Heer and H. Lum (Eds.) *Machine Intelligence and Autonomy for Aerospace Systems*, Washington DC: American Institute of Aeronautics and Astronautics.
- 4 McClelland, J.L. and Rumelhart, D.E. (1985) Distributed memory and the representation of general and specific information. Journal of Experimental Psychology: General, 114, 159-188.
- 5 Rumelhart, D. (1989) The architecture of mind: A connectionist approach. In M.I. Posner (Ed.) *Foundations of Cognitive Science*, Cambridge, MA: MIT Press, 133-159.
- 6 Boose, J.H. and Gaines, B. (1990) *The Foundations of Knowledge Acquisition*, London: Academic Press.
- 7 Pritsker, A.B., Wortman, D.B., Secum, C., Chubb, G., and Seifert, D.J. (1974) SAINT: Vol I: Systems analysis of an integrated network of tasks. Technical Report AAMRL-TR-73-126, Armstrong Aerospace Medical Research Laboratory: Wright-Patterson AFB, Ohio.
- 8 Wherry, R.J. (1976) Human operator simulator: HOS. In T. Sheridan and G. Johansen (Eds.) *Monitoring Behavior and Supervisory Control*. New York: Plenum Press.
- 9 Wickens, C.D. (1984) *Engineering Psychology and Human Performance*. Columbus, Ohio: Charles Merrill.
- 10 Gillund, G. and Shiffrin, R.M. (1984) A retrieval model for both recognition and recall. Psychological Review, 91, 1-67.
- 11 Marr, D. (1982) *Vision*. San Francisco: W.H. Freeman.
- 12 Neisser, U. (1976) *Cognition and Reality: Principles and Implications of Cognitive Psychology*. San Francisco: W.H. Freeman.
- 13 Kahneman, D., Slovic, P., and Tversky, A. (1982) *Judgement Under Uncertainty: Heuristics and Biases*. Cambridge, England: Cambridge University Press.
- 14 Kintsch, W. and van Dijk, T.A. (1978) Toward a model of test comprehension and production. Psychological Review, 85, 363-394.
- 15 van Dijk, T.A. and Kintsch, W. (1983) *Strategy of Discourse Comprehension*. New York: Academic Press.
- 16 Keenan, J.M. (1986) Development of microstructure processing in children's reading comprehension: Effect of number of different arguments. Journal of Experimental Psychology: Learning, Memory, and Cognition, 12, 614-622.
- 17 Kintsch, W. (1988) The role of knowledge in discourse comprehension: A construction-integration model. Psychological Review, 95, 163-182.
- 18 Baddeley, A.D. (1990) *Human Memory: Theory and Practice*, Needham Heights, MA: Allyn & Bacon.
- 19 Parasuraman, A.B. and Davies, D.R. (1984) *Varieties of Attention*. New York: Academic Press.
- 20 Miller, G.A. (1956) The magical number seven plus or minus two: Some limits on our capability for processing information. Psychological Review, 63, 81-97.
- 21 Ericsson, K.A., Chase, W.G., and Faloon S. (1980) Acquisition of a memory skill. Science, 208, 1181-1182.
- 22 Chase, W.G. and Ericsson, K.A. (1981) Skilled memory. In: J.R. Anderson (Ed.) *Cognitive Skills and Their Acquisition*. Hillsdale, NJ: Erlbaum.
- 23 Simon, H.A. (1978) Information processing theory of human problem solving. In W.K. Estes (Ed.) *Handbook of Learning and Cognitive Processes*, (Vol. 5), Hillsdale NJ: Erlbaum.
- 24 Simon, H.A. (1981) *The Sciences of the Artificial*. Cambridge, MA: MIT Press.
- 25 Fitts, P.M. and Seeger, C.M. (1953) S-R compatibility: Spatial characteristics of stimulus and response codes. Journal of Experimental Psychology, 46, 199-210.

ERGONOMIC DEVELOPMENT OF DIGITAL MAP DISPLAYS

Adrian Martel
George A. Ward

British Aerospace Defence Ltd.,
Military Aircraft Division,
Richmond Road,
Kingston upon Thames,
Surrey KT2 5QS.
UK.

SUMMARY

In the high workload environment of the cockpit the importance of efficient transfer of information from visual displays to the pilot is of the highest priority. British Aerospace, Kingston, has developed a prototype Situational Awareness display which successfully combines tactical information with a digital map and aeronautical information. The interface in terms of presentation and functionality is designed to complement the process whereby visual information is cognitively integrated into mental models of Situational Awareness by the user.

The development of the display involved a comprehensive literature search on perception and cognition, analysis of map representations, and an iterative evaluation whereby successive prototypes were developed and refined. This paper details the many visual design principles which were identified during this work which were successfully incorporated into this display and which may in addition be of great benefit to other displays. Where displays are being radically revised, a holistic redesign from first principles is preferable to simply adding new features.

1 INTRODUCTION

This study centres around the development of a Situational Awareness (SA) display by the Kingston/Farnborough Cockpit Group¹ of British Aerospace Defence Ltd (Military Aircraft Division). The display includes Tactical information, Low-Flying aeronautical information and a Map. The methodology used is discussed, and the cognitive principles which were used to optimise the interface are described in a way which allows their application in other displays.

1.1 THE INCREASING WORKLOAD

In recent years, the complexity of military fast-jet cockpits has risen with the provision of a greater and more diverse number of sensors supplying more information than ever before. This is a trend that is set to continue.

In the same period it can also be noted that there has been a shift away from multi-crew cockpits towards single pilot ones, second crewmembers being left out of new designs in the name of cost, weight and aerodynamics.

This sets the scene for a problem which has been greatly researched and discussed - that of the pilots workload. Obviously the factors just described have increased the pilots workload. Automation has been used to take care of some systems, but these still have to be monitored. It is consequently essential that any task which occupies the pilots attention should be conducted as effectively as possible so that the workload is minimised.

1.2 THE DESIGN TASK

The particular aspect which will be covered here is that of maximising Situational Awareness.

The task was to develop a SA display which would convey information and meaning in a way allowing the pilot to assimilate information as accurately and quickly as possible to enhance his situational awareness.

The display consisted of three superimposed visual formats. The 'Map' format resembled an Ordnance-Survey type map. Overlaid upon this was an 'Aeronautical Information' format showing airfields, navigational landmarks and other aeronautical information (as shown on low-flying charts). Finally, the 'Tactical' format showed a Present Position (PP) symbol which represented the pilots aircraft together with other symbology designed to allow the pilot to gain an impression of SA and control the display. This included a compass, heading lines, symbols for other aircraft ('tracks') and icons.

2 THE STUDY METHODOLOGY

After an analysis of the principles used in the current formats and maps, and a literature search on cognitive theory (especially of the 'use of contrast'), an initial design philosophy was developed which attempted to implement the display in a form which optimised the transfer of information to the pilot.

Evaluation of this was based on a prototype display which was, at any point in the development, the implementation of the 'current state' of the philosophy. The prototype system was designed to interact with the user in a way which modelled the way the real system would interact with the pilot (Figure 1).

During evaluation, emulated data under the control of a system developer was used to simulate a variety of conditions; in this environment, a 'user' worked his way around the interface. The philosophy and its implementation 'evolved' using iterative development, both on the basis of the feedback from the 'user' in the evaluation and with the expansion of the knowledge-base of applicable cognitive/workload literature.

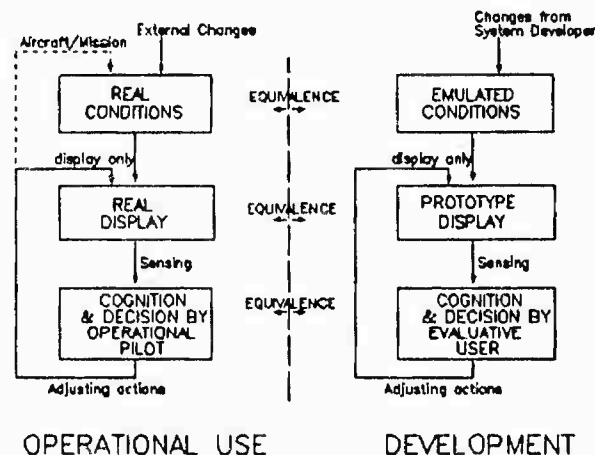

Fig. 1 - The evaluative environment modelled operational use

3 MAXIMISING THE EFFICIENCY OF THE TRANSFER OF INFORMATION INTO SITUATIONAL AWARENESS

3.1 OVERVIEW

The continuous information flow between the pilot and aircraft shown in Fig. 1 can be further divided into major units as shown in Figure 2.

¹ C.K. Vassie contributed expertise in Visual Performance Modelling for this work

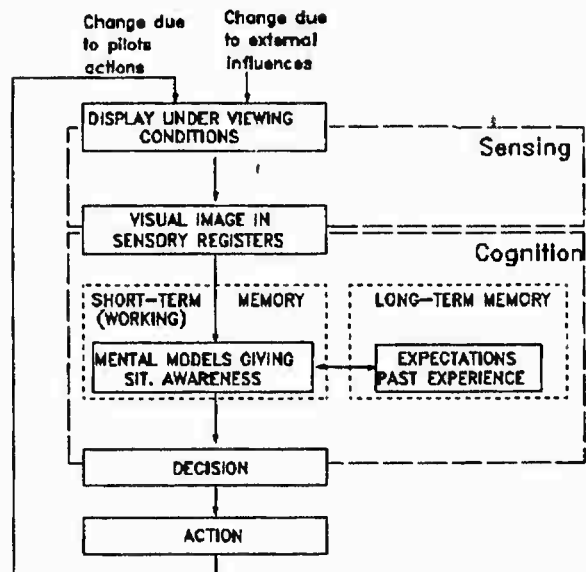

Fig. 2 - The updating of Situational Awareness from display information

Initially the visual information in the display formats is 'sensed' or transferred into the viewers visual sensory registers (Iconic memory) through the cockpit environment and the viewers eye.

It is then that cognition takes place to transform the visual information into an update of Situational Awareness (mental models in short term memory).

This paper and in particular this section (section 3) concentrates on the cognitive process and how this was optimised by the incorporation of psychological principles into the functionality and representation of information in the display formats. Once these cognitive principles have been introduced, it will then be possible to discuss (in section 4) how they may be used to compensate for the loss in sensing efficiency due to 'environmental' factors such as glare.

3.2 THE COGNITIVE PROCESS

The cognitive process is defined by Bailey (1982) as consisting of "all the processes by which sensory input is transformed, reduced, elaborated, stored, recovered and used".

It was said above that the cognitive process turns a visual image of a display into Situational Awareness, or a modified form of the latter. There are several stages within this process, and these can be simplistically termed Recognition, Assimilation and Exploration.

Recognition is one of the lowest-level cognitive processes and involves the basic grouping together of visual features which are compared with known symbol types in memory. In order to be recognised, some mental manipulation of a feature-group may be required, especially rotation and scaling.

Assimilation is the next highest level where a set of symbols have been recognised, and now their relationship (especially in orientation) or attributes (eg the heading of a tracked aircraft) are being determined. In determining how this relates to the stored mental models more mental manipulation may be required, again including rotation and scaling, but the elements being manipulated are no longer just visual features but concepts (like 'hostile aircraft' or 'road').

Exploration is the highest level which will be covered here, and really is just a feedback loop of interaction with the display and its controls to learn more about, in this case, an area shown. The information gained during exploration will usually be more than can be shown on the screen in any one 'mode' and this is what puts exploration above recognition and assimilation. An example of such a 'mode change' for the display might be a change of map scale to see more detail, or study of an area which previously was off the screen.

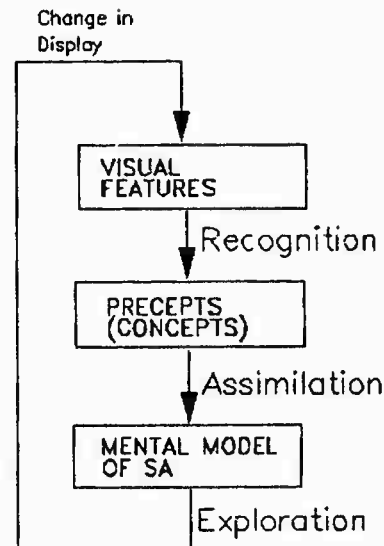

Fig. 3 - The relationship between Recognition, Assimilation and Exploration in Cognition

Recognition, Assimilation and Exploration are all areas where cognitive help can be provided, and are discussed in Sections 3.2.2, 3.2.3 and 3.2.4 respectively.

Before this is done, however, Section 3.2.1 will describe the two basic approaches taken by the mind within Cognitive processing. In doing this, the importance of Consistency in maximising cognitive efficiency will be highlighted.

3.2.1 DATA AND CONCEPTUALLY DRIVEN COGNITIVE PROCESSING

Processing in general can be seen as being composed of two concurrent sub-processes, data-driven and conceptually-driven processing. The bias between these (ie which predominates) may vary according to circumstance, and may be tipped in favour of the latter (which is faster) by utilising visual consistency.

(A) DATA-DRIVEN PROCESSING

'Data-driven' or 'bottom up' processing predominates when little is known about what may be in a visual image. The emphasis is on 'feature analysis' - the conceptualisation of a mental model of situational awareness 'from scratch' using only the interpretation and recognition of visual patterns, features and relationships.

In the context of the situational awareness display this especially relates to gaining the 'first impressions' of map features, aeronautical information and other aircraft in an unknown area.

(B) CONCEPTUALLY DRIVEN PROCESSING

The second of the concurrent processes, 'Conceptually Driven' or 'top down' processing relies on context and expectation. Thus, further reference to a display which has already been studied will be biased towards this because the user has strong expectations about what is presented (perhaps from a 'short list' of possibilities), and will only need to look for evidence to confirm or update this. Such evidence may need to be only a simple aspect of the appearance of a feature which is a relevant discriminator in the context, and thus conceptually driven processing thus requires less time and effort than data-driven processing. It may be noted, however, that in using such minimal evidence, the probability of misidentification of very similar features is raised.

In any situation some features, elements of the SA format in particular, will remain as 'standard' and will be expected by the pilot.

The Assimilation stage of cognition is likely to be mostly of this type of processing as most symbols will have already been recognised.

(C) THE NEED FOR CONSISTENCY

A bias towards the faster conceptually driven processing can be provided by making the visual interface of the display as consistent as possible. This may be achieved using:

I. 'Spatial Consistency'

When spatial consistency is used, symbols or information are positioned where they might be expected (instinctively) to be. This place might be related to the area where the user might be looking (perhaps as part of some related task) or might simply be a single location for that symbol whatever the context. An example of the latter is that the Attitude Indicator is always located in the bottom right hand corner of the screen.

II. 'Representational Consistency'

'Representational consistency' refers to the symbology used to represent a feature, and is optimal when familiar features/stereotypes are used as far as possible.

(a) Attribute Level

Perhaps the lowest level of consistency is consistency in particular feature attributes. Such attributes may be used for quickly discriminating between symbols as this can be achieved through the confirmation of just one feature aspect. Consequently this should be used as much as possible.

One example of such a consistency could be colour. A 'universal' colour consistency is that red refers to danger, and this is echoed in its use in the symbol for Hostile tracks.

In addition, specific consistencies may be used. These may be consistent only within the context of the application, as illustrated by the use of the colour blue to indicate Tactical symbols related to showing distance or range, in particular the grid.

(b) Symbol Level

A higher level of consistency comprises whole symbols.

One example of this is the use of graphics on Icons to show the function to which they may be applied. For example, the Zoom Icon shows a magnifying glass with a letter 'Z', and the Bullseye Icon shows a 'sight' and includes a blue colour relating it to the grid.

On the tactical format, such consistency is based around using the same symbols as are used on previous versions of the SA format. Some of these symbols, in turn, are based on representations used elsewhere in the cockpit. For example, the Attitude Indicator is a 'copy' of that used on other formats, and the compass is a widely known navigational symbol.

For the map and most of the aeronautical information, consistency involves making the digital version completely consistent with the conventions used in paper maps (with which the pilot will already be familiar). Ideally it would be as direct and exact a representation as possible, but the change in medium with the associated problems of the loss of resolution and inability for colours to be additively combined by overprinting mean that compromises do have to be made. However, as long as the abstract conventions in the map presentation are followed, there is no problem in this.

3.2.2 RECOGNITION

This section looks at the cognitive principles which allow visual features to be 'grouped' or segregated for recognition as a specific symbol. Such a process can be taxing under any conditions, but especially is so when a complex distracting background (the map) is present. This emphasises the importance of providing cognitive aids.

The means by which recognition can be promoted include Consistency and those design principles listed below:

- Use of Gestalt Principles
- Exploitation of Selective Attention
- Use of Edge Detection
- Minimisation of Distractions

These are now discussed in detail.

(A) USE OF GESTALT PRINCIPLES

The recognition process can be improved by encompassing 'Gestalt' principles into the format and symbology design. These principles were discovered by German psychologists earlier in the century and are used by the mind to group and unify different features which share various of the principles into a 'whole figure' (the translation of Gestalt).

They are:

- Proximity/Contact
- Similarity
- Continuity
- Closure
- Orientation
- Simplicity of interpretation

Every attempt was made to utilise these, especially in the Tactical format.

I. Use of Closure

The principle of Closure helps to make symbols recognisable, even when partially hidden behind each other or some screen feature like the Grid.

II. The Redesign of the Grid

One example of changes that were made to the previous version of the format to take advantage of the Gestalt principles was the change of grid presentation.

Originally the grid ranges were simply numbers adjacent to, but not touching, the grid. They were also a different colour to the grid. While it could be assumed that they referred to the grid, the connection was not as obvious as it could have been, especially where detailed distracting features appeared around that area.

Consequently the principles of Proximity and Similarity were incorporated to present a much 'tighter' and less ambiguous visual image. Grid numbers were moved from their detached position into a location where the left-most azimuth line crossed the corresponding range line. A shaded box (of the grid colour) was used behind each one to further promote the 'solidity' and continuity of the symbol.

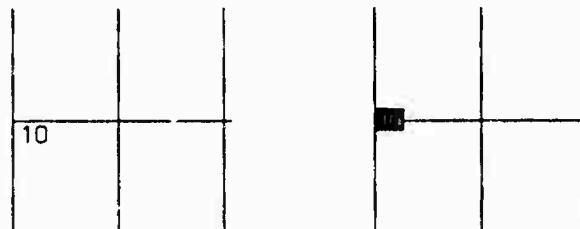

Section of Original Grid

Section of Redesigned Grid

Fig. 4 - Grid Redesign

(B) USE OF SELECTIVE ATTENTION

When the pilot is looking around the cockpit and displays, he cannot give the same amount of attention to everything he sees because attention is a limited resource within cognition. Consequently he will focus it on particular visual images arriving in his sensory memory.

Exactly which are given priority are determined by various factors including:

- Expectations Eg. less time will be needed in searching for a feature which is specifically being sought
- Motivation How much he wants to see a symbol; this can be influenced by fatigue
- Visual Aspects Some features will attract his attention more than others

In producing a display format, the latter are of most concern. In terms of data-driven cognition, the visual aspects which attract attention are:

- Size The larger the better
- Intensity (of the stimulus)
- Contrast (against its background)
- Novelty Eg. relative motion, flashing

In addition, the conceptually driven elements of motivation (the pilot is looking for something) and expectation (the knowledge that a feature is displayed somewhere) increases the likelihood of perceiving the object or symbol.

I. Use of Size

As relatively larger objects have a greater 'attentive priority', the most important symbols are obviously made larger as well. An example of this is the size of track symbols, especially hostile ones. The next target to be fired upon has a larger symbol than the rest.

II. Contrast and Intensity

The more a symbol stands out against its background in terms of appearance (contrast and 'intensity'), obviously the greater its conspicuity (and the lower the amount of time spent looking for it in a search task).

Contrast can be measured in units of Perceivable Just Noticeable Differences (PJNDs), and has two main components with which it has what might be termed a 'Pythagorean' relationship in that it can be represented as a right-angled triangle (Fig. 5). The hypotenuse length, in this model, represents the overall contrast, the shortest side the Chrominance contrast, and the third side the Luminance contrast.

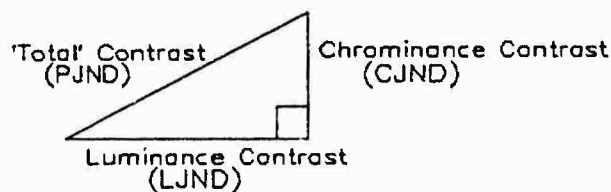

Fig. 5 - Contrast types

In order to improve the overall contrast of a feature, both the Luminance and Chrominance contrasts should be maximised, though not at the expense of each other. Maximising luminance contrast alone would produce just black and white, which includes no Hue, and consequently no chrominance contrast. By the same token, maximising chrominance contrast involves the use of a mid-grey background to features, thereby minimising luminance contrast. The balance between luminance and chrominance contrast depends on context (as seen in the application).

(a) Luminance Contrast

This forms the major component of contrast, can be measured in Luminance Just Noticeable Differences (LJNDs) and literally measures only the lightness within colours. On this scale, the best contrast is represented by the border between black and white - this is exploited within the Tactical Symbolology by the use of contrasting casing (borders) for symbols and backgrounds for text.

(b) Chrominance Contrast

Chrominance contrast is less predictable than Luminance contrast due to the more irregular way different colours are treated within the eye/brain combination.

It has a lesser effect on overall contrast than Luminance contrast and is measured in units of Chromatic Just Noticeable Difference (CJNDs). This contrast is based on the use of Hue to discriminate colours, and also the degree of saturation or 'strength' to the colour. Those features coloured in stronger (more saturated) colours will show up well against relatively pale/unsaturated features.

The best illustration of the use of Chrominance contrast is within the different feature levels within the map (see (c)(ii)). In addition, many different colours (chrominance) and shapes are used to distinguish between the different symbols, a good example being the Hostile, Friendly and Unknown track types.

(c) Application of Luminance and Chrominance Contrast

i. Major Levels

This display was particularly complicated in that it comprised several superimposed formats (levels of information) which were given relative priorities in terms of importance.

Most important was the Tactical Situation format which had been the only format shown on the previous version of the SA display (where it had a black background with the map shown on a separate display). The impression of this format standing very strongly over its background had to be retained.

Below the Tactical format was displayed the Aeronautical Information and Map formats in decreasing order of importance. These also had to be readable against their 'backgrounds' (and 'foreground').

To achieve the required effect, the major contrast component between the top and bottom two layers was different. The greater priority difference between the top two layers was reflected in the use of a predominantly luminance-based contrast between them. This tied in with luminance contrast being the largest component of total contrast. Predominantly chrominance contrast was used as the difference between the lower two layers (with lower priority features being less saturated in colour).

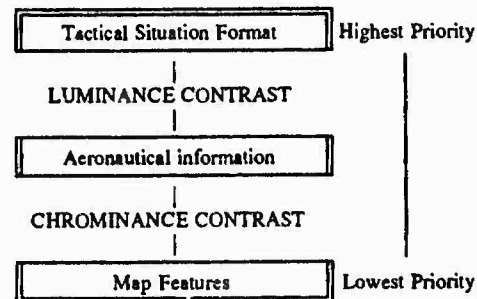

Fig. 6 - Use of contrast to distinguish priority levels

An example of the use of contrast to make high-priority features stand out against lower-priority ones can be seen for linear and point tactical features (eg. heading and compass lines) for which conspicuity is especially important. Contrast was applied by using dark and saturated colours for these enabling them to show up well against the relatively light and less saturated Map and Aeronautical Information layers.

ii. Minor Levels

Map sub-layers were also defined:

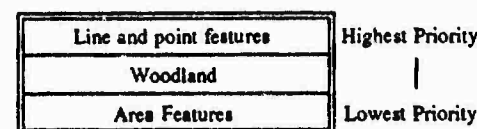

Fig. 7 - Priority levels for display of map features

Unlike the major levels, map features were prioritised according to representational criteria rather than importance:

Distinguishability Less distinguishable features need to be emphasized more in order to stand out.

Interplay of features Features in any single layer are mutually exclusive. This factor particularly comes into its own when dealing with the conversion of map formats between a paper medium and the screen.

Luminance and Chrominance contrast were also used to distinguish between these priority levels (though to a lesser extent than with the major layers). Higher priority features were coloured with darker (luminance contrast) and more saturated colours (chrominance contrast).

III. Use of Movement

Another factor which attracts Selective Attention is 'novelty' or change, and such attributes includes movement and flashing; features with these dynamic attributes will be more visible on a moving screen than on a 'snapshot'.

Examples of this are the aircraft symbol, heading lines, and tracks; as these are important tactical symbols, the increased conspicuity is a real benefit.

(C) EDGE DETECTION

The visual system is particularly sensitive to 'edges' or lines, and this can be used to benefit by using a continuous contrasting 'edge' as an outside border/boundary surrounding features to be grouped together as a single object. This contrasting border is called 'casing' and is of particular benefit where the contrast of the symbol (inside the casing) is low against the background features. A good example of its use is on track symbols.

Of course, the casing makes the symbol slightly larger, and so it shouldn't be used where this would present a problem in terms of obscuration of the background. For this reason, for example, the aircraft present position symbol, the heading lines and the grid are not cased.

(D) REDUCING DISTRACTION FROM OTHER FEATURES

The final factor in the recognition of features is distraction, or in other words the reduction of the conspicuity of any feature due to the distractive effects of features either in the background/same layer or foreground. Since the Tactical symbology is the most important layer to be seen, the former of these is the most important. However, the great conspicuity of Tactical features is itself very distracting when the pilot is trying to study map features (for instance).

I. Reducing Complexity of Background Features

The conspicuity of features on the screen can be also increased by reducing the complexity of the background against which they are seen; this is done by reducing the number and density of background features in the vicinity of those features being sought. This is achieved separately through changes in the layers of detail presented, presentation only of features which should be visible at the current altitude and by scale changes (where lower scales will present less information).

(a) Layers of Detail

If a user is initially offered a maximally detailed and fully 'cluttered' display he might have to spend much more time studying the map and mentally picturing the area than if it was relatively simple; in the circumstances this reflects a degree of cognitive overload.

Consequently a piecemeal approach is adopted which allows the individual features to be most easily assimilated and aids the conceptualisation of the contents of the display using data-driven processing.

When a mapped area is first introduced to the pilot, it is offered in its least detailed form, allowing him to gain a general impression of the layout of the area. This is a 'recognition' process. However, as extra detail is added the 'original' information is more easily consigned to the 'background' while the new information is assimilated, and this is a higher-level 'exploratory' process. (See Section 3.2.4).

Once identification and recognition of [each 'layer' of] objects or features has been performed, further reference to the display will require much less cognitive interpretation because the user will have better expectations of what he will see. Processing will then start with the conceptualisation of what might be shown.

Subsequently, the map has detail gradually removed or gradually added; too major a change in its appearance might cause confusion.

(b) Presentation only of features visible at the Flight Level

If the aircraft has an altitude of above approximately 10,000ft many map features will no longer be easily visible due to their small size and can be removed from the display during visual navigation using the 'High' flight function. The 'Low' flight mode shows all map features.

As with the 'Layers of detail' the pilot is first presented with the least-cluttered 'High' mode, with the 'Low' mode selectable when this has been assimilated.

(c) Scale Changes

Scale changes are performed by 'bouncing' the cursor off the top/bottom of the screen. Although the selection of a lower scale can simplify a detailed map, scale changes are generally part of the higher level 'exploration' process. (See Section 3.2.4).

II. Minimisation of Distraction due to Foreground Features

When the land under and around Tactical Symbols is being studied the distracting features may be in the foreground, and these Tactical symbols may obscure the features of interest.

Where such symbols may present a distraction, they are made as small/narrow as is possible while maintaining their visibility when required.

In addition, though, many of the potentially distracting Tactical symbols including the grid, compass, Attitude Indicator and Horizontal Orientation Indicator (HOI) can be de-selected using various soft keys, and in this way underlying features can be easily seen.

However, some other symbols including the Icons, present position symbol and heading lines cannot be de-selected, and so must present as little of a distraction as possible while still standing out sufficiently corresponding to their importance.

(a) Icons and Icon Windows

Many of the Icons and the windows which are brought up by them (eg the Zoom window) can be slewed to a different location where they will not be as much of a distraction. In addition, the windows can be de-selected.

(b) The Present Position Symbol and Heading Lines

On many other situational awareness displays, the aircraft is shown as a shaded Isosceles triangle. Although this makes the aircraft position highly visible (and so is better than just a triangle outline), it obscures the ground underneath. Consequently such a view is improved while maintaining the visibility of the symbol by making the shading inside the triangle 'translucent' by only colouring a 'matrix' of pixels.

In the same way, the heading of the aircraft is often shown as a single line extending forward from the aircraft symbol in the direction of movement. This obscures the land immediately underneath it which can be of great significance to the pilot, and consequently the line was changed to parallel 'tram lines' with, between them, a narrow central 'clear' area.

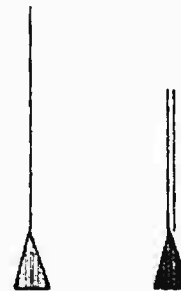

Fig. 8 - Representation of aircraft present position

3.2.3 ASSIMILATION

Once the features have been recognised, they have to be integrated into the mental models which provide Situational Awareness. This can be seen as a higher cognitive level than basic recognition and may involve spatial manipulation techniques and visualisation of the relationships between symbols.

As much visual 'processing' is performed on screen as possible to leave the minimum to be done by the pilot. Some tasks lend themselves to this better than others, and visual aids are provided to benefit those for which the mental processing is superior or more practical.

(A) PERFORMING VISUAL MANIPULATION ON-SCREEN

In performing on-screen visual manipulations that would normally have to be performed mentally by the pilot, his cognitive workload is obviously reduced; consequently this capability is provided as far as possible. The sort of manipulations which lend themselves most to this include orientation changes (north-up and track-up), zooming, adding or removing layers of detail and slewing the view position over the map.

These may be performed using:

Soft-keys for mode changes (eg. north-up vs. track-up, level of detail)

Icons for manipulating the view which is currently available (eg. window-on-world and zooming)

Whatever settings have been chosen, the 'default' settings can be resumed by pressing the 'default' soft-key. This is obviously much quicker and easier than changing many individual settings and therefore may reduce workload.

I. Minimisation of Mental Rotation using Map Orientation Options

One useful capability is the selection of various map orientations relative either to north ('north up') where the aircraft rotates and the land translates, or to the aircraft heading ('track up') where the ground both rotates and translates 'beneath' a fixed aircraft orientation.

(a) North-Up

A north-up format is best for allowing recognition of a known area of map or ground features, as mental representations of map features are usually oriented with north at the top.

In north-up mode the compass is fixed.

(b) Track-Up

Track-up representation are best for studying the positions of features relative to the flight path; recognition of the map position (relative within a known area) is less of a priority, but the view ties in far better with what can be seen out of the cockpit.

Visual aids such as the Horizontal Orientation Indicator (HOI) and compass are used to enhance awareness in track-up mode; these (especially the HOI) are described in part (B).

II. Translation and Slewing of the Map

Whereas paper maps cannot show the actual position of the aircraft, digital maps can show the aircraft either at the screen centre or offset from it.

A central position allows the examination of features all around the aircraft, but an offset position can allow a better look in a particular direction.

A 'window on the world' function can allow a look at any part of the map to the point where the aircraft position may be off the screen, but if this is done the original position is easily recoverable.

III. Use of Zooming

The zoom function produces a picture-in-picture magnification of a small area on the map. Alternatively the 'zoom window' may show a global 'zoomed out' view of the map area.

(B) VISUAL AIDS FOR MENTAL MANIPULATION

Where it is impractical to provide such a replacement for mental manipulation, visual aids are provided to act as references to make the mental processes quicker and more accurate.

I. Position and Orientation

One example of this would be judgements of the orientation or position of navigational features relative to each other. The former of these would be aided by the compass (which rotates in track-up mode) and Horizontal Orientation Indicator, and the second by the grid.

(a) The Grid

It is worth elaborating a little more on the grid representations at this point because it is different for the track-up and north-up modes. The track-up grid is rectangular around the present position symbol because this is what is most familiar and consistent with the experience of the pilots, and was preferred by them for this mode. The north-up grid, on the other hand, has concentric circles of equal-range centred around the PP with radii at 0°(north), 90°(east), 180°(south) and 270°(west); this provides more useful range information than a rectangular grid.

(b) The Horizontal Orientation Indicator (HOI)

An additional aid to mental rotation for track-up displays is the Horizontal Orientation Indicator (HOI) which has been developed for the tactical format. This acts as an additional cue which helps to establish a visualisation of a mentally rotated display, aiding awareness of the horizontal orientation of the aircraft and other features relative to north.

The HOI is a circle where the centre represents the PP and the relative north-up orientation of the radar beam and heading line are shown as a sector and a radial line respectively. A reminder is provided of the direction of north (vertically upwards) in the form of a small 'cased' square on the periphery of the circle.

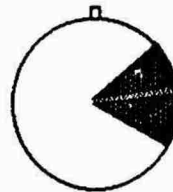

Fig. 9 - Horizontal Orientation Indicator

II. Relative Velocity

Another example of visual aids might be estimating the velocity of the aircraft and tracks in relation to the ground that will be covered; this is shown by the length of the heading lines for the aircraft and the heading vectors for the tracks. These are useful references when the scale of the map has changed, because such changes are not revealed in the size of the PP or track symbols.

These symbols are always drawn as the same size for practical reasons - they are simply markers and cannot represent the actual size of the aircraft over the map (simply because it would be too small).

3.2.4 EXPLORATION

Now that the processing of a 'screen' of information has been covered, it is important to point out that additional information about areas or objects may be selectable to complete a mental picture of an area, as far as can be provided by the aircraft systems. This is part of the high level 'exploration' process, and such functions include:

Changes of Map Scale The representation of information does tend to vary across different map scales. These can be useful for building up SA and can be selected by 'bouncing' the cursor off the top/bottom of the screen (for lower and higher scales respectively)

Extra Map Detail The composition of the map in terms of layers of detail was described earlier (minimising background distraction for Tactical/Air Info. symbols). The default is the minimum detail layer only, and the addition of extra layers is an exploratory process.

Approach 'Plates' In addition to the Aeronautical Information, electronic representations of 'let-down plates' can be selected which contain additional information for approaches into airfields.

4 FACTORS REDUCING THE EFFICIENCY OF THE SENSING OF INFORMATION

So far it has been assumed that the sensory process which transfers information to visual memory is perfect. This is not the case for most environments, and especially not for an adverse lighting environment as can often be found in fast-jet cockpits. This section of the document discusses these interfering factors and the design implications for reducing their effect.

The efficiency of sensing can be limited by:

- (a) **Hardware** The quality of reproduction of the display hardware in terms of colour and the sharp resolution of points, lines and symbols.
- (b) **Veiling Reflections** The effect on the display quality of 'veiling reflections' of ambient light off the screen. Modelling has shown that the main effect is a reduction in contrast of the display with a visual effect akin to viewing the screen through a yellow filter.
- (c)(d) **Glare** Glare is the effect where the pilots eyes are adjusted to a different light level than is generally found on the display. In this context there are two forms for respectively high and low ambient light levels:

Specular Glare (c)

The pilots eyes become adjusted to light levels higher than those on the screen due to the effect of other light sources or reflections within his visual field. Commonly this is due to the sun either in front of the aircraft or behind and reflecting off surfaces. The result is that contrast is lost within the display which appears relatively darker.

Discomfort glare direct from the screen (d)

The pilots eyes become adjusted for lower ambient light levels than generally found on the screen and display features appear excessively bright in comparison. This may happen at dawn, dusk or night.

(e) Quality of Eyesight

The optical efficiency of the Human eye in terms of discrimination of colour and freedom from visual deficiencies (including those due to suboptimal focussing and eye coordination).

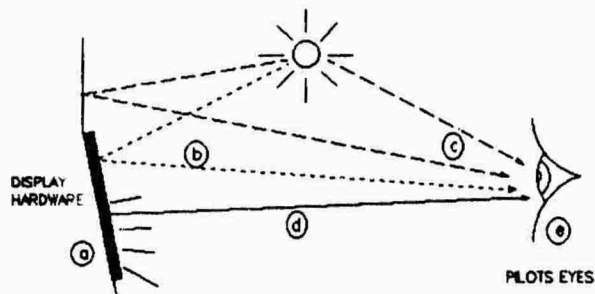

Fig. 10 - Influencing factors in the sensing of a visual display

In designing visual formats to be implemented in software, the degradations that can be countered include those due to veiling reflections (b) and glare (c). These largely reduce the efficiency of the 'recognition' stage of cognition discussed earlier, and so the format solutions which were adopted centred on the principles that promote recognition; in particular this involved maximising the contrast present within the display formats.

Any effects due to the hardware technology used in the display (a) were outside the scope of our work. In any case, any intrinsic differences in terms of resolution and colour rendering due to the display technology used should be minimised in accordance with the display specifications which keep the presentation at a high quality.

In the same way factor (e), that of the individuals eyesight should have a minimal affect in this case because the user population of pilots will have to have met stringent vision requirements already. For other user populations, eyesight might place resolution and colour constraints on the display so that it would still be suitable for users with sub-optimal focussing and various extents of 'colour-blindness'. Symbols incorporating colours which might be confused under colour-blindness would have to be discernible using other factors as well; for instance, the Hostile, Friendly and Unknown track symbols are different in both colour and shape.

4.1 COUNTERING VEILING REFLECTIONS

Veiling reflections can act to reduce the contrast of screens, especially those which aren't as bright as the light being reflected.

4.1.1 IMPACT OF HARDWARE

When considering ways of reducing the impact of veiling reflections, especially in situations where there is a high level of ambient light around, it is worth realising that the choice of display technology can have a significant effect, even though this is outside the scope of what our work could achieve.

Colours shown on Liquid Crystal Displays (LCDs) can be less 'bleached' by light falling on the displays than those on CRT based displays.

However, at the time of procurement CRT technology was at a greater state of technical maturity, and this was chosen. Although its deficiencies can be overcome to some extent using filters, such as polarising filters, this is by no means a 'complete fix'.

4.1.2 MAXIMISING CONTRAST WITHIN FORMAT DESIGN

The software display formats thus had to be designed to compensate for any such loss in display clarity and contrast. This was achieved by maximising contrast within the display, and by ensuring that the latter was as bright as possible in circumstances where veiling reflections might occur.

4.2 GLARE

Glare results from a mismatch between the light levels for which the eyes are adjusted, and the brightness of the screen or features on it.

Specular Glare, which occurred when a brighter object in the same field of view as the screen made the latter less visible, was avoided both by maximising the screen contrast and by making the screen as bright as possible in high ambient light conditions.

With discomfort glare from the display itself, the latter is uncomfortably brighter than the ambient levels to which the pilots eyes are adjusted. This occurs under low light or night conditions, and the solution required some sort of dimming for the display.

In allowing for both forms of glare, the overall brightness of the screen was made approximately equal to the ambient light conditions. This can be impractical for high ambient light conditions, and so the display is just made as bright as possible in those circumstances. It is important that the relative conspicuity of features and the relative appearance of colours is maintained under the various light conditions, and consequently some time was spent studying the 'dimming' of colours while preserving the contrast conventions already applied.

4.3 IMPLEMENTATION OF PALETTES

The work that has been described so far has been for a display with colours viewable in an office environment - where the prototype display was developed. The operational environment is, of course, much more demanding and variable than this and in order to help combat the problems of Veiling reflections and Glare a system of palettes was developed. These changed the display so that colours are perceived as being as constant as possible through different ambient lighting levels.

The four palettes, two for daytime use ('LIGHT' and 'DIM'), two for night ('DUSK' and 'DARK'), were developed together. Prior to their implementation on the 'prototype system' the colours had been suitable for 'office light' or subdued daylight conditions, and this was an equivalent to the 'DIM' palette that was subsequently developed.

4.3.1 HIGH BRIGHTNESS PALETTE

One of the new palettes was a high-contrast high-brightness daylight palette that was optimised for much higher ambient light conditions (referred to as 'LIGHT') which was to overcome the problems of Specular Glare and Veiling reflections.

The Tactical colours were derived from the previous SA format display (but modified in Luminance to conform to the contrast philosophy described earlier).

The Map and Aeronautical Information colours were optically scanned off paper maps so that the representation would be as consistent as possible; these were then 'twisted' to counter affects of the change in representation medium from paper to screen. An additional benefit of using a bright map (as on paper) was that as this was the background to all the other formats it made the overall display bright as well; this was beneficial in combating veiling reflections.

During the development of the colours in this palette, the effectiveness of the format in a high-ambient-light scenario was modelled using a Visual Performance Evaluation tool which was developed in-house. The modelling technique combines the predicted hardware visual performance, eye response and anticipated ambient lighting environment to establish a figure of merit (PJND) which represents the display legibility. It was also possible to simulate the appearance of the display under those conditions to enable a subjective appreciation of the expected viewing conditions. This system ensured that the colours and symbology used in the complex display format would be visible under the extreme lighting conditions.

4.3.2 LOWER LIGHT PALETTES

The colours for features through the other three palettes were derived from that in the high brightness palette using the HLS colour model; in this way a balance of relative conspicuity was maintained in all the palettes. Occasionally this balance was not maintained; pylon symbols are more visible on the night display, and this alerts the pilot to their presence as they are more difficult to see outside at night.

FEATURE LEVEL	RELATIVE... LUMINANCE		CHROMINANCE
	Day	Night	
TACTICAL	Dark	Light	Saturated
AIR INFO	Relatively Bright	Dark	Saturated
MAP	Bright	Relatively Dark	Unsaturated

Fig. 11 - Relative colours in day/night palettes

(A) MAP AND AERONAUTICAL INFORMATION

The Map and Aeronautical information colours in the remaining three palettes were derived by logarithmic interpolation of HLS values between the high-brightness values and black.

(B) THE TACTICAL FORMAT

Although the Hue of the Tactical colours was generally kept constant, the lightness was chosen subjectively to retain conspicuity of the features. As with the contrast philosophy described earlier, the lightness varied radically between the day and night palettes (Figure 11).

5 SUMMARY

This document has looked at the methodology and psychological principles in the design of a Situational Awareness format, and it is believed that the use of such a design method has resulted in an optimally visible and understandable interface. The use of a scientific

assessment of the cognition of a display formalises many design choices. It is the authors opinion that not using a sensory/cognitive basis for the design would result in an inferior product which merely 'throws graphics' at the pilot, something which has happened in recent years in some applications.

An important element of this work is that much of it applies equally to any graphic display in a high-workload context (cognition) and/or high ambient light viewing conditions (colour and contrast).

A final note has to be that when new graphics formats are being developed from older versions, there is much to be said for a redesign from first principles employing many of the consistencies of the previous version rather than a blind 'bolting on' of new features onto the latter. This is especially important when the new version is quite radically changed from the older one as in this application (the older Situational Awareness format had a black background instead of a map). It has been found that a holistic rather than a piecemeal approach is the way ahead for a 'Right First Time' development policy.

6 BIBLIOGRAPHY

- 1) Smyth, Morris, Levy & Ellis (1987) "COGNITION IN ACTION", Lawrence Erlbaum Associates Ltd (LEA), London
- 2) Lindsay & Norman (1977) "HUMAN INFORMATION PROCESSING", Harcourt Brae Jovanovich, London
- 3) Bernstein, Roy, Srull & Wickens (1988) "PSYCHOLOGY", Houghton Mifflin, Boston, USA
- 4) Bailey (1982) "HUMAN PERFORMANCE ENGINEERING", Prentice-Hall, New Jersey

SYSTEM AUTOMATION AND PILOT-VEHICLE-INTERFACE FOR
UNCONSTRAINED LOW-ALTITUDE NIGHT ATTACK

Lt Col T. O. Church
Wright Laboratory
Wright-Patterson AFB, OH 45433-6553, USA

and

W. S. Bennett, II
General Dynamics
P. O. Box 748
Fort Worth, TX 76101, USA

SUMMARY

Unconstrained low-altitude night attack is achievable today through automation and integration of current technologies. Many of these technologies are advanced avionic systems that still require additional development before they are production-ready. However, their performance and synergistic benefits have been demonstrated. Additional efforts are still warranted to increase system safety, improve situational awareness, decrease pilot workload, and provide a more effective weapon system.

1 PROGRAM DESCRIPTION

Close Air Support (CAS) and Battlefield Air Interdiction (BAI) are critical to the success of our ground forces. Air power is required not only at the forward line of troops (FLOT), but also for operations deep in enemy territory to disrupt reinforcements and cut supply lines. The air/land battle of the 1990s will be characterized by highly mobile forces on both sides creating a dynamic, diffuse battlefield. CAS/BAI aircraft must provide responsive, accurate and effective weapons employment to support our ground forces with maximum efficiency. Unconstrained operations are required in all types of weather conditions, day and night, utilizing the full flight envelope of the aircraft. To provide this capability, aircraft/pilot safety and situation awareness must be improved. A high degree of automation and systems integration, coupled with the correct pilot vehicle interfaces, are required.

Increased research and development emphasis has been placed on improving the capability of aircraft to perform the CAS/BAI mission and to better integrate the attacking aircraft with ground operating forces. Improvements include improved communications, low-level navigation, target acquisition, target handoff, target attack, and situation awareness aids. Technology areas that contribute significantly are data links, onboard digital terrain database systems and night vision systems. Digital communication provides the means to rapidly and reliably exchange information

needed to perform the mission while the digital terrain database provides the "common grid" needed to correlate the information between the sender and receiver, as well as to provide for threat intervisibility/tactical mission management and air vehicle guidance and control. The integrated night vision technologies improve pilot night/weather situation awareness. The biggest benefit gained is in the complete automation and integration of these systems into one tool for the single-seat fighter pilot.

A technology demonstrator program was initiated in September 1989 by the Wright Laboratory, Air Force Systems Command, USAF, stressing integration, automation, and pilot situation awareness for low altitude night attack mission improvement. Flight demonstrations of technologies were conducted under realistic mission conditions including interoperability between air and ground forces as well as interflight. The flight test program was conducted at Edwards AFB, California by a Joint Test Force consisting of USAF, NASA, and General Dynamics. This program was conducted on a single-seat current fighter aircraft to maximize the requirements for pilot workload reduction and pilot-vehicle-interface optimization.

2 TECHNOLOGIES INTEGRATED AND AUTOMATED

A technology set, Figure 2-1, was selected that had the greatest potential to enable and improve an unconstrained low-altitude night attack mission. These technologies were developed and fully integrated into the weapon system to maximize effectiveness. The following sections are a discussion of that technology set.

2.1 Digital Data Link

The digital data link served as the interoperability link for both air-to-ground and air-to-air communications. This system was integrated in a way as to require a minimum of pilot actions while providing the maximum system information and flexibility.

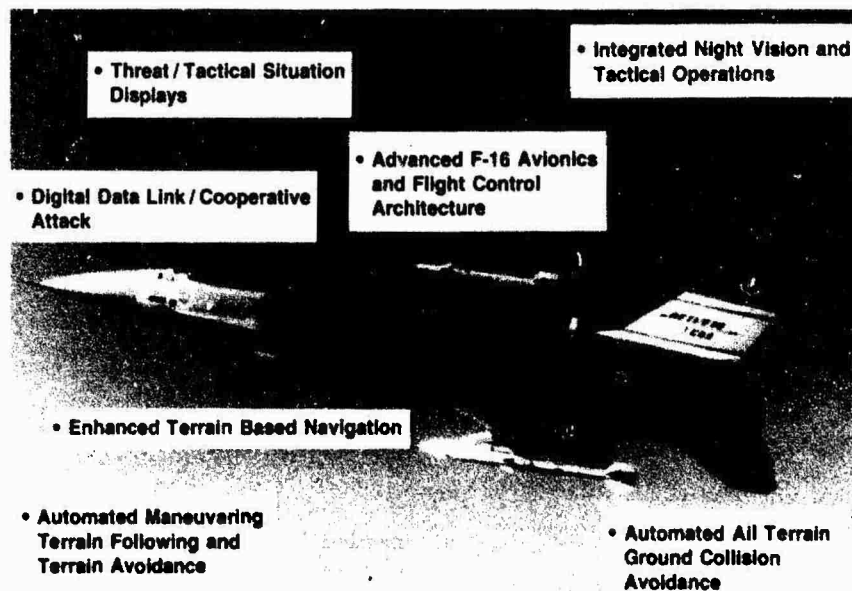

AF00355

Figure 2-1 Technology Set for Flight Demonstration

Features

- Army Protocol
- 1.2K Bits/s Data Rate
- Uses Existing Radios
- Weight: 4.53 Kg (10 lbs)
- Dimensions: 20.4 cm x 13.7 cm x 16.5 cm (8"x5.4"x6.5")
- Power: 49 watts
- 1553 Interface
- Cooling: Convection

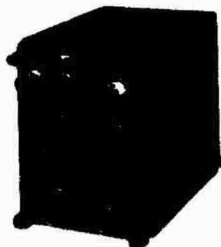
Hardware

AF00356

Figure 2.1-1 Automatic Target Handoff System (Digital Data Link)

Integration

- Target, Friendlies, and Initial Point Locations Displayed on Color Map
- Target Box Displayed in Head Up Display and Helmet Mounted Display
- Free Text Displayed on Multifunction Display
- Target Location Can Be Transmitted to Wingman
- Wingman Location is Received and Displayed on Color Map
- Laser Designator Code Established Over Data Link

The initial data link integrated in the aircraft was the Automatic Target Handoff System (ATHS) developed and in use by the United States Army, see Figure 2.1-1. This system operates at 1.2K baud rate and utilizes the UHF and VHF radios as the carrier medium. When receiver designated data are received, the pilot is alerted by a short-duration warble in his headset. Data received are locations of targets, threats, friendlies, Initial Point, and wingman, as well as free text and laser codes. These data are stored and displayed on all pertinent displays such as Digital Map, Multifunction Displays, Head-Up Display and Helmet Mounted Display. Selected targeting information can be transmitted to the wingman with a single hands-on switch action. All data reception, acknowledgements, and integration are

automated to minimize pilot workload; however, once in the system, the pilot has the flexibility to utilize it the same as any previously stored data.

A second digital data link, the Improved Data Modem (IDM), was installed, replacing the ATHS. It performs essentially the same functions as the latter; however, it operates at a much higher baud rate, 16K Hz, and can accept either Air Force, Army, or Marine protocol messages.

2.2 Threat/Tactical Displays

One of the most significant of all pilot displays for pilot situation awareness is the threat/tactical display, see Figure 2.2-1. This 5 x 5 inch, high brightness, color CRT provides continuous navigation,



Host Processor For

- All Terrain Ground Collision Avoidance
- Maneuvering Terrain Following
- Inflight Route Planner

BF00357

Figure 2.2-1 Stored Terrain Access and Retrieval System (STARS)

geographic, threat, and tactical information for the pilot. The available digital and aeronautical chart formats provide instantly absorbable data to aid the pilot. A bezel of switches, located around the outside of the display, provides commands to and control of the system. Sun shading and cultural features make display interpretations quick and accurate. Digital terrain referenced navigation algorithms provide an accurate, nondrifting aircraft location, with respect to the local terrain, that, combined with the displayed navigation steerpoints and prescribed routes, eliminate positional uncertainty. The flight control automated course steering combined with the auto steerpoint sequencer provide a pilot relief capability in route navigation.

Threat intervisibility at the aircraft set clearance plane, or any of the other preselected altitudes, is displayed to provide the pilot threat situational awareness. Pop-up threats, from ATHS or IDM, are also automatically displayed with their intervisibility area. Threat tracking and lethal ranges are indicated by a color coded vector to the threat. Threat specific symbology identifies the type of threat and location on the map.

Look-ahead capability exists for any steerpoint/target location along with displays of stored photographs. These provide a pre-entry pilot refresh of the known environment for a future location.

A dynamic perspective display of the digital terrain looking forward from the aircraft is also available. This display provides details about the oncoming terrain which are hard to distinguish at night. The terrain data for this system are stored on an optical disk that is controlled by the Digital Terrain System (DTS). The capacity of this disk is 300 Megabytes of which 100 Megabytes are currently being used.

Features

- Digital and Aeronautical Chart Format Displays
- Route / Navigation Symbology
- Threat Intervisibility Displays
- Electronic Flight Instruments
- Digital Terrain Elevation Data Base for Terrain Following and Ground Collision Avoidance
- Terrain Referenced Navigation (SITAN)
- Passive Ranging
- Perspective Display
- Digital Data Link Data Displayed — Targets, Threats, Friendlies, Wingman, and Initial Point

2.3 Inflight Route Planner

The Inflight Route Planner (IFRP), see Figure 2.3-1, provides optimal routes for two mission segment legs, such as target ingress and egress. These routes can be calculated in flight, meaning recalculation for changing conditions or pop-up threats can be accomplished once airborne. The pilot selects, before flight if desired, the segment end points, the corridor width, and the desired aircraft set clearance plane (Route AGL). Routes are calculated that minimize threat intervisibility, route length, and route elevation. Route calculation times are 2 to 3 seconds with no new threats and under 10 seconds with new threats. Pop-up threats generate new route calculations and displays without pilot participation. Pilot actions then only consist of acceptance or rejection of the new route by pressing a bezel switch.

Route steering information for manual flying is displayed in the HUD and HMD. Automated route flying is available that is compatible with the automated terrain following system giving automated terrain following and terrain avoidance.

System wide integrity management (SWIM) verifies proper system operation. The pilot is alerted if SWIM detects any malfunction and if in an automated operation, the system will be disengaged and an automated ground collision avoidance fly-up will be executed.

2.4 Automated Ground Collision Avoidance

The Automated Ground Collision Avoidance System (GCAS) was designed to prevent any penetration of the aircraft into the radar altimeter correlated digital terrain database (DTED) expanded by the minimum clearance distance (MCD), see Figure 2.4-1. This provides the safety net for the pilot when flying an unconstrained low-altitude night attack.

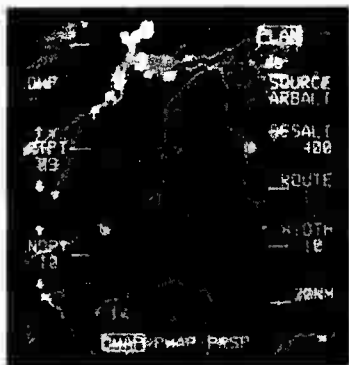

Implementation

- Hosted In Digital Terrain System LRU in 1750 Processor
 - Displayed on STARS Digital Terrain Maps Showing Threat intervisibility and all Symbology
 - Digital Data Link (ATHS / IDM) Provides Pop-Up Threat Information
- Define and Display Optimal Routes for 2 Mission Segments
 - Define and Display Alternate Routes for Influence of up to 5 Pop-up Threats
 - Steering Cues Provided for Manual Flying
 - Automated Route Flying Provided That Is Compatible with Auto TF
 - Three Setable Route Weighting Factors
 - ✓ Threat Intervisibility
 - ✓ Path Distance
 - ✓ Path Elevation
 - Pilot Enterable Parameters
 - ✓ Start and End Points (Steerpoints)
 - ✓ Corridor Width
 - ✓ Route AGL (Optional)
 - System Wide Integrity Management (SWIM) Checks Verify System Operation

BF00358

Figure 2.3-1 Inflight Route Planner

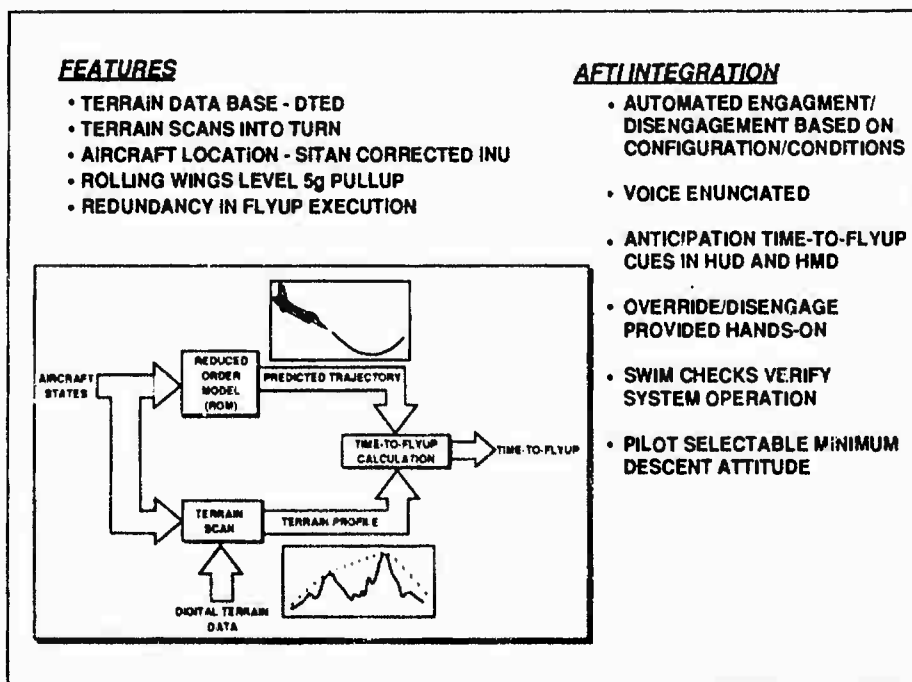
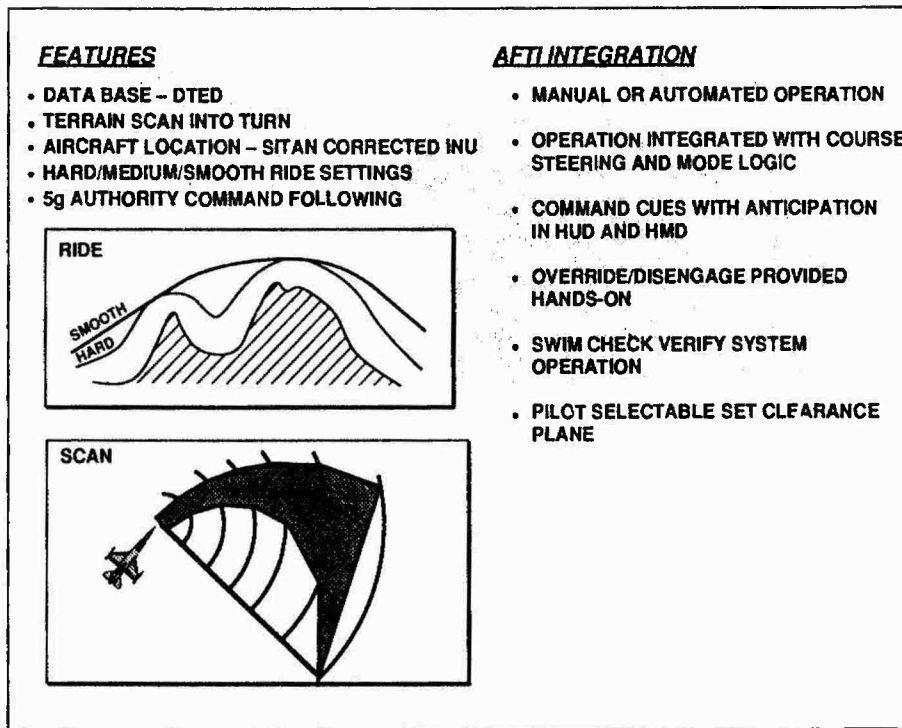

Figure 2.4-1 Ground Collision Avoidance

WSB 025a

The digital terrain database scanning area is a function of the aircraft dynamics and covers all terrain the aircraft could be over during the execution of a fly-up maneuver. The aircraft fly-up trajectory is continuously calculated. The flyup maneuver is a roll to wings level with a 5-g pull-up initiated at or less than 90 degrees bank angle. The comparison of this trajectory and the digital terrain data provide a measure of time until a flyup must be initiated. This time-to-

flyup (TFU) at 5 seconds is presented on the HUD and HMD as chevrons with maximum display separation. As the TFU decreases, the chevrons approach each other, and at TFU equal to zero, they touch, forming a break X. This display provides the pilot an anticipatory cue to the flyup initiation. When in the automated mode, the chevrons contain an internal bar for identification, and the redundant flight control system will execute the flyup maneuver at TFU equal to zero.



WSB 029b

Figure 2.5-1 Maneuvering Terrain Following

The minimum clearance distance is pilot selectable and can be set to as low as 50 feet. The pilot has hands-on override and disconnect capability at all times, and the pilot is also provided a voice synthesis message before the flyup initiation and at the termination of the maneuver.

2.5 Automated Maneuvering Terrain Following and Route Steering

Automated maneuvering terrain following, see Figure 2.5-1, and route steering provide pilot workload reduction during low-altitude ingress and egress mission segments. The system operation is covert since it is based on the radar altimeter correlated digital terrain database. The pilot, through the multifunction displays, can select a ride quality setting, hard, medium, or soft, and the set-clearance-plane altitude. Engagement is a single-switch, pilot-activated function, and status information is presented by cockpit lights and in the HUD and HMD that provide system dynamics monitoring while looking off axis or for flying manually. Hands-on override and disengagement is provided for pilot blending with or exiting the system.

The system is designed for terrain following in a maneuvering environment. The digital terrain data are scanned based on the dynamics of the aircraft. This ensures coverage of all terrain that the aircraft could traverse that would impact the calculation of the terrain following algorithm. This algorithm contains higher-order terms than the normal radar terrain following algorithm.

This allows the a priori knowledge of the terrain to generate a flight path profile that is flat over the peaks and produces a smooth, continuous acceleration command. The system has a 5-g authority and responds to the vertical and horizontal acceleration commands. The route steering from the inflight route planner or the steerpoint course steering are integrated with the terrain following commands and are executed by the redundant digital flight control system. The automated ground collision avoidance provides a safety net during all automated TF operation.

2.6 Head Steerable FLIR

The head steerable FLIR is a key element in accomplishing low-level night flying. This passive system provides sufficient pilot situation awareness to allow him to manually fly the aircraft at low altitudes. Three separate FLIR systems were tested, see Figure 2.6-1, all containing multiple fields-of-view and a large field-of-regard, approximately 120 degrees. One system contained a dual line-of-sight capability, targeting as well as navigation FLIR. The line-of-sight for the FLIRs was driven by a helmet-mounted magnetic line-of-sight system and was communicated to the FLIR over a dedicated high-speed data bus. The FLIR displays were developed and integrated into the total system operation and display capability in such a way as to eliminate all pilot actions except hands-on control for FOV change and the usual targeting sensor commands to that system. The integrated helmet-mounted display provided the raster display for the FLIR image.

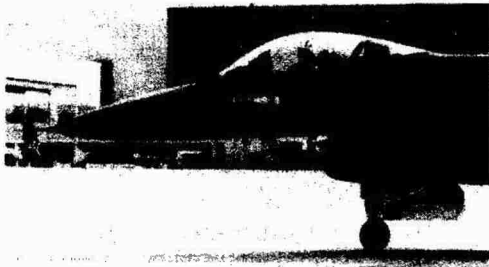

NVIS Cockpit

Head Steered Display

- Integrated Helmet Mounted Display (GEC)
 - ✓ FLIR
 - ✓ Symbology
 - ✓ Image intensifier Tubes
- Helmet Line-of-Sight System (Honeywell)
 - ✓ Magnetic

BF00359

Figure 2.6-1 Night Vision Systems

Falcon Eye (TI)

- Head Steered Pilot Vision FLIR
- Large Field-of-Regard
- 2 Fields-of-View
- Mounts Thru Top of Aircraft Nose — Bulkhead 88

Falcon Knight (WEC)

- Head Steered Targeting and Pilot Vision FLIRs
- Large Fields-of-Regard
- 2 Fields-of-View on Pilot Vision FLIR
- Mounts Thru Radome — Bulkhead 65

LANTIRN Tech Demo (MMES)

- Head Steered improved LANTIRN Targeting FLIRs (Targeting and WFOV Targeting)
- Large Field-of-Regard
- 2 Fields-of-View Each
- Either Mounts on Right Inlet Hard Point

2.7 Integrated Helmet-Mounted Display

The Integrated Helmet-Mounted Display (HUD) provides the pilot with a capability to select either FLIR or NVIS image intensifier tube displays integrated with flight and weapon delivery symbology. The symbology was standardized between the HUD and the HMD to provide a consistent set for pilot interpretation. The 5.8 lb HMD presents a 35-degree binocular field-of-view with hands-on control of the display source and cockpit lighting simultaneously. The helmet also drives the magnetic line-of-sight system that provides cueing for the head-steered FLIR and pilot line-of-sight for other avionics functions.

2.8 Pilot-Activated Recovery System

To provide a safe recovery from pilot disorientation, from any source, a single-switch-action pilot-activated automated aircraft recovery system (PARS) was developed. This system will recover the aircraft from any attitude and flight envelope speed to a wings-level attitude, + or - 15 degrees, with the flight path between 5 and 15 degrees. Voice synthesis announces the termination of the maneuver, and the HUD presents a PARS status label. Diving recoveries are achieved by executing the GCAS flyup maneuver. This ensures a clear flight path during the maneuver. Climbing recoveries are a prescribed rolling pull down maneuver with a rollout before termination. This system has increased value in conditions such as night and weather where the probability for pilot disorientation is greater. Automated aircraft speed control was not implemented, but for aircraft with an electronic engine control, it may be desirable.

3 FLIGHT TEST SUMMARY

Flight test results show unconstrained low-altitude night attack missions can be safely accomplished by an aircraft utilizing available technologies in an integrated and automated system. The following paragraphs are deductions from the flight test program.

1. The Ground Collision Avoidance System and the Automated Terrain Following System greatly reduce pilot workload and increase safety in a night, low-altitude environment.
2. The Head-Steered FLIR and Integrated Helmet-Mounted Display provide good night/under-the-weather pilot visions and situation awareness.
3. An Integrated Digital Data Link is essential for a fast aircraft performing air-to-ground interoperability and cooperative attack missions.
4. The Inflight Route Planner generates timely, survivable routes requiring minimal pilot actions, and provides an aggressive automated route following.
5. The Color Threat/Tactical Display greatly increases the pilot situation awareness in target ingress, attack, and egress. This also results in a large reduction in pilot workload.
6. The Integrated Helmet Display provides good display quality and is usable up to 5 g's. Weight is acceptable for an air-to-ground mission. Adjustment and fit are critical for successful operation.

7. GCAS responds within 0.25 seconds of last initiation time before penetrating the set floor.

4 GROWTH TECHNOLOGY APPLICATIONS

There are several areas where extension of the current technologies or new technologies could improve the safety and/or effectiveness of a low-altitude night attack mission.

1. The digital terrain database cannot represent undefined terrain or obstacles; therefore, there is a need for an active covert sensor, effective in night and weather, that could define the deviations from the database along the aircraft flight path. Several existing sensors fulfill part of this requirement and may provide sufficient benefit to warrant development.
2. The current approach of separate displays for each sensor is not optimal, and increases pilot workload. Display fusion has been demonstrated and would enhance the pilot situation awareness in the night environment.
3. Total integration of all recovery and avoidance systems for the entire aircraft envelope of operation would eliminate most aircraft losses from controlled flight into terrain (CFIT) and g loss of consciousness.
4. Integrated automated aircraft speed control represents the solution to another significant pilot workload item. The definition of the control criteria and the pilot-vehicle-interface represents the difficult part of this task.
5. Integrated real-time intelligence data in the aircraft as a data source for the other technologies would greatly enhance the effectiveness of the other systems and the survivability of the aircraft.

EVALUATION AUTOMATIQUE DE COMBATS AERIENS FONDEE SUR LES INTERVALLES CARACTERISTIQUES

P. POUTIGNAT, H. de FONTENILLES
THOMSON-CSF Département Simulateurs
3 Avenue Albert EINSTEIN
BP116
78192 TRAPPES CEDEX - FRANCE

Cette communication fait suite à l'étude réalisée dans le cadre du marché STTE n° 88 / 86 057.

RESUME

Les simulateurs d'avions d'armes permettent l'entraînement des pilotes à des missions de plus en plus complexes et réalistes, mais rendent la tâche de debriefing associée de plus en plus ardue, en submergeant les pilotes et les instructeurs d'informations plus ou moins exploitables.

Une étude a donc été menée afin de démontrer la faisabilité d'un système d'aide à l'analyse de combat aériens rapprochés.

L'analyse est en grande partie fondée sur un nouveau concept d'intervalle caractéristique, inspiré de la notion de manœuvre, mais moins restrictif et plus fiable.

Ce concept est aussi suffisamment générique pour assurer l'adéquation d'un tel système à n'importe quelle mission, et non pas seulement au domaine très spécifique du combat aérien rapproché.

Le système d'analyse effectue principalement :

- un calcul de critères de performance,
- une extraction d'intervalles caractéristiques,
- une détection de bon ou mauvais comportement selon des règles d'expertise du debriefing.
- une génération d'alternatives pouvant faire intervenir un "pilote idéal", système expert temps réel dans lequel sont exploitées les règles d'expertise du combat aérien.

Les résultats fournis lors de ces différentes étapes peuvent être pleinement exploités grâce à une Interface Homme Machine (IHM) conviviale.

Les règles d'expertise et l'IHM ont été définies en étroite relation avec les utilisateurs finaux et les experts opérationnels.

MOT-CLES

Debriefing, Combat Aérien, Aide à l'évaluation, Système Expert, Interface Homme Machine.

ABSTRACT

The complexity of modern military simulations poses a formidable debriefing task.

A study was therefore conducted to demonstrate feasibility of an evaluation aid system for close air-to-air combat analysis.

This analysis is based on a new concept of Time Interval Characterization (TIC). This concept is an extension of the method of breaking down a combat sequence into individual maneuvers.

The TIC concept is also generic enough to ensure that the proposed aid system is adequate for every type of mission, and not only in the very specific domain of aircraft close-in combat.

The analysis system does principally :

- a measurement of pilot performance,
- an extraction of characteristic intervals,
- a detection of good or bad behavior according to expertise rules of debriefing,
- an optional generation of alternative trajectories by an aircraft combat expert system.

Results obtained during these stages can be fully exploited with the interactive Man Machine Interface (MMI) which forms a part of the aid system.

Expertise rules and MMI have been defined in consultation with relevant experts.

KEYWORDS

Debriefing, Aircraft Combat, Evaluation Aid, Expert System, Man Machine Interface.

1 - INTRODUCTION

Dans les missions aériennes aussi bien réelles que simulées, la phase de debriefing est d'une importance capitale, car elle permet de tirer toutes les leçons nécessaires pour éviter de renouveler certaines erreurs, ou pour tout simplement progresser.

En fonction des missions, l'analyse liée au debriefing peut être effectuée par les pilotes eux-mêmes, notamment par le leader d'une patrouille, ou par des instructeurs spécialisés.

Pourtant, malgré son importance, la phase de debriefing est dans bien des cas raccourcie pour les raisons suivantes :

- dans certains cas comme, par exemple, une grande partie des missions d'interception, aucun système de restitution n'existe. Le combat est donc restitué par les pilotes eux-mêmes, "avec les mains" et avec toutes les imprécisions et l'absence de preuves que cela peut comporter.
- dans les cas où un système de restitution existe :
 - sur simulateur parfois, ce système sert aussi à contrôler le déroulement de l'entraînement. Le temps étant compté, les instructeurs sont donc amenés, tout à fait logiquement, à négliger le debriefing au profit de l'entraînement associé à un debriefing "on line"
 - dans les autres cas, la mission est d'une telle complexité (mission d'attaque au sol par exemple), que le temps imparti pour le debriefing n'est pas suffisant pour évaluer en détail toute la mission si le système de restitution ne comporte aucune aide.

C'est pourquoi à partir de 1989, THOMSON-CSF DSI a mené une étude pour le compte du STTE, en vue de prouver la faisabilité d'un système d'aide au debriefing exploitant les techniques d'Intelligence Artificielle.

Le contexte retenu pour cette étude a été le combat aérien rapproché 1 contre 1. Ce domaine, considéré comme un art par beaucoup de pilotes a été retenu pour deux raisons principales :

- l'environnement le plus avancé techniquement dans le domaine de la tactique et du debriefing était le simulateur du Centre d'Entraînement au Combat (CEC) de Mont-de-Marsan. Ce centre met en œuvre trois sphères destinées au combat aérien et fait appel à des instructeurs qui entraînent les pilotes aux nouvelles tactiques d'emploi des armes. Ces instructeurs et les pilotes en mission d'entraînement au CEC ont donc été les interlocuteurs de choix pour le recueil d'expertise sur lequel s'est appuyée l'étude.
- la richesse du combat aérien permet de poser un grand nombre de problèmes analogues à ceux qui devront être résolus lors de l'extension à des missions comme l'attaque au sol, par exemple. Ce choix représente donc un compromis entre l'exhaustivité de l'étude, et sa durée limitée puisqu'il s'agit d'une étude de faisabilité.

Le chapitre 2 de cet article explique en détail le déroulement du recueil d'expertise et comment ont été résolus les différents problèmes liés au debriefing.

Le chapitre 3 décrit en détails différentes étapes de l'analyse automatique.

Le chapitre 4 cite les fonctionnalités de l'IHM.

Enfin, le chapitre 5 tire les conclusions et perspectives inhérentes à cette étude.

2 - RECUEIL D'EXPERTISE

L'étude a débouché en 1991 sur une maquette logicielle nommée ATISSCA (Analyse Tactique par Informatique Symbolique dans les Simulateurs de Combat Aérien).

Ce système permet de restituer des combats tout en fournissant une boîte à outils d'analyse automatique de ces combats.

Cette maquette exploite deux types d'expertise, recueillie principalement au CEC de Mont-de-Marsan au début de l'étude :

- une expertise du combat aérien, recueillie principalement auprès des instructeurs du CEC et des pilotes venus assister aux séances d'entraînement, ainsi qu'à partir de sources bibliographiques telles que [GUN 83] et [SHA 87].
- une expertise du debriefing, recueillie essentiellement auprès des instructeurs, et qui recense les méthodes utilisées pour évaluer et commenter les combats.

D'un point de vue général, le premier type d'expertise représente la tactique du combat aérien, alors que le second type d'expertise constitue la pédagogie du combat aérien.

En pratique, ces deux types d'expertise sont étroitement mêlés car les pilotes confirmés sont tout à fait aptes à analyser le combat qu'ils viennent d'effectuer, de même que les instructeurs possèdent des compétences aussi avancées que les pilotes en expertise du combat aérien, pour pouvoir évaluer de façon suffisamment approfondie un combat.

L'inter-dépendance entre expertise du combat aérien et expertise du debriefing est illustrée par la figure 1, qui représente de manière simplifiée la façon dont fonctionnerait un système d'analyse automatique idéal.

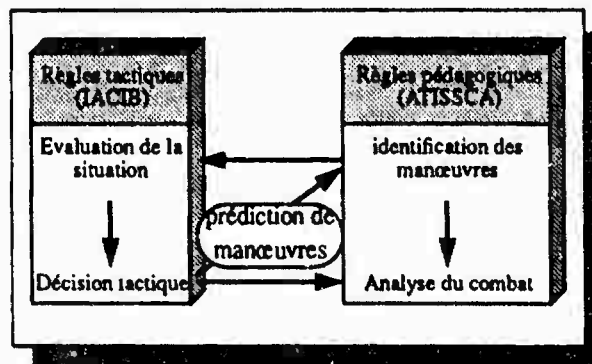

Figure 1 : Comparaison avec un pilote idéal

Dans un tel système, un pilote idéal évalue la situation depuis le début du combat et prend une décision en fonction de cette situation et de règles tactiques.

Le système fait appel à une identification de manœuvres ou d'événements marquants pour découper le combat et effectuer une analyse de ce combat sur chacune des phases ainsi extraites, grâce à des règles pédagogiques.

Le pilote idéal et le système d'analyse sont couplés entre eux de trois façons différentes :

- l'identification des manœuvres sert aussi à analyser la situation à plus long terme pour élaborer une meilleure décision tactique.
- la décision tactique sert de base à l'analyse du combat, puisque dans le cas idéal, ce serait cette décision qu'il faudrait prendre. Cette décision peut par exemple être exploitée pour générer des trajectoires alternatives.
- enfin, le taux de reconnaissance dans l'identification des manœuvres peut être amélioré par corrélation avec la décision tactique qu'effectuerait le pilote idéal à partir de la manœuvre reconnue.

Le recueil d'expertise effectué auprès des opérationnels et le développement progressif de la maquette ont permis de mettre à jour les différents problèmes liés au debriefing du combat aérien, et les contraintes limitant les ambitions du système précédent.

- Tout d'abord, la conception du pilote idéal se heurte aux problèmes inhérents à la nature du combat aérien :
 - Il n'existe pas forcément de décision tactique "idéale" à effectuer à un instant donné. En effet, le déroulement du combat dépend de la stratégie à long terme de chaque pilote, qui elle-même est étroitement liée à sa personnalité et à son expérience.

Le recueil d'expertise a permis de montrer qu'il était utopique de vouloir analyser un combat de façon exhaustive sans tenir compte de l'intention première du pilote.

Cette nécessité de poser des questions aux pilotes pour effectuer une analyse complète implique notamment qu'un système d'analyse automatique doit être avant tout considéré comme une aide à l'évaluation.

- Les règles du combat aérien ne sont pas totalement formalisées et formalisables. Par exemple, l'exécution de manœuvres proprement dite fait appel pour une bonne part aux réflexes psycho-moteurs acquis durant l'apprentissage du pilotage, le pilote est dans ce cas totalement incapable de décrire pourquoi il tire plus ou moins sur le manche.

Du point de vue informatique, un comportement de ce type ne peut être implanté qu'en faisant appel à une loi d'automatique. La mise au point s'avère alors longue, délicate, et pas toujours satisfaisante (cf (WAL 79)).

C'est pourquoi nous nous sommes quelque peu démarqués des systèmes principalement américains apparus après 1980, où l'accent est mis principalement sur l'analyse statistique et les critères de performances, pour privilégier le côté explicatif du système d'analyse, en prolongeant ces critères par d'autres notions telles qu'*intervalles caractéristiques, bons ou mauvais comportements et alternatives*.

- Ensuite apparaissent dans l'analyse du combat des problèmes liés à la notion de manœuvre. Ainsi la reconnaissance des manœuvres qui sert de base à l'analyse du combat est-elle un problème de complexité analogue à celui de la reconnaissance phonétique. Pour un système automatique, il est donc impossible d'avoir un taux de reconnaissance égal à 100 %, et ce d'autant plus que parfois, l'identification visuelle par un expert est elle-même ambiguë.

Ces erreurs d'identification peuvent alors se propager dans les différents niveaux d'analyse du système, et donner finalement lieu à des critiques non valables. Ceci peut donc être préjudiciable à l'utilité et à l'utilisation effective du système d'analyse.

Parallèlement, le recueil d'expertise a montré que l'analyse peut être facilitée et gagner en finesse en considérant plutôt le combat en termes de contraintes à respecter suivant la situation.

Le concept qui est apparu comme permettant d'englober les manœuvres, mais fournissant plus de liberté et de richesse, et suffisamment générique pour s'appliquer à d'autres domaines que le combat aérien a été nommé : *intervalle caractéristique* et sera développé en détail au paragraphe 3.3.

- Enfin, des problèmes liés aux exigences opérationnelles sont apparus. En effet, le debriefing devant pouvoir être fait quasiment immédiatement après l'entraînement, les exigences concernant le système d'analyse ont porté principalement sur le temps d'analyse qui ne devait pas excéder la durée du combat analysé.

D'autre part, toutes ces raisons associées aux contraintes ergonomiques ont orienté l'étude et surtout l'IHM de telle façon que tout au long de l'analyse du combat, elle suggère les résultats de l'analyse plus qu'elle ne les impose. Les pilotes et les instructeurs sont totalement maîtres du déroulement du debriefing et ils choisissent d'afficher les informations qu'ils désirent, comme nous le verrons dans le chapitre 4.

3 - DESCRIPTION DU SYSTEME D'ANALYSE

3.1 - Fonctionnement général

Dans la maquette actuelle, le système d'analyse exploite des fichiers rejou qui contiennent les paramètres numériques nécessaires à la restitution de combats simulés (position, vitesse, attitude des chasseurs, etc.) Ces fichiers représentent des combats 1 contre 1 simulés sur Mirage 2000 effectués par des pilotes en entraînement au CEC de Mont-de-Marsan.

Une fois le fichier rejou lu, l'analyse comprend les étapes suivantes :

- Les paramètres numériques du combat sont discrétisés et transformés en valeurs symboliques qui d'une part serviront à présenter aux pilotes et instructeurs la situation ins-

tantanée des chasseurs sous une forme plus intelligible, et d'autre part seront exploitées lors de la génération d'alternatives par le système IACIB, "pilote idéal" dont nous parlerons plus en détail au paragraphe 3.5.

- Un calcul de critères de performance est effectué à partir des paramètres numériques du combat.
- Une extraction d'*intervalles caractéristiques* reflétant les phases importantes du combat est effectuée par analyse des critères de performance.
- Des tests sont effectués sur les contraintes que doivent respecter les paramètres numériques et les critères de performance durant chaque intervalle caractéristique, et donnent ainsi lieu à la détection de "bons" ou "mauvais" comportements.
- Chaque mauvais comportement donne lieu à la définition de la trajectoire alternative *a priori* optimale générée en faisant appel à la cible intelligente IACIB.

3.2 - Critères de performance

Les critères de performance permettent d'avoir une première idée des avantages pris par l'un ou l'autre des adversaires. Ces critères peuvent être par exemple, l'indice offensif, fonction de paramètres angulaires et de la distance, qui représente en quelque sorte la façon dont le pilote arrive à se positionner dans le domaine de tir, ou encore la conservation du visuel, d'autant plus forte que le pilote parvient à garder le chasseur adverse dans son champ visuel.

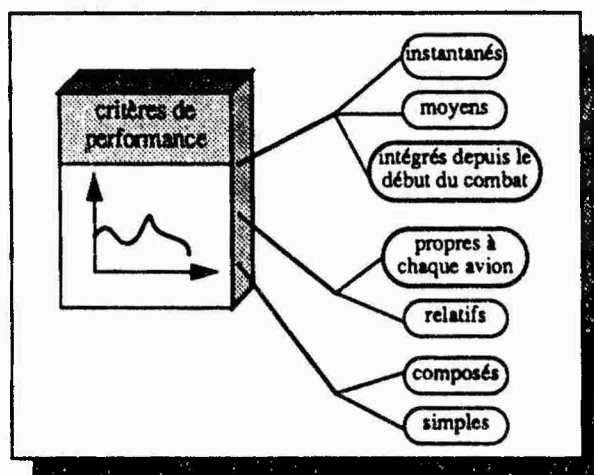

Figure 2 : Taxonomie des différents critères de performance.

La figure 2 illustre les différentes catégories utiles à l'analyse du combat :

- D'un point de vue temporel, les critères peuvent être :
 - instantanés. Ils représentent alors une fonction plus ou moins complexe des paramètres numériques du combat.
 - moyens. Ils représentent alors une fonction plus ou moins complexe de la moyenne sur un intervalle de temps élémentaire des paramètres numériques du combat ou de critères instantanés.

Parmi les critères de ce type, citons par exemple le critère d'acquisition visuelle qui tient compte de la valeur moyenne du facteur de charge subi par le pilote. Dans ce cas, cette valeur moyenne sera en effet beaucoup plus significative qu'une valeur instantanée.

- intégrés depuis le début du combat. Ils représentent alors une fonction plus ou moins complexe de l'intégrale par rapport au temps des paramètres numériques ou des critères instantanés, divisée par la durée écoulée depuis le début du combat.

Des critères de ce type correspondent généralement à des probabilités (cf. [HUY 87]) et permettent de fournir une notation globale du combat. Ainsi, le critère intégré à partir du critère instantané d'indice offensif correspond à la probabilité de victoire.

- Les critères peuvent aussi être :
 - propres à chaque avion, comme par exemple, l'avantage d'un chasseur sur l'autre.
 - relatifs. Ceci indique alors que le critère joue un rôle symétrique entre les deux avions. Le critère relatif le plus simple que l'on peut citer est la distance entre les deux avions.
- Enfin, les critères peuvent être :
 - simples, s'il s'agit de critères directement fonction des paramètres numériques du combat.
 - composés, s'il font appel à d'autres critères, eux-mêmes pouvant être simples ou composés.

3.3 - Intervalles caractéristiques

Les *intervalles caractéristiques* représentent d'une façon très générale : "tout intervalle de temps pendant lequel il se passe quelque chose d'intéressant au sens du combat aérien".

Cette notion remplace et élargit la notion de manœuvre communément adoptée pour décomposer un combat aérien.

Dans le système ATISSCA, un intervalle caractéristique est extrait par analyse des critères de performance, et éventuellement des paramètres numériques. Il sert à décomposer le combat en phases intéressantes.

La notion d'intervalle caractéristique ne préjuge pas de l'algorithme utilisé pour analyser les données. Il est ainsi possible, par exemple d'utiliser une reconnaissance de manœuvres par analyse syntaxique ou par réseaux neuronaux, et à la limite de corréler les deux informations pour améliorer le taux de reconnaissance. Le principal problème consiste bien entendu à être compatible avec les contraintes de temps d'exécution.

Le concept d'intervalle caractéristique permet aussi de corréler des informations classiques telles que les manœuvres reconnues avec des informations plus ponctuelles qui permettront de confirmer ou d'infirmer le résultat, et donc d'améliorer la fiabilité de l'analyse.

En outre, l'évaluation du combat se trouve enrichie, puisqu'elle n'est plus tributaire de notions faisant appel aux événements de durée moyenne que constituent les manœuvres, mais que l'événement pris en compte peut être aussi ponctuel (cas du croisement), ou aussi étendu que l'on veut (cas d'un avantage maintenu jusqu'au tir).

Enfin, cette notion permet de se concentrer sur les situations à discriminer qui vont servir de base à la vérification du bon ou mauvais respect de contraintes associées.

Elle présente toutefois un inconvénient lié à sa richesse : la sélection des critères les plus appropriés permettant de discriminer la situation voulue doit être faite avec soin et n'est pas toujours directement liée aux paramètres sur lesquels les experts raisonnent naturellement.

D'un point de vue pratique, les intervalles caractéristiques possèdent deux rôles :

- permettre à l'utilisateur de se positionner rapidement à un instant important du combat comme nous le verrons au paragraphe 4.3,
- servir de base au système ATISSCA pour la détection automatique de "bons" ou "mauvais" comportements.

Les intervalles caractéristiques sont obtenus :

- soit par des tests logiques que doivent vérifier certains critères de performance,
- soit à partir d'autres intervalles caractéristiques.

Ainsi, l'intervalle caractéristique correspondant aux croisements entre les deux avions peut être calculé en fonction de la distance et de l'angle de présentation entre les deux chasseurs, mais il peut aussi tenir compte du fait qu'un croisement est nécessairement précédé d'une phase d'interception (correspondant à un autre intervalle caractéristique). Cette dépendance vis-à-vis d'autres intervalles caractéristiques permet d'accroître la fiabilité de calcul de l'intervalle caractéristique.

Comme pour les critères de performance, les intervalles caractéristiques peuvent être :

- propres, comme, par exemple, un intervalle caractéristique correspondant à une prise d'avantage sur l'adversaire,
- relatifs, comme, par exemple, l'intervalle caractéristique correspondant aux croisements.

Enfin, ATISSCA offre des fonctions qui permettent de définir des intervalles caractéristiques en fonctions d'autres intervalles caractéristiques.

3.4 - Détection des "bons" ou "mauvais" comportements

La détection des "bons" ou "mauvais" comportements s'inspire directement de la méthode utilisée par les instructeurs pour évaluer les combats. C'est ainsi que le système permet de définir des règles pédagogiques qui, pour un intervalle caractéristique donné, spécifient :

- les contraintes à respecter sur les critères de performance décrits précédemment ou simplement sur les paramètres numériques ou symboliques du combat,
- le commentaire associé au respect ou non respect des contraintes.

Lors de l'analyse automatique, le système applique alors chaque règle sur son intervalle caractéristique associé. Pour ce faire, les contraintes à respecter sont testées sur tous les cycles de combat de l'intervalle caractéristique associé.

- Si toutes ces contraintes sont respectées, la situation analysée correspond à un "bon" comportement, et le système ajoute le compliment associé à ce comportement adéquat,

contenu dans la règle pédagogique.

- Si une contrainte n'est pas respectée, la situation analysée correspond à un "mauvais" comportement, et le système ajoute alors la critique associée à ce comportement inadéquat, contenue dans la règle pédagogique.

A la fin de l'analyse, tous les commentaires sont stockés dans un fichier résultat, que l'utilisateur peut choisir d'imprimer directement pour conserver une trace écrite de l'analyse, ou de visualiser grâce à l'IHM.

L'utilisateur peut aussi associer à chaque compliment une priorité, et à chaque critique une gravité, éventuellement variable en fonction de la situation, qui permet de filtrer les commentaires pour ne garder que ceux qu'il juge primordiaux.

Par exemple, la gravité concernant le décrochage du chasseur peut être proportionnelle à l'angle de cabré de l'avion, car décrocher avec l'avion à plat n'est en général pas grave car temporaire, et peut même être voulu (cas de ciseaux à plat), tandis que décrocher avec le nez haut représente une situation dangereuse et qui n'est jamais temporaire.

Comme une erreur peut être la conséquence d'erreurs précédentes, et qu'il convient dans ce cas de ne pas afficher la critique liée à cette erreur-là, le système offre des fonctions permettant d'exprimer dans le test sur les contraintes les dépendances possibles entre les erreurs. Il sera ainsi inutile d'émettre par exemple une critique sur la direction du chasseur si celui-ci vient juste d'effectuer un décrochage, qui lui-même aura déjà donné lieu à une critique.

De la même façon, les fonctions de manipulation des intervalles caractéristiques citées au paragraphe 3.3 peuvent être utilisées pour inclure dans les contraintes à respecter, un test sur l'existence d'événements plus ou moins complexes qui peuvent influencer sur le bon respect de ces contraintes. Ceci permet, par exemple, de ne pas critiquer le fait que le pilote décroche si l'adversaire vient de tirer un missile secteur arrière, puisque, dans ce cas, l'évasive indiquée consiste à tirer au maximum sur le manche pour gagner de l'angle (manœuvre de break).

Une fois de plus, il est donc possible de nuancer à volonté le jugement suivant la complexité voulue, et ainsi de fournir une analyse suffisamment crédible et réaliste.

3.5 - Génération d'alternatives

Une fois que le système a détecté les erreurs éventuelles, il convient de proposer à l'utilisateur une trajectoire alternative évitant cette erreur, et donc *a priori* meilleure.

Pour ce faire, la méthode utilisée consiste à associer à chaque contrainte une alternative qui sera proposée quand cette contrainte ne sera pas respectée.

La définition des trajectoires alternatives a donc lieu simultanément avec celle des règles qui permettent de détecter les "bons" ou "mauvais" comportements.

Le recueil d'expertise effectué à Mont-de-Marsan a permis de réaliser que la génération d'alternatives constituait le problème le plus épineux et le plus controversé dans la phase de debriefing.

C'est pourquoi le système offre plusieurs méthodes de génération d'alternatives :

- La première méthode consiste à définir l'alternative comme étant manuelle. Ceci permettra alors à l'utilisateur quand il se concentrera sur l'erreur correspondante, de générer lui-même l'alternative voulue :
 - soit de façon totalement manuelle en pilotant lui-même avec le manche et la manette des gaz,
 - soit en s'aidant de la cible intelligente IACIB pour effectuer des manœuvres de façon automatique.
- La deuxième méthode consiste à utiliser directement la cible intelligente à un niveau d'élaboration spécifié par l'utilisateur. Cinq niveaux sont possibles (cf. figure 3) :

- Le niveau d'élaboration le plus haut correspond au fonctionnement normal de IACIB. A ce niveau, la cible intelligente utilise ses règles tactiques pour déterminer quelle est la meilleure manœuvre à effectuer en fonction de la situation présente, et enchaîne automatiquement les manœuvres.

L'utilisateur peut, par exemple, demander l'exécution complète d'une manœuvre de ciseaux à plat.

- Le niveau d'élaboration immédiatement inférieur correspond aux manœuvres dites élémentaires.

Les manœuvres élémentaires sont exécutées à chaque cycle de combat en fonction de la manœuvre à effectuer, et correspondent au respect par l'avion d'un plan de manœuvre, d'un facteur de charge, d'une position des aérofreins et d'une poussée moteur symboliques donnés. Le fait que ces données soient symboliques signifie que les données numériques associées peuvent varier en fonction de la situation instantanée.

L'utilisateur peut, par exemple, demander l'exécution d'une poursuite proportionnelle, pendant laquelle les vecteurs vitesse relative et position relative entre les deux chasseurs sont colinéaires.

- Le niveau d'élaboration encore inférieur correspond au respect par l'avion d'un angle ρ entre le plan vertical passant par le vecteur vitesse de l'avion et le plan de manœuvre de l'avion, d'un facteur de charge, d'une position des aérofreins et d'une poussée moteur numériques.

- L'avant-dernier niveau d'élaboration correspond au respect par l'avion d'un angle de roulis ϕ , d'un facteur de charge, d'une position des aérofreins et d'une poussée moteur numériques.

- Le niveau final d'élaboration correspond au respect par l'avion d'une position du manche, des aérofreins et de la manette des gaz, et donc au pilotage pur.

Enfin, la génération d'alternatives est totalement dynamique. Il est ainsi possible de générer une alternative pour l'avion adverse en réponse à une alternative déjà générée. Cette possibilité rend alors le système plus réaliste et crédible, car, durant un combat réel, le changement de comportement d'un pilote se répercute sur celui de son adversaire.

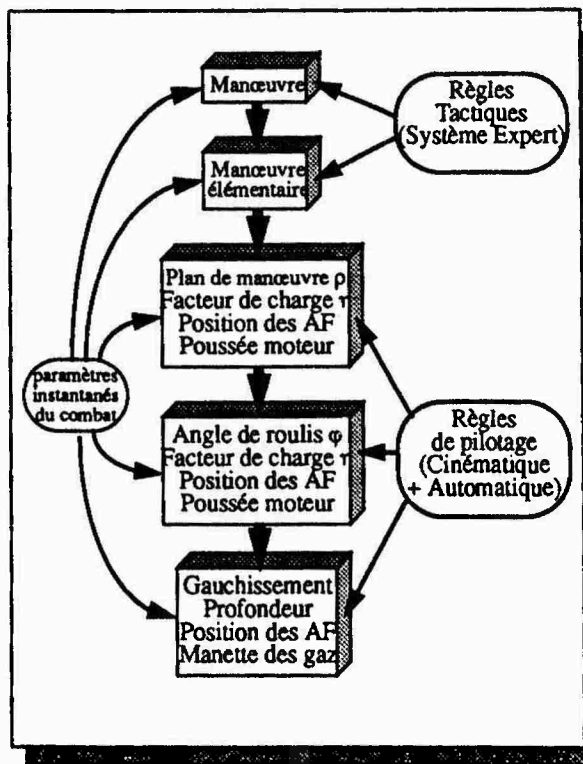

Figure 3 : Niveaux d'élaboration des manœuvres dans IACIB

4 DESCRIPTION DE L'IHM

4.1 Fonctionnement général

L'Interface Homme-Machine a bénéficié lors de sa conception des nombreuses réunions de validation avec les experts.

Ces réunions ont permis de dégager les principes généraux auxquels elle doit satisfaire :

- l'IHM doit être simple d'emploi pour être utilisée sans formation préalable par les pilotes en mission à Mont-de-Marsan.

C'est pourquoi toutes les actions s'effectuent par le biais de la souris et l'utilisateur dispose en permanence d'une fenêtre d'aide en ligne qui lui indique quelles actions il peut effectuer dans la fenêtre où il se trouve.

- La visualisation du combat doit être claire et synthétique, pour pouvoir effectuer une analyse la plus fine possible.

Nous avons ainsi recherché chaque fois que c'était possible des représentations intuitives qui permettent par leur clarté de faire gagner du temps à l'utilisateur.

- L'IHM doit enfin permettre d'exploiter directement et pleinement l'analyse effectuée par le système. C'est pourquoi les fonctionnalités offertes par le multi-fenêtrage et la corrélation des informations ont été utilisées au maximum.

Ainsi, par exemple, il est possible de se positionner directement à un croisement grâce à la représentation des intervalles caractéristiques sous forme de rectangles alignés avec le potentiomètre de temps écoulé.

Les fenêtres affichées dans l'IHM sont de deux types :

- Les fenêtres de visualisation permettent de restituer tous les éléments importants du combat autour du cycle de combat courant.

Ces éléments peuvent être soit tirés directement de l'enregistrement du cas de combat (restitution pure), soit représentés sous la forme la plus adaptée les différentes parties de l'analyse automatique effectuée par le système ATISS-CA.

- Les fenêtres de contrôle permettent de se déplacer à volonté dans la séance en modifiant de plusieurs façons possibles le cycle de combat courant, et d'exploiter pleinement l'analyse automatique effectuée par le système.

Notons que les fenêtres de contrôle permettant d'exploiter l'analyse jouent aussi le rôle partiel de fenêtre de visualisation, comme nous le verrons au paragraphe 4.3.

4.2 Fenêtres de visualisation

- L'aide en ligne indique en permanence la nature de la fenêtre dans laquelle se trouve la souris ainsi que les actions provoquées par chacun des boutons de la souris.

Son contenu varie donc en permanence en fonction de la fenêtre dans laquelle est située la souris.

- La fenêtre CRITERES (figure 4) est composée d'un pavage de sous-fenêtres qui représentent chacune sous la forme de tambour enregistreur la ou les courbes correspondant à un critère de performance.

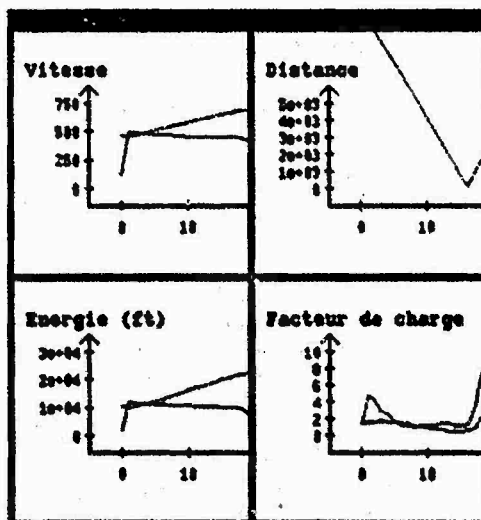

Figure 4 : Visualisation des critères des performance.

- La vue Cockpit (figure 5) permet de mieux appréhender le combat en se plaçant dans le cockpit de chaque pilote.

Etant donnée l'importance de disposer d'un grand champ de vision en combat aérien, cette vue est représentée sous forme sphérique. Ceci permet de voir tous les éléments extérieurs à l'avion situés dans un cône de vision d'angle au sommet donné.

Cette vue est complétée par les instruments les plus importants : altimètre et variomètre, des paramètres numériques tels que : facteur de charge, distance, IAS, Mach, d'une représentation radar simplifiée, d'une représentation du manche et de la manette des gaz, et d'une représentation sous forme de "thermomètre" de l'énergie totale.

Afin de mieux pouvoir comparer ces éléments entre les deux avions, les deux vues cockpits sont mises côte à côte et les éléments tels que thermomètre et paramètres numériques sont disposés de façon symétrique par rapport au milieu de la fenêtre.

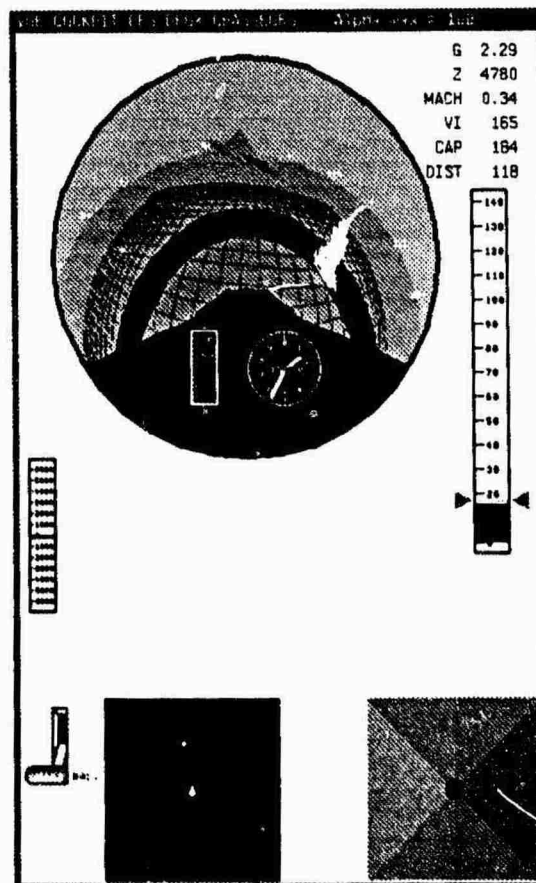

Figure 5 : Fenêtre vue Cockpit.

- La vue 2D représente les trajectoires globales du combat en deux dimensions, vues de face et de dessus. Elle permet à l'utilisateur de se positionner directement avec la souris à un endroit particulier du combat.

- La vue 3D (figure 6) représente les trajectoires partielles

du combat sous forme de rubans et les avions sous forme de facettes triangulaires, en trois dimensions, à l'intérieur d'un cube automatiquement centré autour de la position courante des deux avions.

Cette représentation associée à la projection des trajectoires sur la face basse du cube permet de comprendre clairement et rapidement les manœuvres effectuées par les avions.

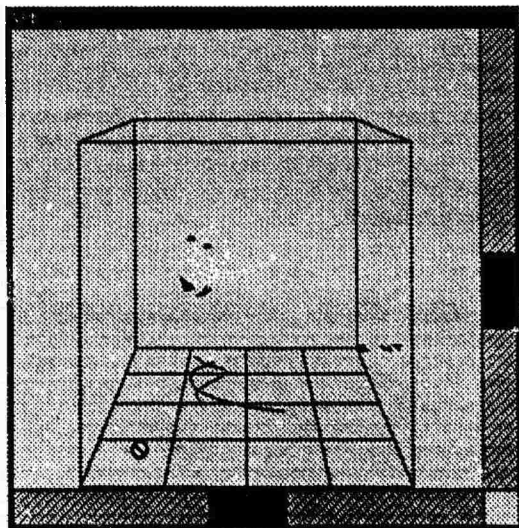

Figure 6 : Fenêtre Vue 3D.

- La fenêtre de visualisation des erreurs (figure 7) ne s'affiche que si l'expert le désire, par le biais de la souris. Les "bons" ou "mauvais" comportements détectés par le système autour du cycle de combat choisi sont alors affichés pour chaque avion dans deux sous-fenêtres distinctes.

Le texte affiché est une vue partielle du fichier généré par le système ATISSCA, dont nous avons parlé au paragraphe 3.4, centrée automatiquement autour du cycle de combat choisi par l'utilisateur.

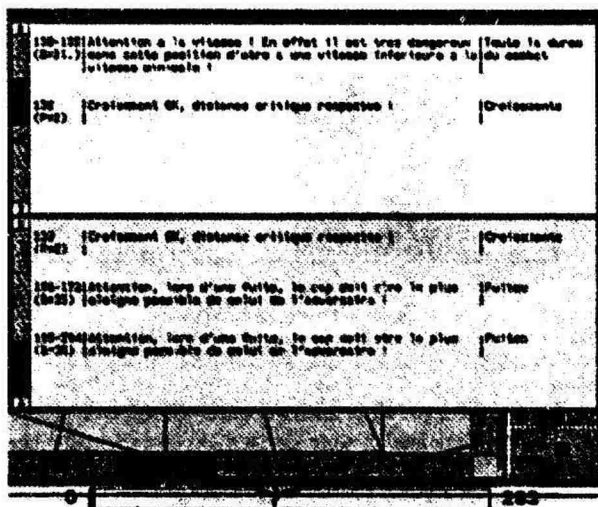

Figure 7 : Fenêtre de visualisation des erreurs.

- La fenêtre SITUS représente la situation symbolique ins-

tantée des chasseurs. Elle permet de rendre compte des paramètres importants du combat de façon intelligible et rapide.

4.3 Fenêtres de contrôle

- La fenêtre de contrôle général (figure 8) est subdivisée en sous-fenêtres correspondant chacune à un groupe de boutons, soit agissant sur une même fenêtre de visualisation, soit ayant des rôles similaires :

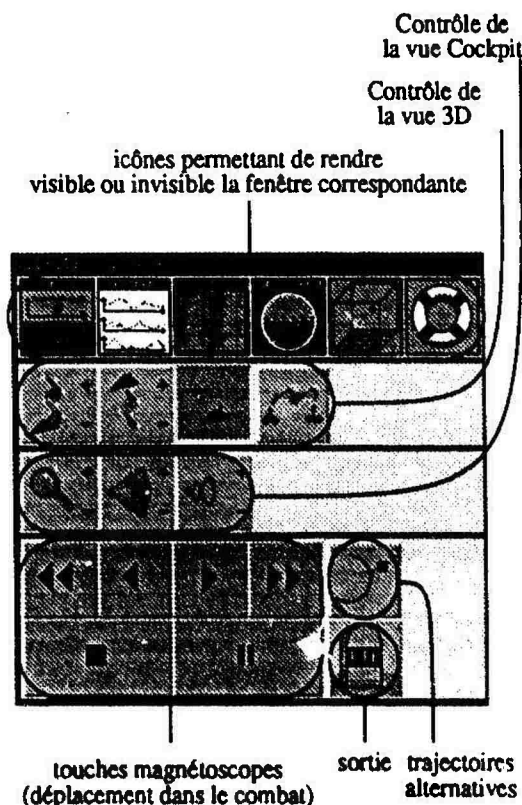

Figure 8 : Fenêtre de contrôle général.

- La fenêtre de temps écoulé sert à la fois au contrôle et à la visualisation. Elle représente sous forme de potentiomètre le temps écoulé en cycles de combat depuis le début du combat.

En-dessous de ce potentiomètre est alignée une représentation graphique des intervalles caractéristiques sous forme de rectangles colorés (noirs pour les intervalles relatifs, rouge et bleu pour les intervalles propres à chaque avion).

Cette représentation permet d'avoir immédiatement une vue globale des événements importants du combat.

- Utilisé avec le bouton gauche de la souris, le potentiomètre de temps écoulé permet de se positionner directement à un cycle de combat voulu, par exemple, un croisement entre les deux chasseurs.

Cette fonctionnalité liée directement à l'analyse automatique permet ainsi de gagner d'autant plus de temps dans

le debriefing que la mission est longue.

- Utilisé avec le bouton central de la souris, le potentiomètre de temps écoulé permet de visualiser les "bons" ou "mauvais" comportements détectés par le système lors de l'analyse automatique, autour du cycle de combat pointé par l'utilisateur.

- Enfin, utilisé avec le bouton droit de la souris, le potentiomètre de temps écoulé permet de charger une alternative dans le système, par l'intermédiaire d'un menu.

Ce menu propose un choix entre les alternatives manuelles, et éventuellement la ou les alternatives qui peuvent exister pour les "mauvais" comportement détectés autour du cycle de combat sur lequel pointe l'utilisateur.

La sélection d'une alternative manuelle ou automatique a alors pour conséquence de positionner le système en mode "alternatives" et d'afficher, dans la fenêtre de génération d'alternatives, les éléments qui permettront d'exploiter cette génération.

- La fenêtre d'exploitation des alternatives permet de générer une alternative qui vient d'être chargée grâce au menu décrit précédemment, avec la possibilité de contrôler pas-à-pas ses caractéristiques.

Cette fenêtre contient des commandes de choix de la manœuvre suivant laquelle l'alternative est générée, aux cinq niveaux de génération décrits au paragraphe 3.5.

Elle permet aussi de contrôler le niveau de génération de l'alternative, sa durée, son enregistrement ou sa restitution. Enfin, elle contient un potentiomètre de temps écoulé depuis le début de l'alternative, pour se positionner directement à un cycle relatif de l'alternative.

5 - CONCLUSION ET PERSPECTIVES

L'étude ATISSCA a tout d'abord permis de prouver la faisabilité d'un système d'analyse automatique de combats aériens en vue d'aider les instructeurs et les pilotes dans leur tâche de debriefing.

Le nouveau concept d'intervalle caractéristique sur lequel est fondé l'analyse des combats s'est révélé plus riche et générique que la notion de manœuvre, et permet ainsi d'envisager d'autres produits de ce type, dans un autre domaine que celui du combat aérien, comme par exemple, les missions air-sol.

Ce système peut également s'appliquer à l'analyse de combats réels.

Enfin, par le moyen d'une analyse statique sur l'ensemble des combats, il pourra être élargi à la validation de systèmes (ergonomie du système d'armes, du cockpit, tactiques du combat).

BIBLIOGRAPHIE

[BUR 75]

AML : An Adaptive Maneuvering Logic computer program for the simulation of one-to-one air-to-air combat.

George H. Burgin, A. J. Owens.

NASA Contractor Report NASA CR-2583

[WAL 79]

Tactical Performance Characterization, basic methodology.

Michael J. Walsh, George H. Burgin, Lawrence J. Fogel.

Technical Report

AIR FORCE SYSTEMS COMMAND 1979

[GUN 83]

Modern Air Combat, the aircraft tactics and weapons employed in aerial warfare today.

Bill Gunston, Mike Spick.

CRESCENT BOOKS 1983

[SHA 87]

Fighter Combat, tactics and maneuvering.

Robert L. Shaw.

NAVAL INSTITUTE PRESS 1985

[HUY 87]

Numerical Optimization of Air Combat Maneuvers

H.T. Huynh, Ph. Costes, C. Aumasson.

ONERA 1987.

Flight Evaluation of a Computer Aided Low-Altitude Helicopter Flight Guidance System

Harry N. Swenson

NASA Ames Research Center
Moffett Field, CA, USA 94035-1000

Capt. Raymond D. Jones, and
Mr Raymond Clark
U.S. Army Avionics R&D Activity
Ft. Monmouth, NJ, USA 07703-5000

SUMMARY

The Flight Systems Development branch of the U.S. Army's Avionics Research and Development Activity (AVRADA) and NASA Ames Research Center have developed for flight testing a Computer Aided Low-Altitude Helicopter Flight (CALAHF) guidance system. The system includes a trajectory-generation algorithm which uses dynamic programming and a helmet-mounted display (HMD) presentation of a pathway-in-the-sky, a phantom aircraft, and flight-path vector/predictor guidance symbology. The trajectory-generation algorithm uses knowledge of the global mission requirements, a digital terrain map, aircraft performance capabilities and precision navigation information to determine a trajectory between mission waypoints that seeks valleys to minimize threat exposure. This system has been developed and evaluated through extensive use of piloted simulation and has demonstrated a "pilot centered" concept of automated and integrated navigation and terrain mission planning flight guidance. This system has shown a significant improvement in pilot situational awareness, and mission effectiveness as well as a decrease in training and efficiency time required for a near terrain, nighttime, adverse weather system.

AVRADA's NUH-60A STAR (Systems Testbed for Avionics Research) helicopter has been specially modified, in house, for the flight evaluation of the CALAHF system. The near-terrain trajectory generation algorithm runs on a multi-processor flight computer. Global Positioning System (GPS) data are integrated with Inertial Navigation Unit (INU) data in the flight computer to provide a precise navigation solution. The near-terrain trajectory and the aircraft state information are passed to a Silicon Graphics computer to provide the graphical "pilot centered" guidance, presented on a Honeywell Integrated Helmet And Display Sighting System (IHADSS). This paper presents the system design, piloted simulation, and initial flight test results.

INTRODUCTION

The complexity of rotorcraft missions involving operations close to the ground in nap-of-the-earth (NOE) flight for long periods of time result in high pilot workload. This is especially true for single-pilot vehicles, such as was originally intended for RAH-66 Comanche. In order to allow a pilot more time to perform mission-oriented tasks, some type of automated system capable of

performing guidance, navigation, and control functions is needed. Automating NOE flight is extremely challenging due to the advances necessary in several technology areas such as terrain flight guidance, obstacle detection, and obstacle avoidance. NASA's Ames Research Center and the U.S. Army's Avionics Research and Development Activity (AVRADA) have joined to develop these technologies and flight test systems and concepts that have the greatest potential for improved low-altitude and NOE rotorcraft flight operations [1].

Currently, rotorcraft operating in threat areas achieve low-level, maneuvering penetration capability during nighttime and adverse weather conditions through the use of a combination of technologies such as terrain-following (TF) radar systems, forward looking infrared sensors and night vision goggles [2]. TF systems were initially developed for fixed-wing tactical and strategic aircraft and provide vertical commands which can be displayed on a flight director for manual flight or fed to the flight control system for automatic flight. The extension of TF capability to include lateral maneuvering by taking advantage of on-board digital terrain data is commonly referred to in the literature as Terrain Following/Terrain Avoidance (TF/TA) [3]. Within the last few years TF/TA algorithms have been modified to suit the requirements of rotorcraft [4,5]. Research at NASA Ames has concentrated on incorporating these algorithms into an operationally acceptable system, referred to as the Computer Aiding for Low-Altitude Helicopter Flight (CALAHF) guidance system [6]. Several piloted simulations of the CALAHF guidance system have been conducted to develop the system and pilot interface and to evaluate pilot tracking performance and situational awareness under various flight and environmental conditions. Based on the system performance and pilot acceptance demonstrated during the third simulation the CALAHF concept was believed ready for flight evaluation, both as a first step in initiating NASA's automated NOE flight research and as a standalone capability to meet the operational military requirements for covert low-altitude penetration. This resulted in an agreement between NASA-Ames and the U.S. Army AVRADA for a joint flight experiment in the AVRADA NUH-60A STAR (Systems Testbed for Avionics Research) helicopter. Validation of the NASA-developed CALAHF system is being carried out on the NUH-60A STAR helicopter. This paper reviews the system concept, simulation effort, test aircraft integration, and the initial series of flight tests.

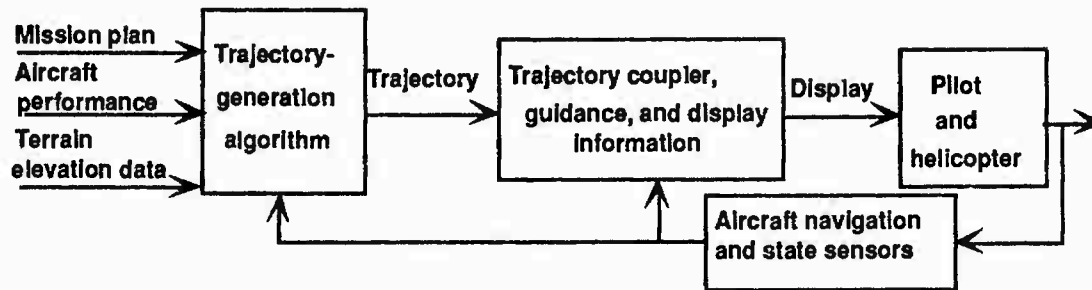

Figure 1, CALAHF system block diagram

CALAHF SYSTEM DESCRIPTION

A functional block diagram of the CALAHF flight system is shown in Fig. 1. The three major components: (1) the trajectory-generation algorithm, (2) trajectory coupler, and (3) displayed information are discussed below.

Trajectory Generation Algorithm

The primary guidance is provided by a valley-seeking, trajectory generating algorithm based on a forward-chaining dynamic-programming technique originally developed for the U.S. Air Force [8]. Significant modifications were made to the original guidance algorithm to adapt it for manual rotorcraft operations. These modifications are discussed in extensive detail in references [4,9], thus the algorithm is described only briefly here. The algorithm uses mission dependent information, i.e. mission waypoints, and Defense Mapping Agency digital terrain elevation data combined with aircraft performance parameters and state information, e.g., maximum bank angle, maximum climb and dive angles, maximum pull up and push over load factor, and set-clearance altitude (desired trajectory altitude above the ground) to compute an optimal path between mission waypoints.

The trajectory generation algorithm uses a decoupled procedure in which the lateral and vertical trajectory solutions are determined independently to obtain an optimal trajectory. In this decoupled procedure, the lateral ground track is first determined by assuming that the aircraft can maintain the vertical set-clearance altitude. The vertical trajectory is then calculated using aircraft normal load factor and flight path angle as maneuver constraints to maintain the aircraft at or slightly above the vertical set clearance as determined from the digital terrain map and the lateral ground track.

The lateral path is calculated using a tree structure of possible two-dimensional trajectories by using discrete values of aircraft bank angle. Assuming constant speed and coordinated flight (zero sideslip), each discrete bank angle produces a possible path which in combination forms a tree of possible paths (Fig. 2). In this implementation, the

bank angle control has five discrete values that are used for the trajectory calculation ($0, \pm 1/3$ maximum bank angle, \pm maximum bank angle). The number of possible paths is reduced to a reasonable level by pruning. Pruning the tree after three to four levels of branching gives the best mix of branch generation and computational speed based upon results from non-real-time computer simulations.

After the tree structure of possible paths has been propagated through the entire patch length, the cumulative cost (J) of all surviving branches are compared, and the path with the lowest cost is selected as the optimal trajectory. The cost function J used to determine the optimal trajectory is

$$J = \sum_{i=1,30} H_i^2 + f(D_i)\omega D_i^2 + \alpha(\Delta\Psi_i)^2 \quad (1)$$

where H_i is the altitude above sea level at node i , D_i is the lateral distance from reference path (as defined by a straight line between waypoints) at node i , ω is the TF/TA ratio, $f(D)$ is a dead band on the lateral deviation cost, $\Delta\Psi_i$ is the error between reference and command heading at node i and α is the heading weight.

The main parameters in this performance measure are the terms representing altitude H and reference-path deviation D . The cost-functional, when driven by these two terms, allows lateral maneuvering to seek lower altitude terrain by the cost reduction from H ; excessive deviation from the reference path is controlled by increasing cost due to D . The TF/TA ratio ω allows blending of these two terms to obtain a desired balance between vertical and horizontal maneuvering. The $f(D)$ and $\alpha(\Delta\Psi_i)^2$ terms were added to reduce undesirable oscillations in the trajectory about the nominal path that are caused by the bank-angle quantization. The $f(D)$ eliminates the need for precise following of the reference path and the $\alpha(\Delta\Psi_i)^2$ term provides a penalty for changing the heading from that given by the reference path. These two terms were added as a result of experience gained in piloted simulations to make the trajectory-generation algorithm emulate pilot control strategies for low-altitude maneuvering flight. The

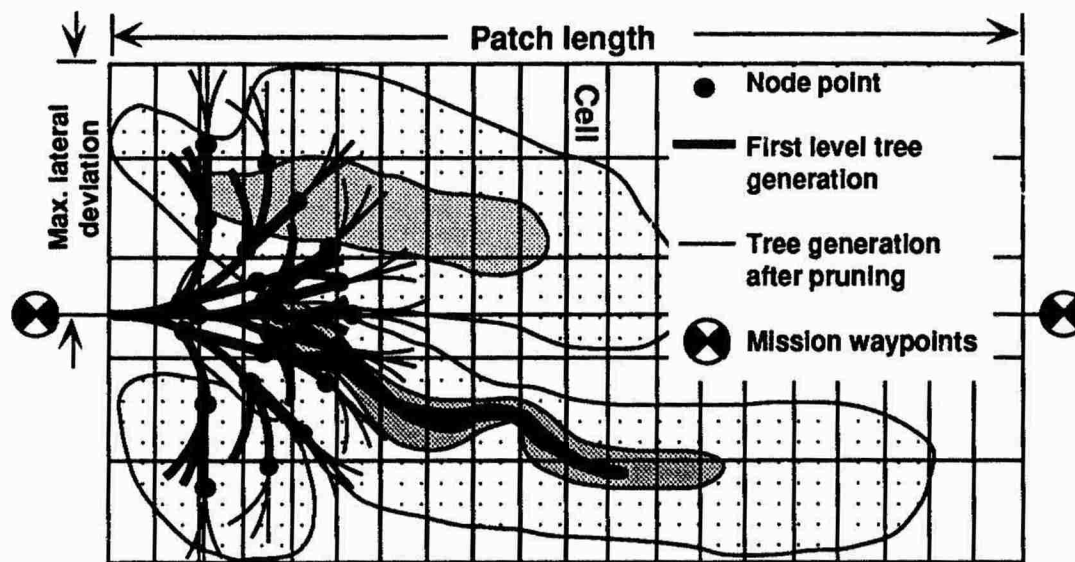

Figure 2: Trajectory Tree generation

trajectory-generation algorithm, as defined above, is designed to compute guidance for a patch which is the area in front of the aircraft's present location. The patch width is the maximum lateral deviation allowed by the algorithm, and the length is the flight preview distance. The algorithm is computationally intensive; for a representative patch length of 30 sec and maximum lateral deviation of 1 km the computational cycle is approximately 4 to 5 sec for a modern (1 to 2 MIP) flight computer. Although the trajectory is updated every cycle time, the updates are blended in such a way that a pilot sees a continuous path and the updates are imperceptible to him. The optimal trajectory is passed to the trajectory coupler. The trajectory is represented by 30 discrete instances of commanded aircraft-inertial state (position, velocity and acceleration) as well as commanded bank, heading and vertical flight-path angles at 1-sec intervals.

Pilot Display Guidance

The guidance and control information is given to the pilot on a helmet mounted display (HMD) in the format shown in Fig. 3. The HMD format is a mixture of screen, body, and inertially referenced symbols. The screen referenced symbols include: a heading tape (023°), engine torque (45%), airspeed (63 kts), radar altitude (105 ft), and ball and slip indicator and are fixed to a location on the HMD display. The body referenced symbols are the aircraft nose ($>$), and the flight-path vector/predictor which move in relation to the pilot's head position relative to the nose and aircraft's flight path vector. All remaining symbols are inertially referenced and are positioned on the display symbolically in the exact position and orientation as dictated by their world coordinates. The primary situational information is presented to the pilot with an inertially stabilized flight-path vector/predictor symbol predicting

the rotorcraft location 4 seconds ahead, and is represented by the circular aircraft icon with attached airspeed flight director tape. The situational information presented on the HMD in Fig. 3 indicates the pilot is turning right with a slight descent as indicated by the flight-path vector/predictor below the horizon, and is looking approximately along the longitudinal axis of the aircraft as indicated by the position of the aircraft nose symbol.

The trajectory information is displayed on the HMD using a pathway-in-the-sky and a phantom aircraft. The pathway symbols represent a three-dimensional perspective of the inertial position and heading of the discretized trajectory. The phantom aircraft, displayed as a delta-winged aircraft represents the instantaneous position along the trajectory that is 4 seconds ahead of the pilot's aircraft. By positioning the flight-path vector symbol on the phantom aircraft, the pilot will track the desired trajectory. In Fig. 3, the HMD symbols are presenting a climbing right turn. The pathway is 30 meters (roughly two rotor diameters) wide at the bottom and parallel to the horizon with vertical projections that are canted at a 45° angle; the width at the top is 60 meters. The depth of the path is 15 meters below the intended trajectory; thus when flying a level straight-line commanded path, the pilots used the analogy of traveling in a full irrigation canal for describing the pathway symbols. Fig. 3 shows a pathway configuration of 7 lines.

Now, we refer to the guidance presented in this fashion as "pilot centered" for the following reasons. First, the presentation allows the pilot to choose the accuracy to which he wishes to track guidance. For example, a pilot can track the phantom aircraft with an intentional vertical bias much like he does when flying formation in near-terrain flight, using pilotage techniques he learned from his

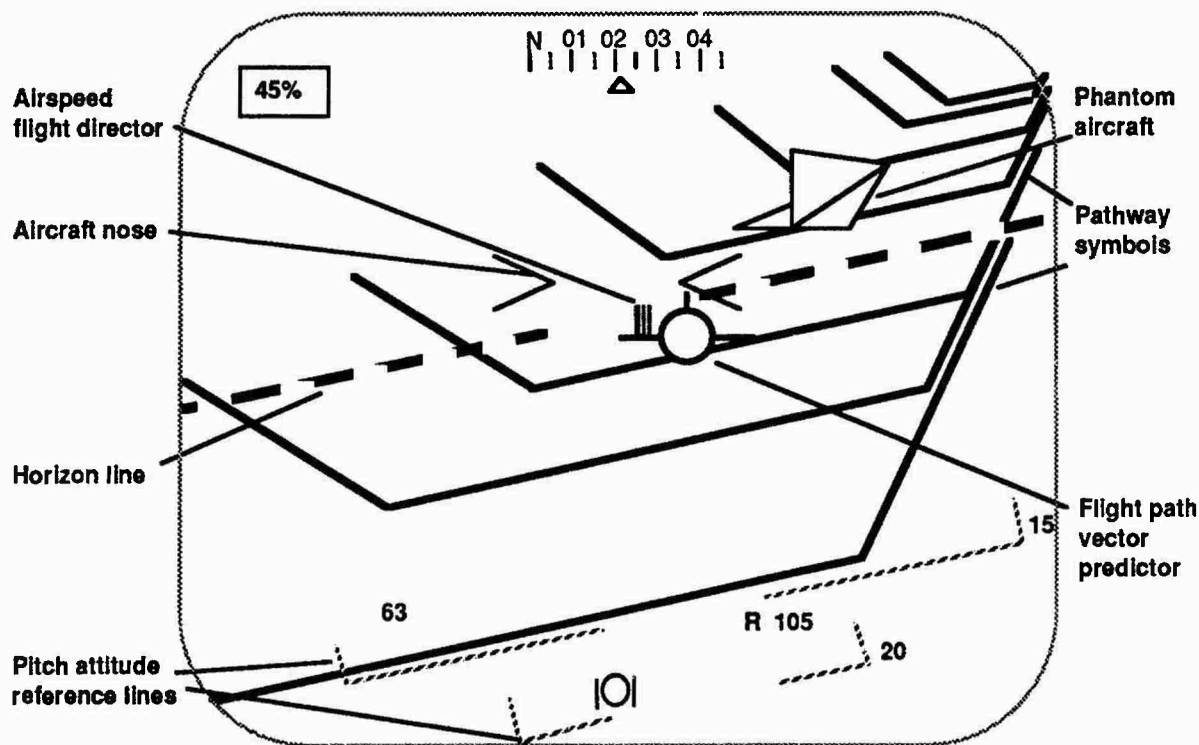

Figure 3: Helmet Mounted display format

first multi-aircraft terrain flight mission. Another reason is the pathway symbology allows the pilot to predict well in advance the maneuvers of the phantom aircraft and determine the pilotage technique most comfortable. This display presentation philosophy is different than traditional "flight director" guidance where the pilot is required to null needles acting as a human autopilot reacting to error signals. Using flight directors pilots often refer to themselves as "meat-servos" and have to trust that the system is operating properly. With the "pilot centered" guidance the pilot no longer has to completely trust the system and can use more of his own judgement in the pilotage of his aircraft.

PILOTED SIMULATION

There have been five piloted simulations dedicated to the development and evaluation of the computer aided for low-altitude helicopter flight guidance concepts [5,6,7]. The simulations were conducted at NASA Ames Research Center on the six-degree-of-freedom Vertical Motion Simulator (VMS). The VMS provides extensive cockpit motion for use in evaluating handling qualities associated with advanced guidance and control concepts for existing and proposed aircraft. The first three simulations were dedicated to concept development of the CALAHF system [5,6]. The final two simulations were conducted in direct support of the joint NASA/ U.S. Army flight test program [7]. In the fifth simulation, 5 NASA and Army project pilots flew over 300 simulation data runs evaluating and defining the system throughout the proposed flight test

envelope. Eighteen guest and evaluation pilots from NASA, DOD and U.S. industry flew the system, giving highly favorable feedback on the system development. The evaluation pilots were able to manually track the HMD guidance through various combinations of terrain, speeds, and weather representative of system use. The guidance can be followed with low pilot workload without detracting from his awareness of the outside world. The pilot was able to combine the guidance with his visual senses to optimize the mission success in varying weather/threat conditions.

AIRCRAFT SYSTEM DESCRIPTION

The U.S. Army and NASA Ames Research Center have started an extensive flight test program of the CALAHF system. The aircraft that is being used for the program is the Army's NUH-60A (STAR) helicopter, Fig. 4. The STAR has been extensively modified to serve as a research aircraft for the U.S. Army [10] and provides digital control and display of all cockpit functions through five multifunction displays (MFD) via a 1553B network. The system is referred to as the Army Digital Avionics System (ADAS). Integrated into the ADAS MFD's is the capability to monitor and control the engines, avionics, circuit breakers, and flight information. ADAS also provides automated secondary systems, checklists, caution/advisory information, and emergency notification and procedure. Due to this unique architecture, the NUH-60 STAR lent itself very well to the integration of the CALAHF system.



Figure 4, NUH-60A STAR helicopter



Figure 6, NUH-60A STAR cockpit configuration & pilot with IHADSS

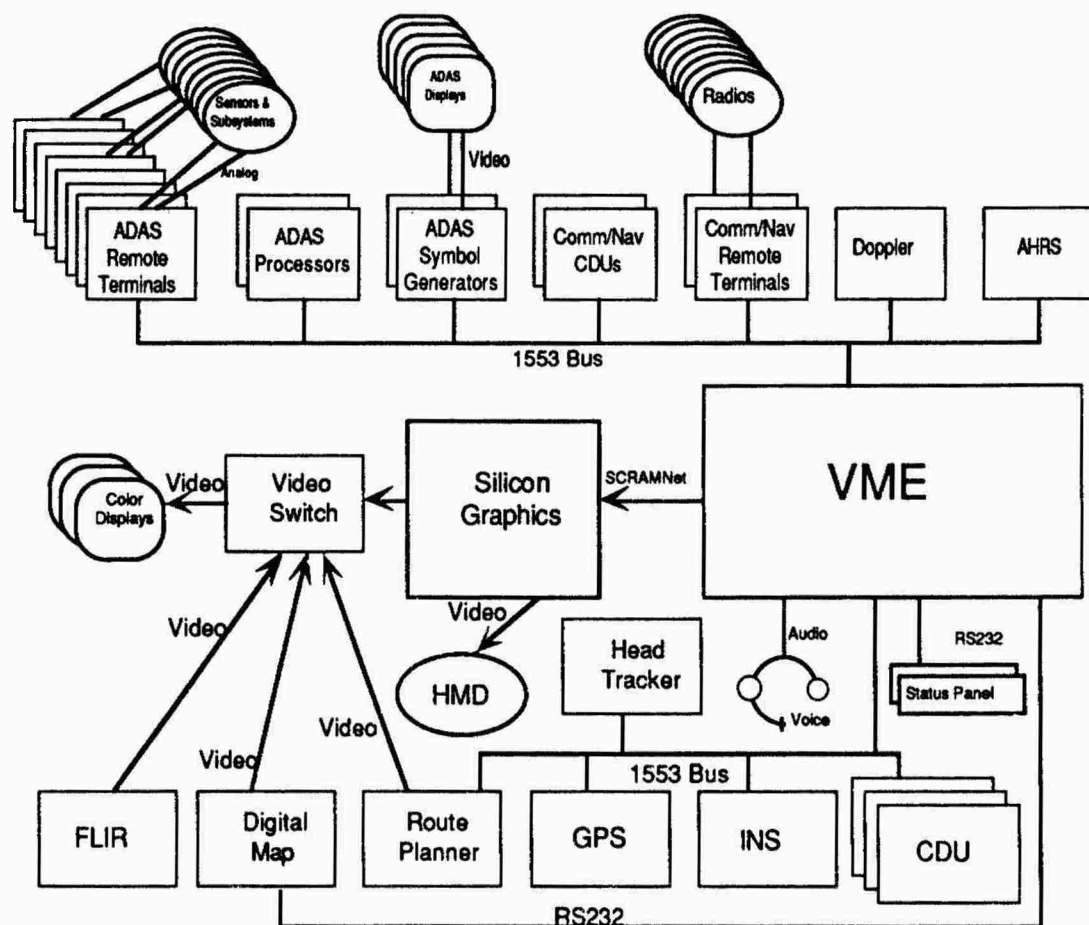

Figure 5, NUH-60A STAR systems diagram

Figure 5 is a block diagram the CALAHF system, as implemented in the STAR. The heart of the system is a general purpose Motorola 68020 based multiprocessor Versa Module Eurocard (VME) computer running a "real-time" operating system. The CALAHF software was rewritten at Ames to include all of the conceptual changes and to be compatible with the VME computer. Connected to the VME on a 1553B network are a Collins RCVR-OH Global Positioning System (GPS) receiver, a Litton LN-39 Inertial Navigation Unit (INU), a Honeywell Integrated Helmet Mounted Display and Sighting System (IHADSS), 3 programmable Collins Control and Display Units (CDU), and an IBM PS2 computer. Also connected to the VME is a Silicon Graphics 4D/120 via a fiber optic SCRAMNet network, and an 386 AT personal computer via a serial line. The VME is also connected to the ADAS system as a remote terminal on its 1553B network. This allows access to airdata, engine performance data, and radar altimeter data.

The VME computer runs the guidance algorithm, integrated navigation, mission plan storage, network control, and overall system software. The VME provides the aircraft state, mission plan, digital terrain elevation data (DTED), and guidance algorithm control data to generate the

trajectory output. The VME then stores the trajectory and passes it as well as the current aircraft state information to the Silicon Graphics at a synchronous 20 Hz rate through the SCRAMNet interface for pilot display. Control of the CALAHF system is through the CDUs located both in the pilots console and engineers station. The CDUs allow mode control, selection of CALAHF flight and display parameters, and mission plan editing.

The navigation integration includes a P-Code GPS to provide high accuracy positional data, and an INU to provide high rate aircraft state information. The navigation software filters and smooths the GPS and INU data providing a continuous output for pilot display. The navigation software on the VME receives the aircraft state data from the GPS at 1 Hz and the INU at 32 Hz via the 1553B. The filters difference the 1 Hz positional information from the GPS and the corresponding INU information to determine latitude, longitude and altitude corrections. The corrections are then ramped back into the INU at 8 Hz rate. Thus the navigation solution for the INU has the accuracy of P-Code GPS in near continuous time (32 Hz).

The helmet mounted display system includes the IHADSS and the Silicon Graphics computer. The IHADSS provides the actual helmet display device and the head positioning data, Fig 6. The Silicon Graphics workstation is the symbol generator containing the software that generates the display symbology shown previously in Fig. 3. The Silicon Graphics computer provides display symbology to the IHADSS via an RS-170 video interface.

A color digitized paper map of the flight test area is generated by an 386 AT PC and presented in the cockpit on a sunlight readable color monitor manufactured by Smith Industries. Superimposed on the map is the current mission plan, helicopter position and the guidance trajectory. The map allows the pilot to maintain a global mission perspective. An automated mission planning and replanning capability is provided by an IBM PS2 computer[11].

The NUH-60A STAR helicopter has a self contained data recording capability. Aircraft state sensor information such as latitude, longitude, altitude, pitch, roll, yaw, airspeed, radar altitude, pilot control inputs, and ground speed are recorded on a VME battery backed-up memory board. Which is transferred to digital tape upon mission completion. The computed trajectory information as well as pilot tracking performance are also recorded. This digital information is recorded at the 20 Hz system rate. Video information from an aircraft nose mounted FLIR Systems, FLIR 2000 Forward Looking Infrared (FLIR) system with superimposed HMD symbology is recorded on a video tape recorder (VTR). Aircraft communications are also recorded on the VTR.

FLIGHT EVALUATION

A flight test evaluation of the CALAHF system has just initiated its data collection phase with the first data collection flight on July 22, 1992, conducted in a rugged, mountainous, uninhabited region just south of Carlisle, Pennsylvania, USA. A DMA data base for the area, covering 77°45' to 77°00' West longitude by 39°45' to 40°15' North latitude was obtained for the evaluation. The terrain is fairly rugged with hills ranging from 150 to 760 meters throughout the test range. A series of waypoints connected by straight lines were selected as the flight test course. Fig. 7 shows the predesignated route of flight superimposed with an actual trajectory flown by the test aircraft over a contour map of the test area.

Five pilots representing the U.S. Army from AVRADA and NASA at Ames Research Center were selected for the flight test. Each of the pilots participated in the simulation program and has a wide range of flight experience in conventional, research and tactical flight regimes. For the flight test, the project pilot was seated in the left seat and a safety pilot was in the right seat of the aircraft. The project pilot's sole function was to fly the aircraft using IHADSS and the CALAHF symbology. The safety pilot was

responsible for overall aircraft control, communications, and any other necessary cockpit function. The flight engineer, seated aft, was responsible for data collection and overall project control.

The two primary objectives of this initial flight test phase were: 1) establish the functionality of the CALAHF system in terms of its accuracy in tracking a vertical terrain profile and horizontal viability of its flight path trajectory, and 2) evaluate the test pilots ability to track the CALAHF symbology. Each of the 5 pilots flew the baseline flight test matrix shown in Table 1, providing a wide array of tracking performance data. The runs were started with the trajectory guidance information displayed on the IHADSS along the first leg of the reference course. The task was to track, precisely and safely, the flight path vector/predictor and phantom aircraft. Pilot and system tracking performance in the vertical and horizontal axis were measured by comparison of the trajectory generated by the guidance algorithm with the actual trajectory flown by the pilots. A typical run was approximately 20 to 30 minutes long. The test pilot flew no more than three consecutive runs, thus eliminating variations in flight performance due to fatigue. The data collected during the flight test were compared with the piloted simulation data discussed earlier.

RESULTS AND DISCUSSION

The system has flown a limited subset of the full test matrix. The results presented here will focus on the functional aspects of the CALAHF system.

Shown in Fig. 7 is a contour map of the flight test area south of Carlisle, Pennsylvania, USA. The mission waypoints, nominal reference path and a sample flight test profile are shown on the map. It can be seen that the CALAHF system followed the mission plan but utilized terrain features to maintain a lower altitude profile whenever possible.

Fig. 8 shows a typical flight in the vertical axis. Both aircraft altitude (commanded and actual) as well as terrain (predicted and actual) are presented. The predicted terrain is determined by the aircraft's precision navigation system and the digital terrain database, and the actual terrain as determined by the aircraft's radar altimeter and its GPS derived mean sea level position. The CALAHF system tracked the predicted terrain reasonably well, however, there are sections where the predicted terrain and actual terrain differ on the order of 60-90 meters. The database accuracy is a major issue with any database-derived guidance system. The effect of terrain discrepancies can be reduced in three possible ways. The first is to fly the system at an altitude greater than 90 meters above the ground. A second approach is feedback radar altimeter information into the vertical trajectory to compute a vertical bias. This approach is thoroughly discussed in [12] where a Kalman filter was used to integrate radar

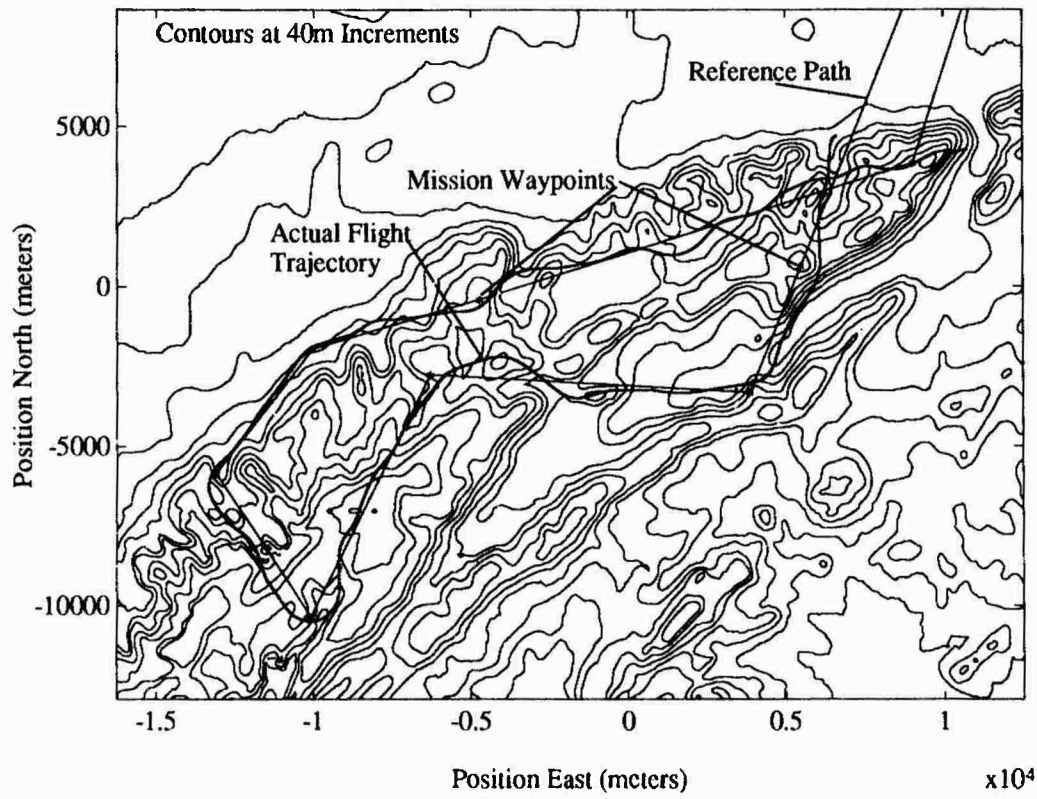

Figure 7, Contour map with mission plan and flight trajectory

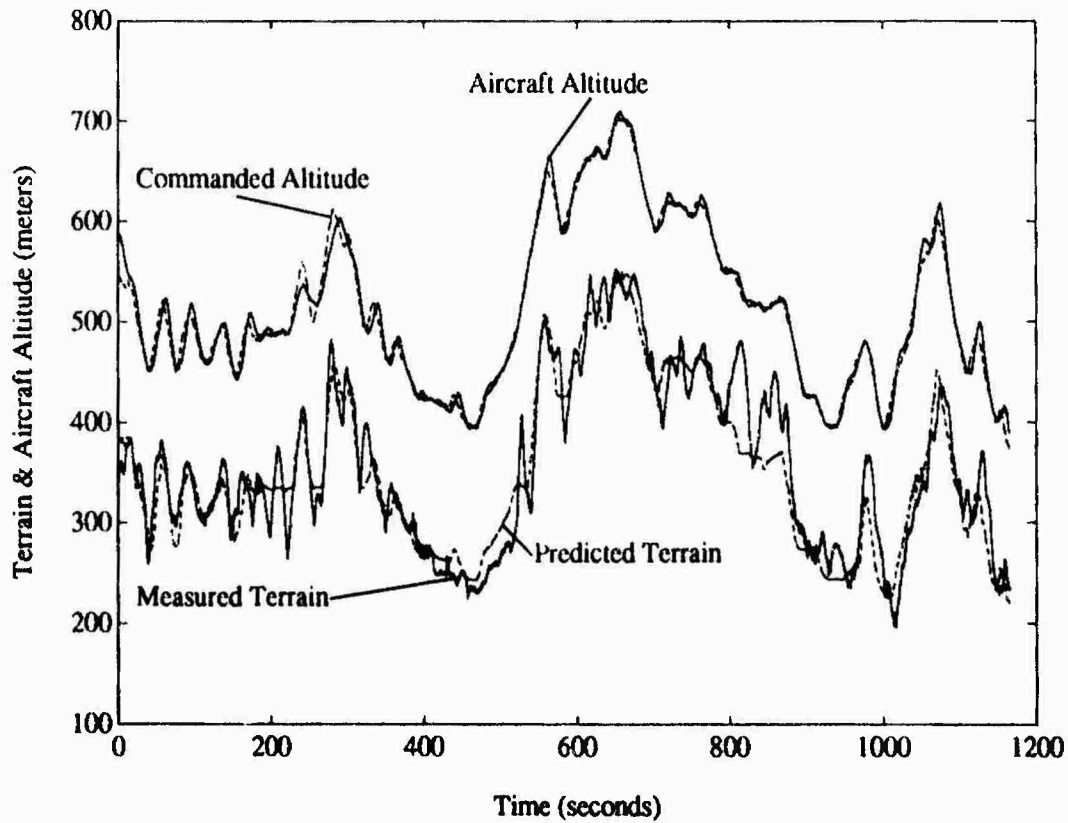

Figure 8, Example vertical trajectory and terrain profile

Table 1, Engineering Evaluation Test Matrix

Flight Plan	Airspeed (knots)	Set-Clear Altitude (ft AGL)	Max Bank (deg)	MaxClimb (deg)	Lead A/C Time (sec)	Pathway 10 lines Pac-Man	TFTA Ratio
Carlisle	80	300	20	6	4	10 lines	TF
Carlisle	80	300	20	6	4	10 lines	TFTA .1
Carlisle	40	300	20	6	4	10 lines	TFTA .1
Carlisle	110	300	20	6	4	10 lines	TFTA .1
Carlisle	80	300	30	6	4	10 lines	TFTA .1
Carlisle	80	300	20	9	4	10 lines	TFTA .1
Carlisle	80	300	20	6	3	10 lines	TFTA .1
Carlisle	80	300	20	6	5	10 lines	TFTA .1
Carlisle	80	300	20	6	4	Pac-Man	TFTA .1
Carlisle	80	300	20	6	4	10 lines	TFTA 0.5
Carlisle	80	150 RAE*	20	6	4	10 lines	TFTA .1
Carlisle	80	100 RAE*	20	6	4	10 lines	TFTA .1

*RAE is Radar Altimeter Enhanced based upon reference [12]

altimeter, precision navigation and digital terrain data for improved vertical performance. The algorithm presented in [12] was validated with actual flight data in an off-line analysis and the results suggest a 15 meters set clearance may be used subject to obstacle avoidance limitations. The final improvement would be to obtain a more accurate terrain database. For the initial test, the set clearance was limited to 90 meters, the radar altimeter feedback system will be integrated in the near future, and the U.S. Army in cooperation with the U.S. Air Force are currently mapping the test area to produce a higher accuracy terrain database.

As well as overall system performance, such as mission completion and terrain usage, consideration needs to be made for the pilots ability to track the system. The lateral, vertical, and terrain tracking performance for a few representative test configurations are shown in Fig. 9. The figure shows the mean and 1-sigma tracking error for four of the configurations tested to date. Also shown in the figure are corresponding results from piloted simulations using the CALAHF system. Flight test and simulation results are consistent in lateral tracking performance with less than ± 10 meters 1-sigma deviation from the commanded trajectory as shown in Fig. 9(a). The notable exception is the flight at 60 knots. At 60 knots the test aircraft's flight control system transitions between heading hold and turn coordination requiring more pilot compensation. Even at 60 knots the pilots tracked the system within 20 meters (or approximately 1 rotor diameter) 1-sigma of the desired trajectory.

For the initial flight test runs vertical pilot tracking performance was much worse than simulator performance. This is attributed to two factors. The small over shoots at terrain peak crossings (Fig. 8) were attributed (by the pilots) to a coupling effect of airspeed, power, and altitude during climb up one hill side and reduction of power to descend down the backside. The pilots felt that on these

initial flight tests, they were not able to track these reversals fast enough. The second factor is that the pilots may still be on the learning curve for the flight system as opposed to the simulation results. Even with these two factors the vertical tracking performance is within ± 15 meters 1 sigma from the desired flight path as seen in Fig. 9(b).

Fig. 9(c) is the statistical variation of the difference between radar altitude and set clearance over a particular test run. Some variation is expected as seen from the simulation data. Also, the CALAHF system does not require the pilot to match every bump in the terrain and a climb performance limitation is imposed on the system. These factors though are overwhelmed by the terrain errors discussed earlier causing a three fold increase in terrain tracking variation as compared to simulation data in the rugged flight test area.

CONCLUSIONS

A low-altitude, covert terrain following/terrain avoidance guidance algorithm for helicopter operations has been developed and flight tested on a NUH-60A helicopter. Initial evaluation of the data reflect that the guidance system could be used reasonably well to track a predesignated course using the terrain for masking in the horizontal and vertical axis. However, the inaccuracy in the DMA database (compared to the actual terrain) mandated a clearance altitude of at least 90 meters in rugged terrain. As DMA data become more accurate and radar altimeter information is fully utilized, the present clearance altitude may be lowered to 15 meters. The pilots were able to follow the computer-aided flight guidance symbology with relative ease and precision.

Comparison of flight and simulation data shows good

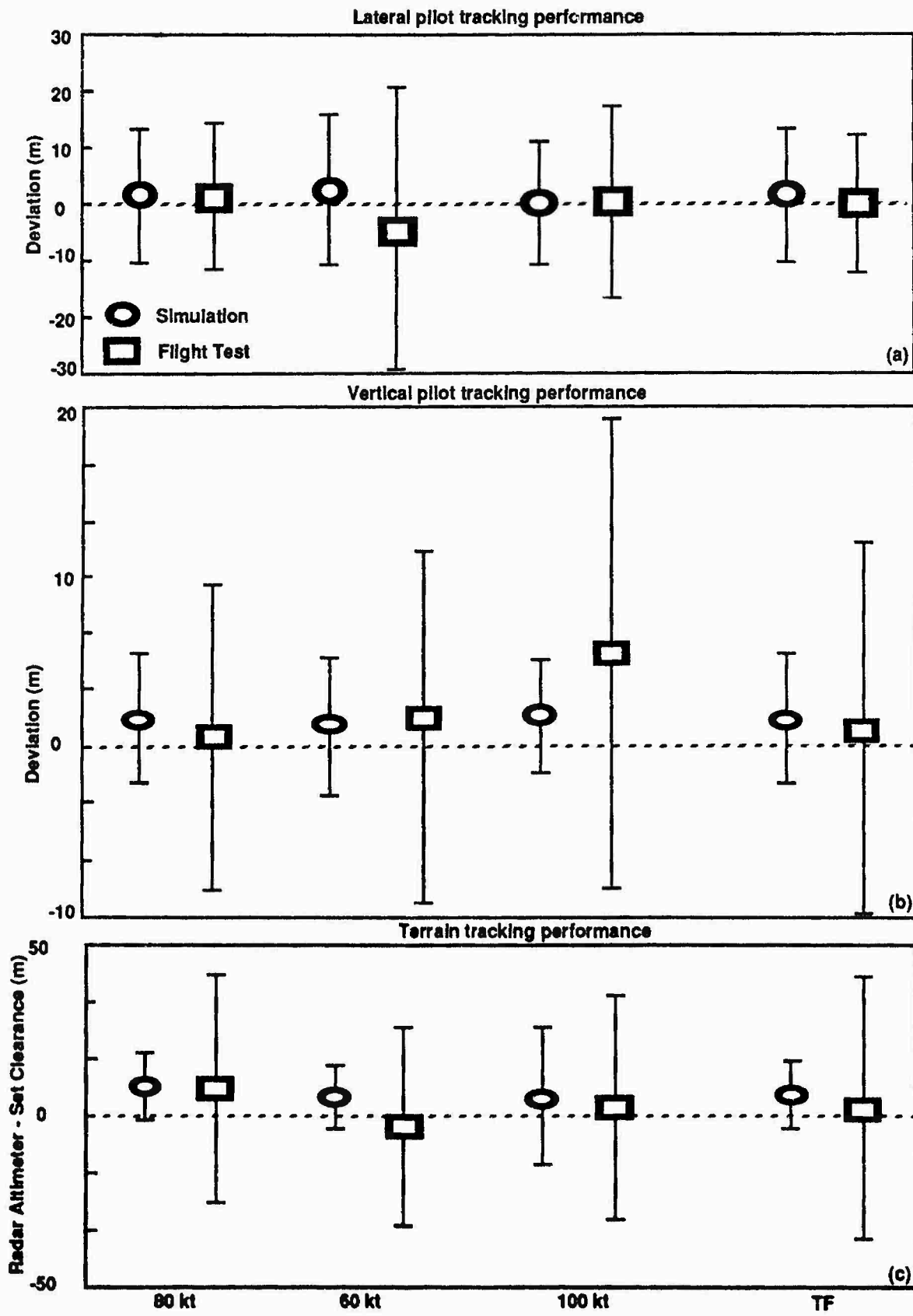

Figure 9, Flight test & simulation statistical comparison

correlation for lateral tracking performance but significant increase in vertical tracking deviations. The major reason for this increase is that airspeed, power and altitude changes seemed to be more highly coupled in the aircraft than during simulation. Another reason is the current analysis is based upon the initial data collected and may not reflect the relative growth in pilot learning as does the simulation data.

Pilot feedback from these initial flights indicates that the guidance system can be followed with low pilot compensation and with minimal distraction from his general situational awareness. This system allows the pilot to combine guidance information with his visual senses to optimize the successful accomplishment of the mission. The Computer-Aiding for Low-Altitude Helicopter Flight System has matured through extensive use of piloted simulation, integration into the NUH-60A STAR helicopter, and recent flight test and evaluation in the rugged terrain of Carlisle Pennsylvania. Future flight tests will include the use of operational pilots from U. S. Army line units using the system in terrain flight missions.

REFERENCES

- [1] Sridhar, B., Cheng, V.L., and Swenson, H.N., "Status of Automatic Guidance Systems for Rotorcraft in Low Altitude Flight," AGARD CP-504, Oct. 1991.
- [2] Clifford, J.E., "PAVE LOW III A Long Awaited Capability, Lessons Learned and Projections," IEEE National Aerospace and Electronics Conference (NAECON), Dayton OH, May 1979.
- [3] Russ, D.E., Houtz, J.E., and Rothstein, S.W., "Evaluations of Alternate TF/TA System Designs Using Pilot In The Loop Simulations," AGARD CP-387, Oct. 1985.
- [4] Dorr, D.W., "Rotary Wing Aircraft Terrain Following/Terrain Avoidance System Development," AIAA Guidance Navigation and Control Conference, Aug. 1986.
- [5] Swenson, H.N., Hardy, G. H., and Morris, P. M., "Simulation Evaluation of Helicopter Terrain Following/Terrain Avoidance Concepts," AIAA/IEEE 8th Digital Avionics Systems Conference, Oct. 1988, San Jose, CA.
- [6] Swenson, H.N. "Computer Aiding for Low-Altitude Helicopter Flight," American Helicopter Society's 46th Annual Forum, Phoenix AZ, May 1991.
- [7] Swenson, H.N., Zelenka, R.E., Hardy, G.H., and Dearing, M.G., "Simulation Evaluation of a Low-Altitude Helicopter Flight Guidance System Adapted for Helmet-Mounted Display," AIAA/IEEE 10th Digital Avionics System Conference, Los Angeles CA, Oct. 1991.
- [8] Denton, R. V., Froeberg, P.L., Jones, J. E., and Nikoukhah, R., "Terrain Following/Terrain Avoidance Algorithm Study," AFWAL TR-85-3007, May 1985.
- [9] Denton, R. V., Pekelsma, N.J., and Smith, F. W., "Autonomous Flight and Remote Site Landing Guidance Research for Helicopters," NASA CR-177478, May 1987.
- [10] Operator's Manual NUH-60A Helicopter, U.S. Army Avionics Research and Development Activities TM-55-1520-237(ADAS)-10, Ft. Monmouth, NJ, Jan. 1987.
- [11] Male, H., Kurshner, M., Anello, S.F., "Integration of an On-Board Route Planner for Helicopter Applications," IEEE/AIAA 11th Digital Avionics Systems Conference, Seattle WA, Oct. 1992.
- [12] Zelenka, R.E., "Integration of Radar Altimeter, Precision Navigation, And Digital Terrain Data for Low-Altitude Flight," AIAA Guidance, Navigation and Control Conference, Hilton Head SC, Aug. 1992.

REQUIREMENTS FOR PILOT ASSISTANCE IN A THRUST-VECTORING COMBAT AIRCRAFT

Emily Howard, Ph.D.
 Robert E. Bitten
Rockwell International, North American Aircraft
P.O. Box 92098; Mail Code 011-GB01
Los Angeles, CA 90009 U.S.A.

ABSTRACT

With the emergence of thrust-vectoring aircraft such as the X-31 and F-22, new questions arise regarding the maximum potential of this technology for increasing air-to-air combat effectiveness. Recent dome-to-dome (man-in-the-loop) simulations have demonstrated a significant increase in close-in air combat effectiveness with the addition of thrust vector capability.¹⁻³ Much of this increased effectiveness can be attributed to the ability of the thrust-vectoring aircraft to continue maneuvering while operating well beyond conventional aircraft stall limits. Such *post-stall* maneuvering (PST) can dramatically increase an aircraft's turn rate while simultaneously minimizing its turn radius, providing a significant tactical advantage in close-in air combat. Comparisons with all-digital (computer-in-the-loop) simulations under the same test conditions, however, show that the combat effectiveness of PST is consistently greater within the all-digital analyses than within the all-manned analyses.

This paper summarizes these comparisons and considers whether pilots may require supplemental assistance in order to exploit the full potential of PST utility. Through analysis of both man- and computer-in-the-loop combat simulations, requirements for pilot assistance have been tentatively identified, along with some of the methods applicable to meeting these requirements. These methods include expanded training, improved displays, and increased automation. This paper presents the results of this analysis, based upon the studies available to date. Plans for further analysis and validation studies are described at the conclusion of the paper.

INTRODUCTION

Future air combat scenarios will undoubtedly involve close-in-combat to some degree. The advent of all-aspect air-to-air missiles has led to the use of point and shoot tactics in which the first aircraft to point at the opponent within weapon launch range is the winner. This requires very high rates of turn at very low turn radii to turn inside the opponent in minimum time. This leads to much slower speed combat engagement conditions in which each opponent utilizes the maximum instantaneous turn rate capability of the aircraft, thereby trading energy for the angles required to achieve the earliest weapons launch. The recent developments in thrust-vectoring technology have risen from the requirement to increase control authority in low speed, low dynamic pressure conditions, such as those experienced in post-stall flight, where aerodynamic control

surfaces are limited in their effectiveness.⁴ Post-stall maneuvering (PST), which utilizes thrust vectoring for control beyond the stall limit of conventional aircraft, allows for such low speed, high turn rate, low turn radius flight conditions, providing a potentially significant tactical advantage in close-in air combat.

POST-STALL EFFECTIVENESS FOR CLOSE-IN COMBAT

Recent dome-to-dome simulation studies have demonstrated that the addition of post-stall maneuvering capability to an aircraft can substantially increase its close-in air combat effectiveness.¹⁻³ The results of three independent studies are shown in Figure 1. These results represent the percent improvement for a series of one-versus-one close-in air combat engagements involving a PST-capable fighter versus a non-PST opponent. Results represent studies involving the X-31, conducted for the USN/DARPA/GMOD "Project Pinball" study,¹ a modified F-16, conducted for the USAF/WRDC/FIGC "Supermaneuverability II" study,² and a modified F-15, conducted for the USAF/WRDC/TXD "Multi-System Integrated Control (MuSIC)" program.³

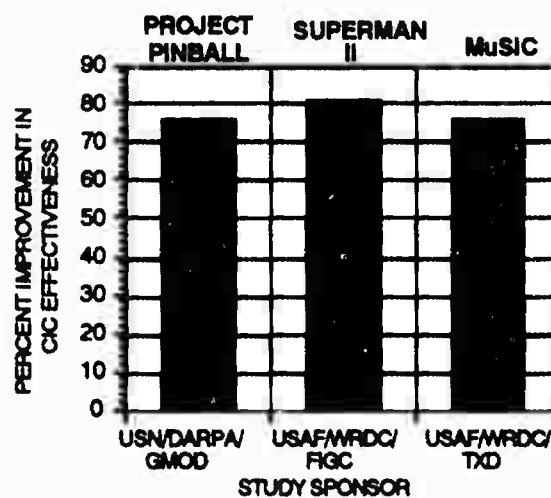

Figure 1. Post-stall Effectiveness For Close-In Combat

Each of the studies utilized a different dome simulation facility. The similarity of the results, even though utilizing different aircraft models and different facilities, indicate that the expected advantage provided by the addition of post-stall capability is consistent and seemingly aircraft independent. The results demonstrate

that the the addition of PST should provide roughly a 75-80% increase in close-in-combat (CIC) operational effectiveness versus an opponent with the same conventional performance.

COMPARISON WITH DIGITAL SIMULATION

Pilot comments from these and other manned simulations^{1,5,6} have provided a series of rules of thumb concerning the use of PST in a tactical situation. The value of these rules of thumb is that they can speed the learning curve of any prospective new post-stall fighter pilot.

These qualitative rules of thumb can also be organized, after analyzing specific trajectories and engagement conditions, into a quantifiable set of rules of PST employment that can then be used in a digital air combat engagement simulation. Through digital simulation, analysts can then conduct detailed studies of air combat engagements in order to understand the tactical benefits of PST more fully. Under company discretionary funding, Rockwell has developed a proprietary version of the Air-to-Air System Performance Evaluation Model (AASPEM)⁷ that uses a six-degree-of-freedom model of the X-31 aircraft dynamics, allowing us to study, in a controlled and repeatable fashion, the utility of post-stall maneuvering for close-in air combat.

In support of the X-31 program, Rockwell has conducted numerous digital simulation analyses in order to fully characterize the tactical advantages gained through post-stall maneuverability.⁷⁻¹¹ These studies have indicated a recurrent trend in the outcome relative to the all-manned simulation studies. The improvement in close-in combat effectiveness for a PST-capable aircraft obtained within the digital simulations is consistently greater than within the manned simulations. Further, this trend is observed whether the results are obtained with Rockwell's AASPEM, or with the digital simulation tools used by Messerschmitt-Bolkow-Blohm (MBB), Rockwell's international partner on the X-31 program.¹² These results suggest that the maximum potential utility of PST capability may be even greater than that which has been previously achieved within the dome simulation studies

A further implication of this finding is that human pilots could possibly benefit from supplemental assistance in exploiting the full potential of PST utility. In previous studies of aircraft human factors, much speculation has been made about the possible limitations in the ability of human pilots and conventional cockpit technology to adapt to highly agile aircraft.¹³⁻¹⁶ If such limitations are discovered, new technology may need to be developed in parallel with thrust vectoring technology to minimize their impact on the overall system performance. Because the trend obtained in our simulation results could be interpreted as indicative of such limitations, we decided to investigate further.

Our most recent effort has been to use AASPEM to replicate the results obtained in the Project Pinball manned simulation study. Project Pinball consisted of a three week simulation effort at the IABG facility in Ottobrunn, Germany and provided a great deal of insight into the tactical usage of PST. In this study, one US Navy, two US Air Force, and one German Air Force pilot participated in the study of the CIC benefits of the X-31's post-stall capability versus an X-31 limited to the conventional flight regime. The objective of the study was to assess the starting conditions and rules of engagement to be used for the upcoming X-31 Phase IV Tactical Utility Flight Test while at the same time understanding how, specifically, the tactical utility was being derived.

Following this study, an extensive effort was then devoted to refining the model in AASPEM to match the Project Pinball results.⁷ Utilizing the same initial starting conditions, weapons, rules of engagement, scoring procedures, and aircraft physical characteristics, a digital simulation study was conducted to yield the same number of engagements as were analyzed within Project Pinball (144 cases). Figure 2 shows the results of the AASPEM simulation study, plotted on the right, compared to the results of the Project Pinball study (repeated from Figure 1), plotted on the left. Figure 2 reveals that the previous trend is again upheld. While the manned simulation study found a 76% improvement in post-stall combat effectiveness, the digital study found a 101% improvement for the same set of test conditions, which is consistent with previous digital studies shown by MBB.¹²

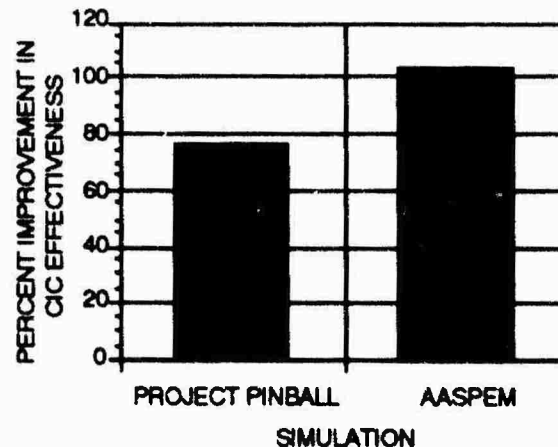

Figure 2. Comparison of Manned and Digital Simulation Results

POST STALL MANEUVER CHARACTERISTICS

To understand how these two types of simulation can yield different levels of PST effectiveness within CIC, the characteristics that define post-stall maneuvering must first be identified. Using the engagement summaries from both types of simulations, PST characteristics have been analyzed from several perspectives. The following

sections summarize these different perspectives in characterizing PST.

PST Phases of Execution

Although the execution of each post-stall maneuver is unique and a function of aircraft state relative to the threat and other engagement conditions, PST can be typically divided into three phases. These phases are based on post-stall maneuvers that have been shown to be of tactical importance.¹ A summary of these PST maneuver phases, and their purpose, is shown in Table 1. The first phase of a PST maneuver consists of a pitch up to a high angle-of-attack (AoA) condition to establish a small turn radius that will enable the PST aircraft to turn inside the opponent, maneuver into a position of advantage, and subsequently achieve a shot opportunity. The second phase is a roll about the velocity vector to align ownship and opponent's maneuver planes. Pilots must have the capability of changing the maneuver plane to fully exploit the advantages of PST for obtaining and maintaining a positional advantage. Without this capability, the pilot could only perform a post-stall pitching maneuver to achieve quick point and shoot opportunities or rapid deceleration.¹ The final phase consists of a pitch down into the conventional flight regime to satisfy weapon launch constraints and/or accelerate to a sustained conventional flight condition.

Table 1. Phases of PST Execution

MANEUVER PHASE	PURPOSE
1) Nose-high Pitch-up	Establish small turn radius
2) Velocity Vector Roll	Align maneuver planes
3) Pitch-down	Resume conventional flight

PST Tactical Usage

The tactical objectives of a PST fighter are the same as a conventional fighter: sound energy-maneuverability tactics must be utilized in order to meet weapons employment conditions. PST merely provides a fighter aircraft with the capability to perform controlled maneuvers beyond maximum conventional AoA. This capability provides another way in which a pilot can manage his energy and angles relative to an opponent to

achieve and sustain a position of advantage to ensure victory. The tactical usage of PST is therefore only an extension of current fighter tactics and, as such, utilizes the same thought process in deciding when and how to implement a PST maneuver. The tactical usage of PST requires that pilot can adequately assess, decide, act and execute a PST maneuver at the appropriate time to defeat an opponent. To appreciate how these tasks must be performed in a PST-capable aircraft, two representative engagements are described below that illustrate the tactical consequences that can occur when PST is utilized. These engagements were selected from the manned simulation results obtained during Project Pinball.

Proper PST Utilization

In this engagement, the Blue PST-capable aircraft performs a post-stall maneuver similar to the "vertical reversal" maneuver illustrated in Figure 3. The left and right plots in Figure 4 are two-dimensional top and side views that depict the aircraft trajectories just prior to and during the execution of the post-stall maneuver. In the upper plots, depicting the start of the engagement, the Red conventional aircraft is seen turning and diving towards the Blue aircraft, which is flying towards and slightly below the Red aircraft. Speed for both aircraft is comparable; however, during this interval, airspeed increases slightly for the Red aircraft and decreases slightly for the Blue aircraft.

The lower plots in Figure 4 show the trajectories continuing as the two aircraft subsequently pass each other. Here, the Blue aircraft initiates PST, shown by the change in line pattern. At the pass the Red aircraft is still somewhat above the Blue aircraft and heading downward at a considerable dive angle, while the Blue aircraft flies slightly upward. During PST, the Blue aircraft pilot increases his angle-of-attack (AoA) and rolls sharply around the velocity vector. AoA increases further as the Blue aircraft pilot points the nose of his vehicle towards the Red aircraft, who is now behind him, and begins pulling his velocity vector around in the same direction. Soon afterward, the Blue aircraft pilot deselects PST and his angle-of-attack drops to conventional levels, while his velocity vector continues turning toward his opponent. His speed then begins to increase as he attempts to gain a missile launch solution. After the maneuver is complete, the remaining time is spent increasing speed and satisfying the missile launch envelope constraints. The Blue aircraft then launches a short-range missile, which intercepts successfully, with no counter launch taken by the Red aircraft. The upper plots in Figure 5 show the trajectories for the entire engagement. The lower plot shows the defining characteristic of PST, the rapid increase and decrease in Blue aircraft AoA as a function of time.

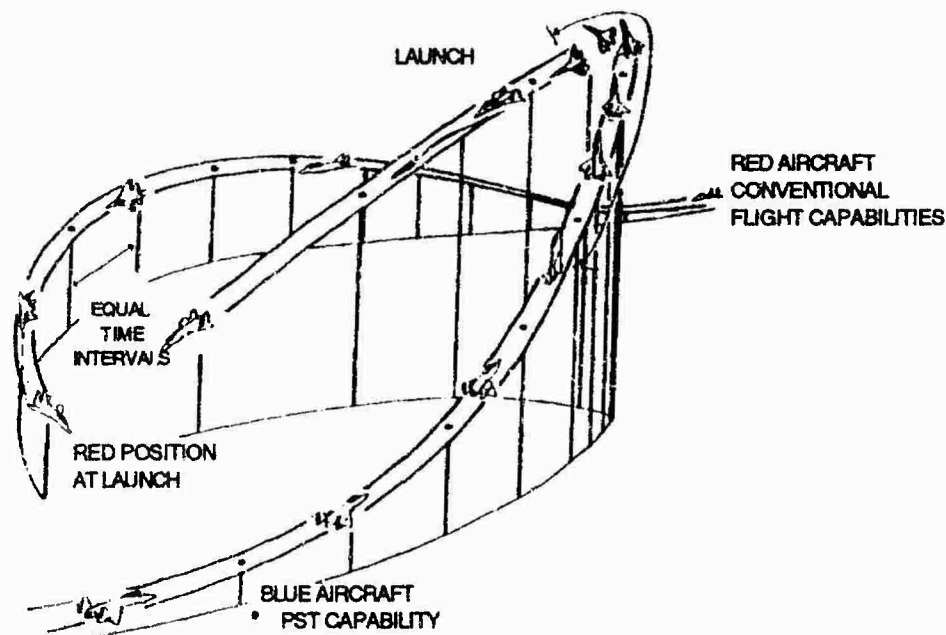

Figure 3. Example "Vertical Reversal" Post Stall Maneuver

The advantages of using PST are primarily due to an increasing turn rate, coupled with a decreasing turn radius, relative to an opponent. The combination of these factors translates directly into a positional, or off-boresight, advantage. The off-boresight, turn rate, and turn radius plots in Figure 6 illustrate how these advantages were achieved in the preceding engagement. Comparison of these plots reveals that a significant off-boresight advantage for the Blue aircraft (via a lower off-boresight angle) results at the same time as turning capability improves relative to the Red aircraft (via increasing turn rate and decreasing turn radius). These gains also correlate in time with the Blue aircraft's increasing AoA values seen previously in Figure 5 (lower plot). Such gains in position and turning capability are not without a price, however. Airspeed, energy, and load factor are all reduced with the use of PST, as seen in the plots within Figure 7. The strategy is to utilize PST only when your gains in position and turning capability to attain a weapon-firing solution before your opponent outweigh your losses in airspeed, load factor, and energy.

Improper PST Utilization

It is just as important to understand when the use of PST is ill-advised as when it is desirable. Poor usage of PST will result in, at best, no improved tactical position, and at worst, a severe tactical disadvantage. The following engagement begins from a neutral start with both aircraft at the same altitude. Figure 8 illustrates the trajectories for this engagement. The upper two plots show that after passing each other, each aircraft turns in towards the other. The Blue aircraft pilot then begins his post-stall maneuver, attempting to get his aircraft "around the circle" sooner than his opponent. The parameters of the engagement are

summarized in Figure 9 and indicate that the Blue aircraft initially gains a temporary off-boresight advantage. The AoA launch restrictions placed upon the missile, however, prevents the Blue aircraft pilot from firing at this time.

To achieve a firing solution, the Blue pilot must decrease his AoA while turning the velocity vector toward his opponent. The decrease in AoA, however, results in an increase in off-boresight angle, reducing the Blue aircraft's advantage. Meanwhile, the Red aircraft pilot has sufficiently decreased his off-boresight angle and fires a missile, which intercepts successfully. The Blue aircraft pilot also fires a missile just before he is killed, but it does not intercept. Because of the AoA launch restriction and the inability to maintain an off-boresight advantage when conventional launch conditions are pursued, using PST is not recommended "across the circle" as just described.

REQUIREMENTS FOR PILOT ASSISTANCE?

Given these "best- and worst-case" characteristics for utilizing PST in air combat, the question arises: how can we ensure that the "ideal" circumstances for PST are consistently achieved? The difference between the digital and manned simulation results in Figure 2 suggests that undiscovered requirements for pilot assistance may need to be satisfied in order to achieve this goal. Other explanations of this difference have been considered, but we were able to rule them out for the most part. Given that the initial starting conditions, weapons, rules of engagement, scoring procedures, and aircraft physical characteristics in both studies were the same, this outcome can be attributed to differences between a digital versus a human pilot. By understanding these differences, potential requirements for pilot assistance can be assessed.

TIME: 0 - 2 SECONDS

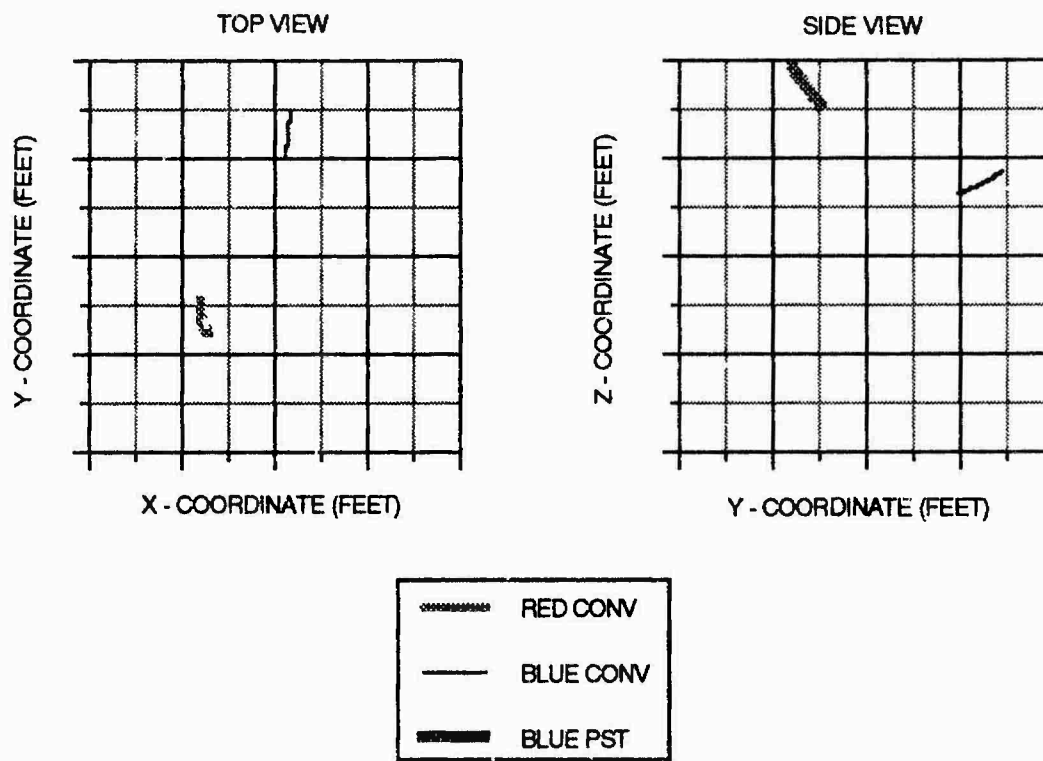

TIME: 0 - 12 SECONDS

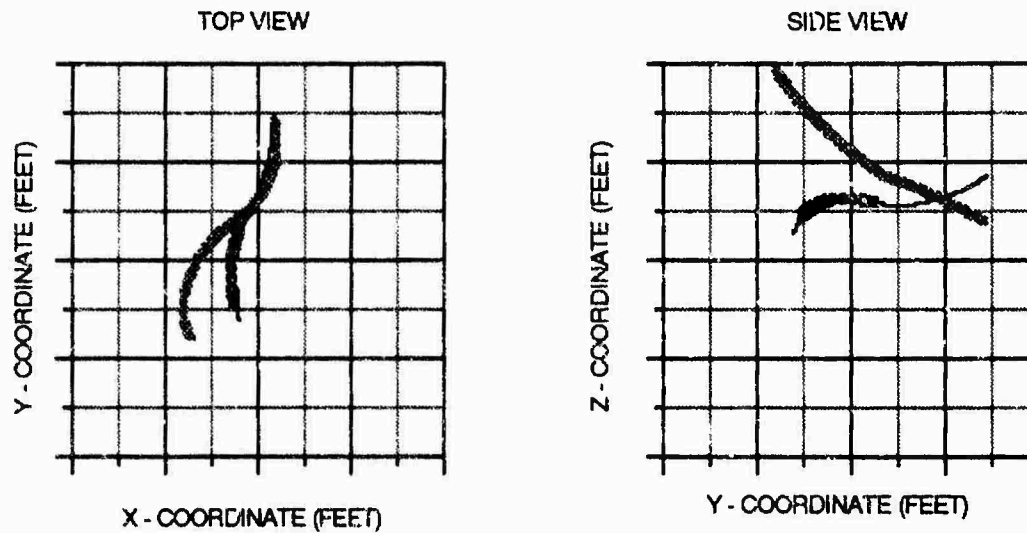

Figure 4. Proper PST Utilization

TIME: 0 - 23 SECONDS

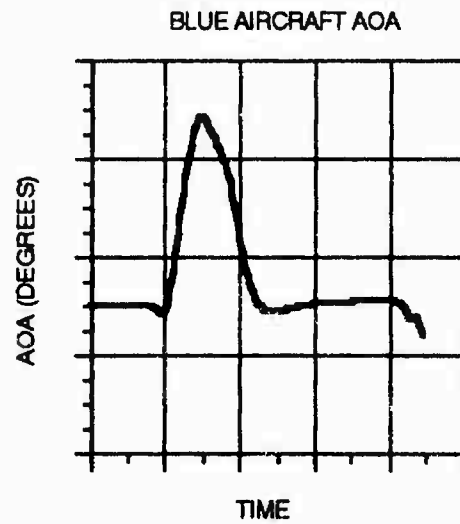
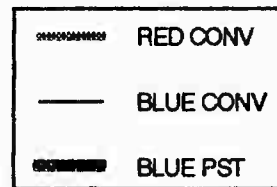
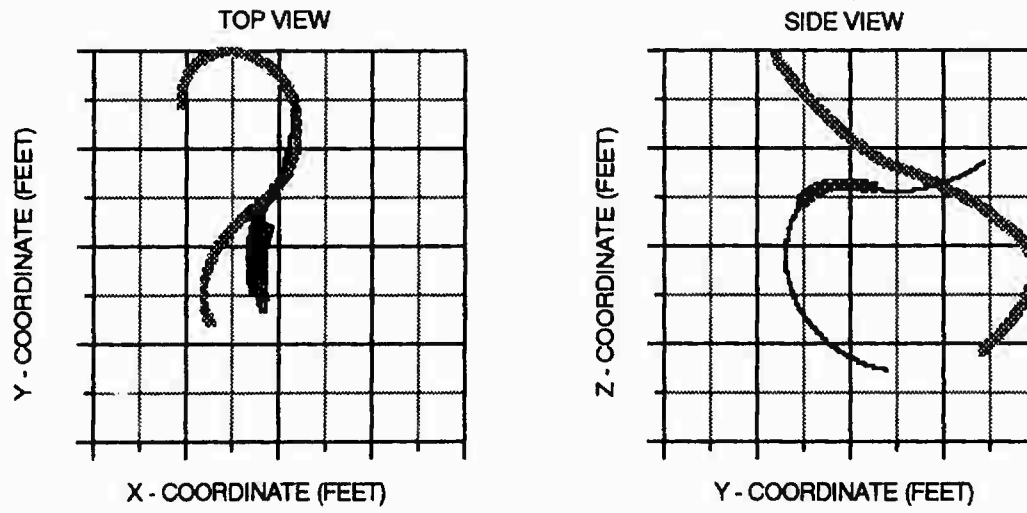

Figure 5. Proper PST Utilization (Cont'd)

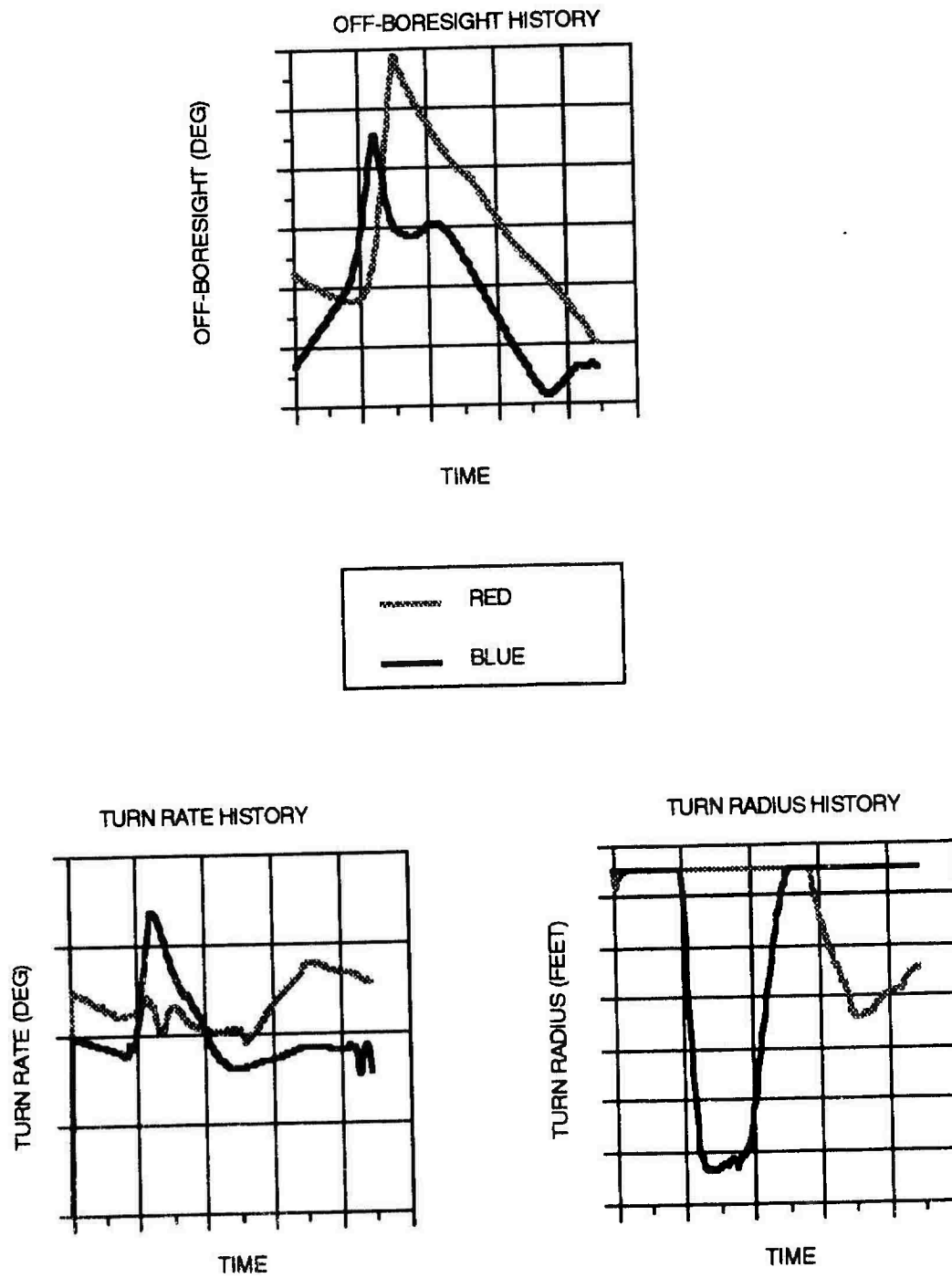

Figure 6. Proper PST Utilization - What is Gained

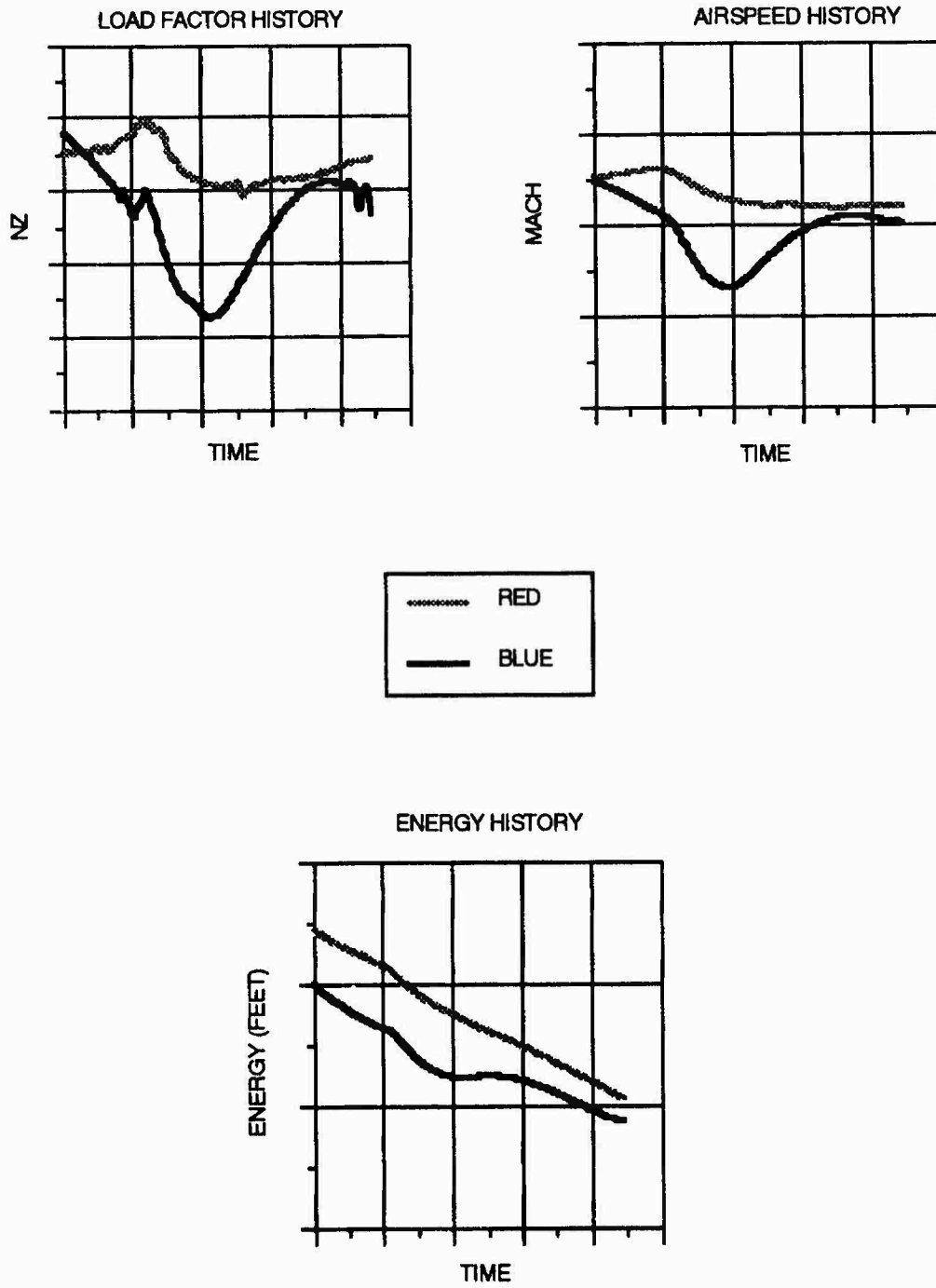
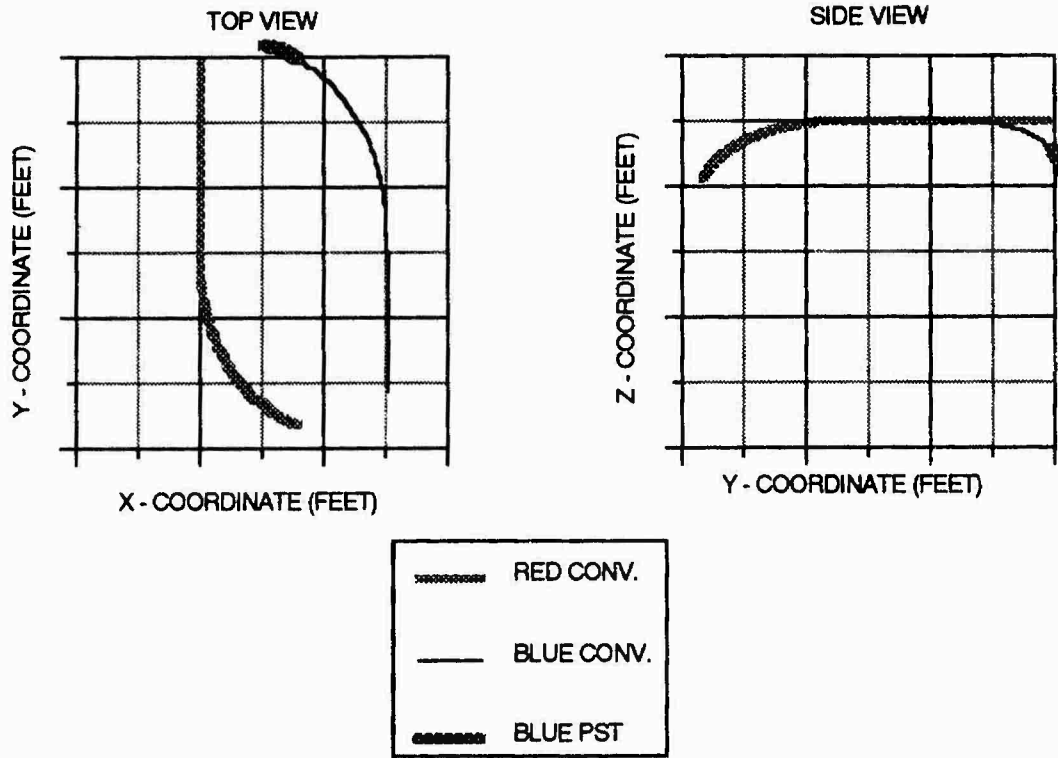

Figure 7. Proper PST Utilization - What is Lost

TIME: 0 - 10 SECONDS



TIME: 0 - 21.5 SECONDS

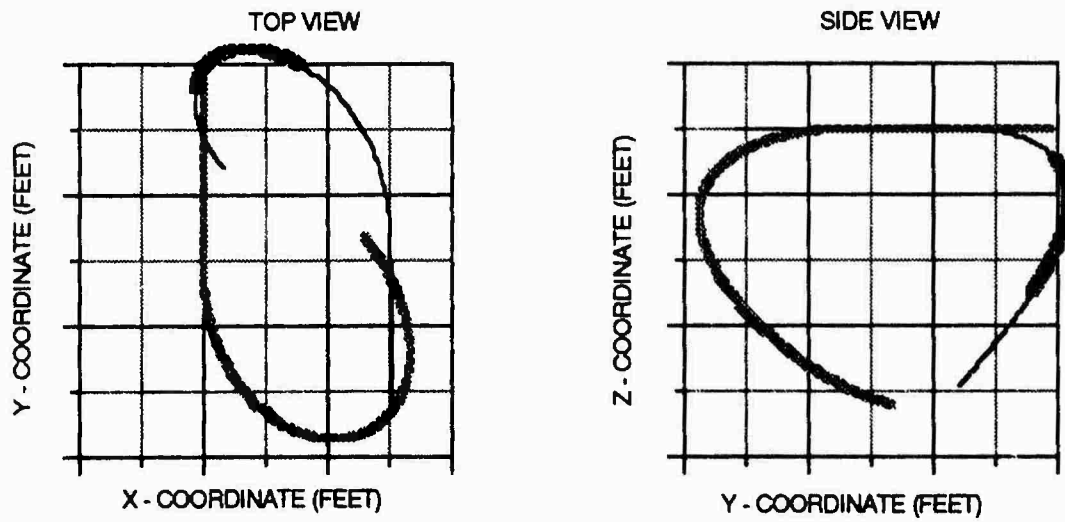

Figure 8. Improper PST Utilization

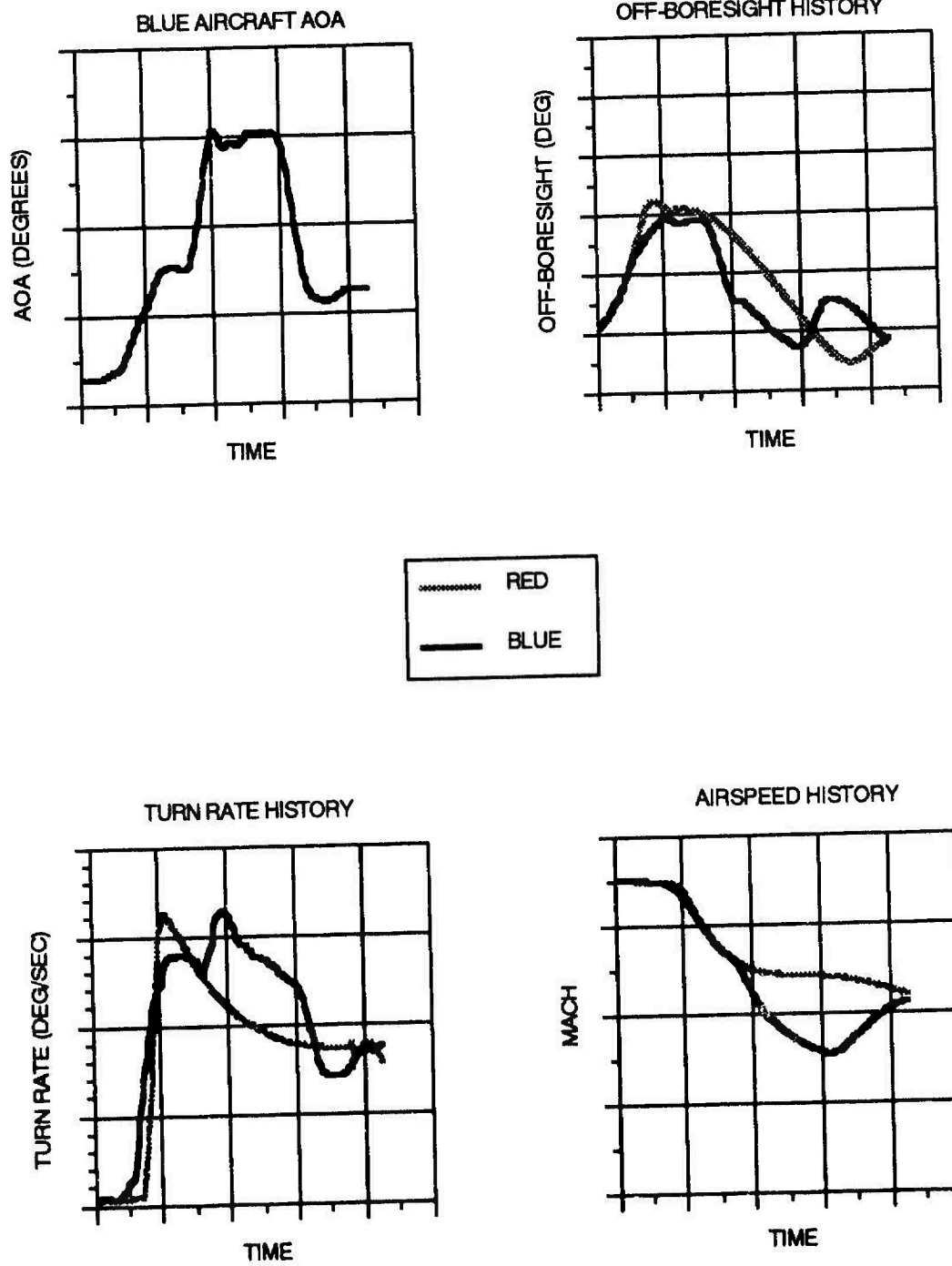

Figure 9. Improper PST Utilization - Engagement Summary

The primary ways that a human pilot may differ from a digital pilot will be in terms of how he identifies and interprets the information provided to him, decides what to do tactically, initiates the action required, and executes the maneuver. Among these tasks, it can be shown how a digital pilot could benefit from at least three distinct advantages in achieving PST effectiveness relative to his human pilot counterpart. First, a digital pilot can routinely apply all of the available knowledge about PST utility in the determination of each successive maneuver, based upon the pre-programmed "rules-of-thumb." This provides the pilot with a high degree of consistency and certainty in the employment of PST under appropriate conditions. Second, the digital pilot can instantly access the many parameters that define the utility of PST within any given tactical situation, resulting in superb situational awareness. Note that this advantage is different from having perfect knowledge or "ground truth" in the simulation, which the PST rules-of-thumb do not require. Finally, the digital pilot can execute each post-stall maneuver with exceptional precision, exploiting the narrow windows in time for initiating, controlling, and terminating the maneuver most effectively. Taken together, these capabilities form an initial set of requirements for assisting pilots in the optimum usage of post-stall maneuvering. Pilot comments from the manned simulation studies also confirm the significance of these requirements for employing PST effectively, indicating that assistance would be well-received in these areas.^{2,5,17}

METHODS OF PILOT ASSISTANCE

With these requirements tentatively identified, we then began to assess applicable methods of providing pilot assistance. We defined the term "assistance" to refer to any effect that enhances a pilot's ability to utilize PST optimally. This definition is deliberately broad so that we may take a comprehensive look at the many factors that determine pilot performance. In our approach, we have identified three general ways of providing assistance to pilots of PST-capable aircraft: through expanded training, improved displays, and increased automation. Drawing upon the lessons learned within our current X-31 fighter demonstrator program, Rockwell is currently investigating each of these methods for assisting pilots in attaining the maximum utility of PST within close-in air combat. The sections below summarize our efforts to date, citing the results of our assessment, conclusions, and recommendations in each of these areas.

Training

The first requirement for the effective use of PST is the consistent application of certain knowledge. In human pilots, such consistency and confidence requires, at the very least, a thorough understanding of the characteristics that define PST utility. As with any new weapons systems capability, the strategies and conditions for employing PST must be carefully learned. This expertise can only be

acquired through training, a process that we are continually reviewing within our X-31 program to insure that the entire arsenal of PST tactics will be fully utilized.

Prior to conducting an evaluation of tactical utility, each pilot undergoes a period of familiarization and training on the use of PST within the X-31 simulator. Using pilot interviews and direct observation of these "pre-test" cases, our studies have consistently shown that pilot training is vitally important to the successful employment of PST maneuvers. Based on our analyses of the conditions necessary for demonstrating PST utility, we have begun to expand our pilot training procedures. Our aim is to insure that pilots receive both sufficient and efficient training in the best utilization of PST capability. To this end, we have also begun to develop useful metrics and diagnostic procedures for assessing training effectiveness. As a result of this effort to date, we have identified at least one important training characteristic that can impact studies of PST combat effectiveness: Pilots must be explicitly taught that not all types of post-stall maneuvers are equally relevant in a tactical situation.

Our findings. We discovered this characteristic by noting that the familiarization process prior to each simulation exercise strives to achieve two objectives. The first objective is to acquaint the pilot with the total "expanded envelope" of maneuvering that characterizes the X-31. To achieve this, pilots are first taught a series of exceptionally dynamic maneuvers, involving very slow speeds and extreme angles of attack. In conjunction, pilots learn to track their performance against their ownship state variables (e.g., heading, bank angle, etc.). The second objective is then to learn how this enhanced maneuvering capability may be used to an advantage during CIC. Achieving this objective, however, requires a somewhat different training emphasis. Typically, the "tactical" maneuvers are not quite as radical in dynamics as the "envelope expansion" maneuvers, and must be learned by monitoring the relative-state variables between target and ownship.

Early simulation studies focused most of the formal instruction on the first set of maneuvers. The subsequent tactical training process was more or less left to the invention of the subject pilot, after being given some general guidance on the conditions that favor PST. Through repeated studies, however, we discovered that some of these well-learned "envelope expansion" maneuvers were occasionally being used during the tactical evaluation. Such demonstration maneuvers are not well-advised tactically, because of the tremendous associated cost in energy needed to attain the region of maximum performance. Currently, we have adapted our training procedures to ensure that explicit guidance is provided on the different types of post-stall maneuvers to minimize the "negative transfer" from one part of the familiarization process to the other. Further analysis is ongoing to

ascertain whether other extensions to our training protocols may be useful.

Displays

The second requirement identified for the effective use of PST is maximal situational awareness. While the role of training is important for establishing the necessary knowledge and proficiency in the optimum use of PST, a pilot's immediate situational awareness within the cockpit comprises another part of his effectiveness in air combat. Although the demand for improved situational awareness is more or less universal among all pilots, our digital simulation studies reveal that the payoff may be particularly great for PST pilots. To this end, we have looked at a variety of cockpit display techniques that may assist the pilot of a PST-capable aircraft in building and maintaining better situational awareness during close-in combat. Because much research has already focused on improving situational awareness within a conventional cockpit, we chose to focus on improvements that would specifically support better utilization of PST.

Previous studies of cockpit designs for a highly agile fighter have attempted to define whether there are any unique pilot information requirements (IR's) associated with PST.¹³⁻¹⁵ The general conclusions seem to be that there are some crucial differences in IR's between post-stall and conventional maneuvering. Note that in these studies, the *types* of IR's for PST were not found to be all that different from conventional maneuvering. The successful employment of any maneuver will always require attitude and energy information related to target and ownship in order to assess kill opportunities and plan tactics. Rather, what is unique about the pilot IR's for PST is the *increased importance* of certain of these attitude and energy parameters (including their status, history, and rates of change). Essentially, a PST pilot does not require new information so much as he simply requires more or better access to what is already available. The overall consensus of these studies, nevertheless, is that a conventional suite of single-seat fighter displays is probably inadequate to provide all of the elements that comprise good situational awareness during PST.

Our findings. Our interviews with pilots following the manned simulations studies have supported the conclusions of these previous studies, and have helped us to identify some of the specific ways we may improve conventional displays. One of the deficiencies with current displays is their inability to represent adequately the wide decoupling between aircraft flight path and fuselage that characterizes PST. Many of the parameters of interest to the pilot during CIC, such as the angles between his velocity vector, flight path, and opponent, become widely spatially separated during PST. This separation is especially challenging for heads-up displays (HUD's) and even helmet-mounted displays (HMD's), which pilots generally prefer over heads-down displays during CIC. For both types of

displays, the conventional format to preserve one-to-one correspondence with the outside world conflicts with the pilot's interest in information outside of his display's instantaneous field of view.

Another deficiency with conventional displays relates to the extreme dynamics of post-stall maneuvering. With conventional formats, the rapid changes in pitch and yaw that accompany PST, for example, can exceed a pilot's perceptual limits in tracking and monitoring the display of these parameters. As with the spatial separation problem given above, the requirement for one-to-one correspondence with the outside world in conventional formats exacerbates this problem in both HUD's and HMD's.

As the result of these analyses, Rockwell has developed several approaches to improve conventional cockpit displays for increased combat effectiveness in a PST-capable aircraft. Each of these approaches addresses the deficiencies with conventional displays noted above. Our approaches examine the utility of both emerging and traditional display technology enhanced with novel formats. Candidate concepts have been designed and are currently undergoing tests for validation and pilot acceptance within Rockwell's X-31 simulator. The results of these tests will be the subject of a future paper. (See also Paper 13 in these proceedings.)

Automation

The third requirement identified for optimum PST employment is precise timing. From the example engagements, it can be seen how the timeliness of pilot actions becomes critical for many reasons. First, the entry conditions regarding when and how to use PST are based on many factors. Prior to engaging PST, pilots must perform a rapid series of "checks" to ensure that conditions are favorable and then make a decision to commit before the opportunity has passed. Further, once initiated, the actions that comprise the successful completion of a given post-stall maneuver are time-compressed, involving close coordination between flight control inputs and continuous assessment of the tactical situation. Given such circumstances, merely having access to all of the necessary knowledge and information is of no use to a pilot if he cannot act upon it in time. Part of the demands on pilot situational awareness, in fact, may be due to the added workload of performing these time-critical PST tasks.

For these reasons, training and displays alone may not provide the pilot with sufficient capability to achieve the maximum utility of PST. Hence, a third form of pilot assistance is being investigated. Through increased automation, we may be able to reduce workload sufficiently to enable the pilot to execute his tasks more efficiently and, in turn, acquire optimum situational awareness more easily.

Our findings. In our assessment, we have identified a wide variety of automation schemes that may be used to assist a PST pilot. Some relatively simple levels of automation strive to reduce workload by integrating many overall system functions into more discrete sets of actions or events. Classical examples of these include integrated flight controls, sensor fusion algorithms, built-in diagnostics, etc., many of which have already been incorporated within the current X-31 cockpit. In our analysis of PST utility, we have begun to focus on the benefits of providing an automatic cueing system that will signal the pilot when certain PST-favorable or other conditions have been achieved. These cues may reduce the number of calculations and "checks" that a pilot must perform in the employment of post-stall maneuvers.

A potentially more useful automated system is one which combines a number of integration functions such as those described above within an expert system shell. Such forms of intelligent automation could provide timely, context-sensitive assistance to the pilot, related not only to his current tactical situation, but to his own apparent plan of action within that situation as well. An example of this concept is the associate system architecture that was used to develop the DARPA/Air Force Pilot's Associate program.¹⁸⁻¹⁹ Figure 10 depicts how context-sensitive support, such as that typified by the Pilot's Associate, could be applied at time-critical events during the course of CIC within a PST-capable aircraft. Using the existing

simulations, both manned and digital, as preliminary knowledge sources, an analogous associate system could be developed to assist pilots in the timely and effective use of PST. Such a system could not only meet the requirement for precision timing in PST execution, but could support the other requirements as well. The resulting decision-aiding system could serve as the basis of an intelligent display manager, selecting presenting and removing information as required to optimize pilot situational awareness. And through the system knowledge bases resident onboard the aircraft, all knowledge and certainty about PST utility will remain available permanently.

Future Plans

On the basis of our efforts thus far, we intend to continue assessing potential requirements for pilot assistance in attaining the maximum utility of a thrust-vectoring combat aircraft. Some of these efforts (such as the training analysis) have already been used to support the X-31 program as it progresses. For the upcoming year, we plan to continue our investigations of the differences between the all-manned and all-digital simulation results, eventually matching a human and digital pilot together in head-to-head CIC simulation. From these studies we hope to learn more about the specific capabilities of each type of pilot, and especially those that are required to achieve the maximum in PST utility.

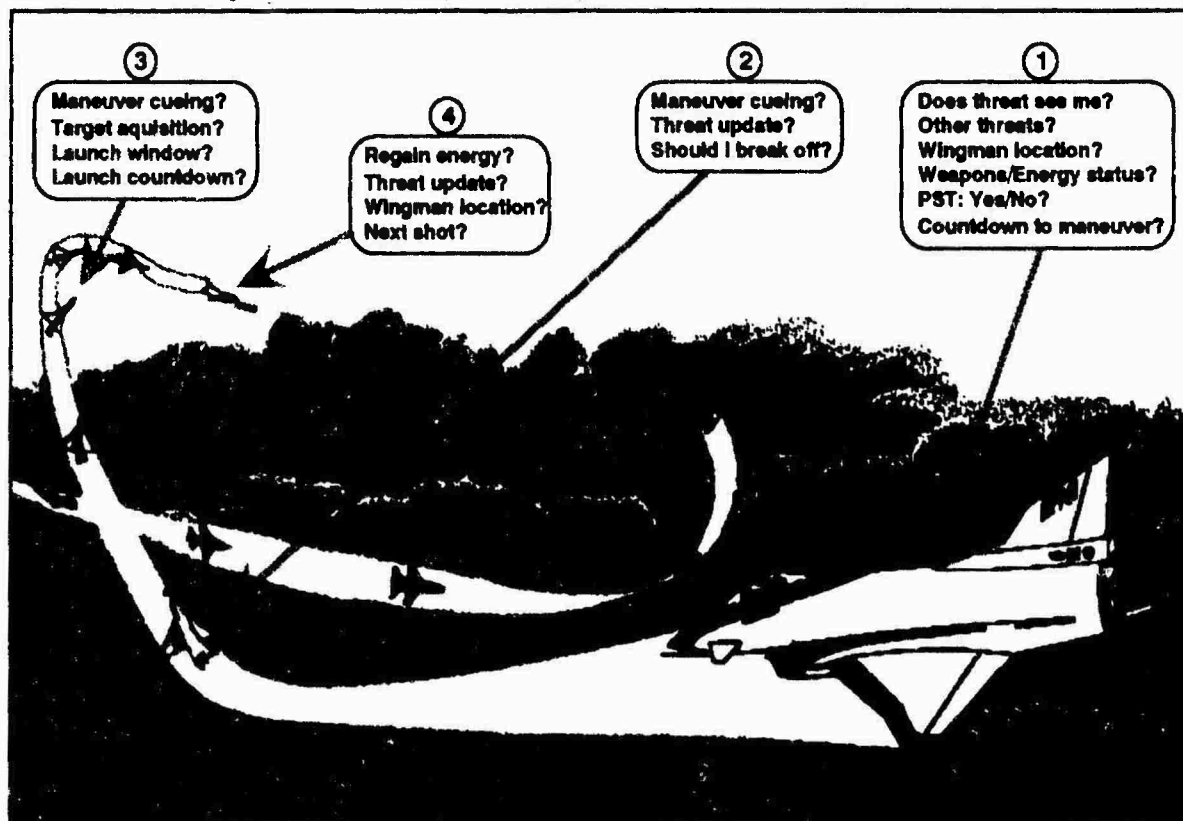

Figure 10. Intelligent Automation Can Meet Numerous Pilot Requirements During Post-Stall CIC

We also intend to continue developing candidate concepts and methods of assistance to meet these required capabilities, identifying those that yield the highest payoff. It may be learned ultimately that the optimum utility of PST depends on providing several forms of assistance to the pilot.

CONCLUSION

In summary, numerous studies have examined the payoff of post-stall (PST) capability within a close-in combat (CIC) engagement. These studies have overwhelmingly shown that pilots equipped with a PST-capable aircraft enjoy a decisive advantage over pilots of vehicles without such capability. The observed increase in CIC performance is approximately 75-80%, and is independent of aircraft model or evaluation facility. Analyses conducted in support of our X-31 program, however, indicate that the *maximum potential* utility of PST capability maybe somewhat greater. These analyses reveal that all-digital simulations matched to identical test conditions consistently produce a higher payoff for PST than the all-manned simulations. In a recent comparison with results of the Project Pinball dome-to-dome simulation study, our digital model produced an improvement in PST effectiveness for CIC of 101%, relative to a 76% improvement from the all-manned simulations. These trends have been similarly observed by MBB, our international partner on the X-31 program. Our findings led us to explore whether this higher potential in PST utility could similarly be realized with human pilots.

Through analysis of the characteristics that define PST utility, coupled with the intrinsic capabilities of the computer pilot within the all-digital simulations, we have identified some tentative requirements for providing supplemental assistance to pilots of thrust-vectoring aircraft. These requirements have been based on the premise that, when in command of a PST-capable aircraft, a digital pilot may benefit from several capabilities that the human pilots do not have. These capabilities include consistent application of certain knowledge, maximal situational awareness, and precise timing.

Subsequently, we have also begun to investigate appropriate ways of meeting these requirements for capitalizing on the full utility of PST for close-in air combat. Three methods for meeting these requirements—expanded training, improved displays, and increased automation—were identified and some preliminary concepts for implementation were discussed. Of these, the use of an intelligent associate system, such as that embodied within the DARPA/Air Force Pilot's Associate program seems to offer the greatest promise in satisfying these requirements most fully. Future plans include additional studies to validate these requirements and to assess high payoff applications among all of the candidate concepts.

In conclusion, we wish to note that our simulation comparisons are not meant to imply that digital pilots are somehow superior to human pilots in overall air combat performance. We still believe that the singular authority on how to achieve the maximum in close-in combat effectiveness, with or without PST, is the human pilot. Our analyses and recommendations for pilot assistance are only a recognition that certain PST-enabling capabilities that are exercised by a digital pilot may be currently underrepresented or unavailable to the human pilots. Our aim is to identify these capabilities, implement them through applicable technologies, and discover what the true potential of post-stall combat effectiveness may be. With such appropriate assistance, then, we would expect to see human pilots ultimately surpass the digital pilot in the demonstrated utility of PST.

Finally, it should be noted that these conclusions and recommendations are still only preliminary, based on data derived from dome simulations. The complete picture for pilot assistance in utilizing PST, however, cannot be known until the X-31's in-flight tactical utility evaluations are conducted. One question of particular interest is whether the difference between the human and digital pilots' performance with a PST-capable aircraft change once the in-flight data are assessed. Such results can be interesting to predict. On the one hand, the effectiveness of ongoing training and the availability of in-flight cues may enhance pilot skill and situational awareness during flight tests, and thus improve the tactical utility results relative to the current dome studies. On the other hand, the added complexities of aircraft motion and acceleration while utilizing PST, coupled with pilot's own head and torso movements during CIC, could in fact exacerbate pilot situational awareness and maneuvering precision—leading to even more requirements for pilot assistance and support. In either case, the tactical utility flight test phase of the X-31 program will be a valuable database from which to explore this question in detail.

ACKNOWLEDGEMENTS

Portions of this work were funded by contract N00019-88-CO288, "Enhanced Fighter Maneuverability (X-31A) Phase IV." The authors also gratefully acknowledge the efforts of Mr. Sid Powers for his thoughtful review of an earlier draft, and Ms. Errie Norris for her cheerful support in preparing the final copy of the text and figures.

REFERENCES

1. Eubanks, D., Bitten, R., "IABG Project Pinball Summary Report", Rockwell NA-92-1632, SEPT 1992

2. Lynch, U., Ettinger, R., Van Pelt, J., Skow, A., "Tactical Evaluation of the Air-to-Air Combat Effectiveness of Supermaneuverability", WRDC-TR-90-3035, JUN 1990
3. Doane, P., Gay, C., Fligg, J., et. al., "Multi-System Integrated Control (MuSIC) Program", WRDC-TR-90-6001, JUN 1990
4. Bitten, R., and Selmon, J., "Operational Benefits of Thrust Vector Control (TVC)", NASA High-Angle-of-Attack Technology Conference, NASA Conference Publication 3149, 30 October - 1 November 1990, Volume I, Part 2, pp 587-602
5. Whiteford, F., "High-Angle-of-Attack Fighter Tactics: The User's Perspective", NASA High-Angle-of-Attack Technology Conference, NASA Conference Publication 3149, 30 October - 1 November 1990, Volume I, Part 2, pp 909-932
6. Trombadore, R., Capt. USMC, "EFM Fighter Tactics in 1v1 ACM (Lessons Learned)", Briefing presented by Capt. Trombadore at IABG, Ottobrunn, Germany, OCT 1991
7. Bitten, R., Eubanks, D., "AASPEM Post-stall Tactics Validation", Rockwell NA-92-1757, SEPT 1992
8. Bitten, R., Cathers, D., "Tactical Effectiveness Evaluation: Phase II Interim Report, EFM/X-31A", TFD-87-1258L, SEP 1987
9. Bitten, R., "Deep versus Moderate Post-stall Tactical Evaluation", TFD-88-1328, MAY 1988
10. Bitten, R., "Enhanced Fighter Maneuverability Manned and Digital Simulation Comparison", NA-90-1166, MAR 1990
11. Bitten, R., "X-31 Thrust Vector Control (TVC) Close-in Air Combat Effectiveness Evaluation", Rockwell TFD-91-1109, JAN 1991
12. Haiplik, R., Eubanks, D., "OR Study Snake", MBB/LKE152/SNAKE/STY/1, MAY 1985
13. Small, R., Hammer, J., Cacioppo, G., Crowe, M., & Smith, R., "Cockpit Design For Super-Maneuverable Fighter", WL-TR-92-3040, JAN 1992.
14. Borowski, R. & Reising, J., "Cockpit Design Considerations for Highly Agile Aircraft", In the Proceedings of the Sixth Symposium on Aviation Psychology, JUN 1991.
15. Howard, E., "Design and Evaluation of a Heads-up Display Format for Enhanced Fighter Maneuverability", Rockwell TFD-89-1457L, SEP 1989
16. Whitley, P., "Human Capabilities in High Angle-of-Attack Aircraft", NASA High-Angle-of-Attack Technology Conference, NASA Conference Publication 3149, 30 October - 1 November 1990, Volume I, Part 2, pp 933-938.
17. Durham, A., Feeney, G., Nelson, P., Zwerneman, W., Holder, J., "Assessment of Thrust Vectoring", NASA High-Angle-of-Attack Technology Conference, NASA Conference Publication 3149, 30 October - 1 November 1990, Volume I, Part 2, pp 877-889.
18. Aldern, T., et al., "Phase I Final Report of the Pilot's Associate Program—Unclassified", WRDC-TR-90-7007, SEP 1990.
19. Aldern, T. et al., "Phase II Interim Report of the Pilot's Associate Program", WL-TR-91-7007.

DESIGN CONSIDERATIONS FOR A NIGHT, AIR-TO-SURFACE ATTACK CAPABILITY ON A DUAL ROLE FIGHTER

Robert A. Hale
Dr. John J. Chino
L. Larkin Niemyer
John R. Jadik
Barry E. Lightner

Westinghouse Electric Corporation
Electro-Optical Systems Department

P.O. Box 1693, Mail Stop G8
Baltimore, MD 21203
&
9820 Satellite Blvd.
Orlando, FL 32837
USA

SUMMARY

The Falcon Knight design objective was to achieve a compact, lightweight and *affordable* night air-to-surface attack capability for a small single seat dual role fighter. The design constraints were cost, performance, physical size, weight, aerodynamic impact and ease of retrofit.

An analysis of the mission and the pilot's tasks and workload during the mission revealed the need for two electro-optical lines-of-sight (LOSs). The first LOS, *pilotage*, is required to provide an uninterrupted night vision, or pilotage, capability for a high level of situational awareness at all normal pilot viewing angles. The second LOS, *targeting*, is to provide a simultaneous independent targeting capability for cueing, search, detection, recognition, fire control tracking and/or weapon hand-off leading to the delivery of weapons on the target.

The Falcon Knight forward looking infrared (FLIR) sensor is a unique *optically multiplexed dual line of sight* (LOS) Head Steered FLIR (HSF) which provides both *pilotage* and *targeting* LOSs simultaneously within the design constraints cited above.

The Falcon Knight FLIR is also integrated with the aircraft's Fire Control Radar (FCR) to create an integrated FLIR/Fire Control Radar Multisensor.

Westinghouse built a company funded Falcon Knight FLIR/Fire Control Multisensor Radar prototype. The prototype has been evaluated in flight on the Westinghouse BAC 1-11 Avionics Test Bed aircraft.

The United States Air Force is currently evaluating the Falcon Knight FLIR/Fire Control Radar Multisensor on the Advanced Fighter Technology Integration (AFTI) F-16 test aircraft at Edwards Air Force Base (AFB) California.

LIST OF ACRONYMS AND SYMBOLS

AGLE	Automatic Gain and Level Equalization
AFA	Air Force Association
AFB	Air Force Base
AFTI	Advanced Fighter Technology Integration
AMAS	Automated Maneuvering Attack System
BAI	Battlefield Air Interdiction
CAS	Close Air Support
DFCS	Digital Flight Control System
E-O	Electro-Optical
FCC	Fire Control Computer
FCR	Fire Control Radar
FDL	Flight Dynamics Laboratory

FLIR	Forward Looking Infrared
FOR	Field of Regard
FOV	Field of View
GD/FW	General Dynamics, Fort Worth Division
HSF	Head Steered FLIR
HMD	Helmet Mounted Display
HMS	Helmet Mounted Sight
HMS/D	Helmet Mounted Sight/Display
HUD	Head-Up Display
IFFC	Integrated Flight and Fire Control
I ² R	Imaging Infrared
IRST	Infrared Search and Track
JTF	Joint Test Force
LOS	Line of Sight
LRU	Line Replaceable Unit
MFD	Multifunction Display
MRT	Minimum Resolvable Temperature
MLU	Mid-Life Upgrade
NASA	National Aeronautics and Space Admin.
NETD	Noise Equivalent Temperature Difference
PSP	Programmable Signal Processor
SFI	Solicitation for Information
STS	Sensor/Tracker Set
SPI	System Point of Interest
TD	Target Designation
TSE	Target State Estimate
USAF	United States Air Force
USN	United States Navy

OBJECTIVE

Since the mid 1960s, tactical air forces have had the requirement to provide Close Air Support (CAS) and Battlefield Air Interdiction (BAI) on a 24-hour basis with dual role fighters such as the F-16¹. The challenge in providing CAS and BAI on a 24-hour basis has been the development of an *affordable* night attack capability (Figure 1).

CAS/BAI MISSION REQUIREMENTS

The basic requirements of the CAS/BAI mission are to *fight* and *survive* (Figure 2).

To *fight* effectively at night, the 24-hour CAS/BAI aircraft needs the ability to execute off-boresight attacks on a first pass basis. This requires good initial targeting data, good inflight navigation accuracy to the target and an effective, accurate first pass target engagement and attack capability.

Affordable Night Attack Capability



for a Dual Role Fighter

Figure 1. The objective is an affordable night attack capability for dual role fighters

Night Attack Mission Drives System Requirements

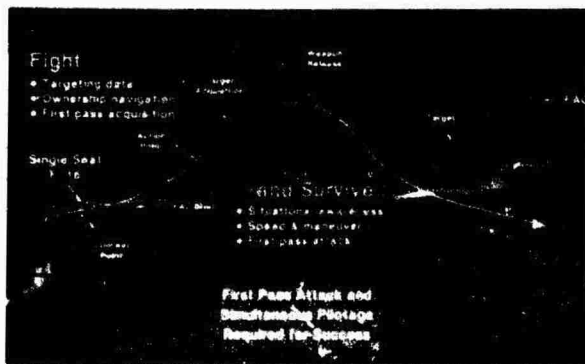

Figure 2. The basic requirements of the night attack mission are to fight and survive

To *survive*, the pilot needs a night vision or pilotage capability that provides a high level of situational awareness. The aircraft needs to remain fast, maneuverable and, again, execute first pass attacks to minimize exposure to hostile air defenses during the attack.

Thus, the functional requirements for the night attack sensor are to provide a full-time heads-up, off-boresight, situational aware *pilotage* capability and, simultaneously, a first pass attack *targeting* capability to the fighter.

SENSOR REQUIREMENTS

The first pass attack targeting requirements were established by analyzing the most difficult targeting task. The most difficult targeting task was the pairing of the weapon with the longest stand-off release range to the smallest expected CAS/BAI targets. The AGM-65D Imaging Infrared (I²R) Maverick missile was chosen as the maximum launch range weapon. The smallest targets were mobile military vehicles such as tanks, armored personnel carriers, etc.

The normal AGM-65D missile launch ranges were established by evaluating field data containing AGM-65D launch range data against tanks in mid-latitude summer weather. On the basis of this data, the average launch range against tanks in the field was determined to be 3.6 kilometers.

The targeting FLIR objective was then established. This objective was to provide a 50 percent or greater probability of recognition at the missile's average launch range (Figure 3).

Given the target and range requirements cited above, the targeting FLIR's design parameters were developed using standard models for target signature, atmospheric transmission and FLIR performance models such as FLIR 90 and

LOWTRAN 7. The result was a targeting FLIR having a 2.0 degree by 2.7 degree field-of-view (FOV) or an 11x magnification

The pilotage FLIR requirements were driven by the need to provide a night vision capability, the ability to execute off-boresight attacks and the need for constant situational awareness. This required that the pilotage FLIR be continuously available, have as wide a field-of-regard (FOR) as possible and provide a good image of the terrain and horizon (Figure 4).

The resulting pilotage FLIR design requirements were a 22.5 degree by 30.0 degree FOV with 1x magnification, a ± 90 degree azimuth and $+60$ degree to -20 degree elevation FOR and an noise equivalent temperature difference (NETD) of 50 millikelvins.

Aircraft speed and maneuverability required that the night vision system be small, lightweight, and low drag.

Affordability required that the unit production cost per FLIR sensor system in a 550 lot production run be less than US \$ 750,000 in 1990.

FALCON KNIGHT APPROACH

Westinghouse responded to the 24-hour CAS/BAI need by using its own resources to develop a unique FLIR/Fire Control Radar (FCR) multisensor system called Falcon Knight.

The Falcon Knight FLIR/FCR multisensor system contains a novel Head Steered FLIR (HSF) having two independent gimbal turrets and LOS (Figure 5). One turret provides a high magnification targeting LOS while the other provides separate and completely independent head steered pilotage LOS.

Tactical Vehicles and Standoff Missiles...

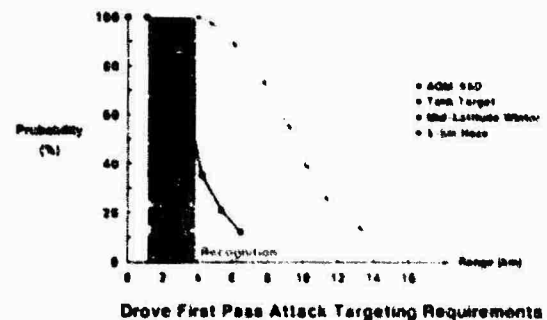

Figure 3. AGM-65D launch data was used to set FLIR targeting range performance requirements for tactical vehicles

Heads-Up Situational Awareness and Off-Boresight Attacks ...

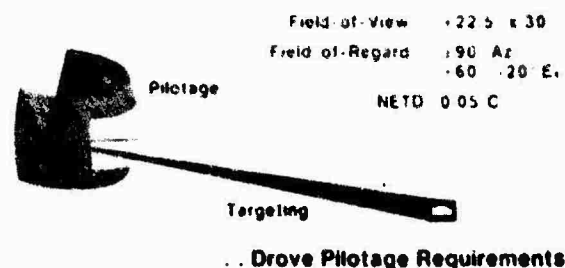
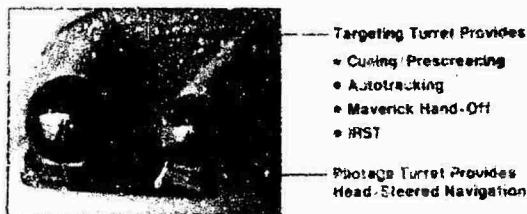

Figure 4. The Pilotage FLIR requirements were set to maximize situational awareness and to maximize off-boresight attack flexibility

To meet the affordability objective, Falcon Knight introduced the optically multiplexed FLIR (Figure 6). The FLIR formed images at a 60 Hz rate. The optical multiplexer alternated the FLIR's LOS between the two turrets so that 30 pilotage and 30 targeting images were formed each second. The result is two continuous normal FLIR video outputs that are generated in parallel at a 30 Hz video rate by a single FLIR sensor.

The Falcon Knight system approach evolved from the FLIR experience gained in two earlier development programs (Figure 7). These programs were the Advanced Fighter Technology Integration (AFTI) F-16 Automated Maneuvering Attack System (AMAS) program and the General Dynamics F-16 HSF program.

Falcon Knight Addresses . . .



. . . Simultaneous Pilotage and Targeting

Figure 5. Falcon Knight's two turrets provide two completely independent lines of sight for targeting and pilotage.

Falcon Knight - a Single Optically Multiplexed, Dual LOS, Head Steered FLIR

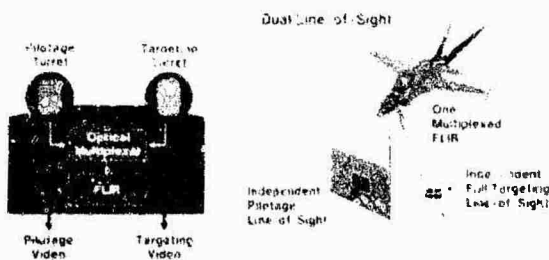

Figure 6. Optical multiplexing allows a single FLIR to generate two simultaneous video outputs for targeting and pilotage.

Falcon Knight Evolved From Two Prior Programs

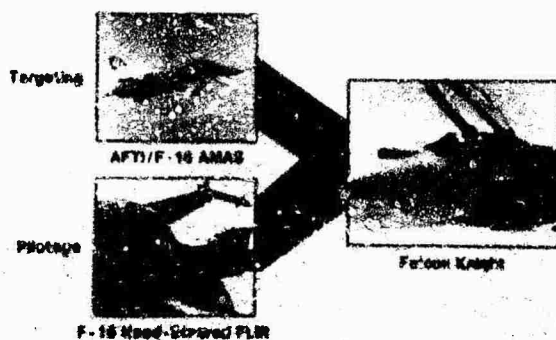

Figure 7. The Falcon Knight design approach evolved from the experience gained on two prior development programs.

AFTI/F-16 AUTOMATED MANEUVERING ATTACK SYSTEM (AMAS)

In the early 1980s, a joint USAF/USN/NASA team was initiating the second phase of the AFTI/F-16 program, the AMAS phase. The AMAS objective was to demonstrate the fully automated delivery of air-to-air and air-to-surface guns and bombs.^{2,3} In addition to ingress and egress steering, the AMAS incorporated the technique of Integrated Flight and Fire Control (IFFC).

The AFTI/F-16 AMAS program was managed by the USAF's Flight Dynamics Laboratory (FDL) with the General Dynamics Fort Worth (GD/FW) Division serving as the prime contractor.

The AMAS phase required the addition of a small conformal electro-optical (E-O) system for both air-to-ground and air-to-air target tracking. The target tracking data, or Target State Estimate (TSE), from this small conformal E-O system was to be coupled to the AFTI/F-16's Fire Control Computer (FCC). The FCC would then produce and deliver weapon delivery steering information to the new Digital Flight Control System (DFCS) resulting in fully automated weapon delivery attacks.

To obtain the new conformal E-O system, GD/FW held a competitive procurement for the Sensor/Tracker Set (STS) in 1980 under the USAF's direction. Westinghouse's offering of a conformal FLIR/Laser STS, with modest integration to the F-16's AN/APG-68 Fire Control Radar (FCR), won this competition in early 1981⁴ (Figure 8).

In late 1984, Westinghouse delivered the completed FLIR/Laser STS to GD/FW.^{5,6} By early 1985, GD/FW had completed the integration of the STS into the AMAS (Figure 9) and on April

AFTI/F-16 Sensor/Tracker . . .

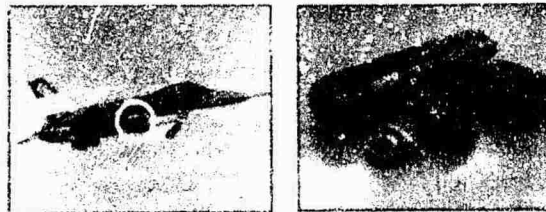

. . . A Conformally Mounted FLIR/Laser Targeting System

Figure 8. The conformal FLIR/Laser Sensor/Tracker Set established a new standard for compact packaging in the early 1980s.

The Sensor/Tracker Was Fully Integrated Into . . .

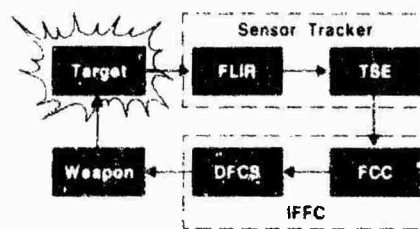

. . . the Automated Maneuvering Attack System

Figure 9. The Sensor/Tracker Set was an integral element of the AMAS's fully automatic IFFC targeting system.

24, 1985, the AFTI/F-16 Joint Test Force (JTF) initiated flight testing of the fully integrated AMAS at Edwards Air Force Base California^{7,8,9,10,11}.

The AFTI/F-16 AMAS successfully completed its air-to-surface weapon delivery demonstrations using the STS in 1986¹² (Figure 10).

In 1987, the United States Air Force Association (AFA) singled out and honored the AFTI/F-16 AMAS program team by awarding it the Theodore Von Karman award, the AFA's highest honor in the field of science and engineering (Figure 10).

On the positive side, the AFTI/F-16 STS demonstrated the viability and accuracy of an air-to-ground targeting FLIR in a fully integrated AMAS aircraft. The FLIR/Laser STS also demonstrated the amount of FLIR miniaturization that could be achieved when the sensor supplier and aircraft manufacturer worked closely together to share computer resources and minimize cooling and structural redundancy.

On the negative side, while the STS provided 24-hour air-to-ground targeting capability, it did not provide a night navigation, or pilotage capability. This led to the exploration of various means to add a night pilotage capability to the aircraft so that it could perform night attack maneuvers in all terrain. The investigations concluded that a navigation, or pilotage capability was needed to complete the AMAS night attack complement.

Early consideration was given to a fixed navigation FLIR displayed in the head-up display (HUD); however it was concluded that a fixed FLIR was too restrictive on aircraft maneuvers and did not provide a sufficient level of situational awareness. The investigations concluded that a Head Steered

FLIR (HSF) offered the most potential for providing the high level situational awareness and off-boresight capability needed for maneuvering night attack (Figure 11).

The addition of an HSF to the STS, when the STS installation already required a left and right FLIR sensor to obtain a full field of regard, resulted in a sensor configuration that was unacceptable from an affordability point of view.

F-16 HEAD STEERED FLIR

To reduce the affordability problem posed by the combination of HSF and Dual STSs, a modified night attack concept was developed. This modified concept eliminated the two separate STS targeting FLIRs and added a second narrow field-of-view to the HSF. The purpose of this second field-of-view was to accomplish the targeting task.

In late 1984, GD/FW initiated an F-16 HSF development project (Figure 12).

The F-16 HSF was mechanized as a single line-of-sight FLIR having two fields-of-view, a 1x magnification field-of-view for pilotage and a 5.6x magnification field-of-view for targeting. GD/FW completed the development of the F-16 HSF and initiated flight demonstrations on an F-16B aircraft in August 1988^{13,14} (Figure 13).

The F-16 HSF flight test results were reported earlier in this symposium in Paper 15 presented by Mr. L. Lydick of GD/FW¹⁵.

The F-16 HSF gained wide approval from the pilots who flew the system¹⁶. Mr. Lydick was awarded the Aviation Week and Space Technology magazine's Laurel Award in January 1990.

AMAS With Sensor / Tracker . . .

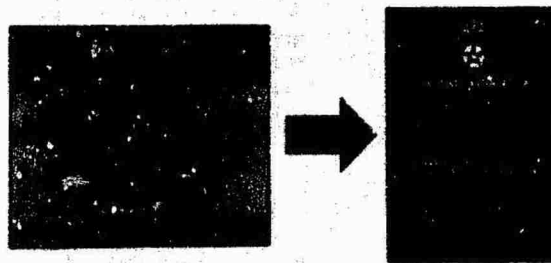

. . . Successfully Demonstrated in 1986

Figure 10. The AFTI/F-16 won the AFA's Von Karman award for conducting fully automated attacks in 1986.

All Terrain, Fully Automated, Maneuvering Night Attack Concepts Were Explored

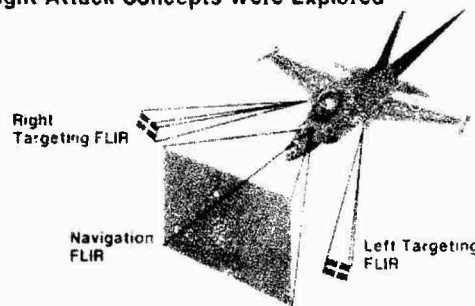

Multiple FLIRs Produced an Affordability Problem

Figure 11. Early concepts for all-terrain maneuvering night attack contained three FLIRs and were too expensive.

The Night Attack Concept Was Modified To Improve Affordability



Figure 12. Consolidating the pilotage and targeting functions in a single FLIR eliminated the multiple FLIR cost problem.

Head-Steered FLIR Capabilities . . .

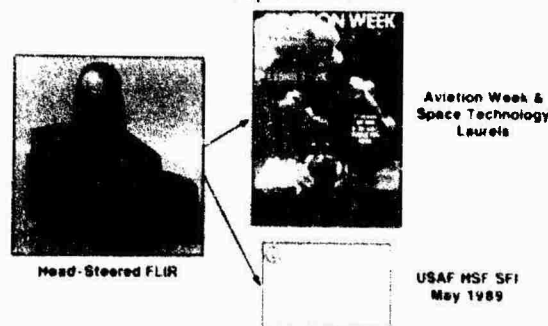

. . . Demonstrated in 1988

Figure 13. Single LOS HSF capabilities were demonstrated by the F-16 HSF.

The successful F-16 HSF flight tests also resulted in the USAF's decision to issue a Solicitation for Information (SFI) for a Head Steered FLIR (HSF) system in May 1989¹⁷. The USAF SFI expressed interest in an internally mounted HSF system that could be retrofitted into Block 30 F-16s that had already been delivered to the USAF^{18,19}. The central HSF issue was affordability. The USAF wanted an HSF system that had a production unit recurring cost of less than \$1.0 million per HSF system.

The USAF expressed a strong interest in:

- 24 hour capability
- Off-axis attack capability
- First Pass Attack capability
- Multiple weapon capability, including AGM-65D
- A greatly reduced FLIR cost

FALCON KNIGHT DEVELOPMENT

Because of the USAF's expressed interest in upgrading fielded F-16s with an HSF sensor, Westinghouse continued to assess the single-seat night attack mission (Figure 14).

The requirement to deliver the AGM-65D IIR Maverick missile against tank sized targets became the targeting FLIR's mission performance driver.

Westinghouse interviewed and analyzed the experience of many USAF pilots who had flown night attack systems.

Westinghouse analyzed the performance capability of the F-16 HSF and reevaluated the AFTI/F-16's STS capability.

On the basis of this assessment, Westinghouse concluded that:

1. Night Pilotage and situational awareness, like that provided by the HSF, were required to provide off-boresight tactical maneuver flexibility and a high level of survivability;
2. Independent Targeting with greater magnification, like the STS, was also needed to detect and track targets at ranges sufficient to deliver weapons in a first pass attack;
3. *Night Pilotage and night Targeting were two closely coupled, but separate and independent tasks. Therefore, a FLIR system having both HSF and STS attributes was required to meet both these needs; and*
4. *The core issue was to combine the pilotage and targeting attributes in a single affordable HSF System.*

As a result of this significant night attack assessment, Westinghouse determined that there was a need to develop a new night attack concept. This need led to the development of the Falcon Knight HSF (Figure 15).

Westinghouse Continued to Address the Dual Requirements

Continuous Head-Up Pilotage	Simultaneous Independent Targeting
--	---

- | | |
|--|---|
| <ul style="list-style-type: none"> • Off-boresight • Situational Awareness | <ul style="list-style-type: none"> • Cueing • Range • Resolution • Tracking |
|--|---|

Affordability Was the Challenge

Figure 14. Satisfying the dual night attack requirements in an affordable manner was the challenge.

Westinghouse Developed the Optically-Multiplexed, Dual LOS . . .

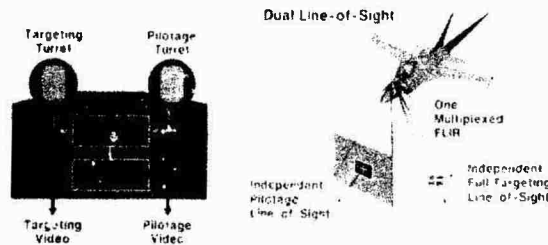

. . . Falcon Knight HSF to Meet the Affordability Challenge.

Figure 15. The optically multiplexed FLIR provided a balance between night attack capability and affordability.

FALCON KNIGHT HSF DESIGN APPROACH

Westinghouse initiated the Falcon Knight HSF system development in mid 1989.

The Falcon Knight HSF is a single optically multiplexed FLIR sensor having two simultaneous and independent optical LOSs which are pointed by two separate and independently controlled gimbals.

The operational design objectives of the Falcon Knight were to provide the single seat F-16 pilot with:

1. A constantly available 1x magnification HSF image for night pilotage and for maintaining a high level of situational awareness and,
2. A simultaneous, independent 11x magnification targeting FLIR image which would aid the pilot and reduce his workload.

This reduction in workload would be accomplished by:

1. Being independently cued to the target area so that the target area could be searched and the target detected at a sufficiently long range to permit either maneuvering for a conventional weapon attack or a stand-off missile attack;
2. Automatically tracking the target after detection and providing TSE inputs to the fire control computer for accurate ingress and attack steering while freeing the pilot to maintain his situational awareness and execute his pilotage function; and
3. Magnifying the target image so that it could be recognized at a sufficiently long range prior to a conventional weapon release attack or a stand-off for missile launch,

The Falcon Knight HSF prototype does not include the Helmet Mounted Sight/Display (HMS/D) system. The HMS/D is considered by the USAF and GD/FW to be a separate subsystem from the HSF. Therefore the HMS/D is an associated subsystem to be provided by the aircraft system integrator.

Falcon Knight had two additional features that enhanced its affordability and retrofitability:

- An F-16 radar bulkhead installation
- FLIR/Fire Control Radar (FCR) integration

FALCON KNIGHT FLIR/RADAR INTEGRATION

The Falcon Knight Dual LOS FLIR sensor assembly was designed to fit into an available open space above the FCR antenna on the F-16s radar bulkhead.

The radar bulkhead installation eliminated the need to relocate existing avionics line replaceable units (LRUs) and the need for structural modifications to install the Falcon Knight sensor head.

The FCR antenna was moved forward 3.8 cm with spacer blocks to make room for an air cooling plenum under the antenna base. The new plenum redistributed existing radar cooling air to both the FCR antenna and the Falcon Knight sensor assembly.

Maintenance access to the Falcon Knight sensor assembly is achieved by opening the radome. Sensor assembly installation and removal are very similar to the FCR antenna installation and removal.

All the electrical signal inputs and outputs from the Falcon Knight sensor assembly are digital. The digital outputs from the Falcon Knight sensor assembly are added to the FCR's wiring harness to the FCR's digital signal processor. This virtually eliminates all the Falcon Knight's retrofit impact on the aircraft's wiring harnesses and support manuals. The retrofit change, with minor exceptions, is confined to the FCR subsystem wiring harness (Figure 16).

The digital Falcon Knight sensor interfaces were all integrated with the F-16 FCR's digital signal processor.

Two complete and independent Falcon Knight/FCR integration designs were developed. The first was for the AN/APG-66 V2A FCR Signal Data Processor being developed under the F-16A/B

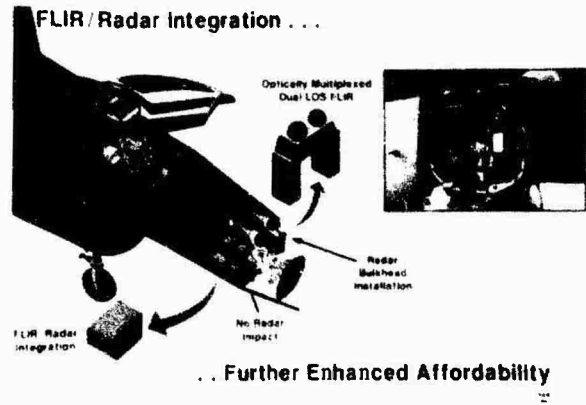

Figure 16. Mounting the Falcon Knight HSF sensor assembly on the radar bulkhead and integrating the FLIR with Fire Control Radar further enhanced affordability

Falcon Knight is a Fully Integrated FLIR Radar Fire Control Multisensor . . .

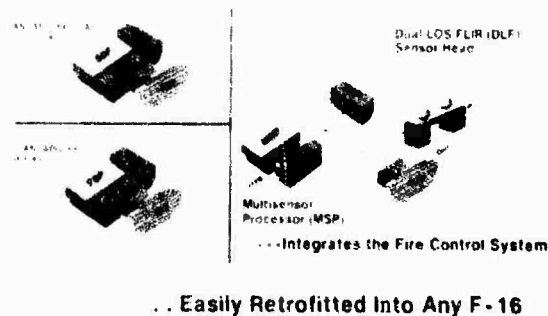

Figure 17. Falcon Knight FLIR/Radar Integration designs were developed for both the F-16A/B's AN/APG-66 FCR and the F-16C/D's AN/APG-68 FCR.

Mid-Life Upgrade (MLU) program. The second was for the AN/APG-68 Block 30/40/50 Programmable Signal Processors (PSP) installed on F-16C/D model aircraft (Figure 17).

The results of the Falcon Knight design initiative are shown in Figure 18. Falcon Knight provides the dual LOS capability needed for night attack. At the same time, Falcon Knight has reduced the volume, weight, drag impact and cost for a FLIR navigation and targeting sensor system by 75% or more when compared to earlier systems built with 1980's technology.

FALCON KNIGHT PROTOTYPE

Westinghouse launched the development of a Falcon Knight prototype in 1989 using company resources (Figure 19).

The Falcon Knight prototype has demonstrated several significant technical advancements as shown in figure 20.

Falcon Knight Has Dramatically Reduced the Impact of Adding . . .

Parameter	1980's Technology	Falcon Knight's 1990's Technology	Change
Volume	0.428 m ³	0.062 m ³	-85%
Weight	386 kg	64 kg	-83%
Drag Increase (M=0.85)	+20%	+5%	-75%
Cost	>\$3,000K	\$750K	-75%

. . . a Night Attack Capability to a Dual Role Fighter

Figure 18. Falcon Knight has dramatically reduced the impact of adding a night attack capability to a dual role fighter.

Westinghouse Developed a Flyable Falcon Knight Prototype



Figure 19. Westinghouse developed a flyable prototype of the Falcon Knight System

Falcon Knight Contains Many Technical Advancements

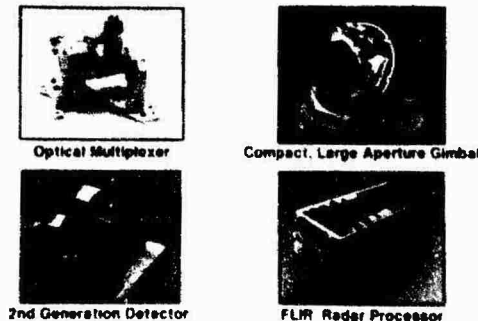

Figure 20. Falcon Knight contains many technical advancements

Falcon Knight's Key Characteristics

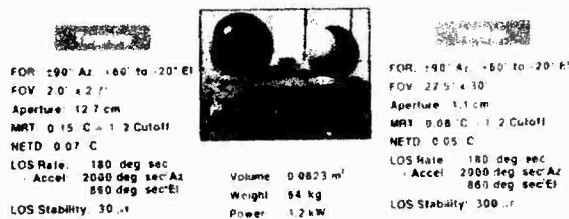

Figure 21. Falcon Knight's Key Characteristics.

Falcon Knight's key characteristics are summarized in figure 21.

PROTOTYPE FLIGHT EVALUATION

The Falcon Knight prototype is now undergoing flight evaluation (Figure 22).

BAC I-11 Flight Evaluation

Falcon Knight's first flight was on the Westinghouse BAC I-11 Avionics Test Bed aircraft on June 6, 1991. A fifty (50) flight evaluation program was conducted between June and October 1991. Forty-one of the 50 flights were for customer demonstration purposes. A total of 241 observers was flown. During this evaluation, Falcon Knight operated for 80 flight hours without a failure.

Westinghouse used the BAC I-11 flight evaluation to verify airborne FLIR sensor and autotracker performance before delivering the Falcon Knight to the AFTI/F-16 JTF.

AFTI/F-16 Flight Evaluation

Upon completion of the BAC I-11 flight evaluation, Falcon Knight was environmentally tested, integrated with the AN/APG-68 FCR and delivered to AFTI/F-16 JTF at Edwards AFB, California²⁰.

AFTI/F-16 Falcon Knight Operating Modes

The Falcon Knight HSF/FCR multisensor was integrated with AFTI/F-16 test aircraft at Edwards AFB in the second quarter of 1992.

In the AFTI/F-16 test configuration, the Pilotage LOS is always slaved to the pilot's head position by the HMS/D.

Prototype in Flight Evaluation

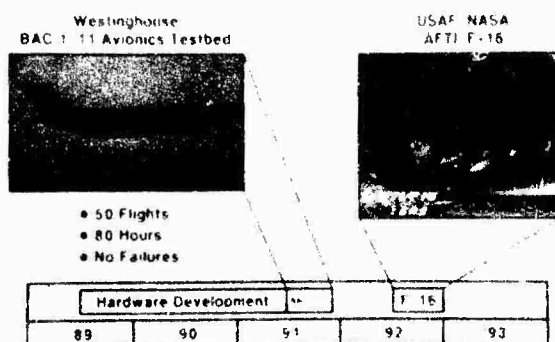

Figure 22. The Falcon Knight prototype is now in flight evaluation

The Targeting LOS is directed by either the HMS/D or FCC. The targeting LOS has two acquisition modes and one tracking mode.

The two target acquisition modes are the HMS/D and the System Point of Interest (SPI) modes.

1. The HMS/D mode slaves the targeting LOS to the pilot's HMS/D so that the pilot can manually point the targeting LOS with his head. In this mode, the pilot can look at the target area and either switch FLIR field-of-view to get an enlarged image of the target or could use the picture-in-picture option to see both the pilotage and targeting FLIR images simultaneously.
2. In the SPI mode, the FCC commands the targeting LOS to move out ahead to the next steerpoint or to the F-16's Target Designation (TD) box location. The pilot can monitor the targeting FLIR image by either (1) looking under the HMS/D combining optics at the chin-up Multifunction Display (MFD) or (2) by looking at the targeting image in the HMS/D.

When viewing the targeting image with the HMS/D, the pilot can view the enlarged target image by either (1) switching FLIR field-of-view or (2) using the picture in picture display.

When the pilot detects the target, he is then free to initiate automatic target tracking using Falcon Knight's targeting gimbal and video autotracker.

The video autotracking mode is initiated by depressing the F-16's Target Designation switch. Once initiated, the targeting LOS tracks the target automatically and delivers a computed target state estimate to the FCC.

After designating the target, the pilot is free to:

1. Return to his pilotage FLIR LOS and execute the attack.
2. Monitor the target track by (1) switching FOVs, (2) using the picture-in-picture option or (3) monitoring the MFD.
3. Refine or "sweeten" the tracker aim point by applying track adjust commands with his cursor thumb control.

To minimize pilot workload, the Falcon Knight dual LOS HSF is a fully automatic all digital FLIR sensor employing dual thermal references for automatic gain and level equalization (AGLE). This automation eliminates the need for pilot adjustments of FLIR gain and level controls during the mission.

AFTI/F-16 Falcon Knight Processor Configuration

The Falcon Knight prototype's FCR PSP is an AN/APG-68 Block 50 PSP. The Block 50 PSP is an Advanced Integrated Circuit technology update of the earlier Block 30/40 AN/APG-68 FCR PSPs. It contains a pair of identical digital array signal processors and MIL-STD-1750A data processors, one for the FCR and the other for the HSF. The PSP also contains the HSF's two new common processor boards.

The FCR is unaffected by the Falcon Knight addition. The FCR retains all its original air-to-air and air-to-surface radar modes.

Falcon Knight's gimbal control, sensor control and AGLE functions are accomplished by the Intel 80960 common processor boards hosted in the FCR PSP. The common processor boards are programmed in Ada.

After the AGLE corrections have been applied, Falcon Knight's digital FLIR video is then processed by software in the PSP's digital array signal processor and 1750A data processors. The 1750A processors are also programmed in Ada.

For the AFTI/F-16 flight evaluation, Falcon Knight's video autotracking modes are implemented in 1750A data processor software.

In the future, additional FLIR video processing modes can be added by developing software upgrades. For example, automatic target detection and cueing modes, automatic target recognition modes and air-to-air infrared search and track (IRST) modes can be added.

In the future, further integration of Falcon Knight's digital FLIR video with radar data in the PSP's digital array processor will yield new combined FLIR, IRST and Radar modes.

Preliminary Flight Evaluation Comments

The AFTI/F-16 Falcon Knight's first flight occurred on June 18, 1992. By August 13, 1992, the Falcon Knight had completed 18 flights. Of these 18 flights, six were specifically dedicated to Falcon Knight test objectives.

The pilots' preliminary comments based on the first six Falcon Knight flights are summarized in Figure 23¹.

SUMMARY

Falcon Knight has demonstrated that a simultaneous head steered Pilotage and an independent first pass attack Targeting capability is both achievable and affordable on a dual role fighter.

Synopsis of Pilot Comments¹:

- Dual LOS concept is greatly preferred
- Dramatic increase in situational awareness
- Falcon Knight video quality exceeds aircraft display capability
- Need improvement in azimuth field-of-regard limitations caused by side-by-side turrets

¹ Purifoy and Demitry, "AFTI/F-16 Night Close Air Support System Testing," presented at the Society of Experimental Test Pilots Symposium, 23-25 September 1992.

Figure 23. Pilot comments after initial Falcon Knight evaluation flights.

REFERENCES

- 1 Russ, Gen. Robert D., No Sitting Ducks, Air Force Magazine, July 1988, pp. 92-97.
- 2 Ross, Lt. Col. D. H., AFTI/F-16 Program - Phase II Overview, Automated Maneuvering Attack System, NAECON, May 1986, pp. 534-537.
- 3 Ramage, J. K., AFTI/F-16 Automated Maneuvering Attack System Configuration Development and Integration, NAECON, May 1986, pp. 538-549.
- 4 Hale, R. A., et. al., AFTI/F-16 Sensor/Tracker System, NAECON, May 1986, pp. 550-559.
- 5 Falcon Eyes Set For Testing, Defense Week, January 21, 1985, pg. 9.
- 6 Westinghouse Delivers First AFTI/F-16 Sensor/Tracker, Jane's Defence Weekly, January 25, 1985.
- 7 McMonagle, Capt. D., Pilot Report: AFTI/F-16, Air Force Magazine, April 1985, Pg. 18.
- 8 AFTI F-16 Equipped With FLIR and Tracker Flies First Flight, Aviation Week and Space Technology, May 20, 1985, Pg. 18.
- 9 FLIR System Tested on AFTI/F-16, Defense Electronics, June 1985, Pg. 24.
- ¹⁰ Cover, Aviation Week and Space Technology, September 30, 1985.
- 11 Klass, P. J., Maneuvering Attack System Prototype Undergoing Testing In F-16, Aviation Week and Space Technology, June 23, 1986, pp. 129-133.
- 12 General Dynamics, Fort Worth Division, AFTI/F-16 Development and Integration Program, AMAS Phase, Final Report For Period December 1978 to May 1987, AFWAL-TR-88-3013, Vol. 1 through 5, August 1988.
- 13 Lydick, L., Falcon Eye, General Dynamics Code One, Vol. 3, No. 4, January 1989.
- 14 Scott, W. B., Falcon Eye FLIR, GEC Helmet Aid F-16 Mission Flexibility, Aviation Week and Space Technology, April 17, 1989, pp. 34-47.
- 15 Lydick, L., Head Steered Sensor Flight Test Results and Implications, NATO AGARD, Paper No. 15, October 1992.
- 16 Shifrin, C. A., TAC Demonstration Bolsters Support For F-16 In CAS Role, Aviation Week and Space Technology, April 17, 1989, pp. 49-50.
- 17 Department of the Air Force, Headquarters Aeronautical Systems Division (AFSC), Solicitation for Information; Close Air Support/Reconnaissance Forward Looking Infrared (FLIR) Night Vision/Night Attack System, May 25, 1989.
- 18 Morocco, J. D., Air Force Drops Plans For New A-16s, Will Modify F-16C/Ds for Close Air Support, Aviation Week and Space Technology, December 3, 1990, Pg. 28.
- 19 Release of Head Steered FLIR RFP May Lead To First Service Requirement, Inside Defense Electronics, December 7, 1990, Pg. 3.
- 20 Westinghouse Improves F-16 Fire Control Radar, Defense News, July 6-12, 1992, Pg. 13.
- 21 Purifoy and Demitry, AFTI/F-16 Night Close Air Support System Testing, Society of Experimental Test Pilots Symposium, September 23-25, 1992.

OVERVIEW OF COCKPIT TECHNOLOGY RESEARCH AND DEVELOPMENT PROGRAMS FOR IMPROVEMENT OF THE MAN/MACHINE INTERFACE

Review of the AGARD AVP Symposium held in Madrid, May 1992

by

P.J.M. Urlings and E.W. Pijpers
National Aerospace Laboratory, NLR
PO Box 90502
1006 BM, Amsterdam
The Netherlands

SUMMARY

This paper provides a review of the AGARD Avionics Panel (AVP) symposium on "Advanced Aircraft Interfaces: the Machine Side of the Man-Machine Interface", held in May 1992 at Madrid. The theme of this symposium was limited to the "machine-side" since a subsequent AGARD symposium at Edinburgh, Scotland, later that year was scheduled to cover the "man-side" of the subject.

This paper was drafted on request of the AVP Technical Programme Committee. It summarizes the main findings of the Madrid symposium for presentation in Edinburgh. The complete text of the papers of the AVP symposium can be found in AGARD Conference Proceedings CP-521.

1. INTRODUCTION

The Spring 1992 symposium of the AGARD Avionics Panel took place at the National Institute of Industry in Madrid on May 18-21. The title of the symposium was "Advanced aircraft interfaces: the machine side of the man-machine interface".

1.1. Theme of the symposium

"The complexity of the modern battle scenario is demanding better situational awareness for the pilot/crew. The advent of laser weapons capable of blinding a pilot or crew member requires that such radiation should not reach the pilot. This dictates that windowless or severely restricted visibility cockpit concepts be used. Emerging technologies, properly applied, offer

potential solutions to answer these conflicting issues."

"The present interface between the pilot/crew and the aircraft is evolving to more sophisticated displays represented on a variety of media including Cathode Ray Tubes (CRTs), flat panels, and Helmet Mounted Displays (HMDs) augmented by multi-function switches and voice. The application of these technologies presents both opportunities and special requirements. These requirements include the development and integration of a variety of concepts to enhance situational awareness while reducing laser threat."

"The exploration of these concepts, their integration in various combinations, and their potential to enhance mission capability was the central theme of the symposium."

1.2. Symposium organization

The symposium was organized in 32 papers divided under 7 sessions, see Table 1. A keynote address preceded the sessions. Discussion was invited after each paper but no period was scheduled for general or round-table discussions.

The number of registered participants was 162 from 14 nations. They attended the symposium either as panel member, as author or as observer. The distribution for each nation is given in Table 2.

During the symposium a technical visit was organized to the CLAEX (Centro Logistico de Armamento Y Experimentation), the Armament, Experimentation and Logistic Center of the Spanish Air Force at Torrejon airbase.

* Paper published in "Combat automation for airborne weapon systems: man-machine interface trends and technologies", Paper 31, AGARD Conference Proceedings of the joint Symposium by the Flight Mechanics Panel and the Guidance and Control Panel, held in Edinburgh, Scotland, United Kingdom, 19-22 October 1992. Published by the NATO Advisory Group for Aerospace Research and Development (AGARD), Flight Mechanics Panel (FMP) and Guidance and Control Panel (GCP).

2. REVIEW OF PAPERS

The symposium keynote address and paper presentations are reviewed next. See the Appendix with symposium program for a detailed list of all papers.

2.1. Keynote Address

Following the opening ceremony performed by Admiral Martin-Granizo, Spanish Chief of Defence Staff and member of the NATO Military Committee, the keynote address was delivered by Mr. Martin-Rico, Director of the SECELSA Simulation and Avionics Branch. In his presentation he emphasized that the need for improvement of pilot's situational awareness and for reduction of pilot workload is not only determined by the complexity of the battlefield scenario but also by a concern about the large number of non-combat losses and peace-time incidents where human factors played a role. Hence, improvement of the peace-time safety level is another operational requirement pushing Research & Development (R&D) for improvement of the Man-Machine-Interface (MMI).

The pilot's mental capability and capacity for the processing of information and decision making is seen as the skill critical to survival and mission effectiveness. R&D should, therefore, focus on the following areas:

- **Task resource demand reduction.** Predominantly aiming at enhancement of the presentation of information and requiring technology developments for noise/clutter reduction and improvement of display resolution.
- **Parallel task processing.** To be enabled by using separate audio-visual-tactile perception and voice-manual control channels for concurrent task execution whenever possible.
- **Task synergy and integration.** As exploited for example in HMDs, allowing the simultaneous processing of different types of information (within the same channel) and in sensor fusion technology and multi-function displays for the integrated presentation of data.
- **Automation.** Seen as the most demanding challenge as it is not a priori clear what to automate. Even when, it is questionable whether automation is (technically) feasible or

even desirable. In every case either the pilot's cooperation is still required or he needs to be informed on the status of automated functions and a good MMI remains imperative. In this area the developments of pilot assistant functions are included.

2.2. Session I: Defining concepts and design issues

In this session, following the keynote address, it would have been useful had a framework been set for the subsequent sessions and discussions. Several general design issues were addressed but, in absence of an overall concept, the relationships and priorities were not made clear. Only paper [3] and [4] were of a conceptual nature.

Bosman [1] provided an introduction to the characteristics of the human eye and the used scan patterns when reading text and numerals as compared to looking at complex scenes. Several factors were discussed that are of importance when considering (monochrome) display layouts for use at times of high workload. It was emphasized that visibility was not only determined by contrast but also by luminance, size, image shape and brightness. The author strongly advocated standards for display design, not only in terms of general guidelines but also in measurable characteristics.

Williams [2] presented an overview of cockpit equipment being investigated for use in future (civil) transport aircraft. Several topics were addressed such as computer graphics, 3-Dimensional (3-D) graphics, helmet mounted displays, knowledge-based systems and fusion of imaging sensors. Emphasis was given to the introduction of larger color, panoramic and flat panel displays.

Burge [3] objected against the piecemeal, non-comprehensive and non-prioritized approach which is traditionally taken in tackling workload problems. Instead she presented the results of a systematic evaluation of the existing problems in which the limitations that result in mission failure were identified as well as possible solutions were given. She arrived at a list of nine categories which require research. The presented list, however, was still not prioritized and the justified conclusion was made that there was still a lot of work to be done.

Struck [4] proposed an alternative computer system arrangement for the generation of graphical display formats, an important part of the design of display interfaces. Such arrangements are of interest as the display technologies themselves are judged to be mature but the bottleneck is seen to be in the required computing and processing power (see also paper [9]). The author did not provide any information about the benefits or trade-offs of these alternative designs.

Paper [5] was, in the absence of its authors, presented by Mr. Dopping-Hepenstal. The paper reported on a questionnaire survey on the attitudes of eight British Aerospace test pilots towards the future of human-electronic cooperation in the cockpit. Ten levels of automation were introduced, called operational relationships, ranging from the level that the pilot is performing the entire activity to the system autonomously performing the action. Overall the pilots welcomed automation that would relieve them of tasks during periods of high critical workload, whilst there is a degree of mistrust and skepticism concerning the integrity and reliability of future automated systems. By consequence, direct intervention of automation into the operation of the flight control system was declared to be unacceptable.

2.3. Session II: Maintenance for advanced cockpits

Newly introduced cockpit systems must have adequate reliability, availability and integrity. The underlying reasons for this are both because of operational considerations as well as of life cycle costs and maintenance. In addition, when new technologies are introduced, these assets are also required to enhance acceptance by the aircrew and to guarantee the intended workload reduction or the increased operational capabilities. Knowing the initial set-backs experienced with e.g. the introduction of CRTs on civil aircraft, one would expect much attention to the subject of reliability and maintenance. However, session II, devoted to these subjects, consisted of only two papers, which emphasized that there is no need to make a distinction between the maintenance of cockpit systems and that of other computer-based on-board equipment.

Collins [6] provided an interesting paper on time stress measurement devices for enhancement of on-board smart Built-in-Test (BIT) performance. The background for the development of

this type of device is given by the high incidence of equipment removal due to intermittent or transient faults caused by environmental factors as temperature and shock. Of the removed units 35-65% are either tested OK or the fault cannot be duplicated on the test bench. These percentages can be reduced by the development of a measurement/recording device in combination with a smart BIT serving as an adjunct to the actual functional test. The principal effect would be less false BIT indications to the pilot and reduced maintenance costs by less unnecessary removals. The development of the measurement-recording device is well under its way. Its small physical size makes retrofit feasible and it was advocated that such devices become a standard part of the equipment design.

Werner [7] presented a paper on the Telefunken Integrated Computer Aided Maintenance System as a tool for integrated logistic support. A plea was made for more attention (hence: funds) to such type of system which was claimed to be particularly useful during the development phase.

2.4. Session III: Panoramic and virtual displays

Advances in computer and display technology are bringing closer the reality of the virtual cockpit concept in which a computer generated world is presented to the pilot in a 3-D visual, auditory and tactile space. Enhanced situational awareness is frequently mentioned as the primary objective and the virtual cockpit is associated with large, "big picture", head-down displays. The virtual cockpit requires the functional integration of a broad range of advanced controls, displays, avionics and (new) sensors. It is essential to realize that these developments are additionally pushed by the selected laser protection requirements: either at the canopy level (in this session) or at the helmet visor level (see [16] in the next session).

Martin [8] outlined a USAF development program in the area of virtual cockpits on a conceptual level. In the described approach, the virtual cockpit will provide 3-D awareness, intuitive control interfaces and automated assistance to the pilot. 3-D visual and auditory information will be presented via the pilot's helmet, while tactile information may be presented through micro stimulators in the pilot's glove. Problem areas were indicated to be real-

time performance and system through-put requirements. The absence of more comprehensive engineering data made it impossible to assess whether the concept is likely to become an effective and useful interface in the foreseeable future.

Hopper [9] described another USAF program, the Panoramic Cockpit Control And Display System (PCCADS). This demonstration program consists of two projects, one arriving at a near term (1995-2000) application, the other at a far term (> 2000) application. The PCCADS approach is to provide the pilot with very large centrally-mounted head-down displays and a helmet-mounted off-axis target acquisition and weapon-targeting system. This concept aims to provide better situational awareness for a pilot in air-to-air situations. To cope with laser threats, the canopy in this concept will be closed by an electrically controlled opaquing layer. Simulator trials with the head-down display in an F-15E cockpit environment claim a significant improvement of 28% increase in exchange ratio versus a standard F-15E cockpit. Coupling the display with a helmet-mounted display for off-axis target acquisition resulted in a 45% increase. The paper provided a good outline of display technologies. It was noted that several technologies are relatively mature but that the bottleneck seems to be in the required computing and processing power.

Larroque [10] described the use of synthetic imagery for day/night and all-weather low-level operations. In the so-called APIS (Aide au Pilotage par Imagerie Synthétique) synthetic head-down and head-up images based on digital terrain data were generated. Experiments in a Falcon-20 simulator with Rafale cockpit-layout by a team of ten Navy and Air Force pilots provided encouraging results. Further evaluation and development will include the combination of synthetic imagery with images from on-board sensors. It was noted that the integrity of the used terrain data bases was an item of concern.

2.5. Session IV: Helmet mounted displays

The operational requirements for improved off-boresight capabilities, for night-under-the-weather operations and for laser protection, have posed increasing demands on the helmet and visor design. The traditional role of the helmet was the protection of the pilot's head while at the same time offering attachment facilities for the oxygen

mask and communication equipment. In the modern high-g capable fighter helmet, weight reduction was of primary interest. Similarly, the visor provided facial protection in the event of ejection, bird strike and other hazard with sun-glare protection as a secondary role. The following development phases may be distinguished:

- **Helmet Mounted Sight (HMS).** In their most primitive form HMSs provide a monocular aiming mark to the pilot with a head position sensor for positioning of the symbology and the slaving of sensors/seekers. The off-boresight aiming/firing capabilities are increased with obvious operational advantages including a reduced manoeuvring requirement. It is however interesting to note that no related weapon developments were presented at the symposium to more fully exploit this capability.
- **Night Vision Goggles (NVG).** In the night-under-the-weather programs the helmet also had to function as an attachment point for the NVG. The added weight, the effects on the combined center-of-gravity and the added frontal area however presented unacceptable problems under higher g-loads while ejection safety was compromised.
- **Helmet Mounted Displays (HMD).** The physical separation of the sensor and the display is the next logical step. In the HMD concept the visor is used for the display of both raster images from electro-optical sensors and stroke symbology for the display of weapon, target and flight data. A more accurate, and dynamically matched, head position sensor system is required for this type of application.

Session IV was only seemingly the largest of the symposium. Although seven papers were planned, one paper [14] was withdrawn while two papers were concerned with different subjects i.e.:

Williams [12] provided an excellent review of human factor guidelines for stereoscopic (3-D) pictorial displays. The research results of several experiments were presented and proof was given that the short-term use of 3-D led to, amongst others, tracking performance improvements using "path-in-the-sky" type of display formats. Overall, however, the 3-D research efforts do primarily focus on head-down display applications.

Howell [17] gave an assessment of the use of synthetic vision for the visual/manual approach and landing of civil aircraft as a possible alternative/back-up for future air- and space-craft with severely restricted outside vision. The described trials carried out by NASA using a Boeing B-737 showed approximately equivalent performance to normal visual landing performance. However, the choice of a TV-like sensor and an HMD were more based on equipment availability than on operational or functional considerations.

The remaining four papers reflected the continuing interest in HMD and the design difficulties in integrating wide-angle, high-resolution displays in the helmet.

De Vos [11] presented a novel Helmet Mounted Vision System (HMVS) design based on the use of holographic optical elements on the visor and a Low Light Level Television (LLLTV) system as an alternative to NVG. Claimed advantages are the absence of optical elements in front of the eye (reduced safety risk), better eye relief and lower weight. Other advantages are better reflection and transmission properties of the visor and larger Field-of-View (FOV). The limitations related to the optical function of the holographic elements and the material properties were described.

Cursolle [13] highlighted the required essential characteristics of HMDs for their use in low level, night and all-weather operations.

Karavis and Southam [15] described the MoD UK Integrated Helmet Technical Demonstrator Programme (IHTDP). After a good review of operational requirements and UK experiences in flying non-integrated HMDs, the need for an integrated approach was described. In the integrated approach the experience and requirements of all disciplines, i.e. human factors, aeromedical and aircraft equipment, would need to be combined. On the human factors side the potential problem of the pilot viewing separate images instead of one "overlayed outside world", as experienced with a conventional Head-Up-Display (HUD), was discussed. As far as the display of symbology is concerned it was stated that the "HUD on the head" approach is too simplistic. However, no specific requirements were given other than the general requirement for a flexible, comprehensive symbol generation capability. The operational requirements for the

IHTDP largely focus on the display of NVG/FLIR images, on laser damage and dazzle protection and on HUD-type symbology compatible with the use of earlier generation weapons.

Foley [16] described the available passive and active optical techniques for protection against nuclear flash and laser dazzle or damage. It was concluded that the required protective functions can be accommodated in a suite of Multi-Function Visors (MFVs). An outer MFV would have to be selected on a mission by mission basis. A permanent inner clear visor would still provide the required mechanical protection and will serve as the HMD combiner. The potential compatibility problem between the MFV and the HUD, the (color) head-down display and the caution/warning panels was briefly mentioned but not discussed in detail.

In summary of session IV, it can be concluded that HMDs offer an alternative for sensor image display in case the outside vision is restricted (because of cockpit design, laser threat or night conditions) while a need for a large FOV exists. The UK paper [15] on the IHTDP is recommended for the detailed listing of technical requirements for the HMD. These requirements can be seen as indicative of the state-of-the-art of HMD technology. The development of holographic visors [11] is exemplary of an alternative research direction. However, in general the R&D of HMDs is pushed by the required operational capability enhancements but their introduction will in first instance only yield a higher pilot workload. The human factor aspects still need further investigation and the possible use of the HMD to minimize vertigo and disorientation (see also [3]) is, at present, only something to be waited for.

Apparently, laser protection is expected to be introduced first at the visor level. However, the introduction of laser protection visors has severe implications on the overall display system concept. Firstly, the combination with HMD impacts on both FOV and raster capability for the conventional HUD, when still present. Secondly, the impact on the use and introduction of wide-angle head-down color displays may be tremendous. Such conceptual considerations were not presented at the symposium.

2.6. Session V: Voice Technology

Voice technology comprises three separate speech processing technologies, i.e.: speech coding & transmission, speech synthesis and speech recognition. Only the latter two technologies play a role in the MMI design. Although human speech covers a wide range of concepts, the introduction of voice technology aims, in first instance, at the execution of aircraft system control tasks and voice messages for crew alerting functions. Continuous control tasks are excluded. In addition, the research efforts in the last decades have primarily focused on speech technology and its potential use in situations where the pilot's hands and eyes are already occupied. As such, voice technology would allow concurrent/parallel task execution and it has the potential to reduce task demand on the visual-motoric control channels.

An extensive introduction to session V was given by Ince [18] including a detailed discussion of speech technology. Technology limitations and problem areas were outlined and a detailed application-oriented discussion followed in the presentations of Hollevoet [19] and Taylor [21]. In the presentation of Barbier [20], the concurrent task execution concept was extended to include the use of eye pointing and hand gestures for control actions in a conceptual "glass" cockpit. Some preliminary experiments were described but, unfortunately, no results were presented. The presentation of Gulli [22] addressed experiments in a centrifuge environment to determine g-load effects on speech recognition performance. The following summary of topics can be made:

- **Recognition algorithms.** The best recognition performance is achieved with speaker-dependent systems. The speaker dependency may be seen as a drawback [18] but possible concerns are alleviated by the use of dynamic speaker adaptation [19] or the use of personal cartridges in the aircraft integration concept. State-of-the-art systems allow voice input/output while using connected speech without artificial pauses.
- **Cockpit environment.** The cockpit environment is classified as hostile for the recognition process [18]. Particularly cockpit and oxygen mask noise and vibrations adversely affect recognition performance. This has implications for both the design of the front-end [19] as well as the processing algorithms [22]. However, the results of an experimental program do indicate that compensation algorithms can be developed to counteract these effects [22].
- **Vocabulary size and syntax.** When large vocabularies are needed [18], this may become a problem both because of the training effort required as well as the adverse effects on response times and/or recognition performance. For near-term applications the vocabulary will however only need around 250 to 300 command words and the real challenge is judged to be in designing for a small active vocabulary size [19]. This can be achieved, amongst others, by the use of syntax, which is also required as part of the MMI concept [21].
- **Pilot/speaker.** Speech as part of a MMI concept is seen as an unnatural language [21]. Speech variability adversely affects performance and may occur as a result of speaker's mental stress or g-loads. In contrast as to g-effects [22], no consistent trends exist for stress effects [18]. Training of the pilots will be needed to adapt to the unnatural language and to train the speech behavior in stress situations, as the natural tendency for humans is to stop speaking [21]. Failing this, voice technology applications will have to limit themselves to control actions not required under stress conditions.
- **Recognition performance.** Recognition accuracies will always be less than 100%. However, it was stated that often too much attention is devoted to recognition accuracies and too little to other parameters like response times and the MMI feedback mechanization [19, 21]. Furthermore, it was pointed out that keyboard operations have less than 100% overall reliability as well. Although none of the presentations concerned actual system developments it was stated that state-of-the-art recognition accuracies of around 90-95% are achievable in a cockpit environment.
- **Feedback and command processing.** The consensus is that feedback to the pilot should be functional and primarily limited to the system response which occurs as a result of the control action execution, see [21] and also [26]. The use of voice echo or word-by-word feedback in an effort to compensate for unacceptable recognition performance is questionable. Intelligent processing of already recognized commands is further deemed necessary to achieve a good MMI [21].

It appears that voice technology is still in the research phase with efforts focusing on signal preprocessing and recognition algorithms. Ideas on integration concepts and MMI designs exist [19, 21, 26] while voice technology issues are best discussed in combination with applications and as part of a total cockpit control moding strategy. If not, unwarranted requirements on speech performance may result in unrealistic expectations on the role of voice technology for control tasks versus the concept of human speech [21]. The experts were however pretty confident on the feasibility of an actual airborne application demonstration on a relatively short term [19]. The focus would then primarily be on the use of voice technology for data entry and display moding functions.

2.7. Session VI: System design concepts and tools

This session, which included 6 papers, focussed around the limitations of the human pilot/operator and the design approach to be taken to overcome these problems. Three general themes were discussed:

- **Information overload.** There exists an ever increasing supply of information caused by the advances of multi-channel, multi-element sensors and the increased use of software which make more and more information available in the cockpit to the pilot.
- **Limitations of pilot/operator.** The pilot acts primarily as a single-channel, slow-processing element and becomes the weakest link in the man-machine system. As the pilot reaches saturation level he will be a limiting factor in the effectiveness of the overall weapon system.
- **Guidelines for man-machine interface design.** Solutions can be provided by cockpit automation and system integration. However, it was stressed by all authors in this session that these automation and integration tasks should be an integral part of the design process in order to obtain an optimal man-machine interface and system performance.

Armogida [23] provided a total system approach for the man-machine interface to be used during planning and execution of offensive missions. Pilot workload in the critical phases of the flight can be greatly reduced by transferring tasks to earlier phases of the mission.

Contributions to obtain this goal can be expected from: multi-national joint force planning, rapid assessment of integrated mission data, automated attack planning, adaptive mission control and mission rehearsal. He advised modular development and stressed the dependency on the integrity of the used data bases.

Lovesey [24] followed a historical approach by presenting Fitt's list of automation tasks and by emphasizing the differences in performance of man or machine. Mission management aids which automate the functions that the pilot is poor at, are required. Despite man's limitations, he has some attributes which cannot yet be reproduced by machine intelligence. With reference to programs like the US "Crew Assistant", the UK "Mission Management Aid" and the French "Copilote Electronique" he stated that it is essential, therefore, to allocate the various mission function components to either the man or to the machine, depending upon which one has the appropriate attributes. Rules for design of the man-machine system were given.

Ovenden [25] highlighted some trends in commercial aviation which have led to the perception that today's aircrew need to deal more with system malfunction than with normal operation. Research work was presented, undertaken to use all available information to provide the aircrew with maximum awareness of system status and to provide advice in case of malfunction or abnormality. An advanced cockpit warning system was discussed to monitor engine performance. The fuzzy logic and rule-based techniques used make this type of warning device most suitable to be used for mechanical components as engines, fuel systems, electrical systems, hydraulic systems and flight controls.

Dopping Hopenstal [26] emphasized that a detailed analysis of the operational scenarios and the specification and design of man-machine interfaces are to be considered as a part of the design process from day one. With practical reference to the various stages of the design process for the European Fighter Aircraft (EFA), an analysis method was presented to classify mission functions and to apply several levels of automation to these functions. Guidelines were derived for cockpit design which included concepts for: displays, hands-on-throttle-and-stick, manual and voice inputs, warning systems, helmet mounted sights and mission data loading.

Weber [27] discussed that in a very early stage of the conceptual design and development of a modern helicopter cockpit, all relevant ergonomic, operational and technical aspects should be considered. He presented a helicopter cockpit simulator as a design tool for the PAH-2 version of the Tiger. This simulator is used in closed-loop operation with future pilots in order to check important areas of the man-machine interface, not only in theory but mainly under practical conditions long before a prototype of the new helicopter exists. A description of the technical set-up of the full-functioning tandem cockpit simulator was given with special attention to the implementation of digital maps, external vision, sensor vision and visual target generation.

Kibbe [28] presented an overview of solutions recommended to reduce pilot workload and concentrated further on the example of an automated target recognition system. It was stated that the operator's interface should vary as a function of the quality of the system. Some automated target recognition systems should be used autonomously for maximum performance, while others should be used with an operator in-the-loop. In addition, the way of interfacing will determine greatly the confidence of the operator in the system and by consequence will determine the overall man-machine system performance.

2.8. Session VII: Device technologies

Due to advantages such as low weight, reduced volume, low power consumption, good illuminance and contrast ratio even in bright sunlight, flat panels have already started to replace the CRTs in the world of military aircraft. Among flat panels, the liquid crystal active matrix display is the most advanced. The papers in this session focused on display technologies and further R&D effort to reduce weight and size and to improve reliability and ease of maintenance.

Wright [29] presented a paper on an active matrix (column) color Liquid Crystal Display (LCD) which has been flight tested in an EFIS configuration as part of the C-130 RAMTIP (Reliability And Maintainability Technology Insertion Program). Although some aspects are still subject to improvement, several advantages were claimed in the area of volume, weight, optics, illuminance and maintenance. It was judged that the active matrix LCD was ready for near-term operational use.

De Lauzun [30] made a similar plea for the use of LCDs in his presentation. Examples of French LCD developments were given which have been flight tested on the Super Puma helicopter and the Rafale-D aircraft.

Lam [31] described an approach for an improved autonomous target cuer with improved reliability and robustness. In the concept presented, the target model is carried in a target correlator and fuzzy logic is applied for controlling filter and parameter choices. A critical factor in such systems is the availability of very fast computers, since image processing and fuzzy logic are very computationally expensive. However, no results were given.

Hellmuth [32] in the closing presentation gave a review of the equipment becoming available for use in a helicopter. He provided an extensive list of examples of equipment taken from project studies and illustrated specific limiting conditions for helicopters. Emphasis was given to operational requirements and the use of LCDs was advocated.

3. CONCLUSIONS

In the presented papers and subsequent discussions, there was a general agreement on the nature of the problems facing the designers of military aircraft cockpits and interfaces. There was also a general consensus on the range of available solutions and the methodology required to obtain them. However, it was generally felt that the limitation in the theme of the symposium to only the machine-side of the man-machine interface was a rather artificial one. Interface issues can only be addressed optimally by a combined attention to both the man- and machine-side of the problem.

The excessive pilot workload and the need for improved situational awareness are frequently mentioned as the driving factors for the presented technological developments. In practice, however, most developments are promoted by operational requirements for e.g. night-under-the-weather and off-boresight firing capabilities. It cannot be denied that these operational requirements are the real driving factors. The need for laser protection exists but in the background, which may be partially attributed to the unclassified nature of the symposium.

A large part of the symposium was devoted to display technology, in particular to the introduction of large flat panel displays. These are considered to be main requisites in realizing the virtual cockpit concept. Common concerns in the presentations were real-time performance and required computational power. Only one paper discussed the possibility of an architectural (re)arrangement of associated avionics to meet these requirements. Most presentations were concerned about the integrity of newly introduced large databases.

Voice technology in cockpit applications is still in the research phase with efforts focussing on signal processing and recognition algorithms. Most feasible near-term applications are the use of voice technology for data entry and display moding functions.

The main issue in the development of helmet mounted displays is to find an engineering solution for the mounting of wide-angle high-resolution displays in a helmet compatible with all safety and operational requirements. There exists

a difference in concepts for laser protection, either at the helmet visor level or at the canopy level.

Among the presented applications there was a strong emphasis on the problems of man-machine interfaces in single-seat fighter aircraft. Although understandable in terms of the magnitude of interface problems in single-seat fighter cockpits, this resulted in almost a total neglect of multi-crew aircraft and hardly any attention for helicopters.

4. ACKNOWLEDGEMENT

A excellent review of the AVP symposium was given by Dr. Geoffrey H. Hunt in the "Technical Evaluation Report on the Avionics Panel 63rd Symposium on Advanced aircraft interfaces; the machine side of the man-machine interface", to be published as an AGARD Advisory Report. The authors gladly acknowledge his consent for using this document as input for this paper.

Table 1: Overview of sessions and papers

Session	US	UK	FR	GE	CA	NE	BE	TU	Total
I - Defining Concepts and Design Issues	2	1		1		1			5
II - Maintenance for Advanced Cockpit Systems	1			1					2
III - Panoramic and Virtual Displays	2		1						3
IV - Helmet Mounted Displays	2	3	1			1			7
V - Voice Technology			2		1		1	1	5
VI - System Design Concepts and Tools	2	3		1					6
VII - Device Technologies	1		1	1	1				4
Total	10	7	5	4	2	2	1	1	32

Table 2: Overview of participants

Nation	Panel	Author	Observer	Total
Spain	2		41	43
United States	8	12	2	23
France	5	8	8	19
United Kingdom	5	10	2	17
Germany	4	4	5	13
The Netherlands	2	1	8	11
Canada	1	5	2	8
Italy	4		4	8
Turkey	3			3
Belgium	1	1		2
Portugal	2			2
Greece	2			2
Norway	2			2
Denmark	1			1
SHAPE	1			1
AGARD				7
Total	43	41	71	162

Appendix: Symposium program**"ADVANCED AIRCRAFT INTERFACES:
THE MACHINE SIDE OF THE MAN-
MACHINE INTERFACE"**

Program chairman: Eng. Jose M.G.B.
Mascarenhas (PO)

- [0] Keynote Address;
Mr. Cristobal Martin-Rico (SP)

**Session I: DEFINING CONCEPTS AND
DESIGN ISSUES**

Chairman: Mr. William E. Howell (US)

- [1] Engineering the visibility of small features on electronic flight displays; Prof. D. Bosman (NE)
- [2] Advanced cockpit technology for future aircraft; Jack J. Hatfield, Rusell V. Parrish, James R. Burley and Steven P. Williams (US)
- [3] Critical Technologies for the next century's aircrews: where should we focus our efforts? Judith H. Lind and Carol G. Burge (US)
- [4] Advanced cockpit - Mission and image management; Dipl.Eng. Jurgen Struck (GE)
- [5] Aircrew acceptance of automation in the integrated cockpit; Ian Ross and Mark Hicks (UK)

**Session II: MAINTENANCE FOR
ADVANCED COCKPIT
SYSTEMS**

Chairman: Ir. H. Timmers (NE)

- [6] Time stress measurement devices for enhancement of on-board BIT performance; Leonard J. Popyack, Mark E. McCallum, James A. Collins et al (US)
- [7] Computer aided maintenance system for avionic application; Dipl.Eng. Werner Wurster and Dipl.Eng. Rolfdieter Preub (GE)

**Session III: PANORAMIC AND VIRTUAL
COCKPITS**

Chairman: Mr. David V. Gaggin (US)

- [8] Developing virtual cockpits; Wayne L. Martin (US)
- [9] Panoramic cockpit displays; Dr. Darrell G. Hopper (US)
- [10] Vol au dessus d'un monde virtuel - Flying over a virtual world; P. Larroque and R. Joannes (FR)

**Session IV: HELMET MOUNTED
DISPLAYS**

Chairman: Dr. Ron Macpherson (CA)

- [11] A new concept for helmet mounted vision; Dr. R.P. Slegtenhorst et al (NE)
- [12] Benefits, limitations and guidelines for applications of stereo 3-D display technology to the cockpit environment; Steven P. Williams, Russell V. Parrish and Anthony M. Busquets (US)
- [13] Un visuel de casque pour le pilotage et la navigation jour/nuit de aéronefs de combat: exigences et approches technique; J.P. Cursolle and J.M. Kraus (FR)
- [14] Advanced head tracking system (withdrawn); R.J. McFarlane (UK)
- [15] The MoD (UK) integrated helmet technical demonstrator programme; A. Karavis and Sqn Ldr T.H. Southam (UK)
- [16] Multifunction visor; John P. Foley and A. Head (UK)
- [17] Flight test of a helmet-mounted display synthetic visibility system; Kenneth R. Yenni and William E. Howell (US)

Session V: VOICE TECHNOLOGY

Chairman: Col. Francis Corbisier (BE)

- [18] Advances in digital speech processing; Prof. Dr. N. Ince (TU)
- [19] The use of voice processing for some aspects of the pilot-vehicle-interface in an aircraft; Fernand Hollevoet and Dr. Christian Wellekens (BE)
- [20] Système de dialogue multimodal pour les cockpits futurs; Jean Noël Perbet, Jean-Jacques Favot and Bruno Barbier (FR)
- [21] Principles for integrating voice I/O in a complex interface; M.M. Taylor and D.A. Waugh (CA)
- [22] G-load effects and efficient acoustic parameters for robust speaker recognition; Christian Gulli et al (FR)

**Session VI: SYSTEM DESIGN CONCEPTS
AND TOOLS**

Chairman: Mr. Manfred Facobsen (GE)

- [23] A system approach to the advanced aircraft man-machine interface; F. Armogida (US)
- [24] Management of avionics data in the cockpit; Dr. E.J. Lovesey (UK)
- [25] Model based reasoning applied to cockpit warning systems; C.R. Ovenden (UK)
- [26] The integration of advanced cockpit and system design; P.R. Wilkinson (UK)
- [27] CVA - Cockpit design and development tool; Christoph Weber (GE)
- [28] The man-machine interface with simulated automatic target recognition systems; Manon P. Kibbe and Edward D. McDowell (US)

Session VII: DEVICE TECHNOLOGIES

Chairman: Mr. J. Dansac (FR)

- [29] The active matrix LC head-down display - Operational experience and growth potential; J. Colin Prince, James F. Farrell and John C. Wright (CA)
- [30] The liquid crystal display as a CRT competitor and as a technical key for future cockpit concept; Frédéric de Lauzun (FR)
- [31] Adaptive autonomous target cue; Chin-Kin Lam, Daniel Searle and Frank Armogida (US)
- [32] Equipment more-or-less ready to be used in helicopters; Dipl.Ing. H. Hellmuth and Dr. H.-D.V. Boehm (GE)

REPORT DOCUMENTATION PAGE

1. Recipient's Reference	2. Originator's Reference	3. Further Reference	4. Security Classification of Document												
	AGARD-CP-520	ISBN 92-835-0706-1	UNCLASSIFIED/ UNLIMITED												
5. Originator	Advisory Group for Aerospace Research and Development North Atlantic Treaty Organization 7 Rue Ancelle, 92200 Neuilly sur Seine, France														
6. Title	COMBAT AUTOMATION FOR AIRBORNE WEAPON SYSTEMS: MAN/MACHINE INTERFACE TRENDS AND TECHNOLOGIES														
7. Presented at	the joint Flight Mechanics Panel and Guidance and Control Panel Symposium, held in Edinburgh, Scotland, United Kingdom from 19th—22nd October 1992.														
8. Author(s)/Editor(s)	Various		9. Date April 1993												
10. Author's/Editor's Address	Various		11. Pages 278												
12. Distribution Statement	There are no restrictions on the distribution of this document. Information about the availability of this and other AGARD unclassified publications is given on the back cover.														
13. Keywords/Descriptors	<table border="0"> <tr> <td>Fighter aircraft</td> <td>Integrated systems</td> </tr> <tr> <td>Man machine systems</td> <td>Data displays</td> </tr> <tr> <td>Data fusion</td> <td>Interfaces</td> </tr> <tr> <td>Situational awareness</td> <td>Parallel processing</td> </tr> <tr> <td>Computer systems architecture</td> <td>Virtual cockpit</td> </tr> <tr> <td>Human factors engineering</td> <td></td> </tr> </table>			Fighter aircraft	Integrated systems	Man machine systems	Data displays	Data fusion	Interfaces	Situational awareness	Parallel processing	Computer systems architecture	Virtual cockpit	Human factors engineering	
Fighter aircraft	Integrated systems														
Man machine systems	Data displays														
Data fusion	Interfaces														
Situational awareness	Parallel processing														
Computer systems architecture	Virtual cockpit														
Human factors engineering															
14. Abstract	<p>Recent advances in combat automation technologies offer significant potential for improving overall mission effectiveness. Development of advanced situational awareness display concepts, parallel distributed computer architecture and tactical information fusion techniques have paved the way for new operational capabilities and weapon system employment tactics. Harnessing these innovative technologies is critically dependent upon establishing an effective and intuitive pilot vehicle interface.</p> <p>Presentation of accurate situational data at the right time in an appropriate format remains a significant challenge. Effective combat systems must employ anticipatory control laws, data management and display techniques. Consequential trend information based on both current decisions and alternative courses of action is essential. Future manned fighter systems must be capable of providing automated command guidance and signal limiting when appropriate. Additionally, future systems must also correctly harmonize the automatic functions consistent with the pilot's intention and total tactical situation.</p> <p>The Symposium addressed changing and possible future operational scenarios, advanced technology concepts, application issues and experimental development efforts and included sessions on: fusion, situation awareness, human capabilities and limitations, and design and evaluation of integrated systems.</p>														

<p>AGARD Conference Proceedings 520 Advisory Group for Aerospace Research and Development, NATO COMBAT AUTOMATION FOR AIRBORNE WEAPON SYSTEMS: MAN/MACHINE INTERFACE TRENDS AND TECHNOLOGIES Published April 1993 278 pages</p> <p>Recent advances in combat automation technologies offer significant potential for improving overall mission effectiveness. Development of advanced situational awareness display concepts, parallel distributed computer architecture and tactical information fusion techniques have paved the way for new operational capabilities and weapon system employment tactics. Harnessing these innovative technologies is critically dependent upon establishing an effective and intuitive pilot vehicle interface.</p> <p>P.T.O.</p>	<p>AGARD-CP-520</p> <p>Fighter aircraft Man machine systems Data fusion Situational awareness Computer systems architecture Human factors engineering Integrated systems Data displays Interfaces Parallel processing Virtual cockpit</p>	<p>AGARD Conference Proceedings 520 Advisory Group for Aerospace Research and Development, NATO COMBAT AUTOMATION FOR AIRBORNE WEAPON SYSTEMS: MAN/MACHINE INTERFACE TRENDS AND TECHNOLOGIES Published April 1993 278 pages</p> <p>Recent advances in combat automation technologies offer significant potential for improving overall mission effectiveness. Development of advanced situational awareness display concepts, parallel distributed computer architecture and tactical information fusion techniques have paved the way for new operational capabilities and weapon system employment tactics. Harnessing these innovative technologies is critically dependent upon establishing an effective and intuitive pilot vehicle interface.</p> <p>P.T.O.</p>	<p>AGARD-CP-520</p> <p>Fighter aircraft Man machine systems Data fusion Situational awareness Computer systems architecture Human factors engineering Integrated systems Data displays Interfaces Parallel processing Virtual cockpit</p>
<p>AGARD Conference Proceedings 520 Advisory Group for Aerospace Research and Development, NATO COMBAT AUTOMATION FOR AIRBORNE WEAPON SYSTEMS: MAN/MACHINE INTERFACE TRENDS AND TECHNOLOGIES Published April 1993 278 pages</p> <p>Recent advances in combat automation technologies offer significant potential for improving overall mission effectiveness. Development of advanced situational awareness display concepts, parallel distributed computer architecture and tactical information fusion techniques have paved the way for new operational capabilities and weapon system employment tactics. Harnessing these innovative technologies is critically dependent upon establishing an effective and intuitive pilot vehicle interface.</p> <p>P.T.O.</p>	<p>AGARD-CP-520</p> <p>Fighter aircraft Man machine systems Data fusion Situational awareness Computer systems architecture Human factors engineering Integrated systems Data displays Interfaces Parallel processing Virtual cockpit</p>	<p>AGARD Conference Proceedings 520 Advisory Group for Aerospace Research and Development, NATO COMBAT AUTOMATION FOR AIRBORNE WEAPON SYSTEMS: MAN/MACHINE INTERFACE TRENDS AND TECHNOLOGIES Published April 1993 278 pages</p> <p>Recent advances in combat automation technologies offer significant potential for improving overall mission effectiveness. Development of advanced situational awareness display concepts, parallel distributed computer architecture and tactical information fusion techniques have paved the way for new operational capabilities and weapon system employment tactics. Harnessing these innovative technologies is critically dependent upon establishing an effective and intuitive pilot vehicle interface.</p> <p>P.T.O.</p>	<p>AGARD-CP-520</p> <p>Fighter aircraft Man machine systems Data fusion Situational awareness Computer systems architecture Human factors engineering Integrated systems Data displays Interfaces Parallel processing Virtual cockpit</p>

<p>Presentation of accurate situational data at the right time in an appropriate format remains a significant challenge. Effective combat systems must employ anticipatory control laws, data management and display techniques. Consequential trend information based on both current decisions and alternative courses of action is essential. Future manned fighter systems must be capable of providing automated command guidance and signal limiting when appropriate. Additionally, future systems must also correctly harmonize the automatic functions consistent with the pilot's intention and total tactical situation.</p> <p>The Symposium addressed changing and possible future operational scenarios, advanced technology concepts, application issues and experimental development efforts and included sessions on: fusion, situation awareness, human capabilities and limitations, and design and evaluation of integrated systems.</p> <p>Copies of papers presented at the joint Flight Mechanics Panel and Guidance and Control Panel Symposium, held in Edinburgh, Scotland, United Kingdom from 19th—22nd October 1992.</p> <p>ISBN 92-835-0706-1</p>	<p>Presentation of accurate situational data at the right time in an appropriate format remains a significant challenge. Effective combat systems must employ anticipatory control laws, data management and display techniques. Consequential trend information based on both current decisions and alternative courses of action is essential. Future manned fighter systems must be capable of providing automated command guidance and signal limiting when appropriate. Additionally, future systems must also correctly harmonize the automatic functions consistent with the pilot's intention and total tactical situation.</p> <p>The Symposium addressed changing and possible future operational scenarios, advanced technology concepts, application issues and experimental development efforts and included sessions on: fusion, situation awareness, human capabilities and limitations, and design and evaluation of integrated systems.</p> <p>Copies of papers presented at the joint Flight Mechanics Panel and Guidance and Control Panel Symposium, held in Edinburgh, Scotland, United Kingdom from 19th—22nd October 1992.</p> <p>ISBN 92-835-0706-1</p>
<p>Presentation of accurate situational data at the right time in an appropriate format remains a significant challenge. Effective combat systems must employ anticipatory control laws, data management and display techniques. Consequential trend information based on both current decisions and alternative courses of action is essential. Future manned fighter systems must be capable of providing automated command guidance and signal limiting when appropriate. Additionally, future systems must also correctly harmonize the automatic functions consistent with the pilot's intention and total tactical situation.</p> <p>The Symposium addressed changing and possible future operational scenarios, advanced technology concepts, application issues and experimental development efforts and included sessions on: fusion, situation awareness, human capabilities and limitations, and design and evaluation of integrated systems.</p> <p>Copies of papers presented at the joint Flight Mechanics Panel and Guidance and Control Panel Symposium, held in Edinburgh, Scotland, United Kingdom from 19th—22nd October 1992.</p> <p>ISBN 92-835-0706-1</p>	<p>Presentation of accurate situational data at the right time in an appropriate format remains a significant challenge. Effective combat systems must employ anticipatory control laws, data management and display techniques. Consequential trend information based on both current decisions and alternative courses of action is essential. Future manned fighter systems must be capable of providing a .omated command guidance and signal limiting when appropriate. Additionally, future systems must also correctly harmonize the automatic functions consistent with the pilot's intention and total tactical situation.</p> <p>The Symposium addressed changing and possible future operational scenarios, advanced technology concepts, application issues and experimental development efforts and included sessions on: fusion, situation awareness, human capabilities and limitations, and design and evaluation of integrated systems.</p> <p>Copies of papers presented at the joint Flight Mechanics Panel and Guidance and Control Panel Symposium, held in Edinburgh, Scotland, United Kingdom from 19th—22nd October 1992.</p> <p>ISBN 92-835-0706-1</p>

AGARD

NATO  OTAN

7 RUE ANCELLE · 92200 NEUILLY-SUR-SEINE
FRANCE

Télécopie (1)47.38.57.99 · Téléc 610 176

DIFFUSION DES PUBLICATIONS
AGARD NON CLASSIFIEES

Aucun stock de publications n'a existé à AGARD. A partir de 1993, AGARD détiendra un stock limité des publications associées aux cycles de conférences et cours spéciaux ainsi que les AGARDographies et les rapports des groupes de travail, organisés et publiés à partir de 1993 inclus. Les demandes de renseignements doivent être adressées à AGARD par lettre ou par fax à l'adresse indiquée ci-dessus. *Veuillez ne pas téléphoner.* La diffusion initiale de toutes les publications de l'AGARD est effectuée auprès des pays membres de l'OTAN par l'intermédiaire des centres de distribution nationaux indiqués ci-dessous. Des exemplaires supplémentaires peuvent parfois être obtenus auprès de ces centres (à l'exception des Etats-Unis). Si vous souhaitez recevoir toutes les publications de l'AGARD, ou simplement celles qui concernent certains Panels, vous pouvez demander à être inclus sur la liste d'envoi de l'un de ces centres. Les publications de l'AGARD sont en vente auprès des agences indiquées ci-dessous, sous forme de photocopie ou de microfiche.

CENTRES DE DIFFUSION NATIONAUX

ALLEMAGNE

Fachinformationszentrum,
Karlsruhe
D-7514 Eggenstein-Leopoldshafen 2

BELGIQUE

Coordonnateur AGARD-VSL
Etat-Major de la Force Aérienne
Quartier Reine Elisabeth
Rue d'Evere, 1140 Bruxelles

CANADA

Directeur du Service des Renseignements Scientifiques
Ministère de la Défense Nationale
Ottawa, Ontario K1A 0K2

DANEMARK

Danish Defence Research Board
Ved Idraetsparken 4
2100 Copenhagen Ø

ESPAGNE

INTA (AGARD Publications)
Pintor Rosales 34
28008 Madrid

ETATS-UNIS

National Aeronautics and Space Administration
Langley Research Center
M/S 180
Hampton, Virginia 23665

FRANCE

O.N.E.R.A. (Direction)
29, Avenue de la Division Leclerc
92322 Châtillon Cedex

GRECE

Hellenic Air Force
Air War College
Scientific and Technical Library
Dekelia Air Force Base
Dekelia, Athens TGA 1010

ISLANDE

Director of Aviation
c/o Flugrad
Reykjavik

ITALIE

Aeronautica Militare
Ufficio del Delegato Nazionale all'AGARD
Aeroporto Pratica di Mare
00040 Pomezia (Roma)

LUXEMBOURG

Voir Belgique

NORVEGE

Norwegian Defence Research Establishment
Attn: Biblioteket
P.O. Box 25
N-2007 Kjeller

PAYS-BAS

Netherlands Delegation to AGARD
National Aerospace Laboratory NLR
P.O. Box 90502
1006 BM Amsterdam

PORTUGAL

Portuguese National Coordinator to AGARD
Gabinete de Estudos e Programas
CLAFAs
Base de Alfragide
Alfragide
2700 Amadora

ROYAUME UNI

Defence Research Information Centre
Kentigern House
65 Brown Street
Glasgow G2 8EX

TURQUIE

Milli Savunma Başkanlığı (MSB)
ARGE Daire Başkanlığı (ARGE)
Ankara

Le centre de distribution national des Etats-Unis (NASA/Langley) ne détient PAS de stocks des publications de l'AGARD. D'éventuelles demandes de photocopies doivent être formulées directement auprès du NASA Center for Aerospace Information (CASI) à l'adresse suivante:

AGENCES DE VENTE

NASA Center for
Aerospace Information (CASI)
P.O. Box 8757
BWI Airport, Maryland 21240
United States

ESA/Information Retrieval Service
European Space Agency
10, rue Mario Nikis
75015 Paris
France

The British Library
Document Supply Division
Boston Spa, Wetherby
West Yorkshire LS23 7BQ
Royaume Uni

Les demandes de microfiches ou de photocopies de documents AGARD (y compris les demandes faites auprès du CASI) doivent comporter la dénomination AGARD, ainsi que le numéro de série d'AGARD (par exemple AGARD-AG-315). Des informations analogues, telles que le titre et la date de publication sont souhaitables. Veuillez noter qu'il y a lieu de spécifier AGARD-R-nnn et AGARD-AR-nnn lors de la commande des rapports AGARD et des rapports consultatifs AGARD respectivement. Des références bibliographiques complètes ainsi que des résumés des publications AGARD figurent dans les journaux suivants:

Scientific and Technical Aerospace Reports (STAR)
publié par la NASA Scientific and Technical
Information Division
NASA Headquarters (NTT)
Washington D.C. 20546
Etats-Unis

Government Reports Announcements and Index (GRA&I)
publié par le National Technical Information Service
Springfield
Virginia 22161
Etats-Unis

(accessible également en mode interactif dans la base de données bibliographiques en ligne du NTIS, et sur CD-ROM)



Imprimé par Specialised Printing Services Limited
40 Chigwell Lane, Loughton, Essex IG10 3TZ