

AD-A266 857



6/28/93

Final Report 9/14/90 to 9/13/93

The Dual and Simultaneous Roles of Nucleophilic Delivery
and Assistance of Leaving Group Departure by Metal Ions
in Phosphate Transfer from Phosphate Diesters

N00014-90-J-4132

Thomas C. Bruice

University of California
Department of Chemistry
Santa Barbara, CA 93106



Office of Naval Research
800 N. Quincy Street
Arlington, VA 22217-5000

93-15810



Distribution Unlimited

93 7 10 02

Our research has centered around the very difficult problem of the catalysis of hydrolysis of phosphate diesters. The study may be divided into two parts. The first deals with the design synthesis and study of new catalytic systems which incorporate a duality of functional groups designed to deliver a nucleophile, preferably metal bound water, and to stabilize the leaving alkoxide, preferably by metal cation. One completed study has been published and others are in progress (one nears completion). The second part of the problem is the design, synthesis, and study of compounds (which we call microgonotropens) which bind in the minor groove of dsDNA at A·T rich regions and direct a catalytic configuration of nucleophile and electrophile to particular dsDNA phosphodiester linkages. We have published one paper, three additional papers dealing with dien-microgonotropens will be published this summer and two on tren-microgonotropens approach completion. We are interested in how the microgonotropens change the shape of dsDNA and this has led us to computer studies of the structures of peptide nucleic acid complexes with dsDNA. Two papers on this topic have been accepted for publication and will appear before the end of 1993.

DNA, microgonotropen, minor groove, major groove, hydrolysis
phosphodiester, metals, topoisomerase, group transfer, recognition

11

Unclassified

Unclassified

Unclassified

UL

FINAL REPORT QUESTIONNAIRE
(FOR ONR use only)

Principal Investigator Name: THOMAS C. BRUICE

Institution: UNIVERSITY OF CALIFORNIA, SANTA BARBARA

Project Title: THE DUAL AND SIMULTANEOUS ROLES OF NUCLEOPHILE DELIVERY AND ASSISTANCE TO LEAVING GROUP DEPARTURE BY METAL IONS IN PHOSPHATE TRANSFER FROM PHOSPHATE DIESTERS

Number of ONR supported

Papers published in refereed journals: 2. (plus 4 accepted & in press and 3 submitted)

Papers or reports in non-refereed publications: 0.

Books or book chapters published: 0.

Number of ONR supported patents/inventions

Filed: 0.

Granted: 0. Patent name and number: N/A.

HAVE YOU LICENSED TECHNOLOGIES (E.G., SOFTWARE) THAT WERE DEVELOPED WITH ONR SUPPORT? IF SO, PLEASE DESCRIBE ON A SEPARATE SHEET.

No

HAVE YOU DEVELOPED INDUSTRIAL/CORPORATE CONNECTIONS BASED ON YOUR ONR SUPPORTED RESEARCH? IF SO, PLEASE DESCRIBE ON A SEPARATE SHEET.

No

Number of presentations: Total ONR Project

Invited: 12.

Contributed: 0.

Trainee Data (only for those receiving full or partial ONR support):

	TOTAL	FEMALE	MINORITY	NON-US CITIZEN
No. Grad. Students:	1			
No. Postdoctorals:	7			5
No. Undergraduates:	0			

DTIC QUALITY INSPECTED 5

AWARDS/HONORS TO PI AND/OR TO MEMBERS OF PI'S RESEARCH GROUP (please describe):

Listed as among "The World's 50 Most Cited Chemists Ranked by Total Citations, 1984-1991" (Science Watch, 3[4]: May 1992).

One of the 5 Most Cited Chemists in the University of California system.

Equipment purchased on grant (number and description of items costing >\$1,500):

- (1) UVI Optical & Control Unit {Pharmacia LKB Biotech Inc.}
- (1) Add-on Memory Board and Memory Module for Power Series {Silicon Graphics}

Dist		Avail and/or Special	
A-1			

FINAL REPORT ON CONTRACT

N00014-90-J-4132

R&T CODE 441n048

PRINCIPAL INVESTIGATOR: Thomas C. Bruice

CONTRACTOR: University of California at Santa Barbara, Santa Barbara, CA 93106

CONTRACT TITLE: The Dual and Simultaneous Roles of Nucleophilic Delivery and Assistance of Leaving Group Departure by Metal Ions in Phosphate Transfer from Phosphate Diesters

PERIOD OF PERFORMANCE: Sept. 14, 1990, to Sept. 13, 1993

RESEARCH OBJECTIVE: Our objectives are two-fold. The first is to design catalysts for phosphate transfer {hydrolysis} from phosphodiester. The second is to design molecules which catalyze DNA hydrolysis at specific sequences. Both objectives are directed to a better understanding of the mechanism of phosphodiester hydrolysis and the practical application of the gained knowledge in the study of the chemistry of DNA.

PROGRESS REPORT:

In the 2.5 years of support by the present grant we have accumulated results that constitute five completed manuscripts and have almost completed three others. Our progress will be discussed in terms of these manuscripts. The first paper (A) represents a study of the hydrolysis of our first designed phosphodiester which is set up for competing metal ion catalysis and nucleophilic catalysis by a nitrogen base. Papers B-H describe the synthesis of dien- and tren-microgonotropens and studies of their interactions with DNA.

The pH dependence of the hydrolysis of bis(8-hydroxyquinoline) phosphate and bis(6-hydroxyquinoline) phosphate {I and II, respectively} was studied in the absence and presence of varying concentrations of Ni^{2+} , Co^{2+} , Zn^{2+} , and Mn^{2+} .^A

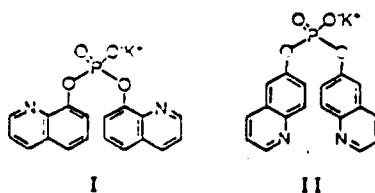

Since both diesters are characterized by having two quinoline nitrogens as basic centers and a negative phosphate, they exist, depending upon pH, as unprotonated, mono-, di-, and tri-protonated species {I⁻, IH, IH₂⁺, and IH₃²⁺ for bis(8-hydroxyquinoline) phosphate [Scheme I]; II⁻, IIH, IIH₂⁺, and IIH₃²⁺ for bis(6-hydroxyquinoline) phosphate}. The partial charges and basicity of the hydroxyl groups of 6- and 8-hydroxyquinoline are comparable. The electronic effect on the rate of hydrolysis brought about by protonation or metal ion complexing to the quinoline nitrogens should be the same for both bis(6-hydroxyquinoline) phosphate and bis(8-hydroxyquinoline) phosphate. Electronic effects upon hydrolytic rates can, therefore, be differentiated from catalysis by proximity effects by comparison of the hydrolytic rate constants of

Scheme I

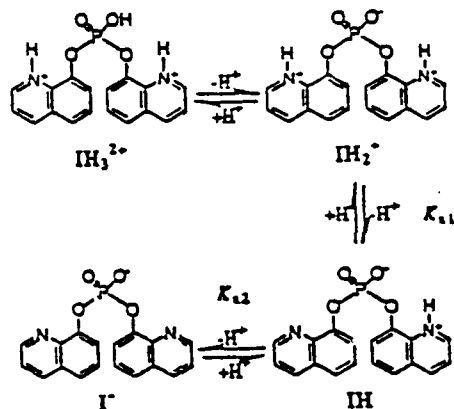

the two diesters. The bis(6-hydroxyquinoline) phosphate hydrolysis is: (i) quite slow (10^{-7} s^{-1}); (ii) pH independent from slightly acidic to neutral pH; and (iii) not catalyzed by the metal ions employed. On the other hand, the hydrolysis of bis(8-hydroxyquinoline) phosphate proceeds rapidly through spontaneous breakdown of IH. In accord with the mechanism of Scheme II, the hydrolysis of IH is: (i) not

Scheme II

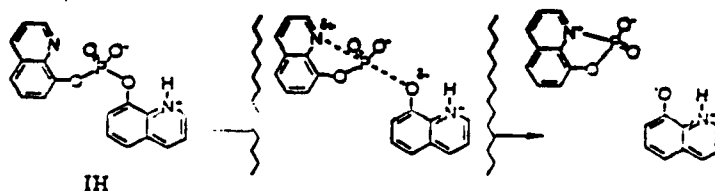

subject to buffer catalysis; (ii) exhibits no deuterium solvent kinetic isotope effect; and (iii) possesses a ΔS^\ddagger of 12 e.u. This mechanism provides a rate enhancement over the hydrolysis of the bis(6-hydroxyquinoline) phosphate of 1.1×10^3 . In the presence of metal ions the hydrolysis of the bis(8-hydroxy-quinoline) phosphate is first order in ester {I⁻ species} and Ni²⁺, Co²⁺ or Zn²⁺ (Mn²⁺ is not reactive). This mechanism provides, at 1 M in metal ion, rate enhancements over the spontaneous hydrolysis of IH of 4.7×10^4 for Ni²⁺, 1.2×10^4 for Co²⁺, and 1.3×10^4 for Zn²⁺. The rate enhancement brought about by the concerted nucleophilic attack of quinoline nitrogen and metal ion assistance to departure of the leaving group is ~ 1 to 5×10^7 at 1 M metal ion.

A rate enhancement of 10^7 M can explain most enzymatic reactions; however, the enzymatic hydrolysis of phosphodiester is different. To explain the kinetics of restriction enzymes one requires effective molarities of 10^{12} M.¹

Scheme III

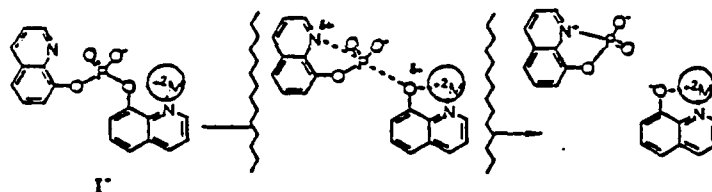

Exploration of the novel idea to employ a pyrrole nitrogen of a tri-pyrrole peptide minor groove binding agent to carry catalytic entities to the phosphates and major groove of DNA has been initiated with the synthesis of dien-microgonotropen-a, -b, and -c {5a, 5b and 5c}.^{B,C} In 5a, 5b and 5c the $-N[\text{CH}_2\text{CH}_2\text{CH}_2\text{N}(\text{CH}_3)_2]_2$

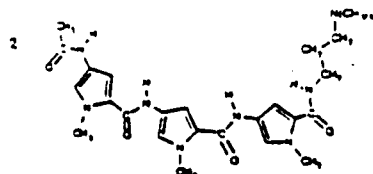
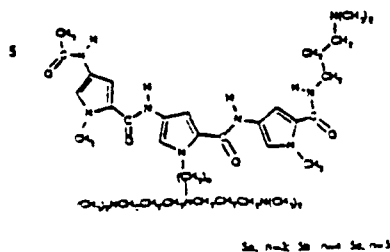

substituent should serve to hold a metal ion adjacent to a single phosphodiester linkage. The metal ions ligated by the $-N[CH_2CH_2CH_2N(CH_3)_2]_2$ moiety also may be bound to the PO^- of the phosphate ester or may act as a carrier of a nucleophilic hydroxyl group. In the absence of metal ions, the three (protonated) amino groups may interact by electrostatic forces and hydrogen bonding with the phosphodiester phosphates and also (as free base) play the role of nucleophile at the phosphate linkages. Replacing the carboxyl terminal amidine and amino terminal formyl functionalities of the natural product distamycin (**Dm**)² by $-CH_2N(CH_3)_2$ and acetyl substituents, respectively, provides **2**, which has greater stability in water than does **Dm**. The synthetic design allows the *N*-methyl

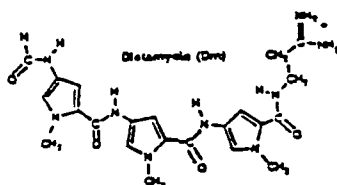

substituent on the central pyrrole of **2** to be replaced by connectors terminating in a dien ligand. The binding of **2**, **5a**, **5b** and **5c** to ctDNA, poly(dA-dT), and poly(dI-dC) has been explored. The specificity and affinity of binding of **5a**, **5b** and **5c** to the 5'-[³²P] 167 bp *Eco* RI/*Rsa* I restriction fragment of pBR322 was determined by DNase I footprint analysis of both 3'- and 5'-labeled strands. Specific inhibition of cleavage was observed at each of the four potential A+T-rich binding sites after pre-incubation with **5a**, **5b** and **5c** at concentrations as high as 50 μ M. Electrophoretic migration of *Hae* III restriction digest fragments of ϕ X-174-RF DNA after pre-incubation with **5a**, **5b** and **5c** was used to assess induction of gross conformational changes in DNA molecules. As the concentration of the agents increases, the effect of the agents in changing the conformation of DNA fragments decreases in the order **5c** > **5b** > **5a** >> **Dm** > Hoechst 33258. The dien-microgonotropens are much more effective in inducing changes than the sum of **Dm** and bis[3-(dimethylamino)propyl]methylamine parts. This is due to the unique relationship between the minor groove binding portion of the dien-microgonotropens and the electrostatic attraction of the covalently attached dien moiety to the phosphodiester backbone of DNA.

A quantitative methodology has been introduced to determine equilibrium constants for minor groove binding by dsDNA oligomers.^D The method is dependent upon the fact that Hoechst 33258 (Ht)³ fluoresces when bound in the minor groove of B-DNA while lexitropsins and dien-microgonotropens do not. Equilibrium constants were determined from competitive binding experiments with Ht at 35 °C. Equilibrium constants for the 1:1 and 1:2 complexing of the dsDNA hexadecamer d(GGCGCAAATTTGGCGG)/d(CCGCCAAATTTGCGCC) with dien-microgonotropen-a, -b and -c {5a, 5b, and 5c} have been compared to the same constants for the complexing of lexitropsins 2 and distamycin (Dm) as well as Ht {Scheme IV}. The equilibrium constants of Scheme IV were

Scheme IV

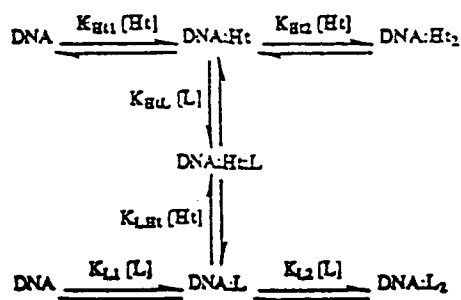

determined. Anticooperativity for complexing of 2 is marked by K_{L2} being an order of magnitude less than K_{L1} . The first and second bindings of 2 to the hexadecamer are between one and four orders of magnitude weaker than the comparable bindings of 5a, 5b, 5c, Dm, or Ht. For the latter, all second association constants $\{K_{\text{Ht2}}, K_{\text{HtL}}, K_{\text{L2}}, \text{ and } K_{\text{LHt}}\}$ are larger than the first association constants by ~ 1 to 3 orders of magnitude, indicating positive cooperativity. Although for 5a, 5b, 5c, Dm, or Ht the equilibrium constants for stepwise complexation of one and two L or Ht species varied, the calculated equilibrium constants for formation of DNA:L₂ or DNA:Ht₂ species ($K_{\text{L1}} \cdot K_{\text{L2}}$ or $K_{\text{Ht1}} \cdot K_{\text{Ht2}}$) were similar $\{(1 \text{ to } 20) \times 10^{16} \text{ M}^{-2}\}$ and 10^4 greater than the comparable constant for 2. The order of affinity is 5a \sim 5b \sim 5c > Ht > Dm \gg 2. Replacement of the triamine substituents of 5a, 5b, 5c with a methyl group provides 2. Thus it can be seen that the triamine substituents contribute substantially to dsDNA complexation of 5a, 5b, and 5c. The use of our methodology for determining sequential equilibrium constants for complexation to DNA is exemplified by the following experiment. The temperature dependence of Ht binding to the hexadecamer between 20 and 40 °C shows a critical temperature at ~ 32

°C. Cooperativity for Ht binding to hexadecamer duplex is 7 orders of magnitude greater below 30 °C ($\log K_{Ht1} = 3.9$, $\log K_{Ht2} = 12.8$) than above 30 °C ($\log K_{Ht1} = 7.6$, $\log K_{Ht2} = 9.1$) even though $\log K_{Ht1} \cdot K_{Ht2}$ is unchanged {Figure 1}. These results are attributed to a marked

Figure 1

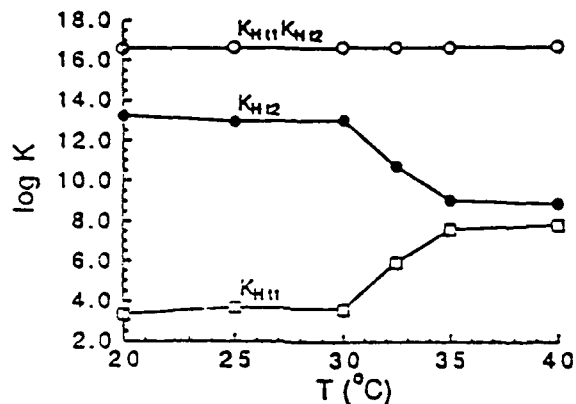

conformational change in the DNA:Ht₁ species.

The solution structures of $d(\text{CGCAAATTTGCG})_2$ and the 1:1 complex of $d(\text{CGCAAATTTGCG})_2$ with dien-microgonotropen-c (**5c**) have been determined by 1D and 2D ¹H NMR spectroscopy and restrained molecular modeling using the X-ray structure of $d(\text{CGCAAATTTGCG})_2$ as the point of departure.^E One hundred and two resonances for the free DNA and 196 for the DNA bound to **5c** were assigned. The 1D (DNA imino protons) and 2D (NOESY) spectra of the 1:1 complex show that there is an asymmetric type of binding in the A+T-rich region involving 5 base pairs (5'-A₆T₇T₈T₉G₁₀). The most stable structure of the $d(\text{CGCAAATTTGCG})_2$:**5c** complex has pyrrole rings A and B coplanar and in the minor groove, with pyrrole ring C out of plane by ~ 70° and out of the minor groove. A structure with pyrrole rings A, B coplanar and ring C out of plane by ~ 11° and in the minor groove {as in the structure of the distamycin DNA complex} is far less stable. This is due to the terminal dimethylpropylamino tail having a more favorable electrostatic interaction with phosphate (P11) of the phosphodiester backbone rather than in the minor groove. The energy barrier between the two bound **5c** conformations when removed from the DNA is but 2.5 kcal/mol in favor of the more coplanar structure. The dien polyamino

Figure 2

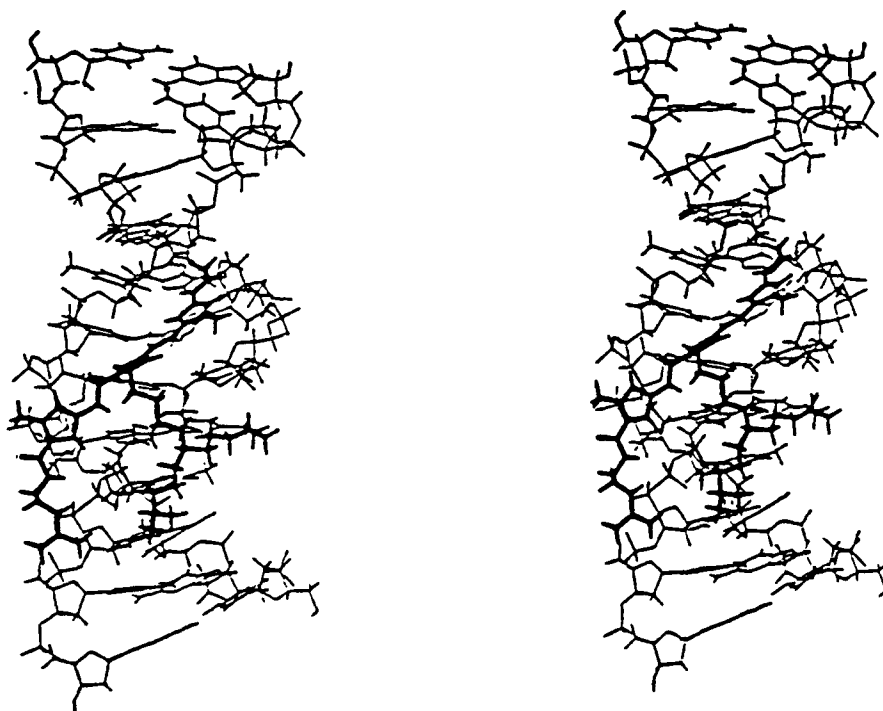
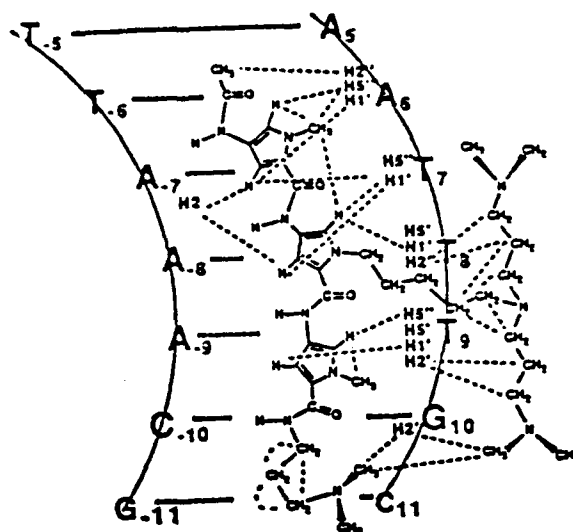
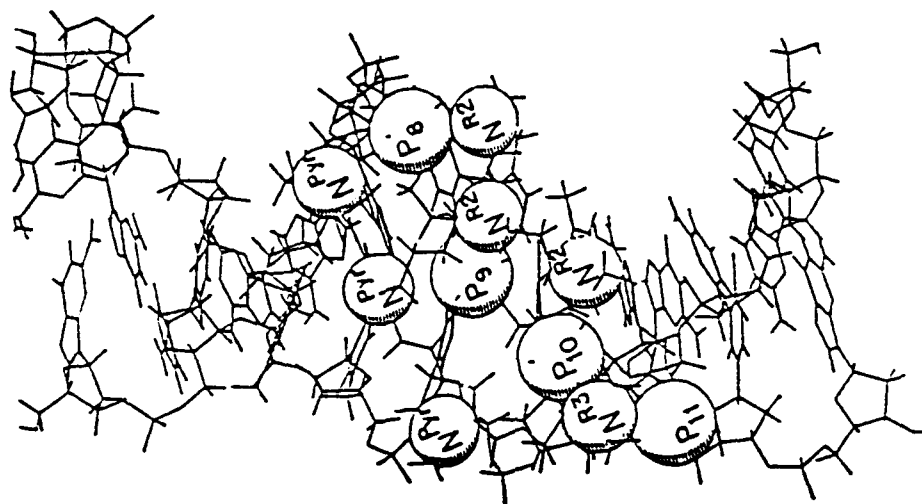

Figure 3

substituent residing on the nitrogen of pyrrole ring C runs above and along the phosphate backbone, towards the major groove. The protonated dien nitrogens reside on the edge of the major groove and pair with the phosphodiester linkages P8, P9, and P10 (Figure 4).

Figure 4



The off-rate of 5c from the 1:1 complex was found to be $1.3 \pm 0.2 \text{ s}^{-1}$, corresponding to an activation energy of 17 kcal/mol. The relative positions of the DNA proton signals change as 5c binds to the DNA. This is due, in part, to the widening of the minor groove (up to 3 Å) in the binding site. Compound 5c binds 5-7 Å from the bottom of the groove and 5-6 and 4-6 Å distant from the (-) and (+) strand, respectively. Comparisons with the crystallographic data of the same DNA with and without distamycin were made. Molecular modeling of the free and 5c bound DNA, based on NOE measurements, show that there is a break in the C_{2v} symmetry of the crystallized DNA as it goes into aqueous solution. A deviation of 1.8° from the two-fold axis of the crystallized DNA was found to occur at the A_6T_7 junction for the solution DNA, while only 0.3° was found for the solution DNA:5c complex. Upon solvation, the length of the duplex increases by 0.2 Å/bp for both the dodecamer and the 5c complexed dodecamer compared to crystal structures of the free DNA and distamycin complexed DNA.

We are within a few weeks of having all the experimental data for this paper.^F Tren-microgonotropen-a, and -b {which have been synthesized and characterized} differ in structure from the dien-microgonotropen-a, and -b in the replacement of the dien ligand of the latter by a tren ligand. The tren ligand has a much greater affinity for metal ions due to an additional secondary amino group. Thus, the tren- Ni^{2+} binding constant is about 10^{15} M^{-1} while the

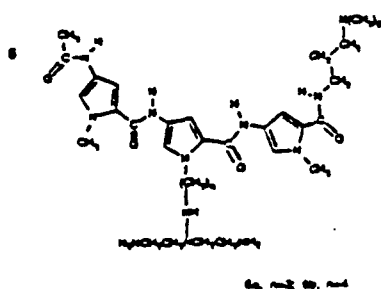

dien-Ni²⁺ binding constant is about 10⁸ M⁻¹.⁴ The footprinting results with tren-microgonotropen-a and -b is much comparable to the results with the dien analogs. Gel shifting is much more marked with the tren analogs, and this is attributable to the more favorable equilibrium constants for association of tren- compared to dien-microgonotropen-a and -b with DNA. Of particular interest is the protection of supercoiled DNA from modification by topoisomerase-I. Tren-microgonotropen-b at 30 μM provides complete protection to topoisomerase-I for over 18 hrs.

All 1D and 2D ¹H NMR data has been collected.^G We are about a month away from writing a paper. All data analysis and computer calculations are not yet complete.

Dien-microgonotropen-c (**5c**), tren-microgonotropen-b (**6b**) and distamycin (**Dm**) bind in the minor groove at the A=T rich region of d(CGCAAATTTGCG)₂ (oligo 12) to form 1:1 (with **5c** and **6b**) and 4:1 (with **Dm**) complexes.^H A 10-20% concentration excess of **5c** and **6b** is a requirement for complete formation of their 1:1 binding complexes with oligo 12. Dien-microgonotropen-c binds 2:1 to an asymmetrical hexadecamer (oligo 16) containing the same A=T binding site as

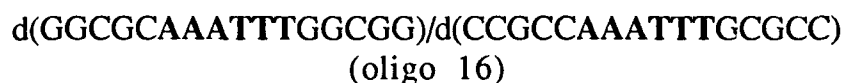

oligo 12. On increase in [**Dm**] to 75% mol excess over oligo 12 there exists in solution a mixture of 4:1 complex, 2:1 complex, and free DNA. Hoechst 33258 displaces the two **5c** molecules bound to oligo 16 by binding simultaneously to the unoccupied A=T region of the opposite strand. Molecular modelling shows that there is a possibility for the A₆T₇ junction to completely lose its hydrogen bonding or to change from Watson-Crick to Hogsteen base pairing.

REFERENCES

Work Supported by this Grant:

- A). Browne, K. A.; Bruice, T. C. Chemistry of Phosphodiester, DNA and Models. II. The Hydrolysis of Bis(8-hydroxyquinoline) Phosphate in the Absence and Presence of Metal Ions, *J. Am. Chem. Soc.* **1992**, 114, 4951.
- B). Bruice, T.C.; Mei, H.-Y.; He, G.-X.; Lopez, V. Rational Design of Substituted Tripyrrole Peptides that Complex with DNA by both Selective Minor-groove Binding and Electrostatic Interaction with the Phosphate Backbone, *Proc. Natl. Acad. Sci. (USA)* **1992**, 89, 1700.
- C). He, G.-X.; Browne, K.A.; Groppe, J. C.; Blaskó, A.; Mei, H.-Y.; Bruice, T.C. Microgonotropens and Their Interactions with DNA. I. Synthesis of the Tri-pyrrole Peptides Dien-Microgonotropen -a, -b, and -c and Characterization of Their Interactions with dsDNA, *J. Am. Chem. Soc.* In Press for Summer 1993.
- D). Browne, K. A.; He, G.-X.; Bruice, T. C. Microgonotropens and Their Interactions with DNA. II. Quantitative Evaluation of Equilibrium Constants for 1:1 and 2:1 Binding of Dien-Microgonotropen-a, -b, -c as well as Distamycin and Hoechst 33258 to d(GGCGCAAATTTGGCGG)/d(CCGCCAAATTTGCGCC), *J. Am. Chem. Soc.* In Press for Summer 1993.
- E). Blaskó, A.; Browne, K.A.; He, G.-X., Bruice, T. C. Microgonotropens and Their Interactions with DNA. III. Structural Analysis of the 1:1 Complex of d(CGCAAATTTGCG)₂ and Dien-Microgonotropen-c by 2D NMR Spectroscopy and Restrained Molecular Modeling, *J. Am. Chem. Soc.* In Press for Summer 1993.
- F). He, G.-X.; Browne, K.A.; Groppe, J. C.; Blaskó, A.; Bruice, T.C. Microgonotropens and Their Interactions with DNA. IV. Synthesis of Tren-Microgonotropen-a, and -b and Characterization of Some Interactions with dsDNA, *J. Am. Chem. Soc.* In Preparation
- G). Blaskó, A.; Browne, K.A.; Bruice, T. C. Microgonotropens and Their Interactions with DNA. V. The Solution Structure of the

1:1 Complex of d(CGCAAATTTGCG)₂ and Tren-Microgonotropen-
b by 2D ¹H NMR Spectroscopy and Restrained Molecular
Modeling, *J. Am. Chem. Soc.* Submitted.

H). Blaskó, A.; Bruice, T. C. Stoichiometry and Structure of
Complexes of DNA Fragments with Microgonotropens and
distamycin by ¹H NMR Spectroscopy and Molecular Modeling,
Proc. Natl. Acad. Sci. (USA) To be Submitted.

I). Ö Almarsson, T. C. Bruice, J. Kerr and R. Zuckermann,
Molecular Mechanics Calculations of the Structures of
Polyamide Nucleic Acid DNA Duplexes and Triple Helical
Hybrids, *Proc. Natl. Acad. Sci. (USA)*, In Press (1993).

J). A. Blaskó and T.C. Bruice, Stoichiometry and Structure of
Complexes of DNA Oligomers with Microgonotropens and
Distamycin by ¹H NMR Spectroscopy and Molecular Modeling,
Proc. Natl. Acad. Sci. (USA), Submitted (1993)

Other References:

1. Carroll, S. S.; Benkovic, S. J. *Chem. Rev.* **1990**, 90, 1291.
2. The *Merck Index*, 11th Edition, 1989, pp 1383.
3. Pjura, P. E.; Grzeskowiak, K.; Dickerson, R. E. *J. Mol. Biol.*
1987, 197, 257.
4. (a) Goldberg, D. E.; Fernelius, W. C. *J. Phys. Chem.* **1959**, 63,
1328. (b) Prue, J. E.; Schwarzenbach, G. *Helv. Chim. Acta.*
1950, 33, 963.