

AD-A265 852



2

NPSEC-93-011

NAVAL POSTGRADUATE SCHOOL
Monterey, California

DTIC
ELECTE
JUN 16 1993
S A D



Design of a Continuous Resistively
Loaded Monopole Antenna

by

Darwish Abd El Aziz Mohamed
Ramakrishna Janaswamy

May 1, 1993

Approved for public release; distribution unlimited.

93-13565



56

5116

Naval Postgraduate School
Monterey, California 93943-5000

Rear Admiral T. A. Mercer
Superintendent

H. Schull
Provost

This report was prepared for and funded by the U. S. Army Communications and Electronics Command.

Reproduction of all or part of this report is authorized.

This report was prepared by:

R. Janaswamy

RAMAKRISHNA JANASWAMY
Associate Professor of
Electrical and
Computer Engineering

Reviewed by:

Released by:

M. A. Morgan

MICHAEL A. MORGAN
Chairman,
Department of Electrical and
Computer Engineering

P. J. Marto

PAUL J. MARTO
Dean of Research

REPORT DOCUMENTATION PAGE

Form Approved
OMB No. 0704-0188

Public reporting burden for this collection of information is estimated to average 1 hour per response, including the time for reviewing instructions, searching existing data sources, gathering and maintaining the data needed, and completing and reviewing the collection of information. Send comments regarding this burden estimate or any other aspect of this collection of information, including suggestions for reducing this burden, to Washington Headquarters Services, Directorate for Information Operations and Reports, 1215 Jefferson Davis Highway, Suite 1204, Arlington, VA 22202-4302, and to the Office of Management and Budget, Paperwork Reduction Project (0704-0188), Washington, DC 20503.

1. AGENCY USE ONLY (Leave blank)		2. REPORT DATE 1 May 1993	3. REPORT TYPE AND DATES COVERED Interim Report 1 Jan 93-1 May 93	
4. TITLE AND SUBTITLE Design of a Continuous Resistively Loaded Monopole Antenna			5. FUNDING NUMBERS	
6. AUTHOR(S) Darwish Abd El Aziz Mohamed and Ramakrishna Janaswamy				
7. PERFORMING ORGANIZATION NAME(S) AND ADDRESS(ES) Naval Postgraduate School Monterey, CA 93943-5000			8. PERFORMING ORGANIZATION REPORT NUMBER NPSEC-93-011	
9. SPONSORING / MONITORING AGENCY NAME(S) AND ADDRESS(ES) U.S. Army CECOM Center for C ³ Systems Fort Monmouth, NJ 07703			10. SPONSORING MONITORING AGENCY REPORT NUMBER	
11. SUPPLEMENTARY NOTES The views expressed in this report are those of the authors and do not reflect the official policy or position of the Department of Defense or the United States Government.				
12a. DISTRIBUTION / AVAILABILITY STATEMENT Approved for public release; distribution unlimited.			12b. DISTRIBUTION CODE	
13. ABSTRACT (Maximum 200 words) Hallen's integral equation with continuous resistive loading is used to design a broadband monopole antenna. The resistive profile is different from that of the well known Wu-King profile and results in a higher efficiency compared to the latter. An optimization function for determining the optimal continuous resistive load of the monopole antenna in order to satisfy the broadband property is constructed. Simplex method is used to perform the optimization. The integral equation is solved by the moment method to determine the current distribution, the efficiency, and the radiation pattern of the monopole.				
14. SUBJECT TERMS			15. NUMBER OF PAGES 30	
			16. PRICE CODE	
17. SECURITY CLASSIFICATION OF REPORT UNCLASSIFIED	18. SECURITY CLASSIFICATION OF THIS PAGE UNCLASSIFIED	19. SECURITY CLASSIFICATION OF ABSTRACT UNCLASSIFIED	20. LIMITATION OF ABSTRACT SAR	

ABSTRACT

Hallen's integral equation with continuous resistive loading is used to design a broadband monopole antenna. The resistive profile is different from that of the well known Wu - King profile and results in a higher efficiency compared to the latter. An optimization function for determining the optimal continuous resistive load of the monopole antenna in order to satisfy the broadband property is constructed. Simplex method is used to perform the optimization. The integral equation is solved by the the moment method to determine the current distribution, the efficiency and the radiation pattern of the monopole.

Accession for	
NTIS (CR&I)	<input checked="" type="checkbox"/>
DTIC (AD)	<input type="checkbox"/>
Unannounced	<input type="checkbox"/>
Justification	
By	
Date	
Approved	
DA	Approved
A-1	

1- INTRODUCTION

A straight wire antenna of fixed length is narrowband due to the rapid variations in its input impedance, and to a lesser degree, in its radiation pattern. A wire antenna is however, light weight, easy to fabricate and simple to mount on any platform. Traveling wave antennas are desirable for purposes of broadband and directional communication. A traveling wave antenna may be obtained by introducing dissipative elements into the antenna system. The introduction of lossy elements will cause a decrease in the efficiency. Altshuler [1] found that a traveling wave could be maintained along a part of a thin cylindrical monopole, if a resistive loading of appropriate magnitude is inserted $1/4$ wavelength from the monopole end. Wu. and King [2] found that if the antenna is made of resistive material so that the internal impedance per unit length, is a particular function of the position along the antenna, a pure outward traveling wave can exist on an antenna of finite length. An attempt had been made by Janaswamy [3] to design a broadband monopole antenna by using the continuous resistive profile proposed by Wu-King. However the Wu-King profile results in a low radiation efficiency. In order to design a monopole wire antenna that has a broadband property and has at the same time higher radiation efficiency than that obtained using the Wu-King profile, we consider a modified Wu-King profile and incorporate it into Hallen's integral equation [4]. The solution of the integral equation will depend upon the loading impedance. We construct a real function which assumes a minimum value when the broadband property is reached. FORTRAN programs are developed for solving the integral equation of the antenna as well as for determining the optimized load impedance. A comparison is made between the performance of the monopole loaded with Wu-King profile and that of the monopole loaded with the optimum profile.

2- FORMULATION OF THE PROBLEM

For thin monopole wire antenna, the current distribution was assumed to be of sinusoidal form. For a finite diameter wire, the sinusoidal current distribution is not exact. To find the current distribution for a cylindrical antenna, an integral equation can be derived [5]. All other antenna properties can be deduced once the current distribution along the wire antenna has been determined. We present a brief outline of the integral equation below.

Consider a thin, cylindrical monopole of radius a and length h , center driven by a delta -function generator of voltage V_δ at the angular frequency ω . Let the monopole be situated in vacuum, have an internal impedance per unit length Z_1 , which could be a function of position along the monopole. The notation used is as follows

$E_z(z)$: the tangential component of \vec{E} at a point z on the antenna surface.

$I(z)$: the current intensity at the same point.

$Z_1(z)$: the internal impedance per unit length of the antenna.

We then have

$$E_z(z) = Z_1(z) I(z) \quad (1)$$

Also, $E_z(z)$ can be expressed in terms of the vector magnetic potential \vec{A} which has only, a z - component A_z , as

$$E_z(z) = -j \omega \left[1 + \frac{1}{k^2} \frac{d^2}{dz^2} \right] A_z(z) \quad (2)$$

Equating (1) and (2), we obtain on the antenna surface that

$$\frac{d^2}{dz^2} A_z(z) + k^2 A_z(z) = \frac{j k^2}{\omega} Z_1(z) I(z) \quad (3)$$

where, $k = \omega \sqrt{\mu_0 \epsilon_0}$

The particular solution of equation (3), is

$$A_{z_p}(z) = j \frac{k}{\omega} \int_0^z Z_1(\bar{z}) I(\bar{z}) \sin k(z-\bar{z}) d\bar{z} \quad (4)$$

The homogeneous solution of equation (3) and corresponding to the condition $A_z(-z) = A_z(z)$ and to a driving voltage V_δ is

$$A_{z_h}(z) = \frac{-j k}{\omega} \left[D \cos kz + \frac{V_\delta}{2} \sin k|z| \right] \quad (5)$$

where D is a constant to be determined. Combining the particular and homogeneous solutions, the solution of the differential equation (3) is obtained as

$$\begin{aligned}
A_z(z) &= A_{zh}(z) + A_{zp}(z) \\
&= \frac{-j k}{\omega} \left[D \cos kz + \frac{V_\delta}{2} \sin k|z| \right] \\
&\quad + j \frac{k}{\omega} \int_0^z Z_1(\bar{z}) I(\bar{z}) \sin k(z-\bar{z}) d\bar{z} \quad (6)
\end{aligned}$$

If the antenna considered is thin, i.e. if $h \gg a$, the vector potential, $A_z(z)$ can be expressed in terms of $I(z)$ as [5]

$$A_z(z) = \frac{\mu_0}{4\pi} \int_0^h I(\bar{z}) \left[\frac{e^{-jkR_1}}{R_1} + \frac{e^{-jkR_2}}{R_2} \right] d\bar{z} \quad (7)$$

where,

$$\begin{aligned}
R_1 &= \left[(z - \bar{z})^2 + a^2 \right]^{1/2} \\
R_2 &= \left[(z + \bar{z})^2 + a^2 \right]^{1/2} \quad (8)
\end{aligned}$$

Combining equations (6) and (7), an integral equation for the current $I(z)$ is obtained, where

$$\begin{aligned}
\int_0^h I(\bar{z}) \left[\frac{e^{-jkR_1}}{R_1} + \frac{e^{-jkR_2}}{R_2} \right] d\bar{z} \\
- \frac{j}{\zeta_0} \int_0^z Z_1(\bar{z}) I(\bar{z}) \sin k(z-\bar{z}) d\bar{z} \\
+ C \cos kz = -j \frac{V_\delta}{2 \zeta_0} \sin k|z| \quad (9)
\end{aligned}$$

where, $\zeta_0 = \sqrt{\mu_0 / \epsilon_0}$ is the intrinsic impedance of vacuum and C is a new constant. equation (9) is the Hallen's integral equation for the current distribution of the loaded monopole antenna.

3- METHOD OF SOLUTION

Moment method techniques [4] will be used to solve the integral equation (9). The current I_z is expanded in terms of N piecewise linear subdomain basis functions, as

$$I_z(\bar{z}) = \sum_{n=1}^N I_n G_n(\bar{z}) \quad (10a)$$

$$G_n(z') = \begin{cases} \frac{\bar{z} - \bar{z}_{n-1}}{\bar{z}_n - \bar{z}_{n-1}} & \bar{z}_{n-1} \leq \bar{z} \leq \bar{z}_n \\ \frac{\bar{z}_{n+1} - \bar{z}}{\bar{z}_{n+1} - \bar{z}_n} & \bar{z}_n \leq \bar{z} \leq \bar{z}_{n+1} \\ 0 & \text{elsewhere} \end{cases} \quad (10b)$$

Also, the internal impedance per unit length Z_i is assumed to be of the form

$$Z_i(z) = \frac{1}{h-z} \sum_{m=1}^M Z_m^2 (z/h)^{m-1} \quad (11)$$

In comparison the Wu-King profile is of the form

$$Z_i^{wk}(z) = \frac{R_0}{h-z}$$

where R_0 depends on ka and kh . Substituting (10) and (11) into (9) yields

$$\begin{aligned} & \sum_{n=1}^N I_n \int_0^h G_n(\bar{z}) \left[\frac{e^{-jkR_1}}{4\pi R_1} + \frac{e^{-jkR_2}}{4\pi R_2} \right] d\bar{z} \\ & -j \frac{1}{\zeta_0} \sum_{n=1}^N I_n \int_0^z \sum_{m=1}^M \frac{1}{h-z} (Z_m)^2 (\bar{z}/h)^{j-1} G_n(\bar{z}) \sin k(z-\bar{z}) d\bar{z} \\ & + C \cos kz = -j \frac{V_0}{2\zeta_0} \sin k|z| \end{aligned} \quad (12)$$

which can be written in a simple form as

$$\sum_{n=1}^N I_n A_n(z) + \sum_{n=1}^N \sum_{m=1}^M I_n Z_m B_{nm}(z) + C \cos kz = -j \frac{V_0}{2 \zeta_0} \sin k|z| \quad (13)$$

where,

$$A_n(z) = \int_0^h G_n(\bar{z}) \left[\frac{e^{-jkR_1}}{4\pi R_1} + \frac{e^{-jkR_2}}{4\pi R_2} \right] d\bar{z} \quad (14)$$

$$B_{nm}(z) = -j \frac{1}{\zeta_0} \int_0^z \frac{1}{h-\bar{z}} (\bar{z}/h)^{m-1} G_n(\bar{z}) \sin k(z-\bar{z}) d\bar{z} \quad (15)$$

To determine the coefficients I_n , $n = 1, 2, \dots, N$ and the unknown C , we will use the point matching method which will result in $(N+1)$ linear equations of the form

$$\sum_{n=1}^N I_n \left[A_n(z_p) + \sum_{m=1}^M Z_m B_{nm}(z_p) \right] + C \cos kz_p = -j \frac{V_0}{2 \zeta_0} \sin k|z_p| \quad (16)$$

$p = 1, 2, 3, \dots, N+1$

Solution of this system of equations can be considered as function of the M parameters Z_m .

4- THE OPTIMIZATION FUNCTION

A broadband monopole antenna in admittance can be synthesized by minimizing a convenient optimization function. An optimization function is constructed which includes the current distribution parameters I_n , and which is minimized by varying the values of the impedance parameters Z_m . The proposed optimization function includes values of both the admittance as well as of the radiation efficiency weighted differently. We construct the optimization function as:

$$F(Z_1, Z_2, \dots, Z_M) = W_{Y_{in}} \sum_{n=1}^{n_f} |Y_{in}(f_n) - Y_{ref}|^2 + W_{\zeta} \sum_{n=1}^{n_f} |\zeta(f_n) - \zeta_{ref}|^2 \quad (17)$$

where,

n_f is a number of spot frequencies in the desired frequency range

$Y_{in}(f_n)$ is the input admittance of the monopole antenna at frequency f_n , and it is equal to

$$Y_{in}(f_n) = 2 I_1(f_n) / V_0 \quad (18)$$

$\xi(f_n)$ is the radiation efficiency at frequency f_n , and it is equal to

$$\xi(f_n) = 1 - P_{loss} / P_{in}, \text{ where}$$

$$P_{in}(f_n) = \frac{1}{2} |I_1(f_n)|^2 R_{in}(f_n), \quad (19)$$

$$P_{loss}(f_n) = \frac{1}{2} \int_0^h Z_i(\bar{z}) |I(\bar{z})|^2 d\bar{z} \quad (20)$$

Y_{cref} is the reference admittance in the desired frequency range, which we take as the average of $Y_{in}(f_n)$ over f_n .

ξ_{cref} is the reference efficiency in the desired frequency range, which we take as the average of $\xi(f_n)$ over f_n .

$W_{Y_{in}}$ and W_{ξ} are the weights for the admittance and efficiency respectively.

The Simplex method of optimization [5] is used for determining the coefficients (Z_m) of the internal impedance by minimizing the optimization function given in (17). The Simplex (body in multi-dimensional space) optimization method computes the values of the optimization function at the vertices of a simplex in the parameter space, and on the bases of these values chooses a new, presumably smaller simplex within which an optimum should be situated. The number of the vertices of the simplex is equal to the number of parameters plus 1. Here we chose $M = 4$ thus, resulting in five vertices (X_0, X_1, X_2, X_3, X_4), where X_i is a vector of the impedance coefficients (Z_1, Z_2, Z_3, Z_4). We have used coefficients corresponding to the Wu - King profile as one of the starting vectors needed to accomplish the optimization.

5- DESIGN OF THE MATCHING NETWORK

Once a resistive profile has been determined, we design a matching network to make the antenna even more broadband. We have designed a matching network using the EESOF (ESYN / TOUCHSTONE) circuit design code [7]. The matching network is a 2-port device inserted between the source with 50 ohm source resistance and the designed monopole antenna. First a matching network was synthesized and

optimized using the program ESYN with lossless lumped elements. Then the synthesized matching network was simulated and further optimized using TOUCHSTONE program but with lossy elements with Q-factor equal to 75. Two matching networks are then synthesized. Two matching networks have also been designed for the monopole loaded with Wu - King profile.

6- RESULTS

For a monopole of length $h = 1.5$ m and radius $a = 0.5$ cm operating over the frequency range 30 - 90 MHz, a FORTRAN program was developed in order to solve the integral equation (16) subject to minimize the optimization function (17) with respect to the coefficients Z_m of the resistive loading impedance. The number of the coefficients Z_m was taken as $M = 4$ and the current distribution was expanded using $N = 10$ basis functions. Different optimal loadings were determined for different permissible values of the optimization function (17), where the broadband property was satisfied. A flat input impedance can be obtained at the expense of the radiation efficiency and vice versa. the optimized resistive load is the one which satisfies the good broadband property and at the same time gives a high antenna radiation efficiency. The optimum load was found with equal weights ($V_{y,n} = V_{\xi} = 1$) to be :

$$Z_l(z) = \frac{1}{h-z} \sum_{m=1}^4 Z_m^2 (z/h)^{m-1} \quad (21)$$

where,

$$\begin{array}{ll} Z_1 = 6.41 & , \\ Z_2 = 2.95, & \\ Z_3 = -13.49 & , \\ Z_4 = 6.81 & \end{array}$$

For the considered monopole ($h = 1.5$ m, $a = 0.5$ cm), Wu - King profile was calculated at the geometric mean frequency of 51.96 MHz. It is

$$Z_l^{WK}(z) = \frac{564.64 - j 148.67}{h-z} \quad \text{ohm/m} \quad (22)$$

For implementation we use only the resistive part. Fig.1 shows the variation of the resistive loading of the optimum load compared with that for Wu - King profile. It is clear from the figure that the internal resistance R_l per unit length for the Wu-King profile is higher compared to the optimum loading. Table (1) shows the variation of the input impedance of the

monopole loaded with the optimum load compared with that of the monopole loaded with Wu and King profile [3]. It can be seen from Fig.2 that the input resistance R_{in} for the monopole with the Wu - King profile is quite flat whereas the one using the optimum load varies from 54.4 ohm at 30 MHz to 343.9 ohm at 90 MHz. Also from Fig.3, it is clear that the input reactance is capacitive for the Wu-King profile over the entire frequency range and has a little change while for the case of the optimum load there is a resonance at 52.7 MHz. Fig.4 shows the main disadvantage of using Wu - King profile : lower value of the radiation efficiency ξ . It can be seen that the maximum value of ξ for the monopole loaded with Wu - King profile is 11.85 % (at 90 MHz) which is less than the minimum value of ξ for the monopole loaded with optimum load, where ξ changes from 15.83 % at 30 MHz to 39.74 % at 90 MHz. Table (2) shows the variation of the efficiency with the frequency for the optimum load compared with that for Wu - King load. The WIRE software program [6] has been used to determine the radiation pattern of the designed monopole using lumped equivalent loading. Fig.5 shows the radiation pattern at frequency 70 MHz for the case of the optimum load. Table.3 summarizes the scattering parameters of the designed matching networks using lossless lumped elements for the two impedance profiles. Fig.6 shows the S_{11} parameter variation across the frequency range and Fig.7 shows that the VSWR for the optimum profile is less than 2 all over the operating frequency. Also it is clear from Fig.8 that the gain (S_{21}) is greater than 0.94 across the frequency band. The overall efficiency of the monopole ($\xi \times |S_{21}|^2$) for the two cases of loading is shown in Fig.9. It can be seen from this figure that the overall efficiency of our design has improved significantly compared to the Wu - King profile. To be the matching networks realizable, the previously designed networks are further optimized using TOUCHSTONE code by making the inductors and capacitors lossy with a Q factor value of 75. Table.4 summarizes the scattering parameters of the designed matching networks obtained using lossy lumped elements. Figs.10, 11 show the variation of the S - parameters across the frequency range for the lossy matching network case. Figs.12 and 13 show the VSWR and the overall efficiency for the lossy matching networks. It is seen that even with lossy elements the present design yields an input VSWR < 2 while still maintaining a high overall efficiency compared to the Wu - King case. Fig.14 shows the topology and element values of the matching network for the optimum loading, while Fig.15 shows the circuit diagram for the

matching network which corresponds to The Wu - King profile.

7- CONCLUSION

It was shown that efficient optimization of wire-antenna admittance can be performed by varying distributed loadings along its length. Depending upon specific requirements on the wire - antennas, it is possible to construct many optimization functions by changing the values of the weights W_{1n} and W_z . The choice of the values of W_{1n} and W_z depends upon the specific requirements of whether a broadband input admittance or overall efficiency is desired. The decision on terminating the optimization procedure depends on the goal of the antenna synthesis process. This report has introduced a new loading to improve the efficiency of a broadband monopole. A matching network was synthesized in order to maintain good impedance matching such that the VSWR is less than 2 across the required frequency band.

REFERENCES

- [1] Altshuler, E. E., "The Traveling-Wave Linear Antenna," IRE. Trans. Ant. Prop. AP-9, No. 4, pp. 324-329, 1961.
- [2] Wu, T. T and R. W. P. King, "The Cylindrical Antenna With Non Reflecting Resistive Loading, " IEEE Trans. Ant. Prop., AP-13, No. 3, pp. 369-373, 1965.
- [3] Janaswamy, R., "Widebanding Techniques For VHF Antennas-I," Naval Postgraduate School, Monterey, Report # NPS-EC 010, 1992.
- [4] Balanis, C. A., Antenna Theory Analysis And Design, Harper and Row, Inc., 1982.
- [5] B. D. Popovic, M. B. Dragovic and A. R. Djordjevic, Analysis and Synthesis of Wire Antennas, Research Studies Press, England, 1982.
- [6] Davis, W. A., WIRE Program, Virginia Polytechnic Institute and State Univ., 1980.
- [7] EESOF, Inc., Touchstone User's Manual, 1986.

TABLE 1. THE INPUT IMPEDANCE OF LOADED MONOPOLE

FREQUENCY MHz	INPUT IMPEDANCE UNLOADED	INPUT IMPEDANCE OPTIMUM LOAD	INPUT IMPEDANCE WU-KING LOAD
30	9.47-j196.03	54.65-j 203.37	252.85-j 305.60
40	20.16-j 80.47	75.98-j 96.28	254.51-j 241.49
50	40.76+j 17.53	112.19-j 18.23	253.09-j 209.85
60	84.49+j120.62	171.58+j 36.96	248.56-j 188.14
70	193.44+j242.89	256.88+j 51.89	241.91-j 174.81
80	502.85+j310.63	336.08-j 02.04	234.43-j 164.34
90	789.49-j196.58	343.98-j 98.20	227.13-j 155.28

$h = 15 \text{ m} , a = 0.5 \text{ cm}$

TABLE 2. SCATTERING PARAMETERS OF THE LOADED MONOPOLE
WITH LOSSLESS MATCHING NETWORK

FREQUENCY MHz	OPTIMUM LOAD		WU - KING LOAD	
	S11	S21	S11	S21
30	0.335	0.942	0.036	0.999
40	0.299	0.954	0.019	1.000
50	0.273	0.962	0.019	1.000
60	0.217	0.976	0.029	1.000
70	0.210	0.978	0.014	1.000
80	0.169	0.986	0.034	0.999
90	0.184	0.983	0.033	0.999

$h = 1.5 \text{ m} , a = 0.5 \text{ cm}$

TABLE 3. SCATTERING PARAMETERS OF THE LOADED MONOPOLE
WITH LOSSY MATCHING NETWORK

FREQUENCY MHz	OPTIMUM LOAD		WU - KING LOAD	
	S ₁₁	S ₂₁	S ₁₁	S ₂₁
30	0.259	0.882	0.133	0.918
40	0.265	0.918	0.116	0.939
50	0.243	0.930	0.058	0.947
60	0.193	0.941	0.038	0.946
70	0.187	0.937	0.066	0.938
80	0.153	0.935	0.058	0.932
90	0.201	0.913	0.071	0.922

$h = 1.5 \text{ m}$, $a = 0.5 \text{ cm}$

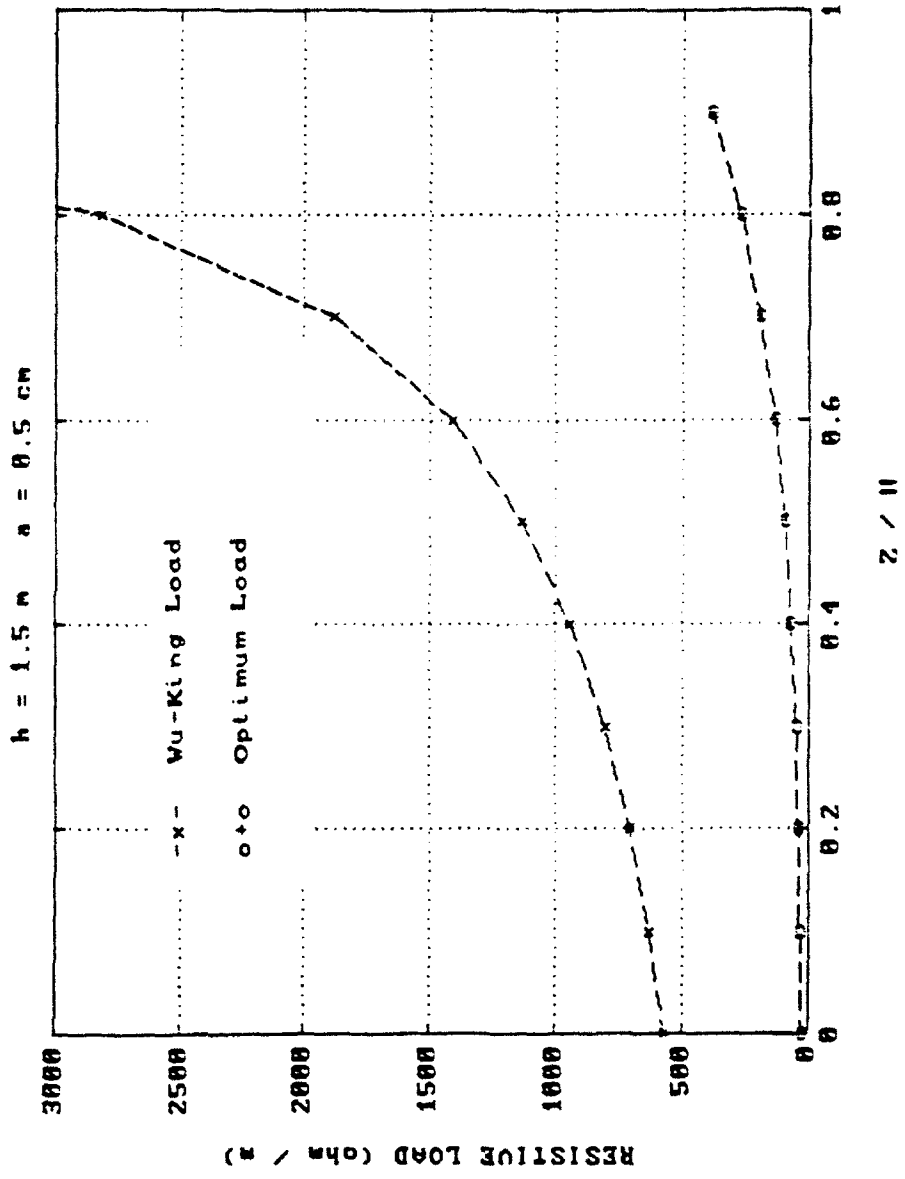

Fig. 1 Variation of the resistive load along the monopole length

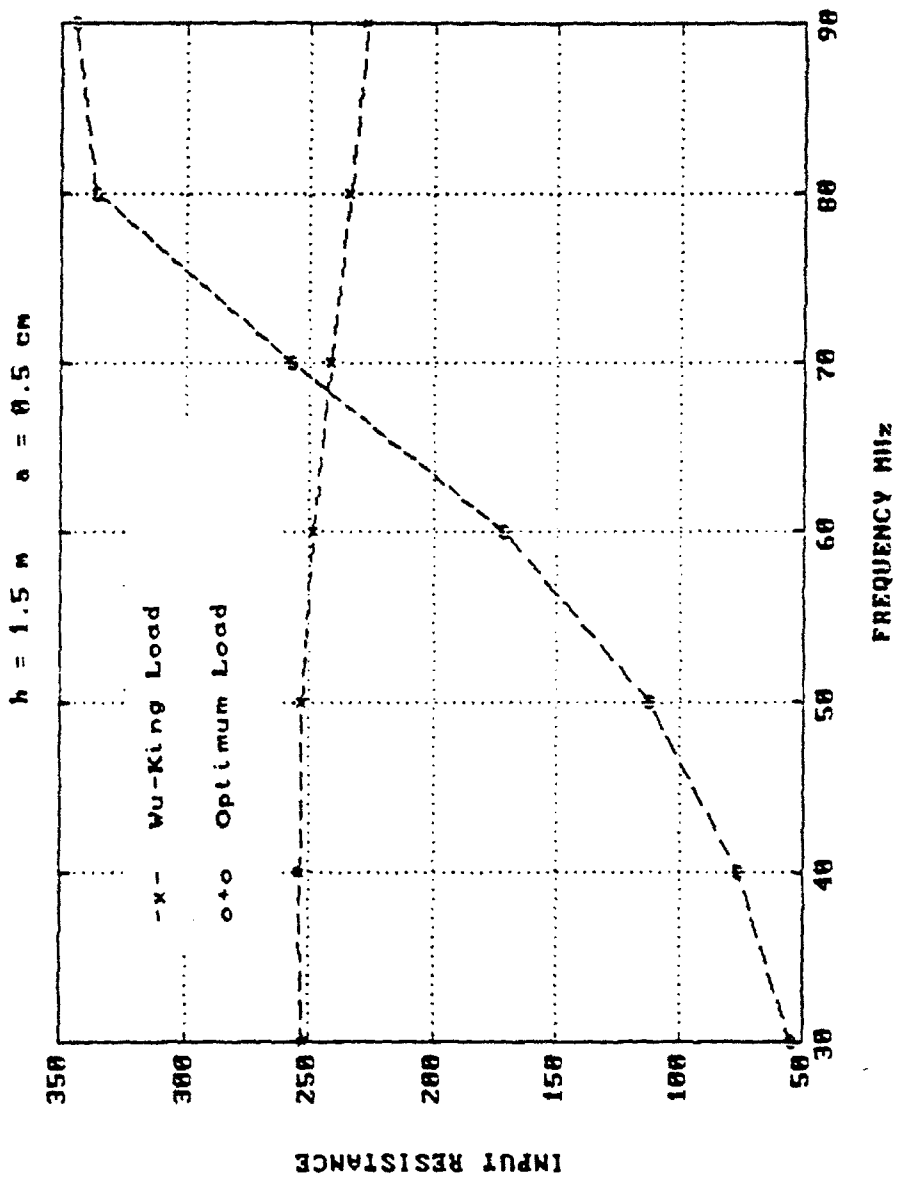

Fig. 2 Input Resistance Variation Against The Frequency

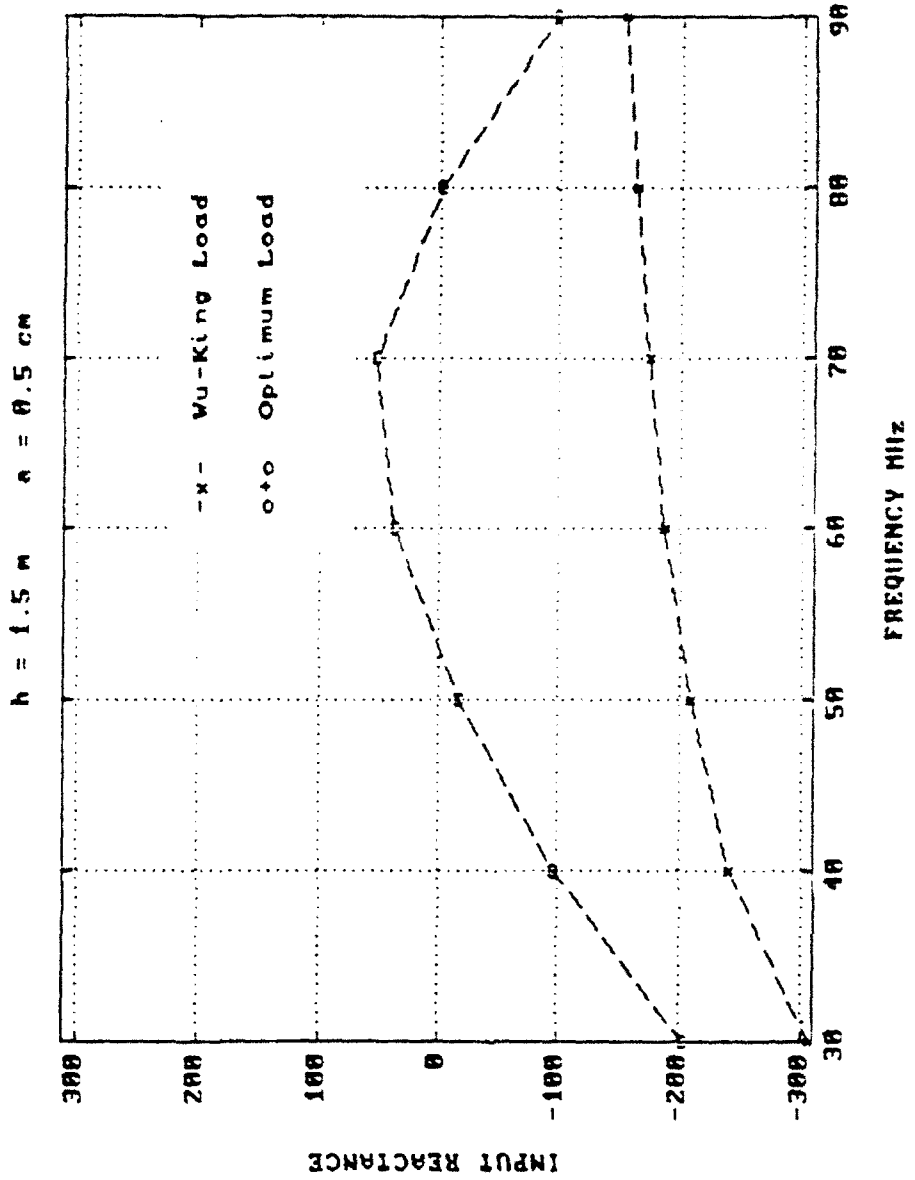

Fig. 3 Input Reactance Variation Versus Frequency

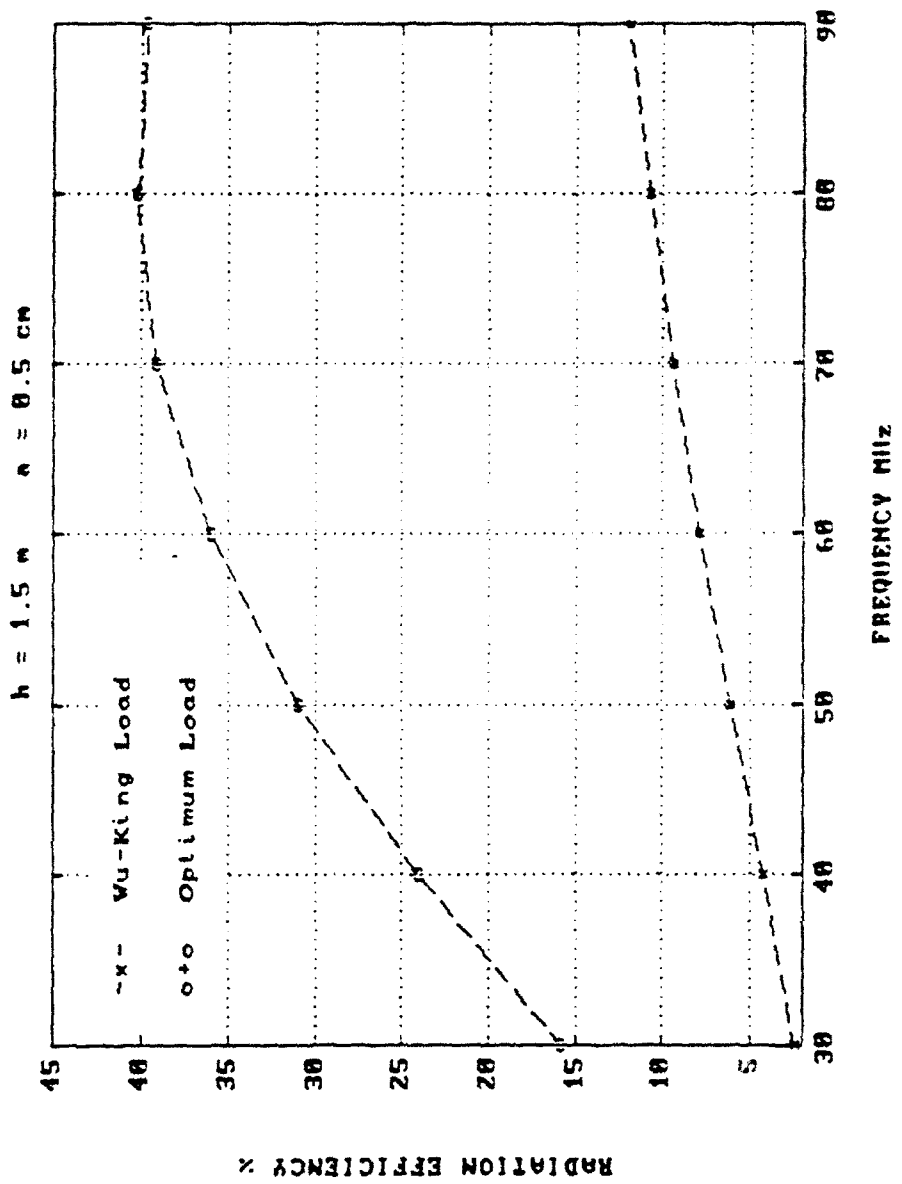

Fig. 4 The Antenna Radiation Efficiency As A Function Of Frequency

Patterns - Vertical Cut 0 Deg
Horizontal - solid : Max = -9.990E+0002 dB
Vertical - dashed : Max = -4.401E+0000 dB

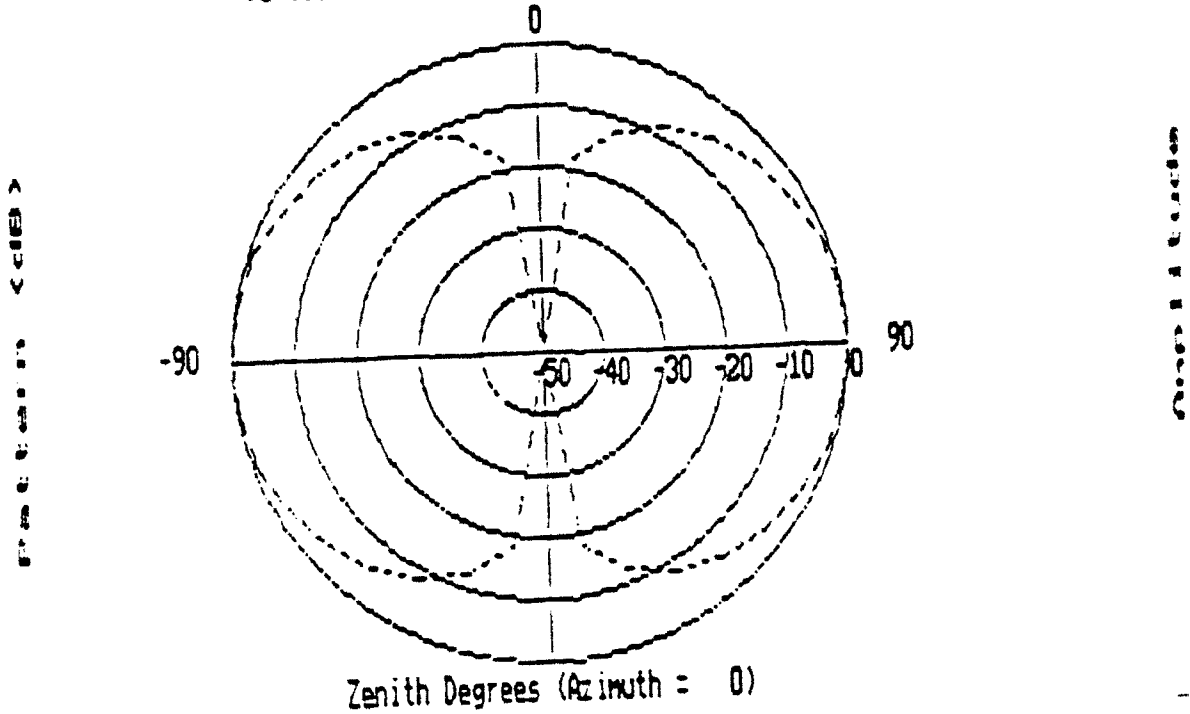

Fig.5 Radiation Pattern Of The Optimum Monopole
At Frequency 70 MHz

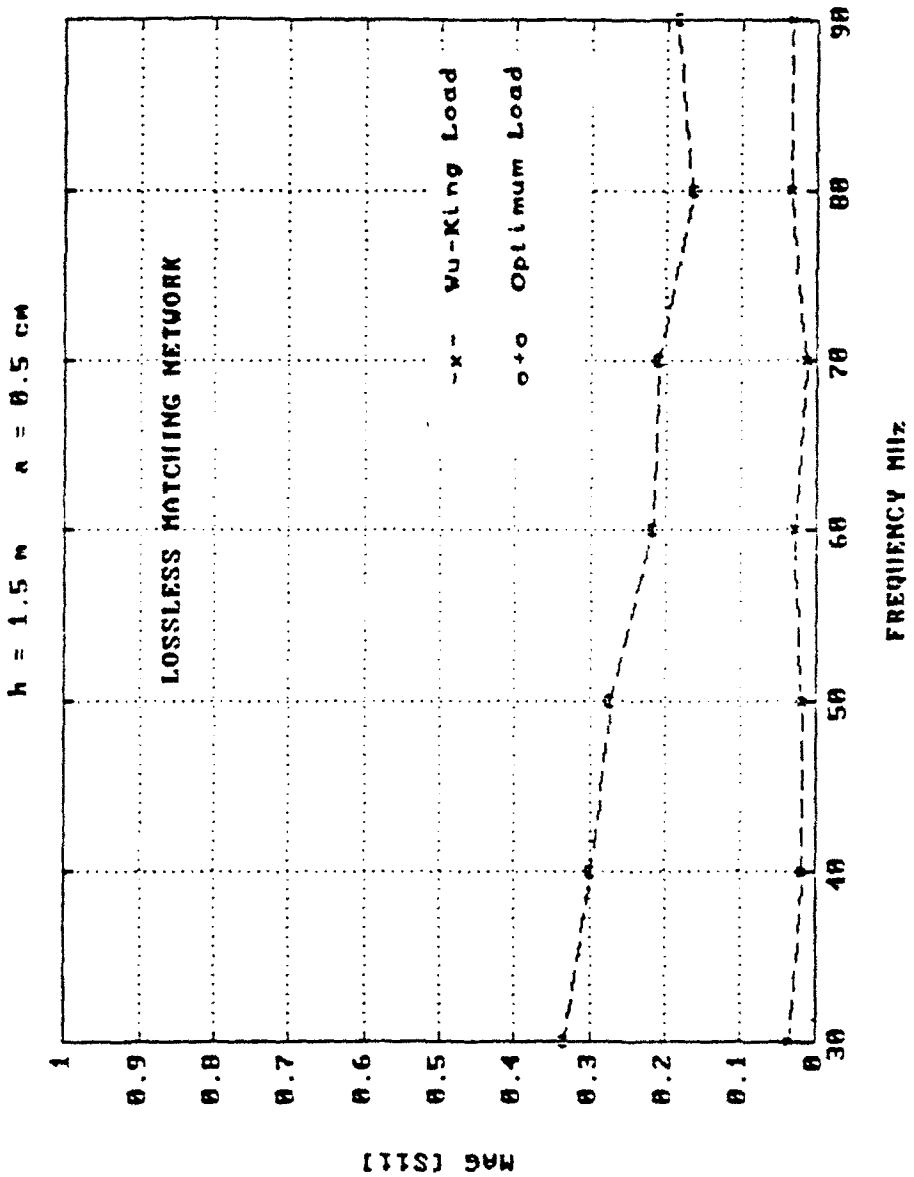

Fig. 6 Input Reflection Coefficient (S11) For The Lossless Matching Network Terminated With The Monopole

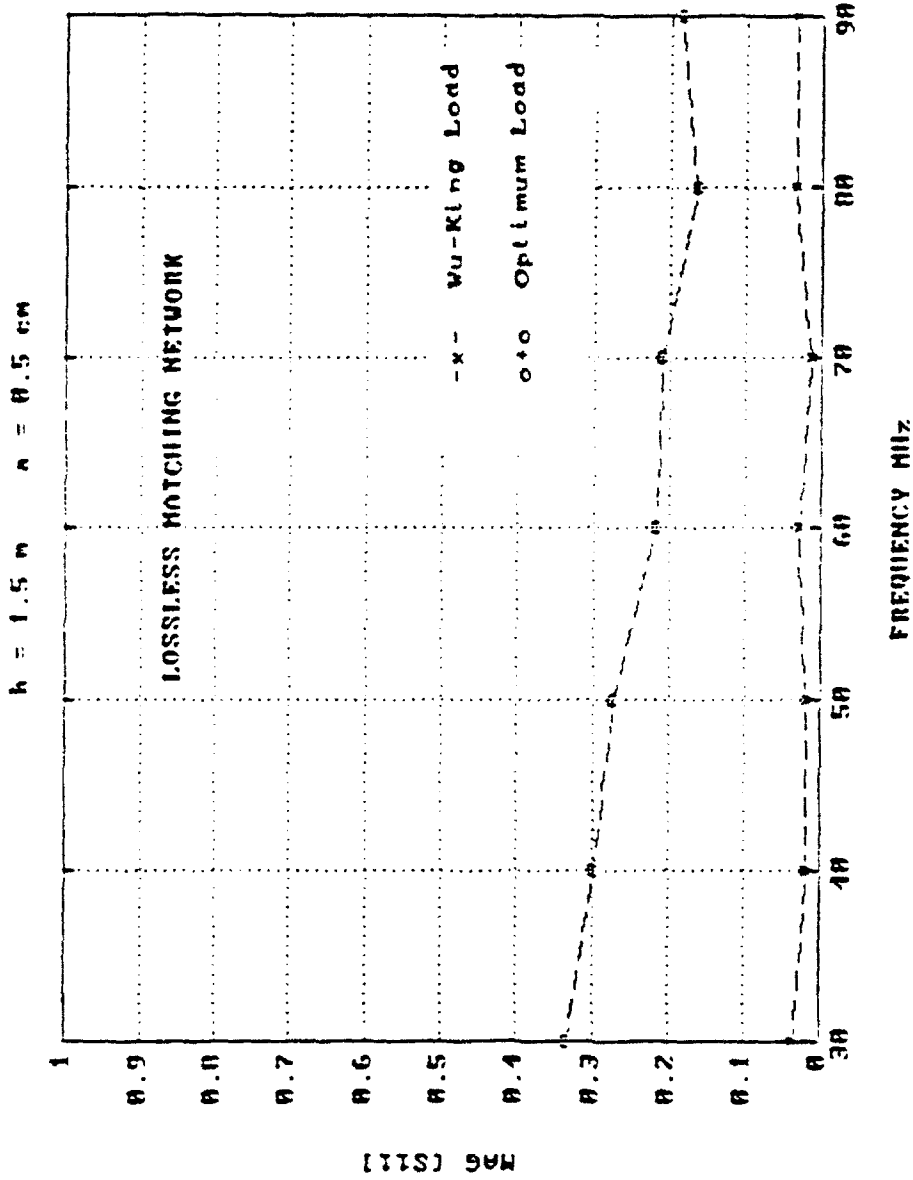

Fig. 6 Input Reflection Coefficient (S11) For The Lossless Matching Network Terminated With The Monopole

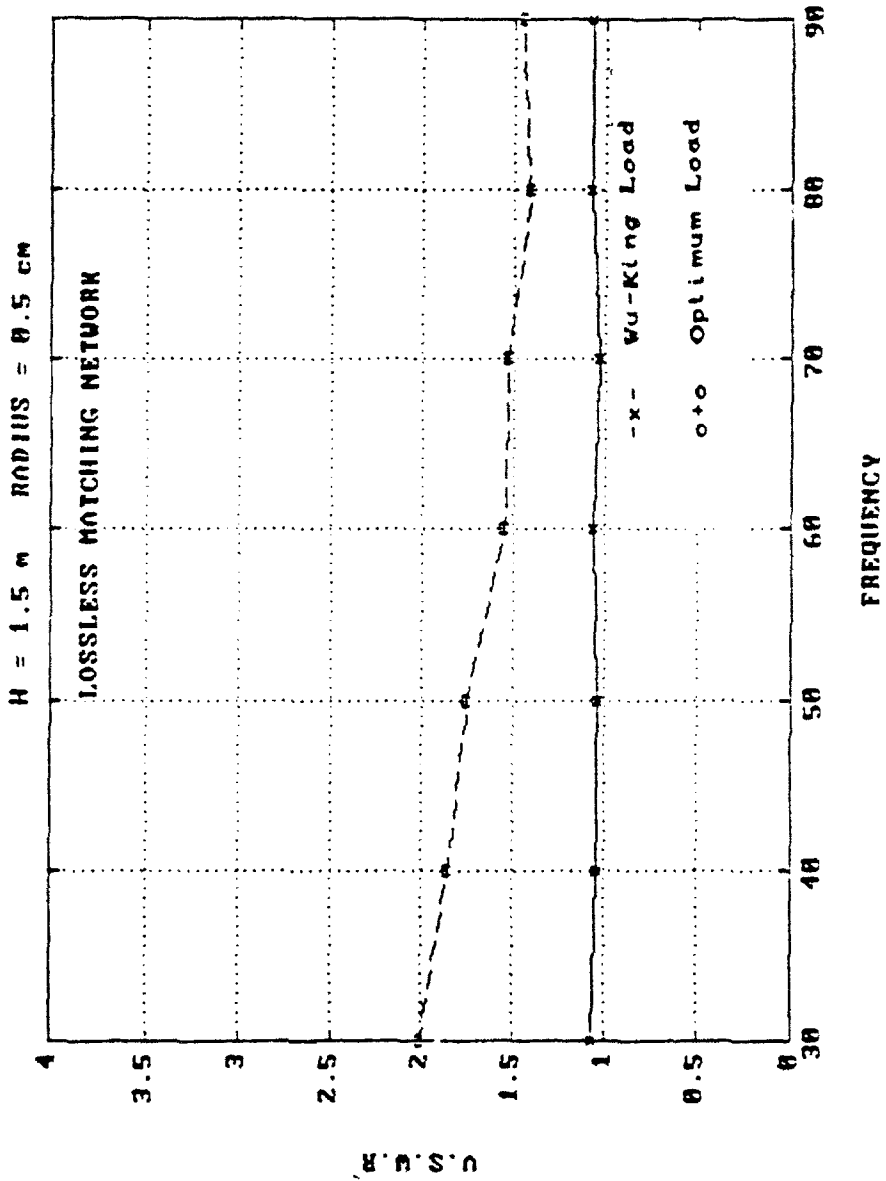

Fig. 7 Input VSWR For The Lossless Matching Network

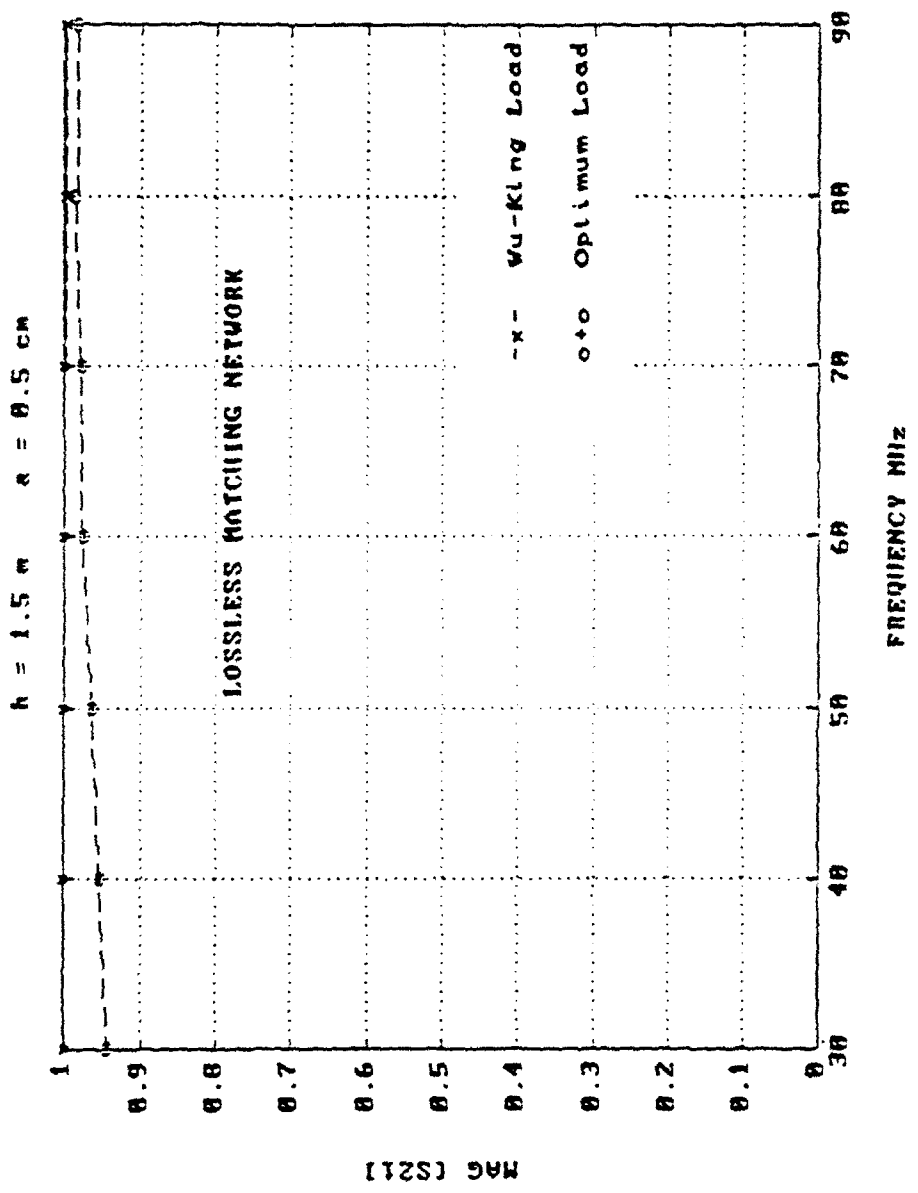

Fig. 8 Transducer Power Gain (S21) For The Lossless Matching Network

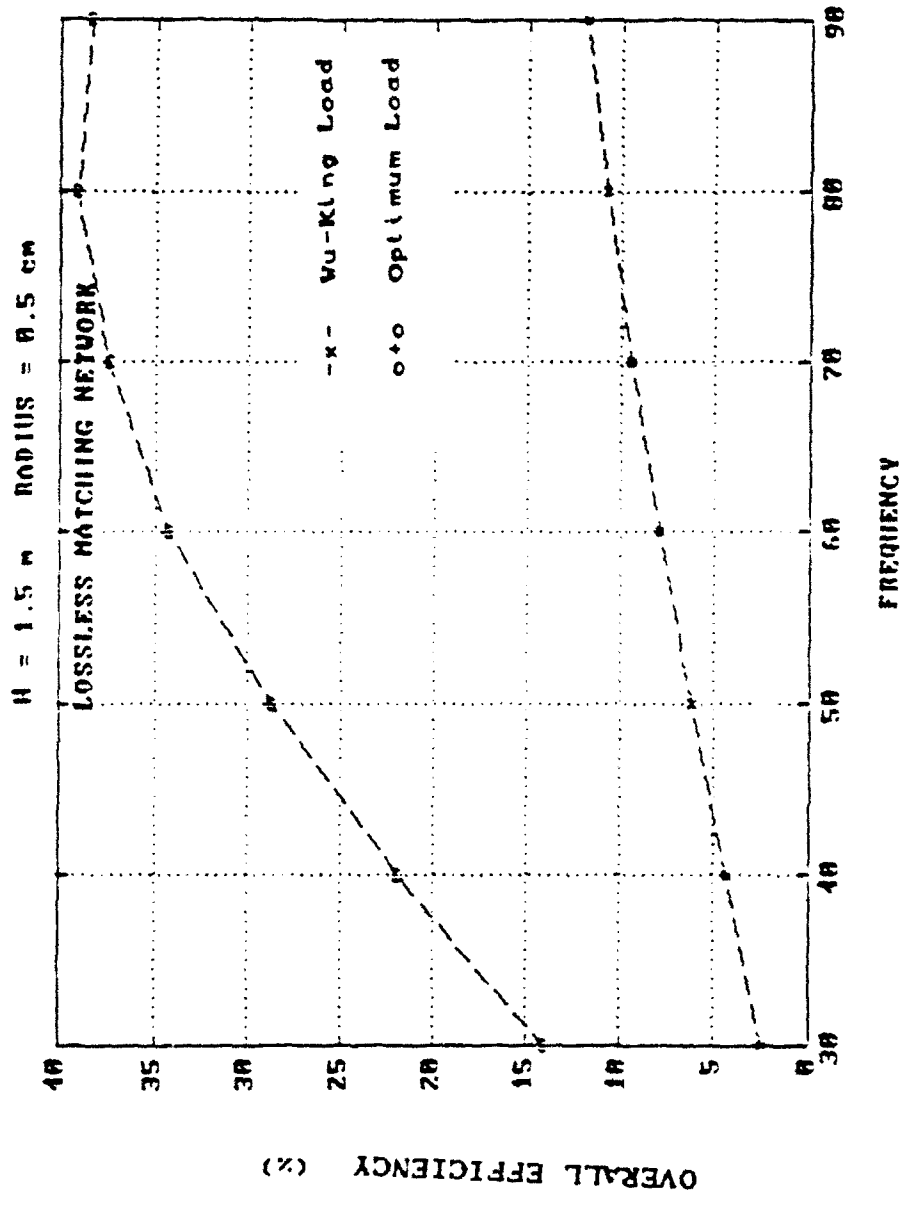

Fig. 9 Overall Efficiency With Lossless Matching Network

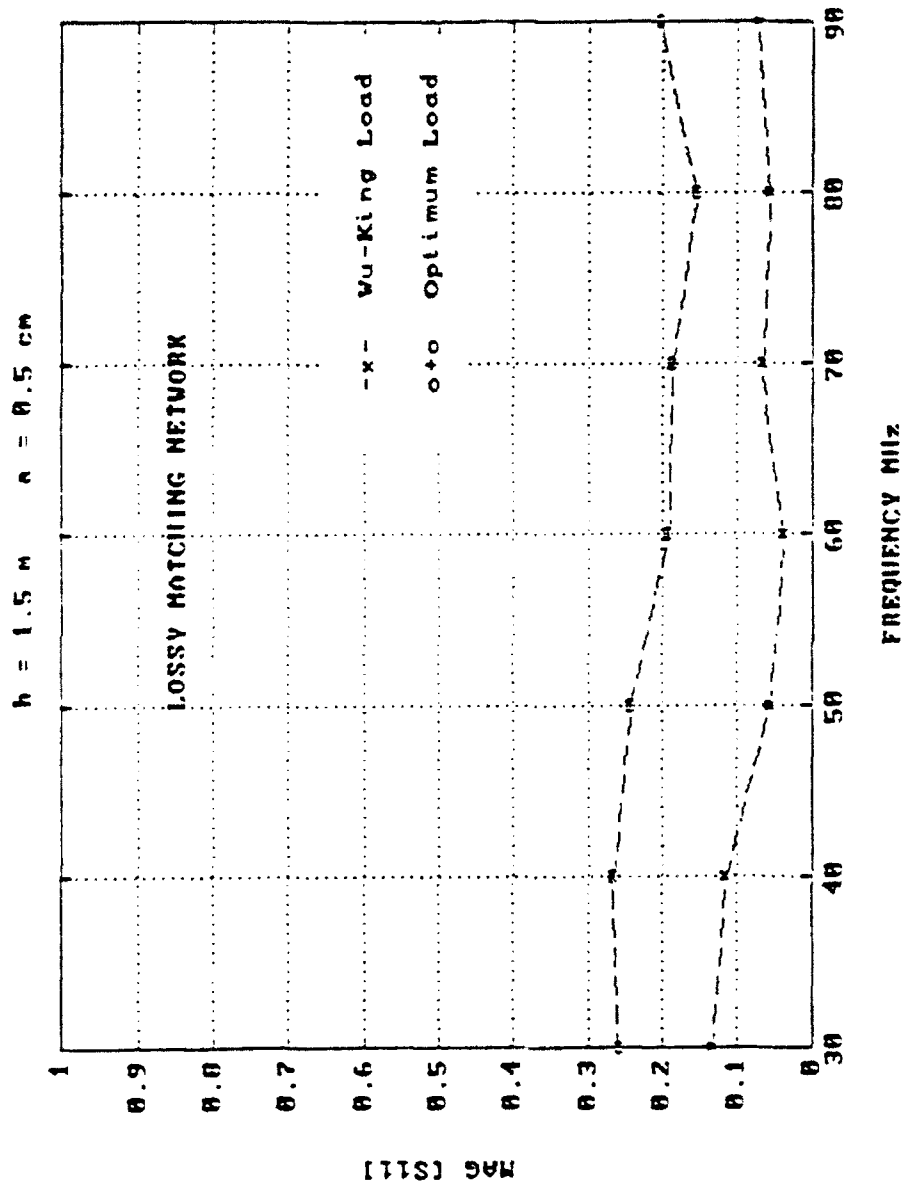

Fig. 10 Input Reflection Coefficient (S_{11}) For The Lossy Matching Network

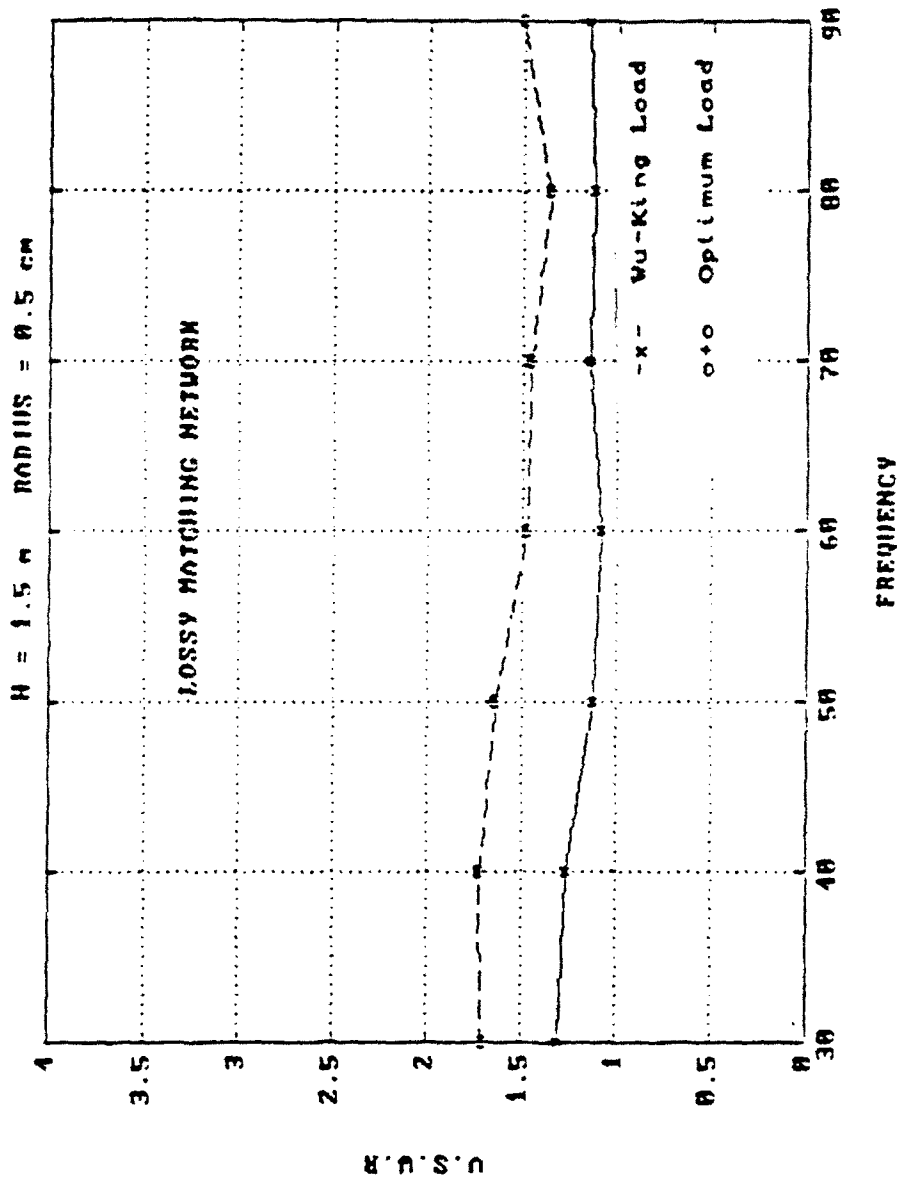

FIG. 11 Input VSWR For The Lossy Matching Network

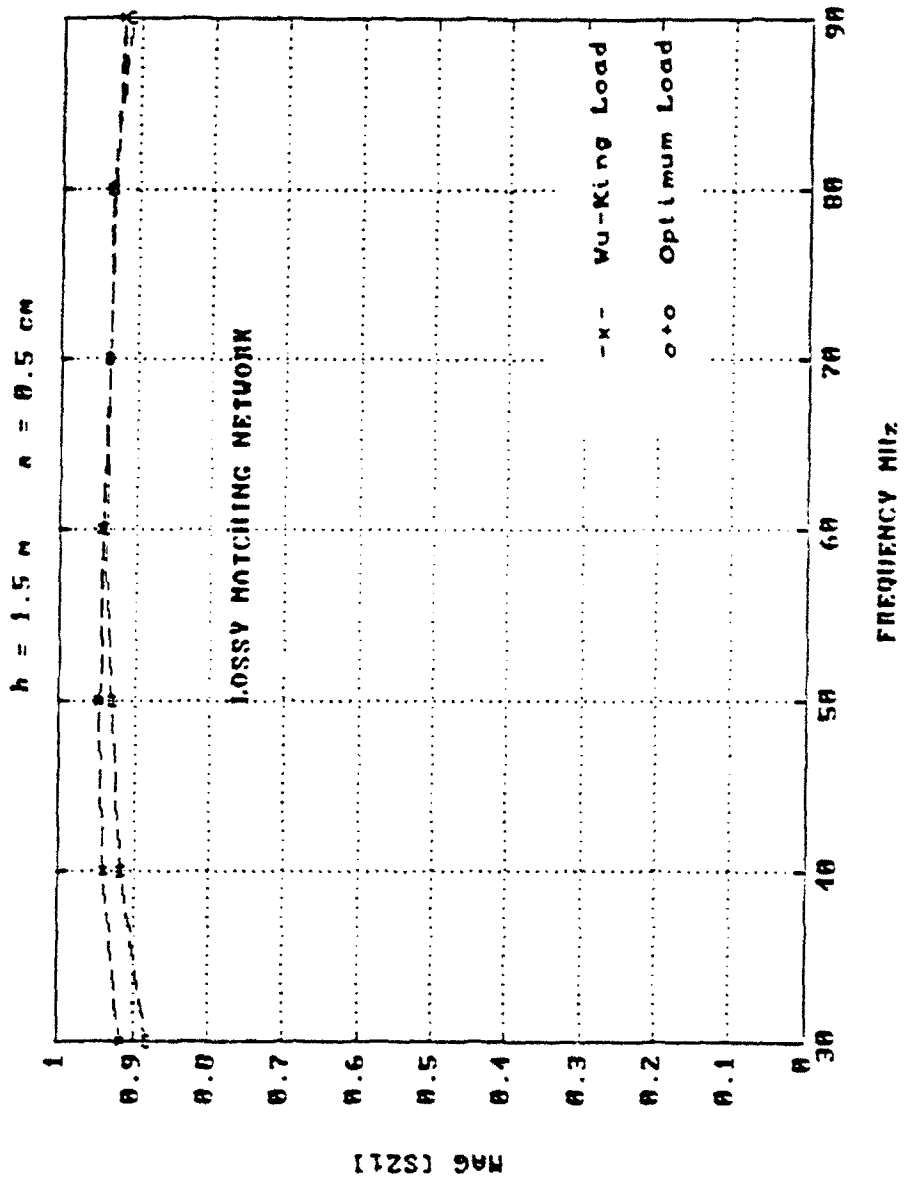

Fig. 12 Transducer Power Gain (S21) For Lossy Matching Network

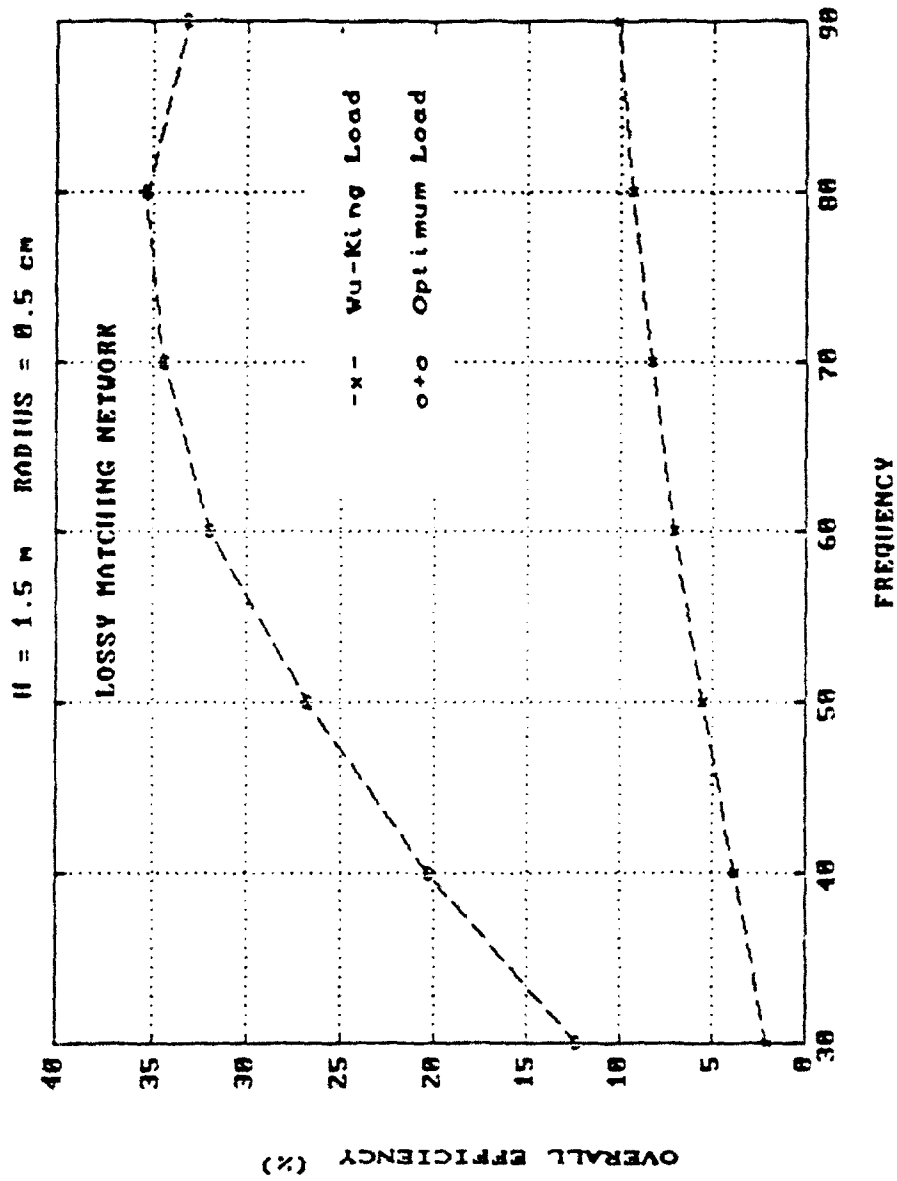
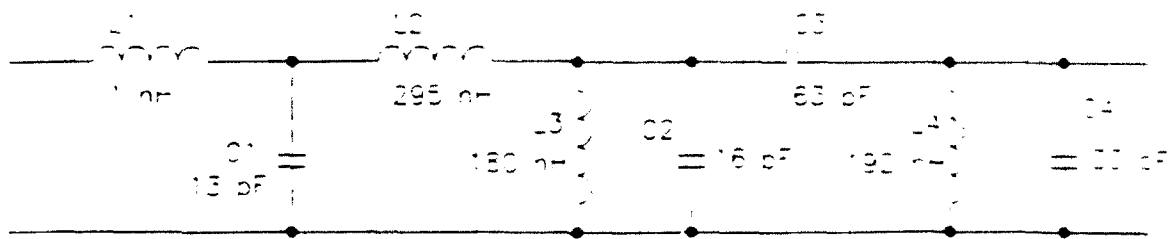
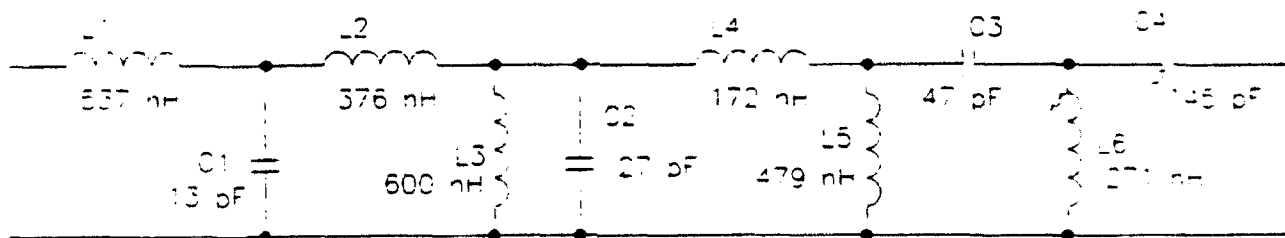

FIG. 13 Overall Efficiency With Lossy Matching Network



**Fig.14 Matching Network For The Monopole Loaded
With The Optimum Load**



**Fig.15 Matching Network For The Monopole Loaded
The Wu - King Profile**

INITIAL DISTRIBUTION LIST

	No. Copies
1. Defense Technical Information Center Cameron Station Alexandria, VA 22304-6145	2
2. Dudley Knox Library, Code 52 Naval Postgraduate School Monterey, CA 93943-5002	2
3. Chairman, Code EC Department of Electrical and Computer Engineering Naval Postgraduate School Monterey, CA 93943-5000	1
4. Professor Ramakrishna Janaswamy, Code EC/Js Department of Electrical and Computer Engineering Naval Postgraduate School Monterey, CA 93943-5000	10
5. Professor Richard Adler, Code EC/Ab Department of Electrical and Computer Engineering Naval Postgraduate School Monterey, CA 93943-5000	1
6. Dr. Darwish Abdel Aziz Mohamed Officers Building Home 2B Flat 44 Toson- Abokir- Alexandria, Egypt	5