

①

AD-A257 680

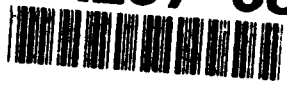

ARI Research Note 92-83

# Trainer's Guide: Multipurpose Arcade Combat Simulator: Moving Target Training

**Arthur D. Osborne**

Litton Computer Services

**Seward Smith**

U.S. Army Research Institute

DTIC  
FLECTE  
OCT 27 1992  
S E D

Field Unit at Fort Benning, Georgia  
Seward Smith, Chief

Training Systems Research Division  
Jack H. Hiller, Director

September 1992



42543

92-28118



18408

**United States Army  
Research Institute for the Behavioral and Social Sciences**

Approved for public release; distribution is unlimited.

92 10 26 161

# REPORT DOCUMENTATION PAGE

Form Approved  
OMB No. 0704-0188

Public reporting burden for this collection of information is estimated to average 1 hour per response, including the time for reviewing instructions, searching existing data sources, gathering and maintaining the data needed, and completing and reviewing the collection of information. Send comments regarding this burden estimate or any other aspect of this collection of information, including suggestions for reducing this burden, to Washington Headquarters Services, Directorate for Information Operations and Reports, 1215 Jefferson Davis Highway, Suite 1204, Arlington, VA 22202-4302, and to the Office of Management and Budget, Paperwork Reduction Project (0704-0188), Washington, DC 20503.

<b>1. AGENCY USE ONLY (Leave blank)</b>		<b>2. REPORT DATE</b> 1992, September	<b>3. REPORT TYPE AND DATES COVERED</b> Final Apr 90 - Sep 90		
<b>4. TITLE AND SUBTITLE</b> Trainer's Guide: Multipurpose Arcade Combat Simulator: Moving Target Training			<b>5. FUNDING NUMBERS</b> MDA903-88-C-0407 63007A 795 3306 C3		
<b>6. AUTHOR(S)</b> Osborne, Arthur D. (Litton); and Smith, Seward (ARI)					
<b>7. PERFORMING ORGANIZATION NAME(S) AND ADDRESS(ES)</b> Litton Computer Services 4747 Hellyer Avenue San Jose, CA 95151-0059			<b>8. PERFORMING ORGANIZATION REPORT NUMBER</b> ---		
<b>9. SPONSORING / MONITORING AGENCY NAME(S) AND ADDRESS(ES)</b> U.S. Army Research Institute for the Behavioral and Social Sciences ATTN: PERI-IJ 5001 Eisenhower Avenue Alexandria, VA 22333-5600			<b>10. SPONSORING / MONITORING AGENCY REPORT NUMBER</b> ARI Research Note 92-83		
<b>11. SUPPLEMENTARY NOTES</b> Contracting Officer's Representative, Seward Smith					
<b>12a. DISTRIBUTION / AVAILABILITY STATEMENT</b> Approved for public release; distribution is unlimited.			<b>12b. DISTRIBUTION CODE</b> ---		
<b>13. ABSTRACT (Maximum 200 words)</b> The Multipurpose Arcade Combat Simulator (MACS) is an inexpensive, computer-based rifle trainer that helps soldiers master perceptual/motor and cognitive shooting skills. To date, more than a thousand MACS devices are being used for basic and unit rifle marksmanship training throughout the Army. This Moving Target Trainer's Guide details a MACS cartridge that provides instruction on engagement of moving targets and gives several levels of practice that gradually increase skill and knowledge requirements. The guide also offers helpful instructor recommendations to assist trainers. The program cartridge and the accompanying copy of the Trainer's Guide for the Commodore computer version of Moving Target MACS are available through the Fort Benning Training Support Center.					
<b>14. SUBJECT TERMS</b> Computer simulation Instructional materials Rifle marksmanship		Training aid Training devices Aiming Sight alignment	Shot grouping Rifles Moving targets	<b>15. NUMBER OF PAGES</b> 111	
				<b>16. PRICE CODE</b> ---	
<b>17. SECURITY CLASSIFICATION OF REPORT</b> Unclassified	<b>18. SECURITY CLASSIFICATION OF THIS PAGE</b> Unclassified	<b>19. SECURITY CLASSIFICATION OF ABSTRACT</b> Unclassified	<b>20. LIMITATION OF ABSTRACT</b> Unlimited		

# U.S. ARMY RESEARCH INSTITUTE FOR THE BEHAVIORAL AND SOCIAL SCIENCES

**A Field Operating Agency Under the Jurisdiction  
of the Deputy Chief of Staff for Personnel**

**EDGAR M. JOHNSON**  
Technical Director

**MICHAEL D. SHALER**  
COL, AR  
Commanding

Research accomplished under contract  
for the Department of the Army

Litton Computer Services

Technical review by

Frederick H. Heller  
MAJ John P. Quigley  
Shawn Stephens

**DTIC QUALITY INSPECTED 2,**

Accession For	
NTIS CRA&I	<input checked="" type="checkbox"/>
DTIC TAB	<input checked="" type="checkbox"/>
Unannounced	<input type="checkbox"/>
Justification	
By	
Distribution/	
Availability Codes	
Dist	Avail and/or Special
<b>A-1</b>	

### NOTICES

**DISTRIBUTION:** This report has been cleared for release to the Defense Technical Information Center (DTIC) to comply with regulatory requirements. It has been given no primary distribution other than to DTIC and will be available only through DTIC or the National Technical Information Service (NTIS).

**FINAL DISPOSITION:** This report may be destroyed when it is no longer needed. Please do not return it to the U.S. Army Research Institute for the Behavioral and Social Sciences.

**NOTE:** The views, opinions, and findings in this report are those of the author(s) and should not be construed as an official Department of the Army position, policy, or decision, unless so designated by other authorized documents.

# TRAINER'S GUIDE

## MULTIPURPOSE ARCADE COMBAT SIMULATOR

(MACS-M16 RIFLE)  
BASIC RIFLE MARKSMANSHIP  
and  
MOVING TARGET TRAINING

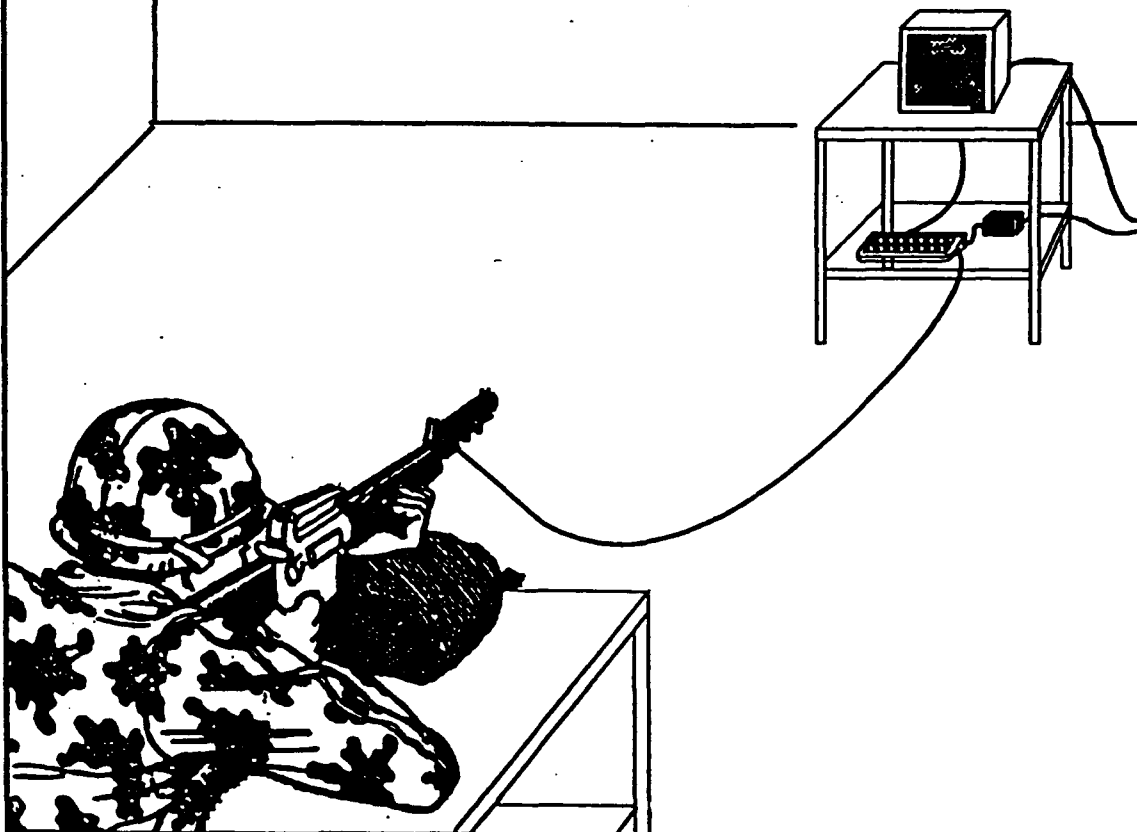

**Prepared for the U. S.-Army Research Institute Field Unit at  
Fort Benning, Georgia, under contract #MDA 903-88-C-0407.**

*Additional copies may be obtained from the Training Support Center at Fort Benning,  
Georgia.*

## TABLE OF CONTENTS

<b>MACS System Assembly Instructions</b>	<b>1-1</b>
<b>Light Pen Mount Alignment</b>	<b>2-1</b>
<b>The Basic Rifle Marksmanship Program</b>	<b>3-1</b>
<b>Description of the MACS Menu</b>	<b>4-1</b>
<b>Troubleshooting Tips</b>	<b>5-1</b>
<b>MACS Moving Target Program</b>	<b>6-1</b>

# **MACS SYSTEM ASSEMBLY INSTRUCTIONS**

**NOTE:**

The MACS system can be easily assembled using the instructions found in this section. The instructions should be read before attempting to assemble the system to prevent damage to the system. Particular care must be taken to **NEVER** insert or remove the program cartridge while the keyboard power is **ON**.



# MACS SYSTEM ASSEMBLY INSTRUCTIONS

**PLEASE READ ALL INSTRUCTIONS BEFORE ATTEMPTING TO ASSEMBLE THE MACS SYSTEM.**

## CAUTION:

**· MAKE SURE ALL EQUIPMENT IS TURNED OFF BEFORE PROCEEDING OR DAMAGE TO EQUIPMENT WILL RESULT.**

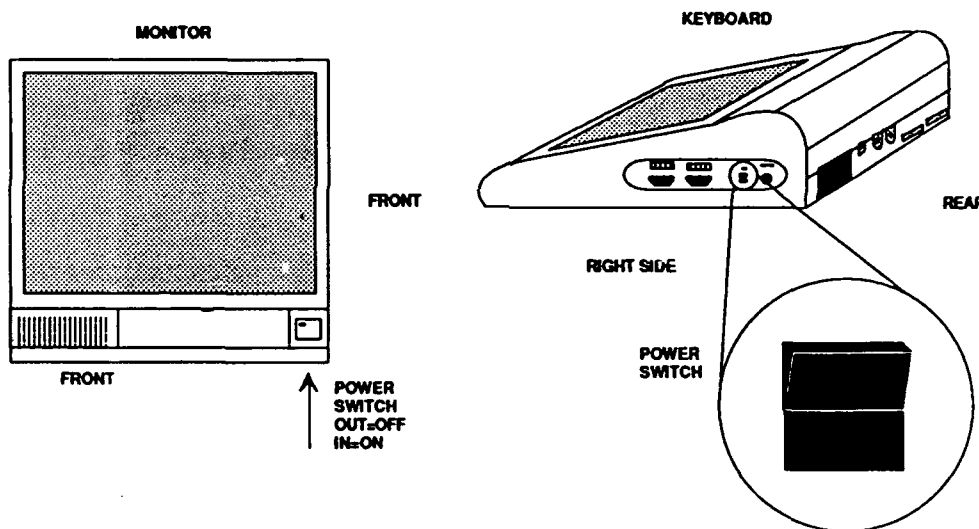

## NOTE:

**If your system contains a switched power supply box, please note that the power switch is on the front. If there is no power when the switch is in the ON position, check the fuse found in the back of the box.**

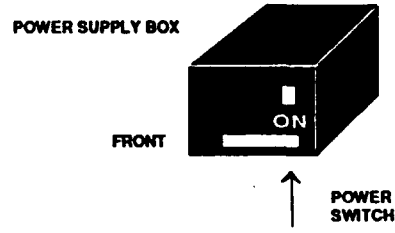

## STEP 1 UNPACK EQUIPMENT

- Unpack the equipment carefully.
- Each system should have the following components:

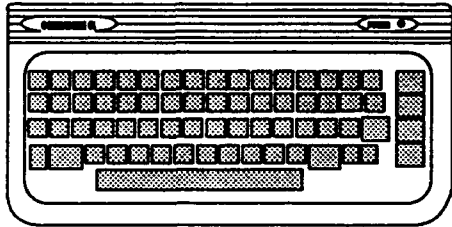

• Keyboard/computer

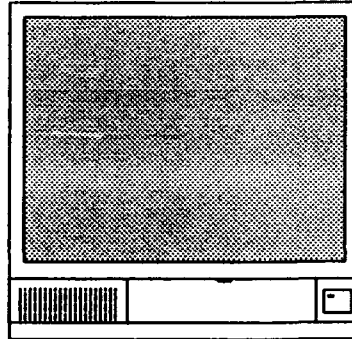

• 13" color monitor

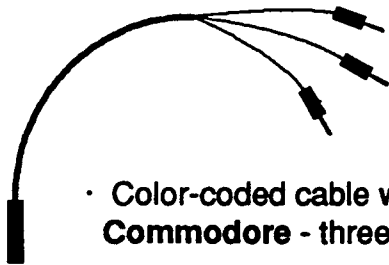

• Color-coded cable with jacks.  
Commodore - three jacks used.

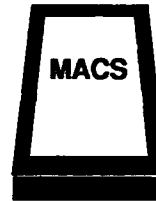

• MACS cartridge

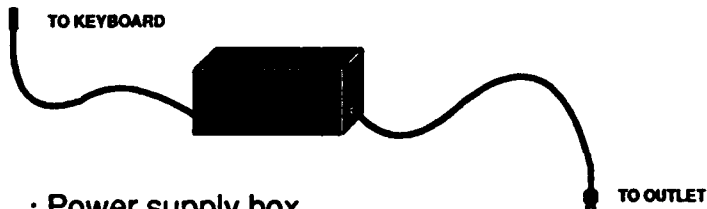

• Power supply box

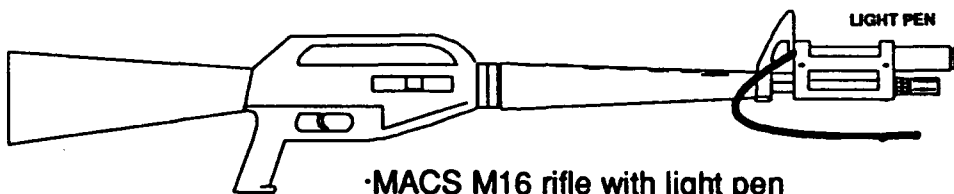

• MACS M16 rifle with light pen

## STEP 2 EQUIPMENT PLACEMENT

- All equipment should be placed on a firm, steady surface.
- Sandbags are required for supported position.
- Computer equipment should be located near a three-pronged receptacle.
- MACS M16 rifle should be aimed at monitor.
- Place monitor exactly 7'6" from light pen.
- **NOTE:** Mark distance on connector cord.

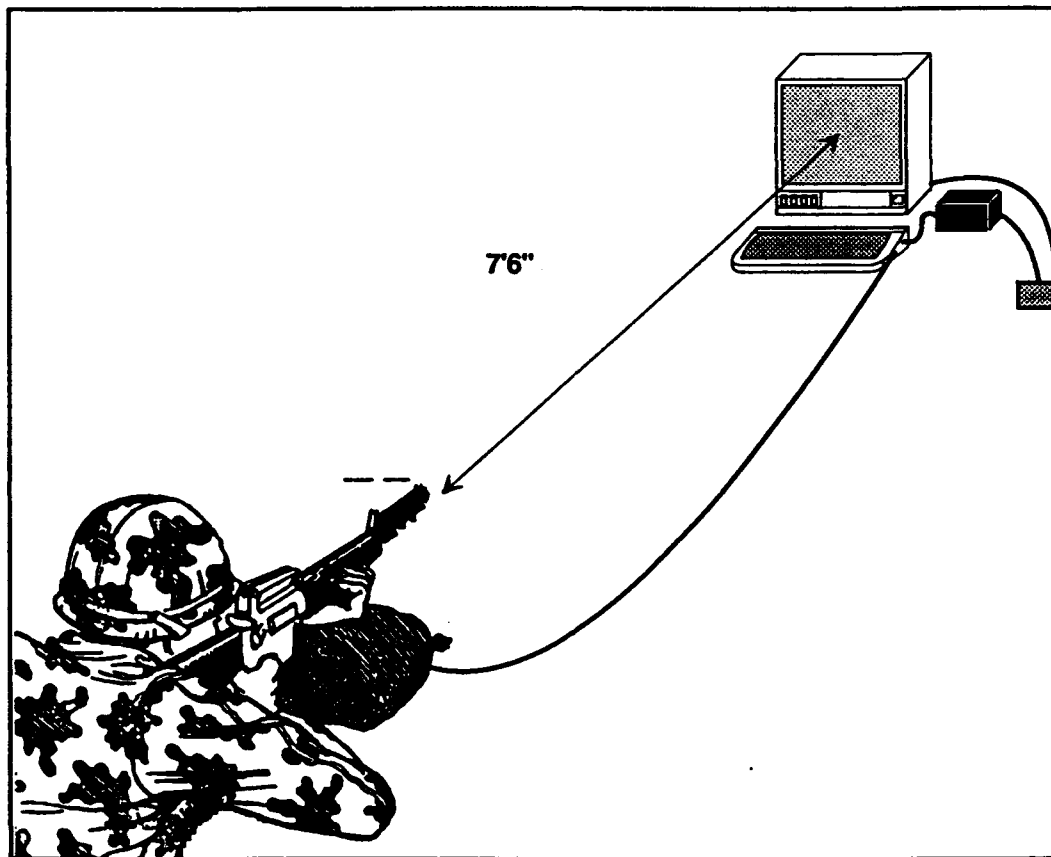

### STEP 3 MACS CARTRIDGE

#### CAUTION:

- **MAKE SURE ALL EQUIPMENT IS TURNED OFF BEFORE PROCEEDING OR DAMAGE TO EQUIPMENT WILL RESULT.**
- Insert MACS cartridge (label up) into slot in back of keyboard.
  - Use firm steady pressure, gently rocking cartridge left and right.
  - Cartridge is firmly seated when it can no longer be rocked.

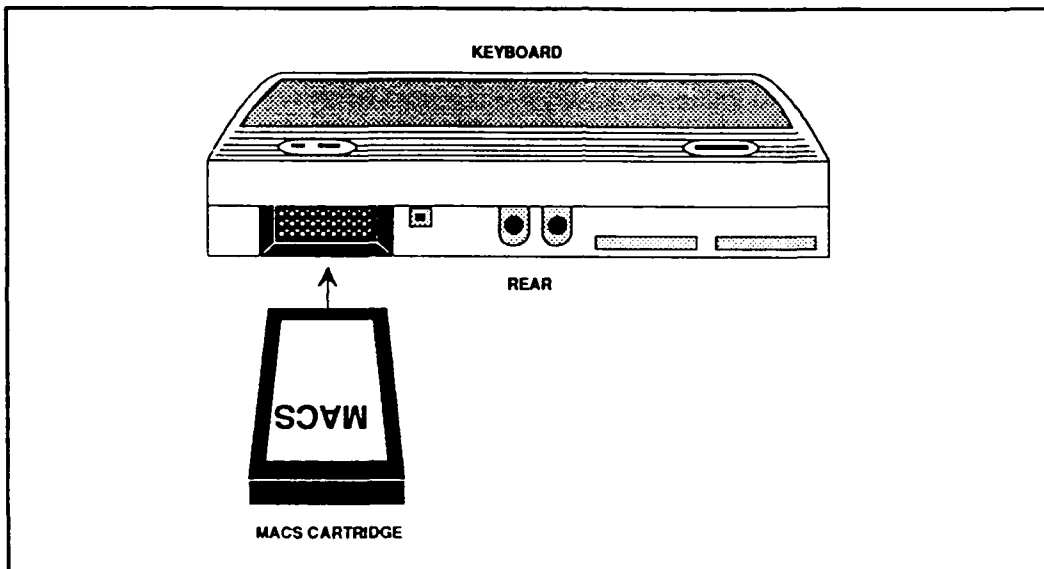

## STEP 4 COLOR-CODED CABLE WITH JACKS

### COMMODORE MONITOR (1802)

- Plug cable jacks into rear of monitor.
  - Sockets and cable jacks are color-coded
  - Jacks must be plugged in correct sockets for program to run correctly.
- With notch in twelve o'clock position, plug other end of color-coded cable into left-hand port as you face rear of keyboard.
- Set position of controls on front of monitor:
  - Brightness and tint to detent
  - Color and contrast to maximum

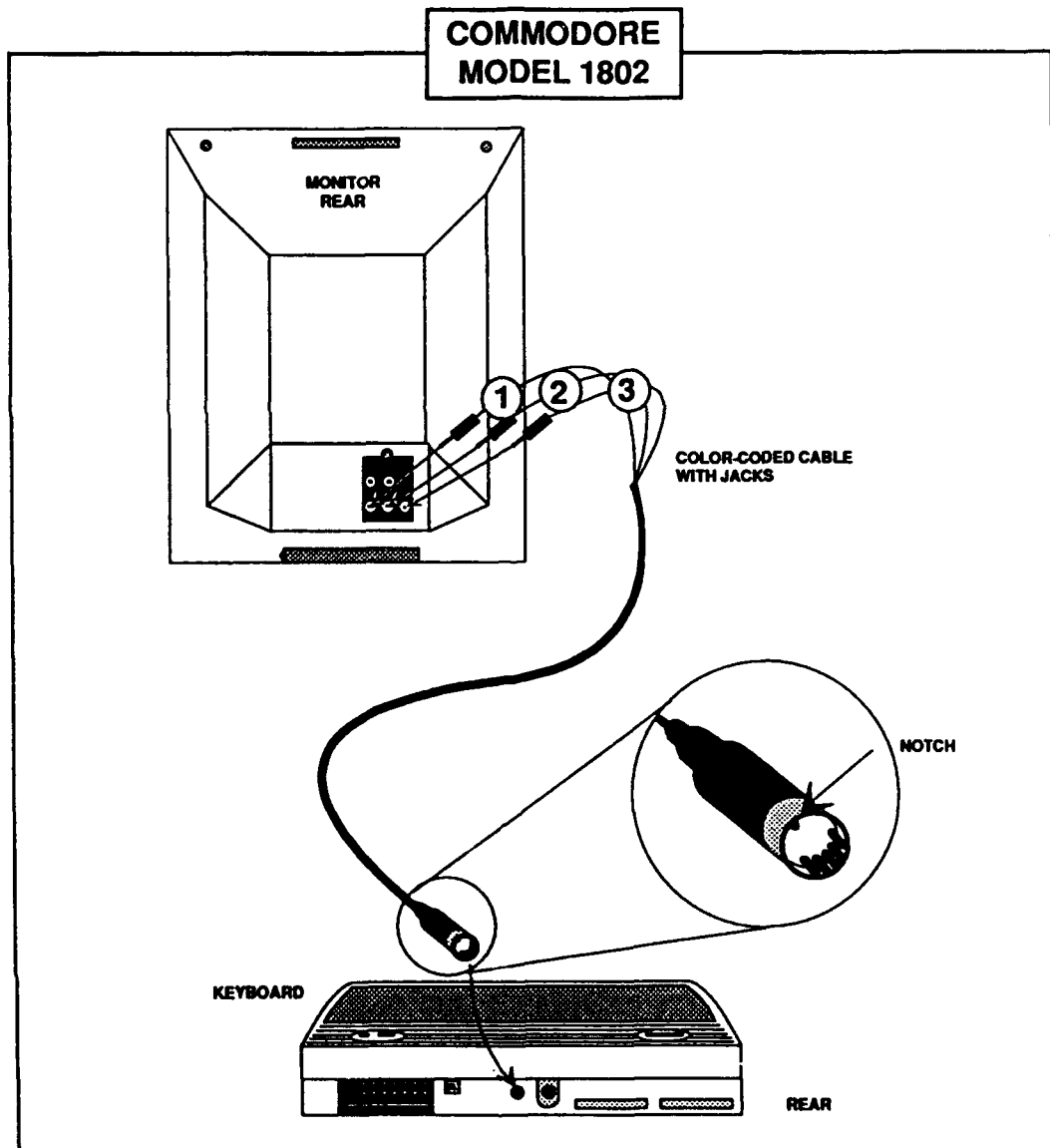

## STEP 4 COLOR-CODED CABLE WITH JACKS

### HITACHI MONITOR

- Plug cable jacks into rear of monitor.
  - Sockets and cable jacks are designated 1 and 2.
  - **IGNORE COLOR OF SOCKETS and JACKS!**
  - **IGNORE EXTRA JACKS!**
  - Jacks must be plugged in correct sockets for program to run correctly.
- Set rear switch to **NTSC**.
- With notch in twelve o'clock position, plug other end of color-coded cable into left-hand port, as you face the rear of keyboard.

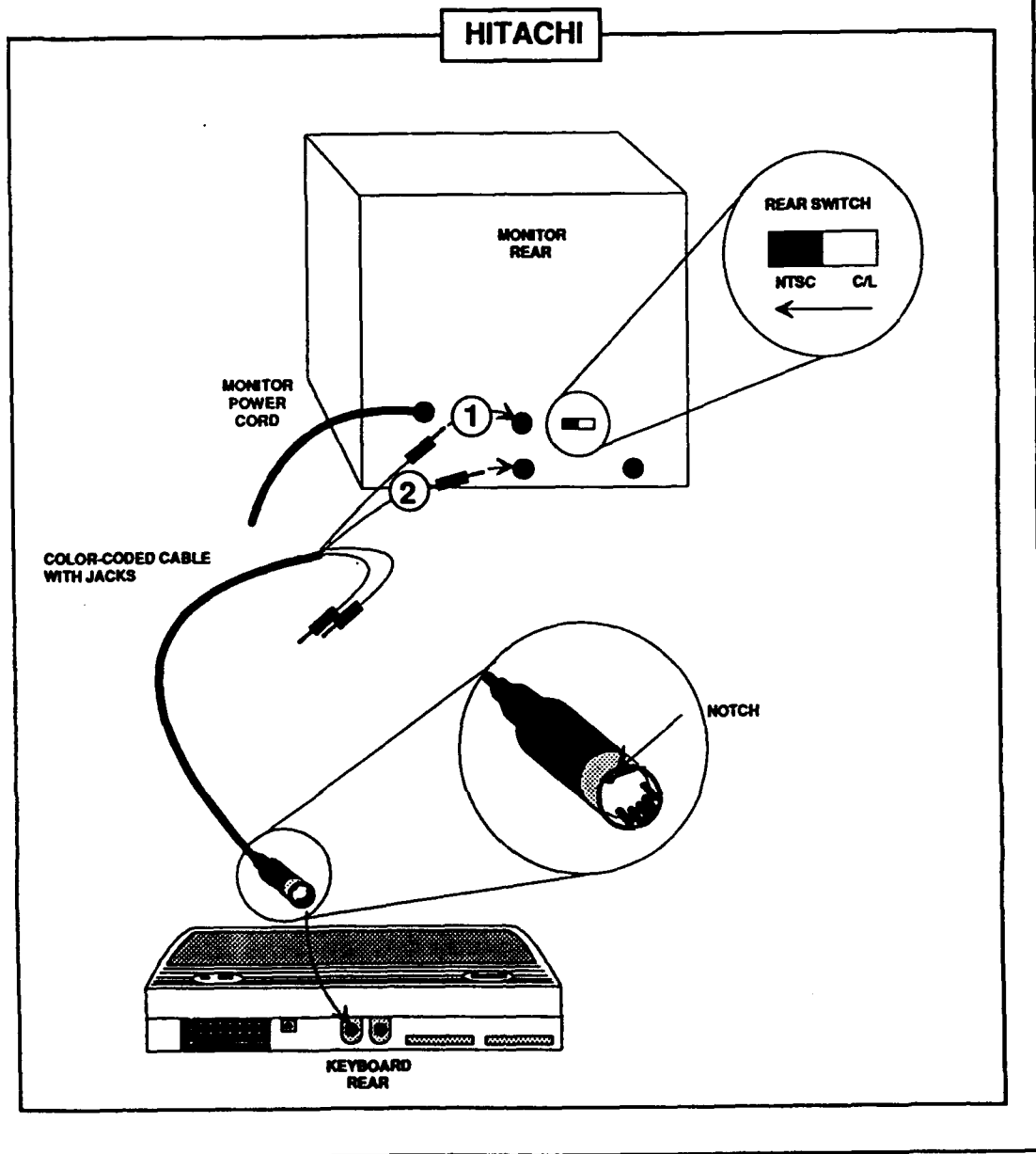

## STEP 5 TERMINAL CONNECTION

- Plug terminal connection (from power supply box) into keyboard power socket.
- As you face the keyboard, socket is found on right hand side next to the off-on switch.

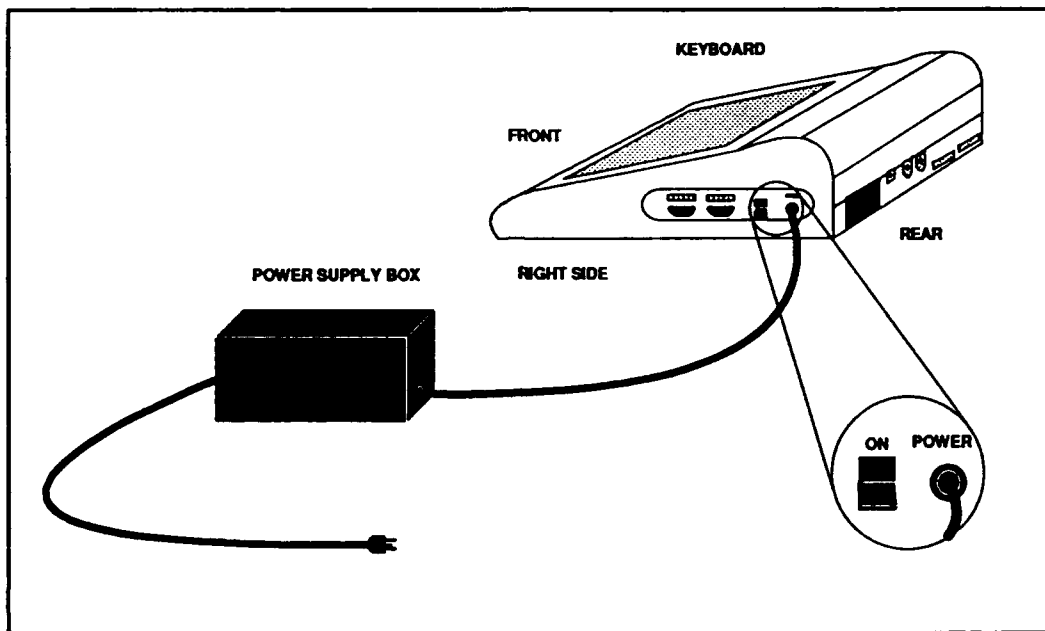

## STEP 6 M16 CABLE PLUG

- Plug MACS M16 rifle light pen cable into control port 1 slot found on right-hand side of keyboard.

**CAUTION:**

**PLUG ONLY FITS ONE WAY!**

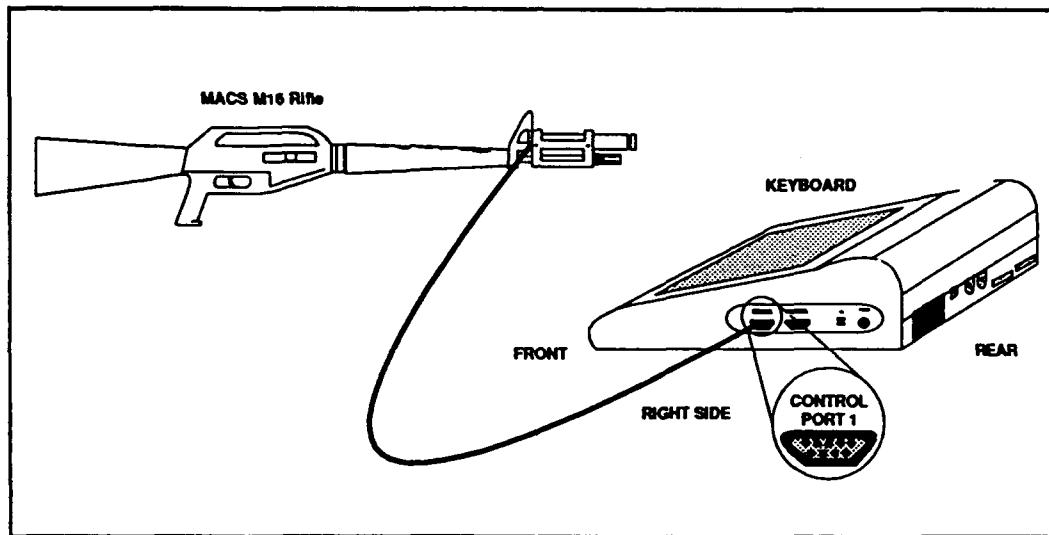



## STEP 7 PLUG POWER CORDS INTO OUTLET

- Plug in three-pronged AC power cord from power supply box.
- Use of a surge protector power strip is strongly recommended.
- Plug in monitor power cord.
- Monitor power cord is found on bottom rear of monitor.

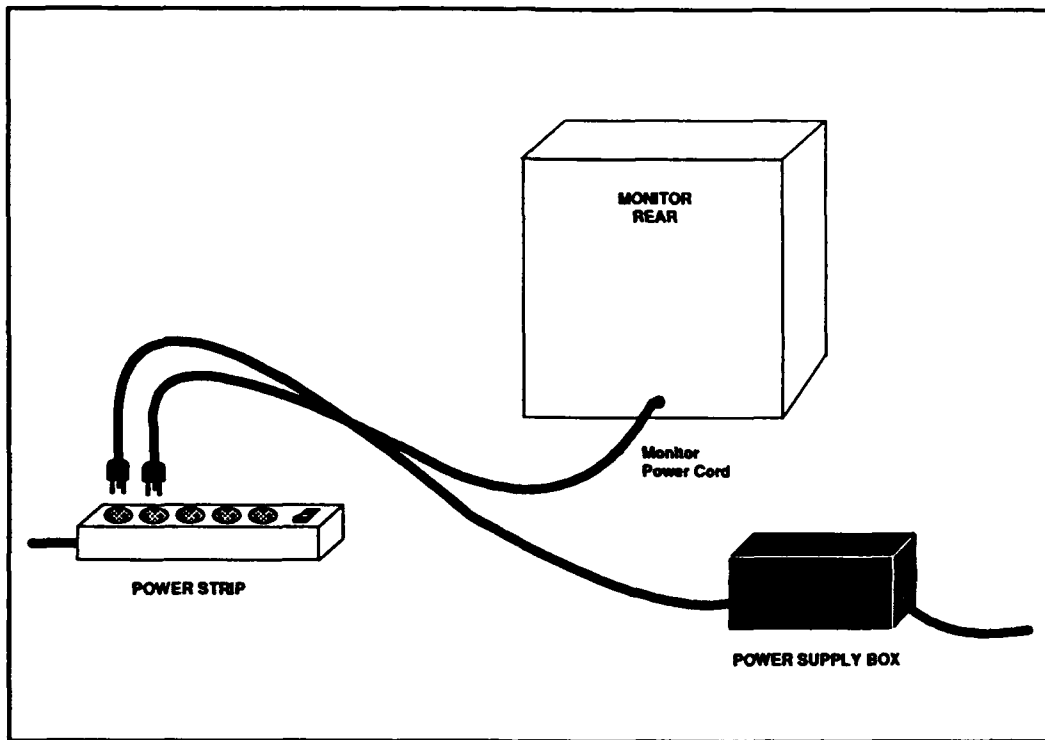

## STEP 8 TURN ON THE SYSTEM

Turn on components of system in following order.

1. **Computer:** switch located on right side of keyboard
2. **Monitor:** switch located on bottom right front

### Commodore (Model 1802)

- Adjust BRIGHT and TINT to halfway between maximum and minimum (detent).
- Adjust COLOR and CONTRAST to maximum.
- Adjust VOLUME to halfway.

### Hitachi

- Adjust BRIGHT and CONTRAST to maximum (clockwise).
- Adjust VOLUME and COLOR to detent.

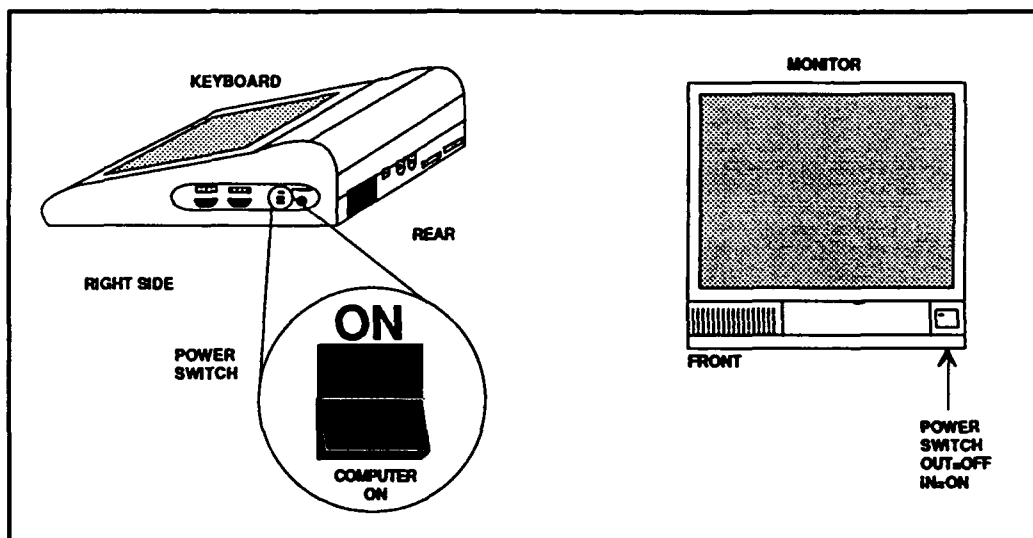

The MACS Welcome Screen should appear in color and with sound.

IF NOT REFER TO TROUBLESHOOTING TIPS IN SECTION 5.

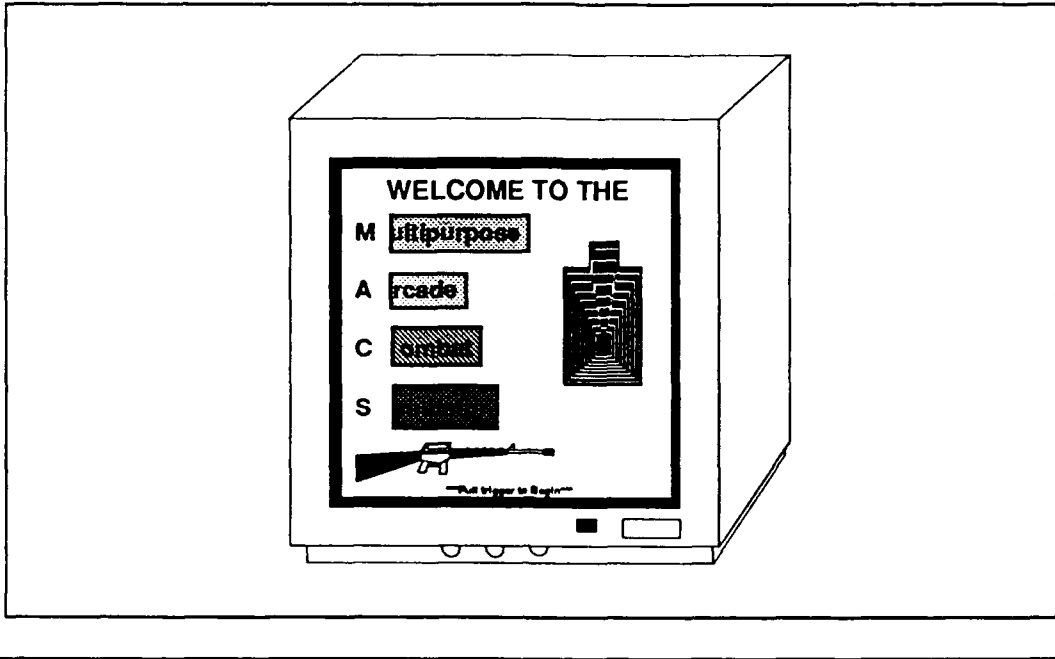

# LIGHT PEN MOUNT ALIGNMENT

**NOTE:**

The MACS system light pen mount occasionally may need to be realigned. The only tool needed is an allen wrench ( $9/64$ " for demilitarized rifle or  $7/64$ " for M16 replica rifle).

Older MACS systems have an adjustable focal ring on the light pen. An incorrect gap is the most frequent and easily corrected problem if the light pen is not reading the computer screen (detected by a purple border). On these systems, always check to ensure the gap between the focal ring and light pen barrel is approximately  $5/8$ ", before attempting to adjust the light pen mount.

Detailed instructions for adjusting the light pen mount are provided in section 2 of this guide.

## LIGHT PEN MOUNT ALIGNMENT

### NOTE:

#### BEFORE PROCEEDING WITH ALIGNMENT OF LIGHT PEN MOUNT

- Place rifle 7'6" from screen.
- Turn on computer.
- The MACS Welcome Screen will appear.

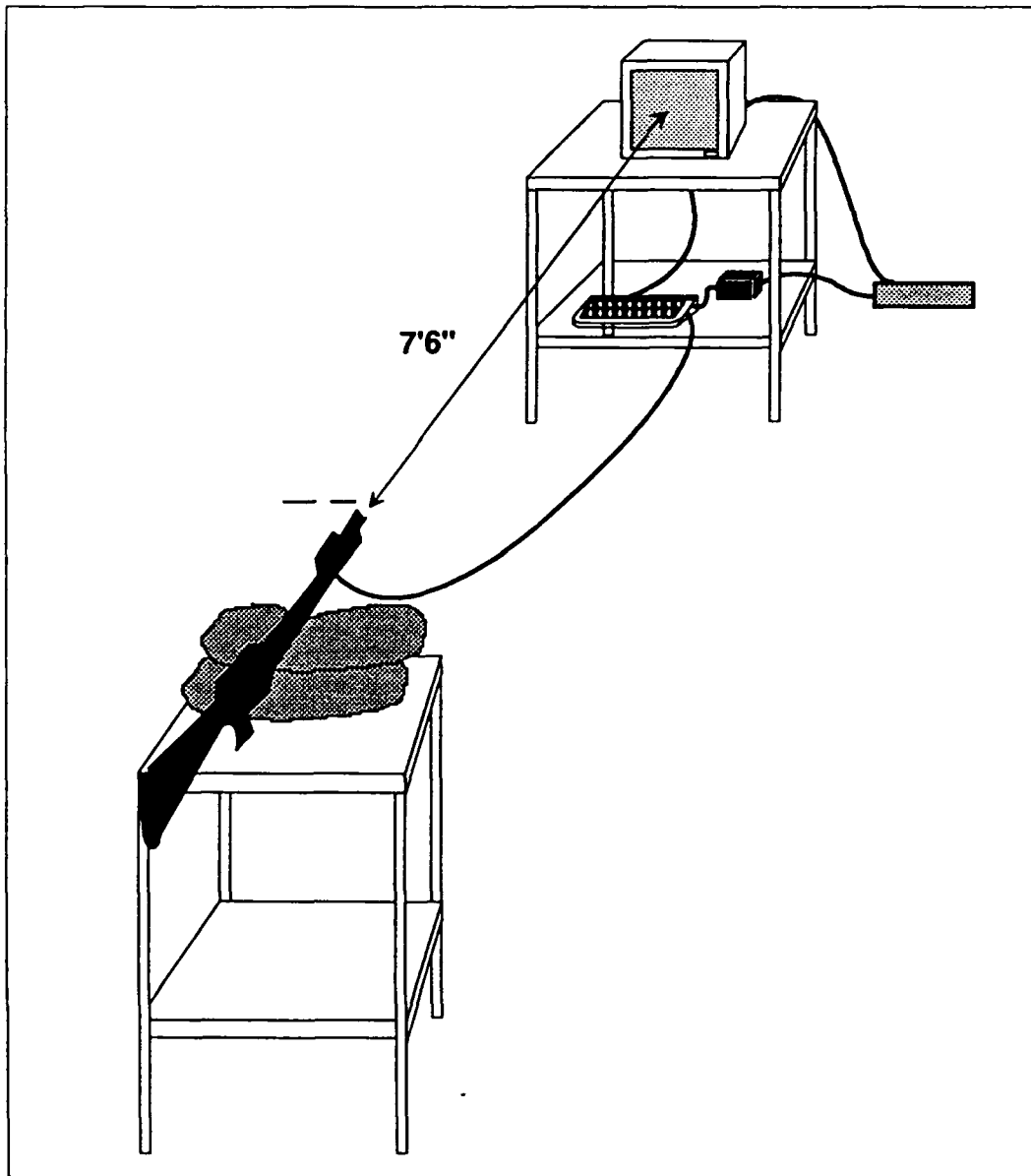

## STEP 1 CHECK ALIGNMENT OF THE LIGHT PEN MOUNT

- Type LP at MACS welcome screen or;
- Press **RUN STOP** to enter MACS menu.
- Type letters LP then RETURN to start light pen mount alignment program.
- Aim at center of blue cross and pull trigger.
- **While holding rifle steady look over sight.**
  - If light pen mount alignment is correct, O.K. will appear on the screen and black dot will appear in rectangle.
- Go to **STEP 3.**

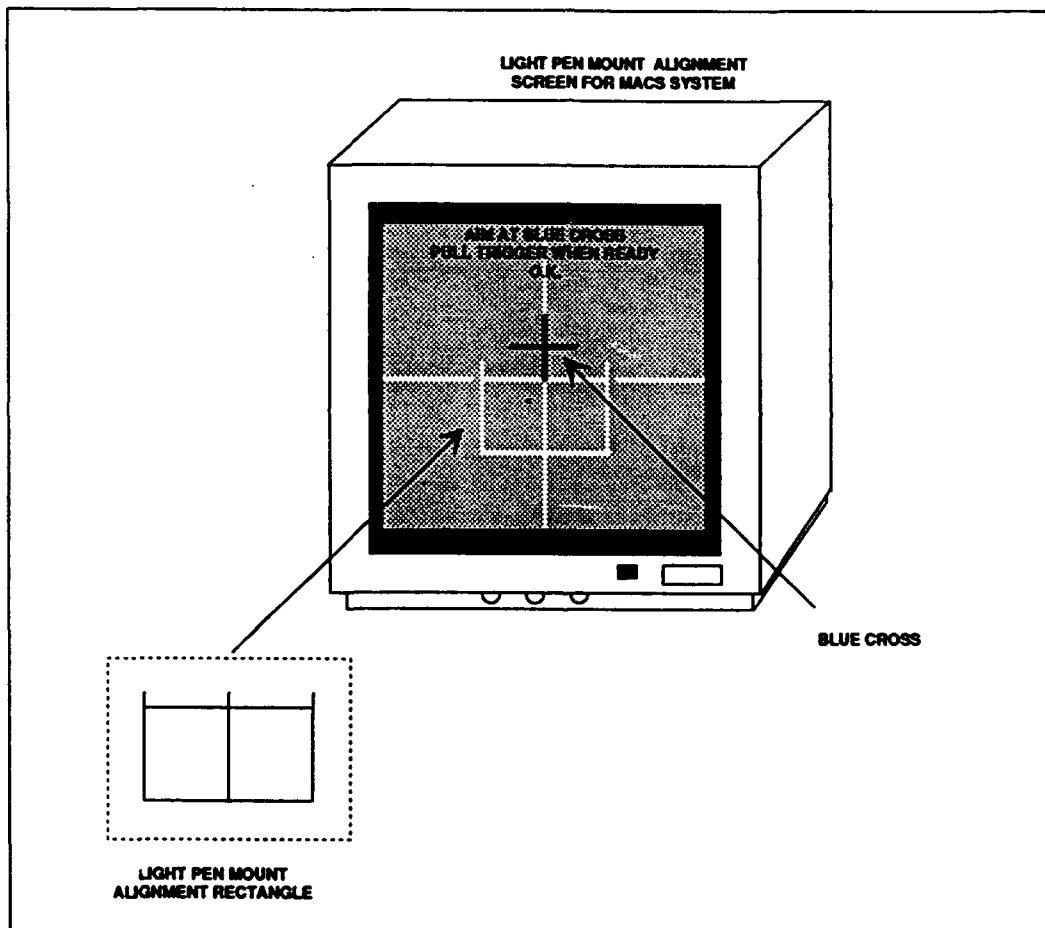

**IF BLACK DOT IS NOT IN ALIGNMENT RECTANGLE AND O.K. DOES NOT APPEAR LIGHT PEN MOUNT NEEDS ADJUSTMENT. GO TO STEP 2.**

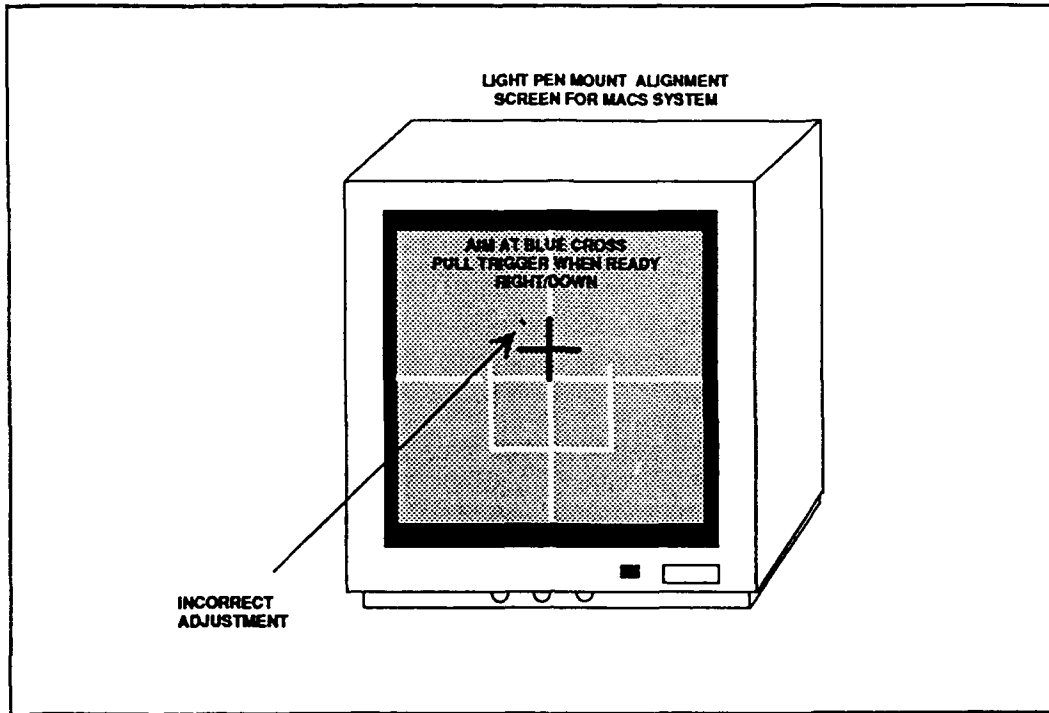



## STEP 2 LIGHT PEN MOUNT ADJUSTMENT

LIGHT PEN MOUNT ADJUSTMENT IS REQUIRED ONLY IF THE BLACK DOT DOES NOT APPEAR WITHIN THE ALIGNMENT RECTANGLE WHEN RIFLE IS AIMED AT CENTER OF BLUE CROSS.

### NOTE:

For light pen mount adjustment two people are recommended unless a vise is available to hold rifle securely.

- For light pens with adjustable focal rings:
  - Ensure gap between focal ring and light pen barrel is 5/8".
- Loosen screws on light pen mount.
  - 9/64" for demilitarized M16 rifle.
  - 7/64" for replica M16 rifle.
- Holding rifle securely, aim rifle at center of blue cross.
- Adjust light pen mount to move black dot into rectangle.
- When O.K. appears, tighten screws on light pen mount.
- If this does not work; see trouble shooting in section 5.

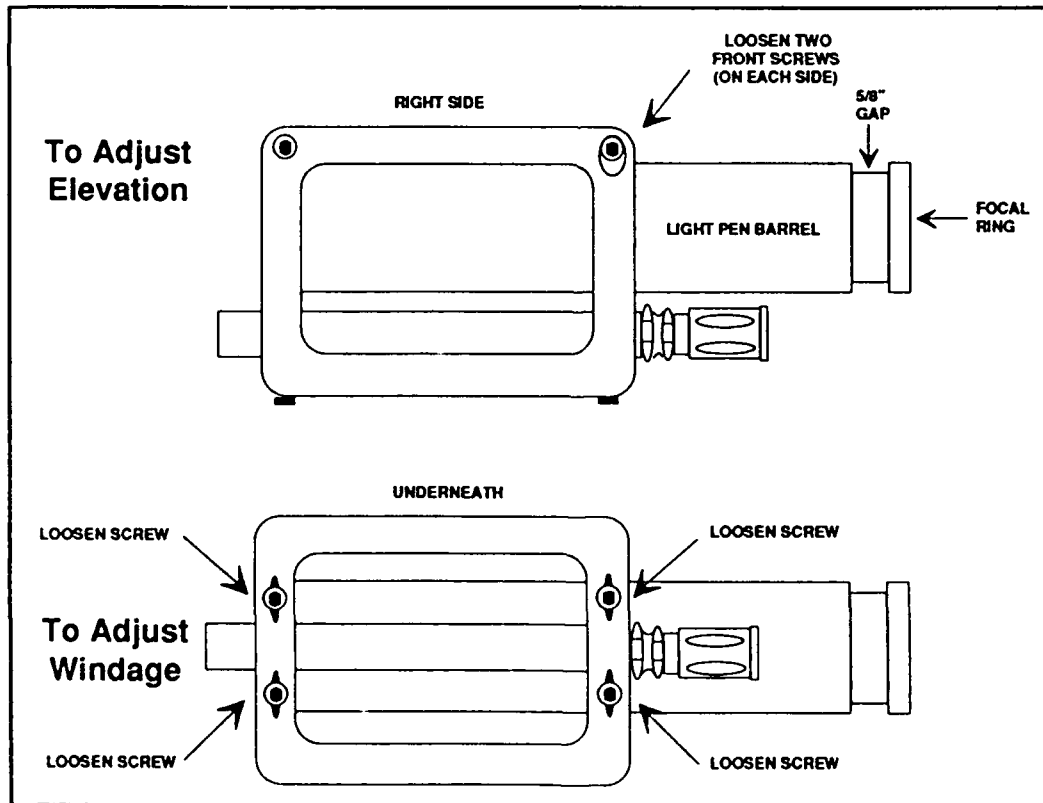

### STEP 3 PERFORM LIGHT PEN TRACKING TEST

- Look over the rifle sights at the monitor screen.
- Aim rifle toward different points on screen.

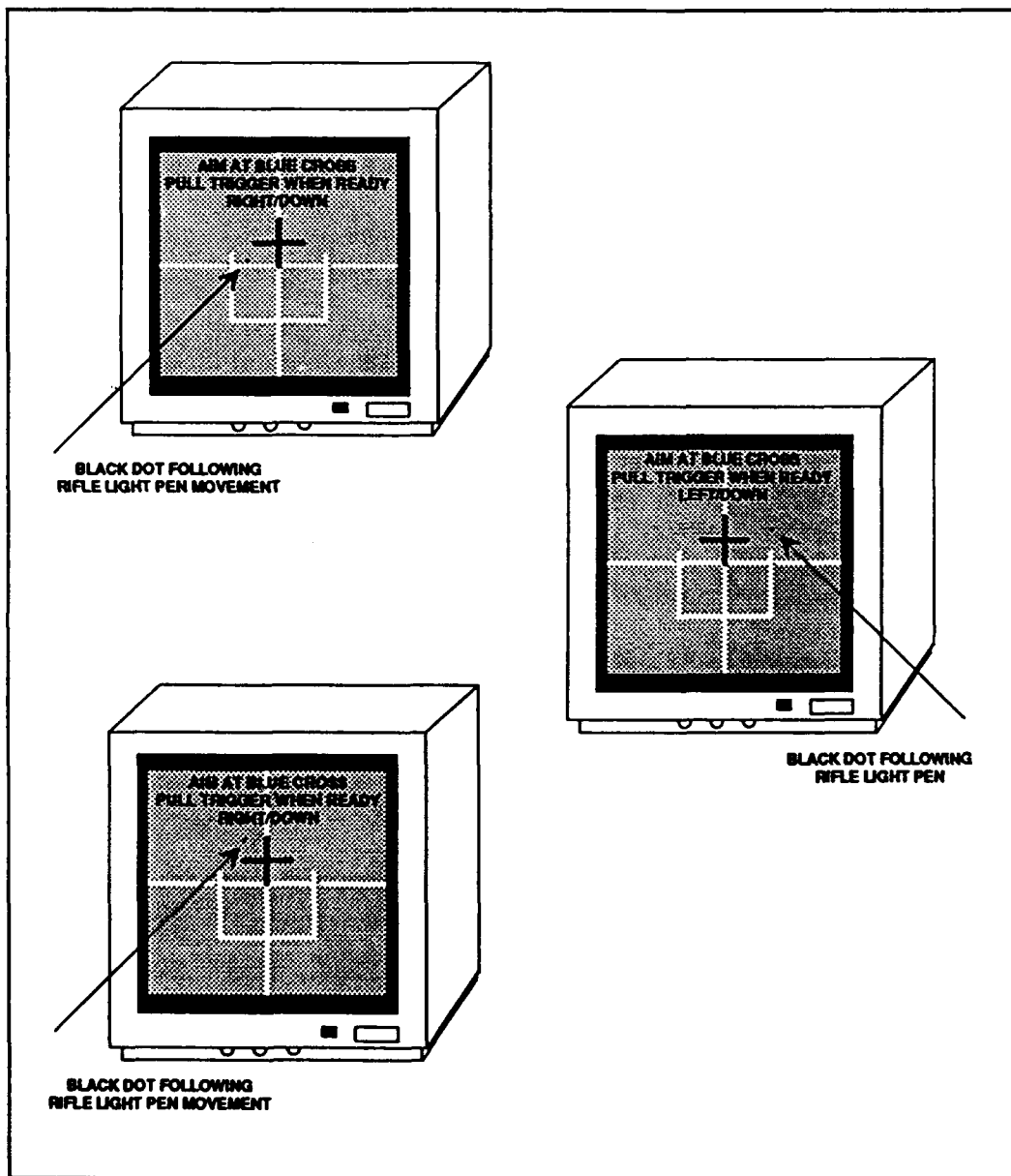

**IF BLACK DOT SMOOTHLY FOLLOWS MOVEMENT OF RIFLE, LIGHT PEN MOUNT ALIGNMENT PROCEDURE IS COMPLETE!**

**LIGHT PEN MOUNT ALIGNMENT IS CORRECT WHEN:**

- O.K. APPEARS ON SCREEN
- BLACK DOT APPEARS IN RECTANGLE

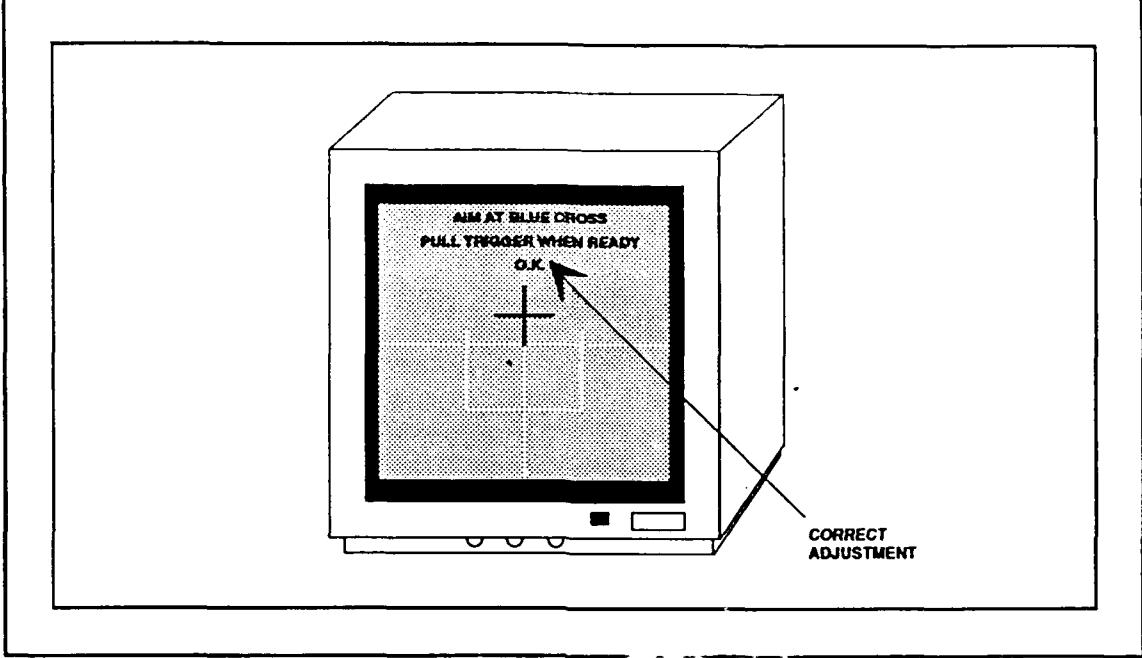

**Pull trigger to return to MACS Welcome Screen**

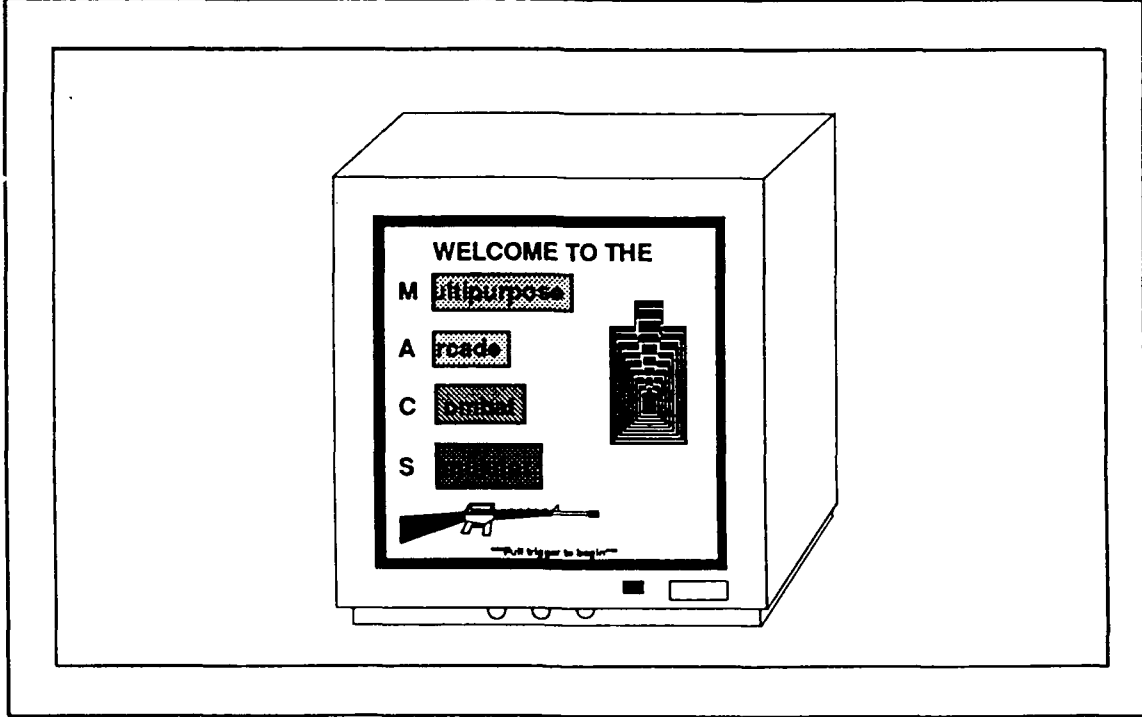

# **THE BASIC RIFLE MARKSMANSHIP PROGRAM**

## OVERVIEW OF MACS SYSTEM AND BRM PROGRAM

MACS system is a low-cost, part-task weapons trainer that has been validated as a teaching device with entry-level soldiers. The system may be used for basic, preparatory, sustainment, and remedial training.

The MACS system has four parts:

1. An M16 demilitarized or replica rifle with a light pen attached to the barrel;
2. A Commodore 64 computer;
3. A computer monitor; and
4. The BRM software cartridge designed for use with the M16 rifle.

MACS allows soldiers to practice Basic Rifle Marksmanship (BRM) skills by firing at targets at scaled ranges displayed on a computer screen. Diagnostic feedback is provided on the screen.

The program written for the MACS system provides part-task training in BRM. A skill test is followed by a main program which has nine increasingly more difficult levels of training. Stationary targets at ranges between 50 and 300 meters are presented at varying time intervals depending on the level being practiced. Specific performance standards are set for each level, and are incorporated into the program. Upon completion of a level, the shooter's performance is evaluated against these standards.

Depending on performance the shooter may:

1. Advance to the next level;
2. Stay at the same level; or
3. Be sent back one level.

The MACS BRM program is specifically designed to help the average and below average shooter, and does this in two ways:

- First, it provides the shooter with more feedback than can be obtained from live fire on a range.
- Second, because the rifle has no flash, recoil, or cartridge ejection system, it allows the shooter to develop the psycho-motor skills needed to achieve steady position, correct aiming, breath control, and control of the weapon at trigger closure, without having to overcome the instinct to flinch or blink when a weapon is fired.

MACS provides additional flexibility, allowing the instructor to go directly to any level using the MENU. Other OPTIONS include introducing wind of different speeds and directions into any of the nine levels, and a "call your shot" routine. A list of options and menu instructions are found in section 4.

The MACS system software is largely self-explanatory, but assumes the presence of an instructor. It is designed to enable a sergeant to train a squad. On-screen diagnostic feedback is provided to the shooter, which helps the instructor in identifying problems, and recommending corrective action.

**At the first four levels, shot-by-shot feedback is provided:**

- **Steady position**
- **Breath control**
- **Aiming**
- **Trigger squeeze**
- **Shot location**
- **Replay of sight picture**

**At all levels summary feedback is provided:**

- **Single target shot groups for each range.**
- **Average diagnostic scores or a summary of shots is presented at the end of each level.**

**The type of feedback provided at each level of difficulty is summarized beginning on page 3-17.**

The MACS BRM program has incorporated features to enable a single instructor to monitor the progress of several soldiers at the same time (with multiple systems). Standards embedded in the program determine the shooter's progress from level to level.

The color of the screen border changes to draw the instructor's attention to any soldier having difficulty. The colors of the borders indicate the soldier's status:

- **BLACK - Making satisfactory progress.**
- **RED - Refiring some targets at a particular range, or a part of a level.**
- **BLUE - Refiring an entire level.**
- **YELLOW - Has been sent back one level.**
- **PURPLE - Aiming off the screen, or light pen not reading.**

Information on the soldier's progress is included in the upper left corner of the screen.

- **L - Level being shot.**
- **T - Target being shot within a level.**
- **R - Number of refires within a level.**

Before using the MACS system as a teaching device with soldiers, the instructor should read the MACS Trainer's Guide and shoot the entire program several times.

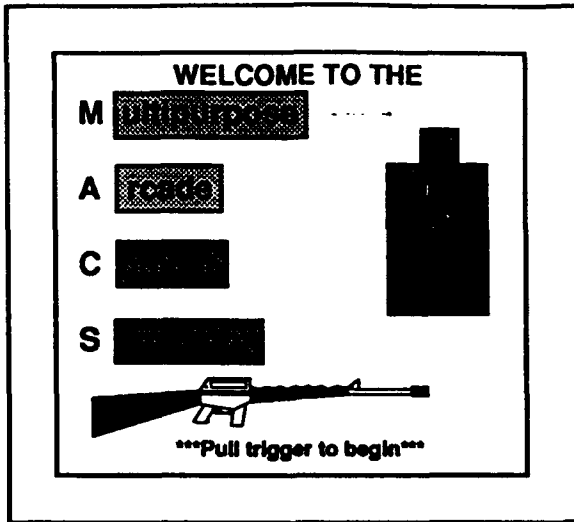

## MACS WELCOME SCREEN

- First screen of MACS BRM program.
- Adjust volume.
- Pull trigger to begin program.

or

Press  key to access

MACS program menu (see section 4).

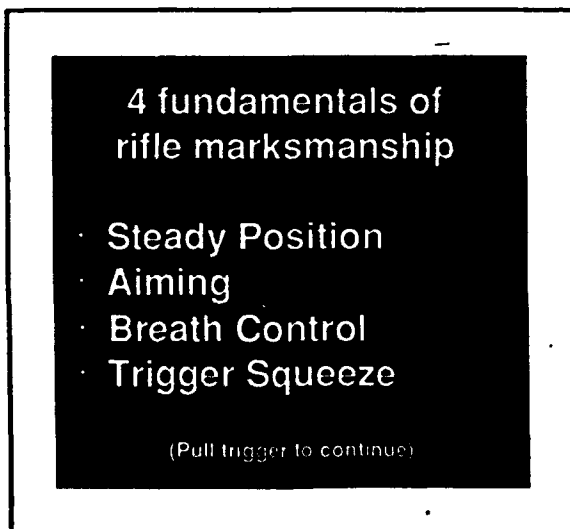
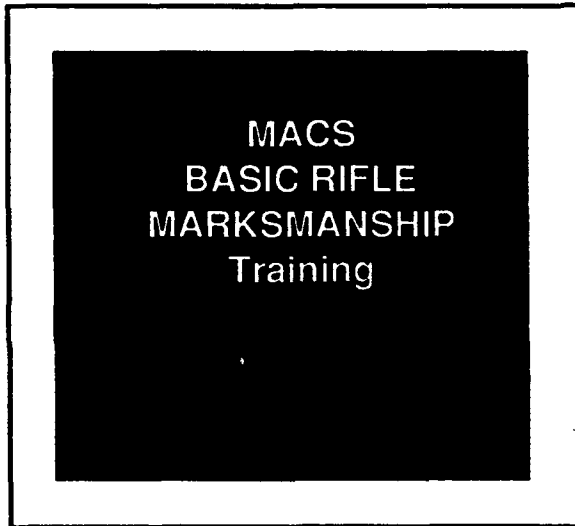

NOTE:  on keyboard will

substitute for trigger pull on screens not showing targets.

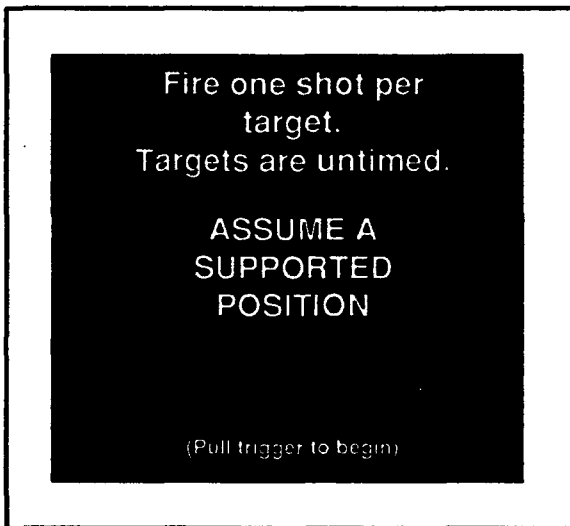
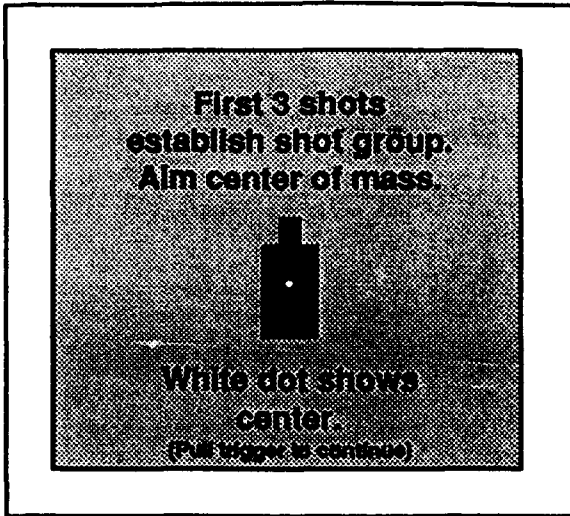

## ESTABLISH SHOT GROUP

- It is important to get a good shot group.
- Targets are at 250 m.

**NOTE:** Adjustment of brightness or contrast after establishing shot group changes system calibration (firer must rezero).

## SHOOTING INSTRUCTIONS

- The next three shots establish shot group.

**NOTE:** Pulling rifle trigger sends signal to computer to continue.



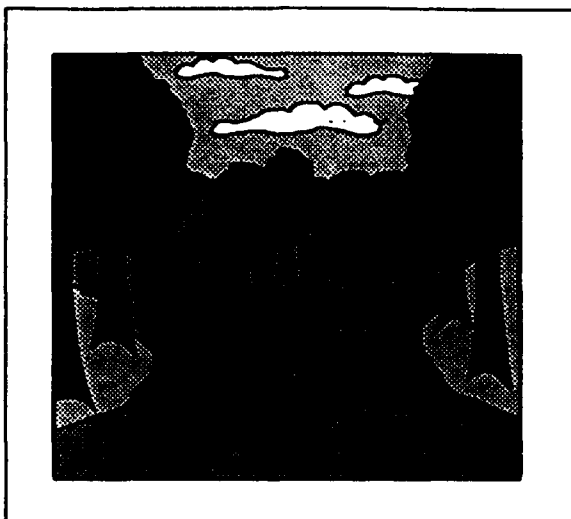

## FIRE SHOT GROUP

- Soldier fires one shot at each of three targets.

**NOTE:** Purple border appears when light pen is not aimed at screen.

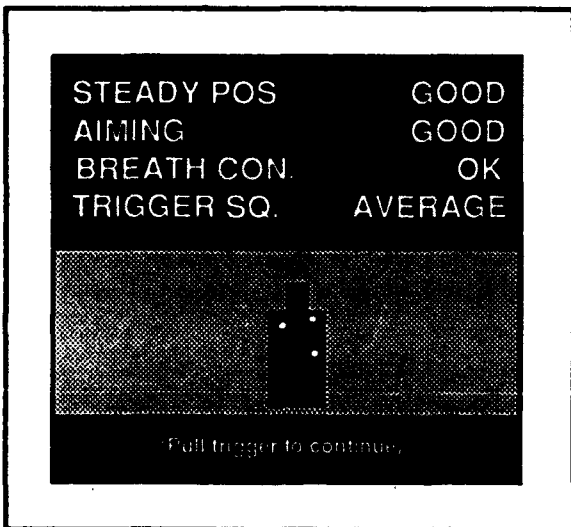

## SHOT GROUP SUMMARY SCREEN

- Shot locations pictured on target.
- Feedback for three shots summarized.
- Good shot group calibrates system.

**IF SHOT GROUP IS INVALID:**

- An invalid shot group is one in which one or more shots hit outside a rectangular area (not seen by the shooter) which is the same size as the light pen mount alignment rectangle shown on the next page.

## IF SECOND SHOT GROUP IS INVALID:

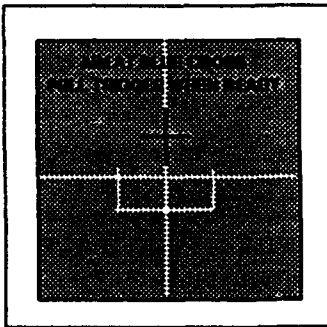
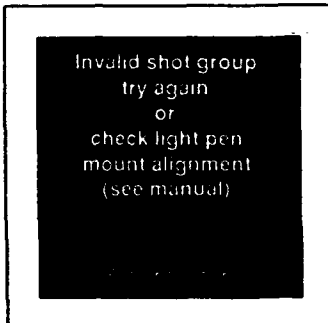

### If second shot group is invalid:

- Press  on Keyboard to start light pen mount alignment program.

**NOTE:** See section 2 for instructions on aligning the light pen mount.

- Follow directions for alignment.
- Following alignment the program will return to WELCOME TO MACS screen.

## IF SHOT GROUP IS VALID:

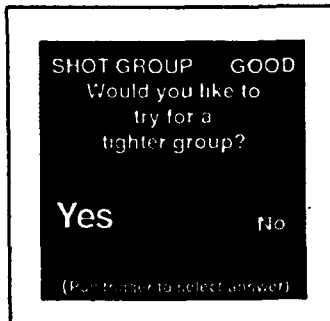

- Pull trigger when selected answer (YES or NO) is enlarged.
- If YES:  
Refire shot group.
- If NO:  
Initial skill test criteria determine starting level.

## INITIAL SKILL TEST CRITERIA

To pass each skill test two GOOD ratings and two EXCELLENT ratings must be earned on measures of shot location, steady position, aiming, and trigger squeeze.

## IF CRITERIA ARE NOT MET:

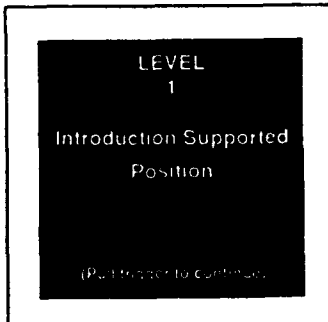

- Program starts at Level 1.
- See page 3-12.

## IF CRITERIA ARE MET:

Next three shots help  
decide start level.

ASSUME AN  
UNSUPPORTED  
POSITION

(Pull trigger to continue)

- Skill test is continued.
- Soldier fires one shot as each of three targets is presented from an unsupported firing position.



STEADY POS	GOOD
AIMING	GOOD
BREATH CON.	OK
TRIGGER SQ.	GOOD

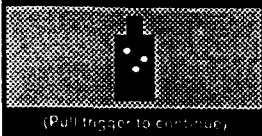

(Pull trigger to continue)

## IF CRITERIA ARE NOT MET:

LEVEL  
2

Introduction Unsupported  
Position

(Pull trigger to continue)

- Program starts at Level 2.

## IF CRITERIA ARE MET:

You have done well!  
Now try  
timed targets.

ASSUME A  
SUPPORTED  
POSITION

(Pull trigger to begin.)

- Skill test is continued.
- 3 shots fired at timed targets in supported position to determine starting level for better shooters.



- Timed targets at 100, 250, and 300 m are presented.

You will start at...

## IF CRITERIA ARE NOT MET:

LEVEL  
3

Timed Targets Supported  
Position

(Pull trigger to continue.)

- Program starts at Level 3.

**NOTE:** If criteria are met, three shots are then fired from the unsupported position. Program can begin at Level 4 or Level 5 depending on results of this skill test.

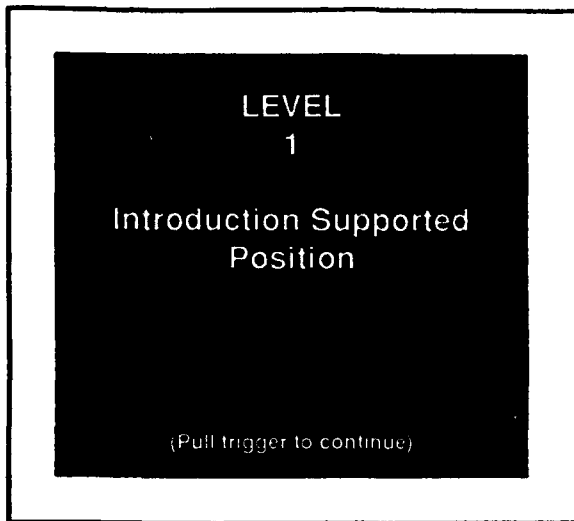

## LEVEL 1

- First firing level in BRM program.

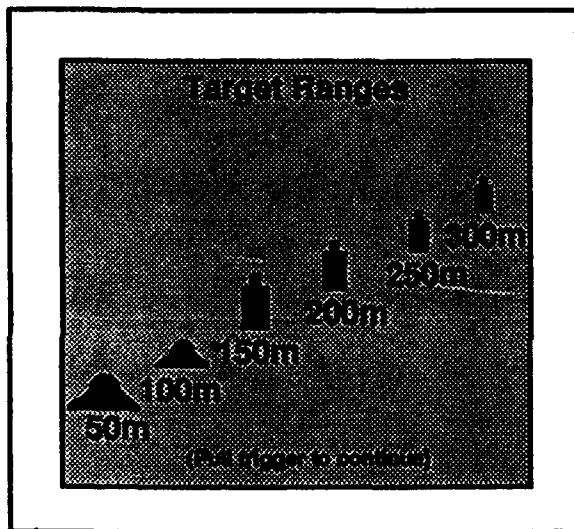

## TARGET RANGES

- Targets at each range are illustrated.

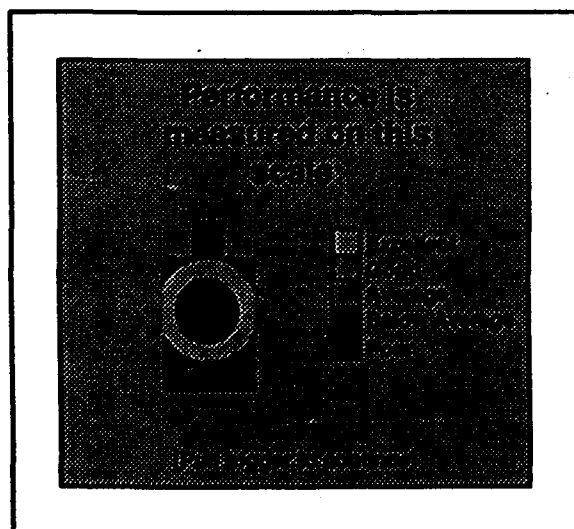

## SHOT LOCATION STANDARDS

- The shooter must hit center of mass for shot location to be graded excellent.

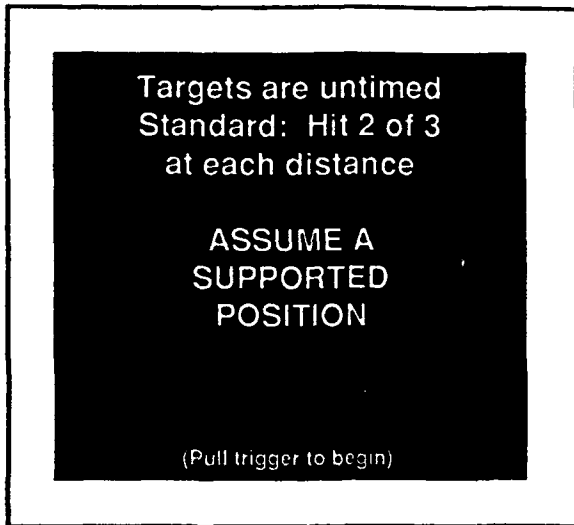

## SHOOTING INSTRUCTIONS

- Untimed targets.
- Hit 2 of 3 at each distance.
- Supported position.
- First three targets are at 50 meters.

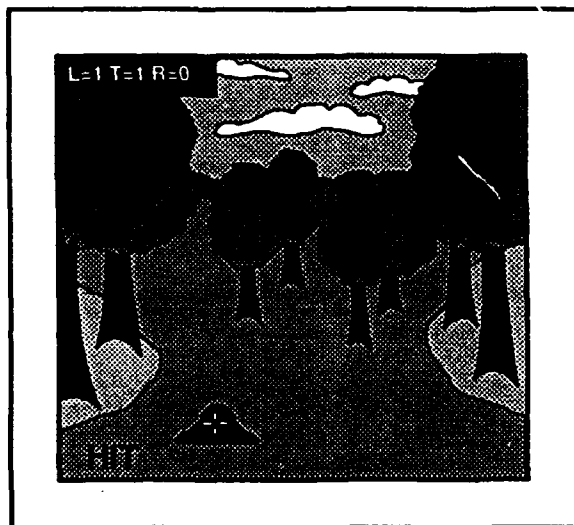

## TARGET SCREENS

- Three target screens are presented.
- Feedback screens follow each target presentation.

—+— indicates bullet strike.

- HIT or MISS appears in lower left corner of screen.

**NOTE:** In the upper left corner of the screen:

- L=Level being shot.
- T=Target being shot within a level.
- R=Number of refires within a level.

## FEEDBACK SCREEN SEQUENCE

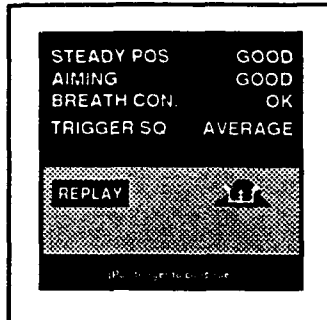

 correct sight placement (black).

 your sight placement (white).

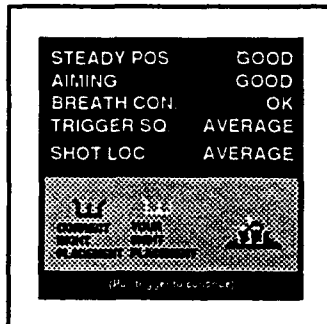

- Each shot is followed by a replay of the sight placement of the shooter compared to the correct sight placement, and bullet strike.
- Shooter's sight placement in moments before bullet strike (white) is superimposed over correct sight placement (black).
- The shot can be replayed as many times as necessary.

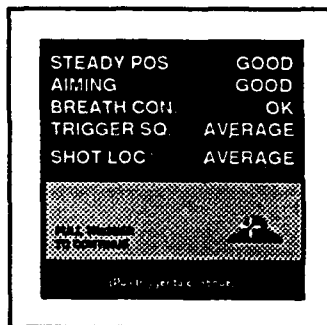

- PULL TRIGGER TO CONTINUE to next target screen.
- Bullet strike is displayed on target.

**NOTE:** For an explanation of MACS Feedback turn to page 3-17.



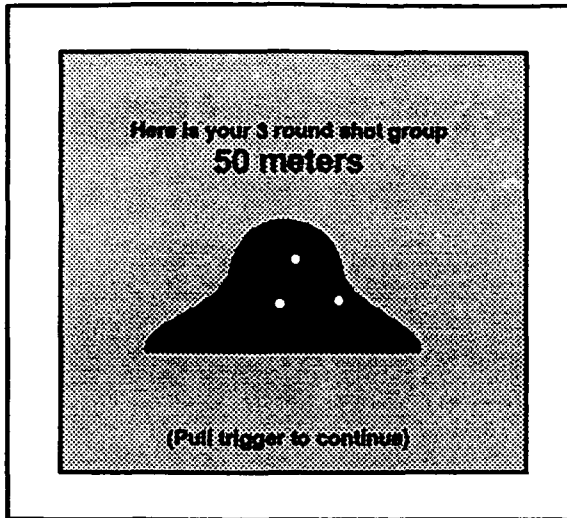

### 3 ROUND SHOT GROUP

- Target and feedback screens repeated for 100, 150, 200, 250, and 300 m targets.
- Shot group displayed on target at each range.
- These screens can be analyzed as if shots were fired at a known distance (KD) range.
- Must hit 2 of 3 targets to meet standard.

### TRAINER'S TIP

Trainer should assist the soldier by performing a shot group analysis, & give corrective action.

For example, the soldier's shot group at 100m is centered horizontally, but is too high.  
**Corrective action:** explain adjusted aiming point.

### FAILURE TO MEET STANDARD

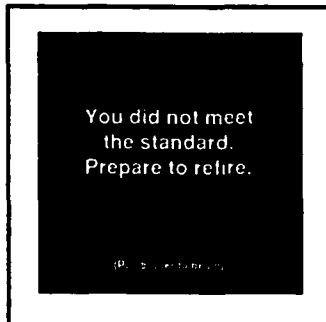

- Repeats presentation of target and feedback screens for each of the 3 shots.
- 3 round shot group is displayed for the range.

**NOTE:** Red border appears during refire of a range.

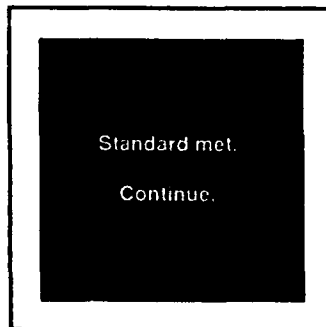

- This screen appears following refire at a specified range.
- Border color will return to black as program continues.

**SUMMARY : LEVEL 1**

Steady Pos	GOOD
Aiming	AVERAGE
BREATH CON	OK
Trigger Sq	AVERAGE
Shot Loc	AVERAGE

(Pull trigger to continue)

• If standard is met the shooter goes on to Level 2.

**STANDARD FOR LEVEL 1 NOT MET**

You are being sent back to Level 1 because one of your SUMMARY Scores was poor or below average.

- Blue border will appear during refire of a level.
- Yellow border will appear if shooter has regressed from a higher level.

4 fundamentals of rifle marksmanship

- Steady Position
- Aiming
- Breath Control
- Trigger Squeeze

(Pull trigger to continue)

## Summary Description of Levels

### Level 1. Introduction to Supported Position

#### Summary description

- No time limit.
- Supported position.
- Single-target presentations.
- Eighteen targets presented, three targets at each of six ranges.
- Targets engaged in order of range: 50, 100, 150, 200, 250, and 300 m.

#### Feedback

- Words **HIT** or **MISS** appear on screen for each shot.
- Cross hair appears on screen to show bullet strike.
- Diagnostics and replay are shown after each shot.
- Screen shows 3 rounds on single target after each group of three shots.
- Summary screen at end of level shows average diagnostic scores.

#### Standards

- Two hits out of three shots at each range within level. Failure to meet standard at a given range results in immediate refire of 3 more targets at that range. Refires continue until standard is met.
- Refire of level is required if any score on summary screen is **BELOW AVERAGE** or **POOR**.
- Breath control is rated **OK** or **CHECK**. These ratings are tied to the steady position score.

### Level 2. Introduction to Unsupported Position

#### Identical to Level 1, with these exceptions:

- It is fired in the unsupported position.
- Shooter is regressed a level if any 2 scores on summary screen are **POOR**.

### Level 3. Timed Targets in Supported Position

#### Summary description

- Time limit approximately 1 1/3 times that of record fire.
- Supported position.
- Single target presentations.
- Twenty-four targets in random sequence (four presentations per range).

#### Feedback

- Cross hair appears on screen to show bullet strike.
- For a hit, target disappears immediately after bullet strike is shown.
- Diagnostics and replay are shown after bad shots only. Criteria for bad shot is a POOR for any score or a BELOW AVERAGE for shot location.
- Audible tone when target exposure time limit has expired.
- Summary screen at end of level showing average diagnostic scores.
- Summary screens showing four shots at each range on single targets.

#### Standards

- Three hits out of four shots at each range within level. For each range at which this standard is not met, a refire of four targets at each of those ranges is required. Refires continue until standard is met.
- Refire of level is required if any score on summary screen is BELOW AVERAGE or POOR.
- Shooter is regressed a level if any two scores on summary screen are POOR.

### Level 4. Timed Targets in Unsupported Position

#### Identical to Level 3, with these exceptions:

- Level 4 is fired in the unsupported position.
- Standard is lower. Three hits out of four shots at 50, 100, 150, and 200 m, and two hits out of four shots at 250 m and 300 m.

## Level 5. Practice Record Fire I

### Summary description

- Time limit same as for record fire.
- Supported and unsupported positions.
- Single or double presentations.
- Targets presented in random sequence.
- 20 targets fired supported, then 20 fired unsupported.

### Feedback

- Cross hair appears on screen to show bullet strike.
- For a hit, target disappears after bullet strike is shown.
- Audible tone when target exposure time limit has expired.
- OUT OF AMMO appears on screen when 20 shots have been fired.
- Interim summary of performance (hits, misses, and no fires) and shot location score given at end of each position and final summary at end of course of fire.
- Summary screens showing shots at each range on a single target at end of supported position and at end of unsupported position.
- Overall performance is graded Expert (36-40), Sharpshooter (30-35), Marksman (23-29), or Unqualified (0-22).

### Standards

- Fifteen hits out of 20 shots in both supported and unsupported positions. Refire of position if standard not met.
- On double target exposures, a penalty is recorded if furthest target is engaged first (a penalty indicates a tactical error, but does not reduce the total number of hits).
- Regress one level for shot location score of POOR. Stay at same level for mean shot location score of BELOW AVERAGE. Otherwise pass.

## Level 6. Practice Record Fire II

Identical to Level 5, with the exception that the cross hair showing bullet strike appears only after misses. Target disappears when hit.

## Level 7. Record Fire

### Summary description

- Time limit same as actual live-fire qualification course.
- Supported and unsupported positions.
- Single or double presentations.
- Targets presented in random sequence.
- 20 targets fired supported, then 20 fired unsupported.

### Feedback

- Targets disappear when hit.
- **OUT OF AMMO** appears on screen when 20 shots have been fired.
- Audible tone when target exposure time limit has expired.
- Cross hairs showing bullet strike for misses on refires only.
- Interim summary of performance (hits, misses, and no fires) and shot location score given at end of each position and final summary at end of course of fire.
- Summary screens showing shots at each range on a single target at end of supported position and at end of unsupported position.
- Overall performance is graded Expert (36-40), Sharpshooter (30-35), Marksman (23-29), or Unqualified (0-22).

### Standards

- Fifteen hits out of 20 shots in both supported and unsupported positions. Refire of position if standard not met.
- On double target exposures, a penalty is recorded if furthest target is engaged first.
- Regress one level for average shot location score of POOR. Stay at same level for mean shot location score of BELOW AVERAGE. Otherwise pass.

## Level 8. Rapid Record Fire

Identical with Level 7, except that the exposure times of targets are 2/3 of those used in record fire.

## Level 9. Combat Fire

### Summary description

- Time limits variable, dependent on number of targets presented.
- Supported and unsupported positions..
- Single, double, and multiple presentations.
- Eighty targets in two attack/retreat scenarios each of 40 targets. First scenario is fired supported and second unsupported.

### Feedback

- Targets disappear when hit.
- **OUT OF AMMO** appears on screen when 40 shots have been fired.
- Cross hairs showing bullet strike for misses on refires only.
- Summary of shot location (hits, misses, and no fires) given at end of supported position and at end of unsupported position.
- Summary screens showing shots at each range on a single target at end of supported position and at end of unsupported position.
- Performance graded as Expert (36-40), Sharpshooter (30-35), Marksman (23-29), or Unqualified (0-22).

### Standard

- Twenty-three hits out of 40 shots in both supported and unsupported positions. Refire of position if standard not met.

# TOP GUN

A	B	C	D	E	F	G
H	I	J	K	L	M	N
O	P	Q	R	S	T	U
V	W	X	Y	Z		

Enter your initials

Level 9 High Scores

1. JMB	2. WWG
3. MAC	4. ARI
5. LCS	6. WWG
7. JMB	8. JWP
9. RFM	10. EWW

**CONGRATULATIONS**

You are finished  
with this program.  
Call instructor.

Push **ENTER**

- At the end of Level 9, combat fire, high scorers may enter initials for display on high score screen. The high score screen will alternate with the MACS welcome screen until computer is turned off.

- Alternates with MACS welcome screen
- Activated after shooter fires high score on Level 9.



**NOTE:**

The following charts provide a summary of the MACS BRM Cartridge.

# MACS FEEDBACK FOR BRM CARTRIDGE

LEVEL	SHOT-BY-SHOT DIAGNOSTIC FEEDBACK				ON-SCREEN FEEDBACK DURING SHOOTING				SUMMARY FOLLOWING SHOOTING SEQUENCE		
	Diagnoses feedback and frequency of each shot	Diagnoses feedback for poor shots only	Tip or miss in lower left corner of screen	Cross hairs showing bullet strike	Target disappears when hit	Out of aim in lower right corner of screen	Priority for not having missed target shot	Shot group displayed on target at each range	Average diagnostic scores at end of each range	Summary of hits, misses, and no fires	Classification ratings
1	X	X	X					X			
2	X	X	X					X			
3			X	X				X			
4			X	X				X			
5			X	X	X			X	X	X	X
6			X*	X	X			X	X	X	X
7			X**	X	X			X	X	X	X
8			X**	X	X			X	X	X	X
9			X**	X	X			X	X	X	X

\*FOR MISSES ONLY  
\*\*FOR MISSES ON REFRES ONLY

## MACS BRM CARTRIDGE

LEVEL	TITLE	TIME LIMIT	POSITION	TARGET PRESENTATION	TARGET SEQUENCE	NUMBER OF TARGETS	STANDARDS
1	INTRODUCTION TO SUPPORTED POSITION	NONE	SUPPORTED	SINGLE	IN ORDER 50-100-150- 200-250-300	18 (3 PER RANGE)	HIT 2 OF 3 TARGETS AT EACH DISTANCE
2	INTRODUCTION TO UNSUPPORTED POSITION	NONE	UNSUPPORTED	SINGLE	IN ORDER 50-100-150- 200-250-300	18 (3 PER RANGE)	HIT 2 OF 3 TARGETS AT EACH DISTANCE
3	TIMED TARGETS IN SUPPORTED POSITION	1 1/3 TIMES GREATER THAN TIME ALLOWED FOR RECORD FIRE	SUPPORTED	SINGLE	RANDOM	24 (4 PER RANGE)	HIT 3 OF 4 TARGETS AT EACH DISTANCE
4	TIMED TARGETS IN UNSUPPORTED POSITION	1 1/3 TIMES GREATER THAN TIME ALLOWED FOR RECORD FIRE	UNSUPPORTED	SINGLE	RANDOM	24 (4 PER RANGE)	HIT 3 OF 4 TARGETS AT 50-100-150-200 HIT 2 OF 4 TARGETS AT 250-300
5	PRACTICE RECORD FIRE I	SAME AS RECORD FIRE	SUPPORTED/ UNSUPPORTED	SINGLE OR DOUBLE	RANDOM	40	HIT 15 OF 20 TARGETS IN EACH POSITION
6	PRACTICE RECORD FIRE II	SAME AS RECORD FIRE	SUPPORTED/ UNSUPPORTED	SINGLE OR DOUBLE	RANDOM	40	HIT 15 OF 20 TARGETS IN EACH POSITION
7	RECORD FIRE	SAME AS ACTUAL LIVE-FIRE QUALIFICATION COURSE	SUPPORTED/ UNSUPPORTED	SINGLE OR DOUBLE	RANDOM	40	HIT 15 OF 20 TARGETS IN EACH POSITION
8	RAPID RECORD FIRE	1/3 LESS THAN TIME ALLOWED FOR RECORD FIRE	SUPPORTED/ UNSUPPORTED	SINGLE OR DOUBLE	RANDOM	40	HIT 15 OF 20 TARGETS IN EACH POSITION
9	COMBAT FIRE	VARIABLES	SUPPORTED/ UNSUPPORTED	MULTIPLE	ATTACK/ RETREAT	80	HIT 23 OF 40 TARGETS IN EACH POSITION

# DESCRIPTION OF THE MACS MENU

## DESCRIPTION OF THE MACS MENU

The MACS Menu provides flexibility for the instructor using the MACS program.

To access the MACS program menu, press the  key:

- At the Welcome to MACS screen.
- At any Level screen.
- Repeatedly during a level when a target is on the screen.

## DESCRIPTION OF THE MACS MENU

Instructions for using the MACS menu options are on the pages listed below.

Start Level: 1  
Final Level: 9  
Wind Speed: 0 mph

- 1: Introduction Supported Position
- 2: Introduction/Unsupported Position
- 3: Timed Targets Supported Position
- 4: Timed Targets Unsupported Position
- 5: Practice Record Fire I
- 6: Practice Record Fire II
- 7: Record Fire
- 8: Rapid Record Fire
- 9: Combat Fire

	Page
L: Select Start Final Level .....	4-4
N: New Firer .....	4-4
W: Set Wind Speed .....	4-6
CS: Turn on "Call your shot" option .....	4-5
LP: Light pen mount adjustment .....	2-1
SG: Sight and grouping program .....	4-8
EZ: Set Level 1 targets for 250 meters .....	4-4
G: Go to start .....	4-4

Select number or letter & press RETURN

? \_\_\_\_\_

## LEVEL OPTION

- Permits instructor to set levels before students arrive.

Choose level option	→	Select letter & press RETURN ? L
Enter starting level	→	Select number & press RETURN Start level (1-9)? 4
Enter final level	→	Select number & press RETURN Final level (4-9)? 9
Begin program	→	Select letter & press RETURN ? G

## NEW FIRER OPTION

- Program returns to Establish Shot Group screen.
- Used when one firer has completed firing and a new firer takes over.

→ Select letter & press RETURN  
? N

## EZ OPTION

- Sets all targets in Level 1 to 250m.

→ Select letter & press RETURN  
? EZ

## G OPTION

- Returns user to starting or previous level.

→ Select letter & press RETURN  
?G

## USING THE CALL YOUR SHOT OPTION

Enter: **C** **S**

**NOTE:** The "Call Your Shot" option works with Levels 1 and 2 only.

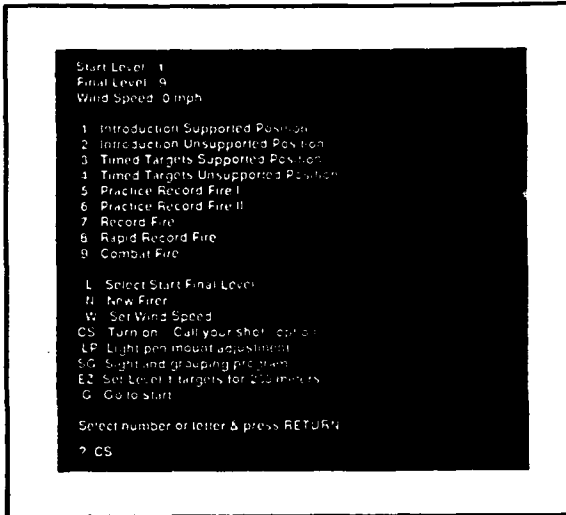

### CALL YOUR SHOT

- Firer has 5 seconds to call out shot location after the trigger is pulled.
- **CALL YOUR SHOT** appears on the bottom of the screen.

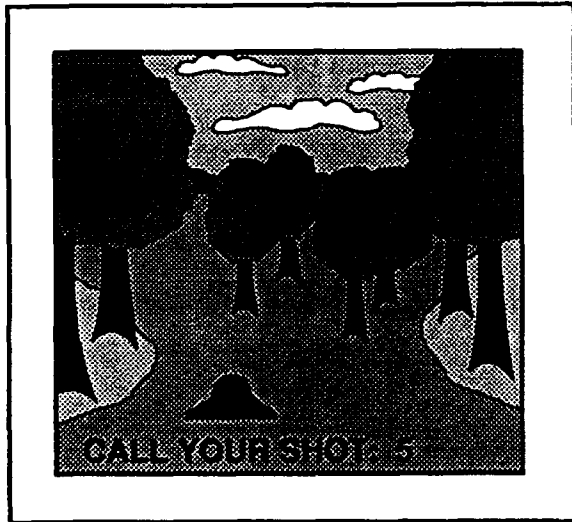

- When time expires crosshairs appear on target showing shot location.

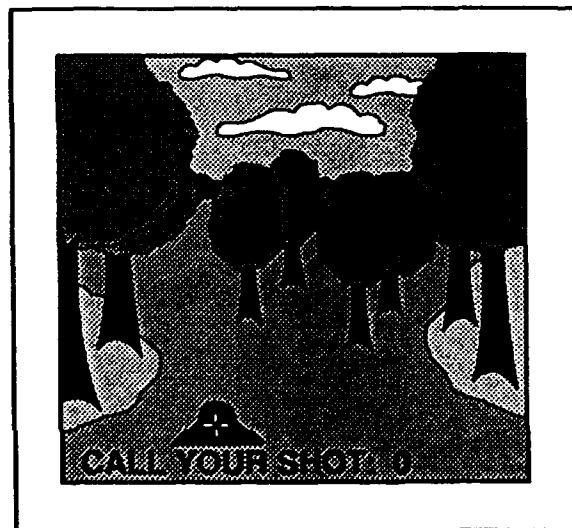

## USING THE SET WIND SPEED OPTION

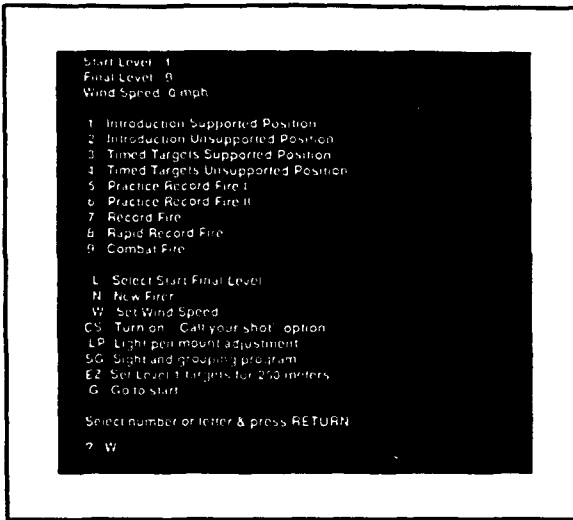

· Enter **W** to select wind.

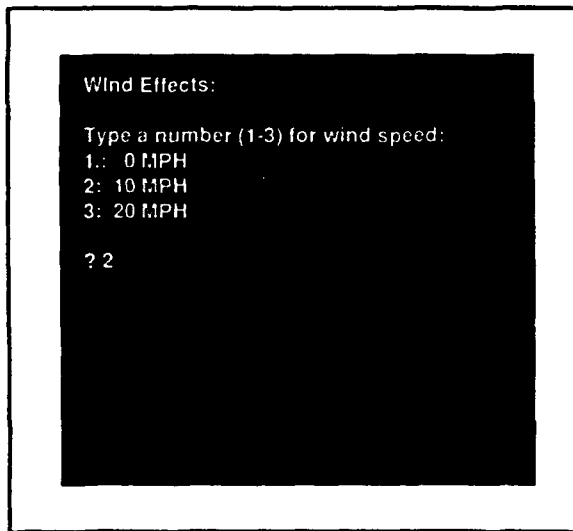

## WIND EFFECTS

· Enter **1** **2** or **3**

to select wind speed.

**NOTE:** There is no wind effect at 0 mph.

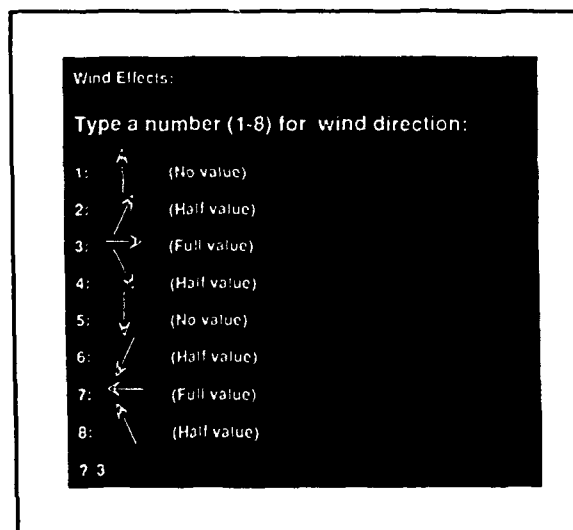

## WIND DIRECTION

· Enter **1** to **8**

to select wind direction.

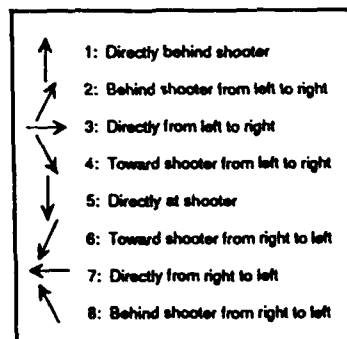



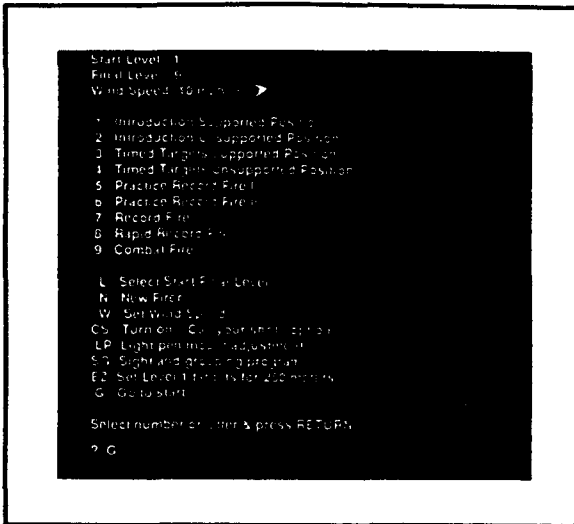

· Now return to skill level.

· Enter **G** to return to skill level.

· Title screen for selected level will appear next.

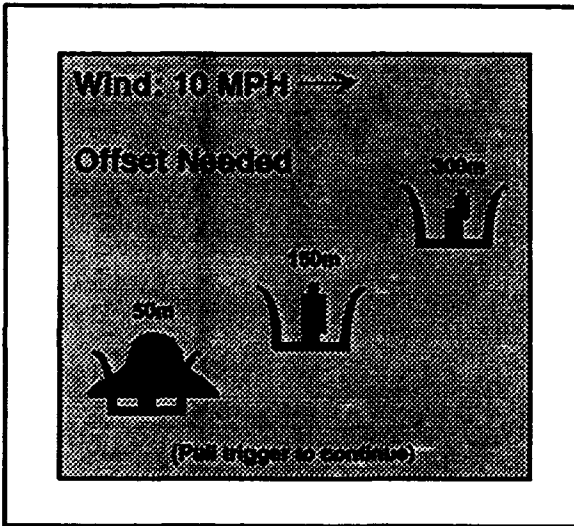

### WIND

- The correct offset is illustrated for targets at three distances.
- The offset changes with each wind effect.

**NOTE:** Wind speed and direction will remain in effect unless program is restarted, or new wind speed and direction are entered using the menu.

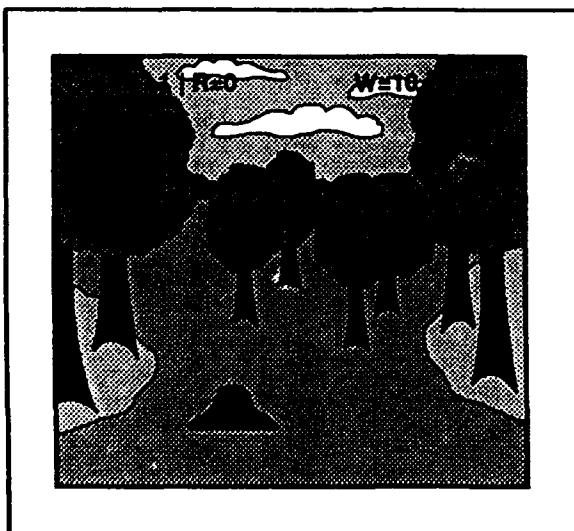

### TARGET SCREEN

- Wind speed and direction are shown in upper right-hand corner of screen.

## SIGHT AND GROUPING PROGRAM

### MACS Basics of Aiming

(Pull TRIGGER to begin)

### Correct Application of Sight Alignment and Aiming Improves Marksmanship Skills

(Pull TRIGGER to continue)

### MACS Sight Alignment and Aiming Program

(Pull TRIGGER to continue)

- The sight and grouping program is designed to teach and test the basic skills of sight alignment, aiming, and shot grouping to the novice marksman.
- The sight and grouping program has three parts:
  1. Sight alignment program.
  2. Aiming program.
  3. Grouping program.

## SIGHT ALIGNMENT PROGRAM

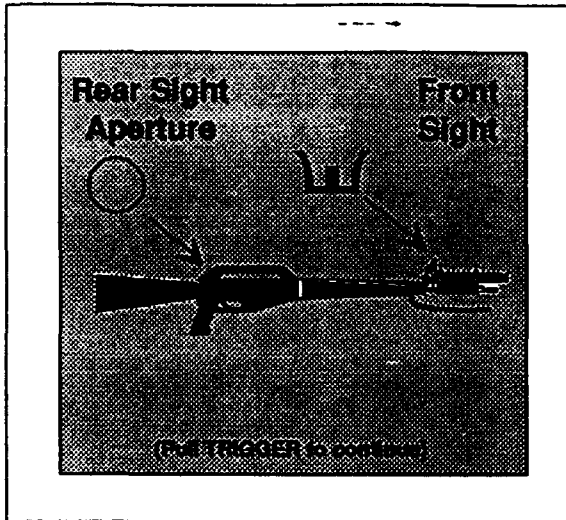

### LOCATION OF SIGHTS

- Front sight.
- Rear sight aperture.

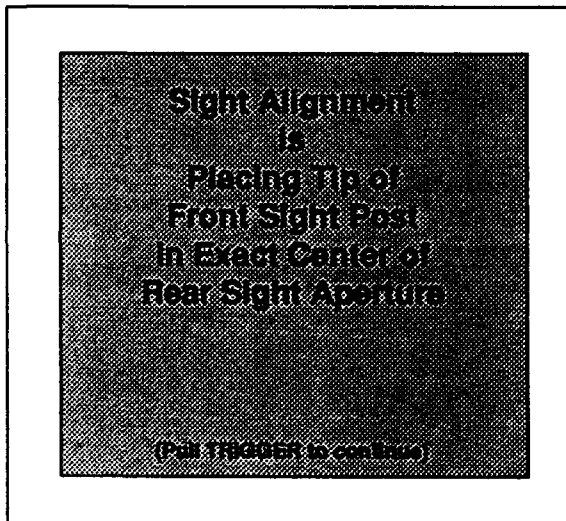

### DEFINITION OF SIGHT ALIGNMENT

# DEMONSTRATION OF SIGHT ALIGNMENT

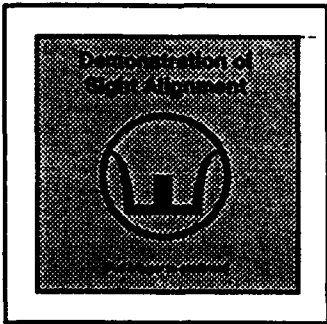

## SIGHT ALIGNMENT

### Part 1:

- Tip of front sight post is placed in center of rear sight aperture.

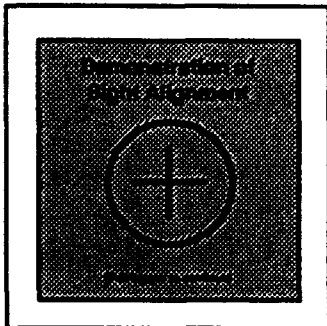

### Part 2:

- Center of rear sight aperture is designated by red cross.

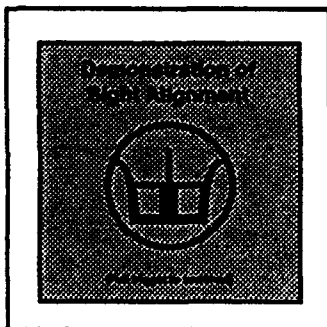

### Part 3:

- Complete demonstration screen.
- Sequence returns to Part 1 unless trigger is pulled.

## SIGHT ALIGNMENT TEST

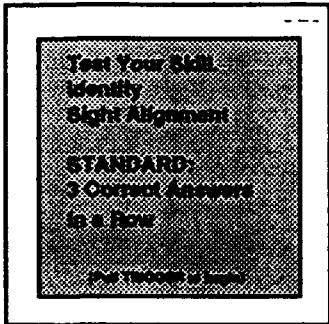

### TEST INFORMATION SCREEN

- Tests ability to identify correct sight alignment.
- Must correctly identify three sight pictures in a row to pass test.

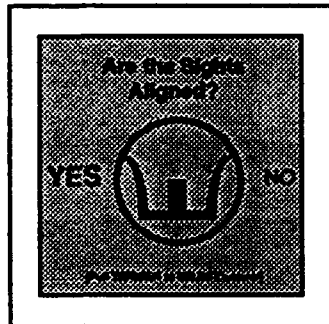

### TEST SCREEN

- Front and rear sights pictured.
- YES and NO alternately appear in large (boldface) type.
- Select answer by pulling trigger when choice appears in large (boldface) type.

## SIGHT ALIGNMENT TEST FEEDBACK SCREENS

### INCORRECT RESPONSE FEEDBACK

- Red border appears.
- Red cross designates correct placement of front sight in rear aperture.
- Error is described.

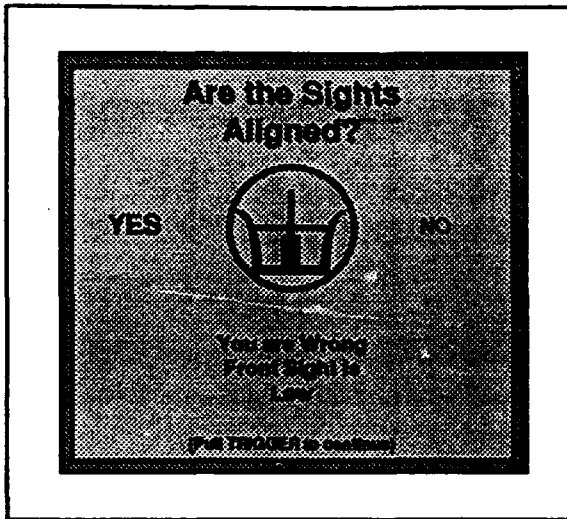

### EXAMPLE

- Red border appears.
- Red cross designates correct placement of front sight in rear aperture.
- Error is described.

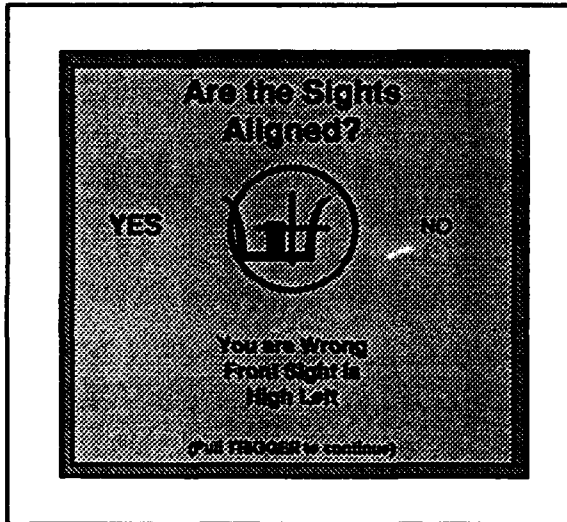

### CORRECT RESPONSE FEEDBACK

- You are correct.

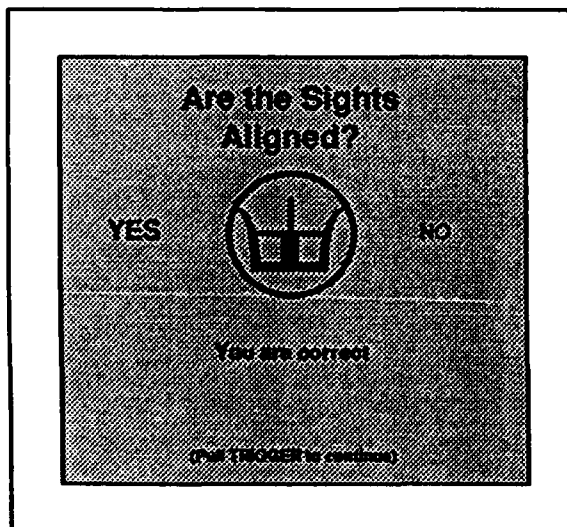

## AIMING PROGRAM

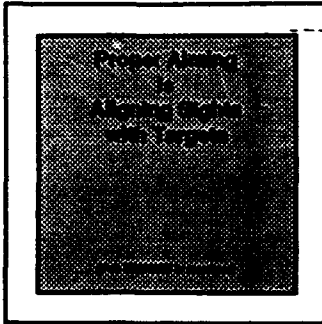

### Definition

- Proper aiming is aligning sights with target.

## DEMONSTRATION OF AIMING

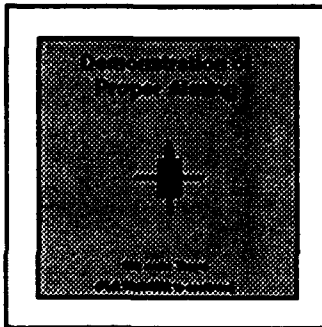

### EXPLANATION

#### Part 1:

- Cross hairs designate center of mass of target.

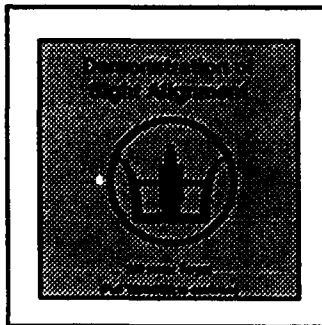

#### Part 2:

- Correct sight alignment is placed at center of mass.

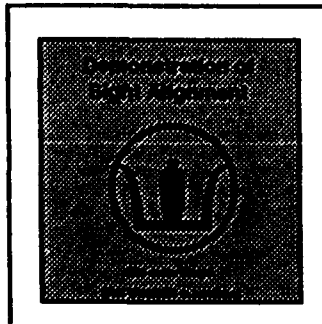

#### Part 3:

- Cross hairs are removed.
- Correct sight alignment shown at center of mass.
- Sequence returns to Part 1 unless trigger is pulled.

## AIMING TEST

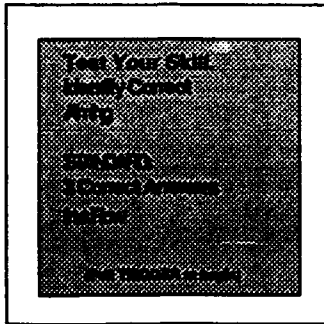

### AIMING SKILL TEST

- Tests ability to identify correct sight picture.
- Must correctly identify three sight pictures in a row to pass test.

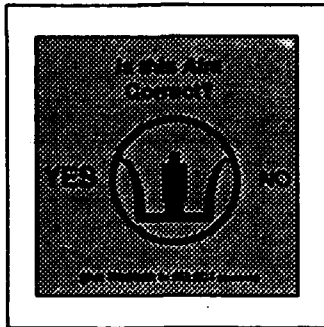

### TEST SCREEN

- YES and NO alternately appear in large (boldface) type.
- Select answer by pulling trigger when choice appears in large (boldface) type.



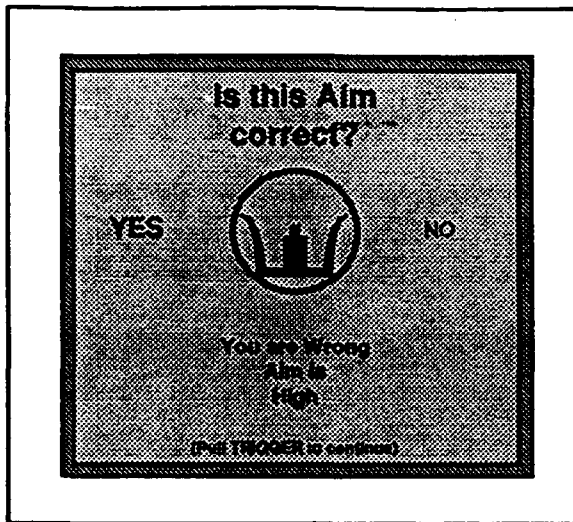

## AIMING TEST FEEDBACK SCREENS

### INCORRECT RESPONSE FEEDBACK

- Red border appears.
- Red cross designates center of mass of the target.
- Error is described.

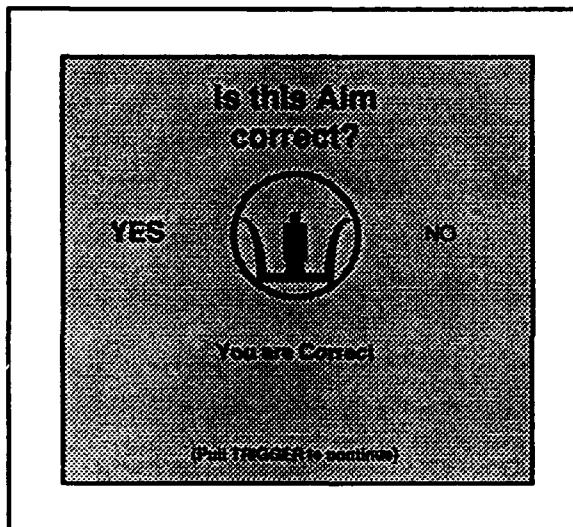

### CORRECT RESPONSE FEEDBACK

- You are correct.

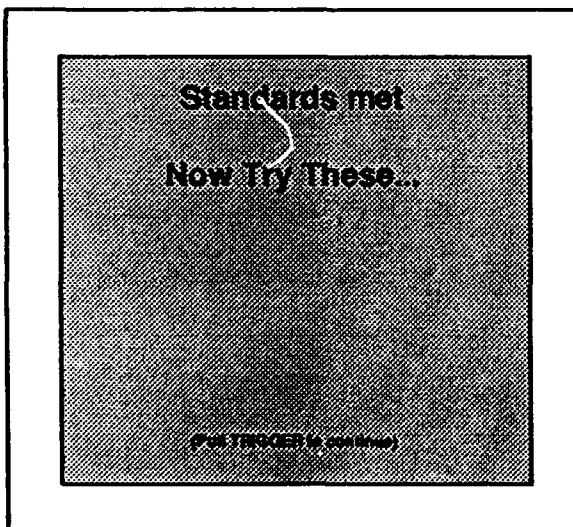

### AFTER THREE CORRECT RESPONSES IN A ROW:

- Next set of screens test ability to identify correct sight alignment and sight picture.

## ADVANCED AIMING TEST

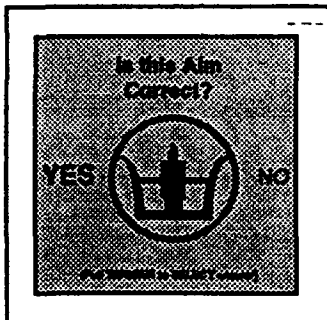

### ADVANCED AIMING SKILL TEST

- Tests ability to identify correct sight alignment and sight picture.
- YES and NO alternately appear in large (boldface) type.
- Select answer by pulling trigger when choice appears in large (boldface) type.
- Must correctly identify three in a row to exit test.

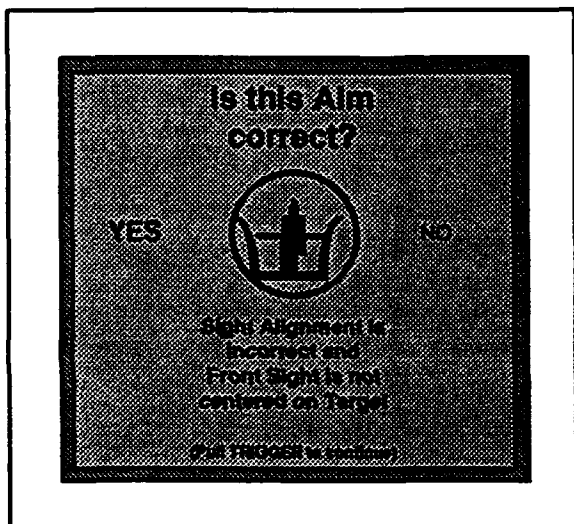

### ADVANCED AIMING TEST FEEDBACK SCREENS

#### INCORRECT RESPONSE FEEDBACK

- Red border appears.
- Red cross designates center of mass of the target.
- Error is described.

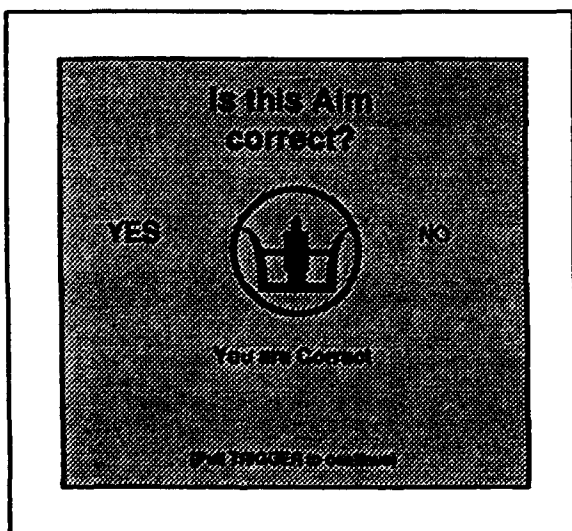

#### CORRECT RESPONSE FEEDBACK

- You are correct.
- Front and rear sights are aligned correctly.
- Front sight is placed on center of mass of target.

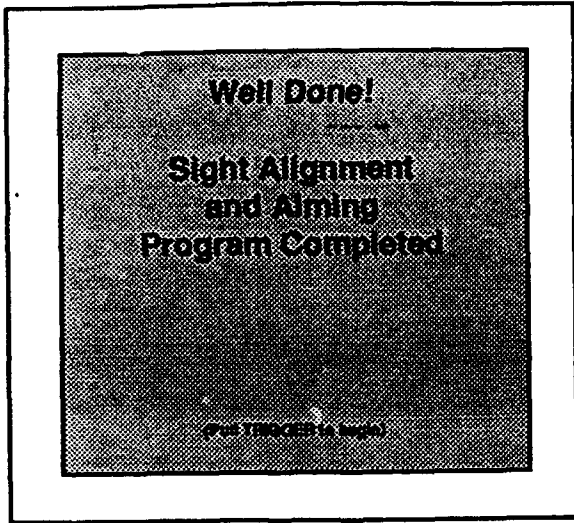

**AFTER THREE CORRECT  
RESPONSES IN A ROW:**

- End of Aiming Program.

# GROUPING PROGRAM

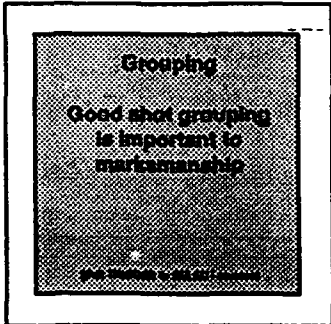

## STATEMENT OF IMPORTANCE

- Tight shot groups indicate correct application of the four fundamentals of marksmanship.
  - Steady position
  - Aiming
  - Breath control
  - Trigger squeeze

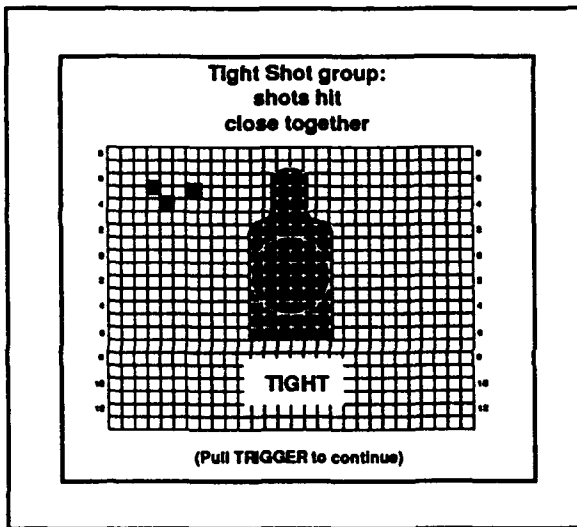

## ILLUSTRATION OF SHOT GROUPS

### TIGHT SHOT GROUP

- Shots fit in 4 cm circle.

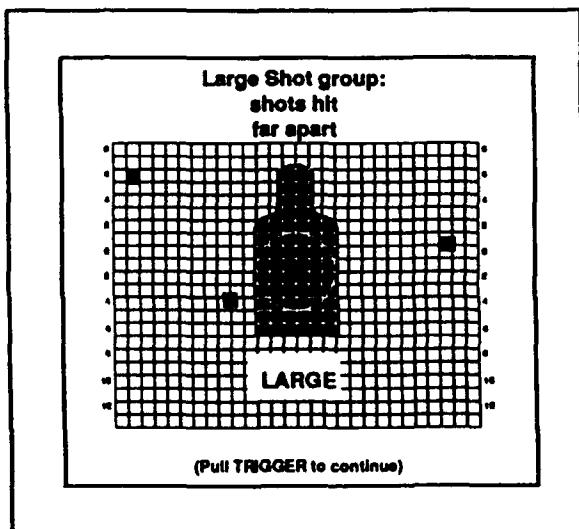

### LARGE SHOT GROUP

- Shots do not fit in 4 cm circle.

## TIGHT SHOT GROUP

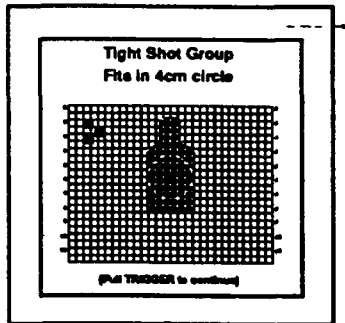

### Part 1:

- 3 shots hit close together.

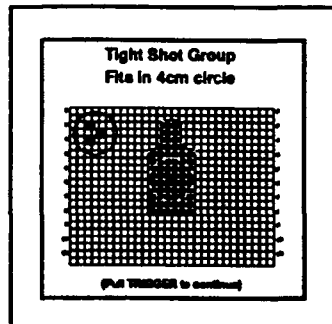

### Part 2:

- Circle appears around shot group.

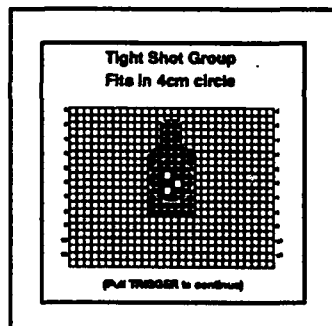

### Part3:

- Shot group moves to center of target.

## TWO SHOT GROUP

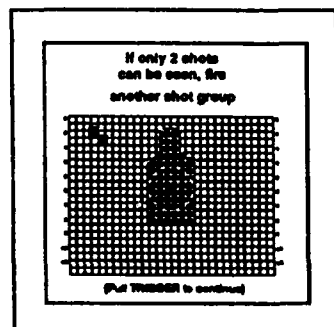

- One shot missed target.
- Fire another shot group.

# GROUPING PROGRAM TEST

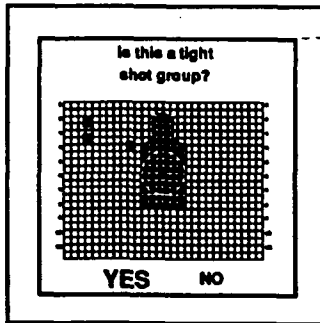

## SHOT GROUP SKILL TEST

- Tests recognition of tight shot group.
- YES and NO alternately appear in large (boldface) type.
- Select answer by pulling trigger when choice appears in large (boldface) type.
- Must correctly identify three in a row to pass test.

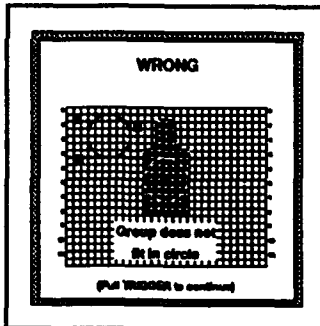

## INCORRECT RESPONSE

- Red border appears.
- Scaled, 4 cm circle moves to middle of shot group.
- Error is described.

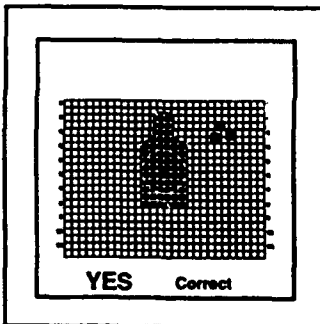

## CORRECT RESPONSE

- You are correct.

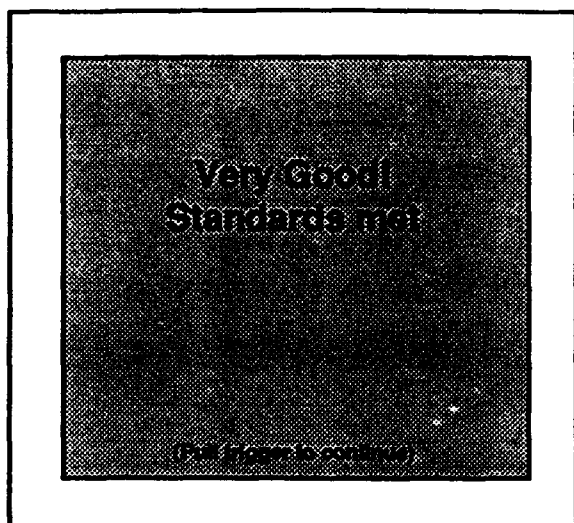

### AFTER THREE CORRECT RESPONSES IN A ROW

- Standards met.

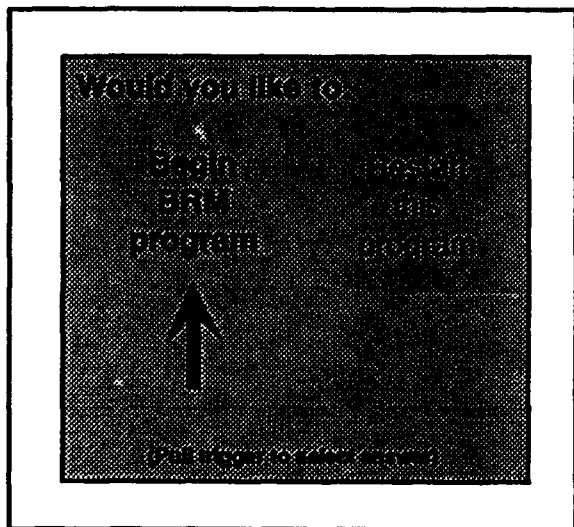

### END OF PROGRAM

- Select choice by pulling trigger when arrow points to desired response.

# TROUBLESHOOTING TIPS



## TROUBLESHOOTING TIPS

PROBLEM	SOLUTION
<b>Computer will not come on.</b>	Ensure power cords are plugged in.
	Ensure all power switches are turned on.
	Use a different outlet.
<b>Program does not start.</b>	<b>Turn off all power switches.</b> Take out and reinsert BRM cartridge.
	Turn on all power switches.
	Ensure shift lock key on keyboard is in UP position.
<b>No sound.</b>	Adjust volume control on monitor.
	Recheck cable connections.
<b>Light pen does not work (purple border appears or light pen fails tracking test as described on page 2-7).</b>	Check 5/8" gap on focal ring, if applicable.
	Recheck cable connections.
	Check distance to monitor screen. (Should be 7'6").
	Increase monitor brightness and/or contrast.
	Turn off computer. Restart system.
	Let monitor warm up.

## COMMODORE (Model 1802)

No picture.

Adjust BRIGHT to maximum (clockwise).  
(BRIGHT knob is located behind the panel  
at the front of the monitor).

Turn off all power switches.  
Recheck cable connections.

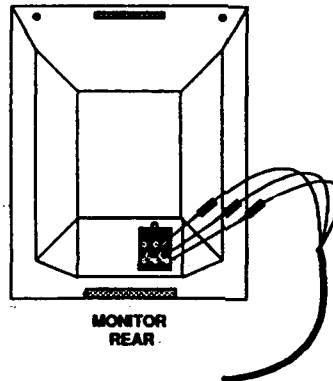

## HITACHI

No picture.

Adjust BRIGHT to maximum (clockwise).  
(BRT knob is located along the lower edge  
of the monitor at the front.)

Turn off all power switches.  
Recheck cable connections.

Ensure rear switch on back of  
monitor is set to NTSC.

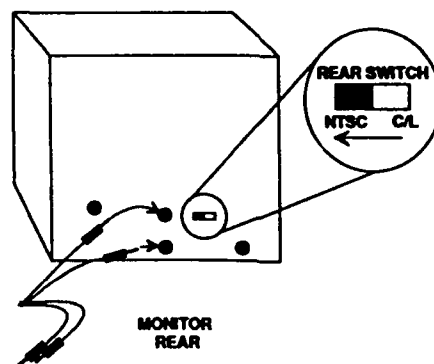

## FOR FURTHER INFORMATION

Broom, J. M., Champion, D. F., Greene, W. H., Martere, R. F., Purvis, J. W. , & Sills, E. G. (1989). Multipurpose arcade combat simulator (MACS) basic rifle marksmanship (BRM) program. (ARI Research Report 90-01). Alexandria, VA: U. S. Army Research Institute for the Behavioral and Social Sciences.

This research report provides a more detailed discussion of the rationale behind the instructional design, standards, and feedback contained in the MACS BRM program.

Evans, K. L. (1988). Development and evaluation of the multipurpose arcade combat simulator: A research summary (ARI Research Report 1488). Alexandria, VA: U. S. Army Research Institute for the Behavioral and Social Sciences.

*Available from the Defense Technical Information Center order no. AD-B 130 099.*

This research report summarizes the results of over 20 developmental hardware tests, training and cost effectiveness evaluations, and informal field investigations conducted since 1982. Benefits associated with MACS training used in conjunction with standard training appear to be increased performance, fewer failures to meet performance standards, significantly lower expenditures of ammunition, improved performance feedback, and greater soldier interest.

Heller, F. H. & Evans, K. L. (1989). Joint service multipurpose arcade combat simulator (JMACS) user guide (ARI Research Product 89-23). Alexandria, VA: U. S. Army Research Institute for the Behavioral and Social Sciences.

This research product presents information on system assembly, operation, and troubleshooting of the JMACS hardware. Features of the JMACS training software and associated performance standards are also described. The MACS BRM software described in the Trainer's Guide and the report by Broom and associates (1989) has replaced the JMACS training software throughout the services. The updated software is available from the Training Support Center, Fort Benning, Georgia.

# MACS MOVING TARGET PROGRAM

## MOVING TARGET TRAINING

The ability to hit moving targets on the battlefield is recognized as a high-priority combat task. During the past 100 years, several attempts have been made to conduct moving target training, but many complicating factors have always prevented it from becoming a formal part of the Army's rifle marksmanship program. During the past few years, limited training on the engagement of moving targets has been presented to 11B and 11M Infantry soldiers undergoing One Station Unit Training at Fort Benning, Georgia, using the Army's only operational moving target ranges. Most leaders and trainers have not received instruction or practice on the engagement of moving targets.

The MACS Moving Target Program has been developed so that all soldiers who have access to a Commodore MACS system may receive training and practice on the engagement of moving targets. While every attempt should be made to practice on a live fire range, extensive use of the MACS Moving Target Program will improve the ability of most soldiers to hit moving combat targets.

Guidance on moving target training is contained in FM 23-9, M16A1 and M16A2 Rifle Marksmanship. A somewhat more detailed discussion of moving target training is contained in FC 23-11, Unit Rifle Marksmanship Training Guide. Given the current state of moving target training, the MACS Moving Target Program includes detailed instructional material which will allow a soldier to learn with minimum supervision. The MACS Moving Target instruction is compatible with the above references but it represents a refinement and enhancement of previously available instructional material.

The Weaponeer Marksmanship Trainer and Firearms Training System are devices with moving target capabilities. These are very effective; however, they are currently available in limited numbers. The ranges throughout the Army which include moving rifle targets are very limited in numbers and will normally not be available for the conduct of effective moving target training. Accordingly, the only moving target training available to most soldiers will be the MACS Moving Target Program. For any existing Commodore MACS system, all that is needed is a moving target cartridge which may be obtained from the Training Support Center at Fort Benning.

Moving Target Training should be an integral part of every marksmanship program. The instructional portion of MACS may be presented to several soldiers at once, but each soldier should be provided at least one hour to progress through the entire program, with opportunities to repeat the training as often as possible.

## OVERVIEW OF MACS MOVING TARGET PROGRAM

The MACS Moving Target Program is designed for a soldier who has completed Basic Rifle Marksmanship (BRM) training. As a minimum, anyone firing the moving target program should first complete the BRM MACS program.

The initial requirement is to zero the rifle. This procedure electronically zeros the rifle by taking an average of three shots fired and placing the center of the shot group at target center. If less than an excellent shot group is obtained, the soldier will be given an option to shoot for a better zero.

Following zero, the soldier is given an option to view moving target instruction or move directly to firing exercises. All soldiers who are new to moving target training should view the instruction. The instruction is designed to provide an understanding of why lead is required on moving targets. Several examples of correct target leads are presented and the soldier is taught how to use a single lead rule which will hit most high-priority combat targets.

The MACS Moving Target Program is organized in 10 levels of training and practice as follows:

Level 1 is a Tracking Exercise. Tracking is explained and demonstrated and the soldier is required to demonstrate good tracking techniques before advancing.

Level 2 is a Trapping Exercise. The trapping technique is explained and demonstrated and the soldier is required to use good trapping techniques before advancing.

Level 3 provides practice on a 60-meter target at lateral speeds of 1.5, 3, and 6 miles per hour. On this and following levels, the soldier may use tracking or trapping to engage targets. Soldiers will be provided a separate evaluation on each technique and will be able to determine which method works best. As with all levels, standards must be met before advancing to the next level.

Levels 4, 5 and 6 are similar to Level 3, but provide practice at ranges of 75, 125, and 185 meters. A detailed performance feedback review is provided for each shot.

Level 7 is a free moving scenario of single targets, but it incorporates stationary targets with moving targets. Detailed feedback is provided each time a target is missed and a crosshair shows the location of all hits and misses.

Level 8 is an advanced scenario in that it includes multiple exposures of stationary and moving targets which are more difficult to engage. Additionally, this level provides more bullets than targets, so targets that are missed may be engaged a second time. On this level, no detailed feedback is provided and a crosshair is shown for misses only.

Level 9 is a good primer for the Fort Benning Moving Target Range because the target speeds, distance, and exposure times are similar. As on the range, no feedback is provided on shot performance.

Level 10 is the most complex scenario in that it includes short-exposure stationary targets and unpredictable moving targets.

A soldier who successfully completes all ten levels of the MACS program is ready for the experience of a live-fire range.

At any time the MACS program is being used, the instructor or student may return to the menu screen by pressing the RUN/STOP key one or more times. The menu screen allows for movement directly to any level or the selection of several options.

The feedback provided allows an instructor to monitor several shooters and determine their progress. The color of the screen border changes to draw the instructor's attention to any soldier having difficulty. The colors of the border indicate the soldier's status:

- BLACK - Making satisfactory progress.
- RED - Refiring targets at a particular range.
- PURPLE - Aiming off the screen or light pen not reading.

Information on the soldier's progress is included in the upper left corner of the screen.

- L - Level being shot.
- T - Target being shot within a level.
- R - Number of refires within a level.

<b>Fundamentals</b>		
<b><u>Stationary</u></b>	<b><u>Moving (Track)</u></b>	<b><u>Moving (Trap)</u></b>
<b>Steady Position</b>	<b>Smooth Track</b>	<b>Steady Position</b>
<b>Aiming</b>	<b>Lead</b>	<b>Lead</b>
<b>Breath Control</b>	<b>Breath Control</b>	<b>Breath Control</b>
<b>Trigger Squeeze</b>	<b>Trigger Squeeze</b>	<b>Trigger Pull</b>

It should be noted that the four fundamentals of marksmanship learned during the engagement of stationary targets have been retained, in so far as possible, for the engagement of moving targets. When tracking moving targets, it is important to develop a smooth track, the ability to move the rifle smoothly in concert with the target movement. The MACS evaluation measures the consistency of the aiming point relative to target movement prior to firing. The proper lead must be established and maintained. The lead score is a function of how close the aiming point was to the proper lead point prior to firing. As with stationary targets, breathing must be momentarily stopped before firing. The MACS system cannot measure breathing; therefore, if the soldier maintains a smooth track on the target, it is assumed that breathing is okay. If a smooth track is not maintained, MACS feedback will indicate that breathing should be checked as a possible problem, along with other factors. Trigger squeeze continues to be the most important fundamental for the successful engagement of targets. One advantage of tracking is that the trigger is squeezed, similar to a stationary target engagement, so that the exact moment of firing cannot be anticipated. A good trigger squeeze should begin with pressure on the trigger so that final pressure can be applied rapidly. It may take only a fraction of a second to squeeze the trigger, but that is enough time to prevent a flinch, which will probably result in a target miss. The trigger squeeze rating is taken at the moment of firing, so a flinch will be reflected in a low rating. When trapping targets, a steady position should be established in front of the target. This measure is similar to the measurement of a steady position for the engagement of stationary targets. The same target lead must be applied. The MACS rating indicates how close the aiming point was to the proper lead spot when the weapon was fired. Breath control is measured the same for all firings. Trigger pull is very important for a successful trap. The trigger cannot be squeezed, but it must be pulled so the soldier knows precisely when the rifle is going to shoot. This is a disadvantage of the trapping technique because many soldiers will unconsciously react (flinch) when they know the weapon is going to fire. The rifle must be held somewhat more firmly and the trigger must be pulled without disturbing the lay of the weapon. The MACS rating will reflect any excessive movement during trigger pull.

# MACS MOVING TARGET PROGRAM SEQUENCE

## SCREENS

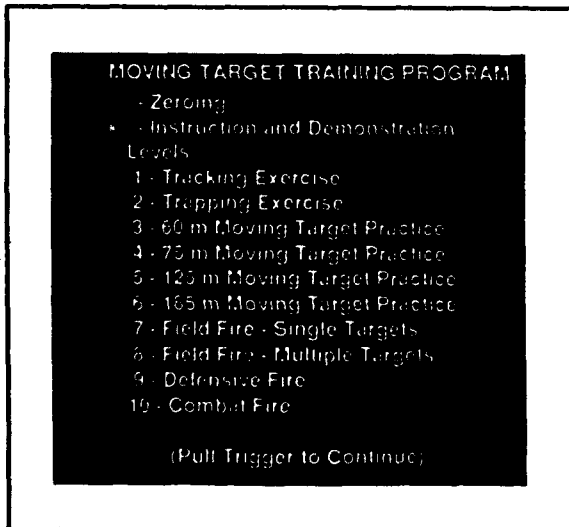
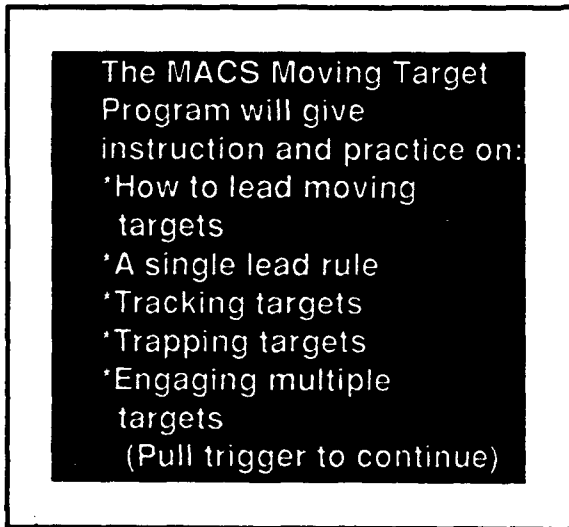
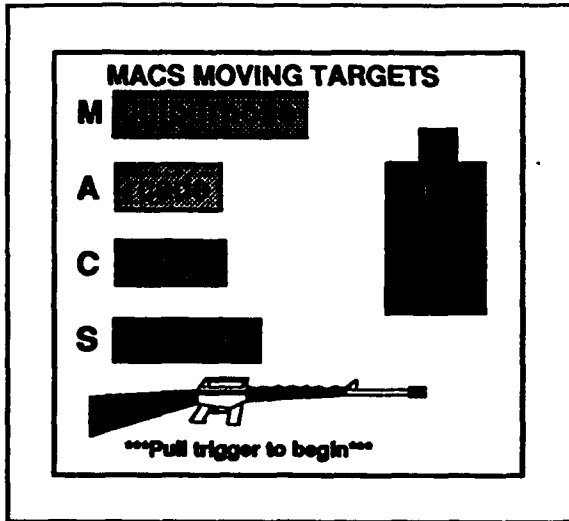

## NOTES TO TRAINER

- Introductory Screen of MACS Moving Target Program.
- Adjust volume so the rifle shot is at the desired level.
- Make final adjustments to brightness and contrast.

- General overview of instruction.

- This is an information screen for the shooter.

- The instructor or shooter may access the program menu (page 6-35) at any time by pressing the



times.



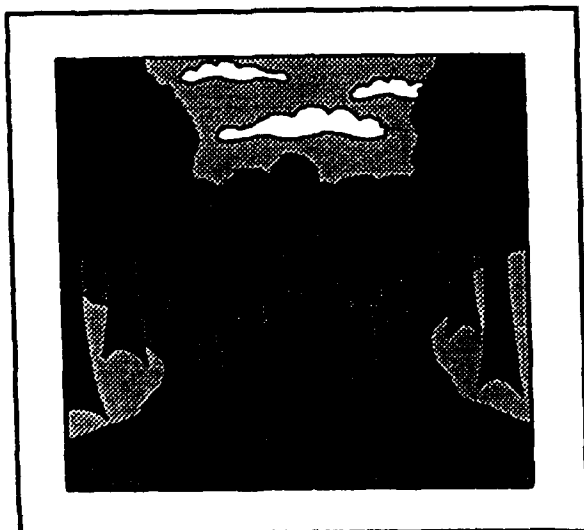
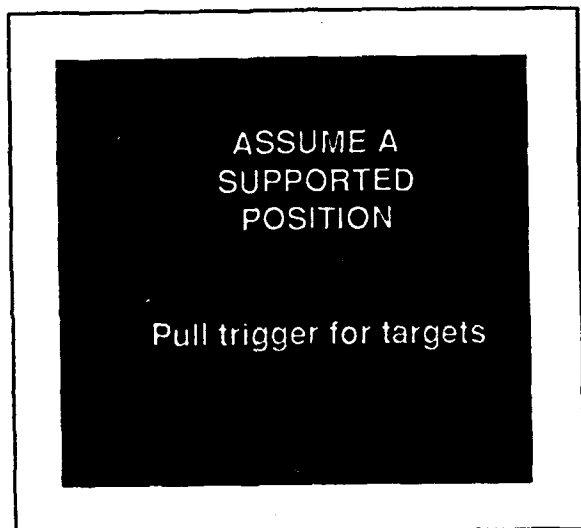
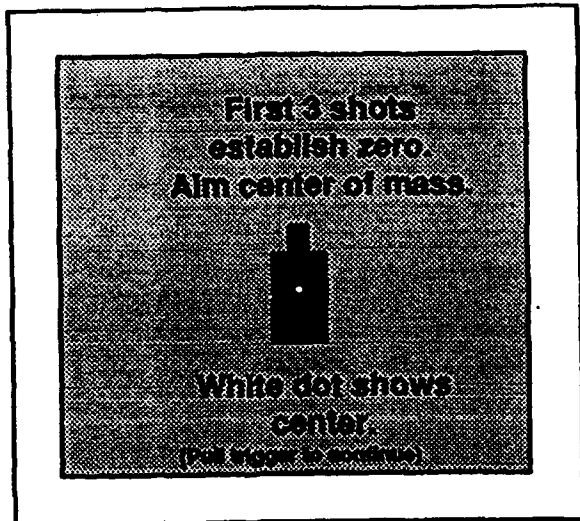

- Each new shooter should fire the zero program. This electronically zeros the rifle to the shooter's personal zero.
- The zero target is a scaled 250-meter target, which is the zero range for the M16A1 rifle. The M16A2 rifle is zeroed for 300 meters, which means it will hit farther above the point of aim at ranges out to 250 meters. For example, shooting a 185-meter target, the M16A1 will hit about 2.9 inches above point of aim and the M16A2 will hit about 5.6 inches above point of aim. However, this small difference in the vertical placement of bullets should not limit the benefit of this Moving Target Program for soldiers armed with the M16A2, because the lead requirements are the same for both weapons.
- The position used for zeroing should be the same position the shooter expects to use while firing the program.
- No position requirements are stated during the program, so available support should be used to maximum advantage. Trainers may eliminate support or require firing from a prone position to vary training.
- To establish zero, three, stationary, untimed targets are presented.
- The shooter should fire one well-aimed shot at each target.

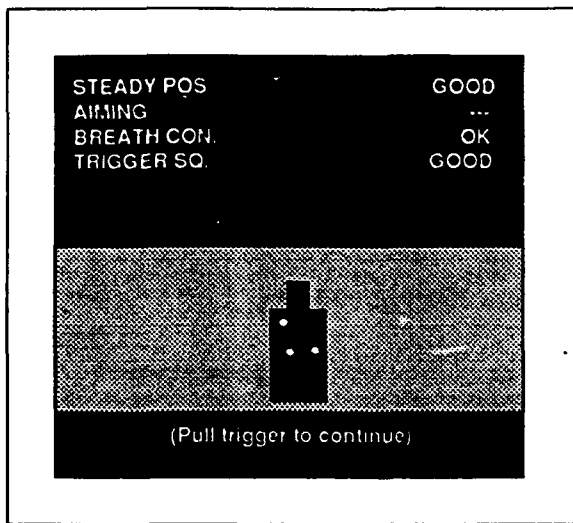

- The Zero Summary Screen evaluates the zero performance and locates the shot group at target center.
- Note that "aiming" is not evaluated, but for the rest of the program the evaluation of aiming is based on the zero obtained.
- A good zero is important. If the shot group is rated excellent, the shooter will advance.

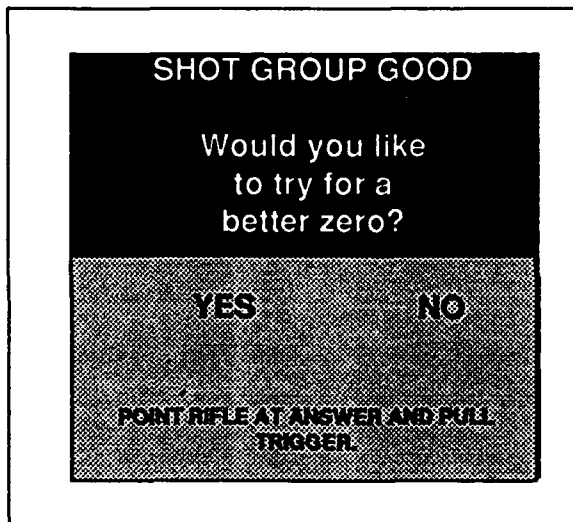

- If the shot group is rated less than excellent, the shooter is given a choice to improve his zero by shooting a tighter shot group.
- If YES is selected, the zero will be repeated.
- If NO is selected, the shooter will advance.

**IF FIRST SHOT GROUP IS INVALID:**

Invalid shot group

Try again

(Pull trigger to continue)

- An invalid shot group is one in which one or more shots hit outside a rectangular area (not seen by the shooter).

## IF SECOND SHOT GROUP IS INVALID:

Invalid shot group  
try again  
or  
check light pen  
mount alignment  
(see manual)

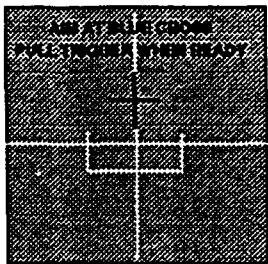

### If second shot group is invalid:

- Press **RUN** or **STOP** on Keyboard to start light pen mount alignment program.

**NOTE:** See section 2 for instructions on aligning the light pen mount.

- Follow directions for alignment.
- Following alignment the program will return to MACS MOVING TARGET Introductory Screen.

MOVING TARGET  
INSTRUCTION &  
DEMONSTRATION



START  
FIRING  
EXERCISES

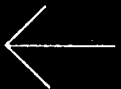

POINT RIFLE AT ANSWER  
AND PULL TRIGGER

- After zeroing, the shooter has the option of beginning the firing exercises immediately or receiving moving target instruction and demonstration.
- The only personnel who should go directly to firing exercises are those who have previously demonstrated proficiency on the program.

You may miss moving targets by aiming at center mass, because the target will be moving as the bullet travels down range.

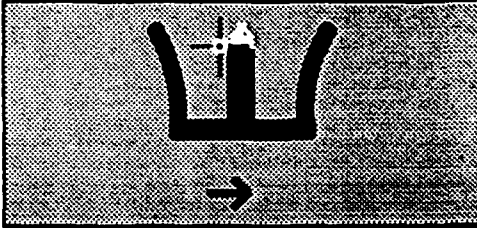

Without lead you miss  
185 meters  
6 mph lateral speed  
(Pull Trigger to Continue)

To hit a target that is moving laterally across your front, you must aim ahead of target center. This is called LEAD.

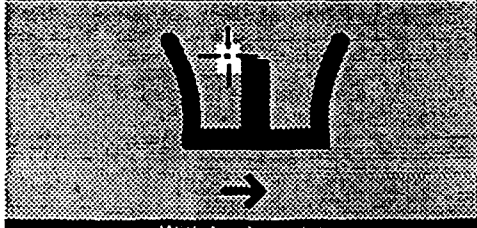

With lead you hit  
185 meters  
6 mph lateral speed  
(Pull Trigger to Continue)

The amount of lead needed to hit target center will increase when the target is farther away and/or is moving faster laterally across your front.  
12 examples follow  
(Pull Trigger for 12 examples)

When a football receiver goes out for a pass and makes a 90-degree cut across the field, it is very obvious that the quarterback must aim the ball in front of the receiver so the ball can be caught. The same principle must be applied when shooting a bullet at a running target. Even though the bullet leaves the rifle at over 2,000 miles per hour, a target moving at 6 miles per hour will travel over 6 inches while the bullet travels 60 meters, over 8 inches while the bullet travels 75 meters, 14 inches while the bullet travels 125 meters, and over 22 inches while the bullet travels 185 meters. Therefore, the rifle must be aimed in front of a moving target to ensure good target hits.

You will note that all targets on the MACS Moving Target Program are moving at 90 degrees and a lateral speed of 1.5, 3, or 6 mph. If a target is moving at 90 degrees to the shooter, its lateral speed and its true speed are the same. However, if a target is running directly at the shooter, its lateral speed will be zero and it should be engaged as if it were a stationary target. If the target is at an angle of less than 90 degrees, the lead required will be reduced. For example, a 7 mile per hour target at a 35-degree angle covers the same space, from the shooter's point of view, as a 4 mile per hour target at 90 degrees. In other words, the three speeds used on MACS represent a wide range of possible speed and angle combinations. To illustrate, the lead requirements are the same for a 1.5 mile per hour target at 90 degrees, a 3 mile per hour target at 30 degrees, a 4 mile per hour target at 20 degrees, a 6 mile per hour target at 15 degrees, and an 8 mile per hour target at 10 degrees.

Note that to obtain a dead center hit, a different aiming point must be used for each speed and range.

# DIFFERENT LEAD REQUIREMENTS FOR DEAD-CENTER HITS

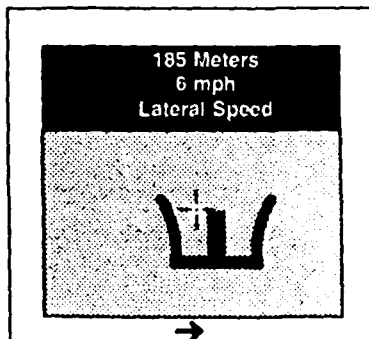
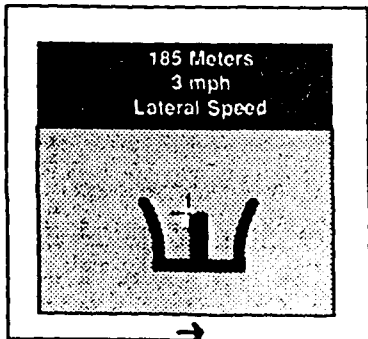
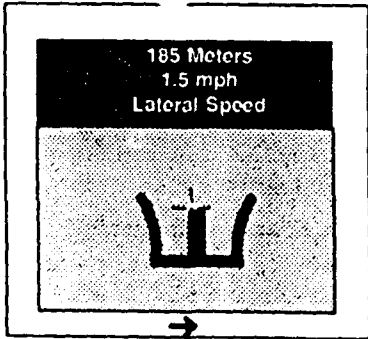
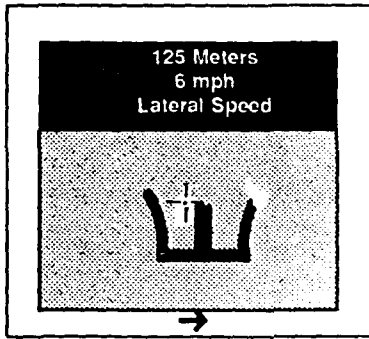
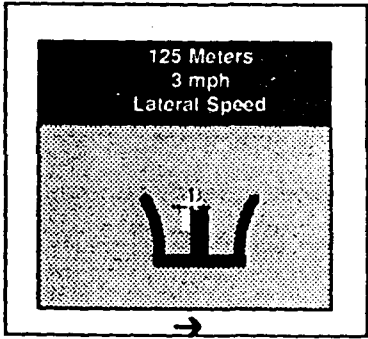
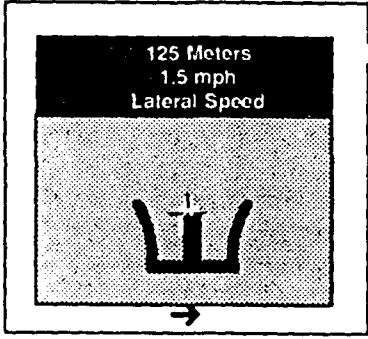
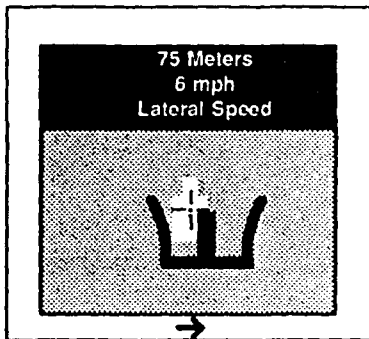
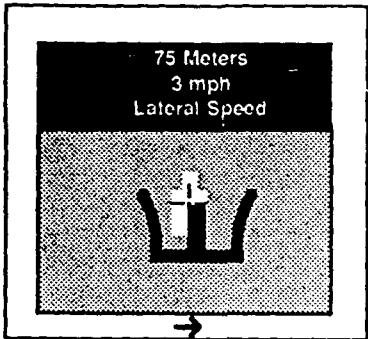
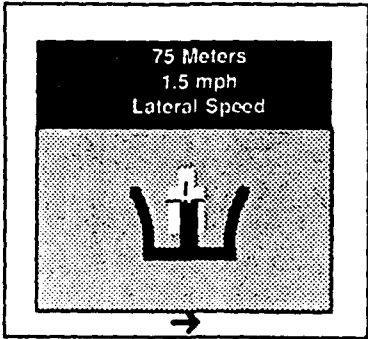
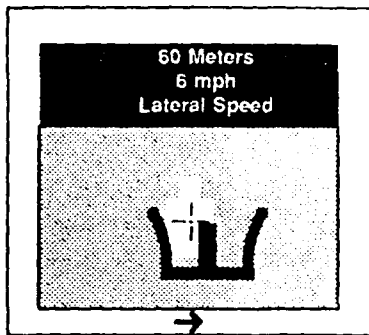
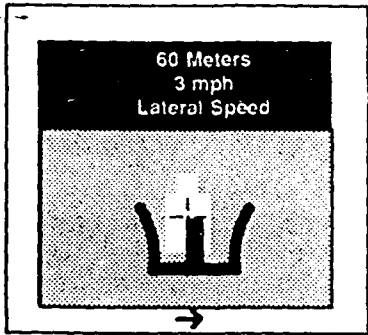
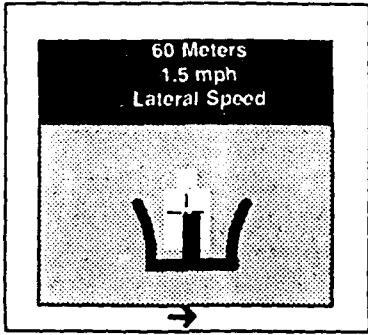

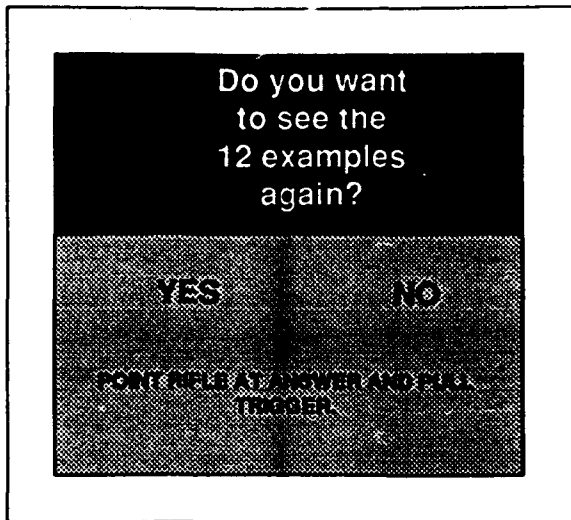

- Since the examples move quickly, the shooter is provided an option of seeing them again.
- Selecting YES will rerun the 12 examples, and selecting NO will continue with the program.

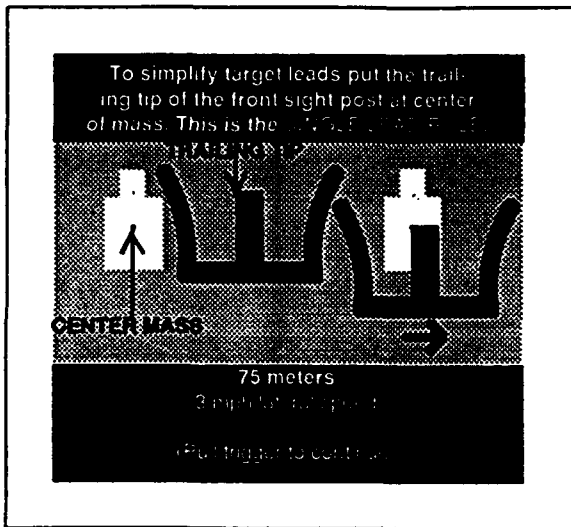

- Given that it is impossible to remember all of the various leads required to obtain a dead center hit even if the speed, angle, and range of the target could be determined, the single lead rule will result in hitting most high-priority combat targets.
- For soldiers being introduced to the engagement of moving targets, the single lead rule should be taught.

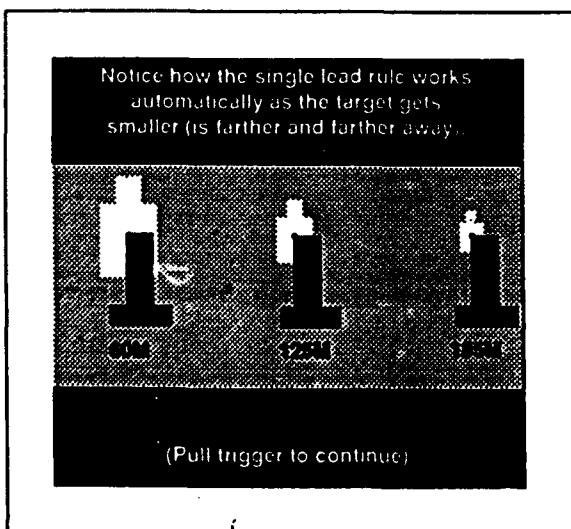

- A good zero results in the average bullet strike being at the center of the front sight post. Therefore, when the trailing edge of the sight is placed at target center, the perceived distance from the edge of the sight to the center results in lead.
- Since the sight is perceived to cover a very small portion of the target at close range and a large portion at more distant ranges, using this rule results in the small amount of lead needed for close targets and a greater amount of lead which is needed for more distant targets.

Following are eleven examples of the single lead rule, showing where the bullet will hit the target. Remember to put the trailing tip of the sight post at center mass.

(Pull trigger to see 11 examples)

- Eleven examples of the single lead rule are graphically shown (one after another without a break) each showing where the bullet hits for the given range and target speed.
- Note that the trailing edge of the sight is placed at target center on all targets but that bullet strike varies somewhat from the center of the target.

**HIT LOCATIONS USING SINGLE LEAD RULE:**

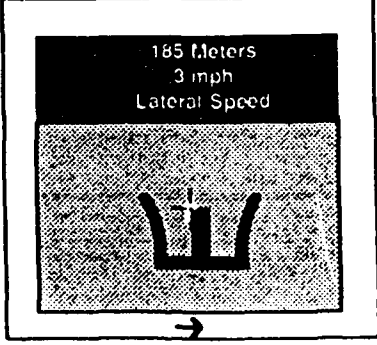
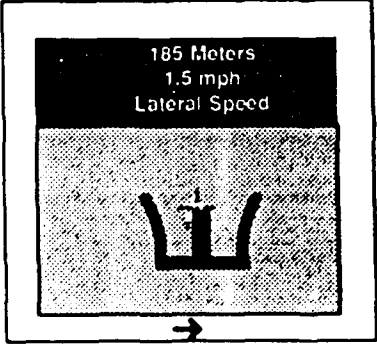
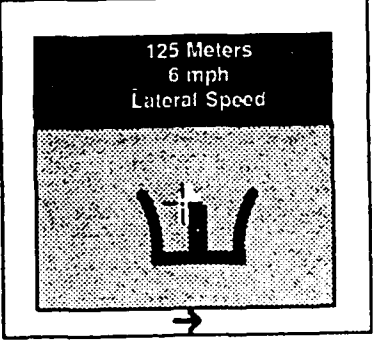
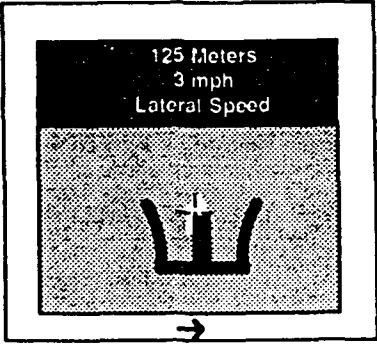
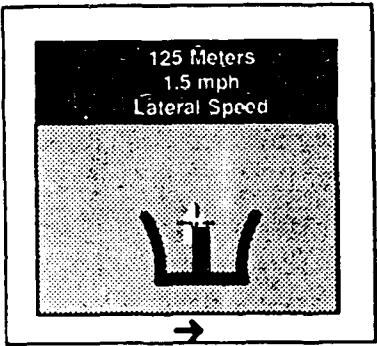
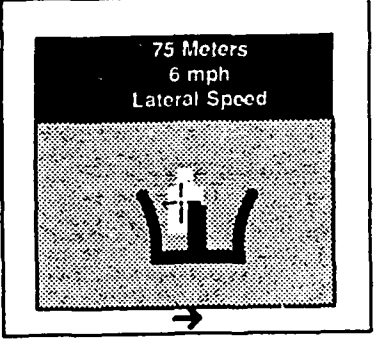
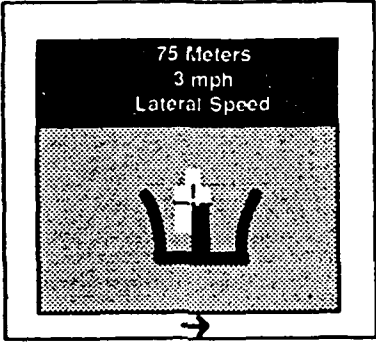
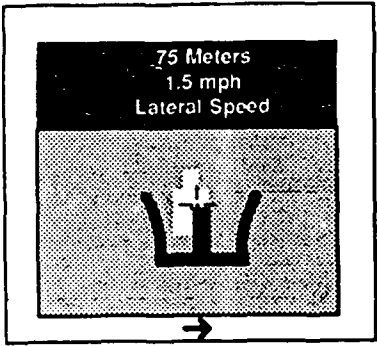
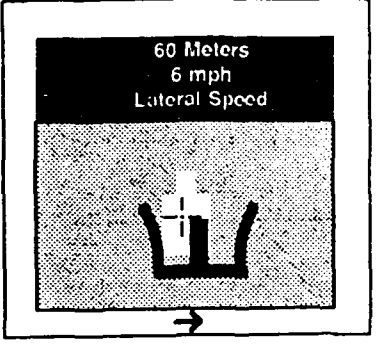
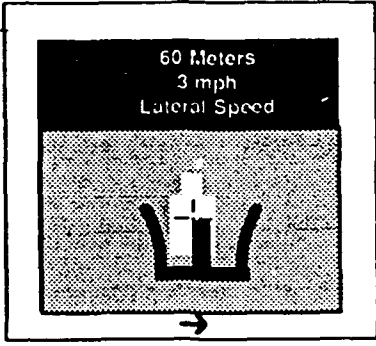
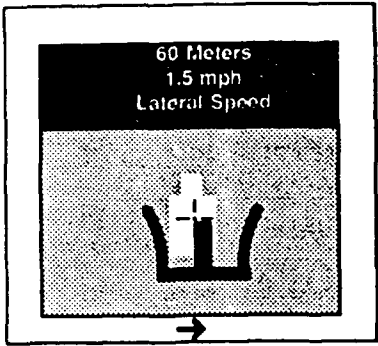



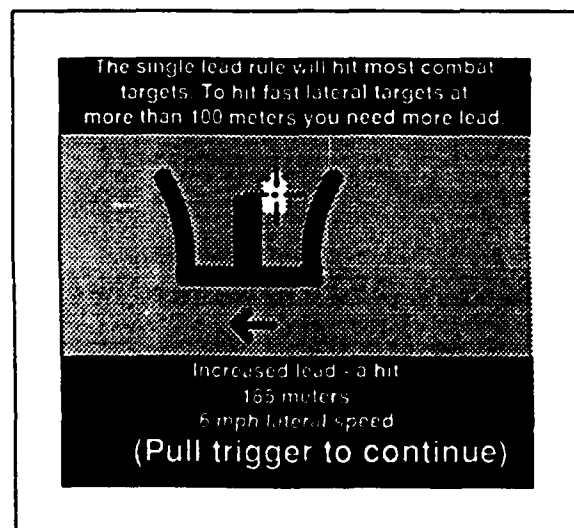
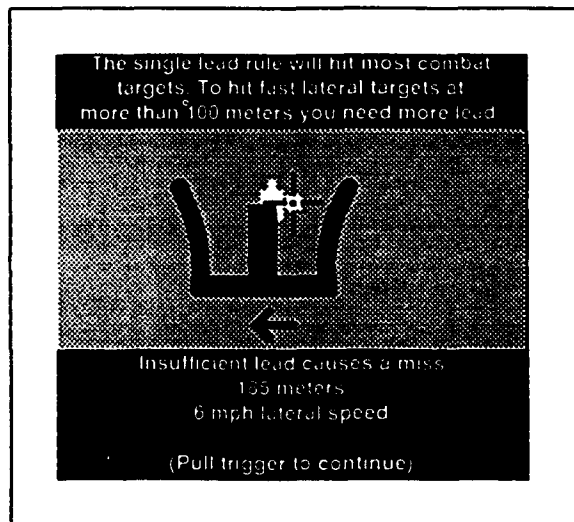
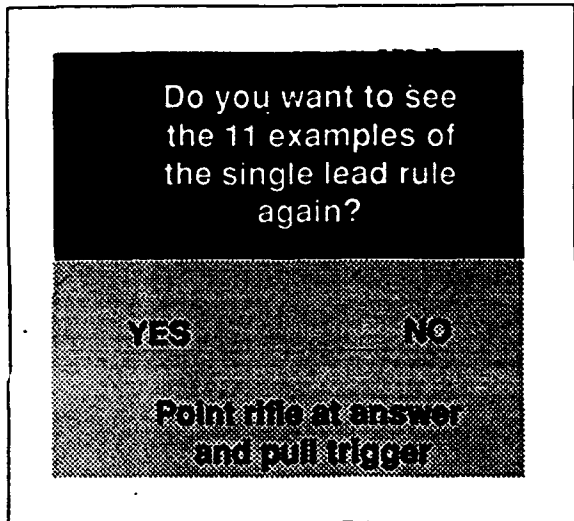

- The lead rule examples in this Guide have been placed on one page so they may be reproduced for closer study.

- While the single lead rule is the appropriate starting point, as soldiers become more skilled, they should modify the rule to put all bullets as close to target center as possible.

- The single lead rule will not work on distant targets with fast lateral speed. These targets require more lead.

- Moving the trailing edge of the front sight out to the leading edge of the target provided the additional lead needed for this category of target.

- Instructional Levels 1 and 2 are devoted to tracking and trapping.

Two ways to engage moving targets are tracking & trapping. You will get to try both methods to see how they work.

(Pull trigger to continue)

## Level 1. Tracking Exercise

### PURPOSE

- Explanation of tracking.
- How to track.
- Tracking practice.

### SUMMARY DESCRIPTION

- 75 meter target at 3 miles per hour.
- Ten targets presented - Five moving from left to right and five moving right to left.

### FEEDBACK

- Words HIT or MISS appear on screen for each shot.
- Cross hair appears on screen to show bullet strike.
- Replay after each shot.
- Shooter will be corrected if trapping technique is used to engage targets.

### STANDARDS

- Smooth track and proper lead (EXCELLENT or GOOD ratings) on 3 of 5 targets in each direction.
- *Refire* is required if a standard is not met.

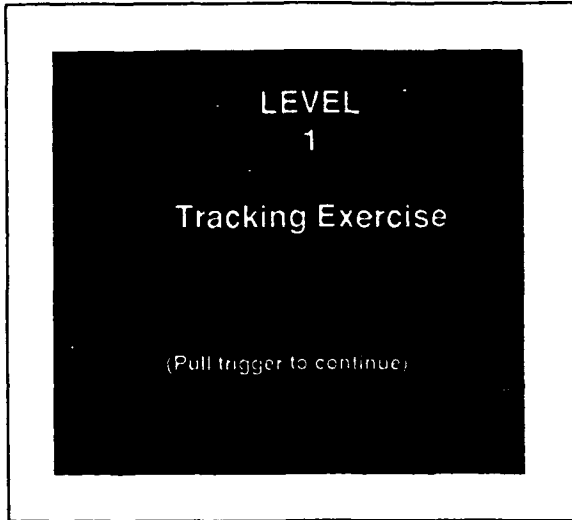

- On this level, the soldier is required to use the tracking technique of moving target engagement.

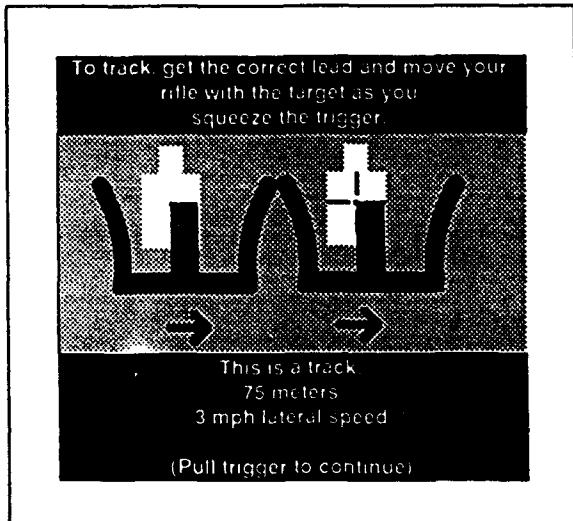

- When using the tracking technique, the trigger can be squeezed similar to a stationary target engagement. The shooter should establish the correct lead and then attempt to maintain that lead as he applies more and more pressure to the trigger.

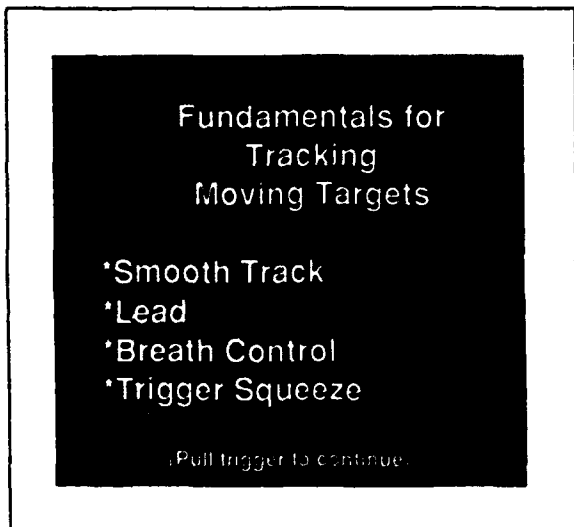

- Note that the four fundamentals of marksmanship have been modified only slightly, with steady position being replaced by smooth track and aiming replaced by lead.

Use the non-firing hand as a pivot. Smoothly track the target by moving your upper body.

(Pull trigger to continue)

- Prior to starting the exercise, each soldier should adjust his position so he can smoothly track the width of the screen, from left to right and from right to left.

10 targets  
Feedback after each shot  
Standard:  
Smooth track and proper lead on 3 of 5 targets in each direction.

Pull trigger for targets

- The first five targets will move from left to right.

SMOOTH TRACK	EXCELLENT
LEAD	GOOD
BREATH CON	OK
TRIGGER SQ	GOOD



Pull trigger to continue.

- When each shot is fired, miss or hit will be displayed on the screen and the bullet location will be shown with a crosshair.
- Each fundamental is rated POOR, BELOW AVERAGE, AVERAGE, GOOD or EXCELLENT. A rating is provided for shot locations which are hits.
- The black sight on the display shows the perfect sight placement while the white sight shows the shooter's aiming track.
- This feedback screen will be repeated until the trigger is pulled to continue.

On the last target  
you trapped. Try to  
track every target  
for the rest of this  
practice exercise.

Pull trigger for targets

If at any time the shooter does not track (traps instead), this screen is provided. When this occurs, shooter cycles back to the same target.

Your 5 shots  
75 meters  
3 mph →



(Pull trigger to continue)

When five targets have been tracked, this screen shows the location of the five bullets.

Summary  
Standard: Good or  
Excellent Track and  
Lead on 3 of 5  
targets  
Your Score:  
Smooth Track - 4 of 5  
Lead - 3 of 5

(Pull trigger to continue)

To progress, the shooter must have received a **GOOD** or **EXCELLENT** score for smooth track on at least 3 of 5 targets and must have received a score of **GOOD** or **EXCELLENT** on lead for at least 3 of 5 targets.

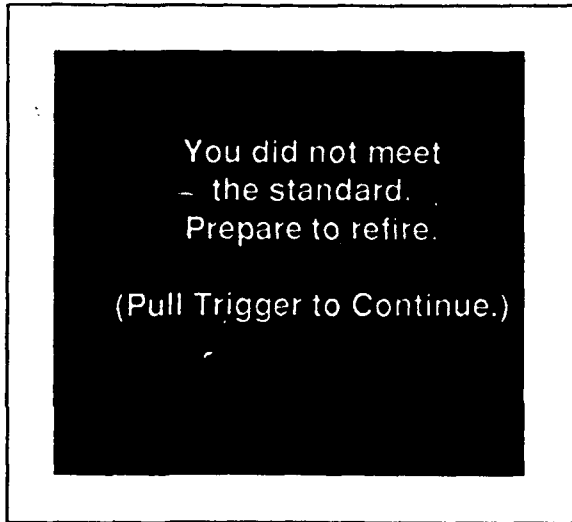

- If the shooter does not obtain at least 3 of 5 on smooth track and lead, this screen will be displayed.

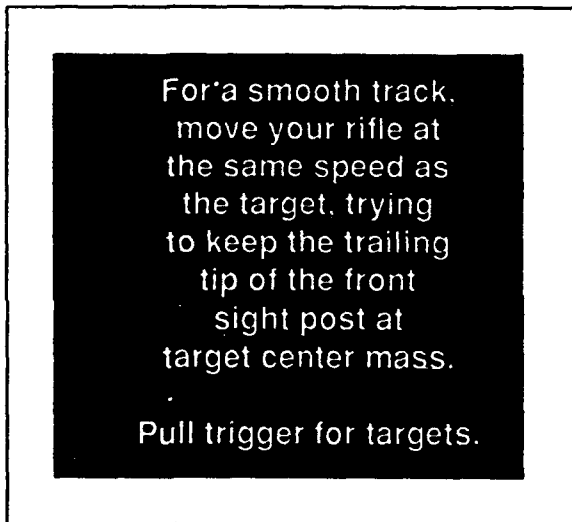

- This screen is provided as a reminder of what the requirements are to obtain a smooth track and proper lead.
- Once the standard has been met on targets moving from left to right, the soldier progresses to the next series of five targets.
- When standards have been met on targets moving from right to left, the shooter advances to Level 2.

## Level 2. Trapping Practice

### PURPOSE

- Explanation of trapping.
- How to trap.
- Trapping practice.

### SUMMARY DESCRIPTION

- Ten targets presented.
- Five moving from left to right and five moving from right to left.

### FEEDBACK

- Words **HIT** or **MISS** appear on screen for each shot.
- Cross hair appears on screen to show bullet strike.
- Replay after each shot.
- Shooter will be corrected if tracking technique is used to engage targets.

### STANDARDS

- **Good or excellent** trap lead on 3 of 5 targets.
- Refire of targets is required if standard is not met.

Level 2  
Trapping Exercise

(Pull trigger to continue)

- This level requires the soldier to use the trapping technique of moving target engagement.

To trap, establish a steady position in front of the target and pull the trigger when the target gets to the right spot.

This is a trap.  
75 meters  
3 mph lateral speed

(Pull trigger to continue)

- A good trap establishes a steady position forward of the target and waits for the target to get to the right position to pull the trigger.

Fundamentals for  
Trapping  
Moving Targets

- \*Steady Position
- \*Lead
- \*Breath Control
- \*Trigger Pull

(Pull trigger to continue)

- To trap targets, a steady position is established in front of the target. Lead is a matter of timing – the rifle should be fired when target center reaches the near edge of the sight post. Breath control is the same as for other engagements. The trigger cannot be squeezed, but it must be pulled so the shooter knows precisely when the rifle is going to shoot.