

AD-A257 611



FINAL REPORT
JUNE 1992

REPORT NO. 92-10

AMMUNITION CERTIFICATION
OF U.S. MARINE CORPS (USMC)
M927A1 AND
M923A1 TRUCKS



OTIC
ELECTE
NOV 05 1992
S E D

Prepared for:

Commander

U.S. Marine Corps Systems Command

ATTN: SSCMT

Fort Belvoir, VA 22134-5080

Distribution Unlimited

396852

92-28752



17406



U.S. ARMY
ARMAMENT
MUNITIONS
CHEMICAL COMMAND

U.S. ARMY DEFENSE AMMUNITION
CENTER AND SCHOOL

11 03 057

VALIDATION ENGINEERING DIVISION
SAVANNA, ILLINOIS 61074-9639

AVAILABILITY NOTICE

A copy of this report will be furnished each attendee on automatic distribution. Additional copies or authority for reprinting may be obtained by written request from Director, U.S. Army Defense Ammunition Center and School, ATTN: SMCAC-DEV, Savanna, IL 61074-9639.

DISTRIBUTION INSTRUCTIONS

Destroy this report when no longer needed. Do not return.

Citation of trade names in this report does not constitute an official endorsement.

The information contained herein will not be used for advertising purposes.

| REPORT DOCUMENTATION PAGE | | | | Form Approved OMB No. 0704-0188 | |
|---|-------|--|---|--|-------------------------|
| 1a. REPORT SECURITY CLASSIFICATION UNCLASSIFIED | | 1b. RESTRICTIVE MARKINGS | | | |
| 2a. SECURITY CLASSIFICATION AUTHORITY | | 3. DISTRIBUTION / AVAILABILITY OF REPORT UNLIMITED | | | |
| 2b. DECLASSIFICATION / DOWNGRADING SCHEDULE | | | | | |
| 4. PERFORMING ORGANIZATION REPORT NUMBER(S) 92-10 | | 5. MONITORING ORGANIZATION REPORT NUMBER(S) | | | |
| 6a. NAME OF PERFORMING ORGANIZATION U.S. Army Defense Ammunition Center and School | | 6b. OFFICE SYMBOL (if applicable) SMCAC-DEV | 7a. NAME OF MONITORING ORGANIZATION | | |
| 6c. ADDRESS (City, State, and ZIP Code) ATTN: SMCAC-DEV Savanna, IL 61074-9639 | | 7b. ADDRESS (City, State, and ZIP Code) | | | |
| 8a. NAME OF FUNDING / SPONSORING ORGANIZATION U.S. Marine Corps Systems Command | | 8b. OFFICE SYMBOL (if applicable) SSCMT | 9. PROCUREMENT INSTRUMENT IDENTIFICATION NUMBER | | |
| 8c. ADDRESS (City, State, and ZIP Code) ATTN: SSCMT Quantico, VA 22134-5080 | | 10. SOURCE OF FUNDING NUMBERS | | | |
| | | PROGRAM ELEMENT NO. | PROJECT NO. | TASK NO. | WORK UNIT ACCESSION NO. |
| 11. TITLE (Include Security Classification) Ammunition Certification of U.S. Marine Corps (USMC) M927A1 and M923A1 Trucks | | | | | |
| 12. PERSONAL AUTHOR(S) A. C. McIntosh, Jr. | | | | | |
| 13a. TYPE OF REPORT Final | | 13b. TIME COVERED FROM _____ TO _____ | | 14. DATE OF REPORT (Year, Month, Day) 1992 June | 15. PAGE COUNT |
| 16. SUPPLEMENTARY NOTATION | | | | | |
| 17. COSATI CODES | | | 18. SUBJECT TERMS (Continue on reverse if necessary and identify by block number) | | |
| FIELD | GROUP | SUB-GROUP | | | |
| | | | | | |
| | | | | | |
| 19. ABSTRACT (Continue on reverse if necessary and identify by block number) The U.S. Army Defense Ammunition Center and School (USADACS), Validation Engineering Division (SMCAC-DEV), was tasked by the U.S. Marine Corps (USMC) Systems Command, to test an M927A1 truck with a 20-foot International Organization for Standardization (ISO) bed and an M923A1 truck with a 14-foot cargo bed for compliance with Transportability Testing Procedures, TP-91-01, July 1991. The procedures include rail impact and road transportation tests. Both vehicles satisfied the test requirements after hardware replacement and modifications were accomplished. | | | | | |
| 20. DISTRIBUTION / AVAILABILITY OF ABSTRACT <input checked="" type="checkbox"/> UNCLASSIFIED/UNLIMITED <input type="checkbox"/> SAME AS RPT. <input type="checkbox"/> DTIC USERS | | | 21. ABSTRACT SECURITY CLASSIFICATION UNCLASSIFIED | | |
| 22a. NAME OF RESPONSIBLE INDIVIDUAL JEROME H. KROHN | | 22b. TELEPHONE (Include Area Code) 815-273-8929 | | 22c. OFFICE SYMBOL SMCAC-DEV | |

**U.S. ARMY DEFENSE AMMUNITION CENTER AND SCHOOL
 VALIDATION ENGINEERING DIVISION
 SAVANNA, IL 61074-9639**

REPORT NUMBER 92-10

**AMMUNITION CERTIFICATION OF U.S. MARINE CORPS (USMC)
 M927A1 AND M923A1 TRUCKS**

JUNE 1992

TABLE OF CONTENTS

| | |
|--------------------|-------------------------------------|
| For | |
| RF&I | <input checked="" type="checkbox"/> |
| ... | <input type="checkbox"/> |
| ... | <input type="checkbox"/> |
| Availability Codes | |
| Dist | Avail and/or Special |
| A-1 | |

| PART | DTIC QUALITY INSPECTED 4 | PAGE NO. |
|--------------------------------|--------------------------|----------|
| 1. INTRODUCTION | | 1-1 |
| A. BACKGROUND | | 1-1 |
| B. AUTHORITY | | 1-1 |
| C. OBJECTIVE | | 1-1 |
| D. CONCLUSION | | 1-1 |
| E. RECOMMENDATIONS | | 1-2 |
| 2. ATTENDEES | | 2-1 |
| 3. TEST PROCEDURES | | 3-1 |
| 4. TEST RESULTS | | 4-1 |
| 5. PHOTOGRAPHS | | 5-1 |
| 6. OUTLOADING PROCEDURES | | 6-1 |
| 7. ACCELEROMETER DATA | | 7-1 |

PART 1

INTRODUCTION

A. BACKGROUND. The U. S. Army Defense Ammunition Center and School (USADACS), Validation Engineering Division (SMCAC-DEV), was tasked by the U. S. Marine Corps (USMC) System Command to test the M923A1 and M927A1 5-ton cargo trucks with 14-foot and 20-foot International Organization for Standardization (ISO) beds, respectively, for conformance to test requirements set forth in TP-91-01, Transportability Testing Procedures, July 1991.

B. AUTHORITY. This test was conducted IAW mission responsibilities delegated by U.S. Army Armament, Munitions and Chemical Command (AMCCOM), Rock Island, IL 61299-6000. Reference is made to Change 4, 4 October 1974, to AR 740-1, 23 April 1971, Storage and Supply operations; AMCCOMR 10-17, 13 January 1986, Mission and Major Functions of U.S. Army Defense Ammunition Center and School.

C. OBJECTIVE. The objectives of these tests are to validate the design criteria of the newly manufactured ISO beds for the M923A1 and M927A1 trucks. The new beds are equipped with ISO fittings for securing containers as well as regularly secured cargo. The transportation tests these loaded vehicles were subjected to include the following: rail, road hazard, road, panic stops, and washboard. Both vehicles were loaded to the maximum load capacity of 10,000 pounds.

D. CONCLUSION. Both vehicles were tested during the 31 March - 2 April 1992 timeframe. The M927A1 truck, with the 20-foot ISO bed, passed rail and road test procedures. The M923A1 truck failed the rail impact test when the rear bed mounts sheared from the truck chassis. A field fix, using 3/8-inch bolts also failed the rail impact test. A decision was made to

modify the rear body mounts to accept 1/2-inch bolts for securing the bed to the truck chassis. This configuration was retested on 5 May 1992 and passed all transportation requirements.

E. **RECOMMENDATIONS.** Based on the results of the tests performed on these vehicles, the following recommendations are offered:

1. The front shackles on each truck must be replaced as the ones delivered were not strong enough to secure the trucks in a rail transportation environment. The replacement shackle which was found to have adequate strength is NSN: 4030-01-222-6037.

2. Replace the body-to-chassis mounting bracket rivets with 1/2-inch UNF, grade 5 bolts on the M923A1 14-foot truck. The holes in the chassis and mounting bracket will have to be drilled to 17/32-diameter. This fix is necessary to ensure the body will remain fixed during rail shipment.

3. The removable sidewall stowage compartment covers must be strengthened. The strengthening can be accomplished by several longitudinal bends in the existing gate. During the rail impact test, the sidewall slid into the cover and deformed it. As a result of this deformation, it was difficult to remove the cover and could prevent accessing the sidewalls.

4. Two ball pins are used to retain the sidewall stowage compartment cover in place during vehicular movement. It was observed that these pins kept sliding out of the inside hole during the testing program. Further investigation showed that the inside holes were larger in diameter than the outside holes. The larger inside diameter prevented the pins from locking in position. Future production should ensure the following:

- (a) These holes are the correct diameter.
- (b) Holes are drilled correctly so the locking pin can be inserted correctly.

PART 2

ATTENDEES

31 March-2 April 1992, 5 May 1992

**Captain John Mayles
DSN 278-4281
703-640-4281
703-640-4287**

**A. C. McIntosh, Jr.
General Engineer
DSN 585-8989
815-273-8989
E-Mail: amcintos@savanna-emh1.army.mil**

**Richard S. Haynes
Industrial Engineering Technician
DSN 585-8225
815-273-8225**

**Ron Kirchofner*
710-477-6404**

**Dan Healy
Senior Inspector
708-392-6846**

**Quinn D. Hartman
General Engineer
DSN 585-8992
815-273-8999
E-Mail: qhartman@savanna-emh1.army.mil**

**Commander
U.S. Marine Corps Systems Command
ATTN: SSCMT
Quantico, VA 22134-5080**

**Director
U. S. Army Defense Ammunition Center
and School
ATTN: SMCAC-DEV
Savanna, IL 61074-9639**

**Director
U. S. Army Defense Ammunition Center
and School
ATTN: SMCAC-DET
Savanna, IL 61074-9639**

**Turtle Mountain Manufacturing Company
Highway 5 West
P.O. Box 770
Belcourt, ND 58316**

**Association of American Railroads/
Bureau of Explosives
309 North Douglas Avenue
Arlington Heights, IL 60004**

**Director
U. S. Army Defense Ammunition Center
and School
ATTN: SMCAC-DEV
Savanna, IL 61074-9639**

David V. Valant
Electronics Technician
DSN 585-8988
815-273-8988
E-Mail: dvvalant@savanna-emh1.army.mil

Director
U. S. Army Defense Ammunition Center
and School
ATTN: SMCAC-DEV
Savanna, IL 61074-9639

*** Not present on 5 May 1992.**

PART 3

TEST PROCEDURES

A. These test procedures are extracted from TP-91-01, Transportability Testing Procedures, July 1991, for tactical vehicles used for shipping munitions by tactical truck or tactical truck on a railcar.

B. The test load was prepared using the same blocking and bracing methods specified in the tiedown procedures proposed for use with the munitions. A copy of these procedures is contained in part 6 of this report. The truck used in this test was inspected to ensure its adequacy for munition transport. Items used to build the load were inert (nonexplosive). The weight and physical characteristics of the load configuration was identical to the live (explosive) ammunition provided for in the tiedown procedure; i.e., weights, physical dimensions, center of mass, materials, etc. The ammunition packages duplicated that of the live ammunition.

C. Tests for this set of load configurations is as follows:

1. Rail impact (test method no. 1).
2. Hazard course (test method no. 2).
3. Road trip (test method no. 3).
4. Hazard course (test method no. 2).
5. Washboard course (test method no. 6).

D. The Test Methods used are as follows:

1. Test Method No. 1 - (Rail Impact Test). The test load or vehicle was positioned in/on a railcar. For containers, the loaded container was positioned on a container chassis and securely locked in place using the twist locks at each corner. The container chassis was secured to a railcar. Equipment needed to perform the test included the specimen (hammer) car, five empty railroad cars connected together to serve as the anvil, and a railroad locomotive. These anvil cars were positioned on a level section of track with air and hand brakes set and with the draft gears compressed. The locomotive unit pulled the specimen car several hundred yards away from the anvil cars and, then, pushed the specimen car toward the anvil at a predetermined speed, then disconnected from the specimen car approximately 50 yards away from the anvil cars which allowed the specimen car to roll freely along the track until it struck the anvil. This constituted an impact. Impacting was accomplished at speeds of 4, 6, and 8.1 mph in one direction and at a speed of 8.1 mph in the opposite direction. The 4 and 6 mph impact speeds were approximate; the 8.1 mph speed was a minimum. Impact speeds are to be determined by using an electronic counter to measure the time required for the specimen car to traverse an 11-foot distance immediately prior to contact with the anvil cars (see figure 1).

2. Test Method No. 2 - (Hazard Course). This step required the loads transported on the USMC truck be driven over the 200-foot-long segment of concrete-paved road which consisted of two series of railroad ties projecting 6-inches above the level of the road surface. The truck traversed this course two times.

3. Test Method No. 3 - (Road Trip). The USMC truck was used to transport loads for a distance of 30 miles over a combination of roads surfaced with gravel, concrete, or asphalt. The test route included curves, corners, railroad crossings, cattle guards, and stops and starts. The truck traveled at the maximum speed suitable for the particular road being traversed, except as

**ASSOCIATION OF AMERICAN RAILROADS (AAR)
STANDARD TEST PLAN**

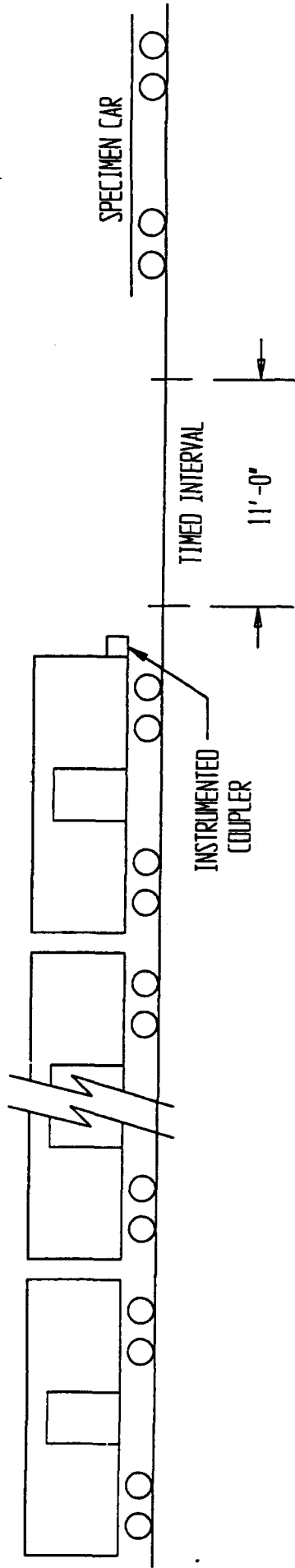
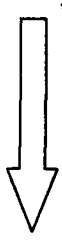

**5 BUFFER CARS (ANVIL) WITH DRAFT GEAR
COMPRESSED AND AIR BRAKES IN A SET
POSITION**

ANVIL CAR TOTAL WT 250,000 LBS (APPROX)

**SPECIMEN CAR
IS RELEASED BY
SWITCH ENGINE TO
ATTAIN: IMPACT NO. 1 @ 4 MPH
IMPACT NO. 2 @ 6 MPH
IMPACT NO. 3 @ 8.1 MPH**

**THEN THE CAR IS REVERSED AND
RELEASED BY SWITCH ENGINE TO
ATTAIN: IMPACT NO 4. @ 8.1 MPH**

FIGURE 1

limited by legal restrictions. Upon completion of the 30-mile road trip, the loaded truck was subjected to three full airbrake stops while traveling in the forward direction and one in the reverse direction. The first three stops were at 5, 10, and 15 mph, while the stop in the reverse direction was approximately 5 mph.

4. Test Method No. 6 - (Washboard Course). The USMC truck loaded with MILVAN/SIXCONS was driven over the washboard course (figure 2) at a speed which produced the most violent response of the vehicle. The washboard course is constructed as shown in figure 2.

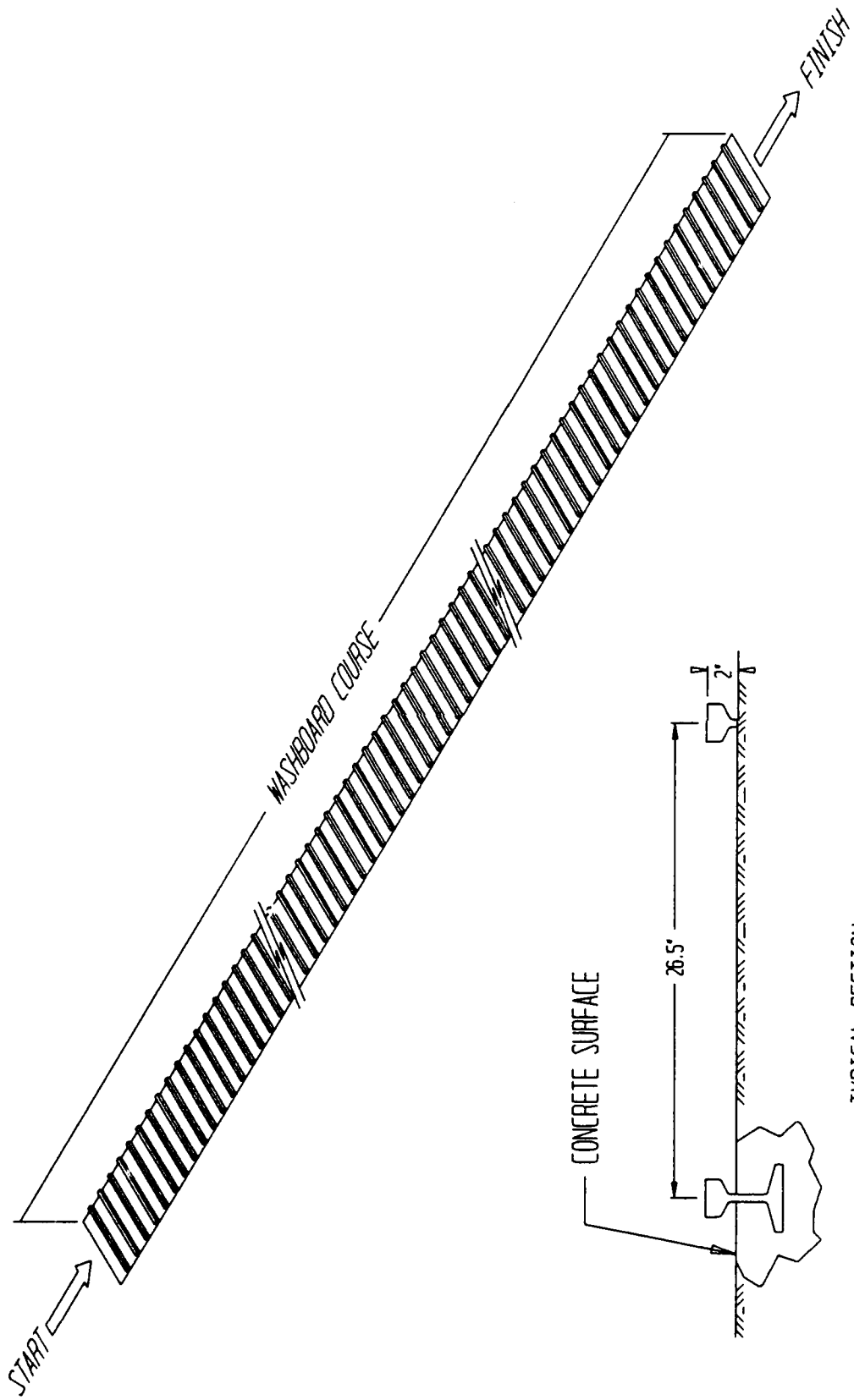
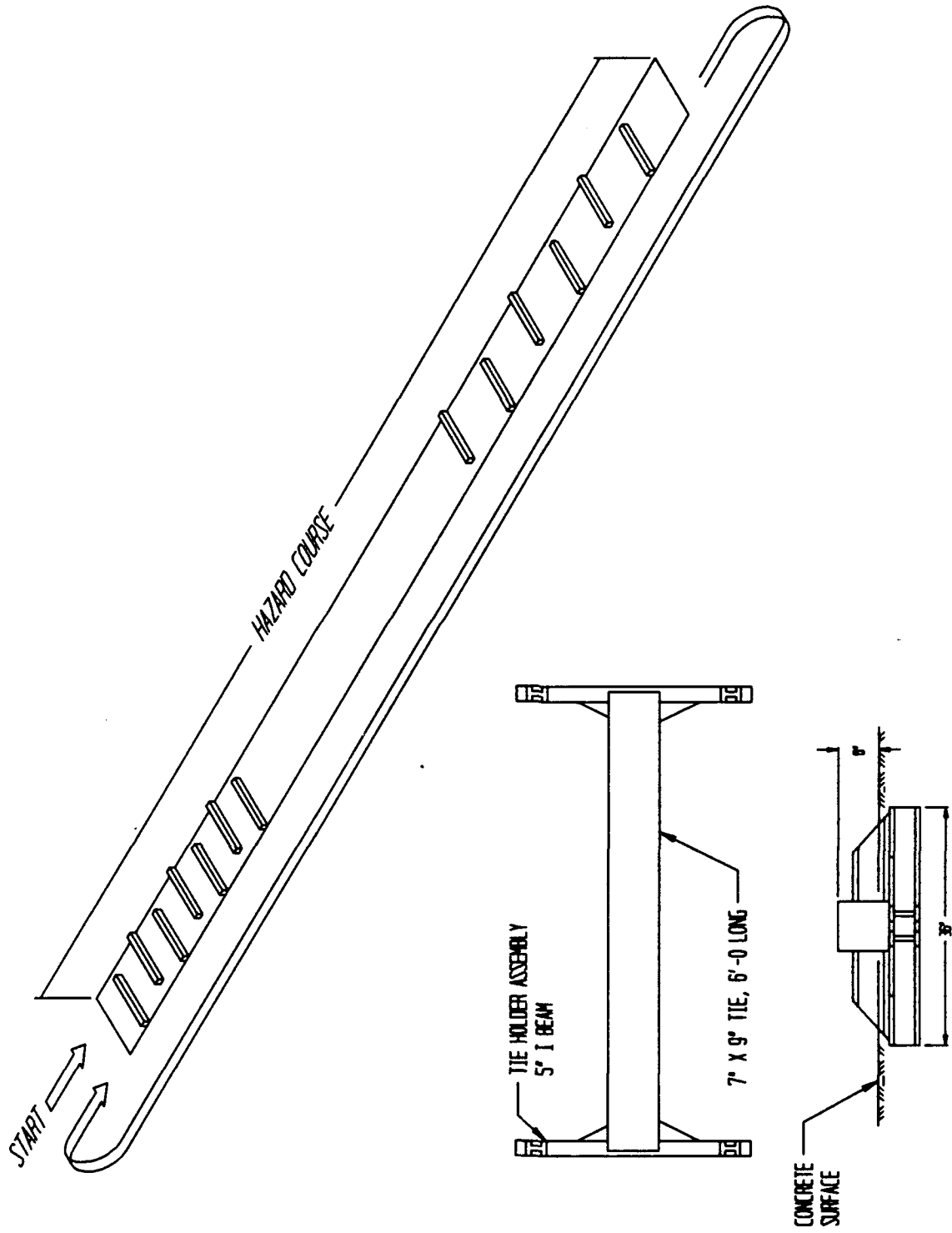

FIGURE 2



TIE HOLDER DETAILS

FIGURE 3

PART 4

TEST RESULTS

TEST SPECIMEN AND RESULTS

RAIL IMPACT DATA

Test No.: 1

Date: 31 March 1992

Specimen Load: M927A1 5-ton long bed truck equipped with ISO corner fittings
transporting a MILVAN loaded to 10,000 pounds.

Flatcar No.: BN 600108

Lt. Wt.: 46,900

5-Ton Truck Long Bed

Wt.: 25,035

Container Type: MILVAN

Wt.: 10,500

Total Specimen Wt.: 84,535

Buffer Car (five cars) Wt.: 250,000

| <u>Impact</u> | <u>End Struck</u> | <u>Velocity</u> | <u>Remarks:</u> |
|---------------|-------------------|-----------------|---|
| 1 | Forward | 4.46 | Shackle on the vehicle left rear spreading. Sheared off safety pin. |
| 2 | Forward | 6.70 | Additional shackle spread. Still holding. |
| 3 | Forward | 8.33 | Shackle yielded and cables loose. Replaced shackle and retested. |
| 4 | Forward | 8.24 | Cable held. No damage to vehicle. |
| 5 | Reverse | 8.33 | No damage. |

Note: Tiedown Shackles mounted on the front of the truck were replaced with NSN 4030-01-222-6037. These shackles are heavier and do not spread from impulse loads encountered during rail impact testing of the 5-ton class of vehicles.

TEST SPECIMEN AND RESULTS

ROAD TEST DATA

TEST NO.: 2

DATE: 31 March 1992

Specimen Load: M927A1 5-ton long bed truck equipped with ISO corner fittings transporting a MILVAN container.

ROAD HAZARD COURSE:

PASS 1-A OVER FIRST SERIES OF TIES: 0.11 MIN 5.16 MPH

PASS 1-B OVER SECOND SERIES OF TIES: 0.10 MIN 5.68 MPH

REMARKS: No load movement or visible damage to the vehicle or load.

PASS 2-A OVER FIRST SERIES OF TIES: 0.09 MIN 6.31 MPH

PASS 2-B OVER SECOND SERIES OF TIES: 0.10 MIN 5.68 MPH

REMARKS: No load movement or visible damage to the vehicle or load.

30-MILE ROAD TEST: No load movement or visible damage to the vehicle or load.

PANIC STOP TEST: No panic stops were done since this load was previously rail impact tested.

PASS 3-A OVER FIRST SERIES OF TIES: 0.10 MIN 5.68 MPH

PASS 3-B OVER SECOND SERIES OF TIES: 0.09 MIN 6.31 MPH

REMARKS: No load movement or visible damage to the vehicle or load.

PASS 4-A OVER FIRST SERIES OF TIES: 0.09 MIN 6.31 MPH

PASS 4-B OVER SECOND SERIES OF TIES: 0.10 MIN 5.68 MPH

REMARKS: No load movement or visible damage to the vehicle or load.

TEST SPECIMEN AND RESULTS

ROAD TEST DATA

TEST NO.: 3

DATE: 31 March - 2 April 1992

Specimen Load: M927A1 5-ton long bed truck loaded with two MLRS pods configured two high and secured with web straps.

ROAD HAZARD COURSE:

PASS 1-A OVER FIRST SERIES OF TIES: 0.11 MIN 5.16 MPH

PASS 1-B OVER SECOND SERIES OF TIES: 0.10 MIN 5.68 MPH

REMARKS: No load movement.

PASS 2-A OVER FIRST SERIES OF TIES: 0.09 MIN 6.31 MPH

PASS 2-B OVER SECOND SERIES OF TIES: 0.10 MIN 5.68 MPH

REMARKS: No load movement.

30 MILE ROAD TEST: No load movement.

PANIC STOP TEST: No load movement.

PASS 3-A OVER FIRST SERIES OF TIES: 0.08 MIN 7.10 MPH

PASS 3-B OVER SECOND SERIES OF TIES: 0.09 MIN 6.31 MPH

REMARKS: No load movement.

PASS 4-A OVER FIRST SERIES OF TIES: 0.10 MIN 5.68 MPH

PASS 4-B OVER SECOND SERIES OF TIES: 0.09 MIN 6.31 MPH

REMARKS: No load movement.

WASHBOARD COURSE: No load movement greater than 1/2-inch. Load weight 10,000 pounds.

TEST SPECIMEN AND RESULTS

RAIL IMPACT DATA

Test No.: 4

Date: 1 April 1992

Specimen Load: M923A1 5-ton truck with two SIXCONs loaded to 5,000 pounds each.

Flatcar No.: BN 600108

Lt. Wt.: 46,900

5-Ton Truck

Wt.: 22,175

Container Type: Two SIXCONs

Wt.: 10,000

Total Specimen Wt.: 78,175

Buffer Car (five cars) Wt.: 250,000

| <u>Impact</u> | <u>End Struck</u> | <u>Velocity</u> | <u>Remarks:</u> |
|---------------|-------------------|-----------------|--|
| 1 | Forward | 4.12 | No damage. |
| 2 | Forward | 6.15 | No damage. Severe deflection of vehicle at center on impact. |
| 3 | Forward | 8.24 | Failure. Rear riveted body mounts sheared off on both sides of the truck. Field fix is replace rivets with 3/8-inch UNF grade 5 bolts. |
| 4 | Forward | 4.21 | No damage of repaired mounts. |
| 5 | Forward | 6.20 | Failure. Bolts used to fasten rear body mounts to truck chassis sheared. |

Note: Tiedown shackles mounted on the front of the truck were replaced with NSN 4030-01-222-6037. These shackles are heavier and do not spread from impulse loads encountered during rail impact testing of the 5-ton class of vehicles.

TEST SPECIMEN AND RESULTS

RAIL IMPACT DATA

Test No.: 5

Date: 5 May 1992

Specimen Load: M923A1 5-ton truck with two SIXCONs loaded to 5,000 pounds each.

Flatcar No.: BN 600108

Lt. Wt.: 46,900

5-Ton Truck

Wt.: 22,175

Container Type: Two SIXCONs

Wt.: 10,000

Total Specimen Wt.: 78,175

Buffer Car (five cars) Wt.: 250,000

| <u>Impact</u> | <u>End Struck</u> | <u>Velocity</u> | <u>Remarks:</u> |
|---------------|-------------------|-----------------|-------------------------------|
| 1 | Forward | 4.55 | No damage. |
| 2 | Forward | 6.30 | No damage. |
| 3 | Forward | 8.43 | No damage. |
| 4 | Reverse | 8.72 | No damage to repaired mounts. |

Note: a. Tiedown shackles mounted on the front of the truck were replaced with NSN 4030-01-222-6037. These shackles are heavier and do not spread from impulse loads encountered during rail impact testing of the 5-ton class of vehicles.

b. Rear body mounts secured to the truck chassis with U.S. manufactured 1/2-inch UNF grade 5 bolts torqued to approximately 70 ft-lbs.

TEST SPECIMEN AND RESULTS

ROAD TEST DATA

TEST NO.: 6

DATE: 5 May 1992

Specimen Load: M923A1 5-ton truck with two SIXCONs loaded to 5,000 pounds each.

ROAD HAZARD COURSE.

PASS 1-A OVER FIRST SERIES OF TIES: 0.09 MIN 6.31 MPH

PASS 1-B OVER SECOND SERIES OF TIES: 0.11 MIN 5.16 MPH

REMARKS: No load movement or visible damage to the vehicle or load.

PASS 2-A OVER FIRST SERIES OF TIES: 0.09 MIN 6.31 MPH

PASS 2-B OVER SECOND SERIES OF TIES: 0.10 MIN 5.68 MPH

REMARKS: No load movement or visible damage to the vehicle or load.

30-MILE ROAD TEST: No load movement or visible damage to the vehicle or load.

PANIC STOP TEST: No panic stops were done since this load was previously rail impact tested.

PASS 3-A OVER FIRST SERIES OF TIES: 0.12 MIN 4.73 MPH

PASS 3-B OVER SECOND SERIES OF TIES: 0.09 MIN 6.31 MPH

REMARKS: No load movement or visible damage to the vehicle or load.

PASS 4-A OVER FIRST SERIES OF TIES: 0.09 MIN 6.31 MPH

PASS 4-B OVER SECOND SERIES OF TIES: 0.11 MIN 5.16 MPH

REMARKS: No load movement or visible damage to the vehicle or load.

WASHBOARD COURSE: No load movement or visible damage to the vehicle or load.

PART 5

PHOTOGRAPHS

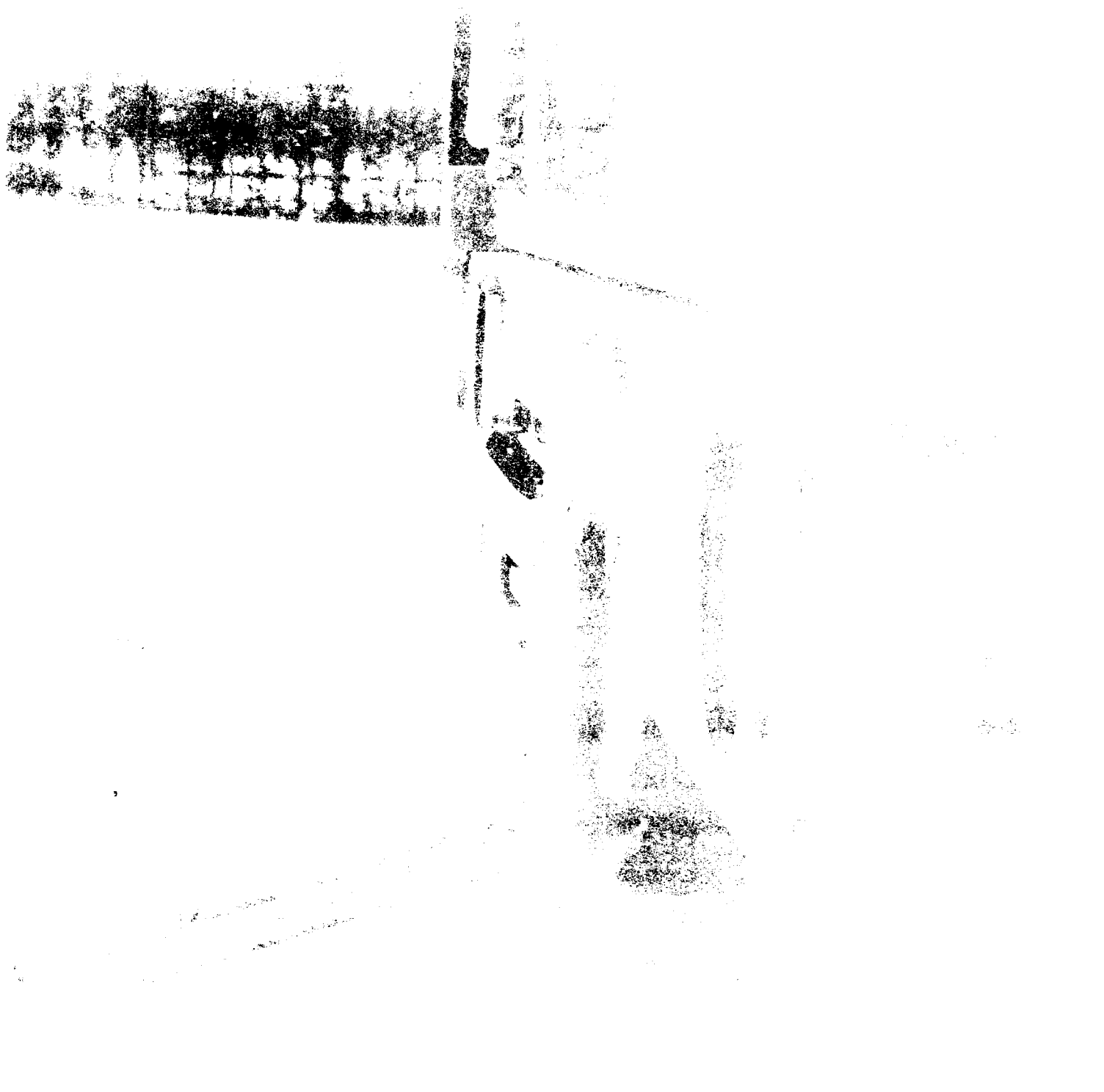

U.S. ARMY DEFENSE AMMUNITION CENTER
SCHOOL - SAVANNAH, IL

Photo No. A0317-SPN92-180-1595. This is a photo view of a 5-ton truck. The truck is loaded with a MILVAN in the truck bed. The lading is 10,000 pounds. Note on the left side of the compartment cover plate. This was caused by the rail impact. Deformation of the cover prevents removal of the side walls.

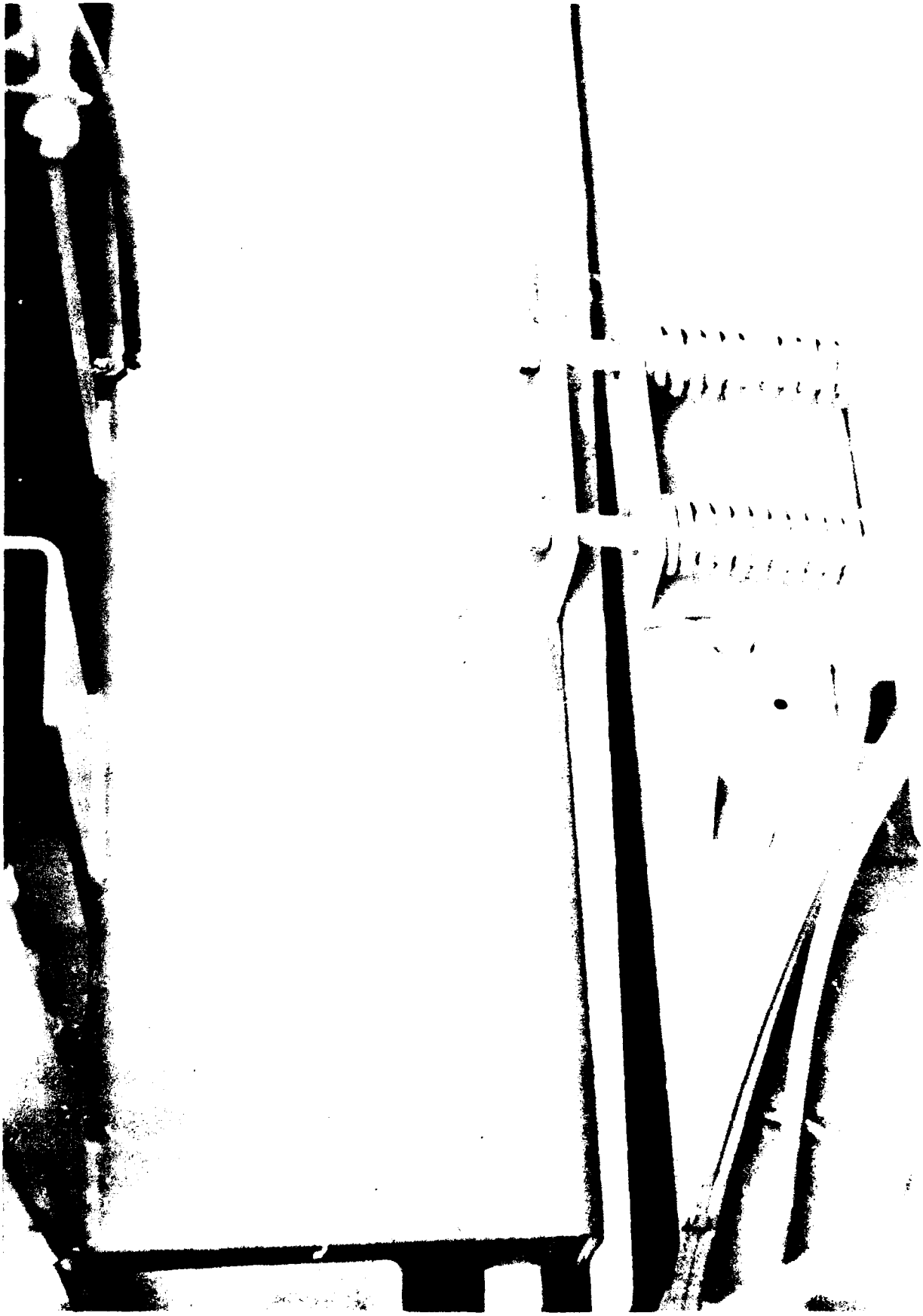

U.S. ARMY DEFENSE AMMUNITION CENTER AND SCHOOL - SAVANNA, IL

Photo No. A0317-SPN92-180-1609. This shows the forward chassis-bed interface on the M927A1 truck. The gap is a result of the forces induced into the vehicle when it is secured to a flatcar for rail transportation. This mount is located behind the truck cab.

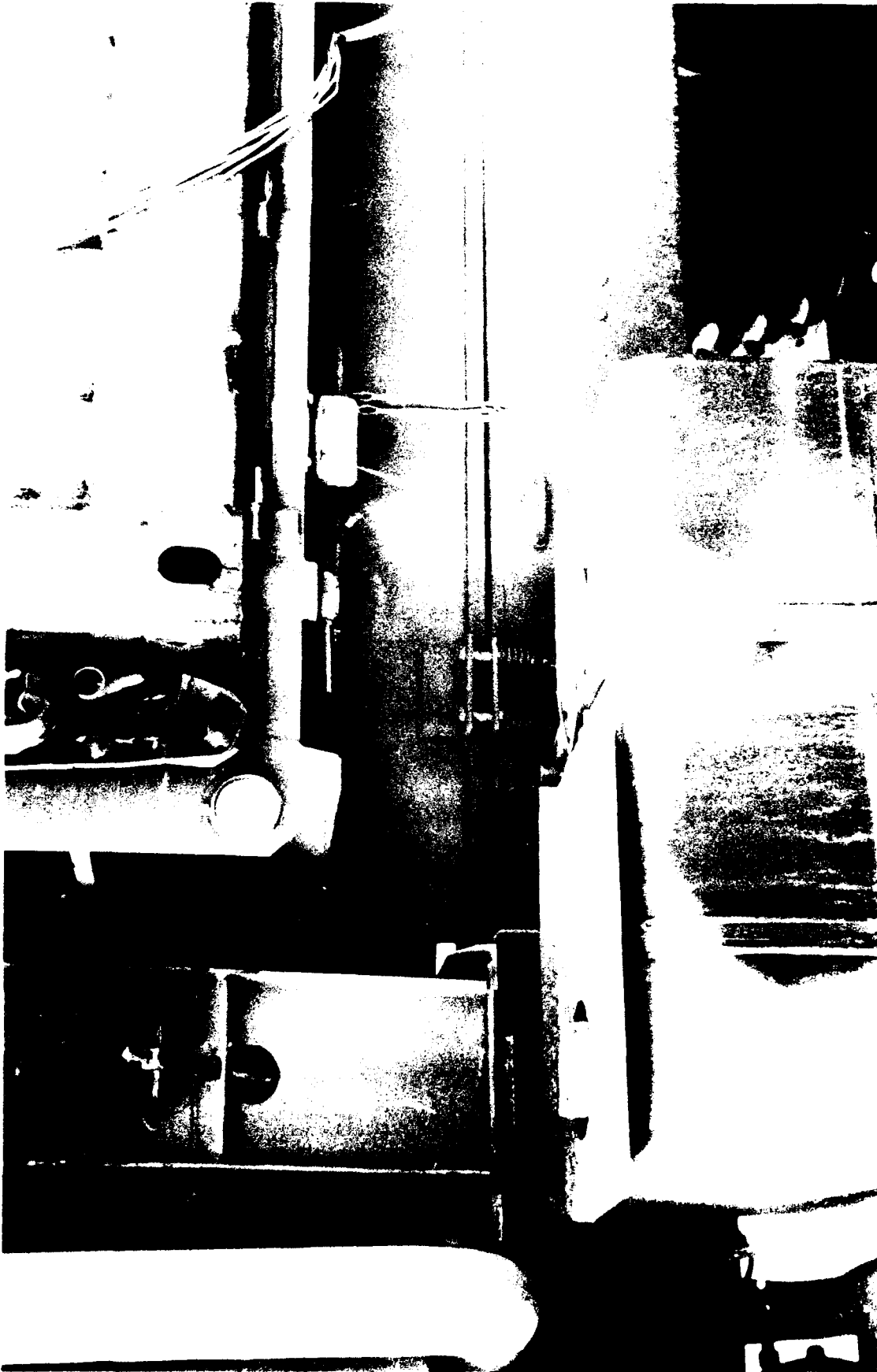

U.S. ARMY DEFENSE AMMUNITION CENTER AND SCHOOL - SAVANNA, IL

Photo No. A0317-SPN92-180-1611. This photo shows the forward chassis-bed interface of the M927A1 truck. A wooden strip is used as a barrier between the units. It is tapered at the front end and spring-loaded to accommodate frame twisting. The gap shown is induced by the tension in the vehicle tiedown cables at the front and rear of the vehicle.



| | |
|--|--|
| U.S. ARMY DEFENSE AMMUNITION CENTER AND SCHOOL - SAVANNA, IL | Photo No. A0317-SPN92-180-1620. This photo shows the M923A1 5-ton truck mount cabled to an instrumented flatcar for rail impact testing. |
|--|--|



U.S. ARMY DEFENSE AMMUNITION CENTER AND SCHOOL - SAVANNA, IL

Photo No. A0317-SPN92-180-1593. This photo shows the tiedown configuration used to secure the M923A1 5-ton truck to a flatcar for rail transportation. The shackles mounted on the bumper are not the standard issue. Previous testing has shown that the shackles used here will withstand the rail transportation environment, while those issued with the truck do not. The stock number for these replacement shackles is NSN 4030-01-222 6037.

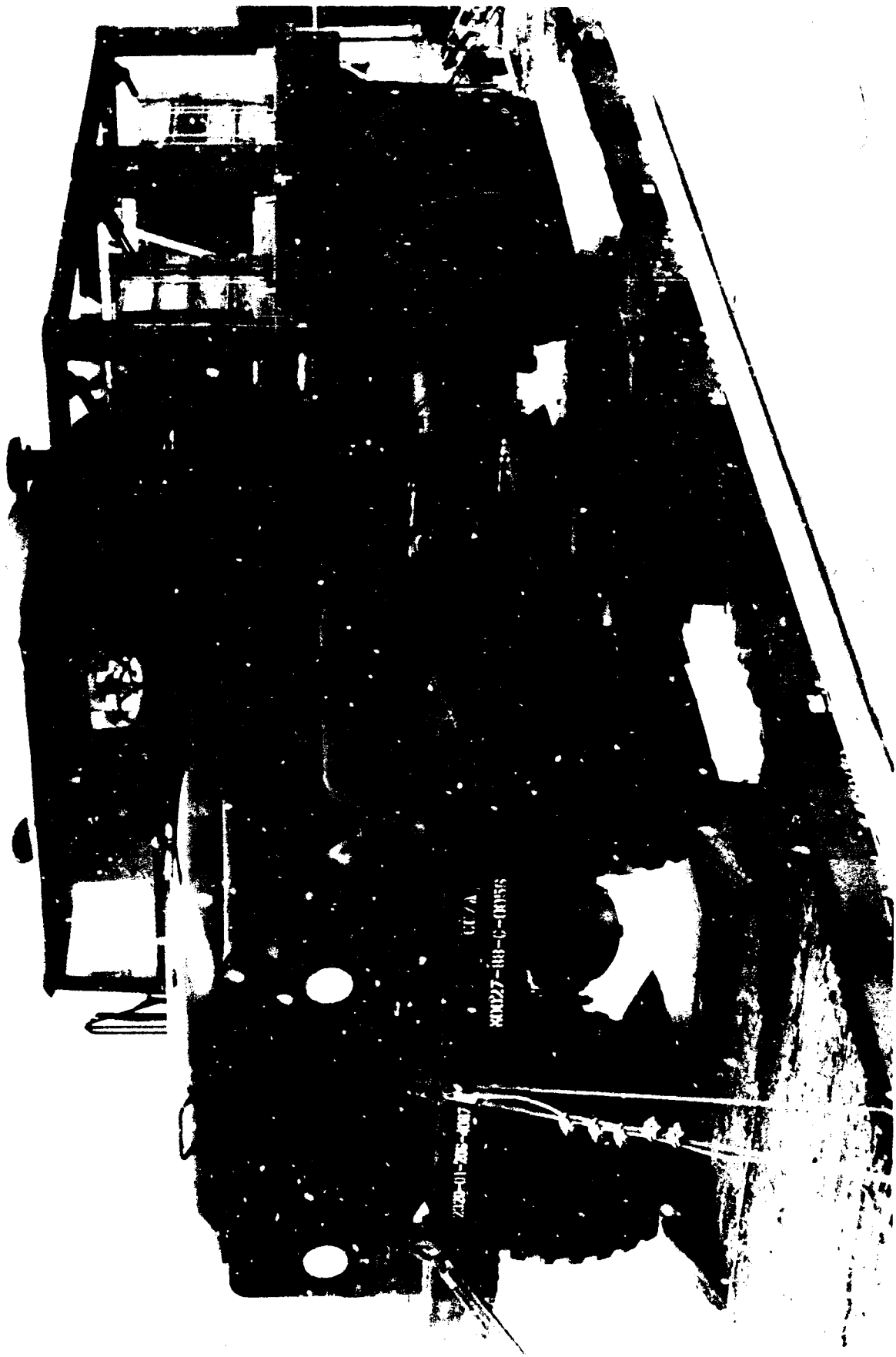

U.S. ARMY DEFENSE AMMUNITION CENTER AND SCHOOL - SAVANNA, IL

Photo No. A0317-SPN92-180-1617. This photo shows an overview of the M923A1 5-ton truck tied down to a flatcar for rail impact testing. Note the front shackles. These are standard issue shackles which failed in a rail mode of transportation. They must be replaced with NSN 4030-01-222-6037.

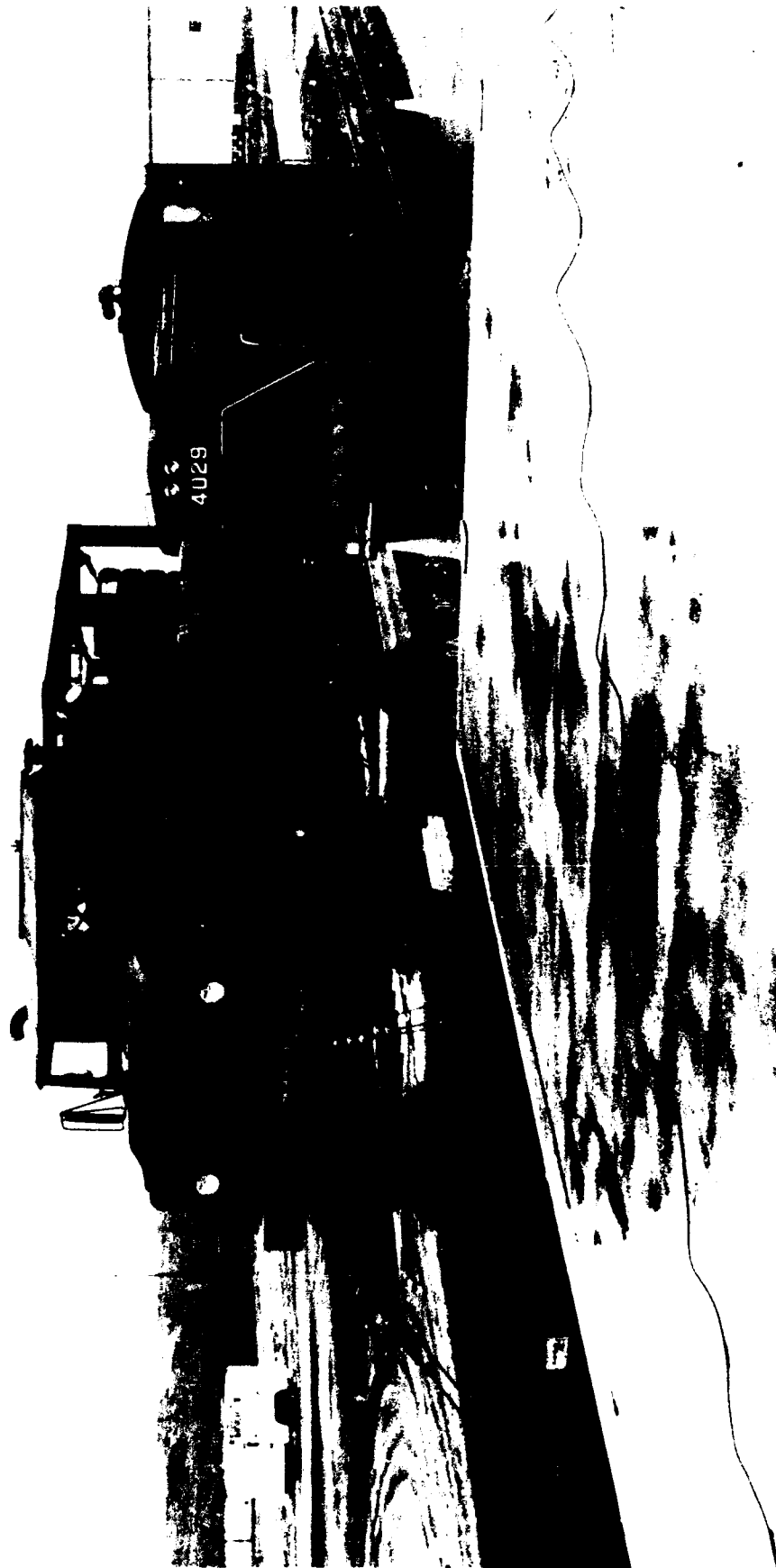

U.S. ARMY DEFENSE AMMUNITION CENTER AND SCHOOL - SAVANNA, IL

Photo No. A0317-SPN92-180-1605. This photo shows the M923A1 5-ton truck cabled to a flatcar and coupled to the switch engine, ready for an impact.



U.S. ARMY DEFENSE AMMUNITION CENTER AND SCHOOL - SAVANNA, IL

Photo No. A0317-SPN92-180-1581. This is typical of the damage that occurs to an undersized schackle when used for securing the M923A1 5-ton truck to a flatcar for shipment by rail. The shackle sheared off the safety pin (not seen at the right) and caused it to spread far enough to disengage from the pin. The rear shackles should be replaced with NSN 4030-01-222-6037.



| | | |
|--|--|--|
| | U.S. ARMY DEFENSE AMMUNITION CENTER AND SCHOOL - SAVANNA, IL | |
| <p>Photo No. A0317-SPN92-180-1601. This photo shows the rear mounting brackets that are used to mount the ISO bed to the M923A1 chassis. The lower bracket was riveted to the truck frame. Rail impact testing caused the lower bracket to slip and shear all three rivets. Field repair was accomplished with 3/8-inch UNF grade 5 bolts. The field repair also failed.</p> | | |

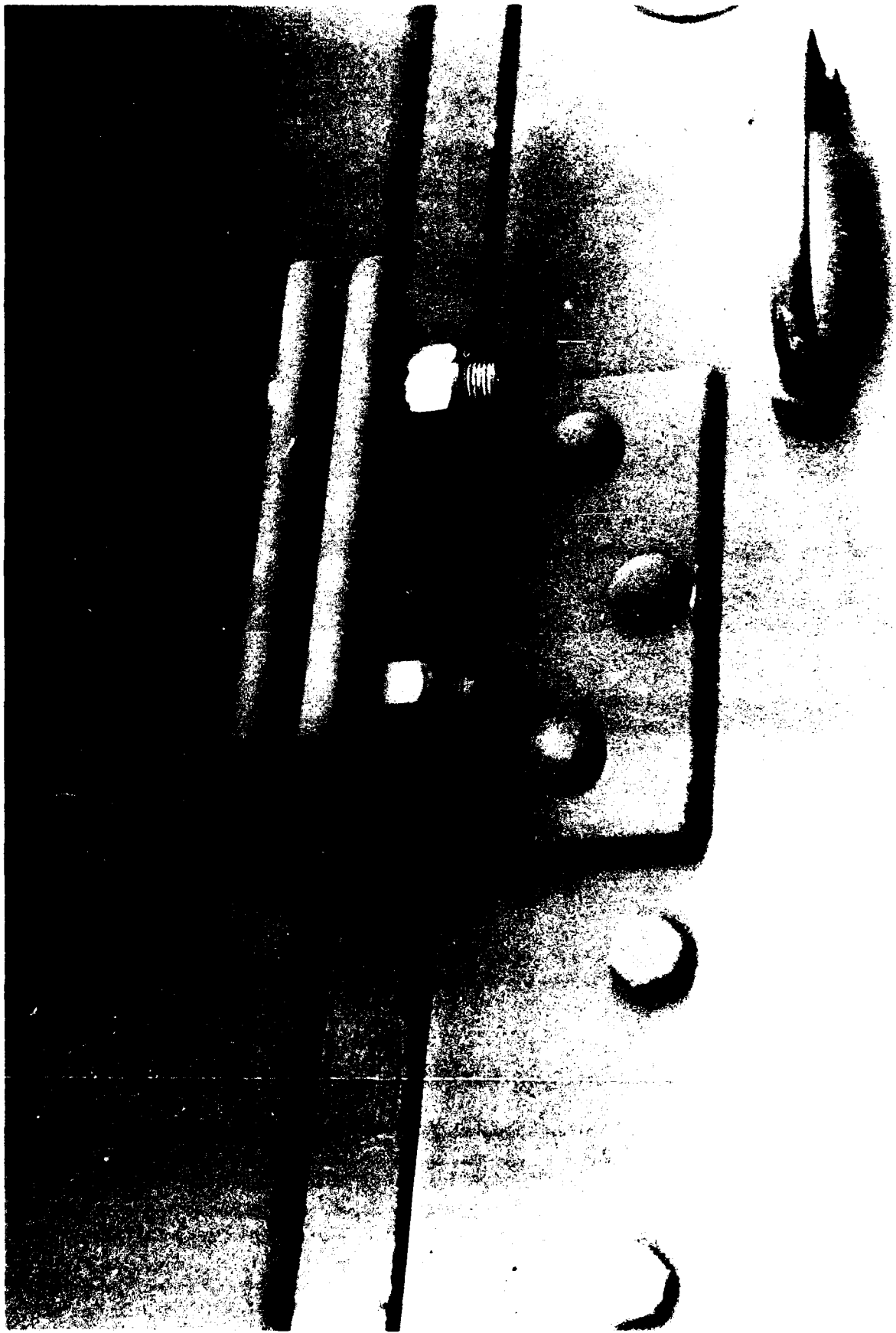

U.S. ARMY DEFENSE AMMUNITION CENTER AND SCHOOL - SAVANNA, IL

Photo No. A0319-SPN92-180-1596. This photo shows the rear mounting brackets used to secure the ISO bed to the M923A1 truck. Note the chipped paint on the lower bracket and at the left where the bracket attached to the truck frame. Chipped paint is the first sign of an impending failure.



U.S. ARMY DEFENSE AMMUNITION CENTER AND SCHOOL - SAVANNA, IL

Photo No. A0317-SPN92-180-1599. This photo shows the remainder of a lower riveted mounting bracket after impact testing sheared the fasteners. A field fix of 3/8-inch UNF grade 5 bolts also failed.

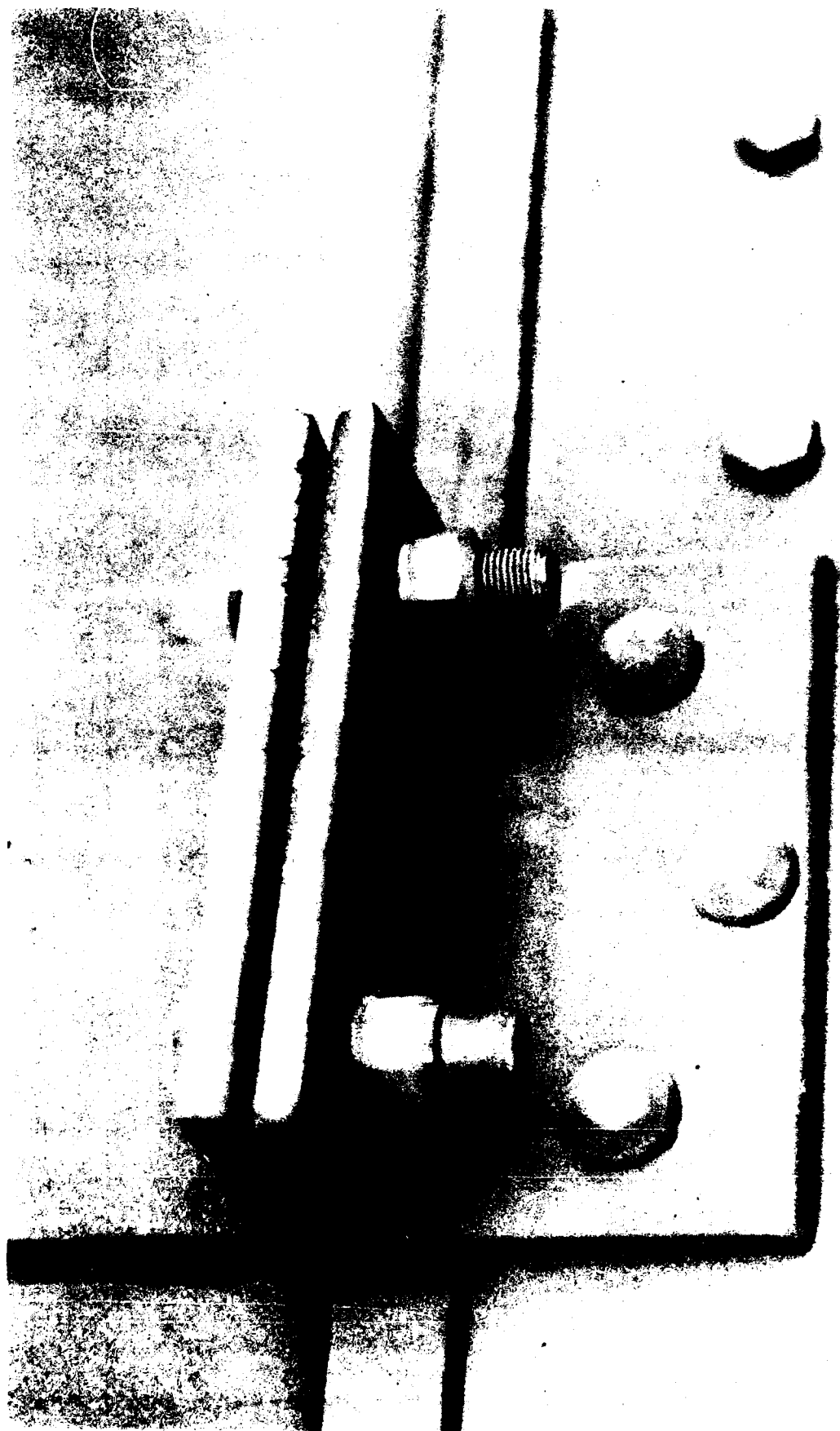

U.S. ARMY DEFENSE AMMUNITION CENTER AND SCHOOL - SAVANNA, IL

Photo No. A0317-SPN92-180-1594. This photo shows the rear mounting brackets used to secure the ISO bed to the M923A1 chassis. Cracked paint is observed on the mount.

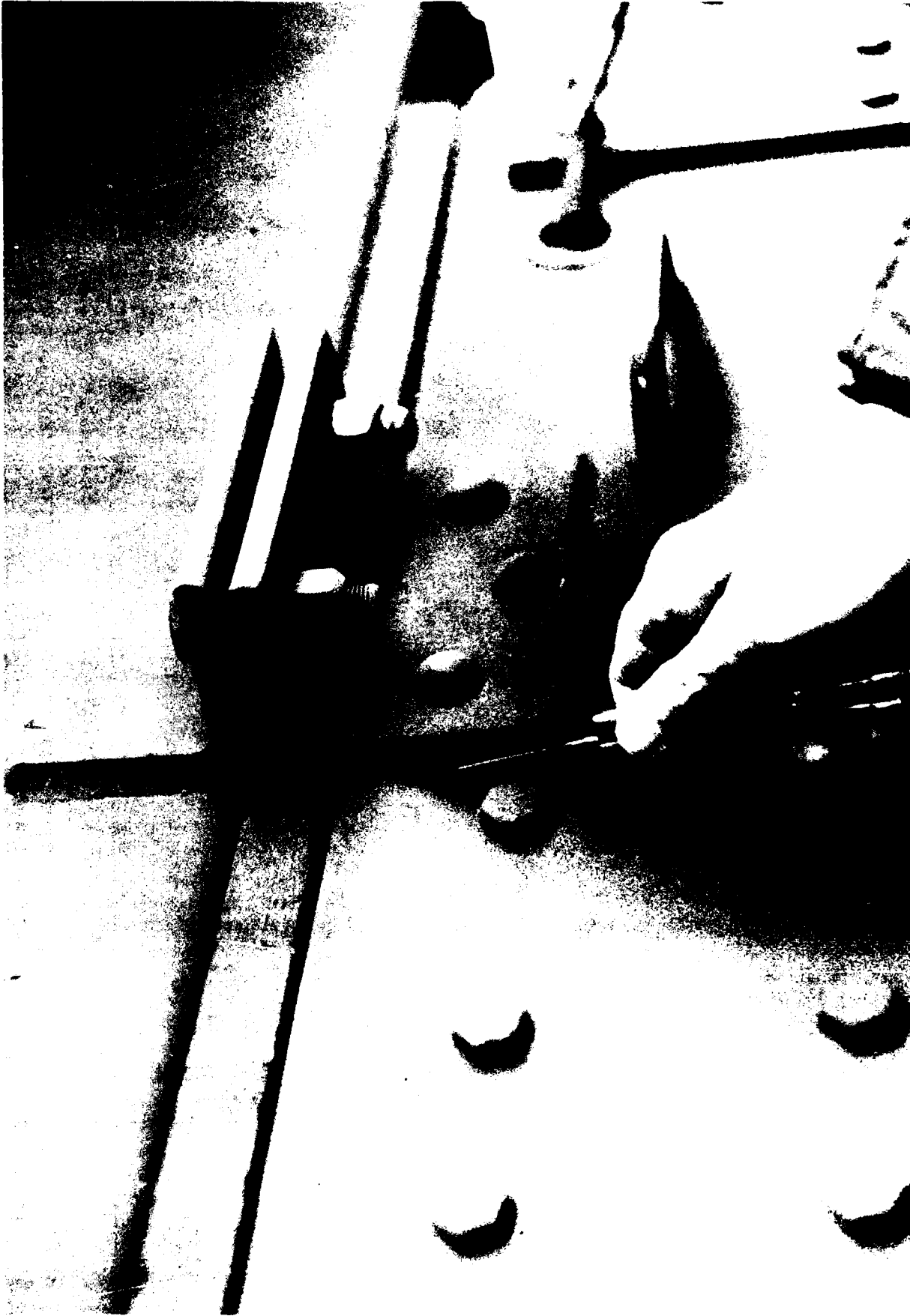

U.S. ARMY DEFENSE AMMUNITION CENTER AND SCHOOL - SAVANNA, IL

Photo No. A0317-SPN92-180-1597. This photo shows the rear mounting brackets used to secure the ISO bed to the M923A1 truck chassis. The knife is used to point to the cracked paint between the chassis and mount.



U.S. ARMY DEFENSE AMMUNITION CENTER AND SCHOOL - SAVANNA, IL

Photo No. A0317-SPN92-180-1583. This photo shows a separated shackle. It separated as a result of rail impact testing and not having enough strength. It is suggested that this shackle be replaced with NSN 4030-01-222-4089.



U.S. ARMY DEFENSE AMMUNITION CENTER AND SCHOOL - SAVANNA, IL

Photo No. A0317-SPN92-180-1585. This photo illustrates the extent to which a shackle will deform in a railroad transportation environment. For this reason, it is suggested that the shackle be replaced with NSN 4030-01-222-4089.

(KEY NUMBERS CONTINUED)

⑧ THIMBLE, STANDARD, SIZE 5/8" (8 RECD). USE ONE PER STAKE POCKET AND ONE PER VEHICLE TIEDOWN DEVICE. NOTE THAT AN "OPEN PATTERN" THIMBLE IS RECOMMENDED. SECURE TO CABLES MARKED ⑥ WITH ONE CLIP PER EACH THIMBLE. SEE GENERAL NOTE "O" ON PAGE 2, AND THIMBLE DETAILS ON PAGES 41 AND 42.

⑨ WATERPROOF PAPER OF A SUFFICIENT SIZE TO POSITION UNDER AND EXTEND 2" ABOVE PIECES MARKED ② AND ④.

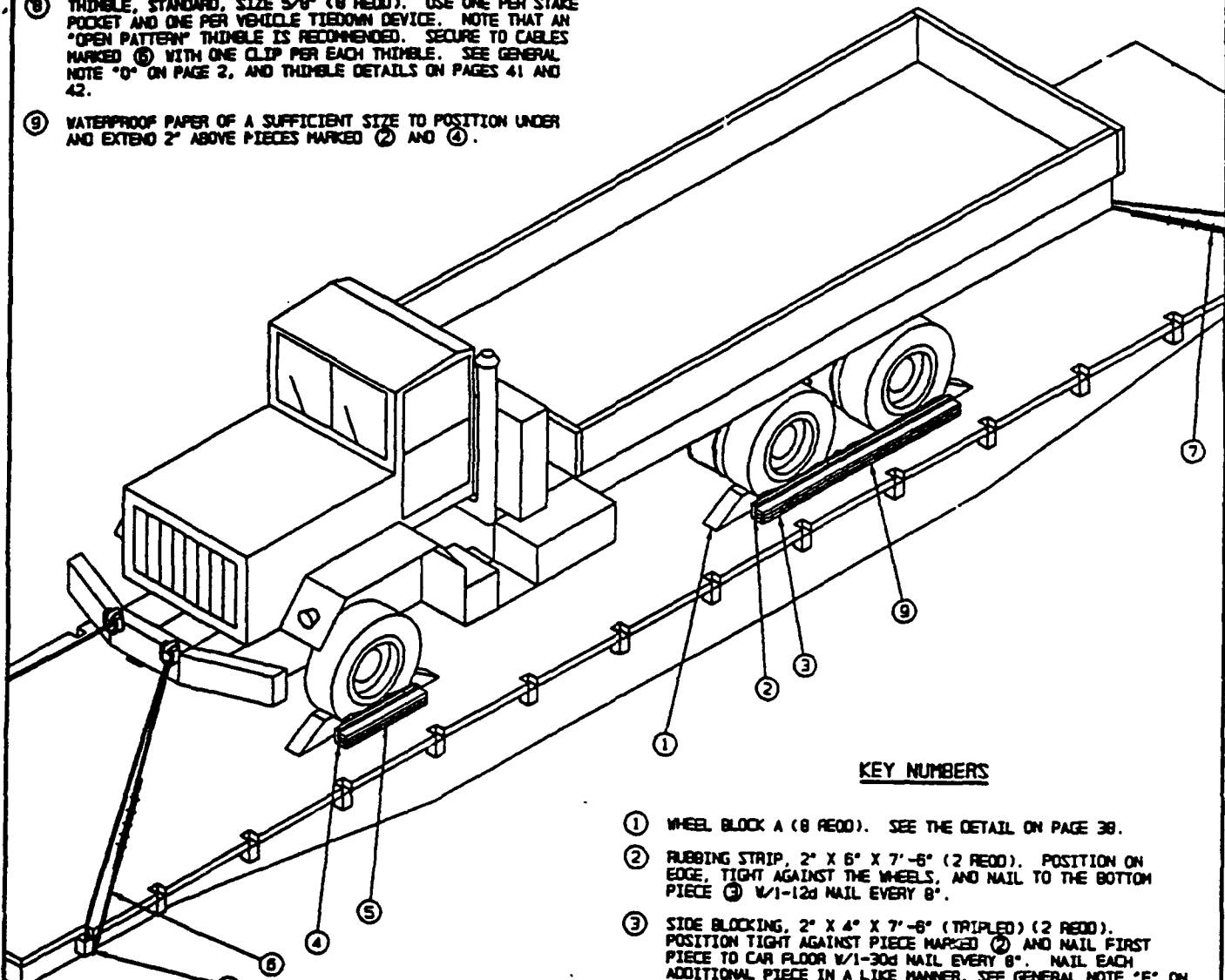

ISOMETRIC VIEW

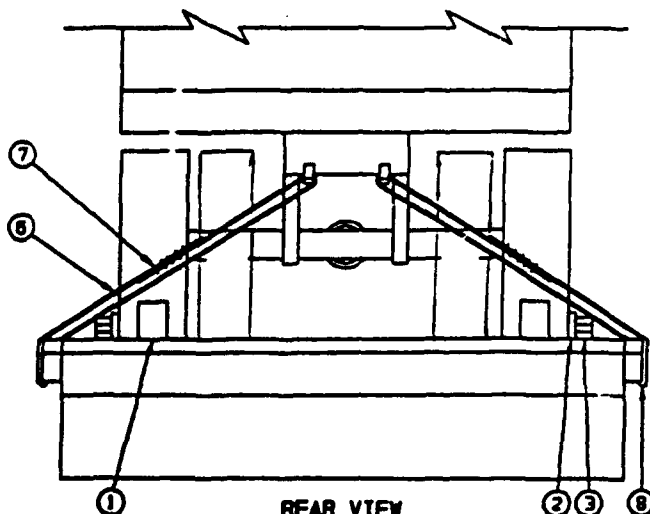

REAR VIEW

KEY NUMBERS

- ① WHEEL BLOCK A (8 RECD). SEE THE DETAIL ON PAGE 38.
- ② RUBBING STRIP, 2" X 6" X 7'-8" (2 RECD). POSITION ON EDGE, TIGHT AGAINST THE WHEELS, AND NAIL TO THE BOTTOM PIECE ③ 1/4-12d NAIL EVERY 8".
- ③ SIDE BLOCKING, 2" X 4" X 7'-8" (TRIPLED) (2 RECD). POSITION TIGHT AGAINST PIECE MARKED ② AND NAIL FIRST PIECE TO CAR FLOOR 1/4-30d NAIL EVERY 8". NAIL EACH ADDITIONAL PIECE IN A LIKE MANNER. SEE GENERAL NOTE "F" ON PAGE 2.
- ④ RUBBING STRIP, 2" X 6" X 36" (2 RECD). POSITION ON EDGE, TIGHT AGAINST THE WHEEL, AND NAIL TO A BOTTOM PIECE ⑤ 1/4-12d NAILS.
- ⑤ SIDE BLOCKING, 2" X 4" X 36" (TRIPLED) (2 RECD). POSITION TIGHT AGAINST PIECE MARKED ④ AND NAIL FIRST PIECE TO CAR FLOOR 1/4-30d NAILS. NAIL EACH ADDITIONAL PIECE IN A LIKE MANNER. SEE GENERAL NOTE "F" ON PAGE 2.
- ⑥ STEEL WIRE ROPE, 5/8" DIAMETER, 17.9 TONS (4 RECD). INSTALL EACH CABLE TO APPROXIMATE THE ANGLE SHOWN AND TO FORM A COMPLETE LOOP FROM THE STAKE POCKET ON THE CAR THROUGH A VEHICLE TIEDOWN DEVICE AND BACK THROUGH THE STAKE POCKET. SEE THE "CABLE JOINT B" DETAIL ON PAGE 40, GENERAL NOTES "O", "H", "K" AND "L" ON PAGE 2, AND LOADING AND TIEDOWN PROCEDURES NOTE 3 ON PAGE 4. NOTE: CABLE OF A LARGER SIZE MAY BE USED, IF AVAILABLE, WHEN SPECIFIED CABLE IS NOT AVAILABLE.
- ⑦ CLIP, SIZE 5/8" (28 RECD). FIVE PER CABLE JOINT OF PIECE MARKED ⑥, AND ONE PER THIMBLE MARKED ⑧. NOTE: A STANDARD THIMBLE AS SPECIFIED CAN BE SECURED TO A CABLE WITH A 5/8" CLIP. HOWEVER, IF DESIRED, OR IF THE 5/8" THIMBLE BEING USED IS OF A TYPE WHICH CANNOT BE SECURED TO A CABLE WITH A 5/8" CLIP, A 3/4" CLIP MAY BE USED. ALTERNATIVE: NUMBER 14 GAGE WIRE MAY BE USED IN LIEU OF A CLIP FOR SECUREMENT OF A THIMBLE MARKED ⑧ TO A CABLE MARKED ⑥, IF DESIRED.

(KEY NUMBERS CONTINUED ABOVE)

SPECIAL NOTES:

1. A 5-TON M927A1 CARGO TRAILER, HAVING DIMENSIONS OF 97-1/2" WIDE BY 381" LONG (402-1/2" WITH WINCH), AND WEIGHING 25,000 POUNDS EMPTY, OR 35,000 POUNDS FULLY LOADED, IS SHOWN SECURED TO A 10'-0" WIDE BY 52'-0" LONG FLAT CAR HAVING 15 STAKE POCKETS. SEE GENERAL NOTE "C" ON PAGE 2.
2. THE VEHICLE SHOWN WAS SELECTED AS TYPICAL ONLY AND VEHICLES OF OTHER DIMENSIONS AND WEIGHTS MAY BE SECURED TO A FLAT CAR USING THESE SAME PROCEDURES.
3. IF THE VEHICLE BEING LOADED WEIGHS 25,000 POUNDS OF LESS, USE 1/2" STEEL WIRE ROPE IN LIEU OF 5/8" STEEL WIRE ROPE MARKED (6). ALSO, USE 1/2" SIZE CLIPS IN LIEU OF THE 5/8" SIZE CLIPS MARKED (7), AND 1/2" SIZE THIMBLES IN LIEU OF THE 5/8" SIZE THIMBLES MARKED (8). SEE LOADING AND TIEDOWN PROCEDURES NOTE 2 ON PAGE 4; AND CABLE JOINT A DETAIL ON PAGE 40.

LOAD AS SHOWN (EMPTY VEHICLE)

| ITEM | QUANTITY | WEIGHT (APPROX) |
|--------------|----------|---------------------|
| VEHICLE | 1 | 25,000 LBS |
| DUNNAGE | | 333 LBS* |
| TOTAL WEIGHT | | 25,333 LBS (APPROX) |

BILL OF MATERIAL

| LUMBER | LINEAR FEET | BOARD FEET |
|----------------------------|-------------|------------|
| 2" X 4" | 62 | 42 |
| 2" X 8" | 36 | 36 |
| 8" X 8" | 10 | 40 |
| NAILS | NO. REQD | POUNDS |
| 12d (3-1/4") | 30 | 2 |
| 30d (4-1/2") | 98 | 5 |
| 40d (5") | 56 | 3-1/2 |
| 60d (6") | 16 | 1-3/4 |
| ROPE, STEEL WIRE, 5/8" DIA | 96' REQD | 66 LBS |
| CLIPS, 5/8" | 24 REQD | 15 LBS |
| THIMBLES, STANDARD, 5/8" | 8 REQD | 3 LBS |
| WATERPROOF PAPER OR BURLAP | AS REQD | NIL |

LOAD AS SHOWN (FULLY LOADED VEHICLE)

| ITEM | QUANTITY | WEIGHT (APPROX) |
|--------------|----------|---------------------|
| VEHICLE | 1 | 25,000 LBS |
| LOAD | | 10,000 LBS |
| DUNNAGE | | 333 LBS |
| TOTAL WEIGHT | | 35,333 LBS (APPROX) |

PART 7

ACCELEROMETER DATA

M927A1 TRUCK

| ACCELEROMETER POSITIONS | | |
|-------------------------|---------|--------------|
| LOCATION | CHANNEL | ORIENTATION |
| A | 10 | LONGITUDINAL |
| A | 11 | VERTICAL |
| B | 7 | LONGITUDINAL |
| B | 8 | LATERAL |
| B | 9 | VERTICAL |
| C | 4 | LONGITUDINAL |
| C | 5 | LATERAL |
| C | 6 | VERTICAL |
| D | 2 | LONGITUDINAL |
| D | 3 | VERTICAL |
| E | 8 | LONGITUDINAL |
| E | 1 | VERTICAL |

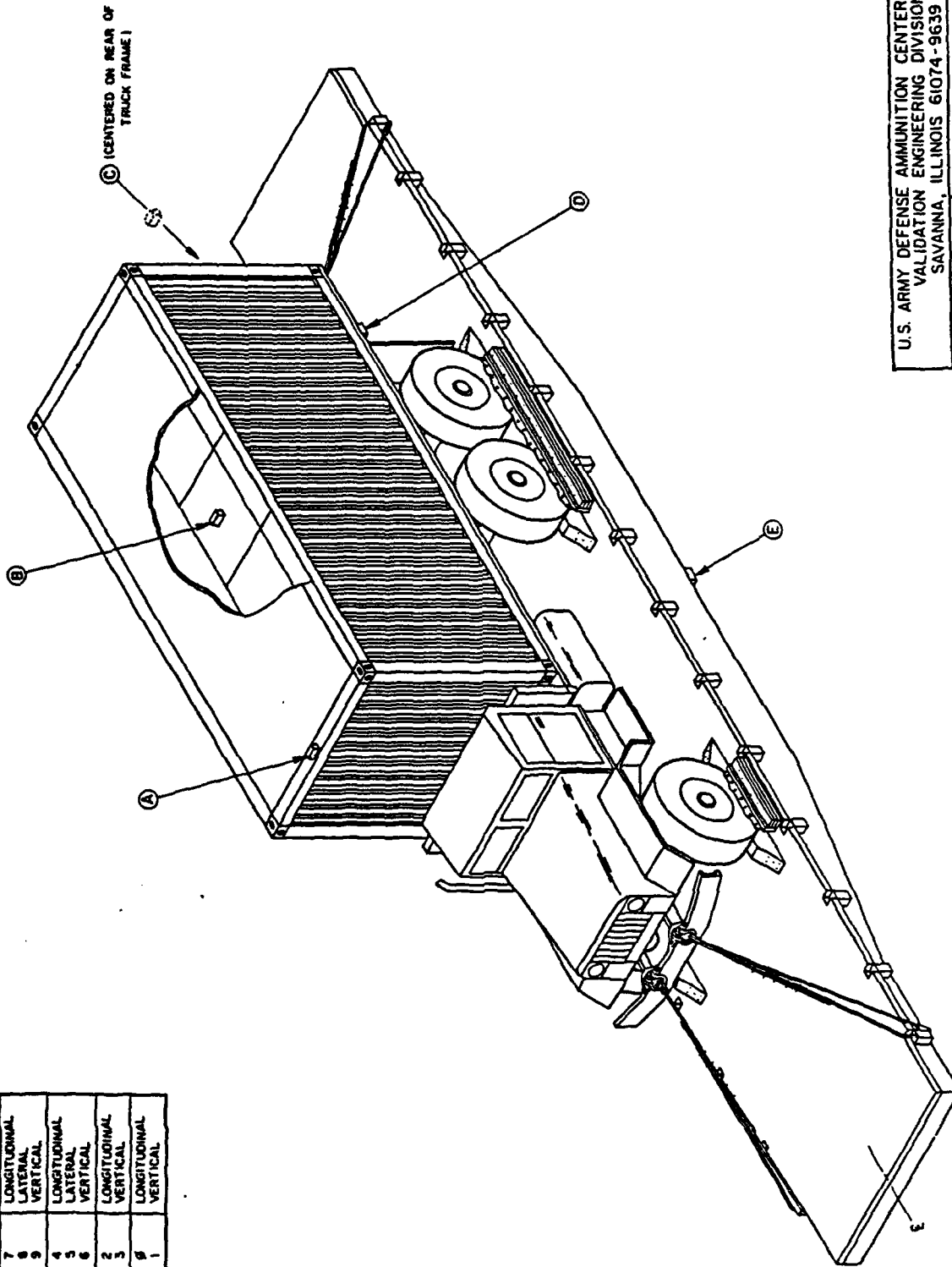

U.S. ARMY DEFENSE AMMUNITION CENTER & SCHOOL
 VALIDATION ENGINEERING DIVISION
 SAVANNA, ILLINOIS 61074-9639

PROFESSOR TOM SIMMONS TITLE U. S. M. C. CONTAINER
 TRANSPORTING CARGO
 TRUCK

TEST ENGINEER AL MCINTOSH

CHIEF, VALIDATION ENGINEERING DIVISION
 JEROME H. KRONH

WORK NO 92-010-0-T00069
 DATE 2 APRIL 1992
 SHEET 1 of 1

Anno Cert of USMC M927A1 Truck, Impact 1 Mar 31 09:23:22 1992

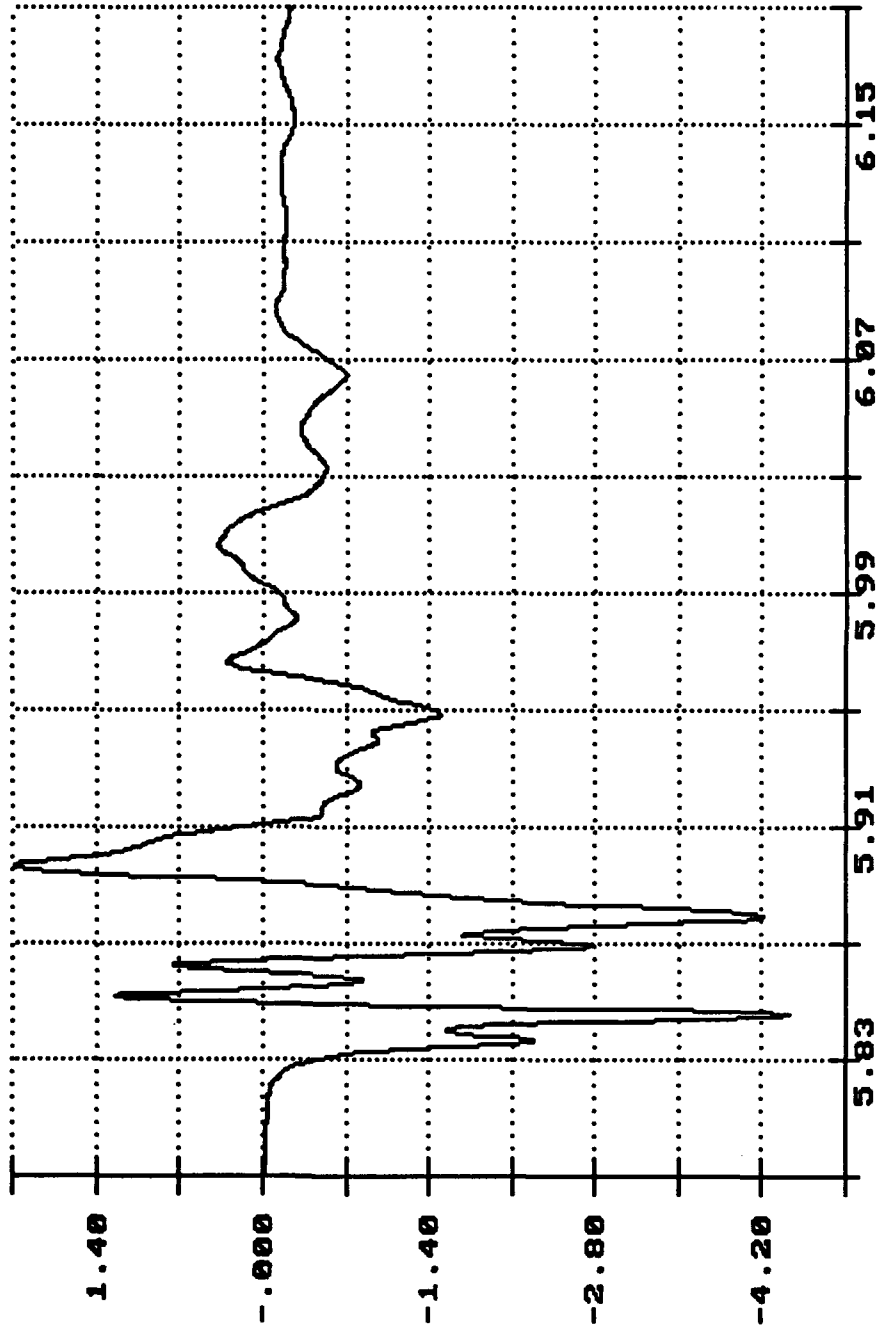

Long. Acceleration
Center Still
Gs X 1.0000

Time of Sample

Seconds X 1.0000

Anno Cert of USMC M927A1 Truck, Impact 1 Mar 31 09:23:22 1992

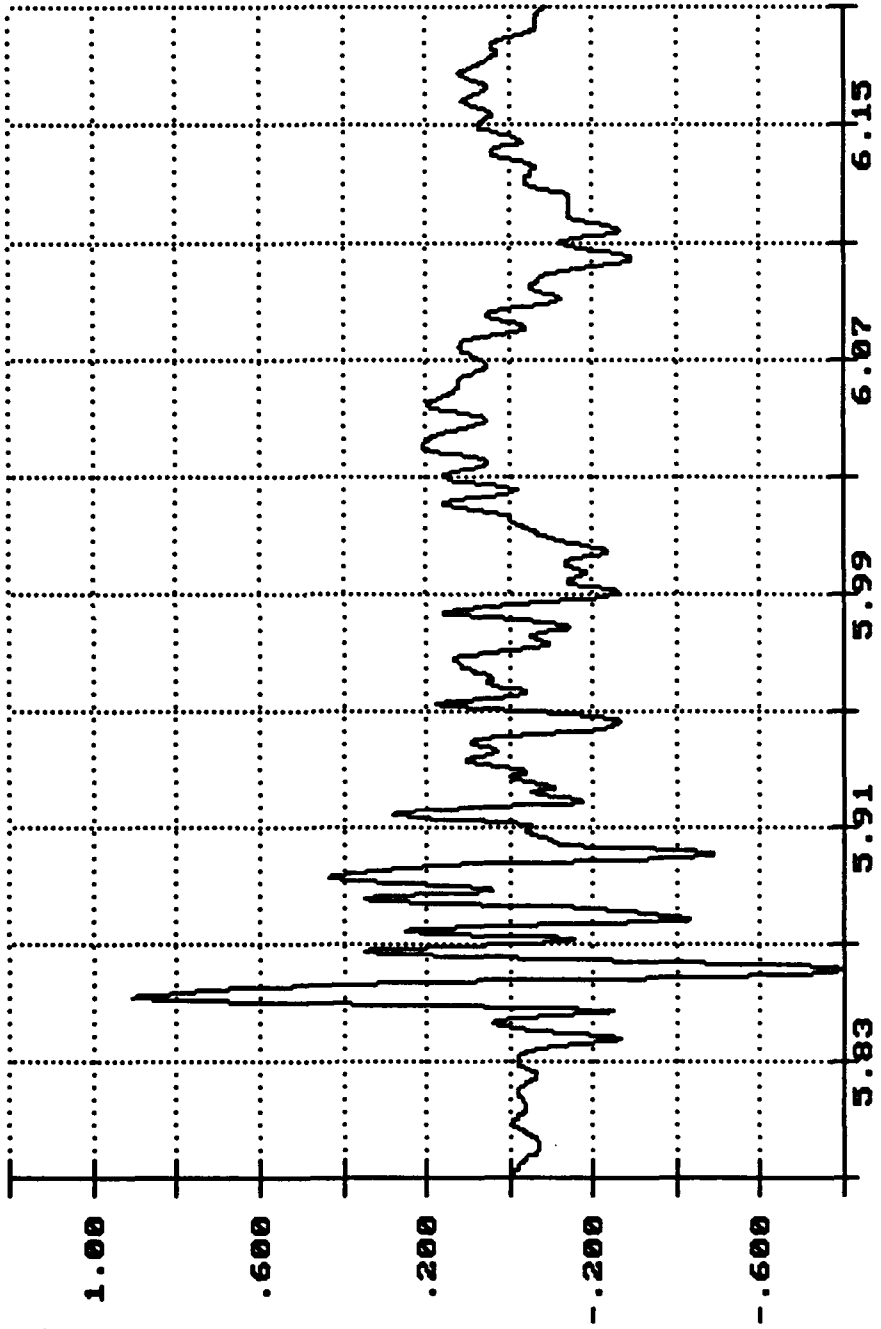

Vert. Acceleration
Center Sill
Gs X 1.0000

Time of Sample
Seconds X 1.0000

Anno Cert of USMC M927A1 Truck, Impact 1 Mar 31 09:23:22 1992

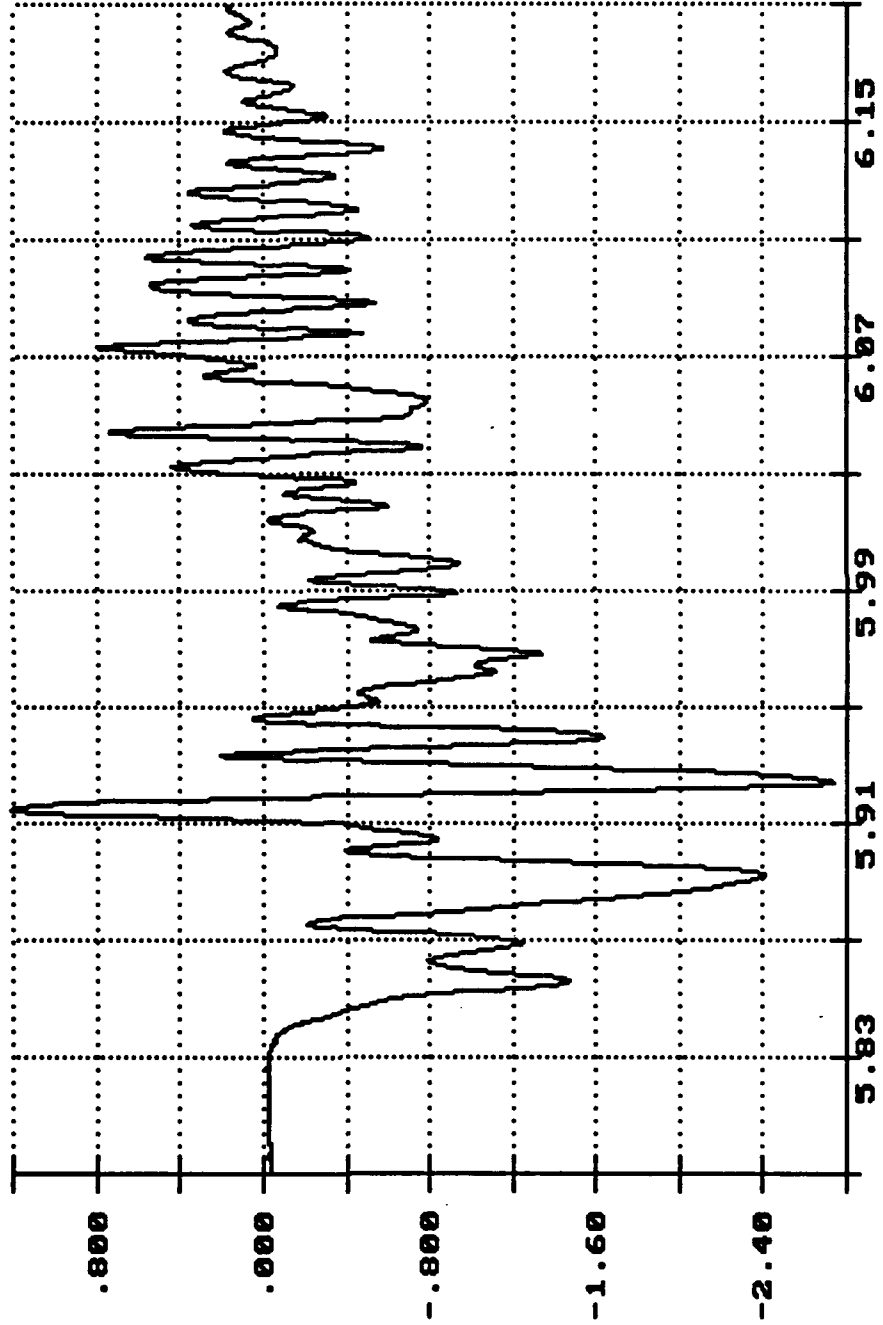

Long. Acceleration
Truck Bed
Gs X 1.0000

Time of Sample

Seconds X 1.0000

Anno Cert of USMC M927A1 Truck, Impact 1 Mar 31 09:23:22 1992

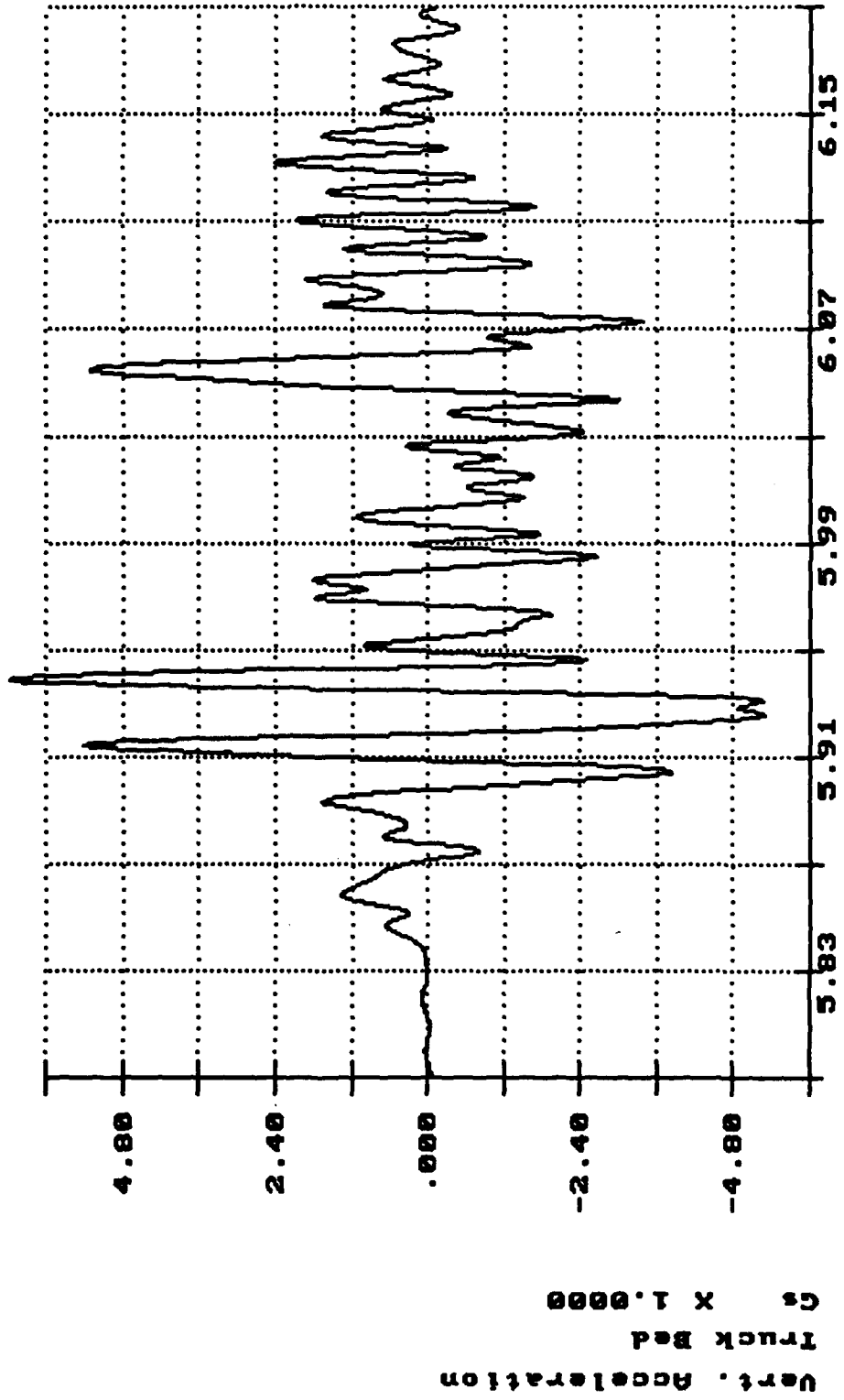

Anno Cert of USMC M927A1 Truck, Impact 1 Mar 31 09:23:22 1992

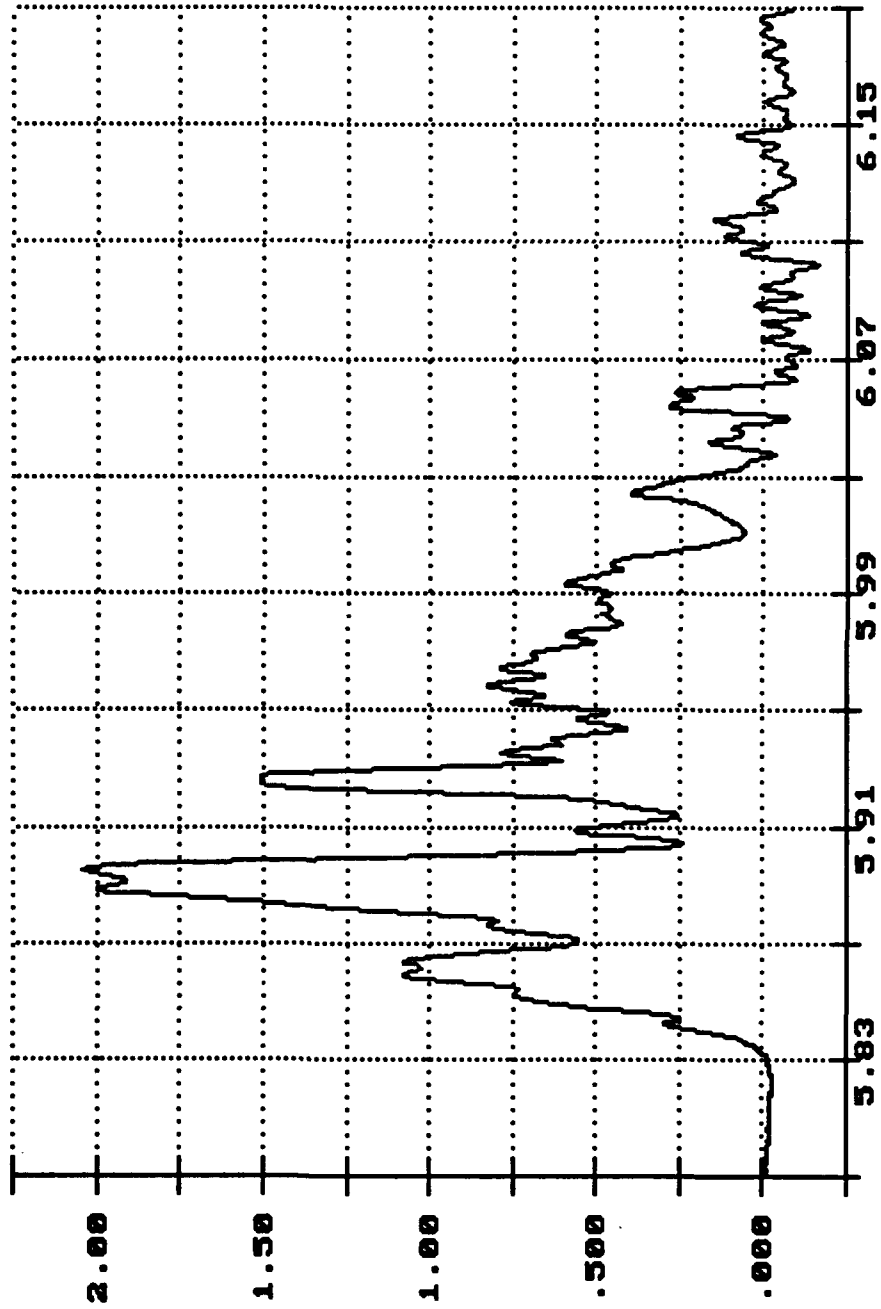

Long. Acceleration
Truck Frame
Gs X 1.0000

Time of Sample

Seconds X 1.0000

Anno Cert of USMC M927A1 Truck, Impact 1 Mar 31 09:23:22 1992

7

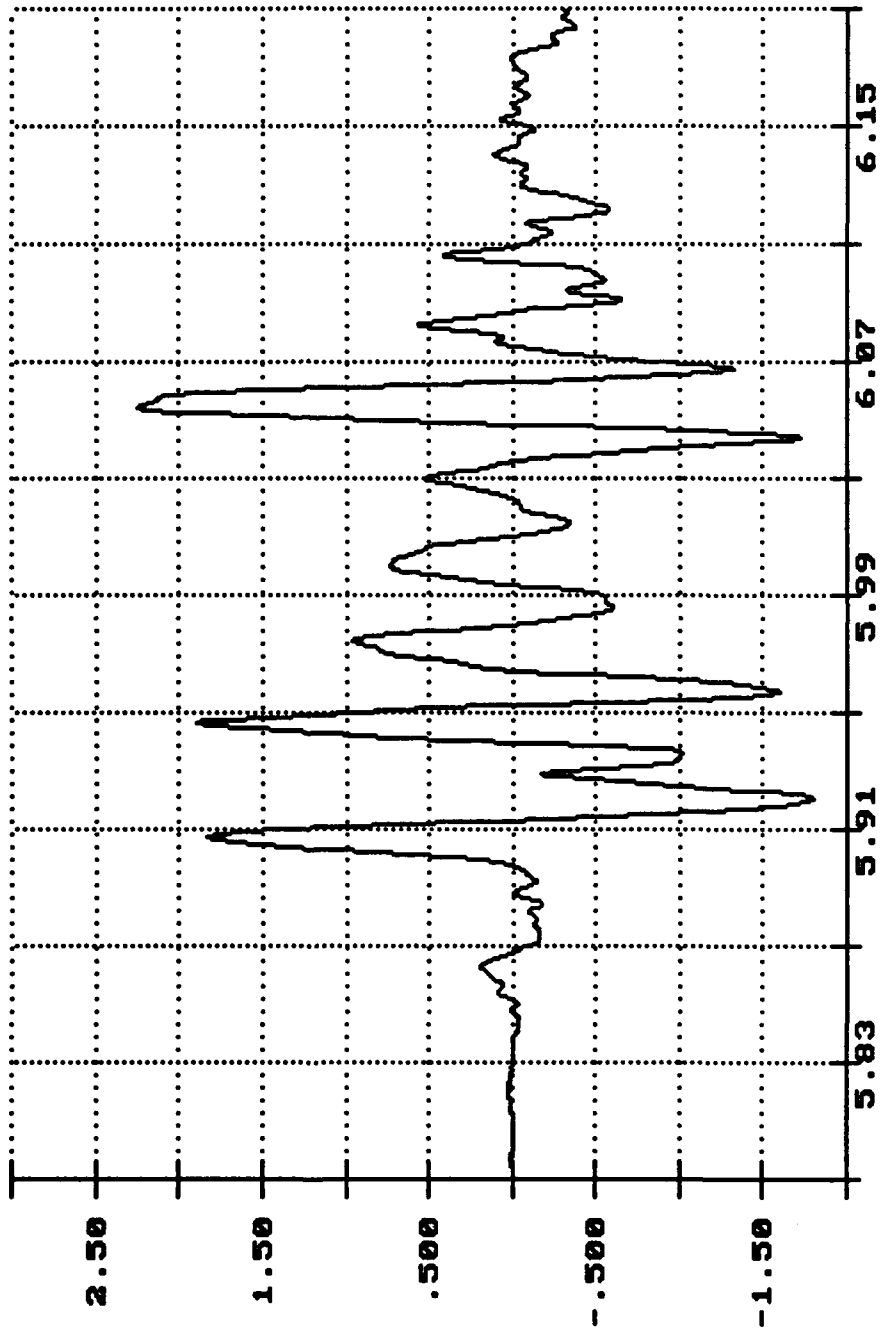

Time of Sample

Seconds X 1.0000

Anno Cert of USMC M927A1 Truck, Impact 1 Mar 31 09:23:22 1992

7

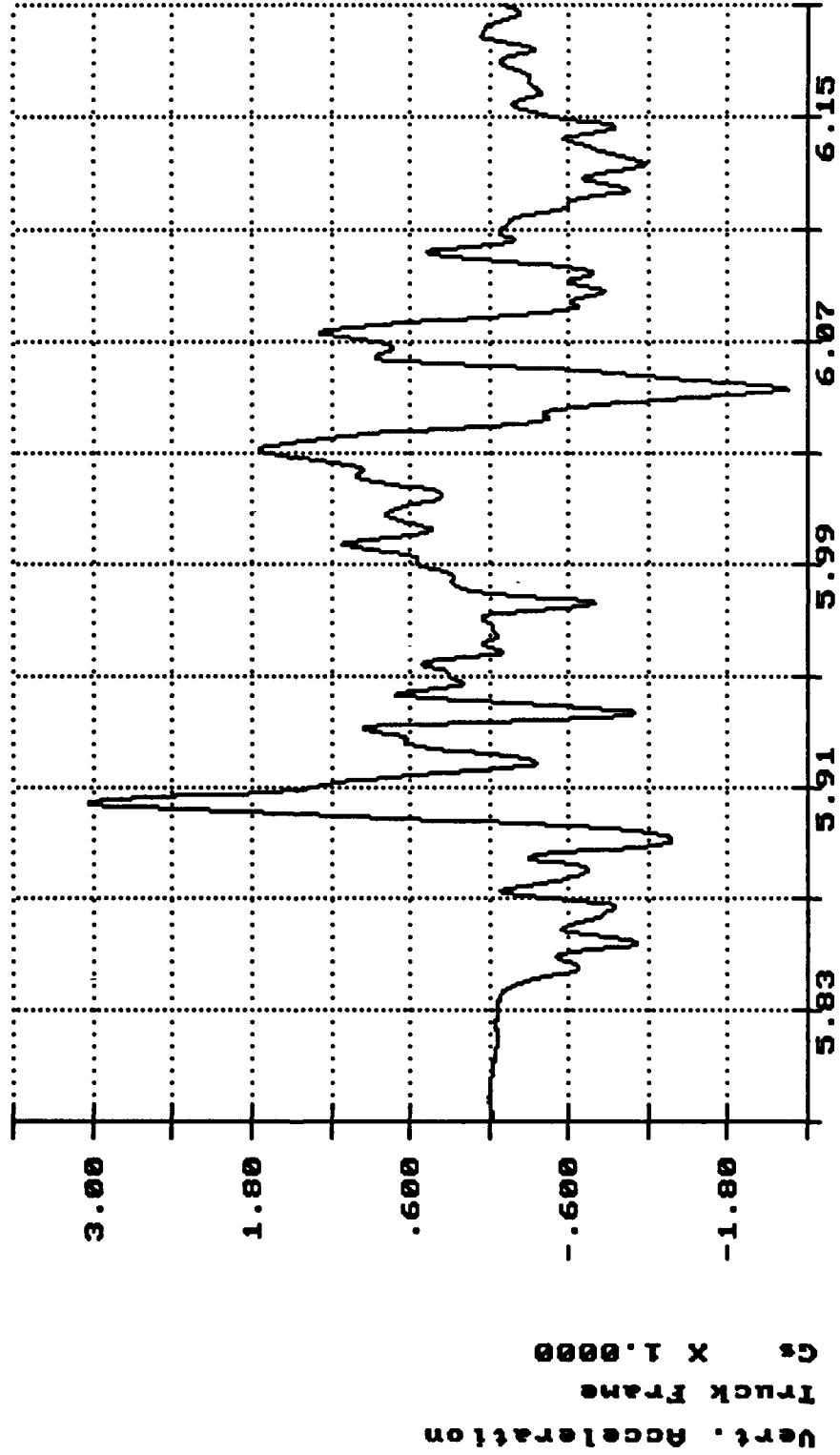

Anno Cert of USMC M927A1 Truck, Impact 1 Mar 31 09:23:22 1992

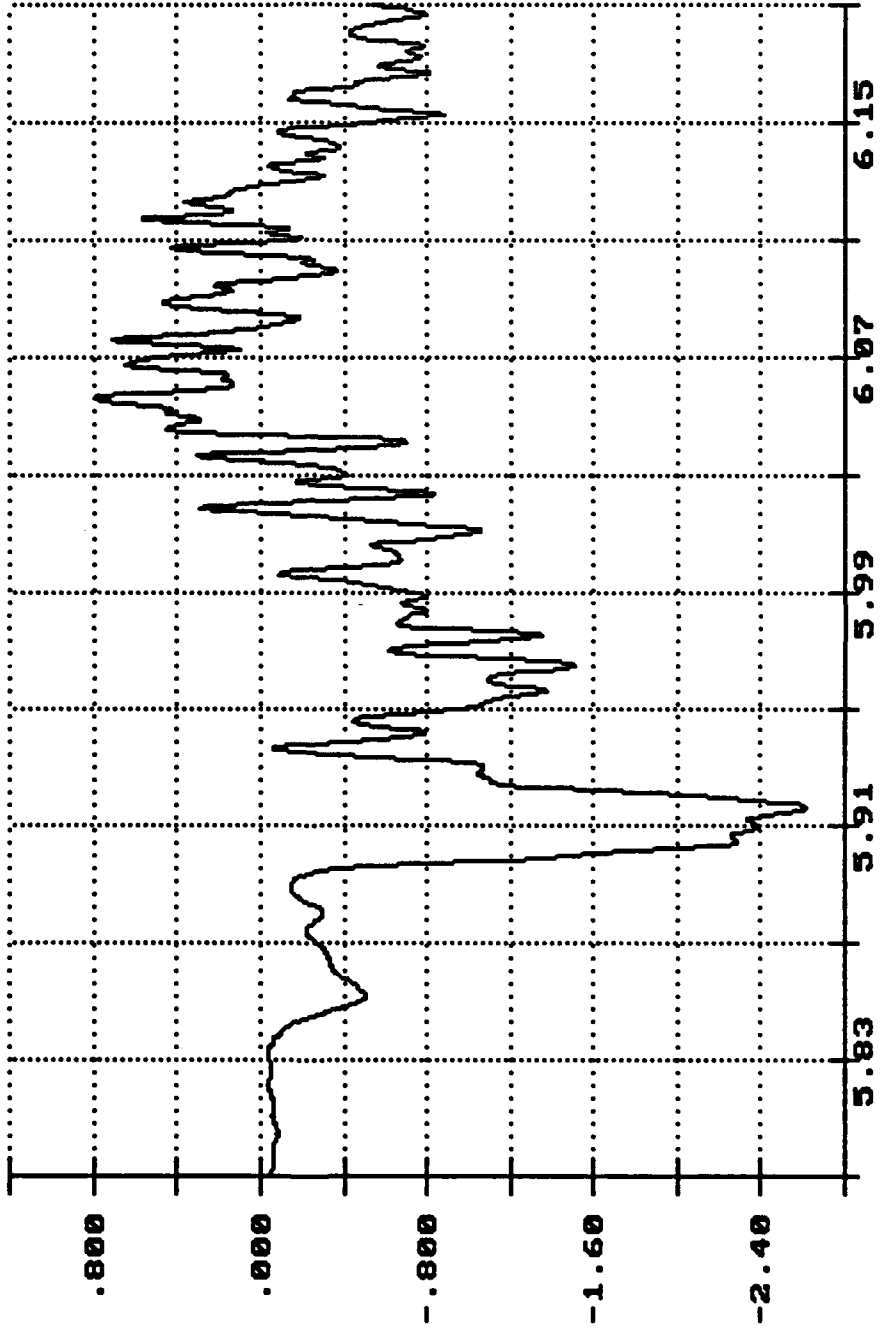

Time of Sample

Seconds X 1.0000

Anno Cert of USMC M927A1 Truck, Impact 1 Mar 31 09:23:22 1992

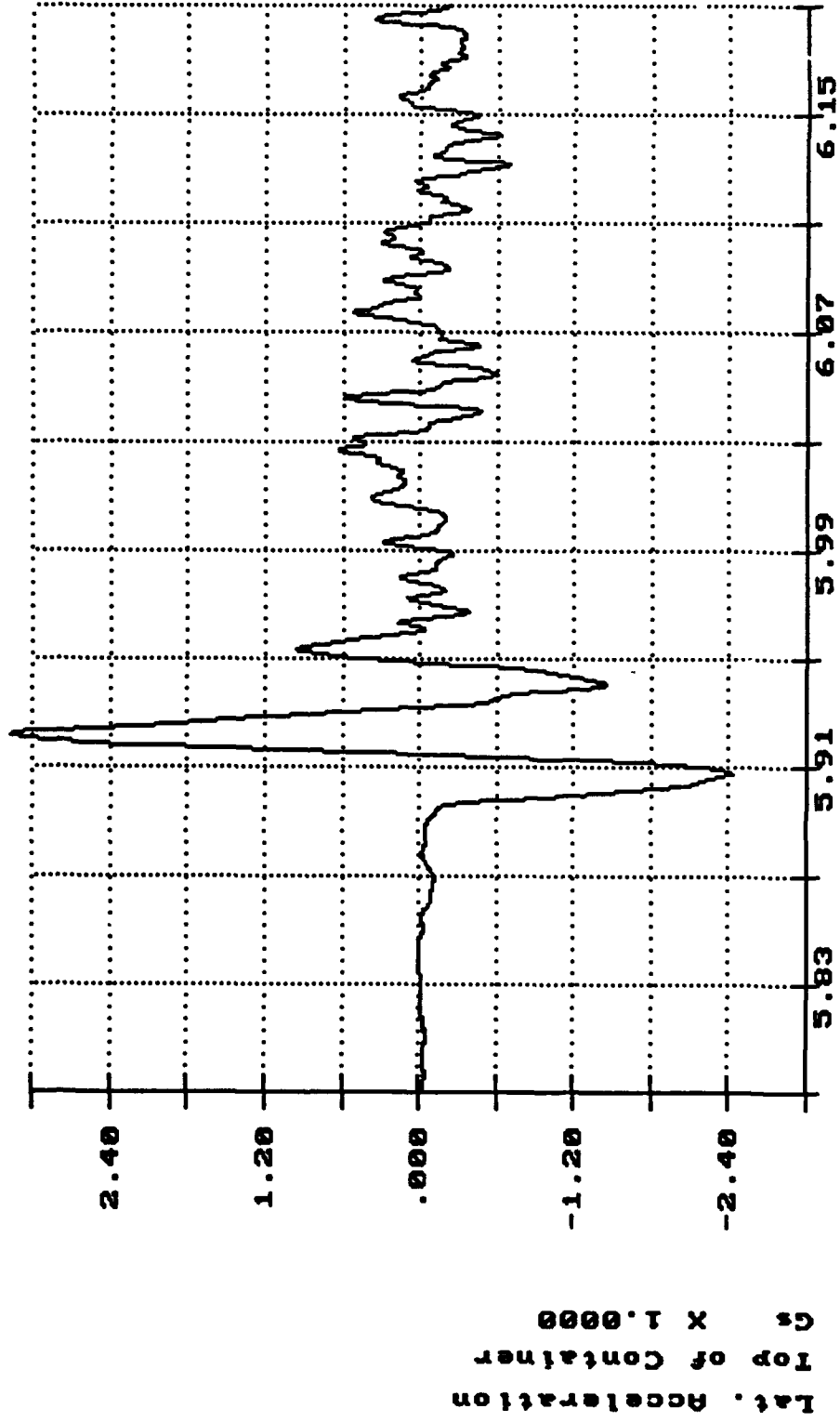

Time of Sample

Seconds X 1.0000

Anno Cert of USMC M927A1 Truck, Impact 1 Mar 31 09:23:22 1992

7

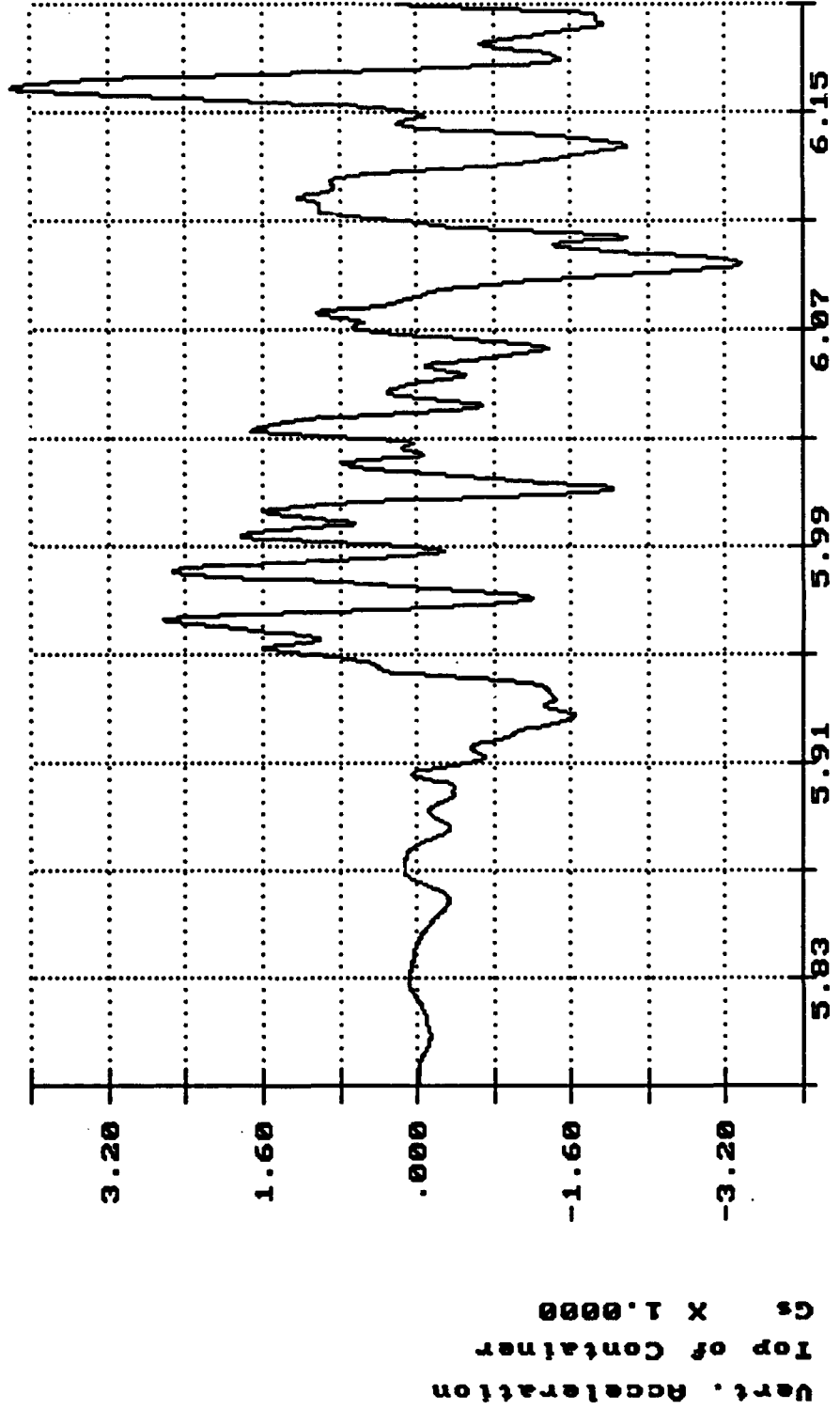

Anno Cert of USMC M927A1 Truck, Impact 1 Mar 31 09:23:22 1992

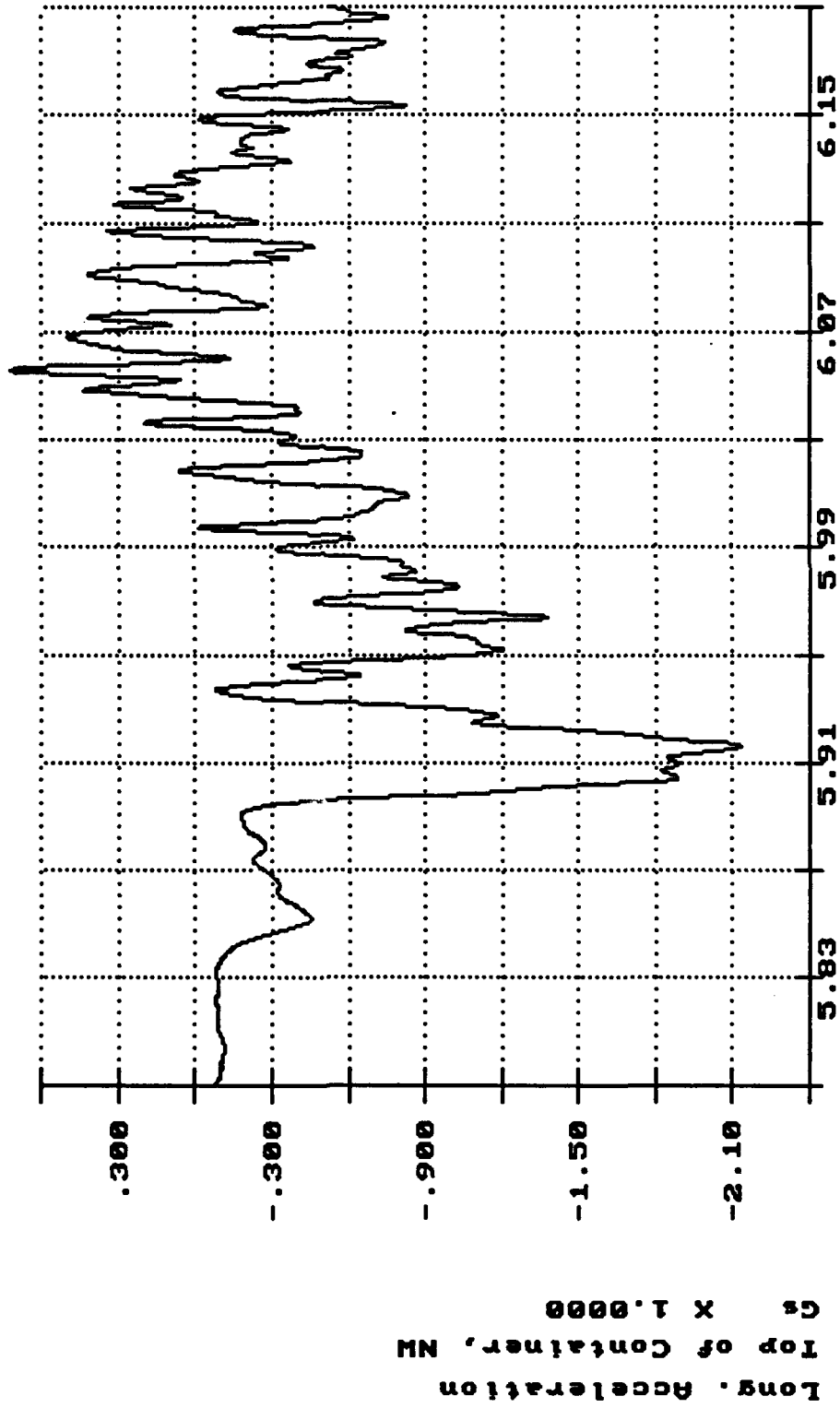

Time of Sample

Seconds X 1.0000

Anno Cert of USMC M927A1 Truck, Impact 1 Mar 31 09:23:22 1992

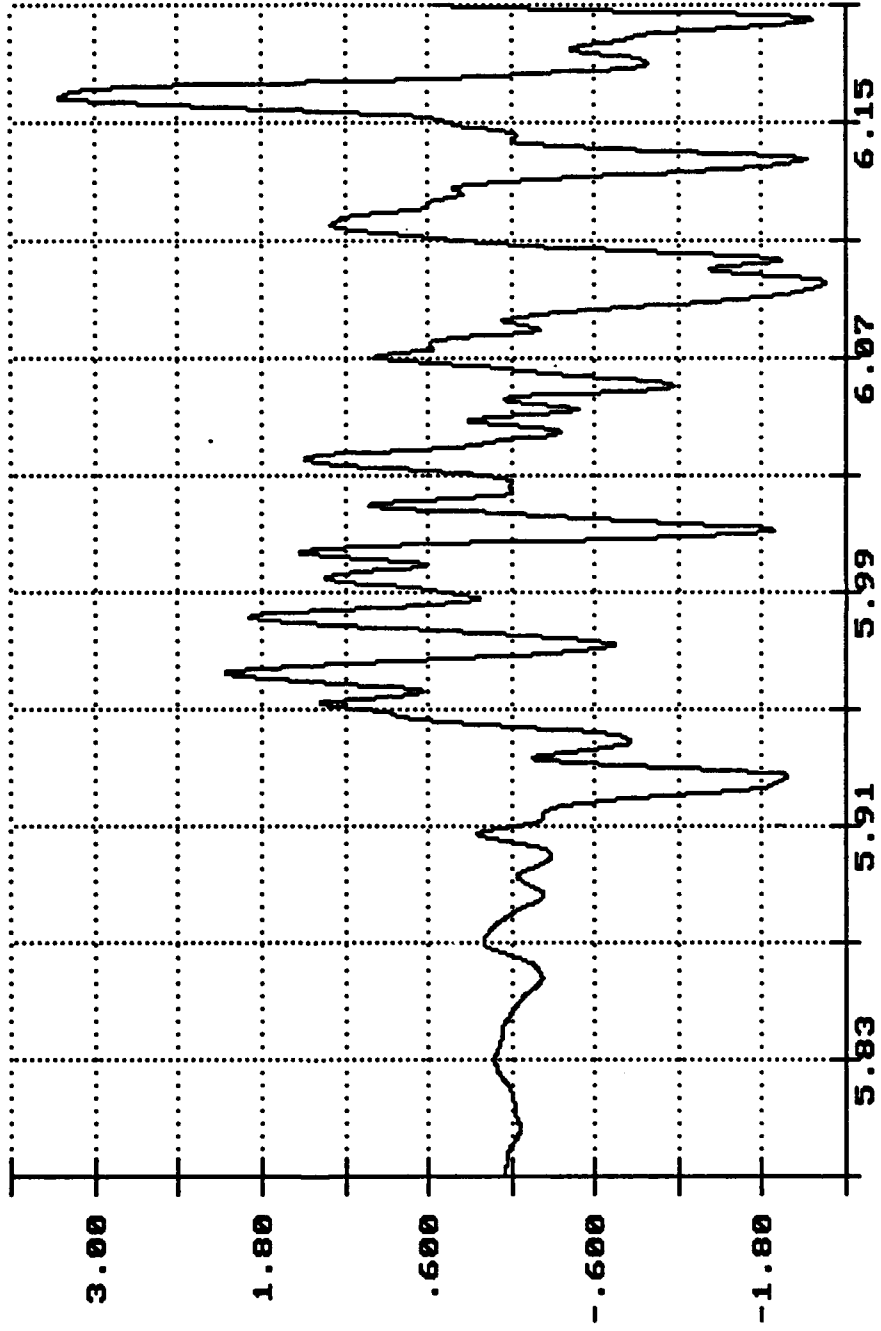

Time of Sample

Seconds X 1.0000

7
Anno Cert of USMC M927A1 Truck, Impact 2 Mar 31 09:33:09 1992

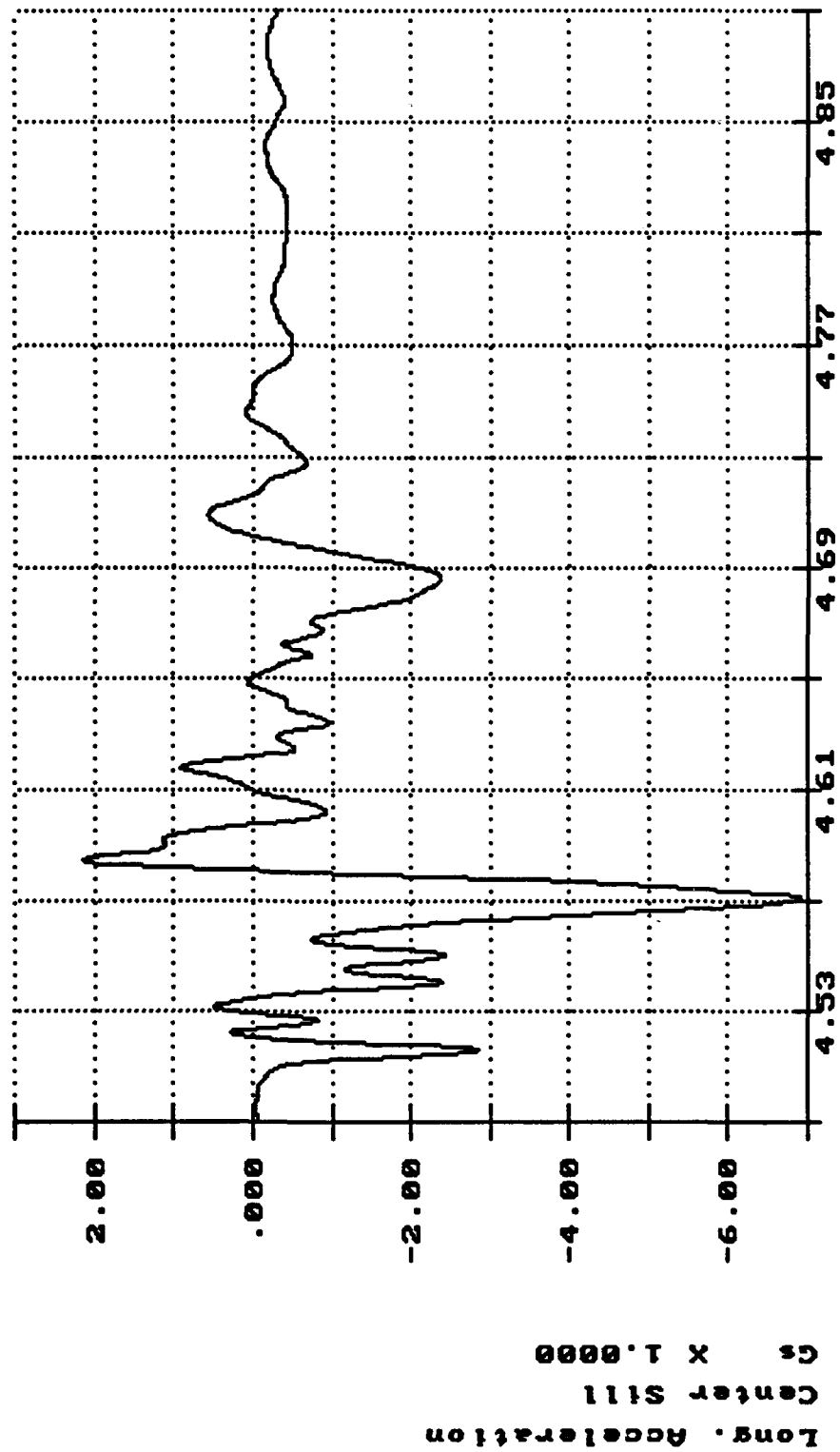

Time of Sample

Seconds X 1.0000

Anno Cert of USMC M927A1 Truck, Impact 2 Mar 31 09:33:09 1992

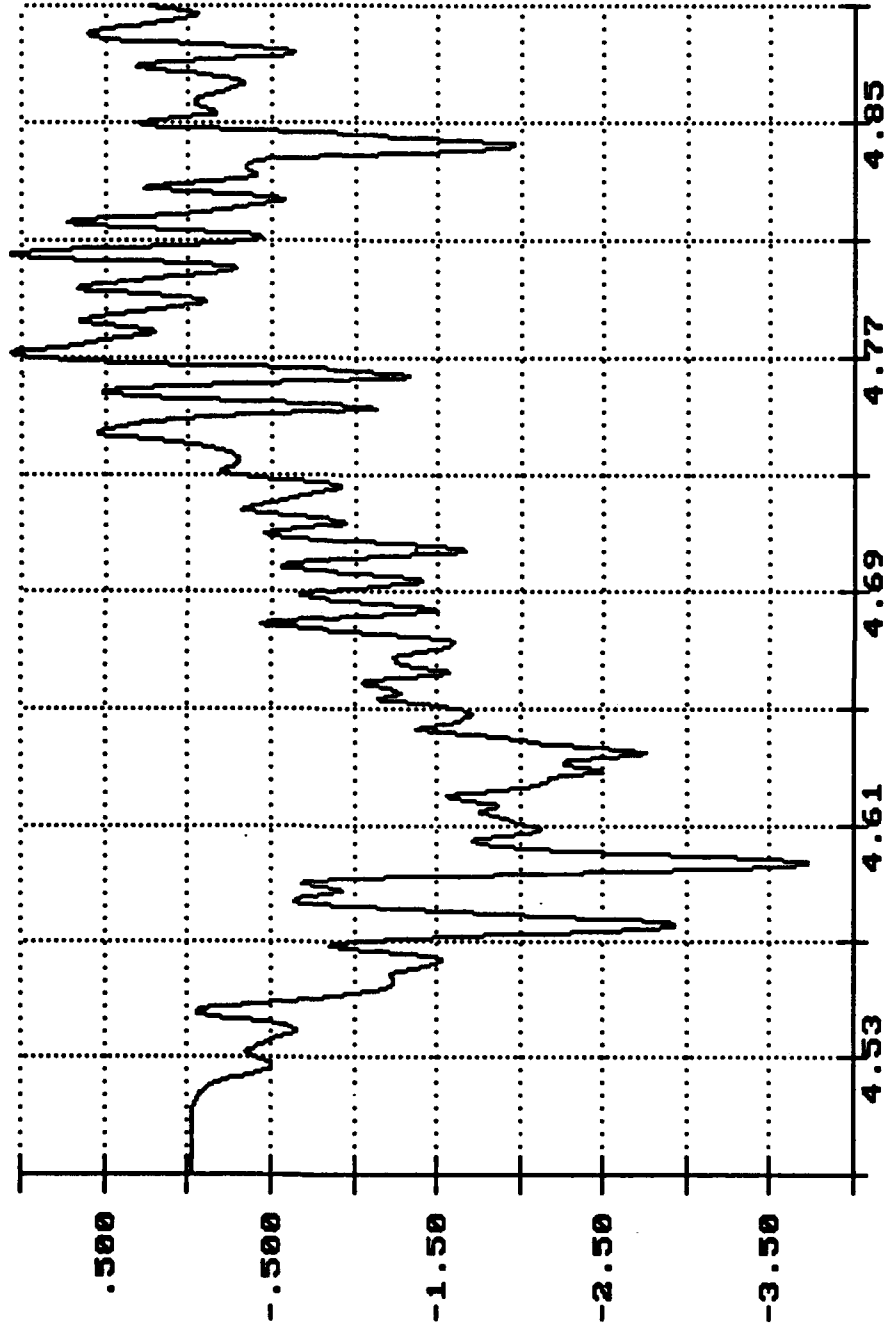

Long. Acceleration
Truck Bed
Gs X 1.0000

Time of Sample

Seconds X 1.0000

Anno Cert of USMC M927A1 Truck, Impact 2 Mar 31 09:33:09 1992

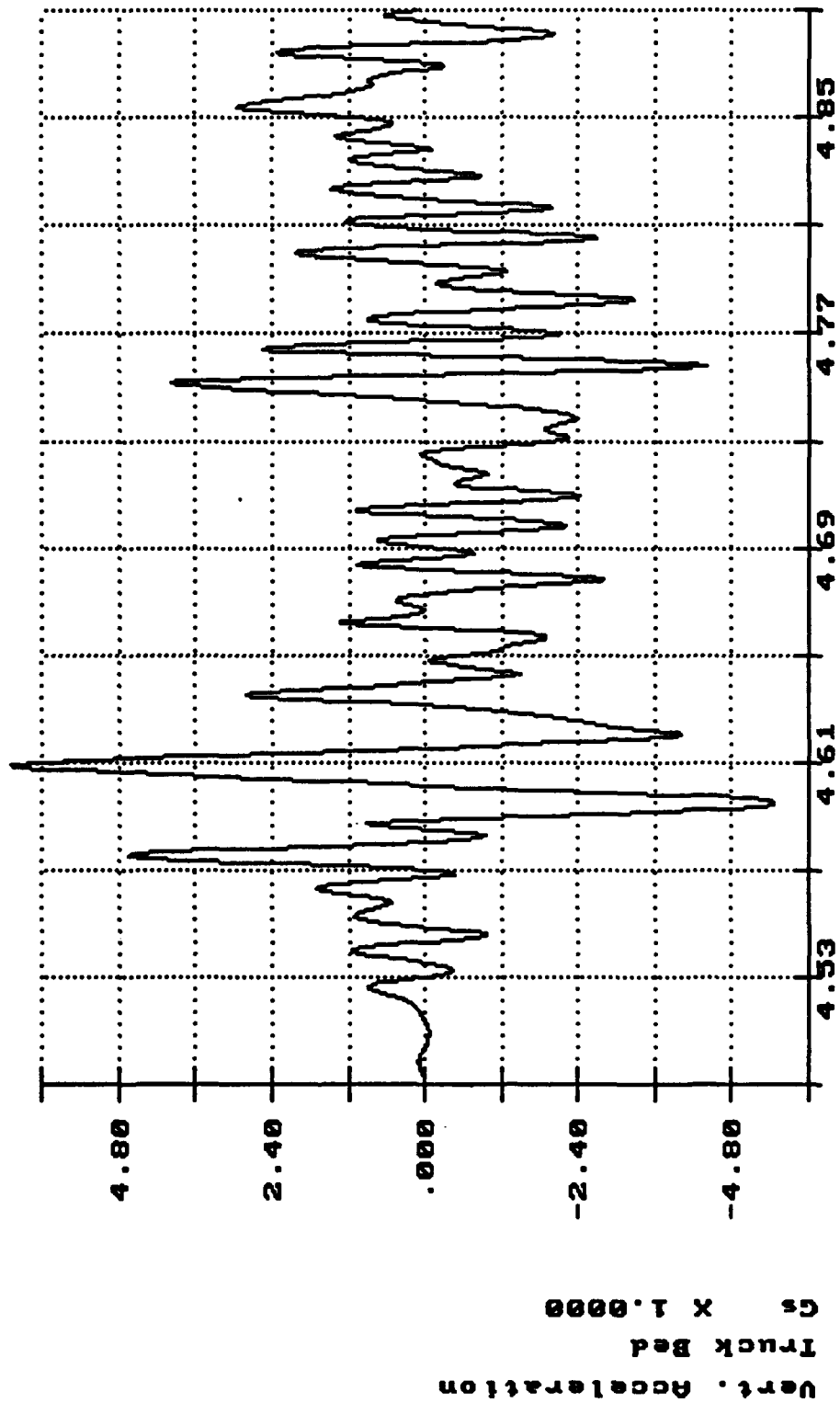

Anno Cert of USMC M927A1 Truck, Impact 2 Mar 31 09:33:09 1992

7

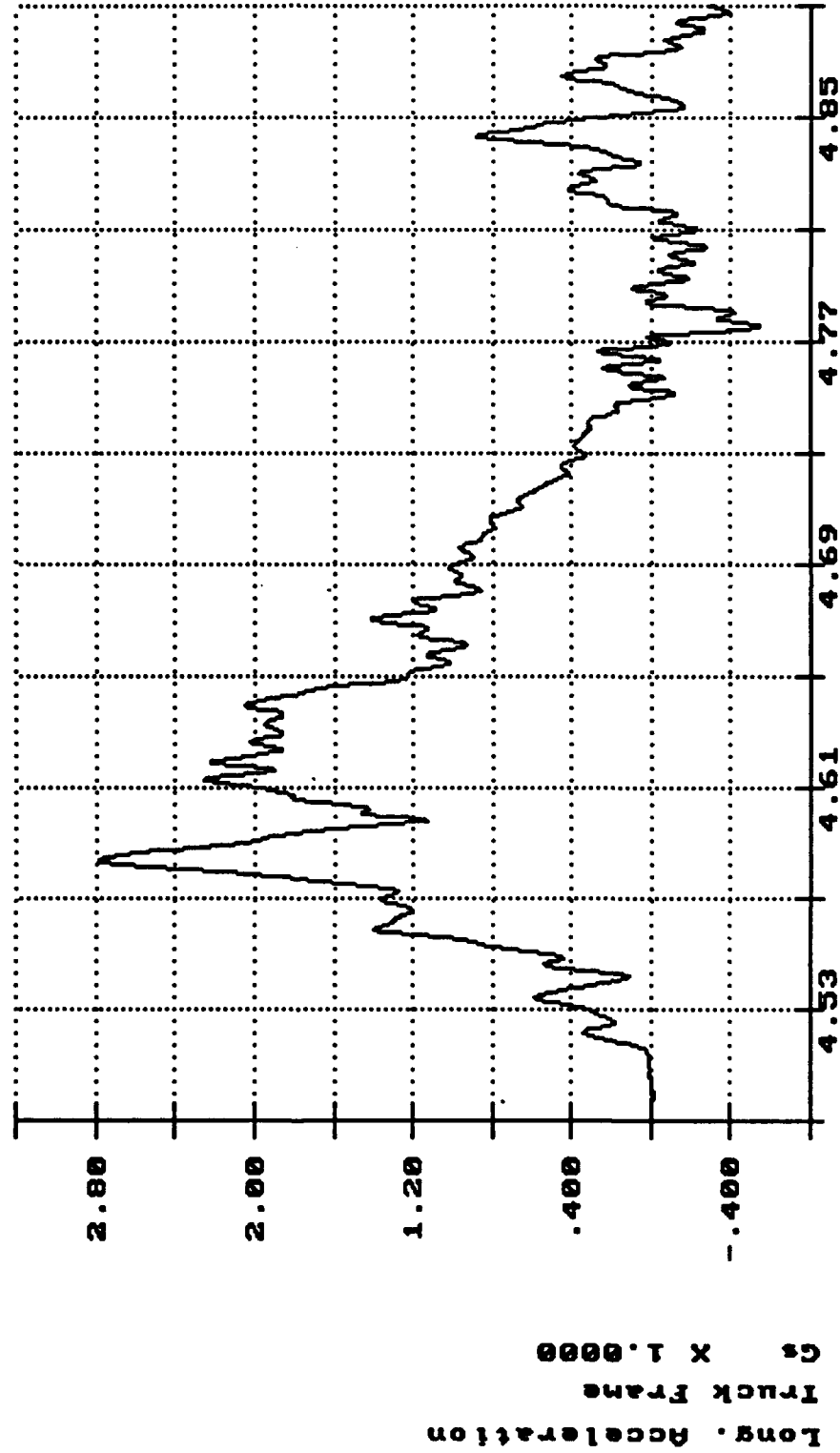

Time of Sample

Seconds X 1.0000

Anno Cert of USMC M927A1 Truck, Impact 2 Mar 31 09:33:09 1992

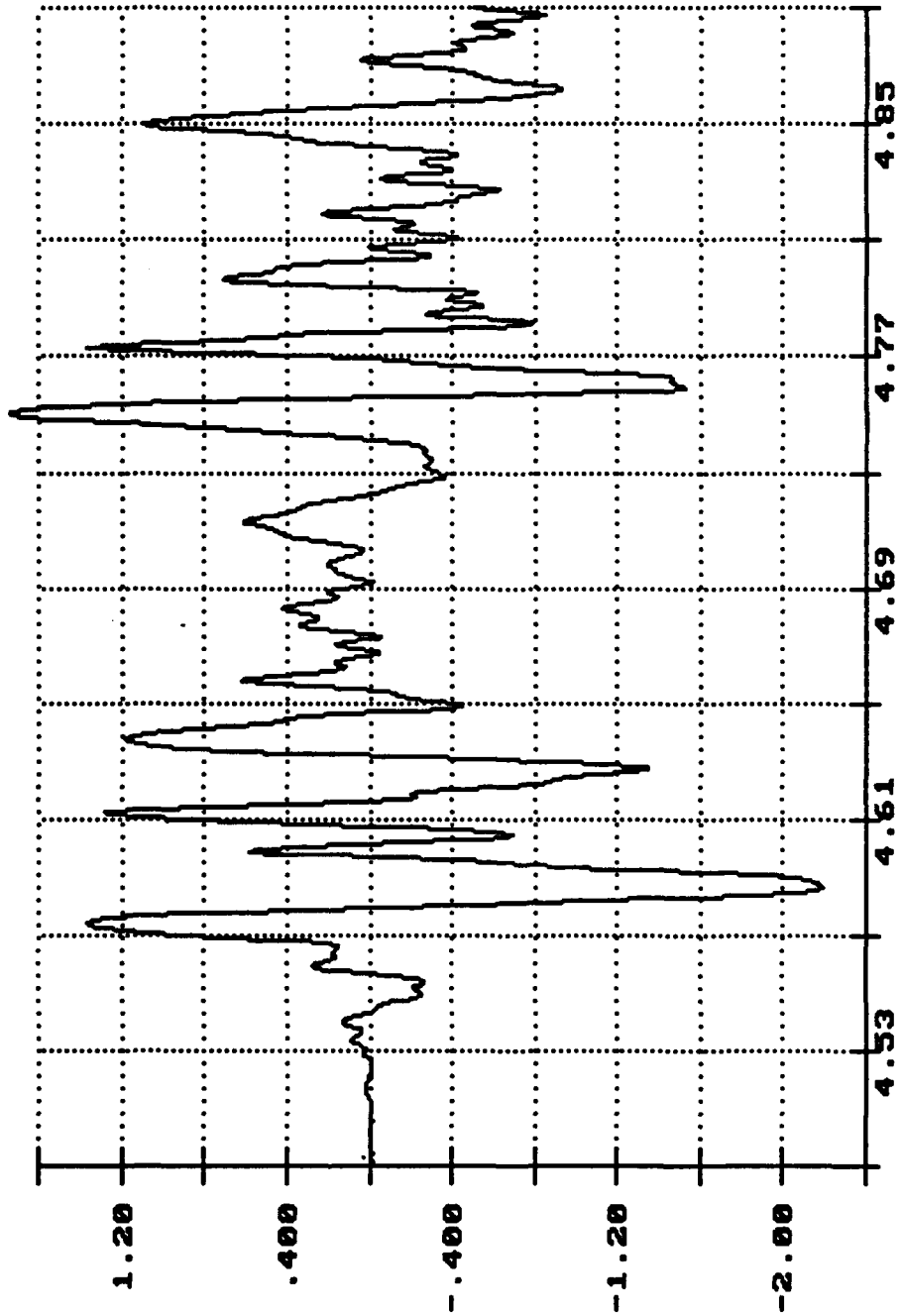

Lat. Acceleration
Truck Frame
Gs X 1.0000

Time of Sample

Seconds X 1.0000

Anno Cert of USMC M927A1 Truck, Impact 2 Mar 31 09:33:09 1992

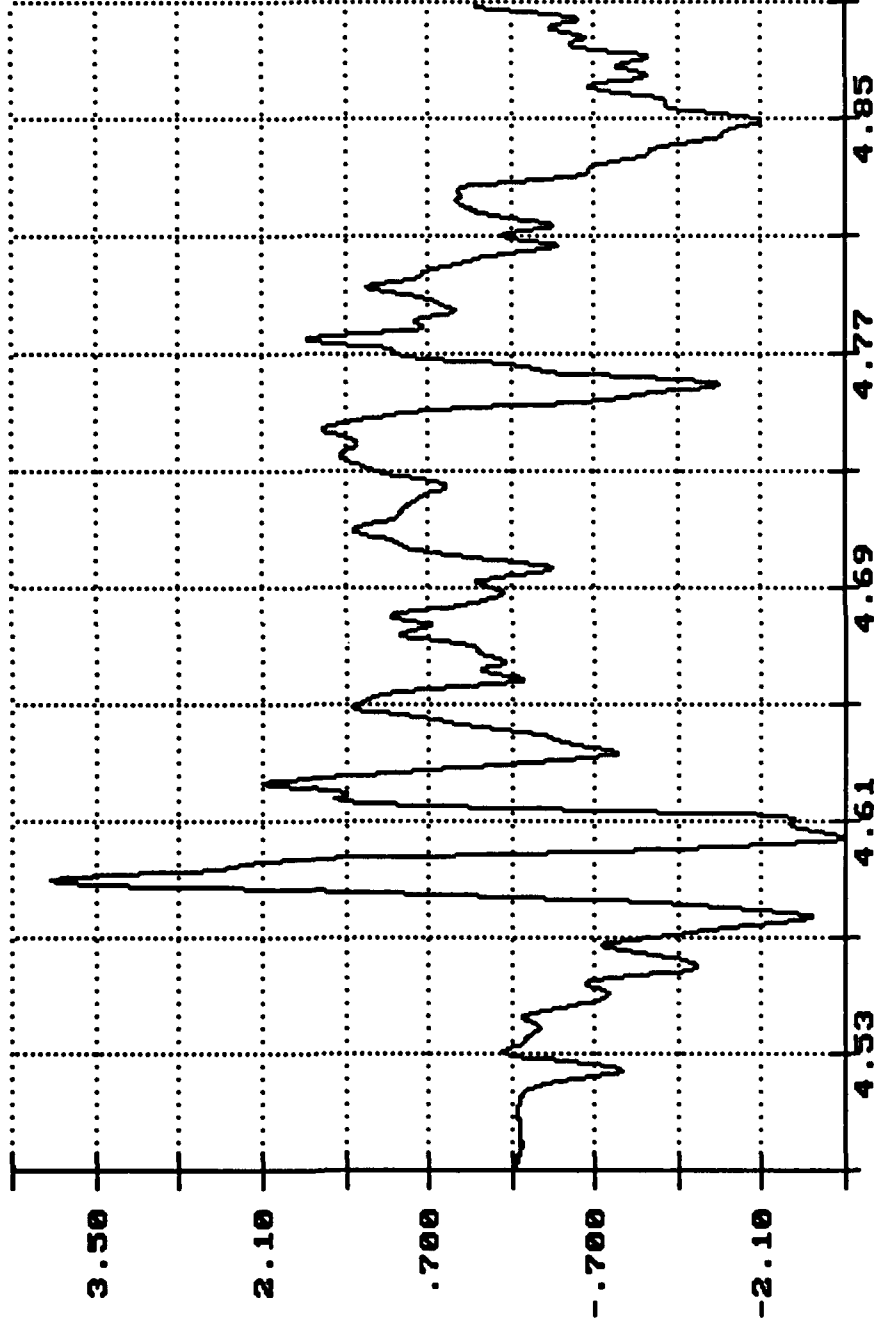

Time of Sample

Seconds X 1.0000

Vert. Acceleration
Truck Frame
Gs X 1.0000

Anno Cert of USMC M927A1 Truck, Impact 2 Mar 31 09:33:09 1992

7

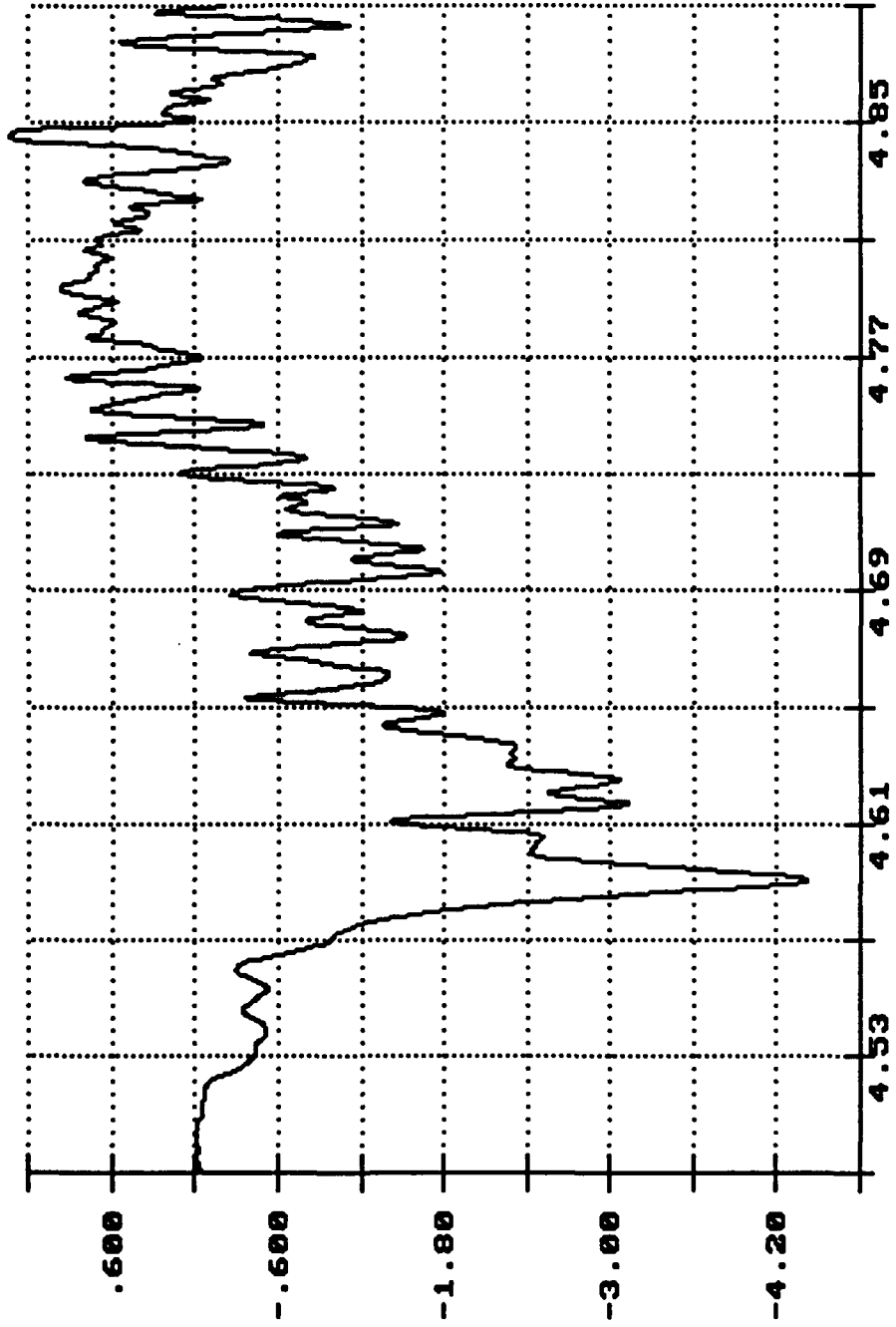

Long. Acceleration
Top of Container
Gs X 1.0000

Time of Sample
Seconds X 1.0000

Anno Cert of USMC M927A1 Truck, Impact 2 Mar 31 09:33:09 1992

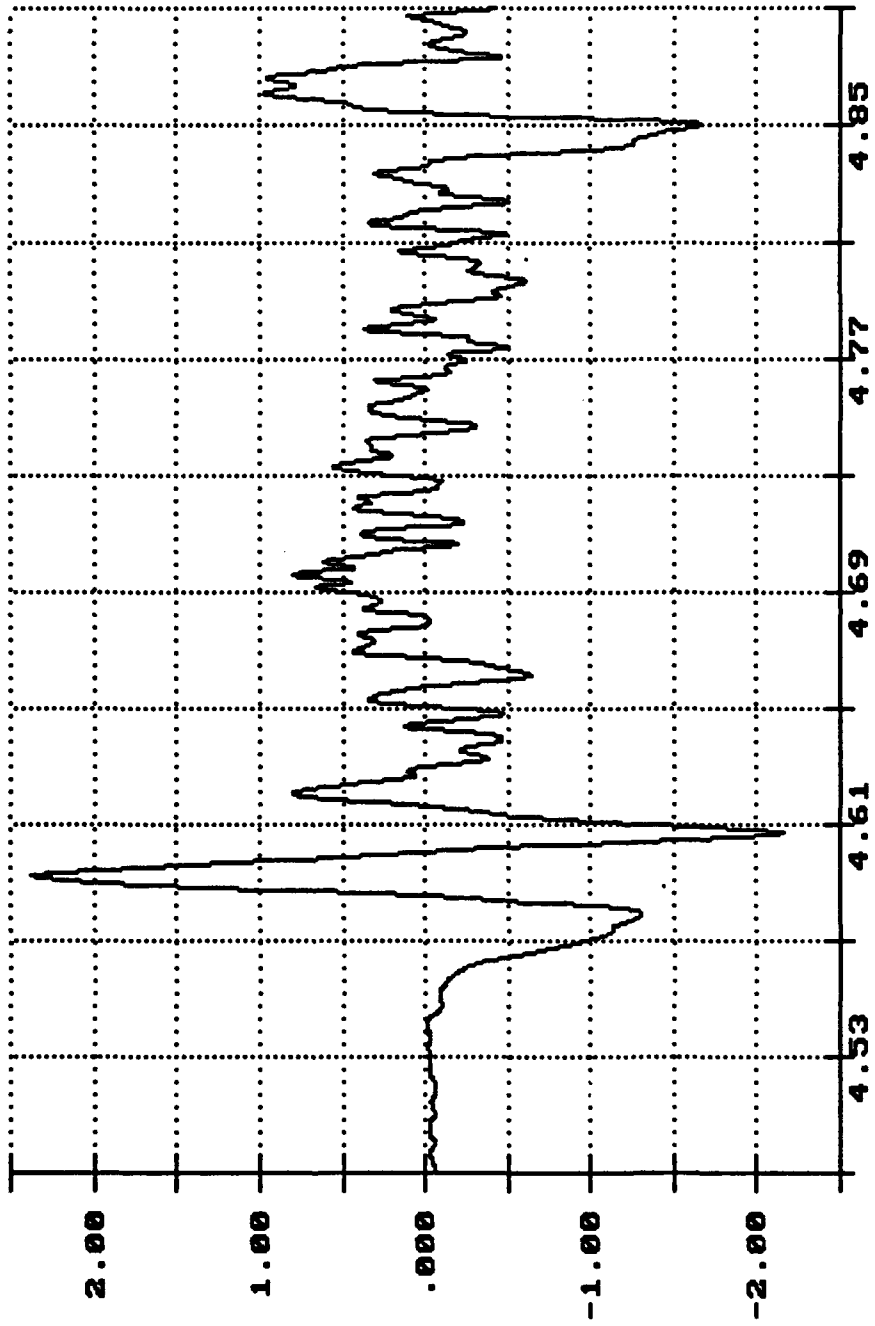

Lat. Acceleration
Top of Container
Gs X 1.0000

Time of Sample

Seconds X 1.0000

Anno Cert of USMC M927A1 Truck, Impact 2 Mar 31 09:33:09 1992

7

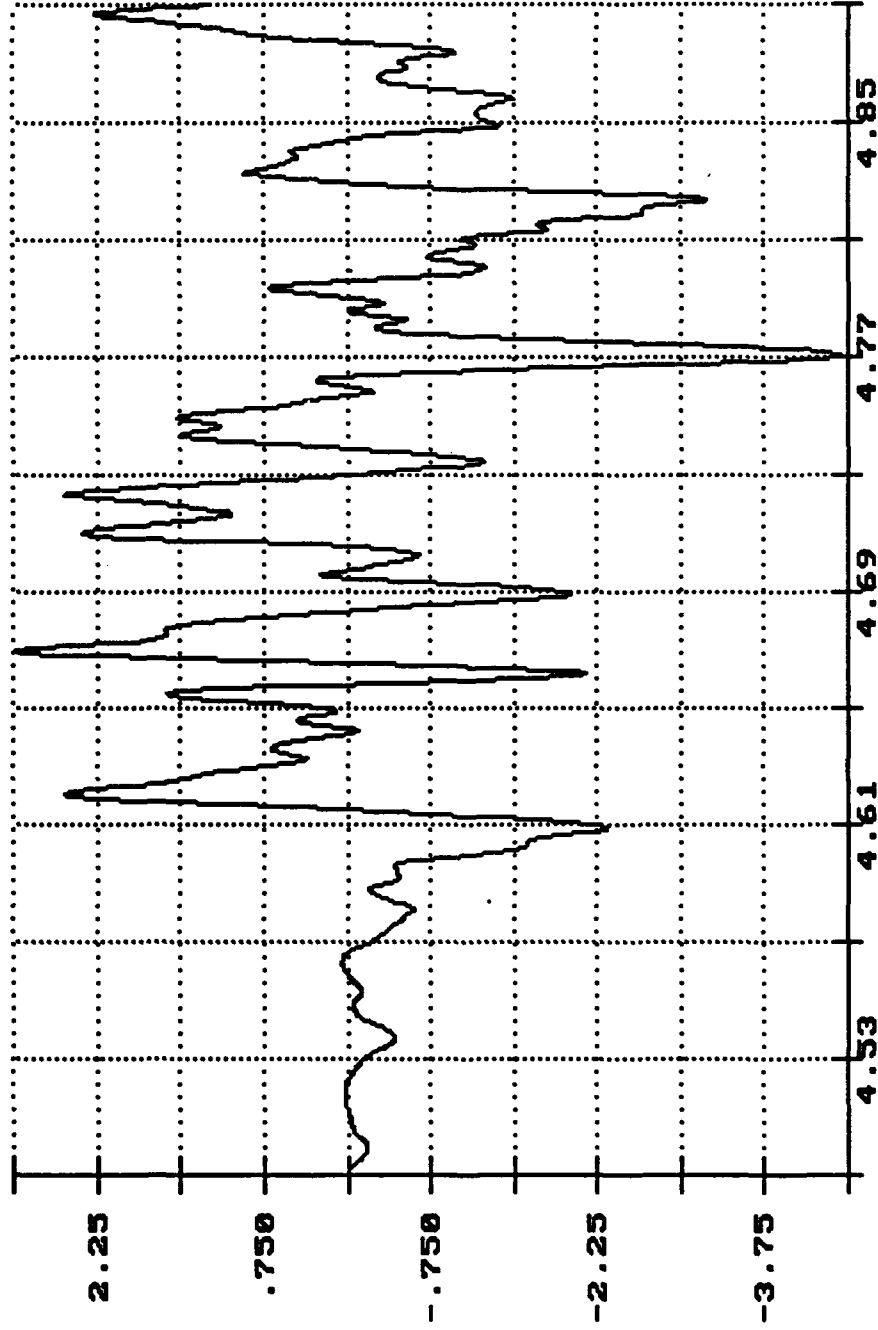

Vert. Acceleration
Gs X 1.0000
Top of Container

Time of Sample

Seconds X 1.0000

Anno Cert of USMC M927A1 Truck, Impact 2 Mar 31 09:33:09 1992

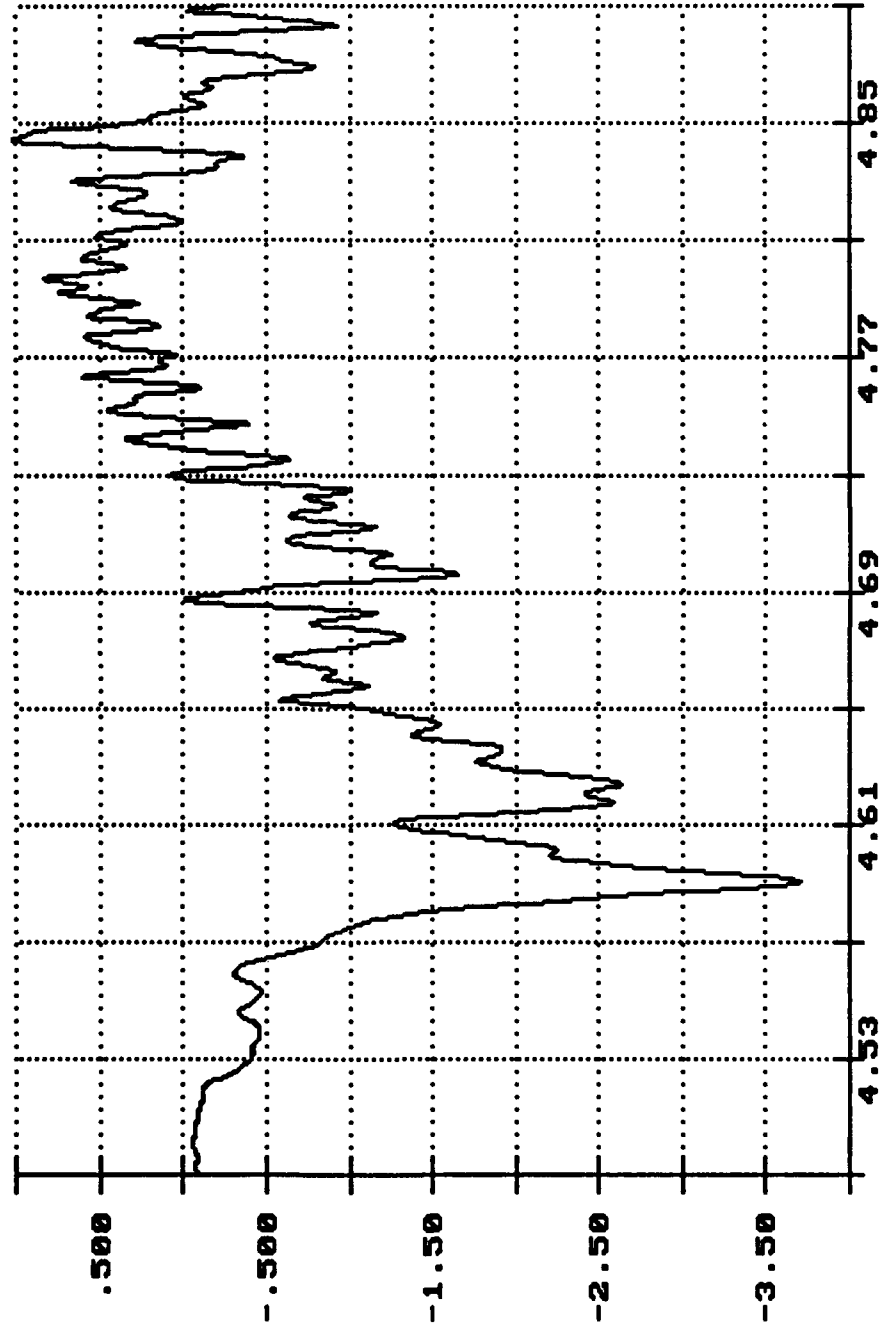

Long. Acceleration
Top of Container, NH
Gs X 1.0000

Time of Sample

Seconds X 1.0000

Anno Cert of USMC M927A1 Truck, Impact 2 Mar 31 09:33:09 1992

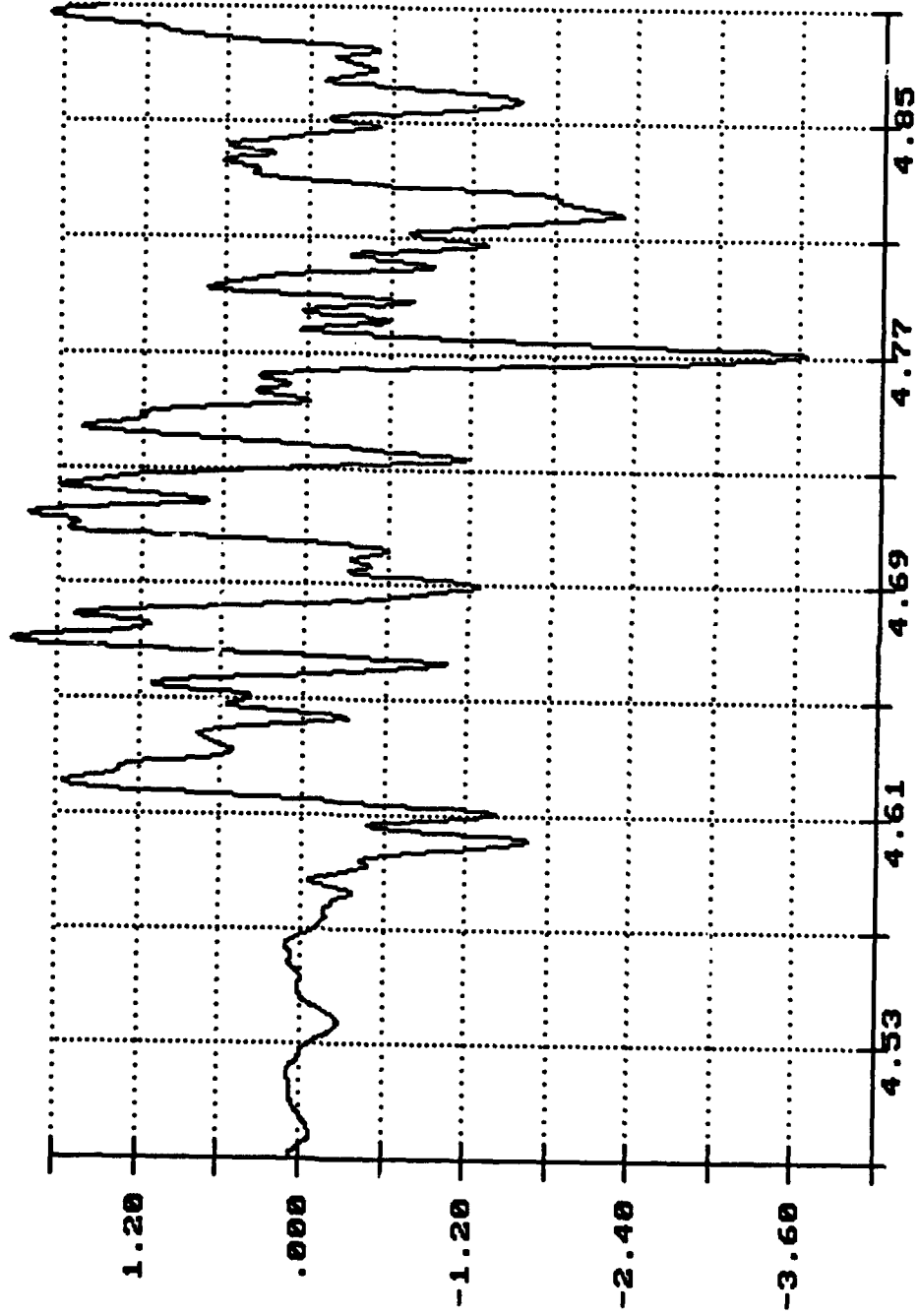

Vert. Acceleration
Top of Container, NM
Gs X 1.0000

Time of Sample
Seconds X 1.0000

7

Annex Cert of USMC M927A1 Truck, Impact 3 Mar 31 09:41:19 1992

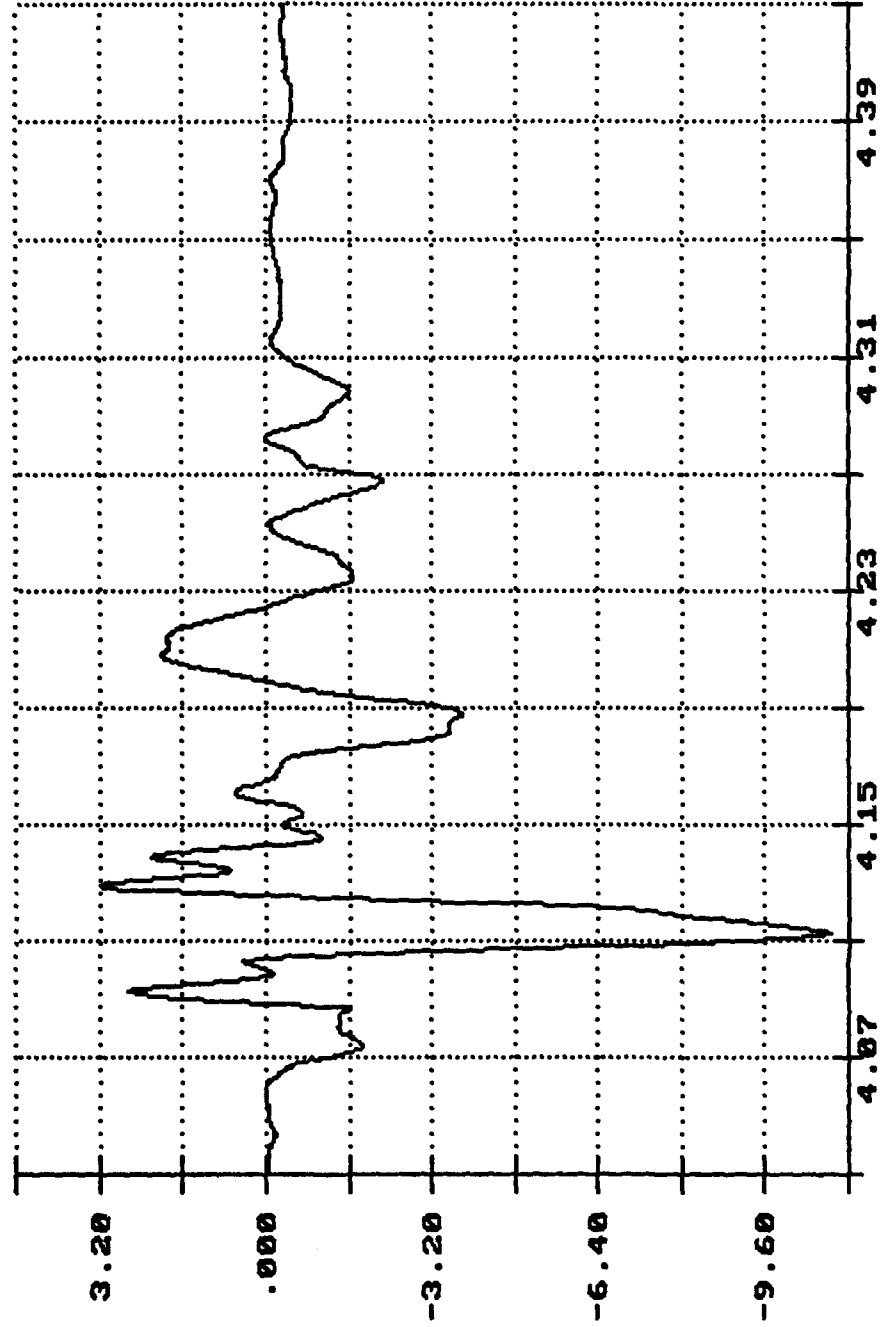

Long. Acceleration
Center Sill
Gs X 1.0000

Time of Sample

Seconds X 1.0000

Anno Cert of USMC M927A1 Truck, Impact 3 Mar 31 09:41:19 1992

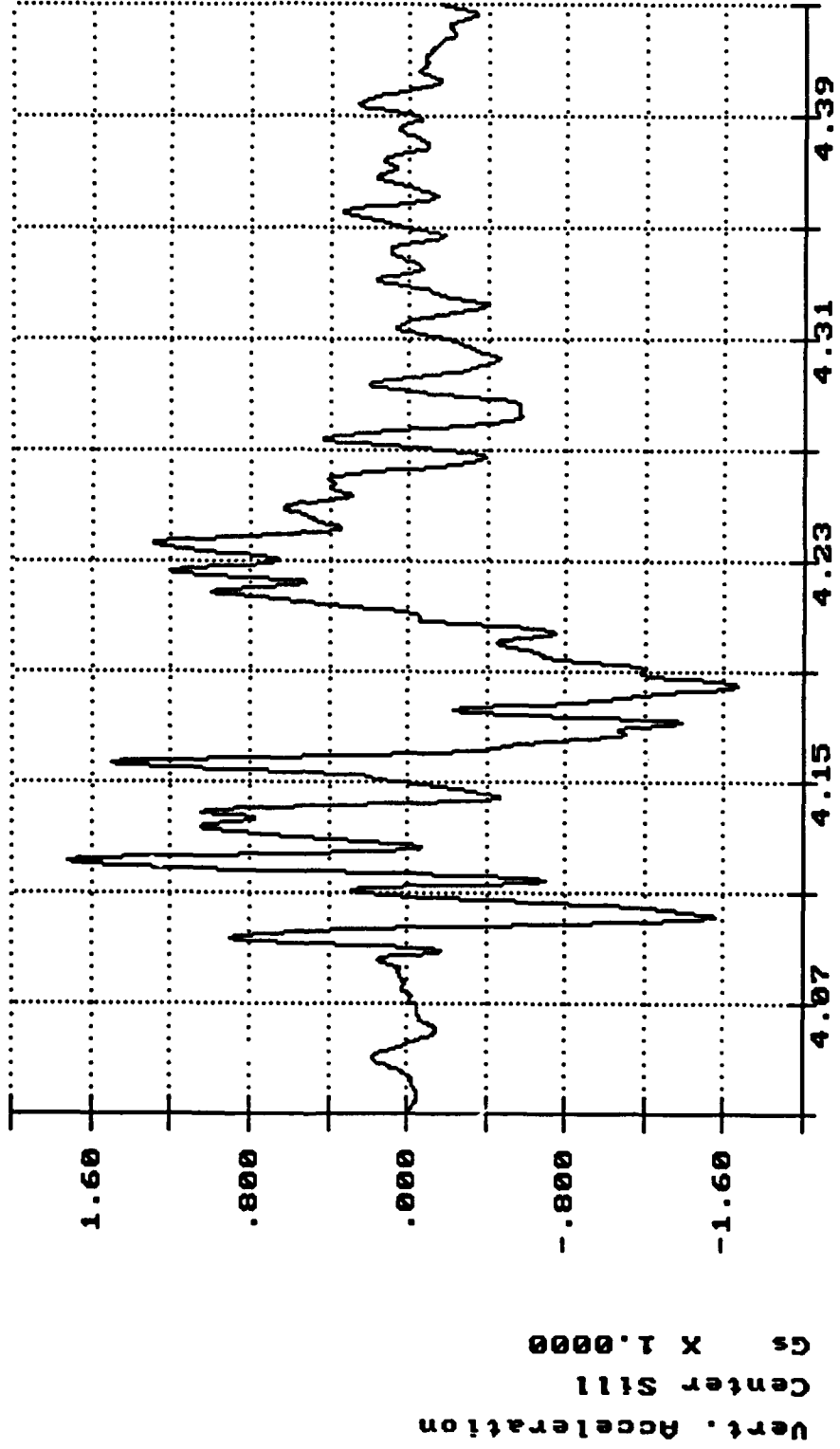

Time of Sample

Seconds X 1.0000

7
Anno Cert of USMC M927A1 Truck, Impact 3 Mar 31 09:41:19 1992

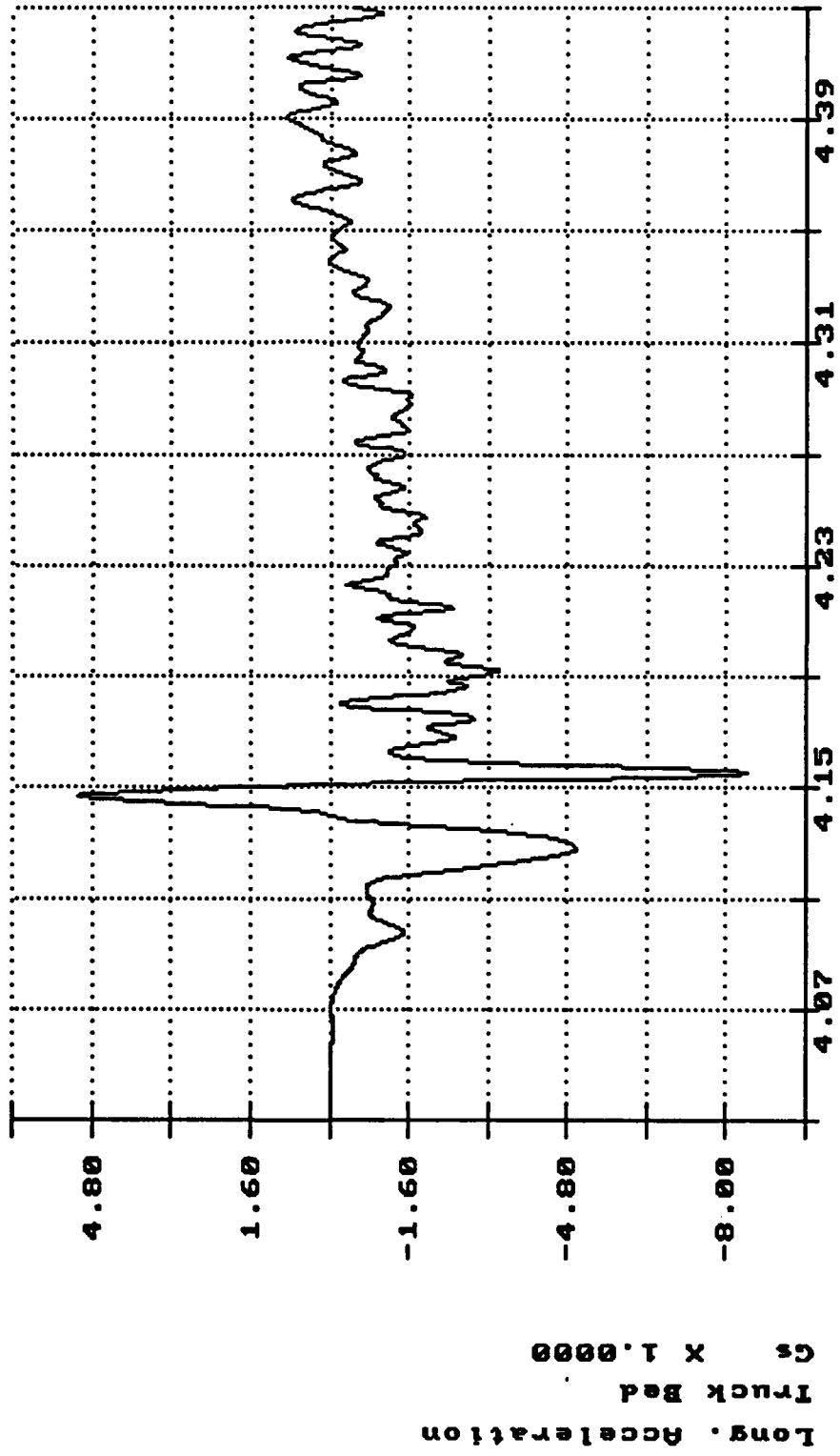

Time of Sample

Seconds X 1.0000

Anno Cert of USMC M927A1 Truck, Impact 3 Mar 31 09:41:19 1992

7

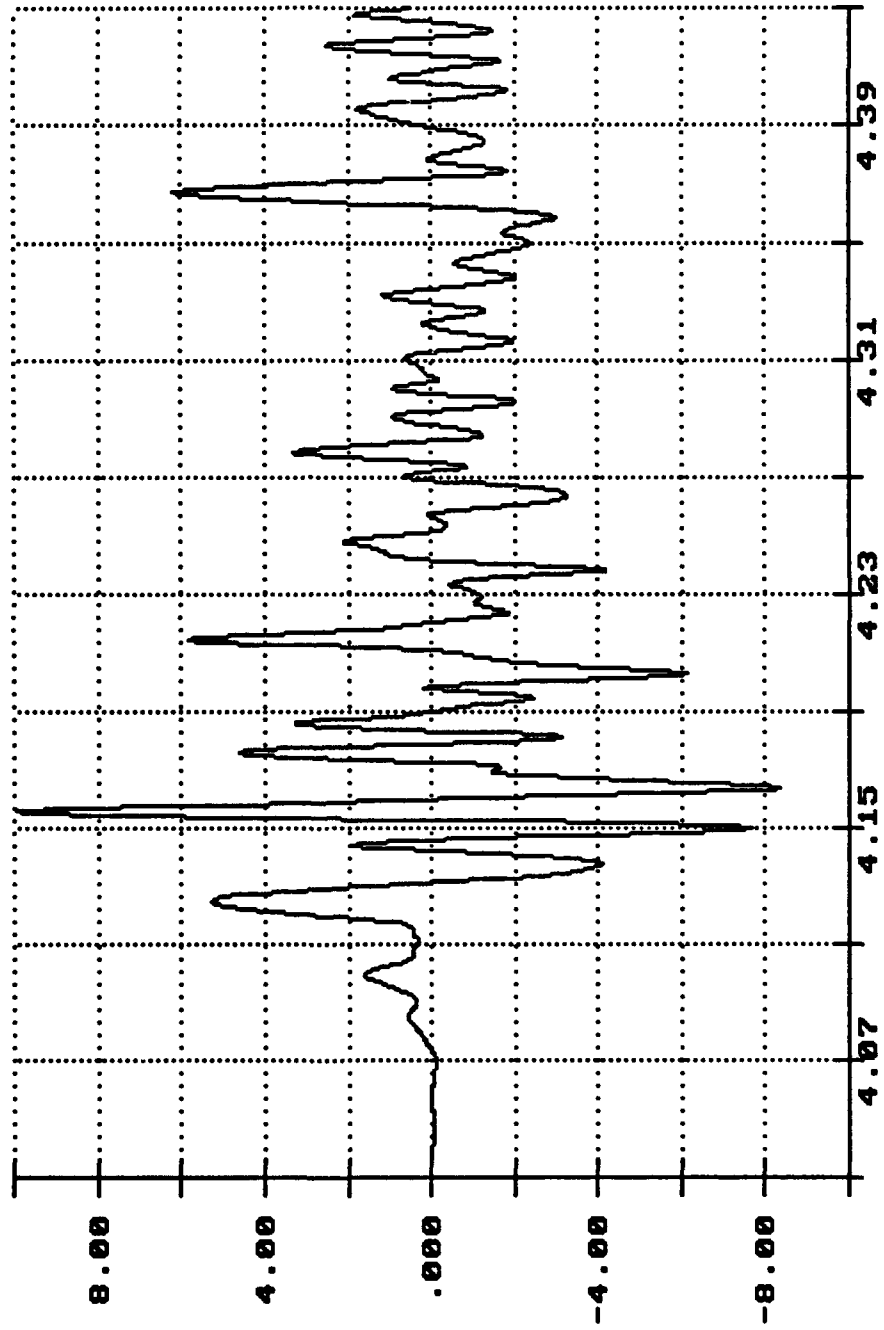

Time of Sample

Seconds X 1.0000

Vert. Acceleration
Truck Bed
Gs X 1.0000

7
Anno Cert of USMC M927A1 Truck, Impact 3 Mar 31 09:41:19 1992

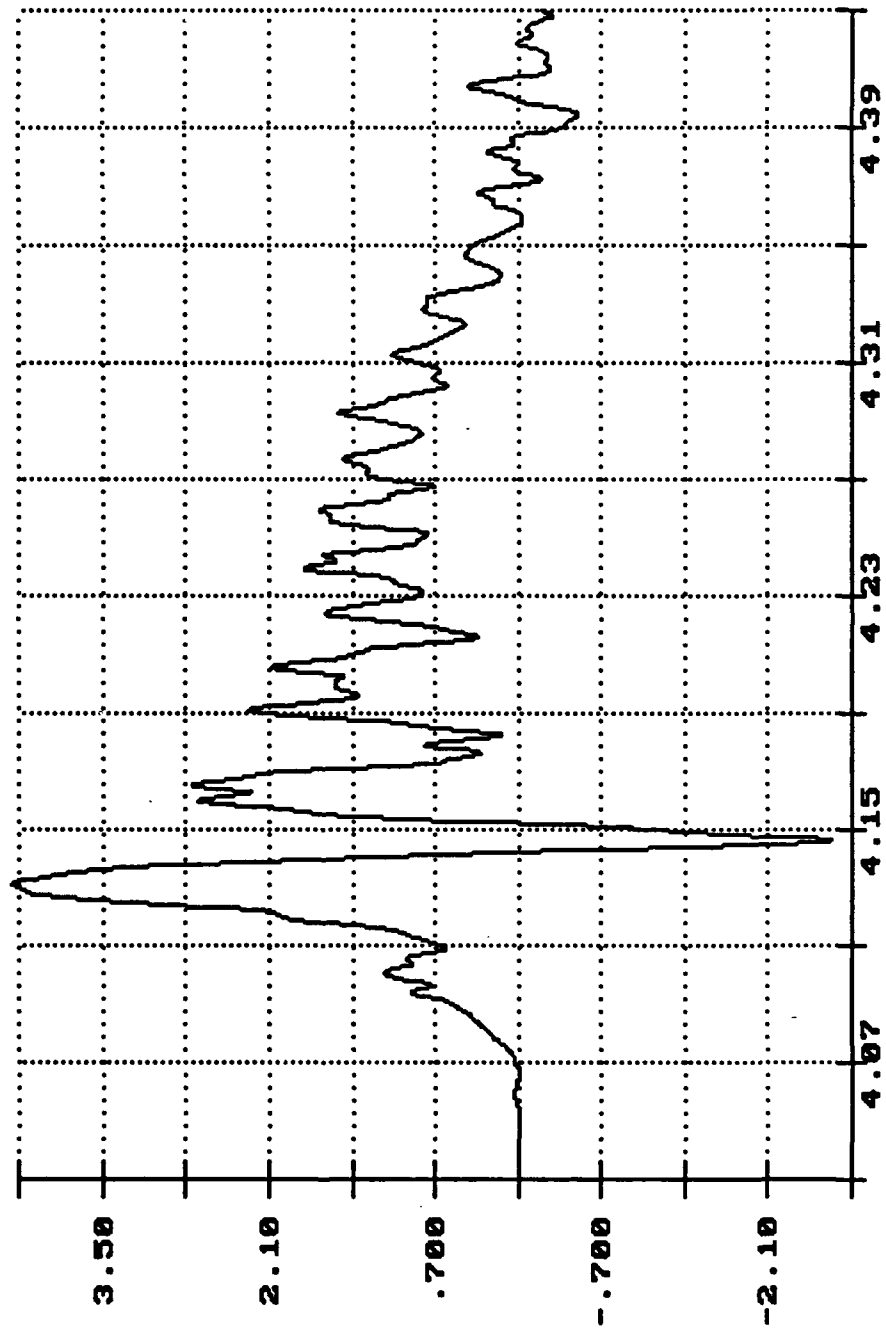

Long. Acceleration
Truck Frame
Gs X 1.0000

Time of Sample

Seconds X 1.0000

7
Anno Cert of USMC M927A1 Truck, Impact 3 Mar 31 09:41:19 1992

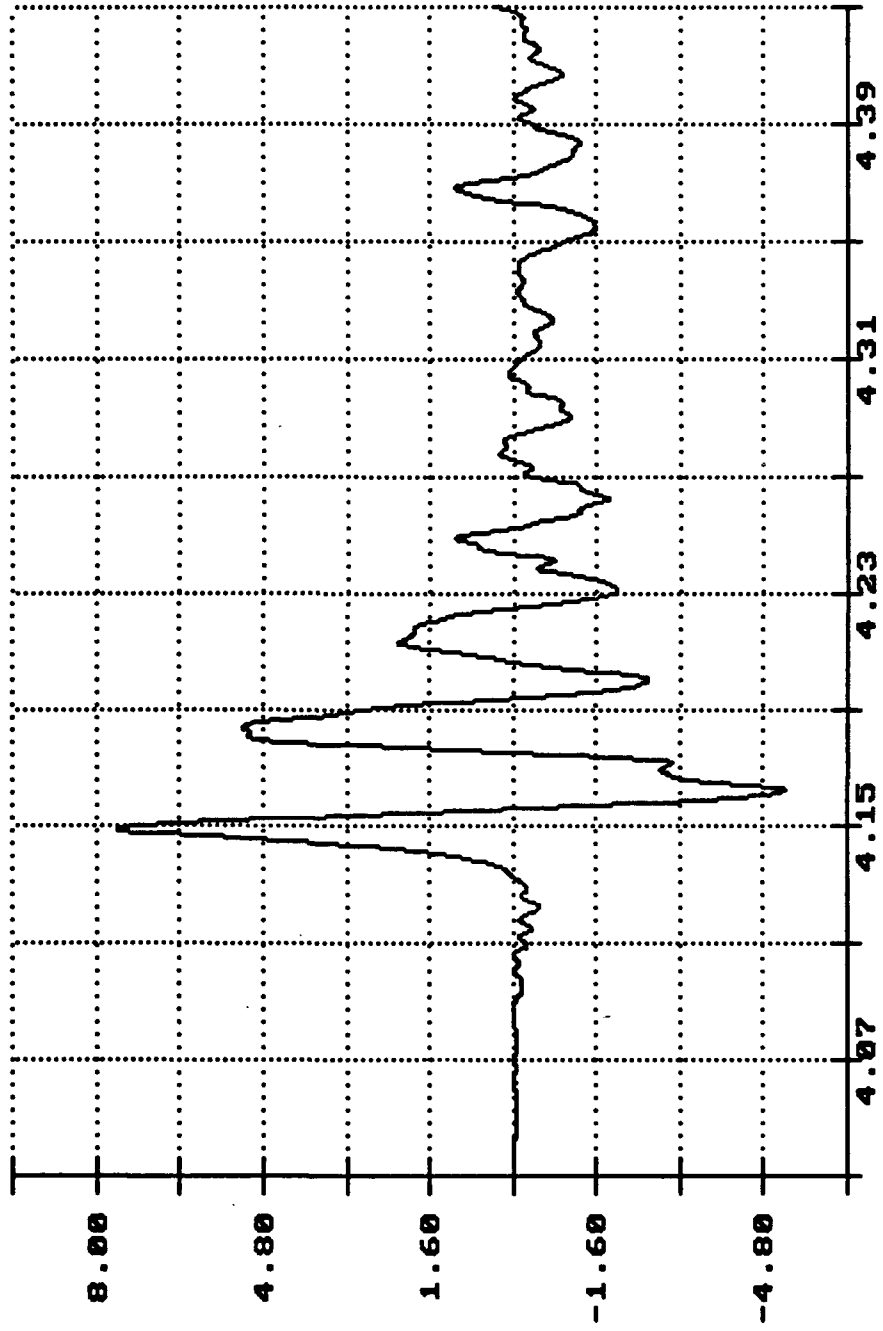

Time of Sample

Seconds X 1.0000

Anno Cert of USMC M927A1 Truck, Impact 3 Mar 31 09:41:19 1992

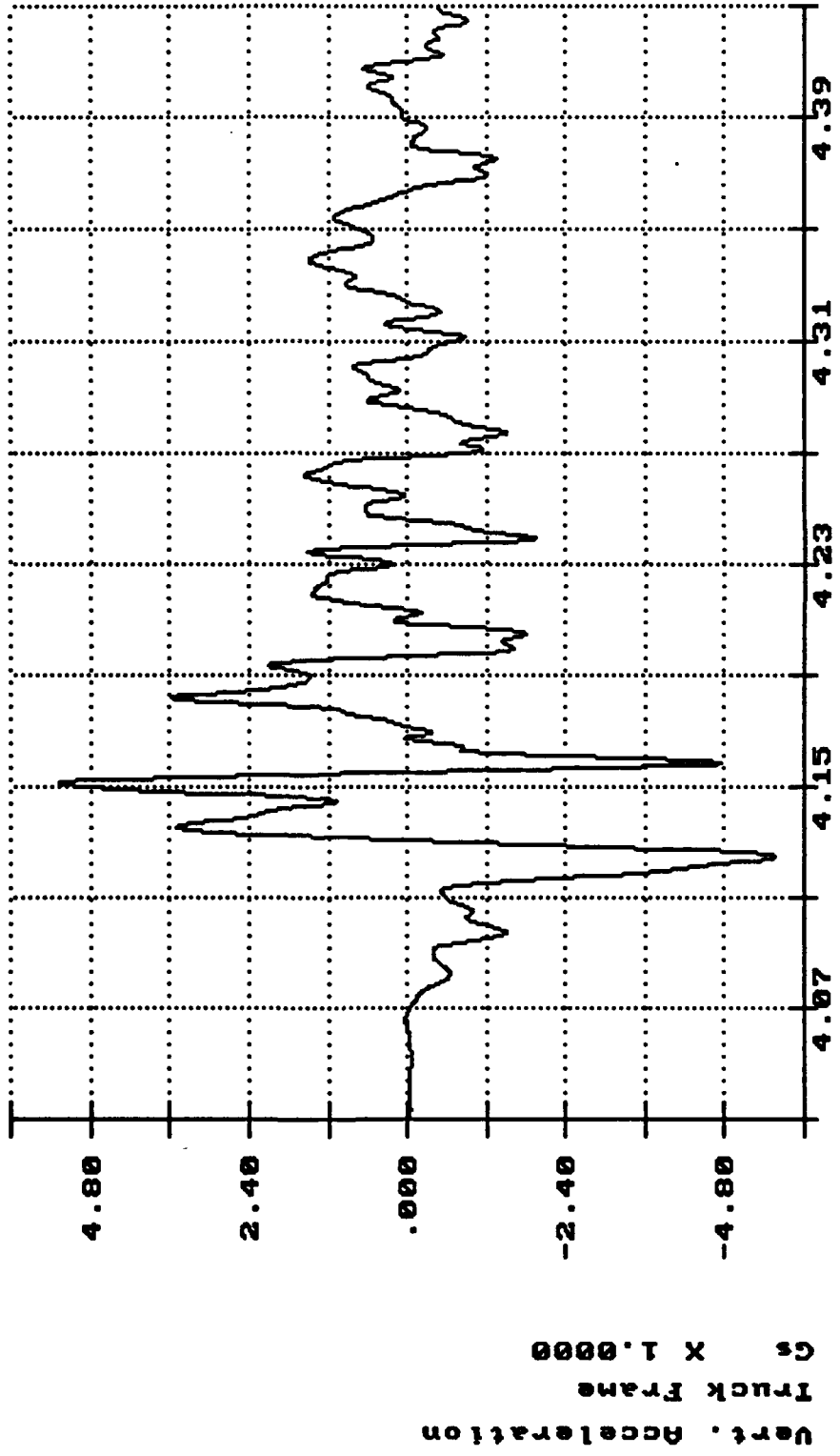

Anno Cert of USMC M927A1 Truck, Impact 3 Mar 31 09:41:19 1992

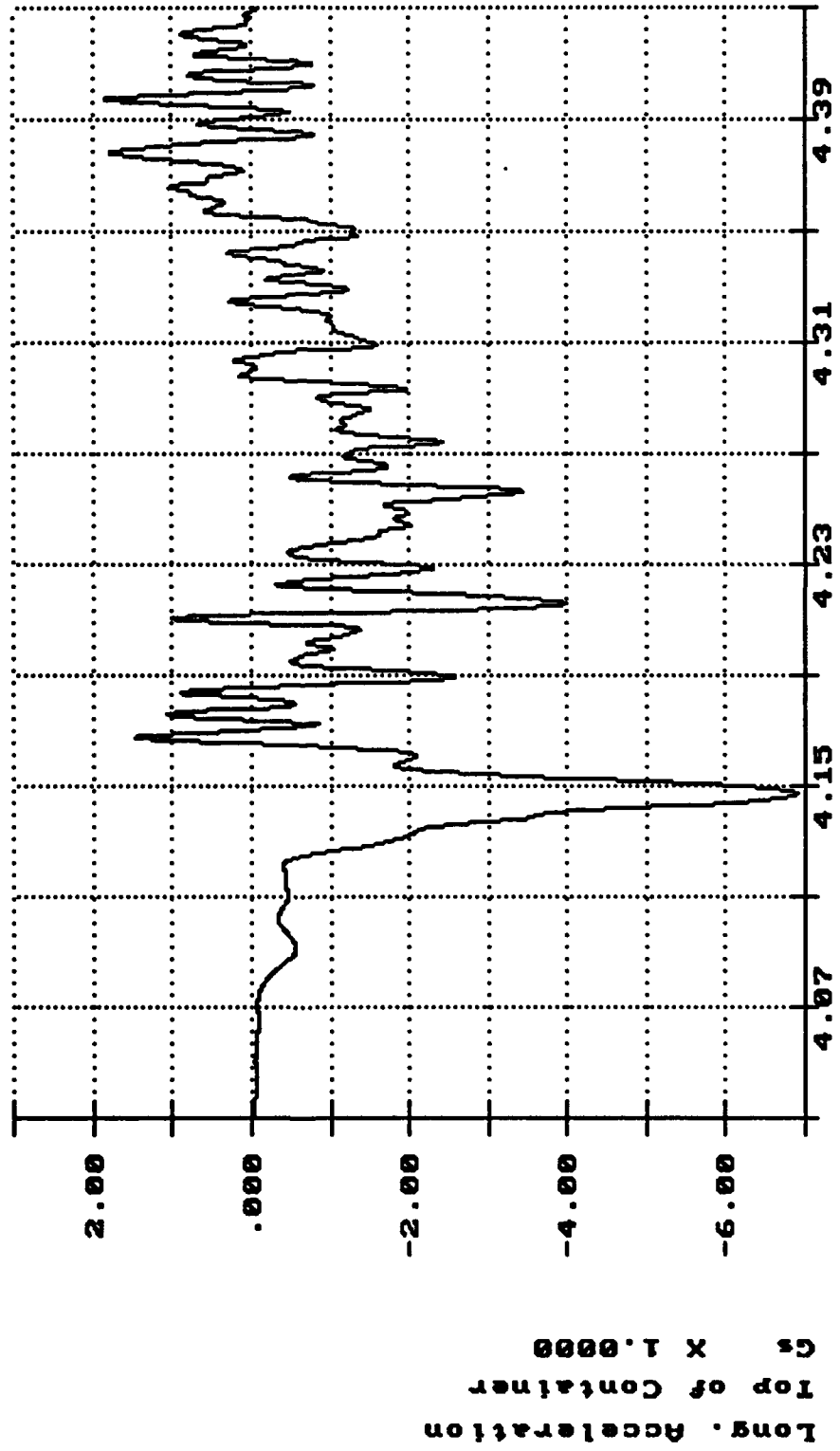

Time of Sample
Seconds X 1.0000

Anno Cart of USMC M927A1 Truck, Impact 3 Mar 31 09:41:19 1992

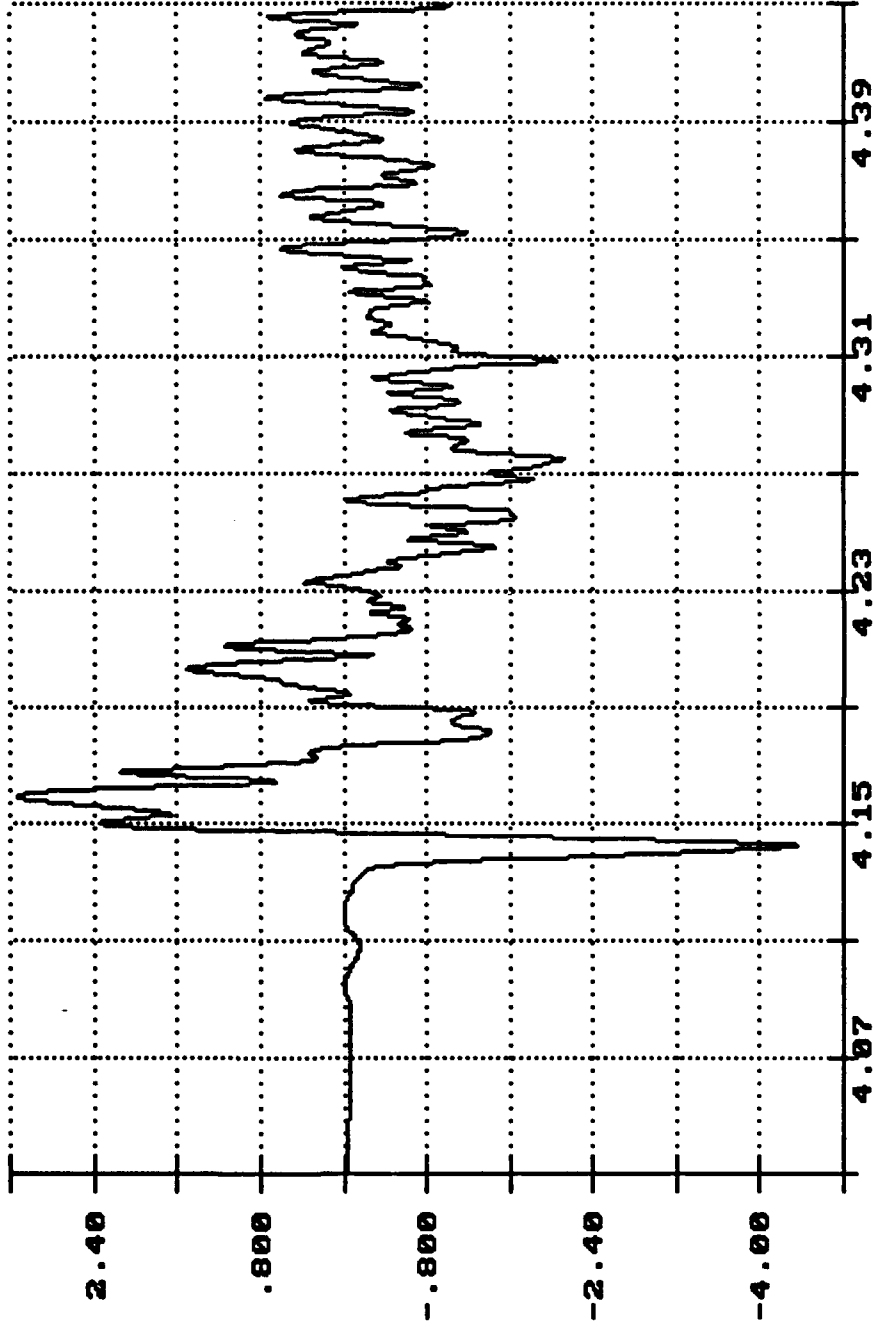

Time of Sample

Seconds X 1.0000

Anno Cert of USMC M927A1 Truck, Impact 3 Mar 31 09:41:19 1992

7

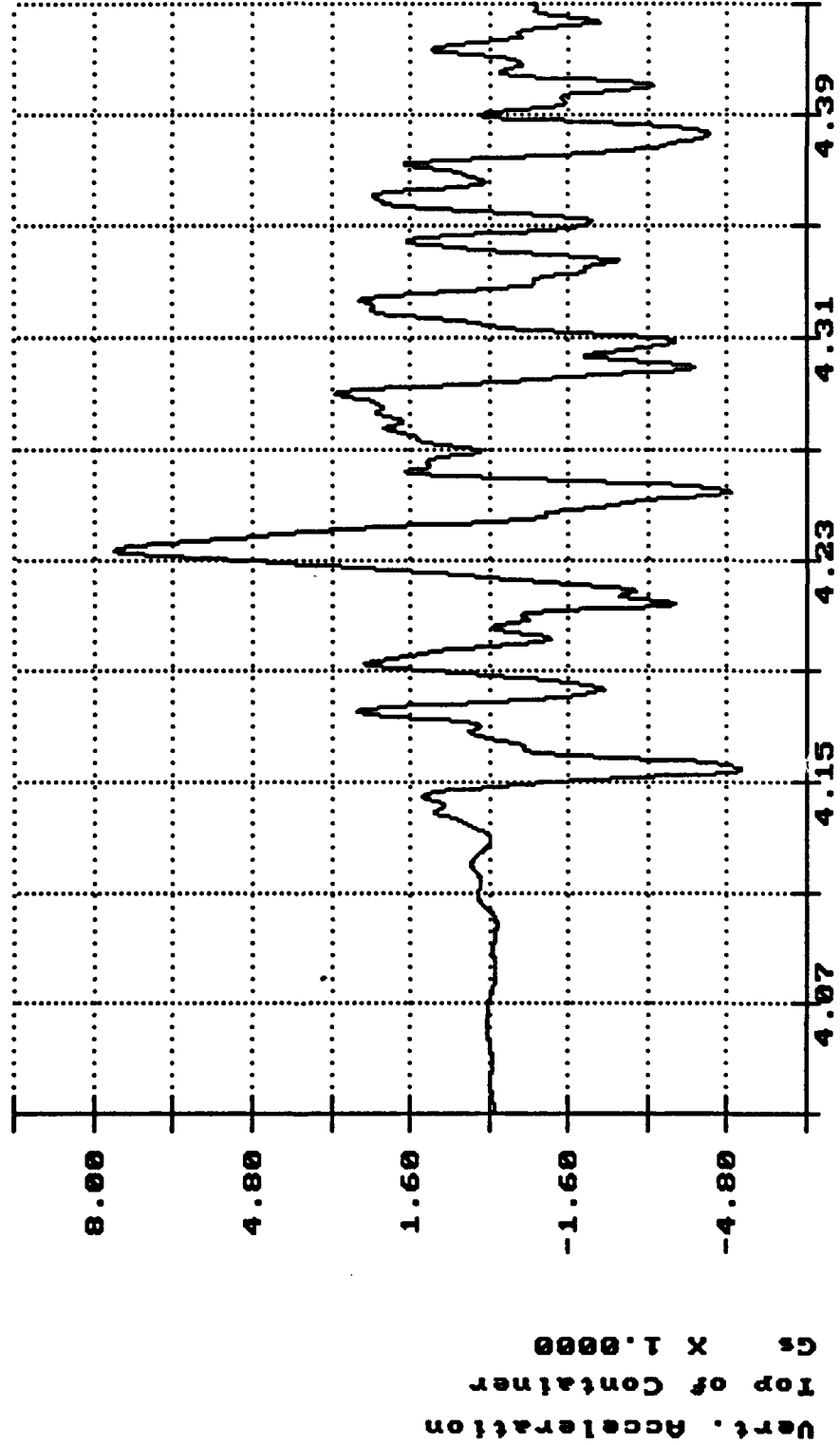

Time of Sample

Seconds X 1.0000

Anno Cert of USMC M927A1 Truck, Impact 3 Mar 31 09:41:19 1992

7

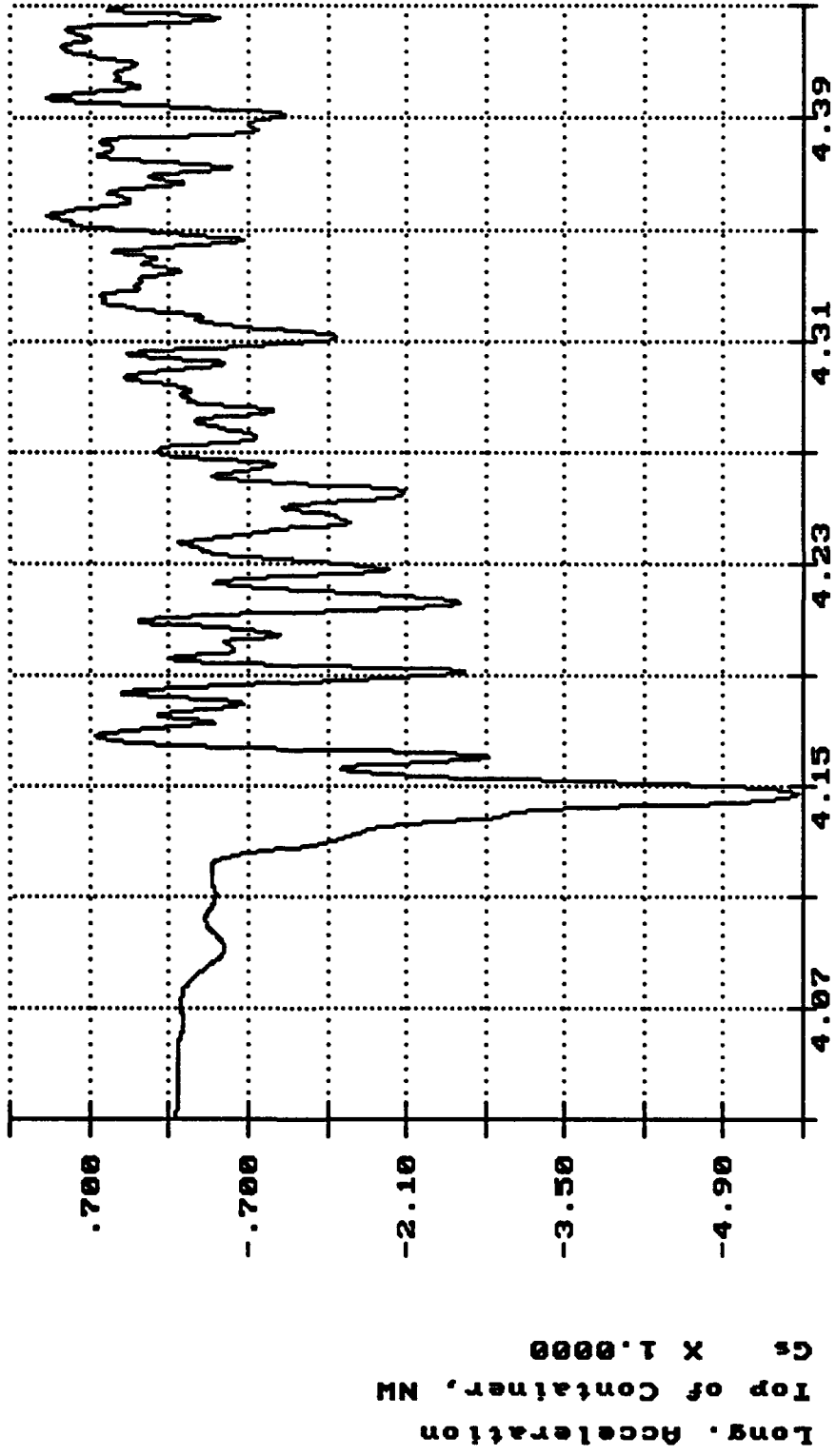

Long. Acceleration
Top of Container, NH
Gs X 1.0000

Time of Sample

Seconds X 1.0000

Anno Cert of USMC M927A1 Truck, Impact 3 Mar 31 09:41:19 1992

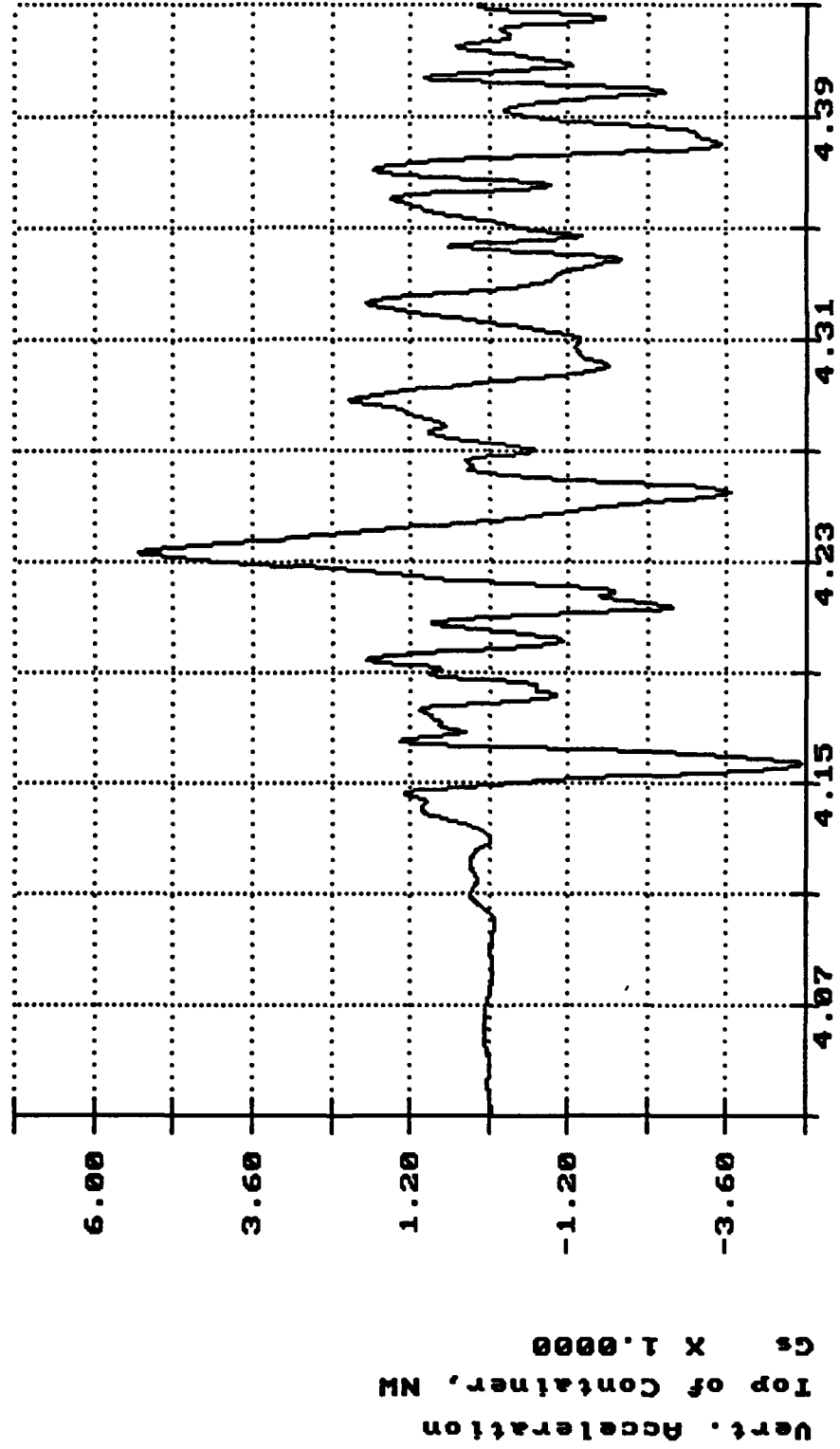

Time of Sample
Seconds X 1.0000

Anno Cert of USMC M927A1 Truck, Impact 4 Mar 31 10:37:07 1992

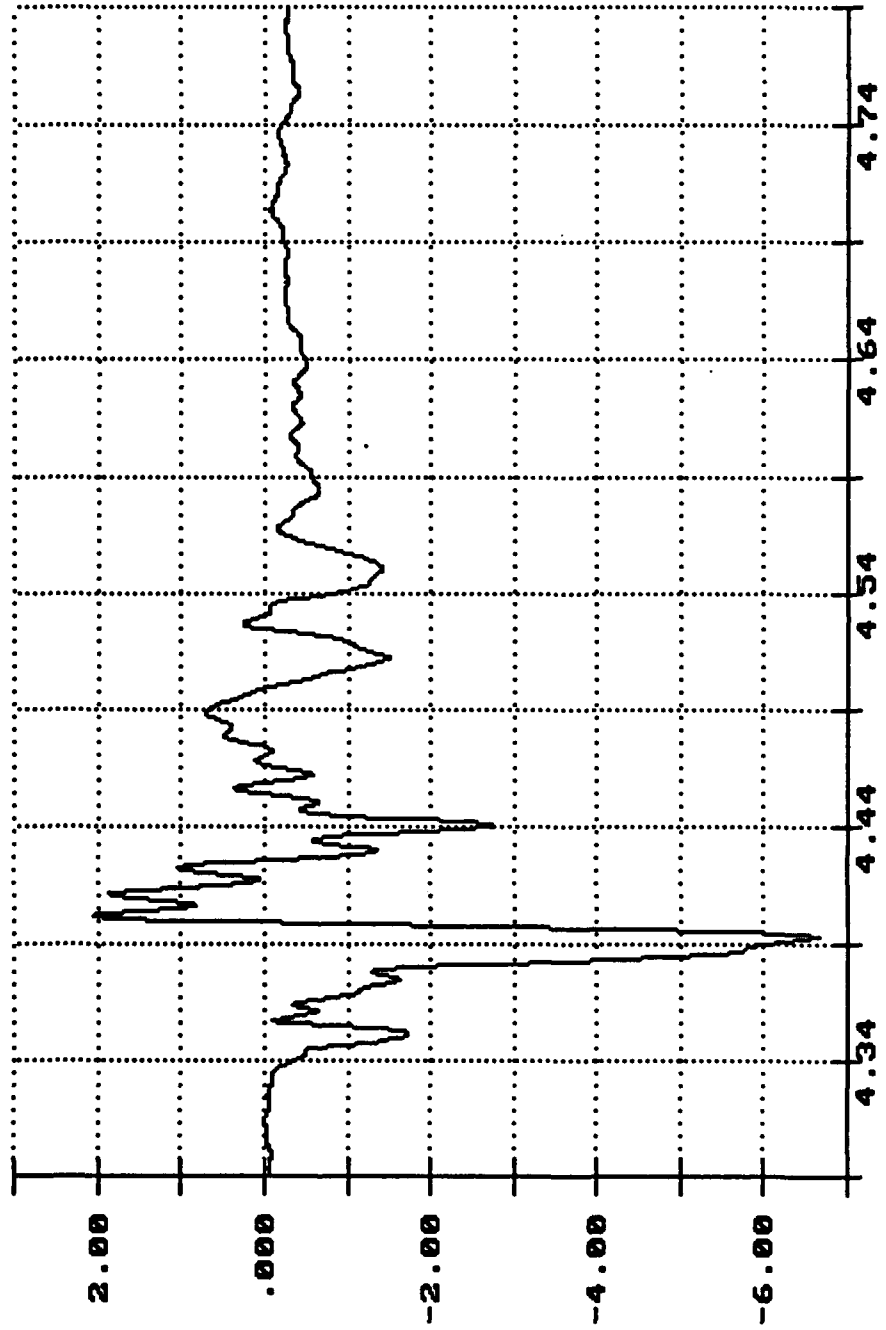

Time of Sample

Seconds X 1.0000

Long. Acceleration
Center Sill
Gs X 1.0000

7

Amno Cert of USMC M927A1 Truck, Impact 4 Mar 31 10:37:07 1992

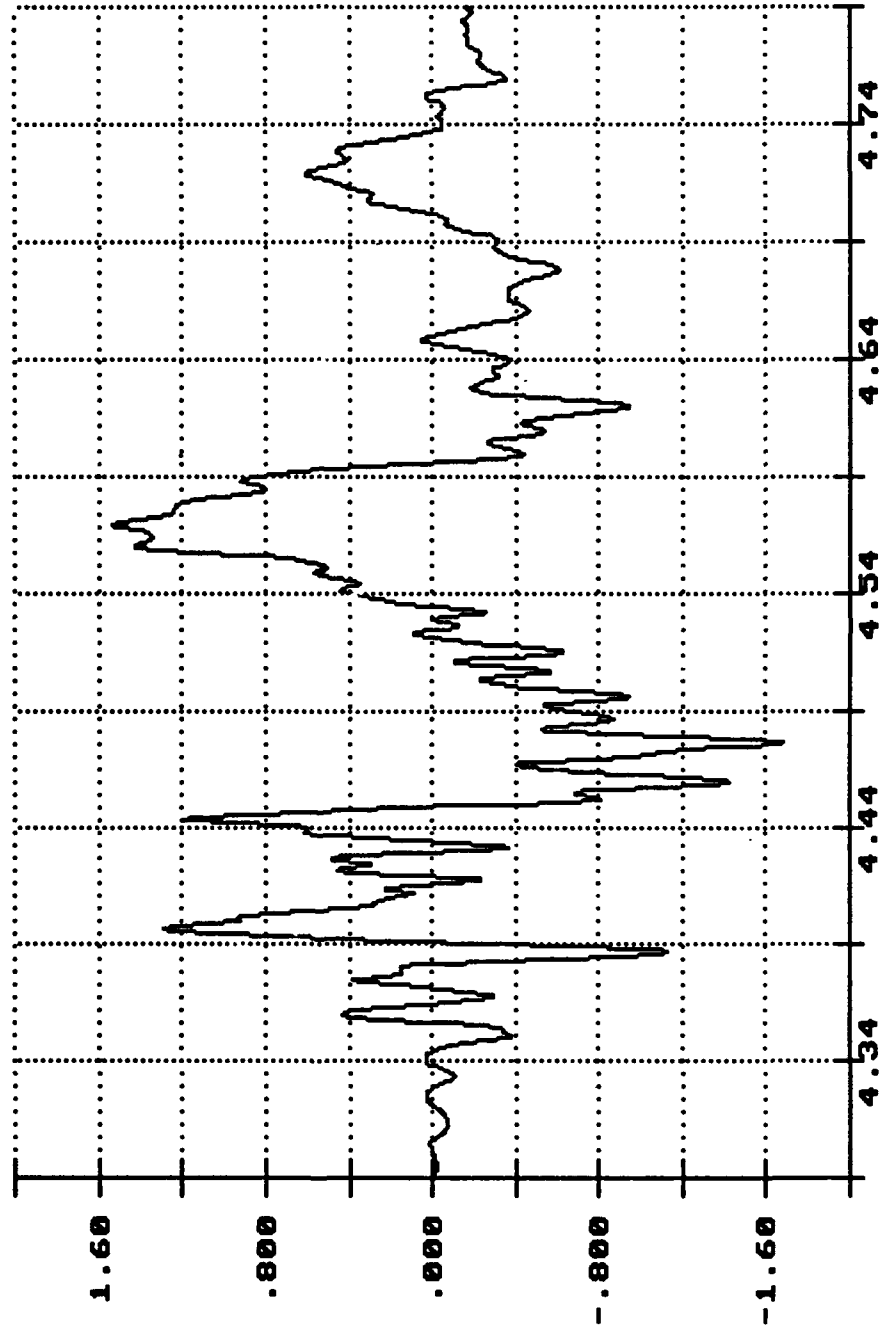

Time of Sample

Seconds X 1.0000

Amro Cert of USMC M927A1 Truck, Impact 4 Mar 31 10:37:07 1992

7

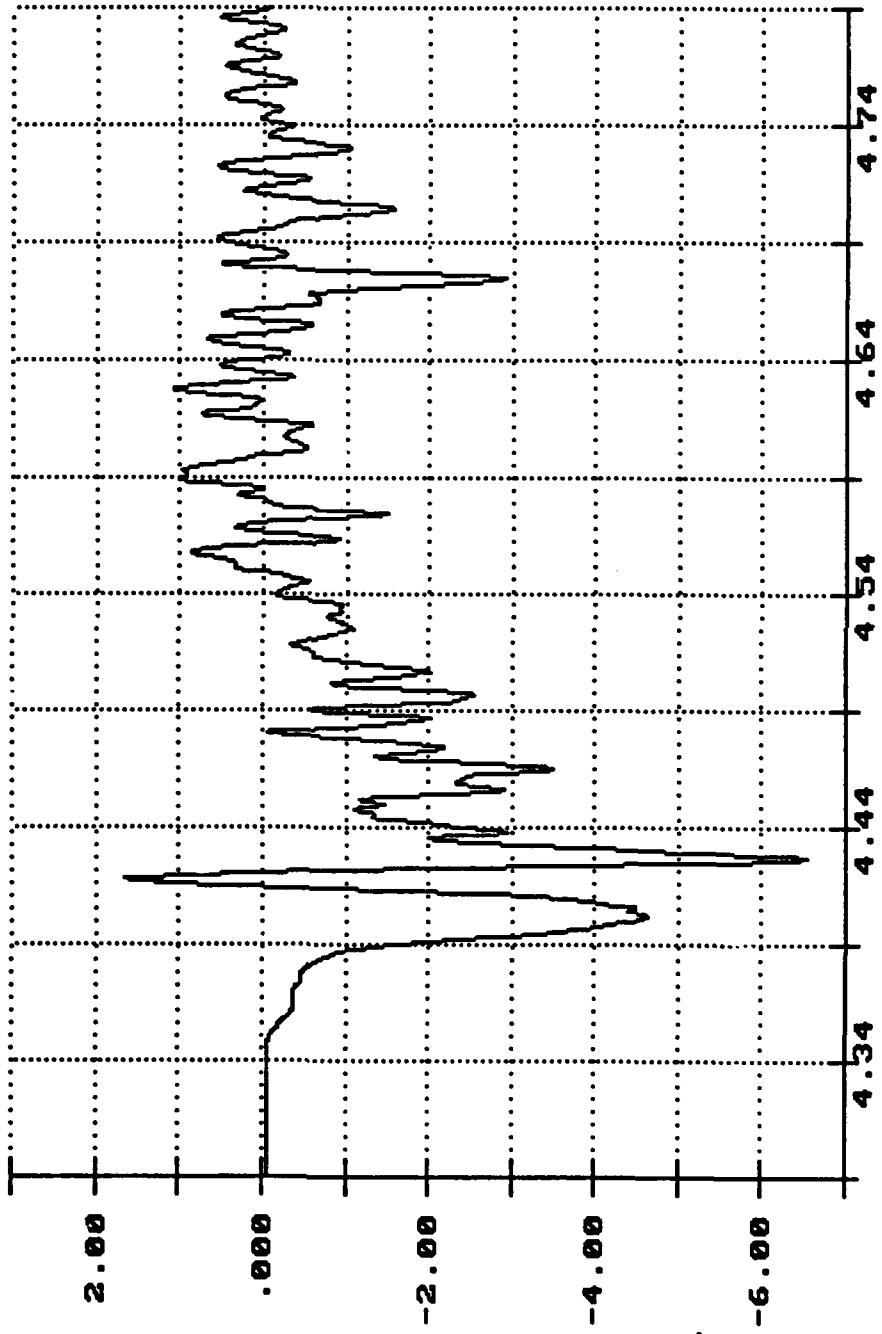

Long. Acceleration
Truck Bed
Gs X 1.0000

Time of Sample
Seconds X 1.0000

Anno Cert of USMC M927A1 Truck, Impact 4 Mar 31 10:37:07 1992

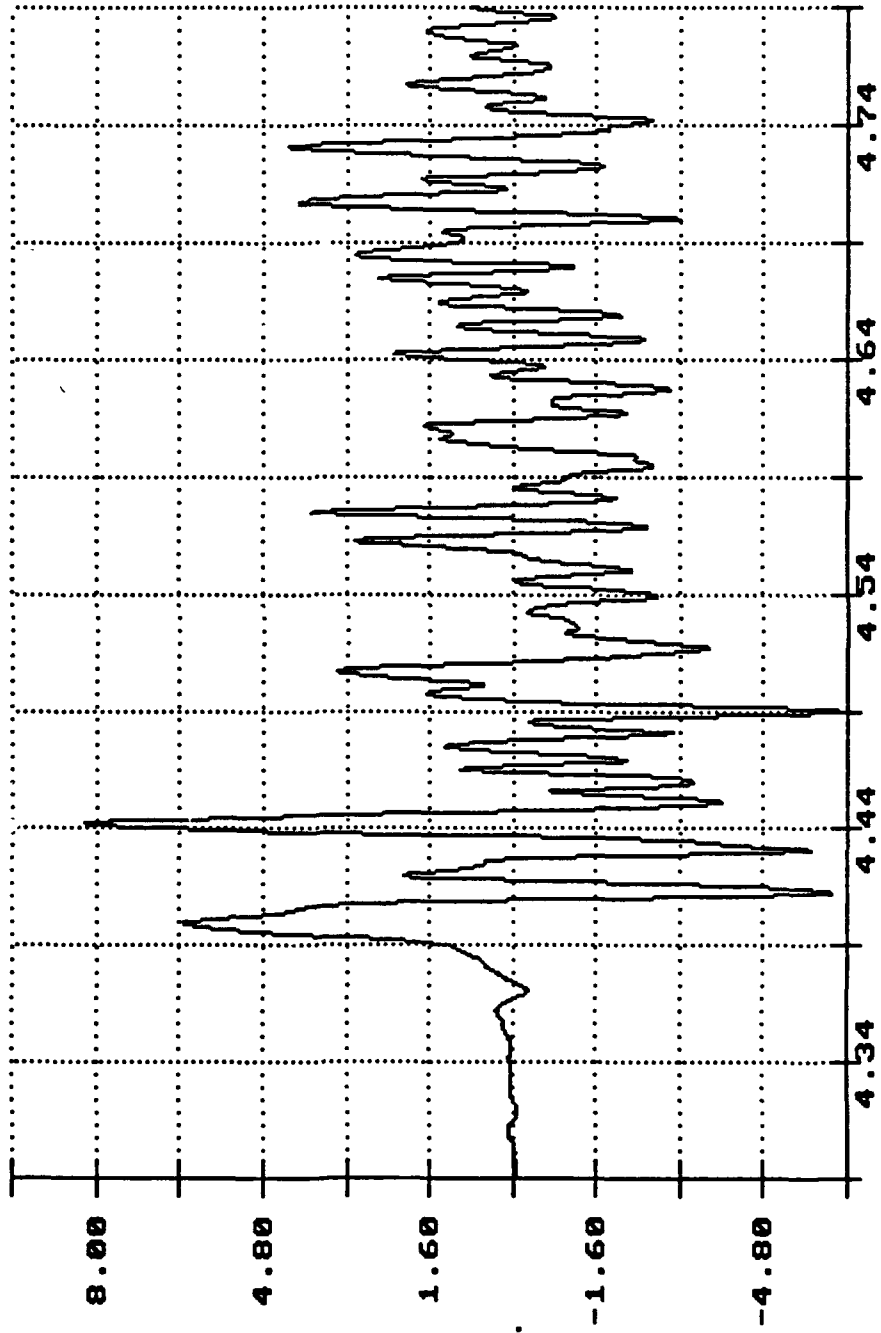

Time of Sample

Seconds X 1.0000

Anno Cert of USMC M927A1 Truck, Impact 4 Mar 31 10:37:07 1992

7

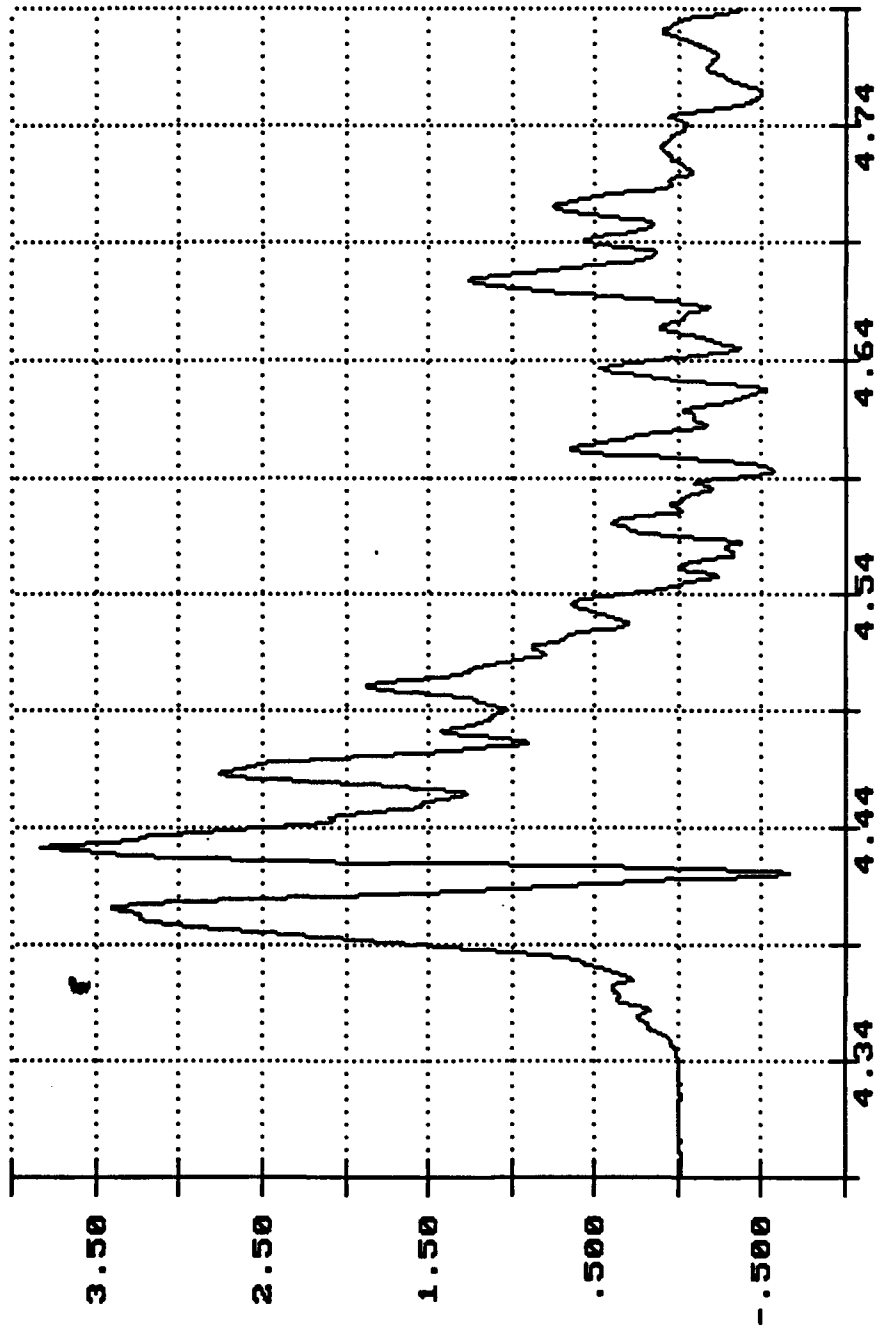

Long. Acceleration
Truck Frame
Gs X 1.0000

Time of Sample
Seconds X 1.0000

Anno Cert of USMC M927A1 Truck, Impact 4 Mar 31 10:37:07 1992

7

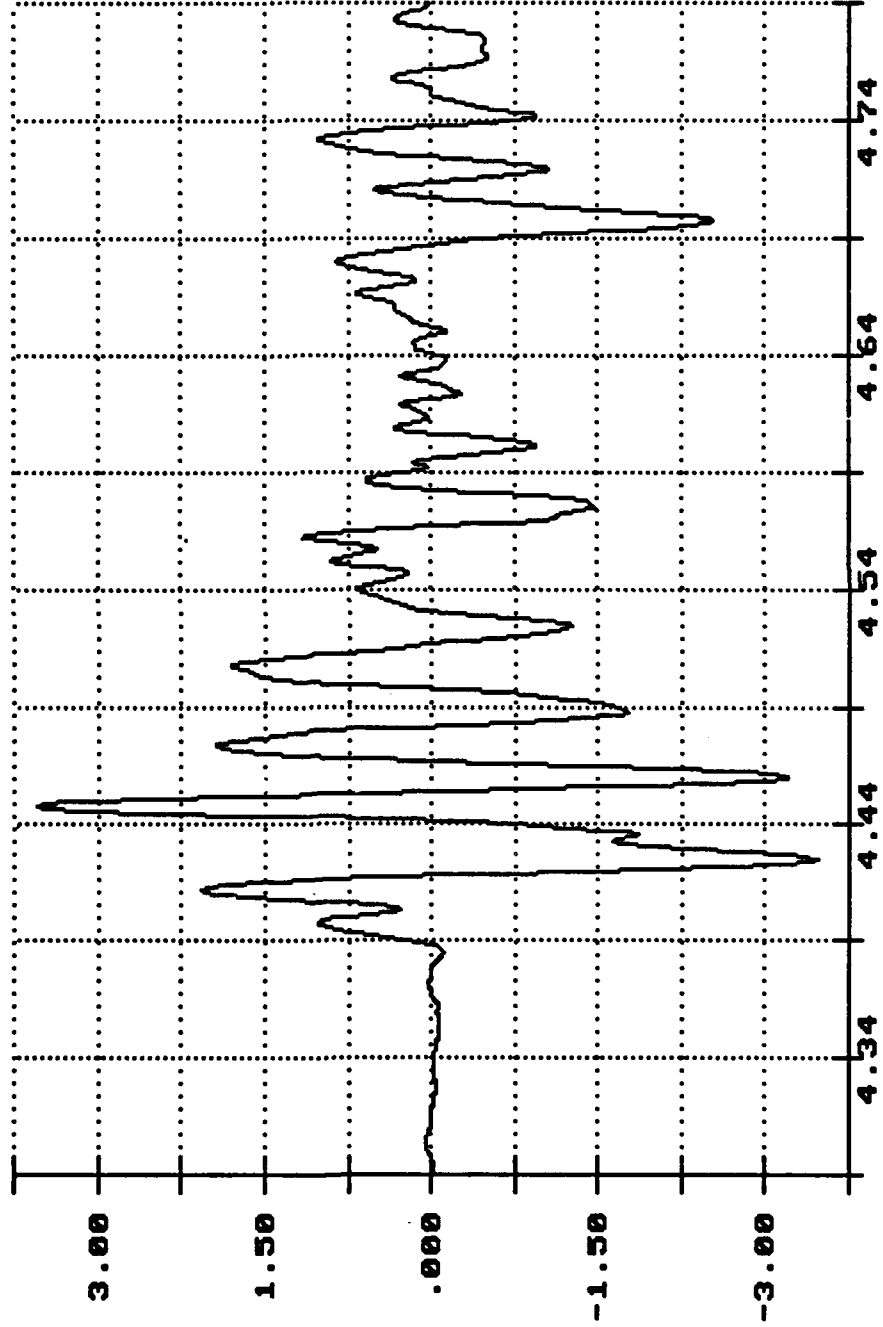

Lat. Acceleration
Truck Frame
Gs X 1.0000

Time of Sample
Seconds X 1.0000

Anno Cert of USMC M927A1 Truck, Impact 4 Mar 31 10:37:07 1992

7

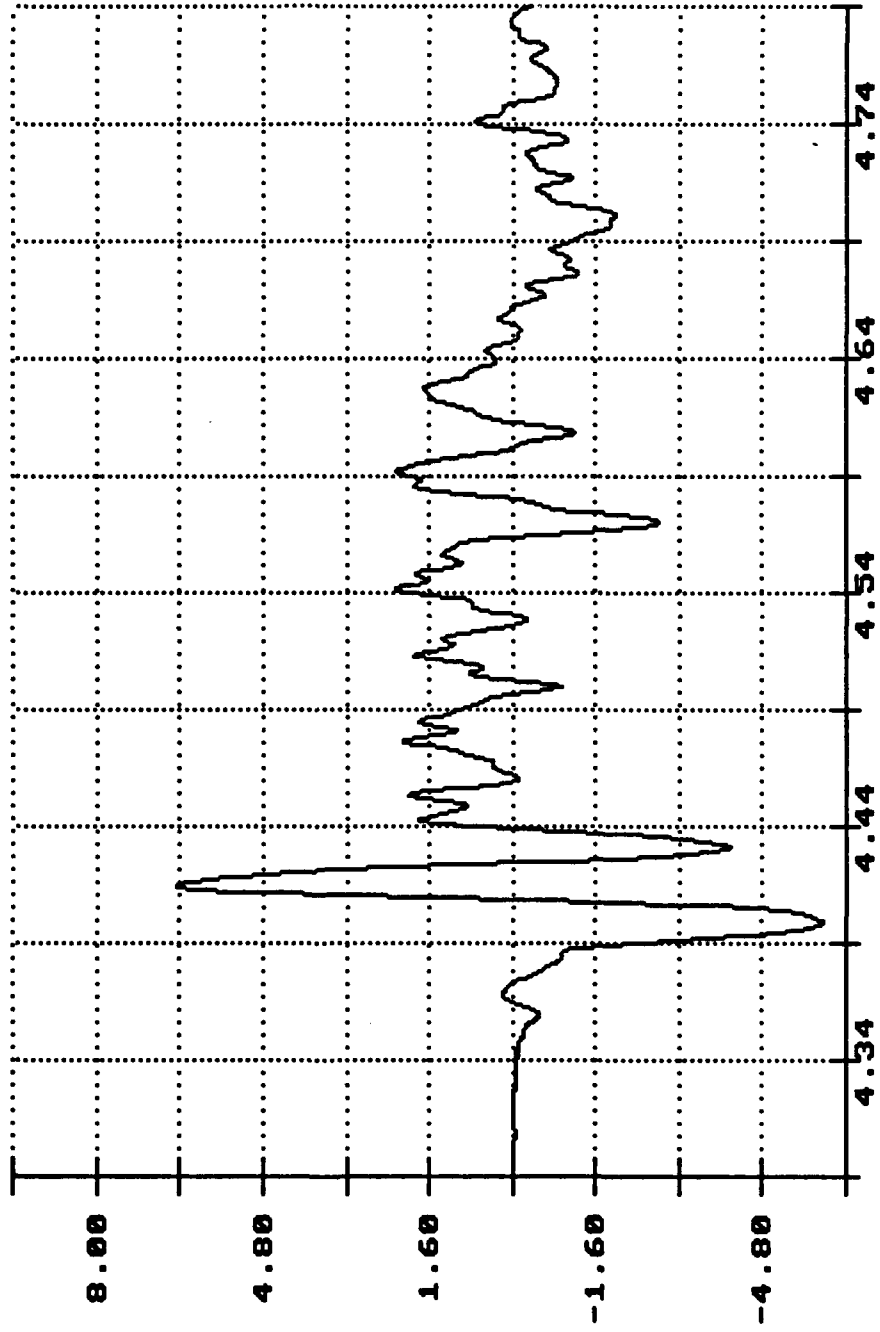

Time of Sample

Seconds X 1.0000

Anno Cert of USMC M927A1 Truck, Impact 4 Mar 31 10:37:07 1992

7

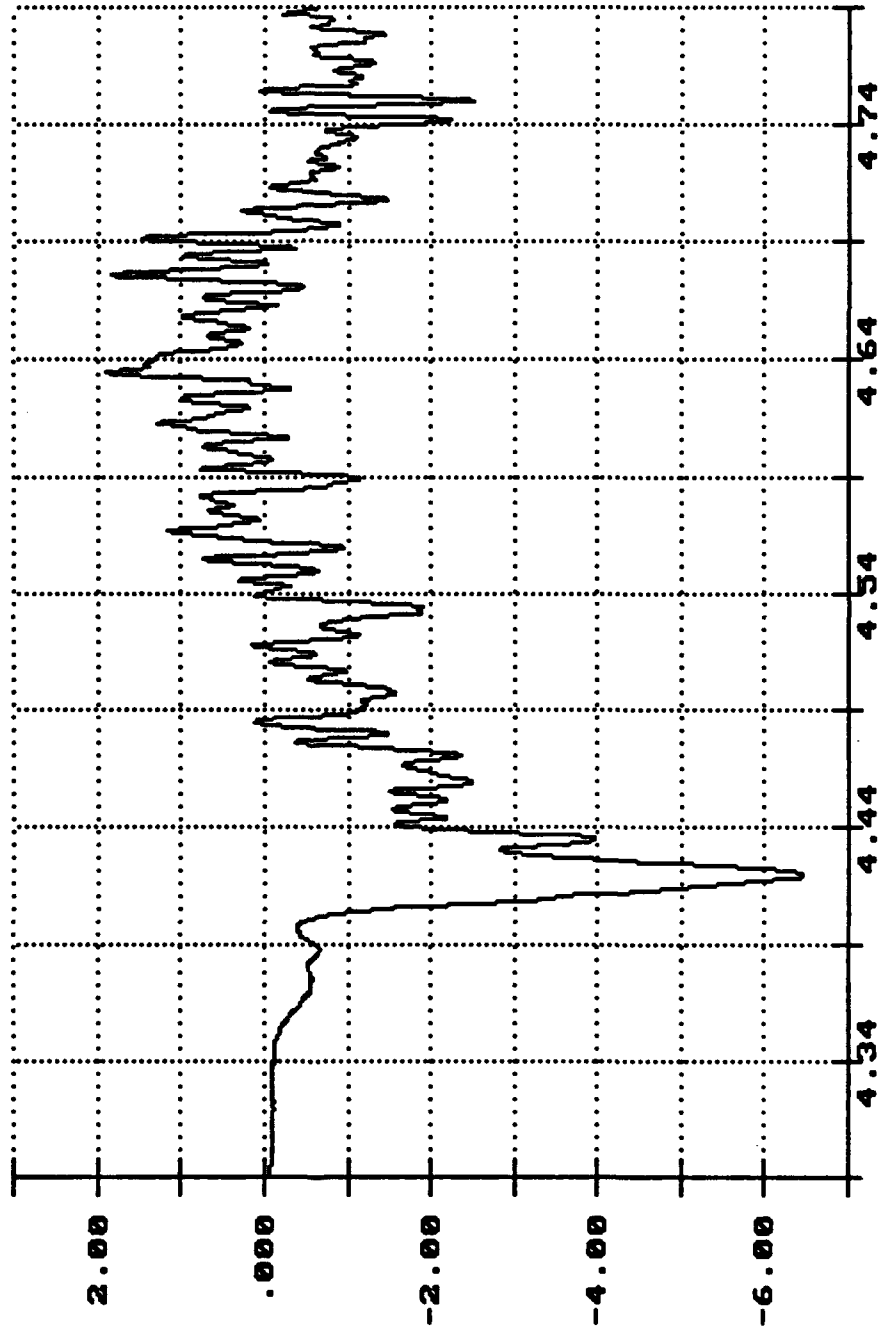

Time of Sample

Seconds X 1.0000

Long. Acceleration
Gs X 1.0000
Top of Container

Anno Cert of USMC M927A1 Truck, Impact 4 Mar 31 10:37:07 1992

7

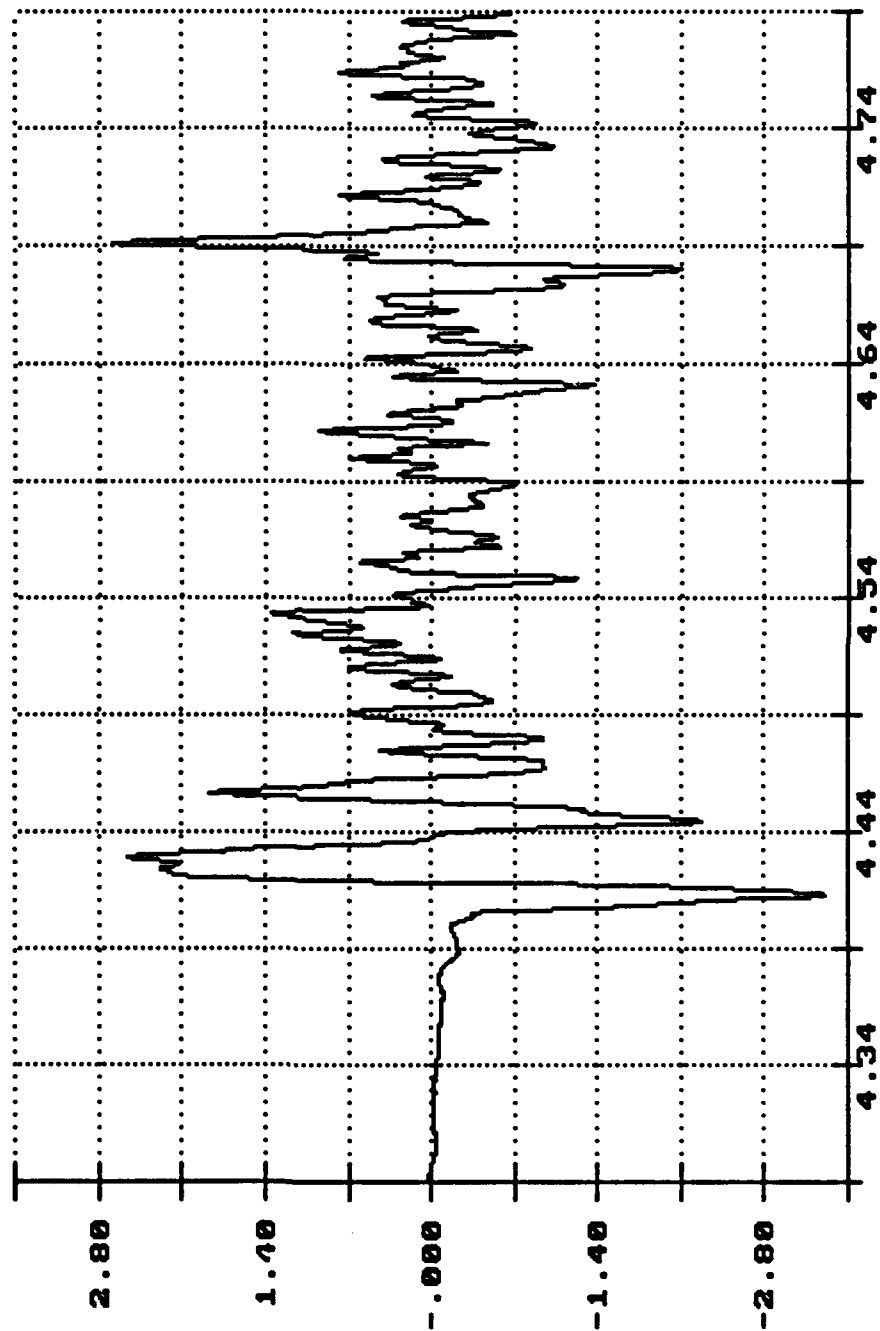

Lat. Acceleration
Gs X 1.0000
Top of Container

Time of Sample

Seconds X 1.0000

Anno Cert of USMC M927A1 Truck, Impact 4 Mar 31 10:37:07 1992

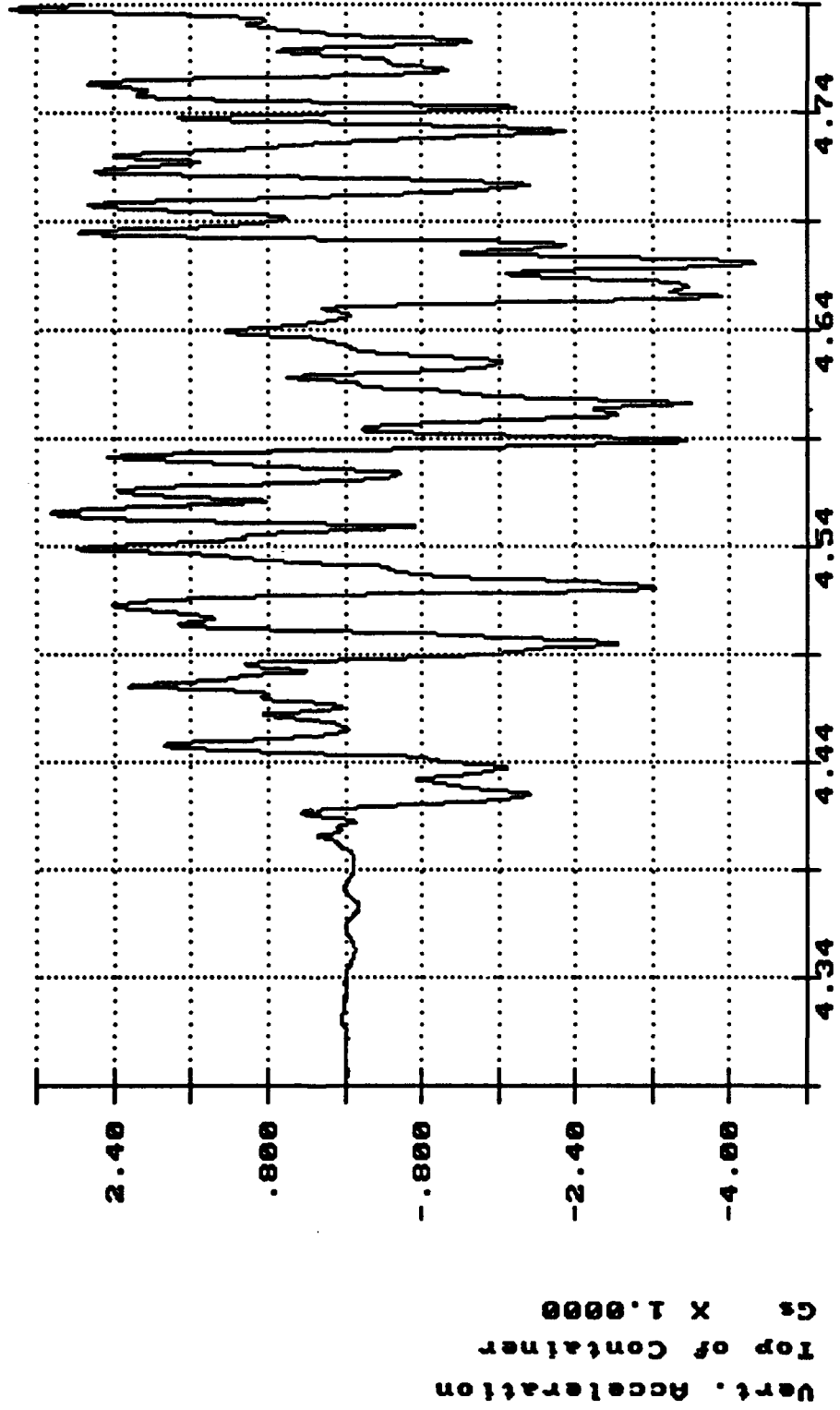

Time of Sample
Seconds X 1.0000

7
Anno Cert of USMC M927A1 Truck, Impact 4 Mar 31 10:37:07 1992

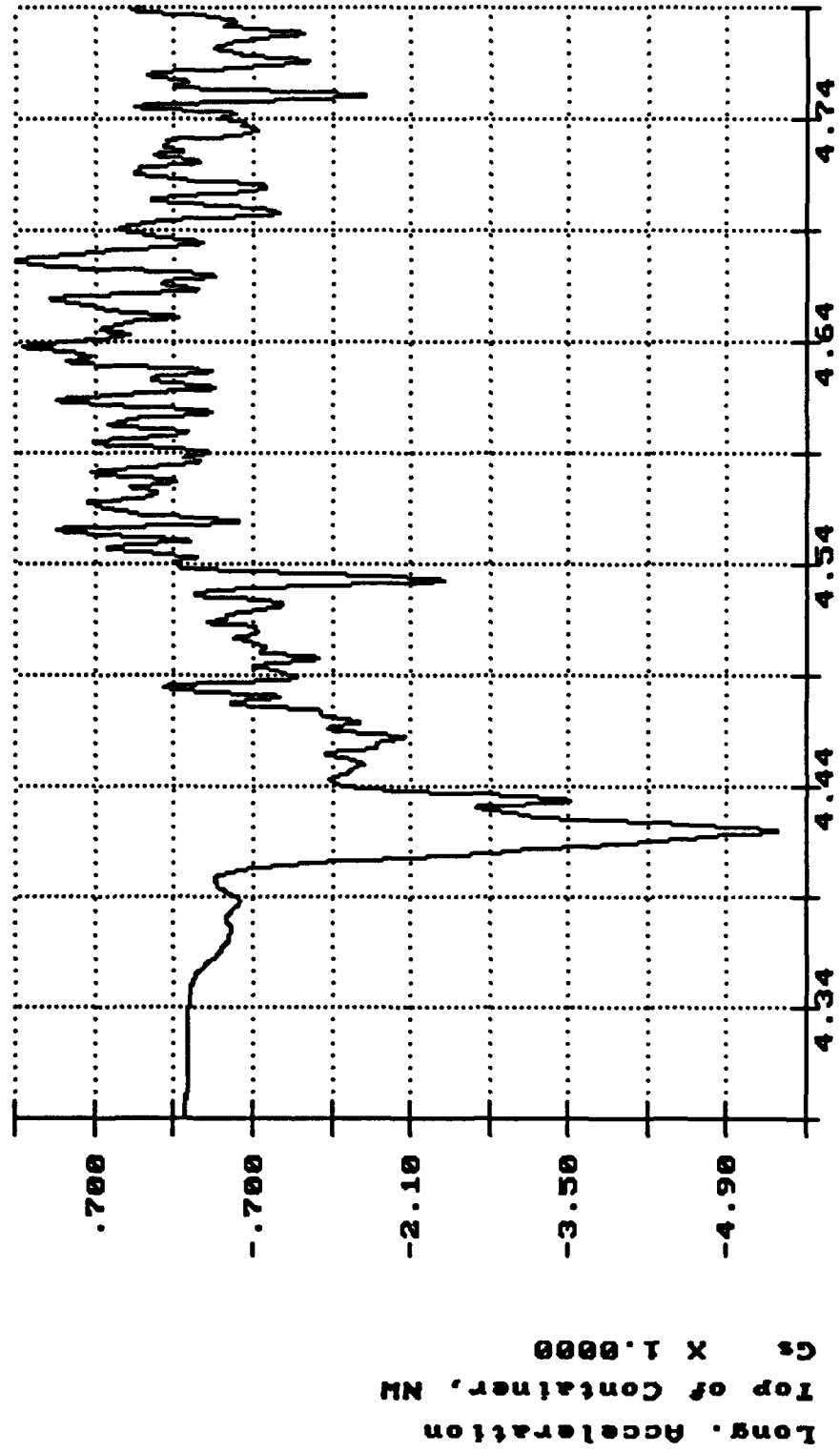

Time of Sample

Seconds X 1.0000

7
Anno Cert of USMC M927A1 Truck, Impact 4 Mar 31 10:37:07 1992

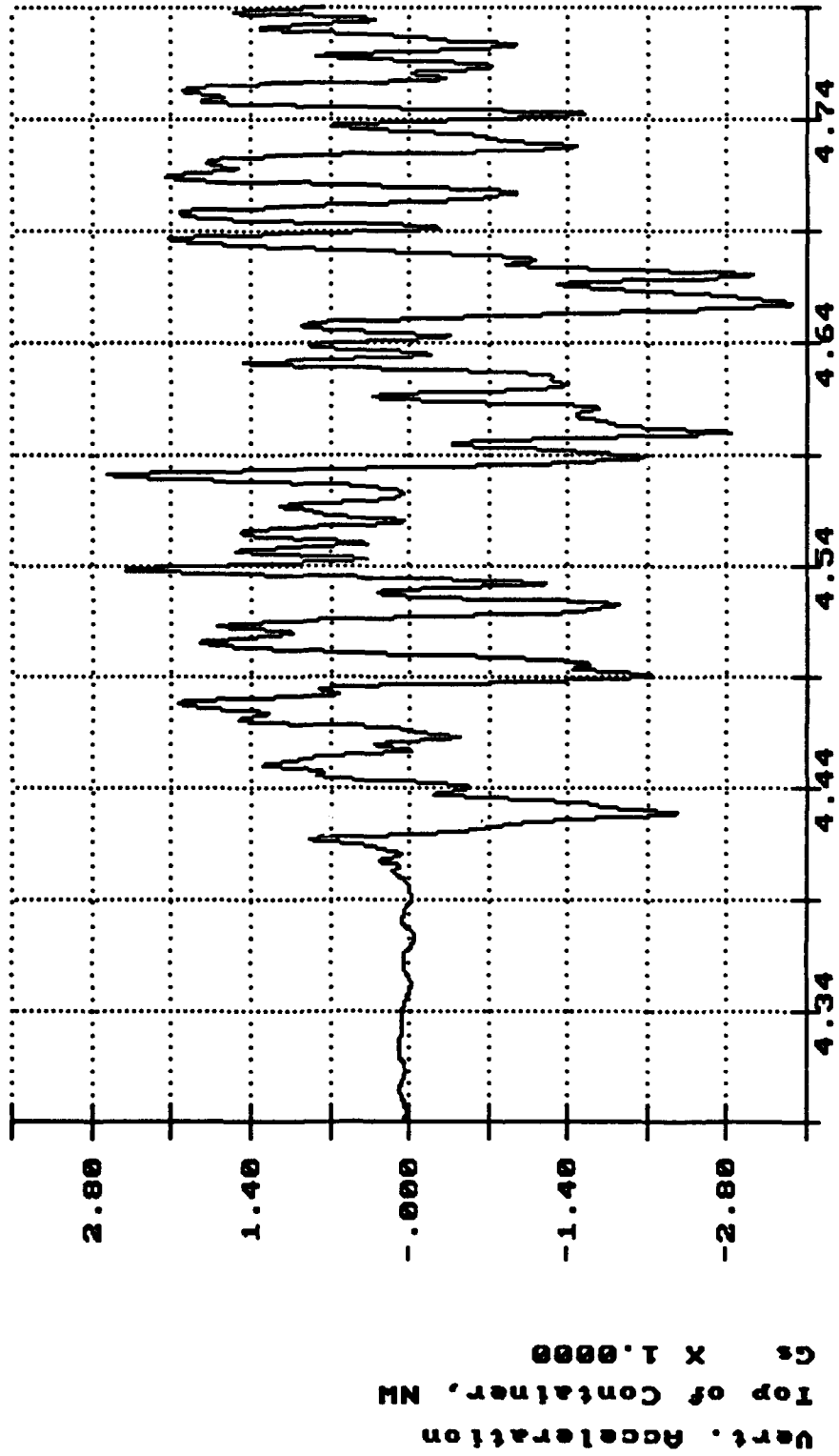

7

Anno Cert of USMC M927A1 Truck, Impact 5 Mar 31 11:09:38 1992

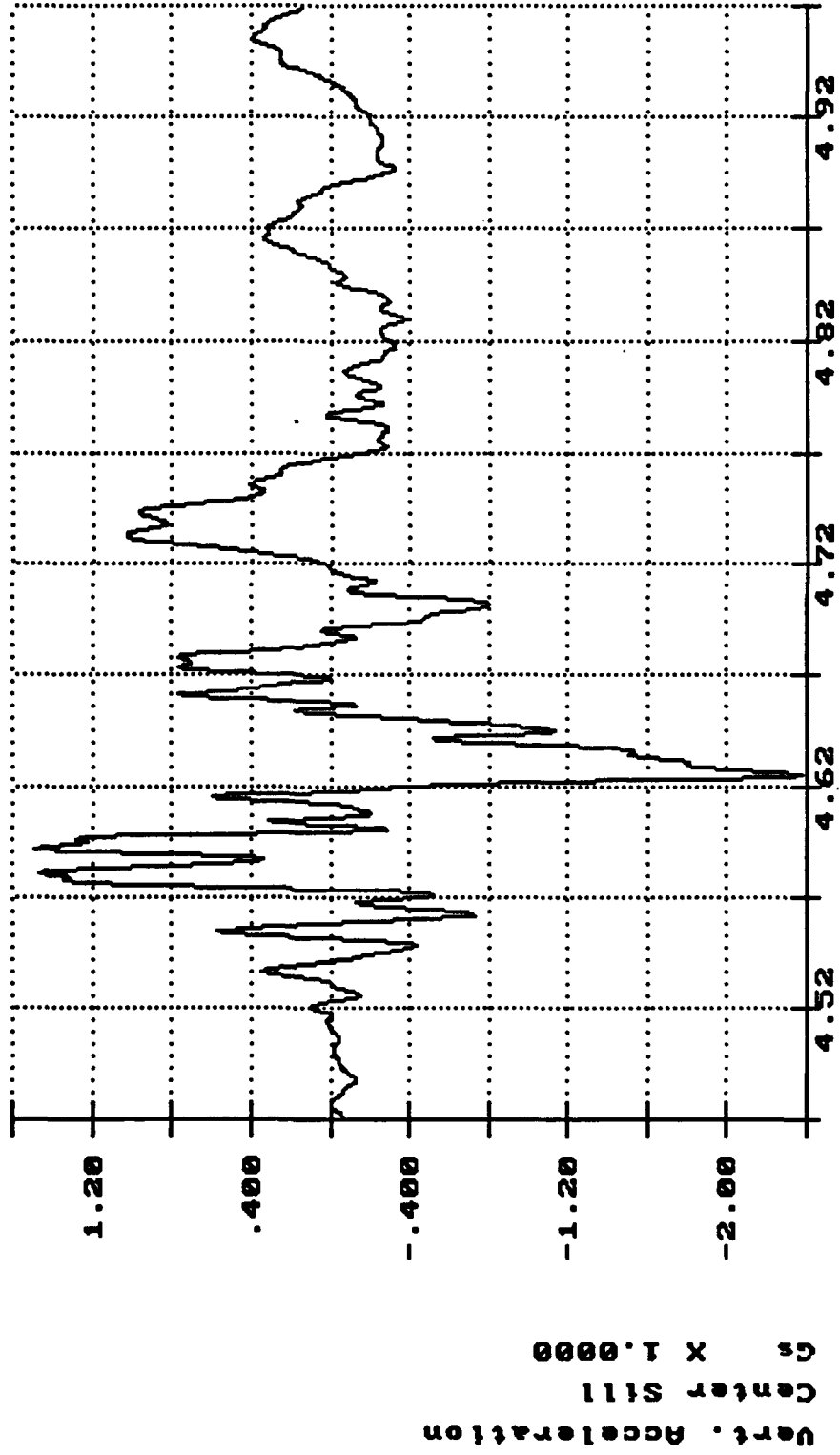

Anno Cart of USMC M927A1 Truck, Impact 5 Mar 31 11:09:38 1992

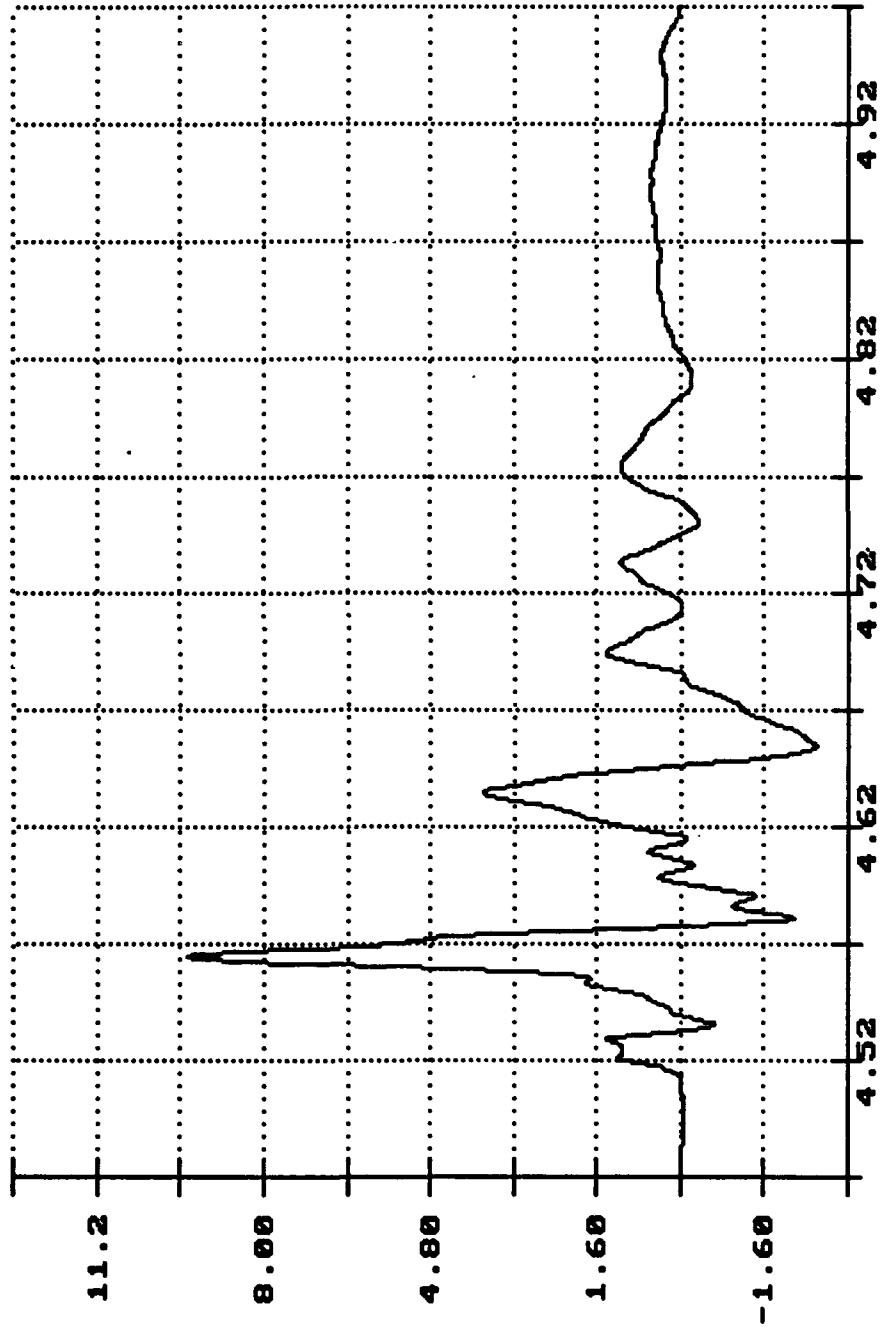

Long. Acceleration
Center Sill
Gs X 1.0000

Time of Sample

Seconds X 1.0000

Anno Cert of USMC M927A1 Truck, Impact 5 Mar 31 11:09:38 1992

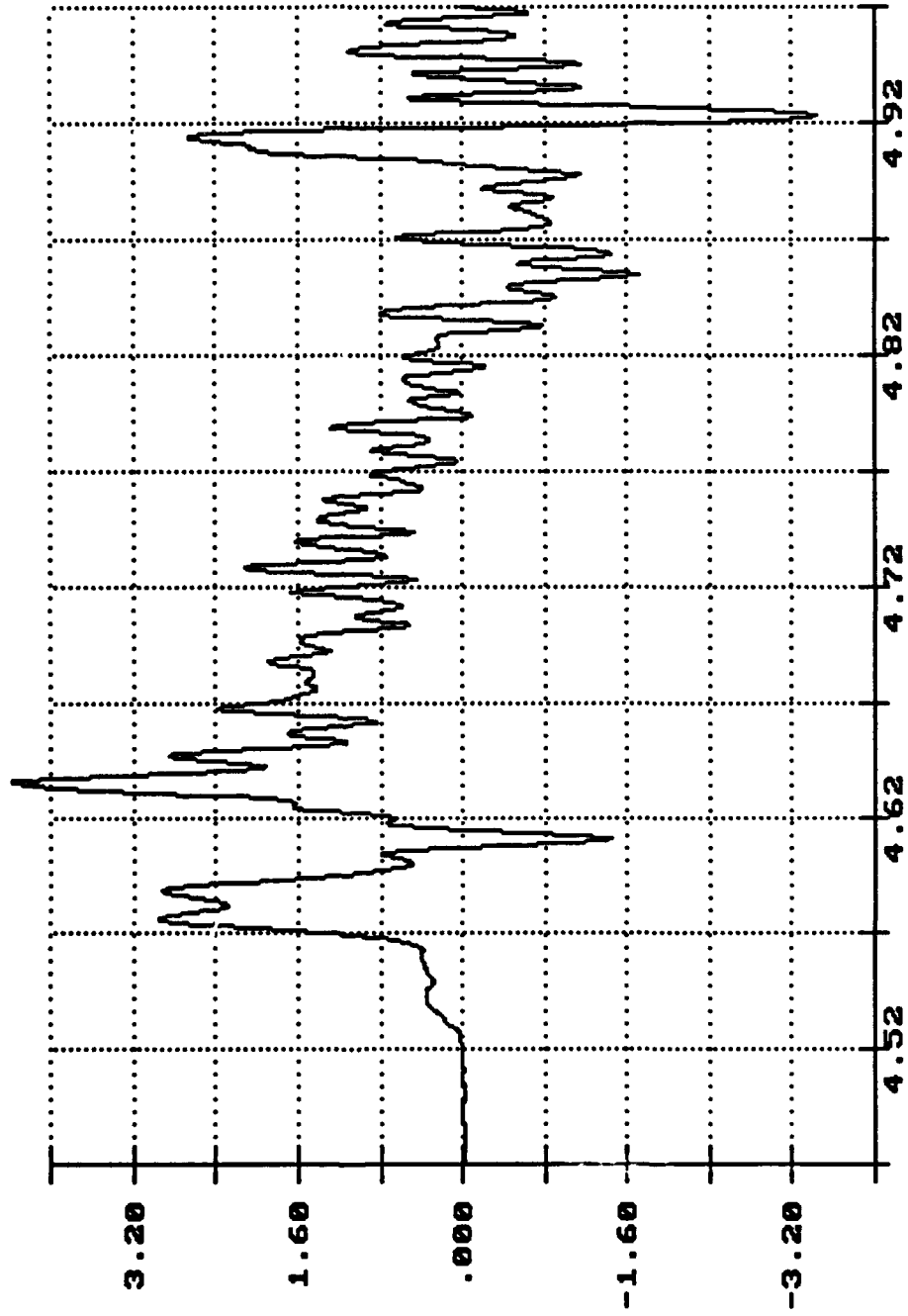

Long. Acceleration
Truck Bed
Gs X 1.0000

Time of Sample

Seconds X 1.0000

Anno Cert of USMC M927A1 Truck, Impact 5 Mar 31 11:09:38 1992

7

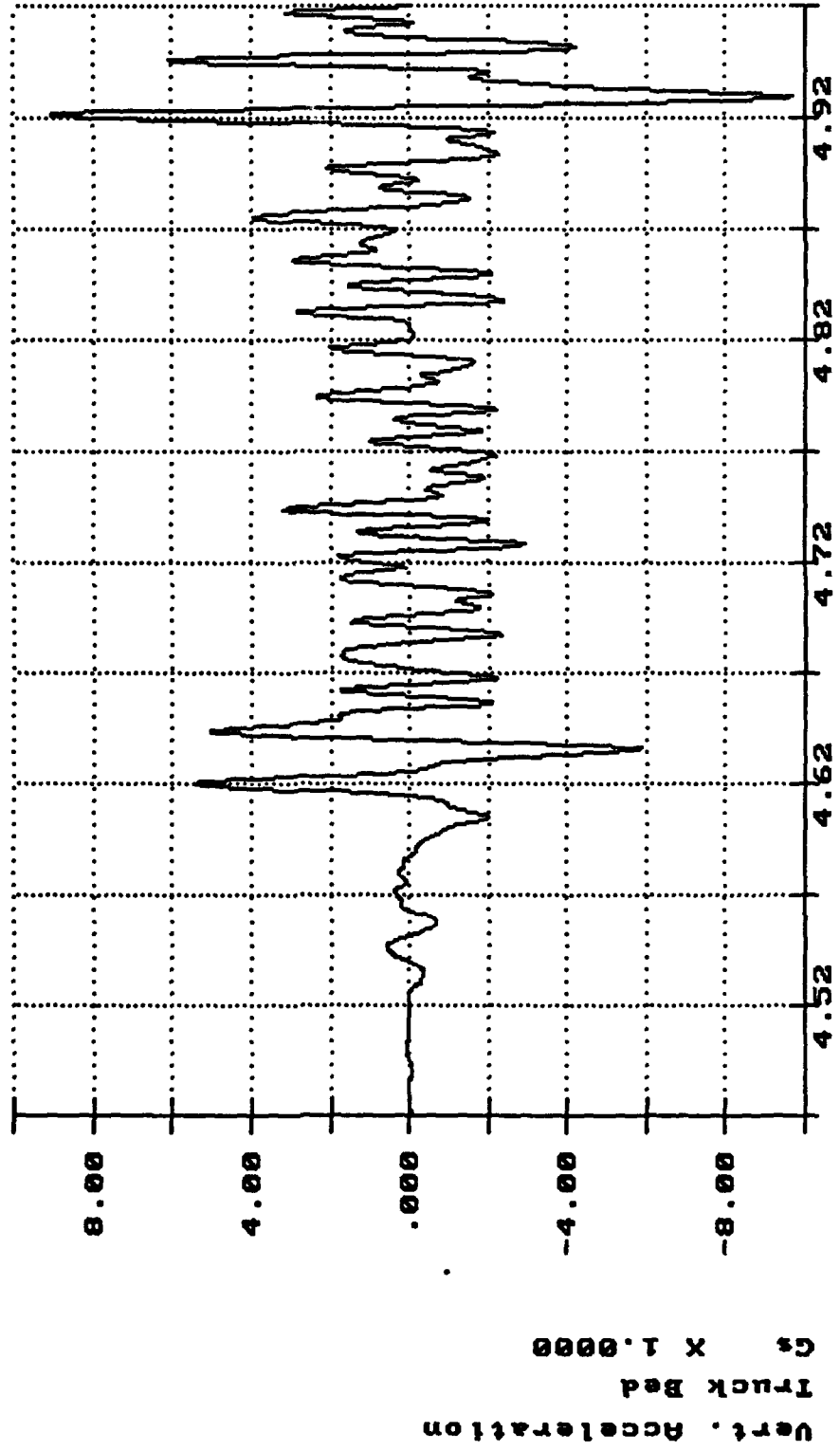

Anno Cert of USMC M927A1 Truck, Impact 5 Mar 31 11:09:38 1992

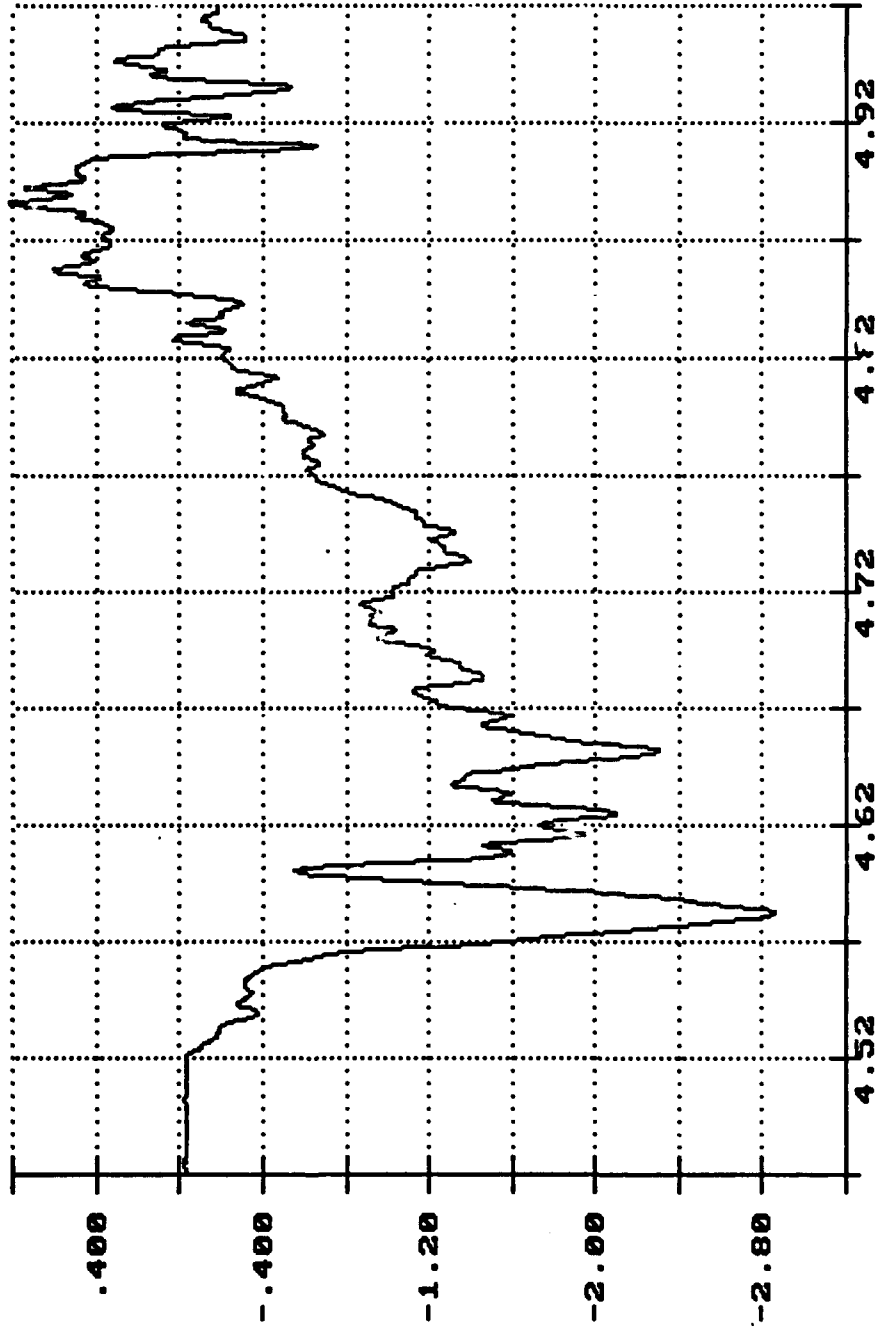

Long. Acceleration
Truck Frame
Gs X 1.0000

Time of Sample

Seconds X 1.0000

7
Anno Cert of USMC M927A1 Truck, Impact 5 Mar 31 11:09:38 1992

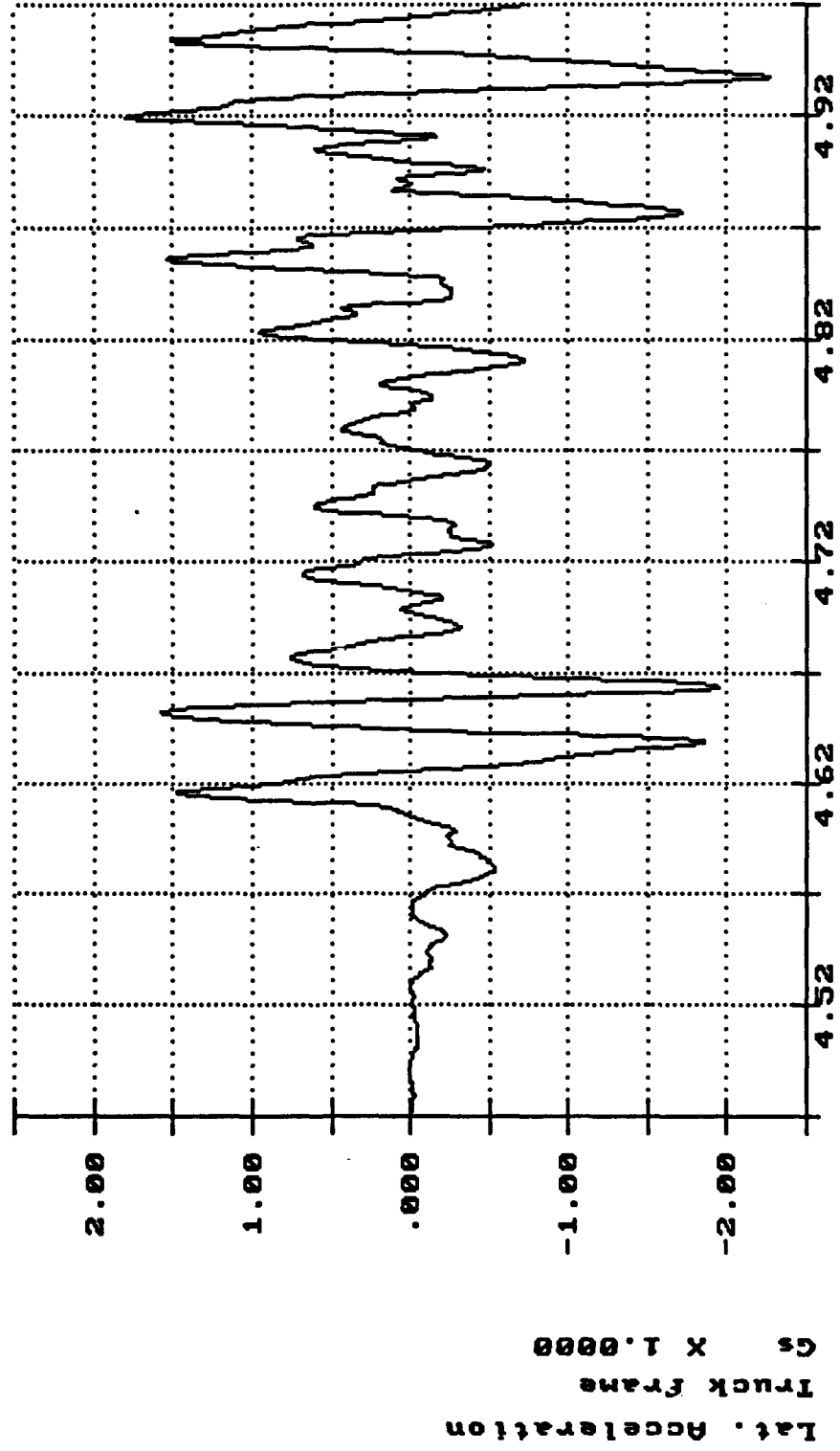

Time of Sample

Seconds X 1.0000

Lat. Acceleration
Truck Frame
Gs X 1.0000

Anno Cert of USMC M927A1 Truck, Impact 5 Mar 31 11:09:38 1992

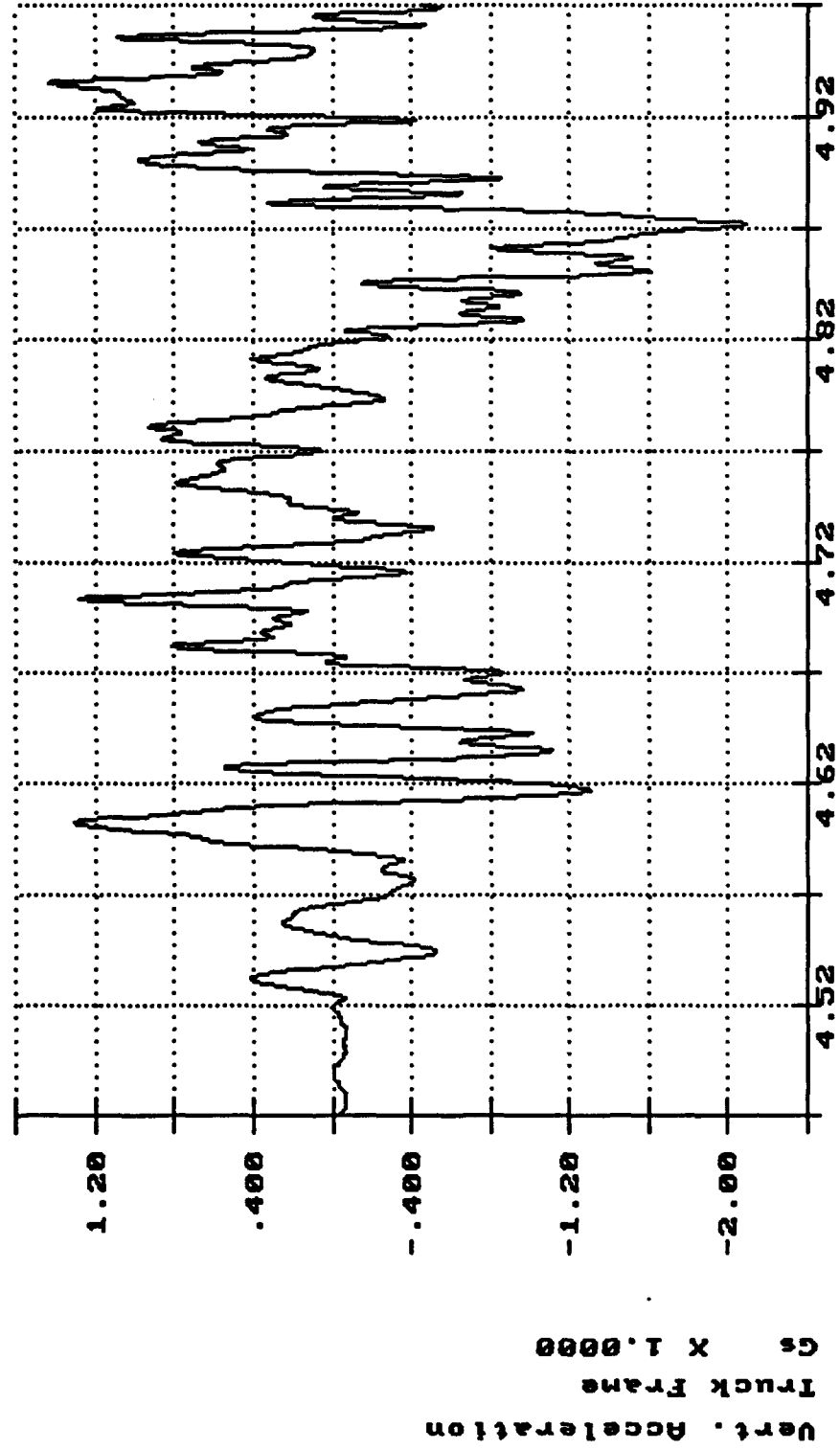

Anno Cert of USMC M927A1 Truck, Impact 5 Mar 31 11:09:38 1992

7

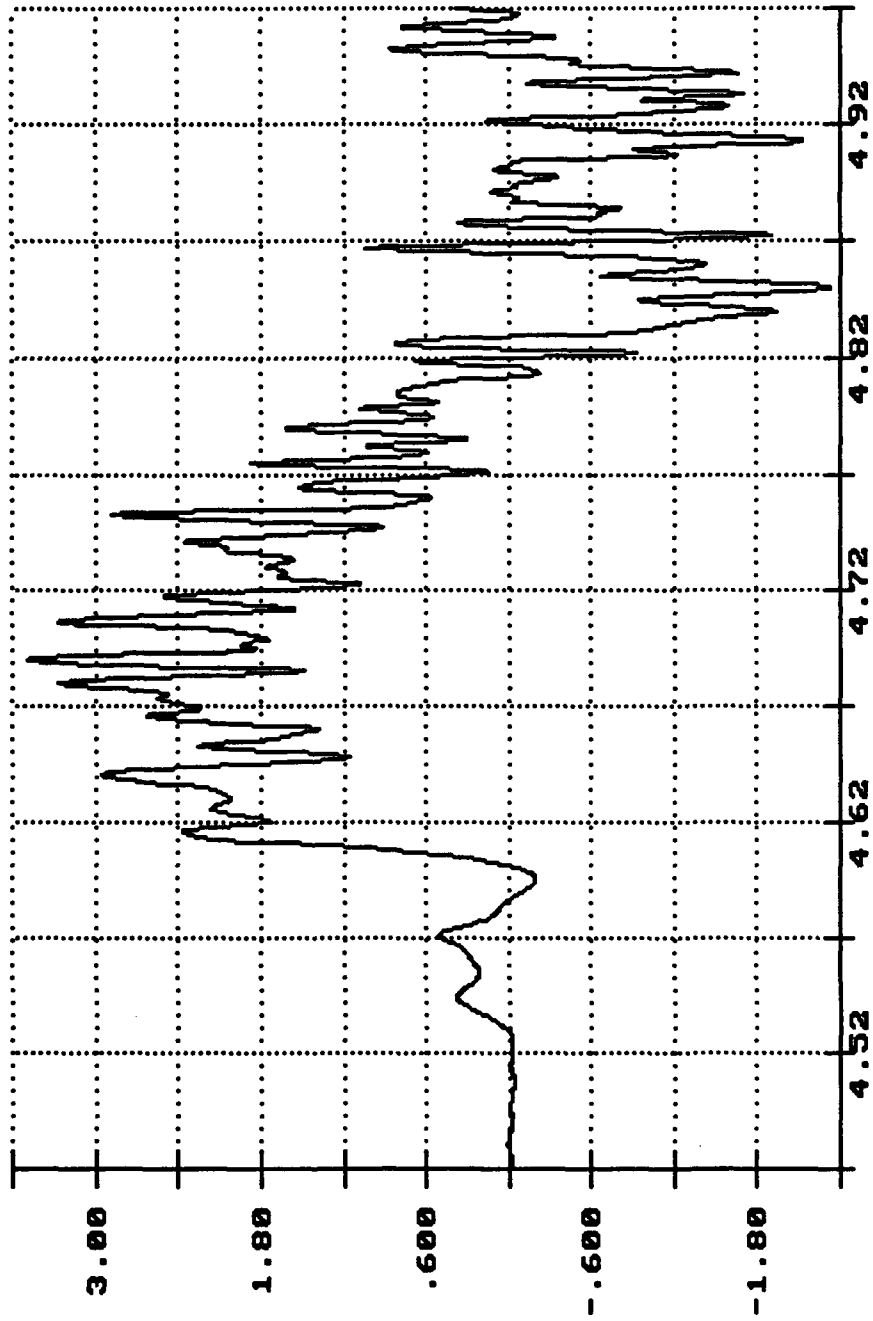

Long. Acceleration
Top of Container
Gs X 1.0000

Time of Sample
Seconds X 1.0000

Anno Cart of USMC M927A1 Truck, Impact 5 Mar 31 11:09:38 1992

7

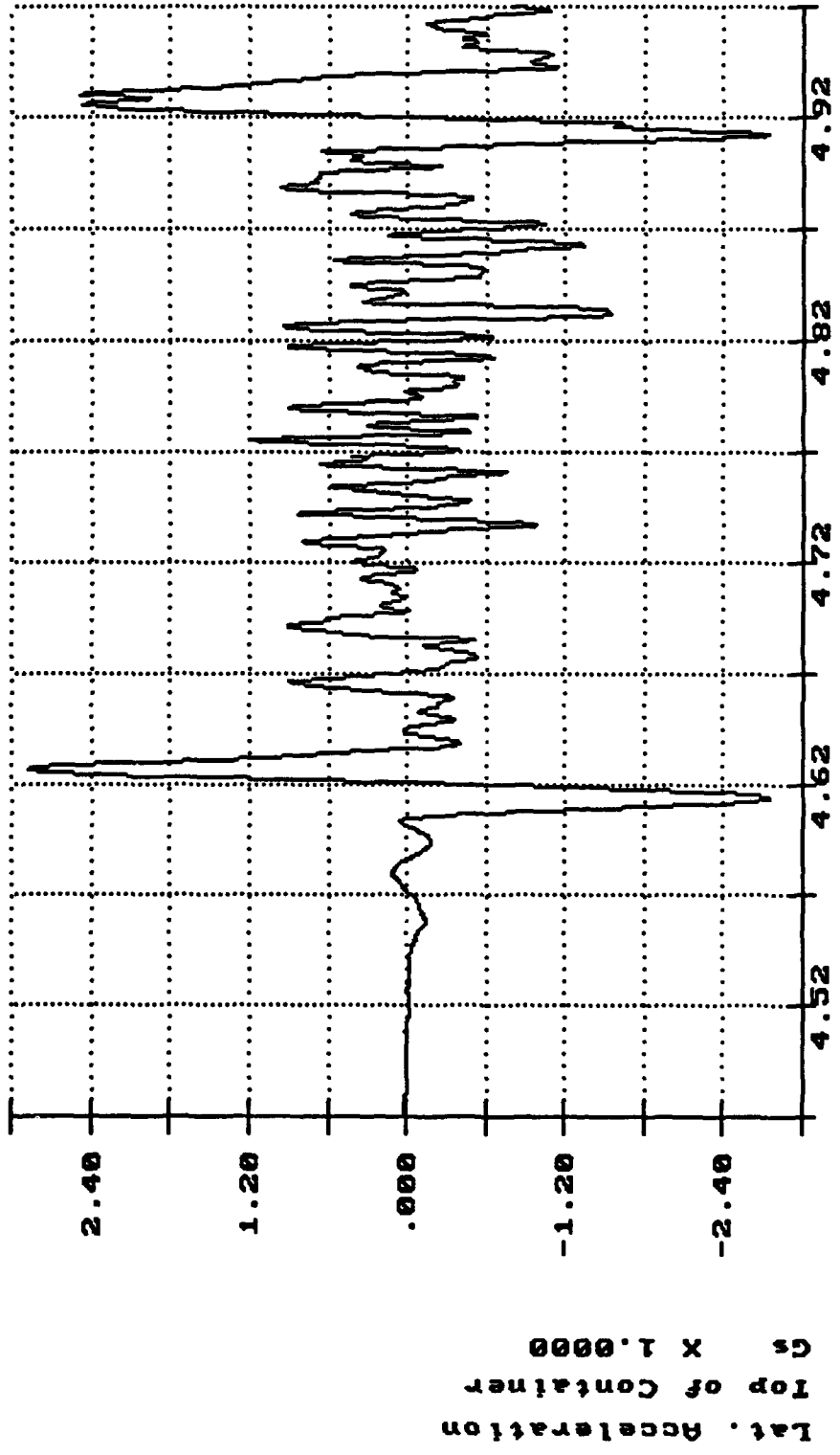

Time of Sample

Seconds X 1.0000

Lat. Acceleration
Top of Container
Gs X 1.0000

Anno Cert of USMC M927A1 Truck, Impact 5 Mar 31 11:09:38 1992

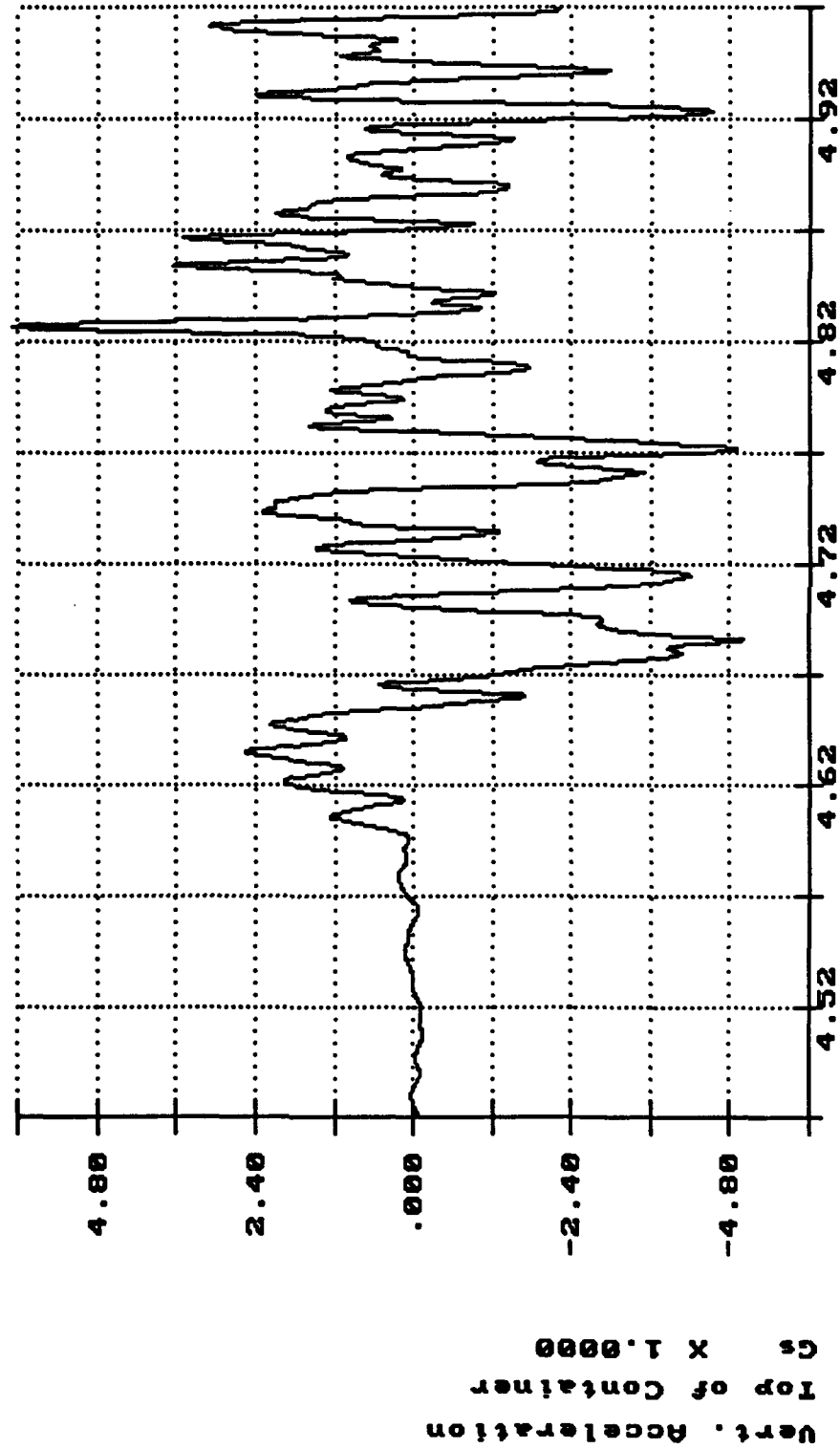

Time of Sample
Seconds X 1.0000

Anno Cert of USMC M927A1 Truck, Impact 5 Mar 31 11:09:38 1992

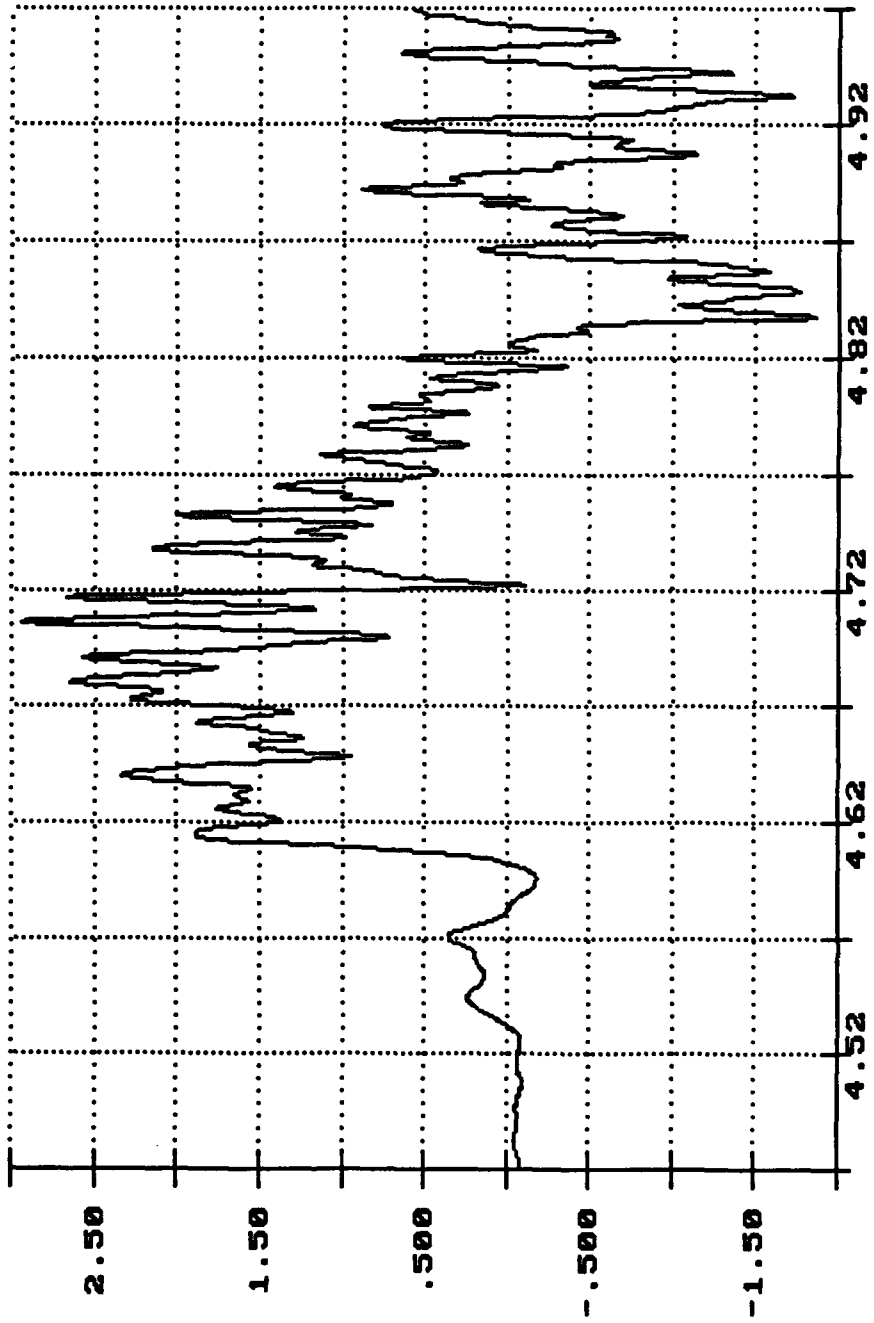

Time of Sample

Seconds X 1.0000

Anno Cart of USMC M927A1 Truck, Impact 5 Mar 31 11:09:38 1992

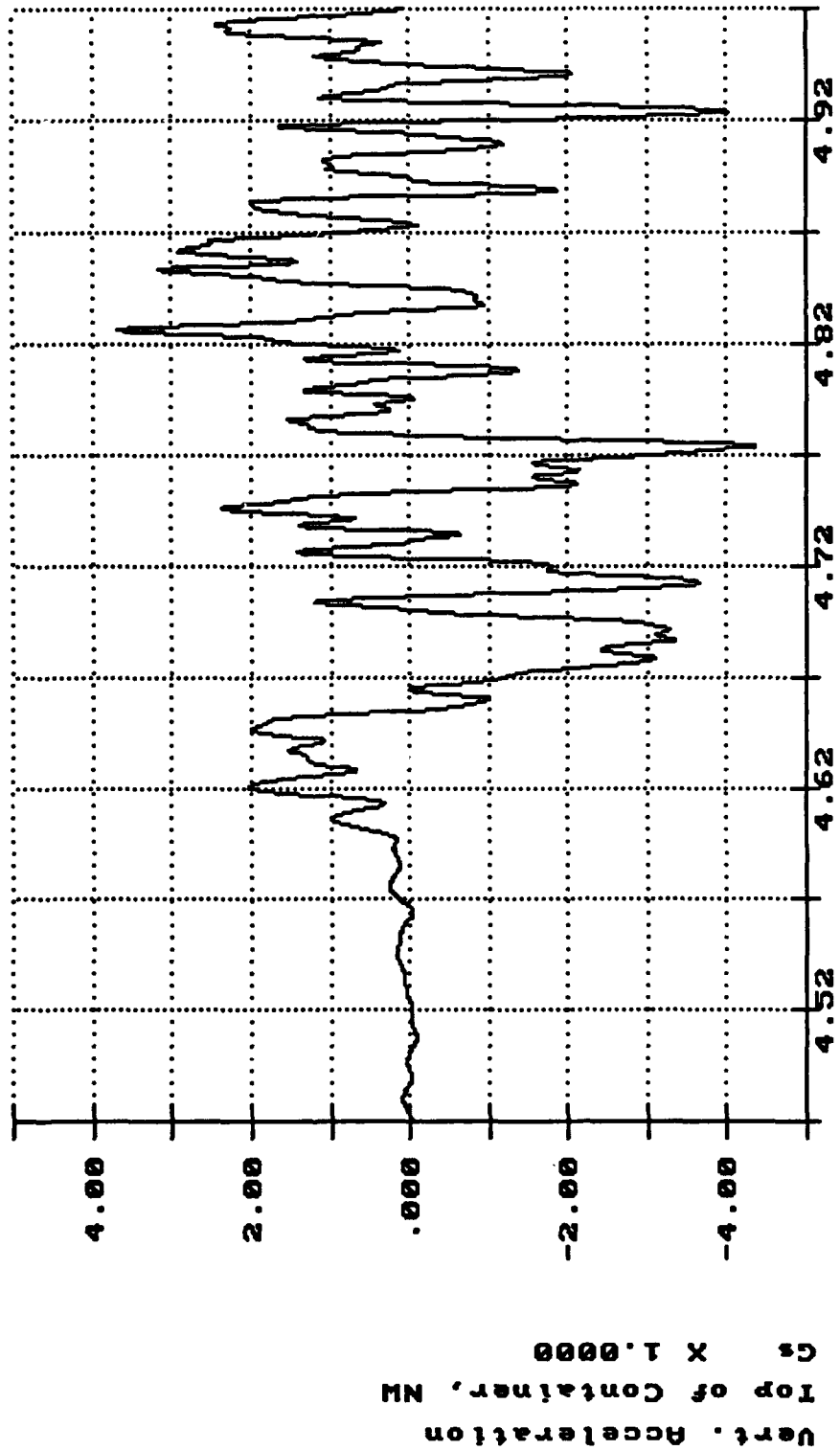

M923A1 TRUCK

| REVISION | |
|----------|-------------|
| NO. | DESCRIPTION |
| | |
| | |

| ACCELEROMETER POSITIONS | | |
|-------------------------|---------|--------------|
| LOCATION | CHANNEL | ORIENTATION |
| A | 7 | LONGITUDINAL |
| A | 8 | LATERAL |
| A | 9 | VERTICAL |
| B | 10 | LONGITUDINAL |
| B | 11 | VERTICAL |
| C | 4 | LONGITUDINAL |
| C | 5 | LATERAL |
| C | 6 | VERTICAL |
| D | 2 | LONGITUDINAL |
| D | 3 | VERTICAL |
| E | 1 | LONGITUDINAL |
| E | 1 | VERTICAL |

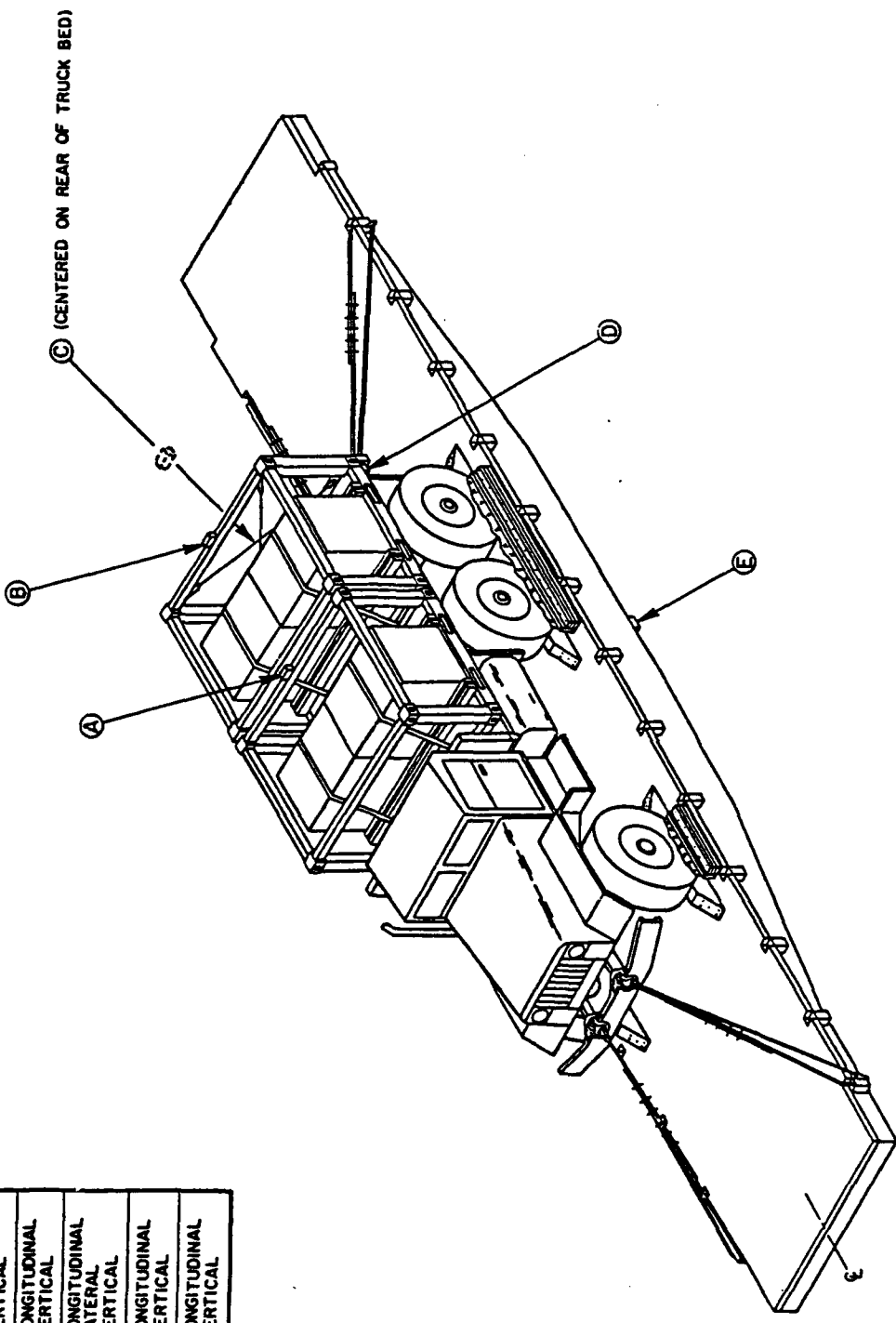

| | | | |
|---|------------------------------|--|-----------------|
| U.S. ARMY DEFENSE AMMUNITION CENTER & SCHOOL VALIDATION ENGINEERING DIVISION SAVANNA, ILLINOIS 61074-9639 | | TITLE U. S. M. C. CONTAINER TRANSPORTING CARGO TRUCK | |
| DRAFTSMAN TOM SIMMONS | TEST ENGINEER AL MCINTOSH | DWG. NO. 92-010-0-T00070 | SHEET 1 of 1 |
| CHIEF, VALIDATION ENGINEERING DIV. JEROME H. KROHN | | DATE 13 JULY 1992 | |

Anno Cert of USMC M923A1 Truck, Impact 1 Apr 01 10:16:04 1992

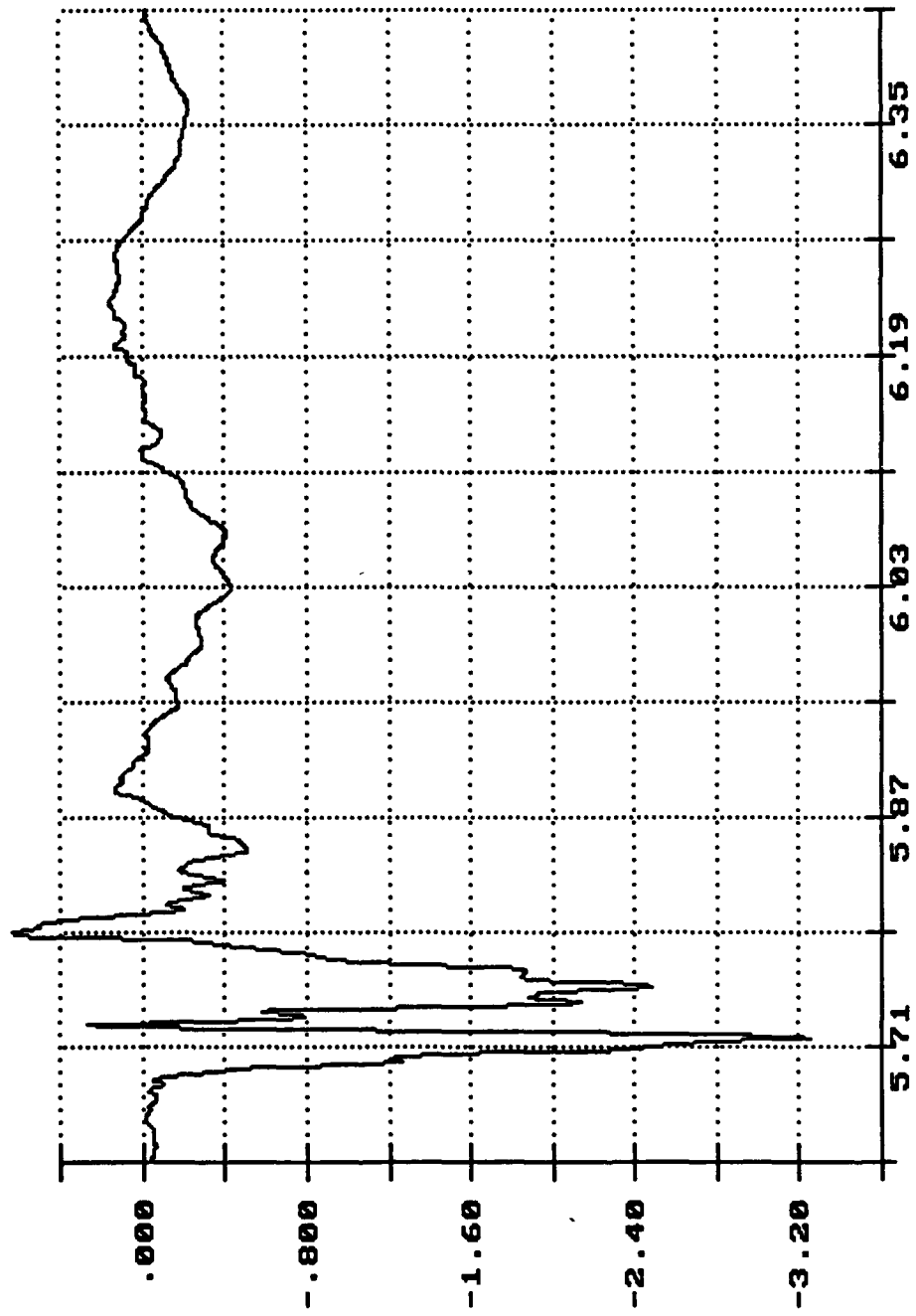

Long. Acceleration
Center Sill
Gs X 1.0000

Time of Sample

Seconds X 1.0000

Anno Cert of USMC M923A1 Truck, Impact 1 Apr 01 10:16:04 1992

7

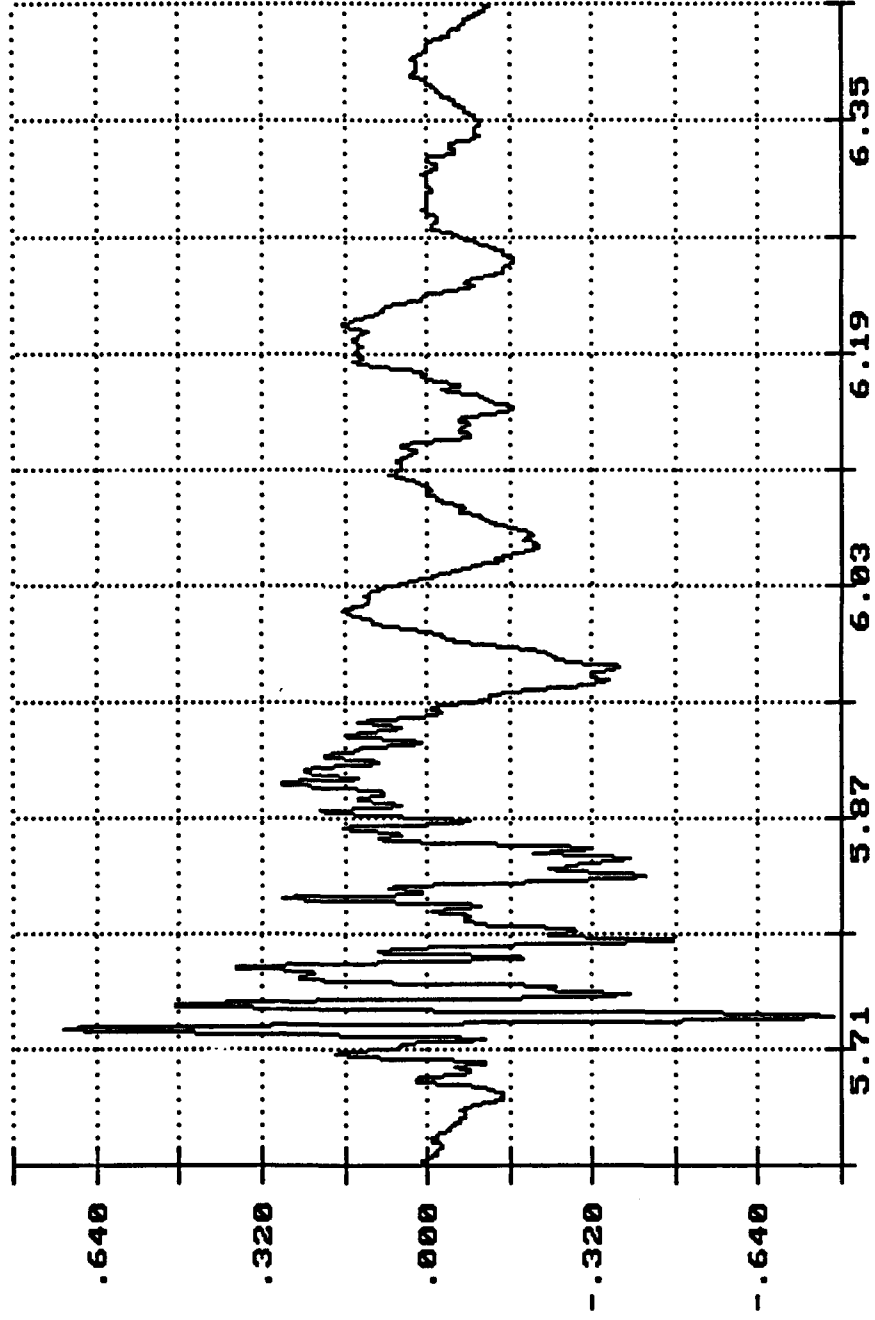

Vert. Acceleration
Center Sill
G's X 1.0000

Time of Sample

Seconds X 1.0000

Anno Cert of USMC M923A1 Truck, Impact 1 Apr 01 10:16:04 1992

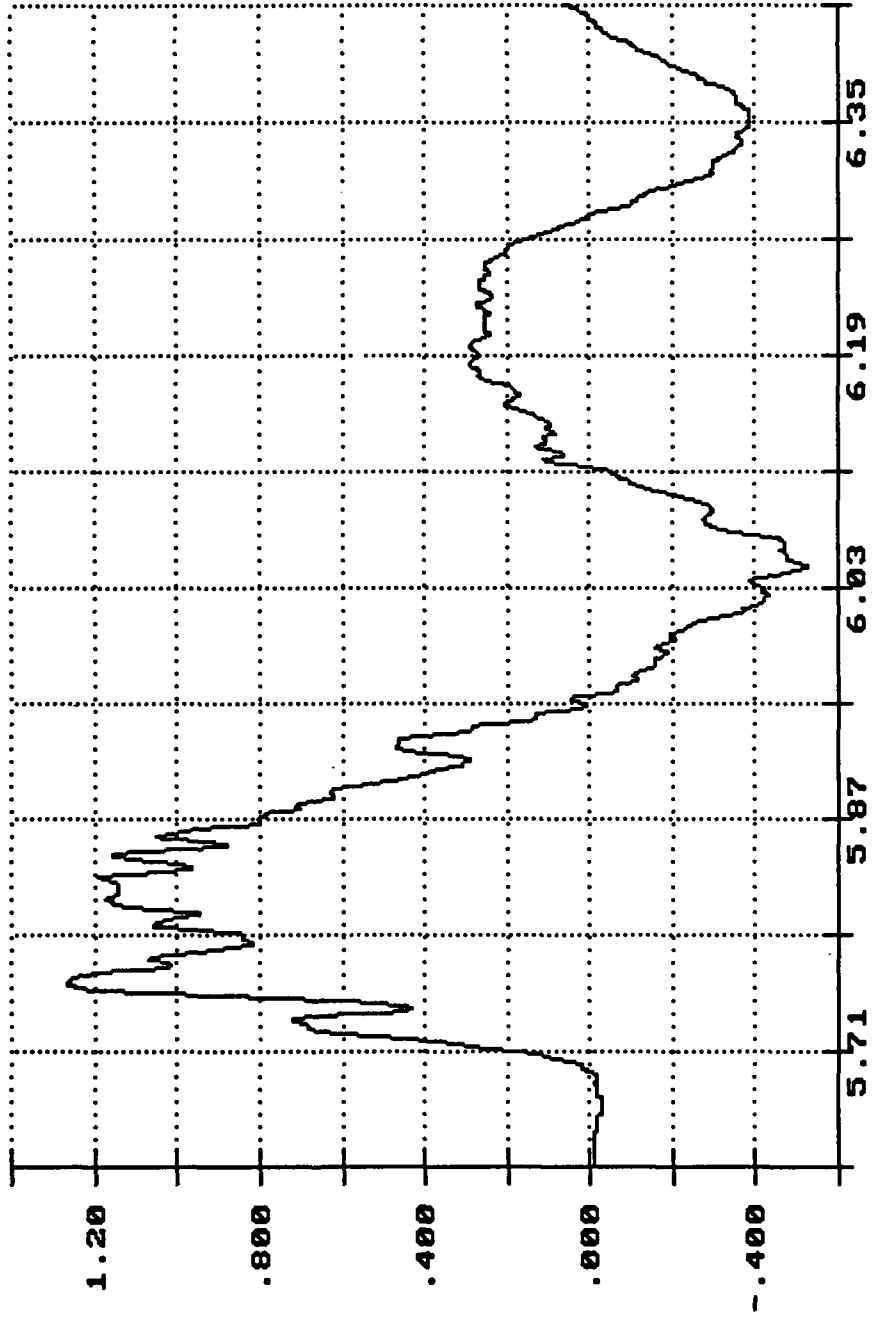

Long. Acceleration
Truck Frame
Gs X 1.0000

Time of Sample
Seconds X 1.0000

Anno Cert of USMC M923A1 Truck, Impact 1 Apr 01 10:16:04 1992

7

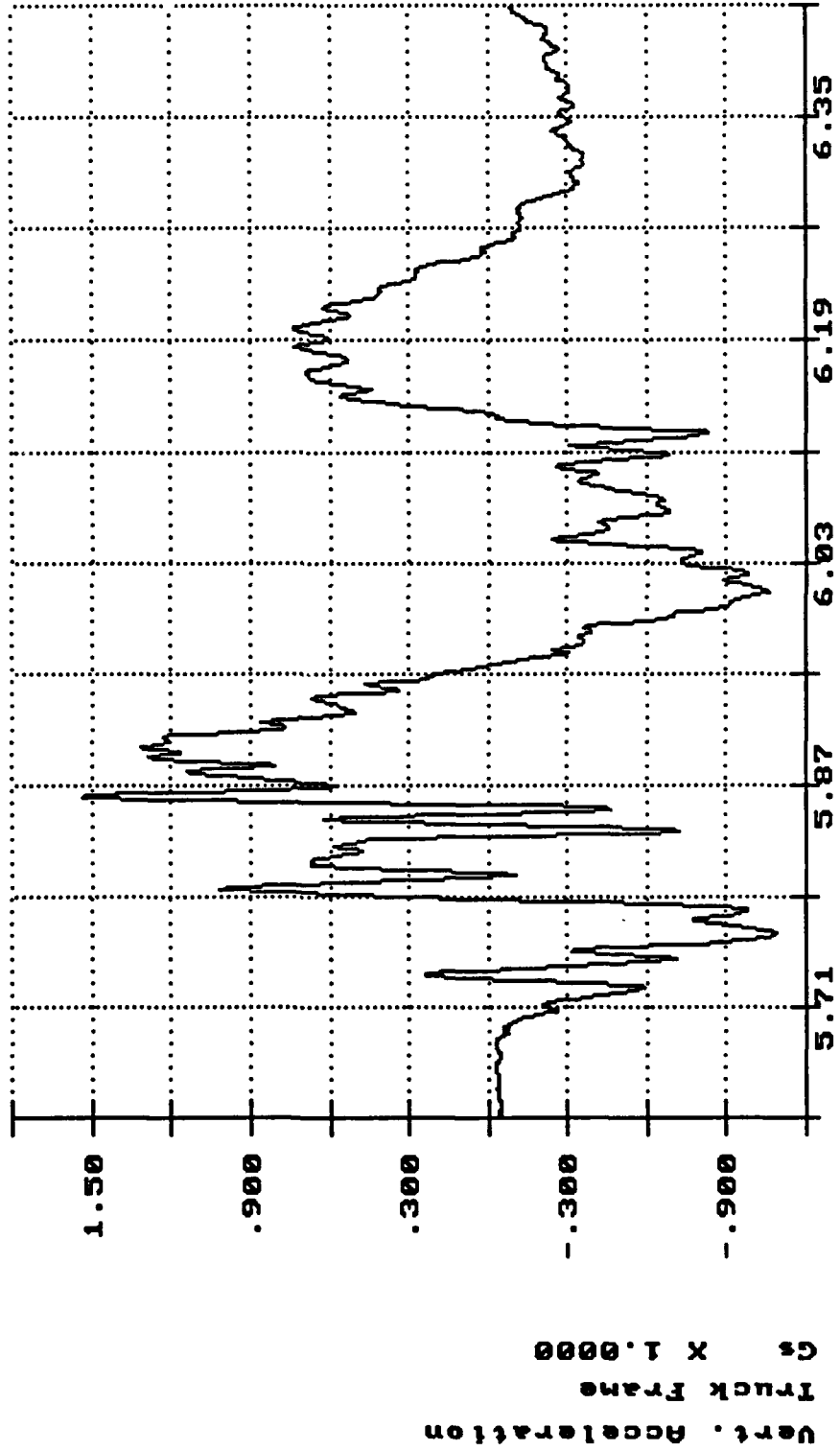

Anno Cert of USMC M923A1 Truck, Impact 1 Apr 01 10:16:04 1992

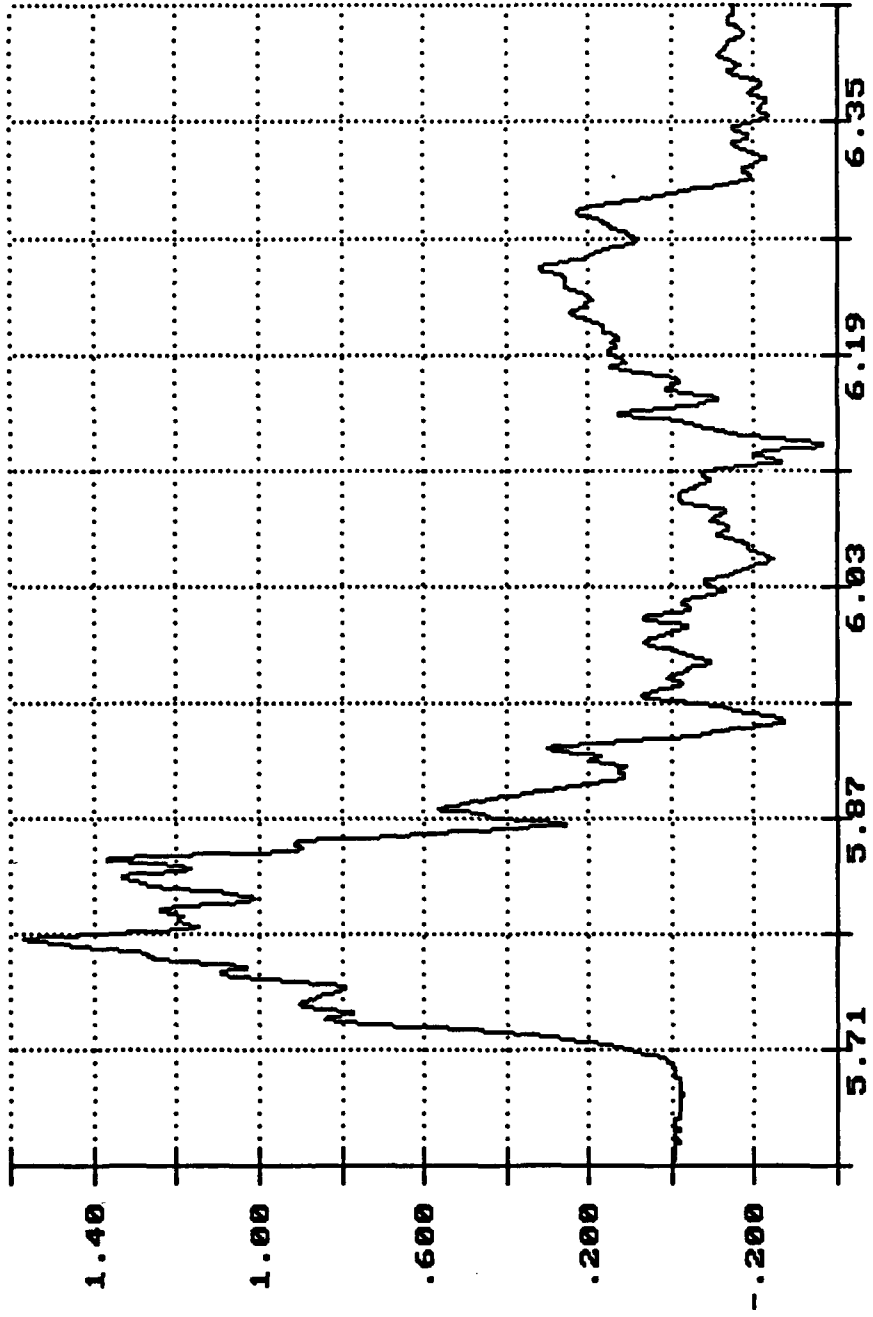

Long. Acceleration
Truck Bed
Gs X 1.0000

Time of Sample
Seconds X 1.0000

Amno Cart of USMC M923A1 Truck, Impact 1 Apr 01 10:16:04 1992

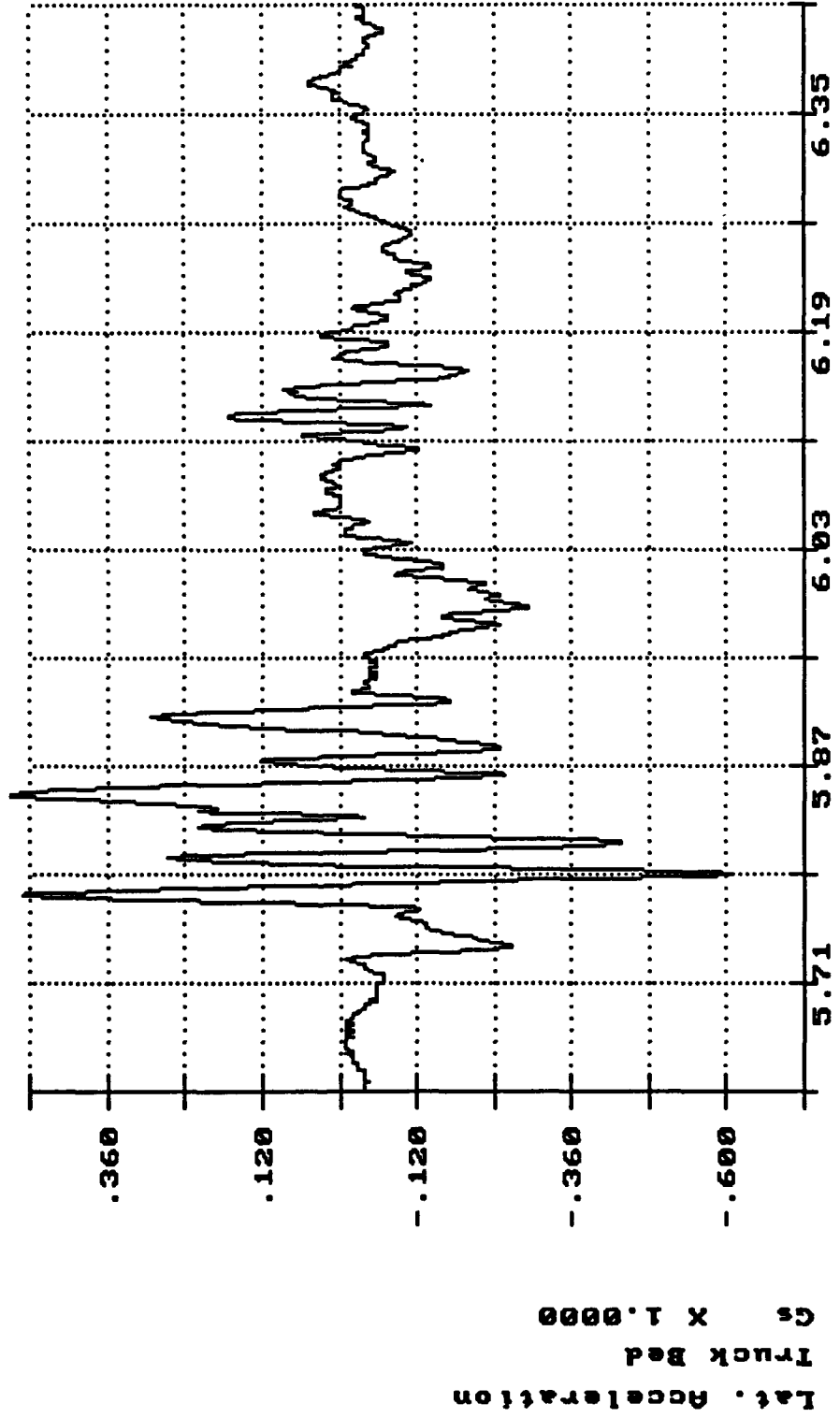

7

Anno Cert of USMC M923A1 Truck, Impact 1 Apr 01 10:16:04 1992

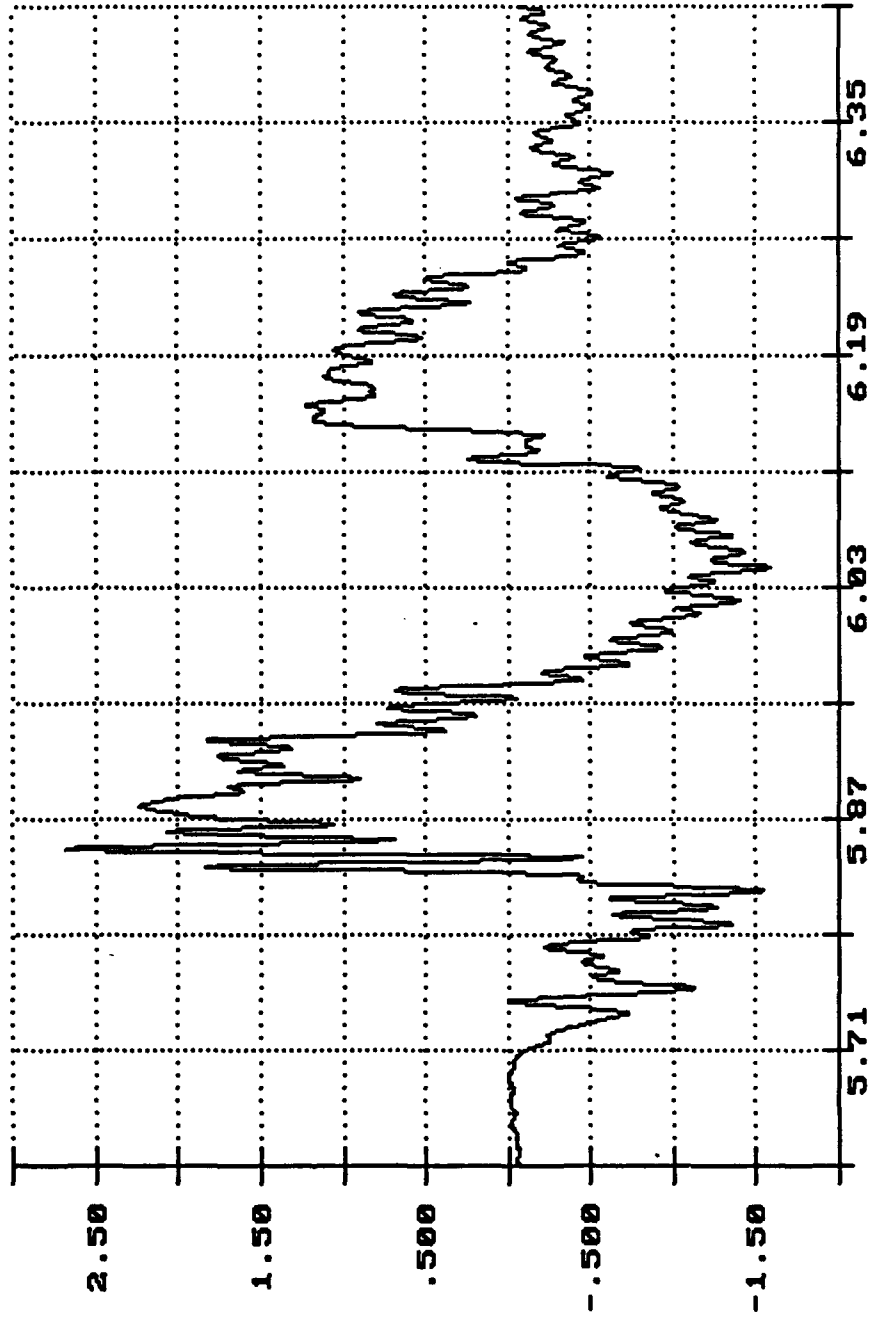

Time of Sample

Seconds X 1.0000

Anno Cert of USMC M923A1 Truck, Impact 1 Apr 01 10:16:04 1992

7

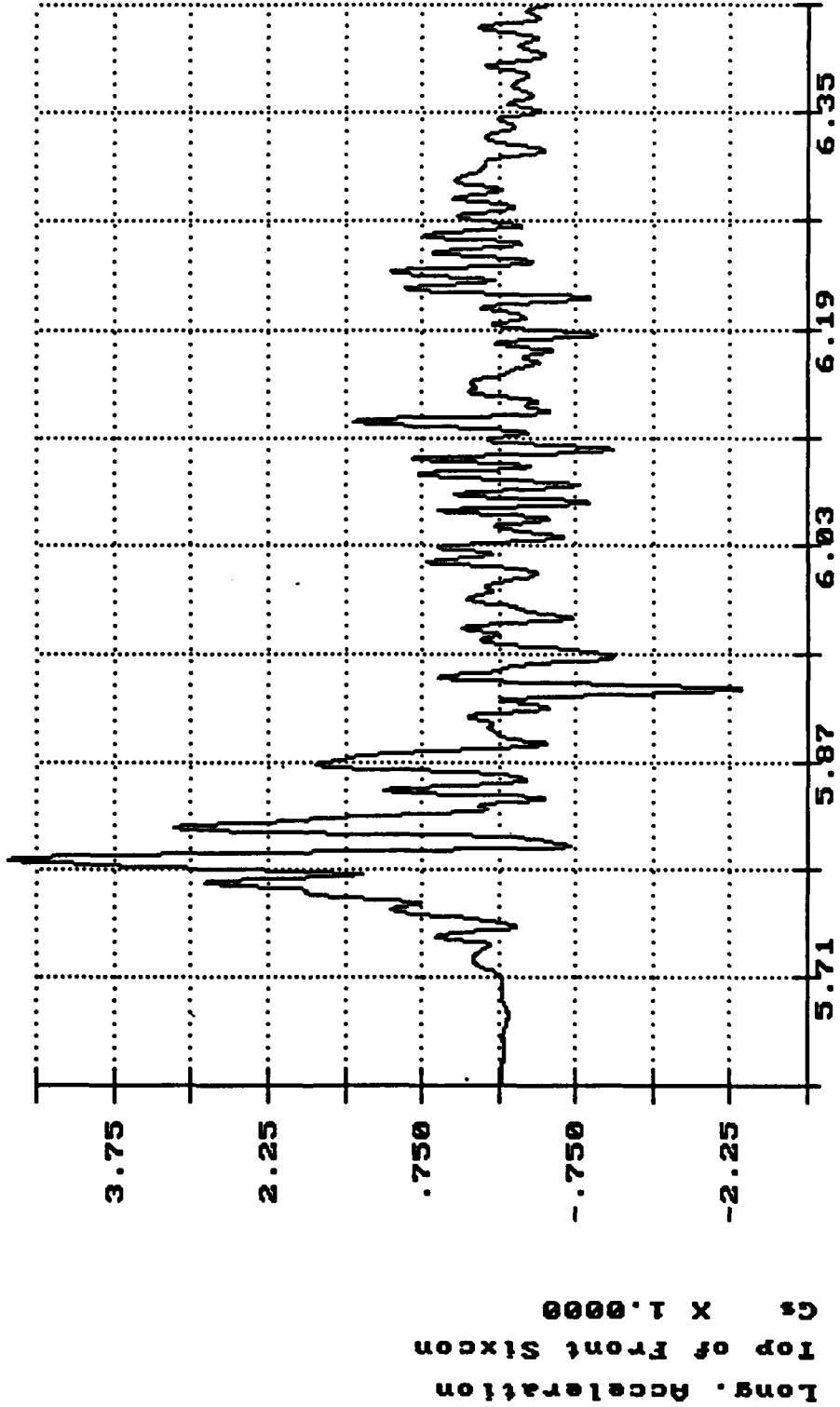

Long. Acceleration
Top of Front Sixcon
Gs X 1.0000

Time of Sample

Seconds X 1.0000

Anno Cert of USMC M923A1 Truck, Impact 1 Apr 01 10:16:04 1992

7

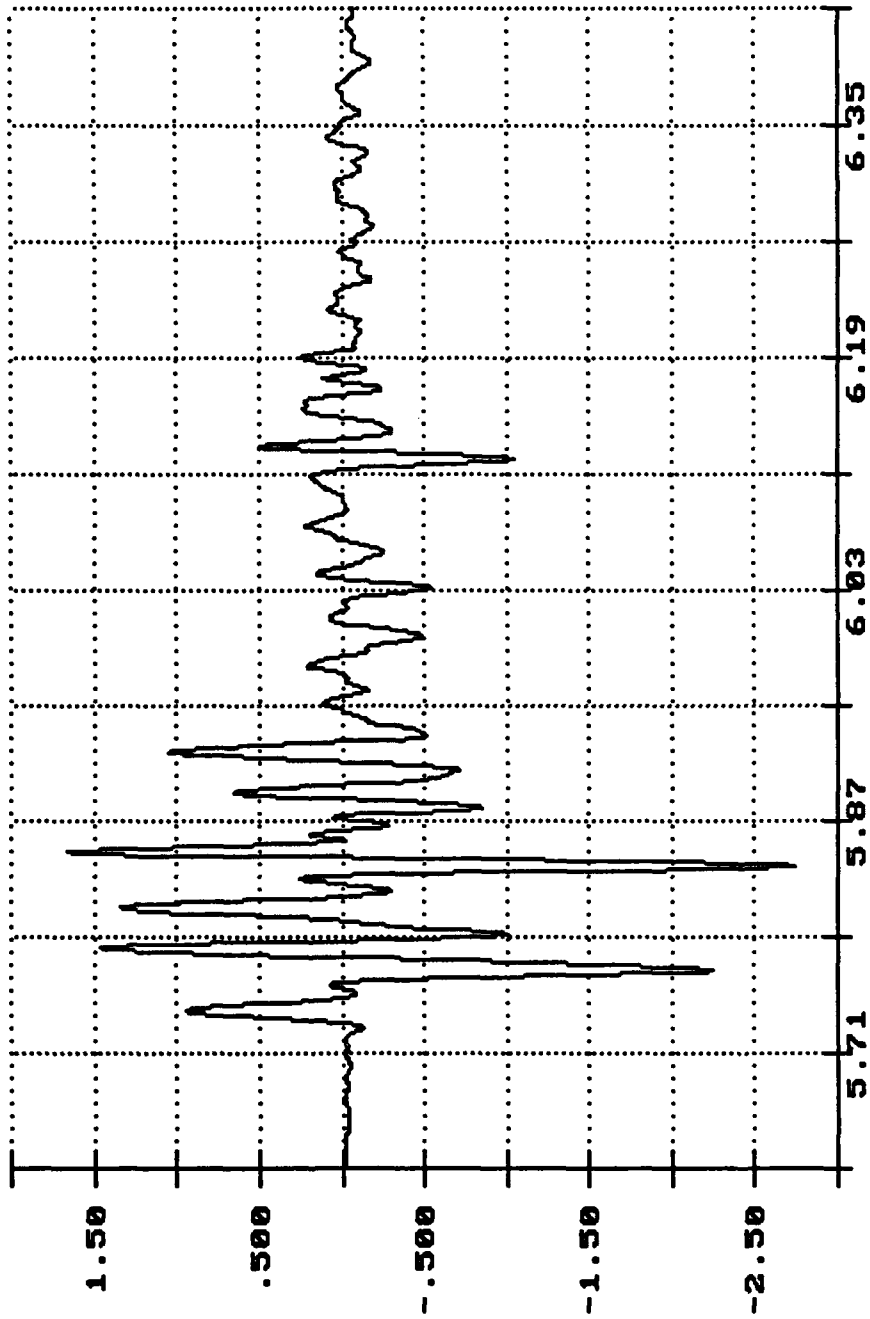

Lat. Acceleration
Top of Front Sixcon
Cs X 1.0000

Time of Sample
Seconds X 1.0000

Anno Cert of USMC M923A1 Truck, Impact 1 Apr 01 10:16:04 1992

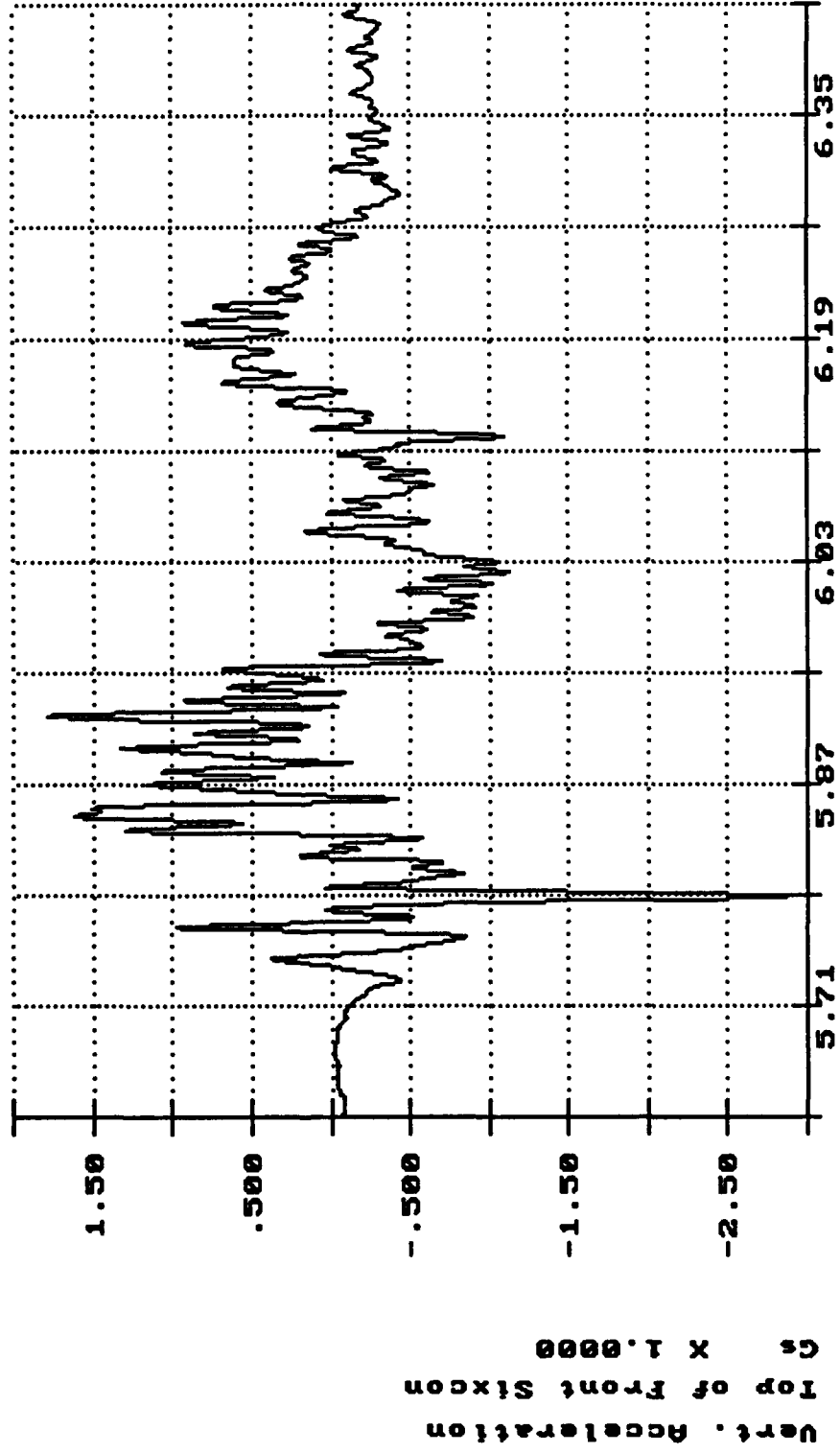

Time of Sample
Seconds X 1.0000

Anno Cert of USMC M923A1 Truck, Impact 1 Apr 01 10:16:04 1992

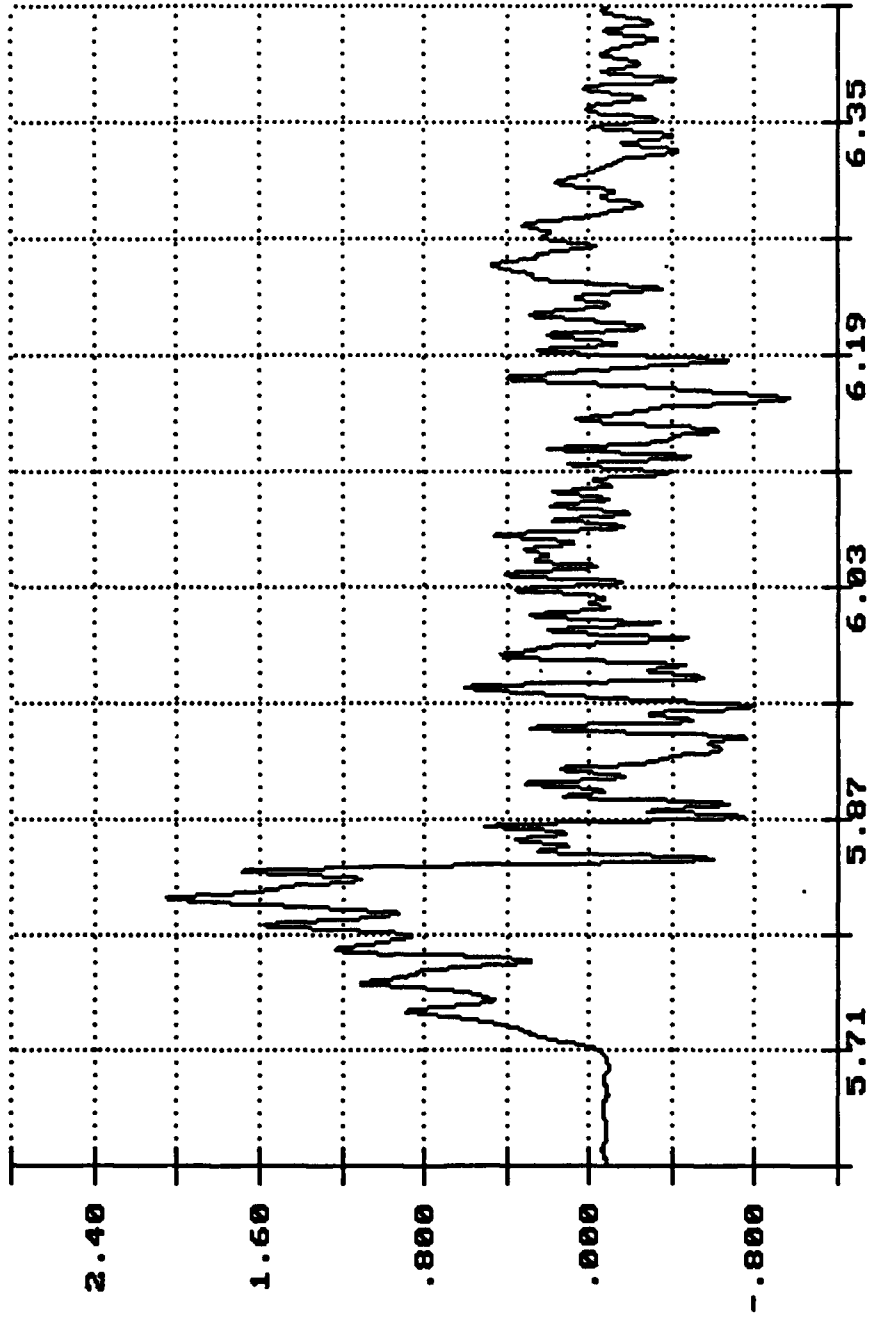

Long. Acceleration
Top of Rear Sixcon
Gs X 1.0000

Time of Sample

Seconds X 1.0000

Anno Cert of USMC M923A1 Truck, Impact 1 Apr 01 10:16:04 1992

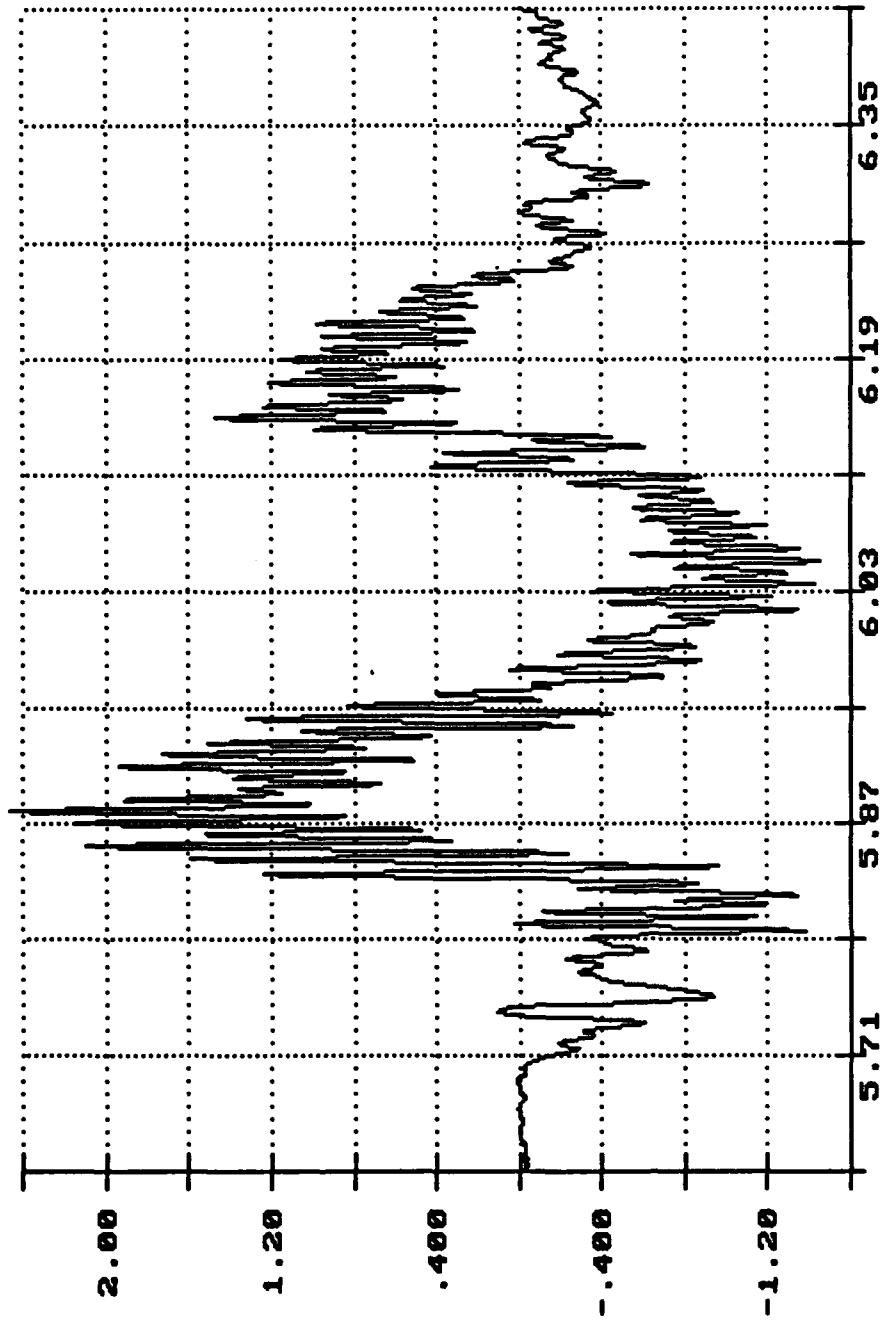

Vert. Acceleration
Top of Rear Sixcon
Gs X 1.0000

Time of Sample

Seconds X 1.0000

Anno Cert of USMC M923A1 Truck, Impact 2 Apr 01 10:23:59 1992

7

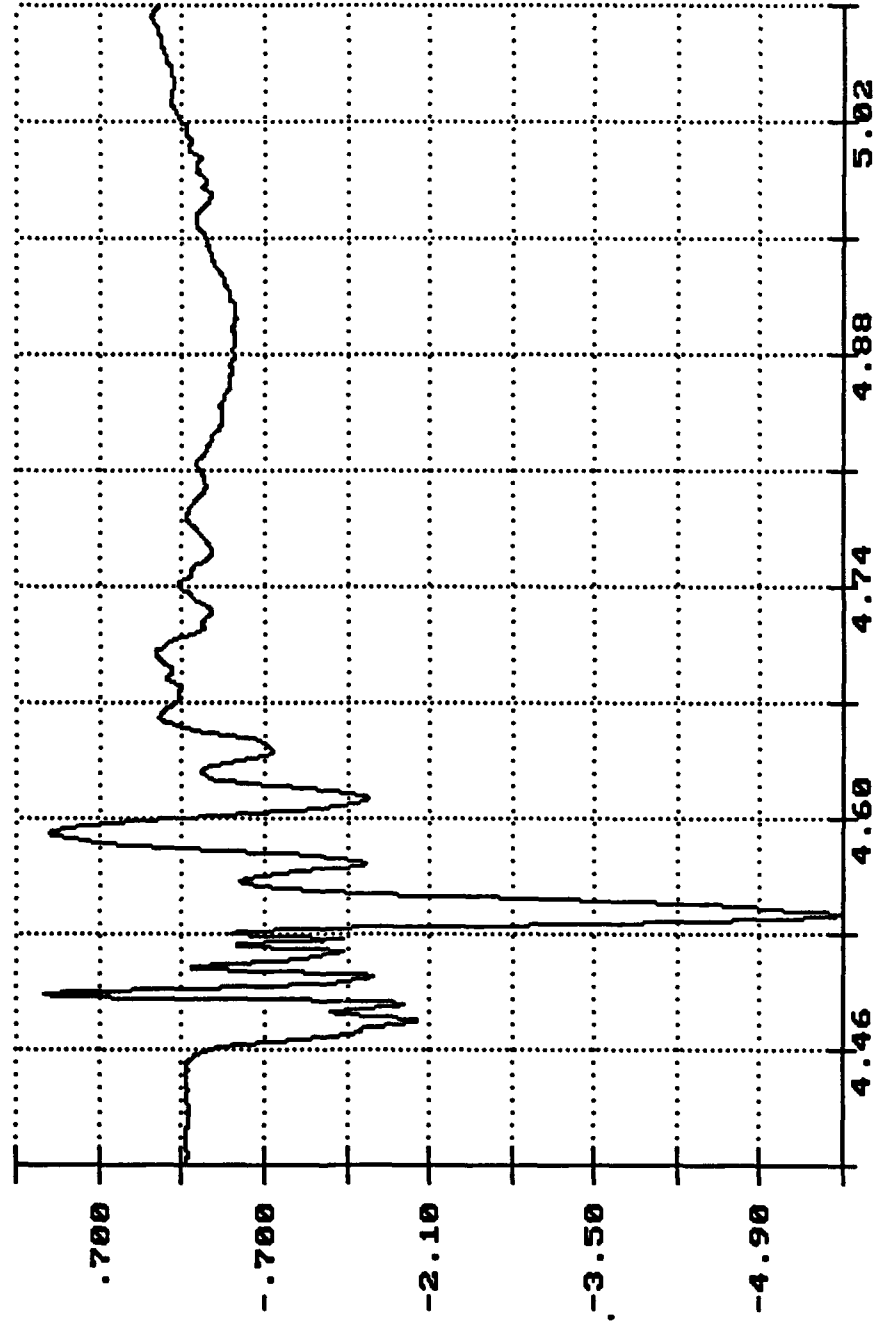

Long. Acceleration
Center Sill
Gs X 1.0000

Time of Sample

Seconds X 1.0000

Anno Cert of USMC M923A1 Truck, Impact 2 Apr 01 10:23:59 1992

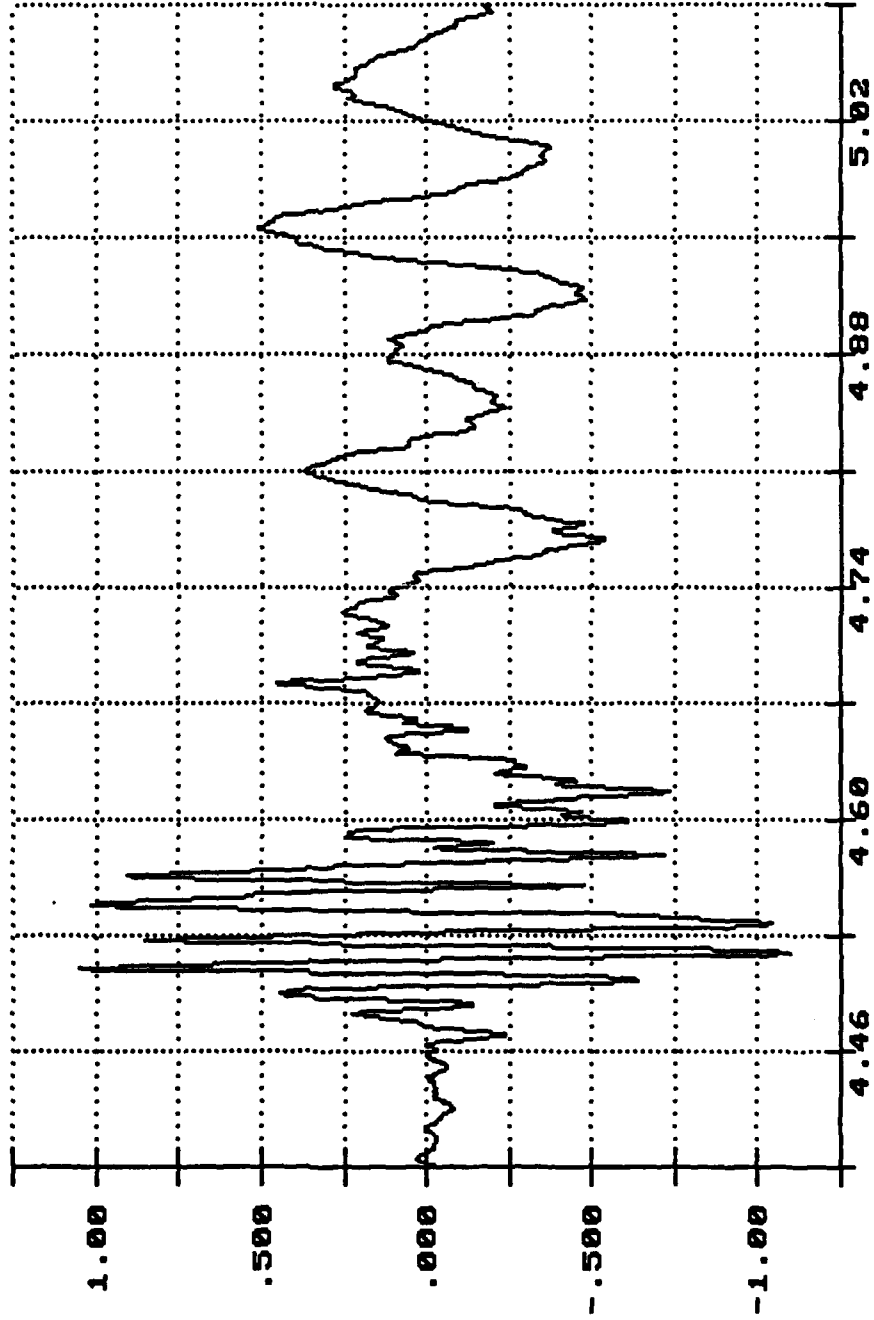

Vert. Acceleration
Center Sill
Gs X 1.0000

Time of Sample

Seconds X 1.0000

7
Anno Cert of USMC M923A1 Truck, Impact 2 Apr 01 10:23:59 1992

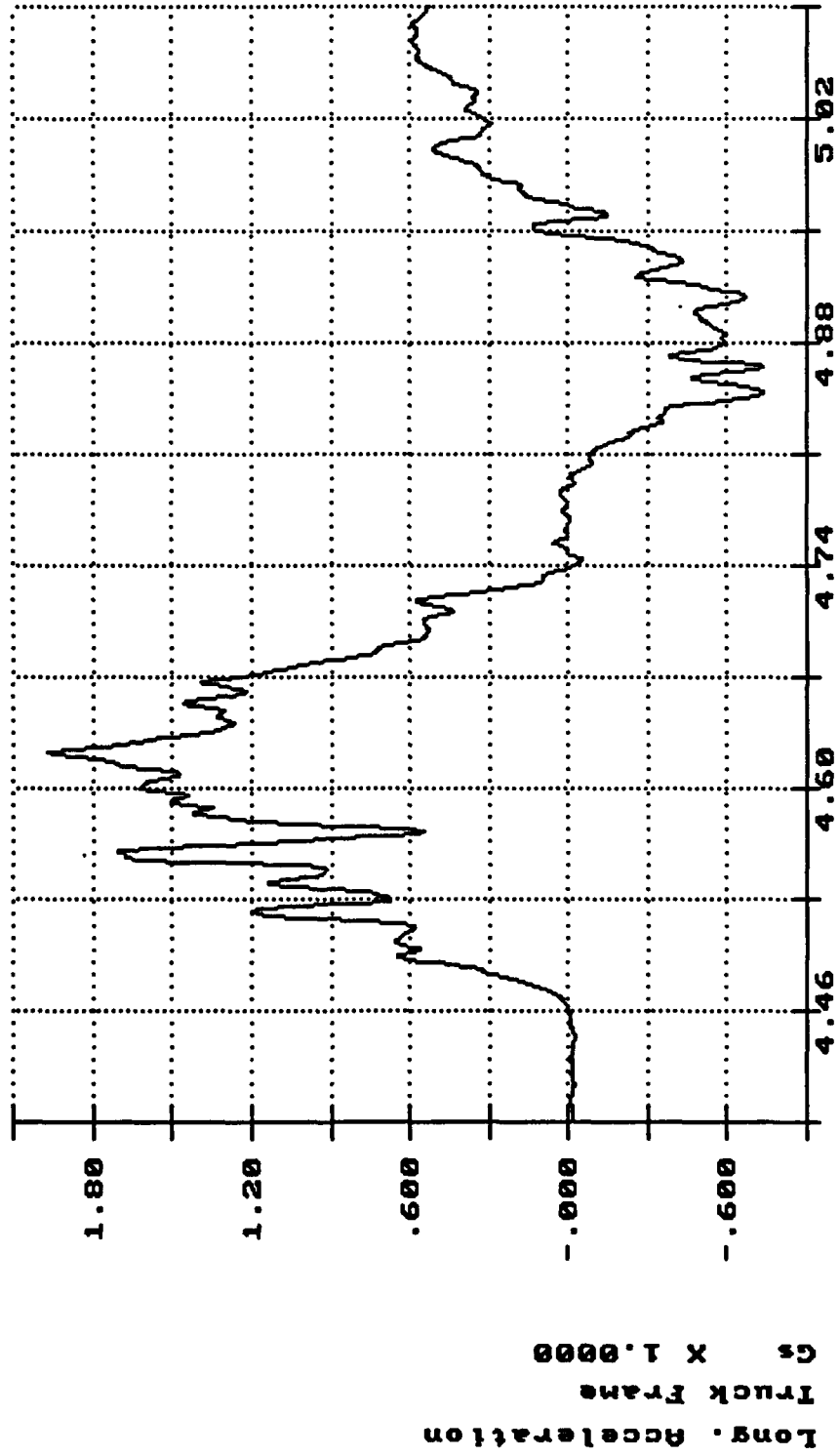

Time of Sample

Seconds X 1.0000

7

Anno Cert of USMC M923A1 Truck, Impact 2 Apr 01 10:23:59 1992

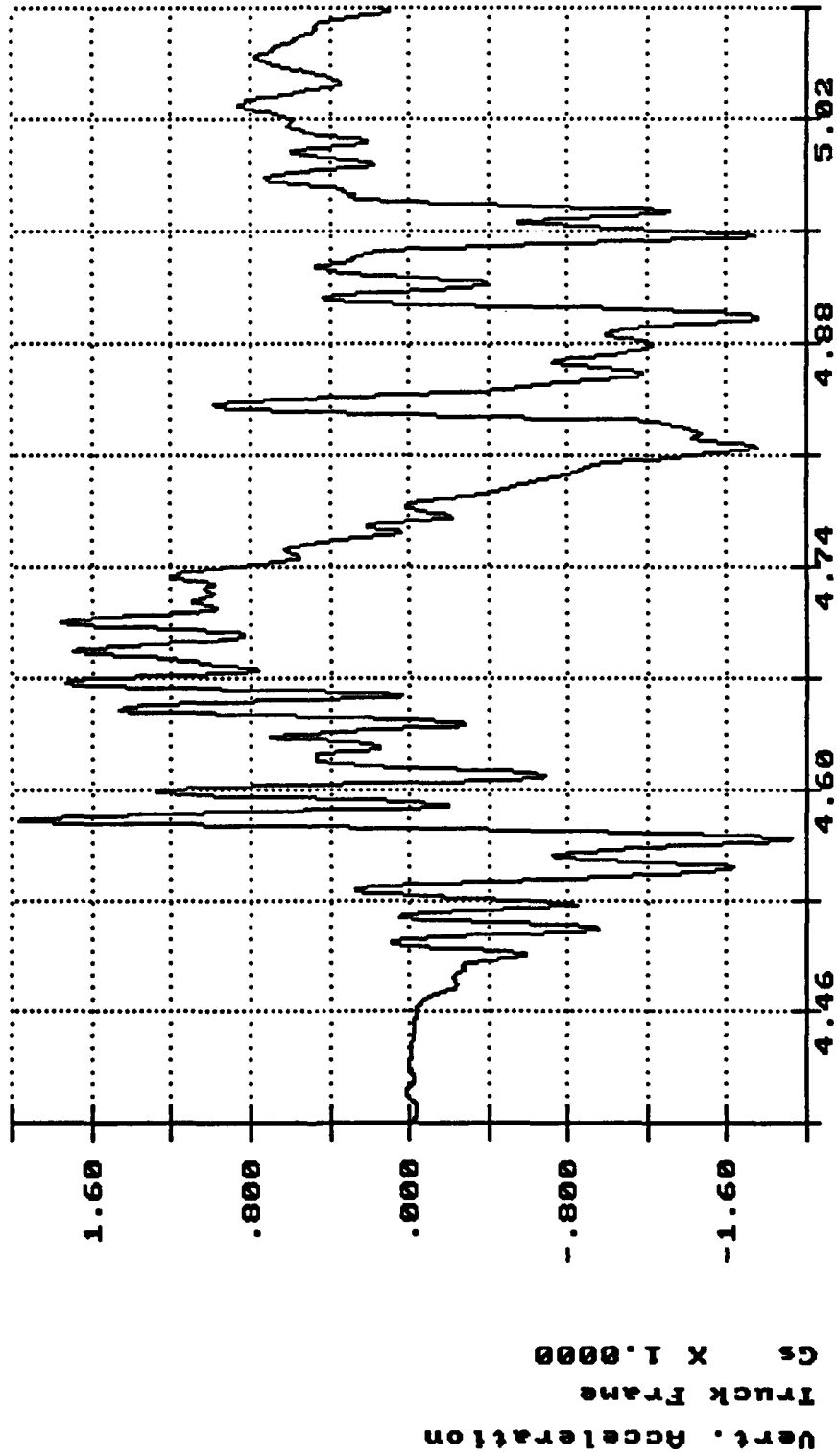

7
Anno Cert of USMC M923A1 Truck, Impact 2 Apr 01 10:23:59 1992

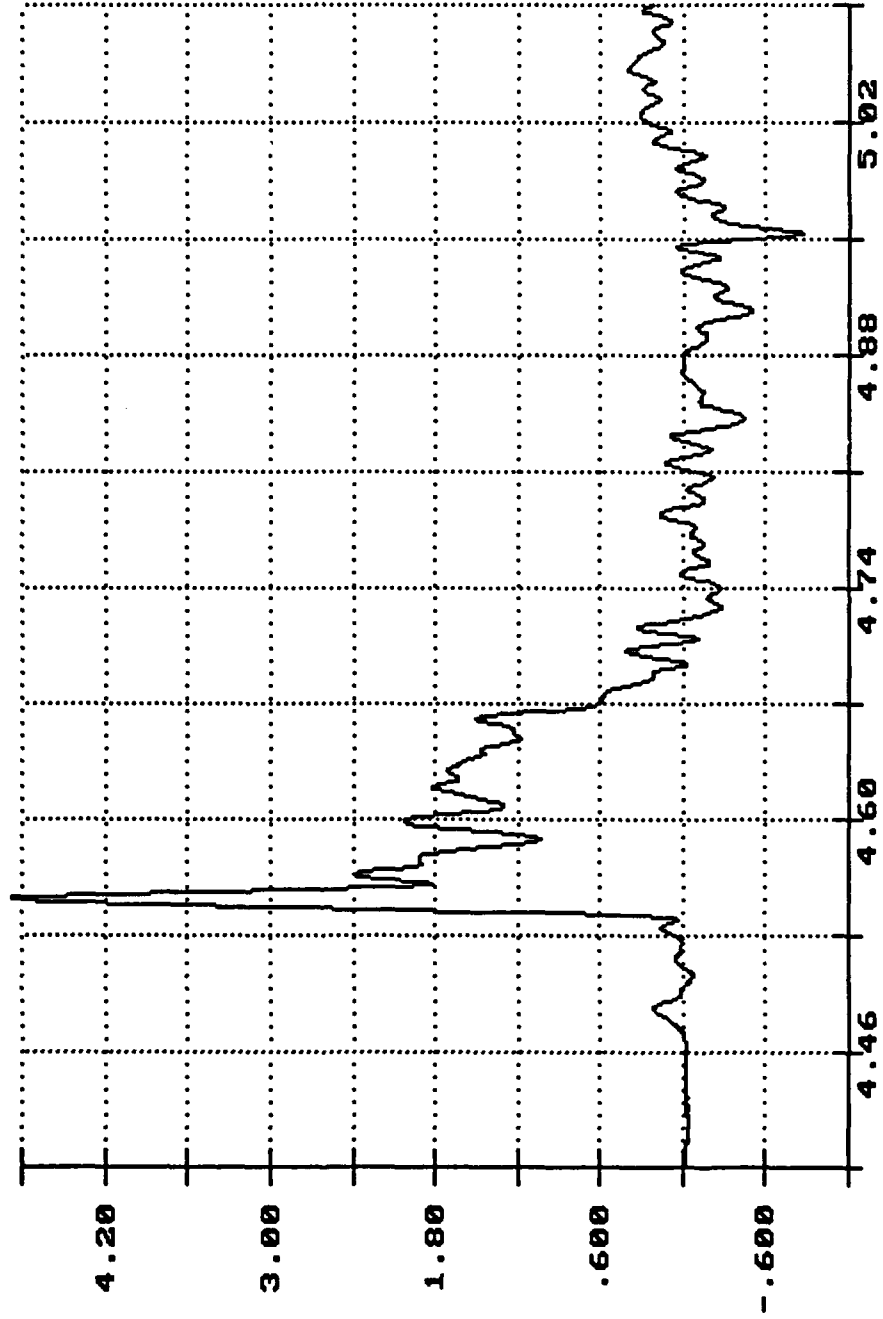

Long. Acceleration
Truck Bed
Gs X 1.0000

Time of Sample
Seconds X 1.0000

Anno Cert of USMC M923A1 Truck, Impact 2 Apr 01 10:23:59 1992

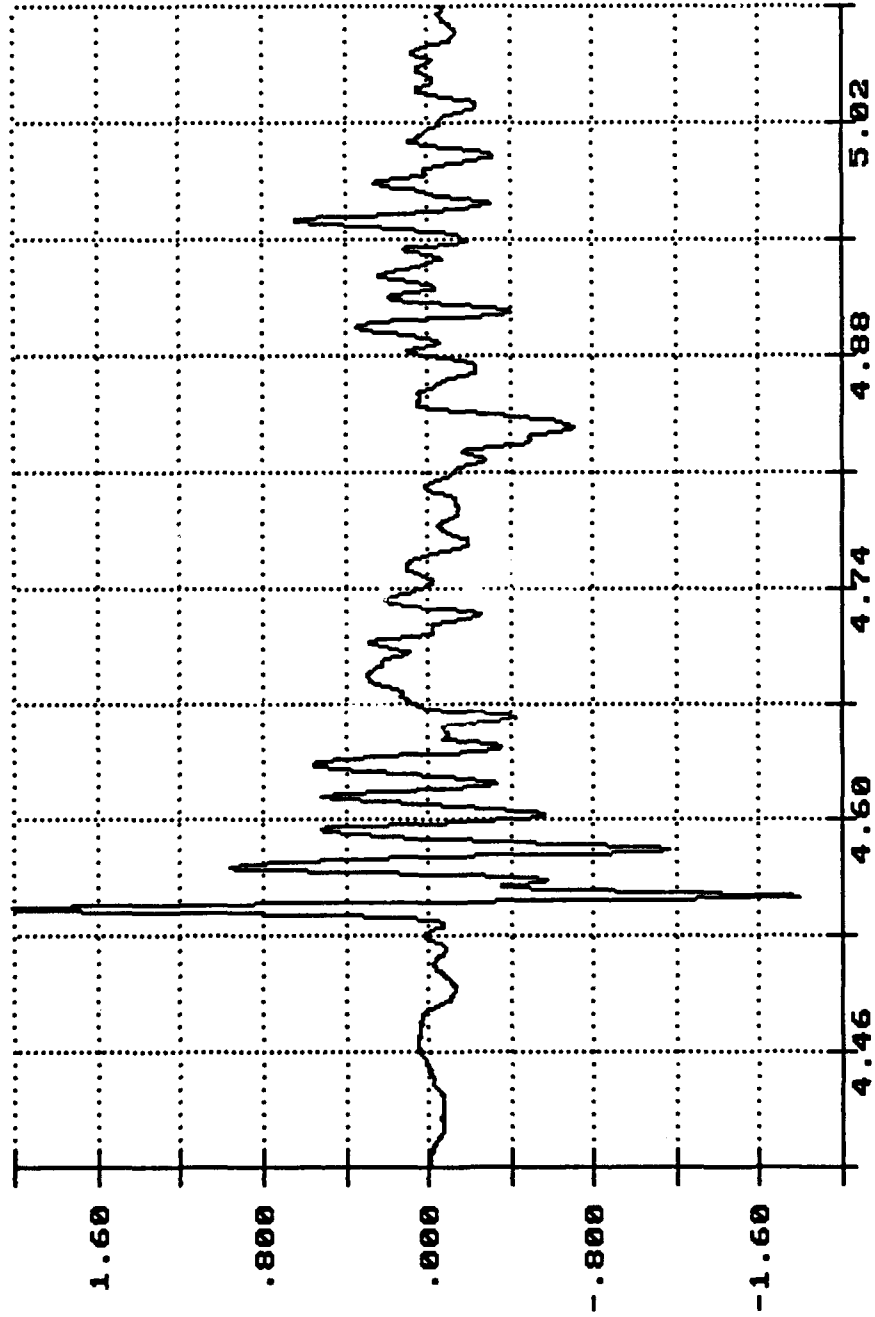

Lat. Acceleration
Truck Bed
Gs X 1.0000

Time of Sample

Seconds X 1.0000

Anno Cert of USMC M923A1 Truck, Impact 2 Apr 01 10:23:59 1992

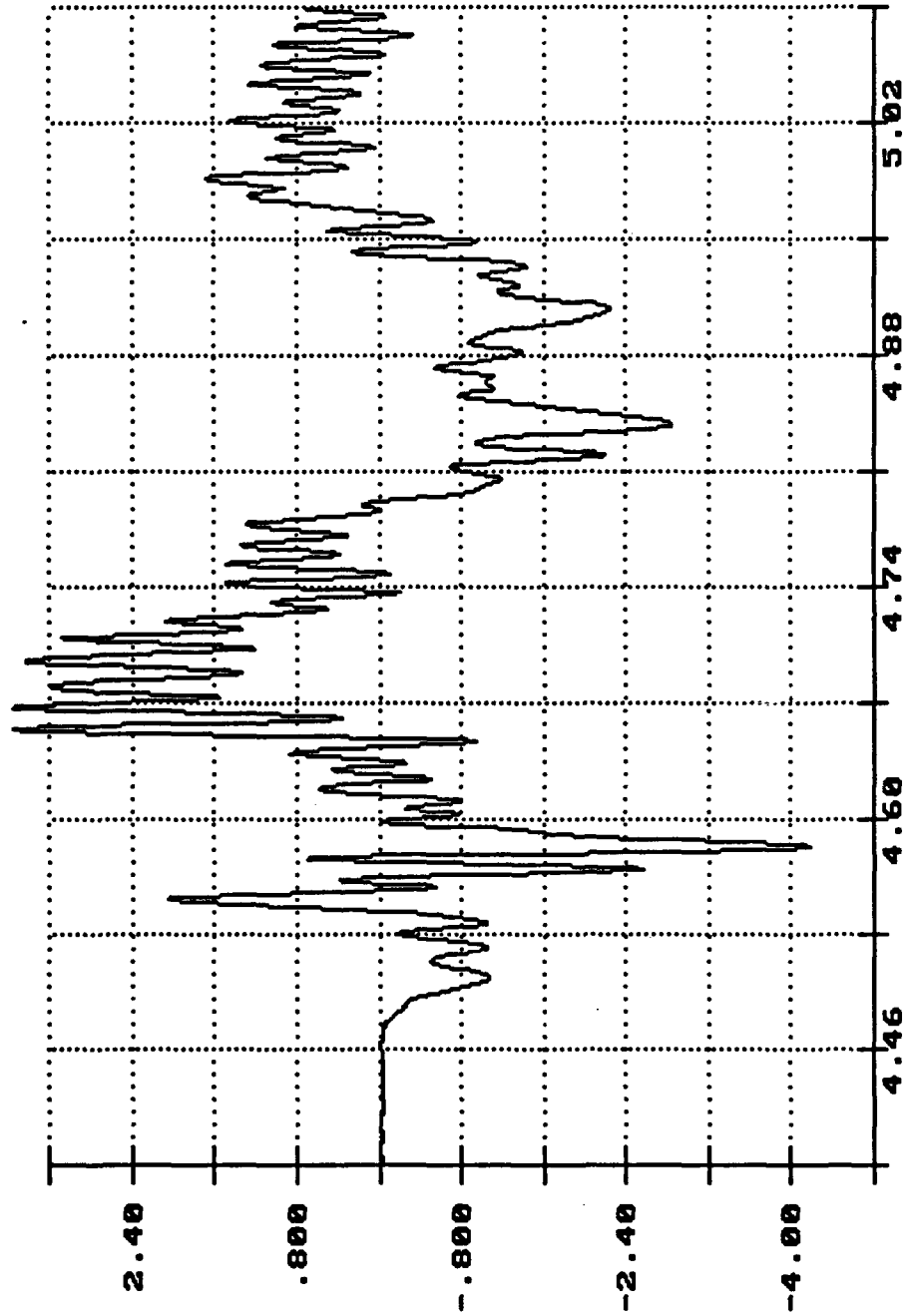

Time of Sample
Seconds X 1.0000

Anno Cert of USMC M923A1 Truck, Impact 2 Apr 01 10:23:59 1992

7

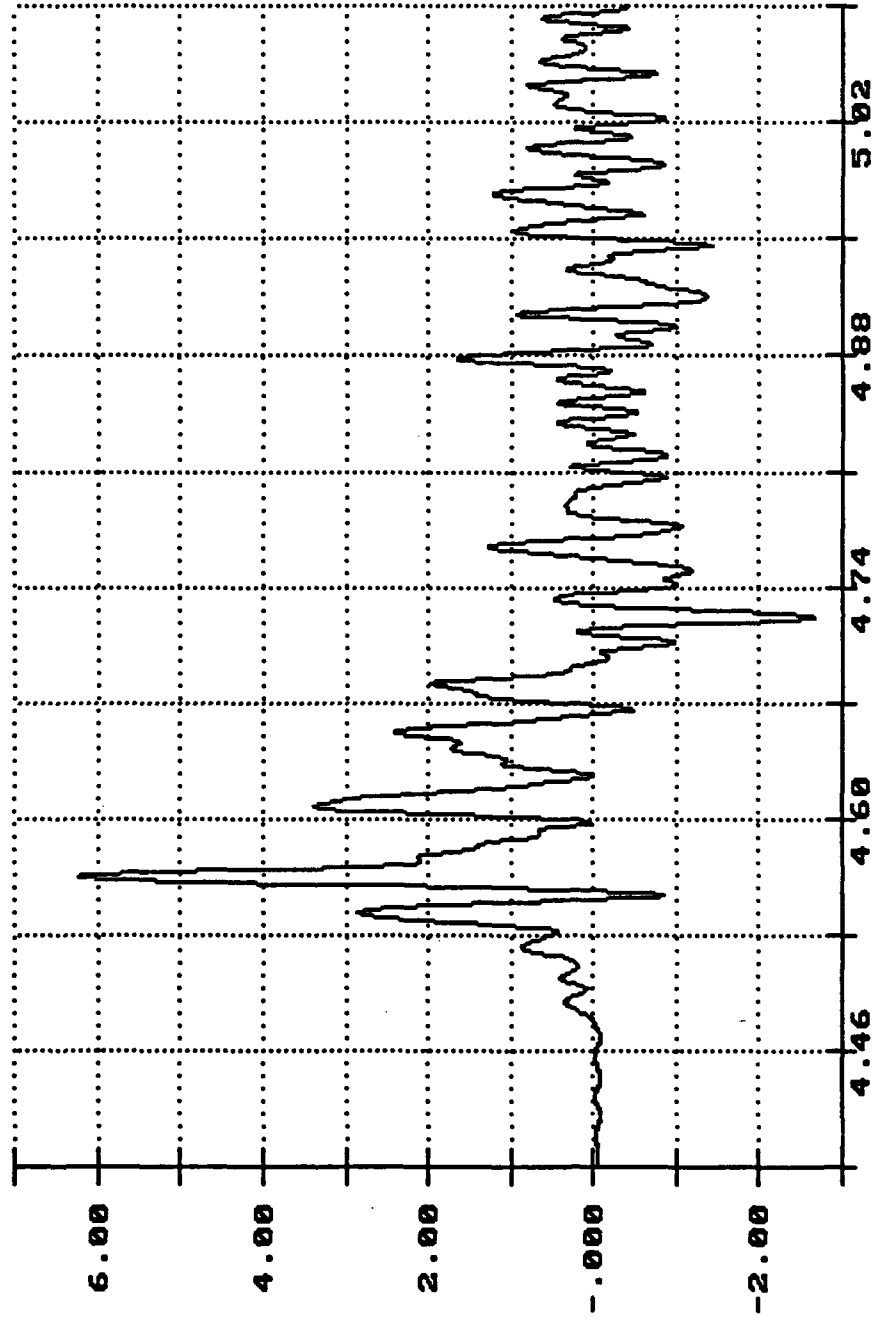

Long. Acceleration
Top of Front Sixcon
Gs X 1.0000

Time of Sample

Seconds X 1.0000

Amno Cert of USMC M923A1 Truck, Impact 2 Apr 01 10:23:59 1992

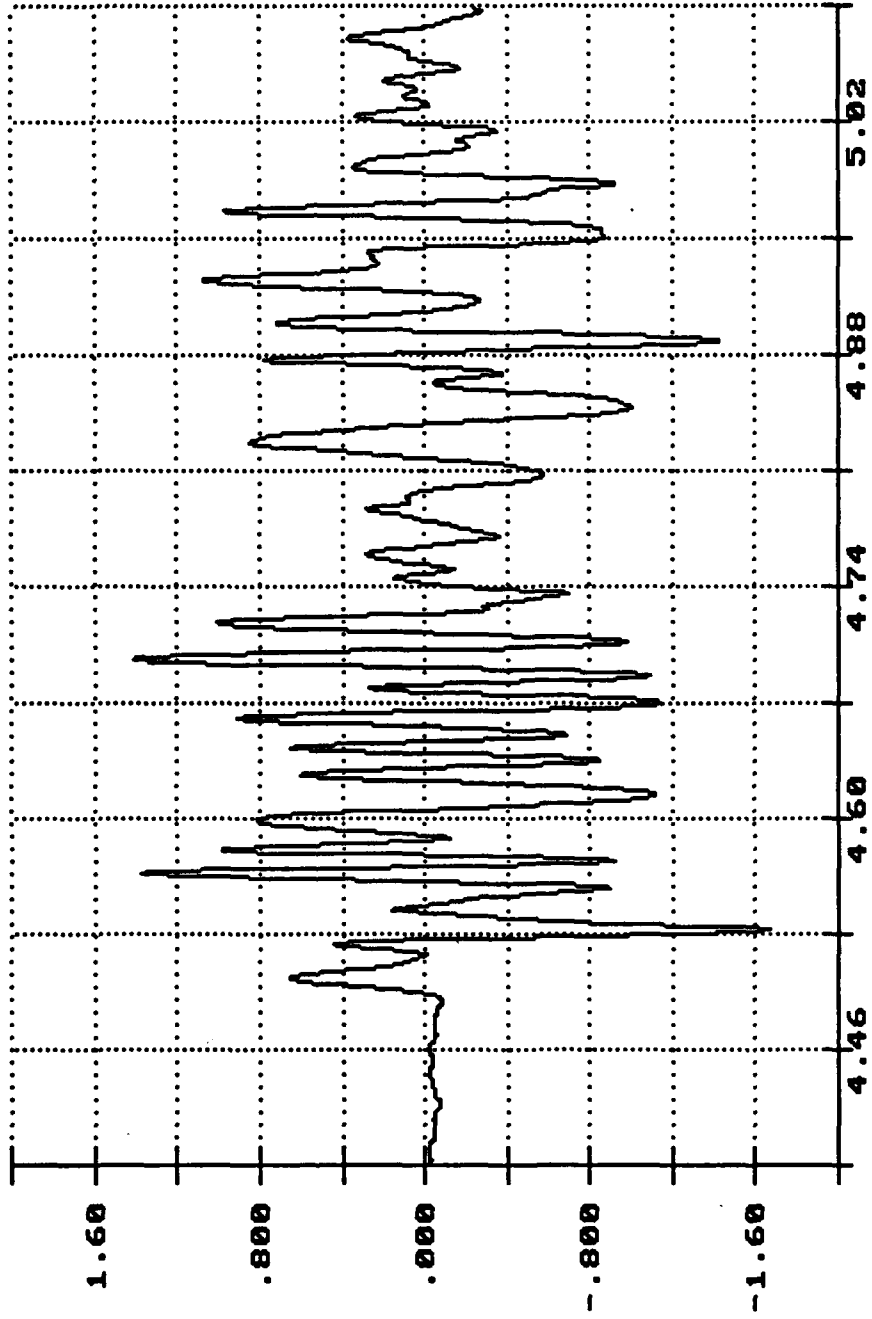

Time of Sample

Seconds X 1.0000

Lat. Acceleration
Gs X 1.0000
Top of Front Sixcon

Ammo Cert of USMC M923A1 Truck, Impact 2 Apr 01 10:23:59 1992

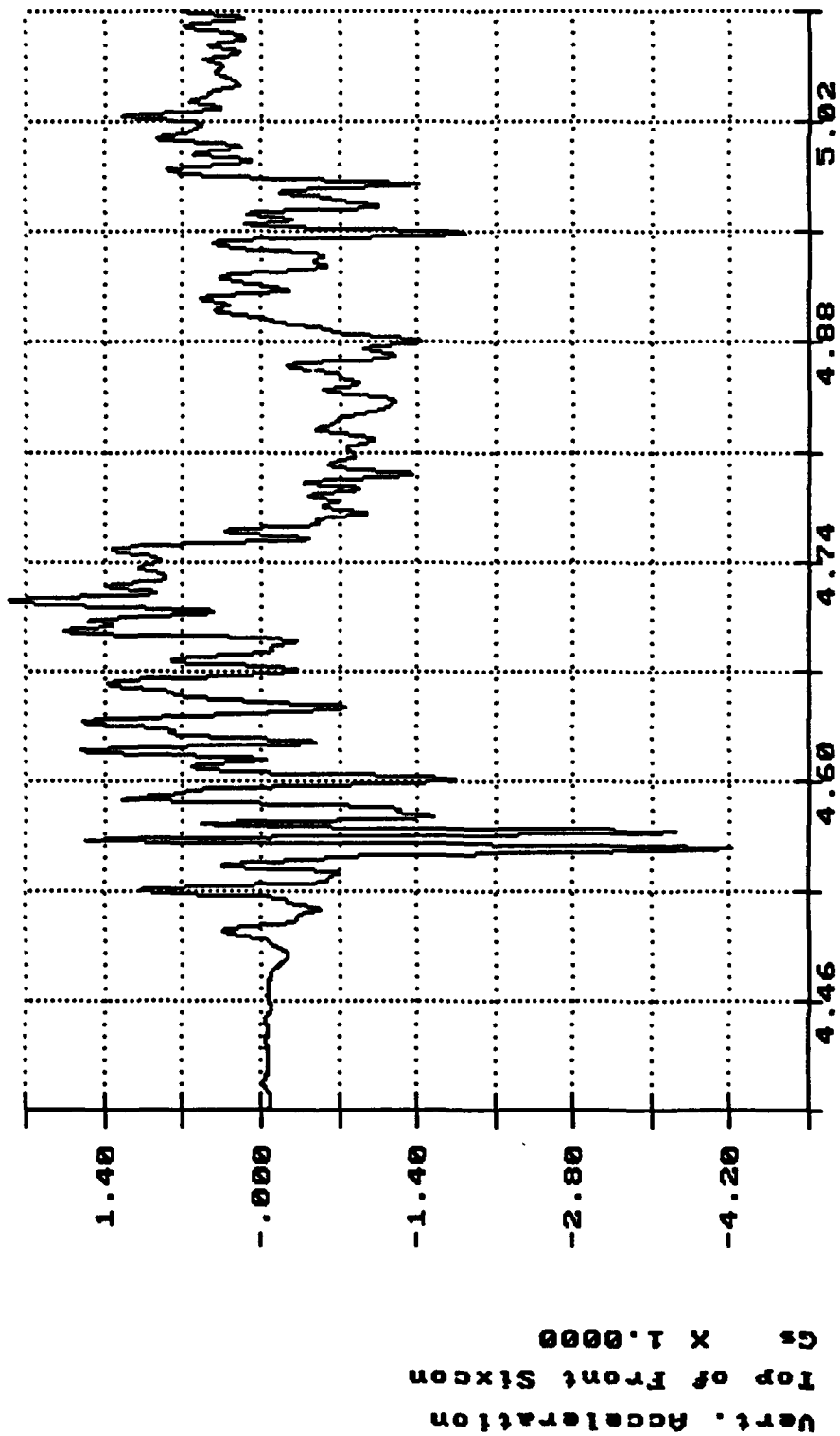

Time of Sample

Seconds X 1.0000

Anno Cert of USMC M923A1 Truck, Impact 2 Apr 01 10:23:59 1992

7

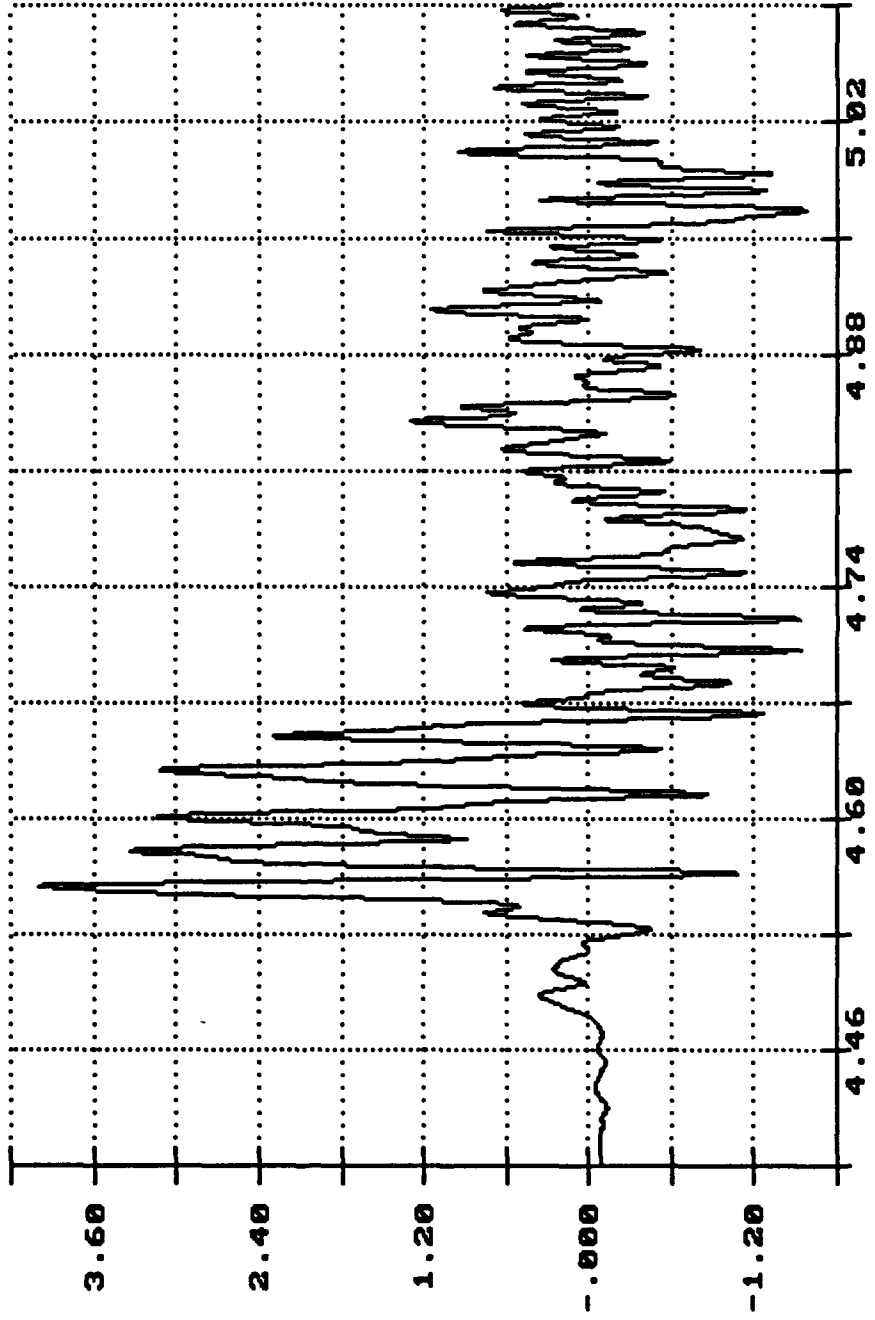

Long. Acceleration
Top of Rear Sixcon
Gs X 1.0000

Time of Sample

Seconds X 1.0000

Anno Cert of USMC M923A1 Truck, Impact 2 Apr 01 10:23:59 1992

7

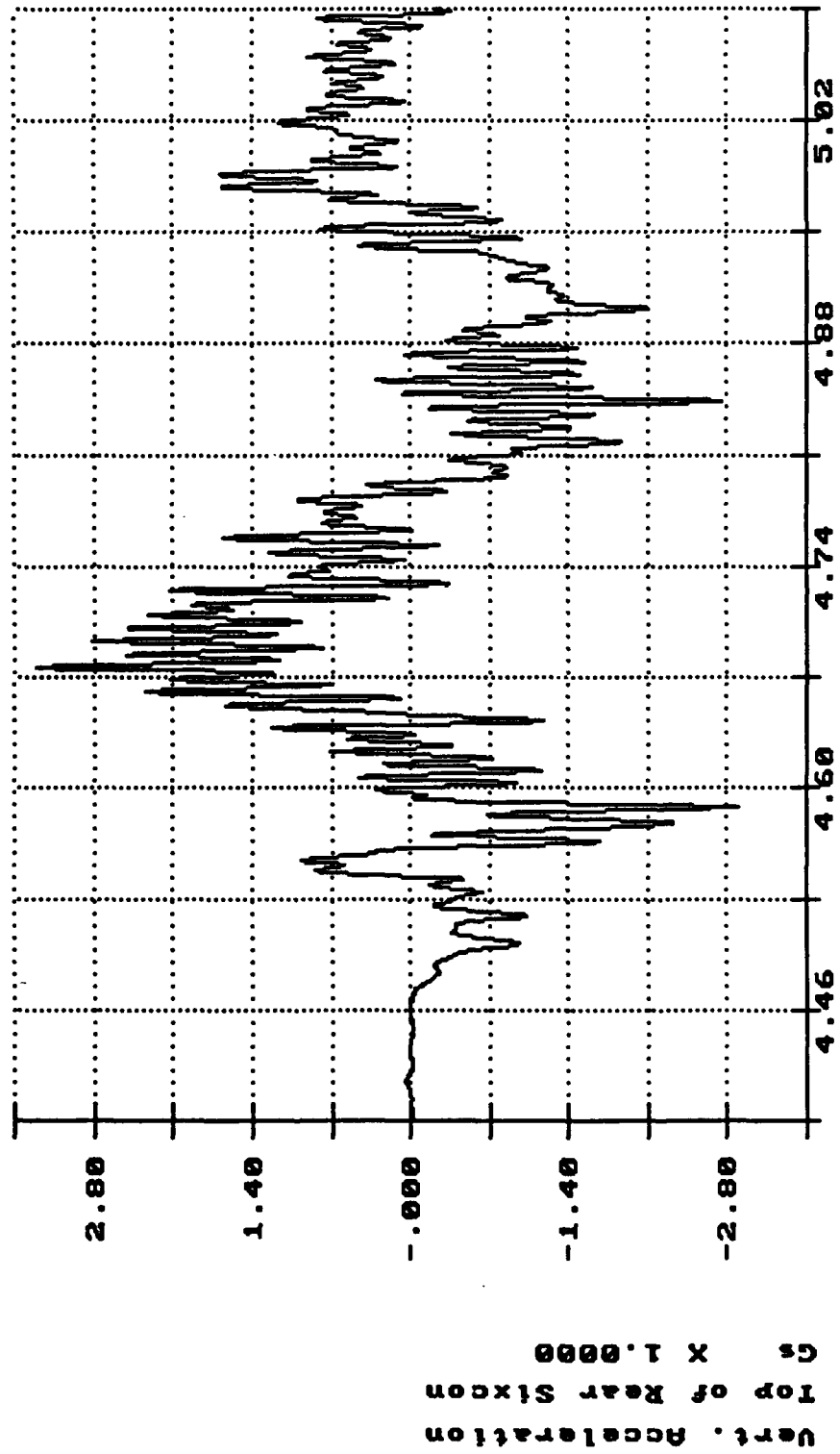

Anno Cert of USMC M923A1 Truck, Impact 3 Apr 01 10:31:37 1992

7

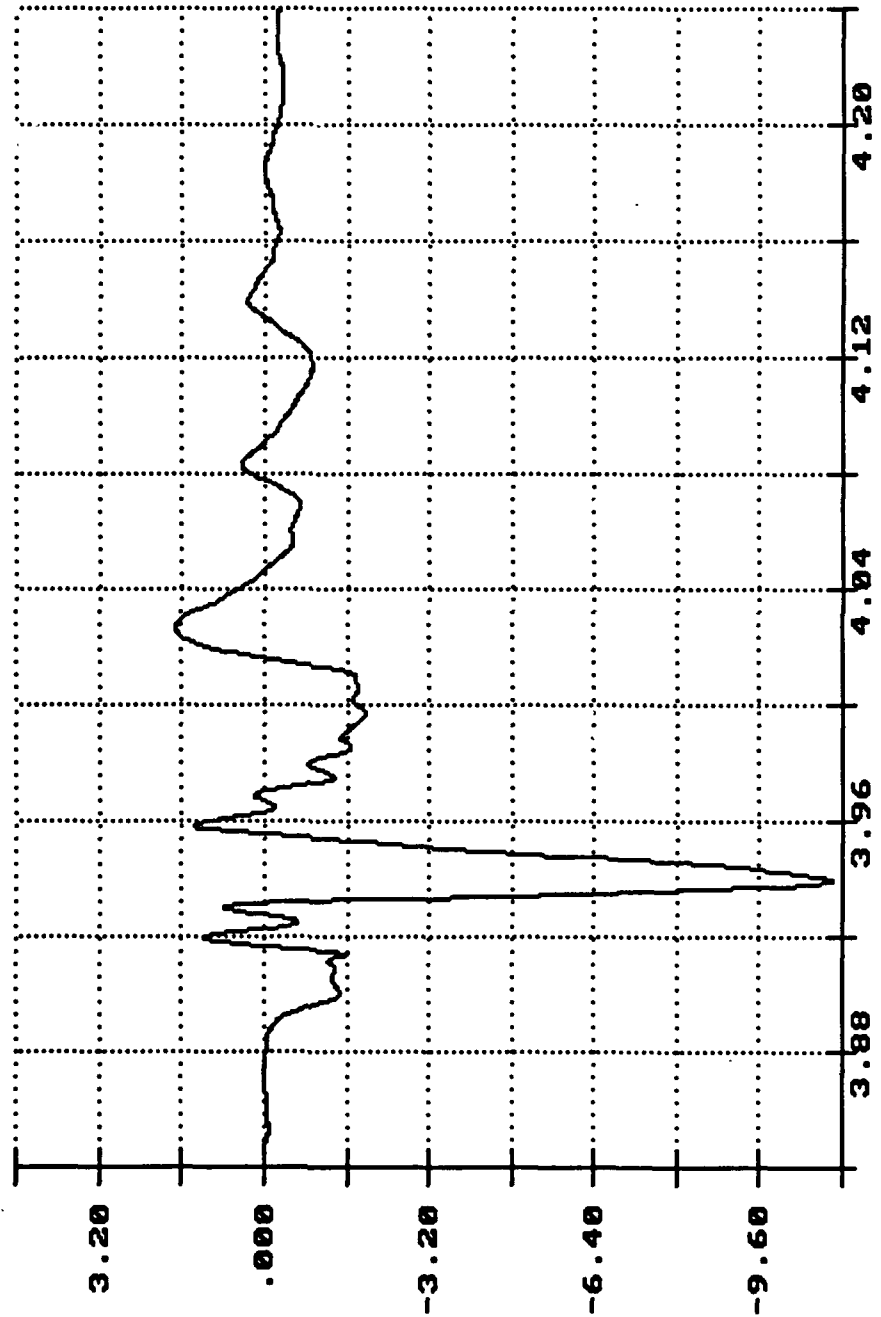

Long. Acceleration
Center Sill
Gs X 1.0000

Time of Sample
Seconds X 1.0000

7

Amno Cert of USMC M923A1 Truck, Impact 3 Apr 01 10:31:37 1992

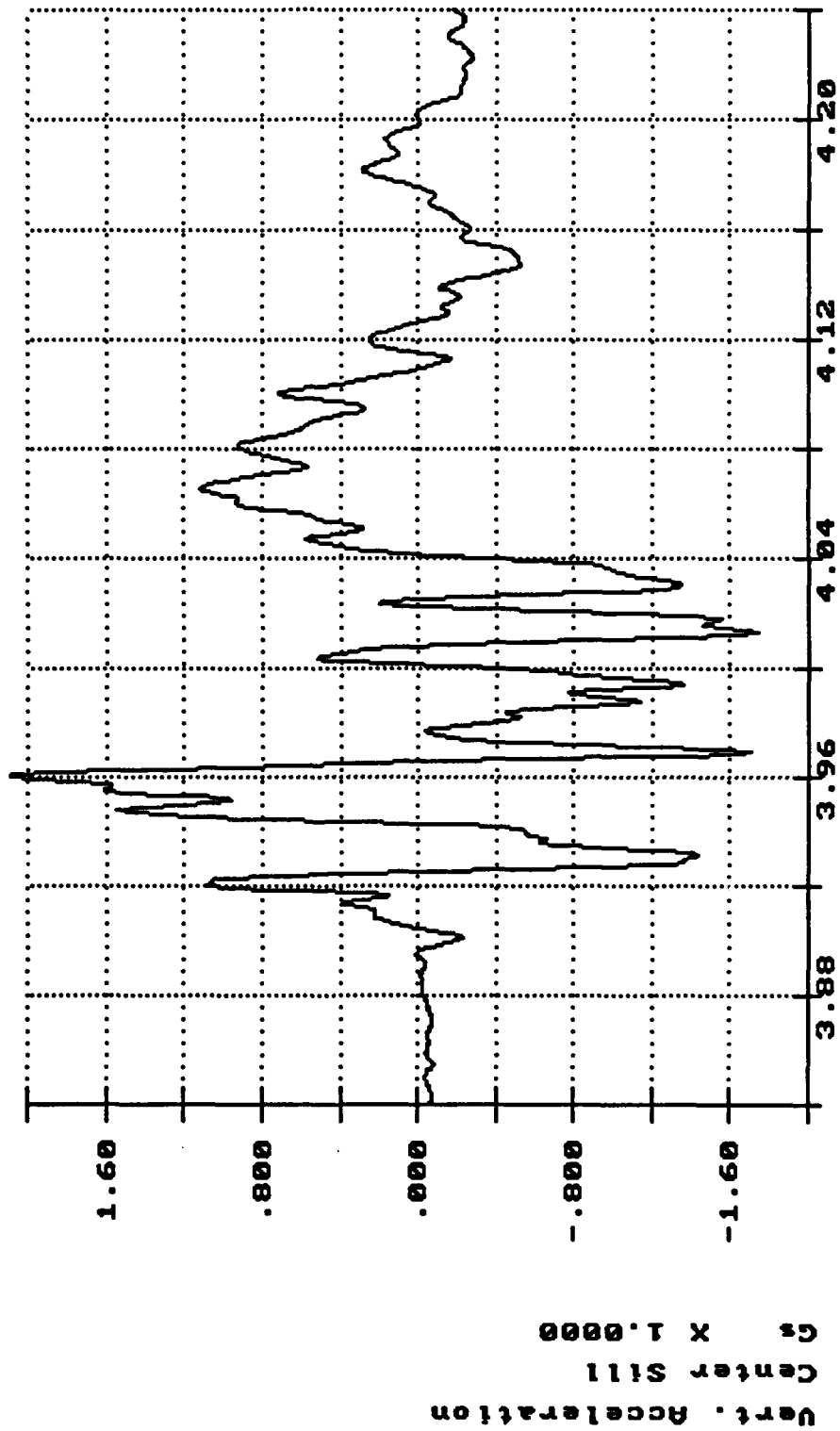

Anno Cert of USMC M923A1 Truck, Impact 3 Apr 01 10:31:37 1992

7

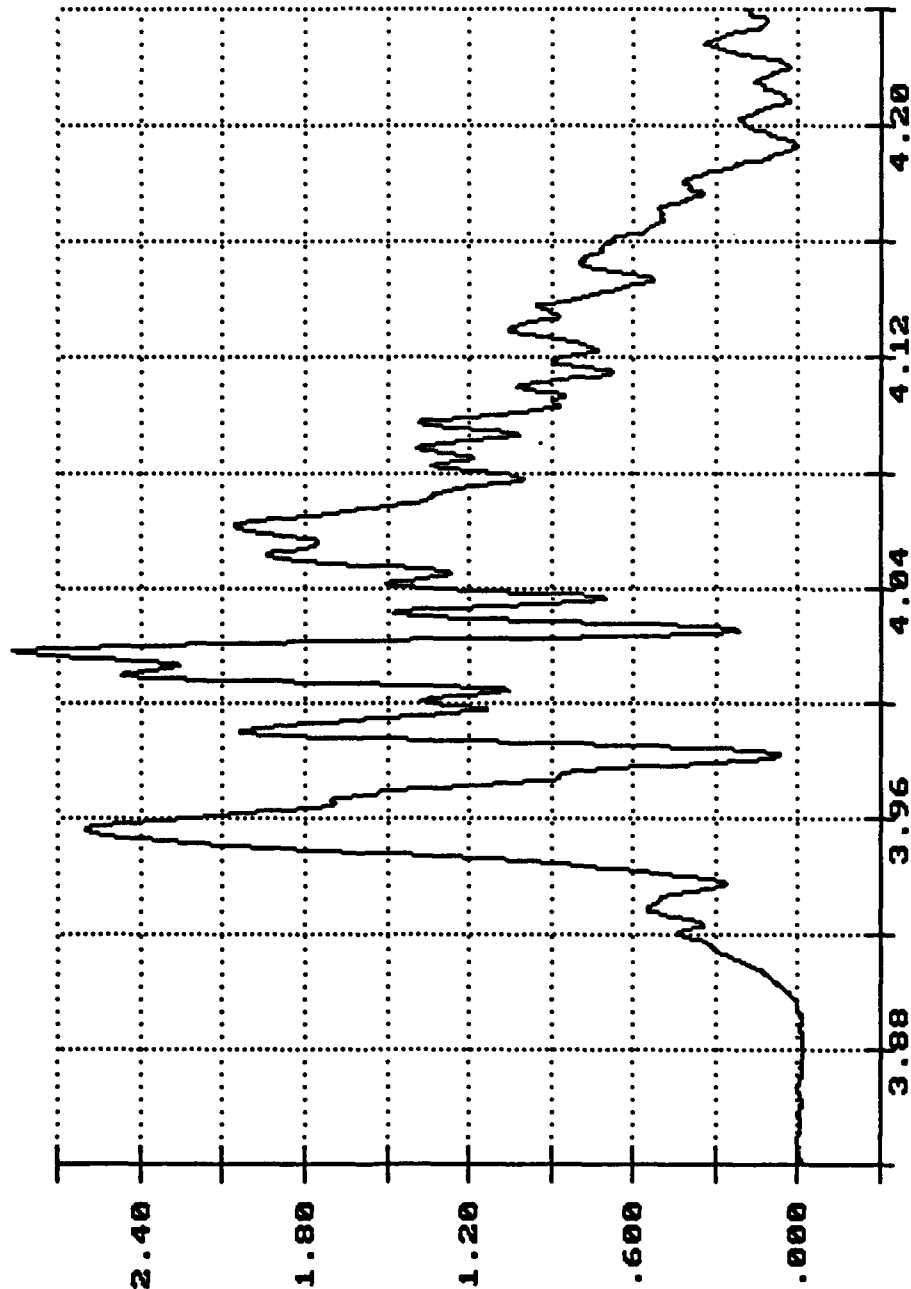

Long. Acceleration
Truck Frame
Gs X 1.0000

Time of Sample

Seconds X 1.0000

Anno Cert of USMC M923A1 Truck, Impact 3 Apr 01 10:31:37 1992

7

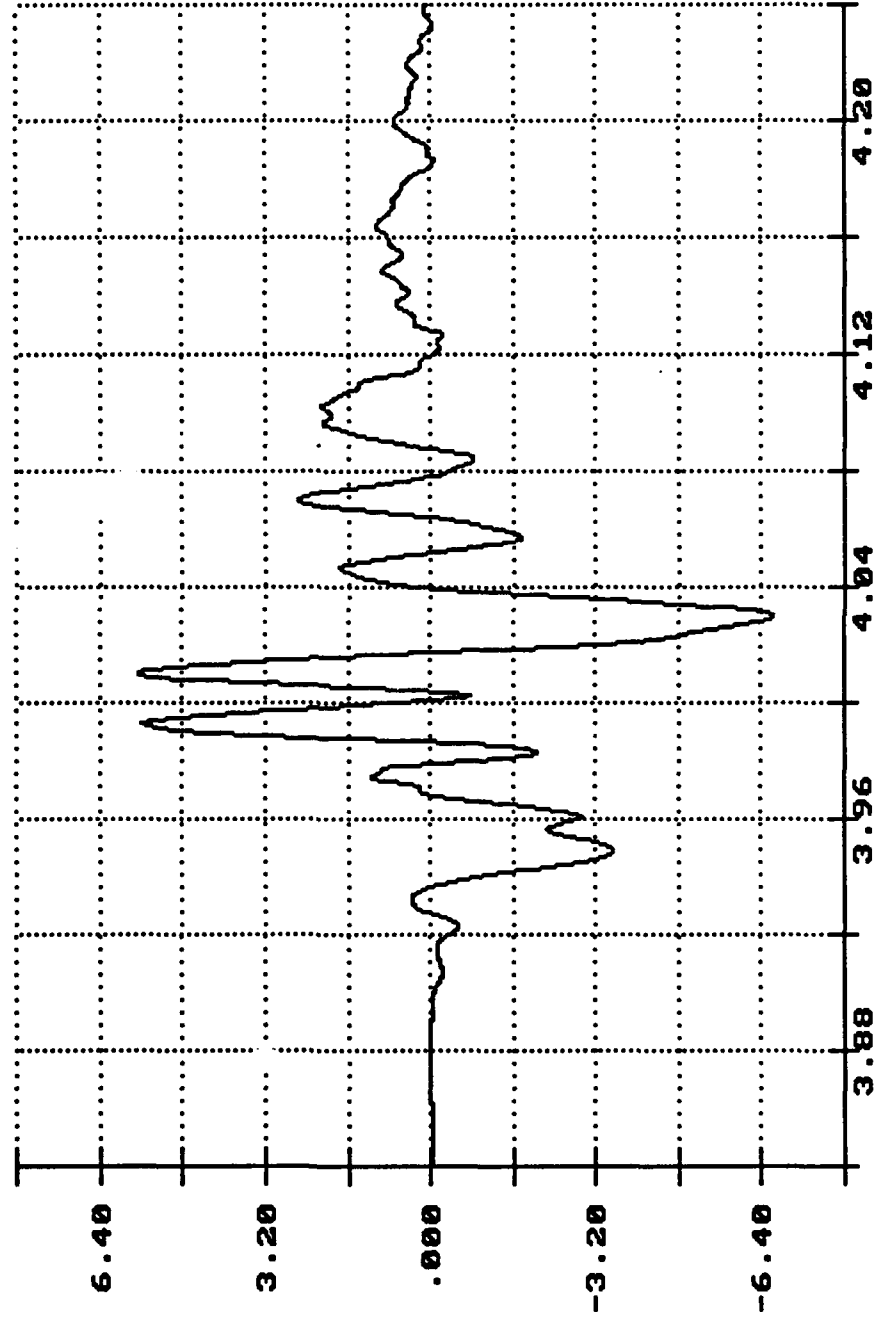

Vert. Acceleration
Truck Frame
Gs X 1.0000

Time of Sample
Seconds X 1.0000

7

Amo Cert of USMC M923A1 Truck, Impact 3 Apr 01 10:31:37 1992

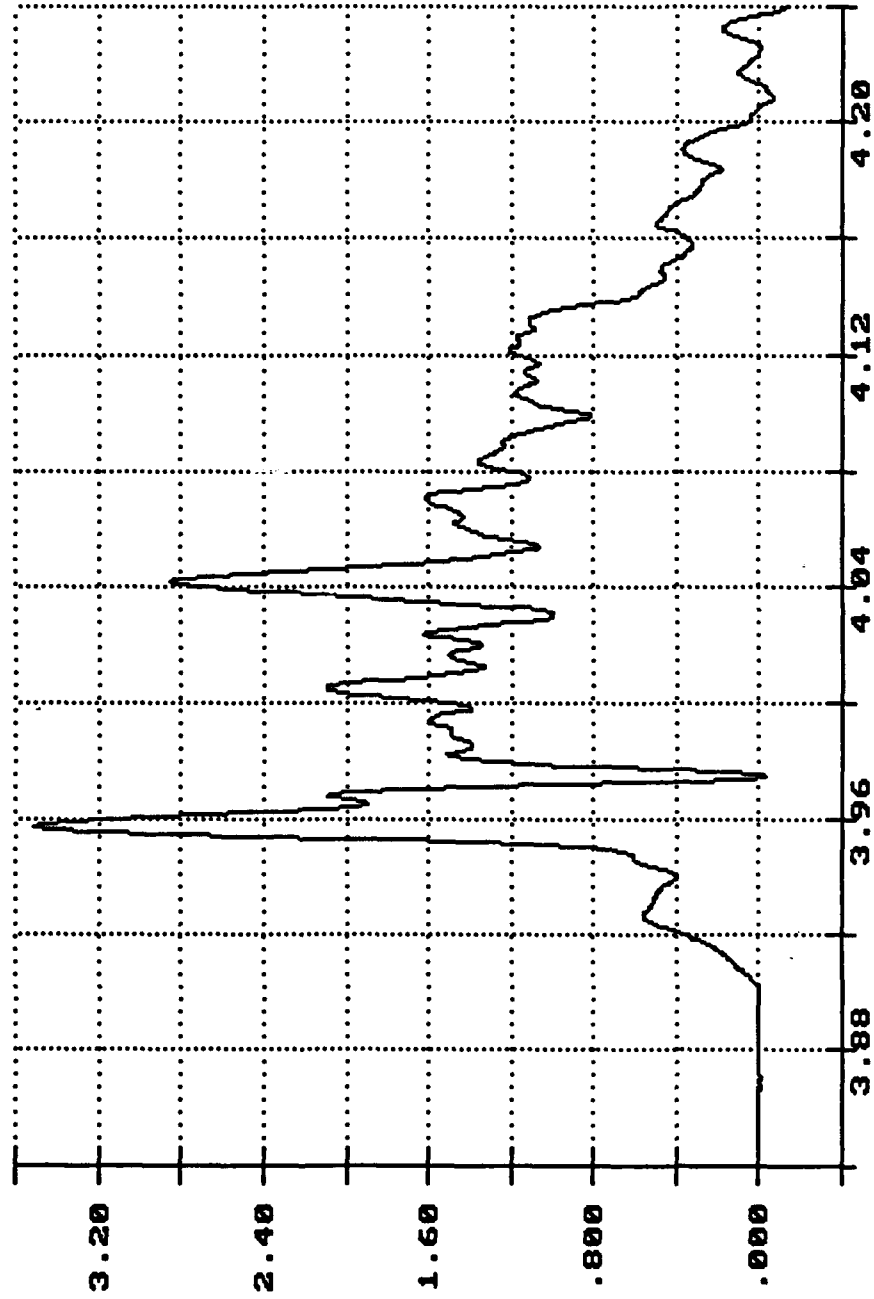

Long. Acceleration
Truck Bed
Gs X 1.0000

Time of Sample

Seconds X 1.0000

7
Ammo Cert of USMC M923A1 Truck, Impact 3 Apr 01 10:31:37 1992

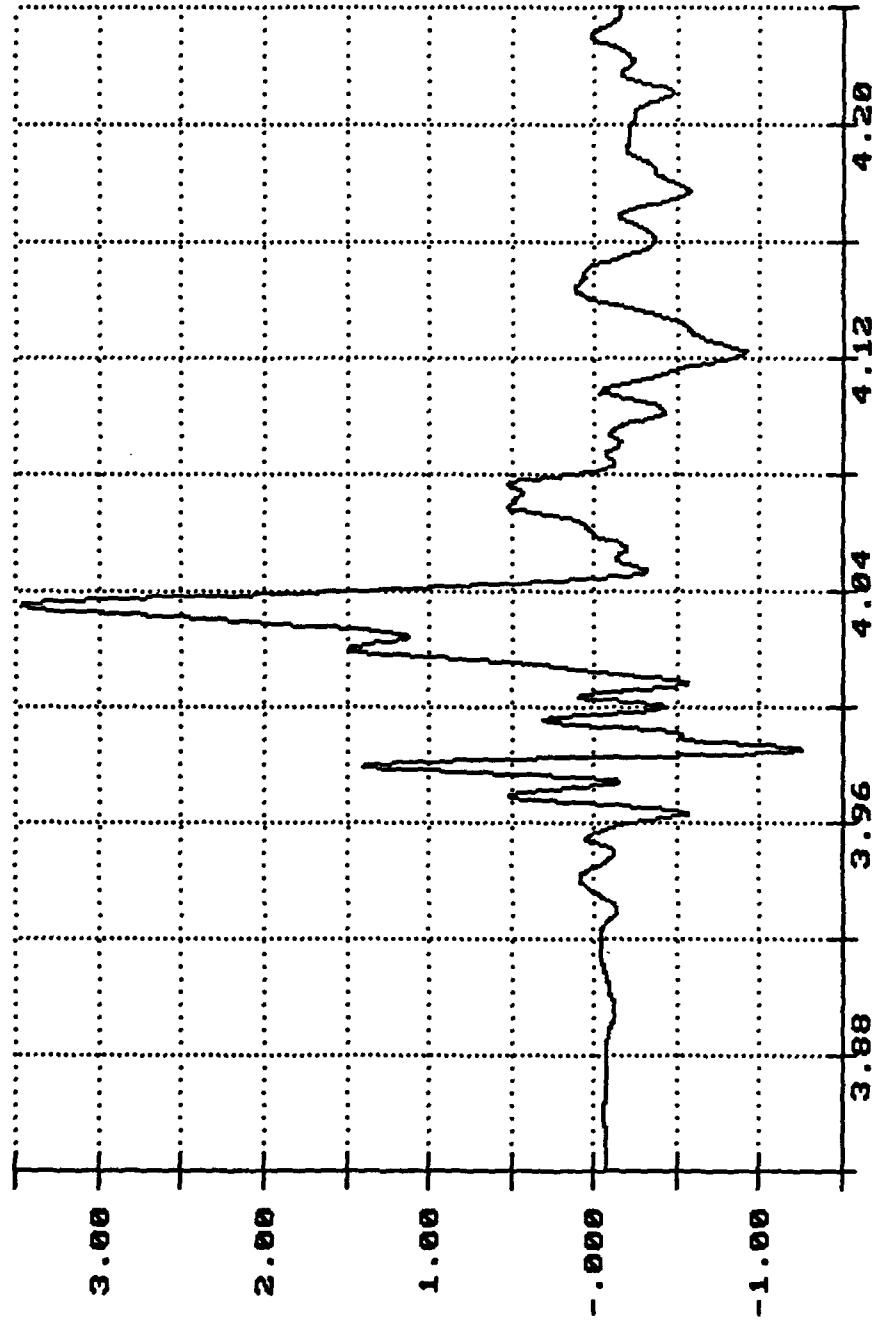

Lat. Acceleration
Truck Bed
Gs X 1.0000

Time of Sample
Seconds X 1.0000

Anno Cert of USMC M923A1 Truck, Impact 3 Apr 01 10:31:37 1992

7

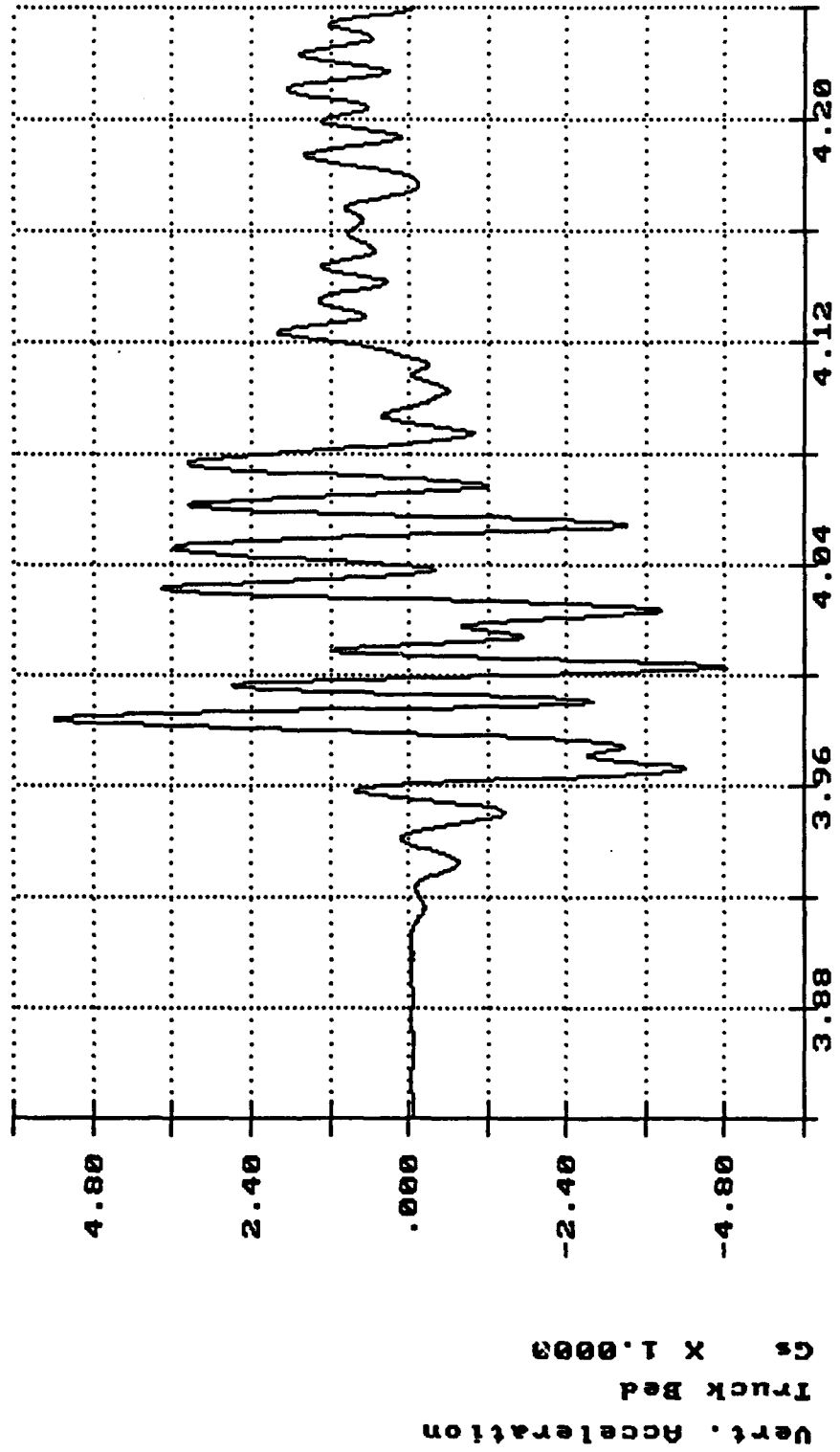

Time of Sample
Seconds X 1.0000

Anno Cert of USMC M923A1 Truck, Impact 3 Apr 01 10:31:37 1992

7

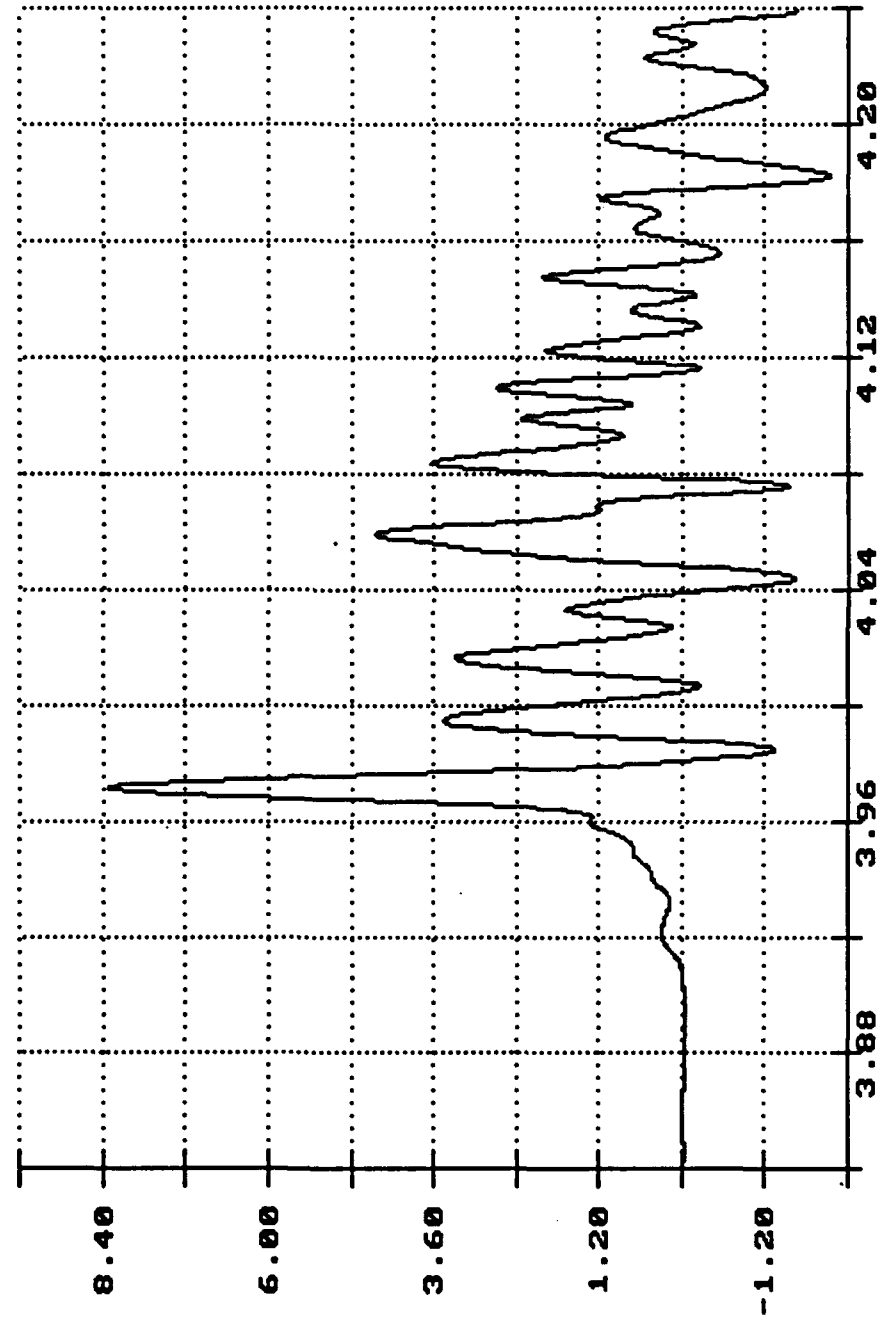

Long. Acceleration
Top of Front Sixcon
Gs X 1.0000

Time of Sample
Seconds X 1.0000

Anno Cert of USMC M923A1 Truck, Impact 3 Apr 01 10:31:37 1992

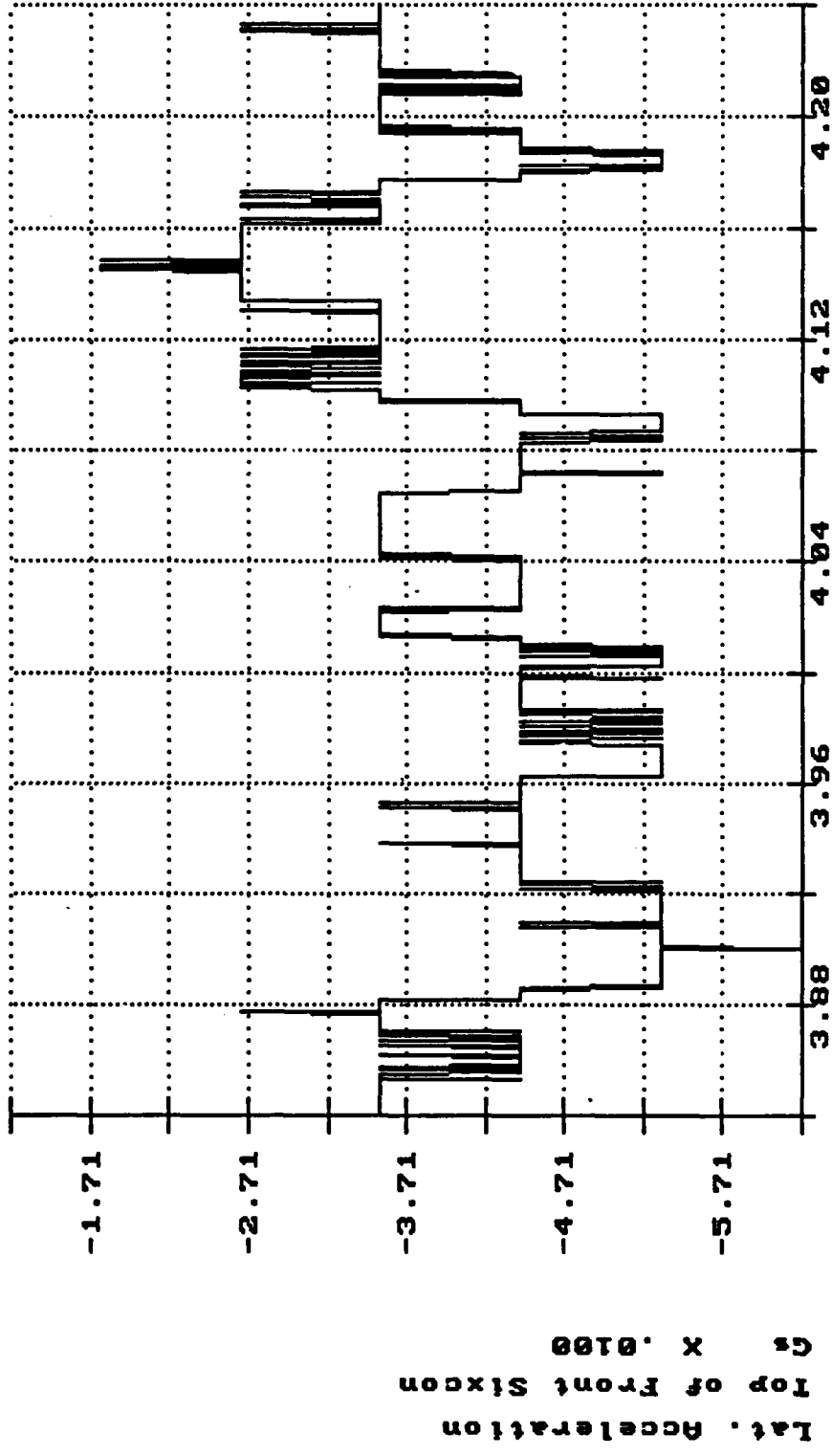

Anno Cert of USMC M923A1 Truck, Impact 3 Apr 01 10:31:37 1992

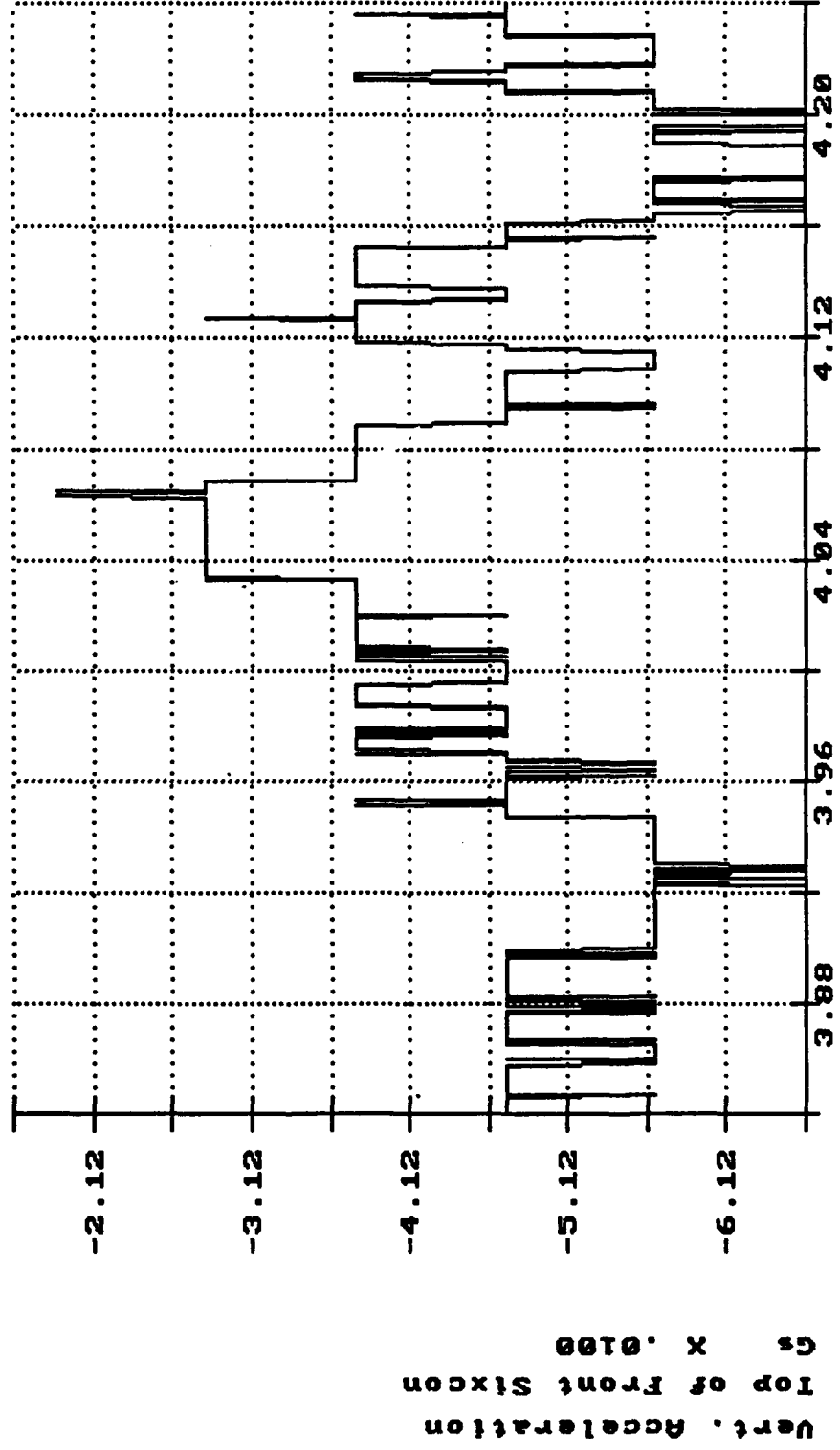

Time of Sample

Seconds X 1.0000

Anno Cert of USMC M923A1 Truck, Impact 3 Apr 01 10:31:37 1992

7

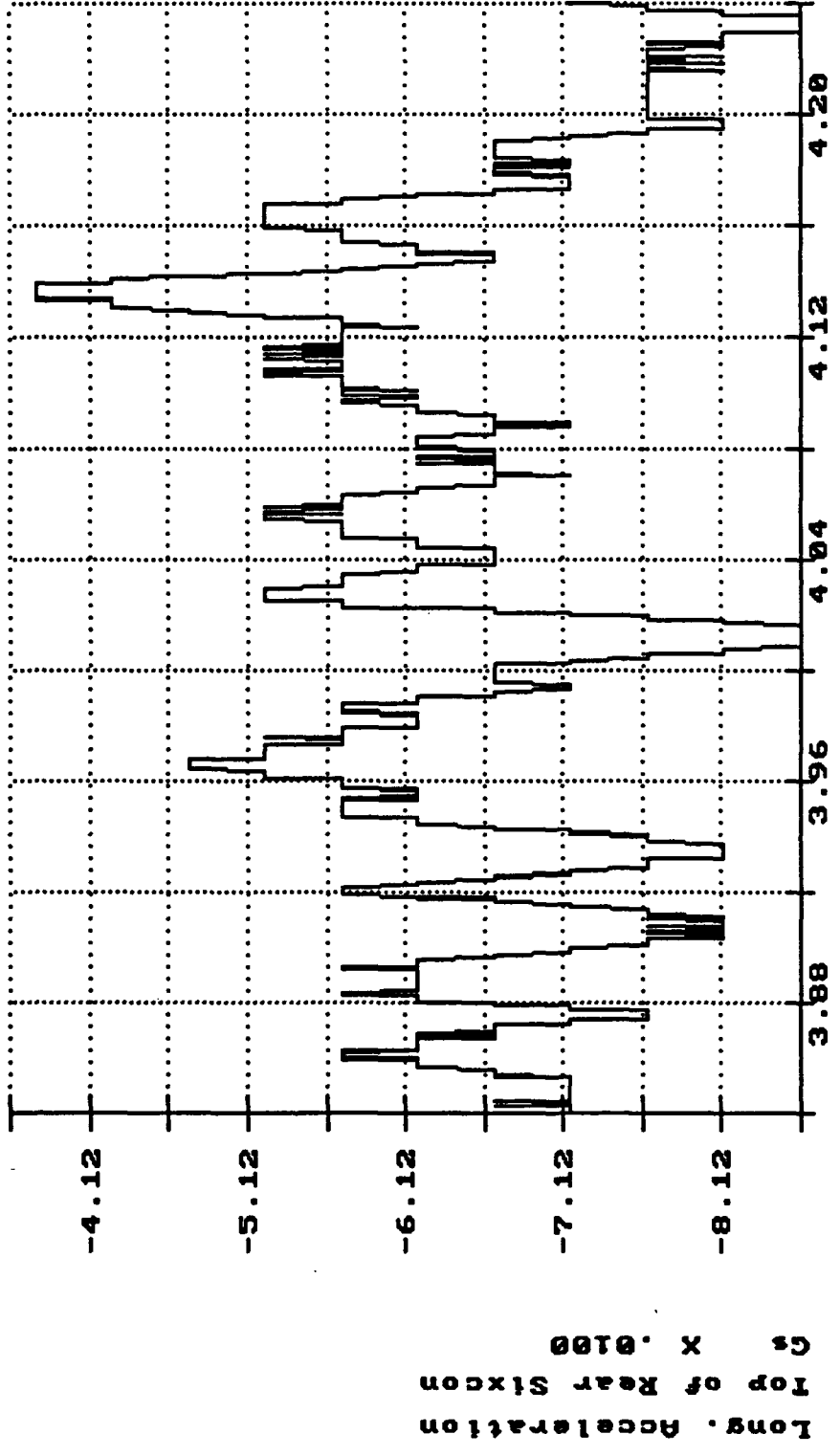

Long. Acceleration
Top of Rear Sixcon
Gs X .0100

Time of Sample
Seconds X 1.0000

Anno Cert of USMC M923A1 Truck, Impact 3 Apr 01 10:31:37 1992

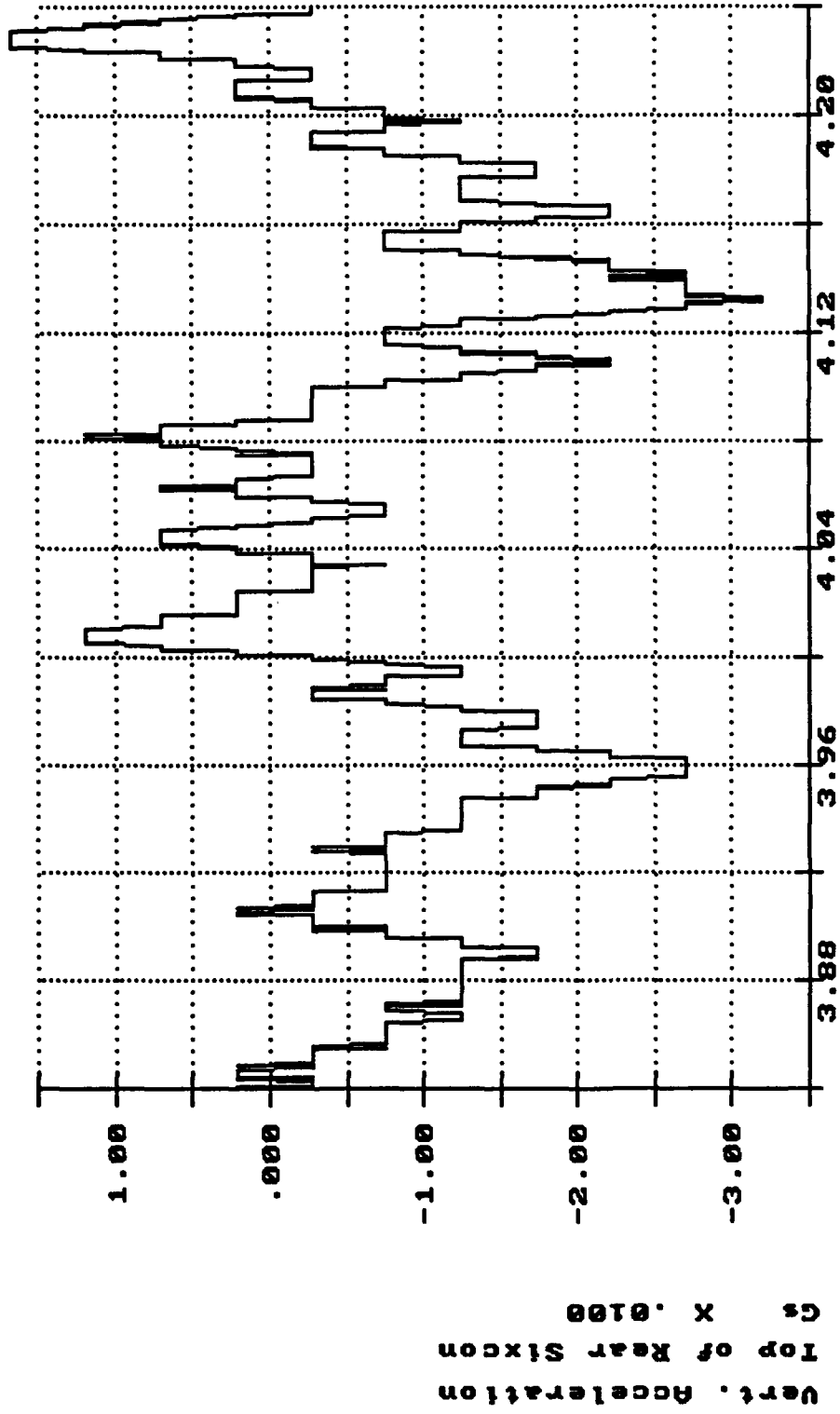

Time of Sample
Seconds X 1.0000

Amno Cert of USMC M923A1 Truck, Impact 4 Apr 01 13:52:06 1992

7

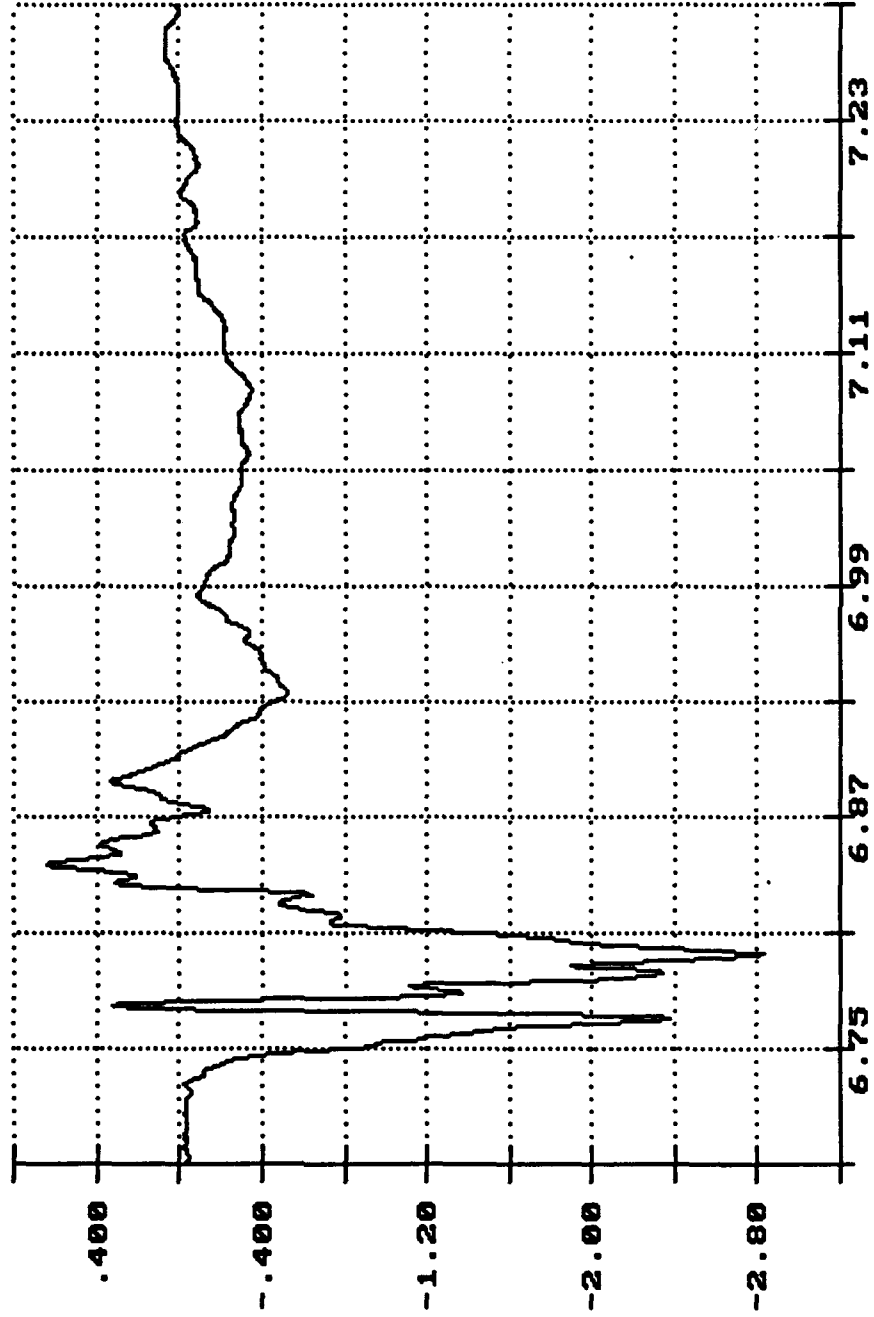

Long. Acceleration
Gs X 1.0000
Center Sill

Time of Sample
Seconds X 1.0000

Anno Cert of USMC M923A1 Truck, Impact 4 Apr 01 13:52:06 1992

7

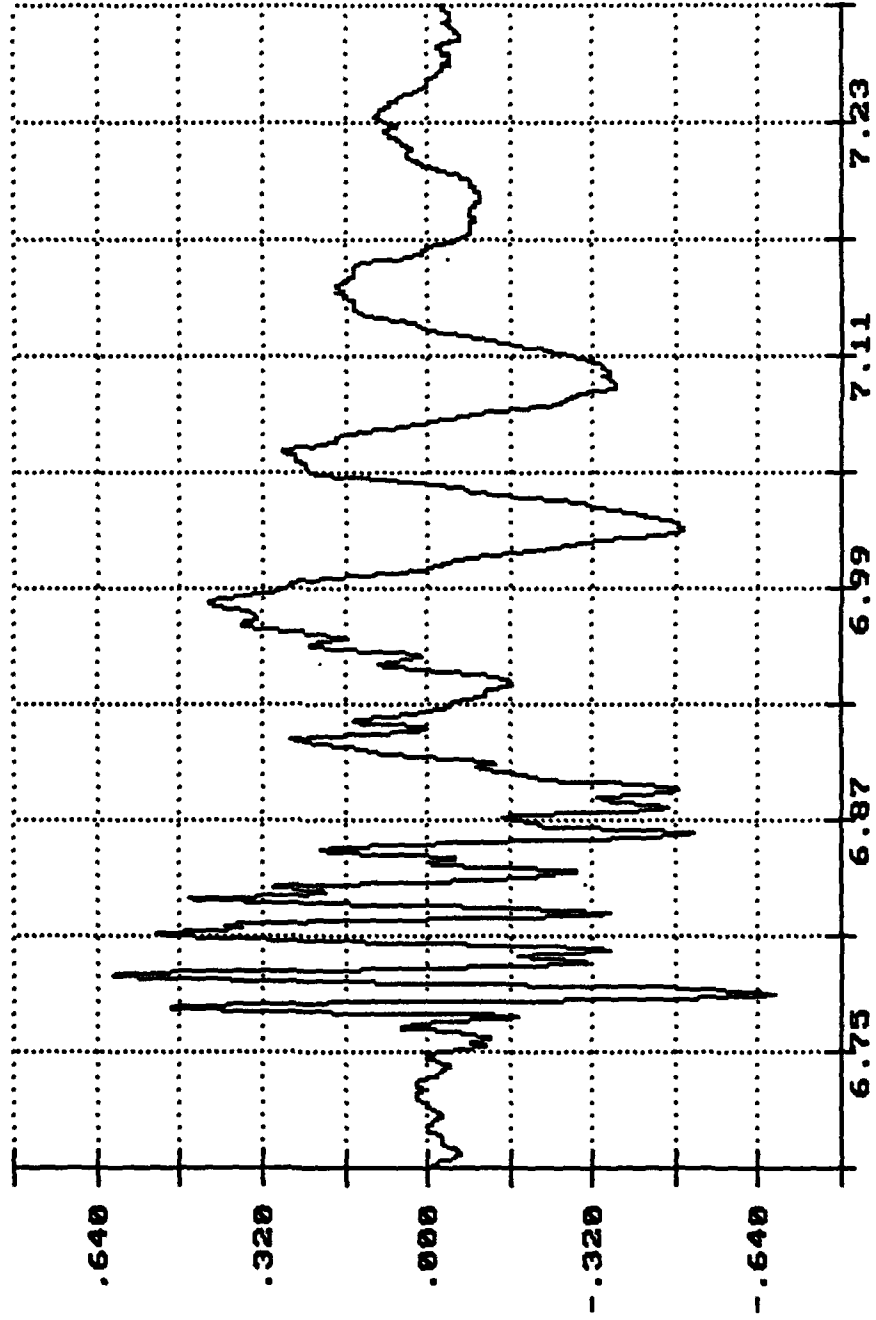

Cert. Acceleration
Center Sill
Gs X 1.0000

Time of Sample

Seconds X 1.0000

7

Ammo Cert of USMC M923A1 Truck, Impact 4 Apr 01 13:52:06 1992

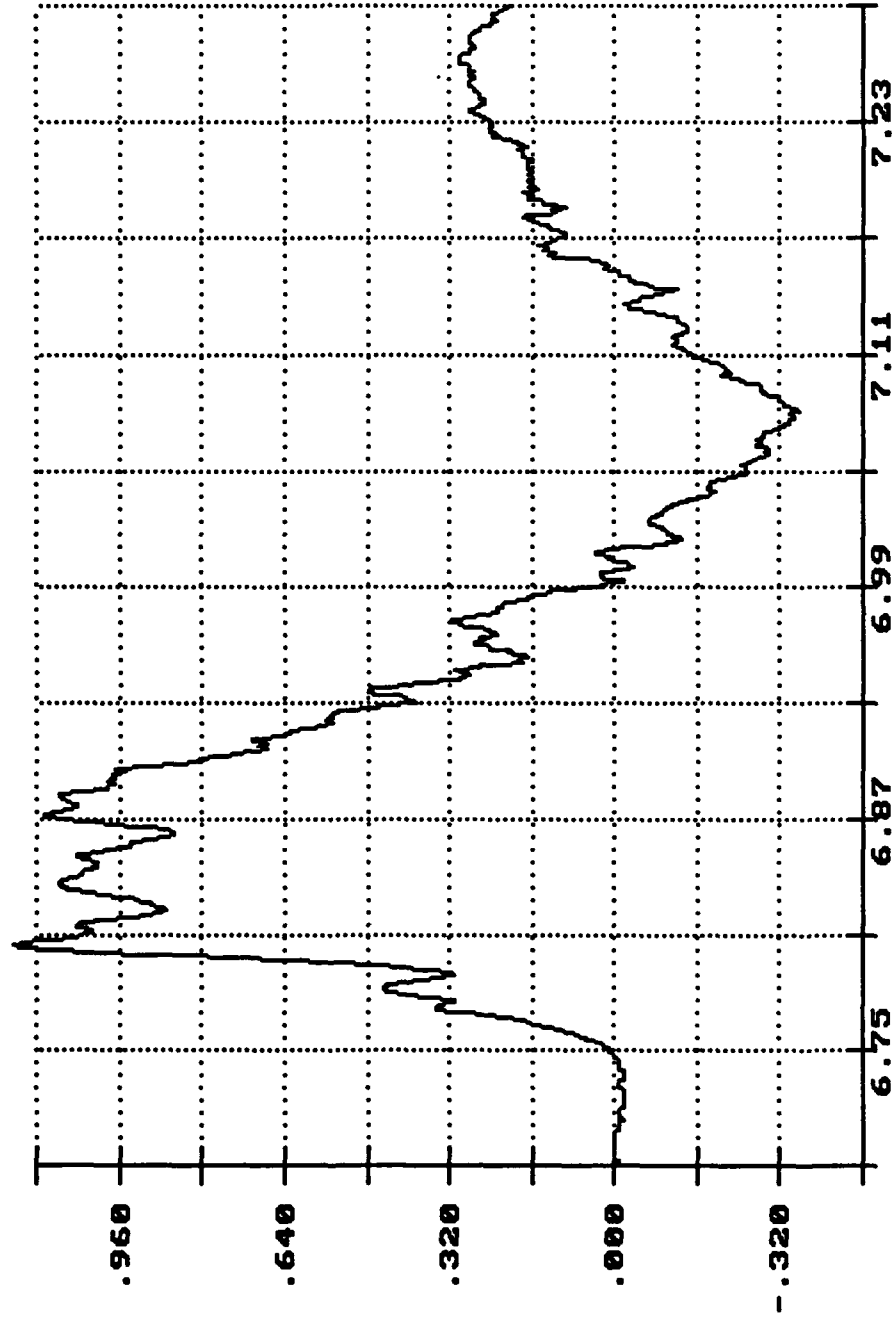

Long. Acceleration
Truck Frame
Gs X 1.0000

Time of Sample

Seconds X 1.0000

Anno Cert of USMC M923A1 Truck, Impact 4 Apr 01 13:52:06 1992

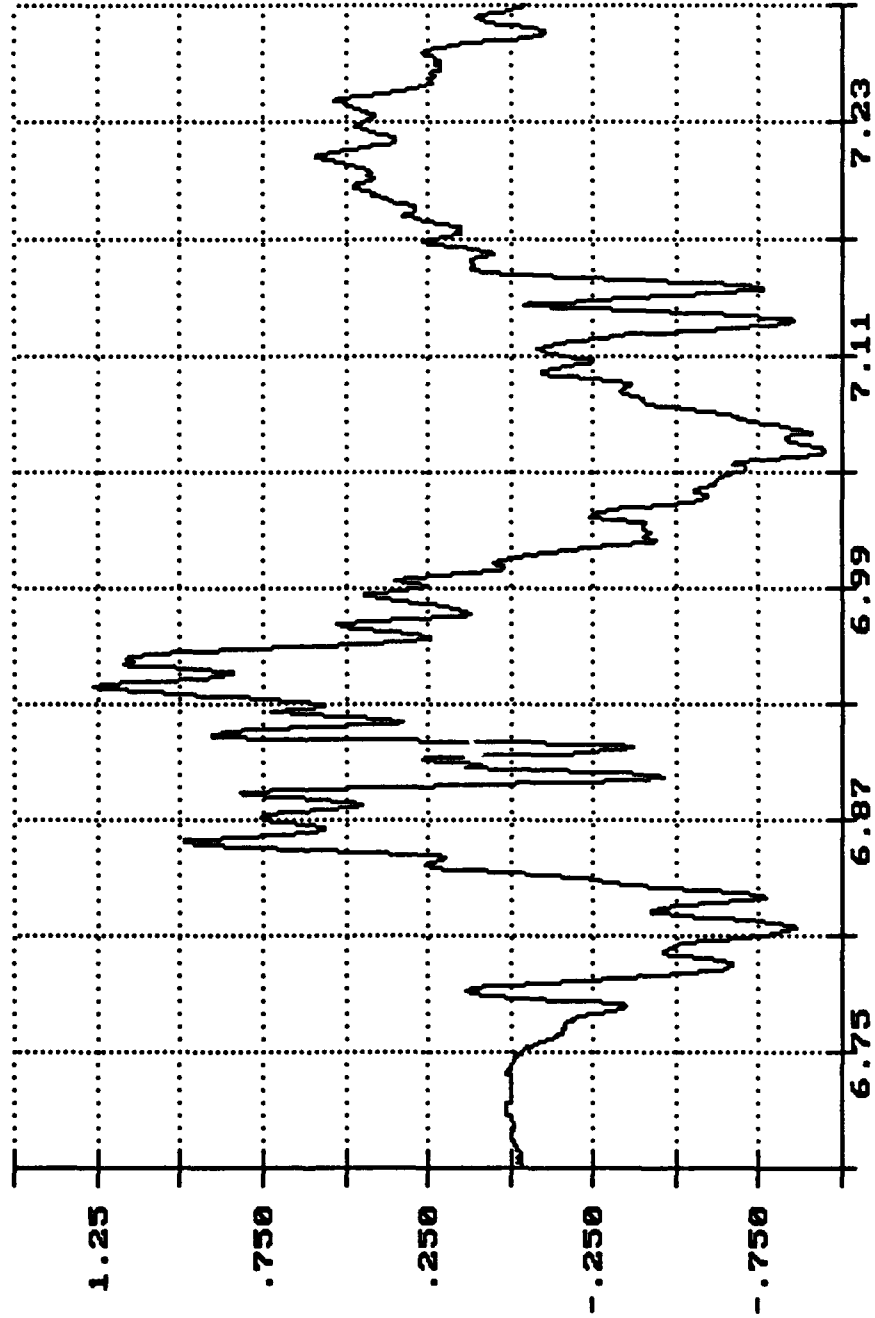

Vert. Acceleration
Truck Frame
Gs X 1.0000

Time of Sample

Seconds X 1.0000

Anno Cert of USMC M923A1 Truck, Impact 4 Apr 01 13:52:06 1992

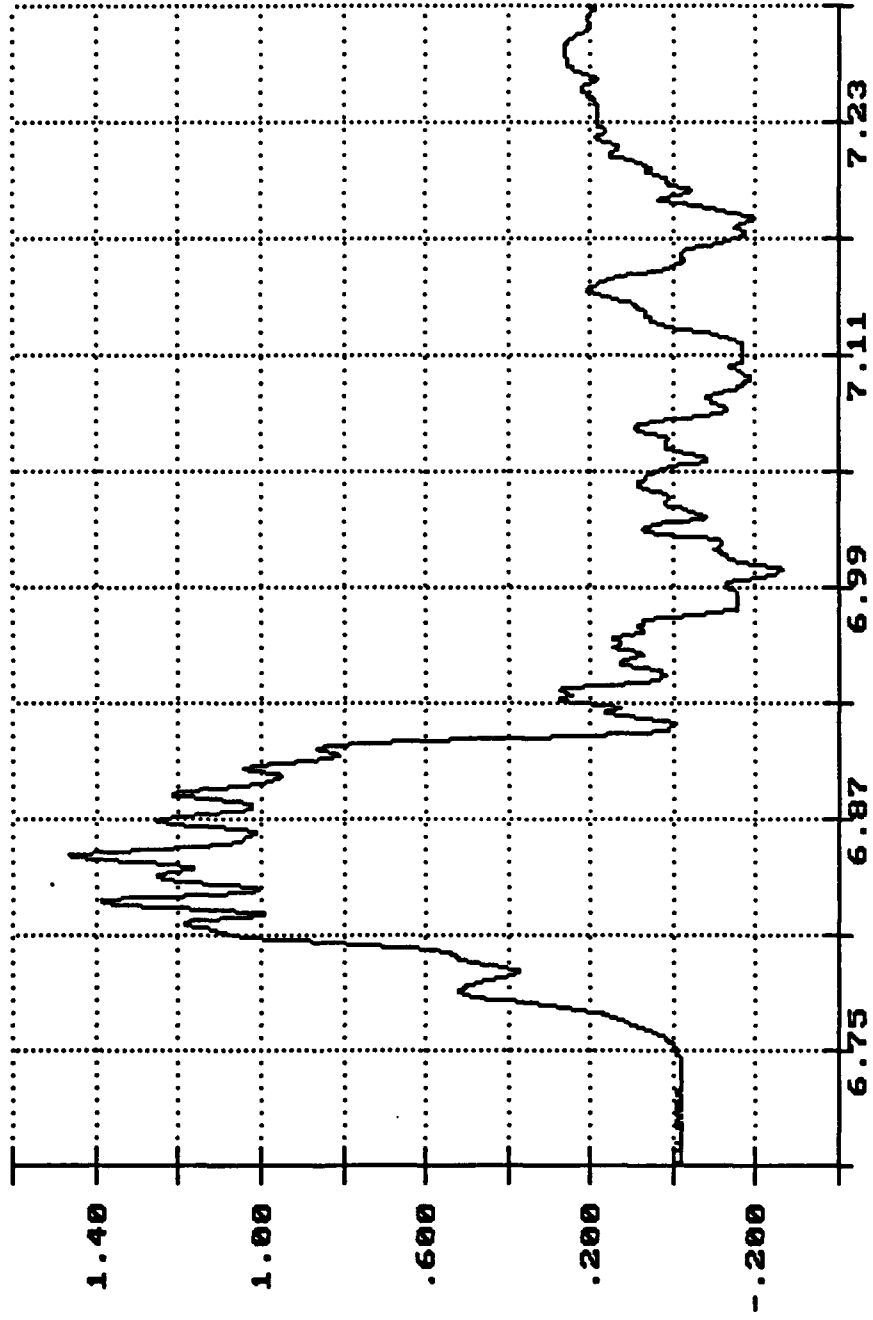

Long. Acceleration
Truck Bed
Gs X 1.0000

Time of Sample

Seconds X 1.0000

7

Anno Cert of USMC M923A1 Truck, Impact 4 Apr 01 13:52:06 1992

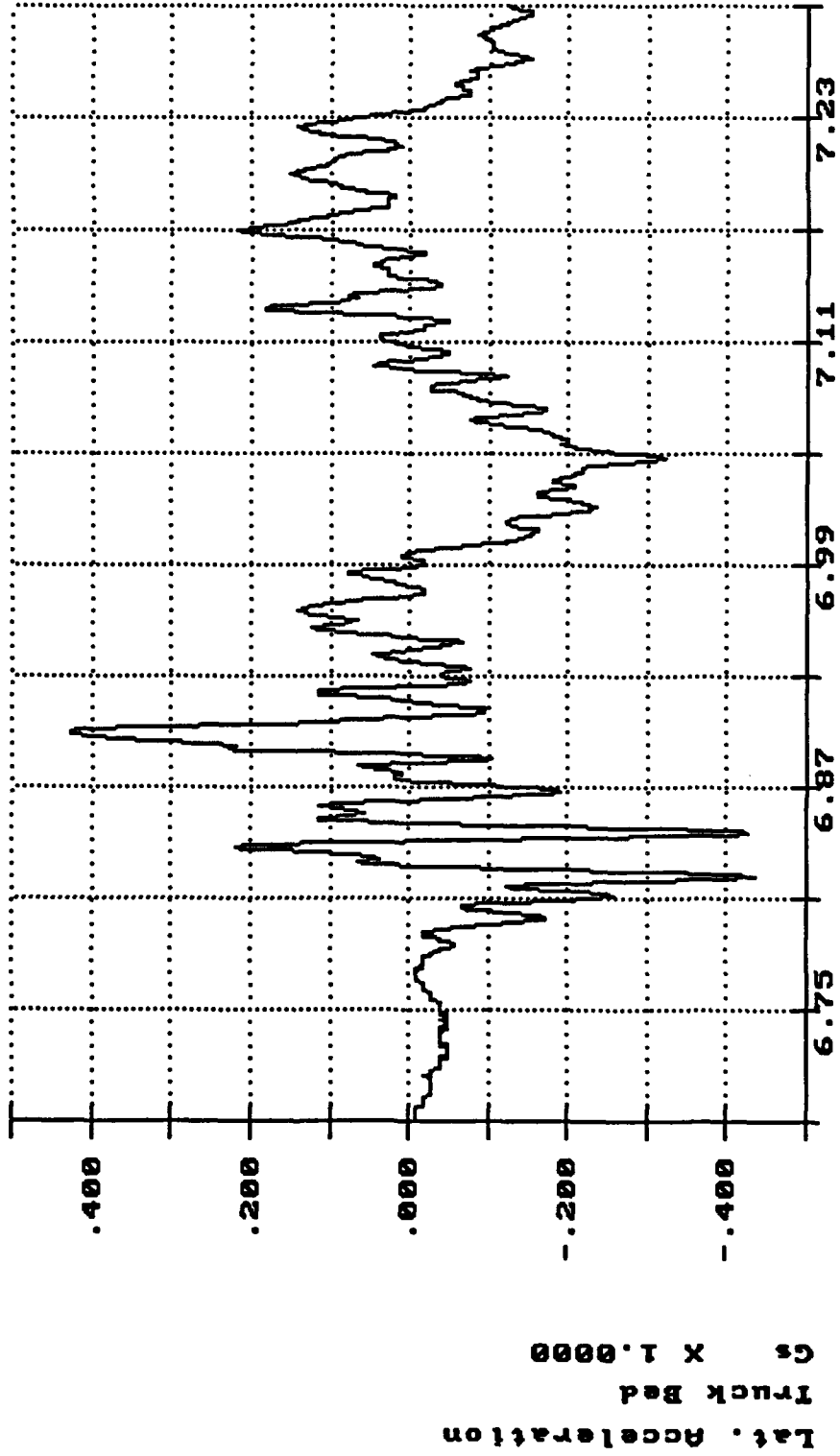

Anno Cert of USMC M923A1 Truck, Impact 4 Apr 01 13:52:06 1992

7

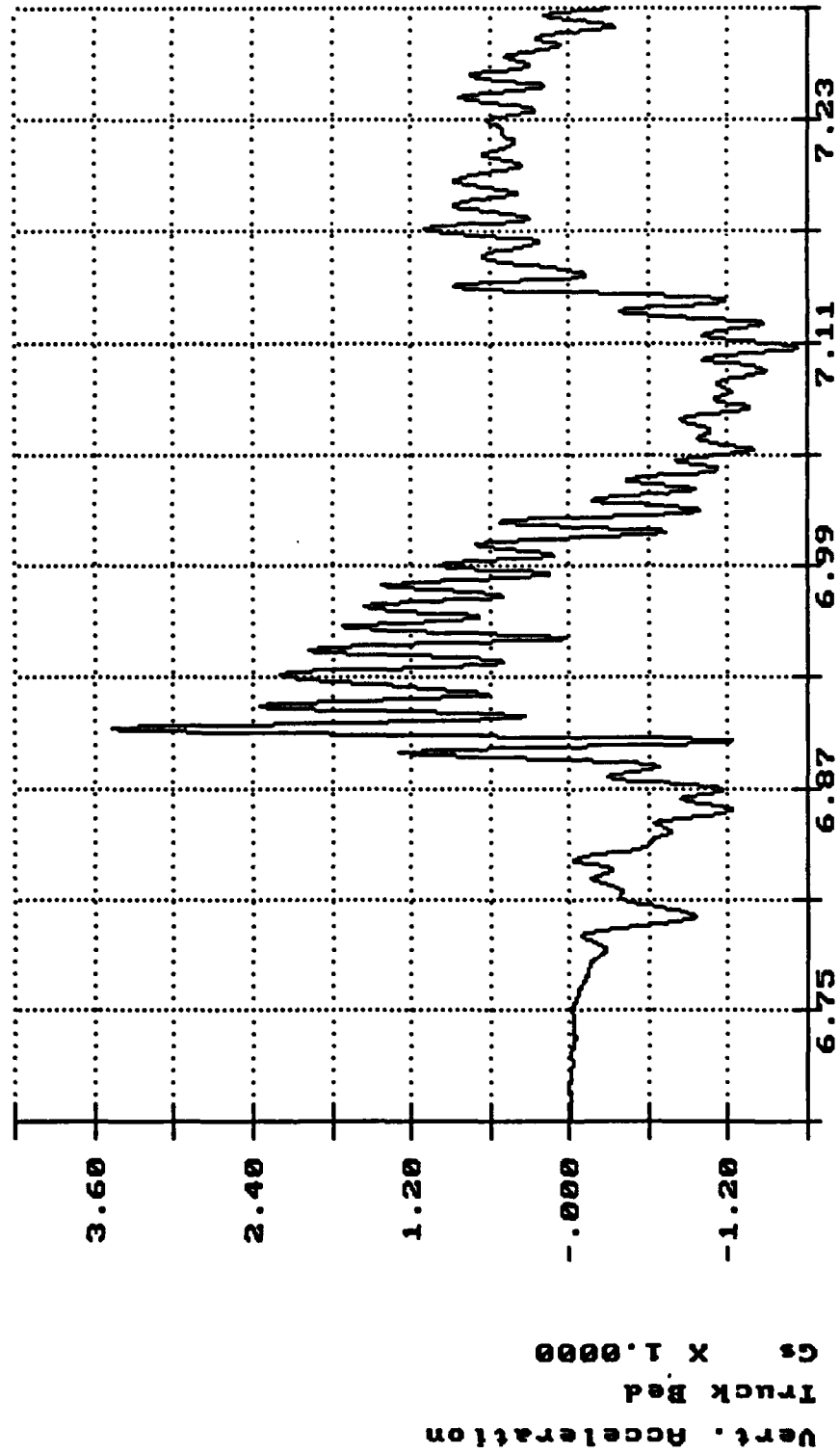

Anno Cert of USMC M923A1 Truck, Impact 4 Apr 01 13:52:06 1992

7

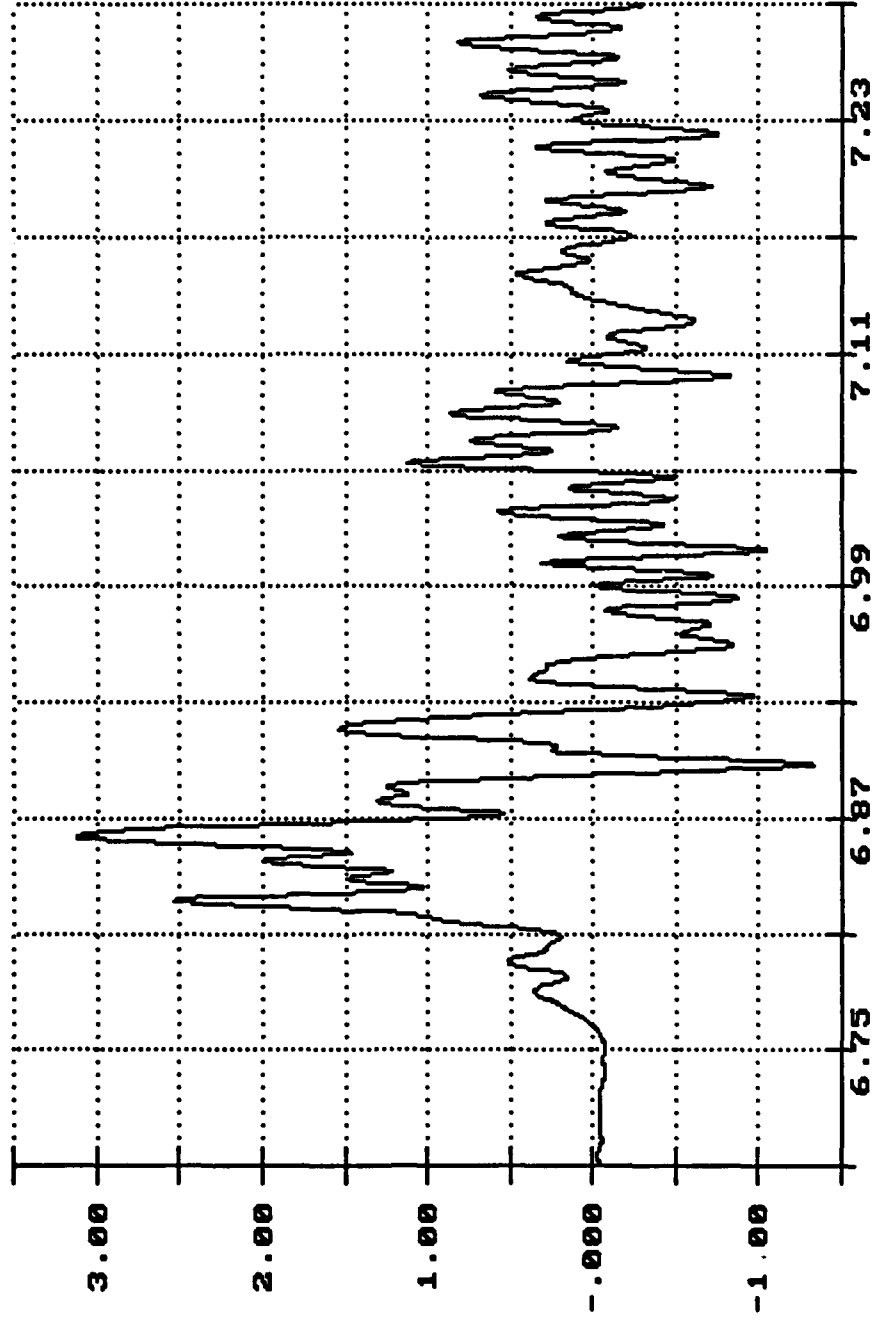

Long. Acceleration
Top of Front Sixcon
Gs X 1.0000

Time of Sample
Seconds X 1.0000

Anno Cert of USMC M923A1 Truck, Impact 4 Apr 01 13:52:06 1992

7

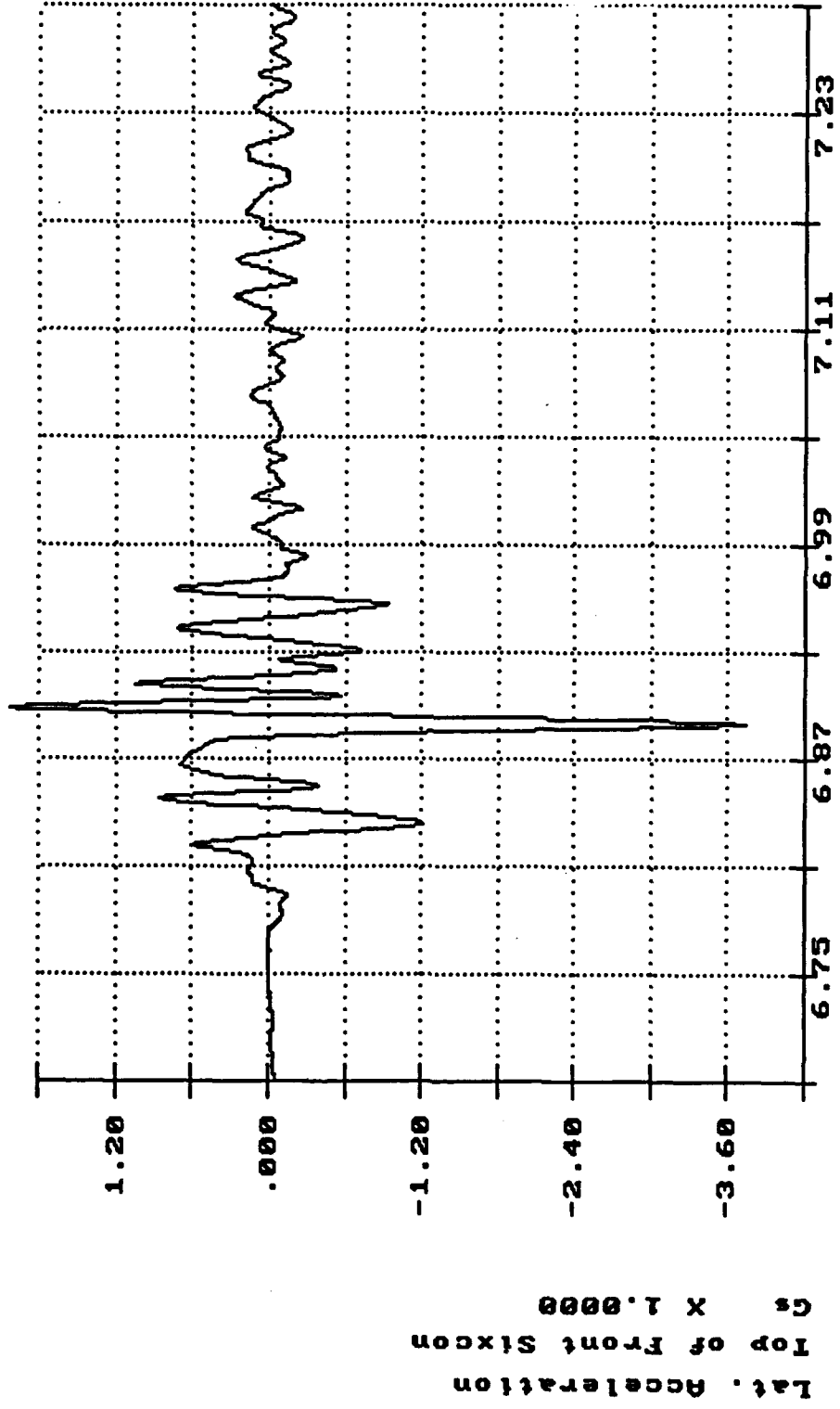

7

Anno Cart of USMC M923A1 Truck, Impact 4 Apr 01 13:52:06 1992

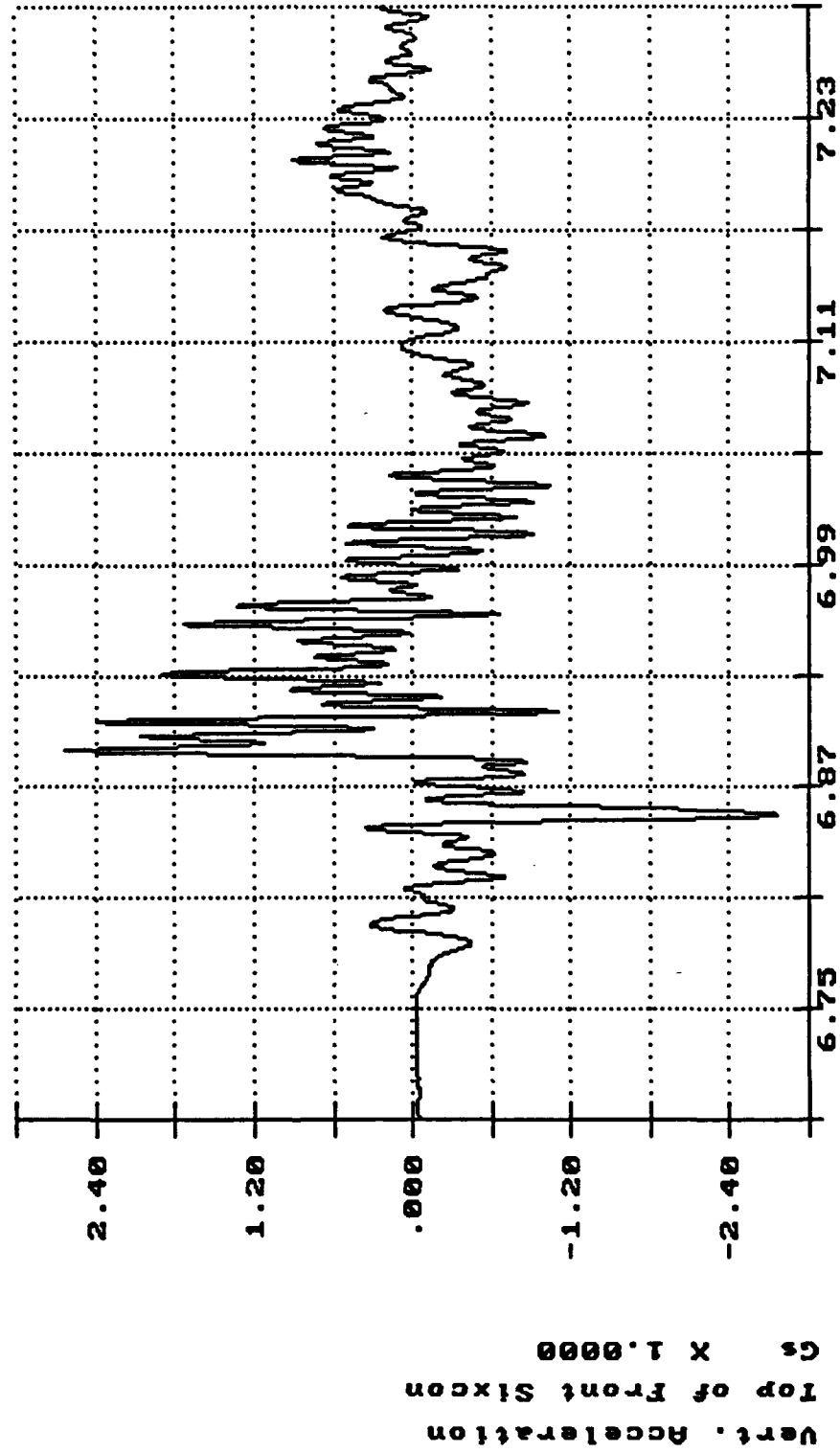

Time of Sample

Seconds X 1.0000

Anno Cert of USMC M923A1 Truck, Impact 4 Apr 01 13:52:06 1992

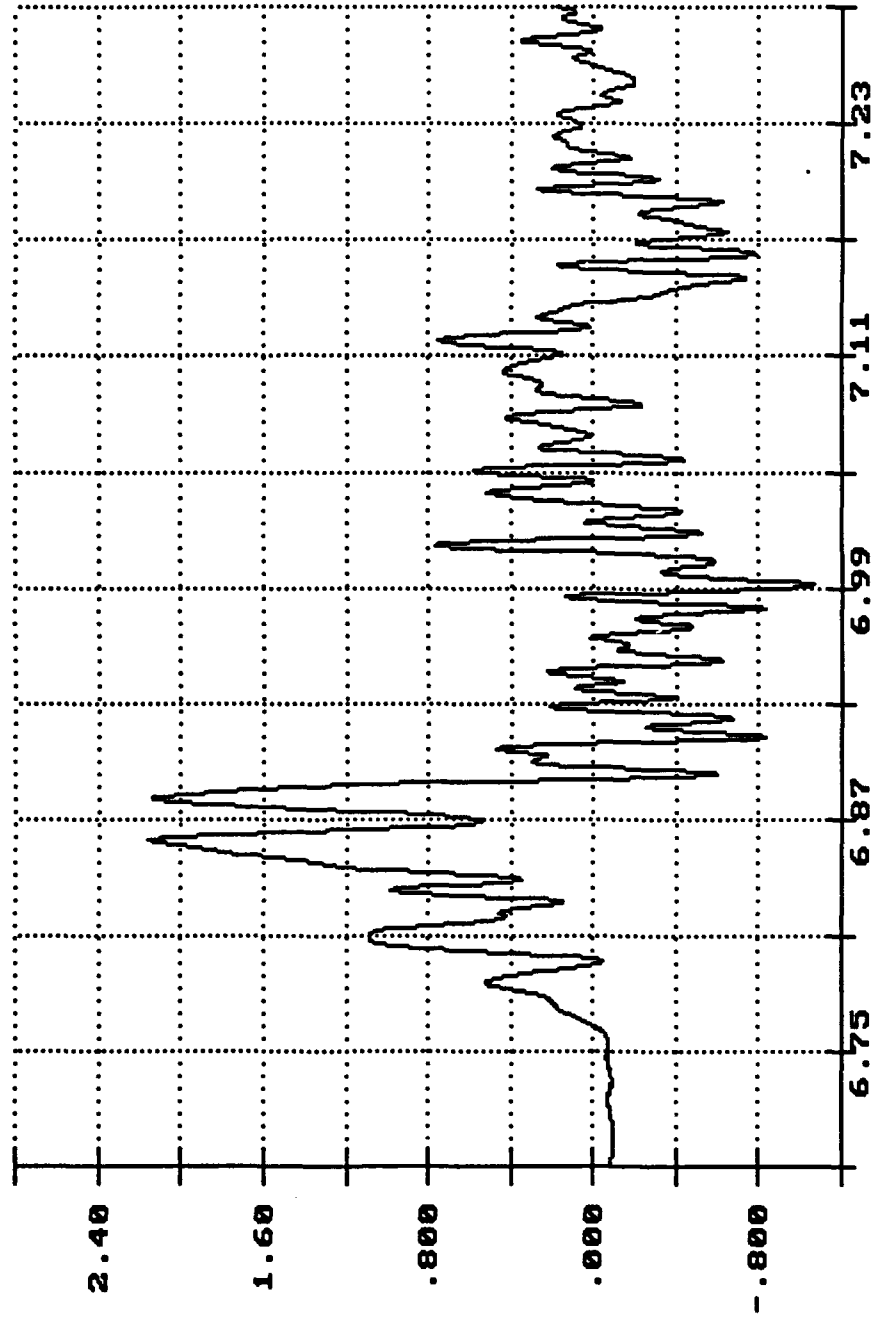

Long. Acceleration
Top of Rear Sixcon
Gs X 1.0000

Time of Sample

Seconds X 1.0000

7

Anno Cert of USMC M923A1 Truck, Impact 4 Apr 01 13:52:06 1992

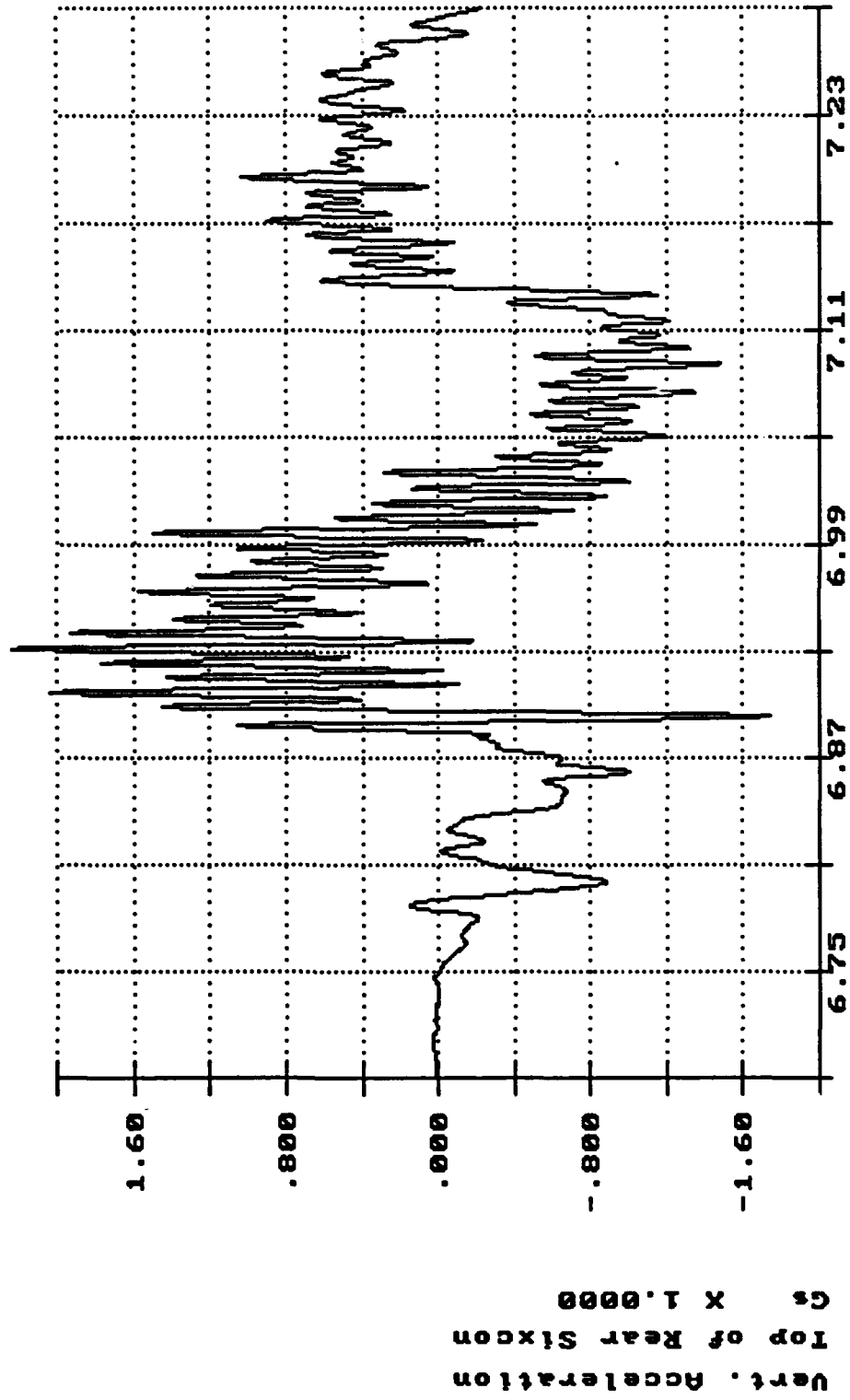

Anno Cert of USMC M923A1 Truck, Impact 5 Apr 01 14:00:06 1992

7

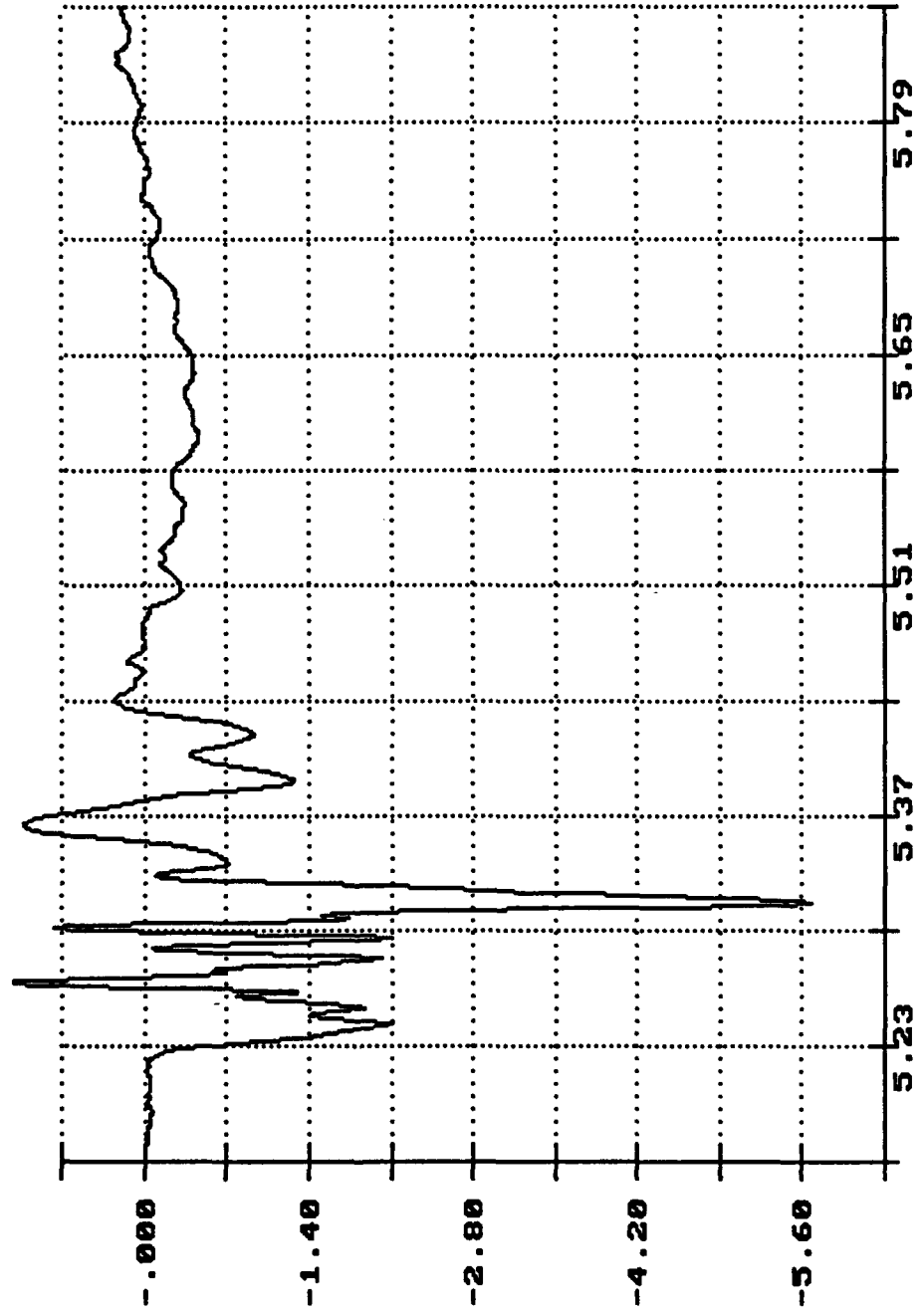

Long. Acceleration
Gs X 1.0000
Center Sill

Time of Sample
Seconds X 1.0000

Anno Cert of USMC M923A1 Truck, Impact 5 Apr 01 14:00:06 1992

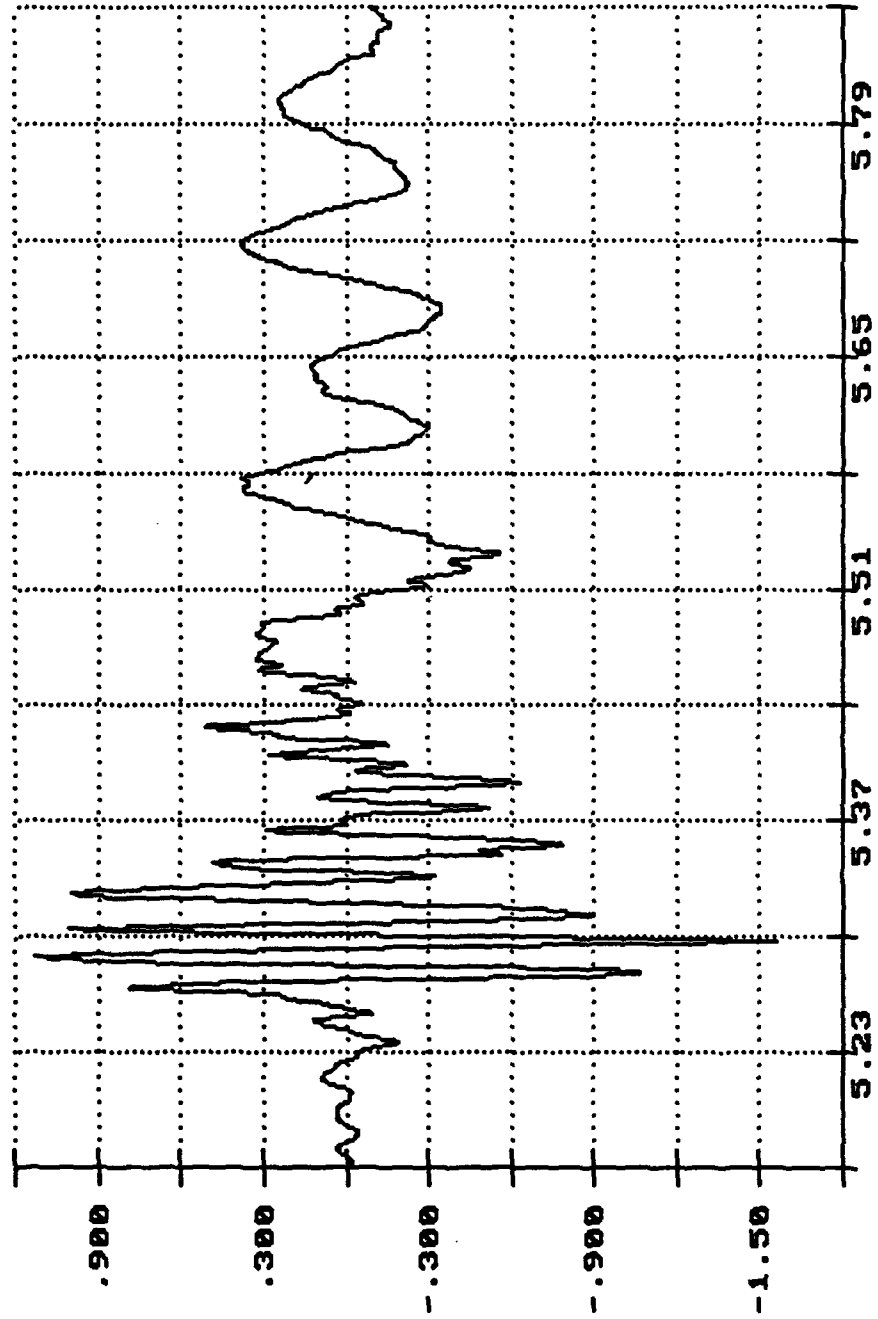

Vert. Acceleration
Center Still
Gs X 1.0000

Time of Sample
Seconds X 1.0000

Anno Cert of USMC M923A1 Truck, Impact 5 Apr 01 14:00:06 1992

7

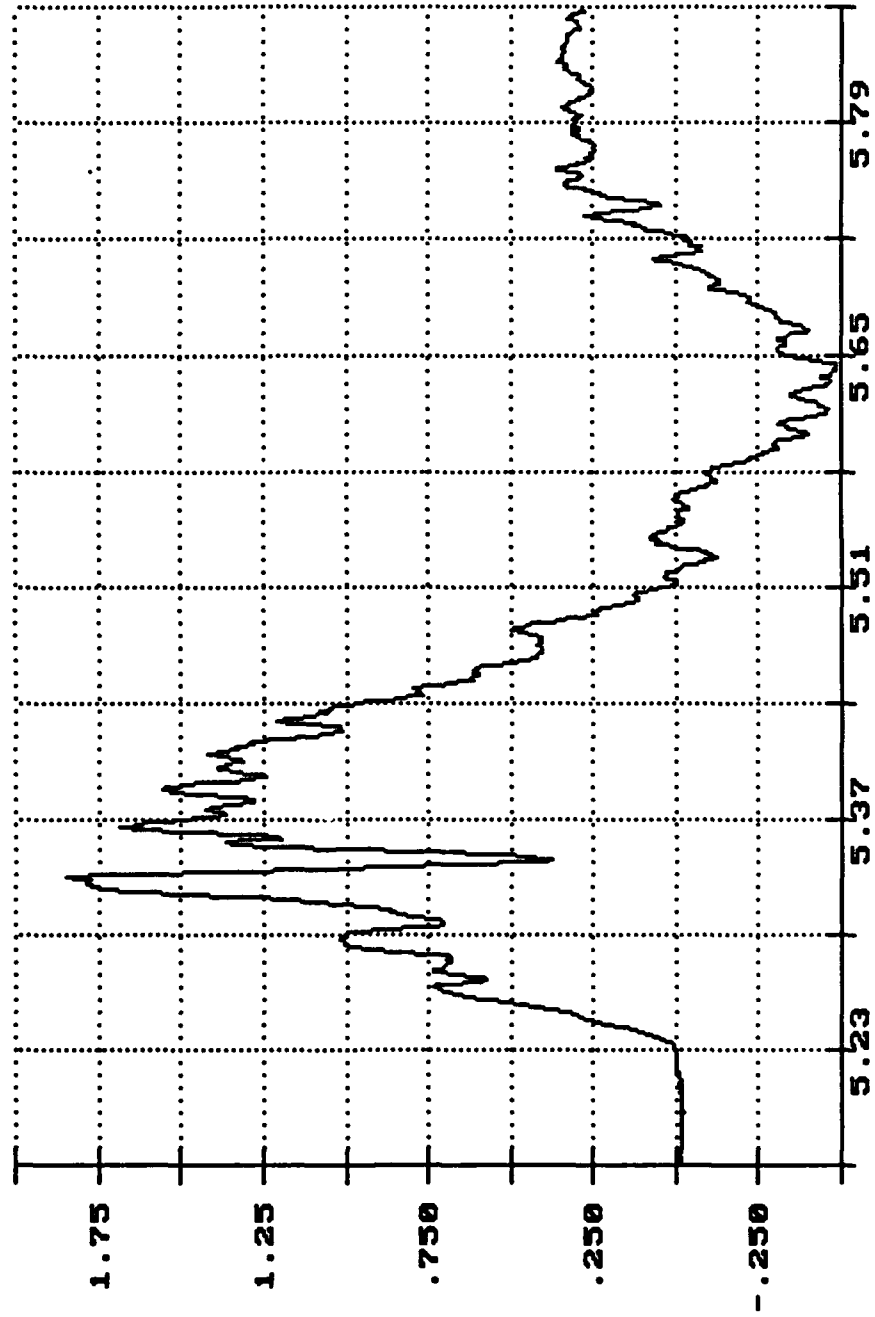

Long. Acceleration
Truck Frame
Gs X 1.0000

Time of Sample

Seconds X 1.0000

Anno Cert of USMC M923A1 Truck, Impact 5 Apr 01 14:00:06 1992

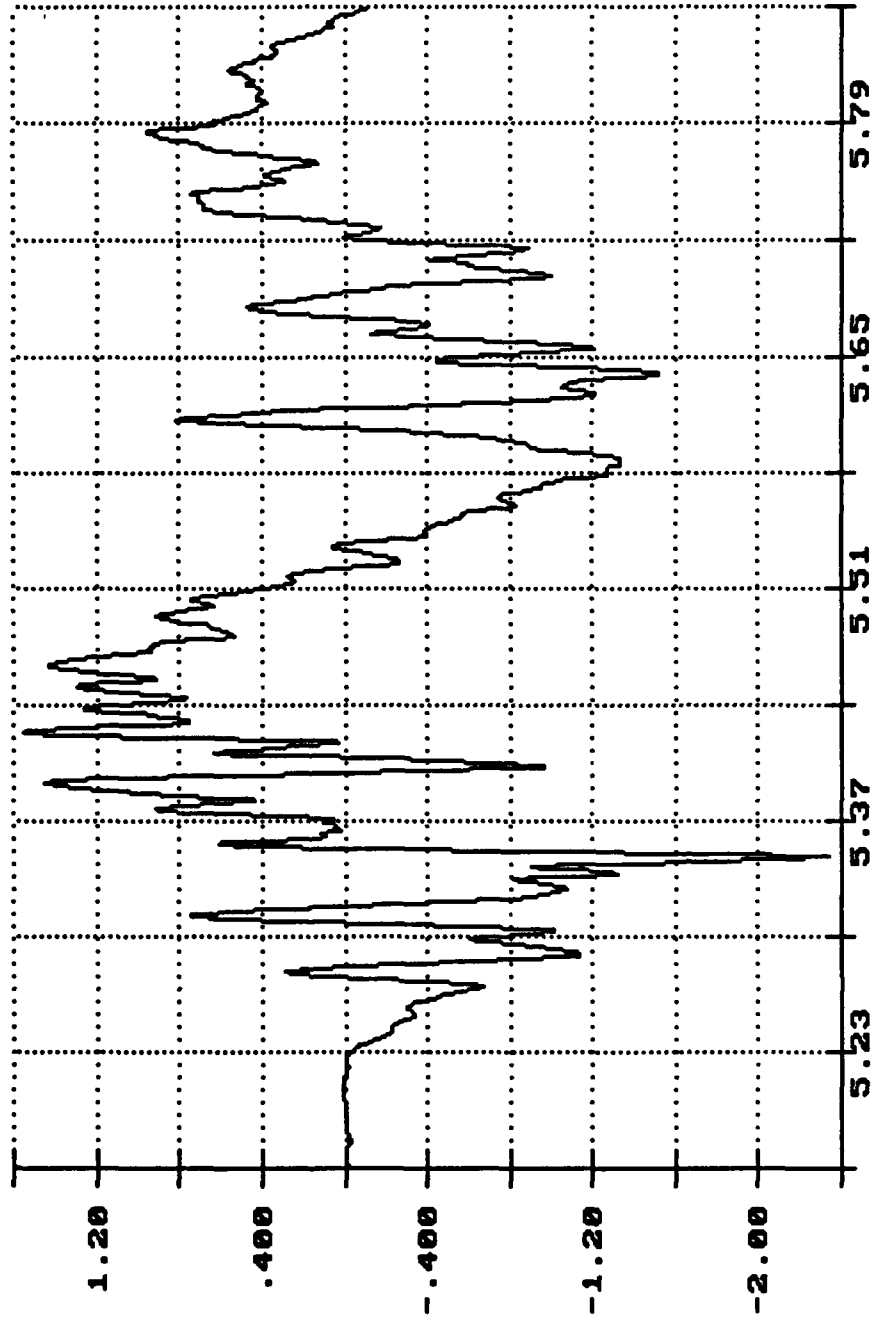

Time of Sample

Seconds X 1.0000

Vert. Acceleration
Truck Frame
Gs X 1.0000

Anno Cert of USMC M923A1 Truck, Impact 5 Apr 01 14:00:06 1992

7

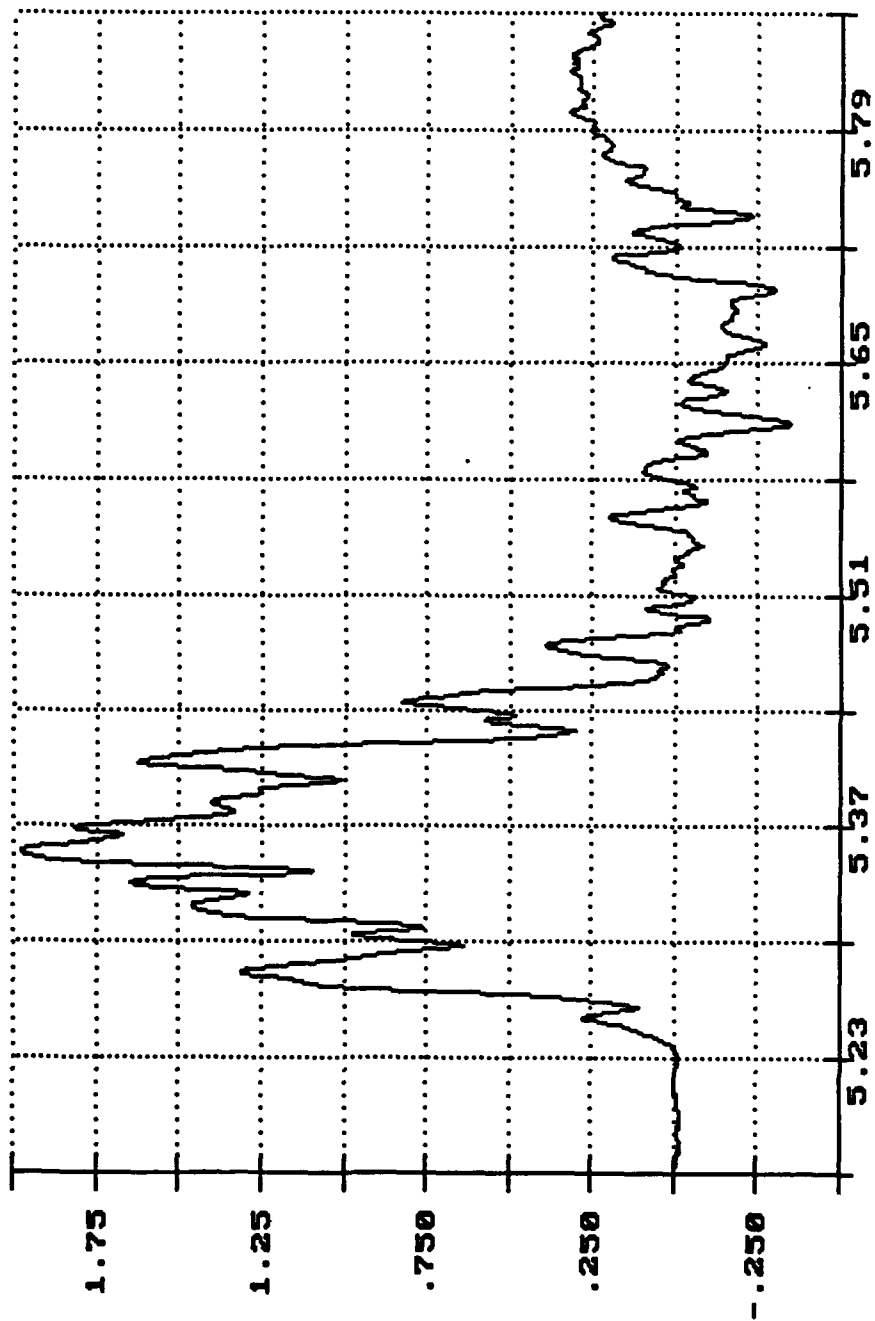

Long. Acceleration
Truck Bed
Gs X 1.0000

Time of Sample

Seconds X 1.0000

Anno Cert of USMC M923A1 Truck, Impact 3 Apr 01 14:00:06 1992

7

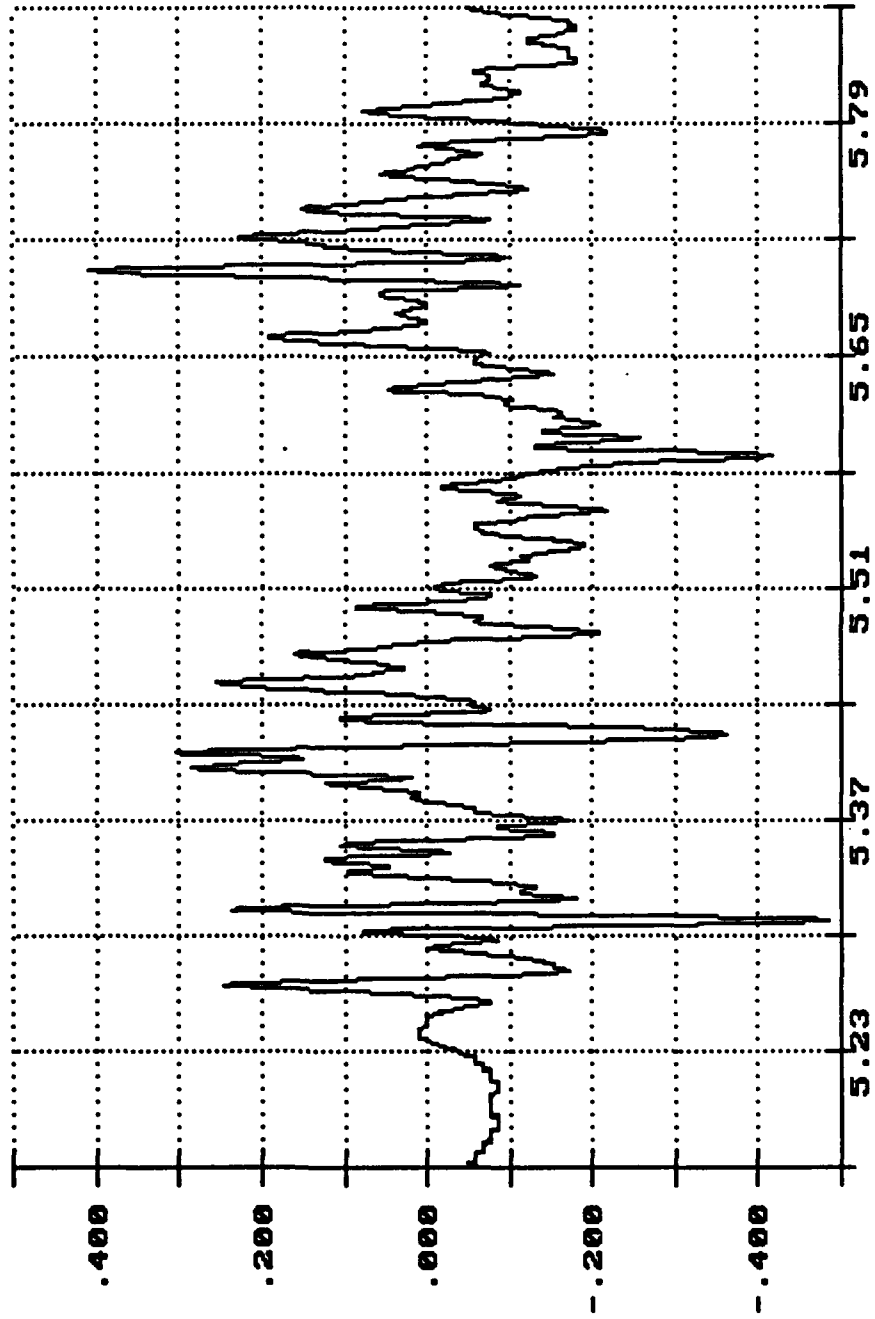

Lat. Acceleration
Truck Bed
Gs X 1.0000

Time of Sample

Seconds X 1.0000

7
Ammo Cert of USMC M923A1 Truck, Impact 5 Apr 01 14:00:06 1992

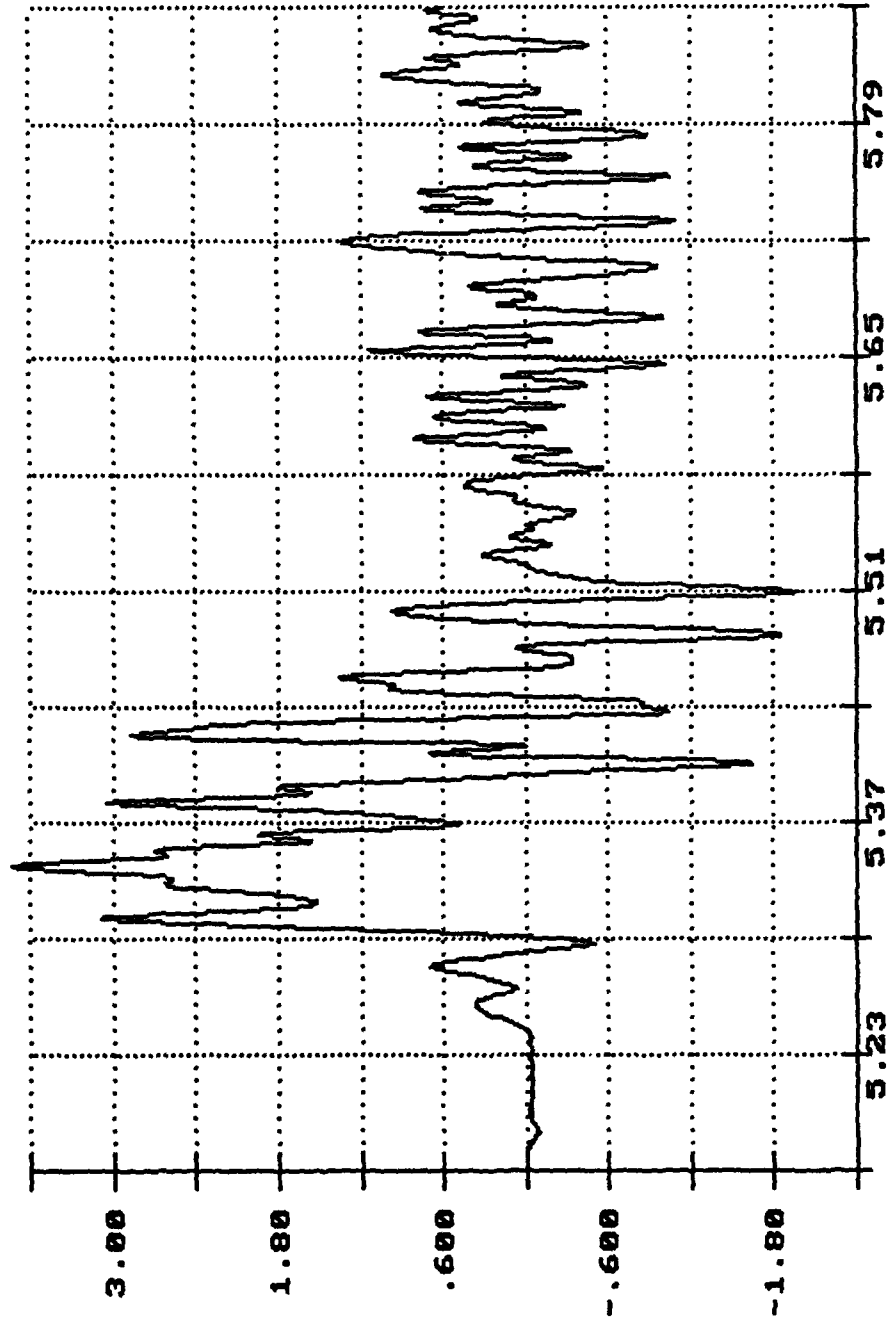

Long. Acceleration
Top of Front Sixcon
Gs X 1.0000

Time of Sample
Seconds X 1.0000

Anno Cert of USMC M923A1 Truck, Impact 5 Apr 01 14:00:06 1992

7

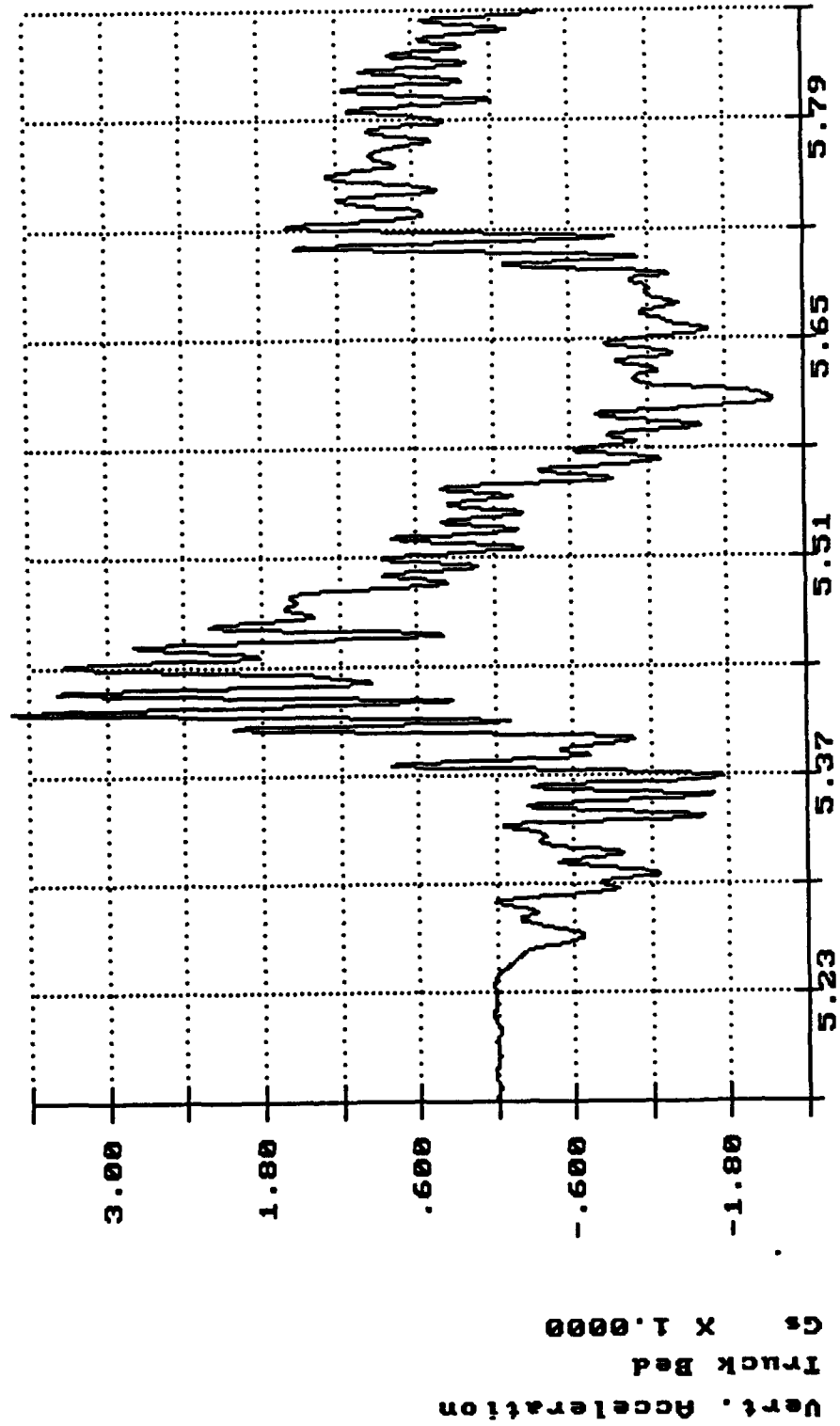

Anno Cert of USMC M923A1 Truck, Impact 5 Apr 01 14:00:06 1992

7

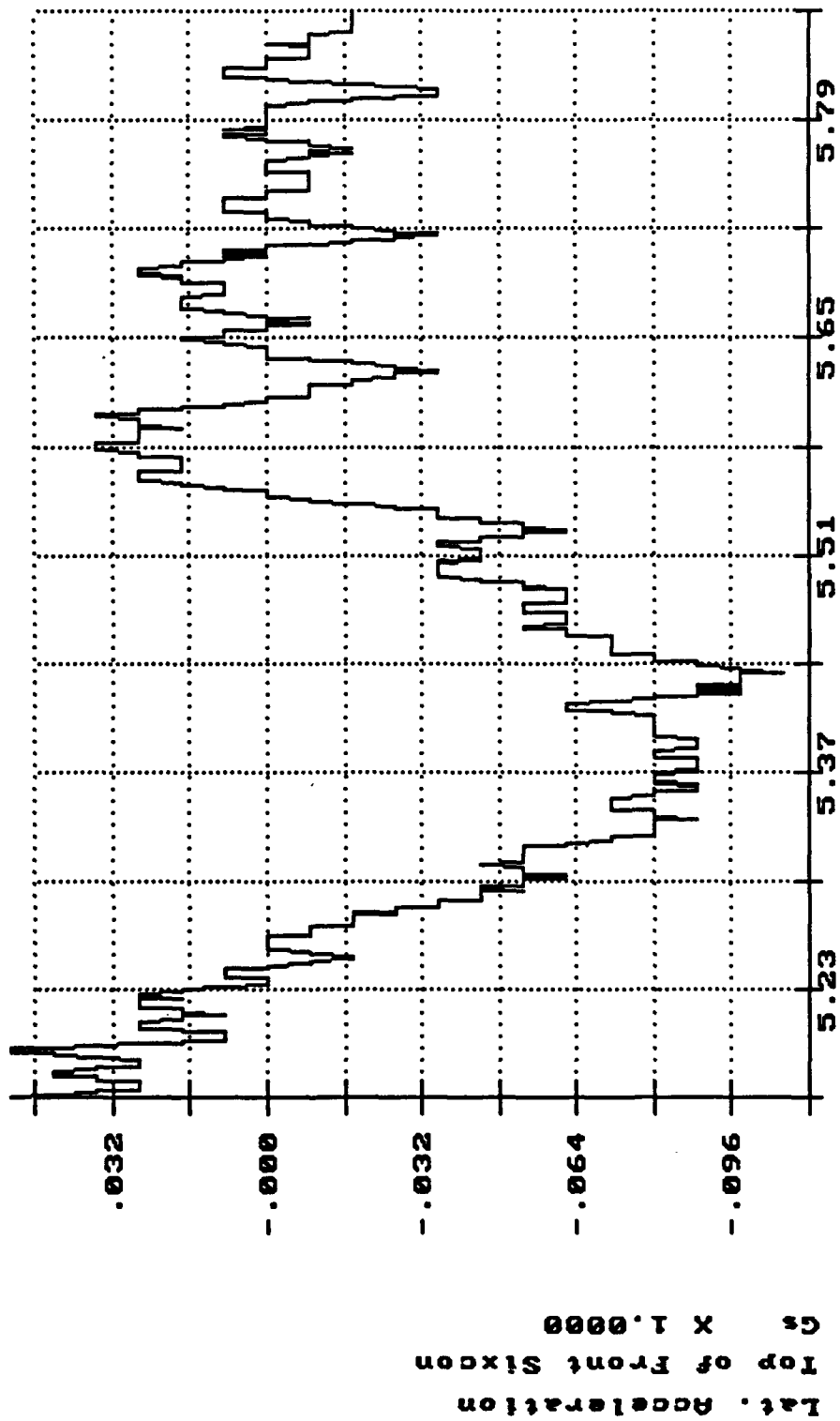

Time of Sample

Seconds X 1.0000

Anno Cert of USMC M923A1 Truck, Impact 5 Apr 01 14:00:06 1992

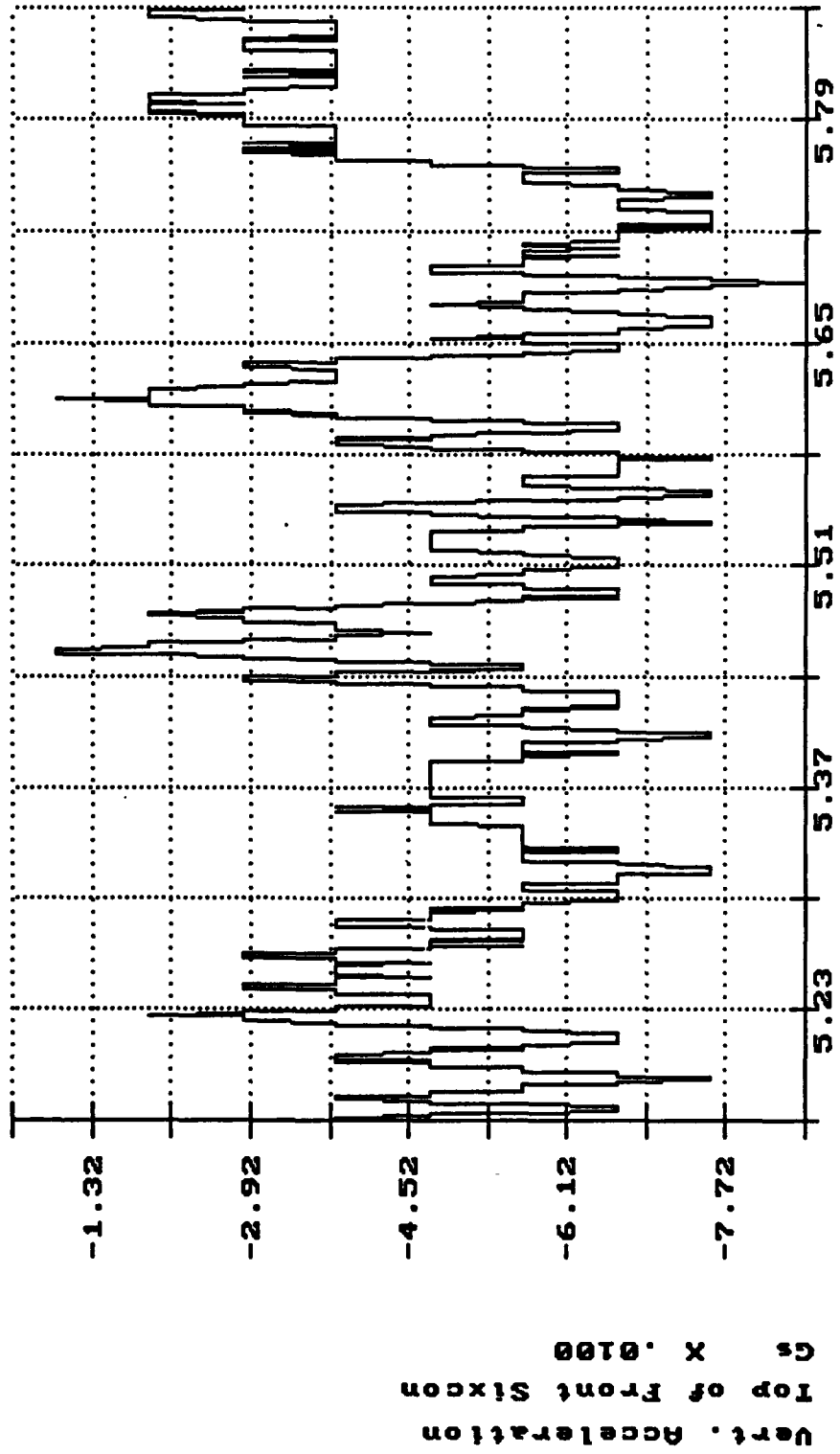

Time of Sample

Seconds X 1.0000

Anno Cert of USMC M923A1 Truck, Impact 5 Apr 01 14:00:06 1992

7

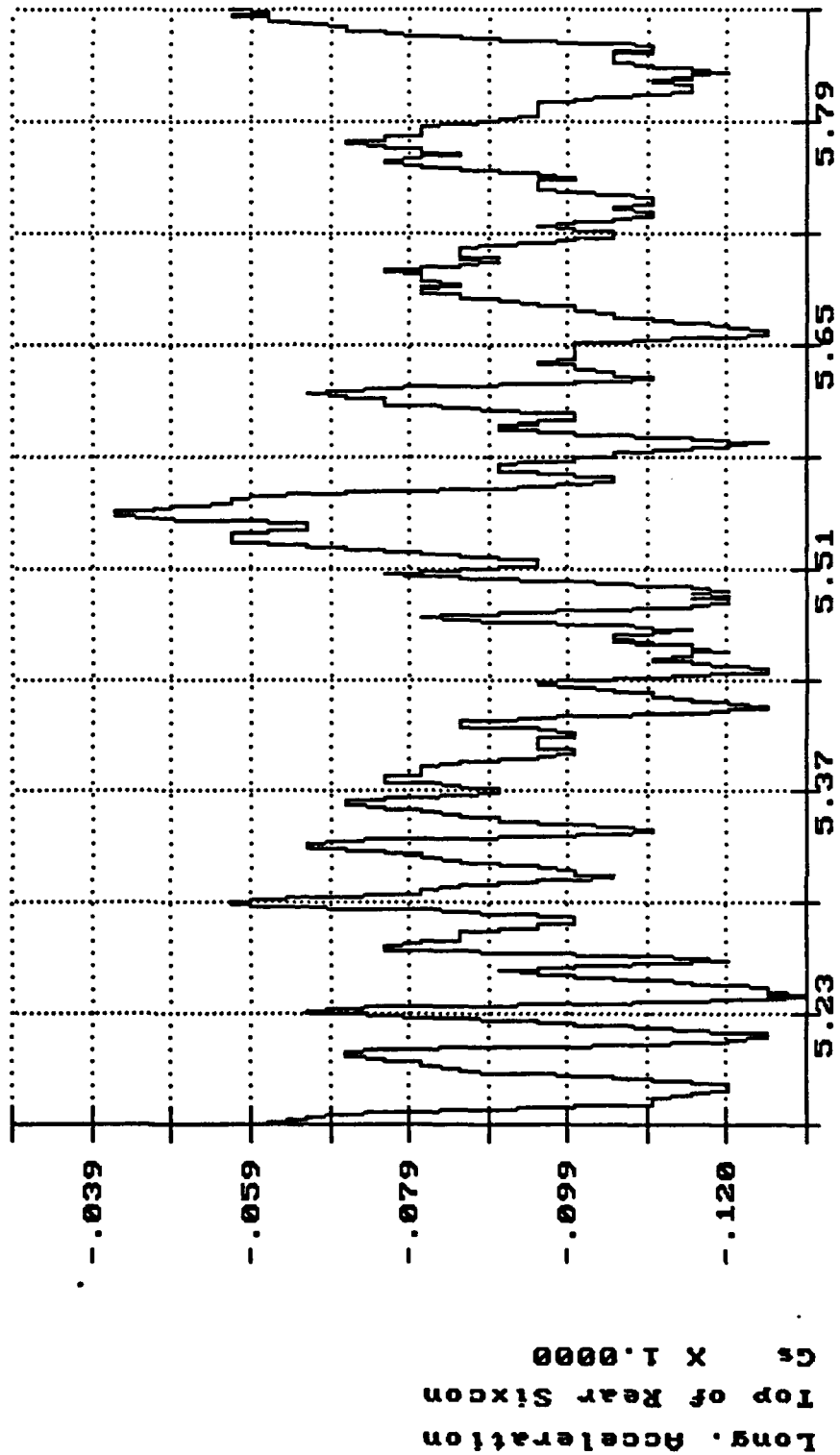

Time of Sample

Seconds X 1.0000

Anno. Cert of USMC M923A1 Truck, Impact 5 Apr 01 14:00:06 1992

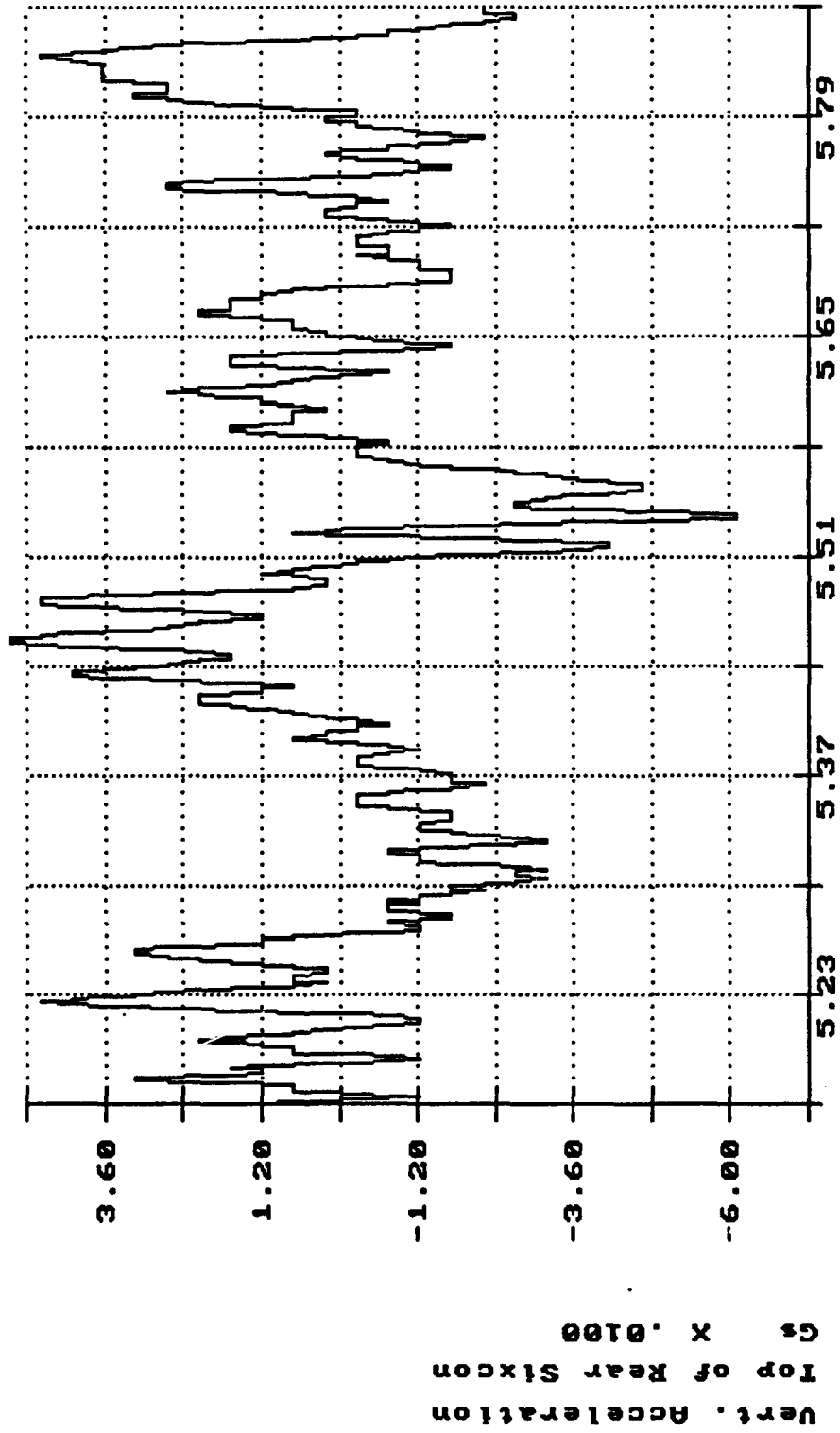

Time of Sample

Seconds X 1.0000