

2

MTL TR 92-43

AD-A256 881



AD

CHARACTERIZATION OF THICK GLASS REINFORCED COMPOSITES

JONATHAN FAZLI

SINTECH
NEEDHAM, MA

ELIZABETH GOEKE

U.S. ARMY MATERIALS TECHNOLOGY LABORATORY
MATERIALS TESTING AND EVALUATION BRANCH

JOHN NUNES

U.S. ARMY MATERIALS TECHNOLOGY LABORATORY
MATERIALS PRODUCIBILITY BRANCH

July 1992

Approved for public release; distribution unlimited.

DTIC
ELECTE
NOV 05 1992
E D



US ARMY
LABORATORY COMMAND
MATERIALS TECHNOLOGY LABORATORY

92-28894



2408

U.S. ARMY MATERIALS TECHNOLOGY LABORATORY
Watertown, Massachusetts 02172-0001

92 11 04 060

The findings in this report are not to be construed as an official Department of the Army position, unless so designated by other authorized documents.

Mention of any trade names or manufacturers in this report shall not be construed as advertising nor as an official indorsement or approval of such products or companies by the United States Government.

DISPOSITION INSTRUCTIONS

Destroy this report when it is no longer needed.
Do not return it to the originator.

REPORT DOCUMENTATION PAGE		READ INSTRUCTIONS BEFORE COMPLETING FORM
1. REPORT NUMBER MTL TR 92-43	2. GOVT ACCESSION NO.	3. RECIPIENT'S CATALOG NUMBER
4. TITLE (and Subtitle) CHARACTERIZATION OF THICK GLASS REINFORCED COMPOSITES		5. TYPE OF REPORT & PERIOD COVERED Final Report
		6. PERFORMING ORG. REPORT NUMBER
7. AUTHOR(s) Jonathan Fazli,* Elizabeth Goeke, and John Nunes		8. CONTRACT OR GRANT NUMBER(s)
9. PERFORMING ORGANIZATION NAME AND ADDRESS U.S. Army Materials Technology Laboratory Watertown, Massachusetts 02172-0001 SLCMT-MRM		10. PROGRAM ELEMENT, PROJECT, TASK AREA & WORK UNIT NUMBERS
11. CONTROLLING OFFICE NAME AND ADDRESS U.S. Army Laboratory Command 2800 Powder Mill Road Adelphi, Maryland 20783-1145		12. REPORT DATE July 1992
		13. NUMBER OF PAGES 19
14. MONITORING AGENCY NAME & ADDRESS (if different from Controlling Office)		15. SECURITY CLASS. (of this report) Unclassified
		15a. DECLASSIFICATION/DOWNGRADING SCHEDULE
16. DISTRIBUTION STATEMENT (of this Report) Approved for public release; distribution unlimited.		
17. DISTRIBUTION STATEMENT (of the abstract entered in Block 20, if different from Report)		
18. SUPPLEMENTARY NOTES *Sintech, Needham, Massachusetts		
19. KEY WORDS (Continue on reverse side if necessary and identify by block number) Glass reinforced composites Flexural properties Tension Mechanical testing Compression		
20. ABSTRACT (Continue on reverse side if necessary and identify by block number) (SEE REVERSE SIDE)		

Block No. 20

ABSTRACT

As a follow-on to a composite structural armor development program, a mechanical testing program for the composite materials was carried out. The composites are thick laminates of glass fabric and polyester resin. The tests used were flexure, tension, and compression. Because of the laminate thicknesses, redesign of the standard test specimens was necessary. The test results provide a characterization of the materials.

CONTENTS

	Page
INTRODUCTION	1
EXPERIMENTAL MATERIAL AND PROCEDURES	
Materials	2
Flexure Test	2
Tension Test	3
Compression Test	4
EXPERIMENTAL RESULTS	
Flexure	5
Tension	7
Compression	11
Discussion	15
CONCLUSIONS	16
ACKNOWLEDGMENTS	16

Accession For	
NTIS GPO	<input checked="" type="checkbox"/>
DTIC TAB	<input type="checkbox"/>
Unannounced	<input type="checkbox"/>
Justification	
By _____	
Distribution /	
Availability Codes	
Dist	Avail and/or Special
A-1	

DTIC QUALITY INSPECTED 4

INTRODUCTION

The application of thick organic matrix composites for structural armor on ground combat vehicles is a major thrust of Army strategy to *lighten the force*. The aim is to reduce weight while maintaining present ballistic requirement levels. Essential to this effort is the establishment of a materials property database which allows efficient design of components. This study addresses the need to obtain valid mechanical property data on composites up to two inches in thickness through the design and development of suitable specimen configurations and testing methods.

The U.S. Army Materials Technology Laboratory (MTL) has demonstrated the advantages and durability of composite structural armor application to ground combat vehicles during the Composite Infantry Fighting Vehicle (CIFV) program (see Figure 1). The thick welded aluminum hull structure of the Bradley Fighting Vehicle (BFV) was redesigned using the more weight efficient composite structural armor. This study measured mechanical properties of the CIFV materials. Flat plates of the composites used as armor were fabricated for material characterization.

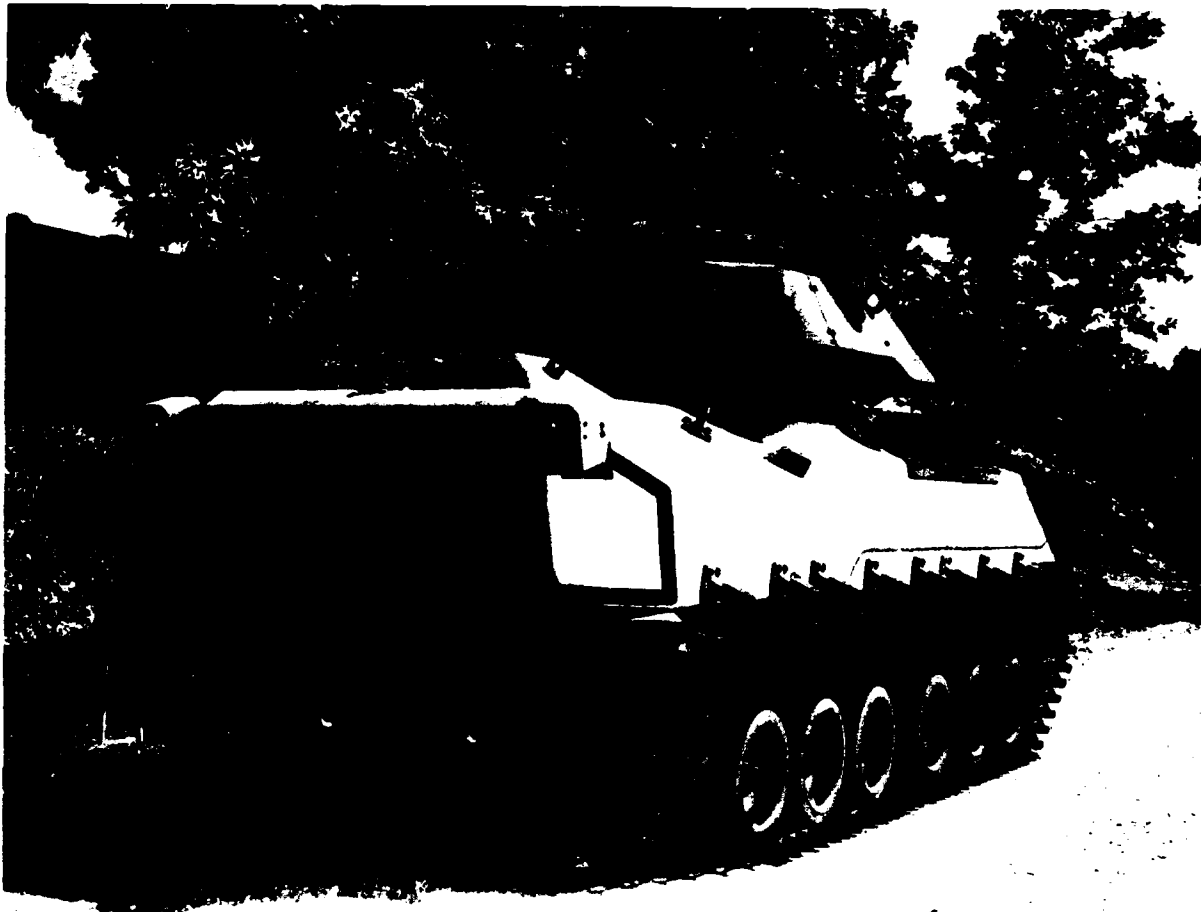

Figure 1 The Bradley Fighting Vehicle with the Composite Structural Armor in place.

The task of material characterization of the composite armor materials offered several challenges. These materials are coarse woven glass fabric polyester composites that are thicker by a factor of up to seven times than the materials for which composites testing standards are currently written. Two approaches can be used to deal with laminates that do not fit the standard tests available. One is to cut the standard specimen from the laminate and assume it characterizes the material. This approach was not used because such specimens would not fit well on the fabric structure; the weave structure is the same size or larger than the specimen. Thus, generating design data with thin laminates of these materials (0.25 inches thick) may give inaccurate properties when scaling up to the full thickness of the hull structure (1.75 inches). The other approach is to modify the specimen design to adapt it to the laminate being studied. Both modification of the current tests and choice of a new test configuration were included in these studies.

When considering a test method for inclusion in an extensive program the amount of material necessary for the test specimen, the amount of machining necessary to prepare the specimens and the complexity of the test fixture must be considered because of cost. The compression specimen chosen for this study is an optimization of these factors.

Three types of tests were chosen to characterize the mechanical properties of these materials, flexure, tension, and compression. The flexure test was chosen because it is often used for quality control since it is quite simple to perform. However, the data from this test is not considered valid material property data as the results depend upon specimen configuration. Such test data is useful when comparing similar materials under similar conditions.

Mechanical property data obtained from the tension and compression tests are widely used in materials research and development, product design, and quality control. As a result, their limitations and attributes are fairly well understood. There is also data available with which to make comparisons when evaluating materials.

EXPERIMENTAL MATERIAL AND PROCEDURES

Materials

There were two CIFV candidate materials evaluated in this study. Both materials contained the same reinforcement, a plain weave S-2 glass fabric with a weight of 24 ounces per square yard. The matrices were different polyester resin systems from American Cyanamid and Owens Corning. Specimen thicknesses ranged from 0.5 inches to 1.75 inches, specifically 20, 30, 40, 60, and 70 plies. Owens Corning fabricated 2 foot by 4 foot plates using their resin while MTL fabricated similar size plates using the American Cyanamid resin. The Owens Corning plates contained 53% volume fraction fiber while the American Cyanamid plates contained 57%.

Flexure Test

The flexure test specimen configuration used was obtained from ASTM D 790¹ which describes a beam in three point or four point loading to be used for reinforced plastics. The projected material properties indicated that a length-to-depth ratio of 16 would give valid failures for the study materials. The composite thickness dictated that even for this ratio the beam would be fairly large.

1. Standard Test Methods for Flexural Properties of Unreinforced and Reinforced Plastic and Electrical Insulating Materials. D790, v. 8.01, ASTM Annual Book of Standards, Philadelphia, PA, 1991.

To conserve material a square cross section was chosen for the testing although ASTM D 790 calls for a rectangular cross section. The available thicknesses of the materials were tested to investigate size effects on the strength of the material; there were five thicknesses for the Owens Corning and four for the American Cyanamid.

Specimens were loaded in three point bending at a displacement rate that was changed with specimen thickness such that the strain rate was constant. This was a *static* rate of 0.01 inch/inch/minute. Load-deflection curves were recorded utilizing the test machine crosshead movement. Load-strain data were also obtained utilizing strain gages located midspan on the tensile side of the beam. A schematic of the test configuration is shown in Figure 2. The flexural moduli were calculated from data obtained on measuring both the slope of the load-deflection and the load-strain curves. The resulting two sets of values were compared. From maximum load data the flexural strengths were calculated.

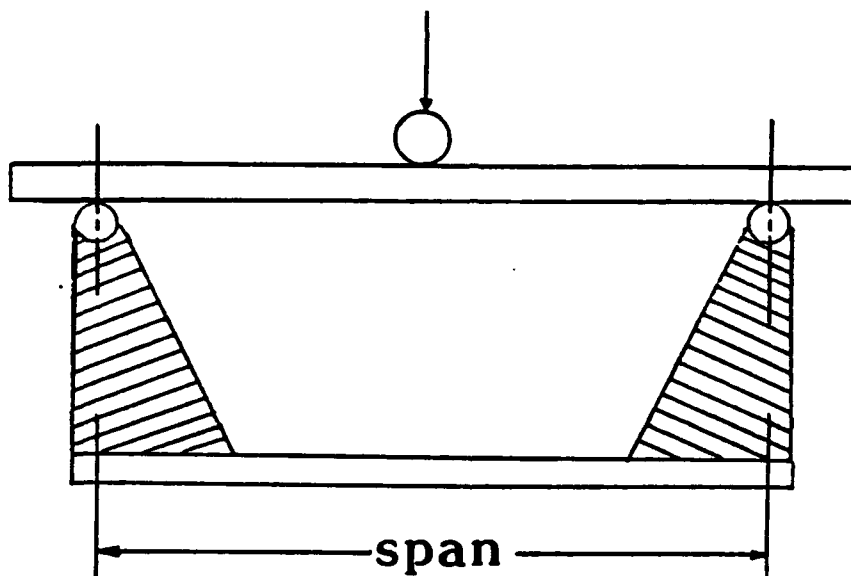

Figure 2. Three point bend test.

Two testing sequences were used. The preliminary one used a fixed span to validate the chosen span to depth ratio. The main sequence posed two questions: (1) do the materials differ significantly in properties, and (2) do the properties change as the material thickness changes?

Tension Test

Glass/polyester composites with thicknesses of a quarter inch or less are routinely tested in tension using straight-sided specimens as described in ASTM D 3039.² Stronger and stiffer composites such as graphite/epoxy require the addition of end tabs to improve load transfer and to minimize failures at the grips. It has also been shown³ that a contoured specimen can be used to obtain valid test data eliminating the need for end tabs.

2. Standard Test Method for Tensile Properties of Fiber-Resin Composites. D3039, v. 15.03, ASTM Annual Book of Standards, Philadelphia, PA, 1991.

3. OPLINGER, D. W., GANDHI, K. R., and PARKER, B. S. *Studies of Tension Test Specimens for Composite Material Testing*. U.S. Army Materials Technology Laboratory, AMMRC TR 82-27.

Considerable work had been done previously on contoured specimens at MTL including a *bowtie* specimen configuration. This specimen geometry was chosen for testing the thick composites of this study as it was simpler to fabricate than other types of contours and did not require the addition of tabs. The *bowtie* specimen consists of two long tapered ends with a straight-sided gage section between (see Figure 3). A taper of 5% and an overall length of 36 to 44 inches was chosen. Strain gages were used to obtain accurate modulus values and to measure Poisson's ratio. Specimens were cut from plates of three thicknesses of American Cyanamid and five thicknesses of Owens Corning.

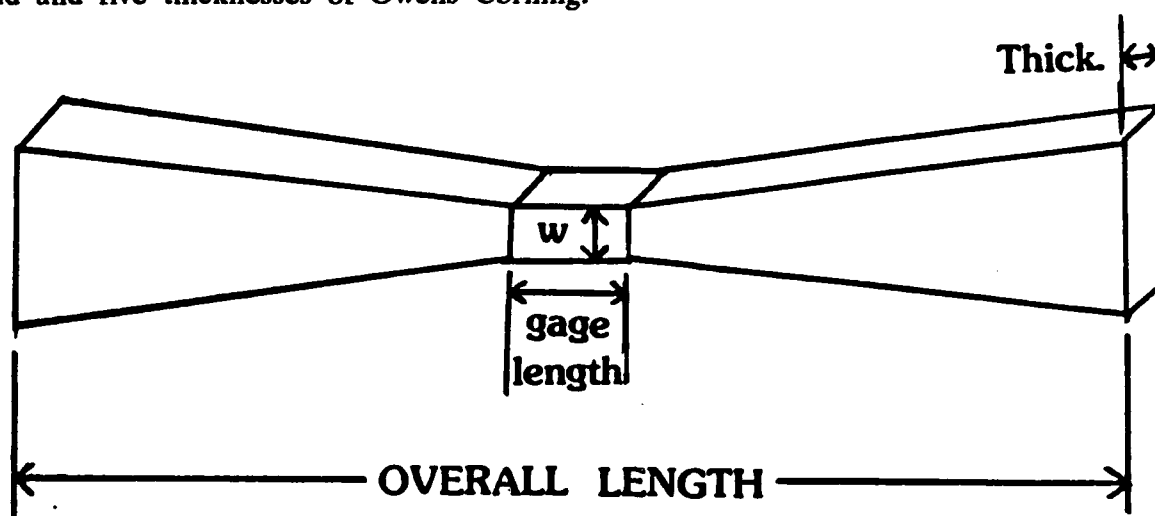

Overall Length	36 or 44 inches
Thickness	0.5 to 1.75 inches
Width	0.75 to 1.75 inches
Gage Length	1.125 to 2.625 inches

Figure 3. Tensile Specimen.

Tension tests were conducted at a constant displacement rate of 0.2 inches per minute. Load-strain data were obtained up to material yielding. Beyond yield load-deflection data were recorded up to failure.

Compression Test

The compression specimens described in ASTM D 3410⁴ did not offer any easy application for these materials; as the test describes thin coupons tested in a supported configuration or a honeycomb beam. However one of the specimens described in ASTM D 695⁵ offered a simpler solution. This is an unsupported rectangular prism where the height is related to the thickness of the laminate. It was modified to be a square prism to reduce the possibility of buckling. A width of one inch was used to include sufficient of the weave pattern that the weaving crossovers are averaged. The plate thickness was used for the specimen height. The resulting specimen is much smaller than the test specimens used for the other portions of this study. It is shown in Figure 4.

4. Standard Test Method for Compressive Properties of Unidirectional or Crossply Fiber-Resin Composites. D3410, Vol. 15.03, ASTM Annual Book of Standards, Philadelphia, PA, 1991.

5. Standard Test Method for Compressive Properties of Rigid Plastics. D3410, v. 15.03, ASTM Annual Book of Standards, Philadelphia, PA, 1991.

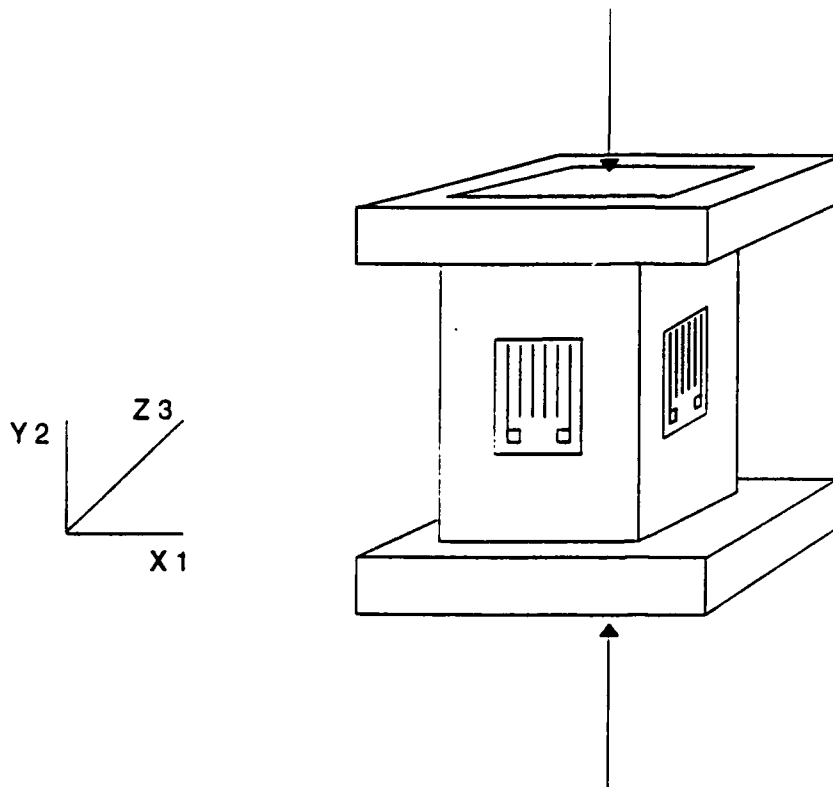

Figure 4. Prism specimen with collars and strain gages.

Compression specimens were cut from only one thickness of each material, the 1.75 inch plates. They were cut in the three Cartesian directions, through the thickness and the two fiber directions. Five specimens in each direction were used.

Specimens were tested between flat platens at a *static* displacement rate of 0.02 inches per minute. A hemispherical seat was used on the bottom platen to improve alignment. Strain gages were used on two adjacent unloaded faces to measure compressive modulus and Poisson's ratio. In order to improve the accuracy of the elastic property measurement three load-unload cycles were applied prior to loading to failure.

Testing was done in two groups. The first group consisted of three of each direction and included aluminum collars at the top and bottom of each specimen. Because there was no evidence of brooming on the tested specimens, of the first group, the remaining specimens were tested without the collars.

EXPERIMENTAL RESULTS

Flexure

The preliminary set of flexure tests was run with three thicknesses of material and a testing span of 10 inches. This investigated the validity of the choice of span-to-depth ratio. The ratio varied from 37 to 6. The data from this (see Table 1) shows that the measured modulus does not vary with span-to-depth ratio. The evidence on stress at yield is not as clear.

Table 1. PRELIMINARY FLEXURE DATA

Thickness (Inch)	Stress at Yield (ksi)	Modulus (Msi)	1/d
0.272	24.9	2.94	37
1.070	34.4	2.71	9.3
1.664	25.8	2.68	6

The main test sequence used the ratio of 16 based upon this evidence. Since specimens were cut from a range of thicknesses of both materials, testing was done at a range of spans; the data is shown in Table 2 and also plotted in Figure 5. Examination of these shows that the modulus of the materials is fairly consistent with changing thickness and approximately the same for the two resins. The flexural modulus results obtained from the load-strain data were consistently higher than those obtained from the load-deflection data (about 15 percent higher). The strength values show larger variability; they indicate that thicker material is slightly weaker.

Table 2. FLEXURE DATA

	Thickness (Inches)	Strength (ksi)	Modulus (Msi)
Owens Corning	0.5	30.2	3.07
	0.75	41.2	3.66
	1.00	29.9	3.37
	1.50	26.9	3.45
	1.75	23.9	3.07
American Cyanamid	0.50	40.7	3.11
	0.75	30.1	2.89
	0.80	41.6	3.28
	1.73	29.7	3.31

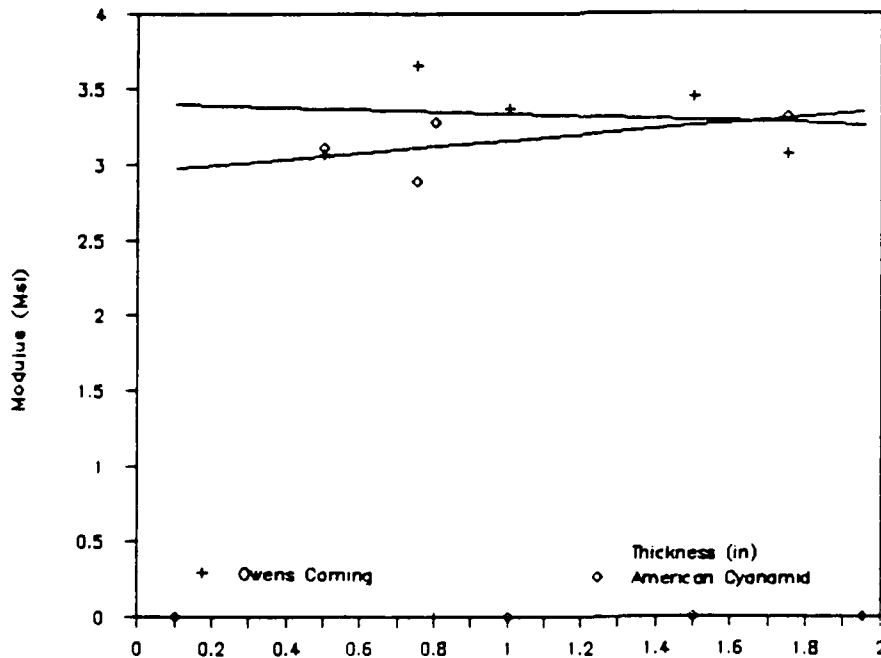

Figure 5a. Flexural modulus versus thickness.

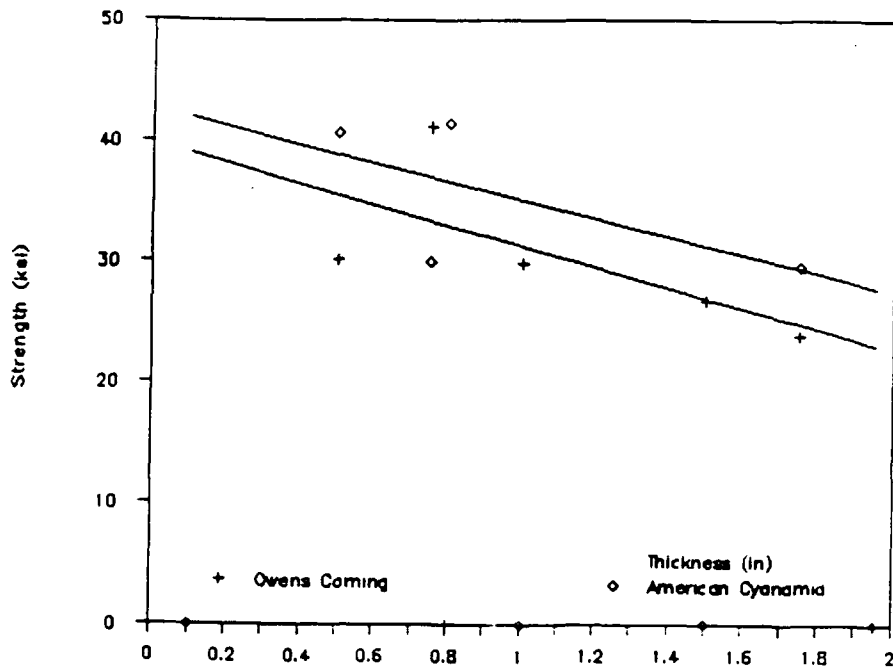

Figure 5b. Flexural strength versus thickness.

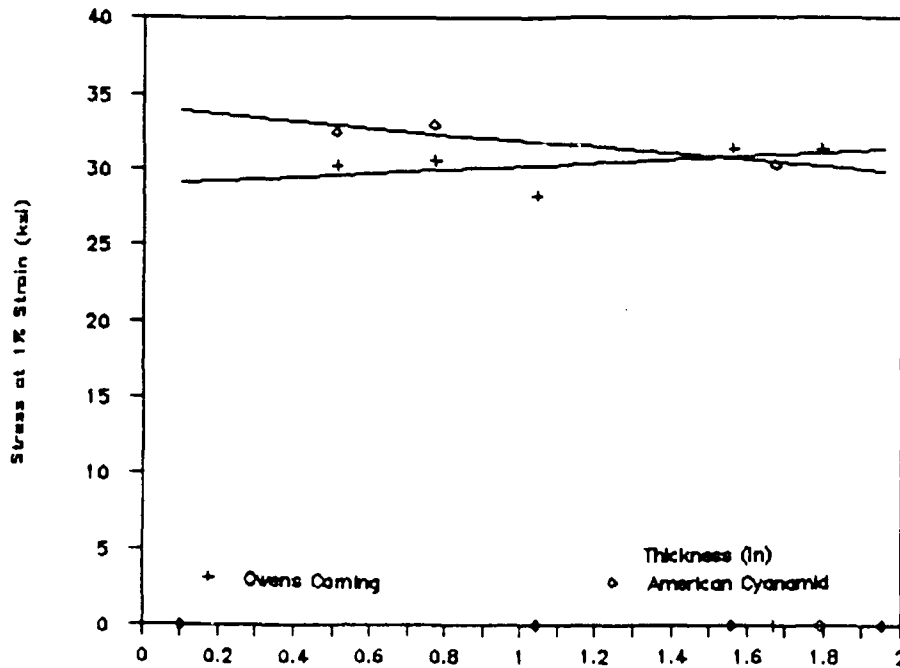

Figure 5c. Stress at 1% strain versus thickness.

Tension

Figure 6 shows a failed specimen in one of the testing machines. The data from the tensile tests is shown in Table 3. Values are given for failure stress obtained from maximum load data, elastic moduli and Poisson's ratios. The tensile modulus, failure strength, and stress at a constant strain of 1% are plotted in Figure 7. The constant strain data show that both materials

exhibited essentially the same stress-strain curves during their initial loading history including the nonlinear yielding region. An examination of all the data leads to the conclusion that the properties of the materials do not vary with specimen thickness as evidenced by the approximately zero slope least squares curves of the plots. As a result, the values for each material have been averaged. It is, therefore, concluded from the averages that the Owens Corning material is slightly stronger than the American Cyanamid material. Except for extremely small strains (less than 0.0005), a negative Poisson's effect was observed through the thickness resulting in an expansion of the specimen's thickness up to failure. Failure proceeded by initial delamination of plies followed by progressive and extensive fiber fracture up to the maximum load where an abrupt drop in load (80% to 90% of the applied load decreased) signified failure.

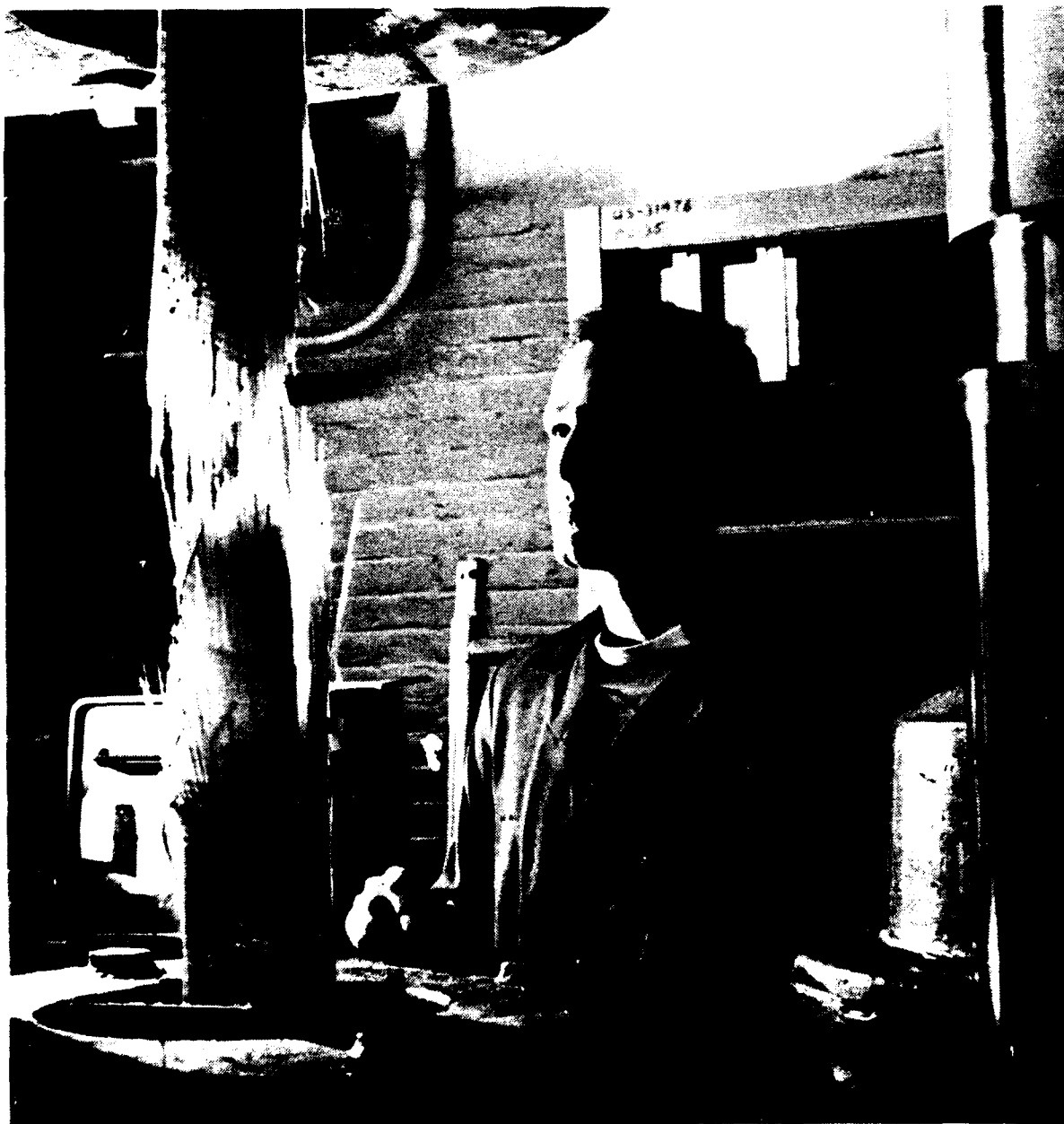

Figure 6. A failed tensile specimen in an open loop hydraulic test machine.

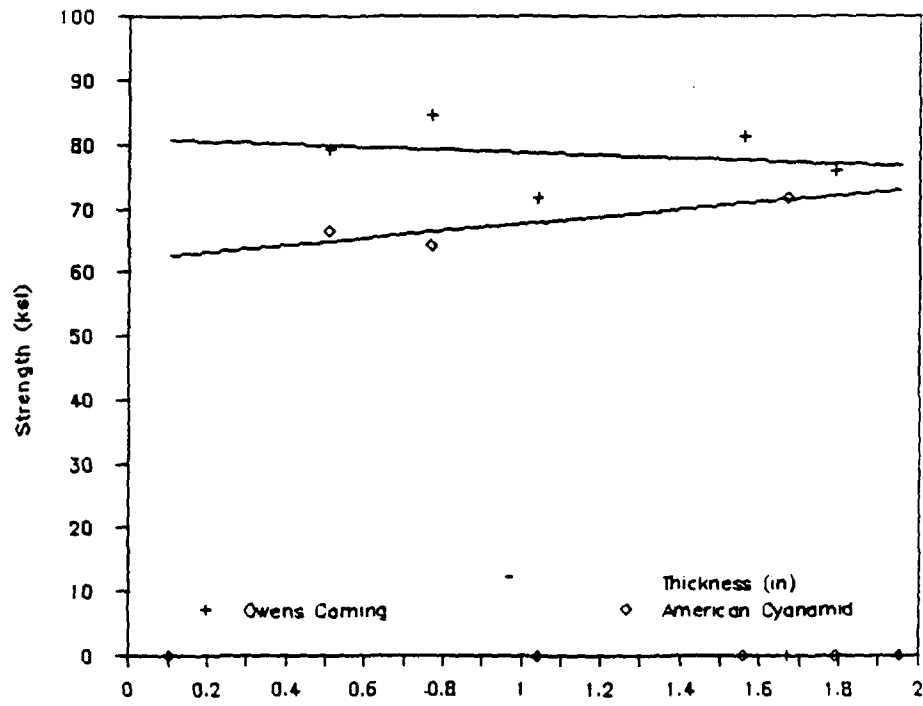

Figure 7a. Tensile strength versus thickness.

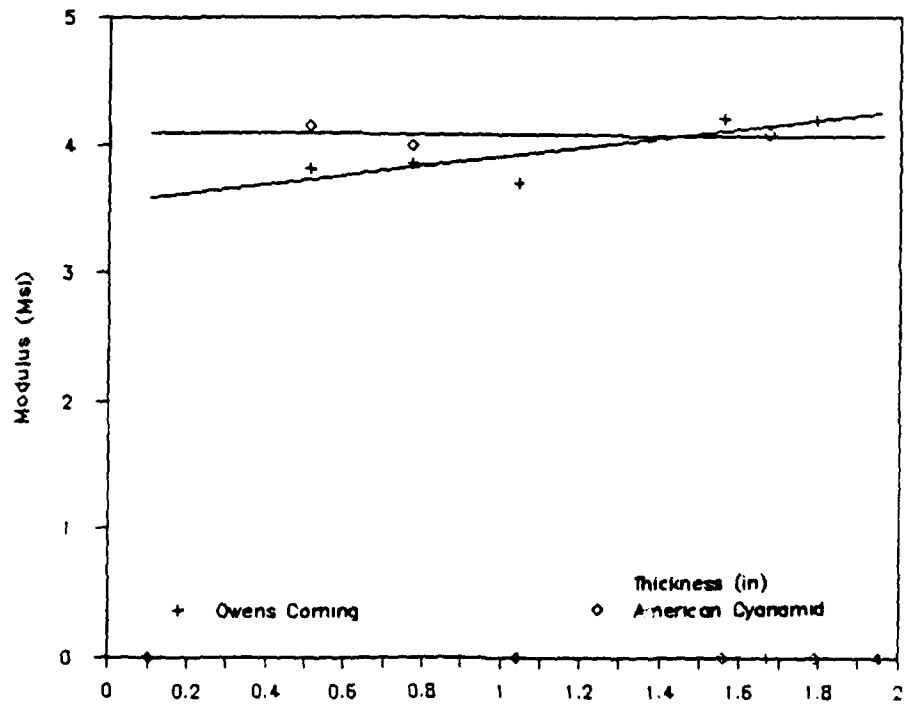

Figure 7b. Tensile modulus versus thickness.

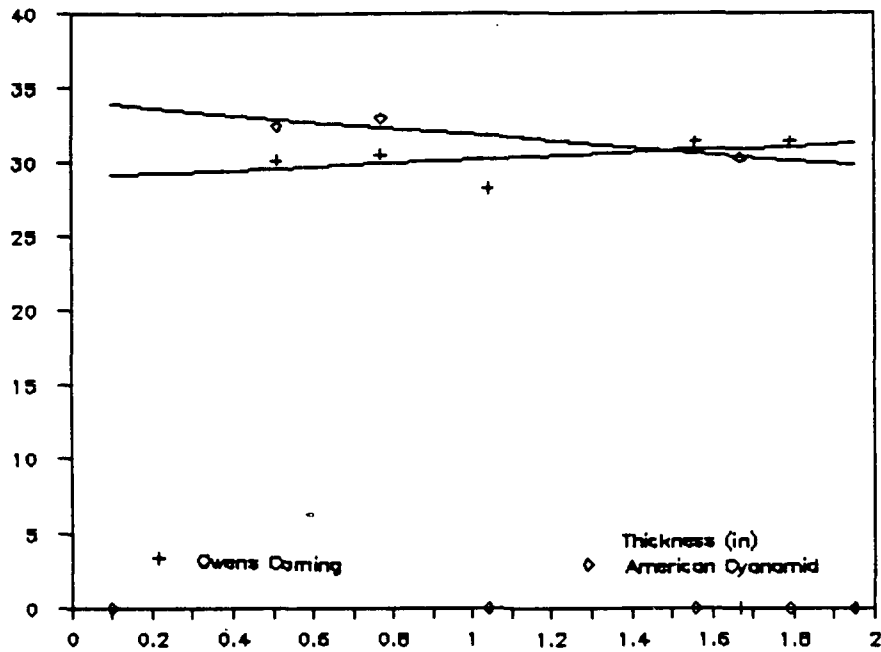

Figure 7c. Stress at 1% strain versus thickness.

Table 3. TENSILE DATA

	Thickness (Inches)	Strength (ksi)	Modulus (Msi)	12*	Nu 13
American Cyanamid	0.53	66.6	4.16	0.11	0.37
	0.79	64.4	4.00	0.11	0.31
	1.67	72.0	4.09	0.10	0.31
Owens Corning	0.51	79.4	3.82	0.08	0.22
	0.77	84.7	3.86	0.10	0.27
	1.04	71.9	3.71	0.08	0.28
	1.56	81.4	4.21	0.10	0.31
	1.79	76.2	4.19	0.10	0.34
Averages					
	American Cyanamid	67.7	4.08	0.11	0.33
	Owens Corning	78.7	3.96	0.09	0.28

*Nu 12 is the fabric face value for fiber direction specimens.

Compression

Figure 8 shows a compression specimen in the test machine ready to be tested. The test results are given in Table 4 and plotted in Figure 9. The maximum strain values were recorded with the strain gages. The compression values were calculated from the ram displacements. These are the condensation of two subgroups of results.

Table 4. COMPRESSIVE DATA SUMMARY

	Modulus (Msi)	Strength (ksi)	Nu 12*	Nu 13	Failure Strain (%)	Compression (%)
Owens Corning						
Through Thickness	2.46	59.2	0.08	0.07	0.13	9.3
Fiber Direction	4.01	25.0	0.12	0.31	0.52	1.8
American Cyanamid						
Through Thickness	1.75	87.9	0.16	0.17	2.8	9.0
Fiber Direction	4.38	31.8	0.11	0.37	0.72	2.2

*Nu 12 is the fabric face value for fiber direction specimens.

All of the fiber direction data has been combined since no difference was found between the two sets of specimens, as shown in Table 5. The data with and without collars has also been combined since no significant difference was found between those sets, as shown in Table 6.

Table 5. COMPARISON OF FIBER DIRECTION DATA

	Modulus (Msi)	Strength (ksi)	Nu 12*	Nu 13	Failure Strain (%)	Compression (%)
Owens Corning						
Direction A	3.86	25.2	0.136	0.399	0.40	1.70
Direction B	4.16	24.8	0.111	0.327	0.65	1.94
American Cyanamid						
Direction A	4.29	31.2	0.125	0.342	0.71	2.2
Direction B	4.46	32.5	0.101	0.399	0.73	2.2

*Nu 12 is the fabric face value for fiber direction specimens.

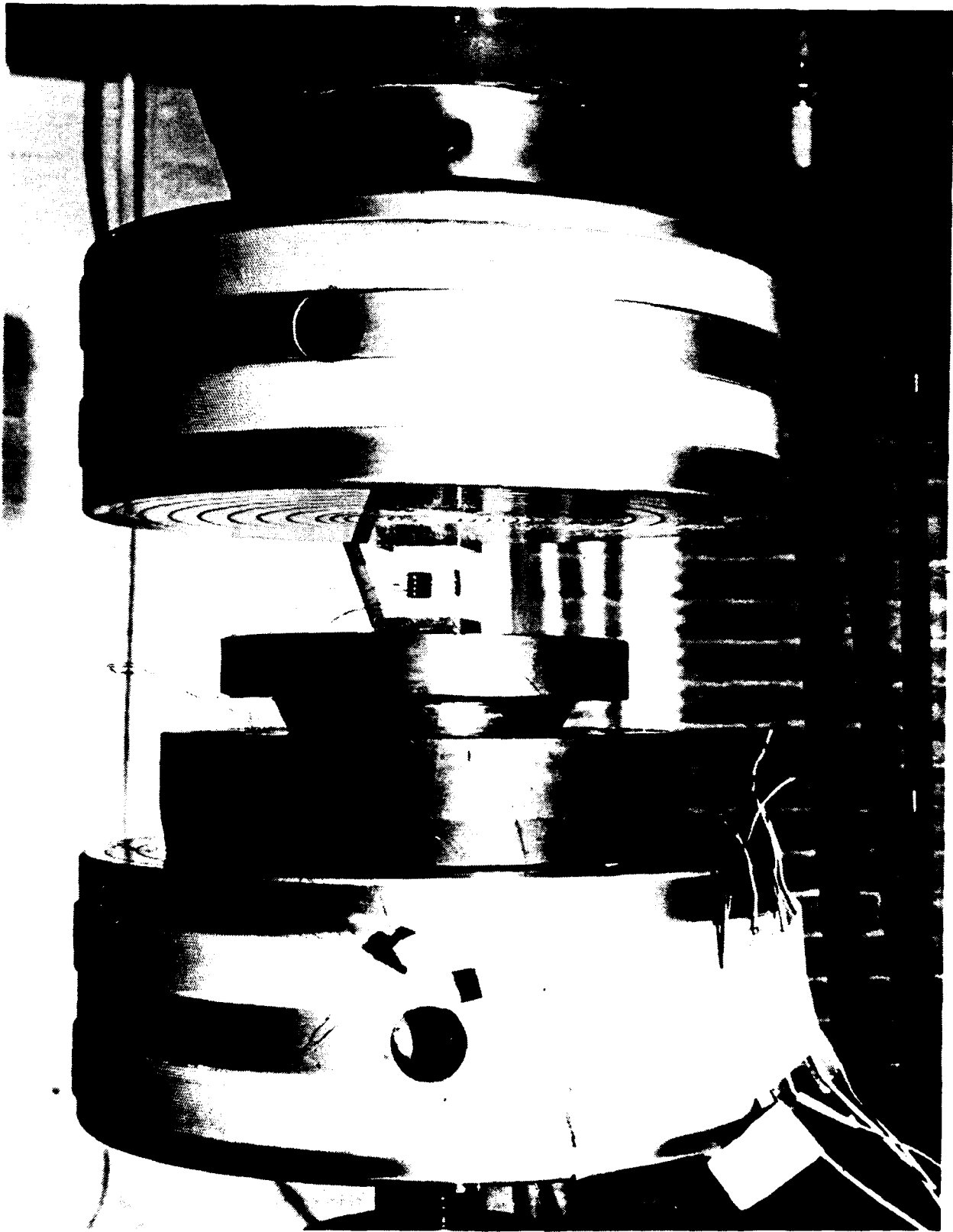

Figure 8. A compression specimen ready for test in a servo-hydraulic test machine.

Table 6. EFFECT OF COLLARS ON PROPERTIES

	Modulus (Msi)	Strength (ksi)	Nu 12*	Nu 13	Failure Strain (%)	Compression (%)
Owens Corning						
Thickness						
With	2.44	59.6	0.045	0.065	0.14	9.6
No	2.50	58.7	0.127	0.116	0.12	8.8
Fiber Direction						
With	3.94	23.9	0.128	0.378	0.47	1.77
No	4.18	27.6	0.126	0.311	0.70	1.96
American Cyanamid						
Thickness						
With	1.81	76.2	0.176	0.143	2.60	10.9
No	1.66	88.1	0.151	0.156	3.08	11.2
Fiber Direction						
With	4.36	30.7	0.126	0.386	0.70	2.2
No	4.38	33.3	0.122	0.345	0.74	2.2

*Nu 12 is the fabric face value for fiber direction specimens.

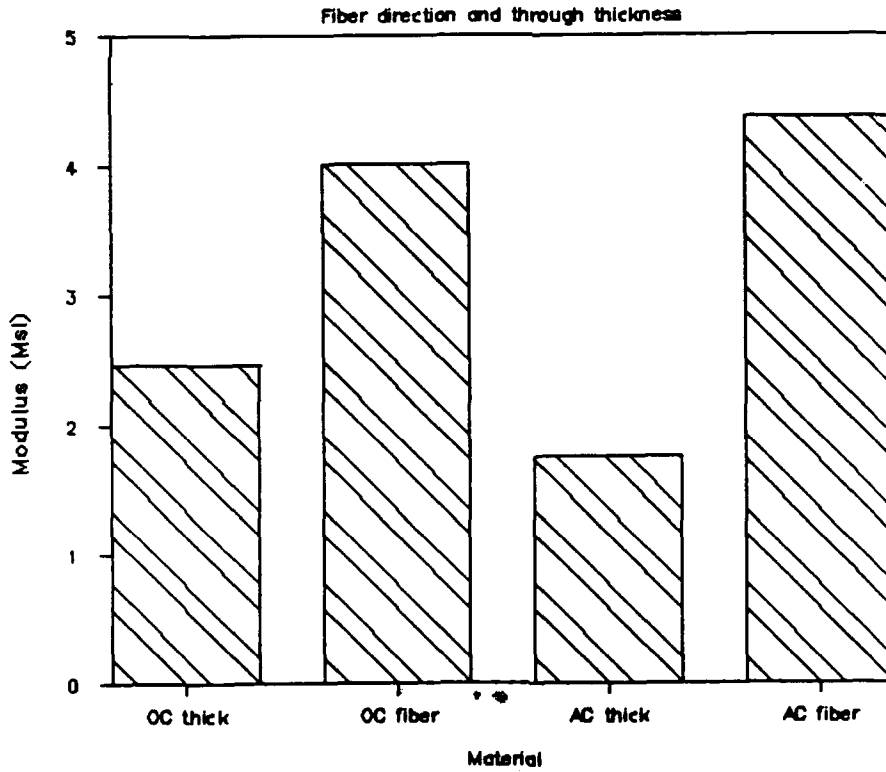

Figure 9a. Compressive modulus.

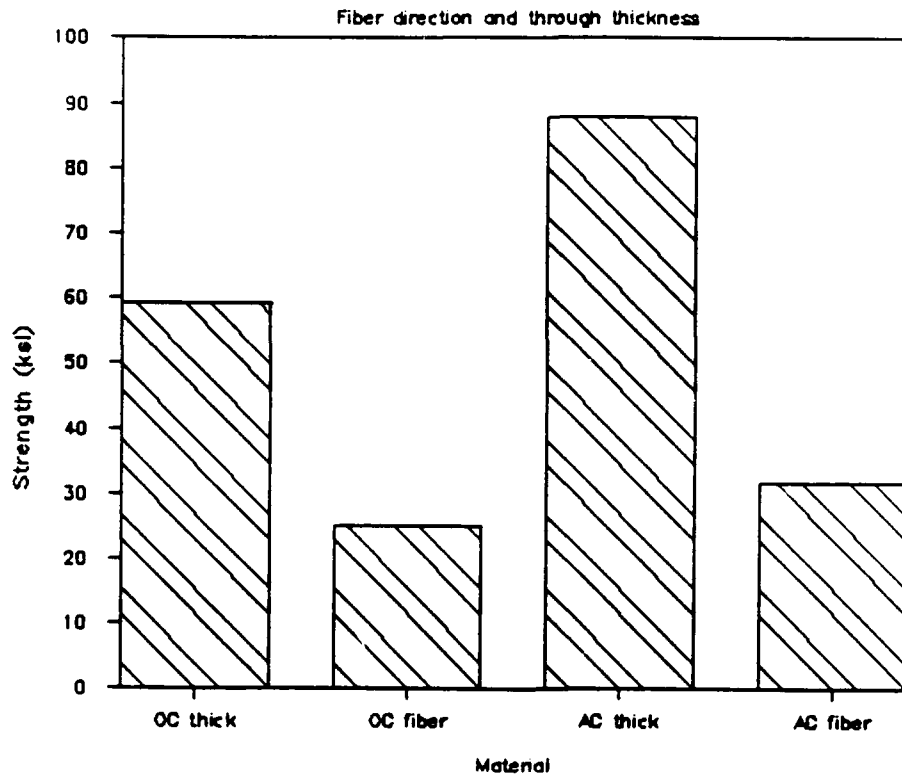

Figure 9b. Compressive strength.

The dominant failure mode was a shear line across the thickness of the laminate. Figure 10 shows such a failure. Some splitting or delamination was also observed.

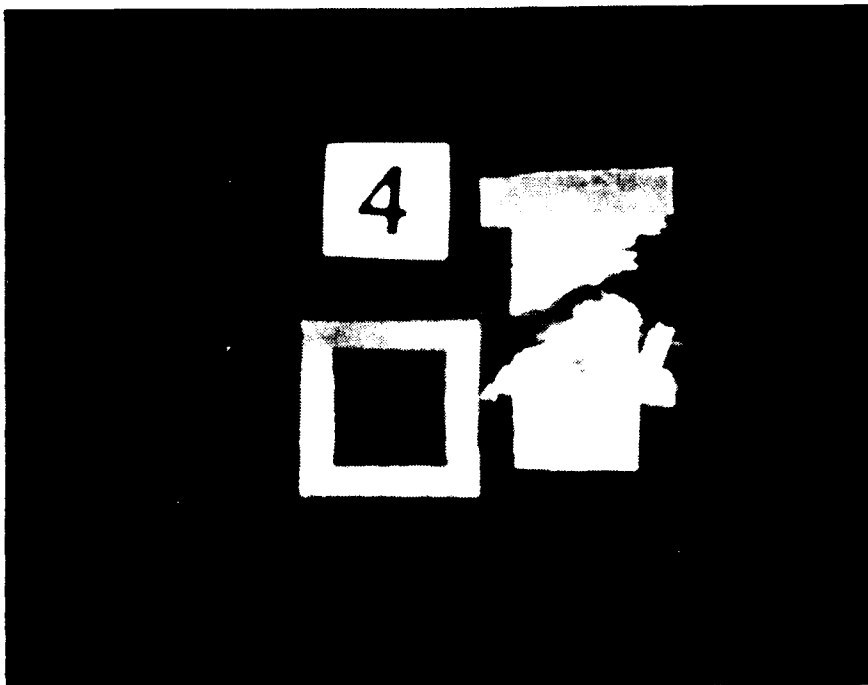

Figure 10. A failed compression specimen with the aluminum collars.

Discussion

Considering the three tests performed on the CIFV material, a sufficient number of replications have been made to show that the test methods give reproducible data. As to how well this data represents the material, it can be compared to the properties measured by FMC as part of the development contract.⁶ These values are given in Table 7. It is noted that although we are comparing the same fiber and resin the form of the laminates differs. FMC used an 8-ply quasi-isotropic layup for all but the through thickness compression test. The test series reported here used fabric laminates.

Table 7. FMC PROPERTIES
MATERIAL: 8-PLY [0/90/+45]s

	Modulus (Msi)	Strength (ksi)	Poisson's ratio
Tensile (10 in.)	2.87	43.8	0.37
Compression (IITRI)	2.12	16.0	
Through Thickness (Cylinder)*	0.71	67.7	
Flexure	3.59	35.0	

*44-Ply Panel

Table 8 compares the FMC data with the American Cyanamid data from this study. Although the flexural data compares well, the majority of the data shows larger values for the AMTL work. How much this reflects the difference between fabric and unidirectional plies is not clear. It may also indicate better test configurations for the AMTL work. Conventional wisdom states that fabric is weaker than a layup of unidirectional plies.

Table 8. PROPERTY COMPARISON

Property	FMC Value	AMTL (OC)	Value (AC)
Tensile Modulus Msi	2.87	3.96	4.08
Tensile Poisson's Ratio	0.37	0.28	0.33
Tensile Strength ksi	43.8	78.7	67.7
Compressive Modulus Msi			
Fiber Direction	2.12	4.01	4.38
Through Thickness	0.71	1.75	2.46
Compressive Strength ksi			
Fiber Direction	16.0	25.0	31.8
Through Thickness	67.7	59.2	87.9
Flexural Modulus Msi	3.59	3.32	3.15
Flexural Strength ksi	35.0	30.4	35.5

A comparison of the data from the three test methods shows that the flexural moduli from the load-strain data are of the same magnitude as the tensile moduli and the compressive moduli. The tensile strengths are more than a factor of two larger than the compressive strengths. Values for the Poisson's ratio are similar for the tension and compression tests.

6. WEERTH, D. Crich. Composite Infantry Fighting Vehicle (CIFV) Program, Phase I. FMC Corp., MTL TR 89-23, March, 1989.

CONCLUSIONS

Because the data is reproducible, compares well with other available data, and the failure modes are satisfactory, the results of this experimental study can be considered as a valid representation of the material properties of these two CIFV candidate materials. The three test configurations have been shown to be useful for characterizing thick fabric composites.

ACKNOWLEDGMENTS

The design and testing of the flexure and tensile specimens was done by Jonathan Fazli. The design and testing of the compressive specimens was done by Elizabeth Goeke.

John Nunes was group leader and directed the effort during all of the experimental effort. The report was assembled by Elizabeth Goeke under the leadership of Roger Lamothe.

Yolanda Hinton, William Haskell III, and Steven Serabian reviewed and critiqued the report.

DISTRIBUTION LIST

No. of
Copies

To

1 Office of the Under Secretary of Defense for Research and Engineering,
The Pentagon, Washington, DC 20301

Defense Technical Information Center, Cameron Station, 5010 Duke Street,
Alexandria, VA 22304-6145

2 ATTN: DTIC-FDAC

Commander, U.S. Army Laboratory Command, 2800 Powder Mill Road, Adelphi,
MD 20783-1145

1 ATTN: AMSLC-AT, Dr. Don E. Snider

1 ATTN: AMSLC-TL, Technical Library

Commander, U.S. Army Foreign Science and Technology Center, 220 7th Street,
N.E. Charlottesville, VA 22901-5396

1 ATTN: AIFRTC, Mr. Wm. Marley

Commander, U.S. Army Tank-Automotive Command, Warren, MI 48397-5000

1 ATTN: AMSTA-Z, Mr. J. Florence

1 ATTN: AMSTA-RS, Dr. James Thompson

Director, U.S. Army Ballistic Research Laboratory, Aberdeen Proving Ground
MD 21005-5066

1 ATTN: SLCBR-SE, Ms. Barbara Moore

1 ATTN: SLCBR-IB, Dr. Bruce Burns

1 ATTN: SLCBR-IB-M, Dr. Travis Bogetti

Commander, U.S. Army Laboratory Command, Low Observable Technology Office,
2800 Powder Mill Road, Adelphi, MD 20783-1145

1 ATTN: Mr. Don Woodbury

Director, U.S. Army Natick Research, Development and Engineering Center,
Natick, MA 01760

1 ATTN: Technical Library

Commander, U.S. Army Armament, Munitions and Chemical Command, Dover,
NJ 07801

1 ATTN: AMDAR-LCA, PLASTECH Director

David Taylor Naval Ship Research & Development Center, Caderock Division,
Bethesda, MD 20084

1 ATTN: Mr. Rod Peterson, Code 1240

1 ATTN: Mr. Rich Swanek, Code 1240

Director, Aviation Applied Technology Directorate, Ft. Eustis, VA 23604-5277

1 ATTN: Mr. George McCallister

Wright Laboratories, Wright Patterson AFB, OH 45433-6553

1 ATTN: WL/FIVS, Mr. Al Kurtz

No. of
Copies

To

1 Owen-Corning Fiberglas Corporation, Technical Center, 2790 Columbus Road,
Route 16, Granville, OH 43023
ATTN: Mr. Dave Hartman

1 Du Pont Company, Composites Division, Bldg 705, Chestnut Run, Wilmington,
DE 19898
ATTN: Mr. Richard O. Myers

1 Erskine-Johns Company, 306 Swan's Wharf Row, Brick Market Place, Newport,
RI 02840
ATTN: Richard O'Meara

1 FMC Corporation, 2890 De La Cruz Blvd, Santa Clara, CA 95052-2619
ATTN: Mr. Paul Para
1 Mr. George Thomas

1 General Dynamics Land Systems Division, P.O. Box 1804, Warren, MI 48090-2094
ATTN: Mr. David K. Rock

1 Simula Inc. 10016 South 51st Street, Phoenix, AZ 85044-5203
ATTN: Mr. Joseph Coltman

1 BMY Combat Systems, P.O. Box 15512, York, PA 17405-1512
ATTN: Ms. Ellen Brady

1 American Technology Applications Knowledge, Inc., 95 South Market Street,
Suite 300, San Jose, CA 95113
ATTN: Mr. Erich Weerth

2 Director, U.S. Army Materials Technology Laboratory, Watertown, MA 02172-0001
ATTN: SLCMT-TML
3 Authors

U.S. Army Materials Technology Laboratory
Watertown, Massachusetts 02172-0001
CHARACTERIZATION OF THICK GLASS
REINFORCED COMPOSITES -
Jonathan Fazli, Elizabeth Goeke, and John Nunes

AD UNCLASSIFIED
UNLIMITED DISTRIBUTION
Key Words

Glass reinforced composites
Tension
Compression

Technical Report MTL TR 92-43, July 1992, 19 pp-
illus-tables,

As a follow-on to a composite structural armor development program, a mechanical testing program for the composite materials was carried out. The composites are thick laminates of glass fabric and polyester resin. The tests used were flexure, tension, and compression. Because of the laminate thicknesses, redesign of the standard test specimens was necessary. The test results provide a characterization of the materials.

U.S. Army Materials Technology Laboratory
Watertown, Massachusetts 02172-0001
CHARACTERIZATION OF THICK GLASS
REINFORCED COMPOSITES -
Jonathan Fazli, Elizabeth Goeke, and John Nunes

AD UNCLASSIFIED
UNLIMITED DISTRIBUTION
Key Words

Glass reinforced composites
Tension
Compression

Technical Report MTL TR 92-43, July 1992, 19 pp-
illus-tables,

As a follow-on to a composite structural armor development program, a mechanical testing program for the composite materials was carried out. The composites are thick laminates of glass fabric and polyester resin. The tests used were flexure, tension, and compression. Because of the laminate thicknesses, redesign of the standard test specimens was necessary. The test results provide a characterization of the materials.

U.S. Army Materials Technology Laboratory
Watertown, Massachusetts 02172-0001
CHARACTERIZATION OF THICK GLASS
REINFORCED COMPOSITES -
Jonathan Fazli, Elizabeth Goeke, and John Nunes

AD UNCLASSIFIED
UNLIMITED DISTRIBUTION
Key Words

Glass reinforced composites
Tension
Compression

Technical Report MTL TR 92-43, July 1992, 19 pp-
illus-tables,

As a follow-on to a composite structural armor development program, a mechanical testing program for the composite materials was carried out. The composites are thick laminates of glass fabric and polyester resin. The tests used were flexure, tension, and compression. Because of the laminate thicknesses, redesign of the standard test specimens was necessary. The test results provide a characterization of the materials.

U.S. Army Materials Technology Laboratory
Watertown, Massachusetts 02172-0001
CHARACTERIZATION OF THICK GLASS
REINFORCED COMPOSITES -
Jonathan Fazli, Elizabeth Goeke, and John Nunes

AD UNCLASSIFIED
UNLIMITED DISTRIBUTION
Key Words

Glass reinforced composites
Tension
Compression

Technical Report MTL TR 92-43, July 1992, 19 pp-
illus-tables,

As a follow-on to a composite structural armor development program, a mechanical testing program for the composite materials was carried out. The composites are thick laminates of glass fabric and polyester resin. The tests used were flexure, tension, and compression. Because of the laminate thicknesses, redesign of the standard test specimens was necessary. The test results provide a characterization of the materials.