

AD-A256 243



2

SHORE PROTECTION AND RESTORATION PROGRAM

INSTRUCTION REPORT CERC-92-1

USER'S GUIDE TO THE SHORELINE MODELING SYSTEM (SMS)

by

Mark B. Gravens

Coastal Engineering Research Center

DEPARTMENT OF THE ARMY

Waterways Experiment Station, Corps of Engineers  
3909 Halls Ferry Road, Vicksburg, Mississippi 39180-6199

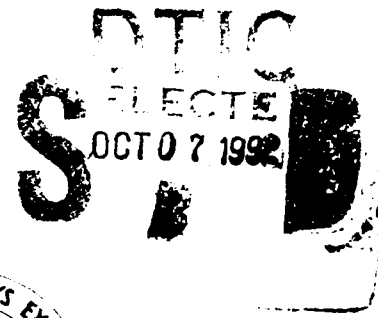

August 1992  
Final Report

Approved For Public Release; Distribution Is Unlimited

Prepared for DEPARTMENT OF THE ARMY  
US Army Corps of Engineers  
Washington, DC 20314-1000

Under Shoreline and Beach Topography  
Response Modeling Work Unit 32592

US Army Corps of Engineers

SHORELINE MODELING SYSTEM  
DIRECTORY STRUCTURE & PROGRAMS

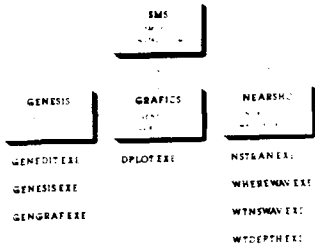

SHORELINE MODELING SYSTEM  
DIRECTORY STRUCTURE & PROGRAMS

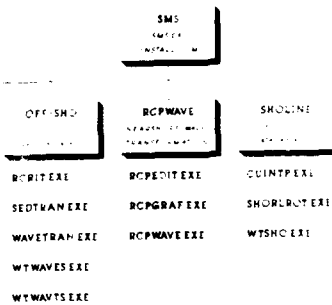

SMS

Shoreline Modeling System  
Version 1, March 1992  
SMS Level 1 menu, Main

GENESIS BCPWAVE UTILITIES CONFIGURE EXE

92-26523

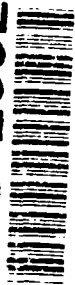

037050

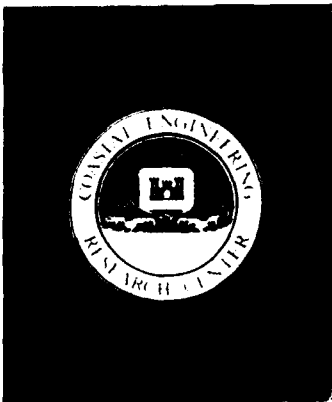

Destroy this report when no longer needed. Do not return it  
to the originator.

The findings in this report are not to be construed as an  
official Department of the Army position unless so  
designated by other authorized documents.

The contents of this report are not to be used for  
advertising, publication, or promotional purposes.  
Citation of trade names does not constitute an  
official endorsement or approval of the use  
of such commercial products.

REPORT DOCUMENTATION PAGE			Form Approved OMB No. 0704-0188	
Public reporting burden for this collection of information is estimated to average 1 hour per response, including the time for reviewing instructions, searching existing data sources, gathering and maintaining the data needed, and completing and reviewing the collection of information. Send comments regarding this burden estimate or any other aspect of this collection of information, including suggestions for reducing this burden, to Washington Headquarters Services, Directorate for Information Operations and Reports, 1215 Jefferson Davis Highway, Suite 1204, Arlington, VA 22202-4302, and to the Office of Management and Budget, Paperwork Reduction Project (0704-0188), Washington, DC 20503				
1. AGENCY USE ONLY (Leave blank)	2. REPORT DATE August 1992	3. REPORT TYPE AND DATES COVERED Final report		
4. TITLE AND SUBTITLE User's Guide to the Shoreline Modeling System (SMS)			5. FUNDING NUMBERS Work Unit 32592	
6. AUTHOR(S) Mark B. Gravens				
7. PERFORMING ORGANIZATION NAME(S) AND ADDRESS(ES) USAE Waterways Experiment Station Coastal Engineering Research Center 3909 Halls Ferry Road, Vicksburg, MS 39180-6199			8. PERFORMING ORGANIZATION REPORT NUMBER Instruction Report CERC-92-1	
9. SPONSORING / MONITORING AGENCY NAME(S) AND ADDRESS(ES) U.S. Army Corps of Engineers, Washington, DC 20314-1000			10. SPONSORING / MONITORING AGENCY REPORT NUMBER	
11. SUPPLEMENTARY NOTES Available from National Technical Information Service, 5285 Port Royal Road, Springfield, VA 22161.				
12a. DISTRIBUTION / AVAILABILITY STATEMENT Approved for public release; distribution is unlimited.			12b. DISTRIBUTION CODE	
13. ABSTRACT (Maximum 200 words) <p>This report documents a microcomputer-based software package (SHORELINE MODELING SYSTEM) that contains a collection of generalized computer programs assembled to enable the user to perform complete longshore sediment transport processes and shoreline evolution assessments. This software package was developed at the Coastal Engineering Research Center (CERC) to facilitate the technology transfer of recently developed coastal engineering tools throughout the Corps. The modeling system is presently comprised of two major numerical models (RCPWAVE and GENESIS) packaged together with more than 15 system support programs. The system support programs automate the data analysis and input data generation tasks necessary to execute RCPWAVE and GENESIS in design-oriented applications.</p> <p>Technical documentation with example applications of each of the computer programs and numerical models is provided in the GENESIS report series (CERC-89-19, Reports 1 and 2). This report provides general instructions for the operation of the SHORELINE MODELING SYSTEM and outlines the capabilities of the individual components contained in the system.</p>				
14. SUBJECT TERMS Numerical model Numerical modeling system Shoreline change			15. NUMBER OF PAGES 91	
			16. PRICE CODE	
17. SECURITY CLASSIFICATION OF REPORT UNCLASSIFIED			18. SECURITY CLASSIFICATION OF THIS PAGE UNCLASSIFIED	19. SECURITY CLASSIFICATION OF ABSTRACT
20. LIMITATION OF ABSTRACT				

# Contents

---

Preface .....	vi
Conversion Factors, Non-SI to SI (Metric) Units Of Measurement .....	vii
1 Introduction .....	1
SMS Contents .....	1
Recommended Hardware .....	2
Report Overview .....	3
2 General System Structure and Use .....	4
Directory Structure .....	4
Menu Structure .....	6
3 File Editors .....	14
GENEDIT .....	14
RCPEDIT .....	16
4 Graphics Programs .....	21
GENGRAF .....	21
RCPGRAF .....	29
DPLOT .....	37
5 Analysis Procedures .....	43
Shoreline Data Analysis .....	44
Analysis of Offshore Wave Data .....	47
Analysis of Nearshore Wave Data .....	48
6 Overview of Numerical Models .....	54
GENESIS .....	54
RCPWAVE .....	59

References .....	63
Appendix A	
Shoreline Modeling System (SMS) Installation .....	A1
SMS Software Installation .....	A1
Graphics Software Installation .....	A2
Appendix B	
Input Data Set for GENGRAF Example .....	B1
Appendix C	
Input Data Set for RCPGRAF Example .....	C1
Appendix D	
Input Data Set for DPLOT Example .....	D1

<b>Accession For</b>	
NTIS GRA&I	<input checked="" type="checkbox"/>
DTIC TAB	<input type="checkbox"/>
Unannounced	<input type="checkbox"/>
Justification	
By _____	
Distribution/	
Availability Codes	
Dist	Avail and/or Special
A-1	

# Figures

---

Figure 1. Directory structure and programs in the SMS . . . . .	5
Figure 2. SMS menu levels and menu options . . . . .	7
Figure 3. SMS Level 1 menu: Main . . . . .	8
Figure 4. Schematic illustration of the RCPEDIT screen . . . . .	17
Figure 5. Required RCPWAVE input data cards . . . . .	18
Figure 6. Optional RCPWAVE input data cards . . . . .	19
Figure 7. SMS Level 3 menu: GENESIS-Graphics (GENESIS Data Visualization System) . . . . .	22
Figure 8. Example net transport rate plot . . . . .	24
Figure 9. Shoreline change plot options menu (GENESIS Data Visualization System) . . . . .	25
Figure 10. Example shoreline change plot . . . . .	26
Figure 11. Example shoreline position plot . . . . .	27
Figure 12. Shoreline plot with intermediate shoreline positions and zoom option . . . . .	28
Figure 13. SMS Level 3 menu: RCPWAVE-Graphics (RCPWAVE Data Visualization System) . . . . .	29
Figure 14. RCPGRAF: 2-D RCPWAVE Grid menu (data type options) .	31
Figure 15. Example RCPWAVE contour plot . . . . .	32
Figure 16. RCPWAVE-Graphics: Write option menu . . . . .	33

Figure 17. Example cross-shore data plot . . . . .	34
Figure 18. RCPGRAF: <i>Nearshore Reference Line</i> menu (data type options) . . . . .	35
Figure 19. Example nearshore wave height plot . . . . .	36
Figure 20. Example nearshore wave angle plot . . . . .	36
Figure 21. SMS Level 2 menu: Utilities . . . . .	38
Figure 22. Selected DPLOT menus . . . . .	39
Figure 23. Digitized shoreline data . . . . .	40
Figure 24. Digitized and interpolated shorelines . . . . .	41
Figure 25. Shoreline data analysis procedure . . . . .	45
Figure 26. SMS Level 3 menu: Utility-Shorelines . . . . .	46
Figure 27. Offshore wave data analysis procedure . . . . .	47
Figure 28. SMS Level 4 menu: Utility-Waves-Offshore . . . . .	49
Figure 29. Nearshore wave data analysis procedure . . . . .	50
Figure 30. SMS Level 4 menu: Utility-Waves-Nearshore . . . . .	53
Figure 31. Input and output file structure of GENESIS . . . . .	55
Figure 32. RCPWAVE and GENESIS coordinate systems and conventions	61
Figure B1. GENGRAF input file START.EXP . . . . .	B2
Figure B2. GENGRAF input file SHORL.EXP . . . . .	B4
Figure B3. GENGRAF input file SHORM.EXP . . . . .	B4
Figure B4. GENGRAF input file SHORC.EXP . . . . .	B4
Figure B5. GENGRAF input file OUTPT.EXP (Sheet 1 of 3) . . . . .	B5
Figure C1. RCPGRAF input file RCP_OUT (Sheet 1 of 4) . . . . .	C2

Figure C2. RCPGRAF input file RCPEXP.NSR .....	C6
Figure D1. DPLOT input file 82SHO.ROT .....	D1
Figure D2. DPLOT input file 86SHO.ROT .....	D1
Figure D3. DPLOT input file 82SHO.ISH .....	D2
Figure D4. DPLOT input file 86SHO.ISH .....	D3



# Preface

---

The work described herein was authorized as a part of the Civil Works Research and Development Program by Headquarters, US Army Corps of Engineers (HQUSACE). Work was performed under the Shoreline and Beach Topography Response Modeling Work Unit 32592, which is part of the Shore Protection and Restoration Program at the Coastal Engineering Research Center (CERC), US Army Engineer Waterways Experiment Station (WES). Messrs. John H. Lockhart, Jr., John G. Housley, James E. Crews, and Robert H. Campbell were HQUSACE Technical Monitors.

This report was written over the period 1 July through 31 December 1991 by Mr. Mark B. Gravens, Coastal Processes Branch (CPB), Research Division (RD), CERC. Ms. Holley J. Messing, CPB, assisted in formatting and organizing the report. Messrs. Dorwin T. Shields, Jr. and Byron M. Reed assisted in the coding of many of the computer programs discussed herein. The author would like to thank the participants of the Shoreline Modeling System (SMS) Workshop (November 1991) for the constructive comments and exchanges that were received concerning the refinement and presentation of the SMS. This study was conducted under the administrative supervision of Dr. James R. Houston, Director, CERC; Mr. Charles C. Calhoun, Jr., Assistant Director, CERC; Mr. H. Lee Butler, Chief, RD, CERC; and Mr. Bruce A. Ebersole, Chief, CPB, CERC. Ms. Carolyn M. Holmes, CERC, was Program Manager, Shore Protection and Restoration Program, and Mr. Gravens was Principal Investigator, Shoreline and Beach Topography Response Modeling Work Unit 32592.

This report was edited by Ms. Janean Shirley, Information Technology Laboratory, WES.

At the time of publication of this report, Director of WES was Dr. Robert W. Whalin. Commander and Deputy Director was COL Leonard G. Hassell, EN.

# Conversion Factors, Non-SI to SI (Metric) Units Of Measurement

---

Non-SI units of measurement used in this report can be converted to SI (metric) units as follows:

<b>Multiply</b>	<b>By</b>	<b>To Obtain</b>
cubic feet	0.02831685	cubic meters
cubic yards	0.7646	cubic meters
feet	0.3048	meters
inches	25.4	millimeters

# 1 Introduction

---

This report describes the structure, capabilities, and use of the Shoreline Modeling System (SMS) developed at the Coastal Engineering Research Center (CERC), US Army Engineer Waterways Experiment Station. The SMS is a collection of generalized computer programs assembled to form a functional system. The primary purpose of the SMS is to enable complete design-level shoreline evolution investigations to be performed by engineers with numerical models (regardless of their computer-programming capabilities) on the commonly available personal computer (PC) hardware platform.

## SMS Contents

The SMS Version 1 contains two special-purpose file editors, two special-purpose data visualization programs, one general-purpose graphics program, 12 system-support programs, and two major coastal processes numerical models. A summary of the purpose and function of the major components of the SMS is given in the following paragraphs.

The two major numerical simulation models contained in the SMS are the shoreline change model GENESIS (GENERALized model for SIMulating SHoreline change) (Hanson 1987; Hanson and Kraus 1989; Gravens, Kraus, and Hanson 1991) and the wave transformation model RCPWAVE (Regional Coastal Processes WAVE propagation model) (Ebersole 1985; Ebersole, Cialone, and Prater 1986). The numerical model GENESIS calculates shoreline change produced by spatial and temporal differences in longshore sand transport produced by breaking waves. The longshore extent of the modeled reach can range from less than a kilometer to tens of kilometers, and simulation intervals can range from less than a month to tens of years. The shoreline evolution portion of the numerical model is based on one-line theory, which assumes that beach profile shape remains unchanged, allowing shoreline change to be described uniquely in terms of the translation of a single point on the profile. Other features of the model include a wave transformation module to calculate shoaling, refraction, and diffraction; sand bypassing and transmission at shore-perpendicular structures such as groins and jetties; wave transmission at detached breakwaters; and a variety of terminal and internal boundary conditions and constraints.

The numerical model RCPWAVE simulates wave propagation over an arbitrary bathymetry. The governing equations solved in the model are the "mild slope" equation for linear, monochromatic waves, and the equation specifying irrotationality of the wave phase function gradient. Finite-difference approximations of these equations are solved to predict wave propagation outside the surf zone. The RCPWAVE has become the standard monochromatic wave transformation model used for estimating open-coast nearshore wave conditions for input to GENESIS. Chapter 6 provides a more detailed discussion of GENESIS and RCPWAVE.

The two file editor programs allow users to generate the model configuration and input files for GENESIS and RCPWAVE (the two coastal process numerical models). Upon completion, user-provided specifications are processed to detect potential errors that will cause the numerical model(s) to have run-time errors and fail. Detailed descriptions of these programs and their use are provided in Chapter 3.

The SMS contains two special-purpose graphics programs; one of the programs was developed specifically for the visualization of results generated by GENESIS, and the other for the visualization of results generated by RCPWAVE. These special-purpose graphics programs enable the generation of several typically required plots. For example, for GENESIS, three types of plots can be created: (a) computed average net transport rate, (b) shoreline change, and (c) shoreline position. For RCPWAVE, contour plots of water depth, wave height, and wave angle can be displayed in addition to plots of wave height and wave angle along a nearshore reference line that will be used by GENESIS. The SMS also contains a graphics program that allows the user to create additional plots. Several of the system-support programs produce files used specifically as input to the general-purpose graphics program. All three programs are discussed in detail in Chapter 4.

The 12 system-support programs included in the SMS automate most of the data preparation and analysis typically required in the generation of complete input data sets for GENESIS. The 12 system-support programs have been assembled into three recommended analysis procedures and are discussed in detail in Chapter 5.

## **Recommended Hardware**

The SMS is designed to be run on a minimum hardware configuration of an IBM PC-AT machine with 640-Kb memory and a math co-processor. Much of the system development and testing, however, were conducted on a 386 25-MHz PC with a math co-processor and a Video Graphics Array (VGA) color monitor. Acknowledging that many of the computer algorithms contained in the SMS programs are computationally intensive dictates that effective use of the system will require a hardware platform somewhat more powerful than the minimum

configuration given above, such as a 386 or 486 PC with a fast clock (20 MHz or faster) and a math co-processor.

The graphics programs in the SMS were developed on a machine with a VGA color adapter and monitor; consequently, the various graphical displays available are best suited for a VGA color adapter and monitor. However, the SMS can be configured to operate with Color Graphics Adapter (CGA) or Enhanced Graphics Adapter (EGA) equipment.

Installation of the SMS software on the PC requires approximately 4 Mb of free disk space on the hard disk. However, the data files associated with a typical numerical shoreline change investigation can easily require an additional 10 to 15 Mb of disk space.

## Report Overview

This document provides general instructions for the operation of the SMS and outlines the capabilities of the various individual programs contained within the system. As such, only summary information (including reference to available technical documentation) on the computational programs is provided herein. Chapter 2 contains a detailed description of the overall structure of the system. Chapter 3 provides documentation of and instructions for the use of the two special-purpose file editors contained in the system. Chapter 4 provides instructions for the use of the two special-purpose and one general-purpose graphics programs in the SMS. Chapter 5 describes the interrelationships between the 12 programs that comprise the GENESIS system-support programs, and provides guidance and recommendations for use of the system-support programs by suggesting three data preparation and analysis procedures. The three suggested data preparation and analysis procedures include all tasks typically required in the conduct of a numerical shoreline change investigation. Chapter 6 gives a summary of the input data requirements, assumptions, and usage of the two major coastal processes numerical models in the SMS.

## 2 General System Structure and Use

---

The first part of this chapter describes the appearance of the SMS on the monitor after the system has been installed on the PC's hard disk. Appendix A provides detailed instructions for installing the system from the distribution disks. The second part of the chapter defines and discusses the multi-level menuing system from which the individual components of the system are invoked or executed.

### Directory Structure

The SMS operates within a specific directory structure. After installation of the system on the PC's hard disk (according to the instructions provided in Appendix A), the user should find a subdirectory named SMS in the root directory of the drive on which the system was installed. Within the SMS directory there should be two files (SMS.EXE and INSTALL.COM) and six subdirectories (subdirectories are represented in Figure 1 as boxes). Each of the subdirectories should contain the executable programs listed beneath the subdirectory box. The subdirectories separate the programs that comprise SMS into functional areas: three GENESIS-specific programs; one general-purpose graphics program; four nearshore wave data analysis programs; five offshore wave data analysis programs; three RCPWAVE-specific programs; and three shoreline data analysis programs.

All of the executable programs listed in Figure 1 can be run in a stand-alone mode outside of the SMS. In general, the programs that make up the SMS were originally designed to be executed interactively in a stand-alone mode. Typically the program will prompt the user for several inputs (e.g., input and output file names, etc.), perform some computations, and terminate. The SMS, therefore, is simply a controller program containing the appropriate logic branches enabling the user to move through the multi-level menuing system and initiate execution of any one of the programs listed in Figure 1 on an individual basis.

Execution of the SMS can be initiated from any directory or subdirectory on the disk drive on which the system is installed provided the \SMS directory

# SHORELINE MODELING SYSTEM DIRECTORY STRUCTURE & PROGRAMS

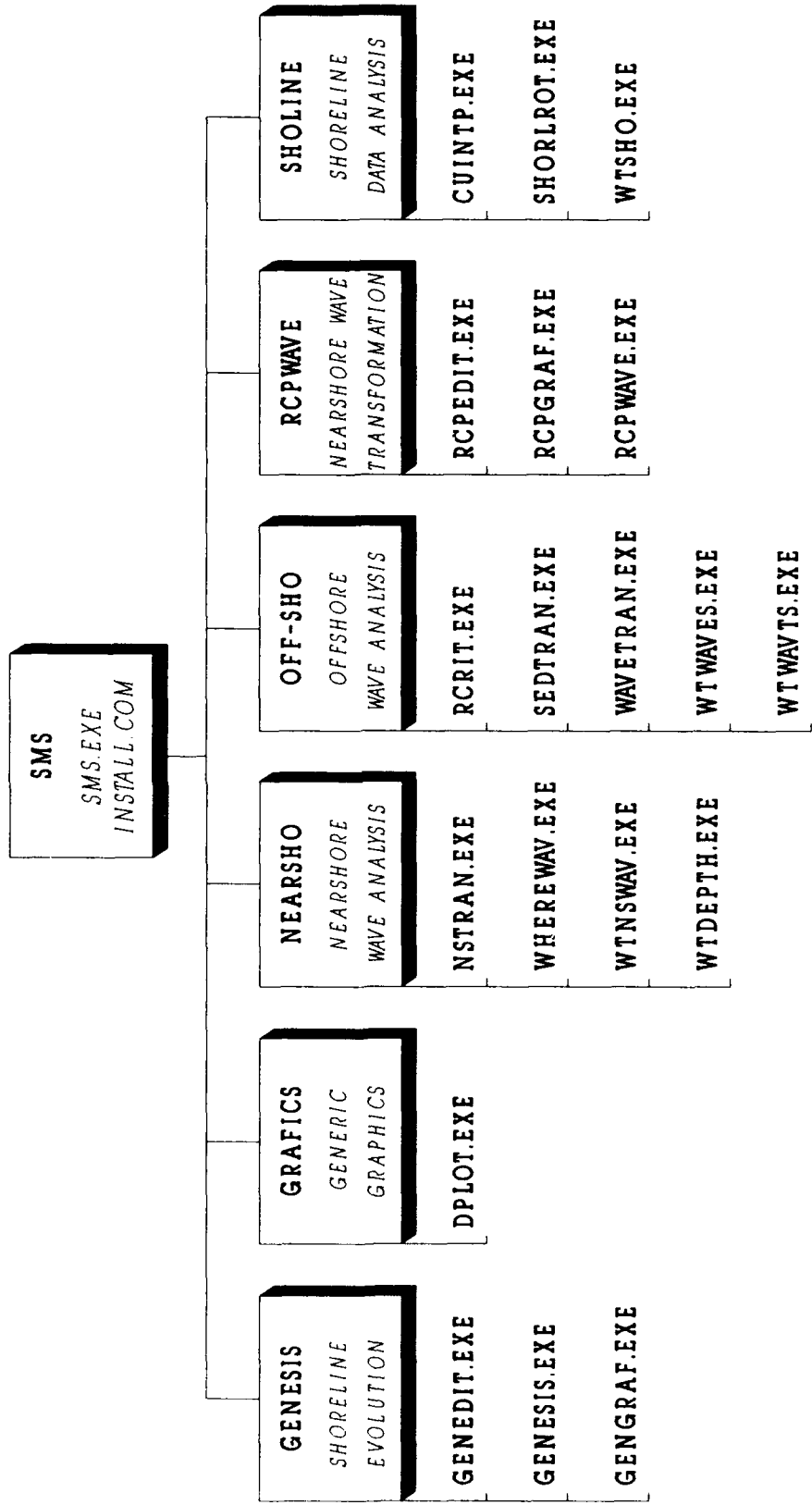

Figure 1. Directory structure and programs in the SMS

is in the path command. In practice, the user will make the directory containing the data files the default directory (e.g., set default to \DATA) and then initiate execution of the system (e.g., issue the command SMS). Although having all data in the default directory is not required for correct operation of all programs in the SMS, it is required for operation of GENESIS and GENGRAF.

## Menu Structure

The SMS contains four menu levels. The individual programs within the SMS are executed by highlighting a menu option using either the cursor keys or mouse and then pressing the ENTER key or mouse button. Figure 2 shows the available options at each of the four menu levels. Figure 3 is a schematic illustration of the SMS level 1 menu screen that is displayed on the PC monitor when the SMS is started. By default the left-most menu option is highlighted (the GENESIS option in Figure 3). The format of all the menu screens is the same. The version number and compilation date are given under the system logo (SMS) followed by the specific menu level and title. At the bottom of the screen are the menu options. Above the options list is a one-line description of the action that will be taken if the highlighted option is selected. In general, the description will include the word "Perform" or "Run" if the highlighted option will transfer the user to another menu level. Likewise, the description will typically include the word "Execute" if selection of the highlighted menu will initiate execution of one of the SMS programs. The following paragraphs provide a summary description of the operation performed for each of the menu options available in the four menu levels.

### Level 1 menu: Main

This is the initial menu screen in the system (see Figure 3) and it contains five options. Three of the options transfer the user to the level 2 menus shown in Figure 2. The *GENESIS* option transfers the user to the SMS level 2 menu: GENESIS. The *RCPWAVE* option transfers the user to the SMS level 2 menu: RCPWAVE. The *Utilities* option transfers the user to the SMS level 2 menu: Utilities.

The *Configure* option initiates execution of the INSTALL.COM procedure allowing the user to install (or configure) the programs SMS.EXE (the SMS controller program), GENGRAF.EXE (the GENESIS-specific graphics program), RCPGRAF.EXE (the RCPWAVE specific graphics program), and DPLOT.EXE (the general-purpose graphics and DOS operations program) to their specific PC environment (e.g., VGA monitor, Hewlett Packard (HP) laser printer, etc.). Upon selection of the *Configure* option, the user is prompted for the name of the program that he or she wants to install. At this point, the user should enter the program name including the path (for instance, to install the program GENGRAF.EXE, the user should enter: "\SMS\GENESIS\GENGRAF.EXE"). The program then prompts the user to specify his system's display adapter (e.g.,



# SHORELINE MODELING SYSTEM

## Menu Structure & Options

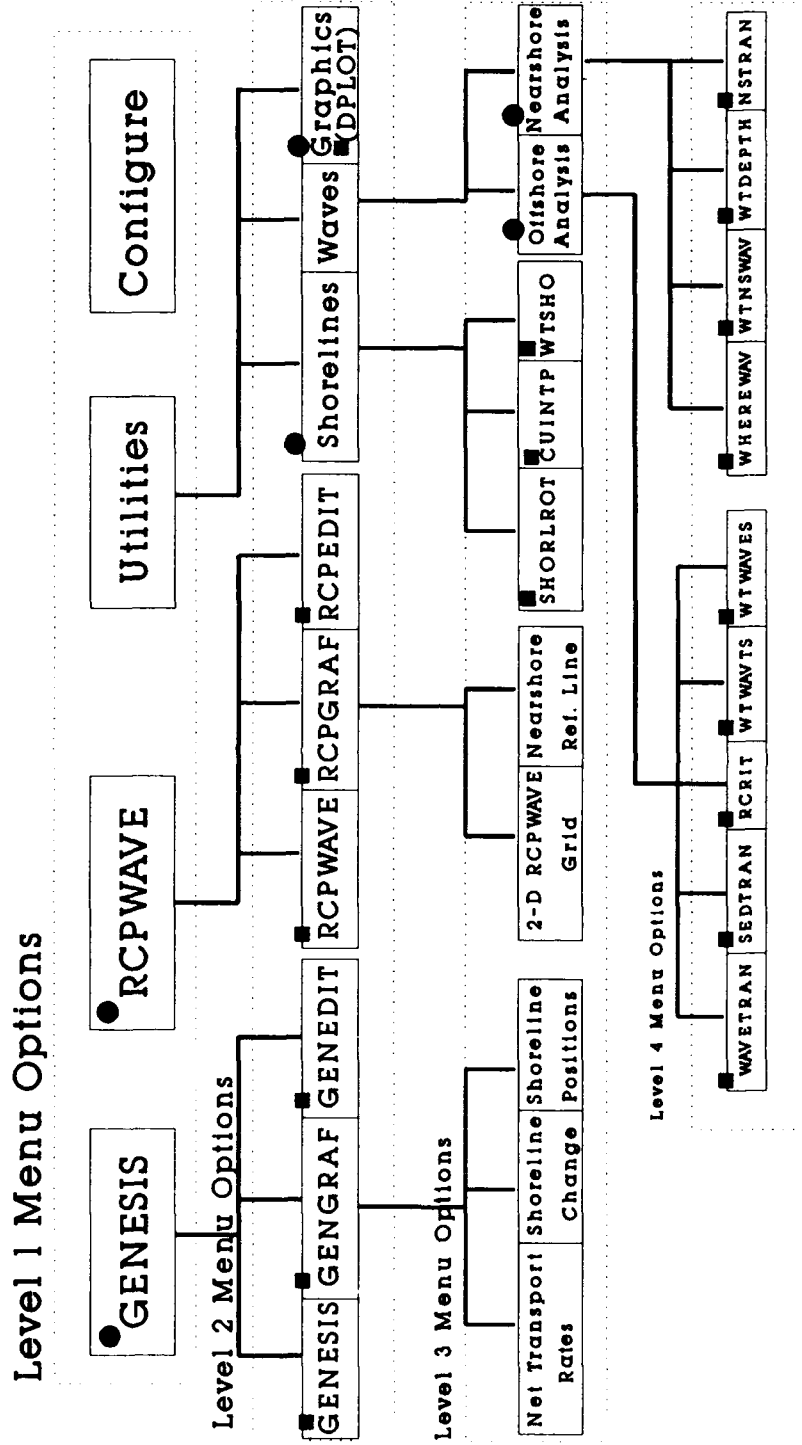

- Sub-directory from Figure 1
- Computer program from Figure 1

Figure 2. SMS menu levels and menu options

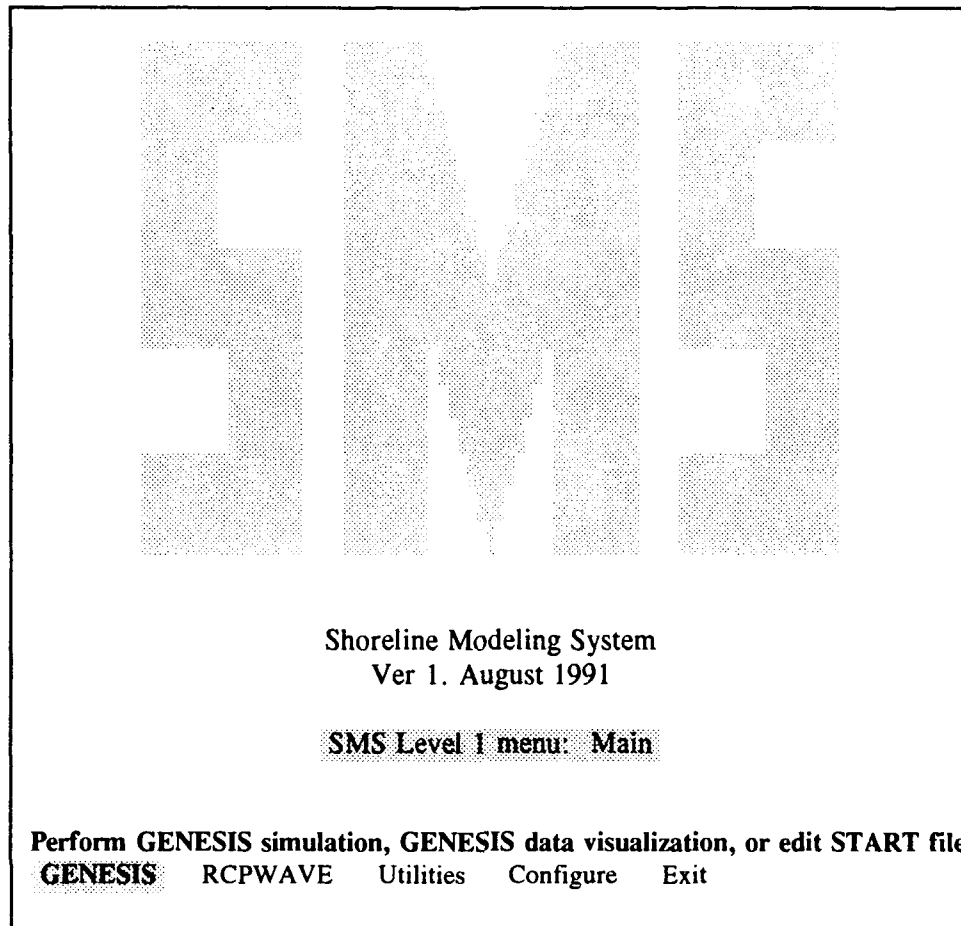

Figure 3. SMS Level 1 menu: Main

monochrome, CGA, EGA, or VGA), pen plotter (e.g., none, HP compatible 2-, 6-, or 8-pen, or HP LaserJet III), graphics printer (e.g., none, IBM graphics, Epson FX/RX series, HP LaserJet, or HP PaintJet), the plotter port, and finally the printer port.

The *Exit* option terminates the SMS session.

#### Level 2 menu: GENESIS

This menu screen contains four options. The *GENESIS* option initiates execution of the shoreline evolution model *GENESIS*. The program then executes and upon completion, the user is returned to the SMS level 2 menu: RCPWAVE. As with previously released versions of *GENESIS*, the program prompts the user for the three-character extension of the input data files (see Gravens, Kraus, and Hanson 1991). It is assumed that the input data files reside in the default directory. Chapter 6 gives an overview of the *GENESIS* model and its input data requirements.

The *GENGRAF* option transfers the user to the SMS level 3 menu: GENESIS-Graphics.

The *GENEDIT* option initiates execution of the START.ext file editor, which allows generation or modification of the GENESIS input file START.ext. The program GENEDIT.EXE is a special-purpose file editor that also performs quality checking (error processing) of user-provided input specifications. Use of this program will effectively eliminate input mismatch errors in the START.ext file that would cause GENESIS to terminate prematurely. Chapter 3 provides a detailed discussion of the various features and usage of the program GENEDIT.EXE.

The *Exit* option transfers the user to the SMS level 1 menu: Main.

### Level 2 menu: RCPWAVE

This menu screen has four options. The *RCPWAVE* option initiates execution of the monochromatic nearshore wave transformation model RCPWAVE. The program (RCPWAVE) prompts the user for the file name associated with the RCPWAVE input data set. If the input data set does not exist in the default directory, the path should also be entered at this time.

The *RCPGRAF* option transfers the user to the SMS level 3 menu: RCPWAVE-Graphics.

The *RCPEDIT* option initiates execution of the RCPWAVE input file editor, which enables generation or modification of the primary RCPWAVE input data file. The program RCPEDIT.EXE is a special-purpose file editor that also performs quality checking (error processing) of user-provided input specifications. Chapter 3 provides a detailed discussion of the various features and usage of the program RCPEDIT.EXE.

The *Exit* option transfers the user to the SMS level 1 menu: Main.

### Level 2 menu: Utilities

This menu screen again contains four options. The *Shorelines* option transfers the user to the SMS level 3 menu: Utilities-Shorelines. The *Waves* option transfers the user to the SMS level 3 menu: Utilities-Waves.

The *Graphics* option initiates execution of the general-purpose graphics and DOS operations program DPLOT.EXE (from HGRAPH version 5.1\*). The program DPLOT.EXE is versatile in that it can be used to produce and modify custom plots and perform many useful DOS applications such as list the contents

---

\* HGRAPH, a graphics software package developed for the PC by David W. Hyde, Structural Engineer, US Army Engineer (USAE) Waterways Experiment Station, Structures Laboratory.

of the current directory, change directories, list the contents of a specific file, and temporarily exit to DOS. Chapter 4 gives a detailed discussion of the various features and usage of the program DPLOT.EXE.

The *Exit* option transfers the user to the SMS level 1 menu: Main.

### **Level 3 menu: GENESIS-Graphics**

From this menu screen the user can graphically post-process results generated by GENESIS. Current GENESIS users will be familiar with this graphics system since it has previously been released as the GENESIS Data Visualization System. Three types of plots can be processed using the options in this menu screen. The *Net Transport Rate* option displays the average annual net longshore sand transport rate computed over the simulation period, together with the average annual net longshore sand transport rate for the entire simulation reach (a straight line average for the simulation reach). The *Shoreline Change* option allows the user to display the computed shoreline change between the final shoreline position and the initial shoreline position, or the measured shoreline position, or an external (user-specified) shoreline position data file. The *Shoreline Positions* option enables the user to plot the initial and calculated shoreline positions, together with the specified coastal structures simulated, including beach fills, seawalls, groins, and detached breakwaters. Additional shorelines such as the measured shoreline position, the seaward-most computed shoreline position, the landward-most computed shoreline position, the intermediate shoreline positions (specified in the START.ext file), and external (user-specified) shoreline position data files can also be displayed. The *Exit* option transfers the user to the SMS level 2 menu: GENESIS.

### **Level 3 menu: RCPWAVE-Graphics**

From this menu screen, the user can graphically post-process results previously generated by RCPWAVE. Two types of plots can be generated from within this menu screen. The *2-D RCPWAVE Grid* option enables the user to display contour plots of the water depth, wave height, or wave angle on the two-dimensional RCPWAVE computational grid. Additionally, transects in the offshore direction can be selected from the contour plot and displayed in an X-Y-type plot (e.g., from the depth contour plot, profile lines can be selected and plotted separately). The *Nearshore Reference Line* option enables the user to plot both wave heights and wave angles along the nearshore reference line. Information (wave heights and angles) on the nearshore reference line (oriented in the longshore direction) are used by GENESIS to define nearshore wave conditions. The *Exit* option transfers the user to the SMS level 2 menu: RCPWAVE.

### **Level 3 menu: Utility-Shorelines**

This menu screen contains three options that invoke the execution of three generalized programs. These enable the user to perform the shoreline position data analysis procedures (see Gravens 1991 and Gravens, Kraus, and Hanson

1991) required to generate the two shoreline position data files necessary to perform a GENESIS simulation. A detailed discussion of the shoreline data analysis procedure is provided in Chapter 5.

The *SHORLROT* option initiates execution of a program that performs a coordinate system rotation and origin translation on digitized X-Y shoreline position data. This procedure is required to map the digitized data into the GENESIS coordinate system.

The *CUINTP* option executes a program that uses a cubic spline interpolation algorithm to interpolate uniformly spaced shoreline positions from the rotated data.

The *WTSHO* option initiates execution of the program WTSHO, which reads the shoreline position data generated by the program CUINTP and writes a shoreline position data file for input to GENESIS.

The *Exit* option transfers the user to the SMS level 2 menu: Utilities.

### **Level 3 menu: Utility-Waves**

The three options in this menu screen simply transfer the user to another menu screen. The *Offshore Analysis* option transfers the user to the SMS level 4 menu: Utility-Waves-Offshore. The *Nearshore Analysis* option transfers the user to the SMS level 4 menu: Utility-Waves-Nearshore. The *Exit* option transfers the user to the SMS level 2 menu: Utilities.

### **Level 4 menu: Utility-Waves-Offshore**

This menu screen contains five options that invoke the execution of five generalized programs enabling the user to process offshore wave data for input to GENESIS, to compute potential longshore sand transport rates from the offshore wave data, and to develop a regional sediment budget (Gravens 1991; Gravens, Kraus, and Hanson 1991). A detailed discussion of the interaction between and usage of the programs available within this menu screen is provided in Chapter 5 under the heading "Analysis of Offshore Wave Data."

The *WAVETRAN* option initiates execution of a program that performs a Wave Information Study (WIS) Phase III-type transformation on the input time series of wave conditions according to user-specified constraints. This program is typically used to transform a time series of deepwater wave conditions to a finite water depth corresponding to the average water depth along the offshore boundary of the nearshore wave transformation bathymetry grid (RCPWAVE grid). As constraints, the user specifies shoreline orientation and one- or two-sided wave energy sheltering angles.

The *SEDTRAN* option executes the program SEDTRAN, which computes potential longshore sand transport rates from the input time series of wave

conditions. The results of these computations can be used to develop a regional scale longshore sand transport sediment budget.

The *RCRIT* option initiates execution of the program *RCRIT*, which processes an input time series of wave conditions and effectively eliminates from the time series those wave conditions that are either propagating offshore, are calm, or are determined to be insignificant in terms of their ability to produce longshore sand transport rates sufficient to impact long-term shoreline change (Kraus, Hanson, and Larson 1988). In general, use of this program will significantly reduce the execution time required to perform a given shoreline change simulation using *GENESIS*.

The *WTWAVTS* option executes a program that is used to either select and write (to a new file) a subset of the input time series, or to append two or more time series of wave conditions together.

The *WTWAVES* option initiates execution of the program *WTWAVES*, which enables the user to reformat a time series of wave conditions for use as input to *GENESIS*.

The *Exit* option transfers the user to the SMS level 3 menu: Utility-Waves.

#### **Level 4 menu: Utility-Waves-Nearshore**

This menu screen contains four options that invoke the execution of four generalized programs enabling the user to analyze an offshore time series of wave conditions to determine which nearshore wave transformation simulations should be performed, to process nearshore wave data (specifically output from *RCPWAVE*) for input to *GENESIS*, and to compute potential longshore sand transport rates using nearshore wave information to develop a local (or project level) sediment budget (Gravens 1991; Gravens, Kraus, and Hanson 1991). A detailed discussion of the interaction between and usage of the programs available within this menu screen is provided in Chapter 5 under the heading of "Analysis of Nearshore Wave Data."

The *WHEREWAV* option initiates execution of a program that computes wave height, period, and angle of approach statistics of an input time series of wave conditions. These statistics are subsequently used to determine which nearshore wave transformation simulations are required to describe, in general, the transformation of the offshore time series over a digitized bathymetry to nearshore (near-breaking) conditions.

The *WTNSWAV* option executes the program *WTNSWAV*, which is used to read output (wave height and angle of approach data along the user-specified nearshore reference line) generated by *RCPWAVE* and write a database of nearshore wave information for input to *GENESIS*.

The *WDEPTH* option executes the program WTDEPTH, which is used to read output (water depths along the nearshore reference line) generated by RCPWAVE and write a DEPTH.ext file for input to GENESIS.

The *NSTRAN* option initiates execution of a program that computes potential longshore sand transport rates from an input time series of offshore wave conditions, a nearshore wave database, and nearshore reference water depths (DEPTH.ext file). Output from this program can be used to develop a local (or project level) sediment budget.

The *Exit* option transfers the user to the SMS level 3 menu: Utility-Waves.

## 3 File Editors

---

This chapter documents the two special-purpose file editors (GENEDIT.EXE and RCPEDIT.EXE) included in the SMS. These programs were designed to facilitate the efficient generation and modification of the primary model configuration input data file used by the two major numerical models in the system (GENESIS and RCPWAVE). In addition to allowing the user to enter and modify various model set-up and configuration specifications, the programs perform extensive quality checks on user-provided inputs. If errors are detected, the programs report where the errors were found and allow the user to correct these errors prior to termination of the program. The following paragraphs detail the usage and operation of the two special-purpose editors.

### GENEDIT

Execution of the program GENEDIT.EXE can be initiated either from the SMS level 2 menu: GENESIS or in a stand-alone mode by issuing the command "\SMS\GENESIS\GENEDIT." Regardless of how the program is started, the program first displays an introductory screen, which gives the program name and version. Pressing any key will dismiss the introductory screen. The program then prompts the user for the file name. Upon entry of the desired file name (followed by pressing the ENTER key) the program will scan the default directory (or the directory in the path specified together with the file name) for the file. If the specified file name is not found, the program will prompt the user to indicate whether or not the requested file is a new file. If a new file is indicated, then the program will open a file with the user-specified name and a template of the START.ext will appear on the monitor. If a new file is not indicated, then the program will prompt the user for another file name. If, on the other hand, the program finds the user-specified file, then a template of the START.ext file with the existing input will appear on the monitor.

Upon entry of the START.ext file template, the cursor is positioned in the first data entry field (line A.1 RUN TITLE). If the file is a new file, the field



will be blank; if it is an existing file, the title of the previous run will appear in the data field. The information in the data field can be updated by typing in the desired title. When the cursor appears as an underscore, data entry is in the overstrike mode. When the cursor appears as a small box, data entry is in the insert mode.

In general, movement of the cursor between the data fields (for instance, moving from the data field associated with line A.1 to the data field associated with line A.2) is achieved by using the up or down cursor keys or by pressing the ENTER key. The exception to this is when the user is in a data buffer field (inputs in these fields may exceed one line). There are 16 of these data buffer fields that are required for array data entry on lines A.9, D.4, D.5, E.4, E.5, E.6, F.3, G.6, G.7, G.8, G.9, I.4, I.5, I.6, I.7, and I.8. To exit or move the cursor out of the data buffer fields, the up or down cursor keys must be used. Alternatively, a mouse can be used to move the cursor between the various data fields and data buffer fields, either by placing the mouse cursor on the desired data field, or by dragging the scroll bar (located on the right side of the template) up or down, or by clicking the mouse button on the scroll arrows (located at the upper and lower right side of the template). Furthermore, the PAGE DOWN and PAGE UP keys will advance and rewind the template one screen, respectively (provided that the cursor is in a data entry field and not a data buffer field). Within the data buffer fields, the PAGE DOWN and PAGE UP keys will advance and rewind the cursor one window height (two lines), respectively.

The program GENEDIT contains an on-line help utility. The help utility is activated by pressing the F1 key. The help utility provides both general instructions for using the program (cursor movement, data entry modes, etc.) and specific instructions for data entry. Within the help utility, the user can obtain additional information on specific topics by highlighting (using either the cursor keys or mouse) the text shown in reverse video and pressing the ENTER key. To exit the help utility, the user must press the Esc key.

To conclude the editing session (after completing the desired data entry or modification), the user must press the Esc key. The program then displays a banner, on the PC monitor, that instructs the user to either press the letter N to abort the session and terminate the program without saving the file, or to press the letter Y to save the file and exit the program. If the letter N is pressed, the program terminates without saving the file and the user is returned either to the SMS level 2 menu: GENESIS or to the DOS prompt, depending on how the program was initiated. If the letter Y is pressed, however, the program initiates numerous data quality checks on the user-provided entries. If errors are detected, the program displays, on the monitor, each of the specific data errors and allows the user to either terminate the editing session by pressing the Esc key or reenter the editor and correct the detected errors.

As the user will note (from the template), the START.ext file is divided into sections according to general subject. Gravens, Kraus, and Hanson (1991) provide step-by-step instructions for preparing the START.ext file for input to GENESIS. Gravens, Kraus, and Hanson (1991) should be consulted for a

definition and explanation of the input variables that the user is required to specify in the START.ext file.

## RCPEDIT

Execution of the program RCPEDIT.EXE, like GENEDIT.EXE, can be initiated either from the SMS level 2 menu: RCPWAVE or in a stand-alone mode by issuing the command "\SMS\RCPWAVE\RCPEDIT." Regardless of how the program is started, the program first displays an introductory screen that gives the program name and version. Pressing any key will dismiss the introductory screen. At this point, the RCPEDIT editor screen is displayed on the monitor. The editor screen is divided into two areas, the *Command Area*, and the *Editor Area*. The Command Area is further divided into the file manipulation command buttons (located at the top of the screen) and the RCPWAVE input record selection buttons (located at the bottom of the screen). The *Editor Area* is located in the central portion of the screen. Figure 4 is a schematic illustration of the RCPEDIT screen.

The file manipulation command buttons are activated by highlighting the desired button and pressing the ENTER key or clicking the mouse button. The command buttons can be highlighted using either the cursor keys or a mouse. The functions of the five file-manipulation buttons are as described in the following paragraph.

The *SAVE* button saves the current input data records listed in the editor window in a user-specified file name. The *LOAD* button allows the user to load an existing RCPWAVE input data set into the editor window for modification. The *EXIT* button is used to save the input data set file in the editor window and exit the program (terminate the editing session). The *PRINT* button causes the data in the editor window to be sent to the printer. The *ABORT* button terminates the editing session without saving the data in the editor window.

The format of the RCPWAVE input data set is defined in Gravens, Kraus, and Hanson (1991). Each record (or line) in the RCPWAVE input data set is divided into ten fields, each field containing eight columns. Field 1, columns one through eight, must contain a record identification label. Fields 2-10 contain data that may be real, integer, or character in type. Integers must be right-justified. Real numbers must be either right-justified or contain a decimal point. Character data entries do not need to be justified. Array data, such as bathymetry, are read (by the numerical model) with DO or implied DO loops. No label is required for array data. However, a general specification record, such as BATHSPEC for bathymetry data, must precede the array. Use of the program RCPEDIT eliminates the need for the user to be concerned about the various format rules as they are automatically formatted by the program.

There are a total of ten different input data records in the RCPWAVE input data set. The input record selection buttons are located at the bottom of the

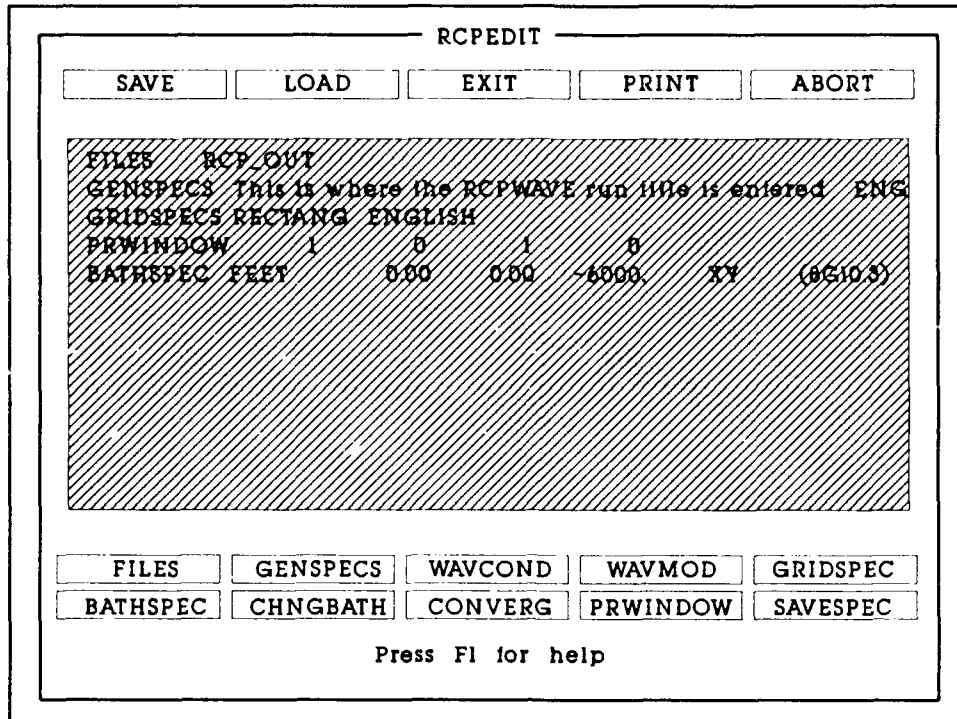

Figure 4. Schematic illustration of the RCPEDIT screen

RCPEDIT screen (see Figure 4) and are identified by the record name (or record identification label). Highlighting a record selection button and pressing the ENTER key will cause an input window for the selected record to pop up in the editor window. Clicking the mouse button on the record selection buttons will also cause the input window to pop up. Figures 5 and 6 provide schematic illustrations of the ten pop-up input windows for the RCPWAVE input records. As seen in Figures 5 and 6, the input windows contain data entry fields for each of the input variables on the input record. If the variable has a default value, the data field will initially contain the default value. If an existing input data set is retrieved (loaded) into the editor, the input variables will contain the existing values. The input records shown in Figure 5 are required for all simulations and an RCPWAVE input data set can contain only one of each of these records. At least one WAVCOND record (shown in Figure 6) is also required for all simulations; however, an input data set may contain up to ten WAVCOND records. The other input records shown in Figure 6 are optional records and are used to activate either a feature of the model (such as explicit specification of wave conditions on the offshore boundary through the WAVMOD record, and definition of the nearshore reference line through the SAVESPEC record) or to change model parameters (CONVERG record) or change bathymetry values (CHNGBATH record). Optional input records (WAVMOD, CHNGBATH, CONVERG, and SAVESPEC) and WAVCOND records can be inserted into the data set using the record selection buttons located at the bottom of the screen. Likewise, the required input records can be modified or changed using the record selection buttons.

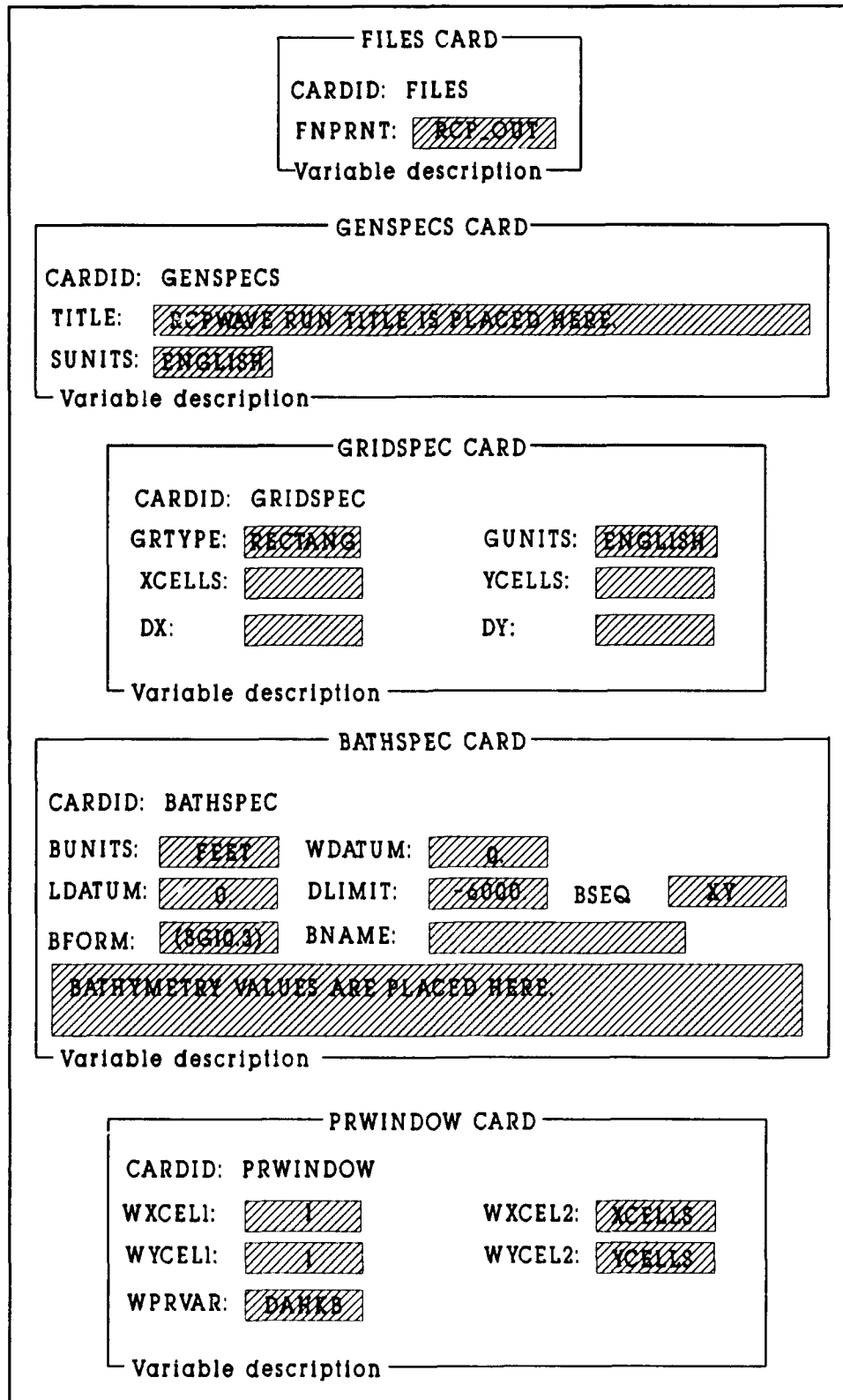

Figure 5. Required RCPWAVE input data cards

WAVCOND CARD	
CARDID: WAVCOND	
HDEEP: <input style="width: 80px; height: 15px;" type="text"/>	TDEEP: <input style="width: 80px; height: 15px;" type="text"/>
ZDEEP: <input style="width: 80px; height: 15px;" type="text"/>	CNTRANG: <input style="width: 80px; height: 15px;" type="text" value="0.0"/>
DIFFR: <input style="width: 80px; height: 15px;" type="text" value="YES"/>	
Variable description	
WAVMOD CARD	
CARDID: WAVMOD	
HUTIL: <input style="width: 80px; height: 15px;" type="text"/>	HUTIL2: <input style="width: 80px; height: 15px;" type="text"/>
ZUTIL: <input style="width: 80px; height: 15px;" type="text"/>	ZUTIL2: <input style="width: 80px; height: 15px;" type="text"/>
Variable description	
CONVERG CARD	
CARDID: CONVERG	
HCONVR: <input style="width: 80px; height: 15px;" type="text" value="0.0005"/>	SCONVR: <input style="width: 80px; height: 15px;" type="text" value="0.00025"/>
ITAMAX: <input style="width: 80px; height: 15px;" type="text" value="50"/>	IDIFF: <input style="width: 80px; height: 15px;" type="text" value="15"/>
STABL: <input style="width: 80px; height: 15px;" type="text" value="0.4"/>	DECAY: <input style="width: 80px; height: 15px;" type="text" value="0.2"/>
Variable description	
CHNGBATH CARD	
CARDID: CHNGBATH	
BATH: <input style="width: 80px; height: 15px;" type="text"/>	
XIINDX: <input style="width: 80px; height: 15px;" type="text"/>	YIINDX: <input style="width: 80px; height: 15px;" type="text"/>
X2INDX: <input style="width: 80px; height: 15px;" type="text" value="0"/>	Y2INDX: <input style="width: 80px; height: 15px;" type="text" value="0"/>
Variable description	
SAVESPEC CARD	
CARDID: SAVESPEC	
FILOUT: <input style="width: 150px; height: 15px;" type="text" value="NSRFOUT"/>	
NSRFIL: <input style="width: 150px; height: 15px;" type="text"/>	
NSRCELLS: <input style="width: 300px; height: 15px;" type="text" value="LOCATION OF NEARSHORE REFERENCE LINE IS SPECIFIED HERE (ARRAY OF X-CELL VALUES)"/>	
Variable description	

Figure 6. Optional RCPWAVE input data cards

Use of the optional input record WAVMOD enables the user to explicitly specify wave conditions on the offshore boundary of the computational grid. However, the input data set must contain one WAVMOD record for each WAVCOND record. It should be noted that the first WAVMOD record operates on the first WAVCOND record, and the second WAVMOD record operates on the second wave condition, and so on.

Within the editor window (centrally located on the screen) input records can be added, deleted, or modified. An existing input record can be deleted by highlighting the record using either the cursor keys or mouse and pressing the DELETE key. However, the required records shown in Figure 5 cannot be deleted. Input records can be modified by highlighting the record and pressing the ENTER key. This action causes the input window to pop up and from within the input window, the user can change the value (or specification) of any of the input variables. Exiting a pop-up input window is accomplished by either pressing the ESC key or by pressing the ENTER key when the cursor is located in the last data entry field. Input records can be inserted into the input data set from within the editor window by pressing the INSERT key. This action causes a window containing the record selection buttons to pop up within the editor window. At this point, the user can select the record he or she wishes to insert into the data set by highlighting the appropriate record selection button using the cursor keys and pressing the ENTER key or by highlighting the button using the mouse and clicking the mouse button. After the user has inserted the desired input records, the window containing the record selection buttons is dismissed by pressing the ESC key.

The RCPEDIT program contains an on-line help utility. The user can access the help utility by pressing the F1 key. The information within the help utility provides the user with instructions for using the program (moving the cursor, editing input data records, deleting input records, etc.). The user is referred to Chapter 6 for an overview of the numerical model RCPWAVE, and to Gravens, Kraus, and Hanson (1991) or Cialone (1991) for information on and definition of specific RCPWAVE input variables. Ebersole (1985) and Ebersole, Cialone, and Prater (1986) provide complete technical documentation of the theory, assumptions, and numerical algorithms used in RCPWAVE. Gravens, Kraus, and Hanson (1991) provide procedural guidance for the use of RCPWAVE in shoreline change investigations where results generated by RCPWAVE are used as input to GENESIS.

## 4 Graphics Programs

---

This chapter documents the two special-purpose graphics programs (GENGRAF.EXE and RCPGRAF.EXE) and one general-purpose graphics program (DPLOT.EXE) included in the SMS. The special-purpose graphics programs were designed to allow the user to visualize results generated by the two major coastal processes numerical models (GENESIS and RCPWAVE) in the SMS. The general-purpose graphics program DPLOT.EXE\* is included in the SMS to allow users to graphically display output generated by many of the system support programs. The following paragraphs detail the usage and capabilities of the graphics programs included in the SMS.

### GENGRAF

The program GENGRAF was developed specifically for the visualization of results generated by GENESIS. GENGRAF allows the user to produce typically required plots depicting the results of a GENESIS simulation using the standard GENESIS input and output files as input. Execution of the program GENGRAF is initiated from the SMS level 2 menu: GENESIS. Alternatively, GENGRAF can be started from the DOS prompt by issuing the command "\SMS\GENESIS\GENGRAF." Upon initiation of the program, the SMS level 3 menu: GENESIS-Graphics menu screen is displayed on the PC monitor. Figure 7 provides a schematic illustration of this menu. As seen in Figure 7, three types of plots can be processed using the options in this menu screen. The *Net Transport Rate* option displays the average annual net longshore sand transport rate computed at each grid cell for the simulation period, together with the mean annual net longshore sand transport rate for the entire simulation reach (a straight line average for the reach). The *Shoreline Change* option allows the user to display the computed shoreline change between the final computed shoreline position and the initial shoreline position, or the measured shoreline position, or an external (user-specified) shoreline position data file. The *Shoreline Positions* option enables the user to plot the initial and calculated shoreline positions, together with the specified coastal structures simulated, including beach fills, seawalls,

---

\* The program DPLOT was developed by David W. Hyde, Structural Engineer, USAE Waterways Experiment Station, Structures Laboratory.

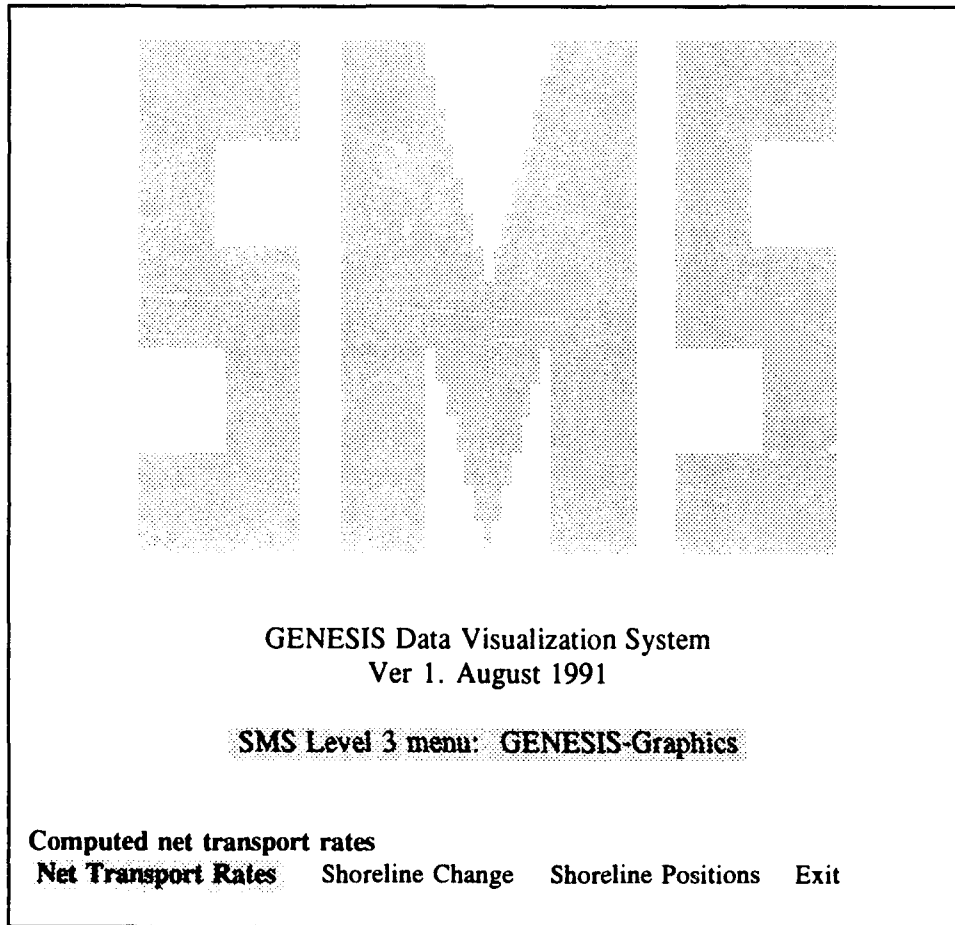

Figure 7. SMS Level 3 menu: GENESIS-Graphics  
(GENESIS Data Visualization System)

groins, and detached breakwaters. Additional shorelines such as the measured shoreline position, seaward-most computed shoreline position, landward-most computed shoreline position, intermediate shoreline positions (specified in the START.ext file), and external (user-specified) shoreline position data files can also be displayed. The *Exit* option terminates the program GENGRAF, which either transfers the user to the SMS level 2 menu: GENESIS, or returns the user to the DOS prompt.

As stated previously, GENGRAF uses the standard GENESIS input and output files as input. These files are identified by their common file name extension (listed here as ".ext"). Specifically, the files START.ext, SHORL.ext, SHORM.ext, SHORC.ext, and OUTPT.ext are used as input by GENGRAF. Since GENGRAF identifies these files by their filename extension, they must reside in the default directory, which means that the user should set default to the directory containing the data files prior to starting either the SMS or the program GENGRAF from the DOS prompt. After the user selects one of the plot types from the initial menu screen (by highlighting the option using either the cursor



keys or mouse and pressing the ENTER key or clicking the mouse button), the program requests that the user enter the file name extension. At this point, the program searches the default directory, opens the required files, and reads the data necessary to produce the requested plot. After the requested graphic image is displayed on the PC monitor, the user can modify the plot using various options that are displayed along the lower portion of the screen. To illustrate the use of these options and the overall usage of the program GENGRAF, an example (GENGRAF) plotting session is provided in the following paragraphs. The GENESIS input and output files listed in Appendix B will provide the example input data set for the plotting session.

### Example GENGRAF plotting session

Before initiating the GENGRAF plotting session, the user must set the default directory to the one containing the GENESIS input and output data files. Then the user initiates the SMS system by issuing the command "\SMS\SMS." From the SMS level 1 menu: Main the user selects the GENESIS option. Then the program is started by selecting the GENGRAF option. At this point, the PC monitor should look similar to Figure 7. To plot the calculated longshore sand transport rates, the user selects (highlights) the *Net Transport Rate* option and then presses the ENTER key.

### Net transport rate plot

After selection of the *Net Transport Rate* option, the PC screen is cleared and the program prompts the user to input the file name extension. For this example (using the files listed in Appendix B), the extension "EXP" is entered. At this point a plot similar to the one shown in Figure 8 is displayed on the PC screen. As shown in Figure 8, there is a menu bar containing ten options at the bottom of the screen. Just above the menu bar is a one-line description of the highlighted menu option. The options and their one-line descriptions are as follows:

- a. Q Quit - exit graphics.
- b. @ read Y value(s) @ X=?.
- c. D screen Dump to printer.
- d. E Erase a curve.
- e. L relocate Legend.
- f. C Change labels.
- g. R Read X, Y data points from a curve.
- h. V list peak Values.
- i. Z Zoom.
- j. P Plotter functions.

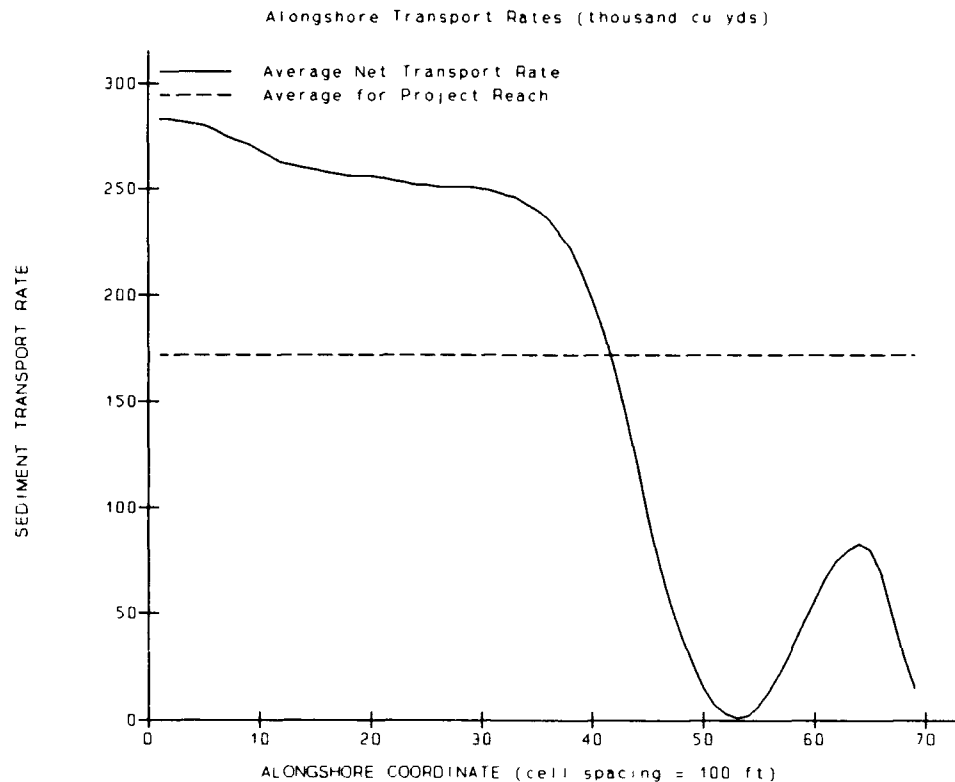

Quit - exit graphics

Q @ D E L C R V Z P

Figure 8. Example net transport rate plot

As indicated, the **Q** option terminates the graphics subroutine and returns the user to the initial menu screen (shown in Figure 7). The **@** option will report the Y values for each curve displayed in the plot at a user-specified X value. The **D** option causes the graphic image on the monitor to be sent to the printer. The **E** option allows the user to select and erase any curve in the plot. The **L** option allows the user to relocate the legend anywhere on the plot. The **C** option allows the user to change all of the text displayed on the plot, including the legend, the X and Y axis labels, the title, and also including a toggle switch for turning the date on and off. The **R** option allows the user to first select a curve and then as the user moves the cursor along the curve (using the cursor keys), the program reports the X and Y values at the cursor location. The **V** option lists the maximum and minimum Y values, together with the corresponding X values for each of the curves displayed on the screen. The **Z** option allows the user to zoom in on a user-specified portion of the graphic image. The **Z** option is also used to reset a previously specified window (i.e., display the full graphic image). The **P** option allows the user to download the graphic image to an HP-compatible pen plotter (or HP LaserJet III laser printer) or to create an ASCII file containing the graphic image in Hewlett Packard Graphics Language. In fact, Figure 8 was originally created from within the

SMS and then dumped to a file using the **P** option and subsequently imported into this document.

For this example, if the user selects the **V** option, the program reports that Curve 1 has a minimum value of  $Y=1$  at  $X=53$  and a maximum value of  $Y=283$  at  $X=1$ . Likewise, Curve 2 has a minimum value of  $Y=171.9$  at  $X=1$  and a maximum value of  $Y=171.9$  at  $X=1$ .

Selection of the **Q** option results in the user being transferred back to the SMS level 3 menu: **GENESIS-Graphics** (illustrated in Figure 7). From this screen, the user can select the *Shoreline Change* option as discussed in the following paragraph.

### Shoreline change plot

After selection of the *Shoreline Change* option, a screen similar to the one shown in Figure 9 appears on the PC monitor. From this screen, the user selects

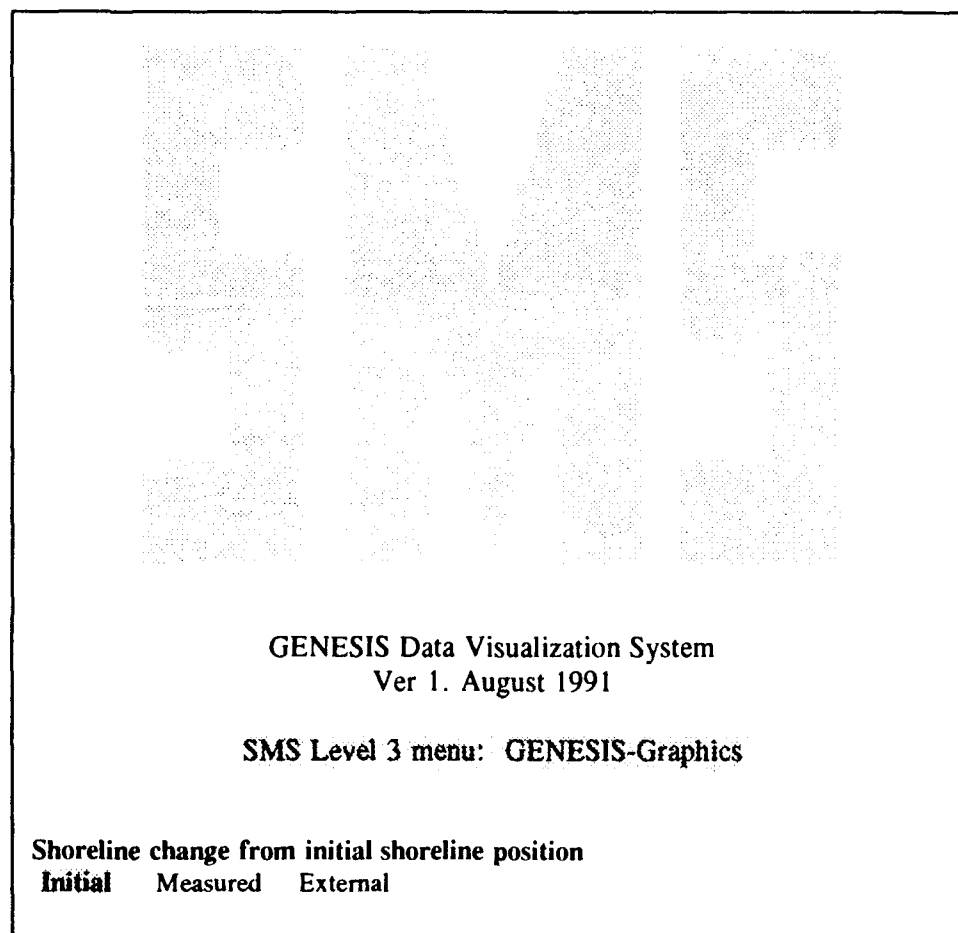

Figure 9. Shoreline change plot options menu  
(GENESIS Data Visualization System)

one of three possible options for the shoreline change plot. If the *Initial* option is selected, the plot will reflect calculated shoreline change from the initial shoreline position to the final calculated shoreline position. If the *Measured* option is selected, the shoreline change between the measured shoreline and final calculated shoreline position will be plotted. Likewise, selection of the *External* option will produce a plot of the shoreline change between some user-specified shoreline file (GENESIS SHORL.ext file format is required) and the final calculated shoreline position. For this example, the *Initial* option is selected and (after the file extension "EXP" is entered) a plot similar to the one shown in Figure 10 is displayed on the PC monitor. As shown in Figure 10, the list of options available for modification of the shoreline change plot is identical to those available for the net transport rate plot.

Selection of the @ option results in a prompt for entry of the desired X value. If the value 44 is entered for this example, the program reports the following: "at X = 44.0 , Y<sub>1</sub> = 300.3, Y<sub>2</sub> = 0.0." Similarly, the program will report Y values at any X value specified on subsequent calls to this option. The dashed line (defining the line between erosion and accretion) shown in Figure 10 can be removed from the plot by highlighting the E option, pressing the ENTER

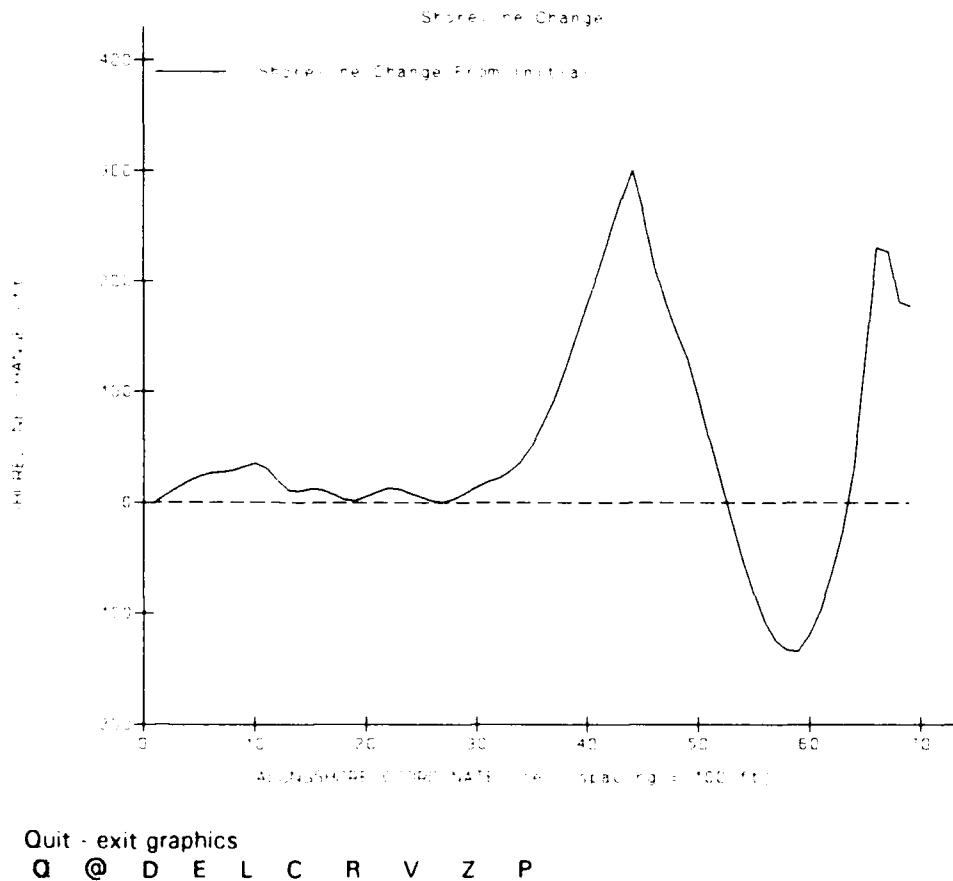

Figure 10. Example shoreline change plot

key, and then placing the cross hairs on the dashed line and pressing the ENTER key again.

### Shoreline position plot

Selection of the *Shoreline Positions* option from the SMS level 3 menu: GENESIS-Graphics (Figure 7) produces a plot, after entry of the file extension "EXP," similar to the one shown in Figure 11. Note that there are two additional options available below the default shoreline position plot shown in Figure 11. These options, **S** and **I**, enable the user to display additional shorelines available in the GENESIS output. Specifically, the **S** option allows the plotting of the *Measured* shoreline position, the landward-most (*Minimum*) calculated shoreline position, the seaward-most (*Maximum*) calculated shoreline position, or any other user-specified (*External*) shoreline position data file (GENESIS SHORL.ext file format is required). The **I** option allows the user to plot the requested intermediate shoreline positions specified to be saved in the START.ext file. The intermediate shorelines can be plotted in a step-by-step sequence by requesting the *Step* option, or all at once by requesting the *All* option. As seen in Figure 11, the default plot includes the initial and final

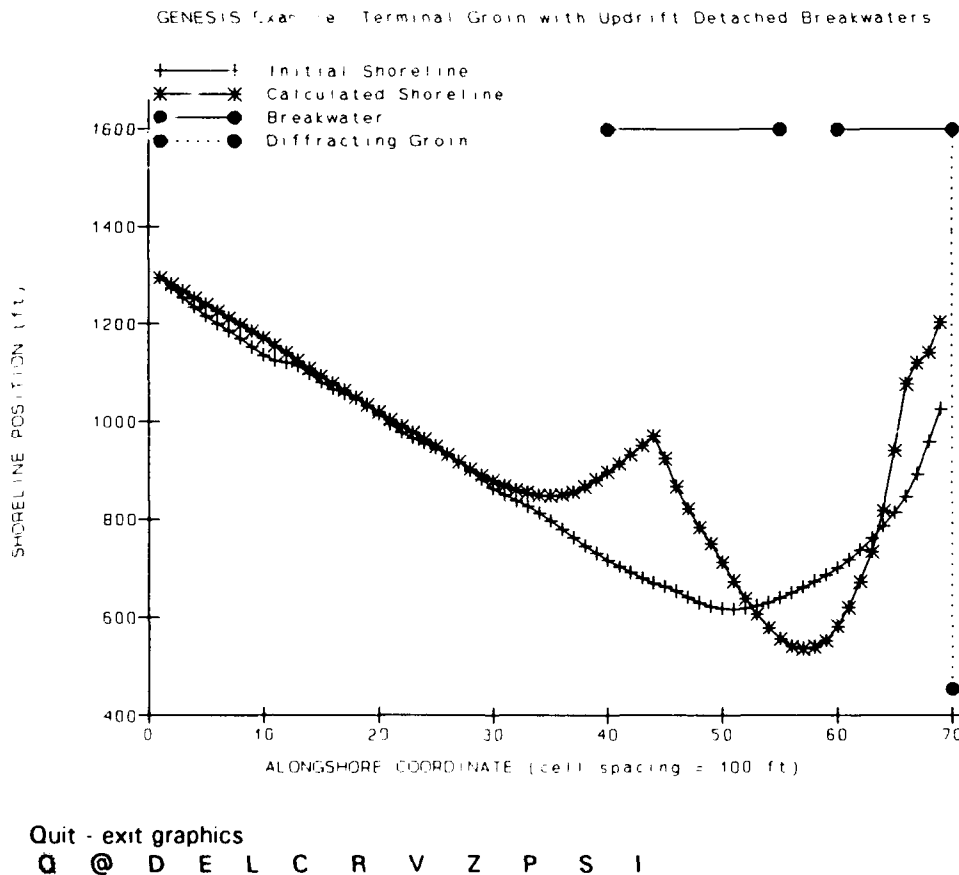

Figure 11. Example shoreline position plot

calculated shoreline positions and all of the coastal structures simulated in the modeled reach. Other coastal structures that can be plotted but were not included in this example application are seawalls and non-diffracting groins. If the simulation included a beach fill, the longshore extent of the beach fill is denoted in the graphic as well.

The graphic shown in Figure 12 reflects the result obtained after the **I** option is selected to display the five intermediate shoreline positions requested in the START.EXP input file and after the **Z** option was used to window in on the shoreline reach between alongshore coordinates 25 and 70. After selecting the **Z** option, the user can request that the complete graphic image be displayed or that a specific window within the graphic image be displayed by defining the upper right and lower left corners of the window using the cross hairs that appear on the screen when the window option is selected.

The program GENGRAF is very flexible and can be used to display many different GENESIS results. Up to six different shoreline position curves can be displayed and uniquely labeled using the *Shoreline Positions* plot. Average annual net longshore sand transport rates can be plotted using the *Net Transport Rates* plot, and the difference between two shorelines can be plotted using the *Shoreline Change* plot. All of the text within the various default plots can be changed to satisfy specific project needs by using the **C** option.

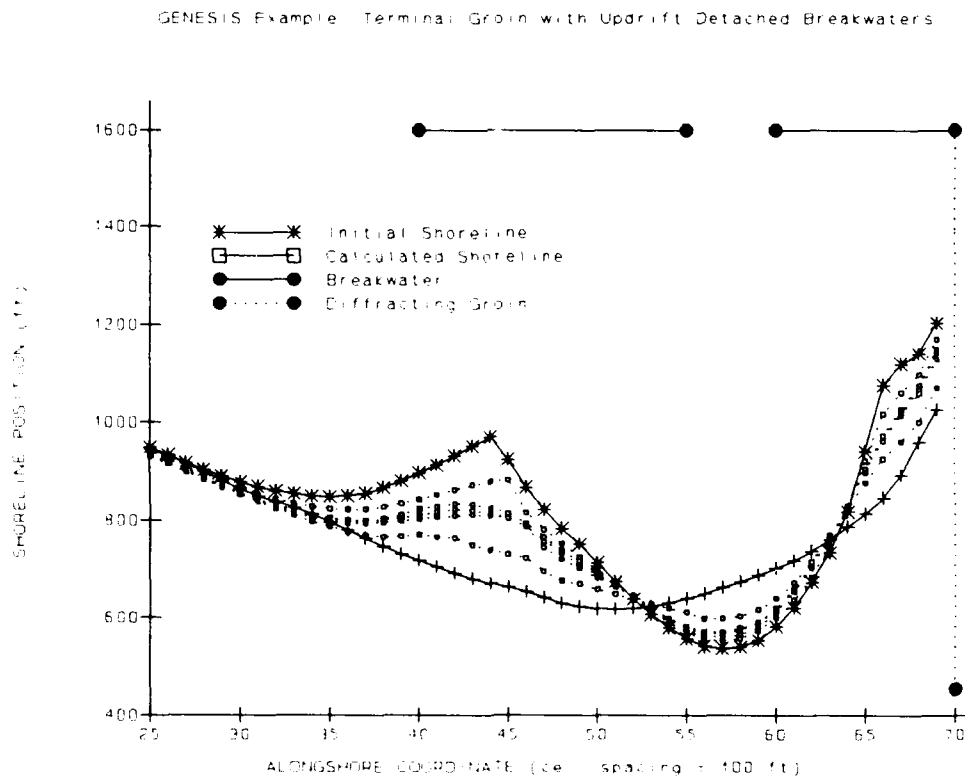

Figure 12. Shoreline plot with intermediate shoreline positions and zoom option

## RCPGRAF

The program RCPGRAF, like GENGRAF, was specifically designed to utilize standard output (in this case from RCPWAVE) to create graphic images for the presentation and interpretation of model results. There are two general types of plots available from RCPGRAF. These are contour plots of information on the full two-dimensional computation grid, and X-Y plots of wave information along the nearshore reference line (the nearshore wave information used by GENESIS). A plotting session using the program RCPGRAF can be initiated from either the SMS level 2 menu: RCPWAVE or in a stand-alone mode from the DOS prompt by issuing the command "\SMS\RCPWAVE\RCPGRAF." Upon initiation of the program, the SMS level 3 menu: RCPWAVE-Graphics menu screen is displayed on the PC monitor. Figure 13 provides a schematic illustration of this menu. As seen in Figure 13, two types of plots can be processed using the options in this menu screen. The *2-D RCPWAVE Grid* option enables the user to produce contour plots of the water depth (bathymetry), wave height, and wave

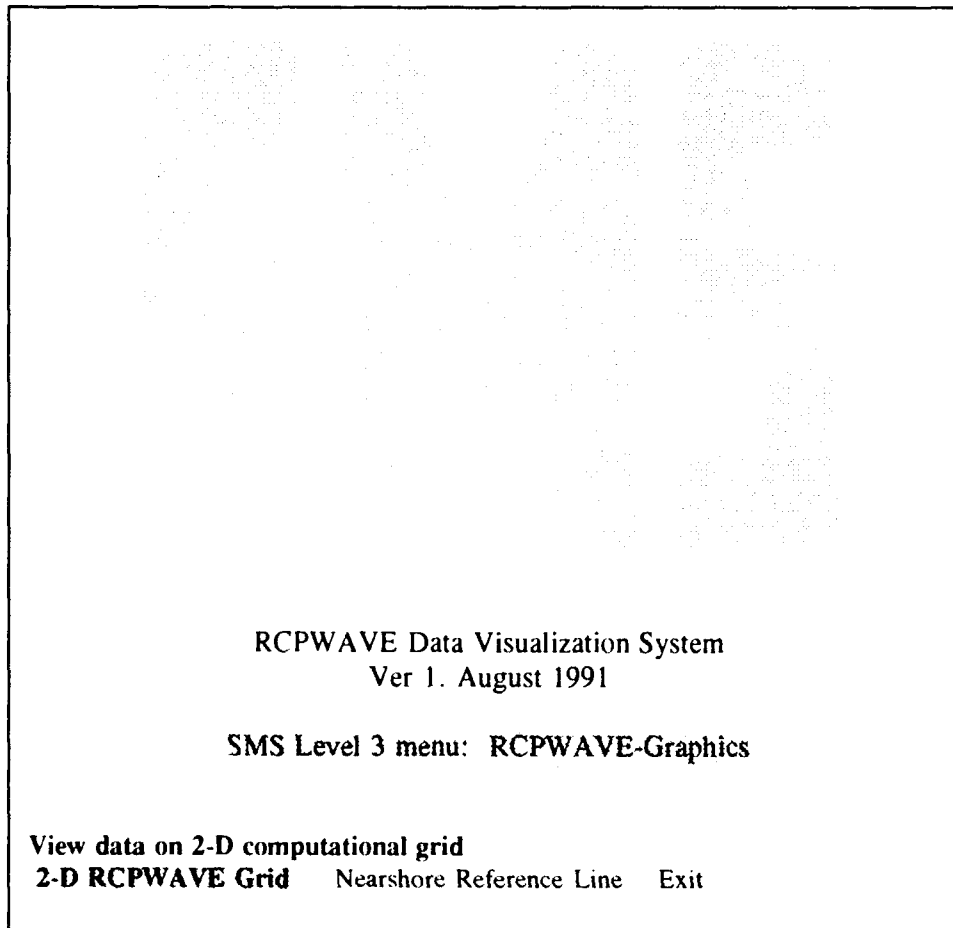

Figure 13. SMS Level 3 menu: RCPWAVE-Graphics  
(RCPWAVE Data Visualization System)

angle over the full RCPWAVE grid. These contour plots can be of either the isoline type or they can be displayed in shaded contour levels. The *Nearshore Reference Line* option allows the user to plot wave heights and angles along the nearshore reference line (see Gravens, Kraus, and Hanson 1991), where they will be utilized as input to GENESIS. Highlighting the *Exit* option and pressing the ENTER key will result in the user being transferred back to the SMS level 2 menu: RCPWAVE or to the DOS prompt, depending on how the program was initiated.

As stated previously, the program RCPGRAF uses the standard RCPWAVE output files as input. Information for the contour plots is obtained from the output file specified on the input FILES record (see Figure 5). This file name (and the path if the file is not in the default directory) must be entered after the *2-D RCPWAVE Grid* option is selected. Likewise, data for the X-Y plots of wave information along the nearshore reference line are obtained from the output file specified on the SAVESPEC record (see Figure 6). This file name (and the path if the file is not in the default directory) must be entered after the *Nearshore Reference Line* option is selected. Like GENGRAF, after the graphic image is displayed on the PC monitor, there are various options available to the user for modification or analysis of the graphically displayed data. To illustrate a few of the available options associated with RCPGRAF, an example plotting session is provided in the following paragraphs. The RCPWAVE input and output files listed in Appendix C were used for the example input data set for the plotting session.

### Example RCPGRAF plotting session

This example RCPGRAF plotting session is initiated from the root directory (for example, C:\) by issuing the command "\SMS\SMS." From the SMS level 1 menu: Main the user selects the RCPWAVE option, then the graphics program is started by selecting the RCPGRAF option. At this point, the PC monitor should look similar to Figure 13. To plot the bathymetry over which the input wave conditions were transformed, the user selects (highlights) the *2-D RCPWAVE Grid* option and then presses the ENTER key.

### 2-D RCPWAVE Grid plot

After selection of the *2-D RCPWAVE Grid* option the PC screen is cleared and the program prompts the user to input the file name (if the input file is not in the default directory, the path should be entered as well). For this example (assuming the files listed in Appendix C reside in the directory C:\SMS\DATA), the following is entered: "\SMS\DATA\RCP\_OUT." At this point, a menu similar to the one shown in Figure 14 appears on the PC monitor. From this menu, the user selects the specific data type that will be plotted (water depths, wave heights, or wave angles). After the user specifies the type of data to be plotted (in this example *Depths* is selected), the following prompt appears on the screen:

" (D)isplay, (P)lotter, or (H)PGL plot file? [D] "



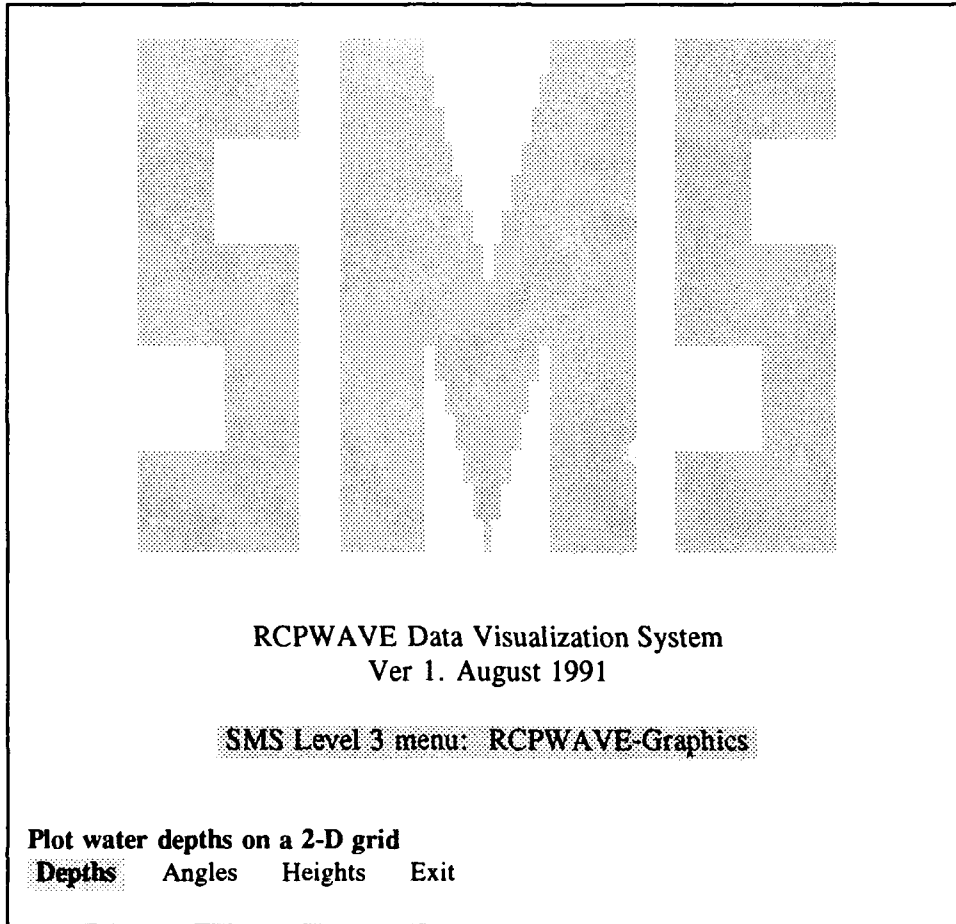

Figure 14. RCPGRAF: 2-D RCPWAVE Grid menu (data type options)

The user then specifies the device on which the plot should be processed. By default the plot will be processed on the PC monitor (denoted by **[D]**). As an alternative the plot could be sent to the plotter by entering **P** or to a file by entering **H**. In this example a **D** is entered. Next the program prompts for entry of the plot type as follows:

" select **1**) contour lines  
 or **2**) shaded contour levels [**1**] █ "

Contour lines will be plotted by default (denoted by **[1]**), or the user can request that the data be displayed as a series of shaded contour levels. For this example, the contour lines are requested by entering the value **1**. The program then scans the data and reports the following to the PC monitor:

"     **Minimum value ... 1.000**

**Maximum value ... 38.00**

**Enter number of intervals (24 max), low value, high value.**  
**(0,0,0 to abort) ... █ "**

For this example, the values 6, 5, 35 are entered, specifying that the plot should contain six contour lines with the shallowest contour line corresponding to the 5 ft<sup>1</sup> contour and the deepest corresponding to the 35-ft contour. The resulting plot is similar to the one shown in Figure 15. As shown in Figure 15, there is a menu bar containing four options along the bottom of the screen. Directly above the menu bar is a one-line description of the highlighted menu option. The options and their one-line descriptions are as follows:

- a. **Quit** Exit graphics.
- b. **Read** Find interpolated Z, given X and Y.
- c. **Write** Write Z values for each, given X and Y.
- d. **Print** Send a screen dump to graphics printer.

The **Quit** option terminates the 2-D graphics subroutine and either returns the user to the **SMS Level 3 menu: RCPWAVE-Graphics** or if the **Write** option has been activated, the user is transferred to another menu screen where the selected

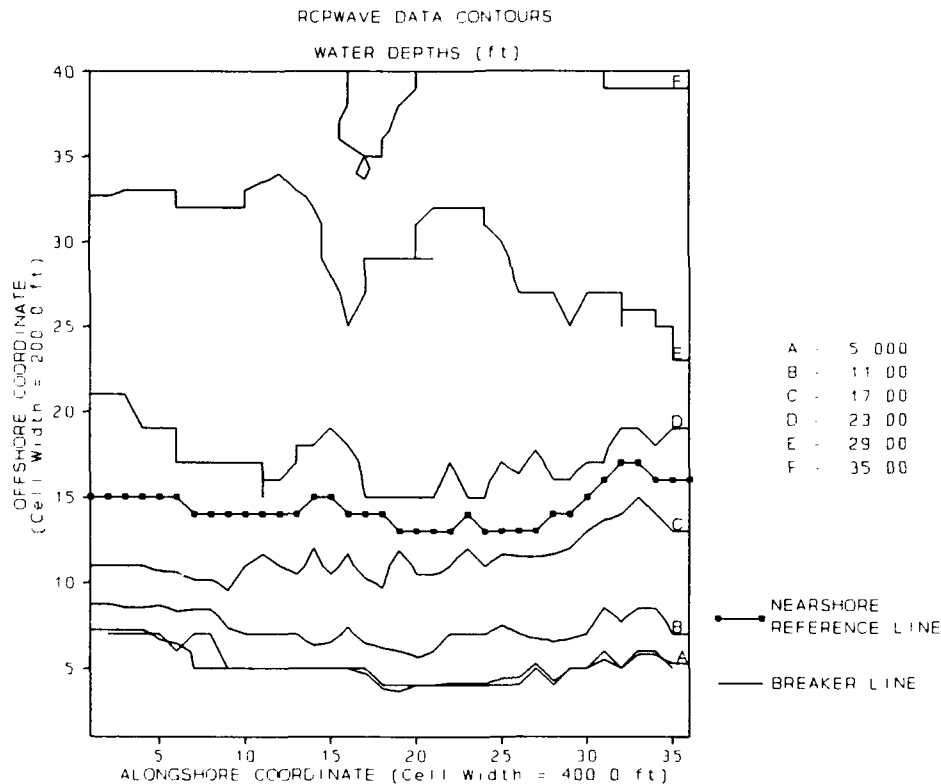

Exit graphics  
Quit Read Write Print

Figure 15. Example RCPWAVE contour plot

<sup>1</sup>A table of factors for converting non-SI units of measurement to SI (metric) units is presented on page vii.

data can be plotted in an X-Y type format. The **Read** option allows the user to determine the Z value (in this example, representing water depths) at any specified (X,Y) location. For example, if the user selected the **Read** option and specified an X value of 23, and a Y value of 27, the program would report on the screen that "at X,Y = 23.00, 27.00, Z = 28.00." The **Write** option enables the user to select specific transects across the 2-D computational grid and then after exiting the 2-D plot, these selected cross-shore data can be viewed, plotted in an X-Y type graphic, or saved to a user-specified file name. The user activates the **Write** option by highlighting the **Write** button and pressing the ENTER key. At this point, a vertical line appears on the graphic image, the vertical line is moved across the graphic image using the left and right cursor keys, and the desired transects are selected by pressing the SPACE bar. This procedure was used to select transects at alongshore coordinates 8, 19, and 33 in Figure 15. After the transects have been selected, the user presses the ENTER key to signal the program that all desired selections have been made. When the user exits the 2-D graphics subroutine (by selecting the **Quit** option) a menu similar to the one shown in Figure 16 appears on the monitor. As shown in Figure 16, there are four options available in this menu. The **View** option allows the user to view the

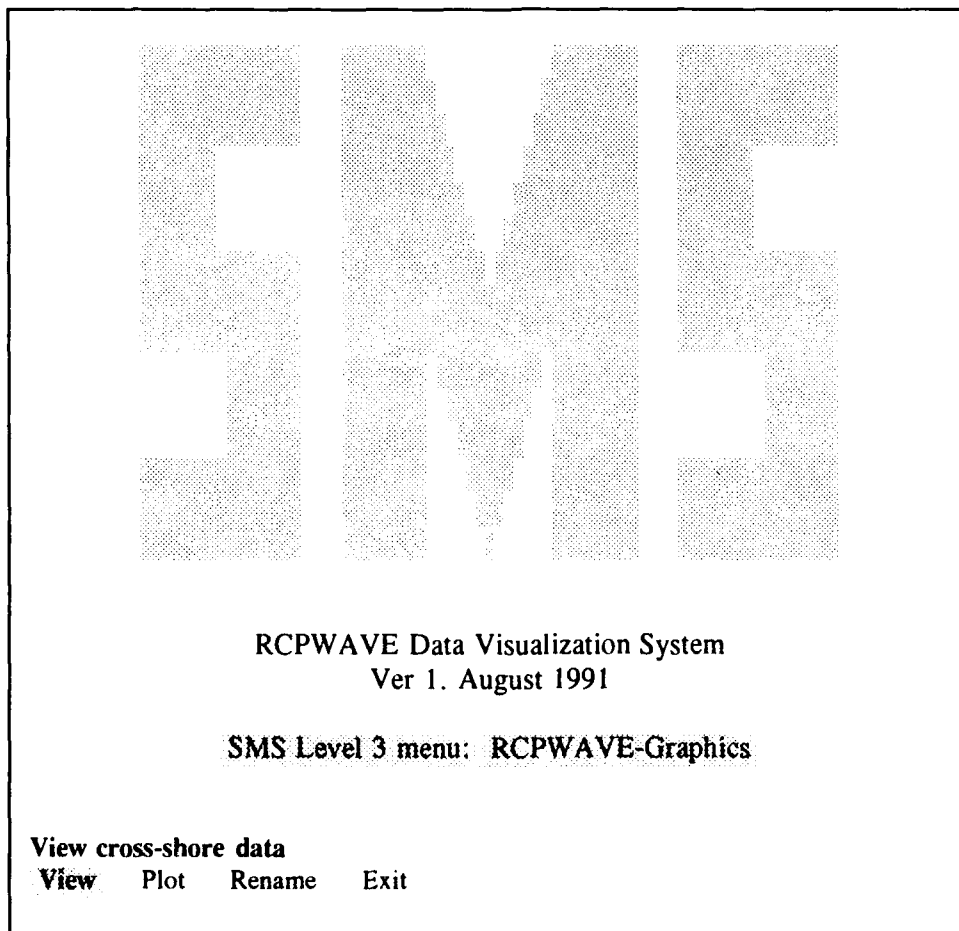
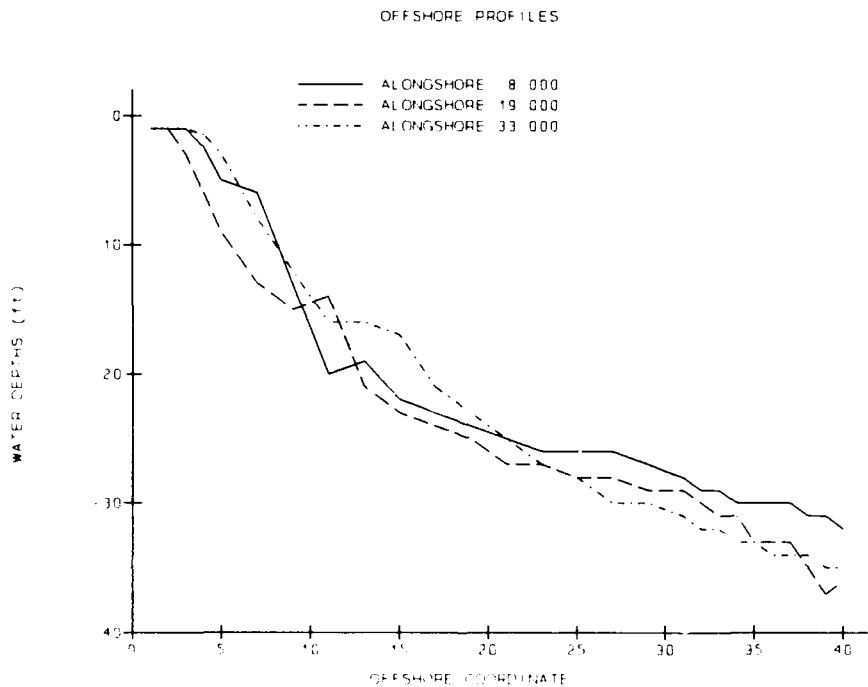

Figure 16. RCPWAVE-Graphics: Write option menu

numerical information (in this example, water depths) along the selected transects. The *Plot* option allows the user to plot the data in an X-Y type plot. The *Rename* option allows the user to rename the file containing the data to a unique user-specified file name, and, of course, the *Exit* option returns the user to the SMS level 3 menu: RCPWAVE-Graphics. In this example, the *Plot* option is selected and a graphic image similar to the one shown in Figure 17 appears on the screen. Note that the standard graphic options discussed previously in the GENGRAF example application (see page 22) are available for these cross-shore transect plots as well.

### Nearshore reference line plot

After selection of the *Nearshore Reference Line* option from the menu shown in Figure 13, a menu similar to the one shown in Figure 18 appears on the PC monitor. As indicated in Figure 18, both wave heights and wave angles along the nearshore reference line can be plotted. Wave information (wave height, incident angle, and water depth) are saved on the nearshore reference line in a special output file for subsequent processing using the programs WTNSWAV and WTDEPTH, and are subsequently input to the shoreline evolution model GENESIS (Gravens, Kraus, and Hanson 1991).



Quit - exit graphics

Q @ D E L C R V Z P

Figure 17. Example cross-shore data plot

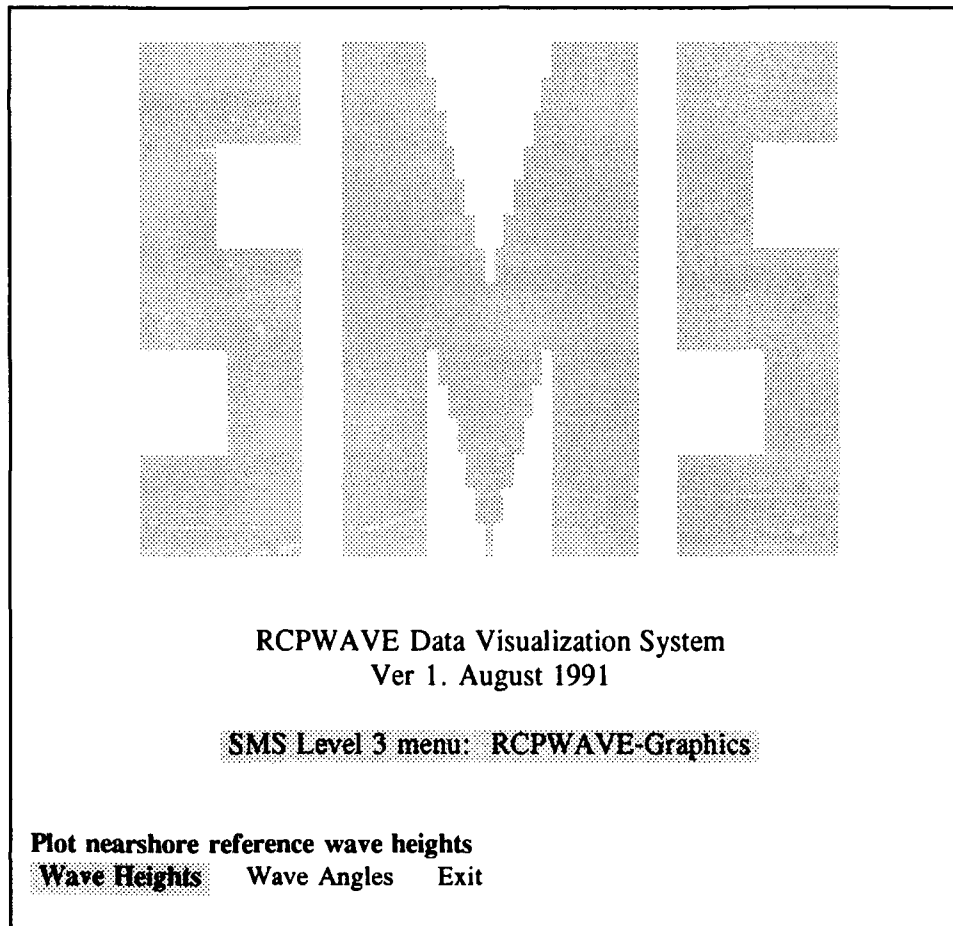

Figure 18. RCPGRAF: *Nearshore Reference Line* menu (data type options)

After selection of the desired option (in this example, *Wave Heights*), the PC screen is cleared and the program prompts the user to input the file name (if the input file is not in the default directory, the path should be entered as well). For this example (assuming the files listed in Appendix C reside in the directory C:\SMS\DATA, and that the session was initiated from the root directory C:\), the following is entered: "\SMS\DATA\RCPEXP.NSR." Next, the program prompts the user to enter the number of wave blocks (the number of alongshore RCPWAVE cells) in the file. In this example, there are 36 wave blocks, so the value 36 is entered. At this point, a plot of the nearshore wave heights similar to the one shown in Figure 19 appears on the screen. Likewise, if the *Wave Angles* option had been selected, a plot similar to the one shown in Figure 20 would be displayed. Again, the same ten plot modification options previously discussed are available for the modification of these graphic images.

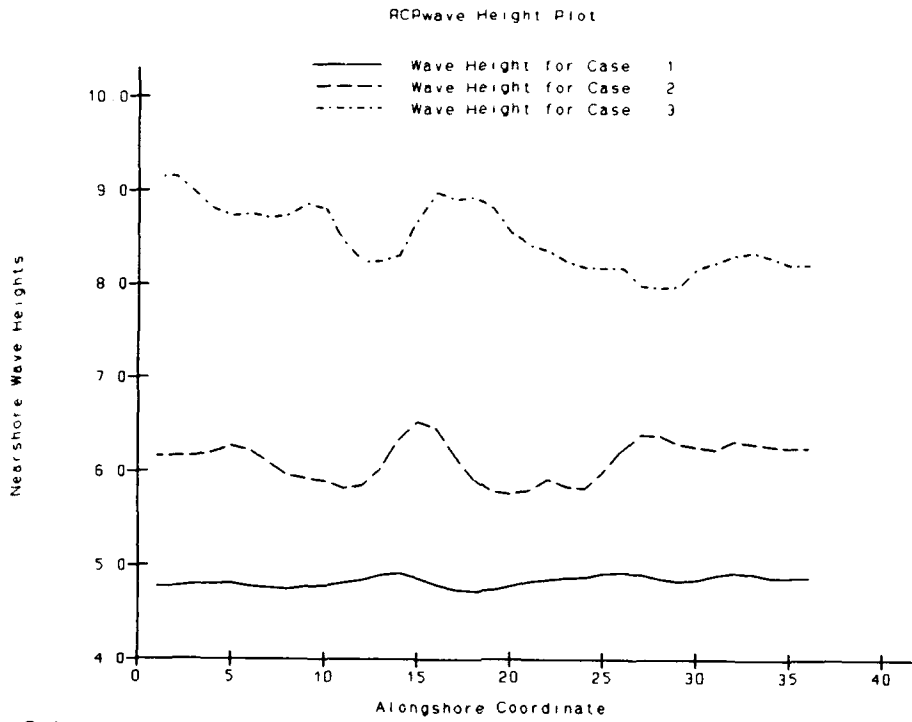

Figure 19. Example nearshore wave height plot

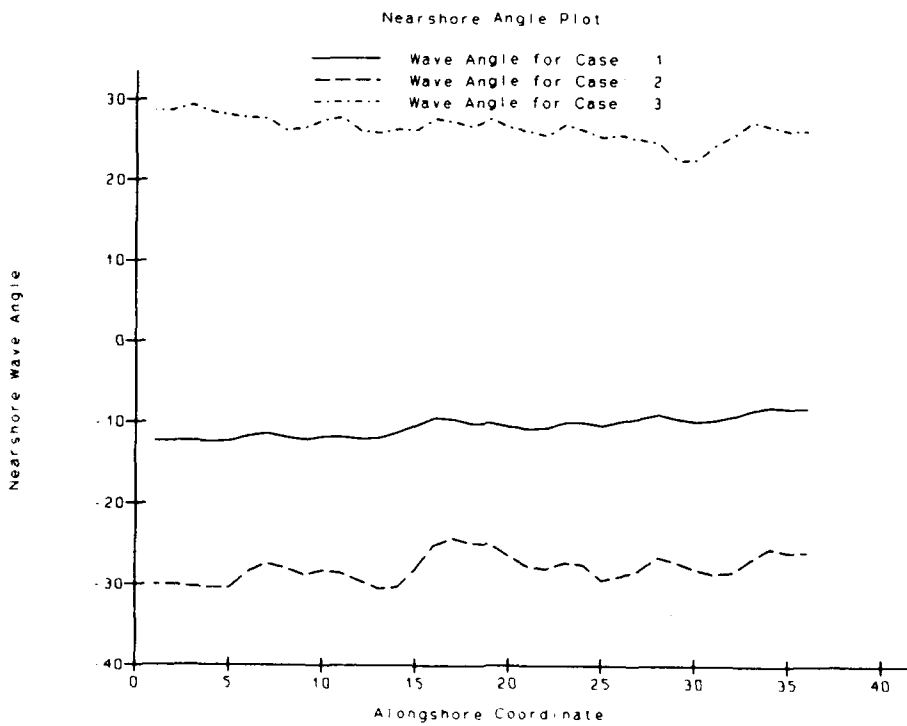

Figure 20. Example nearshore wave angle plot

## DPLOT

The general-purpose graphics program DPLOT was developed by Mr. David W. Hyde (Structural Engineer, USAE Waterways Experiment Station), and is a comprehensive X-Y plotting program that gives the user control in producing customized plots. The program is part of the HGRAPH graphics package upon which most of the Shoreline Modeling System graphics and menus were built. DPLOT is simple to use and has been included in the SMS to provide users substantial flexibility in operating the SMS as well as to provide a means of graphically displaying results produced by many of the system-support programs discussed in Chapter 5. This section will present some of the useful characteristics of the program DPLOT and provide an example application; however, no attempt to fully document the program will be made.

DPLOT.EXE, like any of the other programs included in the SMS, can be executed from within the SMS or in a stand-alone mode. To run DPLOT from within the SMS, the user first selects the *Utilities* option from the SMS level 1 menu: Main (see Figure 3). Then the SMS level 2 menu: Utilities (shown in Figure 21) appears on the PC monitor. The *Shorelines* and *Waves* options in Figure 21 will be discussed in Chapter 5. Selection of the *Graphics* option will initiate execution of the program DPLOT.EXE. Execution of the program DPLOT.EXE can also be initiated by issuing the command "`\SMS\GRAFICS\DPLOT`" from the DOS prompt. After starting DPLOT, a list of options (shown in Figure 22a) appears on the screen. The first step is to read the file or files containing the data to be plotted. This is accomplished by highlighting the *Get/Save Data* option, and pressing the ENTER key. At this point, another menu appears on the screen (shown in Figure 22b). Next the user selects the *Read data points from a file* option. The user then specifies how many files will be read and the name(s) of the file(s). Finally, the program prompts the user to specify the input data format. DPLOT will accept three types of input data file formats as follows:

### Type 1

```
npts
x(1),y(1) ... x(npts),y(npts)
```

### Type 2

```
npts
dx      (assumes x(1)=0)
y(1) ... y(npts)
```

### Type 3

```
npts
ny
x(1), y(1,1) ... y(ny,1)
x(2), y(1,2) ... y(ny,2)
.
.
x(npts), y(1,npts) ... y(ny,npts)
```

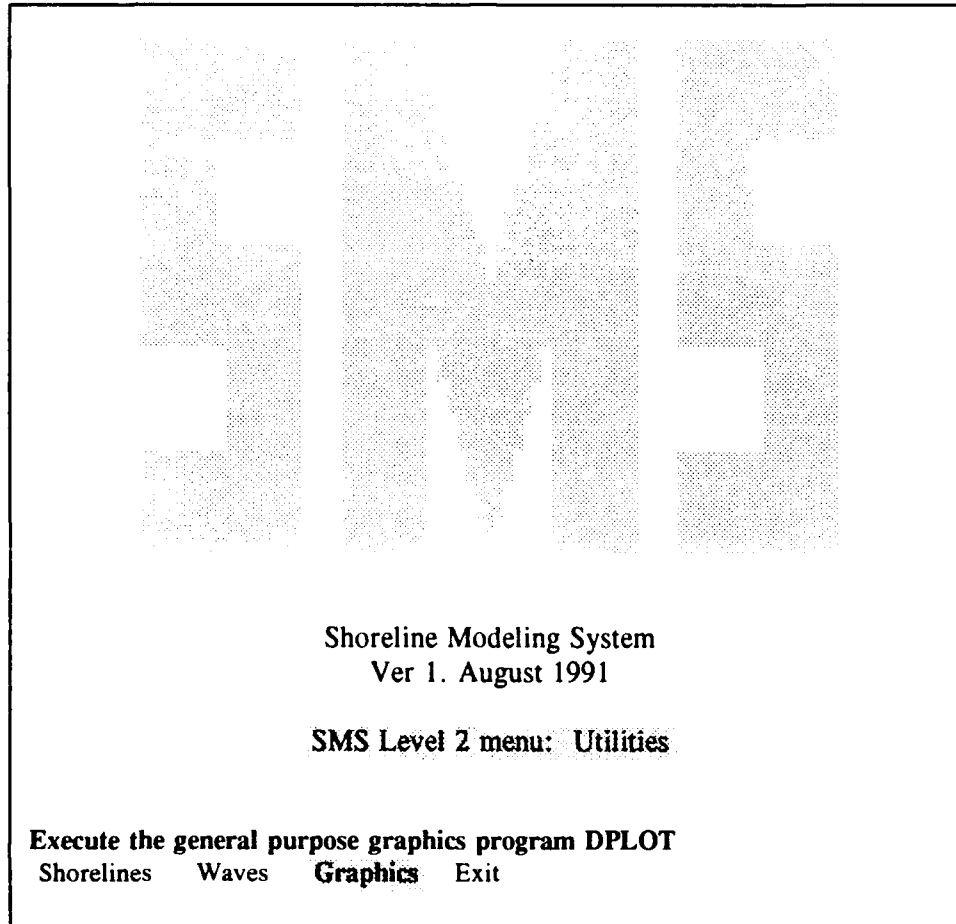

Figure 21. SMS Level 2 menu: Utilities

At this point, the data have been read by the program and the user is returned back to the entry menu (Figure 22a). The next step is to specify the output device (Figure 22c), and plot the data by selecting the *Plot* option. The following steps will depend on the preference of the user and the type of data being plotted, but should involve labeling the axes and providing a plot title. Other items may include changing default line types and symbols (Figure 22d).

Aside from the plotting capabilities, the ability to perform various DOS operations through DPLOT is very convenient (Figure 22e). It should be noted, however, that the *Change directory*, and *New default drive* options are effective only while the program DPLOT is running. Regardless, the ability to view the contents of a specific directory, list file contents, and to exit temporarily (shell) to the DOS prompt are desirable attributes of a general-purpose graphics program and modeling system. In the following paragraphs a simple example plotting session using DPLOT is provided using output files generated by the SMS system support programs SHORLROT and CUINTP. A listing of the data files that will be plotted in the following example application is provided in Appendix D.



### Example DPLLOT plotting session

The SMS, in this example DPLLOT application, is initiated from the SMS\DATA subdirectory where the files listed in Appendix D (82SHO.ROT, 86SHO.ROT, 82SHO.ISH, and 86SHO.ISH) are assumed to reside. From the SMS level 1 menu: Main, shown in Figure 3, the *Utilities* option is selected. From the SMS level 2 menu: Utilities, shown in Figure 21, the *Graphics* option is selected, and finally, the program DPLLOT.EXE is started.

At this point, the options shown in Figure 22a are on the PC monitor. The first step is to read in the data. This is accomplished by first selecting the *Get/Save Data* option, and then selecting *Read data points from a file* from the option list shown in Figure 22b. The program DPLLOT then prompts the user for entry of the number of input data files and for this example, the value 2 is entered. Next the program prompts the user for entry of the first data file name and the name 83SHO.ROT is entered. Next, the program prompts the user to specify the input file format type. For this example, the value 1 is entered. Output from both SHORLROT and CUINTP are of the Type 1 format accepted by DPLLOT and defined above. The program reads the specified input data file and then repeats this series of prompts for the second input data file. After the

specified number of input data files have been read, the user is returned to the initial DPLLOT menu screen (Figure 22a). If the user selects the *Plot* option, a simple plot (without titles, axes labels, or legends, etc.) of the data is displayed on the screen. At this point the user can formalize the graphic image by quitting the plot (by pressing **Q**), and selecting the *Titles, Label* and/or the *Scaling, Styles, etc.* options. For this example, the *Title, Label* option was used to incorporate a plot title, axes labels, and a legend, then the *Scaling, Styles, etc.*

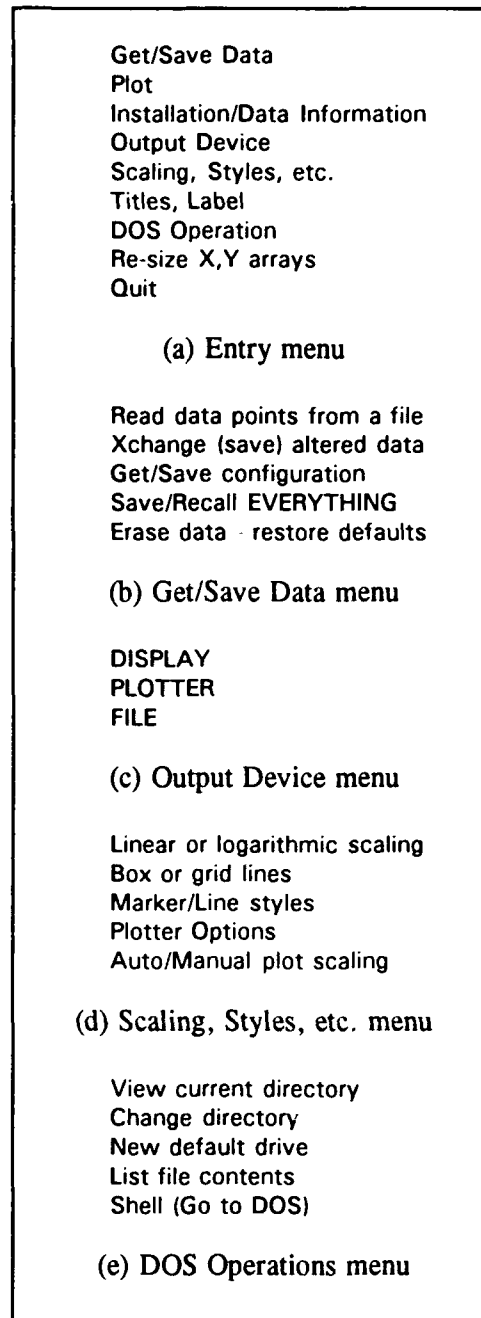

Figure 22. Selected DPLLOT menus

option was used to define the line types and symbols. The resulting graphic image is shown in Figure 23. If the user anticipates producing several plots with the same basic format, DPLOTT has an option that enables the user to save the plot configuration or setup (titles, labels, legends, line types and symbols, etc.). In order to save the plot configuration, the user exits from the plot mode (by pressing **Q**), and then selects the *Get/Save Data* option. From the *Get/Save Data* option menu the user selects the *Get/Save configuration* option (Figure 22b). At this point, there are two options available: *Recall* and *Save*. By selecting the *Save* option and entering a file name, the program writes the plot information to the user-specified file name. The graphic shown in Figure 24 was created by reading the four input files listed in Appendix D and importing the previously saved plot configuration file using the *Recall* option from the *Get/Save configuration* menu. However, the legend and line and marker types for the interpolated shoreline curves had to be defined using the *Title*, *Label* and the *Scaling*, *Styles*, etc. options.

All plots generated by DPLOTT can be modified using the 18 options listed at the bottom of the screen while the graphic image is displayed on the PC monitor. The available options and their functions are as follows:

- a. **Q** Quit - exit graphics.
- b. **@** read Y value(s) @ X=?.
- c. **A** Average all curves.

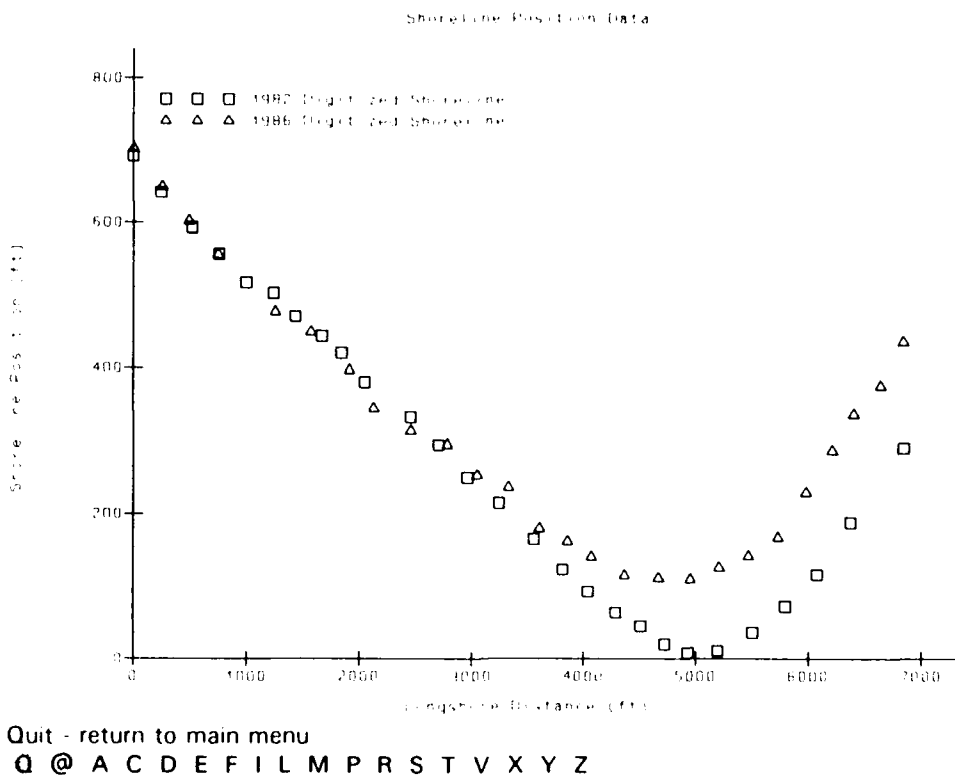
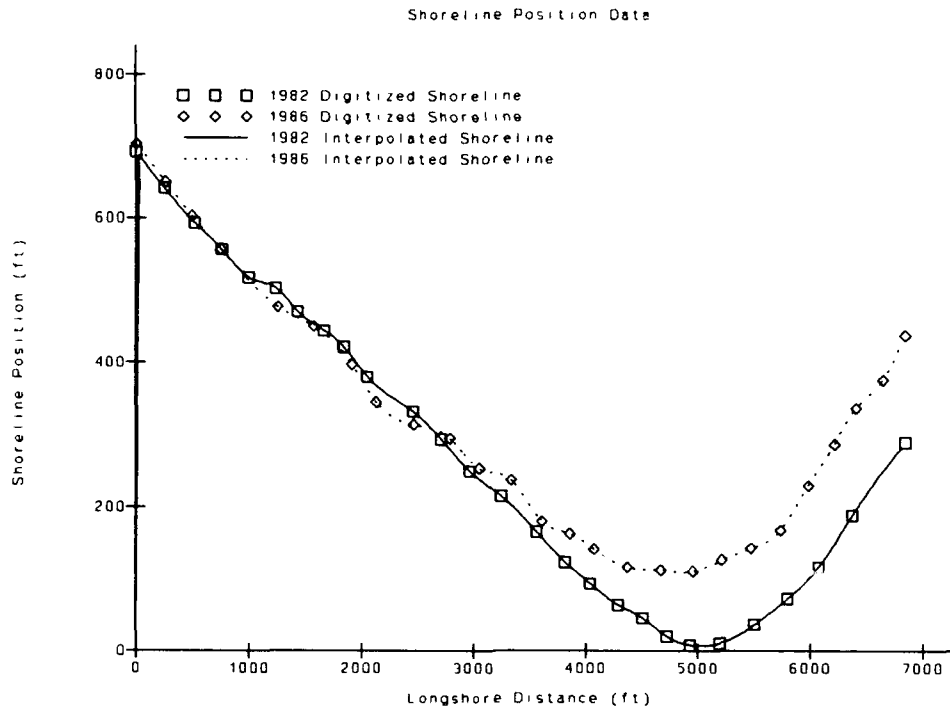

Figure 23. Digitized shoreline data



Quit - return to main menu

Q @ A C D E F I L M P R S T V X Y Z

Figure 24. Digitized and interpolated shorelines

- d. **C** Combine (add) records.
- e. **D** screen Dump to printer.
- f. **E** Erase a curve.
- g. **F** curve Fit using least-squares.
- h. **I** Integrate area under curve.
- i. **L** relocate Legend.
- j. **M** Multiply y coordinates by a constant.
- k. **P** label Points.
- l. **R** Read X, Y data points from a curve.
- m. **S** Stretch (multiply by a constant) x axis.
- n. **T** Truncate-delete points outside a range.
- o. **V** list peak Values.
- p. **X** add a constant to X values.
- q. **Y** add a constant to Y values.
- r. **Z** Zoom.

Four of the GENESIS system support programs discussed in Chapter 5 create output files specifically designed to allow visualization of the computed results using the program DPLOT. These programs are SHORLROT, CUINTP, SEDTRAN, and NSTRAN.

## 5 Analysis Procedures

---

This chapter describes the interrelationships between and the functions of 12 data preparation and analysis programs included in the SMS. These programs are referred to as the GENESIS system-support programs and are fully documented with multiple example applications in the GENESIS Workbook (Gravens, Kraus, and Hanson 1991). Recommendations for the use of the system-support programs are provided herein by suggesting three broad analysis and data preparation procedures, which in a general sense, outline the necessary steps in conducting a shoreline change study.

In shoreline change investigations, where GENESIS is selected as the engineering analysis tool of choice, there are two dominant physical data types that must be assembled for input to the model. These are shoreline position data and wave data. Wave data, as utilized in GENESIS, can be divided into two categories: (a) time history of offshore wave data; and (b) database of nearshore wave information. In addition to these fundamental data types, GENESIS requires many other project-specific, physical, and model setup inputs as discussed in Chapter 6. In this chapter, however, the discussion will be limited to the handling of the basic data types of shoreline data and offshore and nearshore wave information.

The shoreline position (defined by a single point on the beach profile) and a description of its movement over a specific time (as governed by one-line theory) is the focus of the GENESIS model. Consequently, the model requires specification of the initial shoreline at the beginning of all simulations. For comparison purposes, GENESIS also requires input of a measured shoreline position corresponding to the end of the simulation, which is used to compute a calibration/verification error. Additionally, if the project reach of interest contains shore-parallel structures such as seawalls, revetments, bulkheads, or sea cliffs that constrain shoreline movement, the location and position of these structures must be input to the model. The preparation of these three input data files, all of which are of the shoreline type, is discussed below in the **Shoreline Data Analysis** section.

With respect to offshore wave data, GENESIS requires a time history of wave height, period, and incident wave angle. This time series of offshore wave data may be for a specific period of time spanning an interval over which surveys of

shoreline position are available, typically desirable for model calibration and verification simulations. However, wave data exactly corresponding to a specific project area and spanning the required time interval are rarely available, and in these cases, a representative or statistically correct randomly generated time history of offshore wave conditions is input to GENESIS. Selection of a representative time history of wave conditions is, of course, a subjective task, and in shoreline change modeling the selected wave conditions will heavily influence predicted or forecast shoreline positions. As such, it is desirable to estimate the range of possible shoreline positions or to develop an envelope of shoreline evolution. This will require selection of several extreme sequences of offshore wave conditions. Consequently, a thorough analysis and understanding of available offshore wave information is required. A collection of five programs has been assembled and incorporated in the SMS to aid the engineer in this analysis and preparation of offshore wave data for input to GENESIS. These programs are discussed in the **Analysis of Offshore Wave Data** section of this chapter.

GENESIS can accept, as an input option, specific nearshore wave information oriented in the longshore direction across the project reach. Nearshore wave data are not required but can be used to achieve a more refined estimate of the incident wave climate in relatively shallow water before significant wave breaking. The specification of nearshore wave conditions in a GENESIS simulation requires not only that output from an external wave transformation model (such as RCPWAVE) be input to GENESIS but also that the nearshore wave data somehow be keyed or linked to the offshore time series of wave conditions. Four programs that automate the task of reformatting the output from RCPWAVE to an acceptable format for input to GENESIS and correlating the nearshore wave information to the offshore time history of wave conditions are included in the SMS and are discussed in the **Analysis of Nearshore Wave Data** section of this chapter.

## Shoreline Data Analysis

Generally, the preparation of shoreline (or seawall) position data for input to GENESIS involves four individual tasks or steps. The first task is the initial digitization of the shoreline data, typically obtained from engineering drawings, or maps derived from surveys or aerial photography. The initial digitization of shoreline position is usually carried out with respect to some rectilinear (Mercator projection) coordinate system, such as state plane coordinates using commonly available commercial hardware and software. The next step is to map the digitized coordinate system into the required GENESIS coordinate system. This typically involves rotation of the coordinate system and translation of the origin such that the X-axis is oriented along the general trend of the shoreline and the Y-axis is directed offshore. The program SHORLROT is a generalized program that will automatically perform the coordinate system rotation and origin translation according to user-provided input specifications. Digitized shoreline data in a simple X-Y format are the standard input to SHORLROT in addition to the user-provided inputs that are prompted for by the program. The third step

is to obtain shoreline positions (Y-coordinates) at uniformly spaced distances along the project reach (X-coordinates). The program CUINTP performs this step utilizing a cubic spline interpolation algorithm to obtain shoreline positions at a user-specified alongshore cell spacing. Output from the program SHORLROT is used as the primary input data file to the program CUINTP. The final step in the preparation of shoreline position data is the reformatting of the shoreline position data to satisfy input format requirements for GENESIS. A GENESIS shoreline position data file contains only shoreline position (Y-coordinate) information since the longshore cell spacing is constant and specified elsewhere in the complete input data set. Furthermore, all GENESIS input data files have a four-line header that typically contains general information concerning the data that follow. The program WTSHO was developed to accept output generated by CUINTP with additional user specifications to create a shoreline position data file in the appropriate format for input to GENESIS. Figure 25 provides a schematic illustration in the form of a flowchart for program usage in the shoreline data preparation procedure.

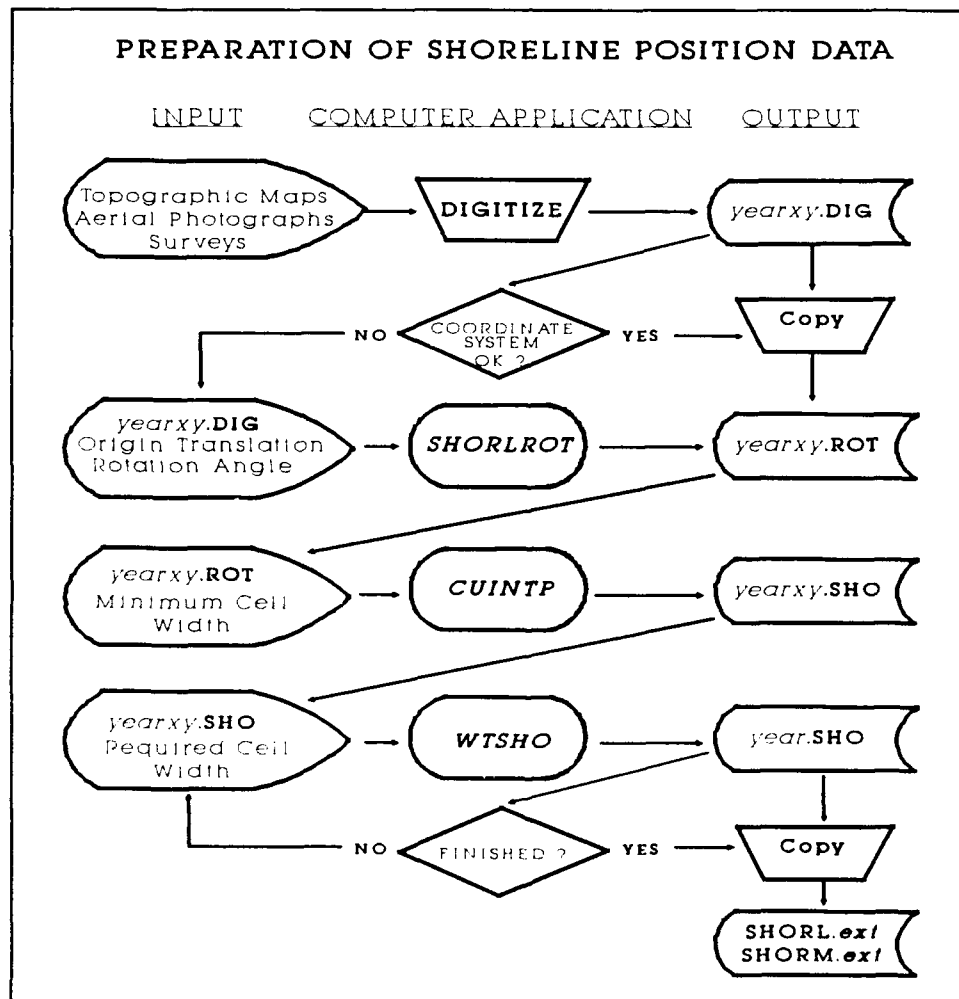

Figure 25. Shoreline data analysis procedure

The shoreline data analysis programs are selected from the SMS level 3 menu: Utility-Shorelines (illustrated in Figure 26). Output from the programs SHORLROT and CUINTP is plotted using the general-purpose graphics program DPLOT whereas output from WTSHO is plotted using the *External* option of the *Shoreline Positions* plot in program GENGRAF. Complete step-by-step example applications of the programs SHORLROT, CUINTP, and WTSHO are provided in Gravens, Kraus, and Hanson (1991).

GENESIS requires data (distance from the baseline) at each grid cell along the modeled reach in the seawall position file (SEAWL.ext) as well as shoreline position files (SHORL.ext and SHORM.ext). However, a seawall may not be continuous along a particular project reach that is to be modeled; therefore, the user must either edit the seawall position file generated by WTSHO and add the appropriate position of the seawardmost effective seawall (road or parking lot), or enter seawall position values of -9999. at grid cells where no seawall is present.

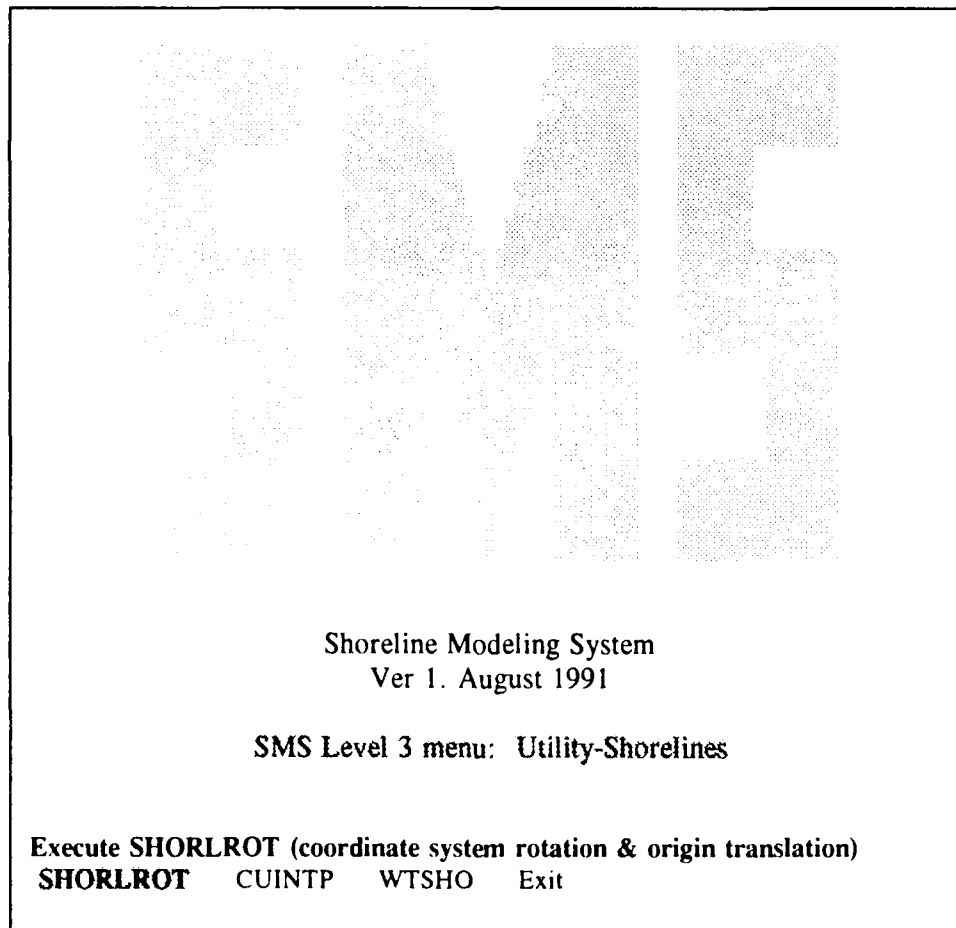

Figure 26. SMS Level 3 menu: Utility-Shorelines



## Analysis of Offshore Wave Data

The procedure for analysis of offshore wave data presented herein assumes the availability of a continuous time history of wave height, period, and direction. For most open coast sites in the United States, this type of wave record can be obtained from the hindcast estimates produced by the WIS data. Acquisition of the WIS data for a particular site is possible by accessing a regional database using the Coastal Engineering Data Retrieval System being implemented at Corps District offices, or by written request to the WIS staff at CERC. CEDRS regional databases are being developed at CERC under the Coastal Field Data Collection Program. The SMS programs require the input data files containing the wave time series to be of the WIS format type or reformatted output from one of the GENESIS system support programs.

The analysis of offshore wave data using programs provided in the SMS can take several paths depending on the intent of the analysis or investigation. The procedure outlined in Figure 27 attempts to illustrate the recommended flow of a typical analysis. The left side of Figure 27 can be followed to estimate a

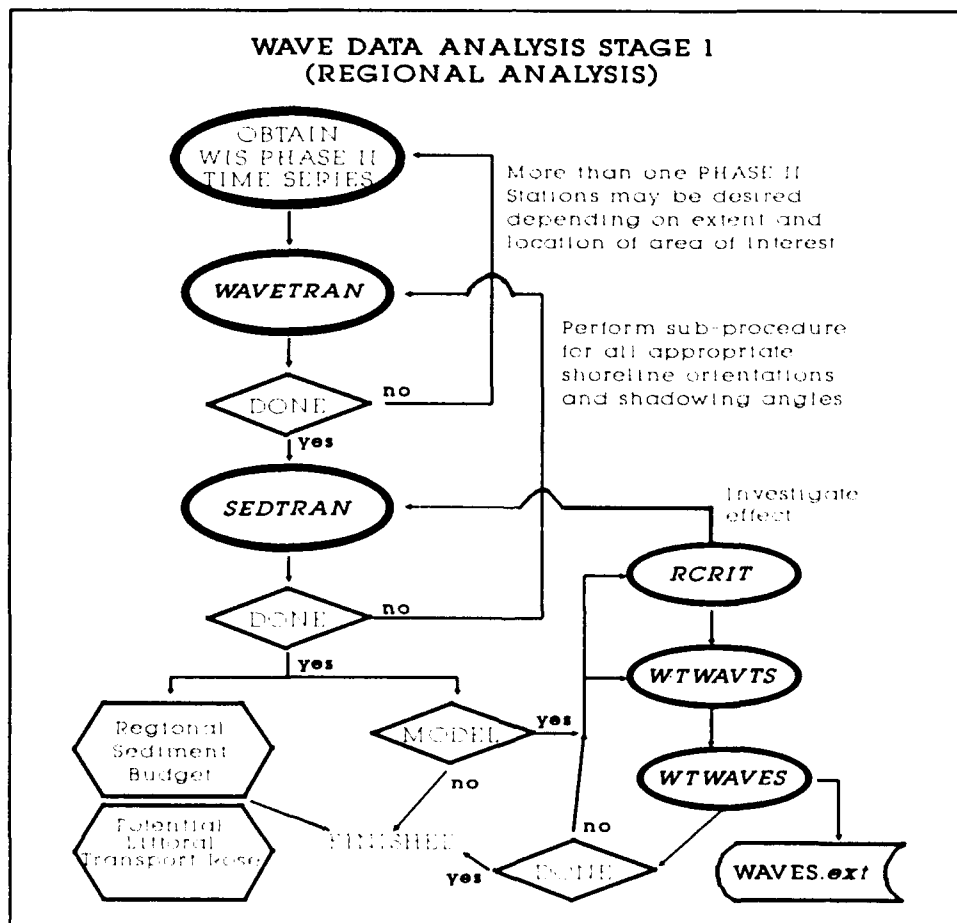

Figure 27. Offshore wave data analysis procedure

regional longshore sediment budget in a reconnaissance level investigation. The analysis involves a WIS Phase III type spectral transformation (WAVETRAN) of the wave time series to bring the offshore wave data into the local project area and then applies a simple potential longshore sediment transport rate program (SEDTRAN). This two-step procedure can be performed several times in succession to obtain an estimate of a regional longshore sediment transport rate, taking into account all local shoreline orientations and shadowing (or sheltering) configurations as appropriate.

Likewise, the analysis can be extended to include numerical shoreline evolution modeling using GENESIS through the application of three additional programs. The end product in this analysis procedure will be the preparation of necessary wave data input for a scoping mode application of GENESIS. The purposes of the three additional programs are: (a) to pre-process the hindcast wave estimates to identify those wave events that are calm, propagating offshore, or are insignificant with respect to their capacity to produce longshore sediment transport and impact expected shoreline evolution (RCRIT), (b) to provide an automated means of compiling a specific time series (WTWAVTS), and (c) to rewrite the wave time series into the format required for input to GENESIS.

When the offshore wave data analysis procedure is combined with the shoreline data analysis procedure, all the input data files (except for the START.ext file, which is compiled using the program GENEDIT as described in Chapter 3) required to execute GENESIS in a scoping mode can be assembled. The offshore wave data analysis programs may be executed either in a stand-alone mode or by selection from the SMS level 4 menu: Utility-Waves-Offshore (illustrated in Figure 28). The general-purpose graphics program DPLOT can be used to plot sediment transport rates output by the program SEDTRAN. Complete step-by-step example applications of the programs WAVETRAN, SEDTRAN, RCRIT, WTWAVTS, and WTWAVES are provided in Gravens, Kraus, and Hanson (1991).

## Analysis of Nearshore Wave Data

The analysis of nearshore wave data procedure presented herein extends the analysis for offshore wave data. The intent here is to refine and improve the description of nearshore wave conditions over the method of simplified internal wave transformation contained within GENESIS. This is achieved by utilizing an external wave transformation model, which simulates the effect of wave transformation over an irregular nearshore bathymetry. The specific external wave transformation model for which the programs in this suggested analysis procedure have been assembled is RCPWAVE (Ebersole, Cialone, and Prater 1986). The refined description of nearshore wave conditions is realized in nonuniform wave height transformation coefficients and incident wave angles

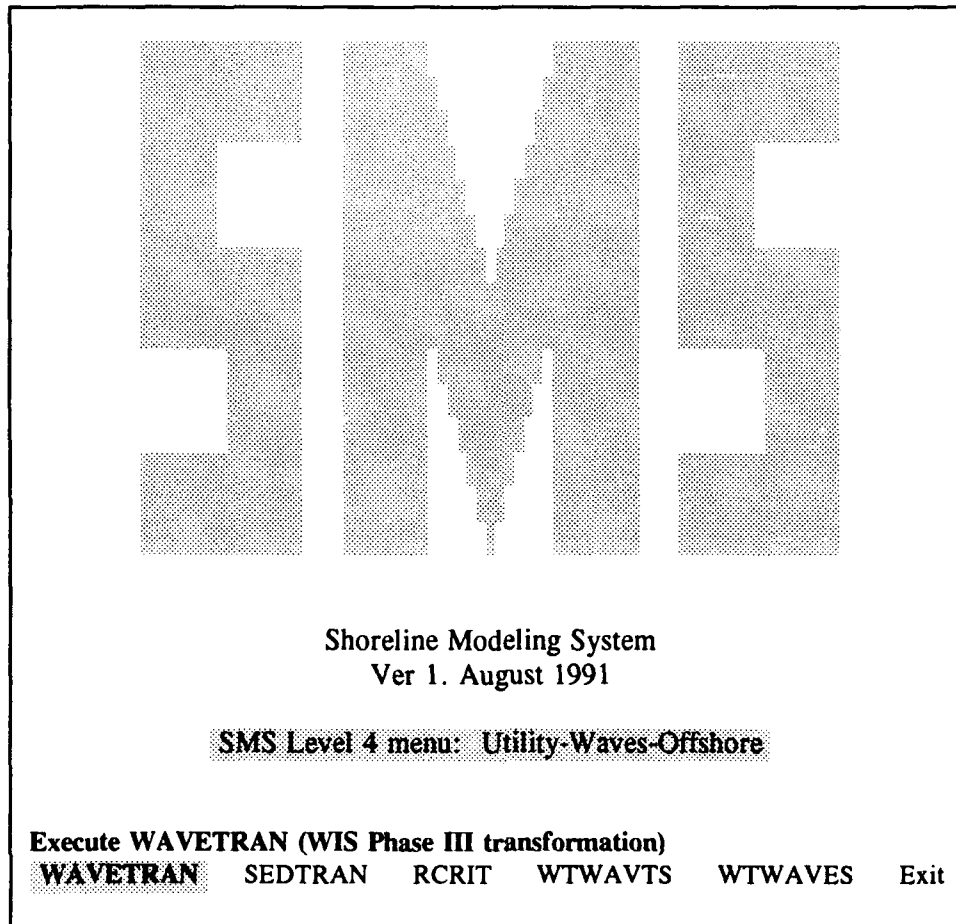

Figure 28. SMS Level 4 menu: Utility-Waves-Offshore

along the project reach. These are the necessary data computed by the external wave transformation model (RCPWAVE) and required for input by GENESIS. More specifically, GENESIS requires pre-breaking wave height, angle, and water depth alongshore (the wave period is also required, but is obtained from the offshore wave event). Use of an external wave transformation model is recommended for design mode applications of GENESIS, and is essential in estimating the impact of excavating nearshore borrow sites (for beach nourishment purposes) on future shoreline evolution.

The overall flow of the nearshore wave data analysis procedure is illustrated in Figure 29. As indicated in Figure 29, the nearshore wave data analysis procedure involves the application of five programs: WHEREWAV, RCPWAVE, WTNSWAV, WTDEPTH, and NSTRAN. Although RCPWAVE is an integral component of the nearshore wave data analysis procedure, a description of this model is deferred to Chapter 6 and this section will concentrate on providing a description of the functionality of the programs WHEREWAV, WTNSWAV, WTDEPTH, and NSTRAN.

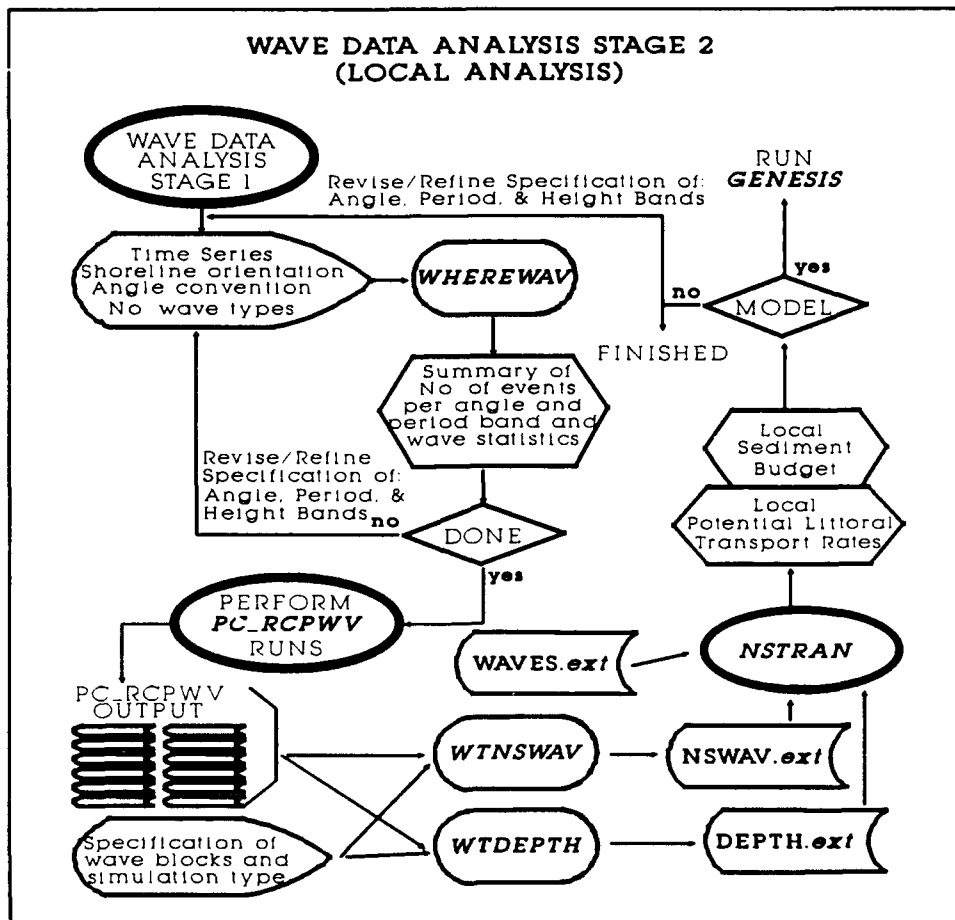

Figure 29. Nearshore wave data analysis procedure

Data required at the beginning of the nearshore wave data analysis procedure (i.e., input to WHEREWAV) are time series of wave conditions corresponding to the offshore boundary of the RCPWAVE bathymetry grid. This time series is typically obtained as a result of performing the offshore wave data analysis procedure. In other words, the input time series to WHEREWAV represents wave data that have been transformed from an offshore WIS hindcast station to the average water depth along the offshore boundary of the RCPWAVE bathymetry grid using WAVETRAN and subsequently processed through the program RCRIT.

The program WHEREWAV categorizes wave events in the input time series by wave period (referred to as "period bands") and direction of wave propagation (referred to as "angle bands"), and reports various statistical properties of each of the period and angle band categories. This information is subsequently used to define the number of simulations required to describe the transformation of the offshore time series to nearshore wave conditions. Considering that there could be as many as 2,920 unique offshore wave events in a typical GENESIS simulation using a 6-hr time step and a 1-year-long offshore wave time series consisting of two wave conditions (sea and swell) per time step, the shoreline modeler must

make some assumptions concerning nearshore wave transformation and the number of simulations required to adequately describe the transformation of offshore wave conditions to nearshore conditions. The program WHEREWAV was developed to standardize these assumptions based on shoreline change modeling experience at CERC. At present, the program WHEREWAV utilizes a total of nine wave period bands (six 2-sec wave-period bands between 5 and 17 sec, one for wave periods less than 5 sec, another for wave periods between 17 and 23 sec, and, finally, one for wave periods greater than 23 sec). For direction of wave propagation, the program WHEREWAV utilizes sixteen 22.5-deg wide-angle bands (of course waves can only approach the shore from nine of those angle bands). Therefore, using this classification system, there are only 81 unique angle-period band combinations (nine period bands by nine angle bands) for each wave type. However, all 81 possible wave combinations rarely occur in an actual offshore time series.

WHEREWAV input requirements beyond specification of the input and output file names include: (a) input file format, (b) convention of wave angles (determined by WIS Phase type), and (c) shoreline orientation with respect to north. Output from the program is presented in a series of tables, which include for each angle band: (a) the number of events occurring within the angle band, (b) the average wave angle, (c) the average wave height, and (d) the period bands encountered within the angle band. Likewise, output for each period band includes: (a) the number of events occurring within the period band, (b) the average wave period, (c) the average wave height, and (d) the angle bands encountered within the period band. With these tables, the shoreline modeler can both identify the number of nearshore wave transformation simulations required and specify the input wave conditions for each of the simulations.

At this point in the analysis procedure (illustrated in Figure 29), the program RCPWAVE is utilized to perform the various wave transformation simulations. Use of the program RCPWAVE is discussed further in Chapter 6. For the purpose of this instruction procedure, the reader should assume that all of the appropriate simulations have been performed and the results are stored in several different output files on the PC hard disk.

The next step in the nearshore wave data analysis procedure is to translate the results generated by RCPWAVE into input data files for GENESIS. As mentioned previously, GENESIS requires pre-breaking wave height, angle, and water depth alongshore. Two programs (WTNSWAV and WTDEPTH) were developed and are included in the SMS to perform the required data translation from RCPWAVE output to GENESIS input.

The program WTNSWAV reads nearshore wave information (wave height transformation coefficient and direction of propagation) along the nearshore reference line from an RCPWAVE output file and writes a nearshore wave database file (NSWAV.ext) for input to GENESIS. The data in the nearshore wave database file consist of an offshore wave identification key (which relates the nearshore wave data to offshore waves occurring from a specific angle-period band combination), followed by a set of nearshore wave height transformation

coefficients and wave angles that correspond to wave conditions along the nearshore reference line for a specific RCPWAVE run. These data are listed sequentially in the NSWAV.ext file for each of the angle-period band wave conditions transformed using RCPWAVE. In compiling the NSWAV.ext file using the program WTNSWAV, several different RCPWAVE output files can be processed in a single WTNSWAV session.

The program WTDEPTH reads water depth information (along the nearshore reference line) from an RCPWAVE output file and writes a DEPTH.ext file for input to GENESIS. The data in the DEPTH.ext file specify the water depths along the nearshore reference line where the nearshore wave data were saved.

The final step in the proposed nearshore wave data analysis procedure consists of computing potential longshore sand transport rates using the nearshore wave information. The program NSTRAN performs this task using an offshore time series, the nearshore wave database, and the nearshore reference water depths as input. A by-product of performing this task is a quality check on the nearshore wave database, in that the procedure for relating nearshore wave conditions to the offshore wave time series in NSTRAN is identical to that used in GENESIS. Output from the program NSTRAN can be used to estimate a local (project-level) potential longshore sand transport sediment budget. As input, the program NSTRAN requires: (a) an offshore wave time series generated by the program WTWAVES, (b) a nearshore wave database generated by the program WTNSWAV, and (c) a file containing the nearshore reference water depths generated by the program WTDEPTH. These three input files, together with user-specified input of the offshore wave time series time step, and number of events per time step, provide the necessary input for the computations to proceed.

To execute GENESIS in a design mode, the nearshore wave data analysis procedure is combined with the offshore data analysis procedure. Then all of the input data files (except for the START.ext file, which is compiled using the GENEDIT program described in Chapter 3) can be assembled. The nearshore wave data analysis programs may be executed either in a stand-alone mode or by selection from the SMS level 4 menu: Utility-Waves-Nearshore (illustrated in Figure 30). The general-purpose graphics program DPLOT can be used to plot sediment transport rates output by the program NSTRAN. Complete step-by-step example applications of the programs WHEREWAV, WTNSWAV, WTDEPTH, and NSTRAN are provided in Gravens, Kraus, and Hanson (1991).

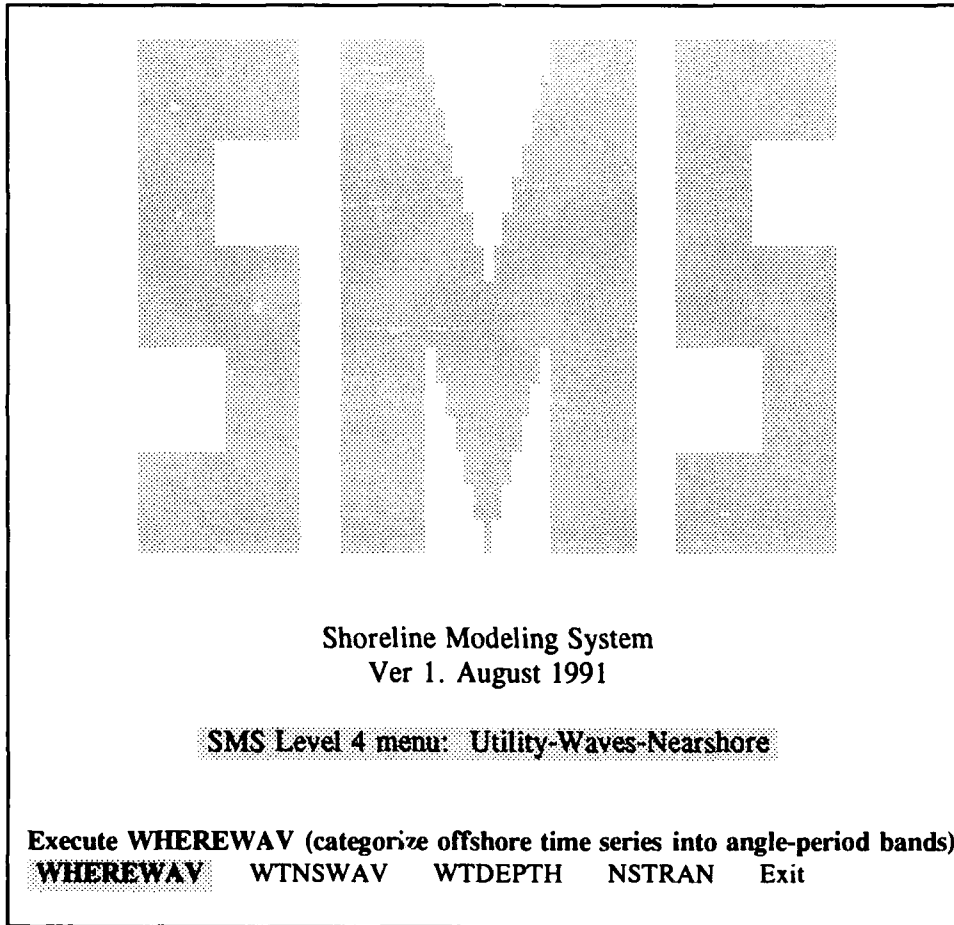

Figure 30. SMS Level 4 menu: Utility-Waves-Nearshore

## 6 Overview of Numerical Models

---

This chapter provides an overview of the two major coastal processes numerical models (GENESIS and RCPWAVE) included in the SMS. The application of these two programs at project sites throughout the Corps by field engineers provided the impetus for the development of the SMS. This chapter will review recommended techniques and procedures for the use of these numerical models in the refinement and evaluation of proposed design alternatives as well as the intended role of the models in general coastal processes investigations. Detailed documentation of the shoreline change model GENESIS has been provided by Hanson (1987), Hanson and Kraus (1989), and Gravens, Kraus, and Hanson (1991). Detailed documentation of the nearshore wave transformation model RCPWAVE is available in Ebersole (1985) and Ebersole, Cialone, and Prater (1986).

### GENESIS

The acronym GENESIS stands for GENERalized model for SImulating SHoreline change. The model, since its development, has evolved into a flexible and efficient engineering tool for simulating long-term shoreline change on a regional scale, with emphasis on the influence of engineering activities (such as beach nourishment and coastal structures) on shoreline evolution. The model is particularly suited for tasks involving the analysis and evaluation of coastal projects with regard to the long-term fate of beach fills, feeder beaches, renourishment cycles, and coastal structures designed to enhance the longevity of placed beach fill material. Operation of the GENESIS model requires preparation of up to seven input data files. These input data streams include model setup specifications (spatial and temporal ranges of the simulation, and model calibration parameters), project reach specification (including boundary conditions, coastal structures, and beach fill configurations within the project reach), shoreline position data, and wave information from which longshore sand transport rates are calculated to compute shoreline change.

Preparation and analysis of the input and output data streams occupy a substantial portion, perhaps a majority, of the time spent on a GENESIS project.



This aspect of the modeling process cannot be overemphasized for two major reasons:

*The data organization and analysis process itself forms the first (and necessary) level in understanding coastal processes at the project site.*

*The simulation results must be interpreted within the context of regional and local coastal processes, and the natural variability of the coastal system.*

Preparation of the data streams needed to run GENESIS and interpretation of simulation results form the core of the process of conceptualizing a project. The degree of success in a shoreline change modeling effort, to a large extent, depends on preparation and analysis of the input data.

Figure 31 shows the input and output file structure of GENESIS. The file names on the left side of the figure represent input files and those on the right represent output files. The four input files outlined with solid borders are required for all model simulations, whereas those with the open-line borders are required only if a seawall is to be modeled (SEAWL.ext) or if nearshore wave information is to be utilized by the model (NSWAV.ext and DEPTH.ext). Those files that have a "G" adjacent to their border provide input to the special-purpose graphics program GENGRAF discussed in Chapter 4. The file-naming convention utilized by GENESIS is strict in that the file names shown in capital letters

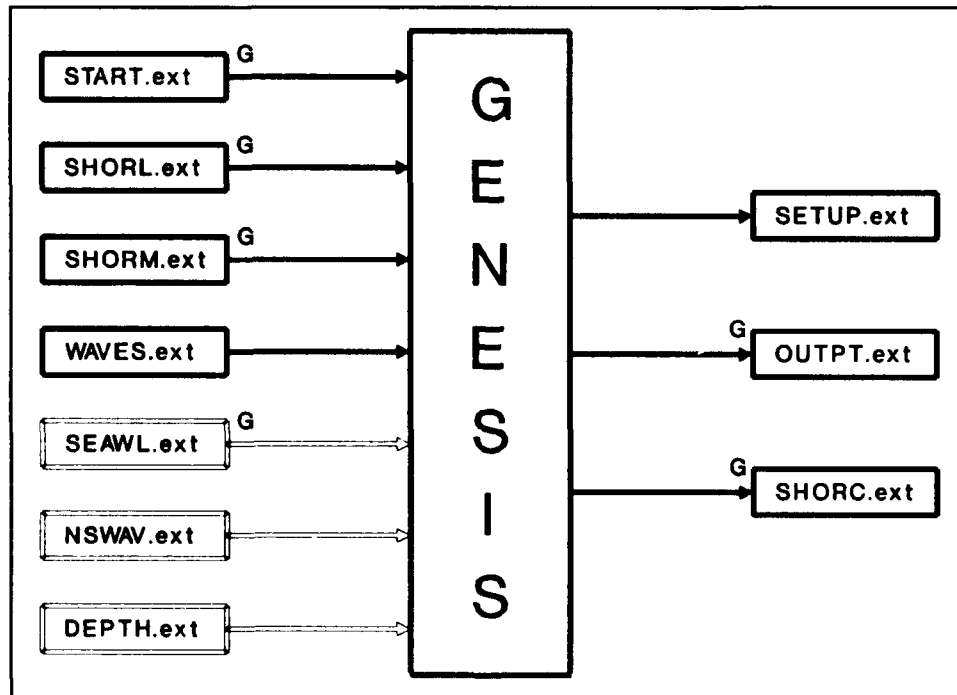

Figure 31. Input and output file structure of GENESIS

are mandatory, whereas the file extension denoted by ".ext" in the figure is left for user specification. The file name extension for a given input data set must be the same for all input files in the data set and is used to identify specific model simulations (GENESIS prompts the user for the input file extension upon execution). Output files will be assigned the same file name extension as the input data files. The primary input data file, START.ext, may be compiled using the special-purpose file editor GENEDIT discussed in Chapter 3. The shoreline-type data files (SHORL.ext, SHORM.ext, and SEAWL.ext) are generated as a result of the shoreline data analysis procedure presented in Chapter 5. The offshore wave time series file, WAVES.ext, is created as a result of the offshore wave data analysis procedure discussed in Chapter 5. The two input data files that provide specification of nearshore wave conditions (NSWAV.ext and DEPTH.ext) are compiled by the nearshore wave data analysis procedure also presented in Chapter 5. Therefore, all of the required input data files can be compiled and analyzed using various components of the SMS. Also, output generated by GENESIS can be visualized from within the SMS using the program GENGRAF. What the SMS cannot do for the user is enforce proper operation of numerical model GENESIS or provide an engineering interpretation of model results. This is the responsibility of the user and requires engineering judgement and knowledge of standard procedures in the application of the model. The remainder of this section reviews standard procedures in the application of GENESIS and suggests techniques for engineering interpretation of model results.

### **Calibration and verification procedures**

Before GENESIS can be used to quantitatively estimate shoreline change or predict the performance of a proposed shore-protection project at a project reach, the capability of the model to provide reliable estimates of shoreline evolution at the site must be demonstrated. Demonstration of this capability is realized through model calibration and verification. Calibration refers to the procedure of reproducing with GENESIS the changes in shoreline position that were measured over a certain time interval, and involves determining specific values of adjustable input coefficients that control the magnitude and rate of shoreline change within GENESIS. Verification refers to the procedure of applying the model with the coefficient values determined in the calibration to reproduce changes measured over a time interval different from the calibration interval. Successful verification is taken to indicate that model predictions are independent of the simulation interval. If major physical or engineering changes occur within the verification period, such as extension of a jetty or placement of fill, these changes are incorporated in the simulation. Recognizing that the purpose of GENESIS is to evaluate long-term shoreline change implies that the calibration and verification intervals must represent a long period of time with respect to longshore sand transport processes on the project coast. In other words, the calibration and verification intervals should be on the order of 1 year long, or longer, and should also begin and end in the same season. Preferably, the verification interval would be of the same duration as the anticipated forecasts. Assuming that the verification interval will begin with completion of the calibration interval, a minimum of three measured shoreline position data sets are required to perform the calibration and verification procedure. In the selection

of calibration and verification intervals one should avoid, if possible, intervals that contain anomalous environmental conditions or shoreline change (e.g., extremely severe storm events, periods of prolonged reversal in the dominant net sand transport direction, etc.). Also, because GENESIS only predicts shoreline change resulting from gradients in the longshore sand transport rate, the calibration and verification intervals should begin and end in the same season. This is important because at many beaches seasonal variation in shoreline position can exceed the annual or long-term shoreline change.

In practice, data sets sufficiently complete to perform a rigorous calibration and verification are rare. Typically, wave data are not available for the time intervals between measured shoreline positions, and unambiguous complete data on historical shoreline change are often unavailable. Lack of complete physical data sets in the modeling process introduces additional unknowns and reduces the reliability of model forecasts. This is not to say that the usefulness of the model is negated by incomplete data sets, but, rather, that in these situations the degree of certainty associated with the model forecast is reduced and one must rely more on coastal experience, knowledge of local coastal processes, and experience with the GENESIS model to estimate values for the input parameters and to interpret calculated results.

Model predictions are readily compared using the special-purpose graphics program GENGRAF (see Chapter 3). Plots of predicted and measured shoreline positions can be displayed easily using the *Shoreline Positions* option of the GENGRAF program. The difference between the calculated and measured shoreline positions can be displayed using the *Shoreline Change* option. GENESIS also provides a mathematically based value called the "Calibration/Verification Error," which gives an objective measure of "goodness of fit." The Calibration/Verification Error is the average absolute difference between calculated and measured shoreline positions at each model grid point. However, a mathematically based criterion should always be checked by visual inspection of the shoreline position, since in some instances it may be more important to reproduce as accurately as possible shoreline change along what are considered sensitive portions of the beach at the expense of good average agreement for the entire modeled reach.

Although the prediction of long-term shoreline change is the principal aim of GENESIS, it is important to monitor gross and net longshore sand transport rates along the project reach to ensure that correct magnitude of transport is being calculated. Remember that shoreline change (as computed within GENESIS) is the result of gradients in the net longshore transport rate and, consequently, a specific rate of shoreline change can be achieved with vastly different net transport rates.

In the end, once GENESIS has been sufficiently calibrated and verified (the best possible agreement between calculated and measured shoreline positions has been achieved), the modeler should scrutinize the results noting the relative performance of the model along various model reaches. The intent here is to identify and internalize regions of similar model performance for use in inter-

preting model results. For instance, if the GENESIS model overpredicted shoreline erosion in a specific region along the modeled reach in both the calibration and verification simulations, the modeler can expect the model to continue to overpredict shoreline erosion in this region in subsequent project simulations. Model performance during the calibration and verification simulations is critical information that the modeler should utilize in interpreting subsequent model results. Gravens, Scheffner, and Hubertz (1989) introduced a verification variability range that is numerically equal to the difference between the surveyed shoreline change and the calculated shoreline change over the verification simulation interval. This range was subsequently superimposed on predicted shoreline positions for project simulations to provide a quantified estimate of potential variation about predicted shoreline positions (a sort of correction based on model performance during the verification simulation). In simple terms, the modeler cannot expect the model to perform better during project simulations than it did for the calibration and verification intervals.

The shoreline change modeler should always keep in mind that a forecast shoreline position computed using a deterministic numerical model such as GENESIS represents only a single potential solution, and that this one result is a representative result that has been smoothed over a large number of unknown and highly variable conditions. The modeler should also strive to provide not only a single result but to establish a range of potential results.

### **Sensitivity testing**

Another procedure for estimating a range of potential shoreline positions at some future date may be obtained by performing what is known as sensitivity testing. Sensitivity testing refers to the process of examining changes in model forecasts resulting from intentional changes in the model input. If large variations in model predictions are produced by small changes in the input, calculated results will depend greatly on the quality (accuracy) of the input. The intent of sensitivity testing is to obtain a quantitative estimate on how much variation can be expected about a given forecast. In the START.ext file, GENESIS allows the user to systematically modify input wave conditions (both wave heights and wave angles) in order to easily perform sensitivity tests. Experience has shown that GENESIS is usually insensitive to small changes in parameter values and typically more sensitive to input wave conditions. Consequently, the modeler may choose to investigate the sensitivity of predicted shoreline changes resulting from performing a given simulation several times using a different offshore input time series for each successive simulation. By performing the offshore wave data analysis procedure, the modeler can easily identify and compile multiple input time series, each containing desirable characteristics for use in these simulations.

### **Interpretation of model results**

Shoreline change forecasts should always be checked for general reasonability. For instance, predicted longshore sand transport rates should agree favorably with the regional and local sediment budget (as obtained from the offshore and nearshore wave data analysis procedures). The overall trend of shoreline evolu-

tion should not deviate significantly from that observed in recent shoreline surveys or aerial photographs. While interpreting model results, the modeler should always be aware that a one-dimensional (1-D) numerical model was used to predict shoreline change which, in nature, is governed by nonlinear processes, many of which are represented in GENESIS. However, as much as possible, experience should be called upon to evaluate the correctness of results and to comprehend the trends in shoreline change produced.

The most powerful characteristic of a time-dependent predictive shoreline change model such as GENESIS is in the objective comparison of multiple proposed design alternatives. GENESIS can be utilized to efficiently evaluate the relative performance of widely varying design alternatives. Although the absolute magnitude of shoreline change in some instances may be questionable, the relative performance of a particular design alternative as compared to another oftentimes is very apparent. When GENESIS is used to evaluate absolute shoreline change or volumetric requirements (such as in the case of quantifying beach fill renourishment intervals), the modeler should always qualify the forecasted estimates based on model performance in the calibration and verification simulations.

## RCPWAVE

The acronym RCPWAVE stands for Regional Coastal Processes WAVE propagation model. RCPWAVE can be used to predict linear, plane wave propagation over a regional area of arbitrary bathymetry. RCPWAVE was developed by Ebersole (1985) and documented by Ebersole, Cialone, and Prater (1986), and its use is recommended for design mode applications of GENESIS. As stated previously, GENESIS will accept as input two types of wave information. At a minimum, GENESIS requires input of an offshore time series of wave height, period, and angle. Additional nearshore wave information (nearshore wave height and angle at specific nonuniform nearshore water depths) along the project reach can be input to the model as an option. Ultimately, GENESIS calculates breaking wave conditions along the simulated reach from which longshore sand transport rates are estimated and shoreline change is subsequently calculated. Without specification of nearshore wave conditions, GENESIS will utilize an internal wave transformation model (based on simplified assumptions of straight and parallel bathymetric contours) to estimate breaking wave conditions from the offshore time series. Conversely, if nearshore wave conditions just prior to breaking are provided as input to GENESIS, a more accurate assessment of wave transformation over the nearshore zone can be taken into account in the estimates of breaking wave conditions.

The governing equations solved in RCPWAVE are a modified form of the "mild slope" equation for linear, monochromatic waves, and the equation specifying irrotationality of the wave phase function gradient. Finite-difference

approximations of these equations are solved to predict wave propagation outside the surf zone. Solution of the finite-difference expressions of the governing equations is performed on a rectilinear computational grid. For technical details of the numerical solution scheme and its implementation, the references provided above should be consulted, as only an overview of the model is given herein. However, one technical point of importance is the computational stability of the RCPWAVE solution scheme and the implications it has in the use of RCPWAVE together with GENESIS.

### **RCPWAVE computational stability**

RCPWAVE may become unstable for input wave conditions with extremely oblique incident wave angles. Consequently, comments concerning the computational stability of RCPWAVE are in order.

In RCPWAVE, the aspect ratio ( $\Delta y/\Delta x$ , where  $\Delta y$  is the grid cell size in the longshore direction and  $\Delta x$  is the grid cell size in the offshore direction) of the computational grid plays an important role in determining the computational stability of the numerical solution scheme. It has been empirically determined that the maximum allowable wave angle (in a given grid cell) may be approximated as the inverse tangent of the ratio  $\Delta y/\Delta x$ . Therefore, larger wave angles can be resolved by the model as this ratio increases. For example, for  $\Delta y/\Delta x = 1$ , the maximum local wave angle is approximately 45 deg, and for  $\Delta y/\Delta x = 3$ , the maximum local wave angle is approximately 71 deg. However, increasing the  $\Delta y$  dimension for a specific shoreline reach will decrease the number of discrete nearshore wave data points available for input to GENESIS, so there is a trade-off between the ability to resolve the transformation of extremely oblique wave conditions in RCPWAVE and the resolution of nearshore wave conditions in GENESIS. For shoreline change modeling efforts, an RCPWAVE computational grid aspect ratio between 2 and 3 is recommended.

### **Coordinate system conventions**

To relate output from one numerical model (RCPWAVE) to another (GENESIS), it is necessary to identify (and understand) the coordinate systems and conventions used in each. Figure 32 provides an illustration of the coordinate system and conventions used in GENESIS and RCPWAVE.

The conventions for describing direction of wave propagation (wave angle) in GENESIS and RCPWAVE are identical. However, as seen in Figure 32, the location of the origin in the RCPWAVE coordinate system is at the landward left-hand side of the project reach (with the Y-axis extending alongshore and the X-axis extending offshore), whereas the location of the origin in the GENESIS coordinate system is at the landward right-hand side of the project reach (with the X-axis extending alongshore and Y-axis extending offshore). This difference in coordinate systems between RCPWAVE and GENESIS requires end-for-end swapping of wave and water depth data in the alongshore direction. As shown in Figure 32, the alongshore cell spacing of the RCPWAVE computational grid is often coarser than the GENESIS alongshore grid. The necessary interpolations

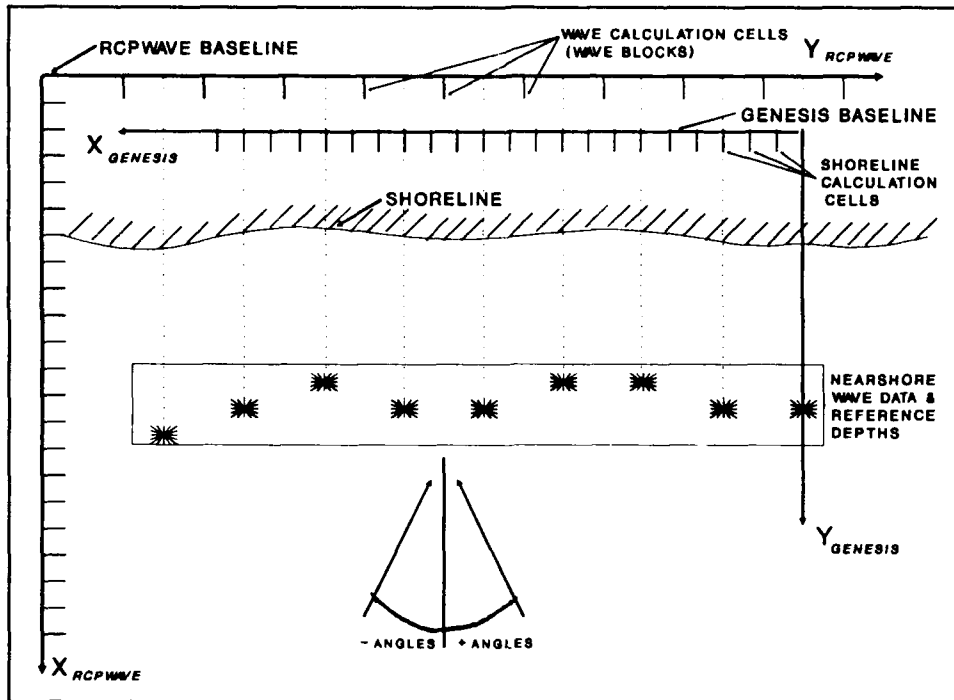

Figure 32. RCPWAVE and GENESIS coordinate systems and conventions

are performed within GENESIS, with the requirement that the RCPWAVE cell spacing be a constant multiple of the GENESIS cell spacing.

Furthermore, because GENESIS is a 1-D model, the offshore cell spacing in the RCPWAVE grid does not enter within the context of shoreline change modeling using GENESIS. The offshore location of the nearshore wave conditions in GENESIS is determined by the water depth at which the data were saved.

### Wave transformation techniques

RCPWAVE provides a steady-state solution of the wave field over the RCPWAVE computational grid. The wave height and angle at each grid cell along the nearshore reference line depend on the water depth (a constant) and the offshore wave height, period, and angle. Because RCPWAVE is based on monochromatic wave theory, the equations governing wave refraction and shoaling do not depend on wave height, and nearshore wave transformation simulations can be performed using a unit wave height as the offshore input, leaving only two independent variables (offshore wave period and wave angle). Therefore, if the time series of offshore wave conditions is categorized into wave angle bands and period bands (with a resolution such that the difference in the transformation of wave events at the limits of the angle-period bands is small), a relatively few (typically between 50 and 100) nearshore wave transformation simulations can approximate the nearshore wave characteristics for the entire offshore wave time series. The RCPWAVE solution using this technique consists of a wave height

transformation coefficient and wave angle at the center of each grid cell for each of the wave angle and period band combinations.

The nearshore wave data requirements of GENESIS are pre-breaking wave height, angle, and water depth alongshore (and wave period, which is constant and obtained from the offshore time series). Consequently, RCPWAVE generates much more information (wave characteristics over the entire RCPWAVE grid) than is required by GENESIS. In fact, GENESIS requires only the wave height and angle and the corresponding water depth at one (RCPWAVE) offshore grid cell for each of the alongshore cells within the project reach. As stated previously, GENESIS will interpolate between the alongshore RCPWAVE grid cells (referred to as "wave blocks") and GENESIS grid cells (referred to as "shoreline calculation cells") if the alongshore wave block cell spacing is greater than the grid cell size in GENESIS.

Other wave transformation models could be used to estimate nearshore wave conditions for input to GENESIS, provided that pre-breaking wave heights, wave angles, and associated water depths at uniform alongshore spacing are included in the output. However, the programs WTNSWAV and WTDEPTH that translate RCPWAVE output to GENESIS input are specific to RCPWAVE and would require revision for use with another wave transformation model.



# References

---

Cialone, M. A. 1991. "Coastal Modeling System (CMS) User's Manual," Instruction Report CERC-91-1, Coastal Engineering Research Center, US Army Engineer Waterways Experiment Station, Vicksburg, MS.

Ebersole, B. A. 1985. "Refraction-Diffraction Model for Linear Waves," *Journal of Waterway, Port, Coastal, and Ocean Engineering*, Vol 111, No. WW6, pp 939-953.

Ebersole, B. A., Cialone, M. A., and Prater, M. D. 1986. "Regional Coastal Processes Numerical Modeling System, Report 1, RCPWAVE - A Linear Wave Propagation Model for Engineering Use," Technical Report CERC-86-4, Coastal Engineering Research Center, US Army Engineer Waterways Experiment Station, Vicksburg, MS.

Gravens, M. B. 1991. "Development of an Input Data Set for Shoreline Change Modeling," Proceedings Coastal Sediments 91, American Society of Civil Engineers, pp 1800-1813.

Gravens, M. B., Kraus, N. C., and Hanson, H. 1991. "GENESIS: Generalized Model for Simulating Shoreline Change, Report 2, Workbook and System User's Manual," Technical Report CERC-89-19, Coastal Engineering Research Center, US Army Engineer Waterways Experiment Station, Vicksburg, MS.

Gravens, M. B., Scheffner, N. W., and Hubertz, J. M. 1989. "Coastal Processes from Asbury Park to Manasquan, New Jersey," Miscellaneous Paper CERC-89-11, Coastal Engineering Research Center, US Army Engineer Waterways Experiment Station, Vicksburg, MS.

Hanson, H. 1987. "GENESIS, a Generalized Shoreline Change Model for Engineering Use," Report No. 1007, Department of Water Resources Engineering, University of Lund, Lund, Sweden.

Hanson, H., and Kraus, N. C. 1989. "GENESIS: Generalized Model for Simulating Shoreline Change, Report 1, Technical Reference," Technical Report CERC-89-19, Coastal Engineering Research Center, US Army Engineer Waterways Experiment Station, Vicksburg, MS.

## References

Kraus, N. C., Hanson, H., and Larson, M. 1988. "Threshold for Longshore Sand Transport and Application to a Shoreline Change Simulation Model," Proceedings on Mathematical Modelling of Sediment Transport in the Coastal Zone, International Association of Hydraulic Research, pp 117-126.

# Appendix A

## Shoreline Modeling System (SMS) Installation

---

Installation of this version of the SMS requires installing SMS in a specific directory and customizing the graphics setup. The next two sections describe these installation procedures.

### SMS Software Installation

The SMS software is distributed on one high-density (1.44 Mb) diskette. To install SMS on a hard disk requires creating a directory where SMS will reside, and de-archiving the files on the SMS distribution diskette to that directory. The required steps are detailed below.

1. Use the DOS **MD** or **MKDIR** command to create a subdirectory in which the SMS files will reside. The SMS software requires that the subdirectory be called **SMS** and that it be a subdirectory of the *root* directory of the drive in use (for example **C:\SMS**). The example below provides step-by-step instructions for installation on the C: drive.

```
CD C:\ (go to the root directory)
```

```
MD C:\SMS (create the SMS directory)
```

```
CD \SMS (move into the SMS directory)
```

2. Insert the SMS distribution disk in Drive B (or available 3.5-in. high-density disk drive) and enter the command:

```
B:\SMS_V1 -d
```

The SMS software will now be installed in the subdirectory **C:\SMS**. Refer to the section of Appendix A titled "**Graphics Software Installation**," for instructions for configuring the SMS graphics for your computing environment.

3. Any last-minute changes or additions to the SMS are documented in a file called **README.SMS**. Review this file and make note of any changes. To display the **README.SMS** file, enter the command:

**TYPE README.SMS | MORE**

4. For the execution of the SMS from any directory on the hard disk add the following to the **PATH** command in the **AUTOEXEC.BAT** file.

**C:\SMS**

5. To run the SMS, enter the command:

**SMS**

## Graphics Software Installation

The SMS and the SMS graphics software should be configured for the user's specific computing environment using a special program called **INSTALL.COM**. The following section provides an example installation using the program **INSTALL.COM**.

### Example of SMS graphics installation

A typical interactive session for **INSTALL.COM** is described below. Please note that all user responses are highlighted in **boldface** type. Standard default options (inside brackets [ ]) can be selected by pressing the **ENTER** key. This example installation assumes the following configuration to be installed:

- Video Graphics Array (VGA)
- Resolution (640 x 480)
- Supporting 16 colors
- Printer Type - Hewlett Packard (HP) LaserJet (LPT1:)
- Plotter Type - Hewlett Packard (HP) LaserJet III (LPT1:)

The SMS software may be configured for this computing environment by following these steps (user responses are highlighted in **boldface** type):

1. **C:\SMS> INSTALL**
2. **INSTALL 5.2 ... 13 July 1990**  
What program do you want to install?  
Type the filename (e.g. **CONWEP.EXE**)  
and press **RETURN ... SMS.EXE**

3. The user enters the code for the display adapter that matches his system:

- 0) Monochrome Display Adapter (No graphics)
- 1) Color Graphics Adapter (CGA)
- 2) Enhanced Graphics Adapter (EGA)
- 3) Video Graphics Array (VGA)
- 4) Other

Enter selection [1] .... 3

4. The user enters the code for the VGA and display monitor that matches his system:

- |   | Resolution x Colors       |
|---|---------------------------|
| 0) Return to previous menu  |                           |
| 1) Video Graphics Array<br>w/ analog monitor                      | 640x480x16 or 320x200x256 |
| 2) Video 7 VGA<br>w/ multi-frequency analog monitor               | 720x540x16 or 640x400x256 |
| 3) Video 7 VGA<br>w/ multi-frequency analog monitor               | 800x600x16 or 640x400x256 |
| 4) Video 7 VGA with 512K RAM<br>w/ multi-frequency analog monitor | 800x600x16 or 640x480x256 |
| 5) ORCHID/GENOA VGA<br>w/ multi-frequency analog monitor          | 800X600X16 or 320x200x256 |
| 6) AST/PARADISE VGA<br>w/ multi-frequency analog monitor          | 800x600x16 or 640x400x256 |

Enter selection [0] .... 1

5. Select a pen plotter:
- 0) No plotter
  - 1) HP compatible 2-pen plotter
  - 2) HP compatible 6-pen plotter
  - 3) HP compatible 8-pen plotter
  - 4) HP LaserJet III

Enter selection [1] .... 4

6. Select a graphics printer:
- 0) No printer
  - 1) IBM Graphics
  - 2) Epson FX/RX Series
  - 3) HP LaserJet
  - 4) HP PaintJet

Enter selection [1] .... 3

Appendix A

7. Select plotter port:

- 1) COM1:      2) COM2:  
3) LPT1:      4) LPT2:      5) LPT3:

Enter selection [1] .... 3

8. Select printer port:

- 1) LPT1:      2) LPT2:      3) LPT3:

Enter selection [1] .... 1

Please wait ...

Finished installing SMS.EXE

The special-purpose graphics programs GENGRAF.EXE and RCPGRAF.EXE should be similarly installed. This installation (or configuration) procedure may be executed in a stand-alone mode as described above or by selecting the *Configure* option from the SMS Level 1 menu: Main as discussed in Chapter 2.

# **Appendix B Input Data Set for GENGRAF Example**

---

This appendix contains a listing of the GENESIS input and output data files that served as input to the program GENGRAF.EXE in the GENGRAF example application described in Chapter 4. The input data set consisted of three GENESIS input data files (START.EXP, SHORL.EXP, and SHORM.EXP) and two GENESIS output data files (SHORC.EXP and OUTPT.EXP) as shown in Figures B1 through B5.

```

*****
* INPUT FILE START.DAT TO GENESIS (Workbook) VERSION 2.0 *
*****

A----- MODEL SETUP -----A
A.1 RUN TITLE
    GENESIS Example: Terminal Groin with Updrift Detached Breakwaters
A.2 INPUT UNITS (METERS = 1; FEET = 2): ICONV
    2
A.3 TOTAL NUMBER OF CALCULATION CELLS AND CELL LENGTH: NN, DX
    69 100
A.4 GRID CELL NUMBER WHERE SIMULATION STARTS AND NUMBER OF CALCULATION
    CELLS (N = -1 MEANS N = NN): ISSTART, N
    1 69
A.5 VALUE OF TIME STEP IN HOURS: DT
    6
A.6 DATE WHEN SHORELINE SIMULATION STARTS
    (DATE FORMAT YYMMDD: 1 MAY 1992 = 920501): SIMDATS
    920101
A.7 DATE WHEN SHORELINE SIMULATION ENDS OR TOTAL NUMBER OF TIME STEPS
    (DATE FORMAT YYMMDD: 1 MAY 1992 = 920501): SIMDATE
    930101
A.8 NUMBER OF INTERMEDIATE PRINT-OUTS WANTED: NOUT
    5
A.9 DATES OR TIME STEPS OF INTERMEDIATE PRINT-OUTS
    (DATE FORMAT YYMMDD: 1 MAY 1992 = 920501, NOUT VALUES): TOUT(I)
    920301 920501 920701 920901 921101
A.10 NUMBER OF CALCULATION CELLS IN OFFSHORE CONTOUR SMOOTHING WINDOW
    (SMOOTH = 0 MEANS NO SMOOTHING, ISMOOTH = N MEANS STRAIGHT LINE.
    RECOMMENDED DEFAULT VALUE = 11): ISMOOTH
    11
A.11 REPEATED WARNING MESSAGES (YES = 1; NO = 0): IRWM
    1
A.12 LONGSHORE SAND TRANSPORT CALIBRATION COEFFICIENTS: K1, K2
    0.3 0.2
A.13 PRINT-OUT OF TIME STEP NUMBERS? (YES = 1, NO = 0): IPRINT
    1

B----- WAVES -----B
B.1 WAVE HEIGHT CHANGE FACTOR, WAVE ANGLE CHANGE FACTOR AND AMOUNT (DEG)
    (NO CHANGE: HCONGF = 1, ZCONGF = 1, ZCONGA = 0): HCONGF, ZCONGF, ZCONGA
    1 1 0
B.2 DEPTH OF OFFSHORE WAVE INPUT: DZ
    45
B.3 IS AN EXTERNAL WAVE MODEL BEING USED (YES = 1; NO = 0): NWD
    1
B.4 COMMENT: IF AN EXTERNAL WAVE MODEL IS NOT BEING USED, CONTINUE TO B.9
B.5 NUMBER OF SHORELINE CALCULATION CELLS PER WAVE MODEL ELEMENT: ISPW
    4
B.6 NUMBER OF HEIGHT BANDS USED IN THE EXTERNAL WAVE MODEL TRANSFORMATIONS
    (MINIMUM IS 1, MAXIMUM IS 9): NBANDS
    1
B.7 COMMENT: IF ONLY ONE HEIGHT BAND WAS USED CONTINUE TO B.9
B.8 MINIMUM WAVE HEIGHT AND BAND WIDTH OF HEIGHT BANDS: HBMIN, HBWIDTH
    0 0
B.9 VALUE OF TIME STEP IN WAVE DATA FILE IN HOURS (MUST BE AN EVEN MULTIPLE
    OF, OR EQUAL TO DT): DTW
    6
B.10 NUMBER OF WAVE COMPONENTS PER TIME STEP: N WAVES
    2
B.11 DATE WHEN WAVE FILE STARTS (FORMAT YYMMDD: 1 MAY 1992 = 920501): WDATS
    920101

C----- BEACH -----C
C.1 EFFECTIVE GRAIN SIZE DIAMETER IN MILLIMETERS: D50
    0.2
C.2 AVERAGE BERM HEIGHT FROM MEAN WATER LEVEL: ABH
    3
C.3 CLOSURE DEPTH: OCLOS
    20

D----- NON-DIFFRACTING GROINS -----D
D.1 ANY NON-DIFFRACTING GROINS? (NO = 0, YES = 1): INDG
    0
D.2 COMMENT: IF NO NON-DIFFRACTING GROINS, CONTINUE TO E.
D.3 NUMBER OF NON-DIFFRACTING GROINS: NNDG
    0
D.4 GRID CELL NUMBERS OF NON-DIFFRACTING GROINS (NNDG VALUES): IXNDG(I)
D.5 LENGTHS OF NON-DIFFRACTING GROINS FROM X-AXIS (NNDG VALUES): YNDG(I)

```

Figure B1. GENGRAF input file START.EXP (continued)



```

E----- DIFFRACTING (LONG) GROINS AND JETTIES -----E
E.1 ANY DIFFRACTING GROINS OR JETTIES? (NO = 0, YES = 1): IDG
1
E.2 COMMENT: IF NO DIFFRACTING GROINS, CONTINUE TO F.
E.3 NUMBER OF DIFFRACTING GROINS/JETTIES: NDG
1
E.4 GRID CELL NUMBERS OF DIFFRACTING GROINS/JETTIES (NDG VALUES): IXDG(I)
70
E.5 LENGTHS OF DIFFRACTING GROINS/JETTIES FROM X-AXIS (NDG VALUES): YDG(I)
1800.
E.6 DEPTHS AT SEAWARD END OF DIFFRACTING GROINS/JETTIES(NDG VALUES): DDG(I)
19.
F----- ALL GROINS/JETTIES -----F
F.1 COMMENT: IF NO GROINS OR JETTIES, CONTINUE TO G.
F.2 REPRESENTATIVE BOTTOM SLOPE NEAR GROINS: SLOPE2
0.02
F.3 PERMEABILITIES OF ALL GROINS AND JETTIES (NNDG + NDG VALUES): PERM(I)
0
F.4 IF GROIN OR JETTY ON LEFT-HAND BOUNDARY, DISTANCE FROM SHORELINE
OUTSIDE GRID TO SEAWARD END OF GROIN OR JETTY: YG1
0
F.5 IF GROIN OR JETTY ON RIGHT-HAND BOUNDARY, DISTANCE FROM SHORELINE
OUTSIDE GRID TO SEAWARD END OF GROIN OR JETTY: YGN
500
G----- DETACHED BREAKWATERS -----G
G.1 ANY DETACHED BREAKWATERS? (NO = 0, YES = 1): IDB
1
G.2 COMMENT: IF NO DETACHED BREAKWATERS, CONTINUE TO H.
G.3 NUMBER OF DETACHED BREAKWATERS: NDB
2
G.4 ANY DETACHED BREAKWATER ACROSS LEFT-HAND CALCULATION BOUNDARY
(NO = 0, YES = 1): IDB1
0
G.5 ANY DETACHED BREAKWATER ACROSS RIGHT-HAND CALCULATION BOUNDARY
(NO = 0, YES = 1): IDBN
0
G.6 GRID CELL NUMBERS OF TIPS OF DETACHED BREAKWATERS
(2 * NDB - (IDB1 + IDBN) VALUES): IXDB(I)
40 55 60 70
G.7 DISTANCES FROM X-AXIS TO TIPS OF DETACHED BREAKWATERS
(1 VALUE FOR EACH TIP SPECIFIED IN G.6): YDB(I)
1800. 1800. 1800. 1800.
G.8 DEPTHS AT DETACHED BREAKWATER TIPS (1 VALUE FOR EACH TIP
SPECIFIED IN G.6): DDB(I)
20. 20. 19. 19.
G.9 TRANSMISSION COEFFICIENTS FOR DETACHED BREAKWATERS (NDB VALUES): TRANDB(I)
0.3 0.0
H----- SEAWALLS -----H
H.1 ANY SEAWALL ALONG THE SIMULATED SHORELINE? (YES = 1; NO = 0): ISW
0
H.2 COMMENT: IF NO SEAWALL, CONTINUE TO I.
H.3 GRID CELL NUMBERS OF START AND END OF SEAWALL (ISWEND = -1 MEANS
ISWEND = N): ISWBEG, ISWEND
1 69
I----- BEACH FILLS -----I
I.1 ANY BEACH FILLS DURING SIMULATION PERIOD? (NO = 0, YES = 1): IBF
0
I.2 COMMENT: IF NO BEACH FILLS, CONTINUE TO K.
I.3 NUMBER OF BEACH FILLS DURING SIMULATION PERIOD: NBF
0
I.4 DATES OR TIME STEPS WHEN THE RESPECTIVE FILLS START
(DATE FORMAT YYMMDD: 1 MAY 1992 = 920501, NBF VALUES): BFDATS(I)
I.5 DATES OR TIME STEPS WHEN THE RESPECTIVE FILLS END
(DATE FORMAT YYMMDD: 1 MAY 1992 = 920501, NBF VALUES): BFDATE(I)
I.6 GRID CELL NUMBERS OF START OF RESPECTIVE FILLS (NBF VALUES): IBFS(I)
I.7 GRID CELL NUMBERS OF END OF RESPECTIVE FILLS (NBF VALUES): IBFE(I)
I.8 ADDED BERM WIDTHS AFTER ADJUSTMENT TO EQUILIBRIUM CONDITIONS
(NBF VALUES): YADD(I)
K----- COMMENTS -----K
* COMMENTS AND VERSION UPDATE INFORMATION PLACED HERE
----- END -----

```

Figure B1. (Concluded)

Appendix B

```

MEASURED SHORELINE POSITION OF 820101; CELL SPACING (DX = 100. ft)
THESE DATA WERE OBTAINED FROM THE FILE: 1982xy.ISH
STARTING AT ALONGSHORE POSITION X = 0. AND ENDING AT X = 6800.
.....
1296.1 1274.4 1254.1 1234.8 1216.6 1200.2 1186.7 1170.4 1152.7 1136.5
1124.7 1120.0 1113.2 1097.9 1080.2 1067.1 1067.2 1048.7 1032.8 1013.9
993.9 977.8 966.7 956.6 946.0 932.2 918.9 899.8 881.4 864.3
850.1 838.2 828.3 812.6 798.7 779.8 762.8 746.8 730.6 716.9
704.1 691.2 679.4 670.0 662.4 653.0 640.6 629.1 621.8 618.2
617.2 618.7 623.0 630.0 639.1 649.6 661.2 673.6 686.7 700.9
717.4 737.6 761.0 786.7 813.8 846.2 892.9 959.6 1026.4
    
```

Figure B2. GENGRAF input file SHORL.EXP

```

MEASURED SHORELINE POSITION OF 820101; CELL SPACING (DX = 100. ft)
THESE DATA WERE OBTAINED FROM THE FILE: 1982xy.ISH
STARTING AT ALONGSHORE POSITION X = 0. AND ENDING AT X = 6800.
.....
1296.1 1274.4 1254.1 1234.8 1216.6 1200.2 1186.7 1170.4 1152.7 1136.5
1124.7 1120.0 1113.2 1097.9 1080.2 1067.1 1067.2 1048.7 1032.8 1013.9
993.9 977.8 966.7 956.6 946.0 932.2 918.9 899.8 881.4 864.3
850.1 838.2 828.3 812.6 798.7 779.8 762.8 746.8 730.6 716.9
704.1 691.2 679.4 670.0 662.4 653.0 640.6 629.1 621.8 618.2
617.2 618.7 623.0 630.0 639.1 649.6 661.2 673.6 686.7 700.9
717.4 737.6 761.0 786.7 813.8 846.2 892.9 959.6 1026.4
    
```

Figure B3. GENGRAF input file SHORM.EXP

```

.....
FINAL SHORELINE LOCATION. BY COPYING THIS FILE TO SHORL.DAT AND UP-DATING
START.DAT, THE MODEL MAY BE RUN AGAIN FOR A NEW CONFIGURATION.
.....
1296.1 1281.1 1267.2 1253.2 1240.0 1226.4 1212.8 1199.1 1186.0 1170.4
1156.0 1139.6 1123.7 1107.9 1092.7 1078.4 1064.2 1049.6 1034.3 1019.6
1003.8 990.6 977.3 963.4 949.2 933.0 917.3 903.1 890.0 878.7
868.6 860.4 854.8 849.7 848.2 850.6 856.8 866.4 881.1 897.1
913.7 932.1 961.7 970.3 926.0 867.2 821.7 783.6 751.3 713.2
673.6 638.2 606.6 678.9 666.4 640.9 636.2 640.3 652.9 681.9
620.4 672.6 733.8 817.8 941.0 1076.8 1119.9 1141.0 1204.1
    
```

Figure B4. GENGRAF input file SHORC.EXP

RUN: GENESIS Example: Terminal Groin with Updrift Detached Breakwaters										
INITIAL SHORELINE POSITION (FT)										
1295.1	1274.4	1264.1	1234.8	1216.5	1200.2	1185.7	1170.4	1152.7	1136.5	
1124.7	1120.0	1113.2	1087.9	1080.2	1067.1	1057.2	1046.7	1032.8	1013.9	
993.9	977.8	965.7	955.5	945.0	932.2	916.9	899.8	881.4	864.3	
850.1	838.2	828.3	812.5	796.7	779.8	762.6	745.8	730.5	718.9	
704.1	691.2	678.4	670.0	662.4	653.0	640.5	629.1	621.8	618.2	
617.2	618.7	623.0	630.0	638.1	649.6	661.2	673.6	686.7	700.9	
717.4	737.5	761.0	788.7	813.6	846.2	882.9	919.5	959.5	1028.4	
SHORELINE POSITION (FT) AFTER 237 TIME STEPS. DATE IS 820301										
1295.1	1278.8	1262.7	1248.9	1231.3	1218.0	1200.9	1185.5	1170.5	1158.2	
1141.5	1127.0	1112.0	1097.1	1083.0	1069.0	1055.0	1041.1	1027.0	1012.3	
997.4	983.4	969.9	958.4	942.2	924.8	905.5	888.8	869.1	853.0	
838.2	824.0	810.3	797.2	786.5	777.0	769.8	766.0	766.8	770.7	
765.7	764.1	750.0	738.6	729.8	722.3	695.0	675.8	669.0	658.5	
647.7	637.7	627.8	619.1	610.8	598.0	588.0	602.9	616.5	639.4	
672.4	715.0	769.1	822.4	877.5	926.8	961.0	1000.6	1070.9		
SHORELINE POSITION (FT) AFTER 481 TIME STEPS. DATE IS 820501										
1295.1	1280.3	1265.5	1250.9	1236.6	1222.4	1207.8	1193.6	1179.3	1164.2	
1148.8	1133.0	1117.2	1101.7	1086.6	1071.9	1057.2	1042.9	1028.2	1012.9	
997.8	982.4	967.2	951.9	936.9	919.2	902.2	885.3	869.2	853.8	
839.4	828.5	815.0	805.5	798.5	794.5	793.5	795.1	798.8	803.5	
806.8	809.4	811.3	809.8	804.4	786.5	743.6	719.6	701.8	682.3	
663.6	641.9	619.7	598.4	581.7	571.4	570.1	578.0	588.8	617.8	
658.9	706.7	764.5	828.8	889.3	962.4	1015.6	1069.5	1130.0		
SHORELINE POSITION (FT) AFTER 725 TIME STEPS. DATE IS 820701										
1295.1	1280.2	1265.6	1251.2	1236.7	1222.5	1208.0	1193.5	1178.7	1163.8	
1149.2	1134.3	1119.2	1104.0	1088.7	1073.3	1057.8	1042.8	1027.6	1012.0	
996.2	980.5	965.1	948.9	932.9	915.9	898.9	882.6	866.9	853.1	
840.4	828.9	818.4	811.7	805.6	801.3	799.2	800.7	805.1	810.7	
817.4	822.2	820.5	814.4	804.0	786.6	767.7	733.8	708.0	688.3	
665.4	640.8	617.4	596.4	579.5	567.2	567.2	573.6	590.8	619.0	
656.9	703.9	762.0	827.3	888.8	962.1	1019.4	1069.1	1143.5		
SHORELINE POSITION (FT) AFTER 973 TIME STEPS. DATE IS 820901										
1295.1	1280.6	1265.9	1251.3	1237.1	1223.2	1208.9	1194.5	1180.1	1165.7	
1150.9	1136.0	1120.7	1104.8	1089.4	1073.7	1058.3	1042.9	1026.9	1010.9	
994.8	978.8	962.9	947.5	932.0	915.9	899.6	883.9	869.1	855.7	
843.4	831.6	820.8	810.1	803.3	799.1	796.0	802.9	811.7	824.1	
828.2	834.1	832.7	824.7	813.6	793.2	765.1	739.8	716.0	693.0	
670.0	645.1	615.5	589.8	572.2	562.4	560.5	564.8	580.9	611.9	
654.4	705.0	762.8	828.5	895.2	973.4	1027.3	1075.7	1150.1		
SHORELINE POSITION (FT) AFTER 1217 TIME STEPS. DATE IS 821101										
1295.1	1280.7	1265.6	1252.6	1238.8	1224.9	1211.0	1196.9	1182.5	1167.8	
1152.5	1137.1	1121.6	1105.9	1090.1	1074.1	1057.9	1042.0	1026.6	1011.6	
997.3	982.9	968.4	953.8	938.8	923.2	907.3	891.9	877.7	864.7	
853.2	843.3	834.8	828.4	824.3	822.3	822.2	827.5	834.7	842.9	
852.4	862.5	872.3	879.6	882.4	815.6	780.9	752.6	725.0	699.1	
671.1	642.7	615.7	591.1	570.1	564.5	562.9	567.5	573.4	600.2	
636.4	683.1	746.2	823.5	922.8	1017.5	1060.8	1098.6	1170.1		
GROSS TRANSPORT VOLUME (YARDS <sup>3</sup> /1000) FOR CALCULATED PART OF YEAR 1										
358	356	356	355	354	353	352	351	351	351	
352	353	353	351	348	345	343	344	345	345	
348	346	344	340	334	326	320	318	316	314	
310	304	294	284	269	256	247	229	218	206	
191	174	151	127	102	79	61	49	42	44	
45	42	43	41	39	39	47	51	56	64	
76	79	83	85	83	70	49	30	15	0	

Figure B5. GENGRAF input file OUTPT.EXP (Sheet 1 of 3)

Appendix B

NET TRANSPORT VOLUME										(YARDS3/1000) FOR CALCULATED PART OF YEAR 1									
283	283	282	281	280	278	276	273	271	268	285	282	281	280	259	258	257	256	256	256
265	264	253	252	252	251	251	251	251	250	249	247	246	243	240	236	229	222	211	198
183	165	145	121	96	73	55	40	26	16	7	3	1	2	7	14	23	34	45	56
67	76	80	83	80	69	49	30	15	0										
TRANSPORT VOLUME TO THE LEFT										(YARDS3/1000) FOR CALCULATED PART OF YEAR 1									
-36	-36	-36	-36	-37	-37	-38	-39	-40	-41	-43	-45	-46	-46	-44	-43	-43	-43	-44	-44
-46	-46	-46	-43	-41	-37	-34	-33	-32	-31	-30	-28	-24	-20	-14	-10	-8	-3	-3	-3
-4	-4	-3	-3	-2	-2	-3	-4	-7	-14	-18	-19	-21	-19	-16	-12	-12	-8	-6	-3
-4	-1	-1	0	-1	0	0	0	0	0										
TRANSPORT VOLUME TO THE RIGHT										(YARDS3/1000) FOR CALCULATED PART OF YEAR 1									
319	319	319	318	317	315	314	312	311	309	309	308	307	306	303	301	300	300	300	301
300	300	299	298	293	289	286	285	283	282	279	276	270	263	255	246	238	225	215	202
187	170	148	124	99	76	58	45	34	30	26	22	22	22	23	26	35	42	50	60
71	77	82	84	81	70	49	30	15	0										
OUTPUT OF BREAKING WAVE STATISTICS FOR SELECTED LOCATIONS										LOCATIONS									
N.B. WAVE DIFFRACTION IS NOT ACCOUNTED FOR!																			
GRID CELL NUMBERS																			
1	1	2	4	5	6	8	9	11	12	13	15	16	17	19	20	22	23	24	26
27	28	30	31	33	34	35	37	38	40	41	42	44	45	46	48	49	51	52	53
55	56	57	59	60	62	63	64	66	67										
AVERAGE UNDIFFRACTED BREAKING WAVE HEIGHTS (FT).																			
2.0	2.0	2.0	2.0	2.0	2.0	2.0	2.0	2.1	2.1	2.1	2.1	2.1	2.1	2.1	2.1	2.0	2.0	2.0	2.0
2.0	2.0	2.0	2.0	2.0	2.0	2.0	2.0	2.1	2.1	2.1	2.1	2.1	2.1	2.1	2.0	2.0	2.0	2.0	2.1
2.1	2.1	2.1	2.1	2.1	2.0	2.0	2.0	2.0	2.1	2.1	2.1	2.1	2.1	2.1	2.1	2.1	2.1	2.2	2.1
AVERAGE UNDIFFRACTED BREAKING WAVE ANGLE TO SHORELINE (DEG)																			
6.8	6.8	6.8	6.7	6.7	6.7	6.6	6.5	6.5	6.5	6.4	6.3	6.2	6.1	6.2	6.2	5.9	5.7	5.9	6.6
6.9	6.9	6.7	6.5	6.0	6.0	6.6	4.4	2.9	0.9	0.8	0.5	4.4	6.6	10.0	10.2	8.7	8.3	8.8	8.8
9.8	9.6	7.6	4.4	2.3	-0.4	-2.1	-3.6	-3.4	2.7										
AVERAGE LONGSHORE TRANSPORT RATE BASED ON UNDIFFRACTED WAVES (FT3/SEC)																			
0.24	0.24	0.24	0.24	0.24	0.24	0.24	0.23	0.23	0.23	0.23	0.22	0.22	0.22	0.22	0.22	0.21	0.20	0.20	0.21
0.22	0.22	0.21	0.21	0.20	0.20	0.19	0.16	0.11	0.03	0.03	0.01	0.16	0.24	0.32	0.35	0.30	0.29	0.30	0.33
0.34	0.34	0.28	0.17	0.11	-0.01	-0.08	-0.15	-0.16	0.11										
LONGSHORE TRANSPORT (FT3/SEC)																			
0.06	0.06	0.06	0.06	0.06	0.06	0.06	0.06	0.06	0.06	0.06	0.06	0.06	0.06	0.06	0.06	0.06	0.06	0.06	0.06
0.06	0.06	0.06	0.06	0.06	0.06	0.06	0.06	0.06	0.06	0.06	0.06	0.06	0.06	0.06	0.06	0.06	0.06	0.06	0.06
0.06	0.06	0.06	0.06	0.06	0.06	0.06	0.06	0.06	0.06	0.06	0.06	0.06	0.06	0.06	0.06	0.06	0.06	0.06	0.06
0.02	0.01	0.00	0.00	0.07	0.07	0.05	0.03	0.03	0.03	0.02	0.01	0.01	0.01	0.01	0.01	0.01	0.01	0.01	0.00
0.00	0.00	0.00	0.00	-0.02	-0.02	0.02	0.01	0.01	0.00										
CALCULATED FINAL SHORELINE POSITION (FT)																			
1295.1	1281.1	1287.2	1253.2	1240.0	1226.4	1212.8	1199.1	1185.0	1170.4	1155.0	1139.5	1123.7	1107.9	1092.7	1078.4	1064.2	1048.5	1034.3	1019.5
1003.8	990.6	977.3	963.4	949.2	933.0	917.3	903.1	890.0	878.7	868.6	860.4	854.8	849.7	848.2	850.5	855.6	866.4	881.1	897.1
913.7	932.1	951.7	970.3	925.0	867.2	821.7	783.8	751.3	713.2	673.6	638.2	606.5	578.9	556.4	540.9	536.2	540.3	552.9	581.9
620.4	672.6	733.8	817.8	941.0	1076.8	1119.9	1141.0	1204.1											

Figure B5. (Sheet 2 of 3)

B6

Input Data Set for GENGRAF Example

CALCULATED SEAWARDMOST SHORELINE POSITION (FT)									
1295.1	1281.2	1267.2	1253.8	1240.0	1226.5	1213.0	1199.1	1185.3	1172.0
1166.4	1140.1	1124.5	1109.1	1093.7	1078.4	1064.7	1050.5	1035.2	1019.9
1004.8	990.6	978.4	965.3	951.4	934.1	918.1	904.2	891.6	880.6
871.0	862.8	856.2	852.0	850.2	850.8	855.6	866.4	881.1	897.1
914.2	936.9	952.9	974.7	925.0	867.2	821.7	783.6	751.3	713.2
674.5	654.5	632.1	630.0	638.1	649.6	661.2	673.6	686.7	700.9
717.4	737.5	779.4	843.9	847.4	1078.9	1119.9	1141.0	1204.1	
CALCULATED LANDWARDMOST SHORELINE POSITION (FT)									
1295.1	1274.4	1254.1	1234.6	1216.5	1200.2	1184.9	1169.5	1152.7	1135.5
1124.7	1118.7	1105.8	1092.5	1080.2	1067.1	1054.1	1040.1	1025.7	1009.1
991.9	977.7	962.9	947.3	931.2	915.2	898.6	881.8	866.5	852.2
837.9	823.7	808.6	793.6	782.8	769.6	755.0	742.8	730.5	716.9
704.0	691.2	679.4	670.0	662.2	653.0	640.5	629.1	621.8	618.2
617.2	618.1	606.4	678.8	656.3	635.6	633.3	630.9	643.3	675.1
617.4	670.4	730.4	784.3	813.6	846.2	892.9	959.5	1026.4	
CALCULATED REPRESENTATIVE OFFSHORE CONTOUR POSITION (FT)									
2279.4	2265.4	2251.4	2237.4	2223.4	2209.5	2195.3	2181.0	2166.6	2152.1
2137.5	2122.8	2108.0	2093.2	2078.4	2063.6	2048.8	2034.1	2019.3	2004.7
1990.1	1975.8	1961.6	1947.8	1934.3	1921.4	1909.1	1897.7	1887.5	1878.7
1871.4	1865.9	1862.3	1860.8	1861.0	1862.3	1864.2	1866.1	1867.5	1867.7
1866.0	1861.7	1854.2	1842.9	1827.2	1807.7	1785.3	1760.8	1735.0	1708.7
1683.1	1659.3	1638.6	1622.3	1612.1	1609.6	1615.1	1628.3	1649.3	1678.5
1715.3	1759.2	1809.3	1864.9	1929.5	1994.2	2068.9	2123.6	2188.3	
CALIBRATION/VERIFICATION ERROR = 75.9366									
CALCULATED VOLUMETRIC CHANGE = + 2.76E+05 (YARDS <sup>3</sup> )									
SIGN CONVENTION: EROSION (-), ACCRETION (+)									

Figure B5. (Sheet 3 of 3)

# Appendix C

## Input Data Set for RCPGRAF Example

---

This appendix contains a listing of the RCPWAVE output data files that served as input to the program RCPGRAF.EXE in the RCPGRAF example application described in Chapter 4. The input data set consisted of two RCPWAVE output data files (RCP\_OUT and RCPEXP.NSR) as shown in Figures C1 and C2.

Appendix C

```

SHORELINE MODELING SYSTEM (SMS): PC RCPWAVE, VERSION 1.

---          SMS USER'S MANUAL EXAMPLE          ---

***** FILES CARD: SPECIFICATION OF PERMANENT FILE NAMES FOR DATA STORAGE
AND RETRIEVAL

VARIABLE DESCRIPTION OF USAGE:          VALUE:
-----
FNPRINT  FILE FOR PRINTED OUTPUT        RCP_OUT
FOUT     SAVESPEC FILE FOR OUTPUT       RCPEXP.NSR

***** GENSPecs CARD: SPECIFICATION OF TITLE AND GENERAL SYSTEM OF UNITS

VARIABLE DESCRIPTION OF USAGE:          VALUE:  NOTES:
-----
SUNITS   UNITS SYSTEM USED IN COMPUTATIONS  ENGLISH

***** GRIDSpec CARD: SPECIFICATION OF THE TYPE OF FINITE-DIFFERENCE GRID USED

VARIABLE DESCRIPTION OF USAGE:          VALUE:  NOTES:
-----
GRTYPE   TYPE OF FINITE-DIFFERENCE GRID    RECTANG
GUNITS   SYSTEM OF UNITS USED FOR THE GRID  ENGLISH
XCELL    NUMBER OF GRID CELLS, X DIRECTION  40
YCELL    NUMBER OF GRID CELLS, Y DIRECTION  36
DX       SPATIAL STEPSIZE IN X DIRECTION   200.00
DY       SPATIAL STEPSIZE IN Y DIRECTION   400.00

***** PRINTING OF FIELD ARRAY VARIABLES:  1 AREAS

AREA  * STARTING ENDING STARTING ENDING * VARIABLE FIELD
NUMBER * X CELL  X CELL  Y CELL  Y CELL NOTES: * ARRAYS TO PRINT: NOTES:
-----
1     * X= 1   X= 40  Y= 1   Y= 36   * DAHKB

***** WAVCOND CARD: NUMBER OF WAVE CONDITIONS:  3

WAVE CONDITION NUMBER:  1

VARIABLE DESCRIPTION OF USAGE:          VALUE:  NOTES:
-----
TDEEP  WAVE PERIOD                        4.00
HDEEP  DEEPWATER WAVE HEIGHT              5.00
ZDEEP  DEEPWATER WAVE ANGLE              -11.00
CNTRANG OFFSHORE CONTOUR ANGLE            0.00
DIFFR  DIFFRACTION SIMULATED              YES

WAVE CONDITION NUMBER:  2

VARIABLE DESCRIPTION OF USAGE:          VALUE:  NOTES:
-----
TDEEP  WAVE PERIOD                        6.00
HDEEP  DEEPWATER WAVE HEIGHT              6.00
ZDEEP  DEEPWATER WAVE ANGLE              -33.00
CNTRANG OFFSHORE CONTOUR ANGLE            0.00
DIFFR  DIFFRACTION SIMULATED              YES

WAVE CONDITION NUMBER:  3

VARIABLE DESCRIPTION OF USAGE:          VALUE:  NOTES:
-----
TDEEP  WAVE PERIOD                        8.00
HDEEP  DEEPWATER WAVE HEIGHT              8.00
ZDEEP  DEEPWATER WAVE ANGLE              33.00
CNTRANG OFFSHORE CONTOUR ANGLE            0.00
DIFFR  DIFFRACTION SIMULATED              YES

```

Figure C1. RCPGRAF input file RCP\_OUT (Sheet 1 of 4)

C2

Input Data Set for RCPGRAF Example

```

***** WAVMOD CARD: NUMBER OF WAVE CONDITIONS:

      WAVE CONDITION NUMBER:  1

      VARIABLE DESCRIPTION OF USAGE:          VALUE:  NOTES:
      -----
      HUTIL1  OFFSHORE BOUNDARY HEIGHT AT J=YCELLS          4.90
      HUTIL2  OFFSHORE BOUNDARY HEIGHT AT J = 1             6.10
      ZUTIL1  OFFSHORE BOUNDARY ANGLE AT J = 1             -14.00
      ZUTIL2  OFFSHORE BOUNDARY ANGLE AT J = YCELLS        -8.00

      WAVE CONDITION NUMBER:  2

      VARIABLE DESCRIPTION OF USAGE:          VALUE:  NOTES:
      -----
      HUTIL1  OFFSHORE BOUNDARY HEIGHT AT J=YCELLS          6.80
      HUTIL2  OFFSHORE BOUNDARY HEIGHT AT J = 1             6.20
      ZUTIL1  OFFSHORE BOUNDARY ANGLE AT J = 1             -36.00
      ZUTIL2  OFFSHORE BOUNDARY ANGLE AT J = YCELLS       -31.00

      WAVE CONDITION NUMBER:  3

      VARIABLE DESCRIPTION OF USAGE:          VALUE:  NOTES:
      -----
      HUTIL1  OFFSHORE BOUNDARY HEIGHT AT J=YCELLS          8.30
      HUTIL2  OFFSHORE BOUNDARY HEIGHT AT J = 1             7.70
      ZUTIL1  OFFSHORE BOUNDARY ANGLE AT J = 1             31.00
      ZUTIL2  OFFSHORE BOUNDARY ANGLE AT J = YCELLS       33.00

***** SAVESPEC CARD:

      16   16   16   16   16   16
      14   14   14   14   14   14
      14   16   16   14   14   14
      13   13   13   13   14   15
      13   13   13   14   14   16
      16   17   17   16   16   16

***** BATHSPEC CARD: SPECIFICATION OF BATHYMETRY/TOPOGRAPHY -

      VARIABLE DESCRIPTION OF USAGE:          VALUE:  NOTES:
      -----
      BUNITS  SYSTEM OF UNITS FOR DEPTH DATA          FEET
      BSEQ    READ SEQUENCE FOR DEPTH DECK             YX
      WDATUM  DATUM FOR WATER DEPTHS                   0.000
      LDATUM  DATUM FOR LAND ELEVATIONS                 0.000
      DLIMIT  MAXIMUM DEPTH ALLOWED                     0.0
      BFORM   FORMAT OF DEPTH DATA                     (10F7.1)

      NUMBER OF ELEVATION CHANGES =  0

      .....
      * INPUT PROCESSING COMPLETED: *
      * FATAL ERRORS = 0  WARNINGS = 0 *
      .....
    
```

Figure C1. (Sheet 2 of 4)





WATER DEPTHS (MULTIPLIED BY 10.)																		
I/J:	19	20	21	22	23	24	25	26	27	28	29	30	31	32	33	34	35	36
25:	280	280	280	280	280	280	280	270	280	280	290	280	280	280	280	280	280	280
26:	280	280	280	280	280	280	280	280	285	285	285	285	285	285	285	285	285	285
27:	280	280	280	280	280	280	280	290	280	280	300	290	290	280	300	290	290	290
28:	285	285	285	280	280	275	280	295	295	295	305	300	295	295	300	295	295	295
29:	280	280	290	280	280	270	280	300	300	300	310	310	300	300	300	300	300	300
30:	290	290	285	280	280	280	290	300	300	300	310	310	305	305	305	310	305	305
31:	290	290	280	280	280	290	300	300	300	300	310	310	310	310	310	320	310	310
32:	300	310	290	290	290	280	300	300	310	310	310	310	310	310	310	320	320	320
33:	310	310	310	310	310	310	300	300	310	320	320	320	320	330	320	320	330	330
34:	310	310	310	310	310	310	320	320	320	330	330	320	320	330	330	330	330	330
35:	330	310	310	310	320	320	320	320	320	330	330	330	330	330	330	330	330	330
36:	330	320	320	320	320	320	310	320	330	330	330	330	330	340	340	340	330	330
37:	330	330	320	330	330	330	320	330	330	330	340	340	340	340	340	340	340	340
38:	350	330	330	330	330	330	330	330	340	340	340	340	340	340	340	340	340	340
39:	370	350	340	340	340	340	340	340	340	340	340	340	350	350	350	350	350	350
40:	360	360	340	340	340	340	340	340	340	350	350	350	350	350	350	350	350	350

BREAKING INDEX (CHARACTER INFORMATION; NO MULTIPLIER NEEDED)																		
I/J:	1	2	3	4	5	6	7	8	9	10	11	12	13	14	15	16	17	18
1:	.	B	B	B	B	B	.	.	.	.	.	B	B	B	B	B	B	B
2:	.	B	B	B	B	B	.	.	.	.	.	B	B	B	B	B	B	B
3:	.	B	B	B	B	B	B	B	B	B	B	B	B	B	B	B	B	B
4:	.	B	B	B	B	B	B	B	B	B	B	B	B	B	B	B	B	B
5:	.	B	B	B	B	B	B	B	B	B	B	B	B	B	B	B	B	B
6:	.	B	B	B	B	B	B	B	.	.	.	.	.	.	.	.	.	.
7:	.	B	B	B	B	.	B	B	.	.	.	.	.	.	.	.	.	.
8:	.	.	.	.	.	.	.	.	.	.	.	.	.	.	.	.	.	.

BREAKING INDEX (CHARACTER INFORMATION; NO MULTIPLIER NEEDED)																		
I/J:	19	20	21	22	23	24	25	26	27	28	29	30	31	32	33	34	35	36
1:	B	B	B	B	B	B	B	B	B	B	B	B	B	B	B	B	B	B
2:	B	B	B	B	B	B	B	B	B	B	B	B	B	B	B	B	B	B
3:	B	B	B	B	B	B	B	B	B	B	B	B	B	B	B	B	B	B
4:	B	B	B	B	B	B	B	B	B	B	B	B	B	B	B	B	B	B
5:	.	.	.	.	.	.	.	.	B	.	B	B	B	B	B	B	B	B
6:	.	.	.	.	.	.	.	.	.	.	.	.	B	.	B	B	.	.
7:	.	.	.	.	.	.	.	.	.	.	.	.	.	.	.	.	.	.
8:	.	.	.	.	.	.	.	.	.	.	.	.	.	.	.	.	.	.

Figure C1. (Sheet 4 of 4)

Appendix C

WAVE CONDITION NUMBER 1: HEIGHT = 5.000 PERIOD = 4.000 ANGLE = -11.000									
1	15	4.7781	-12.3620	20.00	19	13	4.7451	-10.0624	21.00
2	16	4.7761	-12.3620	20.00	20	13	4.7869	-10.5243	21.00
3	16	4.7998	-12.3364	21.00	21	13	4.8319	-10.7502	21.00
4	16	4.8053	-12.3708	21.00	22	13	4.8538	-10.8319	20.00
5	16	4.8135	-12.3058	21.00	23	14	4.8704	-9.8549	21.00
6	16	4.7789	-11.8712	20.00	24	13	4.8778	-9.9323	21.00
7	14	4.7622	-11.3647	20.50	25	13	4.9178	-10.3707	21.00
8	14	4.7618	-11.8367	20.50	26	13	4.9241	-9.8211	20.00
9	14	4.7753	-12.1483	20.50	27	13	4.9097	-9.3530	20.00
10	14	4.7857	-11.7892	20.00	28	14	4.8618	-8.8772	20.00
11	14	4.8164	-11.7460	21.00	29	14	4.8343	-9.4577	20.00
12	14	4.8442	-11.9898	20.50	30	16	4.8548	-9.7357	20.00
13	14	4.8980	-11.8810	20.50	31	16	4.9022	-9.5881	21.00
14	15	4.9224	-11.2445	21.00	32	17	4.9248	-9.1350	21.00
15	15	4.8659	-10.3748	20.00	33	17	4.9185	-8.3536	21.00
16	14	4.7993	-9.3988	20.00	34	16	4.8814	-7.9179	20.00
17	14	4.7390	-9.5346	21.00	35	16	4.8791	-8.1387	20.50
18	14	4.7252	-10.1067	21.00	36	16	4.8791	-8.1387	20.50
WAVE CONDITION NUMBER 2: HEIGHT = 6.000 PERIOD = 6.000 ANGLE = -33.000									
1	15	6.1658	-30.0225	20.00	19	13	6.7925	-24.8648	21.00
2	16	6.1658	-30.0225	20.00	20	13	6.7635	-26.3819	21.00
3	16	6.1638	-30.3318	21.00	21	13	6.8059	-27.6898	21.00
4	16	6.2017	-30.4371	21.00	22	13	6.9202	-28.0188	20.00
5	16	6.2735	-30.3756	21.00	23	14	6.8478	-27.1880	21.00
6	16	6.2253	-28.3472	20.00	24	13	6.8234	-27.4717	21.00
7	14	6.0932	-27.3718	20.50	25	13	6.0051	-29.4019	21.00
8	14	6.9590	-27.9235	20.50	26	13	6.2321	-28.8355	20.00
9	14	6.9245	-28.8175	20.50	27	13	6.3972	-28.0769	20.00
10	14	6.8993	-28.2327	20.00	28	14	6.3874	-26.4752	20.00
11	14	6.8229	-28.5835	21.00	29	14	6.3030	-27.1269	20.00
12	14	6.8520	-29.5555	20.50	30	16	6.2632	-27.9732	20.00
13	14	6.0319	-30.4808	20.50	31	16	6.2358	-28.5753	21.00
14	15	6.3406	-30.3020	21.00	32	17	6.3279	-28.3768	21.00
15	15	6.5284	-28.0177	20.00	33	17	6.3060	-26.7449	21.00
16	14	6.4612	-25.1004	20.00	34	16	6.2803	-25.3861	20.00
17	14	6.1642	-24.1924	21.00	35	16	6.2591	-25.8852	20.50
18	14	6.9197	-24.8186	21.00	36	16	6.2591	-25.8852	20.50
WAVE CONDITION NUMBER 3: HEIGHT = 8.000 PERIOD = 8.000 ANGLE = 33.000									
1	15	8.1520	28.6382	20.00	19	13	8.8175	27.7379	21.00
2	16	8.1520	28.6382	20.00	20	13	8.5591	26.7149	21.00
3	16	8.9828	29.2892	21.00	21	13	8.4229	26.2424	21.00
4	16	8.8101	28.5237	21.00	22	13	8.3652	25.6493	20.00
5	16	8.7367	28.1241	21.00	23	14	8.2504	27.1101	21.00
6	16	8.7572	27.8268	20.00	24	13	8.1857	26.3850	21.00
7	14	8.7114	27.7162	20.50	25	13	8.1788	25.5069	21.00
8	14	8.7413	26.2820	20.50	26	13	8.1787	25.7634	20.00
9	14	8.8604	26.5580	20.50	27	13	7.9865	25.2467	20.00
10	14	8.8176	27.5727	20.00	28	14	7.9688	24.8362	20.00
11	14	8.4617	27.9092	21.00	29	14	7.9807	22.6308	20.00
12	14	8.2404	26.2258	20.50	30	16	8.1793	22.7325	20.00
13	14	8.2531	25.9373	20.50	31	16	8.2410	24.4143	21.00
14	16	8.3148	26.4121	21.00	32	17	8.3182	25.7744	21.00
15	16	8.6933	26.3285	20.00	33	17	8.3601	27.4792	21.00
16	14	8.9883	27.8425	20.00	34	16	8.2952	26.9136	20.00
17	14	8.9130	27.4160	21.00	35	16	8.2190	26.3395	20.50
18	14	8.9364	28.8230	21.00	36	16	8.2190	26.3395	20.50

Figure C2. RCPGRAF input file RCPEXP.NSR

# Appendix D

## Input Data Set for DPLOT Example

---

This appendix contains a listing of the SHORLROT and CUINTP output data files that served as input to the program DPLOT.EXE in the DPLOT example application described in Chapter 4. The input data set consisted of two SHORLROT output data files (82SHO.ROT and 86SHO.ROT) and two CUINTP output data files (82SHO.ISH and 86SHO.ISH) as shown in Figures D1 through D4.

27								
0.1	692.0	247.4	641.2	515.6	592.9	755.9	556.6	
997.5	517.5	1238.4	502.6	1432.1	470.3	1667.5	443.8	
1845.8	420.6	2054.6	380.0	2456.3	332.3	2708.6	294.0	
2964.0	249.5	3248.0	214.4	3561.5	164.9	3815.6	123.0	
4041.6	93.0	4289.5	63.7	4509.8	45.5	4722.5	20.1	
4928.5	8.3	5194.1	11.0	5504.5	36.5	5798.6	72.1	
6077.6	115.9	6376.1	188.1	6844.1	289.5			

Figure D1. DPLOT input file 82SHO.ROT

26								
2.9	702.3	257.5	650.1	491.0	602.5	747.8	556.8	
1254.4	477.0	1572.8	449.9	1917.1	397.0	2132.4	344.8	
2460.6	313.9	2785.3	295.0	3050.6	253.2	3333.5	236.8	
3609.4	179.7	3860.0	162.3	4073.1	141.3	4369.8	116.0	
4671.5	112.0	4956.1	110.3	5212.9	126.2	5474.1	142.2	
5735.4	167.5	5982.4	229.2	6213.0	286.7	6403.4	336.8	
6646.1	375.3	6844.5	436.7					

Figure D2. DPLOT input file 86SHO.ROT

Appendix D

273	25.0000					
0.	0.0	25. 686.8	50. 681.6	75. 676.4	100. 671.2	
125. 666.0	150. 660.9	175. 655.8	200. 650.7	225. 645.7		
250. 640.7	275. 635.8	300. 630.9	325. 626.1	350. 621.4		
375. 616.8	400. 612.3	425. 607.8	450. 603.6	475. 599.4		
500. 595.3	525. 591.5	550. 587.7	575. 584.0	600. 580.4		
625. 576.8	650. 573.2	675. 569.5	700. 565.7	725. 561.7		
750. 557.6	775. 553.3	800. 548.7	825. 544.1	850. 539.5		
875. 535.1	900. 530.8	925. 526.7	950. 523.1	975. 519.9		
1000. 517.3	1025. 515.2	1050. 513.6	1075. 512.4	1100. 511.3		
1125. 510.3	1150. 509.2	1175. 507.9	1200. 506.2	1225. 504.0		
1250. 501.2	1275. 497.7	1300. 493.7	1325. 489.4	1350. 484.8		
1375. 480.2	1400. 475.7	1425. 471.4	1450. 467.6	1475. 464.1		
1500. 460.9	1525. 458.0	1550. 455.3	1575. 452.8	1600. 450.3		
1625. 447.9	1650. 445.5	1675. 443.0	1700. 440.4	1725. 437.6		
1750. 434.6	1775. 431.4	1800. 427.9	1825. 424.1	1850. 419.9		
1875. 415.3	1900. 410.5	1925. 405.5	1950. 400.4	1975. 395.3		
2000. 390.3	2025. 385.4	2050. 380.8	2075. 376.5	2100. 372.6		
2125. 368.9	2150. 365.5	2175. 362.4	2200. 359.4	2225. 356.6		
2250. 353.9	2275. 351.4	2300. 348.8	2325. 346.3	2350. 343.8		
2375. 341.3	2400. 338.7	2425. 335.9	2450. 333.1	2475. 330.0		
2500. 326.8	2525. 323.4	2550. 319.8	2575. 316.1	2600. 312.2		
2625. 308.2	2650. 304.1	2675. 299.9	2700. 295.5	2725. 291.1		
2750. 286.5	2775. 282.0	2800. 277.4	2825. 272.8	2850. 268.4		
2875. 263.9	2900. 259.7	2925. 255.5	2950. 251.6	2975. 247.9		
3000. 244.4	3025. 241.1	3050. 238.0	3075. 234.9	3100. 232.0		
3125. 229.1	3150. 226.2	3175. 223.3	3200. 220.4	3225. 217.3		
3250. 214.1	3275. 210.8	3300. 207.3	3325. 203.7	3350. 199.9		
3375. 196.1	3400. 192.1	3425. 188.0	3450. 183.9	3475. 179.7		
3500. 175.5	3525. 171.2	3550. 166.9	3575. 162.6	3600. 158.2		
3625. 153.9	3650. 149.6	3675. 145.4	3700. 141.2	3725. 137.1		
3750. 133.1	3775. 129.1	3800. 125.3	3825. 121.6	3850. 118.1		
3875. 114.6	3900. 111.2	3925. 107.9	3950. 104.7	3975. 101.5		
4000. 98.3	4025. 95.1	4050. 91.9	4075. 88.7	4100. 85.5		
4125. 82.3	4150. 79.1	4175. 76.0	4200. 73.1	4225. 70.2		
4250. 67.6	4275. 65.1	4300. 62.8	4325. 60.7	4350. 58.7		
4375. 56.8	4400. 54.9	4425. 53.0	4450. 51.0	4475. 48.9		
4500. 46.5	4525. 43.9	4550. 41.0	4575. 37.9	4600. 34.8		
4625. 31.6	4650. 28.4	4675. 25.3	4700. 22.5	4725. 19.9		
4750. 17.5	4775. 15.5	4800. 13.8	4825. 12.3	4850. 11.0		
4875. 9.9	4900. 9.1	4925. 8.4	4950. 7.8	4975. 7.5		
5000. 7.2	5025. 7.1	5050. 7.2	5075. 7.5	5100. 7.9		
5125. 8.5	5150. 9.2	5175. 10.2	5200. 11.3	5225. 12.6		
5250. 14.0	5275. 15.7	5300. 17.4	5325. 19.4	5350. 21.4		
5375. 23.6	5400. 25.9	5425. 28.3	5450. 30.8	5475. 33.4		
5500. 36.0	5525. 38.7	5550. 41.5	5575. 44.4	5600. 47.3		
5625. 50.3	5650. 53.3	5675. 56.4	5700. 59.5	5725. 62.6		
5750. 65.8	5775. 69.0	5800. 72.3	5825. 75.6	5850. 78.9		
5875. 82.3	5900. 85.8	5925. 89.5	5950. 93.3	5975. 97.2		
6000. 101.4	6025. 105.8	6050. 110.5	6075. 115.4	6100. 120.6		
6125. 126.1	6150. 131.8	6175. 137.7	6200. 143.7	6225. 149.9		
6250. 156.2	6275. 162.6	6300. 168.9	6325. 175.3	6350. 181.6		
6375. 187.8	6400. 193.9	6425. 199.9	6450. 205.8	6475. 211.6		
6500. 217.3	6525. 222.9	6550. 228.4	6575. 233.9	6600. 239.3		
6625. 244.6	6650. 249.9	6675. 255.1	6700. 260.2	6725. 265.4		
6750. 270.5	6775. 275.5	6800. 280.6				

Figure D3. DPLOT input file 82SHO.ISH

D2

Input Data Set for DPLOT Example

273	25.0000				
0.	0.0	25. 697.8	50. 692.7	75. 687.6	100. 682.5
125. 677.4	150. 672.3	175. 667.2	200. 662.0	225. 656.8	
250. 651.7	275. 646.5	300. 641.2	325. 636.0	350. 630.8	
375. 625.6	400. 620.5	425. 615.5	450. 610.5	475. 605.6	
500. 600.8	525. 596.1	550. 591.5	575. 587.0	600. 582.6	
625. 578.2	650. 573.8	675. 569.5	700. 565.1	725. 560.8	
750. 556.4	775. 552.0	800. 547.6	825. 543.2	850. 538.7	
875. 534.3	900. 529.9	925. 525.5	950. 521.2	975. 517.0	
1000. 512.8	1025. 508.7	1050. 504.7	1075. 500.8	1100. 497.0	
1125. 493.3	1150. 489.8	1175. 486.5	1200. 483.3	1225. 480.3	
1250. 477.5	1275. 474.9	1300. 472.4	1325. 470.1	1350. 468.0	
1375. 465.9	1400. 464.0	1425. 462.0	1450. 460.1	1475. 458.1	
1500. 456.2	1525. 454.1	1550. 452.0	1575. 449.7	1600. 447.3	
1625. 444.7	1650. 441.9	1675. 439.0	1700. 435.8	1725. 432.4	
1750. 428.7	1775. 424.8	1800. 420.6	1825. 416.2	1850. 411.4	
1875. 406.3	1900. 400.9	1925. 395.1	1950. 389.1	1975. 382.8	
2000. 376.3	2025. 369.9	2050. 363.6	2075. 357.5	2100. 351.7	
2125. 346.3	2150. 341.4	2175. 337.1	2200. 333.3	2225. 329.9	
2250. 326.9	2275. 324.4	2300. 322.1	2325. 320.2	2350. 318.6	
2375. 317.2	2400. 316.1	2425. 315.1	2450. 314.2	2475. 313.5	
2500. 312.8	2525. 312.1	2550. 311.4	2575. 310.6	2600. 309.7	
2625. 308.7	2650. 307.4	2675. 305.9	2700. 304.0	2725. 301.9	
2750. 299.3	2775. 296.4	2800. 292.9	2825. 289.0	2850. 284.9	
2875. 280.5	2900. 276.0	2925. 271.5	2950. 267.2	2975. 263.0	
3000. 259.3	3025. 256.0	3050. 253.3	3075. 251.2	3100. 249.6	
3125. 248.5	3150. 247.7	3175. 247.0	3200. 246.3	3225. 245.4	
3250. 244.3	3275. 242.8	3300. 240.7	3325. 237.9	3350. 234.3	
3375. 230.0	3400. 225.0	3425. 219.6	3450. 213.9	3475. 207.9	
3500. 202.0	3525. 196.2	3550. 190.7	3575. 185.7	3600. 181.2	
3625. 177.5	3650. 174.5	3675. 172.1	3700. 170.2	3725. 168.7	
3750. 167.4	3775. 166.3	3800. 165.3	3825. 164.2	3850. 162.9	
3875. 161.3	3900. 159.4	3925. 157.2	3950. 154.8	3975. 152.2	
4000. 149.5	4025. 146.7	4050. 143.9	4075. 141.1	4100. 138.3	
4125. 135.6	4150. 133.0	4175. 130.5	4200. 128.0	4225. 125.8	
4250. 123.6	4275. 121.7	4300. 119.9	4325. 118.3	4350. 116.9	
4375. 115.8	4400. 114.9	4425. 114.1	4450. 113.6	4475. 113.2	
4500. 112.9	4525. 112.8	4550. 112.6	4575. 112.6	4600. 112.5	
4625. 112.4	4650. 112.2	4675. 112.0	4700. 111.6	4725. 111.2	
4750. 110.8	4775. 110.3	4800. 109.9	4825. 109.6	4850. 109.4	
4875. 109.3	4900. 109.3	4925. 109.6	4950. 110.1	4975. 110.9	
5000. 111.9	5025. 113.2	5050. 114.6	5075. 116.2	5100. 117.9	
5125. 119.7	5150. 121.6	5175. 123.4	5200. 125.3	5225. 127.1	
5250. 128.8	5275. 130.4	5300. 132.1	5325. 133.6	5350. 135.1	
5375. 136.6	5400. 138.1	5425. 139.5	5450. 140.9	5475. 142.2	
5500. 143.6	5525. 145.1	5550. 146.6	5575. 148.3	5600. 150.3	
5625. 152.5	5650. 155.1	5675. 158.1	5700. 161.6	5725. 165.6	
5750. 170.3	5775. 175.5	5800. 181.2	5825. 187.2	5850. 193.6	
5875. 200.3	5900. 207.0	5925. 213.8	5950. 220.6	5975. 227.3	
6000. 233.7	6025. 240.0	6050. 246.1	6075. 252.2	6100. 258.2	
6125. 264.2	6150. 270.4	6175. 276.7	6200. 283.2	6225. 290.0	
6250. 297.0	6275. 304.1	6300. 311.1	6325. 318.0	6350. 324.5	
6375. 330.6	6400. 336.1	6425. 340.9	6450. 345.1	6475. 348.8	
6500. 352.2	6525. 355.5	6550. 358.9	6575. 362.5	6600. 366.4	
6625. 371.0	6650. 376.2	6675. 382.2	6700. 388.9	6725. 396.3	
6750. 404.2	6775. 412.5	6800. 421.0			

Figure D4. DPLLOT input file 86SHO.ISH