

AD-A255 938



1

FINAL REPORT
OCTOBER 1991

REPORT NO. 91-20

U.S. NAVY (USN)
ALPHA MINE ROAD TEST

DTIC
ELECTE
SEP 25 1992
S A D

Prepared for:
Commanding Officer
Naval Weapons Station, Earle
ATTN: Code 8024
Colts Neck, NJ 07722-5000

Distribution Unlimited

92-25739
Barcode

24
pgs

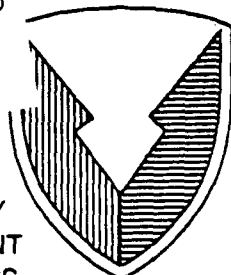

92 9 23 054

424283

VALIDATION ENGINEERING DIVISION
SAVANNA, ILLINOIS 61074-9639

U.S. ARMY
ARMAMENT
MUNITIONS
CHEMICAL COMMAND
U.S. ARMY DEFENSE AMMUNITION
CENTER AND SCHOOL

AVAILABILITY NOTICE

A copy of this report will be furnished each attendee on automatic distribution. Additional copies or authority for reprinting may be obtained by written request from Director, U.S. Army Defense Ammunition Center and School, ATTN: SMCAC-DEV, Savanna, IL 61074-9639.

DISTRIBUTION INSTRUCTIONS

Destroy this report when no longer needed. Do not return.

Citation of trade names in this report does not constitute an official endorsement.

The information contained herein will not be used for advertising purposes.

REPORT DOCUMENTATION PAGE				Form Approved OMB No. 0704-0188	
1a. REPORT SECURITY CLASSIFICATION UNCLASSIFIED		1b. RESTRICTIVE MARKINGS			
2a. SECURITY CLASSIFICATION AUTHORITY		3. DISTRIBUTION / AVAILABILITY OF REPORT UNLIMITED			
2b. DECLASSIFICATION / DOWNGRADING SCHEDULE					
4. PERFORMING ORGANIZATION REPORT NUMBER(S) EVT 33-90-1		5. MONITORING ORGANIZATION REPORT NUMBER(S)			
6a. NAME OF PERFORMING ORGANIZATION U.S. Army Defense Ammunition Center and School		6b. OFFICE SYMBOL <i>(if applicable)</i> SMCAC-DEV	7a. NAME OF MONITORING ORGANIZATION		
6c. ADDRESS <i>(City, State, and ZIP Code)</i> ATTN: SMCAC-DEV Savanna, IL 61074-9639		7b. ADDRESS <i>(City, State, and ZIP Code)</i>			
8a. NAME OF FUNDING / SPONSORING ORGANIZATION Naval Weapons Station, Earle		8b. OFFICE SYMBOL <i>(if applicable)</i>	9. PROCUREMENT INSTRUMENT IDENTIFICATION NUMBER		
8c. ADDRESS <i>(City, State, and ZIP Code)</i> ATTN: Code 8024 Colts neck, NJ 07722-5000		10. SOURCE OF FUNDING NUMBERS			
		PROGRAM ELEMENT NO.	PROJECT NO.	TASK NO.	WORK UNIT ACCESSION NO.
11. TITLE <i>(Include Security Classification)</i> U.S. Navy (USN) Alpha Mine Road Test					
12. PERSONAL AUTHOR(S) William R. Meyer					
13a. TYPE OF REPORT Final		13b. TIME COVERED FROM _____ TO _____		14. DATE OF REPORT <i>(Year, Month, Day)</i> 1991 October	15. PAGE COUNT
16. SUPPLEMENTARY NOTATION					
17. COSATI CODES			18. SUBJECT TERMS <i>(Continue on reverse if necessary and identify by block number)</i>		
FIELD	GROUP	SUB-GROUP			
19. ABSTRACT <i>(Continue on reverse if necessary and identify by block number)</i> The U.S. Army Defense Ammunition Center and School (USADACS), Validation Engineering Division (SMCAC-DEV), was tasked by Naval Weapons Station, Earle (NWS-Earle) to perform road transportability tests on the U.S. Navy (USN) Alpha Quickstrike/DST-41 mines. The following report contains test results and successful completion of all road transportability tests.					
20. DISTRIBUTION / AVAILABILITY OF ABSTRACT <input checked="" type="checkbox"/> UNCLASSIFIED/UNLIMITED <input type="checkbox"/> SAME AS RPT. <input type="checkbox"/> DTIC USERS			21. ABSTRACT SECURITY CLASSIFICATION UNCLASSIFIED		
22a. NAME OF RESPONSIBLE INDIVIDUAL JEROME H. KROHN		22b. TELEPHONE <i>(Include Area Code)</i> 815-273-8929		22c. OFFICE SYMBOL SMCAC-DEV	

U.S. ARMY DEFENSE AMMUNITION CENTER AND SCHOOL
VALIDATION ENGINEERING DIVISION
SAVANNA, IL 61074-9639

REPORT NO. 91-20
U.S. NAVY (USN) ALPHA MINE ROAD TEST

TABLE OF CONTENTS

PART	PAGE NO.
1. INTRODUCTION	1-1
A. BACKGROUND.....	1-1
B. AUTHORITY	1-1
C. OBJECTIVE.....	1-1
2. ATTENDEES	2-1
3. ROAD TEST PROCEDURES.....	3-1
4. ITEMS TESTED.....	4-1
5. TEST RESULTS.....	5-1
6. CONCLUSION.....	6-1
7. PHOTOGRAPHS	7-1
8. APPENDIX.....	8-1

PART 1

INTRODUCTION

A. BACKGROUND. The U.S. Army Defense Ammunition Center and School (USADACS), Validation Engineering Division (SMCAC-DEV), was tasked by Naval Weapons Station, Earle (NWS-Earle) to perform road transportability tests on the U.S. Navy (USN) Alpha Quickstrike/DST-41 mines.

B. AUTHORITY. Testing was accomplished in accordance with mission responsibilities delegated by the U.S. Army Armament, Munitions and Chemical Command (AMCCOM), Rock Island, IL.

C. OBJECTIVE. The objective of this test is to determine if the MK84 bombs can be assembled with MK-165-0 mine kits, MK32 arming devices, and MK-42-7 firing mechanisms at a remote site and safely transported to the flight line for aircraft uploading. Previous procedures required assembly on the flight line resulting in delays and slow turnaround of the aircraft.

Accession For	
NTIS (CRAP)	✓
DTIC TAB	✓
Unannounced	✓
Justification	
By _____	
Distribution /	
Availability Codes	
Dist	Avail and/or Special
A-1	

DTIC QUALITY INSPECTED 3

PART 2

U.S. NAVY (USN) ALPHA MINE ROAD TEST

OCTOBER 1991

ATTENDEES

NAME AND PHONE NO.	ORGANIZATION
William R. Meyer Test Engineer DSN 585-8090 815-273-8090	U.S. Army Defense Ammunition Center and School ATTN: SMCAC-DEV Savanna, IL 61074-9639
Ralph Arnold Engineering Technician DSN 585-8071 815-273-8071	U.S. Army Defense Ammunition Center and School ATTN: SMCAC-DET Savanna, IL 61074-9639
Michael L. Gearhart DSN 449-2855 908-577-2855	Naval Weapons Station, Earle ATTN: Code 8024 Colts Neck, NJ 07722
James S. Foster DSN 958-3729 804-888-3729	Naval Mine Warfare Engineering ATTN: Code 31 Yorktown, PA 23012
Dennis Mills DSN 563-4976 803-743-4976	MOMAG Unit Eleven 2511 Command St. North Charleston, SC 29418
Steve Ciccarello DSN 563-4976 803-743-4976	MOMAG Unit Eleven 2511 Command St. North Charleston, SC 29418
Patrick J. Rappley DSN 563-4976 803-743-4976	MOMAG Unit Eleven 2511 Command St. North Charleston, SC 29418

PART 3

ROAD TEST PROCEDURES

Five separate road testing steps are required as identified herein:

A. Step No. 1. This step provides for the specimen load to be driven over a 200-foot-long segment of concrete-paved road which consists of two series of railroad ties projecting 6 inches above the level of the road surface. This hazard course was traversed two times and repeated per step no. 4.

(1) The first series of ties is spaced on 8-foot centers and alternately positioned on opposite sides of the road centerline for a distance of 50 feet.

(2) Following the first series of ties, a paved roadway of 75 feet separates the first and second series of railroad ties.

(3) The second series of ties is alternately positioned similiarly to the first, but spaced on 10-foot centers for a distance of 50 feet.

(4) The specimen load was driven across the hazard course at speeds that would produce the most violent vertical and side-to-side rolling reaction obtainable in traversing the hazard course (approximately 5 miles per hour [mph]).

B. Step No. 2. This step consists of 30 miles of travel over available rough roads consisting of gravel, concrete and asphalt, curves, cattle gates, and stops and starts.

C. Step No. 3. This step provides for the specimen load to be subjected to three full air brake stops while traveling in the forward direction, and one in the reverse direction down a

7 percent grade. The first three stops are at speeds of 5, 10, and 15 mph while the stop in the reverse direction is at approximately 5 mph.

D. Step No. 4. This step consists of a repeat of that identified in step no. 1.

E. Step No. 5. This step provides for the specimen load to be driven over a 300-foot-long segment of concrete-paved road which has rails spaced in 26 1/2-inch centers and protruding 2 inches above the road surface. The specimen load was driven at the speed which will produce the most violent response.

NOTE: Steps nbs. 3 and 5 may be deleted at the discretion of the test engineer.

INSPECTION AND DATA COLLECTION. At selected intervals during testing, thorough inspections of the specimen loads were made by technically proficient personnel to collect data on the specimen load and equipment resulting from above load test steps. The data are recorded in part 5 of this report.

US ARMY DEFENSE AMMUNITION CENTER AND SCHOOL

TRANSPORTABILITY ROAD COURSE

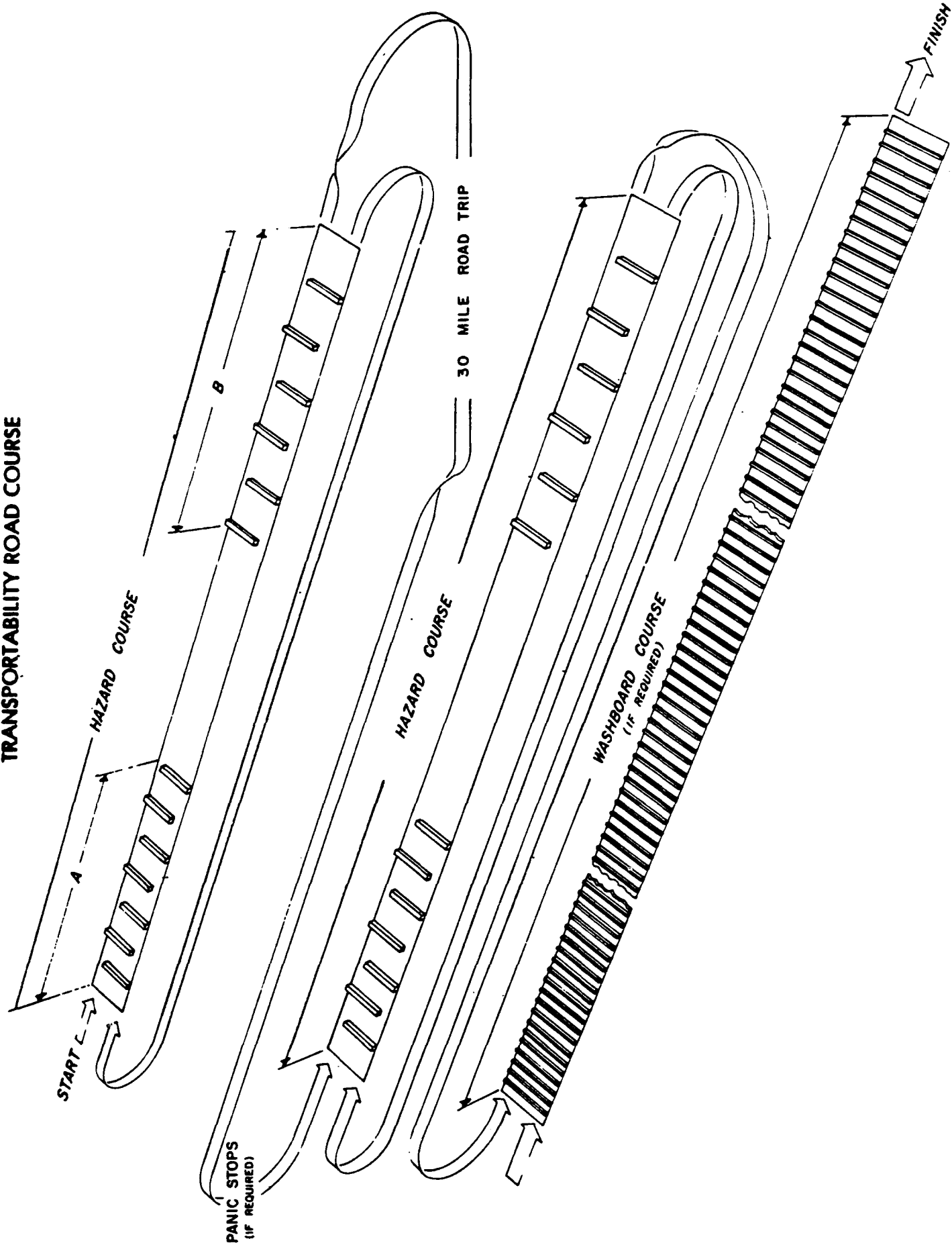

PART 4

ITEMS TESTED

A. U.S. Navy (USN) Alpha Quickstrike/DST-41 Mines.

- (1) MK 32 Mod 3 Arming Device
- (2) MK 42 Mod 7 Firing Mechanism.
- (3) MK 160-0 Mine Flight Gear.
- (4) MK 165-0 Arming Hardware.
- (5) MK 84 2,000-Pound Bombs.
- (6) MK 79 Lower Pallet Adapter.

B. Test Weight: 8,530 pounds.

ALPHA MINE ROAD TEST

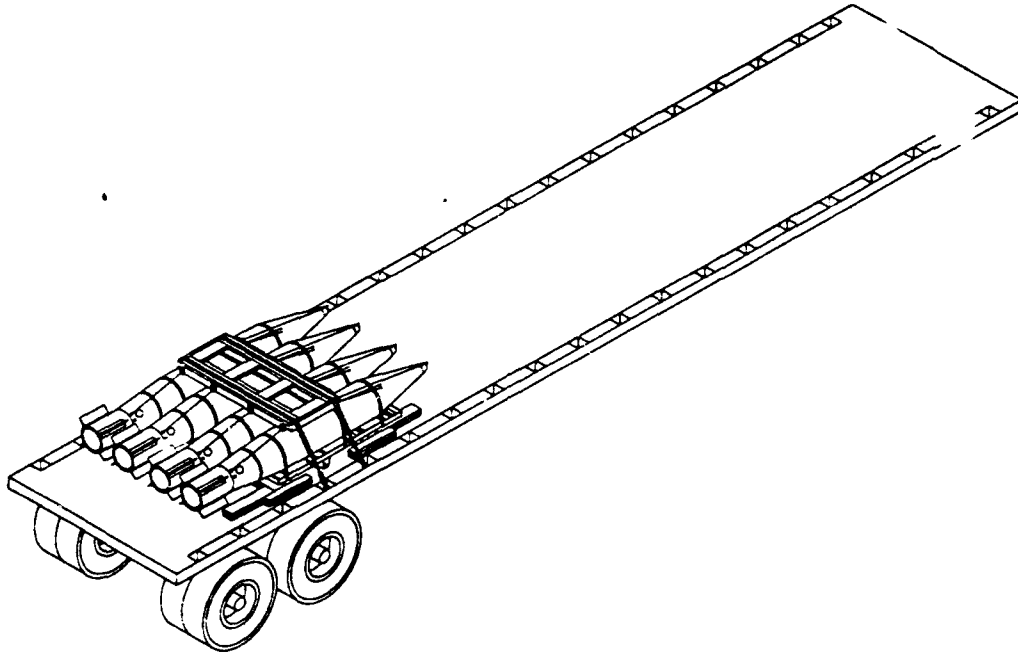

NOTES:

1. TEST CONDUCTED ON A 40 FT. COMMERCIAL TRAILER

FOR INFORMATION ONLY

TITLE

U.S. NAVY ALPHA
MINE ROAD TEST

DWG NO

91-020-0-T00045

VALIDATION ENGINEERING DIVISION

SHEET 1 OF 1

PART 5

TEST RESULTS

A. Prior to testing, the USN Alpha Quickstrike/DST-41 mines had the MK 79 top metal adapter removed with the MK 84 bombs fastened to the lower pallet adapter with three 1 1/2-inch metal bands. Also, prior to testing, both test pallets were readjusted to eliminate tail fin contact on two bombs, and bomb misalignment of 1-inch on a third. Both pallets were tested on the rear of a commercial 40-foot flatbed trailer, which generated the greatest amount of shock in the test samples. Floor line blocking, restricted longitudinal movement, and a wooden top pallet adapter, chains, and load binders restricted the vertical movement (see the appendix for details).

B. After the first pass over the railroad tie course and in all subsequent tests, the forward most metal bands restraining the bombs were loose. This was due to the projectiles sliding to the rear of the pallet and trailer. This rear movement, noted during most phases of testing, was longitudinal movement to the rear of the trailer of less than 2 inches (see table 1). This movement and loose bands did not have an adverse effect on test results.

Table 1

Longitudinal Bomb Movement

	Bomb Position			
	Far Right (Inches)	Center Right (Inches)	Center Left (Inches)	Far Left (Inches)
After 1st Rail Tie Pass	0.75	0.375	0.125	0.50
After 2nd Rail Tie Pass	0.875	0.25	0.125	0.625
After 30-Mile Road Course	1.125	0.25	0.50	0.75
After 5 MPH Panic Stop	1.25	0.125	0.50	0.625
After 10 MPH Panic Stop	1.25	0.125	0.375	0.625
After 15 MPH Panic Stop	1.25	0.125	0.375	0.625
After 5 MPH Rev. Panic Stop	1.75	0.75	0.875	1.50
After 3rd Rail Tie Pass	1.375	0.375	0.50	0.875
After 4th Rail Tie Pass	1.375	0.875	0.50	0.875
After Washboard Course	1.375	0.75	0.50	0.875

Note: Measurements of bomb movement rearward in relation to the pallet.

C. During all phases of testing, slight bomb rotation was noted with the clearances between tail fin assemblies being recorded (see table 2). This rotation did not have an adverse effect on the test results; however, the geometry of the tail fin assemblies could result in tail fin contact

and damage if several adjacent bombs rotated in opposite directions at the same time. However, this was not observed during testing.

Table 2

	Bomb Rotation		
	Rightside Bombs (Inches)	Center Bombs (Inches)	Leftside Bombs (Inches)
Before Testing	0.75	1.75	0.625
After 1st Rail Tie Pass	0.625	1.625	0.375
After 2nd Rail Tie Pass	0.50	1.75	0.25
After 30-Mile Road Course	0.50	1.75	0.25
After 5 MPH Panic Stop	0.50	1.75	0.25
After 10 MPH Panic Stop	0.50	1.75	0.25
After 15 MPH Panic Stop	0.50	1.75	0.25
After 5 MPH Rev. Panic Stop	0.50	1.75	0.187
After 3rd Rail Tie Pass	0.50	1.75	0.062
After 4th Rail Tie Pass	0.50	1.75	0.125 (1)*
After Washboard Course	0.50	1.625	0.125 (1)*

Note: Measurements taken from right to left facing the rear of the trailer.

*(1) Indicates absolute clearance between fins, all other figures indicate horizontal clearance.

D. The following times and speeds were recorded during testing over the railroad tie and washboard courses with no problems encountered (see table 3).

Table 3

Railroad Tie And Washboard Course Speeds

	Seconds	MPH
Railroad Tie Course (Pass 1)	25.71	4.64
Railroad Tie Course (Pass 2)	25.64	4.65
Railroad Tie Course (Pass 3)	25.37	4.70
Railroad Tie Course (Pass 4)	25.59	4.66
Washboard Course	109.02	1.88

PART 6

CONCLUSION

As tested, the items identified above passed all phases of transportability tests. The rotation and longitudinal movement of the bombs was not severe enough to have an adverse effect on test results.

PART 7

PHOTOGRAPHS



U.S. ARMY DEFENSE AMMUNITION CENTER AND SCHOOL - SAVANNA, IL

Photo No. AO317-SON-91-297-4890. This photo shows an overall view of the test load.

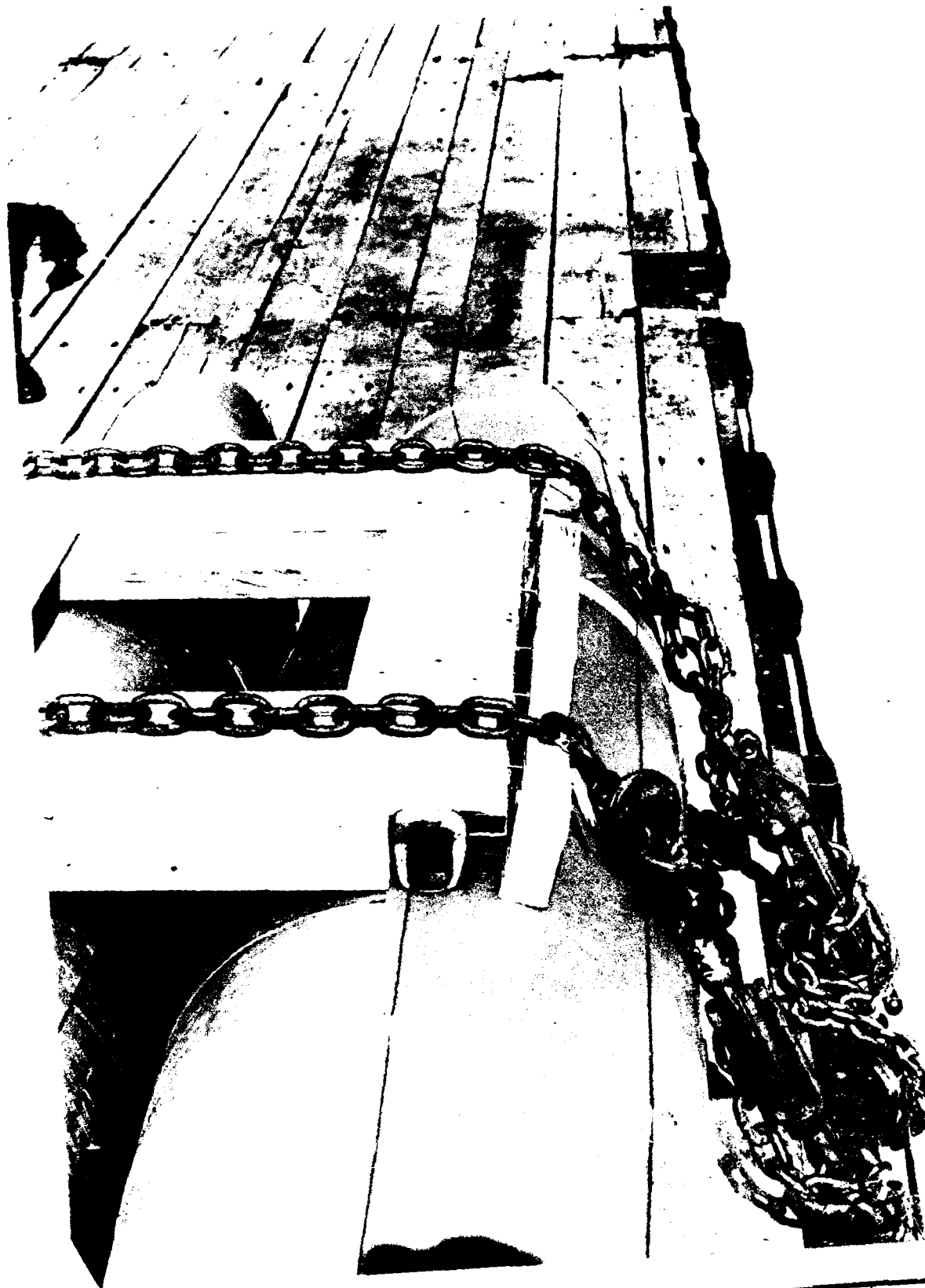

U.S. ARMY DEFENSE AMMUNITION CENTER AND
SCHOOL - SAVANNA, IL

Photo No. AO317-SEN-91-297-4989. This photo shows the damage to dunnage
prior to testing by chain load binders.



U.S. ARMY DEFENSE AMMUNITION CENTER AND SCHOOL - SAVANNA, IL

Photo No. AO317-SPN-91-297-4891. After testing, the 2,000-pound bombs moved rearward resulting in loose bands (as shown in this photo).

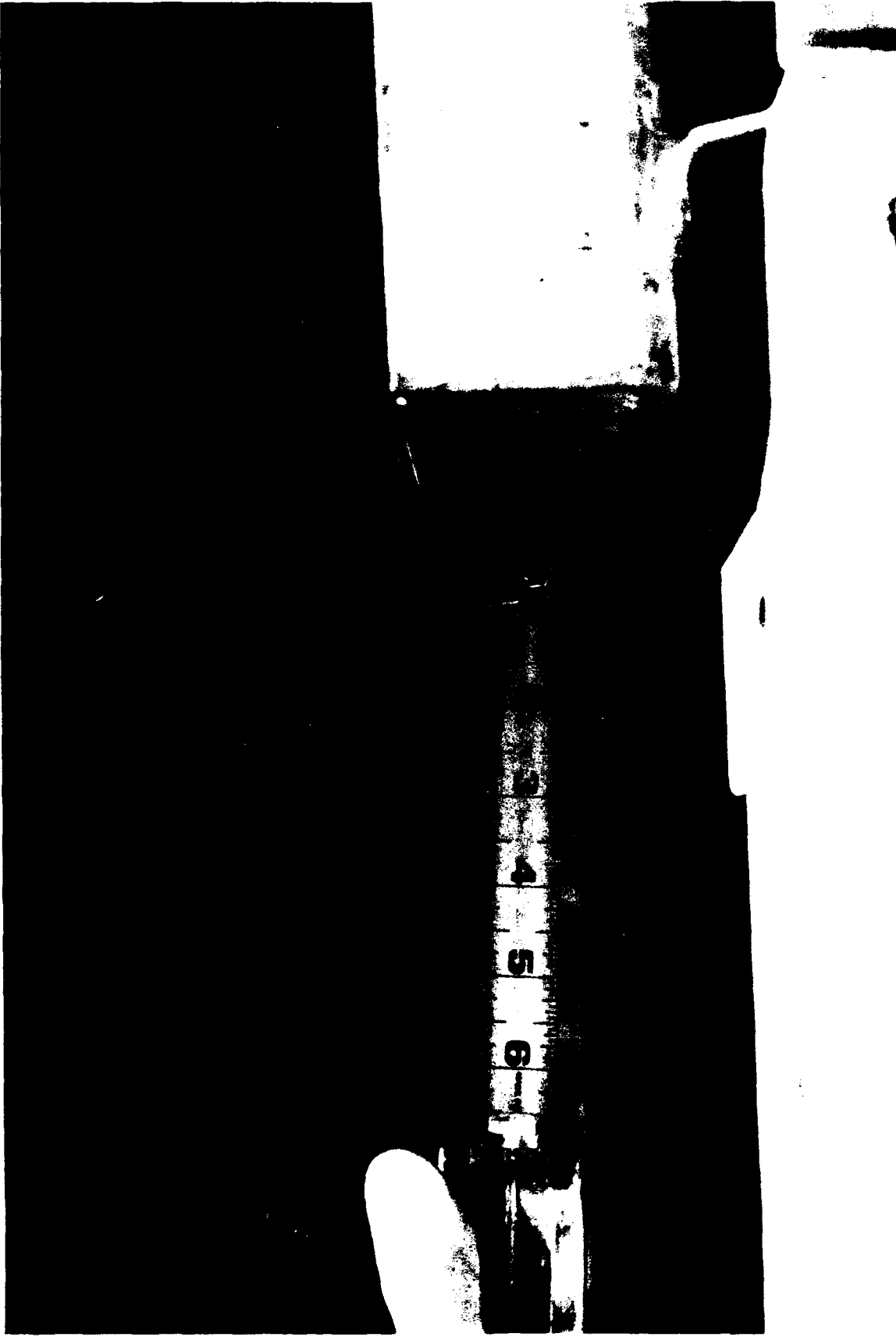

U.S. ARMY DEFENSE AMMUNITION CENTER AND SCHOOL - SAVANNA, IL

Photo No. AO317-SPN-91-297-4892. This photo shows a 1 1/2-inch rearward movement of bombs after testing.



	U.S. ARMY DEFENSE AMMUNITION CENTER AND SCHOOL - SAVANNA, IL	
--	---	--

Photo No. AO317-SPN-91-297-4899. This photo shows the rotational movement of bombs. Note, this movement can result in laterally adjacent fins coming in contact.

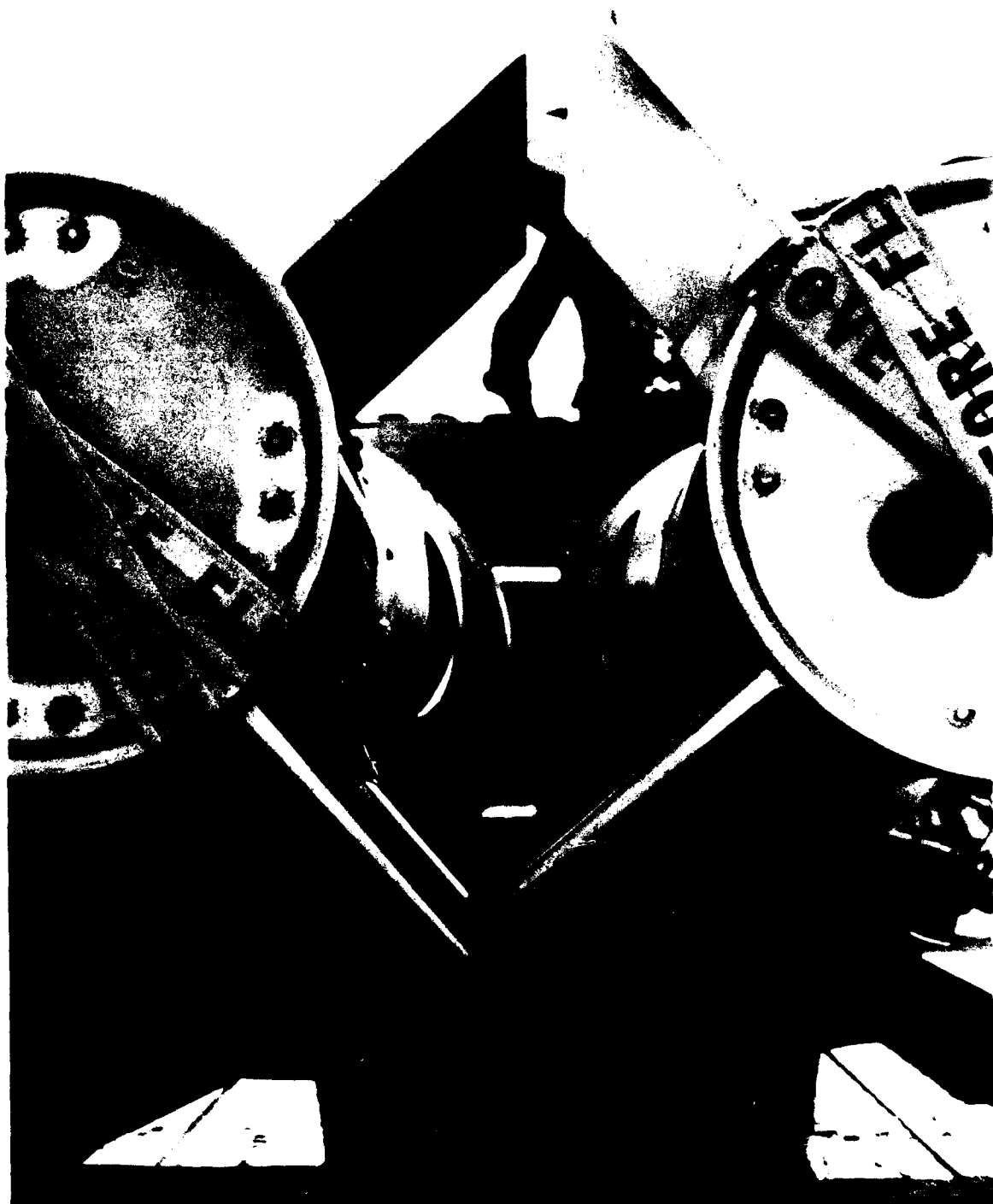

U.S. ARMY DEFENSE AMMUNITION CENTER AND
SCHOOL - SAVANNA, IL

Photo No. AO317-SPN-91-297-4900. This photo indicates the rotational movement of one bomb. Note, the tail fin clearances.

PART 8

APPENDIX

COPY AVAILABLE TO DTIC DOES NOT PERMIT FULLY LEGIBLE REPRODUCTION

PALLETING PROCEDURE

- 1 POSITION ONE BOMB ON RIGHT HAND SIDE OF PALLET
- 2 TIGHTEN STRAPS (THREE STRAPS PER BOMB) BETWEEN PALLET AND BOMB AS SHOWN IN MAIN DRAWING AND SECTION A-A
- 3 TIGHTEN AND TIGHTEN UP NOTCH STRAPS AS SHOWN IN MAIN DRAWING AND SECTION B-B
- 4 POSITION STRAP FOR LEFT HAND BOMB AND PLACE BOMB ON PALLET
- 5 TIGHTEN AND SEAL STRAPS AS SHOWN IN SECTION B-B
- 6 ALL STRAPS MUST BE THREADED UNDERNEATH ARMED WIRES

UNIT LOAD DATA

NUMBER OF DESTROYERS PER UNIT LOAD 2
 WEIGHT OF ONE DESTROYER (APPROX) 1989 LBS
 WEIGHT OF M-79 ADAPTER BOTTOM FRAME (APPROX) 175 LBS
 WEIGHT OF STEEL STRAPPING (APPROX) 7 LBS
 GROSS WEIGHT OF UNIT LOAD (APPROX) 4150 LBS
 CUBE 78.5 CU FT

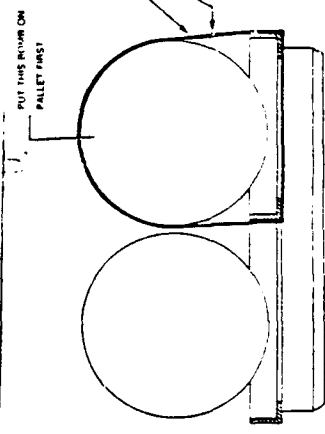
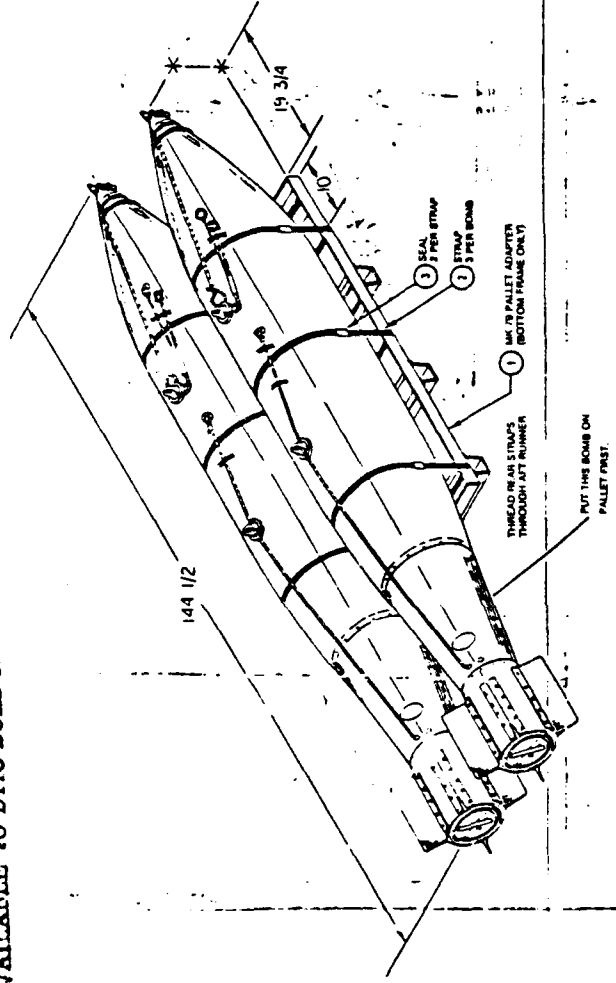

SECTION A-A

STRAPPING ROUTE FOR RIGHT HAND BOMB

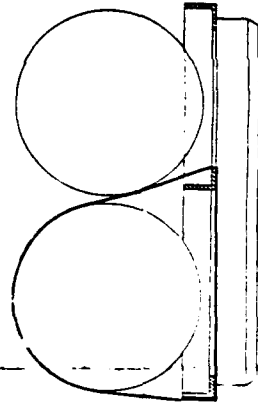

SECTION B-B

STRAPPING ROUTE FOR LEFT HAND BOMB

NOTES:

- 1 UNLESS OTHERWISE SPECIFIED, MATERIAL SHALL BE IN ACCORDANCE WITH MIL STD 1302 (MIL-S-1302)
- 2 COLD ROLLED, HEAT TREATED Q31 STRAPPING MAY BE SUBSTITUTED

LIST OF MATERIALS

QTY	DESCRIPTION	MATL/DWG	DIMENSIONS
12	STRAP SEAL	SEE NOTE 1	1 1/4 INCL SZ
5	STEEL STRAP	SEE NOTES 1 & 2	1 1/4 L, 0.35 X 8 FT
1	M-79 ADAPTER (BOTTOM)	24-2547	

INTERPRET DRAWING IN ACCORDANCE WITH MIL-STD-100 AND 100A. DO NOT SCALE. DRAWING DIMENSIONS ARE IN INCHES UNLESS OTHERWISE SPECIFIED. PARTS OF THIS DRAWING ARE NOT TO BE REPRODUCED OR TRANSMITTED IN ANY FORM OR BY ANY MEANS, ELECTRONIC OR MECHANICAL, INCLUDING PHOTOCOPYING, RECORDING, OR BY ANY INFORMATION STORAGE AND RETRIEVAL SYSTEM.	PART OR DRAWING NO. DESCRIPTION PART LIST	NOMENCLATURE OR SPECIFICATION MATERIAL OR MFG
STRAPPING ROUTE FOR RIGHT HAND BOMB STRAPPING ROUTE FOR LEFT HAND BOMB	NAVY WEAPONS WEAPONS CENTER CODE 3411 (1717)	DIVISION OF THE NAVY WASHINGTON, D.C. 20340
CLASSIFICATION OF DRAWING/ITERATIVE (SEE MIL-STD-200)	DATE FOR REVISION (SEE MIL-STD-100)	DATE FOR REVISION (SEE MIL-STD-100)
CRYSTAL NAME NUMBER	D 53711 Dwg No 10768	SHEET 1 OF 1

GENERAL NOTES

1. THE CONTRACTOR SHALL BE RESPONSIBLE FOR THE PROTECTION OF ALL UTILITIES AND STRUCTURES EXISTING ON THE PROJECT.
2. THE CONTRACTOR SHALL BE RESPONSIBLE FOR THE PROTECTION OF ALL UTILITIES AND STRUCTURES EXISTING ON THE PROJECT.
3. THE CONTRACTOR SHALL BE RESPONSIBLE FOR THE PROTECTION OF ALL UTILITIES AND STRUCTURES EXISTING ON THE PROJECT.
4. THE CONTRACTOR SHALL BE RESPONSIBLE FOR THE PROTECTION OF ALL UTILITIES AND STRUCTURES EXISTING ON THE PROJECT.
5. THE CONTRACTOR SHALL BE RESPONSIBLE FOR THE PROTECTION OF ALL UTILITIES AND STRUCTURES EXISTING ON THE PROJECT.
6. THE CONTRACTOR SHALL BE RESPONSIBLE FOR THE PROTECTION OF ALL UTILITIES AND STRUCTURES EXISTING ON THE PROJECT.
7. THE CONTRACTOR SHALL BE RESPONSIBLE FOR THE PROTECTION OF ALL UTILITIES AND STRUCTURES EXISTING ON THE PROJECT.
8. THE CONTRACTOR SHALL BE RESPONSIBLE FOR THE PROTECTION OF ALL UTILITIES AND STRUCTURES EXISTING ON THE PROJECT.
9. THE CONTRACTOR SHALL BE RESPONSIBLE FOR THE PROTECTION OF ALL UTILITIES AND STRUCTURES EXISTING ON THE PROJECT.
10. THE CONTRACTOR SHALL BE RESPONSIBLE FOR THE PROTECTION OF ALL UTILITIES AND STRUCTURES EXISTING ON THE PROJECT.
11. THE CONTRACTOR SHALL BE RESPONSIBLE FOR THE PROTECTION OF ALL UTILITIES AND STRUCTURES EXISTING ON THE PROJECT.
12. THE CONTRACTOR SHALL BE RESPONSIBLE FOR THE PROTECTION OF ALL UTILITIES AND STRUCTURES EXISTING ON THE PROJECT.
13. THE CONTRACTOR SHALL BE RESPONSIBLE FOR THE PROTECTION OF ALL UTILITIES AND STRUCTURES EXISTING ON THE PROJECT.
14. THE CONTRACTOR SHALL BE RESPONSIBLE FOR THE PROTECTION OF ALL UTILITIES AND STRUCTURES EXISTING ON THE PROJECT.
15. THE CONTRACTOR SHALL BE RESPONSIBLE FOR THE PROTECTION OF ALL UTILITIES AND STRUCTURES EXISTING ON THE PROJECT.
16. THE CONTRACTOR SHALL BE RESPONSIBLE FOR THE PROTECTION OF ALL UTILITIES AND STRUCTURES EXISTING ON THE PROJECT.
17. THE CONTRACTOR SHALL BE RESPONSIBLE FOR THE PROTECTION OF ALL UTILITIES AND STRUCTURES EXISTING ON THE PROJECT.
18. THE CONTRACTOR SHALL BE RESPONSIBLE FOR THE PROTECTION OF ALL UTILITIES AND STRUCTURES EXISTING ON THE PROJECT.
19. THE CONTRACTOR SHALL BE RESPONSIBLE FOR THE PROTECTION OF ALL UTILITIES AND STRUCTURES EXISTING ON THE PROJECT.
20. THE CONTRACTOR SHALL BE RESPONSIBLE FOR THE PROTECTION OF ALL UTILITIES AND STRUCTURES EXISTING ON THE PROJECT.

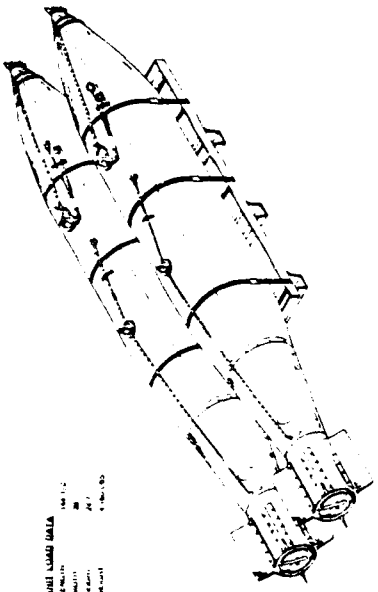
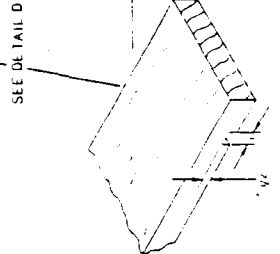
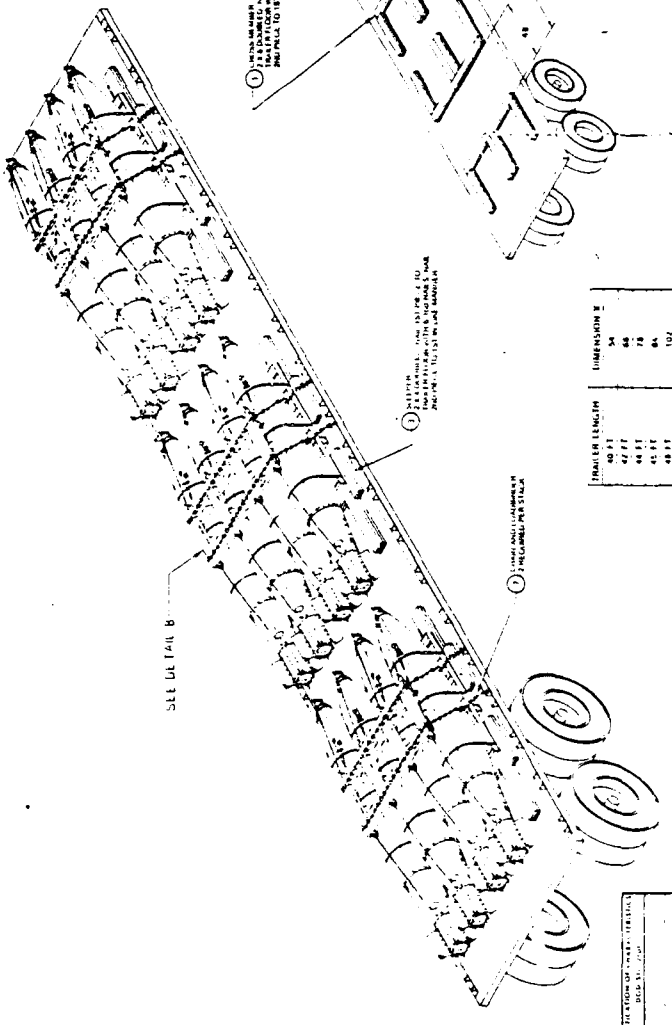
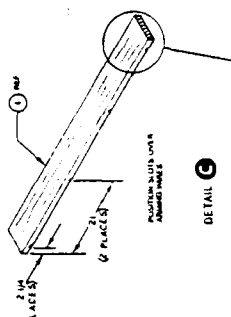
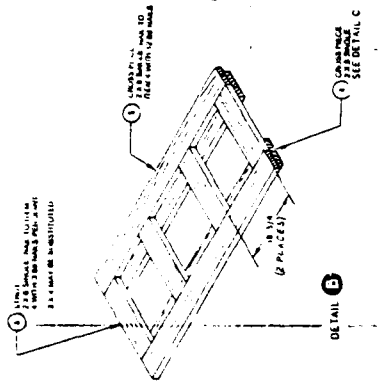

TABLE 1 - BRIDGE DATA

BRIDGE NO.	101
SPAN	100 FT
TYPE	CONCRETE
DATE	10/1/63



LIST OF MATERIALS

ITEM NO.	DESCRIPTION	QUANTITY	UNITS
1	CONCRETE	1000	CU YD
2	STEEL REINFORCEMENT	100	TONS
3	FORMWORK	1000	SQ YD
4	PAINT	100	GALLONS
5	GRANULAR FILL	1000	CY
6	ASPHALT	1000	SQ YD
7	BRICK	1000	1000'S
8	GLASS	1000	SQ FT
9	WOOD	1000	CU YD
10	IRON	1000	TONS

PREPARATION BUILDING

PROJECT NO.	101
DATE	10/1/63
SCALE	1/4" = 1'-0"
DESIGNED BY	J. D. SMITH
CHECKED BY	M. J. BROWN
APPROVED BY	A. C. GREEN
DATE	10/1/63

COPY AVAILABLE TO DTIC DOES NOT PERMIT FULLY REPRODUCIBLE