

0150

1686

ADA-255507

R D & E

C E N T E R

Technical Report

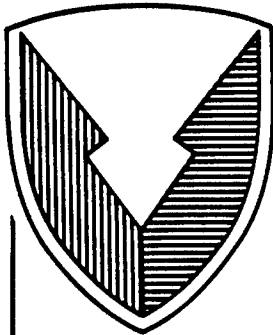

No. 13562

COMPUTER-BASED SIMULATION AND
STABILITY ANALYSIS OF M35A2/M105A2 COMBINATION

MARCH 1992

Michael K. Pozolo
U.S. Army Tank-Automotive Command
ATTN: AMSTA-RYA
Warren, MI 48397-5000

By _____

APPROVED FOR PUBLIC RELEASE
DISTRIBUTION IS UNLIMITED

20040105187

**U.S. ARMY TANK-AUTOMOTIVE COMMAND
RESEARCH, DEVELOPMENT & ENGINEERING CENTER
Warren, Michigan 48397-5000**

NOTICES

This report is not to be construed as an official Department of the Army position.

Mention of any trade names or manufacturers in this report shall not be construed as an official endorsement or approval of such products or companies by the U.S. Government.

Destroy this report when it is no longer needed. Do not return it to the originator.

REPORT DOCUMENTATION PAGE

Form Approved
OMB No. 0704-0188

Public reporting burden for this collection of information is estimated to average 1 hour per response, including the time for reviewing instructions, searching existing data sources, gathering and maintaining the data needed, and completing and reviewing the collection of information. Send comments regarding this burden estimate or any other aspect of this collection of information, including suggestions for reducing this burden, to Washington Headquarters Services, Directorate for Information Operations and Reports, 1215 Jefferson Davis Highway, Suite 1204, Arlington, VA 22202-4302, and to the Office of Management and Budget, Paperwork Reduction Project (0704-0188), Washington, DC 20503

1. AGENCY USE ONLY (Leave blank)		2. REPORT DATE March 1992	3. REPORT TYPE AND DATES COVERED Final	
4. TITLE AND SUBTITLE Computer Based Simulation and Stability Analysis of M35A2/M105A2 Combination			5. FUNDING NUMBERS	
6. AUTHOR(S) Michael K. Pozolo				
7. PERFORMING ORGANIZATION NAME(S) AND ADDRESS(ES) U.S. Army Tank-Automotive Command System Simulation and Technology Division (AMSTA-RYA) Warren, MI 48397-5000			8. PERFORMING ORGANIZATION REPORT NUMBER 13562	
9. SPONSORING / MONITORING AGENCY NAME(S) AND ADDRESS(ES) U.S. Army Tank-Automotive Command System Simulation and Technology Division (AMSTA-RYA) Warren, MI 48397-5000			10. SPONSORING / MONITORING AGENCY REPORT NUMBER	
11. SUPPLEMENTARY NOTES Unlimited				
12a. DISTRIBUTION / AVAILABILITY STATEMENT			12b. DISTRIBUTION CODE	
13. ABSTRACT (Maximum 200 words) This report describes the computer-based modeling, simulation and analysis of the M35A2 2-1/2-ton truck towing the M105A2 1-1/2-ton cargo trailer. It analyzes the effect that the towing eye position of the M105A2 trailer has on the overall performance and stability of the truck/trailer combination. The combination was simulated performing a severe slalom-type maneuver at varying truck speeds and with several different trailer payload configurations. The resulting roll angle, roll rate, and yaw angle of both the truck and trailer were recorded and are discussed in the report.				
14. SUBJECT TERMS Computer-Based Simulation, Dynamic Modeling Vehicle Performance			15. NUMBER OF PAGES 80	
			16. PRICE CODE	
17. SECURITY CLASSIFICATION OF REPORT Unclassified	18. SECURITY CLASSIFICATION OF THIS PAGE Unclassified	19. SECURITY CLASSIFICATION OF ABSTRACT Unclassified	20. LIMITATION OF ABSTRACT SAR	

CONTENTS

SUMMARY.....	7
INTRODUCTION/OBJECTIVE.....	7
PROCEDURE.....	8
RESULTS/DISCUSSION.....	10
CONCLUSIONS/RECOMMENDATIONS.....	17
DISTRIBUTION LIST.....	DIST-1

FIGURES

Figure 1. M35A2 Rigid Body Distance Constraints.....	9
Figure 2. M105A2 Rigid Body Distance Constraints.....	9
Figure 3. Slalom Course Maneuver.....	10

TABLES

Table 1. Trailer Payload Configurations.....	8
Table 2. M105A2 Trailer Simulation Results (40 mph).....	11
Table 3. Peak Values, No Load.....	13
Table 4. Peak Values, Half Load, Even Distribution.....	13
Table 5. Peak Values, Half Load, Front Half.....	14
Table 6. Peak Values, Half Load, Rear Half.....	14
Table 7. Peak Values, Half Load, Left Center.....	15
Table 8. Peak Values, Full Load, Even Distribution.....	15
Table 9. Peak Values, Full Load, Front Half.....	16
Table 10. Peak Values, Full Load, Rear Half.....	16
Table 11. Peak Values, Full Load, Left Center.....	17

APPENDICES

Appendix A. Time History Plots; 0 lbs Payload.....	A-1
Appendix B. Time History Plots; 1500 lbs Payload; Even Distribution.....	B-1
Appendix C. Time History Plots; 1500 lbs Payload; Front Half Distribution.....	C-1
Appendix D. Time History Plots; 1500 lbs Payload; Rear Half Distribution.....	D-1
Appendix E. Time History Plots; 1500 lbs Payload; Left Center Distribution.....	E-1
Appendix F. Time History Plots; 3000 lbs Payload; Even Distribution.....	F-1
Appendix G. Time History Plots; 3000 lbs Payload; Front Half Distribution.....	G-1
Appendix H. Time History Plots; 3000 lbs Payload; Rear Half Distribution.....	H-1
Appendix I. Time History Plots; 3000 lbs Payload; Left Center Distribution.....	I-1

SUMMARY

This paper describes the computer-based modeling, simulation, and analysis of the M35A2 2-1/2-ton truck towing the M105A2 1-1/2-ton trailer. The simulations were performed by the Analytical and Physical Simulation Branch (AMSTA-RYA) of the U.S. Army Tank-Automotive Command, System Simulation and Technology Division.

A rollover accident occurred involving the M35A2/M105A2 combination. An inspection of the accident scene concluded that the towing eye, or lunette, on the M105A2 trailer was installed upside down and that the accident was the result of this improper installation. The purpose of the computer simulations was to investigate what effect the towing eye position of the M105A2 trailer has on the stability of the M35A2/M105A2 combination.

Dynamic Analysis and Design System (DADS) software was used to develop the computer-based dynamic models of the M35A2 truck and M105A2 trailer. Computer simulations of the truck and trailer combination were run with the towing eye of M105A2 in both the correct and the upside down positions. The simulations consisted of a slalom maneuver by the combination at several vehicle speeds and a variety of trailer payload configurations.

The results of the simulations indicate that the towing eye position of the M105A2 trailer has virtually no effect on the stability of the M35A2 truck. The roll stability of the M105A2 trailer itself is degraded slightly when the towing eye is in the upside down position.

INTRODUCTION/OBJECTIVE

The System Simulation and Technology Division (AMSTA-RY) of the U.S. Army Tank-Automotive Command (TACOM) was asked to perform a computer-based simulation and analysis of the effect of towing eye position on the stability of the M35A2 2-1/2-ton truck when towing the M105A2 1-1/2-ton cargo trailer. The request for the simulation came from the Trailer Branch (AMSTA-UEC) of the Systems Engineering Directorate, Tactical Vehicle Division. The request was in response to an accident report (Case No. 901221011) involving a rollover of the M35A2 2-1/2-ton truck while towing the M105A2. Upon technical inspection at the accident scene, it was noticed that the towing eye of the M105A2 was installed incorrectly in an upside down position (i.e. rotated 180 degrees about the longitudinal axis).

Computer simulation was agreed upon as an acceptable method of analyzing the influence of the towing eye position on the stability of the M35A2/M105A2 combination. Due to the circumstances of the accident, which involved a sudden swerving of the M35A2, the simulations consisted of a series of slalom maneuvers at varying vehicle speeds. The vehicle speeds were increased until a roll over of the truck or the trailer occurred. The M35A2 was first simulated performing the slalom maneuver without towing the M105A2 to determine a baseline for the truck's performance. The M35A2 was then simulated towing the trailer with the towing eye installed in both the correct and upside down positions. Because of a lack of information about the payload configuration in the M105A2 at the time of the accident, an assortment of payload weights and weight distributions were simulated as shown in table 1.

LUNETTE IN CORRECT POSITION	LUNETTE UPSIDE DOWN
A. Unloaded Trailer	A. Unloaded Trailer
B. 1/2 Load (1500 lbs)	B. 1/2 Load (1500 lbs)
1. Evenly distributed	1. Evenly Distributed
2. Centered in Front Half	2. Centered in Front Half
3. Centered in Rear Half	3. Centered in Rear Half
4. Centered on Left Side	4. Centered on Left Side
C. Full Load (3000 lbs)	C. Full Load (3000 lbs)
1. Evenly distributed	1. Evenly Distributed
2. Centered in Front Half	2. Centered in Front Half
3. Centered in Rear Half	3. Centered in Rear Half
4. Centered on Left Side	4. Centered on Left Side

Table 1. Trailer payload configurations.

PROCEDURE

Dynamic models of the M35A2 and M105A2 were developed using DADS software. DADS software is a set of general-purpose computer programs that are used to model and predict the motion of a variety of real-world mechanical systems. The System Simulation and Technology Division uses DADS primarily for the modeling of military vehicles, either in the design phase, or for the analysis of existing vehicle systems.

The dynamic models of the M35A2 2-1/2-ton truck and M105A2 1-1/2-ton cargo trailer are shown schematically in figures 1 and 2, respectively. The models consist of a series of rigid bodies (chassis, axles, wheels, payload, etc.) linked together by assorted joints, distance constraints, and translational spring-

damper-actuators. The vertical, longitudinal, and lateral stiffness properties of the tires are incorporated into the vehicle models along with the performance characteristics of the vehicle springs and shock absorbers. The mass and inertial properties of each rigid body are also included in the model.

The dynamic parameter characteristics such as spring stiffness, tire stiffness, mass and inertia properties, suspension roll center and roll stiffness, that are included in the models are normally determined empirically in a laboratory setting. The Physical Simulation laboratory at TACOM does not have the capability of performing these types of tests on large vehicles such as the M35A2. Consequently, large vehicles are normally sent to private institutions to have their dynamic characteristics determined. For the purposes of this analysis, however, the expense of having the M35A2 characterized was deemed imprudent. One reason for this decision was that the primary focus of this analysis was on the stability of the M105A2 trailer and the effects of towing eye position on that stability. Another reason for the decision was that the data collected would be of little future use due to impending replacement of the M35A2 truck by the FMTV program. Therefore, the characteristic data that was not available for the M35A2 was determined through proven theoretical calculations. All characteristic data needed for the dynamic model of the M105A2 trailer were determined by TACOM personnel in the Physical Simulation laboratory.

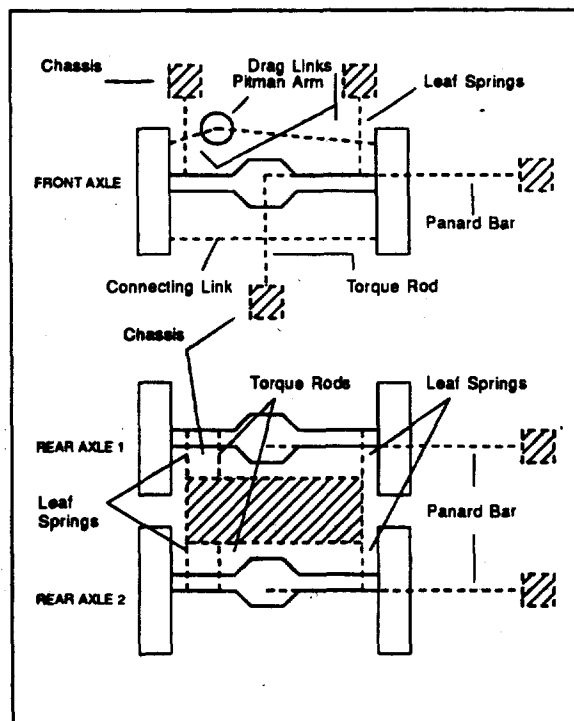

Figure 1. M35A2 Rigid Body Distance Constraints.

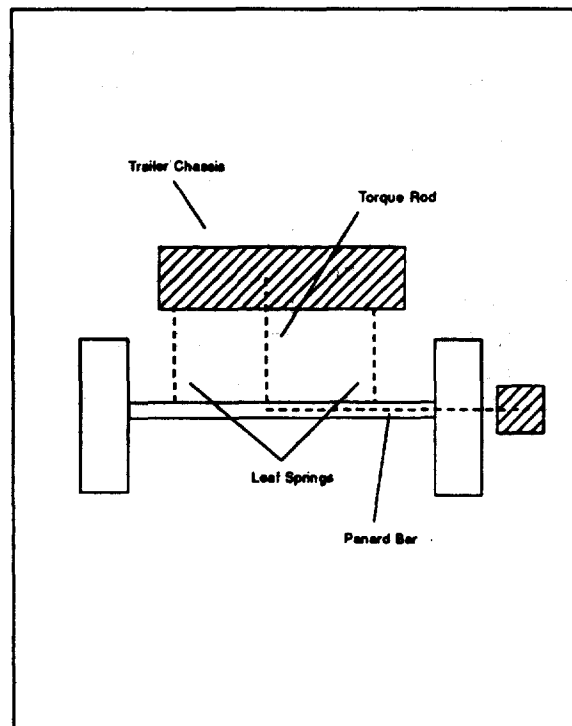

Figure 2. M105A2 Rigid Body Distance Constraints.

The M35A2/M105A2 combination was simulated negotiating a slalom course which consisted of the combination starting in the right hand lane, making an 11-foot lateral transition into the left lane within a 90-foot longitudinal transition, and returning to the right lane immediately within another 90-foot transition (see fig. 3). The truck and truck/trailer combinations were simulated at speeds of 30, 35, and 40 mph.

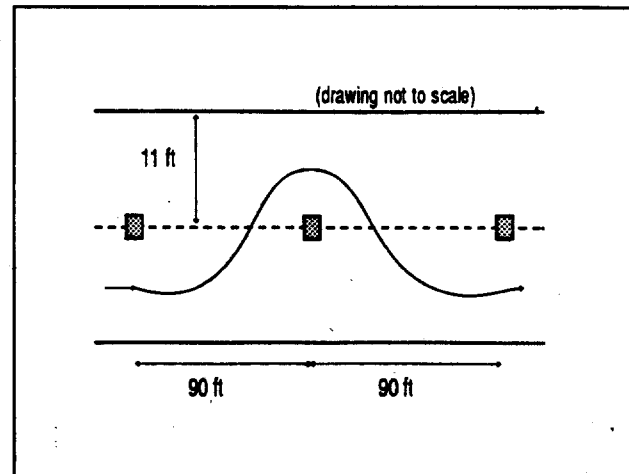

Figure 3. Slalom Course Maneuver.

In preliminary simulations, the M35A2 was able to successfully accomplish this maneuver at speeds up to 40 mph when **not** towing the M105A2. The truck and trailer roll angle, yaw angle, and roll rate were recorded and plotted for each simulation performed. In all, 57 simulations were performed with a total of 333 dynamic time history responses plotted.

RESULTS/DISCUSSION

In all of the computer simulations, the M35A2 truck never approached a rollover situation. The M105A2 trailer rolled over only when the slalom maneuver was attempted at 40 mph. Table 2 summarizes the reaction of the M105A2 during the slalom maneuver simulation at 40 mph.

The time history responses of roll angle, yaw angle, and roll rate were recorded for both the M35A2 and M105A2. Tables 3-11 present a comparison of the peak values of the dynamic parameters analyzed for each simulation. Appendices A-I show the entire time history responses of the dynamic parameters. The following section of the report will highlight the time history responses of each parameter analyzed.

	Correct Lunette Position	Upside Down Lunette Position
0 lbs Payload	Stable	Stable
1500 lbs Payload		
Even Distribution	Stable	Stable
Front Half Distribution	Stable	Stable
Rear Half Distribution	Unstable	Unstable
Left Center Distribution	Roll Over	Roll Over
3000 lbs Payload		
Even Distribution	Roll Over	Roll Over
Front Half Distribution	Unstable	Unstable
Rear Half Distribution	Roll Over	Roll Over
Left Center Distribution	Roll Over	Roll Over

Table 2. M105A2 Trailer Simulation Results (40 mph).

M35A2 Roll Angle

The time history plots of the M35A2 truck roll angle (plots 1-3; appendices A-I) clearly show no significant change in the performance of the truck when towing the M105A2 with the lunette in either the correct or the upside down position. This result was true regardless of the trailer payload or payload distribution.

The roll angle of the M35A2 when towing the M105A2 (lunette in either position) was degraded slightly compared to the performance of the M35A2 when **not** towing the trailer. This result was most evident at the speed of 40 mph. At the trailer payload of **1500 lbs**, the roll stability of the M35A2 was degraded primarily when the payload was centered in the rear half of the trailer or centered on the left side. The differences in roll angle for these conditions were only a few degrees. The roll angle of the M35A2 while towing the M105A2 (lunette in either position) with the full **3000 lb** payload again was most affected at the 40 mph speed with the payload in the rear half of the trailer or centered on the left side. The maximum roll angle reached by the M35A2 was close to 25 degrees. This occurred with the M105A2 lunette installed in the **correct** position and the payload centered in the rear of the trailer. Although 25 degrees is a severe roll angle for a truck the size of the M35A2, it is only about half the angle required for the truck to roll over.

M35A2 Yaw Angle

The yaw angle of the M35A2 truck (plots 4-6; appendices A-I) was not affected by the lunette position of the M105A2 trailer in most of the simulations performed. The only simulations where a significant difference resulted between the yaw angle of the

M35A2, with and without towing the trailer, was when the trailer had the full 3000 lb payload distributed in the rear and left center of the trailer (see plot 6; appendices H and I). The differences in yaw angle that occurred during these simulations can be discredited because they happened after the M105A2 trailer rolled over. The roll over of the trailer caused a jackknife situation which in turn caused the excessive yaw angle of the M35A2. A quirk of the DADS software is that when a rigid body, using the DADS tire model, overturns, the tires on the vehicle attempt to follow the road profile although the vehicle is upside down. This results in a chaotic situation where the simulation results **after the rollover** are meaningless. This does not cause a problem with the analysis since the results leading up to and during the rollover event are valid.

M35A2 Roll Rate

Like the yaw angle, the resulting roll rates of the M35A2 truck (plots 7-9; appendices A-I) during the simulations did not vary between the M35A2 itself and the M35A2 towing the M105A2 trailer with either lunette position. The only differences that result in the time history plots of this parameter occur after a roll over of the trailer (see plot 9; appendices E, F, H, and I). As mentioned in the previous paragraph, these results are insignificant.

M105A2 Roll Angle

The roll angle of the M105A2 trailer (plot 10-12; appendices A-I) with the lunette in the correct position was consistently smaller than the roll angle of the M105A2 with the lunette installed upside down. This was true for all of the simulations performed. The differences, however, were negligible. The maximum difference is approximately 0.66 degrees.

M105A2 Yaw Angle

There were no significant differences in the yaw angle of the M105A2 trailer (plots 13-15; appendices A-I) regardless of lunette position, payload, payload distribution, or vehicle speed.

M105A2 Roll Rate

There were no significant differences in the roll rate of the M105A2 (plot 16-18; appendices A-I) trailer regardless of lunette position, payload, payload distribution, or vehicle speed.

0000 LBS PAYLOAD	M35A2 TRUCK			M105A2 TRAILER		
	ROLL ANGLE	YAW ANGLE	ROLL RATE	ROLL ANGLE	YAW ANGLE	ROLL RATE
30 MPH						
TRUCK ONLY	1.48	10.60	8.31			
TRUCK W/M105A2 LOW POSITON	1.49	10.60	7.90	0.59	10.63	3.96
TRUCK W/M105A2 HIGH POSITION	1.49	10.60	7.90	0.74	10.61	3.96
35 MPH						
TRUCK ONLY	1.81	11.10	9.05			
TRUCK W/M105A2 LOW POSITON	1.82	11.15	9.26	0.76	11.24	3.79
TRUCK W/M105A2 HIGH POSITION	1.82	11.15	9.26	1.07	11.23	3.79
40 MPH						
TRUCK ONLY	6.34	12.91	40.79			
TRUCK W/M105A2 LOW POSITON	6.39	13.00	41.26	1.27	15.43	10.76
TRUCK W/M105A2 HIGH POSITION	6.39	13.00	41.26	1.70	15.39	10.76

Table 3. Peak values, no load. Units are degrees and degrees/sec.

1500 LBS PAYLOAD	M35A2 TRUCK			M105A2 TRAILER		
	ROLL ANGLE	YAW ANGLE	ROLL RATE	ROLL ANGLE	YAW ANGLE	ROLL RATE
30 MPH						
TRUCK ONLY	1.48	10.60	8.31			
TRUCK W/M105A2 LOW POSITON	1.49	10.61	7.77	1.61	10.81	5.62
TRUCK W/M105A2 HIGH POSITION	1.49	10.61	7.77	1.87	10.77	5.62
35 MPH						
TRUCK ONLY	1.81	11.10	9.05			
TRUCK W/M105A2 LOW POSITON	1.84	11.17	9.36	2.23	11.80	7.37
TRUCK W/M105A2 HIGH POSITION	1.84	11.17	9.36	2.63	11.73	7.37
40 MPH						
TRUCK ONLY	6.34	12.91	40.79			
TRUCK W/M105A2 LOW POSITON	6.22	13.05	41.41	3.88	17.72	28.5
TRUCK W/M105A2 HIGH POSITION	6.22	13.05	41.41	4.54	17.58	28.5

Table 4. Peak values, half load, even distribution. Units are degrees and degrees/sec.

1500 LBS PAYLOAD FRONT HALF DISTRIBUTION	M35A2 TRUCK			M105A2 TRAILER		
	ROLL ANGLE	YAW ANGLE	ROLL RATE	ROLL ANGLE	YAW ANGLE	ROLL RATE
30 MPH						
TRUCK ONLY	1.48	10.60	8.31			
TRUCK W/M105A2 LOW POSITON	1.51	10.63	7.62	1.43	10.79	4.85
TRUCK W/M105A2 HIGH POSITION	1.51	10.63	7.62	1.65	10.75	4.85
35 MPH						
TRUCK ONLY	1.81	11.10	9.05			
TRUCK W/M105A2 LOW POSITON	1.87	11.19	9.58	1.97	11.55	6.51
TRUCK W/M105A2 HIGH POSITION	1.87	11.19	9.58	2.35	11.51	6.51
40 MPH						
TRUCK ONLY	6.34	12.91	40.79			
TRUCK W/M105A2 LOW POSITON	6.03	13.20	40.92	3.84	18.39	35.10
TRUCK W/M105A2 HIGH POSITION	6.03	13.20	40.93	4.04	18.29	35.10

Table 5. Peak values, half load, front half. Units are degrees and degrees/sec.

1500 LBS PAYLOAD REAR HALF DISTRIBUTION	M35A2 TRUCK			M105A2 TRAILER		
	ROLL ANGLE	YAW ANGLE	ROLL RATE	ROLL ANGLE	YAW ANGLE	ROLL RATE
30 MPH						
TRUCK ONLY	1.48	10.60	8.31			
TRUCK W/M105A2 LOW POSITON	1.49	10.59	7.78	1.84	10.86	7.21
TRUCK W/M105A2 HIGH POSITION	1.49	10.59	7.78	2.14	10.80	7.21
35 MPH						
TRUCK ONLY	1.81	11.10	9.05			
TRUCK W/M105A2 LOW POSITON	1.81	11.16	9.67	2.57	12.33	8.91
TRUCK W/M105A2 HIGH POSITION	1.81	11.16	9.67	3.01	12.24	8.91
40 MPH						
TRUCK ONLY	6.34	12.91	40.79			
TRUCK W/M105A2 LOW POSITON	6.33	12.94	42.94	19.86	16.98	99.53
TRUCK W/M105A2 HIGH POSITION	6.33	12.94	42.94	20.02	16.78	99.62

Table 6. Peak values, half load, rear half. Units are degrees and degrees/sec.

1500 LBS PAYLOAD	M35A2 TRUCK			M105A2 TRAILER		
LEFT CENTER DISTRIBUTION	ROLL ANGLE	YAW ANGLE	ROLL RATE	ROLL ANGLE	YAW ANGLE	ROLL RATE
30 MPH						
TRUCK ONLY	1.48	10.60	8.31			
TRUCK W/M105A2 LOW POSITON	1.50	10.61	7.74	3.48	11.16	5.58
TRUCK W/M105A2 HIGH POSITION	1.50	10.61	7.74	3.48	11.05	5.58
35 MPH						
TRUCK ONLY	1.81	11.10	9.05			
TRUCK W/M105A2 LOW POSITON	1.85	11.17	9.38	4.37	12.61	12.65
TRUCK W/M105A2 HIGH POSITION	1.85	11.17	9.38	4.86	12.44	12.64
40 MPH						
TRUCK ONLY	6.34	12.91	40.79			
TRUCK W/M105A2 LOW POSITON	6.24	13.06	42.92	XXX	XXX	XXX
TRUCK W/M105A2 HIGH POSITION	6.24	13.06	42.92	XXX	XXX	XXX

Table 7. Peak values, half load, left center. Units are degrees and degrees/sec. (XXX = Trailer Rollover)

3000 LBS PAYLOAD	M35A2 TRUCK			M105A2 TRAILER		
EVEN DISTRIBUTION	ROLL ANGLE	YAW ANGLE	ROLL RATE	ROLL ANGLE	YAW ANGLE	ROLL RATE
30 MPH						
TRUCK ONLY	1.48	10.60	8.31			
TRUCK W/M105A2 LOW POSITON	1.50	10.61	7.74	2.66	10.95	7.44
TRUCK W/M105A2 HIGH POSITION	1.50	10.61	7.74	2.98	10.88	7.44
35 MPH						
TRUCK ONLY	1.81	11.10	9.05			
TRUCK W/M105A2 LOW POSITON	1.84	11.17	9.34	3.75	12.68	10.78
TRUCK W/M105A2 HIGH POSITION	1.84	11.17	9.34	4.21	12.56	10.78
40 MPH						
TRUCK ONLY	6.34	12.91	40.79			
TRUCK W/M105A2 LOW POSITON	6.12	13.07	40.60	XXX	XXX	XXX
TRUCK W/M105A2 HIGH POSITION	6.12	13.07	40.60	XXX	XXX	XXX

Table 8. Peak values, half load, even distribution. Units are degrees and degrees/sec. (XXX = Trailer Rollover)

3000 LBS PAYLOAD	M35A2 TRUCK			M105A2 TRAILER		
FRONT HALF DISTRIBUTION	ROLL ANGLE	YAW ANGLE	ROLL RATE	ROLL ANGLE	YAW ANGLE	ROLL RATE
30 MPH						
TRUCK ONLY	1.48	10.60	8.31			
TRUCK W/M105A2 LOW POSITON	1.52	10.65	7.53	2.31	10.92	6.86
TRUCK W/M105A2 HIGH POSITION	1.52	10.65	7.53	2.60	10.85	6.86
35 MPH						
TRUCK ONLY	1.81	11.10	9.05			
TRUCK W/M105A2 LOW POSITON	1.90	11.24	9.59	3.22	12.11	9.21
TRUCK W/M105A2 HIGH POSITION	1.90	11.24	9.59	3.64	12.01	9.21
40 MPH						
TRUCK ONLY	6.34	12.91	40.79			
TRUCK W/M105A2 LOW POSITON	5.92	13.45	40.97	60.60	20.20	118.33
TRUCK W/M105A2 HIGH POSITION	5.92	13.45	40.97	60.94	19.60	120.05

Table 9. Peak values, full load, front half. Units are degrees and degrees/sec. (XXX = Trailer Rollover)

3000 LBS PAYLOAD	M35A2 TRUCK			M105A2 TRAILER		
REAR HALF DISTRIBUTION	ROLL ANGLE	YAW ANGLE	ROLL RATE	ROLL ANGLE	YAW ANGLE	ROLL RATE
30 MPH						
TRUCK ONLY	1.48	10.60	8.31			
TRUCK W/M105A2 LOW POSITON	1.48	10.58	7.71	3.10	10.97	9.53
TRUCK W/M105A2 HIGH POSITION	1.48	10.58	7.71	3.44	10.89	9.53
35 MPH						
TRUCK ONLY	1.81	11.10	9.05			
TRUCK W/M105A2 LOW POSITON	1.82	11.18	9.90	4.41	13.74	13.41
TRUCK W/M105A2 HIGH POSITION	1.82	11.18	9.90	4.91	13.59	13.41
40 MPH						
TRUCK ONLY	6.34	12.91	40.79			
TRUCK W/M105A2 LOW POSITON	24.68	45.03	66.96	XXX	XXX	XXX
TRUCK W/M105A2 HIGH POSITION	12.58	39.66	69.55	XXX	XXX	XXX

Table 10. Peak values, full load, rear half. Units are degrees and degrees/sec. (XXX = Trailer Rollover)

3000 LBS PAYLOAD LEFT CENTER DISTRIBUTION	M35A2 TRUCK			M105A2 TRAILER		
	ROLL ANGLE	YAW ANGLE	ROLL RATE	ROLL ANGLE	YAW ANGLE	ROLL RATE
30 MPH						
TRUCK ONLY	1.48	10.60	8.31			
TRUCK W/M105A2 LOW POSITON	1.50	10.61	7.68	6.26	11.61	7.92
TRUCK W/M105A2 HIGH POSITION	1.50	10.61	7.68	6.29	11.40	7.92
35 MPH						
TRUCK ONLY	1.81	11.10	9.05			
TRUCK W/M105A2 LOW POSITON	1.95	11.17	9.34	16.68	14.98	73.16
TRUCK W/M105A2 HIGH POSITION	1.95	11.18	9.34	17.22	14.62	73.16
40 MPH						
TRUCK ONLY	6.34	12.91	40.79			
TRUCK W/M105A2 LOW POSITON	10.12	13.22	67.05	XXX	XXX	XXX
TRUCK W/M105A2 HIGH POSITION	9.86	13.21	84.25	XXX	XXX	XXX

Table 11. Peak values, full load, left center. Units are degrees and degrees/sec. (XXX = Trailer Rollover)

CONCLUSIONS/RECOMMENDATIONS

The computer simulations indicate that the position of the towing eye on M105A2 trailer, when installed either properly, or in the upside down position, has **little effect** on the stability of the M35A2 2-1/2-ton truck. Based on these results, it can be concluded that the incorrect towing eye position of the M105A2 trailer was not the cause of the rollover accident (Case No. 901221011) mentioned in the introduction of this report.

Installation of the towing eye in the upside down position does slightly degrade the stability of the M105A2 trailer itself. When the lunette is installed in the upside down position, the center of gravity of the trailer is raised approximately 0.32 inches and the subsequent trailer pitch angle is approximately 2.08 degrees. The combination of these two factors accounts for the small reduction in roll stability of the trailer compared to when the trailer lunette is installed correctly. In real-life situations, the increased pitch angle of the trailer can increase the likelihood of having the trailer payload shift to the rear of the trailer. The simulation results show that when the payload is centered in the rear of the trailer, the trailer stability decreases.

Based upon the computer simulations, it is recommended that as an extra safety precaution, the lunette on the M105A2 trailer should always be installed in the proper position. However, it should be noted that improper installation of the lunette would not greatly affect the trailer performance and certainly would not greatly affect the stability of the M35A2 truck.

**APPENDIX A
TIME HISTORY PLOTS
0 LBS. PAYLOAD**

A - 1

**THIS DOCUMENT CONTAINED
BLANK PAGES THAT HAVE
BEEN DELETED**

M35A2 Roll Angle; 30 MPH; M105A2 Payload = 0 lbs

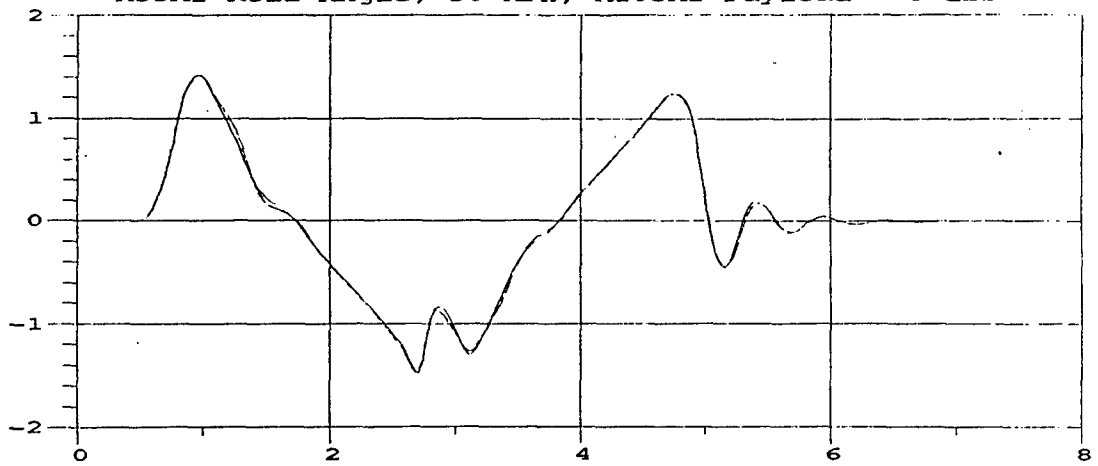

_____ w/o trailer (degrees) vs time (sec)
 w/ trailer in low position (degrees) vs time (sec)
 - - - - - w/ trailer in high position (degrees) vs time (sec)

1

M35A2 Roll Angle; 35 MPH; M105A2 Payload = 0 lbs

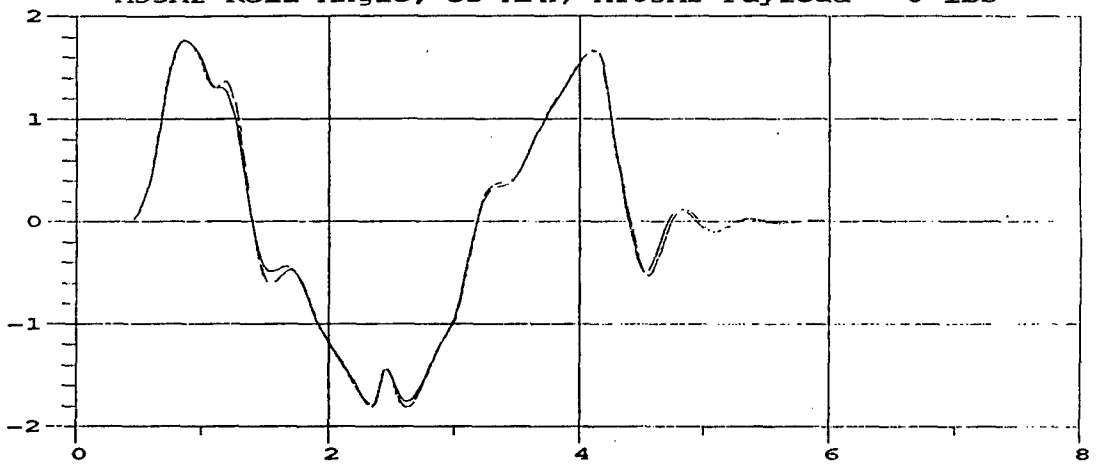

_____ w/o trailer (degrees) vs time (sec)
 w/ trailer in low position (degrees) vs time (sec)
 - - - - - w/ trailer in high position (degrees) vs time (sec)

2

M35A2 Roll Angle; 40 MPH; M105A2 Payload = 0 lbs

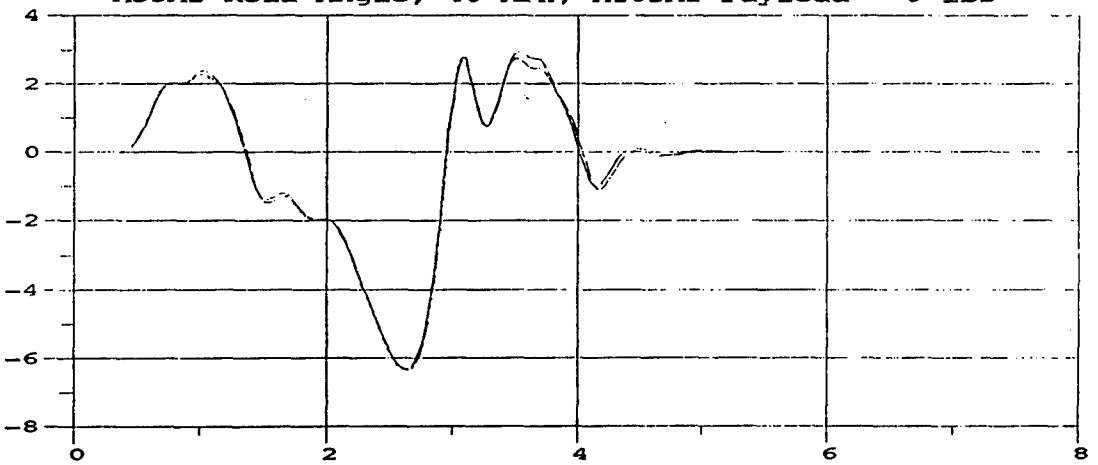

_____ w/o trailer (degrees) vs time (sec)
 w/ trailer in low position (degrees) vs time (sec)
 - - - - - w/ trailer in high position (degrees) vs time (sec)

3

M35A2 Yaw Angle; 30 MPH; M105A2 Payload = 0 lbs

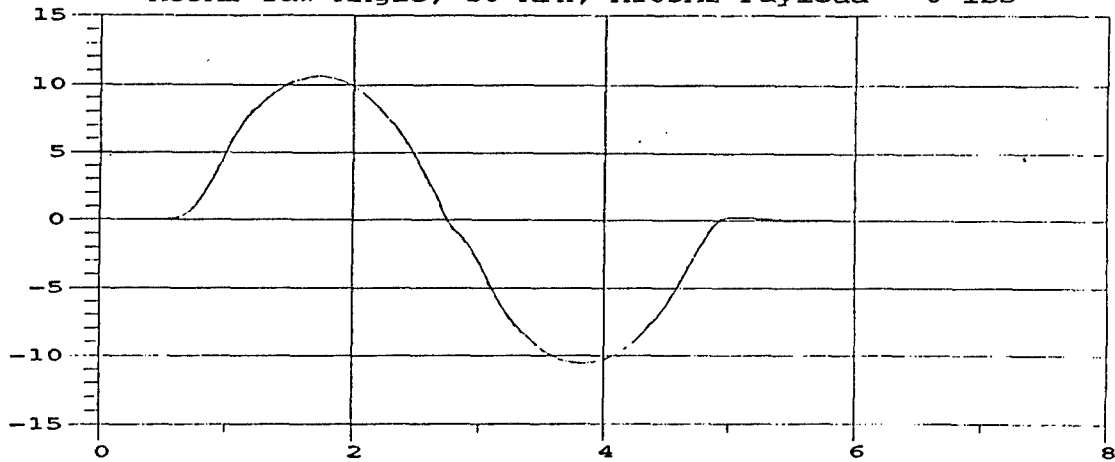

——— w/o trailer (degrees) vs time (sec)
 w/ trailer in low position (degrees) vs time (sec)
 - - - w/ trailer in high position (degrees) vs time (sec)

4

M35A2 Yaw Angle; 35 MPH; M105A2 Payload = 0 lbs

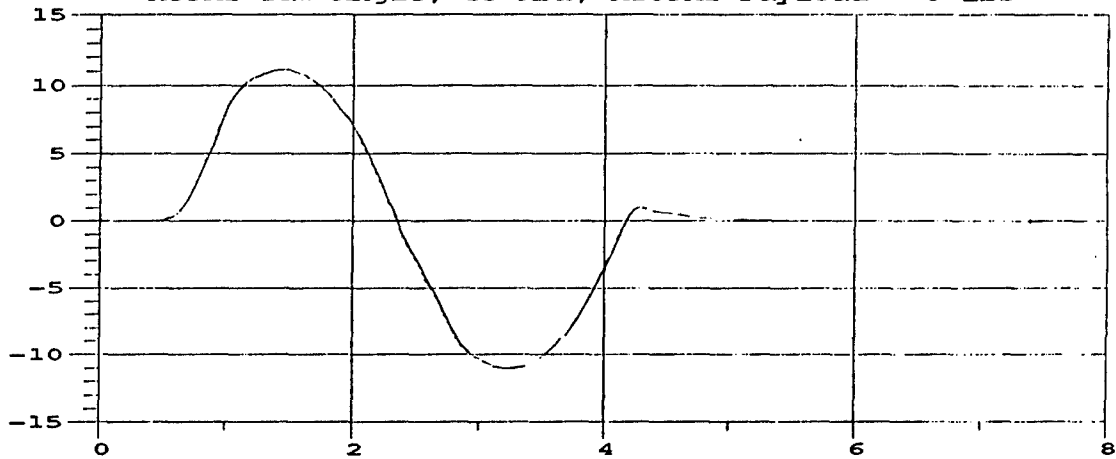

——— w/o trailer (degrees) vs time (sec)
 w/ trailer in low position (degrees) vs time (sec)
 - - - w/ trailer in high position (degrees) vs time (sec)

5

M35A2 Yaw Angle; 40 MPH; M105A2 Payload = 0 lbs

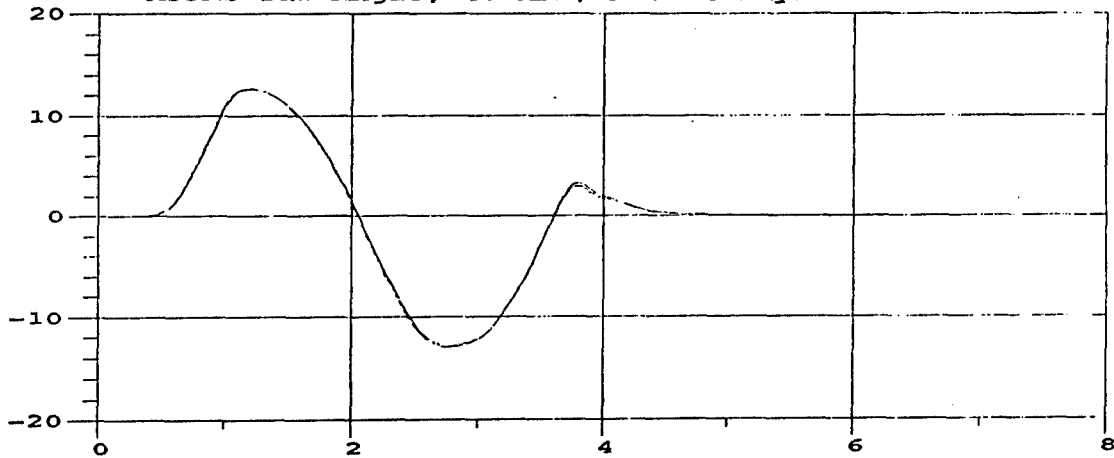

——— w/o trailer (degrees) vs time (sec)
 w/ trailer in low position (degrees) vs time (sec)
 - - - w/ trailer in high position (degrees) vs time (sec)

6

M35A2 Roll Rate; 30 MPH; M105A2 Payload = 0 lbs

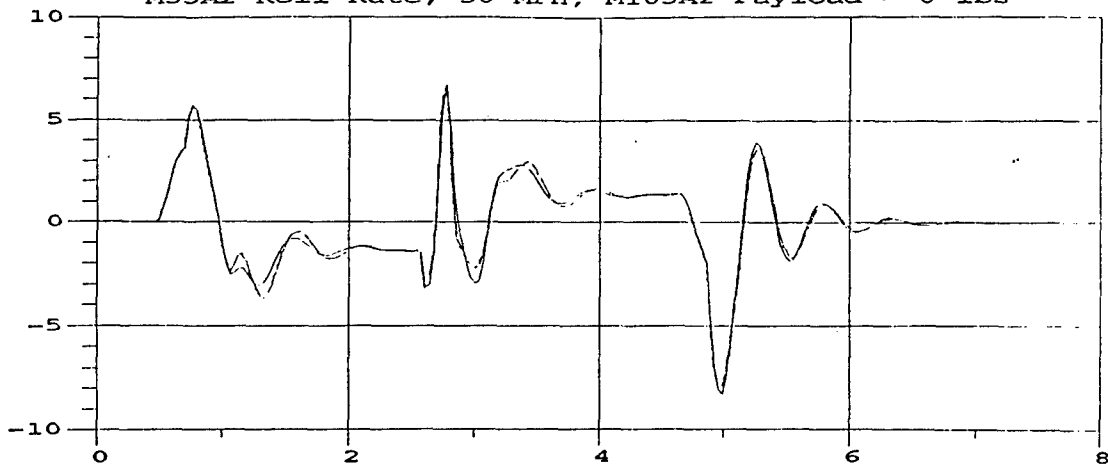

— w/o trailer (deg/sec) vs time (sec)
 w/ trailer in low position (deg/sec) vs time (sec)
 - - - w/ trailer in high position (deg/sec) vs time (sec)

7

M35A2 Roll Rate; 35 MPH; M105A2 Payload = 0 lbs

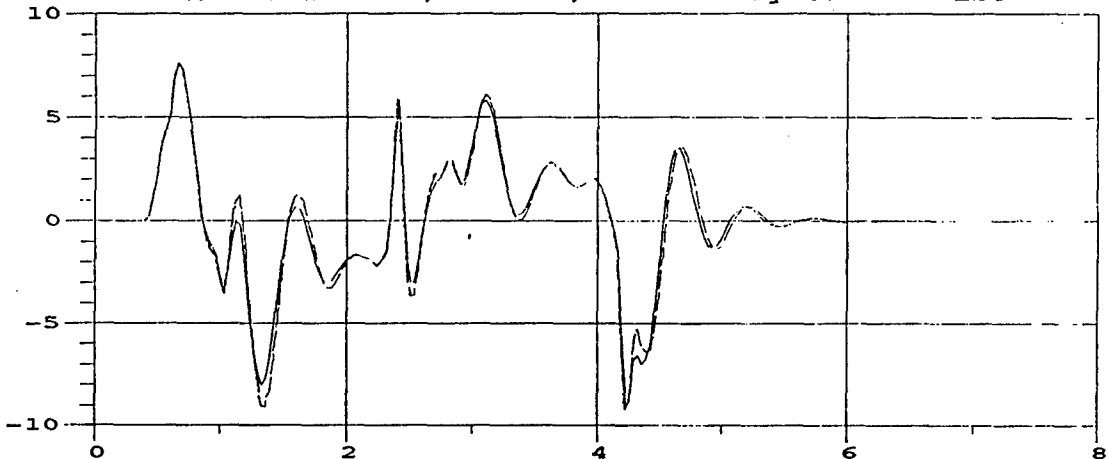

— w/o trailer (deg/sec) vs time (sec)
 w/ trailer in low position (deg/sec) vs time (sec)
 - - - w/ trailer in high position (deg/sec) vs time (sec)

8

M35A2 Roll Rate; 40 MPH; M105A2 Payload = 0 lbs

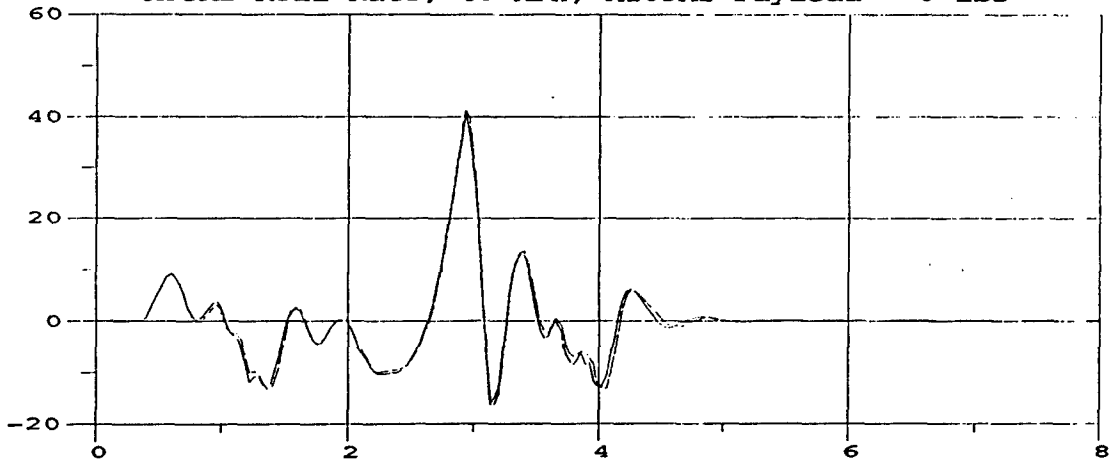

— w/o trailer (deg/sec) vs time (sec)
 w/ trailer in low position (deg/sec) vs time (sec)
 - - - w/ trailer in high position (deg/sec) vs time (sec)

9

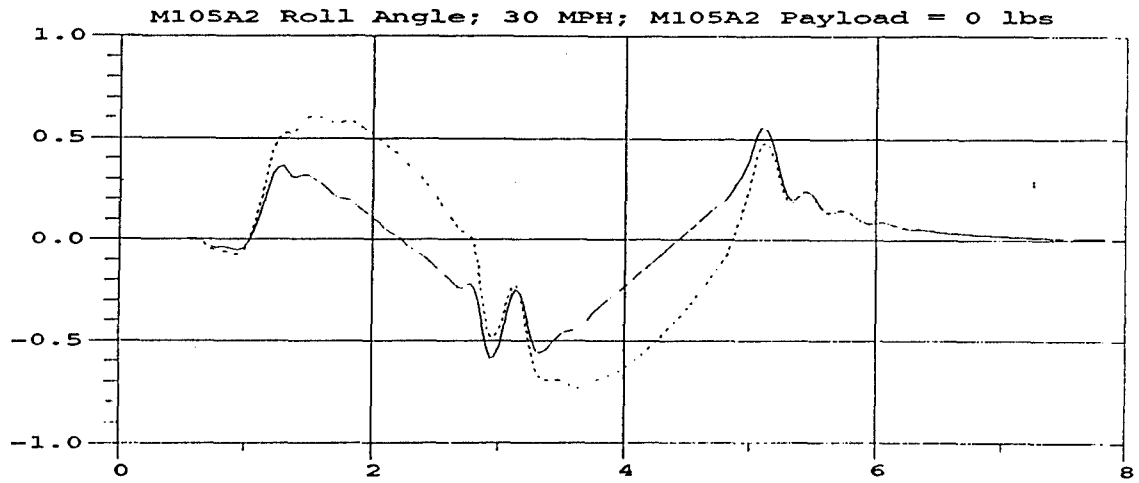

—— trailer in low position (degrees) vs time (sec)
 trailer in high position (degrees) vs time (sec)

10

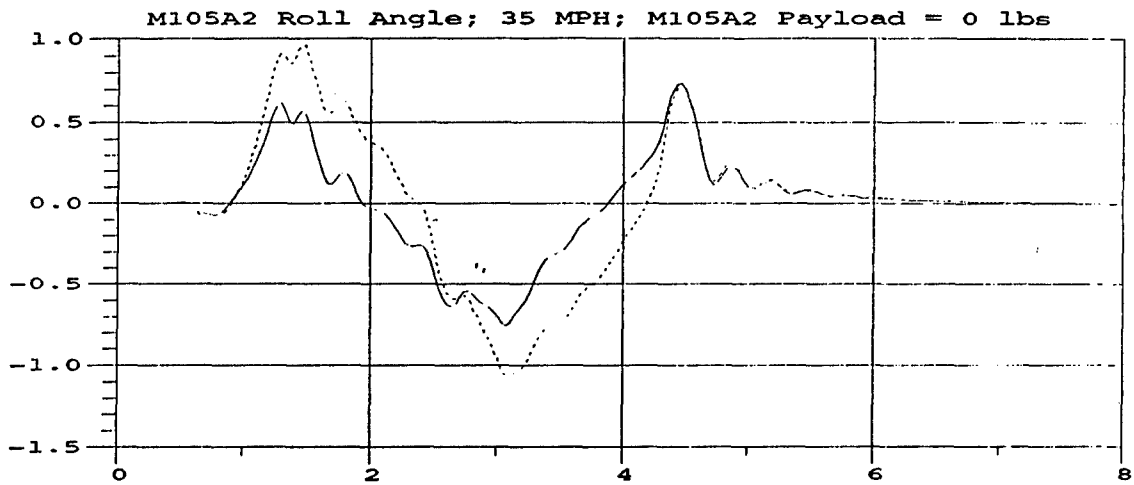

—— trailer in low position (degrees) vs time (sec)
 trailer in high position (degrees) vs time (sec)

11

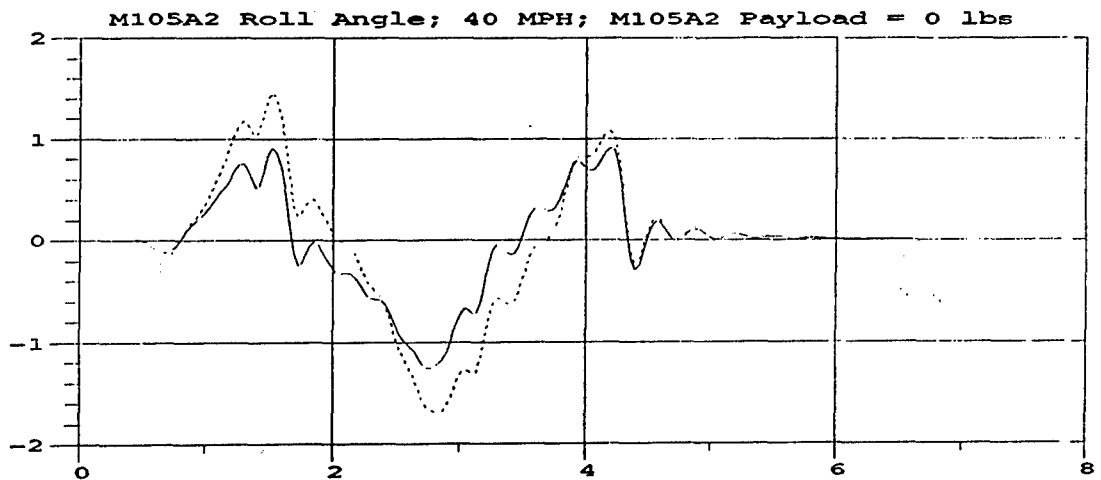

—— trailer in low position (degrees) vs time (sec)
 trailer in high position (degrees) vs time (sec)

12

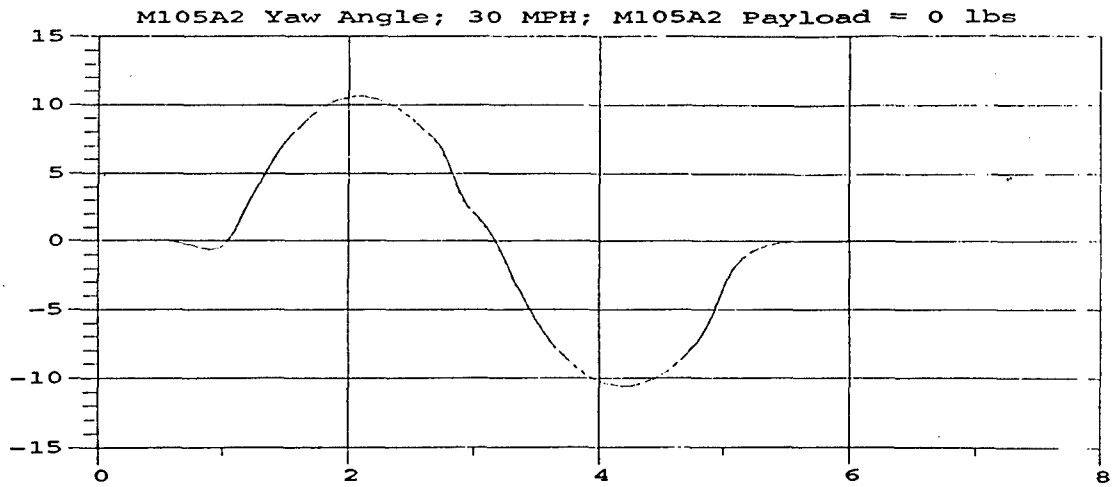

—— trailer in low position (degrees) vs time (sec)
 - - - - trailer in high position (degrees) vs time (sec)

13

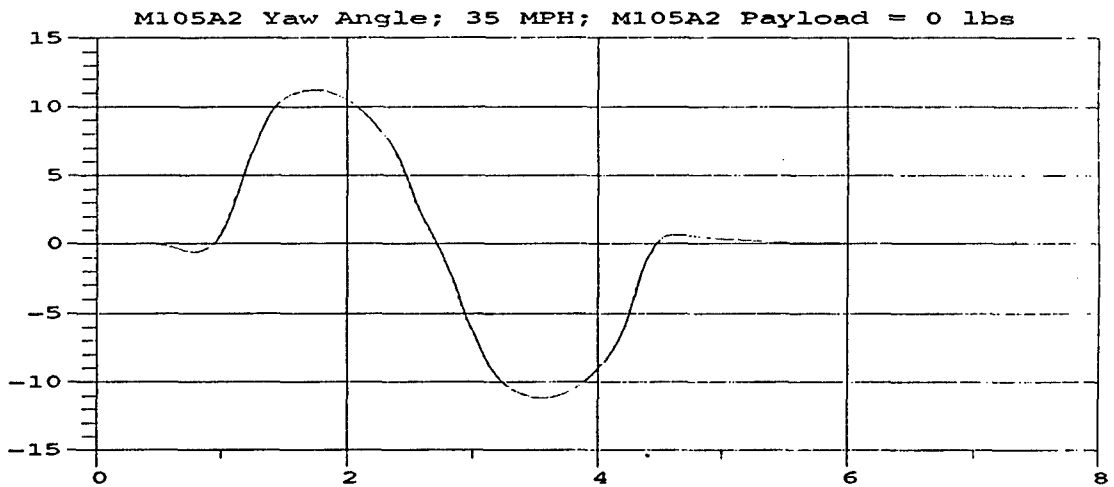

—— trailer in low position (degrees) vs time (sec)
 - - - - trailer in high position (degrees) vs time (sec)

14

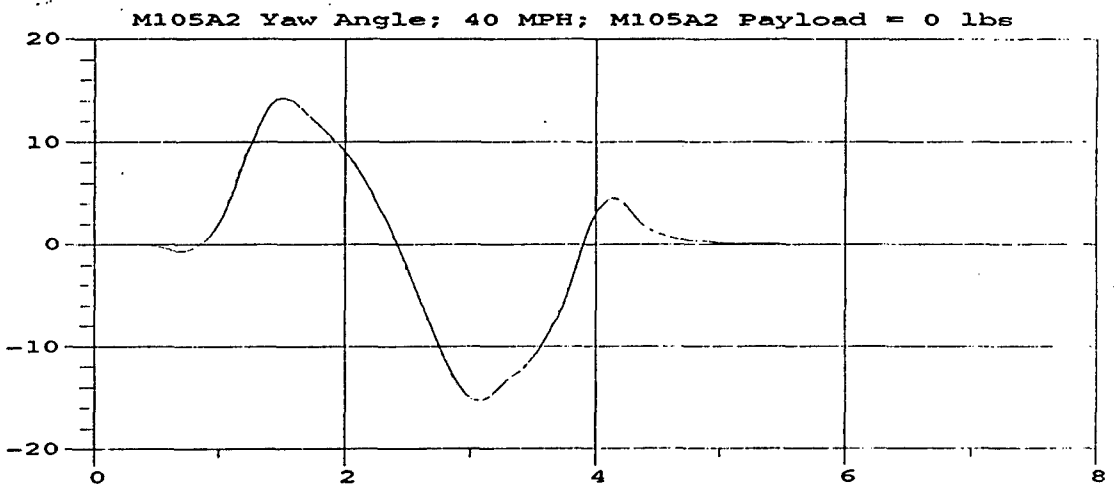

—— trailer in low position (degrees) vs time (sec)
 - - - - trailer in high position (degrees) vs time (sec)

15

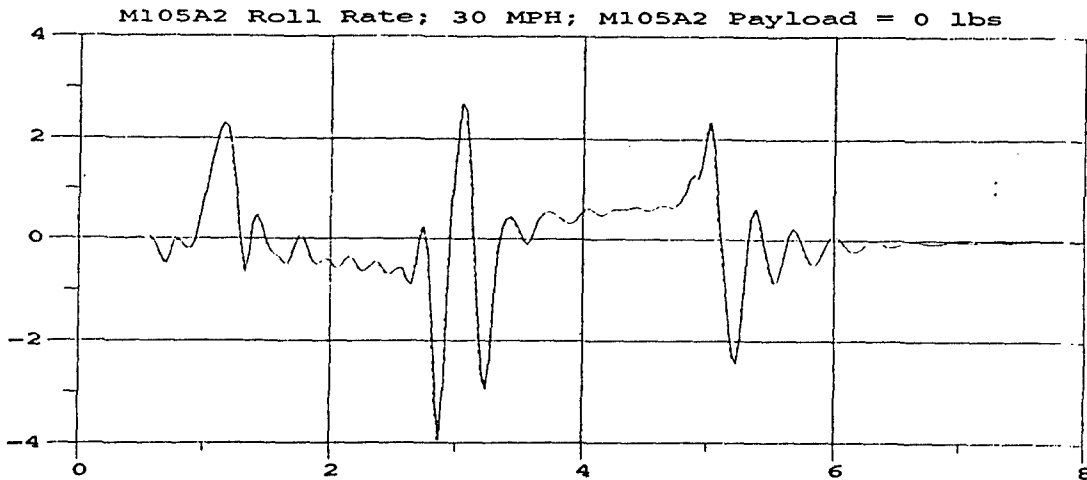

----- trailer in low position (deg/sec) vs time (sec)
 trailer in high position (deg/sec) vs time (sec)

16

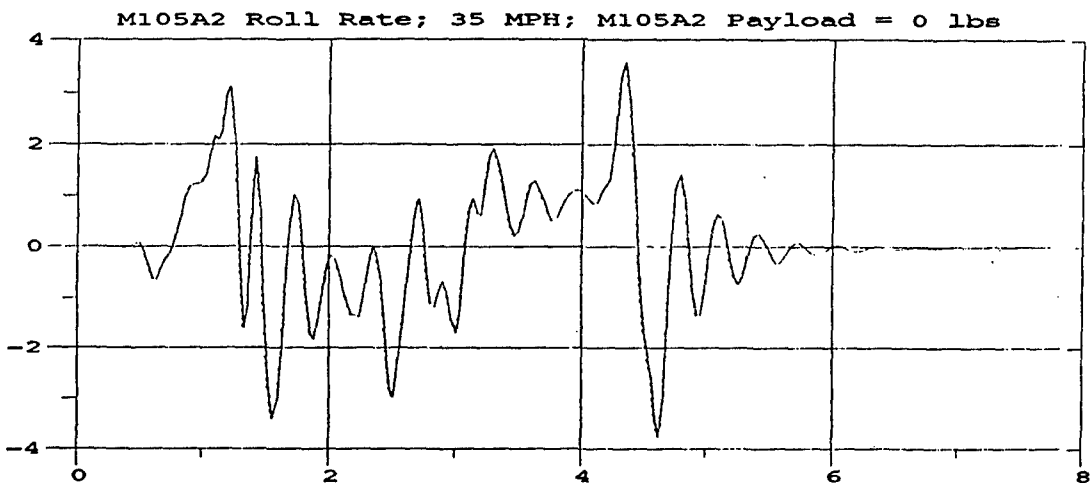

----- trailer in low position (deg/sec) vs time (sec)
 trailer in high position (deg/sec) vs time (sec)

17

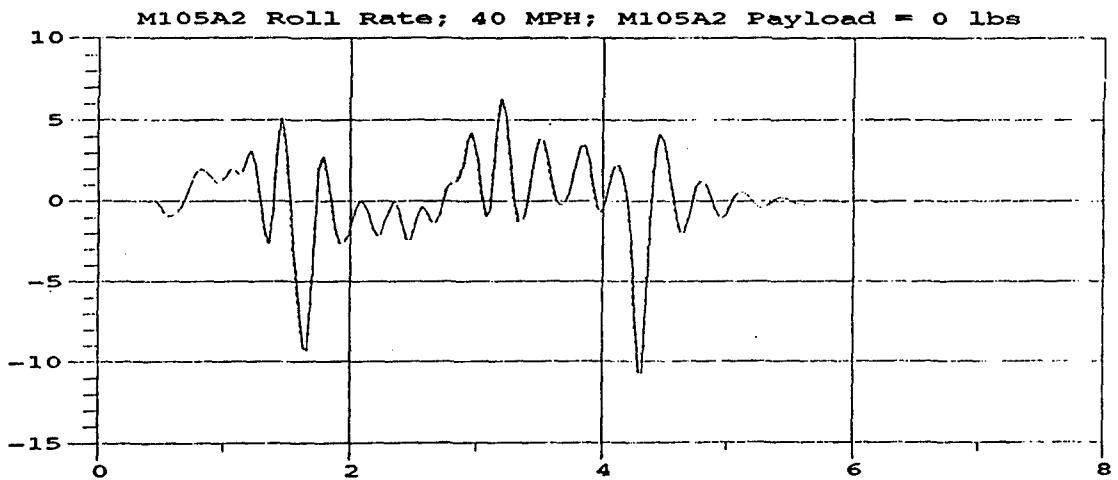

----- trailer in low position (deg/sec) vs time (sec)
 trailer in high position (deg/sec) vs time (sec)

18

APPENDIX B
TIME HISTORY PLOTS
1500 LBS. PAYLOAD; EVEN DISTRIBUTION

M35A2 Roll Angle; 30 MPH; M105A2 Payload = 1500 lbs, even dist.

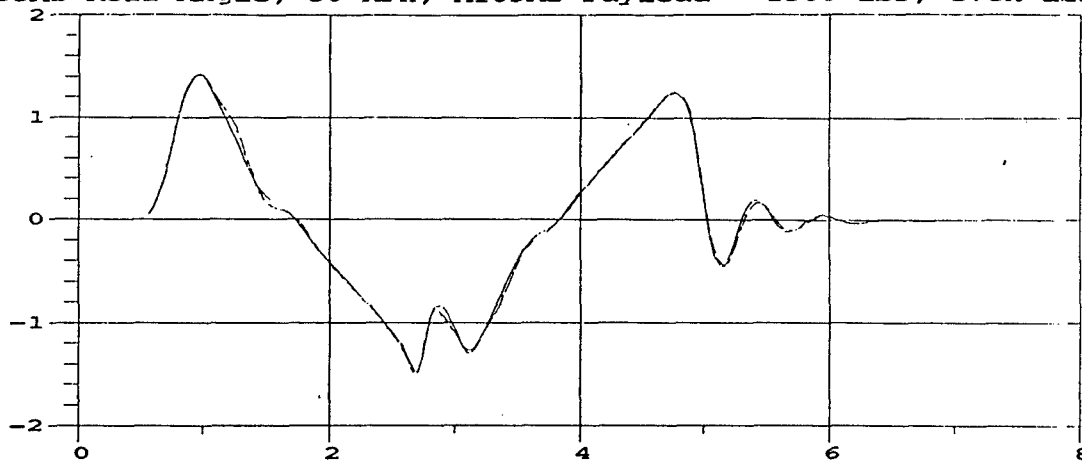

_____ w/o trailer (degrees) vs time (sec)
 w/ trailer in low position (degrees) vs time (sec)
 - - - - w/ trailer in high position (degrees) vs time (sec)

1

M35A2 Roll Angle; 35 MPH; M105A2 Payload = 1500 lbs, even dist.

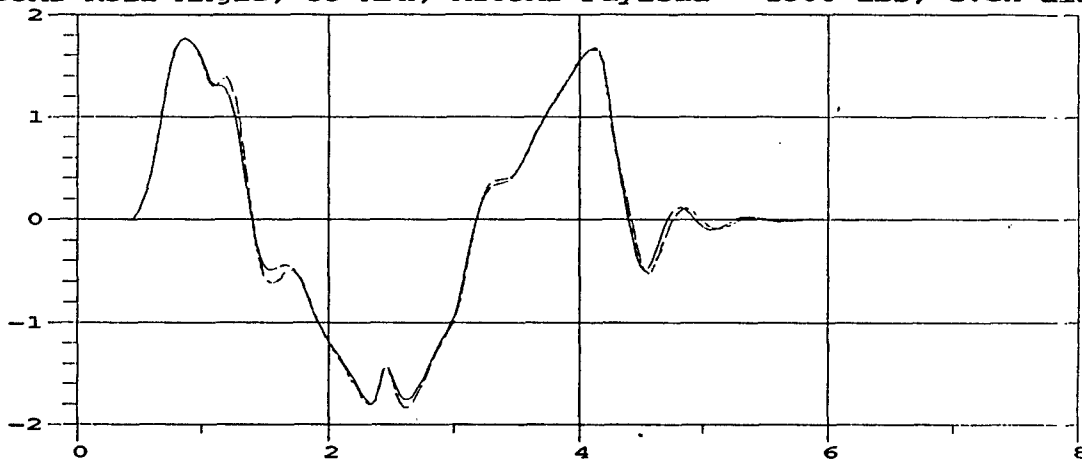

_____ w/o trailer (degrees) vs time (sec)
 w/ trailer in low position (degrees) vs time (sec)
 - - - - w/ trailer in high position (degrees) vs time (sec)

2

M35A2 Roll Angle; 40 MPH; M105A2 Payload = 1500 lbs, even dist.

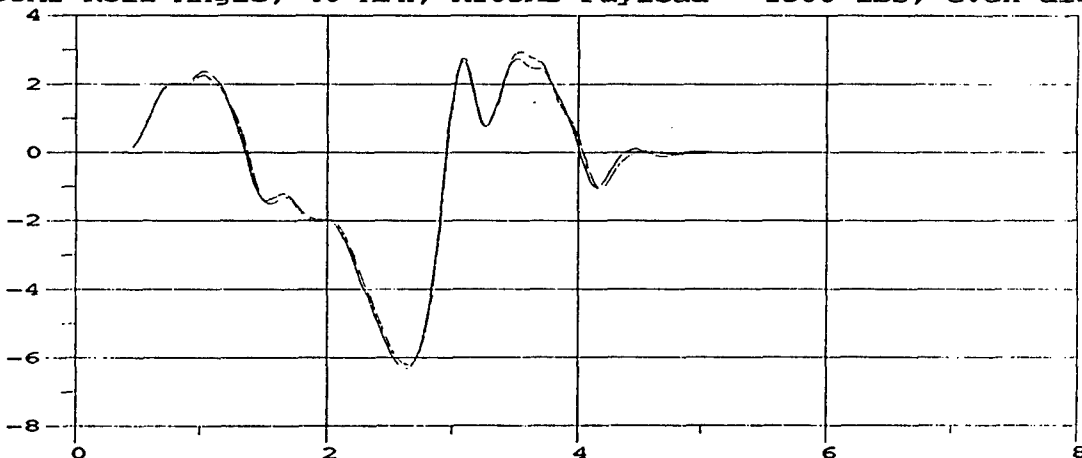

_____ w/o trailer (degrees) vs time (sec)
 w/ trailer in low position (degrees) vs time (sec)
 - - - - w/ trailer in high position (degrees) vs time (sec)

3

M35A2 Yaw Angle; 30 MPH; M105A2 Payload = 1500 lbs, even dist.

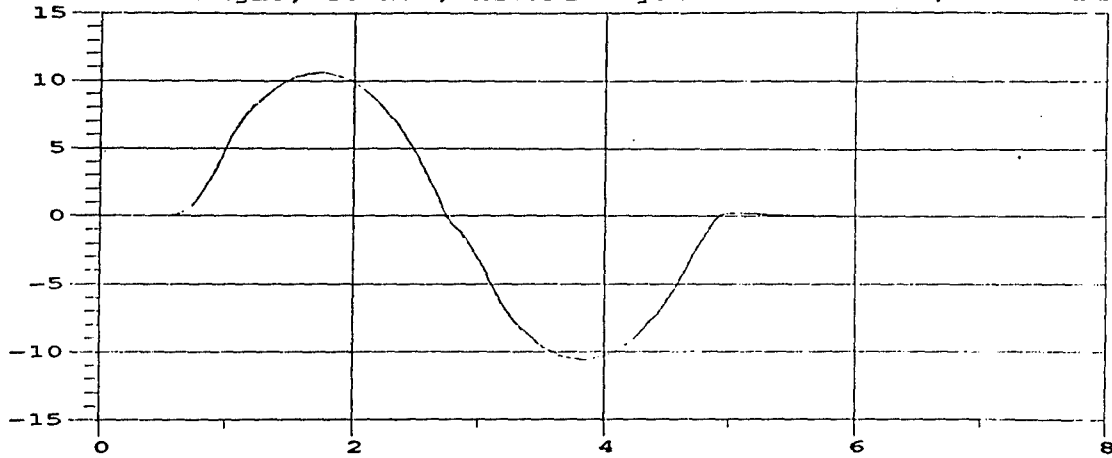

_____ w/o trailer (degrees) vs time (sec)
 w/ trailer in low position (degrees) vs time (sec)
 - - - - - w/ trailer in high position (degrees) vs time (sec)

4

M35A2 Yaw Angle; 35 MPH; M105A2 Payload = 1500 lbs, even dist.

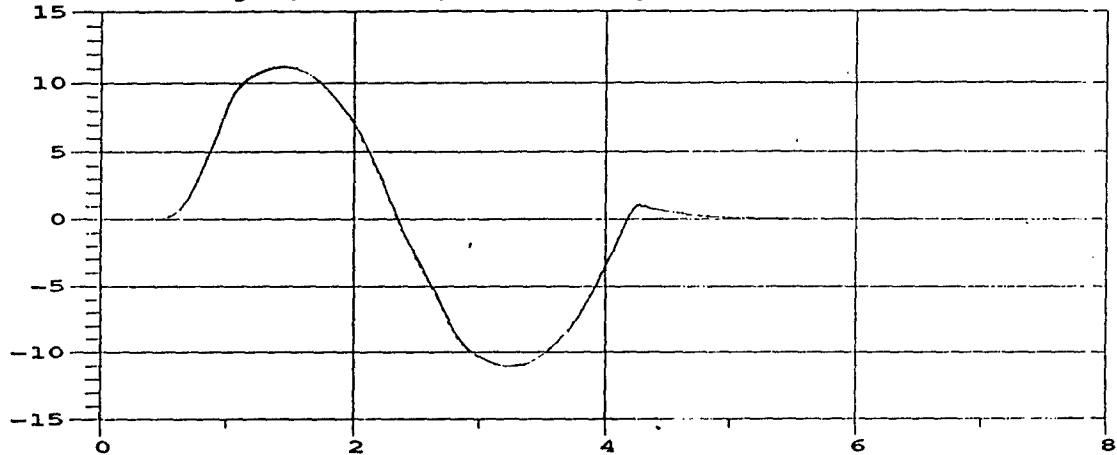

_____ w/o trailer (degrees) vs time (sec)
 w/ trailer in low position (degrees) vs time (sec)
 - - - - - w/ trailer in high position (degrees) vs time (sec)

5

M35A2 Yaw Angle; 40 MPH; M105A2 Payload = 1500 lbs, even dist.

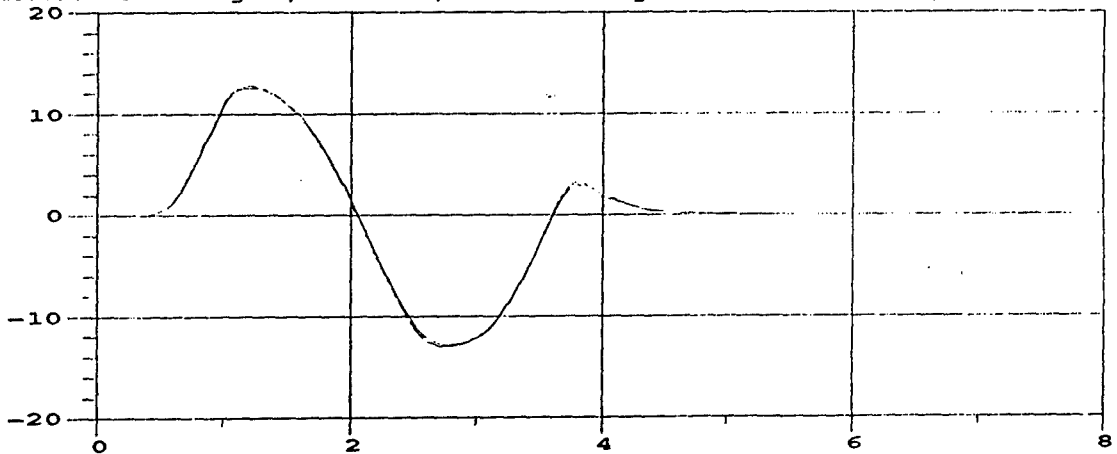

_____ w/o trailer (degrees) vs time (sec)
 w/ trailer in low position (degrees) vs time (sec)
 - - - - - w/ trailer in high position (degrees) vs time (sec)

6

M35A2 Roll Rate; 30 MPH; M105A2 Payload = 1500 lbs, even dist.

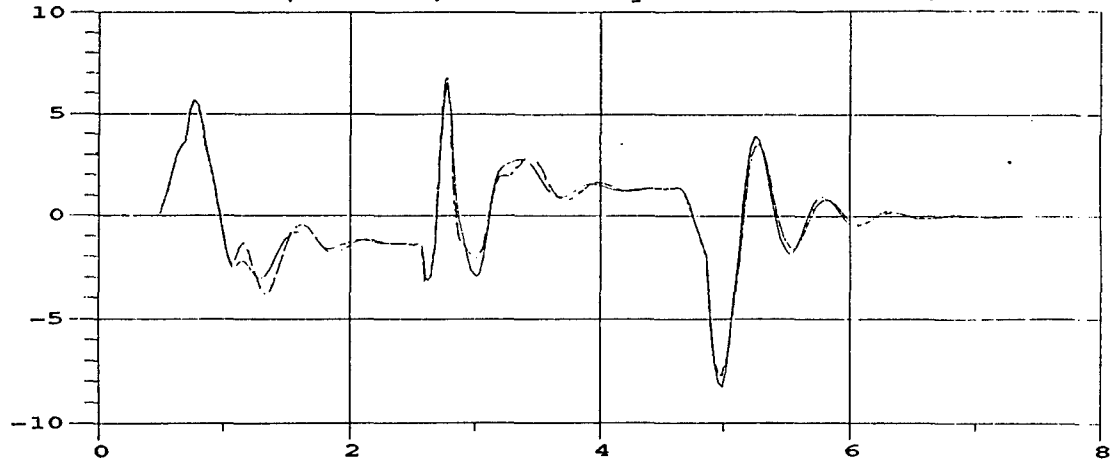

_____ w/o trailer (deg/sec) vs time (sec)
 w/ trailer in low position (deg/sec) vs time (sec)
 - - - - - w/ trailer in high position (deg/sec) vs time (sec)

7

M35A2 Roll Rate; 35 MPH; M105A2 Payload = 1500 lbs, even dist.

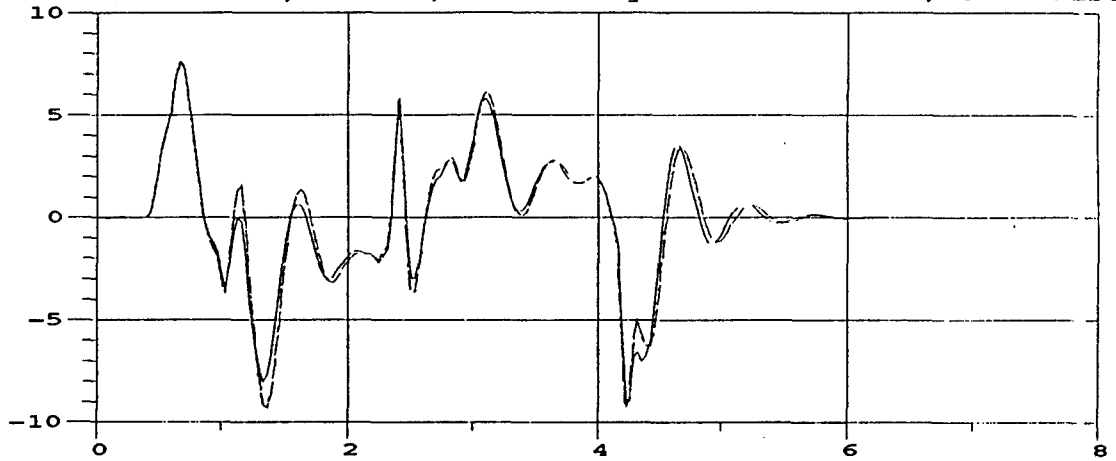

_____ w/o trailer (deg/sec) vs time (sec)
 w/ trailer in low position (deg/sec) vs time (sec)
 - - - - - w/ trailer in high position (deg/sec) vs time (sec)

8

M35A2 Roll Rate; 40 MPH; M105A2 Payload = 1500 lbs, even dist.

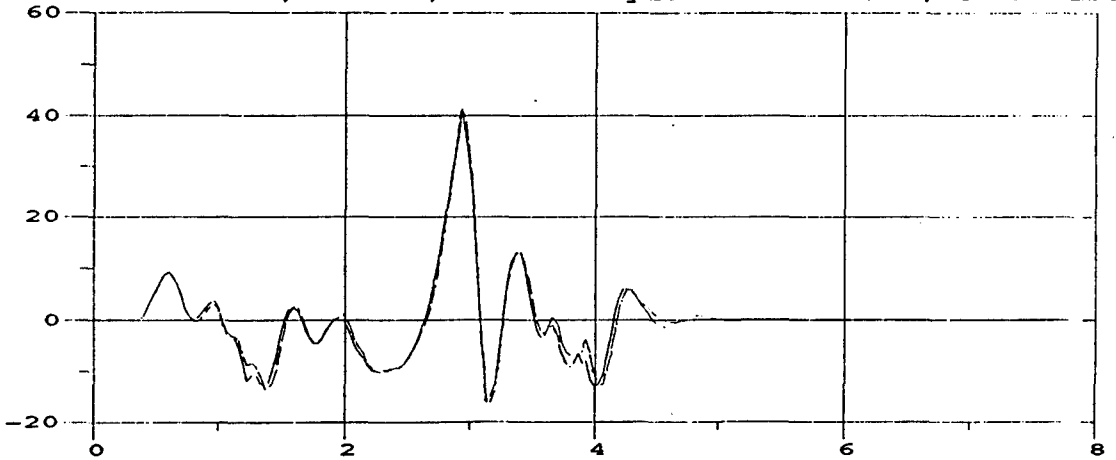

_____ w/o trailer (deg/sec) vs time (sec)
 w/ trailer in low position (deg/sec) vs time (sec)
 - - - - - w/ trailer in high position (deg/sec) vs time (sec)

9

M105A2 Roll Angle; 30 MPH; M105A2 Payload = 1500 lbs, even dist.

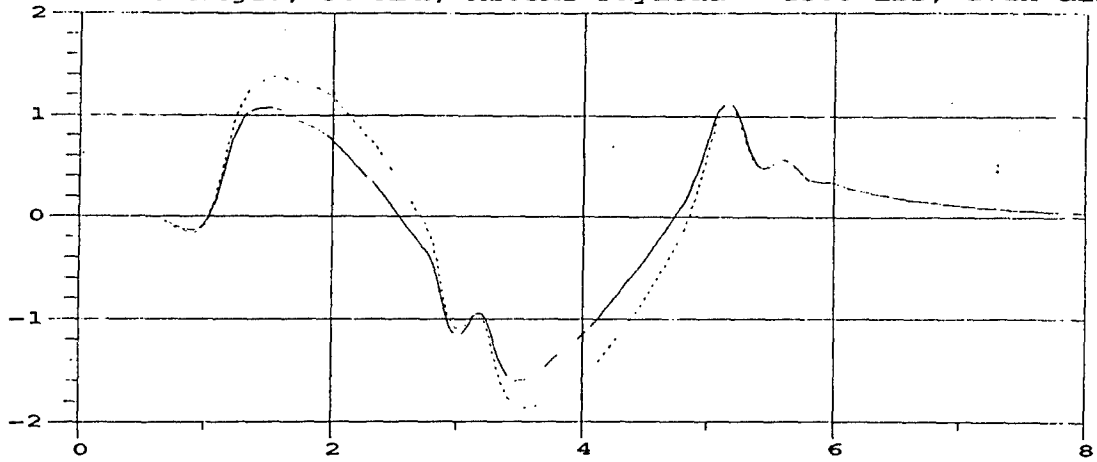

— trailer in low position (degrees) vs time (sec)
..... trailer in high position (degrees) vs time (sec)

10

M105A2 Roll Angle; 35 MPH; M105A2 Payload = 1500 lbs, even dist.

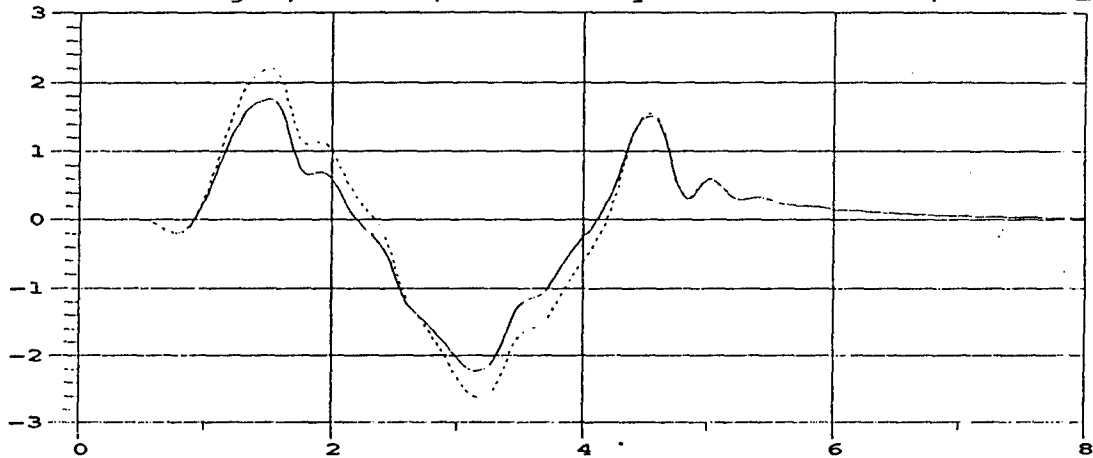

— trailer in low position (degrees) vs time (sec)
..... trailer in high position (degrees) vs time (sec)

11

M105A2 Roll Angle; 40 MPH; M105A2 Payload = 1500 lbs, even dist.

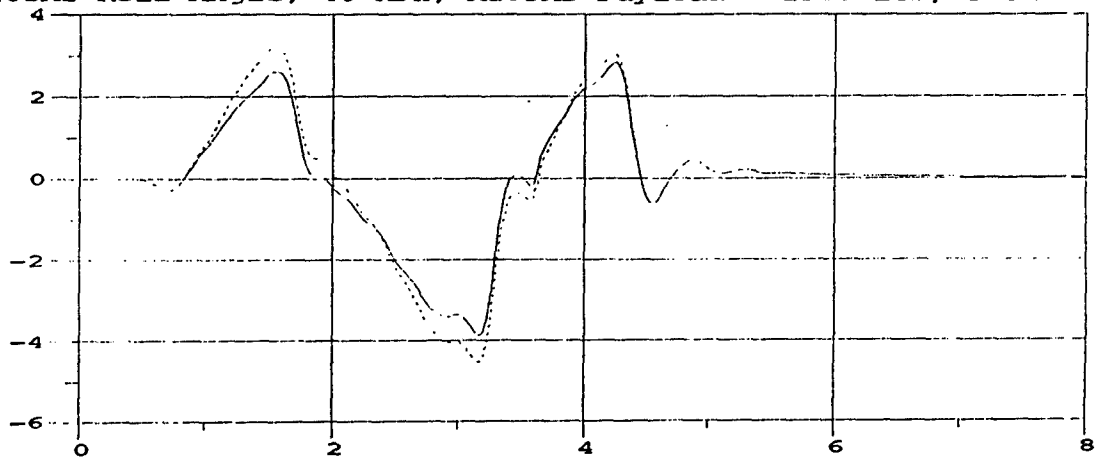

— trailer in low position (degrees) vs time (sec)
..... trailer in high position (degrees) vs time (sec)

12

M105A2 Yaw Angle; 30 MPH; M105A2 Payload = 1500 lbs, even dist.

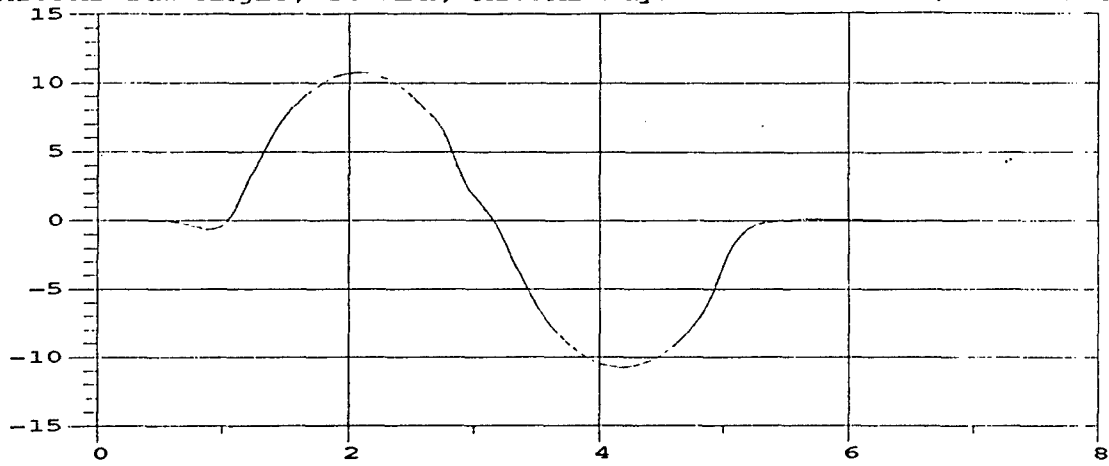

— trailer in low position (degrees) vs time (sec)
- - - trailer in high position (degrees) vs time (sec)

13

M105A2 Yaw Angle; 35 MPH; M105A2 Payload = 1500 lbs, even dist.

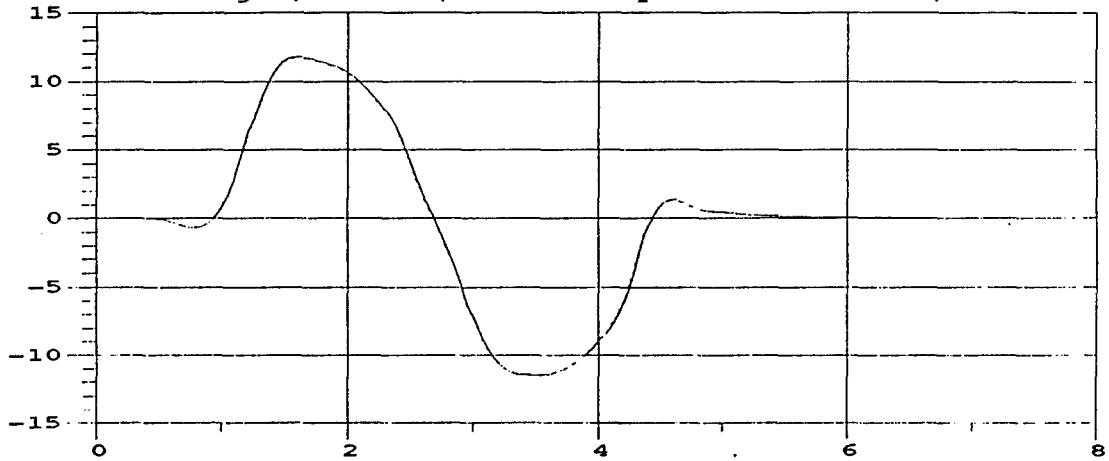

— trailer in low position (degrees) vs time (sec)
- - - trailer in high position (degrees) vs time (sec)

14

M105A2 Yaw Angle; 40 MPH; M105A2 Payload = 1500 lbs, even dist.

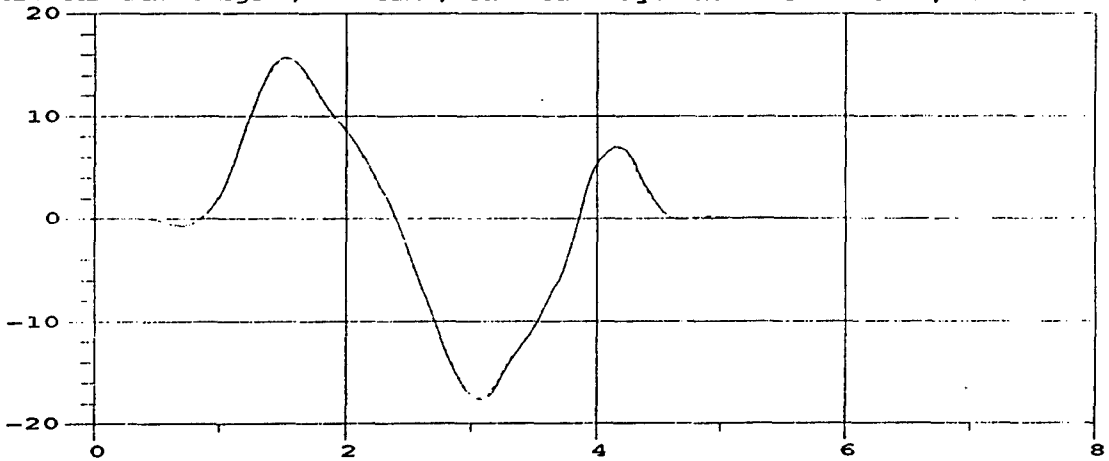

— trailer in low position (degrees) vs time (sec)
- - - trailer in high position (degrees) vs time (sec)

15

M105A2 Roll Rate; 30 MPH; M105A2 Payload = 1500 lbs, even dist.

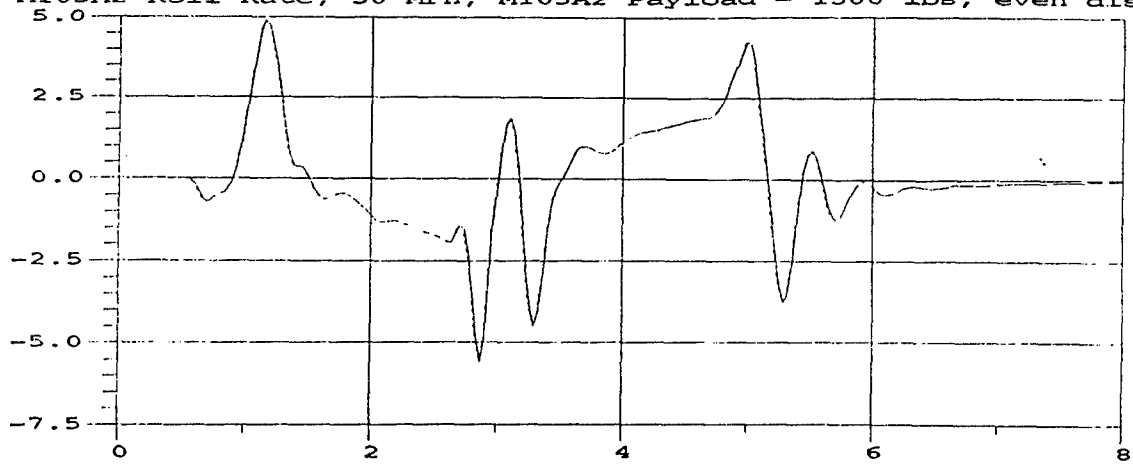

—— trailer in low position (deg/sec) vs time (sec)
----- trailer in high position (deg/sec) vs time (sec)

16

M105A2 Roll Rate; 35 MPH; M105A2 Payload = 1500 lbs, even dist.

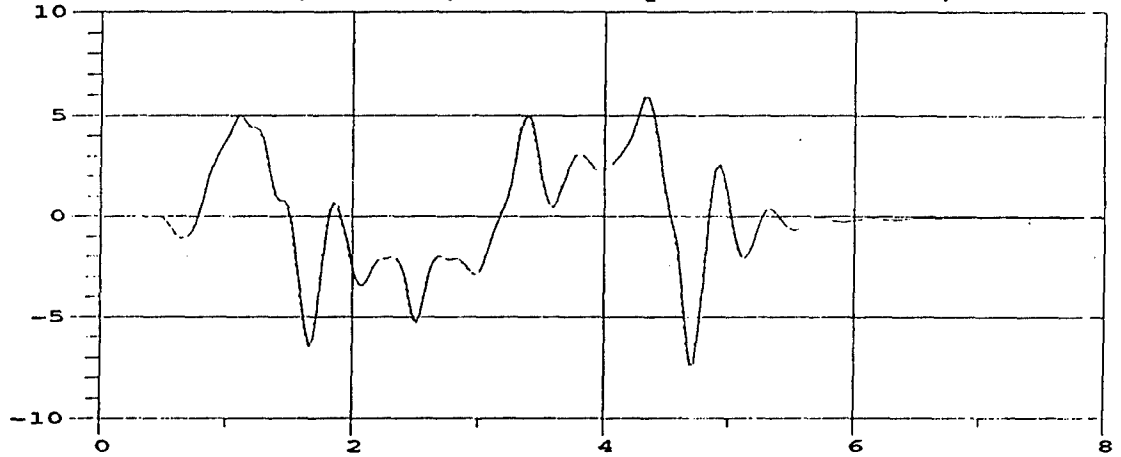

—— trailer in low position (deg/sec) vs time (sec)
----- trailer in high position (deg/sec) vs time (sec)

17

M105A2 Roll Rate; 40 MPH; M105A2 Payload = 1500 lbs, even dist.

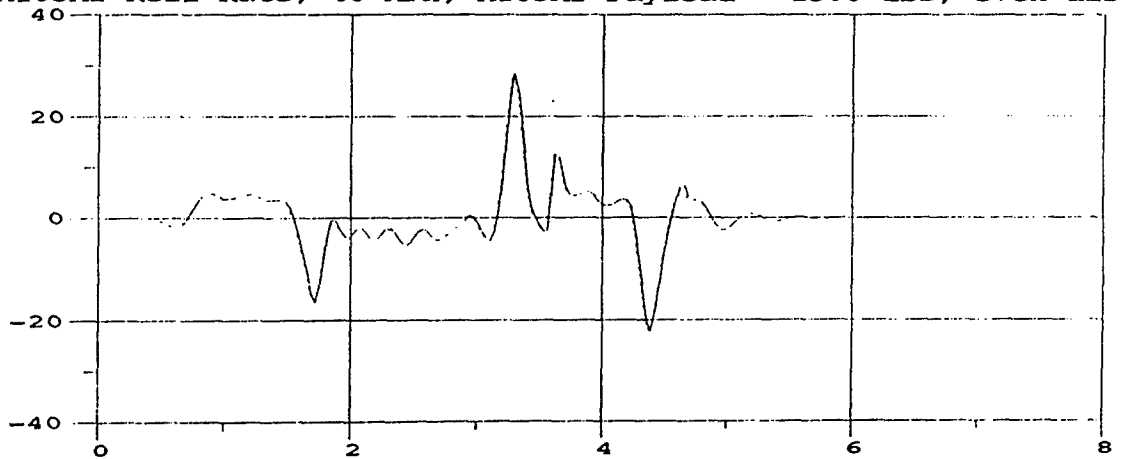

—— trailer in low position (deg/sec) vs time (sec)
----- trailer in high position (deg/sec) vs time (sec)

18

APPENDIX C
TIME HISTORY PLOTS
1500 LBS. PAYLOAD; FRONT HALF DISTRIBUTION

M35A2 Roll Angle; 30 MPH; M105A2 Payload = 1500 lbs, front half

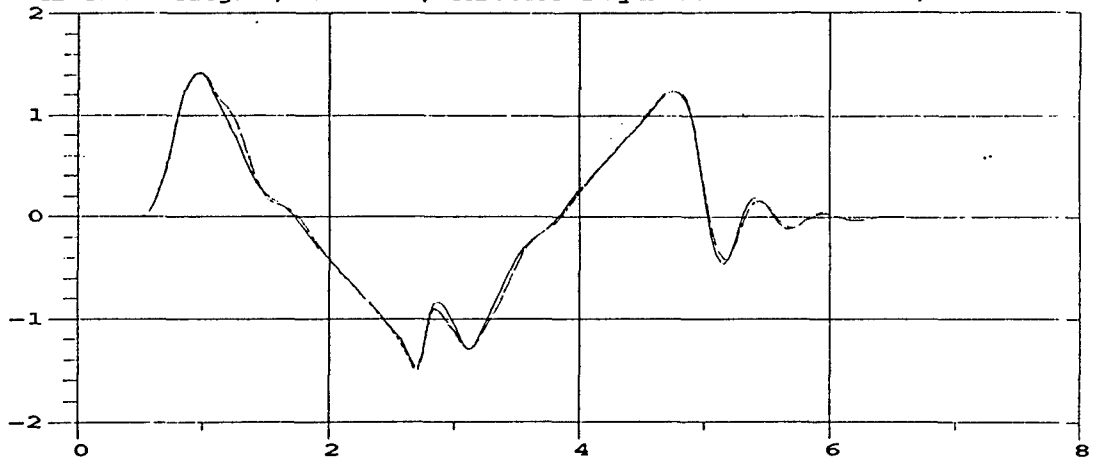

----- w/o trailer (degrees) vs time (sec)
 w/ trailer in low position (degrees) vs time (sec)
 ----- w/ trailer in high position (degrees) vs time (sec)

1

M35A2 Roll Angle; 35 MPH; M105A2 Payload = 1500 lbs, front half

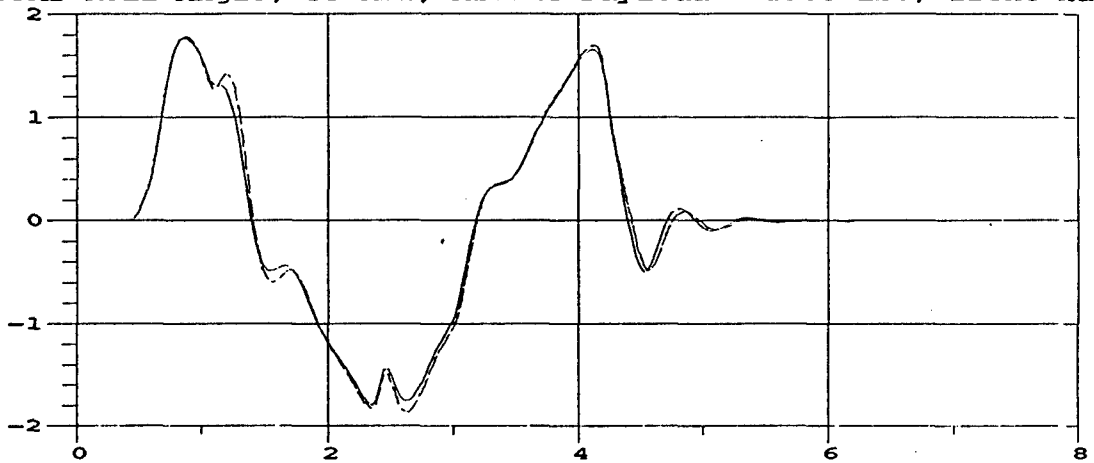

----- w/o trailer (degrees) vs time (sec)
 w/ trailer in low position (degrees) vs time (sec)
 ----- w/ trailer in high position (degrees) vs time (sec)

2

M35A2 Roll Angle; 40 MPH; M105A2 Payload = 1500 lbs, front half

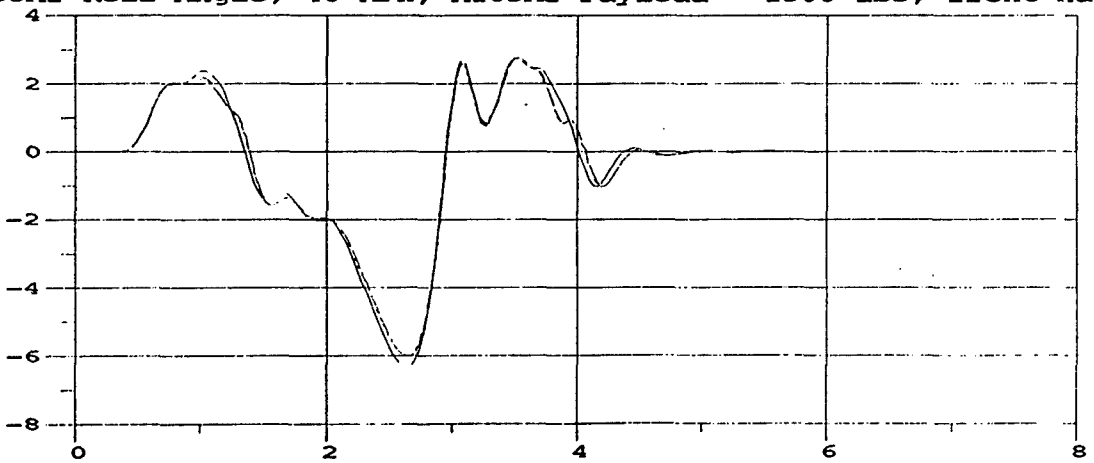

----- w/o trailer (degrees) vs time (sec)
 w/ trailer in low position (degrees) vs time (sec)
 ----- w/ trailer in high position (degrees) vs time (sec)

3

M35A2 Yaw Angle; 30 MPH; M105A2 Payload = 1500 lbs, front half

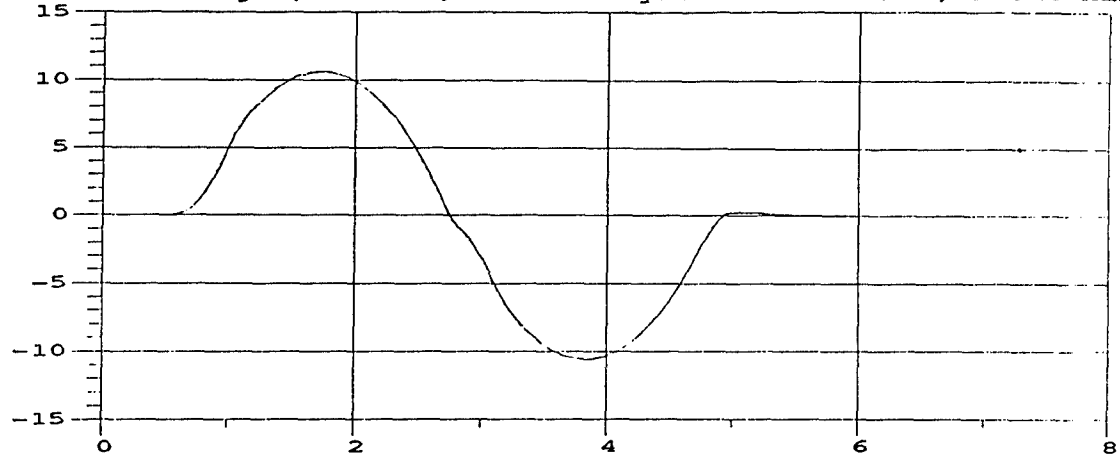

— w/o trailer (degrees) vs time (sec)
 w/ trailer in low position (degrees) vs time (sec)
 - - - w/ trailer in high position (degrees) vs time (sec)

4

M35A2 Yaw Angle; 35 MPH; M105A2 Payload = 1500 lbs, front half

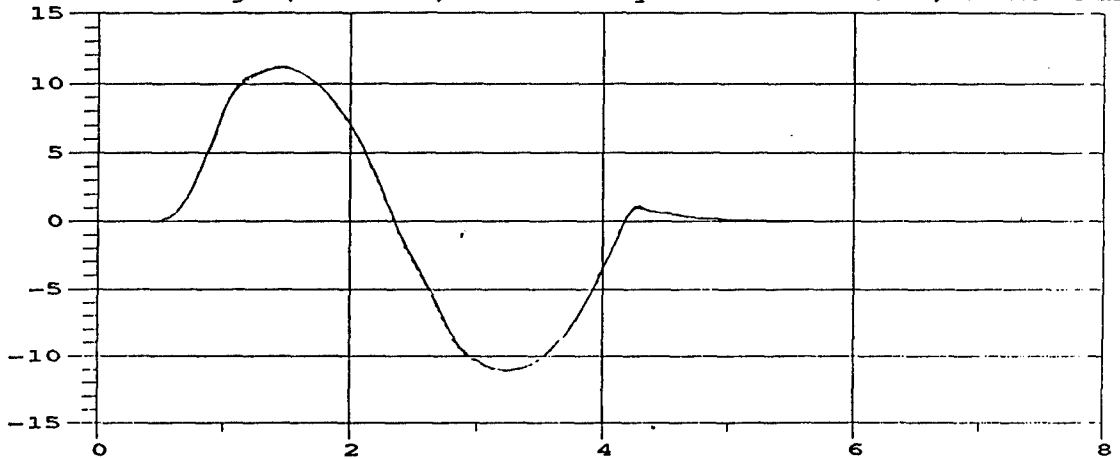

— w/o trailer (degrees) vs time (sec)
 w/ trailer in low position (degrees) vs time (sec)
 - - - w/ trailer in high position (degrees) vs time (sec)

5

M35A2 Yaw Angle; 40 MPH; M105A2 Payload = 1500 lbs, front half

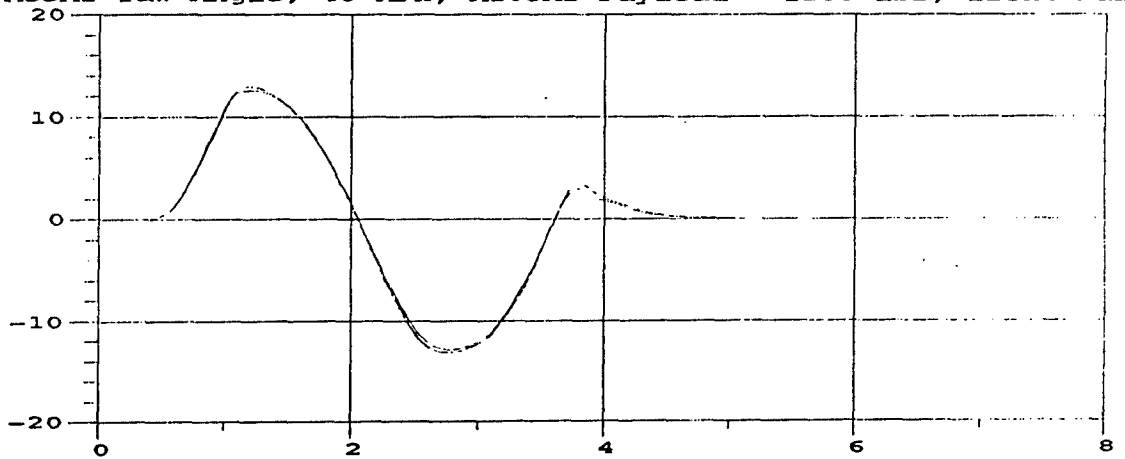

— w/o trailer (degrees) vs time (sec)
 w/ trailer in low position (degrees) vs time (sec)
 - - - w/ trailer in high position (degrees) vs time (sec)

6

M35A2 Roll Rate; 30 MPH; M105A2 Payload = 1500 lbs, front half

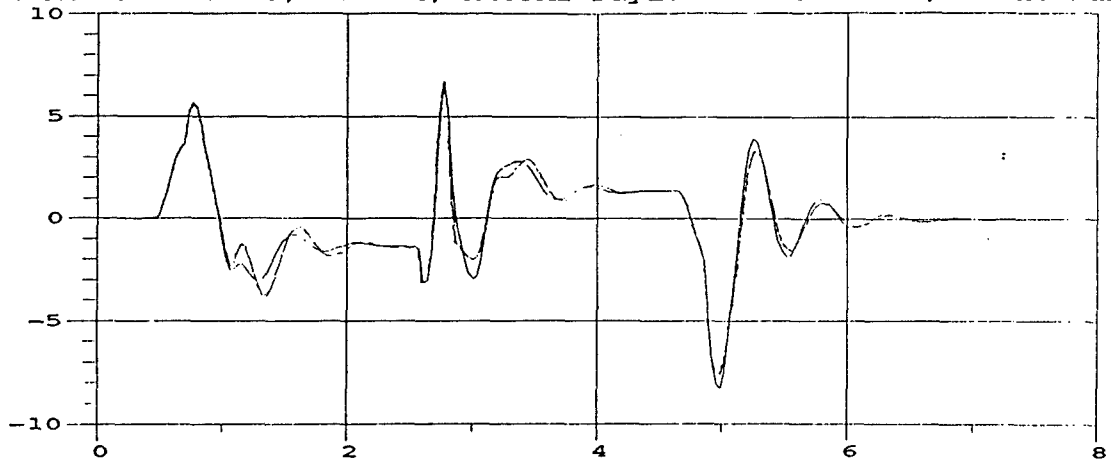

_____ w/o trailer (deg/sec) vs time (sec)
 w/ trailer in low position (deg/sec) vs time (sec)
 - - - - w/ trailer in high position (deg/sec) vs time (sec)

7

M35A2 Roll Rate; 35 MPH; M105A2 Payload = 1500 lbs, front half

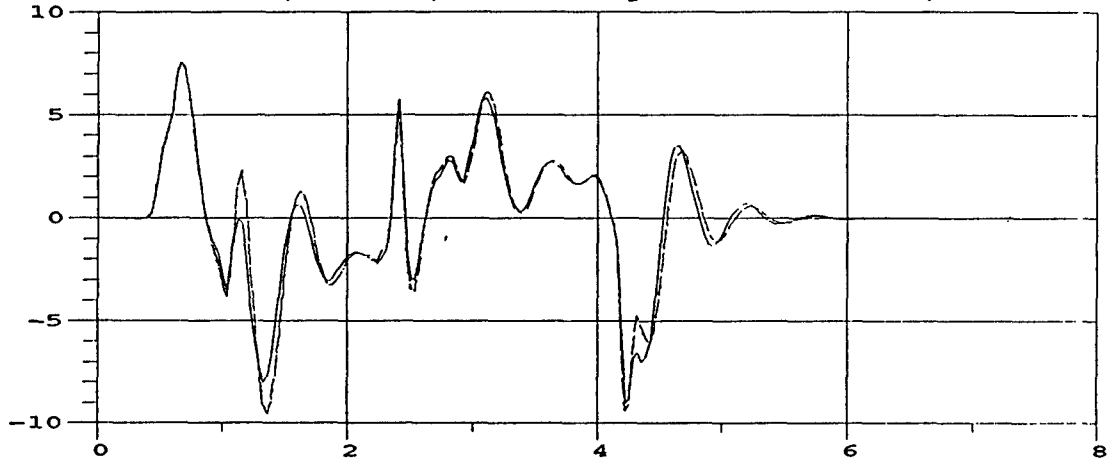

_____ w/o trailer (deg/sec) vs time (sec)
 w/ trailer in low position (deg/sec) vs time (sec)
 - - - - w/ trailer in high position (deg/sec) vs time (sec)

8

M35A2 Roll Rate; 40 MPH; M105A2 Payload = 1500 lbs, front half

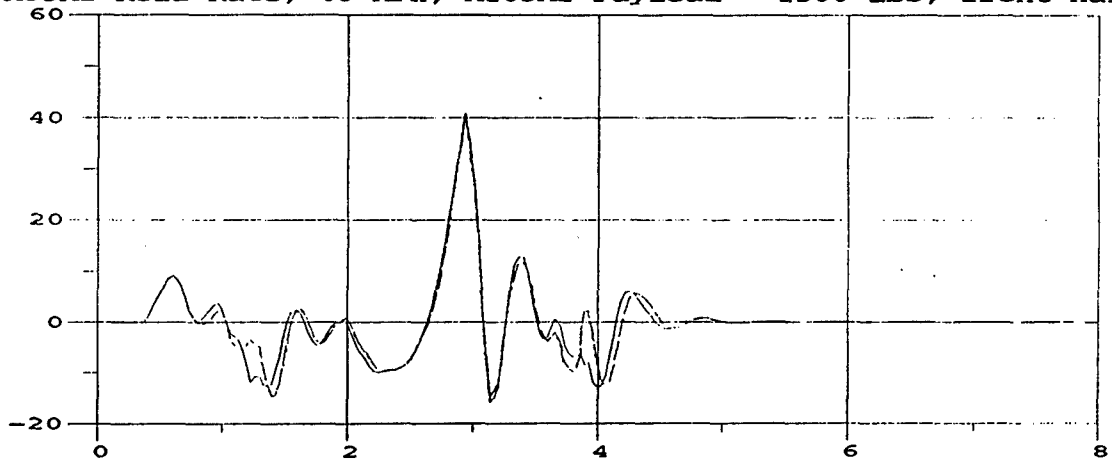

_____ w/o trailer (deg/sec) vs time (sec)
 w/ trailer in low position (deg/sec) vs time (sec)
 - - - - w/ trailer in high position (deg/sec) vs time (sec)

9

M105A2 Roll Angle; 30 MPH; M105A2 Payload = 1500 lbs, front half

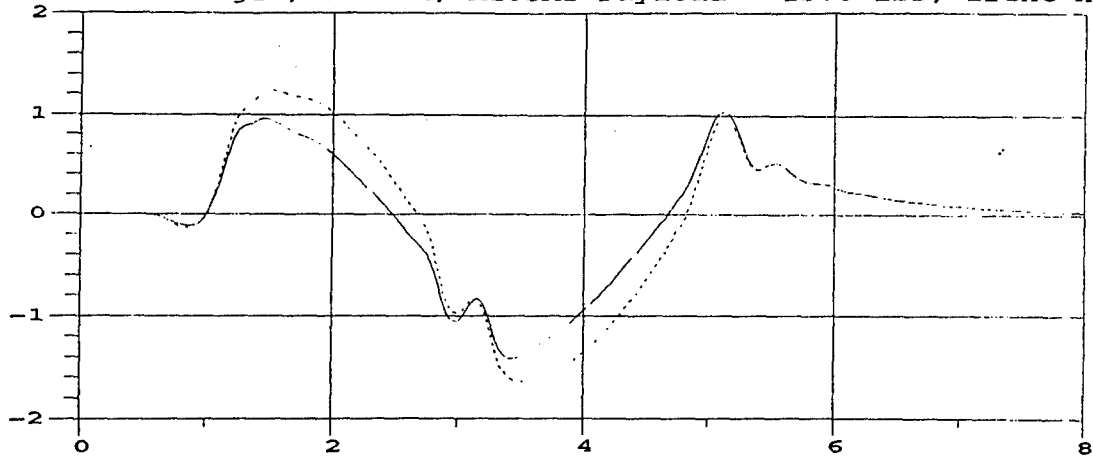

— trailer in low position (degrees) vs time (sec)
..... trailer in high position (degrees) vs time (sec)

10

M105A2 Roll Angle; 35 MPH; M105A2 Payload = 1500 lbs, front half

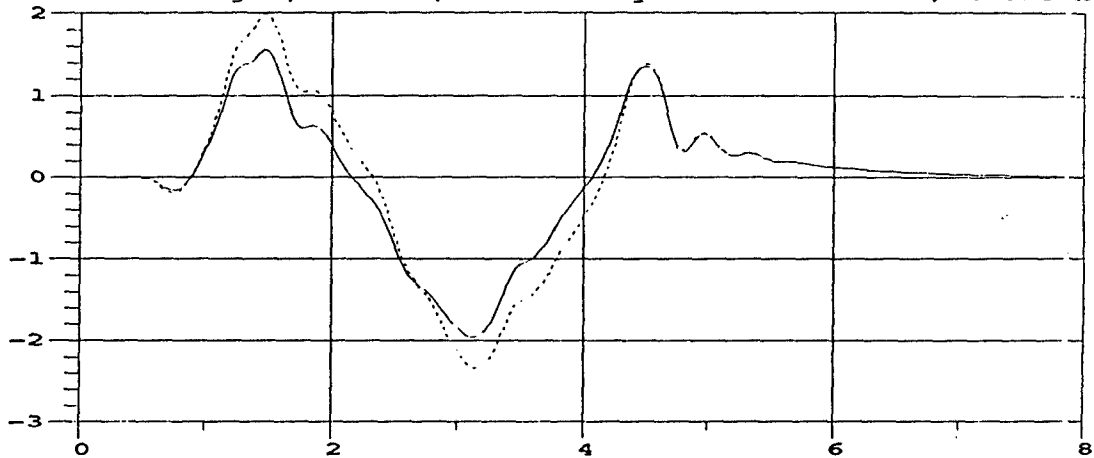

— trailer in low position (degrees) vs time (sec)
..... trailer in high position (degrees) vs time (sec)

11

M105A2 Roll Angle; 40 MPH; M105A2 Payload = 1500 lbs, front half

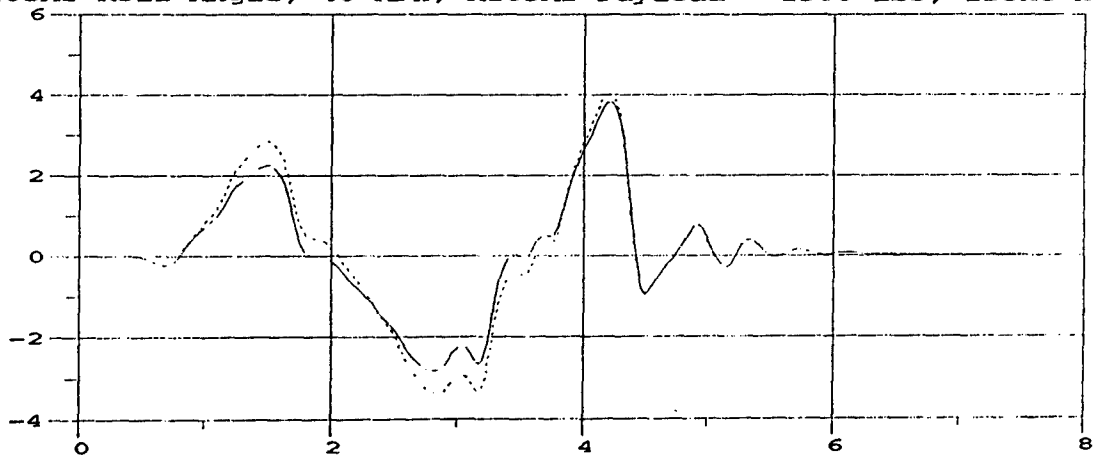

— trailer in low position (degrees) vs time (sec)
..... trailer in high position (degrees) vs time (sec)

12

M105A2 Yaw Angle; 30 MPH; M105A2 Payload = 1500 lbs, front half

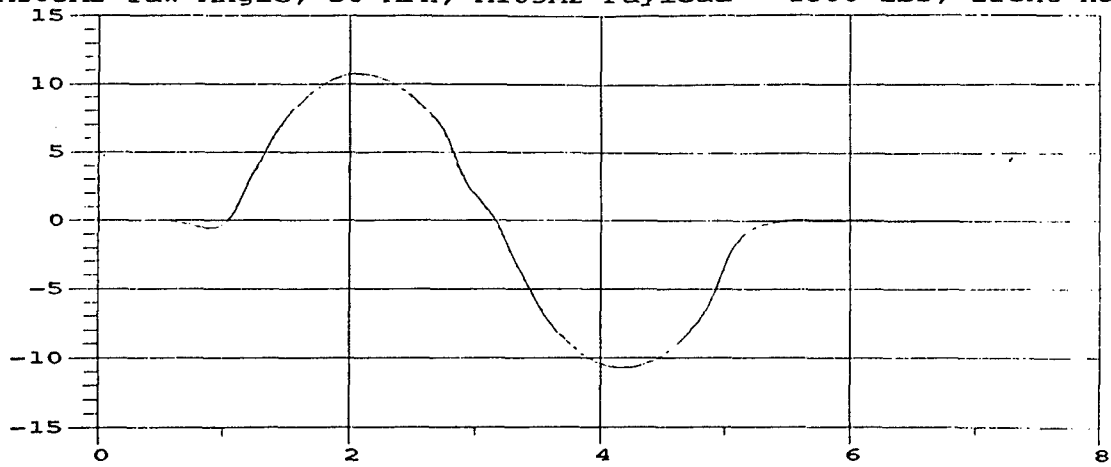

— trailer in low position (degrees) vs time (sec)
- - - trailer in high position (degrees) vs time (sec)

13

M105A2 Yaw Angle; 35 MPH; M105A2 Payload = 1500 lbs, front half

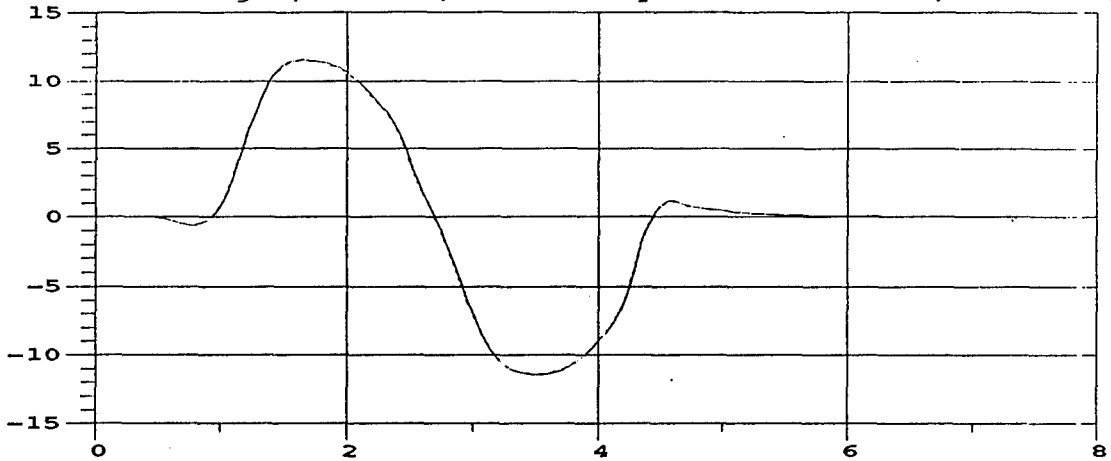

— trailer in low position (degrees) vs time (sec)
- - - trailer in high position (degrees) vs time (sec)

14

M105A2 Yaw Angle; 40 MPH; M105A2 Payload = 1500 lbs, front half

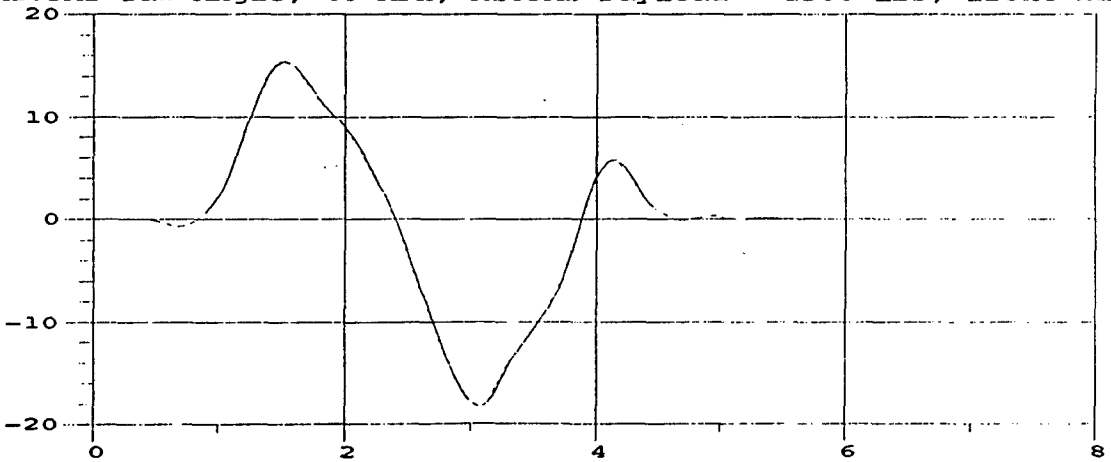

— trailer in low position (degrees) vs time (sec)
- - - trailer in high position (degrees) vs time (sec)

15

M105A2 Roll Rate; 30 MPH; M105A2 Payload = 1500 lbs, front half

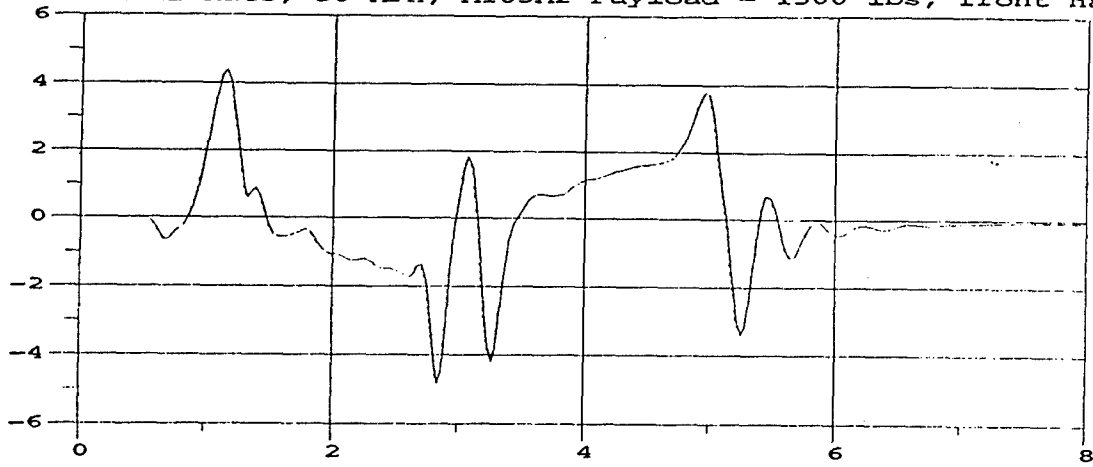

—— trailer in low position (deg/sec) vs time (sec)
..... trailer in high position (deg/sec) vs time (sec)

16

M105A2 Roll Rate; 35 MPH; M105A2 Payload = 1500 lbs, front half

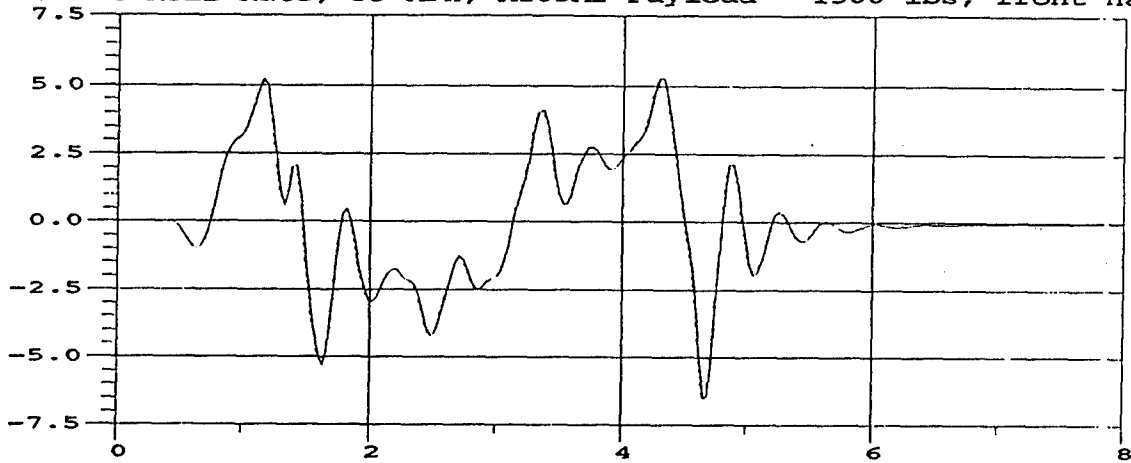

—— trailer in low position (deg/sec) vs time (sec)
..... trailer in high position (deg/sec) vs time (sec)

17

M105A2 Roll Rate; 40 MPH; M105A2 Payload = 1500 lbs, front half

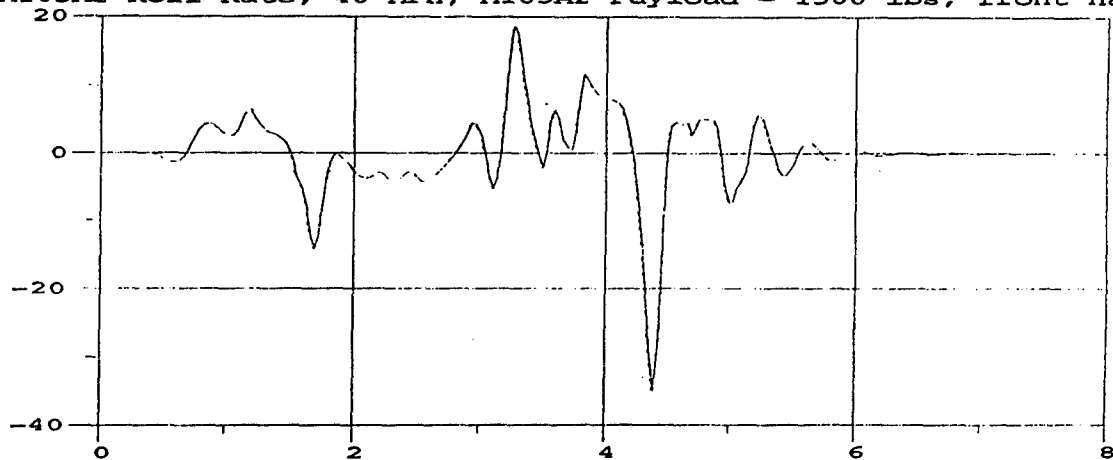

—— trailer in low position (deg/sec) vs time (sec)
..... trailer in high position (deg/sec) vs time (sec)

18

APPENDIX D
TIME HISTORY PLOTS
1500 LBS. PAYLOAD; REAR HALF DISTRIBUTION

M35A2 Roll Angle; 30 MPH; M105A2 Payload = 1500 lbs, rear half

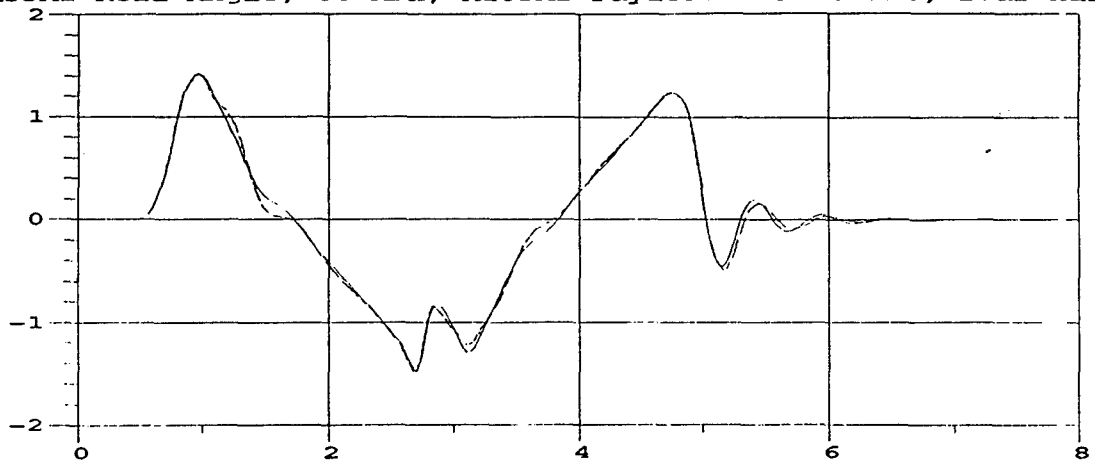

----- w/o trailer (degrees) vs time (sec)
 w/ trailer in low position (degrees) vs time (sec)
 ----- w/ trailer in high position (degrees) vs time (sec)

1

M35A2 Roll Angle; 35 MPH; M105A2 Payload = 1500 lbs, rear half

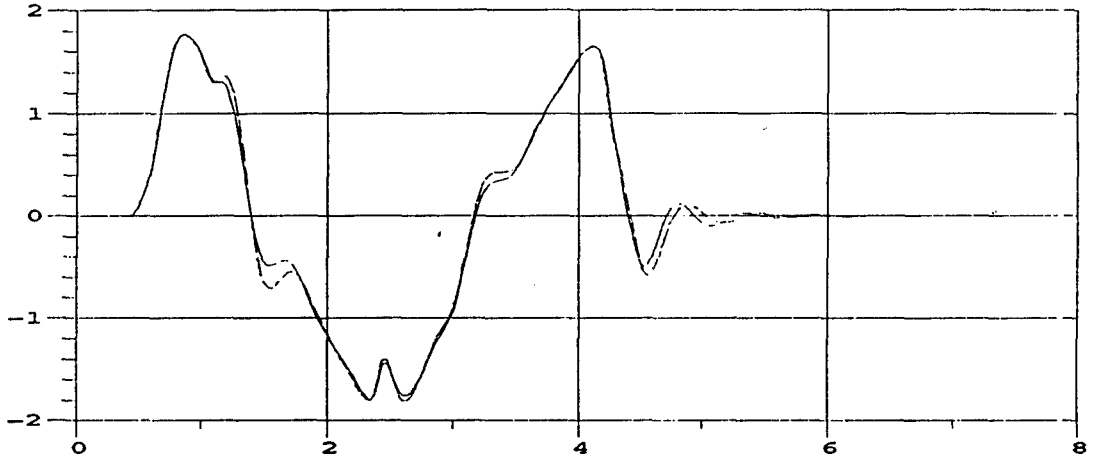

----- w/o trailer (degrees) vs time (sec)
 w/ trailer in low position (degrees) vs time (sec)
 ----- w/ trailer in high position (degrees) vs time (sec)

2

M35A2 Roll Angle; 40 MPH; M105A2 Payload = 1500 lbs, rear half

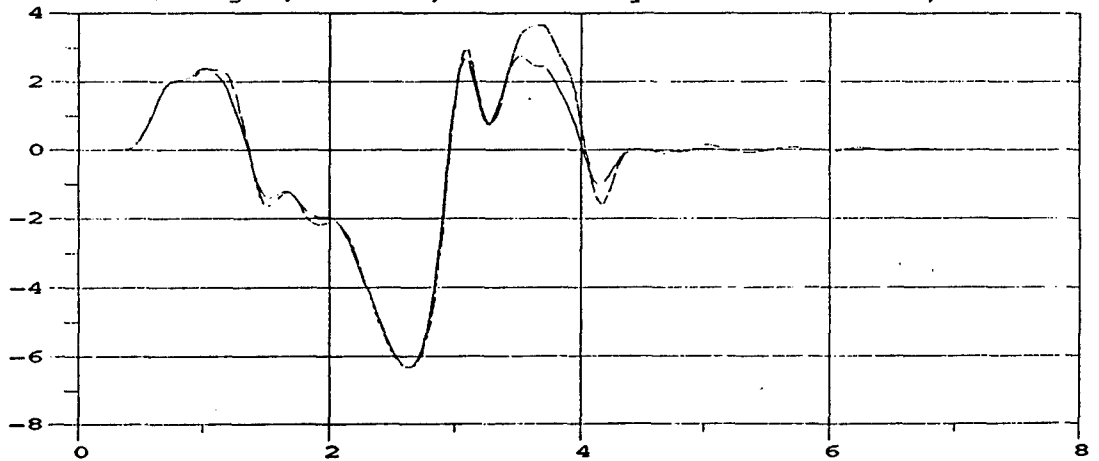

----- w/o trailer (degrees) vs time (sec)
 w/ trailer in low position (degrees) vs time (sec)
 ----- w/ trailer in high position (degrees) vs time (sec)

3

M35A2 Yaw Angle; 30 MPH; M105A2 Payload = 1500 lbs, rear half

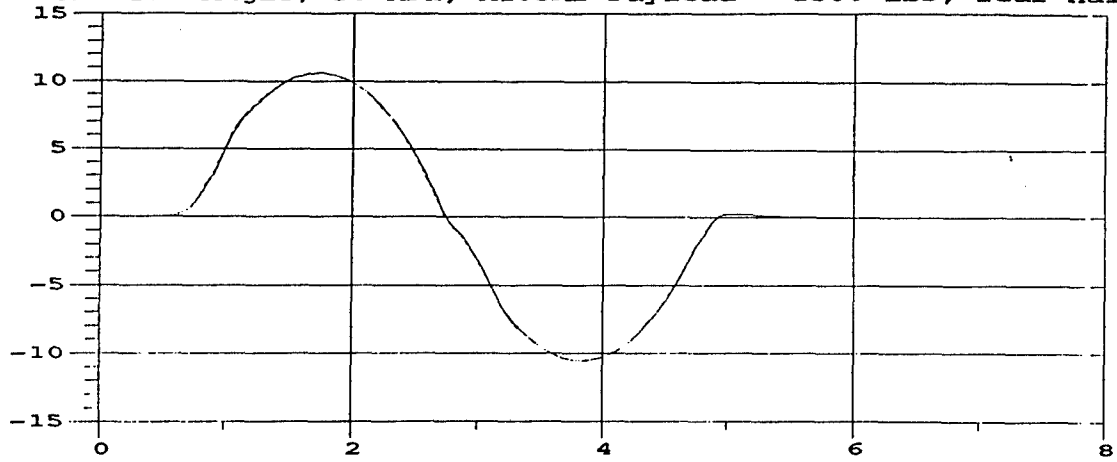

— w/o trailer (degrees) vs time (sec)
 w/ trailer in low position (degrees) vs time (sec)
 - - - w/ trailer in high position (degrees) vs time (sec)

4

M35A2 Yaw Angle; 35 MPH; M105A2 Payload = 1500 lbs, rear half

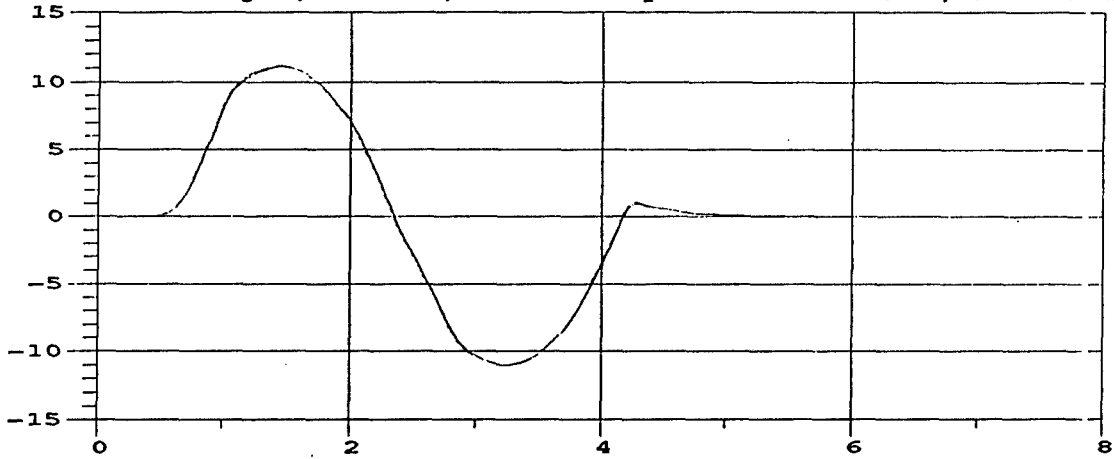

— w/o trailer (degrees) vs time (sec)
 w/ trailer in low position (degrees) vs time (sec)
 - - - w/ trailer in high position (degrees) vs time (sec)

5

M35A2 Yaw Angle; 40 MPH; M105A2 Payload = 1500 lbs, rear half

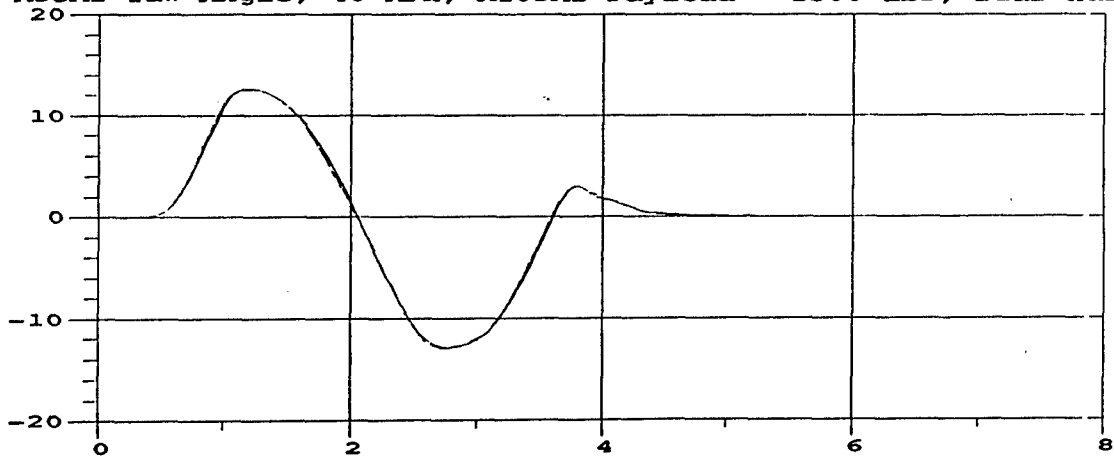

— w/o trailer (degrees) vs time (sec)
 w/ trailer in low position (degrees) vs time (sec)
 - - - w/ trailer in high position (degrees) vs time (sec)

6

M35A2 Roll Rate; 30 MPH; M105A2 Payload = 1500 lbs, rear half

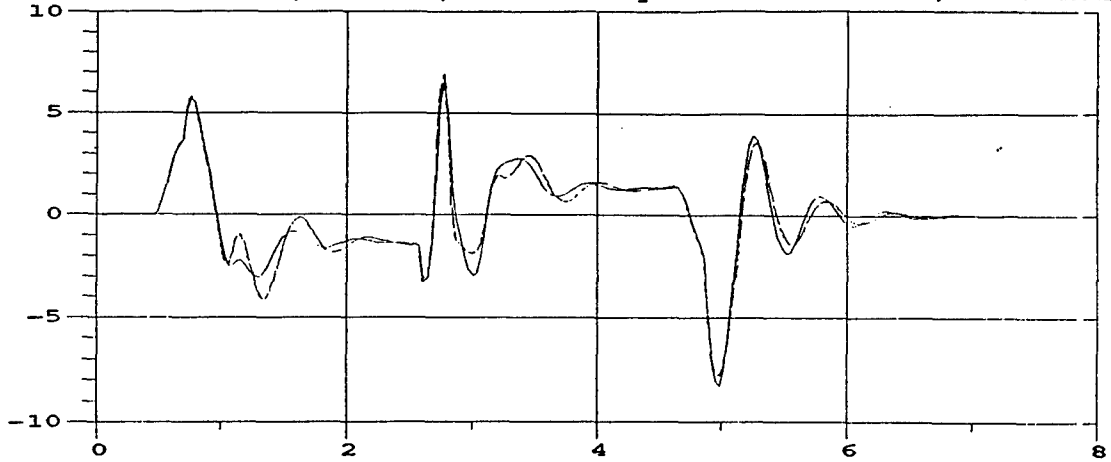

_____ w/o trailer (deg/sec) vs time (sec)
 w/ trailer in low position (deg/sec) vs time (sec)
 - - - - - w/ trailer in high position (deg/sec) vs time (sec)

7

M35A2 Roll Rate; 35 MPH; M105A2 Payload = 1500 lbs, rear half

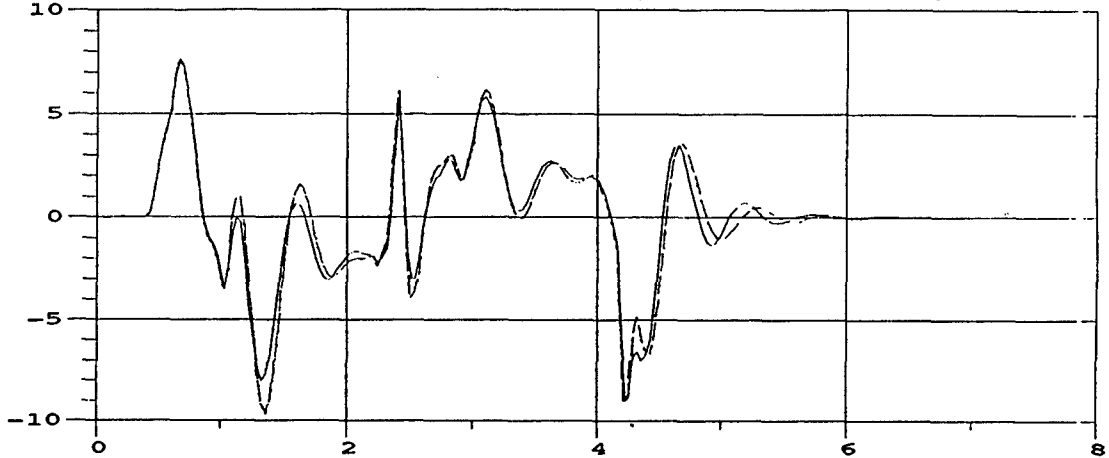

_____ w/o trailer (deg/sec) vs time (sec)
 w/ trailer in low position (deg/sec) vs time (sec)
 - - - - - w/ trailer in high position (deg/sec) vs time (sec)

8

M35A2 Roll Rate; 40 MPH; M105A2 Payload = 1500 lbs, rear half

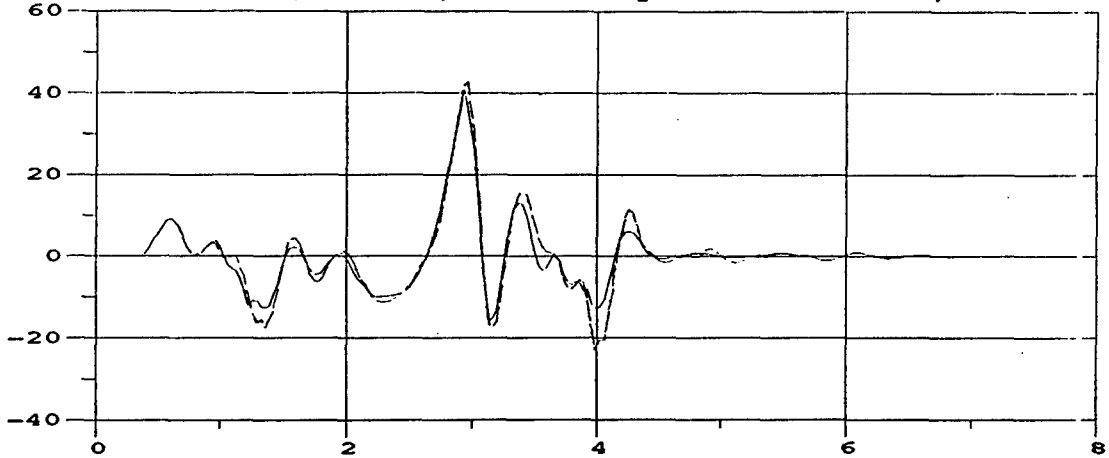

_____ w/o trailer (deg/sec) vs time (sec)
 w/ trailer in low position (deg/sec) vs time (sec)
 - - - - - w/ trailer in high position (deg/sec) vs time (sec)

9

M105A2 Roll Angle; 30 MPH; M105A2 Payload = 1500 lbs, rear half

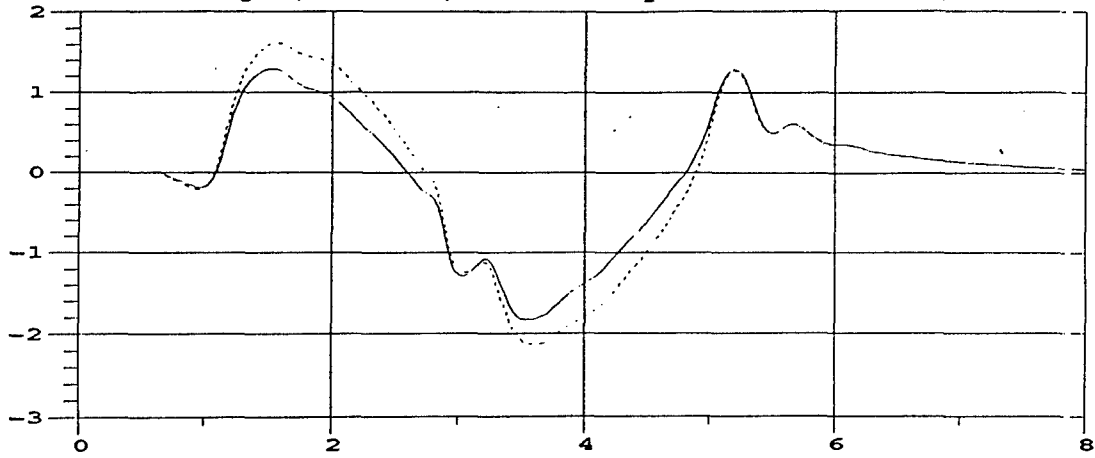

—— trailer in low position (degrees) vs time (sec)
..... trailer in high position (degrees) vs time (sec)

10

M105A2 Roll Angle; 35 MPH; M105A2 Payload = 1500 lbs, rear half

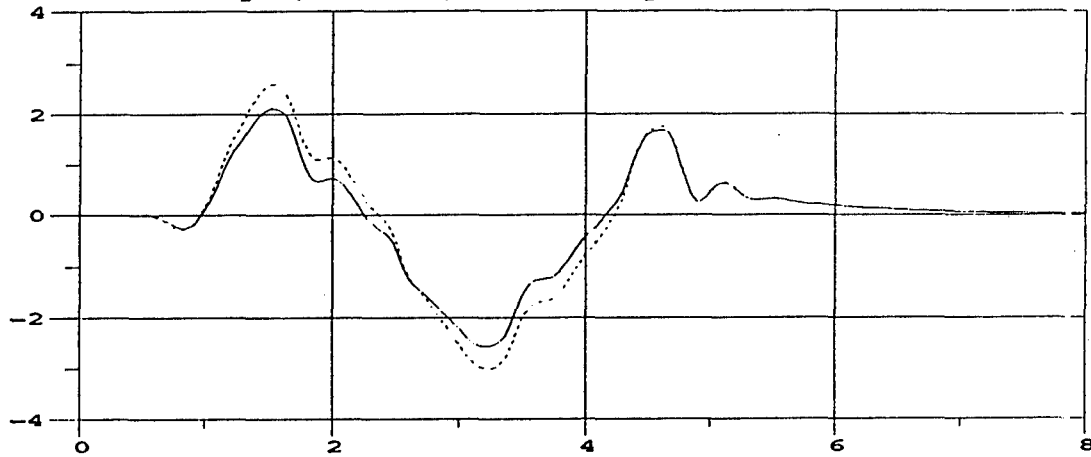

—— trailer in low position (degrees) vs time (sec)
..... trailer in high position (degrees) vs time (sec)

11

M105A2 Roll Angle; 40 MPH; M105A2 Payload = 1500 lbs, rear half

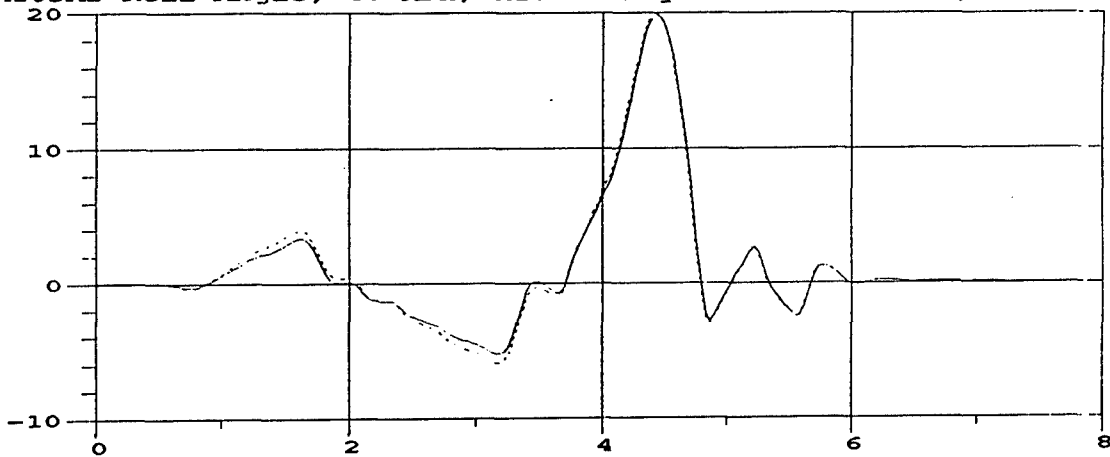

—— trailer in low position (degrees) vs time (sec)
..... trailer in high position (degrees) vs time (sec)

12

M105A2 Yaw Angle; 30 MPH; M105A2 Payload = 1500 lbs, rear half

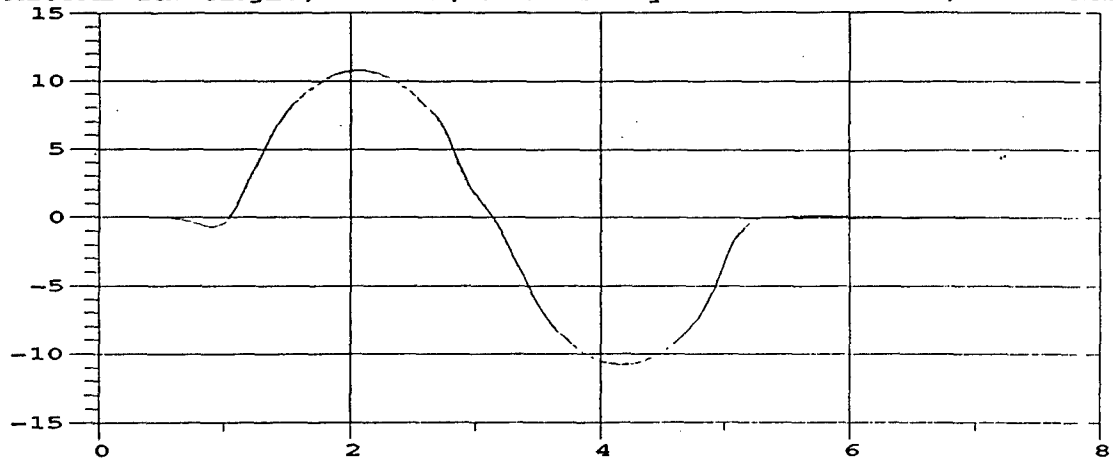

----- trailer in low position (degrees) vs time (sec)
..... trailer in high position (degrees) vs time (sec)

13

M105A2 Yaw Angle; 35 MPH; M105A2 Payload = 1500 lbs, rear half

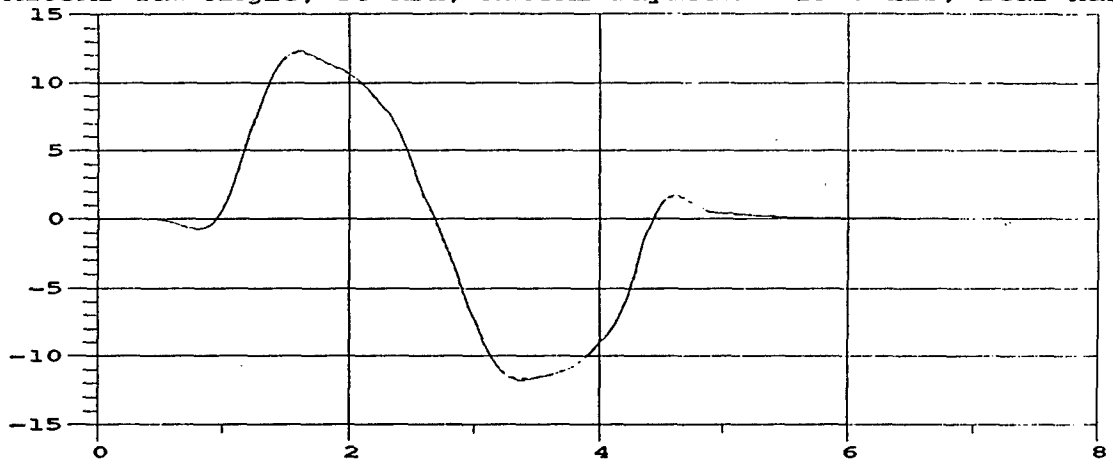

----- trailer in low position (degrees) vs time (sec)
..... trailer in high position (degrees) vs time (sec)

14

M105A2 Yaw Angle; 40 MPH; M105A2 Payload = 1500 lbs, rear half

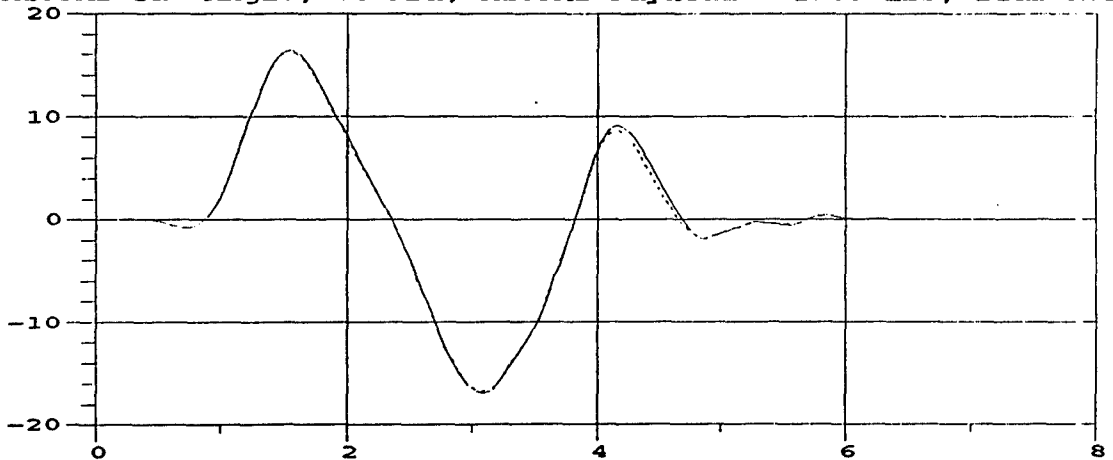

----- trailer in low position (degrees) vs time (sec)
..... trailer in high position (degrees) vs time (sec)

15

M105A2 Roll Rate; 30 MPH; M105A2 Payload = 1500 lbs, rear half

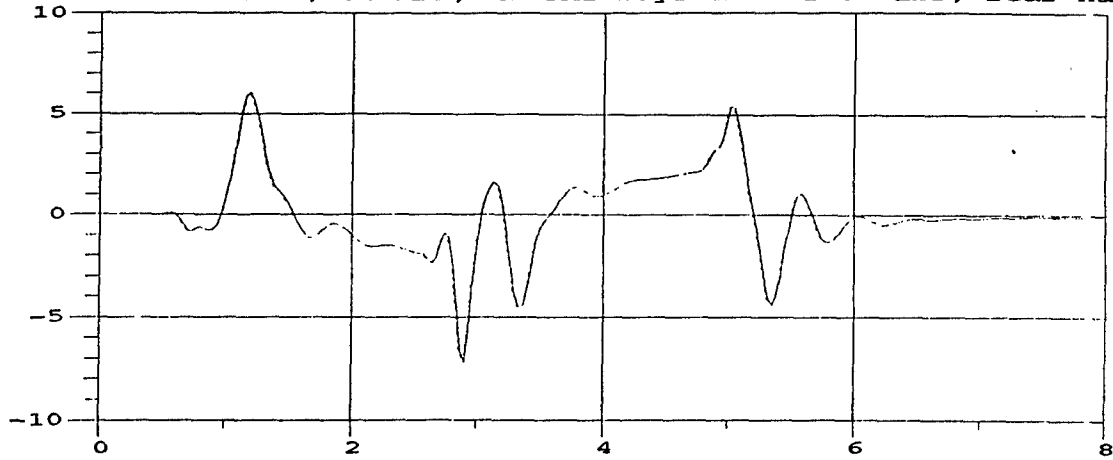

— trailer in low position (deg/sec) vs time (sec)
..... trailer in high position (deg/sec) vs time (sec)

16

M105A2 Roll Rate; 35 MPH; M105A2 Payload = 1500 lbs, rear half

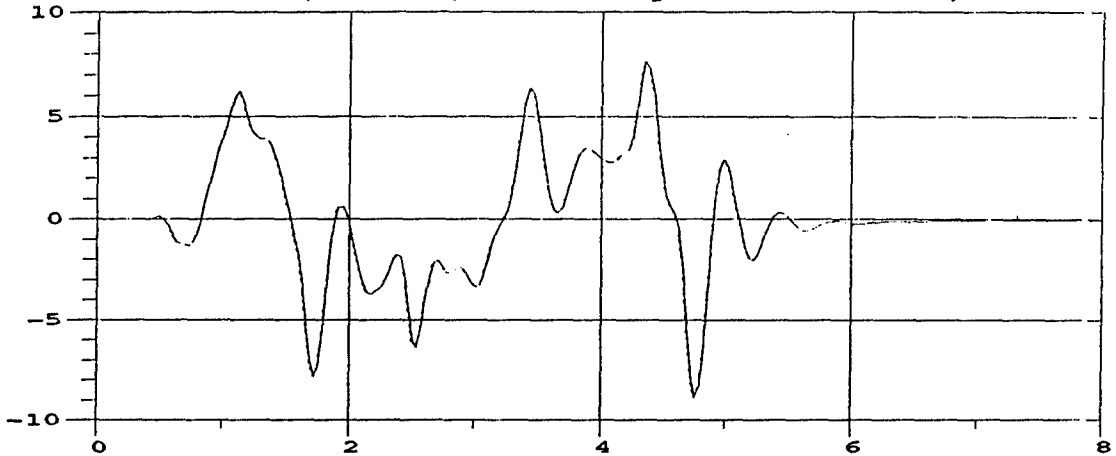

— trailer in low position (deg/sec) vs time (sec)
..... trailer in high position (deg/sec) vs time (sec)

17

M105A2 Roll Rate; 40 MPH; M105A2 Payload = 1500 lbs, rear half

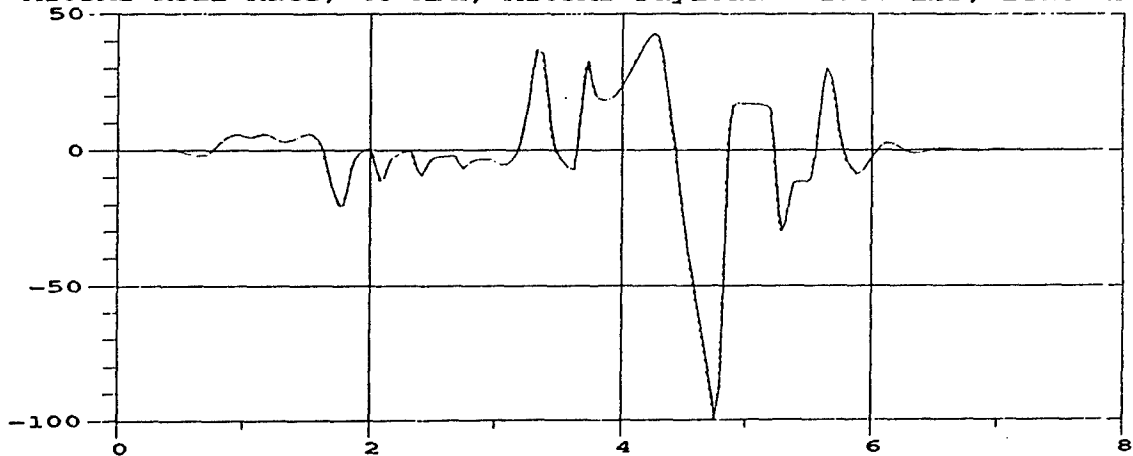

— trailer in low position (deg/sec) vs time (sec)
..... trailer in high position (deg/sec) vs time (sec)

18

APPENDIX E
TIME HISTORY PLOTS
1500 LBS. PAYLOAD; LEFT CENTER DISTRIBUTION

M35A2 Roll Angle; 30 MPH; M105a2 Payload = 1500 lbs, left center

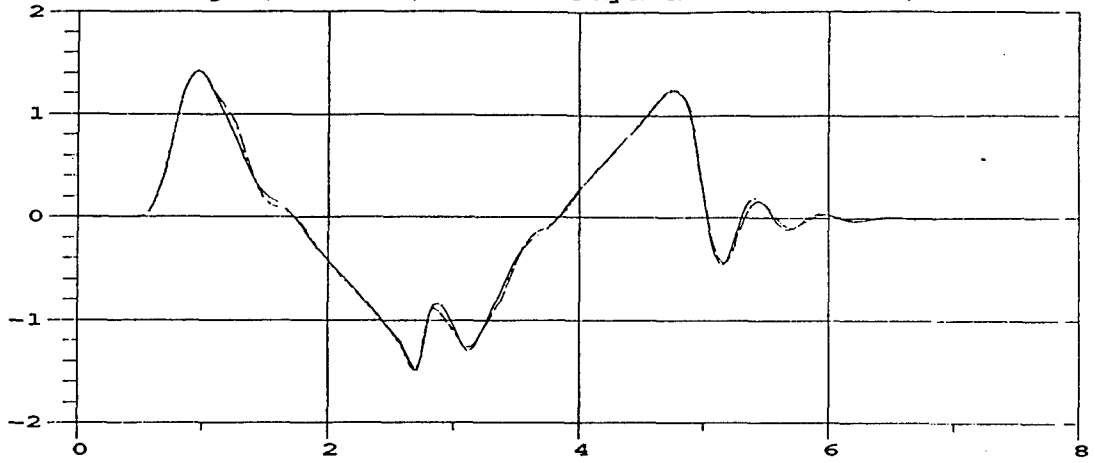

— w/o trailer (degrees) vs time (sec)
 w/ trailer in low position (degrees) vs time (sec)
 - - - w/ trailer in high position (degrees) vs time (sec)

1

M35A2 Roll Angle; 35 MPH; M105a2 Payload = 1500 lbs, left center

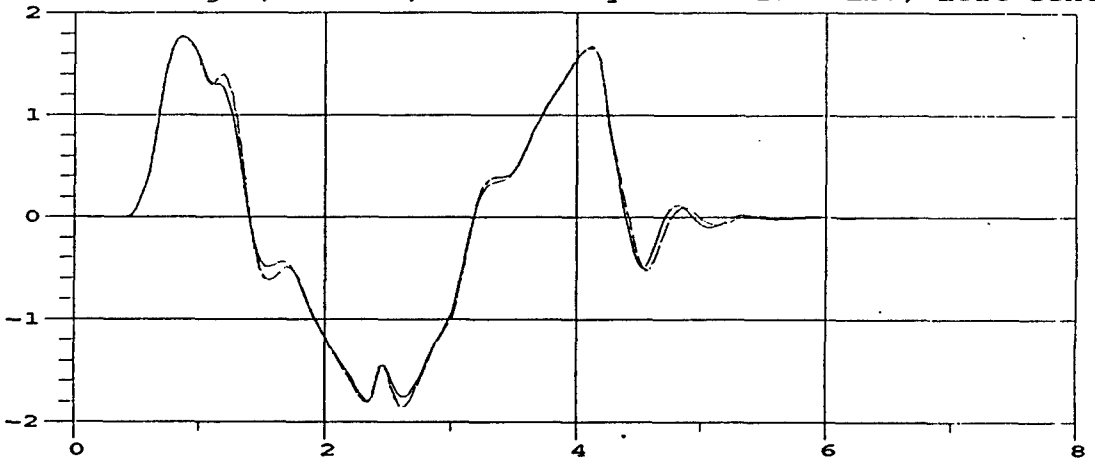

— w/o trailer (degrees) vs time (sec)
 w/ trailer in low position (degrees) vs time (sec)
 - - - w/ trailer in high position (degrees) vs time (sec)

2

M35A2 Roll Angle; 40 MPH; M105a2 Payload = 1500 lbs, left center

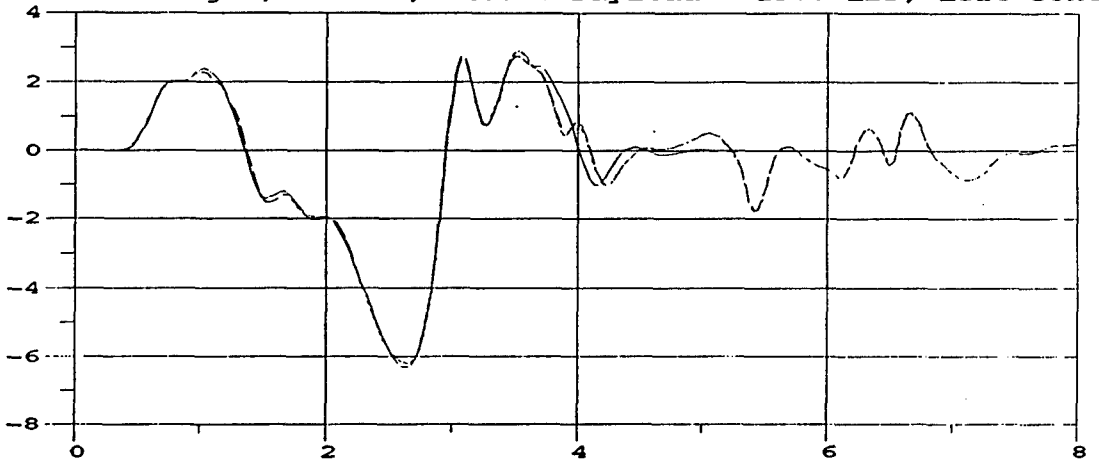

— w/o trailer (degrees) vs time (sec)
 w/ trailer in low position (degrees) vs time (sec)
 - - - w/ trailer in high position (degrees) vs time (sec)

3

M35A2 Yaw Angle; 30 MPH; M105a2 Payload = 1500 lbs, left center

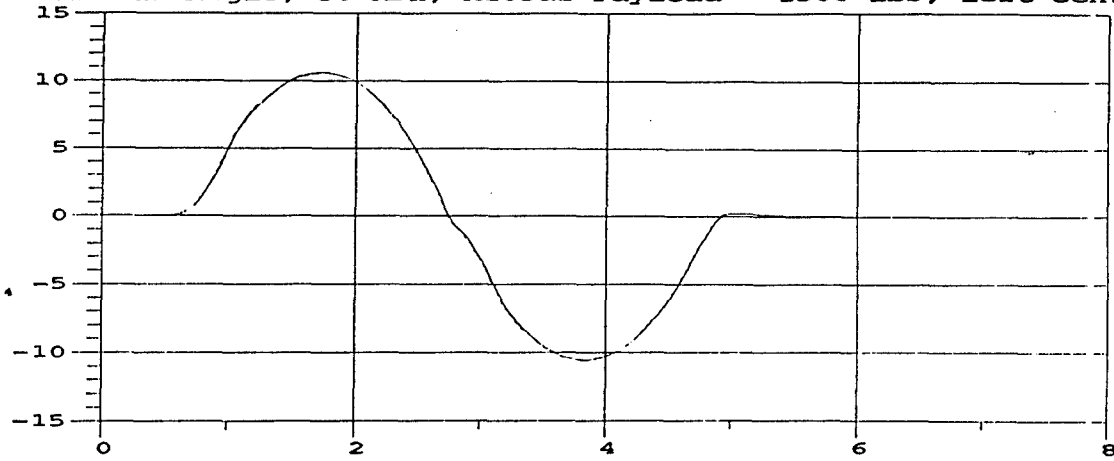

— w/o trailer (degrees) vs time (sec)
 w/ trailer in low position (degrees) vs time (sec)
 - - - w/ trailer in high position (degrees) vs time (sec)

4

M35A2 Yaw Angle; 35 MPH; M105a2 Payload = 1500 lbs, left center

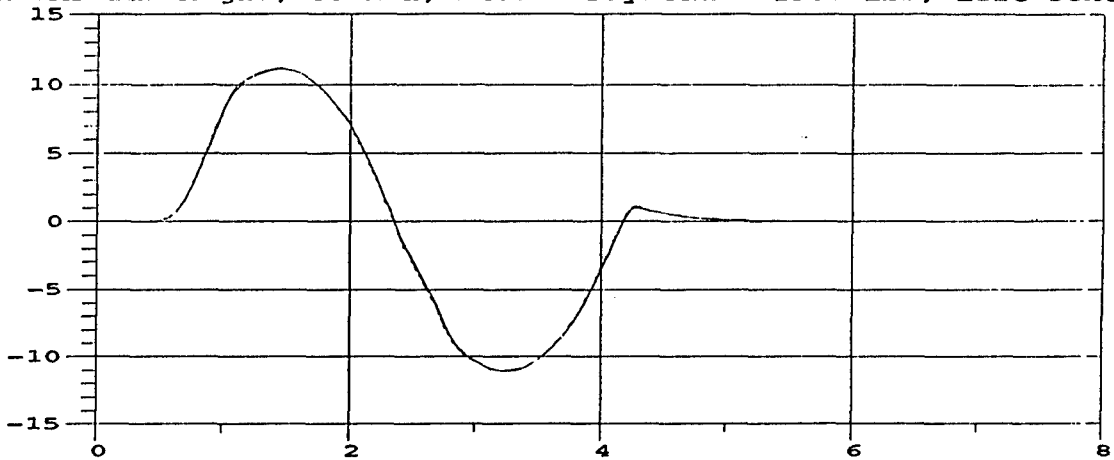

— w/o trailer (degrees) vs time (sec)
 w/ trailer in low position (degrees) vs time (sec)
 - - - w/ trailer in high position (degrees) vs time (sec)

5

M35A2 Yaw Angle; 40 MPH; M105a2 Payload = 1500 lbs, left center

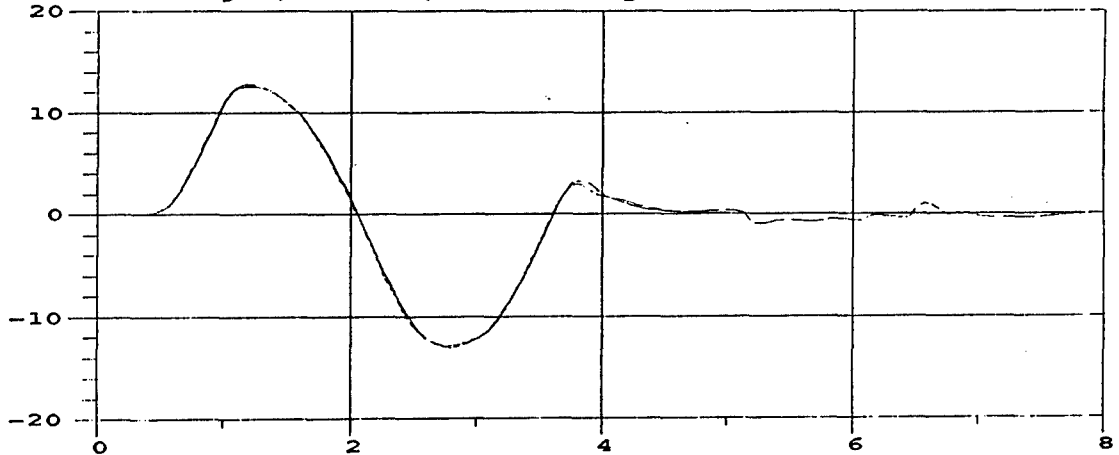

— w/o trailer (degrees) vs time (sec)
 w/ trailer in low position (degrees) vs time (sec)
 - - - w/ trailer in high position (degrees) vs time (sec)

6

M35A2 Roll Rate; 30 MPH; M105a2 Payload = 1500 lbs, left center

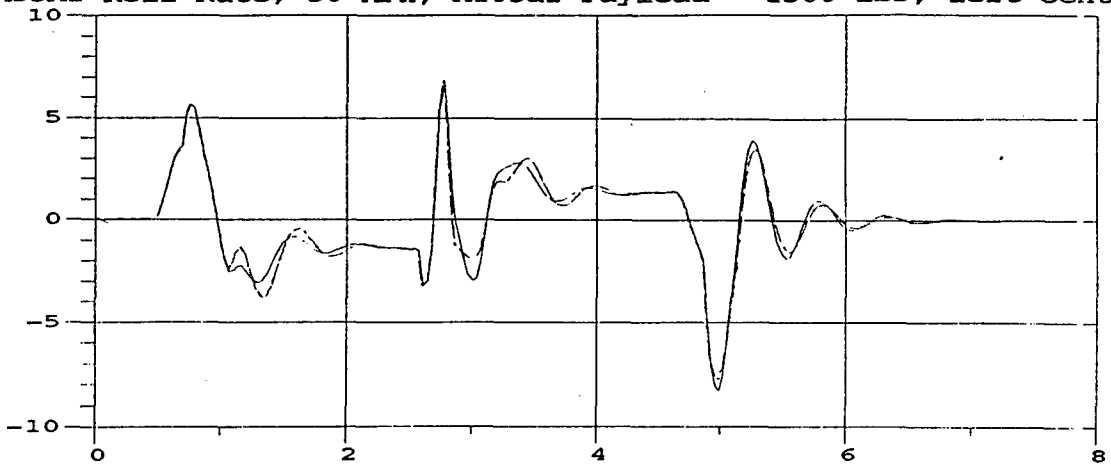

— w/o trailer (deg/sec) vs time (sec)
..... w/ trailer in low position (deg/sec) vs time (sec)
- - - w/ trailer in high position (deg/sec) vs time (sec)

7

M35A2 Roll Rate; 35 MPH; M105a2 Payload = 1500 lbs, left center

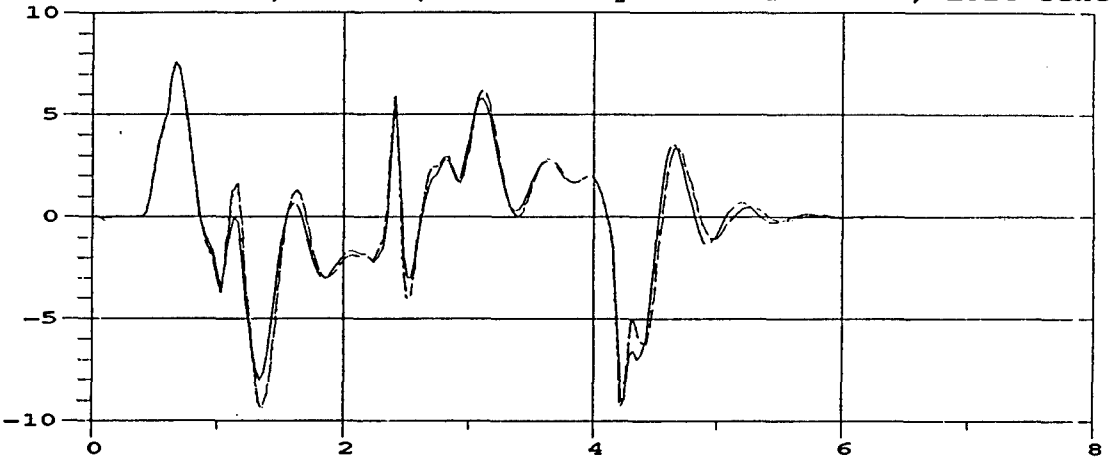

— w/o trailer (deg/sec) vs time (sec)
..... w/ trailer in low position (deg/sec) vs time (sec)
- - - w/ trailer in high position (deg/sec) vs time (sec)

8

M35A2 Roll Rate; 40 MPH; M105a2 Payload = 1500 lbs, left center

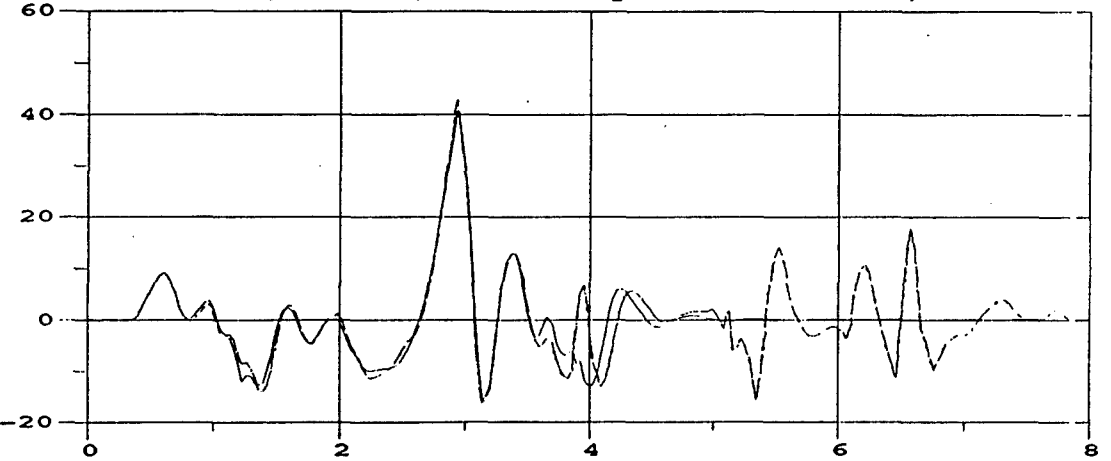

— w/o trailer (deg/sec) vs time (sec)
..... w/ trailer in low position (deg/sec) vs time (sec)
- - - w/ trailer in high position (deg/sec) vs time (sec)

9

M105A2 Roll Angle; 30 MPH; M105a2 Payload = 1500 lbs, left center

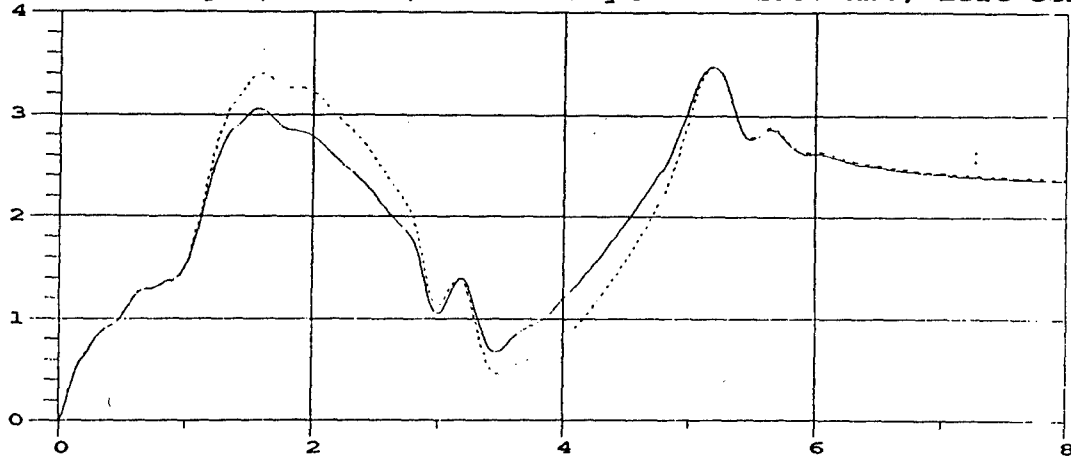

— trailer in low position (degrees) vs time (sec)
..... trailer in high position (degrees) vs time (sec)

10

M105A2 Roll Angle; 35 MPH; M105a2 Payload = 1500 lbs, left center

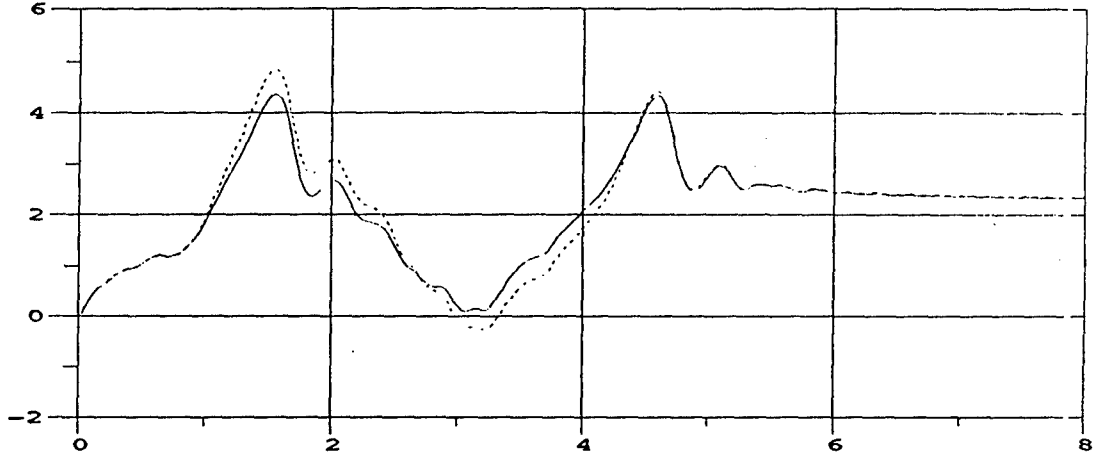

— trailer in low position (degrees) vs time (sec)
..... trailer in high position (degrees) vs time (sec)

11

M105A2 Roll Angle; 40 MPH; M105a2 Payload = 1500 lbs, left center

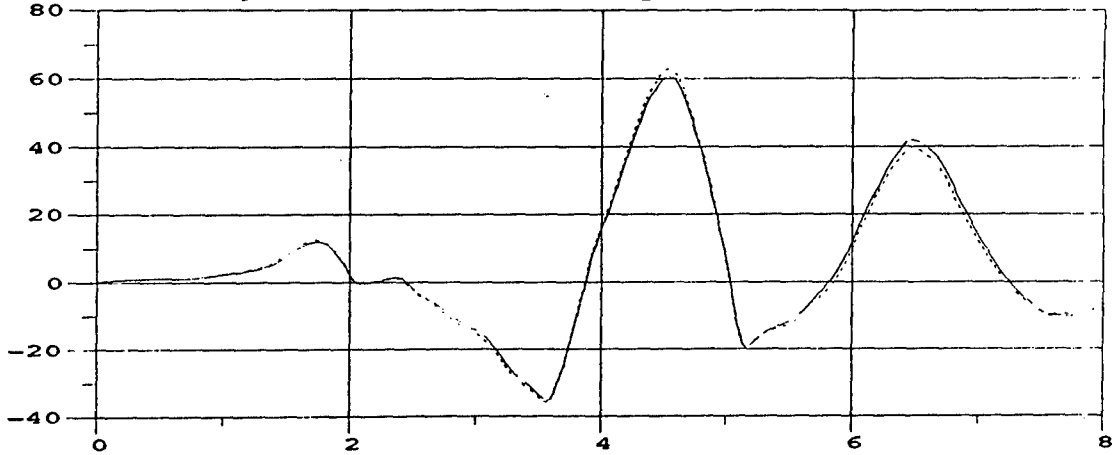

— trailer in low position (degrees) vs time (sec)
..... trailer in high position (degrees) vs time (sec)

12

M105A2 Yaw Angle; 30 MPH; M105a2 Payload = 1500 lbs, left center

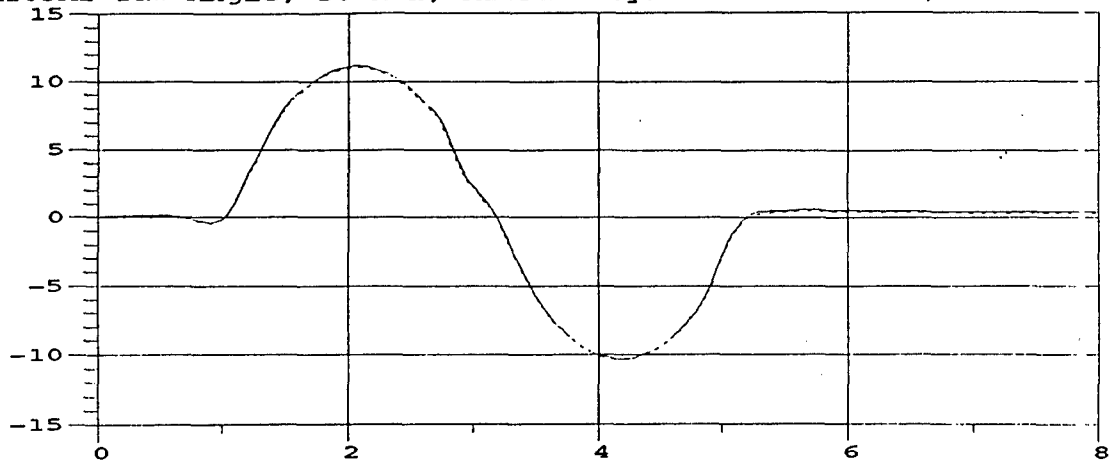

— trailer in low position (degrees) vs time (sec)
- - - trailer in high position (degrees) vs time (sec)

13

M105A2 Yaw Angle; 35 MPH; M105a2 Payload = 1500 lbs, left center

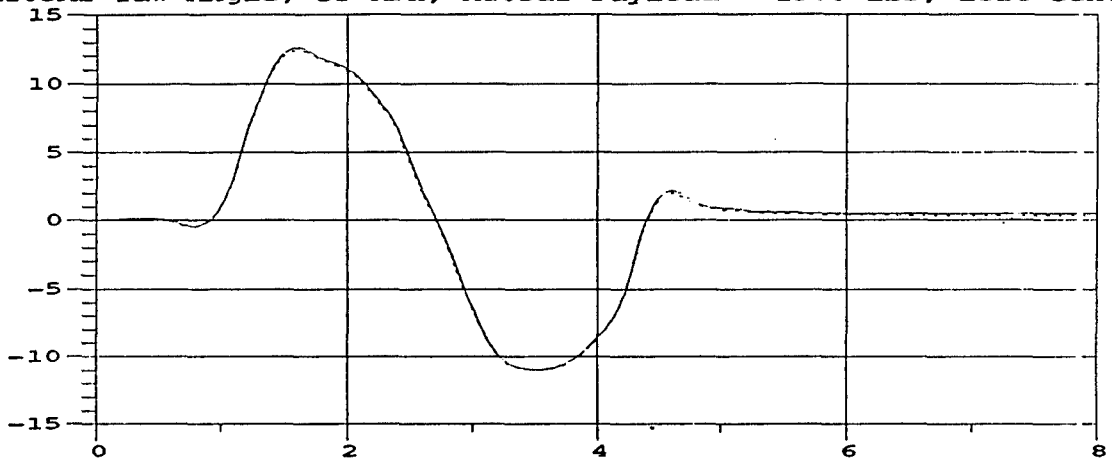

— trailer in low position (degrees) vs time (sec)
- - - trailer in high position (degrees) vs time (sec)

14

M105A2 Yaw Angle; 40 MPH; M105a2 Payload = 1500 lbs, left center

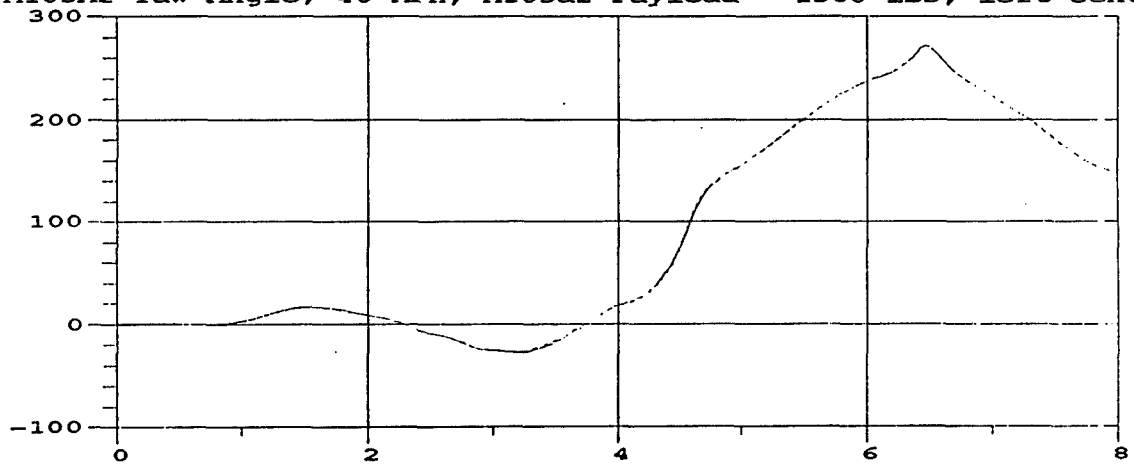

— trailer in low position (degrees) vs time (sec)
- - - trailer in high position (degrees) vs time (sec)

15

M105A2 Roll Rate; 30 MPH; M105a2 Payload = 1500 lbs, left center

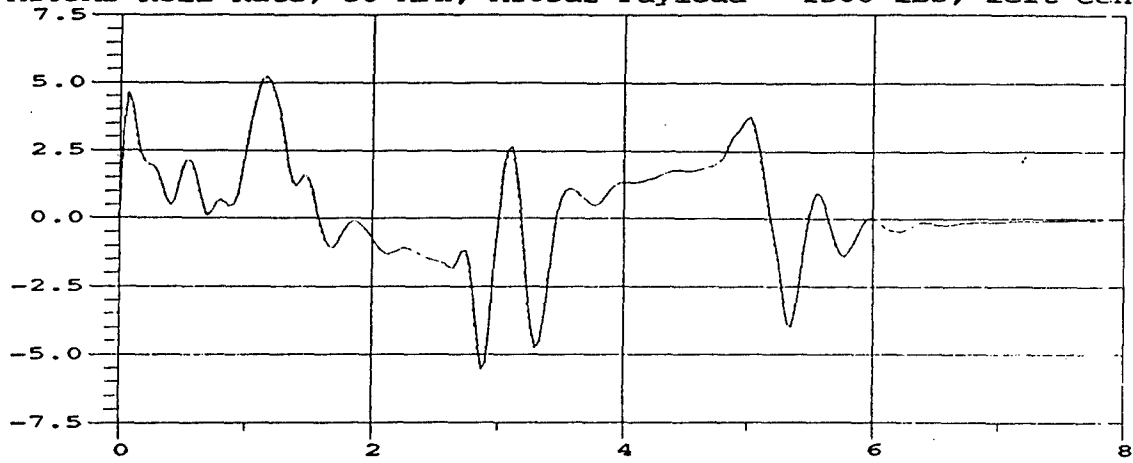

—— trailer in low position (deg/sec) vs time (sec)
..... trailer in high position (deg/sec) vs time (sec)

16

M105A2 Roll Rate; 35 MPH; M105a2 Payload = 1500 lbs, left center

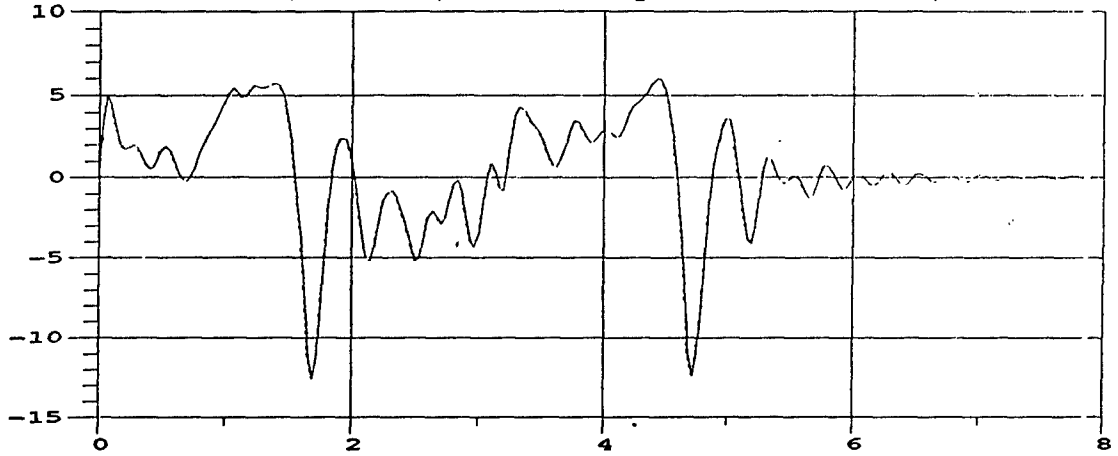

—— trailer in low position (deg/sec) vs time (sec)
..... trailer in high position (deg/sec) vs time (sec)

17

M105A2 Roll Rate; 40 MPH; M105a2 Payload = 1500 lbs, left center

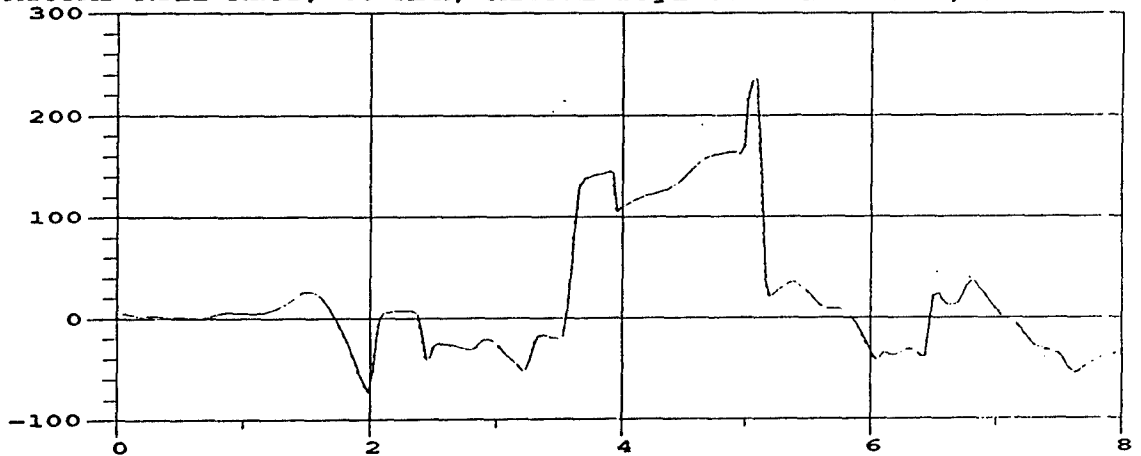

—— trailer in low position (deg/sec) vs time (sec)
..... trailer in high position (deg/sec) vs time (sec)

18

APPENDIX F
TIME HISTORY PLOTS
3000 LBS. PAYLOAD; EVEN DISTRIBUTION

M35A2 Roll Angle; 30 MPH; M105A2 Payload = 3000 lbs, even dist.

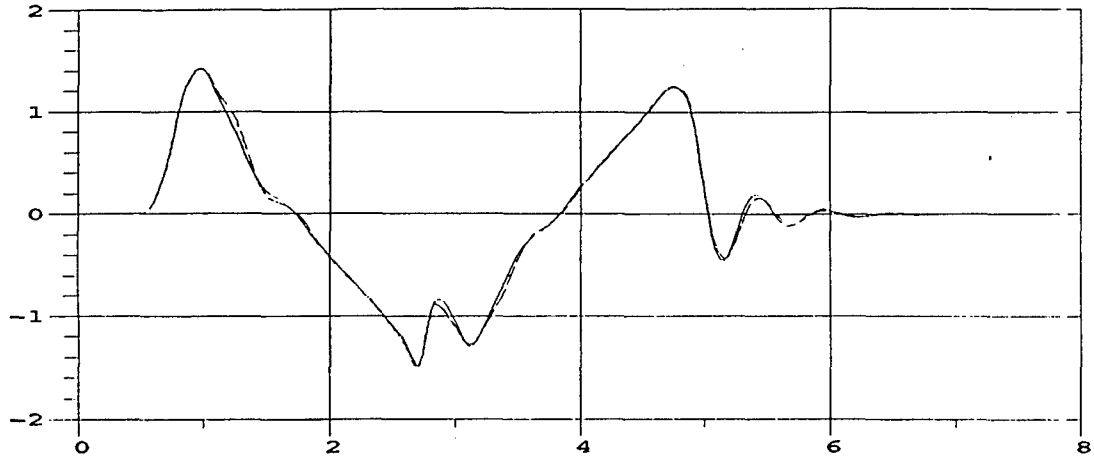

_____ w/o trailer (degrees) vs time (sec)
 w/ trailer in low position (degrees) vs time (sec)
 - - - - - w/ trailer in high position (degrees) vs time (sec)

1

M35A2 Roll Angle; 35 MPH; M105A2 Payload = 3000 lbs, even dist.

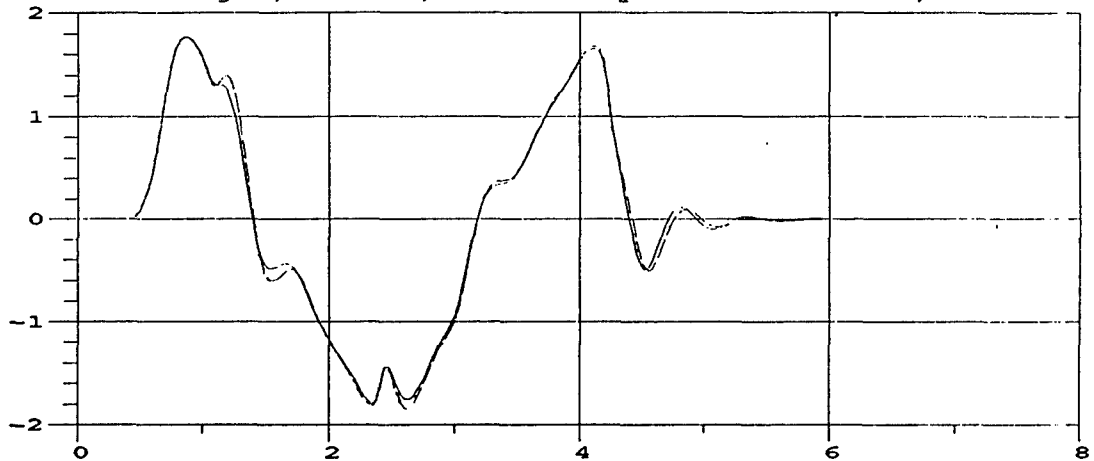

_____ w/o trailer (degrees) vs time (sec)
 w/ trailer in low position (degrees) vs time (sec)
 - - - - - w/ trailer in high position (degrees) vs time (sec)

2

M35A2 Roll Angle; 40 MPH; M105A2 Payload = 3000 lbs, even dist.

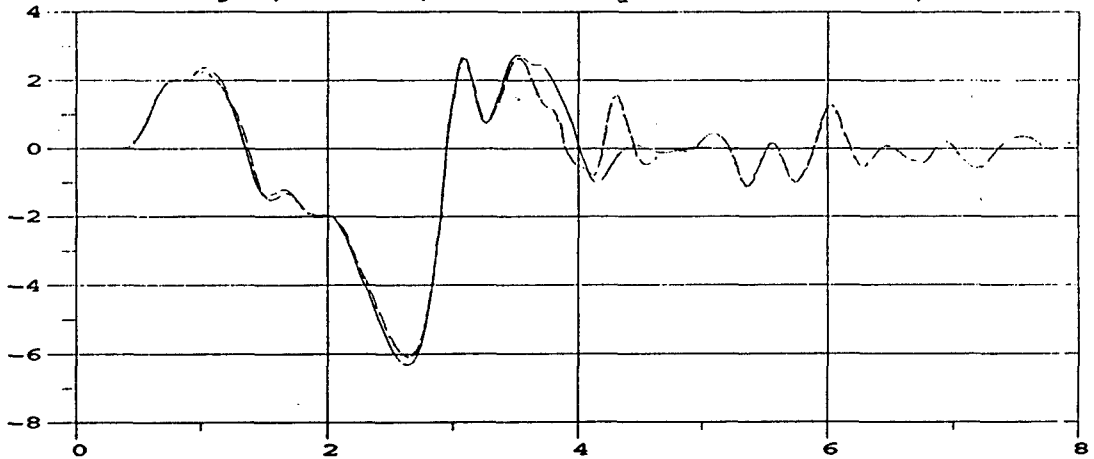

_____ w/o trailer (degrees) vs time (sec)
 w/ trailer in low position (degrees) vs time (sec)
 - - - - - w/ trailer in high position (degrees) vs time (sec)

3

M35A2 Yaw Angle; 30 MPH; M105A2 Payload = 3000 lbs, even dist.

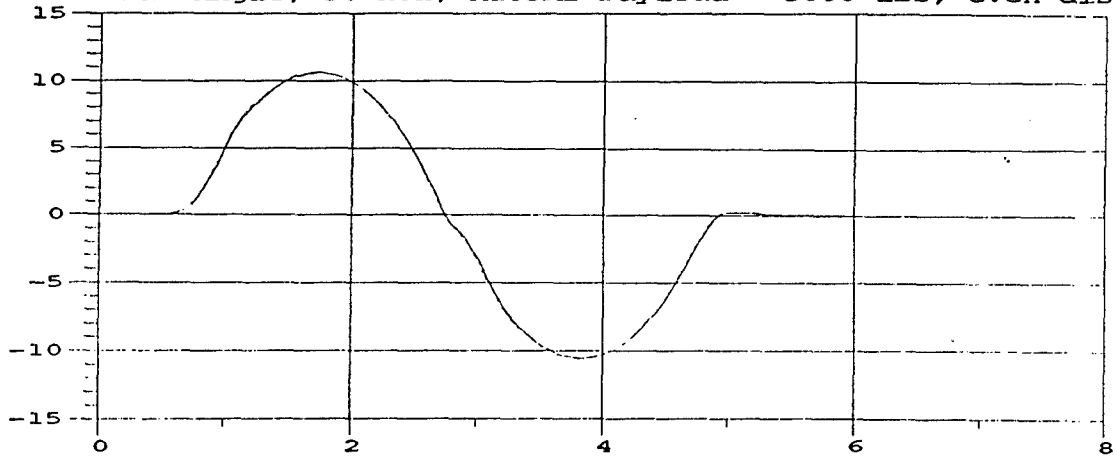

_____ w/o trailer (degrees) vs time (sec)
 w/ trailer in low position (degrees) vs time (sec)
 - - - - w/ trailer in high position (degrees) vs time (sec)

4

M35A2 Yaw Angle; 35 MPH; M105A2 Payload = 3000 lbs, even dist.

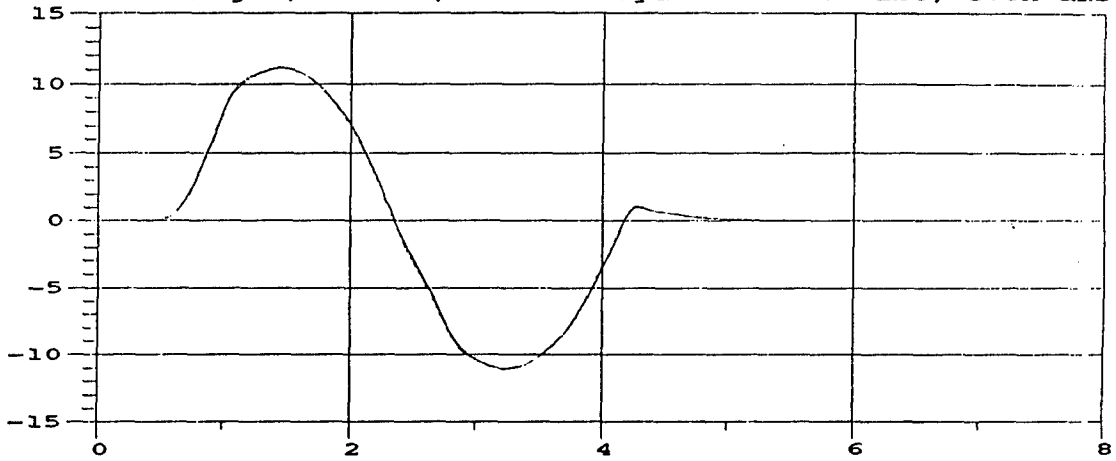

_____ w/o trailer (degrees) vs time (sec)
 w/ trailer in low position (degrees) vs time (sec)
 - - - - w/ trailer in high position (degrees) vs time (sec)

5

M35A2 Yaw Angle; 40 MPH; M105A2 Payload = 3000 lbs, even dist.

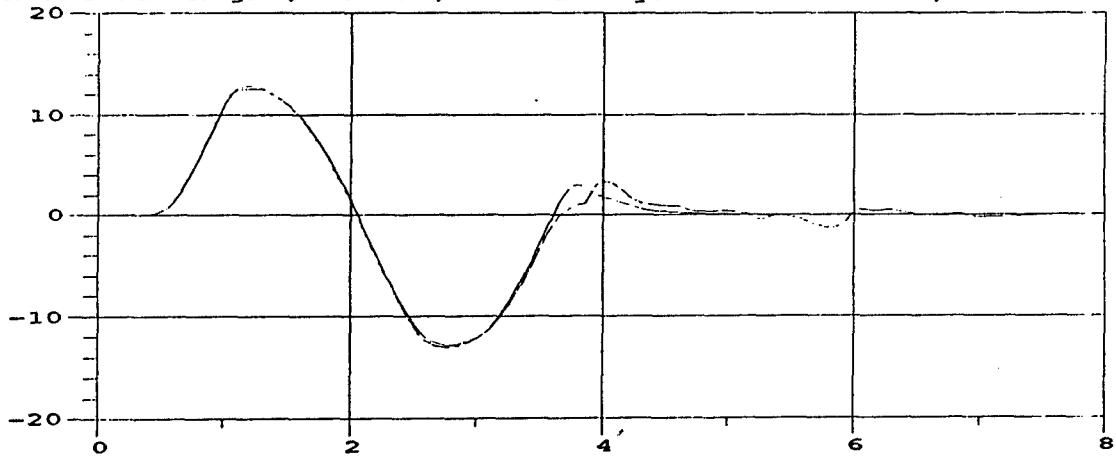

_____ w/o trailer (degrees) vs time (sec)
 w/ trailer in low position (degrees) vs time (sec)
 - - - - w/ trailer in high position (degrees) vs time (sec)

6

M35A2 Roll Rate; 30 MPH; M105A2 Payload = 3000 lbs, even dist.

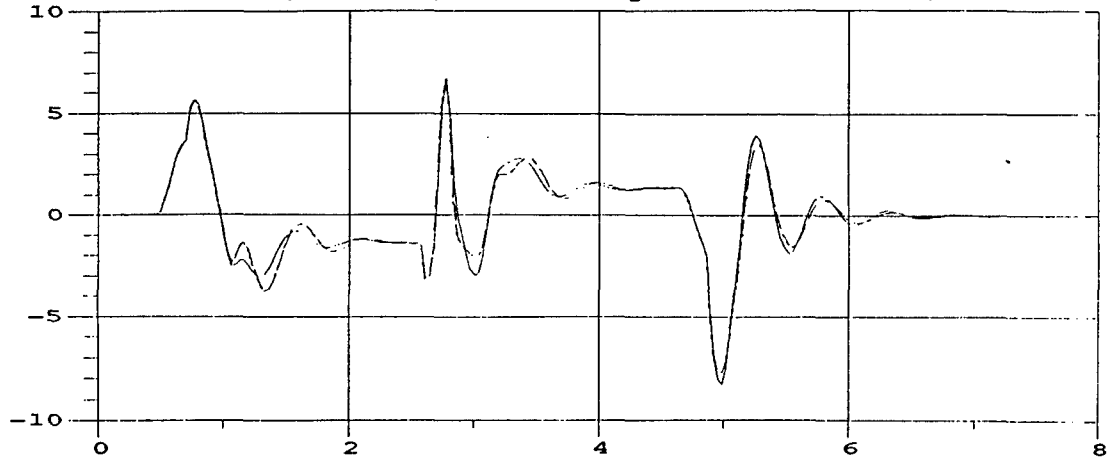

— w/o trailer (deg/sec) vs time (sec)
 w/ trailer in low position (deg/sec) vs time (sec)
 - - - w/ trailer in high position (deg/sec) vs time (sec)

7

M35A2 Roll Rate; 35 MPH; M105A2 Payload = 3000 lbs, even dist.

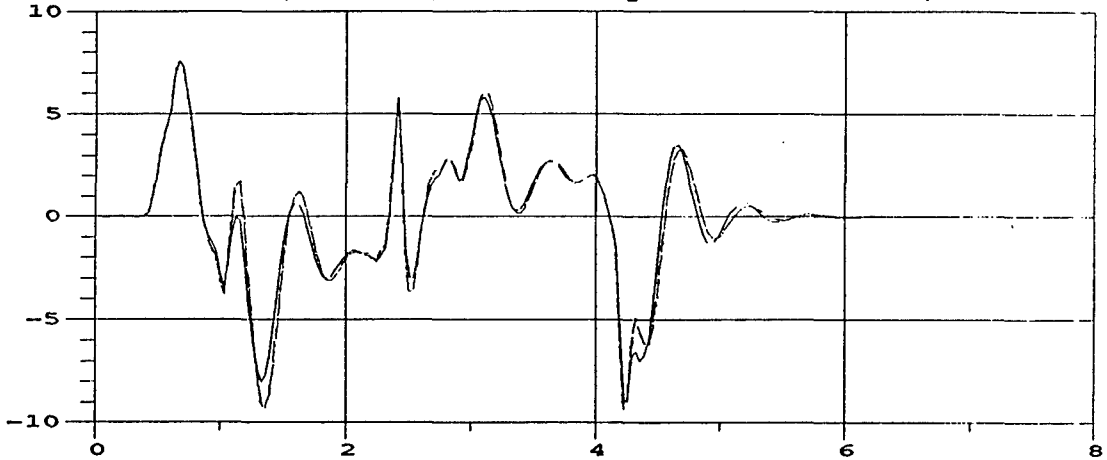

— w/o trailer (deg/sec) vs time (sec)
 w/ trailer in low position (deg/sec) vs time (sec)
 - - - w/ trailer in high position (deg/sec) vs time (sec)

8

M35A2 Roll Rate; 40 MPH; M105A2 Payload = 3000 lbs, even dist.

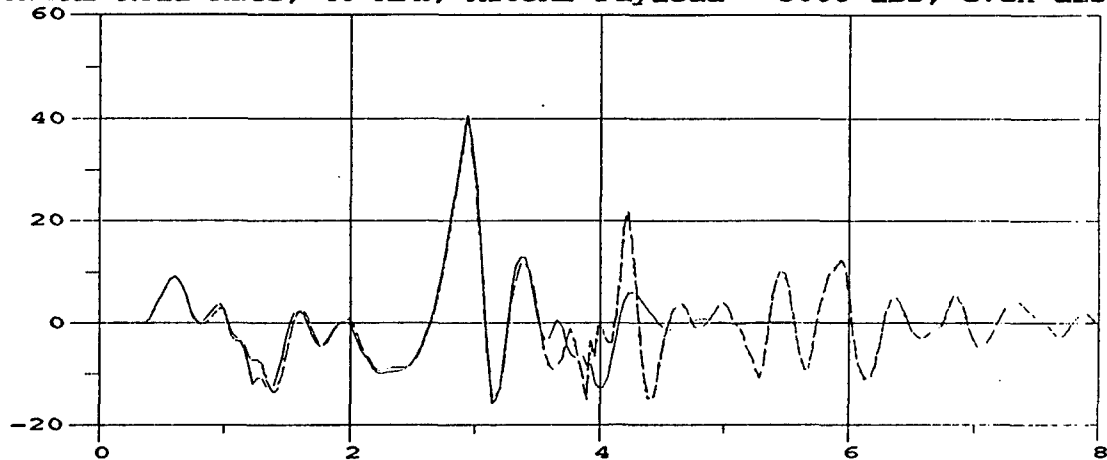

— w/o trailer (deg/sec) vs time (sec)
 w/ trailer in low position (deg/sec) vs time (sec)
 - - - w/ trailer in high position (deg/sec) vs time (sec)

9

M105A2 Roll Angle; 30 MPH; M105A2 Payload = 3000 lbs, even dist.

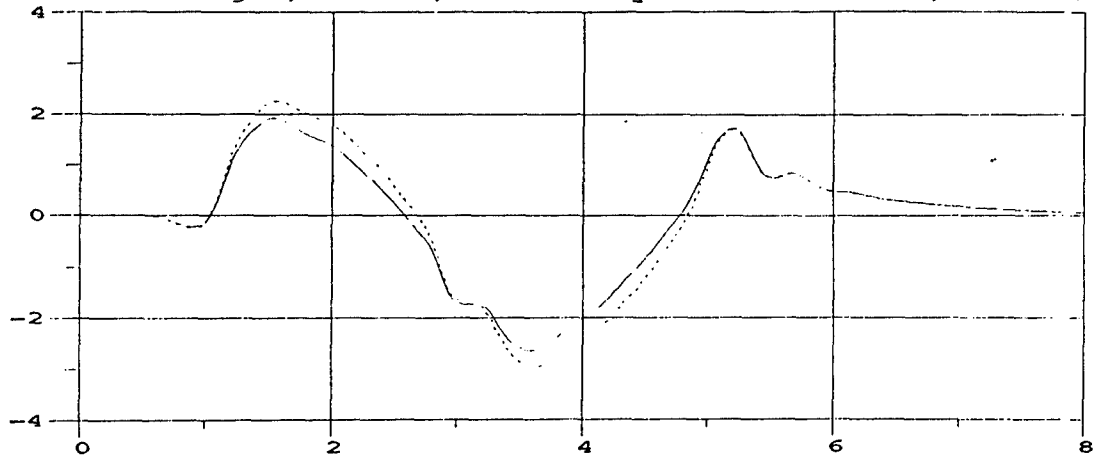

— trailer in low position (degrees) vs time (sec)
..... trailer in high position (degrees) vs time (sec)

10

M105A2 Roll Angle; 35 MPH; M105A2 Payload = 3000 lbs, even dist.

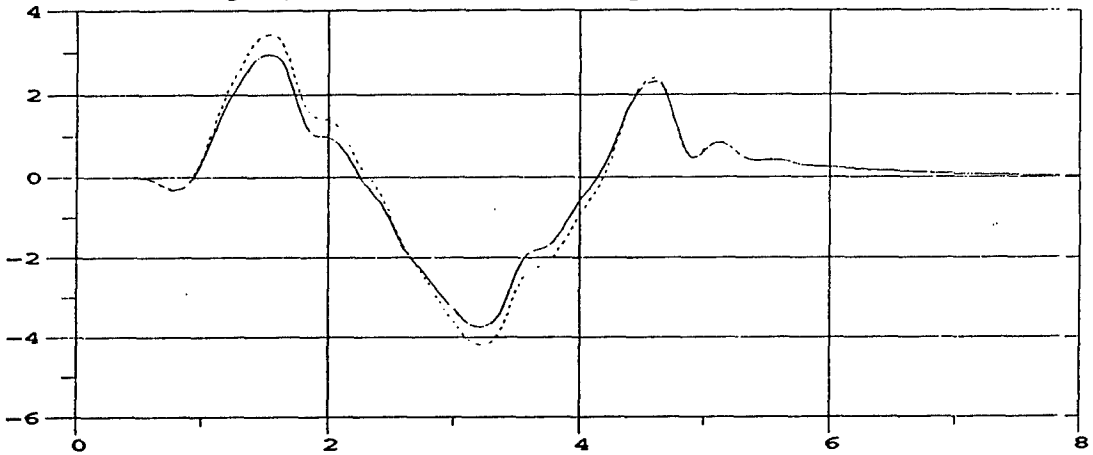

— trailer in low position (degrees) vs time (sec)
..... trailer in high position (degrees) vs time (sec)

11

M105A2 Roll Angle; 40 MPH; M105A2 Payload = 3000 lbs, even dist.

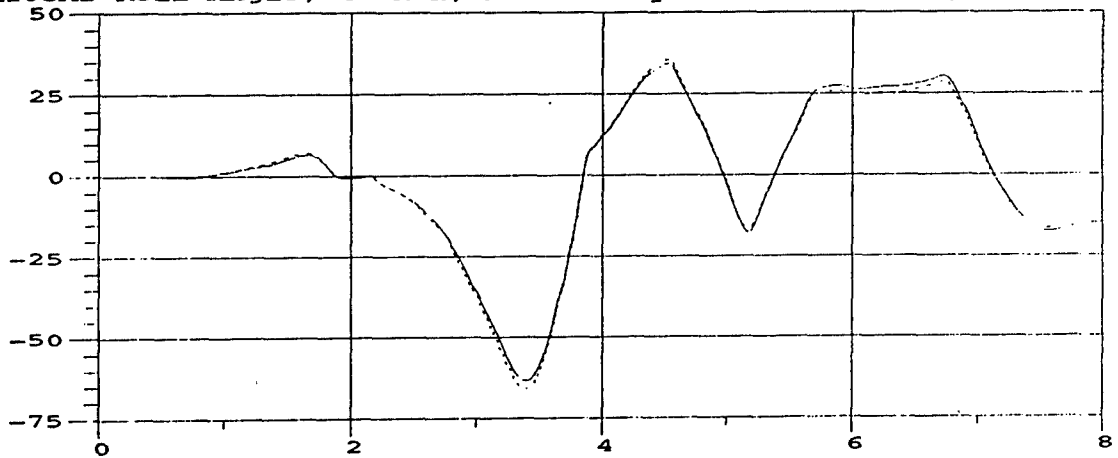

— trailer in low position (degrees) vs time (sec)
..... trailer in high position (degrees) vs time (sec)

12

M105A2 Yaw Angle; 30 MPH; M105A2 Payload = 3000 lbs, even dist.

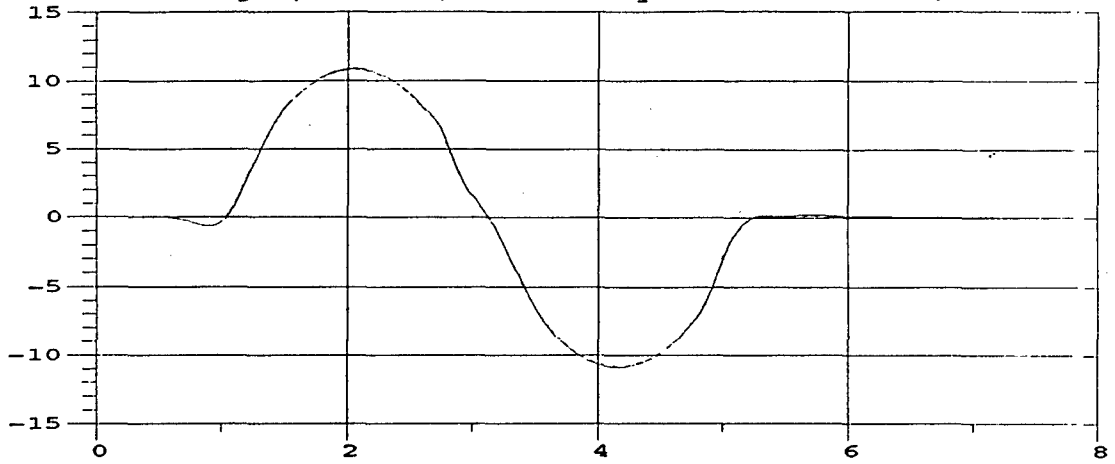

—— trailer in low position (degrees) vs time (sec)
----- trailer in high position (degrees) vs time (sec)

13

M105A2 Yaw Angle; 35 MPH; M105A2 Payload = 3000 lbs, even dist.

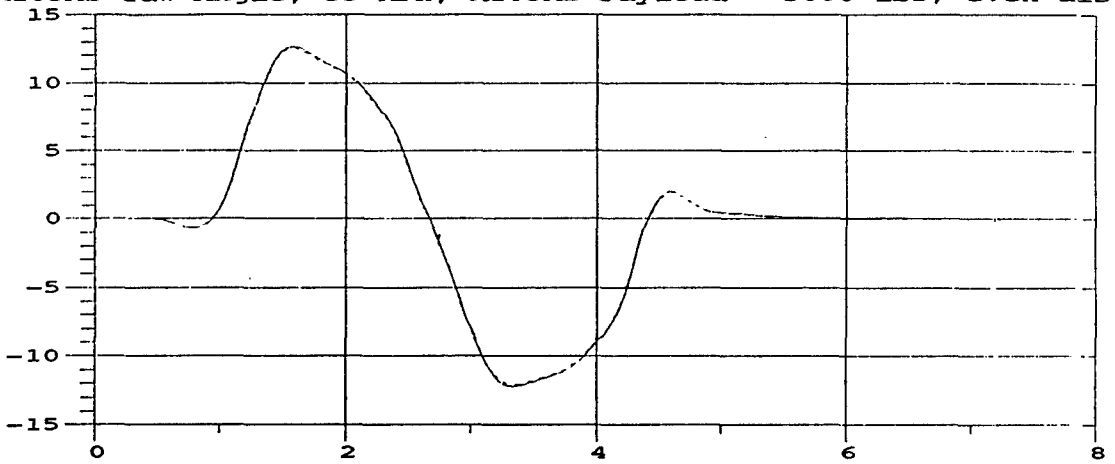

—— trailer in low position (degrees) vs time (sec)
----- trailer in high position (degrees) vs time (sec)

14

M105A2 Yaw Angle; 40 MPH; M105A2 Payload = 3000 lbs, even dist.

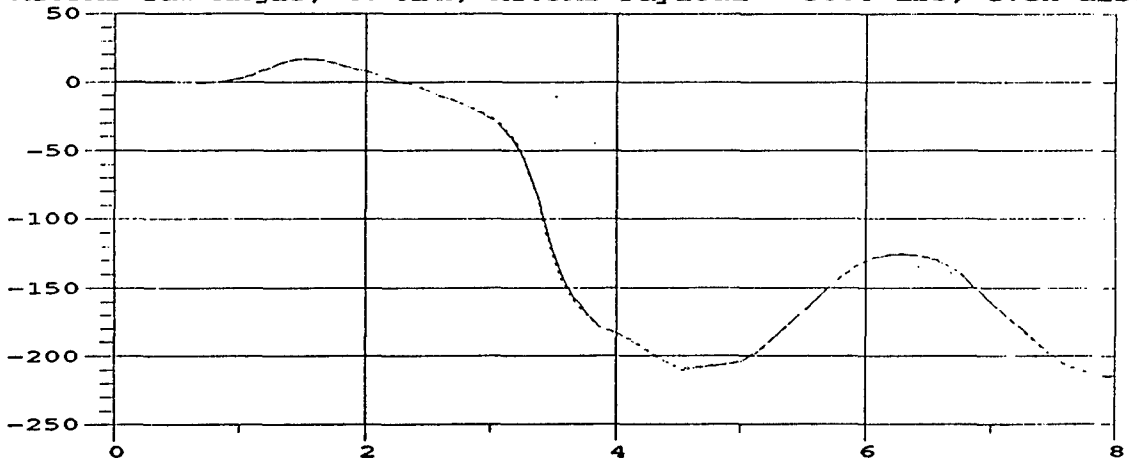

—— trailer in low position (degrees) vs time (sec)
----- trailer in high position (degrees) vs time (sec)

15

M105A2 Roll Rate; 30 MPH; M105A2 Payload = 3000 lbs, even dist.

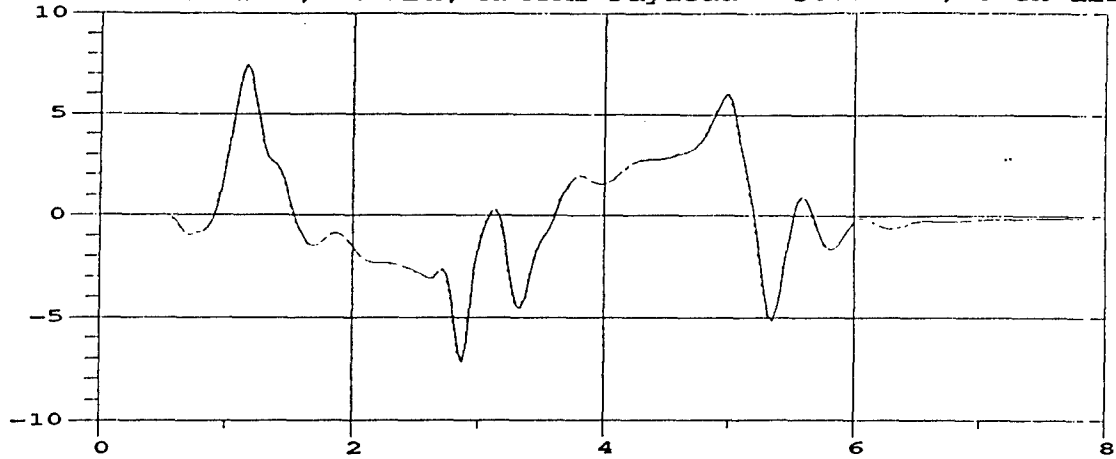

—— trailer in low position (deg/sec) vs time (sec)
----- trailer in high position (deg/sec) vs time (sec)

16

M105A2 Roll Rate; 35 MPH; M105A2 Payload = 3000 lbs, even dist.

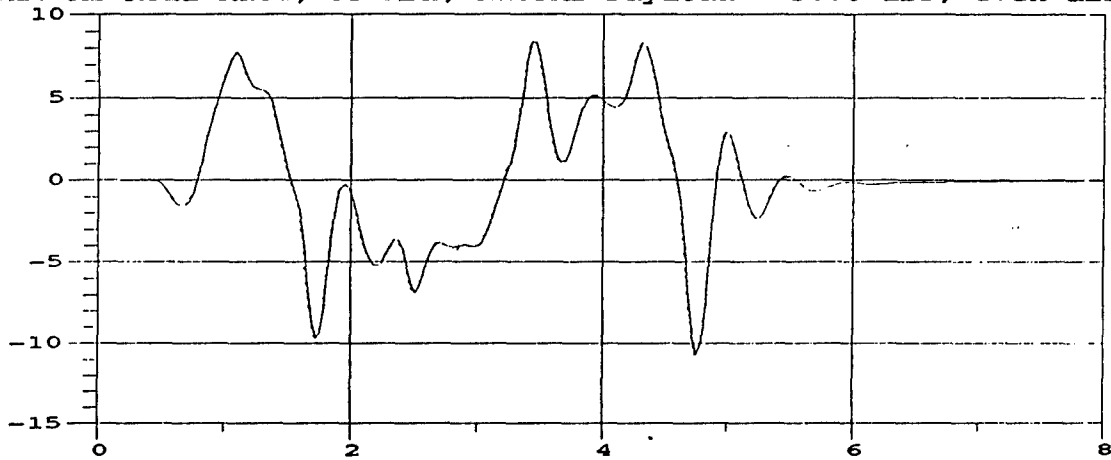

—— trailer in low position (deg/sec) vs time (sec)
----- trailer in high position (deg/sec) vs time (sec)

17

M105A2 Roll Rate; 40 MPH; M105A2 Payload = 3000 lbs, even dist.

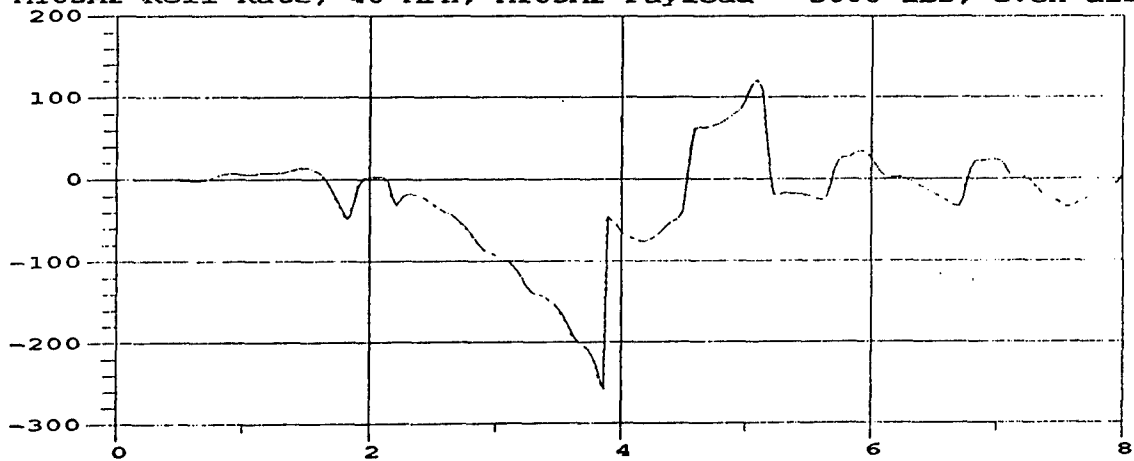

—— trailer in low position (deg/sec) vs time (sec)
----- trailer in high position (deg/sec) vs time (sec)

18

APPENDIX G
TIME HISTORY PLOTS
3000 LBS. PAYLOAD; FRONT HALF DISTRIBUTION

M35A2 Roll Angle; 30 MPH; M105A2 Payload = 3000 lbs, front half

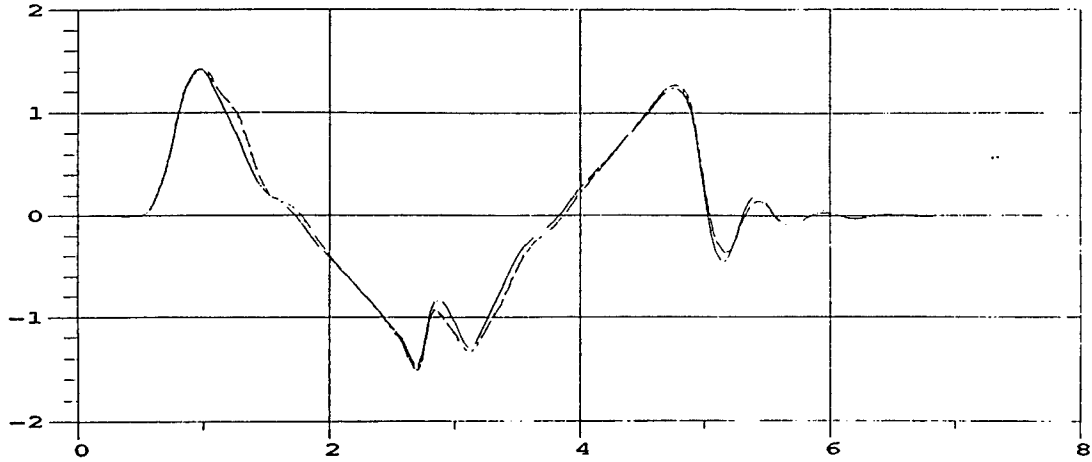

_____ w/o trailer (degrees) vs time (sec)
 w/ trailer in low position (degrees) vs time (sec)
 - - - - - w/ trailer in high position (degrees) vs time (sec)

1

M35A2 Roll Angle; 35 MPH; M105A2 Payload = 3000 lbs, front half

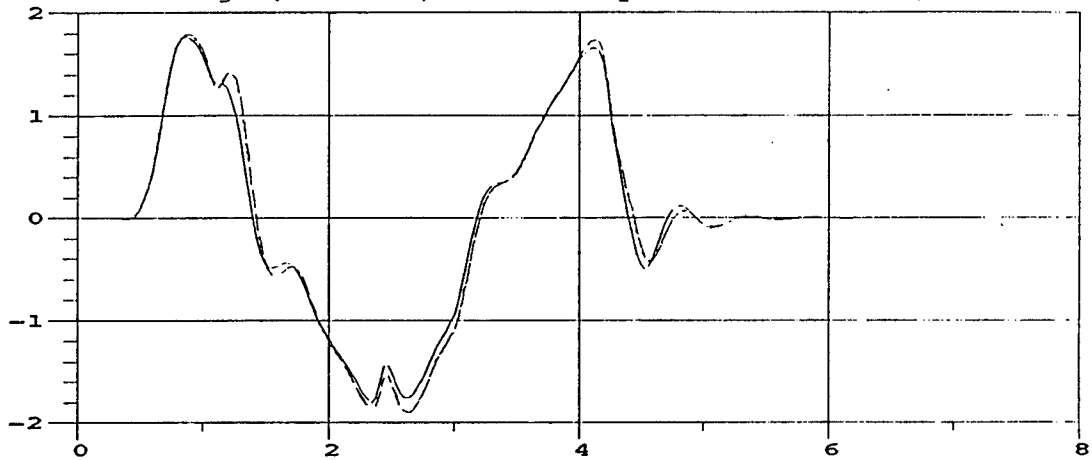

_____ w/o trailer (degrees) vs time (sec)
 w/ trailer in low position (degrees) vs time (sec)
 - - - - - w/ trailer in high position (degrees) vs time (sec)

2

M35A2 Roll Angle; 40 MPH; M105A2 Payload = 3000 lbs, front half

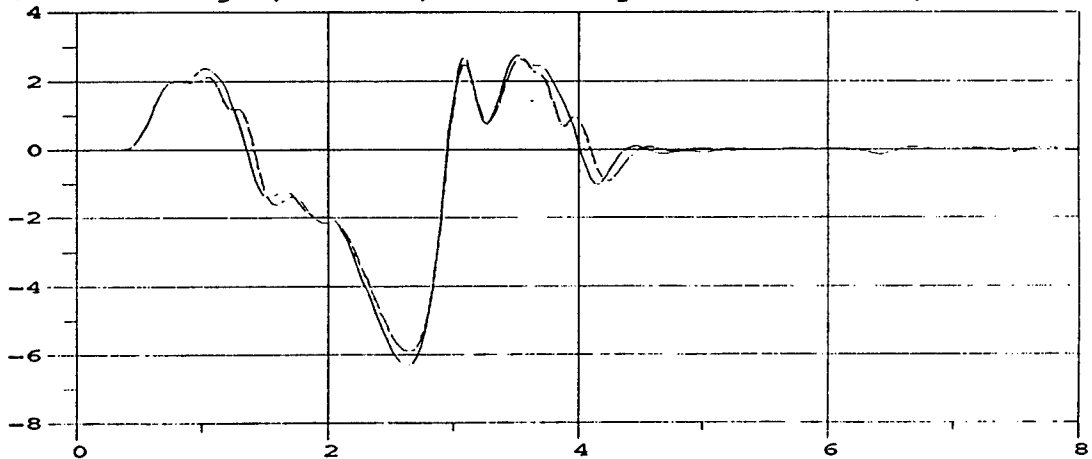

_____ w/o trailer (degrees) vs time (sec)
 w/ trailer in low position (degrees) vs time (sec)
 - - - - - w/ trailer in high position (degrees) vs time (sec)

3

M35A2 Yaw Angle; 30 MPH; M105A2 Payload = 3000 lbs, front half

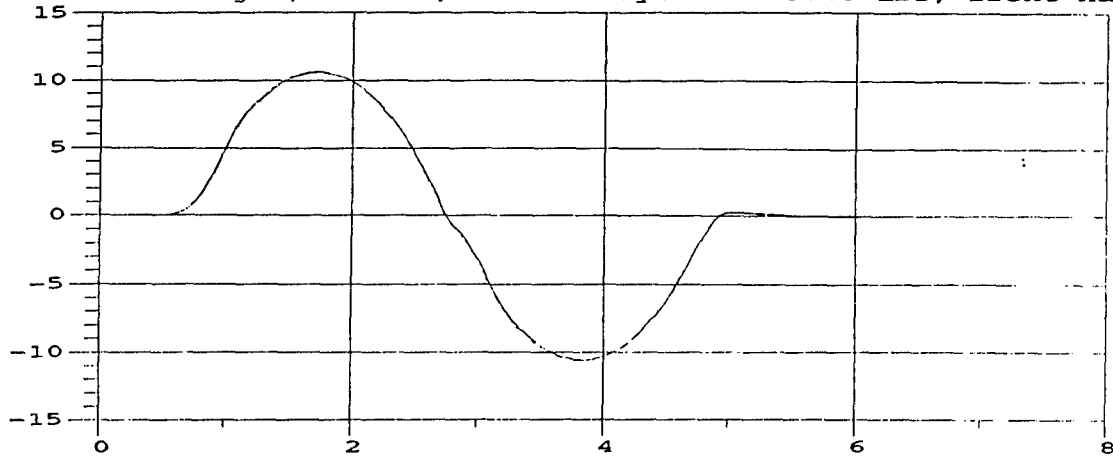

— w/o trailer (degrees) vs time (sec)
 w/ trailer in low position (degrees) vs time (sec)
 - - - w/ trailer in high position (degrees) vs time (sec)

4

M35A2 Yaw Angle; 35 MPH; M105A2 Payload = 3000 lbs, front half

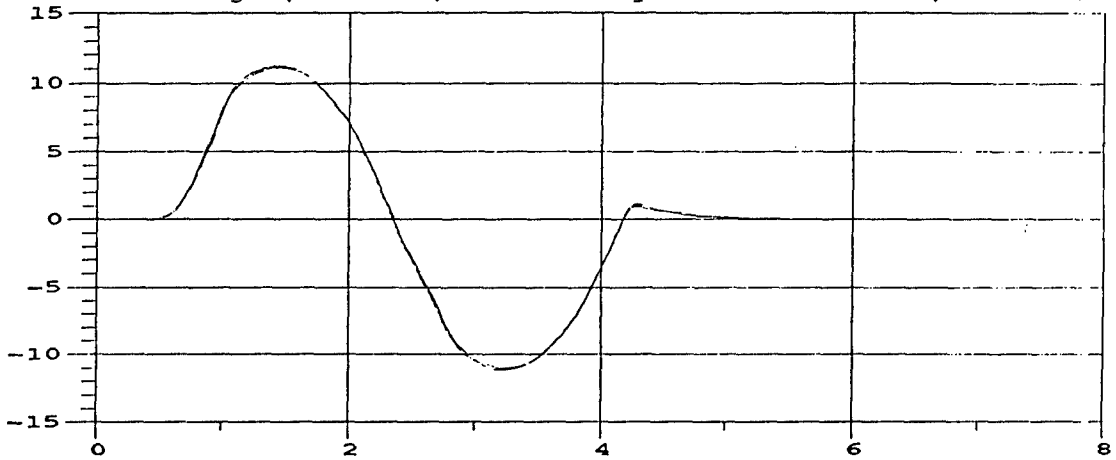

— w/o trailer (degrees) vs time (sec)
 w/ trailer in low position (degrees) vs time (sec)
 - - - w/ trailer in high position (degrees) vs time (sec)

5

M35A2 Yaw Angle; 40 MPH; M105A2 Payload = 3000 lbs, front half

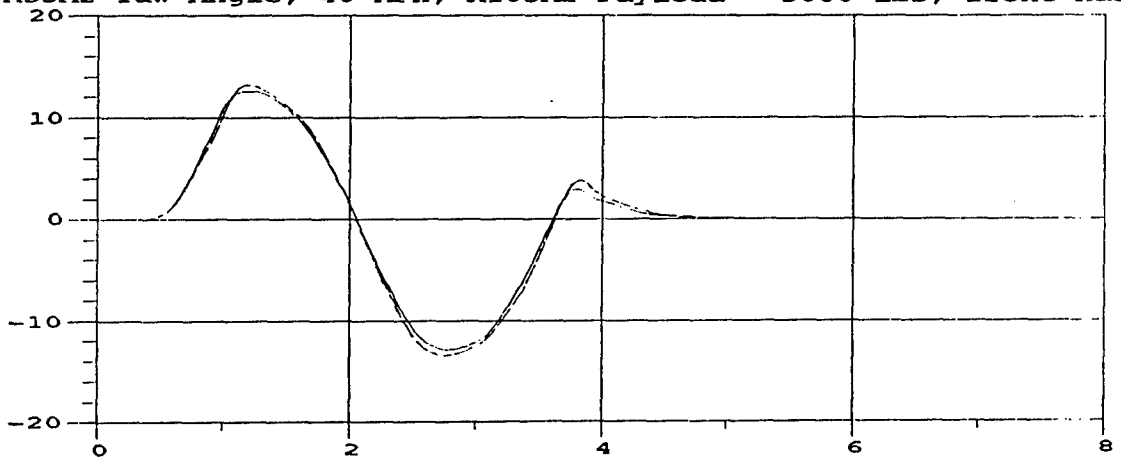

— w/o trailer (degrees) vs time (sec)
 w/ trailer in low position (degrees) vs time (sec)
 - - - w/ trailer in high position (degrees) vs time (sec)

6

M35A2 Roll Rate; 30 MPH; M105A2 Payload = 3000 lbs, front half

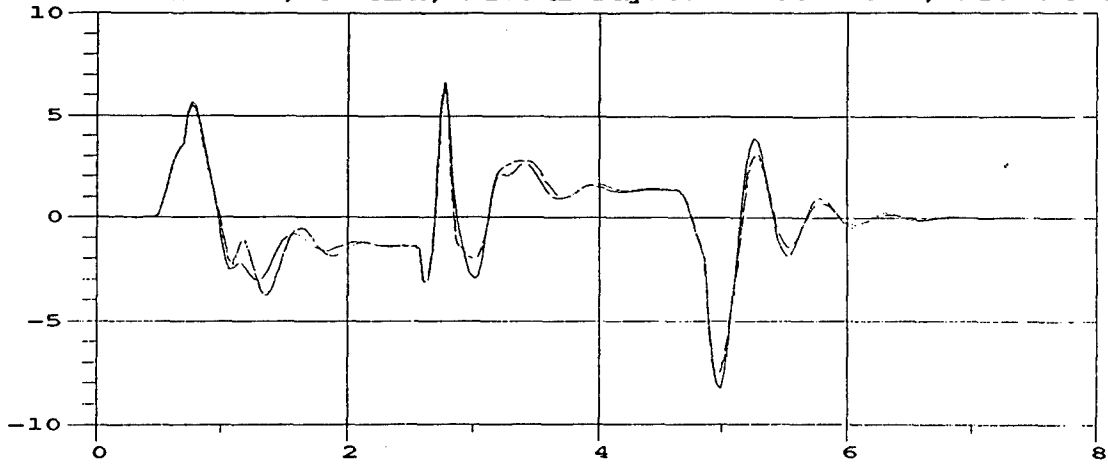

_____ w/o trailer (deg/sec) vs time (sec)
 w/ trailer in low position (deg/sec) vs time (sec)
 - - - - w/ trailer in high position (deg/sec) vs time (sec)

7

M35A2 Roll Rate; 35 MPH; M105A2 Payload = 3000 lbs, front half

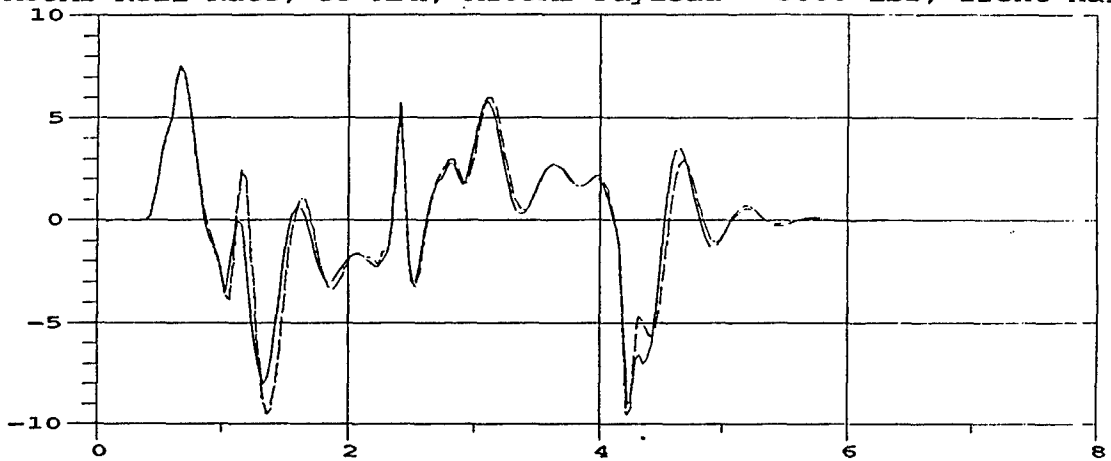

_____ w/o trailer (deg/sec) vs time (sec)
 w/ trailer in low position (deg/sec) vs time (sec)
 - - - - w/ trailer in high position (deg/sec) vs time (sec)

8

M35A2 Roll Rate; 40 MPH; M105A2 Payload = 3000 lbs, front half

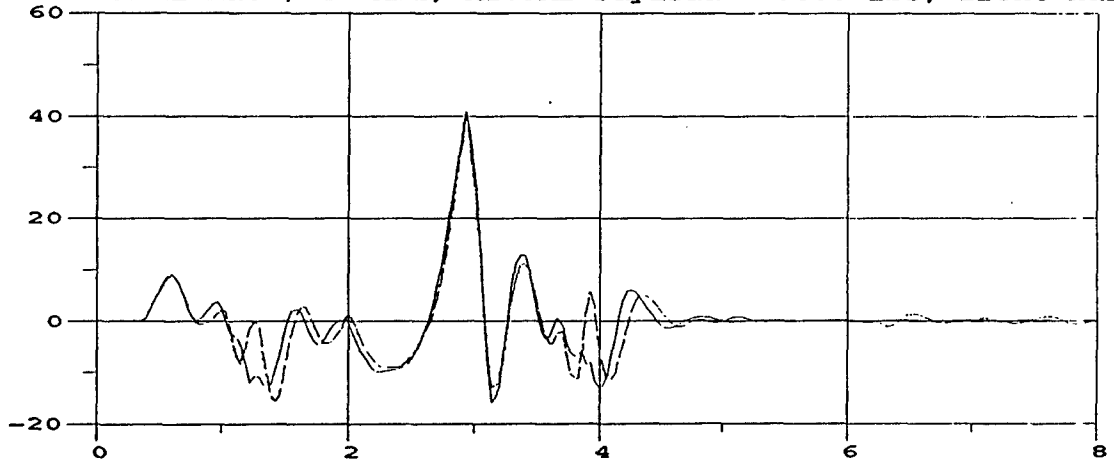

_____ w/o trailer (deg/sec) vs time (sec)
 w/ trailer in low position (deg/sec) vs time (sec)
 - - - - w/ trailer in high position (deg/sec) vs time (sec)

9

M105A2 Roll Angle; 30 MPH; M105A2 Payload = 3000 lbs, front half

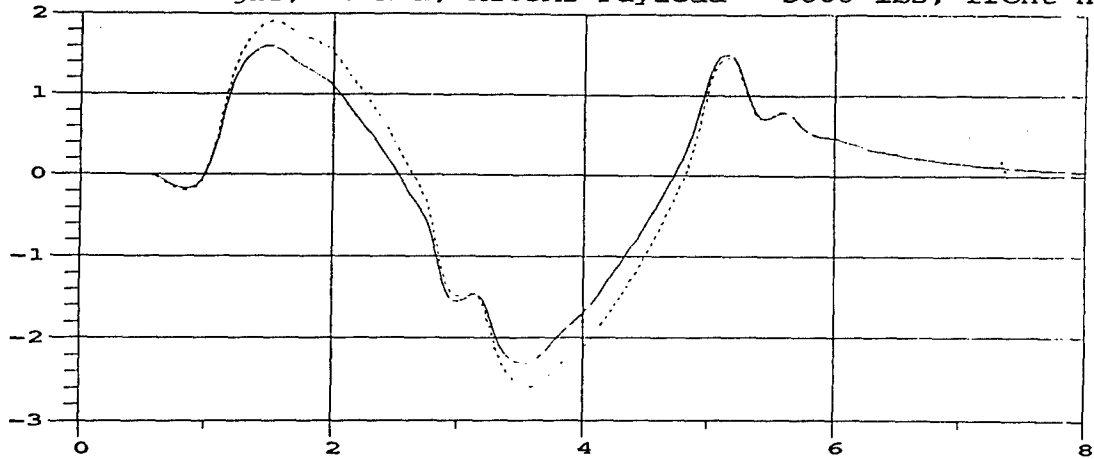

—— trailer in low position (degrees) vs time (sec)
..... trailer in high position (degrees) vs time (sec)

10

M105A2 Roll Angle; 35 MPH; M105A2 Payload = 3000 lbs, front half

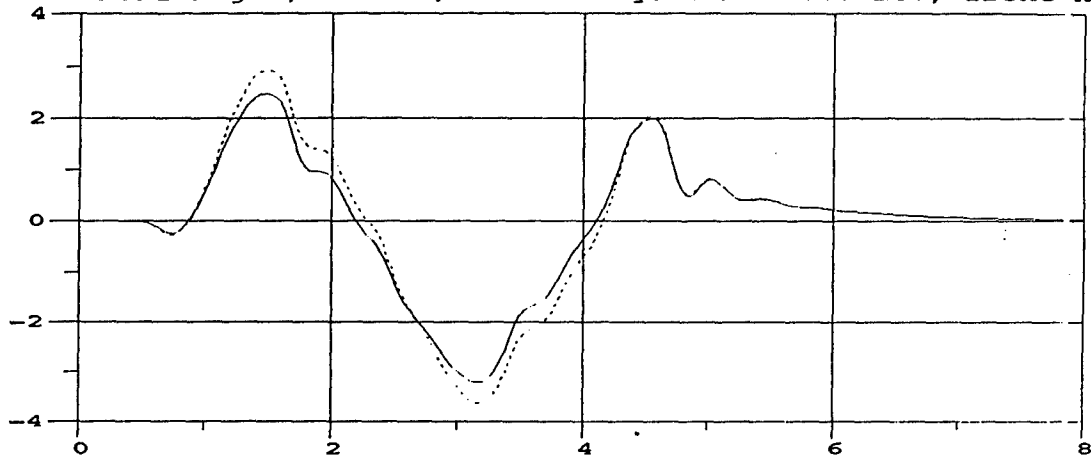

—— trailer in low position (degrees) vs time (sec)
..... trailer in high position (degrees) vs time (sec)

11

M105A2 Roll Angle; 40 MPH; M105A2 Payload = 3000 lbs, front half

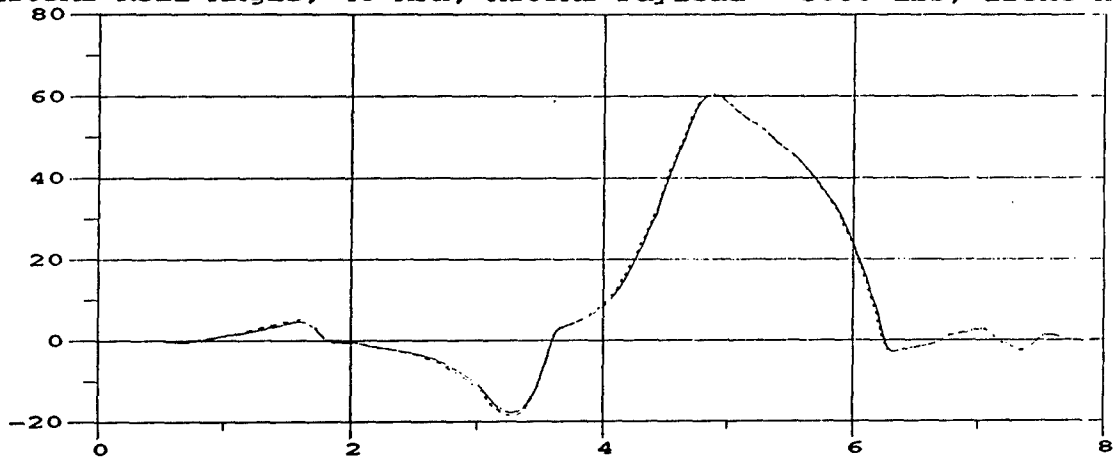

—— trailer in low position (degrees) vs time (sec)
..... trailer in high position (degrees) vs time (sec)

12

M105A2 Yaw Angle; 30 MPH; M105A2 Payload = 3000 lbs, front half

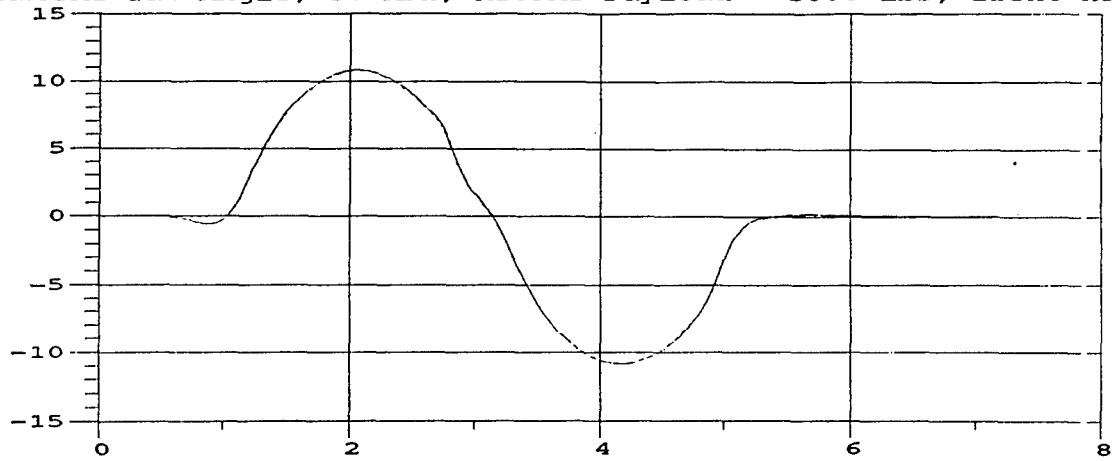

— trailer in low position (degrees) vs time (sec)
..... trailer in high position (degrees) vs time (sec)

13

M105A2 Yaw Angle; 35 MPH; M105A2 Payload = 3000 lbs, front half

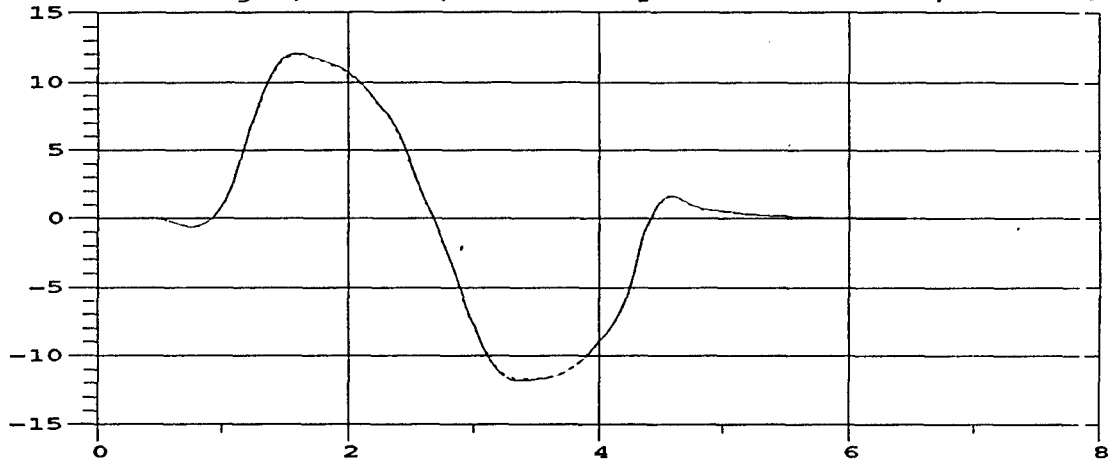

— trailer in low position (degrees) vs time (sec)
..... trailer in high position (degrees) vs time (sec)

14

M105A2 Yaw Angle; 40 MPH; M105A2 Payload = 3000 lbs, front half

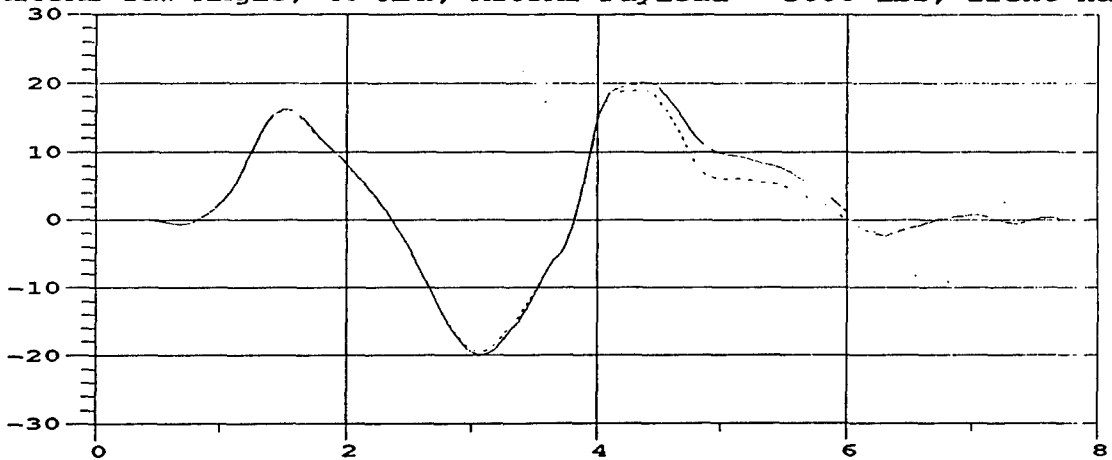

— trailer in low position (degrees) vs time (sec)
..... trailer in high position (degrees) vs time (sec)

15

M105A2 Roll Rate; 30 MPH; M105A2 Payload = 3000 lbs, front half

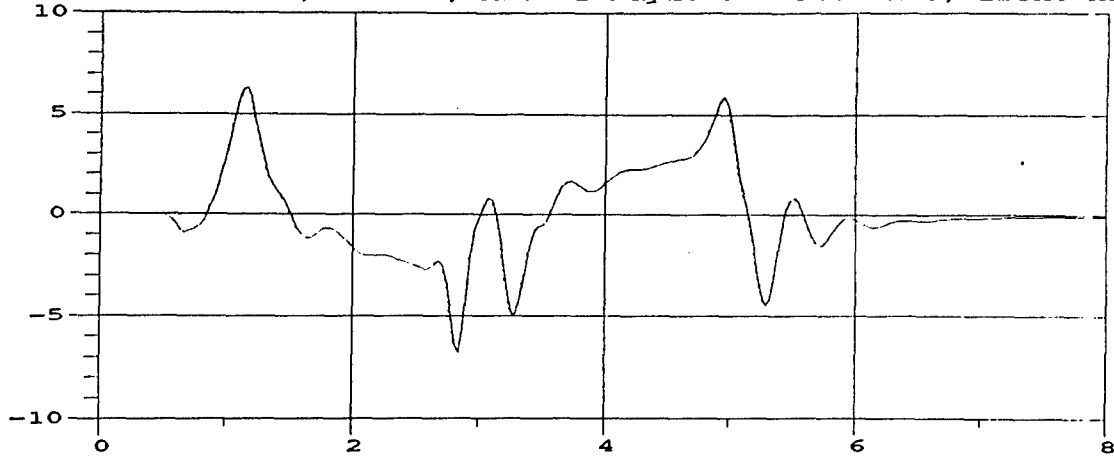

—— trailer in low position (deg/sec) vs time (sec)
..... trailer in high position (deg/sec) vs time (sec)

16

M105A2 Roll Rate; 35 MPH; M105A2 Payload = 3000 lbs, front half

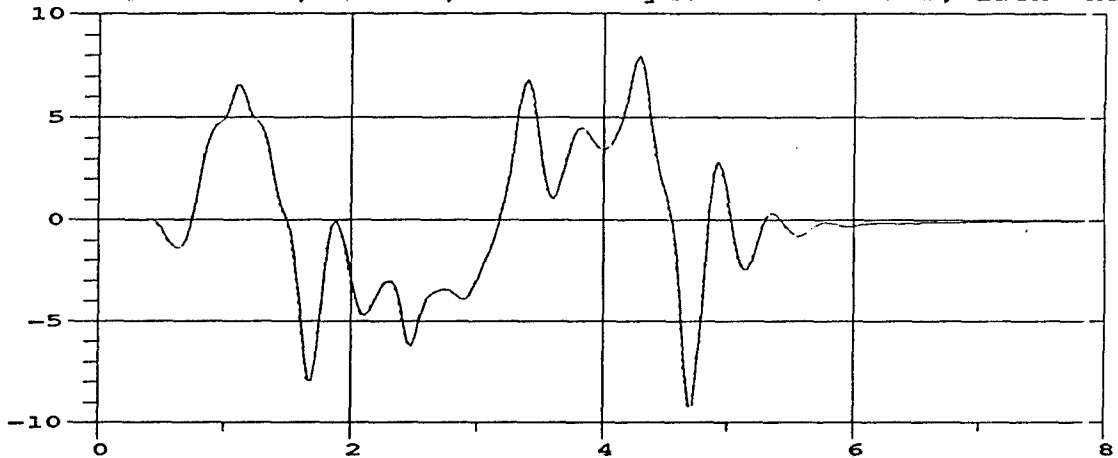

—— trailer in low position (deg/sec) vs time (sec)
..... trailer in high position (deg/sec) vs time (sec)

17

M105A2 Roll Rate; 40 MPH; M105A2 Payload = 3000 lbs, front half

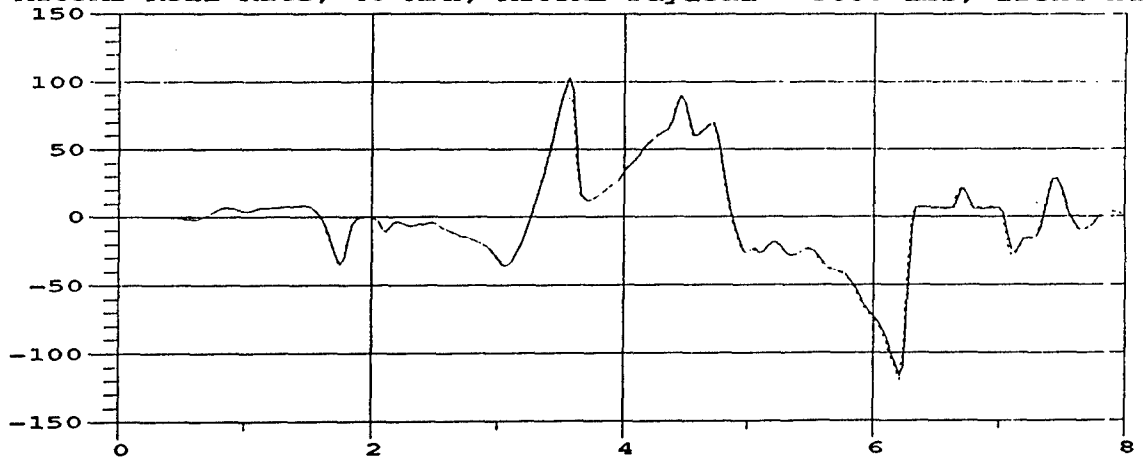

—— trailer in low position (deg/sec) vs time (sec)
..... trailer in high position (deg/sec) vs time (sec)

18

APPENDIX H
TIME HISTORY PLOTS
3000 LBS. PAYLOAD; REAR HALF DISTRIBUTION

M35A2 Roll Angle; 30 MPH; M105A2 Payload = 3000 lbs, rear half

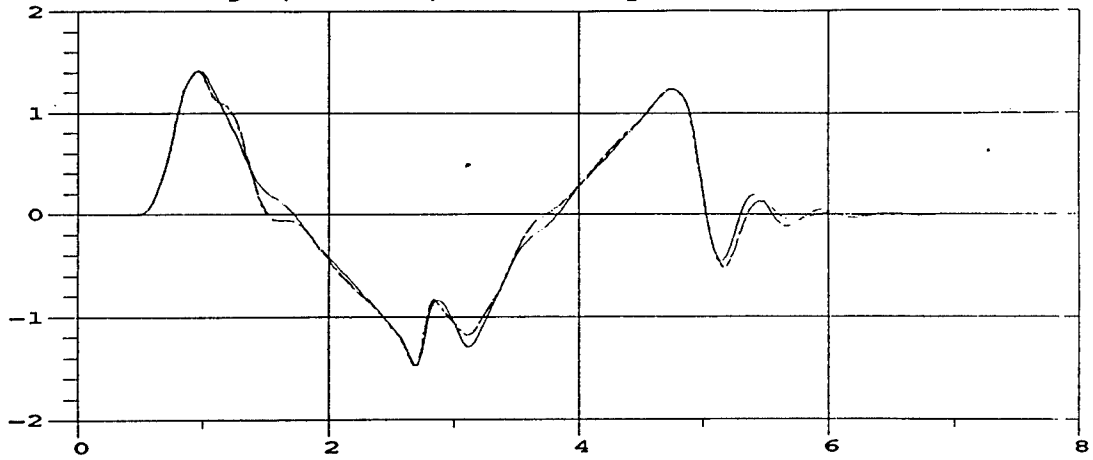

——— w/o trailer (degrees) vs time (sec)
 w/ trailer in low position (degrees) vs time (sec)
 - - - w/ trailer in high position (degrees) vs time (sec)

1

M35A2 Roll Angle; 35 MPH; M105A2 Payload = 3000 lbs, rear half

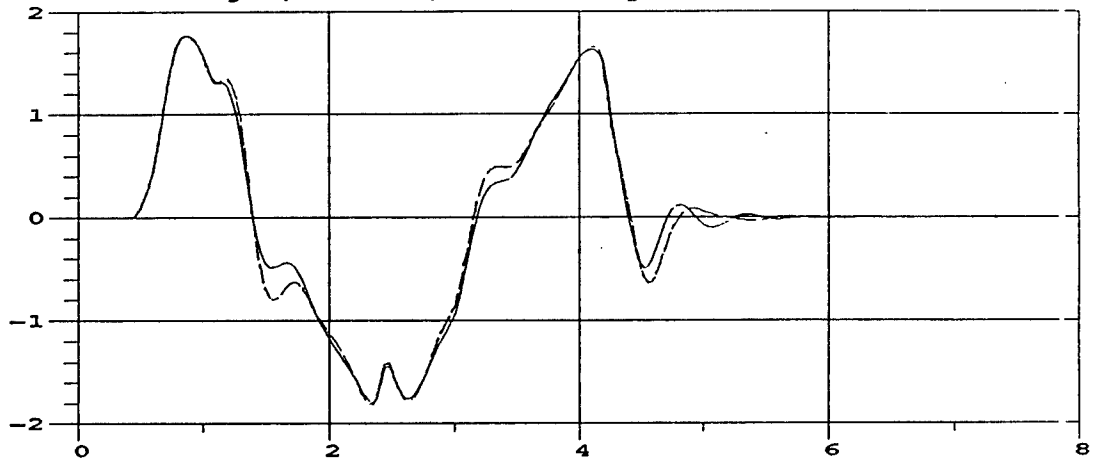

——— w/o trailer (degrees) vs time (sec)
 w/ trailer in low position (degrees) vs time (sec)
 - - - w/ trailer in high position (degrees) vs time (sec)

2

M35A2 Roll Angle; 40 MPH; M105A2 Payload = 3000 lbs, rear half

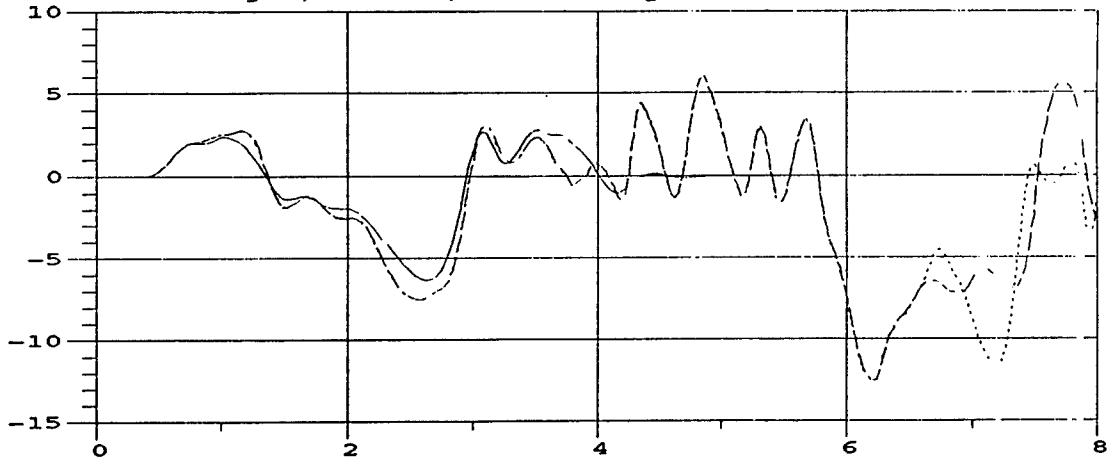

——— w/o trailer (degrees) vs time (sec)
 w/ trailer in low position (degrees) vs time (sec)
 - - - w/ trailer in high position (degrees) vs time (sec)

3

M35A2 Yaw Angle; 30 MPH; M105A2 Payload = 3000 lbs, rear half

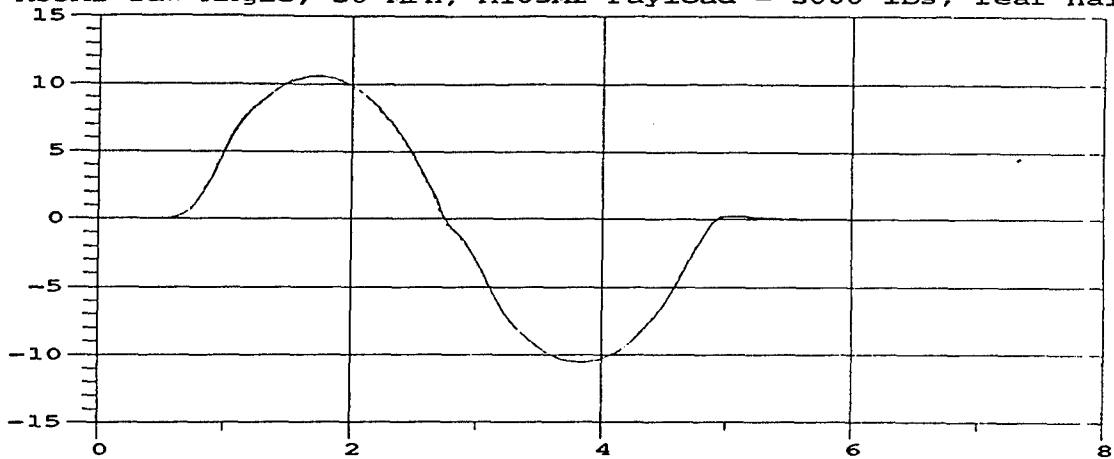

— w/o trailer (degrees) vs time (sec)
 w/ trailer in low position (degrees) vs time (sec)
 - - - w/ trailer in high position (degrees) vs time (sec)

4

M35A2 Yaw Angle; 35 MPH; M105A2 Payload = 3000 lbs, rear half

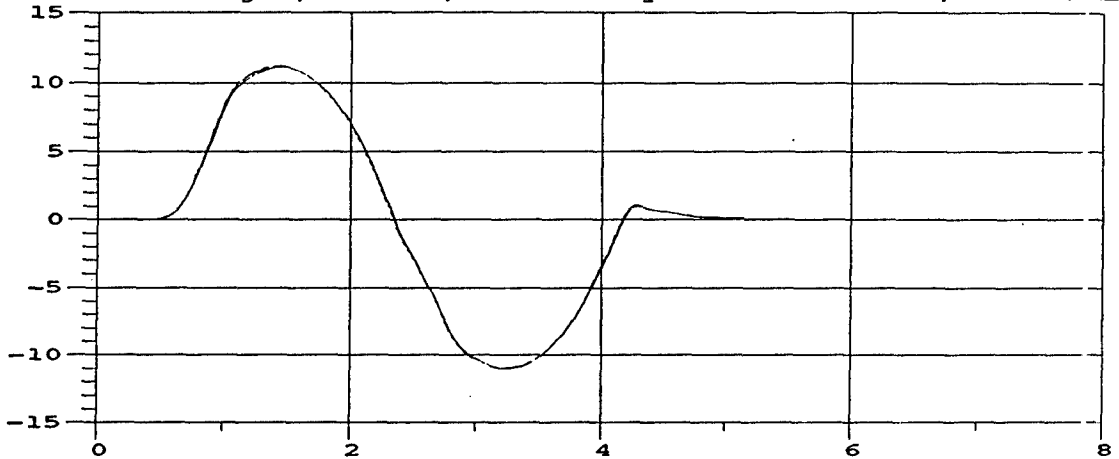

— w/o trailer (degrees) vs time (sec)
 w/ trailer in low position (degrees) vs time (sec)
 - - - w/ trailer in high position (degrees) vs time (sec)

5

M35A2 Yaw Angle; 40 MPH; M105A2 Payload = 3000 lbs, rear half

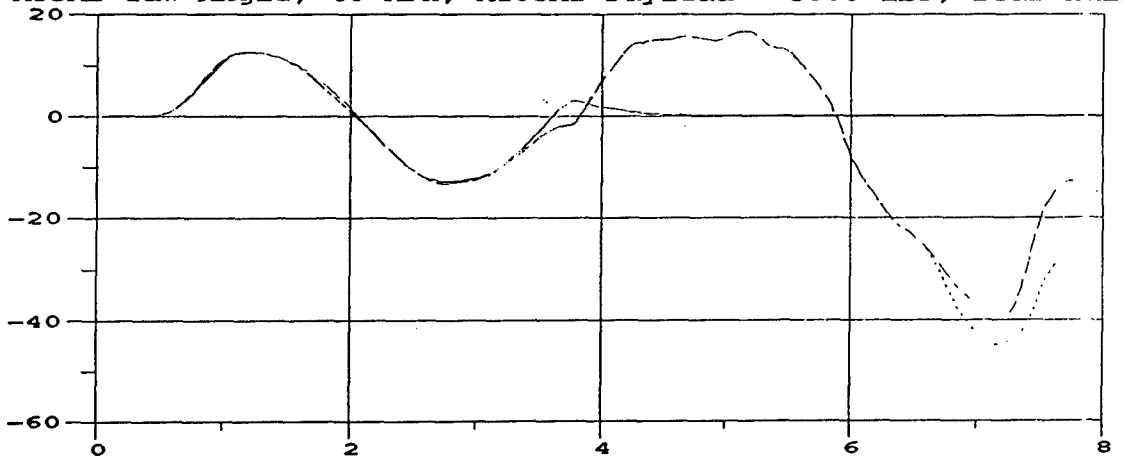

— w/o trailer (degrees) vs time (sec)
 w/ trailer in low position (degrees) vs time (sec)
 - - - w/ trailer in high position (degrees) vs time (sec)

6

M35A2 Roll Rate; 30 MPH; M105A2 Payload = 3000 lbs, rear half

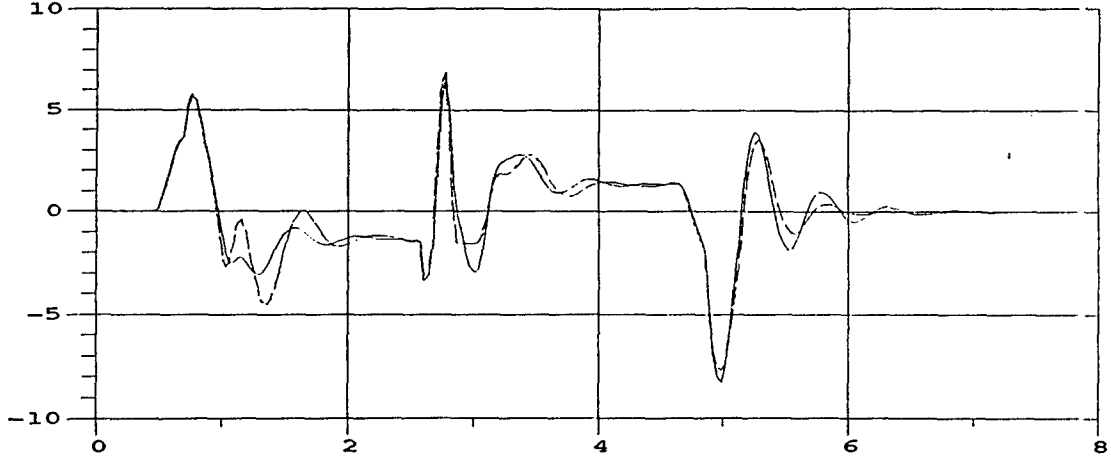

— w/o trailer (deg/sec) vs time (sec)
 w/ trailer in low position (deg/sec) vs time (sec)
 - - - w/ trailer in high position (deg/sec) vs time (sec)

7

M35A2 Roll Rate; 35 MPH; M105A2 Payload = 3000 lbs, rear half

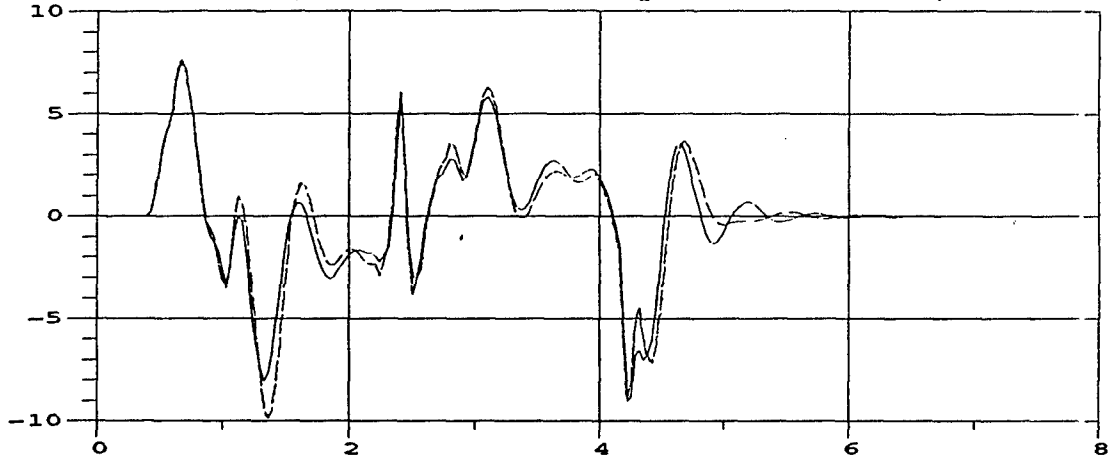

— w/o trailer (deg/sec) vs time (sec)
 w/ trailer in low position (deg/sec) vs time (sec)
 - - - w/ trailer in high position (deg/sec) vs time (sec)

8

M35A2 Roll Rate; 40 MPH; M105A2 Payload = 3000 lbs, rear half

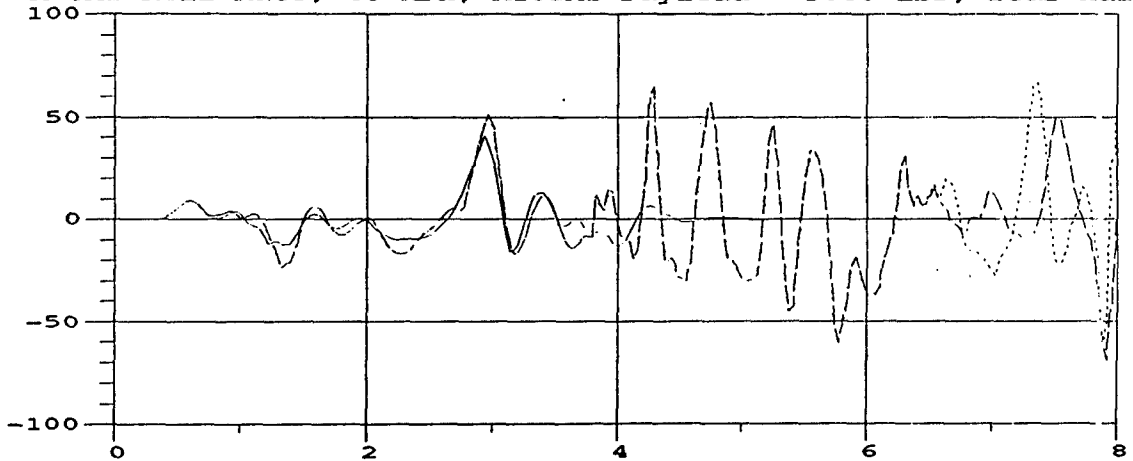

— w/o trailer (deg/sec) vs time (sec)
 w/ trailer in low position (deg/sec) vs time (sec)
 - - - w/ trailer in high position (deg/sec) vs time (sec)

9

M105A2 Roll Angle; 30 MPH; M105A2 Payload = 3000 lbs, rear half

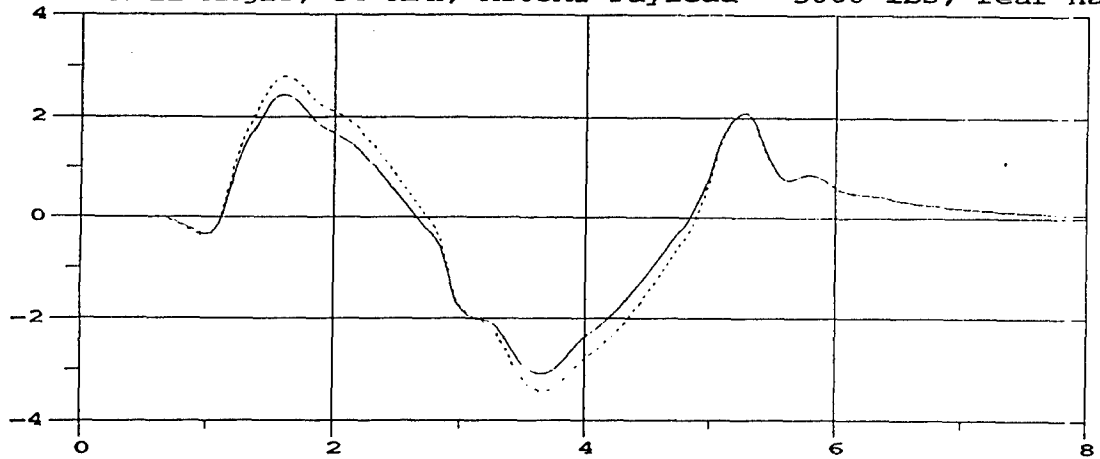

— trailer in low position (degrees) vs time (sec)
..... trailer in high position (degrees) vs time (sec)

10

M105A2 Roll Angle; 35 MPH; M105A2 Payload = 3000 lbs, rear half

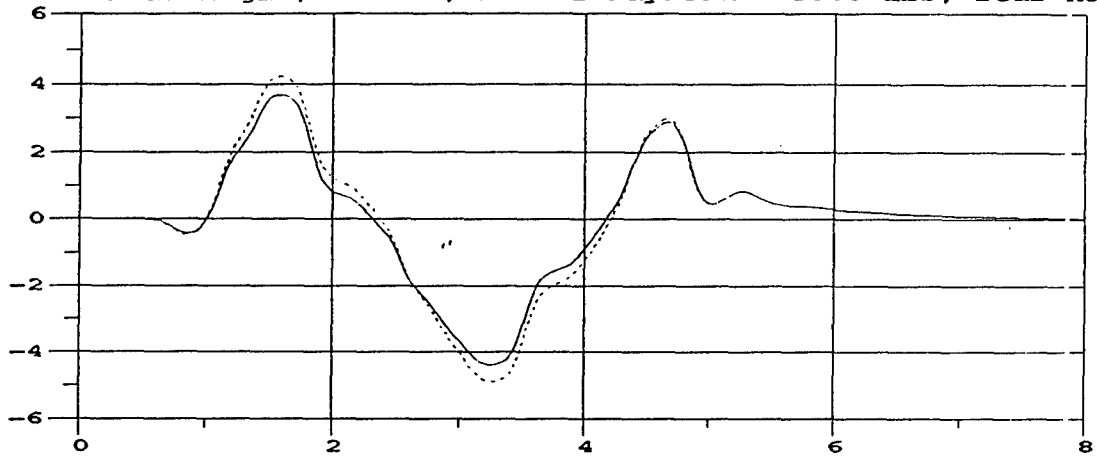

— trailer in low position (degrees) vs time (sec)
..... trailer in high position (degrees) vs time (sec)

11

M105A2 Roll Angle; 40 MPH; M105A2 Payload = 3000 lbs, rear half

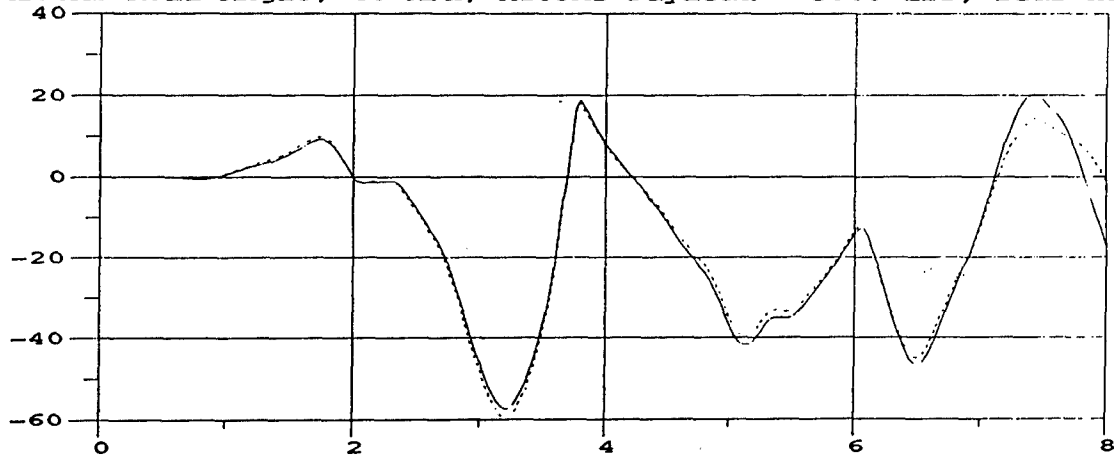

— trailer in low position (degrees) vs time (sec)
..... trailer in high position (degrees) vs time (sec)

12

M105A2 Yaw Angle; 30 MPH; M105A2 Payload = 3000 lbs, rear half

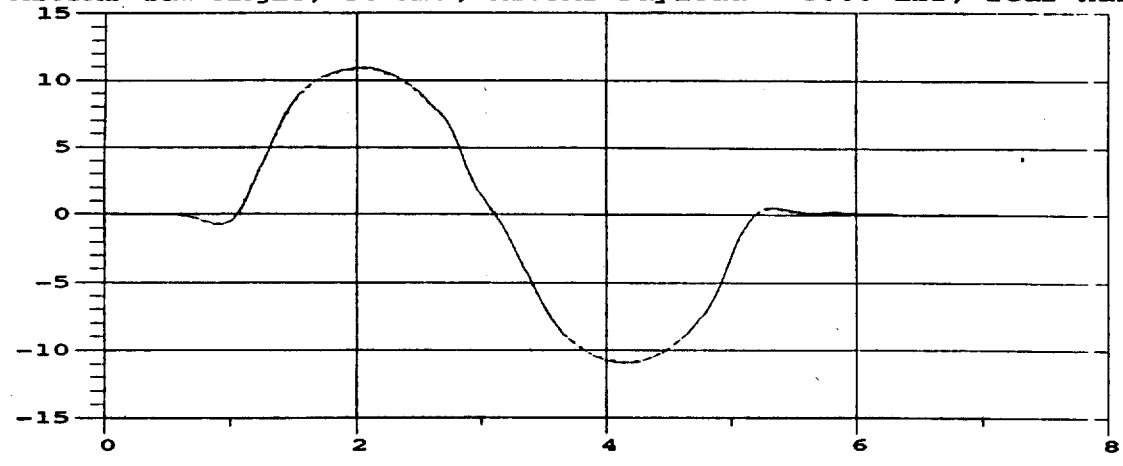

—— trailer in low position (degrees) vs time (sec)
..... trailer in high position (degrees) vs time (sec)

13

M105A2 Yaw Angle; 35 MPH; M105A2 Payload = 3000 lbs, rear half

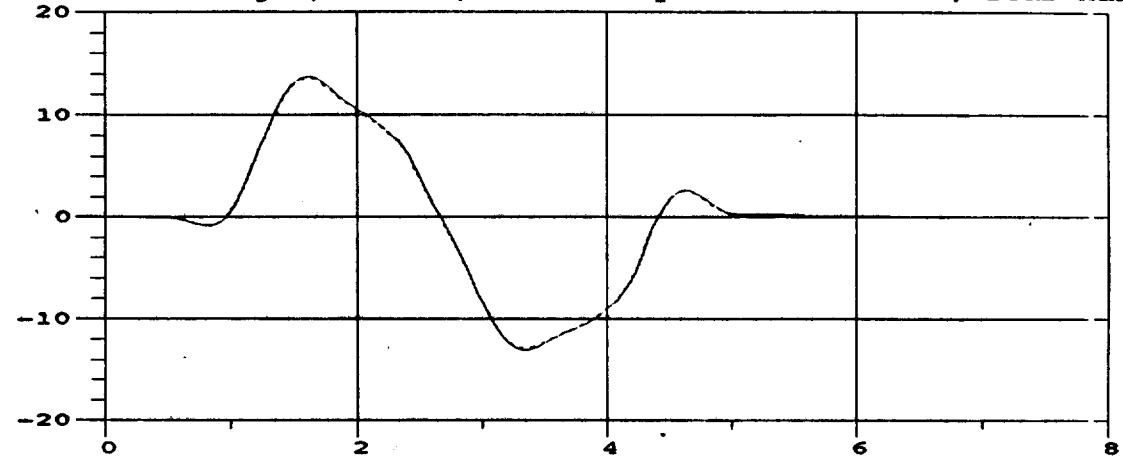

—— trailer in low position (degrees) vs time (sec)
..... trailer in high position (degrees) vs time (sec)

14

M105A2 Yaw Angle; 40 MPH; M105A2 Payload = 3000 lbs, rear half

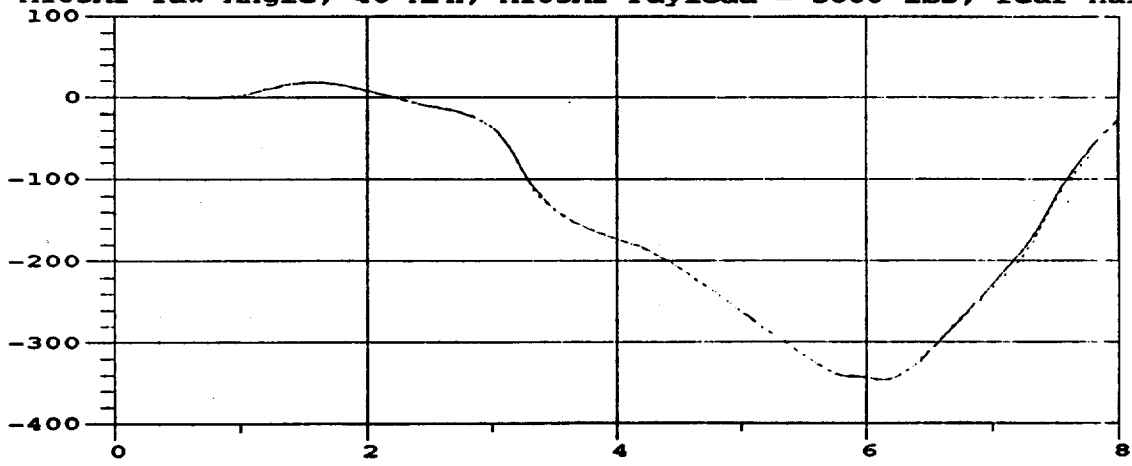

—— trailer in low position (degrees) vs time (sec)
..... trailer in high position (degrees) vs time (sec)

15

M105A2 Roll Rate; 30 MPH; M105A2 Payload = 3000 lbs, rear half

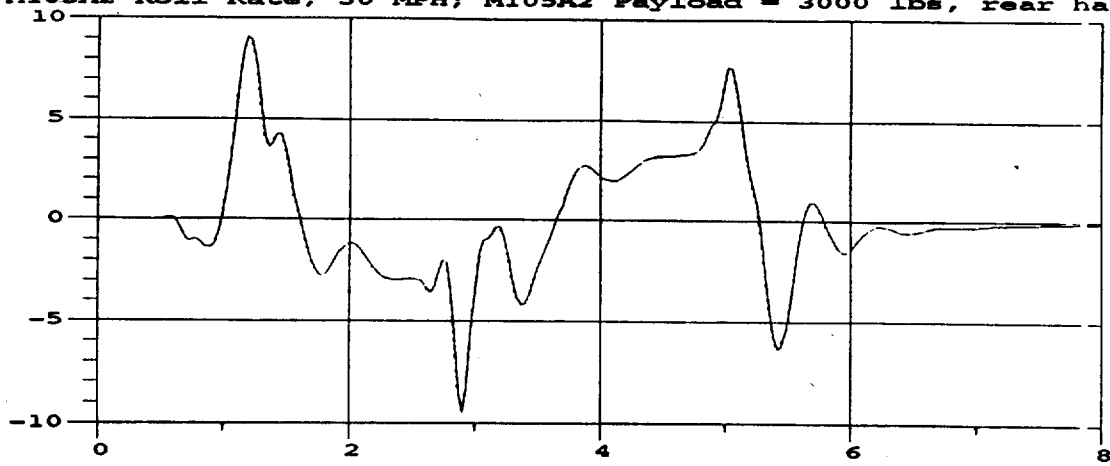

—— trailer in low position (deg/sec) vs time (sec)
..... trailer in high position (deg/sec) vs time (sec)

16

M105A2 Roll Rate; 35 MPH; M105A2 Payload = 3000 lbs, rear half

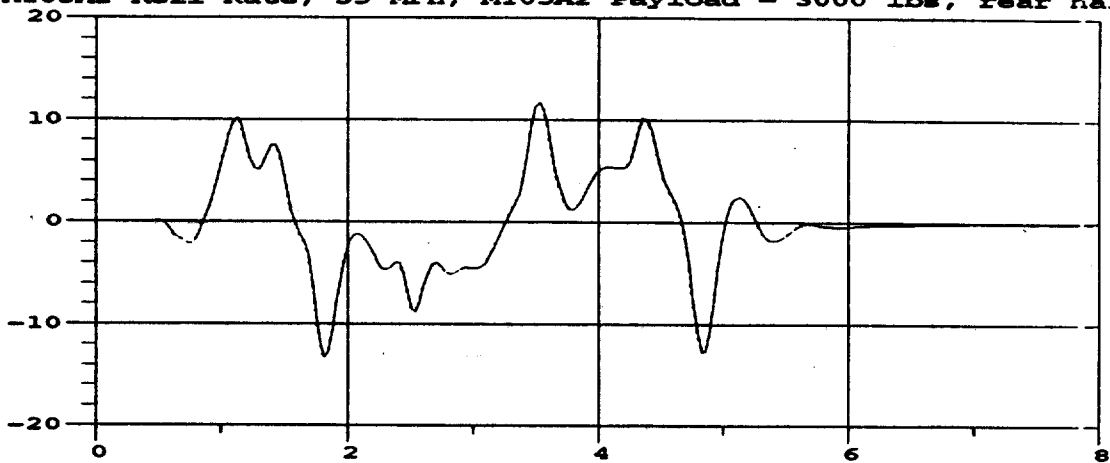

—— trailer in low position (deg/sec) vs time (sec)
..... trailer in high position (deg/sec) vs time (sec)

17

M105A2 Roll Rate; 40 MPH; M105A2 Payload = 3000 lbs, rear half

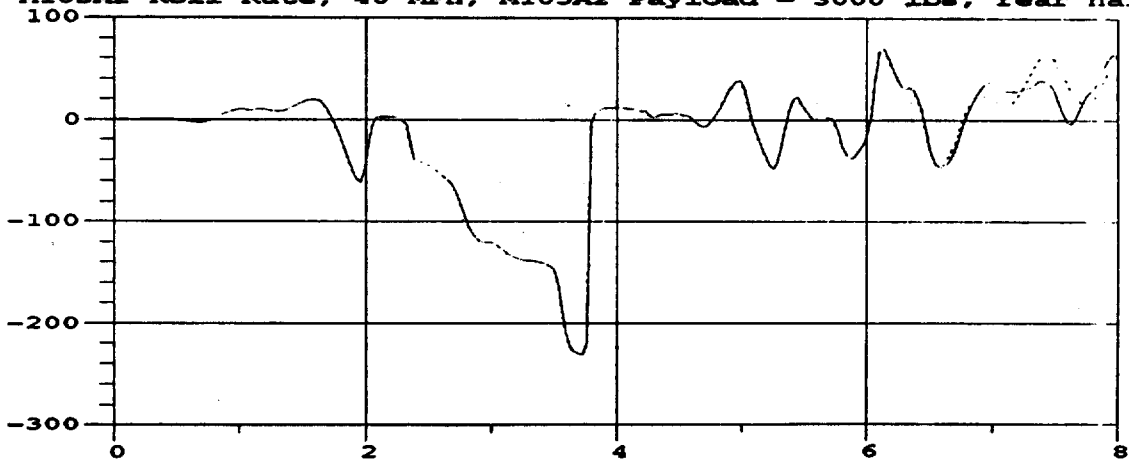

—— trailer in low position (deg/sec) vs time (sec)
..... trailer in high position (deg/sec) vs time (sec)

18

APPENDIX I
TIME HISTORY PLOTS
3000 LBS. PAYLOAD; LEFT CENTER DISTRIBUTION

M35A2 Roll Angle; 30 MPH; M105A2 Payload = 3000 lbs, left center

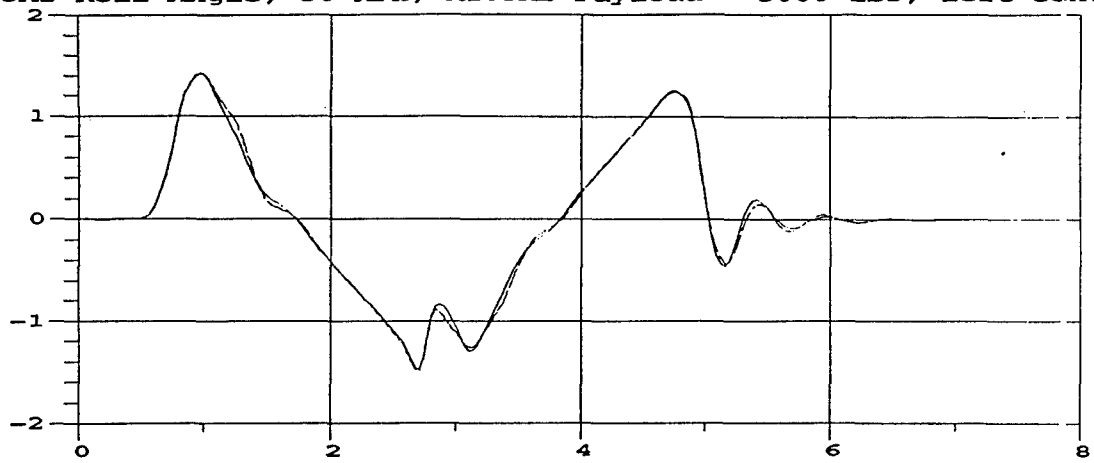

— w/o trailer (degrees) vs time (sec)
 w/ trailer in low position (degrees) vs time (sec)
 - - - w/ trailer in high position (degrees) vs time (sec)

1

M35A2 Roll Angle; 35 MPH; M105A2 Payload = 3000 lbs, left center

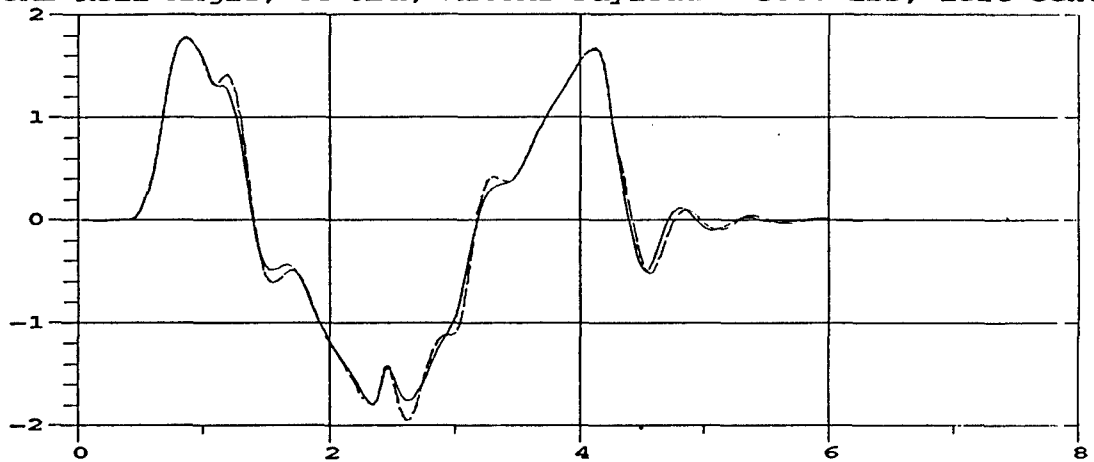

— w/o trailer (degrees) vs time (sec)
 w/ trailer in low position (degrees) vs time (sec)
 - - - w/ trailer in high position (degrees) vs time (sec)

2

M35A2 Roll Angle; 40 MPH; M105A2 Payload = 3000 lbs, left center

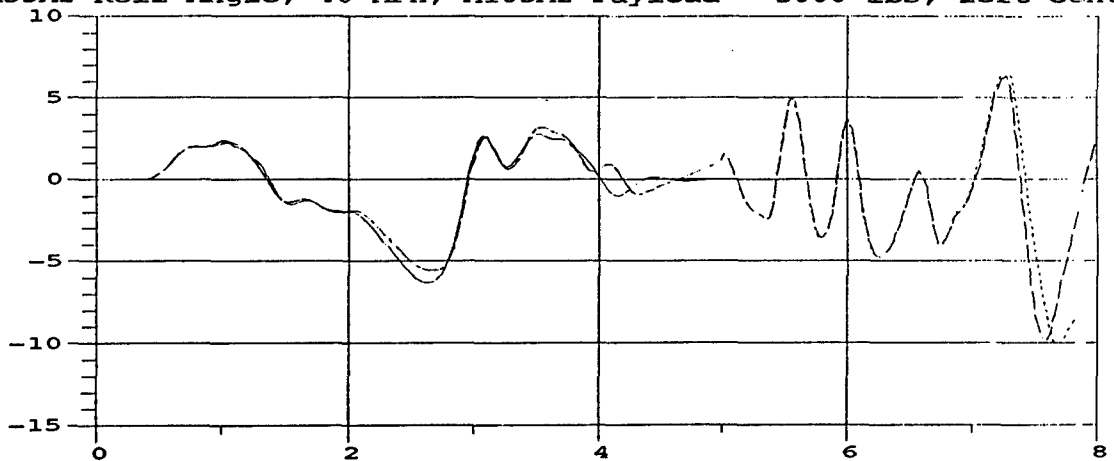

— w/o trailer (degrees) vs time (sec)
 w/ trailer in low position (degrees) vs time (sec)
 - - - w/ trailer in high position (degrees) vs time (sec)

3

M35A2 Yaw Angle; 30 MPH; M105A2 Payload = 3000 lbs, left center

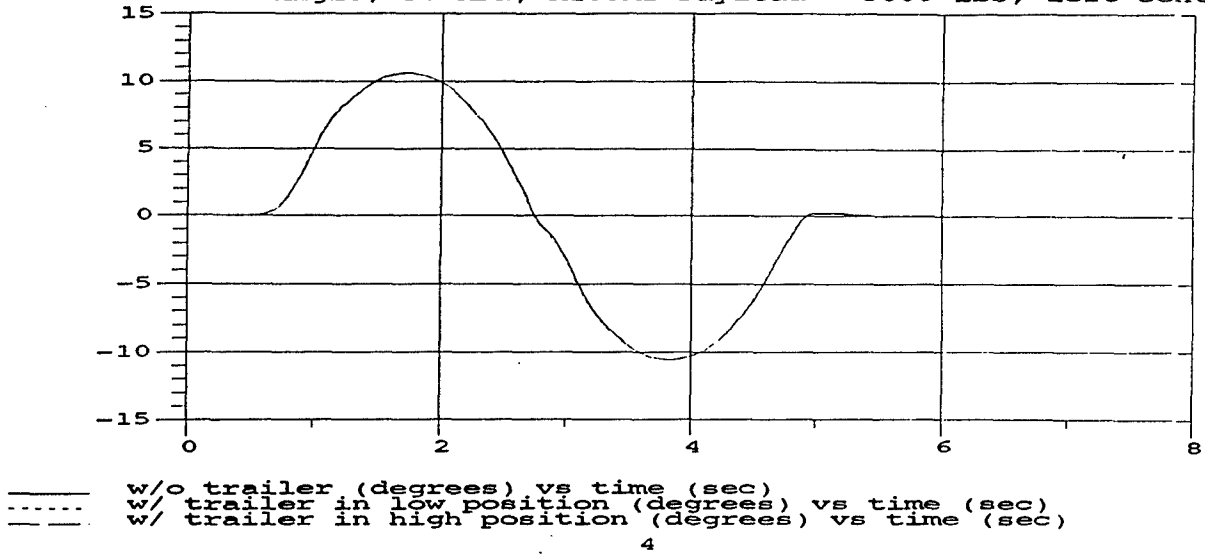

M35A2 Yaw Angle; 35 MPH; M105A2 Payload = 3000 lbs, left center

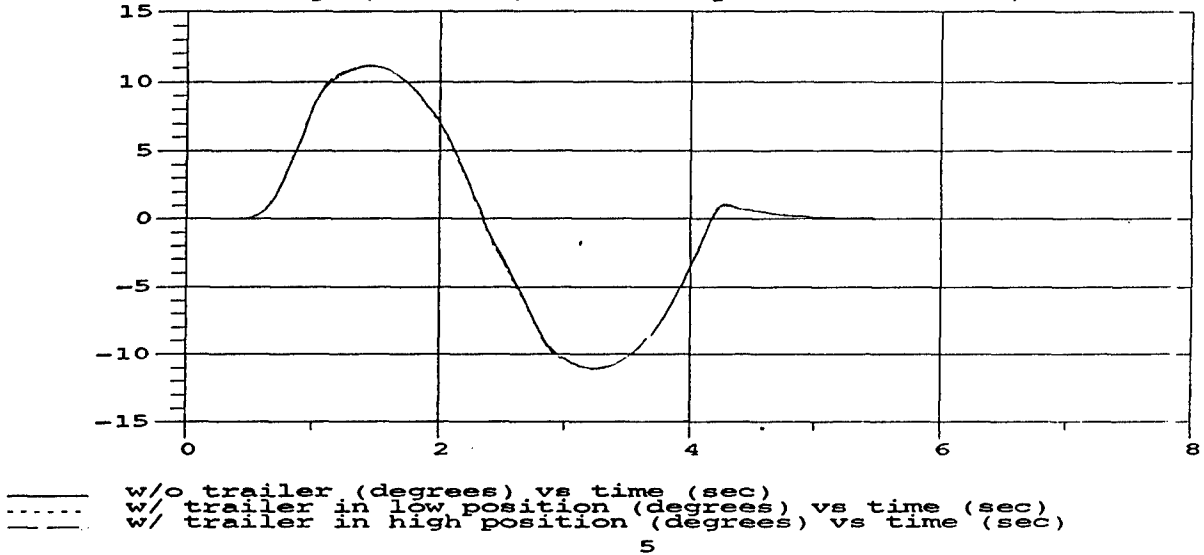

M35A2 Yaw Angle; 40 MPH; M105A2 Payload = 3000 lbs, left center

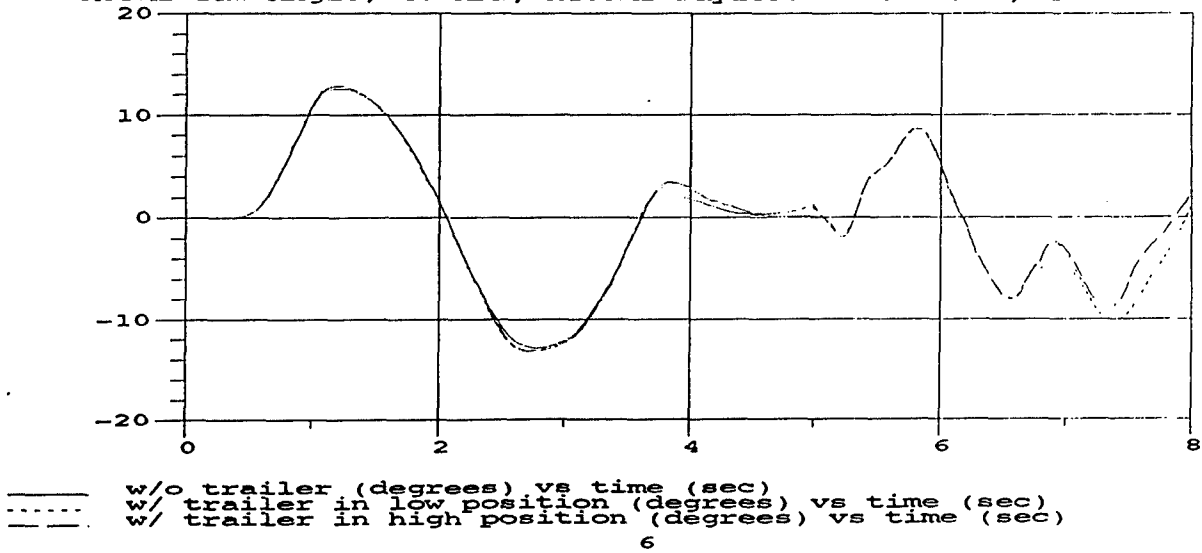

M35A2 Roll Rate; 30 MPH; M105A2 Payload = 3000 lbs, left center

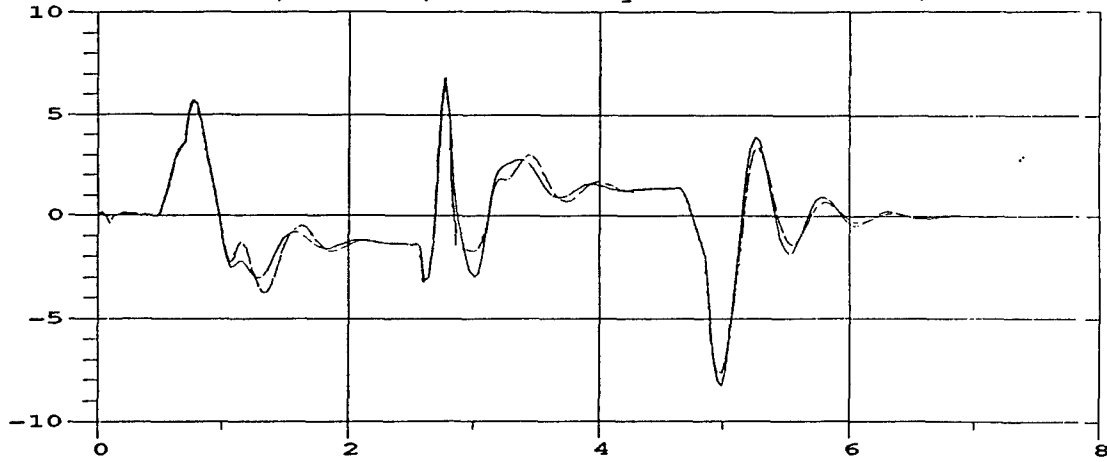

——— w/o trailer (deg/sec) vs time (sec)
 w/ trailer in low position (deg/sec) vs time (sec)
 - - - w/ trailer in high position (deg/sec) vs time (sec)

7

M35A2 Roll Rate; 35 MPH; M105A2 Payload = 3000 lbs, left center

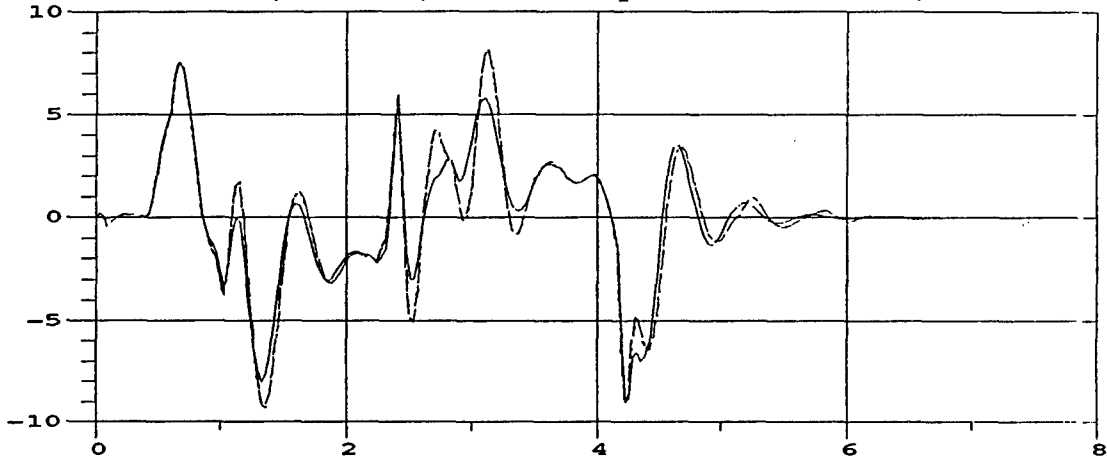

——— w/o trailer (deg/sec) vs time (sec)
 w/ trailer in low position (deg/sec) vs time (sec)
 - - - w/ trailer in high position (deg/sec) vs time (sec)

8

M35A2 Roll Rate; 40 MPH; M105A2 Payload = 3000 lbs, left center

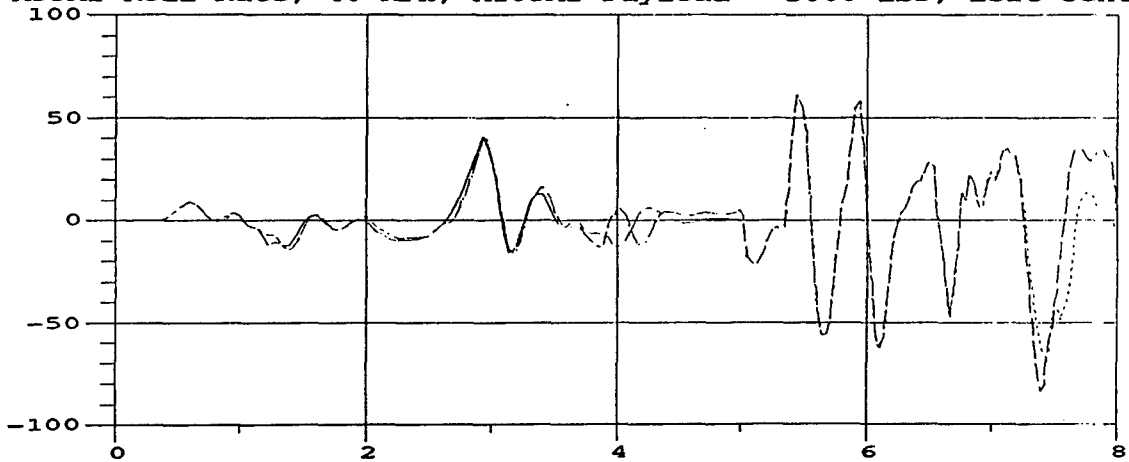

——— w/o trailer (deg/sec) vs time (sec)
 w/ trailer in low position (deg/sec) vs time (sec)
 - - - w/ trailer in high position (deg/sec) vs time (sec)

9

M105A2 Roll Angle; 30 MPH; M105A2 Payload = 3000 lbs, left center

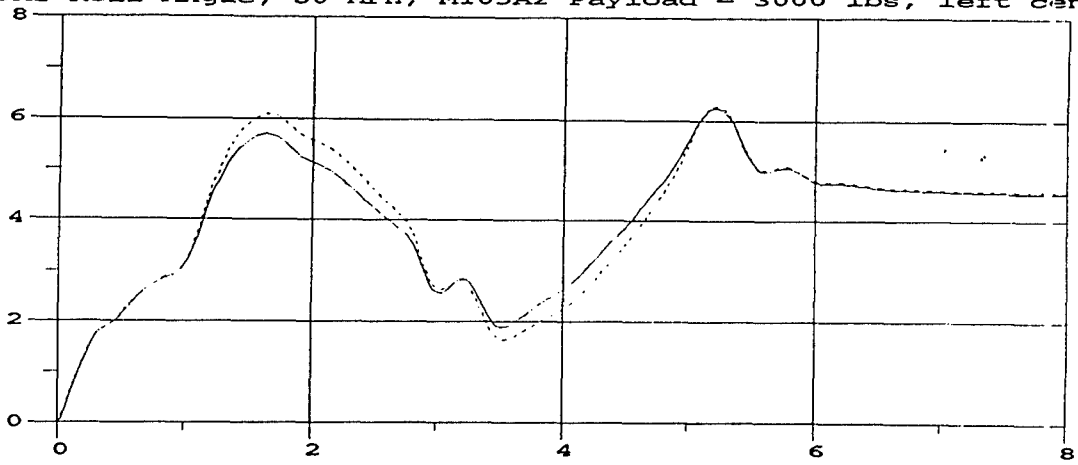

—— trailer in low position (degrees) vs time (sec)
..... trailer in high position (degrees) vs time (sec)

10

M105A2 Roll Angle; 35 MPH; M105A2 Payload = 3000 lbs, left center

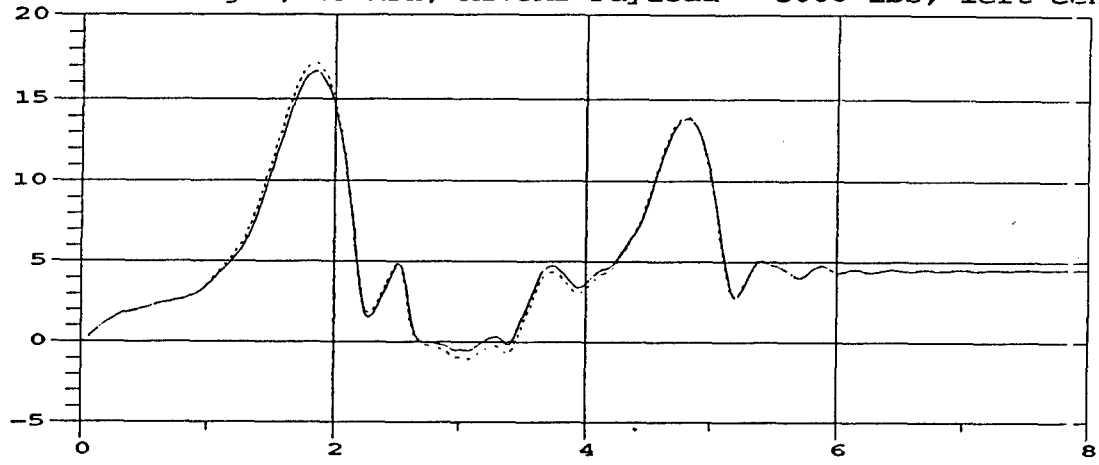

—— trailer in low position (degrees) vs time (sec)
..... trailer in high position (degrees) vs time (sec)

11

M105A2 Roll Angle; 40 MPH; M105A2 Payload = 3000 lbs, left center

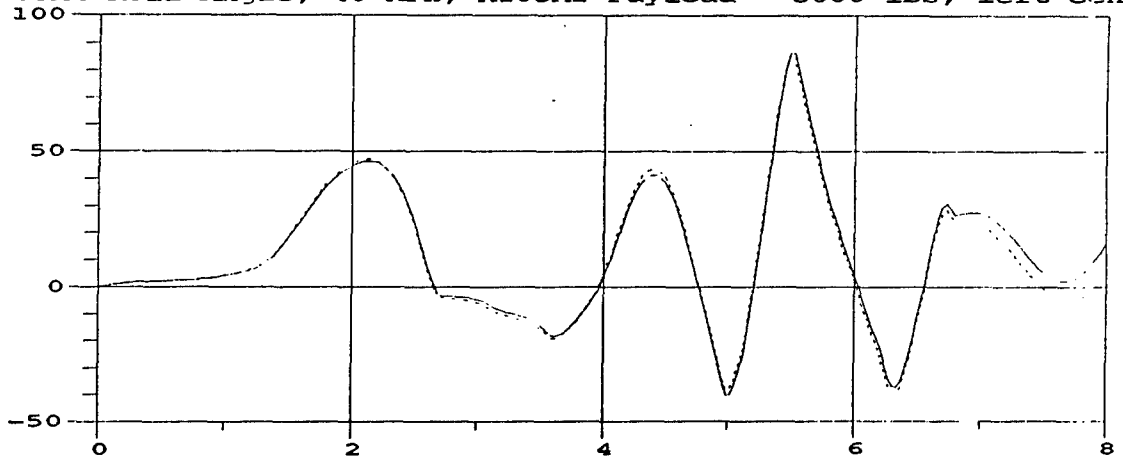

—— trailer in low position (degrees) vs time (sec)
..... trailer in high position (degrees) vs time (sec)

12

M105A2 Yaw Angle; 30 MPH; M105A2 Payload = 3000 lbs, left center

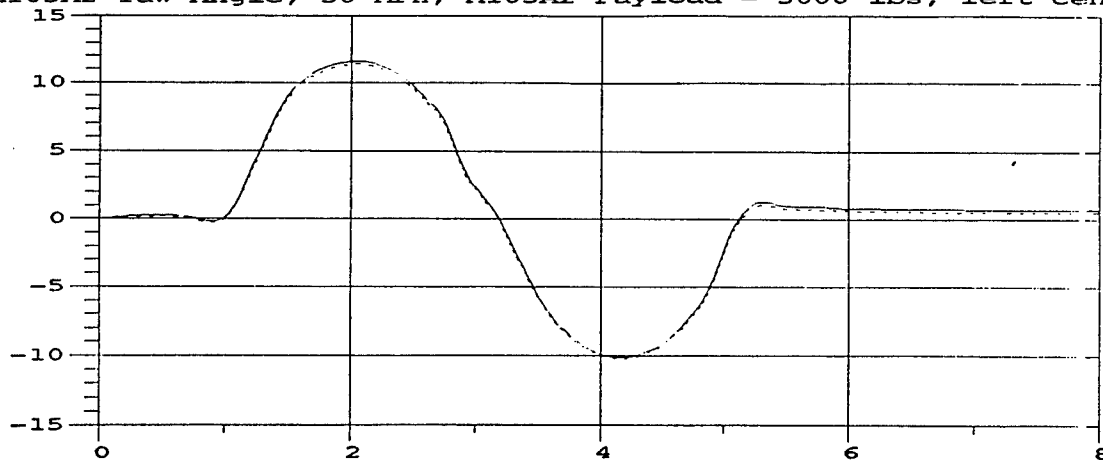

— trailer in low position (degrees) vs time (sec)
- - - trailer in high position (degrees) vs time (sec)

13

M105A2 Yaw Angle; 35 MPH; M105A2 Payload = 3000 lbs, left center

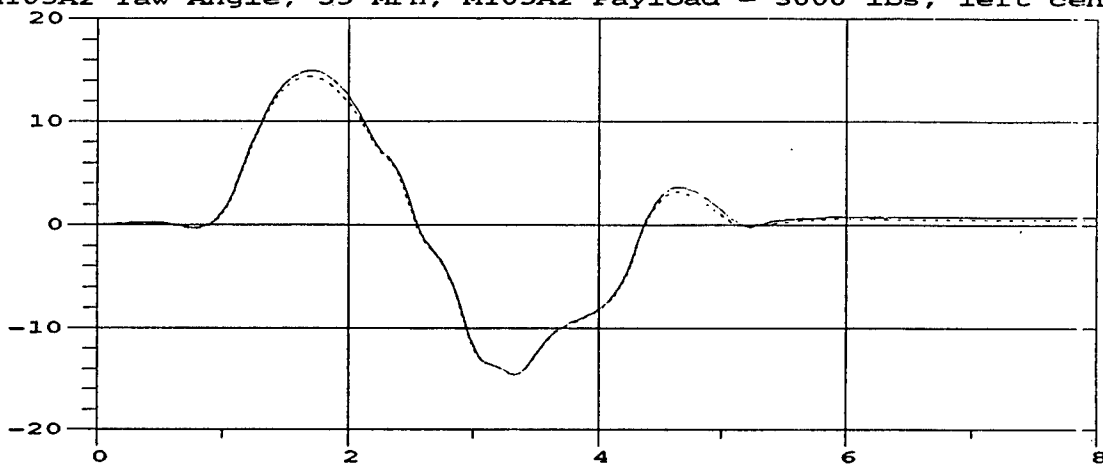

— trailer in low position (degrees) vs time (sec)
- - - trailer in high position (degrees) vs time (sec)

14

M105A2 Yaw Angle; 40 MPH; M105A2 Payload = 3000 lbs, left center

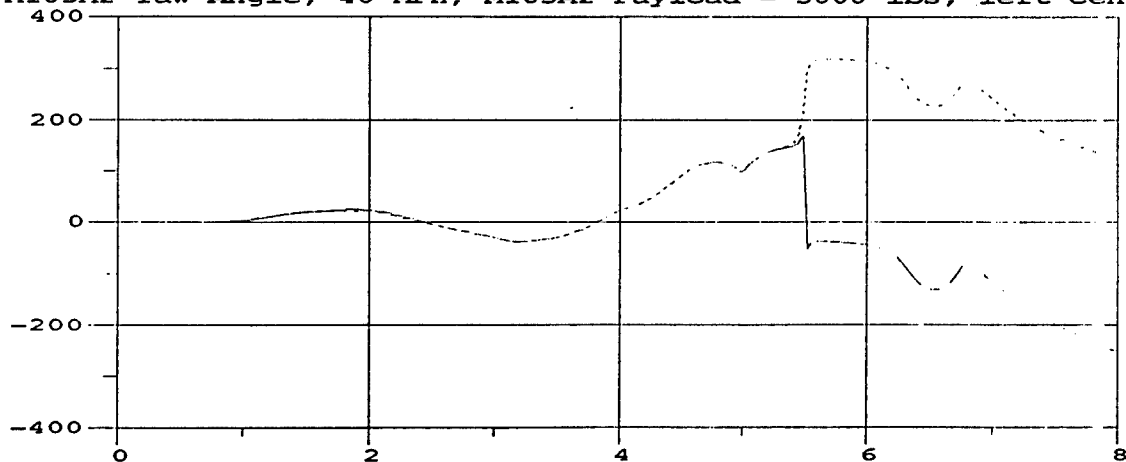

— trailer in low position (degrees) vs time (sec)
- - - trailer in high position (degrees) vs time (sec)

15

M105A2 Roll Rate; 30 MPH; M105A2 Payload = 3000 lbs, left center

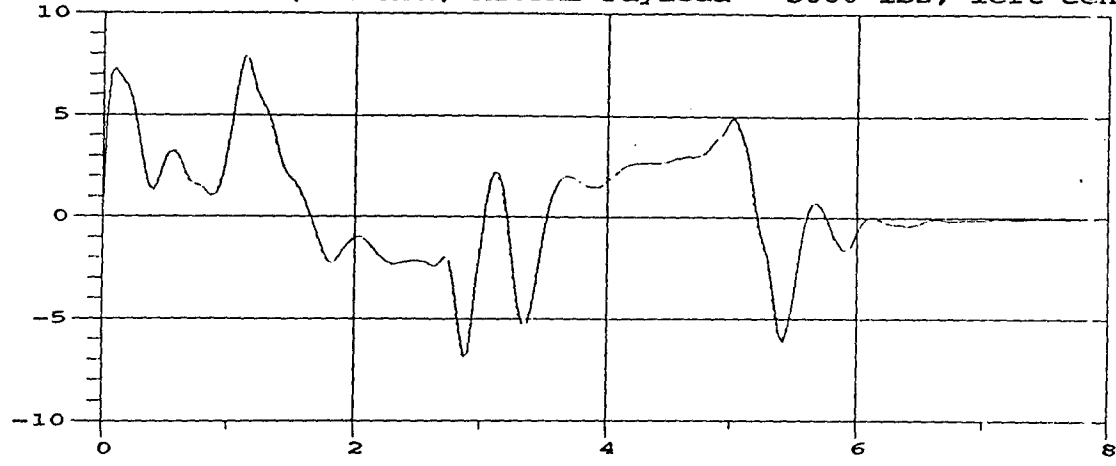

—— trailer in low position (deg/sec) vs time (sec)
..... trailer in high position (deg/sec) vs time (sec)

16

M105A2 Roll Rate; 35 MPH; M105A2 Payload = 3000 lbs, left center

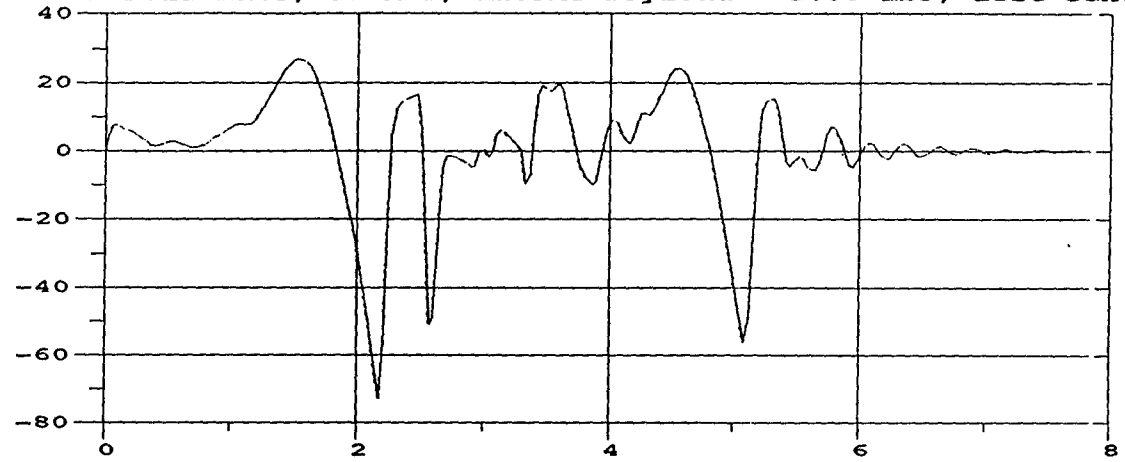

—— trailer in low position (deg/sec) vs time (sec)
..... trailer in high position (deg/sec) vs time (sec)

17

M105A2 Roll Rate; 40 MPH; M105A2 Payload = 3000 lbs, left center

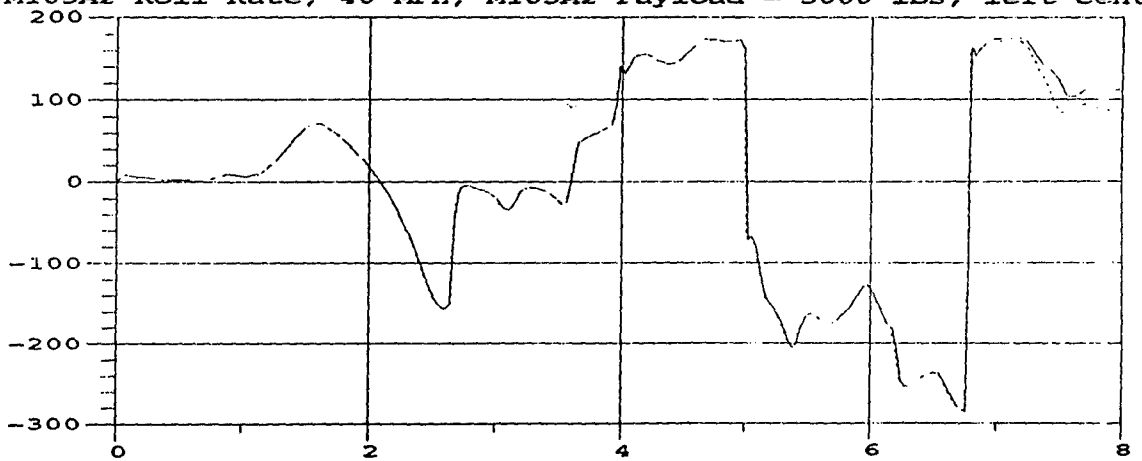

—— trailer in low position (deg/sec) vs time (sec)
..... trailer in high position (deg/sec) vs time (sec)

18

DISTRIBUTION LIST

	Copies
Commander Defense Technical Information Center Bldg. 5, Cameron Station ATTN: DDAC Alexandria, VA 22304-9990	2
Manager Defense Logistics Studies Information Exchange ATTN: AMXMC-D Fort Lee, VA 23801-6044	2
Commander U.S. Army Tank-Automotive Command ATTN: ASQNC-TAC-DIT (Technical Library) Warren, MI 48397-5000	2
Commander U.S. Army Tank-Automotive Command ATTN: AMSTA-CF (Dr. Oscar) Warren, MI 48397-5000	1
Director U.S. Army Materiel Systems Analysis Activity ATTN: AMXSU-MP (Mr. Cohen) Aberdeen proving Ground, MD 21005-5071	1
Commander U.S. Army Tank-Automotive Command Attn: AMSTA-RYA (Mr. Pozolo) Warren, MI 48397-5000	5