

AD-A254 892



SLCET-TR-88-1 (Rev 5.2)

# QUARTZ CRYSTAL RESONATORS AND OSCILLATORS

For Frequency Control and Timing Applications

A TUTORIAL

John R. Vig

U.S. Army Electronics Technology and Devices  
Laboratory (LABCOM)  
Fort Monmouth, NJ 07703-5601

**DTIC**  
ELECTE  
AUG 28 1992  
**S C D**

658517  
92-23877  
27288

July 1992

DISTRIBUTION STATEMENT

Approved for public release.  
Distribution is unlimited.

2

## **NOTICES**

### **Disclaimers**

**The findings in this report are not to be construed as an official Department of the Army position, unless so designated by other authorized documents.**

**The citation of trade names and names of manufacturers in this report is not to be construed as official Government indorsement or approval of commercial products or services referenced herein.**

# REPORT DOCUMENTATION PAGE

Form Approved  
OMB No. 0704-0188

Public reporting burden for this collection of information is estimated to average 1 hour per response, including the time for reviewing instructions, searching existing data sources, gathering and maintaining the data needed, and completing and reviewing the collection of information. Send comments regarding this burden estimate or any other aspect of this collection of information, including suggestions for reducing this burden, to Washington Headquarters Services, Directorate for Information Operations and Reports, 1215 Jefferson Davis Highway, Suite 1204, Arlington, VA 22202-4302, and to the Office of Management and Budget, Paperwork Reduction Project (0704-0188), Washington, DC 20503.

1. AGENCY USE ONLY (Leave blank)		2. REPORT DATE July 1992	3. REPORT TYPE AND DATES COVERED Technical Report	
4. TITLE AND SUBTITLE Quartz Crystal Resonators and Oscillators for Frequency Control and Timing Applications - A Tutorial			5. FUNDING NUMBERS PE: 1L1 PR: 62705 TA: AH94	
6. AUTHOR(S) John R. Vig				
7. PERFORMING ORGANIZATION NAME(S) AND ADDRESS(ES) US Army Laboratory Command (LABCOM) Electronics Technology and Devices Laboratory (ETDL) ATTN: SLCET-EF Fort Monmouth, NJ 07703-5601			8. PERFORMING ORGANIZATION REPORT NUMBER  SLCET-TR-88-1 (Rev. 5.2)	
9. SPONSORING/MONITORING AGENCY NAME(S) AND ADDRESS(ES)			10. SPONSORING/MONITORING AGENCY REPORT NUMBER	
11. SUPPLEMENTARY NOTES This report is a revision of Technical Report SLCET-TR-88-1 (Rev. 4.1), same title, dated January 1991, AD A231604.				
12a. DISTRIBUTION/AVAILABILITY STATEMENT Approved for public release. Distribution is unlimited.			12b. DISTRIBUTION CODE	
13. ABSTRACT (Maximum 200 words) Subjects covered include: applications of frequency standards; types of oscillators (quartz and atomic); quartz resonator properties; quartz growing, sweeping, and material characteristics; Q and its significance; resonator and oscillator stability, including aging, short-term instability, frequency vs. temperature characteristics, oscillator circuit caused instabilities, frequency vs. drive level effects, acceleration effects, the effect of shock, and radiation effects; emerging technologies; atomic frequency standards; comparison of the major oscillator types; oscillator specifications and selection guidelines; time and timekeeping; clock errors; relativistic time; time transfer; time and frequency subsystem; and other applications of quartz resonators.  The goal of this document is to assist in presenting to the nonspecialist the most frequently encountered concepts in frequency control and timing. The document originated as a set of "hard copies" of presentation visuals (i.e., vu-graphs).				
14. SUBJECT TERMS Quartz; quartz crystal; quartz resonator; quartz oscillator; resonator; oscillator; stability; aging; Allan variance; phase noise; frequency control; frequency standard; clock; time; timekeeping; atomic frequency standard, rubidium standard; cesium standard; atomic resonator; radiation effects; vibration effects.			15. NUMBER OF PAGES 272	
			16. PRICE CODE	
17. SECURITY CLASSIFICATION OF REPORT Unclassified	18. SECURITY CLASSIFICATION OF THIS PAGE Unclassified	19. SECURITY CLASSIFICATION OF ABSTRACT Unclassified	20. LIMITATION OF ABSTRACT UL	

## Contents

Preface .....	iv
1. Applications and Requirements.....	1
2. Quartz Crystal Oscillators.....	2
3. Quartz Crystal Resonators.....	3
4. Oscillator Stability .....	4
5. Quartz Material Properties .....	5
6. Emerging/Improving Oscillator Technologies.....	6
7. Atomic Frequency Standards .....	7
8. Oscillator Comparison and Specification .....	8
9. Time and Timekeeping .....	9
10. Related Devices and Applications.....	10
11. General References*.....	11
Index .....	12

\* Chapter-specific references are listed at the end of each chapter.

## Preface

# Why This Tutorial?

"Everything should be made as simple as possible - but not simpler," said Einstein. The main goal of this "tutorial" is to assist with presenting the most frequently encountered concepts in frequency control and timing, as simply as possible.

In my position as Chief, Frequency Control and Timing Branch, US Army Electronics Technology and Devices Laboratory, I am often called upon to brief visitors, management, and potential users of precision oscillators. I have also been invited to present seminars and review papers before university, IEEE, and other professional groups. In the beginning, I spent a great deal of time preparing these presentations. Much of the time was spent on preparing the presentation visuals (i.e., the vu-graphs). As I accumulat-

ed more and more vu-graphs, it became easier and easier to prepare successive presentations. Since I was frequently asked for "hard-copies" of the vu-graphs, I started organizing, adding some text, and filling the gaps in the vu-graph collection. As the collection grew, I began receiving favorable comments and requests for additional copies. Apparently, others, too, found this collection to be useful. Eventually, I assembled this document, the "Tutorial."

References are listed at the end of each chapter. General references are listed just before the index at the end. Comments and suggestions for future revisions will be welcome.

John R. Vig

①

# Applications and Requirements

DTIC QUALITY INSPECTED 6

Accession For	
NTIS GR&I	<input checked="" type="checkbox"/>
DTIC TAB	<input type="checkbox"/>
Unannounced	<input type="checkbox"/>
Justification	
By	
Distribution/	
Availability Codes	
Dist	Special
A-1	

# Applications of Quartz Crystals

<b>Military &amp; Aerospace</b>	<b>Industrial</b>	<b>Consumer</b>
Communications	Communications	Watches & clocks
Navigation	Telecommunications	Radio & hi-fi eq'pment
IFF	Mobile/cellular/portable	Home computers
Radar	radio, telephone & pager	Telephones (cordless)
Sensors	Aviation	Color TV
Guidance systems	Marine	VCR & video camera
Fuses	Navigation	CB radio
Electronic warfare	Instrumentation	Amateur radio
Sonobuoys	Computers	CATV
<b>Research &amp; Metrology</b>	Digital systems	Toys & games
Instruments	CRT displays	<b>Automotive</b>
Astronomy & geodesy	Floppy disks	Engine control
Space tracking	Modems	Radio & clock
Celestial navigation	Tagging/identification	Trip computer
	Utilities	

# Quartz Crystal Device Market

	Commercial	Military
Production (no./yr.)	~ 1 billion	~ 1 million
Unit cost (typical)	~ \$1	~ \$50
Major markets	Watches, clocks, color TV, autos	C <sup>3</sup> , nav., IFF, radar, fuses, sonobuoys
Major R&D thrusts	Less expensive, smaller	Higher stability (aging, noise, temperature, acceleration, radiation) lower power, smaller, less expensive, more rugged



# Commercial - Military Comparison

Commercial		Military & Space		
Typical	State-Of-The-Art	Parameters	Fielded Systems	Evolving Systems
~ 92%	~ 2%	% of Market (\$)	~ 5%	~ 1%
CB radios, watches, color TVs, microcomputers	Instruments, Commercial Spacecraft	Typical Applications	PRC-77, VRC-12	Radios, ECCM, IFF, Navigation, Surveillance
10-4	10-7	Accuracy per year	5 x 10 <sup>-5</sup>	10-6 to 10-9
0°C to 60°C	0°C to 71°C	Temperature	-55°C to +100°C	-55°C to 85°C
No Requirement	No Requirement	Vibration	No Requirement	10-12 to 10-10 per g
100 to 1,000 g	100 g	Shock	100 g	up to 16,000 g
100 cm <sup>3</sup>	300 cm <sup>3</sup>	Size	100 cm <sup>3</sup>	< 20 cm <sup>3</sup>
Not oven-controlled	4 W	Power	Not oven-controlled	< 10 mW to < 0.25 W
Not oven-controlled	10 min	Warmup time	Not oven-controlled	< 3 min
No Requirement	No Requirement	Radiation hardening	Not specified	Radiation hardened

Number of U.S. Companies ~ 60

# Navigation

Precise time is essential to precise navigation. Historically, navigation has been a principal motivator in man's search for better clocks. Even in ancient times, one could measure latitude by observing the stars' position. However, to determine longitude, the problem became one of timing. Since the earth makes one revolution ( $360^\circ$ ) in 24 hours, one can determine longitude from the time difference  $\Delta t$  between local time (which was determined from the sun's position) and the time at the Greenwich meridian (which was determined by a clock). Longitude in degrees =  $(360^\circ/24 \text{ hours}) \times \Delta t$  in hours.

In 1714, the British government offered a reward of 20,000 pounds to the first person to produce a clock that allowed the determination of a ship's longitude to 30 nautical miles at the end of a six week voyage (i.e., a clock accuracy of three seconds per day). The Englishman John Harrison won the competition in 1735 for his chronometer invention.

Today's electronic navigation systems still require ever greater accuracies. Since light (radio waves) travels 300 meters per microsecond, e.g., if a vessel's timing was in error by one millisecond, a navigational error of 300 kilometers would result. In the Global Positioning System (GPS), atomic clocks in the satellites and quartz oscillators in the receivers provide nanosecond-level accuracies. The resulting (worldwide) navigational accuracies are about ten meters (see chapter 9 for further details about GPS).

# Commercial Two-way Radio

Historically, as the number of users of commercial two-way radios have grown, channel spacings have been narrowed, and higher-frequency spectra have had to be allocated to accommodate the demand. Narrower channel spacings and higher operating frequencies necessitate tighter frequency tolerances for both the transmitters and the receivers. In 1940, when only a few thousand commercial broadcast transmitters were in use, a 500 ppm tolerance was adequate. Today, the millions of cellular telephones (which operate at frequency bands above 800 MHz) must maintain a frequency tolerance of 2.5 ppm. TCXOs of 2 ppm frequency accuracy are used for frequency control. The 896-901 MHz and 935-940 MHz mobile radio bands require frequency tolerances of 0.1 ppm at the base station and 1.5 ppm at the mobile station.

The need to accommodate more users will continue to require higher and higher frequency accuracies. For example, NASA is developing a personal satellite communication system, using walkie-talkie-like hand-held terminals, which employs a 30 GHz uplink, a 20 GHz downlink, and a 10 kHz channel spacing. The terminals' frequency accuracy requirement is a few parts in  $10^8$ .

# Digital Network Synchronization

- Synchronization plays a critical role in digital telecommunication systems. It ensures that information transfer is performed with minimal buffer overflow or underflow events, i.e., with an acceptable level of "slips." Slips cause problems, e.g., missing lines in FAX transmission, clicks in voice transmission, loss of encryption key in secure voice transmission, and data retransmission.
- In AT&T's network, timing is distributed down a hierarchy of nodes. A timing source-receiver relationship is established between pairs of nodes containing clocks. The clocks are of four types, in four "stratum levels."

Stratum	Accuracy (Free running)		Clock type	Number used
	long term	per 1st day		
1	$1 \times 10^{-11}$	N.A.	GPS w. two Rb	16
2	$1.6 \times 10^{-8}$	$1 \times 10^{-10}$	Rb or OCXO	~200
3	$4.6 \times 10^{-6}$	$3.7 \times 10^{-7}$	OCXO or TCXO	1000's
4	$3.2 \times 10^{-5}$	N.A.	XO	~1 million

# Phase Noise in PLL and PSK Systems

The phase noise of oscillators can lead to erroneous detection of phase transitions, i.e., to bit errors, when phase shift keyed (PSK) digital modulation is used. In digital communications, for example, where 8-phase PSK is used, the maximum phase tolerance is  $\pm 22.5^\circ$ , of which  $\pm 7.5^\circ$  is the typical allowable carrier noise contribution. Due to the statistical nature of phase deviations, if the RMS phase deviation is  $1.5^\circ$ , for example, the probability of exceeding the  $\pm 7.5^\circ$  phase deviation is  $6 \times 10^{-7}$ , which can result in a bit error rate that is significant in some applications.

Shock and vibration can produce large phase deviations even in "low noise" oscillators. Moreover, when the frequency of an oscillator is multiplied by N, the phase deviations are also multiplied by N. For example, a phase deviation of  $10^{-3}$  radian at 10 MHz becomes 1 radian at 10 GHz. Such large phase excursions can be catastrophic to the performance of systems, e.g., of those which rely on phase locked loops (PLL) or phase shift keying. Low noise, acceleration insensitive oscillators are essential in such applications.

# Utility Fault Location

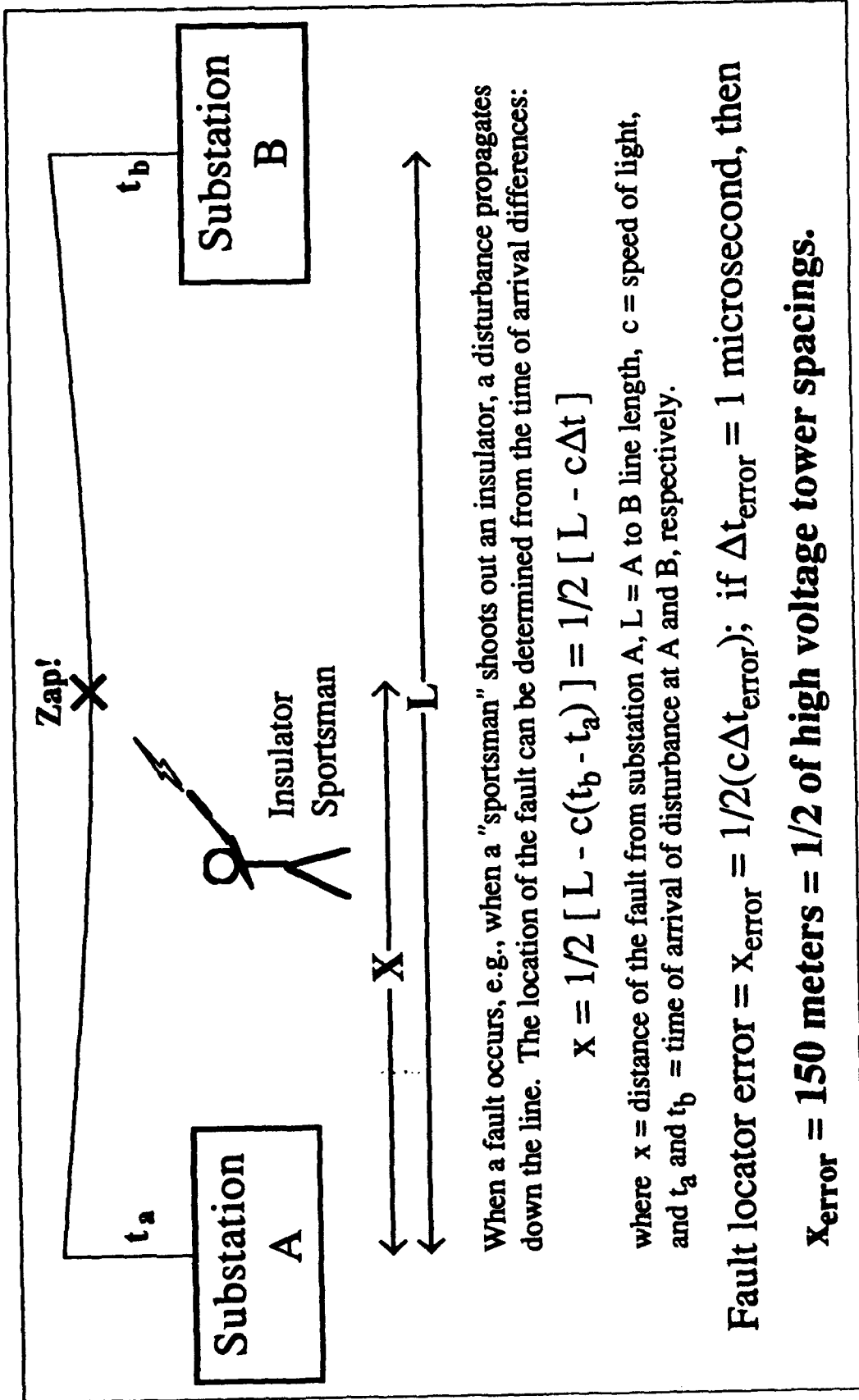

When a fault occurs, e.g., when a "sportsman" shoots out an insulator, a disturbance propagates down the line. The location of the fault can be determined from the time of arrival differences:

$$x = 1/2 [ L - c(t_b - t_a) ] = 1/2 [ L - c\Delta t ]$$

where  $x$  = distance of the fault from substation A,  $L$  = A to B line length,  $c$  = speed of light, and  $t_a$  and  $t_b$  = time of arrival of disturbance at A and B, respectively.

Fault locator error =  $x_{error} = 1/2(c\Delta t_{error})$ ; if  $\Delta t_{error} = 1$  microsecond, then

$x_{error} = 150$  meters = 1/2 of high voltage tower spacings.

# Space Exploration

How does NASA know where a spacecraft is in deep space? The spacecraft's precise range, velocity and angular position are determined with the aid of highly stable frequency standards. The range is determined from the propagation time of microwave radiation between an antenna on Earth and the spacecraft. The velocity is determined from the "doppler," i.e., by comparing the phase of the incoming carrier signal with that of a reference signal generated from the ground station frequency standard.

The angular position is determined by Very Long Baseline Interferometry (VLBI) in which widely separated stations (in California, Spain and Australia) simultaneously receive signals from the spacecraft. Differences between times of arrival coupled with knowledge of the baseline vectors joining the station antennas provide direct geometric determination of the angles between the baseline vectors and the direction to the spacecraft. Hydrogen masers provide the best stability ( $\sim 10^{-15}$ ) for the propagation times of interest, which typically range from minutes to hours. VLBI is also used for high resolution angular measurements in radioastronomy.

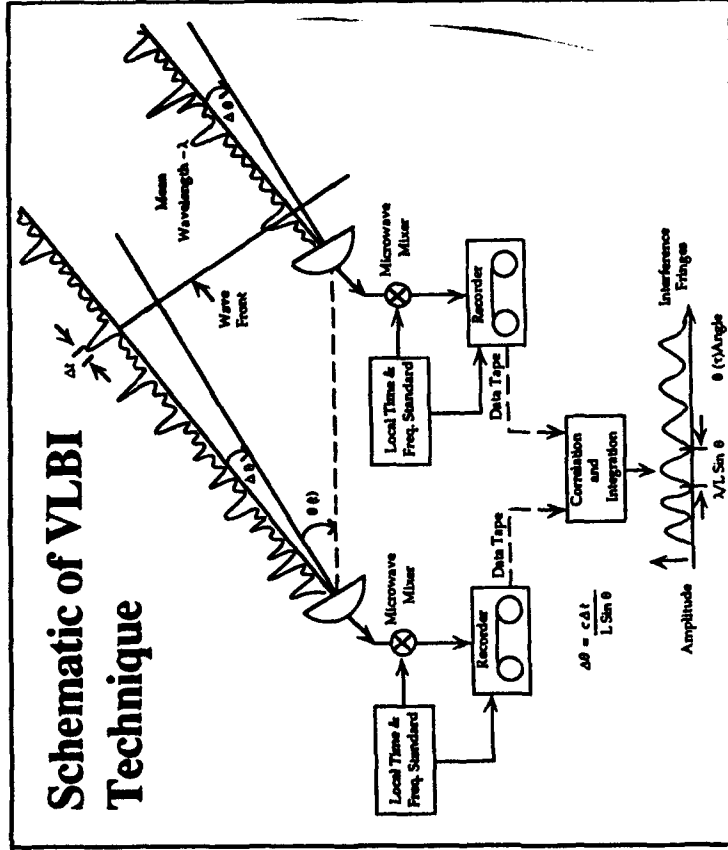

# **Military Requirements**

**Military needs are a prime driver of frequency control technology. Modern military systems require oscillators/clocks that are:**

- **Stable over a wide range of parameters (time, temperature, acceleration, radiation, etc.)**
- **Low noise**
- **Low power**
- **Small size**
- **Fast warmup**
- **Low life-cycle cost**



# Impacts of Oscillator Technology Improvements

- Higher jamming resistance & improved ability to hide signals
- Improved ability to deny use of systems to unauthorized users
- Longer autonomy period (radio silence interval)
- Faster signal acquisition (net entry)
- Lower power for reduced battery consumption
- Improved spectrum utilization
- Improved surveillance capability (e.g., slow-moving target detection, bistatic radar)
- Improved missile guidance (e.g., on-board radar vs. ground radar)
- Improved identification-friend-or-foe (IFF) capability
- Improved electronic warfare capability (e.g., emitter location via TOA)
- Lower error rates in digital communications
- Improved navigation capability
- Improved survivability and performance in radiation environment
- Improved survivability and performance in high shock applications
- Longer life, and smaller size, weight, and cost
- Longer recalibration interval (lower logistics costs)

# Spread Spectrum Systems

- In a spread spectrum system, the transmitted signal (e.g., a voice channel of a few kHz bandwidth) is spread over a bandwidth that is much wider (e.g., many MHz) than the bandwidth required to transmit the information being sent. This is accomplished by modulating a carrier signal with the information being sent, and with a wideband pseudonoise (PN) encoding signal. A spread spectrum receiver with the appropriate PN code can demodulate and extract the information being sent. Those without the PN code may completely miss the signal, or if they detect the signal, it appears to them as noise.
- Two of the spread spectrum modulation types are: 1. direct sequence, in which the carrier is modulated by a digital code sequence, and 2. frequency hopping, in which the carrier frequency jumps from frequency to frequency, within some predetermined set, the order of frequencies being determined by a code sequence.
- Transmitter and receiver contain *clocks* which must be synchronized; e.g., in a frequency hopping system, the transmitter and receiver must hop to the same frequency at the same time. The faster the hopping rate, the higher the jamming resistance, and the more accurate the clocks must be.
- Advantages of spread spectrum systems include the following capabilities: 1. rejection of intentional and unintentional jamming, 2. low probability of intercept (LPI), 3. selective addressing, 4. multiple access, and 5. high accuracy navigation and ranging.

# Clock for Very Fast Frequency Hopping Radio

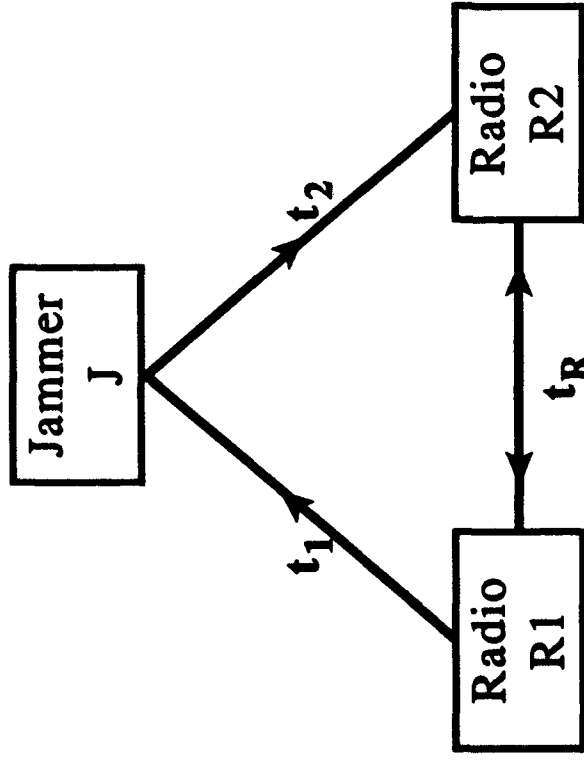

To defeat a "perfect" follower jammer, need a hop rate given by:

$$t_m < (t_1 + t_2) - t_R,$$

where  $t_m \approx$  msg. duration/hop  
 $\approx$  1/hop rate

## Example

Let R1 to R2 = 1 km, R1 to J = 5 km, and J to R2 = 5 km. Then, since propagation delay =  $3.3 \mu\text{s}/\text{km}$ ,  $t_1 = t_2 = 16.5 \mu\text{s}$ ,  $t_R = 3.3 \mu\text{s}$ , and  $t_m < 30 \mu\text{s}$ .

Allowed clock error =  $0.2 t_m$   
 $= 6 \mu\text{s}$ .

For a 4 hour resynch interval, clock accuracy requirement is:

$$4 \times 10^{-10}$$

# Clocks and Frequency Hopping C<sup>3</sup> Systems

Slow hopping ← → Good clock

Fast hopping ← → Better clock

Extended radio silence ← → Better clock

Extended calibration interval ← → Better clock

Orthogonality ← → Better clock

Interoperability ← → Better clock

# Identification-Friend-Or-Foe (IFF)

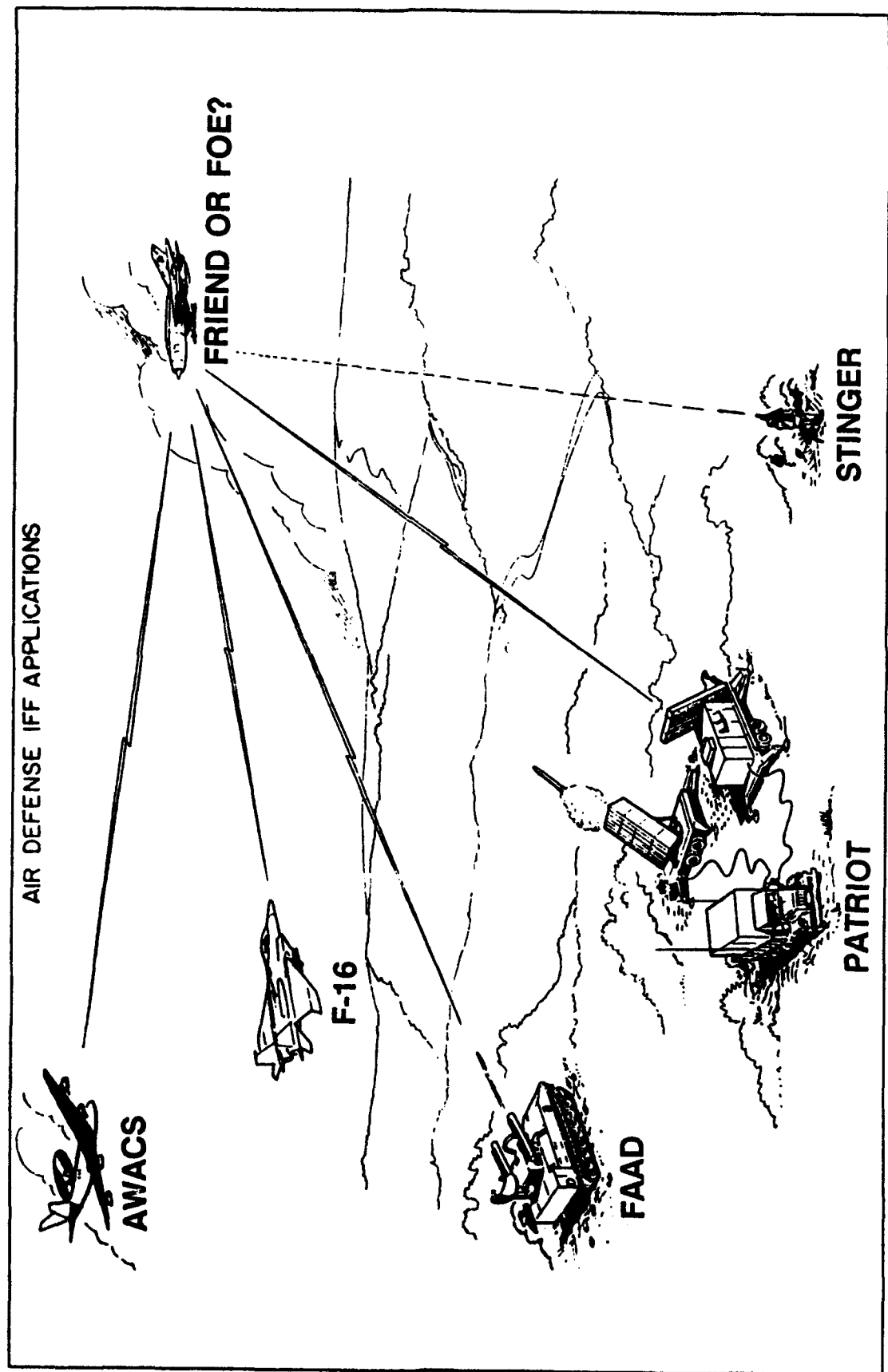

# Identification-Friend-Or-Foe (IFF)

In a modern battle, when the sky is filled with friendly and enemy aircraft, and a variety of advanced weapons are ready to fire from both ground and airborne platforms, positive identification of friend and foe is critically important. For example, fratricide due to identification errors was a major problem in the 1973 Arab-Israeli war.

Current IFF systems use an interrogation/response method which employs cryptographically encoded spread spectrum signals. The interrogation signal received by a friend is supposed to result in the "correct" code being automatically sent back via a transponder on the friendly platform. The "correct" code must change frequently to prevent a foe from recording and transmitting that code ("repeat jamming"), thereby appearing as a friend. The code is changed at the end of what is called the Code Validity Interval, or CVI.

The better the clock accuracy, the shorter can be the CVI, the more resistant the system can be to repeat jamming, and the longer can be the autonomy period for users who cannot resynchronize their clocks during a mission.

# Effect of Noise in Doppler Radar System

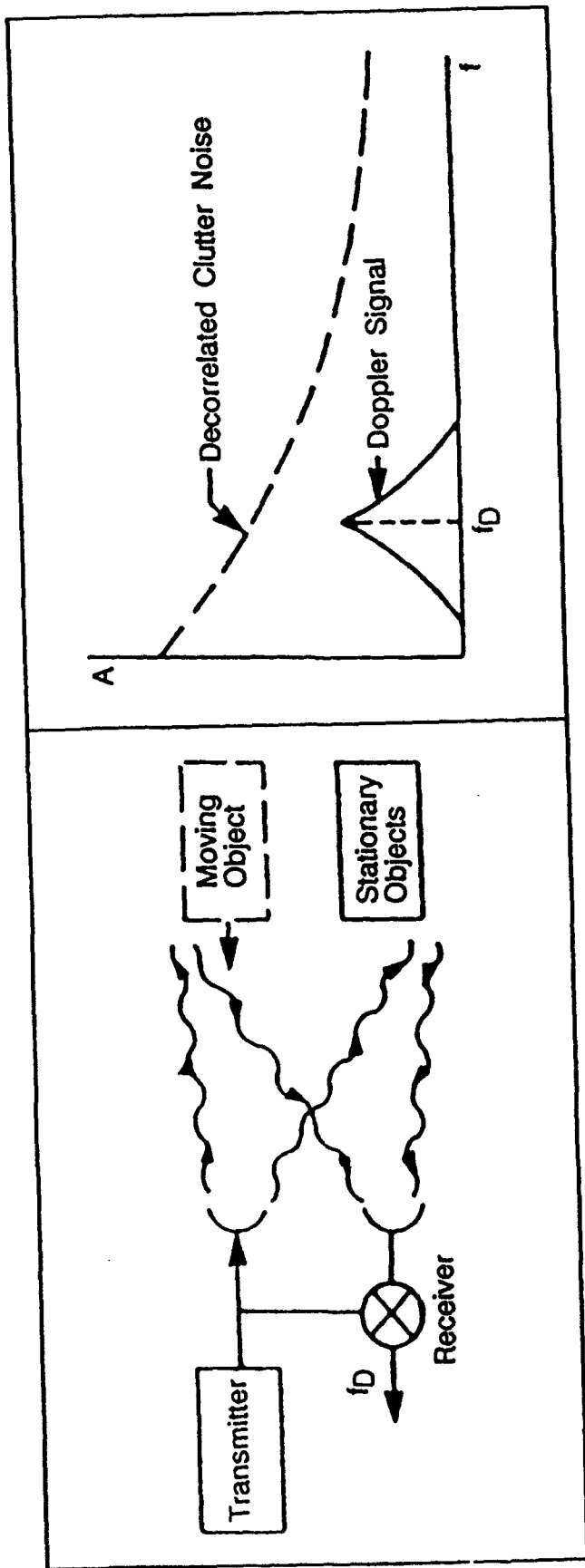

- Echo = Doppler shifted echo from moving target + large "clutter" signal
- (Echo signal) - (reference signal)  $\longrightarrow$  Doppler shifted signal from target
- Phase noise of the local oscillator modulates (decorrelates) the clutter signal, generates higher frequency clutter components, and thereby degrades the radar's ability to separate the target signal from the clutter signal.

# Bistatic Radar

Conventional (i.e., "monostatic") radar, in which the illuminator and receiver are on the same platform, is vulnerable to a variety of countermeasures. Bistatic radar, in which the illuminator and receiver are widely separated, can greatly reduce the vulnerability to countermeasures such as jamming and antiradiation weapons, and can increase slow moving target detection and identification capability via "clutter tuning" (receiver maneuvers so that its motion compensates for the motion of the illuminator, creates zero Doppler shift for the area being searched). The transmitter can remain far from the battle area, in a "sanctuary". The receiver can remain "quiet."

The timing and phase coherence problems can be orders of magnitude more severe in bistatic than in monostatic radar, especially when the platforms are moving. The two reference oscillators must remain synchronized and syntonized during a mission so that the receiver knows when the transmitter emits each pulse, and so that the phase variations will be small enough to allow a satisfactory image to be formed. Low noise crystal oscillators are required for short term stability; atomic frequency standards are often required for long term stability.

Illuminator



Receiver



Target



# Doppler Shifts

Doppler radars require low-phase-noise oscillators. The velocity of the target and the radar frequency are the primary factors that determine the oscillator noise requirements. For example, to detect slow-moving targets, the noise close to the carrier must be low.

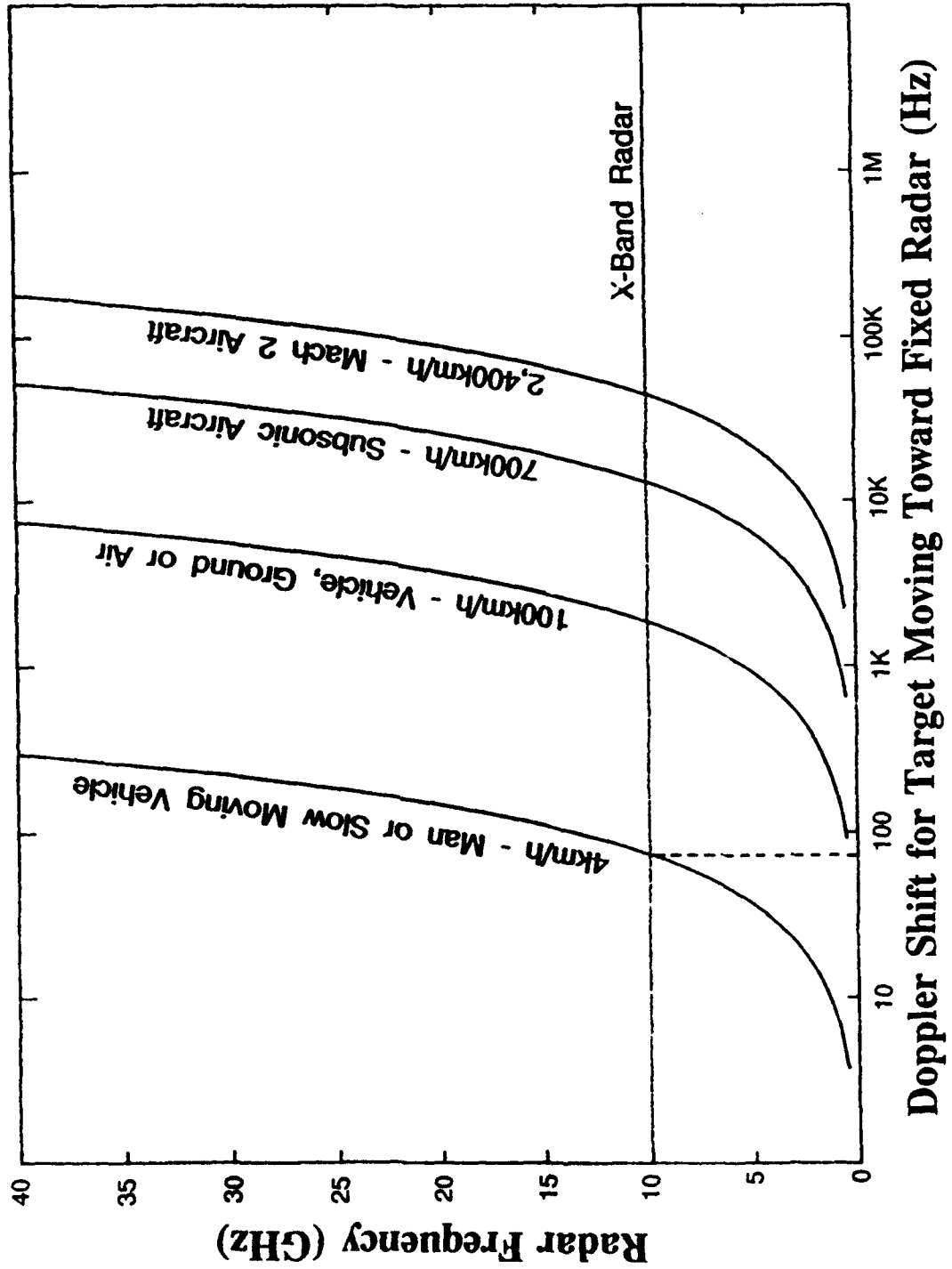

## Chapter 1 References

- Quartz for the National Defense Stockpile. Report of the Committee on Cultured Quartz for the National Defense Stockpile, National Materials Advisory Board Commission on Engineering and Technical Systems, National Research Council, NMAB-424, National Academy Press, Washington, D.C., 1985.
- 1-5 R. Kinsman and D. Gunn, "Frequency Control Requirements for 800 MHz Land Mobile Communication," Proc. 35th Ann. Symp. Frequency Control, pp. 501-510, 1981.
- 1-6a J. E. Abate, E. W. Butterline, R. A. Carley, P. Greendyk, A. M. Montenegro, C. D. Near, S. H. Richman, and G. P. Zampetti, "AT&T's New Approach to the Synchronization of Telecommunication Networks," IEEE Communications Magazine, pp. 35-45, April 1989.
- 1-6b J. Pan, "Present and Future of Synchronization in the US Telephone Network," IEEE Transactions on Ultrasonics, Ferroelectrics, and Frequency Control, Vol. UFFC-34, No. 6, pp. 629-638, November 1987.
- 1-7a P. Kartaschoff, "Frequency Control and Timing Requirements for Communications Systems," Proc. 31st Annual Symposium on Frequency Control, pp. 478-483, 1977, AD-A088221. Copies available from NTIS, 5285 Port Royal Rd., Springfield, VA 22161.
- 1-7b P. Kartaschoff, "Synchronization in Digital Networks," Proc. IEEE, vol. 79, pp. 1019-1028, 1991.
- 1-8 M. A. Street, "Delivery and Application of Precise Timing for a Traveling Wave Powerline Fault Locator System," Proc. 22nd Ann. Precise Time and Time Interval (PTTI) Applications and Planning Meeting, pp. 355-360, 1990.
- 1-9a J. S. Border & E. R. Fursinski, "Deep Space Tracking and Frequency Standards," Proc. 45th Ann. Symp. on Frequency Control, pp. 594-607, 1991, IEEE Cat. No. 91CH2965-2.
- 1-9b R. F. C. Vessot, "Applications of Highly Stable Oscillators to Scientific Measurements," Proc. of the IEEE, pp. 1040-1053, 1991.
- 1-12a R. C. Dixon, Spread Spectrum Systems. John Wiley and Sons, New York, 1976.
- 1-12b D. L. Schilling, R. L. Picholtz and L. B. Milstein, "Spread Spectrum Goes Commercial," IEEE Spectrum, Vol. 27, pp. 40-45, 1990.

- 1-13** A. D. Robertson and F. C. Painter, "Tactical Jamming," *Defense Science and Engineering*, pp. 20-28, September 1985.
- 1-17a** M. I. Skolnik, Introduction to Radar Systems, Second Edition, McGraw-Hill Book Company, 1980.
- 1-17b** D. B. Leeson, and G. F. Johnson, "Short-Term Stability for a Doppler Radar: Requirements, Measurements, and Techniques," *Proc. of the IEEE*, Vol. 54, No. 2, pp. 244-248, February 1966.
- 1-18** N. J. Willis, "Bistatic Radar," in Radar Handbook, M. I. Skolnik, editor, Chapter 25, McGraw-Hill Publishing Co., 1990.

②

# Quartz Crystal Oscillators

# Crystal Oscillator

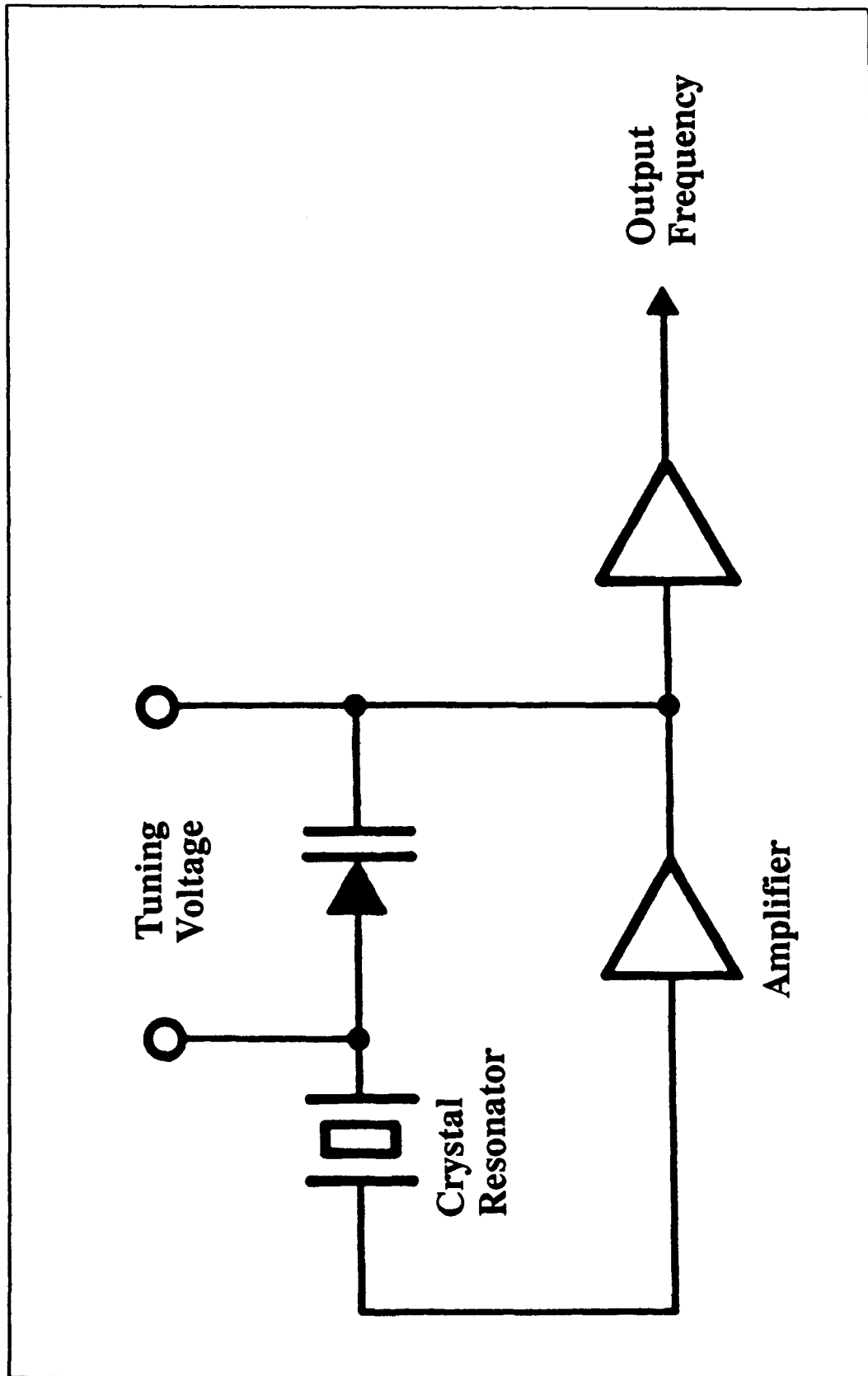

# Oscillation

- At the frequency of oscillation, the closed loop phase shift =  $2n\pi$ .
- When initially energized, the only signal in the circuit is noise. That component of noise, the frequency of which satisfies the phase condition for oscillation, is propagated around the loop with increasing amplitude. The rate of increase depends on the excess; i.e., small-signal, loop gain and on the BW of the crystal network.
- The amplitude continues to increase until the amplifier gain is reduced either by nonlinearities of the active elements ("self limiting") or by some automatic level control.
- At steady state, the closed-loop gain = 1.

# Oscillation and Stability

- If a phase perturbation  $\Delta\phi$  occurs, the frequency must shift  $\Delta f$  to maintain the  $2n\pi$  phase condition, where  $\Delta f/f = -\Delta\phi/2Q_L$  for a series-resonance oscillator, and  $Q_L$  is the loaded  $Q$  of the crystal in the network. The "phase slope"  $d\phi/df$  is proportional to  $Q_L$  in the vicinity of the series resonance frequency (see "Equivalent Circuit" and "Frequency vs. Reactance" in Chapt. 3).
- Most oscillators operate at "parallel resonance," where the reactance vs. frequency slope,  $dX/df$ , i.e., the "stiffness," is inversely proportional to  $C_1$ , the motional capacitance of the crystal unit.
- For maximum frequency stability with respect to phase (or reactance) perturbations in the oscillator loop, the phase slope (or reactance slope) must be maximum, i.e.,  $C_1$  should be minimum and  $Q_L$  should be maximum. A quartz crystal unit's high  $Q$  and high stiffness makes it the primary frequency (and frequency stability) determining element in oscillators.

# Tunability and Stability

Making an oscillator tunable over a wide frequency range degrades its stability because making an oscillator susceptible to intentional tuning also makes it susceptible to factors that result in unintentional tuning. The wider the tuning range, the more difficult it is to maintain a high stability. For example, if an OCXO is designed to have a short term stability of  $1 \times 10^{-12}$  for some averaging time and a tunability of  $1 \times 10^{-7}$ , then the crystal's load reactance must be stable to  $1 \times 10^{-5}$  for that averaging time. Achieving such stability is difficult because the load reactance is affected by stray capacitances and inductances, by the stability of the varactor's capacitance vs. voltage characteristic, and by the stability of the voltage on the varactor. Moreover, the  $1 \times 10^{-5}$  load reactance stability must be maintained not only under benign conditions, but also under changing environmental conditions (temperature, vibration, radiation, etc.). Whereas a high stability, ovenized 10 MHz voltage controlled oscillator may have a frequency adjustment range of  $5 \times 10^{-7}$  and an aging rate of  $2 \times 10^{-8}$  per year, a wide tuning range 10 MHz VCXO may have a tuning range of 50 ppm and an aging rate of 2 ppm per year.



# Oscillator Acronyms

- **XO**..... Crystal Oscillator
- **VCXO**..... Voltage Controlled Crystal Oscillator
- **OCXO**.....Oven Controlled Crystal Oscillator
- **TCXO**.....Temperature Compensated Crystal Oscillator
- **TCVCXO**.....Temperature Compensated/Voltage Controlled  
Crystal Oscillator
- **OCVCXO**.....Oven Controlled/Voltage Controlled Crystal Oscillator
- **MCXO**.....Microcomputer Compensated Crystal Oscillator
- **RbXO**..... Rubidium-Crystal Oscillator

# Crystal Oscillator Categories

The three categories, based on the method of dealing with the crystal unit's frequency vs. temperature characteristic, are:

- **XO, crystal oscillator**, which does not contain means for reducing the crystal's  $f$  vs.  $T$  characteristic (also called PXO - packaged crystal oscillator).
- **TCXO, temperature compensated crystal oscillator**, in which the output signal from a temperature sensor (thermistor) is used to generate a correction voltage that is applied to a voltage-variable reactance (varactor) in the crystal network. The reactance variations compensate for the crystal's  $f$  vs.  $T$  characteristic. Analog TCXO's can provide about a 20X improvement over the crystal's  $f$  vs.  $T$  variation.
- **OCXO, oven controlled crystal oscillator**, in which the crystal and other temperature sensitive components are in a stable oven which is adjusted to the temperature where the crystal's  $f$  vs.  $T$  has zero slope. OCXO's can provide a >1000X improvement over the crystal's  $f$  vs.  $T$  variation.

# Crystal Oscillator Categories

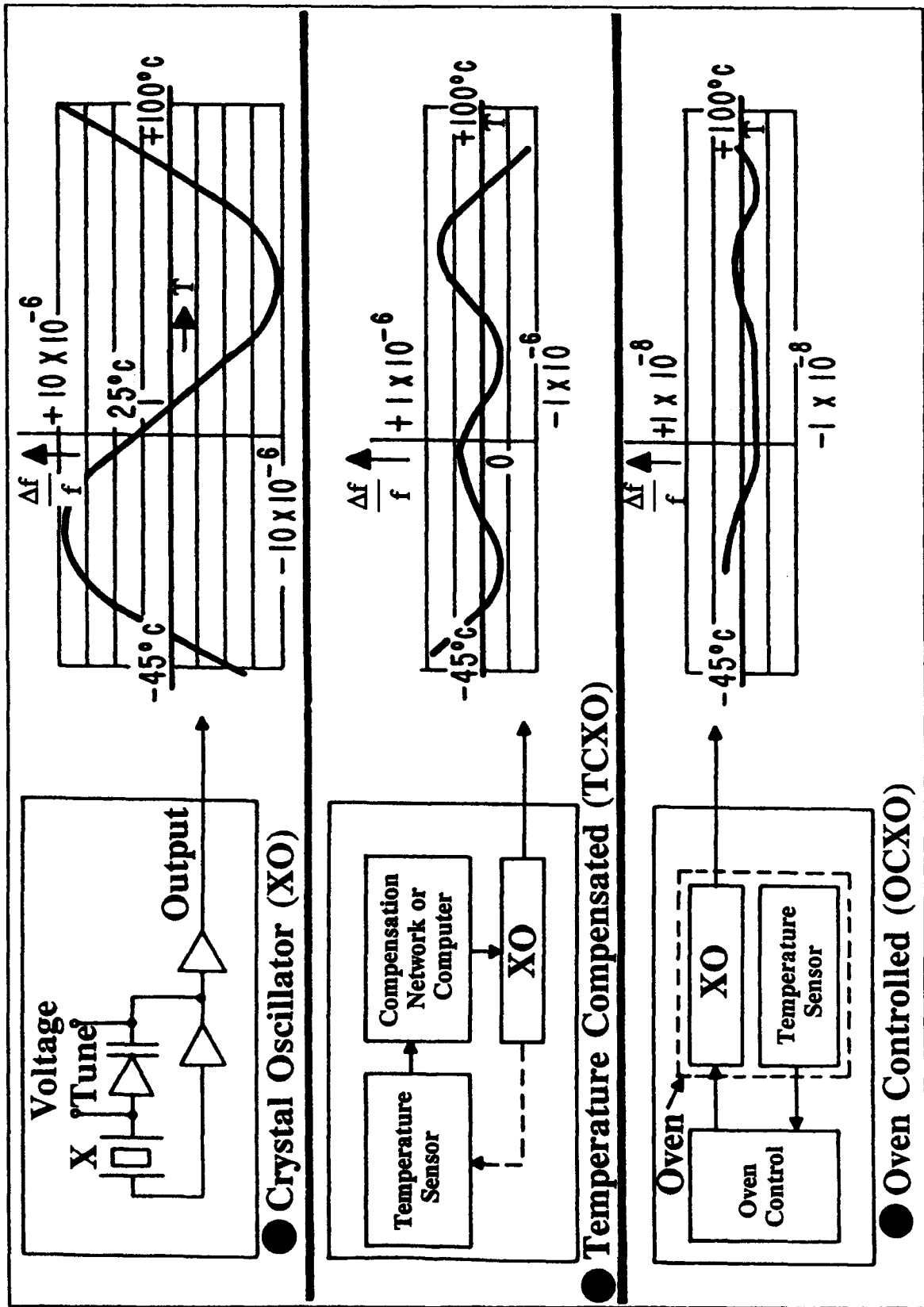

# Hierarchy of Oscillators

Oscillator Type*	Accuracy**	Typical Applications
● Crystal oscillator (XO)	10 <sup>-5</sup> to 10 <sup>-4</sup>	Computer timing
● Temperature compensated crystal oscillator (TCXO)	10 <sup>-6</sup>	Frequency control in tactical radios
● Microcomputer compensated crystal oscillator (MCXO)	10 <sup>-8</sup> to 10 <sup>-7</sup>	Spread spectrum system clock
● Oven controlled crystal oscillator (OCXO)	10 <sup>-8</sup> (with 10 <sup>-10</sup> per g option)	Navigation system clock & frequency standard, MTI radar
● Small atomic frequency standard (Rb, RbXO)	10 <sup>-9</sup>	C <sup>3</sup> satellite terminals, bistatic & multistatic radar
● High performance atomic standard (Cs)	10 <sup>-12</sup> to 10 <sup>-11</sup>	Strategic C <sup>3</sup> , EW

\*Sizes range from < 5 cm<sup>3</sup> for clock oscillators to > 30 liters for Cs standards. Costs range from < \$5 for clock oscillators to > \$40,000 for Cs standards.

\*\*Including the effects of military environments and one year of aging.

# Oscillator Circuit Types

Of the numerous oscillator circuit types, three of the more common ones, the Pierce, the Colpitts and the Clapp, consist of the same circuit except that the rf ground points are at different locations. The Butler and modified Butler are also similar to each other; in each, the emitter current is the crystal current. The gate oscillator is a Pierce-type that uses a logic gate plus a resistor in place of the transistor in the Pierce oscillator. (Some gate oscillators use more than one gate.)

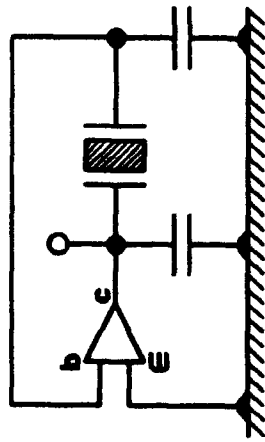

Pierce

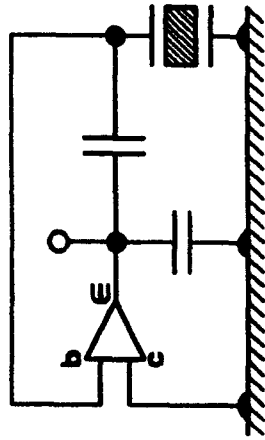

Colpitts

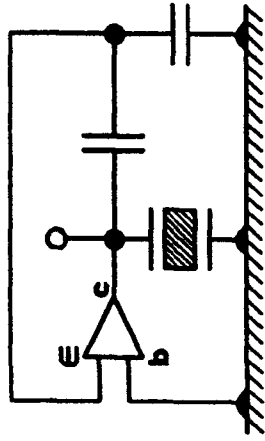

Clapp

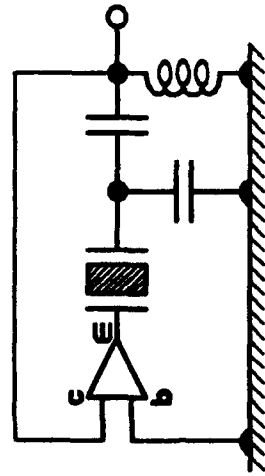

Butler

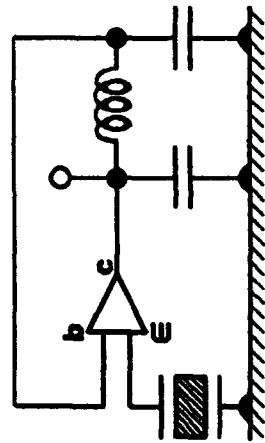

Modified Butler

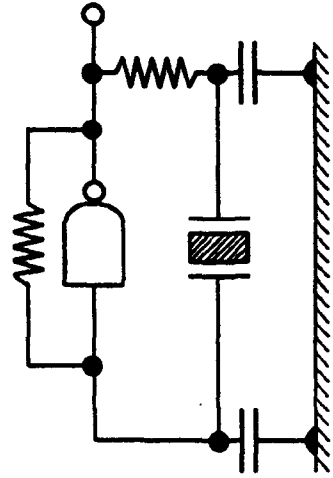

Gate

# Oscillator Circuit Types - Comments

The choice of oscillator circuit type depends on factors such as the desired frequency, stability, input voltage and power, output power and waveform, tunability, design complexity, cost, and the crystal unit's characteristics.

In the Pierce family, the ground point location has a profound effect on the performance. The Pierce configuration is generally superior to the others, e.g., with respect to the effects of stray reactances and biasing resistors, which appear mostly across the capacitors in the circuit rather than the crystal unit. It is one of the most widely used circuits for high stability oscillators. In the Colpitts configuration, a larger part of the strays appears across the crystal, and the biasing resistors are also across the crystal, which can degrade performance. The Clapp is seldom used because, since the collector is tied directly to the crystal, it is difficult to apply a dc voltage to the collector without introducing losses or spurious oscillations. (See the references for more details.)

The Pierce family usually operates at "parallel resonance" (see "Resonator Frequency vs. Reactance" in Chapt. 3), although it can be designed to operate at series resonance by connecting an inductor in series with the crystal. The Butler family usually operates at (or near) series resonance. The Pierce can be designed to operate with the crystal current above or below the emitter current.

Gate oscillators are common in digital systems when high stability is not a major consideration.

# Oscillator Outputs

Most users require a sine wave, or a TTL-compatible, or a CMOS-compatible, or an ECL-compatible output. The latter three can be simply generated from a sine wave. The four output types are illustrated below, with the dashed lines representing the supply voltage inputs, and the bold solid lines, the outputs. (There is no "standard" input voltage for sine wave oscillators, and the input voltage for CMOS typically ranges from 5V to 15V.)

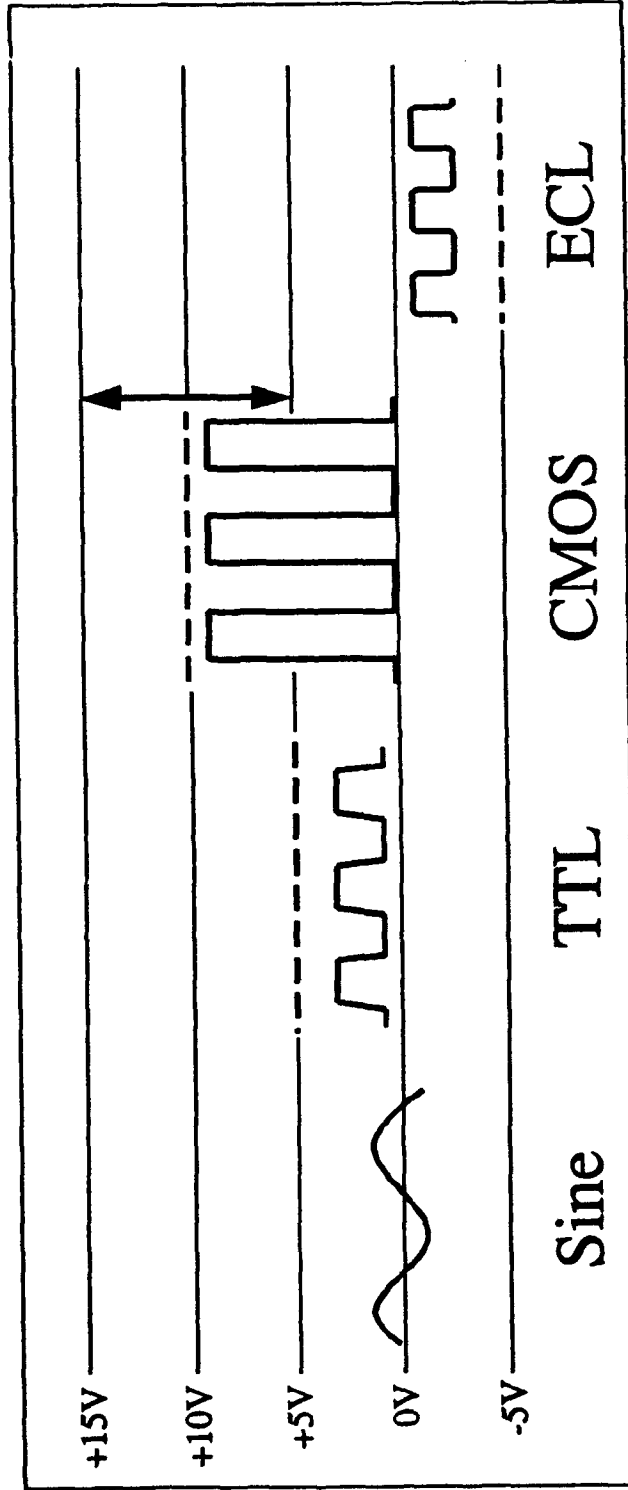

## Chapter 2 References

- W. L. Smith, "Precision Oscillators," in E. A. Gerber and A. Ballato, Precision Frequency Control, Vol. 2, pp. 45-98, Academic Press, 1985.
- B. Parzen, Design of Crystal and Other Harmonic Oscillators. John Wiley and Sons, Inc., 1983.
- M. E. Frerking, "Temperature Control and Compensation," in E. A. Gerber and A. Ballato, Precision Frequency Control, Vol. 2, pp. 99-111, Academic Press, 1985.
- M. E. Frerking, Crystal Oscillator Design and Temperature Compensation, Van Nostrand Reinhold Company, 1978.
- "Fundamentals of Quartz Oscillators," Hewlett-Packard application note AN 200-2, Hewlett-Packard Company, Attention: Inquiries Manager, Customer Information Center, 19310 Pruneridge Ave., 49A, Cupertino, CA 95014. Press, 1985.
- A. Benjaminson, "Computer-Aided Design of Crystal Oscillators," U. S. Army R & D Technical Report DELET-TR-84-0386-F, August 1985, AD B096820; "Advanced Crystal Oscillator Design," U. S. Army R & D Technical Report SLCET-TR-85-0445-F, January 1988, AD B121288; "Advanced Crystal Oscillator Design," U. S. Army R & D Technical Report SLCET-TR-88-0804-1, February 1989, AD B134514; "Advanced Crystal Oscillator Design," U. S. Army R & D Technical Report SLCET-TR-88-0804-F, December 1991.



③

# Quartz Crystal Resonators

# Why Quartz?

Quartz is the only material known that possesses the following combination of properties:

- Piezoelectric ("pressure-electric"; piezein = to press, in Greek)
- Zero temperature coefficient cuts exist
- Stress compensated cut exists
- Low loss (i.e., high Q)
- Easy to process; low solubility in everything, except fluoride etchants, under "normal" conditions; hard but not brittle
- Abundant in nature; easy to grow in large quantities, at low cost, and with relatively high purity and perfection. Of the man-grown single crystals, quartz, at >2,000 tons per year, is second only to silicon in quantity grown.

# The Piezoelectric Effect

The direct piezoelectric effect was discovered by the Curie brothers in 1880. They showed that when a weight was placed on a quartz crystal, charges appeared on the crystal surface; the magnitude of the charge was proportional to the weight. In 1881, the converse piezoelectric effect was illustrated; when a voltage was applied to the crystal, the crystal deformed due to the lattice strains caused by the effect. The strains reversed when the voltage was reversed. The piezoelectric effect can, thereby, provide a coupling between an electrical circuit and the mechanical properties of a crystal. Under the proper conditions, a "good" piezoelectric resonator can stabilize the frequency of an oscillator circuit.

Of the 32 crystal classes, 20 exhibit the piezoelectric effect (but only a few of these are useful). Piezoelectric crystals lack a center of symmetry. When a force deforms the lattice, the centers of gravity of the positive and negative charges in the crystal can be separated so as to produce surface charges. The figures show

one example (from Kelvin's qualitative model) of the effect in quartz. Each silicon atom is represented by a plus, and each oxygen atom by a minus. When a strain is applied so as to elongate the crystal along the Y-axis, there are net movements of negative charges to the left and positive charges to the right (along the X-axis).

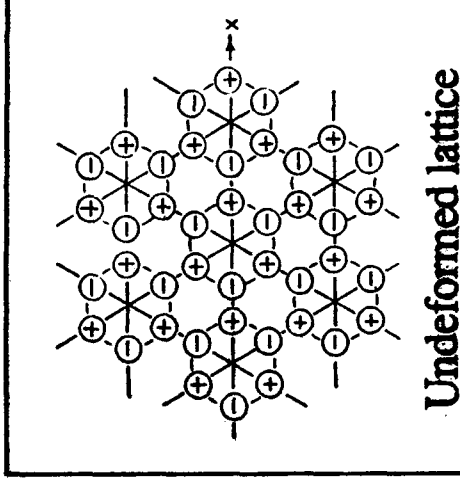

Undeformed lattice

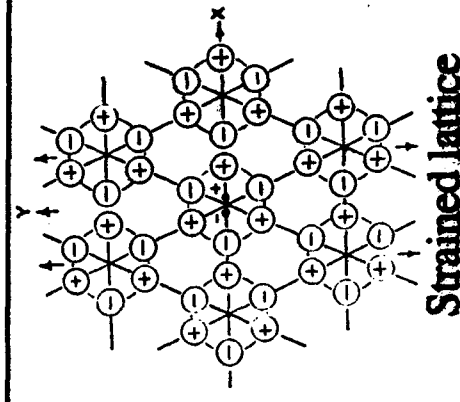

Strained lattice





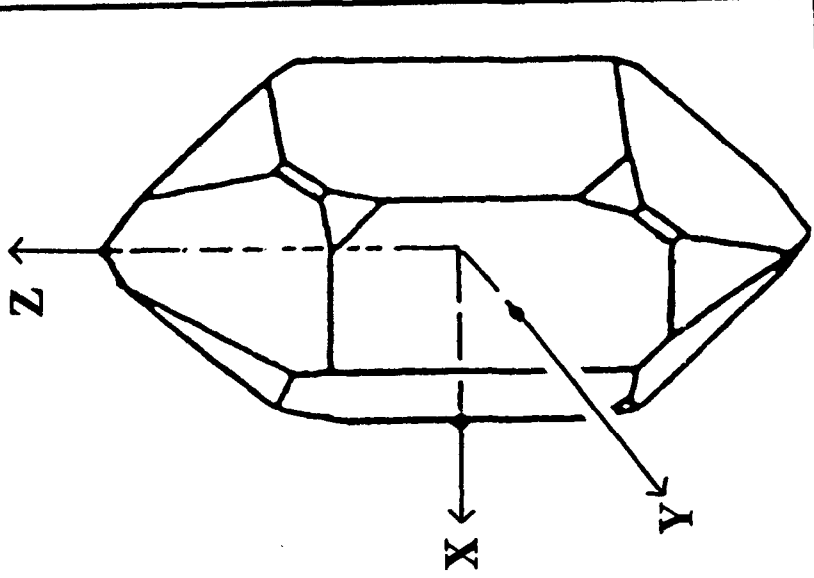

# The Piezoelectric Effect

STRAIN		FIELD along:		
		X	Y	Z
↕ <b>EXTENSIONAL</b> along:	X	✓		
	Y	✓		
	Z			
↕ <b>SHEAR</b> about:	X	✓		
	Y		✓	
	Z			✓

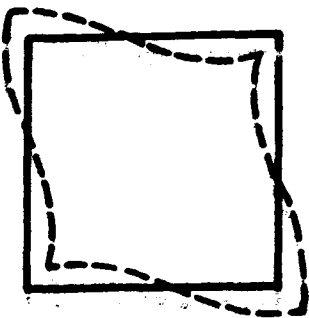

In quartz, the five strain components shown may be generated by an electric field. The modes shown on the next page may be excited by suitably placed and shaped electrodes. The shear strain about the Z-axis produced by the Y-component of the field is used in the rotated Y-cut family which includes the AT, BT, and ST-cuts.

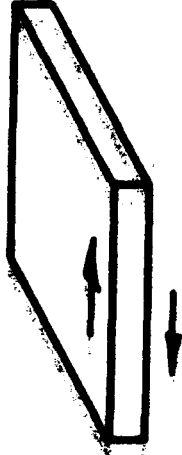
# Modes of Motion

 <p data-bbox="746 1453 796 1801">Flexure Mode</p>	 <p data-bbox="746 829 796 1285">Extensional Mode</p>	 <p data-bbox="746 262 796 709">Face Shear Mode</p>
 <p data-bbox="1197 1417 1329 1831">Thickness Shear Mode</p>	 <p data-bbox="1197 808 1329 1306">Fundamental Mode Thickness Shear</p>	 <p data-bbox="1197 283 1329 688">Third Overtone Thickness Shear</p>

# Resonator Packaging

Two-point mount package

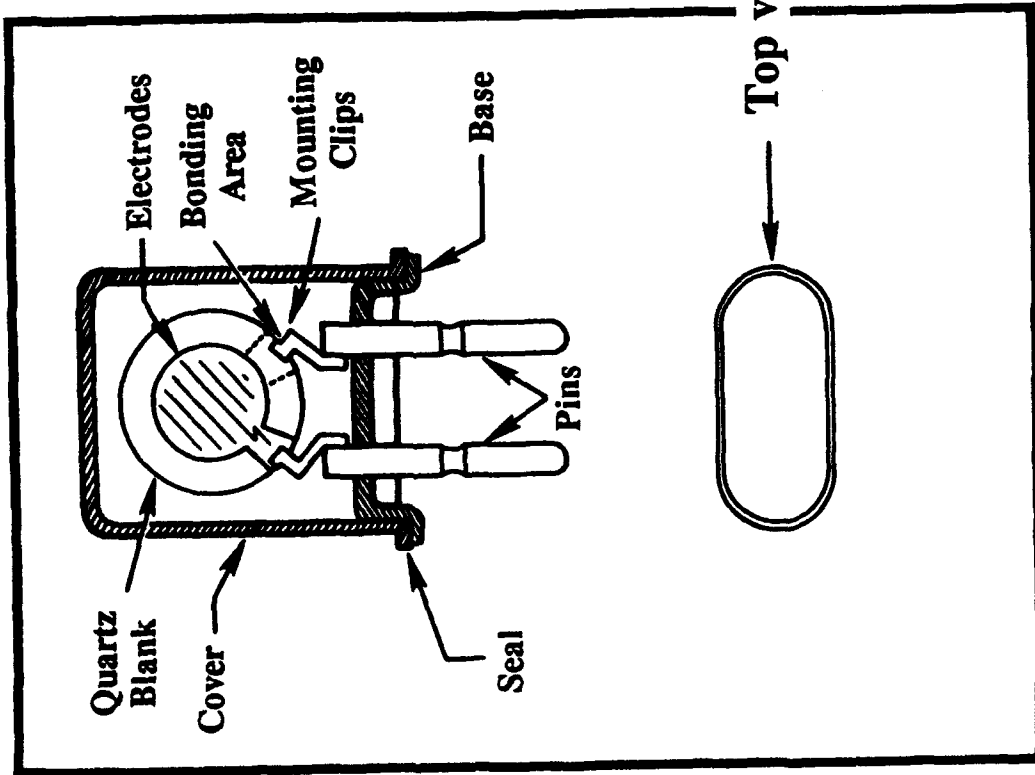

Three-and four-point mount package

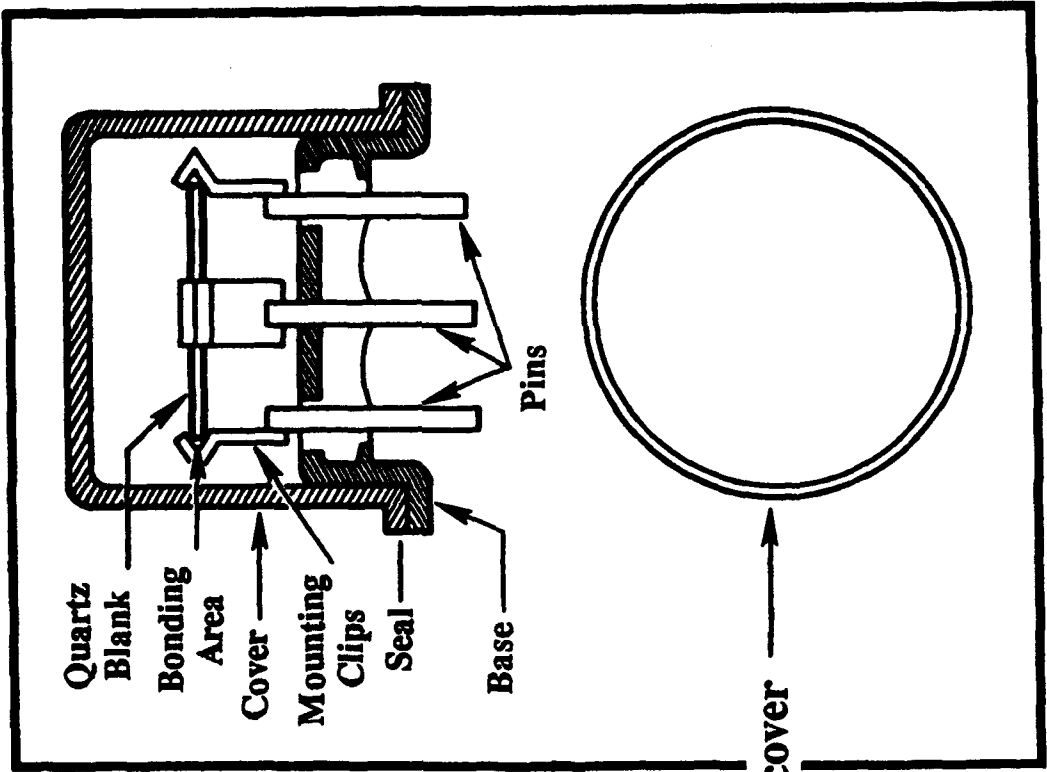

# Ceramic Flatpack and Metal-Enclosed Resonators

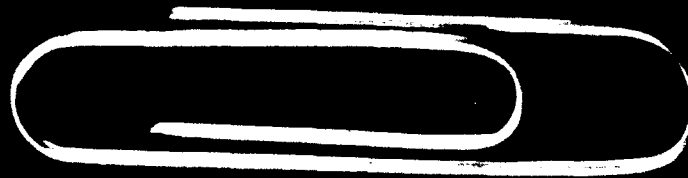
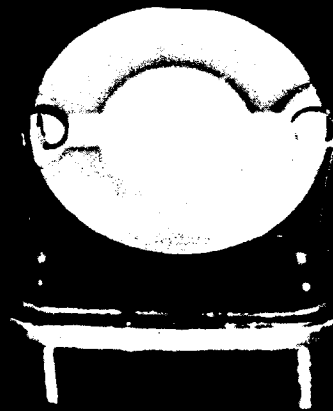
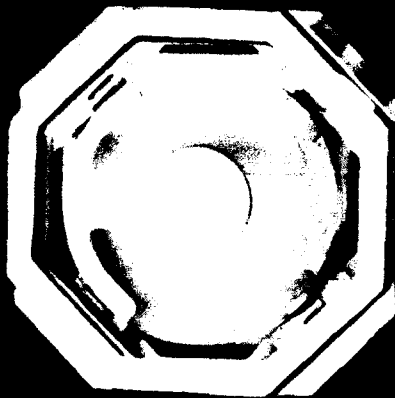
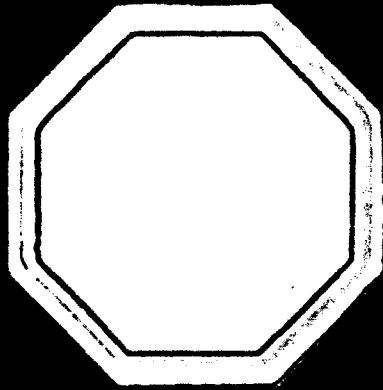

# Resonator Vibration Amplitude Distribution

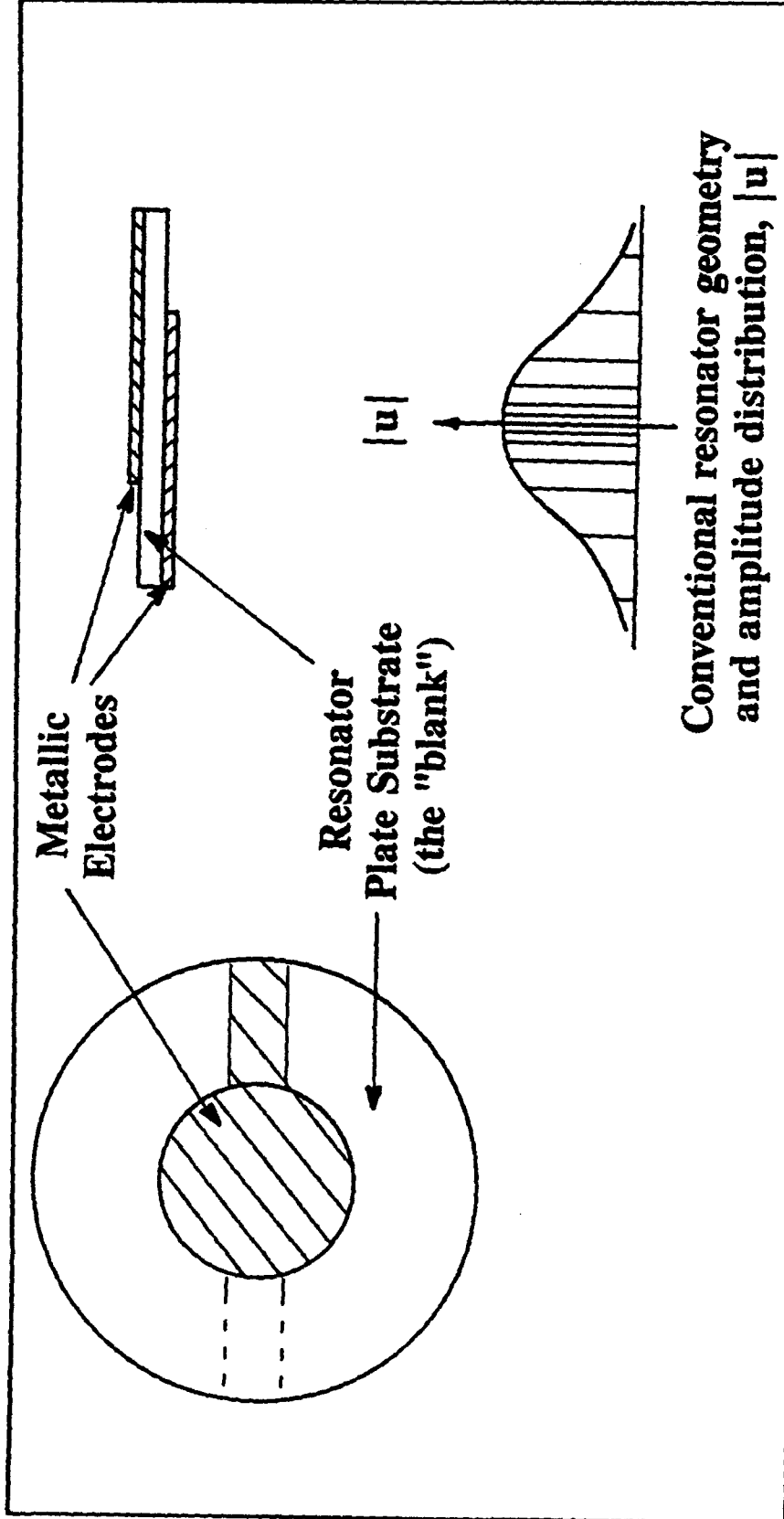

In an ideal resonator, the amplitude of vibration falls off exponentially outside the electrodes. In a properly designed resonator, a negligible amount of energy is lost to the mounting and bonding structure, i.e., the edges must be inactive in order for the resonator to be able to possess a high Q. The displacement of a point on the resonator surface is proportional to the drive current. At the typical drive currents used in (e.g., 10 MHz) thickness shear resonators, the peak displacement is on the order of a few atomic spacings.



# Resonant Vibrations of a Quartz Plate

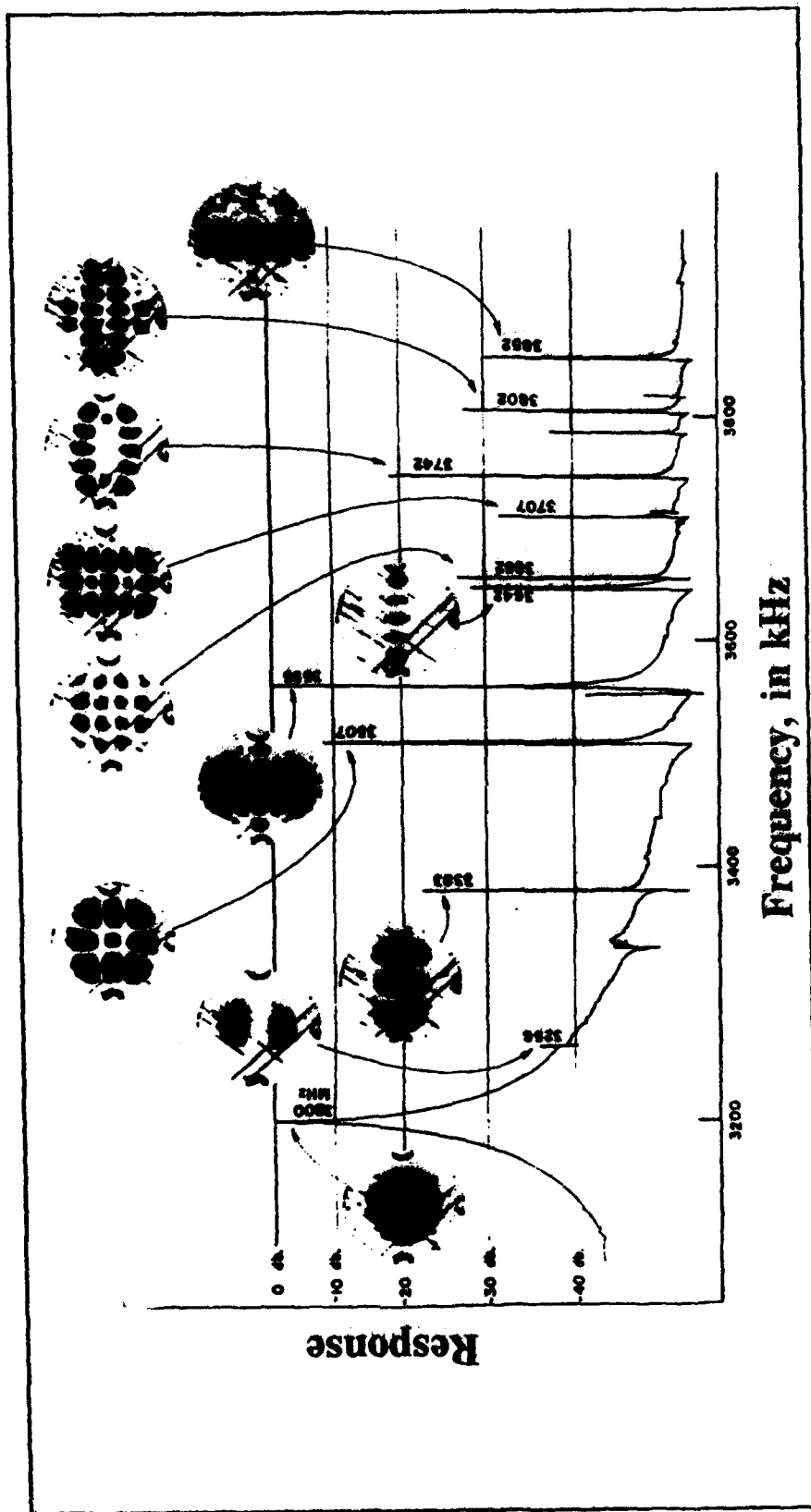

X-ray topographs ( $2\bar{1}\cdot 0$  plane) of various modes excited during a frequency scan of a fundamental mode, circular, AT-cut resonator. The first peak, at 3.2 MHz, is the main mode; all others are unwanted modes. Dark areas correspond to high amplitudes of displacement.

# Unwanted Modes vs. Temperature

(3 Mhz rectangular AT-cut resonator, 22 x 27 x 0.552 mm)

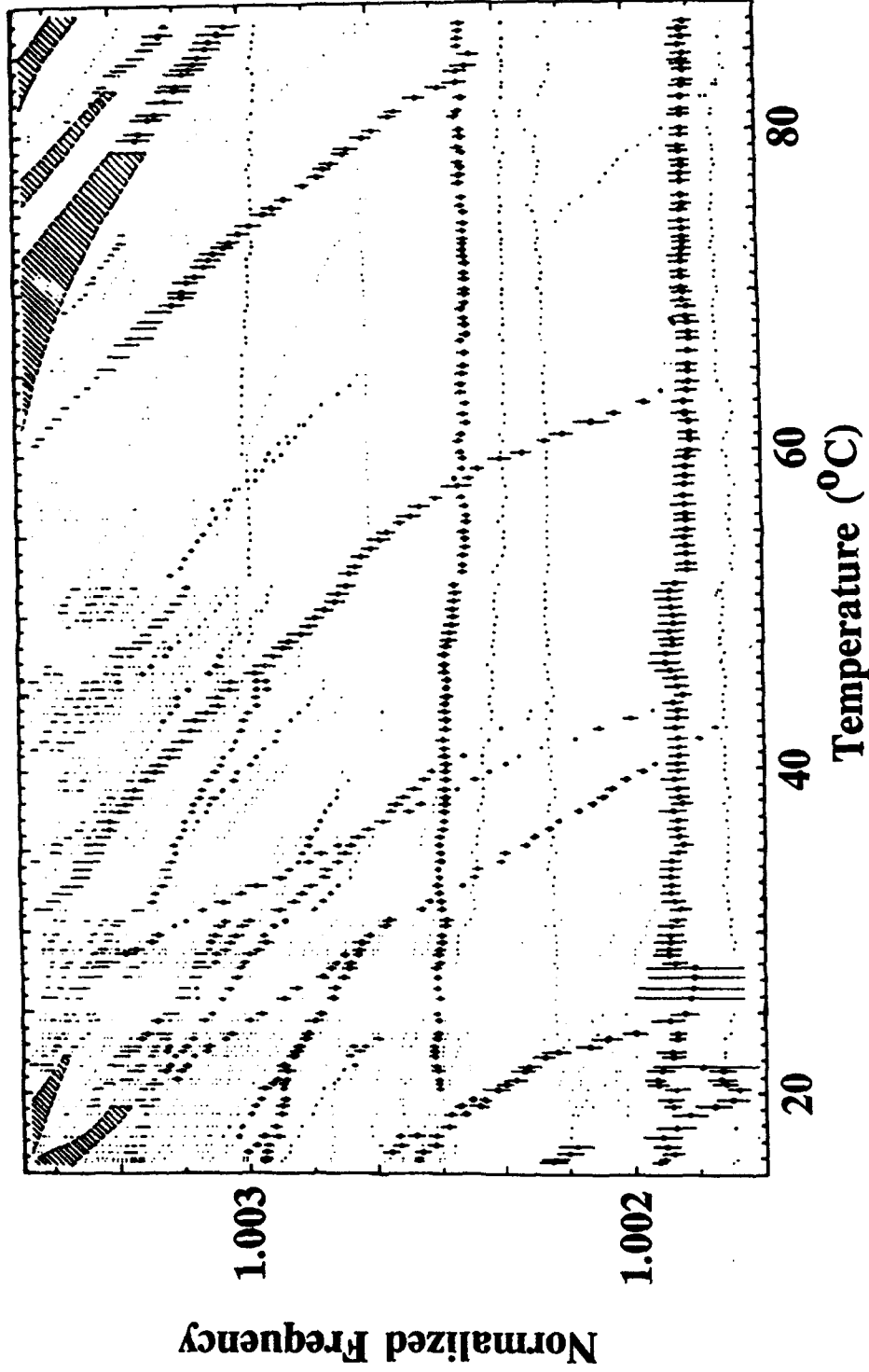

Activity dips occur where the  $f$  vs.  $T$  curves of unwanted modes intersect the  $f$  vs.  $T$  curve of the wanted mode. Such activity dips are highly sensitive to drive level and load reactance.

# Mathematical Description of a Quartz Resonator

- In piezoelectric materials, electrical current and voltage are coupled to elastic displacement and stress:

$$\{T\} = [C] \{S\} - [e] \{E\}$$

$$\{D\} = [e] \{S\} + [\epsilon] \{E\}$$

where  $\{T\}$  = stress tensor,  $[C]$  = elastic stiffness matrix,  $\{S\}$  = strain tensor,  $[e]$  = piezoelectric matrix,

$\{E\}$  = electric field vector,  $\{D\}$  = electric displacement vector, and  $[\epsilon]$  = dielectric matrix.

- For a linear piezoelectric material:

$$\begin{bmatrix} T_1 \\ T_2 \\ T_3 \\ T_4 \\ T_5 \\ T_6 \\ D_1 \\ D_2 \\ D_3 \end{bmatrix} = \begin{bmatrix} c_{11} & c_{12} & c_{13} & c_{14} & c_{15} & c_{16} & -e_{11} & -e_{21} & -e_{31} \\ c_{21} & c_{22} & c_{23} & c_{24} & c_{25} & c_{26} & -e_{12} & -e_{22} & -e_{32} \\ c_{31} & c_{32} & c_{33} & c_{34} & c_{35} & c_{36} & -e_{13} & -e_{23} & -e_{33} \\ c_{41} & c_{42} & c_{43} & c_{44} & c_{45} & c_{46} & -e_{14} & -e_{24} & -e_{34} \\ c_{51} & c_{52} & c_{53} & c_{54} & c_{55} & c_{56} & -e_{15} & -e_{25} & -e_{35} \\ c_{61} & c_{62} & c_{63} & c_{64} & c_{65} & c_{66} & -e_{16} & -e_{26} & -e_{36} \\ e_{11} & e_{12} & e_{13} & e_{14} & e_{15} & e_{16} & \epsilon_{11} & \epsilon_{12} & \epsilon_{13} \\ e_{21} & e_{22} & e_{23} & e_{24} & e_{25} & e_{26} & e_{21} & e_{22} & e_{23} \\ e_{31} & e_{32} & e_{33} & e_{34} & e_{35} & e_{36} & e_{31} & e_{32} & e_{33} \end{bmatrix} \begin{bmatrix} S_1 \\ S_2 \\ S_3 \\ S_4 \\ S_5 \\ S_6 \\ E_1 \\ E_2 \\ E_3 \end{bmatrix}$$

where

$$\begin{aligned} T_1 &= T_{11}, & S_1 &= S_{11}, \\ T_2 &= T_{22}, & S_2 &= S_{22}, \\ T_3 &= T_{33}, & S_3 &= S_{33}, \\ T_4 &= T_{23}, & S_4 &= 2S_{23}, \\ T_5 &= T_{13}, & S_5 &= 2S_{13}, \\ T_6 &= T_{12}, & S_6 &= 2S_{12}. \end{aligned}$$

- Elasto-electric matrix for quartz:

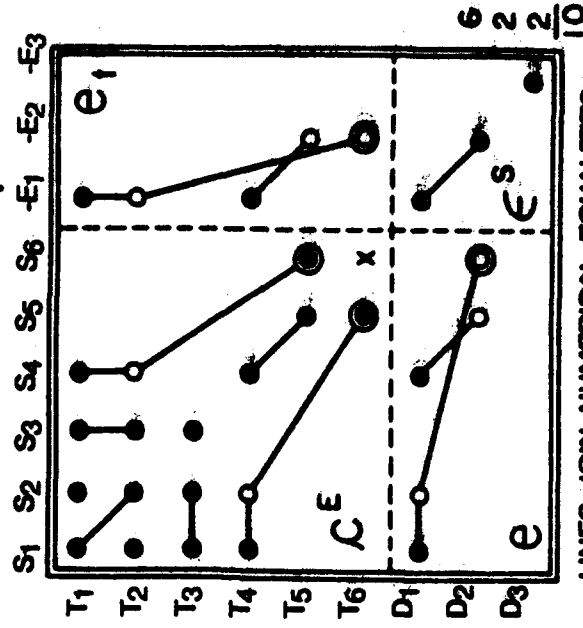

LINES JOIN NUMERICAL EQUALITIES EXCEPT FOR COMPLETE RECIPROcity ACROSS PRINCIPAL DIAGONAL. O INDICATES NEGATIVE CF. ● INDICATES TWICE THE NUMERICAL EQUALITIES. X INDICATES 1/2 (c<sub>11</sub>-c<sub>12</sub>)

# Mathematical Description - Continued

- Number of independent non-zero constants depend on crystal symmetry. For quartz (trigonal, class 32), there are 10 independent linear constants - 6 elastic, 2 piezoelectric and 2 dielectric. "Constants" depend on temperature, stress, coordinate system, etc.

- To describe the behavior of a resonator, the differential equations for Newton's law of motion for a continuum, and for Maxwell's equation\* must be solved, with the proper electrical and mechanical boundary conditions at the plate surfaces. (  $\rho = m a \Rightarrow \bar{\nabla} \cdot \bar{D} = 0 \Rightarrow \frac{\partial D_i}{\partial x_i} = 0$ ,

$$\mathbf{E}_i = - \frac{\partial \phi}{\partial x_i} ; \quad \mathbf{S}_{ij} = \frac{1}{2} \left( \frac{\partial u_i}{\partial x_j} + \frac{\partial u_j}{\partial x_i} \right) ; \text{ etc.}$$

- Equations are very "messy" - have never been solved in closed form for physically realizable three-dimensional resonators. Nearly all theoretical work has used approximations.

- Some of the most important resonator phenomena (e.g., acceleration sensitivity) are due to nonlinear effects. Quartz has numerous higher order constants, e.g., 14 third-order and 23 fourth-order elastic constants, as well as 16 third-order piezoelectric coefficients are known; nonlinear equations are extremely messy.

---

\* Magnetic field effects are generally negligible; quartz is diamagnetic.

# Infinite Plate Thickness Shear Resonator

$$f_n = \frac{n}{2h} \sqrt{\frac{c_{ij}}{\rho}} \quad n=1, 3, 5$$

Where  $f_n$  = resonant frequency of n-th harmonic

$h$  = plate thickness

$\rho$  = density

$c_{ij}$  = elastic modulus associated with the elastic wave being propagated

$$T_f = \frac{d(\log f_n)}{dT} = \frac{1}{f_n} \frac{df_n}{dT} = \frac{-1}{h} \frac{dh}{dT} - \frac{1}{2\rho} \frac{d\rho}{dT} + \frac{1}{2c_{ij}} \frac{dc_{ij}}{dT}$$

$T_f$ , the linear temperature coefficient of frequency, is negative for most materials (i.e., "springs" become "softer" as  $T$  increases). The coefficient for quartz can be +, - or zero (see next page).

# Quartz Is Highly Anisotropic

- The properties of quartz vary greatly with crystallographic direction. For example, when a quartz sphere is etched deeply in HF, the sphere takes on a triangular shape when viewed along the Z-axis, and a lenticular shape when viewed along the Y-axis. The etching rate is more than 100 times faster along the fastest etching rate direction (the Z-direction) than along the slowest direction (the slow-X-direction).
- The thermal expansion coefficient is  $7.8 \times 10^{-6}/^{\circ}\text{C}$  along the Z-direction, and  $14.3 \times 10^{-6}/^{\circ}\text{C}$  perpendicular to the Z-direction; the temperature coefficient of density is, therefore,  $-36.4 \times 10^{-6}/^{\circ}\text{C}$ .
- The temperature coefficients of the elastic constants range from  $-3300 \times 10^{-6}/^{\circ}\text{C}$  (for  $C_{12}$ ) to  $+164 \times 10^{-6}/^{\circ}\text{C}$  (for  $C_{66}$ ).
- For the proper angles of cut, the sum of the first two terms in  $T_f$  on the previous page is cancelled by the third term, i.e., temperature compensated cuts exist in quartz. (See next page.)

# Zero Temperature Coefficient Quartz Cuts

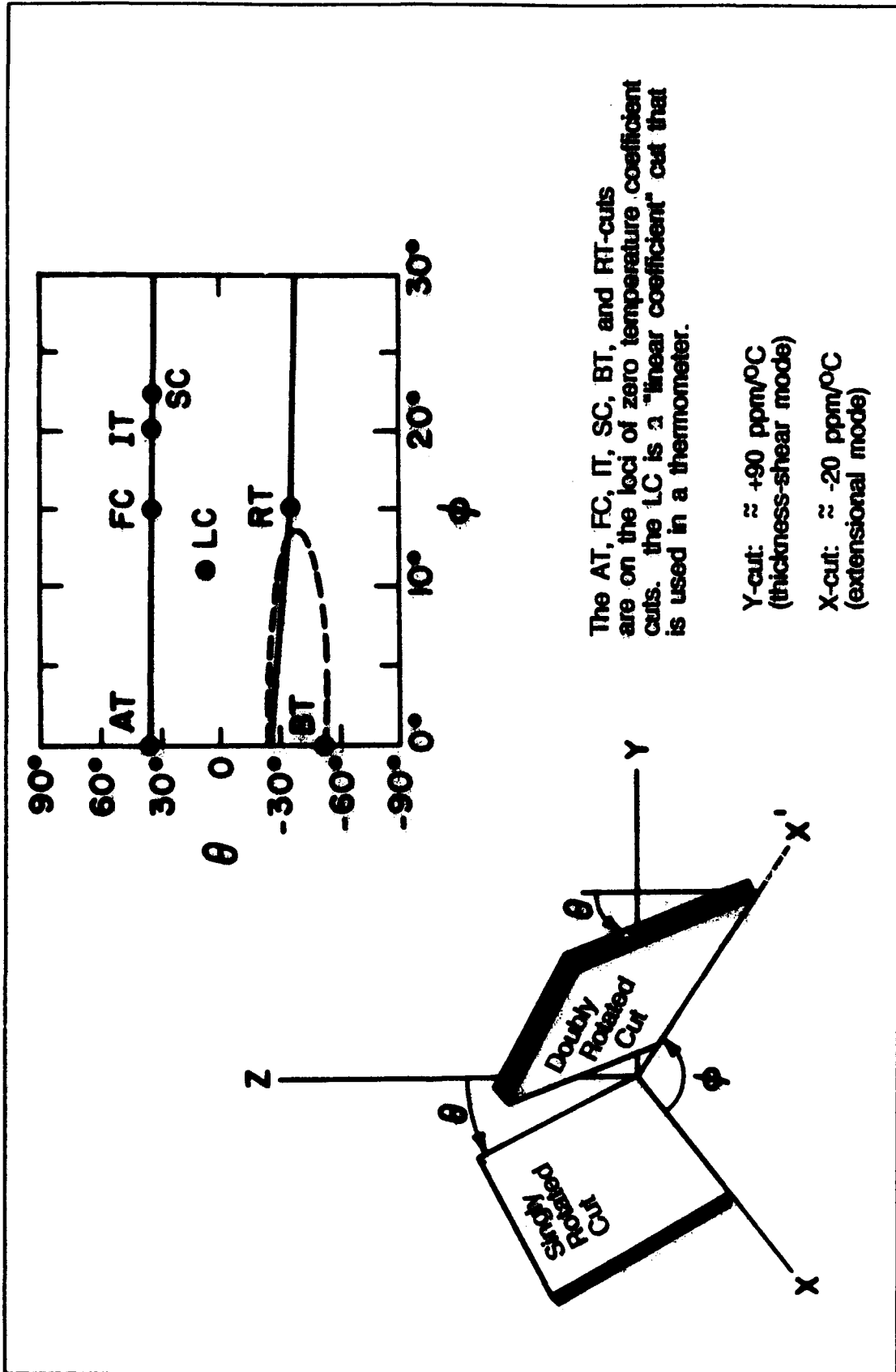

# Equivalent Circuits

The mechanically vibrating system and the circuit shown in the figure are "equivalent," because each can be described by the same differential equation. The mass, spring and damping element (i.e., the dashpot) correspond to the inductor, capacitor and resistor. The driving force corresponds to the voltage, the displacement of the mass to the charge on the capacitor, and the velocity to the current.

A crystal resonator is a mechanically vibrating system that is linked, via the piezoelectric effect, to the electrical world. In the (simplified) equivalent circuit (of one mode of vibration) of a resonator, on the next page,  $C_0$  is called the "shunt" capacitance. It is the capacitance due to the electrodes on the crystal plate (plus the stray capacitances due to the crystal enclosure). The  $R_1$ ,  $L_1$ ,  $C_1$  portion of the circuit is the "motional arm" which arises from the mechanical vibrations of the crystal. The  $C_0$  to  $C_1$  ratio is a measure of the interconversion between electrical and mechanical energy stored in the crystal, i.e., of the piezoelectric coupling factor,  $k$ , and  $C_1$  is a measure of the crystal's "stiffness," i.e., its tunability - see the equation under the equivalent circuit on the next page. When a dc voltage is applied to the electrodes of a resonator, the  $C_0/C_1$  is also a measure of the ratio of electrical energy stored in the capacitor formed by the electrodes to the energy stored elastically in the lattice due to the lattice strains produced by the piezoelectric effect. The  $C_0/C_1$  is also a measure of the antiresonance-resonance frequency separation. (Let  $r = C_0/C_1$ , then  $f_A - f_R = f_R/2r$ , and  $2r = (\pi N/2k)^2$ , where  $N = 1, 3, 5, \dots$  is the overtone number.)

Some of the numerous advantages of a quartz crystal resonator over a tank circuit built from discrete  $R$ 's,  $C$ 's and  $L$ 's are that the crystal is far stiffer and has a far higher  $Q$  than what could be built from normal discrete components. For example, a 5 MHz fundamental mode AT-cut crystal may have  $C_1 = 0.01$  pF,  $L_1 = 0.1$  H,  $R_1 = 5 \Omega$ , and  $Q = 10^6$ . A 0.01 pF capacitor is not available, since the leads attached to such a capacitor would alone probably contribute more than 0.01 pF. Similarly, a 0.1 H inductor would be physically large, it would need to include a large number of turns, and would need to be superconducting in order to have a  $\leq 5 \Omega$  resistance.

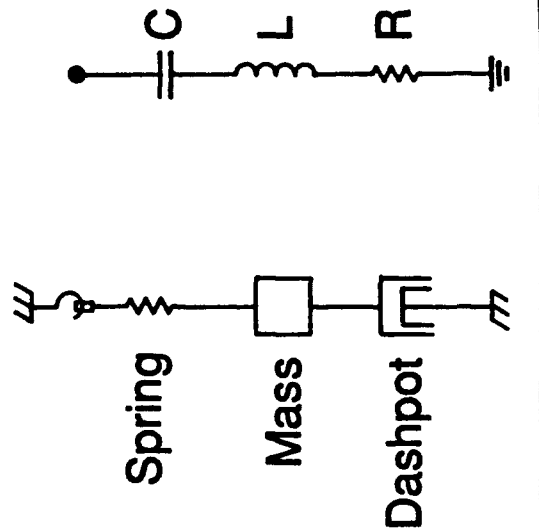



# Equivalent Circuit of a Resonator

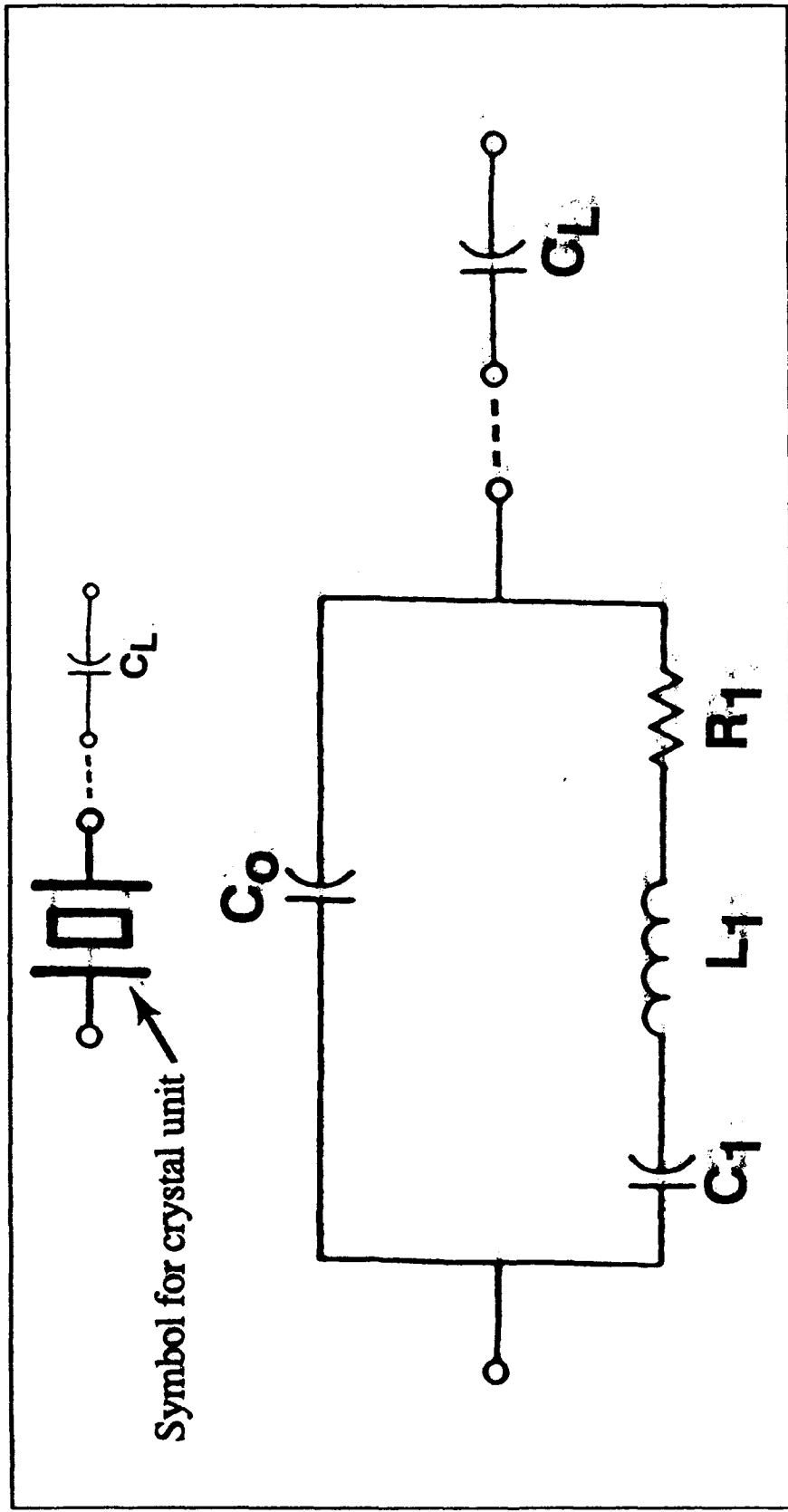

$$\frac{\Delta f}{f_s} \approx \frac{C_1}{2(C_0 + C_L)}$$

↑

1. Voltage control (VCXO)      2. Temperature compensation (TCXO)

# Crystal Oscillator f vs. T Compensation

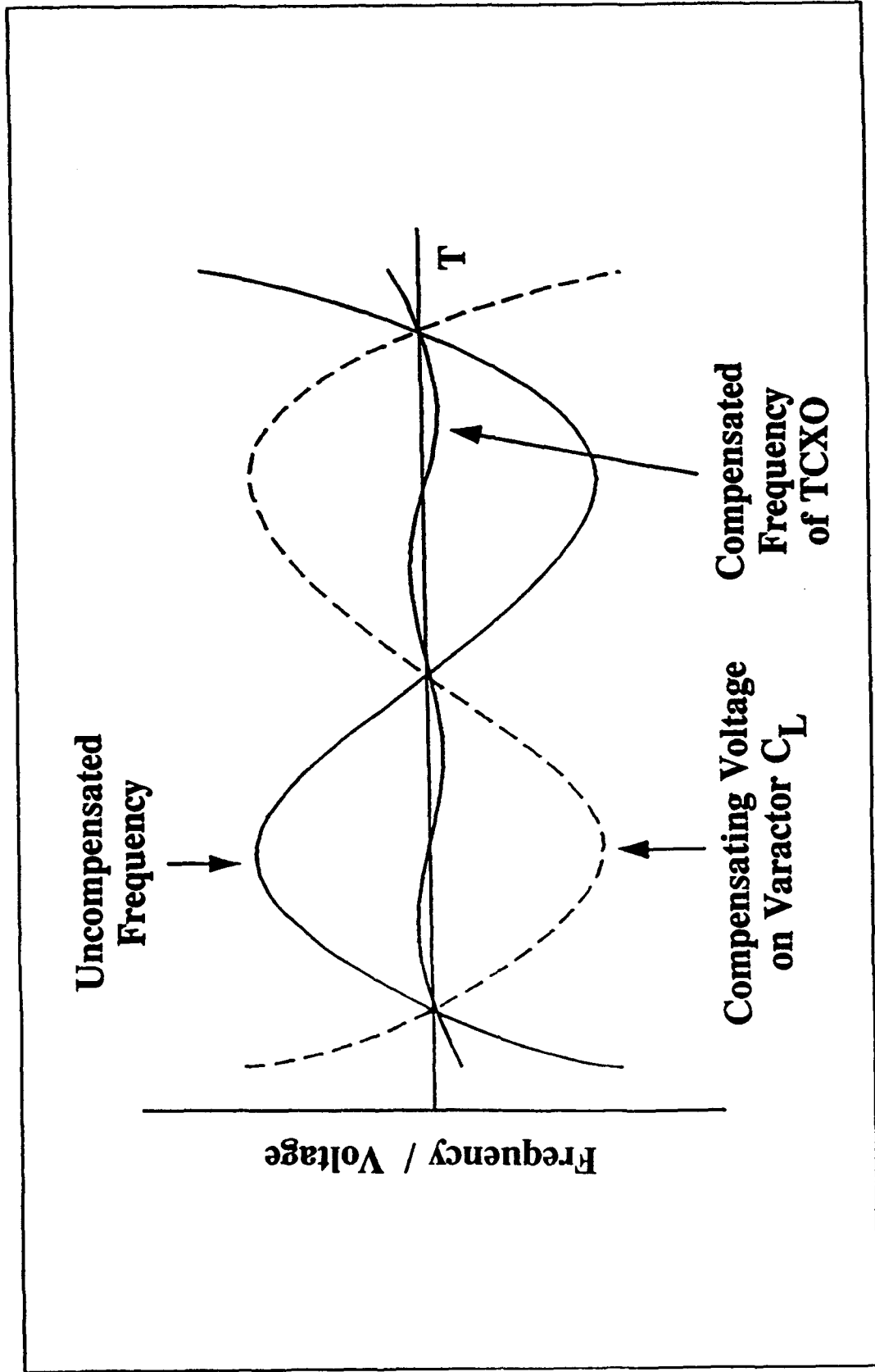

# Resonator Frequency vs. Reactance

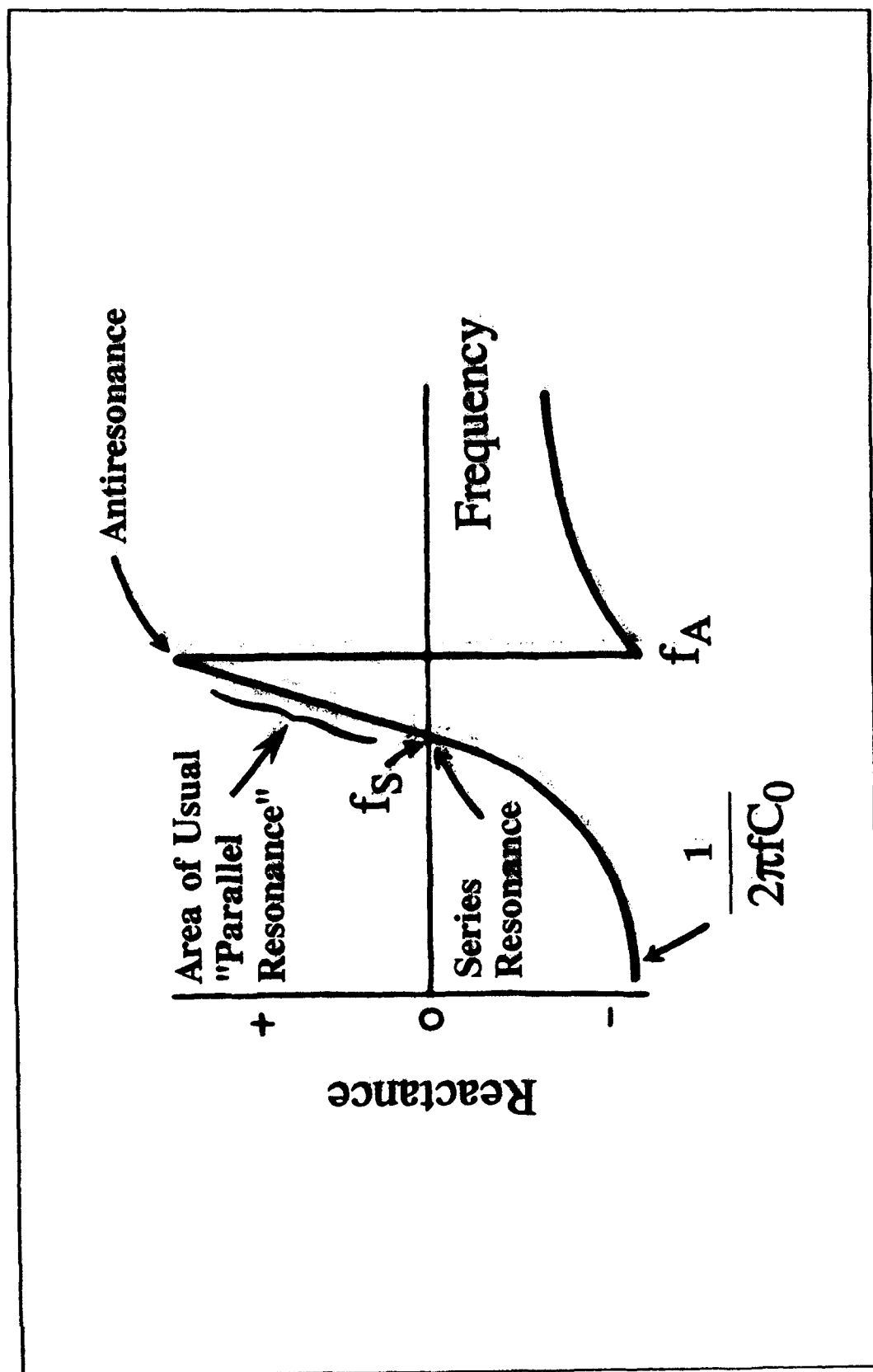

# Equivalent Circuit Parameter Relationships

$$C_0 \cong \epsilon \frac{A}{t}$$

$$f_s = \frac{1}{2\pi} \sqrt{\frac{1}{C_1 L_1}}$$

$$Q = \frac{1}{2\pi f_s R_1 C_1}$$

$$\tau_1 = R_1 C_1 \cong 10^{-14} \text{ s}$$

$$C_n \propto \frac{f C_1}{n^3}$$

$$r = \frac{C_0}{C_1}$$

$$f_a - f_s \cong \frac{f_s}{2r}$$

$$\varphi = \frac{1}{R_1} \frac{\omega L_1}{\omega C_1}$$

$$\frac{d\varphi}{df} \cong \frac{360}{\pi} \frac{Q}{f_s}$$

$$L_n \propto \frac{n^3 L_1}{f^3}$$

$$R_n \propto \frac{n^3 R_1}{f}$$

$$2r = \left( \frac{\pi n}{2k} \right)^2$$

$C_0$  : Static capacitance  
 $C_1$  : Motional capacitance  
 $L_1$  : Motional inductance  
 $R_1$  : Motional resistance  
 $\epsilon$  : Dielectric permittivity of quartz  
 $\cong 40 \times 10^{-3}$  pF/mm (average)  
 $A$  : Electrode area  
 $t$  : Plate thickness  
 $f_s$  : Series resonance frequency  $\cong fr$   
 $f_a$  : Antiresonance frequency  
 $Q$  : Quality factor  
 $\tau_1$  : Motional time constant  
 $r$  : Capacitance ratio  
 $\omega$  : Angular frequency  $= 2\pi f$   
 $\varphi$  : Phase angle of the impedance  
 $n$  : Overtone number  
 $k$  : Piezoelectric coupling factor  
 $= 8.8\%$  for AT-cut,  $4.99\%$  for SC

# What Is Q and Why Is It Important?

$$Q \equiv \frac{\text{Energy stored during a cycle}}{\text{Energy lost during the cycle}}$$

- Q is proportional to the decay-time, and is inversely proportional to the linewidth of resonance (see next page).
- The higher the Q, the higher the frequency stability and accuracy capability of a resonator. If, e.g.,  $Q=10^6$ , then  $10^{-10}$  accuracy requires determining center of resonance curve to 0.01% of the linewidth, and stability (for some averaging time) of  $10^{-12}$  requires ability to stay at same point on resonance curve to  $10^{-6}$  of linewidth.
- Phase noise close to the carrier has an especially strong dependence on Q ( $S_{\phi} \propto 1/Q^4$ ).

# Decay Time, Linewidth, and Q

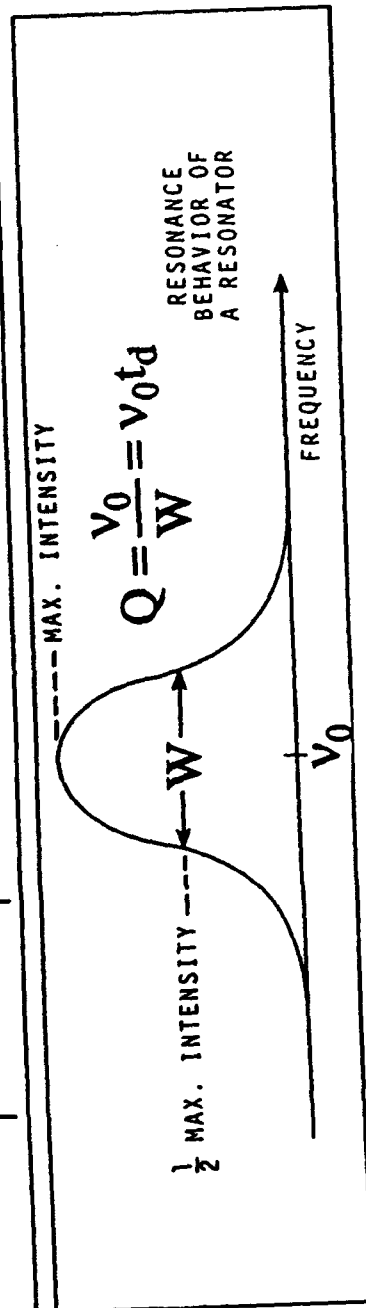
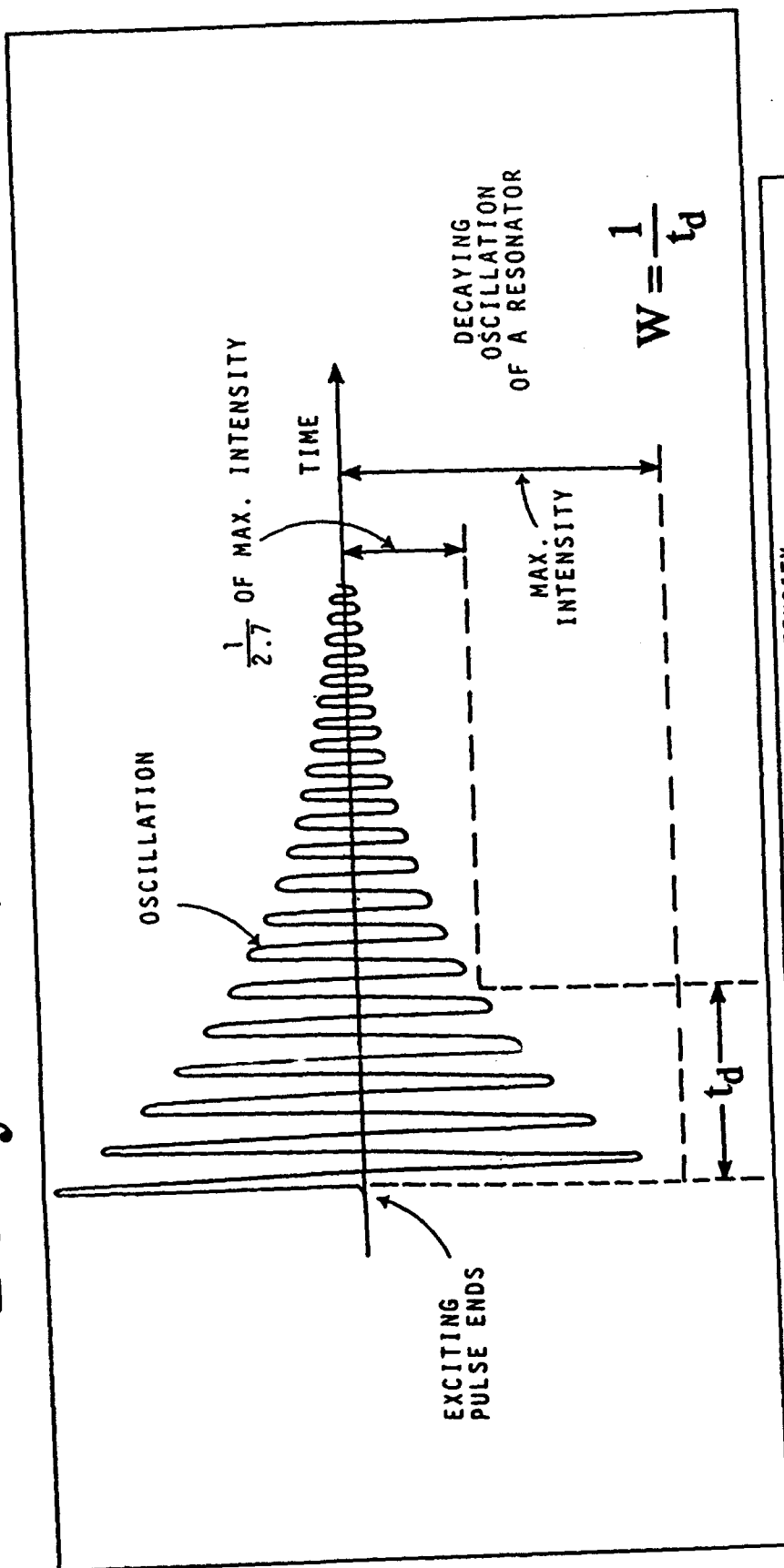

# Factors That Determine Resonator Q

The maximum Q of a quartz crystal resonator is given by:

$$Q_{\max} = \frac{1}{2\pi f\tau}$$

where  $f$  is the frequency in Hz, and  $\tau$  is an empirically determined time constant in seconds, which varies with the angles of cut and the mode of vibration. For example,  $\tau = 1 \times 10^{-14}$ s for the AT-cut's c-mode ( $Q_{\max} = 3.2$  million at 5 MHz),  $\tau = 9.9 \times 10^{-15}$ s for the SC-cut's c-mode, and  $\tau = 4.9 \times 10^{-15}$ s for the BT-cut's b-mode.

Other factors which affect the Q of a resonator include:

- Overtone
- Surface finish
- Material impurities and defects
- Mounting stresses
- Bonding stresses
- Temperature
- Electrode geometry and type
- Blank geometry (contour, dimensional ratios)
- Drive level
- Gases inside the enclosure (pressure, type of gas)
- Interfering modes
- Ionizing radiation

# Resonator Fabrication Steps

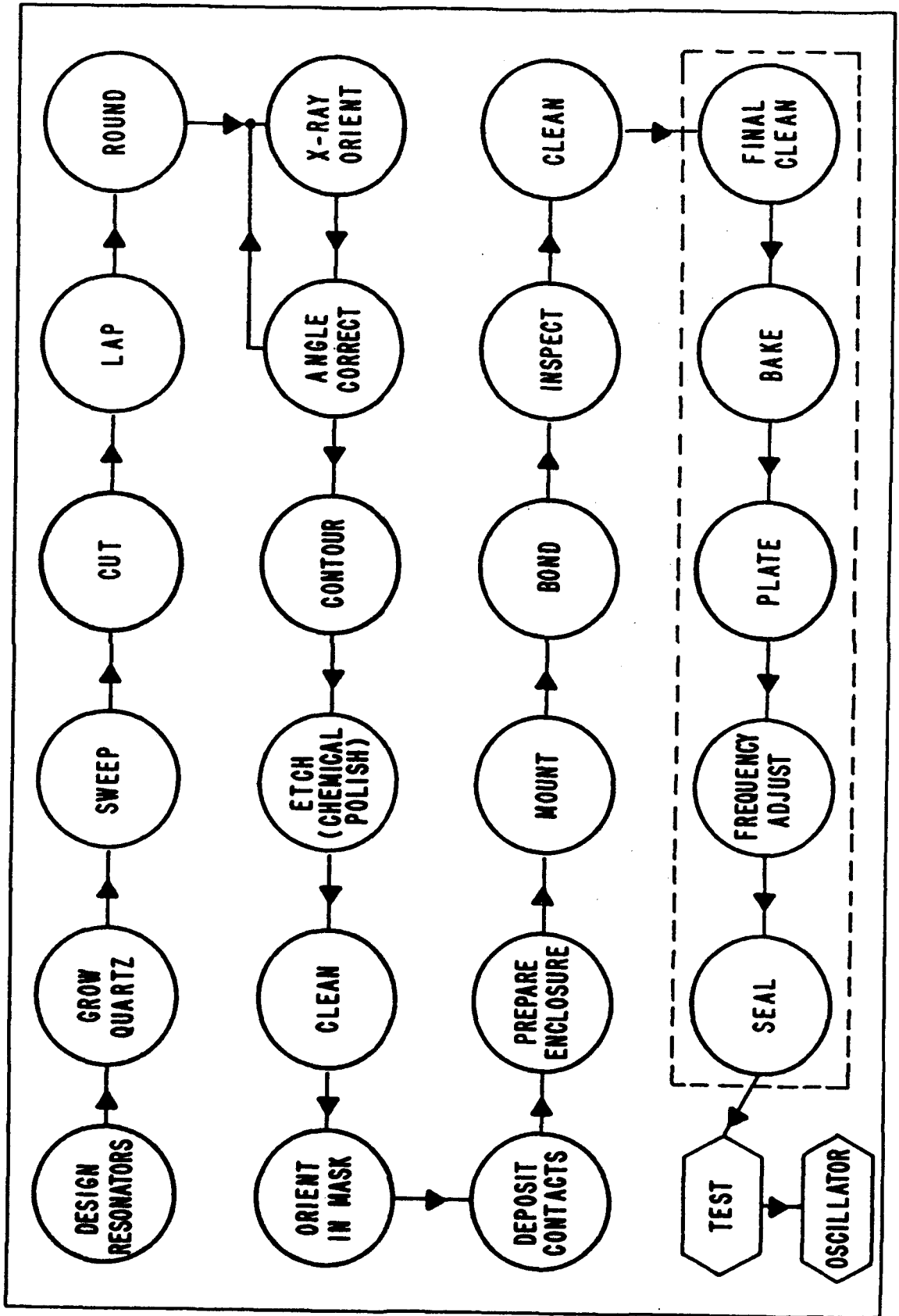



# Milestones in Quartz Technology

- 1880 Piezoelectric effect discovered by Jacques and Pierre Curie
- 1905 First hydrothermal growth of quartz in a laboratory - by G. Spezia
- 1917 First application of piezoelectric effect, in sonar
- 1918 First use of piezoelectric crystal in an oscillator
- 1926 First quartz crystal controlled broadcast station
- 1927 First temperature compensated quartz cut discovered
- 1927 First quartz crystal clock built
- 1934 First practical temp. compensated cut, the AT-cut, developed
- 1949 Contoured, high-Q, high stability AT-cuts developed
- 1956 First commercially grown cultured quartz available
- 1956 First TCXO described
- 1972 Miniature quartz tuning fork developed; quartz watches available
- 1974 The SC-cut (and TS/TTC-cut) predicted; verified in 1976
- 1982 First MCXO with dual c-mode self-temperature sensing

### Chapter 3 References

- A. Ballato, "Piezoelectric Resonators," in B. Parzen, Design of Crystal and Other Harmonic Oscillators, pp. 66-122, John Wiley and Sons, Inc., 1983.
- V. E. Bottom, Introduction to Quartz Crystal Unit Design, Van Nostrand Reinhold Company, 1982.
- E. Hafner, "Resonator and Device Measurements," in E. A. Gerber and A. Ballato, Precision Frequency Control, Vol. 2, pp.1-44, Academic Press, 1985.
- R. A. Heising, Quartz Crystals for Electrical Circuits, D. Van Nostrand Co., 1946.
- J. A. Kusters, "Resonator and Device Technology," in E. A. Gerber and A. Ballato, Precision Frequency Control, Vol. 1, pp. 161-183, Academic Press, 1985.
- 3-8a K. Haruta and W. J. Spencer, "X-ray Diffraction Study of Vibrational Modes," Proc. 20th Annual Symposium on Frequency Control, pp. 1-13, April 1966, AD800523. Copies available from National Technical Information Service, U.S. Dept. of Commerce, 5285 Port Royal Road, Sills Bldg., Springfield, VA 22161.
- 3-8b W. J. Spencer, "Observation of Resonant Vibrations and Defect Structure in Single Crystals by X-ray Diffraction Topography," in Physical Acoustics, Vol. V, W. P. Mason and R. N. Thurston Eds., Academic Press, New York, 1968.
- 3-9 H. Fukuyo, H. Yoshie, and M. Nakazawa, "The Unwanted Responses of the Crystal Oscillator Controlled by AT-cut Plate," Proc. 21st Annual Symposium on Frequency Control, pp. 402-419, April 1967, AD659792. Copies available from National Technical Information Service, U.S. Dept. of Commerce, 5285 Port Royal Road, Sills Bldg., Springfield, VA 22161.
- 3-10 T. R. Meeker, "Theory and Properties of Piezoelectric Resonators and Waves," in E. A. Gerber and A. Ballato, Precision Frequency Control, Vol. 1, pp. 47-119, Academic Press, 1985.
- 3-14 A. Ballato, "Doubly Rotated Thickness Mode Plate Vibrators," in Physical Acoustics, Vol. XIII, W. P. Mason and R. N. Thurston, Eds., pp. 115-181, Academic Press, New York, 1977.

3-21 H. Hellwig, "Frequency Standards and Clocks: A Tutorial Introduction," NBS Technical Note 616, 1977, Time and Frequency Division, NIST, Boulder, CO 80303.

3-24a W. A. Marrison, "The Evolution of the Quartz Crystal Clock," Bell System Technical Journal, Vol. 27, pp. 510-588, 1948.

3-24b F. D. Lewis, "Frequency and Time Standards," Proc. of the Institute of Radio Engineers, pp. 1046-1068, Sept. 1955.

3-24c V. E. Bottom, "A History of the Quartz Crystal Industry in the USA," Proc. 35th Annual Symposium on Frequency Control, pp. 3-12, 1981.

④

# Oscillator Stability

# What is One Part in $10^{10}$ ?

•  $\sim 1/2$  cm out of the circumference of the earth

•  $\sim 1/4$  second per human lifetime ( $\sim 80$  years)

# Accuracy, Precision and Stability

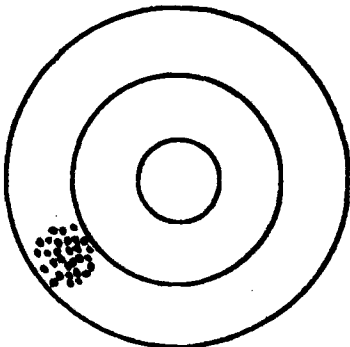
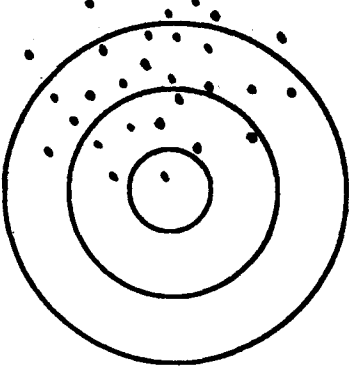
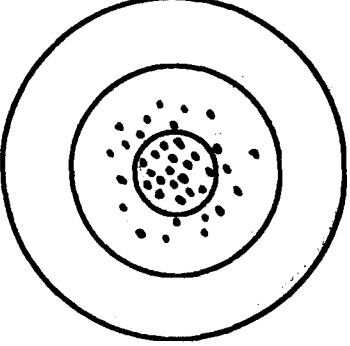
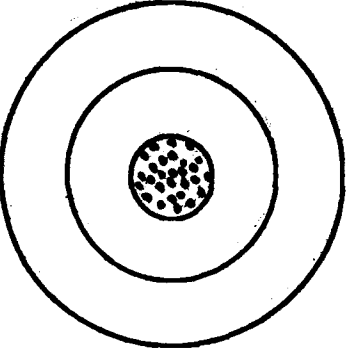
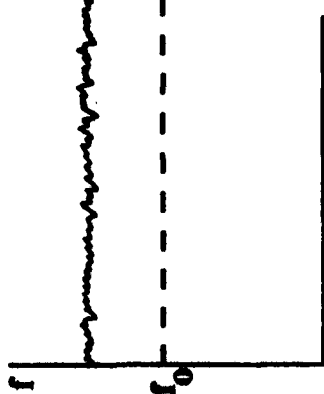
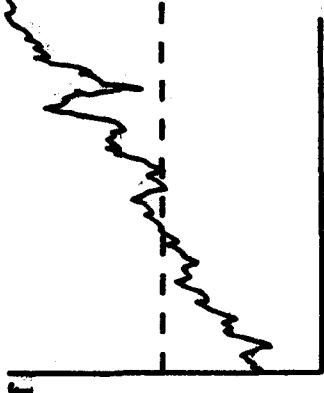
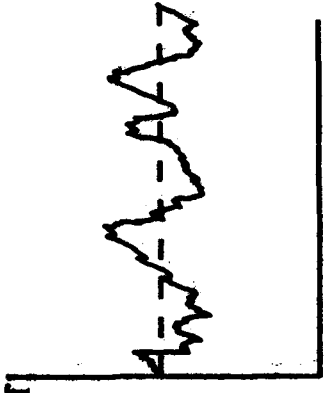
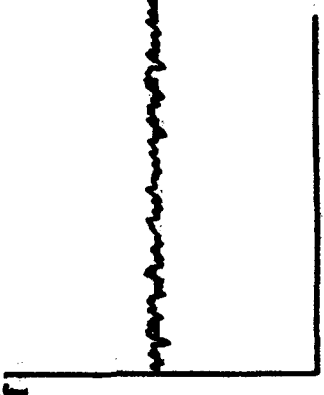
 <p>Precise but not accurate</p>	 <p>Not accurate and not precise</p>	 <p>Accurate but not precise</p>	 <p>Accurate and precise</p>
 <p>Stable but not accurate</p>	 <p>Not stable and not accurate</p>	 <p>Accurate but not stable</p>	 <p>Stable and accurate</p>

# Influences on Oscillator Frequency

- **Time**
  - Short term (noise)
  - Intermediate term (e.g., due to oven fluctuations)
  - Long term (aging)
  
- **Temperature**
  - Static frequency vs. temperature
  - Dynamic frequency vs. temperature (warmup, thermal shock)
  - Thermal history ("hysteresis," "retrace")
  
- **Acceleration**
  - Gravity (2g tipover)
  - Acoustic noise
  - Vibration
  - Shock
  
- **Ionizing radiation**
  - Steady state
  - Pulsed
  - Photons (X-rays,  $\gamma$ -rays)
  - Particles (neutrons, protons, electrons)
  
- **Other**
  - Power supply voltage
  - Humidity
  - Atmospheric pressure (altitude)
  - Magnetic field
  - Load impedance

# Idealized Frequency-Time-Influence Behavior

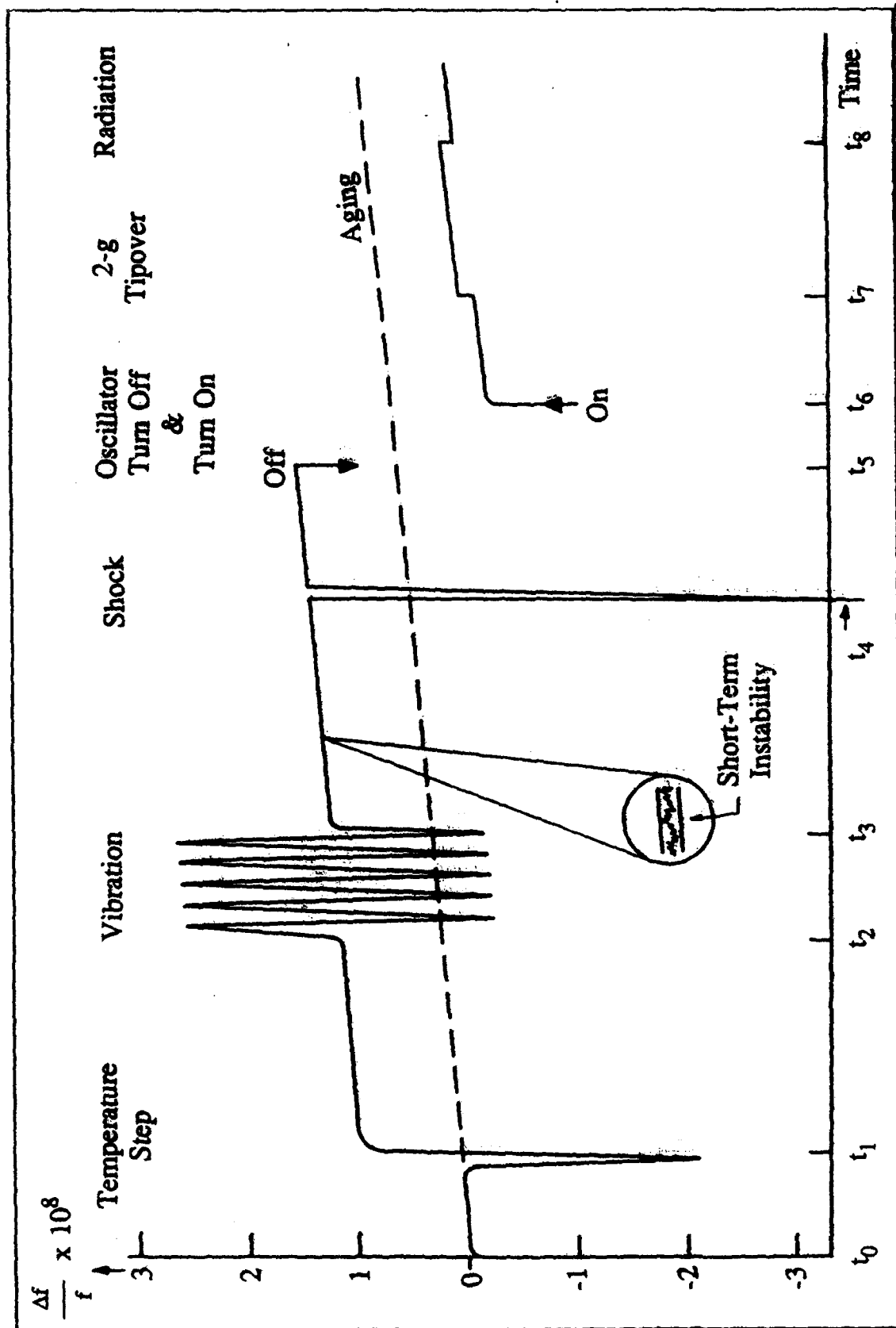



# Aging and Short-Term Stability

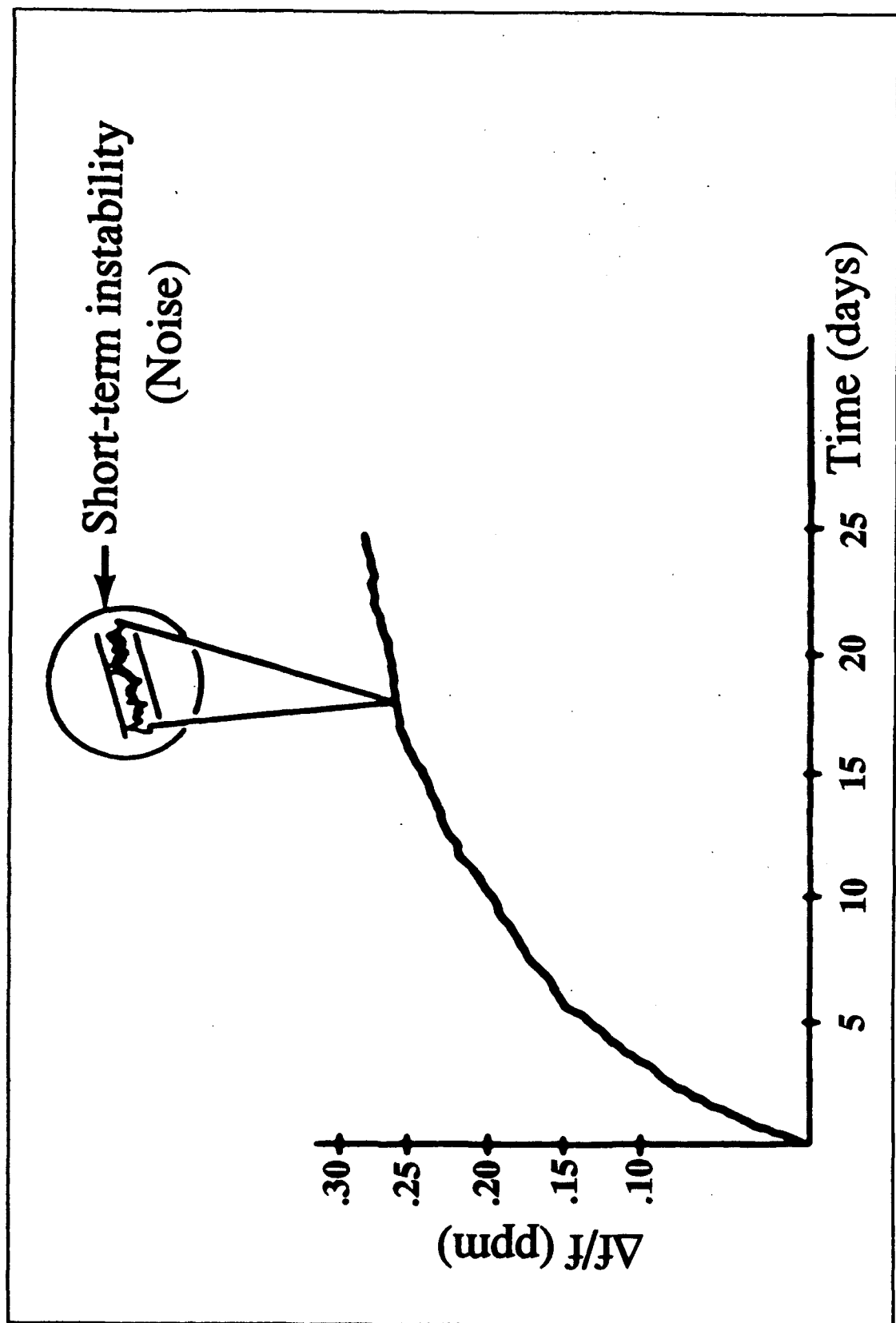

# Aging Mechanisms

- **Mass transfer due to contamination**  
Since  $f \propto 1/t$ ,  $\Delta f/f = -\Delta t/t$ ; e.g.,  $f_{5\text{MHz}} \approx 10^6$  molecular layers, therefore, 1 quartz-equivalent monolayer  $\Rightarrow \Delta f/f \approx 1$  ppm
- **Stress relief in the resonator's: mounting and bonding structure, electrodes, and in the quartz (?)**
- **Other effects**
  - Quartz outgassing
  - Diffusion effects
  - Chemical reaction effects
  - Pressure changes in resonator enclosure (leaks and outgassing)
  - Oscillator circuit aging (load reactance and drive level changes)
  - Electric field changes (doubly rotated crystals only)
  - Oven-control circuitry aging

# Typical Aging Behaviors

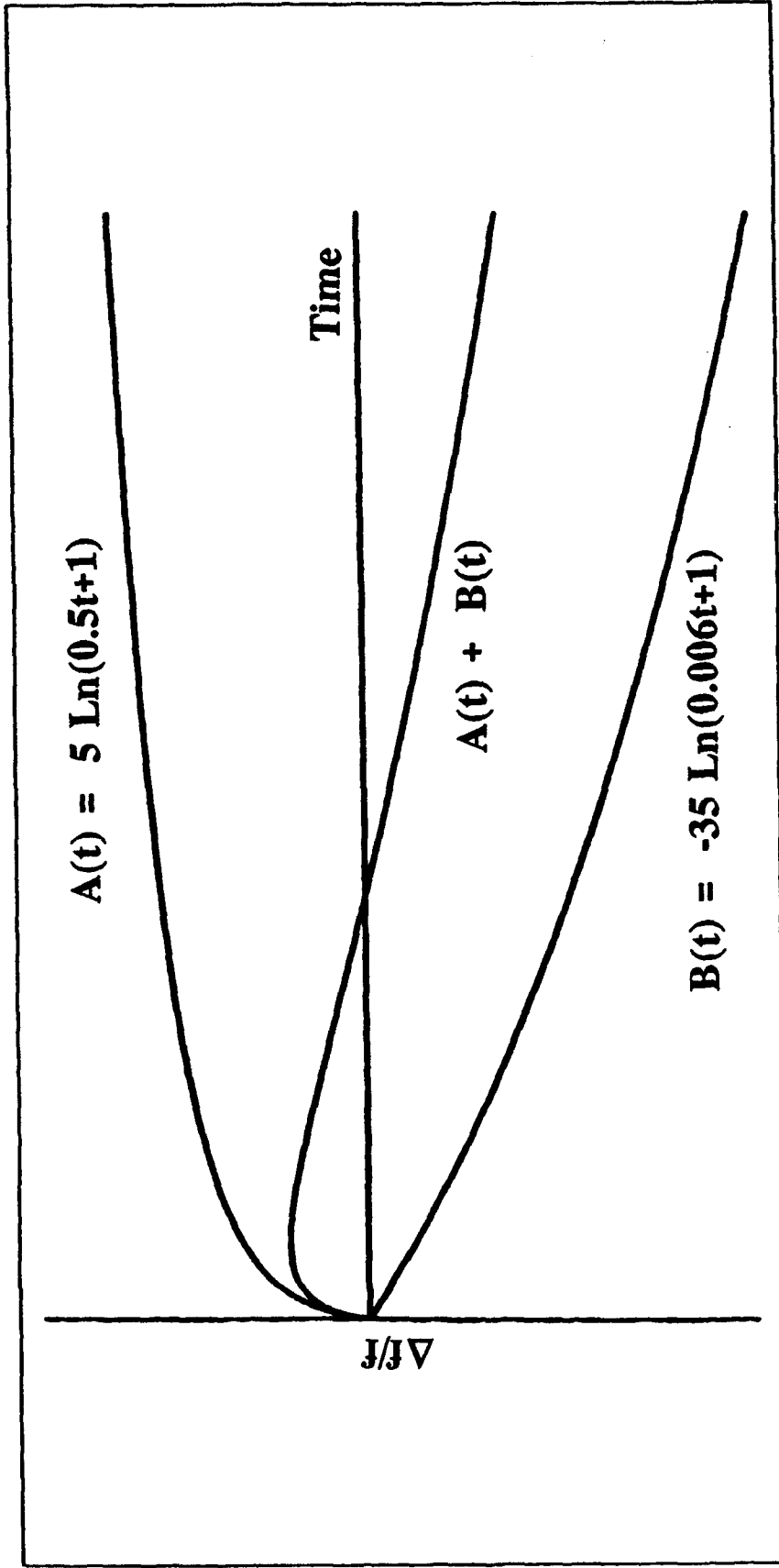

Aging can be positive or negative. Occasionally, a reversal of aging direction is observed. The above (computer generated) curves illustrate the three types of aging behaviors. The curve showing the reversal is the sum of the other two curves. Reversal indicates the presence of at least two aging mechanisms.

# Thermal Expansion Coefficient of Quartz

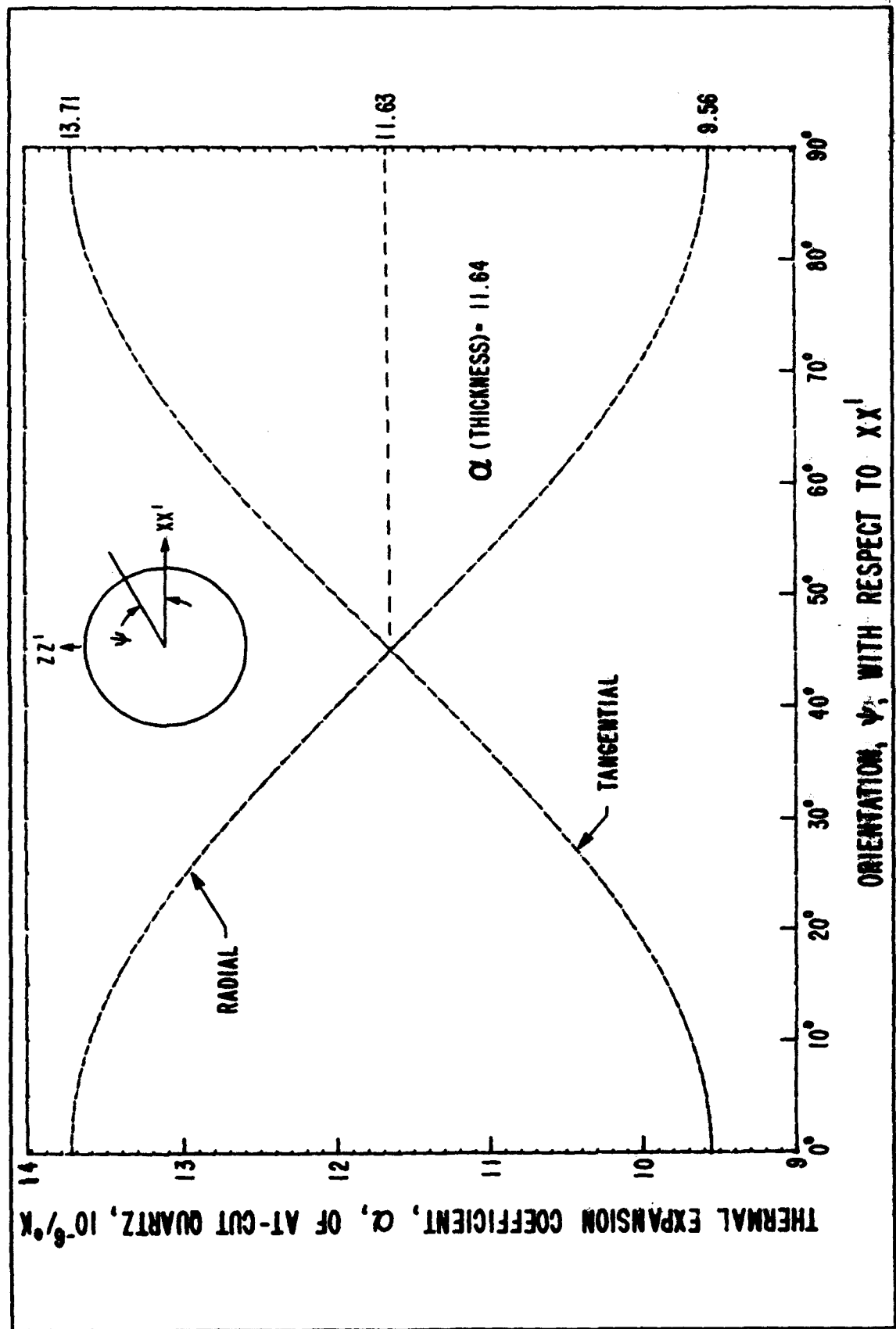

# Force-Frequency Coefficient

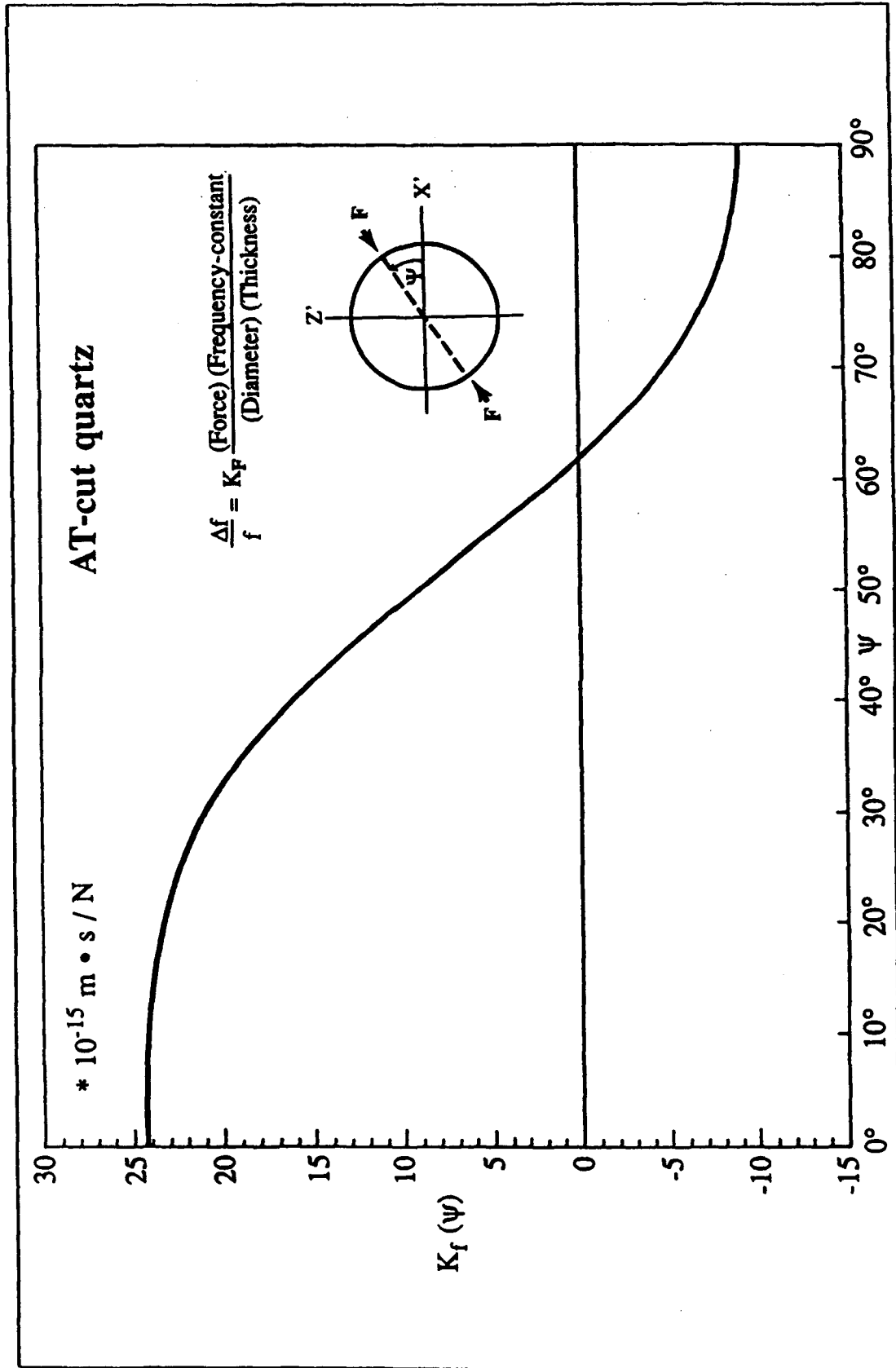

# Strains Due To Mounting Clips

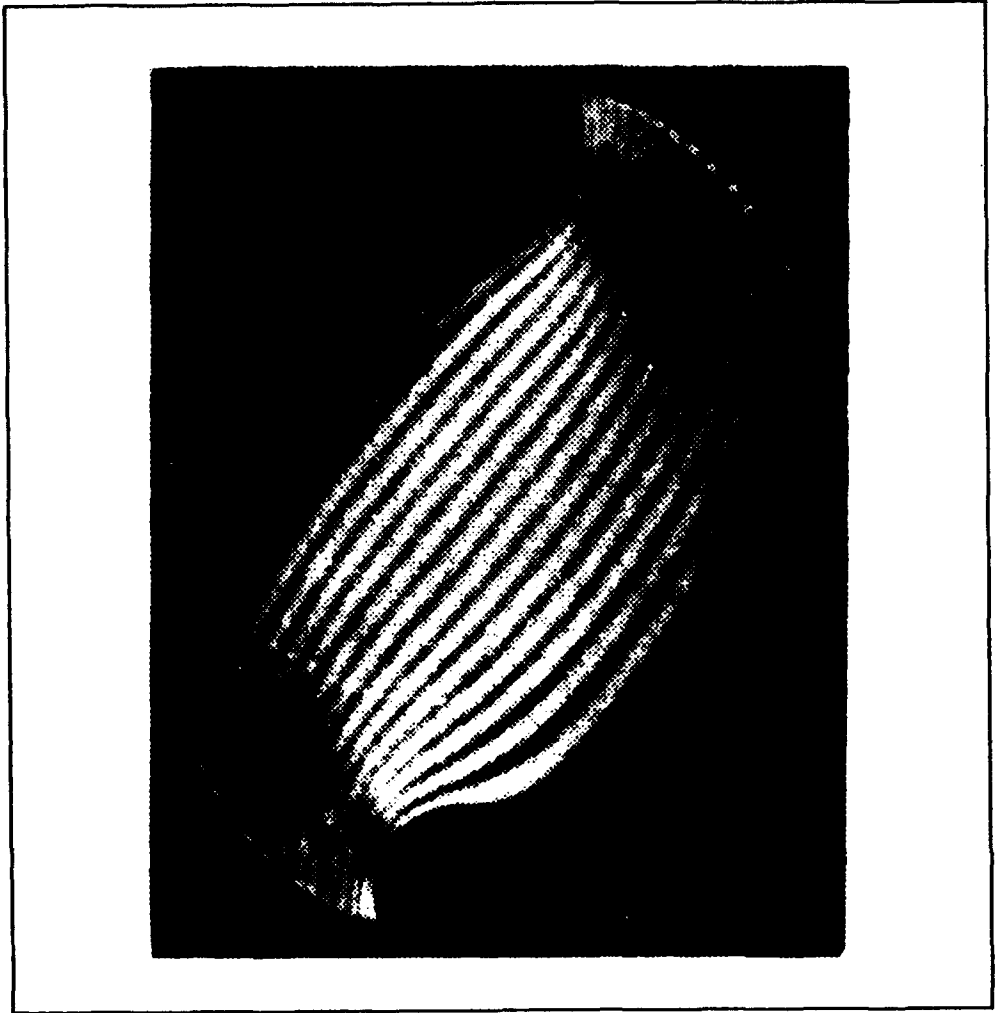
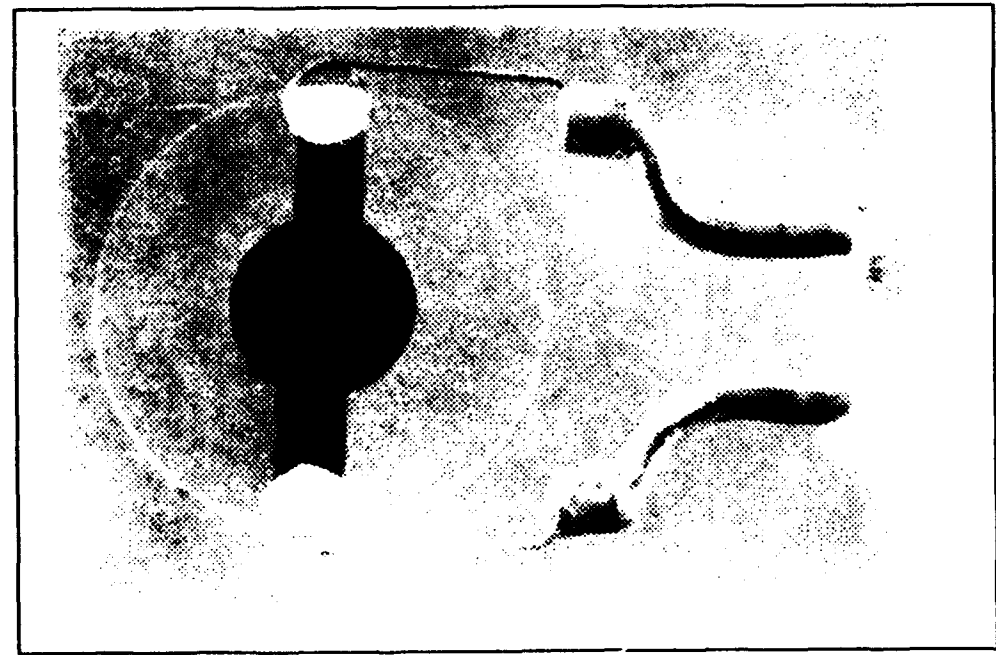

Photograph of a 1 cm diameter AT-cut resonator and its X-ray topograph. The topograph shows the lattice distortion due to the mounting stresses.

# Strains Due To Bonding Cements

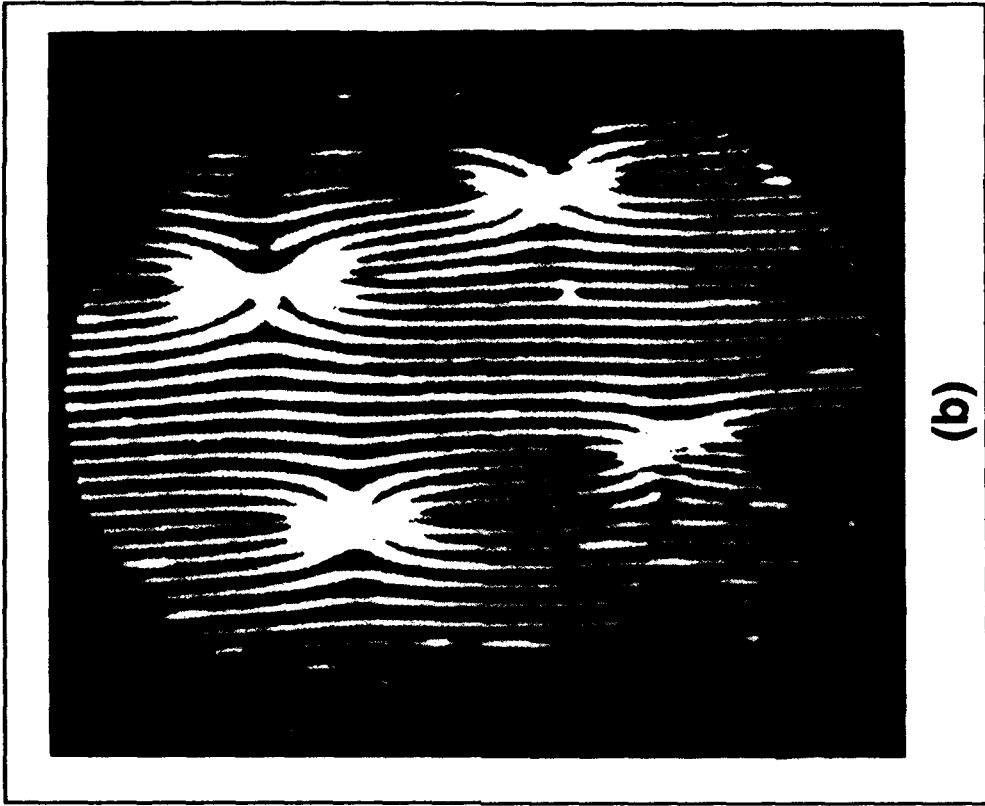
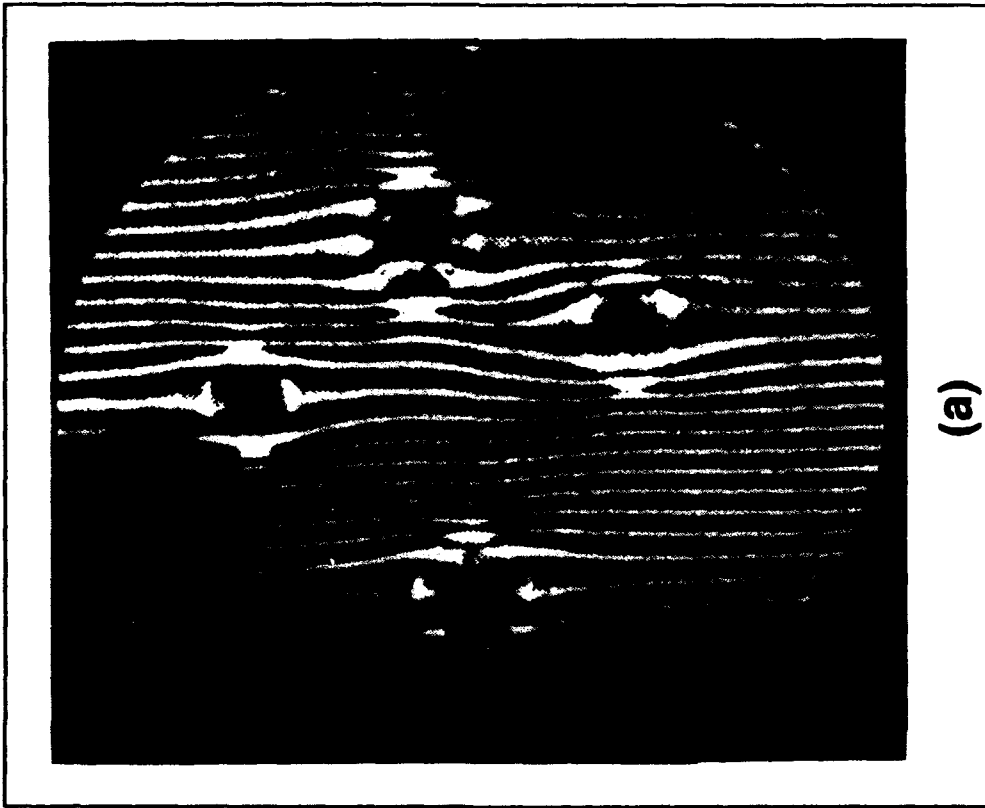

X-ray topographs showing lattice distortions caused by bonding cements; (a) Bakelite cement - expanded upon curing, (b) DuPont 5504 cement - shrank upon curing.

# Mounting Force Induced Frequency Changes

The force-frequency coefficient,  $K_F(\Psi)$ , is defined by

$$\frac{\Delta f}{f} = K_F \frac{\text{(Force) (Frequency-constant)}}{\text{(Diameter) (Thickness)}}$$

Maximum  $K_F$  (AT-cut) =  $24.5 \times 10^{-15}$  m-s/N at  $\Psi = 0^\circ$

Maximum  $K_F$  (SC-cut) =  $14.7 \times 10^{-15}$  m-s/N at  $\Psi = 44^\circ$ .

As an example, consider 5 MHz 3rd overtone, 14 mm diameter resonators. Then, since 1 gram =  $9.81 \times 10^{-3}$  newtons, and assuming the presence of diametrical forces only,

$$\left(\frac{\Delta f}{f}\right)_{\text{Max}} = \begin{cases} 2.9 \times 10^{-8} \text{ per gram for an AT-cut resonator} \\ 1.7 \times 10^{-8} \text{ per gram for an SC-cut resonator} \end{cases}$$

$$\left(\frac{\Delta f}{f}\right)_{\text{Min}} = 0 \text{ at } \Psi = 61^\circ \text{ for an AT-cut resonator, and at } \Psi = 87^\circ \text{ for an SC-cut.}$$

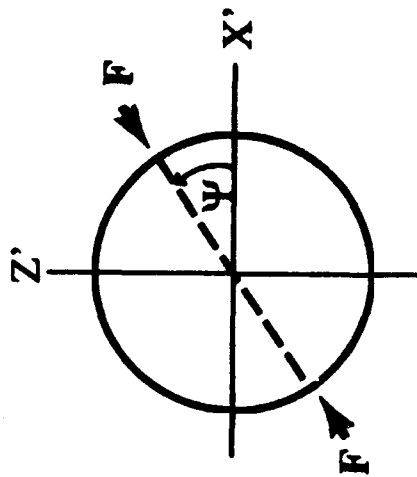



# Bonding Strains Induced Frequency Changes

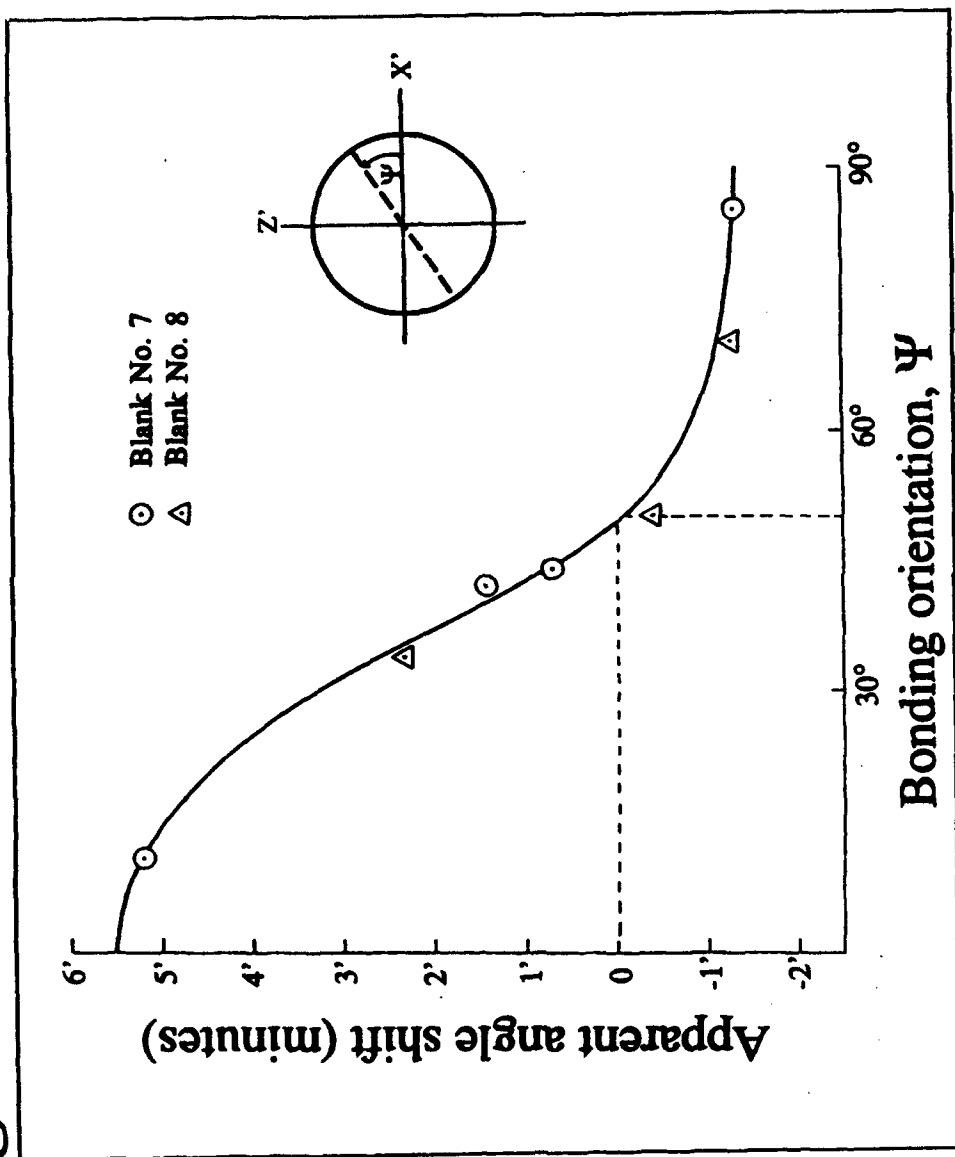

When 22 MHz fundamental mode AT-cut resonators were reprocessed so as to vary the bonding orientations, the  $f$  vs.  $T$  characteristics of the resonators changed as if the angles of cut had been changed. The resonator blanks were 6.4 mm in diameter, plano-plano, and were bonded to low-stress mounting clips by nickel electrobonding.

# Short Term Instability (Noise)

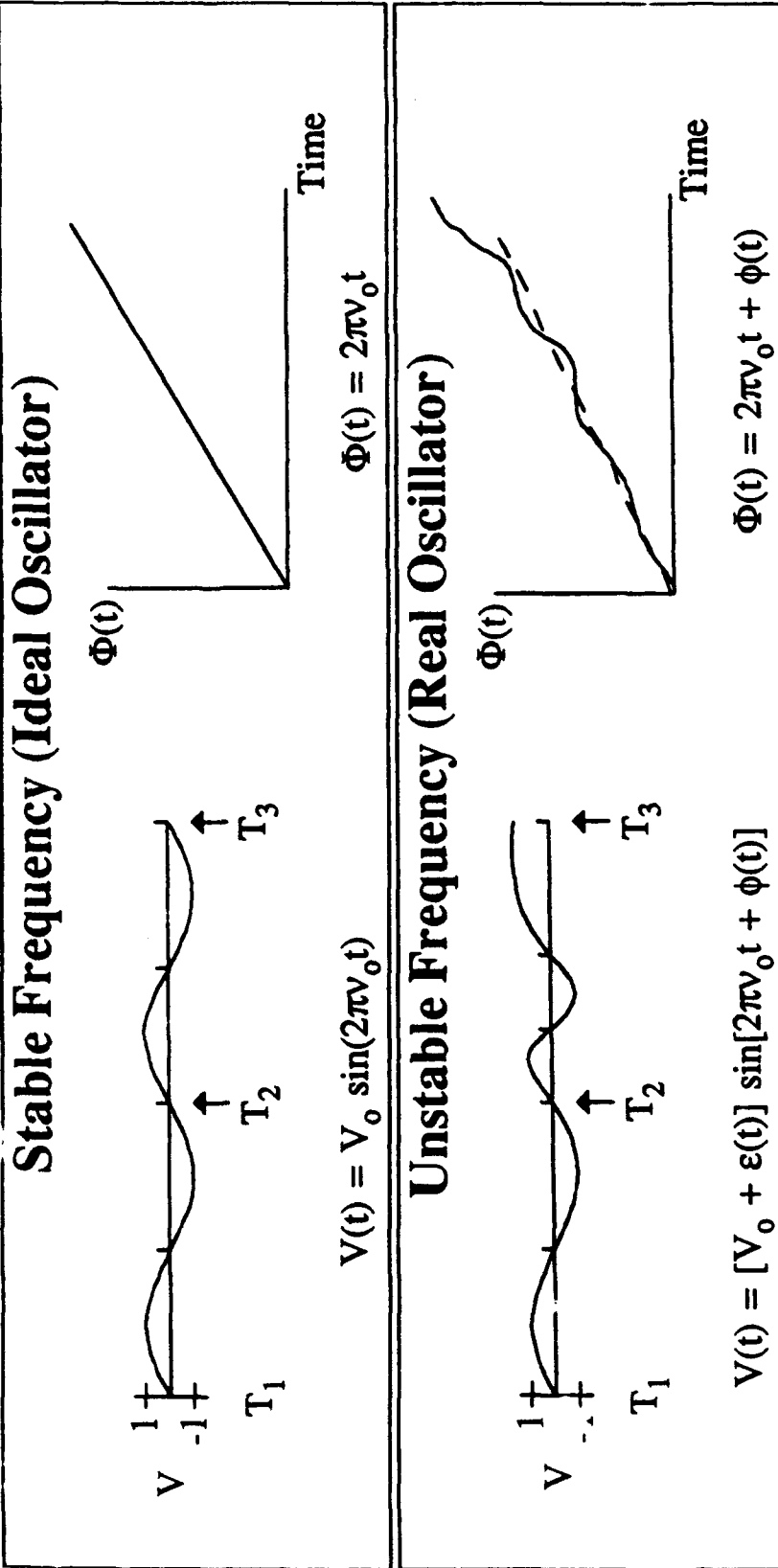

Instantaneous frequency,  $\nu(t) = \frac{1}{2\pi} \frac{d\Phi(t)}{dt} = \nu_0 + \frac{1}{2\pi} \frac{d\phi(t)}{dt}$

$V(t)$  = Oscillator output voltage,  $V_0$  = Nominal peak voltage amplitude

$\epsilon(t)$  = Amplitude noise,  $\nu_0$  = Nominal (or "carrier") frequency

$\Phi(t)$  = Instantaneous phase, and  $\phi(t)$  = Deviation of phase from nominal (i.e., the ideal)

# Impacts of Oscillator Noise

- Limits the ability to determine the current state and the predictability of precision oscillators
- Limits synchronization and synchronization accuracy
- Limits receivers' useful dynamic range, channel spacing, and selectivity; can limit jamming resistance
- Limits radar performance (especially Doppler radar's)
- Causes timing errors [  $\sim \tau \sigma_y(\tau)$  ]
- Causes bit errors in digital communication systems
- Limits navigation accuracy
- Limits ability to lock to narrow-linewidth (atomic) resonances
- Can cause loss of lock; can limit acquisition/reacquisition capability in phase-locked-loop systems

# Causes of Short Term Instabilities

- Temperature fluctuations - thermal transient effects
  - activity dips at oven set-point
- Johnson noise (thermally induced charge fluctuations, i.e., "thermal emf" in resistive elements)
- Acoustic losses (i.e.,  $Q$ )
- Random vibration
- Fluctuations in the number of adsorbed molecules
- Stress relief, fluctuations at interfaces (quartz, electrode, mount, bond)
- Noise due to oscillator circuitry (active and passive components)
- Shot noise in atomic frequency standards
- ???

# Time Domain - Frequency Domain

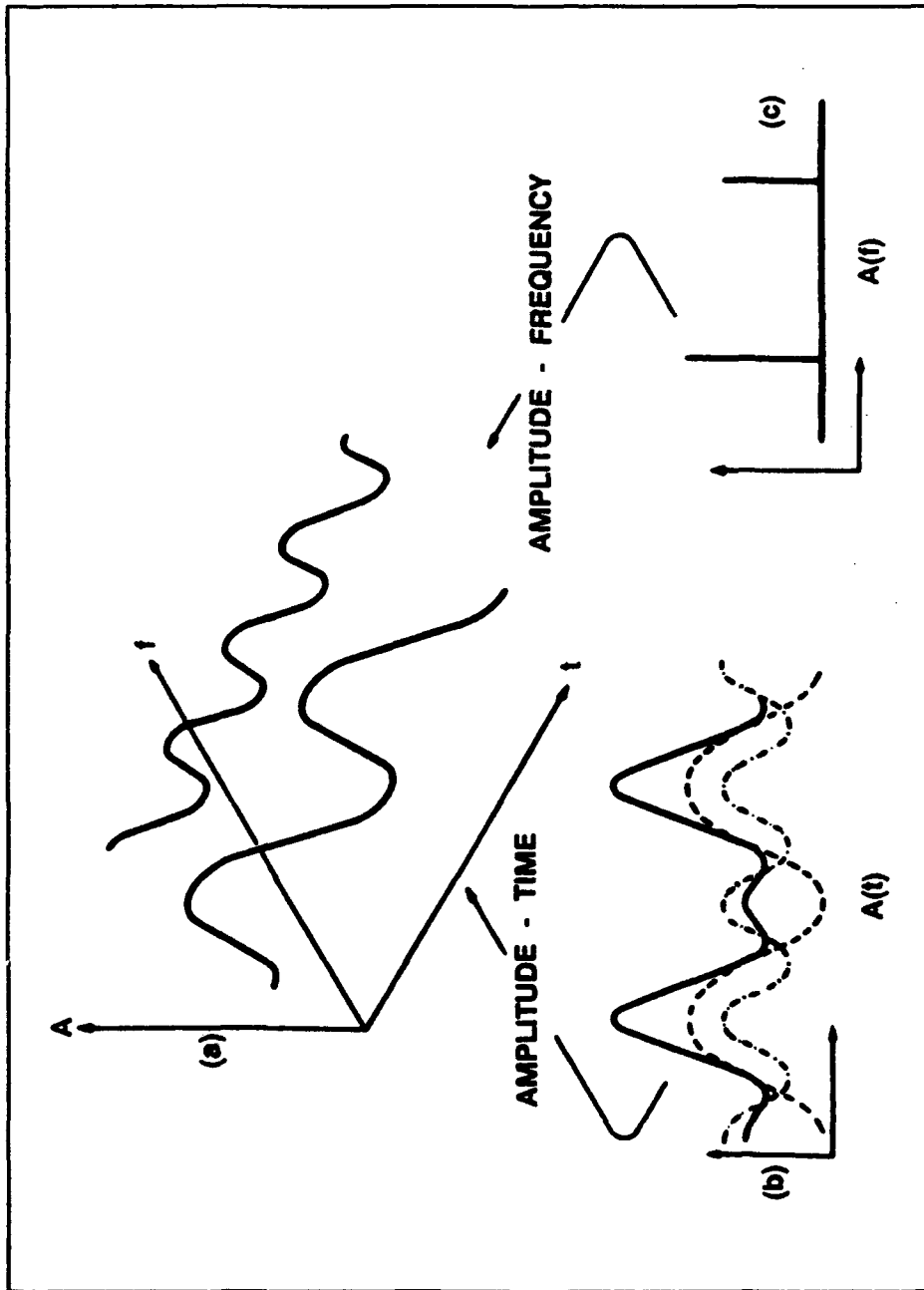

Example (a) shows a sine wave and its second harmonic. A signal consisting of the sum of the two waves is shown in the time domain (b), and in the frequency domain (c). In the time domain, all frequency components are summed together. In the frequency domain, signals are separated into their frequency components and the power level at each frequency is displayed.

# Short-Term Stability Measures

Measure	Symbol
Two-sample deviation (square-root of Allan variance)	$\sigma_y(\tau)^*$
Spectral density of phase deviations	$S_\phi(f)$
Spectral density of fractional frequency deviations	$S_y(f)$
Phase noise	$\mathcal{L}(f)^*$

\* Most frequently found on oscillator specification sheets

$$f^2 S_\phi(f) = v^2 S_y(f); \quad \mathcal{L}(f) \equiv 1/2[S_\phi(f)] \quad (\text{per IEEE Std. 1139-1988}),$$

$$\text{and} \quad \sigma_y^2(\tau) = \frac{2}{(\pi v \tau)^2} \int_0^\infty S_\phi(f) \sin^4(\pi f \tau) df$$

where  $\tau$  = averaging time,  $f$  = Fourier frequency, or "frequency from the carrier", and  $v$  = carrier frequency.

## Allan Variance

The two-sample deviation, or square-root of the "Allan variance," is the standard method of describing the short-term stability of oscillators in the time domain. It is usually denoted by  $\sigma_y(\tau)$ ,

where

$$\sigma_y^2(\tau) = \frac{1}{2} \langle (y_{k+1} - y_k)^2 \rangle .$$

The fractional frequencies,  $y = \frac{\Delta f}{f}$ , are measured over a time interval,  $\tau$ ;  $(y_{k+1} - y_k)$  are the differences between pairs of successive measurements of  $y$ , and, ideally,  $\langle \rangle$  denotes a time average of an infinite number of  $(y_{k+1} - y_k)^2$ . A good estimate can be obtained by a limited number,  $m$ , of measurements ( $m \geq 100$ ).  $\sigma_y(\tau)$  generally denotes  $\sqrt{\sigma_y^2(\tau, m)}$ , i.e.,

$$\sigma_y^2(\tau) = \sigma_y^2(\tau, m) = \frac{1}{m} \sum_{j=1}^m \frac{1}{2} (y_{k+1} - y_k)_j^2$$

## Why Allan Variance?

- **Classical variance:**  $\sigma^2 = \frac{1}{m-1} \sum (y_i - \bar{y})^2$ ,

diverges for commonly observed noise processes, such as random walk, i.e., the variance increases with increasing number of data points.

- **Allan variance:**
  - Converges for all noise processes observed in precision oscillators.
  - Has straightforward relationship to power law spectral density types.
  - Is easy to compute.
  - Is faster and more accurate in estimating noise processes than the Fast Fourier Transform.



# Frequency Noise and $\sigma_y(\tau)$

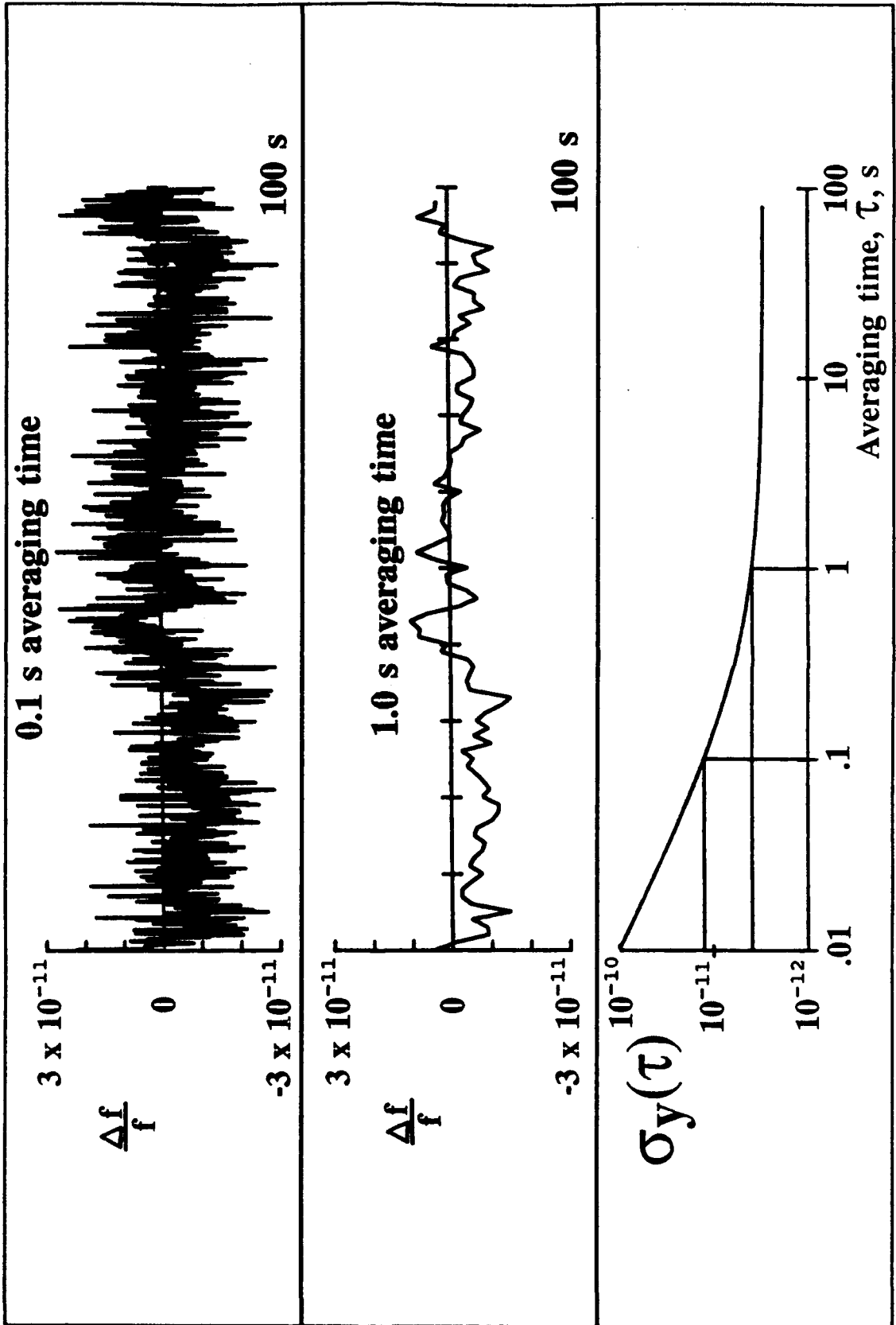

# Time Domain Stability

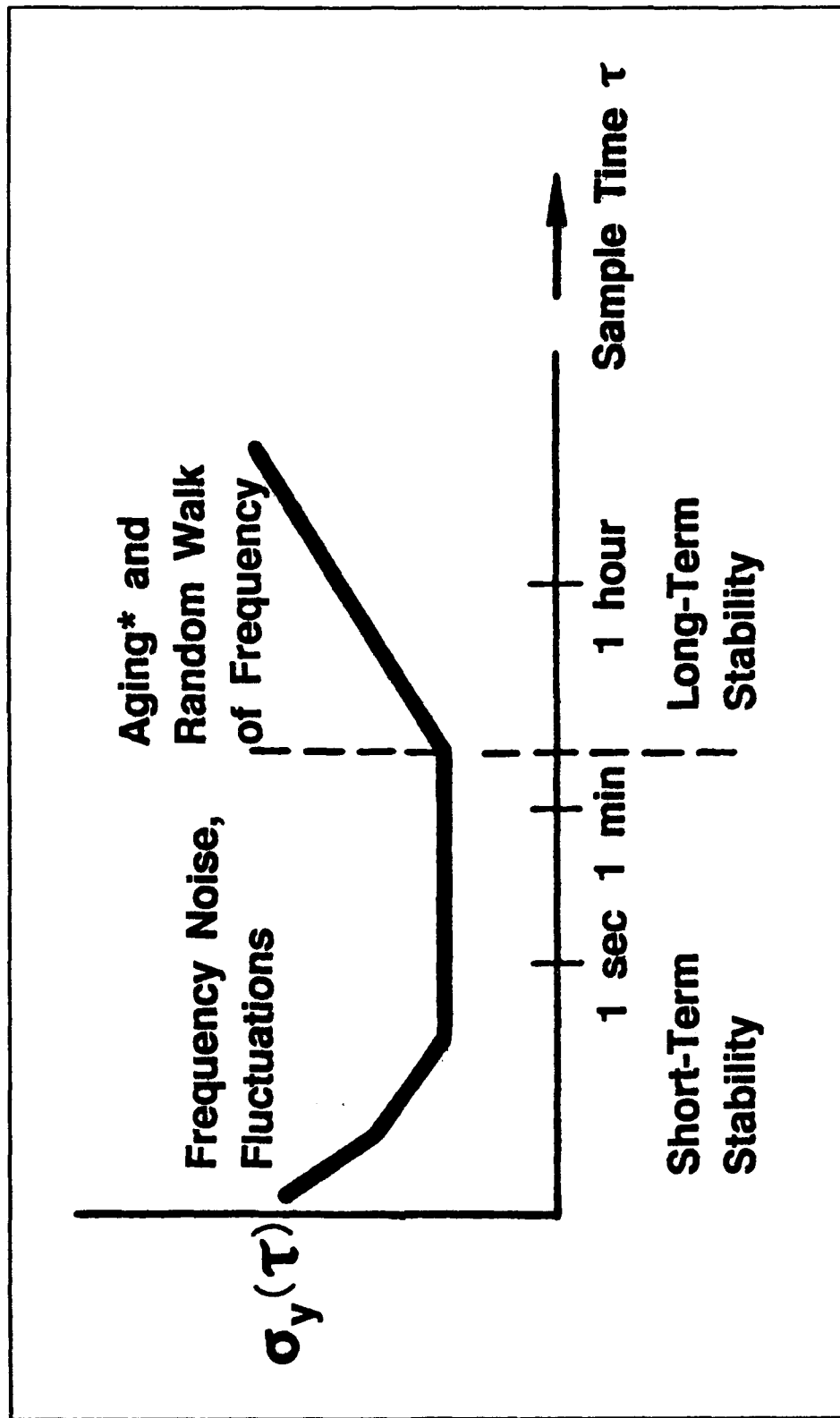

\*For  $\sigma_y(\tau)$  to be a proper measure of random frequency fluctuations, aging must be properly subtracted from the data at long  $\tau$ 's.

# Power Law Dependence of $\sigma_y(\tau)$

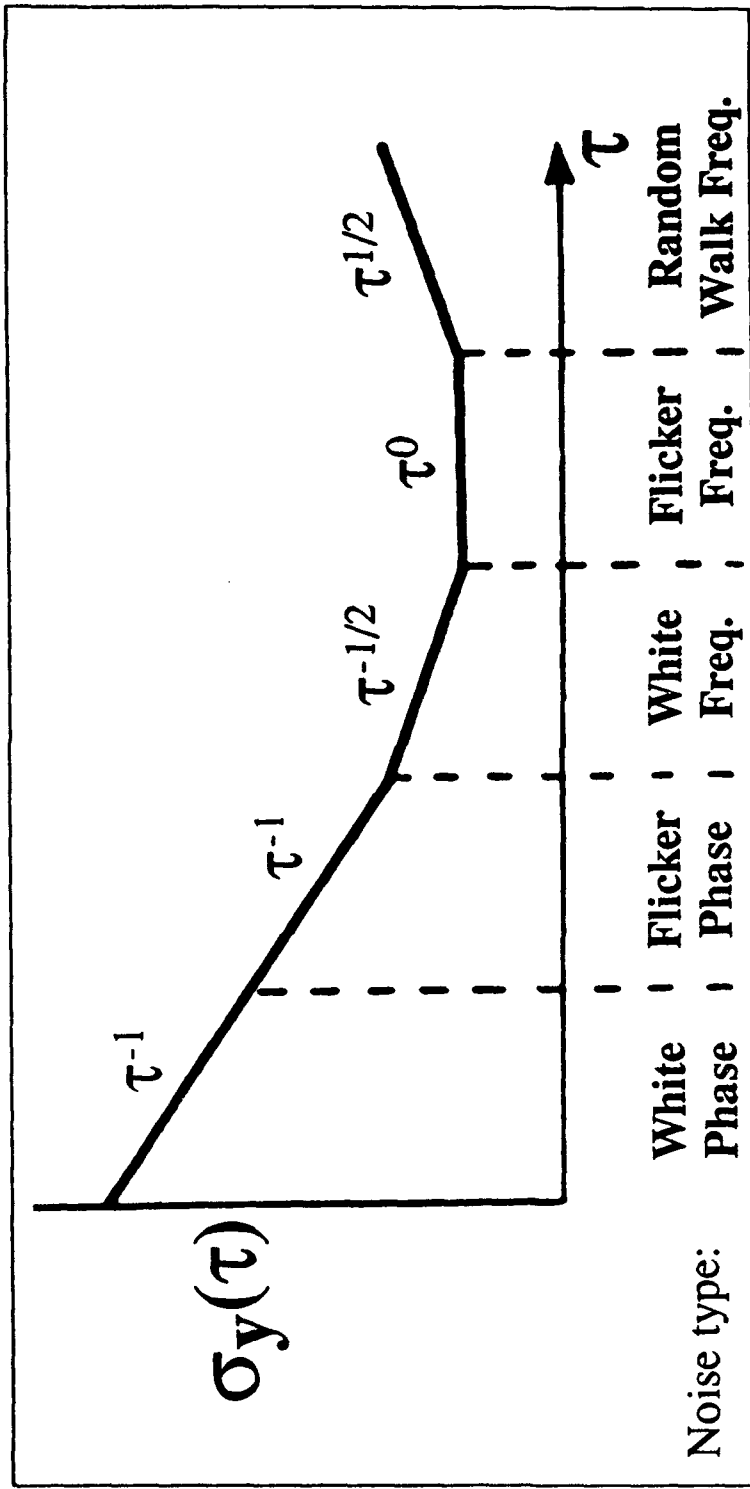

Below the flicker of frequency noise (i.e., the "flicker floor") region, crystal oscillators typically show  $\tau^{-1}$  (white phase noise) dependence. Atomic standards show  $\tau^{-1/2}$  (white frequency noise) dependence down to about the servo-loop time constant, and  $\tau^{-1}$  dependence at less than that time constant. Typical  $\tau$ 's at the start of flicker floors are: 1 second for a crystal oscillator,  $10^3$  s for a Rb standard and  $10^5$  s for a Cs standard.



# Spectral Densities

$$V(t) = [V_0 + \varepsilon(t)] \sin [2\pi\nu_0 t + \phi(t)]$$

In the frequency domain, due to the "phase noise",  $\phi(t)$ , some of the power is at frequencies other than  $\nu_0$ . The stabilities are characterized by "spectral densities." The spectral density  $S_V(f)$ , the mean-square voltage  $\langle V^2(t) \rangle$  in a unit bandwidth centered at  $f$ , is not a good measure of frequency stability because both  $\varepsilon(t)$  and  $\phi(t)$  contribute to it, and because it is not uniquely related to frequency fluctuations (although  $\varepsilon(t)$  is usually negligible in precision frequency sources.)

The spectral densities of phase and fractional-frequency fluctuations,  $S_\phi(f)$  and  $S_y(f)$ , respectively, are used to characterize stabilities in the frequency domain. The spectral density  $S_g(f)$  of a quantity  $g(t)$  is the mean square value of  $g(t)$  in a unit bandwidth centered at  $f$ . Moreover, the RMS value of  $g^2$  in bandwidth BW is given by  $g_{\text{RMS}}^2(t) = \int_{\text{BW}} S_g(f) df$ .

# Pictures of Noise

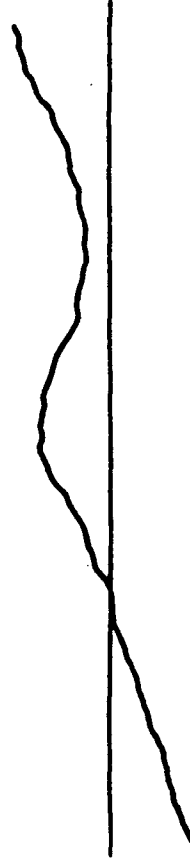
Plot of $z(t)$ vs. $t$	$S_z(f) = h_\alpha f^\alpha$	Noise name
	$\alpha = 0$	White
	$\alpha = -1$	Flicker
	$\alpha = -2$	Random walk
	$\alpha = -3$	

Plots show fluctuations of a quantity  $z(t)$ , which can be, e.g., the output of a counter ( $\Delta f$  vs.  $t$ ) or of a phase detector ( $\phi[t]$  vs.  $t$ ). The plots show simulated time-domain behaviors corresponding to the most common (power-law) spectral densities;  $h_\alpha$  is an amplitude coefficient. Note: since  $S_{\Delta f} = f^2 S_\phi$ , e.g. white frequency and random walk of phase are equivalent.

# Mixer Functions

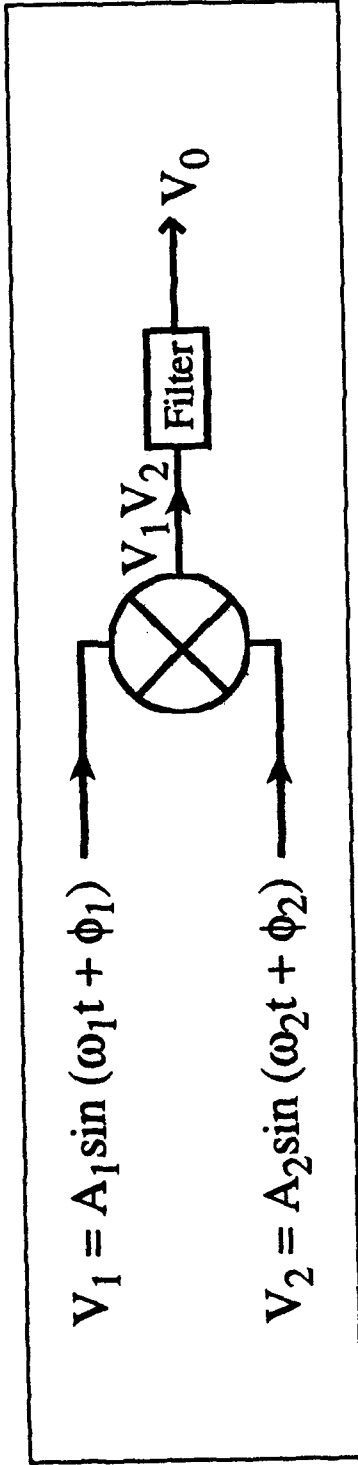

Trigonometric identities:  $\sin(x)\sin(y) = 1/2 \cos(x-y) - 1/2 \cos(x+y)$   
 $\cos(x \pm \pi/2) = \sin(x)$

Let  $\omega_1 = \omega_2$ ;  $\Phi_1 \equiv \omega_1 t + \phi_1$ , and  $\Phi_2 \equiv \omega_2 t + \phi_2$ . Then the mixer can become:

- **Phase detector:** When  $\Phi_1 = \Phi_2 + \pi/2$  and  $A_1 = A_2 = 1$ , then

$$V_0 = \frac{1}{2} \sin(\Phi_1 - \Phi_2) = \frac{1}{2} (\Phi_1 - \Phi_2) \text{ for small } \phi's$$

- **AM detector:** When  $A_2 = 1$  and the filter is a low-pass filter, then

$$V_0 = \frac{1}{2} A_1 \cos(\Phi_1 - \Phi_2); \text{ if } \phi_1 \approx \phi_2, \text{ then } V_0 \approx \frac{1}{2} A_1$$

- **Frequency multiplier:** When  $V_1 = V_2$  and the filter is band-pass at  $2\omega_1$ , then

$$V_0 = \frac{1}{2} A_1^2 \cos(2\omega_1 t + 2\phi_1) \implies \text{Doubles the frequency and phase error.}$$

# Phase Detector

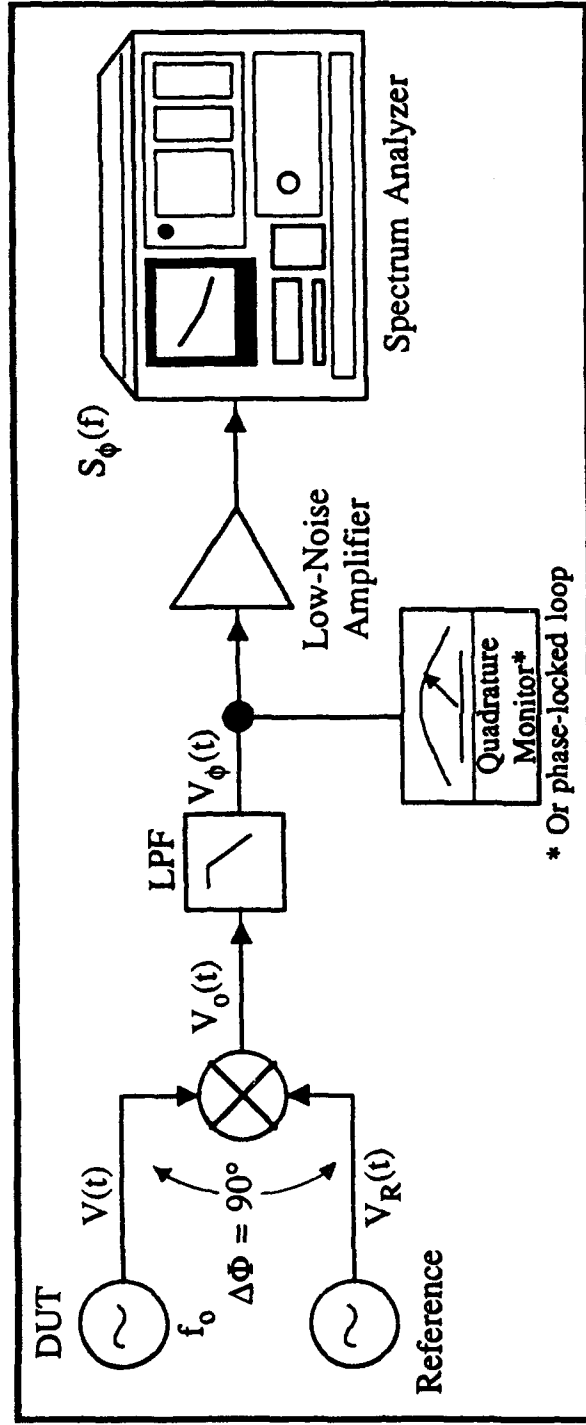

The device under test (DUT) and a reference source, at the same frequency and in phase quadrature (i.e.,  $90^\circ$  out of phase), are input to a double-balanced mixer. Then,

$$V_O(t) = V(t) V_R(t) = K \cos[\phi(t) - \phi_R(t) + \pi/2] + K \cos[2\pi(\nu + \nu_R)t + \dots]$$

The low-pass filter (LPF) eliminates the second cosine term. Then,

$$\text{for } \phi_R(t) \ll \phi(t) \ll \pi/2, \quad V_\phi(t) = K\phi(t),$$

i.e., the phase detector converts phase fluctuations to voltage fluctuations.

# Phase Noise Measurements

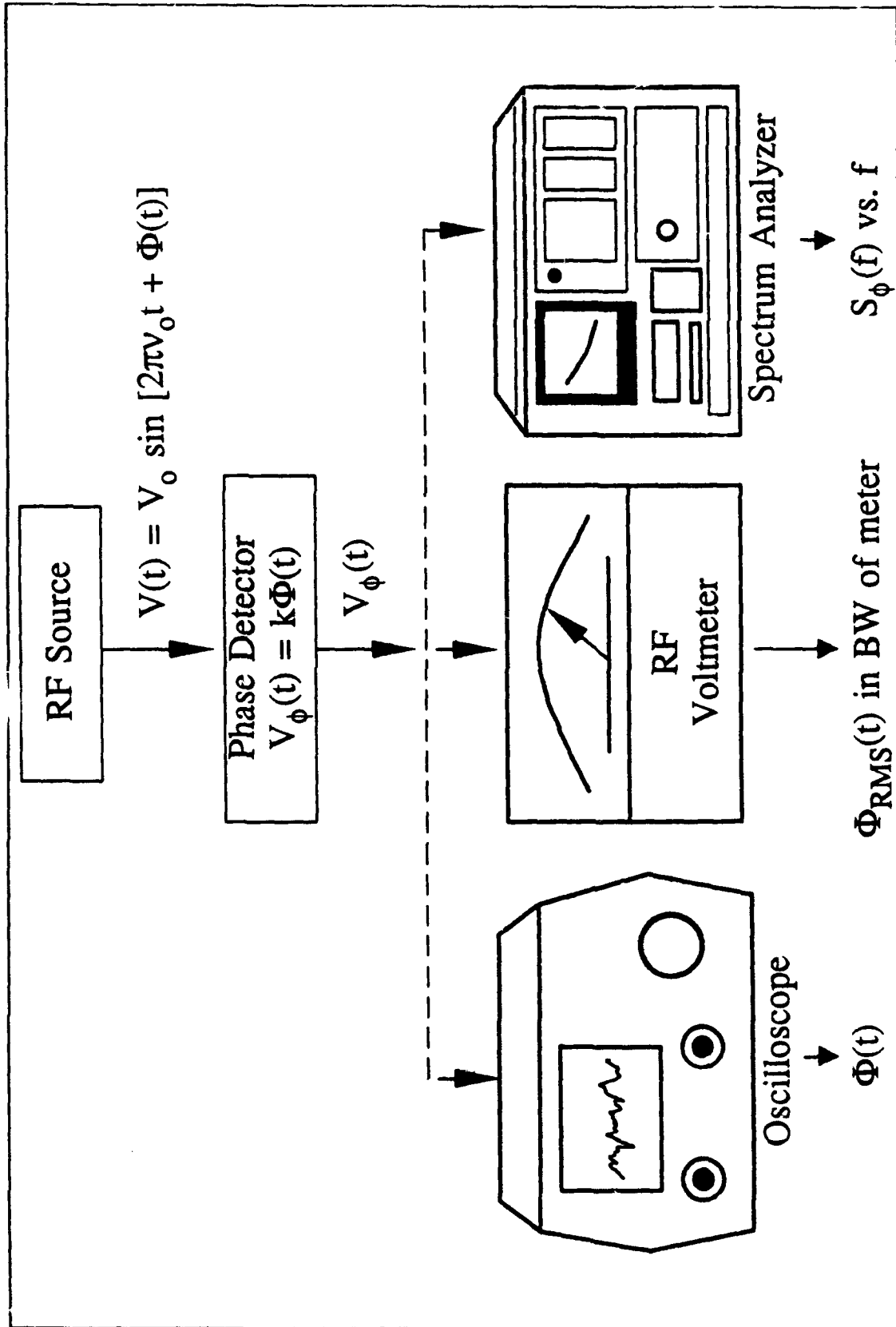



# Frequency - Phase - Time Relationships

$$v(t) = v_0 + \frac{1}{2\pi} \frac{d\phi(t)}{dt} = \text{"instantaneous" frequency}; \quad \phi(t) = \phi_0 + \int_0^t 2\pi[v(t') - v_0] dt'$$

$$y(t) \equiv \frac{v(t) - v_0}{v_0} = \frac{\dot{\phi}(t)}{2\pi v_0} = \text{normalized frequency}; \quad \phi_{\text{RMS BW}}^2 = \int S_{\phi}(f) df$$

$$S_{\phi}(f) = \frac{\phi_{\text{RMS}}^2}{\text{BW}} = \left(\frac{v_0}{f}\right)^2 S_y(f); \quad \mathcal{L}(f) \equiv 1/2 S_{\phi}(f), \text{ per IEEE Standard 1139-1988}$$

$$\sigma_y^2(\tau) = 1/2 \langle (\bar{y}_{k+1} - \bar{y}_k)^2 \rangle = \frac{2}{(\pi v_0 \tau)^2} \int_0^{\infty} S_{\phi}(f) \sin^4(\pi f \tau) df$$

The five common power-law noise processes in precision oscillators are:

$$S_y(f) = h_2 f^2 + h_1 f + h_0 + h_{-1} f^{-1} + h_{-2} f^{-2}$$

(White PM) (Flicker PM) (White FM) (Flicker FM) (Random-walk FM)

$$\text{Time deviation} = x(t) = \int_0^t y(t') dt' = \frac{\phi(t)}{2\pi v_0}$$

\* MIL-O-55310B's definition of phase noise is  $\mathcal{L}(f) = 10 \log [S_{\phi}(f)/2]$ , where the unit of  $\mathcal{L}(f)$  is dBc.

# $S_{\phi}(f)$ to SSB Power Ratio Relationship

Consider the "simple" case of sinusoidal phase modulation at frequency  $f_m$ . Then,  $\phi(t) = \phi_0(t)\sin(2\pi f_m t)$ , and  $V(t) = V_o \cos[2\pi f_c t + \phi(t)] = V_o \cos[2\pi f_c t + \phi_0(t)\sin(2\pi f_m t)]$ , where  $\phi_0(t)$  = peak phase excursion, and  $f_c$  = carrier frequency. Cosine of a sine function suggests a Bessel function expansion of  $V(t)$  into its components at various frequencies via the identities:

$$\begin{aligned} \cos(X + Y) &= \cos X \cos Y - \sin X \sin Y \\ \cos X \cos Y &= 1/2[\cos(X + Y) + \cos(X - Y)] \\ -\sin X \sin Y &= [\cos(X + Y) - \cos(X - Y)] \\ \cos(B \sin X) &= J_0(B) + 2 \sum_{n=1}^{\infty} J_{2n}(B) \cos(2nX) \\ \sin(B \sin X) &= 2 \sum_{n=0}^{\infty} J_{2n+1}(B) \sin[(2n + 1)X] \end{aligned}$$

After some messy algebra,  $S_v(f)$  and  $S_{\phi}(f)$  are as shown on the next page.

Then, SSB Power Ratio at  $f_m = \frac{V_o^2 J_1^2[\Phi(f_m)]}{V_o^2 J_0^2[\Phi(f_m)] + 2 \sum_{i=1}^{\infty} J_i^2[\Phi(f_m)]}$   
 if  $\Phi(f_m) \ll 1$ , then  $J_0 = 1$ ,  $J_1 = 1/2\Phi(f_m)$ ,  $J_n = 0$  for  $n > 1$ , and

$$\text{SSB Power Ratio} = \mathcal{L}(f_m) = \frac{\Phi^2(f_m)}{4} = \frac{S_{\phi}(f_m)}{2}$$

# $S_{\phi}(f)$ , $S_v(f)$ and $\mathcal{L}(f)$

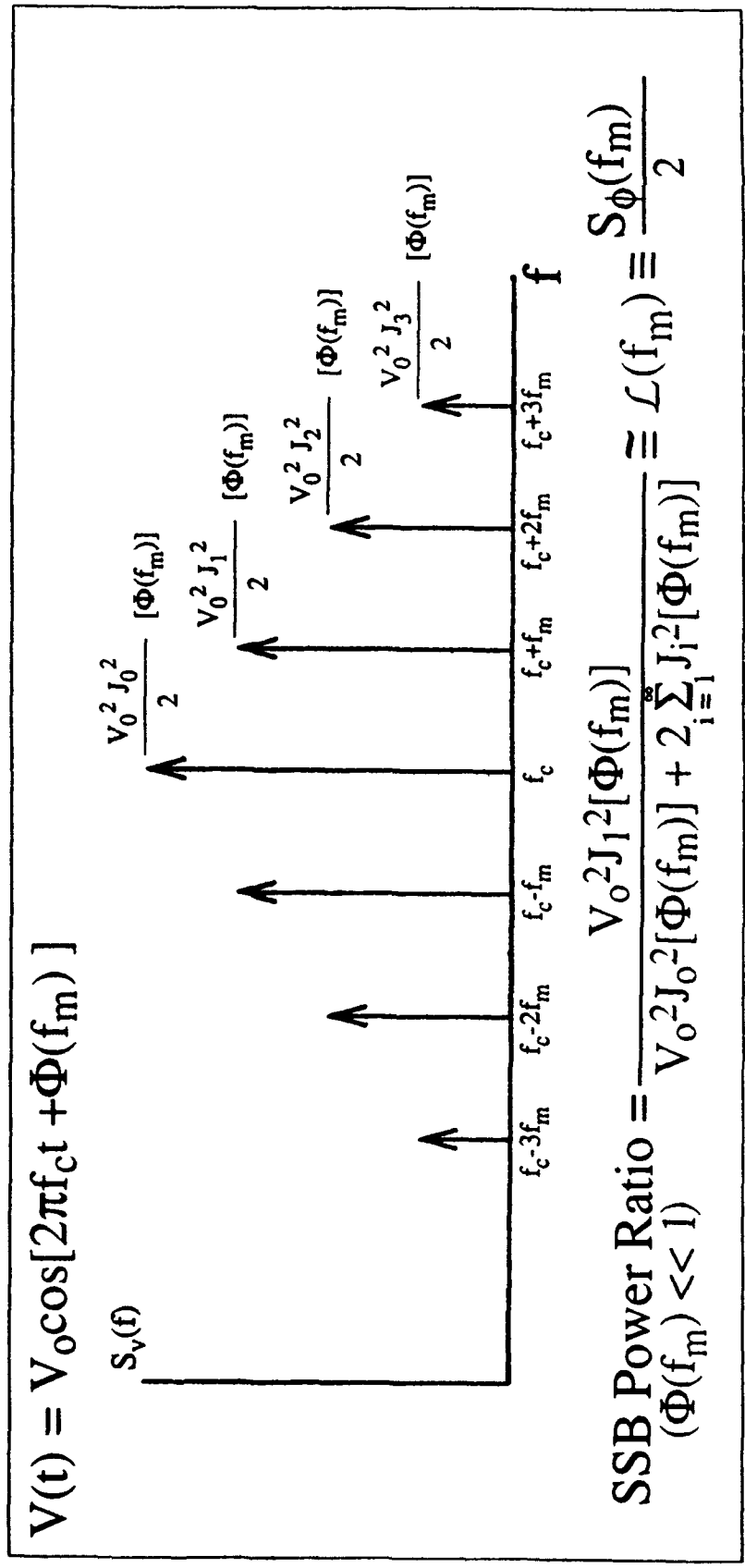
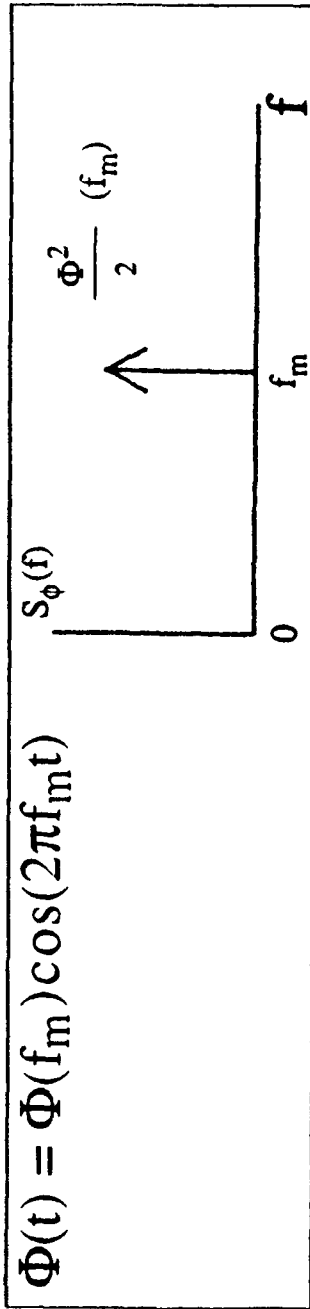

# Types of Phase Noise

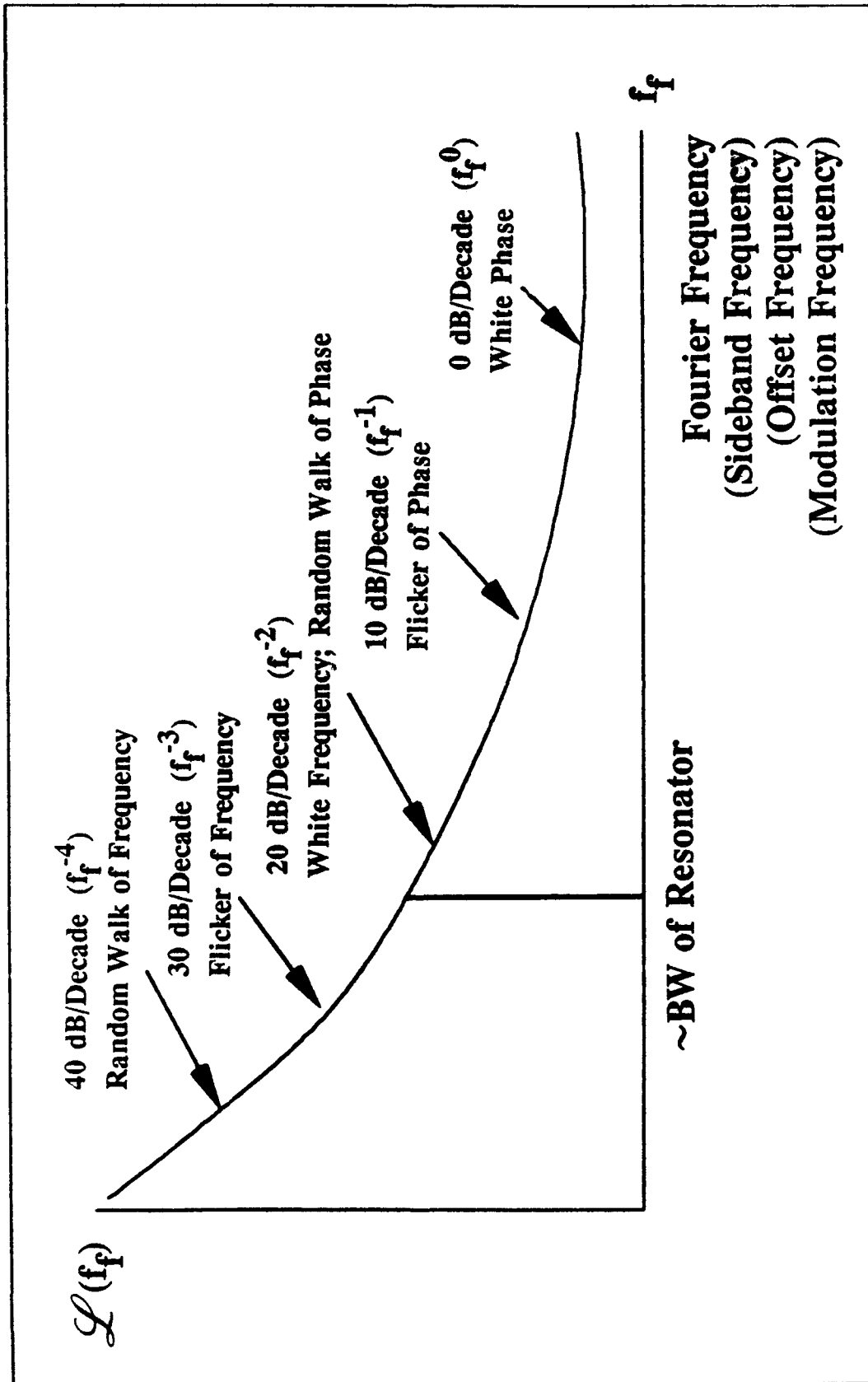

# Noise in Crystal Oscillators

- The resonator is the primary noise source close to the carrier; the oscillator circuitry is the primary source far from the carrier.
- Frequency multiplication by  $N$  increases the phase noise as  $N^2$  (i.e., by  $20 \log N$ , in dB's).
- Vibration-induced "noise" can dominate all other sources of noise in many applications (see acceleration effects section, later).
- Close to the carrier (within BW of resonator),  $S_y(f)$  varies as  $1/f$ ,  $S_\phi(f)$  as  $1/f^3$ , where  $f = \text{offset from carrier frequency}$ ,  $v$ ;  $S_\phi(f)$  also varies as  $1/Q^4$ , where  $Q = \text{unloaded } Q$ . Since  $Q_{\max} v = \text{const.}$ ,  $S_\phi(f) \propto v^4$ . ( $Q_{\max} v$ )<sub>BAW</sub> =  $1.6 \times 10^{13}$  Hz; ( $Q_{\max} v$ )<sub>SAW</sub> =  $1.05 \times 10^{13}$  Hz.
- In the time domain, noise floor is  $\sigma_y(\tau) \geq (2.0 \times 10^{-7})Q^{-1} \approx 1.2 \times 10^{-20} v$ ,  $v$  in Hz. In the regions where  $\sigma_y(\tau)$  varies as  $\tau^{-1}$  and  $\tau^{-1/2}$  ( $\tau^{-1/2}$  occurs in atomic frequency standards),  $\sigma_y(\tau) \propto (QS_R)^{-1}$ , where  $S_R$  is the signal-to-noise ratio; i.e., the higher the  $Q$  and the signal-to-noise ratio, the better the short term stability (and the phase noise far from the carrier, in the frequency domain).
- Loaded  $Q$  of oscillator affects noise when the oscillator circuitry is a significant noise source.
- Noise floor is limited by Johnson noise; noise power,  $kT = -174$  dBm/Hz at  $290^\circ\text{K}$ .
- Higher signal level will improve the noise floor but not the close-in noise. (In fact, high drive levels generally degrade the close-in noise.)
- Low noise SAW vs. low noise BAW multiplied up: BAW is lower noise at  $f < \sim 1$  kHz, SAW is lower noise at  $f > \sim 1$  kHz; can phase lock the two to get the best of both.

# Low-Noise SAW and BAW Multiplied to 10 GHz

(in a nonvibrating environment)

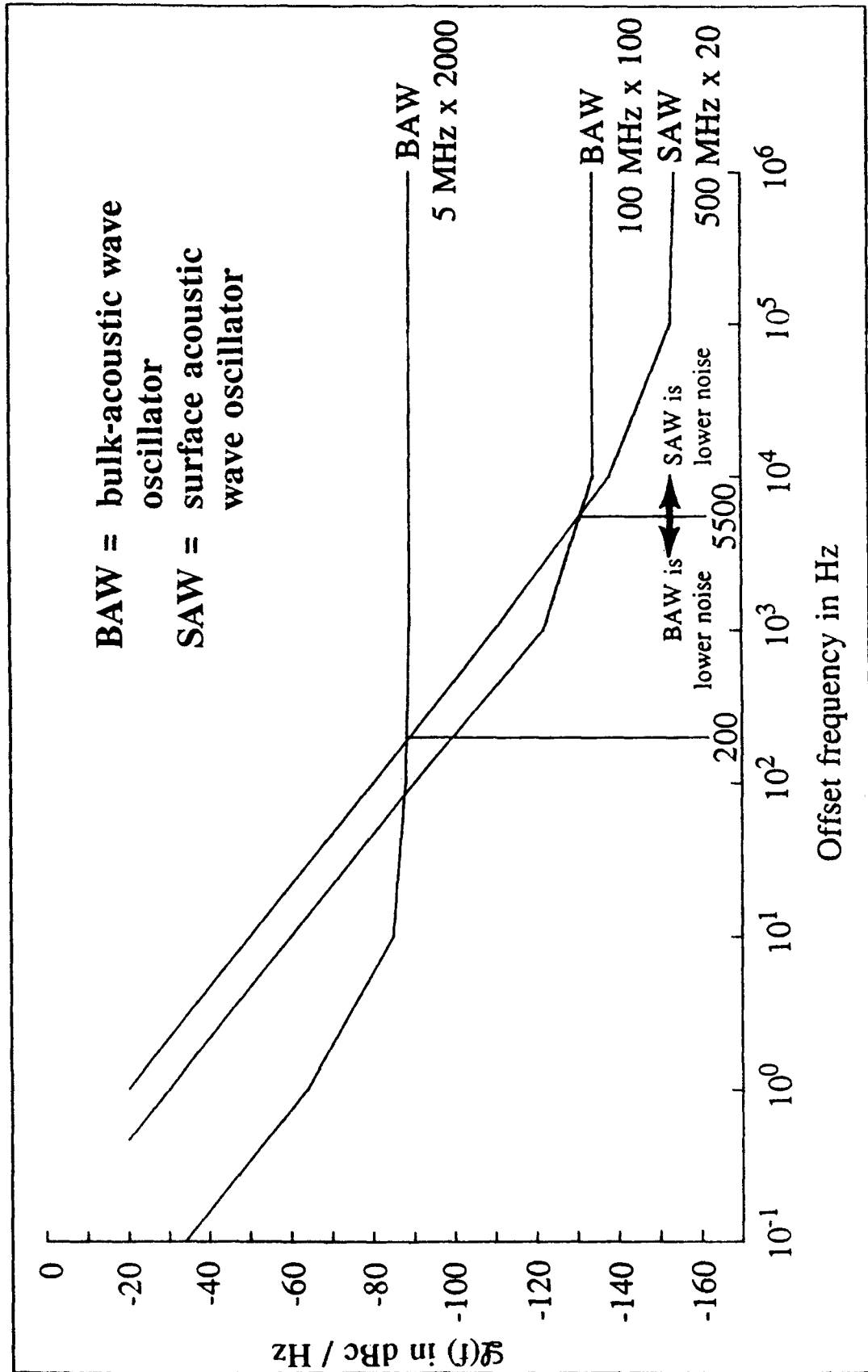

# Low-Noise SAW and BAW Multiplied to 10 GHz

(in a vibrating environment)

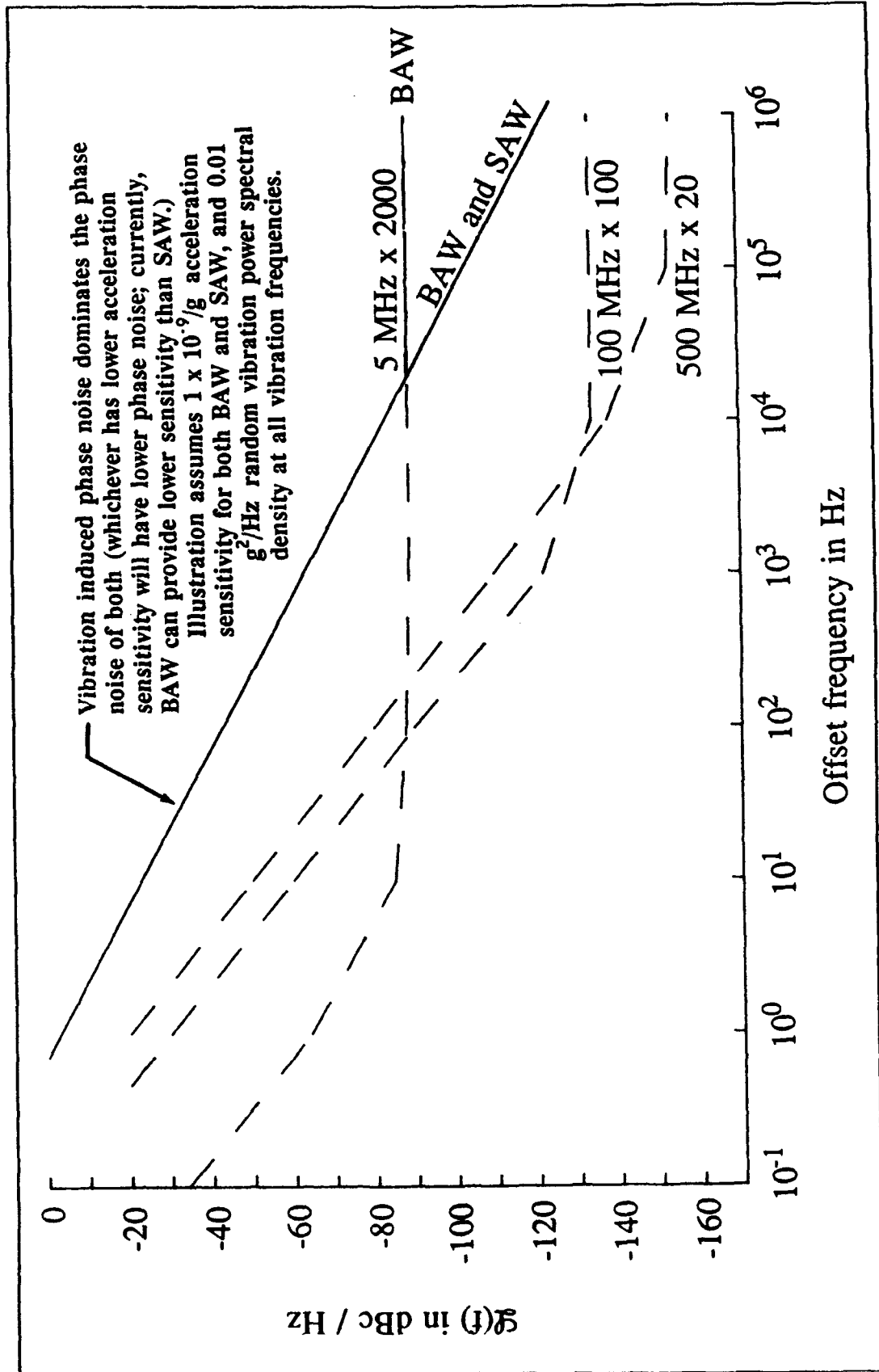

# Effects of Frequency Multiplication

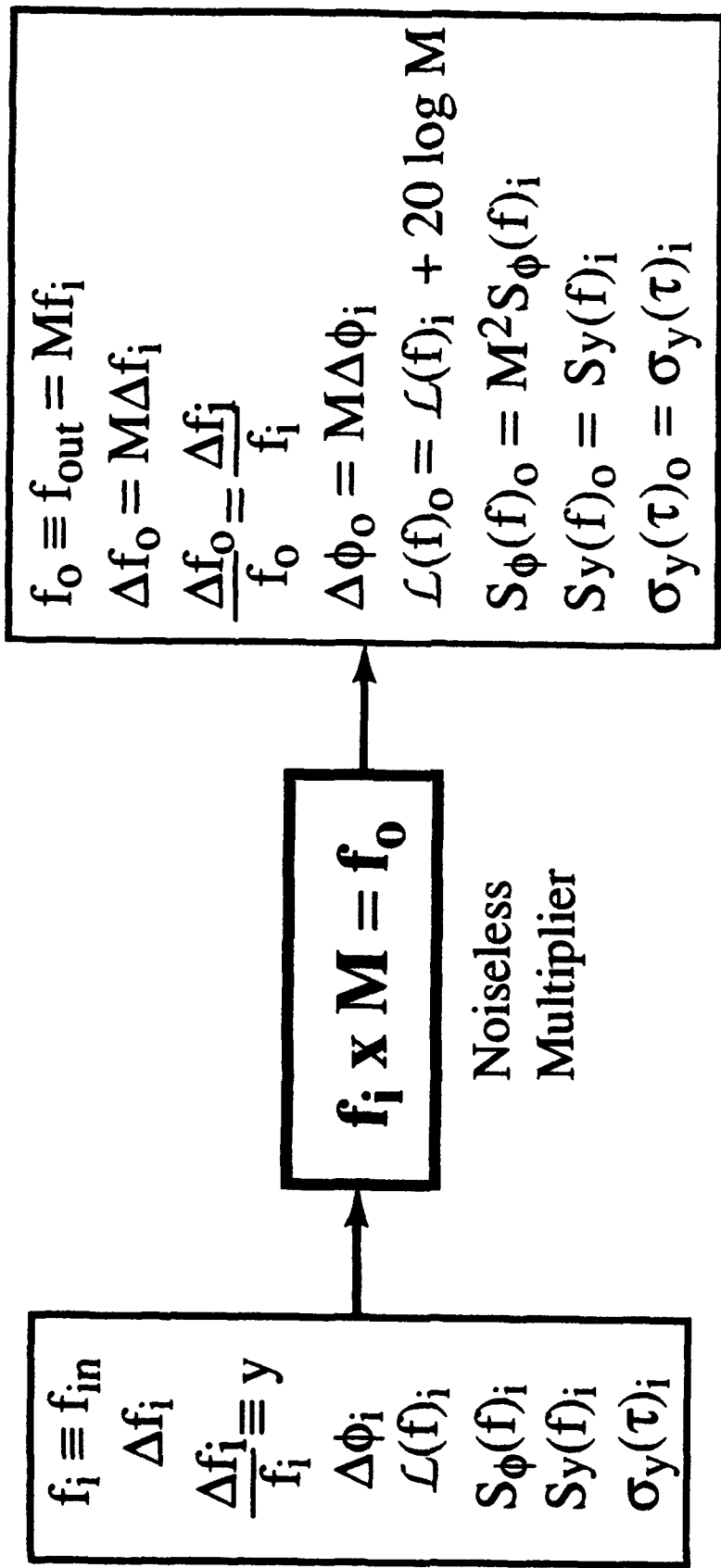

Note that  $y = \frac{\Delta f}{f}$ ,  $S_y(f)$ , and  $\sigma_y(\tau)$  are unaffected by frequency multiplication.



# Quartz Wristwatch Accuracy vs. Temperature

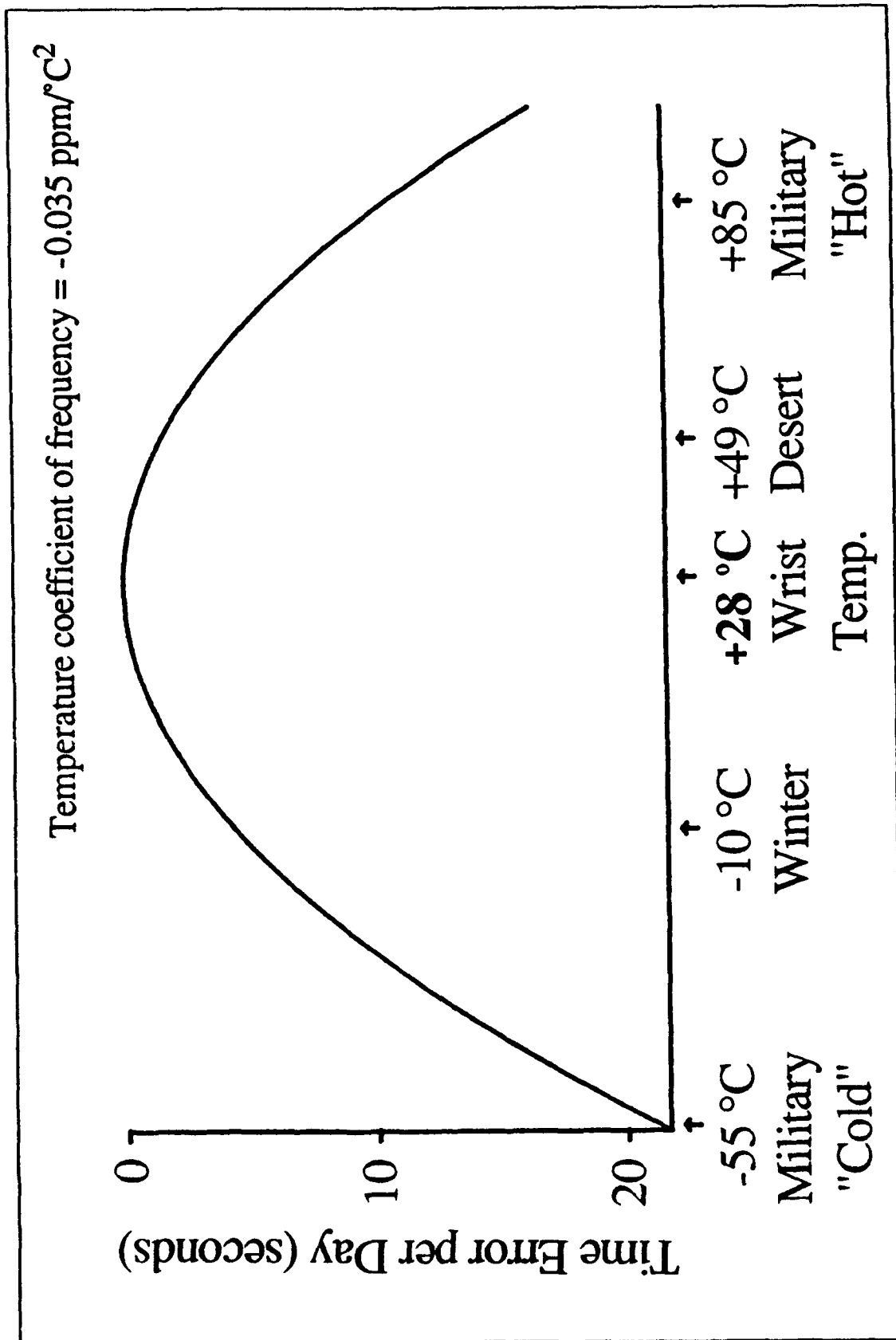

# Frequency vs. Temperature Characteristic

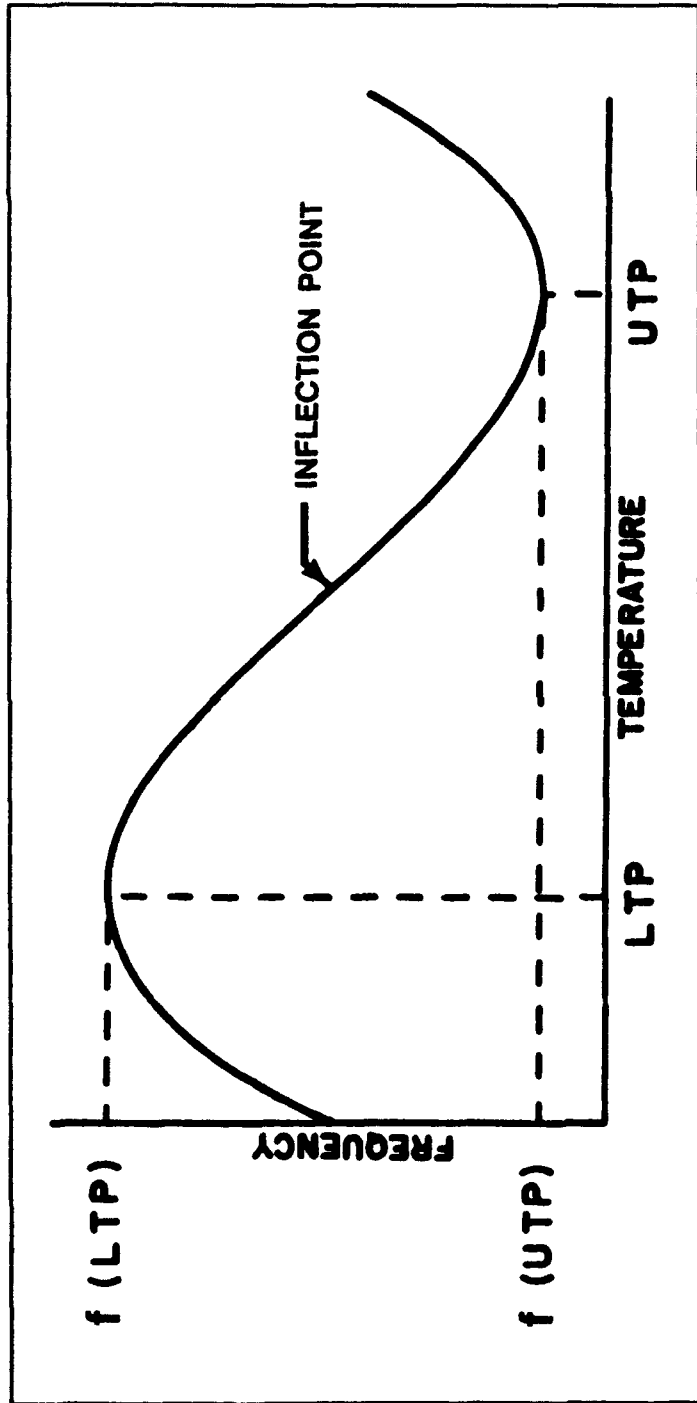

This frequency vs. temperature characteristic is typical of AT-cut and SC-cut resonators. The upper and lower turnover points (UTP and LTP)

are the points where  $\frac{df(T)}{dT} = 0$ . The inflection point is where  $\frac{d^2f(T)}{dT^2} = 0$ .

The inflection temperatures are  $\approx 26^\circ\text{C}$  for AT-cuts, and  $\approx 96^\circ$  to  $105^\circ\text{C}$  for SC-cuts.

# Resonator f vs. T Determining Factors

- **Primary:** Angles of cut
- **Secondary:**
  - ☛ Overtone
  - ☛ Blank geometry (contour, dimensional ratios)
  - ☛ Material impurities and strains
  - ☛ Mounting & bonding stresses (magnitude and direction)
  - ☛ Electrodes (size, shape, thickness, density, stress)
  - ☛ Drive level
  - ☛ Interfering modes
  - ☛ Load reactance (value & temperature coefficient)
  - ☛ Temperature rate of change
  - ☛ Thermal history
  - ☛ Ionizing radiation

# Frequency-Temperature vs. Angle-of-Cut, AT-cut, AT-cut

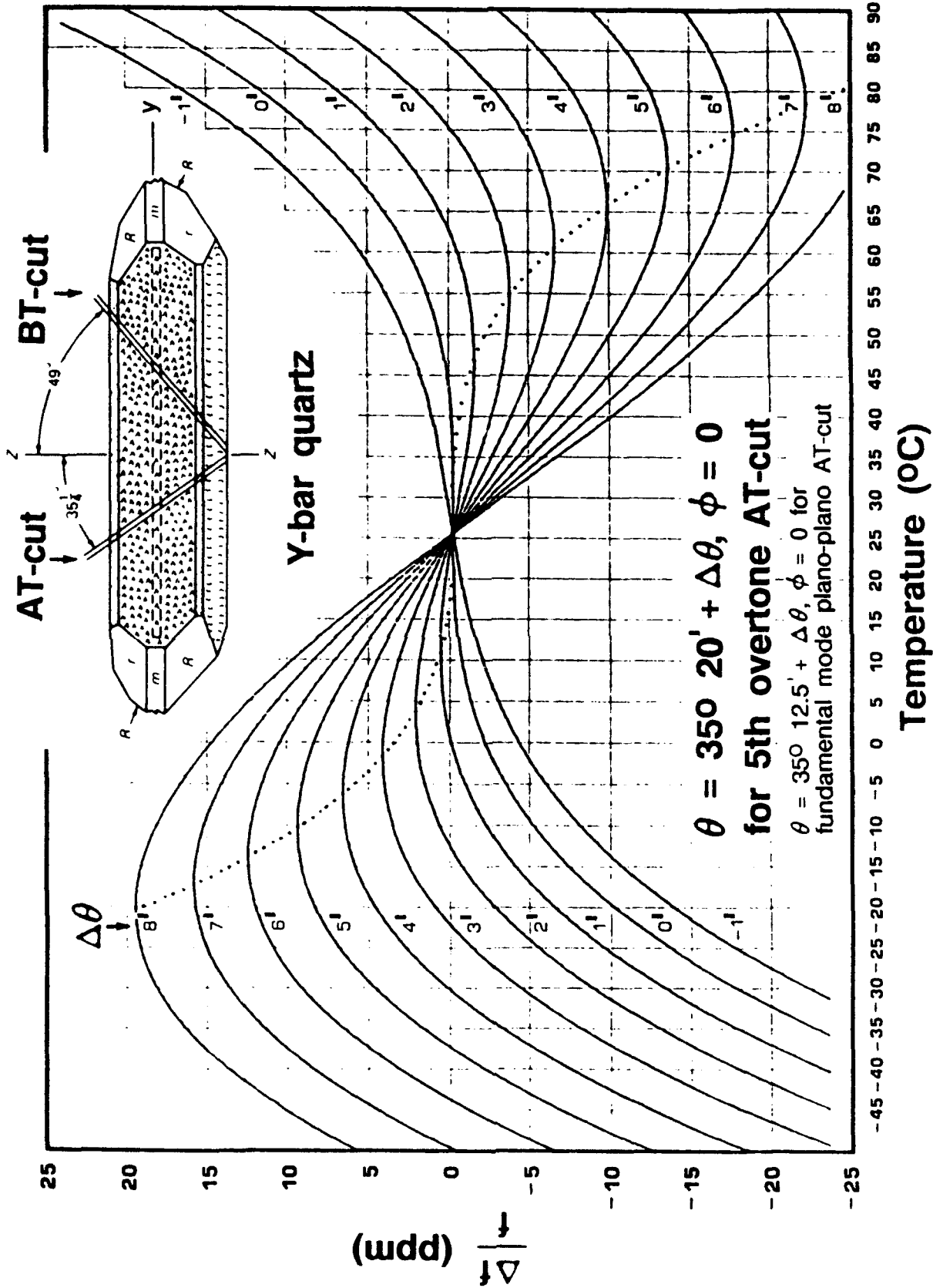

# Desired f vs. T for SC-cut Resonator

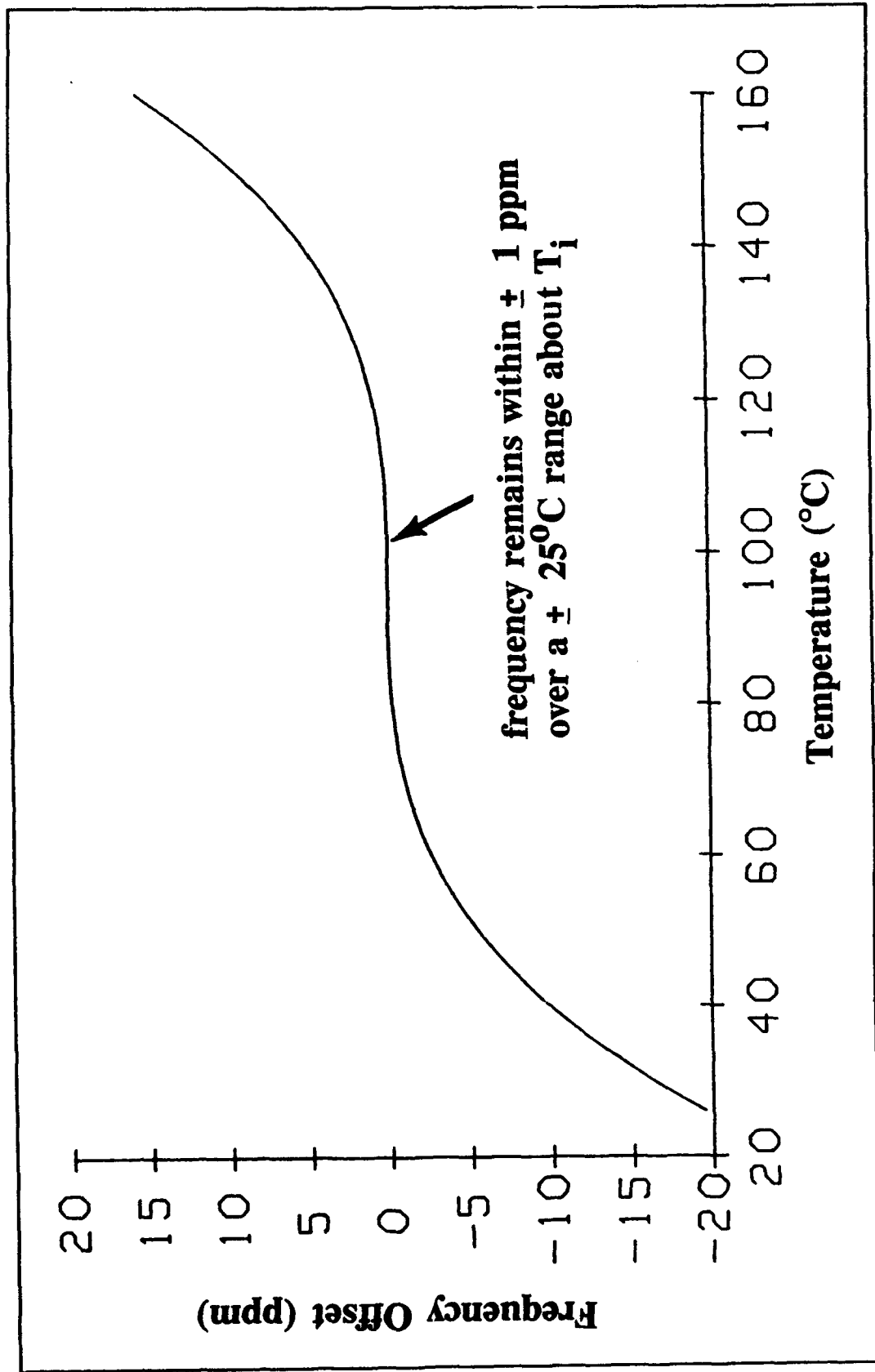

# OCXO Oven's Effect on Stability

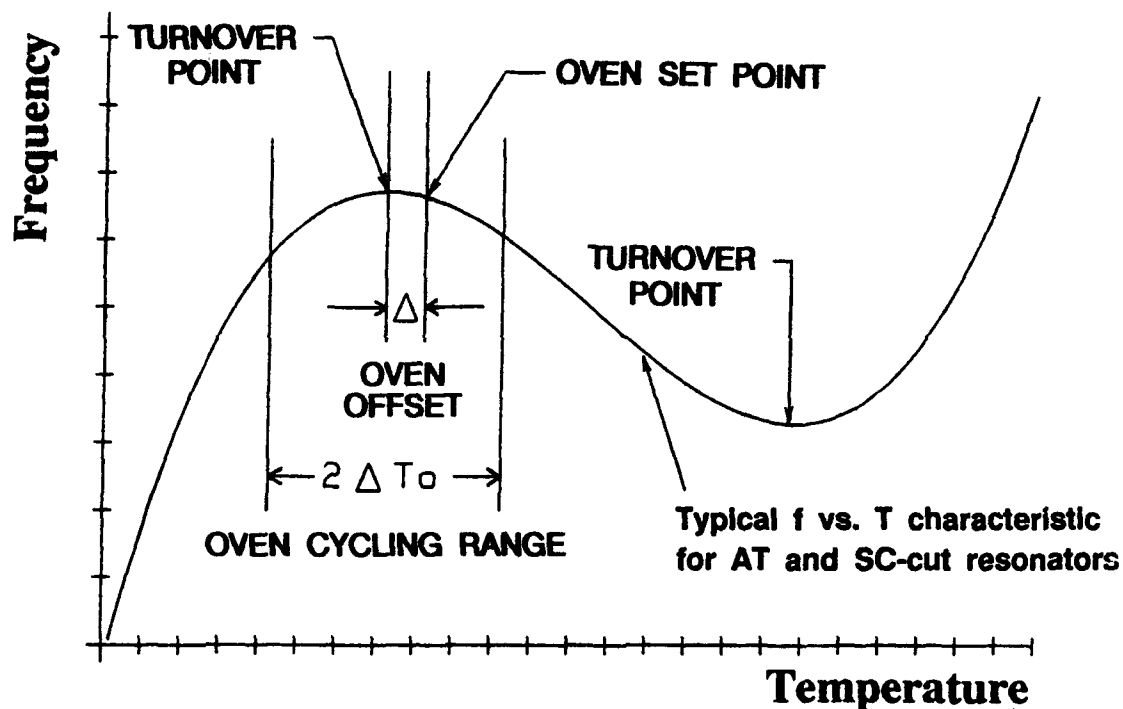

## Oven Parameters vs. Stability for SC-cut Oscillator Assuming $T_i - T_{LTP} = 10^\circ\text{C}$

$T_i - T_{LTP} = 10^\circ\text{C}$		Oven Cycling Range (millidegrees)			
		10	1	0.1	0.01
Oven Offset (millidegrees)	100	$4 \times 10^{-12}$	$4 \times 10^{-13}$	$4 \times 10^{-14}$	$4 \times 10^{-15}$
	10	$6 \times 10^{-13}$	$4 \times 10^{-14}$	$4 \times 10^{-15}$	$4 \times 10^{-16}$
	1	$2 \times 10^{-13}$	$6 \times 10^{-15}$	$4 \times 10^{-16}$	$4 \times 10^{-17}$
	0.1	$2 \times 10^{-13}$	$2 \times 10^{-15}$	$6 \times 10^{-17}$	$4 \times 10^{-18}$
	0	$2 \times 10^{-13}$	$2 \times 10^{-15}$	$2 \times 10^{-17}$	$2 \times 10^{-19}$

A comparable table for AT and other non-thermal-transient compensated cuts of oscillators would not be meaningful because the dynamic  $f$  vs.  $T$  effects would generally dominate the static  $f$  vs.  $T$  effects.

# Effect of Load Capacitance on $f$ vs. $T$

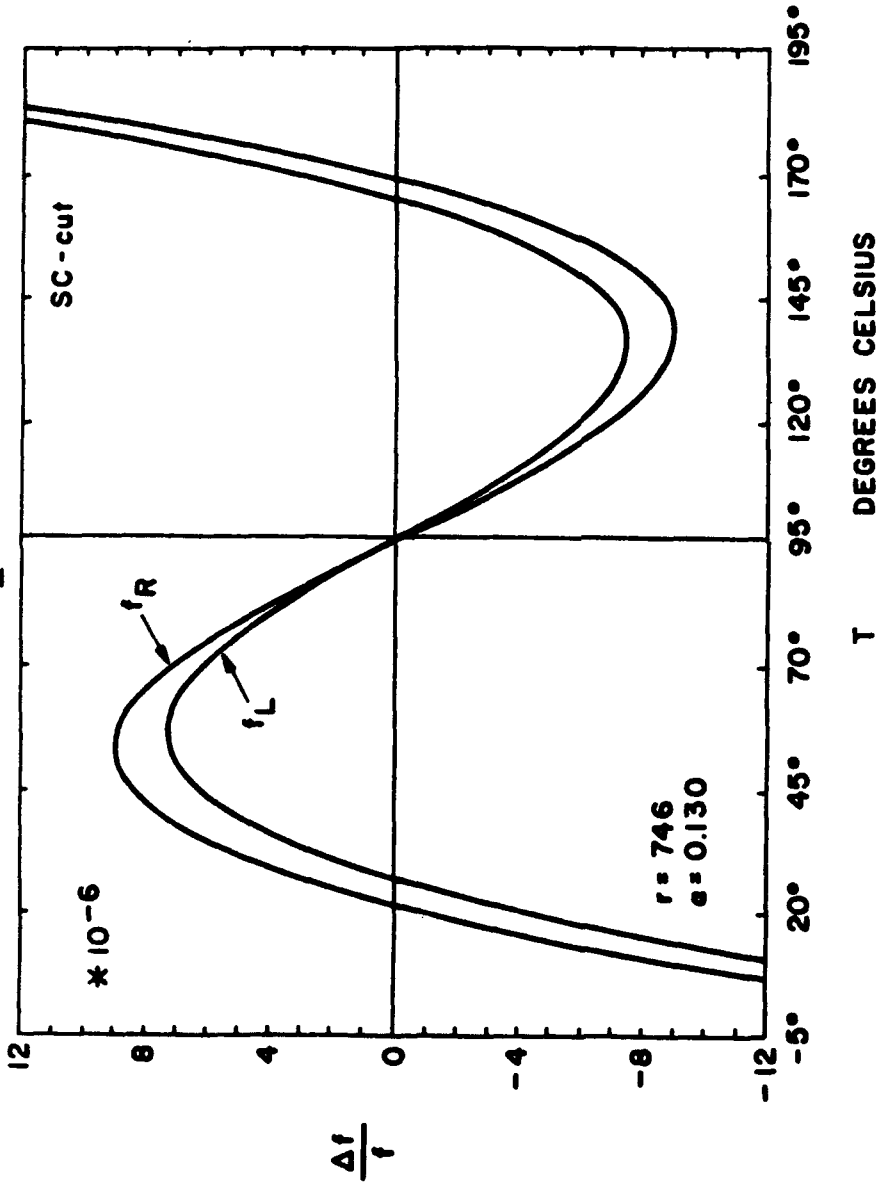

The  $f$  vs.  $T$  characteristics with and without a load capacitor: 1.  $C_L$  raises the frequency at all  $T$ 's (curve with  $f_L$  has been vertically displaced for clarity), 2.  $C_L$  rotates the  $f$  vs.  $T$  to lower apparent angle of cut, i.e., it reduces peak-to-peak  $f$  and turning-point-to-turning-point  $T$ , and 3. temperature coefficient of  $C_L$  can greatly amplify  $f$  vs.  $T$  rotation.

# Effects of Harmonics on f vs. T

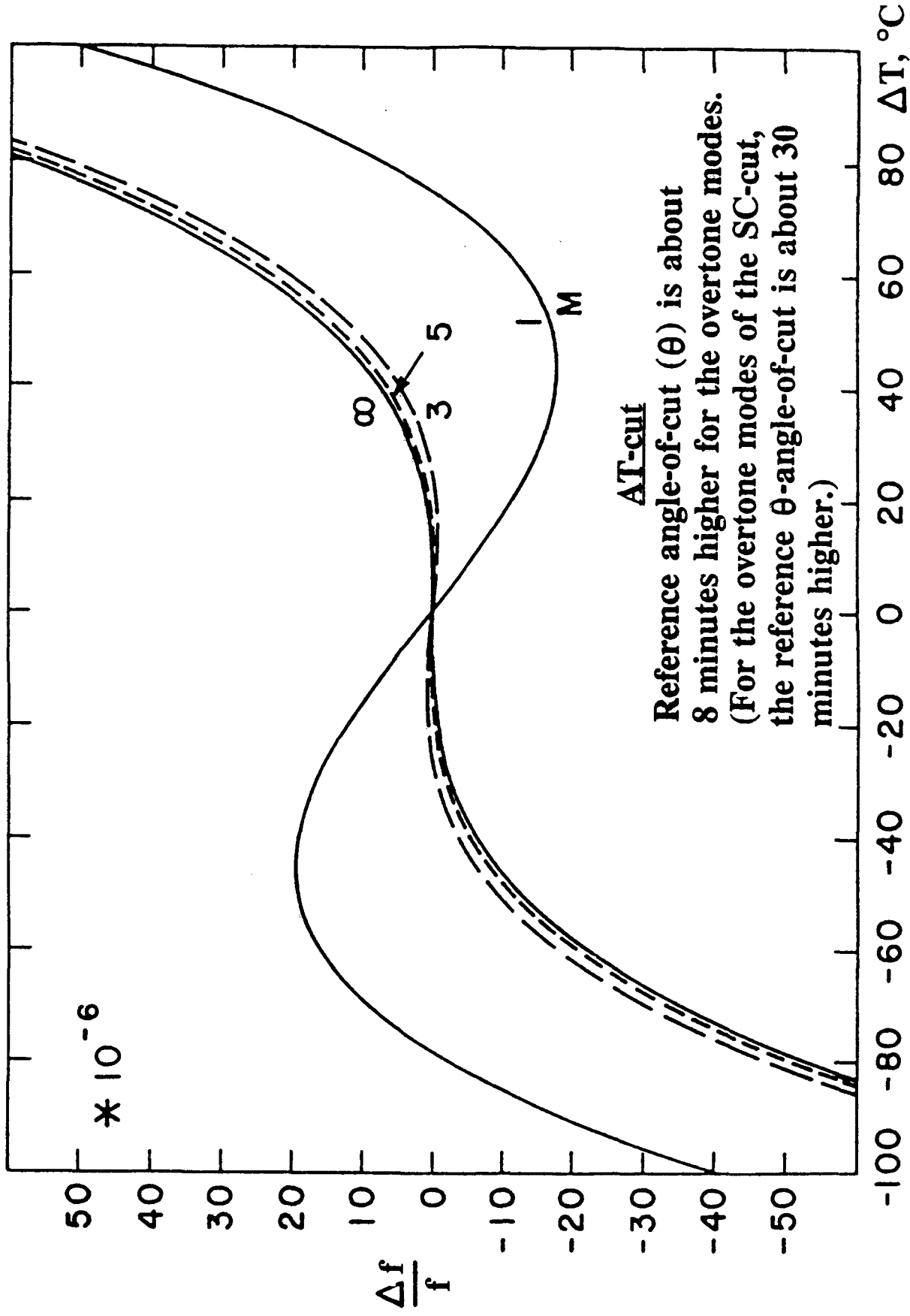

**AT-cut**  
 Reference angle-of-cut ( $\theta$ ) is about 8 minutes higher for the overtone modes.  
 (For the overtone modes of the SC-cut, the reference  $\theta$ -angle-of-cut is about 30 minutes higher.)



# Warmup of AT- and SC-cut Resonators

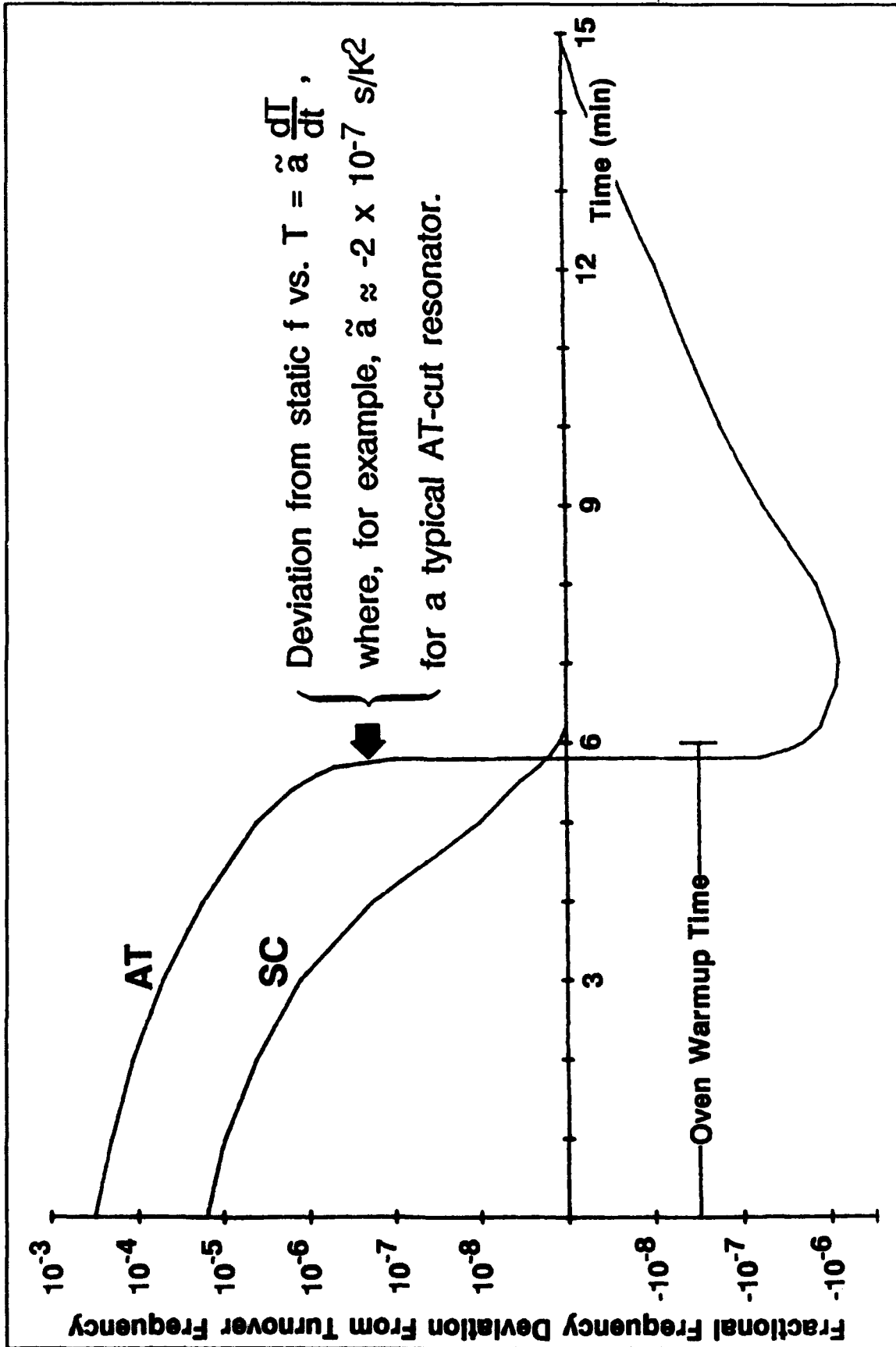

# TCXO Thermal Hysteresis

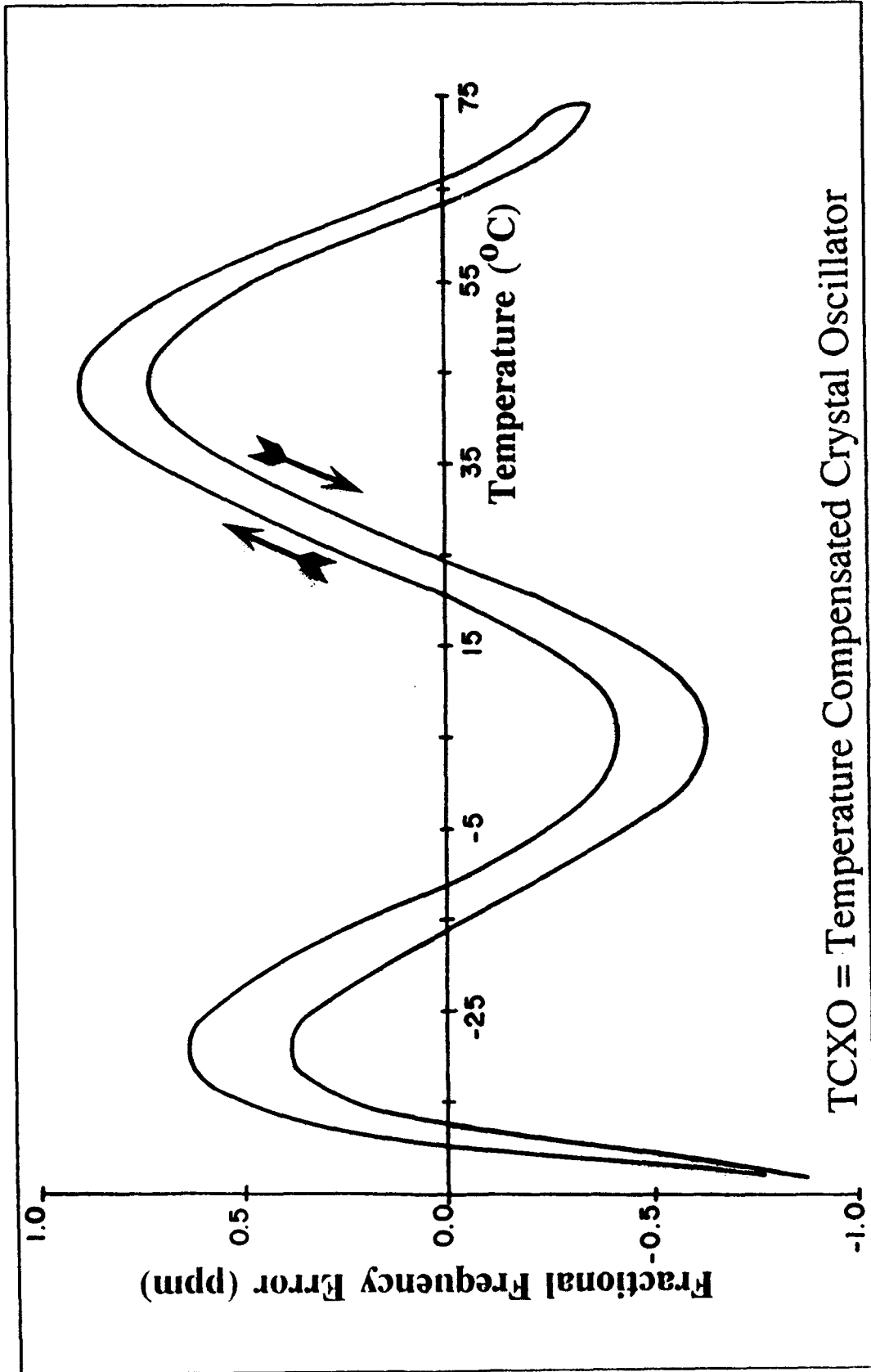

TCXO = Temperature Compensated Crystal Oscillator

# OCXO Retrace

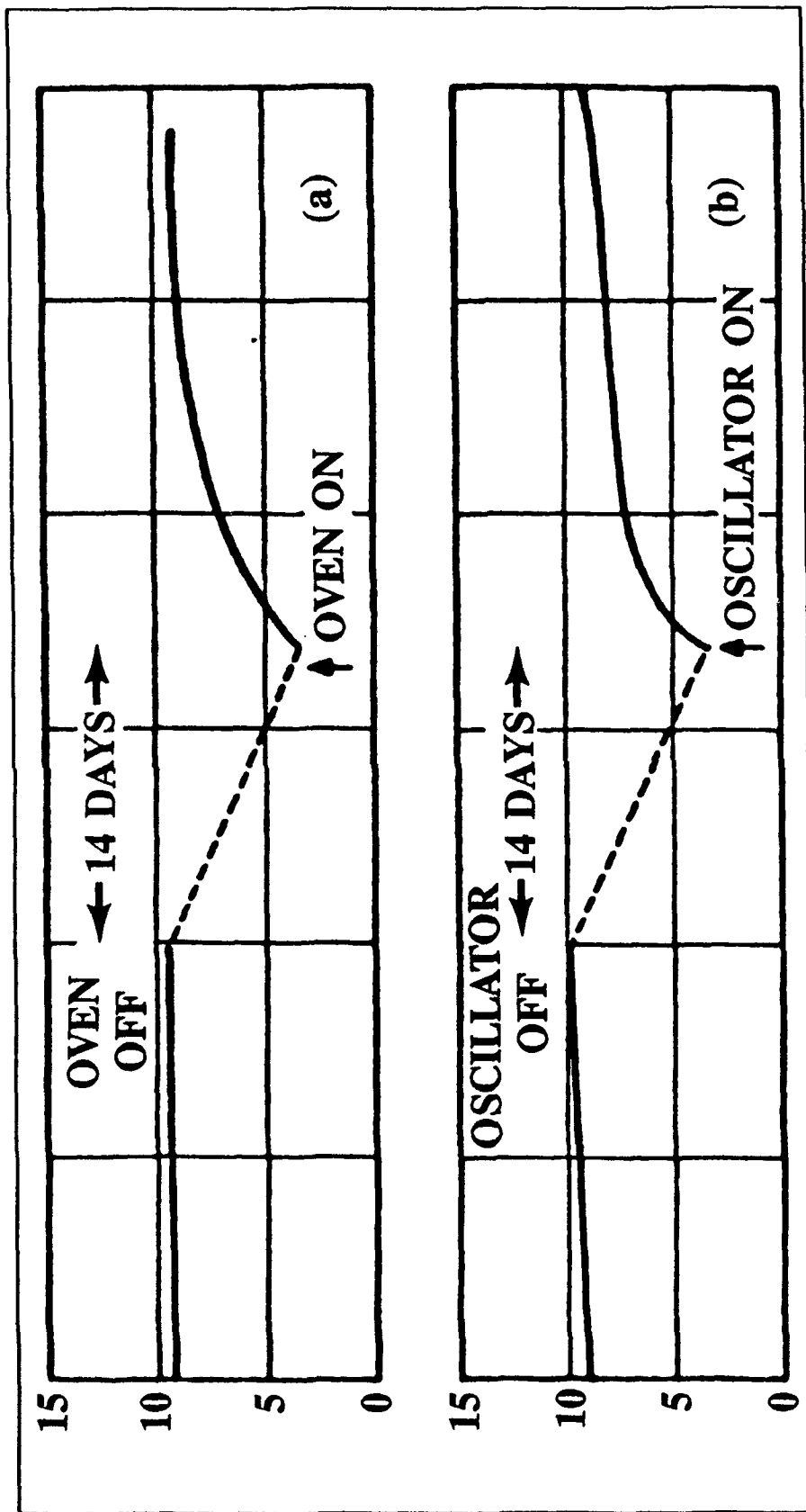

In (a), the oscillator was kept on continuously while the oven was cycled off and on. In (b), the oven was kept on continuously while the oscillator was cycled off and on.

# TCXO Trim Effect

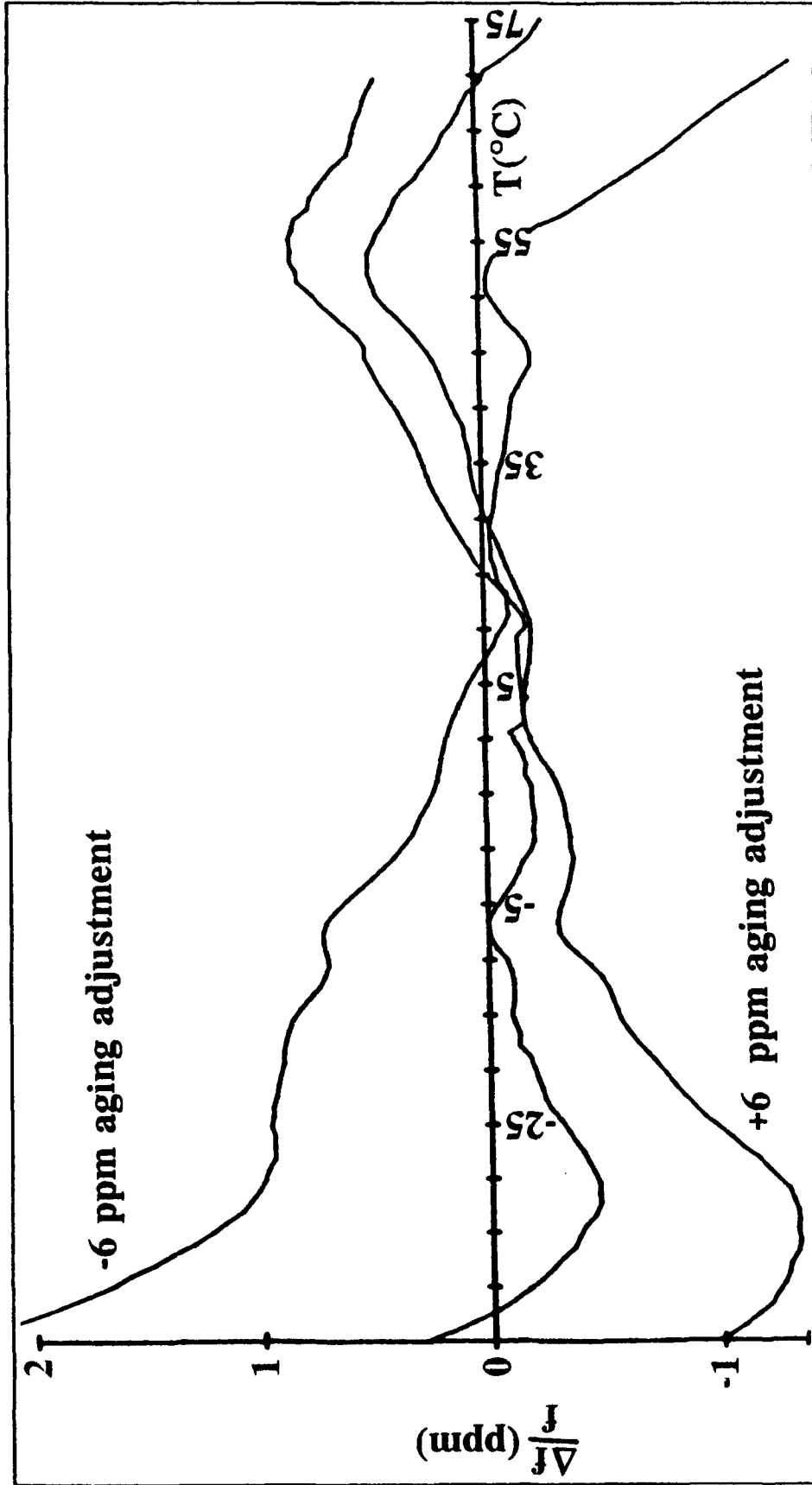

In TCXO's, temperature sensitive reactances are used to compensate for  $f$  vs.  $T$  variations. A variable reactance is also used to compensate for TCXO aging. The effect of the adjustment for aging on  $f$  vs.  $T$  stability is the "trim effect." Curves show  $f$  vs.  $T$  stability of a "0.5 ppm TCXO," at zero trim and at  $\pm 6$  ppm trim. (Curves have been vertically displaced for clarity.)

# Why the Trim Effect?

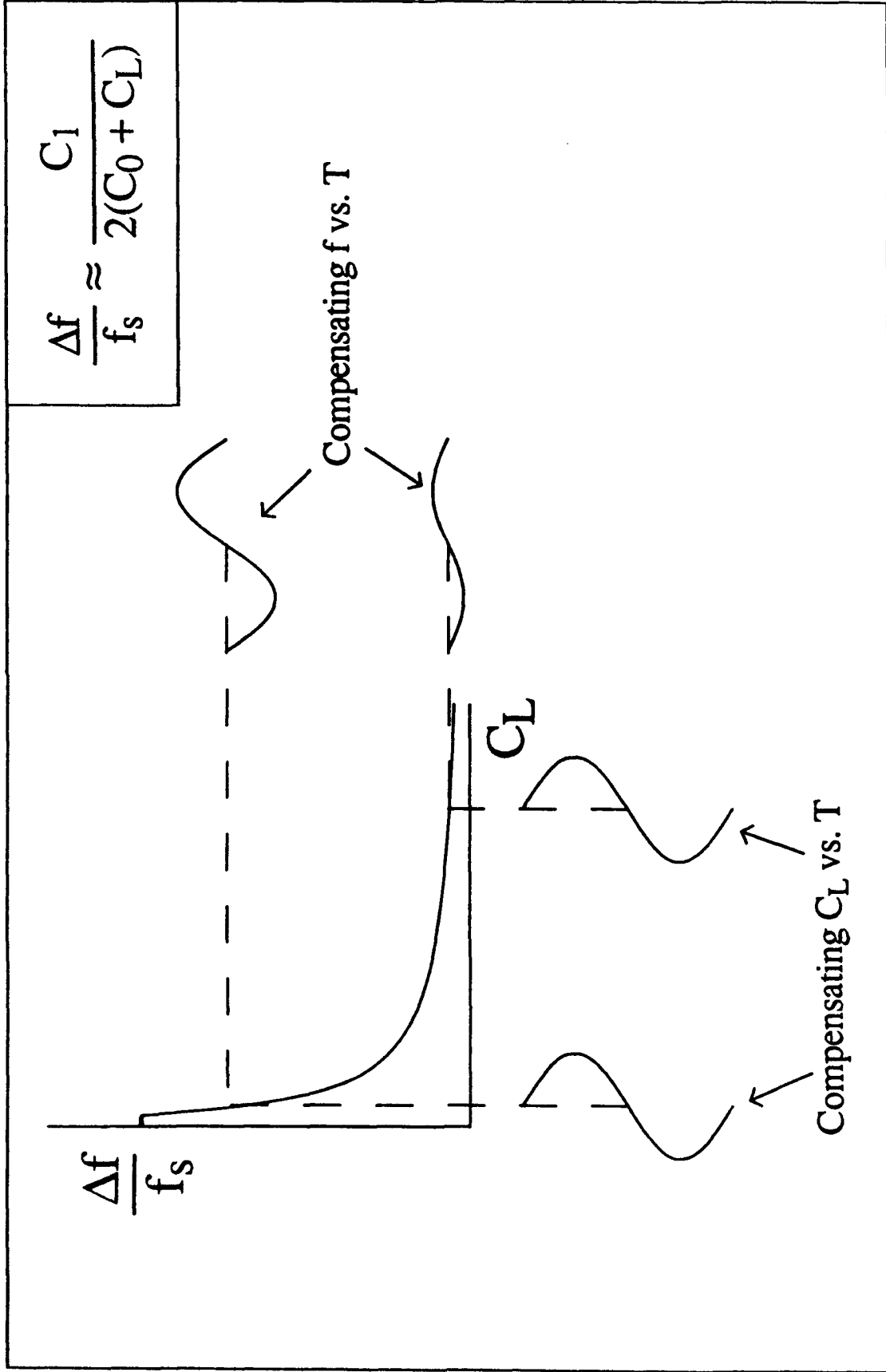

# Activity Dips

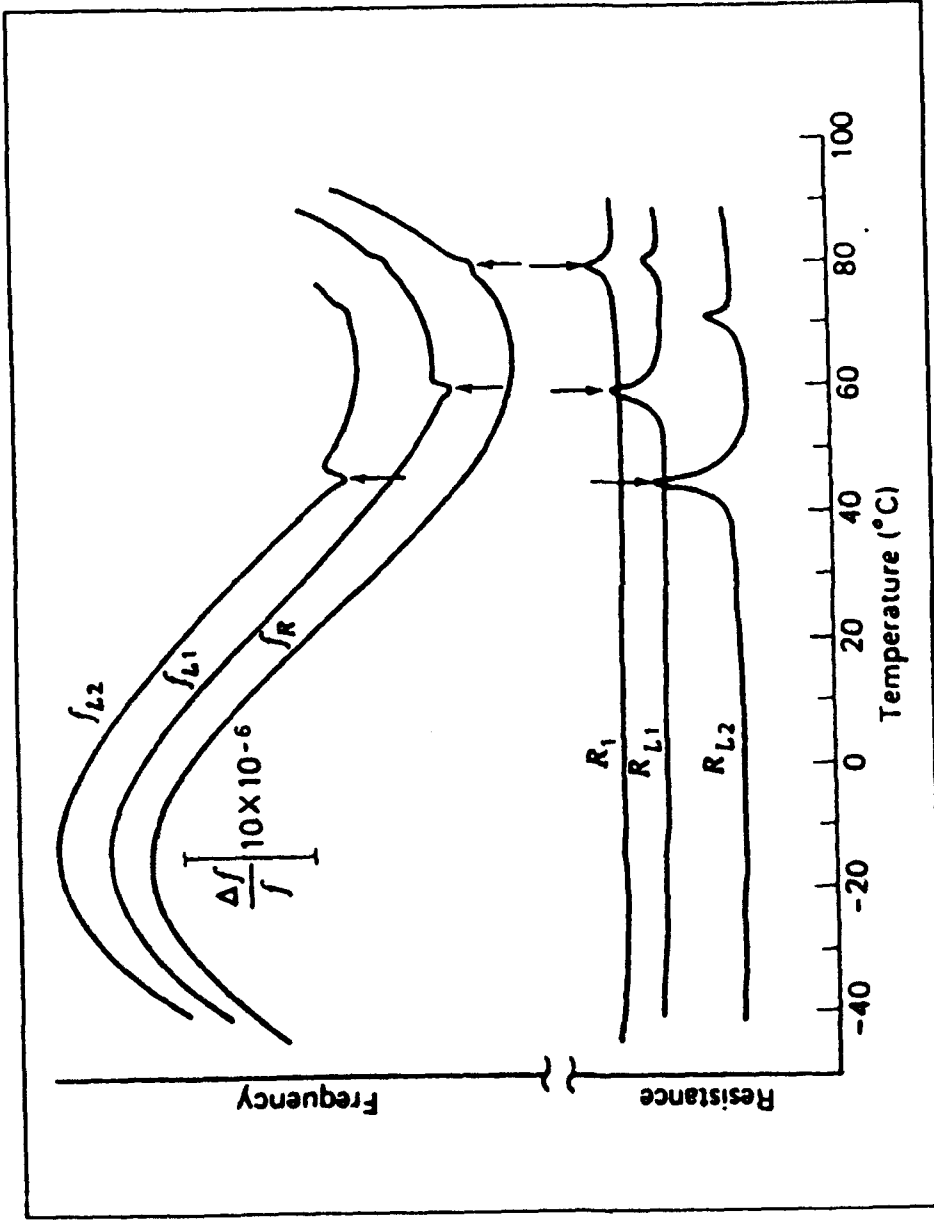

Activity dips in the  $f$  vs.  $T$  when operated with and without load capacitors. (Curves have been vertically displaced for clarity.) Dip temperatures are a function of  $C_L$ , which indicates that the dip is caused by a mode (probably flexure) with a large negative temperature coefficient. See also "Unwanted Modes vs. Temperature" in Chapter 3.

# Oscillator Circuit Caused Instabilities

- **Effect of load reactance change:**

$$\text{Let } \delta f \equiv \frac{\Delta f}{f} = \frac{C_1}{2(C_0 + C_L)},$$

$$\text{then, } \frac{\Delta(\delta f)}{\Delta C_L} = - \frac{C_1}{2(C_0 + C_L)^2}$$

**Example:** If  $C_0 = 5$  pF,  $C_1 = 14$  fF and  $C_L = 20$  pF, then  $\Delta C_L = 10$  fF ( $= 5 \times 10^{-4}$ ) causes  $\approx 1 \times 10^{-7}$  frequency change, and  $C_L$  aging of 10 ppm per day causes  $2 \times 10^{-9}$  per day of oscillator aging.

- **Drive level changes:** Typically  $10^{-8}$  per  $\text{ma}^2$  for a 10 MHz 3rd SC-cut.
- **DC bias on the crystal** also contributes to oscillator aging.

# Frequency vs. Drive Level

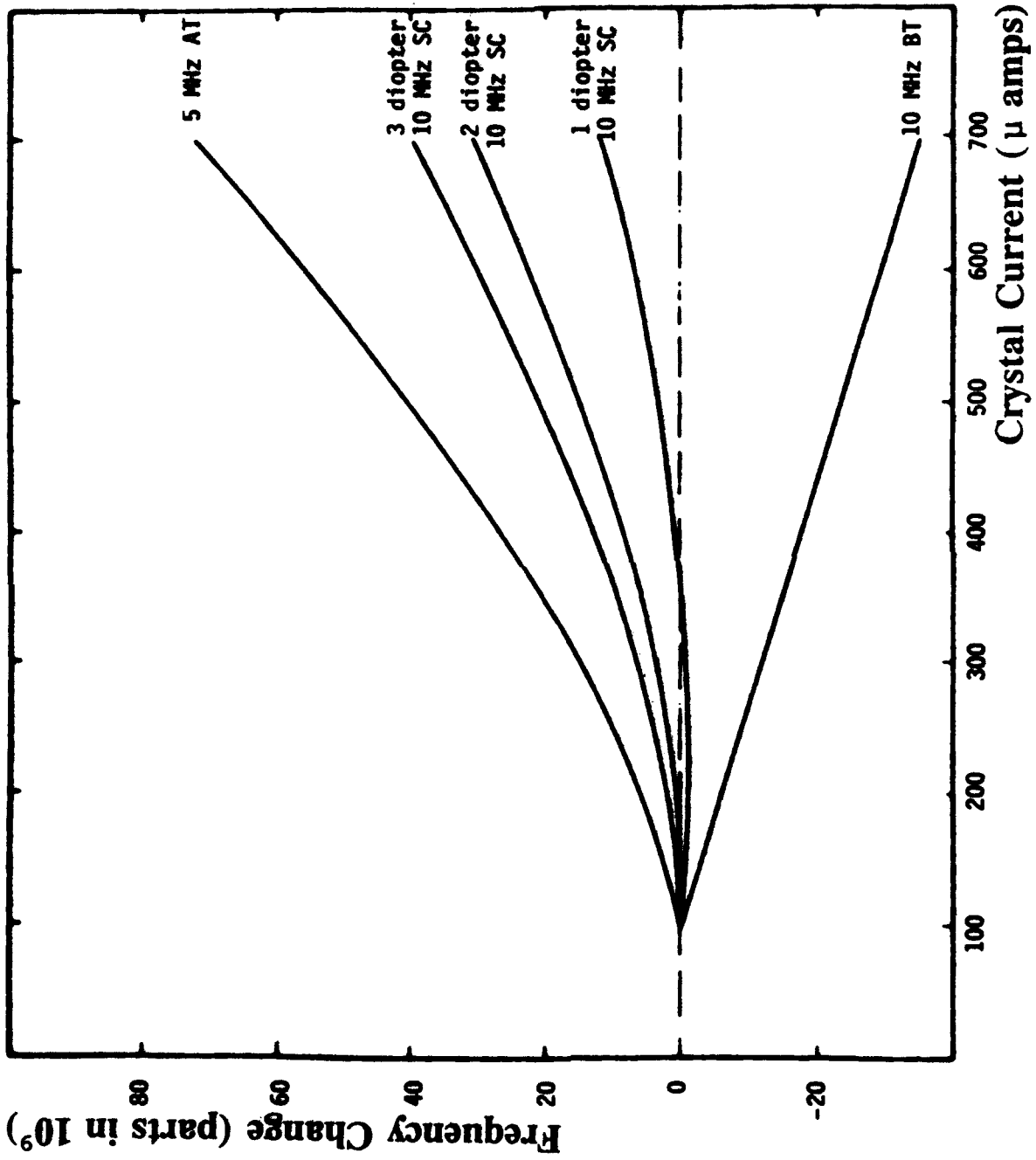



# Amplitude - Frequency Effect

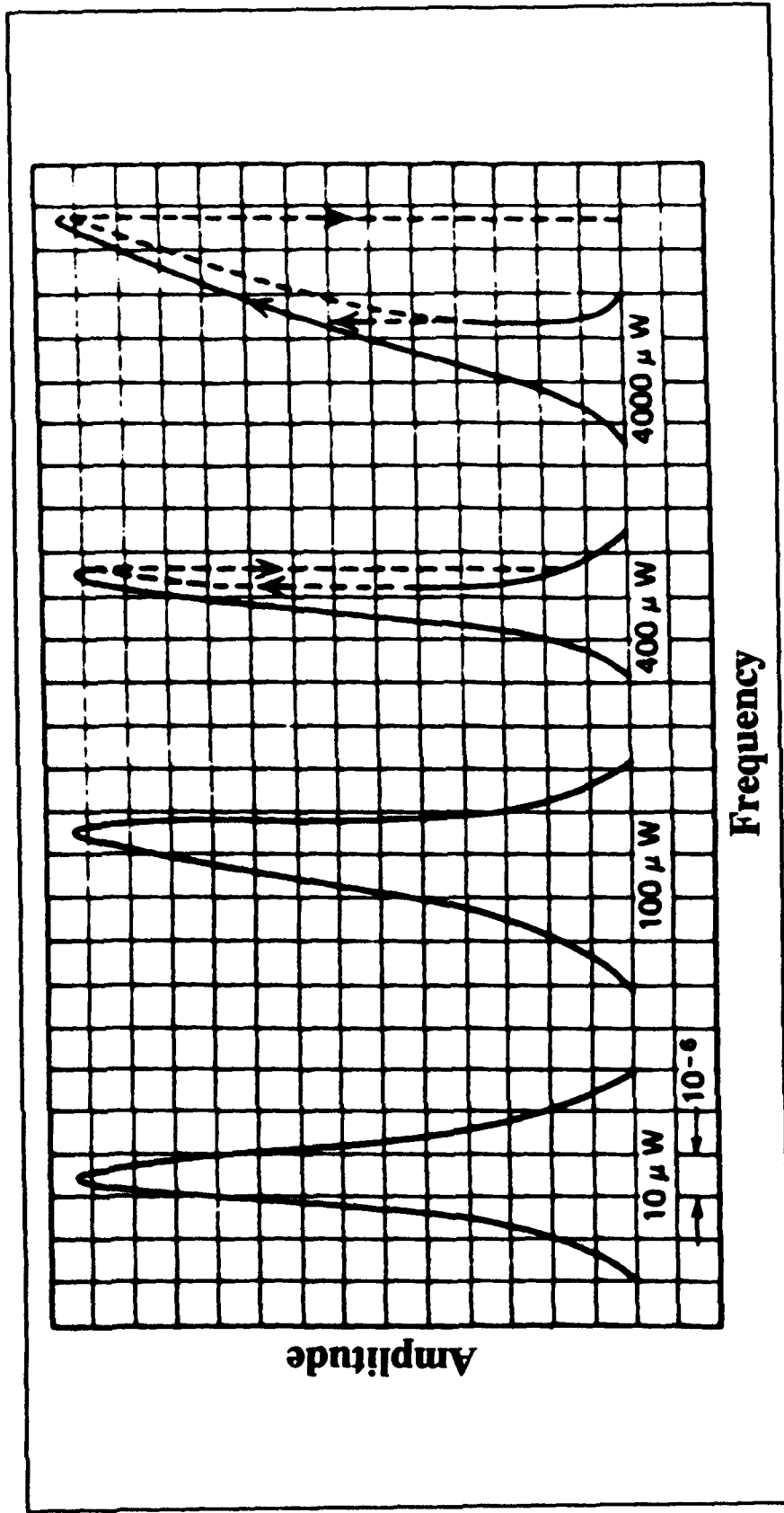

At high drive levels, resonance curves become asymmetric due to the nonlinearities of quartz.

# Drive Level vs. Resistance

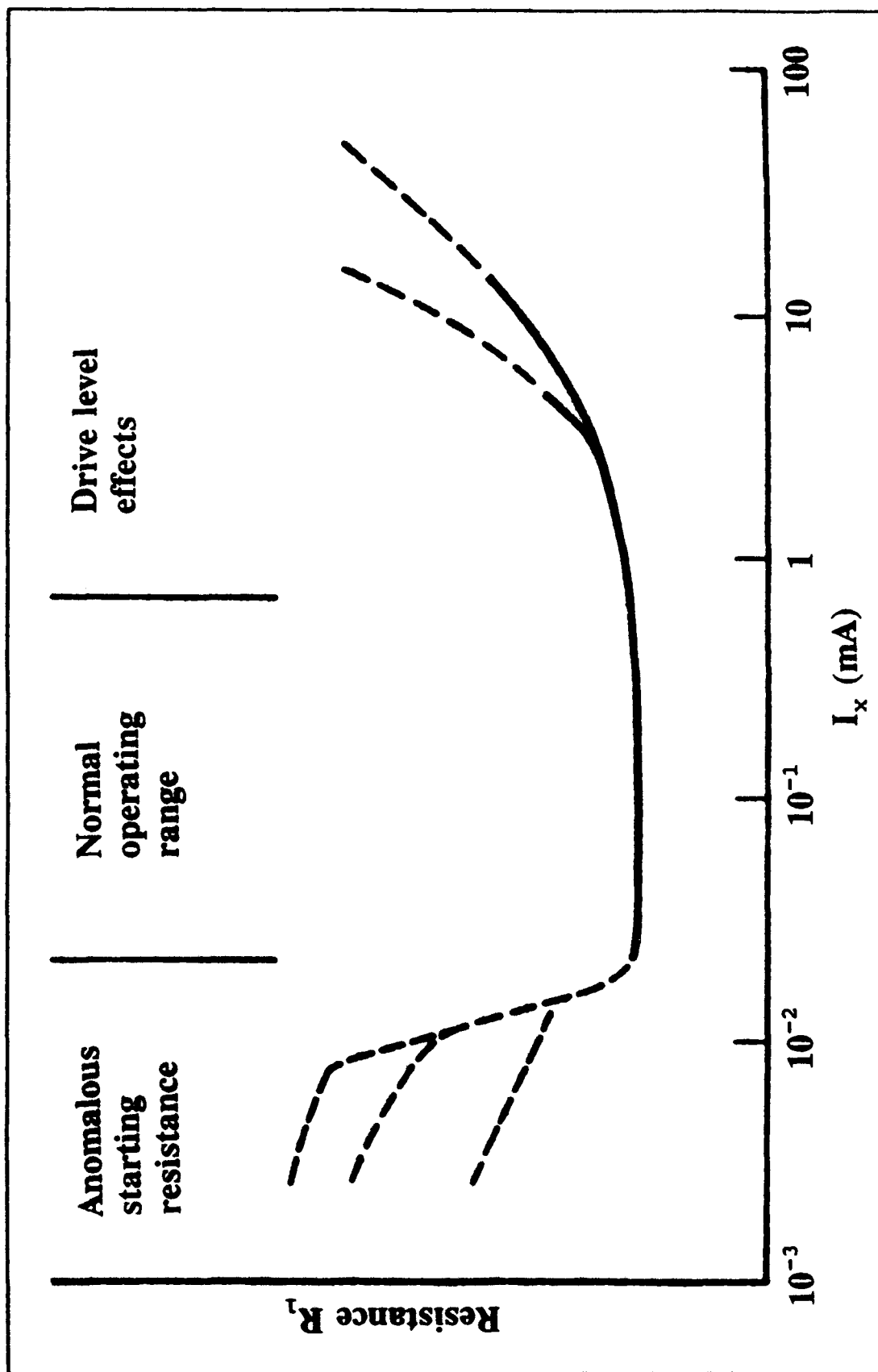

# Second Level of Drive Effect

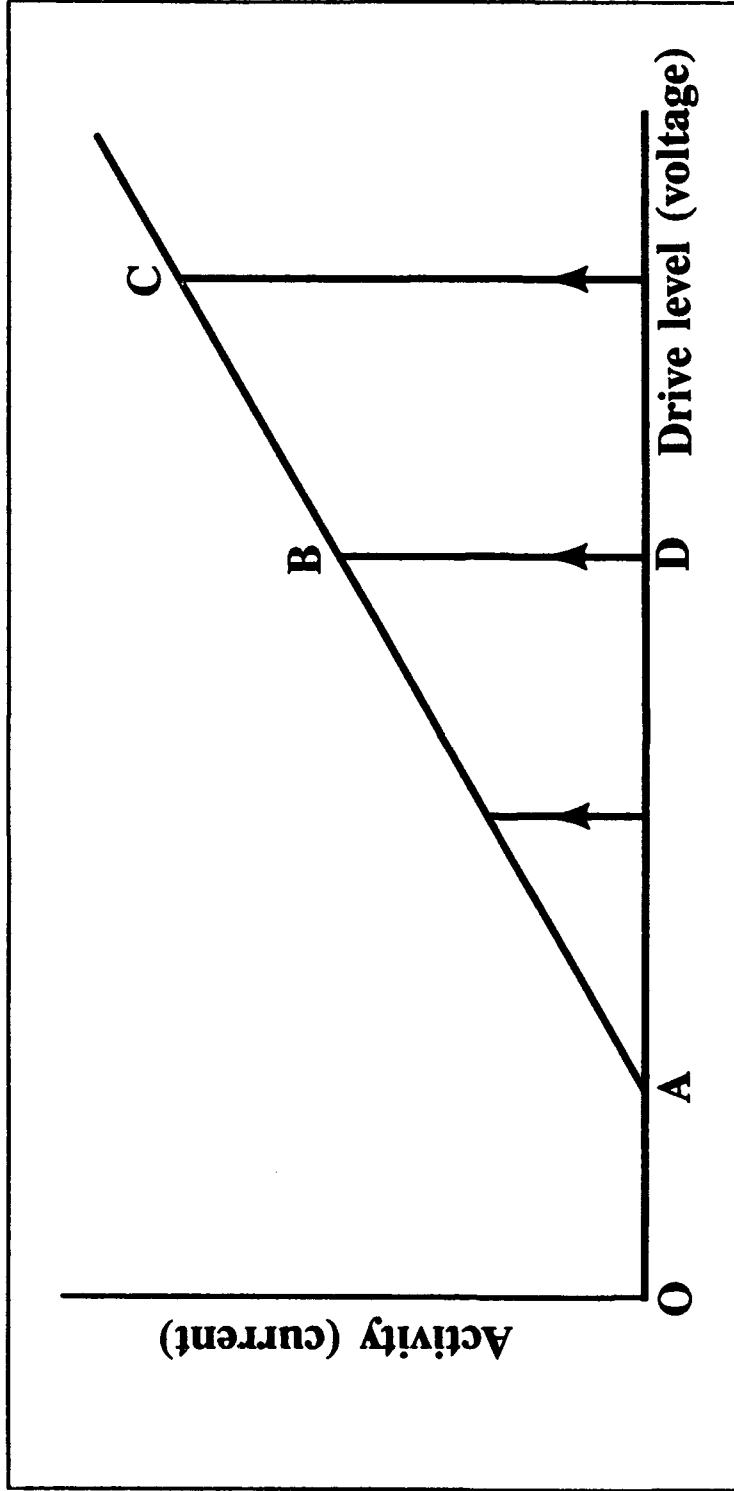

A 'good' crystal will follow the path OABCBAO without hysteresis. A 'bad' crystal will follow a path OADBCBAO: hence the term 'second level of drive'. On again increasing the drive, there is a tendency for the magnitude of the effect to decrease, but in a very irregular and irreproducible manner. The effect is usually due to particulate contamination, loose electrodes, or other surface defects.

# Acceleration vs. Frequency Change

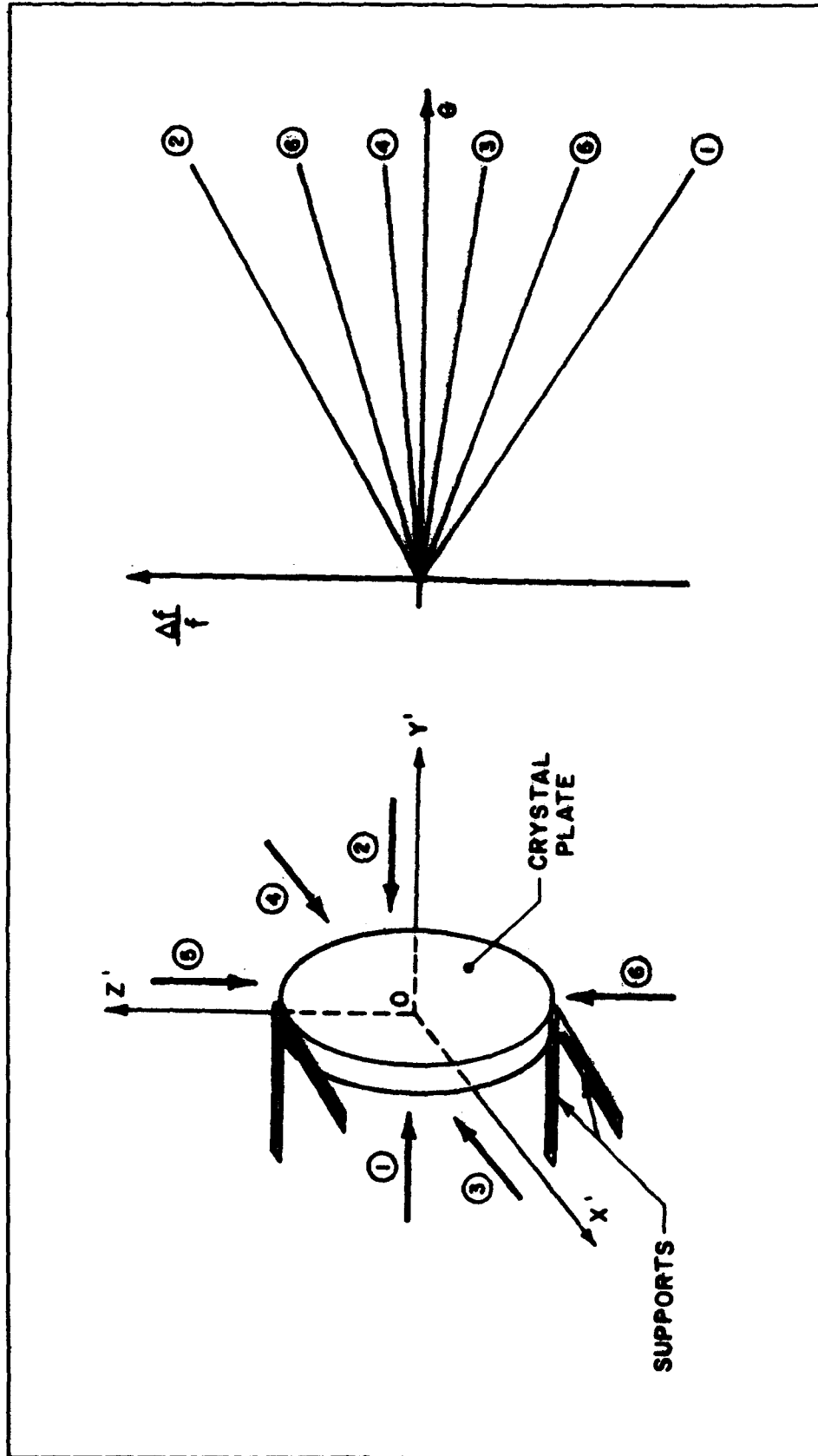

Frequency shift is a function of the magnitude and direction of the acceleration, and is linear with magnitude up to at least 50 g's.

# 2-g Tipover Test

( $\Delta f$  vs. attitude about three axes)

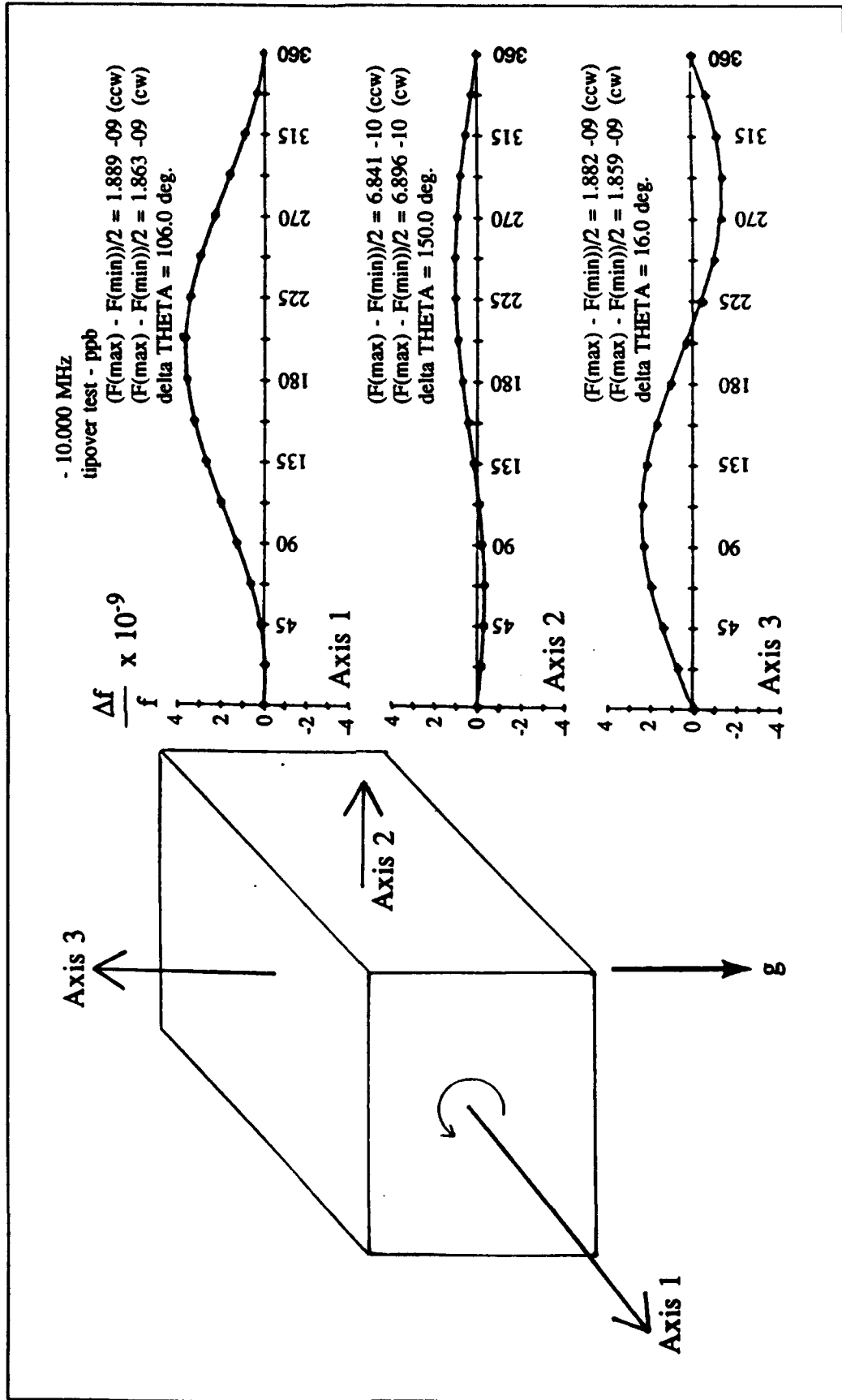

# Sinusoidal Vibration Modulated Frequency

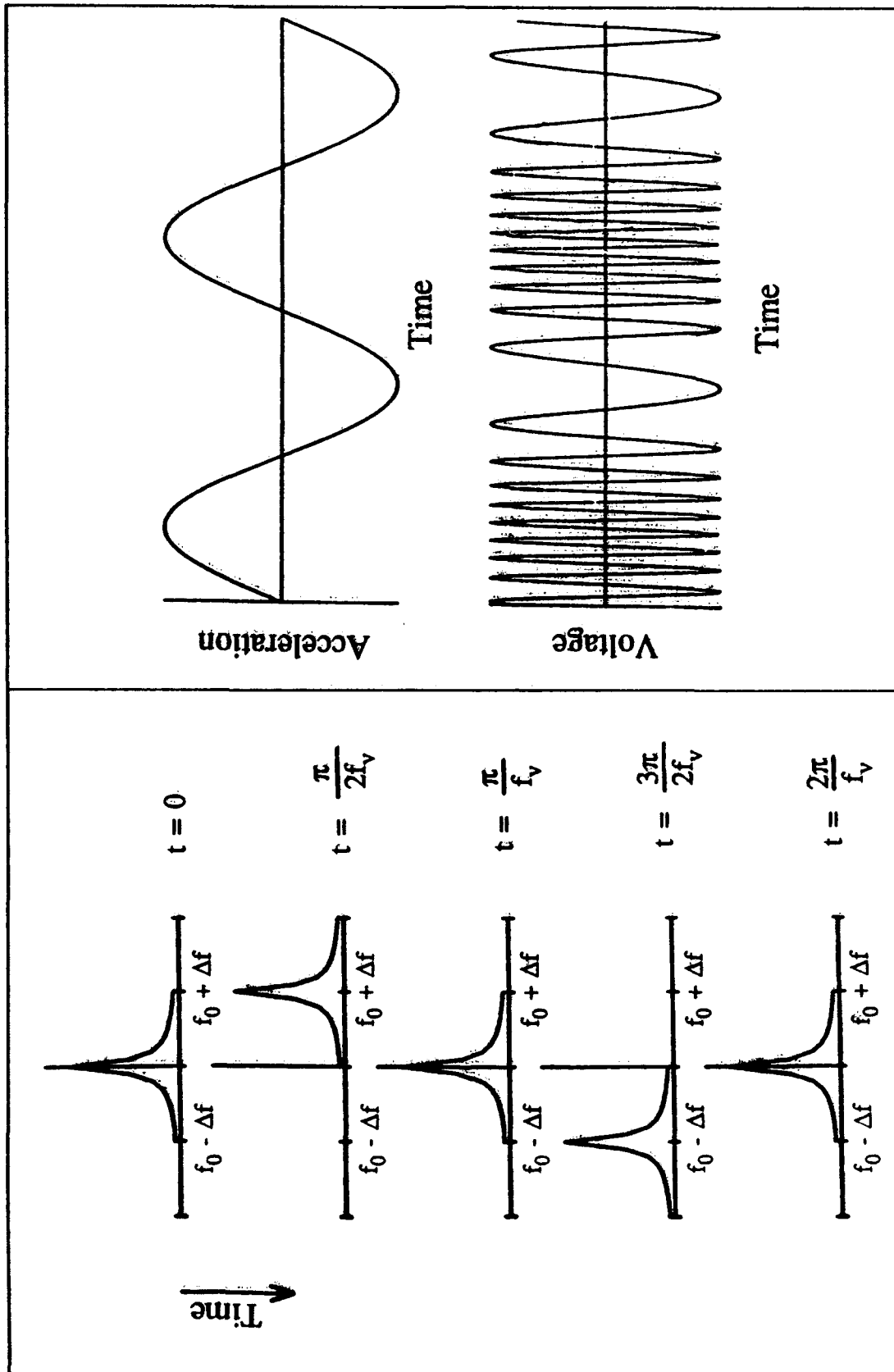

# Acceleration Levels and Effects

Environment	Acceleration typical levels*, in g's	Frequency change $\times 10^{-11}$ , for $1 \times 10^{-9}$ /g oscillator
Buildings**, quiescent	0.02 rms	2
Tractor-trailer (3-80 Hz)	0.2 peak	20
Armored personnel carrier	0.5 to 3 rms	50 to 300
Ship - calm seas	0.02 to 0.1 peak	2 to 10
Ship - rough seas	0.8 peak	80
Propeller aircraft	0.3 to 5 rms	30 to 500
Helicopter	0.1 to 7 rms	10 to 700
Jet aircraft	0.02 to 2 rms	2 to 200
Missiles - boost phase	15 peak	1,500
Railroads	0.1 to 1 peak	10 to 100

\* Levels at the oscillator depend on how and where the oscillator is mounted.

Platform resonances can greatly amplify the acceleration levels.

\*\* Building vibrations can have significant effects on noise measurements.

# Acceleration Sensitivity Vector

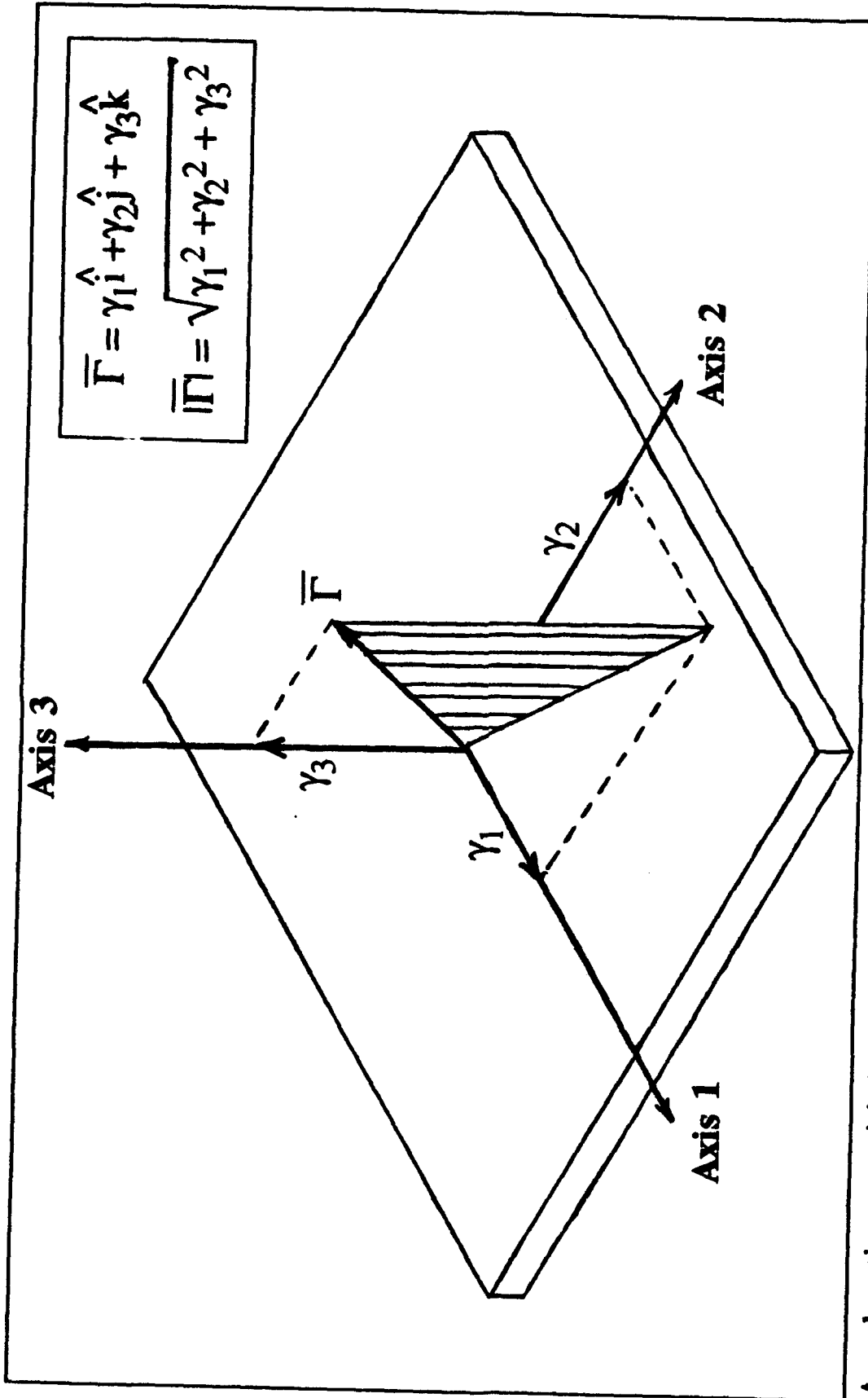

Acceleration-sensitivity is a vector, i.e., the acceleration-induced frequency shift is maximum when the acceleration is along the acceleration-sensitivity vector;  $\Delta f = \vec{\Gamma} \cdot \vec{A}$ .



# Vibration-Induced Allan Variance Degradation

Vibration modulates the frequency and, thereby, degrades the short-term stability. The typical degradation due to sinusoidal vibration varies with averaging time, as shown. Since a full sine wave averages to zero, the degradation is zero for averaging times that are integer multiples of the period of vibration. The peaks occur at averaging times that are odd multiples of half the period of vibration. The  $\sigma_y(\tau)$  due to a single-frequency vibration is:

$$\sigma_y(\tau) = \frac{\Gamma \cdot a \tau_v}{\pi \tau} \sin^2\left(\pi \frac{\tau}{\tau_v}\right),$$

where  $\tau_v$  is the period of vibration,  $\tau$  is the measurement averaging time,  $\Gamma$  is the acceleration sensitivity vector, and  $a$  is the acceleration.

## Example:

$$f_v = 20 \text{ Hz}$$

$$a = 1.0 \text{ g along } \Gamma$$

$$|\Gamma| = 1 \times 10^{-9}/\text{g}$$

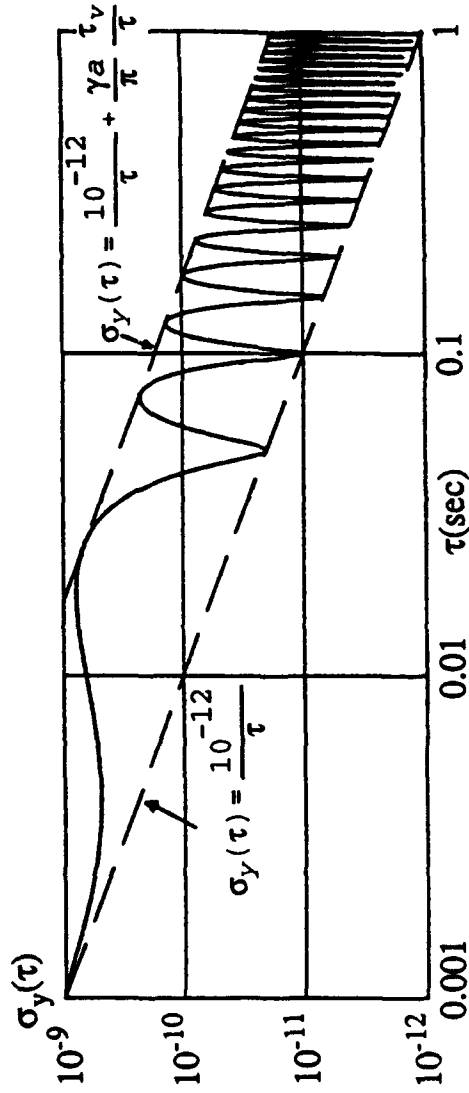

# Vibration-Induced Phase Excursion

The phase of a vibration modulated signal is

$$\phi(t) = 2\pi f_o t + \left( \frac{\Delta f}{f_v} \right) \sin(2\pi f_v t).$$

When the oscillator is subjected to a simple sinusoidal vibration, the peak phase excursion is

$$\Delta \phi_{peak} = \frac{\Delta f}{f_v} = \frac{(\bar{\Gamma} \cdot \bar{a}) f_o}{f_v}$$

Example: if a 10 MHz,  $1 \times 10^{-9}$ /g oscillator is subjected to a 10 Hz sinusoidal vibration of amplitude 1 g, the peak vibration-induced phase excursion is  $1 \times 10^{-3}$  radians. If this oscillator is used as the reference oscillator in a 10 GHz radar system, the peak phase excursion at 10 GHz will be 1 radian. Such a large phase excursion can be catastrophic to the performance of many systems, such as those which employ phase locked loops (PLL) or phase shift keying (PSK).

# Vibration-Induced Sidebands

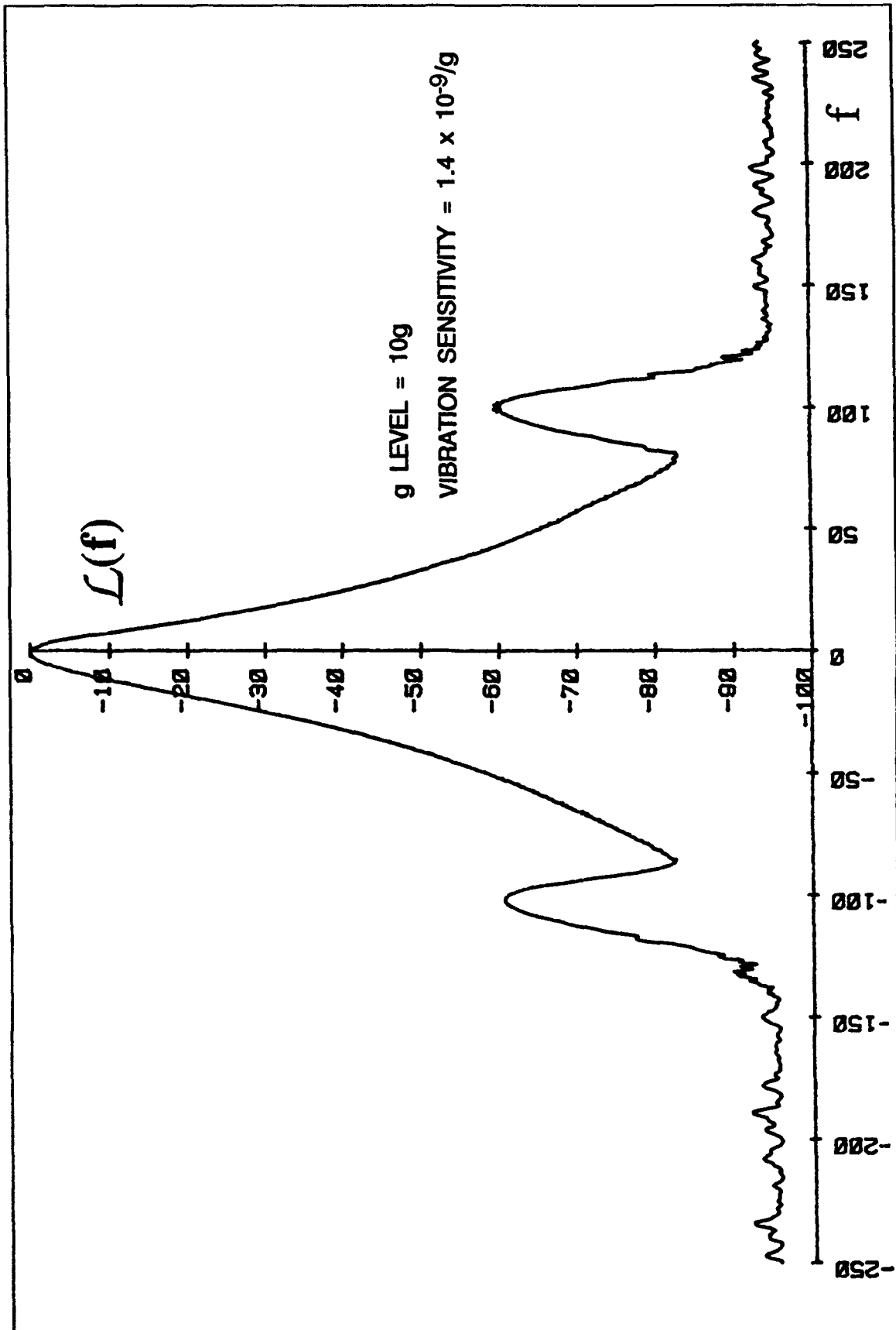

# Vibration-Induced Sidebands

Each frequency multiplication  
by 10 increases the sidebands  
by 20 dB.

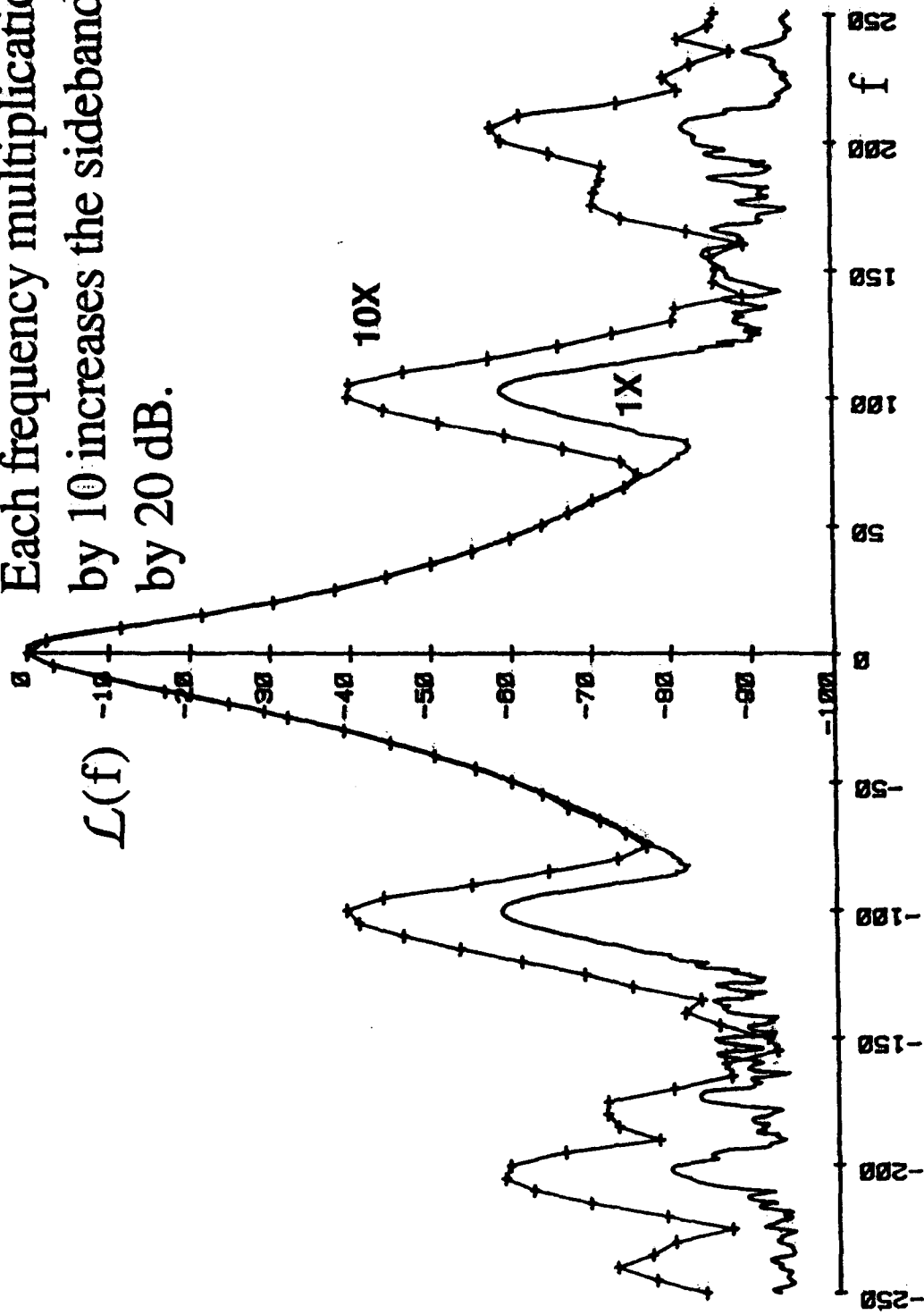

# Sine Vibration-Induced Phase Noise

Sinusoidal vibration produces spectral lines at  $\pm f_v$  from the carrier, where  $f_v$  is the vibration frequency.

$$\mathcal{L}'(f_v) = 20 \log \left( \frac{\overline{|\Gamma \cdot A f_o|}}{2f_v} \right)$$

e.g., if  $|\overline{\Gamma}| = 1 \times 10^{-9}/g$  and  $f_o = 10$  MHz, then even if the oscillator is completely noise free at rest, the phase "noise," i.e., the spectral lines, due solely to a sine vibration level of 1g will be:

Vibr. freq., $f_v$ , in Hz	$\mathcal{L}'(f_v)$ , in dBc
1	-46
10	-66
100	-86
1,000	-106
10,000	-126

# Random Vibration-Induced Phase Noise

Random vibration's contribution to phase noise is given by:

$$\mathcal{L}(f) = 20 \log \left( \frac{\overline{\Gamma} \cdot A f_0}{2f} \right), \text{ where } |\overline{A}| = [(2)(\text{PSD})]^{1/2}$$

e.g., if  $|\overline{\Gamma}| = 1 \times 10^{-9}/g$  and  $f_0 = 10 \text{ MHz}$ , then even if the oscillator is completely noise free at rest, the phase noise due solely to a vibration  $\text{PSD} = 0.1 \text{ g}^2/\text{Hz}$  will be:

Offset freq., f, in Hz	$\mathcal{L}(f)$ , in dBc/Hz
1	-53
10	-73
100	-93
1,000	-113
10,000	-133

# Random-Vibration-Induced Phase Noise

Phase noise under vibration is for  $\Gamma = 1 \times 10^{-9}$  per g and  $f = 10$  MHz

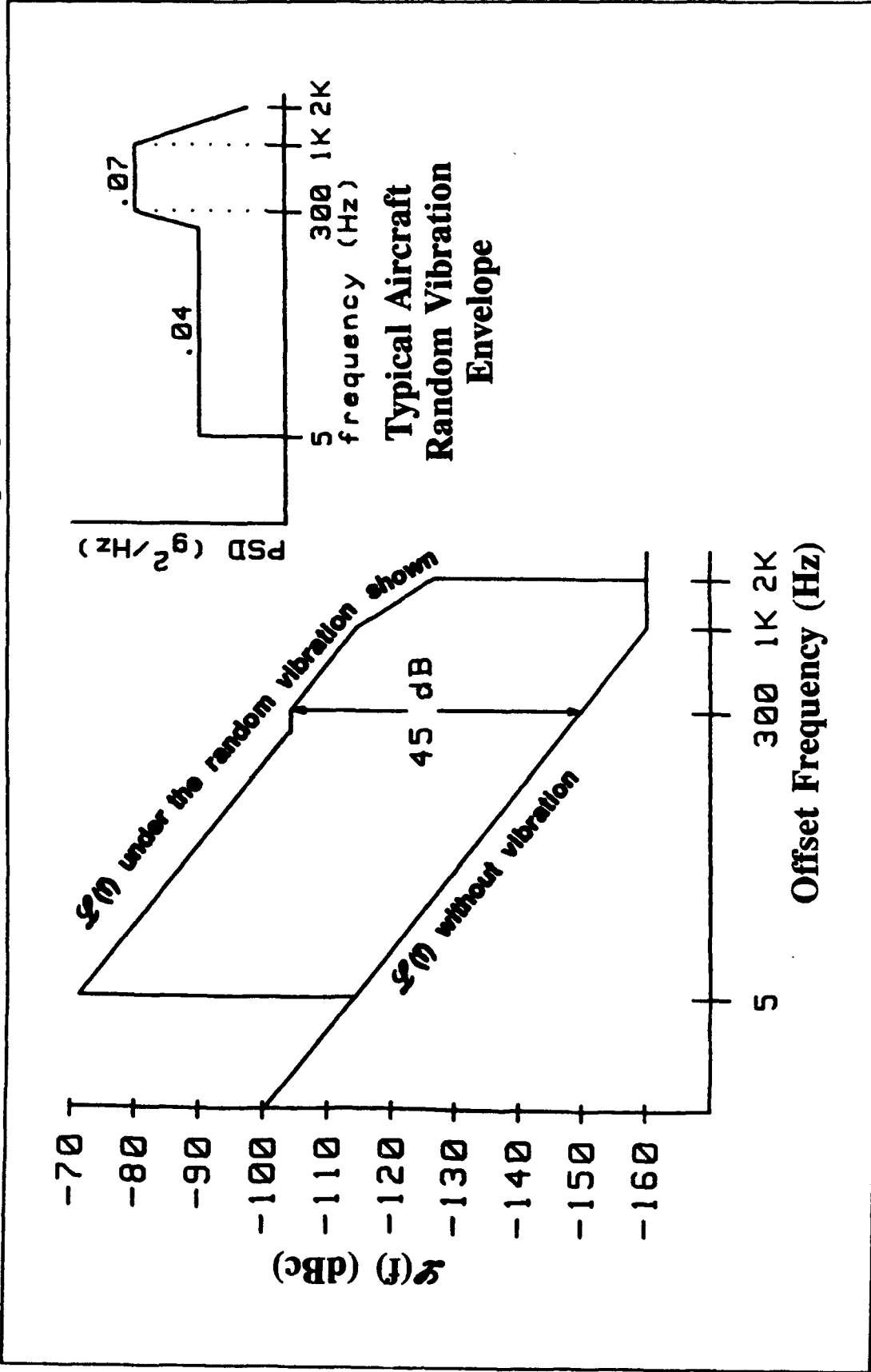

# Acceleration Sensitivity vs. Vibration Frequency

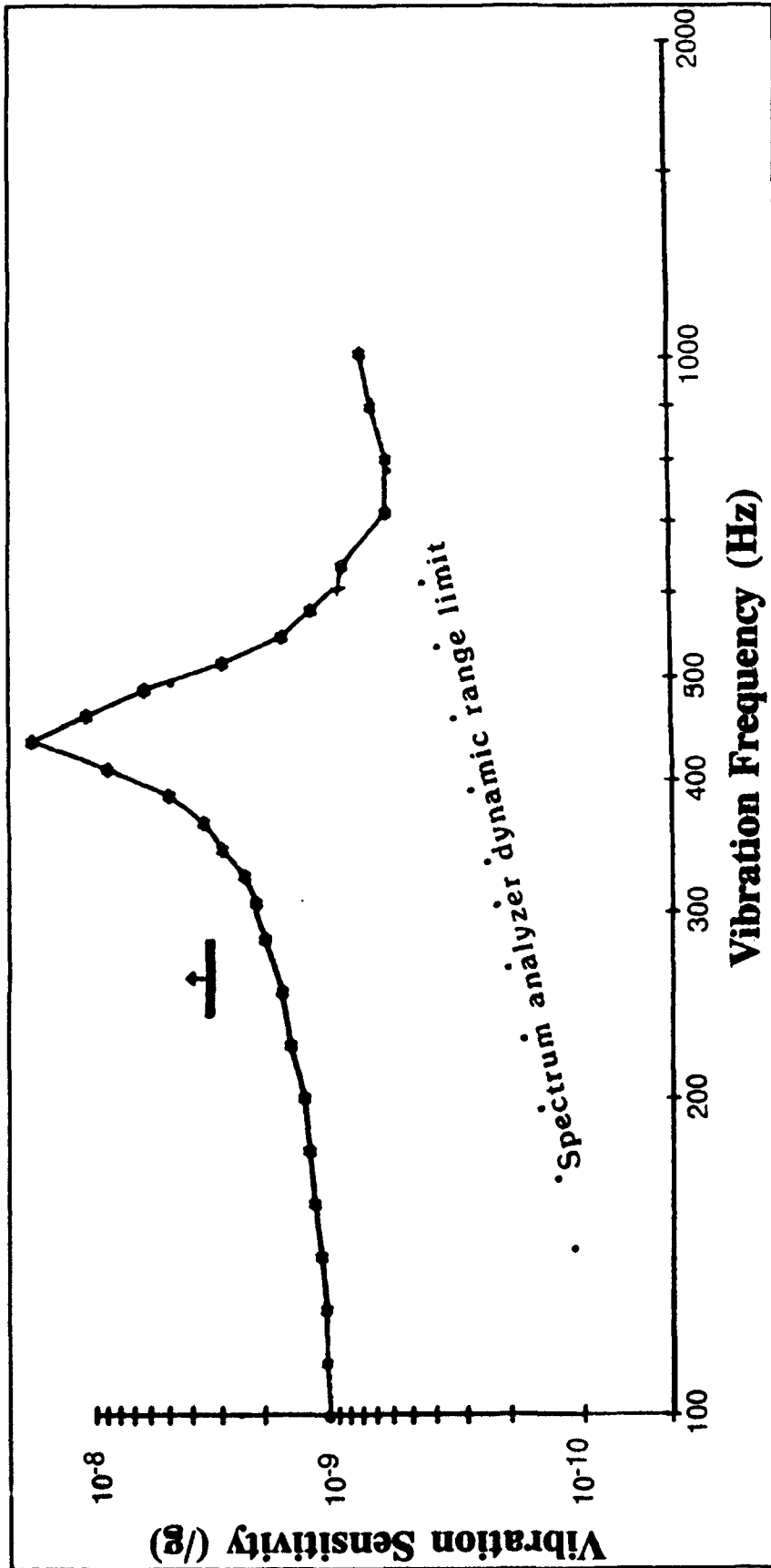

The acceleration sensitivity can be calculated from the vibration induced sidebands. The preferred method is to measure the sensitivity at a number of vibration frequencies in order to reveal resonances. The example above shows the results for an OCXO. The resonance at 424 Hz amplified the sensitivity 17-fold.



# Acceleration Sensitivity of Quartz Resonators

Resonator acceleration sensitivities range from the low parts in  $10^{10}$  per g for the best commercially available SC-cuts, to parts in  $10^7$  per g for tuning-fork-type watch crystals. When a wide range of resonators was examined: AT, BT, FC, IT, SC, AK, and GT-cuts; 5 MHz 5th overtones to 500 MHz fundamental mode inverted mesa resonators; resonators made of natural quartz, cultured quartz, and swept cultured quartz; numerous geometries and mounting configurations (including rectangular AT-cuts); nearly all of the results were within a factor of three of  $1 \times 10^{-9}$  per g. On the other hand, the fact that a few resonators have been found to have sensitivities of less than  $1 \times 10^{-10}$  per g (for unknown reasons) indicates that the observed acceleration sensitivities are not due to any inherent natural limitations. Recent theoretical and experimental evidence indicates that the major variables yet to be controlled properly are the mode shape and location (i.e., the amplitude of vibration distribution), and the strain distribution associated with the mode of vibration. Until the acceleration sensitivity problem is solved, acceleration compensation and vibration isolation can provide lower than  $1 \times 10^{-10}$  per g, for a limited range of vibration frequencies, and at a cost.

# Phase Noise Degradation Due to Vibration

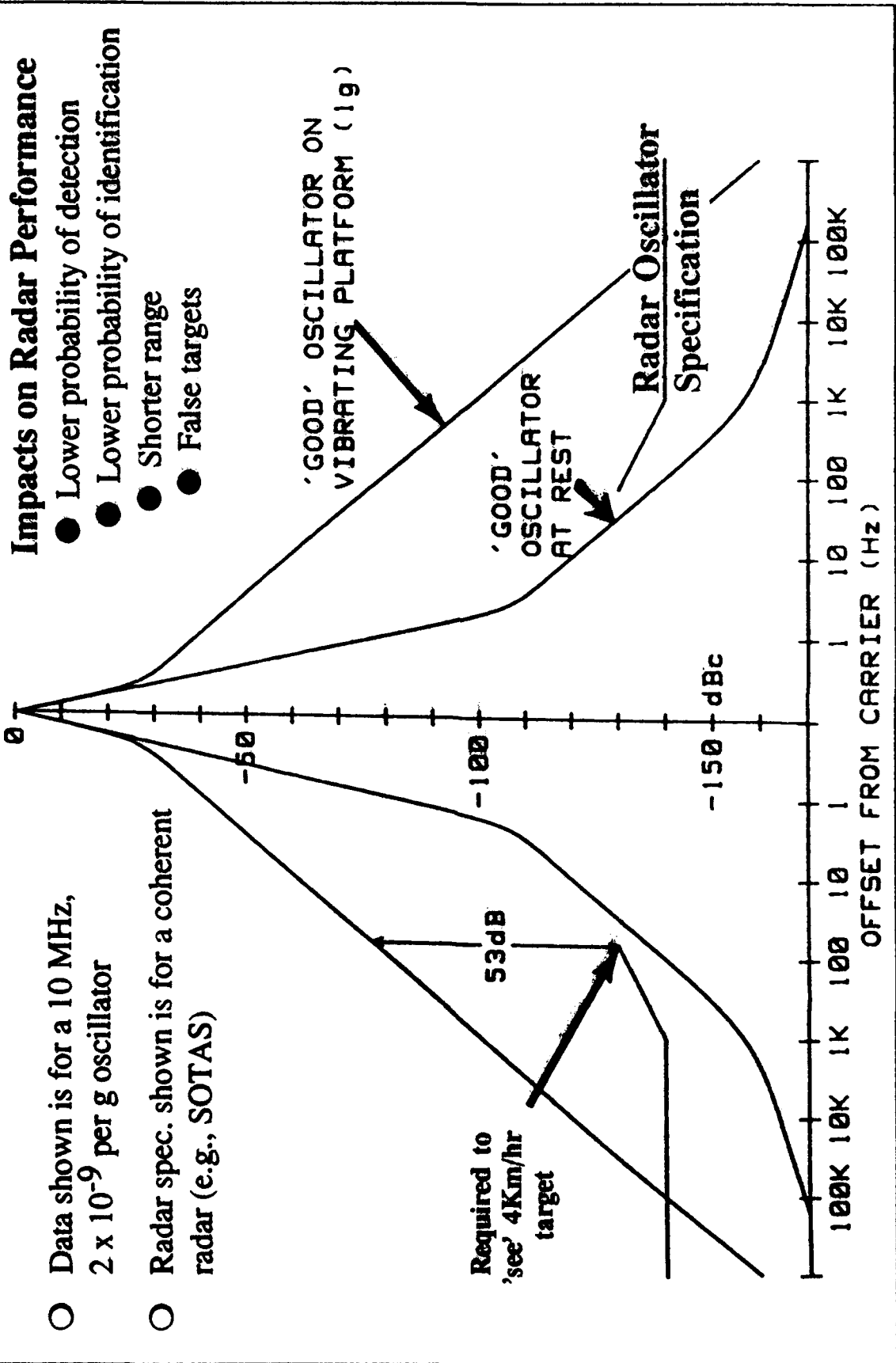

# Coherent Radar Probability of Detection

To "see" 4 km/h targets, low phase noise 70 Hz from the carrier is required. Shown is the probability of detection of 4 km/h targets vs. the phase noise 70 Hz from the carrier of a 10 MHz reference oscillator. (After multiplication to 10 GHz, the phase noise will be at least 60 dB higher.) The phase noise due to platform vibration, e.g., on an aircraft, reduces the probability of detection of slow-moving targets to zero.

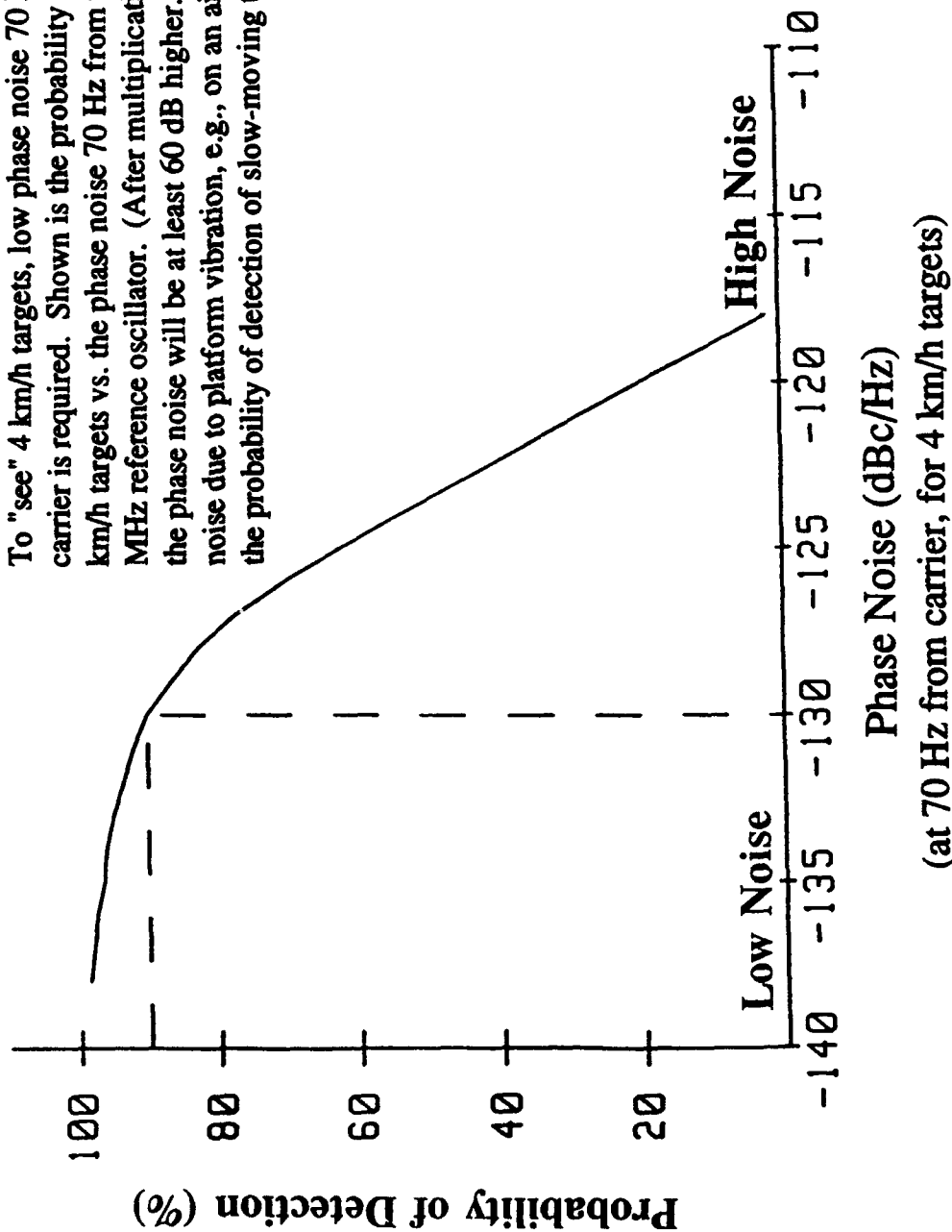

# Vibration Isolation

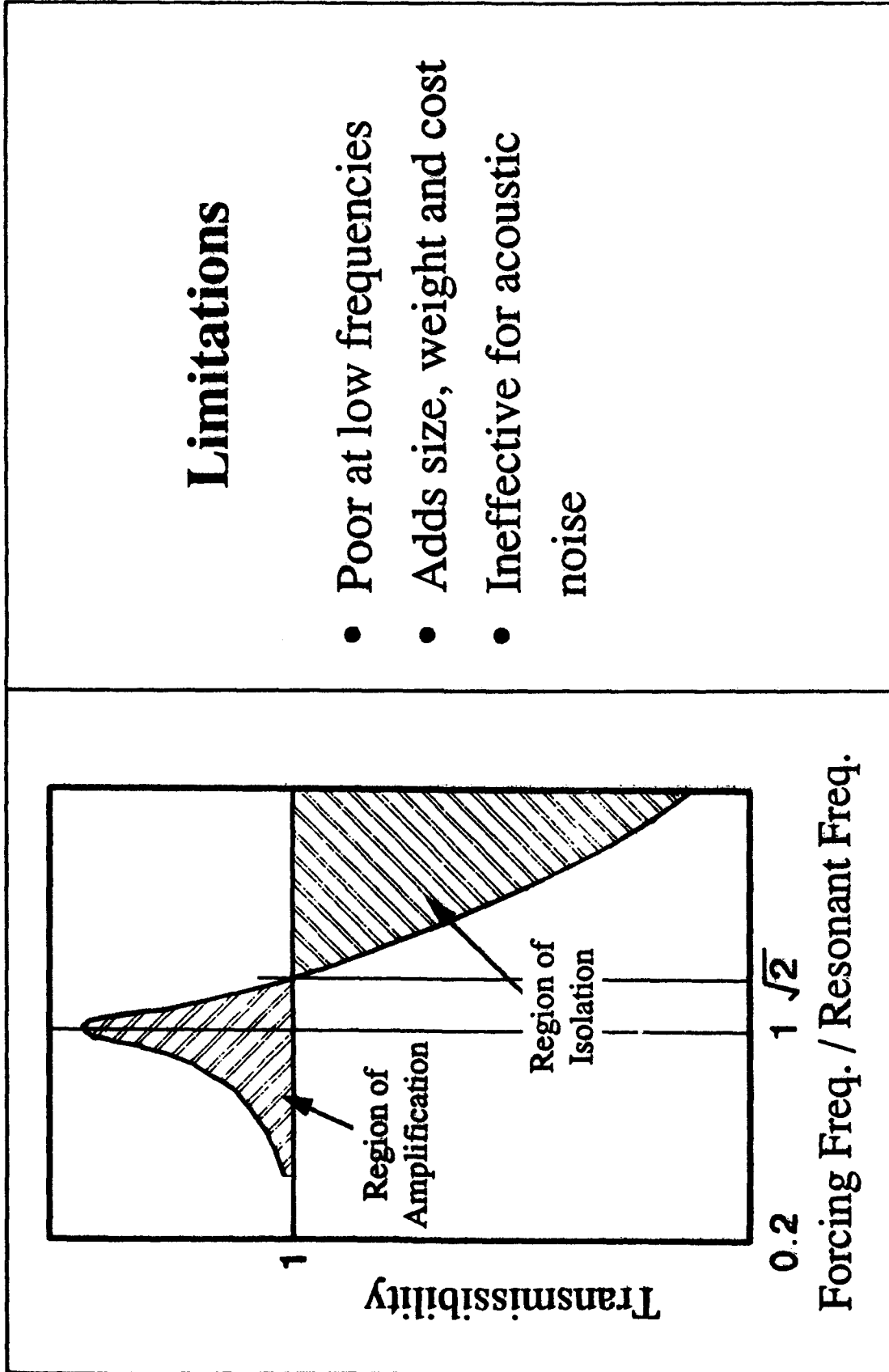

## Limitations

- Poor at low frequencies
- Adds size, weight and cost
- Ineffective for acoustic noise

# Vibration Compensation

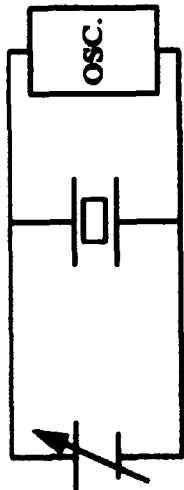
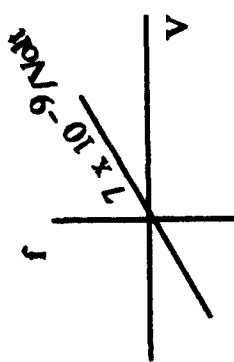
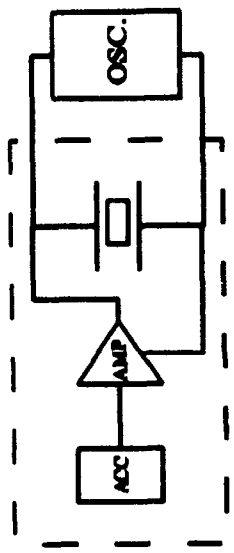
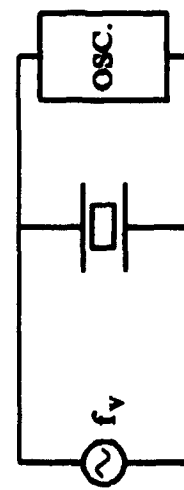
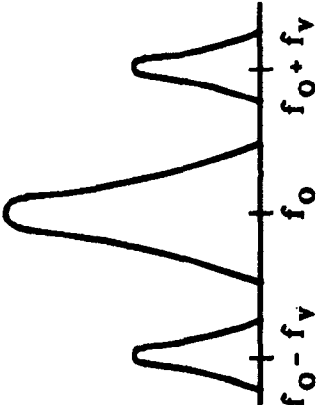
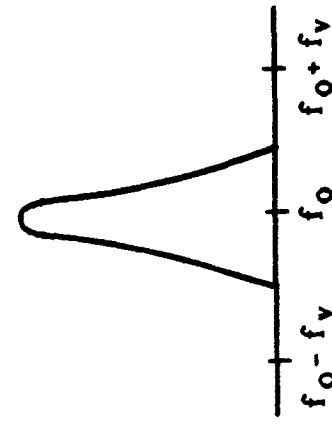
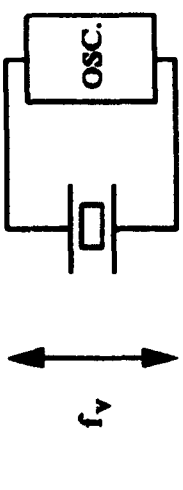
<p><b>Stimulus</b></p>  <p><b>DC Voltage on Crystal</b></p>	<p><b>Response</b></p>  <p><math>7 \times 10^{-9} \text{ Hz/V}</math></p> <p>5 MHz fund. SC</p>	<p><b>Compensated Oscillator</b></p>  <p>Vibration Compensated Oscillator</p> <p>ACC = accelerometer</p>
<p><b>AC Voltage on Crystal</b></p>  <p><b>AC Voltage on Crystal</b></p>		<p><b>Response to Vibration</b></p> 
<p><b>Crystal Being Vibrated</b></p> 		

# Vibration Sensitivity Measurement System

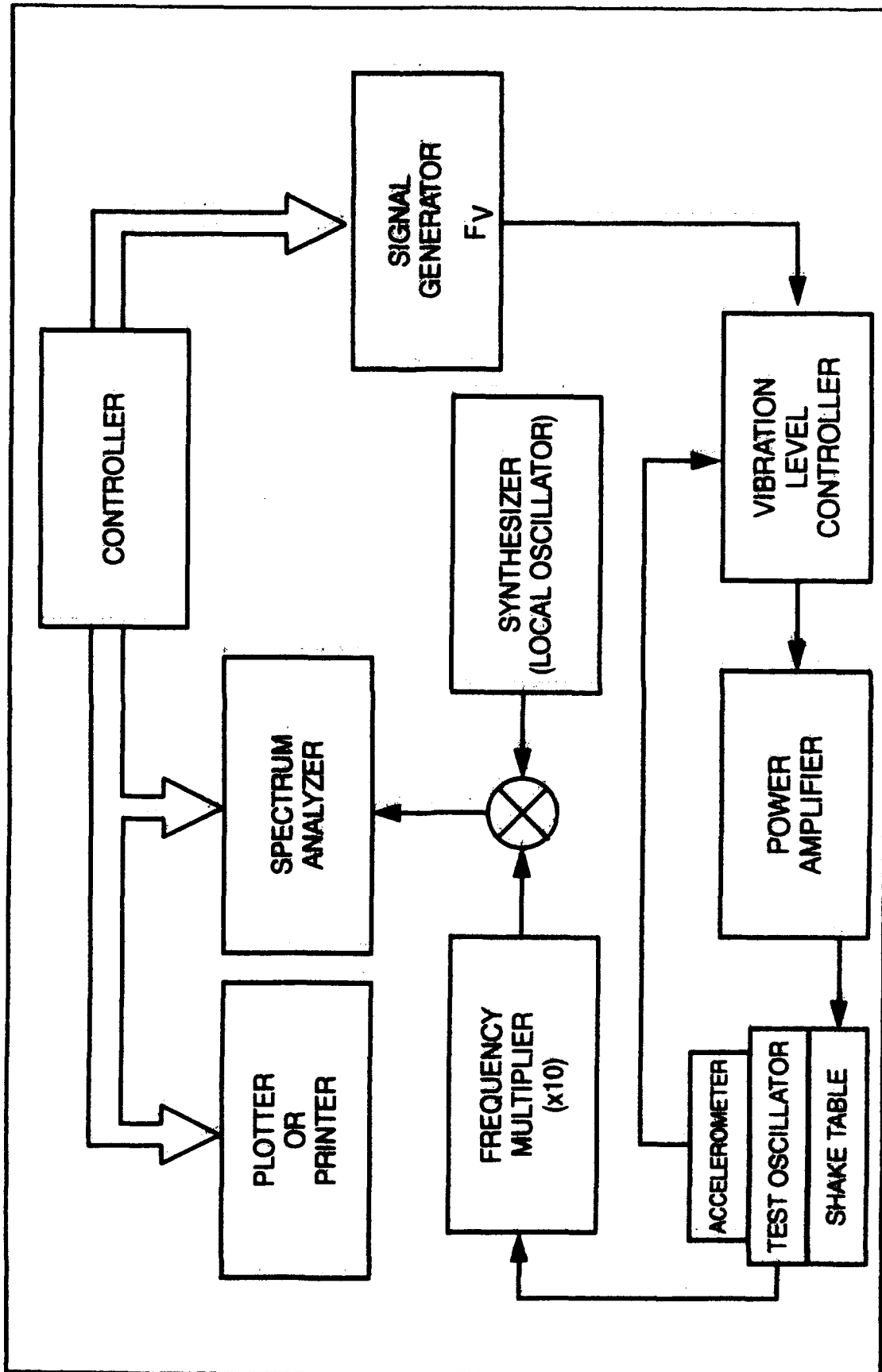

# Shock

The frequency excursion during a shock is due to the resonator's stress sensitivity. The magnitude of the excursion is a function of resonator design, and of the shock induced stresses on the resonator. (Resonances in the mounting structure will amplify the stresses.) The permanent frequency offset can be due to: shock induced stress changes, the removal of (particulate) contamination from the resonator surfaces, and changes in the oscillator circuitry. Survival under shock is primarily a function of resonator surface imperfections. Chemical-polishing-produced scratch-free resonators have survived shocks of up to 36,000 g in air gun tests, and have survived the shocks due to being fired from a 155 mm howitzer (16,000 g, 12 ms duration).

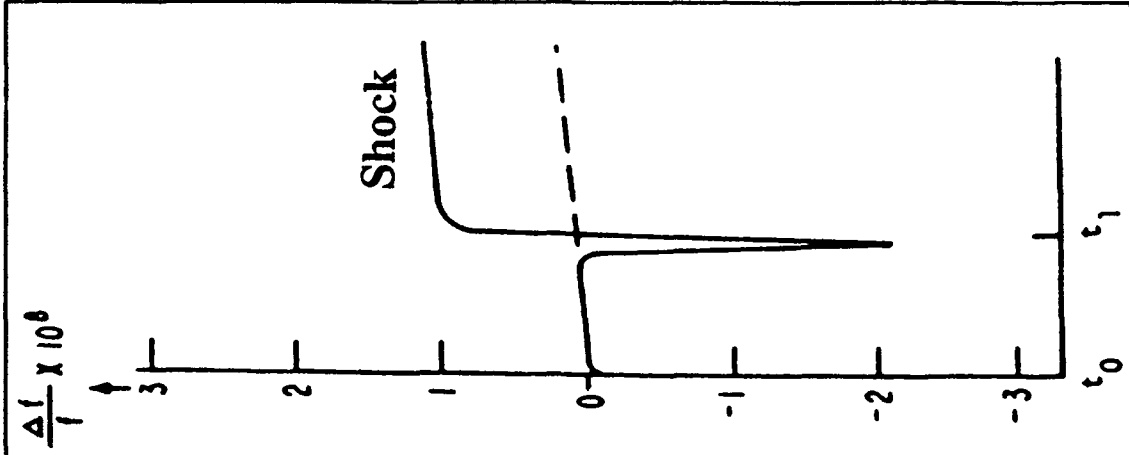

# Radiation-Induced Frequency Shifts

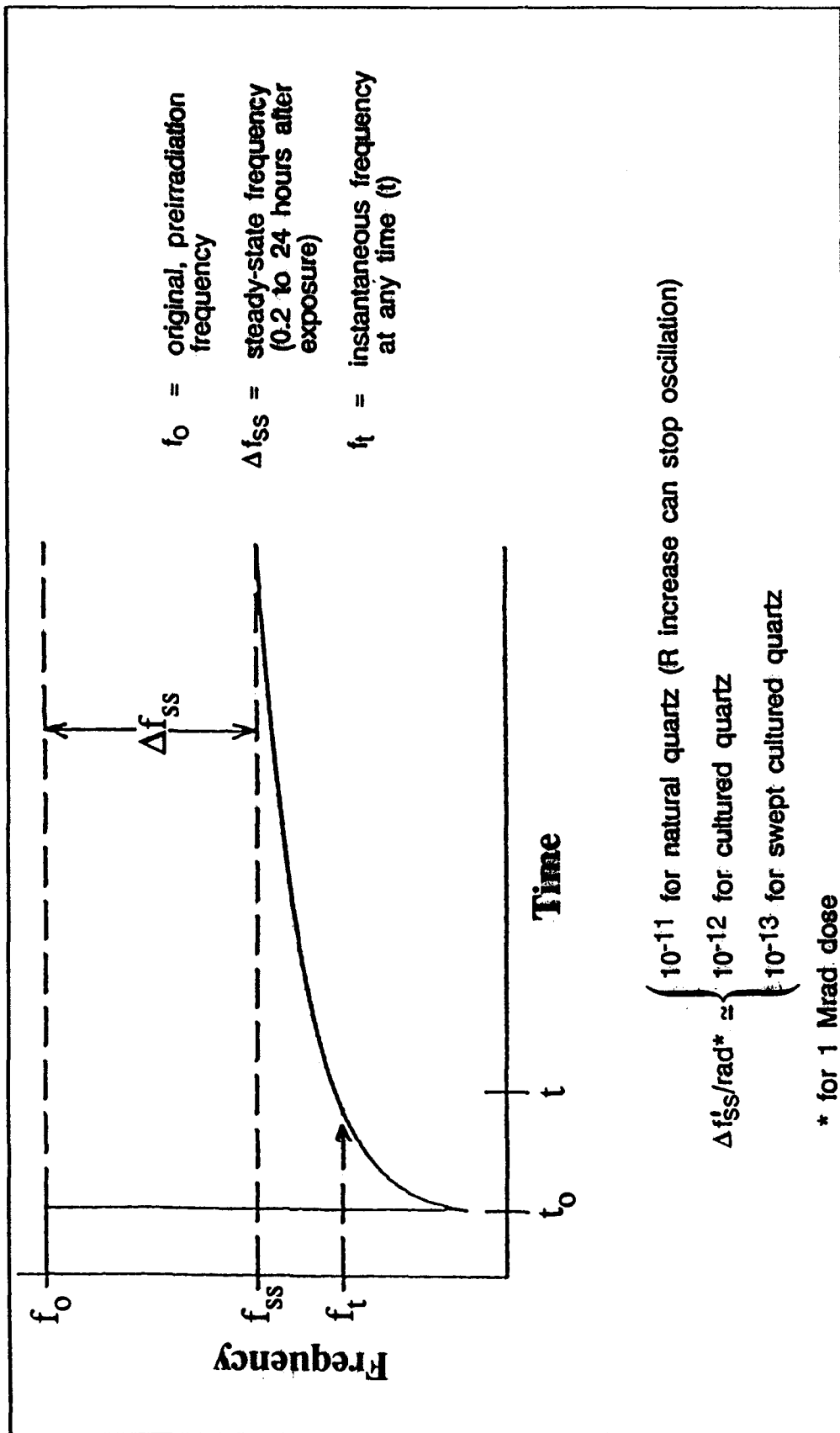

Idealized frequency vs. time behavior for a quartz resonator following a pulse of ionizing radiation.



# Effects of Repeated Irradiations

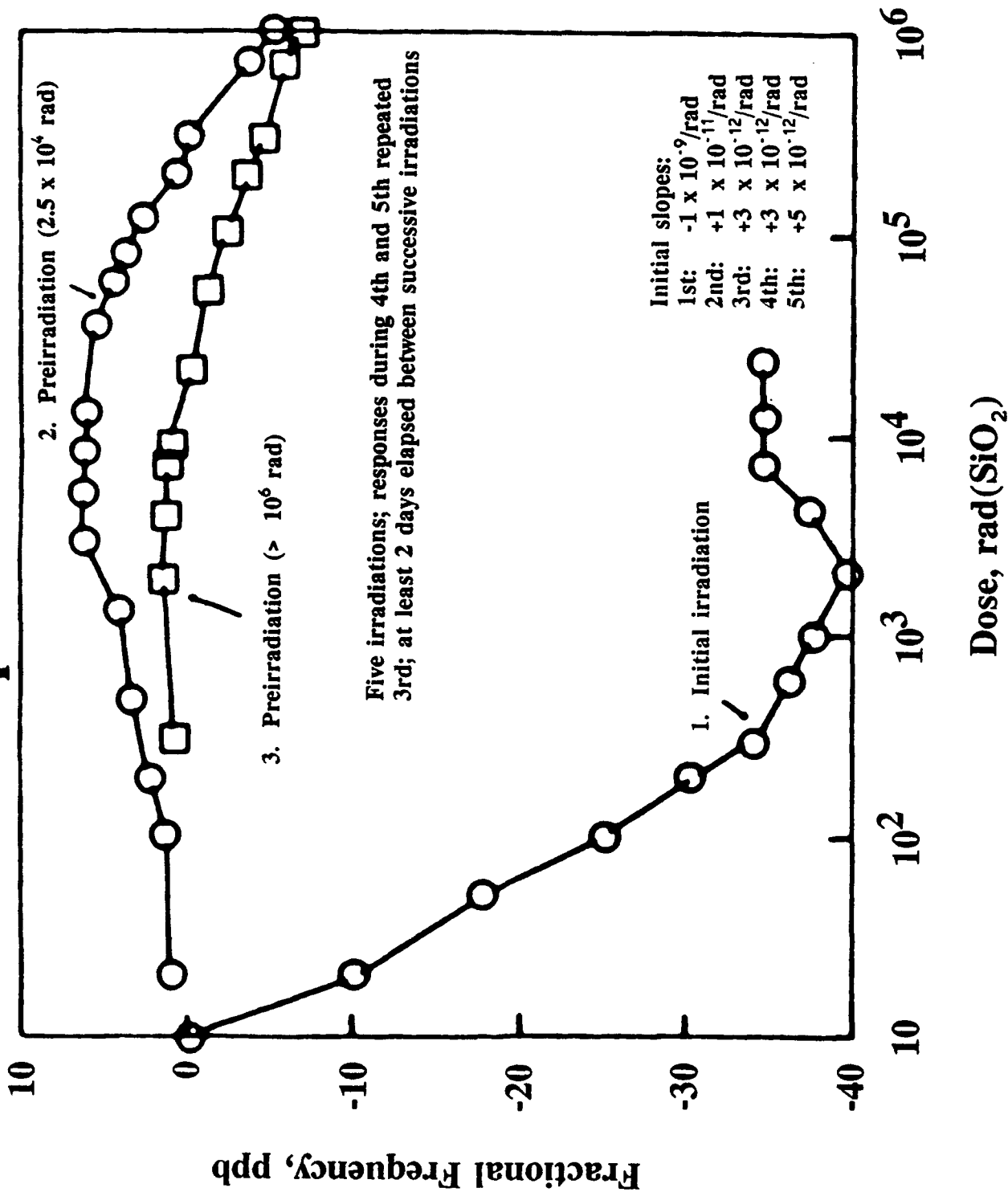

# Radiation Induced $\Delta f$ vs. Dose and Quartz-Type

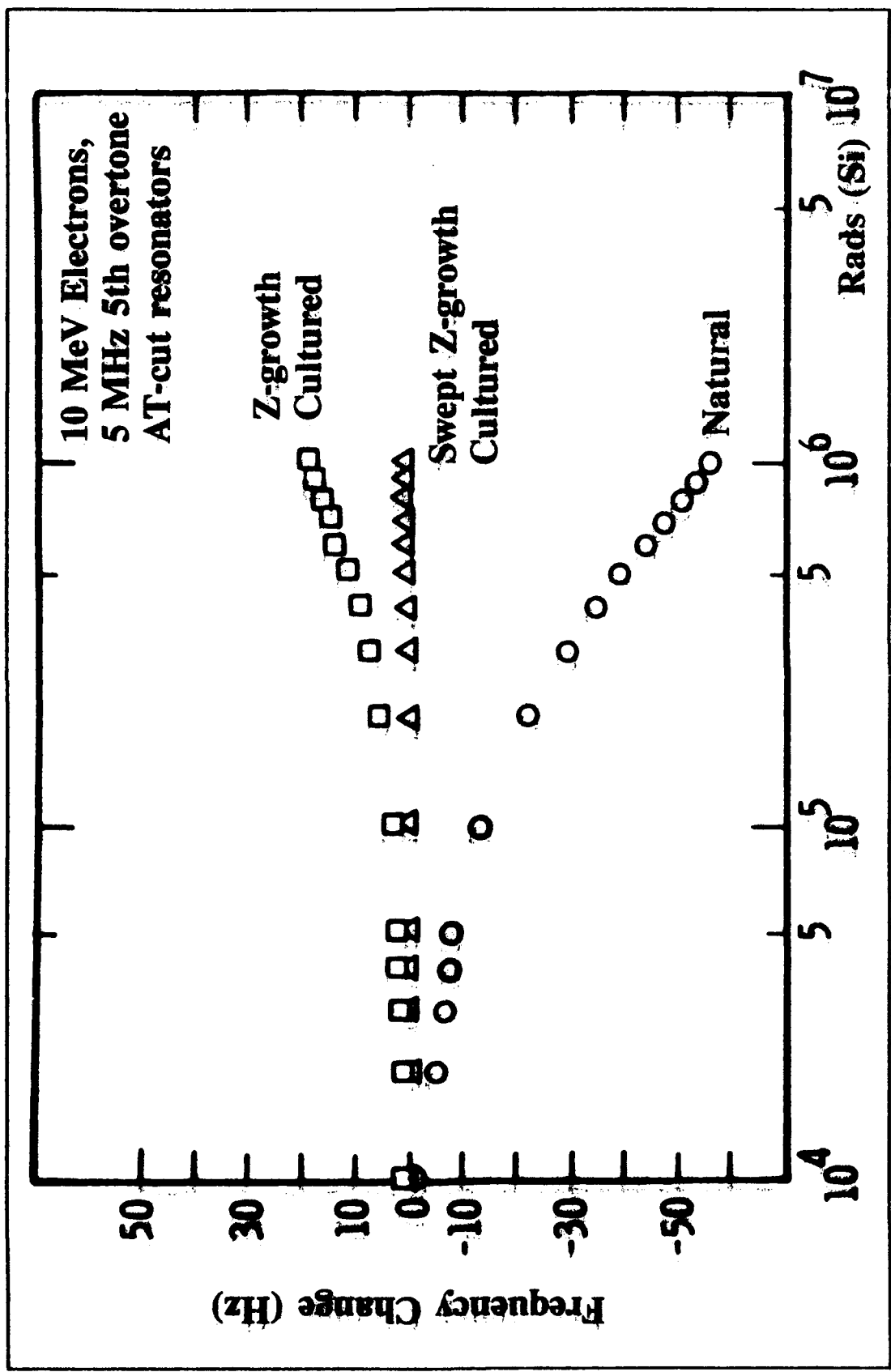

# Annealing of Radiation Induced f Changes

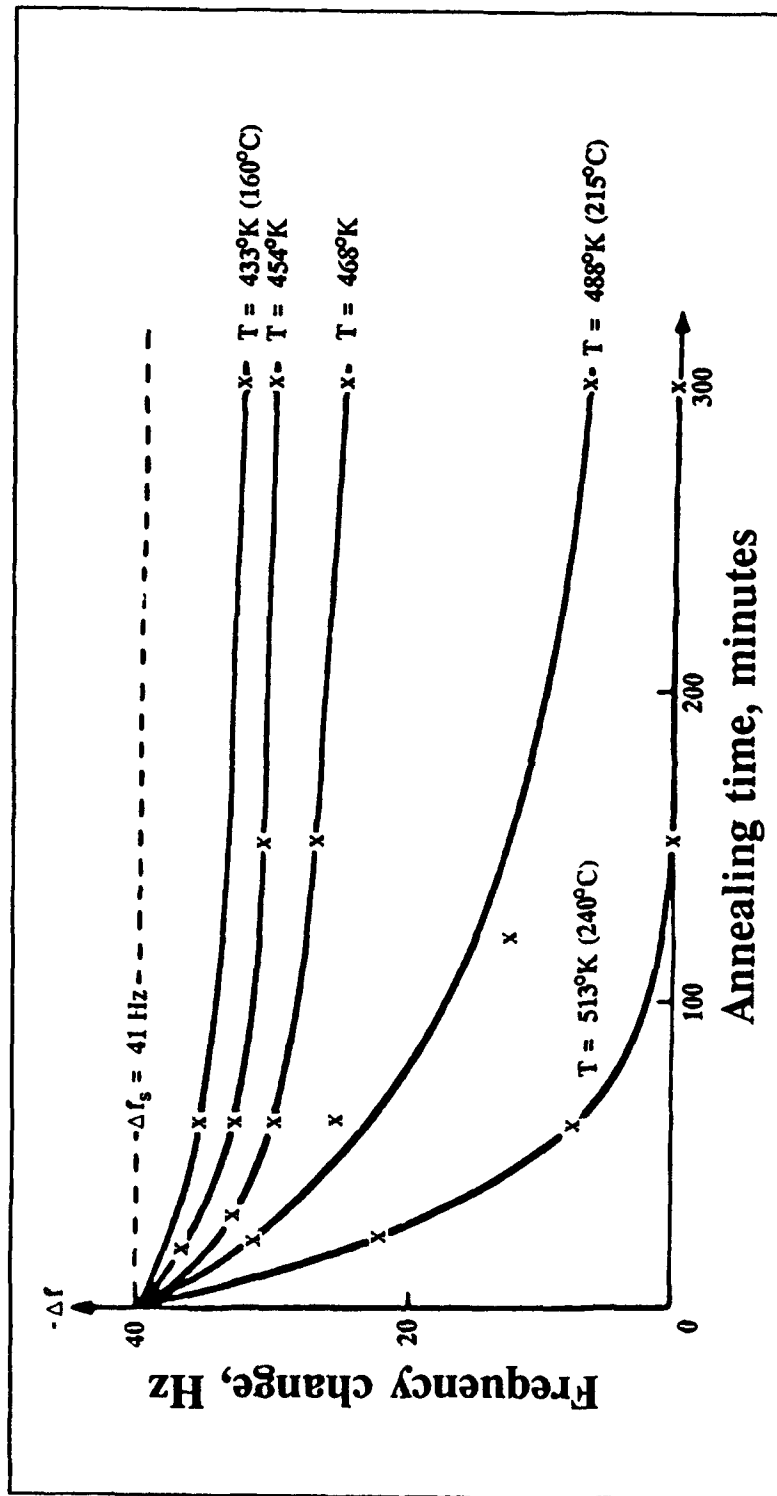

- For 4 MHz AT-cut resonator, X-ray dose of  $6 \times 10^6$  rads produced  $\Delta f = 41$  Hz.
- Activation energies were calculated from the temperature dependence of the annealing curves. The experimental results can be reproduced by two processes, with activation energies  $E_1 = 0.3 \pm 0.1$  eV and  $E_2 = 1.3 \pm 0.3$  eV.
- Annealing was complete in less than 3 hours at  $> 240^\circ\text{C}$ .

# Transient $\Delta f$ After a Pulse of $\gamma$ Radiation

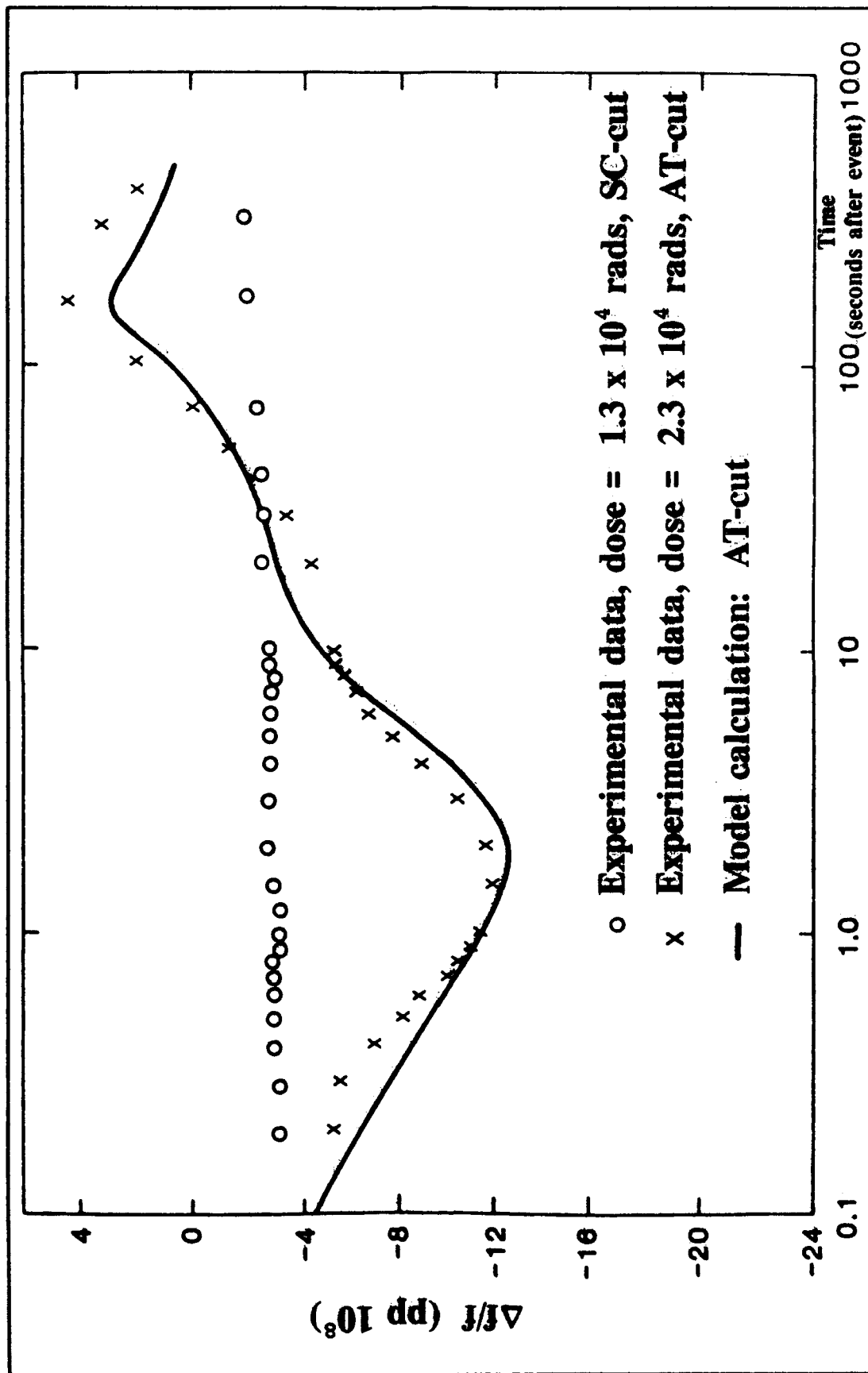

# Effects of Flash X-rays on $R_s$

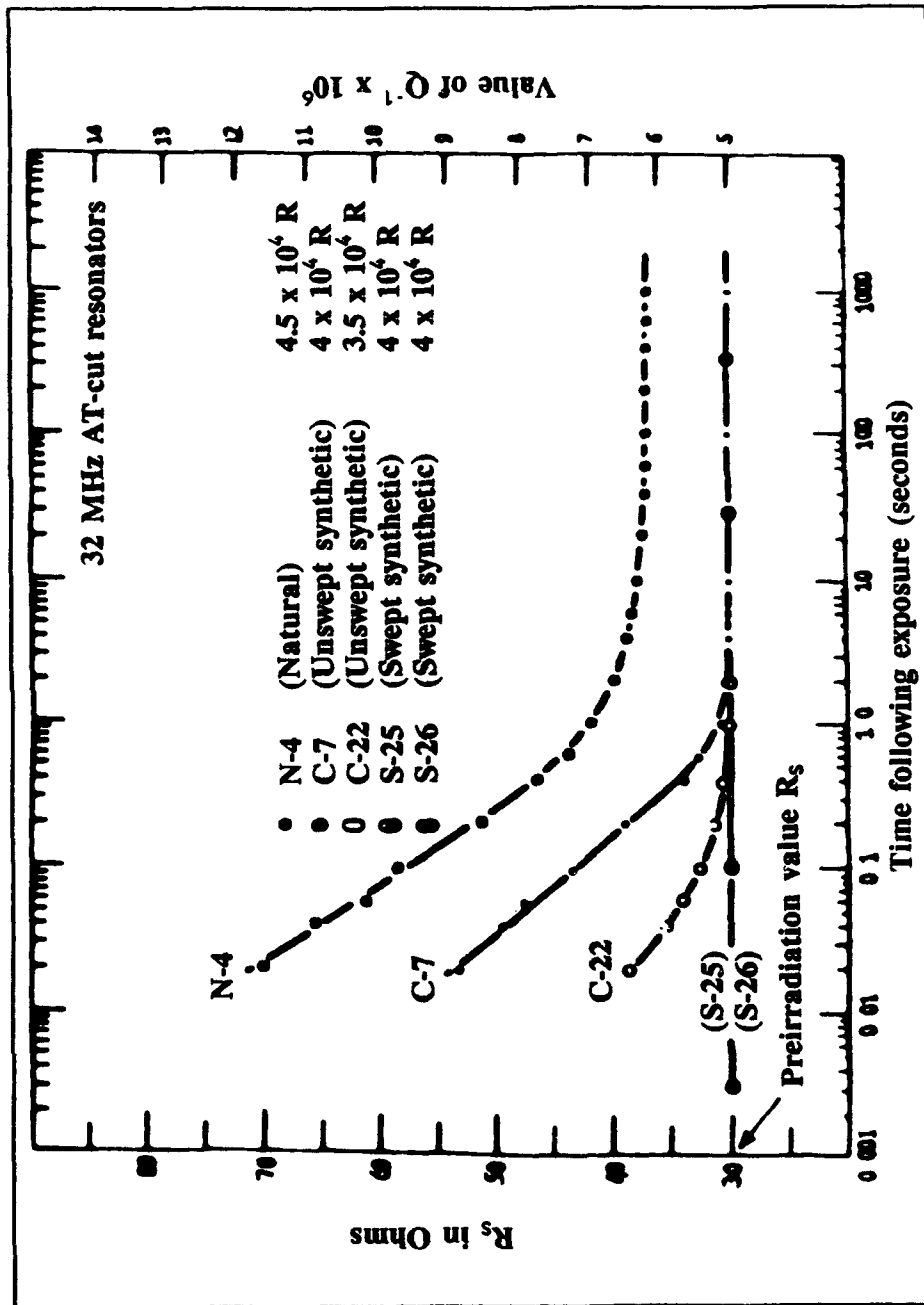

The curves show the series resonance resistance,  $R_s$ , vs. time following a  $4 \times 10^4$  rad pulse. Resonators made of swept quartz show no change in  $R_s$  from the earliest measurement time (1 ms) after exposure, at room temperature. Large increase in  $R_s$  (i.e., large decrease in the  $Q$ ) will stop the oscillation.

# Frequency Change due to Neutrons

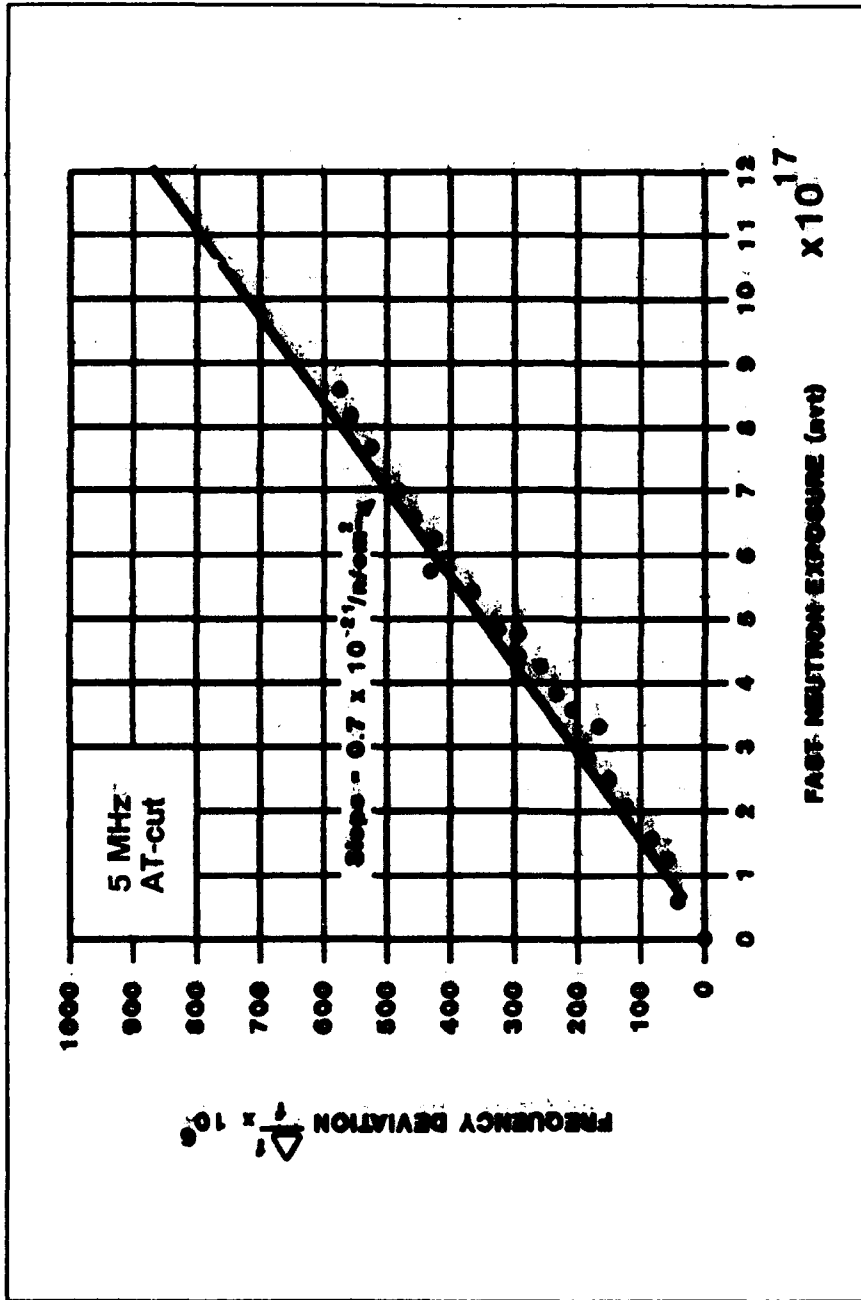

Curve shows the nearly linear increase in resonant frequency of a crystal unit as a function of reactor irradiation. At other fluences, the slopes are, for example,  $8 \times 10^{-21}/n/cm^2$  at  $10^{10}$  to  $10^{12}n/cm^2$ , and  $5 \times 10^{-21}/n/cm^2$  at  $10^{12}$  to  $10^{13}n/cm^2$ .

# Neutron Damage

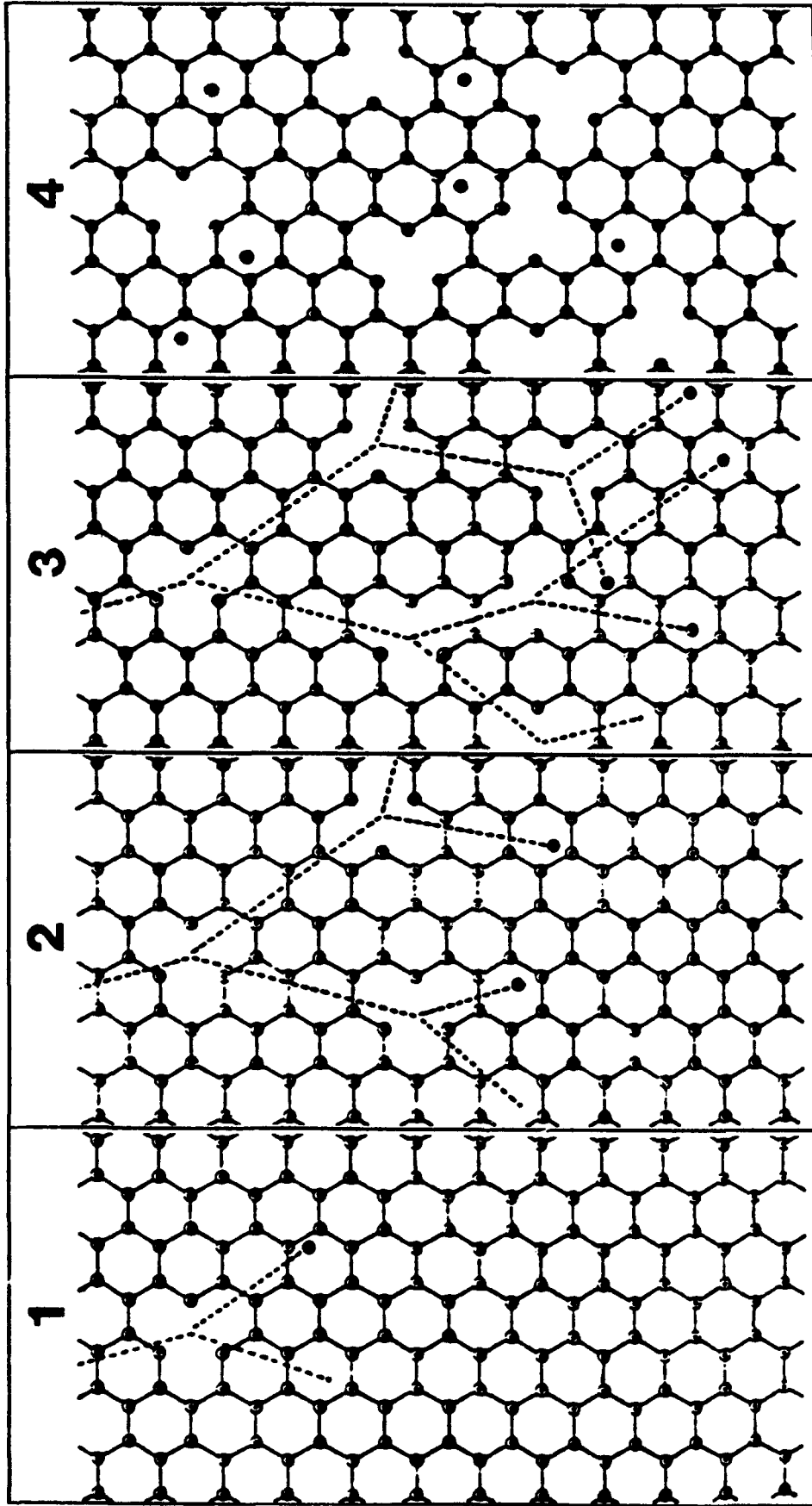

A fast neutron can displace about 50 to 100 atoms before it comes to rest. Most of the damage is done by the recoiling atoms. Net result is that each neutron can cause numerous vacancies and interstitials.

# Summary - Steady-State Radiation Results

- Dose vs. frequency change is nonlinear;  $f$  change per rad is larger at low doses.
- At doses  $> 1$  KRad,  $f$  change is quartz impurity dependent. The ionizing radiation produces electron-hole pairs; the holes are trapped by the impurity Al sites while the compensating cation (e.g., Li or Na) is released. The freed cations are loosely trapped along the optic axis. The lattice near the Al is altered, the elastic constant is changed; therefore, the  $f$  shifts. Ge impurity is also troublesome.
- At a 1 MRad dose,  $f$  change ranges from  $pp\ 10^{11}$  per rad for natural quartz to  $pp\ 10^{14}$  per rad for high quality swept quartz.
- Frequency change is negative for natural quartz; it can be positive or negative for cultured and swept cultured quartz.
- Frequency change saturates at doses  $> 10^6$  rads.
- $Q$  degrades if quartz contains high concentration of alkali impurities;  $Q$  of resonators made of properly swept cultured quartz is unaffected.
- High dose radiation can also rotate  $f$  vs.  $T$  characteristic.
- Frequency change anneals at  $T > 240^\circ\text{C}$  in less than 3 hours.
- Preconditioning (e.g., with doses  $> 10^5$  rads) reduces the high dose radiation sensitivities upon subsequent irradiations.
- At doses  $< 100$  rad,  $f$  change is not well understood. Radiation induced stress relief and surface effects (adsorption, desorption, dissociation, polymerization and charging) may be significant.



# Summary - Pulse Irradiation Results

- For applications requiring circuits hardened to pulse irradiation, quartz resonators are the least tolerant element in properly designed oscillator circuits.
- Resonators made of unswept quartz or natural quartz can experience a large increase in  $R_s$  following a pulse of radiation; the radiation pulse can stop the oscillation.
- Natural, cultured, and swept cultured AT-cut quartz resonators experience an initial negative frequency shift immediately after exposure to a pulse of X-rays (e.g.,  $10^4$  to  $10^5$  Rad of flash X-rays),  $\Delta f/f$  is as large as  $-3$  ppm at 0.02 sec after burst of  $10^{12}$  Rad/sec.
- Transient  $f$  offset anneals as  $t^{-1/2}$ ; the nonthermal-transient part of the  $f$  offset is probably due to the diffusion and retrapping of hydrogen at the  $Al^{3+}$  trap.
- Resonators made of properly swept quartz experience a negligibly small change in  $R_s$  when subjected to pulsed ionizing radiation (the oscillator circuit does not require a large reserve of gain margin).
- SC-cut quartz resonators made of properly swept high Q quartz do not exhibit transient frequency offsets following a pulse of ionizing radiation.
- Crystal oscillators will stop oscillating during an intense pulse of ionizing radiation because of the large prompt photoconductivity in quartz and in the transistors comprising the oscillator circuit. Oscillation will start up within 15  $\mu$ sec after burst if swept quartz is used in the resonator and the oscillator circuit is properly designed for the radiation environment.

# Summary - Neutron Irradiation Results

- When a fast neutron (~MeV energy) hurtles into a crystal lattice and collides with an atom, it is scattered like a billiard ball. The recoiling atom, having an energy ( $\sim 10^4$  to  $10^6$  eV) that is much greater than its binding energy in the lattice, leaves behind a vacancy and, as it travels through the lattice, it displaces and ionizes other atoms. A single fast neutron can thereby produce numerous vacancies, interstitials, and broken interatomic bonds. Neutron damage thus changes both the elastic constants and the density of quartz. Of the fast neutrons that impinge on a resonator, most pass through without any collisions, i.e., without any effects on the resonator. The small fraction of neutrons that collide with atoms in the lattice cause the damage.
- Frequency increases approximately linearly with fluence. For AT- and SC-cut resonators, the slopes range from  $+0.7 \times 10^{-21}$  /n/cm<sup>2</sup> at very high fluences ( $10^{17}$  to  $10^{18}$  n/cm<sup>2</sup>) to  $5 \times 10^{-21}$  /n/cm<sup>2</sup> at  $10^{12}$  to  $10^{13}$  n/cm<sup>2</sup>, and  $8 \times 10^{-21}$  /n/cm<sup>2</sup> at  $10^{10}$  to  $10^{12}$  n/cm<sup>2</sup>. Sensitivity probably depends somewhat on the quartz defect density and on the neutron energy distribution. (Thermonuclear neutrons cause more damage than reactor neutrons.)
- Neutron irradiation also rotates the frequency vs. temperature characteristic.
- When a heavily neutron irradiated sample was baked at 500° C for six days, 90% of the neutron-induced frequency shift was removed (but the 10% remaining was still 93 ppm).

# Other Effects on Stability

- **Electric field** - affects doubly-rotated resonators; e.g., a voltage on the electrodes of a 5 MHz fundamental mode SC-cut resonator results in a  $\Delta f/f = 7 \times 10^{-9}$  per volt. The voltage can also cause sweeping, which can affect the frequency (of all cuts).
- **Magnetic field** - quartz is diamagnetic, however, magnetic fields can induce Eddy currents, and will affect magnetic materials in the resonator package and the oscillator circuitry. Induced ac voltages can affect varactors, AGC circuits and power supplies. Typical frequency change of a "good" quartz oscillator is  $<< 10^{-10}$  per gauss.
- **Ambient pressure (altitude)** - deformation of resonator and oscillator packages, and change in heat transfer conditions affect the frequency.
- **Humidity** - can affect the oscillator circuitry, and the oscillator's thermal properties.
- **Power supply voltage, and load impedance** - affect the oscillator circuitry, and indirectly, the resonator's drive level and load reactance. A change in load impedance changes the amplitude or phase of the signal reflected into the oscillator loop, which changes the phase (and frequency) of the oscillation. The effects can be minimized through voltage regulation and buffering.
- **Gas permeation** - stability can be affected by excessive levels of atmospheric hydrogen and helium diffusing into "hermetically sealed" metal and glass enclosures (e.g., hydrogen diffusion through nickel resonator enclosures, and helium diffusion through glass Rb standard bulbs).

# Interactions Among Influences

In attempting to measure the effect of a single influence, one often encounters interfering influences, the presence of which may or may not be obvious.

Measurement	Interfering Influence
Resonator aging	$\Delta T$ due to oven T (i.e., thermistor) aging $\Delta$ drive level due to osc. circuit aging
Short term stability	Vibration
Vibration sensitivity	Induced voltages due to magnetic fields
2-g tipover sensitivity	$\Delta T$ due to convection inside oven
Resonator f vs. T (static)	Thermal transient effect, humidity T-coefficient of load reactances
Radiation sensitivity	$\Delta T$ , thermal transient effect, aging

## Chapter 4 References

- A. Ballato, "Piezoelectric Resonators," in B. Parzen, Design of Crystal and Other Harmonic Oscillators, John Wiley & Sons, 1983.
- T. E. Parker, "Characteristics and Sources of Noise in Stable Oscillators," Proc. 41st Annual Symposium on Frequency Control, pp. 99-110, 1987, IEEE Catalog No. 87CH2427-3.
- Frequency Stability: Fundamentals and Measurement, V. F. Kroupa, ed., IEEE Press, NY, 1983, IEEE Order No. PC01644.
- W. P. Robins, Phase Noise in Signal Sources: Theory and Applications, IEE Telecommunications Series 9, Peter Peregrinus, 1982.
- Characterization of Clocks and Oscillators, edited by D. B. Sullivan, et al., NIST Technical Note 1337, March 1990. Time & Frequency Div., NIST, 325 Broadway, Boulder, CO 80303.
- J. R. Vig, et al., The Effects of Acceleration on Precision Frequency Sources, U. S. Army Laboratory Command Research and Development Technical Report SLCET-TR-91-3, March 1991, AD-A235470.
- J. C. King and D. R. Koehler, "Radiation Effects on Resonators," in E. A. Gerber and A. Ballato, Precision Frequency Control, Vol. 1, pp. 147-159, Academic Press, 1985.
- S. R. Stein and J. R. Vig, Frequency Standards for Communications, U. S. Army Laboratory Command Research and Development Technical Report SLCET-TR-91-2, January 1991, AD-A231990.
- 4-5 T. R. Meeker, and J. R. Vig, The Aging of Bulk Acoustic Wave Resonators, Oscillators and Filters, Proc. 45th Ann. Symp. on Frequency Control 1991, IEEE Cat. No. 91CH2965-2.
- 4-8 Provided by Arthur Ballato, U.S. Army LABCOM, private communication, circa 1978.
- 4-9 A. Ballato, E. P. EerNisse, and T. Lukaszek, "The Force-Frequency Effect in Doubly Rotated Quartz Resonators," Proc. 31st Annual Symposium on Frequency Control, pp. 8-16, 1977, AD-A088221. Proc. copies available from NTIS.
- 4-10 R. A. Young, R. B. Belser, A. L. Bennett, W. H. Hicklin, J. C. Meaders, and C. E. Wagner, "Special X-ray Studies of Quartz

- Frequency Control Units," Proc. 19th Annual Symposium on Frequency Control, pp. 23-41, 1965, AD-471229. Proc. copies available from NTIS.
- 4-11 R. B. Belser and W. H. Hicklin, "Aging Characteristics of Quartz Resonators With Comments on the Effects of Radiation," Proc. 17th Annual Symposium on Frequency Control, pp. 127-175, 1963, AD423381. Proc. copies available from NTIS.
- 4-13 R. L. Filler, and J. R. Vig, "The Effect of Bonding on the Frequency vs. Temperature Characteristics of AT-cut Resonators," Proc. 30th Annual Symposium on Frequency Control, pp. 264-268, 1976, AD-046089. Proc. copies available from NTIS.
- 4-18 S. R. Stein, "Frequency and Time - Their Measurement and Characterization," in E. A. Gerber and A. Ballato, Precision Frequency Control, Vol. 2, pp. 191-232, Academic Press, 1985.
- 4-19 D. W. Allan, "Time and Frequency (Time-Domain) Characterization, Estimation, and Prediction of Precision Clocks and Oscillators," IEEE Transactions on Ultrasonics, Ferroelectrics, and Frequency Control, Vol. UFFC-34, No. 6, pp. 647-654, November 1987.
- 4-25 R. F. Voss, "1/f (Flicker) Noise: A Brief Review," Proc. 33rd Annual Symposium on Frequency Control, pp. 40-46, 1979, AD-A213544. Proc. copies available from NTIS..
- 4-30 The analysis and graphs on pp. 4-30 and 4-31 were provided by Raymond L. Filler, U.S. Army LABCOM, 1989.
- 4-41 J. R. Vig, W. Washington, and R. L. Filler, "Adjusting the Frequency vs. Temperature Characteristics of SC-cut Resonators by Contouring," Proc. 35th Ann. Symp. on Frequency Control, pp. 104-109, 1981, AD-A110870. Proc. copies available from NTIS.
- 4-42 A. Ballato, and J. R. Vig, "Static and Dynamic Frequency-Temperature Behavior of Singly and Doubly Rotated, Oven-Controlled Quartz Resonators," Proc. 32nd Annual Symposium on Frequency Control, pp. 180-188, 1978, AD-A955718.
- 4-43 A. Ballato, "Frequency-Temperature-Load Capacitance Behavior of Resonators for TCXO Application," IEEE Trans. Sonics Ultrasonics., SU-25, pp.185-191, July 1978.
- 4-44 A. Ballato, and T. Lukaszek, "Higher Order Temperature Coefficients of Frequency of Mass-Loaded Piezoelectric Crystal Plates," Proc. 29th Ann. Symp. on Frequency Control, pp. 10-25, 1975, AD-A017466. Proc. copies available from NTIS.

- 4-46 J. A. Kusters and J. R. Vig, "Thermal Hysteresis in Quartz Resonators - A Review," Proc. 44th Annual Symposium on Frequency Control, pp. 165-175, 1990, IEEE Catalog No. 90CH2818-3.
- 4-47a W. L. Smith, and W. J. Spencer, "Quartz Crystal Controlled Oscillators," Final Report, U.S. Army Contract DA36-039 SC-85373, Report No. 25335-H, 15 March 1963, AD-419717.
- 4-47b R. A. Sykes, W. L. Smith, and W. J. Spencer, "Studies on High Precision Resonators," Proc. 17th Annual Symposium on Frequency Control, pp. 4-27, 1963, AD423381. Proc. copies available from NTIS..
- 4-48 R. L. Filler, V. J. Rosati, S. S. Schodowski, and J. R. Vig, "Specification and Measurement of the Frequency Versus Temperature Characteristics of Crystal Oscillators," Proc. 43rd Annual Symposium on Frequency Control, pp. 253-255, 1989, IEEE Catalog No. 89CH2690-6.
- 4-50 A. Ballato and R. Tilton, "Electronic Activity Dip Measurement," IEEE Transactions on Instrumentation and Measurement, Vol. IM-27, No. 1, pp. 59-65, March 1978.
- 4-52 J. A. Kusters, "The SC Cut Crystal - An Overview," Proc. the 1981 IEEE Ultrasonics Symposium, pp. 402-409.
- 4-53a R. L. Filler, "The Amplitude-Frequency Effect in SC-Cut Resonators," Proc. 39th Annual Symposium on Frequency Control, pp. 311-316, 1985, IEEE Catalog No. 85CH2186-5.
- 4-53b D. Hammond, C. Adams, and L. Cutler, "Precision Crystal Units," Proc. 17th Annual Symposium on Frequency Control, pp. 215-232, 1963, AD-423381. Proc. copies available from NTIS.
- 4-55 J. E. Knowles, "On the Origin of the 'Second Level of Drive' Effect in Quartz Oscillators," Proc. 29th Annual Symposium on Frequency Control, pp. 230-236, 1975, AD-A017466. Proc. copies available from NTIS.
- 4-56 M. Valdois, J. Besson, and J. J. Gagnepain, "Influence of Environment Conditions on a Quartz Resonator," Proc. 28th Annual Symposium on Frequency Control, pp. 19-32, 1974, AD-A011113. Proc. copies available from NTIS.
- 4-57 R. L. Filler, "The Acceleration Sensitivity of Quartz Crystal Oscillators: A Review," IEEE Transactions on Ultrasonics, Ferroelectrics, and Frequency Control, Vol. 35, No. 3, pp. 297-305, May 1988.

- 4-69 E. P. EerNisse, R. W. Ward and O. L. Wood, "Acceleration-Induced Frequency Shifts in Quartz Resonators," Proc. 43rd Ann. Symposium on Frequency Control, pp. 388-395, 1989, IEEE Cat. No. 89CH2690-6.
- 4-73 V. J. Rosati and R. L. Filler, "Reduction of the Effects of Vibration on SC-Cut Quartz Crystal Oscillators," Proc. 35th Annual Symposium on Frequency Control, pp. 117-121, 1981, AD-A110870. Proc. copies available from NTIS..
- 4-75 R. L. Filler, L. J. Keres, T. M. Snowden, and J. R. Vig, "Ceramic Flapack Enclosed AT and SC-cut Resonators," Proc. 1980 IEEE Ultrasonic Sump., pp. 819-824, 1980.
- 4-77 L. J. Palkuti and Q. T. Truong, "An X-Ray Irradiation System for Total-Dose Testing of Quartz Resonators," Proc. 38th Annual Symposium on Frequency Control, pp. 55-62, 1984, AD-A217381. Proc. copies available from NTIS..
- 4-78 B. R. Capone, A. Kahan, R. N. Brown, and J. R. Buckmelter, "Quartz Crystal Radiation Effects," IEEE Trans. Nuclear Sci., NS-17, pp. 217-221, 1970.
- 4-79 P. Freymuth and G. Sauerbrey, "Ausheilung von Bestrahlungsschaden in Quarz- Schwingkristallen," J. Phys. Chem. Solids, Pergamon Press, Vol. 24, pp. 151-155, 1963.
- 4-80 J. C. King and D. R. Koehler, "Radiation Effects on Resonators," in E. A. Gerber and A. Ballato, Precision Frequency Control, Vol. 1, pp. 147-159, Academic Press, 1985.
- 4-81 J. C. King and H. H. Sander, "Transient Change in Q and Frequency of AT-Cut Quartz Resonators Following Exposure to Pulse X-Rays," IEEE Trans. Nucl. Sci., NS-20, pp. 117-125, 1973.
- 4-82 J. C. King and D. B. Fraser, "Effects of Reactor Irradiation on Thickness Shear Crystal Resonators," Proc. 16th Annual Symposium on Frequency Control, pp. 8-31, 1962, AD-285086. Proc. copies available from NTIS.
- 4-84 T. M. Flanagan, R. E. Leadon and D. L. Shannon, "Evaluation of Mechanisms for Low-Dose Frequency Shifts in Crystal Oscillators," Proc. 40th Ann. Symp. on Frequency Control, pp. 127-133, 1986, IEEE Cat. No. 86CH2330-9.
- 4-87 F. L. Walls, "Environmental Sensitivities of Quartz Crystal Oscillators," Proc. 22nd Ann. Precise Time & Time Interval (PTTI) Applications & Planning Meeting, pp. 465-486, 1990, AD-A239372.



5

# Quartz Material Properties

# Hydrothermal Growth of Quartz

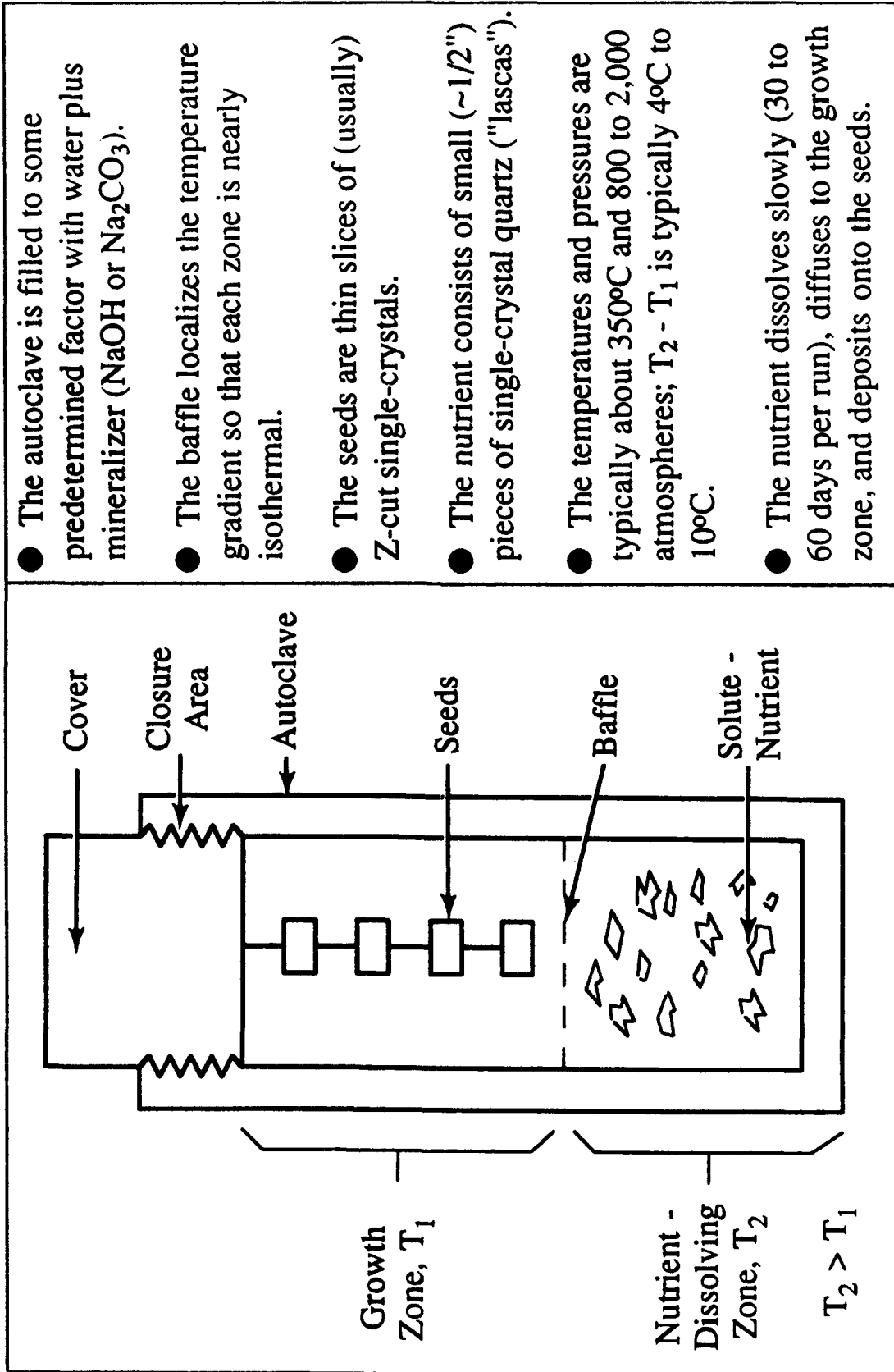

- The autoclave is filled to some predetermined factor with water plus mineralizer (NaOH or Na<sub>2</sub>CO<sub>3</sub>).
- The baffle localizes the temperature gradient so that each zone is nearly isothermal.
- The seeds are thin slices of (usually) Z-cut single-crystals.
- The nutrient consists of small (~1/2") pieces of single-crystal quartz ("lascas").
- The temperatures and pressures are typically about 350°C and 800 to 2,000 atmospheres; T<sub>2</sub> - T<sub>1</sub> is typically 4°C to 10°C.
- The nutrient dissolves slowly (30 to 60 days per run), diffuses to the growth zone, and deposits onto the seeds.

# Left-Handed and Right-Handed Quartz

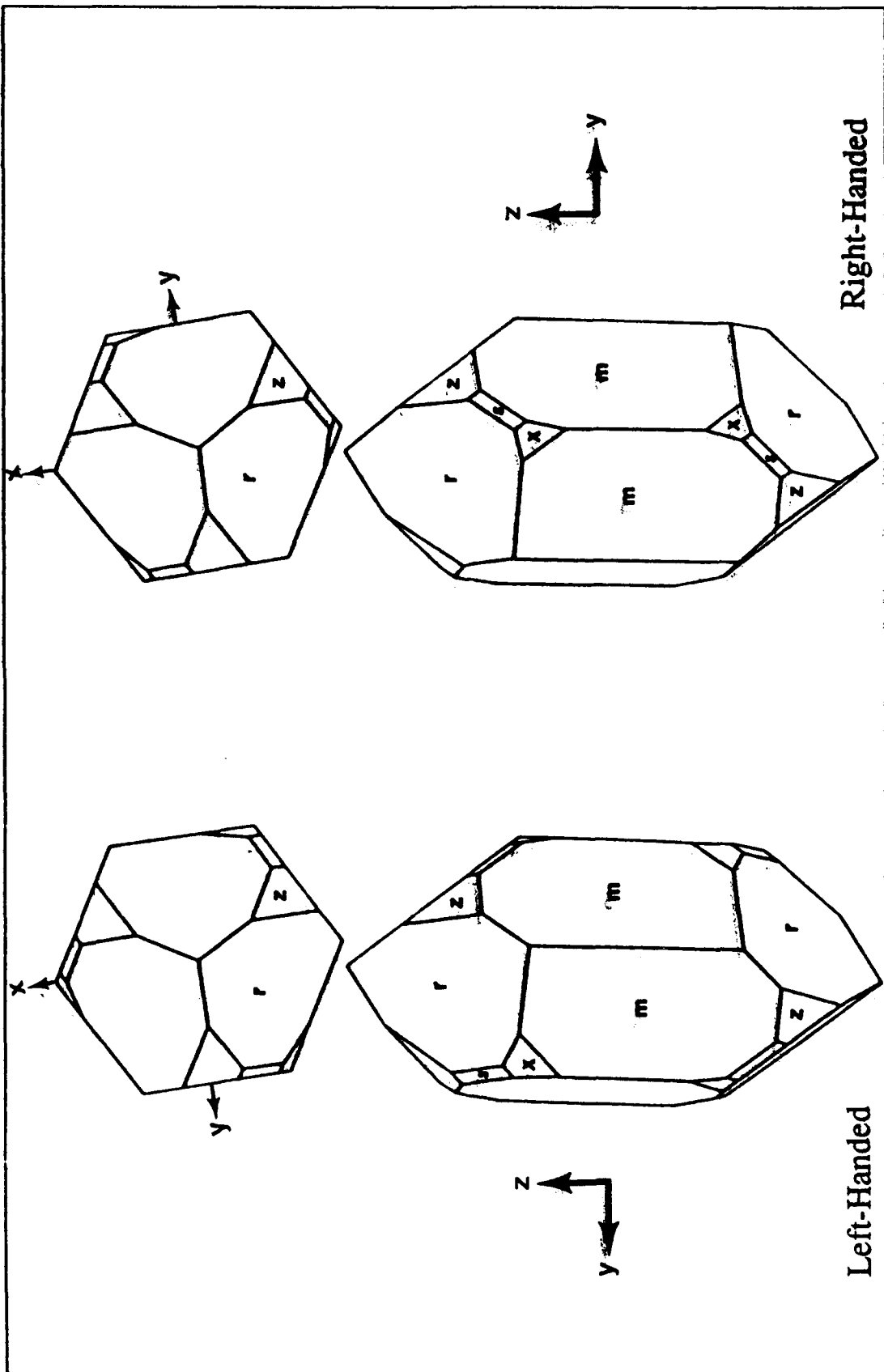

# The Quartz Lattice

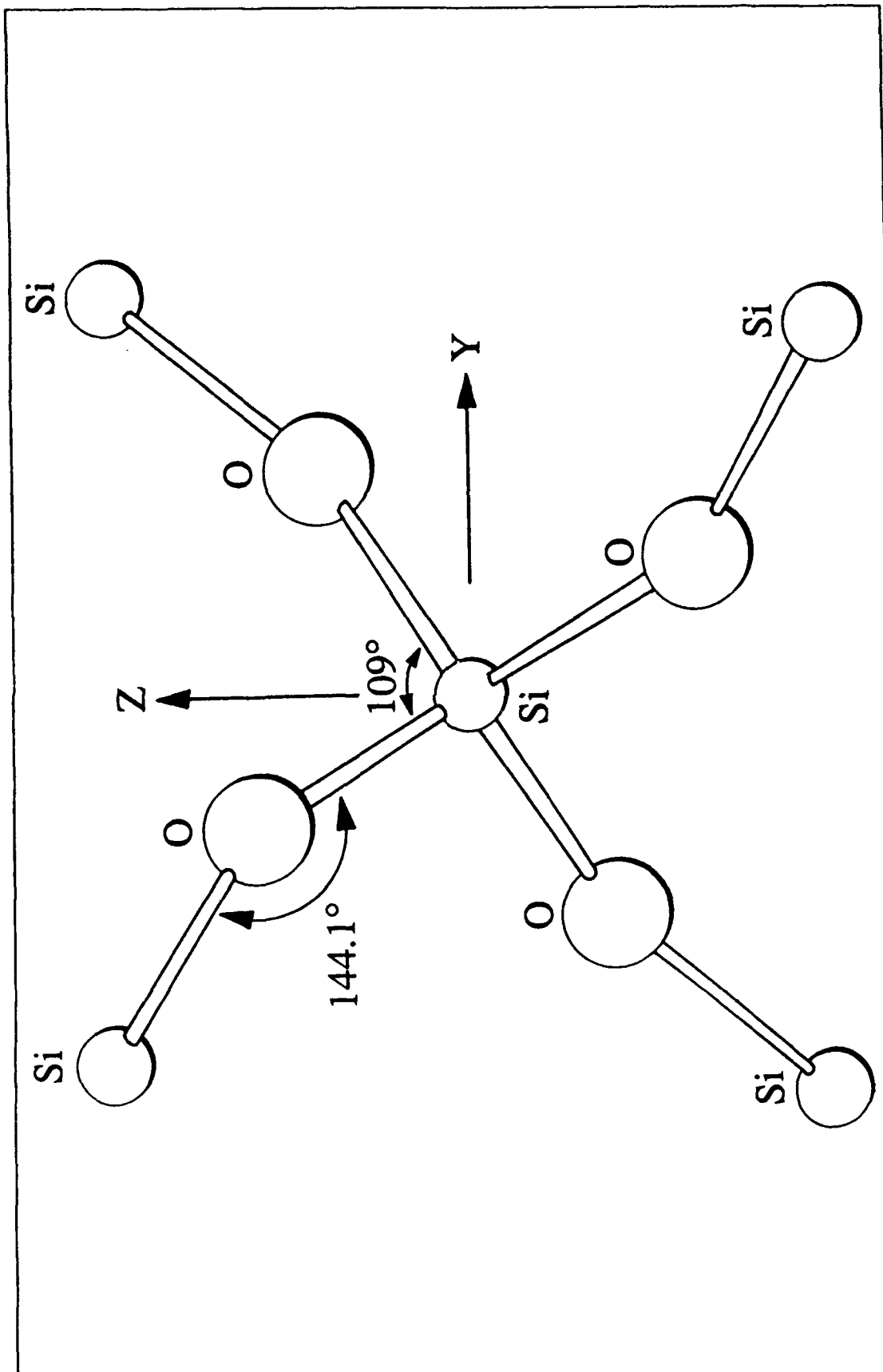

# Quartz Properties' Effects on Device Properties

Quartz Property	Device and Device-Fabrication Property
Q	Oscillator short-term stability, phase noise close to carrier, long-term stability, filter loss
Purity (Al, Fe, Li, Na, K, -OH, H <sub>2</sub> O)	Radiation hardness, susceptibility to twinning, optical characteristics
Crystalline Perfection, Strains	Sweepability, etchability for chem. polishing and photolithographic processing, optical properties, strength, aging(?), hysteresis (?)
Inclusions	High-temperature processing and applications, optical characteristics, etchability

# Ions in Quartz - Simplified Model

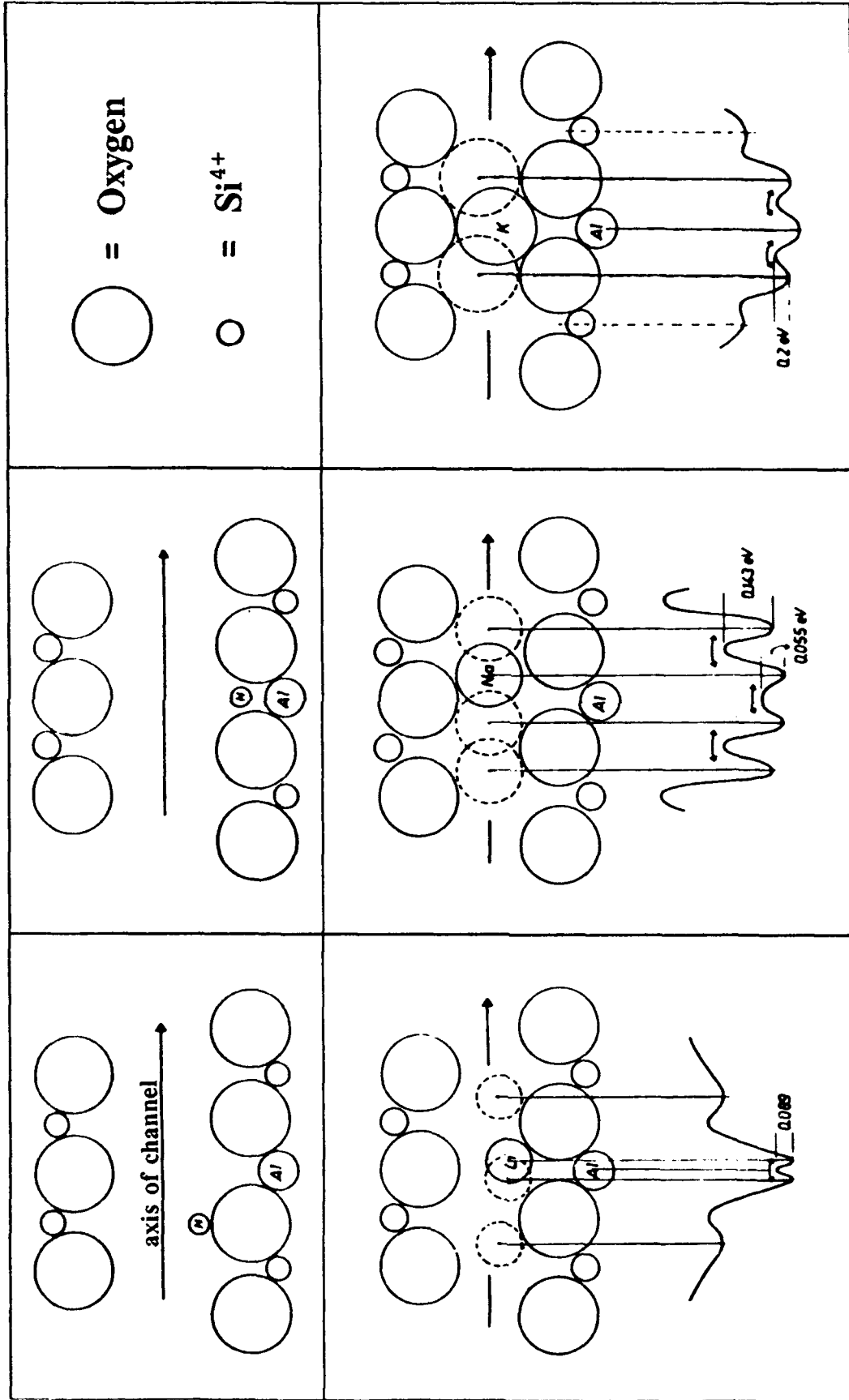

Models show the positions of H<sup>+</sup> and alkali ions in the channels of the quartz lattice and the corresponding trends of the potential energy curves.

# Aluminum Associated Defects

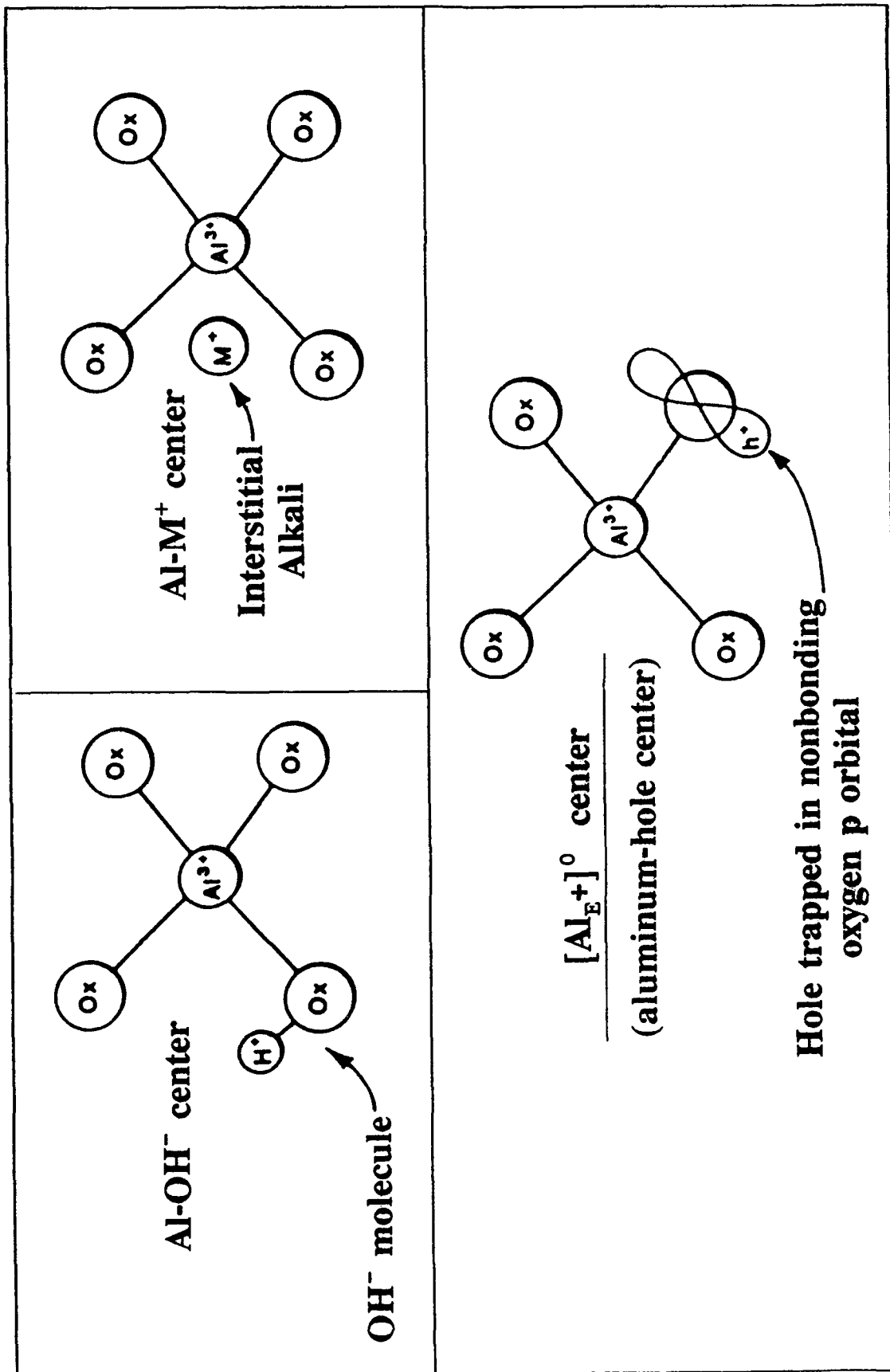

# Sweeping

Sweeping is a purification process which removes certain impurities from the quartz and thereby improves the radiation hardness and etching properties of quartz crystals. It is an electric-field driven, solid-state diffusion process that is performed at an elevated temperature. The major steps of a typical sweeping process consist of applying electrodes to the Z-surfaces of a lumbered quartz bar, heating the bar slowly to 500°C, applying a voltage to the electrodes such that the electric field along the Z-direction is about 1 kV/cm, monitoring the current through the bar (as the sweeping progresses, the current decreases), and after the current decays to some constant value, cooling the bar slowly to room temperature, then removing the voltage.

Under the influences of the high electric field and the high temperature, the positive impurity ions, such as  $\text{Li}^+$  and  $\text{Na}^+$ , diffuse to the cathode and are removed when the electrodes are removed in subsequent processing. In addition to improving radiation hardness, sweeping also greatly reduces the number of etch channels that are produced when quartz is etched.



# Typical Sweeping Method

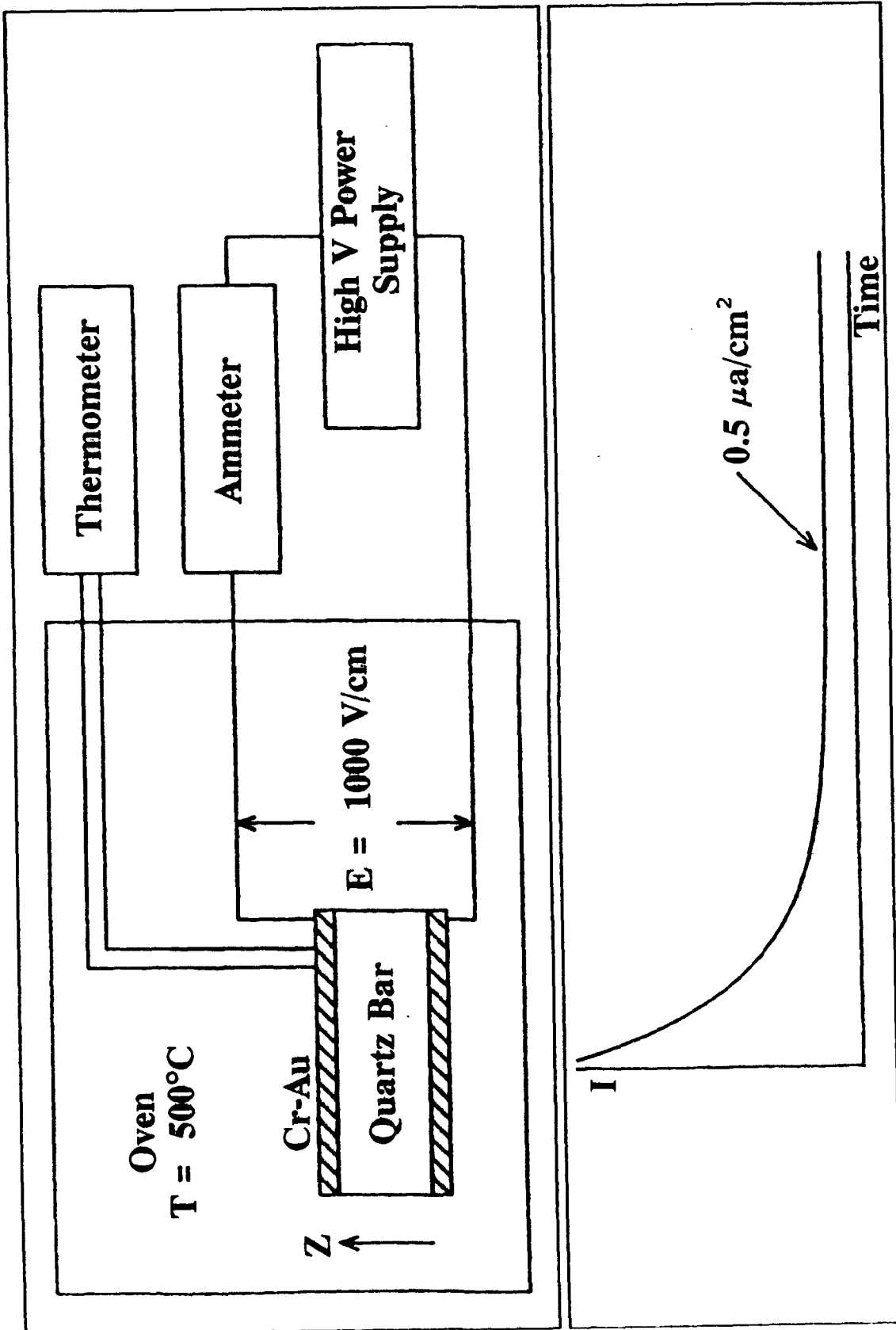

# Quartz Quality Indicators

- Infrared absorption coefficient \*
- Etch-channel density \*
- Etch-pit density
- Inclusion density \*
- Impurity analysis
- X-ray topography
- UV absorption
- Birefringence along the optic axis
- Thermal shock induced fracture
- Electron spin resonance
- ???

\* EIA Standard 477-1 contains standard test method for this quantity

# Infrared Absorption

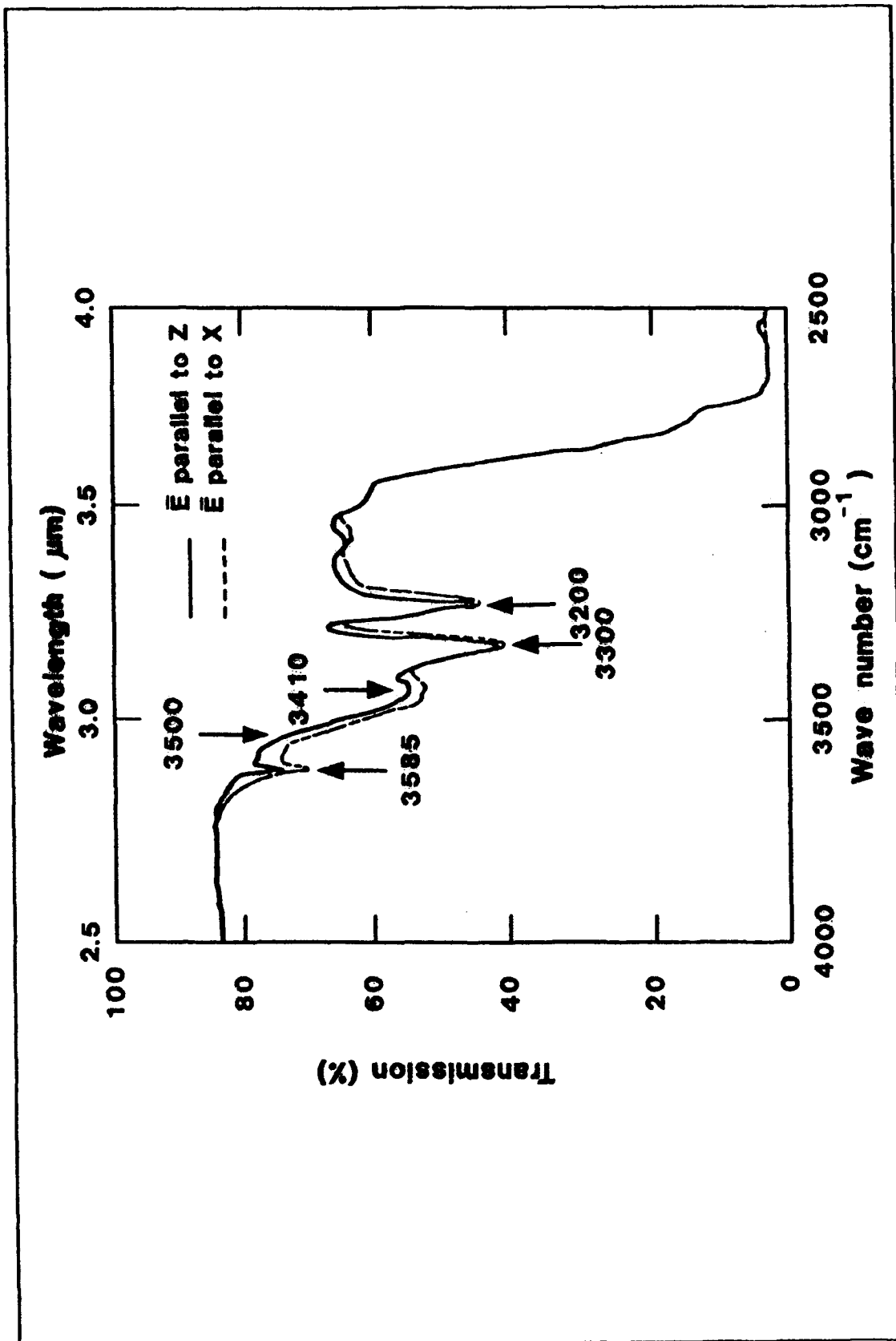

# Infrared Absorption

One of the factors that determine the maximum achievable resonator Q is the OH content of the quartz. Infrared absorption measurements are routinely used to measure the intensities of the temperature-broadened OH defect bands. The **infrared absorption coefficient**  $\alpha$  is defined by ELA Standard 477-1 as

$$\alpha = \frac{A (3500 \text{ cm}^{-1}) - A (3800 \text{ cm}^{-1})}{Y\text{-cut thickness in cm}}$$

where the A's are the logarithm (base 10) of the fraction of the incident beam absorbed at the wave numbers in the parentheses.

Grade	$\alpha$ , in $\text{cm}^{-1}$	Approx. max. Q*
A	0.03	3.0
B	0.045	2.2
C	0.060	1.8
D	0.12	1.0
E	0.25	0.5

\* In millions, at 5 MHz ( $\alpha$  is a quality indicator for unswept quartz only).

# Quartz Twinning

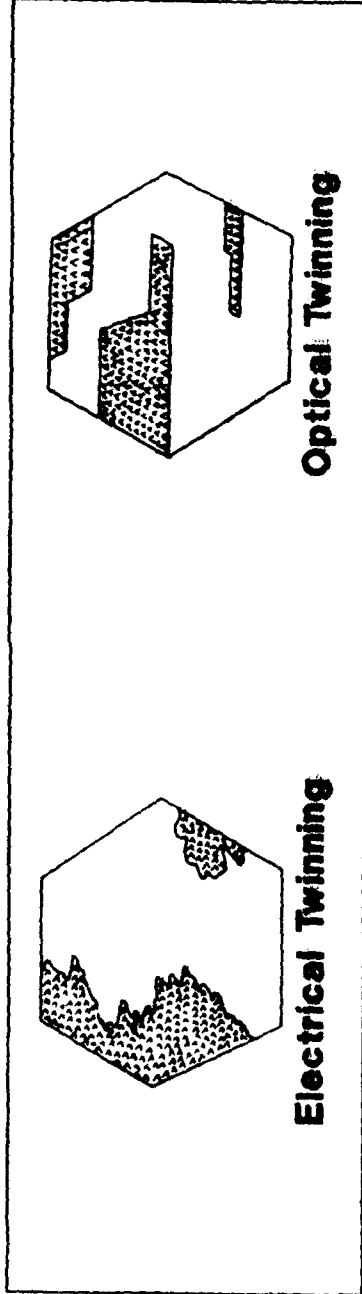

- The X-axes of quartz, the electrical axes, are parallel to the line bisecting adjacent prism faces; the +X-direction is positive upon extension due to tension.
- Electric twinning (also called Dauphiné twinning) consists of localized reversal of the X-axes. It usually consists of irregular patches, with irregular boundaries. It can be produced artificially by inversion from high-quartz, thermal shock, high local pressure (even at room temperature), and by an intense electric field.
- In right-handed quartz, the plane of polarization is rotated clockwise as seen by looking toward the light source; in left handed, it is CCW. Optically twinned (also called Brazil twinned) quartz contains both left and right-handed quartz. Boundaries between optical twins are usually straight.
- Etching can reveal both kinds of twinning.

# Twinning - Axial Relationships

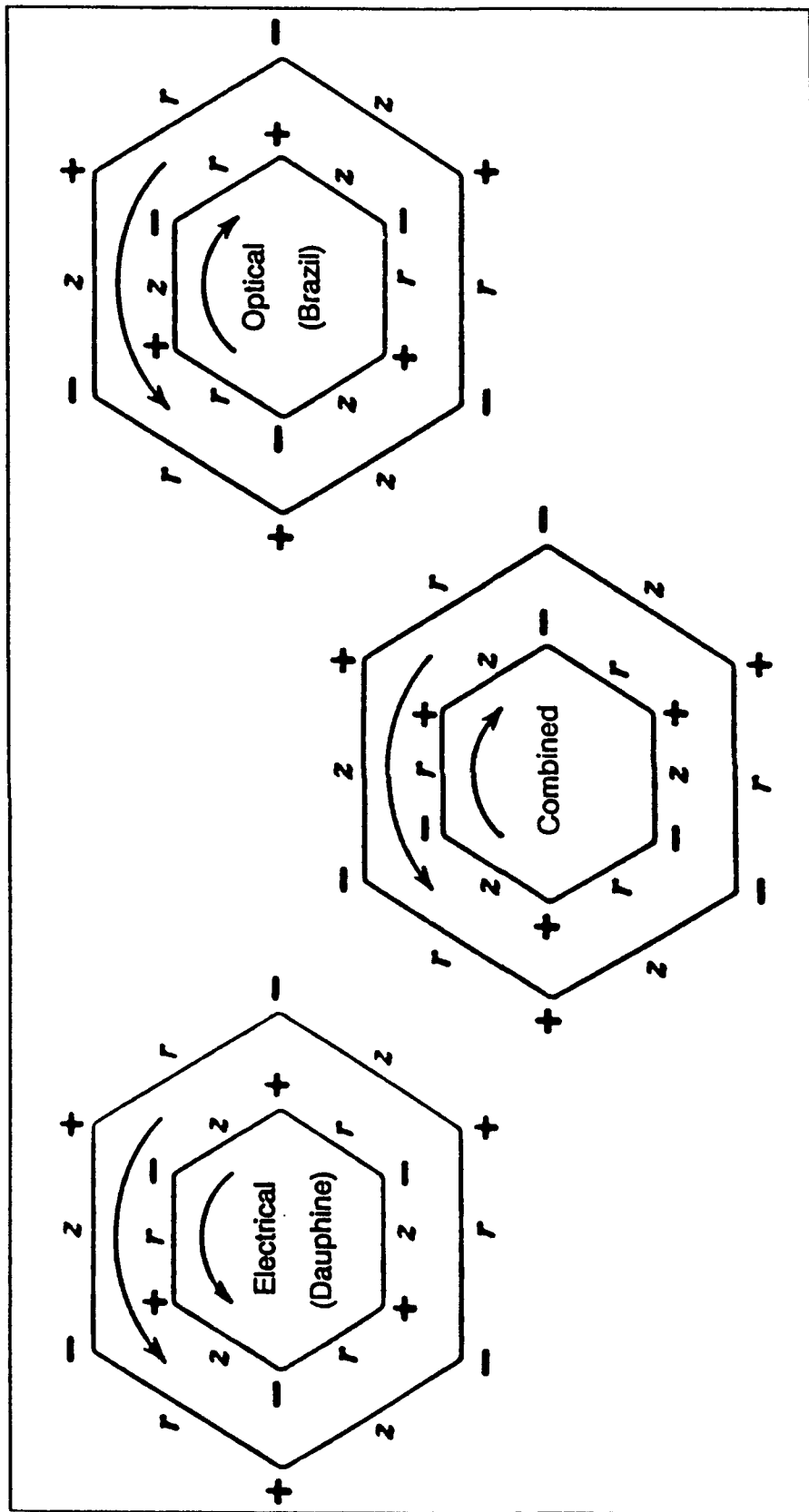

The diagrams illustrate the relationship between the axial system and hand of twinned crystals. The arrows indicate the hand.

# Quartz Lattice and Twinning

Z-axis projection showing electric (Dauphiné) twins separated by a twin wall of one unit cell thickness. The numbers in the atoms are atom heights expressed in units of percent of a unit cell height. The atom shifts during twinning involve motions of  $< 0.03$  nm.

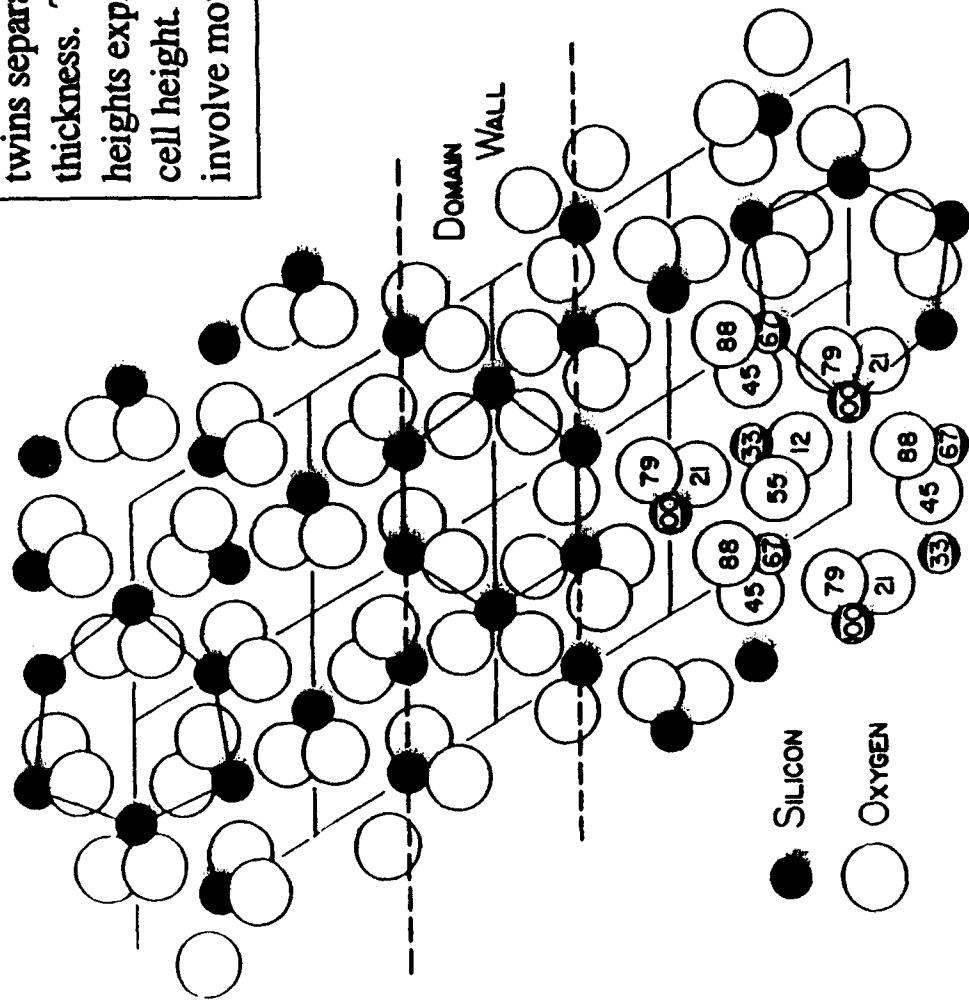

# Quartz Inversion

- Quartz undergoes a high-low inversion ( $\alpha - \beta$  transformation) at 573°C. (It is 573°C at 1 atm on rising temperature; it can be 1° to 2°C lower on falling temperature.)
- Bond angles between adjoining ( $\text{SiO}_4$ ) tetrahedra change at the inversion. Whereas low-quartz ( $\alpha$  - quartz) is trigonal, high quartz ( $\beta$  - quartz) is hexagonal. Both forms are piezoelectric.
- An abrupt change in nearly all physical properties takes place at the inversion point; volume increases by 0.86% during inversion from low to high quartz. The changes are reversible, although Dauphiné twinning is usually acquired upon cooling through the inversion point.
- Inversion temperature decreases with increasing Al and alkali content, increases with Ge content, and increases 1°C for each 40 atm increase in hydrostatic pressure.



# Phase Diagram of Silica ( $\text{SiO}_2$ )

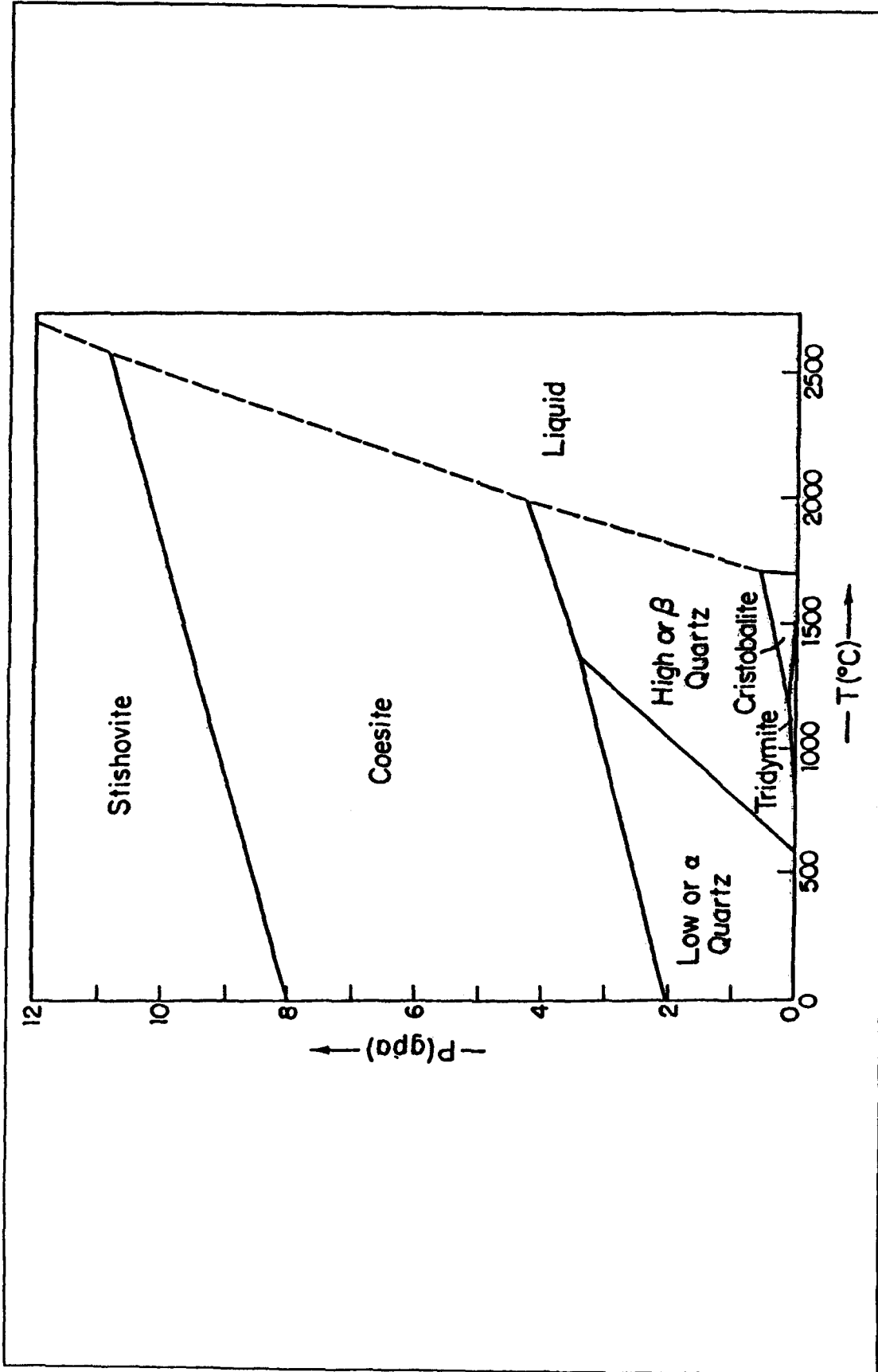

## Chapter 5 References

- Quartz for the National Defense Stockpile, Report of the Committee on Cultured Quartz for the National Defense Stockpile, National Materials Advisory Board Commission on Engineering and Technical Systems, National Research Council, NMA-B-424, National Academy Press, Washington, D.C., 1985.
- L. E. Halliburton, J. J. Martin and D. R. Koehler, "Properties of Piezoelectric Materials," in E. A. Gerber and A. Ballato, Precision Frequency Control, Vol. 1, pp. 1-45, Academic Press, 1985.
- C. Frondel, The System of Mineralogy, Vol. III, "Silica Minerals", John Wiley and Sons, Inc., New York, 1962.
- J. C. Brice, "Crystals for Quartz Resonators," Reviews of Modern Physics, Vol. 57, No. 1, pp. 105-146, January 1985.
- 5-1 R. A. Laudise and R. L. Bams, "Perfection of Quartz and Its Connection to Crystal Growth," IEEE Transactions on Ultrasonics, Ferroelectrics, and Frequency Control, Vol. 35, No. 3, pp. 277-287, May 1988, IEEE Catalog 88CH2588-2.
- 5-3 J. D. Jorgensen, "Compression Mechanisms in  $\alpha$ -quartz Structures - SiO<sub>2</sub> and GeO<sub>2</sub>," J. Appl. Phys. Vol 49, pp. 5473-78, 1978.
- 5-5 J. M. Stevels and J. Volger, "Further Experimental Investigations on the Dielectric Losses of Quartz Crystals in Relation to Their Imperfections," Philips Res. Repts. 17, pp. 283-314, 1962.
- 5-6a L. E. Halliburton, M. E. Markes, and J. J. Martin, "Point Defects in Synthetic Quartz: A Survey of Spectroscopic Results With Application to Quality Assurance," Proc. 34th Annual Symposium on Frequency Control, pp. 1-8, 1980, ADA213670. Proc. copies available from NTIS..
- 5-6b L. E. Halliburton, N. Koumvakalis, M. E. Markes, and J. J. Martin, "Radiation Effects in Crystalline SiO<sub>2</sub>: The Role of Aluminum," J. Appl. Phys., Vol. 52, pp. 3565-3574, 1981.
- 5-7a J. J. Martin, "Electrodiffusion (Sweeping) of Ions in Quartz," IEEE Transactions on Ultrasonics, Ferroelectrics, and Frequency

Control, Vol. 35, No. 3, pp. 288-296, May 1988, IEEE Catalog 88CH2588-2.

- 5-7b** J. G. Gualtieri, "Sweeping Quartz Crystals," Proc. 1989 IEEE Ultrasonics Symposium, pp. 381-391, 1989.
- 5-9a** G. R. Johnson and R. A. Irvine, "Etch Channels in Single Crystal Cultured Quartz," Proc. 41st Annual Symposium on Frequency Control, pp. 175-182, 1987, IEEE Catalog No. 87CH2427-3.
- 5-9b** J. R. Vig, J. W. LeBus and R. L. Filler, "Chemically Polished Quartz," Proc. 31st Annual Symposium on Frequency Control, pp. 131-143, 1977, ADA088221. Proc. copies available from NTIS.
- 5-10a** J. C. Brice and A. M. Cole, "The Characterization of Synthetic Quartz by Using Infrared Absorption," Proc. 32nd Annual Symposium on Frequency Control, pp. 1-10, 1978.
- 5-10b** B. Sawyer, "Quality Indications From Infrared Absorption Measurements on Cultured Quartz," IEEE Transactions on Ultrasonics, Ferroelectrics, and Frequency Control, Vol. UFFC-34, No. 5, pp. 558-565, September 1987.
- 5-14** T. L. Anderson, R. E. Newnham and L. E. Cross, "Coercive Stress for Ferroelastic Twinning in Quartz," Proc. 31st Annual Symposium on Frequency Control, pp. 171-177, 1977, ADA088221. Proc. copies available from NTIS.

⑥

# Emerging Oscillator Technologies

# Emerging/Improving Technologies

- SC-cut resonators
- Resonator theory and finite element modeling
- Advanced fabrication techniques
  - ☛ Surface cleaning (UV-ozone, plasma; ice scrubber for particle removal)
  - ☛ Chemical polishing & chemical milling
  - ☛ Plate, mount and electrode geometries (lateral field, BVA, polygonal)
  - ☛ Bonding (parallel gap, thermocompression)
  - ☛ Packaging (ceramic flatpack, ceramic-metal, all-quartz)
  - ☛ Ultrahigh vacuum, high temperature & automated processing
- High purity, low defect density quartz
- UHF and miniature (photolithography/etching produced) resonators
- Acceleration sensitivity reduction and compensation techniques
- Microcomputer compensation (temperature, acceleration, radiation)
- Miniature fast warmup OCXO & directly heated crystal plate
- Rubidium-crystal oscillator (RbXO)
- Optically pumped atomic frequency standards

# Comparison of SC and AT-cuts

## ● Advantages of the SC-cut

- ☞ Thermal transient compensated (allows faster warmup OCXO)
  - ☞ Static and dynamic  $f$  vs.  $T$  allow higher stability OCXO and MCXO
  - ☞ Better  $f$  vs.  $T$  repeatability allows higher stability OCXO and MCXO
  - ☞ Far fewer activity dips
  - ☞ Lower drive level sensitivity
  - ☞ Planar stress compensated; lower  $\Delta f$  due to edge forces and bending
  - ☞ Lower sensitivity to radiation
  - ☞ Higher capacitance ratio (less  $\Delta f$  for oscillator reactance changes)
  - ☞ Higher  $Q$  for fundamental mode resonators of similar geometry
  - ☞ Less sensitive to plate geometry - can use wide range of contours
- **Disadvantage of the SC-cut** : More difficult to manufacture for OCXO (but is easier to manufacture for MCXO than is an AT-cut for precision TCXO)
- ## ● Other Significant Differences
- ☞ B-mode is excited in the SC-cut, although not necessarily in LFR's
  - ☞ The SC-cut is sensitive to electric fields (can be used for compensation)

# Lateral Field Resonator

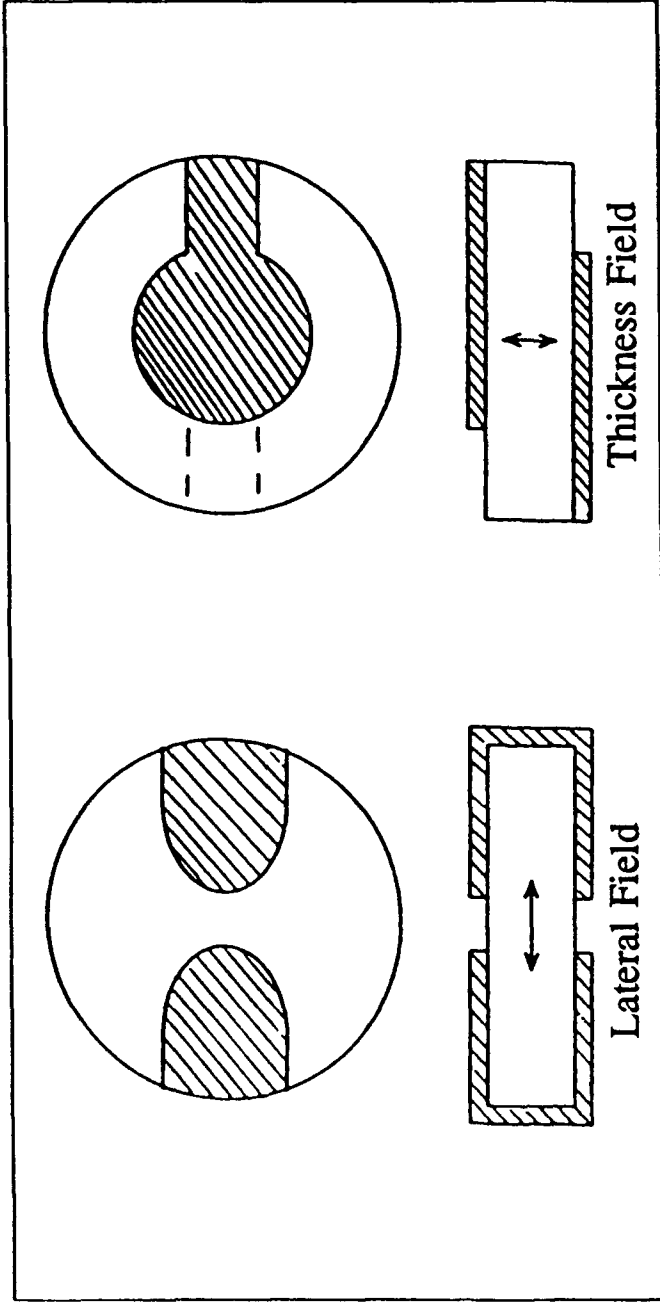

In lateral field resonators (LFR): 1. the electrodes are absent from the regions of greatest motion, and 2. varying the orientation of the gap between the electrodes varies certain important resonator properties. Advantages of LFR are:

- Ability to eliminate undesired modes, e.g., the b-mode in SC-cuts
- Potentially higher Q (less damping due to electrodes and mode traps)
- Potentially higher stability (less electrode and mode trap effects, smaller  $C_1$ )

# Microcomputer Compensated Crystal Oscillator (MCXO)

- Accuracy: 5 msec per day ( $5 \times 10^{-8}$ ), with  $< 50$  mW power
- Major barriers: thermal hysteresis, thermometry, circuit instabilities
- Solutions: high stability overtone SC-cut and lateral field resonators, dual-mode oscillator and digital compensation techniques
- Advantages over analog TCXO: much higher accuracy possible, rapid and easy compensation and recalibration

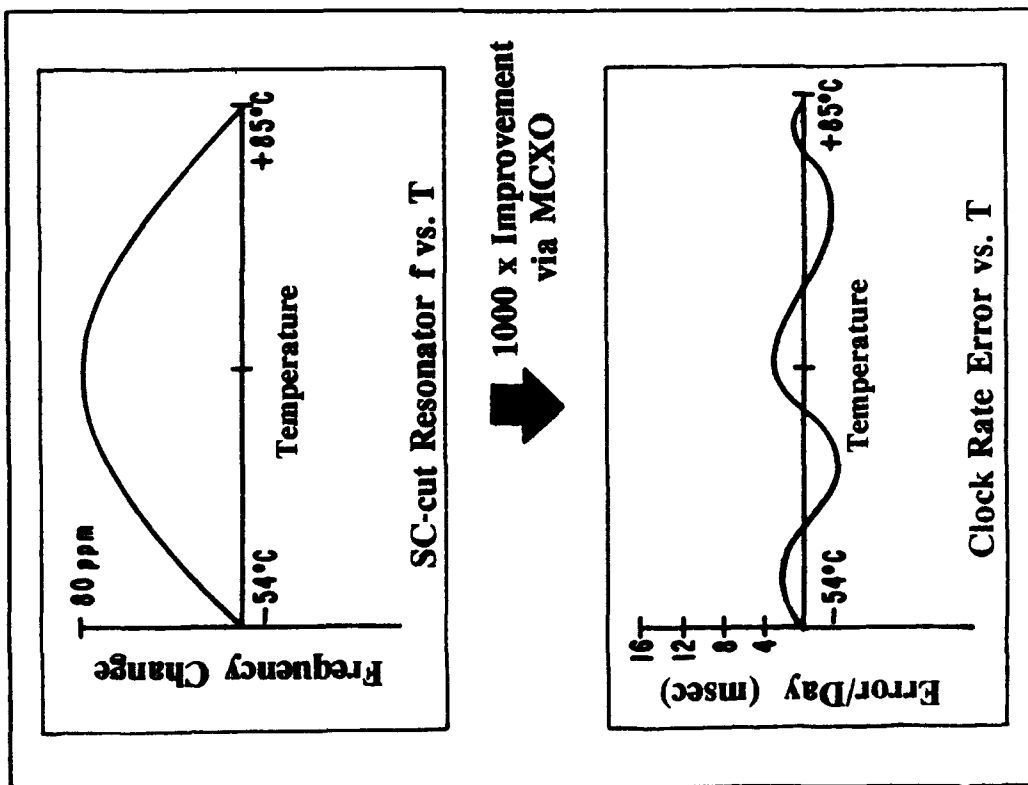



# MCXO - Description of Operation

The following analogy illustrates the difference between an MCXO-based clock and a conventional TCXO-based clock. Suppose one has a clock that gains 24 seconds per day. The conventional way to maintain accurate time with such a clock is to adjust the frequency of the internal oscillator to the proper frequency, and then to maintain that frequency, e.g., with a TCXO. Another way to maintain accurate time is to set the clock, and then to stop the clock for 1 second every hour, or for 1/60 sec every minute, or for 1/3600 sec every second, etc. For a conventional clock, the second method would be very inconvenient and difficult to use for accurate timekeeping. The MCXO, however, operates somewhat as the second method, i.e., the MCXO provides accurate time from an inaccurate (but highly reproducible) frequency source, by correcting for the known frequency inaccuracies.

Simplified block diagrams of two implementations of the MCXO are shown on the two pages following this description. In the pulse deletion method, the dual-mode oscillator provides output signals at two frequencies, one of which,  $f_{\beta}$ , is the resonator temperature indicator. The signals are processed by the microcomputer which, from  $f_{\beta}$ , determines the necessary correction to  $f_c$  and then subtracts the required number of pulses from  $f_c$  to obtain the corrected output  $f_o$ . Fractions of pulses that cannot be subtracted within the update interval ( $\sim 1$  s) are used as a carry, so that the long-term average is within the  $\pm 2 \times 10^{-8}$  design accuracy. Correction data in the PROM are unique to each crystal and are obtained from a precise thermal characterization of the  $f_c$  and  $f_{\beta}$  output signals. The corrected output signal  $f_o$  can be divided down to produce a 1 pps time reference or can be used directly to drive a clock. Due to the objectionable noise characteristics

# MCXO - Description of Operation, Cont'd

created by the pulse deletion process, additional signal processing is necessary to provide a useful RF output for frequency control applications. This can be accomplished by, for example, imparting the MCXO frequency accuracy to a second, low-noise, low-cost, voltage controlled crystal oscillator.

A sinewave RF output may be obtained directly by using an alternate MCXO approach that is based on phase-locked-loop frequency summing instead of pulse deletion. As in the pulse deletion method, a dual-mode oscillator generates the two output frequencies,  $f_c$  and  $f_\beta$ . The microcomputer computes a number  $N$  which is used to control a direct digital synthesizer (DDS). The DDS generates a correction frequency  $df_c$  which, when added to  $f_c$ , results in the compensated output frequency  $f_o$ . The phase-locked-loop frequency summer incorporates a VCXO that is adjusted, in frequency and phase, to the desired sum frequency  $f_o$ .

The MCXO has major advantages over conventional temperature compensated crystal oscillators (TCXO's) for the following reasons: 1. the MCXO circumvents the need for pulling the crystal frequency and, therefore, permits the use of "stiff", high stability SC-cut crystal units, 2. the MCXO allows resonator self-temperature sensing, using a dual-mode oscillator; thermometry-caused errors are thus eliminated, 3. the trim effect is eliminated, 4. automatic recalibration features can be designed into the MCXO algorithm; an offset can be stored in memory following simple injection of an external, higher-accuracy reference signal, and 5. an accurate but very low-power clock is possible through duty-cycling the MCXO to periodically update a low-power, wristwatch-type clock (e.g., six seconds on, one minute off).

# MCXO - Pulse Deletion Method

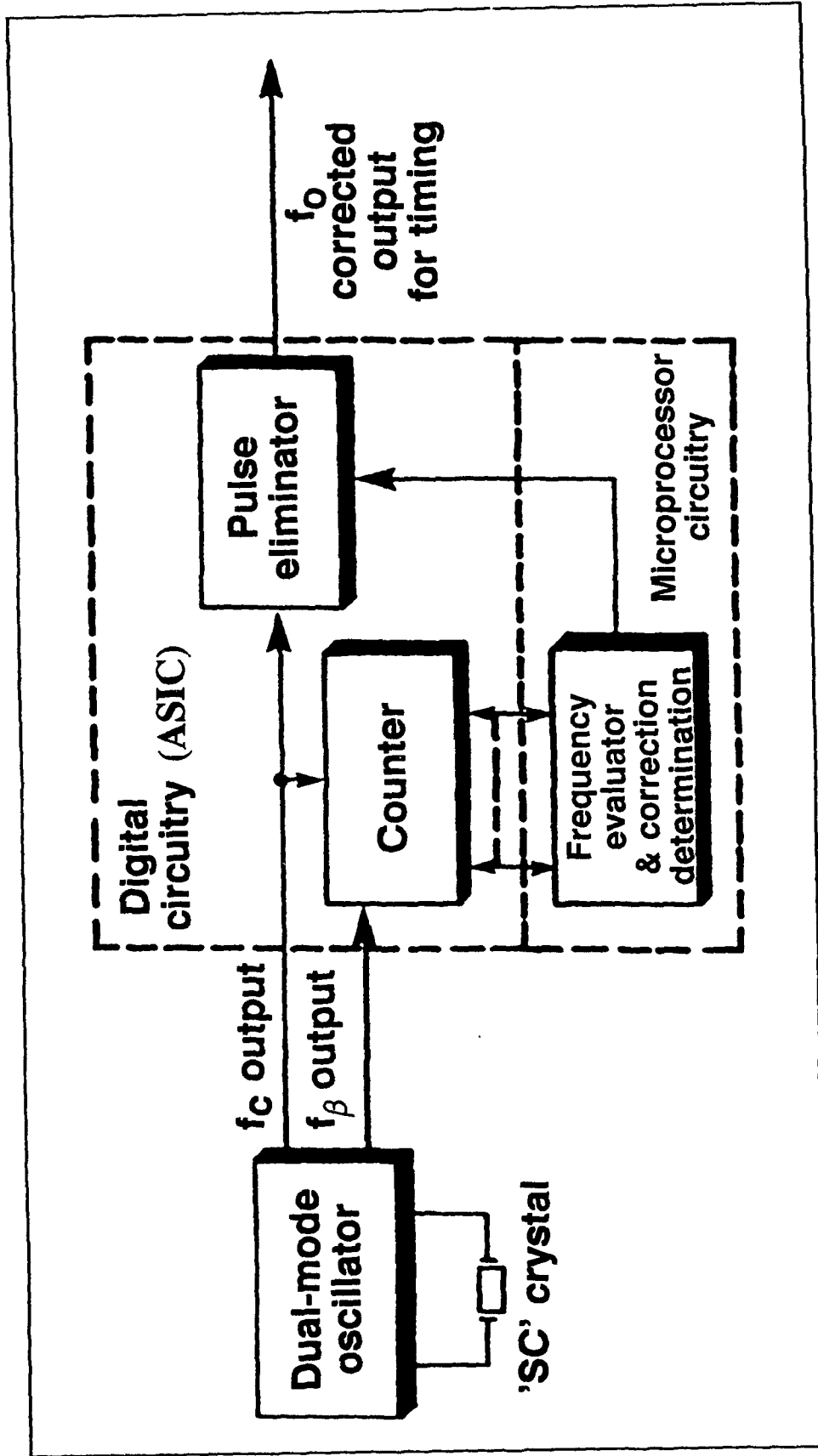

Microcomputer compensated crystal oscillator (MCXO) block diagram - pulse deletion method.

# MCXO - PLL Frequency Summing Method

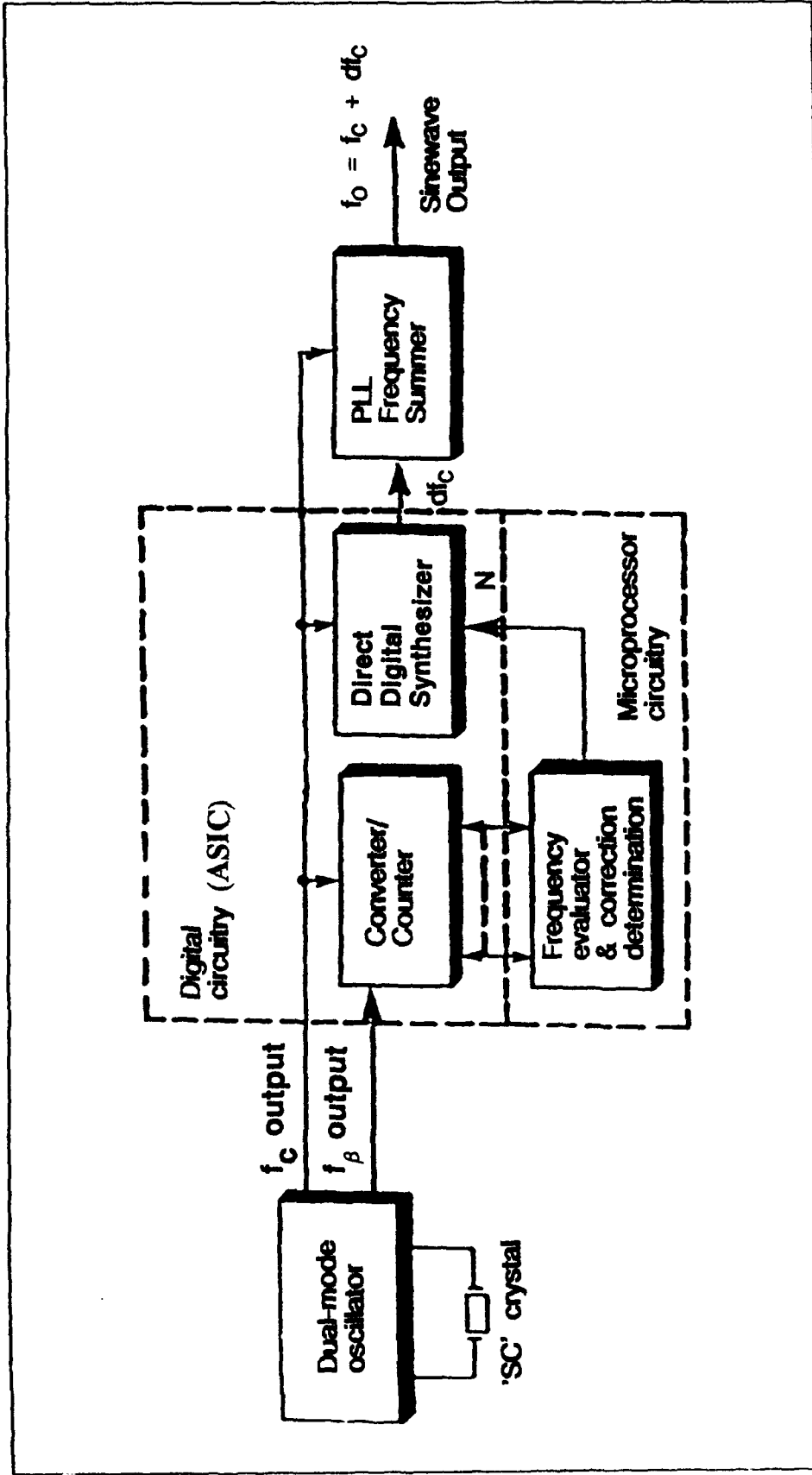

Microcomputer compensated crystal oscillator (MCXO) block diagram - phase-locked-loop frequency summing method.

# Rubidium - Crystal Oscillator(RbXO)

Rubidium Frequency Standard $\approx 25 \text{ W @ } -55^{\circ}\text{C}$	RbXO Interface $\approx 80 \text{ mW}$	Crystal Oscillator $\approx 300 \text{ mW @ } -55^{\circ}\text{C}$
--	--	--

The RbXO provides the best of both worlds, the long term stability of a Rb standard and the low power requirement of a crystal oscillator. Occasionally, e.g., once a week, power is applied to the Rb standard for a few minutes. Upon warmup of the Rb standard, the RbXO interface synchronizes the crystal oscillator and cuts off power to the Rb standard.

# RbXO Principle of Operation

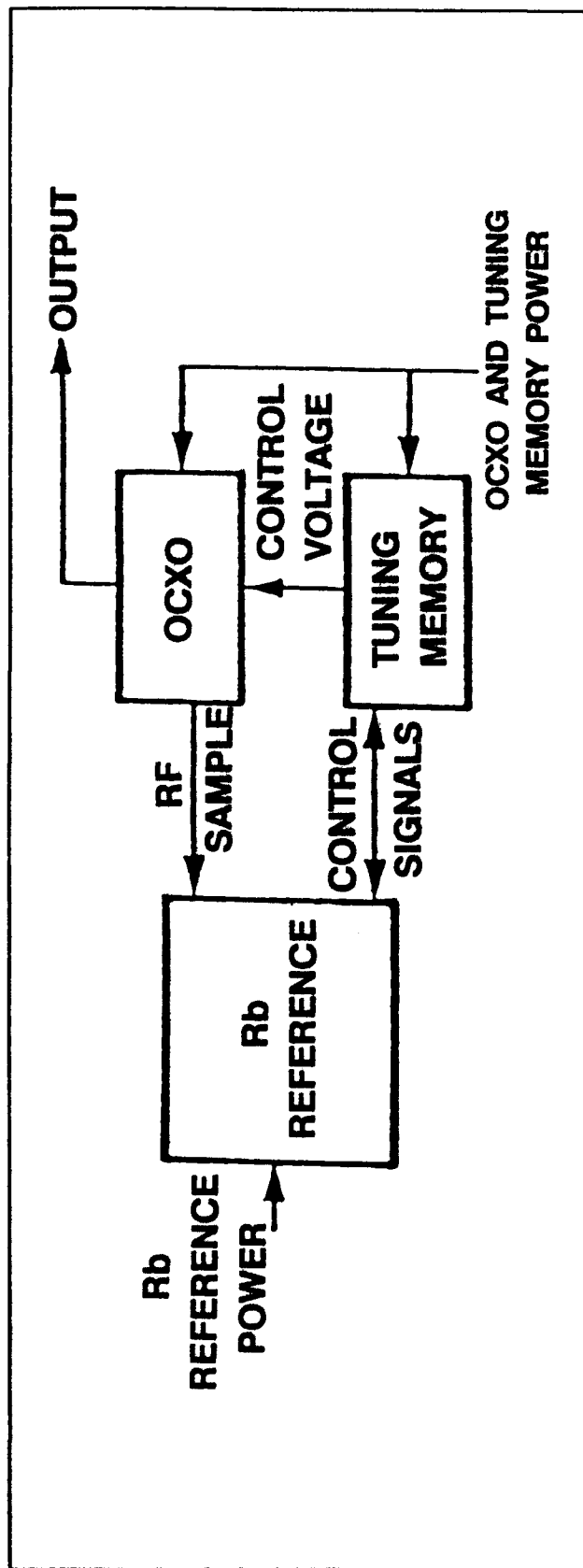

A block diagram of the RbXO is shown here. The Rb reference is a miniature Rb frequency standard (RFS) that has been modified to control an external crystal oscillator. The OCXO (or MCXO) includes a digital tuning memory to hold the frequency control voltage while the Rb reference is off. The OCXO is ON continually. Periodically, the user system applies power to the RFS. After the few minutes necessary for the warmup of the RFS, the interface circuits adjust the frequency of the OCXO to the RFS reference, then shut off the RFS. For manpack applications, the OCXO will be separable from the rest of the RbXO so that the manpack can operate with minimum size, weight, and power consumption, while having nearly the accuracy of the RFS for the duration of a mission.

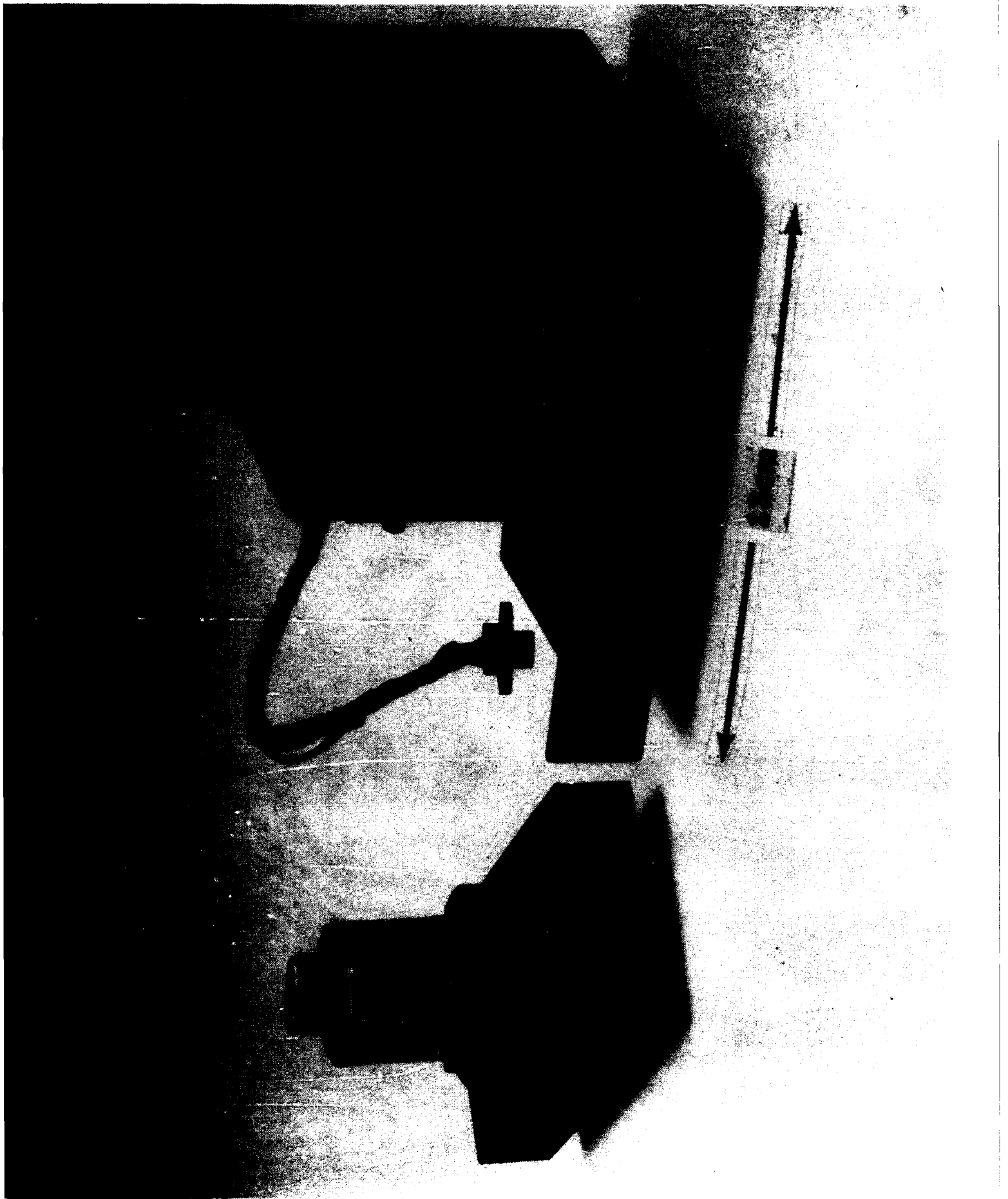

# Accuracy vs. Power-Requirement\*

(Goal is to move the technologies toward the upper left)

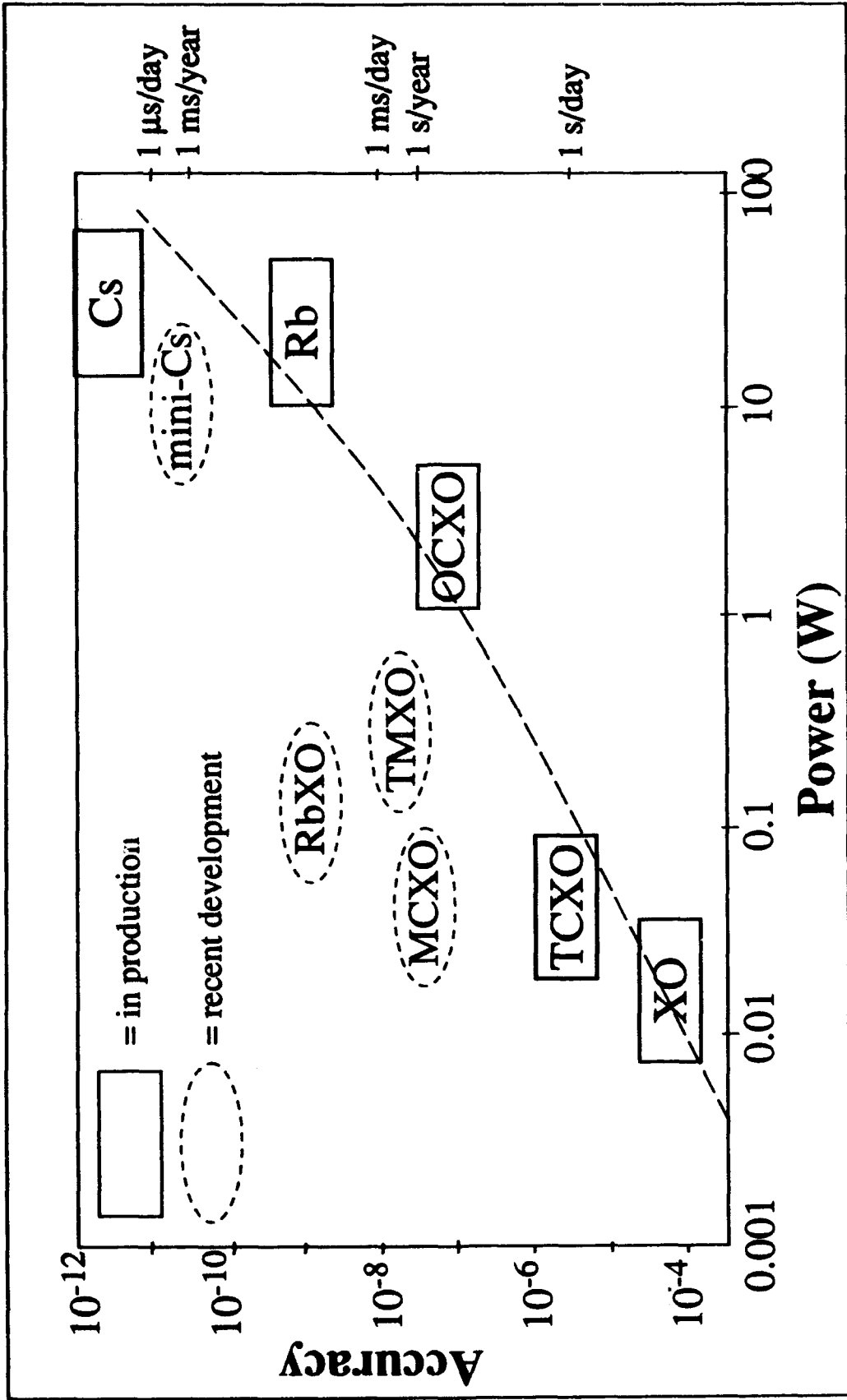

\* Accuracy vs. size, and accuracy vs. cost have similar relationships.



# Summary of Crystal Problems & Solutions

Problem	Major Causes	Solutions
Aging	Contamination transfer, stress relief, material defects(?)	Ultraclean processing; SC-cut; "good" quartz, mounting, bonding, electrodes, and package
Thermal Hysteresis (Retrace)	Stress relief, contamination transfer, material defects(?)	Ultraclean processing; SC-cut; "good" quartz, mounting, bonding, electrodes, and package
Frequency vs. Temperature	Incorrect angles-of-cut, interfering modes	Precision X-ray goniometer, angle-correction, SC-cut
Thermal Shock (Warmup)	Stress sensitivity of quartz, thermal time constant of package	SC-cut, ceramic flatpacks
Vibration	Stress sensitivity of quartz (non-linearities), mode shape	SC-cut, compensation, control of mode shape and strains
Mechanical Shock	Surface and bulk imperfections, deformation in mount/bond	Chemical polishing; blank inspection; "good" quartz, proper mounting and bonding
Radiation	Quartz impurities	High purity quartz (sweeping), compensation

## Chapter 6 References

- 6-2a** A. Ballato, "Doubly Rotated Thickness Mode Plate Vibrators," *Physical Acoustics*, Vol. XIII, pp. 115-181, Academic Press, Inc., 1977.
- 6-2b** J. A. Kusters, "The SC Cut Crystal - An Overview," Proc. IEEE Ultrasonics Symposium, pp. 402-409, 1981.
- 6-3a** A. W. Warner, Jr. and B. Goldfrank, "Lateral Field Resonators," Proc. 39th Annual Symposium on Frequency Control, pp. 473-474, 1985, AD-A217404.
- 6-3b** A. W. Warner, "Measurement of Plano-Convex SC Quartz Blanks Using Lateral Field Excitation," Proc. 42nd Annual Symposium on Frequency Control, pp. 202-204, 1988, AD-A217275.
- 6-4** S. Schodowski, R. L. Filler, J. A. Messina, V. J. Rosati and J. R. Vig, "Microcomputer Compensated Crystal Oscillator for Low-Power Clocks," Proc. 21st Ann. Precise Time and Time Interval (PTTI) Applications and Planning Meeting, pp. 445-465, 1989, AD-A224769.
- 6-5a** S. Schodowski, "Resonator Self-Temperature-Sensing Using a Dual-Harmonic-Mode Crystal Oscillator," Proc. 43rd Annual Symposium on Frequency Control, pp. 2-7, 1989, IEEE Catalog No. 89CH2690-6.
- 6-5b** R. Filler and J. Vig, "Resonators for the Microcomputer-Compensated Crystal Oscillator," Proc. 43rd Annual Symposium on Frequency Control, pp. 8-15, 1989, IEEE Catalog No. 89CH2690-6.
- 6-5c** R. Filler, J. Messina and V. Rosati, "Frequency-Temperature and Aging Performance of Microcomputer Compensated Crystal Oscillators," Proc. 43rd Annual Symposium on Frequency Control, pp. 47-50, 1989, IEEE Catalog No. 89CH2690-6.
- 6-7** M. Bloch, M. Meirs and J. Ho, "The Microcomputer Compensated Crystal Oscillator (MCXO)," Proc. 43rd Annual Symposium on Frequency Control, pp. 16-19, 1989, IEEE Catalog No. 89CH2690-6.
- 6-8** A. Benjaminson and S. Stallings, "A Microcomputer-Compensated Crystal Oscillator Using Dual-Mode Resonator," Proc. 43rd Annual Symposium on Frequency Control, pp. 20-26, 1989, IEEE Catalog No. 89CH2690-6.

**6-9** W. J. Riley, Jr. and J. R. Vaccaro, "A Rubidium-Crystal Oscillator (RbXO)," IEEE Transactions on Ultrasonics, Ferroelectrics, and Frequency Control, Vol. UFFC-34, No. 6, pp. 612-618, November 1987.

# Atomic Frequency Standards\*

7

\* There are two important reasons for including this section: 1. atomic frequency standards are one of the most important applications of precision quartz oscillators, and 2. those who study or use crystal oscillators ought to be aware of what is available in case they need an oscillator with better long-term stability than what crystal oscillators can provide.

# Precision Frequency Standards

- Quartz crystal resonator-based ( $f \sim 5$  MHz,  $Q \sim 10^6$ )
- Atomic resonator-based
  - ☛ Rubidium<sup>87</sup> ( $f_0 = 6.8$  GHz,  $Q \sim 10^7$ )
  - ☛ Cesium<sup>133</sup> ( $f_0 = 9.2$  GHz,  $Q \sim 10^8$ )
  - ☛ Hydrogen ( $f_0 = 1.4$  GHz,  $Q \sim 10^9$ )
  - ☛ Trapped ions ( $f_0 > 10$  GHz,  $Q > 10^{11}$ )

# Atomic Frequency Standard Basic Concepts

When an atomic system changes energy from an excited state to a lower energy state, a photon is emitted. The photon frequency  $\nu$  is given by Planck's law

$$\nu = \frac{E_2 - E_1}{h}$$

where  $E_2$  and  $E_1$  are the energies of the upper and lower states, respectively, and  $h$  is Planck's constant. An atomic frequency standard produces an output signal the frequency of which is determined by this intrinsic frequency rather than some property of a bulk material (as it is in quartz oscillators).

The properties of isolated atoms at rest, and in free space, would not change with space and time. Therefore, the frequency of an ideal atomic frequency standard would not change with time or with changes in the environment. Unfortunately, in real atomic frequency standards: 1) the atoms are moving at thermal velocities, 2) the atoms are not isolated but experience collisions and electric and magnetic fields, and 3) some of the components needed for producing and observing the atomic transitions contribute to instabilities.

# Hydrogen-Like Atoms

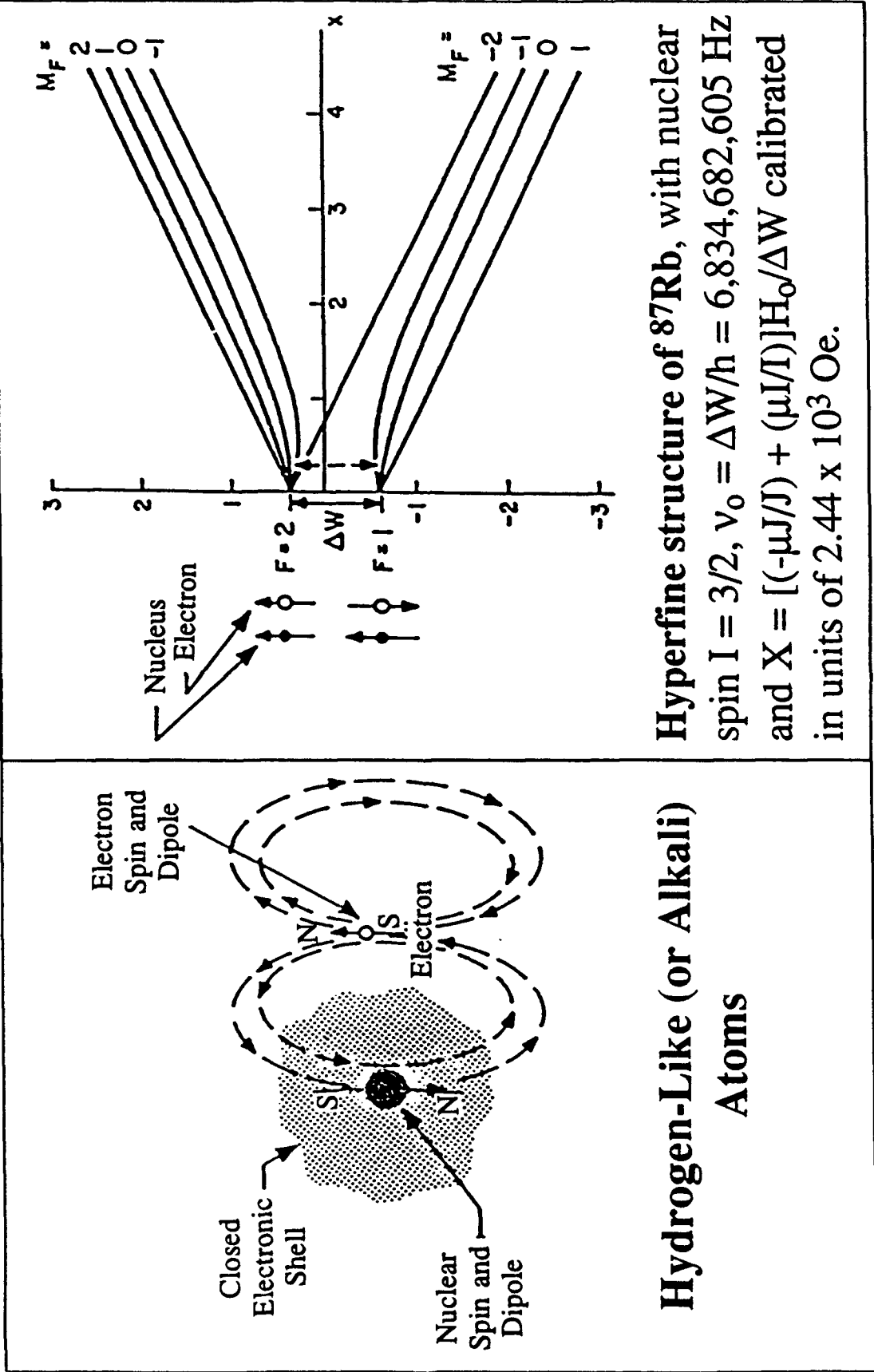

# Atomic Frequency Standard

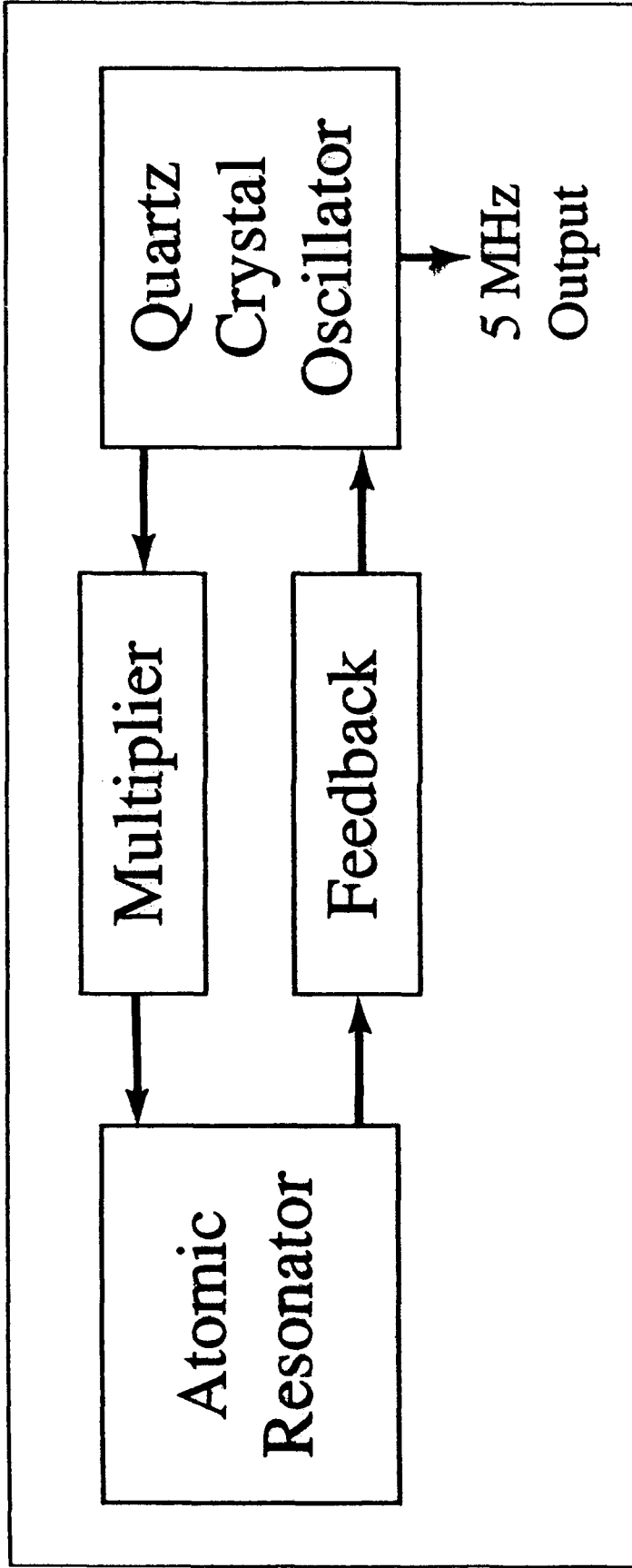

A voltage controlled crystal oscillator (VCXO) is locked to the atomic resonator, which is a highly stable frequency reference generated from an atomic transition. Of the many atomic transitions available, the ones selected are from those which are least sensitive to environmental effects and which can be conveniently locked to the VCXO. The long term stability is determined by the atomic resonator, the short term stability, by the crystal oscillator.



# Generalized Atomic Resonator

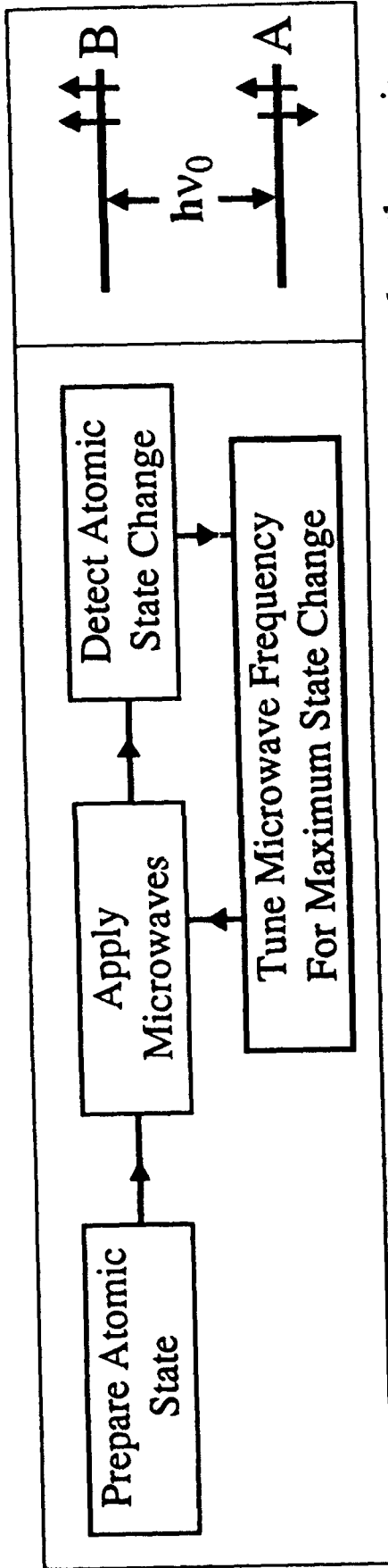

- Let A and B be two possible energy states of an atom, separated by energy  $h\nu_0$ ; then  $\nu_0$  is the frequency of the electromagnetic radiation required to convert the atoms from A to B, or from B to A;  $\nu_0$  is in the microwave range for all currently manufactured atomic standards.
- Population difference between energy states, when  $h\nu_0 \ll kT$ , is near zero. Therefore, in a natural ensemble of atoms, when  $\nu_0$  is applied, about half the atoms absorb  $h\nu_0$  and half emit  $h\nu_0$ ; the net effect is zero.
- A nonthermal distribution is prepared, i.e., one of the states is "selected," by optical excitation from one of the levels to a third level or by magnetic deflection of an atomic beam.
- Microwave energy is absorbed in the process of converting the selected atoms to the other energy state, e.g., from A to B. Thus, the applied microwave frequency can be "locked" to the frequency corresponding to the atomic transition.

# Atomic Resonator Concepts

- The energy levels used are due to the spin-spin interaction between the atomic nucleus and the outer electron in the ground state ( $^2S_{1/2}$ ) of the atom; i.e., the ground state hyperfine transitions.
- Nearly all atomic standards use Rb or Cs atoms; nuclear spins  $I = 3/2$  and  $7/2$ , respectively.
- Energy levels split into  $2(I \pm 1/2) + 1$  sublevels in a magnetic field; the "clock transition" is the transition between the least magnetic-field-sensitive sublevels. A constant magnetic field, the "C-field," is applied to minimize the probability of the more magnetic-field-sensitive transitions.
- Magnetic shielding is used to reduce external magnetic fields at least 100-fold (e.g., the earth's).
- The Heisenberg uncertainty principle limits the achievable accuracy:  $\Delta E \Delta t \geq h/2\pi$ ,  $E = h\nu$ , therefore,  $\Delta\nu \Delta t \geq 1$ , therefore, long observation time  $\longrightarrow$  small frequency uncertainty.
- Resonance linewidth (i.e.,  $1/Q$ ) is inversely proportional to coherent observation time  $\Delta t$ ;  $\Delta t$  is limited by: 1.) when atom enters and leaves the apparatus, and 2.) when the atom stops oscillating due to collisions with other atoms or with container walls (collisions disturb atom's electronic structure).
- Since atoms move with respect to the microwave source, resonance frequency is shifted due to the Doppler effect ( $\mathbf{k} \cdot \mathbf{v}$ ); velocity distribution results in "Doppler broadening"; the second-order Doppler shift ( $1/2 v^2/c^2$ ) is due to relativistic time dilation.

# Cesium-Beam Frequency Standard

Cs atomic resonator schematic diagram

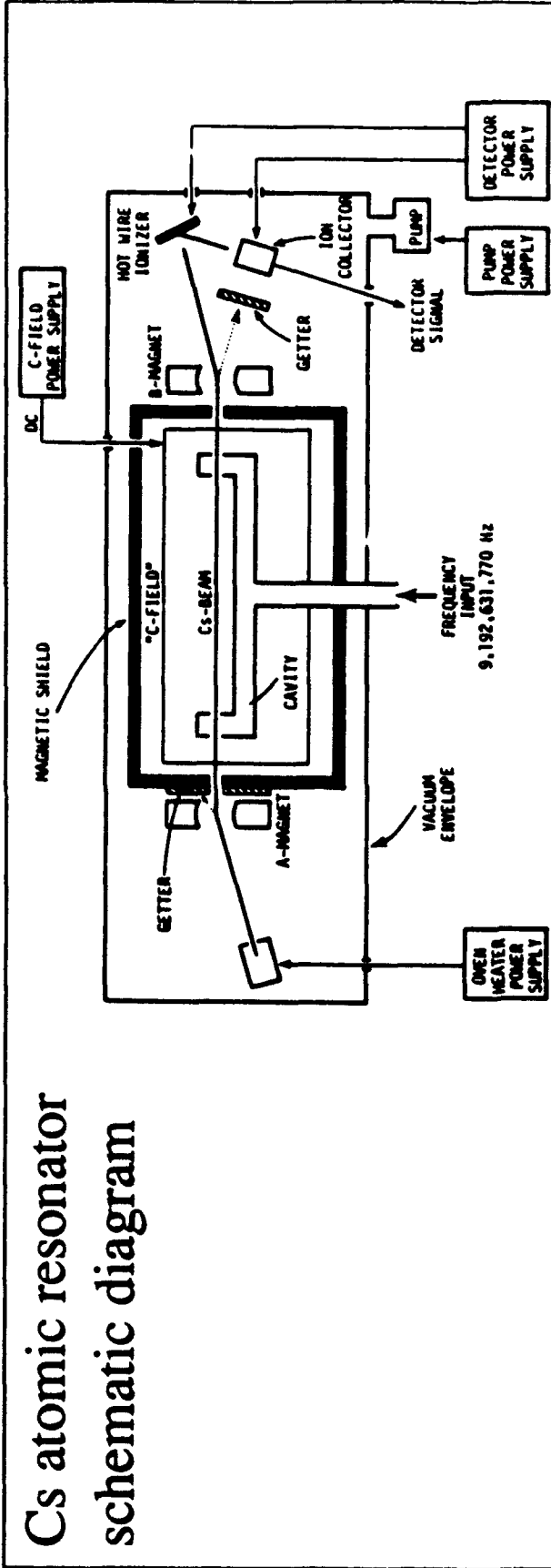

Atomic state selection

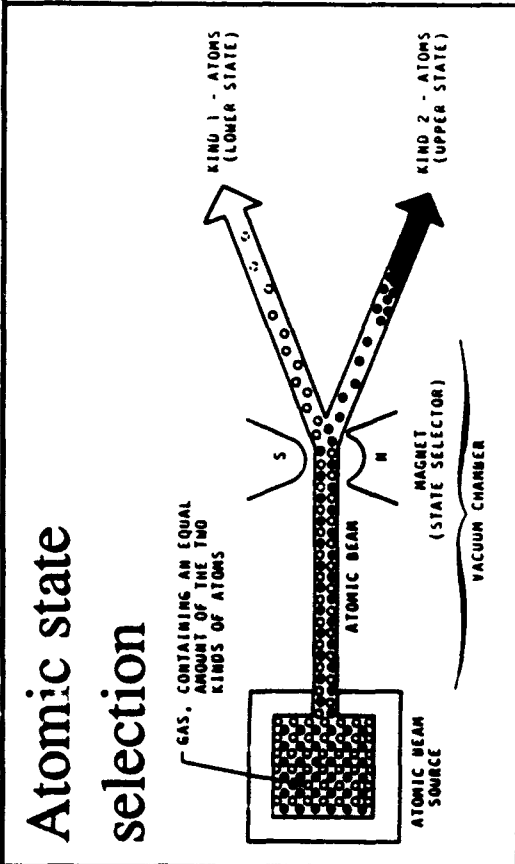

Cs atom detection

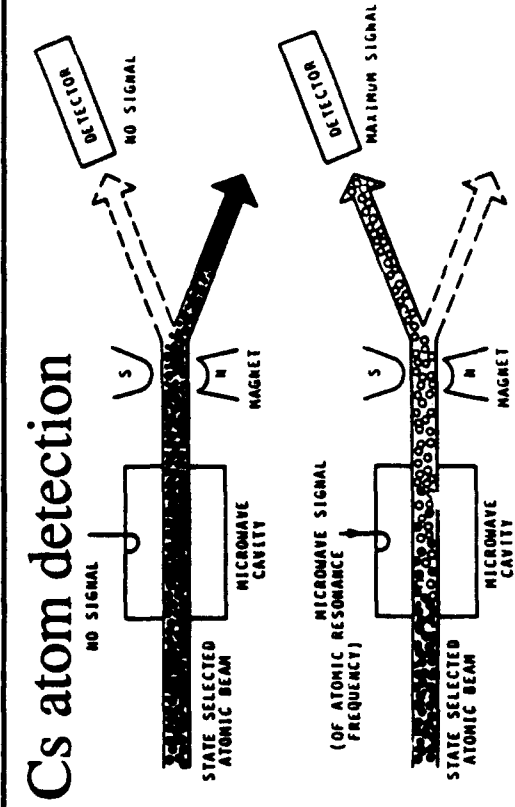

# Cesium-Beam Frequency Standard

- The atomic resonance used is at 9,192,631,770 Hz - by definition (of the second).
- Oven is at  $\sim 100^\circ\text{C}$ , Cs pressure in the oven  $\sim 10^{-3}$  torr, cavity is at  $\sim 10^{-9}$  torr; typical atom speed is 100 m/s; typical cavity length in commercial standards is 10 to 20 cm; interaction time  $\sim 1$  to  $2 \times 10^{-3}$  s; linewidth  $\sim 0.5$  to 1 kHz;  $Q \sim 10^7$ ; in standard lab's, length  $\sim 4$  meters,  $Q \sim 10^8$ .
- It would be desirable to operate at zero magnetic field - all transitions would behave as a single transition, signal would be 7X larger, but that would require  $< 10^{-8}$  gauss for errors  $< 1 \times 10^{-12}$ ; not feasible; C-field must be applied; a 0.06 gauss C-field separates the sublevels by 40 kHz.
- The (3,0) to (4,0) clock transition has a small quadratic dependence on magnetic field; C-field must be stable and uniform; high degree of shielding is required for  $\pm 1 \times 10^{-13}$ /gauss (e.g., the HP 004 uses a triple shield).
- State selecting magnet A "selects" one of the two atomic levels; the applied microwave causes a state change; the second magnet deflects to the detector the atoms which have undergone the state change; A and B magnets' peak field  $\sim 10$  kgauss.
- Atom detector is a ribbon or wire (e.g., W or Pt) at  $\sim 900^\circ\text{C}$ ; Cs atoms are ionized, ions are collected, current is amplified and fed back into feedback network; microwave frequency is locked to the frequency of maximum ion current, thus the atomic transition frequency controls the microwave frequency, i.e., the frequency of the crystal oscillator. Much less than 1% of the Cs atoms reach the detector in conventional Cs standards (hence optical pumping's advantage.)

# Cs Hyperfine Energy Levels

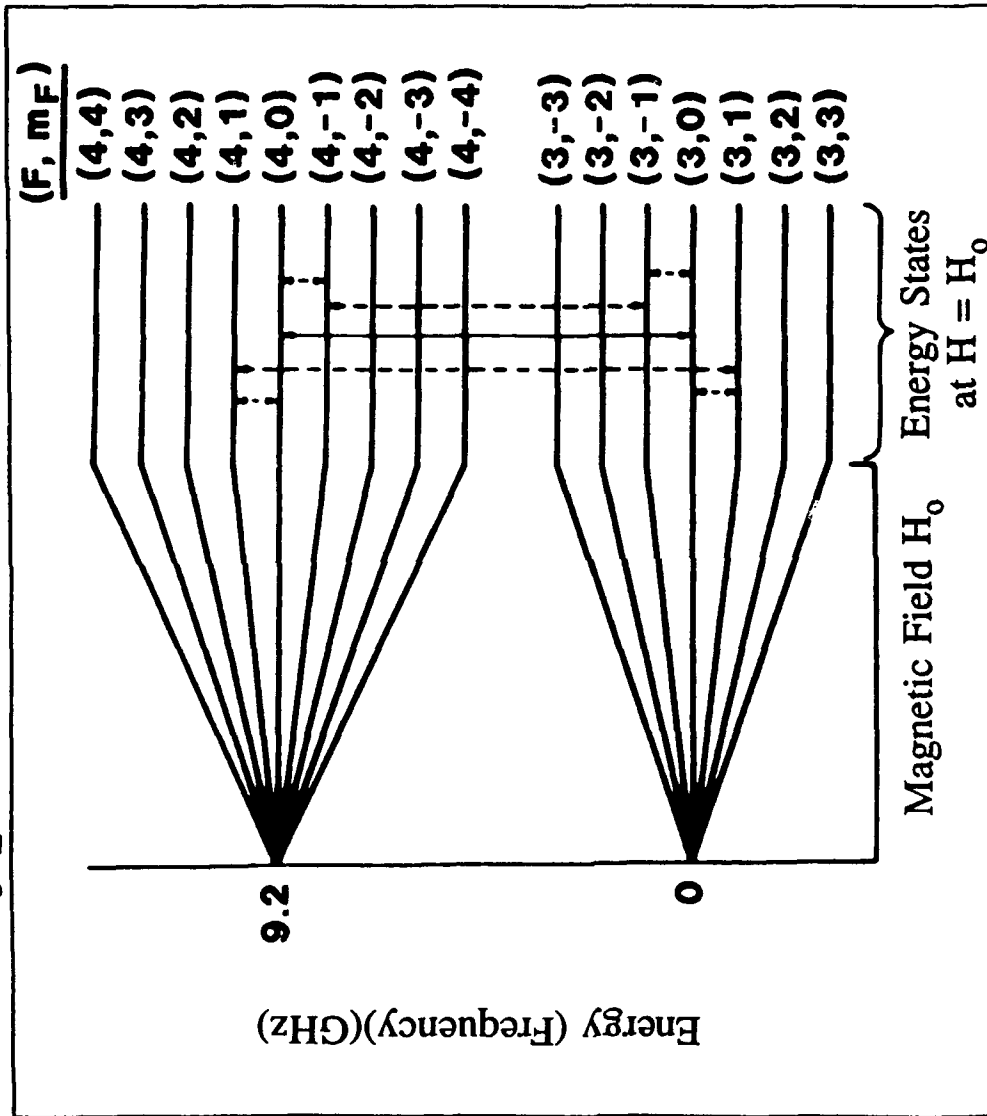

Magnetic field dependence of the hyperfine energy levels in the ground state of the cesium atom (nine in the upper state, seven in the lower). The magnetic field is plotted up to the value  $H_0$ . The solid arrow represents the "clock" transition; the dashed arrows depict the magnetic-field-sensitive (Zeeman) transitions.  $F$  is the hyperfine quantum number, and  $m_F$  is the magnetic quantum number of the atom.

# Rubidium Gas Cell Resonator

- The atomic resonance used is at 6,834,682,608 Hz.
- Cell contains Rb gas at  $\sim 10^{-6}$  torr and an inert buffer gas at  $\sim 1$  torr; Rb atom oscillation lifetime is limited by collisions to  $\sim 10^{-2}$  s; linewidth  $\sim 100$  Hz;  $Q \sim 5 \times 10^7$ . Buffer gas, a mixture of positive (e.g.,  $N_2$ ) and negative (e.g., Ar) pressure-shift gases, provides zero temperature coefficient at some T, confines Rb atoms to small region to reduce wall-collision and 1st order Doppler effects.
- Optical pumping relies on the natural coincidence of optical resonance frequencies between  $^{85}\text{Rb}$  and  $^{87}\text{Rb}$ , both at 795 nm.
- Rf excited  $^{87}\text{Rb}$  lamp emits wavelengths corresponding to both the  $F=1$  and  $F=2$  transitions;  $^{85}\text{Rb}$  filter cell absorbs more of the  $F=2$  transition light; light which passes through filter is absorbed by the  $^{87}\text{Rb}$   $F=1$  state; excited atoms relax to both the  $F=1$  and  $F=2$  states, but the  $F=1$  states are excited again;  $F=2$  state is overpopulated; 6.8 GHz converts  $F=2$  back to  $F=1$ , which provides more atoms to absorb light. Microwave resonance causes increased light absorption, i.e., a ( $< 1\%$ ) dip in the light detected by the photocell; microwave frequency is locked to photocell detection dip, thus the atomic transition frequency controls the microwave frequency, i.e., the frequency of the crystal oscillator.

# Atomic Resonator Instabilities

- **Noise** - due to the circuitry, crystal resonator, and atomic resonator. (See next page.)
- **Cavity pulling** - microwave cavity is also a resonator; atoms and cavity behave as two coupled oscillators; effect can be minimized by tuning the cavity to the atomic resonance frequency, and by maximizing the atomic resonance  $Q$  to cavity  $Q$  ratio.
- **Collisions** - cause frequency shifts and shortening of oscillation duration.
- **Doppler effects** - 1st order is classical, can be minimized by design; 2nd order is relativistic.
- **Magnetic field** - this is the only influence that directly affects the atomic resonance frequency.
- **Microwave spectrum** - asymmetric frequency distribution causes frequency pulling; can be made negligible through proper design.
- **Environmental effects** - magnetic field changes, temperature changes, vibration, shock, radiation, atmospheric pressure changes, and He permeation into Rb bulbs.

# Noise in Atomic Frequency Standards

If the time constant for the atomic-to-crystal servo-loop is  $t_0$ , then at  $\tau < t_0$ , the crystal oscillator determines  $\sigma_y(\tau)$ , i.e.,  $\sigma_y(\tau) \sim \tau^{-1}$ . From  $\tau > t_0$  to the  $\tau$  where the "flicker floor" begins, variations in the atomic beam intensity (shot-noise) determine  $\sigma_y(\tau)$ , and  $\sigma_y(\tau) \sim (i\tau)^{-1/2}$ , where  $i$  = number of signal events per second. Shot noise within the feedback loop shows up as white frequency noise (random walk of phase). Shot noise is generally present in any electronic device (vacuum tube, transistor, photodetector, etc.) where discrete particles (electrons, atoms) move across a potential barrier in a random way.

In commercial standards,  $t_0$  ranges from 0.01 s for a small Rb standard to 60 s for a high-performance Cs standard. In the regions where  $\sigma_y(\tau)$  varies as  $\tau^{-1}$  and  $\tau^{-1/2}$ ,  $\sigma_y(\tau) \propto (Q S_R)^{-1}$ , where  $S_R$  is the signal-to-noise ratio, i.e., the higher the  $Q$  and the signal-to-noise ratio, the better the short term stability (and the phase noise far from the carrier, in the frequency domain).



# Short-Term Stability of a Cs Standard

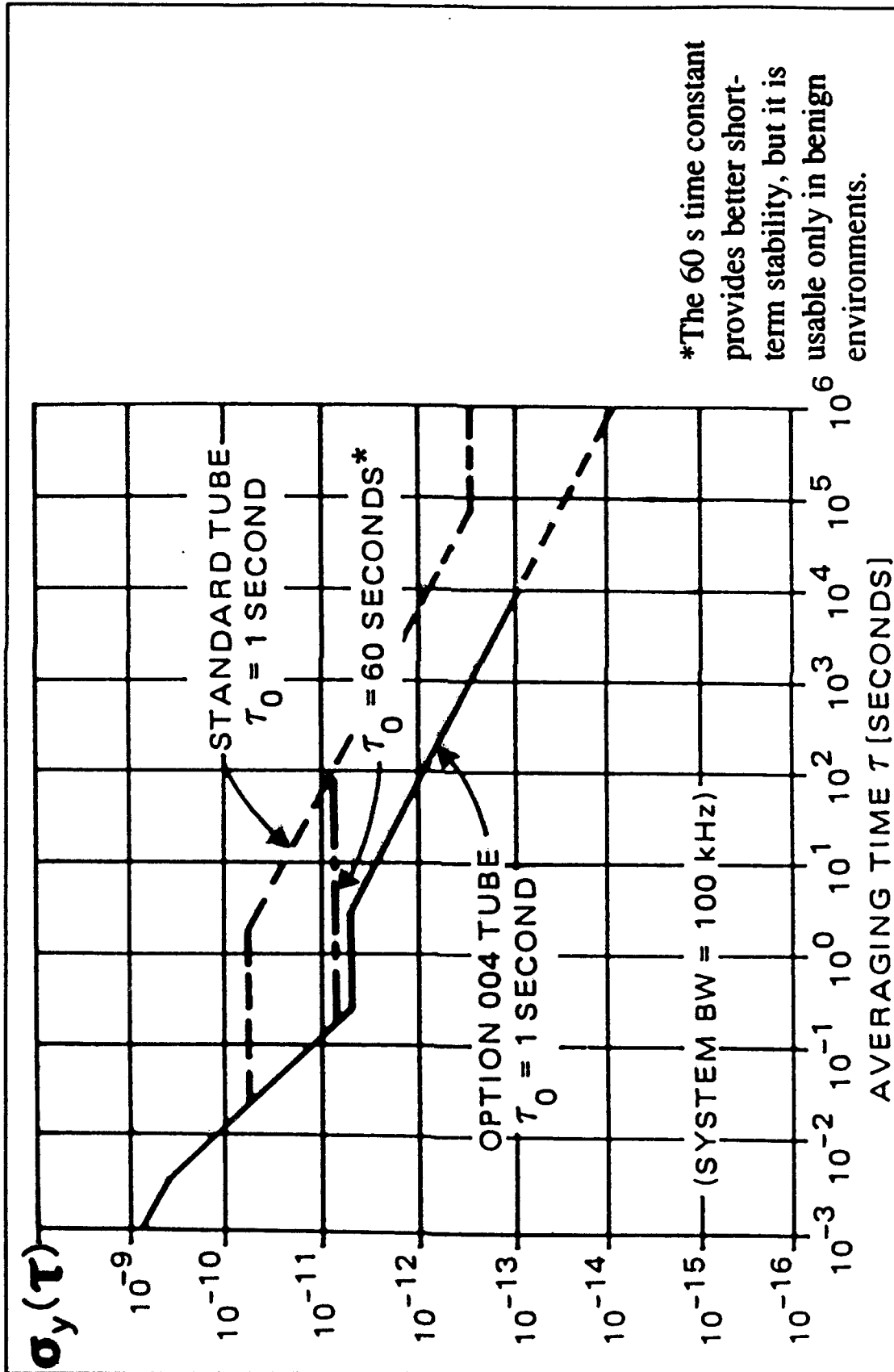

# Short-Term Stability of a Rb Standard

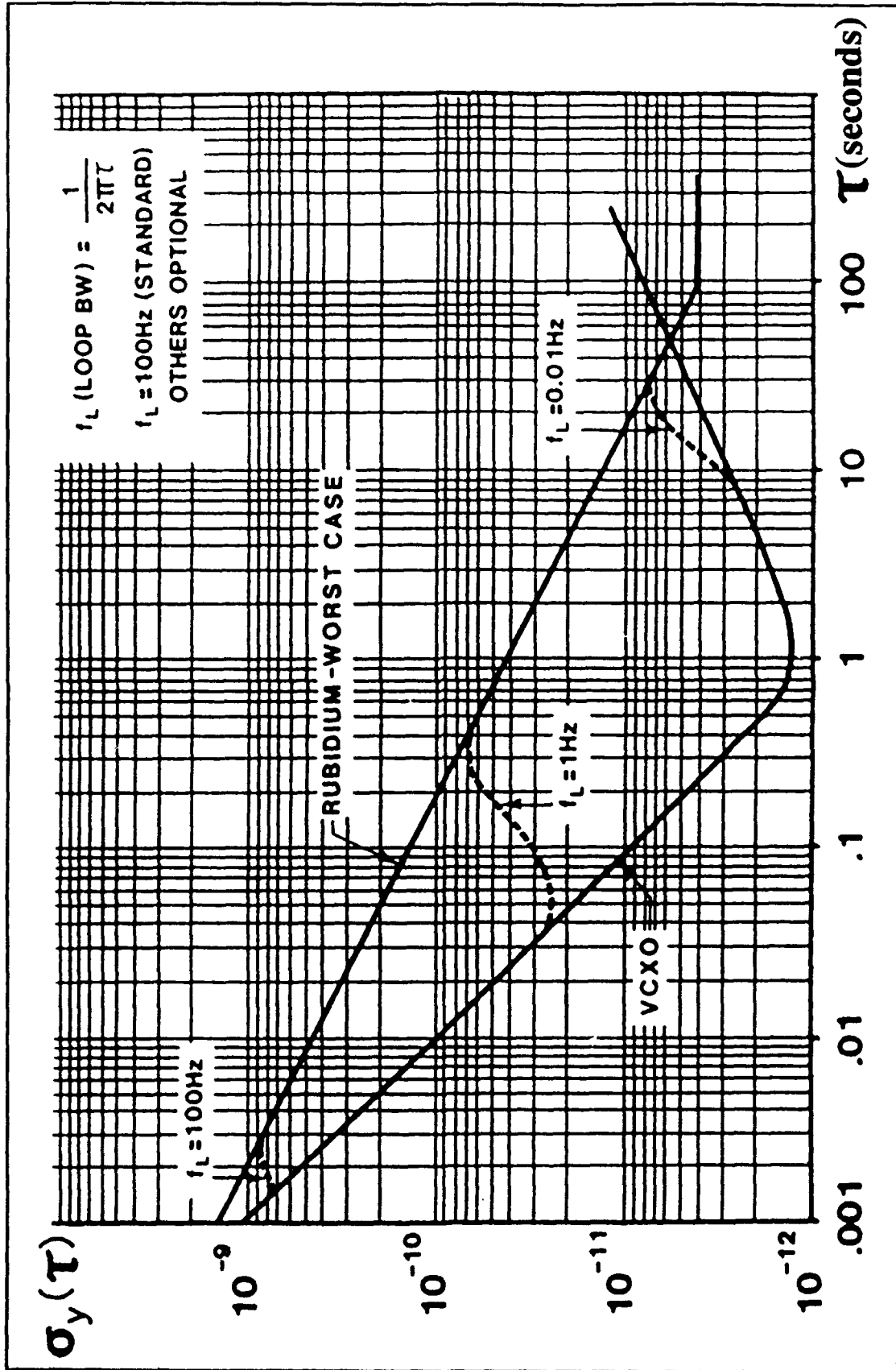

# Acceleration Sensitivity of Atomic Standards

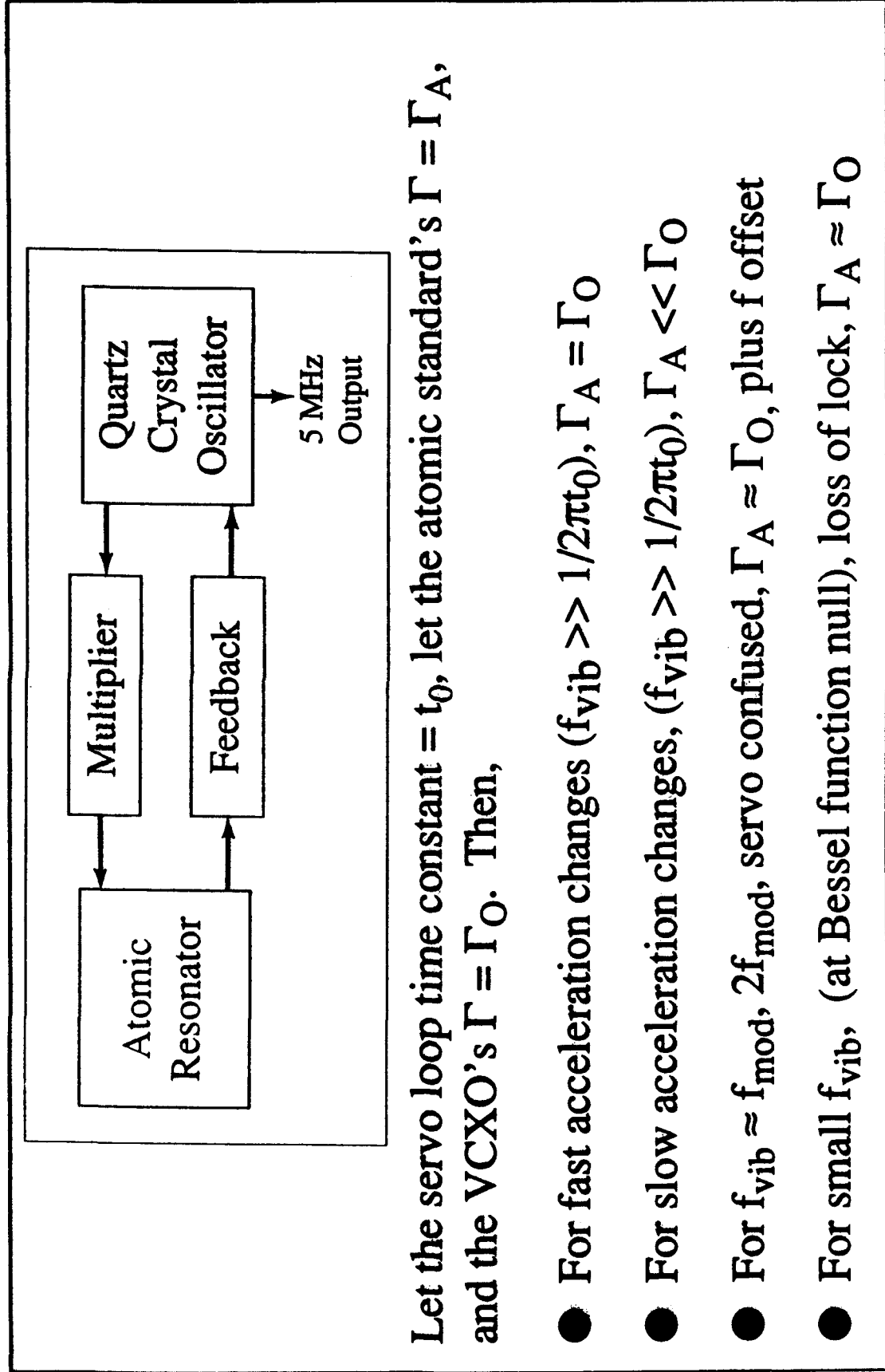

# Atomic Standard Acceleration Effects

**In Rb cell standards**, high acceleration can cause  $\Delta f$  due to light shift, power shift, and servo effects:

- Location of molten Rb in the Rb lamp can shift
- Mechanical changes can deflect light beam
- Mechanical changes can cause rf power changes

**In Cs beam standards**, high acceleration can cause  $\Delta f$  due to changes in the atomic trajectory with respect to the tube & microwave cavity structures:

- Vibration modulates the amplitude of the detected signal. Worst when  $f_{\text{vib}} = f_{\text{mod}}$ .
- Beam to cavity position change causes cavity phase shift effects
- Velocity distribution of Cs atoms can change
- Rocking effect can cause  $\Delta f$  even when  $f_{\text{vib}} < f_{\text{mod}}$

**In H-masers**, cavity deformation causes  $\Delta f$  due to cavity pulling effect

# Magnetic Field Sensitivities of Atomic Clocks

Clock transition frequency  $\nu = \nu_0 + C_H H_0^2$ , where  $C_H$  is the quadratic Zeeman effect coefficient (which varies as  $1/\nu_0$ ).

Atom	Transition Frequency	C-field* (milligauss)**	Shielding Factor*	Sensitivity* per gauss**
<b>Rb</b>	$\nu = 6.8 \text{ GHz} + (574 \text{ Hz/G}^2) B_0^2$	250	5,000	$10^{-11}$
<b>Cs</b>	$\nu = 9.2 \text{ GHz} + (427 \text{ Hz/G}^2) B_0^2$	60	50,000	$10^{-13}$
<b>H</b>	$\nu = 1.4 \text{ GHz} + (2750 \text{ Hz/G}^2) B_0^2$	0.5	50,000	$10^{-13}$

\* Typical values.

\*\* 1 gauss =  $10^{-4}$  Tesla; Tesla is the SI unit of magnetic flux density.

# Crystal's Influences on Atomic Standard

- **Short term stability** - for averaging times less than the atomic-to-crystal servo loop time constant,  $\tau_L$ , the crystal oscillator determines  $\sigma_y(\tau)$ .
- **Loss of lock** - caused by large phase excursions in  $t < \tau_L$  (due to shock, attitude change, vibration, thermal transient, radiation pulse). At a Rb standard's 6.8 GHz, for a  $\Delta f = 1 \times 10^{-9}$  in 1s, as in a 2g tipover in 1s,  $\Delta\phi \sim 7\pi$ . Control voltage sweeping during reacquisition attempt can cause the phase and frequency to change wildly.
- **Maintenance or end of life** - when crystal oscillator frequency offset due to aging approaches EFC range (typically  $\sim 1$  to  $2 \times 10^{-7}$ ).
- **Long term stability** - noise at second harmonic of modulation  $f$  causes time varying  $\Delta f$ 's; this effect is significant only in the highest stability (e.g., H and Hg) standards.

# Miniature Optically Pumped Cs Standard

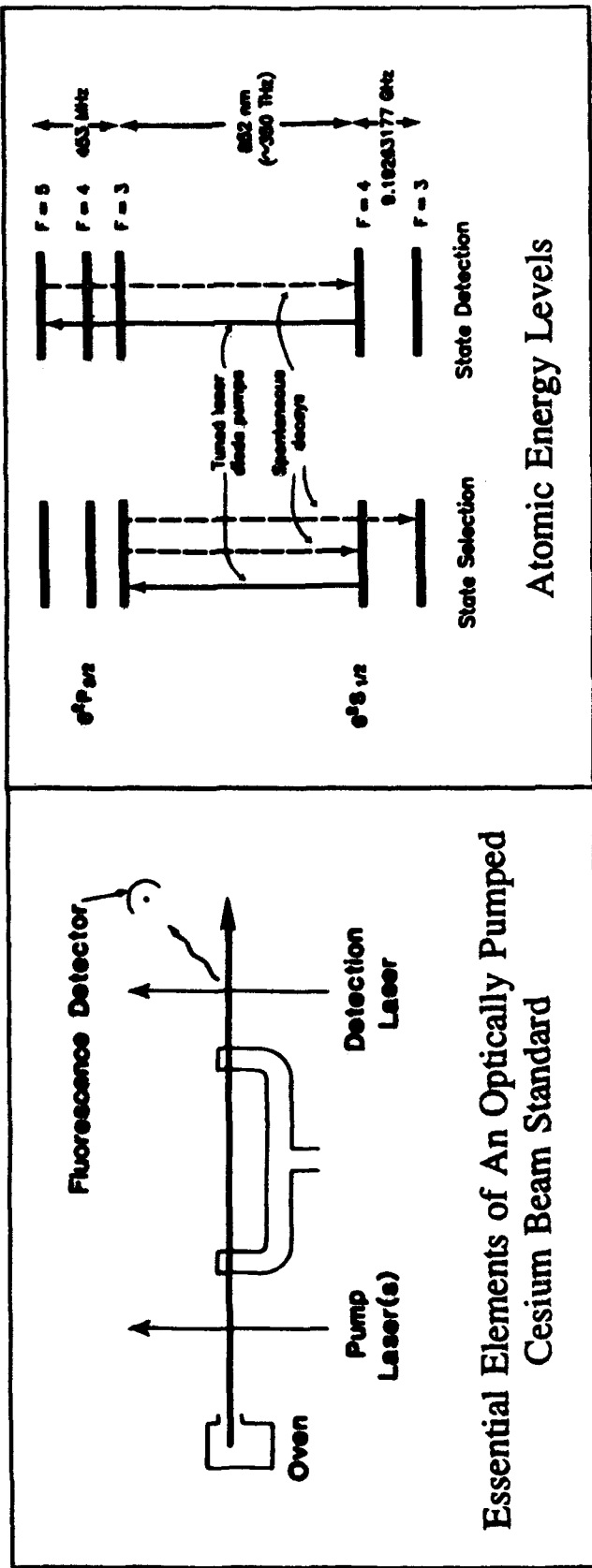

The proper atomic energy levels are populated by optical pumping with a laser diode, which provides superior utilization of Cs atoms. The potential advantages include: higher S/N, longer life, lower weight, and the possibility of trading off size for accuracy. The main goals of the miniature Cs standard development program are  $1 \times 10^{-11}$  accuracy, and a 1 liter volume, i.e., about 100x higher accuracy than a Rb standard, in about the same volume (but not necessarily the same shape factor).

## Chapter 7 References

- H. Hellwig, "Frequency Standards and Clocks: A Tutorial Introduction," NBS Technical Note 616, 1977, Time and Frequency Division, NIST, 325 Broadway, Boulder, Colorado, 80303.
- H. Hellwig, "Microwave Frequency and Time Standards," in E. A. Gerber and A. Ballato, Precision Frequency Control, Vol. 2, pp. 113-176, Academic Press, 1985.
- H. Hellwig, "Microwave Time and Frequency Standards," Radio Science, Vol. 14, No. 4, pp. 561-572, July-August 1979.
- S. R. Stein and J. R. Vig, "Frequency Standards for Communications," U. S. Army Laboratory Command Research and Development Technical Report SLCEP-TR-91-2 (Rev. 1), October 1991, AD A243211.
- J. Vanier and C. Audoin, The Quantum Physics of Atomic Frequency Standards, ISBN 0-85274-434-X, Adam Hilger, 1978.
- N. F. Ramsey, Molecular Beams, Oxford University Press, 1956.
- P. Forman, "Atomichron: The Atomic Clock from Concept to Commercial Product," Proc. of the IEEE, Vol. 73, No. 7, pp. 1181-1204, July 1985.
- Several review papers, including three on the environmental sensitivities of atomic frequency standards, are contained in the Proc. 22nd Ann. Precise Time and Time Interval (PTTI) Applications and Planning Meeting, NASA Conference Publ. 3116, 1990; AD-A239372.
- Proceedings of the IEEE, Special Issue on Time and Frequency, J. Jespersen & D. W. Hanson, ed's., Vol. 79, No. 7, July 1991.
- 7-3 R. F. C. Vessot, "A Review of Atomic Clock Technology, The Performance Capability of Present Spaceborne and Terrestrial Atomic Clocks, and a Look Toward the Future," National Aeronautics and Space Administration, Workshop on Relativistic Gravitation Experiments in Space, Annapolis, MD, June 28-30, 1988, Smithsonian Astrophysical Observatory, Center for Astrophysics, Cambridge, MA 02138, Preprint Series No. 2738.



**7-14 Hewlett-Packard 5061B Data Sheet (Pub. 5952-7912D), Hewlett-Packard, Attn: Inquiry Manager, 1820 Embarcadero Road, Palo Alto, CA 94303.**

**7-15 Rubidium Atomic Frequency Standard, Model FE-5600A data sheet, Frequency Electronics, Inc., 55 Charles Lindbergh Blvd., Mitchel Field, NY 11553.**

**7-16 J. R. Vig, et. al. "Acceleration, Vibration and Shock Effects - IEEE Standards Project P1193," Proc. 1992 IEEE Frequency Control Symposium, 1992.**

⑧

# Oscillator Comparison and Specification

# Oscillator Comparison

	Quartz Oscillators			Atomic Oscillators		
	TCXO	MCXO	OCXO	Rubidium	RbXO	Cesium
<b>Accuracy*</b> (per year)	2 x 10 <sup>-6</sup>	5 x 10 <sup>-8</sup>	1 x 10 <sup>-8</sup>	5 x 10 <sup>-10</sup>	7 x 10 <sup>-10</sup>	2 x 10 <sup>-11</sup>
<b>Aging/Year</b>	5 x 10 <sup>-7</sup>	2 x 10 <sup>-8</sup>	6 x 10 <sup>-9</sup>	2 x 10 <sup>-10</sup>	2 x 10 <sup>-10</sup>	0
<b>Temp. Stab.</b> (range, °C)	5 x 10 <sup>-7</sup> (-55 to +85)	2 x 10 <sup>-8</sup> (-55 to +85)	1 x 10 <sup>-9</sup> (-55 to +85)	3 x 10 <sup>-10</sup> (-55 to +68)	5 x 10 <sup>-10</sup> (-55 to +85)	2 x 10 <sup>-11</sup> (-28 to +65)
<b>Stability, <math>\sigma_y(\tau)</math></b> ( $\tau = 1$ s)	1 x 10 <sup>-9</sup>	1 x 10 <sup>-10</sup>	1 x 10 <sup>-12</sup>	3 x 10 <sup>-11</sup>	5 x 10 <sup>-12</sup>	5 x 10 <sup>-11</sup>
<b>Size</b> (cm <sup>3</sup> )	10	50	20-200	800	1200	6000
<b>Warmup Time</b> (min)	0.1 (to 1 x 10 <sup>-6</sup> )	0.1 (to 2 x 10 <sup>-8</sup> )	4 (to 1 x 10 <sup>-8</sup> )	3 (to 5 x 10 <sup>-10</sup> )	3 (to 5 x 10 <sup>-10</sup> )	20 (to 2 x 10 <sup>-11</sup> )
<b>Power (W)</b> (at lowest temp.)	0.05	0.04	0.25 - 4	20	0.35	30
<b>Price (~\$)</b>	100	1,000	2,000	8,000	10,000	40,000

\* Including environmental effects (note that the temperature ranges for Rb and Cs are narrower than for quartz).

# Accuracy vs. Power-Requirement\*

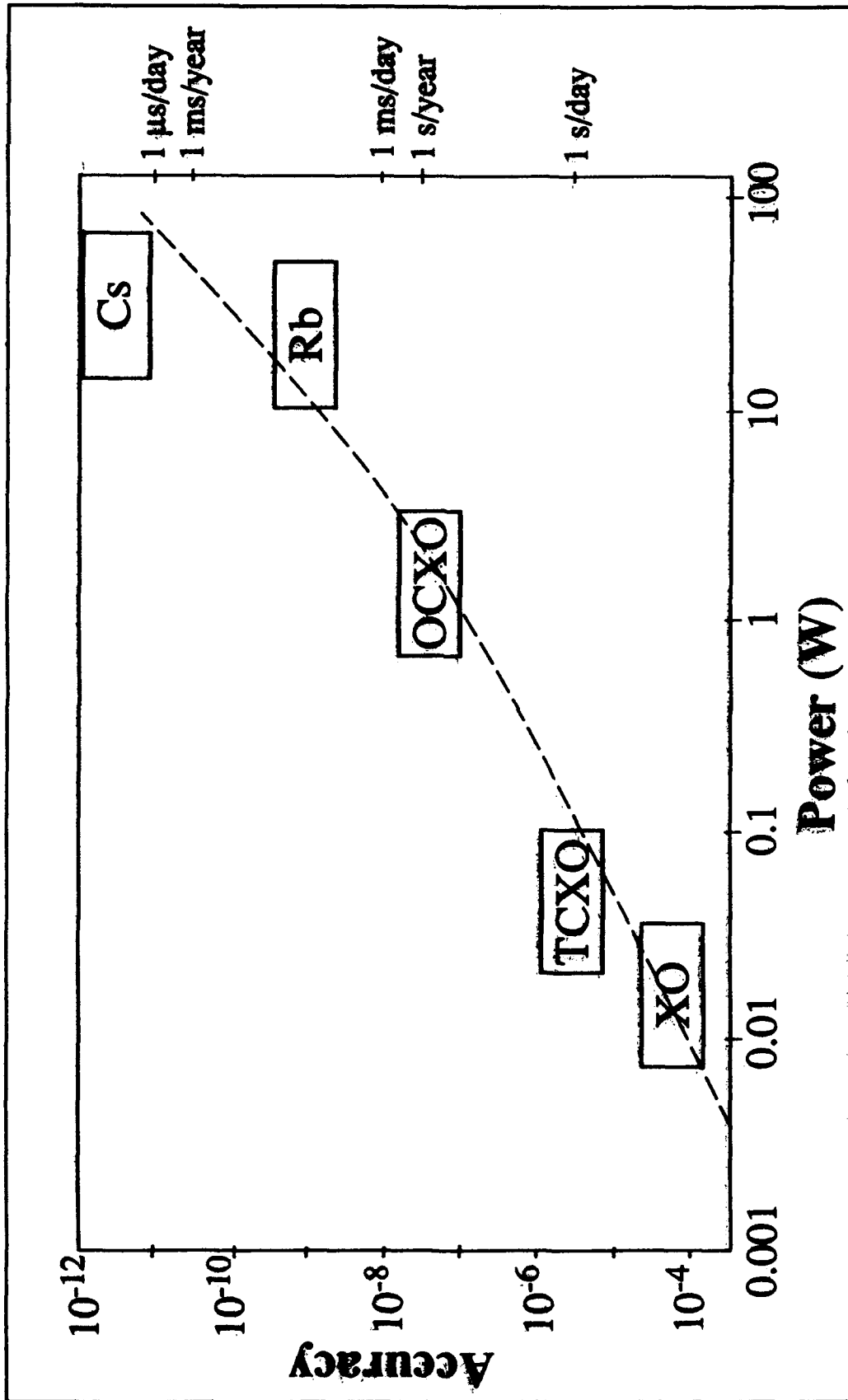

\* Accuracy vs. size, and accuracy vs. cost have similar relationships.

# Stability Ranges of Various Frequency Standards

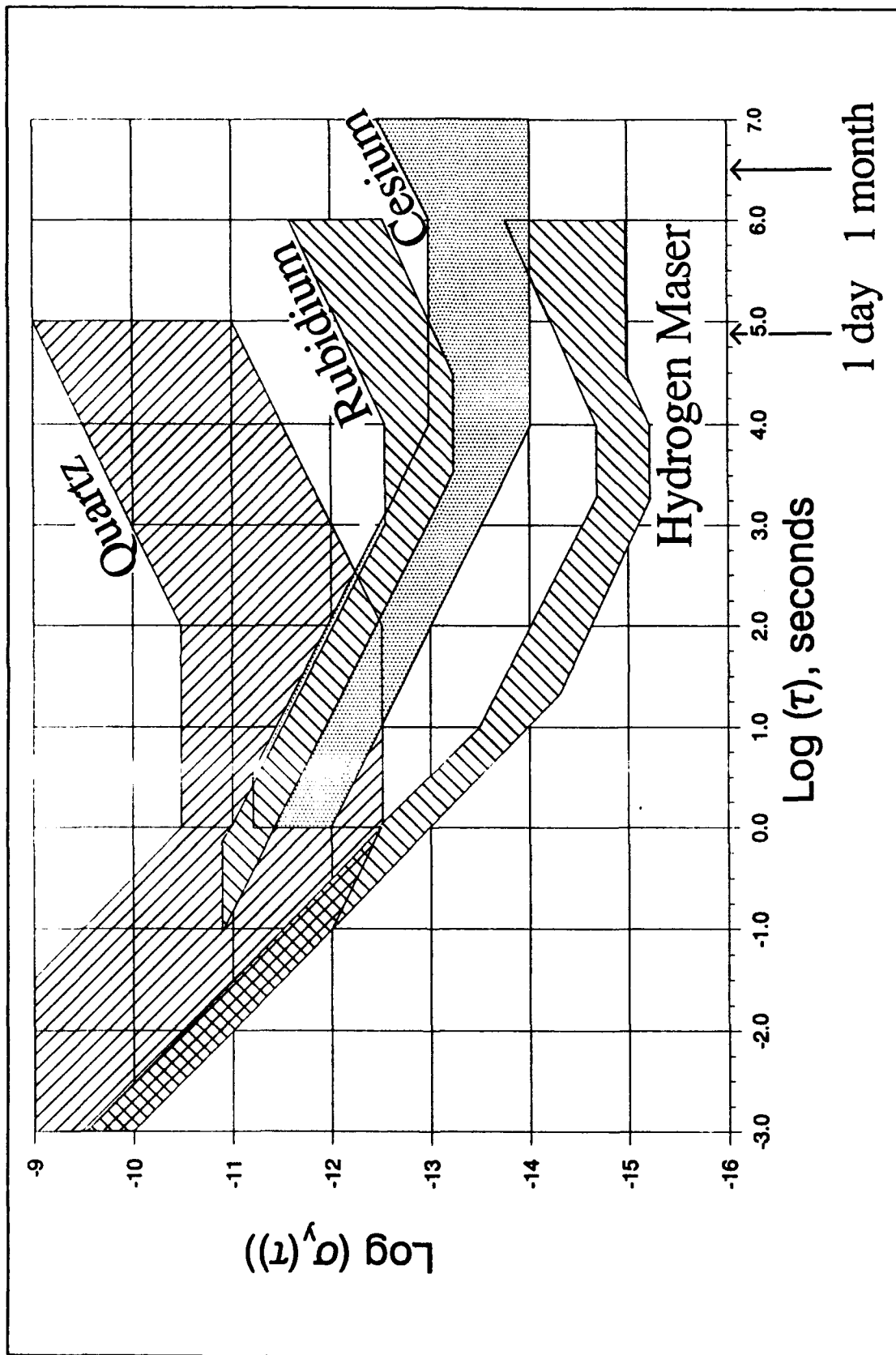

# Phase Instabilities of Various Frequency Standards

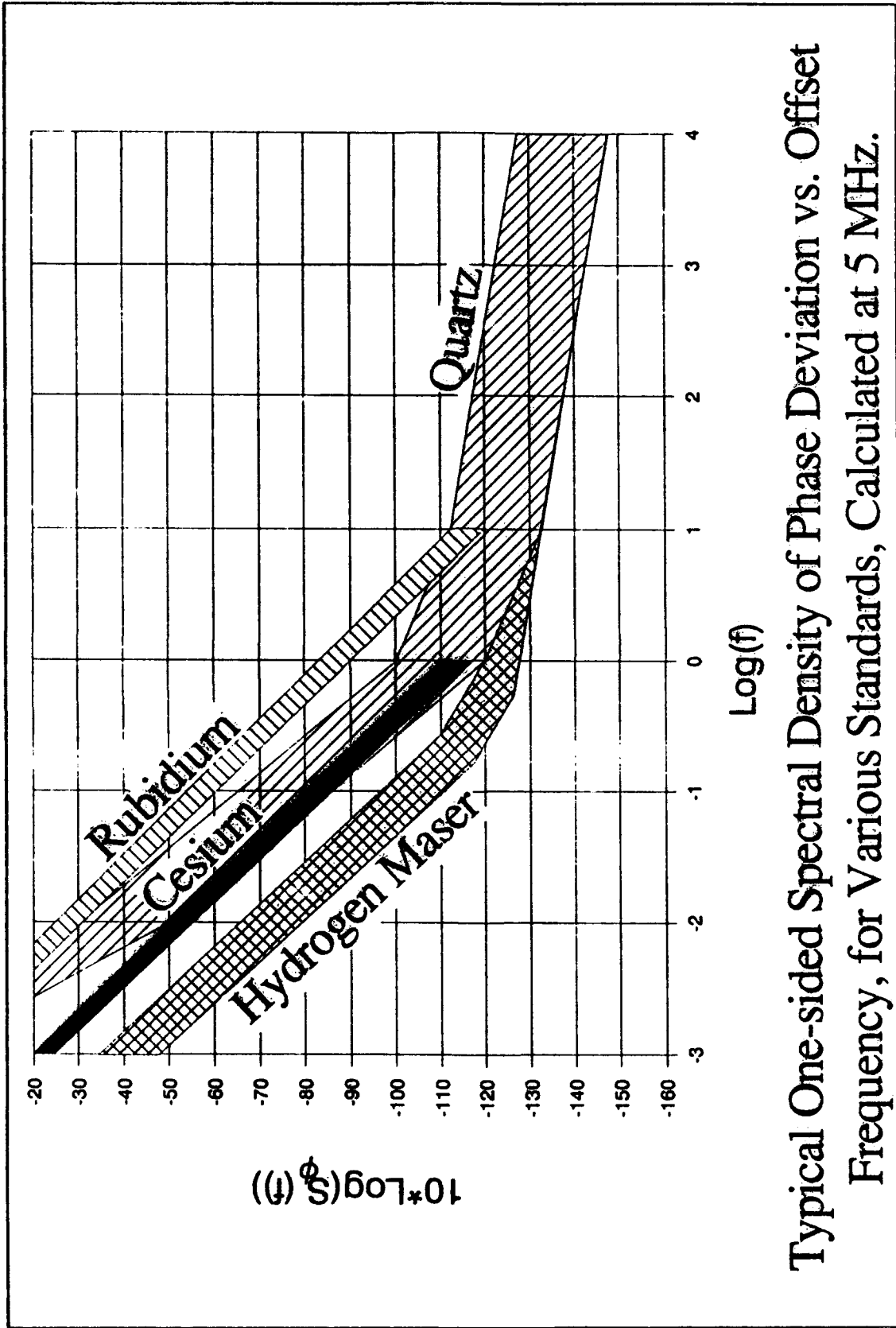

Typical One-sided Spectral Density of Phase Deviation vs. Offset Frequency, for Various Standards, Calculated at 5 MHz.

# Weaknesses and Wearout Mechanisms

	Weaknesses	Wearout Mechanisms
Quartz	Aging Rad hardness	None
Rubidium	Life Power Weight	Rubidium depletion Buffer gas depletion Glass contaminants
Cesium	Life Power Weight Cost Temp. range	Cesium supply depletion Spent cesium gettering Ion pump capacity Electron multiplier

# Oscillator Selection Considerations

- Frequency accuracy or reproducibility requirement
- Recalibration interval
- Environmental extremes
- Power availability - must it operate from batteries?
- Allowable warmup time
- Short term stability (phase noise) requirements
- Size and weight constraints
- Cost to be minimized - acquisition or life cycle cost



# Crystal Oscillator Specification MIL-O-55310

MIL-O-55310B  
10 May 1988  
SUPERSEDING  
MIL-O-55310A  
29 November 1976

## MILITARY SPECIFICATION OSCILLATORS, CRYSTAL, GENERAL SPECIFICATION FOR

This specification is approved for use by all Departments and Agencies of the Department of Defense.

### 1. SCOPE

1.1 Statement of scope. This specification covers the general requirements and quality and reliability assurance requirements for bulkwave quartz crystal oscillators designed for frequency control or timekeeping in Armed Services electronic equipment.

## Chapter 8 References

- A listing of "Specifications and Standards Relevant to Frequency Control," appears in the back pages of the latest Proceedings of the IEEE Frequency Control Symposium - see listing on p. 11-2.
  - E. Hafner, "Specifications and Standards," in E. A. Gerber and A. Ballato, Precision Frequency Control, Vol. 2, pp. 297-304, Academic Press, 1985.
  - S. R. Stein and J. R. Vig, "Frequency Standards for Communications," U. S. Army Laboratory Command Research and Development Technical Report SLCET-TR-91-2 (Rev. 1), October 1991, AD-A243211.
- 8-3 The graphs on pp.8-3 and 8-4 were prepared and provided by Richard Sydnor, Jet Propulsion Laboratory, 1989.
- 8-7 Copies of MIL-O-55310 are available by mail from: Military Specifications and Standards, Bldg. 4D, 700 Robbins Avenue, Philadelphia, PA 19111-5094. Customer Service telephone: (215) 697-2667/2179; Telephone Order Entry System (requires a touch tone telephone and a customer number): (215) 697-1187 thru 1195.

⑨

# Time and Timekeeping

# What Is Time?

- "What, then, is time? If no one asks me, I know; if I wish to explain to him who asks, I know not." --- Saint Augustine, circa 400 A.D.
- The question, both a philosophical and a scientific one, has no entirely satisfactory answer. "Time is what a clock measures." "It defines the temporal order of events." "It is an element in the four-dimensional geometry of space-time." "It is nature's way of making sure that everything doesn't happen at once."
- Why are there "arrows" of time? The arrows are: entropy, electromagnetic waves, expansion of the universe, k-meson decay, and psychological. Does time have a beginning and an end? (Big bang; no more "events", eventually.) See, e.g., Time's Arrows, by Richard Morris, Simon & Schuster, NY, 1985.
- The unit of time, the second, is one of the seven base units in the International System of Units (SI units). Since time is the quantity that can be measured with the highest accuracy, it plays a central role in metrology.

# Dictionary Definition of "Time"

(From The Random House Dictionary of the English Language, © 1987)

time (tīm), *n.*, *adj.*, *u.* **Speed, timing.** —*n.* 1. the system of those sequential relations that any event has to any other, as past, present, or future; indefinite and continuous duration regarded as that in which events succeed one another. 2. duration regarded as belonging to the present life as distinct from the life to come or from eternity; finite duration. 3. (sometimes cap.) a system or method of measuring or reckoning the passage of time; mean time; apparent time; Greenwich time. 4. a limited period or interval, as between two successive events; a long time. 5. a particular period considered as distinct from other periods; Youth is the best time of life. 6. Often, *times*. a. a period in the history of the world, or contemporary with the life or activities of a notable person; prehistoric times; Lincoln's time. b. the period or era now or previously present; a sign of the times; How times have changed! c. a period considered with reference to its events or prevailing conditions, tendencies, ideas, etc.; hard times; a time of war. 7. a prescribed or allotted period, as of one's life, for payment of a debt, etc. 8. the end of a prescribed or allotted period, as of one's life or a pregnancy; His time had come, but there was no one left to mourn over him. When her time came, her husband accompanied her to the delivery room. 9. a period with reference to personal experience of a specified kind; to have a good time; a hot time in the old town tonight. 10. a period of work of an employee, or the pay for it; working hours or days or an hourly or daily pay rate. 11. Informal. a term of enforced duty or imprisonment; to serve time in the army; do time in prison. 12. the period necessary for or occupied by something; The time of the baseball game was two hours and two minutes. The bus takes too much time, so I'll take a plane. 13. leisure time; sufficient or spare time; to have time for a vacation; I have no time to stop now. 14. a particular or definite point in time, as indicated by a clock; What time is it? 15. a particular part of a year, day, etc.; season or period; It's time for lunch. 16. an appointed fit time, or proper instant or period; a time for sowing; the time when the sun crosses the meridian; There is a time for everything. 17. the particular point in time when an event is scheduled to take place; train time; curtain time. 18. an indefinite, frequently prolonged period or duration in the future; Time will tell if what we have done here today was right. 19. the right occasion or opportunity to watch one's time. 20. each occasion of a recurring action or event; to do a thing five times; It's the pitcher's time at bat. 21. times, used as a multiplicative word in phrasal combinations expressing

how many instances of a quantity or factor are taken together; Two goes into six three times; five times faster. 22. Drama. one of the three unities. Cf. unity (def. 8). 23. Proc. a unit or a group of units in the measurement of meter. 24. Music. a. tempo; relative rapidity of movement. b. the metrical duration of a note or rest. c. proper or characteristic tempo. d. the general movement of a particular kind of musical composition with reference to its rhythm, metrical structure, and tempo. e. the movement of a dance or the like to music so arranged; waltz time. 25. Mil. rate of marching, calculated on the number of paces taken per minute; double time; quick time. 26. *Monks*. each completed action or movement of the horse. 27. *minutes* time, in an effort to finish something within a limited period; We worked against time to get out the newspaper. 28. ahead of time, before the time due; early; The building was completed ahead of time. 29. at one time, a. once; in a former time; At one time they owned a restaurant. b. at the same time; at once; They all tried to talk at one time. 30. at the same time, nevertheless; yet; I'd like to try it but at the same time I'm a little afraid. 31. at times, at intervals; occasionally; At times the city becomes intolerable. 32. beat someone's time, *Slang*. to compete for or win a person being dated or courted by another; prevail over a rival; He seemed me, his own brother, trying to beat his time. 33. behind the times, old-fashioned; dated; These attitudes are behind the times. 34. for the time being, temporarily; for the present; Let's forget about it for the time being. 35. from time to time, on occasion; occasionally; at intervals; She comes to see us from time to time. 36. gain time, to postpone in order to make preparations or gain an advantage; delay the outcome of; He hoped to gain time by putting off signing the papers for a few days more. 37. in good time, a. at the right time; on time; punctually. b. in advance of the right time; early; We arrived at the appointed spot in good time. 38. in no time, in a very brief time; almost at once; Working together, they cleaned the entire house in no time. 39. in time, a. early enough; to come in time for dinner. b. in the future; eventually; In time he'll see what is right. c. in the correct rhythm or tempo; There would always be at least one child who couldn't play in time with the music. 40. keep time, a. to record time, as a watch or clock does. b. to mark or observe the tempo. c. to perform rhythmic movements in unison. 41. kill time, to occupy oneself with some activity to make time pass quickly; While I

was waiting, I killed time counting the cars on the freight trains. 42. make time, a. to move quickly, as in an attempt to recover lost time. b. to travel at a particular speed. 43. make time with, *Slang*. to pursue or take as a sexual partner. 44. messy a time, again and again; frequently; Many a time they didn't have enough to eat and went to bed hungry. 45. meet time, a. to suspend progress temporarily, as to await developments; fail to advance. b. Mil. to move the feet alternately as in marching, but without advancing. 46. on one's own time, during one's free time; without payment; He worked out more efficient production methods on his own time. 47. on time, a. at the specified time; punctually. b. to be paid for within a designated period of time, as in installments; Many people are never out of debt because they buy everything on time. 48. out of time, not in the proper rhythm; His singing was out of time with the music. 49. pass the time of day, to converse briefly with or greet someone; The women would stop in the market to pass the time of day. 50. take one's time, to be slow or leisurely; dawdle; Speed was important here, but he just took his time. 51. three after time, again and again; repeatedly; often; I've told him time after time not to alarm the door. 52. time and time again, repeatedly; often; Time and time again I warned her to stop smoking. Also, *time and again*. 53. time of life, (one's) age; At your time of life you must be careful not to overdo things. 54. time of one's life, Informal. an extremely enjoyable experience; They had the time of their lives on their trip to Europe. —*adj.* 55. of, pertaining to, or showing the passage of time. 56. (of an explosive device) containing a clock so that it will detonate at the desired moment; a time bomb. 57. Com. payable at a stated period of time after prearrangement; time drafts or notes. 58. of or pertaining to purchases on the installment plan, or with payment postponed. —*u.* 59. to measure or record the speed, duration, or rate of; to time a race. 60. to fix the duration of; The professor timed the test at 15 minutes. 61. to fix the interval between (actions, events, etc.); They timed their strokes at six per minute. 62. to regulate (a train, clock, etc.) as to time. 63. to appoint or choose the moment or occasion for; schedule; He timed the attack perfectly. —*v.* 64. to keep time; sound or move in unison. [bef. 900; (*n.*) ME; OE *tīma*; c. ON *tīmi*; (*v.*) ME *tīmer* to arrange a time, deriv of the *n.*; akin to *tīgg*] —*Syn.* 4. term, spell, span. 6. epoch, era.

# The Second

- The SI unit of time is the second (symbol s).
- The second was defined, by international agreement, in October, 1967, at the XIII General Conference of Weights and Measures.
- **The second is "the duration of 9,192,631,770 periods of the radiation corresponding to the transition between the two hyperfine levels of the ground state of the cesium atom 133."**
- Prior to 1967, the unit of time was based on astronomical observations; the second was defined in terms of ephemeris time, i.e., as "1/31,556,925.9747 of the tropical year..."
- The unit of frequency is defined as the hertz (symbol Hz). One hertz equals the repetitive occurrence of one "event" per second.

# Frequency and Time

$$f = \frac{1}{\tau}$$

where  $f$  = frequency (= number of "events" per unit time), and  
 $\tau$  = period (= time between "events")

$$\text{Accumulated clock time} = \frac{\text{Total number of events}}{\text{Number of events per unit of time}}$$

Example:  $\frac{3 \text{ rotations of the earth}}{1 \text{ rotation/day}} = 3 \text{ days.}$

Frequency source + counting mechanism  $\longrightarrow$  clock

Examples of frequency sources: the rotating earth, pendulum, quartz crystal oscillator, and atomic frequency standard.

# Typical Clock System

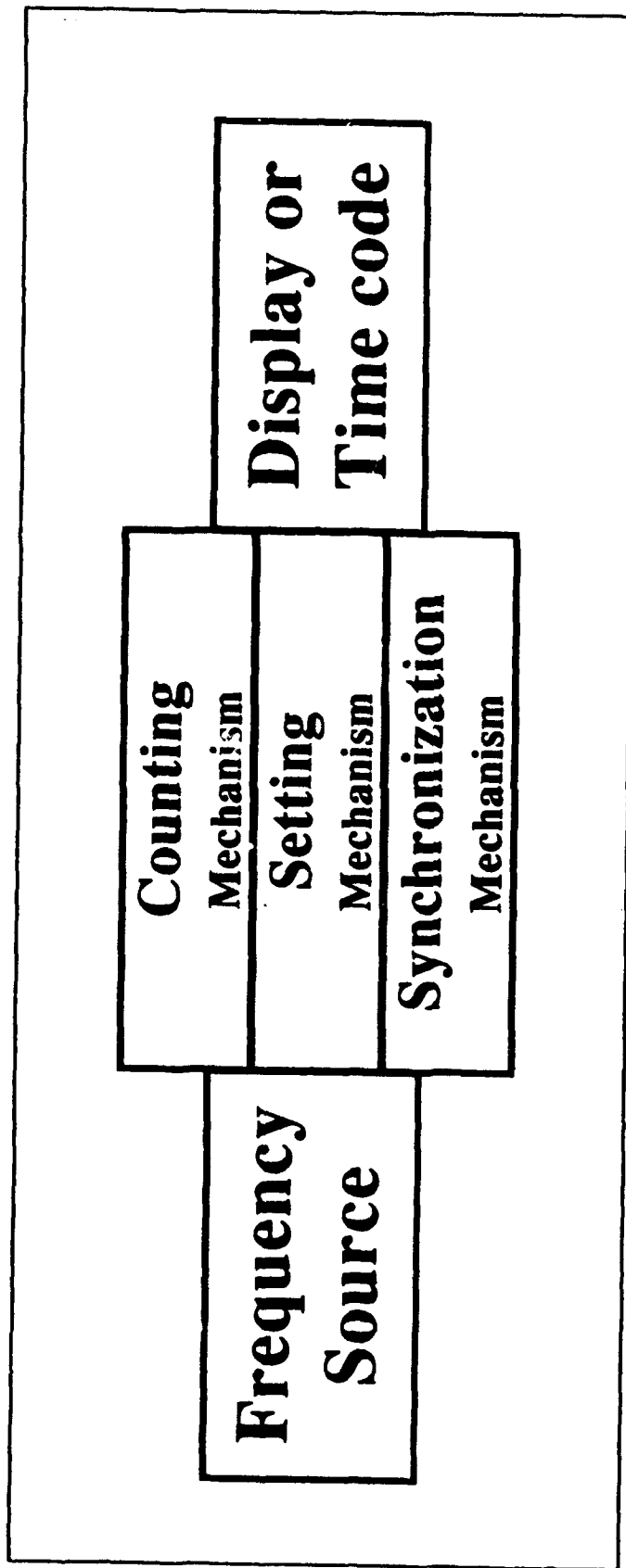

$$t = t_0 + \Sigma \Delta \tau$$

where  $t$  is the time output,  $t_0$  is the initial setting, and  $\Delta \tau$  is the time interval being counted.



# Evolution of Clock Technologies

- Sundials, and continuous flow of:
  - ☛ Water (clepsydra)
  - ☛ Sand (hour glass)
  - ☛ Falling weights, with frictional control of rate
- Vibrating, but non-resonant motion - escapement mechanisms:  
falling weight applies torque through train of wheels; rate control depends on moments of inertia, friction and torque; period is the time it takes to move from one angular position to another.
- Resonant control:
  - ☛ Mechanical: pendulum, hairspring and balance wheel
  - ☛ Mechanical, electrically driven: tuning fork, quartz resonator
  - ☛ Atomic and molecular

# Progress in Timekeeping

Time Period	Clock / Milestone	Accuracy Per Day
4th millennium B.C.	Day & night divided into 12 equal hours	
Up to 1280 A.D.	Sundials, water clocks (clepsydrae)	~ 1 h
~ 1280 A.D.	Mechanical clock invented - assembly time for prayer was first regular use.	~ 30 to 60 min
14th century	Invention of the escapement; clockmaking becomes a major industry	~ 15 to 30 min
~ 1345	Hour divided into minutes and seconds	
15th century	Clock time used to regulate people's lives (work hours)	~ 2 min
16th century	Time's impact on science becomes significant (Galileo times physical events, e.g., free-fall)	~ 1 min
~ 1657	First pendulum clock (Huygens)	~ 100 s
18th century	Temperature-compensated pendulum clocks	1 to 10 s
19th century	Electrically driven free-pendulum clocks	10 <sup>-2</sup> to 10 <sup>-1</sup> s
~1910 to 1920	Wrist watches become widely available	
1920 to 1934	Electrically driven tuning forks	10 <sup>-3</sup> to 10 <sup>-2</sup> s
1921 to present	Quartz crystal clocks (and watches, since ~1971)	10 <sup>-5</sup> to 10 <sup>-1</sup> s
1949 to present	Atomic clocks	10 <sup>-9</sup> to 10 <sup>-7</sup> s

# Clock Errors

$$T(t) = T_0 + \int_0^t R(t)dt + \varepsilon(t) = T_0 + (R_0t + 1/2At^2 + \dots) + \int_0^t E_i(t)dt + \varepsilon(t)$$

Where,

$T(t)$  = time difference between two clocks at time  $t$  after synchronization.

$T_0$  = synchronization error at  $t = 0$

$R(t)$  = the rate (i.e., fractional frequency) difference between the two clocks

under comparison;  $R(t) = R_0 + At + \dots$   $E_i(t)$

$\varepsilon(t)$  = error due to random fluctuations  $\approx \tau \sigma_y(\tau)$

$R_0 = R(t)$  at  $t = 0$

$A$  = linear aging term (higher order terms are included if the aging is not linear)

$E_i(t)$  = rate difference due to environmental effects (temperature, etc.)

-----  
**Example:** If a watch is set to within 0.5 seconds of a time tone ( $T_0 = 0.5$  s), and the watch initially gains 2 s/week ( $R_0 = 2$  s/week), and the watch rate ages -0.1 s per week<sup>2</sup>, ( $A = -0.1$  s/week<sup>2</sup>), then after 10 weeks (and assuming  $E_i(t) = 0$ ):

$$T(10 \text{ weeks}) = 0.5 + (2 \times 10) + 1/2 (-0.1 \times (10)^2) = 15.5 \text{ seconds.}$$

# Frequency Error vs. Time Error

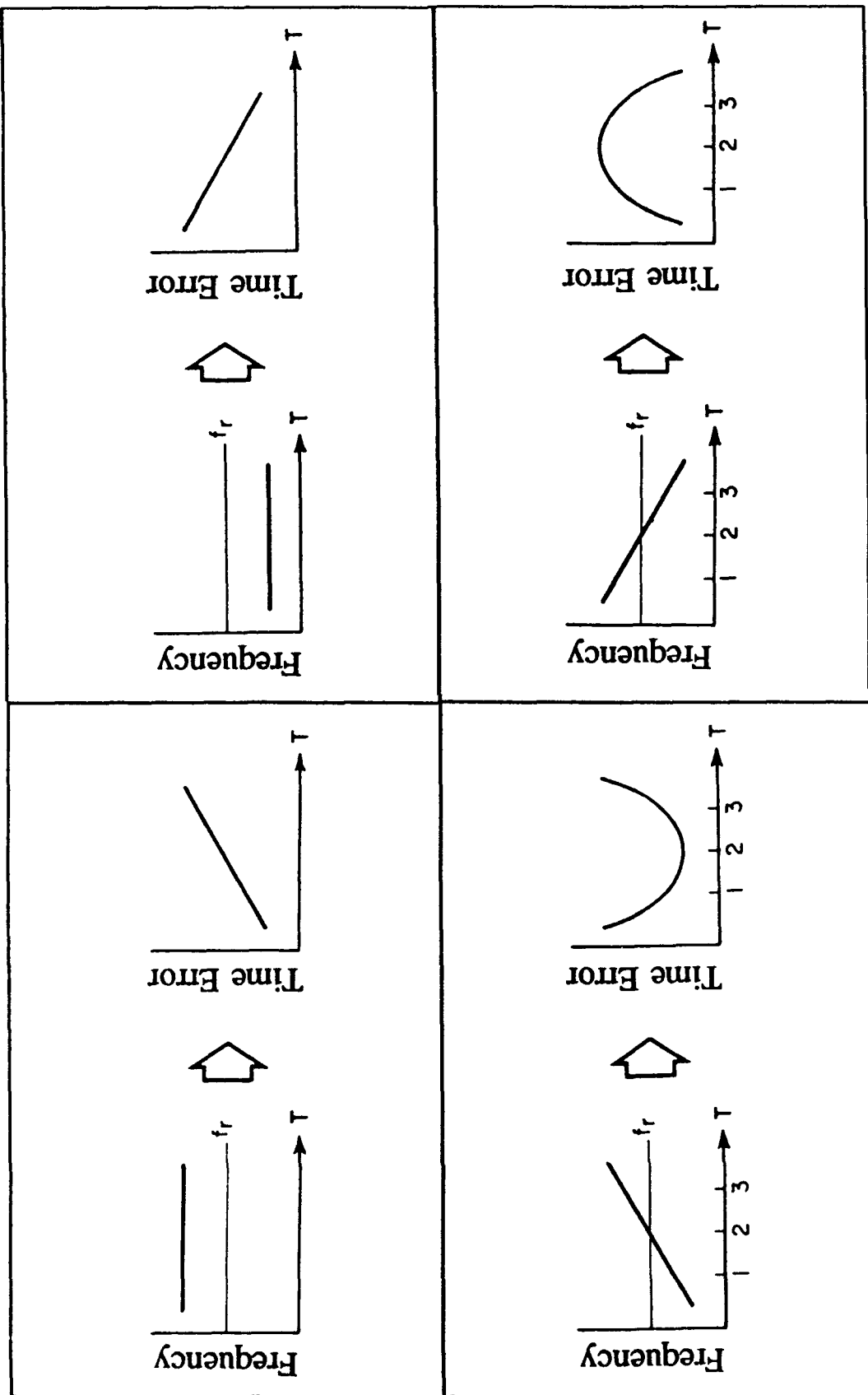

$f_r$  = reference (i.e., the "correct") frequency

# Clock Error vs. Resynchronization Interval

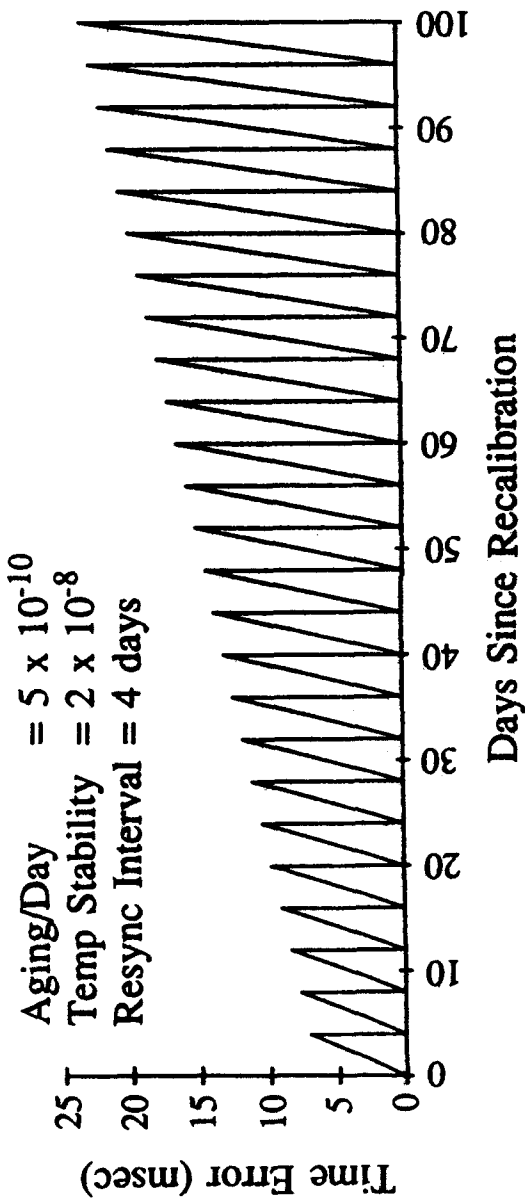

	TCXO	OCXO	MCXO	RbXO
Avg. Temp. Stab.	$1 \times 10^{-6}$	$2 \times 10^{-8}$	$2 \times 10^{-8}$	$2 \times 10^{-8}$
Aging/Day	$1 \times 10^{-8}$	$1 \times 10^{-10}$	$5 \times 10^{-11}$	$5 \times 10^{-13}$
Resynch Interval* (A/J & Security)	10 min 6 hr	4 da 6 hr	4 da 6 hr	4 da 6 hr
Recal Interval* (Maint Cost)	10 yr 80 da	50 yr 1.5 yr	94 yr 3 yr	None 300 yr Needed

\* Calculated for an accuracy requirement of 25 milliseconds. Many modern systems need much better.

# Time Error vs. Elapsed Time

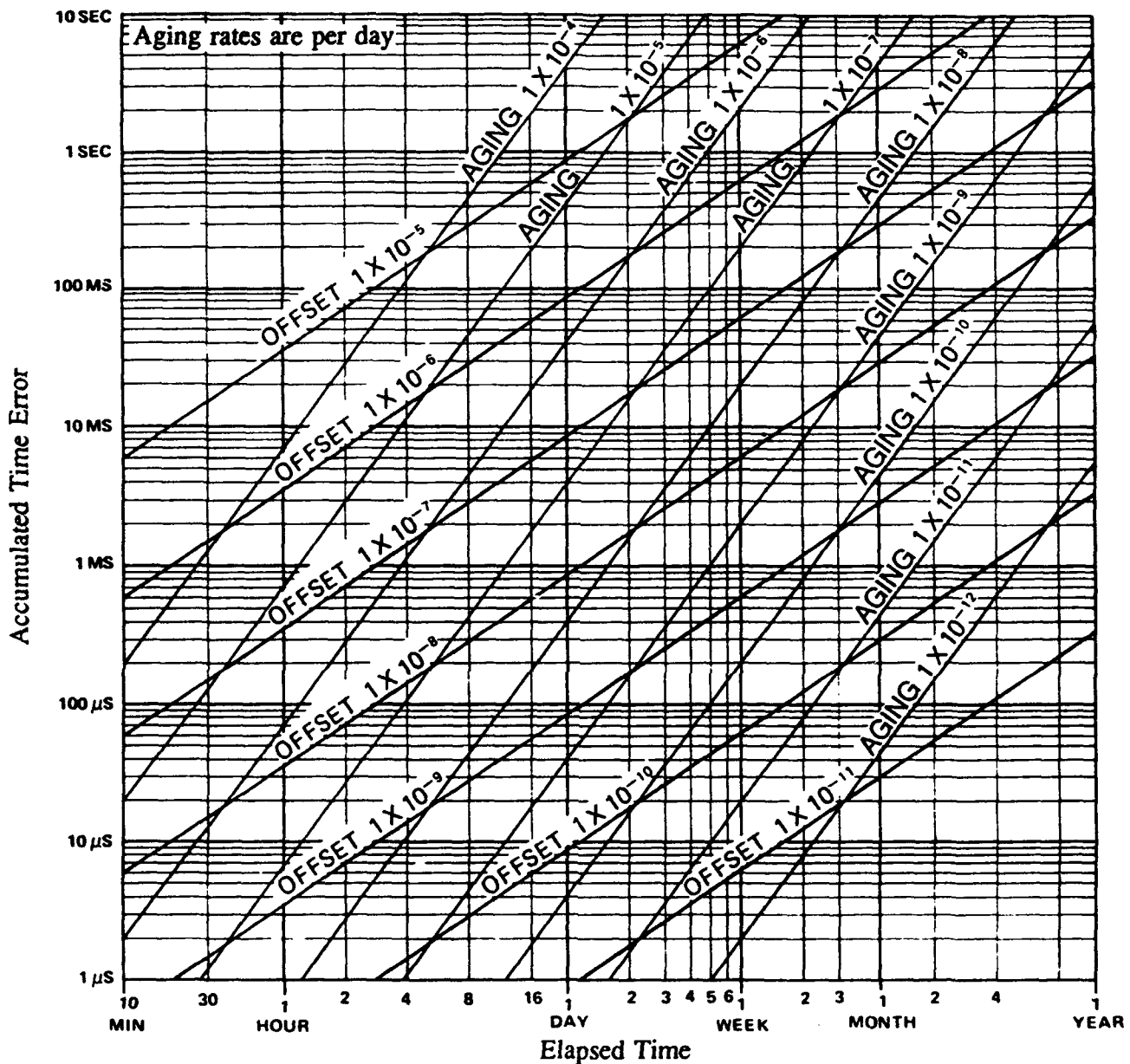

## To Estimate the Accumulated Time Error

- ① Estimate the initial frequency offset plus the average expected offsets due to temperature and other environmental effects.
- ② Find the time error caused by the sum of the offsets.
- ③ Find the time error caused by the oscillator's specified aging rate.
- ④ Add the results of ② and ③ to estimate the total time error.

# On Using Time for Clock Rate Calibration

It takes time to measure the clock rate (i.e., frequency) difference between two clocks. The smaller the rate difference between a clock to be calibrated and a reference clock, the longer it takes to measure the difference ( $\Delta t/t \approx \Delta f/f$ ).

For example, assume that a reference timing source (e.g., Loran or GPS) with a time uncertainty of 100 ns is used to calibrate the rate of a clock to  $1 \times 10^{-11}$  accuracy. A frequency offset of  $1 \times 10^{-11}$  will produce  $1 \times 10^{-11} \times 3600$  s/hour = 36 ns time error per hour. Then, to have a high certainty that the measured time difference is due to the frequency offset rather than the reference clock uncertainty, one must accumulate a sufficient amount ( $\geq 100$  ns) of time error. It can take hours to perform the calibration. (See the next page for a different example.) If one wishes to know the frequency offset to a  $\pm 1 \times 10^{-12}$  precision, then the calibration will take more than a day.

Of course, if one has a cesium standard for frequency reference, then, for example, with a high resolution frequency counter, one can make frequency comparisons of the same precision much faster.

# Calibration With a 1 pps Reference.

- Let  $A$  = desired clock rate accuracy after calibration  
 $A'$  = actual clock rate accuracy  
 $\Delta\tau$  = jitter in the 1 pps of the reference clock, rms  
 $\Delta\tau'$  = jitter in the 1 pps of the clock being calibrated, rms  
 $t$  = calibration duration  
 $\Delta t$  = accumulated time error during calibration

Then, what should be the  $t$  for a given set of  $A$ ,  $\Delta\tau$ , and  $\Delta\tau'$ ?

**Example:** The crystal oscillator in a clock is to be calibrated by comparing the 1 pps output from the clock with the 1 pps output from a standard. If  $A = 1 \times 10^{-9}$ ;  $\Delta\tau = 0.1 \mu\text{s}$ , and  $\Delta\tau' = 1.2 \mu\text{s}$ , then,  $[(\Delta\tau)^2 + (\Delta\tau')^2]^{1/2} \approx 1.2 \mu\text{s}$ , and when  $A = A'$ ,  $\Delta t = (1 \times 10^{-9})t \equiv (1.2 \mu\text{s})N$ , and  $t = (1200N)$  s. The value of  $N$  to be chosen depends on the statistics of the noise processes, on the confidence level desired for  $A'$  to be  $\leq A$ , and on whether one makes measurements every second or only at the end points. If one measures at the end points only, and the noise is white phase noise, and the measurement errors are normally distributed, then, with  $N = 1$ , 68% of the calibrations will be within  $A$ ; with  $N = 2$ , and 3, 95% and 99.7% , respectively, will be within  $A$ . One can reduce  $t$  by about a factor  $2/N^{3/2}$  by making measurements every second; e.g., from 1200 s to  $2 \times (1200)^{2/3} = 225$  s.



# Time Transfer Methods

Method	Accuracy	Cost ('92)
Portable Cs clock	10 - 100 ns	\$40K
GPS time dissemination GPS common view	50 - 100 ns 2 - 20 ns	\$3K - 10K*
Two-way via satellite	~ 1 ns	~ \$100K
Loran-C	100 ns	\$10K
HF (WWV)	200 $\mu$ sec	\$3K
Portable quartz & Rb clocks	Calibration interval dependent	\$1K - 10K

\* Projected to be < \$1K by 1994

# The Global Positioning System

The Global Positioning System (GPS) is the most precise navigation system available. As it is capable of providing nanosecond-level timing accuracies, it is also one of the most accurate sources of time.

GPS is a satellite-based radio navigation and positioning system that is designed to provide global, all-weather, 24-hour, accurate navigation to an unlimited number of users. Each of the satellites contains four atomic clocks. The satellites transmit a navigation message that provides satellite position, time, and atmospheric propagation correction data. The GPS receiver, which contains a quartz crystal clock, measures the transit time of the satellite signal and multiplies that time by the speed of light to compute range to the satellite. The satellite clocks are more accurate than the receiver clocks. Therefore, although three satellites can provide latitude, longitude and altitude, the signal from a fourth satellite is used to correct for the navigational error caused by the receiver clock's inaccuracy, i.e., the receivers calculate their  $x$ ,  $y$ ,  $z$ , and  $t$  from receiving each of four satellite's  $x$ ,  $y$ ,  $z$ , and  $t$ . Velocity is determined from the doppler shifts of the the transmitted carrier frequencies.

# Global Positioning System

- GPS can provide global, all-weather, 24-hour, real-time, accurate navigation and time reference to an unlimited number of users.
- *GPS Accuracies* ( $2\sigma$ )  
**Position:** 120 m (Standard Positioning Service, SPS), 40 m (Precise Positioning Service, PPS), 1 cm + 1ppm (differential, static land survey); **Velocity:** 0.3 m/s (SPS), 0.1 m/s (PPS).  
**Time:** 350 ns to < 10 ns
- 24 satellites in 6 orbital planes; 6 to 10 visible at all times; partially deployed now, fully operational by 1993; ~12 h period 20,200 km orbits; types of military sets: 1 channel (manpack, vehicular), 2 channel (helicopter), 5 channel (high dynamic platforms); 1 and 2 ch. sets acquire sequentially.
- PRN navigation signals broadcast at  $L_1 = 1.575$  GHz (19 cm) and  $L_2 = 1.228$  GHz (24 cm); two codes, C/A and P are sent; messages provide satellite position, time, and atmospheric propagation data; users select the optimum 4 satellites to track. PPS (for DOD users) uses L1 and L2, SPS uses L1 only.

# Oscillators' Impact on GPS

- Satellite oscillator (clock) inaccuracy is a major source of navigational inaccuracy. In sequencing receivers, the oscillator's stability during the time it takes to acquire the satellites sequentially (minutes) affects nav. accuracy.
- Receiver oscillator affects GPS performance, as follows:

Oscillator Parameter	GPS Performance Parameter
Warmup time	Time to first fix
Power	Mission duration, logistics costs (batteries)
Size and weight	Manpack size and weight
Short term stability (0.1 s to 100 s)	Range measurement accuracy, acceleration performance, jamming resistance
Short term stability (~15 minute)	Time to subsequent fix, navigation accuracy in sequencing sets
Phase noise	Jamming margin, data demodulation, tracking
Acceleration sensitivity	See short term stab. and phase noise effects

# Time Scales

- A "time scale" is a system of assigning dates, i.e., a "time," to events; e.g., 6 January 1989, 13 h, 32 m, 46.382912 s, UTC, is a date.
- A "time interval" is a "length" of time between two events; e.g., five seconds.
- Universal time scales, UT0, UT1, and UT2, are based on the earth's spin on its axis, with corrections.
- Celestial navigation: clock (UT1) + sextant  $\longrightarrow$  position.
- International Atomic Time (TAI) is maintained by the International Bureau of Weights and Measures (BIPM), and is derived from an ensemble of more than 160 atomic clocks, from more than 25 nations.
- Coordinated Universal Time (UTC) is the time scale today, by international agreement. The rate of UTC is determined by TAI, but, in order to not let the time vs. the earth's position change indefinitely, UTC is adjusted by means of leap seconds so as to keep UTC within 0.9 s of UT1.

# Relativistic Time

- Time is not absolute. The "time" at which a distant event takes place depends on the observer. For example, if two events, A and B, are so close in time or so widely separated in space that no signal traveling at the speed of light can get from one to the other before the latter takes place, then, even after correcting for propagation delays, it is possible for one observer to find that A took place before B, for a second to find that B took place before A, and for a third to find that A and B occurred simultaneously. Although it seems bizarre, all three can be right.
- Rapidly moving objects exhibit a "time dilation" effect. (Twin on a spaceship moving at 0.87c will age 6 months while twin on earth ages 1 year. There is no "paradox" because spaceship twin must accelerate; i.e., there is no symmetry to the problem.)
- A clock's rate also depends on its position in a gravitational field. A high clock runs faster than a low clock.

# Relativistic Time Effects

- Transporting "perfect" clocks slowly around the surface of the earth along the equator yields  $\Delta t = -207$  ns eastward and  $\Delta t = +207$  ns westward (portable clock is late eastward). The effect is due to the earth's rotation.
- At latitude  $40^\circ$ , for example, the rate of a clock will change by  $1.091 \times 10^{-13}$  for each kilometer above sea level. Moving a clock from sea level to 1km elevation makes it gain 9.4 nsec/day at that latitude.
- In 1971, atomic clocks flown eastward then westward around the world in airlines demonstrated relativistic time effects; eastward  $\Delta t = -59$  ns, westward  $\Delta t = +273$  ns; both values agreed with prediction to within the experimental uncertainties.
- Spacecraft Examples:
  - For a space shuttle in a 325 km orbit,  $\Delta t = t_{\text{space}} - t_{\text{gnd}} = -25 \mu\text{sec/day}$
  - For GPS satellites (12 hr period circular orbits),  $\Delta t = +44 \mu\text{sec/day}$
- In precise time and frequency comparisons, relativistic effects must be included in the comparison procedures.

# Relativistic Time Corrections

The following expression accounts for relativistic effects, provides for clock rate accuracies of better than 1 part in  $10^{14}$ , and allows for global-scale clock comparisons of nanosecond accuracy, via satellites:

$$\Delta t = \frac{-1}{c^2} \int_0^T \left[ \frac{1}{2} (v_s^2 - v_g^2) - (\phi_s - \phi_g) \right] dt + \frac{2\omega}{c^2} A_E$$

Where  $\Delta t$  = time difference between spacecraft clock and ground clock,  $t_s - t_g$

$v_s$  = spacecraft velocity ( $\ll c$ ),  $v_g$  = velocity of ground station

$\Phi_s$  = gravitational potential at the spacecraft

$\Phi_g$  = gravitational potential at the ground station

$\omega$  = angular velocity of rotation of the earth

$A_E$  = the projected area on the earth's equatorial plane swept out by the vector whose tail is at the center of the earth and whose head is at the position of the portable clock or the electromagnetic signal pulse. The  $A_E$  is taken positive if the head of the vector moves in the eastward direction.

Within 24 km of sea level,  $\Phi = gh$  is accurate to  $1 \times 10^{-14}$  where  $g = (9.780 + 0.052 \sin^2 \Psi) \text{ m/s}^2$ ,  $\Psi$  = the latitude,  $h$  = the distance above sea level, and where the  $\sin^2 \Psi$  term accounts for the centrifugal potential due to the earth's rotation. The "Sagnac effect,"  $(2\omega/c^2)A_E = (1.6227 \times 10^{-21} \text{ s/m}^2)A_E$ , accounts for the earth-fixed coordinate system being a rotating, noninertial reference frame.



# Some Useful Relationships

- Propagation delay =  $1 \text{ ns}/30 \text{ cm} = 1 \text{ ns}/\text{ft} = 3.3 \text{ } \mu\text{s}/\text{km} \approx 5 \text{ } \mu\text{s}/\text{mile}$
- 1 day = 86,400 s; 1 year =  $3.1536 \times 10^7 \text{ s}$
- Clock accuracy:  $1 \text{ ms}/\text{day} \approx 1 \times 10^{-8}$
- At 10 MHz: period = 100 ns; phase deviation of  $1^\circ = 0.3 \text{ ns}$  of time deviation
- Doppler shift\* =  $\Delta f/f = 2v/c$

-----

\* **Doppler shift example:** if  $v = 4 \text{ km/h}$  and  $f = 10 \text{ GHz}$  (e.g., a slow-moving vehicle approaching an X-band radar), then  $\Delta f = 74 \text{ Hz}$ , i.e., low phase noise 74 Hz from the carrier is necessary in order to "see" the vehicle.

# One Pulse-Per-Second Timing Signal

(MIL-STD-188-115)

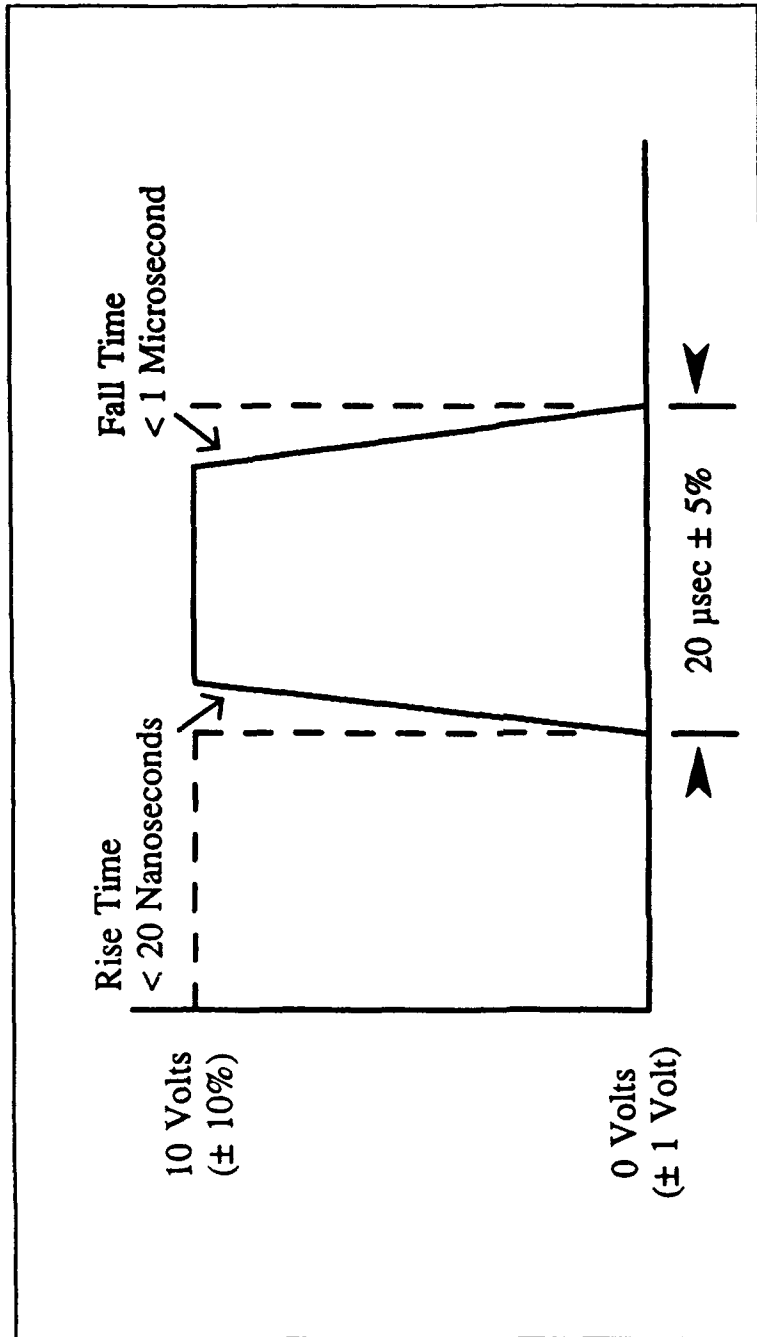

"The leading edge of the BCD code (negative going transitions after extended high level) shall coincide with the on-time (positive going transition) edge of the one pulse-per-second signal to within  $\pm 1$  millisecond." See next page for the MIL-STD BCD code.

# BCD Time Code

(MIL-STD-188-115)

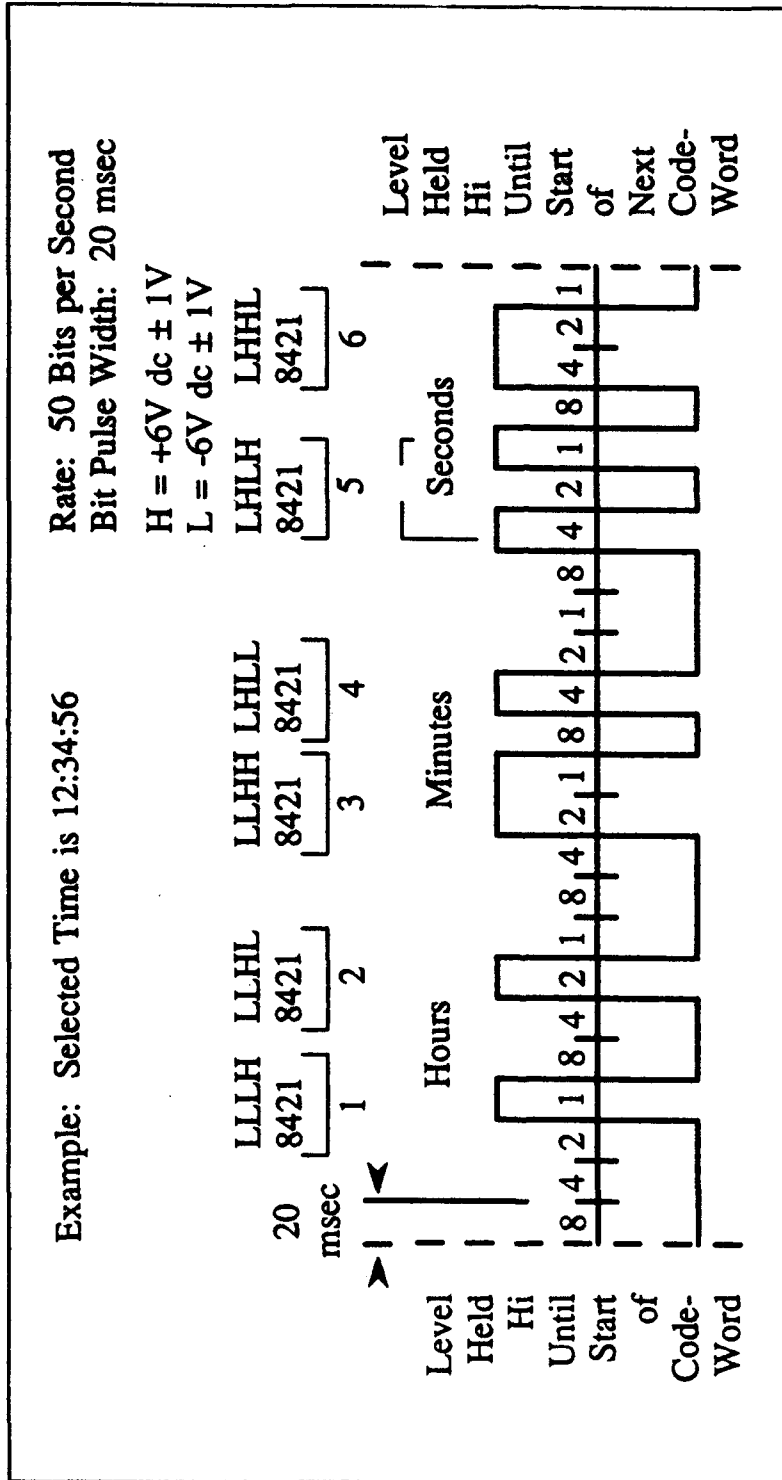

## 24 Bit BCD Time Code\*

\* May be followed by 12 bits for day-of-year and/or 4 bits for figure-of-merit (FOM). The FOM ranges from better than 1 ns (BCD character 1) to greater than 10 ms (BCD character 9).

# Time and Frequency Subsystem

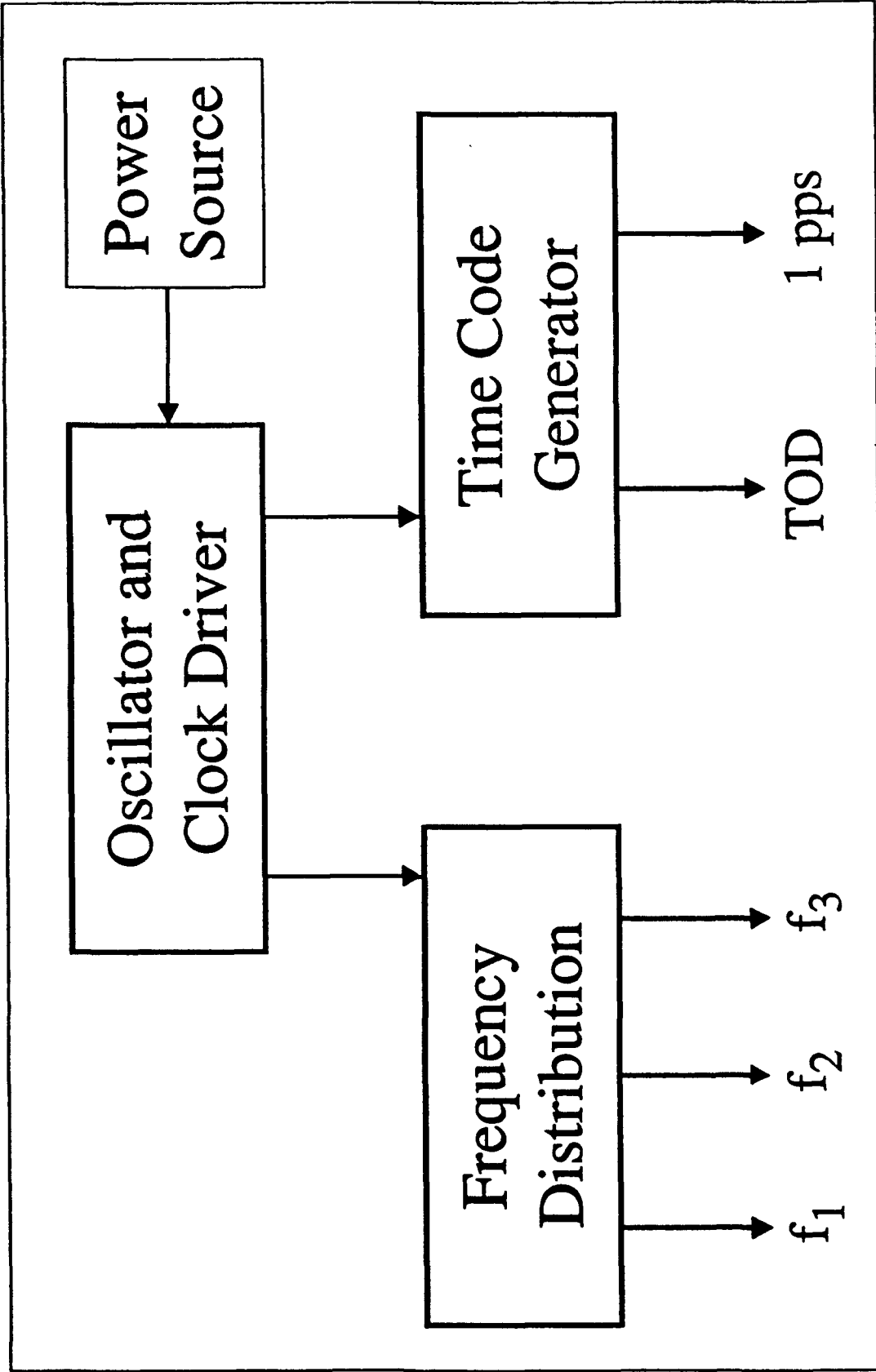

# The MIFTTI Subsystem

MIFTTI = Modular Intelligent Frequency, Time and Time Interval

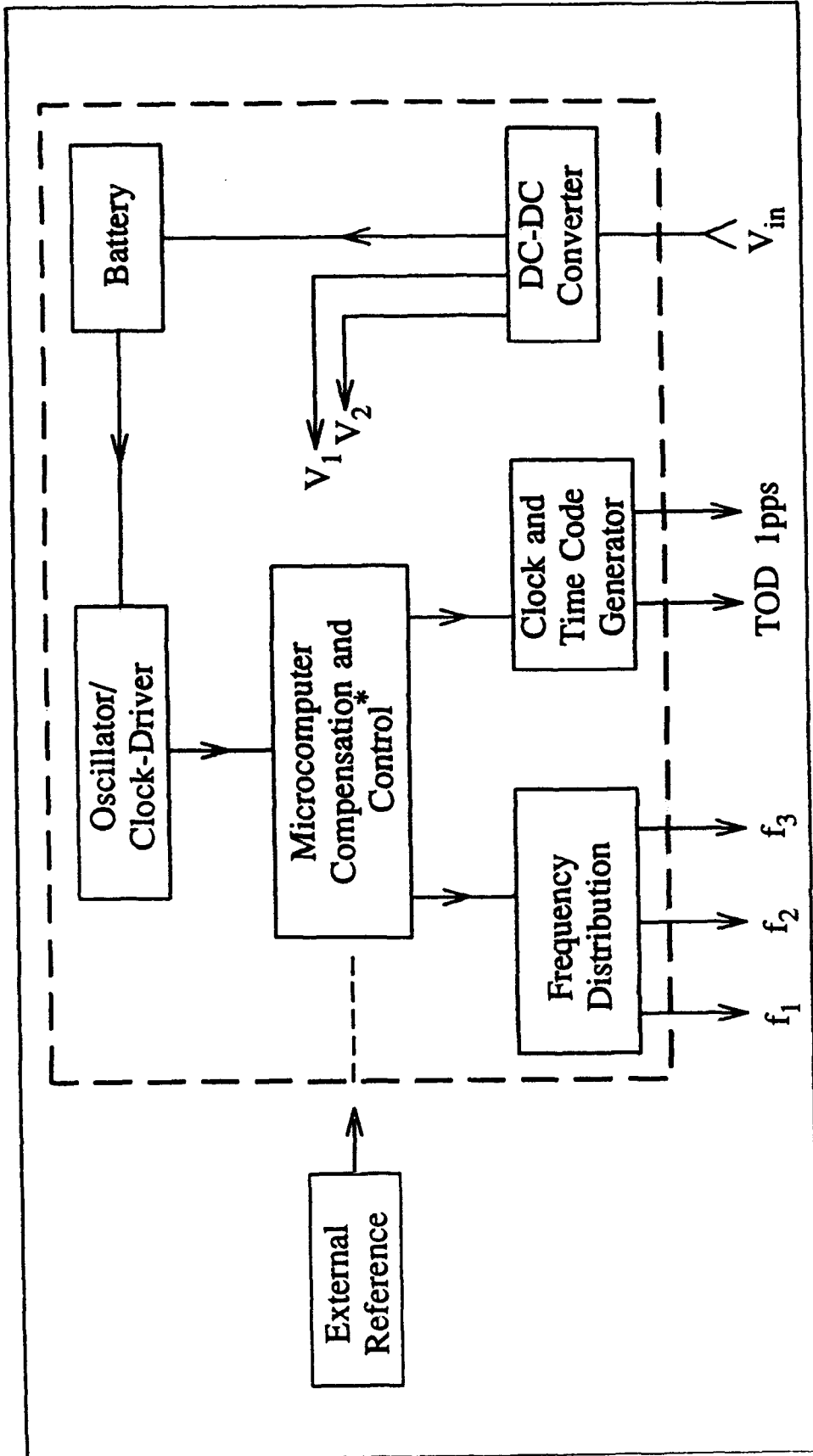

\* The microcomputer compensates for systematic effects (after filtering random effects), and performs: automatic synchronization and calibration when an external reference is available, and built-in-testing.

## Chapter 9 References

- G. M. R. Winkler, "Timekeeping and Its Applications," Advances in Electronics and Electron Physics, Vol. 44, pp. 34-97, 1977.
- Time and Frequency User's Manual, ed. by G. Kamas and S. L. Howe, NBS Special Publication 559, 1979; Time and Frequency Division, NIST, 325 Broadway, Boulder, Colorado, 80303.
- Characterization of Clocks and Oscillators, ed. by D. B. Sullivan, et al., NIST Technical Note 1337, 1990, Time and Frequency Division, NIST, 325 Broadway, Boulder, Colorado, 80303.
- D. W. Allan, "Frequency and Time Coordination, Comparison, and Dissemination," in E. A. Gerber and A. Ballato, Precision Frequency Control, Vol. 2, pp. 233-273, Academic Press, 1985.
- H. Hellwig, K. M. Evenson and D. J. Wineland, "Time, Frequency and Physical Measurement," Physics Today, pp. 23-30, December 1978.
- "Fundamentals of Time and Frequency Standards," Application Note 52-1, Hewlett Packard Co., September 1986.
- "Timekeeping and Frequency Calibration," Application Note 52-2, Hewlett Packard Co., November 1986.
- R. Morris, Time's Arrows: Scientific Attitudes Toward Time, Simon and Schuster, New York, 1985.
- Proceedings of the IEEE, Special Issue on Time and Frequency, J. Jespersen & D. W. Hanson, ed's., Vol. 79, No. 7, July 1991.
- MIL-HDBK-421, "Communications Timing and Synchronization Subsystems," Military Handbook (U.S.A.), 17 May 1991
- 9-13 The results on p. 9-13 are based on an analysis by Samuel R. Stein, Ball Communication Systems Div., private communication, November 1989.
- 9-16a A. J. Van Dierendonck and M. Birnbaum, "Time Requirements in the NAVSTAR Global Positioning System (GPS)," Proc. 30th Annual Symposium on Frequency Control, pp. 375-383, 1976, AD046089. Proc. available from NTIS.

- 9-16b** F. E. Butterfield, "Frequency Control and Time Information in the NAVSTAR/Global Positioning System," Proc. 30th Annual Symposium on Frequency Control, pp. 371-374, 1976, AD046089. Proc. available from NTIS.
- 9-17** D. L. Hessick and W. C. Euler, "GPS User Receivers and Oscillators," Proc. 38th Annual Symposium on Frequency Control, pp. 341-362, 1984, IEEE Catalog No. 84CH2062-8.
- 9-19** C. Alley, "Relativity and Clocks," Proc. 33rd Annual Symposium on Frequency Control, pp. 4-39, 1979. Proc. available from NTIS.
- 9-21a** "Relativistic Effects in a Terrestrial Coordinate Time System," CCIR Report 439-3 (Mod F), Document 7/1017-E, 10 January 1986.
- 9-21b** N. Ashby and D. W. Allan, "Practical Implications of Relativity for a Global Coordinate Time Scale," Radio Science, Vol. 14, No. 4, pp. 649-669, July-August 1979.
- 9-21c** D. W. Allan, M. A. Weiss, and N. Ashby, "Around-the-World Relativistic Sagnac Experiment," Science, Vol. 228, pp. 69-70, 5 April 1985.
- 9-23** MIL-STD-188-115, Military Standard, "Interoperability and Performance Standards for Communications Timing and Synchronization Subsystems," 31 March 1986. Copies are available from Naval Publications and Forms Center, 5801 Tabor Ave., Philadelphia, PA 19120.
- 9-26a** K. Lyon, W. Riley and J. Vaccaro, "The Modular Intelligent Frequency, Time and Time Interval (MIFTTI) Subsystem Program," Proc. 43rd Annual Symposium on Frequency Control, 1989, IEEE Catalog No. 89CH2690-6; also, U. S. Army LABCOM R & D Tech. Rep't SLCET-TR-87-0715-F, October 1990, AD B161142.
- 9-26b** S. R. Stein, "Modular Intelligent Frequency, Time and Time Interval Subsystem Study Program," U. S. Army LABCOM R & D Tech. Rep't SLCET-TR-87-0717-F, January 1989, AD B131151.

**10**

# **Related Devices and Applications**



# Discrete-Resonator Crystal Filter

A Typical Six-pole Narrow-band Filter

Layout

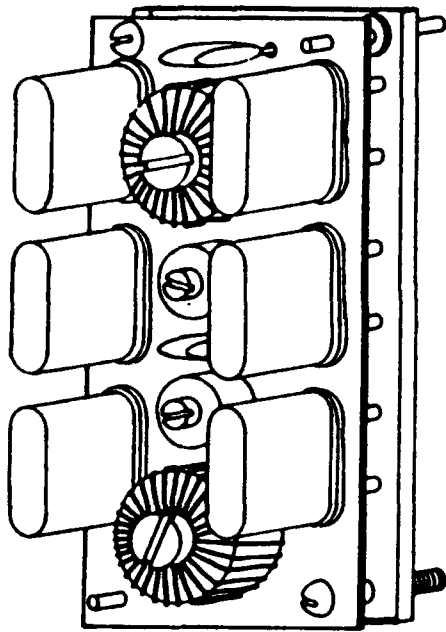

Circuit

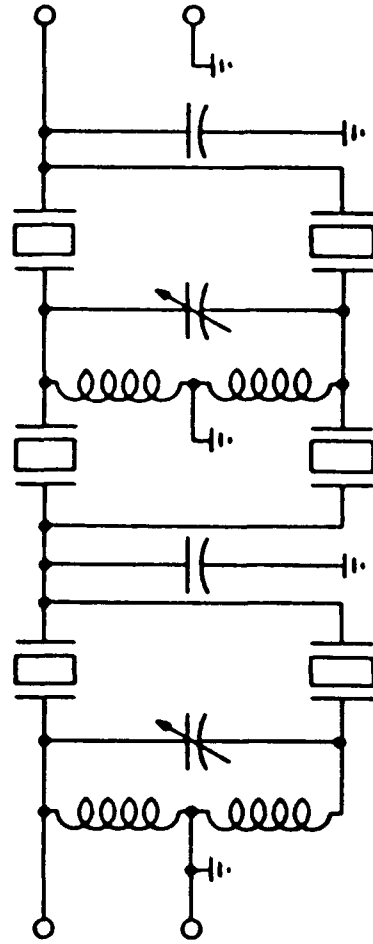

# Monolithic Crystal Filter

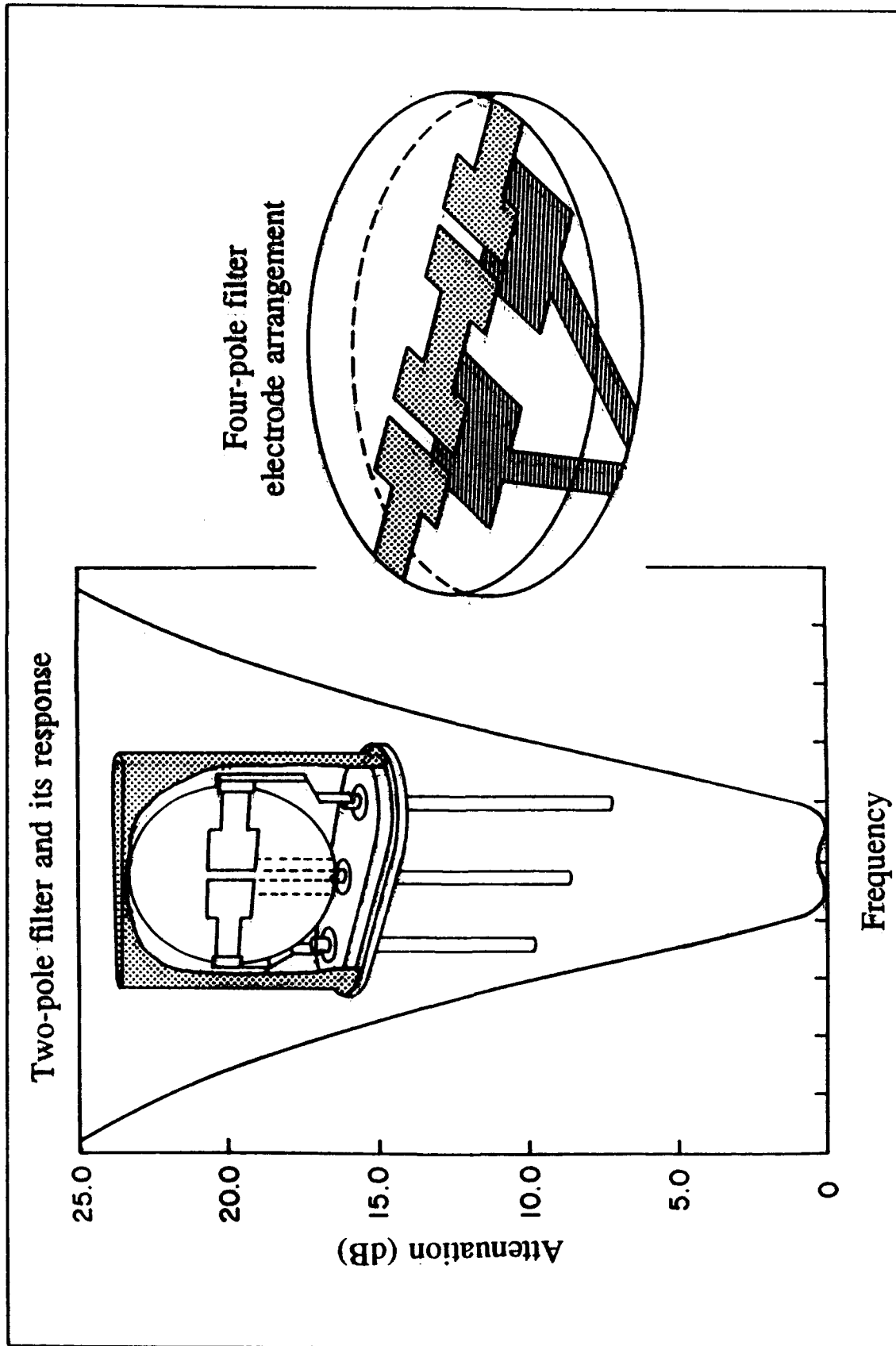

# Surface Acoustic Wave (SAW) Devices

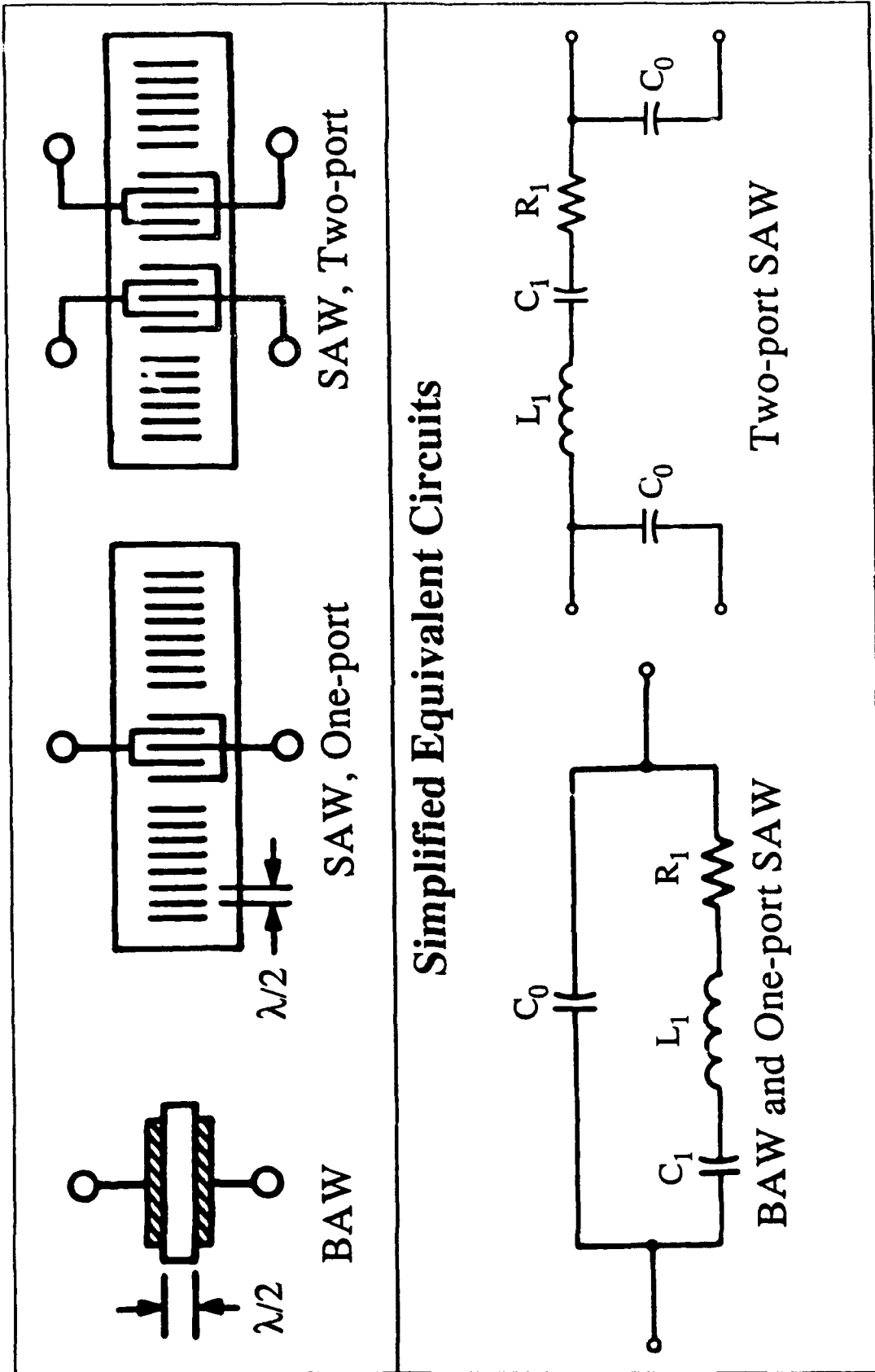

# SAW Devices

- The primary application of SAW devices is in filters. Applications in precision frequency control and timing are limited because the long term stability and temperature stability of the best bulk-acoustic-wave (BAW) devices are significantly better than those of the best SAW devices.
- For BAW resonators, the plate thickness determines the fundamental-mode frequency. For SAW resonators (SAWR), the interdigital transducers' (IDT) spacings determine the frequency. For quartz, a 300 MHz BAWR plate is 6  $\mu\text{m}$  thick. A 2.6 GHz SAWR has 0.3  $\mu\text{m}$  IDT spacings, and can be produced by e-beam lithography.
- In SAWRs, wave motion is concentrated at the surface of the crystal; motion decays exponentially with distance from surface; 90 to 95% of the energy is within one acoustic wavelength of the surface.
- In one-port SAWRs and BAWRs, the static capacitance,  $C_0$ , provides a low-impedance path that can mask out the desired resonance at high f's. An external inductor is usually placed in parallel with  $C_0$  to "resonate out"  $C_0$ . In two-port SAWRs  $C_0$  does not shunt the motional arm of the equivalent circuit, therefore, two-port SAWRs are preferred in many applications.

# Quartz Bulk-Wave Resonator Sensors

In frequency control and timekeeping applications, resonators are designed to have minimum sensitivity to environmental parameters. In sensor applications, the resonator is designed to have a high sensitivity to an environmental parameter, such as temperature, force, pressure and acceleration.

Quartz resonators' advantages over other sensor technologies are:

- High resolution and wide dynamic range (due to excellent short-term stability); e.g., one part in  $10^7$  ( $10^{-6}$  g out of 20 g) accelerometers are available, and quartz sorption detectors are capable of sensing  $10^{-12}$  grams.
- High long-term accuracy and stability, and
- Frequency counting is inherently digital.

# Tuning Fork Resonator Sensors

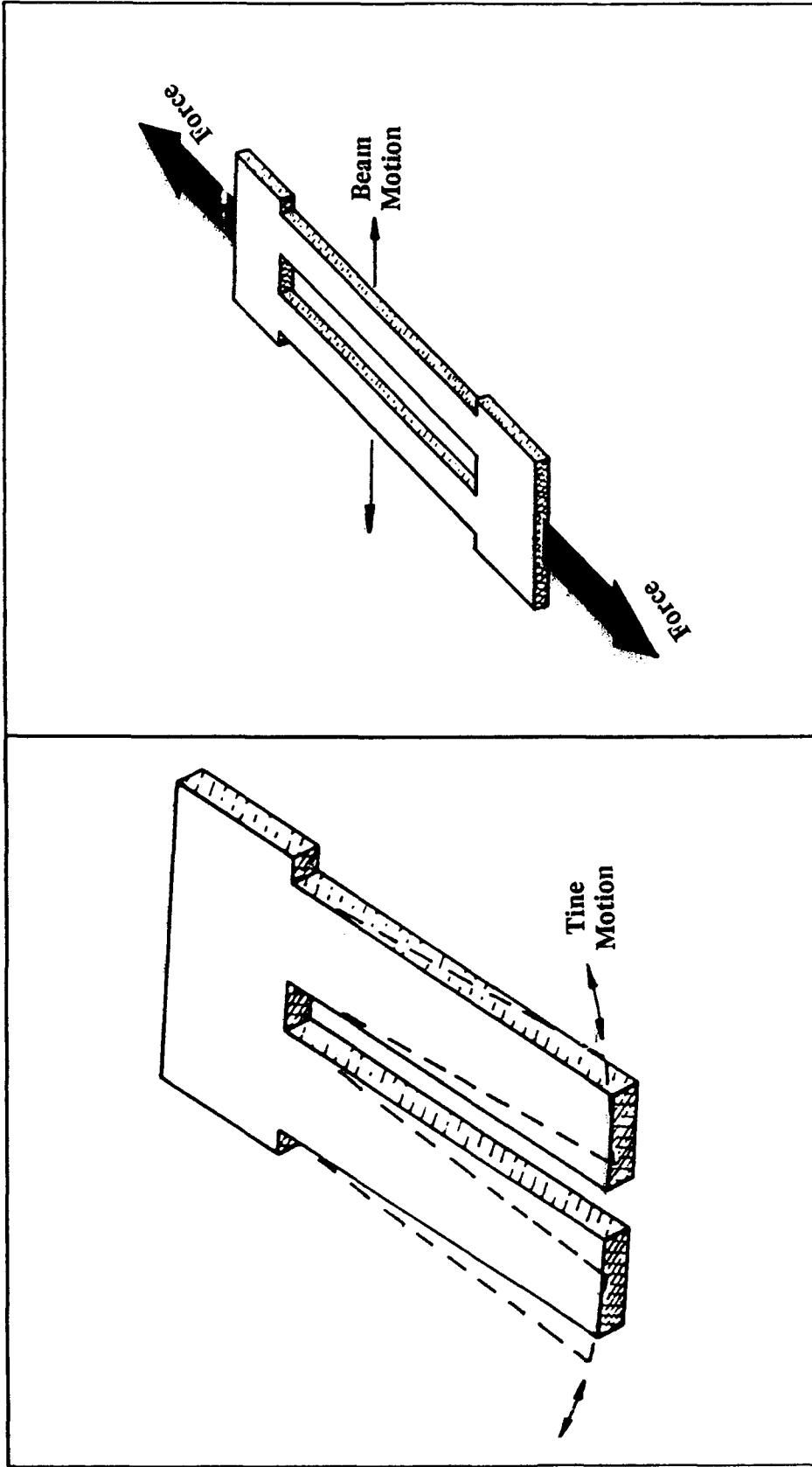

Photolithographically produced tuning forks, single- and double-ended (flexural-mode or torsional-mode), can provide low-cost, high-resolution sensors for measuring temperature, pressure, force, and acceleration. Shown are flexural-mode tuning forks.

## Chapter 10 References

- F. L. Walls and J. J. Gagnepain, "Special Applications," in E. A. Gerber and A. Ballato, Precision Frequency Control, Vol. 2, pp. 287-296, Academic Press, 1985.
- 10-1 R. C. Smythe and R. S. Wagers, "Piezoelectric and Electromechanical Filters," in E. A. Gerber and A. Ballato, Precision Frequency Control, Vol. 1, pp. 185-269, Academic Press, 1985.
- 10-3 W. R. Shreve and P. S. Cross, "Surface Acoustic Waves and Resonators," in E. A. Gerber and A. Ballato, Precision Frequency Control, Vol. 1, pp. 119-145, Academic Press, 1985.
- 10-5a E. P. EerNisse, R. W. Ward and R. B. Wiggins, "Survey of Quartz Bulk Resonator Sensor Technologies," IEEE Transactions on Ultrasonics, Ferroelectrics, and Frequency Control, Vol. 35, No. 3, pp. 323-330, May 1988.
- 10-5b G. G. Guilbault and J. M. Jordan, "Analytical Uses of Piezoelectric Crystals: A Review," CRC Critical Reviews in Analytical Chemistry, Vol. 19, Issue 1, pp. 1-28, 1988.
- 10-5c J. J. McCallum, "Piezoelectric Devices for Mass and Chemical Measurements," Analyst, Vol. 114, pp. 1173-1189, Oct. 1989.
- 10-5d R. M. White, "New Prospects for Acoustic Sensors: An Overview," Proc. 41st Annual Symposium on Frequency Control, pp. 333-338, 1987. Proc. available from NTIS.

## General References

- **Proceedings of the Annual Symposium on Frequency Control** - see the next page for information on obtaining copies of these Proceedings.
- **Proceedings of the Annual Precise Time and Time Interval (PTTI) Applications and Planning Meeting** - information on obtaining copies of these Proceedings is available from the U.S. Naval Observatory, Time Services Department, 34th and Massachusetts Avenue, N.W., Washington, D.C. 20392-5100.
- **Proceedings of the European Frequency and Time Forum** - copies available from the Swiss Foundation for Research in Microtechnology (FSRM), Rue de l'Orangerie 8, CH-2000 Neuchâtel, Switzerland.
- **E. A. Gerber and A. Ballato, Precision Frequency Control**, Academic Press, 1985. This book includes a complete bibliography up to 1983.
- **S. R. Stein and J. R. Vig, Frequency Standards for Communications**, U. S. Army Laboratory Command Research and Development Technical Report SLCET-TR-91-2, January 1991, AD A231990.
- **Proceedings of the IEEE, Special Issue on Time and Frequency**, J. Jespersen & D. W. Hanson, ed's., Vol. 79, No. 7, July 1991.
- **V. E. Bottom, Introduction to Quartz Crystal Unit Design**, Van Nostrand Reinhold Co., 1982.
- **H. Hellwig, "Frequency Standards and Clocks: A Tutorial Introduction"**, NBS Technical Note 616, 1977, Time and Frequency Division, NIST, Boulder, Colorado, 80303.
- **P. Kartaschoff, Frequency and Time**, Academic Press, 1978.
- **B. Parzen, Design of Crystal and Other Harmonic Oscillators**, John Wiley and Sons, 1983.



**IEEE Frequency Control Symposium\***  
**PROCEEDINGS AVAILABILITY INFORMATION**

NO.	YEAR	DOCUMENT NO.	OBTAIN FROM*	PRICE (in 1992)	
				MICROFICHE	HARDCOPY
10	1956	AD-298322	NTIS	\$9.00	\$59.00
11	1957	AD-298323	NTIS	9.00	66.00
12	1958	AD-298324	NTIS	9.00	66.00
13	1959	AD-298325	NTIS	9.00	73.00
14	1960	AD-246500	NTIS	9.00	50.00
15	1961	AD-265455	NTIS	9.00	43.00
16	1962	AD-285086	NTIS	9.00	50.00
17	1963	AD-423381	NTIS	9.00	66.00
18	1964	AD-450341	NTIS	9.00	66.00
19	1965	AD-471229	NTIS	9.00	66.00
20	1966	AD-800523	NTIS	9.00	66.00
21	1967	AD-659792	NTIS	9.00	59.00
22	1968	AD-844911	NTIS	9.00	66.00
23	1969	AD-746209	NTIS	9.00	43.00
24	1970	AD-746210	NTIS	9.00	43.00
25	1971	AD-746211	NTIS	9.00	43.00
26	1972	AD-771043	NTIS	9.00	43.00
27	1973	AD-771042	NTIS	9.00	50.00
28	1974	AD-A011113	NTIS	9.00	50.00
29	1975	AD-A017466	NTIS	9.00	50.00
30	1976	AD-A046089	NTIS	9.00	59.00
31	1977	AD-A088221	NTIS	9.00	66.00
32	1978	AD-A955718	NTIS	9.00	59.00
33	1979	AD-A213544	NTIS	9.00	73.00
34	1980	AD-A213670	NTIS	9.00	59.00
35	1981	AD-A110870	NTIS	19.00	73.00
36	1982	AD-A130811	NTIS	9.00	59.00
37	1983	AD-A136673	NTIS	9.00	59.00
38	1984	AD-A217381	NTIS	12.50	43.00
39	1985	AD-A217404	NTIS	19.00	59.00
40	1986	86CH2330-9	IEEE	70.00	70.00
41	1987	AD-A216858	NTIS	17.00	59.00
42	1988	AD-A217275	NTIS	17.00	59.00
43	1989	AD-A235629	NTIS	19.00	66.00
44	1990	90CH2818-3	IEEE	90.00	90.00
45	1991	91CH2965-2	IEEE	110.00	110.00
46	1992	92CH3083-3	IEEE	TBD	TBD

\*NTIS - National Technical Information Service  
 5285 Port Royal Road, Sills Building  
 Springfield, VA 22161, U. S. A.  
 Tel: 703-487-4650

\*IEEE - Inst. of Electrical & Electronics  
 Engineers  
 445 Hoes Lane  
 Piscataway, NJ 08854, U.S.A.  
 Tel: 800-678-4333 or 908-981-0060

\* Prior to 1992, the name of the Symposium was the "Annual Symposium on Frequency Control".

## Index

Acceleration, 4-4, 4-56 to 4-74, 6-1

Accuracy, 4-2, 8-2

Activity Dips, 3-9, 4-50

Aging, 4-3 to 4-13, 4-51, 4-88, 6-13, 8-1

Allan Variance, 4-18 to 4-23, 4-29 to 4-36, 4-61, 7-12 to 7-15, 8-1, 8-3

Altitude, 4-3, 4-87

Amplitude, 3-7, 4-52 to 4-55

Amplitude Distribution, 3-7

Applications, 1-1 to 1-19, 4-70 to 4-71, 9-15, 9-25, 9-26

ASFC Proceedings, 11-2

AT-Cut, 3-8, 3-14, 3-19, 4-9 to 4-13, 4-40, 4-42, 4-44, 4-45, 4-52, 4-69, 4-78 to 4-82, 4-85, 4-86

Atmospheric Pressure, 4-3, 4-87

Atomic Frequency Standards, 2-8, 6-1, 6-8 to 6-11, 7-1 to 8-5

BCD Time Code, 9-23

Bistatic Radar, 1-18

Bonding Strains, 4-11, 4-13

Calibration, 9-12, 9-13

Ceramic Flatpack, 3-6, 6-1, 6-13

Cesium-Beam Frequency Standard, 2-8, 7-1, 7-7 to 7-9, 7-12, 7-13, 7-17, 7-18, 7-20, 8-1 to 8-5

Clocks, 4-37, 9-4 to 9-12, 9-19 to 9-22, 9-25, 9-26

Commercial vs. Military Markets, 1-2, 1-3

Conversions, 9-21

Doppler, 1-9, 1-17 to 1-19, 9-21

Doubly Rotated Cuts, 3-14

Drive Level, 4-52 to 4-55, 4-88

Electric Field, 4-87

**Emerging/Improving Technologies, 6-1 to 6-13**

**Environmental Effects, 4-3, 4-4**

**Equivalent Circuit, 3-15, 3-16, 3-18**

**Fabrication Steps, 3-23**

**Filters, 10-1, 10-2**

**Force-Frequency Effect, 4-9 to 4-13**

**Frequency Hopping, 1-12 to 1-14**

**Frequency Multiplication, 4-26, 4-33 to 4-36, 4-64, 4-70, 4-71**

**Frequency vs. Temperature, 3-12 to 3-14, 3-17, 4-37 to 4-49, 4-88, 6-13**

**g-sensitivity, 4-4, 4-54, 4-56 to 4-74, 4-88, 6-1**

**Global Positioning System (GPS), 1-4, 9-14 to 9-17**

**Harmonics, 3-4, 3-8, 3-9, 4-44**

**Historical Information, 3-24, 9-6, 9-7**

**Humidity, 4-3, 4-87**

**Hysteresis, 4-46, 6-13**

**Identification Friend or Foe (IFF), 1-11, 1-15, 1-16**

**Impacts of Technology, 1-11 to 1-18, 4-15, 4-68, 9-17**

**Influences on Frequency, 4-3, 4-4, 4-88**

**Infrared Absorption, 5-9 to 5-11**

**Interactions, 4-88**

**Inversion, quartz, 5-15, 5-16**

**Jitter, 4-62, 9-13**

**Johnson Noise, 4-16, 4-33**

**Lateral Field Resonator, 6-1, 6-3**

**Load Capacitance, 3-16, 3-17, 4-39, 4-43, 4-49 to 4-51**

**Load Impedance, 3-16, 3-17, 4-3, 4-39, 4-43, 4-49 to 4-51**

**Loran, 9-12, 9-14**

**Magnetic Field, 4-3, 4-87, 7-9, 7-12, 7-18**

**Mathematical Description of a Resonator, 3-10 to 3-12**

**MCXO, 2-5, 2-8, 6-1, 6-2, 6-4 to 6-8, 6-12, 8-1, 9-10**  
**MIFTTI, 9-26**  
**Milestones in Quartz Technology, 3-24**  
**Milestones in Timekeeping, 9-7**  
**Military Requirements, 1-10 to 1-19**  
**Mixer, 4-26, 4-27**  
**Modes of Motion, 3-3, 3-4, 3-8, 3-9**  
**Motional Parameters, 3-15, 3-19**  
**Navigation, 1-4, 9-15 to 9-17**  
**Neutrons, Effects of, 4-82, 4-83, 4-86**  
**Noise, 4-3, 4-5, 4-14 to 4-16, 4-18 to 4-25, 4-28 to 4-36, 7-12 to 7-19**  
**OCXO, 2-5 to 2-8, 4-42, 4-45, 4-47, 8-1, 8-2, 9-10**  
**One Pulse Per Second, 9-13, 9-23**  
**Optically Pumped Cs Standard, 7-20**  
**Oscillation, 2-2 to 2-4**  
**Oscillator Categories, 2-6**  
**Oscillator Circuit Caused Instabilities, 4-51**  
**Oscillator Circuits, 2-9, 2-10**  
**Oscillator Comparison, 8-1 to 8-5**  
**Oscillator Hierarchy, 2-8**  
**Oscillator Outputs, 2-11**  
**Oscillator Selection, 8-6**  
**Oscillator Specification, 8-7**  
**Oscillator Types, 2-5 to 2-8**  
**Oscillators, 2-1 to 2-8, 6-4 to 6-12, 8-1 to 8-5**  
**Oven, 4-42, 4-45**  
**Packaging, 3-5, 3-6**  
**Phase, 2-2, 2-3, 4-14, 4-24, 8-1 to 8-5**  
**Phase Detector, 4-26 to 4-28**

**Phase Diagram of Silica, 5-16**

**Phase Jitter, 4-62**

**Phase Noise, 1-7, 1-17, 4-14 to 4-36, 4-60 to 4-67, 4-70, 4-71**

**Piezoelectricity, 3-1 to 3-3, 3-10 to 3-12**

**Power Requirements, 8-1, 8-2**

**Power Supply, 2-9, 4-3, 4-87**

**Precision, 4-2**

**Proceedings, ASFC, 11-2**

**Propagation Delay, 9-22**

**Q, 3-19 to 3-22, 4-16, 4-33, 4-84, 4-85, 5-3, 5-11, 7-1, 7-6, 7-12, 7-13**

**Quartz (material), 3-1, 3-13, 5-1 to 5-16**

**Quartz Cuts, 3-14, 4-40**

**Quartz Inversion, 5-15, 5-16**

**Quartz Lattice, 5-3, 5-5, 5-14**

**Quartz Phases, 5-16**

**Quartz Twinning, 5-12 to 5-14**

**Radar, 1-17 to 1-19, 4-15, 4-70, 4-71, 9-22**

**Radiation Effects, 4-4, 4-76 to 4-86, 4-88, 5-3, 6-13, 8-5**

**Radio, two-way, 1-5**

**RbXO, 2-5, 2-8, 6-1, 6-9 to 6-11, 8-1, 8-2**

**Relativistic Time, 9-19 to 9-21**

**Resonator Packaging, 3-5, 3-6, 4-87**

**Resonator Theory, 3-10 to 3-12**

**Resonators, 3-2 to 3-24**

**Restart, 4-47**

**Retrace, 4-46, 4-47**

**Rubidium Frequency Standard, 2-8, 6-1, 6-9 to 6-11, 7-1, 7-3, 7-5, 7-10, 7-11, 7-13, 7-15, 8-1 to 8-5**

**SAW, 4-33 to 4-35, 10-3, 10-4**

SC-Cut, 3-14, 4-12, 4-41 to 4-43, 4-45, 4-51, 4-52, 4-69, 4-73, 4-80, 4-85, 6-1 to 6-3,  
6-4 to 6-8, 6-13

Sensors, 10-5, 10-6

Shock, 4-3, 4-4, 4-75, 6-13

Short-Term Instability Causes, 4-16, 7-13

Short-Term Stability, 4-3 to 4-5, 4-14 to 4-36, 7-12 to 7-19, 8-1 to 8-4

Short-Term Stability Measures, 4-18 to 4-20, 4-24

Shot Noise, 4-16, 7-13

Signal-to-noise ratio, 4-33, 7-13

Silica, 5-16

Space Exploration, 1-9

Specifications, 8-7

Spectral Densities, 4-24, 4-25, 4-28 to 4-36

Spread Spectrum, 1-11 to 1-16

Stability, 2-3, 2-4, 4-2 to 4-87, 8-3, 8-4

Strains, 4-9 to 4-13

Sweeping, 5-7, 5-8

TCXO, 2-5 to 2-8, 3-16, 3-17, 4-46, 4-48, 4-49, 8-1, 8-2, 9-10

Telecommunication, 1-6

Thermal Expansion of Quartz, 4-8

Thermal Hysteresis, 4-46, 6-13

Thermal Transient Effect, 4-42, 4-45, 4-85, 4-88

Time & Frequency Subsystem, 9-25, 9-26

Time, 9-1 to 9-28

Time Code, 9-23, 9-24

Time Constant, 3-19 to 3-22

Time Domain - Frequency Domain, 4-17

Time Errors, 9-8 to 9-11

Time Scales, 9-18

**Time Transfer, 9-12 to 9-16, 9-20, 9-21**  
**Timing Signal, 9-23, 9-24**  
**Trim Effect, 4-48, 4-49**  
**Tunability, 2-4, 3-16**  
**Twinning, 5-12 to 5-14**  
**Two-way Radio, 1-5**  
**Universal Time, 9-18**  
**UTC, 9-18**  
**Utility Fault Location, 1-8**  
**VCXO, 2-5, 3-16**  
**Vibration, 4-4, 4-16, 4-58 to 4-74**  
**Vibration-Induced Sidebands, 4-63 to 4-66, 4-74, 4-88**  
**Vibration Compensation, 4-73, 4-74**  
**Vibration Isolation, 4-72**  
**Very Long Baseline Interferometry (VLBI), 1-9**  
**Warmup, 4-45, 8-1**  
**Wearout Mechanisms, 8-5**  
**Wristwatch, 4-37**  
**Zero Temperature Coefficient Cuts, 3-12 to 3-14**