

AD-A254 827

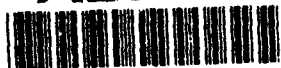

NASA CR 189122
USAAVSCOM TR-92-C-010
Report No. EDR 15982

2

COOLED HIGH-TEMPERATURE RADIAL TURBINE PROGRAM

II - FINAL REPORT

by Dr. Philip H. Snyder

**ALLISON GAS TURBINE DIVISION
GENERAL MOTORS CORPORATION
P.O. Box 420
Indianapolis, IN 46206-0420**

May 1992

Prepared for
Lewis Research Center
Contract NAS3-24230

**DTIC
SELECTE
SEP 02 1992**
S B D

NASA

National Aeronautics and
Space Administration

Lewis Research Center
Cleveland, Ohio 44135
AC 216 433-4000

DISTRIBUTION STATEMENT A
Approved for public release
Distribution Unlimited



387544

92-24117



9508

92 8 31 027

VS92-1401

REPORT DOCUMENTATION PAGE			Form Approved OMB No. 0704-0188	
Public reporting burden for this collection of information is estimated to average 1 hour per response, including the time for reviewing instructions, searching existing data sources, gathering and maintaining the data needed, and completing and reviewing the collection of information. Send comments regarding this burden estimate or any other aspect of this collection of information, including suggestions for reducing this burden, to Washington Headquarters Services, Directorate for Information Operations and Reports, 1215 Jefferson Davis Highway, Suite 1204, Arlington, VA 22202-4302, and to the Office of Management and Budget, Paperwork Reduction Project (0704-0188), Washington, DC 20503.				
1. AGENCY USE ONLY (Leave blank)	2. REPORT DATE	3. REPORT TYPE AND DATES COVERED Final Contractor Report		
4. TITLE AND SUBTITLE Cooled High-Temperature Radial Turbine Program II - Final Report		5. FUNDING NUMBERS WU- 505-62-OK 505-68-10 NAS3-24230		
6. AUTHOR(S) Dr. Philip H. Snyder				
7. PERFORMING ORGANIZATION NAME(S) AND ADDRESS(ES) Allison Gas Turbine Division General Motors Corporation P. O. Box 420 Indianapolis, IN 46206-0420		8. PERFORMING ORGANIZATION REPORT NUMBER 15982		
9. SPONSORING/MONITORING AGENCY NAMES(S) AND ADDRESS(ES) NASA Lewis Research Center Cleveland, Ohio 44135-3191 and Propulsion Directorate U.S. Army Aviation Systems Command Cleveland, Ohio 44135-3191		10. SPONSORING/MONITORING AGENCY REPORT NUMBER NASA CR- 189122 USAAVSCOM TR-92-C-010		
11. SUPPLEMENTARY NOTES Richard J. Roelke, Project Manager NASA Lewis Research Center Cleveland, OH 44135				
12a. DISTRIBUTION/AVAILABILITY STATEMENT Unclassified - Unlimited Subject Category - STAR Category 07		12b. DISTRIBUTION CODE		
13. ABSTRACT (Maximum 200 words) The objective of this program was the design and fabrication of a air-cooled high-temperature radial turbine (HTRT) intended for experimental evaluation in a warm turbine test facility at the Lewis Research Center. The rotor and vane were designed to be tested as a scaled version (rotor diameter of 14.4 inches diameter) of a 8.021 inch dia diameter rotor designed to be capable of operating with a rotor inlet temperature (RIT) of 2300°F, a nominal mass flow of 4.56 lbm/sec, a work level of equal or greater than 187 Btu/lbm, and an efficiency of 86% or greater. The rotor was also evaluated to determine it's feasibility to operate at 2500°F RIT. The rotor design conformed to the rotor blade flow path specified by NASA for compatibility with their test equipment. Fabrication was accomplished on three rotors, a bladeless rotor, a solid rotor, and an air-cooled rotor.				
14. SUBJECT TERMS Turbine, Radial Inflow, Cooled Rotor, Rotorcraft Engine			15. NUMBER OF PAGES 88	
			16. PRICE CODE	
17. SECURITY CLASSIFICATION OF REPORT Unclassified	18. SECURITY CLASSIFICATION OF THIS PAGE Unclassified	19. SECURITY CLASSIFICATION OF ABSTRACT Unclassified	20. LIMITATION OF ABSTRACT	

TABLE OF CONTENTS

<u>Section</u>	<u>Title</u>	<u>Page</u>
1.0	SUMMARY.....	1
2.0	INTRODUCTION.....	2
3.0	RESULTS AND DISCUSSION.....	5
3.1	Turbine Design.....	5
3.1.1	Engine Configuration Cycle.....	
3.1.2	Meanline Velocity Diagram and.....	5
	Aerodynamic Design	
3.1.3	Vane Aerodynamic Design.....	31
3.2	Rotor Coolant Passage Design.....	31
3.2.1	Coolant Passage Design.....	39
	Constraints	
3.2.2	Selection of Coolant Passageway.....	41
	Configuration	
3.3	Heat Transfer & Stress Analysis Results.....	45
3.3.1	Heat Transfer Results.....	45
3.3.2	Stress Analysis Results.....	54
3.4	Test Rig Rotor Scaling.....	54
3.5	Test Rotor Fabrication.....	64
3.6	Rotor Spin Test.....	64
4.0	CONCLUSIONS.....	65
5.0	REFERENCES.....	79
	DISTRIBUTION LIST.....	80

DTIC QUALITY INSPECTED 3

Accession For	
NTIS GRA&I	<input checked="" type="checkbox"/>
DTIC TAB	<input type="checkbox"/>
Unannounced	<input type="checkbox"/>
Justification	
By	
Distribution/	
Availability Codes	
DTst	Avail and/or Special
A-1	

LIST OF TABLES

Table 3.1-2	Engine Cycle, Intermediate Rated (IRP)
Table 3.1-3	Engine Cycle, 75% Power
Table 3.1-4	Engine Cycle-Idle
Table 3.1-5	Turbine Performance at Intermediate Rated Power
Table 3.1-6	Turbine Performance Estimate at 75% Power
Table 3.1-7	Turbine Performance Estimate at Idle Power
Table 3.1-8	Comparison of Vane Design
Table 3.3-1	Summary of Rotor Life Criteria at Two Rotor Inlet Temperatures
Table 3.4-1	Test Rig Conditions Modeling Engine Rotor Performance

LIST OF FIGURES

- Figure 2.0-1 Dual Alloy HIP Bonded Radial Turbine Rotor
- Figure 3.1-1 Typical Small Engine Incorporating the Cooled HIRT
- Figure 3.1-2 Meridional Flowpath
- Figure 3.1-3 Flowpath with Blade Thickness Regions
- Figure 3.1-4 Blade Metal Normal Thickness
- Figure 3.1-5 Rotor Blade Angle Distribution
- Figure 3.1-6 Rotor Streamline Predictions and Blade Section Locations
- Figure 3.1-7 Rotor Blade Sections
- Figure 3.1-8 Rotor Exit Swirl at IRP
- Figure 3.1-9 NASA HIRT Rotor Velocity Profile, HUB Streamline
- Figure 3.1-10 NASA HIRT Rotor Velocity Profile, Mean Streamline
- Figure 3.1-11 NASA HIRT Rotor Velocity Profile, Shroud Streamline
- Figure 3.1-12 AGT100 Power Turbine Rotor Velocity Profile, HUB Streamline
- Figure 3.1-13 AGT100 Power Turbine Rotor Velocity Profile, Mean Streamline
- Figure 3.1-14 AGT100 Power Turbine Rotor Velocity Profile, Shroud Streamline
- Figure 3.1-15 NASA HIRT Rotor Boundary Layer Analysis, HUB Streamline
- Figure 3.1-16 NASA HIRT Rotor Boundary Layer Analysis, Mean Streamline
- Figure 3.1-17 NASA HIRT Rotor Boundary Layer Analysis, Shroud Streamline
- Figure 3.1-18 Predicted Blade Relative Velocities for Baseline Rotor Flowpath
- Figure 3.1-19 Comparison of the Baseline Flowpath Separated Region with that of the Task I Rotor Design
- Figure 3.1-20 Revised HUB Contours to Reduce Diffusion Characteristics
- Figure 3.1-21 Vane Design
- Figure 3.1-22 Vane Velocity Profile

Figure 3.1-23 Vane Pressure Surface Incompressible Form Factor

Figure 3.1-24 Vane Suction Surface Incompressible Form Factor

Figure 3.2-1 Comparison: Previous Coolant Path with Present Study

Figure 3.2-2 Coolant Flowpath Concepts

Figure 3.2-3 Rotor Internal Coolant Flowpath Model

Figure 3.2-4 Final Coolant Flowpath Design

Figure 3.2-5 NASA HIRT Coolant Flowpath Normal Thickness Distribution

Figure 3.2-6 Coolant Flowpath Within Blade

Figure 3.2-7 NASA Cooled HIRT Rig

Figure 3.2-8 Preswirl Design Modification to NASA Rig

Figure 3.2-9 Preswirl Details

Figure 3.3-1 Steady State Blade Metal Temperatures at Design Conditions, RIT = 2300°F

Figure 3.3-2 Idle to IRP Transient Temperature Profile at Time = 20 sec.

Figure 3.3-3 Steady State Blade Metal Temperatures at 2500°F RIT

Figure 3.3-4 Idle to IRP Transient Equivalent Stress for 2500°F RIT

Figure 3.4-1 Hot Side Gas Path Convection Coefficients, Rig Test Conditions

Figure 3.4-2 Gas Path Adiabatic Wall Temperatures, Rig Test Conditions

Figure 3.4-3 HUB Platform Adiabatic Wall Temperatures, Rig Test Conditions

Figure 3.4-4 Internal Cooling Convection Coefficients, Rig Test Conditions

Figure 3.4-5 Calculated Metal Temperatures, Rig Test Conditions

Figure 3.4-6 Calculated Coolant Temperatures, Rig Test Conditions

Figure 3.5-1 Final Machined Solid Turbine Rotor

Figure 3.5-2 Ceramic Cores Used to Cast Coolant Flow Passages

Figure 3.5-3 Wax Replica of Cooled Rotor

Figure 3.5-4 Wax Replica of Cooled Rotor, Exducer End

Figure 3.5-5 Final Machined Air-Cooled Turbine Rotor

- Figure 3.5-6 Final Machined Air-Cooled Turbine Rotor
- Figure 3.5-7 Sectioned Casting, Pressure Side
- Figure 3.5-8 Sectioned Casting, Pressure Side
- Figure 3.5-9 Sectioned Casting, Suction Side
- Figure 3.5-10 Sectioned Casting, Suction Side
- Figure 3.5-11 Sectioned Casting, Blade HUB
- Figure 3.6-1 Air-Cooled Rotor, Post Spin Test
- Figure 3.6-2 Air-Cooled Rotor - Post Spin Test

1.0 Summary

This is the final report for work on this contract and covers the results of the Tasks V and VII. The original effort was structured with four tasks. Task I, was entitled Design Goals and Requirements and consisted of the aerodynamic and structural design of an air-cooled vane and rotor. Work on this task was reported in NASA CR-179606, reference 1. Task II comprised a total test rig design. This partially completed task was subsequently canceled. Task III, also cancelled, was to have accomplished fabrication of equipment designed to Task II. Task IV was directed at preparation of technical, financial, and scheduler reporting.

Tasks V, VI, and VII were added to the original program to accomplish the redirected program goals. Task V, entitled Turbine Design, consisted of the aerodynamic design of an uncooled vane and the aerodynamic, heat transfer, and structural design of an air cooled rotor. Results of this task were summarized in an AIAA paper, reference 2, and are reported in detail herein. Effort on Task VI comprised test rig interface work required to ensure compatibility of the cooled radial turbine rotor designed in Task V with the LeRC designed test rig, and was accomplished through close coordination with NASA LeRC test equipment personnel. Based on detailed turbine test rig drawings, the compatibility of the NASA test rig with the research rotor was established. Included was a critical speed analysis, squeeze film damper analysis, fragment containment casing study, and rotor cooling air supply assessment. The results of these engineering studies are documented in separate analysis reports and are not part of this final report. Task VII accomplished the rotor fabrication. Following NASA approvals, detailed drawings were made and parts were released for fabrication. A bladeless rotor, a solid-bladed rotor, and an air-cooled rotor were fabricated. The bladeless rotor was machined from solid stock. The solid and hollow rotor were cast at the Howmet Turbine Components Corporation, LaPort Division. The bladed rotors were balanced and spin tested before delivery to NASA LeRC.

2.0 Introduction

Requirements for advanced turbine engines call for increased specific power and improved specific fuel consumption (SFC). Results of basic gas turbine cycle studies have in general shown these requirements can be met through the use of increased turbine inlet temperatures and increased cycle pressure ratios. The result is a significant reduction in core equivalent mass flow rates and hence a commensurate reduction in core flow passage dimensions. For axial turbines, small passage dimensions are usually associated with low aspect ratio airfoils giving rise to secondary flow losses and increased tip clearances, both of which reduce stage efficiencies. Past studies have shown that radial turbines offer lower sensitivity to the efficiency penalties of reduced passage dimensions and, hence, result in designs having higher turbine efficiencies at low equivalent flow values. In addition, radial turbines offer the potential of high loading per stage. This gives rise to the possible reduction in number of stages which can result in cost benefits. The use of a radial turbine in the gasifier section thus becomes attractive in the design of small turbine engines.

The development of high temperature capabilities in radial turbines has recently been pursued via ceramic blading. However prior to the development of a mature ceramic radial turbine technology, the use of the air cooled metallic radial turbine has been proposed for advanced engines with high power-to-weight and improved SFC requirements.

The addition of cooling to the blades of a metal radial turbine has provided a significant challenge. The investment cast and HIP-bonded approach developed as part of a previous Army contract (reference 3) has demonstrated the greatest promise in meeting coolant passage constraints while yielding rotors demonstrating adequate life. The rotor developed for that program is shown just prior to the HIP bond process in Figure 2.0-1. The design reported here builds upon that work. This study adds to the design approach by developing a second generation investment cast and HIP-bonded cooled metal rotor design capable of commercial fabrication and promising acceptable efficiency and rotor life. The current program seeks to enhance rotor aerodynamics, further improve cooling performance, and furnish the test rotors necessary to provide definitive experimental aerodynamic and heat transfer information on cooling of a high temperature radial turbine rotor.

This report presents the results of work performed on the Cooled High-Temperature Radial Turbine Program conducted by the Allison Gas Turbine Division of General Motors and funded by the NASA Lewis Research Center under NASA contract NAS3-24230. The objective of this program was to design and fabricate two radial turbine rotors for the experimental investigation of the cooled, high-temperature radial turbine (HTRT) concept. This vane/rotor system was designed to operate at a rotor inlet temperature (RIT) of 2300°F and a cycle pressure ratio of 14:1 with rotor flow of 4.6 lbm/sec. An addendum to the design task was to also evaluate the cooling design effectiveness and rotor life operating at 2500°F RIT.

Design goals were high aerodynamic performance ($\eta_{TT} > 86\%$), a rotor life of 5000 hours, a low-cycle fatigue (LCF) life of 6000 cycles, and the utilization of fabrication capabilities and material properties available within the next 10 years. The rotor design features improved cooling effectiveness and blade angle distribution compared to prior Allison advanced radial turbine design efforts. The stator was designed assuming ceramic technology eliminating the need for stator cooling. Effort included the fabrication of two bladed rotors intended for instrumentation and test at the NASA Lewis Research Center warm turbine test facility.

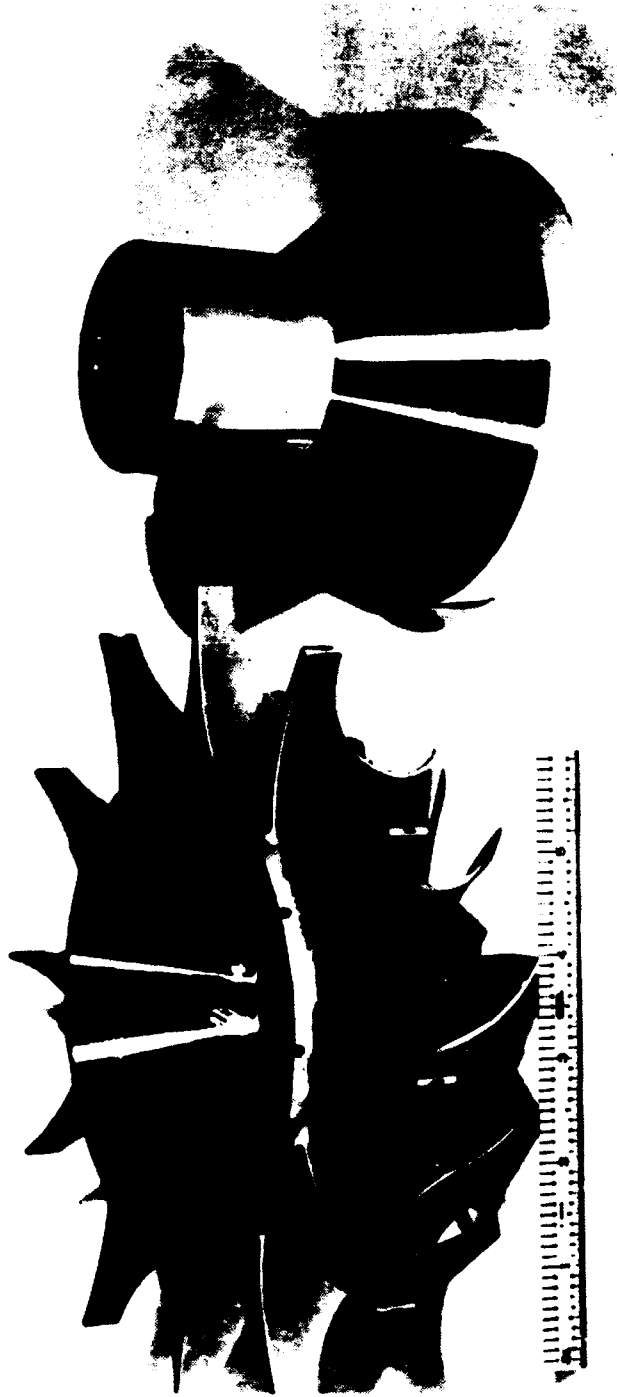

INVESTMENT CAST BLADE SHELL POWERED METAL HUB

FIGURE 2.0-1 DUAL ALLOY HIP BONDED RADIAL TURBINE ROTOR

3.0 RESULTS AND DISCUSSION

3.1 Turbine Design

3.1.1 Engine Configuration Cycle

The radial-inflow turbine design is based on a hypothetical engine configuration incorporating the design requirements of Table 3.1-1. The cycle is selected to satisfy these criteria at intermediate rated power (IRP) as presented in Table 3.1-2. The gas generator incorporates a compressor of 14.4:1 pressure ratio with 4.75 lbm/sec airflow. Shaft power is 920 hp with an SFC of 0.44 lb.hp.hr. Part power (75% IRP) conditions are presented in Table 3.1-3. Engine cycle data at idle is shown in Table 3.1-4.

Table 3.1-1. HIRT Design Point Conditions.

Rotor Inlet Total Temperature (°F)	2300
Vane Inlet Total Pressure (psia)	200
Total-to-total Expansion Ratio	3.66
Actual Flow (lbm/sec)	4.56
Equivalent Flow (lbm/sec)	0.80
Power Output (hp)	1191
Corrected Work ($\Delta H/\theta_c$)	34.2
Mechanical Speed (rpm)	61,900
Direction of rotation as viewed from the rear of the turbine	CCW
Rotor Diameter (inches)	8.02
Rotor Tip Speed (ft/sec)	2166
Specific Speed (rpm/ft ^{3/4} sec ^{1/2})	62.2
Blade-jet Speed Ratio	0.66
Adiabatic Efficiency (T-to-T, %)	87.0

Cooling flows for the gasifier turbine section are set at 5.7%. The vane is uncooled assuming ceramic construction, the rotor cooling is divided between internal passage (4.3%), hub film (0.5%) and hub bore (1.0%).

The engine general arrangement shown in Figure 3.1-1 is a carry over from the Task I effort. The gas generator turbine rotor bore diameter has been sized to allow passage of the power turbine extension drive shaft, which is capable of transmitting in excess of 1000 shp.

3.1.2 Meanline Velocity Diagram and Aerodynamic Design.

Design studies conducted as part of the Task I work have served as a basis for the turbine design reported here. Table 3.1-5 presents design point values for the radial turbine. The design reflects selection of the operating point within the optimal range in terms of specific speed and blade-jet speed ratio. Average exit swirl values were set to zero for design point operation. The design does not attempt to be fully optimal and does reflect limitations imposed by rig hardware design constraints. This limitation set the vane inner and outer radii and width, the rotor tip diameter and width, the outer shroud contour, and the exit tip and hub diameters.

TABLE 3.1-2 ENGINE CYCLE, INTERMEDIATE RATED (IRP)

ALT STAGE	VEL	XM	KIAS	KIAS	DEFF	ERAN	RPR	PAMB	P1-ID	TAMR-R	TAMR-F	Y1-F	RC-DA	EFF-DA	CASE
0.	0.0	0.0	0.0	0.0	0.9900	0.9900	0.990	16.696	14.696	518.67	59.00	59.00	16.40	0.8111	1.0
I-R	P-PSIA	W-COR	WD	R	EFF	FAR	AREA	XMN	PS-PSIA	THETA	DELTA	H	SF-N.1	NSI	IN
518.7	14.549	4.791	4.743	16.4000	0.8111	0.0	0.0	0.0	0.0	1.000	0.990	126.0	0.2796	0	1
1229.0	209.511	0.479	4.438	0.9850	0.9900	0.0	4.2	0.200	0.0	203.884	14.549	268.7	0.5585	0	2
2760.0	208.368	0.747	4.350	0.0	0.0	0.3534	0.0	0.0	0.0	5.331	14.602	746.1	0.0	0	3
2144.8	58.309	0.769	4.550	3.6652	0.8450	0.0	21.6	0.200	0.0	54.558	14.602	562.0	1.0480	0	4
2109.7	58.460	2.452	4.550	0.9850	0.0	0.0	0.0	0.0	0.0	4.132	3.571	562.0	0.5838	0	5
1623.5	16.150	7.555	4.746	3.4341	0.0	0.0	0.0	0.0	0.0	3.721	3.774	551.2	0.0	0	6
1623.5	16.150	7.756	4.817	1.0000	0.0	0.0	68.8	0.200	15.728	3.310	1.099	412.3	0.0	0	7
1586.1	14.696	8.424	4.817	1.0989	0.0	0.0	38.5	0.403	14.696	3.658	1.099	412.3	0.0	0	8
			4.817	1.0000	0.0	0.0	38.5	0.403	14.696	3.658	1.000	401.9	1.0000	0	9
														0.0	10
														0.0	11
														0.0	12

ES=1 NVAR=2 MATRIX=0 LOOPS=9 EMAX=0.00005 NLINE=33

IF T (3); T (4) VE=3000.000; 2500.000; 0.0 EE=2760.000; 0.0 L=1
 2=EFF (1); R (4) VE=1.000; 0.0 E=0.500; 0.0 E=3.665; 0.0 L=1

COMPRESSOR BLEED INFORMATION

BLEED NO.	1	2	3	4	5	6	7	8	9	10	11	12	TOTALS
MPR 1 BLEED	0.0	0.0416	0.0150	0.0080	0.0000	0.0000	0.0000	0.0	0.0	0.0	0.0	0.0	0.0644
ID DEL-H	1.0000	1.0000	1.0000	1.0000	1.0000	1.0000	1.0000	1.0000	1.0000	1.0000	1.0000	1.0000	0.305
LPC FLOW	0.0	0.196	0.071	0.038	0.0	0.0	0.0	0.0	0.0	0.0	0.0	0.0	0.0
LPC TEMP	0.0	1229.0	1229.0	1229.0	0.0	0.0	0.0	0.0	0.0	0.0	0.0	0.0	0.0
LPC PRESS	0.0	209.51	209.51	209.51	0.0	0.0	0.0	0.0	0.0	0.0	0.0	0.0	0.0
LPC IMF	1	1	1	1	1	1	1	1	1	1	1	1	0.0
NTC(N) N=	3	6	1	1	1	1	1	1	1	1	1	1	0/R

COMPONENT PERFORMANCE

ID	ETA	XN	XN-HAP	HP	HPX/PIP	SFIN,2)	FFF-HAP	R-HAP	M-HAP	SMRELL	FLOW ID	EFF ID	MARTYP
1 LPC	1.0000	100.000	100.000	1372.83	12.06	0.0	0.8280	3.0000	100.0000	0.0	0.0	0.0	0.0
4 LPT	0.0	100.000	100.000	1842.83	0.0	0.0	0.8254	3.2562	99.9999	0.0	0.0	0.0	0.0
7 PT	0.0	100.000	100.000	921.04	0.0	0.0	0.8620	3.2304	100.0000	0.0	0.0	0.0	0.0

NOZZLE PERFORMANCE

NOZZLE	(N)	TYP	FC	FN	CFG	CD	AREA(TH)	V-EXIT	SF(TH,2)	SF(EX,2)	CEGT ID	CDT ID	MARTYP
1 (8-9)	10	1	106.39	106.39	1.0989	0.9850	38.48	721.3	5.239	0.0	0.0	0.0	1

FINAL ENGINE PERFORMANCE

F-RAM	WA-ENG	WA-COR	EFF-PROP	FN-PROP	FN-TOT	SFC-TOT	EFF-TH	FHV	DTAMTP	WFE	MODISS	PMSBGF
0.0	4.743	4.791	0.0	2302.6	2609.0	0.1680	0.3146	18400.0	0.0	404.8	1	1.00000
PMSD	SFC	WFT	PMSD-R1	FN	PMSD-EQ	SFC-EQ	PH/WA	DEFTIP	ERAMTP	HPXPT	FAR-ST	WFTGF
921.0	0.4395	404.8	930.3	106.4	963.6	0.4201	194.189	0.0	0.0	0.0	0.067751	1.00000

TABLE 3.1-3 ENGINE CYCLE, 75% POWER

ALT	BYANS	VEL	XM	KTAS	KIAS	DEFF	ERAH	RPR	PAMB	PL-ID	TAMR-R	TAMR-F	T1-F	RC-DA	EFF-DA	CASE
0.	0.0	0.0	0.0	0.0	0.0	0.9900	0.9900	0.990	14.696	14.696	518.67	59.00	59.00	12.40	0.8100	2.0
(N) ID	Y-R	P-PSIA	W-COR	WD	R	EFF	FAR	AREA	XIHH	PS-PSIA	THETA	DELTA	M	SF-N,1	MSI	(N)
1 LPC	518.7	14.549	4.361	4.317	12.0000	0.8100	0.0	0.0	0.0	0.0	1.000	0.990	124.0	0.9283	0	1
2 BUIN	1176.5	180.412	0.476	4.039	0.9750	0.9900	0.0	4.3	0.200	175.566	2.268	12.276	285.3	0.5572	0	2
3 COUL	2516.0	177.706	0.752	4.126	0.8880	0.8050	0.02105	0.0	0.0	0.0	4.351	12.092	649.2	0.0	0	3
4 LPL	1932.1	46.203	2.575	4.126	0.9250	0.0	0.02105	22.2	0.200	45.889	3.752	3.172	697.2	0.0480	0	4
5 DOWL	1932.1	46.203	2.575	4.126	0.9250	0.0	0.02105	0.0	0.0	0.0	3.752	3.172	697.2	0.0480	0	5
6 COWL	1213.2	16.120	4.702	4.370	0.8032	0.8770	0.02042	0.0	0.0	0.0	2.627	1.440	488.3	0.0290	0	6
7 HELP	1213.2	16.120	4.702	4.370	1.0000	0.0	0.02042	60.0	0.200	15.726	2.917	1.099	380.5	0.0	0	7
10 NUT2	1213.2	16.120	4.702	4.370	1.0000	0.0	0.02042	33.5	0.404	14.696	2.848	1.000	370.8	1.0000	0	10
11 NUT	1477.4	14.696	7.375	4.370	1.0000	0.0	0.02042	33.5	0.404	14.696	2.848	1.000	370.8	1.0000	0	11
12 EXP	1477.4	14.696	7.375	4.370	1.0000	0.0	0.02042	33.5	0.404	14.696	2.848	1.000	370.8	1.0000	0	12

IDES= 1 NVAR= 1 MATRIX= 0 LOOP= 11 EMAX= 0.0002 NLIN= 3

C 1= T (3), T (4) V= 3000.000, 2500.000, 0.0 E= 2516.000, 0.0 L= 1

COMPRESSOR BLEED INFORMATION

BLEED NO.	1	2	3	4	5	6	7	8	9	10	11	12	TOTALS
COMPRA BLEED	0.0	0.0414	0.0150	0.0080	0.0000	0.0000	0.0000	0.0000	0.0000	0.0000	0.0000	0.0000	0.0644
NO. ID DEL-H	1.0000	1.0000	1.0000	1.0000	1.0000	1.0000	1.0000	1.0000	1.0000	1.0000	1.0000	1.0000	0.278
1 LPC FLOW	0.0	0.179	0.045	0.035	0.0	0.0	0.0	0.0	0.0	0.0	0.0	0.0	0.0
1 LPC TEMP	0.0	1176.5	1176.5	1176.5	0.0	0.0	0.0	0.0	0.0	0.0	0.0	0.0	0.0
1 LPC PRESS	0.0	180.41	180.41	180.41	0.0	0.0	0.0	0.0	0.0	0.0	0.0	0.0	0.0
1 LPC NTC(N)	3	1	1	1	1	1	1	1	1	1	1	1	1

COMPONENT PERFORMANCE

NO.	1	2	3	4	5	6	7	8	9	10	11	12	TOTALS
M ID	1.0000	1.0000	1.0000	1.0000	1.0000	1.0000	1.0000	1.0000	1.0000	1.0000	1.0000	1.0000	0.0644
1 LPC	100.000	100.000	100.000	100.000	100.000	100.000	100.000	100.000	100.000	100.000	100.000	100.000	0.278
2 LPC	100.000	100.000	100.000	100.000	100.000	100.000	100.000	100.000	100.000	100.000	100.000	100.000	0.0
7 PT	100.000	100.000	100.000	100.000	100.000	100.000	100.000	100.000	100.000	100.000	100.000	100.000	0.0

NOZZLE PERFORMANCE

NOZZLE	(N)	10	11	12	13	14	15	16	17	18	19	20	21	22	23	24	25
NOZZLE	(N)	10	11	12	13	14	15	16	17	18	19	20	21	22	23	24	25
FRI (8-9)	10	93.55	93.55	93.55	93.55	93.55	93.55	93.55	93.55	93.55	93.55	93.55	93.55	93.55	93.55	93.55	93.55

FINAL ENGINE PERFORMANCE

F-RAN	WA-ENG	WA-COR	EFF-PROP	FN-PROP	FN-TOT	SFC-TOT	EFF-TH	FHV	DTAHTP	MFE	NOBISS	PMSDGF
F-RAN	WA-ENG	WA-COR	EFF-PROP	FN-PROP	FN-TOT	SFC-TOT	EFF-TH	FHV	DTAHTP	MFE	NOBISS	PMSDGF
0.0	4.317	0.0	0.0	1635.8	1729.3	0.1820	0.2874	18400.0	0.0	314.8	1	1.00000
PMSD	SFC	MFT	PMSD-R1	FN	PMSD-EQ	SFC-EQ	PH/WA	DEFTIP	ERAHTP	HPXPT	FAR-ST	MFTGF
654.3	0.4811	314.8	660.9	93.5	691.7	0.4550	151.564	0.0	0.0	0.0	0.067751	1.00000

TABLE 3.1-4 ENGINE CYCLE-IDLE

ALT STAIRS	VEL	XM	KIAS	KIAS	DEFF	ERAM	RPR	PAMB	P1-ID	TAMB-R	TAMB-F	T1-F	RC-DA	EFF-DA	CASE
(N) ID	I-R	P-PSIA	M-COR	WD	R	EFF	FAR	AREA	XIN	PS-PSIA	THETA	DELTA	H	SF-N.1	NSI (H)
1 LPC	518.7	1.549	1.707	1.690	3.8900	0.7200	0.0	0.0	0.0	0.0	1.000	0.990	124.0	0.8696	0.1
2 HURN	450.0	0.732	0.742	1.591	0.9500	0.7900	0.0	4.7	0.200	53.778	1.639	3.782	304.1	0.5474	0.1
3 COWL	1539.0	0.754	0.754	1.597	0.9500	0.8550	0.0	0.0	0.0	0.0	2.967	3.706	383.5	0.0	0.3
4 LPT	1213.1	1.183	1.974	1.597	0.9500	0.0	0.0	17.3	0.200	17.007	2.715	3.706	304.1	1.9358	0.4
5 DELP	1213.1	1.183	1.974	1.597	0.9500	0.0	0.0	0.0	0.0	0.0	2.715	1.237	277.3	0.2619	0.5
6 COWL	1165.4	1.055	1.988	1.567	1.1333	0.8400	0.00925	0.0	0.0	0.0	2.715	1.237	277.3	0.0	0.5
7 PT	1165.4	1.055	1.988	1.567	1.1333	0.8400	0.00925	0.0	0.0	0.0	2.715	1.237	277.3	0.0	0.7
8 DELP	1160.7	1.030	2.305	1.667	1.0000	0.0	0.00939	20.4	0.200	15.503	2.238	1.084	283.7	0.0	0.8
9 COWL	1160.7	1.030	2.305	1.667	1.0000	0.0	0.00939	20.4	0.200	15.503	2.238	1.084	283.7	0.0	0.8
10 HNZ2	1136.0	1.596	2.335	1.692	1.0840	0.0	0.00939	12.4	0.371	14.696	2.190	1.000	277.3	0.0	1.1
11 THB	1136.0	1.596	2.335	1.692	1.0840	0.0	0.00939	12.4	0.371	14.696	2.190	1.000	277.3	0.0	1.1
12 EX9	1136.0	1.596	2.504	1.692	1.0000	0.0	0.00939	12.4	0.371	14.696	2.190	1.000	277.3	0.0	1.2

IDES=1 NVAR=1 MATRX=1 LOOP=4 EMAX=0.0002 NLIN=3

C I= T (3), Y (4) V= 2000.000, 1000.000, 0.0 E= 1539.000, 0.0 L=1

COMPRESSOR BLEED INFORMATION

BLEED NO.	1	2	3	4	5	6	7	8	9	10	11	12	TOTALS
COMP 1 BLEED	0.0	0.0414	0.0150	0.0080	0.0000	0.0000	0.0	0.0	0.0000	0.0000	0.0	0.0	0.0644
P.O. ID	1.0000	1.0000	1.0000	1.0000	1.0000	1.0000	1.0000	1.0000	1.0000	1.0000	1.0000	1.0000	0.109
FLOW	0.0	0.070	0.025	0.014	0.0	0.0	0.0	0.0	0.0	0.0	0.0	0.0	0.0
LPC TEMP	0.0	55.29	55.29	55.29	0.0	0.0	0.0	0.0	0.0	0.0	0.0	0.0	0.0
LPC PRESS	1.0	1.0	1.0	1.0	1.0	1.0	1.0	1.0	1.0	1.0	1.0	1.0	1.0
LPC TRF	1.0	1.0	1.0	1.0	1.0	1.0	1.0	1.0	1.0	1.0	1.0	1.0	1.0
LPC NTC(N) N=	3	6	6	6	6	6	6	6	6	6	6	6	6

COMPONENT PERFORMANCE

N ID	BETA	XN	XN-MAP	H.P.	HPX/PHP	SFIN(2)	EFF-MAP	R-MAP	W-MAP	SMRELL	FLOW ID	EFF ID	MAPTYP
1 LPC	1.0000	100.000	100.000	191.62	3.00	0.0	0.8280	3.0000	100.0000	0.0	0.0	0.0	1
4 LPT	0.0	100.000	100.000	194.62	0.0	0.0	0.8254	3.8961	99.9999	0.0	0.0	0.0	1
7 PT	0.0	100.000	100.000	20.16	0.0	0.0	0.8620	3.2303	99.9999	0.0	0.0	0.0	1

NOZZLE PERFORMANCE

NOZZLE PRI (8-9)	(N) TYP	FC	FN	CFG	CD	AREA(IN)	V-EXIT	SF(IN,2)	SF(EX,2)	CFGT ID	CDT ID	MAPTYP
1	1	25.19	25.19	1.0840	0.9850	1.0000	583.5	6.135	0.0	0.0	0.0	1

F I N A L E N G I N E P E R F O R M A N C E

F-RAM	WA-ENG	WA-COR	EFF-PROP	FN-PROP	FN-TOT	SFC-TOT	EFF-TH	FHV	DTAMTP	WEE	HODISS	PMSDGF
0.0	1.690	1.707	0.0	50.4	79.6	0.7120	0.0492	18400.0	0.0	56.7	1	1.00000
PMSD	SFC	WFT	PMSD-R1	FN	PMSD-EQ	SFC-EQ	PH/WA	DEFIIP	ERAMTP	HPXPT	FAR-ST	WFTGF
20.2	2.810	56.7	20.4	29.2	31.8	1.7801	11.930	0.0	0.0	0.0	0.067751	1.00000

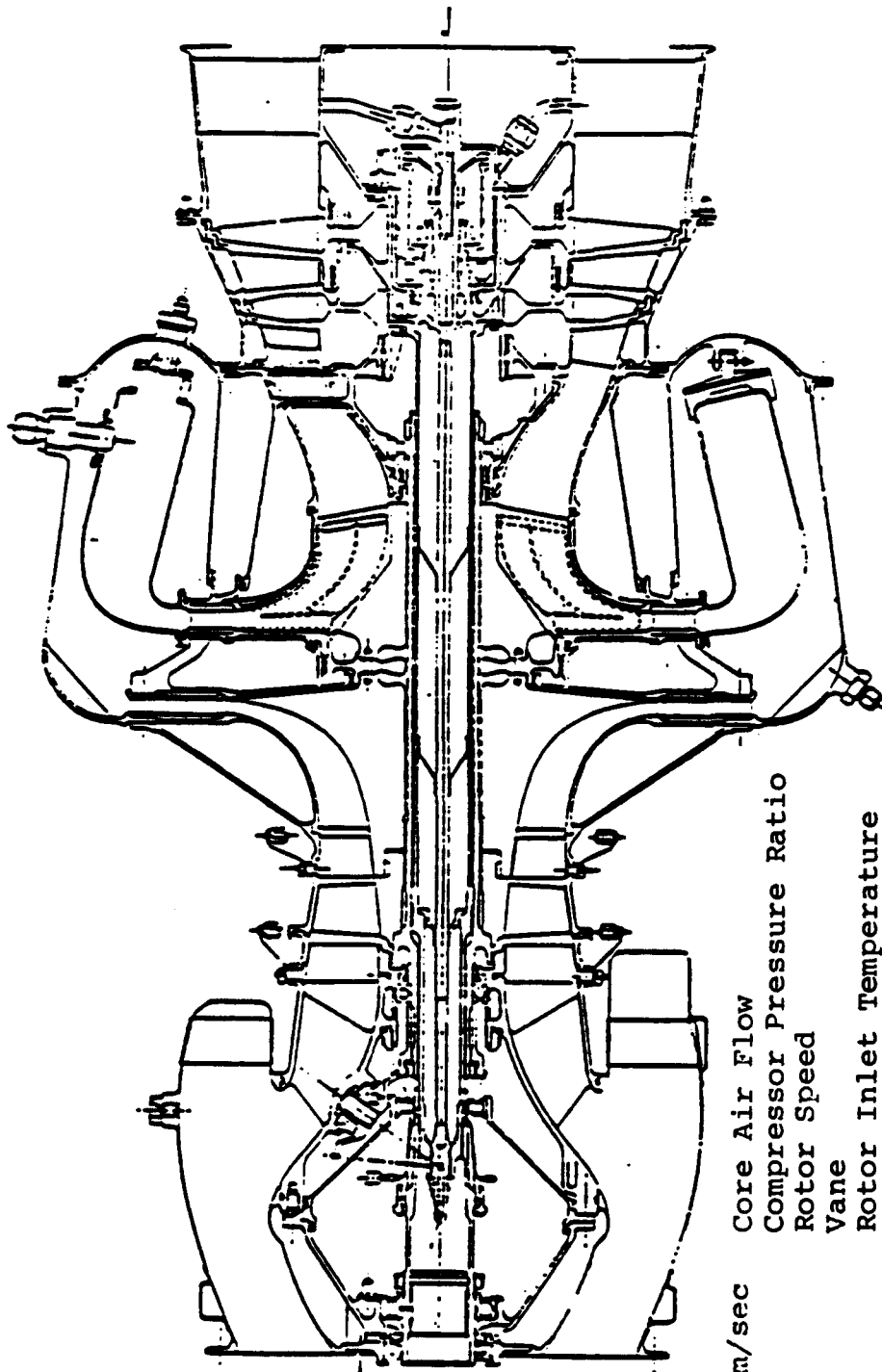

4.74	lbm/sec	Core Air Flow
14.4		Compressor Pressure Ratio
61900		Rotor Speed
Ceramic		Vane
2300°F		Rotor Inlet Temperature
920	hp	Power Output
0.44		SFC

FIGURE 3.1-1 TYPICAL SMALL ENGINE INCORPORATING THE COOLED HTRT

TABLE 3.1-5 TURBINE PERFORMANCE AT INTERMEDIATE RATED POWER

ACTUAL
 W= 4.5596
 DELH(ADIABATIC)=186.846
 SPEED= 6190.00
 HP(NET)= 1190.780
 TORQUE= 102.273
 U/CT= 0.6606

CYCLE PARAMETERS
 U/CS= 0.6490
 RT= 3.8728

CORRECTED
 WRTHC/D= 0.7939
 DELH/TMC(ADIABATIC)= 36.243
 N/RTHC= 27262.32
 HP/DRTHC= 38.5365
 TE/D= 7.843
 SPEED-FLOW PAR= 360.72

EFF-TT(ADIABATIC)= 0.8700
 EFF-TS(ADIABATIC)= 0.8396
 EFF-TT(NET)= 0.8552
 EFF-TS(NET)= 0.8295
 ROT= 3.6658
 RT= 3.8728

STATION 0
 1
 2
 3

CP
 0.2992
 0.2992
 0.2926

T STATIC P
 2754.596
 2464.611
 2420.523
 2106.326

W
 198.298
 117.140
 107.887
 51.643

VR
 284.518
 554.168
 630.306
 634.026

WU
 -1.26
 -1.26
 -1.26

ALPHA
 0.0
 79.725
 73.769
 1.051

BETA
 -0.115
 -58.999

STATION 0
 1
 2
 3

W/MCR
 0.1168
 0.8974
 0.9708
 0.2917

W
 630.307
 1231.007
 1231.007

WU
 -1.26
 -1.26
 -1.26

ALPHA
 0.0
 79.725
 73.769
 1.051

BETA
 -0.115
 -58.999

STATION 0
 1
 2
 3

AREA
 11.8864
 9.2464
 8.6658
 15.6789

NOZZLE
 VANELESS SPACE
 INCIDENCE
 AXIAL CLEARANCE
 RADIAL CLEARANCE
 ROTOR
 WINDAGE
 EXIT

DELTA
 6.976
 0.651
 0.084
 3.269
 2.966
 13.537
 2.260
 8.031

BLADE HEIGHT T
 0.3439
 0.3439
 0.3439
 1.2634

PRESS RECD V
 0.9591
 0.9964
 0.8696
 0.813
 0.3968

OMEGA
 0.1094
 0.0732

NOZZLE GEOMETRIC PARAMETERS
 NO. OF BLADES= 15.0
 SOLIDITY= 1.399
 CHORD= 2.509
 SPACING(EXIT)= 1.792
 TR EDGE THICK= 0.0200

ROTOR
 NO. OF BLADES= 13.0
 SOLIDITY= 3.386
 SPACING(EXIT-H)= 0.962
 SPACING(EXIT-H)= 0.649
 TR EDGE THICK= 0.0650

GENERAL PARAMETERS
 SPECIFIC SPEED= 62.225
 SPECIFIC DIAMETER= 1.6266
 AN SORDE= 0.4119E+09
 UNTAPERED HUB STRESS= 77555.87
 BORE STRESS= 98557.69
 THROAT CHOKED W= 4.5616
 PS REACTION= 0.3791

THETA TOTAL/L= 0.0100
 AXIAL CLEARANCE= 0.0300
 RADIAL CLEARANCE= 0.0100
 BLADE INLET ANGLE= 0.0

VELOCITY DIAGRAM
 U
 284.518
 2103.479
 2254.997
 634.135

VELOCITY DIAGRAM
 V
 0.0
 2029.168
 2165.123
 11.742

D3 H/D3T= 0.5153
 D3M/D2= 0.4925
 H1/D2= 0.4229
 D1/D2= 1.0670
 D0/D1= 1.2855
 STATION 1 CHOKED W= 4.5616
 REY NO= 0.31795E+06

STATION 1 CHOKED W= 4.5616
 REY NO= 0.31795E+06

VANE THROAT AREA 2.3148 in.²
 VANE THROAT WIDTH 0.4487 in.

Development of a radial turbine taking full advantage of increased design capabilities awaits its application in a suitable engine program.

The meanline performance analysis at 100% IRP shown in Table 3.1-5 presents the relevant geometric, and aerodynamic performance data. Information is broken down into cycle parameter, velocity diagram, flow path/blade geometry, loss analysis, and general parameters. Station definition is as follows: 00-inlet, 0-vane inlet outer diameter, 1-vane exit diameter, 2-rotor inlet diameter, 3-rotor exit plane.

The Allison radial turbine aerodynamic analysis program was used to predict performance at two additional points, 75% power and idle. These results are presented in Tables 3.1-6 and 3.1-7.

Detailed aerodynamic design of the rotor was accomplished using 2-D and 3-D inviscid codes in conjunction with a 1-D boundary layer analyses. For the purpose of this study, the shroud contour and inducer width were predetermined for conformance to NASA rig hardware constraints. The meridional flow path is shown in Figure 3.1-2. The blade angle distribution and hub contour were design parameters subject to selection in providing the desired blade loading distributions.

The logarithmic blade thickness distributions used were based strongly on previous HIRT optimization studies. A region of constant wall thickness as shown in Figure 3.1-3 was employed which reflects casting technology constraint on the design. Blade metal normal thickness (total for the two side walls) distributions are shown in Figure 3.1-4.

Blade angle distribution was selected to achieve near constant aerodynamic loading on the blade for the mean and shroud contours, with minimal turning downstream of the rotor throat. Distributions of this type load the blade uniformly over its length and avoid diffusion on the blade suction surfaces. The selected blade angle distribution is shown in Figure 3.1-5 along with the AGT 100 power turbine design. The AGT 100 power turbine has demonstrated superior performance and was used as a guide in this design. Blade sections of the resulting design are shown and presented in Figures 3.1-6 and 7. The rotor was designed to produce a near zero exit swirl at design conditions. Figure 3.1-8 shows the exducer section exit swirl angle as a function of exducer span.

The resulting surface velocity distributions for the rotor are shown in Figure 3.1-9 through 3.1-11 as predicted by two methods, a meridional solution (2-D) and a blade to blade solution (quasi 3-D). Comparable results for the AGT 100 power turbine are shown in Figures 3.1-12 to 14. The three dimensional results were subsequently smoothed and a 1-D boundary layer solution was performed. Results are summarized in Figures 3.1-15 to 17. Figure 3.1-18 presents a summary of the results for the hub, mean, and tip streamlines.

Note that for the hub streamline, an excessive amount of diffusion was present over a significant portion of the blade. This was partly the result of specification of radial filament blading for the rotor as is common in radial turbine design practice.

TABLE 3.1-6 TURBINE PERFORMANCE ESTIMATE AT 75% POWER

ACTUAL
 W= 4.2222
 DELH/ADIABATIC)=169.615
 SPEED= 61900.00
 HP(NET)= 999.099
 TORQUE= 85.971
 U/GT=0.6943 U/GS=0.6821

CYCLE PARAMETERS
 T TOTAL 2516.000
 P TOTAL 177.700
 0 2516.000
 1 170.980
 2 2516.000
 3 1947.567

VELOCITY DIAGRAM
 U 270.295
 1 1939.857
 2 2166.385
 3 1066.914

GEOMETRY
 DIAMETER 11.0019
 1 11.0019
 2 8.5584
 3 8.0210
 3.9502

LOSS ANALYSIS
 DELH 5.973
 VANELESS SPACE 0.560
 INCIDENCE 0.209
 AXIAL CLEARANCE 3.014
 RADIAL CLEARANCE 2.735
 ROTOR 11.984
 MINDAGE 2.367
 EXIT 7.217

GEOMETRIC PARAMETERS

NOZZLE OF BLADES=15.0
 SOLIDITY= 1.399
 CHORD 2.509
 SPACING(EXIT)= 1.792
 TR EDGE THICK=0.0200

GENERAL PARAMETERS
 SPECIFIC SPEED= 65.030
 ROTOR DIAMETER= 1.6357
 AN SQRD= 0.41719E+09
 ANTAPERED HUB STRESS= 77555.87
 BORE STRESS= 98557.69
 THROAT CHOKED W= 4.2449 VEL
 TRS REACTION= 0.4098

EFF-TT(ADIABATIC)=0.8724
 EFF-TS(ADIABATIC)=0.8421
 EFF-TT(NET)=0.8602
 EFF-TS(NET)=0.8303
 RTOT= 3.6271
 RTOS= 3.8297

T STATIC P STATIC GAMMA
 2511.122 176.203 1.298
 2264.778 108.081 1.298
 2227.512 100.202 1.306
 1922.905 46.401 1.306

W WU
 VU 0.9
 1871.326 602.698 -169.68
 1996.706 1158.256 -992.81
 W/MCR MW

BLADE HEIGHT T AREA
 0.3439 11.8864
 0.3439 9.2464
 0.3439 8.6658
 1.2634 15.6789

DEL ETA PRESS RECO V OMEGA E BAR
 0.0307 0.9619 0.1077 0.0736
 0.0029 0.9967
 0.0011
 0.0155
 0.0141
 0.0616
 0.0122
 0.0371 0.8709 0.826 0.4017

ROTOR
 NO. OF BLADES=13.0
 SOLIDITY= 3.386
 SPACING(EXIT-M)= 0.962
 SPACING(EXIT-H) 0.649
 TR EDGE THICK=0.0650

DE H/D3T=0.5153
 DEH/D2=0.4925
 H1/D2=0.0429
 D1/D2= 1.0670
 D0/D1= 1.2855
 STATION 1 CHOKED W= 4.2449
 REACTION= 0.5339

CORRECTED
 WRTHC/D= 0.7900
 DELH/THC(ADIABATIC)= 36.092
 N/RTHC= 28553.68
 HP/DRTHC= 38.1146
 TE/D= 7.420
 SPEED-FLOW PAR= 375.94

CP T RELATIVE
 0.2992 2251.759
 0.2926 2014.461

ALPHA BETA
 VR 270.295 0.0
 511.061 74.725
 578.319 73.847
 596.555 7.081
 -16.352
 -58.999

THETA TOTAL/L=0.0100
 AXIAL CLEARANCE=0.0300
 RADIAL CLEARANCE=0.0100
 BLADE INLET ANGLE= 0.0

4.2449
 REY NO= 0.31588E+06

TABLE 3.1-7 TURBINE PERFORMANCE ESTIMATE AT IDLE POWER

ACTUAL
 W= 1.6516
 DELH(ADIABATIC)= 84.171
 SPEED= 39039.00
 HP(NET)= 194.617
 TORQUE= 26.448
 U/CT=0.6188
 U/CS=0.6102
 CORRECTED
 WRTHC/D= 0.7880
 DELH/THC(ADIABATIC)= 29.281
 N/RTHC= 23037.13
 HP/DRTHC= 30.9522
 TE/D= 7.443
 SPEED-FLOW PAR= 302.56

EFF-TT(ADIABATIC)=0.8636
 EFF-TS(ADIABATIC)=0.8399
 EFF-TT(NET)=0.8545
 EFF-TS(NET)=0.8310
 RTDS= 2.7889
 RTDS= 2.8818
 T STATIC P STATIC GAMMA CP T RELATIVE
 1536.031 54.043 1.298 0.2992
 1383.928 32.885 1.298 0.2992
 1360.900 30.453 1.298 0.2992
 1247.450 18.912 1.306 0.2926
 1377.422
 1282.939

VELOCITY DIAGRAM
 STATION U V W WU ALPHA BETA
 0 210.871 0.0 210.871 0.0
 1 1524.081 1470.238 401.523 74.725
 2 1366.993 1568.744 497.518 73.833
 3 673.225 55.110 721.116 -618.12 8.440
 23.924
 -59.000

CYCLE PARAMETERS
 T TOTAL P TOTAL
 1539.000 54.500
 1539.000 54.500
 1539.000 52.253
 1539.000 52.062
 1257.072 19.542

GEOMETRY
 STATION DIAMETER BLADE HEIGHT T AREA
 0 11.0019 0.3439 11.3864
 1 8.5584 0.3439 9.2464
 2 8.0210 0.3439 8.6658
 3 3.9502 1.2634 15.6790

LOSS ANALYSIS
 DELH DELH ETA PRESS RECO V OMEGA E BAR
 3.985 0.0409 0.9584
 0.376 0.0039 0.9963
 1.177 0.0121
 1.494 0.0153
 1.356 0.0139
 4.645 0.0477
 0.888 0.0091
 2.815 0.0289
 0.962 0.4561

NOZZLE
 N O OF BLADES=15.0
 SOLIDITY= 1.399
 CHORD= 2.509
 SPACING(EXIT)= 1.792
 TR EDGE THICK=0.0200
 ROTOR
 NO OF BLADES=13.0
 SOLIDITY= 3.386
 SPACING(EXIT-H)= 0.962
 SPACING(EXIT-H)= 0.649
 TR EDGE THICK=0.0650

GENERAL PARAMETERS
 SPECIFIC SPEED= 54.346
 SPECIFIC DIAMETER= 1.7443
 UN TAPERED HUB STRESS= 30879.98
 HUB STRESS= 39242.02
 THROAT CHOKED W= 1.6646 VEL REACTION= 0.3243
 PS REACTION= 0.3243
 STATION 1 CHOKED W= 1.6576
 REY NO= 0.17953E+06
 THETA TOTAL/LE=0.0100
 AXIAL CLEARANCE=0.0300
 RADIAL CLEARANCE=0.0100
 BLADE INLET ANGLE= 0.0

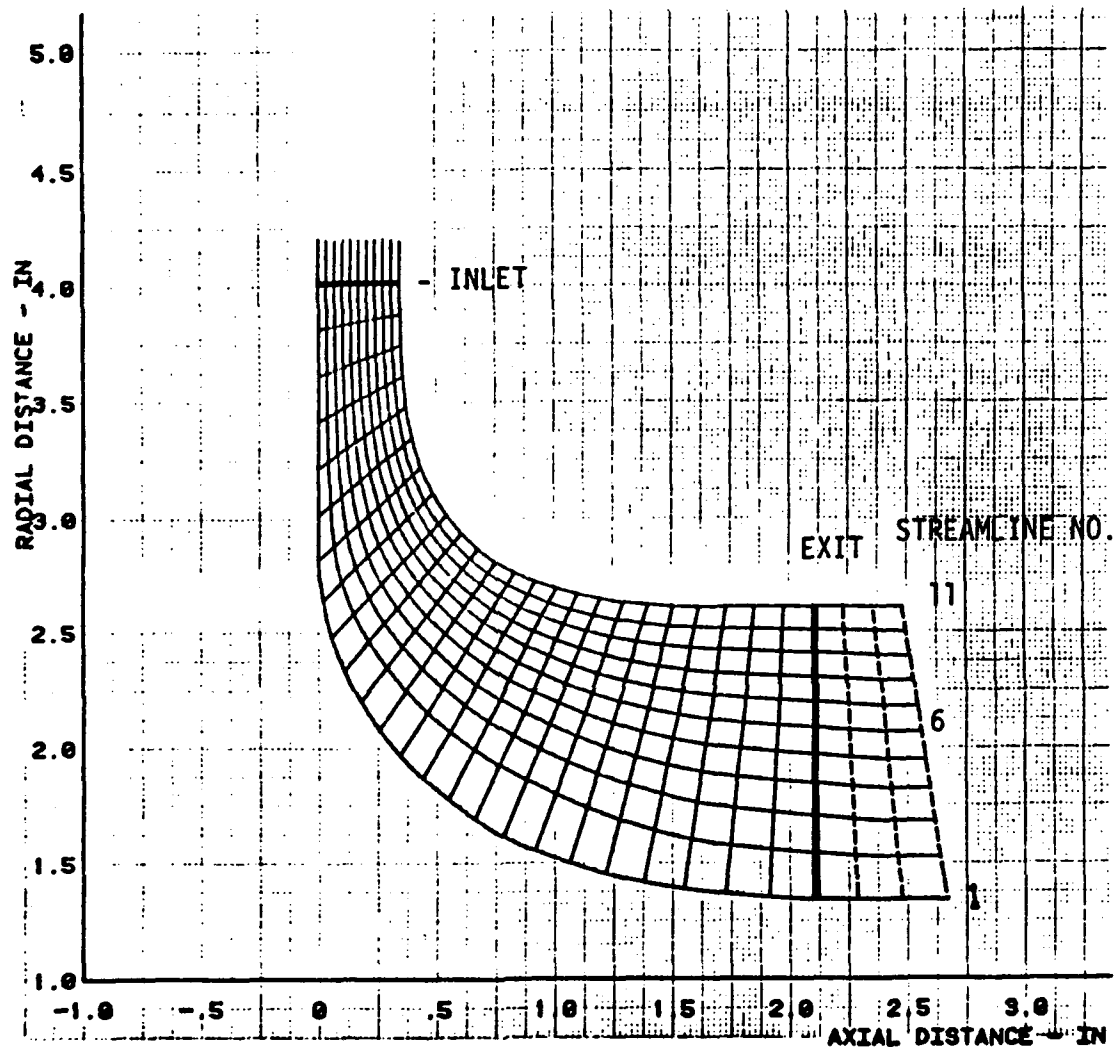

FIGURE 3.1-2 MERIDONIAL FLOWPATH

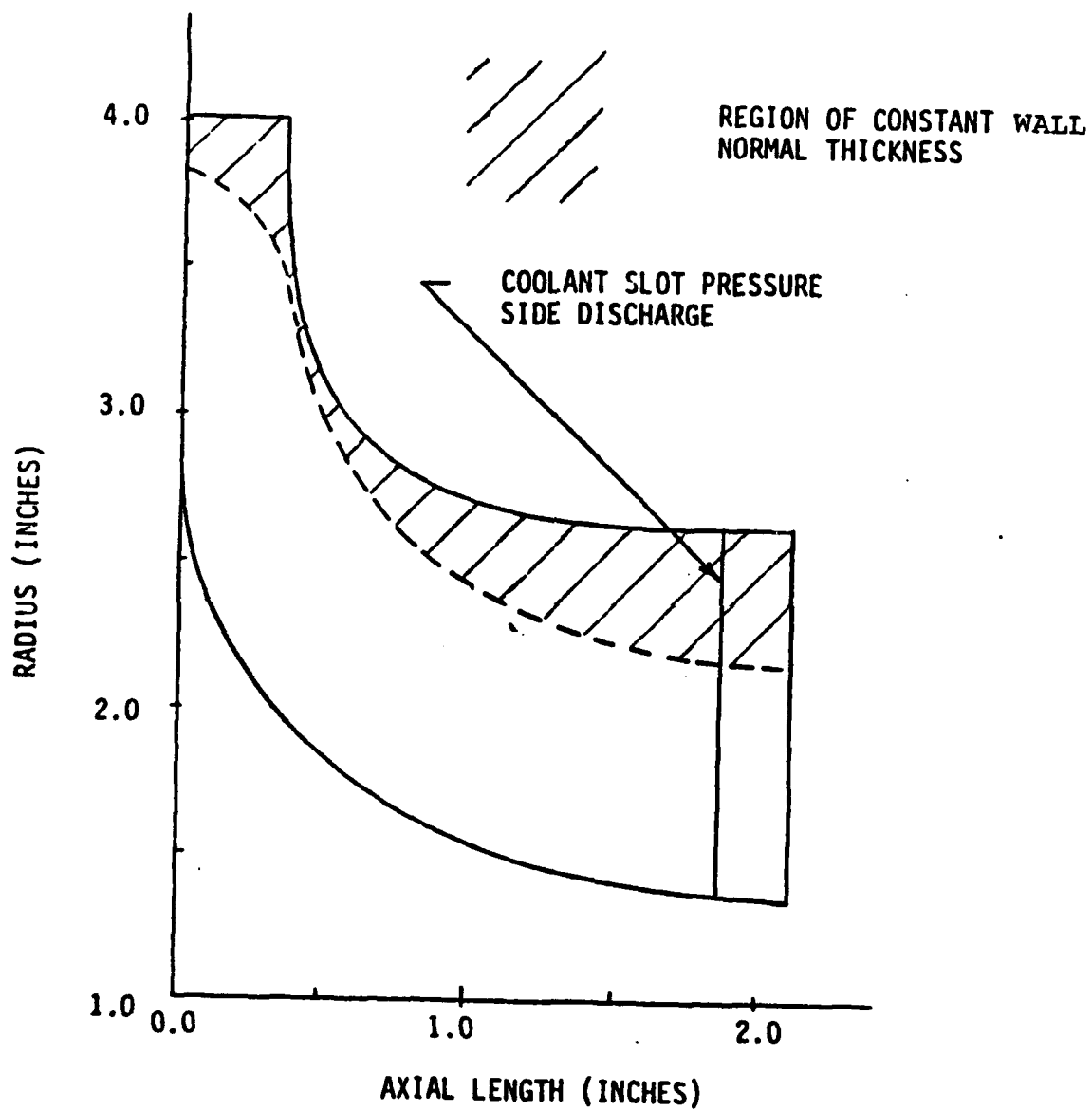

FIGURE 3.1-3 FLOWPATH WITH BLADE THICKNESS REGIONS

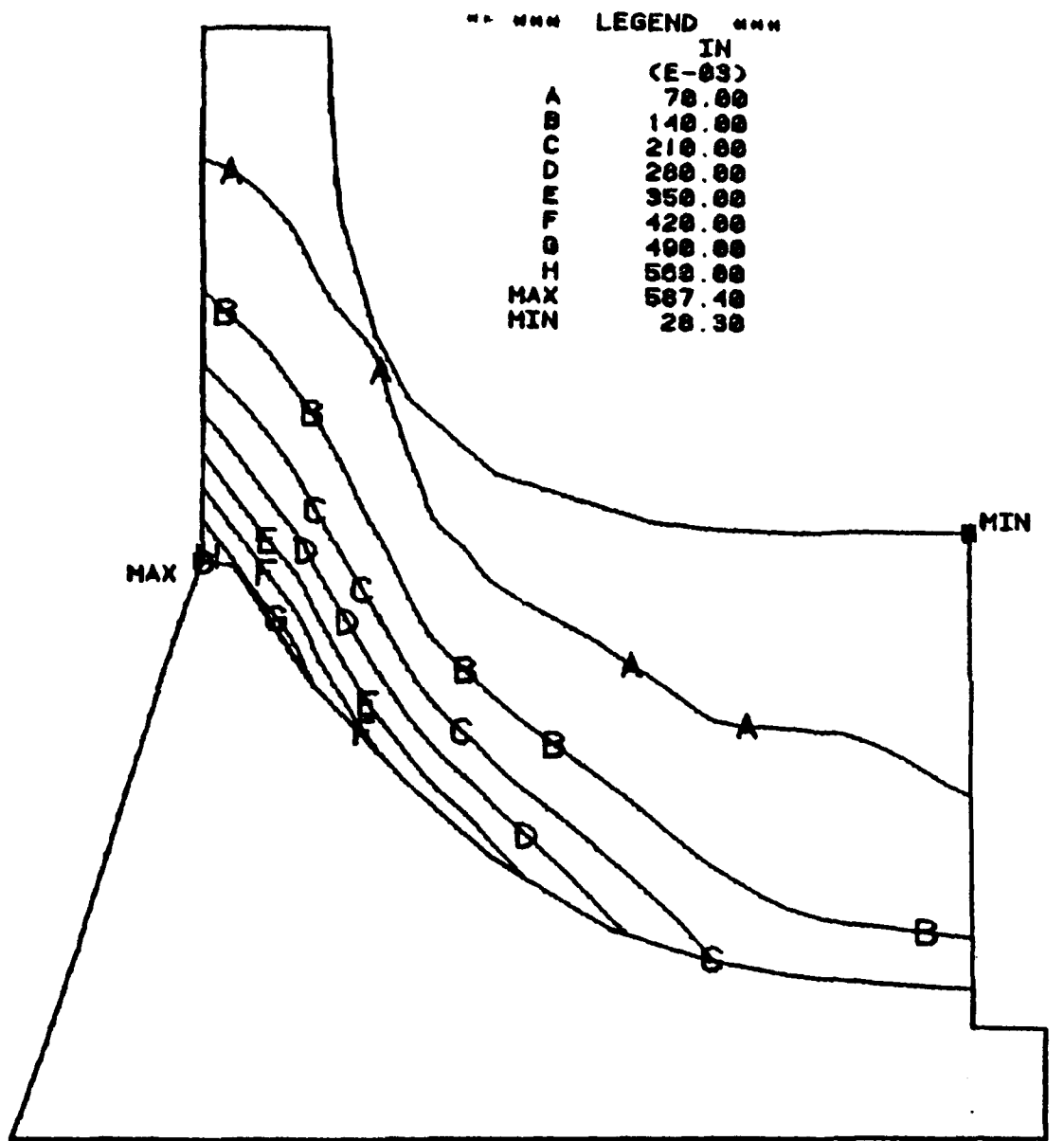

FIGURE 3.1-4 BLADE METAL NORMAL THICKNESS

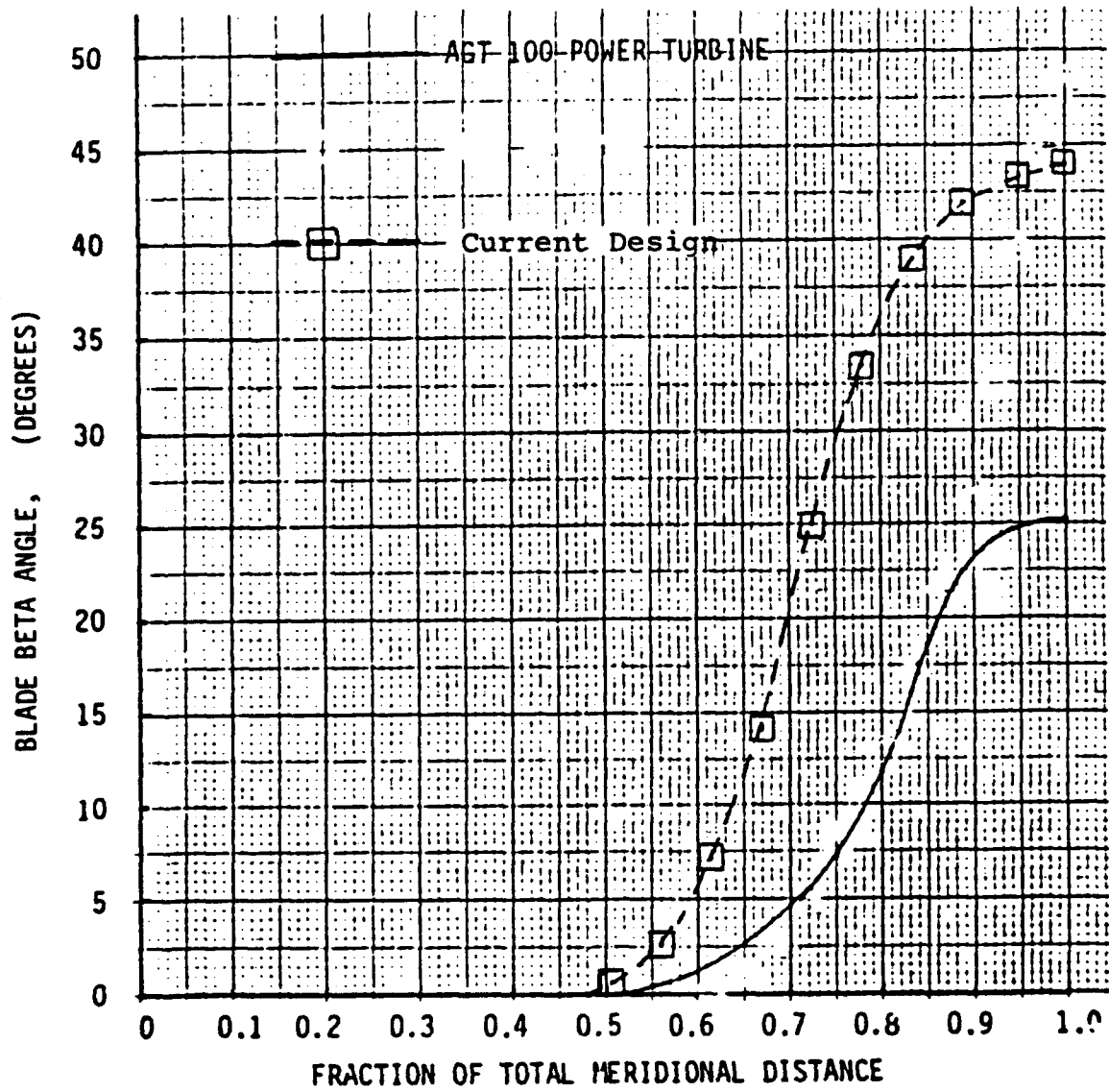

FIGURE 3.1-5 ROTOR BLADE ANGLE DISTRIBUTION

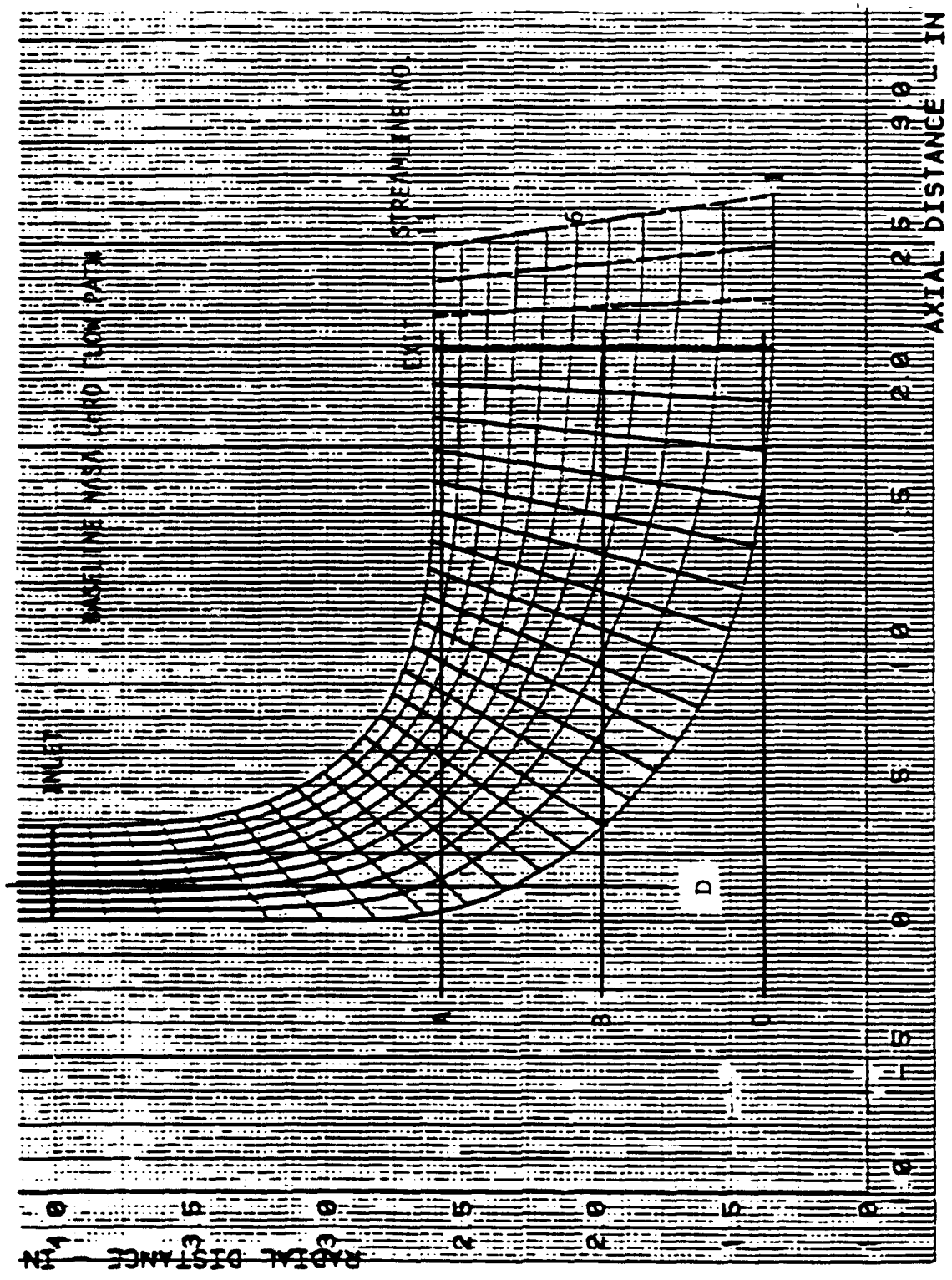

FIGURE 3.1-6 ROTOR STREAMLINE PREDICTIONS AND
BLADE SECTION LOCATIONS

THE CUTTING PLANE IS

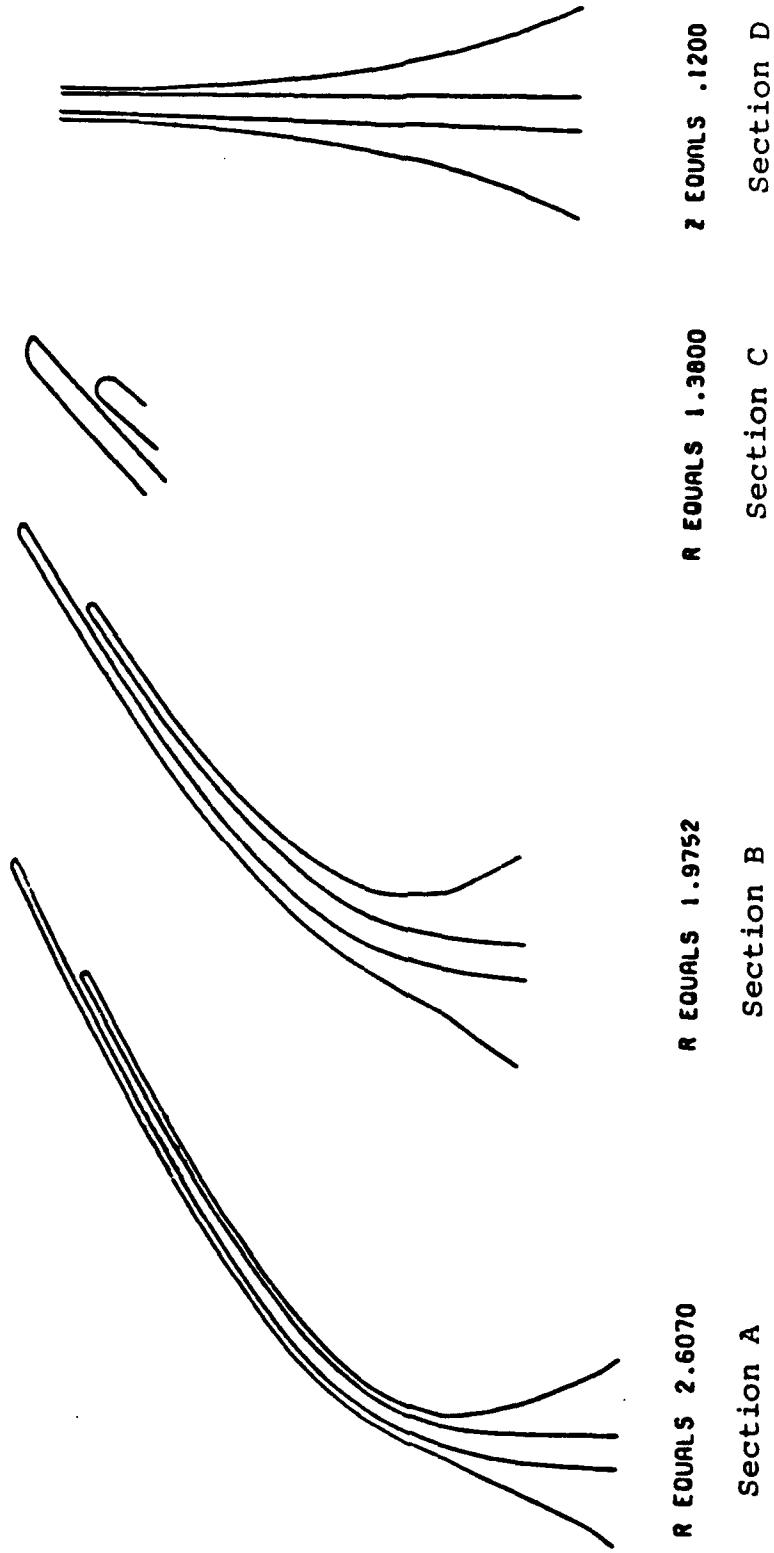
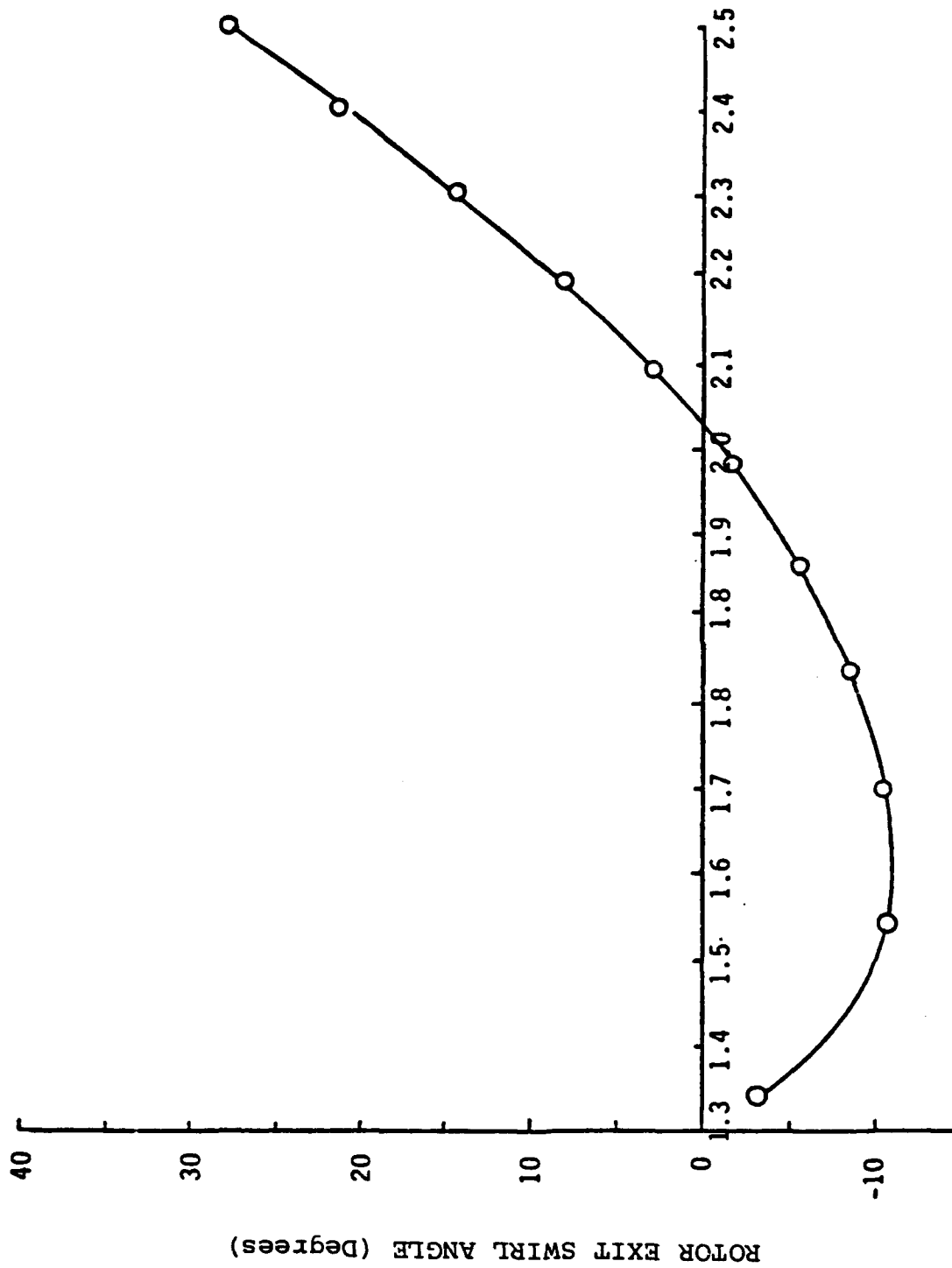

FIGURE 3.1-7 ROTOR BLADE SECTIONS



RADIAL LOCATION AT ROTOR EXIT (inches)

FIGURE 3.1-8 ROTOR EXIT SWIRL AT IRP

INITIAL FLOWPATH, STREAMLINE 1.

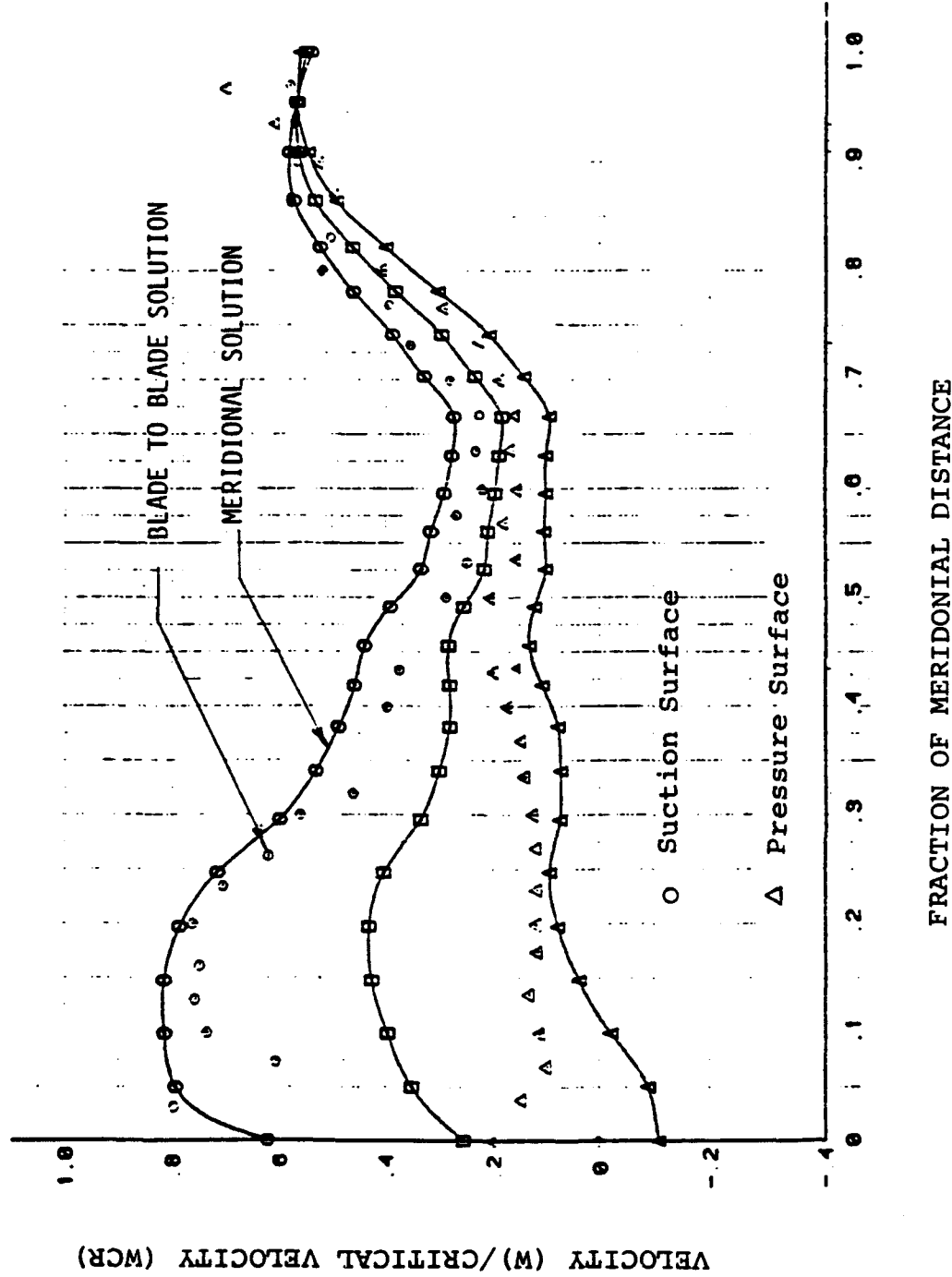

FIGURE 3.1-9 NASA HTRT ROTOR VELOCITY PROFILE, HUB STREAMLINE

INITIAL FLOW PATH, STREAMLINE 6

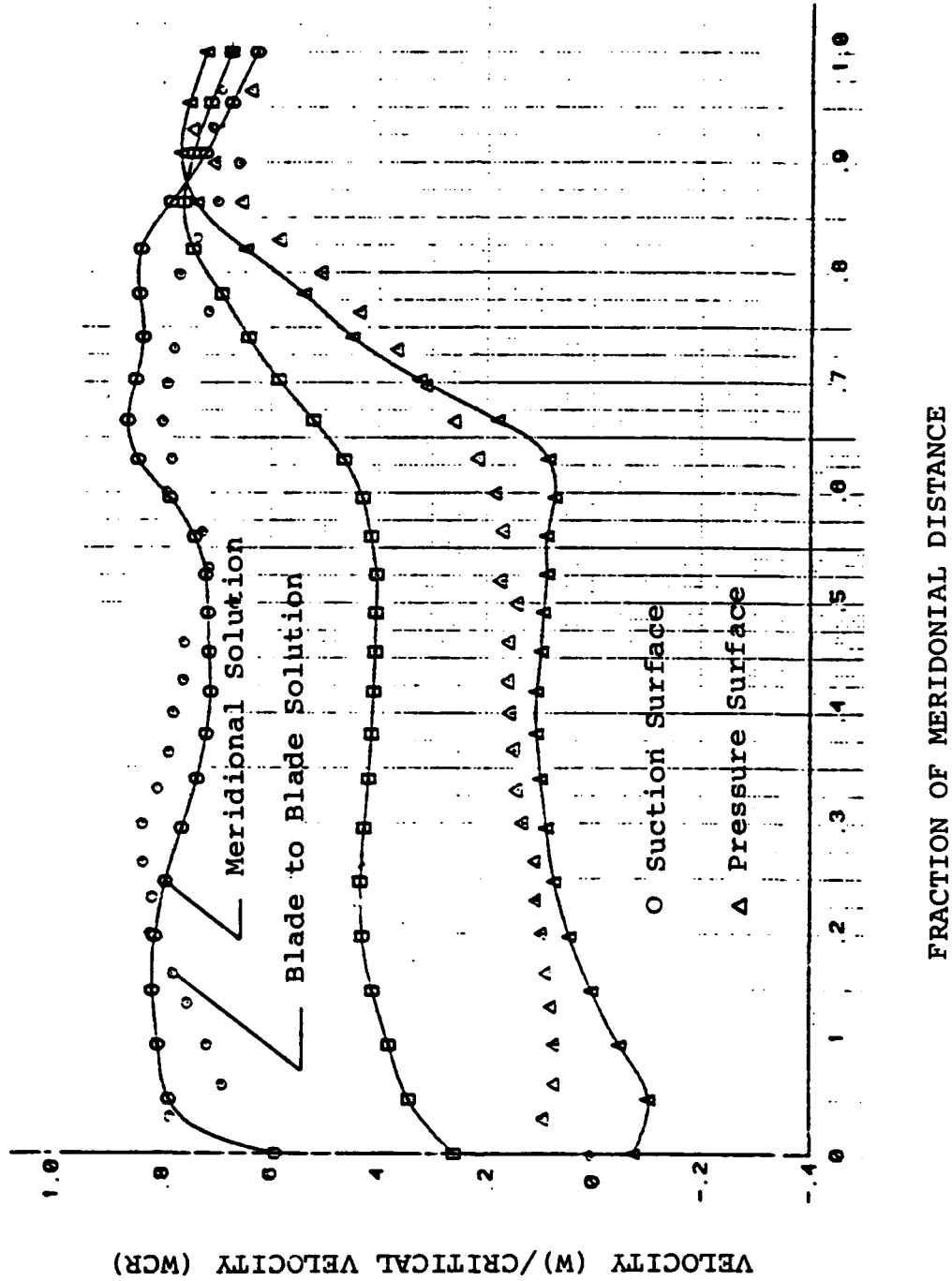
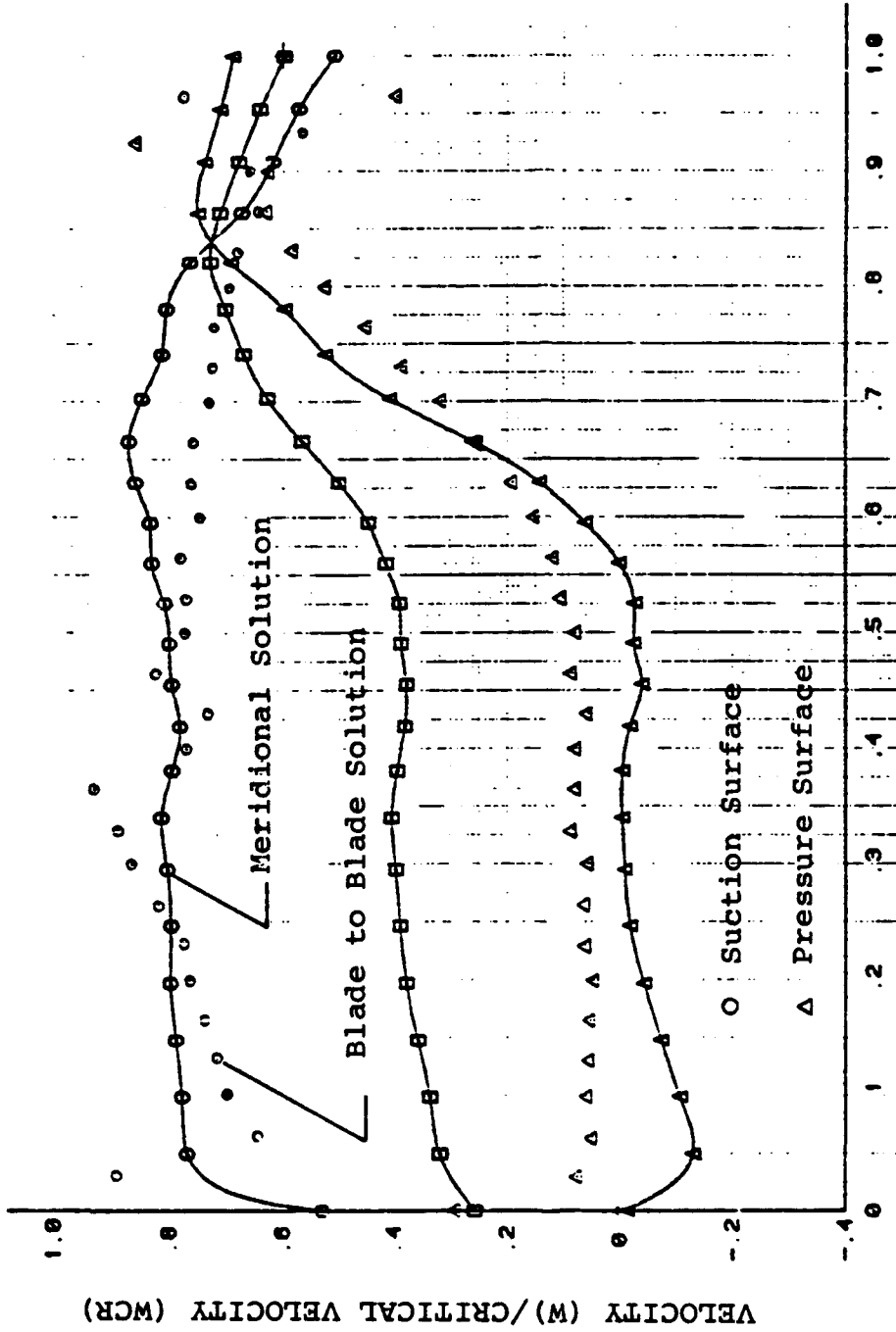

FIGURE 3.1-10 NASA HTRT ROTOR VELOCITY PROFILE, MEAN STREAMLINE

INITIAL FLOWPATH, STREAMLINE 11



FRACTION OF MERIDONIAL DISTANCE

FIGURE 3.1-11 NASA HTRT ROTOR VELOCITY PROFILE, SHROUD STREAMLINE

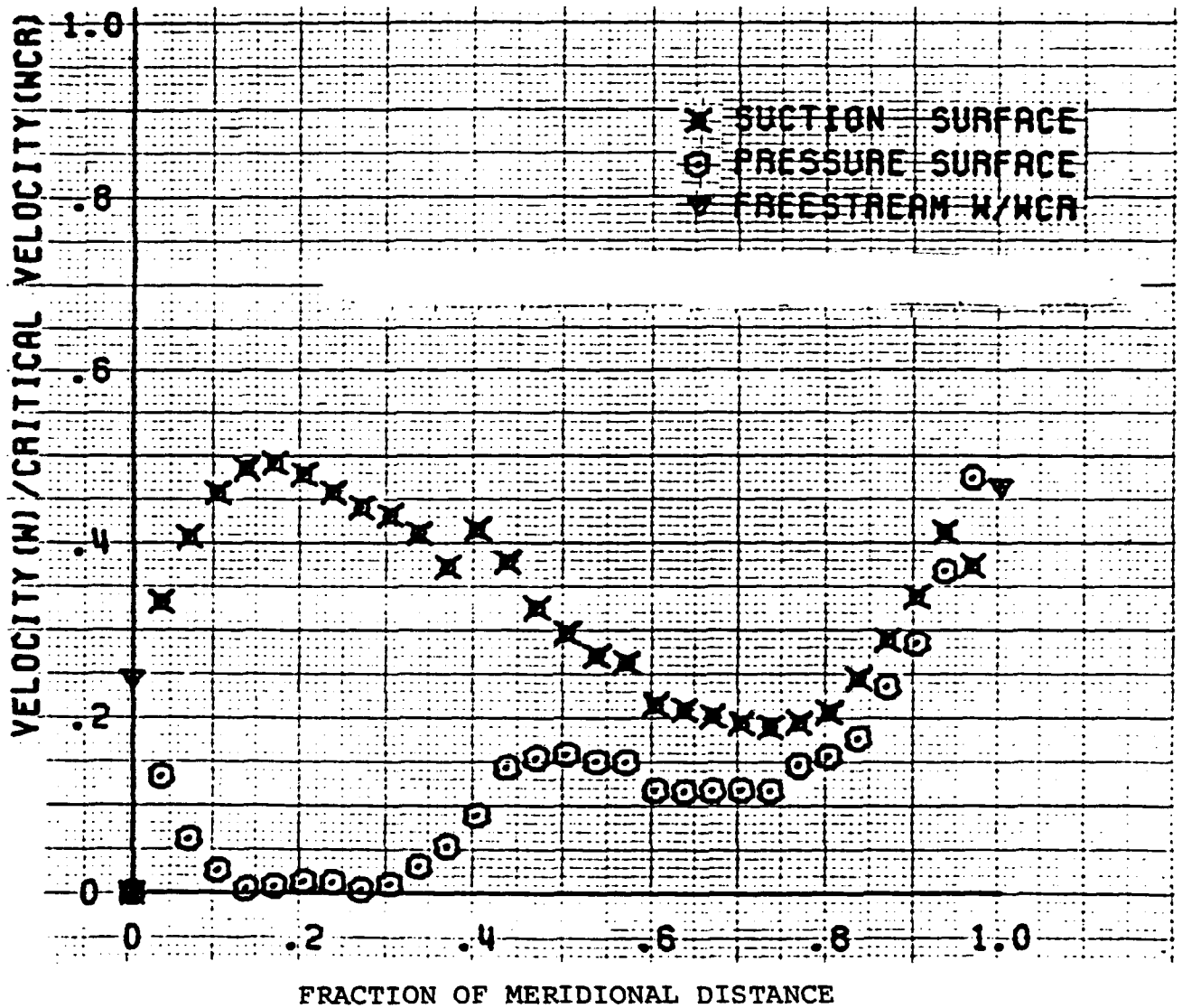

FIGURE 3.1-12 AGT100 POWER TURBINE ROTOR
VELOCITY PROFILE, HUB STREAMLINE

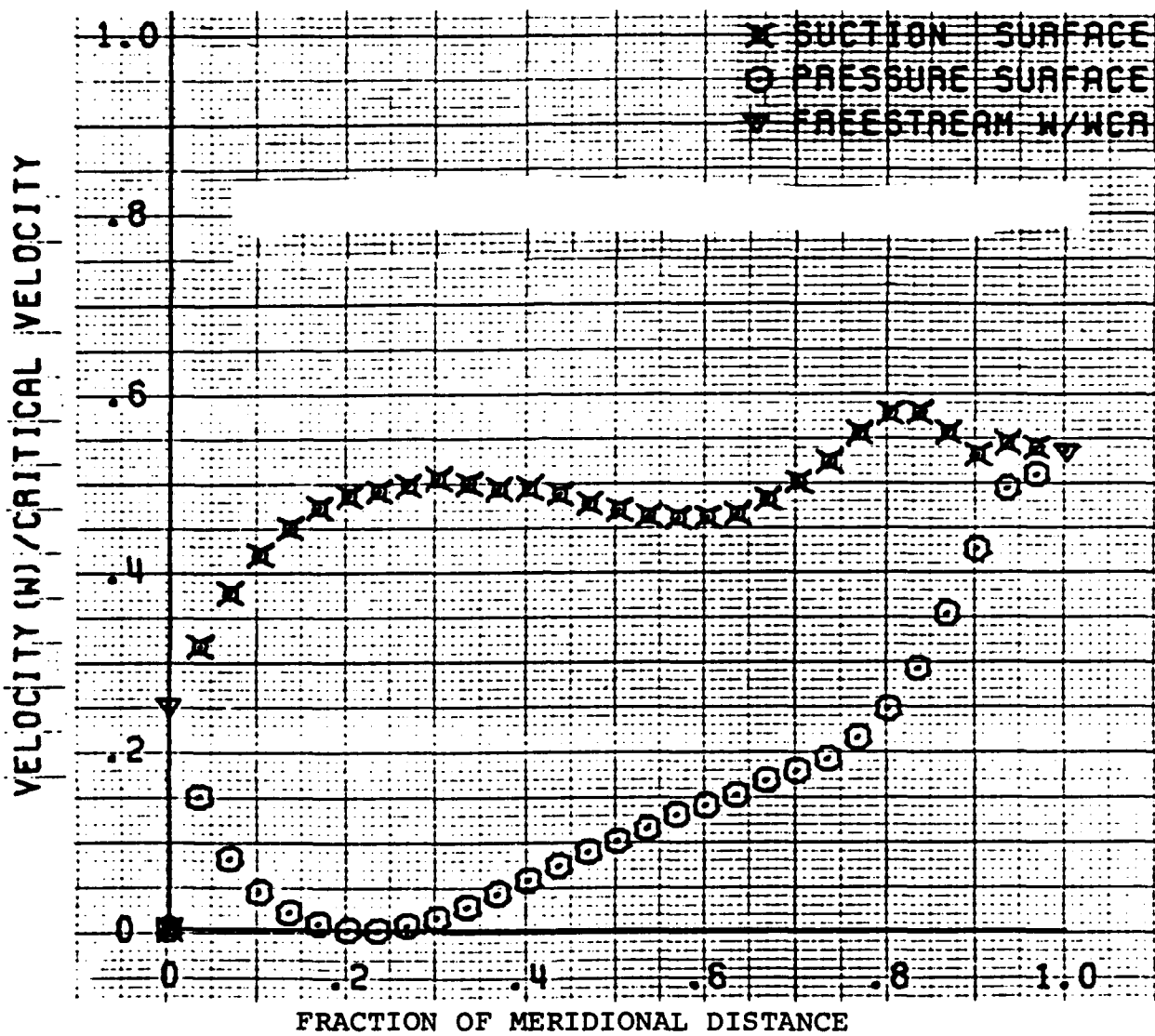

FIGURE 3.1-13 AGT100 POWER TURBINE ROTOR
VELOCITY PROFILE, MEAN STREAMLINE

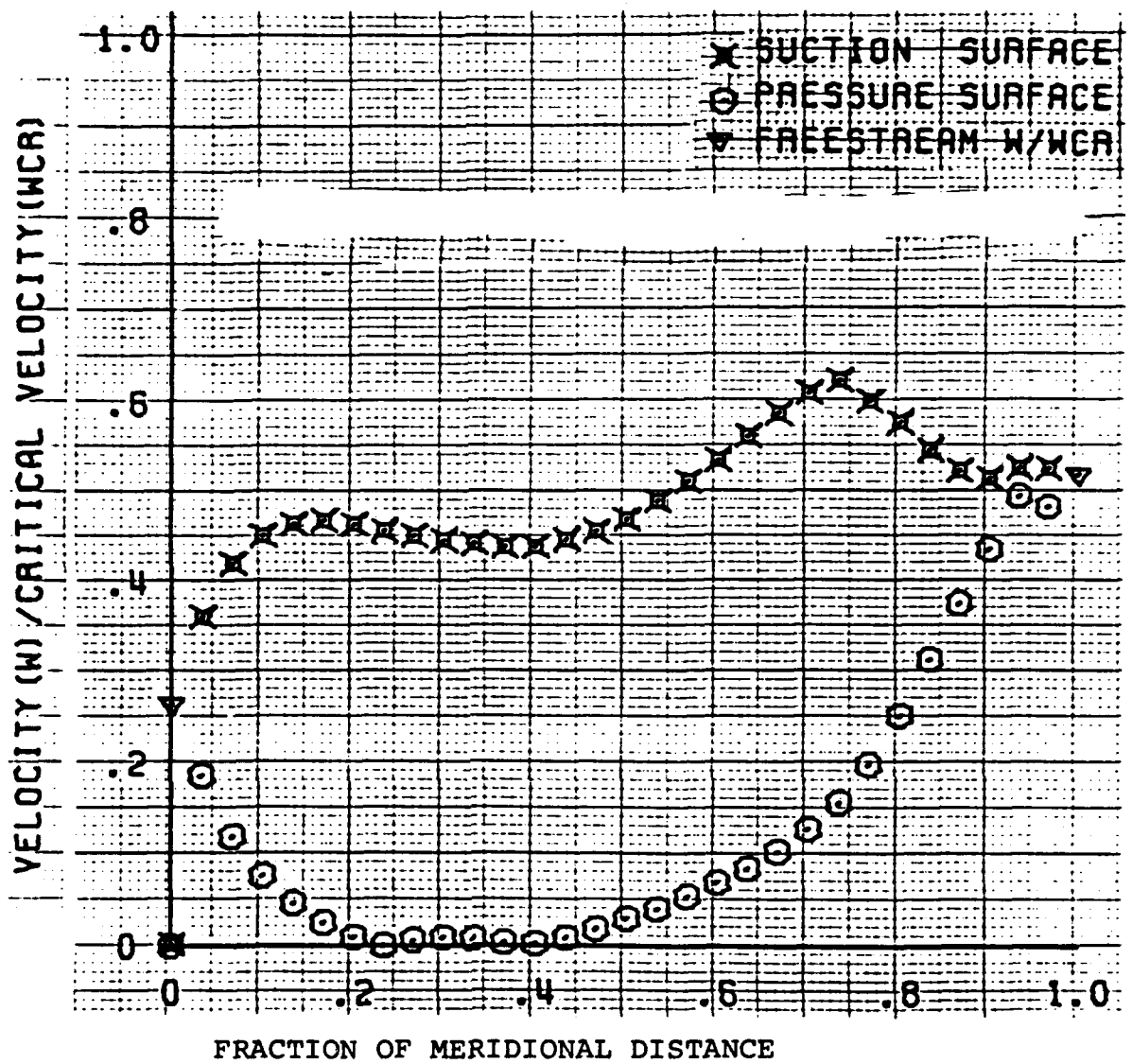

FIGURE 3.1-14 AGT100 POWER TURBINE ROTOR
VELOCITY PROFILE, SHROUD STREAMLINE

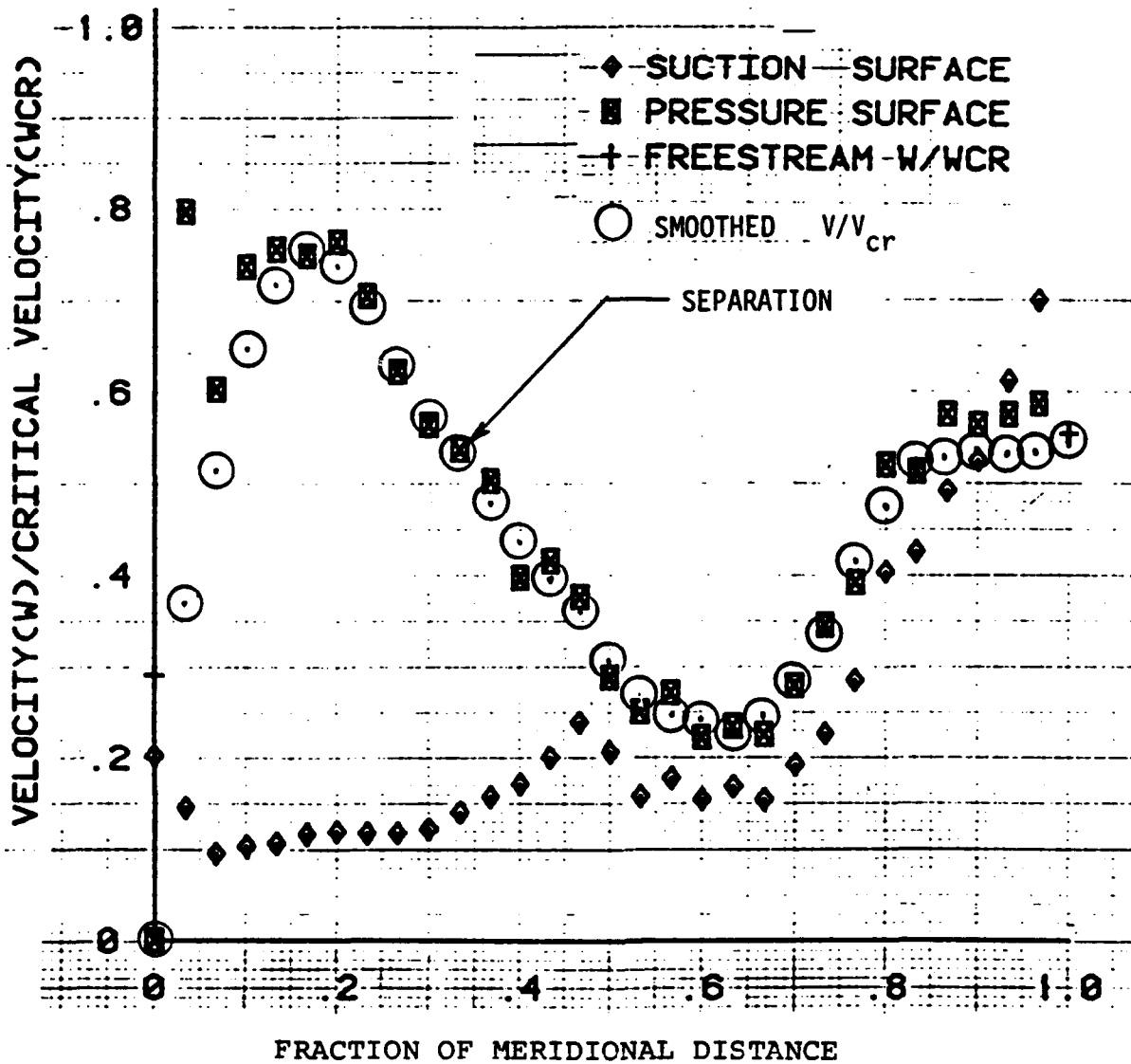

FIGURE 3.1-15 NASA HTRT ROTOR BOUNDARY LAYER ANALYSIS, HUB STREAMLINE

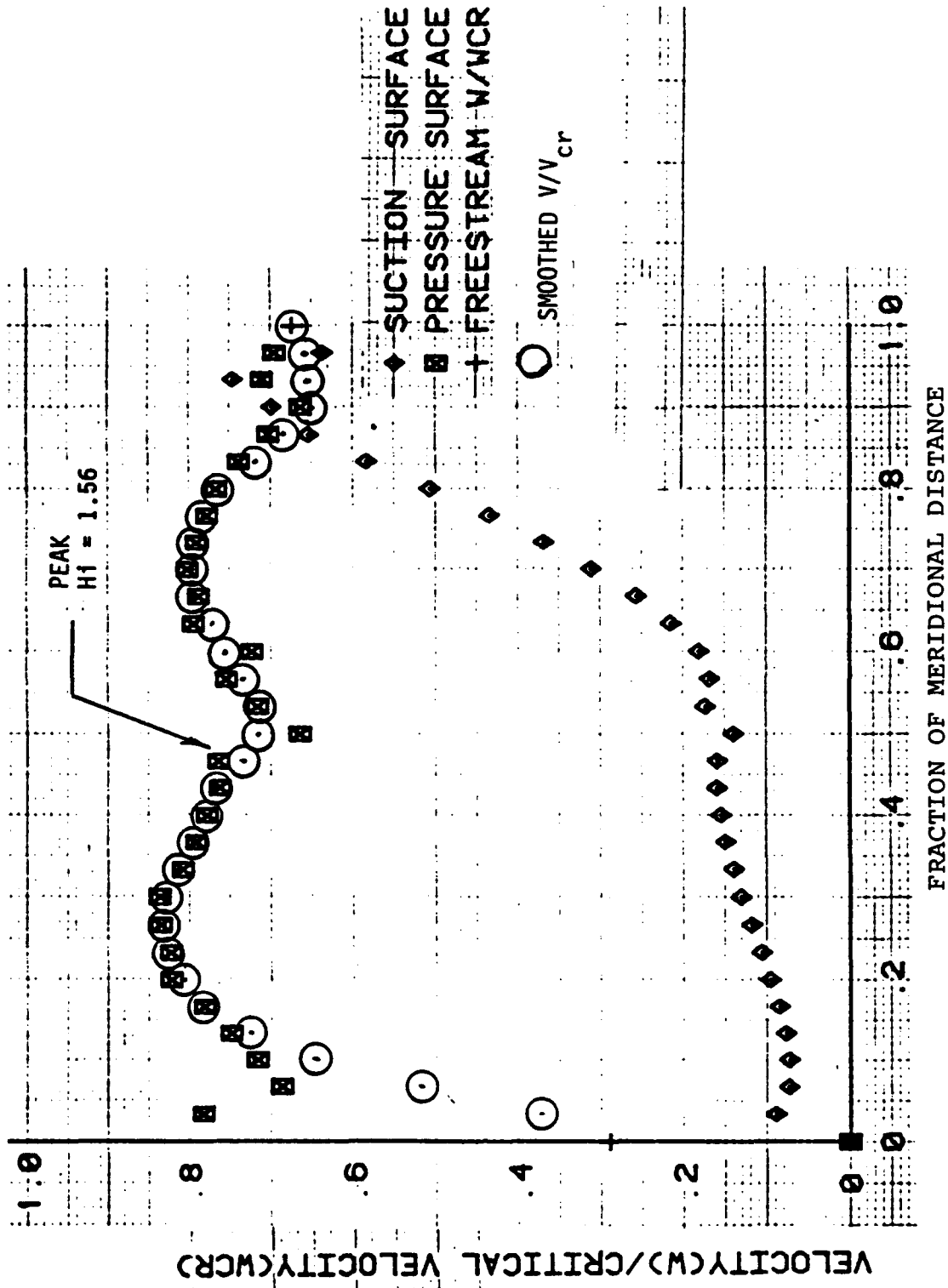

FIGURE 3.1-16 NASA HTRT ROTOR BOUNDARY LAYER ANALYSIS, MEAN STREAMLINE

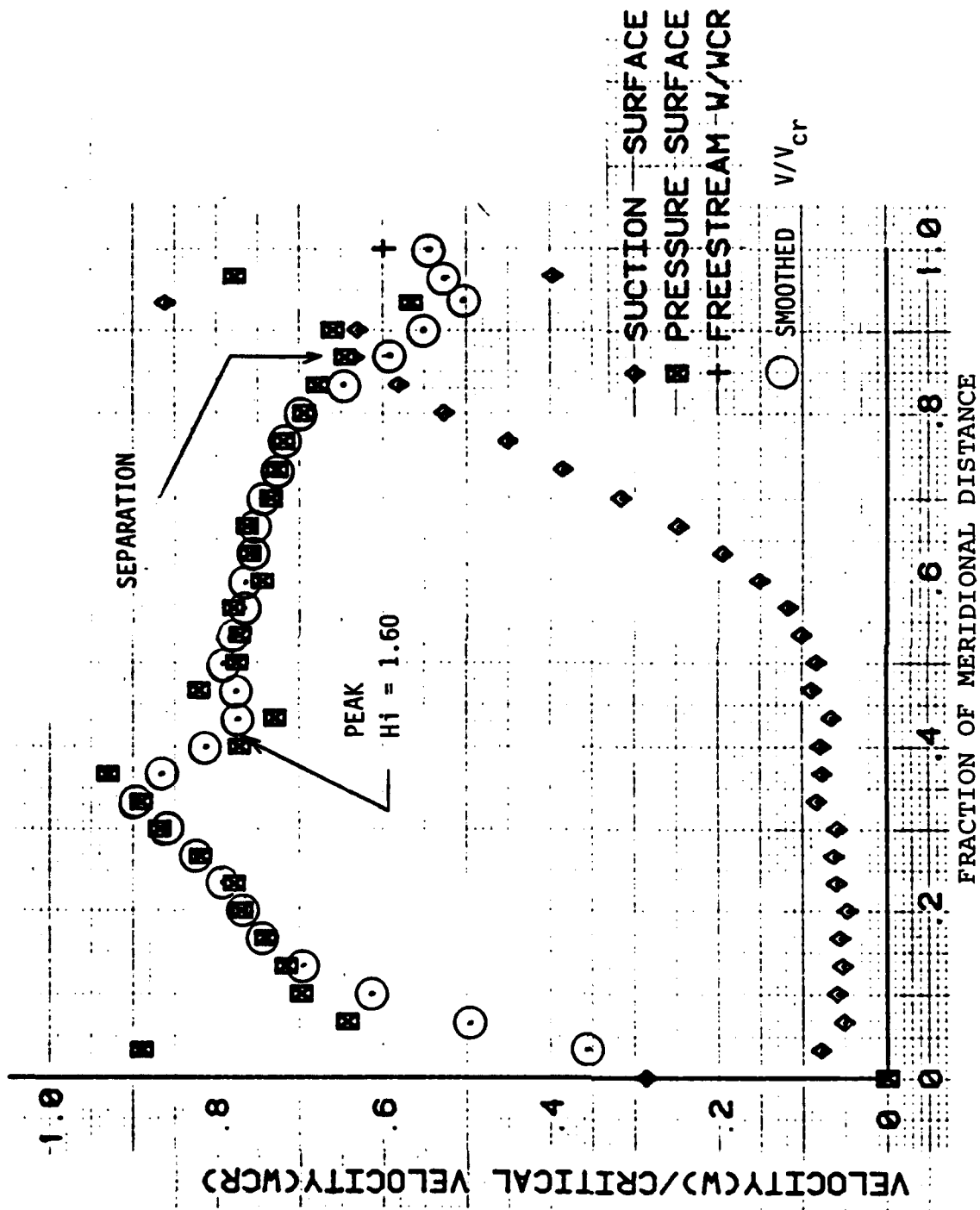
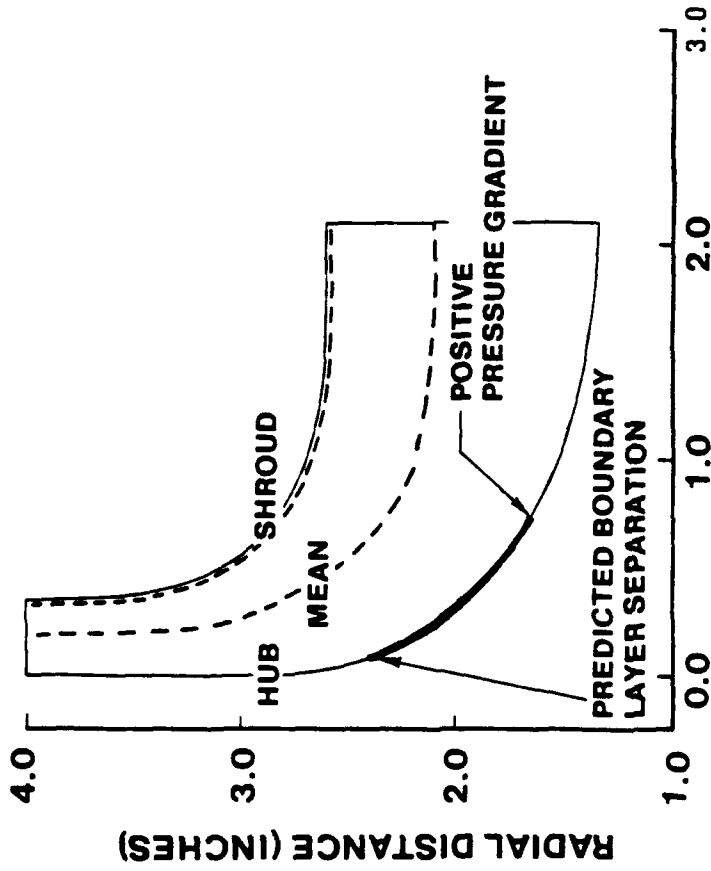
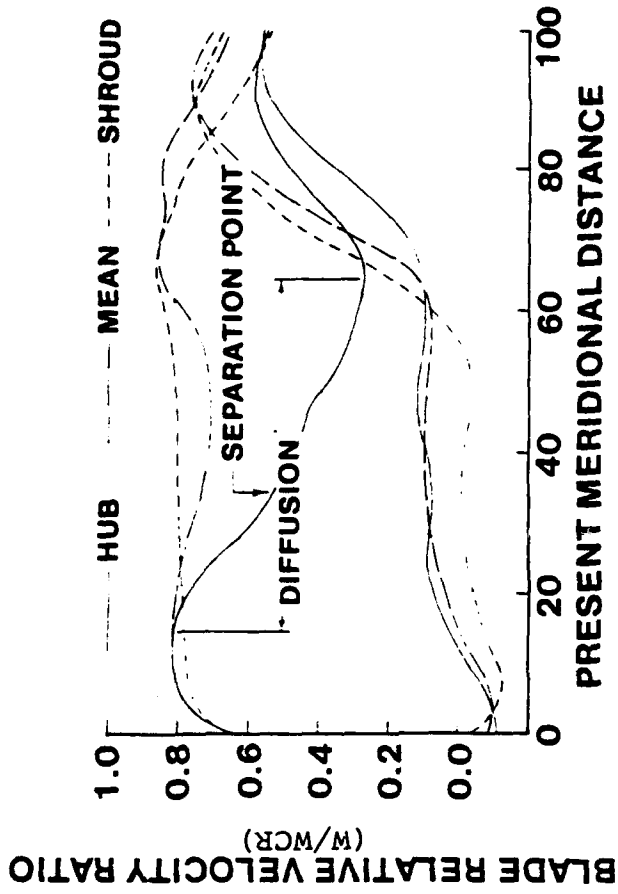

FIGURE 3.1-17 NASA HTRT ROTOR BOUNDARY LAYER ANALYSIS, SHROUD STREAMLINE

BASELINE FLOWPATH



**2-D INVISCID VELOCITY CALCULATION,
1-D BOUNDARY LAYER ANALYSIS**



TE88-4706

**FIGURE 3.1-18 PREDICTED BLADE RELATIVE VELOCITIES FOR
BASELINE ROTOR FLOWPATH**

Radial filament blading eliminates bending stresses in the blade caused by rotational forces and thus reduces the overall blade stresses.

The one dimensional boundary layer analysis indicated the likelihood of boundary layer separation near the intersection of the hub and blade suction surfaces. This separated region was significantly larger than a similar region noted on the Task I rotor design as shown in Figure 3.1-19

In order to avoid this loss producing mechanism, the alternate hub contours of Figure 3.1-20 were examined for their potential in reducing the degree of diffusion. Results also shown on Figure 3.2-20 indicated that separation can be delayed or eliminated. Alterations to the mean and shroud streamline loadings with this hub contouring were found to be insignificant. However it was realized that the impact to the rotor and blade stress caused by this modification can be significant. Although blade stresses generally decrease with shortened blades, the potential exists for rotor disk stresses to rise. Thus, the addition of significant material to the disk, as in contour B, call for a comprehensive re-evaluation of the blade/disk stress picture tradeoffs. This analysis was beyond the scope of the study. For the purpose of this study, the improvements in hub diffusion offered by contour A were sufficiently improved over those of the baseline to warrant incorporation into the final rotor design.

3.1.3 Vane Aerodynamic Design

Design point performance of the vane was specified in Table 3.1-5. Table 3.1-8 presents the results of the design process along with a comparison with both the vane design results for the Task I turbine and the original NASA design for which the turbine research rig was designed.

Design of the blading was accomplished through the use of the Allison vane section generator. The resulting blade profile is presented in Figure 3.1-21. Vane velocity profiles are shown in Figure 3.1-22. Results of the 1-D boundary layer analysis shown in Figure 3.1-23 and 24 indicate a flow free of separation.

3.2 Rotor Coolant Passage Design

As part of the previously funded cooled radial turbine effort, a highly instrumented engine scale rotor was tested under warm turbine test conditions to evaluate it's cooling performance. Based on this work, the need for improvements in internal airfoil coolant passage design was identified as a next step in a cooled high temperature radial turbine fully meeting the requirements of advanced technology engines. A thorough consideration of the coolant flow path design constraints was found to be most important in achieving a successful design.

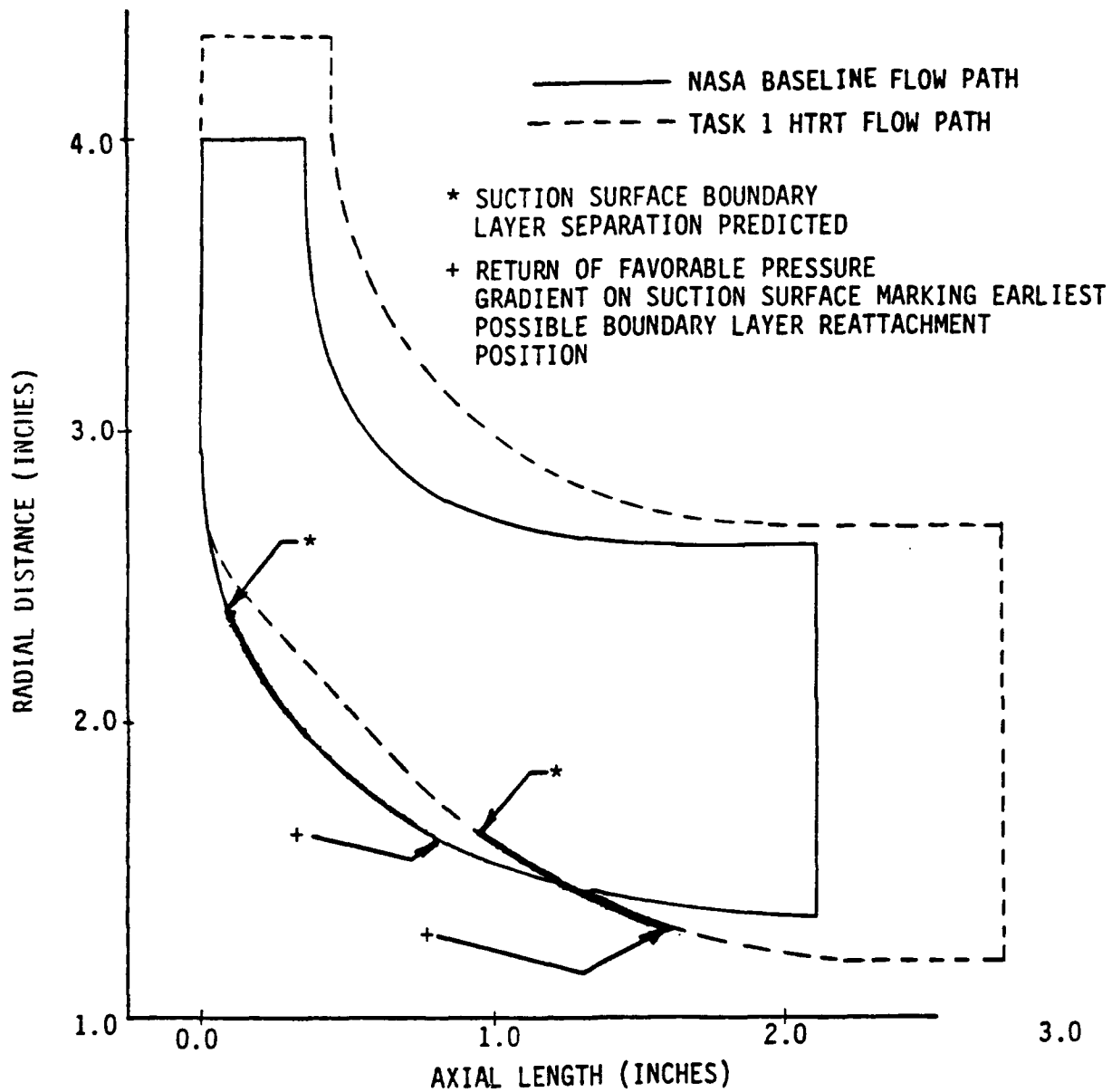

FIGURE 3.1-19 COMPARISON OF THE BASELINE FLOWPATH SEPARATED REGION WITH THAT OF THE TASK I ROTOR DESIGN

SOLUTIONS FOR HUB STREAMLINES

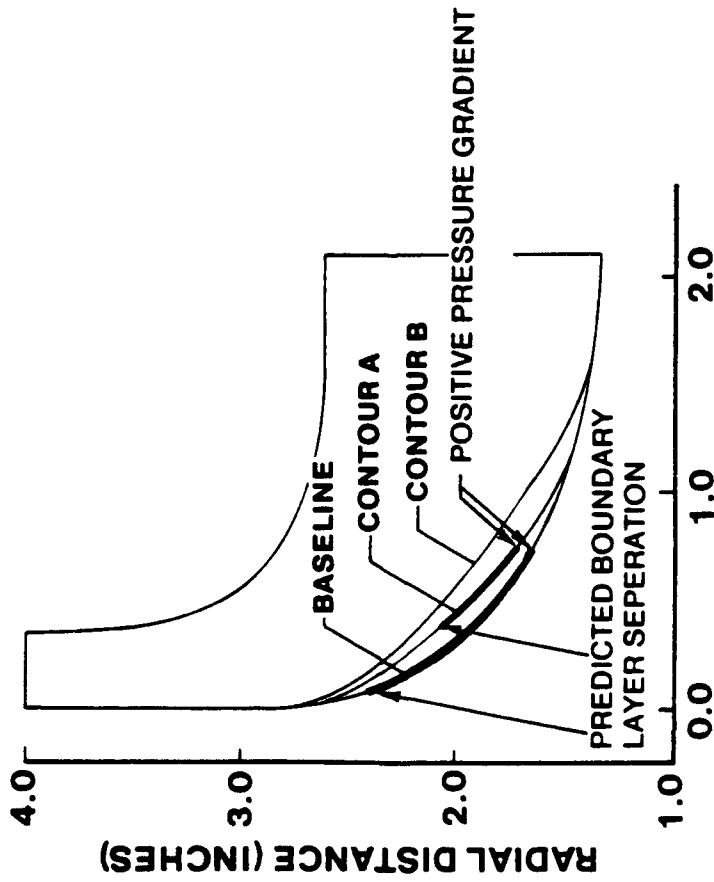
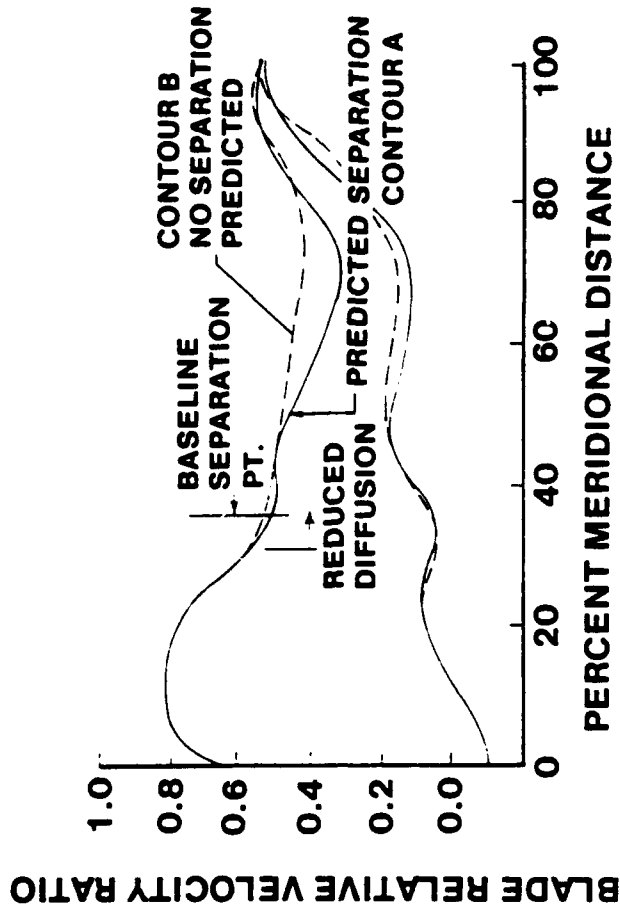

FIGURE 3.1-20 REVISED HUB CONTOURS TO REDUCE DIFFUSION CHARACTERISTICS

TABLE 3.1-8 COMPARISON OF VANE DESIGNS

	<u>NASA BASELINE</u>	<u>CURRENT DESIGN</u>	<u>TASK I DESIGN</u>
TRAILING EDGE DIAMETER (IN)	0.043	0.020 (CERAMIC)	0.040
LEADING EDGE DIAMETER (IN)	0.307	0.300 (MINOR MODIFICATION)	0.300
THROAT DIMENSION (IN)	0.500	0.449 (ROTOR MATCH)	0.3927
DESIGN FLOW EXIT ANGLE (DEGREES)	73.9	74.7 (ROTOR MATCH)	74.9
OUTER RADIUS (IN)	5.501	5.501 (UNCHANGED)	5.629
INNER RADIUS (IN)	4.225	4.279 (DESIGN SOLIDITY)	4.605
NUMBER OF VANES	15	15 (UNCHANGED)	18
PASSAGE WIDTH (IN)	0.3439	0.3439 (UNCHANGED)	0.4375
ROTOR DIAMETER (IN)	8.021	8.021 (UNCHANGED)	8.710

RADIAL INFLOW

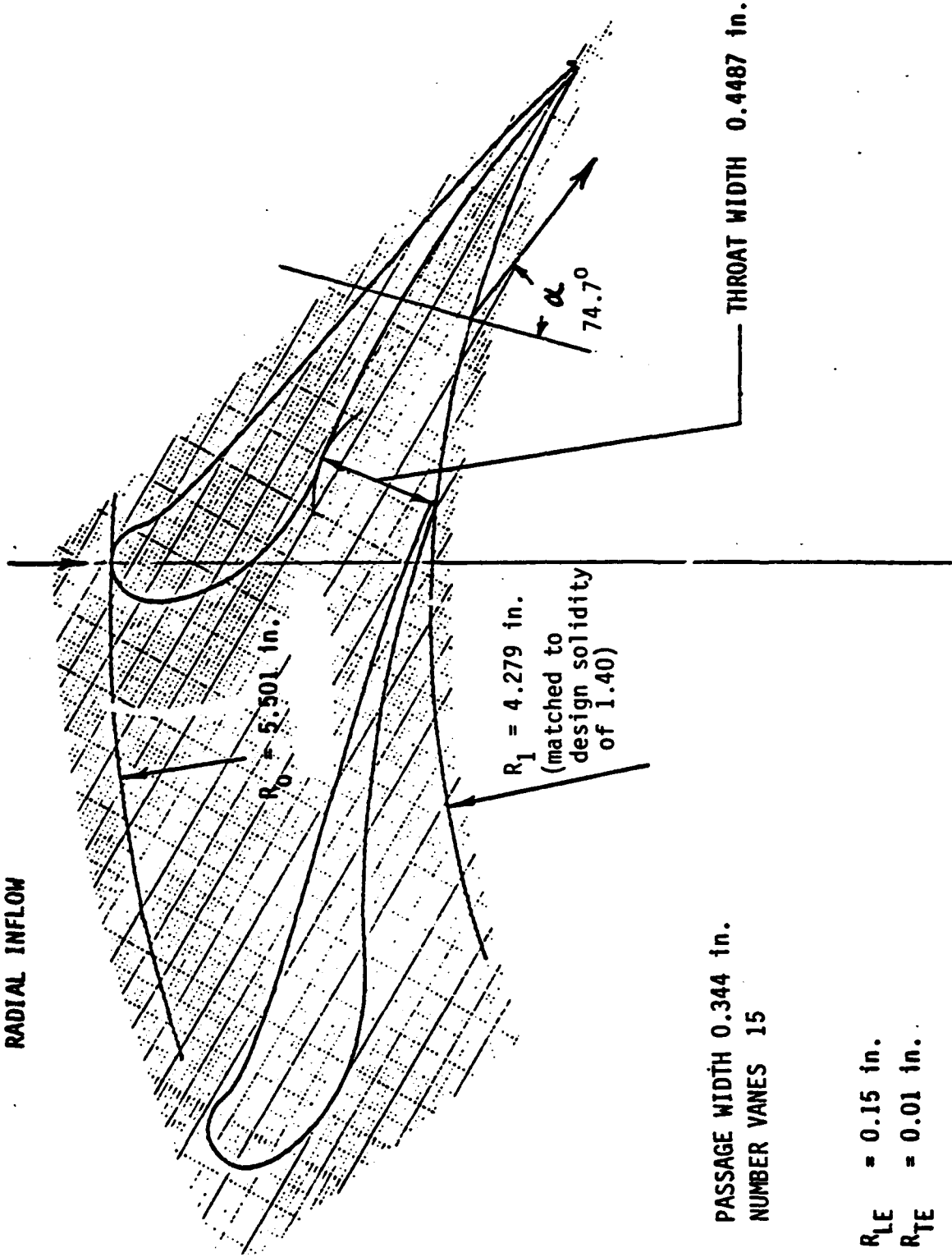

FIGURE 3.1-21 VANE DESIGN

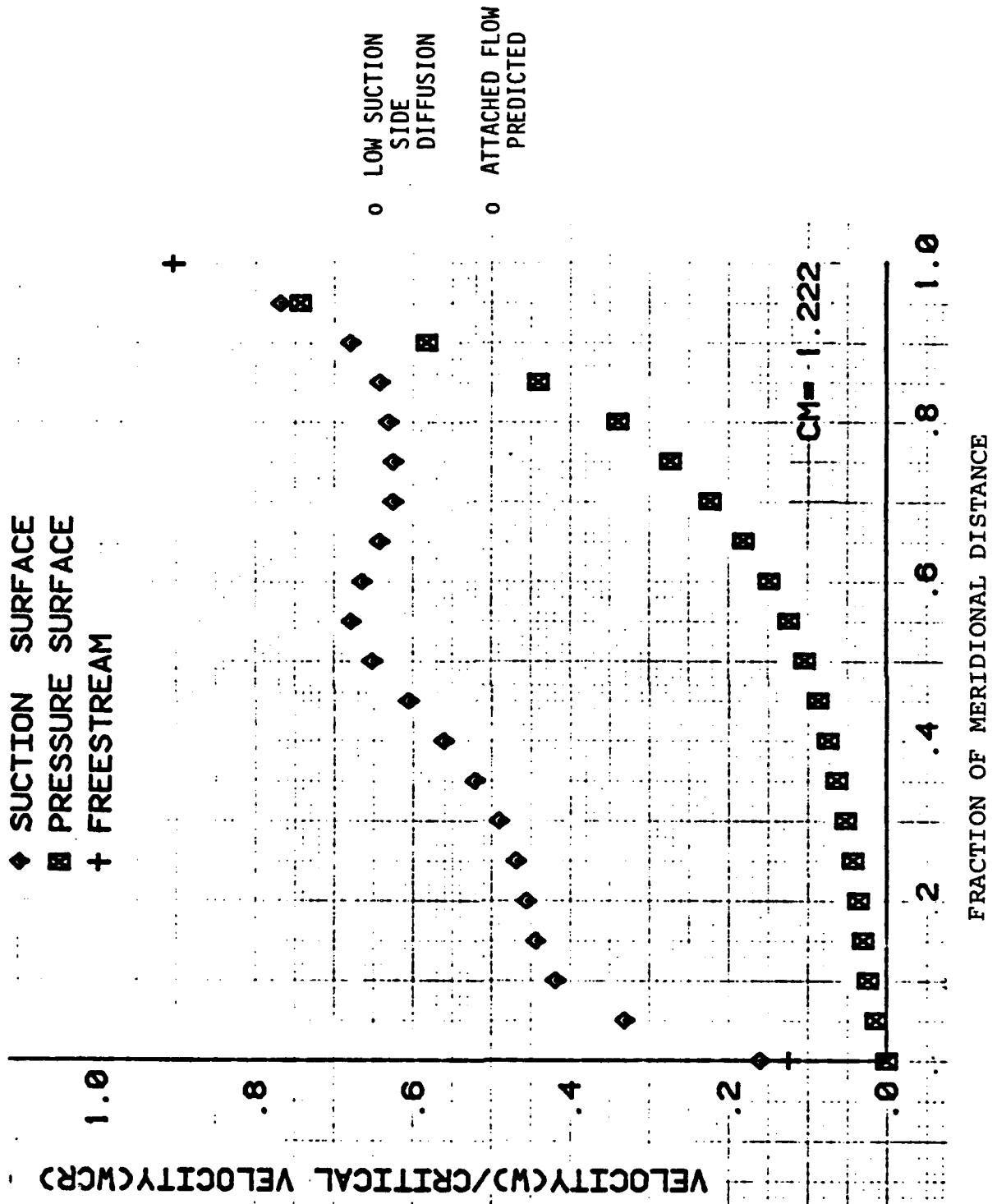

FIGURE 3.1-22 VANE VELOCITY PROFILE

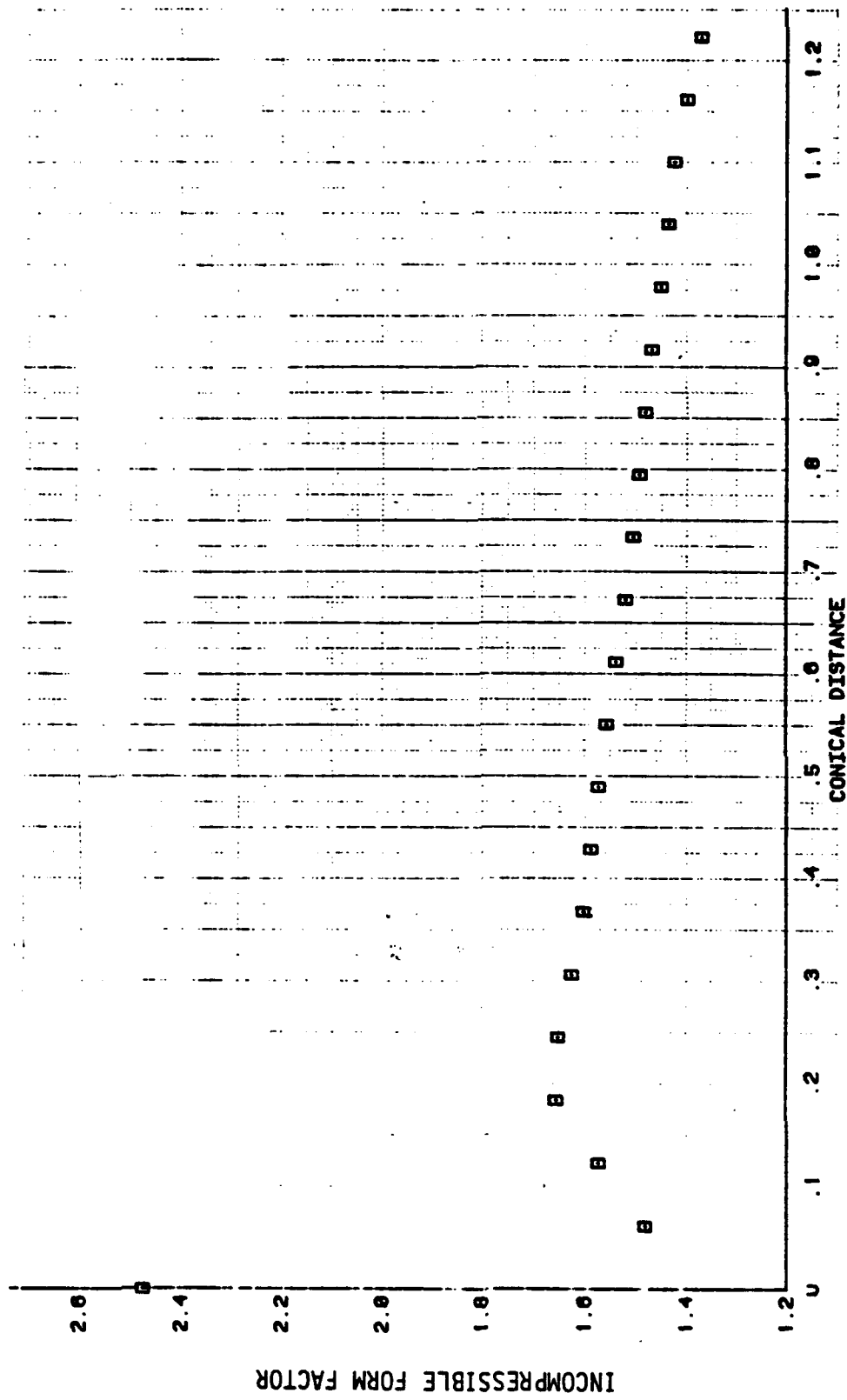

FIGURE 3.1-23 VANE PRESSURE SURFACE INCOMPRESSIBLE FORM FACTOR

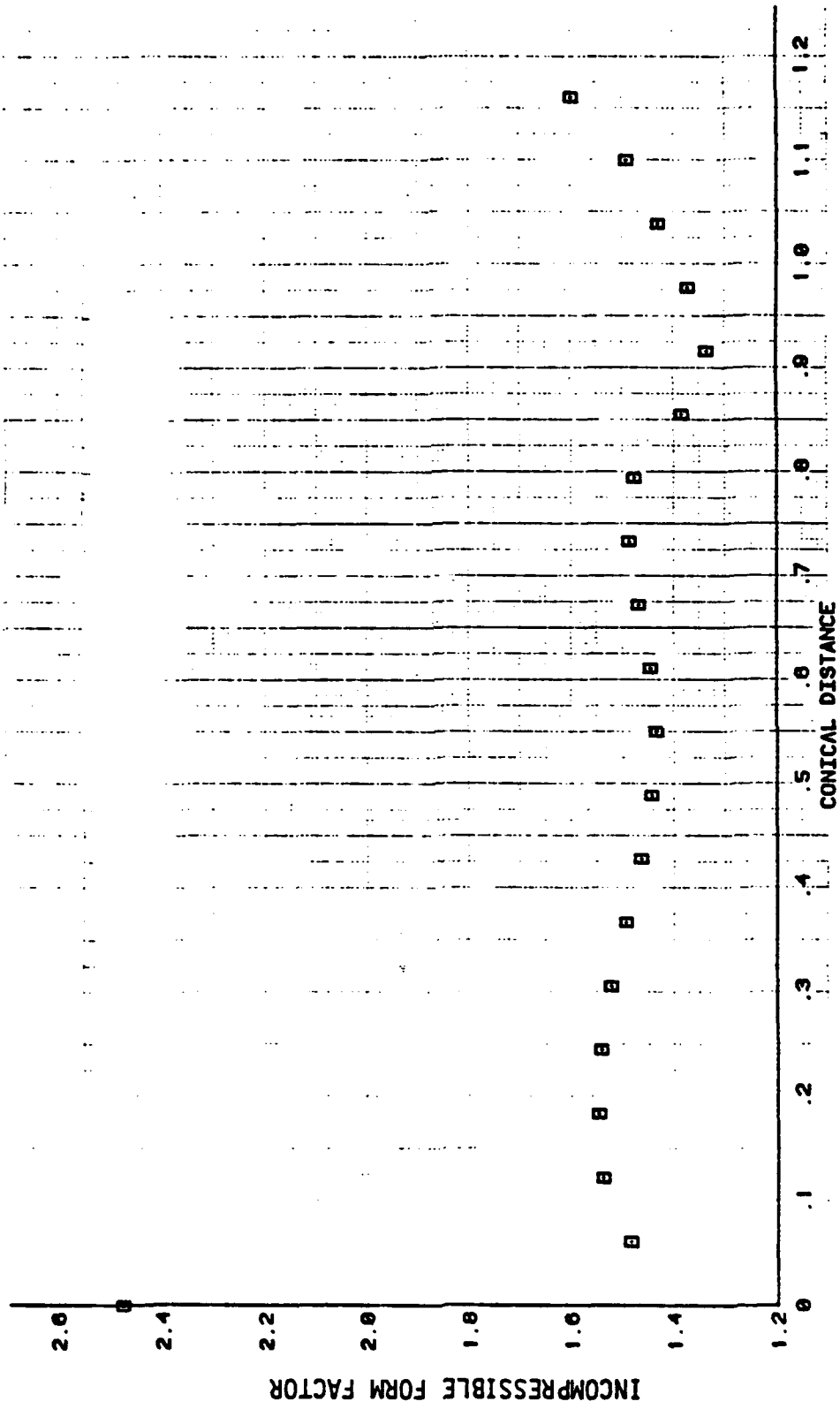

FIGURE 3.1-24 VANE SUCTION SURFACE INCOMPRESSIBLE FORM FACTOR

3.2.1 Coolant Passage Design Constraints

Design of the coolant passages within the the blade is constrained by three considerations:

- o blade internal heat transfer
- o coolant flow pressure losses
- o compatibility with fabrication methods.

Fabrication constraints are by far the most restrictive of the three constraints such that the design process, to a high degree, revolves around the limits placed upon coolant passage geometry. Fabrication is accomplished by the lost wax investment casting process which imposes several constraints on the cooling passage design.

Figure 3.2-1 illustrates the successfully fabricated coolant flow passageway of the previous program and compares it to the cooling path ultimately designed for the rotor considered here. A major feature of the previous design was the flow split between the inducer directed coolant flow and the flow directed to the hub section of the blade. The presence of this split resulted in an inherent uncertainty as to the actual distribution of coolant flow within the blade. This uncertainty is due in part to the lack of appropriate means to adequately inspect the internal structure of the final cast shell. Additional uncertainty arises in modeling the complexities of the coolant flowpath pressure loss characteristics in the presence of rotational forces setup within the blade. Uncertainties in the magnitude of coolant flow within the blade inducer region gave rise to difficulties in interpreting heat transfer data received from testing this rotor.

Fabrication of the rotor in this previous effort was, however, highly successful. Features of this design which contributed to it's success were: the position of the flow inlet on the rotor back-face, the pressure side discharge arrangement, and the internal tie between coolant passages at the flow split position. Also important to this program was the capability of securing the core during the fabrication process via protrusions through the shell at the inducer tip and the hub sections. Both openings are later closed by a braze process on the usable rotor casting.

Fabrication constraints which limit the allowable core passage geometries are in general based upon previous casting experience. These are summarized below:

- o minimum core cross sectional area (0.040 square inches)
- o maximum length of unsupported core section (dependent upon thickness of section)
- o minimum core and wall metal thicknesses (0.020inch)
- o minimum pin fin diameter (0.040 inch).

These criteria apply specifically to a nominal 8 inch diameter rotor. Heat transfer considerations in general call for complete coverage of the blade surface with adequate internal convective coefficients obtained via appropriate combinations of flow velocity, passage width, and wall surface roughness treatment.

Army HTRT (1981)
 5.2 lbm/sec
 12:1 Compressor
 2300 F RIT
 2080 ft/sec tip speed
 12 blades

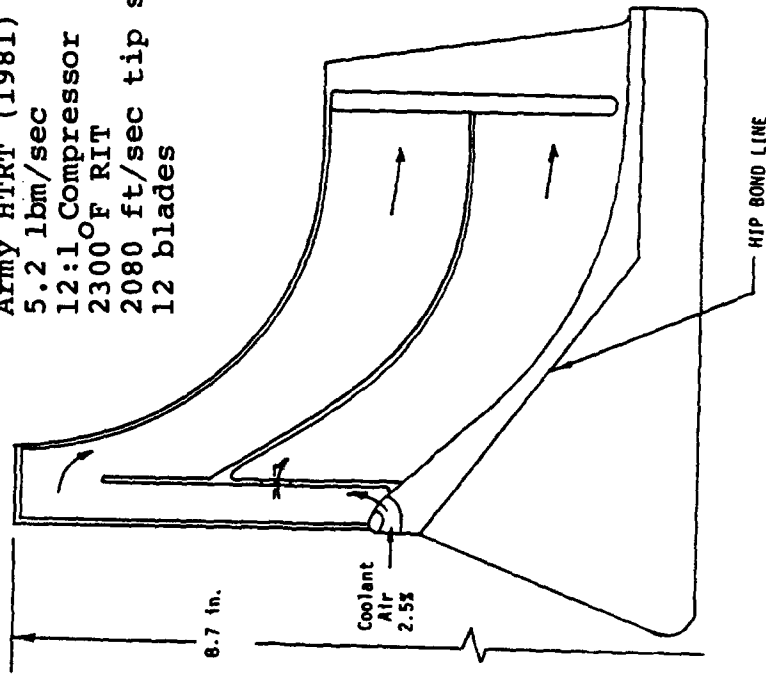

NASA HTRT
 4.5 lbm/sec
 14.4:1 Compressor
 2300 F RIT
 2170 f/sec Tip Speed
 13 blades

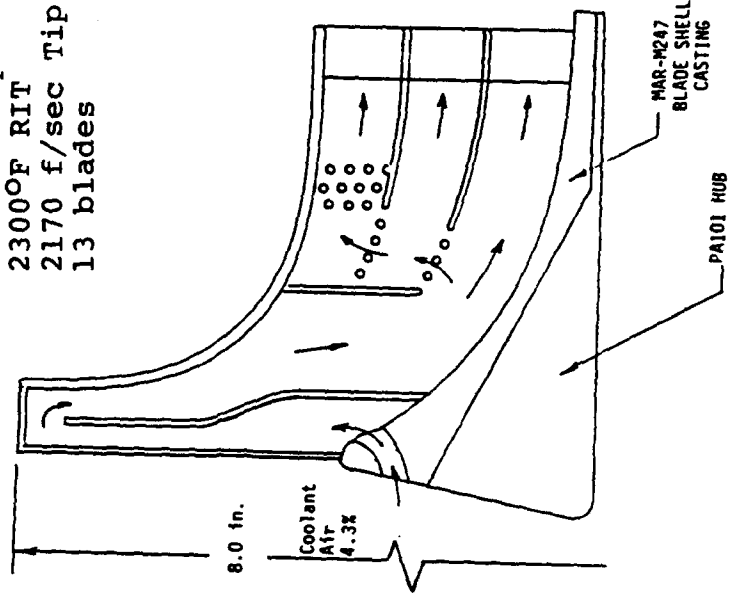

FIGURE 3.2-1 COMPARISON: PREVIOUS COOLANT PATH WITH PRESENT STUDY

Coolant flow pressure loss is limited by available coolant pressures from compressor bleed and the position at which the coolant air is discharged. It is the mutual satisfaction of these considerations which results in a successful design.

3.2.2 Selection of Coolant Passageway Configuration

The design process consisted of selecting cooling concepts, ranking of concepts according to compatibility with the established constraints, examining the ability of each to perform the required cooling, selecting the final conceptual scheme, and finally determining the detailed coolant flow path design. Figure 3.2-2 presents concepts initially examined along with perceived benefits and deficiencies. Due to the goal of the program to produce a rotor capable of heat transfer test under well defined conditions, the benefit of producing a design with well defined internal flow characteristics was emphasized.

Figure 3.2-1 presents the resulting concept used for the detailed design effort. Of key importance to this concept was eliminating the branching coolant flow within the important inducer section. It was, however, determined that branching was required within the exducer section in order to achieve an even distribution of coolant air discharge, thus providing cooling to the trailing edge region. Constraints on minimum wall and core thickness preclude the use of trailing edge injection without excessively thickened blade trailing edges. Thick trailing edges result in excessive turbine efficiency penalties due to high flow blockage.

3.2.3 Detailed Coolant Flow Path Design

Design of the detailed area distribution and branching coolant flow circuitry was accomplished using a detailed internal coolant flow model as indicated in Figure 3.2-3. The method utilizes 1 dimensional flow modeling within the blade passages via discrete elements which include frictional and bend losses, branching losses, and "pumping effects" (changes in pressure due to fluid movement within the rotating passage). Loss coefficients for each of the flow elements were determined from correlations available in the open literature. Wall and coolant temperature changes due to both heat transfer and rotational effects and coolant flow preswirling (tangential onboard injection) were also similarly modeled.

The flow solution summarized in Figure 3.2-4 demonstrated that pumping effects are extremely influential within the flow path. These forces cause significant compressions and expansions of the coolant flow with change in radius. Thus in order to achieve a uniform distribution of coolant air at the discharge, the circuitry employing pin fins and segmented exit passages was devised. The placement of pin fins within the coolant passage is designed to provide a well defined flow resistance in the radially outward direction to counter the pumping effect. The pumping force tends to drive the flow radially outward to the outer most coolant slot. The series nature of the resistance is designed to provide a cumulative resistance with increasing radius to counter the cumulative effects of rotation.

ADVANTAGES:

- POSITIVE INDUCER FLOW
- POSITIVE INDUCER FLOW
- GOOD FLOW DISTRIBUTION
- POSITIVE INDUCER FLOW
- ADJ. FLOW DISTRIBUTION

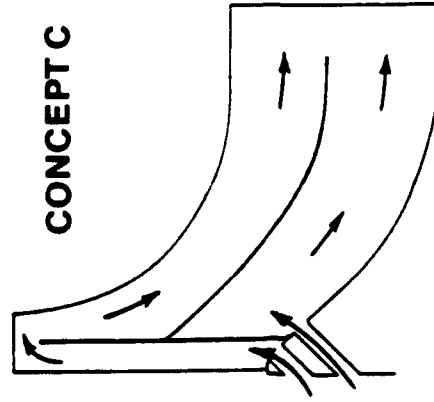
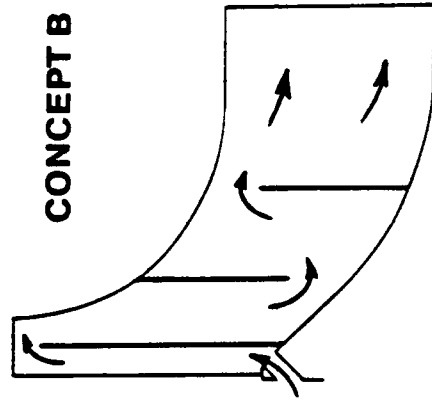
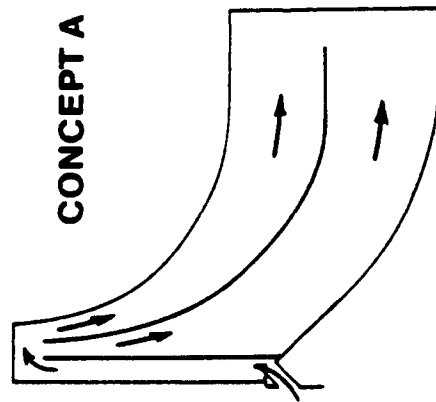

DISADVANTAGES:

- FLOW SPLIT NOT PREDICTABLE
- SLENDER CORE
- POOR CASTABILITY
- POOR CASTABILITY
- HUB COMPLEXITY

FIGURE 3.2-2 COOLANT FLOWPATH CONCEPTS

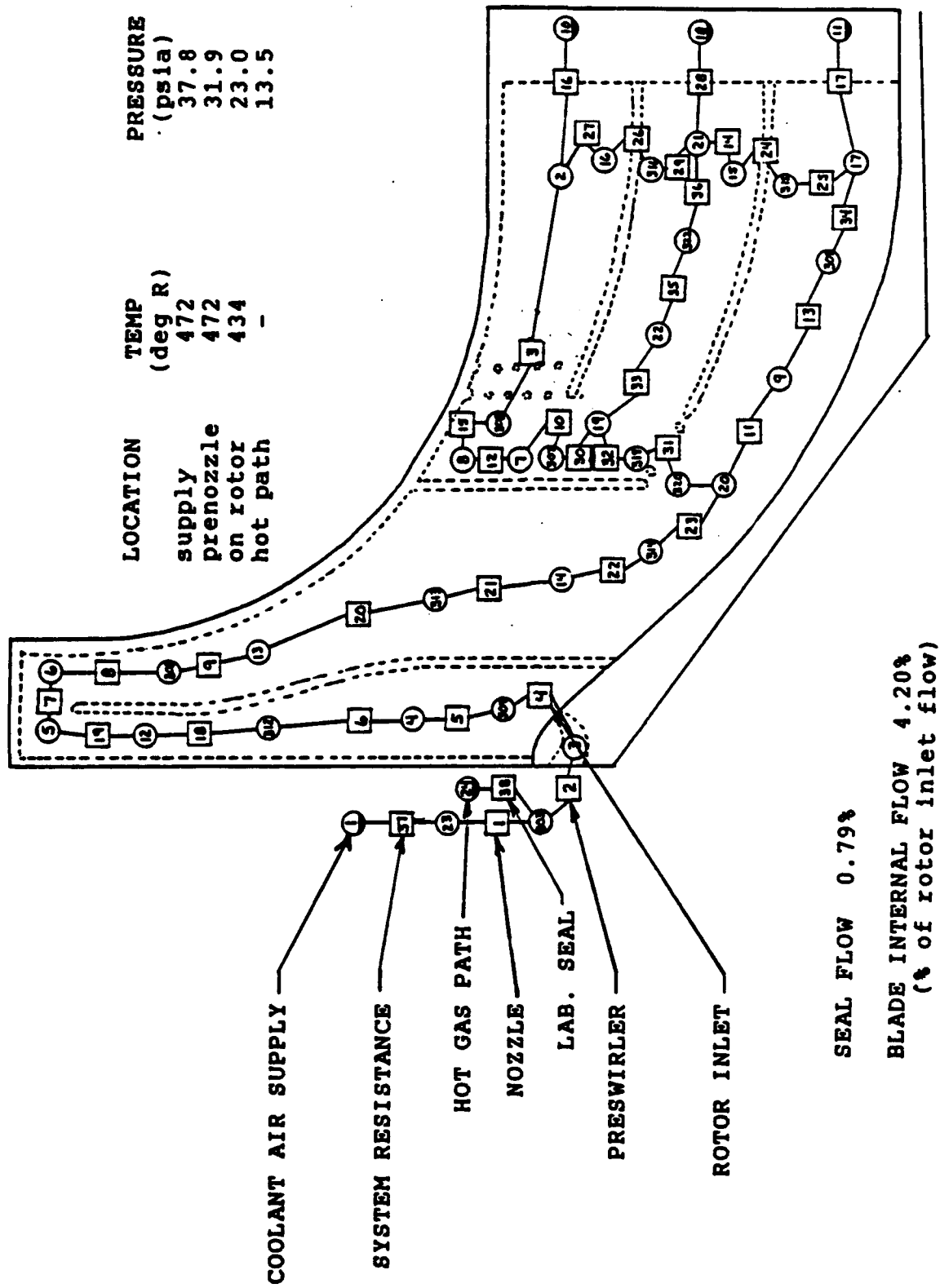
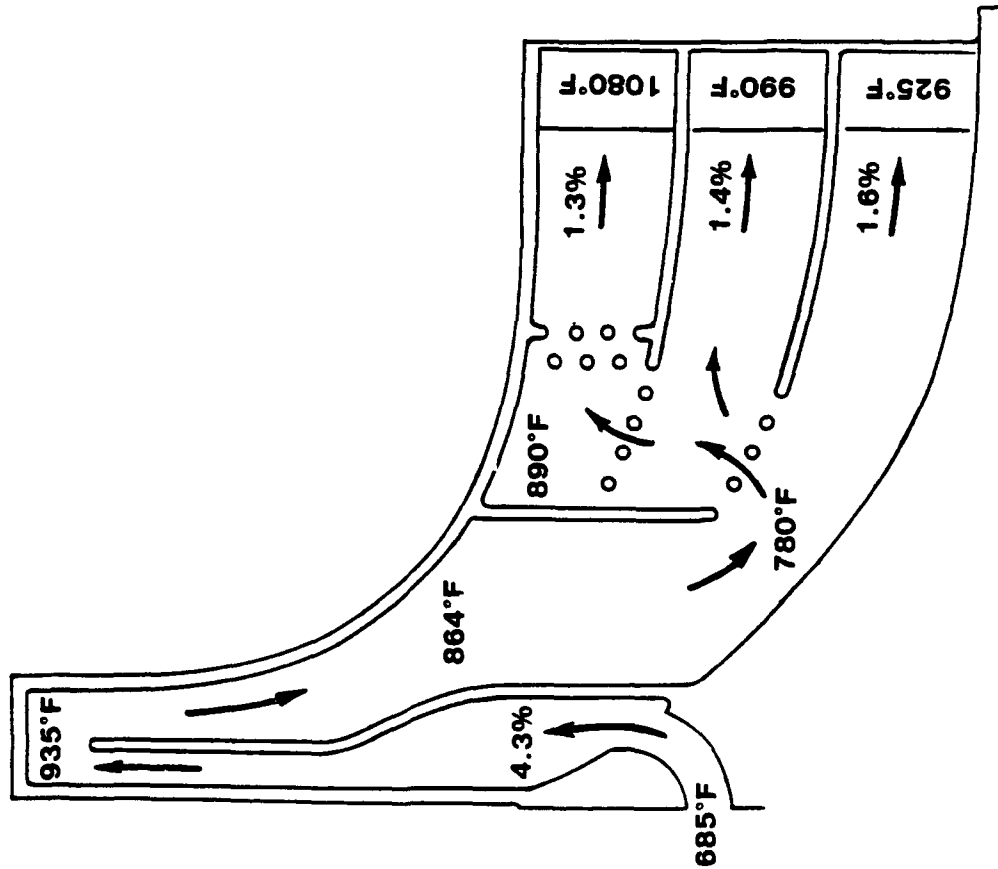

FIGURE 3.2-3 ROTOR INTERNAL COOLANT FLOWPATH MODEL



INTERNAL FLOW MODEL INCLUDED EFFECTS OF

- HEAT TRANSFER
- COMPRESSIBILITY
- FRICTION, TURNING, & BRANCHING
- ROTATION

ADVANTAGES:

- POSITIVE INDUCER FLOW
- GOOD FLOW DISTRIBUTION
- GOOD CASTABILITY

FIGURE 3.2-4 FINAL COOLANT FLOWPATH DESIGN

The rotational effects are sufficient to result in predicted temperature decreases in the bulk coolant flow for radially inward legs even though the fluid continues to pickup heat. Final design of the coolant flow path and determination of required coolant air flow rates was determined by an iterative process involving heat transfer analyses described in section 3.3 below.

An additional benefit is derived by selecting a design in which the entire coolant flow is routed through the rotor tip region. The design results in coolant passage tip region flow velocities giving high convective heat transfer coefficients. This eliminates the need for the geometric complexity of heat transfer enhancement through the use of discreet wall roughness.

Results of the design work resulted in the baffle and passage thickness pattern of Figure 3.2-5. Representation of slices of the blade showing final coolant passage width distributions are shown in Figure 3.2-6. The trailing edge discharge configuration selected closely follows cooled vane design technology and minimizes blade trailing edge thickness. The use of choked flow at the discharge point is, in this case, not feasible due to the minimum core size constraint. Blade angle distributions shown are the result of the comprehensive rotor aerodynamic design described above.

In addition, a preswirler was designed as a modification to the NASA test rig. The function of the preswirler is to efficiently bring the coolant air up to wheel speed and hence provide coolant air to the blade at the lowest possible temperatures, a benefit to either an engine or a rig design. The basic rig without preswirler is shown in Figure 3.2-7. The details of the preswirler design are presented in Figure 3.2-8 and 9.

3.3 Heat Transfer and Stress Analysis Results

As part of the detailed design process, 2-D and quasi 3-D finite element heat transfer and stress analyses were made of the engine rotor. Coolant flow values and coolant passage geometry were selected to give acceptable temperatures and material strengths within the dual property rotor in meeting rotor life requirements. Analysis techniques parallel those of the Task I effort previously reported.

3.3.1 Heat Transfer Results

A comprehensive analysis of the rotor design at 2300 °F (program requirements) was completed. Figure 3.3-1 presents metal temperatures at design conditions for the 2-D analysis. The results indicated that cooling was adequate in terms of peak blade (50 degrees below Task 1 values) and hub temperature (below 1200°F) requirements. Figure 3.3-2 gives similar results for the analysis of the transient analysis used for LCF determination. In addition heat transfer calculations evaluating design feasibility at 2500°F were also completed. Results of the 2-D heat transfer analysis are shown in Figure 3.3-3. Rotor internal blade cooling was set at 4.3% of rotor inlet flow. In addition, a 1% hub film cooling and a 0.5% bore cooling was included.

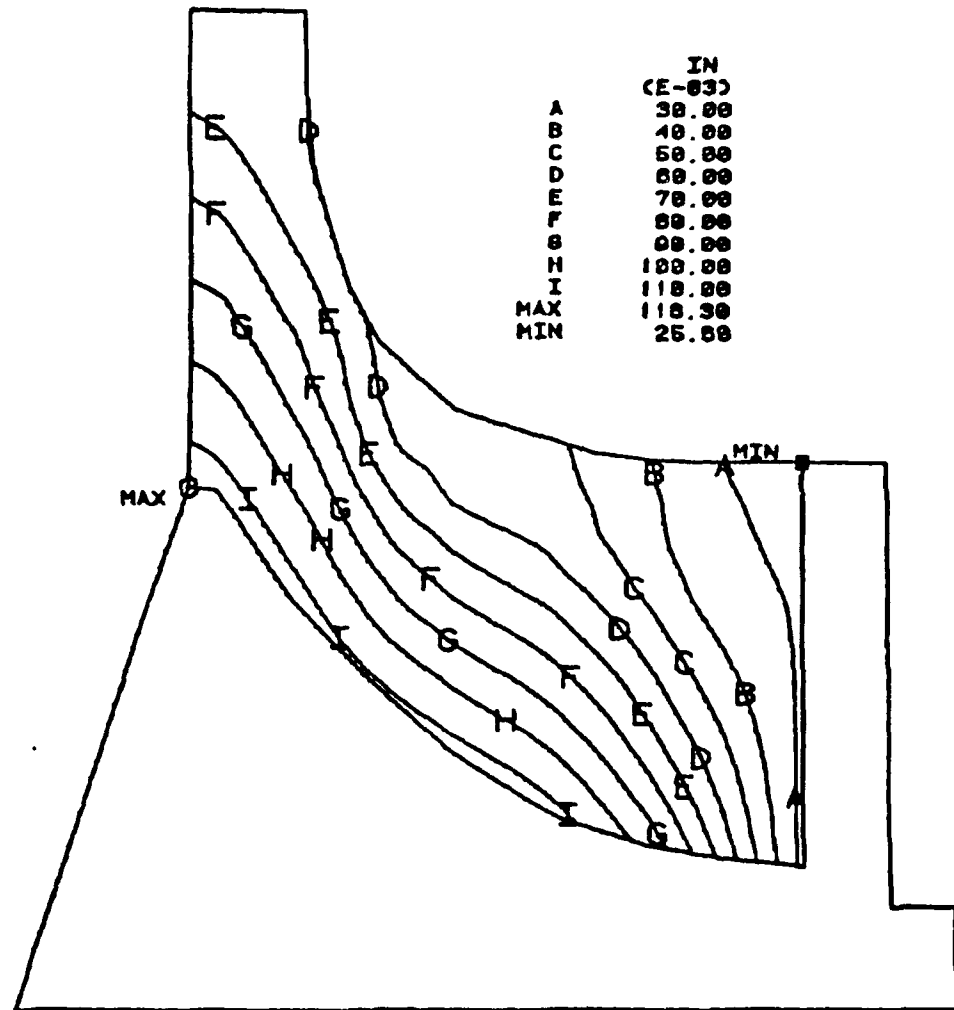

FIGURE 3.2-5 NASA HTRT COOLANT FLOWPATH
NORMAL THICKNESS DISTRIBUTION

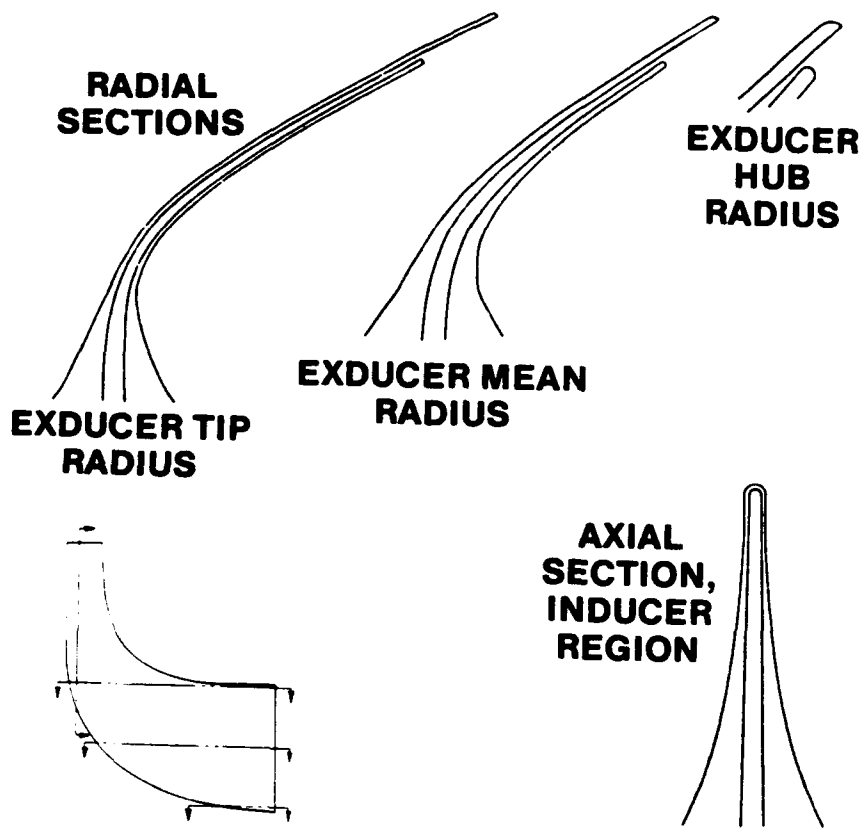
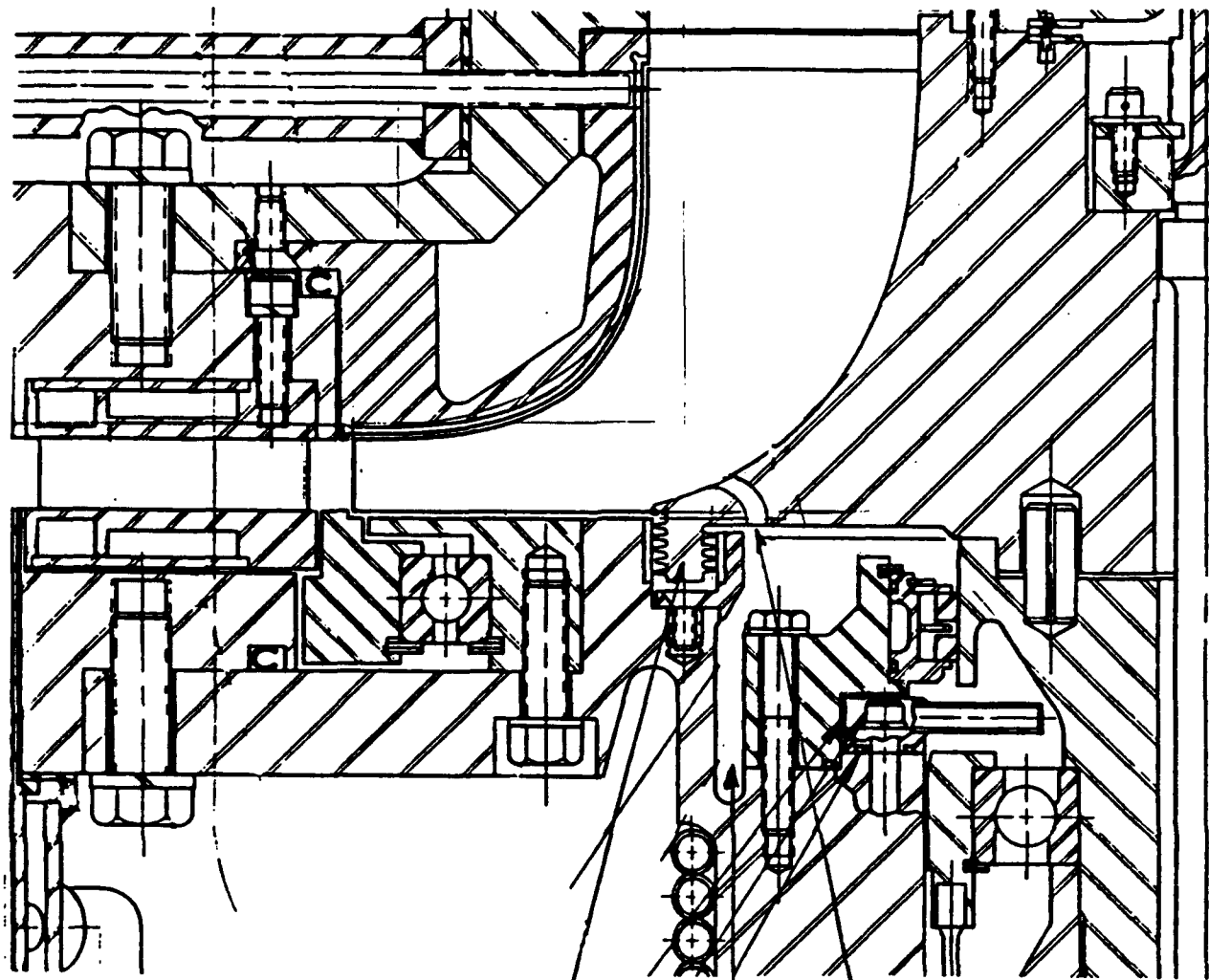

FIGURE 3.2-6 COOLANT FLOWPATH WITHIN BLADE



NASA RIG AS DESIGNED

ROTOR SEAL

COOLANT AIR SUPPLY CAVITY

BLADE COOLANT AIR ENTRANCE

FIGURE 3.2-7 NASA COOLED HTRT RIG

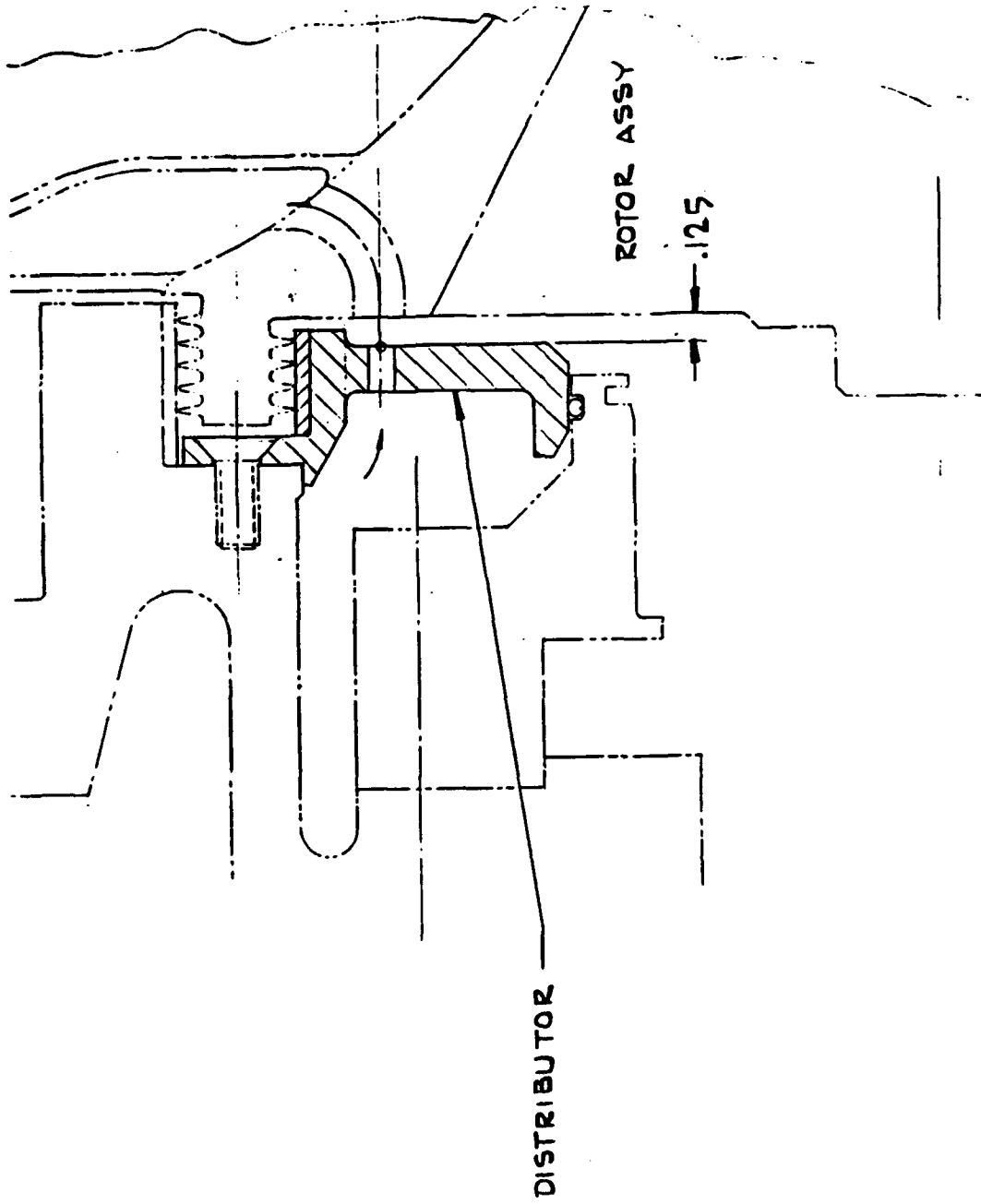

FIGURE 3.2-8 PRESWIRLER DESIGN MODIFICATION TO NASA RIG

PRESWIRLER DETAILS

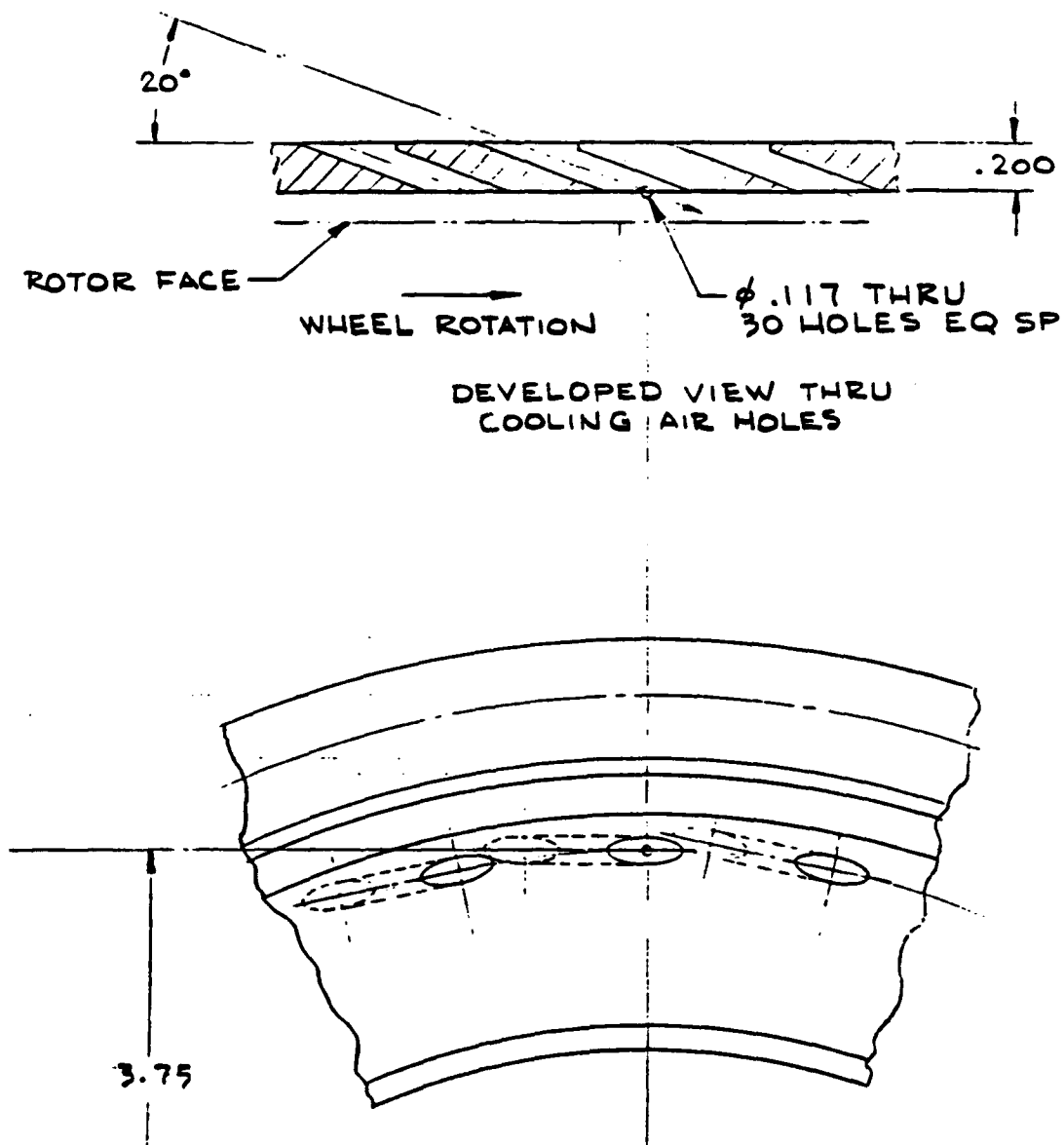
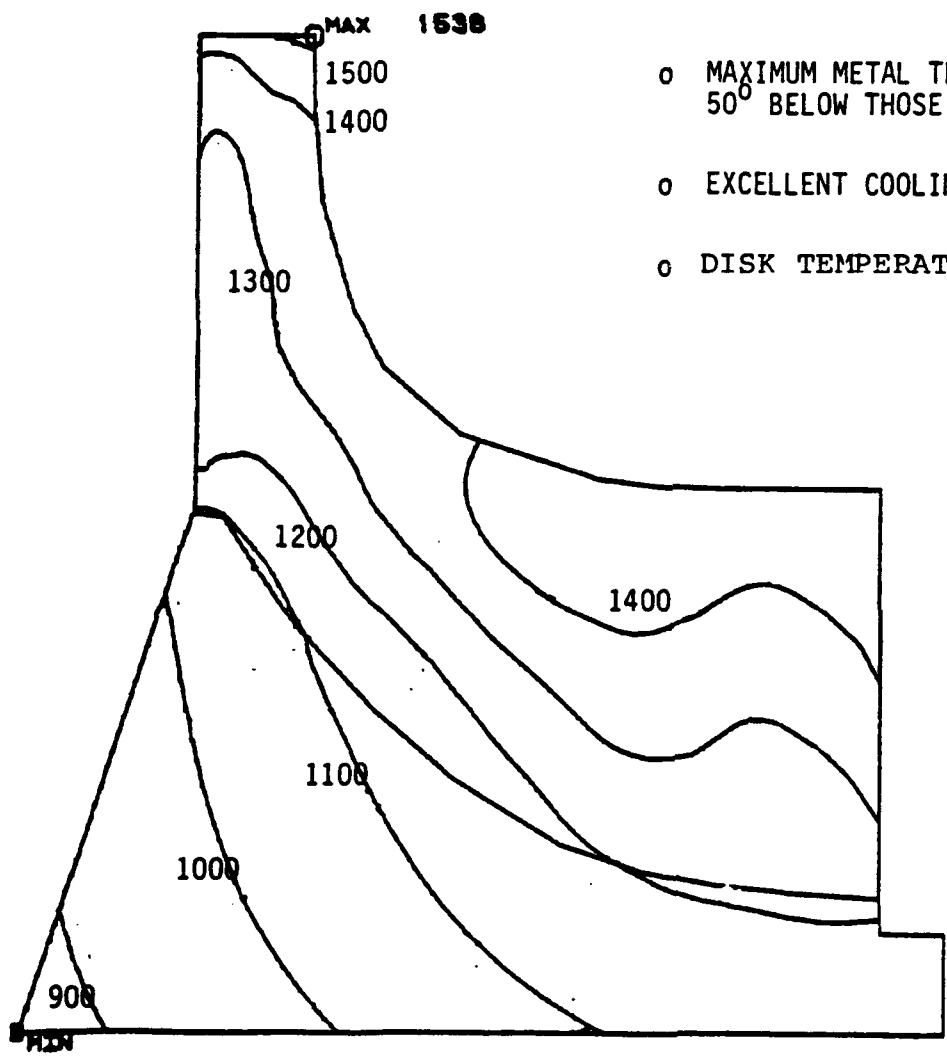

FIGURE 3.2-9 PRESWIRLER DETAILS



- o MAXIMUM METAL TEMPERATURES
50° BELOW THOSE FOR TASK I DESIGN
- o EXCELLENT COOLING OF INDUCER REGION
- o DISK TEMPERATURE \leq 1200°F

FIGURE 3.3-1 STEADY STATE BLADE METAL TEMPERATURES AT DESIGN CONDITIONS, RIT = 2300°F

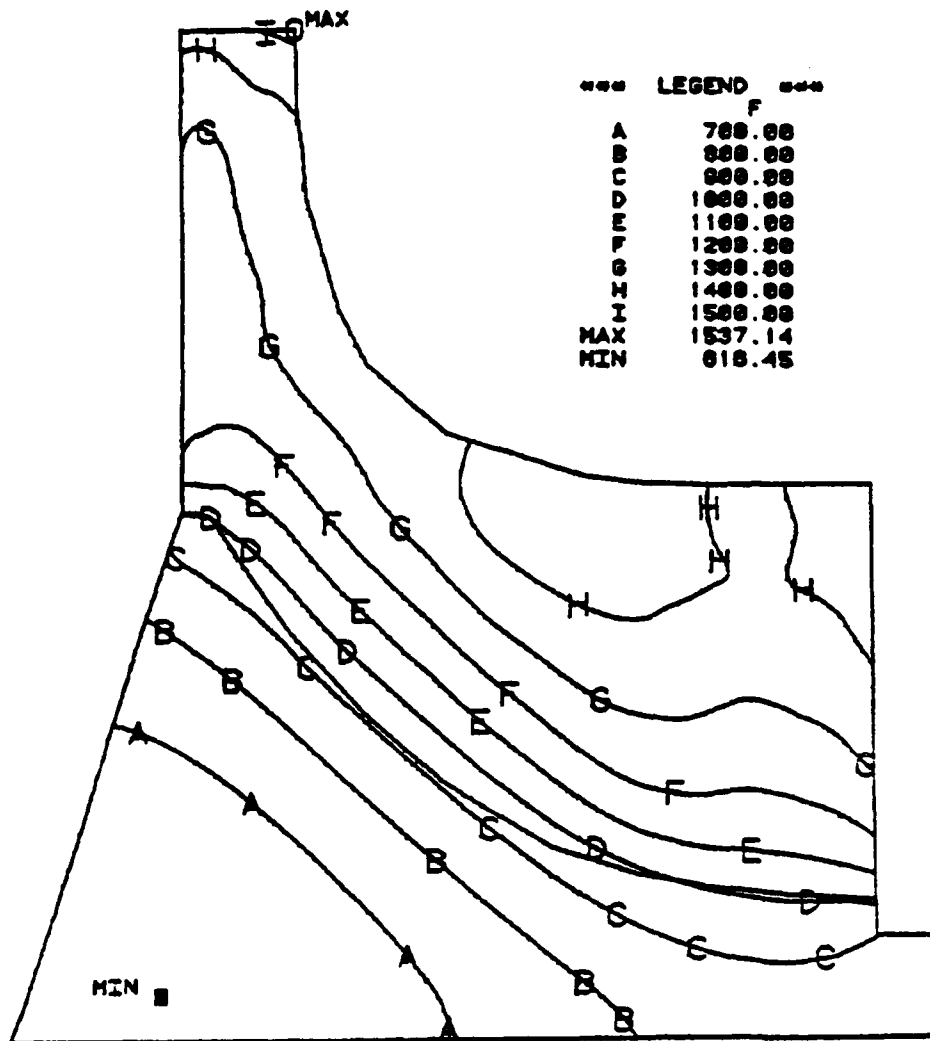

FIGURE 3.3-2 IDLE TO IRP TRANSIENT TEMPERATURE PROFILE AT TIME = 20 sec.

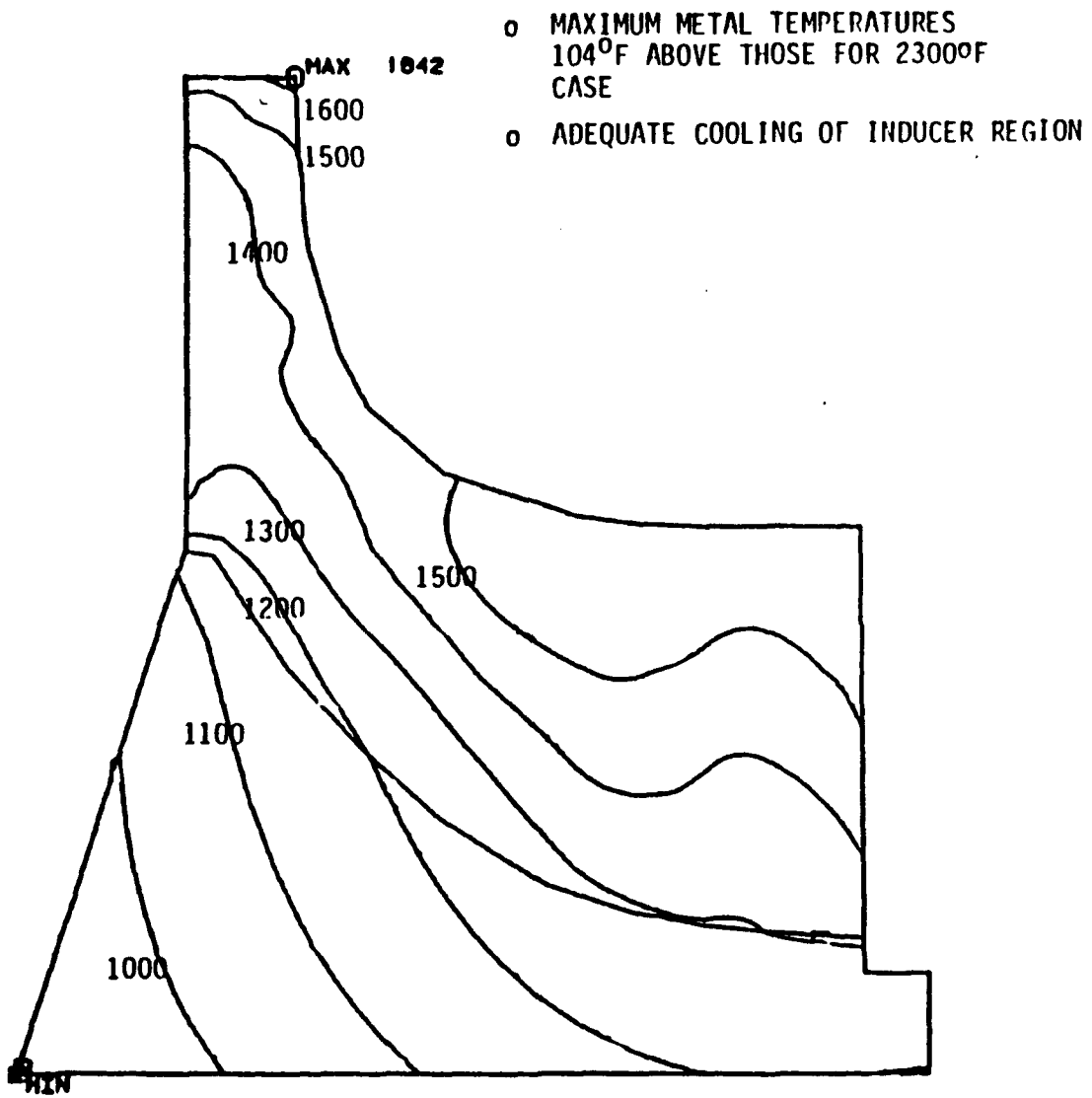

FIGURE 3.3-3 STEADY STATE BLADE METAL TEMPERATURES
AT 2500°F RIT

Significant features of these heat transfer results are the uniformity of blade temperatures, with a peak value of 1642 °F, adequate for the Mar M247 material in the tip region. Peak temperatures within the PA101 material are in the 1260 °F range ensuring retainment of suitable material properties within the hub. Thermal gradients within the hub are relatively low giving rise to low steady state thermal stresses in the hub.

3.3.2 Stress Analysis Results

Determination of low cycle fatigue (LCF) life is of prime concern for a radial turbine rotor particularly with a center bore hole. LCF life assessment was made by modeling transient heat transfer performance of the rotor during the period of acceleration from idle to design point conditions. Results for the time interval giving rise to maximum thermal gradients within the rotor serve as input to the stress analysis. Stress modeling based upon results for the 2500 F case are shown in Figure 3.3-4. As expected, maximum stresses existed at the hub bore. A summary of the results of the complete stress analysis is shown in Table 3.3-1. The results show that the rotor exceeds all life requirements based on anticipated 10 year advances in metal technology.

3.4 Test Rig Rotor Scaling

Analysis of heat transfer test results from the previous Army sponsored effort demonstrated the need for a test rotor capable of measuring the hot gas heat transfer conditions imposed on a radial turbine rotor. A key component to this work is the comprehensive testing of the final rotor design. This testing is designed to demonstrate turbine aerodynamic performance and coolant flow path performance. At the same time it will provide fundamental data on heat transfer requirements of the radial turbine blading.

Warm turbine testing will be accomplished utilizing a 1.4 X scaled up rotor operated with turbine inlet temperatures near 600 °F. Scaling on key turbine parameters; isentropic spouting velocity ratio and Reynolds number, results in a test conditions as shown in Table 3.4-1 for the 14.4 inch diameter rotor.

A limited analysis was made of test conditions for which the radial turbine may be operated in a warm air facilities to simulate engine operating conditions. Figures 3.4-1 through 4 present convection coefficients and adiabatic wall temperatures for the test conditions. Calculated metal temperatures are shown in Figure 3.4-5. Coolant air temperatures are shown in Figure 3.4-6.

TABLE 3.3-1 SUMMARY OF ROTOR LIFE CRITERIA
AT TWO ROTOR INLET TEMPERATURES

ROTOR LIFE CRITERIA ARE SATISFIED AT 2500°F RIT

SUMMARY OF STRESS ANALYSIS RESULTS

<u>CRITERIA</u> <u>(3σ)</u>	<u>REQUIRED</u>	<u>COMPUTED</u>	
		2300°F	2500°F
.2 CREEP	1,000 HRS	10,870 HRS	> 1,900 HRS
BURST SPEED	71,300 RPM (130%)	79,300 HRS	79,300 HRS
LOW CYCLE FATIGUE	6,000 CYCLES	8,398 CYCLES	6,367 CYCLES
		(3,880 CYCLES W/O 10% MATERIALS IMPROVEMENT)	(3,248 CYCLES W/O 10% MATERIALS IMPROVEMENT)

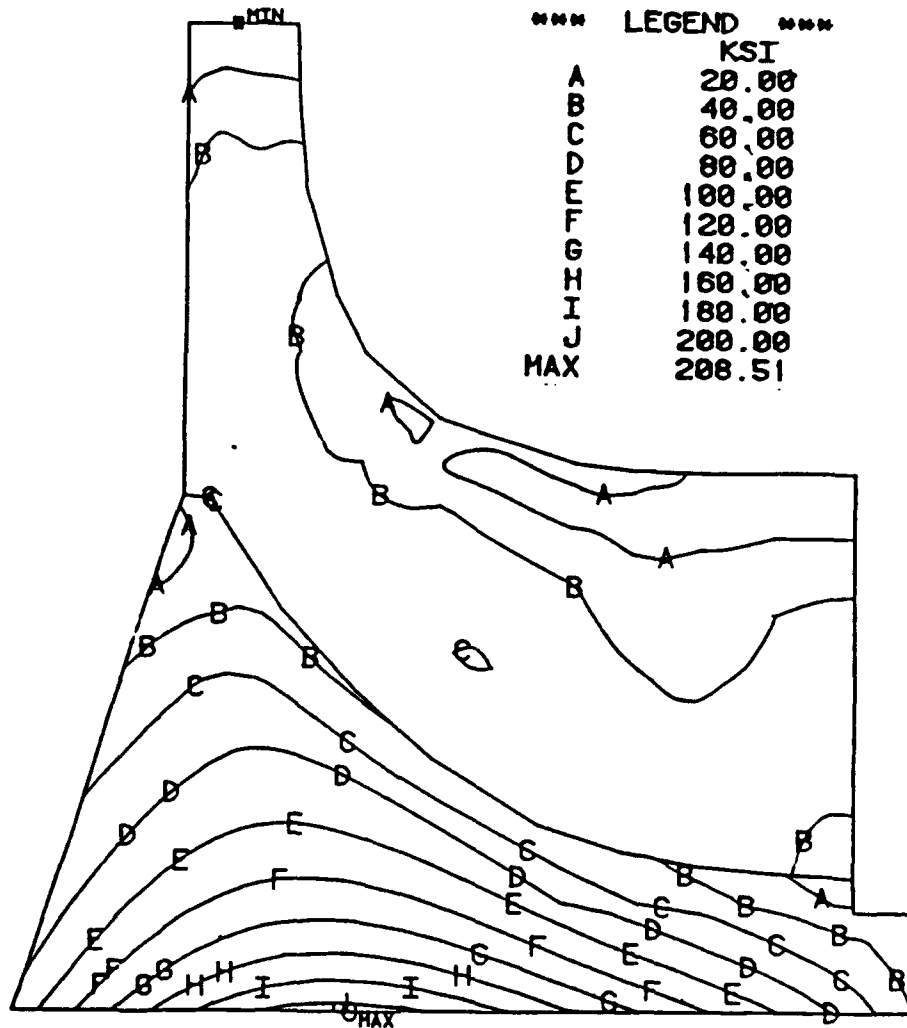

FIGURE 3.3-4 IDLE TO IRP TRANSIENT EQUIVALENT STRESS FOR 2500°F RIT

TABLE 3.4-1 TEST RIG CONDITIONS MODELING ENGINE ROTOR PERFORMANCE

PARAMETERS	ENGINE	RIG
ROTOR INLET TOTAL TEMPERATURE °F		600
ROTOR EXIT TOTAL TEMPERATURE °F	1674	306
INLET TOTAL PRESSURE - psia	200	37.8
ROTOR EXIT TOTAL PRESSURE - psia	54.6	9.5
EQUIVALENT FLOW - lbm/sec	0.799	2.567
ACTUAL FLOW - lbm/sec	4.559	4.593
EQUIVALENT SPEED - RPM	27,262	15,146
ACTUAL SPEED - RPM	61,900	21,574
EXPANSION RATIO, T-T	3.66	3.97
$U_T / \sqrt{2gJ\Delta h_{1S}}$	0.661	0.661
POWER - IIP	1191	471
TORQUE - ft-lbf	102	116
REYNOLDS NUMBER	3.81×10^5	2.81×10^5
SPECIFIC SPEED	62.2	62.9
ROTOR DIAMETER - in.	8.021	14.4
ACTUAL ROTOR COOLANT FLOW-lbm/sec	0.196 (4.3%)	0.193
ROTOR COOLANT SUPPLY TEMP - °F	769	12
$\Delta H/\theta_C$ - Btu/lbm	34.9	

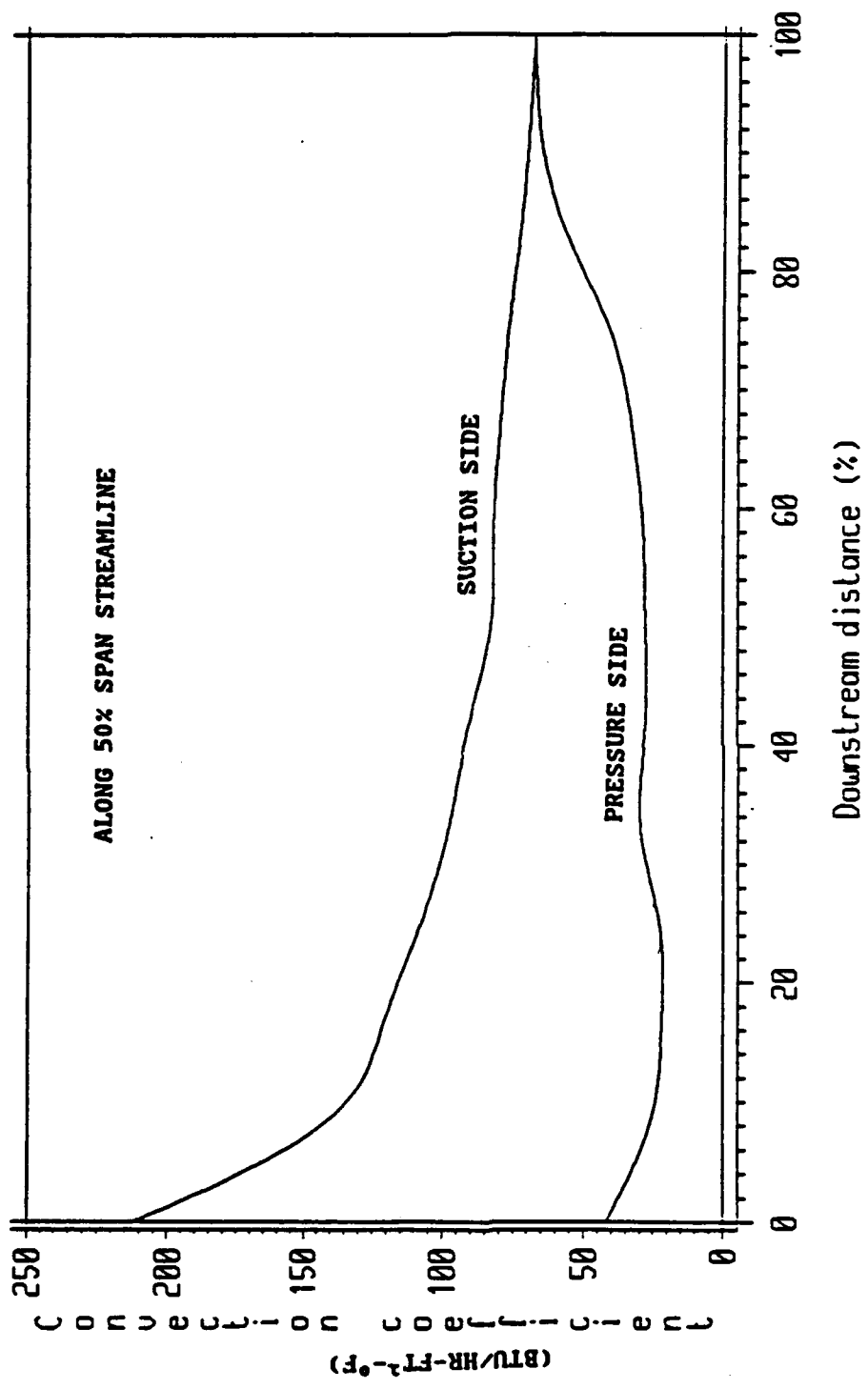

FIGURE 3.4-1 HOT SIDE GAS PATH CONVECTION COEFFICIENTS, RIG TEST CONDITIONS

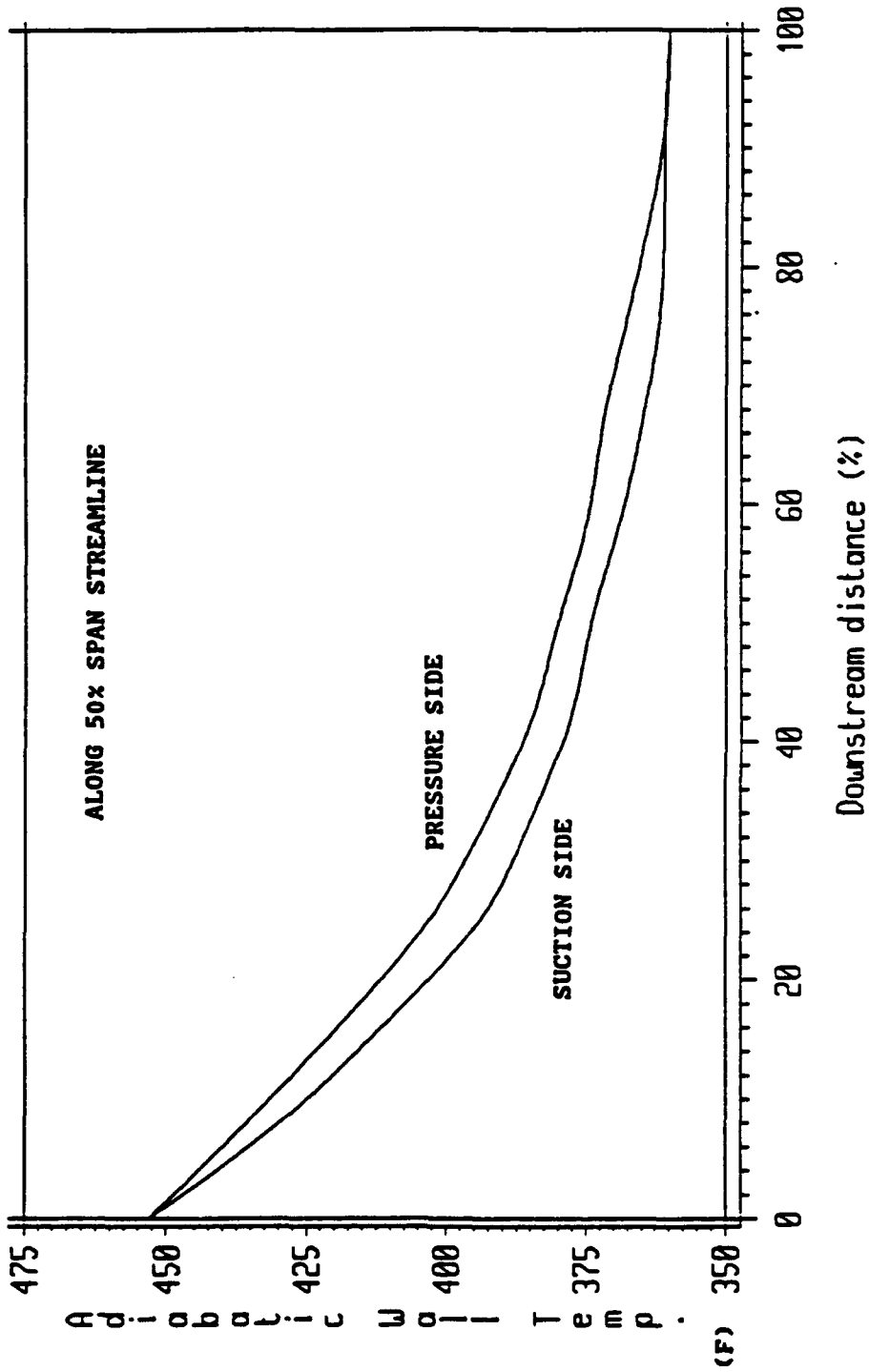

FIGURE 3.4-2 GAS PATH ADIABATIC WALL TEMPERATURES, RIG TEST CONDITIONS

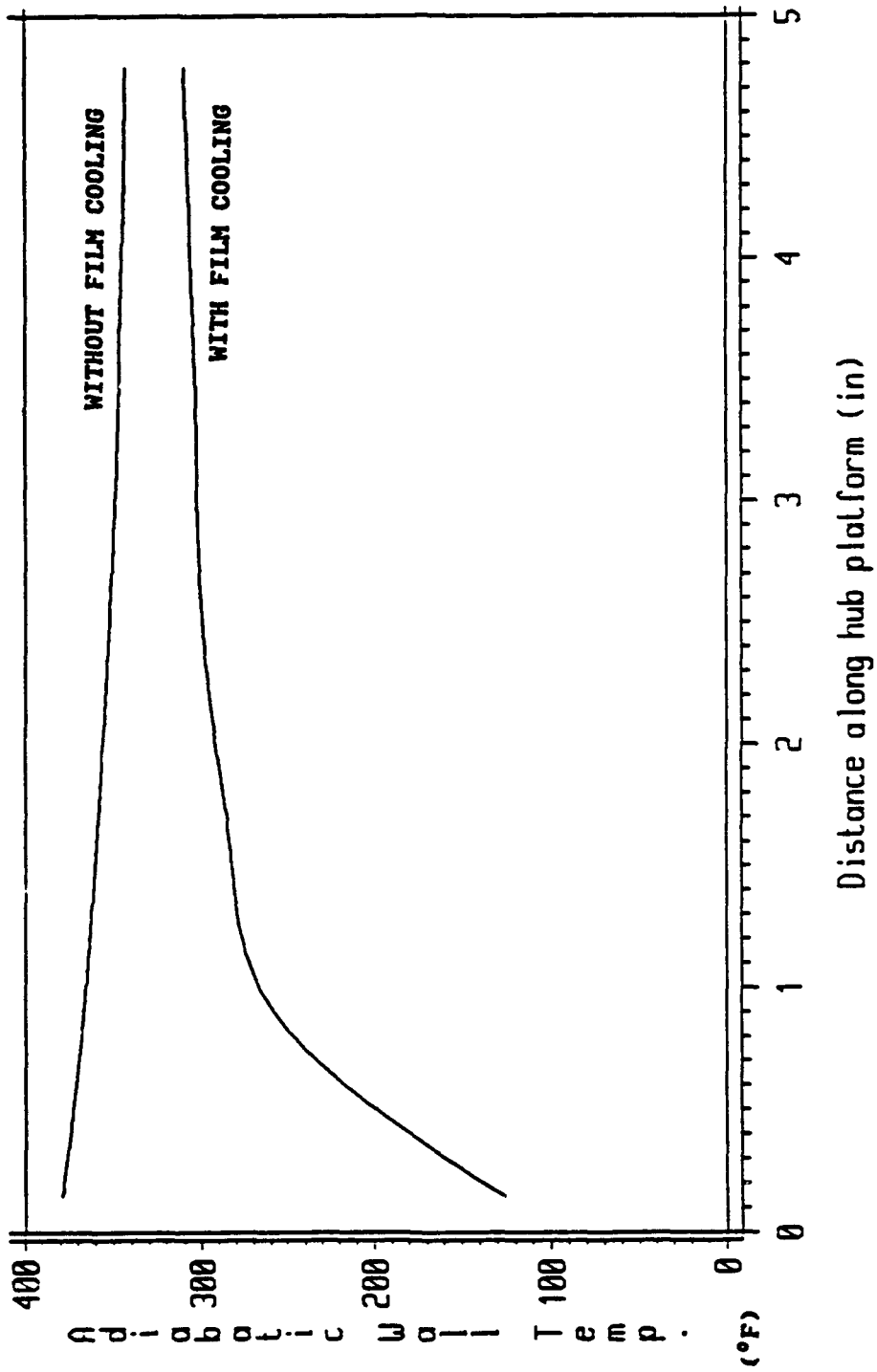

FIGURE 3.4-3 HUB PLATFORM ADIABATIC WALL TEMPERATURES, RIG TEST CONDITIONS

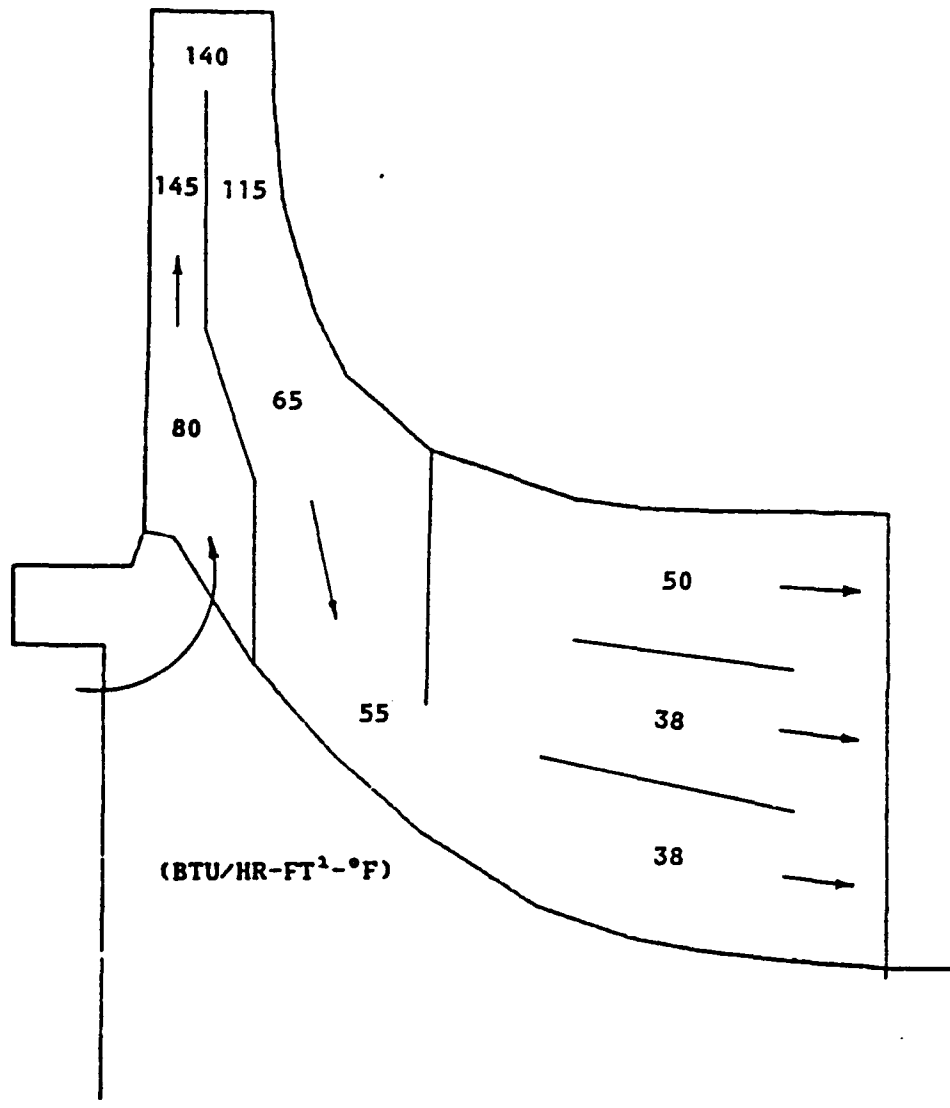

FIGURE 3.4-4 INTERNAL COOLING CONVECTION COEFFICIENTS,
RIG TEST CONDITIONS

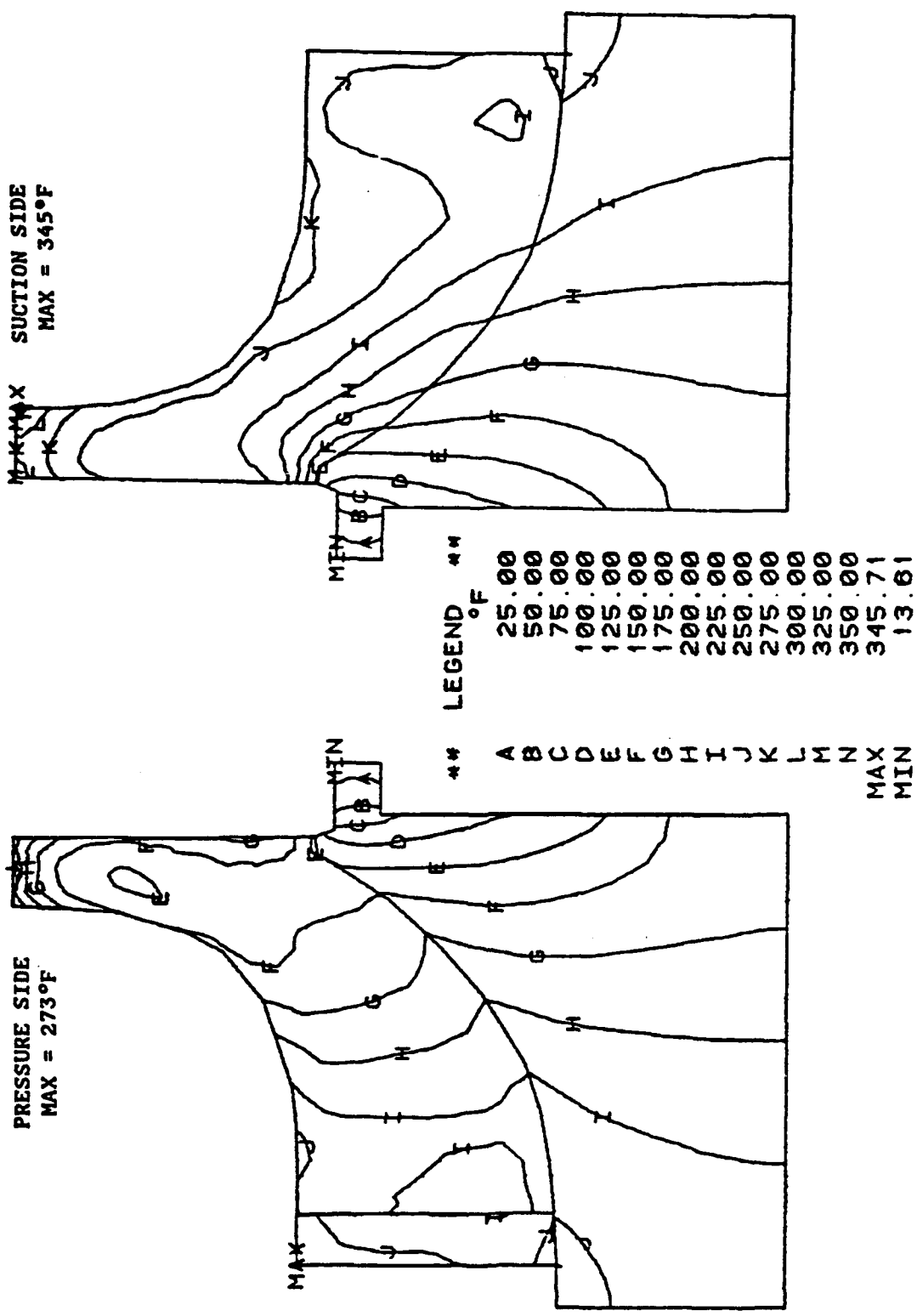

FIGURE 3.4-5 CALCULATED METAL TEMPERATURES, RIG TEST CONDITIONS

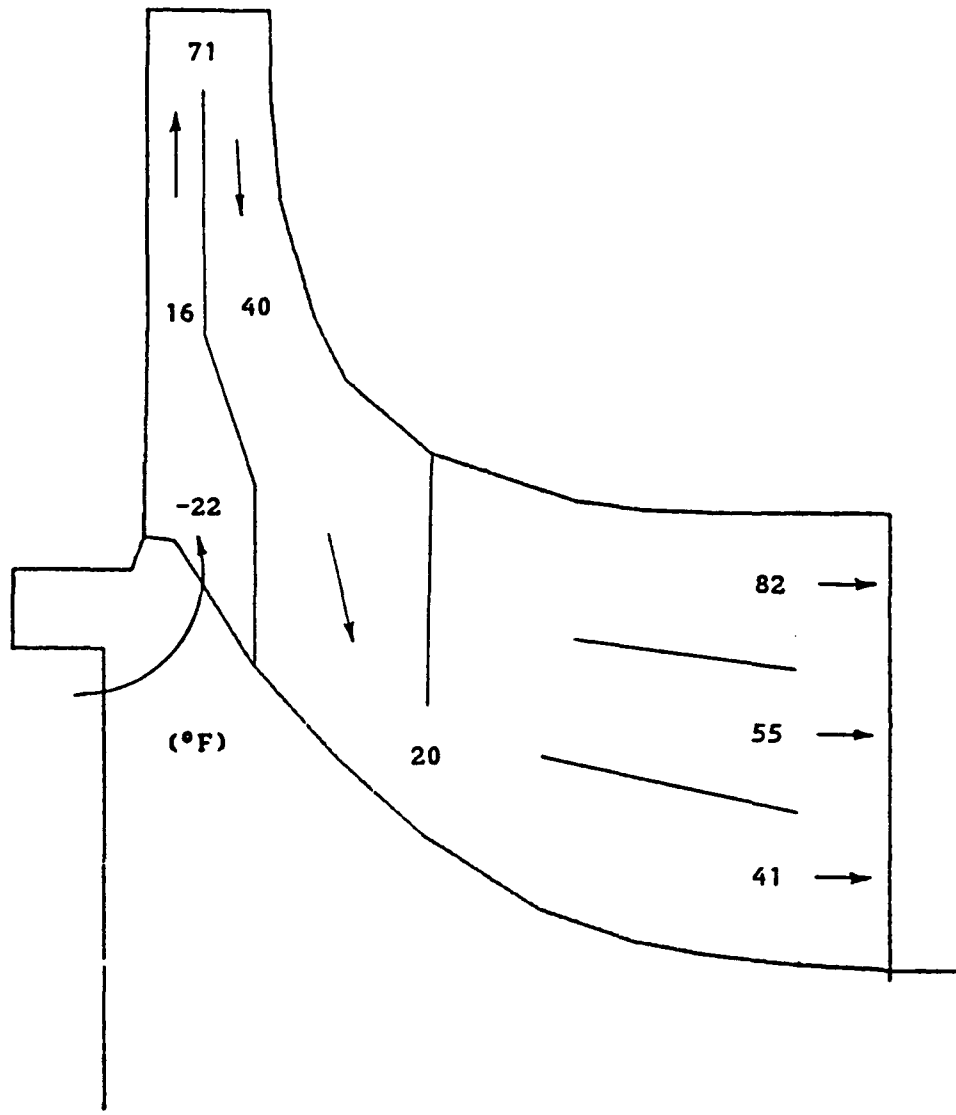

FIGURE 3.4-6 CALCULATED COOLANT TEMPERATURES,
RIG TEST CONDITIONS

3.5 Test Rotor Fabrication

Two 13 bladed test rotors were fabricated. A solid rotor, fabricated without coolant passages, provides the capability of detailed aerodynamic testing including rotating static pressure measurements and is shown in Figure 4.5-1. A cooled or "hollow" rotor, fabricated with cooled passages in place, was designed for extensive heat transfer testing. Because of the large number and type of rotor instrumentation, two test rotors are required. Both rig rotors are designed to be compatible with the NASA Lewis Research Center's warm turbine test facility. Because of the reduced rotor stress loading at rig operating conditions, both rotors are designed to be single alloy castings, thus omitting the required fabrication of the PA101 hub and use of the HIP-bonding process. Fabrication of the cooled rotor was determined to be completely compatible with this fabrication technique.

Fabrication of the hollow rotor was accomplished using the ceramic cores of the type shown in Figure 3.5-2. Details of the coolant flow path within the highly wrapped blade are shown for both the blade pressure and suction surfaces. The wax replica of the cooled rotor with cores in place is shown in Figure 3.5-3. Core-mold attachment points are shown at the inducer tip and coolant discharge slot. Also shown are ceramic protrusions at the coolant inlet locations. A second view is shown in Figure 3.5-4.

Figures 3.5-5 and 6 show the final machined casting with integral cooling passages. A better appreciation of the cooling passages within the casting is gained in Figures 3.5-7 through 11 showing a casting cut to reveal the interior geometry. It should be noted that the rotor cut to reveal interior geometry differs in one minor detail to the delivered rotor shown in Figure 3.5-5. The two "half-pins" in the second row of pin fins in the outer passage of the exducer were omitted in the rotor of Figure 3.5-7 through 11. This change in core tooling was made during late attempts to improve fabrication accuracy which proved unnecessary. No rotors cast in this late serial number group were final machined.

3.6 Rotor Spin Test

Prior to delivery of the machined solid bladed and air cooled metal rotors, a spin test was conducted to demonstrate mechanical integrity. Figures 3.6-1 and 2 show the rotor after successful test. The rough balance slots and spin arbor are shown.

4.0 Conclusions

An advanced air cooled metal rotor has been designed. A combination of series and parallel branched internal flow channels carrying coolant air flow of 4.3%, adequately cools the rotor for an inlet temperature of 2500°F. All fabrication limitations were considered in developing the successful design. Predicted rotor aerodynamics were enhanced through tailoring of blade angle distribution and hub contour shape to achieve improved blade loading distributions at the hub, mean, and shroud streamline positions.

Heat transfer and stress examinations indicate that the resulting design of the cooled metal radial turbine rotor is capable of meeting all rotor life and efficiency requirements. Hence the design of a cooled metallic radial turbine capable of operation at rotor inlet temperatures of 2500°F has been successfully completed.

The rotor is compatible with requirements of an advanced turbine engine utilizing a 14:1 compressor pressure ratio and a 2500°F rotor inlet temperature. Further effort shows promise in improving turbine efficiency through the comprehensive study of hub contour modification. Modification should be driven by aerodynamic performance improvement and developed in conjunction with heat transfer and stress optimization analyses.



FIGURE 3.5-1 FINAL MACHINED SOLID TURBINE ROTOR

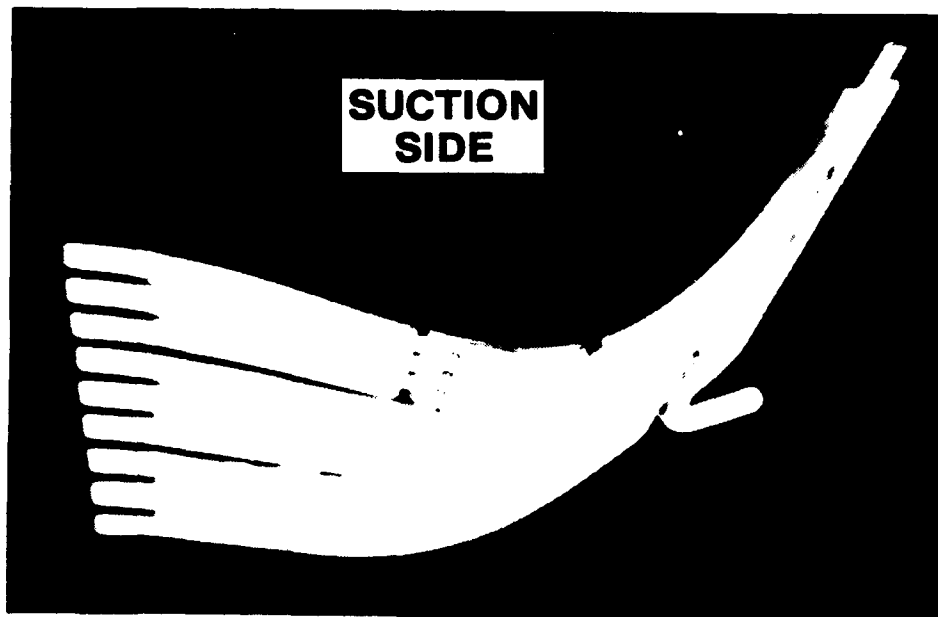
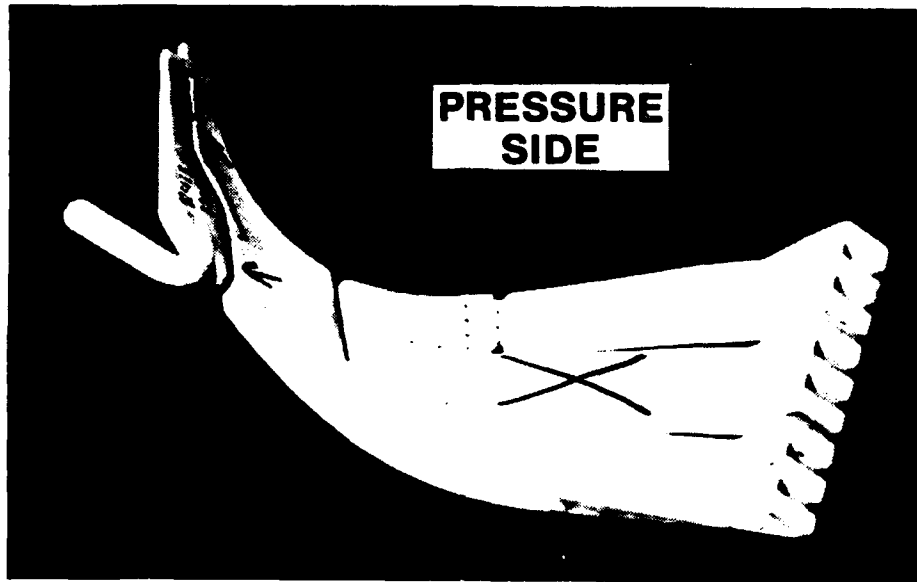

FIGURE 3.5-2 CERAMIC CORES USED TO CAST COOLANT FLOW PASSAGES

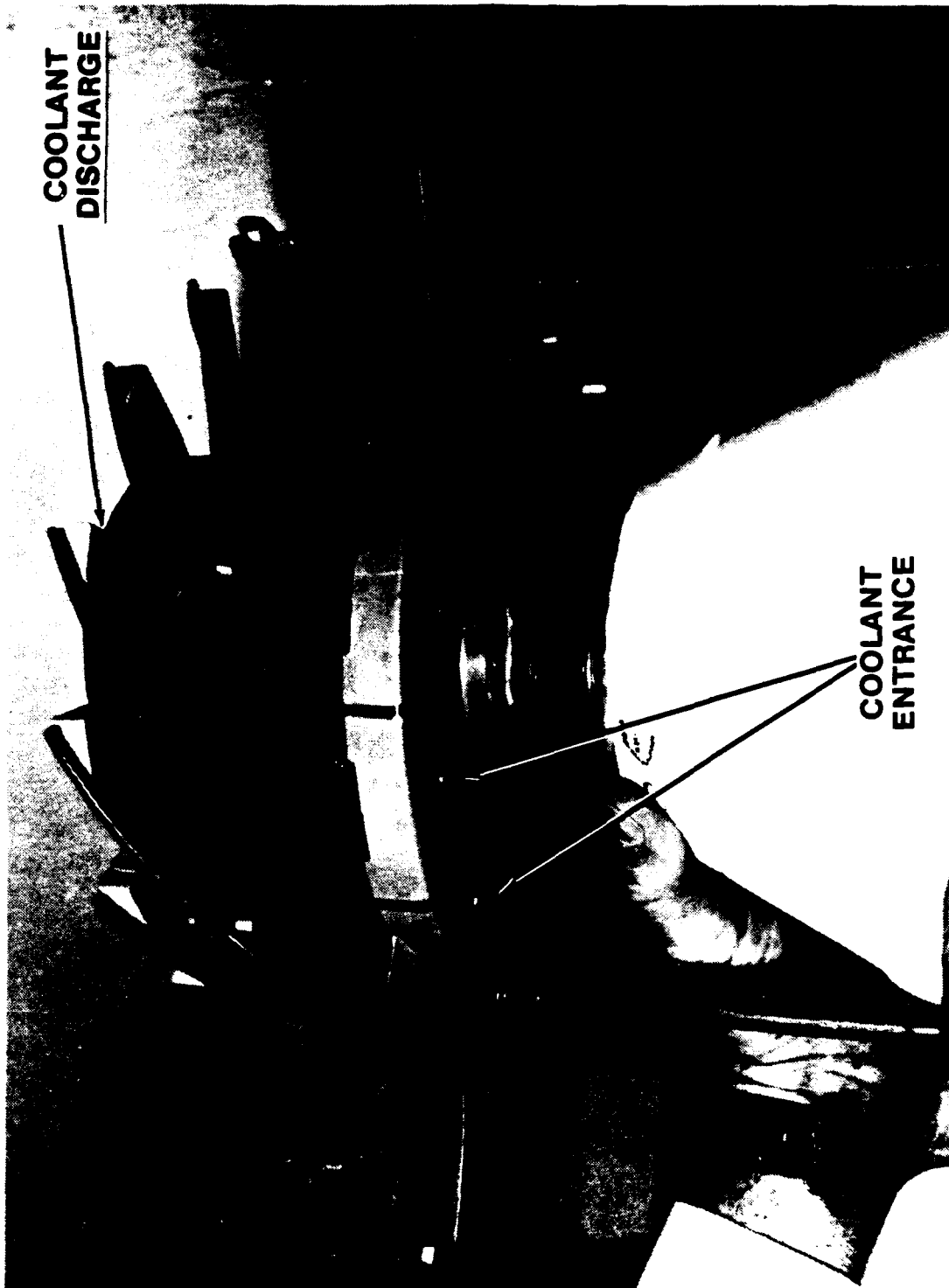

FIGURE 3.5-3 WAX REPLICA OF COOLED ROTOR

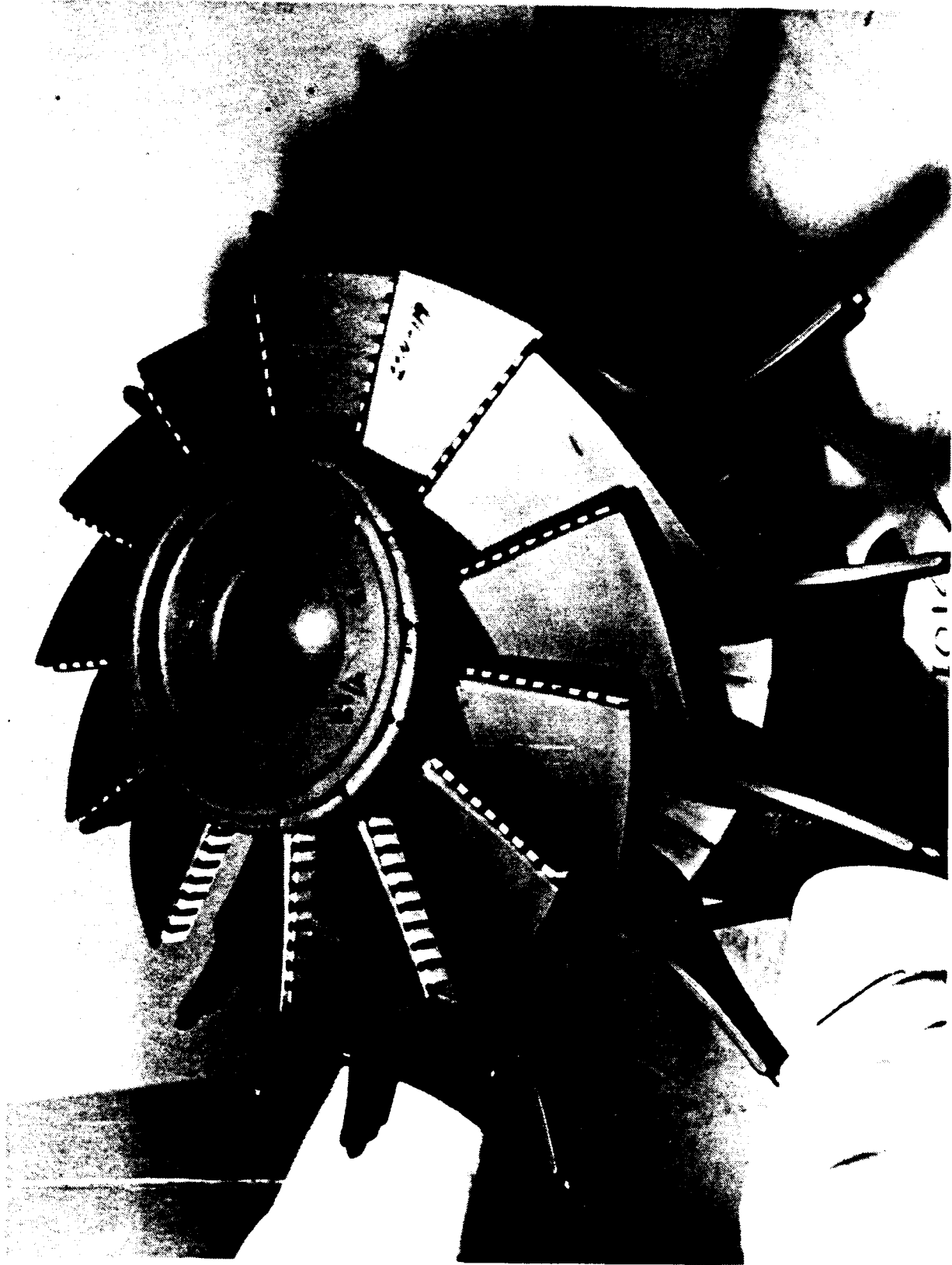

FIGURE 3.5-4 WAX REPLICA OF COOLED ROTOR, EXDUCER END

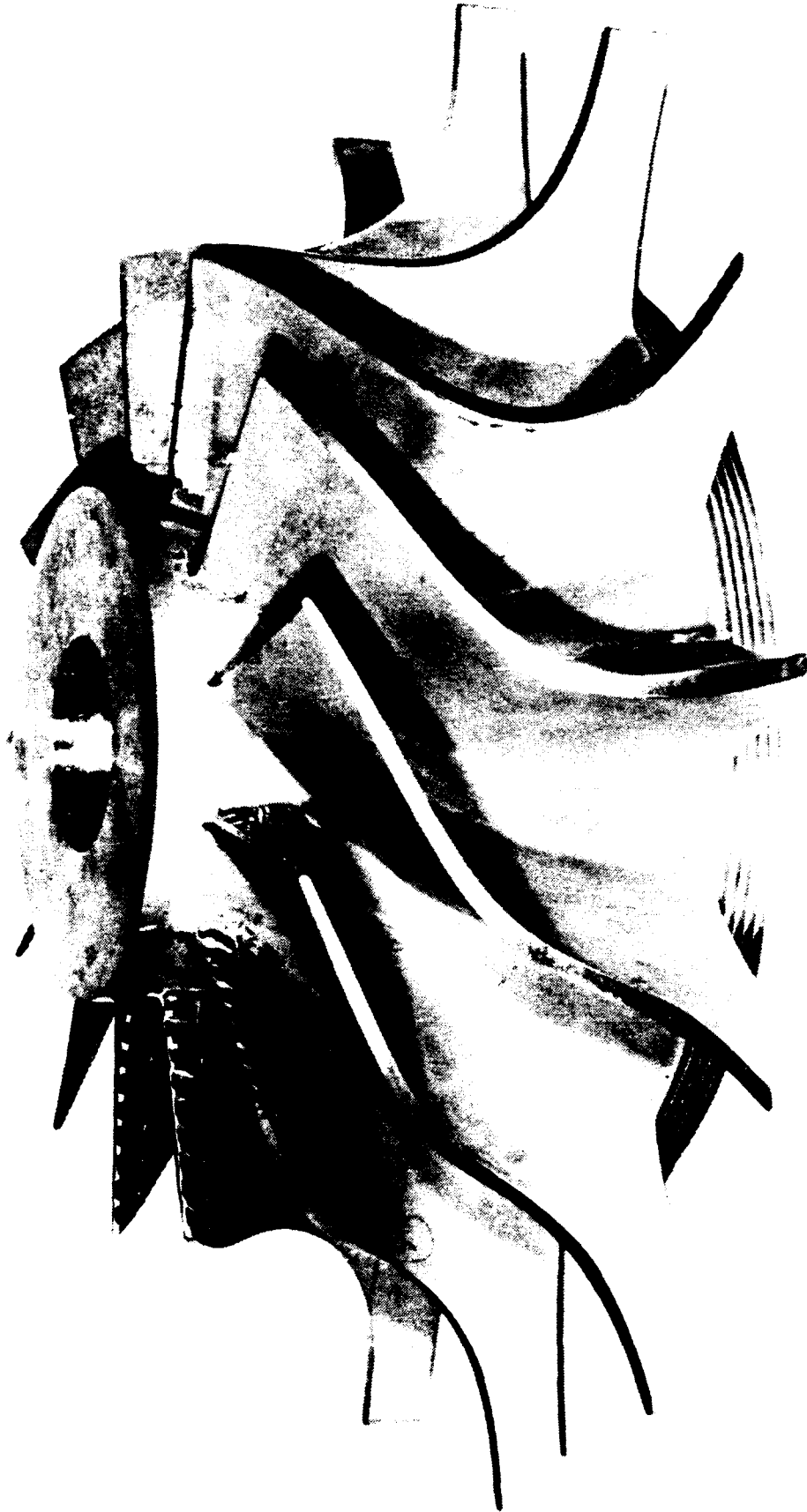

FIGURE 3.5-5 FINAL MACHINED AIR-COOLED TURBINE ROTOR

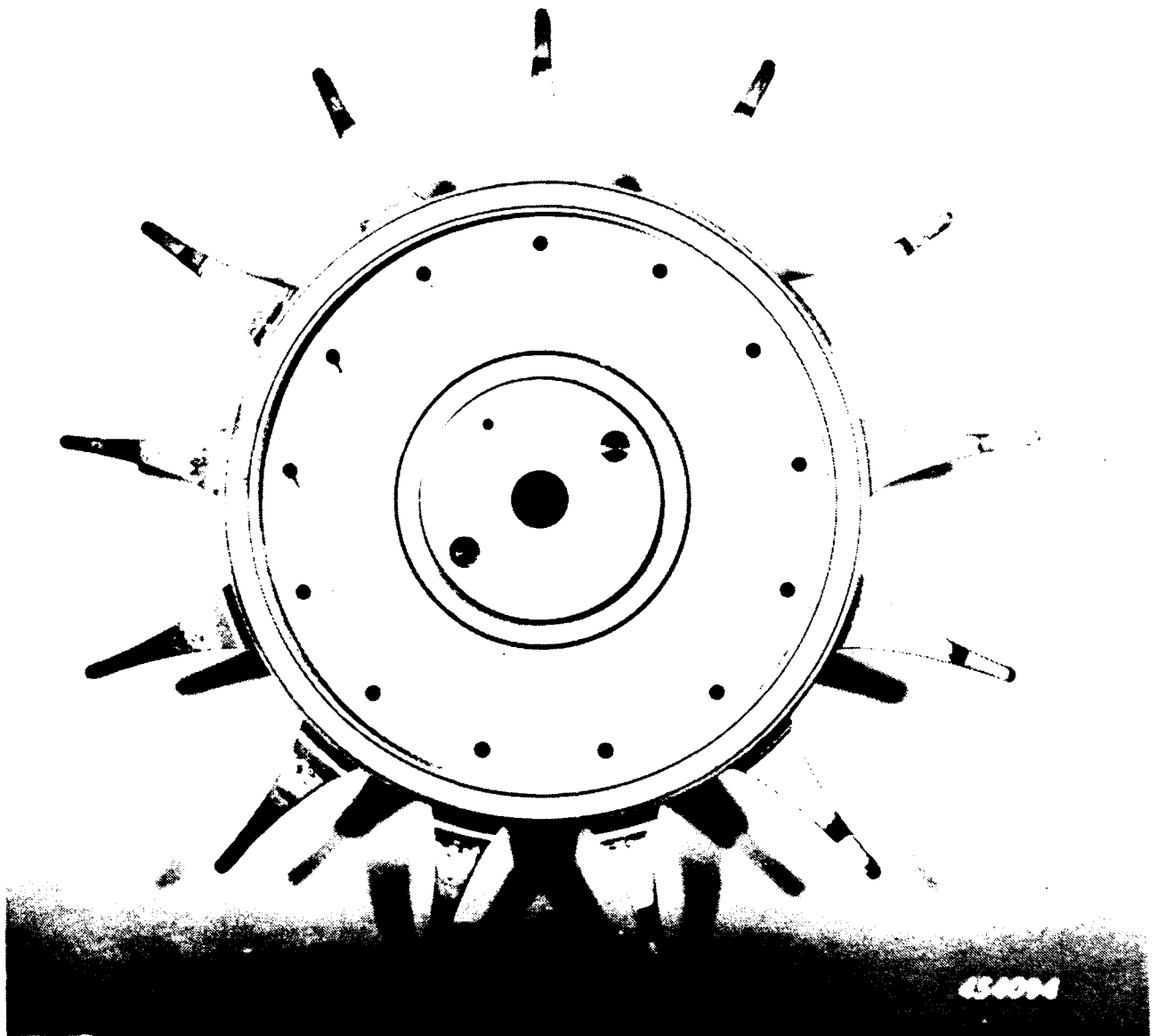

FIGURE 3.5-6 FINAL MACHINED AIR-COOLED TURBINE ROTOR

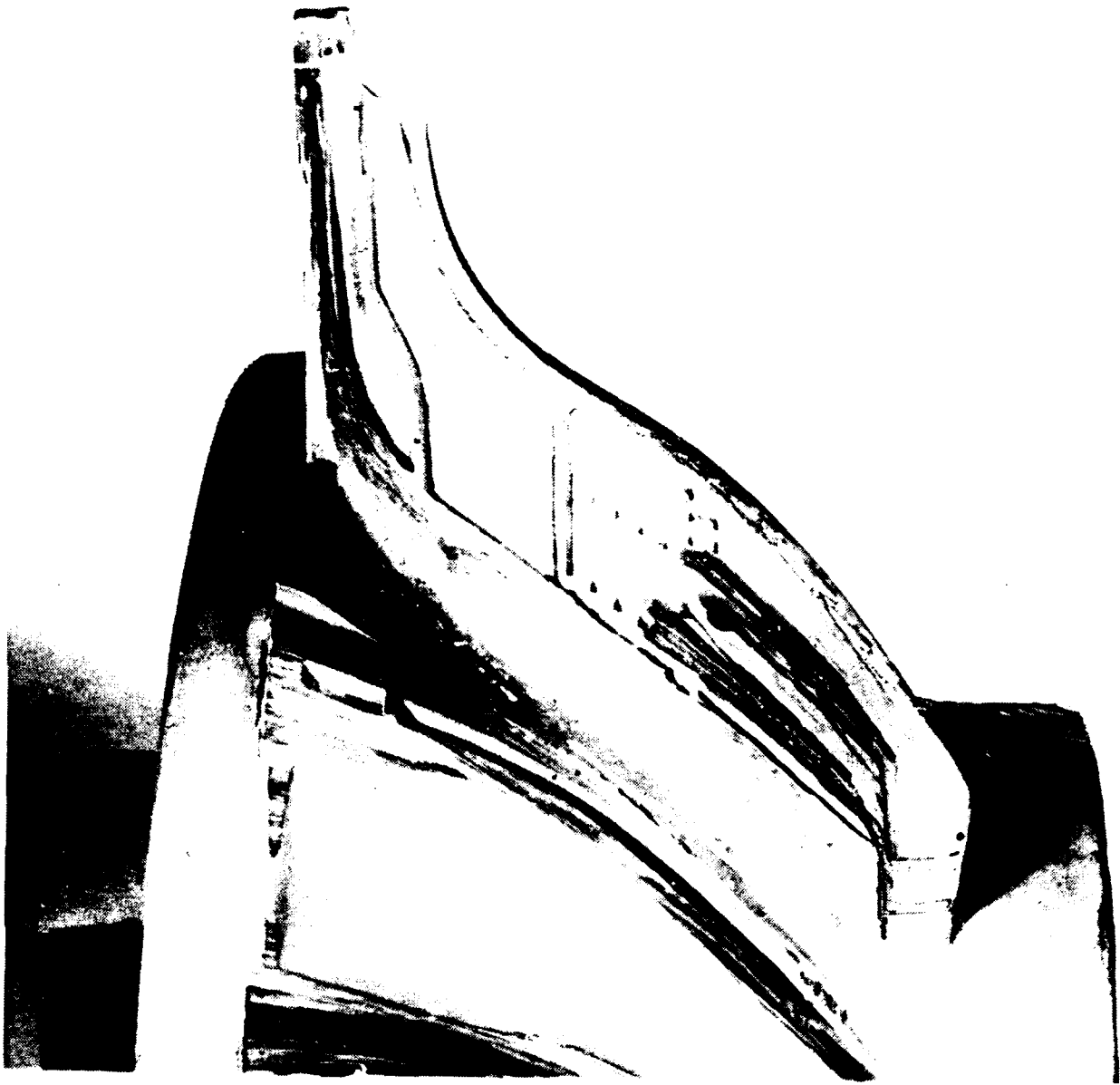

FIGURE 3.5-7 SECTIONED CASTING, PRESSURE SIDE

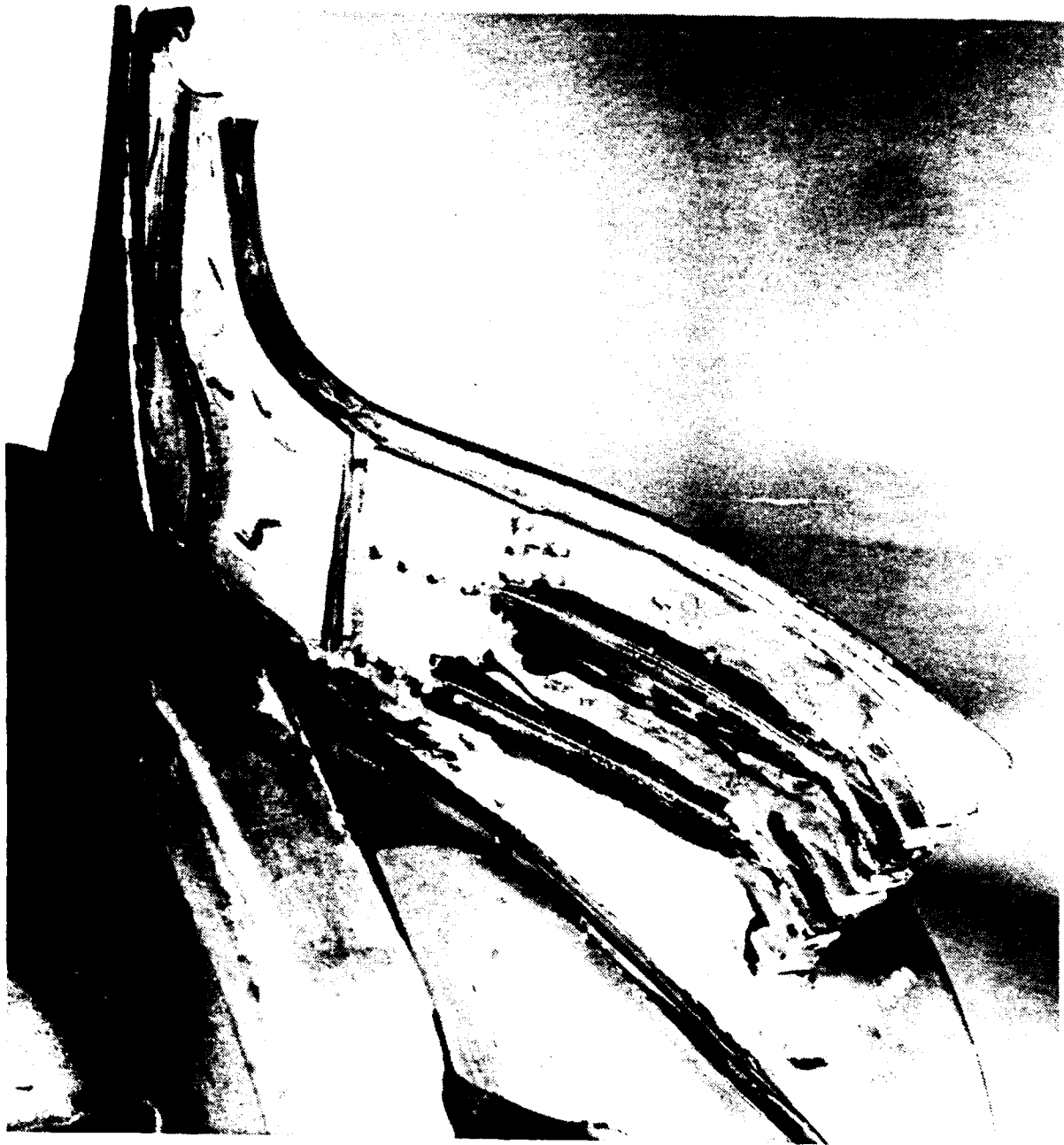

FIGURE 3.5-8 SECTIONED CASTING, PRESSURE SIDE



FIGURE 3.5-9 SECTIONED CASTING, SUCTION SIDE



FIGURE 3.5-10 SECTIONED CASTING, SUCTION SIDE

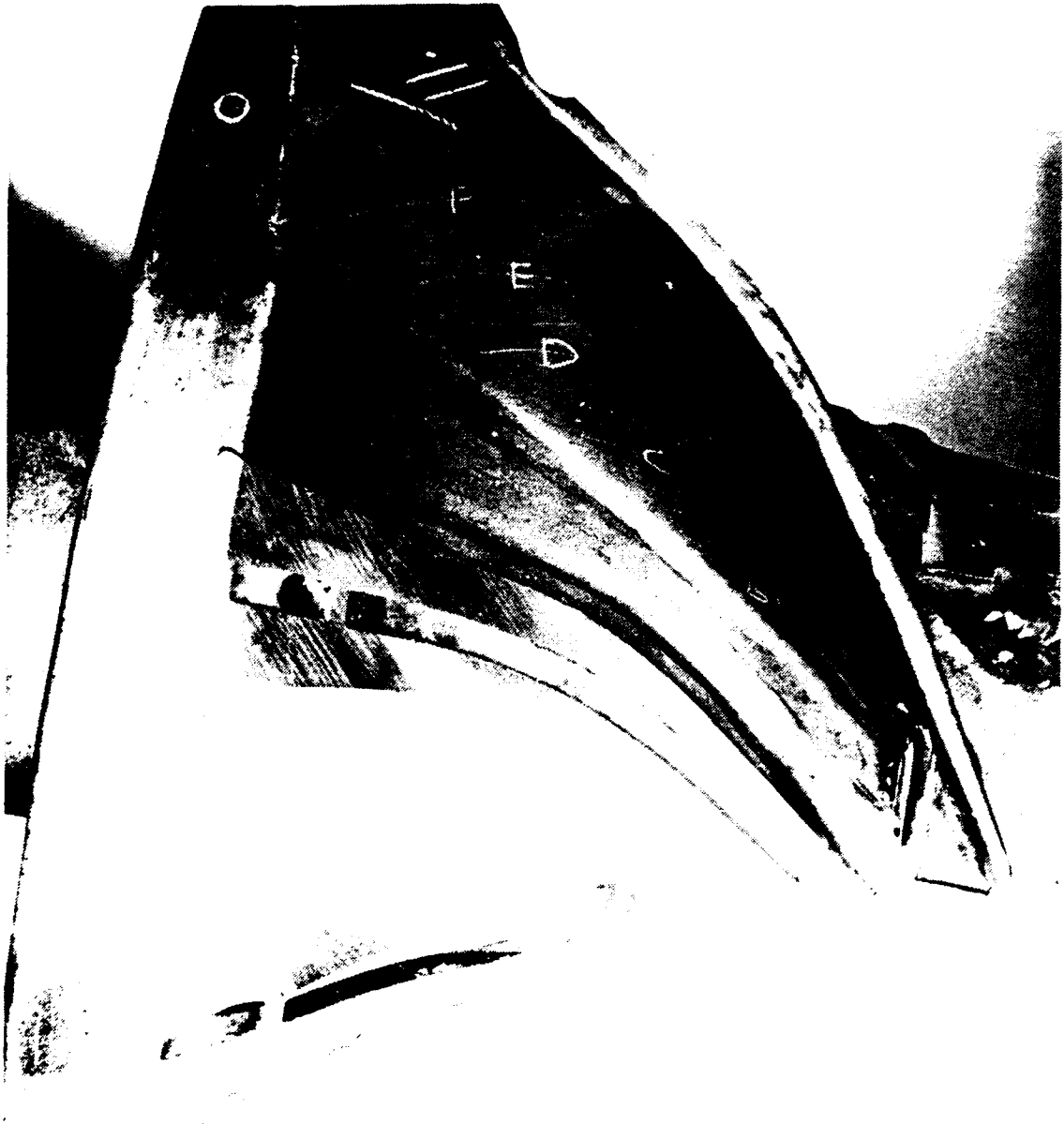

FIGURE 3.5-11 SECTIONED CASTING, BLADE HUB

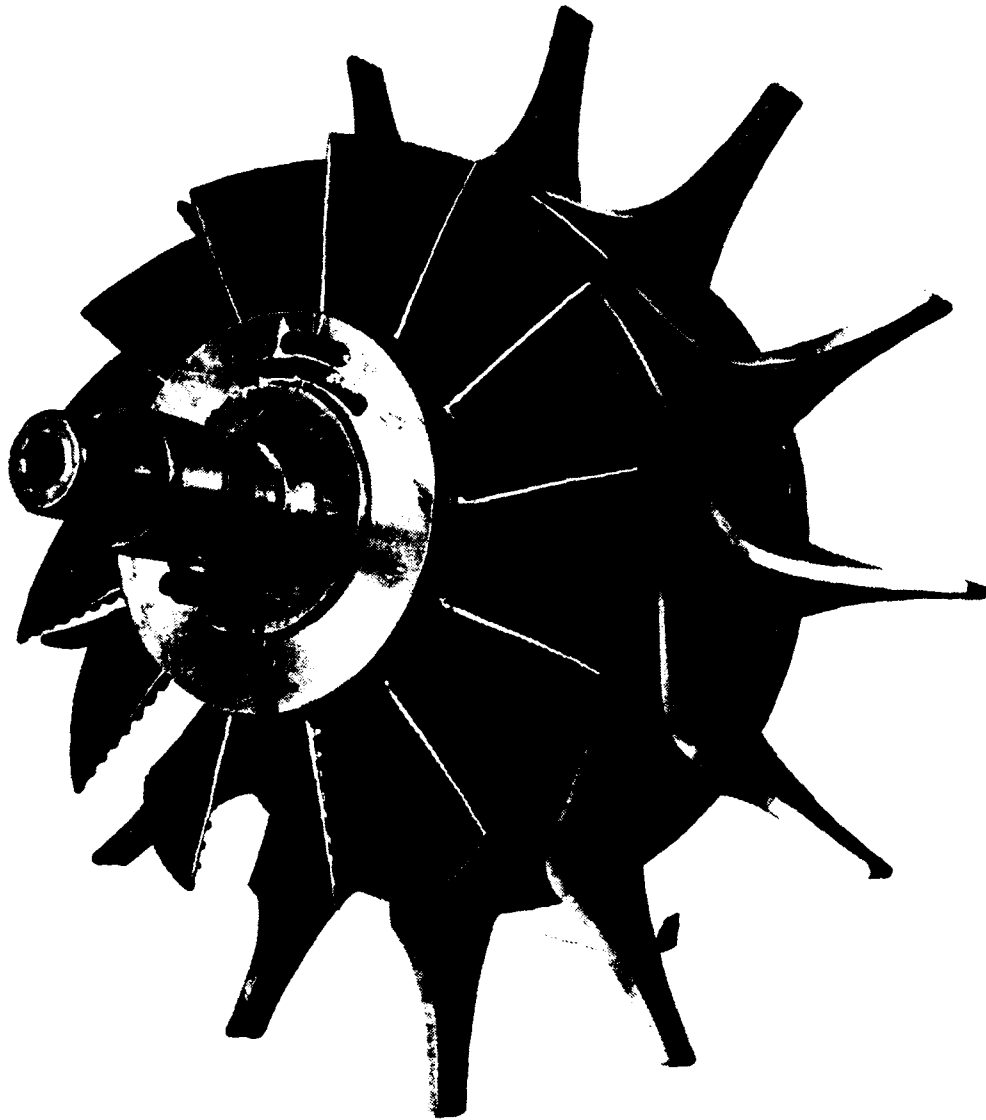

FIGURE 3.6-1 AIR-COOLED ROTOR, POST SPIN TEST

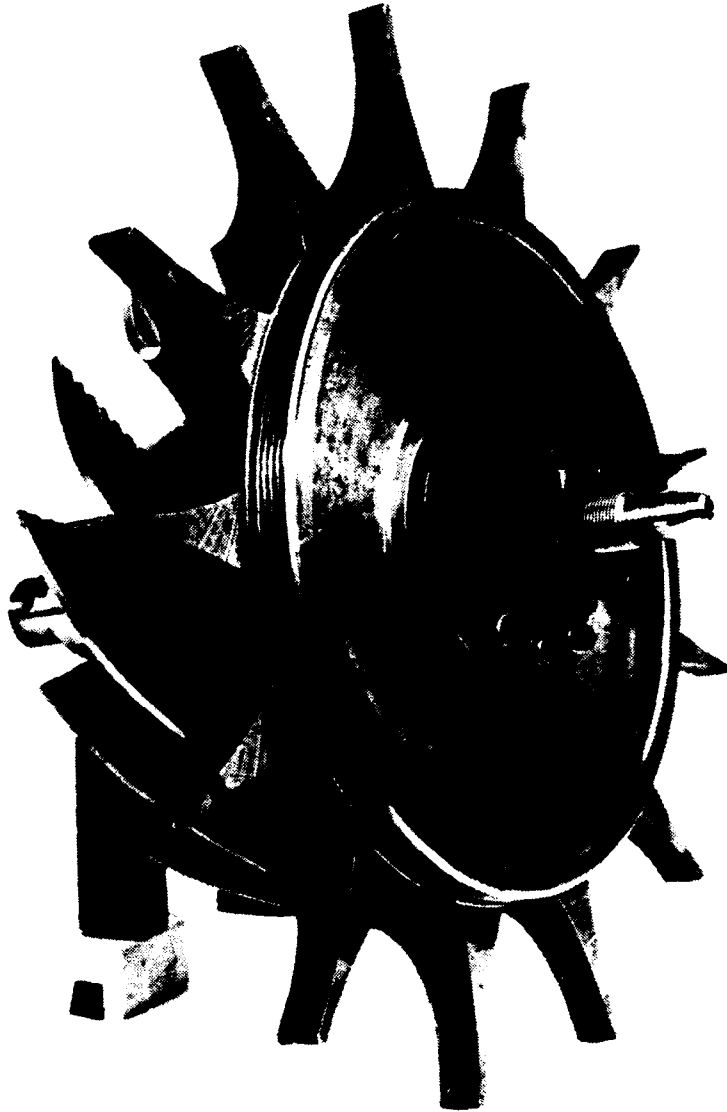

FIGURE 3.6-2 AIR-COOLED ROTOR - POST SPIN TEST

5.0 References

1. Snyder, P. H., "Cooled High-Temperature Radial Turbine Program, I - First Turbine Design", NASA CR-179606, May 1987.
2. Snyder, P. H., and Roelke, R. J., "The Design of an Air-Cooled Metallic High Temperature Radial Turbine", Journal of Propulsion and Power, Vol 26, No. 3, May-June 1990, pages 283-288.
3. Monson, D. S., and Ewing, B. A., "High-Temperature Radial Turbine Demonstration", USAAVRADCOM-TR-80-D-6, April 1980.

DISTRIBUTION LIST

COOLED HIGH-TEMPERATURE RADIAL TURBINE PROGRAM II - FINAL REPORT NAS3-24230

	<u>Number of Copies</u>
NASA Lewis Research Center 21000 Brookpark Road Attn: Report Control, MS 60-1 Cleveland, OH 44135	1
NASA Lewis Research Center 21000 Brookpark Road Attn: Library, MS 60-3 Cleveland, OH 44135	2
NASA Lewis Research Center 21000 Brookpark Road Attn: TU Office, MS 7-3 Cleveland, OH 44135	1
NASA Lewis Research Center 21000 Brookpark Road Attn: J. A. Ziemianski, MS 86-1 Cleveland, OH 44135	1
NASA Lewis Research Center 21000 Brookpark Road Attn: C. L. Ball, MS 86-1 Cleveland, OH 44135	1
NASA Lewis Research Center 21000 Brookpark Road Attn: W. Girard, MS 500-305 Cleveland, OH 44135	1
NASA Lewis Research Center 21000 Brookpark Road Attn: L. J. Bober, MS 77-6 Cleveland, OH 44135	1

**COOLED HIGH-TEMPERATURE RADIAL TURBINE PROGRAM
DISTRIBUTION LIST**

	<u>Number of Copies</u>
NASA Lewis Research Center 21000 Brookpark Road Attn: K. C. Civinskas, MS 77-6 Cleveland, OH 44135	10
NASA Lewis Research Center 21000 Brookpark Road Attn: P. L. Meitner, MS 77-12 Cleveland, OH 44135	1
NASA Lewis Research Center 21000 Brookpark Road Attn: R. W. Niedzwiecki, MS 77-10 Cleveland, OH 44135	1
NASA Lewis Research Center 21000 Brookpark Road Attn: R. Stabe, MS 6-9 Cleveland, OH 44135	1
NASA Lewis Research Center 21000 Brookpark Road Attn: D. DiCicco, MS 6-9 Cleveland, OH 44135	1
NASA Lewis Research Center 21000 Brookpark Road Attn: R. Gaugler, MS 5-11 Cleveland, OH 44135	1
NASA Lewis Research Center 21000 Brookpark Road Attn: D. C. Mikkelson, MS AAC-1 Cleveland, OH 44135	1

**COOLED HIGH-TEMPERATURE RADIAL TURBINE PROGRAM
DISTRIBUTION LIST**

	<u>Number of Copies</u>
Sverdrup Technology, Inc. Lewis Research Center Group 2001 Aerospace Parkway Attn: L. Tirres Brookpark, OH 44142	1
Sverdrup Technology, Inc. Lewis Research Center Group 2001 Aerospace Parkway Attn: P. S. Simonyi Brookpark, OH 44142	1
Sverdrup Technology, Inc. Lewis Research Center Group 2001 Aerospace Parkway Attn: L. Tran Brookpark, OH 44142	1
NASA Headquarters Attn: RP/N. Nijhawan Washington, D.C. 20546	1
NASA Headquarters Attn: RP/J. R. Facey Washington, D.C. 20546	1
NASA Scientific and Technical Information Facility P. O. Box 8757 Attn: Acquisition Branch Baltimore/Washington International Airport Baltimore, MD 21240	25
Director Aviation Applied Technology Directorate U.S. Army Aviation Research and Technology Activity - AVSCOM Attn: SAVRT-TY-AT Ft. Eustis, VA 23604-5577	2

**COOLED HIGH-TEMPERATURE RADIAL TURBINE PROGRAM
DISTRIBUTION LIST**

Number of Copies

Director
Aviation Applied Technology Directorate
U.S. Army Aviation Research and
Technology Activity - AVSCOM
Attn: SAVRT-TY-ATP (Sandra Hoff)
Ft. Eustis, VA 23604-5577 1

Director
Advanced Systems Research Office - AVSCOM
Attn: SAVRT-R (Library)
M/S 219-3
Ames Research Center
Moffet Field, CA 94035-1000 1

Commander
U.S. Army Aviation Systems Command
Attn: AMSAV - N
4300 Goodfellow Boulevard
St. Louis, MO 63120-1798 1

Commander
U.S. Army Aviation Systems Command
Attn: AMSAV-EQP
4300 Goodfellow Boulevard
St. Louis, MO 63120-1798 1

Commander
U.S. Army Aviation Systems Command
Attn: AMSAV-DIL (Ms. Feng)
4300 Goodfellow Boulevard
St. Louis, MO 63120-1798 4

Commander
U.S. Army Mobility Equipment R&D Command
Attn: STRBE-ZT (Mr. T. Lovelace)
Ft. Belvoir, VA 22060 1

**COOLED HIGH-TEMPERATURE RADIAL TURBINE PROGRAM
DISTRIBUTION LIST**

	<u>Number of Copies</u>
Director U.S. Army Tank-Automotive R&D Command Attn: AMSTA-RGE (Dr. R. Munt) Warren, MI 48090	1
The Pentagon Room 1809, OSD/OUSTR&E (ET) Attn: Dr. Donald Dix Staff Specialist for Propulsion Washington, D.C. 20301	1
Director Army Research Office Attn: Dr. R. Singleton P. O. Box 12211 Research Triangle Park, NC 27709-2211	1
Commandant U.S. Military Academy Attn: Chief, Department of Mechanics West Point, NY 10996	1
Commander Southwest Research Institute U.S. Army Fuels and Lubricants Research Laboratory P. O. Drawer 28510 San Antonio, TX 78284	1
Department of the Army Aviation Systems Division ODCSRDA (DAMA-WSA, R. Ballard) Room B454, The Pentagon Washington, D.C. 20310	1
U.S. Army Materiel Systems Analysis Activity Attn: DRXSJ-MP (Mr. Herbert Cohen) Aberdeen Proving Ground, MD 21005	1

**COOLED HIGH-TEMPERATURE RADIAL TURBINE PROGRAM
DISTRIBUTION LIST**

	<u>Number of Copies</u>
Director, Turbopropulsion Laboratory Code 67Sf Naval Postgraduate School Monterey, CA 93940	1
U.S. Department of Energy 1000 Independence Avenue Attn: Mr. Richard Alpaugh Washington, D.C. 20585	1
ORI, Inc. 1375 Piccard Drive Attn: Mr. Bill Cleary Associate Division Director Rockville, MD 20850	1
U.S. Army Aberdeen Proving Ground Installation Support Activity Attn: AMXSY-MP Aberdeen Proving Ground, MD 21005	1
Wright Research and Development Center Attn: Robert E. Gray Mail Code POTC Dayton, OH 45433	1
Wright Research and Development Center Attn: W. Troha Mail Code POTC Dayton, OH 45433	1
General Electric Aircraft Engines Attn: B. Gregory, MS A322 One Neumann Way Cincinnati, OH 45215-6301	1

**COOLED HIGH-TEMPERATURE RADIAL TURBINE PROGRAM
DISTRIBUTION LIST**

	<u>Number of Copies</u>
General Electric Aircraft Engines Attn: D. Evans, MS A34034 1000 Western Avenue Lynn, MA 01910	1
Allison Gas Turbine Division General Motors Corporation Attn: P. Tramm P. O. Box 420 Indianapolis, IN 46206-0420	1
Allison Gas Turbine Division General Motors Corporation Attn: P. Snyder P. O. Box 420 Indianapolis, IN 46206-0420	10
United Technologies Research Center Attn: B. Johnson Silver Lane East Hartford, CT 06108	1
United Technologies Research Center Attn: R. Dring, MS 16 Silver Lane East Hartford, CT 06108	1
United Technologies Research Center Attn: M. Blair, MS 16 Silver Lane East Hartford, CT 06108	1
Pratt & Whitney Government Engine Business Attn: F. Huber, MS 715-92 P. O. Box 109600 West Palm Beach, FL 33410	1

**COOLED HIGH-TEMPERATURE TURBINE PROGRAM
DISTRIBUTION LIST**

	<u>Number of Copies</u>
Pratt & Whitney Government Engine Business Attn: A. Fredmonski, MS 715-92 P. O. Box 109600 West Palm Beach, FL 33410	1
Pratt & Whitney Commercial Engine Business Attn: O. Sharma, MS 163-01 400 Main Street East Hartford, CT 06108	1
Pratt & Whitney Commercial Engine Business Attn: S. Tanrikut, MS 163-01 400 Main Street East Hartford, CT 06108	1
Pratt & Whitney Canada, Inc. Attn: U. Okapuu C. P. 10 Longueuil, Quebec J4K 4X9 CANADA	1
Garrett Engine Division Attn: Bill Waterman P. O. Box 5217 Phoenix, AZ 85010	1
Sundstrand Corp. Attn: Colin Rodgers P. O. Box 85757 San Diego, CA 92186-5757	1
Textron Lycoming Attn: Rick Bozzola 550 Main Street Stratford, CT 06497-2452	1

**COOLED HIGH-TEMPERATURE RADIAL TURBINE PROGRAM
DISTRIBUTION LIST**

	<u>Number of Copies</u>
Textron Lycoming Attn: George Minkkinen 550 Main Street Stratford, CT 06497-2452	1
Teledyne CAE Attn: Eli Benstein 1330 Laskey Road P. O. Box 6971 Toledo, OH 43612	1
Teledyne CAE Attn: Casimir Rogo 1330 Laskey Road P. O. Box 6971 Toledo, OH 43612	1
Williams International Attn: Ron Pampreen 2280 W. Maple Road P. O. Box 200 Walled Lake, MI 48088	1