



ION PAGE

Form Approved
OMB No. 0704-0188

Pub
ga
col
Da

page 1 hour per response, including the time for reviewing instructions, searching existing data sources, the collection of information. Send comments regarding this burden estimate or any other aspect of this Washington Headquarters Services, Directorate for Information Operations and Reports, 1215 Jefferson Management and Budget, Paperwork Reduction Project (0704-0188), Washington, DC 20503.

1. AGENCY USE ONLY (Leave blank)

2. REPORT DATE
5/22/92

3. REPORT TYPE AND DATES COVERED

(2)

4. TITLE AND SUBTITLE

Optical Limiting

5. FUNDING NUMBERS

DAAL 03-90-G-0089

6. AUTHOR(S)

Dr. Eric VanStryland

DTIC

7. PERFORMING ORGANIZATION NAME(S) AND ADDRESS(ES)

CREOL
University of Central Florida
12424 Research Parkway
Suite 400
Orlando, FL. 32826

PERFORMING ORGANIZATION
REPORT NUMBER
AUG 11 1992
S A D

9. SPONSORING/MONITORING AGENCY NAME(S) AND ADDRESS(ES)

U. S. Army Research Office
P. O. Box 12211
Research Triangle Park, NC 27709-2211

10. SPONSORING/MONITORING AGENCY REPORT NUMBER

ARO 27838.4-PH

11. SUPPLEMENTARY NOTES

The view, opinions and/or findings contained in this report are those of the author(s) and should not be construed as an official Department of the Army position, policy, or decision, unless so designated by other documentation.

12a. DISTRIBUTION/AVAILABILITY STATEMENT

Approved for public release; distribution unlimited.

12b. DISTRIBUTION CODE

13. ABSTRACT (Maximum 200 words)

We have been performing careful measurements of the nonlinear optical properties of some organic dyes to determine their suitability for use in devices that can protect sensors against damage from high intensity laser radiation. Dyes that show large excited state absorption with small linear absorption are suitable for such devices. We investigated the nonlinearities for pulses from picoseconds to nanoseconds and find that, since the excited state absorption is cumulative, that the dyes can limit well for nanosecond pulses but not for picoseconds. However, when used in tandem with a second passive nonlinear optical material, we find that we can significantly increase the temporal range over which the device limits. In addition, we find that the dynamic range of limiting devices can be substantially increased using two elements without a significant increase in the optical limiting threshold.

419928

32 pg

92-21138



14. SUBJECT TERMS

Optical Limiting, Nonlinear Optics, Organics

OF PAGES

16. PRICE CODE

17. SECURITY CLASSIFICATION OF REPORT

UNCLASSIFIED

18. SECURITY CLASSIFICATION

UNCLASSIFIED

19. SECURITY CLASSIFICATION OF ABSTRACT

UNCLASSIFIED

20. LIMITATION OF ABSTRACT

UL

Optical Limiting

Final Report

Eric W. Van Stryland

May 22, 1992

U.S. Army Research Office

ARO Proposal Number: 27838-PH

**CREOL
Center for Research and Education in Optics and Lasers
University of Central Florida
12424 Research Parkway
Orlando, FL 32826**

Approved for Public Release

Distribution Unlimited

Accession For	
NTIS CR&I	J
DTIC TAB	U
Unannounced	
Justification	
By	
Distribution /	
Availability	
Dist	
A-1	

DTIC QUALITY INSPECTED 5



List of Appendixes

Papers published associated with this research

Statement of the Problem Studied

Sensors can be damaged by high intensity laser radiation. We have been studying the use of the combination of two passive nonlinear materials in tandem for optical limiting. Such an optical limiter has high transmittance at low inputs and low transmittance at high inputs. It can, thus act as a sensor protection device.

Summary of the Most Important Results

Metallophthalocyanine solutions show promise as optical limiting elements for sensor protection applications. The mechanism, referred to as reverse saturable absorption, is primarily due to excited state absorption (ESA). We spent much of our time on this research project determining the exact nature of the nonlinear interaction of light with these organic materials. We measured nonlinear absorption and nonlinear refraction coefficients in solutions of metallo-phthalocyanines using 532 nm picosecond pulses of different duration. Both nonlinearities are shown to be dominated by real population of the excited state.

We have separated the nonlinear absorption from the nonlinear refraction in phthalocyanine solutions using the "Z-scan" technique.[1] This method is a combined nonlinear transmittance and beam distortion method. Measurements on solutions of chloro-aluminum phthalocyanine (CAP) and on a silicon naphthalocyanine (Nc) derivative, $\text{Si}(\text{OSi}(\text{hexyl})_2)_2\text{Nc}$, referred to as SiNc show that both the nonlinear absorption and refraction are dominated by creation of a real population of excited states. This is true even though the wavelength of observation lies between absorption bands where the linear absorption is relatively weak. Using nanosecond pulses excited triplet state absorption limits the transmission. However, we found by using picosecond pulses that excited singlet state absorption becomes important and self-focusing is observed. We can speculate that the cause for the observed positive sign of the nonlinear refraction is the addition of absorption centered at a slightly shorter wavelength than our 532 nm light. Measurements of the transient absorption spectrum confirm increasing the absorption centered at a shorter wavelength than 532 nm for CAP. In SiNc it is not clear where with respect to 532 nm the increased absorption is centered, and we see a considerably smaller positive nonlinear refraction. In addition we are on the high frequency side of the Q-band absorption which we are saturating. The nonlinear refraction from this saturation is, therefore, also positive in both CAP and SiNc.

Preliminary screening measurements show a trend toward larger nanosecond nonlinearities as the metal substituent mass is increased from Si to Ge to Sn, and even heavier atom solvents are used. We speculate that the intersystem crossing time is being affected by both the mass of the metal substituent as well as the solvent. As the triplet ESA is stronger than the singlet ESA, faster intersystem crossing is beneficial to limiting. Recent experiments at the Jet Propulsion Lab bear this out.

We have also observed a saturation of the excited state transition at high input fluences that allows us to determine the lifetime of the state populated during ESA (i.e. S2 level). We measure this lifetime to be ≈ 900 fs. As far as we are aware this is the first measurement of this lifetime in these types of molecules.

After developing a good understanding of the nonlinear interaction of light with these

organic dyes we investigated their use in conjunction with a second nonlinear material. We previously demonstrated that semiconductors can have rapid response, low limiting energy, broadband response, relatively high linear transmittance, and high dynamic range for picosecond pulses; however, their dynamic range becomes low for longer (nanosecond) pulses. Excited state absorbing dyes appear to limit well for nanosecond pulses due to the accumulation of excited state population with time, but they are poor limiters for picosecond pulses for the same reason. Therefore, we have studied the possible use of a tandem limiter where the organic dye precedes the semiconductor along the propagation direction. The dye limits for nanosecond pulses protecting both the semiconductor and subsequent optics, and the semiconductor will limit for short optical pulses. We found that indeed the organic dye could significantly increase the dynamic range of the limiter with only a small increase in the limiting threshold.

We first used two nonlinear materials in which the two nonlinear elements were in contact. We find that this may not be the optimum geometrical arrangement to obtain both a low limiting energy (power, irradiance or fluence) and a large dynamic range. A finite physical separation between these elements may be advantageous depending on the nonlinearities of the two nonlinear materials. We have examined this feasibility using SiNc along with a thermal limiting element. We found that if the elements were placed in close proximity that the limiting threshold of the thermal limiter was significantly increased by the presence of the SiNc placed in front of it. The dynamic range was greatly increased. However, if the SiNc was moved farther in front of the thermal element (away from the focal position) the threshold was effected much less and the dynamic range was still significantly increased, although not as much. These experiments imply that there must be an optimal position of the two elements in the optical change depending on the required limiting threshold and required dynamic range. We are currently investigating if there is an optimal geometry in the case of a metallo-phthalocyanine used in conjunction with a semiconductor element.

In addition to the above experiments, we have set up an experiment to time resolve the spatial irradiance distribution of the pulse transmitted through a nonlinear medium. We had previously performed this experiment on 30 psec pulses with 2 psec resolution. We have slowed our streak camera to observe ≈ 10 nsec pulses. This in principal should allow us to, for example, monitor the thermally induced self-focusing occurring in ZnSe. We had previously speculated that this self-focusing can overcome the carrier-induced self-defocusing for tight focusing geometries and eventually lead to the observed optical damage for nanosecond pulses. Unfortunately the sensitivity of this experiment was insufficient to see the onset of the thermal nonlinearity.

We have been in contact with researchers from Brooks AFB in San Antonio, TX. Major Mark Rogers and Ben Rockwell visited our labs during the course of this research to learn about the Z-scan technique. They worked in the lab two days. In addition, Mark Schmeltz from the Natick Research, Development and Engineering Center toured our labs.

Accession For	
NTIS CRA&I	<input checked="" type="checkbox"/>
DTIC TAB	<input type="checkbox"/>
Unannounced	<input type="checkbox"/>
Justification	
By	
Distribution /	
Availability	
Dist	Availability Special
A-1	

Publications

"Excited State Absorption and Optical Limiting in Solutions of Metallophthalocyanines", J.W. Perry, L.R. Khundkar, D.R. Coulter, T.H. Wei, E.W. Van Stryland and D.J. Hagan, Proceedings of the NATO workshop on "Organic Materials for Nonlinear Optics and Photonics", La Rochelle, France, Aug. 26-31, 1990.

Invited: "Nonlinear Optical Characterization of Organic Materials", M.J. Soileau, T.H. Wei, M. Sheik-Bahae, D.J. Hagan, Martine Sence, and E.W. Van Stryland, Mol. Cryst. Liq. Cryst. 207, 97-101 (1991).

"Direct Measurements of Nonlinear Absorption and Refraction in Solutions of Phthalocyanines", T.H. Wei, D.J. Hagan, M.J. Sence, E.W. Van Stryland, J.W. Perry, and D.R. Coulter, Applied Physics, B54, 46-51 (1992).

Presentations

Invited: "Nonlinear Optical Characterization of Organic Materials", M.J. Soileau, T.H. Wei, M. Sheik-Bahae, D.J. Hagan, Martine Sence, and E.W. Van Stryland, III International Topical Meeting on Optics of Liquid Crystals, Optical Properties and Applications of Liquid Crystals and Organic Materials, Cetraro, Italy, Oct. 1-5, 1990.

"Excited State Absorption and Optical Limiting in Solutions of Metallophthalocyanines", J.W. Perry, L.R. Khundkar, D.R. Coulter, T.H. Wei, E.W. Van Stryland and D.J. Hagan, NATO workshop on "Organic Materials for Nonlinear Optics and Photonics", La Rochelle, France, Aug. 26-31, 1990.

"Hybrid Optical Limiters Utilizing Metallophthalocyanine Based Dyes and II-IV Semiconductors", T.H. Wei, E.W. Van Stryland, D.J. Hagan, J.W. Perry, L.R. Khundkar, D.R. Coulter and M.E. Kenney, Conference on Lasers and Electro-Optics (CLEO), Anaheim CA, (1990)

"Excited State Absorption and Optical Nonlinearities of Metallophthalocyanines and Naphthalocyanines in Solution", J.W. Perry, L.R. Khundkar, D.R. Coulter, T.H. Wei, E.W. Van Stryland and D.J. Hagan, IEEE/OSA Meeting on Nonlinear Optics: Materials, Phenomena and Devices, Kauai, Hawaii, July 16-20, 1990.

"Excited State Absorption and Optical Nonlinearities of Metallophthalocyanines and Naphthalocyanines in Solution", J.W. Perry, L.R. Khundkar, D.R. Coulter, T.H. Wei, E.W. Van Stryland and D.J. Hagan, conference on Organic Materials for Nonlinear Optics II, Oxford, U.K., Sept. 4-6, 1990.

"Nonlinear Absorption Studies in Metallophthalocyanines", T.H. Wei, M.J. Sence, E.W. Van Stryland, D.J. Hagan, J.W. Perry, D.R. Coulter, and L.R. Khundkar, OSA Annual meeting, Boston, Mass., 1990.

Invited talk: "Measurements of Third Order Nonlinearities of Nematic Liquid Crystals", P. Palffy-Mulhoray, H.J. Yuan, L. Li, M.A. Lee, J.R. DeSalvo, T.H. Wei, M. Sheik-bahae, D.J. Hagan, and E.W. Van Stryland, III International Topical Meeting on Optics of Liquid Crystals, Optical Properties and Applications of Liquid Crystals and Organic Materials, Cetraro, Italy, Oct. 1-5, 1990.

"Excited State Absorption and Refraction in Metallophthalocyanine Solutions", T.H. Wei, D.J. Hagan, M. Sence, J.W. Perry, L.R. Khundkar, and D.R. Coulter, Conference

on Lasers and Electro-Optics (CLEO), Baltimore, Md., (1991).

"Measurement and Understanding of Optical Nonlinearities", E.W. Van Stryland, Nonlinear Optics 1991, Adelaide, Australia, 1991.

"Overview of Nonlinear Characterization Techniques", G. Stegeman and E.W. Van Stryland, Electronics and Glass and Optical Materials Joint Meeting, American Ceramic Society, Crystal City, Oct. 20-23, 1991.

"Nonlinear Refraction and Absorption Measurements by the Z-Scan", D.J. Hagan, M Sheik-Bahae, A.A. Said, and E.W. Van Stryland, joint meeting of the Glass and Optical Materials Division and Electronics Division of the American Ceramic Society, Crystal City, VA, Oct. 20-23, 1991.

"Characterization of Nonlinear Optical Materials", E.W. Van Stryland, M. Sheik-Bahae, G. Stegeman, and D. J. Hagan, American Association for Crystal Growth, Fourth Conference on Crystal Growth, Atlantic City, NJ, Oct.2-4, 1991.

"Excited State Nonlinear Absorption and Refraction in Organic Solutions", T.H. Wei, D.J. Hagan, E.W. Van Stryland, J.W. Perry, S.R. Marder, D. Alvarez, and K.J. Perry, IV International Topical Meeting on Optics of Liquid Crystals, OLC'91, Cocoa Beach, FL, Oct. 7-11, 1991.

"Measurement of Nonlinear Absorption and Refraction of Light by Matter", D.J. Hagan, M. Sheik-Bahae, M.J. Soileau and E.W. Van Stryland, AAPT Winter meeting Orlando, FL, 1992.

"Self-Protecting Optical Limiters Using Cascading Geometries", A.A. Said, T.H. Wei, J.R. DeSalvo, M. Sheik-Bahae, D.J. Hagan and E.W. Van Stryland, SPIE Orlando, FL (1992).

Participating Personnel

Eric W. Van Stryland
David G. Hagan
M.J. Soileau

The experiments on this contract were performed by Mr. Tai Wei, a graduate student supervised by the principal investigators. He recently completed his PhD dissertation using the results from this research.

Bibliography

1. M. Sheik-bahae et. al., Jour. Quan. Elect., QE 26, 760-769 (1990).
2. D.R. Coulter et. al., SPIE, 1105, 42-51 (1989).

NONLINEAR OPTICAL CHARACTERIZATION OF ORGANIC MATERIALS

M.J. Soileau, T.H. Wei, M. Sheik-bahae, D.J. Hagan,
Martine Sence, and E.W. Van Stryland

CREOL, Center for Research in Electro-Optics and Lasers
Physics and Electrical Engineering Departments
University of Central Florida, Orlando, Florida 32816

We report a sensitive single beam technique for measuring both the nonlinear refractive index and nonlinear absorption coefficient for a wide variety of materials. We describe the experiment and present a brief analysis including cases where nonlinear refraction is accompanied by nonlinear absorption. In these experiments the transmittance of a sample is measured through a finite aperture in the *far-field* as the sample is moved along the propagation path (z) of a focused Gaussian beam. The sign and magnitude of the nonlinear refraction are easily deduced from such a transmittance curve (Z-scan). Employing this technique a sensitivity of better than $\lambda/300$ wavefront distortion has been achieved using picosecond frequency doubled Nd:YAG laser pulses. In cases where nonlinear refraction is accompanied by nonlinear absorption, it is possible to separately evaluate the nonlinear refraction as well as the nonlinear absorption by performing a second Z-scan with the aperture removed. We demonstrate this method for a solution of chloro-aluminum-phthalocyanine at 532 nm where excited state absorption is present and the nonlinear refraction is positive.

We have recently developed a sensitive single beam technique for measuring both nonlinear refraction and nonlinear absorption.^{1,2} We refer to this technique as a Z-scan. This method is rapidly gaining use for measuring electronic nonlinearities (eg. n_2) and nonlinear absorption (eg. two-photon absorption coefficients β or excited-state cross sections σ) in materials from semiconductors to glasses to organics. We review this technique and the analysis of Z-scan data to show how nonlinear refraction can be separated from nonlinear absorption. We then apply this technique to a solution of chloro-aluminum-phthalocyanine (CAP) dissolved in methanol which we have previously used for passive optical limiting.³

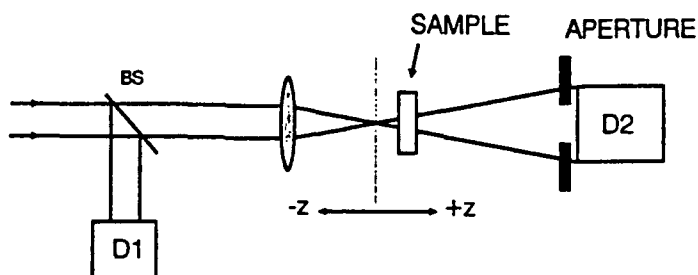

Fig.1 The Z-scan experimental apparatus in which the ratio $D2/D1$ is recorded as a function of the sample position z .

Using a Gaussian laser beam in a tight focus limiting geometry, we measure the transmittance of a nonlinear medium through a finite aperture placed in the far field as a function of the sample position (z) measured with respect to the focal plane as shown in Fig. 1. If only nonlinear refraction is present the following example qualitatively explains how such a trace (Z-scan) yields n_2 . First assume $n_2 < 0$. As the sample is moved toward focus the increased irradiance leads to a negative lensing effect which tends to collimate the beam, thus, increasing the aperture transmittance. With the sample on the $+z$ side of focus, the negative lensing effect tends to augment diffraction and the aperture transmittance is reduced. The approximate null at $z=0$ is analogous to placing a thin lens at focus which results in a minimal far field pattern change. For still larger $+z$ the irradiance is reduced and the transmittance returns to the original linear value. A positive nonlinearity results in the opposite effect, i.e. lowered transmittance for the sample at negative z and enhanced transmittance for positive z . We refer to the transmittance change from peak to valley as ΔT_{p-v} . Theoretical Z-scan curves for both positive and negative nonlinear refraction are shown in Fig. 2 for a peak on axis, time averaged phase distortion $\Delta\Phi$ (phase delay or advance) of $\lambda/25$. For example, for an instantaneous positive nonlinearity this phase distortion is given by;

$$\Delta\Phi_0 \approx \frac{2\pi}{\lambda} \Delta n L = \frac{2\pi}{\lambda} \gamma I L = \frac{2\pi}{\lambda} \frac{n_2 E_0^2}{2} L \quad (1)$$

where L is the sample length, I the irradiance (MKS) and E_0 the field (CGS), and γ and n_2 are related by $n_2(\text{esu}) = (cn_0/40\pi)\gamma(\text{m}^2/\text{W})$, where c (m/sec) is the speed of light in vacuum.

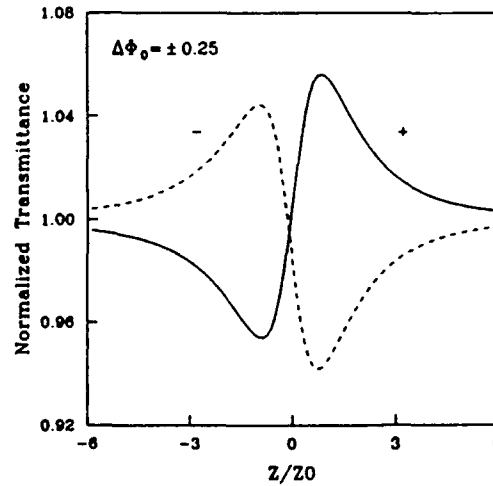

Fig. 2 Theoretical output of a Z-scan for a) negative n_2 and b) for a positive n_2 .

We can define an easily measurable quantity ΔT_{p-v} as the difference between the normalized peak (maximum) and valley (minimum) transmittances. The variation of this quantity as a function of $\Delta\Phi_0$, as calculated for various aperture sizes is found to be almost linearly dependent on $\Delta\Phi_0$. Based on a numerical fitting, the following relationship can be used to determine $\Delta\Phi_0$ from the Z-scan to within a $\pm 2\%$ accuracy;

$$\Delta T_{p-v} \approx 0.406(1-S)^{0.25} |\Delta\Phi_0| \quad \text{for } |\Delta\Phi_0| \leq \pi, \quad (2)$$

where S is the transmittance of the aperture in the linear regime. If our experimental apparatus and data acquisition systems are capable of resolving transmission changes ΔT_{p-v} of $\approx 1\%$, we will be able to measure phase changes corresponding to less than $\lambda/250$ wavefront distortion.

If the aperture is removed (i.e. $S=1$ in Eq. 2) the Z-scan is no longer sensitive to nonlinear refraction. A Z-scan then results in no signal unless nonlinear absorption is present in which case a symmetrical curve about the focal position is obtained. If both

nonlinear refraction and nonlinear absorption are present simultaneously, an analysis of the "open" aperture ($S=1$) and "closed" aperture ($S<1$) experiments can be used to separately determine the nonlinear refraction and nonlinear absorption.

The separation and evaluation process is simple: divide the "closed" aperture normalized Z-scan by the one with open aperture. The result is a new Z-scan where ΔT_{p-v} agrees to within $\pm 10\%$ of that obtained from a purely refractive Z-scan. This division process will give a faithful value for n_2 as long as the nonlinear absorption is not dominant. In practice we have found this method to work quite well provided the curve obtained by division looks like Fig. 2 (ie. appears antisymmetric). We have checked it by numerically calculating the results of Z-scans including both nonlinearities.³

We define β as the two-photon absorption (2PA) coefficient and σ as the excited state absorption (ESA) coefficient. For small nonlinear absorption (ie. $\Delta T_{p-v} < 0.1$) the following approximation can be used to determine β or σ from the open aperture Z-scan;

$$\Delta T_{p-v} \approx -\frac{\beta}{2\sqrt{2}} I_0 (1-R) L_{\text{eff}}, \text{ for 2PA,} \quad (3a)$$

$$\Delta T_{p-v} \approx -\frac{\sigma \alpha}{4\hbar\omega} F_0 (1-R) L_{\text{eff}}, \text{ for ESA,} \quad (3b)$$

where $L_{\text{eff}} = (1 - e^{-\alpha L})/\alpha$, with α the linear absorption coefficient.^{4,5} Here I_0 (W/cm^2) is the peak on axis irradiance assuming a temporally and spatially Gaussian shaped pulse, and F_0 (J/cm^2) is the on axis fluence assuming a Gaussian spatial beam. In the case of CAP we found that the nonlinear absorption was due to ESA and not 2PA. We determined this by monitoring the nonlinear absorption for different pulsewidths of 29 ps and 61 ps (FWHM). The same fluence for the different pulsewidths gave the same nonlinear absorption as expected from Eq. 3b for excited state absorption. Equation 3a for 2PA predicts that the same irradiance would give the same absorption.

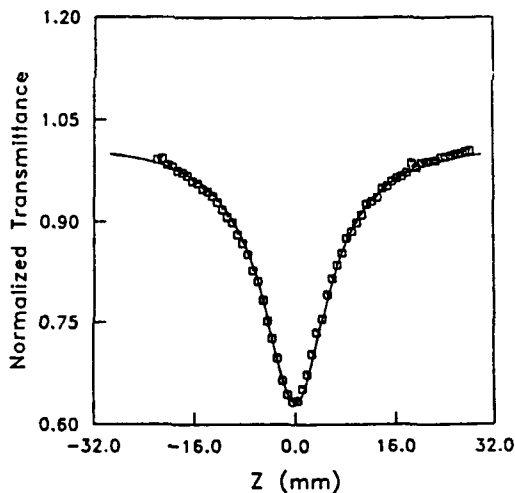

Fig. 3. Open aperture Z-scan on CAP at $3.18 \mu\text{J}$ and theoretical fitting (solid line) with $\sigma = 1.8 \times 10^{-17} \text{ cm}^2$ at a concentration of 1.0×10^{-3} moles/liter.

The open aperture Z-scan, along with a numerical fit, is shown in Fig. 3 for an input energy of $3.2 \mu\text{J}$ at 532 nm using $\approx 27 \text{ ps}$ (FWHM) pulses. Note that for Fig. 3 the $\Delta T > 0.1$ and Eq. 3b is not applicable.³ The parameters used are $w_0 = 28 \mu\text{m}$ ($\text{HW}1/e^2\text{M}$), $R = 0.05$, $L = 0.2 \text{ cm}$, $\alpha = 1.42 \text{ cm}^{-1}$ (or 1390 cm^{-1} per mole per liter) as determined from the 68% measured linear transmittance for a concentration of 1.02×10^{-3} moles per liter. This numerical fit gives a value for σ of $\approx 1.8 \times 10^{-17} \text{ cm}^2$.

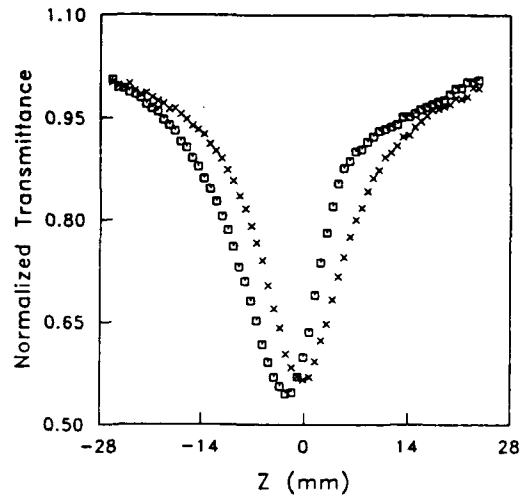

Fig. 4. Open aperture Z-scan (cross) and closed aperture Z-scan (square) results for CAP presented as the normalized transmittance versus z position [mm].

Figure 4 shows both the open and closed aperture ($S=0.4$) Z-scan results for CAP for an input energy of $4.8 \mu\text{J}$. Figure 5 shows the results of dividing the closed aperture Z-scan by the open aperture Z-scan, thus, giving the nonlinear refractive contribution. The value obtained for n_2 is, $n_2 \approx 2.1 \times 10^{-12}$ esu. We found, however, that this nonlinear refraction is associated with the real excitation of the singlet state and is, therefore, also fluence dependent. Thus, this nonlinear refraction is not a true $\chi^{(3)}$ effect but is associated with a sequential $\chi^{(1)}:\chi^{(1)}$ process.

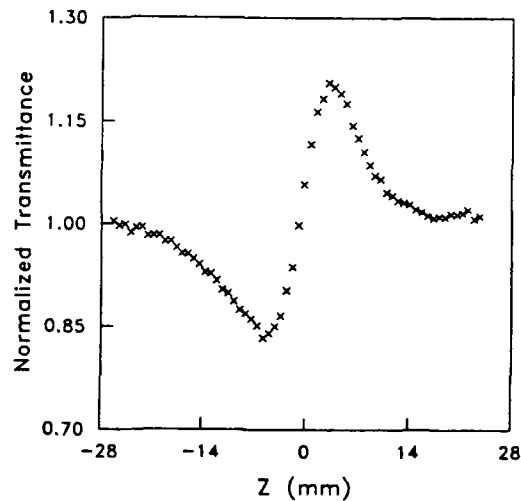

Fig. 5 The results of the division of the curves in Fig. 4 (ie. closed aperture results divided by open aperture results).

In conclusion we have demonstrated a simple sensitive single beam technique for measuring both nonlinear absorption and nonlinear refraction. The sign of the nonlinear refraction is also obtained. We give simple relations that allow the refractive index to be obtained directly from the Z-scan data without resorting to computer fits. We have applied

this technique to several materials displaying a variety of nonlinearities on different time scales. Here we have presented data on chloro-aluminum-phthalocyanine that gives the excited state absorption cross section and the nonlinear refractive index, all for 0.53 μm picosecond pulses. It is expected that this method will be a valuable tool for experimenters searching for highly nonlinear materials.

ACKNOWLEDGEMENT

We gratefully acknowledge the support of the Army Research Office, the National Science Foundation grant #ECS-8617066, the support of DARPA/CNVEO and the Florida High Technology and Industry Council. We also thank Dan Coulter and Joe Perry of the Jet Propulsion Laboratory for providing samples and their expertise on materials.

1. M. Sheik-bahae, A.A. Said, and E.W. Van Stryland, "High Sensitivity, Single Beam n_2 Measurements", *Opt. Lett.* 14, 955-957 (1989).
2. M. Sheik-bahae, A.A. Said, T.H. Wei, D.J. Hagan, and E.W. Van Stryland, "Sensitive Measurement of Optical Nonlinearities Using a Single Beam", *Jour. Quan. Elect., QE* 26, 760-769 (1990).
3. D.R. Coulter, V.M. Miskowsky, J.W. Perry, T.H. Wei, E.W. Van Stryland, and D.J. Hagan, *Proceedings of SPIE, Materials for Optical Switches, Isolators, and Limiters*, 1105, 42-51 (1989).
4. E.W. Van Stryland, H. Vanherzeele, M.A. Woodall, M.J. Soileau, A.L. Smirl, S. Guha, and T.F. Boggess, "Two-Photon Absorption, Nonlinear Refraction, and Optical Limiting in Semiconductors", *Opt. Eng.* 24, 613-623 (1985).
5. T.F. Boggess, S.C. Moss, I.W. Boyd, and A.L. Smirl, *Opt. Lett.* 9, 291 (1984).

Direct Measurements of Nonlinear Absorption and Refraction in Solutions of Phthalocyanines

H. Wei¹, D. J. Hagan¹, M. J. Sence¹, E. W. Van Stryland¹, J. W. Perry², and D. R. Coulter²

¹Center for Research in Electro-Optics and Lasers and Department of Physics, University of Central Florida, Orlando, FL 32816, USA

²Jet Propulsion Laboratory, California Institute of Technology, Pasadena, CA 91109, USA

Received 16 June 1991/Accepted 12 September 1991

Abstract. We report direct measurements of the excited singlet state absorption cross section and the associated nonlinear refractive cross section using picosecond pulses at 532 nm in solutions of phthalocyanine and naphthalocyanine dyes. By monitoring the transmittance and far field spatial beam distortion for different pulsewidths in the picosecond regime, we determine that both the nonlinear absorption and refraction are fluence (energy per unit area) rather than irradiance dependent. Thus, excited state absorption (ESA) is the dominant nonlinear absorption process, and the observed nonlinear refraction is also due to real population excitation.

PACS: 33.00, 42.65, 42.80

In recent years, conjugated organic molecules and polymers have come under critical study regarding their potential as nonlinear optical materials [1]. This has led to interest in: 1) developing a fundamental understanding of the mechanisms which contribute to the nonlinear optical response, 2) identifying means of enhancing and maximizing the nonlinear susceptibilities, and 3) obtaining well defined and accurate measurements of the refractive and absorptive contributions to the observed nonlinearities. Here we report on the separation of nonlinear absorption and refraction in phthalocyanine and naphthalocyanine solutions on the picosecond timescale using a combined nonlinear transmittance and beam distortion method which we refer to as the "Z-scan" technique [2,3]. We find that both the nonlinear absorption and refraction are dominated by creation of a real population of excited states even though the wavelength of observation lies between electronic absorption bands.

Metallophthalocyanines and related conjugated ring molecules have attracted recent interest [4-11] because, as confined, reduced-dimensionality (2D) delocalized electronic systems, large electronic nonlinearities are expected. The rigid structural framework of these molecules leads to a small geometry change on excitation and a concentration of intensity into the $S_1 \leftarrow S_0$ 0,0 vibronic transition, resulting in a strong narrowband absorption ($Q(0)$ band) [12]. Thus, the phthalocyanine dyes can exhibit a low saturation intensity depending on the relevant relaxation rates. For example, chloro-aluminium phthalocyanine (CAP) is well known as a saturable absorber at

694 nm and was used early on as a passive Q -switch for ruby lasers [13-15]. It also exhibits excited triplet state absorption [16] at shorter wavelengths in the range between the Q and B bands [12] where the linear absorption is quite weak. The nonlinear optical response in this spectral region is of interest because it can function as an optical pulse energy limiter [6, 11]. This type of response has been referred to as reverse saturable absorption [17].

As part of our search for dyes which may be useful for optical limiting applications, we have surveyed the nonlinear transmission of a number of metallophthalocyanines and metallo-naphthalocyanines [6, 11]. Here, we present data using picosecond laser pulses on two dyes in solution: CAP in methanol solution and a silicon naphthalocyanine (Nc) derivative [18], $\text{Si}(\text{OSi}(\text{n-hexyl})_3)_2\text{Nc}$, which we will refer to as SINC, in toluene solution. The Q -band absorption peaks of these solutions are at 670 nm and 774 nm respectively, while we are exciting at 532 nm. With picosecond input pulses (shorter than the time required to populate the triplet state), we find that the excited singlet state absorption is quite strong for both dyes [6, 11]. The generic level structure for these molecules is shown in Fig. 1, and consists of five levels showing the possibility of both excited singlet and excited triplet state absorption. The linear absorption at 532 nm is initially low since we are exciting high in the vibrational manifold of S_1 . The fast relaxation to the bottom of this electronic state makes the excited state absorption (ESA) resonant with the 532 nm input light. For longer pulses, intersystem crossing also leads to resonant triplet

Meas.

S_N

S_1

S_0

S_0

Fig. 1
 cyan
 state
 const
 corre
 const

stat
 time
 for
 for
 Tat

]

In
 mi
 Se
 W
 sir
 tra
 ra
 re
 ec
 dl
 ar
 d.

T
 C

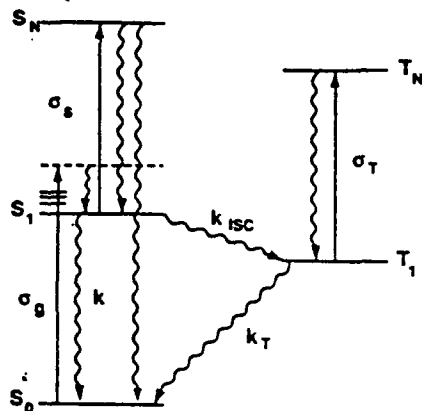

Fig. 1. Generic five-state model for nonlinear behavior of phthalocyanines. S_0 , S_1 , and S_N are singlet states and T_1 and T_N are triplet states. The σ 's are absorption cross sections and the k 's are rate constants. σ_S is represented in the text simply as σ . Wavy lines correspond to spontaneous decay processes. The total decay rate constant for S_1 is $k_S = k + k_{ISC}$.

state ESA. This ability to respond on both fast and slow timescales makes these materials particularly attractive for optical limiting. The singlet lifetimes and triplet state formation yields for both CAP and SINC are listed in Table 1.

1 Excited State Absorption

In the following analysis we examine the nonlinear transmittance of a material in which ESA is dominant. In Sect. 3 we show this to be the case for these materials. We solve a rate equation model including excited singlet-singlet state absorption as well as integration over the transverse beam profile. In this model we ignore saturation as discussed in Sect. 4. For pulses short relative to the decay time of the intermediate level the following equations apply:

$$dI/dz' = -\alpha I - \sigma NI \quad (1)$$

and

$$dN/dt = \alpha I / \hbar\omega, \quad (2)$$

where dz' is the differential element of depth in the sample, I the irradiance, α the linear absorption coefficient, σ the excited singlet-singlet absorption cross section, N the density of excited states, and $\hbar\omega$ the photon energy. By temporal integration of (1) and (2) we find

$$dF/dz' = -\alpha F - \alpha\sigma/2\hbar\omega F^2, \quad (3)$$

where F is the fluence (i.e. energy per unit area). The solution to this equation, after integrating over the Gaussian spatial distribution of the pulse of on axis fluence F_0 , gives the normalized change in transmittance ΔT of

$$\Delta T = \frac{T}{T_{lin}} - 1 = \frac{\ln(1+q)}{q} - 1 \cong -\frac{q}{2} = -\frac{\alpha\sigma F_0 L_{eff}}{4\hbar\omega}, \quad (4)$$

where T is the transmittance, T_{lin} the linear transmittance, and $L_{eff} = (1 - e^{-\alpha L})/\alpha$ with L the sample length. Here the last equality defines q and the approximation is valid for small q (i.e. for small ΔT). All energy and fluence levels are quoted as incident in the fluid (i.e. after surface reflections are taken into account).

From (4), the same F for two different pulsewidths is expected to give the same nonlinear absorption for ESA. A similar analysis for two-photon absorption (2PA) gives a result that is I rather than F dependent. Thus, the transmittance change ΔT at a fixed input pulse energy will be independent of pulsewidth for ESA, but will depend on pulsewidth for 2PA. This serves as a simple test to determine the nonlinear mechanism.

2 Z-Scan Techniques

Most of the measurements of the nonlinear properties reported in this paper employed the "Z-scan" technique. This technique, as shown in Fig. 2, involves measurements of the far field sample transmittance of a focused Gaussian beam as a function of the position (Z) of the material relative to the beam waist [2, 3]. Here, we give a brief description of the determination of nonlinear absorption and refraction using this method. First, consider a sample with a negative nonlinear refractive index and an aperture in place in Fig. 2. If we normalize the transmittance T to the linear transmittance of the aperture, and we begin the scan at large negative values of Z in Fig. 2, T is unity. As the sample is moved toward the focus of a

Table 1. Singlet and triplet properties of CAP and SINC

Molecule	τ_S^a	ϕ_T^b	τ_{ISC}^c	ϵ_S^d	ϵ_T^e	ϵ_S^f
CAP ^g	7.0 (1)	0.4 ^b	18	580 (40)	19,000	6,000
SINC ⁱ	3.15 (5)	0.2 ^j	16	740 (40)	40,000	10,200

^a S_1 fluorescence lifetime (ns) measured using time-correlated single photon counting

^b Triplet yield

^c Calculated intersystem crossing time constant (ns)

^d Ground state extinction coefficient ($M^{-1} cm^{-1}$) at 532 nm

^e Triplet-triplet extinction coefficient ($M^{-1} cm^{-1}$) at 532 nm estimated from $T-T$ spectra in [16] for CAP and [20] for SINC

^f Excited singlet-singlet extinction coefficient ($M^{-1} cm^{-1}$) calculated from measured σ values, this work

^g In ethanol solution

^h In 1-chloronaphthalene solution, [19]

ⁱ In toluene solution

^j [20]

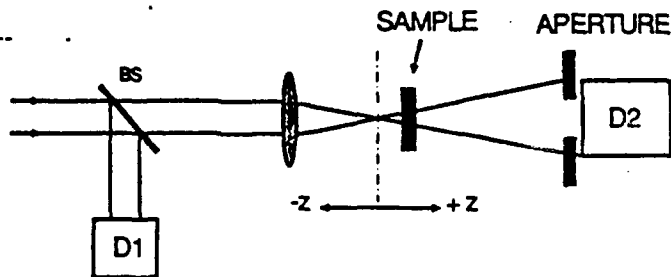

Fig. 2 The Z-scan experimental apparatus in which the ratio $D2/D1$ is recorded as a function of the sample position Z

laser beam the increased irradiance leads to a negative lensing effect which tends to collimate the beam, thus increasing the energy transmitted through the aperture ($T > 1$). With the sample on the $+Z$ side of focus, the negative lensing effect tends to augment beam divergence and the energy transmittance is reduced ($T < 1$). The approximate null at $Z \cong 0$ is analogous to the effect of placing a thin lens at focus which results in a minimal far field pattern change. For still larger $+Z$ values the irradiance is reduced and the transmittance returns to unity. A positive nonlinearity results in the opposite effect, i.e. lowered transmittance for the sample at negative Z and enhanced transmittance for positive Z . The Z-scans are readily analyzed to extract the nonlinear refraction as described in detail in [3].

The induced peak-on-axis phase distortion $\Delta\Phi_0$ is determined by integration of the following equation through the entire length L of the sample:

$$d\Phi_0/dz' = 2\pi\Delta n(z')/\lambda, \quad (5)$$

where Δn is the irradiance or fluence dependent change in refractive index and λ is the wavelength. z' is the distance within the sample, to be distinguished from the sample position, Z . For an instantaneous (irradiance dependent) nonlinearity $\Delta n = n_2|E|^2/2$, where $|E|$ is the electric field amplitude. For an index change due to population of an excited state,

$$\Delta n = \frac{\sigma_r N \lambda}{2\pi}, \quad (6)$$

where σ_r is defined as the nonlinear refractive cross section. Thus, from (2) Δn depends on the temporal integral of the irradiance, or more simply, the fluence.

If the aperture in the Z-scan experiment of Fig. 2 is removed (we term this an "open" aperture Z-scan as opposed to "closed" aperture described above), the Z-scan becomes insensitive to nonlinear refraction and results in a null signal (i.e. flat response with Z) unless nonlinear absorption is present. In this case a symmetrical curve showing a reduced transmittance ($T < 1$) about the focal position is obtained described by (4) where F_0 is a function of Z . If both nonlinear refraction and nonlinear absorption are present simultaneously, an analysis of the open and closed aperture Z-scans can be used to separately determine the nonlinear refraction and nonlinear absorption.

The separation and evaluation process is simple: the closed aperture normalized Z-scan is divided by the one with the aperture open. The result is a new Z-scan showing the sign and magnitude of the refractive nonlinearity. This division process will give a faithful representation of the nonlinear refraction as if nonlinear absorption were absent for relatively small nonlinear absorption. However, in the case of the large ESA shown by these dyes nonlinear absorption dominates, and we fit the data by numerical solution of (2-6) following the analysis given in [3].

3 Experiment and Results

CAP (Eastman Kodak Co.), was extracted from the commercial product with methanol and filtered to remove insoluble material. The methanol was removed by rotary evaporation using a room temperature bath. The resulting solid CAP was used for experiments. SINC was synthesized by the method described in [18]. Solvents used for measurements were absolute methanol for CAP and high purity toluene for SINC.

In our experiments, we use single pulses of picosecond duration at 532 nm with a high quality TEM₀₀ spatial mode obtained from a frequency doubled mode-locked Nd:YAG laser, with a single pulse switch-out apparatus. By selection of various etalons within the laser cavity, the pulsewidth can be varied from 30 to 100 ps full width at half maximum (FWHM). For all of our Z-scan measurements, the beam is focused to a waist of radius $w_0 = 19 \mu\text{m}$ half width at $1/e^2$ maximum (HW $1/e^2$ M) and the sample path length is 1 mm.

We performed Z-scan experiments on CAP at a concentration of 1.3×10^{-3} moles per liter. The linear transmittance of 84% gives a linear absorption coefficient of $\alpha = 1.8 \pm 0.1 \text{ cm}^{-1}$, which corresponds to an extinction coefficient of $580 \pm 40 \text{ liters cm}^{-1} \text{ mole}^{-1}$. Here the extinction coefficient is defined as, $\epsilon = -\log_{10} T/CL = 10^{-3}\sigma N_A/\ln(10)$, where C is the concentration in moles per liter. We also give the relation for an absorption cross section σ in cm^2 where N_A is Avogadro's number. In this paper we use σ as the ESA cross section. Similar measurements on SINC give a transmittance of 84% ($\alpha = 1.8 \pm 0.1 \text{ cm}^{-1}$) at a concentration of 1.0×10^{-3} mole per liter, corresponding to an extinction coefficient of $740 \pm 40 \text{ liters cm}^{-1} \text{ mole}^{-1}$.

Figure 3 shows open aperture Z-scans on a CAP solution at 532 nm for two different pulsewidths of 29 ps and 61 ps (FWHM) using the same input energy of $1.17 \mu\text{J}$ and hence, the same on axis fluence at focus of $F_0(Z=0) = 205 \text{ mJ/cm}^2$. Clearly the nonlinear transmittance is independent of pulsewidth and hence we conclude that the mechanism is dominated by ESA.

The solid lines in Fig. 3 are the results of numerically fitting the data to (4) by integrating over space. Here F_0 is a function of Z . This numerical fit gives a value for σ of $\cong 2.3 \times 10^{-17} \text{ cm}^2$ ($\epsilon = 6,020 \text{ liters cm}^{-1} \text{ mole}^{-1}$). Measurements show that σ is the same for concentrations of 5.5×10^{-4} moles per liter and 1.3×10^{-3} moles per liter. A similar measurement on SINC gave σ of $\cong 3.9 \times$

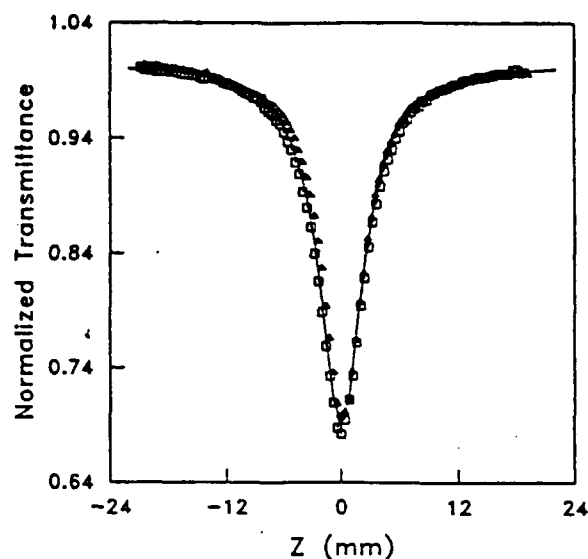

Fig. 3. Open aperture Z-scans for 29 ps (squares) and 61 ps (triangles) pulsewidths at an incident energy of $1.16 \mu\text{J}$ in CAP

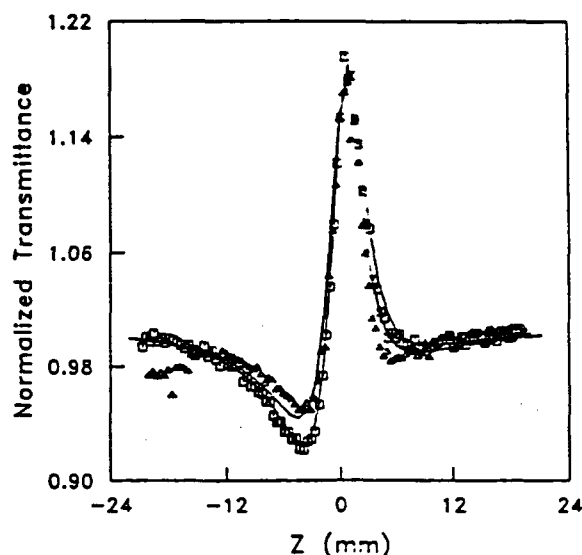

Fig. 5. The results of the division of the closed aperture Z-scan data by the open aperture Z-scan data for 29 ps (squares) and 61 ps (triangles) pulsewidths at an incident energy of $1.89 \mu\text{J}$ in SINC

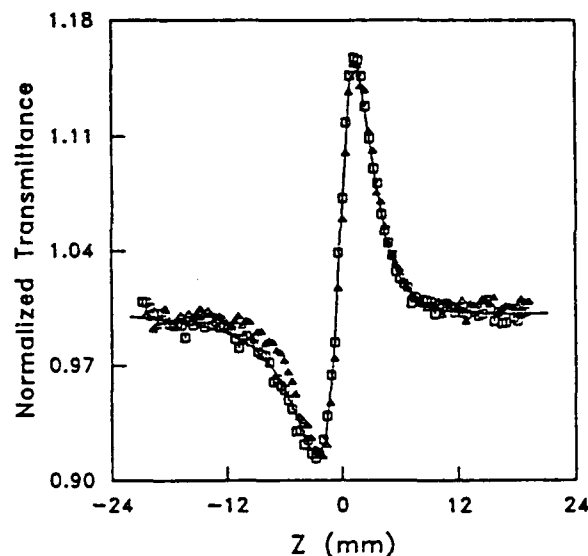

Fig. 4. The results of the division of the closed aperture Z-scan data by the open aperture Z-scan data of Fig. 3 for 29 ps (squares) and 61 ps (triangles) pulsewidths at an incident energy of $1.16 \mu\text{J}$ in CAP

10^{-17} cm^2 ($\epsilon = 10,200 \text{ liters cm}^{-1} \text{ mole}^{-1}$). We obtain the same values for σ in CAP at input fluence from $0.4 \mu\text{J}$ to $3.6 \mu\text{J}$ and for SINC from $0.4 \mu\text{J}$ to $1.9 \mu\text{J}$. Absolute errors in the σ values of $\pm 13\%$ were determined from an estimated 7% error in the concentration, 5% fitting error and a 10% possible error in the fluence calculation.

In order to determine the nonlinear refractive coefficients of these dyes, we performed closed aperture Z-scans on CAP for 29 ps and 61 ps (FWHM) pulsewidths. Figure 4 shows the results of dividing these Z-scans by the open-aperture scans of Fig. 3 taken under identical conditions. Clearly we see that the index change is positive and identical for the same fluence. This nonlinear refraction is therefore fluence dependent and as-

sociated with the real excitation of the singlet state. To determine the contribution of the solvent, Z-scans were performed on the pure methanol and toluene solvents. This yielded an n_2 for methanol of $2.5 \times 10^{-13} \text{ esu}$ and for toluene of $1.9 \times 10^{-12} \text{ esu}$. As expected, no nonlinear absorption was seen in the pure solvents. For the calculation of σ_r , contributions of both solvent (n_2) and dye (σ_r) were included, thus $\Delta n = n_2|E|^2/2 + \sigma_r N \lambda/2\pi$. Substituting this expression into (5) and temporally integrating to numerically fit the data of Fig. 4 then yields $\sigma_r = 1.8 \times 10^{-17} \text{ cm}^2$ for CAP. Measurements at concentrations of $\approx 5.5 \times 10^{-4} \text{ moles/liter}$ and $\approx 1.3 \times 10^{-3} \text{ moles/liter}$ in CAP showed the same σ_r . In Fig. 5, we show divided Z-scans for SINC, again for pulsewidths of 29 ps and 61 ps (FWHM) and with an incident energy of $1.89 \mu\text{J}$. The solid lines show fits obtained in the same way as described above for CAP, giving $\sigma_r = 4.7 \times 10^{-18} \text{ cm}^2$ for SINC. The reason that the two curves in Fig. 5 do not coincide, as do the curves for CAP, is that the instantaneous large nonlinear refraction (n_2) of the toluene solvent plays a significant role. In the case of CAP, the overlap of the Z-scans at different pulsewidths and the independence of our measurements on concentration indicate that the nonlinear refractive contribution of the solvent is negligible. We obtain the same values of σ_r over the input fluence ranges quoted for the determination of σ .

4 Discussion

Our results demonstrate the importance of measuring the nonlinearities at different pulsewidths. Had we looked with only a single pulsewidth, we could equally well have fit the data of Figs. 4 and 5 with simple n_2 values. For example for a pulsewidth of 29 ps for CAP this gives an $n_2 = 4.6 \times 10^{-12} \text{ esu}$ and for SINC this gives

$n_2 = 3.0 \times 10^{-12}$ esu. However, we would obtain a larger n_2 using 61 ps. From these fits and the n_2 's of the solvents, the contribution to the "effective" n_2 's for CAP and SINC at the given concentrations can be obtained by simple subtraction to give $n_2 = 4.4 \times 10^{-12}$ esu for CAP and $n_2 = 1.1 \times 10^{-12}$ esu for SINC. These correspond to effective third order hyperpolarizabilities of 4.5×10^{-31} esu for CAP and 3.3×10^{-32} esu for SINC. The "effective" n_2 is only globally valid if the index change is dependent on the instantaneous irradiance and hence responds on an ultrafast timescale. The most common example of this is the bound electronic Kerr effect. However, if it is due to the population of excited states, it is much more useful to quote the excited state refractive coefficient. Hence what we are observing is not a true $\chi^{(3)}$ effect but is a sequential $\chi^{(1)} : \chi^{(1)}$ process, where $\chi^{(j)}$ refers to the j th order electric susceptibility. Here, the first $\chi^{(1)}$ is associated with the ground state absorption, the second with the resulting excited state refraction.

These refractive changes are a direct result of the changes in the linear absorption, as described by the Kramers-Kronig relations [20]. These relations predict a decrease in index above the induced absorption resonance and an increase below resonance. We can speculate that the cause for the observed positive sign of the nonlinear refraction is the addition of such an absorption centered at a slightly shorter wavelength than our 532 nm light. Measurements of the transient absorption spectrum confirm increasing the absorption centered at a shorter wavelength than 532 nm for CAP [6]. In SINC it is not clear where with respect to 532 nm the increased absorption is centered, and we see a considerably smaller positive nonlinear refraction. In addition we are on the high frequency side of the Q-band absorption which we are saturating. The nonlinear refraction from this saturation is, therefore, also positive in both CAP and SINC.

We have ignored the above mentioned saturation of the Q-band absorption, i.e. depletion of the ground state population, since we experimentally do not see a significant deviation from the fits using (4) and (6) until nearly an order of magnitude higher input fluence. This is our observation even though a simple calculation shows significant ground state depletion at the fluence levels used in these experiments. Allowing for saturation in the rate equations, and numerically integrating, gives excited state cross sections nearly 30% larger than we quote. However, we find a much better fit to the data over the entire range of input fluences used in these experiments with the simple (nonsaturating) model given here. A partial direct repopulation of the ground state from the excited state absorption process may account for the absence of saturation. Time resolved absorption spectra would answer this question. Nevertheless, the main conclusion that excited state absorption and excited state refraction dominate in these experiments remains unchanged.

Garito et al. [9] have recently reported an enhancement of the third order hyperpolarizability using third harmonic generation at 1.54 μm upon optically inducing a population in the excited singlet state. In our experiments this would appear as a higher order nonlinearity (i.e. a $\chi^{(1)} : \chi^{(3)}$ process, $\chi^{(1)}$ for the initial excitation to the ex-

cited state, and $\chi^{(3)}$ for the subsequent increase in hyperpolarizability). Therefore, the excited state nonlinearities we observe are not directly related to the nonlinearities observed by Garito.

A summary of the results of our measurements along with the singlet and triplet photophysical properties of CAP and SINC are given in Table 1. The excited singlet lifetimes are two orders of magnitude longer than the 30–60 ps pulse durations used in our measurements, so that our results are for excited singlet absorption and we neglect singlet decay in the analysis. While the excited singlet extinction coefficients are roughly an order of magnitude larger than those for the ground states at this wavelength, they are a factor of 3 to 4 smaller than those for the triplet states at 532 nm. The triplet absorption would play a significant role only with much longer pulses.

5 Conclusion

In conclusion we have used a simple sensitive single beam technique (Z-scan) to measure both nonlinear absorption and nonlinear refraction in solutions of phthalocyanine and naphthalocyanine dyes on a picosecond time scale. The nonlinear refraction is determined to be positive and both the nonlinear absorption and refraction are dependent on input pulse fluence (i.e. depend on the excited singlet state population). We give simple relations that allow this excited state absorption cross section and the associated nonlinear refractive cross section to be obtained directly from Z-scan data. For longer nanosecond time scales the triplet excited state absorption becomes significant and will lead to further enhancement of the absorptance. These materials are, therefore, promising materials for optical limiting applications.

Acknowledgements. A portion of this work was performed by the Jet Propulsion Laboratory, California Institute of Technology, as part of its Center for Space Microelectronics Technology. This work was supported in part by the U.S. Army Vulnerability Assessment Laboratory (VAL, LABCOM) through an agreement with the National Aeronautic and Space Administration. The CREOL authors also gratefully acknowledge the support of the U.S. Army Research Office, VAL, LABCOM, the National Science Foundation grant # ECS-8617066, DARPA/CNVEO and the Florida High Technology and Industry Council. The authors also thank Prof. M. E. Kenney of Case Western Reserve University for a sample of $\text{Si}(\text{OSi}(n\text{-hexyl})_3)_2\text{Nc}$, (SINC).

EVS thanks Prof. T. Boggess for helpful discussions.

References

1. See for example, a) D.S. Chemla, J. Zyss (eds.): *Nonlinear Optical Properties of Organic Molecules and Crystals*, Vols. 1 and 2 (Academic, Orlando, 1987) b) R.A. Hann, D. Bloor (eds.): *Organic Materials for Nonlinear Optics* (The Royal Society of Chemistry, London, 1989) c) J. Messier, F. Kajzar, P. Prasad, D. Ulrich (eds.): *Nonlinear Optical Effects in Organic Polymers* NATO ASI Series E, Vol. 162 (Kluwer, Dordrecht 1989)
2. M. Sheik-bahae, A.A. Said, E.W. Van Stryland: *Opt. Lett.* 14, 955–957 (1989)

Mea:
3. A
1:
4. Z
(
5. V
6. T
(
7. :
8. :
9. :
10. :

3. M. Sheik-bahae, A.A. Said, T.H. Wei, D.J. Hagan, E.W. Van Stryland: *IEEE J. QE-26*, 760-769 (1990)
4. Z.Z. Ho, C.Y. Ju, W.M. Hetherington III: *J. Appl. Phys.* 62, 716 (1987)
5. M.K. Casstevens, M. Samoc, J. Pfeleger, P.N. Prasad: *J. Chem. Phys.* 92, 2019 (1990)
6. D.R. Coulter, V.M. Miskowski, J.W. Perry, T.H. Wei, E.W. Van Stryland, D.J. Hagan: *Materials for Optical Switches, Isolators and Limiters*, ed. by M.J. Soileau, Proc. SPIE 1105, 42-51 (1989)
7. J.W. Wu, J.R. Heflin, R.A. Norwood, K.Y. Wong, O. Zamani-Khamiri, A.F. Garito, P. Kalyanaraman, J.R. Sounik: *J. Opt. Soc. Am. B* 6, 707 (1989)
8. J.S. Shirk, J.R. Lindle, F.J. Bartoli, C.A. Hoffman, A.H. Kafafi, A.W. Snow: *Appl. Phys. Lett.* 55, 1287 (1989)
9. A.F. Garito, J.R. Heflin, N.Q. Wang, Y.M. Cai: Technical digest of the conference on *Nonlinear Optics: Materials, Phenomena and Devices* (IEEE, Washington D.C. 1990) p. 73
10. A. Kaltbeitzl, D. Neher, C. Bubeck, T. Sauer, G. Wegner, W. Caseri: In *Electronic properties of Conjugated Polymers III*, Springer Series in Solid State Sci. 91, 220 (1989)
11. J.W. Perry, L.R. Khundkar, D.L. Coulter, D. Alvarez Jr., S.R. Marder, T.H. Wei, M.J. Sence, E.W. Van Stryland, D.J. Hagan: In *Organic Molecules for Nonlinear Optics and Photonics*, ed. by J. Messier, F. Kajzar, P. Prasad, NATO ASI Series E, Vol. 194 (Kluwer, Dordrecht 1991) p. 369
12. M. Gouterman: In *The Porphyrins*, ed. by D. Dolphin (Academic, New York 1978) Vol. III, p. 1
13. F. Gires, F. Combaud: *J. de Phys.* 26, 325 (1965)
14. J.A. Armstrong: *J. Appl. Phys.* 36, 471 (1965)
15. M. Hercher, W. Chu, D.L. Stockman: *IEEE J. QE-4*, 954 (1968)
16. T. Ohno, S. Kato, A. Yamada, T. Tanno: *J. Phys. Chem.* 87, 775 (1983)
17. W. Blau, H. Byrne, W.M. Dennis, J.M. Kelly: *Opt. Commun.* 56, 25 (1985)
18. B.L. Wheeler, G. Nagasubramanian, A.J. Bard, L.A. Schectman, D.R. Dininny, M.E. Kenney: *J. Am. Chem. Soc.* 106, 7404 (1984)
19. J.H. Brannon, D. Magde: *J. Am. Chem. Soc.* 102, 62 (1980)
20. D.C. Hutchings, M. Sheik-Bahae, D.J. Hagan, E.W. Van Stryland: *Opt. Quantum Electron* (to be published, 1991)

Proc. Nato Adv. Res. W'shop
"Organic molecules for NLO & photonic"
La Rochelle, France, August 1990.

Excited State Absorption and Optical Limiting in Solutions of Metallophthalocyanines

J. W. Perry*, L. R. Khundkar*, D. R. Coulter*, D. Alvarez, Jr.‡, S. R. Marder*§
T. H. Wei†, M. J. Sence†, E. W. Van Stryland†, and D. J. Hagan†

*Jet Propulsion Laboratory, California Institute of Technology
Pasadena, CA 91109

§Beckman Institute, California Institute of Technology,
Pasadena, CA 91125

†Center for Research in Electro-Optics and Lasers and Department of Physics
University of Central Florida
Orlando, FL 32816

ABSTRACT. Picosecond and nanosecond pulsed laser studies of nonlinear absorption and nonlinear refraction in solutions of metallophthalocyanines and metallonaphthalocyanines are presented. The role of excited state absorption and dynamics in the singlet and triplet manifolds and the implications for passive optical limiters is discussed. Performance of optical limiters based on metallomacrocylic dyes is presented as are results on hybrid optical limiters employing a tandem combination of dye solution and a semiconductor slab.

1. INTRODUCTION

Optical limiting devices are currently of interest for protecting sensors and eyes from high intensity laser light as well as for thresholding elements in optical processing systems (1). The response of an ideal optical limiter is illustrated in Figure 1. The limiter exhibits linear response at low input levels and for inputs above some threshold level the output is clamped. One mechanism which can provide a response resembling that of the ideal optical limiter is nonlinear absorption, such as two-photon absorption or sequential single-photon absorption. It is well known that numerous organic and metal complex type chromophores exhibit absorption from excited electronic states to higher lying electronic states subsequent to excitation. These excited state absorptions typically involve singlet-singlet (2,3) or triplet-triplet transitions (4). An energy level scheme involving singlet and triplet manifolds is shown in Figure 2. In order to be useful for optical limiting devices, chromophores should exhibit weak but finite absorption, in the relevant spectral region, from the ground state to an excited electronic state resulting in prompt population of excited states which display strong absorption at the wavelength of excitation.

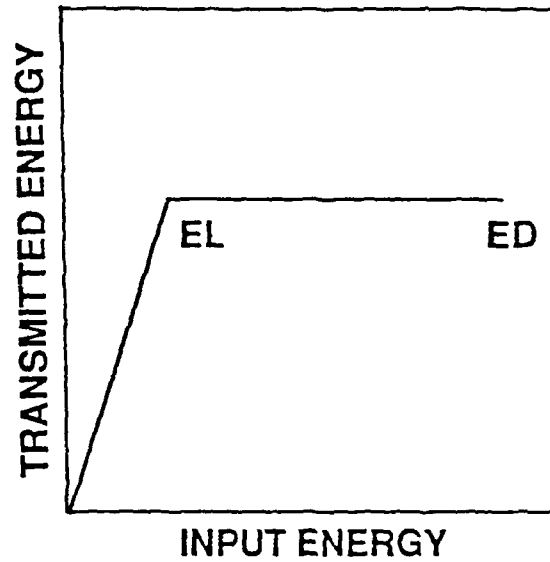

Figure 1. Input-output response of an ideal optical limiter. EL is the threshold limiting energy, ED is the damage threshold and the dynamic range is defined as $DR = ED/EL$.

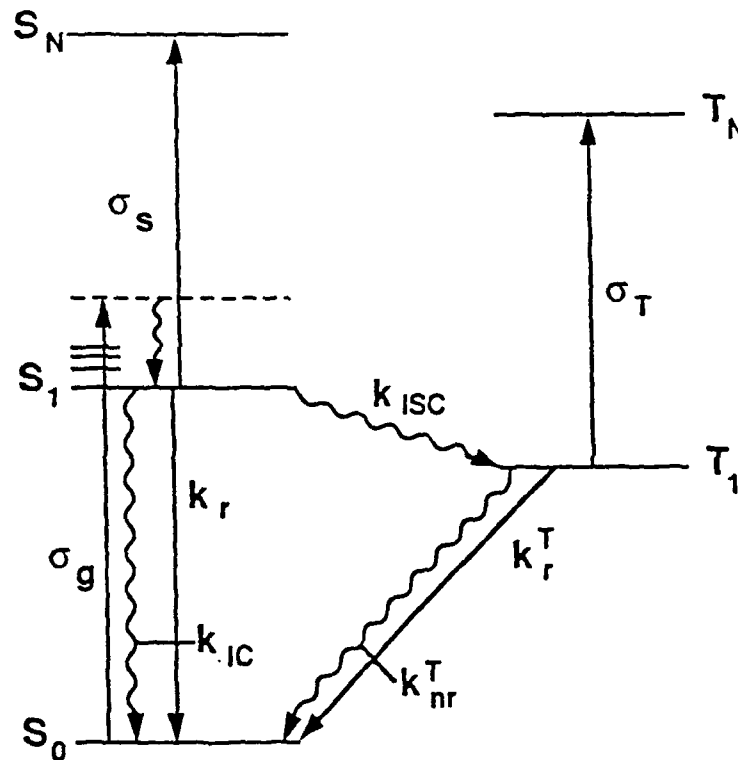

Figure 2. Qualitative state diagram illustrating excited state absorption processes in singlet and triplet manifolds. σ_s are absorption cross sections and k_s are relaxation rates.

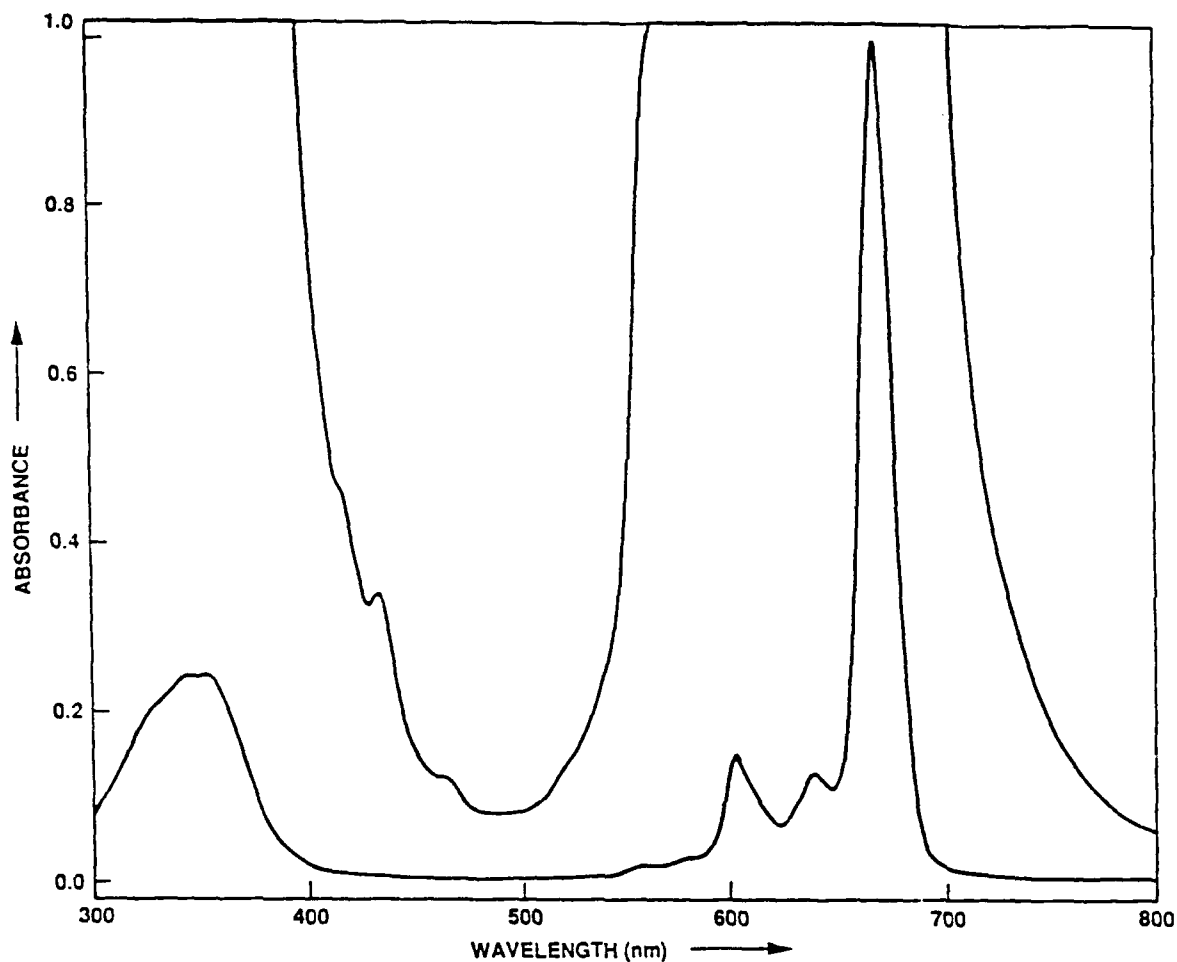

Figure 3. Absorption spectrum of chloroaluminumphthalocyanine in ethanol solution. The lower trace is for a concentration of 4×10^{-6} M and the upper trace is for 3.2×10^{-4} M. The pathlength is 1 cm.

The optical density of a medium containing such chromophores will thus increase with the degree of excitation leading to a potentially useful response.

Conjugated macrocyclic ring compounds meet the basic requirements for optical limiting via excited state absorption in the visible spectral region (5). Metallophthalocyanines, for example, exhibit a relatively broad region of low absorption (see Figure 3.) between the strong absorptions due to the so-called Q and B bands (6) and they can also exhibit excited state absorption in the same region (4,7,8). Such metallomacrocyclic dyes have attracted considerable interest regarding their nonlinear optical properties (9-15). We have recently reported on the optical limiting of picosecond and nanosecond duration 532 nm laser pulses by solutions of metallophthalocyanines and metallonaphthalocyanines (11), as well as on the use of tandem combinations of these solutions and wide-gap semiconductors as hybrid optical limiters (16). In this paper, we will present some recent results on 1) a survey study of a set of

metallophthalocyanines for prompt excited state absorption at 532 nm, 2) detailed characterization of excited state absorption and nonlinear refraction in solutions of chloroaluminumphthalocyanine (CAP) in ethanol and a silicon naphthalocyanine (Nc) derivative (17), SiNc(OSi(hexyl)₃)₂ or SiNc, dissolved in toluene using the "Z-scan" technique (18), and 3) performance of these dyes in optical limiting devices. We begin with a brief discussion of the relevant photophysical properties of CAP and SiNc.

2. PHOTOPHYSICAL PROPERTIES

Some of the photophysical properties of CAP and SiNc in solution are summarized in Table 1. CAP is well known as a saturable absorber at 694 nm and was used early on as a passive Q-switch for ruby lasers (19-21). It is a fluorescent phthalocyanine with a moderately long singlet lifetime, τ_S (22). The ground state absorption at 532 nm is weak whereas the excited state absorption in the triplet manifold is over a factor of 30 higher (7,8). We will discuss excited

TABLE 1. Singlet and Triplet Properties of CAP and SiNc.

Molecule	λ_{max}^a nm	ϵ_G^b M ⁻¹ cm ⁻¹	ϵ_T M ⁻¹ cm ⁻¹	τ_S ns	ϕ_f	ϕ_T	τ_T ms
CAP							
this work	670 ^c	580(40)		7.0			
ref 22	694 ^d			6.8	0.58	0.4	0.37
ref.7			26600 ^e 19000 ^b				
SiNc							
this work	774 ^f	740(40)		3.15			
ref. 24	776 ^g	<1000	70000 ^h 40000 ^b			0.2	0.33

a) Q-band maximum b) at 532 nm c) ethanol solvent d) 1-chloronaphthalene e) at 490 nm f) toluene solvent g) benzene solvent h) at 590 nm.

state absorption in the singlet manifold (23) below. While the Q-band of SiNc (17, 24) is significantly red-shifted relative to CAP the ground state absorption at 532 nm is still weak. SiNc is also fluorescent but with a shorter lifetime than CAP. Figure 4 shows a comparison of the time resolved fluorescence decays for CAP and SiNc measured using time-correlated single photon counting. SiNc shows relatively stronger triplet-triplet absorption than CAP. Both compounds have comparable triplet lifetimes. Using $\tau_{ISC} = \tau_S / \phi_T$, we estimate triplet state formation times of 18 and 16 ns for CAP and SiNc, respectively.

3. NANOSECOND TRANSIENT ABSORPTION AT 532 NM

A series of metallophthalocyanines and metallonaphthalocyanines were surveyed for prompt transient absorption at 532 nm. The screening

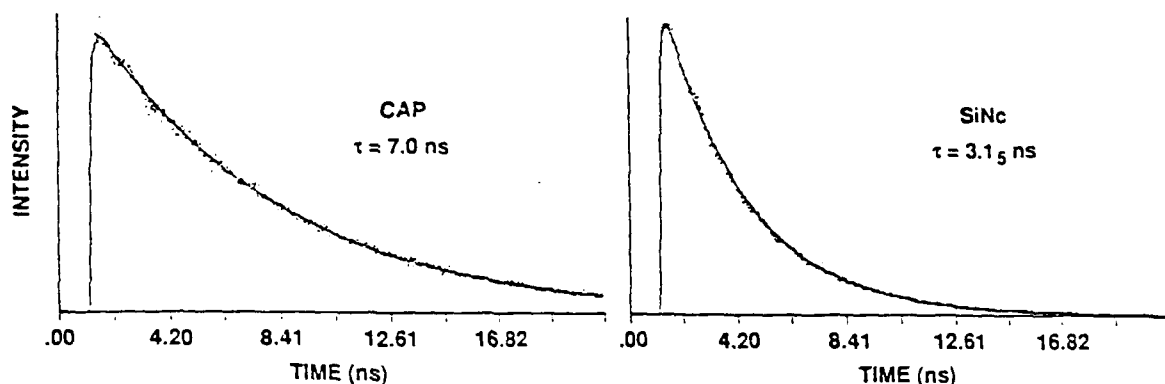

Figure 4. Fluorescence decays for CAP in ethanol and SiNc in toluene. Time resolution of apparatus < 70 ps. Points are experimental data and solid curve is the best fit to a single exponential convoluted with the response function.

measurements were quite simple. The laser source used was a frequency-doubled Q-switched Nd:YAG laser (Quantel YG 660) with a multimode pulse envelope width of about 8 ns. A 2.5 mm aperture was installed in the laser cavity to achieve a near Gaussian transverse profile. In the measurements an unfocused beam with a $1/e^2$ diameter of 4.6 mm at the sample was used. The 532 nm beam passed through a high power variable attenuator and was directed through the sample cell, a 1 cm pathlength spectrometric cuvette. The transmitted beam was detected using a Scientech volume absorbing calorimeter (Model 38-0101) with a 1" absorbing disc. The detector was placed close to the cuvette and it collected all the transmitted energy. Thus, changes in the transmitted energy as a function of input intensity are due only to absorption processes. A nominal input pulse energy of about 5 mJ was used corresponding to a fluence of about 0.032 J/cm^2 . Dye solutions were prepared in an appropriate solvent to give a linear transmission in a 1 cm cuvette of about 75%, as measured with a spectrophotometer or with very low energy laser pulses. This corresponds to dye concentrations of about $2 - 3 \times 10^{-4} \text{ M}$. The pulse energies for individual laser shots were measured with no cell in place, with a cell containing only solvent in place, and with a cell containing dye solution in place. From these measurements the transmission of the dye solution at the corresponding laser fluence can be readily calculated. If the dye exhibits nonlinear absorption the measured transmission at the moderate laser fluence will be different from 75%. To facilitate comparison we calculate the transmission ratio $R_T = T(I) / T(0)$ where $T(I)$ is the transmission at the moderate laser fluence and $T(0)$ is the linear or low intensity transmission. If

the dye does not exhibit nonlinear absorption the ratio is 1. If the dyes exhibit bleaching the ratio is > 1 . Dyes of interest to us are those that exhibit induced absorption and show a ratio < 1 . Thus, the transmission ratio is used to screen the various dyes for induced absorption.

The results on a series of phthalocyanine dyes are given in Table 2. There are several important points to be gleaned from this survey. First, note that the dye ClAlPc or CAP is the blue dye for which we have previously reported optical limiting (11) and it exhibits a transmission ratio of 0.76. Next, a series of group IV metalloid phthalocyanines is compared. These dyes exhibit stronger excited state absorption at 532 nm than CAP. The transmission ratio decreases in the order $\text{Si} > \text{Ge} > \text{Sn}$ indicating stronger excited state absorption at 532 nm as the atomic number, Z , of the metalloid atom increases. From the triplet risetimes estimated above, the fraction of population promoted to the triplet manifold during the ~ 8 ns laser pulse for SiPc is small, $< 10\%$ (25). Since the intersystem crossing rate is known to increase with Z (22, 26), the increased excited state absorption may reflect an increased triplet population during the laser pulse and more favorable triplet-triplet absorption at 532 nm. On the other hand the results could be due to more favorable singlet-singlet absorption for the molecules with the heavier central atom. While the SiPc dye showed strong nonlinear absorption, an oxo-bridged dimer (17) of the same dye, $(\text{Si}(\text{OR})\text{Pc})_2\text{O}$,

TABLE 2. Nanosecond Nonlinear Transmission of Metallophthalocyanines.

Solution ^a	T(0) ^b	T(I) ^c	T(I)/T(0)
ClAlPc (EtOH)	0.75	0.57	0.76
Si(OR) ₂ Pc (tol)	0.755	0.50	0.66
Ge(OR) ₂ Pc (tol)	0.75	0.46	0.62
Sn(OR) ₂ Pc (tol)	0.75	0.42	0.56
(Si(OR)Pc) ₂ O (tol)	0.745	0.66	0.89
VO(t-Bu) ₄ Pc (tol)	0.75	0.48	0.64
Co(t-Bu) ₄ Pc (tol)	0.75	0.74	0.99
NiPc(SO ₃ ⁻ Na ⁺) ₄ (H ₂ O)	0.75	0.71	0.95
CuPc(SO ₃ ⁻ Na ⁺) ₄ (H ₂ O)	0.75	0.49	0.65
Zn(t-Bu) ₄ NPc (DMF)	0.75	0.60	0.80
ClAl(t-Bu) ₄ NPc (tol)	0.76	0.75	0.99
Si(OR) ₂ NPc (tol)	0.75	0.47	0.63

a) Solvent indicated in parentheses. b) T(0) = low intensity transmission. c) T(I) = transmission at 0.032 J/cm². Abbreviations: NPc = naphthalocyanine, Pc = phthalocyanine, DMF = dimethylformamide, tol = toluene, EtOH = ethanol, R = Si(n-hexyl)₃, t-Bu = tert-butyl.

showed significantly reduced nonlinear absorption. This is consistent with the known shortening of the singlet lifetime of the dimer due to excitonic interactions (27). The next series is a group of first row transition metal phthalocyanines. In this case, there is no simple trend with Z. Of course, the central atom electronic configuration is also varying. Both the complex with vanadium(IV) (28) and that with copper(II) (29, 30) show prompt, strong transient absorption. These complexes are both paramagnetic but so is the inactive cobalt complex. The last series is a group of metallonaphthalocyanines. We note here only that SiNc exhibits strong prompt transient absorption comparable to that of the group IV phthalocyanines.

3. EXCITED STATE ABSORPTION AND REFRACTION OF CAP AND SiNc.

3.1 Nonlinear absorption measurements

We have examined the nonlinear absorption characteristics of CAP and SiNc at 532 nm in greater detail on both the nanosecond and picosecond timescales. To clearly illustrate the relative nonlinear absorption of CAP and SiNc, we show in Figure 5 plots of the total transmitted energy, measured as discussed above, versus input energy. The solid line indicates the behavior of a linear medium with 75% transmission. These data clearly illustrate that the prompt excited state absorption at 532 nm in SiNc is stronger than in CAP (by a factor of about 1.5 for nanosecond pulses), consistent with the screening measurements. In order to clearly quantify the excited state absorption in the singlet manifold of these dyes, measurements were performed using pulses (about 30 ps duration) which were much shorter than the singlet lifetimes of CAP or SiNc. In this case relaxation of the intermediate singlet state may be ignored and the rate

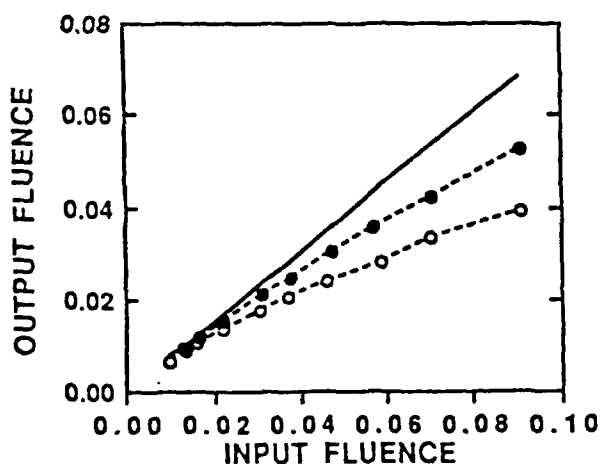

Figure 5. Nanosecond nonlinear transmission of CAP (filled circles) and SiNc (open circles) solutions. Solid line corresponds to linear response with $T = 0.75$. Fluence is in J/cm^2 .

equation analysis of the measurements is simplified. Measurements of both nonlinear absorption and nonlinear refraction were made using a combined nonlinear transmittance and beam distortion method which we refer to as the "Z-scan" technique.(18). The "Z-scan" technique, see Figure 6, involves measurements of the far field transmittance of a focussed Gaussian beam through a material as a function of the position (Z) of the sample relative to the beam waist. In these experiments single pulses of 30 ps FWHM at 532 nm with a high quality TEM₀₀ spatial mode were used. These pulses were obtained from a frequency-doubled mode-locked Nd:YAG laser. Measurements are made on the total pulse energy transmitted through the sample (referred to as an open aperture Z-scan), which depends only on nonlinear absorption, as well as on the pulse energy transmitted through a finite aperture placed in the far field (referred to as a closed aperture Z-scan), which depends on nonlinear absorption and refraction. Through these combined measurements nonlinear absorption and refraction can be separated and evaluated as illustrated below.

An open aperture Z-scan for CAP is shown in Figure 7. For this measurement the input pulse energy was 3.2 μ J, the Gaussian beam waist radius was 28 μ m (HW1/e²M), the sample pathlength was 0.2 cm and the concentration was 1.0 $\times 10^{-3}$ M, corresponding to a linear transmittance of 0.77. The solid curve in the figure is the calculated dependence using a rate equation model involving excited singlet-singlet absorption, neglecting relaxation of the intermediate singlet and including transverse beam profile averaging. The

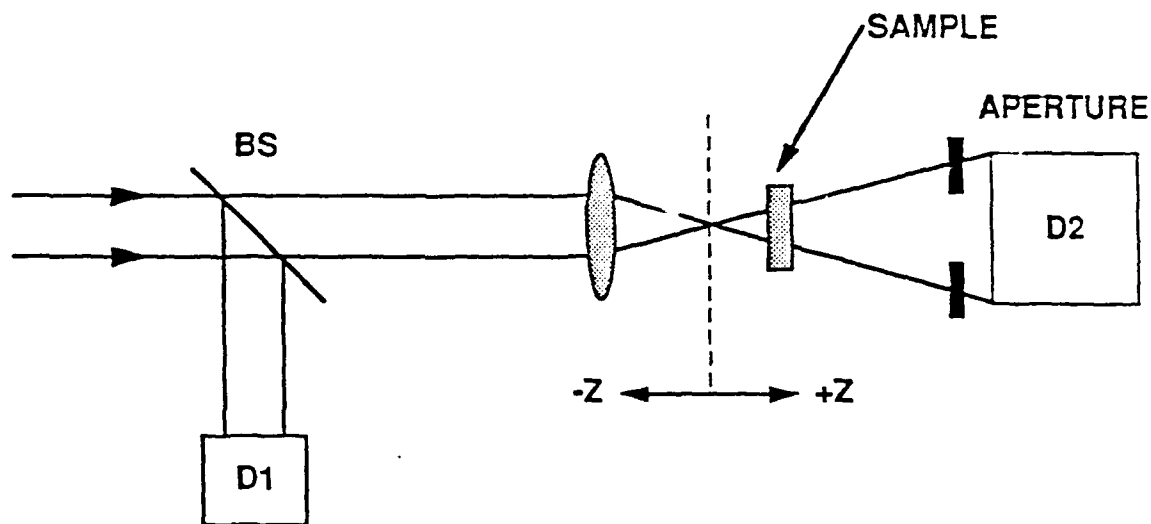

Figure 6. Schematic illustration of experimental configuration for Z-scan measurements.

following differential equations for the population of the first excited singlet state and the propagation of light were used:

$$dN/dt = \alpha I / \hbar \omega \quad dI/dz = -\alpha I - \sigma N I$$

where I is the irradiance, α is the linear absorption coefficient, σ is the excited singlet-singlet absorption cross-section, $\hbar \omega$ is the photon energy and N is the excited state number density. These equations were solved by numerical integration including a Gaussian transverse beam profile to give a calculated open aperture Z-scan, ie., the function T / T_{lin} versus z . The numerical fit to the experimental data gave $\sigma(532 \text{ nm})$ for CAP equal to $2.3 \times 10^{-17} \text{ cm}^2$. A similar measurement on SiNc in toluene solution gave a value of $3.9 \times 10^{-17} \text{ cm}^2$. These σ values correspond to ϵ_{SS} values of $6000 \text{ M}^{-1}\text{cm}^{-1}$ for CAP and $10,200 \text{ M}^{-1} \text{ cm}^{-1}$ for SiNc.

3.2 Nonlinear refraction measurements

Figure 8 shows a comparison of open and closed aperture (transmits 40% of the undistorted beam energy) Z-scans for CAP for an input pulse energy of $4.8 \mu\text{J}$. It has been shown that the ratio of the closed aperture scan to the open aperture scan yields a refractive Z-scan, the shape of which depends on the sign and magnitude of the nonlinear refractive index (18). Figure 9 shows the refractive Z-scan for CAP. The scan shows a dip in transmission at negative Z ,

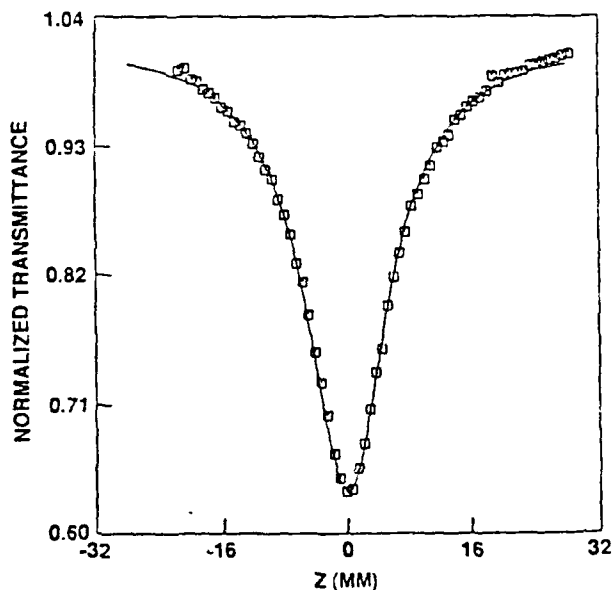

Figure 7. Open aperture Z-scan measurement on CAP solution. Solution pathlength = 0.2 cm , concentration = $1 \times 10^{-3} \text{ M}$. Points are experimental data, solid line is numerical fit using a rate equation model as described in text.

closer to the input focusing lens, and a peak in transmission at positive Z. This is indicative of a *positive* nonlinear index change. This can be visualized as the effect of moving a lens, created by the exciting beam, through the focus of a laser beam. A positive lens located after the beam waist tends to collimate the beam leading to increased energy transmitted through the aperture. If such a lens is located before the waist it will cause the beam to focus earlier and thus diverge more at the aperture plane leading to reduced transmission through the aperture. It has been shown (18) that the difference in the maximum (peak) and minimum (valley) transmittances, ΔT_{p-v} is directly proportional to the nonlinear phase shift $\Delta\Phi$, from which the nonlinear index change can be obtained using:

$$|\Delta\Phi| = 2\pi/\lambda \Delta n (1 - e^{-\alpha l}) / (2)^{1/2} \alpha'$$

where $\alpha' = \alpha + \alpha\sigma F/2\hbar\omega$. A numerical analysis (18) has shown that

$$\Delta T_{p-v} = 0.406 (1 - S)^{0.25} |\Delta\Phi| \quad \text{for } |\Delta\Phi| \leq \pi$$

where S is the aperture transmittance for the undistorted beam. The determined nonlinear index changes give effective values of the nonlinear refractive indices n_2 for CAP (1.2×10^{-3} M) and SiNc (1×10^{-3} M) solutions of 2.2×10^{-12} esu and 3.8×10^{-12} esu, respectively, for 30 ps pulses. These nonlinearities are roughly an order of magnitude larger than that of the pure solvent for CAP and about a factor of two for SiNc. Recent measurements with equal energy pulses of different duration show the same refractive Z-scans and thus the same index change. This indicates that the observed refractive nonlinearities, being dependent on fluence, are also due to real excitation of the excited singlet, as is the prompt nonlinear absorption. The results suggest a large change in polarizability on excitation for these phthalocyanines. Interestingly, Garito et al have recently demonstrated that SiNc exhibits a large increase in hyperpolarizability, γ , on excitation to the excited singlet (14).

4. PERFORMANCE OF OPTICAL LIMITERS

The performance of optical limiters based on solutions of metallomacrocyclic dyes have been characterized. The basic limiter device configuration is the same as the arrangement used in the Z-scan measurements as illustrated in Figure 6. Figure 10 shows the limiting response of a solution of CAP for single 30 ps pulses at 532 nm. The observed response is due to the combined action of nonlinear absorption and refraction by the dye solution. In order to optimize the nonlinear refraction contribution to the limiting response, the cell containing the dye solution was located at the position of minimum transmittance as

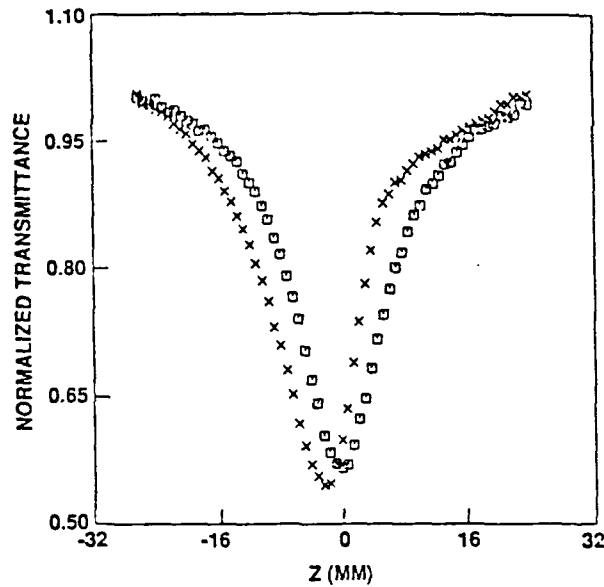

Figure 8. Open aperture (boxes) and closed aperture, $S = 0.4$, (crosses) Z-scans for CAP in ethanol. Same conditions as for Figure 7.

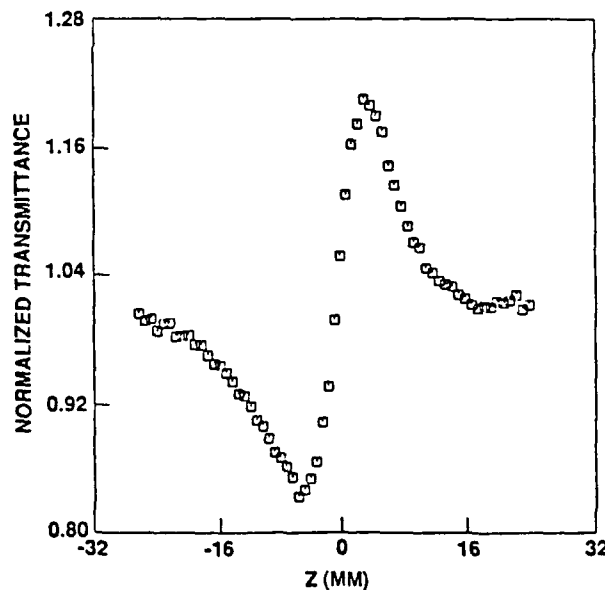

Figure 9. Refractive Z-scan for CAP in ethanol. This data was obtained by dividing the closed aperture Z-scan by the open aperture Z-scan of the previous figure.

indicated by Z-scan measurements. The CAP solution limiter shows a threshold limiting energy of about $1.6 \mu\text{J}$ for 30 ps, 532 nm pulses. Solutions of SiNc with the same linear transmission show a threshold limiting energy of $0.45 \mu\text{J}$.

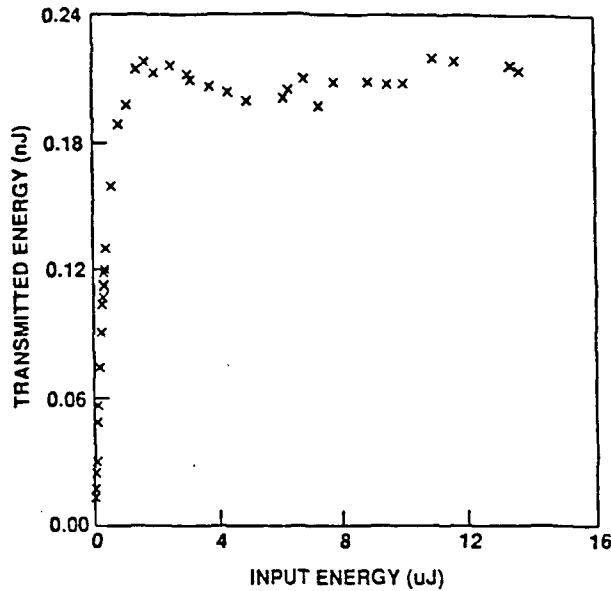

Figure 10. Input / output response of a CAP solution optical limiter for 30 ps 532 nm pulses. Solution cell pathlength was 1 cm. Beam waist radius was 20 μm . Solution concentration was 7.9×10^{-4} M corresponding to 34% transmission at 532 nm for 1 cm.

Table 3. Characteristics of CAP and SiNc solution limiters (1cm length) and tandem dye solution (0.8cm) / ZnSe (0.2cm) hybrid limiters.

Limiter	EL(μJ)	ED(μJ)	DR
ZnSe	0.15	2	13
CAP	1.6	--	--
CAP/ZnSe	0.8	50	63
SiNc	0.45	--	--
SiNc/ZnSe	0.25	>80	>320

We have also investigated the characteristics of hybrid optical limiters based on tandem combinations of dye solutions and the wide-gap compound semiconductor ZnSe. The optical limiting characteristics of ZnSe slabs have been reported previously (31). Limiters based on ZnSe show a low threshold limiting energy of 0.15 μJ , but exhibit a small dynamic range due to optical damage. Whereas the CAP and SiNc solutions exhibit thresholds of $\sim\mu\text{J}$, they are able to withstand on the order of millijoules, under moderately tight focussing conditions (10s of μm beam waist radii), before damaging. In

addition, the dye solutions are to a certain extent self-healing. Thus, we reasoned that by using a limiting dye solution in front of a ZnSe slab, that we might be able to achieve a relatively low threshold limiting energy and that the dye solution would protect the semiconductor leading to an increased dynamic range. Table 3 presents results on the limiting characteristics of the CAP and SiNc solutions, ZnSe and corresponding tandem combinations. The results demonstrate that indeed the dye solutions are able to protect the ZnSe slab and afford an enhanced dynamic range.

5. CONCLUSIONS

We have presented results which suggest that excited state absorption and nonlinear refraction in metallophthalocyanine solutions can be effectively used in passive optical limiters. The survey study showed that a number of dyes in this class exhibit prompt excited state absorption in the visible spectrum and we are attempting to reconcile the results in terms of the photophysics of the dyes. Detailed studies of CAP and SiNc have quantified the excited singlet state absorption cross-sections at 532 nm and recent results indicate that the effective nonlinear refractive index is also dominated by the excited state population, i.e. Δn is fluence dependent. Passive optical limiters using only metallomacrocyclic dye solutions show μJ thresholds and hybrid limiters with dye solutions and ZnSe slabs show sub- μJ thresholds and higher dynamic range than ZnSe alone.

ACKNOWLEDGMENTS

The work described in this paper was performed in part by the Jet Propulsion Laboratory, California Institute of Technology, as part of its Center for Space Microelectronics Technology, and was supported in part by the U. S. Army Vulnerability Assessment Laboratory (VAL, LABCOM) through an agreement with the National Aeronautics and Space Administration. The University of Central Florida authors gratefully acknowledge support from the Army Research Office and VAL, the National Science Foundation (Grant # ECS-8617066), DARPA/CNVEO and the Florida High Technology and Industry Council. The authors thank Prof. M. Kenney for a sample of SiNc, Dr. A. Stiegman for helpful discussions, Mr. K. Perry for technical assistance and Dr. V. Miskowski for earlier contributions to this project. D. Alvarez gratefully thanks the James Irvine Foundation for a postdoctoral fellowship.

REFERENCES

1. See for example: "Materials for Optical Switches, Isolators and Limiters," M. J. Soileau, Editor Proc. SPIE Vol. 1105, 42, 1989
2. R. S. Taylor and S. Mihailov Appl. Phys. B, 38, 131, 1985
3. S. Spieser and N. Shakkour, Appl. Phys. B, 38, 191, 1985
4. I. Carmicheal, G. L. Hug, J. Phys. Chem. Ref. Data, 15, 1, 1986

5. W. Blau, H. Byrne, W. M. Dennis, and J. M. Kelly, *Opt. Commun.*, 56, 25, 1985
6. M. Gouterman, "The Porphyrins," ed. D. Dolphin (Academic Press, N. Y., 1978), vol. 3, p.1.
7. T. Ohno, S. Kato, A. Yamada, T. Tanno, *J. Phys. Chem.*, 87, 775, 1983
8. J. R. Darwent, I McCubbin and D. Phillips, *J. Chem. Soc. Faraday Trans. 2*, 78, 347, 1982
9. Z. Z. Ho, C. Y. Ju, and W. M. Hetherington III, *J. Appl. Phys.*, 62, 716, 1987
10. P. N. Prasad, M. K. Casstevens, J. Pflieger and P. Logadon, *Proc. SPIE Vol.* 878, 106, 1988
11. D. R. Coulter, V.M. Miskowski, J. W. Perry, T.-H. Wei, E. W. Van Stryland, and D. J. Hagan, "Materials for Optical Switches, Isolators and Limiters," M. J. Soileau, Editor *Proc. SPIE Vol.* 1105, 42, 1989.
12. J. W. Wu, J. R. Heflin, R. A. Norwood, K. Y. Wong, O. Zamani-Khamiri, A. F. Garito, P. Kalyanaraman and J. R. Sounik, *J. Opt. Soc. Am. B*, 6, 707, 1989
13. J. S. Shirk, J. R. Lindle, F. J. Bartoli, C. A. Hoffman, A. H. Kafafi, and A. W. Snow, *Appl. Phys. Lett.*, 55, 1287, 1989
14. A. F. Garito, et al , paper in this NATO proceedings.
15. C. Bubeck et al , paper in this NATO proceedings.
16. T. H. Wei, E. W. Van Stryland, D. J. Hagan, J. W. Perry, L. R. Khundkar, D. R. Coulter and M. E. Kenney, *CLEO '90, Digest of Technical Papers, Anaheim, 1990*
17. B. L. Wheeler, G. Nagasubramanian, A. J. Bard, L. A. Schectman, D. R. Dininny and M. E. Kenney, *J. Am. Chem. Soc.*, 106, 7404, 1984
18. M. Sheik-Bahae, A. A. Said, T.-H. Wei, D. J. Hagan and E. W. Van Stryland, *IEEE J. Quantum Elec.*, 26, 760, 1990
19. F. Gires and F. Combaud, *J. de Phys.*, 26, 325, 1965
20. J. A. Armstrong, *J. Appl. Phys.*, 36, 471 (1965).
21. M. Hercher, W. Chu, and D. L. Stockman, *J. Quantum Electronics*, 4, 954, 1968
22. J. H. Brannon and D. Magde, *J. Am. Chem. Soc.*, 102, 62, 1980
23. W. E. K. Gibbs, *Appl. Phys. Lett.*, 11, 113 1967
24. P. A. Firey, W. E. Ford, J. R. Sounik, M. E. Kenney, and M. A. J. Rogers, *J. Am. Chem. Soc.*, 110, 7626, 1988
25. I. Carmicheal, G. L. Hug, *J. Phys. Chem.*, 89, 4036, 1985
26. P. Jacques and A. M. Braun, *Helv. Chim. Acta*, 64, 1800, 1981
27. A. Kaltbeitzel, et al, *Springer Ser. Solid St. Sci.*, 91, 220, 1989
28. K.-Y. Law, *Inorg. Chem*, 24, 1778, 1985
29. J. McVie, R. S. Sinclair and T. G. Truscott, *J. Chem. Soc. Faraday Trans. 1*, 72, 1870, 1976
30. D. R. Prasad and G. Ferraudi, *Inorg. Chem.*, 21, 2967, 1982
31. E. W. Van Stryland, Y. Y. Wu, D. J. Hagan, M. J. Soileau, K. Mansour, *J. Opt. Soc. Am. B*, 5, 1980, 1988.

NONLINEAR TRANSMISSION MEASUREMENTS
ON CAP AND SiNC USING 30 PICOSECOND
PULSES AT 532 NANOMETER.

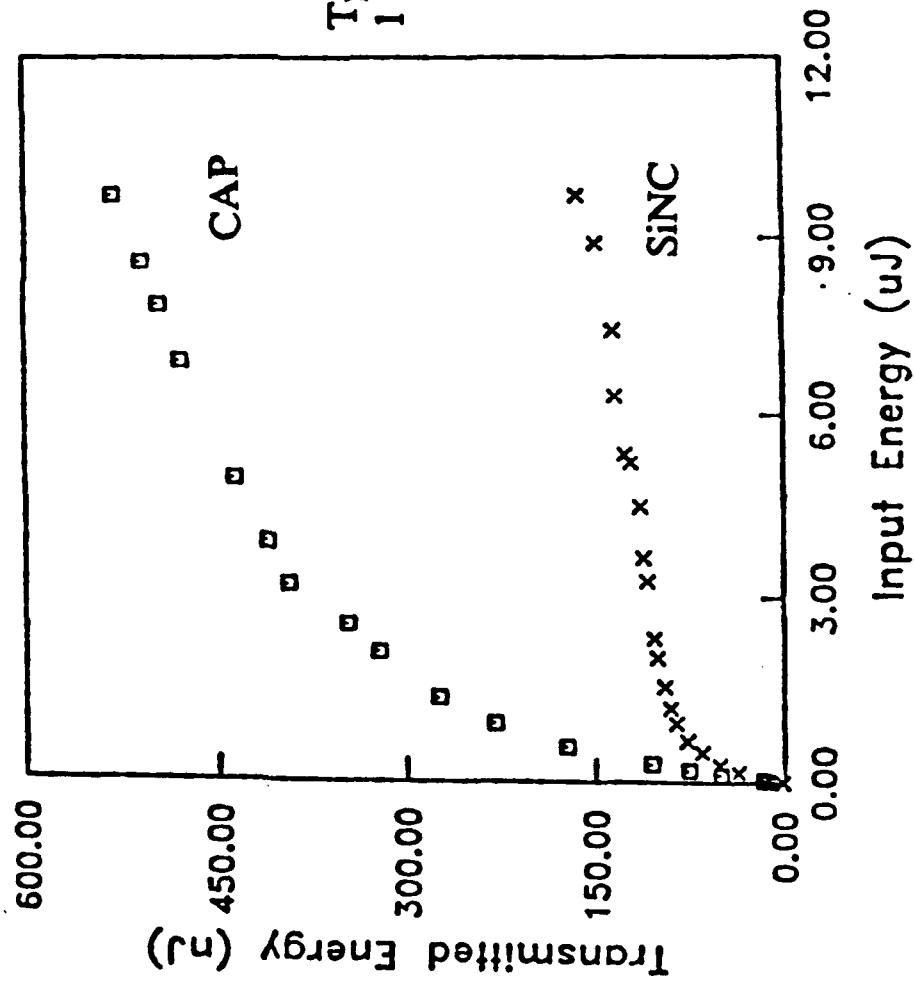

$T_{\text{linear}} = 0.365$ FOR CAP AND SiNC IN
1 CM CELLS.