

**AD-A250 625**



**92-13821**



# DISCLAIMER NOTICE

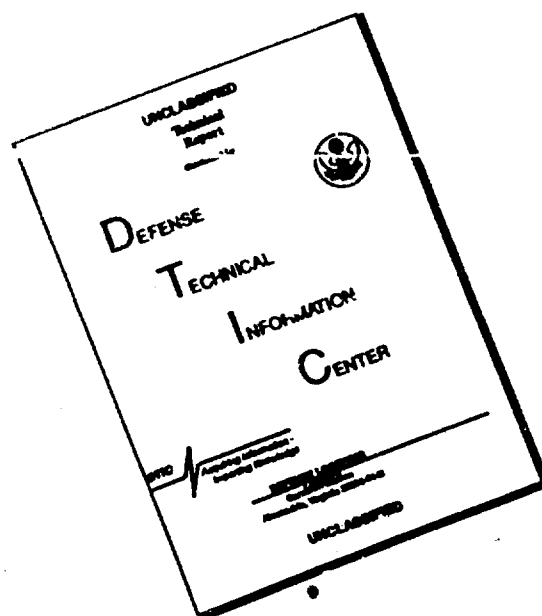

**THIS DOCUMENT IS BEST QUALITY AVAILABLE. THE COPY FURNISHED TO DTIC CONTAINED A SIGNIFICANT NUMBER OF PAGES WHICH DO NOT REPRODUCE LEGIBLY.**

THIS  
PAGE  
IS  
MISSING  
IN  
ORIGINAL  
DOCUMENT

*pages A 3, \*7, \*8, \*10 thru A 26  
A 28 thru A 45*

**Development  
of  
Predictive Equations Based  
on  
Pavement Condition Index Data**

**by  
Christopher V. O. Floro**

**A report submitted in partial fulfillment  
of the requirements for the degree of  
Master of Science in Civil Engineering**

**University of Washington  
March 1992**

Available For	
Public	<input checked="" type="checkbox"/>
Private	<input type="checkbox"/>
Available and Distribution	<input type="checkbox"/>
by <i>Per Form 50</i>	
Distribution/	
Availability Codes	
Dist	Avail and/or Special
<i>A-1</i>	

## TABLE OF CONTENTS

		Page
ABSTRACT		iii
LIST OF TABLES		v
LIST OF FIGURES		viii
LIST OF APPENDICES		x
ACKNOWLEDGEMENT		xi
LEGEND		xii
CHAPTER ONE	INTRODUCTION	
	1.1 Background	1
	1.2 The Problem	3
	1.3 Synopsis	5
	1.4 Report Overview	5
CHAPTER TWO	METHODOLOGY AND PCI APPLICATIONS	
	2.1 Research Methodology	7
	2.1.1 Summary of PCI Procedures	8
	2.2 Pavement Distresses and PCI Evaluations	10
	2.3 Modeling Objectives	12
	2.4 PCI vs AGE Curves	13
	2.5 The Pavement Condition Index Rating Scale	15
CHAPTER THREE	DATA REVIEW AND ANALYSIS	
	3.1 Introduction	18
	3.2 Review of 1988 Data and Conclusions	20
	3.3 Data Interpretation of 1991 Surveys	21
	3.4 Pavements Comparisons for 1st and 2nd Surveys	22
	3.5 Data Review	23
	3.5.1 Flexible Pavements	23
	3.5.2 AC Overlays	33
	3.5.3 Bituminous Surface Treatments	35
	3.5.4 Surface Maintenance Applications and Techniques	37
	3.5.5 Portland Cement Concrete Pavements	39

## TABLE OF CONTENTS (cont'd)

CHAPTER FOUR	ANALYSIS AND RESULTS	
4.1	Analysis Introduction	40
4.2	Regression Modeling	40
4.2.1	Regression Models	41
4.2.2	Regression Assumptions	43
4.2.3	Regression Equations Development	43
4.3	Regression Analysis and Results	44
4.3.1	Flexible Pavements	45
4.3.1.1	Regression Models	45
4.3.1.2	Survival Statistics	55
4.3.2	AC Overlays	60
4.3.2.1	Regression Models	60
4.3.2.2	Survival Statistics	60
4.3.3	Bituminous Surface Treatment	64
4.3.4	Miscellaneous Surface Treatments	70
4.3.5	Portland Cement Concrete Pavements	74
4.4	Discussion	78
4.4.1	Deterioration Rate Comparisons	78
4.4.2	Surface Maintenance Techniques	78
4.4.3	Exponential vs. Polynomial Modeling	79
4.4.4	PCI Acceptable Limits	79
CHAPTER FIVE	SUMMARY, CONCLUSIONS, AND RECOMMENDATIONS	
5.1	Summary	80
5.2	Conclusions	81
5.3	Recommendations	82

**University of Washington  
Abstract**

**"Development of  
Predictive Equations Based on  
Pavement Condition Index Data"**

**by  
Christopher V. O. Floro**

**Committee Chairman: Professor J. P. Mahoney  
Department of Civil Engineering**

This research project evaluated runway pavement condition survey information in order to develop models or equations capable of predicting future pavement performance and projected life expectancy. The data was obtained from the Federal Aviation Administration (FAA), and the Washington State Department of Transportation (WSDOT). A previous research report analyzed the first set of Pavement Condition Index (PCI) data obtained from runway pavements in the tri-state area of Washington, Oregon, and Idaho. The analysis performed in this report included only runways with a second set of PCI survey data. The two primary surface categories evaluated were flexible and rigid pavements. The former includes asphalt concrete (AC) original surface courses, AC overlays, bituminous surface treatments (BST's), and slurry seal maintenance applications. The latter consisted only of portland cement concrete pavements. Statistical analysis in the form of regression modeling was applied to the available data and various models/equations and graphic representations developed to predict pavement performance and projected life. The models and graphs were developed using the software packages MINITAB and Microsoft Cricket Graph, respectively.

The models and graphs, pavement life projections, and consolidated data base, will be additional tools or assets available to enable airport planners and managers to manage, budget, and plan more effectively for pavement rehabilitation, replacement, maintenance, and design modifications as needed.



\*\*\*\*\*

**LIST OF TABLES**

\*\*\*\*\*

TABLE	TITLE	PAGE
3-1a	Flexible pavements with associated PCI survey results and corresponding AGE (Pavement sections 2 - 3 inches AC on 6 - 8 inches of base).	25
3-1b	Flexible pavements with associated PCI survey results and corresponding AGE (Pavement sections 2 - 3 inches AC on greater than 8 inches of base).	26
3-1c	Flexible pavements with associated PCI survey results and corresponding AGE (Pavement sections with greater than 3 inches AC on any base or subbase).	27
3-1d	Flexible pavements with associated PCI survey results and corresponding AGE for runways constructed during World War Two (WWII).	27
3-1e	Flexible pavement life for pavements constructed after WWII.	29
3-1f	Flexible pavement life for pavements constructed during WWII.	31
3-2	Flexible pavement AC overlays with associated PCI results and corresponding AGE.	34
3-3a	Bituminous surface treatments with PCI results and corresponding AGE.	36
3-3b	Bituminous surface treatments LIFE data.	36
3-4	Slurry seal surface maintenance applications with PCI results and corresponding AGE.	38
3-5	Portland cement concrete pavement PCI results and corresponding AGE.	40

\*\*\*\*\*

**LIST OF TABLES**  
**(continued)**

\*\*\*\*\*

<b>TABLE</b>	<b>TITLE</b>	<b>PAGE</b>
4-1a	Regression equations for flexible pavement structural sections consisting of 2 -3 inches AC on 6 - 8 inches of base.	46
4-1b	Regression equations for flexible pavement structural sections consisting of 2 -3 inches AC on greater than 8 inches of base.	49
4-1c	Regression equations for flexible pavement structural sections consisting of greater than 3 inches AC on any base/subbase.	52
4-1d	Regression equations for flexible pavements less than 3 inches AC on 6 - 8 inches of base/subbase built during WWII.	55
4-1e	Pavement LIFE characteristics for pavements constructed after WWII with categories for greater than and less than 3 inches AC.	57
4-1f	Pavement LIFE characteristics for pavements constructed after WWII with varying AC thicknesses - Weisenberger [1].	58
4-1g	Pavement LIFE characteristics for pavements constructed during WWII with categories for greater than and less than 3 inches AC.	59
4-2a	Pavement LIFE characteristics for AC overlays 2 to 4 inches.	60
4-2b	Regression equations for flexible pavement structural sections with AC overlays ranging from 3/4 to 3 inches on any base.	61
4-3a	Regression equations for flexible pavement structural sections with bituminous surface treatments on any base/subbase.	65
4-3b	Pavement LIFE characteristics for pavements with bituminous surface treatments.	68

\*\*\*\*\*

**LIST OF TABLES**  
**(continued)**

\*\*\*\*\*

TABLE	TITLE	PAGE
4-3c	Pavement LIFE characteristics for bituminous surface treatments with BST and DBST categories.	69
4-4a	Pavement LIFE characteristics for slurry seal pavements.	70
4-4b	Regression equations for flexible pavement structural sections with slurry seal surface applications.	71
4-5	Regression equations for portland cement concrete pavements.	75

\*\*\*\*\*

**LIST OF FIGURES**

\*\*\*\*\*

FIGURE	TITLE	PAGE
1-1	Pavement Life Cycle typical performance curve compared to maintenance/replacement costs.	6
2-1	Example model of PCI vs AGE for any pavement showing straight line and curvilinear representations.	14
2-2	Example model of PCI vs AGE for a flexible pavement with constant AC and varying base composition.	16
2-3	Airport Pavement Condition Index (PCI) and Rating Scale	17
4-1a	Washington PCI vs AGE for 2 - 3 inches AC on 6 - 8 inches base showing plots without high influence points (HIP's).	47
4-1b	Oregon PCI vs AGE for 2 - 3 inches AC on 6 - 8 inches base.	47
4-1c	Combined PCI vs AGE all pavements 2 - 3 inches AC on 6 - 8 inches base.	48
4-2a	Washington PCI vs AGE for 2 - 3 inches AC on greater than 8 inches base showing plots with and without HIP's.	50
4-2b	Oregon PCI vs AGE for 2 - 3 inches AC on greater than 8 inches base.	50
4-2c	Combined PCI vs AGE all pavements 2 - 3 inches AC on greater than 8 inches base.	51
4-3a	Washington PCI vs AGE for greater than 3 inches AC on any base.	53
4-3b	Oregon PCI vs AGE for greater than 3 inches AC on any base.	53

\*\*\*\*\*

**LIST OF FIGURES**  
**(continued)**

\*\*\*\*\*

FIGURE	TITLE	PAGE
4-3c	Combined PCI vs AGE for all pavements greater than 3 inches AC on any base.	54
4-4	WWII PCI vs AGE for Washington pavements with less than 3 inches AC on 6 - 8 inches base.	56
4-5a	AC overlays PCI vs AGE for Washington pavements.	62
4-5b	AC overlays PCI vs AGE for Oregon pavements.	62
4-5c	Combined PCI vs AGE for all pavements with AC overlays.	63
4-6a	Bituminous surface treatment PCI vs AGE for Washington pavements.	66
4-6b	Bituminous surface treatment PCI vs AGE for Oregon pavements.	66
4-6c	Combined PCI vs AGE for all pavements with BST	67
4-7a	Slurry seal surface treatment PCI vs AGE for Washington pavements.	72
4-7b	Slurry seal surface treatment PCI vs AGE for Oregon pavements.	72
4-7c	Combined PCI vs AGE for all pavements with slurry seal surface treatment.	73
4-8a	Portland cement concrete PCI vs AGE for Washington pavements.	76
4-8b	Portland cement concrete PCI vs AGE for Oregon pavements.	76
4-8c	Combined PCI vs AGE for all pavements with PCC.	77

\*\*\*\*\*

**LIST OF APPENDICES**

\*\*\*\*\*

APPENDIX	TITLE
A	Washington State General Aviation Pavement Condition Survey Data - Includes PCI survey for Othello Municipal Airport.
B	Oregon State General Aviation Pavement Condition Survey Data - Includes PCI survey data for Tillamook Airport.
C	Advisory Circular 150/5380-6, U.S. Department of Transportation, Federal Aviation Administration, "Guidelines and Procedures for Maintenance of Airport Pavements."
D	MINITAB Software calculations and models derived for pavement categories.
E	Idaho State General Aviation Pavement Condition Survey Data - 1986 Data Only.

\*\*\*\*\*

## ACKNOWLEDGMENT

\*\*\*\*\*

I would like to take this opportunity to thank Professor J. P. Mahoney. His patience, guidance, enthusiasm, and never-ending encouragement were critical to the completion of this research project. His tutelage and empathy for a novice to the pavement field proved invaluable at various stages throughout this project.

Special thanks to Mr. Frederick Mills of WSDOT and Mr. Wade Bryant of the FAA for providing the data necessary to accomplish the analysis needed. Mr. Mills also provided a great opportunity to conduct an on-site PCI survey which lent valuable experience to evaluating the data acquired.

My family's patience, and especially my wife Barbara's understanding during the final weeks of preparation of this report, made a world of difference in completing this major requirement for the Master's degree. Thank you Barbara, Andrew, Ian, and Stephen.

\*\*\*\*\*

**ABBREVIATION**

**LEGEND**

\*\*\*\*\*

AC	- ASPHALT CONCRETE
B	- BASE
BS	- BITUMINOUS SURFACE
BSB	- BITUMINOUS STABILIZED BASE
BST	- BITUMINOUS SURFACE TREATMENT
CS	- CHIP SEAL
CB	- CINDER BASE
DBST	- DOUBLE BITUMINOUS SURFACE TREATMENT
E	- EMULSION
FS	- FOG SEAL
NWF	- NON-WOVEN FABRIC
OL	- OVERLAY
PFC	- POROUS FRICTION COURSE
PRG	- PIT RUN GRAVEL
PRB	- PIT RUN BASE
PRSB	- PIT RUN SUBBASE
SAND S	- SAND SEAL
SB	- SUBBASE
SC	- SEAL COAT
SS	- SLURRY SEAL
TBST	- TRIPLE BITUMINOUS SURFACE TREATMENT



## CHAPTER ONE

### INTRODUCTION

#### 1.1 BACKGROUND

Many of our nation's airport managers have, in recent years, begun to realize the importance of an effective pavement management system. An effective and useful system permits managers to anticipate future maintenance and rehabilitation needs by utilizing whatever tools there are available to ensure that the selection of maintenance and rehabilitation strategies provide cost effective solutions to eliminate existing problems. A pavement management system not only evaluates the present condition of a pavement but predicts its future condition through the use of a pavement condition indicator. Pavement systems have evolved over the past two decades, having grown from databases geared towards compiling the amount, type, and condition of pavement within the pavement network to more sophisticated systems that can select future cost effective rehabilitation treatments.

A basic component of any pavement management system is the ability to track a pavement's deterioration and determine the cause of the deterioration. This requires an evaluation process that is objective, systematic and repeatable. A pavement condition rating system that is based on the quantity, severity, and type of distress is a rating of the surface condition of a pavement performance with implications of structural performance [1]. Condition rating data collected periodically will track the performance of a pavement.

Most airports presently utilize the Pavement Condition Index (PCI) rating system developed by the U. S. Army Corps of Engineers (COE) to assess current pavement conditions [1,3]. The Federal Aviation Administration (FAA) established Advisory Circular (AC) 150/5380-6 "Guidelines and Procedures for Maintenance of Airport Pavements" in 1982 [3]. This document outlined the detailed procedures for performing the PCI survey as previously developed by the COE. In short, individual pavement distress types are identified in asphalt and concrete pavements and rated according to severity levels and quantities. The rating is numerical with a range of 0 to 100 which provides a reasonably objective and repeatable indication of the average pavement condition.

The FAA states the following three primary objectives of rating a pavement based on the PCI method:

- (1) Determine present condition of the pavement in terms of the apparent structural integrity and operational surface condition.
- (2) Provide the FAA with a common index for comparing the condition and performance of pavements at all airports and also provide a rational basis for justification of pavement rehabilitation projects.
- (3) Provide feedback on pavement performance for validation and improvement of current pavement design, evaluation, and maintenance procedures.

Pavement condition surveys can evaluate normal distresses in a pavement structure resulting from surface weathering, fatigue effects, poor drainage, and differential settlement or movement in the subbase over a period of time. PCI surveys evaluate flexible

pavements based on sixteen different types of pavement distress, and rigid pavements based on fifteen types of distress. Chapter 2 will discuss pavement distress in some detail.

## 1.2 THE PROBLEM

Although PCI surveys are relatively simple, they can be somewhat time consuming depending on the size of the airport, and the amount of air traffic serviced during any given operational day. The problem, however, is not the time associated with conducting the surveys, but the effective and proper use of the data obtained from these surveys. Once the data is collected, it would appear that airports, primarily general aviation airfields may not be privy to the data collected, or how best to utilize the data if it has been made available. As stated previously the PCI is a number which represents the average condition of the pavement. This number establishes a range for a pavement from "very poor" to "excellent". These numbers, however, can be put to greater use to evaluate progressive deterioration of pavements, and further provide a better insight to actual pavement life expectancies compared to original 20-year projections.

The lack of adequate pavement performance models or equations which are needed to predict pavement performance for a variety of uses is the inherent problem regarding the data collected from the surveys previously mentioned. In 1988 a research project conducted by LT Kim Weisenberger, Civil Engineer Corps, U.S. Navy, evaluated statistical data on pavement condition indices of various general aviation runways throughout the northwest tri-state area of Washington, Oregon, and Idaho [1].

After compiling a database, Weisenberger [1] developed pavement performance models, through the use of regression equations, and survival statistics based on a comparison of

pavement features with similar characteristics. The information generated by the research project was only the beginning in terms of PCI data compilation for the northwest's mostly general aviation airports. Although much was accomplished with the information obtained for the research, the conclusion was that much more was needed to strengthen and verify the modeling methodology used.

The regression equations used were intended to assist the FAA and airport managers in determining which northwest airport pavements were in greatest need of maintenance or rehabilitation. These equations could also be of use in the following areas:

- a) pavement life estimates
- b) relative measures of rehabilitation effectiveness
- c) life-cycle costing
- d) general design decisions or modifications based on effectiveness
- e) planning decisions
- f) budget programming

This paper will attempt to take Weisenberger's [1] research a step further due to accomplishment of additional PCI surveys conducted by the Washington Department of Transportation (WSDOT) and the Oregon Department of Transportation (ODOT) in conjunction with the FAA. The same modeling techniques will be used to confirm, as stated previously, the validity of the regression equations and methodology used.

Runway pavements for the state of Idaho will not be addressed as a second set of PCI surveys have not been accomplished to provide updated data on their general aviation airports. These runways are included for age comparisons only in Chapter Three, and preliminary PCI information, pavement structural features, and rehabilitation history are

also attached as Appendix E for further reference. In addition, as in the research project accomplished by Weisenberger [1], only runway pavement conditions will be evaluated.

### 1.3 SYNOPSIS

This paper will attempt to assess deterioration rates of the airfields common to the research conducted by Weisenberger [1] and that accomplished by this author, after reviewing the initial research and assessing the data collected for comparison by this author. As evidenced by the Pavement Life Cycle curve in Figure 1-1, it is evident that once a pavement has reached 75% of its life expectancy, costs for renovation can increase as much as five-fold. It is the intent of this paper to (1) provide guideline reference models/equations and their corresponding graphic representation that will be useful to an airport manager and their pavement management system, (2) establish that if data collected from the accomplishment of PCI surveys is utilized in the proper fashion, costs for pavement rehabilitation and projected maintenance may be kept to a minimum, and (3) provide a consolidated report of the pertinent and current data to the FAA and all interested parties.

### 1.4 REPORT OVERVIEW

The objectives stated above will be addressed in a structured manner with Chapter Two highlighting the research methodology adopted for the report analysis and PCI procedures and applications. Chapter Three presents the data categories to be analyzed, a review of the Weisenberger [1] report data, and interpretation of the data used in this report. Analyses and data evaluation, equations development and pavement life calculations, are detailed in Chapter Four. Finally, a report summary including various conclusions and general

recommendations will be presented as Chapter Five. A list of references and report appendices follow the closing chapter.

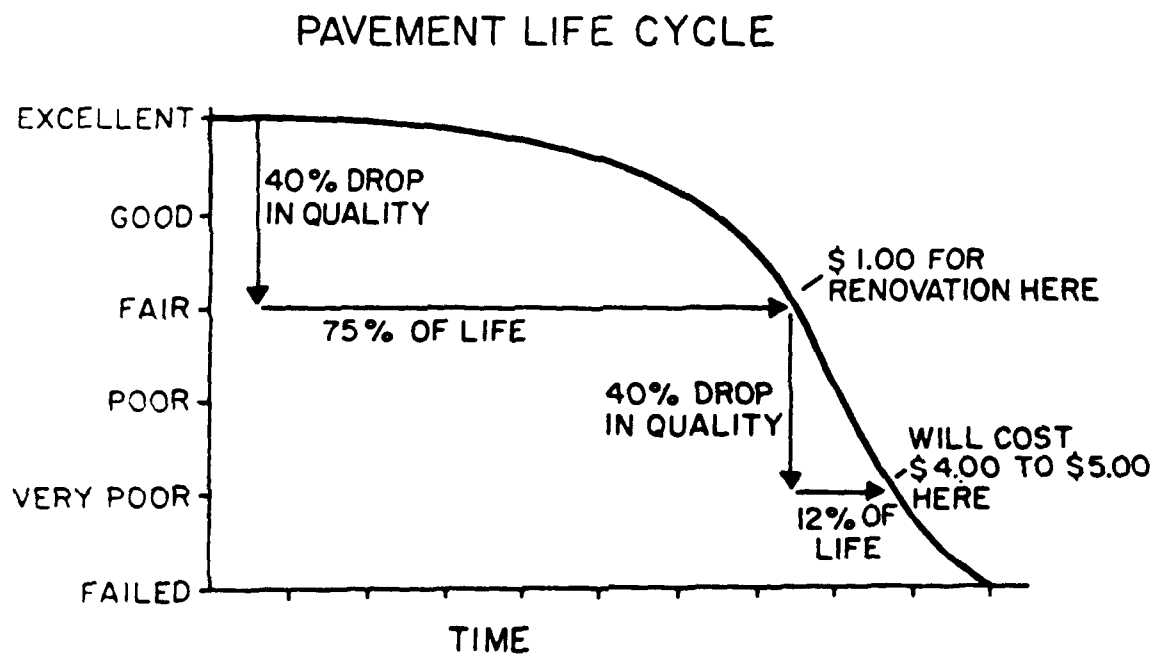

**Figure 1-1 Pavement Life Cycle Typical Performance Curve Compared To Maintenance/Replacement Costs [4]**

## CHAPTER TWO

### METHODOLOGY AND PCI APPLICATIONS

#### 2.1 RESEARCH METHODOLOGY

Chapter One stated the primary intent of this report was to develop equations or models that would represent a pavement's behavior and therefore be an asset to an airport manager or planner in the decision making process with respect to their pavement management system. The models provide numerical output that can be used by a planner or manager for future planning and programming.

Since this report consolidates and compiles data from general aviation airports in the tri-state area, correlations among the different types of repairs used, the life of original pavement sections, and in turn the life of various correction methods will be examined. The rate of deterioration between an established point of time "zero" and the first PCI surveys will be compared against deterioration between the first and second points, and the overall deterioration from time "zero" to the second survey points for those runways with three points for evaluation.

Various surface treatment applications and the time elapsed between successive applications will be discussed, and in addition, the age of various pavements based on the application of a surface treatment to an original section of pavement.

The subject matter was evaluated primarily based on the following two objectives:

a) Establish PCI vs AGE curves for all pavements common to the first and second surveys for different thicknesses of flexible and portland cement concrete pavements. The flexible pavements include various thicknesses of AC pavements, AC overlays, bituminous surface treatments, and slurry seal surface maintenance treatments. Applications such as fog seals, chip seals, and emulsions were not common to first and second surveys.

b) Evaluate AGE data for the pavement features being studied. Essentially, an estimation of the projected life expectancy based on past performance of similar pavements will be evaluated.

#### 2.1.1 SUMMARY OF PCI PROCEDURES

##### Condition Survey Procedure

The procedure is limited to flexible pavements (pavements with conventional bituminous concrete surfaces) and jointed rigid pavements (jointed non-reinforced concrete pavements with joint spacing not exceeding 25 feet).

##### Objectives:

- a. Determine present condition of the pavement in terms of apparent structural integrity and operational safe condition.
- b. Provide the FAA with a common index for comparing the condition and performance of pavements at all airports and also provide a rational basis for justification of pavement rehabilitation projects.



- c. Provide feedback on pavement performance for validation and improvement of current design, evaluation, and maintenance procedures.

The airport pavement condition survey and the determination of the PCI are the primary means of obtaining and recording vital airport pavement performance data. The condition survey for both rigid and flexible pavement facilities consists primarily of a visual inspection of the pavement surfaces for signs of pavement distress resulting from the influences of aircraft traffic and environment.

### **Basic Airport Information**

Basic airport data is incorporated into the condition survey report.

- a. Design/construction/maintenance history.
- b. Traffic history - carriers, commuters, cargo, military aircraft traffic records including aircraft type, typical gross loads, and frequency..
- c. Climatological data - ranges and precipitation.
- d. Airport layout - plans and cross section of major components, including subsurface drainage systems.
- e. Frost action - record of pavement behavior during freezing periods and subsequent thaws.
- f. Photographs.
- g. Pavement condition survey reports.

### **Outline of Basic Condition Rating Procedure:**

1. **Divide pavements into "features" (increments)** - overall airport pavements must be divided into features based on the pavements' design, construction history, and traffic area. A designated pavement feature therefore has consistent structural thickness and materials, was constructed at the same time, and is located on one airport facility, i.e. runway, taxiway, etc.

- 2. **Divide pavement feature into sample units** - # of slabs or # square feet.

3. **Inspect sample units** - determine distress types and severity levels and measure density.
4. **Determine deduct values** - these are obtained from appropriate curves.
5. **Compute total deduct values (TDV)** - sum all deduct values for each distress condition observed.
6. **Adjust total deduct value** - a corrected deduct value (CDV) is determined using procedures in the appropriate section for jointed rigid or flexible pavements..
7. **Compute pavement condition index** -  $PCI = 100 - CDV$  for each sample unit inspected.
8. **Compute PCI of entire feature** - average PCI's of sample units.

The procedure for conducting PCI surveys as stated in Advisory Circular 150/5380-6 has a confidence level of 95 %, however recently the confidence level was reduced to 92% to allow for a smaller inspection area. The confidence level indicates the probability that an obtained value computed from the random sampling survey technique will fall within a 10% range ( $\pm 5\%$ ) of representing the entire pavement feature being surveyed. The range is now 16 % ( $\pm 8\%$ ).

## 2.2 PAVEMENT DISTRESSES AND PCI EVALUATIONS

The deterioration of a pavement, runway or highway, is most often readily apparent by external signs or indicators which can be associated with the probable causes of the failure or imperfection. The discussions of problems related to pavement distresses are generally related to the pavement type; concrete or bituminous/flexible [4]. However, while each has its own particular characteristics, the various pavement distress manifestations for bituminous and concrete pavements generally fall into one of the following broad categories [4]:

a) Cracking - often a result of stresses caused by contraction or warping of the pavement in concrete pavements. Overloading, loss of subgrade support, inadequate or improperly cut joints are also possible causes. In bituminous pavements causes are mostly attributed to deflection of the surface over an unstable foundation, shrinkage of the surface, poorly constructed lane joints, or reflection cracking.

b) Distortion - a change in the pavement surface from its original position and results from foundation settlement, expansive soils, frost susceptible soils, or loss of fines through inadequate drainage systems. In bituminous pavements insufficient compaction of pavement courses, unstable bituminous mix, and poor bonding between surface and underlying layers also lead to distortion.

c) Disintegration - improper curing and finishing, unsuitable aggregates, and improper mixing of concrete lead to the breaking up of pavements into small, loose particles. Insufficient compaction of the surface, insufficient asphalt in the mix, or overheating of the mix leads to disintegration in a bituminous pavement.

d) Skid resistance - surface texture reduction and contaminant build-up such as rubber deposit accumulation over a period of time will reduce a pavement's skid resistance. In bituminous pavements, too much asphalt in the mix or too heavy a prime coat will reduce skid resistance.

During the PCI survey procedure, as alluded to previously, sample units are inspected and a determination of the distress types and severity levels is made. Standard distress types can be checked from a listing on the inspection sheet and their severity and density noted.

Severity levels are then assigned "deduct values", totaled, adjusted, and an overall PCI rating obtained by deducting the value for the sample from 100%. See Appendix C pages C-14 and C-17 for the standard forms used in conducting the survey.

### 2.3 MODELING OBJECTIVES

The correlation and regression modeling equation calculations were accomplished using the statistical software program MINITAB [3], and graphically presented using the Microsoft Cricket Graph software package. Correlation is a means of measuring the association between two variables. whereas regression goes a step further by establishing an equation which determines one of the variables based on knowing the second. The variables are classified as independent and dependent. In the case of this report the independent variable is AGE, and the dependent variable is the corresponding PCI value.

An equation or curve will therefore show the relationship between these two variables over a period of time. There are several important criteria needed in developing reliable pavement models, with each respective criterion capable of significantly altering the model obtained during the evaluation or investigation. The primary criteria are [1,2]:

- a) A reliable data base.
- b) Include any variable that will significantly affect pavement performance.
- c) A usable and functional form of the model.
- d) An accurate model which meets statistical requirements.

Modeling attempts to depict the past performance of a particular element based on input data. The data used during the course of this report is simple, however, the PCI values

recorded are based on a pavement's overall condition which incorporates most of the variables associated with a pavement's deterioration including, construction method, materials, construction date, environment, traffic frequency and loading. The models attempted and presented are considered the most applicable based on the constraints, and the above elements apply with the exception of a "variable that will significantly affect the pavement's performance."

#### 2.4 PCI vs. AGE CURVES

As stated earlier in this chapter, the first objective is to develop PCI vs AGE curves for different thicknesses of flexible and rigid pavements. There are varying representations of curve fitting for data being evaluated ranging from a straight line fit to logarithmic curve fit of the data. The straight line fit is represented by an equation that reads as follows :  $PCI(\%) = B_0 - B_1(AGE)$ . As in the case of any straight line equation,  $B_0$  is the intercept on the PCI (y) axis and  $B_1$  the slope of the line plotted. Based on the fact that a curve best represents the deterioration of a pavement however, other equations involving exponential relationships between the PCI rating and AGE, or polynomial relationships with additional constants and AGE raised to increasing powers best depict the deterioration of a pavement. These equations will be discussed in further detail in Chapter Four.

The following example depicts a typical graph and model that is indicative of the primary objective of this report:

(a) Assume the points indicated in Figure 2-1 represent any pavement section. Two of the possible curves that can be developed to "fit" the four available data points are shown. The initial data point is considered to be  $PCI = 100$ , and  $AGE = 0$ . This is the assumed value throughout this report for the original pavement construction time frame or where a new surface treatment is applied. The remaining data points are (5,85), (10, 65),

and (15, 30). It is apparent that the curve more readily depicts the rate of deterioration of a pavement versus the straight line depiction. If, for example, failure is considered to have occurred at a PCI of 10%, then the age at failure is 21 years for the straight line fit and 17 years for the curvilinear fit.

### Typical PCI vs. AGE Plot

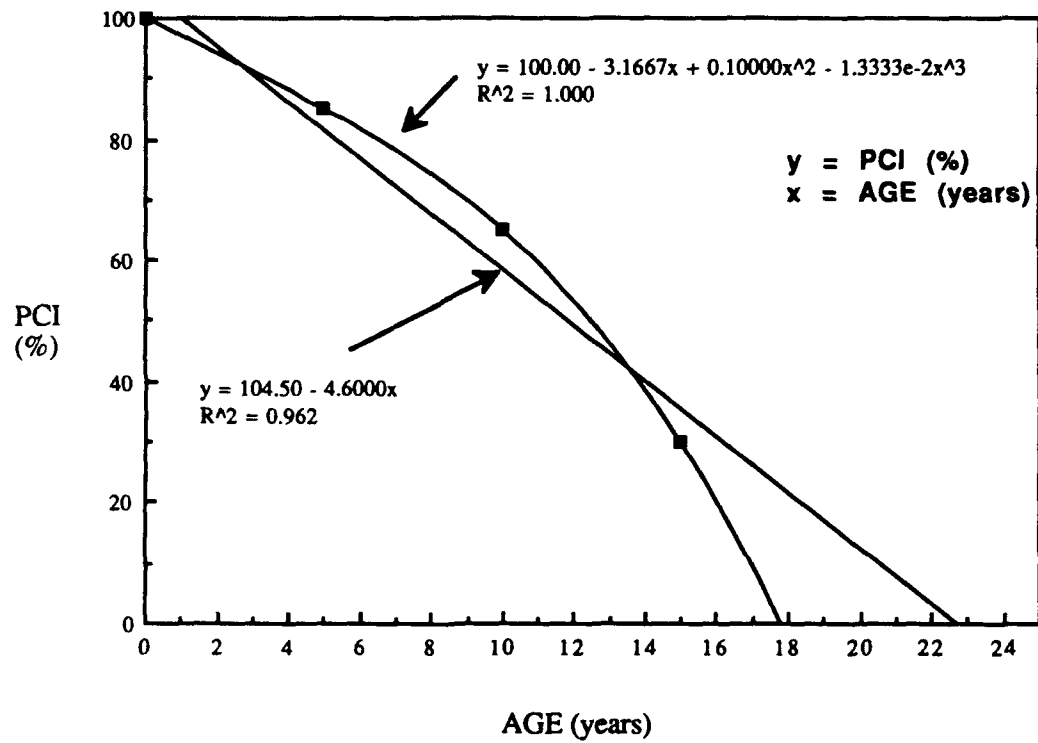

Figure 2-1 Example model of PCI vs AGE for any pavement showing straight line and curvilinear representations.

The  $R^2$  values indicated on the preceding graph will be addressed in Chapter Four.

The second objective of the report is to look at the correlation between pavement structures and estimated LIFE. The time elapsed between original construction of a pavement and a corrective or maintenance application defines the LIFE of that pavement. Regression modeling results can be compared with simple LIFE calculations to determine if a developed model compares favorably or not with results from these calculations. Standard deviation computations will also be used when evaluating pavement LIFE data.

Figure 2-2 depicts typical straight-line performance plots of an AC surface course of two inches asphalt concrete on varying base thicknesses. The correlation of increased base thickness to increased pavement life [1] is apparent from the actual plots shown. An assumption of similar construction materials and processes must also be made when evaluating data results and graphic depictions such as these.

## 2.5 THE PAVEMENT CONDITION RATING SCALE

The PCI rating scale indicates the respective levels of pavement rated conditions. As shown in Figure 2-3, however, failure of any particular pavement does not occur until a 10% PCI rating has been achieved. Although it was stated previously that 55% is the recommended rehabilitation or replacement point, in fact a pavement is not considered in very poor condition until between 10 and 25%. There is obviously a significant grey area of rating unacceptability which needs to be better defined.

If the scale depicted an established point where the runway pavement was determined to be not usable, then interpretation and subjectivity would become lesser factors in the use of the

the scale. Highways are evaluated using a similar rating method with their scale known as the Pavement Condition Rating (PCR) scale, but there is an implied PCR value of unacceptability at a PCR of 40% [1,8]. This rating is somewhat equal to the PCI 55% rating based on the methods of rating pavements. Figure 2-3 is shown on the following page.

**PCI vs. AGE - Structural Comparisons**

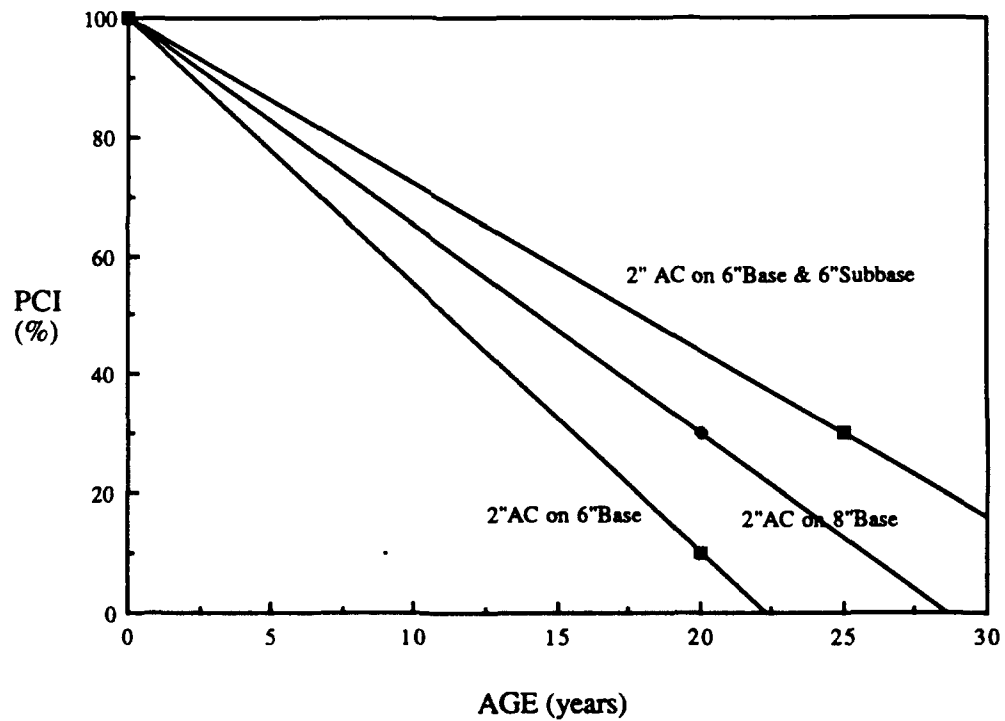

Figure 2-2. Example model of PCI vs AGE for a flexible pavement with constant AC and varying base composition. The equation is  $PCI = B_0 - B_1(AGE)$ .



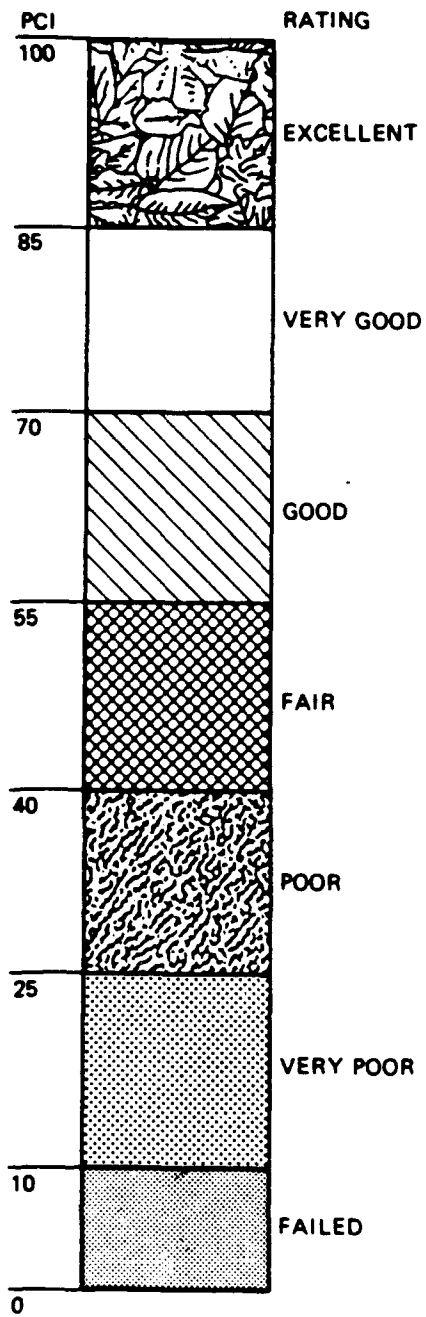

Figure 2-3 Airport Pavement Condition Index (PCI) and Rating Scale [4]

## CHAPTER THREE

### DATA REVIEW AND INTERPRETATION

#### 3.1 INTRODUCTION

This chapter will present the different categories of data evaluated and an explanation for the particular categories chosen. Substantial information from the report completed by Weisenberger [1] in 1988 was reviewed in addition to current data from the FAA and WSDOT. The information reviewed was incorporated into a database and is attached as Appendices A, B, and E. In addition, actual pavement condition surveys for Othello Municipal, WA and Tillamook Airport, OR are included as example surveys in Appendices A, and B, respectively. As in the case of the first PCI analysis report, written descriptions of airport pavement histories were sometimes sketchy to non-existent. All descriptions were read in detail, however, as evidenced from the data there are still many unknown (UNK) pieces of information for many general aviation airports in the region. Terminology was sometimes inconsistent particularly when the use of bituminous surface treatments (BST's) were discussed. At times one could infer that the inspector or author of the particular survey was referring to a seal coat application versus a BST.

During the first analysis 142 general aviation (GA) airports with 240 different runways were evaluated. The analysis included airports in Washington (64), Oregon (56), and Idaho (22). This report addresses 120 GA airports with 202 runways from Washington and Oregon. Data from Idaho was included for age comparison and reference only. Of the 202 runways, only 78 had a second PCI survey conducted with a reduction in the PCI rating. Other second survey data points were available but not used. Twenty-three points

were higher and in a few cases the same as the first survey three or four years prior. In most cases where there was an increase in PCI rating there was a maintenance application or overlay. In other cases the increased rating is attributable to the individual survey, as no record of a surface treatment between surveys was documented. Other second survey PCI ratings were the same as the first with no deterioration in a three or four year period. The 78 runways therefore provided 156 data points for evaluation, in addition to an assumed PCI = 100 for each data category.

As noted in Chapter Two, PCI ratings are based on pavement distress, however, this analysis will not attempt to tie particular distresses to individual PCI rating results. Appendix C includes examples of various distresses found in runways.

Pavement condition surveys address all facets of an airport's pavement system; runways, taxiways, and parking aprons. This study evaluates PCI values associated only with runways at the GA airports in question. As shown in the surveys for Othello and Tillamook airports, each survey includes the following information:

- a) original construction dates
- b) maintenance history
- c) airport layout
- d) sample locations and areas
- e) types of pavement distress
- f) maintenance recommendations
- g) climate data
- h) trend conditions
- i) feature summaries

It is worthy to note that since PCI surveys are conducted by individuals it is to understand that a certain amount of subjectivity accompanies each inspection despite the training of all inspectors by the same FAA office. Since there is no "subjectivity" factor that can be

applied to the data, readings were accepted at face value and treated as collected, with the exception of points that were simply omitted from the analysis due to no deterioration or an increase in the ratings. These points were discussed earlier. The FAA in fact has reviewed the data and deemed the surveys to be of good quality with no need for adjustments. Other data points omitted from the analysis included those with unknown conditions which placed what information there was on the particular runway or airport in doubt.

### 3.2 REVIEW OF 1988 DATA

As is the case in this analysis, Weisenberger [1] experienced difficulty with interpreting data during the first PCI study. There were inconsistencies in the data and terminology which still exist. Pavement histories were sketchy and often non-existent all of which created several problems in establishing a credible database.

Similar pavement categories were chosen for this study for easy comparison with those established in the first study. The areas of notable differences occur in the BST's and surface maintenance applications, as the number of data points obtained from second surveys did not warrant a general breakdown of single, double, and triple bituminous surface treatments and only enabled the investigation of slurry seal applications.

Using selected data, Weisenberger [1] was able to generate regression equations and survival statistics. The performance models provided an approximation of how various pavements and maintenance techniques performed. The models were not intended to be used as strict guidelines in assessing an individual pavement, but as an additional tool in evaluating alternatives.

The assembly and compilation of the data indicated that numerous pavements were in need of repair and replacement, even prior to development of the regression models. The report provided a consolidated database of the tri-state area general aviation pavement conditions and presented a good approximation of projected pavement performance and life. A comparison of regression modeling results will be addressed in Chapter Four.

### 3.3 DATA INTERPRETATION OF 1991 SURVEYS

Some basic and straight forward assumptions were made at the outset when this project was undertaken. All pavements were considered to have a PCI of 100% at original construction or whenever a new surface application was introduced. This assumption can be somewhat tainted by the fact that the construction process could have been faulty or construction materials substandard and therefore nullify the "perfection at the outset" scenario. However, a pavement was considered "satisfactory", PCI = 55% according to the rating scale in Figure 2-3, until the time it received a surface treatment. This elapsed time between construction/surface application and a subsequent maintenance or rehabilitation procedure is considered the life of the pavement. In the case of Tillamook Airport, runway R1 was originally constructed in 1943 with a 2-inch AC surface course. In 1983 a 1.5-inch AC overlay was applied to the runway. This overlay received a PCI rating of 92% in 1987. The LIFE of the pavement was therefore 40 years and the AGE at the survey, 4 years. Other conclusions that can be drawn from the preceding information are:

- a) The 1.5" AC overlay is losing 2 % PCI points per year.
- b) If one follows the rule of thumb that pavements should be repaired at about a PCI = 55% [4], then the rate of PCI loss during the life of the original surface 2-inch AC is about 1.1% PCI points per year, half the rate of the repair treatment. This assumption of replacement at 55% can be both practical and erroneous since

no record of the PCI rating at rehabilitation of individual pavements is available. At the present rate the AC overlay is predicted to last approximately 22.5 years. The difference in the rates of deterioration can be attributable to a number of factors including construction process or materials, as addressed above.

### 3.4 PAVEMENT COMPARISONS FOR 1st AND 2nd SURVEYS

As stated previously, the primary objective for this analysis was to look at pavements with two sets of PCI points, actually three counting PCI = 100 at AGE = 0. These individual points would then be grouped into an overall common category and an attempt made to develop a representative model for the data set. Several pavements received surface treatments between surveys and therefore had higher values of PCI compared to their initial rating. Others received higher ratings, but there was no record of a surface treatment applied and therefore the increased rating was attributable to the individual conducting the rating or the lack of proper documentation for the respective pavement. In addition, six pavements were discovered to have the same PCI rating for both surveys; four with a 4-year difference in rating period and two with a 3-year difference in rating period. All of the above mentioned runways were excluded from the overall analysis since the results were not indicative of normal pavement performance.

Further attention was given to the average loss per year for individual pavements between the following points:

- a) AGE = 0 and the initial PCI rating
- b) PCI rating No. 1 and PCI rating No. 2
- c) AGE = 0 and PCI rating No. 2 (overall loss)

This was done in an effort to try and determine the best representative loss rating and thereby assist in determination of LIFE calculations.

### 3.5 DATA REVIEW

The categories used in the analysis of the data obtained was grouped into five different pavement characteristics, with one the characteristics subdivided in four further groupings. Eight categories of pavements were therefore evaluated and are presented as Tables 3-1 through 3-5. Prior to discussing each of the categories and presentation of the data the following notes are provided:

- a) The AGE associated with each PCI rating is the time elapsed between the last surface treatment, whether original or maintenance treated, and the listed PCI survey rating.
- b) In tables where only AGE values are given and no "asterisk" accompanies the runway, there were no second survey PCI values available for the runway and as such, a PCI evaluation was not conducted for the runway.
- c) The tables indicated in b) are for estimation of that particular pavement feature's overall LIFE.

The five pavement characteristics designated for individual groupings are flexible pavements, AC overlays, bituminous surface treatments, surface maintenance techniques (slurry seals only), and portland cement concrete.

3.5.1 Flexible Pavements - Flexible pavements are normally constructed with a surface course of asphalt concrete, a base course, and depending on design criteria, a subbase course. The base course will normally be composed of a high quality aggregate which can be treated or untreated, crushed or uncrushed, or any combination thereof. If required the subbase would normally be of a lesser quality aggregate than the base. The subdivided categories for flexible pavements are:

a) Two to three inches of AC on six to eight inches of base (Table 3-1a). This category included 12 runways providing 24 data points. Eight runways were from Washington and four from Oregon. The base could be a combination of base and subbase but had to be eight inches or less.

b) Two to three inches of AC on greater than eight inches of base (Table 3-1b). Nine runways with 18 data points were evaluated, with seven from Washington and two from Oregon. The base-subbase composition was irrelevant.

c) Greater than three inches of AC on any base or subbase (Table 3-1c). Five runways with 10 data points were evaluated, with three Washington and two Oregon runways.

d) World War Two constructed AC runways (Table 3-1d). Five runways generated 10 data points to be evaluated and all runways were from Washington.



TABLE 3-1a Flexible pavements with associated PCI survey results and the corresponding AGE for the respective survey (Pavement structural sections consist of 2 - 3 inches AC on 6 - 8 inches of base).

No.	AIRPORT & LOCATION	PCI (%)	AGE (years)	PCI (%)	AGE (years)
1.	BOWERS FIELD, ELLENSBURG, WA (R1)	67	10	64	13
2.	BREMERTON, WA (R5)	82	13	80	17
3.	ELMA MUNICIPAL AP, WA	88	12	83	15
4.	EVERGREEN FIELD, WA (R1)	55	20	51	24
5.	EVERGREEN FIELD (R2)	86	16	77	20
6.	MOSES LAKE, WA (R2)	29	14	18	18
7.	PACKWOOD, WA	94	3	90	6
8.	PORT OF ILWACO, WA	71	15	49	18
9.	ASHLAND, OR (R2)	92	2	88	6
10.	PACIFIC CITY-STATE, OR	79	37	75	41
11.	SEASIDE STATE, OR	88	23	83	27
12.	TRI-CITY STATE, OR	88	4	77	8

Notes: Where a runway designation is not listed there is only one runway presently at the airport.

All "AGE" listings associated with a PCI value are the ages of the pavement feature when the PCI survey was conducted.

TABLE 3-1b Flexible pavements with associated PCI survey results and the corresponding AGE for the respective survey (Pavement structural sections consist of 2 - 3 inches AC on greater than 8 inches of base).

No.	AIRPORT & LOCATION	PCI (%)	AGE (years)	PCI (%)	AGE (years)
1.	ANACORTES, WA (R2)	95	13	90	16
2.	ANACORTES (R3)	100	13	92	16
3.	AUBURN, WA (R2)	90	19	87	23
4.	EPHRATA, WA (R2B)	89	4	84	8
5.	KELSO-LONGVIEW, WA	90	4	82	8
6.	OLYMPIA, WA (R2)	89	8	85	11
7.	PULLMAN, WA (R2)	70	18	48	21
8.	HOOD RIVER, OR (R1)	96	1	92	5
9.	HOOD RIVER (R2)	95	1	90	5

Notes: Where a runway designation is not listed there is only one runway presently at the airport, or one runway feature of the main runway that was evaluated at the time of the survey.

In certain cases, for example, R2 indicates a separate second runway, however, in others such as Pullman R2, the PCI values are for a specific section of the main runway. Appendices A & B list the differences and show the composition of the pavements for different runways.

TABLE 3-1c Flexible pavements with associated PCI survey results and the corresponding AGE for the respective survey (Pavement structural sections consist of greater than 3 inches AC on any base or subbase).

No.	AIRPORT & LOCATION	PCI (%)	AGE (years)	PCI (%)	AGE (years)
1.	BREMERTON, WA (R2)	83	13	75	17
2.	BREMERTON (R3)	86	13	80	17
3.	PULLMAN, WA (R3)	81	18	68	21
4.	CHRISTMAS VALLEY, OR	90	2	86	6
5.	ILLINOIS VALLEY, OR (R2)	93	27	91	31

Note: Pullman R3 is not a separate third runway.

TABLE 3-1d Flexible pavements with associated PCI survey results and the corresponding AGE for runways constructed during World War Two (No repair or rehabilitation treatment applied).

No.	AIRPORT & LOCATION	PCI (%)	AGE (years)	PCI (%)	AGE (years)
1.	BOWERMAN FIELD, WA (R1)	77	43	59	46
2.	BOWERS FIELD, WA (R4)	54	44	52	47
3.	DEER PARK, WA (R3)	47	43	39	46
4.	OLYMPIA, WA (R1)	55	46	45	49
5.	WINLOCK-TOLEDO, WA	49	43	42	46

Note: Where a runway designation is not listed there is only one runway presently at the airport, or one pavement feature of the main runway that was evaluated at the time of the survey.

Pavement life for runways with flexible pavements constructed during World War Two (WWII), and those constructed after WWII, was examined and data indicated in the following tables. The WWII period is considered between 1942 and 1945.

a) Post World War Two pavement LIFE (Table 3-1e). The table is separated into two categories for runways with less than three inches of AC, and those greater than three inches AC. Thirty one runways are listed with only seven of the runways examined in the PCI analysis.

b) WWII pavement LIFE runway evaluations (Table 3-1f). These comprised 42 runways with 12 of the runways examined in the PCI analysis. They are separated as in the Post-WWII section. As indicated, several airports were in excess of 40 years old before a surface treatment was applied.

For those runways with a corresponding PCI analysis, the Corrective Measure column indicates the category that includes the particular runway for overall analysis. In addition, Appendix D illustrates individual regression modeling for runways being analyzed. The Corrective Measure stated defined the "LIFE" of the respective pavements, and the AC surface course was the original surface course applied to the runway.

TABLE 3-1e Flexible pavement life for pavements constructed after World War II

Pavements with less than 3 inches of original AC surface course

No.	AIRPORT & LOCATION	AC (in)	AGE (years)	CORRECTIVE MEASURE	YEAR
1.	HARVEY FIELD, WA	2	12	SEAL COAT	1982
2.	PANGBORN FIELD, WA (R1)	2	37	CHIP SEAL	1974
3.	PEARSON AIRPARK, WA (R1)*	1.5	9	CHIP SEAL	1975
4.	PEARSON AIRPARK (R2)*	1.5	9	CHIP SEAL	1975
5.	PIERCE COUNTY, WA	1.5	30	REBUILT	1988
6.	PROSSER, WA	2	4	CHIP SEAL	1981
7.	PULLMAN-MOSCOW, WA (R1)*	2	24	2" AC OVERLAY	1972
8.	SEKIU, WA (R1)	2	15	CHIP/SAND SEAL	1987
9.	SEKIU (R2)	2	8	CHIP/SAND SEAL	1987
10.	ALBANY MUNICIPAL, OR	2	27	2"AC OVERLAY	1986
11.	BANDON STATE, OR	2.5	6	CHIP SEAL	1972
12.	CHILOQUIN, OR	1.25	7	SEAL COAT	1968
13.	FLORENCE MUNICIPAL, OR	1.5	17	2"AC OVERLAY	1985
14.	GOLD BEACH, OR	1	19	REBUILT	1983
15.	HERMISTON, OR	1.5	18	2"AC OVERLAY	1977
16.	ROSEBURG, OR*	2	35	SLURRY SEAL	1986
17.	TRI-CITY, OR*	1.5	13	CHIP SEAL	1983
18.	CALDWELL, ID (R1)	2	11	SL./FOG SEAL	1986
19.	CALDWELL (R2)	2	11	SL./FOG SEAL	1986
20.	CRAIGMONT, ID	1	8	CHIP/FOG SEAL	1983
21.	GOODING MUNICIPAL, ID	2	7	SLURRY SEAL	1985
22.	NAMPA MUNICIPAL, ID	2	9	SL./FOG SEAL	1985
23.	SODA SPRINGS, ID	2.5	14	SLURRY SEAL	1983

Note: "AGE" in Tables 3-1e and 3-1f is the difference between original construction and the year of the corrective measure. See Appendices A, B & E for complete tabular listings.

TABLE 3-1e Flexible pavement life for pavements constructed after World War II

(cont'd)

Pavements with 3 inches or greater of original AC surface course

No.	AIRPORT & LOCATION	AC (in)	AGE (years)	CORRECTIVE MEASURE	YEAR
1.	PANGBORN FIELD (R2)	3	37	CHIP SEAL	1974
2.	PULLMAN-MOSCOW (R2)*	3	17	GROOVED	1985
3.	PULLMAN-MOSCOW (R3)*	4	17	GROOVED	1985
4.	SUNNYSIDE, WA	3	10	SLURRY SEAL	1985
5.	AURORA STATE, OR	3	3	2"AC OVERLAY	1978
6.	ROBERTS FIELD, OR (R1)	4	6	POR. FRIC. CRS.	1981
7.	GRANGEVILLE, ID (R1)	3	18	2" AC OVERLAY	1983
8.	McCALL MUNICIPAL, ID	3	11	SLURRY SEAL	1985

Notes: Where a runway designation is not listed there is only one runway presently at the airport. Idaho runways are included here for comparison with Washington and Oregon state airports with respect to AGE. The former are not included in PCI data comparison or evaluation as there has been no second set of PCI surveys conducted for Idaho airports as of this writing.

\* Indicates airports with a second set of PCI surveys which are included in the data analysis and evaluation of this report. Refer to Tables 3-1a through 3-4 and Appendices A, B, and E for PCI and pavement structural section information.

TABLE 3-1f Flexible pavement life for pavements constructed during World War II.

Pavements with less than 3 inches of original AC surface course

No.	AIRPORT & LOCATION	AC (in)	AGE (years)	CORRECTIVE MEASURE	YEAR
1.	BREMERTON NATIONAL, WA (R1)*	2.5	32	3"AC OL	1974
2.	EPHRATA , WA (R2)*	2.5	27	SLURRY SEAL	1970
3.	KENNEWICK VISTA, WA	2	34	CHIP SEAL	1976
4.	OLYMPIA, WA (R3)*	2.5	38	3"AC OL	1980
5.	RICHLAND, WA (R1)	2	36	2"AC OL	1979
6.	RICHLAND (R2)	2	36	2"AC OL	1979
7.	SANDERSON FIELD, WA*	2	37	SLURRY SEAL	1979
8.	WILLIAM R. FAIRCHILD, WA (R1)	2	37	2"AC OL	1979
9.	WILLIAM R. FAIRCHILD (R2)	2	37	2"AC OL	1979
10.	WILLIAM R. FAIRCHILD (R3)	2	36	2"AC OL	1978
11.	BAKER MUNICIPAL, OR (R1)	2.5	21	SEAL COAT	1963
12.	BAKER MUNICIPAL (R2)	2.5	21	SEAL COAT	1963
13.	BOARDMAN, OR	2	37	1.5" AC OL	1980
14.	BURNS MUNICIPAL, OR (R1)	2	36	CHIP SEAL	1978
15.	BURNS (R2)	2	36	CHIP SEAL	1978
16.	CORVALLIS, OR	2.5	42	3" AC OL	1984
17.	LA GRANDE, OR (R2)	2	32	4"AC OL	1974
18.	LAKE COUNTY, OR*	2	42	SLURRY SEAL	1985
19.	MADRAS COUNTY, OR	2	34	2" AC OL	1977
20.	McMINNVILLE MUNICIPAL, OR (R2)	2	37	SLURRY SEAL	1980
21.	NORTH BEND MUNICIPAL, OR (R2)	2.5	34	2" AC OL	1977
22.	NORTH BEND (R2A)	2.25	34	2" AC OL	1977
23.	PENDELTON, MUNICIPAL, OR (R2)	2	32	PFC/7"AC OL	1974
24.	PENDELTON (R3)	2	36	3" AC OL	1978
25.	PENDELTON (R4)	2	36	5.5" AC OL	1978
26.	PENDELTON (R5)	2	36	10"AC OL	1978
27.	PORT OF ASTORIA, OR (R2)*	2.5	36	3/4" AC OL	1980

TABLE 3-1f Flexible pavement life for pavements constructed during World War II.

(cont'd)

Pavements with less than 3 inches of original AC surface course

No.	AIRPORT & LOCATION	AC (in)	AGE (years)	CORRECTIVE MEASURE	YEAR
28.	SCAPPOOSE INDUSTRIAL, OR	2	43	SLURRY SEAL	1986
29.	NEWPORT MUNICIPAL, OR (R1)	2	40	3" AC OL	1984
30.	NEWPORT (R2)	2	40	SLURRY SEAL	1984
31.	THE DALLES MUNICIPAL, OR (R1)	2.25	22	SLURRY SEAL	1965
32.	TILLAMOOK, OR (R1)	2	40	1.5" AC OL	1983
33.	TILLAMOOK (R2)	2	40	CHIP SEAL	1983

Pavements with 3 inches or greater of original AC surface course

No.	AIRPORT & LOCATION	AC (in)	AGE (years)	CORRECTIVE MEASURE	YEAR
1.	ARLINGTON MUNICIPAL, WA (R2)*	3	34	2" AC OL	1976
2.	BREMERTON NATIONAL (R2)*	3	32	5" AC OL	1974
3.	BREMERTON NATIONAL (R3)*	5	41	CRACK SEAL	1983
4.	BREMERTON NATIONAL (R4)*	3	32	2" AC OL	1974
5.	EPHRATA (R1A)*	3	27	SLURRY SEAL	1970
6.	OMAK, WA*	4.5	31	2.5" AC OL	1974
7.	NORTH BEND, OR (R1)	3	34	2" AC OL	1977
8.	NORTH BEND (R3)	3	9	CHIP SEAL	1952
9.	PENDELTON (R1)	3	32	PFC/7" AC OL	1974

Notes: Where a runway designation is not listed there is only one runway presently at the airport.

\* Indicates airports with a second set of PCI surveys which are included in the data analysis and evaluation of this report. Refer to Tables 3-2 through 3-4 and Appendices A, B, and E for PCI and pavement structural section information.



3.5.2 AC Overlays - AC overlays considered for this category of the analysis ranged from 3/4 inch to 3 inches, with the majority of the runways receiving a 2 inch overlay as a rehabilitation measure. Eighteen runways were evaluated (36 points) with only six receiving less than a 2 inch overlay. Twelve of the 18 runways were Washington, and the remaining six are Oregon runways. Of the corrective measures analyzed for this study, AC overlays were easily the most commonly used. Table 3-2 lists the PCI ratings at the corresponding pavement AGE and AC overlay thickness.

Asphalt concrete overlays are used as a means of rehabilitating existing pavements [1,5]. They restore the existing pavement's surface characteristics and improve its structural integrity. The thickness of an AC overlay is determined by the intended use and can vary from approximately 1 inch, and sometimes less\*, to several inches [5]. The most common thickness used is normally 2 inches. The AC overlays were examined as a single pavement feature with all thicknesses grouped together.

\* The Port of Astoria's runways R1 and R1A each have 3/4-inch AC overlay surface courses.

TABLE 3-2 Flexible pavement AC overlays with associated PCI results and corresponding AGE

No.	AIRPORT & LOCATION	OL (in)	PCI (%)	AGE (years)	PCI (%)	AGE (years)
1.	ANACORTES, WA (R1)	2	96	13	91	16
2.	ARLINGTON, WA (R2)	2	89	10	84	13
3.	BREMERTON, WA (R4)	2	88	13	83	17
4.	CREST, WA	2	97	1	90	5
5.	MOSES LAKE, WA (R1)	2	89	3	81	7
6.	OLYMPIA, WA (R3)	3	86	8	84	11
7.	OMAK, WA	2.5	68	12	65	15
8.	OTHELLO, WA	2	79	11	74	15
9.	PORT OF WILLIPA HARBOR, WA (R1)	1	72	10	58	13
10.	PORT OF WILLIPA HARBOR (R2)	1.25	68	10	59	13
11.	PULLMAN-MOSCOW REGIONAL, WA (R1)	2	75	14	70	17
12.	WILBUR, WA	2	92	1	83	4
13.	ASHLAND, OR (R1)	2	91	1	89	5
14.	ILLINOIS VALLEY, OR (R1)	2	87	10	83	14
15.	PINEHURST, OR	1	83	2	76	6
16.	PORT OF ASTORIA, OR (R1)	3/4	87	7	79	11
17.	PORT OF ASTORIA (R1A)	3/4	77	7	68	11
18.	TILLAMOOK, OR (R1)	1.5	92	4	89	8

Note: Where a runway designation is not listed there is only one runway presently at the airport.

"AGE" is the difference between the year of original construction of the overlay and the year the PCI survey was conducted. Refer to Appendices A and B for PCI survey dates.

**3.5.3 Bituminous Surface Treatments (BST) - Bituminous surface treatments are different from asphalt concrete in that they do very little to enhance a pavement's ability to support loads [6]. The surface treatment is normally less than 1 inch in thickness and consists of a thin layer of bituminous binder containing surface course aggregate [5]. This layer is normally placed on an aggregate base. These applications are most often used as a wearing and waterproofing surface course [1]. BST's are usually applied for maintenance purposes which includes use as a seal coat on previously treated surfaces. This particular difference caused some problems in the case of the first report because of the use of terminology in the PCI surveys, i.e. seal coat versus BST.**

Nine runways were analyzed with no distinction regarding whether the surface course was a single bituminous layer, double, or triple treatment. It should be noted that a DBST does not always mean two single BST layers, and similarly a TBST does not mean necessarily that three single BST layers are present. The difference relates to multiple equivalent layers as opposed gradually increasing aggregate size layers. Table 3-3a lists PCI and AGE results for the 9 runways, 18 points, and Table 3-3b provides LIFE data for those pavements which received surface treatments prior to the two PCI surveys. Only one of the runways was from Oregon.

TABLE 3-3a Bituminous surface treatments with associated PCI results and corresponding AGE.  
 ("AGE" indicated is time elapsed between last surface treatment and survey.)  
 (See Appendices A and B for years of survey for the respective runways.)

No.	AIRPORT & LOCATION	BST COMP.	PCI (%)	AGE (years)	PCI (%)	AGE (years)
1.	CONCRETE MUNICIPAL, WA	DBST	61	12	34	15
2.	DAVENPORT, WA	TBST	82	2	60	5
3.	OCEAN SHORES, WA	DBST	98	1	95	4
4.	ODESSA, WA (R1)	DBST	79	2	46	6
5.	ODESSA (R1A)	TBST	58	2	50	6
6.	SEQUIM VALLEY, WA	DBST	52	3	42	6
7.	STORM FIELD, WA	TBST	73	1	68	4
8.	WOODLAND STATE, WA	TBST	91	3	88	7
9.	NEWHALAM BAY, OR	TBST	80	8	77	12

Note: BST's include both original construction and maintenance ("seal coats")

TABLE 3-3b Bituminous surface treatments LIFE data.

No.	AIRPORT & LOCATION	BST COMP.	SURFACE COURSE	BASE (inches)	AGE (years)
1.	CONCRETE MUNICIPAL, WA	DBST	DBST (OS)	6	NR
2.	DAVENPORT, WA	TBST	BST-DBST	8	11
3.	OCEAN SHORES, WA	DBST	DBST (OS)	8	NR
4.	ODESSA, WA (R1)	DBST	DBST	6	15*
5.	ODESSA (R1A)	TBST	DBST-BST	3	15
6.	SEQUIM VALLEY, WA	DBST	DBST (OS)	12	NR
7.	STORM FIELD, WA	TBST	BST-DBST	8	17
8.	WOODLAND STATE, WA	TBST	TBST (OS)	?	NR
9.	NEWHALAM BAY, OR	TBST	BST-DBST	6	14

Notes: Where a runway designation is not listed there is only one runway presently at the airport.

OS - original surface

NR - no repair/rehab

\* - reconstructed

3.5.4 Surface Maintenance Applications & Techniques - The only surface maintenance technique evaluated in this study, was the category of slurry seals, as this treatment was the only one present in runways with two sets of PCI surveys. Surface maintenance applications are normally sprayed asphalt treatments and are a repair measure rather than a structural enhancement method. Waterproofing and improvement of skid resistance are two of the primary uses of these applications [1]. The first analysis had six groupings of surface seal applications, but as noted above only slurry seal maintenance will be addressed here. This was not considered a problem since it is the most common repair method. Slurry seals are a mixture of well-graded fine aggregate, mineral filler, emulsified asphalt, and water applied to a pavement as a surface treatment.

Of the airports evaluated, none have received a subsequent treatment, therefore maintenance technique LIFE investigations were not possible. Eleven runways with 22 PCI/AGE points were analyzed. Eight of the 11 runways were from Washington.

Weisenberger's [1] study addressed surface treatment LIFE evaluations for various applications, however, the data make-up and groupings will not be restated here. Findings from the analysis of the data will be summarized for reference in Chapter Four.

TABLE 3-4 Slurry seal surface maintenance applications with PCI results and corresponding AGI  
(Age listed is time elapsed since initial surface treatment).

No.	AIRPORT & LOCATION	PCI (%)	AGE (years)	PCI (%)	AGE (years)
1.	EPHRATA MUNICIPAL, WA (R1A)	60	17	55	21
2.	EPHRATA MUNICIPAL (R2)	53	17	43	21
3.	PRU FIELD, WA	83	2	77	6
4.	QUINCY, WA (R1)	72	7	70	11
5.	ROSALIA MUNICIPAL, WA	68	2	49	6
6.	SAND CANYON (CHEWELAH), WA	88	12	70	15
7.	SANDERSON FIELD, WA	77	9	72	12
8.	WHITMAN COUNTY MEMORIAL, WA	57	5	40	8
9.	LAKE COUNTY, OR	71	2	68	6
10.	ROSEBURG MUNICIPAL, OR	77	1	57	5
11.	SCAPPOOSE INDUSTRIAL, OR	65	1	64	5

Note: Where a runway designation is not listed there is only one runway presently at the airport.

3.5.5 Portland Cement Concrete (PCC) Pavements - Eight PCC pavements with sixteen data points were analyzed, and as indicated by the data, only Condon State Airport was constructed after WWII. The runway is also the only Oregon pavement represented in the data. Three of the runways are in poor shape whereas two are in very good to excellent shape. It is interesting to note that the runway at Condon State is the newest of the airports yet it has experienced the most severe deterioration rate (4% PCI loss per year since the first PCI survey). At this rate, significant rehabilitation will be required in another six or seven years, which is almost unacceptable since the pavement life would be a mere 11 years. No record of any maintenance or repair for Bowerman Field R2 or Chehalis-Centralia R1 was found. Table 3-5 lists the pertinent information for this category.

TABLE 3-5 Portland cement concrete pavement PCI results and corresponding AGE.

No.	AIRPORT & LOCATION	PCI (%)	AGE (years)	PCI (%)	AGE (years)
1.	BOWERMAN FIELD, WA (R2)	86	43	84	46
2.	BOWERMAN FIELD (R3)	33	43	26	46
3.	CHEHALIS-CENTRALIA, WA (R1)	84	45	81	49
4.	CHEHALIS-CENTRALIA (R2)	78	45	67	49
5.	EPHRATA, WA (R1)	40	44	33	48
6.	EPHRATA (R2A)	47	44	26	48
7.	QUILLAYUTE, WA	72	44*	69	47*
8.	CONDON STATE, OR	94	1	78	5

\* An original construction date for Quillayute could not be determined, but based on various record information the assumed date of construction was set at 1942.

Note: Where a runway designation is not listed there is only one runway presently at the airport.

## CHAPTER FOUR

### ANALYSIS AND RESULTS

#### 4.1 ANALYSIS INTRODUCTION

The primary analysis in this paper is based on regression modeling. Physical hand calculations were not required with the exception of simple average computations for the average deterioration of various pavements and AGE or LIFE calculations. Reference material and subsequently the use of software packages were the means to the development of these models/equations. The WSDOT study entitled "Regression Analysis for WSDOT Material Applications" [2], and "Prediction Models and Performance Curves" [10], from a Federal Highway Administration short-course were the two primary reference items used during the accomplishment of this analysis and report.

#### 4.2 REGRESSION MODELING

The regression modeling techniques used in this analysis are not recommended to be strict applications for predicting pavement performance. Rather, they are intended to be used as guidelines in assessing individual pavement performance against a select grouping or groupings of pavement. The equations developed and graphic plots depicted are intended to be additional tools in helping an airport manager more effectively use information and assets on hand to better plan and budget the pavement management system respective to the



airport needs. The limited data for analysis restricts the use of the models in any other manner.

4.2.1 Regression Models - Simple linear and non-linear regression analysis were the two methods of analysis applied to the available data . Simple linear regression provides a straight "best-fit" representation and non-linear provides a curvilinear depiction through the use of exponential, polynomial, or logarithmic functions. In the case of this study, both exponential and polynomial applications were used, however, in all cases the polynomial application provided what appeared to be the best curve fit. The two variables which are used throughout the analysis are PCI rating and AGE, with the former being the dependent variable and the latter, the independent variable. The modeling is considered "simple" since only one independent variable exists, with the exception of polynomials, and in the case of the simple linear regression where the equation used is normally  $PCI = B_0 - B_1(AGE)$ , the equation is linear since both parameters ( $B_0, B_1$ ) and the independent variable (AGE) are not power functions. A non-linear model is one where the regression parameters appear as exponents or where the independent variable(s) appear as second order or higher powers [10].

The regression parameters ( $B_0, B_1$ ) are commonly referred to as regression coefficients, and, as stated in Chapter Two,  $B_0$  represents the intercept of the regression line and  $B_1$  the slope of the regression line in a linear equation. Polynomial equations depict more than one independent variable, however, each subsequent variable is a power function of the original independent variable. The following equation indicates this relationship:

$$PCI = B_0 + B_1(AGE) + B_2(AGE)^2.....+B_n(AGE)^n$$

The use of polynomials is restricted in that an attempt should always be made to use the lowest degree polynomial equation to obtain the "best fit" possible.

The preferred method of regression analysis by WSDOT is the exponential form of the standard regression equations where the "power" is fixed, then the regression coefficients are determined based on available data points [10]. WSDOT uses this application in their Pavement Management System by selecting various powers until the best fit is obtained. The equation reads as follows:

$$PCR = B_0 + B_1 (AGE)^n \quad (\text{where "n" is the selected power})$$

Normally the power ranges from 1.0 to 3.0, and results are analyzed in 0.25 increments.

The generation of regression equations is accompanied by factors which give an indication of the reliability or confidence associated with the equation resulting from analysis of the data. The following is a list of the factors and their relationship to the data:

a) R-Squared - R-squared is the coefficient of determination and used to explain how much the total variation in the data is explained by the regression line [2]. This value is expressed as a percent, therefore if all points fall on the regression line the R-squared value is 100% whereas if the point are a significant distance away from the regression line the value will also decrease significantly. The higher the R-squared the more confidence is provided regarding the data and the line chosen to best fit this data.

b) T-Ratio - The T-ratio is the result of a hypothesis test which determines how well the independent variable predicts the dependent variable. The T-ratio should generally be greater than 2.0 for each independent variable to be a relatively strong predictor for the dependent variable [11].

c) SEE - The SEE value is the standard error of the estimate [11]. This value is used to estimate the standard deviation of the dependent variable about the regression line and is in the units of the dependent variable. Smaller SEE values for an equation indicate better reliability.

The MINITAB software used in the analyses provides the values of R-squared, T-ratio, and SEE in addition to the regression equation.

4.2.2 Regression Assumptions - The primary assumption used throughout the analysis of the pavement categories is that the PCI rating at construction or surface treatment is equal to 100%. This therefore facilitated the use of  $PCI = 100$  at  $AGE = 0$  for each set of data points used to describe overall pavement condition. The assumption was also used with the individual runway data when developing single regression equations. The assumption was applied to new construction, reconstruction, AC overlays, and also to slurry seals for this study. In the case of slurry seals, evaluations were conducted for both cases, with the first category evaluated as stated above, and the second assuming PCI was not equal to 100% at  $AGE = 0$ . From the analysis it was evident that the latter assumption was more realistic.

4.2.3 Regression Equation Development - The above stated assumption is instrumental as it provided a third data point in the case of individual runway model or equation development, and an initial data point for each pavement category. In the case of the initial study conducted by Weisenberger [1], an evaluation of the data without the initial data point of  $PCI = 100$  and  $AGE = 0$  in various models, revealed essentially the same equation results with slight differences in the R-squared, T-ratio and PCI (y) intercept. This assumption, however, could be criticized as it implies perfection at the outset or upon corrective applications. This is especially inconsistent in the case of seal coat applications because of the range of quality applications and materials in the field. The data to some extent illustrates this point with some runways already in "fair" and "good" shape after only a year, whereas a few are in "very good" and "excellent" shape after seven and up to twelve years.

The critical decision in conducting the analysis was the choice between the use of the polynomial regression and exponential regression relationships outlined in section 4.2.1. The same process of selection of powers for the best curve fit was applied in the use of polynomial equations with the Microsoft Cricket Graph software. This procedure provided a somewhat comparable curve to the normal expected representation of a pavement's performance.

The data was compared from both standpoints in that exponential regression modeling was accomplished using the MINITAB software and polynomial regression modeling was done with Cricket Graph. Comparisons and an assessment of each set of findings will be discussed in each category. The Cricket Graph software did not however provide T-ratio and SEE values for comparison with the MINITAB analyses. In addition, during the course of analysis certain data point "sets", two PCI survey readings for a runway, were intentionally omitted when presenting the final plot of the best fit curve. This was done in cases where the set provided a significant influence on the outcome of the regression model. In these cases unreported maintenance on the runway surface, construction quality, or poor materials used could have influenced the PCI results for the corresponding AGE of the pavement. The data is shown on the graph but when the "best" representative curve was selected, the high influence data or sets of points which did not appear to be indicative of normal pavement behavior, did not determine the model outcome. It will be very evident from the illustrations which data points were omitted in the development of the final model.

### 4.3 REGRESSION ANALYSIS AND RESULTS

The following sections provide the results and accompanying pertinent assumptions or modifications relative to the category being analyzed. The regression equation listed is per the procedure listed in the preceding section. Where data points have been intentionally

omitted, special graph points will be shown to distinguish them from the points used for the final equation. The category sequence is as presented in Chapter Three and is restated here for quick reference.

Flexible pavements ranging from AC surface course original construction to bituminous surface treatments were evaluated for this report. Slurry seals were the only surface maintenance applications analyzed and for rigid pavements, portland cement concrete was the only runway of choice. Below is the category arrangement for the pavement sections:

- a) Flexible Pavements 4.3.1
- b) AC Overlays 4.3.2
- c) Bituminous Surface Treatments 4.3.3
- d) Slurry Seal Surface Treatments 4.3.4
- e) Portland Cement Concrete 4.3.5

4.3.1 Flexible Pavements - The data for flexible pavements was separated into four categories for performance evaluation using regression analysis. Three of the four were based on thickness, and the fourth was restricted to World War Two (WWII) pavement analysis. Two categories were used in evaluating flexible pavement LIFE, WWII constructed runways and post WWII runways.

4.3.1.1 Regression Models - Tables 4-1a through 4-1d list the regression analysis results obtained for the flexible pavement categories evaluated in this section.

TABLE 4-1a Regression equations for flexible pavement structural sections consisting of 2 - 3 inches AC on 6 - 8 inches of base.

(1)

(With "high influence points")

**WASHINGTON**  
 PCI = 99.1 - 2.14(AGE)  
 t-ratio = 2.78  
 R-sq = 34.0%  
 SEE = 19.2  
 N = 17

**OREGON**  
 PCI = 91.5 - 0.361(AGE)  
 t-ratio = 2.73  
 R-sq = 51.6%  
 SEE = 5.89  
 N = 9

**COMBINED**  
 PCI = 82.0 - 0.486(AGE)  
 t-ratio = 1.13  
 R-sq = 5.3%  
 SEE = 20.01  
 N = 25

**CRICKET GRAPH RESULTS**  
 PCI = 99.11 - 2.14(AGE) WA  
 R-sq = 34.0% N = 17  
 PCI = 91.48 - 0.361(AGE) OR  
 R-sq = 51.6% N = 9  
 PCI = 83.07 - 0.583(AGE) Comb.  
 R-sq = 8.5%

Note: "N" is the number of data points used.

(2)

(Without "high influence points")

**WASHINGTON**  
 PCI = 91.7 - .072(AGE)<sup>2</sup>  
 t-ratio = 3.84  
 R-sq = 53.1%  
 SEE = 11.2  
 N = 15

**OREGON**  
 Same

**COMBINED**  
 PCI = 99.2 - 1.99(AGE)  
 t-ratio = 2.57  
 R-sq = 28%  
 SEE = 19.65  
 N = 21

**CRICKET GRAPH RESULTS**  
 PCI = 99.83 - 1.78(AGE) WA  
 R-sq = 54.9%  
 PCI = 97.9 - 2.07(AGE) Combined  
 R-sq = 40.8%

High Influence Point - HIP

**2-3" AC on 6-8" Base  
(WA Pavements)**

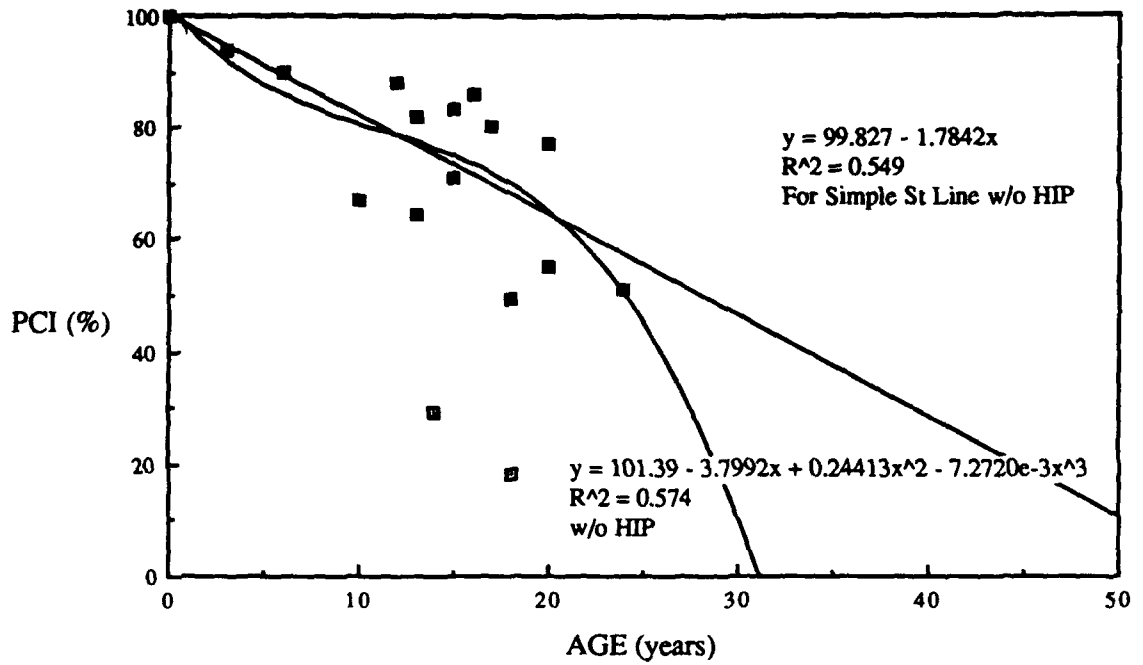

**Figure 4-1a WA PCI vs AGE For 8 Runways  
Showing Plots Without High Influence Pts**

**2-3" AC on 6-8" Base  
(OR Pavements)**

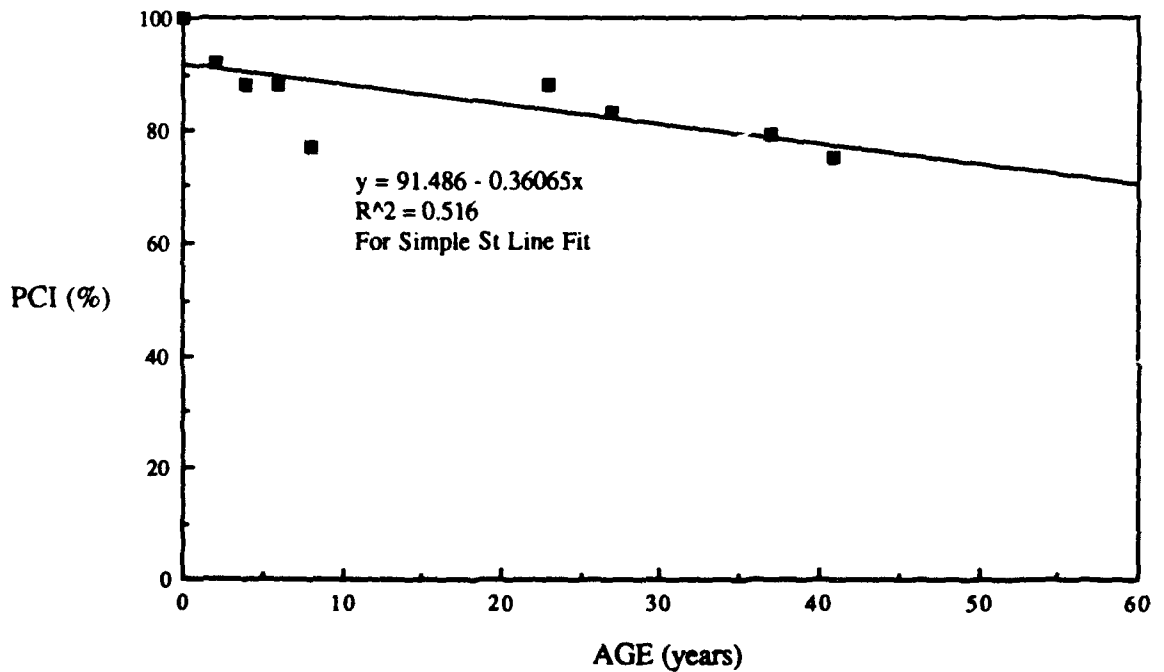

**Figure 4-1b OR PCI vs AGE For 4 Runways**

**2-3" AC on 6-8" Base  
All Pavements**

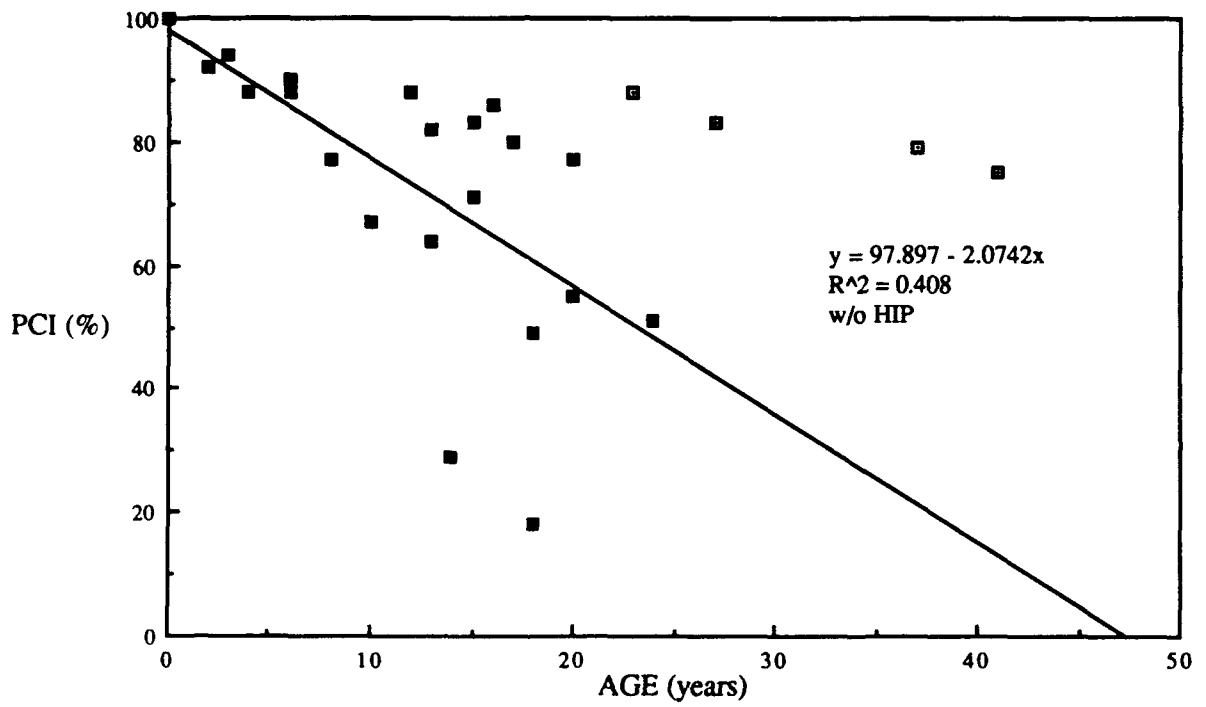

**Figure 4-1c Combined PCI vs AGE**



TABLE 4-1b Regression equations for flexible pavement structural sections consisting of  
2 - 3 inches AC on greater than 8 inches of base/subbase.

(1)

(With HIP's)

**WASHINGTON**

PCI = 96.4 - 0.853(AGE)  
t-ratio = 1.82  
R-sq = 20.3%  
SEE = 11.87  
N = 15

**OREGON**

PCI = 98.1 - 1.47(AGE)  
t-ratio = 4.15  
R-sq = 85.2%  
SEE = 1.71  
N = 5

**COMBINED**

PCI = 96.1 - 0.838(AGE)  
t-ratio = 2.45  
R-sq = 26.1%  
SEE = 10.39  
N = 19

**CRICKET GRAPH RESULTS**

PCI = 96.4 - 0.853(AGE) WA  
R-sq = 20.3%

PCI = 98.1 - 1.47(AGE) OR  
R-sq = 85.2%

PCI = 96.1 - 0.838(AGE) Combined  
R-sq = 26.1%

Note: "N" is number of data points used.

(2)

(Without HIP's)

**WASHINGTON**

PCI = 91.1 - .036(AGE)<sup>2</sup>  
t-ratio = 1.9  
R-sq = 24.7  
SEE = 11.81  
N = 13

**OREGON**

Same

**COMBINED**

PCI = 93.6 - 0.19(AGE)<sup>1.5</sup>  
t-ratio = 2.78  
R-sq = 34%  
SEE = 10.04  
N = 17

**CRICKET GRAPH RESULTS**

See Polynomial Fit Fig. 4-2a of WA  
For Equation R-sq = 28.2%

See Fig 4-2c For Combined Fit  
& Equation R-sq = 36%

**2-3" AC on >8" Base  
(WA Pavements)**

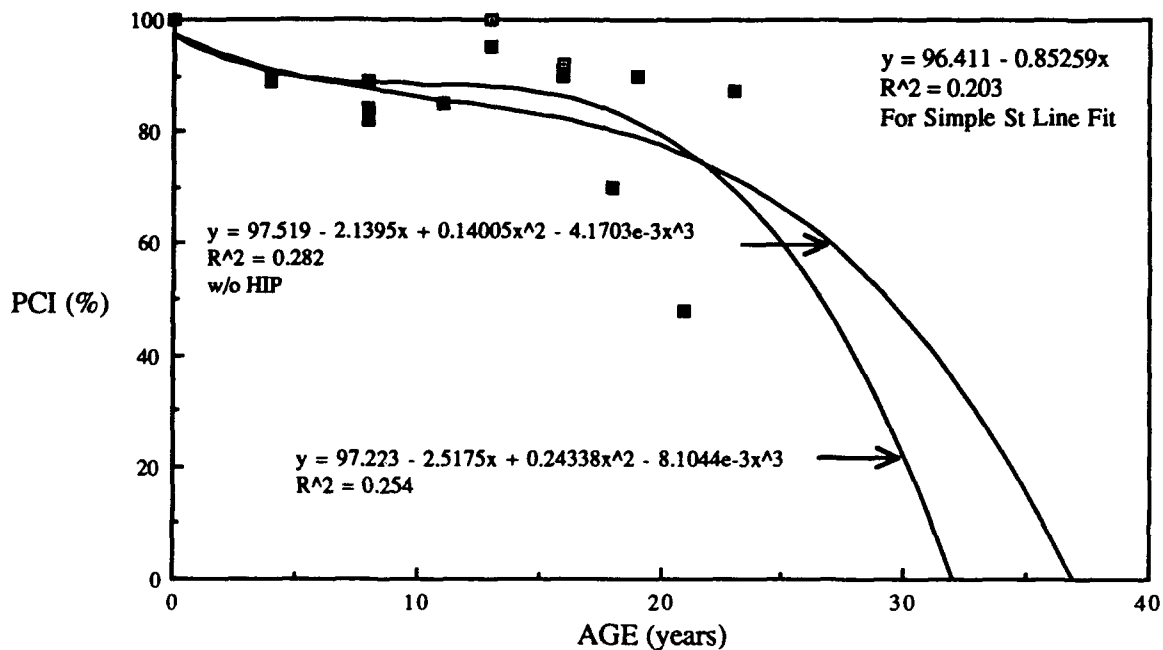

**Figure 4-2a WA PCI vs AGE For 7 Runways  
Shown With & Without High Influence Pts**

**2-3" AC on >8" Base  
(OR Pavements)**

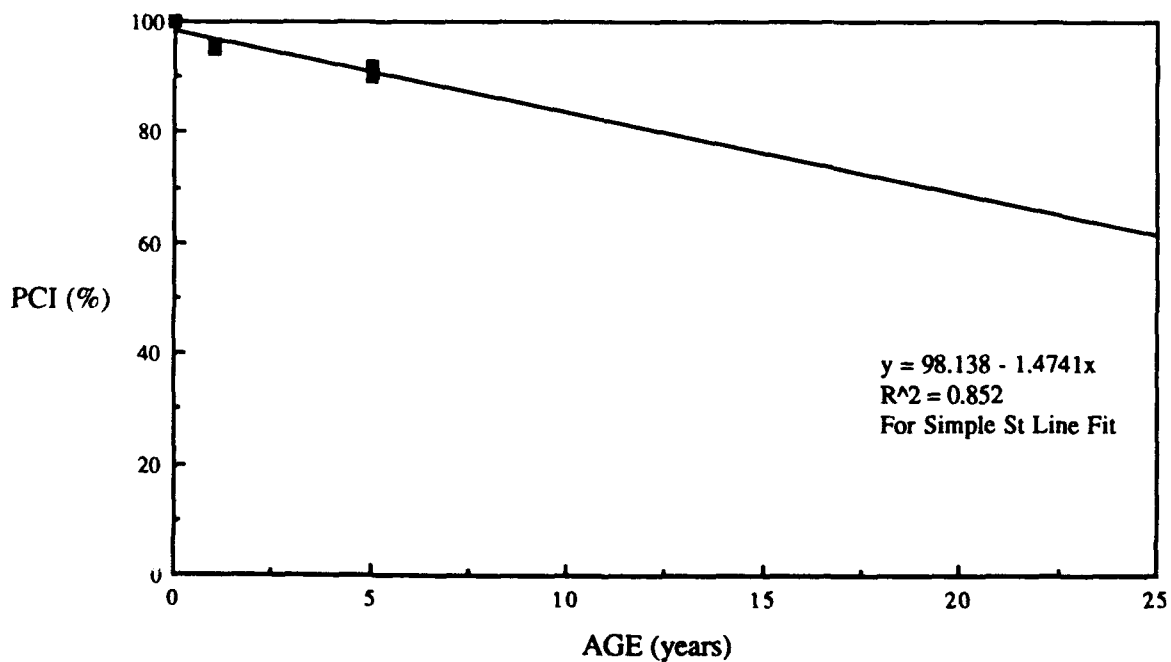

**Figure 4-2b OR PCI vs AGE For 2 Runways**

2-3" AC on >8" Base  
All Pavements

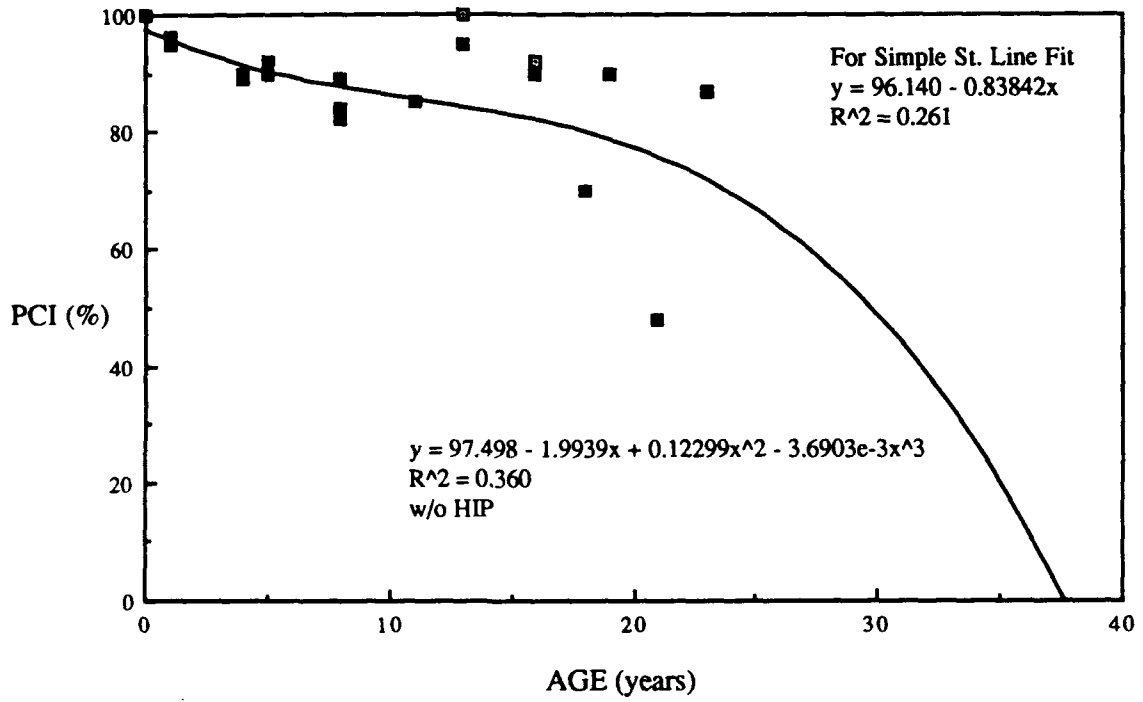

Figure 4-2c Combined PCI vs AGE

TABLE 4-1c Regression equations for flexible pavement structural sections consisting of greater than 3 inches AC on any base/subbase.

(1)

(With HIP's)

**WASHINGTON**

PCI = 99.8 - 0.31(AGE)<sup>1.5</sup>  
 t-ratio = 7.65  
 R-sq = 92.1%  
 SEE = 3.05  
 N = 7

**OREGON**

92.7 - 0.05(AGE)  
 t-ratio = 0.26  
 R-sq = 2.1%  
 SEE = 5.88  
 N = 5

**COMBINED**

PCI = 89.9 - 0.31(AGE)  
 t-ratio = 1.10  
 R-sq = 11.9%  
 SEE = 8.92  
 N = 11

**CRICKET GRAPH RESULTS**

See Polynomial Fit Fig 4-3a of WA  
 For Equation R-sq = 92.3%

(2)

(Without HIP's)

**COMBINED**

PCI = 94.0 - .054(AGE)<sup>2</sup>  
 t-ratio = 6.39  
 R-sq = 85.4%  
 SEE = 3.813  
 N = 9

**OREGON**

PCI = 97.7 - 2.14(AGE)  
 t-ratio = 2.17  
 R-sq = 82.4%  
 SEE = 4.276  
 N = 3

**CRICKET GRAPH RESULTS**

PCI = 98.8 - 4.2(AGE) + 0.4(AGE)<sup>2</sup> - 1.3e<sup>-2</sup>(AGE)<sup>3</sup>  
 R-sq = 93.1%  
 N = 9

**Greater Than 3"AC On Any Base/Subbase  
(WA Pavements)**

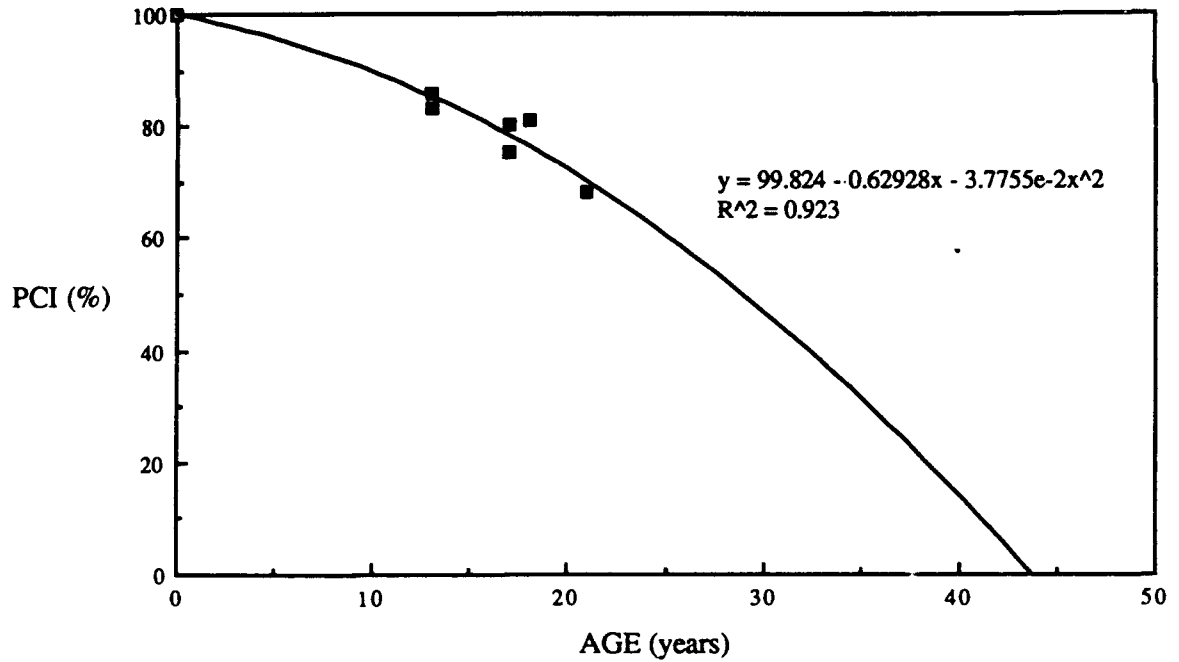

**Figure 4-3a WA PCI vs AGE For 3 Runways**

**Greater Than 3"AC On Any Base/Subbase  
(OR Pavements)**

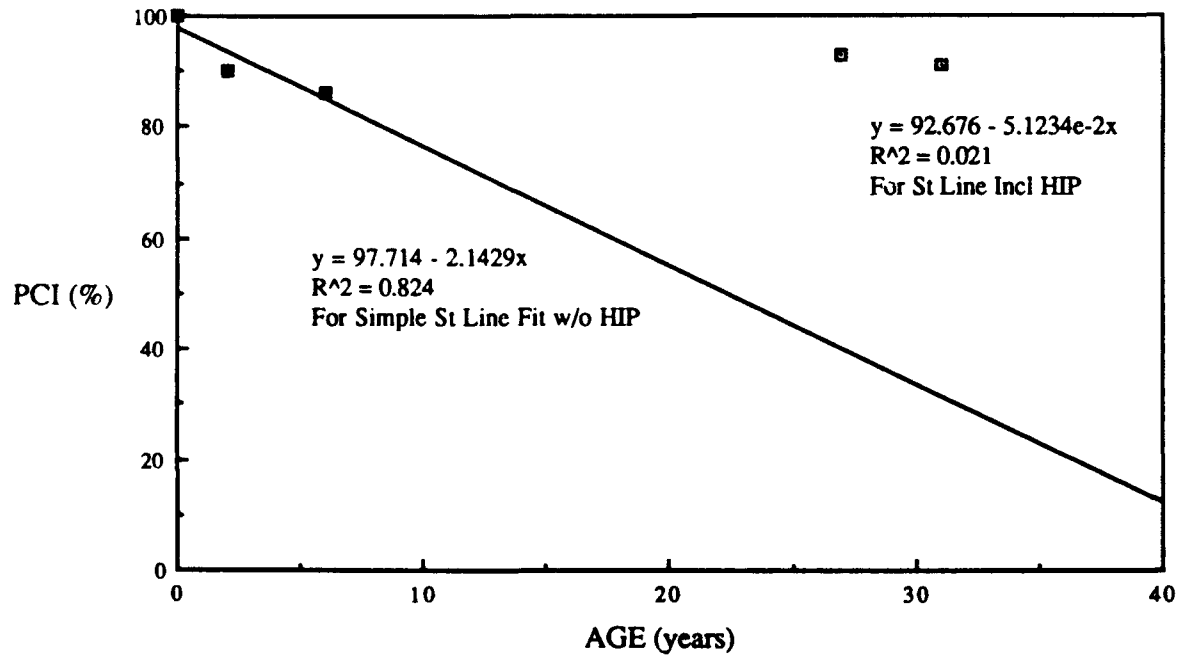

**Figure 4-3b OR PCI vs AGE For 2 Runways**

Greater Than 3" AC On Any Base/Subbase  
All Pavements

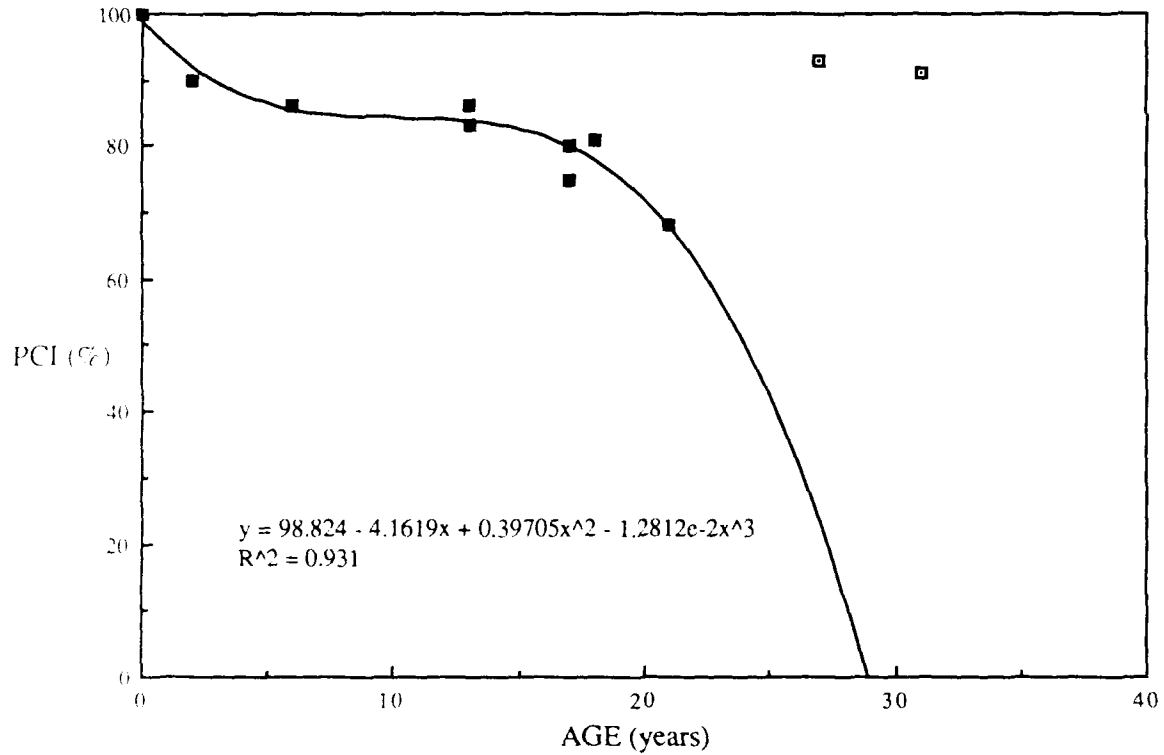

Figure 4-3c Combined PCI vs AGE w/o HIP

TABLE 4-1d Regression equations for flexible pavements less than 3 inches AC on 6 - 8 inches of base/subbase built during World War Two

WASHINGTON	CRICKET GRAPH RESULTS
$PCI = 100 - 0.0234(AGE)^2$ t-ratio = 4.82 R-sq = 72.1% SEE = 9.875 N = 11	See Polynomial Fit Fig 4-4 For Equation R-sq = 72.1% N = 11

4.3.1.2 Survival Statistics - Pavement LIFE was estimated by taking the difference between the pavement's original construction date and the date the pavement received the first maintenance application. This assumes the pavement received a surface application due to necessity and not due to other non-structural requirements. The estimated reduction in PCI, rate per year loss, was based on assuming that resurfacing occurred at approximately 55% PCI. The loss is therefore considered to 45% PCI divided by the average LIFE of the pavement section. This assumption also indicates that PCI at construction was 100%. The runway information was divided into the two AC thickness categories shown as compared to three categories previously studied under the first PCI analysis report.

Table 4-1e shows the characteristics for pavement LIFE for those runways constructed after WWII. Refer to Table 3-1e for the individual pavement information and the corresponding corrective measure applied. Table 4-1g depicts those pavements constructed during WWII and the related findings. Refer to Table 3-1f for corresponding individual runway information.

### WWII Runways <3" AC on 6-8" Base

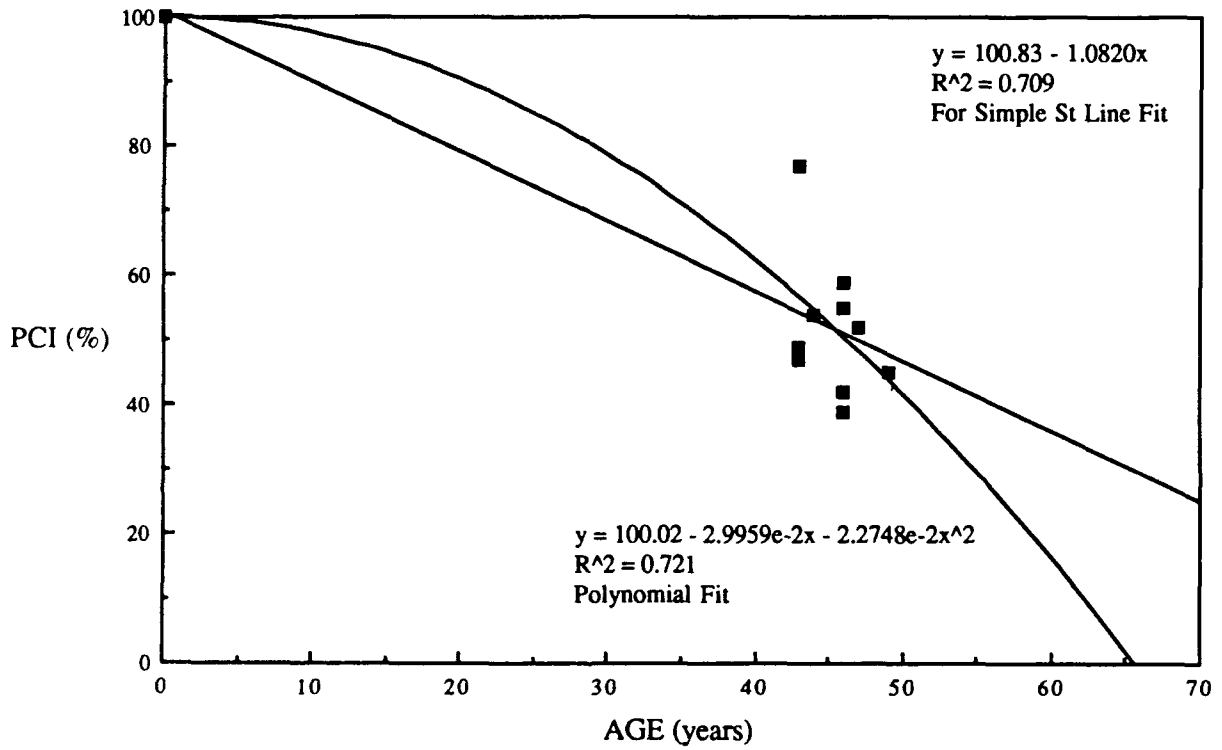

Figure 4-4 WA PCI vs AGE For 5 Runways



TABLE 4-1e Pavement LIFE characteristics for AC pavements constructed after WWII with categories for greater than and less than 3 inches AC.

\*\*\*\*\*

Less than 3 inches

Average LIFE	=	14.3 years
Shortest LIFE	=	4.0 years
Longest LIFE	=	37 years
Avg. PCI LOSS	=	3.0% per year
Standard Deviation	=	9.5
N	=	23

---

3 inches or greater

Average LIFE	=	14.9 years
Shortest LIFE	=	3.0 years
Longest LIFE	=	37.0 years
Avg PCI LOSS	=	3.0% per year
Standard Deviation	=	10.5
N	=	8

\*\*\*\*\*

Note: "N" represents the number of runway pavements in Tables 4-1e, 4-1f, and 4-1g.

TABLE 4-1f Pavement LIFE characteristics for AC pavements constructed after WWII with varying AC thicknesses. Weisenberger [1] results of 1988

\*\*\*\*\*

1/2 inch to 1 1/2 inches

Average LIFE	=	11.7 years
Shortest LIFE	=	3.0 years
Longest LIFE	=	19 years
Avg. PCI LOSS	=	3.8% per year
Standard Deviation	=	6.24
N	=	7

2 inches to 2 1/2 inches

Average LIFE	=	13.0 years
Shortest LIFE	=	4.0 years
Longest LIFE	=	35.0 years
Avg PCI LOSS	=	3.5% per year
Standard Deviation	=	8.88
N	=	13

3 inches or more

Average LIFE	=	14.0 years
Shortest LIFE	=	10.0 years
Longest LIFE	=	18.0 years
Avg PCI LOSS	=	3.2% per year
Standard Deviation	=	3.78
N	=	5

\*\*\*\*\*

TABLE 4-1g Pavement LIFE characteristics for AC pavements constructed during WWII  
with categories for greater than and less than 3 inches AC.  
(Washington and Oregon only)

\*\*\*\*\*

Less than 3 inches

Average LIFE	=	35.0 years
Shortest LIFE	=	21.0 years
Longest LIFE	=	43.0 years
Avg PCI LOSS	=	1.28% per year
Standard Deviation	=	5.5
N	=	33

3 inches or greater

Average LIFE	=	30.2 years
Shortest LIFE	=	9.0 years
Longest LIFE	=	41.0 years
Avg PCI LOSS	=	1.5% per year
Standard Deviation	=	8.7
N	=	9

\*\*\*\*\*

Weisenberger [1] results of 1988 for WA, OR, and ID.

\*\*\*\*\*

Average LIFE	=	27.4 years
Shortest LIFE	=	9.0 years
Longest LIFE	=	43.0 years
Avg PCI LOSS	=	1.6% per year
Standard Deviation	=	11.2
N	=	42

\*\*\*\*\*

4.3.2 AC Overlays - This category of pavements was evaluated as one group instead of dividing the group in different sections. The primary reason for this choice is that most of the overlay sections consisted of 2-inch surface courses. The FAA AC 150/5380-6 [4] also indicates that varying AC pavement thicknesses, unless significant, do not normally have a sizable impact on PCI ratings if the overlay is not a thin layer.

4.3.2.1 Regression Models - It was not readily apparent from the models listed and depicted on the following pages how well these findings compared to the first PCI analysis report completed by Weisenberger [1], as the latter evaluated results using straight line plots only. The straight line plots for Washington and Oregon in this analysis did not compare favorably with those of the first report. There are significant differences in R-squared and SEE values, (confidence and estimate error values, respectively) with the findings of this report being less favorable, i.e. lower values computed than previously. The exponential and polynomial applications to the data, without high influence points, produced better results in terms of expected theoretical representations.

4.3.2.2 Survival Statistics - LIFE computations were the same as those found in Weisenberger's [1] study as none of the pavements have received treatment since then.

TABLE 4-2a Pavement LIFE characteristics for AC overlays with 2 to 4 inches AC - Weisenberger [1].

\*\*\*\*\*

Average LIFE	=	11.6 years
Shortest LIFE	=	8.0 years
Longest LIFE	=	16.0 years
Avg PCI LOSS	=	3.9% per year
Standard Deviation	=	2.63
N	=	7

\*\*\*\*\*

TABLE 4-2b Regression equations for flexible pavement structural sections consisting of AC overlays ranging from 3/4 to 3 inches on any base/subbase.

(1)

(With HIP's)

**WASHINGTON**

PCI = 93.2 - 1.23(AGE)  
 t-ratio = 3.1  
 R-sq = 29.5%  
 SEE = 10.01  
 N = 25

**OREGON**

PCI = 92.4 - 1.17(AGE)  
 t-ratio = 2.44  
 R-sq = 35.1%  
 SEE = 6.99  
 N = 13

**COMBINED**

PCI = 90.8 - 1.03(AGE)  
 t-ratio = 3.17  
 R-sq = 23.3%  
 SEE = 9.32  
 N = 37

**CRICKET GRAPH RESULTS**

PCI = 93.25 - 1.23(AGE) WA  
 R-sq = 29.5% N = 25  
 PCI = 92.4 - 1.17(AGE) OR  
 R-sq = 35.1% N = 13

(2)

(Without HIP's)

**WASHINGTON**

PCI = 92.2 - 0.453(AGE)<sup>1.5</sup>  
 t-ratio = 5.79  
 R-sq = 66.4%  
 SEE = 7.3  
 N = 19

**OREGON**

PCI = 92.5 - 0.5(AGE)<sup>1.5</sup>  
 t-ratio = 3.08  
 R-sq = 51.3%  
 SEE = 6.65  
 N = 11

**COMBINED**

PCI = 91.3 - 0.44(AGE)<sup>1.5</sup>  
 T-ratio = 6.84  
 R-sq = 63.4%  
 SEE = 6.78  
 N = 31

**CRICKET GRAPH RESULTS**

PCI = 91.75 - 1.11(AGE)  
 See Fig 4-5c For Polynomial Fit  
 R-sq = 48.3% (3 HIP's omitted)  
 N = 34

### AC Overlays (WA Pavements)

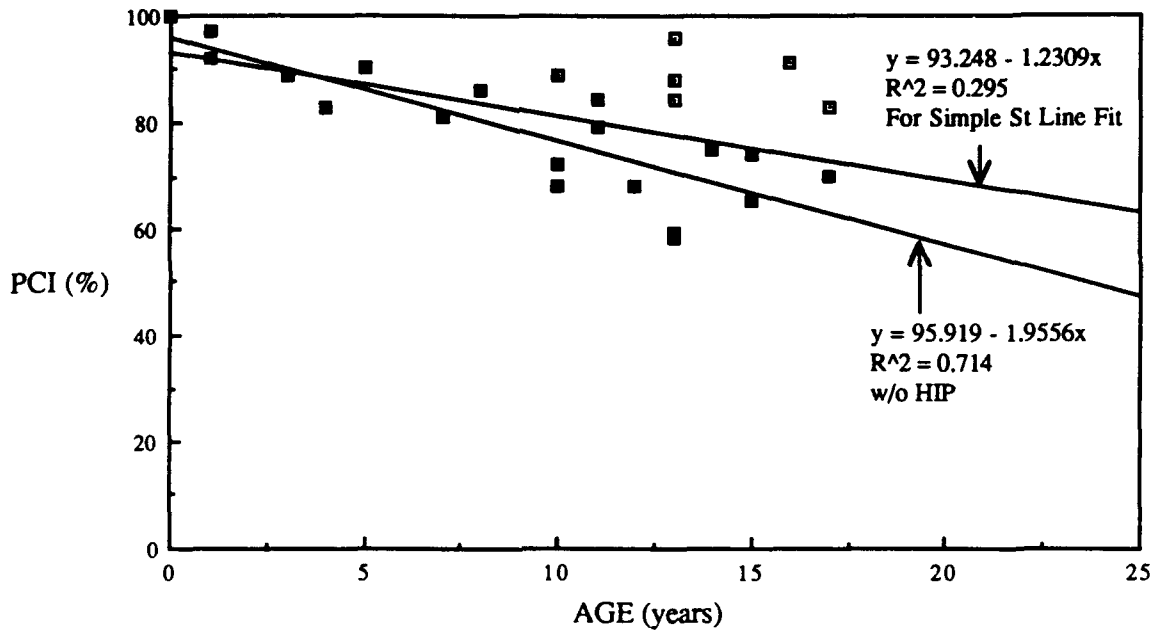

Figure 4-5a WA PCI vs AGE For 12 Runways

### AC Overlays (OR Pavements)

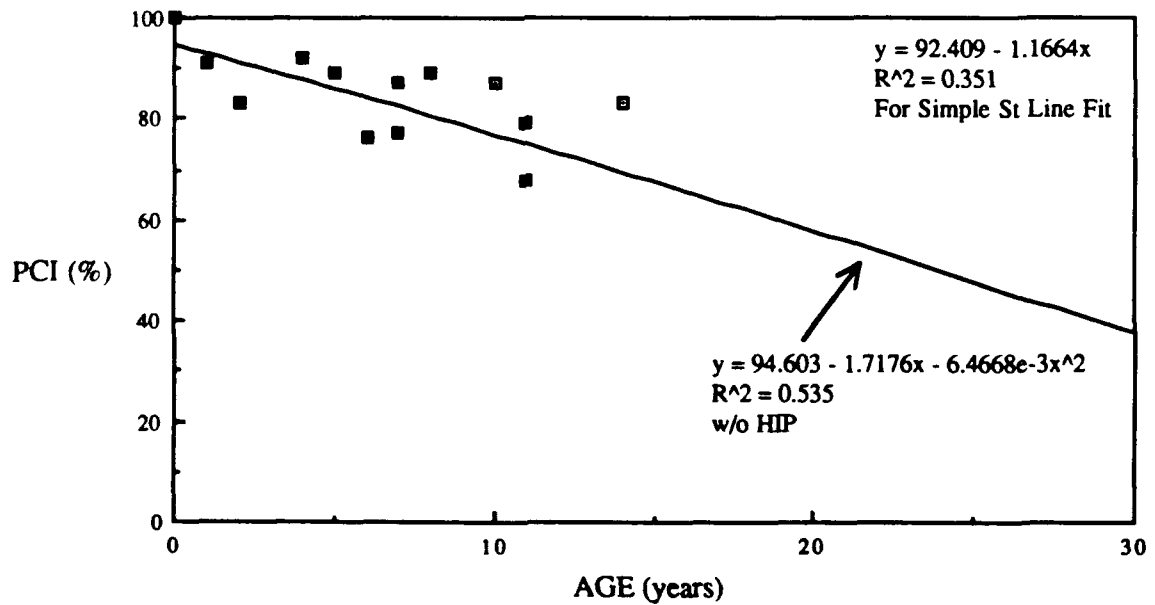

Figure 4-5b OR PCI vs AGE For 6 Runways

### AC Overlays All Pavements

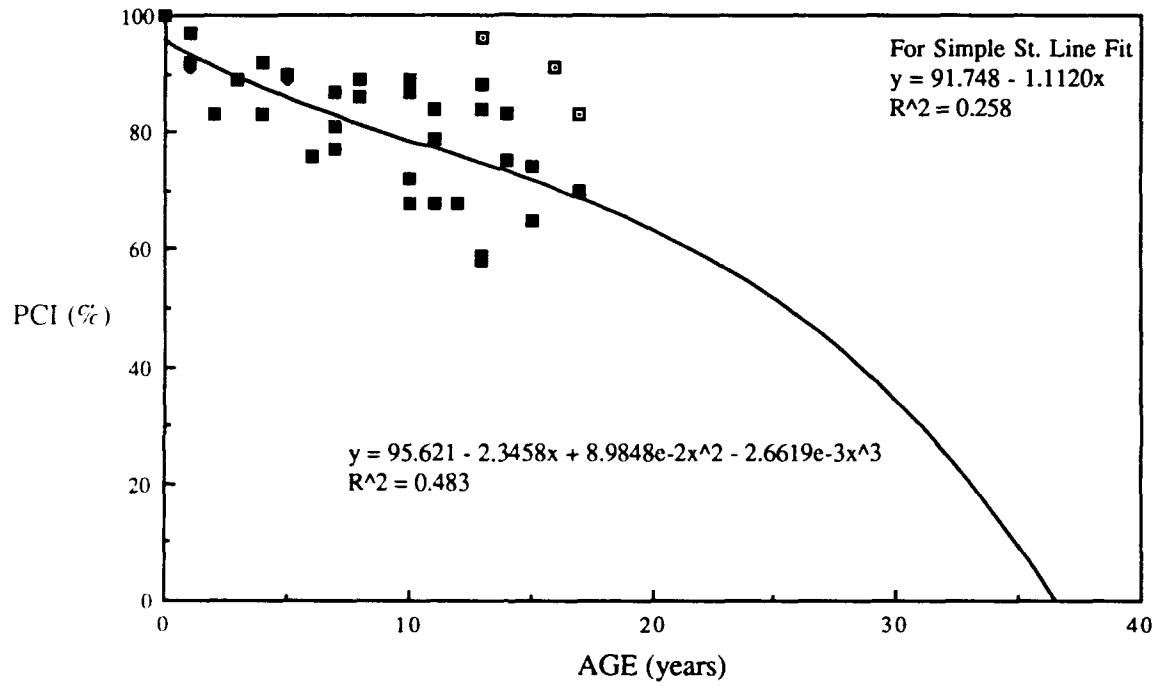

Figure 4-5c Combined PCI vs AGE w/o HIP

4.3.3 Bituminous Surface Treatments - The data compiled for bituminous pavements provided what was interpreted as two possible trends of pavement performance. As a result of this observation, it was decided to examine the two separate trend categories and compare the findings. As stated in Chapter Three, an attempt was not made to evaluate BST's based on the number of treatments or the make-up of the BST surface course.

The results listed and depicted could not be compared with the first PCI analysis report as the models/equations developed in this category were accomplished with non-linear applications. The separation into upper and lower divisions of data provided excellent results particularly in the case of the upper division data points. The lower points points yielded less favorable results, but were not totally unacceptable. Segregation of the data points would pose a problem from an individual runway standpoint however, as a determination would have to be made as to which of the two models would apply to the individual situation. The combined model provides low confidence results, therefore it would seem prudent to select one of the two "partition" models to compare with the individual pavement.



TABLE 4-3a Regression equations for flexible pavement structural sections consisting of bituminous surface treatments on any base/subbase. Data is categorized in "upper" and "lower" portions based on interpreted trends in the data with respect to various runways.

(1)

**WASHINGTON(upper)**

PCI = 97.0 - .07(AGE)<sup>2.5</sup>  
 t-ratio = 22.87  
 R-sq = 99.1%  
 SEE = 2.61  
 N = 7

**OREGON**

PCI = 99.0 - 2.0(AGE)  
 t-ratio = 4.62  
 R-sq = 95.5%  
 SEE = 3.74  
 N = 3

**WASHINGTON(lower)**

PCI = 86.2 - 6.91(AGE)  
 R-sq = 71.8%  
 N = 11

**COMBINED**

PCI = 78.8 - 0.49(AGE)<sup>1.5</sup>  
 t-ratio = 1.93  
 R-sq = 18.0%  
 SEE = 18.59  
 N = 19

(2)

**COMBINED(upper)**

PCI = 95.5 - 0.175(AGE)<sup>3</sup>  
 T-ratio = 9.71  
 R-sq = 93.1%  
 SEE = 5.97  
 N = 9

**CRICKET GRAPH RESULTS**

See Fig 4-6a For Polynomial Fit WA  
 R-sq = 98.8%

See Fig 4-6b for St. Line Fit For OR  
 R-sq = 95.5%

**COMBINED(lower)**

Same as "Washington (lower)"

Same as "Washington (lower)"  
 See Fig 4-6c For Combined Plots

**Bituminous Surface Treatments  
(WA Pavements)**

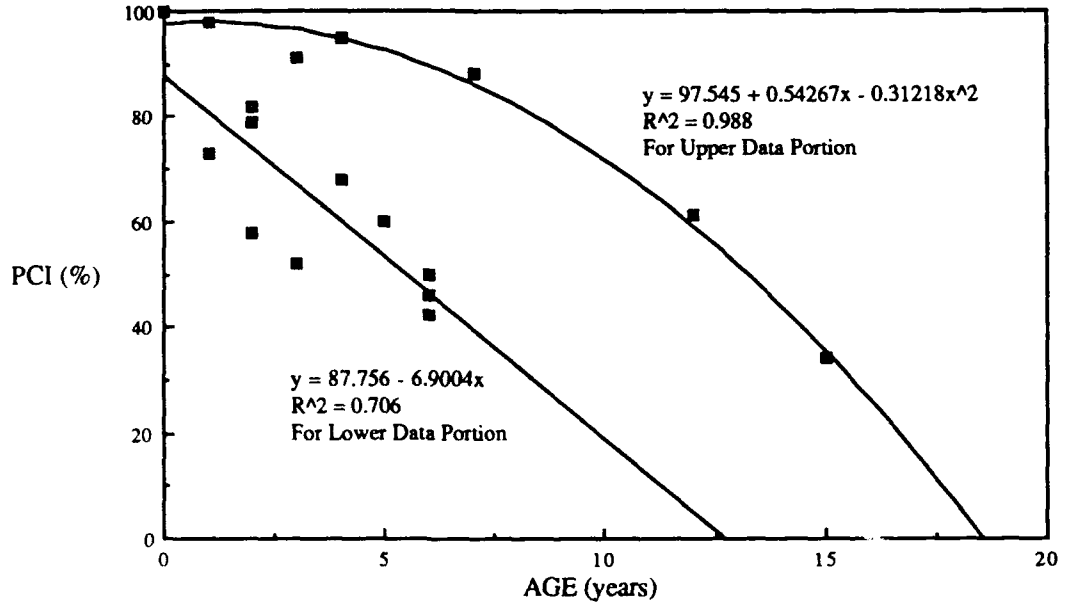

**Figure 4-6a WA PCI vs AGE For 8 Runways  
Data is "Partitioned" in Two Categories**

**Bituminous Surface Treatment  
(OR Pavements)**

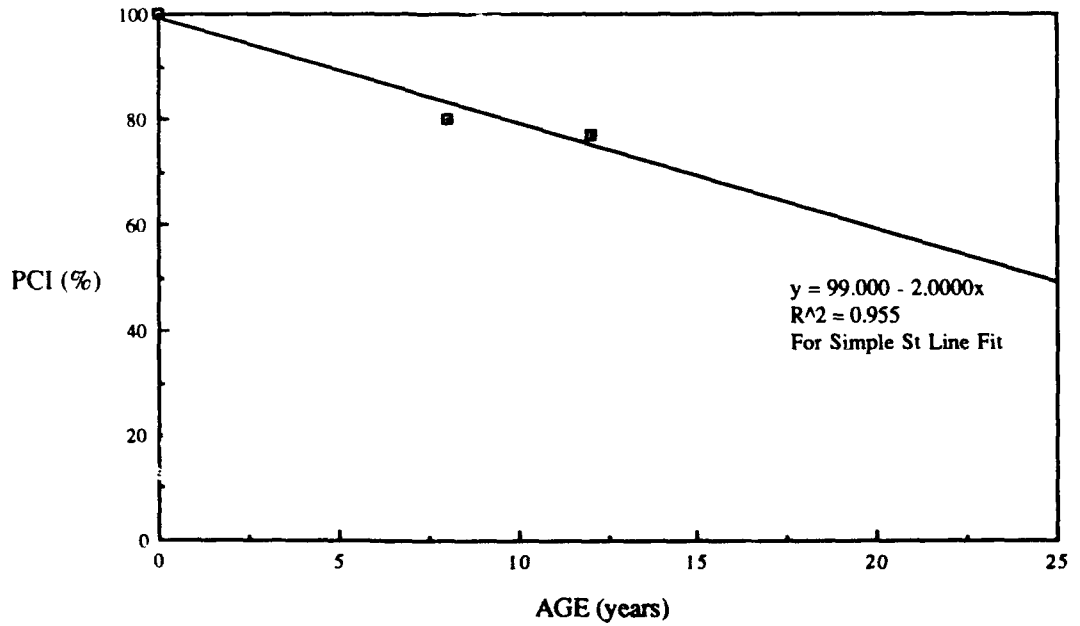

**Figure 4-6b OR PCI vs AGE For 1 Runway**

### Bituminous Surface Treatments All Pavements

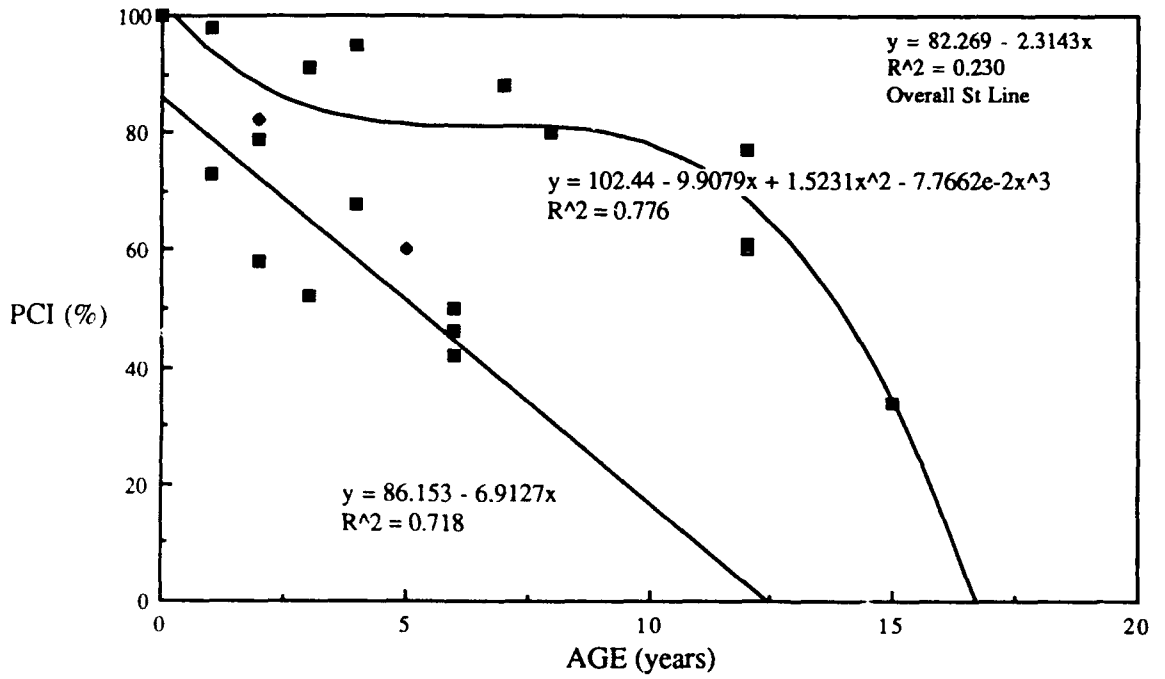

Figure 4-6c Combined PCI vs AGE With  
Data "Partitioned" in Two Categories

TABLE 4-3b Pavement LIFE characteristics for pavements with bituminous surface treatments.

\*\*\*\*\*

Average LIFE	=	14.4 years	——
Shortest LIFE	=	11.0 years	
Longest LIFE	=	17.0 years	
Avg PCI LOSS	=	3.125% per year	
Standard Deviation	=	2.19	
N	=	5	

\*\*\*\*\*

The few number of runways used for the LIFE investigation portion of bituminous surface treatments may lessen the applicability of the findings shown above, however the findings are presented for reference and future analysis. The five runways evaluated were the only ones in this study of runways with two sets of PCI surveys where a subsequent surface treatment had been applied to the previous bituminous surface course.

TABLE 4-3c Pavement LIFE characteristics for pavements with bituminous surface treatments with BST and DBST categories - Weisenberger [1].

\*\*\*\*\*

All data points

Average LIFE	=	9.2 years
Shortest LIFE	=	1.0 year
Longest LIFE	=	29.0 years
Avg PCI LOSS	=	4.9% per year
Standard Deviation	=	6.4
N	=	22

---

BST applications

Average LIFE	=	8.8 years
Shortest LIFE	=	6.0 years
Longest LIFE	=	18.0 years
Avg PCI LOSS	=	5.1% per year
Standard Deviation	=	5.17
N	=	5

---

DBST applications

Average LIFE	=	5.6 years
Shortest LIFE	=	2.0 years
Longest LIFE	=	13.0 years
Avg PCI LOSS	=	8.0% per year
Standard Deviation	=	3.4
N	=	9

\*\*\*\*\*

4.3.4 Surface Maintenance Applications and Techniques - Chapter Three indicated the evaluation of only slurry seals in this report since this technique was the only one common to runways with two sets of PCI surveys. As in the case of BST's, two categories were observed in Washington pavements. The two were evaluated and are presented in Table 4-4b and Figures 4-7a through 4-7c. The graphic plot in Figure 4-7c of the combined data points is a polynomial equation but as evidenced by the plot of the equation, the curve shows a slight upward trend between approximately five and twelve years. This portion of the curve is therefore not a good depiction of real life pavement performance especially in the case of slurry seals. The combined regression models, with and without high influence points, do not provide reliable models for application to individual pavements. These findings are attributable to data that one would normally expect to gather on slurry seal surfaces. Construction methods and materials are critical to the finished product. In addition, the assumption of using PCI = 100% at AGE = 0 is probably not a good one, as slurry seal surface treatments apparently do not result in a PCI rating of 100% at AGE = 0. Pavement LIFE results from the Weisenberger [1] report are listed below.

TABLE 4-4a Pavement LIFE characteristics for slurry seal pavements.  
Weisenberger [1]

\*\*\*\*\*

Average LIFE	=	5.6 years
Shortest LIFE	=	3.0 years
Longest LIFE	=	10.0 years
Avg PCI LOSS	=	8.0% per year
Standard Deviation	=	2.99
N	=	6

\*\*\*\*\*

TABLE 4-4b Regression equations for flexible pavement structural sections with slurry seal surface maintenance applications. Washington pavements were again segregated into two sections, with the upper portion addressed in this table.

**WASHINGTON\***

PCI = 87.3 - 0.42(AGE)<sup>1.5</sup>  
 t-ratio = 7.3  
 R-sq = 85.5%  
 SEE = 6.35  
 N = 11(upper)

**OREGON**

PCI = 79.9 - 1.37(AGE)<sup>1.5</sup>  
 t-ratio = 1.69  
 R-sq = 36.4%  
 SEE = 12.17  
 N = 7

**COMBINED(w/HIP)**

PCI = 72.6 - 0.2(AGE)<sup>1.5</sup>  
 t-ratio = 2.15  
 R-sq = 18%  
 SEE = 13.11  
 N = 23

**CRICKET GRAPH RESULTS**

See Fig 4-7a For Curve Fits WA  
 R-sq = 87% For Polynomial Fit

See Fig 4-7b For St. Line Fit OR  
 R-sq = 46.5%

**COMBINED(w/o HIP)**

PCI = 71.9 - 0.23(AGE)<sup>1.5</sup>  
 t-ratio = 2.59  
 R-sq = 26.1%  
 SEE = 12.33  
 N = 20

\* Note: The analysis did not include PCI = 100 at AGE = 0. See Appendix D for MINITAB printouts of both cases.

### Slurry Seal Surface Treatments (WA Pavements)

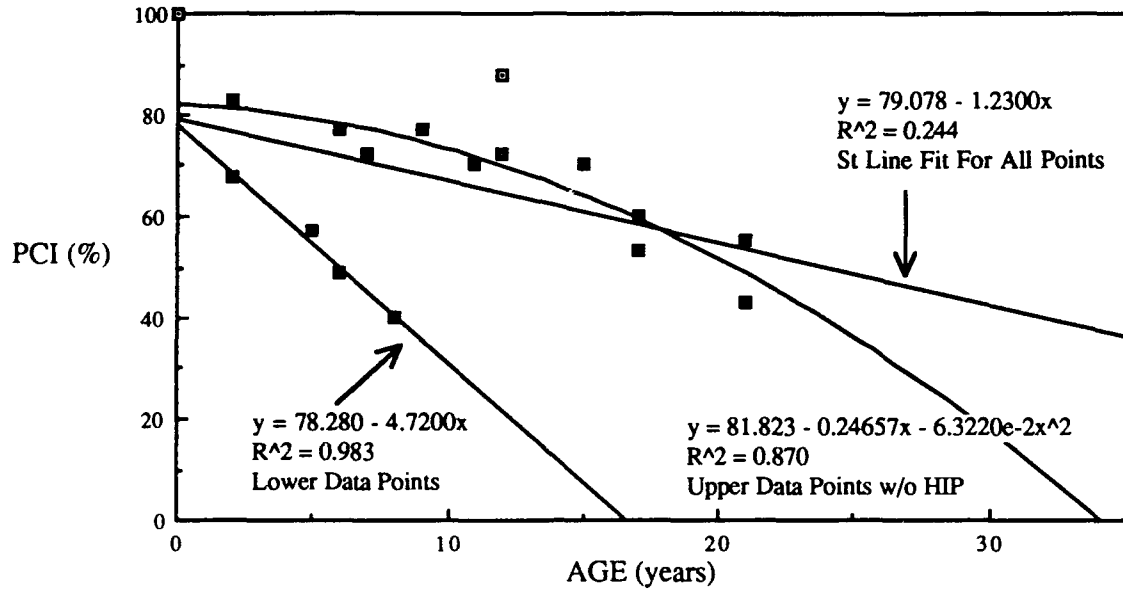

Figure 4-7a WA PCI vs AGE For 8 Runways  
w/Data "Partitioned" in Two Categories

### Slurry Seal Surface Treatments (OR Pavements)

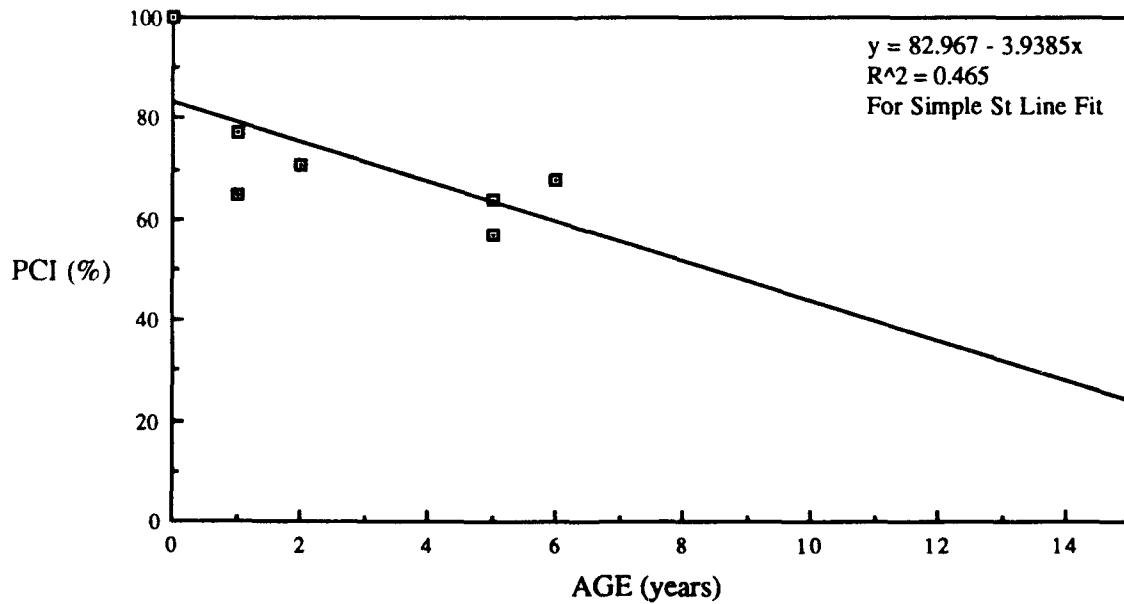

Figure 4-7b OR PCI vs AGE For 3 Runways



### Slurry Seal Surface Treatments All Pavements

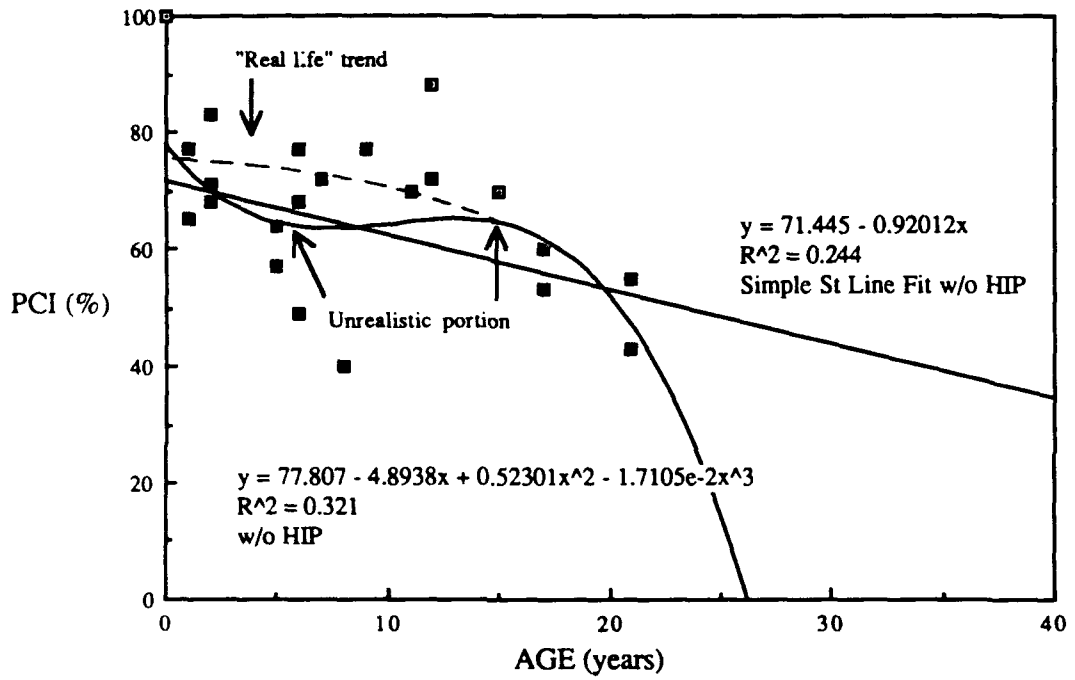

Figure 4-7c Combined PCI vs AGE w/o HIP

4.3.5 Portland Cement Concrete (PCC) Pavements - Eight rigid PCC pavements with sixteen data points as individually listed in section 3.5.5 were analyzed. The lone pavement that was not constructed during WWII is Condon State airport in Oregon. This runway is apparently deteriorating at an overall rapid rate of 4.5% PCI per year, more than four times that of the Washington pavements, as evidenced by the slope of the straight lines. The small R-squared and high SEE values for the Washington and Combined categories preclude these models from being used in a reliable fashion. In the first PCI analysis report, virtually the same model equation was obtained, however, the model did not include PCI = 100 at AGE = 0. When this point was included, the model yielded a second equation with an R-squared (adj) value of 71.3% and a SEE value of 12.97, compared to the values listed in Table 4-6 below.

There were two significant groups of runway PCI results for Washington, with four of the seven runways in one group and three in another. No reasonable explanation for the two groupings could be determined from individual files on the respective pavements. All upper points were above PCI = 67%, and all lower points were below PCI = 47%.

TABLE 4-5 Regression equations for portland cement concrete pavements.

---

**WASHINGTON**

PCI = 99.5 - 0.88(AGE)  
t-ratio = 1.69  
R-sq = 18.0%  
SEE = 23.51  
N = 15

**OREGON**

PCI = 99.2 - 4.29(AGE)  
t-ratio = 12.99  
R-sq = 99.4%  
SEE = 1.234  
N = 3

**COMBINED**

PCI = 92.4 - 0.73(AGE)  
t-ratio = 2.29  
R-sq = 25.9%  
SEE = 22.15  
N = 17

**CRICKET GRAPH RESULTS**

See Fig 4-8a through 4-8c For Plots  
All St. Line Plots Same as MINTAB

---

### Portland Cement Concrete (WA Pavements)

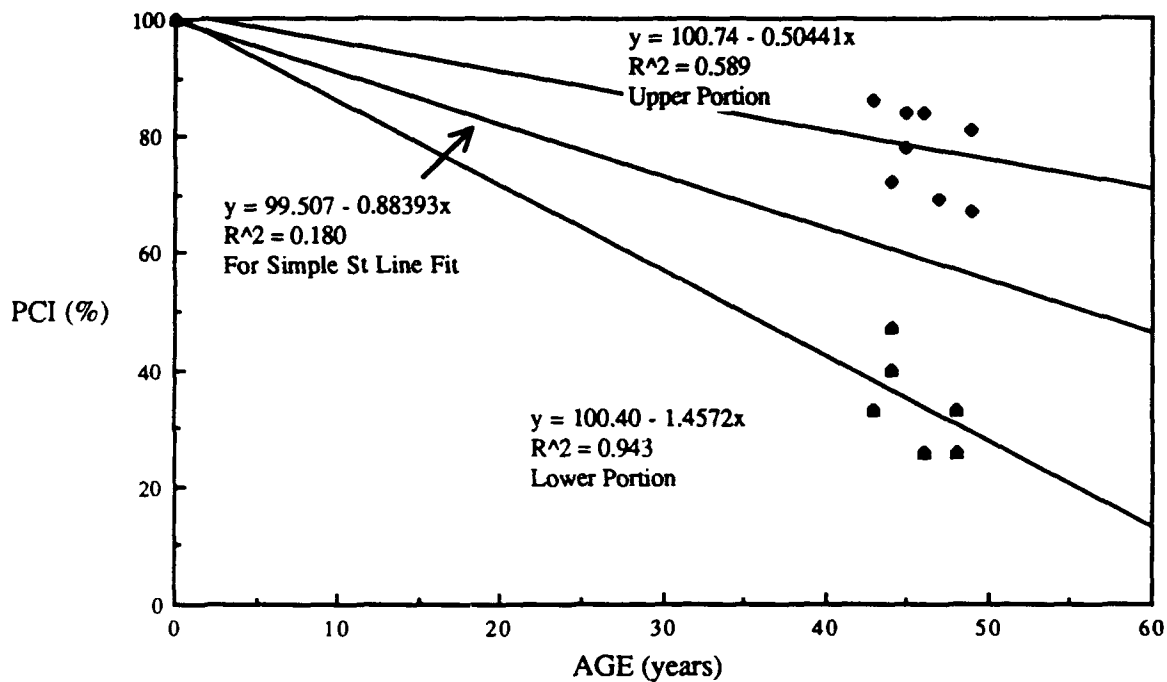

Figure 4-8a WA PCI vs AGE For 7 Runways

### Portland Cement Concrete (OR Pavements)

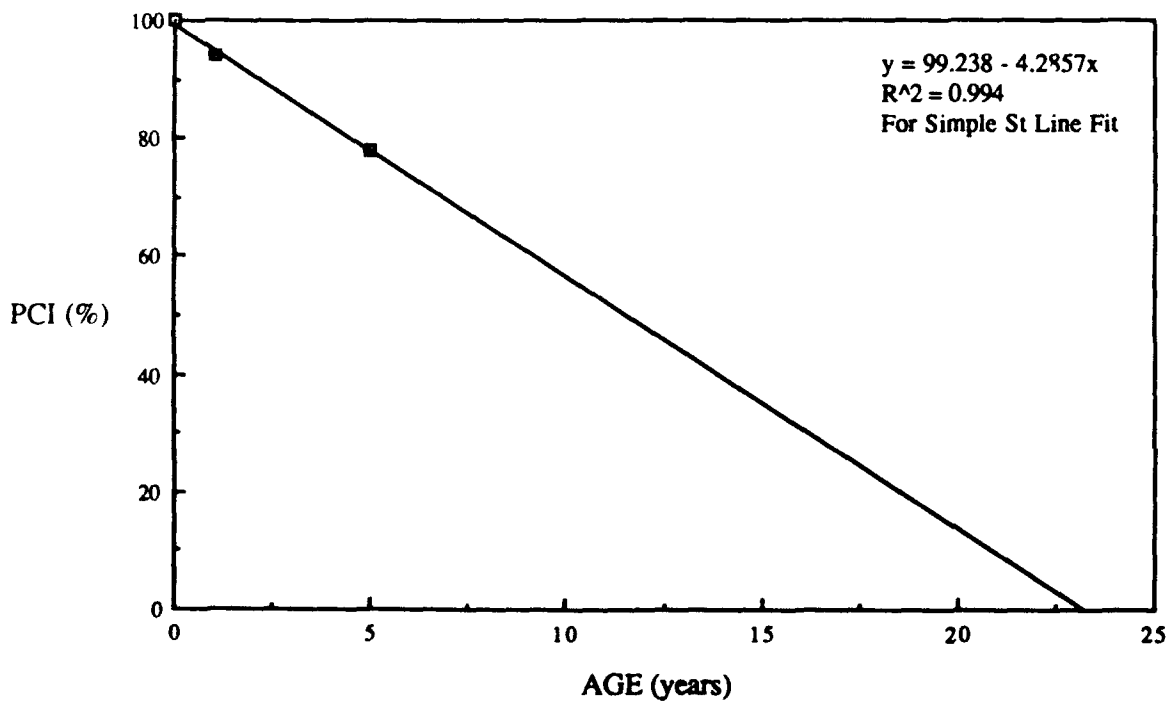

Figure 4-8b OR PCI vs AGE For 1 Runway

### Portland Cement Concrete All Pavements

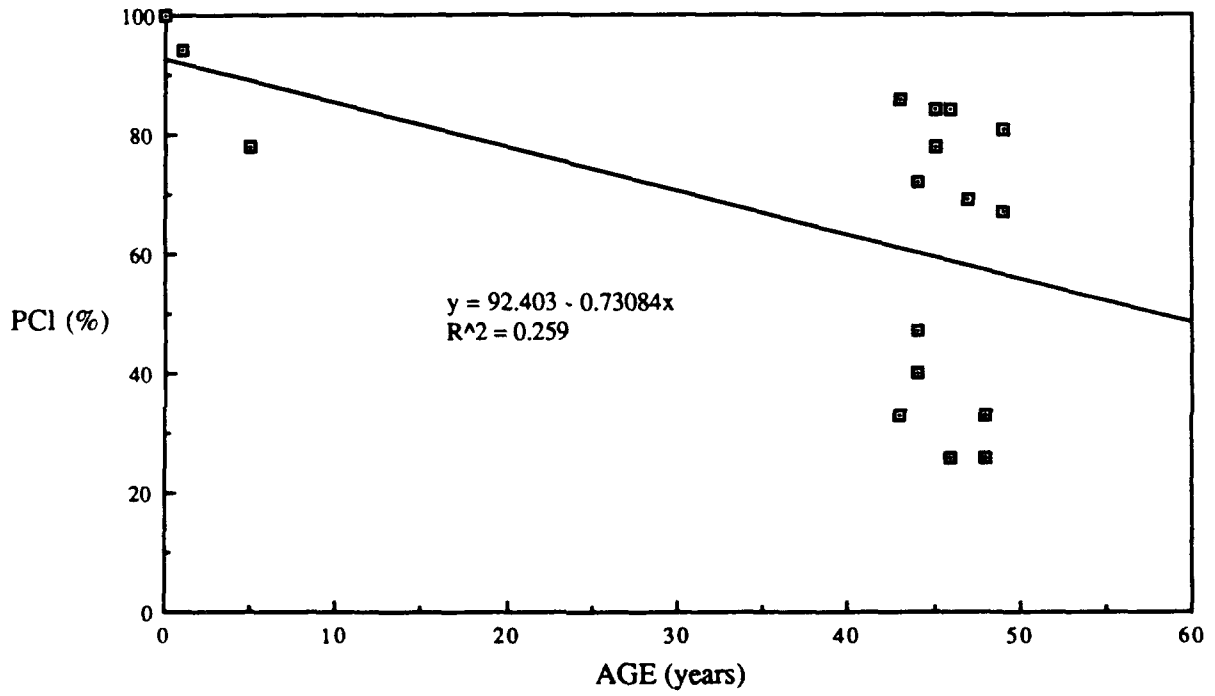

Figure 4-8c Combined PCI vs AGE All Points

## 4.4 DISCUSSION

4.4.1 Deterioration Rate Comparisons - No distinct trend of better performance was observed throughout the analysis with the exception of PCC pavements in section 4.3.5. The inclusion or exclusion of high influence points made a significant difference in several cases in terms of the model fit of the data. The lack, or inconsistency, of data is a possible reason, but there could also be no one factor attributable to a trend or lack thereof. In some cases Washington pavements performed better than Oregon's, and in other cases worse. The amount of data heavily favored the evaluation of Washington pavements, however this fact works both in favor and against when attempting to assess trends. As mentioned previously, factors to consider in evaluating disparity in the data include construction method and materials, however, other factors to be considered are: environment, aircraft loading, survey inspector, and survey consistency. Deterioration rates were more noticeable between surface applications with the most significant decreases in bituminous surface treatments and slurry seals. In addition, pavement LIFE comparisons for flexible pavements did not reveal any significant differences with respect to surface course thickness.

4.4.2 Surface Maintenance Techniques - A survey of the PCI and AGE data of surface maintenance applications reveals that these applications are being primarily used to extend the individual pavement life. The PCI surveys conducted after maintenance treatment of the surface courses reveal only slight increases in pavement ratings. The corrective measures are not sufficient to overcome whatever deficiencies are present in the underlying pavement or restore the respective pavements to near original condition. In addition, the LIFE calculations determined by Weisenberger [1] for AC overlays, BST's, and slurry seals indicate shorter average life spans than those obtained from the analysis conducted in this report.

4.4.3 Exponential vs Polynomial Modeling - This comparison was addressed to some extent earlier in this chapter. The polynomial models developed for several of the categories would seem to encourage the use of exponential models due to the lesser complexity. Several "reliable" models, based on the available data, were developed using the exponential approach of MINITAB, while for the most part polynomial fits were used in the case of graphic depictions. The data also "suggests" that straight line fits were adequate in certain cases. In all cases, however, the R-squared element for polynomials was near or the same value as that developed for the exponential. The exponential method,  $PCI = B_0 + B_1(AGE)^n$ , is the preferred method for simplicity and usage by pavement managers.

4.4.4 PCI Acceptable Limits - The use of 55% PCI as the minimum acceptable PCI rating for pavement repair or rehabilitation is questionable due to the possible implications on survivability of individual pavements. The FAA actually recommends the use of 70% for considering a pavement unusable and in need of maintenance. If this figure is used, the LIFE of many pavements can be reduced by as much as a half, which would seem to be more realistic.

## CHAPTER FIVE

### SUMMARY, CONCLUSIONS, & RECOMMENDATIONS

#### 5.1 SUMMARY

The intent of this paper was to develop models or equations that would be useful to an airport manager or planner in the application of their respective pavement management systems. The regression equations and graphic depictions were developed using select data. The applicability of this data and the corresponding models to a vast number of airfield pavements is obviously restrictive due to the number of data points available. This report, however, is another step towards better models developed from more data, which will be obtained from more PCI surveys. The models included in this report can be used as a guideline for interpreting individual pavements or as a comparison tool if the trend of an individual pavement does not "match" the performance of that particular pavement. In essence, as the database increases due to reports such as this so will the available models that will become available to planners and managers. These models will in turn assist airport professionals in maintenance and budget planning.

As more information is gathered the need for even more to strengthen the results obtained, and conclusions drawn, is evident. Comparisons, where possible, between this report and the first PCI analysis indicate that the models yielded some of the same results. However, due to this report's emphasis on curvilinear representations of a pavement's performance, full comparisons of results could not be adequately accomplished. The representation of a pavement's performance as a straight line is not an overall correct depiction. Individual



portions of a performance curve may be shown as straight lines, but the full performance plot needs to be shown as a curve. This therefore further amplifies the need for additional information to reinforce the exponential and polynomial models presented in this report.

The FAA continues to conduct PCI surveys but the process is slow due to the number of general aviation airports in the region, and the time associated with accomplishing each. This report only addressed 202 of the 240 runways discussed in the first analysis, of which over 100 have second sets of PCI surveys. However, only 78 runways showed PCI's lower than previously, indicating maintenance or corrective applications and/or inconsistent surveys. The state of Idaho has yet to commence it's second set of PCI surveys to compare the results obtained from those accomplished in 1986

## 5.2 CONCLUSIONS

As just stated, the regression models and pavement life results obtained from the data analyzed provide approximate depictions of various pavements' performance. With an understanding of the limitations of the developed models, an individual can use the results of these equations and graphs as a tool to assist in the pavement management arena.

As is normally the case, budgets dictate the route of pavement maintenance and repair. Discussions with some airport managers and WSDOT indicates that the PCI information is a valuable asset to an airport planner, but cost considerations in replacement and corrective action is always the final determinant. This is readily evident from the significant number of runways with PCI ratings in the "poor" to "very poor" range. PCI surveys and their long terms effects on managing for the future of pavements need to be a continued management high priority item.

### 5.3 RECOMMENDATIONS

The next step in collecting PCI data should be the use of the automated data collection. Although this would be a significant initial investment the cost would be recovered in time due to the reduced time and manpower expended in conducting these surveys. The mobile data collection vehicle which takes photographs of a pavement as it travels over the surface could be used in the tri-state area or perhaps two units could be dedicated to the Northwest Region of the FAA and the units shared throughout the seven states covered. This shared coverage would reduce the overall cost of the vehicles and a general schedule could be developed to ease the collection of PCI data for each state. The saved time in surveys would translate to quicker development of models which in turn would be available in a shorter time frame to the airport managers.

The PCI scale requires a more rigid definition especially at the level of acceptability rating. A pavement rated as "fair",  $PCI = 40 \rightarrow 55\%$ , does not give the impression of urgency with respect to pavement upgrade or replacement, and as such may not be given the needed attention from a management or planning standpoint. If the same pavement were deemed unacceptable, then it is anticipated that more pressure would be applied to effect an upgrade of the pavement.

The development of consistent terminology in reports from the surveys is another significant hurdle which needs to be remedied to ease the interpretation of future surveys. Finally, the completeness of individual surveys needs to be improved upon with priority given to the reasons for maintenance or corrective actions.

PCI surveys are critical to an effective pavement management system, whether at a major metropolitan airport or a general aviation airport. It is essential that surveys continue to be conducted and monitored to better plan the pavements of the future and maintain the ones in operation today. Furthermore, it is important for the models developed to be used to whatever extent possible and the confidence level increased by supplementing the existing database with more data from follow-on surveys.

\*\*\*\*\*

REFERENCES

\*\*\*\*\*

1. Weisenberger, K. D., "Statistical Evaluation of Airport Pavement Condition Survey Data for Washington, Oregon, and Idaho", 1988.
2. Mahoney, J. P., "Regression Analysis for WSDOT Material Applications", Research Report WA-RD 143.2, Washington State Department of Transportation, Olympia, Washington, February 1988.
3. Ryan, B. F., Joiner, B. L., and Ryan, T. A., Minitab Handbook, 2nd Edition, PWS Publishers, Boston, MA, 1985.
4. "Guidelines and Procedures for Maintenance of Airport Pavements", Advisory Circular 150/5380-6. U.S. Department of Transportation, Federal Aviation Administration, December 1982.
5. "Pavement Maintenance and Rehabilitation and Techniques Using Asphalt", Institute of Transportation Studies, University of California, Berkeley, CA, 1984.
6. Merritt, F. S., "Standard Handbook for Civil Engineers", 3rd Edition, McGraw Hill, 1983.
7. Ashford N. and Wright P. H., "Airport Engineering", Wiley & Sons, NY, 1979.
8. Nelson T. L. and LeClerc R. V., "Development and Implementation of Washington State's Pavement Management System", Report WA-RD 50.3, WSDOT, February 1983.
9. Key, C. A., "Evaluation of the Northwest Mountain Region Airport System Planning Program 1982-88", FAA Northwest Region, USDOT, FAA, March 1990.
10. Mahoney, J. P. and Jackson N. C., "Prediction Models and Performance Curves", Federal Highway Administration Short Course Notes, November 1991.

## **APPENDIX A**

### **WASHINGTON STATE GENERAL AVIATION PAVEMENT CONDITION SURVEY DATA**

#### **INCLUDING:**

- 1) AIRPORT LOCATION/DESCRIPTION/SECTION DATA
- 2) PAVEMENT IDENTIFICATION & CHARACTERISTICS
- 3) AVERAGE PCI VALUES FOR PAVEMENT FEATURES
- 4) PAVEMENT CONDITION SURVEY DATES
- 5) AVERAGE PCI LOSS WITH AGE
- 6) REPAIR AND REHABILITATION INFORMATION
- 7) OTHELLO MUNICIPAL AIRPORT COMPLETE PCI SURVEY

\*\*\*\*\*

**APPENDIX LEGEND**

\*\*\*\*\*

ID	Runway/Feature Identification Number
OCD	Original Construction Date
PCI	Pavement Condition Index
AVG	Average
YR	Year
RRD	Ruway Rehabilitation Date
ORIG	Original
STRUC.	Structural
SEC.	Section
SURVEY	PCI Inceased Value Attributed To Survey Conducted

PCI DATA (WA) W/AVG LOSS

No.	AIRPORT & LOCATION	ID	OCD	PCI AVG & YR	PCI AVG & YR	AVG LOSS/YR
1	ANACORTES AP	R1	1968	96 - 1986	91 - 1989	1.67
		R2	1968	95 - 1986	90 - 1989	1.67
		R3	1968	100 - 1986	92 - 1989	2.67
2	ARLINGTON MUNICIPAL AP	R1	1942	77 - 1986	78 - 1989	SURVEY
		R2	1942	89 - 1986	84 - 1989	2.67
3	AUBURN MUNICIPAL AP	R1	1968	81 - 1987	84 - 1991	OVERLAY
		R2	1983	90 - 1987	87 - 1991	0.75
4	BLAINE MUNICIPAL AP	R1	1972	72 - 1988	N/A	
5	BOWERMAN FIELD, HOQUIAM	R1	1943	77 - 1986	59 - 1989	6
		R2	1943	86 - 1986	84 - 1989	0.67
		R3	1943	33 - 1986	26 - 1989	2.33
6	BOWERS FIELD, ELLENSBURG	R1	1976	67 - 1986	64 - 1989	1
		R1A	1942	46 - 1986	60 - 1989	SLURRY SL
		R2	1942	67 - 1986	INOP	
		R3	1942	57 - 1986	64 - 1989	SURVEY
		R4	1942	54 - 1986	52 - 1989	0.67
7	BREMERTON NATIONAL	R1	1942	86 - 1987	86 - 1991	0
		R2	1942	83 - 1987	75 - 1991	2
		R3	1942	86 - 1987	80 - 1991	1.5
		R4	1942	88 - 1987	83 - 1991	1.25
		R5	1942	82 - 1987	80 - 1991	0.5
8	CASHMERE - DRYDEN AP	R1	1951	72 - 1988	N/A	
9	CHEHALIS - CENTRALIA AP	R1	1942	84 - 1987	81 - 1991	0.75
		R2	1942	78 - 1987	67 - 1991	2.75
10	CLE ELUM MUNICIPAL AP	R1	1987	56 - 1988	N/A	
11	COLVILLE MUNICIPAL AR	R1	1949	33 - 1986	62 - 1989	TBST ADDED
12	CONCRETE MUNICIPAL	R1	1974	61 - 1986	34 - 1989	9
13	CONNELL CITY AP	R1	1970	69 - 1987	79 - 1991	AC OVLY
14	CREST AP, KENT	R1	1967	97 - 1987	90 - 1991	1.75
15	DAVENPORT AP	R1	1984	82 - 1986	60 - 1989	7.33
16	DEER PARK AP	R1	1943	45 - 1986	76 - 1989	???
		R2	1976	72 - 1986	74 - 1989	SURVEY
		R3	1943	47 - 1986	39 - 1989	2.67
17	ELMA MUNICIPAL AP	R1	1976	88 - 1988	83 - 1991	1.67
18	EPHRATA MUNICIPAL	R1	1943	40 - 1987	33 - 1991	1.75
		R1A	1943	60 - 1987	55 - 1991	1.25
		R2	1943	53 - 1987	43 - 1991	2.5
		R2A	1943	47 - 1987	26 - 1991	5.25
		R2B	1983	89 - 1987	84 - 1991	1.25
19	EVERGREEN FIELD, VANCOUVER	R1	1967	55 - 1987	51 - 1991	1
		R2	1971	86 - 1987	77 - 1991	2.25
20	FERRY COUNTY (REPUBLIC) AP	R1	1974	65 - 1986	70 - 1991	CHP SL ADDED
21	GRAND COULY DAM AP (ELECTRIC CITY)	R1	1972	86 - 1986	N/A	2*AC OVLY
		R2	1980	84 - 1986	N/A	SURVEY

PCI DATA (WA) W/AVG LOSS

No.	AIRPORT & LOCATION	ID	OCD	PCI AVG & YR	PCI AVG & YR	AVG LOSS/YR
22	HARVEY FIELD (SNOHOMISH)	R1	1970	64 - 1986	N/A	
23	IONE MUNICIPAL	R1	1973	76 - 1986	76 - 1989	0
		R2	N/A	N/A	80 - 1989	
24	KELSO-LONGVIEW	R1	1983	90 - 1987	82 - 1991	2
25	KENNEWICK-VISTA FIELD	R1	1942	69 - 1987	N/A	
		R2	1942	68 - 1987	N/A	
26	LAKE CHELAN	R1	UNK	93 - 1988	N/A	
27	LIND AP	R1	1971	51 - 1987	51 - 1991	0
28	MANSFIELD	R1	1973	35 - 1988	N/A	
29	MOSES LAKE MUNICIPAL AP	R1	1961	89 - 1987	81 - 1991	2
		R2	1973	29 - 1987	18 - 1991	2.75
30	NEW WARDEN AP	R1	1977	77 - 1987	79 - 1991	SURVEY
31	OAK HARBOR AIR PARK	R1	1969	73 - 1988	N/A	
32	OCEAN SHORES	R1	1985	98 - 1986	95 - 1989	1
33	ODESSA MUNICIPAL	R1	1970	79 - 1987	46 - 1991	8.25
		R1A	1970	58 - 1987	50 - 1991	2
34	OKANAGAN LEGION AP	R1	1955	76 - 1987	N/A	
35	OLYMPIA AP	R1	1942	55 - 1988	45 - 1991	3.33
		R2	1980	89 - 1988	85 - 1991	1.33
		R3	1942	86 - 1988	84 - 1991	0.67
36	OMAK AP	R1	1943	68 - 1986	65 - 1989	1
37	OTHELLO MUNICIPAL	R1	UNK	79 - 1987	74 - 1991	1.25
		R2	N/A	N/A	90 - 1991	
38	PACKWOOD AP	R1	1975	94 - 1988	90 - 1991	1.33
39	PANGBORN FIELD (WENATCHEE)	R1	1947	63 - 1988	N/A	
		R2	1947	66 - 1988	N/A	
		R4	1947	55 - 1988	N/A	
		R5	1978	90 - 1988	N/A	
40	PEARSON AIRPARK (VANCOUVER)	R1	1966	58 - 1987	58 - 1991	0
		R2	1966	84 - 1987	N/A	
41	PIERCE COUNTY (PUYALLUP)	R1	1958	64 - 1986	98 - 1989	AC OVLY, BS
42	PORT OF ILWACO	R1	1971	71 - 1986	49 - 1989	7.33
43	PORT OF WILLIPA HARBOR	R1	1948	72 - 1986	58 - 1989	4.67
	(RAYMOND)	R2	1948	68 - 1986	59 - 1989	3
44	PROSSER	R1	1977	88 - 1987	N/A	
45	PRU FIELD (RITZVILLE)	R1	1978	83 - 1987	77 - 1991	1.5
46	PULLMAN-MOSCOW REGIONAL AP	R1	1948	75 - 1986	70 - 1989	1.67
		R2	1968	70 - 1986	48 - 1989	7.33
		R3	1968	81 - 1986	68 - 1989	4.33
47	QUILLAYUTE	R1	UNK	72 - 1986	69 - 1989	1
48	QUINCY MUNICIPAL	R1	1977	72 - 1987	70 - 1991	0.5
		R2	1977	31 - 1987	N/A	



PCI DATA (WA) W/AVG LOSS

No.	AIRPORT & LOCATION	ID	CCD	PCI AVG & YR	PCI AVG & YR	AVG LOSS/YR
49	RICHLAND	R1	1943	86 - 1987	N/A	
		R2	1943	84 - 1987	N/A	
		R3	1979	86 - 1987	N/A	
50	ROSALIA MUNICIPAL	R1	1985	68 - 1987	49 - 1991	4.5
51	SAND CANYON (CHEWELAH)	R1	1974	88 - 1986	70 - 1989	6
52	SANDERSON FIELD (SHELTON)	R1	1942	77 - 1988	72 - 1991	1.67
53	SEKIU AP	R1	1972	68 - 1988	N/A	
		R2	1979	88 - 1988	N/A	
54	SEQUIM VALLEY	R1	1985	52 - 1988	42 - 1991	3.33
55	SKAGIT REGIONAL	R1	1942	69 - 1986	N/A	
		R2	1942	64 - 1986	N/A	
56	STORM FIELD (MORTON)	R1	1970	73 - 1988	68 - 1991	1.67
57	SUNNYSIDE	R1	1975	85 - 1987	N/A	
58	TACOMA NARROWS	R1	UNK	84 - 1987	83 - 1991	0.25
		R2	UNK	82 - 1987	81 - 1991	0.25
59	WALLA WALLA CITY/COUNTY AP	R1	1942	81 - 1987	N/A	
		R2	1942	58 - 1987	N/A	
		R4	1942	60 - 1987	N/A	
60	WATERVILLE	R1	1976	65 - 1988	N/A	
61	WHITMAN COUNTY MEM (COLFAX)	R1	1970	57 - 1986	40 - 1989	5.67
62	WILBUR	R1	1971	92 - 1986	83 - 1989	3
63	WILLIAM R. FAIRCHILD INT'L	R1	1942	79 - 1988	N/A	
		R2	1942	86 - 1988	N/A	
		R4	1942	94 - 1988	N/A	
64	WILLARD-TEKOA FIELD	R1	1975	90 - 1986	90 - 1989	0
65	WINLOCK (TOLEDO)	R1	1943	49 - 1986	42 - 1989	2.33
66	WOODLAND STATE	R1	1984	91 - 1987	88 - 1991	0.75
67	FRIDAY HARBOR	R1	UNK	90 - 1988	N/A	
68	GOLDENDALE	R1	UNK	87 - 1989	N/A	
69	OROVILLE	R1	UNK	79 - 1987	N/A	
70	WENTHROP	R1	UNK	73 - 1988	N/A	

WASHINGTON AIRPORT PAVEMENT CHARACTERISTICS

No.	AIRPORT & LOCATION	ID	OCD	ORIG. STRUC. SEC.	FFD	EXISTING STRUCTURE
1	ANACORTES AP	R1	1968	DBST, 7.5'B	1973	2"AC OL, DBST, 7.5'B
		R2	1968	DBST, 7.5'B	1973	2"AC, 3'B, 7"SB
		R3	1968	DBST, 7.5'B	1973	2"AC, 4"B, 6"SB
2	ARLINGTON MUNICIPAL AP	R1	1942	2"AC, 6"B		2" AC, 6"B
		R2	1942	3"AC, 8"B	1976	2"AC OL, 3"AC, 8"B
3	AUBURN MUNICIPAL AP	R1	1968	2"AC, 18"B		2"AC, 18"B
		R2	1983	2"AC, 3"B, 11"SB		2"AC, 3"B, 11"SB
4	BLAINE MUNICIPAL AP	R1	1972	2"AC, 8"B		2"AC, 8"B
5	BOWERMAN FIELD, HOQUIAM	R1	1943	2.5"AC, 12"B		2.5"AC, 12"B
		R2	1943	8"-6"-8"PCC		8"-6"-8"PCC
		R3	1943	8"-6"-8"PCC		8"-6"-8"PCC
6	BOWERS FIELD, ELLENSBURG	R1	1976	3"AC, 6.5"B		3"AC, 6.5B
		R1A	1942	3.5"AC, 6"B		3.5"AC, 6"B
		R2	1942	3"AC, 6.5"B		3"AC, 6.5"B
		R3	1942	2.5"AC, 6"B		2.5"AC, 6"B
		R4	1942	2.5"AC, 3"B, 5"SB		2.5"AC, 3"B, 5"SB
7	BREMERTON NATIONAL	R1	1942	2.5"AC, 6"B	1974	3"AC OL, 2.5"AC, 6"B
		R2	1942	3"AC, 2.5"B, 6"SB	1974	5"AC OL, 3"AC, 2.5"B, 6"SB
		R3	1942	5"AC, 4"B, 6"SB	1983	5"AC, 4"B, 6"SB + CR. SL.
		R4	1942	3"AC, 4"B, 6"SB	1974	2"AC OL, 3"AC, 4"B, 6"SB
		R5	1942	2.5"AC, 6"B		2.5"AC, 6"B
8	CASHMERE - DRYDEN AP	R1	1951	TBST, 9"B	1979	DBST, TSC, TBST, 9"B
9	CHEHALIS - CENTRALIA AP	R1	1942	8"-6"-8"PCC, 6"SB		8"-6"-8"PCC, 6"SB
		R2	1942	8"-6"-8"PCC, 6"SB		8"-6"-8"PCC, 6"SB
10	CLE ELUM MUNICIPAL AP	R1	1987	TBST, 4"B		TBST, 4"B
11	COLVILLE MUNICIPAL AP	R1	1949	DBST, 8"B	1958	SC, DBST, 8"B
12	CONCRETE MUNICIPAL	R1	1974	DBST, 2"E, 4"SB		DBST, 2"B, 4"SB
13	CONNELL CITY AP	R1	1970	BST, 7"B	1979	2"AC OL, BST, 7"B
14	CREST AP, KENT	R1	1967	BST, GRAVEL	1986	2"AC OL, BST, GRAVEL
15	DAVENPORT AP	R1	1973	BST, 8"PRB	1984	TBST, 8"B

WASHINGTON AIRPORT PAVEMENT CHARACTERISTICS

No.	AIRPORT & LOCATION	D	OCJ	ORIG. STRUC. SEC.	RFD	EXISTING STRUCTURE
16	DEER PARK AP	R1	1943	1.5"AC, 6"B		1.5"AC, 6"B
		R2	1976	2"AC, 6"B		2"AC, 6"B
		R3	1943	1.5"AC, 6"B		1.5"AC, 6"B
17	ELMA MUNICIPAL AP	R1	1976	1.5"AC, 3"B		1.5"AC, 3"B
18	EPHRATA MUNICIPAL	R1	1943	6"PCC, 6"SB		6"PCC, 6"SB
		R1A	1943	3"AC, 6"B	1970	SS, 3"AC, 6"B
		R2	1943	2.5"AC, 6"B	1970	SS, 2.5"AC, 6"B
		R2A	1943	6"PCC, 6"SB		6"PCC, 6"SB
		R2B	1983	3"AC, 7"B, 12"SB		3"AC, 7"B, 12"SB
19	EVERGREEN FIELD, VANCOUVER	R1	1967	2"AC, 4"B		2"AC, 4"B
		R2	1971	2"AC, 4"B		2"AC, 4"B
20	FERRY COUNTY (REPUBLIC) AP	R1	1974	BST, 5"B, 6"SB	1978	CS, BST, 5"B, 6"SB
21	GRAND COULY DAM AP	R1	1972	BST, 6"B	1980	2"AC OL, BST, 6"B
	(ELECTRIC CITY)	R2	1980	2"AC, 5"B		2"AC, 5"B
22	HARVEY FIELD (SNOHOMISH)	R1	1970	2"AC, 12"B	1982	SC, 2"AC, 12"B
23	IONE MUNICIPAL	R1	1973	BST, 4"B, 8"PRB	UNK	TBST, 4"CB, 8"PRB
		R2	UNK	UNK	1989	DBST, 4"CB, 10"PRB
24	KELSO-LONGVIEW	R1	1983	3"AC, 5"B, 9"SB		3"AC, 5"B, 9"SB
25	KENNEWICK-VISTA FIELD	R1	1942	2"AC, 6"B	1976	CS, 2"AC, 6"B
		R2	1942	2"AC, 6"B		2"AC, 6"B
26	LAKE CHELAN	R1	UNK	UNK	1986	2"AC, 5"B
27	LIND AP	R1	1971	DBST, 3"B	1982	SS, SS, DBST, 3"B
28	MANSFIELD	R1	1973	BST, 4"B	1983	CS, CS, BST, 4"B
29	MOSES LAKE MUNICIPAL AP	R1	1961	DBST, 6"B	1984	2"AC OL, SS, DBST, 6"B
		R2	1973	.75"AC, ?"B		.75"AC, ?"B
30	NEW WARDEN AP	R1	1977	2"AC, 6"B		2"AC, 6"B
31	OAK HARBOR AIR PARK	R1	1969	SC, 3"B, 7"SB	1971	2"AC OL, SC, 3"B, 7"SB
32	OCEAN SHORES	R1	1985	DBST, 8"B		DBST, 8"B
33	ODESSA MUNICIPAL	R1	1970	DBST, 3"B	1985	DBST, 6"B - RECONSTR.
		R1A	1970	DBST, 3"B	1985	TBST, 3"B

WASHINGTON AIRPORT PAVEMENT CHARACTERISTICS

No.	AIRPORT & LOCATION	ID	OOD	ORIG. STRUC. SEC.	FRD	EXISTING STRUCTURE
34	OKANAGAN LEGION AP	R1	1955	BST, 2"B	1987	DBST, BST, BST, BST, 2"B
35	OLYMPIA AP	R1	1942	2.5"AC, 6"B		2.5"AC, 6"B
		R2	1980	3"AC, 10"B, 6"SB		3"AC, 10"B, 6"SB
		R3	1942	2.5"AC, 6"B	1980	3"AC OL, 2.5"AC, 6"B
36	OMAK AP	R1	1943	4.5"AC, 12"B	1974	2.5"AC OL, 4.5"AC, 12"B
37	OTHELLO MUNICIPAL	R1	UNK	BST, 3"B	1976	2"AC OL, BST, 3"B
		R2	UNK	UNK	1991	3"AC, 6"B
38	PACKWOOD AP	R1	1975	BST, GRAVEL	1985	2"AC, 2"B, BST, GRAVEL
39	PANGBORN FIELD (MENATCHEE)	R1	1947	2"AC, 7"B	1974	CS, 2"AC, 7"B
		R2	1947	3"AC, 8"B	1974	CS, 3"AC, 8"B
		R4	1947	2"AC, 7"B		2"AC, 7"B
		R5	1978	3"AC, 6"B		3"AC, 6"B
40	PEARSON AIRPARK (VANCOUVER)	R1	1966	1.5"AC, ?"B	1975	CS, 1.5"AC, ?"B
		R2	1966	1.5"AC, ?"B	1975	CS, 1.5"AC, ?"B
41	PIERCE COUNTY (PUYALLUP)	R1	1958	1.5"AC, 2"CB, GSB	1988	2"AC, 4"CB, 6"SB - REDEV.
42	PORT OF ILWACO	R1	1971	1.5"AC, GRAVEL		1.5"AC, GRAVEL BASE
43	PORT OF WILLIPA HARBOR (RAYMOND)	R1	1948	BST, 3"BSB, 5"SB	1976	1"AC OL, 3"BSB, 5"SB
		R2	1948	BST, 3"BSB, 7"SB	1976	1.25"AC OL, 3"BSB, 7"SB
44	PROSSER	R1	1977	2"AC, 6"B, 1.5"SB	1981	CS, 2"AC, 6"B, 1.5"SB
45	PRUFIELD (RITZVILLE)	R1	1978	TBST, ?"B	1985	SC, TBST, ?"B
46	PULLMAN-MOSCOW REGIONAL AP	R1	1948	2"AC, 8"B, 7"SB	1972	2"AC OL, 2"AC, 8"B, 7"SB
		R2	1968	3"AC, 15.5"B	1985	3"AC, 15.5"B - GROOVED
		R3	1968	4"AC, 19"SB	1985	4"AC, 19"SB - GROOVED
47	QUILLAYUTE	R1	UNK	6"PCC		6"PCC
48	QUINCY MUNICIPAL	R1	1977	BST, 3"B	1980	SS, BST, 3"B
		R2	1977	BST, 3"B		BST, 3"B
49	RICHLAND	R1	1943	2"AC, 6"B	1979	2"AC OL, 2"AC, 6"B
		R2	1943	2"AC, 8"B	1979	2"AC OL, 2"AC, 8"B
		R3	1979	3"AC, 3"B, 4"SB		3"AC, 3"B, 4"SB
50	ROSALIA MUNICIPAL	R1	1985	SS, BST, 3"B, 3.5"SB		SS, BST, 3"B, 3.5"SB
51	SAND CANYON (CHEWELAH)	R1	1974	SS, 1"AC, DBST, 12"CB		SS, 1"AC, DBST, 12"CB

WASHINGTON AIRPORT PAVEMENT CHARACTERISTICS

No.	AIRPORT & LOCATION	ID	OOD	ORIG. STRUC. SEC.	REFD	EXISTING STRUCTURE
52	SANDERSON FIELD (SHELTON)	R1	1942	2"AC, 6"B	1979	SS, 2"AC, 6"B
53	SEKU AP	R1	1972	2"AC, 6"B	1987	CS, SAND SL, 2"AC, 6"B
		R2	1979	2"AC, 6"B	1987	CS, SAND SL, 2"AC, 6"B
54	SEQUIM VALLEY	R1	1985	DBST, 12"PRG		DBST, 12"PRG
55	SKAGIT REGIONAL	R1	1942	2"AC, 4"B, 6"SB		2"AC, 4"B, 6"SB
		R2	1942	2"AC, 4"B, 12"SB		2"AC, 4"B, 12"SB
56	STORM FIELD (MORTON)	R1	1970	BST, BASE	1987	TBST, BASE
57	SUNNYSIDE	R1	1975	3"AC, 6"B	1985	SS, 3"AC, 6"B
58	TACOMA NARROWS	R1	UNK			2.5"AC, 8"B, 3"SB
		R2	UNK			2"AC, 7"B, 3"SB
59	WALLA WALLA CITY/COUNTY AP	R1	1942	6.5"PCC, 6"SB	1970	1.5"AC, 1"PFC, 6.5"PCC, 6"SB
		R2	1942	6.5"PCC, 6"SB		6.5"PCC, 6"SB
		R4	1942	6.5"PCC, 6"SB		6.5"PCC, 6"SB
60	WATERVILLE	R1	1976	BST, 6"B	1983	SC, BST, 6"B
61	WHITMAN COUNTY MEM (COLFAX)	R1	1970	BST, 6"B	1981	SS, BST, 6"B
62	WILBUR	R1	1971	BST, 6"B	1985	2"AC OL, SC, BST, 6"B
63	WILLIAM R. FAIRCHILD INT'L (PORT ANGELES)	R1	1942	2"AC, 6"AB	1979	2"AC OL, SS, 2"AC, 6"AB
		R2	1942	2"AC, 6"AB	1979	2"AC OL, SS, 2"AC, 6"AB
		R4	1942	2"AC, 6"AB	1978	2"AC OL, SS, 2"AC, 6"AB
64	WILLARD-TEKOA FIELD	R1	1975	2"AC, 4"B, 12"SB		2"AC, 4"B, 12"SB
65	WINLOCK (TOLEDO)	R1	1943	2"AC, 8"B		2"AC, 8"B
66	WOODLAND STATE	R1	1984	TBST, ?"B		TBST, ?"B
67	FRIDAY HARBOR	R1	UNK	UNK		2"AC, 3"B, 4"SB
68	GOLDENDALE	R1	UNK	UNK		2+"AC, 12"B
69	OROVILLE	R1	UNK	UNK		2"AC, 3"B
70	WENTHROP	R1	UNK	UNK		1+"AC, ?"B

**OTHELLO MUNICIPAL AIRPORT,  
WASHINGTON**

**PAVEMENT FEATURES  
&  
PAVEMENT CONDITION SURVEY**

**MAY 20, 1991**

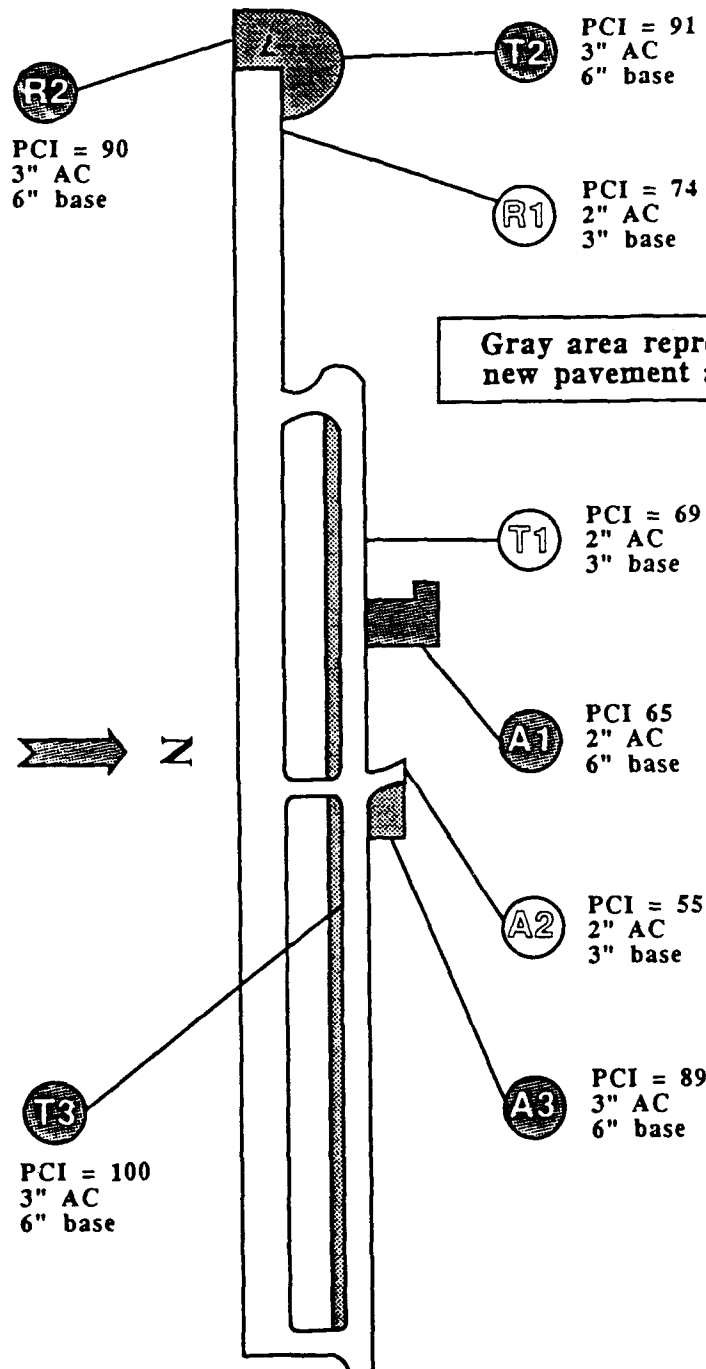

25

**Othello Municipal Airport**  
**Pavement features and PCI numbers**  
**May 20, 1991.**

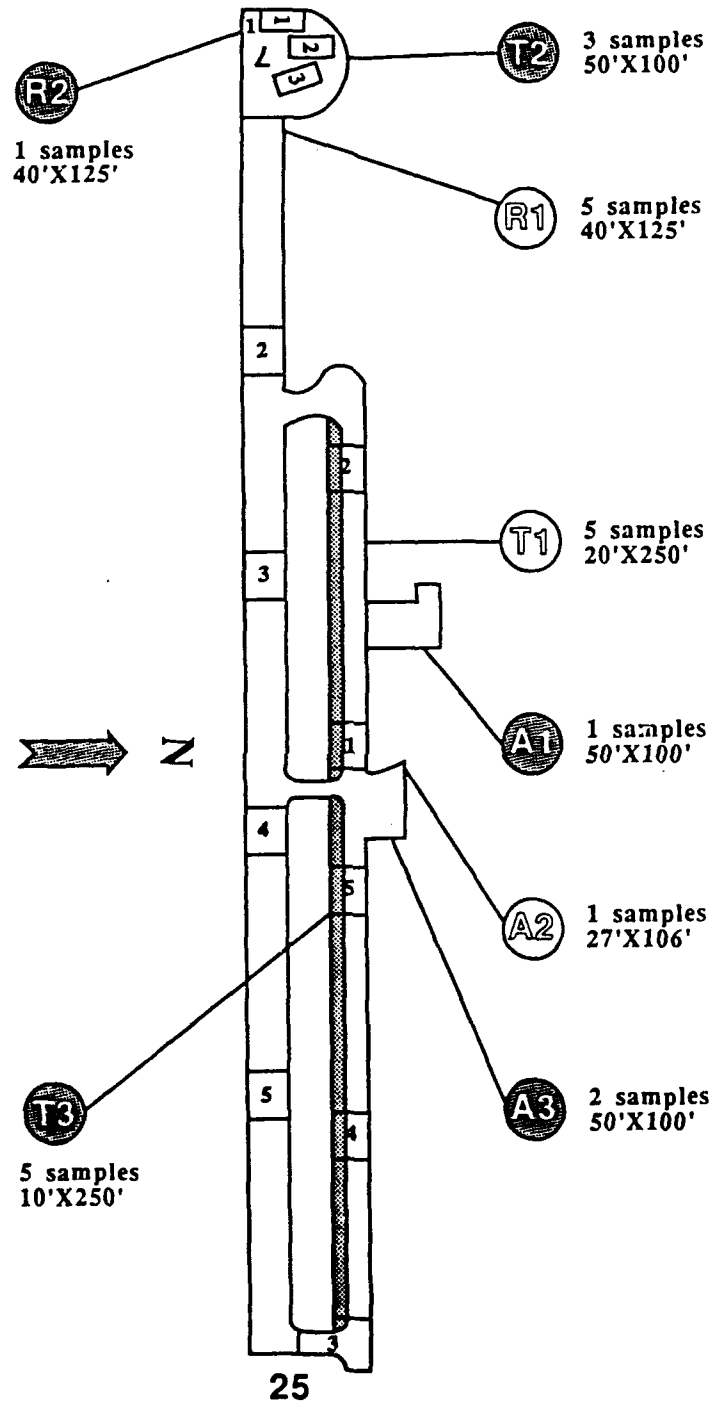

**Othello Municipal Airport**  
**Location of sample areas within each feature**  
**May 20, 1991**



Feature Summaries  
 Othello Municipal Airport  
 Othello Port District

Date of Survey: May 20, 1991  
 By: Frederick N. Mills Jr. and Robert O. Brown

Airport Facility: Runway R-1  
 Total No. of Sample Units: 5

<u>Sample Unit No.</u>	<u>Sample Unit Area</u>	<u>PCI</u>
1	5000	73
2	5000	75
3	5000	55
4	5000	92
5	5000	74
Average PCI: 74		
Condition Rating: Very Good		

\* \* \*

Airport Facility: Runway R-2  
 Total No. of Sample Units: 5

<u>Sample Unit No.</u>	<u>Sample Unit Area</u>	<u>PCI</u>
1	5000	90
Average PCI: 90		
Condition Rating: Excellent		

\* \* \*

Airport Facility: Taxiway T-1  
 Total No. of Sample Units: 5

<u>Sample Unit No.</u>	<u>Sample Unit Area</u>	<u>PCI</u>
1	5000	33
2	5000	78
3	5000	69
4	5000	80
5	5000	87
Average PCI: 69		
Condition Rating: Good		

Airport Facility: Turnaround Taxiway T-2  
Total No. of Sample Units: 3

<u>Sample Unit No.</u>	<u>Sample Unit Area</u>	<u>PCI</u>
1	5000	90
2	5000	93
3	5000	91

Average PCI: 91  
Condition Rating: Excellent

\* \* \*

Airport Facility: Taxiway T-3  
Total No. of Sample Units: 5

<u>Sample Unit No.</u>	<u>Sample Unit Area</u>	<u>PCI</u>
1	2500	100
2	2500	100
3	2500	100
4	2500	100
5	2500	100

Average PCI: 100  
Condition Rating: Excellent

\* \* \*

Airport Facility: Apron A-1  
Total No. of Sample Units: 1

<u>Sample Unit No.</u>	<u>Sample Unit Area</u>	<u>PCI</u>
1	5000	65

Average PCI: 65  
Condition Rating: Good

\* \* \*

Airport Facility: Apron A-2  
Total No. of Sample Units: 1

<u>Sample Unit No.</u>	<u>Sample Unit Area</u>	<u>PCI</u>
1	2862	55

Average PCI: 55  
Condition Rating: Fair

\* \* \*

Airport Facility: Apron A-3  
Total No. of Sample Units: 2

<u>Sample Unit No.</u>	<u>Sample Unit Area</u>	<u>PCI</u>
1	5000	86
2	5000	92

Average PCI: 89  
Condition Rating: Excellent

\* \* \*

#### Principal Distresses

Runway: Longitudinal and transverse cracking; ravelling and depressions.

Taxiway: Alligator; block; longitudinal and transverse cracking; depressions and ravelling.

Apron: A-2 (former fuel pump taxiway) Block; longitudinal and trasverse cracking; depressions and ravelling.

Othello Municipal Airport  
Pavement Development and Maintenance

In 1975 a paved runway existed to some degree consisting of a 3" gravel base with an oil penetration surface (probably means a BST surface). In 1976 the runway was overlaid with a 2" AC surface and was extended. A parallel taxiway and very small apron were constructed. In 1987 it was reported that all pavements appeared to be a 2" AC surface on a 3" crushed aggregate base.

In 1989 several improvements were made: The parallel taxiway was widened from 20' to 30' (3" AC on 7" crushed aggregate base); A runway 7 turnaround was constructed that also resulted in approximately 125' of new runway (3" AC on a 7" crushed aggregate base); two new aprons were constructed (2" AC on 4" base); and approximately 15,000 linear feet of crack sealing was accomplished.

The airport remains a very active agricultural applicator airport with two ag operators on the field. There is reportedly a fair amount of light twin and single engine GA traffic, also. While the runway is at present in good condition, the center 20' appears to be a different mix than the 10' outer lanes on each side. The outer lanes show some ravelling while the center 20' does not. Crackfilling is needed and a fog seal, particularly on the outer lanes, this would help the ravelling condition. Eventually it would be desirable to widen the runway to 60' and overlay the existing 40' width. The old portion of parallel taxiway needs crackfilling and an overlay, and the existing runway exit taxiways should be widened to a minimum of 30' and the older portion overlaid. An Additional apron adjoining the apron work accomplished in 1989 would be desirable in addition to overlaying the older section (former taxiway) running south from the existing fuel pumps and adjoining the east/west taxiway.

#### Planning Considerations

In 1989 a dirt bank running approximately 800' west of the west edge of the west runway exit taxiway was partially removed and the remaining part graded to a 5:1 slope, creating a 75' from runway centerline (C/L) safety area. While this is a significant improvement it is recommended that widening continue to a minimum of 100' (125' desirable) from runway C/L.

PAVEMENT CONDITION TREND

AIRPORT: *OTM...*

DATE OF LAST SURVEY: 5-20-91

NOTES: PCI NUMBER indicates

PAVEMENT CONDITION INDEX

Horizontal scale covers 30 yrs.

Year 0 is year of original

construction, major reconstruct

or overlay

AIRPORT FACILITY: T-2

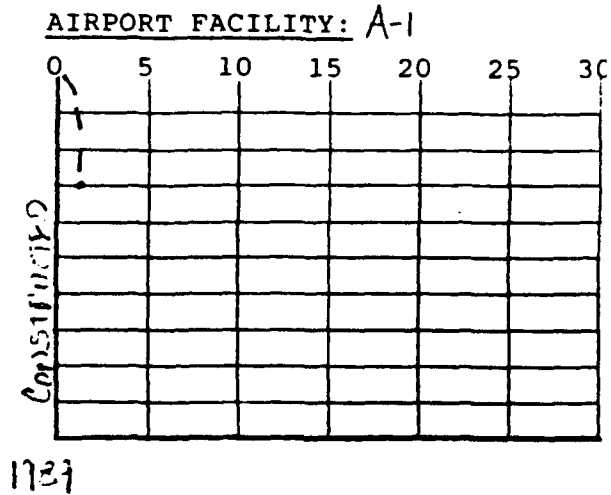
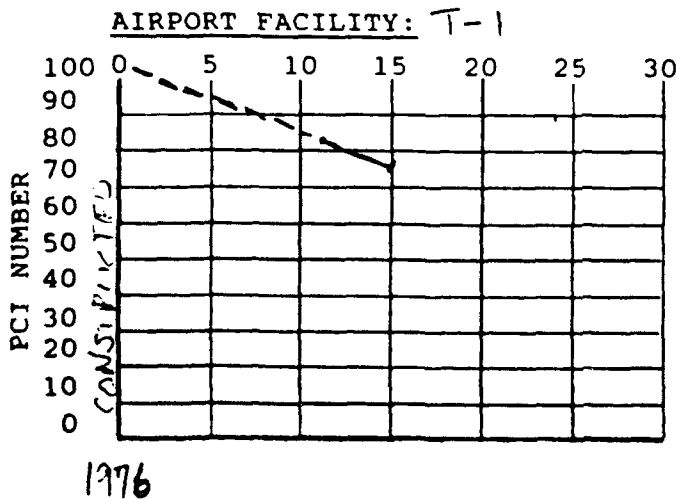
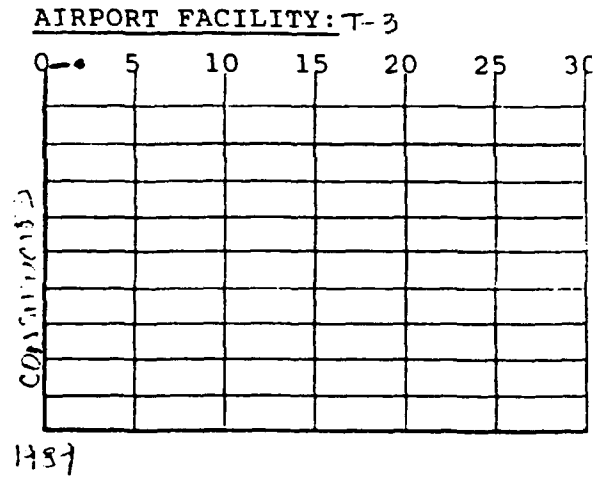
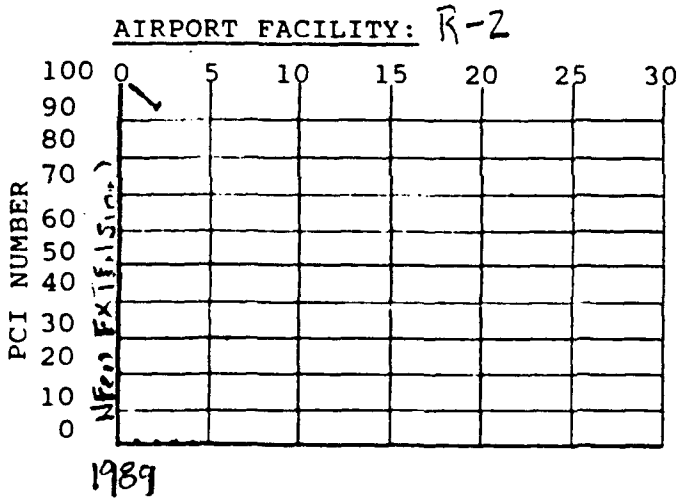
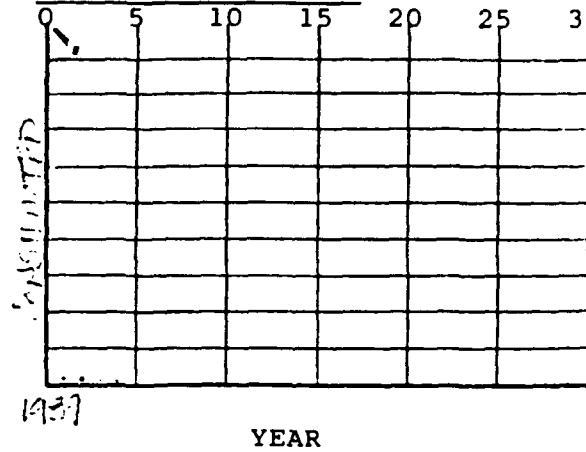
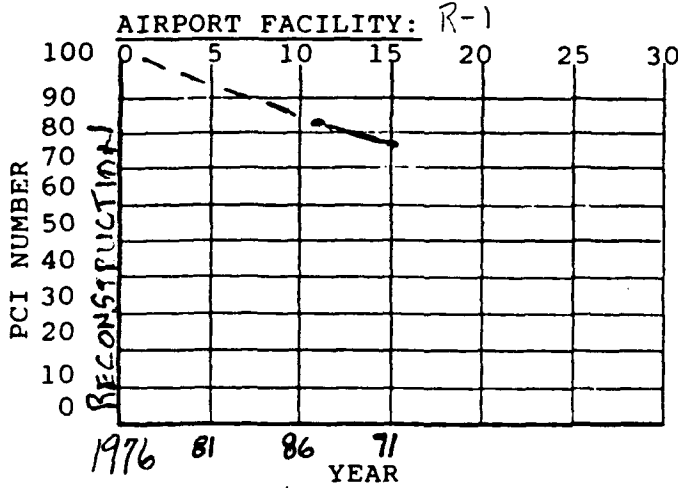

# 2

PAVEMENT CONDITION TREND

AIRPORT: OTHELLO MUNICIPAL AIRPORT

DATE OF LAST SURVEY: 5-20-91

NOTES: PCI NUMBER indicates  
PAVEMENT CONDITION INDEX  
Horizontal scale covers 30 yrs.  
Year 0 is year of original  
construction, major reconstruct.  
or overlay

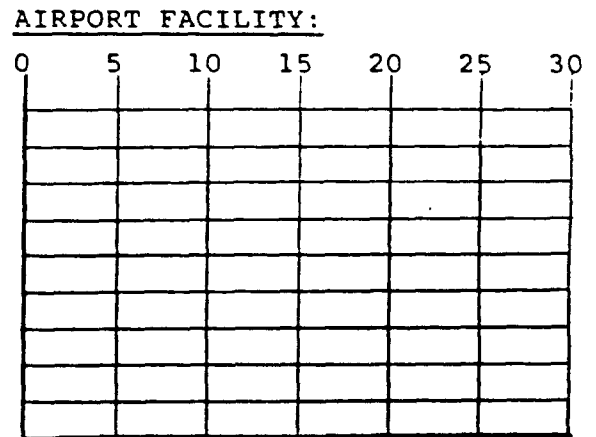
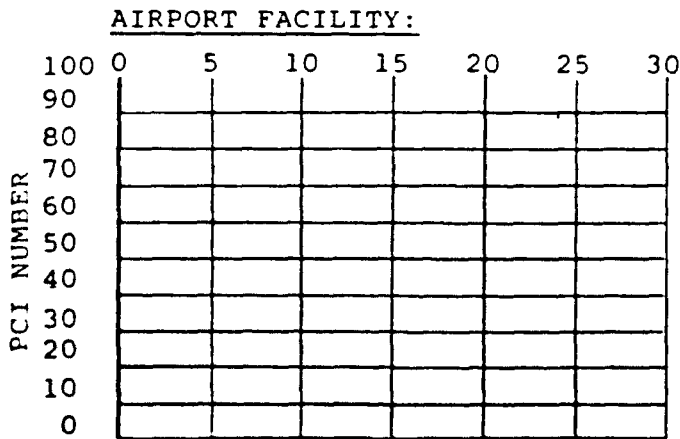
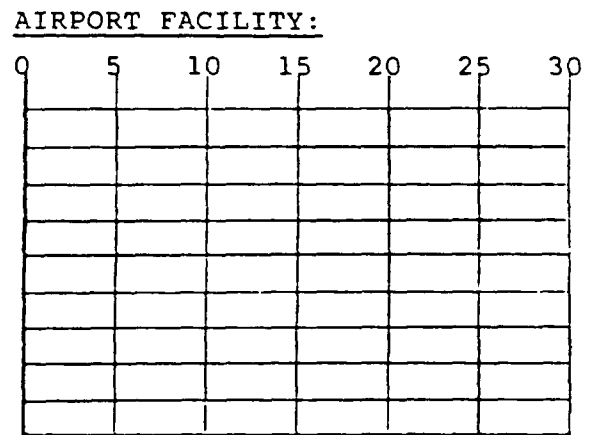
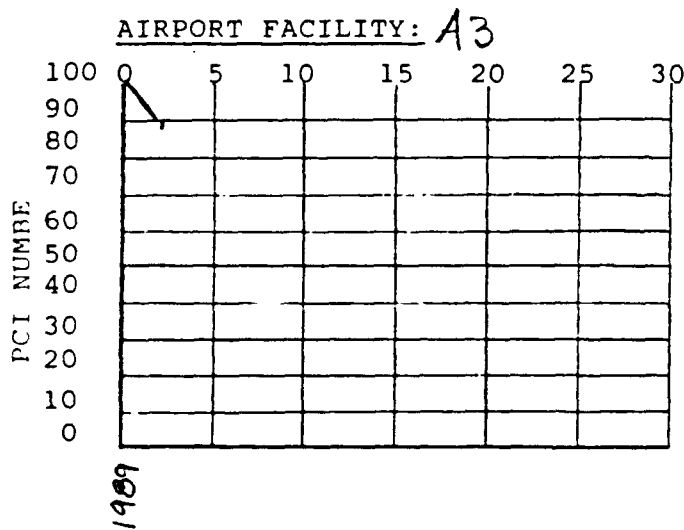
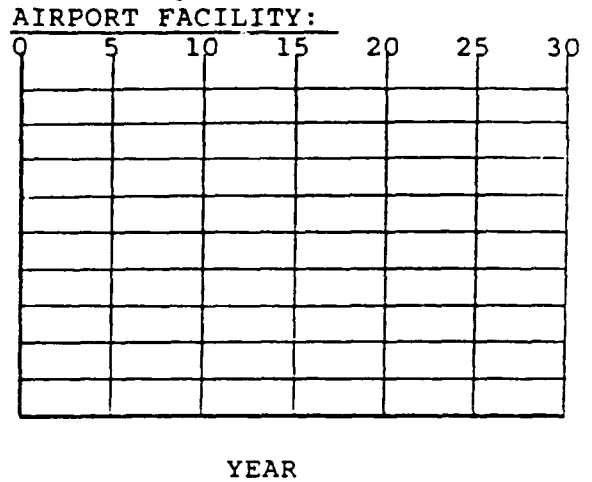
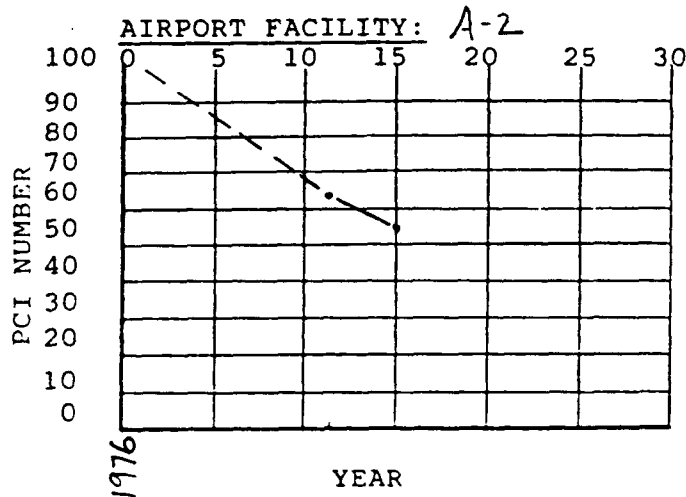

✓ 100' x 125'

FLEXIBLE PAVEMENT  
CONDITION SURVEY DATA SHEET FOR SAMPLE UNIT

AIRPORT: MTW DATE: 5-22-71  
 FACILITY: Runway 7-25 FEATURE: R1 SAMPLE UNIT: 1  
 SURVEYED BY: FM/ST AREA OF SAMPLE: 5000

**DISTRESS TYPES**

1. ALLIGATOR CRACKING
2. BLEEDING
3. BLOCK CRACKING
4. CORRUPTION
5. DEPRESSION
6. JET BLAST
7. JT. REFLECTION (POC)
8. LONG. & TRANS. CRACKING
9. OIL SPILLAGE
10. PATCHING
11. POLISHED AGGREGATE
12. RAVELING/WEATHERING
13. PUTTING
14. SHOWING FROM POC
15. SLIPPAGE CRACKING
16. SWELL

SKETCH:

EXISTING DISTRESS TYPES

SEVERITY	DISTRESS TYPE	SEVERITY	DENSITY %	DUCT VALUE
L	5	L	5.0	19
M	8	L	2.1	8
M	11	M	10.0	20
TOTAL				
DUCT TOTAL				
CORRECTED DUCT VALUE (COV)				

PCI CALCULATION: 73  
 PCI = 100 - COV = 27  
 RATING: Very Good

✓ 100' x 180'

FLEXIBLE PAVEMENT  
CONDITION SURVEY DATA SHEET FOR SAMPLE UNIT

AIRPORT: MTW DATE: 5-22-71  
 FACILITY: Runway 7-25 FEATURE: R1 SAMPLE UNIT: 2  
 SURVEYED BY: FM/ST AREA OF SAMPLE: 5000

**DISTRESS TYPES**

1. ALLIGATOR CRACKING
2. BLEEDING
3. BLOCK CRACKING
4. CORRUPTION
5. DEPRESSION
6. JET BLAST
7. JT. REFLECTION (POC)
8. LONG. & TRANS. CRACKING
9. OIL SPILLAGE
10. PATCHING
11. POLISHED AGGREGATE
12. RAVELING/WEATHERING
13. PUTTING
14. SHOWING FROM POC
15. SLIPPAGE CRACKING
16. SWELL

SKETCH:

EXISTING DISTRESS TYPES

SEVERITY	DISTRESS TYPE	SEVERITY	DENSITY %	DUCT VALUE
L	5	L	0.6	3
M	8	M	1.8	20
M	11	M	3.6	11
M	11	M	0.4	7
M	11	M	10.0	10
TOTAL				
DUCT TOTAL				
CORRECTED DUCT VALUE (COV)				

PCI CALCULATION: 75  
 PCI = 100 - COV = 25  
 RATING: Very Good

**FLEXIBLE PAVEMENT**  
**CONDITION SURVEY DATA SHEET FOR SAMPLE UNIT**

AIRPORT SMITHFIELD MUNICIPAL AIRPORT DATE 5-7-91

FACILITY Rwy 7-25 FEATURE R1 SAMPLE UNIT 3

SURVEYED BY EM/RR AREA OF SAMPLE 5000

**STRESS TYPES**

1. ALLIGATOR CRACKING 10. PATCHING  
 2. BLEEDING 11. POLISHED AGGREGATE  
 3. BLOCK CRACKING 12. RAVELING/WEATHERING  
 4. CORRUPTION 13. RUTTING  
 5. DEPRESSION 14. SHOWING FROM POC  
 6. JET BLAST 15. SLIPPAGE CRACKING  
 7. JT. REFLECTION (POC) 16. SWELL  
 8. LONG. & TRANS. CRACKING  
 9. OIL SPILLAGE

**SKETCH**

40' 125'

**EXISTING DISTRESS TYPES**

SEVERITY	TYPE	DESCRIPTION	AREA
5	B	12	1
140L	2001	5% M	20L
140M	15M		
140L	2001	5% M	205F
140M	15M		
L	2001	5% M	
M			
H			
TOTAL			

**PCI CALCULATION**

DISTRESS TYPE	SEVERITY	DENSITY %	DEDUCT VALUE
1	L	0.4	10
5	L	2.0	14
5	M	2.8	24
8	L	4.0	17
9	M	0.2	6
12	M	5.0	16
<b>DEDUCT TOTAL</b>			<b>95</b>
<b>CORRECTED DEDUCT VALUE (COV)</b>			<b>115</b>

PCI = 100 - COV = 115

RATING = FAIR

**FLEXIBLE PAVEMENT**  
**CONDITION SURVEY DATA SHEET FOR SAMPLE UNIT**

AIRPORT \_\_\_\_\_ DATE \_\_\_\_\_

FACILITY \_\_\_\_\_ FEATURE R1 SAMPLE UNIT 4

SURVEYED BY \_\_\_\_\_ AREA OF SAMPLE \_\_\_\_\_

**STRESS TYPES**

1. ALLIGATOR CRACKING 10. PATCHING  
 2. BLEEDING 11. POLISHED AGGREGATE  
 3. BLOCK CRACKING 12. RAVELING/WEATHERING  
 4. CORRUPTION 13. RUTTING  
 5. DEPRESSION 14. SHOWING FROM POC  
 6. JET BLAST 15. SLIPPAGE CRACKING  
 7. JT. REFLECTION (POC) 16. SWELL  
 8. LONG. & TRANS. CRACKING  
 9. OIL SPILLAGE

**SKETCH**

80' 100'

**EXISTING DISTRESS TYPES**

SEVERITY	TYPE	DESCRIPTION	AREA
5	B	12	1
100L	2001	5% M	20L
140M	15M		
140L	2001	5% M	205F
140M	15M		
L	2001	5% M	
M			
H			
TOTAL			

**PCI CALCULATION**

DISTRESS TYPE	SEVERITY	DENSITY %	DEDUCT VALUE
1	L	0.4	10
5	L	2.4	8
12	L	5.0	7
<b>DEDUCT TOTAL</b>			<b>17</b>

PCI = 100 - COV = 92

RATING = POOR/FAIR



15

**FLEXIBLE PAVEMENT**  
**CONDITION SURVEY DATA SHEET FOR SAMPLE UNIT**

AIRPORT: ORFELLO Municipal Airport DATE: 5-20-91

FACILITY: RWY 7-25 FEATURE: R1 SAMPLE UNIT: 5

SURVEYED BY: FM/SP AREA OF SAMPLE: 5000

**DISTRESS TYPES**

1. ALLIGATOR CRACKING
2. BLEEDING
3. BLOCK CRACKING
4. CORRUGATION
5. DEPRESSION
6. JET BLAST
7. JT. REFLECTION (POC)
8. LONG. & TRANS. CRACKING
9. OIL SPILLAGE
10. PATCHING
11. POLISHED AGGREGATE
12. RAVELING/WEATHERING
13. RUTTING
14. SHOVING FROM POC
15. SLIPPAGE CRACKING
16. SWELL

**SKETCH**

100' x 125'

EXISTING DISTRESS TYPES		PCI CALCULATION			
SEVERITY	DISTRESS TYPE	SEVERITY	DENSITY %	DEDUCT VALUE	
L					
M					
N					
TOTAL SEVERITY					

PCI = 100 - COV = \_\_\_\_\_  
RATING = \_\_\_\_\_

**FLEXIBLE PAVEMENT**  
**CONDITION SURVEY DATA SHEET FOR SAMPLE UNIT**

AIRPORT: ORFELLO Municipal Airport DATE: 5-20-91

FACILITY: RWY 7-25 FEATURE: R1 SAMPLE UNIT: 5

SURVEYED BY: FM/SP AREA OF SAMPLE: 5000

**DISTRESS TYPES**

1. ALLIGATOR CRACKING
2. BLEEDING
3. BLOCK CRACKING
4. CORRUGATION
5. DEPRESSION
6. JET BLAST
7. JT. REFLECTION (POC)
8. LONG. & TRANS. CRACKING
9. OIL SPILLAGE
10. PATCHING
11. POLISHED AGGREGATE
12. RAVELING/WEATHERING
13. RUTTING
14. SHOVING FROM POC
15. SLIPPAGE CRACKING
16. SWELL

**SKETCH**

100' x 125'

EXISTING DISTRESS TYPES		PCI CALCULATION			
SEVERITY	DISTRESS TYPE	SEVERITY	DENSITY %	DEDUCT VALUE	
3					
L	5	8			
M	200L	17.0L			
N	40M	15M			
TOTAL SEVERITY					

PCI = 100 - COV = 74  
RATING = Very Good

DEDUCT TOTAL: 54  
CORRECTED DEDUCT VALUE (COV): 26



**APPENDIX B**

**OREGON STATE  
GENERAL AVIATION  
PAVEMENT CONDITION SURVEY DATA**

INCLUDING:

- 1) AIRPORT LOCATION/DESCRIPTION/SECTION DATA
- 2) PAVEMENT IDENTIFICATION & CHARACTERISTICS
- 3) AVERAGE PCI VALUES FOR PAVEMENT FEATURES
- 4) PAVEMENT CONDITION SURVEY DATES
- 5) AVERAGE PCI LOSS WITH AGE
- 6) REPAIR AND REHABILITATION INFORMATION
- 7) TILLAMOOK AIRPORT COMPLETE PCI SURVEY

CORRECTED DEDUCT VALUE (CDV)

10

CORRECTED DEDUCT VALUE (CDV)

\*\*\*\*\*

**APPENDIX LEGEND**

\*\*\*\*\*

ID	Runway/Feature Identification Number
OCD	Original Construction Date
PCI	Pavement Condition Index
AVG	Average
YR	Year
RRD	Runway Rehabilitation Date
ORIG	Original
STRUC.	Structural
SEC.	Section
SURVEY	PCI Increased Value Attributed To Survey Conducted

PCI LOSS DATA (OR)

No.	AIRPORT & LOCATION	ID	OOD	PCI AVG & YR	PCI AVG & YR	AVG LOSS/YR
29	MADRAS CITY-COUNTY AP	R1	1943	84 - 1986	95 - 1991	CHECK
		R2	1943	16 - 1986	98 - 1991	"
		R3	1943	46 - 1986	N/A	
		R4	1943	39 - 1986	N/A	
30	MCDERMITT STATE AP	R1	1985	96 - 1986	N/A	
31	MCMINNVILLE MUNICIPAL AP	R1	1943	56 - 1988	N/A	
		R2	1943	61 - 1988	N/A	
32	NEWHALAM BAY STATE AP	R1	1965	80 - 1987	77 - 1991	0.75
33	NORTH BEND MUNICIPAL	R1	1943	90 - 1988	N/A	
		R2	1943	88 - 1988	N/A	
		R2A	1943	90 - 1988	N/A	
		R3	1943	75 - 1988	N/A	
34	OAKRIDGE STATE AIRPORT	R1	N/A	N/A	70 - 1991	
35	ONTARIO MUNICIPAL	R1	1978	84 - 1986	N/A	
36	OREGON CITY AIRPARK	R1	1972	45 - 1988	N/A	
37	PACIFIC CITY-STATE AP	R1	1950	79 - 1987	75 - 1991	1
38	PINEHURST STATE AP	R1	1956	83 - 1987	76 - 1991	1.75
39	PENDLETON MUNICIPAL	R1	1942	98 - 1988	N/A	
		R2	1942	97 - 1988	N/A	
		R3	1942	82 - 1988	N/A	
		R4	1942	66 - 1988	N/A	
		R5	1942	87 - 1988	N/A	
		R6	1942	61 - 1988	N/A	
40	PRINEVILLE AP	R1	UNK	87 - 1986	N/A	
		R2	UNK	86 - 1986	N/A	
		R3	UNK	39 - 1986	N/A	
41	PORT OF ASTORIA AP	R1	1944	87 - 1987	79 - 1991	2
		R1A	1944	77 - 1987	68 - 1991	2.25
		R2	1944	73 - 1987	99 - 1991	CHECK
42	ROBERTS FIELD/REDMOND AP	R1	1975	88 - 1986	N/A	
		R1*	1975	91 - 1986	N/A	
		R2	UNK	92 - 1986	N/A	
43	PROSPECT STATE AP	R1	1962	54 - 1987	68 - 1991	CHECK
44	ROSEBURG MUNICIPAL	R1	1951	77 - 1987	57 - 1991	5
45	SCAPPOOSE INDUSTRIAL AP	R1	1943	65 - 1987	64 - 1991	0.25
46	SEASIDE STATE AP	R1	1964	88 - 1987	83 - 1991	1.25
47	SILETZ BAY STATE AP	R1	1971	80 - 1988	N/A	
48	SPORTSMAN AIRPARK-NEWBERG	R1	1965	57 - 1986	N/A	
49	NEWPORT MUNICIPAL AP	R1	1944	91 - 1988	N/A	
		R2	1944	69 - 1988	N/A	
		R3	1944	74 - 1988	N/A	
50	SUNRIVER AP	R1	1970	92 - 1986	N/A	
51	SUTHERLIN MUNICIPAL	R1	1971	90 - 1987	N/A	

PCI LOSS DATA (OR)

No.	AIRPORT & LOCATION	ID	OOD	PCI AVG & YR	PCI AVG & YR	AVG LOSS/YR
52	THE DALLES MUNICIPAL AP	R1	1943	79 - 1988	N/A	
		R2	1943	79 - 1988	N/A	
		R3	1943	79 - 1988	N/A	
53	TILLAMOOK AP	R1	1943	92 - 1987	89 - 1991	0.75
		R2	1943	77 - 1987	100 - 1991	CHECK
54	TRI-CITY STATE AP	R1	1970	88 - 1987	77 - 1991	2.75
55	WASCO STATE AP	R1	1987	87 - 1987	N/A	

OREGON AIRPORT PAVEMENT CHARACTERISTICS

No.	AIRPORT & LOCATION	ID	OOD	ORIG. STRUC. SEC.	FFD	EXISTING STRUCTURE
1	ALBANY MUNICIPAL AP	R1	1959	2"AC, 8"B	1986	2"AC OL, 2"AC, 8"B
2	ASHLAND MUNICIPAL	R1	1965	BST, 4.5"B, 3"SB	1986	2"AC OL, 1"AC, 4.5"B, 3"SB
		R2	1985	2"AC, 8"B		2"AC, 8"B
3	AURORA STATE AP	R1	1975	3"AC, 2"B, 13"SB	1978	2"AC OL, 3"AC, 2"B, 13"SB
4	BAKER MUNICIPAL AP	R2	1942	2.5"AC, 15"B	1963	2.5"AC, 15"B - SEAL
		R3	1942	2.5"AC, 15"B	1963	2.5"AC, 15"B - SEAL
		R4	1983	2.5"AC, 3"B, 10"PRSB	1984	2.5"AC, 3"B, 10"PRSB - FS
		R5	1983	2.5"AC, 5"B, 18"SB	1984	2.5"AC, 5"B, 18"SB - FS
5	BANDON STATE AP	R1	1966	2.5"AC, ?"B	1972	CS, 2.5"AC, ?"B
6	BEND MUNICIPAL	R1	1977	2"AC, 6"B		2"AC, 6"B
		R2	1977	2"AC, 9"B		2"AC, 9"B
7	BOARDMAN AP	R1	1943	2"AC, 2"B, 8"SB	1980	1.5"AC, 2"AC, 2"B, 8"SB
8	BROOKINGS STATE	R1	1968	2.5"AC, 4"B		2.5"AC, 4"B
		R2	1968	1.5"AC, 4"B		1.5"AC, 4"B
9	BURNS MUNICIPAL AP	R1	1942	2"AC, 6"B, 6"SB	1978	CS, CS, 2"AC, 6"B, 6"SB
		R2	1942	2"AC, 6"B, 6"SB	1978	CS, CS, 2"AC, 6"B, 6"SB
10	CHILOQUIN STATE AP	R1	1961	1.25"AC, 4"B	1968	SC, 1.25"AC, 4"B
11	CHRISTMAS VALLEY AP	R1	1985	CS, 3"AC, 4"B, 2"SB		CS, 3"AC, 4"B, 2"SB
12	CONDON STATE AP	R1	1986	5"PCC, 2"B		5"PCC, 2"B
13	CORVALLIS MUNICIPAL AP	R1	1942	2.5"AC, 6"B, 9"SB	1984	3"AC OL, 2.5"AC, 6"B, 9"SB
		R2	1942	2"AC, 6"B, 10"SB		2"AC, 6"B, 10"SB
14	COTTAGE GROVE AP	R1	1966	1.5"AC, 7"B		1.5"AC, 7"B
		R2	1970	1.5"AC, 7"B		1.5"AC, 7"B
15	COUNTY SQUIRE AIRPARK	R1	1976	2"AC, 4-6"B		2"AC, 4-6"B
16	CRESWELL MUNICIPAL AP	R1	1987	2"AC, 4"B, 12"SB		2"AC, 4"B, 12"SB
17	FLORENCE MUNICIPAL AP	R1	1968	1.5"AC, 6"B	1985	2"AC, 6"B - REBUILD
18	GOLD BEACH MUNICIPAL	R1	1964	1"AC, 6"B	1983	1"AC, 6"B - RESURFACE
19	HERMISTON MUNICIPAL	R1	1959	1.5"AC, 3.5"B	1977	2"AC OL, 1.5"AC, 3.5"B
		R2	1977	3"AC, 6"B		3"AC, 6"B

OREGON AIRPORT PAVEMENT CHARACTERISTICS

No.	AIRPORT & LOCATION	D	OOD	ORIG. STRUC. SEC.	RPD	EXISTING STRUCTURE
20	HOOD RIVER AP	R1	1986	2"AC, 9"B		2"AC, 9"B
		R2	1986	2"AC, 13"B		2"AC, 13"B
		R3	1986	2"AC, 6"B		2"AC, 6"B
21	INDEPENDENCE STATE AP	R1	1974	2"AC, 2"B, 6"SB		2"AC, 2"B, 6"SB
22	ILLINOIS VALLEY AP	R1	1953	BST, 4"B, 6"SB	1977	2"AC OL, BST, 4"B, 6"SB
		R2	1960	3"AC, ?"B		3"AC, ?"B
23	JOHN DAY STATE AP	R1	1962	2"AC, 9"B		2"AC, 9"B
		R3	1982	2"AC, 4"B, 9"SB		2"AC, 4"B, 9"SB
24	JOSEPHINE STATE/COUNTY AP	R1	1966	1.5"AC, 5"B		1.5"AC, 5"B
25	LA GRANDE MUNICIPAL AP	R1	1942	2"AC, 4"B, 4.5"SB		2"AC, 4"B, 4.5"SB
		R2	1942	2"AC, 4"B, 4.5"SB	1974	4"AC OL, 2"AC, 4"B, 4.5"SB
		R3	1974	2"AC, 6"B, 4.5"SB		2"AC, 6"B, 4.5"SB
26	LAKE COUNTY AP	R1	1943	2"AC, 11"B, 4"SB	1985	SS, 1.75"AC, 2"AC, 11"B, 4"S
27	LEXINGTON AP	R1	1965	DBST, 4"B, 6-10"SB		DBST, 4"B, 6-10"SB AC
28	LEBANON STATE AP	R1	UNK	2"AC, 6"B	UNK	1.5"AC OL, 2"AC, 6"B
		R2	1972	2"AC, 6.5"B		2"AC, 6.5"B
29	MADRAS CITY-COUNTY AP	R1	1943	2"AC, 7.5"B, 9"SB	1977	2"AC OL, 2"AC, 7.5"B, 9"SB
		R2	1943	2"AC, 4"B, 10"SB		2"AC, 4"B, 10"SB
		R3	1943	9.5"PCC		9.5"PCC
		R4	1943	3"AC, 6"B, 10"SB		3"AC, 6"B, 10"SB
30	MCDERMITT STATE AP	R1	1985	2"AC, 3"B, 7"SB		2"AC, 3"B, 7"SB
31	MCMINNVILLE MUNICIPAL AP	R1	1943	2"AC, 6"B, 8"SB		2"AC, 6"B, 8"SB
		R2	1943	2"AC, 6"B, 10"SB	1980	SS, 2"AC, 6"B, 10"SB
32	NEWHALAM BAY STATE AP	R1	1965	BST, 6"B	1979	TBST, 6"B
33	NORTH BEND MUNICIPAL	R1	1943	3"AC, 6"B, 4.5"SB	1977	2"AC OL, CS, 3"AC, 6"B, 4.5"
		R2	1943	2.5"AC, 5.5"B, 4.75"	1977	2"AC OL, CS, 2.5"AC, 5.5"B, SB
		R2A	1943	2.25"AC, 6.25"B, 4"S	1977	2"AC OL, CS, 2.25"AC, B, SB
		R3	1943	3"AC, 5.5"B, 4"SB	1952	CS, 3"AC, 5.5"B, 4"SB
34	OAKRIDGE STATE AIRPORT	R1	UNK	UNK		TBST, 1"BST, 5"CB
35	ONTARIO MUNICIPAL	R3	1978	2"AC, 6"B, 6"SB		2"AC, 6"B, 6"SB
36	OREGON CITY AIRPARK	R1	1972	1"AC, ?"B		1"AC, ?"B



OREGON AIRPORT PAVEMENT CHARACTERISTICS

No.	AIRPORT & LOCATION	D	OOD	ORIG. STRUC. SEC.	FFD	EXISTING STRUCTURE
37	PACIFIC CITY STATE AP	R1	1950	2"AC, 4"B		2"AC, 4"B
38	PINEHURST STATE AP	R1	1956	BST, 7"B	1985	1"AC OL, BST, 7"B
39	PENDLETON MUNICIPAL	R1	1942	3"AC, 7"B, 6"SB	1974	PFC, 7"ACOL, 3"AC, 7"B, 6"SB
		R2	1942	2"AC, 8"B	1974	PFC, 7"ACOL, 2"AC, 8"B
		R3	1942	2"AC, 8"B	1978	3"AC OL, 2"AC, 8"B
		R4	1942	2"AC, 8"B	1978	5.5"AC OL, 2"AC, 8"B
		R5	1942	2"AC, 5"B	1978	10"AC OL, 2"AC, 5"B
		R6	1942	2"AC, 8"B		CS, 2"AC, 8"B
40	PRINEVILLE AP	R1	UNK	2"AC, 3"B, 3.5"SB		2"AC, 3"B, 3.5"SB
		R2	UNK	2"AC, 6"B		2"AC, 6"B
		R3	UNK	1"BST, 6"B		1"BST, 6"B
41	PORT OF ASTORIA AP	R1	1944	2.5"AC, 13"B	1980	.75"ACOL, 2.5"AC, 13"B
		R1A	1944	9"-6"-9"PCC, 9"SB	1980	.75"ACOL, 9"-6"-9"PCC, 9"S
		R2	1944	2.5"AC, 13"B		2.5"AC, 13"B
42	ROBERTS FIELD/REDMOND AP	R1	1975	4"AC, 7"B, 17"SB	1981	PFC, 4"AC, 7"B, 17"SB
		R1*	1975	4"AC, 7"B, 17"SB		4"AC, 7"B, 17"SB
		R2	UNK	3"AC, 2"B, 10"SB		3"AC, 2"B, 10"SB
43	PROSPECT STATE AP	R1	1962	BST, 6"B	1986	DBST, 6"B
44	ROSEBURG MUNICIPAL	R1	1951	2"AC, 6"B, 6"SB	1986	SS, 2"AC, 6"B, 6"SB
45	SCAPOOSE INDUSTRIAL AP	R1	1943	2"AC, 6"B, 12"SB	1986	SS, 2"AC, 6"B, 12"SB
46	SEASIDE STATE AP	R1	1964	1.75"AC, 6"B		1.75"AC, 6"B
47	SILETZ BAY STATE AP	R1	1971	1.5"AC, 4.5"B, 5"SB		1.5"AC, 4.5"B, 5"SB
48	SPORTSMAN AIRPARK-NEWBERG	R1	1965	2"AC, 4"B, 10"SB		2"AC, 4"B, 10"SB
49	NEWPORT MUNICIPAL AP	R1	1944	2"AC, 6"B, 9"SB	1984	3"AC OL, 2"AC, 6"B, 9"SB
		R2	1944	2"AC, 6"B, 9"SB	1984	SS, 2"AC, 6"B, 9"SB
		R3	1944	4"AC, 6"B, 5"SB		4"AC, 6"B, 5"SB
50	SUNRIVER AP	R1	1970	DBST, 14"CB	1985	2"ACOL, SS/SC, DBST, 14"CB
51	SUTHERLIN MUNICIPAL	R1	1971	2"AC, 12"B		2"AC, 12"B
52	THE DALLES MUNICIPAL AP	R1	1943	2.25"AC, 6.75"B	1965	SS, 2.25"AC, 6.75"B
		R2	1943	2.25"AC, 6.75"B		2.25"AC, 6.75"B
		R3	1943	2.25"AC, 6.75"B		2.25"AC, 6.75"B

OREGON AIRPORT PAVEMENT CHARACTERISTICS

No.	AIRPORT & LOCATION	D	OOD	ORIG. STRUC. SEC.	RPD	EXISTING STRUCTURE
53	TILLAMOOK AP	R1	1943	2"AC, 6"B, 10"SB	1983	1.5"ACOL, 2"AC, 6"B, 10"SB
54	TRI-CITY STATE AP	R2	1943	2"AC, 6"B, 10"SB	1983	CS, 2"AC, 6"B, 10"SB
55	WASCO STATE AP	R1	1970	1.5"AC, 6"B	UNK	CS, 1.5"AC, 6"B
		R1	1987	1"TBST, 4"B, 6"SB		1"TBST, 4"B, 6"SB

# TILLAMOOK AIRPORT, OREGON

## PAVEMENT FEATURES & PAVEMENT CONDITION SURVEY

SEPTEMBER 9, 1991

### TABLE OF CONTENTS

1. Airport Layout w/PCI Numbers	Page	1
2. Sample Area Locations	"	2
3. Feature Summary	"	3,4
4. Pavement Development & Maintenance	"	5,6
5. Pavement Condition Trend	"	7,8

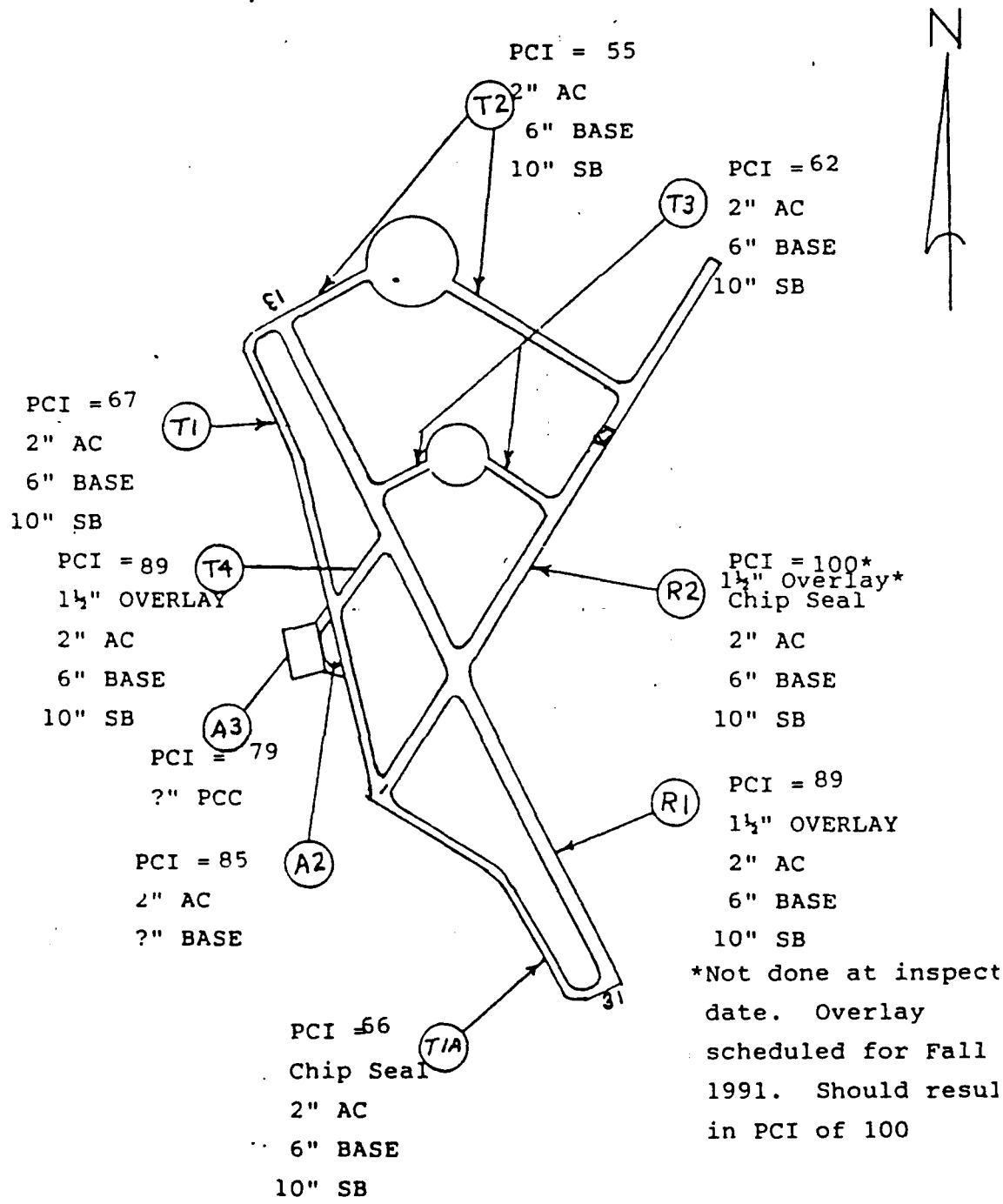

TILLAMOOK AIRPORT  
PAVEMENT FEATURES AND PCI NUMBERS  
SEPTEMBER 9, 1991

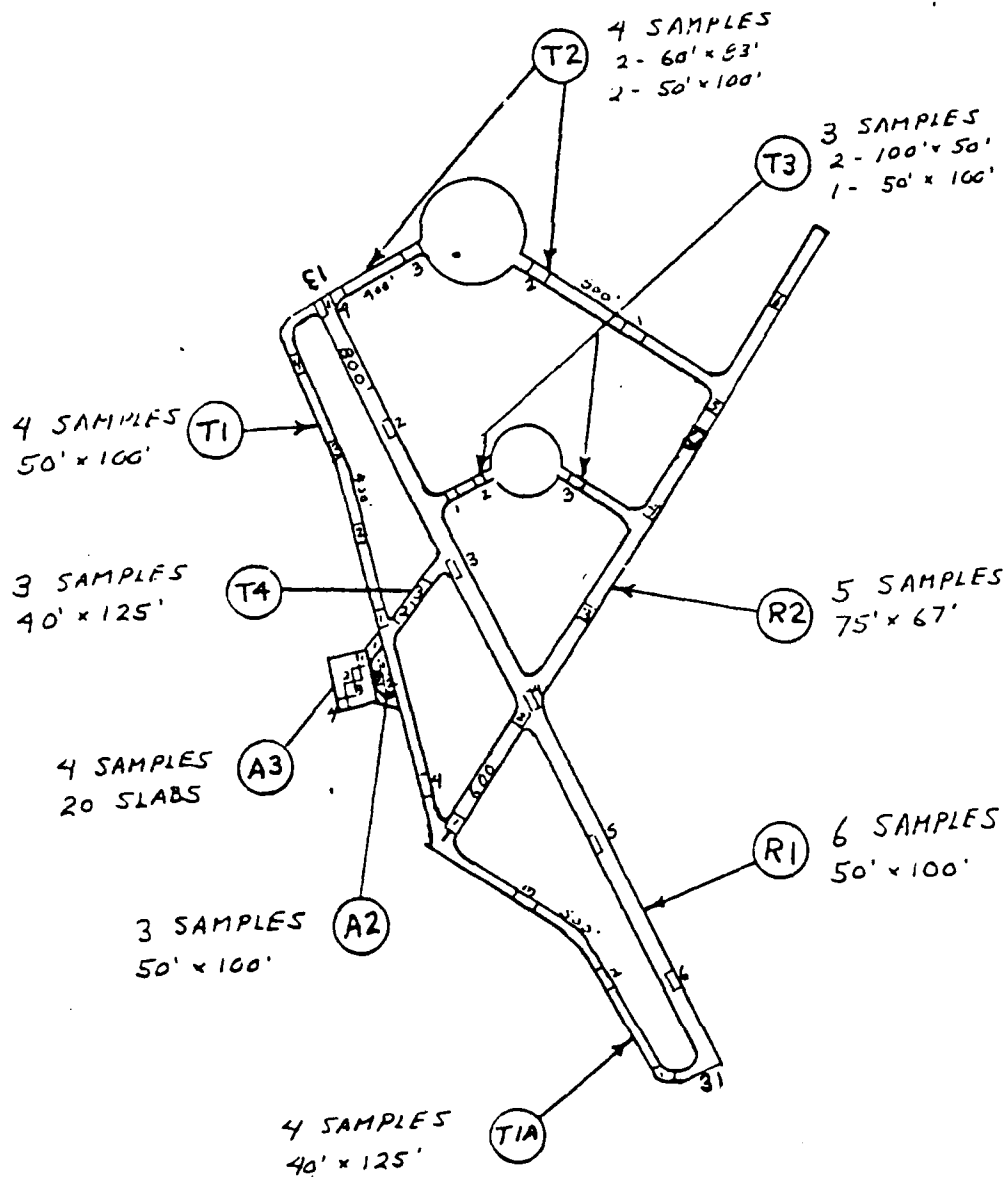

TILLAMOOK AIRPORT  
LOCATION OF SAMPLE AREAS WITHIN EACH FEATURE  
SEPTEMBER 9, 1991

FEATURE SUMMARY

AIRPORT: Tillamook Airport  
DATE OF SURVEY: September 9, 1991

AIRPORT FACILITY: Runway R-1, 13-31  
TOTAL NO. OF SAMPLE UNITS: 6

<u>SAMPLE UNIT NO.</u>	<u>SAMPLE UNIT AREA</u>	<u>PCI</u>
1	5000	88
2	5000	90
3	5000	91
4	5000	87
5	5000	90
6	4000	85

Average PCI: 89  
 Condition Rating: Excellent

AIRPORT FACILITY: Runway R-2, 1-19  
TOTAL NO. OF SAMPLE UNITS: 4

<u>SAMPLE UNIT NO.</u>	<u>SAMPLE UNIT AREA</u>	<u>PCI</u>
------------------------	-------------------------	------------

Not done as overlay shceduled for October 1991. Should result in PCI of 100 this Fall.

Average PCI: \_\_\_\_\_  
 Condition Rating: \_\_\_\_\_

AIRPORT FACILITY: Taxiway T-1  
TOTAL NO. OF SAMPLE UNITS: 4

<u>SAMPLE UNIT NO.</u>	<u>SAMPLE UNIT AREA</u>	<u>PCI</u>
1	5000	67
2	5000	74
3	5000	71
4	5000	56

Average PCI: 67  
 Condition Rating: Good

AIRPORT FACILITY: Taxiway T-  
TOTAL NO. OF SAMPLE UNITS: 4

<u>SAMPLE UNIT NO.</u>	<u>SAMPLE UNIT AREA</u>
1	5000
2	5000
3	5000
4	5000

Average PCI: 66  
 Condition Rating: Good

AIRPORT FACILITY: Taxiway T-  
TOTAL NO. OF SAMPLE UNITS: 4

<u>SAMPLE UNIT NO.</u>	<u>SAMPLE UNIT AREA</u>
1	5000
2	5000
3	5000
4	5000

Average PCI: 55  
 Condition Rating: Good

AIRPORT FACILITY: Taxiway T-  
TOTAL NO. OF SAMPLE UNITS: 3

<u>SAMPLE UNIT NO.</u>	<u>SAMPLE UNIT AREA</u>
1	5000
2	5000
3	5000

Average PCI: 62  
 Condition Rating: Good

**FEATURE SUMMARY**

**AIRPORT:** Tillamook Airport  
**DATE OF SURVEY:** September 9, 1991

**AIRPORT FACILITY:** Taxiway T-4  
**TOTAL NO. OF SAMPLE UNITS:** 3

<u>SAMPLE UNIT NO.</u>	<u>SAMPLE UNIT AREA</u>	<u>PCI</u>
1	5000	85
2	5000	91
3	5000	91

**PRINCIPAL DISTRESSES:**

RUNWAY R-1 Raveling/weathering  
 RUNWAY R-2 Raveling, depressions and cracking

TAXIWAY T-1A Block, longitudinal & transverse cracking, depressions & raveling

TAXIWAY T-1A Raveling, depressions and cracking

TAXIWAY T-2 Block cracking, depressions and raveling/weathering

TAXIWAY T-3 Longitudinal & transverse cracking, depressions & raveling/weathering

TAXIWAY T-4 Raveling/weathering

APRON A-2 Raveling/weathering and oil spillage

APRON A-3 Joint seal damage

**Average PCI:** 89  
**Condition Rating:** Excellent

**AIRPORT FACILITY:** Apron A-2  
**TOTAL NO. OF SAMPLE UNITS:** 3

<u>SAMPLE UNIT NO.</u>	<u>SAMPLE UNIT AREA</u>	<u>PCI</u>
1	5000	88
2	5000	84
3	5000	82

**Average PCI:** 85  
**Condition Rating:** Excellent

**AIRPORT FACILITY:** Apron A-3  
**TOTAL NO. OF SAMPLE UNITS:** 4

<u>SAMPLE UNIT NO.</u>	<u>SAMPLE UNIT AREA</u>	<u>PCI</u>
1	20 slabs	74
2	" "	84
3	" "	82
4	" "	77

**Average PCI:** 79  
**Condition Rating:** Very Good

TILLAMOOK AIRPORT  
PAVEMENT DEVELOPMENT AND MAINTENANCE

SEPTEMBER 9, 1991

The original construction of 1942-43 was a combination of DLAND-USED and Navy. Except for a small concrete apron of unknown thickness, on the west side, all pavements were flexible construction consisting of 2" AC, 6" Base and 10" Subbase. On taxiways and aprons the surface thickness was 2½". It appears nothing was done to the pavement, except for a possible slurry seal on a few sections, until 1983. At that time a Federally funded project assisted in overlay of Runway 13-31, and chip seal on 1-19 and the southern portion of the taxiway parallel to 13-31. Also, at that time the short taxiway from the concrete apron to runway 13-31 was overlaid. The island between the concrete apron and parallel taxiway was surfaced about the same time.

Traffic at this airport has consisted mainly of light single and twin engine aircraft but occasionally a large aircraft will visit the airport.

Currently, runway 13-31 continues to be in excellent condition. But, it does show a significant tendency to ravel with many fine particles coming loose. A fog seal might help this. Runway 1-19 has a lot of loose stone and is scheduled for a 1½" minimum overlay in Fall of this year. That should result in an excellent condition and a PCI rating of 100.

The aprons are in very good condition but the concrete apron could use new joint seal as it has had nothing done to it in 48 years. The bituminous portion of apron shows a significant tendency to ravel and a fog seal might help here also. All of the other pavements are original, although the north portion of the parallel taxiway looks like it had a slurry seal once, and are in good condition. Typically they have some depressions, fine cracking and raveling/weathering. Some have a lot of vegetation in the cracks.



The ideal solution on these pavements would be an overlay as was accomplished on runway 13-31. The active taxiways could be overlaid 35' wide or maybe 40'. This treatment would correct all problems including depressions. But, if funds are insufficient, removing vegetation and slurry sealing these pavements would be a big improvement. Even though the southern portion of the parallel taxiway received a chip seal, an overlay of the entire taxiway at 35' or 40' would be desirable. A short portion of taxiway T-2 from runway end 13 to the T hangar area is scheduled for a slurry seal in Fall of 1991. The remaining longer section of T-2 would seem to be an ideal candidate for a slurry seal.

SUGGESTED PAVEMENT PROGRAM IS AS FOLLOWS:

Overlay parallel taxiway to runway 13-31 approx. 5500' x 35'	
21,389 S. Y. @ \$7.00	= \$150,000
Fog seal runway 13-31	
55,555 S. Y. @ \$0.20	= \$ 11,000
Remove vegetation and slurry seal taxiways between runways to 40' width	
15,000 S. Y. @ \$2.00	= \$ 30,000
Replace joint seal in concrete apron	= \$ 9,000

PAVEMENT CONDITION TREND

AIRPORT: Tillamook

DATE OF LAST SURVEY: Sept. 9, 1991

NOTES: PCI NUMBER indicates  
PAVEMENT CONDITION INDEX  
Horizontal scale covers 30 yrs.  
Year 0 is year of original  
construction, major reconstruct  
or overlay

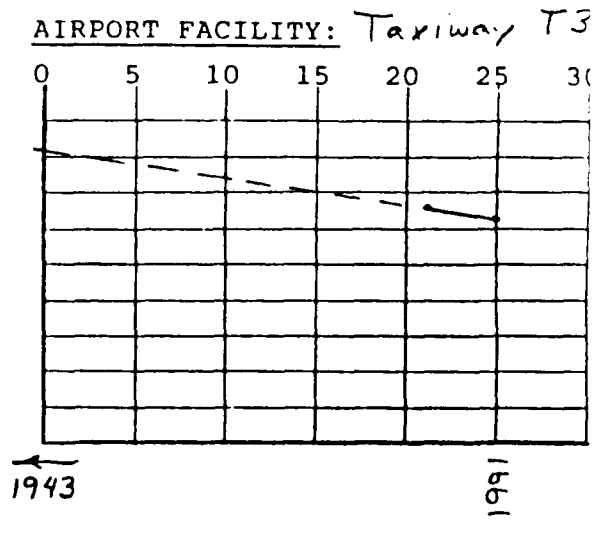
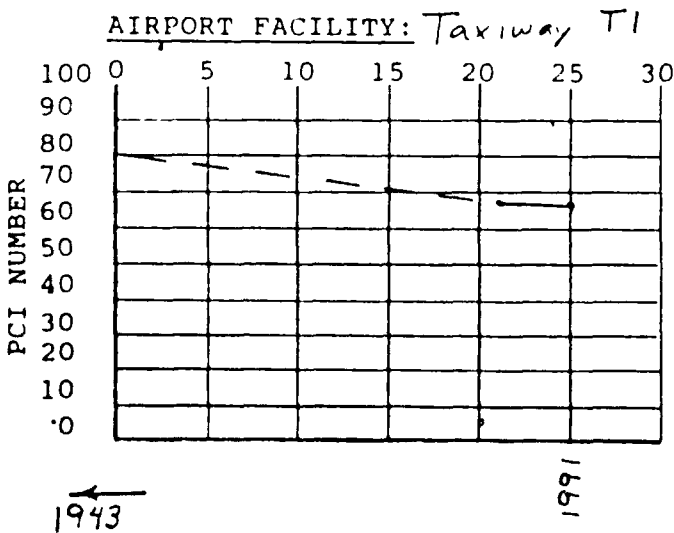
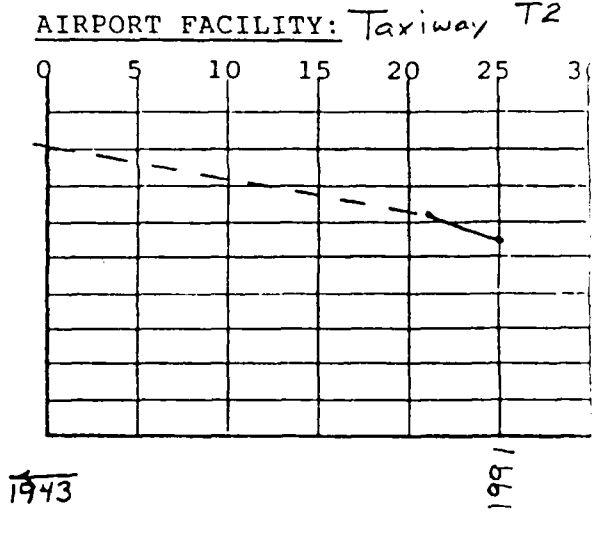
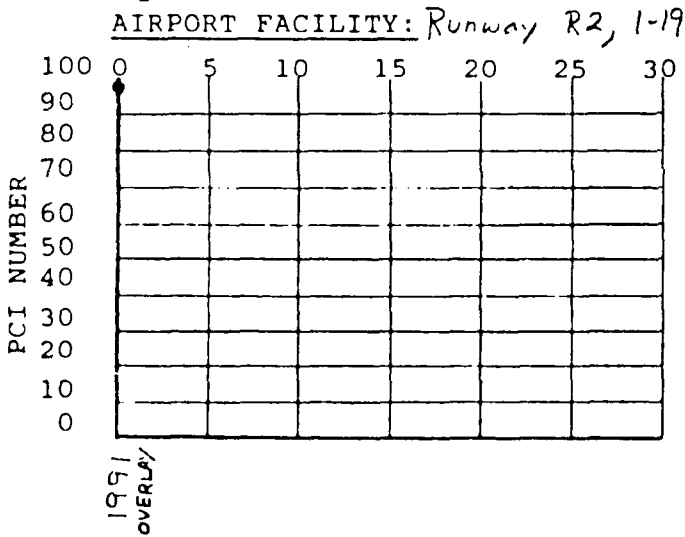
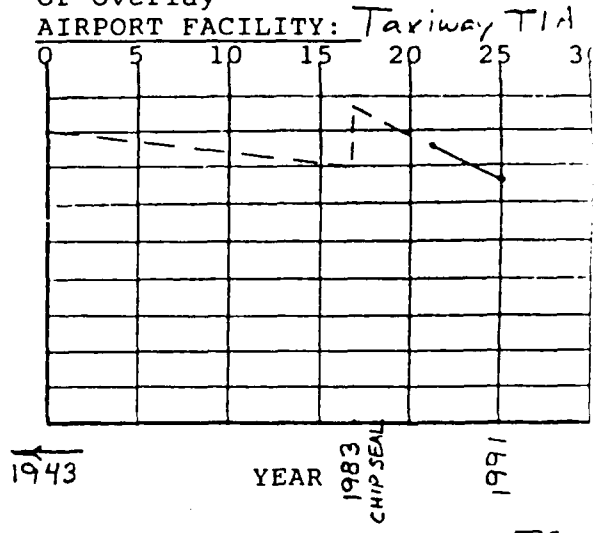
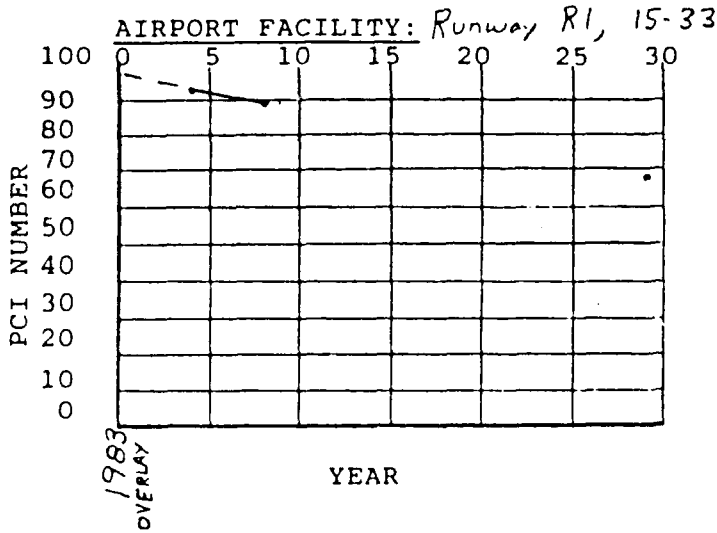

PAVEMENT CONDITION TREND

AIRPORT: Tillamook

DATE OF LAST SURVEY: Sept. 9, 1991

NOTES: PCI NUMBER indicates  
PAVEMENT CONDITION INDEX  
Horizontal scale covers 30 yrs.  
Year 0 is year of original  
construction, major reconstruct  
or overlay

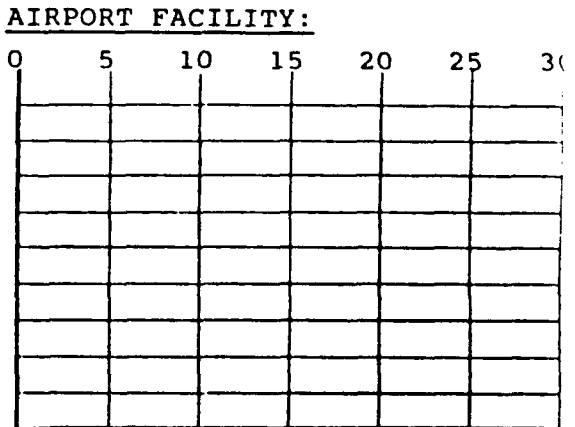
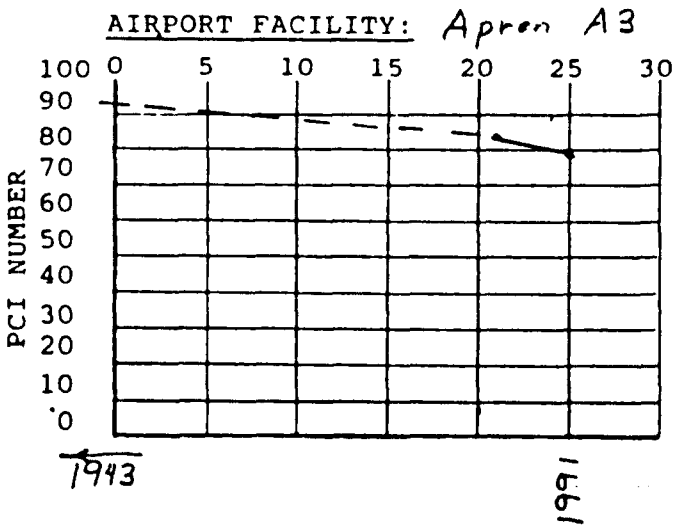
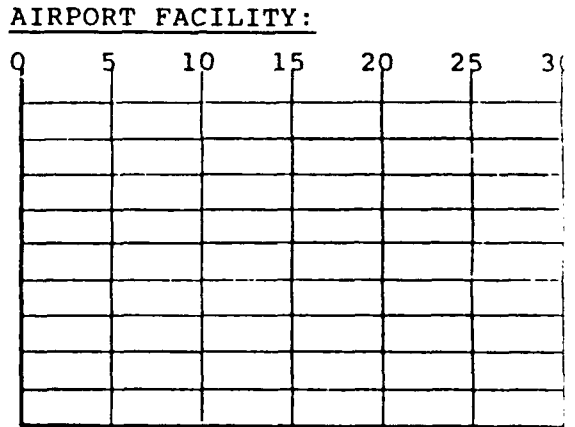
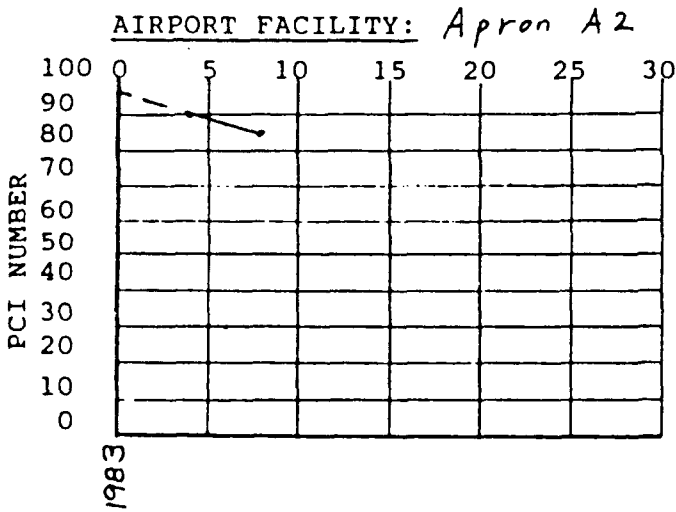
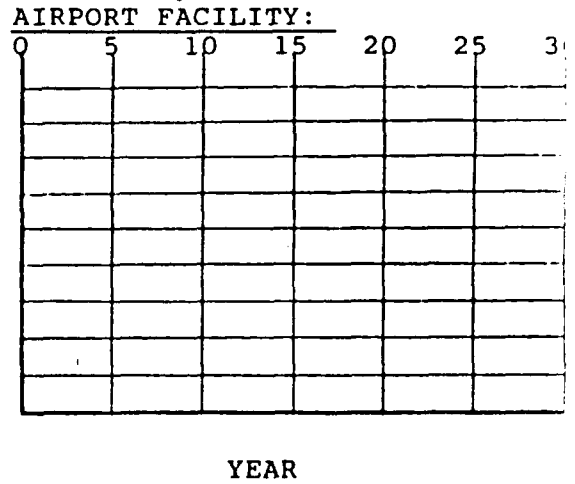
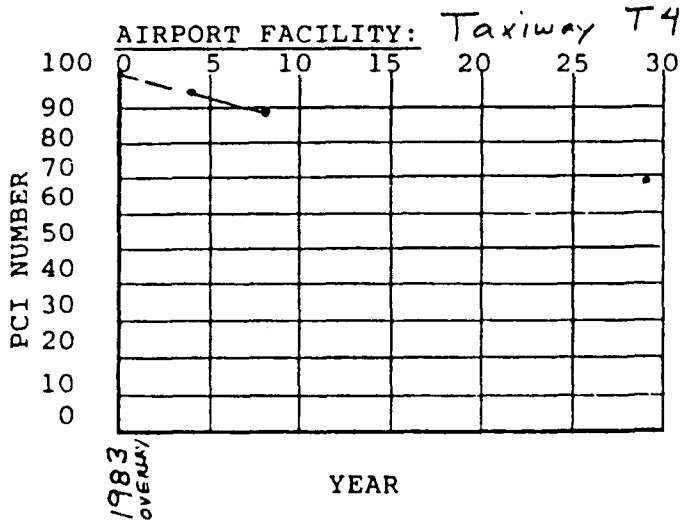

**APPENDIX C**

**GUIDELINES AND PROCEDURES  
FOR  
MAINTENANCE OF AIRPORT PAVEMENTS**

**U. S. DEPARTMENT OF TRANSPORTATION  
FEDERAL AVIATION ADMINISTRATION**

**ADVISORY CIRCULAR**

**AC: 150/5380-6**

**DATE: 12/3/82**



U.S. Department  
of Transportation  
**Federal Aviation  
Administration**

# **Guidelines and Procedures for Maintenance of Airport Pavements**

AC: 150/5380-6  
Date: 12/3/82

**Advisory Circular**



U.S. Department  
of Transportation  
**Federal Aviation  
Administration**

# Advisory Circular

---

**Subject:** GUIDELINES AND PROCEDURES FOR  
MAINTENANCE OF AIRPORT PAVEMENTS

**Date:** 12/3/82  
**Initiated by:** AAS-200

**AC No:** 150/5380-6  
**Change:**

- 
1. PURPOSE. This advisory circular (AC) provides guidelines and procedures for maintenance of rigid and flexible airport pavements.
  
  2. FOCUS.
    - a. Poor maintenance of airport pavements is the result of a variety of causes, among which are lack of funds, untrained personnel, and lack of adequate information. This AC provides specific guidelines and procedures for maintaining airport pavements and establishing an effective maintenance program. Specific types of distress, their probable causes, inspection guidelines, and recommended methods of repair are discussed.
  
    - b. This information has been developed to assist airport managers, engineers, and maintenance personnel responsible for pavement design, performance, maintenance, and repair. It is intended primarily for use at small- and medium-size airports that may lack the technical support of an adequate well-trained engineering/maintenance staff or the financial resources to retain a pavement consultant.
  
  3. RELATED READING MATERIAL. The publications listed in Appendix C, Bibliography, provide further guidance and technical information.

*Leonard E. Mudd*

LEONARD E. MUDD  
Director, Office of Airport Standards

## APPENDIX A: CONDITION SURVEY PROCEDURE

### GENERAL

This appendix gives the detailed procedure for performing a pavement condition survey at civil airports. The procedure is presently limited to flexible pavements (all pavements with conventional bituminous concrete surfaces) and jointed rigid pavements (jointed nonreinforced concrete pavements with joint spacing not exceeding 25 ft). Specific objectives for the condition survey are:

- a. To determine present condition of the pavement in terms of apparent structural integrity and operational surface condition.
- b. To provide FAA with a common index for comparing the condition and performance of pavements at all airports and also provide a rational basis for justification of pavement rehabilitation projects.
- c. To provide feedback on pavement performance for validation and improvement of current pavement design, evaluation, and maintenance procedures.

The airport pavement condition survey and the determination of the PCI are the primary means of obtaining and recording vital airport pavement performance data. The condition survey for both rigid and flexible pavement facilities consists principally of a visual inspection of the pavement surfaces for signs of pavement distress resulting from the influence of aircraft traffic and environment.

### BASIC AIRPORT INFORMATION

A considerable amount of basic airport data is incorporated into the condition survey report. Most of this information is contained in construction and maintenance records and in previous condition survey reports. To facilitate report preparation, the basic data should be accumulated and maintained by the airport engineer. The following items should be compiled for subsequent use during the condition survey:

- a. Design/construction/maintenance history. The history of maintenance, repair, and reconstruction from original construction of the airport pavement system to the present should be maintained. These data should reflect airport paving projects

and airport change projects accomplished either in-house or by a contractor.

- b. Traffic history. Air carrier, commuter, cargo, and military aircraft traffic records, including aircraft type, typical gross loads, and frequency of operation.
- c. Climatological data. Annual temperature ranges and precipitation data should be obtained from the weather office nearest the airport.
- d. Airport layout. Plans and cross sections of all major airport components, including subsurface drainage systems. These should be updated to reflect new construction upon completion of the project.
- e. Frost action. If applicable, records of pavement behavior during freezing periods and subsequent thaws should be recorded.
- f. Photographs. Photographs depicting both general and specific airport conditions should be taken.
- g. Pavement condition survey reports. All previous pavement condition survey reports should be maintained to be referenced in the current report.

A series of data summary sheets has been devised and is presented in Figures A-1 through A-4. These summary sheets should be helpful to the personnel involved in obtaining and maintaining the necessary information. Narrative information pertaining to unusual problems, solutions, or attempted solutions to these problems should be included. This information would be beneficial in determining research needs as well as in providing a means of distributing information.

#### OUTLINE OF BASIC CONDITION RATING PROCEDURE

The steps for performing the condition survey and determining the PCI are described below and in Figure A-5:

- a. Station or mark off the airport pavements in 100-ft increments. This is done semipermanently to assure ease of proper positioning for the condition survey. The overall airport pavements must first be divided into features based on the pavements design, construction history, and traffic area. A designated pavement feature, therefore, has consistent structural thickness and materials, was constructed at the same time, and is located in one airport facility, i.e., runway, taxiway, etc. After initially designating the features on the airport, make a preliminary survey. This survey shall entail a brief but complete visual survey of all the airport pavements. By



observing distress in an individual feature, it may be determined whether there are varying degrees of distress in different areas. In such cases, the feature should be subdivided into two or more features.

- b. The pavement feature is divided into sample units. A sample unit for jointed rigid pavement is approximately 20 slabs; a sample unit for flexible pavement is an area of approximately 5000 sq ft.
- c. The sample units are inspected, and distress types and their severity levels and densities are recorded. Appendix B provides a comprehensive guide for identification of the different distress types and their severity levels. The criteria in Appendix B must be used in identifying and recording the distress types and severity levels in order to obtain an accurate PCI.
- d. For each distress type, density, and severity level within a sample unit, a deduct value is determined from the appropriate curve.
- e. The total deduct value (TDV) for each sample unit is determined by adding all deduct values for each distress condition observed.
- f. A corrected deduct value (CDV) is determined using procedures in the appropriate section for jointed rigid or flexible pavements.
- g. The PCI for each sample unit inspected is calculated as follows:

$$PCI = 100 - CDV$$

If the CDV for a sample unit is less than the highest individual distress deduct value, the highest value should be used in lieu of the CDV in the above equation.

- h. The PCI of the entire feature is the average of the PCI's from all sample units inspected.
- i. The feature's pavement condition rating is determined from a figure that presents verbal descriptions of a pavement condition as a function of PCI value.

#### SAMPLING TECHNIQUES

Inspection of an entire feature may require considerable effort, especially if the feature is very large. This may be particularly true for flexible pavements containing much distress. Because of the time and effort involved, frequent surveys of the entire feature may be

beyond available manpower, funds, and time. A sampling plan has, therefore, been developed so that an adequate estimate of the PCI can be determined by inspecting a portion of the sample units within a feature. Use of the statistical sampling plan described here will considerably reduce the time required to inspect a feature without significant loss of accuracy. However, this statistical sampling plan is optional, and inspection of the entire feature may be desirable. The airport engineer should specify whether statistical sampling may be used. The condition survey proceeds as follows:

- a. Determination of pavement feature. The first step in the condition survey is the designation of pavement features. Each facility such as a runway, taxiway, etc., is divided into segments or features that are definable in terms of (1) the same design, (2) the same construction history, (3) the same traffic area, and (4) generally the same overall condition. General features can be determined from pavement design and construction records and can be further subdivided as deemed necessary based on a preliminary survey. It is important that all pavement in a given feature be such that it can be considered uniform. As an example, the center part of some runways in the traffic lanes should be separate features from the shoulder portion outside the traffic lanes.
- b. Selection of sample units to be inspected. The minimum number of sample units that must be surveyed to obtain an adequate estimate of the PCI of a feature is selected from Figure A-6. Once the number of sample units  $n$  has been determined from Figure A-6, the spacing interval of the units is computed from

$$i = \frac{N}{n}$$

where

$i$  = spacing interval of units to be sampled  
 $N$  = total number of sample units in the feature  
 $n$  = number of sample units to be inspected

All the sample numbers within a feature are numbered and those that are multiples of the interval  $i$  are selected for inspection. The first sample unit to be inspected should be selected at random between 1 and  $i$ . Sample unit size should be 5000 sq ft (generally 50 by 100 ft) for flexible pavement and 20 adjacent slabs for rigid pavement. Figures A-7 and A-8 illustrate the division of a jointed rigid pavement and flexible pavement feature, respectively, into sample units.

Each sample unit is numbered so it can be relocated for future inspections, maintenance needs, or statistical sample purposes. Each of the selected sample units must be inspected and its PCI determined. The mean PCI of a pavement feature is determined by averaging the PCI of each sample unit inspected within the feature. When it is desirable to inspect a sample unit that is in addition to those selected by the above procedure, then one or more additional sample units may be inspected and the mean PCI of the feature computed from:

$$PCI_f = \frac{(N - A)}{N} \overline{PCI}_1 + \frac{A}{N} \overline{PCI}_2$$

where

$PCI_f$  = mean PCI of feature

$N$  = total number of sample units in feature

$A$  = number of additional sample units

$\overline{PCI}_1$  = mean of PCI for  $n$  number of statistically selected units

$\overline{PCI}_2$  = mean PCI for all additional sample units

It is necessary that each sample unit be identified adequately so that it can be relocated for additional inspections to verify distress data or for comparison with future inspections. Based on significant variation of sample unit PCI along a feature and/or significant variation in distress types among sample units, one feature should be divided into two or more features for future inspections and maintenance purposes.

#### DETAIL SURVEY PROCEDURE FOR RIGID PAVEMENT

Each sample unit, or those selected by the statistical sampling procedure, in the feature is inspected. The actual inspection is performed by walking over each slab of the sample unit being surveyed and recording distress existing in the slab on the jointed rigid pavement survey data sheet (Figure A-9). One data sheet is used for each sample unit. A sketch is made of the sample unit, using the dots as joint intersections. The appropriate number code for each distress found in the slab is placed in the square representing the slab. The letters L (low), M (medium), or H (high) are included along with the distress number code to indicate the severity level of the distress. For example, 15L indicates that low severity corner spalling exists in the slab.

Refer to Appendix B for aid in identification of distresses and their severity levels. Follow these guidelines very closely.

Space is provided on the jointed rigid pavement survey data sheet for summarizing the distresses and computing the PCI for the sample unit. Summarize the distress type numbers and their severity levels and the number of slabs in the sample unit containing each type and level. Calculate the percentage of the total number of slabs in the sample unit containing each distress type and severity level. Using Figures A-10 through A-24, determine the deduct value for each distress type and severity level. Sum the deduct values to obtain the deduct total.

Noting how many individual deduct values are greater than 5, consult Figure A-25 to obtain the CDV. The PCI is then calculated and the rating (from Figure A-26) is entered on the jointed rigid pavement survey data sheet (Figure A-9). If the CDV for a sample unit is less than the highest individual distress deduct value, the highest value should be used in determining the PCI.

The PCI's for all sample units are compiled into a feature summary, as shown in Figure A-27. The overall condition rating of the feature is determined by using the mean PCI and Figure A-26.

#### DETAILED PROCEDURE FOR FLEXIBLE PAVEMENT

Each sample unit, or those selected by the sampling procedure, in the feature is inspected. The distress inspection is conducted by walking over the sample unit, measuring the distress type and severity according to Appendix B, and recording the data on the flexible pavement survey data sheet (Figure A-28). One data sheet is used for each sample unit. A hand odometer is very helpful for measuring distress. A 10-ft straightedge and a 12-in. scale must be available for measuring the depths of ruts or depressions. Each column on the data sheet is used to represent a distress type, and the amount and severity of each distress located are listed in the column. For example, distress No. 5 (depression) is recorded as 6 x 4L, which indicates that the depression is 6 by 4 ft and of low severity. Distress type No. 8 (longitudinal and

transverse cracking) is measured in linear feet, thus 10L indicates 10 ft of light cracking. This format is very convenient for recording data in the field.

Each distress type and severity level are summed either in square feet or linear feet, depending on the type of distress. The total units, either in square feet or linear feet, for each distress type and severity level are divided by the area of the sample unit to obtain the percent density. Using Figures A-29 through A-44, determine the deduct value for each distress type and severity level. Sum the deduct values to obtain the deduct total.

Noting how many individual deduct values are greater than 5, use Figure A-45 to obtain the CDV. The PCI is then calculated, and the rating (from Figure A-26) is entered on the flexible pavement survey data sheet. If the CDV for a sample unit is less than the highest individual distress deduct value, the highest value should be used in determining the PCI.

The PCI's for each sample unit are compiled into a feature summary, as shown in Figure A-46. The mean PCI for the feature is determined by averaging the PCI's from each sample unit. The overall condition rating of the feature is determined by use of the mean PCI and Figure A-26.

#### REPORTING CONDITION SURVEY RESULTS

The format for reporting the findings of the airport condition survey may be informal, designed to preclude the necessity of extensive drafting and typing. The pavement distress data and PCI computations can be presented as directly obtained from the survey data sheets and computations. The basic airport data collected will primarily reflect changes in airport pavement systems that have occurred since the last condition survey report. Reports should be prepared by the airport engineer on a recurring cycle at intervals designed to reflect gradual changes in pavement surface conditions. Reports should include, but not be limited to, the following:

- a. Design pavement structure data. A form, such as Figure A-1, to include the history of all airport pavements, from original construction to the most recent changes and additions.

- b. Pavement structural evaluation summary. If available, a summary of the last structural evaluation data (see Figure A-2).
- c. Pavement maintenance record. When, where, and what type of maintenance has been performed (see Figure A-3).
- d. Aircraft traffic data survey. Types of aircraft, typical gross loads, and airport facilities most likely used by the aircraft; also, the frequency of operations (see Figure A-4).
- e. Plans and cross sections.
  - (1) Airport layout plan. The airport layout plan should depict airport pavements existing at the time of the condition survey. All airport facilities should be delineated and identified.
  - (2) Condition rating. An airport layout plan keyed to indicate the narrative condition rating of each feature. The feature PCI's should be indicated, possibly in tabular form.
  - (3) Drainage. Existing problem areas should be identified. Surface and subsurface drainage should be shown in plan and profile for all areas near to and intersecting with airport pavements.
- f. Narrative. A narrative consisting of a written account of the visual condition of each feature. The purposes of the narrative are:
  - (1) To briefly describe the general condition of the pavement facilities.
  - (2) To describe operational conditions and problems.
  - (3) To describe the condition of other airport facilities found near the load-bearing pavements such as runway shoulders and overrun areas.
- g. Photographs. Photographs showing typical or specific pavement conditions. An aerial photograph, current within 3 years, is desirable.

AIRPORT  
PAVEMENT STRUCTURAL EVALUATION SUMMARY

FACILITY	LOCATION	DATE OF EVALUATION	TYPE OF EVALUATION	EVALUATED BY	ALLOWABLE LOAD (AIRCRAFT, LOAD, DEPARTURES)	THICKNESS AND TYPE OF OVERLAY RECOMMENDED

Figure A-2. Pavement structural evaluation summary

AIRPORT

TRAFFIC DATA SURVEY      REVISED

TYPE OF OPERATION	AIRCRAFT OPERATOR	TYPE AIRCRAFT	FACILITY MOST FREQUENTLY USED		TYPICAL GROSS WEIGHT	DEPARTURES PER DAY
			RUNWAY	TAXIWAY APRON		
AIR CARRIER						
COMMUTER						
CARGO						
MILITARY						

Figure A-4. Traffic data survey



STEP 1. DIVIDE PAVEMENTS INTO FEATURES.

STEP 2. DIVIDE PAVEMENT FEATURE INTO SAMPLE UNITS.

STEP 3. INSPECT SAMPLE UNITS; DETERMINE DISTRESS TYPES AND SEVERITY LEVELS AND MEASURE DENSITY.

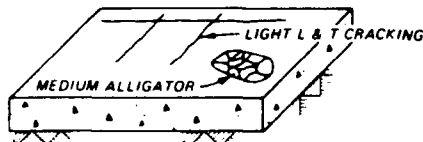

STEP 4. DETERMINE DEDUCT VALUES

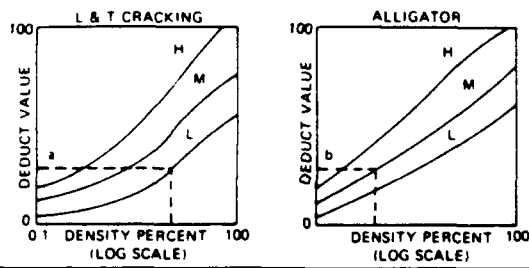

STEP 5. COMPUTE TOTAL DEDUCT VALUE (TDV)  $a + b$

STEP 6. ADJUST TOTAL DEDUCT VALUE

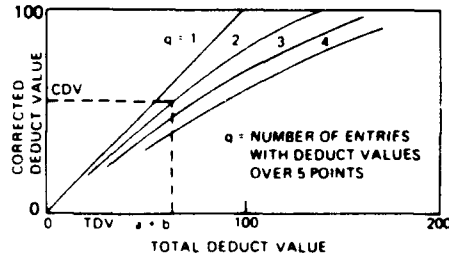

STEP 7. COMPUTE PAVEMENT CONDITION INDEX  
(PCI) = 100 - CDV FOR EACH SAMPLE UNIT INSPECTED.

STEP 8. COMPUTE PCI OF ENTIRE FEATURE (AVERAGE PCI'S OF SAMPLE UNITS).

STEP 9. DETERMINE PAVEMENT CONDITION RATING OF FEATURE.

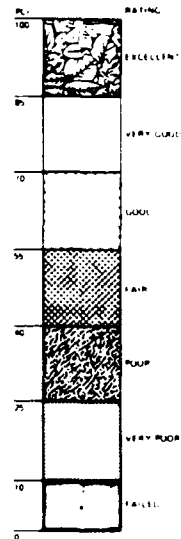

Figure A-5. Steps for determining PCI of a pavement feature

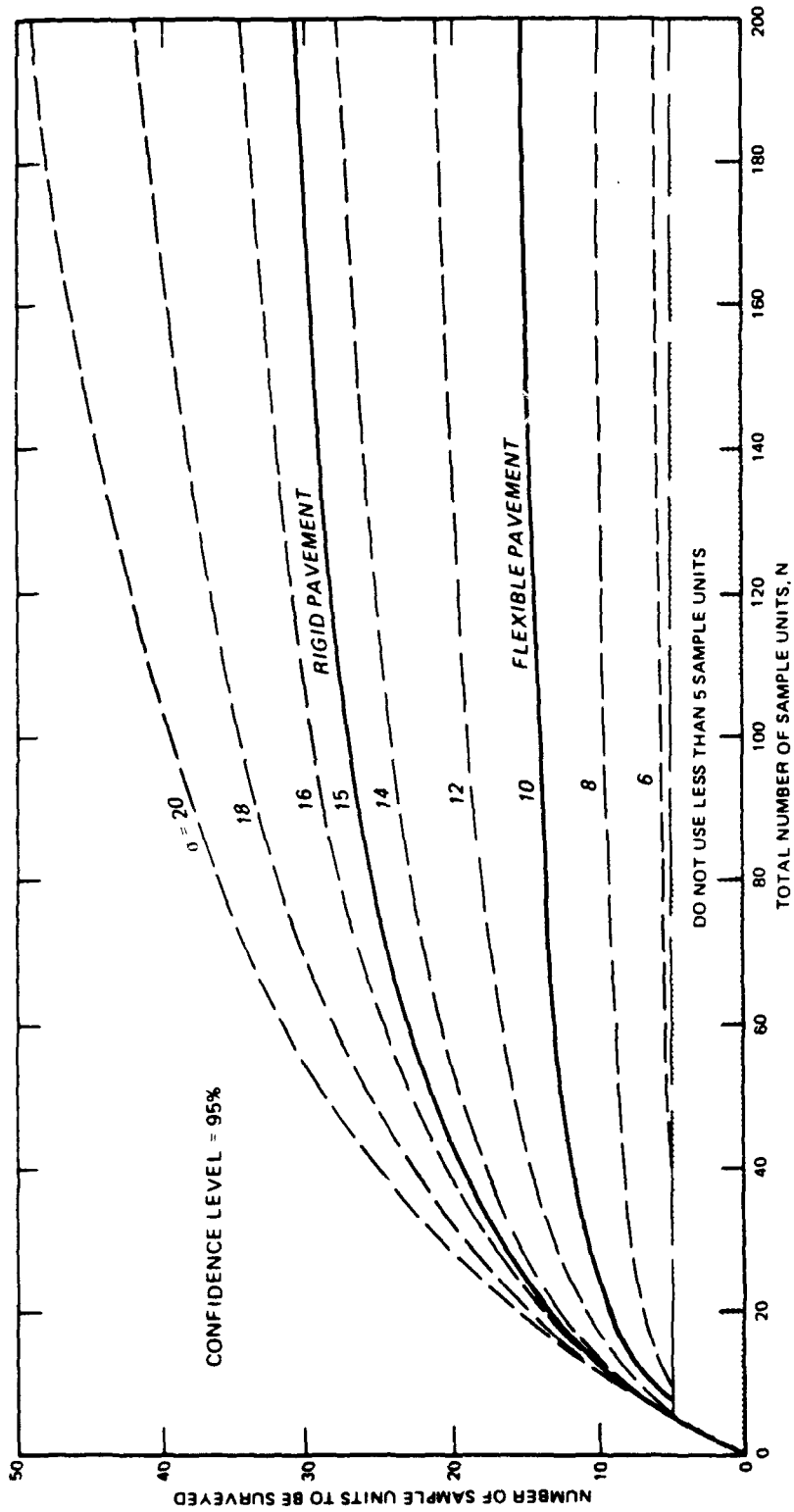

Figure A-6. Selection of minimum number of sample units

JOINTED RIGID PAVEMENT CONDITION SURVEY DATA SHEET FOR SAMPLE UNIT			
AIRPORT WORLD INTERNATIONAL			DATE 5/26/79
FACILITY RWY 9-27	FEATURE R3		SAMPLE UNIT 12
SURVEYED BY JH/DE		SLAB SIZE 12.5 X 15 FT	

DISTRESS TYPES	
1. BLOW-UP	10. SCALING/MAP CRACK/CRAZING
2. CORNER BREAK	11. SETTLEMENT/FAULT
3. LONGITUDINAL/TRANSVERSE/DIAGONAL CRACK	12. SHATTERED SLAB
4. "D" CRACK	13. SHRINKAGE CRACK
5. JOINT SEAL DAMAGE	14. SPALLING -- JOINTS
6. PATCHING, <5 FT <sup>2</sup>	15. SPALLING -- CORNER
7. PATCHING/UTILITY CUT	
8. POPOUTS	
9. PUMPING	

DIST. TYPE	SEV.	NO. SLABS	DENSITY %	DEDUCT VALUE
2	L	1	5	4
3	L	3	15	11
3	M	1	5	11
10	M	1	5	7
12	L	1	5	10
15	L	2	10	3
DEDUCT TOTAL				46
CORRECTED DEDUCT VALUE (CDV)				32
PCI = 100 - CDV = <u>68</u> RATING = <u>GOOD</u>				

Figure A-9. Jointed rigid pavements - condition survey data sheet

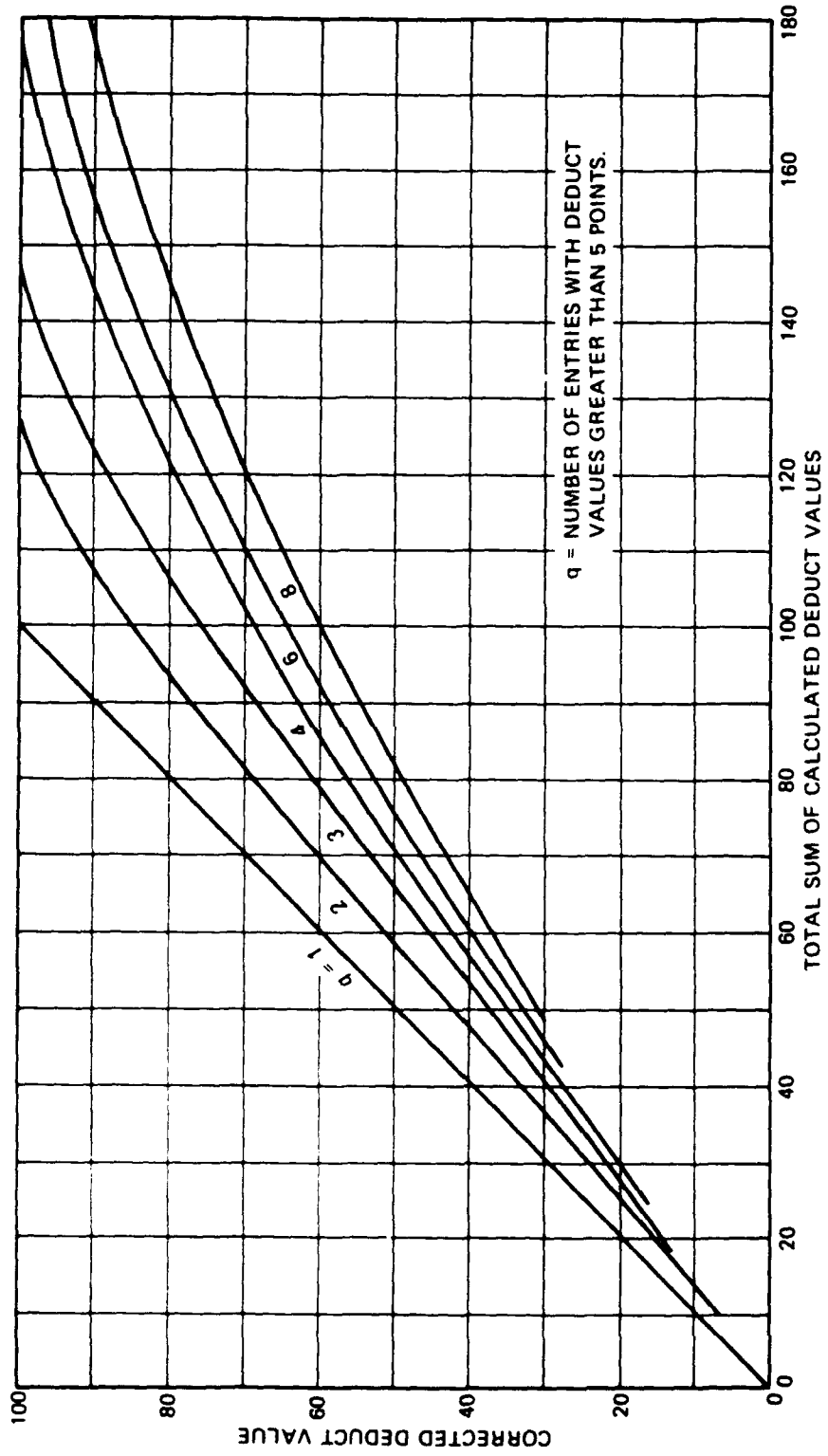

Figure A-25. Corrected deduct values for jointed rigid pavements

Airport: World International

Airport Facility: Taxiway 1

Total No. of Sample Units: 5

Date of Survey: 15 March 1979

<u>Sample Unit No.</u>	<u>No. of Slabs</u>	<u>Slab Size</u>	<u>PCI</u>
1	20	12.5 x 15	68
2	20	12.5 x 15	64
3	20	12.5 x 15	64
4	20	12.5 x 15	74
5	20	12.5 x 15	28

<u>Sample Unit No.</u>	<u>No. of Slabs</u>	<u>Slab Size</u>	<u>PCI</u>

Average PCI for Feature: 62

Condition Rating: Good

Figure A-27. Feature summary - jointed rigid pavement

FLEXIBLE PAVEMENT CONDITION SURVEY DATA SHEET FOR SAMPLE UNIT						
AIRPORT WORLD INTERNATIONAL					DATE 5/26/79	
FACILITY TXY E		FEATURE T-11		SAMPLE UNIT 4		
SURVEYED BY JH/DE			AREA OF SAMPLE 5000 SQ FT			
DISTRESS TYPES			SKETCH			
1 ALLIGATOR CRACKING      10. PATCHING 2 BLEEDING                    11. POLISHED AGGREGATE 3. BLOCK CRACKING        12. RAVELING/WEATHERING 4. CORRUGATION            13. RUTTING 5. DEPRESSION            14. SHOIVING FROM PCC 6. JET BLAST                15. SLIPPAGE CRACKING 7. JT. REFLECTION (PCC)   16. SWELL 8. LONG. & TRANS. CRACKING 9. OIL SPILLAGE						
EXISTING DISTRESS TYPES						
TOTAL SEVERITY	L	6 SQ FT	24 SQ FT	40 FT		
	M	16 SQ FT		10 FT	30 SQ FT	
	H					
PCI CALCULATION						
DISTRESS TYPE	SEVERITY	DENSITY %	DEDUCT VALUE	PCI = 100 - CDV = <u>75</u>  RATING = <u>VERY GOOD</u>		
1	L	0.22	7			
1	M	0.32	19			
5	L	0.48	2			
8	L	0.80	5			
8	M	0.20	5			
12	M	0.60	7			
DEDUCT TOTAL			45			
CORRECTED DEDUCT VALUE (CDV)			25			

Figure A-28. Flexible pavements - condition survey data sheet

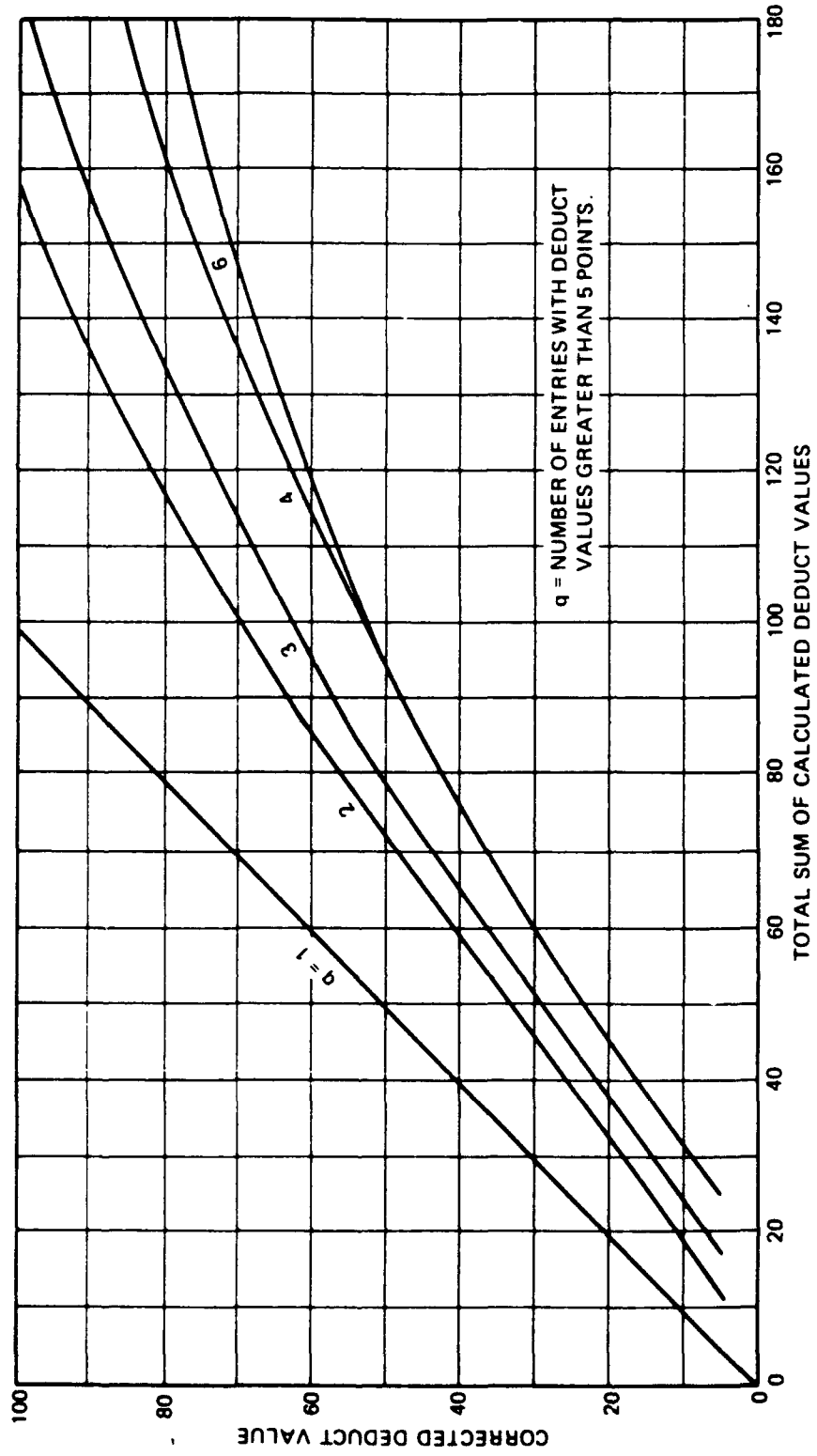

Figure A-45. Corrected deduct values for flexible pavements

## **APPENDIX D**

### **MINITAB SOFTWARE CALCULATIONS AND MODELS DERIVED**

#### **INCLUDES ALL PAVEMENT CATEGORIES**

- 1. APPLICABLE DATA POINTS**
- 2. REGRESSION ANALYSIS OF WASHINGTON DATA**
- 3. REGRESSION ANALYSIS OF OREGON DATA**
- 4. COMBINED STATES DATA REGRESSION ANALYSIS**







## RSCH PLOT DATA

Wed, Mar 4, 1992 2:48 PM

	>3"/B AGE	>3"/B PCI	AC OL AGE	AC OL PCI	BST AGE	BST PCI	SS AGE	SS PCI
1	0.000	100.000	0.000	100.000	0.000	100.000	0.000	100.000
2	13.000	83.000	13.000	96.000	12.000	61.000	17.000	60.000
3	17.000	75.000	16.000	91.000	15.000	34.000	21.000	55.000
4	13.000	86.000	10.000	89.000	2.000	82.000	17.000	53.000
5	17.000	80.000	13.000	84.000	5.000	60.000	21.000	43.000
6	18.000	81.000	13.000	88.000	1.000	98.000	7.000	72.000
7	21.000	68.000	17.000	83.000	4.000	95.000	11.000	70.000
8	2.000	90.000	1.000	97.000	2.000	79.000	2.000	68.000
9	6.000	86.000	5.000	90.000	6.000	46.000	6.000	49.000
10	27.000	93.000	3.000	89.000	2.000	58.000	12.000	88.000
11	31.000	91.000	7.000	81.000	6.000	50.000	15.000	70.000
12			8.000	86.000	3.000	52.000	9.000	77.000
13			11.000	84.000	6.000	42.000	12.000	72.000
14			12.000	68.000	1.000	73.000	5.000	57.000
15			15.000	65.000	4.000	68.000	8.000	40.000
16			11.000	79.000	3.000	91.000	2.000	83.000
17			15.000	74.000	7.000	88.000	6.000	77.000
18			10.000	72.000	8.000	80.000	2.000	71.000
19			13.000	58.000	12.000	77.000	6.000	68.000
20			10.000	68.000			1.000	77.000
21			13.000	59.000			5.000	57.000
22			14.000	75.000			1.000	65.000
23			17.000	70.000			5.000	64.000
24			1.000	92.000				
25			4.000	83.000				
26			10.000	87.000				
27			14.000	83.000				
28			2.000	83.000				
29			6.000	76.000				
30			7.000	87.000				
31			11.000	79.000				
32			7.000	77.000				
33			11.000	68.000				
34			4.000	92.000				
35			8.000	89.000				
36			1.000	91.000				
37			5.000	89.000				

PLOT DATA (WA)

Wed, Mar 4, 1992 2:44

	>3"/B AGE	>3"/B PCI	AC OL AGE	AC OL PCI	BST AGE	BST PCI	SS AGE	SS PCI
1	0.000	100.000	0.000	100.000	0.000	100.000	0.000	100.000
2	13.000	83.000	13.000	96.000	12.000	61.000	17.000	60.000
3	17.000	75.000	16.000	91.000	15.000	34.000	21.000	55.000
4	13.000	86.000	10.000	89.000	2.000	82.000	17.000	53.000
5	17.000	80.000	13.000	84.000	5.000	60.000	21.000	43.000
6	18.000	81.000	13.000	88.000	1.000	98.000	7.000	72.000
7	21.000	68.000	17.000	83.000	4.000	95.000	11.000	70.000
8			1.000	97.000	2.000	79.000	2.000	68.000
9			5.000	90.000	6.000	46.000	6.000	49.000
10			3.000	89.000	2.000	58.000	12.000	88.000
11			7.000	81.000	6.000	50.000	15.000	70.000
12			8.000	86.000	3.000	52.000	9.000	77.000
13			11.000	84.000	6.000	42.000	12.000	72.000
14			12.000	68.000	1.000	73.000	5.000	57.000
15			15.000	65.000	4.000	68.000	8.000	40.000
16			11.000	79.000	3.000	91.000	2.000	83.000
17			15.000	74.000	7.000	88.000	6.000	77.000
18			10.000	72.000				
19			13.000	58.000				
20			10.000	68.000				
21			13.000	59.000				
22			14.000	75.000				
23			17.000	70.000				
24			1.000	92.000				
25			4.000	83.000				

## PLOT DATA (OR)

Wed, Mar 4, 1992 2:31

	2-3*AC/6-8B	2-3/6-8 PCI	2-3/>8 AGE	2-3/>8 PCI	>3*/B AGE	>3*/B PCI	AC OL AGE	AC OL PCI
1	37.000	79.000	0.000	100.000	0.000	100.000	0.000	100.00
2	41.000	75.000	1.000	96.000	27.000	93.000	10.000	87.00
3	23.000	88.000	5.000	92.000	31.000	91.000	14.000	83.00
4	27.000	83.000	1.000	95.000	2.000	90.000	2.000	83.00
5	4.000	88.000	5.000	90.000	6.000	86.000	6.000	76.00
6	8.000	77.000					7.000	87.00
7	2.000	92.000					11.000	79.00
8	6.000	88.000					7.000	77.00
9							11.000	68.00
10							4.000	92.00
11							8.000	89.00
12							1.000	91.00
13							5.000	89.00

PLOT DATA (OR)

Wed, Mar 4, 1992 2:39 PM

	BST AGE	BST PCI	SS AGE	SS PCI	PCC AGE	PCC PCI
1	0.000	100.000	0.000	100.000	0.000	100.000
2	8.000	80.000	2.000	71.000	1.000	94.000
3	12.000	77.000	6.000	68.000	5.000	78.000
4			1.000	77.000		
5			5.000	57.000		
6			1.000	65.000		
7			5.000	64.000		
8						
9						
10						
11						
12						
13						

## WASHINGTON PAVEMENTS

2 - 3 INCHES OF AC  
ON  
6 - 8 INCHES OF BASE.

Includes: Regression Equations  
R-squared (Confidence associated with the regression model)  
t-ratio (Predictability of the dependent variable from the independent variable)  
(Higher values better - typically  $> 4$ )  
s or SEE (Estimate error factor - lower values are better)

Notes: c1 represents the dependent variable PCI.  
c2 represents the independent variable AGE.  
c3, c4, c5 are AGE raised to 1.5, 2, 2.5 powers, respectively.  
Equations with c6 and c7 are raised to the 3 and 3.5 powers.

The regression equation is  
 $\hat{Y}_1 = 99.1 - 2.14 C_2$

Predictor	Coef	Stdev	t-ratio
Constant	99.11	11.58	8.56
C <sub>2</sub>	-2.1406	0.7703	-2.78

S = 19.20      R-sq = 34.0%      R-sq(adj) = 29.6%

Analysis of Variance

SOURCE	DF	SS	MS
Regression	1	2845.7	2845.7
Error	15	5528.2	368.5
Total	16	8373.9	

Unusual Observations

Obs.	C <sub>2</sub>	C <sub>1</sub>	Fit	Stdev. Fit	Residual	St. Resid
1	0.0	100.00	99.11	11.58	0.89	0.06 X
10	14.0	29.00	69.14	4.66	-40.14	-2.16R
11	18.0	18.00	60.58	5.69	-42.58	-2.32R

R denotes an obs. with a large st. resid.  
 CONTINUE?

ATA> 80 12  
 ATA> 83 15  
 ATA> end  
 15 ROWS READ  
 ATB> regress c1 1 c2

The regression equation is  
 $\hat{Y}_1 = 99.6 - 1.78 C_2$

Predictor	Coef	Stdev	t-ratio
Constant	99.827	6.669	14.97
C <sub>2</sub>	-1.7842	0.4481	-3.98

S = 10.99      R-sq = 54.9%      R-sq(adj) = 51.5%

Analysis of Variance

SOURCE	DF	SS	MS
Regression	1	1915.5	1915.5
Error	13	1570.9	120.8
Total	14	3486.4	

ATB >



```
MTB > let c3=c2**1.5
      > regress c1 1 c3
```

The regression equation is  
 $C1 = 95.0 - 0.356 C3$

Predictor	Coef	Stdev	t-ratio
Constant	95.033	5.622	16.90
C3	-0.35619	0.08980	-3.97

s = 11.02      R-sq = 54.8%      R-sq(adj) = 51.3%

Analysis of Variance

SOURCE	DF	SS	MS
Regression	1	1908.9	1908.9
Error	13	1577.5	121.3
Total	14	3486.4	

```
MTB >
```

```
MTB > regress c1 1 c4
```

The regression equation is  
 $C1 = 91.7 - 0.0717 C4$

Predictor	Coef	Stdev	t-ratio
Constant	91.669	5.049	18.16
C4	-0.07166	0.01868	-3.84

s = 11.21      R-sq = 53.1%      R-sq(adj) = 49.5%

Analysis of Variance

SOURCE	DF	SS	MS
Regression	1	1851.4	1851.4
Error	13	1635.0	125.8
Total	14	3486.4	

Unusual Observations

Obs.	C4	C1	Fit	Stdev.Fit	Residual	St.Resid
7	576	51.00	50.40	7.23	0.60	0.07 X

\* denotes an obs. whose X value gives it large influence.

```
MTB >
```

MTB > regress c1 1 c5

The regression equation is  
C1 = 89.1 - 0.0144 C5

Predictor	Coef	Stdev	t-ratio
Constant	89.150	4.691	19.01
C5	-0.014438	0.003933	-3.67

s = 11.48      R-sq = 50.9%      R-sq(adj) = 47.1%

Analysis of Variance

SOURCE	DF	SS	MS
Regression	1	1774.6	1774.6
Error	13	1711.8	131.7
Total	14	3486.4	

Unusual Observations

Obs.	C5	C1	Fit	Stdev.Fit	Residual	St.Resid
7	2832	51.00	48.41	8.03	2.59	0.32 X

X denotes an obs. whose X value gives it large influence.

MTB >

MTB > regress c1 1 c6

The regression equation is  
C1 = 87.2 - 0.00291 C6

Predictor	Coef	Stdev	t-ratio
Constant	87.192	4.449	19.60
C6	-0.0029071	0.0008305	-3.50

s = 11.75      R-sq = 48.5%      R-sq(adj) = 44.6%

Analysis of Variance

SOURCE	DF	SS	MS
Regression	1	1691.6	1691.6
Error	13	1794.8	138.1
Total	14	3486.4	

Unusual Observations

Obs.	C6	C1	Fit	Stdev.Fit	Residual	St.Resid
7	13824	51.00	47.00	8.77	4.00	0.51 X

X denotes an obs. whose X value gives it large influence.

MTB >

## OREGON PAVEMENTS

2 - 3 INCHES OF AC  
ON  
6 - 8 INCHES OF BASE

Includes: Regression Equations  
R-squared (*Confidence associated with the regression model*)  
t-ratio (*Predictability of the dependent variable from the independent variable*)  
(Higher values better - typically > 4)  
s or SEE (*Estimate error factor - lower values are better*)

Notes: c1 represents the dependent variable PCI.  
c2 represents the independent variable AGE.  
c3, c4, c5 are AGE raised to 1.5, 2, 2.5 powers, respectively.  
Equations with c6 and c7 are raised to the 3 and 3.5 powers.

MTB > regress c1 1 c2

The regression equation is  
 $C1 = 91.5 - 0.361 C2$

Predictor	Coef	Stdev	t-ratio
Constant	91.486	2.926	31.27
C2	-0.3607	0.1319	-2.73

s = 5.890      R-sq = 51.6%      R-sq(adj) = 44.7%

Analysis of Variance

SOURCE	DF	SS	MS
Regression	1	259.39	259.39
Error	7	242.63	34.69
Total	8	502.02	

Unusual Observations

Obs.	C2	C1	Fit	Stdev.Fit	Residual	St. Resid
7	8.0	77.00	88.60	2.26	-11.60	-2.13R

\* denotes an obs. with a large st. resid.

MTB >

MTB > regress c1 1 c3

The regression equation is  
 $C1 = 90.0 - 0.0533 C3$

Predictor	Coef	Stdev	t-ratio
Constant	90.216	2.767	32.61
C3	-0.05334	0.02127	-2.51

s = 6.148      R-sq = 47.3%      R-sq(adj) = 39.8%

Analysis of Variance

SOURCE	DF	SS	MS
Regression	1	237.67	237.67
Error	7	264.56	37.79
Total	8	502.22	

Unusual Observations

Obs.	C3	C1	Fit	Stdev.Fit	Residual	St. Resid
7	23	77.00	89.01	2.47	-12.01	-2.13R

\* denotes an obs. with a large st. resid.

MTB >

MTB > regress c1 1 c4

The regression equation is  
C1 = 89.6 - 0.00829 C4

Predictor	Coef	Stdev	t-ratio
Constant	89.635	2.674	33.52
C4	-0.008293	0.003416	-2.43

s = 6.241      R-sq = 45.7%      R-sq(adj) = 38.0%

Analysis of Variance

SOURCE	DF	SS	MS
Regression	1	229.56	229.56
Error	7	272.66	38.95
Total	8	502.22	

Unusual Observations

Obs.	C4	C1	Fit	Stdev.Fit	Residual	St.Resid
7	64	77.00	89.10	2.54	-12.10	-2.12R

R denotes an obs. with a large st. resid.

MTB >

3 > regress c1 1 c5

The regression equation is  
C1 = 89.3 - 0.00130 C5

Predictor	Coef	Stdev	t-ratio
Constant	89.285	2.613	34.17
C5	-0.0013048	0.0005461	-2.39

s = 6.286      R-sq = 44.9%      R-sq(adj) = 37.1%

Analysis of Variance

SOURCE	DF	SS	MS
Regression	1	225.61	225.61
Error	7	276.61	39.52
Total	8	502.22	

Unusual Observations

Obs.	C5	C1	Fit	Stdev.Fit	Residual	St.Resid
7	181	77.00	89.05	2.55	-12.05	-2.10R

R denotes an obs. with a large st. resid.

MTB >

## COMBINED PAVEMENTS

2 - 3 INCHES OF AC  
ON  
6 - 8 INCHES OF BASF

Includes: Regression Equations  
R-squared (Confidence associated with the regression model)  
t-ratio (Predictability of the dependent variable from the independent variable)  
(Higher values better - typically > 4)  
s or SEE (Estimate error factor - lower values are better)

Notes: c1 represents the dependent variable PCI.  
c2 represents the independent variable AGE.  
c3, c4, c5 are AGE raised to 1.5, 2, 2.5 powers, respectively.  
Equations with c6 and c7 are raised to the 3 and 3.5 powers.

The regression equation is  
 $C1 = 82.0 - 0.486 C2$

Predictor	Coef	Stdev	t-ratio
Constant	81.968	7.961	10.30
C2	-0.4855	0.4280	-1.13

s = 20.01      R-sq = 5.3%      R-sq(adj) = 1.2%

Analysis of Variance

SOURCE	DF	SS	MS
Regression	1	515.3	515.3
Error	23	9208.0	400.3
Total	24	9723.4	

Unusual Observations

Obs.	C2	C1	Fit	Stdev.Fit	Residual	St. Resid
10	14.0	29.00	75.17	4.10	-46.17	-2.36R
11	18.0	18.00	73.23	4.09	-55.23	-2.82R
20	37.0	79.00	64.00	9.81	15.00	0.86 X
21	41.0	75.00	62.06	11.39	12.94	0.79 X

CONTINUE?

The regression equation is  
 $C1 = 77.7 - 0.0488 C3$

Predictor	Coef	Stdev	t-ratio
Constant	77.704	6.307	12.32
C3	-0.04879	0.06639	-0.73

s = 20.32      R-sq = 2.3%      R-sq(adj) = 0.0%

Analysis of Variance

SOURCE	DF	SS	MS
Regression	1	223.1	223.1
Error	23	9500.3	413.1
Total	24	9723.4	

Unusual Observations

Obs.	C3	C1	Fit	Stdev.Fit	Residual	St. Resid
10	52	29.00	75.15	4.28	-46.15	-2.32R
11	76	18.00	73.98	4.07	-55.98	-2.81R
20	225	79.00	66.72	10.91	12.28	0.72 X
21	263	75.00	64.90	13.25	10.10	0.66 X

CONTINUE?

The regression equation is  
 $C1 = 75.8 - 0.0047 C4$

Predictor	Coef	Stdev	t-ratio
Constant	75.775	5.457	13.89
C4	-0.0047	0.0001	-47.00

Analysis of Variance

SOURCE	DF	SS	MS
Regression	1	84.0	84.0
Error	23	9639.3	419.1
Total	24	9723.4	

Unusual Observations

Obs.	C4	C1	Fit	Stdev.Fit	Residual	St. Resid
10	196	29.00	74.86	4.38	-45.86	-2.29R
11	324	18.00	74.26	4.10	-56.26	-2.81R
20	1369	79.00	69.38	11.42	9.62	0.57 X
21	1681	75.00	67.93	14.51	7.07	0.49 X

CONTINUE?

The regression equation is

$$C1 = 74.9 - 0.00041 C5$$

Predictor	Coef	Stdev	t-ratio
Constant	74.864	4.992	15.00
C5	-0.000407	0.001642	-0.25

s = 20.53      R-sq = 0.3%      R-sq(adj) = 0.0%

Analysis of Variance

SOURCE	DF	SS	MS
Regression	1	25.9	25.9
Error	23	9697.5	421.6
Total	24	9723.4	

Unusual Observations

Obs.	C5	C1	Fit	Stdev.Fit	Residual	St. Resid
10	733	29.00	74.57	4.42	-45.57	-2.27R
11	1375	18.00	74.30	4.15	-56.30	-2.80R
20	8327	79.00	71.48	11.58	7.52	0.44 X
21	10764	75.00	70.48	15.39	4.52	0.33 X

CONTINUE?



The regression equation is  
 $C1 = 99.2 - 1.99 C2$

Predictor	Coef	Stdev	t-ratio
Constant	99.17	11.55	8.59
C2	-1.9854	0.7712	-2.57

s = 19.65      R-sq = 28.0%      R-sq(adj) = 23.8%

Analysis of Variance

SOURCE	DF	SS	MS
Regression	1	2558.9	2558.9
Error	17	6564.3	386.1
Total	18	9123.2	

Unusual Observations

Obs.	C2	C1	Fit	Stdev.Fit	Residual	St. Resid
1	0.0	100.00	99.17	11.55	0.83	0.05 X
10	14.0	29.00	71.37	4.51	-42.37	-2.22R
11	18.0	18.00	63.43	5.56	-45.43	-2.41R

R denotes an obs. with a large st. resid.  
 CONTINUE?

The regression equation is  
 $C1 = 93.8 - 0.398 C3$

Predictor	Coef	Stdev	t-ratio
Constant	93.753	9.721	9.64
C3	-0.3985	0.1561	-2.55

s = 19.70      R-sq = 27.7%      R-sq(adj) = 23.4%

Analysis of Variance

SOURCE	DF	SS	MS
Regression	1	2527.0	2527.0
Error	17	6596.1	388.0
Total	18	9123.2	

Unusual Observations

Obs.	C3	C1	Fit	Stdev.Fit	Residual	St. Resid
10	52	29.00	72.88	4.54	-43.88	-2.29R
11	76	18.00	63.32	5.61	-45.32	-2.40R

R denotes an obs. with a large st. resid.

The regression equation is  
 $C1 = 89.7 - 0.0797 C4$

Predictor	Coef	Stdev	t-ratio
Constant	89.669	8.574	10.46
C4	-0.07971	0.03236	-2.46

s = 19.89      R-sq = 26.3%      R-sq(adj) = 22.0%

Analysis of Variance

SOURCE	DF	SS	MS
Regression	1	2399.6	2399.6
Error	17	6723.5	395.5
Total	18	9123.2	

Unusual Observations

Obs.	C4	C1	Fit	Stdev.Fit	Residual	St. Resid
7	576	51.00	43.76	12.26	7.24	0.46 X
10	196	29.00	74.05	4.65	-45.05	-2.33R
11	324	18.00	63.84	5.59	-45.84	-2.40R

R denotes an obs. with a large st. resid.  
 CONTINUE?

The regression equation is  
 $C1 = 86.5 - 0.0159 C5$

Predictor	Coef	Stdev	t-ratio
Constant	86.482	7.778	11.12
C5	-0.015860	0.006756	-2.35

s = 20.13      R-sq = 24.5%      R-sq(adj) = 20.0%

Analysis of Variance

SOURCE	DF	SS	MS
Regression	1	2233.6	2233.6
Error	17	6889.5	405.3
Total	18	9123.2	

Unusual Observations

Obs.	C5	C1	Fit	Stdev.Fit	Residual	St. Resid
7	2822	51.00	41.73	13.61	9.27	0.63 X
10	733	29.00	74.85	4.80	-45.85	-2.35R
11	1375	18.00	64.68	5.52	-46.68	-2.41R

R denotes an obs. with a large st. resid.  
 CONTINUE?

**WASHINGTON PAVEMENTS**

**2 - 3 INCHES OF AC  
ON  
GREATER THAN 8 INCHES OF BASE**

X ) regress c1 1 c2

The regression equation is  
 $C1 = 96.4 - 0.853 C2$

Predictor	Coef	Stdev	t-ratio
Constant	96.411	6.457	14.93
C2	-0.8526	0.4684	-1.82

s = 11.87      R-sq = 20.3%      R-sq(adj) = 14.2%

Analysis of Variance

SOURCE	DF	SS	MS
Regression	1	466.5	466.5
Error	13	1830.5	140.8
Total	14	2296.9	

Unusual Observations

Obs.	C2	C1	Fit	Stdev.Fit	Residual	St. Resid
15	21.0	48.00	76.51	5.16	-30.51	-2.86R

R denotes an obs. with a large st. resid.

MTB >

YTB ) regress c1 1 c2

The regression equation is  
 $C1 = 94.6 - 0.877 C2$

Predictor	Coef	Stdev	t-ratio
Constant	94.596	6.148	15.39
C2	-0.8775	0.4547	-1.93

s = 11.76      R-sq = 25.3%      R-sq(adj) = 18.5%

Analysis of Variance

SOURCE	DF	SS	MS
Regression	1	515.3	515.3
Error	11	1522.0	138.4
Total	12	2037.2	

Unusual Observations

Obs.	C2	C1	Fit	Stdev.Fit	Residual	St. Resid
13	21.0	48.00	76.17	5.43	-28.17	-2.70R

R denotes an obs. with a large st. resid.

Z >

MTB > regress c1 1 c3

The regression equation is  
 $C1 = 92.3 - 0.173 C3$

Predictor	Coef	Stdev	t-ratio
Constant	92.310	5.218	17.69
C3	-0.17349	0.09077	-1.91

s = 11.79      R-sq = 24.9%      R-sq(adj) = 18.1%

Analysis of Variance

SOURCE	DF	SS	MS
Regression	1	507.9	507.9
Error	11	1529.4	139.0
Total	12	2037.2	

Unusual Observations

Obs.	C3	C1	Fit	Stdev.Fit	Residual	St.Resid
13	96	48.00	75.61	5.70	-27.61	-2.68R

R denotes an obs. with a large st. resid.

MTB >

MTB > regress c1 1 c4

The regression equation is  
 $C1 = 91.1 - 0.0358 C4$

Predictor	Coef	Stdev	t-ratio
Constant	91.003	4.754	19.16
C4	-0.03579	0.01885	-1.90

s = 11.81      R-sq = 24.7%      R-sq(adj) = 17.8%

Analysis of Variance

SOURCE	DF	SS	MS
Regression	1	503.0	503.0
Error	11	1534.2	139.5
Total	12	2037.2	

Unusual Observations

Obs.	C4	C1	Fit	Stdev.Fit	Residual	St.Resid
13	441	48.00	75.30	5.86	-27.30	-2.66R

R denotes an obs. with a large st. resid.

MTB >

MTB > regress c1 1 c5

The regression equation is  
C1 = 90.3 - 0.00748 C5

Predictor	Coef	Stdev	t-ratio
Constant	90.294	4.490	20.11
C5	-0.007483	0.003981	-1.88

s = 11.84      R-sq = 24.3%      R-sq(adj) = 17.4%

Analysis of Variance

SOURCE	DF	SS	MS
Regression	1	495.3	495.3
Error	11	1542.0	140.2
Total	12	2037.2	

Unusual Observations

Obs.	C5	C1	Fit	Stdev.Fit	Residual	St.Resid
13	2021	48.00	75.17	5.97	-27.17	-2.66R

R denotes an obs. with a large st. resid.

MTB >

The regression equation is  
= 89.7 - 0.00157 C6

Predictor	Coef	Stdev	t-ratio
Constant	89.713	4.326	20.74
C6	-0.0015660	0.0008474	-1.85

s = 11.89      R-sq = 23.7%      R-sq(adj) = 16.8%

Analysis of Variance

SOURCE	DF	SS	MS
Regression	1	482.6	482.6
Error	11	1554.6	141.3
Total	12	2037.2	

Unusual Observations

Obs.	C6	C1	Fit	Stdev.Fit	Residual	St.Resid
5	12167	87.00	70.66	8.20	16.34	1.90 X
13	9261	48.00	75.21	6.03	-27.21	-2.66R

R denotes an obs. with a large st. resid.

X denotes an obs. whose X value gives it large influence.

MTB >

**OREGON PAVEMENTS**

**2 - 3 INCHES OF AC  
ON  
GREATER THAN 8 INCHES OF BASE**

```
DATA> 95 1
      TA> 90 5
DATA> end
      5 ROWS READ
MTB > regress c1 1 c2
```

The regression equation is  
 $C1 = 98.1 - 1.47 C2$

Predictor	Coef	Stdev	t-ratio
Constant	98.138	1.146	85.66
C2	-1.4741	0.3553	-4.15

$s = 1.711$        $R\text{-sq} = 85.2\%$        $R\text{-sq(adj)} = 80.2\%$

Analysis of Variance

SOURCE	DF	SS	MS
Regression	1	50.416	50.416
Error	3	8.784	2.928
Total	4	59.200	

MTB >

```
MTB > let c3=c2**1.5
MTB > regress c1 1 c3
```

The regression equation is  
 $C1 = 97.5 - 0.590 C3$

Predictor	Coef	Stdev	t-ratio
Constant	97.476	1.267	76.92
C3	-0.5903	0.1785	-3.31

$s = 2.061$        $R\text{-sq} = 78.5\%$        $R\text{-sq(adj)} = 71.3\%$

Analysis of Variance

SOURCE	DF	SS	MS
Regression	1	46.458	46.458
Error	3	12.742	4.247
Total	4	59.200	

3 >



MTB > regress c1 c4

\* ERROR \* 2 IS TOO FEW ARGUMENTS

1) regress c1 1 c4

The regression equation is

$$C1 = 97.2 - 0.251 C4$$

Predictor	Coef	Stdev	t-ratio
Constant	97.206	1.307	74.39
C4	-0.25056	0.08258	-3.03

s = 2.202      R-sq = 75.4%      R-sq(adj) = 67.2%

Analysis of Variance

SOURCE	DF	SS	MS
Regression	1	44.650	44.650
Error	3	14.550	4.850
Total	4	59.200	

MTB >

MTB > let c5=c3\*\*2.5

MTB > regress c1 1 c5

The regression equation is

$$C1 = 97.1 - 0.109 C5$$

Predictor	Coef	Stdev	t-ratio
Constant	97.091	1.322	73.44
C5	-0.10943	0.03739	-2.93

s = 2.262      R-sq = 74.1%      R-sq(adj) = 65.4%

Analysis of Variance

SOURCE	DF	SS	MS
Regression	1	43.846	43.846
Error	3	15.354	5.118
Total	4	59.200	

MTB >

**COMBINED PAVEMENTS**

**2 - 3 INCHES OF AC  
ON  
GREATER THAN 8 INCHES OF BASE**

MTB > regress c1 1 c2

The regression equation is  
 $C1 = 96.1 - 0.838 C2$

Predictor	Coef	Stdev	t-ratio
Constant	96.140	4.231	22.72
C2	-0.8384	0.3423	-2.45

s = 10.39      R-sq = 26.1%      R-sq(adj) = 21.7%

Analysis of Variance

SOURCE	DF	SS	MS
Regression	1	647.5	647.5
Error	17	1835.1	107.9
Total	18	2482.6	

Unusual Observations

Obs.	C2	C1	Fit	Stdev. Fit	Residual	St. Resid
15	21.0	48.00	78.53	4.40	-30.53	-3.24R

R denotes an obs. with a large st. resid.

MTB >

MTB > regress c1 1 c3

The regression equation is  
 $C1 = 94.3 - 0.174 C3$

Predictor	Coef	Stdev	t-ratio
Constant	94.303	3.599	26.20
C3	-0.17450	0.07020	-2.49

s = 10.35      R-sq = 26.7%      R-sq(adj) = 22.3%

Analysis of Variance

SOURCE	DF	SS	MS
Regression	1	661.8	661.8
Error	17	1820.8	107.1
Total	18	2482.6	

Unusual Observations

Obs.	C3	C1	Fit	Stdev. Fit	Residual	St. Resid
15	96	48.00	77.51	4.69	-29.51	-3.20R

R denotes an obs. with a large st. resid.

MTB >

The regression equation is  
 $D1 = 93.3 - 0.0373 C4$

Predictor	Coef	Stdev	t-ratio
Constant	93.279	3.277	28.46
C4	-0.03732	0.01484	-2.51

s = 10.32      R-sq = 27.1%      R-sq(adj) = 22.8%

Analysis of Variance

SOURCE	DF	SS	MS
Regression	1	673.1	673.1
Error	17	1809.5	106.4
Total	18	2482.6	

Unusual Observations

Obs.	C4	C1	Fit	Stdev. Fit	Residual	St. Resid
7	529	87.00	73.54	6.07	13.46	1.61 X
15	441	48.00	76.82	4.89	-28.82	-3.17R

R denotes an obs. with a large st. resid.

X denotes an obs. whose X value gives it large influence.

MTB >

The regression equation is  
 $D5 = 92.6 - 0.00802 C5$

Predictor	Coef	Stdev	t-ratio
Constant	92.602	3.087	30.00
C5	-0.008024	0.003172	-2.53

s = 10.30      R-sq = 27.4%      R-sq(adj) = 23.1%

Analysis of Variance

SOURCE	DF	SS	MS
Regression	1	679.0	679.0
Error	17	1803.6	106.1
Total	18	2482.6	

Unusual Observations

Obs.	C5	C1	Fit	Stdev. Fit	Residual	St. Resid
7	2537	87.00	72.25	6.51	14.75	1.85 X
15	2021	48.00	76.39	5.02	-28.39	-3.16R

R denotes an obs. with a large st. resid.

X denotes an obs. whose X value gives it large influence.

MTB >

The regression equation is  
 $C1 = 92.1 - 0.00172 C6$

Predictor	Coef	Stdev	t-ratio
Constant	92.097	2.965	31.07
C6	-0.0017187	0.0006805	-2.53

s = 10.30      R-sq = 27.3%      R-sq(adj) = 23.0%

Analysis of Variance

SOURCE	DF	SS	MS
Regression	1	677.4	677.4
Error	17	1805.2	106.2
Total	18	2482.6	

Unusual Observations

Obs.	C6	C1	Fit	Stdev.Fit	Residual	St.Resid
7	12167	87.00	71.19	6.91	15.81	2.07RX
15	9261	48.00	76.18	5.09	-28.18	-3.15R

R denotes an obs. with a large st. resid.

X denotes an obs. whose X value gives it large influence.

MTE >

COMBINED 2-3  
w/o HIP!

MTB > regress c1 1 c2

The regression equation is  
C1 = 95.9 - 0.961 C2

Predictor	Coef	Stdev	t-ratio
Constant	95.912	4.058	23.64
C2	-0.9606	0.3362	-2.86

s = 9.947      R-sq = 35.2%      R-sq(adj) = 30.9%

Analysis of Variance

SOURCE	DF	SS	MS
Regression	1	807.95	807.95
Error	15	1484.17	98.94
Total	16	2292.12	

Unusual Observations

Obs.	C2	C1	Fit	Stdev.Fit	Residual	St.Resid
13	21.0	48.00	75.74	4.50	-27.74	-3.13R

R denotes an obs. with a large st. resid.

MTB >

MTB > regress c1 1 c3

The regression equation is  
C1 = 93.6 - 0.193 C3

Predictor	Coef	Stdev	t-ratio
Constant	93.640	3.515	26.64
C3	-0.19295	0.06937	-2.78

s = 10.04      R-sq = 34.0%      R-sq(adj) = 29.6%

Analysis of Variance

SOURCE	DF	SS	MS
Regression	1	780.0	780.0
Error	15	1512.1	100.8
Total	16	2292.1	

Unusual Observations

Obs.	C3	C1	Fit	Stdev.Fit	Residual	St.Resid
13	96	48.00	75.07	4.80	-27.07	-3.07R

R denotes an obs. with a large st. resid.

3 >

The regression equation is  
 $C1 = 92.4 - 0.0399 C4$

Predictor	Coef	Stdev	t-ratio
Constant	92.402	3.267	28.28
C4	-0.03990	0.01476	-2.70

s = 10.14      R-sq = 32.7%      R-sq(adj) = 28.3%

Analysis of Variance

SOURCE	DF	SS	MS
Regression	1	750.7	750.7
Error	15	1541.5	102.8
Total	16	2292.1	

Unusual Observations

Obs.	C4	C1	Fit	Stdev. Fit	Residual	St. Resid
5	529	87.00	71.29	6.17	15.71	1.95 X
13	441	48.00	74.81	5.01	-26.81	-3.04R

R denotes an obs. with a large st. resid.  
 X denotes an obs. whose X value gives it large influence.  
 MTR >

The regression equation is  
 $C1 = 91.6 - 0.00834 C5$

Predictor	Coef	Stdev	t-ratio
Constant	91.622	3.136	29.22
C5	-0.008339	0.003176	-2.63

s = 10.23      R-sq = 31.5%      R-sq(adj) = 26.9%

Analysis of Variance

SOURCE	DF	SS	MS
Regression	1	721.8	721.8
Error	15	1570.3	104.7
Total	16	2292.1	

Unusual Observations

Obs.	C5	C1	Fit	Stdev. Fit	Residual	St. Resid
5	2537	87.00	70.47	6.62	16.53	2.12RX
13	2021	48.00	74.77	5.14	-26.77	-3.03R

R denotes an obs. with a large st. resid.  
 X denotes an obs. whose X value gives it large influence.

**WASHINGTON PAVEMENTS  
GREATER THAN 3 INCHES OF AC  
ON  
ANY BASE**



```

DATA> 81 18
      (A) 68 21
DATA> end
      7 ROWS READ
MTB > regress c1 1 c2

```

The regression equation is  
 $C1 = 101 - 1.37 C2$

Predictor	Coef	Stdev	t-ratio
Constant	101.287	3.223	31.43
C2	-1.3739	0.2080	-6.61

$S = 3.486$        $R\text{-sq} = 89.7\%$        $R\text{-sq(adj)} = 87.7\%$

#### Analysis of Variance

SOURCE	DF	SS	MS
Regression	1	530.11	530.11
Error	5	60.75	12.15
Total	6	590.86	

MTB >

```

MTB > let c3=c2**1.5
MTB > regress c1 1 c3

```

The regression equation is  
 $C1 = 99.8 - 0.309 C3$

Predictor	Coef	Stdev	t-ratio
Constant	99.800	2.612	38.20
C3	-0.30895	0.04037	-7.65

$S = 3.049$        $R\text{-sq} = 92.1\%$        $R\text{-sq(adj)} = 90.6\%$

#### Analysis of Variance

SOURCE	DF	SS	MS
Regression	1	544.39	544.39
Error	5	46.47	9.29
Total	6	590.86	

MTB >

```
MTB > let c4=c2**2
      > regress c1 1 c4
```

The regression equation is  
 $C1 = 97.9 - 0.0668 C4$

Predictor	Coef	Stdev	t-ratio
Constant	97.902	2.629	37.24
C4	-0.066815	0.009612	-6.95

s = 3.329      R-sq = 90.6%      R-sq(adj) = 88.7%

Analysis of Variance

SOURCE	DF	SS	MS
Regression	1	535.45	535.45
Error	5	55.41	11.08
Total	6	590.86	

```
MTB >
```

```
MTB > let c5=c2**2.5
      > regress c1 1 c5
```

The regression equation is  
 $C1 = 96.0 - 0.0142 C5$

Predictor	Coef	Stdev	t-ratio
Constant	96.042	2.829	33.94
C5	-0.014191	0.002422	-5.86

s = 3.876      R-sq = 87.3%      R-sq(adj) = 84.7%

Analysis of Variance

SOURCE	DF	SS	MS
Regression	1	515.76	515.76
Error	5	75.10	15.02
Total	6	590.86	

```
MTB >
```

DATA) 90 2  
 TA) 86 6  
 DATA) end  
 5 ROWS READ  
 MTB > regress c1 1 c2

The regression equation is  
 $C1 = 92.7 - 0.051 C2$

Predictor	Coef	Stdev	t-ratio
Constant	92.676	3.733	24.83
C2	-0.0512	0.2007	-0.26

s = 5.881      R-sq = 2.1%      R-sq(adj) = 0.0%

#### Analysis of Variance

SOURCE	DF	SS	MS
Regression	1	2.25	2.25
Error	3	103.75	34.58
Total	4	106.00	

MTB >

MTB > let c3=c2\*\*1.5  
 MTB > regress c1 1 c3

The regression equation is  
 $C1 = 92.3 - 0.0045 C3$

Predictor	Coef	Stdev	t-ratio
Constant	92.299	3.541	26.07
C3	-0.00453	0.03551	-0.13

s = 5.928      R-sq = 0.5%      R-sq(adj) = 0.0%

#### Analysis of Variance

SOURCE	DF	SS	MS
Regression	1	0.57	0.57
Error	3	105.43	35.14
Total	4	106.00	

MTB >

**OREGON PAVEMENTS**  
**GREATER THAN 3 INCHES OF AC**  
**ON**  
**ANY BASE**

OK / 2 AL  
w/o H/F

```
DATA> 90 2  
A) 86 6  
DATA> end  
3 ROWS READ  
MTB > regress c1 1 c2
```

The regression equation is  
 $C1 = 97.7 - 2.14 C2$

Predictor	Coef	Stdev	t-ratio
Constant	97.714	3.614	27.04
C2	-2.1429	0.9897	-2.17

s = 4.276      R-sq = 82.4%      R-sq(adj) = 64.8%

Analysis of Variance

SOURCE	DF	SS	MS
Regression	1	85.71	85.71
Error	1	18.29	18.29
Total	2	104.00	

```
MTB > let c3=c2**1.5
```

```
MTB > let c3=c2**1.5  
MTB > regress c1 1 c3
```

The regression equation is  
 $C1 = 96.5 - 0.772 C3$

Predictor	Coef	Stdev	t-ratio
Constant	96.507	4.404	21.91
C3	-0.7716	0.5097	-1.51

s = 5.621      R-sq = 69.6%      R-sq(adj) = 39.2%

Analysis of Variance

SOURCE	DF	SS	MS
Regression	1	72.40	72.40
Error	1	31.60	31.60
Total	2	104.00	

```
MTB >
```

MTB > regress c1 1 c4

The regression equation is  
C1 = 95.8 - 0.288 C4

Predictor	Coef	Stdev	t-ratio
Constant	95.836	4.714	20.33
C4	-0.2877	0.2254	-1.28

s = 6.290      R-sq = 62.0%      R-sq(adj) = 23.9%

Analysis of Variance

SOURCE	DF	SS	MS
Regression	1	64.44	64.44
Error	1	39.56	39.56
Total	2	104.00	

Unusual Observations

Obs.	C4	C1	Fit	Stdev.Fit	Residual	St.Resid
3	36.0	86.00	85.48	6.27	0.52	1.00 X

X denotes an obs. whose X value gives it large influence.

MTB >

MTB > regress c1 1 c5

The regression equation is  
C1 = 95.5 - 0.111 C5

Predictor	Coef	Stdev	t-ratio
Constant	95.469	4.852	19.68
C5	-0.11090	0.09510	-1.17

s = 6.638      R-sq = 57.6%      R-sq(adj) = 15.3%

Analysis of Variance

SOURCE	DF	SS	MS
Regression	1	59.93	59.93
Error	1	44.07	44.07
Total	2	104.00	

Unusual Observations

Obs.	C5	C1	Fit	Stdev.Fit	Residual	St.Resid
3	88.2	86.00	85.69	6.63	0.31	1.00 X

X denotes an obs. whose X value gives it large influence.

MTB >

**COMBINED PAVEMENTS**  
**GREATER THAN 3 INCHES OF AC**  
**ON**  
**ANY BASE**

DATA> 93 27  
 (A) 91 31  
 DATA> end  
 11 ROWS READ  
 MTB > regress c1 1 c2

The regression equation is  
 $C1 = 89.9 - 0.313 C2$

Predictor	Coef	Stdev	t-ratio
Constant	89.935	5.088	17.68
C2	-0.3131	0.2846	-1.10

s = 8.916      R-sq = 11.9%      R-sq(adj) = 2.1%

Analysis of Variance

SOURCE	DF	SS	MS
Regression	1	96.24	96.24
Error	9	715.40	79.49
Total	10	811.64	

MTB >

MTB > let c3=c2\*\*1.5  
 MTB > regress c1 1 c3

The regression equation is  
 $C1 = 87.5 - 0.0340 C3$

Predictor	Coef	Stdev	t-ratio
Constant	87.516	4.635	18.86
C3	-0.03401	0.05380	-0.63

s = 9.292      R-sq = 4.3%      R-sq(adj) = 0.0%

Analysis of Variance

SOURCE	DF	SS	MS
Regression	1	34.51	34.51
Error	9	777.12	86.35
Total	10	811.64	

MTB >



MTB > let c4=c2\*\*2  
 > regress c1 1 c4

The regression equation is  
 $C1 = 86.1 - 0.00273 C4$

Predictor	Coef	Stdev	t-ratio
Constant	86.051	4.264	20.18
C4	-0.00273	0.009915	-0.27

S = 9.457      R-sq = 0.8%      R-sq(adj) = 0.0%

Analysis of Variance

SOURCE	DF	SS	MS
Regression	1	6.72	6.72
Error	9	804.92	89.44
Total	10	811.64	

MTB >

MTB > regress c1 1 c5

The regression equation is  
 $C1 = 85.2 + 0.00000 C5$

Predictor	Coef	Stdev	t-ratio
Constant	85.177	3.961	21.51
C5	0.000003	0.001795	0.00

S = 9.496      R-sq = 0.0%      R-sq(adj) = 0.0%

Analysis of Variance

SOURCE	DF	SS	MS
Regression	1	0.00	0.00
Error	9	811.64	90.18
Total	10	811.64	

Unusual Observations

Obs.	C5	C1	Fit	Stdev.Fit	Residual	St.Resid
11	5351	91.00	85.19	7.44	5.81	0.98 X

X denotes an obs. whose X value gives it large influence.

MTB >

```
DATA> 91 1
      (A) 89 5
DATA> end
      9 ROWS READ
MTB > regress c1 1 c2
```

The regression equation is  
 $C1 = 96.5 - 1.10 C2$

Predictor	Coef	Stdev	t-ratio
Constant	96.519	2.498	38.64
C2	-1.1017	0.1814	-6.07

s = 3.982      R-sq = 84.0%      R-sq(adj) = 81.8%

Analysis of Variance

SOURCE	DF	SS	MS
Regression	1	584.98	584.98
Error	7	111.02	15.86
Total	8	696.00	

MTB >

```
MTB > let c3=c2**1.5
MTB > regress c1 1 c3
```

The regression equation is  
 $C1 = 95.0 - 0.244 C3$

Predictor	Coef	Stdev	t-ratio
Constant	95.022	2.196	43.28
C3	-0.24407	0.03839	-6.36

s = 3.831      R-sq = 85.2%      R-sq(adj) = 83.1%

Analysis of Variance

SOURCE	DF	SS	MS
Regression	1	593.27	593.27
Error	7	102.73	14.68
Total	8	696.00	

B >

MTB > let c4=c2\*\*2  
 3 > regress c1 1 c4 .

The regression equation is  
 C1 = 94.0 - 0.0544 C4

Predictor	Coef	Stdev	t-ratio
Constant	93.993	2.055	45.74
C4	-0.054443	0.008515	-6.39

s = 3.813      R-sq = 85.4%      R-sq(adj) = 83.3%

Analysis of Variance

SOURCE	DF	SS	MS
Regression	1	594.24	594.24
Error	7	101.76	14.54
Total	8	696.00	

MTB >

MTB > regress c1 1 c5

The regression equation is  
 C1 = 93.1 - 0.0121 C5

Predictor	Coef	Stdev	t-ratio
Constant	93.139	2.011	46.31
C5	-0.012085	0.001952	-6.19

s = 3.918      R-sq = 84.6%      R-sq(adj) = 82.4%

Analysis of Variance

SOURCE	DF	SS	MS
Regression	1	588.56	588.56
Error	7	107.44	15.35
Total	8	696.00	

Unusual Observations

Obs.	C5	C1	Fit	Stdev.Fit	Residual	St.Resid
1	0	100.00	93.14	2.01	6.86	2.04R

R denotes an obs. with a large st. resid.

MTB >

## WORLD WAR TWO PAVEMENTS

Includes: Regression Equations  
R-squared (Confidence associated with the regression model)  
t-ratio (Predictability of the dependent variable from the independent variable)  
(Higher values better - typically  $> 4$ )  
s or SEE (Estimate error factor - lower values are better)

Notes: c1 represents the dependent variable PCI.  
c2 represents the independent variable AGE.  
c3, c4, c5 are AGE raised to 1.5, 2, 2.5 powers, respectively.  
Equations with c6 and c7 are raised to the 3 and 3.5 powers.

The regression equation is  
 $C1 = 101 - 1.08 C2$

Predictor	Coef	Stdev	t-ratio
Constant	100.83	10.00	10.08
C2	-1.0820	0.2313	-4.68

s = 10.09      R-sq = 70.9%      R-sq(adj) = 67.6%

Analysis of Variance

SOURCE	DF	SS	MS
Regression	1	2226.2	2226.2
Error	9	915.9	101.8
Total	10	3142.2	

Unusual Observations

Obs.	C2	C1	Fit	Stdev. Fit	Residual	St. Resid
1	0.0	100.00	100.83	10.00	-0.83	-0.63 X
10	43.0	77.00	54.31	3.07	22.69	2.36R

R denotes an obs. with a large st. resid.  
 I denotes an obs. whose X value gives it large influence.  
 MTR >

The regression equation is  
 $C1 = 101 - 0.160 C3$

Predictor	Coef	Stdev	t-ratio
Constant	100.601	9.732	10.34
C3	-0.15982	0.03339	-4.79

s = 9.923      R-sq = 71.8%      R-sq(adj) = 68.7%

Analysis of Variance

SOURCE	DF	SS	MS
Regression	1	2256.0	2256.0
Error	9	886.2	98.5
Total	10	3142.2	

Unusual Observations

Obs.	C3	C1	Fit	Stdev. Fit	Residual	St. Resid
1	0	100.00	100.60	9.73	-0.60	-0.31 X
10	282	77.00	55.54	3.00	21.46	2.27R

R denotes an obs. with a large st. resid.  
 I denotes an obs. whose X value gives it large influence.  
 MTR >

The regression equation is  
 $C1 = 100 - 0.0234 C4$

Predictor	Coef	Stdev	t-ratio
Constant	99.973	9.544	10.47
C4	-0.023384	0.004852	-4.82

s = 9.875      R-sq = 72.1%      R-sq(adj) = 69.0%

Analysis of Variance

SOURCE	DF	SS	MS
Regression	1	2264.6	2264.6
Error	9	877.6	97.5
Total	10	3142.2	

Unusual Observations

Obs.	C4	C1	Fit	Stdev. Fit	Residual	St. Resid
1	0	100.00	99.97	9.54	0.03	0.01 X
10	1849	77.00	56.74	2.98	20.26	2.15R

R denotes an obs. with a large st. resid.  
 X denotes an obs. whose X value gives it large influence.  
 MTB >

The regression equation is  
 $C1 = 99.0 - 0.00339 C5$

Predictor	Coef	Stdev	t-ratio
Constant	98.996	9.431	10.50
C5	-0.0033914	0.0007099	-4.78

s = 9.937      R-sq = 71.7%      R-sq(adj) = 68.6%

Analysis of Variance

SOURCE	DF	SS	MS
Regression	1	2253.6	2253.6
Error	9	888.6	98.7
Total	10	3142.2	

Unusual Observations

Obs.	C5	C1	Fit	Stdev. Fit	Residual	St. Resid
1	0	100.00	99.00	9.43	1.00	0.32 X
10	12125	77.00	57.88	3.01	19.12	2.02R

R denotes an obs. with a large st. resid.  
 X denotes an obs. whose X value gives it large influence.  
 MTB >

## WASHINGTON

### AC OVERLAY PAVEMENTS

Includes: Regression Equations  
R-squared (Confidence associated with the regression model)  
t-ratio (Predictability of the dependent variable from the independent variable)  
(Higher values better - typically  $> 4$ )  
s or SEE (Estimate error factor - lower values are better)

Notes: c1 represents the dependent variable PCI.  
c2 represents the independent variable AGE.  
c3, c4, c5 are AGE raised to 1.5, 2, 2.5 powers, respectively.  
Equations with c6 and c7 are raised to the 3 and 3.5 powers.

```

DATA> 92 1
      (A) 83 4
DATA> end
      25 ROWS READ
MTB > regress c1 1 c2

```

The regression equation is  
 $C1 = 93.2 - 1.23 C2$

Predictor	Coef	Stdev	t-ratio
Constant	93.248	4.476	20.83
C2	-1.2309	0.3971	-3.10

s = 10.01      R-sq = 29.5%      R-sq(adj) = 26.4%

#### Analysis of Variance

SOURCE	DF	SS	MS
Regression	1	963.4	963.4
Error	23	2305.9	100.3
Total	24	3269.4	

```
MTB >
```

```

DATA> 92 1
      DATA> 83 4
DATA> end
      18 ROWS READ
MTB > regress c1 1 c2

```

The regression equation is  
 $C1 = 94.8 - 1.86 C2$

Predictor	Coef	Stdev	t-ratio
Constant	94.822	3.544	26.75
C2	-1.8635	0.3342	-5.58

s = 6.837      R-sq = 66.0%      R-sq(adj) = 63.9%

#### Analysis of Variance

SOURCE	DF	SS	MS
Regression	1	1453.1	1453.1
Error	16	748.0	46.7
Total	17	2201.1	

```
3 >
```



\* ERROR \* COMPLETION OF COMPUTATION IMPOSSIBLE

MTB > let c3=c2\*\*1.5  
MTB > regress c1 1 c3

The regression equation is  
C1 = 90.7 - 0.421 C3

Predictor	Coef	Stdev	t-ratio
Constant	90.728	3.138	28.92
C3	-0.42081	0.08214	-5.12

s = 7.218      R-sq = 62.1%      R-sq(adj) = 59.8%

Analysis of Variance

SOURCE	DF	SS	MS
Regression	1	1367.5	1367.5
Error	16	833.7	52.1
Total	17	2201.1	

MTB >

MTB > let c4=c2\*\*2  
MTB > regress c1 1 c4

The regression equation is  
C1 = 88.2 - 0.0980 C4

Predictor	Coef	Stdev	t-ratio
Constant	88.245	3.011	29.31
C4	-0.09803	0.02135	-4.59

s = 7.705      R-sq = 56.8%      R-sq(adj) = 54.1%

Analysis of Variance

SOURCE	DF	SS	MS
Regression	1	1251.3	1251.3
Error	16	949.9	59.4
Total	17	2201.1	

MTB >

MTB > regress c1 1 c5

The regression equation is  
C1 = 86.5 - 0.0230 C5

Predictor	Coef	Stdev	t-ratio
Constant	86.460	2.969	29.13
C5	-0.022978	0.005608	-4.10

s = 8.193      R-sq = 51.2%      R-sq(adj) = 48.2%

Analysis of Variance

SOURCE	DF	SS	MS
Regression	1	1127.0	1127.0
Error	16	1074.1	67.1
Total	17	2201.1	

Unusual Observations

Obs.	C5	C1	Fit	Stdev.Fit	Residual	St.Resid
16	1192	70.00	59.08	4.83	10.92	1.65 X

X denotes an obs. whose X value gives it large influence.

MTB >

DATA> 92 1  
 (A) 83 4  
 DATA> end  
 19 ROWS READ  
 MTB > regress c1 1 c2

The regression equation is  
 $C1 = 95.9 - 1.96 C2$

Predictor	Coef	Stdev	t-ratio
Constant	95.919	3.096	30.99
C2	-1.9556	0.2999	-6.52

s = 6.726      R-sq = 71.4%      R-sq(adj) = 69.8%

Analysis of Variance

SOURCE	DF	SS	MS
Regression	1	1923.5	1923.5
Error	17	769.1	45.2
Total	18	2692.6	

MTB >

MTB > let c3=-c2\*\*1.5  
 MTB > regress c1 1 c3

The regression equation is  
 $C1 = 92.2 + 0.453 C3$

Predictor	Coef	Stdev	t-ratio
Constant	92.202	2.910	31.68
C3	0.45322	0.07827	5.79

s = 7.300      R-sq = 66.4%      R-sq(adj) = 64.4%

Analysis of Variance

SOURCE	DF	SS	MS
Regression	1	1786.7	1786.7
Error	17	906.0	53.3
Total	18	2692.6	

MTB >

```

MTB > let c4=c2**2
      > regress c1 1 c4

```

The regression equation is  
 $C1 = 89.8 - 0.107 C4$

Predictor	Coef	Stdev	t-ratio
Constant	89.802	2.887	31.11
C4	-0.10684	0.02104	-5.08

s = 7.933      R-sq = 60.3%      R-sq(adj) = 57.9%

Analysis of Variance

SOURCE	DF	SS	MS
Regression	1	1622.9	1622.9
Error	17	1069.7	62.9
Total	18	2692.6	

```
MTB >
```

```
MTB > regress c1 1 c5
```

The regression equation is  
 $C1 = 88.0 - 0.0252 C5$

Predictor	Coef	Stdev	t-ratio
Constant	88.031	2.905	30.31
C5	-0.025232	0.005638	-4.48

s = 8.527      R-sq = 54.1%      R-sq(adj) = 51.4%

Analysis of Variance

SOURCE	DF	SS	MS
Regression	1	1456.5	1456.5
Error	17	1236.1	72.7
Total	18	2692.6	

Unusual Observations

Obs.	C5	C1	Fit	Stdev.Fit	Residual	St.Resid
17	1192	70.00	57.97	4.97	12.03	1.74 X

X denotes an obs. whose X value gives it large influence.

```
MTB >
```

## **OREGON**

### **AC OVERLAY PAVEMENTS**

Includes:      Regression Equations  
                  R-squared (Confidence associated with the regression model)  
                  t-ratio (Predictability of the dependent variable from the independent variable)  
                            (Higher values better - typically > 4)  
                  s or SEE (Estimate error factor - lower values are better)

Notes:            c1 represents the dependent variable PCI.  
                  c2 represents the independent variable AGE.  
                  c3, c4, c5 are AGE raised to 1.5, 2, 2.5 powers, respectively.  
                  Equations with c6 and c7 are raised to the 3 and 3.5 powers.

```
DATA> 91 1
      1A) 89 5
DATA> end
      13 ROWS READ
MTB > regress c1 1 c2
```

The regression equation is  
 $C1 = 92.4 - 1.17 C2$

Predictor	Coef	Stdev	t-ratio
Constant	92.409	3.712	24.89
C2	-1.1664	0.4786	-2.44

s = 6.986      R-sq = 35.1%      R-sq(adj) = 29.2%

Analysis of Variance

SOURCE	DF	SS	MS
Regression	1	289.90	289.90
Error	11	536.87	48.81
Total	12	826.77	

MTB >

```
MTB > let c3=c2**1.5
MTB > regress c1 1 c3
```

The regression equation is  
 $C1 = 90.2 - 0.281 C3$

Predictor	Coef	Stdev	t-ratio
Constant	90.187	3.289	27.42
C3	-0.2808	0.1324	-2.12

s = 7.304      R-sq = 29.0%      R-sq(adj) = 22.6%

Analysis of Variance

SOURCE	DF	SS	MS
Regression	1	239.88	239.88
Error	11	586.89	53.35
Total	12	826.77	

8 >

MTB > regress c1 1 c4

The regression equation is  
C1 = 88.9 - 0.0691 C4

Predictor	Coef	Stdev	t-ratio
Constant	88.851	3.054	29.09
C4	-0.06914	0.03696	-1.87

s = 7.551      R-sq = 24.1%      R-sq(adj) = 17.2%

Analysis of Variance

SOURCE	DF	SS	MS
Regression	1	199.55	199.55
Error	11	627.22	57.02
Total	12	826.77	

Unusual Observations

Obs.	C4	C1	Fit	Stdev.Fit	Residual	St.Resid
3	196	83.00	75.30	5.44	7.70	1.47 X

X denotes an obs. whose X value gives it large influence.

MTB >

MTB > regress c1 1 c5

The regression equation is  
C1 = 88.0 - 0.0171 C5

Predictor	Coef	Stdev	t-ratio
Constant	87.953	2.908	30.24
C5	-0.01712	0.01029	-1.66

s = 7.749      R-sq = 20.1%      R-sq(adj) = 12.8%

Analysis of Variance

SOURCE	DF	SS	MS
Regression	1	166.23	166.23
Error	11	660.54	60.05
Total	12	826.77	

Unusual Observations

Obs.	C5	C1	Fit	Stdev.Fit	Residual	St.Resid
3	733	83.00	75.40	5.99	7.60	1.55 X

X denotes an obs. whose X value gives it large influence.

MTB >

```

MTB > DATA 91 1
      DATA 89 5
      DATA end
      11 ROWS READ
      MTB > regress c1 1 c2
  
```

The regression equation is  
 $C1 = 94.7 - 1.79 C2$

Predictor	Coef	Stdev	t-ratio
Constant	94.727	3.701	25.60
C2	-1.7903	0.5567	-3.22

s = 6.506      R-sq = 53.5%      R-sq(adj) = 48.3%

Analysis of Variance

SOURCE	DF	SS	MS
Regression	1	437.64	437.64
Error	9	380.90	42.32
Total	10	818.55	

MTB >

```

MTB > let c3=c2**1.5
MTB > regress c1 1 c3
  
```

The regression equation is  
 $C1 = 92.5 - 0.507 C3$

Predictor	Coef	Stdev	t-ratio
Constant	92.482	3.243	28.52
C3	-0.5066	0.1645	-3.08

s = 6.655      R-sq = 51.3%      R-sq(adj) = 45.9%

Analysis of Variance

SOURCE	DF	SS	MS
Regression	1	420.00	420.00
Error	9	398.55	44.28
Total	10	818.55	

MTB >



MTB > let c4=c2\*\*2  
> regress c1 1 c4

The regression equation is  
 $C1 = 91.1 - 0.146 C4$

Predictor	Coef	Stdev	t-ratio
Constant	91.084	2.996	30.40
C4	-0.14593	0.04945	-2.95

s = 6.799      R-sq = 49.2%      R-sq(adj) = 43.5%

Analysis of Variance

SOURCE	DF	SS	MS
Regression	1	402.51	402.51
Error	9	416.04	46.23
Total	10	818.55	

MTB >

MTB > let c5=c2\*\*2.5  
> regress c1 1 c5

The regression equation is  
 $C1 = 90.1 - 0.0423 C5$

Predictor	Coef	Stdev	t-ratio
Constant	90.115	2.850	31.62
C5	-0.04227	0.01494	-2.83

s = 6.937      R-sq = 47.1%      R-sq(adj) = 41.2%

Analysis of Variance

SOURCE	DF	SS	MS
Regression	1	385.40	385.40
Error	9	433.15	48.13
Total	10	818.55	

MTB >

**COMBINED**

**AC OVERLAY  
PAVEMENTS**

Includes: Regression Equations  
R-squared (Confidence associated with the regression model)  
t-ratio (Predictability of the dependent variable from the independent variable)  
(Higher values better - typically > 4)  
s or SEE (Estimate error factor - lower values are better)

Notes: c1 represents the dependent variable PCI.  
c2 represents the independent variable AGE.  
c3, c4, c5 are AGE raised to 1.5, 2, 2.5 powers, respectively.  
Equations with c6 and c7 are raised to the 3 and 3.5 powers.

The regression equation is  
 $C1 = 90.8 - 1.03 C2$

Predictor	Coef	Stdev	t-ratio
Constant	90.837	3.427	26.50
C2	-1.0284	0.3247	-3.17

s = 9.332      R-sq = 23.3%      R-sq(adj) = 21.0%

## Analysis of Variance

SOURCE	DF	SS	MS
Regression	1	873.69	873.69
Error	33	2873.91	87.09
Total	34	3747.60	

## Unusual Observations

Obs.	C2	C1	Fit	Stdev.Fit	Residual	St. Resid
2	13.0	96.00	77.47	1.97	18.53	2.03R
19	13.0	58.00	77.47	1.97	-19.47	-2.13R
21	13.0	59.00	77.47	1.97	-18.47	-2.02R

R denotes an obs. with a large st. resid.

MTB >

The regression equation is  
 $C1 = 88.4 - 0.226 C3$

Predictor	Coef	Stdev	t-ratio
Constant	88.394	2.941	30.06
C3	-0.22597	0.07739	-2.92

s = 9.500      R-sq = 20.5%      R-sq(adj) = 18.1%

## Analysis of Variance

SOURCE	DF	SS	MS
Regression	1	769.43	769.43
Error	33	2978.17	90.25
Total	34	3747.60	

## Unusual Observations

Obs.	C3	C1	Fit	Stdev.Fit	Residual	St. Resid
19	46.9	58.00	77.80	1.98	-19.80	-2.13R
21	46.9	59.00	77.80	1.98	-18.80	-2.02R

R denotes an obs. with a large st. resid.

B >

The regression equation is  
 $C1 = 86.9 - 0.0513 C4$

Predictor	Coef	Stdev	t-ratio
Constant	86.917	2.684	32.38
C4	-0.05131	0.01913	-2.68

s = 9.656      R-sq = 17.9%      R-sq(adj) = 15.4%

Analysis of Variance

SOURCE	DF	SS	MS
Regression	1	670.94	670.94
Error	33	3076.66	93.23
Total	34	3747.60	

Unusual Observations

Obs.	C4	C1	Fit	Stdev.Fit	Residual	St.Resid
19	169	58.00	78.25	1.97	-20.25	-2.14R
21	169	59.00	78.25	1.97	-19.25	-2.04R

R denotes an obs. with a large st. resid.

MTB >

The regression equation is  
 $C1 = 85.9 - 0.0117 C5$

Predictor	Coef	Stdev	t-ratio
Constant	85.873	2.521	34.06
C5	-0.011740	0.004776	-2.46

s = 9.797      R-sq = 15.5%      R-sq(adj) = 12.9%

Analysis of Variance

SOURCE	DF	SS	MS
Regression	1	579.97	579.97
Error	33	3167.63	95.99
Total	34	3747.60	

Unusual Observations

Obs.	C5	C1	Fit	Stdev.Fit	Residual	St.Resid
7	1192	83.00	71.88	4.14	11.12	1.25 X
19	609	58.00	78.72	1.94	-20.72	-2.16R
21	609	59.00	78.72	1.94	-19.72	-2.05R
23	1192	70.00	71.88	4.14	-1.88	-0.21 X

CONTINUE?

MTB > regress c1 1 c2

The regression equation is  
C1 = 94.9 - 1.86 C2

Predictor	Coef	Stdev	t-ratio
Constant	94.921	2.354	40.33
C2	-1.8609	0.2530	-7.36

s = 6.470      R-sq = 66.7%      R-sq(adj) = 65.5%

Analysis of Variance

SOURCE	DF	SS	MS
Regression	1	2264.7	2264.7
Error	27	1130.3	41.9
Total	28	3395.0	

Unusual Observations

Obs.	C2	C1	Fit	Stdev.Fit	Residual	St.Resid
13	13.0	58.00	70.73	1.74	-12.73	-2.04R

R denotes an obs. with a large st. resid.

MTB >

MTB > regress c1 1 c3

The regression equation is  
C1 = 91.3 - 0.438 C3

Predictor	Coef	Stdev	t-ratio
Constant	91.322	2.076	43.99
C3	-0.43759	0.06398	-6.84

s = 6.783      R-sq = 63.4%      R-sq(adj) = 62.1%

Analysis of Variance

SOURCE	DF	SS	MS
Regression	1	2152.6	2152.6
Error	27	1242.3	46.0
Total	28	3395.0	

Unusual Observations

Obs.	C3	C1	Fit	Stdev.Fit	Residual	St.Resid
17	70.1	70.00	60.65	3.10	9.35	1.55 X

X denotes an obs. whose X value gives it large influence.

2 >

MTB > regress c1 1 c4

The regression equation is  
C1 = 89.1 - 0.105 C4

Predictor	Coef	Stdev	t-ratio
Constant	89.113	1.987	44.85
C4	-0.10490	0.01696	-6.19

s = 7.212      R-sq = 58.6%      R-sq(adj) = 57.1%

Analysis of Variance

SOURCE	DF	SS	MS
Regression	1	1990.7	1990.7
Error	27	1404.3	52.0
Total	28	3395.0	

Unusual Observations

Obs.	C4	C1	Fit	Stdev.Fit	Residual	St.Resid
17	289	70.00	58.80	3.68	11.20	1.81 X

X denotes an obs. whose X value gives it large influence.

MTB >

MTB > regress c1 1 c5

The regression equation is  
C1 = 87.6 - 0.0252 C5

Predictor	Coef	Stdev	t-ratio
Constant	87.557	1.963	44.61
C5	-0.025186	0.004530	-5.56

s = 7.656      R-sq = 53.4%      R-sq(adj) = 51.7%

Analysis of Variance

SOURCE	DF	SS	MS
Regression	1	1812.3	1812.3
Error	27	1382.7	51.2
Total	28	3195.0	

Unusual Observations

Obs.	C5	C1	Fit	Stdev.Fit	Residual	St.Resid
17	1192	70.00	87.55	4.29	12.45	1.96 X

X denotes an obs. whose X value gives it large influence.

MTB >

**WASHINGTON**  
**BITUMINOUS SURFACE TREATMENT**  
**PAVEMENTS**

Includes:      Regression Equations  
                  R-squared (Confidence associated with the regression model)  
                  t-ratio (Predictability of the dependent variable from the independent variable)  
                          (Higher values better - typically > 4)  
                  s or SEE (Estimate error factor - lower values are better)

Notes:           c1 represents the dependent variable PCI.  
                  c2 represents the independent variable AGE.  
                  c3, c4, c5 are AGE raised to 1.5, 2, 2.5 powers, respectively.  
                  Equations with c6 and c7 are raised to the 3 and 3.5 powers.

WA NOT UPPER  
PORTION

```
MTB > TA> 98 1  
      TA> 95 4  
      DATA> end  
           7 ROWS READ  
MTB > regress c1 1 c2
```

The regression equation is  
 $C1 = 106 - 4.13 C2$

Predictor	Coef	Stdev	t-ratio
Constant	105.781	4.661	22.70
C2	-4.1302	0.5852	-7.06

s = 8.109      R-sq = 90.9%      R-sq(adj) = 89.1%

Analysis of Variance

SOURCE	DF	SS	MS
Regression	1	3275.3	3275.3
Error	5	328.7	65.7
Total	6	3604.0	

```
MTB >
```

```
MTB > let c3=c2**1.5  
MTB > regress c1 1 c3
```

The regression equation is  
 $C1 = 101 - 1.07 C3$

Predictor	Coef	Stdev	t-ratio
Constant	101.262	2.507	40.39
C3	-1.07143	0.08913	-12.02

s = 4.910      R-sq = 96.7%      R-sq(adj) = 96.0%

Analysis of Variance

SOURCE	DF	SS	MS
Regression	1	3483.5	3483.5
Error	5	120.5	24.1
Total	6	3604.0	

```
MTB >
```



MTB > let c4=c2\*\*2  
> regress c1 1 c4

The regression equation is  
C1 = 98.6 - 0.278 C4

Predictor	Coef	Stdev	t-ratio
Constant	98.647	1.488	66.32
C4	-0.27892	0.01446	-19.24

s = 3.099      R-sq = 98.7%      R-sq(adj) = 98.4%

Analysis of Variance

SOURCE	DF	SS	MS
Regression	1	3556.0	3556.0
Error	5	48.0	9.6
Total	6	3604.0	

MTB >

> regress c1 1 c5

The regression equation is  
C1 = 97.0 - 0.0723 C5

Predictor	Coef	Stdev	t-ratio
Constant	96.984	1.210	80.16
C5	-0.072257	0.003160	-22.87

s = 2.613      R-sq = 99.1%      R-sq(adj) = 98.9%

Analysis of Variance

SOURCE	DF	SS	MS
Regression	1	3569.9	3569.9
Error	5	34.1	6.8
Total	6	3604.0	

Unusual Observations

Obs.	C5	C1	Fit	Stdev.Fit	Residual	St.Resid
4	16	91.000	95.858	1.182	-4.858	-2.08R

R denotes an obs. with a large st. resid.

MTB >

R denotes an obs. with a large st. resid.

```
MTB > let c6=c2**3
      3 > regress c1 1 c6
```

The regression equation is  
 $C1 = 95.8 - 0.0187 C6$

Predictor	Coef	Stdev	t-ratio
Constant	95.826	1.445	66.33
C6	-0.018739	0.001004	-18.67

s = 3.193      R-sq = 98.6%      R-sq(adj) = 98.3%

Analysis of Variance

SOURCE	DF	SS	MS
Regression	1	3553.0	3553.0
Error	5	51.0	10.2
Total	6	3604.0	

MTB >

WA DST LOWEI  
Partial

DATA) 73 1  
TA) 68 4  
DATA) end  
11 ROWS READ  
MTB > regress c1 1 c2

The regression equation is  
C1 = 87.8 - 6.90 C2

Predictor	Coef	Stdev	t-ratio
Constant	87.756	5.851	15.00
C2	-6.900	1.484	-4.65

s = 10.12      R-sq = 70.6%      R-sq(adj) = 67.3%

Analysis of Variance

SOURCE	DF	SS	MS
Regression	1	2216.3	2216.3
Error	9	922.4	102.5
Total	10	3138.7	

MTB >

MTB > let c3=c2\*\*1.5  
MTB > regress c1 1 c3

The regression equation is  
C1 = 81.9 - 2.45 C3

Predictor	Coef	Stdev	t-ratio
Constant	81.934	5.448	15.04
C3	-2.4537	0.6060	-4.05

s = 11.12      R-sq = 64.6%      R-sq(adj) = 60.6%

Analysis of Variance

SOURCE	DF	SS	MS
Regression	1	2026.4	2026.4
Error	9	1112.3	123.6
Total	10	3138.7	

MTB >

MTB > regress c1 1 c4

The regression equation is  
C1 = 78.9 - 0.921 C4

Predictor	Coef	Stdev	t-ratio
Constant	78.867	5.227	15.09
C4	-0.9213	0.2477	-3.72

s = 11.72      R-sq = 60.6%      R-sq(adj) = 56.2%

Analysis of Variance

SOURCE	DF	SS	MS
Regression	1	1901.7	1901.7
Error	9	1237.0	137.4
Total	10	3138.7	

Unusual Observations

Obs.	C4	C1	Fit	Stdev.Fit	Residual	St.Resid
1	0.0	100.00	78.87	5.23	21.13	2.01R

R denotes an obs. with a large st. resid.

MTB >

3 > regress c1 1 c5

The regression equation is  
C1 = 77.1 - 0.357 C5

Predictor	Coef	Stdev	t-ratio
Constant	77.069	5.100	15.11
C5	-0.3569	0.1014	-3.52

s = 12.12      R-sq = 57.9%      R-sq(adj) = 53.2%

Analysis of Variance

SOURCE	DF	SS	MS
Regression	1	1817.7	1817.7
Error	9	1321.0	146.8
Total	10	3138.7	

Unusual Observations

Obs.	C5	C1	Fit	Stdev.Fit	Residual	St.Resid
1	0.0	100.00	77.07	5.10	22.93	2.09R

R denotes an obs. with a large st. resid.

MTB >

**OREGON**  
**BITUMINOUS SURFACE TREATMENT**  
**PAVEMENTS**

Includes:      Regression Equations  
                  R-squared (Confidence associated with the regression model)  
                  t-ratio (Predictability of the dependent variable from the independent variable)  
                            (Higher values better - typically > 4)  
                  s or SEE (Estimate error factor - lower values are better)

Notes:            c1 represents the dependent variable PCI.  
                  c2 represents the independent variable AGE.  
                  c3, c4, c5 are AGE raised to 1.5, 2, 2.5 powers, respectively.  
                  Equations with c6 and c7 are raised to the 3 and 3.5 powers.

original

DATA> 80 8  
DATA> 77 12  
DATA> end  
3 ROWS READ  
3 ) regress c1 1 c2

The regression equation is  
C1 = 99.0 - 2.00 C2

Predictor	Coef	Stdev	t-ratio
Constant	99.0000	3.606	27.46
C2	-2.0000	0.4330	-4.62

s = 3.742      R-sq = 95.5%      R-sq(adj) = 91.0%

Analysis of Variance

SOURCE	DF	SS	MS
Regression	1	298.67	298.67
Error	1	14.00	14.00
Total	2	312.67	

MTB >

MTB > plot c1 c2

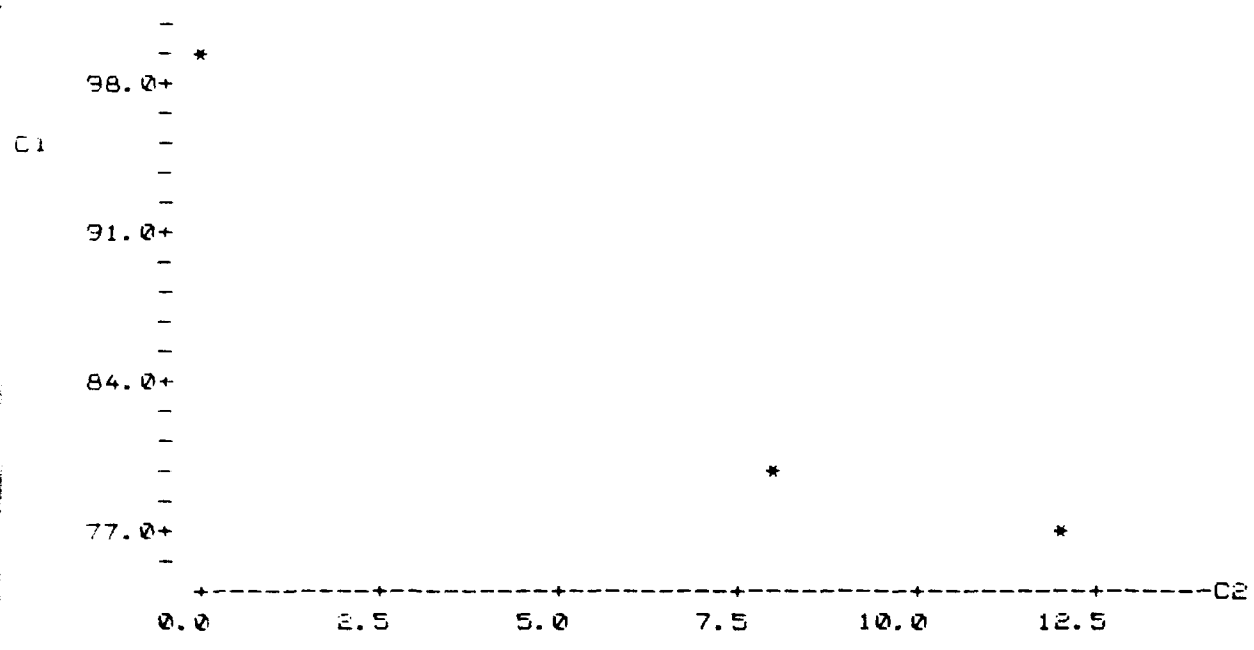

MTB >

**COMBINED**  
**BITUMINOUS SURFACE TREATMENT**  
**PAVEMENTS**

Includes:      Regression Equations  
                  R-squared (Confidence associated with the regression model)  
                  t-ratio (Predictability of the dependent variable from the independent variable)  
                            (Higher values better - typically > 4)  
                  s or SEE (Estimate error factor - lower values are better)

Notes:            c1 represents the dependent variable PCI.  
                  c2 represents the independent variable AGE.  
                  c3, c4, c5 are AGE raised to 1.5, 2, 2.5 powers, respectively.  
                  Equations with c6 and c7 are raised to the 3 and 3.5 powers.

MTB > regress c1 1 c2

The regression equation is  
 $C1 = 105 - 3.62 C2$

Predictor	Coef	Stdev	t-ratio
Constant	105.396	5.544	19.01
C2	-3.6220	0.6513	-5.56

s = 9.768      R-sq = 81.5%      R-sq(adj) = 78.9%

Analysis of Variance

SOURCE	DF	SS	MS
Regression	1	2950.3	2950.3
Error	7	667.9	95.4
Total	8	3618.2	

Unusual Observations

Obs.	C2	C1	Fit	Stdev.Fit	Residual	St.Resid
3	15.0	34.00	51.07	6.21	-17.07	-2.26R

R denotes an obs. with a large st. resid.

MTB >

The regression equation is  
 $C1 = 101 - 0.956 C3$

Predictor	Coef	Stdev	t-ratio
Constant	101.324	3.921	25.84
C3	-0.9560	0.1334	-7.17

s = 7.874      R-sq = 88.0%      R-sq(adj) = 86.3%

Analysis of Variance

SOURCE	DF	SS	MS
Regression	1	3184.2	3184.2
Error	7	434.0	62.0
Total	8	3618.2	

Unusual Observations

Obs.	C3	C1	Fit	Stdev.Fit	Residual	St.Resid
3	58.1	34.00	45.79	5.50	-11.79	-2.09R
9	41.6	77.00	61.59	3.72	15.41	2.22R

R denotes an obs. with a large st. resid.

3 >



MTB > regress c1 1 c4

The regression equation is

$$C1 = 98.7 - 0.253 C4$$

Predictor	Coef	Stdev	t-ratio
Constant	98.744	3.116	31.69
C4	-0.25260	0.02972	-8.50

s = 6.757      R-sq = 91.2%      R-sq(adj) = 89.9%

Analysis of Variance

SOURCE	DF	SS	MS
Regression	1	3298.6	3298.6
Error	7	319.6	45.7
Total	8	3618.2	

Unusual Observations

Obs.	C4	C1	Fit	Stdev.Fit	Residual	St.Resid
9	144	77.00	62.37	3.10	14.63	2.44R

R denotes an obs. with a large st. resid.

MTB >

MTB > regress c1 1 c5

The regression equation is

$$C1 = 96.9 - 0.0666 C5$$

Predictor	Coef	Stdev	t-ratio
Constant	96.929	2.705	35.83
C5	-0.066577	0.007095	-9.38

s = 6.170      R-sq = 92.6%      R-sq(adj) = 91.6%

Analysis of Variance

SOURCE	DF	SS	MS
Regression	1	3351.7	3351.7
Error	7	266.5	38.1
Total	8	3618.2	

Unusual Observations

Obs.	C5	C1	Fit	Stdev.Fit	Residual	St.Resid
9	499	77.00	63.72	2.72	13.28	2.40R

R denotes an obs. with a large st. resid.

MTB >

The regression equation is  
 $C1 = 95.5 - 0.0175 C6$

Predictor	Coef	Stdev	t-ratio
Constant	95.550	2.528	37.80
C6	-0.017478	0.001800	-9.71

s = 5.977      R-sq = 93.1%      R-sq(adj) = 92.1%

Analysis of Variance

SOURCE	DF	SS	MS
Regression	1	3368.1	3368.1
Error	7	250.1	35.7
Total	8	3618.2	

Unusual Observations

Obs.	C6	C1	Fit	Stdev.Fit	Residual	St.Resid
3	3375	34.00	36.56	4.94	-2.56	-0.76 X
9	1728	77.00	65.35	2.53	11.65	2.15R

R denotes an obs. with a large st. resid.  
 X denotes an obs. whose X value gives it large influence.  
 MTB >

MTB > regress c1 1 c7

The regression equation is  
 $C1 = 94.4 - 0.00457 C7$

Predictor	Coef	Stdev	t-ratio
Constant	94.443	2.497	37.82
C7	-0.0045691	0.0004781	-9.56

s = 6.066      R-sq = 92.9%      R-sq(adj) = 91.9%

Analysis of Variance

SOURCE	DF	SS	MS
Regression	1	3360.6	3360.6
Error	7	257.6	36.8
Total	8	3618.2	

Unusual Observations

Obs.	C7	C1	Fit	Stdev.Fit	Residual	St.Resid
3	13071	34.00	34.72	5.19	-0.72	-0.23 X

X denotes an obs. whose X value give it large influence.  
 MTB >

```

MTB > 73 1
      (A) 68 4
DATA > end
      11 ROWS READ
MTB > regress c1 1 c2

```

The regression equation is  
 $C1 = 87.8 - 6.90 C2$

Predictor	Coef	Stdev	t-ratio
Constant	87.756	5.851	15.00
C2	-6.900	1.484	-4.65

s = 10.12      R-sq = 70.6%      R-sq(adj) = 67.3%

Analysis of Variance

SOURCE	DF	SS	MS
Regression	1	2216.3	2216.3
Error	9	922.4	102.5
Total	10	3138.7	

MTB >

```

MTB > let c3=c2**1.5
MTB > regress c1 1 c3

```

The regression equation is  
 $C1 = 81.9 - 2.45 C3$

Predictor	Coef	Stdev	t-ratio
Constant	81.934	5.448	15.04
C3	-2.4537	0.6060	-4.05

s = 11.12      R-sq = 64.6%      R-sq(adj) = 60.6%

Analysis of Variance

SOURCE	DF	SS	MS
Regression	1	2026.4	2026.4
Error	9	1112.3	123.6
Total	10	3138.7	

3 > let

MTB > regress c1 1 c4

The regression equation is  
C1 = 78.9 - 0.921 C4

Predictor	Coef	Stdev	t-ratio
Constant	78.867	5.227	15.09
C4	-0.9213	0.2477	-3.72

s = 11.72      R-sq = 60.6%      R-sq(adj) = 56.2%

Analysis of Variance

SOURCE	DF	SS	MS
Regression	1	1901.7	1901.7
Error	9	1237.0	137.4
Total	10	3138.7	

Unusual Observations

Obs.	C4	C1	Fit	Stdev.Fit	Residual	St.Resid
1	0.0	100.00	78.87	5.23	21.13	2.01R

R denotes an obs. with a large st. resid.

MTB >

MTB > regress c1 1 c5

The regression equation is  
C1 = 77.1 - 0.357 C5

Predictor	Coef	Stdev	t-ratio
Constant	77.069	5.100	15.11
C5	-0.3569	0.1014	-3.52

s = 12.12      R-sq = 57.9%      R-sq(adj) = 53.2%

Analysis of Variance

SOURCE	DF	SS	MS
Regression	1	1817.7	1817.7
Error	9	1321.0	146.8
Total	10	3138.7	

Unusual Observations

Obs.	C5	C1	Fit	Stdev.Fit	Residual	St.Resid
1	0.0	100.00	77.07	5.10	22.93	2.09R

R denotes an obs. with a large st. resid.

MTB >

```

DATA> 80 8
DATA> 77 12
DATA> end
19 ROWS READ
MTB > regress c1 1 c2

```

The regression equation is  
 $C1 = 82.2 - 2.02 C2$

Predictor	Coef	Stdev	t-ratio
Constant	82.206	7.233	11.37
C2	-2.0170	0.9877	-2.04

$S = 18.40$        $R\text{-sq} = 19.7\%$        $R\text{-sq(adj)} = 15.0\%$

Analysis of Variance

SOURCE	DF	SS	MS
Regression	1	1411.5	1411.5
Error	17	5753.7	338.5
Total	18	7165.2	

```
MTB >
```

```
MTB > regress c1 1 c3
```

The regression equation is  
 $C1 = 78.8 - 0.494 C3$

Predictor	Coef	Stdev	t-ratio
Constant	78.761	6.147	12.81
C3	-0.4937	0.2556	-1.93

$S = 18.59$        $R\text{-sq} = 18.0\%$        $R\text{-sq(adj)} = 13.2\%$

Analysis of Variance

SOURCE	DF	SS	MS
Regression	1	1289.4	1289.4
Error	17	5875.7	345.6
Total	18	7165.2	

Inusual Observations

Obs.	C3	C1	Fit	Stdev.Fit	Residual	St.Resid
3	58.1	34.00	50.08	11.26	-16.08	-1.09 X

3 denotes an obs. whose X value gives it large influence.

```
3 >
```

MTB > regress c1 1 c4

The regression equation is  
C1 = 77.1 - 0.128 C4

Predictor	Coef	Stdev	t-ratio
Constant	77.089	5.615	13.73
C4	-0.12826	0.06775	-1.89

s = 18.66      R-sq = 17.4%      R-sq(adj) = 12.6%

Analysis of Variance

SOURCE	DF	SS	MS
Regression	1	1247.5	1247.5
Error	17	5917.7	348.1
Total	18	7165.2	

Unusual Observations

Obs.	C4	C1	Fit	Stdev.Fit	Residual	St.Resid
3	225	34.00	48.23	12.37	-14.23	-1.02 X

X denotes an obs. whose X value gives it large influence.

MTB >

MTB > regress c1 1 c5

The regression equation is  
C1 = 76.1 - 0.0342 C5

Predictor	Coef	Stdev	t-ratio
Constant	76.137	5.301	14.36
C5	-0.03418	0.01804	-1.89

s = 18.65      R-sq = 17.4%      R-sq(adj) = 12.6%

Analysis of Variance

SOURCE	DF	SS	MS
Regression	1	1249.1	1249.1
Error	17	5916.1	348.0
Total	18	7165.2	

Unusual Observations

Obs.	C5	C1	Fit	Stdev.Fit	Residual	St.Resid
3	871	34.00	46.35	13.30	-12.35	-0.94 X

X denotes an obs. whose X value gives it large influence.

MTB >

## WASHINGTON

### SLURRY SEAL PAVEMENTS

Includes: Regression Equations  
R-squared (Confidence associated with the regression model)  
t-ratio (Predictability of the dependent variable from the independent variable)  
(Higher values better - typically > 4)  
s or SEE (Estimate error factor - lower values are better)

Notes: c1 represents the dependent variable PCI.  
c2 represents the independent variable AGE.  
c3, c4, c5 are AGE raised to 1.5, 2, 2.5 powers, respectively.  
Equations with c6 and c7 are raised to the 3 and 3.5 powers.

WA SS  
 1) ALL TIME  
 2) UPPER F

MTB > regress c1 1 c2

The regression equation is  
 $C1 = 79.1 - 1.23 C2$

Predictor	Coef	Stdev	t-ratio
Constant	79.078	6.631	11.92
C2	-1.2300	0.5589	-2.20

s = 14.50      R-sq = 24.4%      R-sq(adj) = 19.4%

Analysis of Variance

SOURCE	DF	SS	MS
Regression	1	1018.1	1018.1
Error	15	3153.5	210.2
Total	16	4171.5	

Inusual Observations

Obs.	C2	C1	Fit	Stdev.Fit	Residual	St.Resid
15	8.0	40.00	69.24	3.70	-29.24	-2.09R

R denotes an obs. with a large st. resid.

MTB >

DATA> 83 2  
 DATA> 77 6  
 DATA> end

11 ROWS READ

MTB > regress c1 1 c2

The regression equation is  
 $C1 = 92.6 - 2.08 C2$

Predictor	Coef	Stdev	t-ratio
Constant	92.568	3.076	30.09
C2	-2.0833	0.2744	-8.89

s = 5.343      R-sq = 89.8%      R-sq(adj) = 88.6%

Analysis of Variance

SOURCE	DF	SS	MS
Regression	1	2255.2	2255.2
Error	9	256.9	28.5
Total	10	2512.2	

)



MTB > regress c1 1 c3

The regression equation is  
 $C1 = 87.3 - 0.418 C3$

Predictor	Coef	Stdev	t-ratio
Constant	87.275	3.124	27.94
C3	-0.41799	0.05729	-7.30

s = 6.354      R-sq = 85.5%      R-sq(adj) = 83.9%

Analysis of Variance

SOURCE	DF	SS	MS
Regression	1	2148.9	2148.9
Error	9	363.3	40.4
Total	10	2512.2	

Unusual Observations

Obs.	C3	C1	Fit	Stdev.Fit	Residual	St.Resid
1	0.0	100.00	87.27	3.12	12.73	2.30R

R denotes an obs. with a large st. resid.

MTB >

MTB > regress c1 1 c4

The regression equation is  
 $C1 = 84.1 - 0.0861 C4$

Predictor	Coef	Stdev	t-ratio
Constant	84.102	3.232	26.03
C4	-0.08608	0.01382	-6.23

s = 7.249      R-sq = 81.2%      R-sq(adj) = 79.1%

Analysis of Variance

SOURCE	DF	SS	MS
Regression	1	2039.3	2039.3
Error	9	472.9	52.5
Total	10	2512.2	

Unusual Observations

Obs.	C4	C1	Fit	Stdev.Fit	Residual	St.Resid
1	0	100.00	84.10	3.23	15.90	2.45R

R denotes an obs. with a large st. resid.

MTB >

MTB > regress c1 1 c5

The regression equation is  
C1 = 82.0 - 0.0180 C5

Predictor	Coef	Stdev	t-ratio
Constant	82.029	3.333	24.61
C5	-0.018009	0.003259	-5.53

s = 7.972      R-sq = 77.2%      R-sq(adj) = 74.7%

Analysis of Variance

SOURCE	DF	SS	MS
Regression	1	1940.2	1940.2
Error	9	572.0	63.6
Total	10	2512.2	

Unusual Observations

Obs.	C5	C1	Fit	Stdev.Fit	Residual	St. Resid
1	0	100.00	82.03	3.33	17.97	2.48R

R denotes an obs. with a large st. resid.

MTB >

## OREGON

### SLURRY SEAL PAVEMENTS

Includes: Regression Equations  
R-squared (Confidence associated with the regression model)  
t-ratio (Predictability of the dependent variable from the independent variable)  
(Higher values better - typically  $> 4$ )  
s or SEE (Estimate error factor - lower values are better)

Notes: c1 represents the dependent variable PCI.  
c2 represents the independent variable AGE.  
c3, c4, c5 are AGE raised to 1.5, 2, 2.5 powers, respectively.  
Equations with c6 and c7 are raised to the 3 and 3.5 powers.

```

DATA> 65 1
      (A) 64 5
DATA> end
      7 ROWS READ
MTB > regress c1 1 c2

```

The regression equation is  
 $C1 = 83.0 - 3.94 C2$

Predictor	Coef	Stdev	t-ratio
Constant	82.967	6.853	12.11
C2	-3.939	1.890	-2.08

s = 11.16      R-sq = 46.5%      R-sq(adj) = 35.8%

Analysis of Variance

SOURCE	DF	SS	MS
Regression	1	540.7	540.7
Error	5	622.7	124.5
Total	6	1163.4	

MTB >

```

MTB > let c3=c2**1.5
MTB > regress c1 1 c3

```

The regression equation is  
 $C1 = 79.9 - 1.37 C3$

Predictor	Coef	Stdev	t-ratio
Constant	79.913	6.684	11.96
C3	-1.3702	0.8105	-1.69

s = 12.17      R-sq = 36.4%      R-sq(adj) = 23.6%

Analysis of Variance

SOURCE	DF	SS	MS
Regression	1	423.1	423.1
Error	5	740.3	148.1
Total	6	1163.4	

3 >

MTB > let c4=c2\*\*2  
3 > regress c1 1 c4

The regression equation is  
C1 = 78.5 - 0.516 C4

Predictor	Coef	Stdev	t-ratio
Constant	78.492	6.590	11.91
C4	-0.5157	0.3443	-1.50

s = 12.67      R-sq = 31.0%      R-sq(adj) = 17.2%

Analysis of Variance

SOURCE	DF	SS	MS
Regression	1	360.3	360.3
Error	5	803.1	160.6
Total	6	1163.4	

MTB >

MTB > let c5=c2\*\*2.5  
MTB > regress c1 1 c5

The regression equation is  
C1 = 77.7 - 0.201 C5

Predictor	Coef	Stdev	t-ratio
Constant	77.672	6.554	11.85
C5	-0.2008	0.1462	-1.37

s = 13.00      R-sq = 27.4%      R-sq(adj) = 12.9%

Analysis of Variance

SOURCE	DF	SS	MS
Regression	1	318.7	318.7
Error	5	844.7	168.9
Total	6	1163.4	

MTB >

OR SS  
w/o 1

```
DATA> 65 1  
DATA> 64 5  
DATA> end  
      6 ROWS READ  
MTB > regress c1 1 c2
```

The regression equation is  
 $C1 = 72.7 - 1.70 C2$

Predictor	Coef	Stdev	t-ratio
Constant	72.658	4.874	14.91
C2	-1.697	1.245	-1.36

s = 6.265      R-sq = 31.7%      R-sq(adj) = 14.7%

Analysis of Variance

SOURCE	DF	SS	MS
Regression	1	72.99	72.99
Error	4	157.01	39.25
Total	5	230.00	

MTB >

```
MTB > let c3=c2**1.5  
MTB > regress c1 1 c3
```

The regression equation is  
 $C1 = 71.2 - 0.606 C3$

Predictor	Coef	Stdev	t-ratio
Constant	71.233	4.190	17.00
C3	-0.6064	0.4704	-1.29

s = 6.373      R-sq = 29.4%      R-sq(adj) = 11.7%

Analysis of Variance

SOURCE	DF	SS	MS
Regression	1	67.51	67.51
Error	4	162.49	40.62
Total	5	230.00	

MTB >

= 100%  
AGE = C

```
MTB > let c1=c2**2
      > regress c1 1 c4
```

The regression equation is  
 $c1 = 70.5 - 0.2298 c4$

Predictor	Coef	Stdev	t-ratio
Constant	70.523	3.958	17.82
c4	-0.2298	0.1016	-1.20

s = 6.502      R-sq = 26.5%      R-sq(adj) = 8.1%

Analysis of Variance

SOURCE	DF	SS	MS
Regression	1	60.89	60.89
Error	4	169.11	42.28
Total	5	230.00	

```
MTB >
```

```
MTB > let c5=c2**2.5
      > regress c1 1 c5
```

The regression equation is  
 $c1 = 70.1 - 0.0884 c5$

Predictor	Coef	Stdev	t-ratio
Constant	70.262	3.876	18.06
c5	-0.08843	0.08006	-1.10

s = 6.638      R-sq = 23.4%      R-sq(adj) = 4.2%

Analysis of Variance

SOURCE	DF	SS	MS
Regression	1	53.76	53.76
Error	4	176.24	44.06
Total	5	230.00	

```
MTB >
```

## COMBINED

### SLURRY SEAL PAVEMENTS

Includes: Regression Equations  
R-squared (Confidence associated with the regression model)  
t-ratio (Predictability of the dependent variable from the independent variable)  
(Higher values better - typically  $> 4$ )  
s or SEE (Estimate error factor - lower values are better)

Notes: c1 represents the dependent variable PCI.  
c2 represents the independent variable AGE.  
c3, c4, c5 are AGE raised to 1.5, 2, 2.5 powers, respectively.  
Equations with c6 and c7 are raised to the 3 and 3.5 powers.



The regression equation is  
 $C1 = 74.9 - 0.978 C2$

Predictor	Coef	Stdev	t-ratio
Constant	74.908	4.502	16.64
C2	-0.9784	0.4331	-2.26

s = 12.99      R-sq = 19.5%      R-sq(adj) = 15.7%

Analysis of Variance

SOURCE	DF	SS	MS
Regression	1	860.5	860.5
Error	21	3541.4	168.6
Total	22	4401.9	

Unusual Observations

Obs.	C2	C1	Fit	Stdev.Fit	Residual	St.Resid
1	0.0	100.00	74.91	4.50	25.09	2.06R
15	8.0	40.00	67.08	2.71	-27.08	-2.13R

R denotes an obs. with a large st. resid.

MTB >

The regression equation is  
 $C1 = 72.6 - 0.200 C3$

Predictor	Coef	Stdev	t-ratio
Constant	72.585	3.841	18.90
C3	-0.20018	0.09310	-2.15

s = 13.11      R-sq = 18.0%      R-sq(adj) = 14.1%

Analysis of Variance

SOURCE	DF	SS	MS
Regression	1	794.3	794.3
Error	21	3607.6	171.8
Total	22	4401.9	

Unusual Observations

Obs.	C3	C1	Fit	Stdev.Fit	Residual	St.Resid
1	0.0	100.00	72.58	3.84	27.42	2.19R
3	96.2	55.00	53.32	6.83	1.68	0.15 X
5	96.2	43.00	53.32	6.83	-10.32	-0.92 X
15	22.6	40.00	68.06	2.80	-28.06	-2.19R

CONTINUE?

The regression equation is

$$C1 = 71.5 - 0.0436 C4$$

Predictor	Coef	Stdev	t-ratio
Constant	71.498	3.514	20.35
C4	-0.04364	0.02041	-2.14

s = 13.12      R-sq = 17.9%      R-sq(adj) = 14.0%

Analysis of Variance

SOURCE	DF	SS	MS
Regression	1	787.0	787.0
Error	21	3615.0	172.1
Total	22	4401.9	

Unusual Observations

Obs.	C4	C1	Fit	Stdev.Fit	Residual	St.Resid
1	0	100.00	71.50	3.51	28.50	2.25R
3	441	55.00	52.25	7.33	2.75	0.25 X
5	441	43.00	52.25	7.33	-9.25	-0.85 X
15	64	40.00	68.70	2.83	-28.70	-2.24R

CONTINUE?

The regression equation is

$$C1 = 70.9 - 0.00973 C5$$

Predictor	Coef	Stdev	t-ratio
Constant	70.886	3.324	21.32
C5	-0.009729	0.004497	-2.16

s = 13.09      R-sq = 18.2%      R-sq(adj) = 14.3%

Analysis of Variance

SOURCE	DF	SS	MS
Regression	1	802.3	802.3
Error	21	3599.6	171.4
Total	22	4401.9	

Unusual Observations

Obs.	C5	C1	Fit	Stdev.Fit	Residual	St.Resid
1	0	100.00	70.89	3.32	29.11	2.30R
3	2021	55.00	51.22	7.69	3.78	0.36 X
5	2021	43.00	51.22	7.69	-8.22	-0.78 X
15	181	40.00	69.12	2.94	-29.12	-2.28R

CONTINUE?

COMPAINED SS  
W/O HIP

2 regression equation is

$$C1 = 74.9 - 1.19 C2$$

Predictor	Coef	Stdev	t-ratio
Constant	74.890	4.168	17.97
C2	-1.1871	0.4152	-2.86

s = 12.00      R-sq = 30.1%      R-sq(adj) = 26.4%

Analysis of Variance

SOURCE	DF	SS	MS
Regression	1	1177.1	1177.1
Error	19	2735.9	144.0
Total	20	3913.0	

Unusual Observations

Obs.	C2	C1	Fit	Stdev.Fit	Residual	St. Resid
1	0.0	100.00	74.89	4.17	25.11	2.23R
13	8.0	40.00	65.39	2.62	-25.39	-2.17R

R denotes an obs. with a large st. resid.

MTB >

The regression equation is

$$C1 = 71.9 - 0.234 C3$$

Predictor	Coef	Stdev	t-ratio
Constant	71.928	3.628	19.83
C3	-0.23366	0.09011	-2.59

s = 12.33      R-sq = 26.1%      R-sq(adj) = 22.3%

Analysis of Variance

SOURCE	DF	SS	MS
Regression	1	1022.8	1022.8
Error	19	2890.2	152.1
Total	20	3913.0	

Unusual Observations

Obs.	C3	C1	Fit	Stdev.Fit	Residual	St. Resid
1	0.0	100.00	71.93	3.63	28.07	2.38R
3	96.2	55.00	49.44	6.79	5.56	0.54 X
5	96.2	43.00	49.44	6.79	-6.44	-0.63 X
13	22.6	40.00	66.64	2.72	-26.64	-2.21R

WTINUE?

The regression equation is

$$C1 = 70.5 - 0.0487 C4$$

Predictor	Coef	Stdev	t-ratio
Constant	70.529	3.383	20.85
C4	-0.04873	0.01984	-2.46

s = 12.50      R-sq = 24.1%      R-sq(adj) = 20.1%

Analysis of Variance

SOURCE	DF	SS	MS
Regression	1	942.8	942.8
Error	19	2970.1	156.3
Total	20	3913.0	

Unusual Observations

Obs.	C4	C1	Fit	Stdev.Fit	Residual	St. Resid
1	0	100.00	70.53	3.38	29.47	2.45R
3	441	55.00	49.04	7.28	5.96	0.59 X
5	441	43.00	49.04	7.28	-6.04	-0.59 X
13	64	40.00	67.41	2.82	-27.41	-2.25R

CONTINUE?

The regression equation is

$$C1 = 69.8 - 0.0104 C5$$

Predictor	Coef	Stdev	t-ratio
Constant	69.759	3.252	21.45
C5	-0.010437	0.004383	-2.38

s = 12.59      R-sq = 23.0%      R-sq(adj) = 18.9%

Analysis of Variance

SOURCE	DF	SS	MS
Regression	1	899.3	899.3
Error	19	3013.7	158.6
Total	20	3913.0	

Unusual Observations

Obs.	C5	C1	Fit	Stdev.Fit	Residual	St. Resid
1	0	100.00	69.76	3.25	30.24	2.49R
3	2021	55.00	48.67	7.63	6.33	0.63 X
5	2021	43.00	48.67	7.63	-5.67	-0.57 X
13	181	40.00	67.87	2.91	-27.87	-2.27R

CONTINUE?

## WASHINGTON PCC PAVEMENTS

Includes:      Regression Equations  
                  R-squared (Confidence associated with the regression model)  
                  t-ratio (Predictability of the dependent variable from the independent variable)  
                          (Higher values better - typically  $> 4$ )  
                  s or SEE (Estimate error factor - lower values are better)

Notes:            c1 represents the dependent variable PCI.  
                  c2 represents the independent variable AGE.  
                  c3, c4, c5 are AGE raised to 1.5, 2, 2.5 powers, respectively.  
                  Equations with c6 and c7 are raised to the 3 and 3.5 powers.

MTB > regress c1 1 c2

The regression equation is  
 $C1 = 99.5 - 0.884 C2$

Predictor	Coef	Stdev	t-ratio
Constant	99.51	23.19	4.29
C2	-0.8839	0.5238	-1.69

s = 23.51      R-sq = 18.0%      R-sq(adj) = 11.7%

Analysis of Variance

SOURCE	DF	SS	MS
Regression	1	1574.3	1574.3
Error	13	7186.6	552.8
Total	14	8760.9	

Unusual Observations

Obs.	C2	C1	Fit	Stdev.Fit	Residual	St.Resid
1	0.0	100.00	99.51	23.19	0.49	0.13 X

x denotes an obs. whose X value gives it large influence.

MTB >

MTB > regress c1 1 c3

The regression equation is  
 $C1 = 98.5 - 0.127 C3$

Predictor	Coef	Stdev	t-ratio
Constant	98.47	22.86	4.31
C3	-0.12696	0.07614	-1.67

s = 23.56      R-sq = 17.6%      R-sq(adj) = 11.3%

Analysis of Variance

SOURCE	DF	SS	MS
Regression	1	1543.6	1543.6
Error	13	7217.3	555.2
Total	14	8760.9	

Unusual Observations

Obs.	C3	C1	Fit	Stdev.Fit	Residual	St.Resid
1	0	100.00	98.47	22.86	1.53	0.27 X

x denotes an obs. whose X value gives it large influence.

MTB >

MTB > regress c1 1 c4

The regression equation is  
 $C1 = 97.0 - 0.0180 C4$

Predictor	Coef	Stdev	t-ratio
Constant	97.02	22.43	4.33
C4	-0.01800	0.01101	-1.64

s = 23.64      R-sq = 17.1%      R-sq(adj) = 10.7%

Analysis of Variance

SOURCE	DF	SS	MS
Regression	1	1494.3	1494.3
Error	13	7266.7	559.0
Total	14	8760.9	

Unusual Observations

Obs.	C4	C1	Fit	Stdev.Fit	Residual	St.Resid
1	0	100.00	97.02	22.43	2.98	0.40 X

X denotes an obs. whose X value gives it large influence.

MTB >

MTB > regress c1 1 c5

The regression equation is  
 $C1 = 95.3 - 0.00252 C5$

Predictor	Coef	Stdev	t-ratio
Constant	95.25	21.92	4.35
C5	-0.002522	0.001584	-1.59

s = 23.75      R-sq = 16.3%      R-sq(adj) = 9.9%

Analysis of Variance

SOURCE	DF	SS	MS
Regression	1	1430.5	1430.5
Error	13	7330.4	563.9
Total	14	8760.9	

Unusual Observations

Obs.	C5	C1	Fit	Stdev.Fit	Residual	St.Resid
1	0	100.00	95.25	21.92	4.75	0.52 X

X denotes an obs. whose X value gives it large influence.

MTB >

## OREGON PCC PAVEMENTS

Includes:      Regression Equations  
                  R-squared (Confidence associated with the regression model)  
                  t-ratio (Predictability of the dependent variable from the independent variable)  
                          (Higher values better - typically > 4)  
                  s or SEE (Estimate error factor - lower values are better)

Notes:            c1 represents the dependent variable PCI.  
                  c2 represents the independent variable AGE.  
                  c3, c4, c5 are AGE raised to 1.5, 2, 2.5 powers, respectively.  
                  Equations with c6 and c7 are raised to the 3 and 3.5 powers.



(COOK'S DIST)

```
DATA> 94 1
DATA> 78 5
DATA> end
      3 ROWS READ
MTB > regress c1 1 c2
```

```
The regression equation is
C1 = 99.2 - 4.29 C2
```

Predictor	Coef	Stdev	t-ratio
Constant	99.2381	0.9712	102.18
C2	-4.2857	0.3299	-12.99

```
s = 1.234      R-sq = 99.4%      R-sq(adj) = 98.8%
```

Analysis of Variance

SOURCE	DF	SS	MS
Regression	1	257.14	257.14
Error	1	1.52	1.52
Total	2	258.67	

```
MTB >
```

```
MTB > plot c1 c2
```

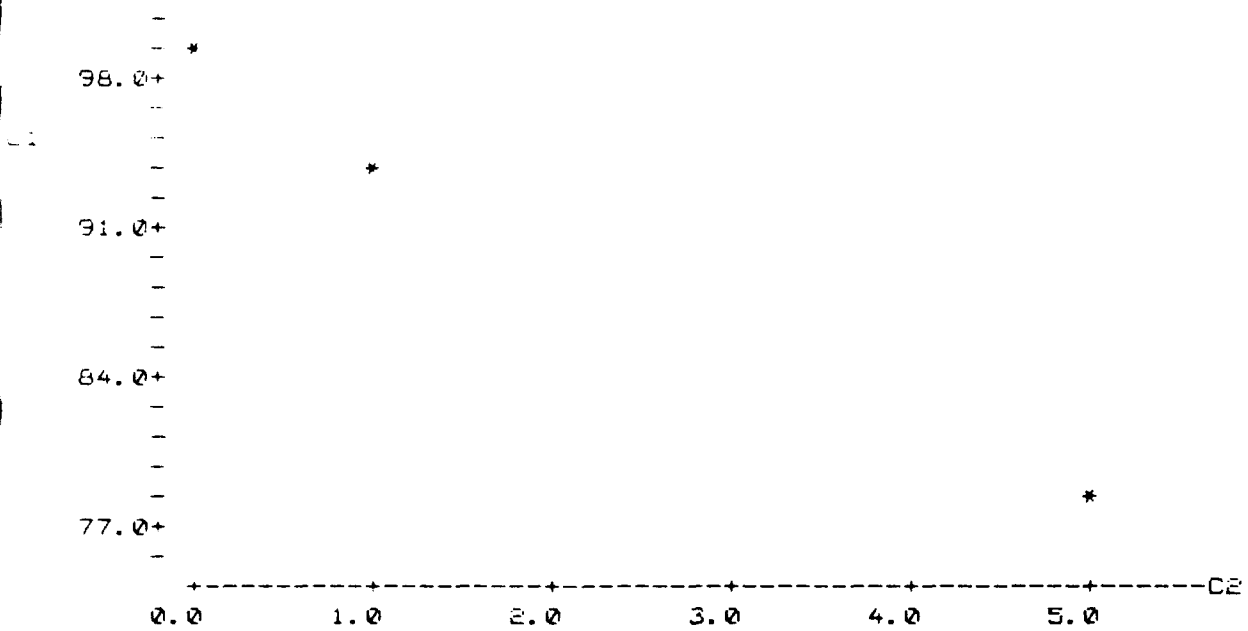

```
MTB >
```

## COMBINED PCC PAVEMENTS

Includes:      Regression Equations  
                  R-squared (Confidence associated with the regression model)  
                  t-ratio (Predictability of the dependent variable from the independent variable)  
                            (Higher values better - typically > 4)  
                  s or SEE (Estimate error factor - lower values are better)

Notes:            c1 represents the dependent variable PCI.  
                  c2 represents the independent variable AGE.  
                  c3, c4, c5 are AGE raised to 1.5, 2, 2.5 powers, respectively.  
                  Equations with c6 and c7 are raised to the 3 and 3.5 powers.

MTB > regress c1 1 c2

The regression equation is  
 $C1 = 92.4 - 0.731 C2$

Predictor	Coef	Stdev	t-ratio
Constant	92.40	13.29	6.95
C2	-0.7308	0.3194	-2.29

s = 22.15      R-sq = 25.9%      R-sq(adj) = 20.9%

Analysis of Variance

SOURCE	DF	SS	MS
Regression	1	2568.6	2568.6
Error	15	7359.5	490.6
Total	16	9928.1	

Unusual Observations

Obs.	C2	C1	Fit	Stdev.Fit	Residual	St.Resid
1	0.0	100.00	92.40	13.29	7.60	0.43 X

X denotes an obs. whose X value gives it large influence.

MTB >

MTB > read c3=c2\*\*2

\* ERROR \* ARGUMENT IS A CONSTANT OR MATRIX, BUT A COLUMN WAS EXPECTED

MTB > let c3=c2\*\*2

MTB > regress c1 1 c3

The regression equation is  
 $C1 = 90.1 - 0.0147 C3$

Predictor	Coef	Stdev	t-ratio
Constant	90.10	12.70	7.09
C3	-0.014737	0.006638	-2.22

s = 22.32      R-sq = 24.7%      R-sq(adj) = 19.7%

Analysis of Variance

SOURCE	DF	SS	MS
Regression	1	2455.3	2455.3
Error	15	7472.8	498.2
Total	16	9928.1	

MTB >

MTB > let c4=c2\*\*2.5

MTB > regress c1 1 c4

The regression equation is  
 $C1 = 89.5 - 0.00212 C4$

Predictor	Coef	Stdev	t-ratio
-----------	------	-------	---------

s = 22.39      R-sq = 24.3%      R-sq(adj) = 19.2%

Analysis of Variance

SOURCE	DF	SS	MS
Regression	1	2409.0	2409.0
Error	15	7519.1	501.3
Total	16	9928.1	

MTB > let c5=c2\*\*

MTB > let c5=c2\*\*3  
MTB > regress c1 1 c5

The regression equation is  
C1 = 88.8 -0.000305 C5

Predictor	Coef	Stdev	t-ratio
Constant	88.82	12.47	7.12
C5	-0.0003047	0.0001410	-2.16

s = 22.47      R-sq = 23.7%      R-sq(adj) = 18.6%

Analysis of Variance

SOURCE	DF	SS	MS
Regression	1	2356.0	2356.0
Error	15	7572.2	504.8
Total	16	9928.1	

MTB >

**APPENDIX E**

**IDAHO STATE  
GENERAL AVIATION  
PAVEMENT CONDITION SURVEY DATA**

**INCLUDING:**

- 1) AIRPORT LOCATION/DESCRIPTION/SECTION DATA
- 2) PAVEMENT IDENTIFICATION & CHARACTERISTICS
- 3) AVERAGE PCI VALUES FOR PAVEMENT FEATURES
- 4) PAVEMENT CONDITION SURVEY DATES
- 5) REPAIR AND REHABILITATION INFORMATION

IDAHO AIRPORT PAVEMENT CHARACTERISTICS AND 1986 PCI

No.	AIRPORT & LOCATION	ID	OOD	ORIG. STRUC. SEC.	FRD	EXISTING STRUCTURE	PCI - 1986
1	ARCO (BUTTE COUNTY) AP	R1	1979	2"AC, 4"B, 6"SB		2"AC, 4"B, 6"SB	66
2	BEAR LAKE COUNTY AP	R1	UNK	2"AC, 6"B, 10"SB		2"AC, 6"B, 10"SB	27
3	BUHL MUNICIPAL AP	R2	1984	2"AC, 2"B, 4"SB		2"AC, 2"B, 4"SB	96
4	BURLEY MUNICIPAL AP	R1	1983	2"AC, 4"B, 6"SB		2"AC, 4"B, 6"SB	69
		R1	UNK	2.5"AC, 12"B	1980	SC, 2"ACOL, 2.5"AC, 12"B	67
5	CALDWELL AP	R2	UNK	2.5"AC, 10"B	UNK	SC, ?OL, 2.5"AC, 10"B	56
		R1	1975	2"AC, 4"B, 5"SB, 7"FC	1986	SS, FS, 2"AC, 4"B, 5"SB, 7"FC	94
6	CHALLIS AP	R2	1975	2"AC, 4"B, 5"SB, 7"FC	1986	SS, FS, 2"AC, 4"B, 5"SB, 7"FC	100
7	COEUR D'ALENE AIR TERMINAL	R1	1973	BST, 6"B	1986	FS, 2"ACOL, BST, 6"B	79
		R1	UNK	2"AC, 6"B	1973	SS, 3"ACOL, 2"AC, 6"B	77
		R2	UNK	2"AC, 6"B	1973	SS, 3"ACOL, 2"AC, 6"B	79
		R3	UNK	2"AC, 6"B	1973	SS, 3"ACOL, 2"AC, 6"B	79
		R4	UNK	3"AC, 8"B	1973	SS, 3"AC, 8"B	89
8	CRAIGMONT MUNICIPAL AP	R1	1975	1"AC, 5"B, 10"SB	1983	CS, FS, 1"AC, 5"B, 10"SB	57
9	DRIGGS MUNICIPAL AP	R1	1975	2"AC, 4"B, 6"SB		2"AC, 4"B, 6"SB	81
10	GOODING MUNICIPAL AP	R1	1978	2"AC, 8"B	1985	SS, 2"AC, 8"B	86
11	GRANGEVILLE (IDAHO CO.) AP	R1	1965	3"AC, 12"B, 12"SB	1983	2"ACOL, 3"AC, 12"B, 12"SB	71
		R2	1983	4"AC, 18"B		4"AC, 18"B	73
		R3	1983	4"AC, 18"B		4"AC, 18"B	73
12	JEROME COUNTY AP	R1	UNK	7.5"AC, 3.5"B	1975	CS, FS, 7.5"AC, 3.5"B	65
		R2	1981	2"AC, 4"B, 6"SB		2"AC, 4"B, 6"SB	90
13	KELLOGG (SHOSHONE CO.) AP	R1	UNK	1"AC, 4"B, 24"SB	1980	1"ACOL, 1"AC, 4"B, 24"SB	94
		R2	UNK	1"AC, 5"B, 24"SB	1980	1"ACOL, 1"AC, 5"B, 24"SB	94
		R3	UNK	1.5"AC, 5"B	1983	SS, 1.5"AC, 5"B	40
		R4	UNK	1"AC, 5"B, 24"SB	1980	3"ACOL, 1"AC, 5"B, 24"SB	96
		R5	UNK	1"AC, 4"B, 24"SB	1980	3"ACOL, 1"AC, 4"B, 24"SB	93
14	MCCALL MUNICIPAL AP	R1	1974	3"AC, 6"B	1985	SS, 3"AC, 6"B	87
15	MOUNTAIN HOME MUNICIPAL AP	R1	1973	2"AC, 7.5"B, 8"SB		2"AC, 7.5"B, 8"SB	70
16	NAMPA MUNICIPAL AP	R1	1976	2"AC, 3"B, 8"SB	1985	SS, FS, 2"AC, 3"B, 8"SB	91
17	OROFINO MUNICIPAL AP	R1	1969	2"AC, 4"B, 4"SB	UNK	SS, 2"AC, 4"B, 4"SB	81
18	PRIEST RIVER MUNICIPAL AP	R1	1975	2.5"AC, 6"B	UNK	SS, 2.5"AC, 6"B	86

IDAHO AIRPORT PAVEMENT CHARACTERISTICS AND 1986 PCI

No.	AIRPORT & LOCATION	ID	OCD	ORIG. STRUC. SEC.	FRD	EXISTING STRUCTURE	PCI - 1986
19	REXBURG (MADISON COUNTY) AP	R1	1972	2"AC, 6"B, 6"SB	UNK	SS, 2"AC, 6"B, 6"SB	63
		R3	1977	2.5"AC, 6"B, 6"SB	UNK	SS, 2.5"AC, 6"B, 6"SB	71
		R4	1977	2.5"AC, 8"B, 12"SB	UNK	SS, 2.5"AC, 8"B, 12"SB	61
20	ST. MARIES MUNICIPAL AP	R1	1978	1.5"AC, 11"B, NWF		1.5"AC, 11"B, NWF	59
21	SANDPOINT AP	R1	1952	BST, 6"B, 6"SB	UNK	DBST, 6"B, 6"SB	24
		R2	UNK	2"AC, ?B, ?SB		2"AC, ?B, ?SB	45
22	SODA SPRINGS AP	R1	1969	2.5"AC, ?B, ?SB	1983	SS, 2.5"AC, ?B, ?SB	42