

WRDC-TR-90-8007  
Volume V  
Part 12

**AD-A250 452**



1

INTEGRATED INFORMATION SUPPORT SYSTEM (IISS)  
Volume V - Common Data Model Subsystem  
Part 12 - Neutral Data Manipulation Language (NDML) Precompiler  
Parse Procedure Division Product Specification

M. Apicella, J. Slaton, B. Levi

Control Data Corporation  
Integration Technology Services  
2970 Presidential Drive  
Fairborn, OH 45324-6209

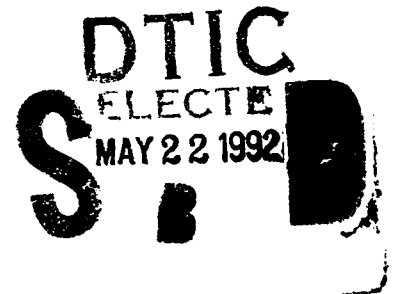

September 1990

Final Report for Period 1 April 1987 - 31 December 1990

Approved for Public Release; Distribution is Unlimited

**92-13585**



MANUFACTURING TECHNOLOGY DIRECTORATE  
WRIGHT RESEARCH AND DEVELOPMENT CENTER  
AIR FORCE SYSTEMS COMMAND  
WRIGHT-PATTERSON AIR FORCE BASE, OHIO 45433-6533

NOTICE

When Government drawings, specifications, or other data are used for any purpose other than in connection with a definitely related Government procurement operation, the United States Government thereby incurs no responsibility nor any obligation whatsoever, regardless whether or not the government may have formulated, furnished, or in any way supplied the said drawings, specifications, or other data. It should not, therefore, be construed or implied by any person, persons, or organization that the Government is licensing or conveying any rights or permission to manufacture, use, or market any patented invention that may in any way be related thereto.

This technical report has been reviewed and is approved for publication.

This report is releasable to the National Technical Information Service (NTIS). At NTIS, it will be available to the general public, including foreign nations

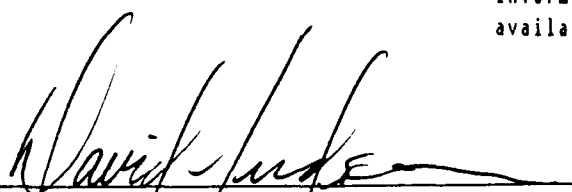
  
DAVID L. JUDSON, Project Manager  
WRDC/MTI  
Wright-Patterson AFB, OH 45433-6533

25 July 91  
DATE

FOR THE COMMANDER:

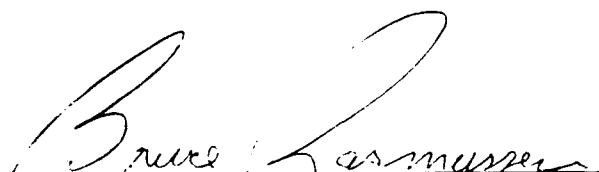
  
BRUCE A. RASMUSSEN, Chief  
WRDC/MTI  
Wright-Patterson AFB, OH 45433-6533

25 July 91  
DATE

If your address has changed, if you wish to be removed from our mailing list, or if the addressee is no longer employed by your organization please notify WRDC/MTI, Wright-Patterson Air Force Base, OH 45433-6533 to help us maintain a current mailing list.

Copies of this report should not be returned unless return is required by security considerations, contractual obligations, or notice on a specific document.

<b>REPORT DOCUMENTATION PAGE</b>												
1a. REPORT SECURITY CLASSIFICATION Unclassified		1b. RESTRICTIVE MARKINGS										
2a. SECURITY CLASSIFICATION AUTHORITY		3. DISTRIBUTION/AVAILABILITY OF REPORT Approved for Public Release; Distribution is Unlimited.										
2b. DECLASSIFICATION/DOWNGRADING SCHEDULE												
4. PERFORMING ORGANIZATION REPORT NUMBER(S) PS 620341212		5. MONITORING ORGANIZATION REPORT NUMBER(S) WRDC-TR-90-8007 Vol. V, Part 12										
6a. NAME OF PERFORMING ORGANIZATION Control Data Corporation; Integration Technology Services		6b. OFFICE SYMBOL (if applicable)	7a. NAME OF MONITORING ORGANIZATION WRDC/MTI									
6c. ADDRESS (City, State, and ZIP Code) 2970 Presidential Drive Fairborn, OH 45324-6209		7b. ADDRESS (City, State, and ZIP Code)  WPAFB, OH 45433-6533										
8a. NAME OF FUNDING/SPONSORING ORGANIZATION Wright Research and Development Center, Air Force Systems Command, USAF		8b. OFFICE SYMBOL (if applicable)  WRDC/MTI	9. PROCUREMENT INSTRUMENT IDENTIFICATION NUM.  F33600-87-C-0464									
8c. ADDRESS (City, State, and ZIP Code) Wright-Patterson AFB, Ohio 45433-6533		10. SOURCE OF FUNDING NOS. <table border="1" style="width:100%; border-collapse: collapse; margin-top: 5px;"> <thead> <tr> <th style="padding: 2px;">PROGRAM ELEMENT NO.</th> <th style="padding: 2px;">PROJECT NO.</th> <th style="padding: 2px;">TASK NO.</th> <th style="padding: 2px;">WORK UNIT NO.</th> </tr> </thead> <tbody> <tr> <td style="padding: 2px;">78011F</td> <td style="padding: 2px;">595600</td> <td style="padding: 2px;">F95600</td> <td style="padding: 2px;">20950607</td> </tr> </tbody> </table>			PROGRAM ELEMENT NO.	PROJECT NO.	TASK NO.	WORK UNIT NO.	78011F	595600	F95600	20950607
PROGRAM ELEMENT NO.	PROJECT NO.				TASK NO.	WORK UNIT NO.						
78011F	595600	F95600	20950607									
11. TITLE (Include Security Classification) <b>See block 19</b>												
12. PERSONAL AUTHOR(S) Control Data Corporation: Apicella, M. L., Slaton, J., Levi, B.												
13a. TYPE OF REPORT Final Report		13b. TIME COVERED 4 / 1 / 87 - 12 / 31 / 90	14. DATE OF REPORT (Yr., Mo., Day) 1990 September 30	15. PAGE COUNT 32								
16. SUPPLEMENTARY NOTES WRDC/MTI Project Priority 6203												
17. COSATI CODES <table border="1" style="width:100%; border-collapse: collapse; margin-top: 5px;"> <thead> <tr> <th style="padding: 2px;">FIELD</th> <th style="padding: 2px;">GROUP</th> <th style="padding: 2px;">SUB GR.</th> </tr> </thead> <tbody> <tr> <td style="padding: 2px;">1308</td> <td style="padding: 2px;">0905</td> <td style="padding: 2px;"></td> </tr> </tbody> </table>		FIELD	GROUP	SUB GR.	1308	0905		18. SUBJECT TERMS (Continue on reverse if necessary and identify block no.)				
FIELD	GROUP	SUB GR.										
1308	0905											
19. ABSTRACT (Continue on reverse if necessary and identify block number)  This specification establishes the design of Function PRE2, "Parse Procedure Division", one of the major functions of the Configuration Item "Precompiler" to be built and formally accepted by the ICAM Program Office.  <b>BLOCK 11:</b>  <b>INTEGRATED INFORMATION SUPPORT SYSTEM</b> <b>Vol V - Common Data Model Subsystem</b>  <b>Part 12 - Neutral Data Manipulation Language (NDML) Precompiler Parse Procedure Division Product Specification</b>												
20. DISTRIBUTION/AVAILABILITY OF ABSTRACT UNCLASSIFIED/UNLIMITED x SAME AS RPT. DTIC USERS		21. ABSTRACT SECURITY CLASSIFICATION Unclassified										
22a. NAME OF RESPONSIBLE INDIVIDUAL David L. Judson		22b. TELEPHONE NO. (Include Area Code) (513) 255-7371	22c. OFFICE SYMBOL WRDC/MTI									

FOREWORD

This technical report covers work performed under Air Force Contract F33600-87-C-0464, DAPro Project. This contract is sponsored by the Manufacturing Technology Directorate, Air Force Systems Command, Wright-Patterson Air Force Base, Ohio. It was administered under the technical direction of Mr. Bruce A. Rasmussen, Branch Chief, Integration Technology Division, Manufacturing Technology Directorate, through Mr. David L. Judson, Project Manager. The Prime Contractor was Integration Technology Services, Software Programs Division, of the Control Data Corporation, Dayton, Ohio, under the direction of Mr. W. A. Osborne. The DAPro Project Manager for Control Data Corporation was Mr. Jimmy P. Maxwell.

The DAPro project was created to continue the development, test, and demonstration of the Integrated Information Support System (IISS). The IISS technology work comprises enhancements to IISS software and the establishment and operation of IISS test bed hardware and communications for developers and users.

The following list names the Control Data Corporation subcontractors and their contributing activities:

<u>SUBCONTRACTOR</u>	<u>ROLE</u>
Control Data Corporation	Responsible for the overall Common Data Model design development and implementation, IISS integration and test, and technology transfer of IISS.
D. Appleton Company	Responsible for providing software information services for the Common Data Model and IDEF1X integration methodology.
ONTEK	Responsible for defining and testing a representative integrated system base in Artificial Intelligence techniques to establish fitness for use.
Simpact Corporation	Responsible for Communication development.
Structural Dynamics Research Corporation	Responsible for User Interfaces, Virtual Terminal Interface, and Network Transaction Manager design, development, implementation, and support.
Arizona State University	Responsible for test bed operations and support.

TABLE OF CONTENTS

		<u>Page</u>
SECTION 1.0	SCOPE .....	1-1
1.1	Identification .....	1-1
1.2	Functional Summary .....	1-1
SECTION 2.0	DOCUMENTS .....	2-1
2.1	Reference Documents .....	2-1
2.2	Terms and Abbreviations .....	2-1
SECTION 3.0	REQUIREMENTS .....	3-1
3.1	Structural Description .....	3-1
3.2	Functional Flow .....	3-1
3.3	Interfaces .....	3-1
3.3.1	Inputs/Outputs .....	3-2
3.4	Program Interrupts .....	3-2
3.5	Timing and Sequencing Description ...	3-2
3.6	Special Control Features .....	3-2
3.7	Storage Allocation .....	3-2
3.7.1	Database Definition .....	3-2
3.7.1.1	File Description .....	3-3
3.7.1.2	Table Description .....	3-3
3.7.1.3	Item Description .....	3-3
3.8	Object Code Creation .....	3-3
3.9	Adaptation Data .....	3-3
3.10	Detail Design Description .....	3-3
3.10.1	Where Include File Used List .....	3-3
3.10.2	Where External Routine Used List .....	3-6
3.10.3	Main Program Parts List .....	3-7
3.10.4	Module Documentation .....	3-9
3.10.5	Include File Description .....	3-14
3.10.6	Hierarchy Chart .....	3-23
3.11	Program Listings Comments .....	3-25
SECTION 4.0	QUALITY ASSURANCE PROVISIONS .....	4-1
4.1	Introduction and Definitions .....	4-1
4.2	Computer Programming and Test Evaluation .....	4-1

SECTION 1

SCOPE

1.1 Identification

This specification establishes the design of Function PRE2, "Parse Procedure Division", one of the major functions of the Configuration Item "Precompiler" to be built and formally accepted by the ICAM Program office. This CI constitutes one of the subsystems of the Common Data Model Processor (CDMP).

1.2 Functional Summary

The purpose of this Computer Program Configuration Item (CPCI) is to identify all Neutral Data Manipulation Language (NDML or SQL) commands contained within the Application Program and for each command, insure all other Precompiler activities are performed.

The following functions will be performed by this CPCI:

1. Scan input file for the start of an NDML or SQL command.
2. Call the Parser to syntactically check the command.
3. For each command:
  - a. Populate the External Schema (ES) action and qualify lists.
  - b. Control all other precompiler activities.

Accession For	
NTIS GRA&I	<input checked="" type="checkbox"/>
DTIC TAB	<input type="checkbox"/>
Unannounced	<input type="checkbox"/>
Justification	
By	
Distribution/	
Availability Codes	
Dist	Avail and/or Special
A-1	

SECTION 2

DOCUMENTS

2.1 Reference Documents

1. ICAM Documentation Standards: IDS15012000A, 28 December 1981.
2. D. Appleton Co., CDM Administrator's Manual; UM620141000, March 1984.
3. D. Appleton Co., CDM1-IDEF Model of the Common Data Model; CCS620141000, 15 May 1985.
4. D. Appleton Co., Computer Program Development Specification (DS) for ICAM Integrated Support System (IISS) Configuration Item: NDML Precompiler; DS620141200, October 1984.
5. D. Appleton Co., Embedded NDML Programmer's Reference Manual; PRM620141200, March 1985.
6. Softech, Inc., NTM Programmer's Guide; UM620140001, July 1984.
7. Control Data Corp., Computer Program Development Specification (DS) for ICAM Integrated Support System (IISS) Configuration Item: NDDL Command Processor; DS620141100, June 1985.

2.2 Terms and Abbreviations

Attribute Use Class: (AUC)

Conceptual Schema: (CS)

Common Data Model Processor: (CDMP)

Common Data Model: (CDM) Describes common data application process formats, form definitions, etc, of the IISS and includes conceptual schema, external, internal schemas, and schema transformation operators.

Data Field: (DF) An element of data in the external schema. It is by this name that an NDML programmer references data.

Database Management System: (DBMS)

Distributed Request Supervisor: (DRS) This IISS CDM subsystem configuration item controls the execution of distributed NDML queries and non distributed updates.

Domain: A logical definition of legal attribute class values.

Domain Constraint: Predicate that applies to a single domain.

External Schema: (ES)

**Forms:** Structured views which may be imposed on windows or other forms. A form is composed of fields where each field is a form, item, or window.

**Forms Processor: (FP)** A set of callable execution time routines available to an application program for form processing.

**Internal Schema: (IS)**

**Integrated Information Support System: (IISS)** A test computing environment used to investigate, demonstrate and test the concepts of information management and information integration in the context of Aerospace Manufacturing. The IISS addresses the problems of integration of data resident on heterogeneous databases supported by heterogeneous computers interconnected via a local Area Network.

**Mapping:** The correspondence of independent objects in two schemas: ES to CS or CS to IS.

**Network Transaction Manager: (NTM)** Performs the coordination, communication and housekeeping functions required to integrate the application processes and system services resident on the various hosts into a cohesive system.

**Neutral Data Manipulation Language: (NDML)** A language developed by the IISS project to provide uniform access to common data, regardless of database manager or distribution criteria. It provides distributed retrieved and single node updates.

**ORACLE:** Relational DBMS based on the SQL (Structured Query Language, a product of ORACLE Corp, Menlo Park, CA). The CDM is an ORACLE database.

**Parcel:** A sequential file containing sections source code of the input application program.

**Request Processor: (RP)** A COBOL program that will satisfy a retrieval or update NDML subtransaction against a particular Database Management System.

**User Interface: (UI)** Controls the user's terminal and interfaces with the rest of the system.

**Virtual Terminal Interface: (VTI)** Performs the interfacing between different terminals and the UI. This is done by defining a specific set of terminal features and protocols which must be supported by UI software which constitutes the Virtual Terminal Definition. Specific terminals are then mapped against the Virtual Terminal software by specific software modules written for each type of real terminal supported.



SECTION 3  
REQUIREMENTS

3.1 Structural Description

A graphic portrayal of this CPCI is included in Section 3.10. This chart shows the hierarchical relationships of each module making up this CPCI.

This CPCI uses a number of lower level modules to handle specific operations such as:

1. Open associated files and parcels (OPNFIL).
2. Read associated files and parcels (INPFIL).
3. Write records to associated files and parcels (OUTFIL).
4. Close associated files and parcels (CLSFIL).
5. Syntactically check the NDML or SQL command (NDMLPAR).
6. Semantically check the NDML or SQL command and populate external schema action and qualify lists (CDPRE2A).

3.2 Functional Flow

This CPCI implements the logic defined in the Development Specification for this CPCI. Details of inputs/outputs and relationships between modules are to be found in Section 3.10.

This CPCI has been designated to operate in a batch or interactive mode. It must use the ORACLE DBMS installed on a DEC VAX computer.

3.3 Interfaces

The following diagram depicts the interface of PRE2 with other CPCI's on the system.

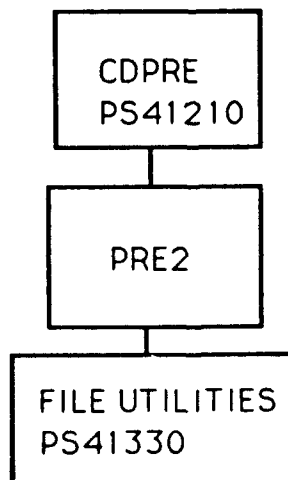

### 3.3.1 Inputs/Outputs

The following table depicts the inputs and outputs of this CPCI. A detail description for each item can be found in the DS for this CPCI.

Function: PRE2

<u>INPUT</u>	<u>OUTPUT</u>
Parcel 1 File Pointer	Code generator table
Parcel 2 File Pointer	File Status
Parcel 3 File Pointer	Module Status
Parcel 4 File Pointer	
Error File Pointer	
Source Language	
Current Host	
Target Host	
User Module Name	
Last Case Number	
Logical Unit of Work Name	
Input File Pointer	
Embedded Language	
SQL Variable Table	
Curley Stack	
Subroutine Language	

### 3.4 Program Interface

Not applicable to this CPCI.

### 3.5 Timing and Sequencing Description

This CPCI is called upon by the CDPRE precompiler control module to parse and precompile each NDML or SQL statement found in a COBOL procedure division or FORTRAN or C executable code section. PRE2 remains in control until the end of the user software module is detected. Function PRE1 has previously scanned the input until the beginning of executable host language statements.

### 3.6 Special Control Features

Not applicable to this CPCI.

### 3.7 Storage Allocation

#### 3.7.1 Database Definition

The database used by this CPCI is the Common Data Model (CDM) database. This model is defined by the CDM1, the IDEF-1 model of the CDM, Reference Document Number 3. The database was constructed using ORACLE.

### 3.7.1.1 File Description

No permanent files have been defined for this CPCI. It uses temporary scratch files for program source code.

### 3.7.1.2 Table Description

All tables used by this CPCI have been defined by the Development Specification for this CPCI.

### 3.7.1.3 Item Description

Not applicable to this CPCI.

### 3.8 Object Code Creation

The object code for this CPCI will be created by the system integration test team by using defined IISS Software Configuration Management procedures. This CPCI will use the COBOL and "C" language compilers. In addition, source code generated by the YACC and LEX UNIX tools must be compiled to become objects in the final, executable software package.

### 3.9 Adaptation Data

This CPCI has been coded using ANSI COBOL and a "standard" subset of the "C" language. The intent was to provide a transportable system. Any system environment supporting these languages, a virtual memory management scheme, and the ORACLE Database Management System should be able to support this CPCI. Every possible attempt has been made to localize and identify any machine or environment dependent modules through the original design of the IISS and application of Configuration Management Procedures.

### 3.10 Detail Design Description

The following sections have been computer generated for this CPCI.

#### 3.10.1 Where Include File Used List

The following lists each include file in the documentation group and all the modules documented in this specification which include them. The purpose of each module is listed as well.

DOCGROUP PS41212 Where-include-file-used List

Include File -----	Module Name -----
CURTAB	CDPRE2 CDPRE2A CDQCSTK
WHENTAB	CDPRE2 CDPRE2A CDQCSTK
NDMLSTK	CDPRE2 CDPRE2A CDQCSTK
MACDAT	CDPRE2
SBSTLST	CDPRE2
FORVAR	CDPRE2 CDQCSTK
ERRCDM	CDPRE2 CDPRE2A CDQCSTK
CHKCDM	CDPRE2 CDQCSTK
ERRFS	CDPRE2 CDPRE2A CDQCSTK
CGTABLE	

DOCGROUP PS41212 Where-include-file-used List

Include File -----	Module Name -----
SQLVAR	CDPRE2 CDQCSTK
ERRPRO	CDPRE2 CDPRE2A CDQCSTK
ATTRNOS	CDPRE2 CDPRE2A CDQCSTK
LISTNOS	CDPRE2A
CMDNOS	CDPRE2A CDQCSTK
ESAL	CDPRE2A CDQCSTK
UVABBR	CDPRE2A CDQCSTK
ESQUAL	CDPRE2A CDQCSTK
CSQUAL	CDPRE2A CDQCSTK
BOOLST	CDPRE2A CDQCSTK

DOCGROUP PS41212 Where-include-file-used List

Include File -----	Module Name -----
	CDPRE2A CDQCSTK
CSAL	
RFTABLE	CDQCSTK
APL	CDQCSTK
BLSTACK	CDQCSTK

3.10.2 Where External Routine Used List

The following lists each external function or routine in the documentation group and all the documented modules which call it. The purpose of each module is listed as well.

DOCGROUP PS41212 Where-external-routine-used List

System Module -----	Module Name -----
RPTERR	CDPRE2 CDPRE2A CDQCSTK
NAMFIL	CDPRE2
OPNFIL	CDPRE2
SQLFILE	CDPRE2
UNPLINE	CDPRE2
CLSFIL	CDPRE2
NDMLPAR	CDPRE2
TOKEN	CDPRE2
INPFIL	CDPRE2
CURLCNT	CDPRE2
CDMACR	CDPRE2
OUTFIL	CDPRE2
ERRPRO	CDPRE2 CDPRE2A CDQCSTK
SET_LEVEL	

DOCGROUP PS41212 Where-external-routine-used List

System Module -----	Module Name -----
	CDPRE2A CDQCSTK
GET_FIRST_SYMB	
	CDPRE2A CDQCSTK
GET_FRST_CHAIN	
	CDPRE2A
GET_NEXT_SYMB	
	CDPRE2A CDQCSTK
COLCHK	
	CDPRE2A
LOWUPP	
	CDPRE2A
GET_NEXT_CHAIN	
	CDPRE2A
FREE_SYMTAB	
	CDQCSTK
CDTRANS	
	CDQCSTK
CDPRE4	
	CDQCSTK
CDP10S	
	CDQCSTK
CDP10T	
	CDQCSTK

3.10.3 Main Program Parts List

The following lists each Main Program in the documentation group and all the modules which are called either by that module itself or by any of the documented modules which it calls. It is possible for a non-main module to be listed more than once if it is called by multiple modules. The called modules, in this case known as program parts, are marked as to whether they are documented here. If so, the phrase "well-defined module" appears by the module name, if not it is an "external routine". The Purpose of the Main Program module is listed as well.

DOCGROUP PS41212 Main Program Parts List

Main Pgm Name -----	Module Name -----	Module Type -----
CDPRE2	RPTERR	External routine
	NAMFIL	External routine
	OPNFIL	External routine
	SQLFILE	External routine
	UNPLINE	External routine
	CLSFIL	External routine
	NDMLPAR	External routine
	CDQCSTK	Well-defined module
	TOKEN	External routine
	INPFIL	External routine
	CURLCNT	External routine
	CDMACR	External routine
	OUTFIL	External routine
	ERRPRO	External routine
CDPRE2A	RPTERR	External routine
	ERRPRO	External routine
	SET_LEVEL	External routine
	GET_FIRST_SYMB	External routine
	GET_FRST_CHAIN	External routine
	GET_NEXT_SYMB	External routine
	COLCHK	External routine
	LOWUPP	External routine
GET_NEXT_CHAIN	External routine	
CDQCSTK	RPTERR	External routine
	ERRPRO	External routine
	SET_LEVEL	External routine
	GET_FIRST_SYMB	External routine
	GET_NEXT_SYMB	External routine



DOCGROUP PS41212 Main Program Parts List

Main Pgm Name -----	Module Name -----	Module Type -----
	FREE_SYMTAB	External routine
	CDPRE2A	External routine
	CDTRANS	External routine
	CDPRE4	External routine
	CDP10S	External routine
	CDP10T	External routine

3.10.4 Module Documentation

The following documentation describes information which is specific to each individual module in the documentation group being documented in this specification. It provides a compact way of getting information that would be otherwise buried within each module's source code.

The specific items in this module documentation have the following meanings:

NAME: Name of program Module.

PURPOSE: Purpose of Module as detailed in the source code.

LANGUAGE: Programming language source code is written in.  
The choices are:  
VAX-11 FORTRAN  
C (I/S-1 Workbench 'C')  
VAX-11 COBOL

MODULE TYPE: Whether a Program, Subroutine, or Function.

SOURCE FILE: Name of Source File from file specification.

SOURCE FILE TYPE: Source File Extension from file specification.

HOST: Whether this is a host-dependent routine (VAX or IBM) or blank if host-independent.

SUBSYSTEM: IISS sub-system this file resides in.

SUBDIRECTORY: Sub-directory of that subsystem in which this file resides.

DOCUMENTATION GROUP: Name of documentation group of which this source file is a member.

DESCRIPTION: A description of the module as obtained from the source code.

ARGUMENTS: The arguments with which this routine is called if it is a Subroutine or a Function.

INCLUDE FILES: A list of all the files that are included into this module as well as their purposes.

ROUTINES CALLED: Subroutines or Functions, either documented or external, called by this module, if any.

CALLED DIRECTLY BY: The documented routines which call this module, if any.

USED IN MAIN PROGRAM(S): The documented Main Programs which contain this module in their parts list according to the list in section 3.10.3.

The Module Documentation is arranged alphabetically according to Module Name.

DOCGROUP PS41212 Module Documentation

NAME: CDPRE2  
PURPOSE: PARSE THE PROCEDURE DIVISION OF USERS APPLICATION  
LANGUAGE: VAX-11 COBOL  
SOURCE FILE: CDPRE2  
SOURCE FILE TYPE: COB  
HOST:  
SUBSYSTEM: CDM  
SUBDIRECTORY: NDML

DESCRIPTION:

-----

- CDPRE2 WILL DO THE FOLLOWING:

ARGUMENTS:

-----

USER-MODULE-NAME	DSPLY[X(10)]
LAST-CASE-NO	DSPLY[9(6)]
LUW-NAME	DSPLY[X(30)]
FCB-INPUT	DSPLY[S9(9)]
FCB-1	DSPLY[S9(9)]
FCB-2	DSPLY[S9(9)]
FCB-3	DSPLY[S9(9)]
FCB-4	DSPLY[S9(9)]
FCB-E	DSPLY[S9(9)]
SOURCE-LANGUAGE	DSPLY[X(10)]
EMBEDDED-LANGUAGE	DSPLY[X(10)]

SQL-VARIABLE-TABLE  
MY-HOST  
TARGET-HOST  
CURLEY-STACK  
CODE-GENERATOR-TABLE  
FILE-STATUS  
SUB-LANG  
RET-STATUS

RECRD  
DSPLY[X(3)]  
DSPLY[XXX]  
DSPLY[S9(9)]  
RECRD  
DSPLY[S9(4)]  
DSPLY[X(10)]  
DSPLY[X(5)]

INCLUDE FILES:

-----  
CURTAB  
WHENTAB  
NDMLSTK  
MACDAT  
SBSTLST  
FORVAR  
ERRCDM  
CHKCDM  
ERRFS  
CGTABLE  
SQLVAR  
ERRPRO

ROUTINES CALLED:

-----  
RPTERR  
NAMFIL  
OPNFIL  
SQLFILE  
UNPLINE  
CLSFIL  
NDMLPAR  
CDQCSTK  
TOKEN  
INPFIL  
CURLCNT  
CDMACR  
OUTFIL  
ERRPRO

DOCGROUP PS41212 Module Documentation

NAME: CDPRE2A  
PURPOSE: CDPRE2A - PARSE NDML AND BUILD ES PRECOMPILER LISTS  
LANGUAGE: VAX-11 COBOL  
SOURCE FILE: CDPRE2A  
SOURCE FILE TYPE: COB  
HOST:  
SUBSYSTEM: CDM  
SUBDIRECTORY: NDML

DESCRIPTION:

-----

-

THIS MODULE CONTROL THE LOGIC OF  
PARSING NDML STATEMENTS IN THE USER  
APPLICATION PROGRAM.

ARGUMENTS:

-----

COMMAND-NO	DSPLY[S9(9)]
SCOPE-NO	DSPLY[S9(9)]
NDML-STACK	RECRD
ES-ACTION-LIST	RECRD
UV-ABBR-LIST	RECRD
ES-QUALIFY-LIST	RECRD
CS-QUALIFY-LIST	RECRD
BOOLEAN-LIST	RECRD
FCB-E	DSPLY[S9(9)]
SOURCE-LANGUAGE	DSPLY[X(10)]
EMBEDDED-LANGUAGE	DSPLY[X(10)]
SQL-VARIABLE-TABLE	RECRD
CURSOR-TABLE	RECRD
WHENEVER-TABLE	
RETURN-STATUS	DSPLY[X(5)]

INCLUDE FILES:

-----

ATTRNOS  
LISTNOS  
CMDNOS  
ERRCDM  
ERRFS  
NDMLSTK  
ESAL  
UVABBR  
ESQUAI  
CSQUAL  
BOOLST  
SQLVAR  
CURTAB  
WHENTAB  
ERRPRO

ROUTINES CALLED:

-----  
SET\_LEVEL  
GET\_FIRST\_SYMB  
GET\_FRST\_CHAIN  
GET\_NEXT\_SYMB  
COLCHK  
LOWUPP  
GET\_NEXT\_CHAIN  
RPTERR  
ERRPRO

DOCGROUP PS41212 Module Documentation

NAME: CDQCSTK  
PURPOSE: CDQCSTK - PARSE NDML AND BUILD ES PRECOMPILER LISTS  
LANGUAGE: VAX-11 COBOL  
SOURCE FILE: CDQCSTK  
SOURCE FILE TYPE: COB  
HOST:  
SUBSYSTEM: CDM  
SUBDIRECTORY: NDML

DESCRIPTION:

-----  
-

THIS MODULE CONTROL THE SEQUENCE OF  
PRECOMPILING SUB-COMMAND OF COMBINED COMMAND  
IN THE USER APPLICATION PROGRAM.

DELETED IOS-SECTION PARAMETER -- 2 MAY 1989

ARGUMENTS:

-----  
COMMAND-NO DSPLY[S9(9)]  
NDML-STACK RECRD  
FCB-I DSPLY[S9(9)]  
FCB-F DSPLY[S9(9)]  
FCB-W DSPLY[S9(9)]  
FCB-P DSPLY[S9(9)]  
FCB-E DSPLY[S9(9)]  
SOURCE-LANGUAGE DSPLY[X(10)]  
EMBEDDED-LANGUAGE DSPLY[X(10)]  
PRECOMPILE-HOST DSPLY[XXX]  
AP-TARGET-HOST DSPLY[XXX]  
CODE-GENERATOR-TABLE RECRD  
LAST-CASE-NO DSPLY[9(6)]  
LUW-NAME DSPLY[X(30)]  
USER-MODULE-NAME DSPLY[X(10)]

SQL-VARIABLE-TABLE	RECRD
FIRST-INNER-SELECT	DSPLY[9]
FORTTRAN-VARIABLE-TABLE	RECRD
SUB-LANG	DSPLY[X(10)]
CURSOR-TABLE	RECRD
WHENEVER-TABLE	
RET-STATUS	DSPLY[X(5)]

INCLUDE FILES:

-----  
CMDNOS  
LISTNOS  
CHKCDM  
ERRCDM  
ERRFS  
ESAL  
ESQUAL  
BOOLST  
UVABBR  
CSAL  
CSQUAL  
RFTABLE  
APL  
BLSTACK  
NDMLSTK  
CURTAB  
WHENTAB  
SQLVAR  
CGTABLE  
FORVAR  
ERRPRO

ROUTINES CALLED:

-----  
SET\_LEVEL  
GET\_FIRST\_SYMB  
FREE\_SYMTAB  
GET\_NEXT\_SYMB  
CDPRE2A  
CDTRANS  
CDPRE4  
CDP10S  
CDP10T  
RPTERR  
ERRPRO

### 3.10.5 Include File Descriptions

The following list contains a purpose and description of each include file in the documentation group as specified in the source code. The language it is written in is also given.

DOCGROUP PS41212 Include File Description

FILE NAME: APL  
PURPOSE: JOIN QUERY ATTRIBUTE PAIR LIST  
LANGUAGE: VAX-11 COBOL

DESCRIPTION:  
-----

CONTAINS INFORMATION ABOUT THE JOIN  
ATTRIBUTES FOR NDML SUBTRANSACTIONS

DOCGROUP PS41212 Include File Description

FILE NAME: ATTRNOS  
PURPOSE: THE PARSER.  
LANGUAGE: VAX-11 COBOL

DESCRIPTION:  
-----

DOCGROUP PS41212 Include File Description

FILE NAME: BLSTACK  
PURPOSE: NDML COMMAND NESTING INFORMATION  
LANGUAGE: VAX-11 COBOL

DESCRIPTION:  
-----

DOCGROUP PS41212 Include File Description

FILE NAME: BOOLST  
PURPOSE: BOOLEAN LIST  
LANGUAGE: VAX-11 COBOL

DESCRIPTION:  
-----

CONTAINS THE BOOLEAN OPERATORS, PARENTHESES, AND  
POINTERS TO THE TYPE 2 CONDITIONS FOR AN NDML  
TRANSACTION

DOCGROUP PS41212 Include File Description

FILE NAME: CGTABLE  
PURPOSE: CODE GENERATING TABLE- TRACKS ALL GENERATED SOFTWARE  
LANGUAGE: VAX-11 COBOL

DESCRIPTION:  
-----

HOLDS PERTINENT RESULTS  
ABOUT ALL CODE GENERATED OR MODIFIED BY THE  
PRECOMPILER

DOCGROUP PS41212 Include File Description

FILE NAME: CHKCDM  
PURPOSE: IISS CDMP CHECK STATUS CODES  
LANGUAGE: VAX-11 COBOL

DESCRIPTION:  
-----



DOCGROUP PS41212 Include File Description

FILE NAME: CMDNOS  
PURPOSE:  
LANGUAGE: VAX-11 COBOL

DESCRIPTION:  
-----

Description : Contains a unique command number  
definition for all NDDL and NDML commands.  
This number is used in processing to  
determine the appropriate processor to  
execute.

Related File(s) : CMDID.H is the C version of this copy  
member

Warning(s) : NDDL and NDML command id definitions must not  
conflict (two commands defined as the same  
number. Commands should be kept in alphabetical  
order.

DOCGROUP PS41212 Include File Description

FILE NAME: CSAL  
PURPOSE: CONCEPTUAL SCHEMA ACTION LIST  
LANGUAGE: VAX-11 COBOL

DESCRIPTION:  
-----

TABLE TO HOLD CONCEPTUAL DATA ABOUT THE REQUEST

NOTE!!!!!! This table is cloned in both cdpre5 and cdpre4  
so any changes made to this structure needs to  
be made in these cloned versions. Clone version  
is CSALX for CDPRE4.

NOTE AGAIN Any changes to the CS-ACTION-ENTRY must be  
reflected in CDP10B in the C code generation section.  
The length of CS-STRING2 has been hard coded in the  
generated C code in paragraph 210-GEN-MOVE-OF-TABLES.

DOCGROUP PS41212 Include File Description

FILE NAME: CSQUAL  
PURPOSE: CONCEPTUAL SCHEMA QUALIFY LIST  
LANGUAGE: VAX-11 COBOL

DESCRIPTION:  
-----

CONTAINS CONCEPTUAL SCHEMA INFORMATION FOR  
THE REQUEST'S QUALIFICATION

NOTE!!!!

This table is cloned as CSQUALX in CDPRE4. If it  
is changed, CSQUALX must be changed also.

THE CONCEPTUAL SCHEMA QUALIFY LIST

DOCGROUP PS41212 Include File Description

FILE NAME: CURTAB  
PURPOSE: SQL VARIABLE TABLE  
LANGUAGE: VAX-11 COBOL

DESCRIPTION:  
-----

THIS TABLE HOLDS THE VARIABLES DECLARED IN THE  
EXEC SQL BEGIN DECLARE SECTION.

DOCGROUP PS41212 Include File Description

FILE NAME: ERRCDM  
PURPOSE: IISS ERROR STATUS CODES FOR CDMP MODULES  
LANGUAGE: VAX-11 COBOL

DESCRIPTION:  
-----

CONTAINS ALL ERROR CODES USED BY CDMP \*  
MODULES FOR ERROR HANDLING \*

DOCGROUP PS41212 Include File Description

FILE NAME: ERRFS  
PURPOSE: ERRFS.INC - FILE I/O PRIMITIVES (FILE SERVICES)  
LANGUAGE: VAX-11 COBOL

DESCRIPTION:  
-----

IISS ERROR CODES

THIS FILE DEFINES THE FS STATUS  
CODES IN COBOL FORMAT

DOCGROUP PS41212 Include File Description

FILE NAME: ERRPRO  
PURPOSE: PROCESS ERROR INCLUDE FILE  
LANGUAGE: VAX-11 COBOL

DESCRIPTION:  
-----

DOCGROUP PS41212 Include File Description

FILE NAME: ESAL  
PURPOSE: EXTERNAL SCHEMA ACTION LIST  
LANGUAGE: VAX-11 COBOL

DESCRIPTION:  
-----

CONTAINS THE EXTERNAL SCHEMA INFORMATION FOR AN  
NDML REQUEST

THE EXTERNAL SCHEMA ACTION LIST

DOCGROUP PS41212 Include File Description

FILE NAME: ESQUAL  
PURPOSE: EXTERNAL SCHEMA QUALIFY LIST  
LANGUAGE: VAX-11 COBOL

DESCRIPTION:  
-----

CONTAINS EXTERNAL SCHEMA INFORMATION FOR THE NDML  
QUALIFICATION

THE EXTERNAL SCHEMA QUALIFY LIST

DOCGROUP PS41212 Include File Description

FILE NAME: FORVAR  
PURPOSE: FORTRAN VARIABLE TABLE  
LANGUAGE: VAX-11 COBOL

DESCRIPTION:  
-----

THIS TABLE HOLDS THE ORIGINAL FORTRAN VARIABLE  
AND ITS GENERATED SIX-CHARACTER COUNTERPART.

DOCGROUP PS41212 Include File Description

FILE NAME: LISTNOS  
PURPOSE: NDDL AND NDML LIST NUMBERS  
LANGUAGE: VAX-11 COBOL

DESCRIPTION:  
-----

CONTAINS THE VALID SET LIST NUMBERS USED BY  
NDDL AND NDML FOR STORING AND RETRIEVING TOKENS  
FROM PARSED COMMANDS.

DOCGROUP PS41212 Include File Description

FILE NAME: MACDAT  
PURPOSE: WS VARIABLES FOR MACRO COPY UTILITY  
LANGUAGE: VAX-11 COBOL

DESCRIPTION:  
-----

DOCGROUP PS41212 Include File Description

FILE NAME: NDMLSTK  
PURPOSE: NDML COMMAND NESTING INFORMATION  
LANGUAGE: VAX-11 COBOL

DESCRIPTION:  
-----

DOCGROUP PS41212 Include File Description

FILE NAME: RFTABLE  
PURPOSE: THE RESULT FIELD TABLE  
LANGUAGE: VAX-11 COBOL

DESCRIPTION:  
-----

CONTAINS CONCEPTUAL SCHEMA INFORMATION ABOUT  
THE RESULTS OF AN NDML REQUEST

THE RESULT FIELD TABLE

WHEN CHANGING THE STRUCTURE OF THIS TABLE  
BE SURE TO CHANGE THE LAYOUT IN THE  
LINKAGE SECTION OF THE DRS (CDS01)  
WHICH WAS COPIED FROM THIS.

DOCGROUP PS41212 Include File Description

FILE NAME: SBSTLST  
PURPOSE: WS DEFINITION FOR THE SUBSTITUTION LIST TABLE  
LANGUAGE: VAX-11 COBOL

DESCRIPTION:  
-----

SUBSTITUTION-LIST REPRESENTS THE INPUT TABLE  
OF SUBSTITUTION PARAMETERS FOR THE CDMACR  
MACRO EXPANSION SUBROUTINE

DOCGROUP PS41212 Include File Description

FILE NAME: SQLVAR  
PURPOSE: SQL VARIABLE TABLE  
LANGUAGE: VAX-11 COBOL

DESCRIPTION:  
-----

THIS TABLE HOLDS THE VARIABLES DECLARED IN THE  
EXEC SQL BEGIN DECLARE SECTION.

DOCGROUP PS41212 Include File Description

FILE NAME: UVABBR  
PURPOSE: USER VIEW ABBREVIATION LIST  
LANGUAGE: VAX-11 COBOL

DESCRIPTION:  
-----

CONTAINS THE ABBREVIATIONS FOR ALL USER  
VIEW REFERENCED IN THE NDML REQUEST

3.10.6 Hierarchy Chart

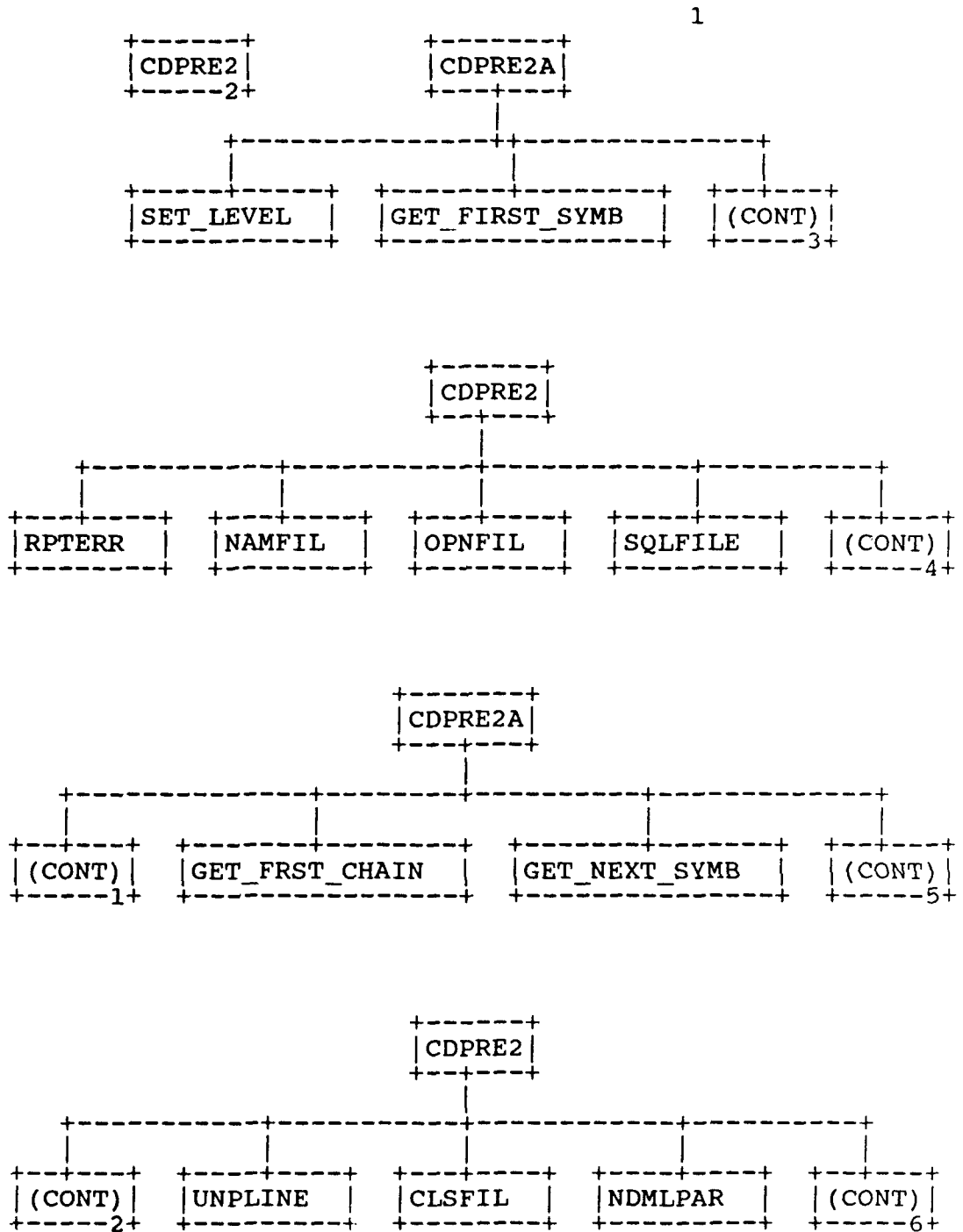

5

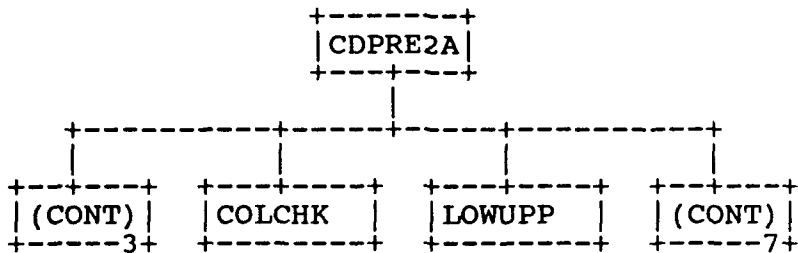

6

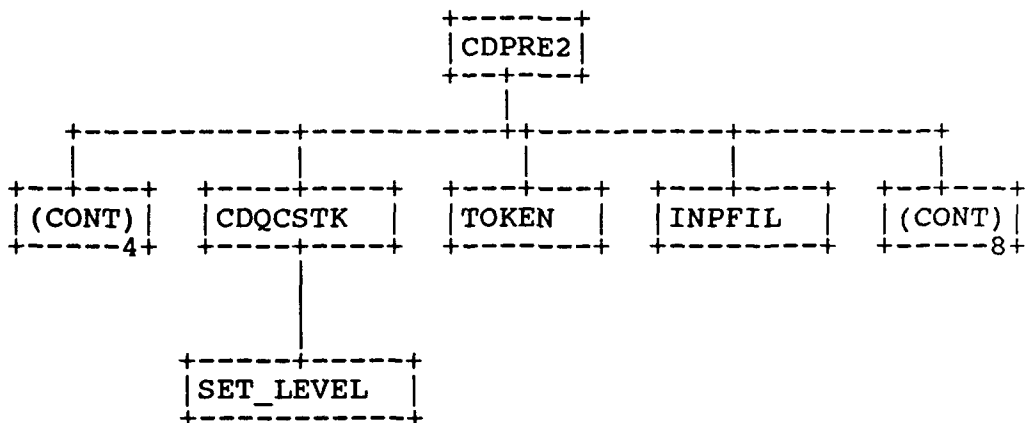

7

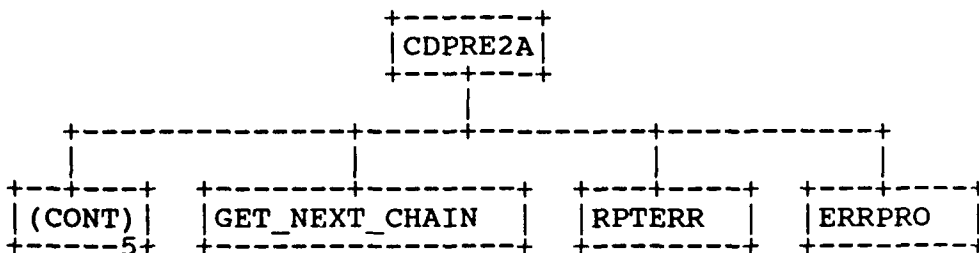

8

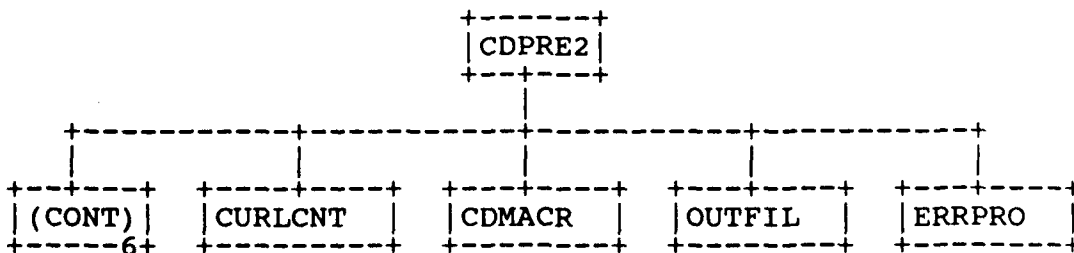



CDMACR  
CDPRE2.....2  
CDPRE2A.....1  
CDQCSTK .....6  
CLSFIL  
COLCHK  
CURLCNT  
ERRPRO  
GET\_FIRST\_SYMB  
GET\_FRST\_CHAIN  
GET\_NEXT\_CHAIN  
GET\_NEXT\_SYMB  
INPFIL  
LOWUPP  
NAMFIL  
NDMLPAR  
OPNFIL  
OUTFIL  
RPTERR  
SET\_LEVEL  
SQLFILE  
TOKEN  
UNPLINE

3.11 Program Listings Comments

This information is contained in the Module Descriptions in section 3.10.

## SECTION 4

### QUALITY ASSURANCE PROVISIONS

#### 4.1 Introduction and Definitions

"Testing" is a systematic process that may be preplanned and explicitly stated. Test techniques and procedures may be defined in advance, and a sequence of test steps may be specified. "Debugging" is the process of isolation and correction of the cause of an error.

"Antibugging" is defined as the philosophy of writing programs in such a way as to make bugs less likely to occur and when they do occur, to make them more noticeable to the programmer and the user. In other words, as much error checking as is practical and possible in each routine should be performed.

#### 4.2 Computer Programming Test and Evaluation

The quality assurance provisions for test consists of the normal testing techniques that are accomplished during the construction process. They consist of design and code walk-throughs, unit testing, and integration testing. These tests are performed by the design team. Structured design, design walk-through and the incorporation of "antibugging" facilitate this testing by exposing and addressing problem areas before they become coded "bugs."