

AD-A248 011



DOT/FAA/ND-91/1

Associate Administrator
for NAS Development
Washington, D.C. 20591

**Evaluation of Advanced
Microwave Landing System
Procedures in the New York
Terminal Area**

Barry C. Scott
Federal Aviation Administration

Jim Dargue
Mitech, Inc.

Tsuyoshi Goka
T. Goka Avionics



March 1991

Final Report

92-07603



This document is available to the public
through the National Technical Information
Service, Springfield, Virginia 22161.

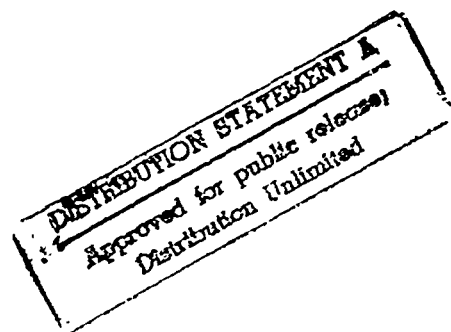

US Department of Transportation
Federal Aviation Administration

**EVALUATION OF ADVANCED
MICROWAVE LANDING SYSTEM PROCEDURES
IN THE
NEW YORK TERMINAL AREA**

Prepared for

**FAA MLS PROGRAM OFFICE
AND-30**

Prepared by

**Barry C. Scott
Federal Aviation Administration**

**Jim Dargue
Mitech, Inc.**

**Tsuyoshi Goka
T. Goka Avionics**

December, 1991

Table of Contents

INTRODUCTION.....	1
BACKGROUND.....	1
OBJECTIVES.....	2
DESCRIPTION OF THE SIMULATION FACILITIES.....	2
Aircraft.....	2
Air Traffic Control Laboratory.....	3
MLS Ground Installations.....	3
DESCRIPTION OF THE TEST METHODOLOGY.....	4
General.....	4
Controller Training.....	5
Data Collection.....	5
LAGUARDIA SIMULATION.....	5
General.....	5
MLS Ground Installation.....	6
Procedures.....	6
Scenarios.....	7
Discussion of Results.....	7
KENNEDY SIMULATION.....	12
General.....	12
MLS Ground Installation.....	12
Procedures.....	12
Scenarios.....	12
Discussion of Results.....	13
NEWARK SIMULATION.....	14
General.....	14
MLS Ground Installation.....	15
Procedures.....	15
Scenarios.....	15
Discussion of Results.....	15
GENERAL COMMENTS.....	16
SUMMARY OF RESULTS.....	18

**APPENDIX A - DESCRIPTION OF THE MLS CAPABILITY IN THE B-727
SIMULATOR**

Ground System, Angle Receiver and DME/P Interrogator Module
MLS/RNAV Algorithms
MLS/RNAV CDU
Interface With Existing B-727 Avionics

**APPENDIX B - DESCRIPTION OF THE AIR TRAFFIC CONTROL
SIMULATOR**

Multiple Controller Station Capability
Plan View Displays
Aircraft Performance Characteristics
Pilot Models
Instrumentation, Navigation and Surveillance Models
Wind and Magnetic Deviation Models

**APPENDIX C - LIST OF ARRIVAL AND DEPARTURE TRAFFIC FOR NEW YORK
AIRPORTS**

**APPENDIX D - STATISTICAL AND GRAPHICAL DATA SUMMARY FOR
INDIVIDUAL AIRPORTS**



Accession For	
NTIS GRA&I	<input checked="" type="checkbox"/>
DTIC TAB	<input type="checkbox"/>
Unannounced	<input type="checkbox"/>
Justification _____	
By _____	
Distribution/	
Availability Codes	
Dist	Avail and/or Special
A-1	

List of Tables

Table 1. MLS Ground Installations at LGA, JFK and EWR	4
Table 2. List of Scenarios for LGA, JFK & EWR Airports	8
Table 3. Statistical Summary of All The Simulation Runs.	10

List of Figures

Figure 1. Relative Proximity of Four Airports in the New York Area	20
Figure 2. MLS Ground Installation at New York LaGuardia Airport	21
Figure 3. MLS Ground Installation at New York JFK International Airport	22
Figure 4. MLS Ground Installation at Newark International Airport	23
Figure 5. NIMMS MLS Approach to LGA Runway 13	24
Figure 6. PETEZ MLS Approach to LGA Runway 13	24
Figure 7. TROSI MLS Approach to LGA Runway 31	25
Figure 8. ALLBE MLS Approach to LGA Runway 31	25
Figure 9. GLOOP MLS Departure from LGA Runway 13	26
Figure 10. MIKES MLS Approach to JFK Runway 13R	26
Figure 11. GOKAS MLS Approach to JFK Runway 13R	27
Figure 12. SCOTT MLS Approach to JFK Runway 13L	27
Figure 13. MIRKY MLS Approach to EWR Runway 11	28
Figure 14. AWKIN MLS Approach to EWR Runway 11	28
Figure 15. BAKAS MLS Approach to EWR Runway 22L	29
Figure 16. Effect of 20 minute Holding at LGA for TEB Operations	29

List of Abbreviations and Acronyms

ADI	Attitude Director Indicator
ATC	Air Traffic Control
ATCS	Air Traffic Control Simulator at MVSRF
BAz	Back Azimuth
CDU	Control Display Unit
CRT	Cathode Ray Tube
DME/P	Precision Distance Measuring Equipment
EWR	Newark International Airport
FAA	Federal Aviation Administration
FAR	Federal Aviation Regulations
FAz	Front Azimuth
ft	feet
HSI	Horizontal Situation Indicator
Hz	Hertz or cycle per second
IFR	Instrument Flight Rules
ILS	Instrument Landing System
JFK	John F. Kennedy International Airport
LED	Light Emitting Diode
LGA	LaGuardia Airport
min	minute
MLS	Microwave Landing System
MVSRF	Man-Vehicle Systems Research Facility at NASA Ames Research Center
NAS	National Airspace System
NASA	National Aeronautics and Space Administration
nmi	nautical mile
OAG	Official Airline Guide
PFAF	Precision Final Approach Fix
RMI	Radio Magnetic Indicator
RNAV	Area Navigation
STAR	Standard Terminal Arrival Route
TEB	Teterboro
TERPS	Terminal Instrument Procedures Specialist
VFR	Visual Flight Rules
VMC	Visual Meteorological Conditions
VOR	Very High Frequency Omni-directional Range

EVALUATION OF ADVANCED MLS PROCEDURES IN THE NEW YORK TERMINAL AREA

INTRODUCTION

In 1988, the Federal Aviation Administration (FAA) established the Microwave Landing System (MLS) Program Office and initiated a series of projects designed to demonstrate the operational, environmental and economic benefits of the MLS. These projects are scheduled to be completed by the end of 1991. The results of all these efforts will provide the FAA, Congress and industry with the data necessary to evaluate the future role of the MLS in the National Airspace System (NAS). The results of the first simulation conducted under the project titled "Evaluation of Complex MLS Procedures in Multi-Airport Environments" are presented in this report. This initial experiment involved LaGuardia (LGA), John F. Kennedy (JFK), and Newark (EWR) airports in the New York Terminal Control Area.

BACKGROUND

During visual meteorological conditions (VMC), air traffic can move at peak efficiency using traffic flows which minimize delays, flying time, and noise, and also optimize airport capacity. Under these conditions, air traffic controllers can radar vector aircraft toward an airport from random directions until the pilot sees the airport and other aircraft. The controller then instructs the pilot to follow a particular aircraft and provide his own spacing for landing. When weather conditions or high traffic volume do not permit such traffic flows, the air traffic control (ATC) system today depends more on radar surveillance to provide separation services and navigation assistance to the pilot. By assigning altitudes, speeds and headings to aircraft, the air traffic controller can provide separation between aircraft and can guide aircraft to a navigation fix or route, such as the final approach course. This often creates longer, less efficient flightpaths and may result in delays to both arrivals and departures.

The primary precision landing aid used today for the final approach course is the Instrument Landing System (ILS). An ILS generates two narrow, straight-line beams which provide a path for an aircraft to follow both laterally and vertically when approaching a runway. Because of the narrow beams and straight-line features of the ILS, aircraft are sequenced for landing in long lines on the final approach. Spacing between aircraft must be provided to protect against wake turbulence penetrations and to allow for departures. ILS restrictions are not a major concern for low traffic volume isolated airports, but for closely spaced airports, crossing of straight-in ILS finals often precludes separation by altitude. In these configurations, the airports become dependent, causing delays and decreasing capacity. The geographical relationship of the four major airports in the New York area is illustrated in Figure 1.

The MLS, which has been designated to be the international standard precision landing system of the future, has a versatility which can overcome many of the limitations inherent in the ILS. The MLS produces up to $\pm 60^\circ$ of azimuth guidance and at least 15° of elevation guidance as compared to the narrow width of the localizer and single fixed glidepath of the ILS. These features allow instrument procedures with curves and descents, under precision navigation, which are not possible with the ILS. Consequently, in many terminal areas, conflicting flightpaths can be eliminated. These new procedures will require changes in the ATC system and must be proven feasible and acceptable. Pilots of all categories of aircraft must be shown the advantages and benefits of procedures based on the MLS, and air traffic controllers must learn how to manage air traffic through the use of MLS procedures. Considerable time will elapse before a large number of aircraft are equipped with the appropriate avionics to fly curved or other advanced MLS instrument procedures. Simulations are therefore the only current way to test and evaluate cockpit procedures for flying the MLS, to develop controller techniques for better management of air traffic using the MLS, and to show the advantages and benefits of the MLS.

OBJECTIVES

The primary objectives of this project are to:

- Evaluate the potential advantages and benefits of advanced MLS procedures for aircraft operations in complex terminal control areas.
- Identify the operational impact on workload and performance for both flight crews and air traffic controllers.
- Evaluate current MLS air traffic control procedures and radar displays and provide a basis for the development of new ones if needed.
- Quantify economic benefits of MLS at each airport simulated and provide a basis for future MLS cost benefits analyses.

DESCRIPTION OF THE SIMULATION FACILITIES

Aircraft - These experiments were conducted in the National Aeronautics and Space Administration (NASA) Ames Research Center Man-Vehicle Systems Research Facility (MVS RF) located at Moffett Field, California. The MVS RF consists of two aircraft simulators and an air traffic control simulation facility. One aircraft simulator and the air traffic control facility were used in these studies. The aircraft simulator was a Singer-Link Boeing 727 (B-727) advanced-technology simulator with a 6-degrees-of-freedom motion system and a Singer-Link-Miles Image II three-channel, four-window, dusk-night visual system. This device is qualified under FAR Part 121, Appendix H, as a Phase II simulator. An MLS simulation module has been added to the B-727 to provide the full capability to fly any advanced procedures.

This module includes a ground system, angle receiver, and Precision Distance Measuring Equipment (DME/P) module, as well as an MLS/Area Navigation (RNAV) Control Display Unit (CDU) for each pilot.

The cockpit layout was kept as conventional as possible, but did contain several modifications felt to be necessary to fly advanced procedures. The two MLS/RNAV CDU's were installed in the center console on either side of the weather radar. These units were designed to provide a rudimentary MLS/RNAV approach capability for the older generation transport aircraft where lack of instrumentation space dictates a compact design. The minimum functional requirements were the ability to tune an MLS channel, select a straight-in reference or curved approach path, and automatically or manually select a back azimuth reference. The flight director system consisted of a conventional Attitude Director Indicator (ADI) and a Horizontal Situation Indicator (HSI). The HSI had two digital DME readouts; one gave straight-line distance and the other gave along-track distance to the DME/P transponder. It also had Course and Heading Select functions that can be remotely or manually driven. A third feature on this HSI was an alert light that illuminates 10 seconds before the next waypoint along the MLS path. Also, the TO/FROM pointers were driven by the MLS information and pointed toward the front or back azimuth station. Finally, with MLS selected, the Radio Magnetic Indicator (RMI) needle pointed to the azimuth station. These modifications were made to accommodate the MLS/RNAV capability in the aircraft. A more detailed description of the MLS capability in the B-727 simulator is found in Appendix A. This includes a functional description of the MLS/RNAV CDU.

Air Traffic Control Laboratory - The MVSFR Air Traffic Control Simulator (ATCS) consists of a host computer, four computer workstations with 19" all color raster type monitors used for controller displays, and four full color graphics terminals used for control of the aircraft targets by the pseudo-pilots. The controller displays have virtually limitless capabilities for drawing symbols and lines for simulating radar displays and developing and evaluating new concepts. The color capability was not used during the tests in order to replicate current controller displays. The computer generated aircraft targets, flown by the pseudo-pilots through keyboard entries, perform with the same characteristics as the aircraft they represent. Aircraft with MLS advanced-procedure capability are identified to the controller by the letter M following the aircraft call sign in the data block (e.g., TWA114_M). Targets are terminated upon landing. The full system can handle over 100 aircraft operations per hour. Various atmospheric conditions can also be simulated. For these tests, wind velocity and direction profiles as a function of altitude were provided by each facility and programmed into the computer. Appendix B contains a more detailed description of the Air Traffic Control Simulator including pictures of the final controller's display for each airport.

MLS Ground Installations - All MLS ground installations were considered representative of the actual future sites. Elevation stations were adjusted for site elevation for threshold crossing heights of 50 - 53 feet. All azimuth stations configured to approach or back azimuth, depending upon the runway direction

selected. Some azimuth transmitter's scan angles were rotated in either direction to accommodate optimum procedure development. DME/P's were collocated with the azimuth stations. Table 1 contains a list of the MLS ground installations used including the channel numbers and the geometric locations. Figures 2 - 4 contain illustrations of the runway layouts for LGA, JFK and EWR airports with the locations of the MLS installations identified.

Table 1. MLS Ground Installations at LGA, JFK and EWR

Runway	Chan	Azimuth		Elevation		BAz		Rotation
		X(ft)	Y(ft)	X(ft)	Y(ft)	X(ft)	Y(ft)	
LGA13 (1)	613	-5402	-221	0	-247	3340	0	0°
LGA31 (1)	631	-8457	0	0	224	285	221	30° Clockwise
LGA22	622	-6189	0	0	-250	1810	0	0°
JFK13L	663	-9641	0	0	-280	3305	0	0°
JFK13R	568	-7842	-350	0	-350	4406	0	0°
EWR22L	672	-8348	0	0	-250	3152	0	0°
EWR11 (2)	611	-5739	-300	0	450	1251	0	10° Clockwise
EWR29 (2)	629	-6189	0	0	450	801	300	0° (3)

- (1) LGA13 and LGA31 are dual installation, meaning the approach and backcourse azimuth functions are reversed.
- (2) EWR11 and EWR29 are dual installation, meaning the approach and backcourse azimuth functions are reversed.
- (3) The bore-site of the backcourse azimuth would be rotated 10° clockwise.

DESCRIPTION OF THE TEST METHODOLOGY

General - For each airport evaluated, a project team was formed with on-site FAA, NASA and contractor staff, controllers and ATC procedures specialists from the area being simulated, a Terminal Instrument Procedures (TERPS) specialist, government and industry pilots, a benefits/cost analyst and representatives from the MLS Industry Task Force. The project team examined all the potential MLS ground sites, developed procedures (takeoff, approach and missed approach) and selected the best ones to be evaluated. The impact of each procedure on surrounding airports and local communities was also closely examined. Approach and departure plates were developed for use by pilots. Each procedure was given a five letter name to be used as an identifier such as NIMMS (Figure 5) or PETEZ (Figure 6). A complete set of the procedures evaluated is found in Figures 5 - 15.

Once this analysis was completed, the MLS ground sites were programmed into the Navigation Aid database, the procedures were entered into the MLS/RNAV computer and the controller video displays were created. A list of aircraft was developed based on a two-hour peak period selected from the Official Airline Guide

(OAG). The OAG represents the idealized landing times at the airport. Arrival times over the final feeder fixes were computed. The aircraft list was divided into "pools" of aircraft at each feeder fix with individual aircraft programmed to appear automatically on the controller display based on the estimated feeder fix arrival times and at the altitudes and airspeeds experienced in current operations. The feeder fix was selected based on the aircraft origination city. A minimum of 10 miles spacing between aircraft was provided over each feeder fix. This same pool of aircraft was used for all scenarios at any one airport. For evaluating the various MLS equipage ratios, it was assumed that an entire airline fleet would be equipped. For example, for the low equipage ratio at LGA, two small airlines were assumed to be equipped. For larger equipage ratios, more airlines were assumed to be equipped.

At this point in the simulation development, several airline pilots were given the opportunity to fly all the procedures in the simulator and provide comments on their flyability and operational acceptability. Final changes to the procedures were then made. The original intent of the program was to have the B-727 simulator, flown by local airline flight crews familiar with the airport being simulated, integrated into the ATC simulation along with the computer generated targets during the final tests. Due to computer interface problems between the B-727 and the ATC simulator, this was not done during the New York area simulations.

Controller Training - Prior to the final test, the facility controllers selected for the experiments were provided a package of training material which included descriptions of the procedures and information on terminology and controller display formats to be used. Hands-on training with the equipment was provided during the first day of the simulation until the controllers were comfortable with the equipment and the procedures.

Data Collection - For the B-727 aircraft, 55 continuous measures and 17 discrete events were sampled at 1 Hz sampling rate during all evaluation flights. In the air traffic simulator, 11 continuous measures were recorded every four seconds for each pseudo-aircraft when the aircraft was active. A video recording was made of the final approach controller's display for later analysis. In addition, subjective comments were obtained from each pilot and controller.

LAGUARDIA SIMULATION

General - The LaGuardia study involved two weeks of simulation time. In the first week, six airline pilots from three major carriers that operate in and out of LaGuardia airport flew the procedures in the B-727 simulator. The objective of these flights was to evaluate the flyability of all the procedures before the controllers were in the simulation. During the first week, pilot comments were recorded and changes to the procedures were made as necessary. Many anomalies in the MLS/RNAV avionics were encountered and documented for later correction. Further pilot participation was limited until computer problems were rectified.

During the second week of testing, controllers from the New York facility were used. Very heavy traffic volumes were simulated for these tests. The preferred mode of operation was to run an ATC scenario for 1.5 to 2.0 hours. This represents a typical controller shift time at a position. Four controller positions were simulated - two feeder controllers, one final approach controller and a departure controller. One feeder controller handled all traffic from the north and east while the other feeder controller handled the south and west traffic. Both feeder controllers handed their traffic off to the final controller. The geographical relationship of the various feeder fixes is illustrated in Figure D-1a. Also, a traffic coordinator was used to determine when aircraft had to be held and subsequently released at the feeder fix. Departures were simulated since they had a significant impact on the number of operations that could be handled. A pool of departure aircraft was developed based on the OAG. A list of aircraft and their earliest available departure time (measured from the start of the simulation run) was provided to the departure controller. The controller was only allowed to clear an aircraft for takeoff if the simulation time was equal to or greater than the departure time on the list and if there was a takeoff gap available in the arrival stream. The list of arrival and departure aircraft is found in Appendix C.

MLS Ground Installation - MLS ground installations were simulated on both runways 13/31 and 4/22. The runway 13 azimuth station had to be offset to the side and placed short of the end of the runway due to installation problems at the actual site. The runway 4, 22, and 31 azimuth stations had to be rotated to provide necessary coverage for the procedures. Installation details are found in Table 1.

Procedures - The ATC simulation analysis of LGA concentrated on the runways 13 and 31 operations. Two MLS approach procedures to each runway were evaluated. When LGA goes to a runway 13 operation, departures out of EWR and arrivals into TEB are severely impacted as the heavy ILS arrival stream of traffic passes directly over the TEB airport. Under such traffic conditions at LGA, EWR departures to the northeast and TEB are essentially shut down. Traffic into LGA must be periodically stopped for gaps of up to 20 minutes to accommodate unrestricted operations at the other two airports. This procedure was simulated during some of the runway 13 evaluations. A curved MLS approach from the north (Figure 5) and one from the south (Figure 6) along the river were used for runway 13 to evaluate the reduction or the elimination of the restrictions on EWR and TEB. Both approaches were designed using present TERPS criteria which allows a minimum straight final segment for Category C and D aircraft of 3.4 nmi. For the runway 31 scenarios, a curved MLS approach from the east (Figure 7) and an MLS approach emulating the runway 31 Expressway Visual approach (Figure 8) were used.

One other procedure was evaluated by the pilots but not the controllers. This procedure was a precision departure off runway 13 using the MLS to provide lateral guidance around a turn to the north. This essentially replicated a non-precision procedure used today to keep departing aircraft out of JFK airspace when JFK is landing on runway 22. The procedure is shown in Figure 9.

Scenarios - Table 2 lists the airport, date and run number, runway configurations evaluated, the approximate MLS equipage ratios used, any special conditions tested and the duration of each test for all scenarios. The length of the runs varied slightly as did the number of aircraft actually handled. The primary emphasis was on the runway 13 operation (land 13, depart 13) with and without consideration for TEB and EWR operations. To allow TEB arrivals and EWR departures, a 20 minute gap was provided over TEB on some of the runs in which there were no aircraft allowed in the airspace. A specific aircraft was selected to be the last one over TEB before the 20 minute time period started. The traffic coordinator reviewed the traffic and held airplanes at the feeder fixes to clear the system of traffic so that the gap could occur. He then released airplanes from holding at the proper time to allow airplanes to re-enter the TEB airspace after 20 minutes. Any MLS aircraft that entered the system could continue without interruption to either of the MLS paths since they did not interfere with TEB airspace. The weather conditions were considered to be IFR but not low enough that departing aircraft had to hold clear of the critical area. The primary purpose in evaluating this operation was to determine if the curved paths into LGA would reduce or eliminate restrictions on the other airports and, if so, at what level of equipage would that occur. Also, the question of whether a controller could control traffic on two converging MLS paths into one final segment without any additional controller aids would be addressed.

The other scenarios involved runway 31 operations (land 31/depart 4). The ILS baseline assumed a ceiling greater than 600 ft. such that all aircraft could use the localizer approach to runway 31. MLS equipage ratios evaluated were 75% (two runs) and 100%. One of the 75% MLS scenarios assumed a ceiling of greater than 600 ft. which allowed all non-MLS equipped aircraft to use either the expressway visual or the localizer-only approach. The other 75% scenario assumed a ceiling of less than 600 ft. so all the non-MLS equipped aircraft had to use the ILS approach to runway 4. All MLS equipped aircraft could use any MLS path in all scenarios. The primary interest with these scenarios was to determine if the current VFR operations could be duplicated under IFR conditions with the addition of the MLS precision approaches.

Discussion of Results - The first scenario evaluated was the 100% ILS operation to runway 13. This represented the current operation and served as a baseline for comparison with the other scenarios. This scenario was done twice, with and without a 20 minute gap in the operation for TEB arrivals and EWR departures (Table 2, #1 & 2). The final controller workload was very high due to the heavy traffic volume and the airspace restrictions.

The next four scenarios evaluated involved the same runway with two MLS paths added and with MLS equipage ratios of 10%, 50%, 75% and 100% (Table 2, #3,4,6,&7). A basic premise used was that any MLS equipped aircraft could also fly an ILS procedure but ILS-only equipped aircraft could not fly MLS procedures. A 20 minute gap for TEB was provided during all four runs. One additional scenario was completed that examined the 50% equipage ratio without a 20 minute gap for TEB and EWR (Table 2, #5).

Table 2. List of Scenarios for LGA, JFK & EWR Airports

No.	Airport	Date	Run	Active Runways	Target Percent MLS	Elapsed Run Time
1	LGA	4/09/90	1	ILS 13/D 13	100% ILS	2:08
2	LGA	4/09/90	2	ILS 13/D 13 (w/ 20 min. TEB hold)	100% ILS	2:19
3	LGA	4/13/90	2	ILS 13 & MLS 13/D 13 (w/ 20 min. TEB hold)	10% MLS	1:57
4	LGA	4/13/90	1	ILS 13 & MLS 13/D 13 (w/ 20 min. TEB hold)	50% MLS	1:57
5	LGA	4/11/90	2	ILS 13 & MLS 13/D 13	50% MLS	2:01
6	LGA	4/11/90	1	ILS 13 & MLS 13/D 13 (w/ 20 min. TEB hold)	75% MLS	2:01
7	LGA	4/10/90	1	MLS 13/D 13	100% MLS	1:57
8	LGA	4/11/90	3	ILS 31/D 04	100% ILS	1:52
9	LGA	4/12/90	3	ILS 04 & MLS 31/D 04	75% MLS	1:52
10	LGA	4/12/90	2	ILS 31 & MLS 31/D 04	75% MLS	1:59
11	LGA	4/12/90	1	MLS 31/D 04	100% MLS	1:53
12	JFK	5/07/90	2	ILS 13L	100% ILS	1:53
13	JFK	5/07/90	3	ILS 13L & MLS 13R	25% MLS	1:49
14	JFK	5/10/90	1	ILS 13L & MLS 13R	50% MLS	1:49
15	JFK	5/08/90	3	MLS 13L & 13R (2 paths, 2 mi. stagger)	100% MLS	1:36
16	JFK	5/10/90	2	MLS 13L & 13R (repeat)	100% MLS	1:30
17	JFK	5/11/90	1	MLS 13L & 13R (1 13R proc., indep. operation)	100% MLS	1:27
18	JFK	5/11/90	3	MLS 13L (single MLS proc.)	100% MLS	1:41
19	JFK	5/09/90	1	ILS 22L & 22R	100% ILS	1:33
20	JFK	5/09/90	2	ILS 22L & 22R/MLS 13R	25% MLS	1:31
21	JFK	5/09/90	3	ILS 22L & 22R/MLS 13R	50% MLS	1:31
22	JFK	5/10/90	3	MLS 22L & 13R	100% MLS	1:27
23	EWR	5/14/90	1	ILS 4R	100% ILS	1:56
24	EWR	5/14/90	2	ILS 4R/MLS 11	25% MLS	1:53
25	EWR	5/15/90	1	ILS 4R/MLS 11	50% MLS	1:45
26	EWR	5/15/90	2	MLS 4R/MLS 11	100% MLS	1:33
27	EWR	5/15/90	3	ILS 22L	100% ILS	1:47
28	EWR	5/16/90	1	ILS 22L/MLS 11	25% MLS	1:43
29	EWR	5/16/90	2	ILS 22L/MLS 11	50% MLS	1:46
30	EWR	5/17/90	1	MLS 22L/MLS 11	100% MLS	1:44
31	EWR	5/17/90	2	MLS 22L/MLS 11 (heavy vol.)	100% MLS	1:20

A statistical summary and a graphical depiction of the simulation results for each scenario at all three airports is found in Appendix D. The data contains average flight times and average flight distances from each feeder fix. This data is computed from the time the aircraft enters the system until it reaches a decision height of 200 ft. above the ground. In addition, a number called "weighted average" is given. This is simply the average flight time or flight distance across all aircraft in the scenario. The minimum flight time and distance flown by an aircraft from each feeder fix is also provided. Differences between average flight times and minimum flight times from each feeder fix are an indication of traffic congestion. The average holding times at the feeder fix for only the aircraft that were actually held and the number of aircraft that were held (in parentheses) is also given. Arrival rates are shown based on the total number of aircraft that landed during the scenario divided by the time between the first landing and the last one. The graphics portion contains an overview of the flight paths of all the aircraft in the scenario as well as a bar chart depiction of when each aircraft entered the airspace, how long it was in a "holding" mode, and the length of each flight. Table 3 summarizes some of the data from all scenarios.

For the 100% ILS versus the 100% MLS scenarios (without a 20 minute hold for TEB), the average flight time savings was 7.07 minutes per MLS equipped aircraft. During these two scenarios, the number of aircraft that had to be held was very small. The average flight time does not include holding times. There are several reasons for the decrease in flight times as the percentage of MLS equipped aircraft increased. One, MLS aircraft were more often able to fly an optimum approach from the north or the south which shortened their flight time. Second, this in turn reduced the "so-called" ILS trombone effect (Figure D-1a) for those aircraft which could only fly an ILS approach. Third, at the 100% MLS equipage level, the trombone effect of ILS is completely gone and even though the volume of traffic caused the controllers to use only one MLS path, there is still a savings in flight time and distance using the MLS. The arrival rate per hour increased from 29.6 using ILS to 31.7 with 100% MLS. Many variables such as faster aircraft speeds throughout the flight time, controller techniques in handling the aircraft, shorter flight distances, etc. could account for the increased arrival rate. Because of these variables, the increase can not be definitively explained.

The flexibility that the MLS offers in the design of flight paths that can substantially reduce interference with other airports is very apparent in the runway 13 operation to LGA. In the 100% ILS scenario with the 20 minute gap provided for TEB and EWR, the average holding time for 34 aircraft which had to be held was 16.09 minutes per aircraft. As the percentage of MLS equipped aircraft increased, the average holding time steadily decreased until, for the 100% MLS equipped scenario, holding was almost eliminated. For the 50% equipage case, even though 15 aircraft had to be held for an average holding time of 12.76 minutes per held aircraft, there was a minimal effect on the arrival rate at the airport. The air traffic controllers were instructed that any MLS equipped aircraft could proceed directly to either of the MLS paths and bypass any aircraft in holding patterns. This effect of MLS equipage ratio on the landing rate at the airport is graphically displayed in Figure 16.

Table 3. Statistical Summary of All The Simulation Runs

No.	Airport	Date	Run	Active Runway	Percent MLS	Avg. Flight Time (min.)	Avg. Flight Dist. (NMI)	Avg. Holding Time (min.)	Arrivals Per Hour
1	LGA	4/09/90	1	ILS 13/D 13	0	24.15	79.63	5.29 (3)	29.6
2	LGA	4/09/90	2	ILS 13/D 13 (w/ 20 min. TEB hold)	0	21.23	73.86	16.09 (34)	27.5
3	LGA	4/13/90	2	ILS 13 & MLS 13/D 13 (w/ 20 min. TEB hold)	12.1	18.88	67.86	16.47 (22)	26.3
4	LGA	4/13/90	1	ILS 13 & MLS 13/D 13 (w/ 20 min. TEB hold)	32.4	18.17	63.35	12.76 (15)	31.5
5	LGA	4/11/90	2	ILS 13 & MLS 13/D 13	32.8	18.93	66.49	0	30.9
6	LGA	4/11/90	1	ILS 13 & MLS 13/D 13 (w/ 20 min. TEB hold)	74.6	17.22	60.94	12.65 (3)	31.9
7	LGA	4/10/90	1	MLS 13/D 13	100.0	17.08	59.65	4.94 (2)	31.7
8	LGA	4/11/90	3	ILS 31/D 04	0	20.89	74.67	5.51 (2)	30.1
9	LGA	4/12/90	3	ILS 04 & MLS 31/D 04	73.0	16.37	61.14	0	31.6
10	LGA	4/12/90	2	ILS 31 & MLS 31/D 04	75.0	17.78	63.70	0	30.5
11	LGA	4/12/90	1	MLS 31/D 04	100.0	17.44	62.92	0	32.3
12	JFK	5/07/90	2	ILS 13L	0	29.50	101.13	20.41 (26)	33.7
13	JFK	5/07/90	3	ILS 13L & MLS 13R	28.7	27.92	95.41	12.27 (25)	39.8
14	JFK	5/10/90	1	ILS 13L & MLS 13R	54.0	26.83	93.48	7.84 (5)	41.9
15	JFK	5/08/90	3	MLS 13L & 13R (2 paths)	100.0	26.01	90.83	0	42.0
16	JFK	5/10/90	2	MLS 13L & 13R (repeat)	100.0	25.35	89.93	0	46.4
17	JFK	5/11/90	1	MLS 13L & 13R (1 13R proc.)	100.0	19.65	78.43	0	53.5
18	JFK	5/11/90	3	MLS 13L (single MLS proc.)	100.0	26.57	89.02	11.43 (35)	37.8
19	JFK	5/09/90	1	ILS 22L & 22R	0	18.88	66.96	10.69 (9)	49.5
20	JFK	5/09/90	2	ILS 22L & 22R/MLS 13R	30.5	16.06	60.21	0	52.6
21	JFK	5/09/90	3	ILS 22L & 22R/MLS 13R	55.4	15.23	57.28	0	56.9
22	JFK	5/10/90	3	MLS 22L & 13R	100.0	15.00	59.44	0	55.3
23	EWR	5/14/90	1	ILS 4R	0	17.11	59.49	0	38.3
24	EWR	5/14/90	2	ILS 4R/MLS 11	25.7	13.47	50.86	0	37.4
25	EWR	5/15/90	1	ILS 4R/MLS 11	50.7	14.06	51.49	0	39.2
26	EWR	5/15/90	2	MLS 4R/MLS 11	100.0	12.60	50.49	0	41.7
27	EWR	5/15/90	3	ILS 22L	0	17.86	67.56	0	36.9
28	EWR	5/16/90	1	ILS 22L/MLS 11	24.2	17.30	65.06	0	37.6
29	EWR	5/16/90	2	ILS 22L/MLS 11	49.3	16.58	63.45	0	36.2
30	EWR	5/17/90	1	MLS 22L/MLS 11	100.0	15.94	57.81	0	38.9
31	EWR	5/17/90	2	MLS 22L/MLS 11 (heavy vol.)	100.0	17.35	60.16	0	45.0

The second series of scenarios involved runways 31 and 4. The TEB and EWR operations were not affected by these procedures. For the 100% ILS versus the 100% MLS scenarios (Table 2, #8 & 11), the average flight time savings was 3.45 minutes per MLS equipped aircraft. During these two scenarios, two aircraft were held in the 100% ILS case and no aircraft were held in the MLS run. There are several reasons for the decrease in flight times as the percentage of MLS equipped aircraft increased. One, the MLS allowed a precision approach equivalent to the present Expressway Visual Approach (ALLBE, Figure 8) to be implemented. This greatly reduced the flight times for aircraft coming from the south feeder fixes. Having the ALLBE procedure available for aircraft coming from the south and the TROSI procedure (Figure 3) for the north aircraft again allowed MLS aircraft to fly the optimum approach when traffic volume permitted. As they did during the runway 13 scenarios, the controllers shifted to a one MLS path operation when the traffic volume became heavy. Second, as in the runway 13 operations, the trombone effect for the ILS operations was again reduced. It should be noted that the ALLBE procedure did not meet present TERPS criteria, however, since it emulated a VFR approach used today, it proved to be easily flyable. The arrival rate per hour increased from 30.1 using ILS to 32.3 with 100% MLS. This increase was consistent with the results demonstrated during the runway 13 operations.

For the 75% MLS equipage scenario which used runway 31 for MLS aircraft and runway 4 for ILS due to the low ceiling (Table 2, #9), the average flight time savings compared to the 100% ILS case was 4.52 minutes per aircraft. This represents a slight increase over the 100% MLS figures (3.45), but this was due to the availability of two runways for this scenario. In most cases, controllers have more flexibility and can provide better service when more than one landing runway is available. With two landing runways available, the controllers could often provide the optimum path to an aircraft.

In general, the controllers would give an MLS equipped aircraft the closest MLS path from the feeder fix to the runway thus reducing the flight time as much as possible. For example, an aircraft coming from the north going to runway 13 would be given the NIMMS approach. Aircraft from the south would be given the PETEZ approach. As long as the traffic volume was not too heavy, the controllers were able to use their judgment as well as the distance markers on their displays to judge proper spacing on final from different MLS paths and to merge the MLS aircraft with the ILS traffic. At times the traffic volume would reach a level that forced the controllers to take all the MLS traffic to one path or all aircraft were given an ILS approach. This tended to penalize some of the MLS aircraft as they could not take advantage of the optimum flight path to the runway. This sequencing and spacing problem should be overcome with training and future ATC automation systems.

Overall, the controllers were able to handle the traffic on all of these scenarios quite comfortably. The consensus of opinion among the controllers was that it was slightly easier to vector aircraft to MLS paths than ILS paths. The ease of merging aircraft from different directions to an MLS path was the same as to an ILS path. The number of communications between the controllers and pseudopilots was

reduced during MLS scenarios by an average of 35%. The workload shifted from vectoring to more concentration on earlier sequencing and spacing. The controllers felt that the spacing and speed control had to be well established farther out when using MLS. This was because they did not have the flexibility to do S-turns for spacing as they presently do with the ILS due to the shorter straight length segments of the MLS paths.

KENNEDY SIMULATION

General - The JFK study involved one week of simulation time. Flying was done to verify the flyability of the proposed MLS procedures. Four controller positions were simulated - three feeder controllers and a final approach controller. A traffic coordinator position was also used. Departure aircraft were not simulated since JFK tends to operate with either a heavy flow of only arrivals or departures. With two sets of parallel runways, departures can be accommodated without generally interrupting arrivals. The list of arrival and departure aircraft is found in Appendix C.

During normal operation at JFK, one sector controller identified as the LENDY sector hands off traffic from the Northwest feeder fix to a second sector controller identified as the ERICK sector. The ERICK sector controller merges the Northwest traffic with the east traffic and hands them off to the third sector controller called the CAMRN sector who must then sequence that traffic with multiple feeders from the south before handing off to the final controller. The geographical relationship of the various feeder fixes is illustrated in Figure D-12a. When runways 22 Left (22L) and 22 Right (22R) and 13 Right (13R) were all being used by landing traffic, the final controller handled the runway 22 arrivals and the CAMRN controller handled the runway 13R MLS traffic.

MLS Ground Installation - MLS ground installations were simulated on both runway 13L and 13R. The runway 13L azimuth station had to be offset to the side by 350 ft. and installed short of the end of the runway due to interference problems with the 22 runways. Installation details are found in Table 1.

Procedures - The primary concentration was on the MLS procedures to runway 13R since there is no ILS there today. Two approaches were developed; one was similar to the present Canarsie approach (Figure 10), and the other involved a right turn to a 3.4 nmi straight final segment (Figure 11). A third MLS procedure was developed to runway 13L (Figure 12) which had appropriate lateral and vertical separation from the runway 13R MLS procedures.

Scenarios - Specific information on all the scenarios evaluated is found in Table 2. The baseline scenarios consisted of 100% ILS to runway 13L and 100% ILS to runways 22L & R. Simultaneous approaches involving an ILS approach to runway 13L and two MLS approaches to runway 13R were then simulated using several different equipage ratios. Three 100% MLS scenarios to runway 13 were evaluated. The first one used both runways, all three MLS approaches, and the controllers used

2 nmi staggered spacing between aircraft on the arrival paths. The second involved one MLS path to each runway and assumed a parallel runway monitor controller was available thus allowing side-by-side operations. The third involved only the MLS approach to runway 13L to evaluate the one runway operation with and without MLS. The basic reason to examine these scenarios was to evaluate the ability of the controllers to handle two streams of traffic with various mixes of MLS equipped aircraft and determine the resultant increase in arrival rates.

With an MLS installed, runway 13R could also be used for overflow traffic when runways 4 or 22 are being used. This was simulated with the commuters and smaller jets using runway 13R. Larger aircraft on runway 13R require coordination with the traffic on runways 4L or 22R because of the potential missed approach conflict. Three different equipage ratios were evaluated. The issue being examined was the ability of the controllers to divert MLS aircraft to runway 13R and integrate that traffic with the operations to runways 4 or 22.

Discussion of Results - The first scenario evaluated was the 100% ILS operation to runway 13L which served as the baseline for the various runway 13 configurations (Table 2, #12). The traffic volume was very heavy and 26 aircraft had to be held an average of 20.41 minutes per held aircraft. For the 100% MLS case, using one MLS approach to the same runway, 35 aircraft were held an average of 11.43 minutes per held aircraft (Table 2, #18). Overall, the average flight time savings for the MLS aircraft amounted to almost 3 minutes per aircraft and the arrival rate increased from 33.7 to 37.8 aircraft per hour. The most logical explanation for the increase in arrival rate for the MLS scenario is that it is primarily due to the training and experience the controllers gained during the week of simulation. The 100% ILS run was the first data run of the week and the 100% MLS run was the last. The flight tracks and bar charts for the two runs show a more orderly and smooth operation for the MLS scenario. The controllers all indicated they became more proficient with the simulation system and the various procedures as the week progressed.

The remainder of the runway 13 scenarios all involved a two runway operation. For the scenarios involving a mix of ILS/MLS traffic, an MLS was installed on runway 13R and two paths were developed. Only commuter aircraft were allowed to use the MIKES approach (Figure 10) because of the short final length. The large majority of MLS aircraft used the GOKAS approach (Figure 11). 25% and 50% equipage ratios were evaluated (Table 2, # 13 & 14). Even though runways 13L & 13R at JFK are more than 6000 ft. apart, there is no parallel runway monitor controller used; consequently, the controllers had to use standard 2 nmi staggered spacing between the two runway operations. For the 25% scenario, almost the same number of aircraft were held as for the ILS-only case, but the average holding time decreased from 20.41 min. to 12.27 min. per aircraft held. The average flight time saved amounted to 1.58 minutes per aircraft. As was expected, the arrival rate increased to 39.8 aircraft per hour with the addition of the second runway. The task of maintaining the 2 nmi staggered spacing was not too difficult since there were relatively few MLS aircraft in the scenario. For the 50% equipage scenario, the task of maintaining the 2 nmi spacing on final was more difficult and required some learning by the controllers during the run. The number of aircraft held was reduced

down to 5 aircraft with an average holding time of 7.84 min. per held aircraft. The average flight time saved increased slightly to 2.67 min. per aircraft and the arrival rate improved to 41.9 aircraft per hour. The reduction in the number of aircraft that had to be held and the increase in arrival rate were due primarily to having enough aircraft available to use the MLS runway. The controllers developed a technique of forming two parallel streams of traffic with the outside stream being the ILS traffic to runway 13L and the inside stream made up of the MLS aircraft to either of the two approaches to runway 13R. The two streams were also separated by altitude so that the aircraft could cross each other safely while being vectored into the final stream for the correct runway.

The first of the 100% MLS scenarios involved both runway 13L & 13R and three MLS approaches. Controllers were instructed to use 2 nmi staggered spacing as there was no parallel runway monitor controller available. The final controller handled both runways. The first time this scenario was evaluated, no aircraft had to be held, the average flight time saved was 3.49 min. per aircraft, and the arrival rate was 42 aircraft per hour (Table 2, #15). This scenario was repeated several days later to determine what effect the increased level of experience in controlling MLS aircraft would have on the results. The second time resulted in an increase in average flight time savings to 4.15 min. per aircraft and an increase in arrival rate to 46.4 aircraft per hour (Table 2, #16). Again, no aircraft had to be held.

The second of the 100% MLS scenarios using both runways involved only one MLS approach to each runway; i.e., SCOTT (Figure 12) to runway 13L and GOKAS to runway 13R. However, it was assumed that a parallel runway monitor controller was available so that independent operations could be conducted (Table 2, #17). Significant improvements in average flight time savings and arrival rate were demonstrated. Average flight time savings increased to 9.85 min. per aircraft and the arrival rate jumped to 53.5 aircraft per hour. The controller's task was simplified by not having to worry about the 2 nmi staggered spacing on final.

The next series of evaluations involved ILS traffic to runways 22L & 22R with MLS traffic (limited to commuters and small jets) going to runway 13R. The 100% ILS baseline case to 22L & 22R resulted in 9 aircraft being held for an average of 10.69 min. per held aircraft (Table 2, #19). The arrival rate was 49.5 aircraft per hour. In comparison, the 100% MLS scenario using only runways 22L & 13R resulted in no holding, an average flight time savings of 3.88 min. per aircraft, and an arrival rate of 55.3 aircraft per hour (Table 2, #22). Two additional runs were evaluated using 25% and 50% equipage ratios (Table 2, #20 & 21). The average flight time saved and the arrival rates both increased as the equipage ratio increased. In fact, the 50% run resulted in the highest arrival rate of all the JFK scenarios at 56.9 aircraft per hour.

NEWARK SIMULATION

General - The EWR study also involved one week of simulation. A minimal amount of B-727 simulator flying was done before the testing started since the procedures were simple and did not require much pilot evaluation. As with the

other studies, four controller positions were simulated. Depending on the traffic flow, either one of two controllers operated as the final approach controller. Again, a traffic coordinator position was used. Departure aircraft were not simulated since departures can be accommodated without generally interrupting arrivals using the parallel runways at EWR. The list of arrival and departure aircraft is found in Appendix C.

The normal operation at EWR for runway 4 operations had the sector controller identified as the MUGZY sector handing off traffic from the east to the sector controller identified as the SHAFF sector. The SHAFF controller merged the east traffic with that from the north and west and handed them off to the final controller. A third sector controller identified as the METKO controller merged the south and Southwest traffic and handed them off to the final controller as well. When runway 22 was being used, the SHAFF sector controller became the final controller. The previous final controller handled all MLS traffic landing on runway 11. The geographical relationship of all the feeder fixes is illustrated in Figure D-23a.

MLS Ground Installation - MLS ground installations were simulated on runways 22L and 11. The runway 22L installation was very conventional, but the azimuth station on runway 11 had to be offset 300 ft. and rotated clockwise 10°. Installation details are found in Table 1.

Procedures - The emphasis at EWR was on MLS operations to runway 11 while operating normal traffic into runways 4R or 22L. Presently, runway 11 has no instrument landing system. Two MLS approaches were designed for this runway. One approach came from the north with a left turn to final (Figure 13) and the other came from the south with a right turn (Figure 14). Both had 3.0 nmi final straight segments and were restricted to commuters and general aviation aircraft. These approaches were also designed to avoid noise sensitive areas that are very close to the approach end of runway 11. A third MLS approach was developed for runway 22L (Figure 15) and had a final segment of 5.9 nmi.

Scenarios - Table 2 lists the runway configurations evaluated, the MLS equipage ratios used, any special conditions tested, and the duration of each test. The baseline scenarios consisted of 100% ILS to runway 4R and 100% ILS to runway 22L. For the runway 4R & 11 MLS operations, 25%, 50% and 100% equipage ratios were evaluated. Large MLS aircraft used the ILS to 4R during these scenarios. For the runways 22L & 11 MLS operations, the same equipage ratios were evaluated. However, for runway 22L, the large MLS equipped aircraft had an MLS path available. The principal objective of all the EWR operations was to evaluate how to coordinate the traffic flow into two perpendicular runways.

Discussion of Results - The first scenario evaluated was the 100% ILS operation to runway 4R which served as the baseline for the various runway 4 configurations (Table 2, #23). The traffic volume was handled quite comfortably by the controllers and no aircraft had to be held. The overall arrival rate was 38.3 aircraft per hour. For the 100% MLS case using runways 4R and 11, the average flight time savings

was 4.51 min. per aircraft and the arrival rate increased to 41.7 aircraft per hour (Table 2, #26). Again, no aircraft were held. To evaluate the mix of ILS and MLS traffic, the 25% and 50% equipage ratios were used (Table 2, #24 & 25). The 25% case was an interesting run. While an improvement in average flight time was found, the arrival rate decreased slightly. During this run, it took the controllers some time to work out the most efficient way to use runway 11 for the MLS aircraft. The addition of runway 11 required two final approach controllers. Also, the controllers had to develop a strategy for integrating two approach paths to the same runway. Having gained experience during the 25% scenario, the controllers were able to handle the 50% scenario traffic more efficiently and smoothly with a resultant increase in arrival rate. This can be graphically seen by comparing Figure D-24a with Figure D-25a. No holding was required for any aircraft in these scenarios.

The last series of scenarios started with the 100% ILS to runway 22L as the baseline (Table 2, #27). The results of this run were very similar to the 100% ILS to runway 4R as the controllers encountered no problems and delivered an arrival rate of 36.9 aircraft per hour with no holding. For the 100% MLS case, which added runway 11 for the small MLS equipped aircraft, the average flight time saved was 1.92 min. per aircraft and the arrival rate improved to 38.9 aircraft per hour (Table 2, #30). The results for the 25% and 50% scenarios fell between the 100% ILS and the 100% MLS runs (Table 2, #28 & 29).

One additional 100% MLS scenario was added to the runways 22L & 11 evaluation. At the completion of the scheduled runs, the controllers indicated that they never really reached a maximum traffic condition. The fact that they never had to hold any aircraft during any runs supported this comment. Consequently, additional traffic were added to the arrival list and the run was repeated to determine the effect of very heavy traffic volume (Table 2, #31). The average flight time saved for this run was negligible, but the arrival rate jumped to 45 aircraft per hour and still no aircraft were held.

GENERAL COMMENTS

In addition to specific findings at the individual airports evaluated, there were some observations made that could pertain to any facility or procedure as they were more generic in nature. These observations can be divided into either air traffic control or flight issues.

One of the primary objectives of this study was to evaluate current MLS air traffic control procedures and radar displays and to provide a basis for the development of new ones if needed. The controllers indicated that the intercept angles that are presently used to capture an ILS path are also adequate for capturing the MLS paths. Intercept angles greater than 30° may be less acceptable for capturing MLS paths than ILS paths as the initial straight segments of a curved MLS procedure may be too short to allow for significant overshoots and recapture maneuvers prior to reaching the curved portions of the procedure. Both the controllers and the pilots indicated that it was very important to deliver the aircraft to the first segment of the MLS

procedure as near to the initial waypoint as possible to insure a clean capture of the path. The shorter the overall path and the closer the initial waypoint is to the coverage limits of the MLS, the more important the initial capture becomes. Once an aircraft enters the MLS coverage volume, there is a finite period of time required for the signal acquisition and validation and for the filters in the MLS/RNAV system to stabilize. Once this takes place, the pilot can follow the guidance information and capture the path. For procedures where the initial waypoint is close to the coverage limit and the aircraft enters the MLS volume at a steep intercept angle and high speed, all of this takes place quickly and the chance of overshoot is high if the controller hasn't positioned the aircraft accurately.

A second factor of considerable importance is speed control. For ILS procedures, controllers often have the aircraft maintain a relatively high speed all the way to the outer marker, at which time they must quickly decelerate and reconfigure the aircraft to capture the glideslope. This technique was unacceptable for MLS procedures. Previous studies have indicated that the final approach fix should be located before the last turn to final with a short straight segment between the final approach fix and the start of the turn. Pilots did not like having to decelerate, reconfigure, capture the glideslope and turn all in a relatively short time. Their suggestion was that the aircraft should be as close as possible to the final approach speed prior to reaching the final approach fix. Controllers were asked to concentrate on speed control and spacing as much as possible. This did not prove to be a problem for the controllers. With the reduction in communications, as a result of less vectoring in the MLS operations, they had more time to devote to speed control.

Possibly the most difficult task the controllers encountered during MLS operations was integrating the ILS straight-in traffic with the MLS curved paths. This typically required the controller to plan ahead a considerable distance in order to merge the two streams of traffic together on the final straight segment with proper spacing. The only aid the controller had for judging distance along the curved MLS paths were the three mile dots placed along the path from the threshold. The standard range rings could be used for the ILS traffic. When the MLS equipage ratio was either very low or very high, the task was somewhat easier. For a mix of aircraft in the 50% equipage range, the controllers sometimes put all aircraft on the ILS path so that they were dealing with only a single stream of traffic.

In general, the terminology used by the controllers for handling MLS aircraft was in compliance with FAA Air Traffic Control Handbook 7110.65F. The principal difference was in the use of the name of the MLS approach when giving the clearance to the aircraft. The present procedures do not address the use of an identifier other than the runway number. The controllers were comfortable using the name of the approach as well as the runway number; e.g., MLS runway 13 NIMMS approach. However, the controller's subjective comments indicated that the issue of terminology should be addressed further.

Many comments were received from the pilots regarding the amount and type of information in the approach plates. The first set of plates for the LGA simulation

did not have waypoint numbers identifying each waypoint. The pilots immediately expressed displeasure; consequently, numbers were added. For all three studies, the numbering sequence used had the initial waypoint as No. 1 with the numbers increasing until reaching the last waypoint located at the runway threshold. Some pilots indicated a preference for the waypoint located at the runway threshold to always be identified as waypoint No. 1 and the numbers increasing as you move back along the procedure. In this way, the pilot always knows how many waypoints are remaining in the procedure. Future studies will use this numbering sequence. Also, the LGA approach plates had latitude, longitude, altitude (radar and MSL) and along track distance in the data block for each waypoint. All pilots indicated that the latitude and longitude information was meaningless to them and it was subsequently removed. They also wanted the waypoint identified as the precision final approach fix (PFAF) to be labeled and in bold letters as a reminder of where the glideslope capture began.

One very important issue raised by the pilots was the question of situation awareness. When maneuvering in the terminal area prior to entering MLS coverage, some of the pilots indicated that their overall situation awareness was not adequate. Even though operating in the radar vectoring environment, competent flight crews prefer to maintain a strong sense of situation awareness. A suggestion was made to tie the initial waypoint of the MLS procedure to either a Standard Terminal Arrival Route (STAR) or a lead-in radial from some VOR to provide the necessary situation awareness information. This was done on as many procedures as possible and solved the problem.

Overall, the pilots said that all the MLS procedures that were flown were operationally acceptable to them. Speed control was deemed to be very important in that the aircraft should be in final configuration prior to the Precision Final Approach Fix so that the speed won't be changing during the turning portion of the procedure. There was universal agreement that the procedures were much easier to fly than originally anticipated.

SUMMARY OF RESULTS

Analysis of the data from the simulations has been completed. Results indicate:

1. The curved approaches to runway 13 at LGA relieve the restrictions which are placed on EWR and TEB when LGA must land on runway 13.
2. When comparing 100% MLS to 100% ILS equipage benefits for all three airports, the following data was measured:
 - Reduction in average flight time from feeder fixes to touchdown ranged from 2 to 7 minutes per aircraft (holding times not included).
 - Under certain conditions average holding times as high as 20 minutes per aircraft held were eliminated.

- Increases in maximum arrival rates of 2 to 4 aircraft per hour for a single runway operation were demonstrated. Many variables such as faster aircraft speeds throughout the flight time, controller techniques in handling the aircraft, shorter flight distances, etc. could account for the increased arrival rate.

- Increases in maximum arrival rates of 3 to 20 aircraft per hour for a two runway operation compared to a single runway operation were demonstrated.

3. All airline pilots that flew the simulator indicated that the procedures, in general, were operationally acceptable and easier to fly than initially anticipated. Speed control was considered to be quite important. The aircraft should be in final configuration prior to the Final Approach Fix, so that the speed won't be changing during the turning portion of the procedure. Proper intercept angles to the initial portion of the MLS procedure was also considered important.

4. Controllers felt that MLS approach and departure procedures as used in the simulations could improve operations at all three airports.

5. During all three simulations, a comparison of controller/pilot communications shows an average reduction of 30 - 35% when flying MLS approaches as compared to 100% ILS approaches.

6. Some benefits were realized by all aircraft in the scenario when the MLS equipage ratio was as low as 10%.

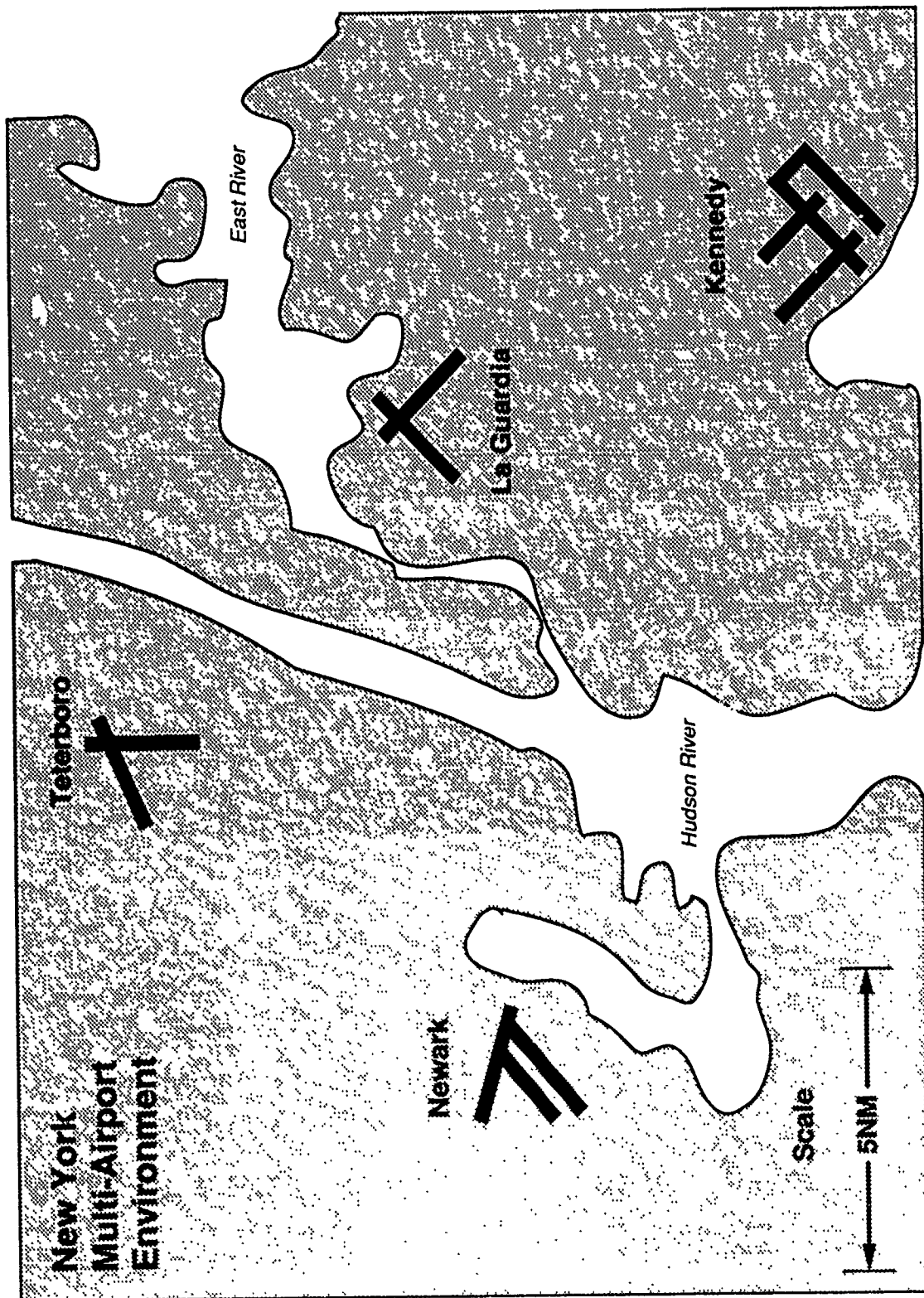

Figure 1. Relative Proximity of Four Airports in the New York Area

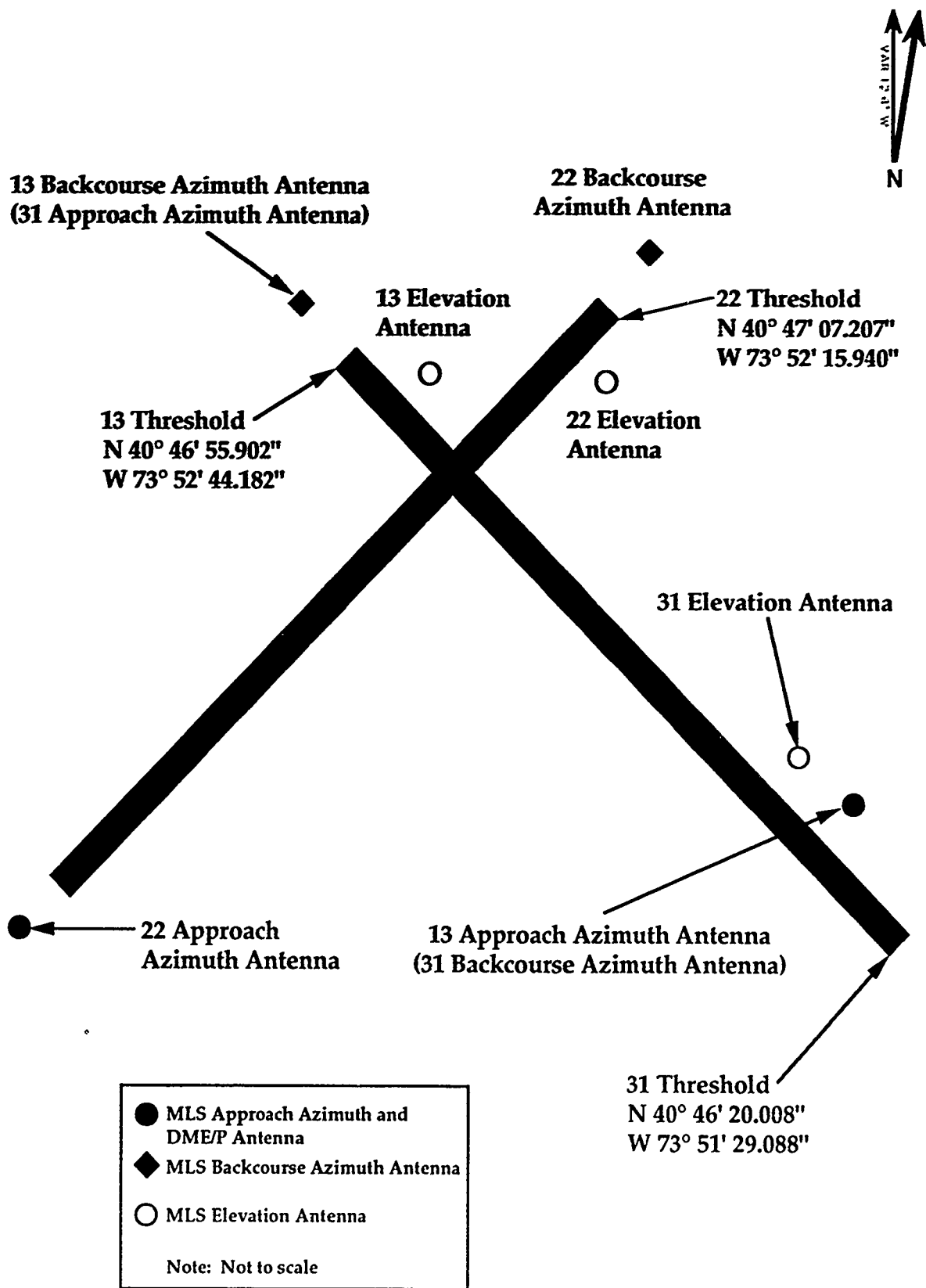

Figure 2. MLS Ground Installation at New York La Guardia Airport

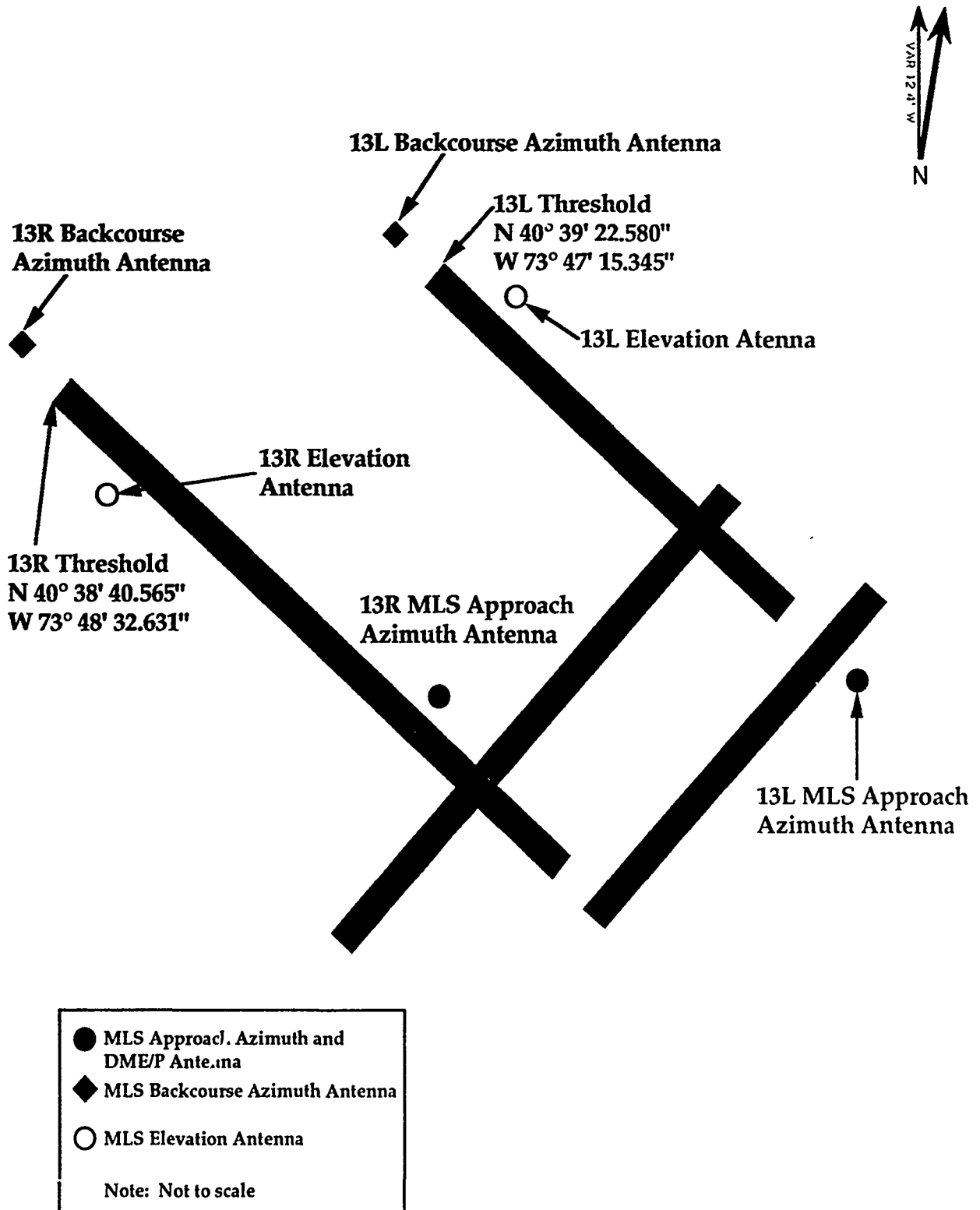

Figure 3. MLS Ground Installation at New York John F. Kennedy International Airport

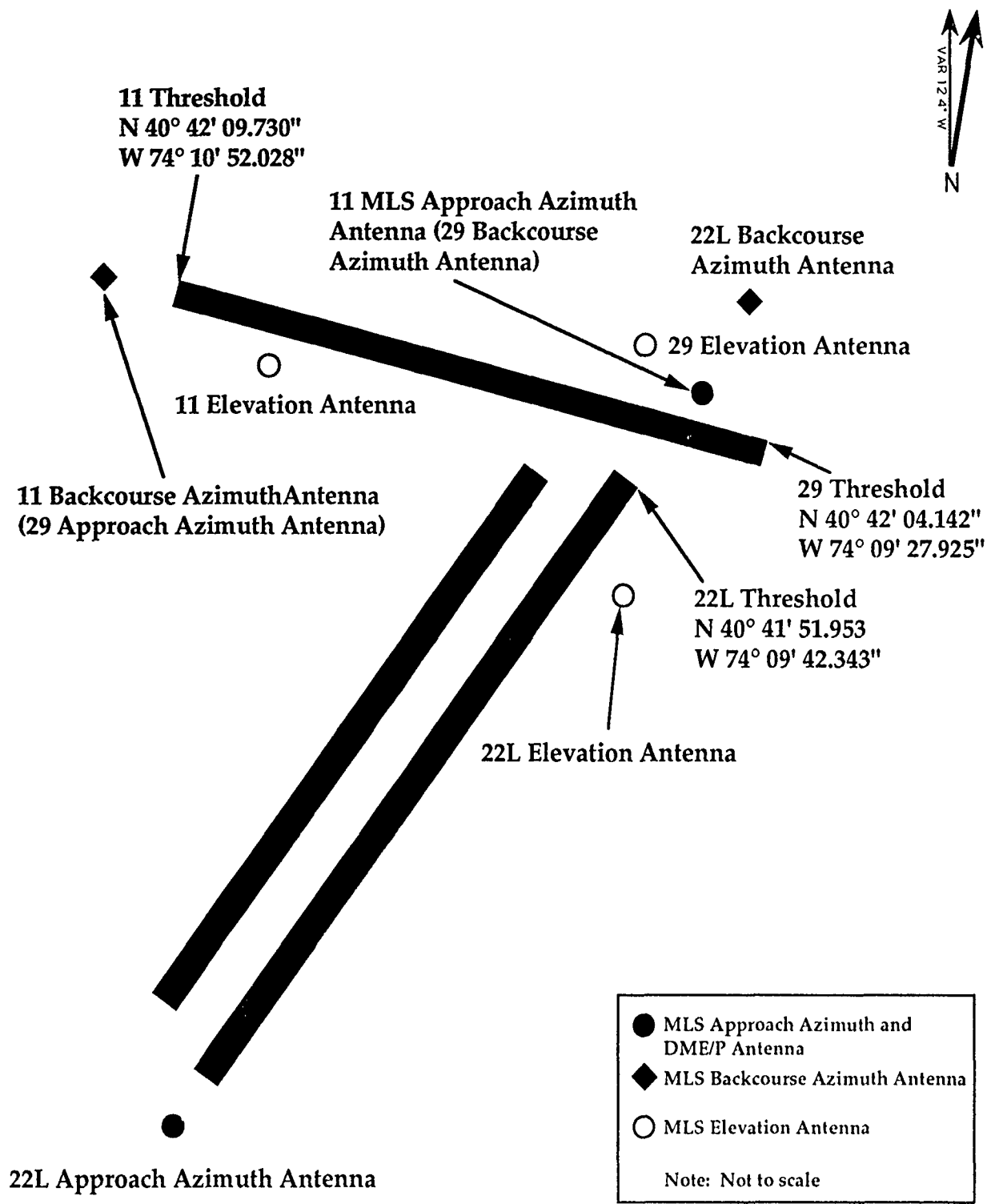

Figure 4. MLS Ground Installation at Newark International Airport

LGA RWY 13 NIMMS MLS/CP (EXPERIMENTAL)

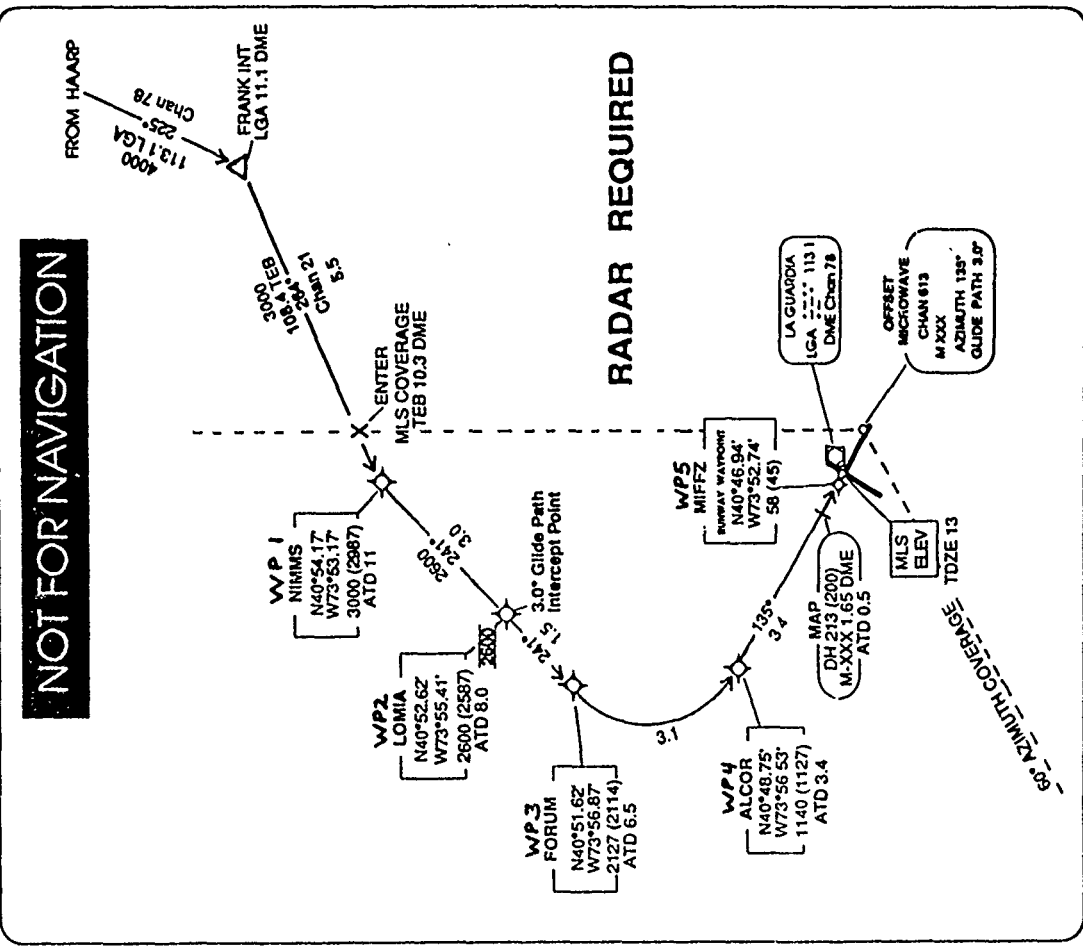

Figure 5. NIMMS MLS Approach to LGA Runway 13

LGA RWY 13 PETEZ MLS/CP (EXPERIMENTAL)

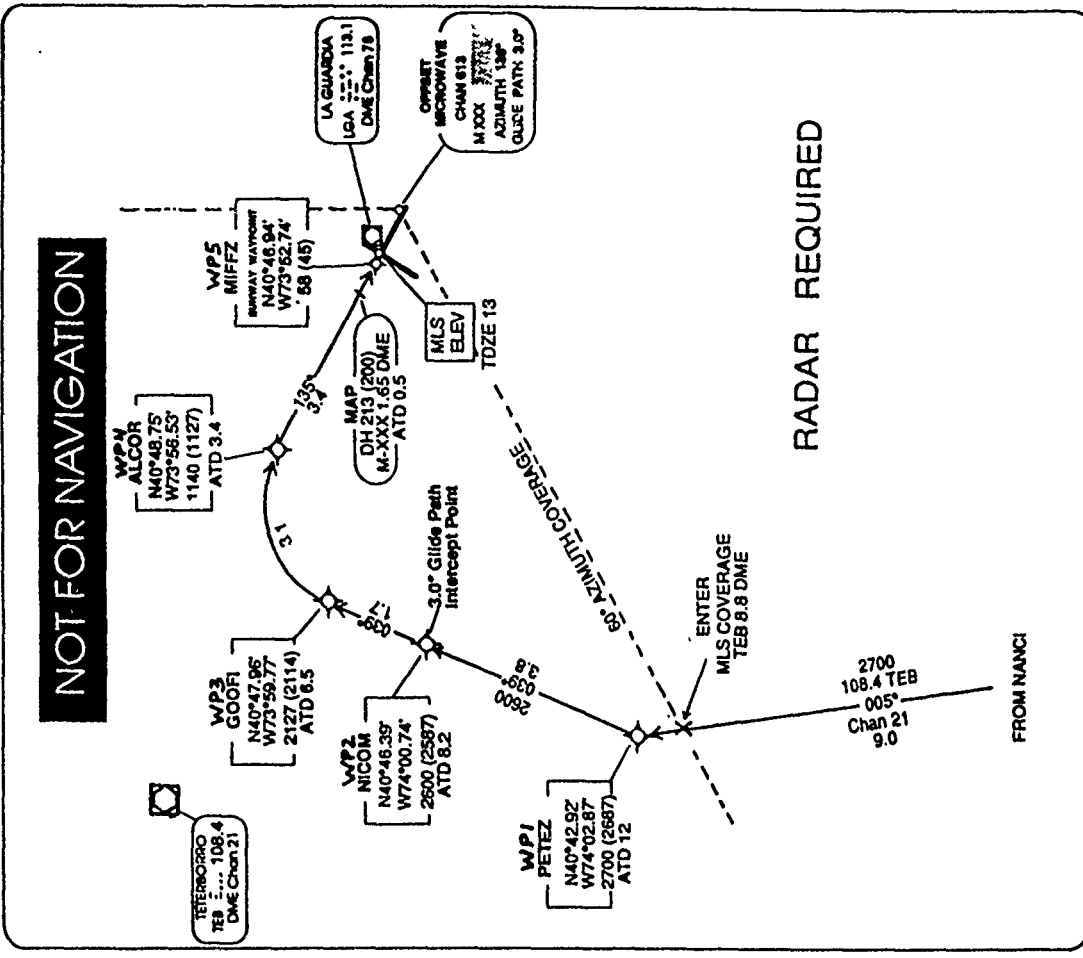

Figure 6. PETEZ MLS Approach to LGA Runway 13

LGA RWY 31 TROSI MLS/CP (EXPERIMENTAL)

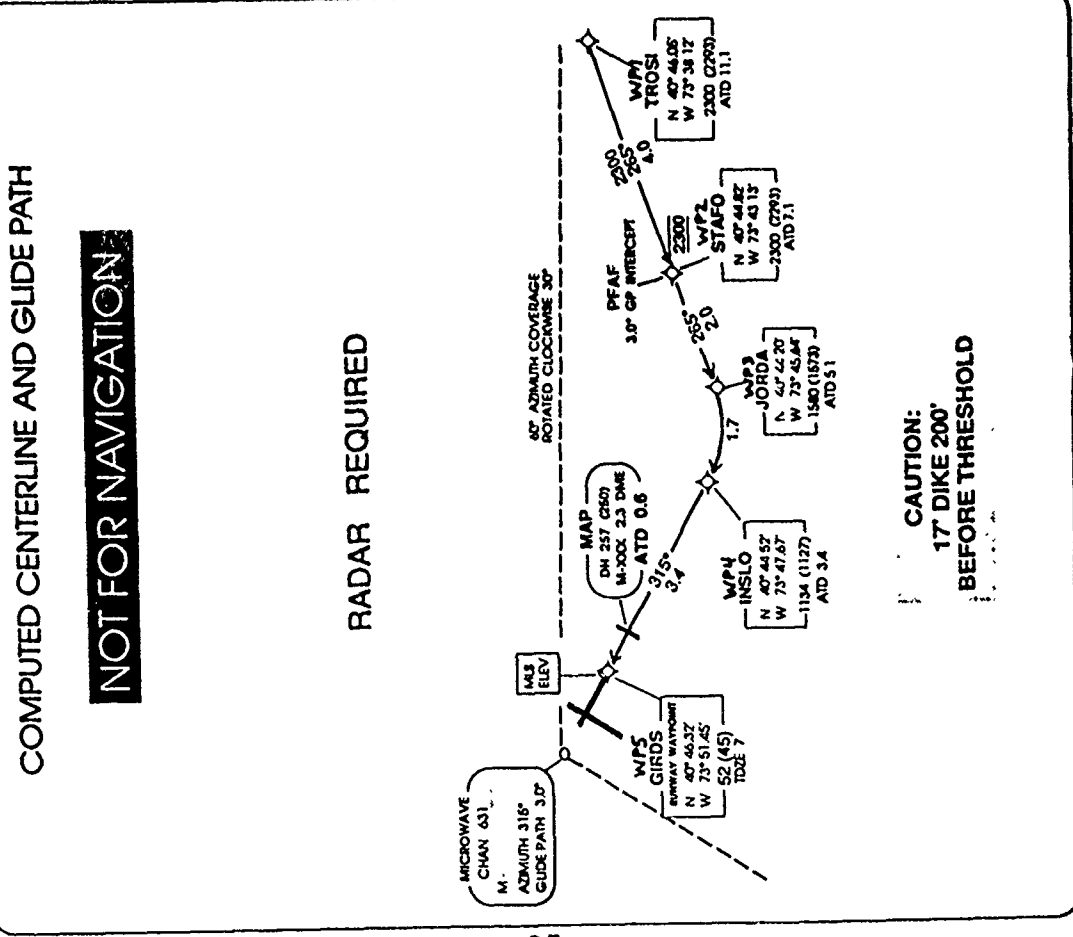

Figure 7. TROSI MLS Approach to LGA Runway 31

LGA RWY 31 ALLBE MLS/CP (EXPERIMENTAL)

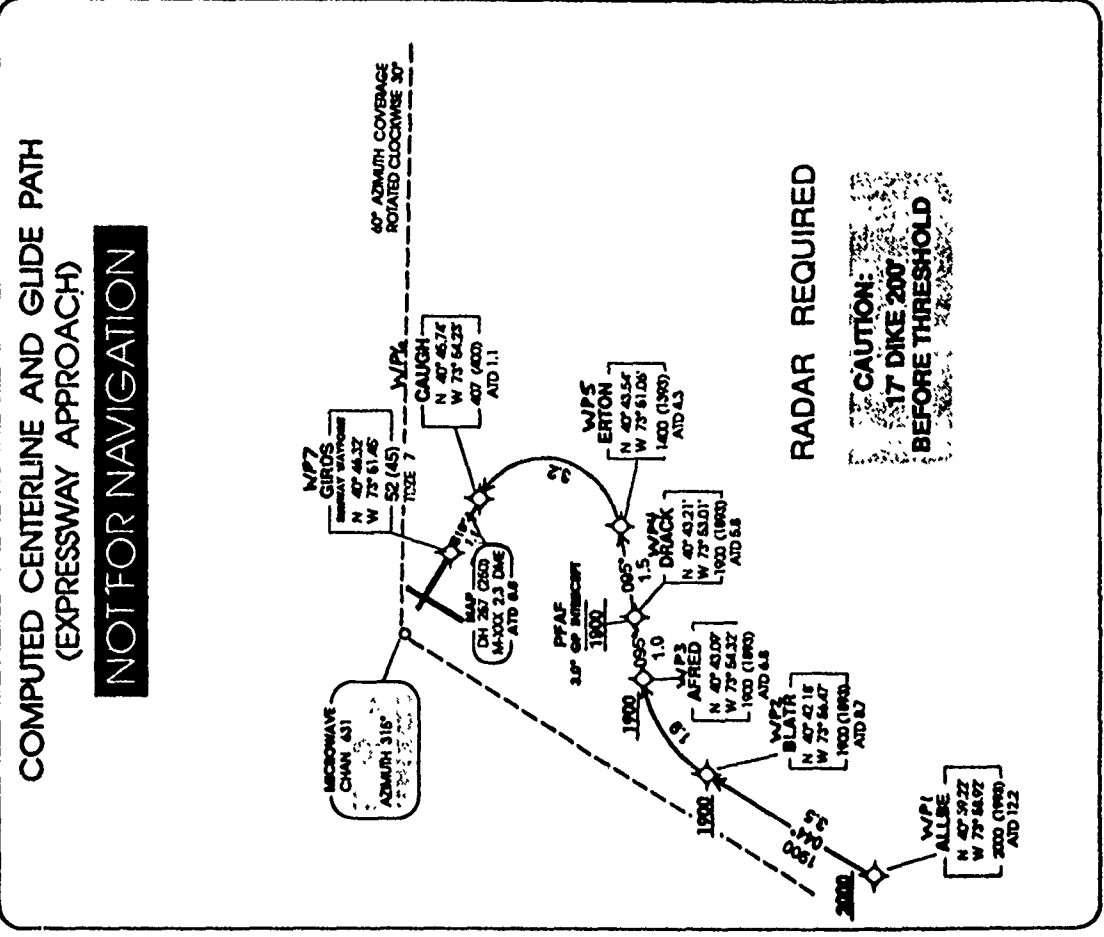

Figure 8. ALLBE MLS Approach to LGA Runway 31

LA GUARDIA GLOOP MLS/CP DEPARTURE (VECTOR)

TOIEN CLIMB

NOT FOR NAVIGATION
(EXPERIMENTAL)

RADAR REQUIRED

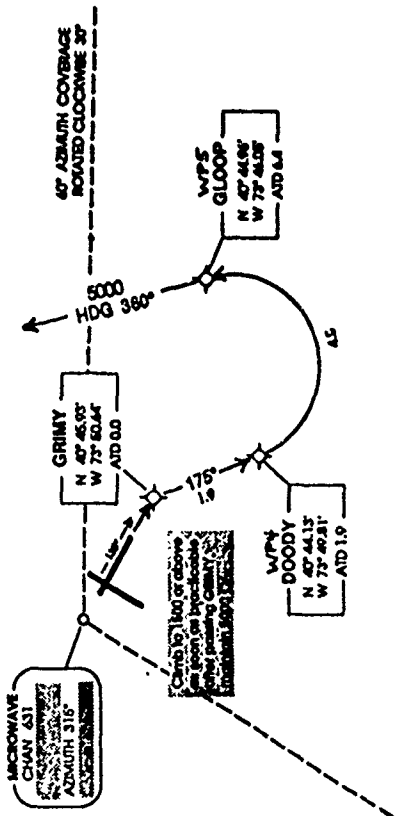

TAKE-OFF RUNWAY 13 (TOIEN CLIMB): Climb to GRIMY via GRIMY R-315. Thence climbing right turn to 1500 or above as soon as practicable after passing GRIMY and follow the published departure procedure to GLOOP waypoint. Thence fly heading 360° after passing GLOOP, maintain 5000. Thence, via vectors to assigned route/fix. Expect clearance to filed altitude/flight level ten minutes after departure.

Figure 9. GLOOP MLS Departure from LGA Runway 13

JFK RWY 13R MIKES MLS/CP-1

(EXPERIMENTAL)

NOT FOR NAVIGATION

RADAR REQUIRED

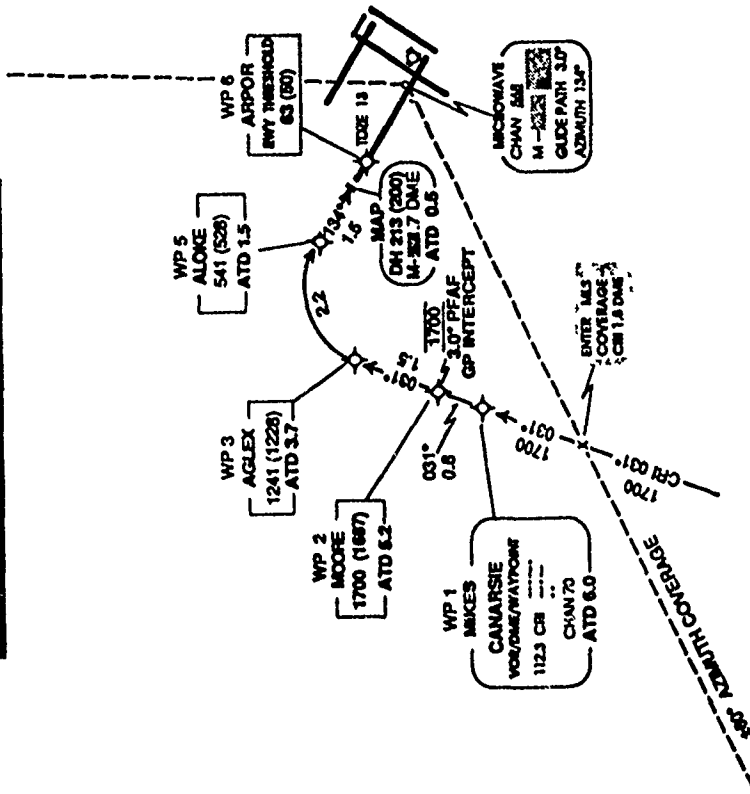

Figure 10. MIKES MLS Approach to JFK Runway 13R

JFK RWY 13R GOKAS MLS/CP-2

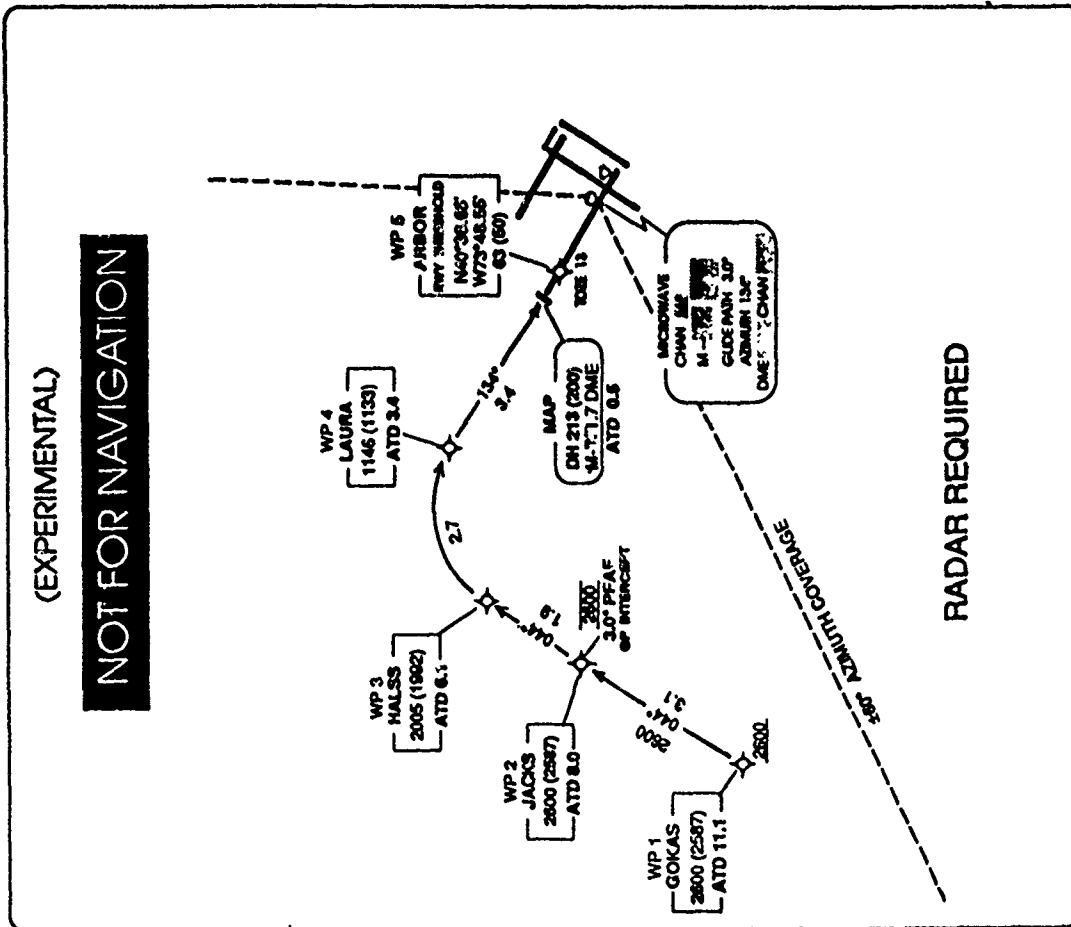

Figure 11. GOKAS MLS Approach to JFK Runway 13R

JFK RWY 13L SCOTT MLS/CP-3

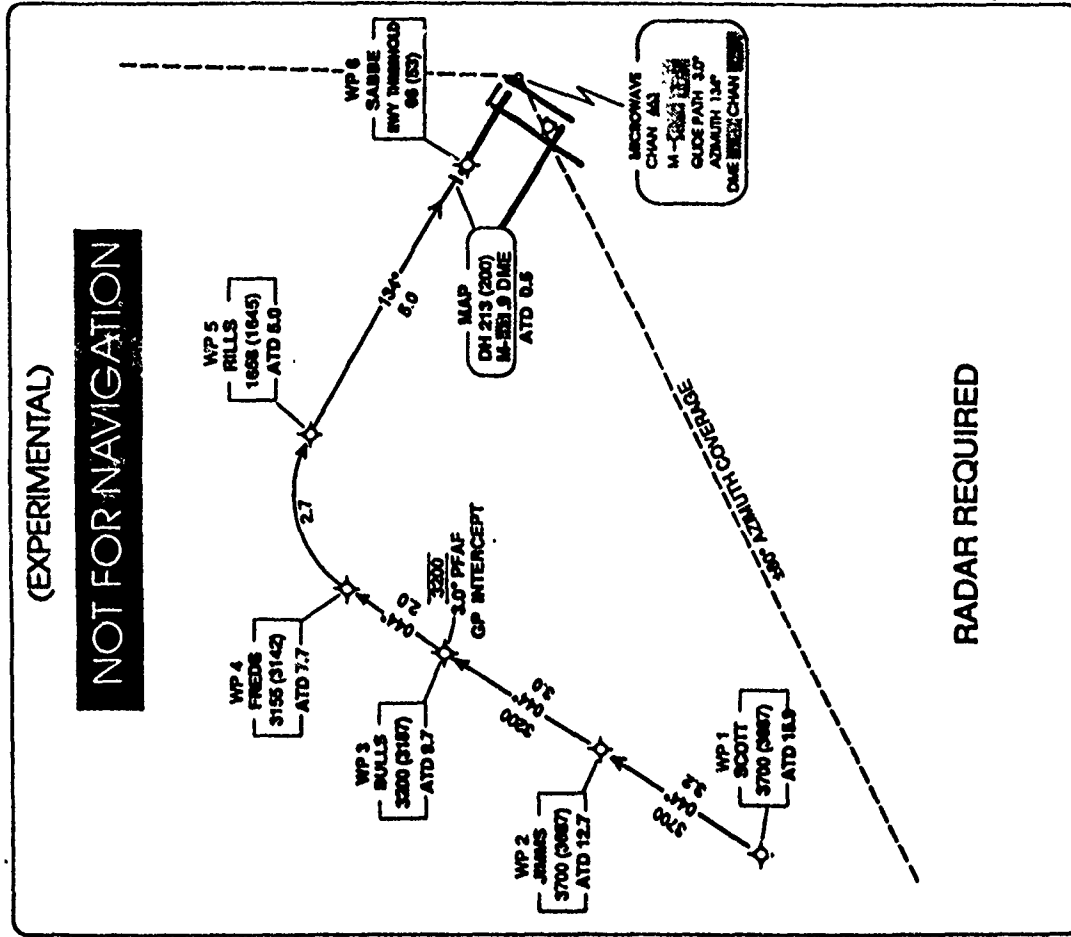

Figure 12. SCOTT MLS Approach to JFK Runway 13L

EWR RWY 11 MIRKY MLS/CP-2

(EXPERIMENTAL)

NOT FOR NAVIGATION

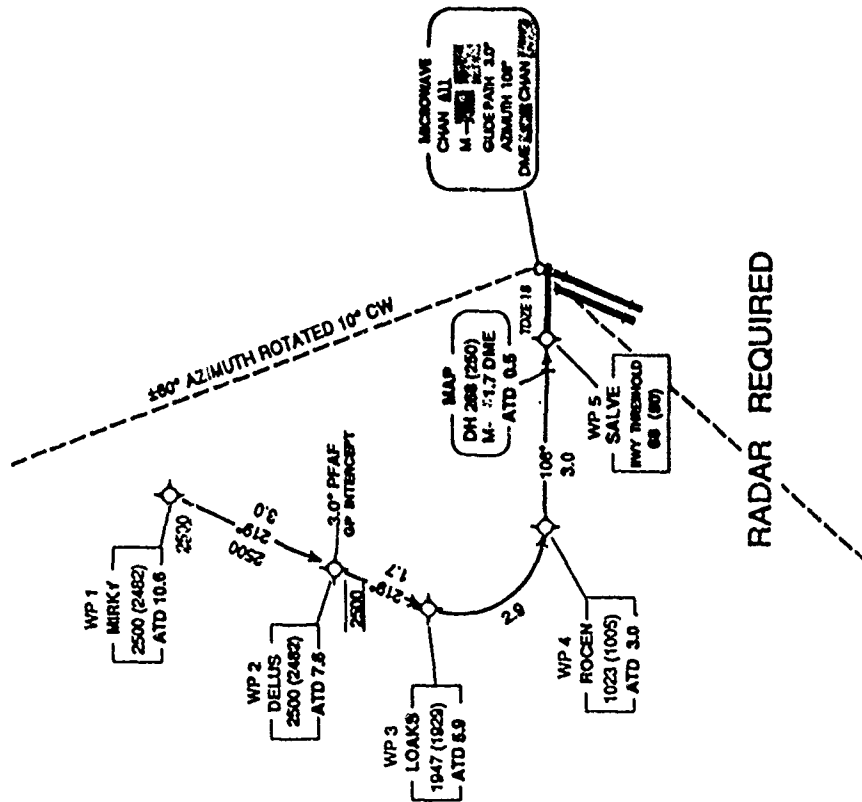

Figure 13. MIRKY MLS Approach to EWR Runway 11

EWR RWY 11 AWKIN MLS/CP-3

(EXPERIMENTAL)

NOT FOR NAVIGATION

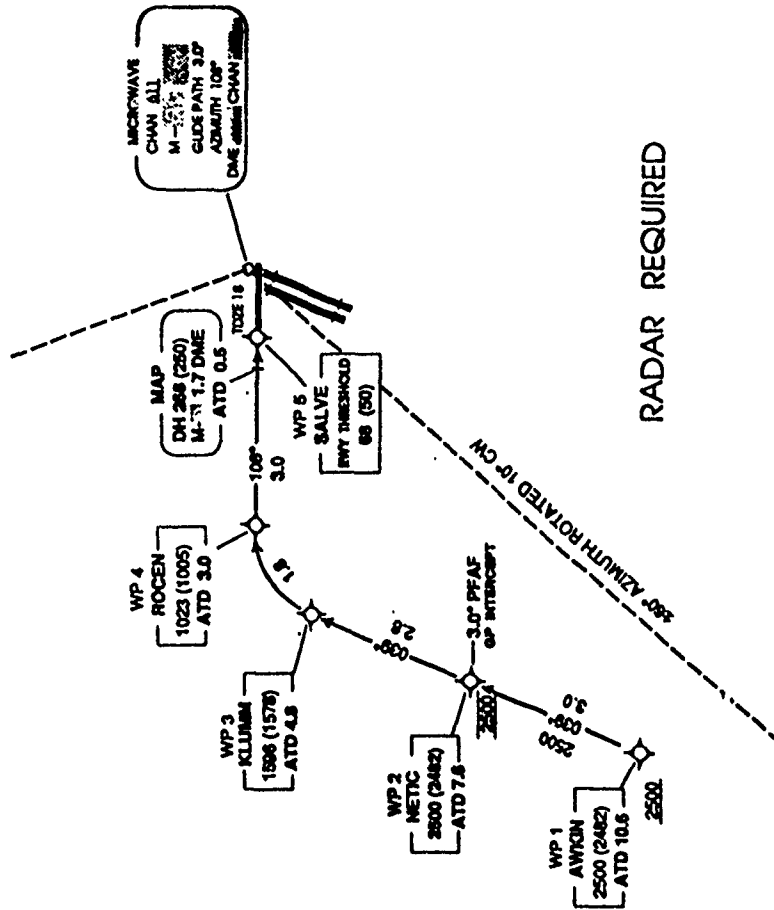

Figure 14. AWKIN MLS Approach to EWR Runway 11

EWR RWY 22L BAKAS MLS/CP-1

(EXPERIMENTAL)

NOT FOR NAVIGATION

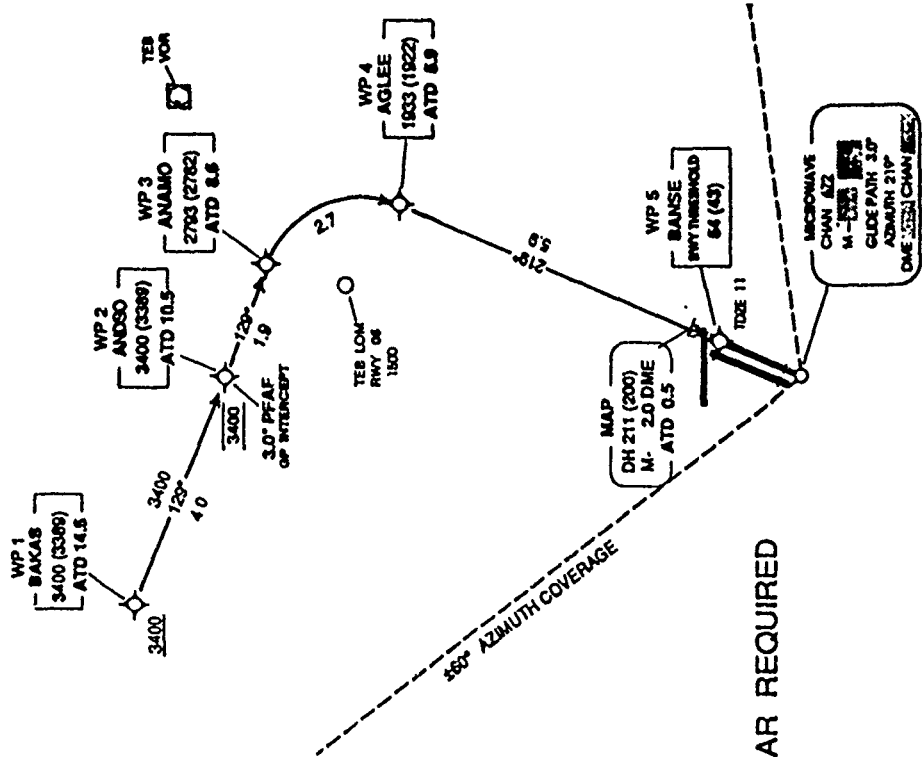

Figure 15. BAKAS MLS Approach to EWR Runway 22L

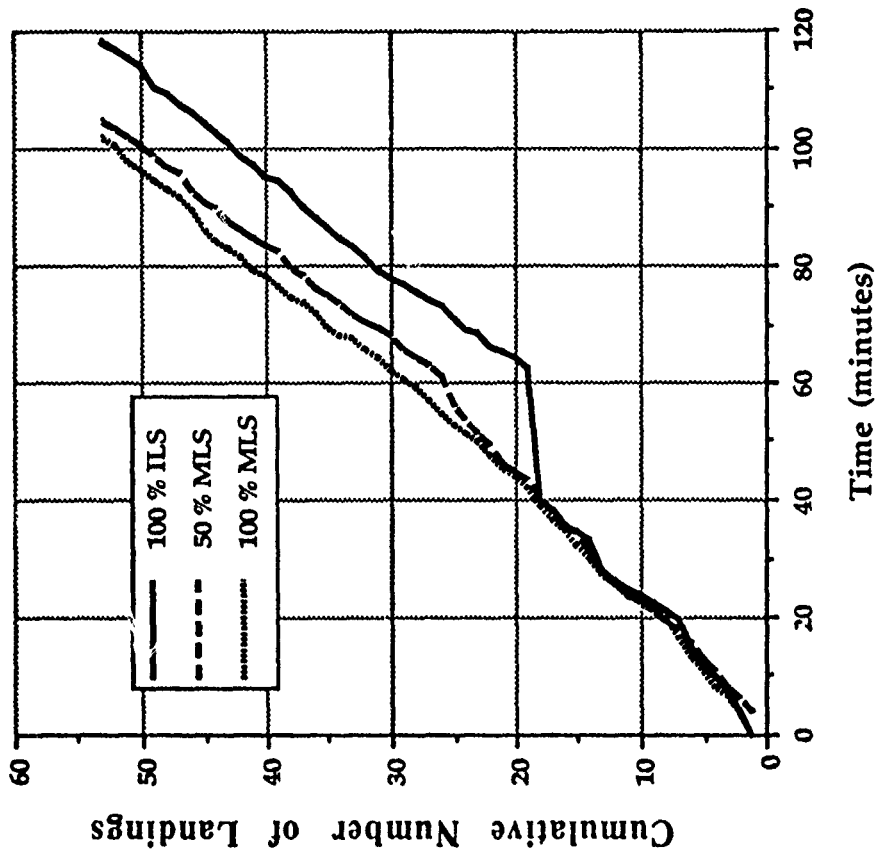

Figure 16. Effect of 20 minute Holding at LGA for TEB Operations

APPENDIX A

DESCRIPTION OF THE MLS CAPABILITY IN THE B-727 SIMULATOR

In this section, a description of the MLS capabilities incorporated into the NASA Ames Research Center's B-727 simulator is provided. The MLS is newly added, specifically aimed toward the current and subsequent FAA MLS research efforts. One of the major thrusts of the FAA MLS research is in evaluating the operational aspects of the MLS in full mission environments that reflect realistic MLS usage. This main thesis dictated the development of the simulation capability to the extent that a realistic operational appearance is maintained above and beyond the functional fidelity. The simulation has been constructed to reflect a potential retrofit to transport aircraft in the near future.

Basically, the MLS simulation consists of these four major elements:

- (a). Ground System, Angle Receiver and DME/P Interrogator;
- (b). MLS/RNAV Algorithms;
- (c). MLS/RNAV Control Display Unit (CDU); and
- (d). Interface with Existing B-727 Avionics.

Ground System, Angle Receiver and DME/P Interrogator Software Module - This module defines the MLS ground installation, performs the receiver tuning for the selected channel, computes the approach azimuth, back course azimuth, elevation, and DME signals, sets the validity flags for each signal, computes the deviations from the selected references, and prepares the deviation signals for display and flight director/autopilot purposes. The typical MLS coverage is summarized in Table A-1.

Angle deviation signals are computed by subtracting the references (as selected by the pilot via the CDU) from the computed values based on the current latitude, longitude, and altitude of the aircraft position. The "dot" signals (which are shown as raw deviations on the Course Deviation Indicator) are then computed by multiplying by the corresponding sensitivity factors. For basic mode use, the sensitivity factors used are $\pm 1.85^\circ$ full scale for the approach azimuth, $\pm 6.0^\circ$ full scale for the back azimuth, and $\pm 0.75^\circ$ for the elevation. For RNAV mode, the azimuth sensitivity is $\pm 1.85^\circ$ full scale until the deviation equals ± 1500 ft and then it remains at ± 1500 ft full scale. This occurs at approximately 6 nmi from the azimuth station. The elevation sensitivity is $\pm 0.75^\circ$ full scale until the deviation equals 625 ft. at which point it remains ± 625 ft. For convenience, this occurs at the same point where the azimuth scaling changes. The back azimuth sensitivity is set at ± 1500 ft. full scale at all points. These signals are sent to the display instruments without any filtering or smoothing.

Table A-1. MLS Coverage Summary

DME	
Range	22 nmi
Coverage	Omni-directional
Approach Azimuth (conical beam shape)	
Range	1,000 ft to 22 nmi
Lateral Coverage	$\pm 60^\circ$
Vertical Coverage	20° to 5,000 ft 15° to 20,000 ft
Elevation (conical beam shape)	
Range	to 22 nmi
Lateral Coverage	$\pm 40^\circ$ about the runway centerline
Vertical Coverage	0.9 to 15°
Backcourse Azimuth (conical beam shape)	
Range	1,000 ft to 22 nmi
Lateral Coverage	$\pm 60^\circ$
Vertical Coverage	20° to 5,000 ft 15° to 20,000 ft

MLS/RNAV Algorithms - The MLS/RNAV algorithms contain the following four major elements: MLS position computation, navigation filter algorithms, RNAV reference path table look-up, and RNAV guidance signal generation. A brief description of each component is given below. These elements are shown in a simplified flow chart in Figure A-1.

The MLS position computation performs the inverse transformation from MLS signals to runway referenced x, y and z rectangular coordinates. There are three cases to consider: front azimuth, distance, barometric altitude; front azimuth, distance, elevation angle; and back azimuth, distance, barometric altitude.

Two decoupled horizontal and vertical filters are contained in the navigation filter module. The horizontal filter consists of the following three parts:

- (a) Two state turn rate estimation filter;
- (b) Four state horizontal filter; and
- (c) Single state signal validity probability filter.

Filter (a) generates heading and turn rate estimates based on measured heading and bank angle. The resultant turn rate estimate is used by (b) to complement the MLS computed x and y coordinates in updating the aircraft's horizontal position and

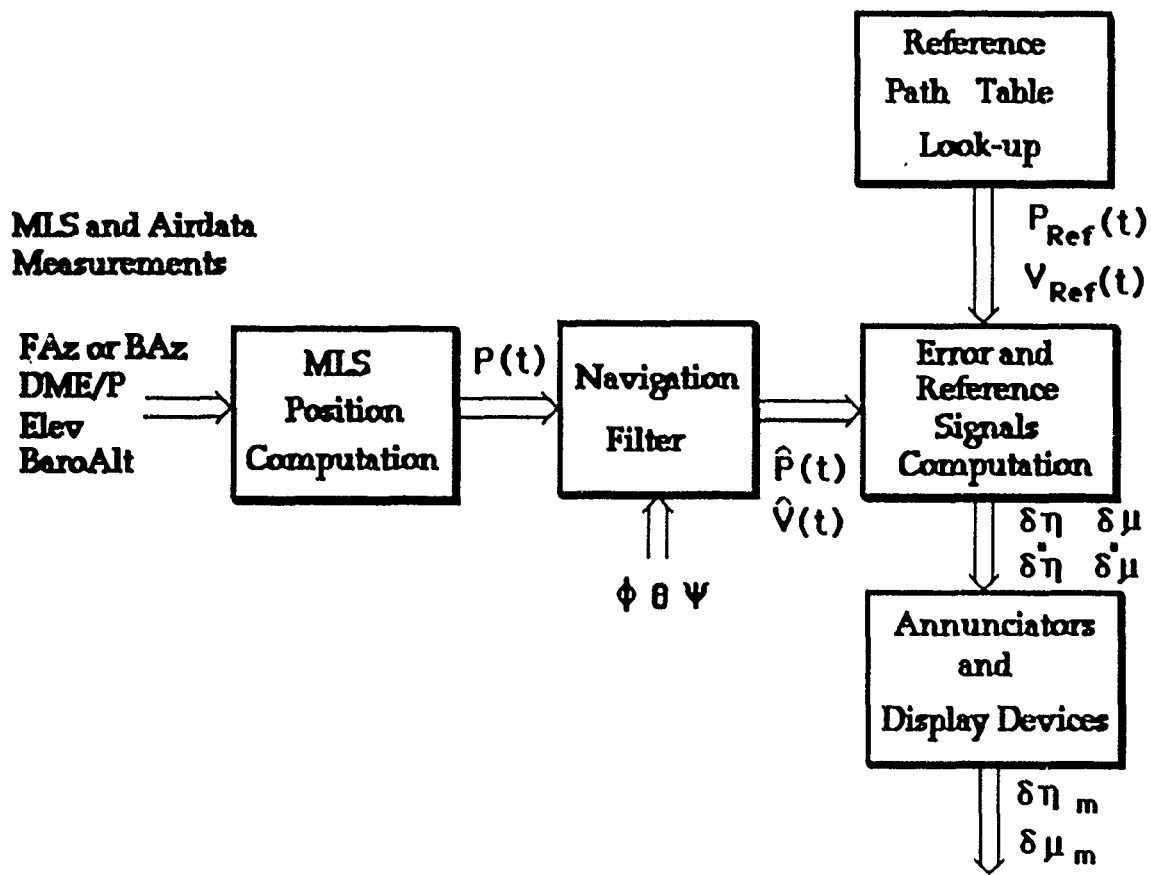

Figure A-1. MLS/RNAV Computation Flow Chart

velocity estimates. This filter design can utilize existing roll, pitch and yaw signals from the vertical and directional gyros and does not require body accelerations or INS grade IRU signals, thus helping to reduce avionics retrofit and upgrade costs. The signal validity probability filter (c) is used to transition gracefully to other filter modes such as dead reckoning.

The vertical filter computes the altitude and altitude rate estimates. It is aided by measured pitch attitude and a ground speed estimate (obtained by the horizontal filter). The second state is an estimate of bias in the computed altitude rate. Because of this aiding, the filter can have a substantial smoothing effect yet exhibit minimum dynamic delay.

All of the required RNAV waypoint data is stored in the computer's read-only memory. The pilot can only select from rather than enter or alter the route database. This method is much faster and also eliminates unnecessary human errors. The following data are retrieved for each MLS/RNAV route:

- waypoint number;
- x, y and z coordinates;
- radius and center of circular-arc;
- next segment course and range-to-go;
- vertical flight path angle;
- nominal ground speed; and
- DME and azimuth readings from the selected MLS azimuth antenna.

The RNAV guidance signal generation module consists of arm and engage modes. The arm mode tests the reference path capture/engage conditions based on a 5 sec look-ahead position. The engage test logic computes along track distance and cross track error for each segment. If the along track distance is less than the segment length and the cross track error is less than two miles, then the test is satisfied. The RNAV ENG flag is set, the RNAV ARM flag is reset, and the waypoint number is stored. Otherwise, it waits until the conditions are satisfied.

During the engage mode, many signals are computed for either display to the pilot through the CDU or for use in the roll and pitch flight director. These signals include:

- active and next waypoint indices;
- cross track error;
- current reference course angle with respect to magnetic North;
- next segment course angle with respect to magnetic North;
- feed-forward roll bias angle, if circular-arc segment;
- altitude reference and altitude error;
- along track distances and time-to-go to the last way point;
- range- and time-to-go to the next way point; and
- next waypoint alert light flag.

MLS/RNAV CDU - In keeping with the main thesis of creating an operationally realistic cockpit environment, special emphasis was placed on the design of the pilot interface unit. This is the device by which pilots communicate with the MLS receiver such as selecting channel number and associated references. This interface device will be referred to as the MLS/RNAV CDU. In effect, the CDU is the MLS as far as what the pilot sees in the cockpit. The Minimum Operational Performance Standards for Airborne MLS Area Navigation Equipment document (MOPS) does not specify the exact technical nature of an interface device through which the pilot invokes the advanced capability. Furthermore, no such device currently exists in the market place. Consequently, an experimental MLS/RNAV CDU had to be designed and manufactured at NASA. Since the B-727 simulator represents the older analog generation of aircraft, the design was aimed toward the retrofit situation. This would provide a rudimentary MLS/RNAV approach capability for the older generation transport aircraft where lack of instrumentation space dictates a compact design. The minimum functional requirements for the CDU were as follows:

- Ability to tune an MLS channel;
- Automatic or manual selection of back azimuth reference;
- Ability to select a straight-in reference or a curved approach path;

The CDU has three interfaces:

- Pilot Interface - provides the pilot with controls and displays for simple and concise operation of the MLS/RNAV system.
- Computer Interface - provides the bidirectional link with the simulation or RNAV computer.
- Avionics Interface - provides control of the MLS receivers by emulating functions of control heads. It also provides additional interfaces for the ARINC 429 data inputs and outputs.

The CDU uses separate assemblies to accommodate the three interfaces. The Pilot Interface and the Computer Interface comprise three of the four circuit assemblies or boards within the control head. The Pilot Interface is microprocessor controlled. This approach reduces the amount of circuitry required to support the pilots' displays and controls. The Avionics Interface is also microprocessor controlled and shares data with the Pilot Interface. The CDU can be reconfigured (using the existing hardware), or an assembly can be replaced to provide capability for future experiments. One feature, available using this design approach, is control head emulation. This emulation will support the use of existing avionics receivers and transponders with advanced pilot display capability. Figure A-2 contains a photograph and labeled drawing of the MLS/RNAV CDU.

The pilot has the following controls and annunciators on the CDU. A LABEL identifies a backlit push button. An ANNUNCIATOR identifies a dead-front status

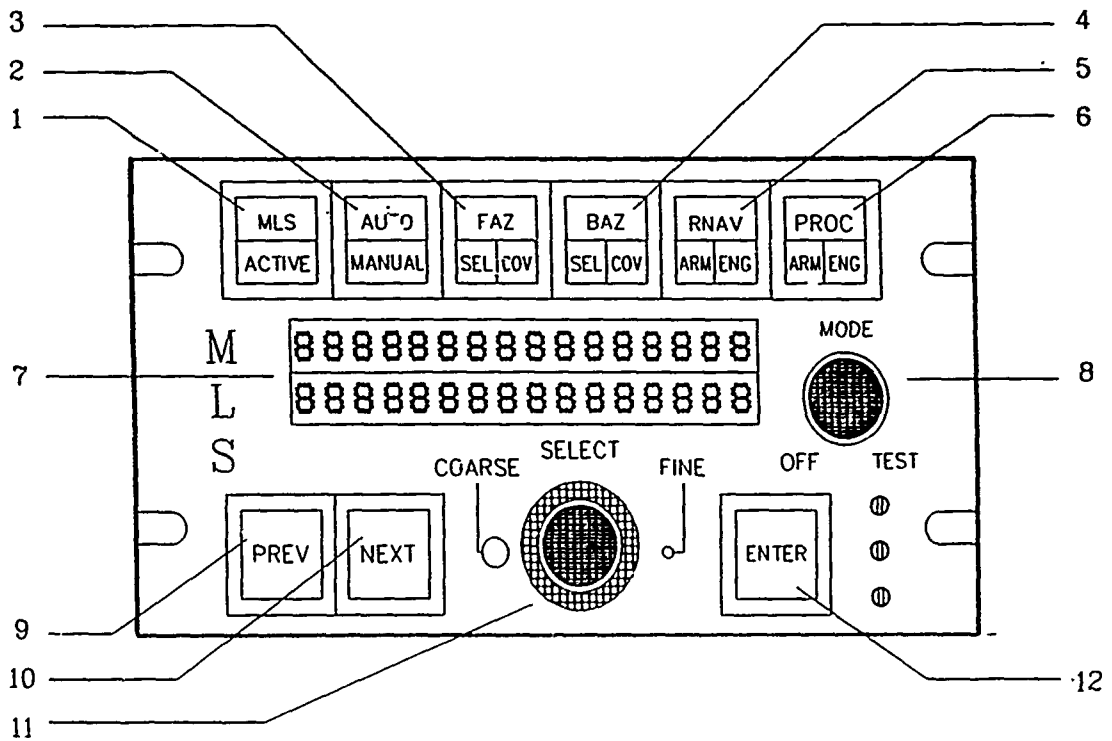
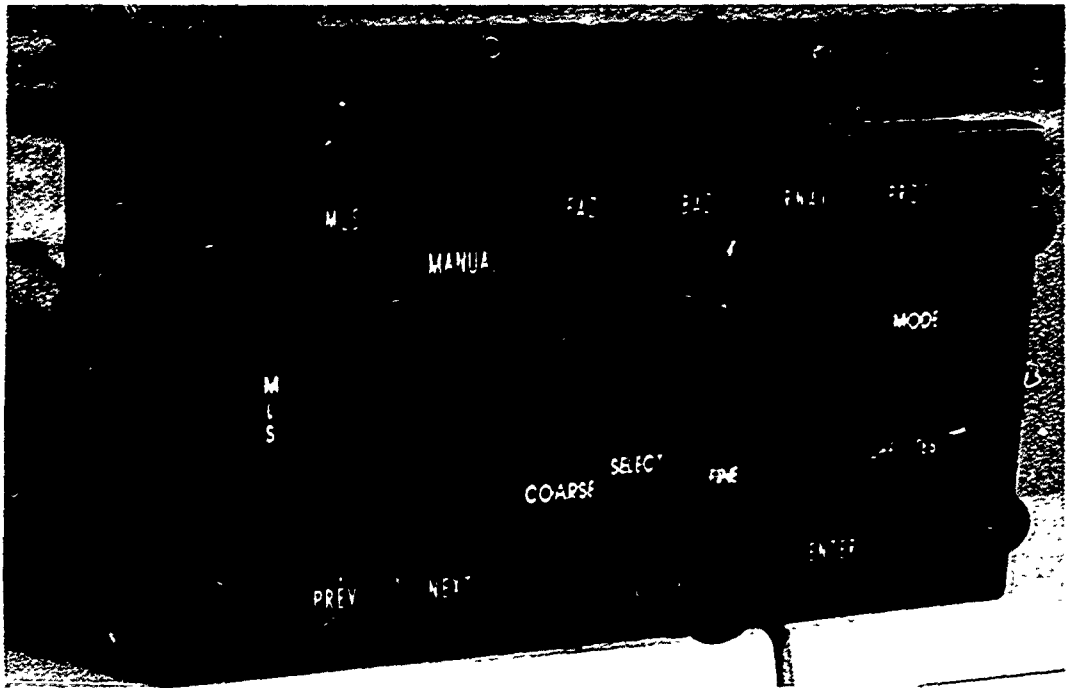

Figure A-2. Picture and Schematic of the MLS/RNAV Control Display Unit

area. A text message on the dead-front annunciator can only be read when the annunciator is lit. The usage of the control pushbuttons and meaning of the status annunciators are described below:

- **#1 MLS (white)/ACTIVE (green) indicator pushbutton.** The MLS label is backlit for identification. The "ACTIVE" indicator lights to identify that the "MLS MODE" is in use.
- **#2 AUTO (white)/MANUAL (white) indicator pushbutton.** This control allows the pilot to select AUTO or MANUAL MLS modes. The AUTO and MANUAL indicators light to display the mode currently in use. Only one indicator lights at a time. Depressing the pushbutton toggles the operating mode. In AUTO mode, the default azimuth, back azimuth and elevation values for the runway are displayed. In MANUAL mode, these three values can be selected by the pilot.
- **#3 FAZ (white)/SEL (green), COV (yellow) indicator pushbutton.** This control selects a Front Azimuth. The "FAZ" label is backlit for identification. The "SEL" indicator will illuminate to show that this azimuth is in use. The "COV" indicator will illuminate when the aircraft is within MLS coverage of the Front Azimuth.
- **#4 BAZ (white)/SEL (green), COV (yellow) indicator pushbutton.** This control selects a Back Azimuth. The "BAZ" label is backlit for identification. The "SEL" indicator will illuminate to show that this azimuth is in use. The "COV" indicator will illuminate when the aircraft is within MLS coverage of the Back Azimuth.
- **#5 RNAV (white)/ARM (yellow), ENG (green) indicator pushbutton.** This control selects advanced MLS modes for approach-path selection. The "RNAV" label is backlit to allow for identification. The "ARM" indicator will illuminate to show that the "RNAV MODE" is selected. The "ENG" indicator will illuminate to show that the computer is performing the RNAV calculations.
- **#6 PROC (white)/ARM (yellow), ENG (green) indicator pushbutton.** This control selects advanced MLS modes related to approach-path interception. The "PROC" label is backlit for identification. The "ARM" indicator will illuminate to show that the "PROCEDURE MODE" is selected. The "ENG" indicator will illuminate to show that the computer is performing the PROCEDURE calculations. This function is not presently available.
- **#7 - 2 LINE x 16 CHARACTER DISPLAY.** The green LED display is a sunlight readable (7000 foot-candles background) dot matrix display. This display provides pilot information and pilot input feedback.

- **#8 - DISPLAY MODE SELECTOR SWITCH.** This 11 position rotary switch has the following functions:
 - OFF - turns the CDU Off.
 - (1 - 9) - selects the main or alternate display modes.
 - TEST - selects the test mode (full-clockwise position).

The OFF position of the switch uses a "PULL-TO-TURN" action to activate this switch position. The panel labels for this switch incorporate the use of lamps for back-lighting.

- **#9 "PREV"** (white) indicator pushbutton. This pushbutton selects the previously displayed field of data entry. The "PREV" label is backlit for identification.
- **#10 "NEXT"** (white) indicator pushbutton. This pushbutton selects the next displayed field for data entry. The "NEXT" label is backlit for identification.
- **#11 "SELECT"** switches (Concentric - Large [coarse], Small [fine]). This rotary control selects items or values on the display for data entry. Each switch has 10 positions and has continuous rotation. The coarse control has a (x10) times-ten multiplier. The fine control has a (x1) times-one multiplier. Channel selection for a range of 200 channels requires two rotations of the coarse select knob. The labels for this control are backlit on the control panel.
- **#12 "ENTER"** (white) indicator pushbutton. This control enters the pilot's choice of data for a specific field on the LED display. The "ENTER" is backlit for identification.

Figure A-3 is a diagram of the MLS/RNAV interface connections to the 727 simulator. The Compaq takes the place of the MLS receiver, DME/P receiver, part of the MLS ground station and RNAV computer for the simulator. Aircraft position information and MLS controls are exchanged between the main-aircraft simulator computer (SEL) and the Compaq. The CDU appears as a terminal to the simulation computer. Pilot pushbutton and rotary switch position data is transmitted from the CDU to the Compaq computer. The two-line LED display and the annunciator data are transmitted from the Compaq to the CDU. The CDU's primary function is to communicate with the RNAV computer which uses the CDU as the pilot interface. In addition, some MLS receivers require control-mode and tuning information from a dedicated control head. This activity is performed by the CDU avionics interface assembly. MLS receivers receive the Radio-Management-System control data from the ARINC 429 communication bus. The CDU selectively displays MLS and DME/P data. This data is received by the CDU by emulating the MLS receivers' original CDU and ARINC 429 communications.

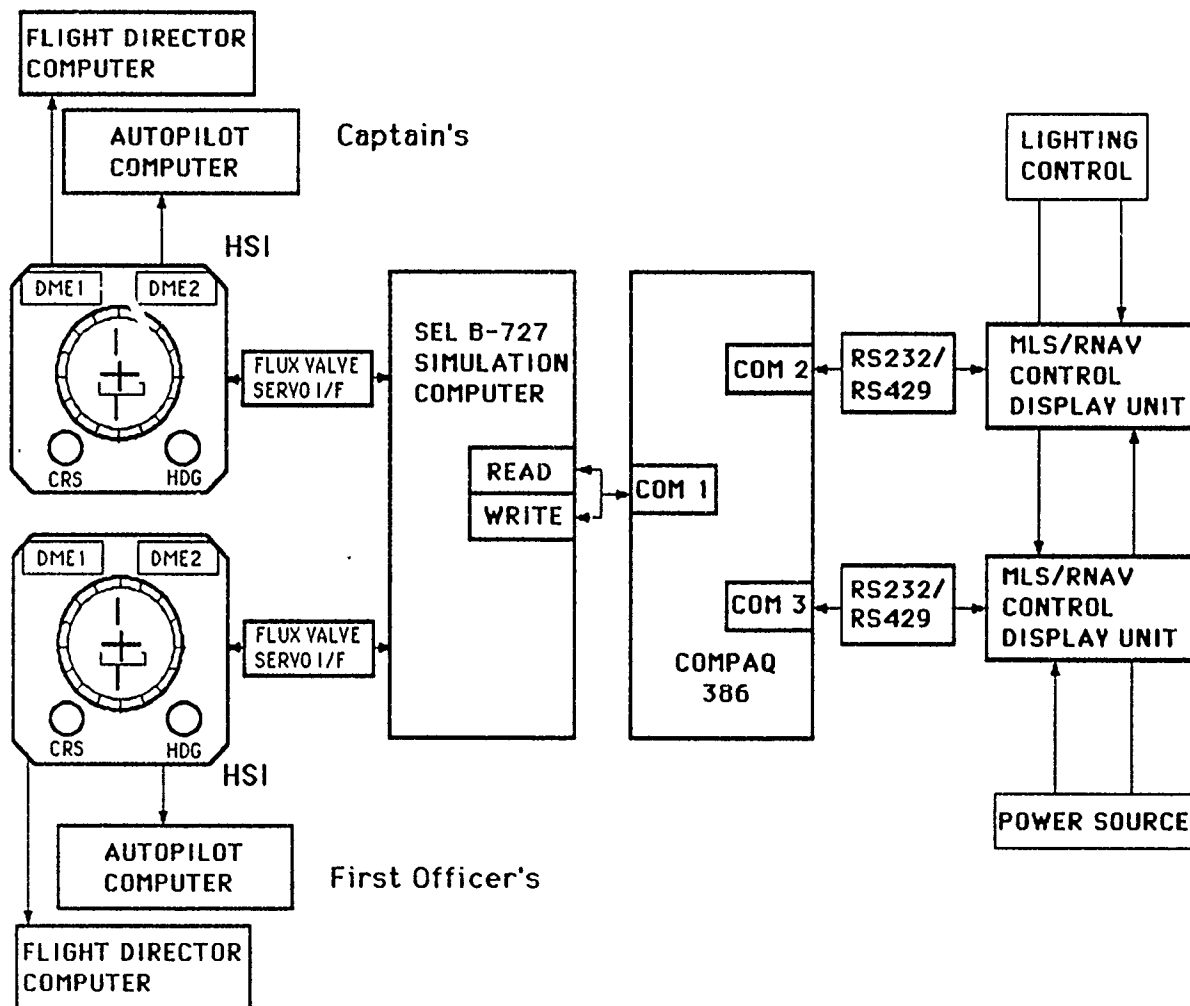

Figure A-3. MLS/RNAV Interface Diagram in the MVSRF B-727 Simulator

Interface With Existing B-727 Avionics - The basic premise for interfacing the MLS capability into the cockpit was to disturb the existing cockpit instrumentation as little as possible, yet make use of as much instrumentation as is rationally justified. No new instrument such as a CRT was installed other than the CDU. Also, no existing instrument was removed to make room for the MLS instrumentation. However, the Horizontal Situation Indicator (HSI) was replaced with a more advanced model found in a significant number of 727 aircraft. This HSI was selected for three reasons. First, the heading control and course control knobs can be remotely driven when pushed in. Second, there are two digital displays of distance available. And third, there is a destination alert annunciator. Figure A-4 is a picture of the Captain's instrumentation and the center control panel of the B-727 simulator showing the location of the MLS/RNAV CDU's.

The remotely driven heading and course control functions were used in the following manner. When the aircraft was outside of MLS coverage, the pilot flying would pull out the heading and course control knobs and manually set the reference course and desired heading to navigate on standard VHF navigation aids. Once the aircraft was within MLS coverage and close enough to the MLS/RNAV procedure path that the MLS/RNAV ENG function was green, the pilot flying would push the heading and course control knobs in and activate the MLS function button on the CDU. The heading bug would immediately slew to the desired course to the next waypoint, and the reference course would be set so that the CDI needles could give correct deviation indications. When the aircraft is within 10 seconds of the next waypoint, the amber destination alert light comes on as a reminder. Upon reaching that waypoint, the heading bug automatically slews to the new course as an indicator to the pilot. At the same time, the reference course is set to the same value. The pilot's task is to keep flying the flight director guidance and monitor raw data for situation awareness.

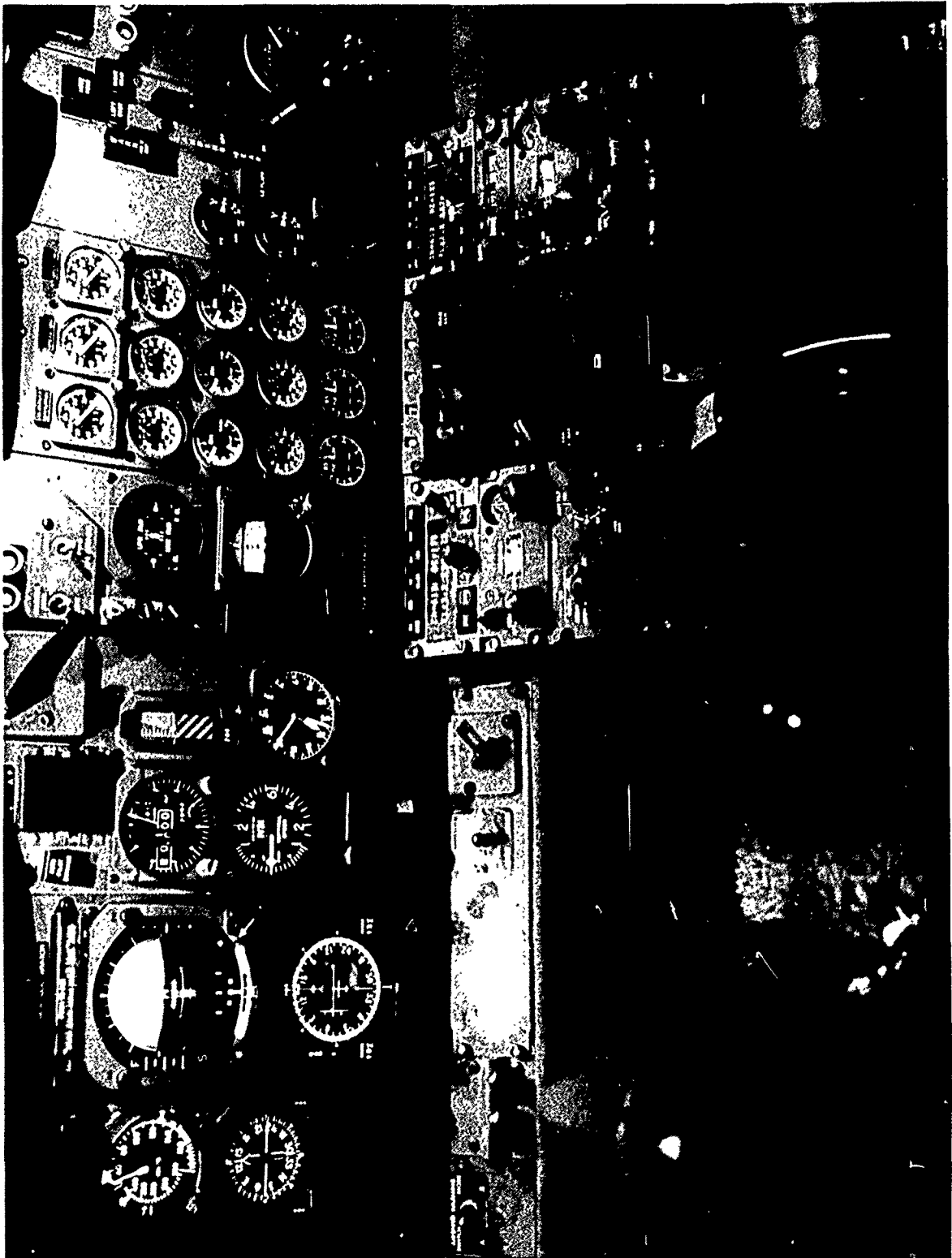

Figure A-4. Cockpit Instrumentation Configuration of the B-727 Simulator

APPENDIX B

DESCRIPTION OF THE AIR TRAFFIC CONTROL SIMULATOR

The Air Traffic Control Simulator (ATCS) is a full-featured simulator built to be used as a testbed for the development of new ATC procedures as well as for training Air Traffic Controllers in the use of these procedures in a safe yet realistic environment. It can also be used to provide a realistic operational environment to flight crews operating in either of two flight simulators. The entire simulation complex consisting of the ATCS, the B-727 simulator and an advanced all-glass cockpit simulator make up the Man-Vehicle Systems Research Facility (MVSRF). This laboratory is dedicated to research in the area of human factors and navigation systems as well as the development and testing of new ATC technologies and procedures. The ATCS can also be used as an effective tool for controller training both for terminal and enroute operations. It combines a very realistic simulation of the ATC environment with a set of scripting capabilities which allow setting up and controlling the training sessions to provide a uniform but flexible teaching environment.

The ATCS consists of three separate stations. The experimenter's station is used to configure, start, and control the flow of events in the simulation. The experimenter can, via keyboard entries, create new aircraft in the simulation, activate and deactivate controller stations, alter wind profiles, and perform numerous other functions which control the simulation environment. The controller station allows the controller to control the traffic. It simulates the traditional radar display used by controllers today. Multiple controller stations can exist in the system. The pseudopilot station is used to input the commands from the controller to the computer. In effect, the operator of the pseudopilot station is flying each of the aircraft under his control.

The ATC environment simulation is designed with a high degree of realism. Some of the characteristics which make the ATCS realistic are:

Multiple Controller Station Capability - The ATCS can support multiple display stations and allows aircraft handoffs between stations. Separate pseudopilot stations are used for entering controller instructions to the aircraft. A sophisticated voice system, with voice disguising capabilities, can be used to enhance the realism. It is therefore possible to use the system for training controllers in the use of advanced procedures requiring coordination among a number of controllers.

Plan View Displays - State-of-the-art workstations are used as controller displays. They provide high resolution (1280 x 1024 pixels) displays with 8 or 24 bit planes. The screen can be configured to simulate current equipment (including complete video map information) as well as accommodate future trends, such as color coding of information. Figures B-1 through B-3 are photographs of the final controller displays for each of the airports with some limited traffic depicted.

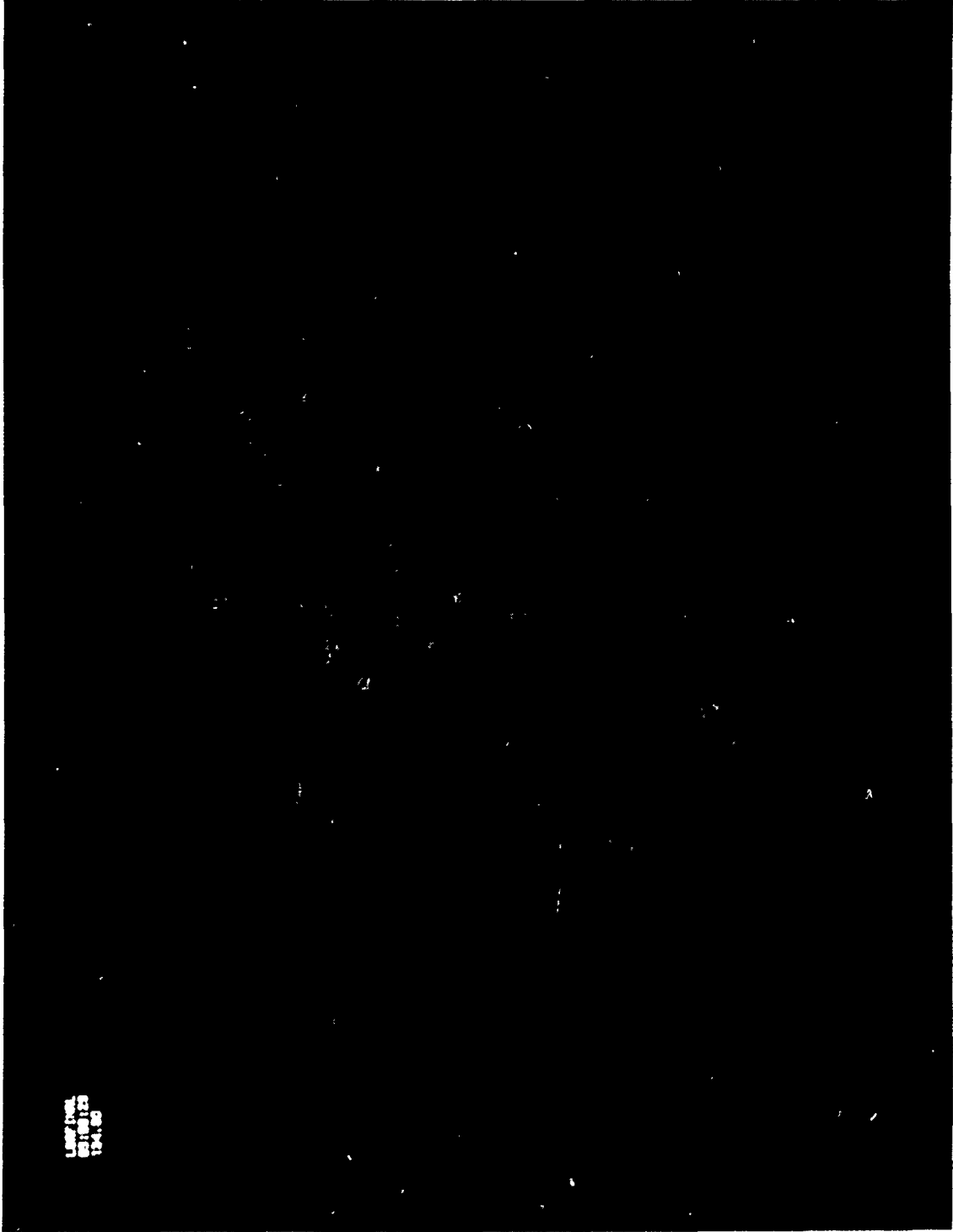

Figure B-1 Laguardia

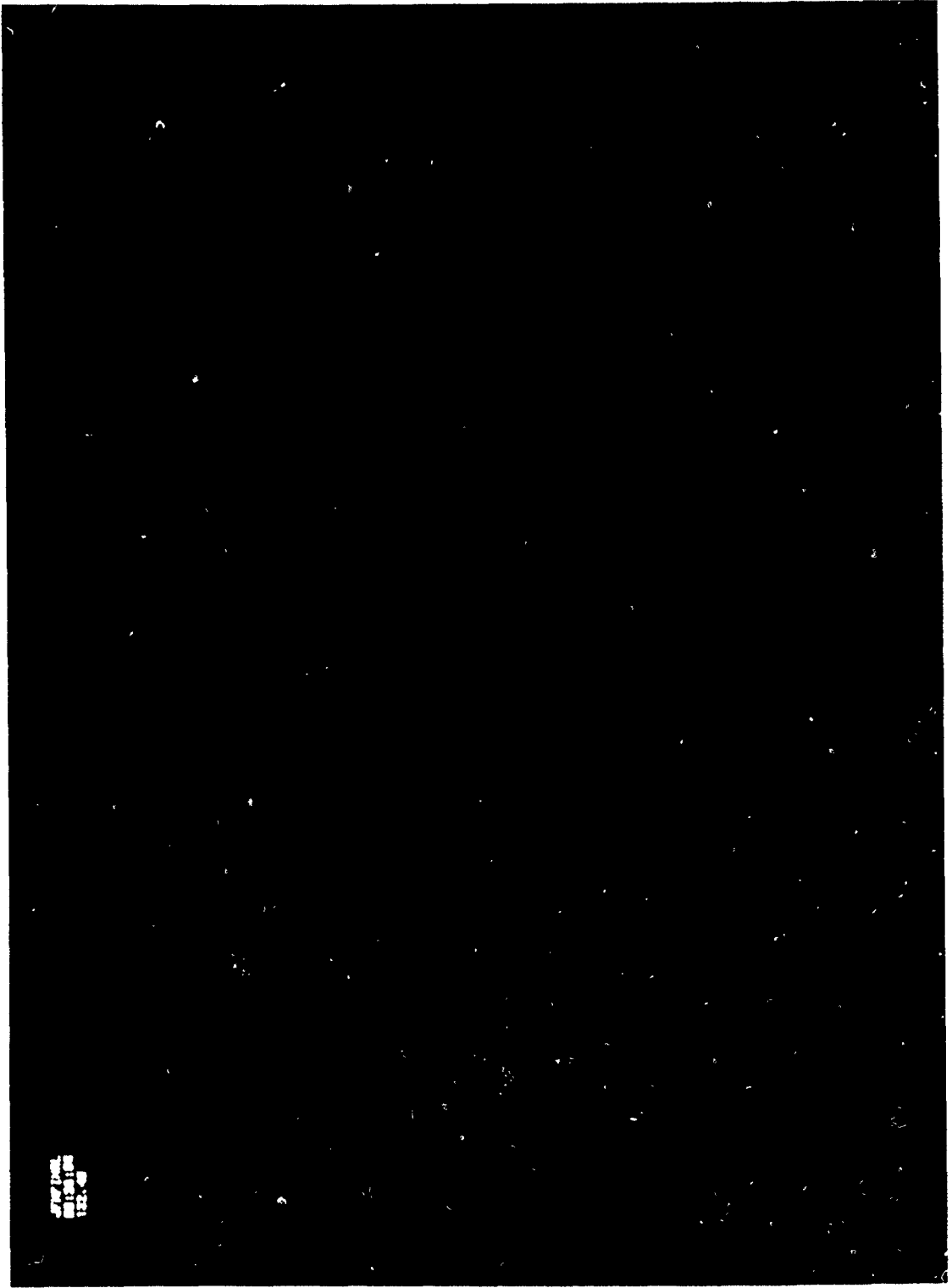

Figure B-2 Kennedy

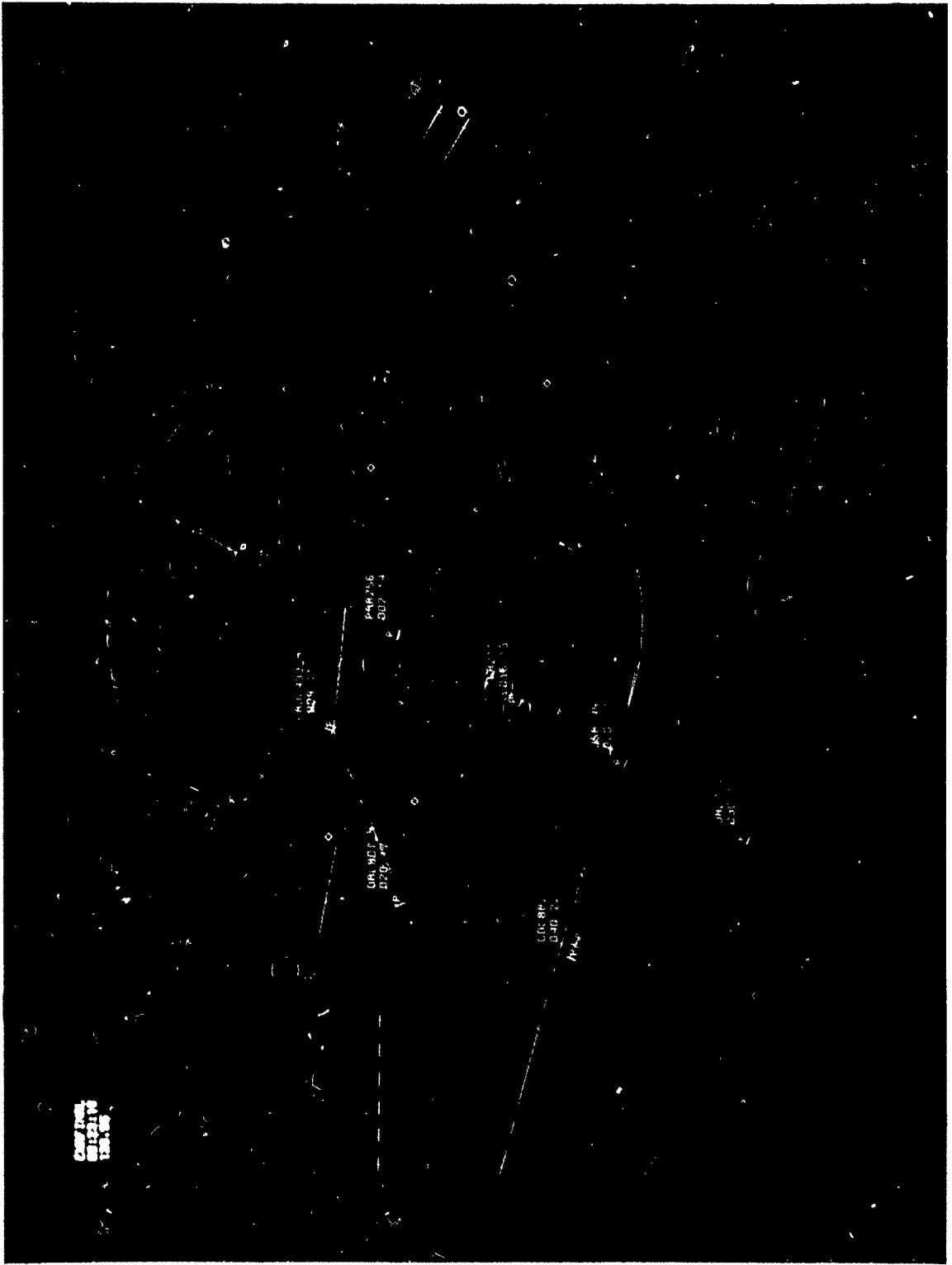

Figure B-3 Newark

Aircraft Performance Characteristics - Aircraft performance greatly affects the control method adopted by controllers. In some cases it may significantly effect the applicability of new control procedures. This is particularly true in the terminal area where traffic is relatively dense and aircraft seldom follow a straight unaccelerated path. The ATCS accommodates high fidelity aircraft performance data for each type of aircraft being simulated.

Pilot Models - Piloting delays in responding to a command and failure to adhere tightly to a commanded altitude, heading or speed are factors that can be adjusted to give added realism to the simulation and provide the controller with a good representation of what they can expect in real-life. Additionally, aircraft are capable of following numerous navigation modes including ILS, RNAV, and MLS curved paths.

Instrumentation, Navigation and Surveillance Models - The ATCS incorporates detailed models for all onboard instrumentation of the simulated aircraft (altimeters, airspeed indicators, heading indicators, VOR, DME, ILS and MLS receivers, etc.), all navigation equipment (VOR's, DME's, ILS, MLS transmitters, etc.) and all surveillance equipment including both terminal area and enroute radars.

Wind and Magnetic Deviation Models - The ATCS can accommodate complex 3-dimensional wind profiles as well as a model for the variability of magnetic deviation with aircraft position.

The ATCS's scripting capability is one of the most important features of the system. It allows the planning and orchestration of each session in great detail. Once developed, scripts can be stored for future use, copied, and edited to introduce variations in the sessions. The scripting mechanism allows the experimenter to execute any command that can be entered in any of the active stations. In addition, the time when such a command is executed can be prespecified, or it can be tied to the occurrence of a simulation event, such as an aircraft reaching a certain waypoint or crossing a certain altitude. Creation of new aircraft are themselves events that can be used to trigger scripted commands. Scripting is a powerful way to insure the repeatability and fine tuning of sessions while at the same time allowing adjustments to be performed during the run itself. This is used to account for the variability in each subject and the individuality in the style with which each controller controls traffic.

The ATCS can be configured in a number of ways. For the MLS - ATC studies, four controller displays and four pseudopilot displays were used. Figure B-4 is a photograph of the lab during a typical experiment.



Figure B-4 ATC Laboratory

APPENDIX C

LIST OF ARRIVAL AND DEPARTURE TRAFFIC
FOR NEW YORK AIRPORTS

Table C-1. LGA Arrivals

ID	Type	Class	Start Time	10%	50%	75%
NOBBI Feeder Fix						
CMD4813	SHD3	L	00:01:00		√	√
GAA89	BE20	L	00:03:00		√	√
GAA775	SHD6	S	00:49:43		√	√
AJC755	BE55	S	00:50:58			
MNE829	SF3	L	01:10:58			
AJC749	BE55	S	01:15:58			
GAA747	SF3	L	01:19:58			√
GAA695	BE20	L	01:45:59			√
GAA707	SHD6	S	01:48:43			√
GAA777	SHD6	S	01:49:59			√
LIZZI Feeder Fix						
NWA530	DC9	L	00:11:36			√
DAL362	B757	L	00:24:36			√
NWA352	B757	L	00:32:34			√
AAL1188	DC9	L	00:36:35		√	√
TWA114	L101	H	00:40:33			√
COA196	DC9	L	00:43:37			
USA1232	B737	L	00:44:53		√	√
NWA662	DC9	L	00:46:03			√
AAL316	DC10	H	00:47:19		√	√
UAL76	B727	L	00:48:34			
MID384	DC9	L	00:58:19		√	√
NWA1204	DC9	L	00:59:34			√
AAL174	B727	L	01:04:35			√
USA702	DC9	L	01:07:34			√
COA228	B737	L	01:13:19			
AWE610	B737	L	01:14:35			√
DAL124	B727	L	01:18:34			√
USA675	B737	L	01:25:34			√
COA168	B737	L	01:37:34			
UAL78	B727	L	01:43:19			
NWA256	B727	L	01:44:34			√
TWA276	B727	L	01:47:05			√
USA180	B727	L	01:48:19			√
USA1464	B727	L	01:49:35			√
AAL408	B727	L	01:54:05			√
NWA1133	DC9	L	01:55:19			√
USA1902	B737	L	01:56:35			√

√ indicates the aircraft is MLS equipped.

ID	Type	Class	Start Time	10%	50%	75%
ARDVOR Feeder Fix						
DAL1160	B727	L	00:12:09			√
EAL108	B757	L	00:17:08			
PAA258	B727	L	00:20:52	√	√	√
EAL187	B727	L	00:22:07			
EAL744	L101	H	00:38:07			
PAA236A	A300	H	00:48:07		√	√
TPS1490	B727	L	00:52:07	√	√	√
UAL1582	B727	L	01:03:07			
USA78	B737	L	01:06:08		√	√
PAA260	B727	L	01:22:07	√	√	√
EAL624	DC9	L	01:36:52			
USA2154	B727	L	01:38:07			√
DAL92	B767	H	01:41:07			√
DAL918	B727	L	01:48:07			√
TPS1500	B727	L	01:52:07	√	√	√
USA1497	B737	L	01:58:07			√
NESSI Feeder Fix						
GAA683	SHD6	S	00:23:28		√	√
AJC735	BE20	L	00:24:45			
ORA415	DH6	S	01:03:29			
AJC725	BE55	S	01:04:44			
VALRE Feeder Fix						
AAL593	B727	L	00:11:29		√	√
USA1294	FA28	L	00:24:13		√	√
PAA539	B727	L	00:25:27	√	√	√
USA123	DC9	L	00:37:27		√	√
TPS1091	B727	L	00:55:27	√	√	√
DAL447	B727	L	01:00:12			√
EAL20	L101	H	01:01:27			
USA1583	B737	L	01:03:27		√	√
NWA35	DC9	L	01:25:27			√
PAA541	B727	L	01:36:27	√	√	√
TPS1101	B727	L	01:55:27	√	√	√

Table C-2. LGA Departures

ID	Type	Class	Departure Time
DAL1187	B757	L	00:15:53
MEP6	DC9	L	00:25:53
PRE636	FA28	L	00:25:53
PCA3502	SHD6	S	00:25:53
AAL1407	B727	L	00:25:53
CMD4879	SHD6	S	00:29:53
EAL25	B757	L	00:29:53
EAL57	L101	H	00:29:53
ACA711	B727	L	00:29:53
AAL179	B727	L	00:30:53
UAL77	B727	L	00:30:53

ID	Type	Class	Departure Time
TPS1491	B727	L	00:30:53
TPS1090	B727	L	00:30:53
USA195	DC9	L	00:30:53
USA1655	B737	L	00:30:53
NWA509	B757	L	00:30:53
AAL362	B727	L	00:41:53
AJC896	BE55	S	00:50:53
DAL1161	B757	L	00:50:53
TWA235	L101	H	00:54:53
MID391	DC9	L	00:55:53
GAA664	BE20	L	00:55:53
EAL111	B727	L	00:59:53
USA1558	FA28	L	00:59:53
PAA261	B727	L	01:00:53
AAL911	B727	L	01:00:53
GAA784	SHD6	S	01:00:53
PAA540	B727	L	01:00:53
GAA790	BE20	L	01:00:53
USA1524	B737	L	01:10:53
COA123	DC9	L	01:10:53
TWA81	B727	L	01:16:53
AAL1073	DC10	H	01:17:53
TWA133	B727	L	01:20:53
COA627	B737	L	01:20:53
USA1983	B737	L	01:25:53
ACA751	B727	L	01:29:53
GAA732	SHD6	S	01:29:53
EAL659	DC9	L	01:29:53
NWA34	DC9	L	01:30:53
AJC736	BE20	L	01:30:53
UAL81	B727	L	01:30:53
AAL173	B727	L	01:30:53
AAL277	B727	L	01:30:53
TPS1100	B727	L	01:30:53
TPS1501	B727	L	01:38:53
DAL329	B727	L	01:46:53
USA1414	FA28	L	01:54:53
AJC754	BE55	S	01:55:53
USA122	DC9	L	01:55:53
ACA713	B727	L	01:55:53
EAL719	B727	L	01:59:53
EAL547	B757	L	01:59:53
UAL597	B767	H	01:59:53
PAA542	B727	L	02:00:53
DAL577	B757	L	02:00:53
PAA263	B727	L	02:00:53
GAA792	BE20	L	02:00:53
GAA776	SHD6	S	02:00:53

Table C-3. JFK Arrivals

ID	Type	Class	Start Time	25%	50%
DIXIE Feeder Fix					
PXX848	AT42	L	00:01:00	√	√
JEX7562	CA21	S	00:26:00		
CMD4808	SHD6	S	00:28:30		√
HNA4362	DH6	S	00:50:00		√
PXX854	DH6	S	01:11:00	√	√
CCC VOR Feeder Fix					
MNE766	BE20	L	00:03:00		
PXX914	AT42	L	00:05:30	√	√
CMD4823	SHD6	S	00:28:00		√
CMD4861	SHD3	L	00:33:00		√
CMD4892	SHD3	L	00:53:00		√
PXX805	DH6	S	00:58:00	√	√
CMD4933	SHD6	S	01:00:30		√
MNE777	BE20	L	01:13:00		
CMD4894	SHD6	S	01:15:30		√
MNE775	BE20	L	01:23:00		
LENDY Feeder Fix					
PAA596	B727	L	00:03:30	√	√
TWA730	L101	H	00:06:00		
USA283	B737	L	00:11:30		√
DAL1424	B727	L	00:14:00		√
NWA18	B747	H	00:16:30		
TWA840	B747	H	00:22:30		
TWA298	B727	L	00:25:00		
TWA806	MD80	L	00:27:30		
PAA558	B727	L	00:30:00	√	√
TWA842	L101	H	00:36:30		
AWE290	B757	L	00:41:30		
PAA554	B727	L	00:44:00	√	√
AAL64	B767	H	00:46:30		
PAA570	B727	L	00:49:00	√	√
USA1862	B737	L	00:51:30		√
TWA708	L101	H	00:54:00		
TWA792	B727	L	00:56:30		
PAA82A	B747	H	00:59:00	√	√
UAL27	B757	L	01:01:30		
AAL2	DC10	H	01:04:00		
PAA2002	B727	L	01:06:30	√	√
UAL800	B747	H	01:16:30		
PAA2026	B727	L	01:19:00	√	√
USA209	FA28	L	01:21:30		√
UAL6	B767	H	01:29:30		
JAL8	B747	H	01:32:00		
PAA74	B747	H	01:34:00	√	√
TWA906	B727	L	01:36:30		
MGM200	B727	L	01:39:00		
AAL98	B727	L	01:45:30		
TWA203	DC9	L	01:48:00		

ID	Type	Class	Start Time	25%	50%
ERICK Feeder Fix					
AFR77	B747	H	00:06:00		√
PAA73	B747	H	00:08:30	√	√
SWR100	B747	H	00:11:00		√
PAA85	A300	H	00:13:30	√	√
IBE951	DC10	H	00:16:00		
DLH408	DC10	H	00:18:30		√
EIN105	B747	H	00:21:00		
PAA1	B747	H	00:23:30	√	√
KLM641	B747	H	00:26:00		√
AZA600	B747	H	00:31:00		
SAB541	B747	H	00:41:00		
AIC101	B747	H	00:43:30		
TWA903	B747	H	00:46:00		
OAL411	B747	H	00:51:00		
DLH404	B747	H	00:53:30		√
FIN103	DC10	H	00:56:00		
BAW183	L101	H	01:01:00		√
TWA904	B727	L	01:05:00		
AAL99	B767	H	01:11:00		
TWA801	B747	H	01:16:00		
TWA769	B767	H	01:18:30		
TWA701	B747	H	01:21:00		
PAA47	A300	H	01:26:00	√	√
AAL45	B767	H	01:35:00		
AAL65	B767	H	01:37:30		
MANTA (CAMERON WATER) Feeder Fix					
AAL678	DC10	H	00:09:00		
AAL68	B767	H	00:23:00		
AAL588	A300	H	00:27:00		
PAA224	A300	H	01:20:00	√	√
TWA11	L101	H	01:34:00		
CAMRN Feeder Fix					
DAL144	B767	H	00:12:00		√
PAA2102	B727	L	00:16:00	√	√
TWA410	B727	L	00:28:00		
PAA476	B727	L	00:34:00	√	√
PAA2072	B727	L	00:39:00	√	
AAL542	B727	L	00:47:00		√
PAA2048	A300	H	00:49:30	√	√
PAA732	B727	L	00:54:00	√	√
PAA500	B727	L	00:56:30	√	√
TWA712	B727	L	01:26:00		
PAA472	B727	L	01:39:00	√	√
TWA804	B727	L	01:46:00		
ZIGGI Feeder Fix					
PXX784	DH6	S	00:19:00	√	√
PXX895	DH6	S	00:29:00	√	√
PXX954	DH6	S	00:54:00	√	√
CMD4948	SHD6	S	01:14:00		√
CMD4945	DH6	S	01:19:00		√

Table C-4. EWR Arrivals

ID	Type	Class	Start Time	25%	50%
SHAFF Feeder Fix					
COA25	DC10	H	00:01:00		
SAS907	B767	H	00:11:00		
COA357	DC9	L	00:29:00		√
USA698	DC9	L	00:49:00		
USA1778	FA28	L	00:58:00		
COA763	B737	L	01:00:30		√
COA388	DC9	L	01:03:00		√
COA847	B737	L	01:05:30		√
COA359	B727	L	01:29:00		√
OEL1806	BA14	L	01:41:00		
ACA786	DC9	L	01:45:00	√	√
RBV Feeder Fix					
ALC3290	DH6	S	00:02:00		
COA616	A300	H	00:04:30		
EAL13	L101	H	00:07:00		
DAL740	B727	L	00:09:30		
COA626	A300	H	00:12:00		
COA747	B727	L	00:14:30		√
COA144	B727	L	00:17:00		√
COA880	MD80	L	00:19:30		
COA611	B737	L	00:22:00		√
AAL570	B727	L	00:26:00	√	√
USA1829	B737	L	00:46:00		
COA316	DC9	L	00:48:30		√
COA630	B737	L	01:00:00		√
USA1479	DC9	L	01:02:30		
USA1015	FA28	L	01:11:00		
COA75	B727	L	01:17:00		√
COA558	B737	L	01:21:00		√
USA1562	B737	L	01:23:30		
COA632	B737	L	01:30:00		√
NWA1086	DC9	L	01:32:30		
AAL948	DC9	L	01:35:00	√	√
EAL158	B757	L	01:37:30		
AAL116	DC10	H	01:40:00	√	√
USA204	DC9	L	01:48:00		
USA78	B737	L	01:51:00		
MUGZY Feeder Fix					
AJC407	AT42	L	00:06:00	√	√
AJC697	AT42	L	00:17:00	√	√
MEP272	DC9	L	00:22:00		
AJC660	AT42	L	00:24:30	√	√
AJC539	AT42	L	00:47:00	√	√
AJC644	DH6	S	01:12:00	√	√
PRE671	DO28	L	01:27:00		

ID	Type	Class	Start Time	25%	50%
PENNS Feeder Fix					
AJC477	BE20	L	00:04:30	√	√
COA28	A300	H	00:08:30		
AAL360	DC9	L	00:11:00	√	√
COA540	B737	L	00:13:30		√
COA380	B737	L	00:16:00		√
COA546	B737	L	00:18:30		√
COA754	B737	L	00:29:30		√
UAL12	DC10	H	00:40:30		
UAL840	B727	L	00:45:30		
NWA556	B727	L	00:48:00		
UAL318	DC8	L	00:50:30		
COA56	DC10	H	01:08:30		
DAL647	B727	L	01:11:00		
AAL552	DC9	L	01:15:30	√	√
COA517	MD80	L	01:19:30		
NWA368	DC9	L	01:26:30		
UAL4	DC10	H	01:29:30		
TWA136	B727	L	01:33:30		
METRO Feeder Fix					
PRE664	DO28	L	00:27:00		
AJC480	AT42	L	00:29:30	√	√
AJC537	AT42	L	00:37:00	√	√
HOL652	BE55	S	01:17:00		
AJC404	AT42	L	01:47:00	√	√
LGA Feeder Fix					
AJC555	BE20	L	00:47:30	√	√
HOL460	BE55	S	00:52:30		
AJC453	BE20	L	00:57:30	√	√
AJC433	BE20	L	01:07:30	√	√

Appendix D

Statistical and Graphical Data Summary

for

Individual Airports

Simulation Characteristics:

Airport: LGA		Percent MLS, Target: 0	Actual: 0
Arrival Runway(s): 13		Departure Runway(s): 13	
No. 1	Date/Run: 4/09/90 # 1	Duration: 128 min.	
No. Completed Arrivals: 54		No. Completed Departures: 39	
Comments: Without TEB hold			

Summary of Simulation Results:

Feeder Fix	Average Flight Time (min.)	Average Flight Dist. (NMI)	Average Holding Time (min.)	Minimum Flight Time (min.)	Minimum Flight Dist. (NMI)
ARDVOR	22.25	79.08	4.90 (1)	15.15	63.91
LIZZI	26.78	94.31	2.83 (1)	18.15	73.22
NESSI	23.36	66.77	0	17.90	57.51
NOBBI	26.86	74.50	8.13 (1)	16.00	49.77
VALRE	19.77	61.71	0	12.60	48.57
Wt. Av.	24.15	79.63	5.29 (3)	N/A	N/A
Arrival Rate Per Hour					
29.6					

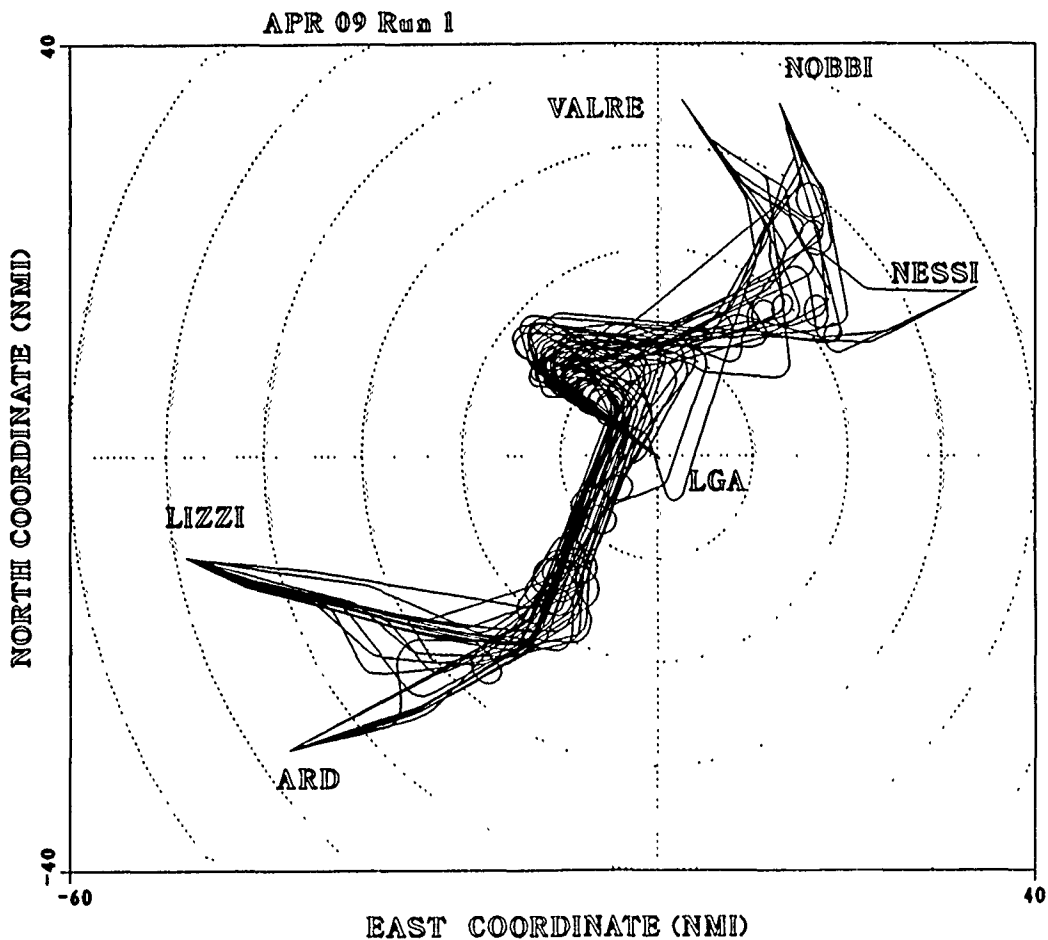

Figure D-1a. Summary Data & Arrival Aircraft Flight Tracks for No. 1

LGA ILS 13/D 13 (4/09/90 #1)

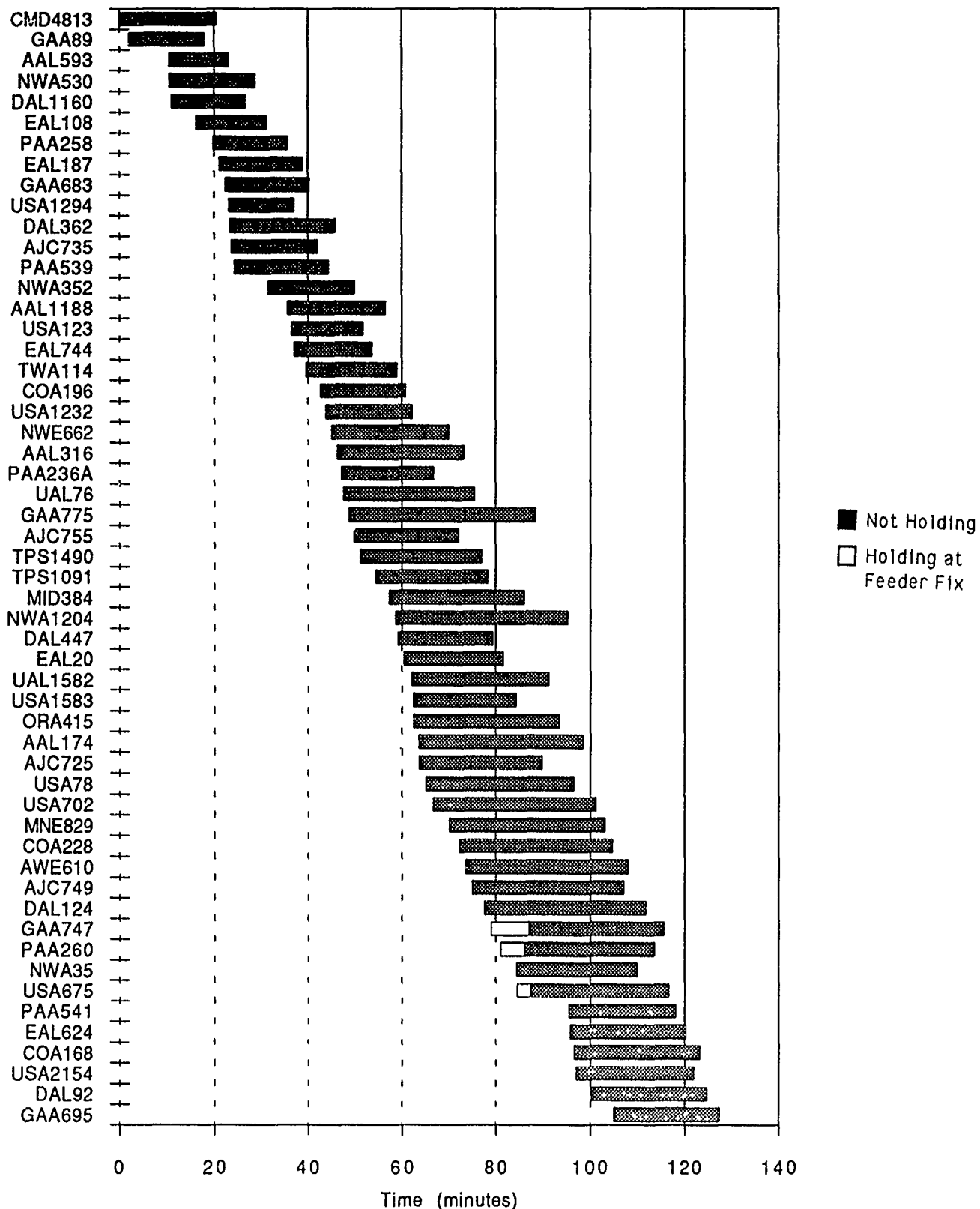

Figure D-1b. Arrival Aircraft Holding and In-flight Time Lines

Simulation Characteristics:

Airport: LGA		Percent MLS, Target: 0	Actual: 0
Arrival Runway(s): 13		Departure Runway(s): 13	
No. 2	Date/Run: 4/09/90 # 2	Duration: 139 min.	
No. Completed Arrivals: 56		No. Completed Departures: 58	
Comments: 20 minute TEB hold			

Summary of Simulation Results:

Feeder Fix	Av. Flight Time (min.)	Av. Flight Dist. (NMI)	Av. Holding Time (min.)	Min. Flight Time (min.)	Min. Flight Dist. (NMI)
ARDVOR	20.52	77.06	15.97 (5)	15.50	64.91
LIZZI	23.42	87.39	16.18 (14)	17.13	72.55
NESSI	20.36	59.92	25.56 (2)	18.18	55.78
NOBBI	20.30	57.83	15.95 (6)	14.60	47.24
VALRE	18.85	61.24	13.42 (7)	14.15	53.02
Wt. Av.	21.23	73.86	16.09 (34)	N/A	N/A
Arrival Rate Per Hour					
27.5					

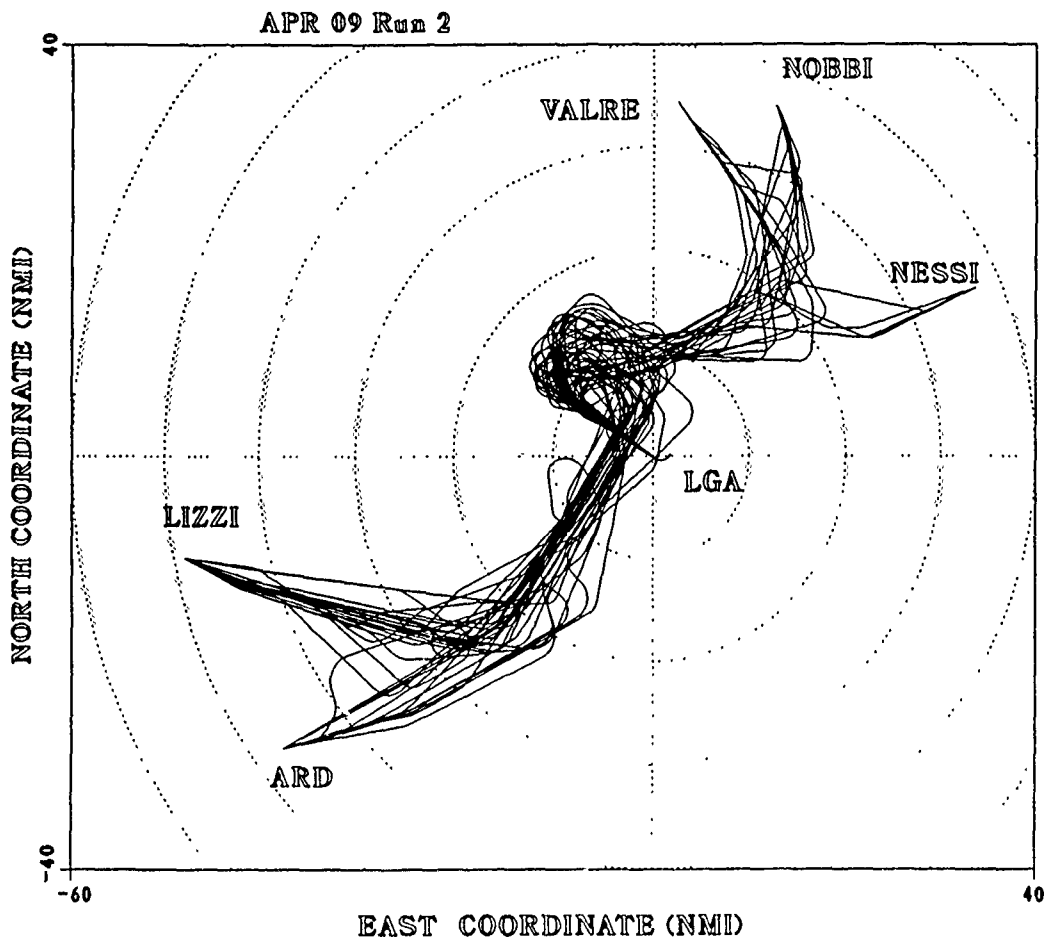

Figure D-2a. Summary Data & Arrival Aircraft Flight Tracks for No.2

LGA ILS 13/D 13 (4/09/90 #2)

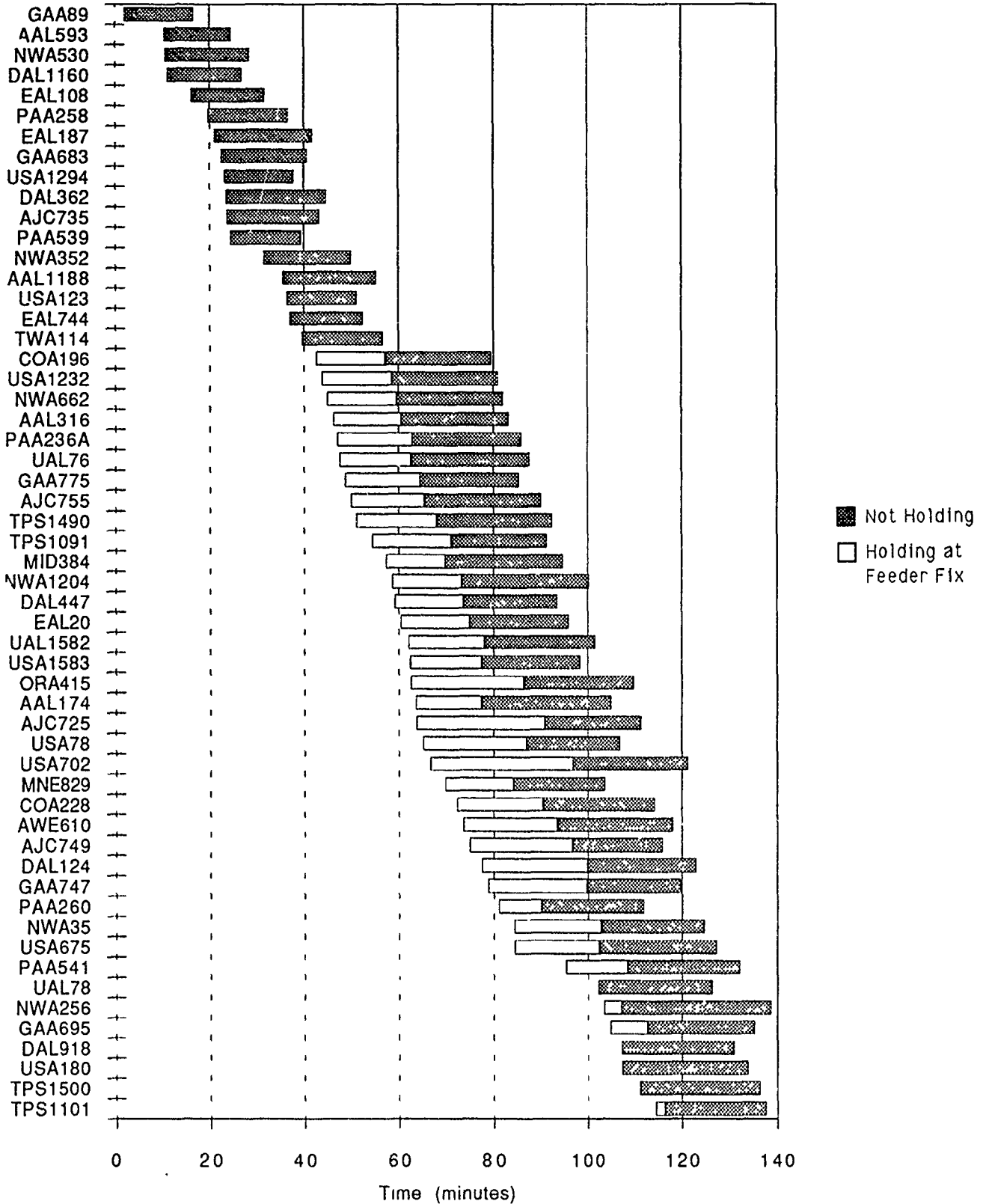

Figure D-2b. Arrival Aircraft Holding and In-flight Time Lines

Simulation Characteristics:

Airport: LGA		Percent MLS, Target: 10.0 Actual: 12.1
Arrival Runway(s): 13		Departure Runway(s): 13
No. 3	Date/Run: 4/13/90 # 2	Duration: 117 min.
No. Completed Arrivals: 42		No. Completed Departures: 53
Comments: 20 minute TEB hold for ILS aircraft		

Summary of Simulation Results:

Feeder Fix	Av. Flight Time (min.)	Av. Flight Dist. (NMI)	Av. Holding Time (min.)	Min. Flight Time (min.)	Min. Flight Dist. (NMI)
ARDVOR	17.39	69.66	16.94 (3)	12.30	54.43
LIZZI	21.40	80.71	14.21 (12)	16.85	72.74
NESSI	17.90	52.95	21.29 (2)	14.38	49.19
NOBBI	19.57	53.87	20.72 (3)	16.53	43.39
VALRE	14.72	52.83	18.06 (2)	10.08	41.32
Wt. Av.	18.88	67.86	16.47 (22)	N/A	N/A
Arrival Rate Per Hour					
26.3					

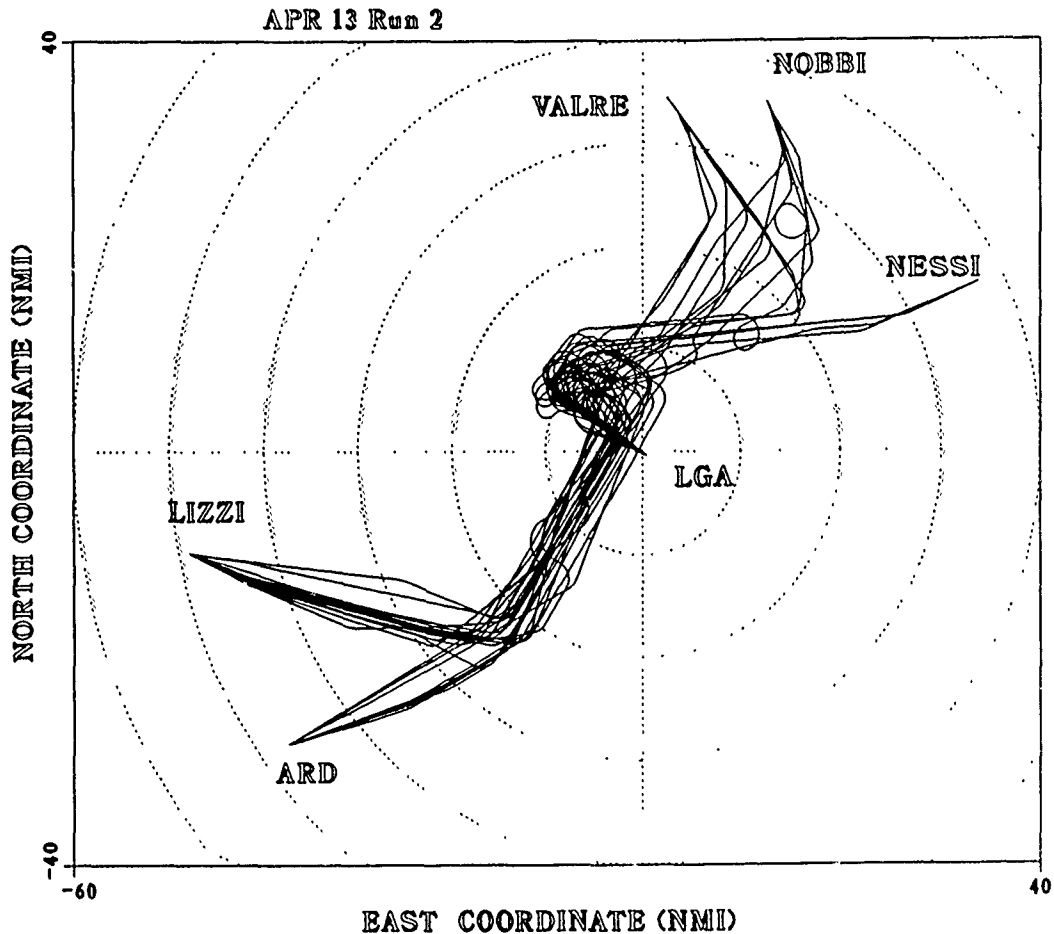

Figure D-3a. Summary Data & Arrival Aircraft Flight Tracks for No.3

LGA ILS 13 & MLS 13/D 13 (4/13/90 #2)

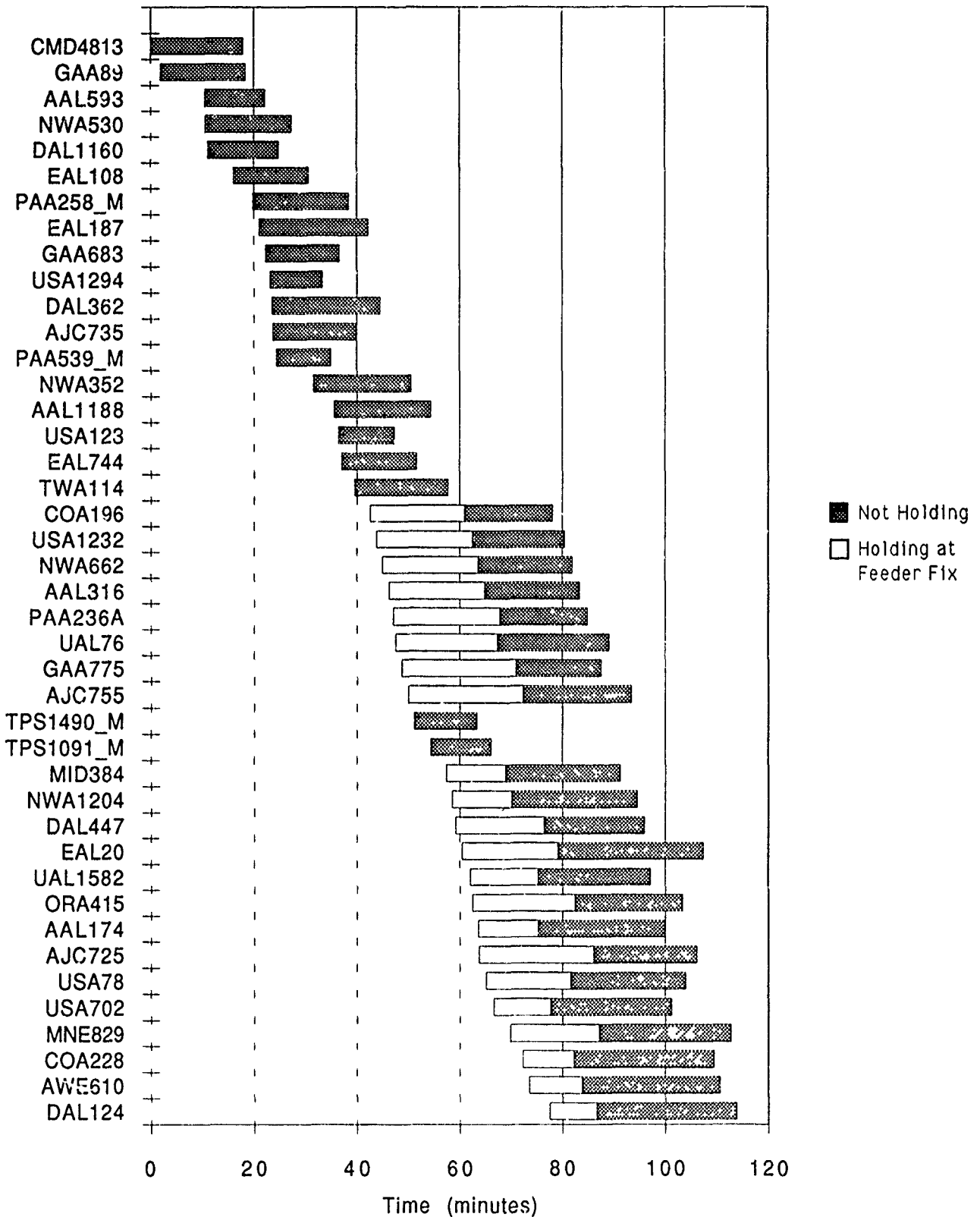

Figure D-3b. Arrival Aircraft Holding and In-flight Time Lines

Simulation Characteristics:

Airport: LGA		Percent MLS, Target: 50.0 Actual: 32.4
Arrival Runway(s): 13		Departure Runway(s): 13
No. 4	Date/Run: 4/13/90 # 1	Duration: 117 min.
No. Completed Arrivals: 53		No. Completed Departures: 44
Comments: 20 minute TEB hold for ILS aircraft		

Summary of Simulation Results:

Feeder Fix	Av. Flight Time (min.)	Av. Flight Dist. (NMI)	Av. Holding Time (min.)	Min. Flight Time (min.)	Min. Flight Dist. (NMI)
ARDVOR	16.94	64.75	0	11.75	51.79
LIZZI	20.60	76.86	12.97 (4)	14.12	58.25
NESSI	17.58	50.98	16.10 (2)	14.23	45.89
NOBBI	19.65	51.99	13.81 (4)	16.28	41.92
VALRE	14.35	48.73	10.43 (5)	10.37	42.30
Wt. Av.	18.17	63.35	12.76 (15)	N/A	N/A
Arrival Rate Per Hour					
31.5					

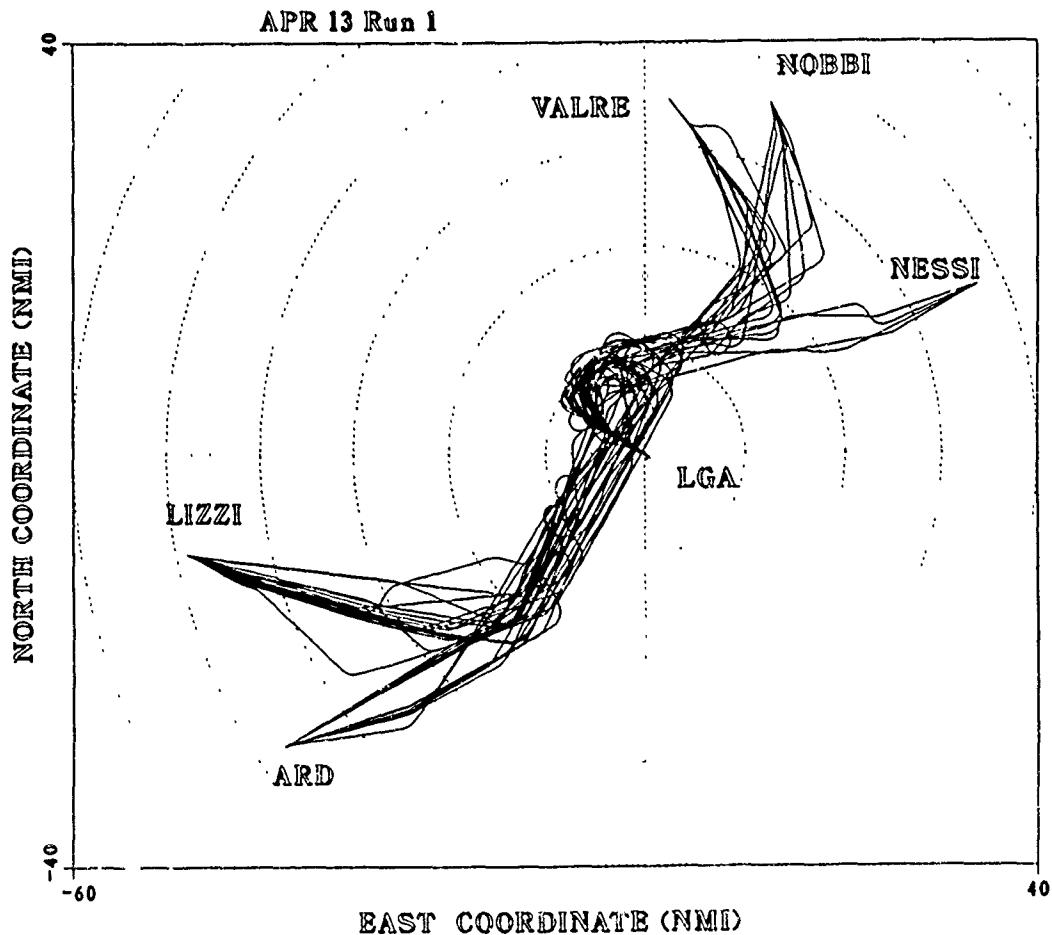

Figure D-4a. Summary Data & Arrival Aircraft Flight Tracks for No.4
D-8

LGA ILS 13 & MLS 13/D 13 (4/13/90 #1)

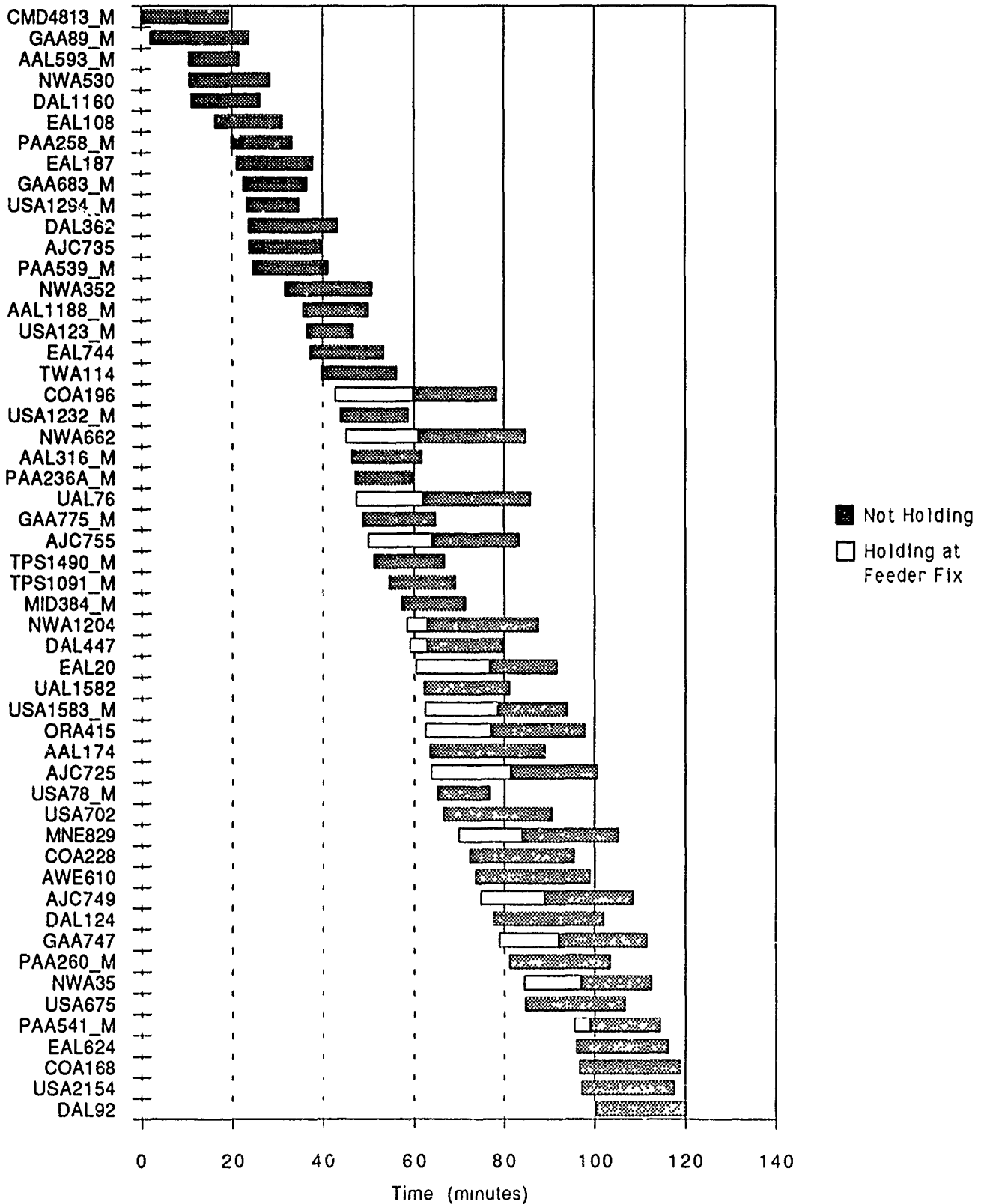

Figure D-4b. Arrival Aircraft Holding and In-flight Time Lines
D-9

Simulation Characteristics:

Airport: LGA		Percent MLS, Target: 50.0 Actual: 32.4
Arrival Runway(s): 13		Departure Runway(s): 13
No. 5	Date/Run: 4/11/90 # 2	Duration: 121 min,
No. Completed Arrivals: 52		No. Completed Departures: 48
Comments: Without TEB hold		

Summary of Simulation Results:

Feeder Fix	Av. Flight Time (min.)	Av. Flight Dist. (NMI)	Av. Holding Time (min.)	Min. Flight Time (min.)	Min. Flight Dist. (NMI)
ARDVOR	17.49	68.15	0	11.25	51.77
LIZZI	22.46	82.75	0	15.38	62.25
NESSI	19.18	55.86	0	13.63	46.08
NOBBI	19.33	52.26	0	13.35	41.75
VALRE	13.57	47.80	0	10.75	43.27
Wt. Av.	18.93	66.49	0	N/A	N/A
Arrival Rate Per Hour					
30.9					

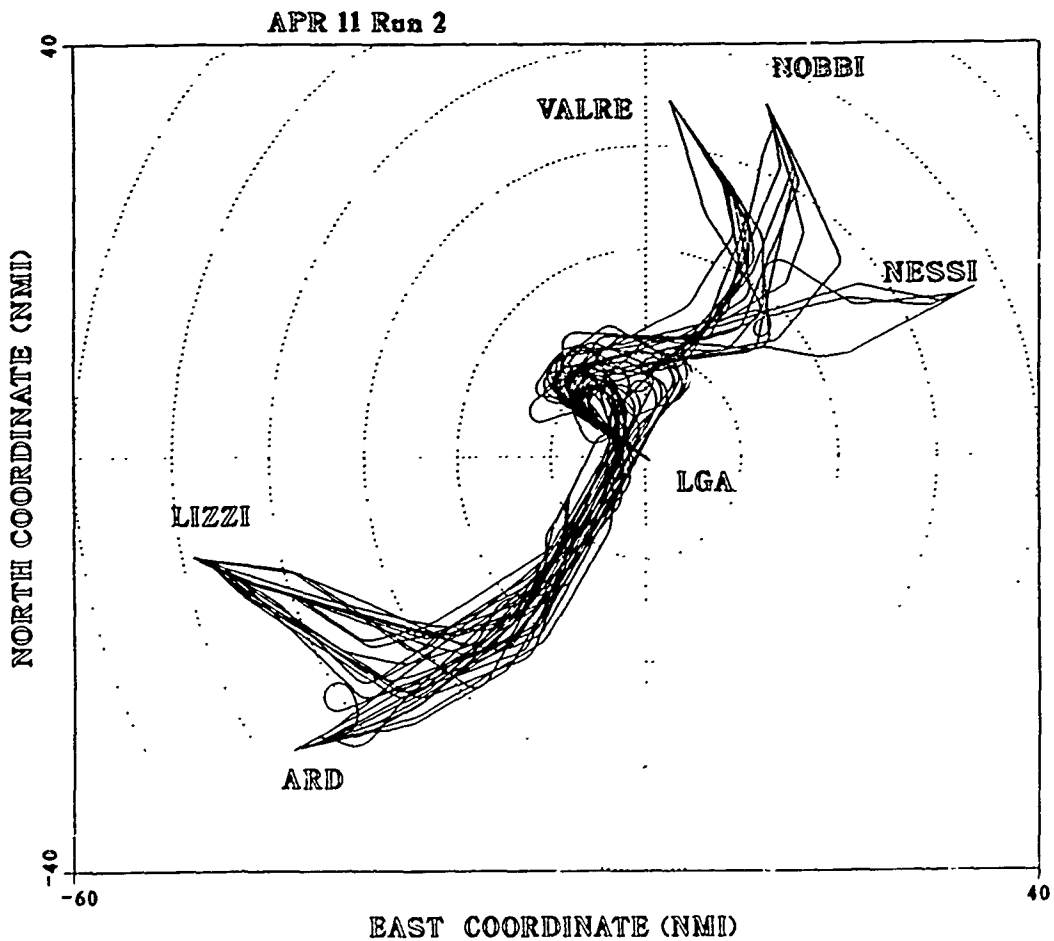

Figure D-5a. Summary Data & Arrival Aircraft Flight Tracks for No. 5

LGA ILS 13 & MLS 13/D 13 (4/11/90 #2)

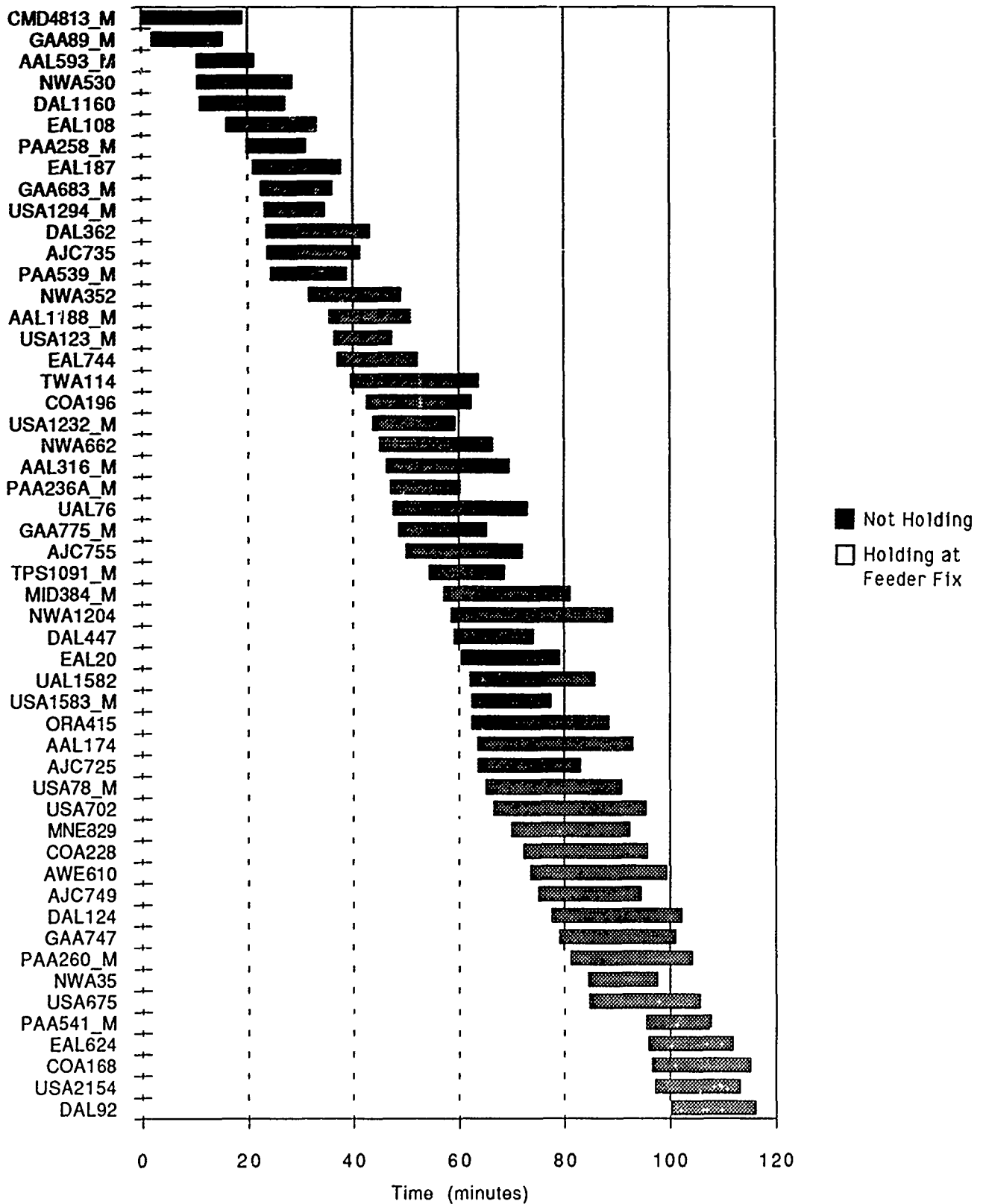

Figure D-5b. Arrival Aircraft Holding and In-flight Time Lines

Simulation Characteristics:

Airport: LGA		Percent MLS, Target: 75.0 Actual: 74.6
Arrival Runway(s): 13		Departure Runway(s): 13
No. 6	Date/Run: 4/11/90 # 1	Duration: 121 min.
No. Completed Arrivals: 54		No. Completed Departures: 48
Comments: 20 minute TEB hold for ILS aircraft		

Summary of Simulation Results:

Feeder Fix	Av. Flight Time (min.)	Av. Flight Dist. (NMI)	Av. Holding Time (min.)	Min. Flight Time (min.)	Min. Flight Dist. (NMI)
ARDVOR	16.01	62.29	0	11.72	51.38
LIZZI	18.12	69.64	14.7 (2)	13.00	58.93
NESSI	21.85	63.11	0	14.23	46.19
NOBBI	19.39	51.67	8.57 (1)	13.13	42.00
VALRE	13.64	47.42	0	10.05	43.47
Wt. Av.	17.22	60.94	12.65 (3)	N/A	N/A
Arrival Rate Per Hour					
31.9					

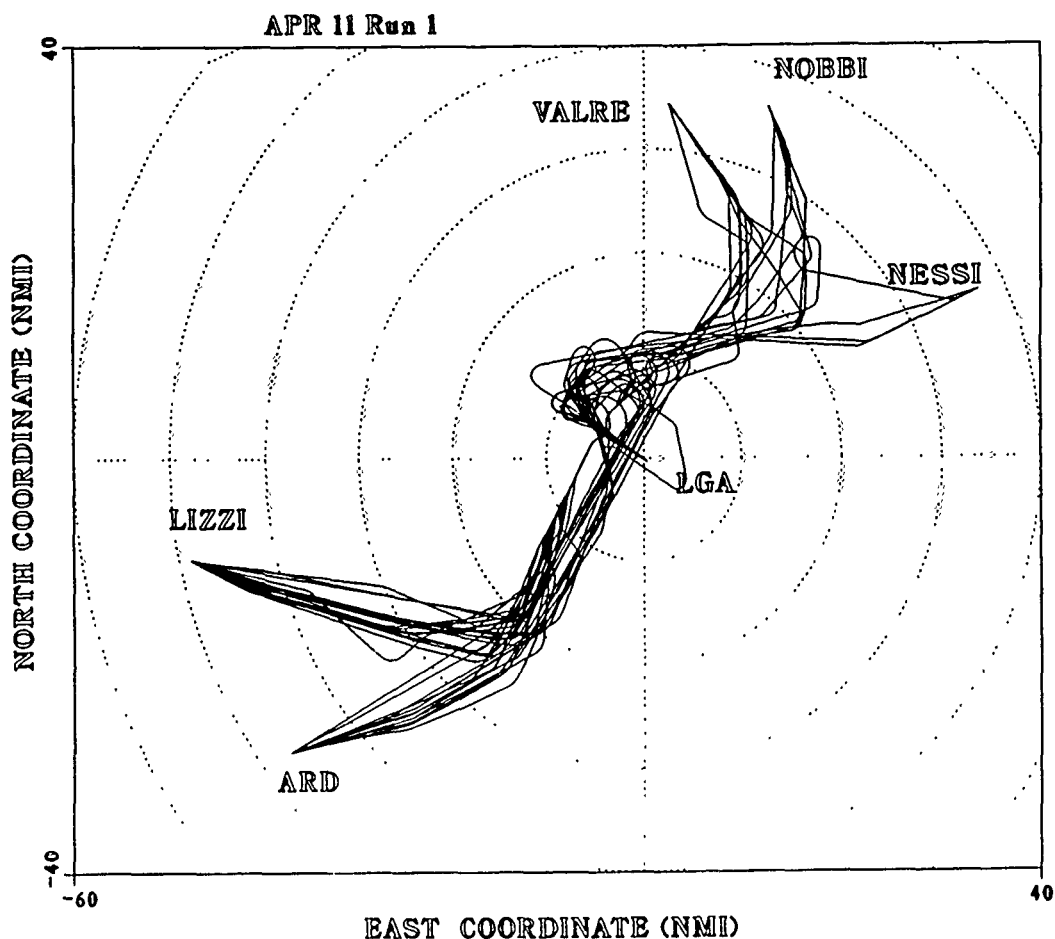

Figure D-6a. Summary Data & Arrival Aircraft Flight Tracks for No. 6

LGA ILS 13 & MLS 13/D 13 (4/11/90 #1)

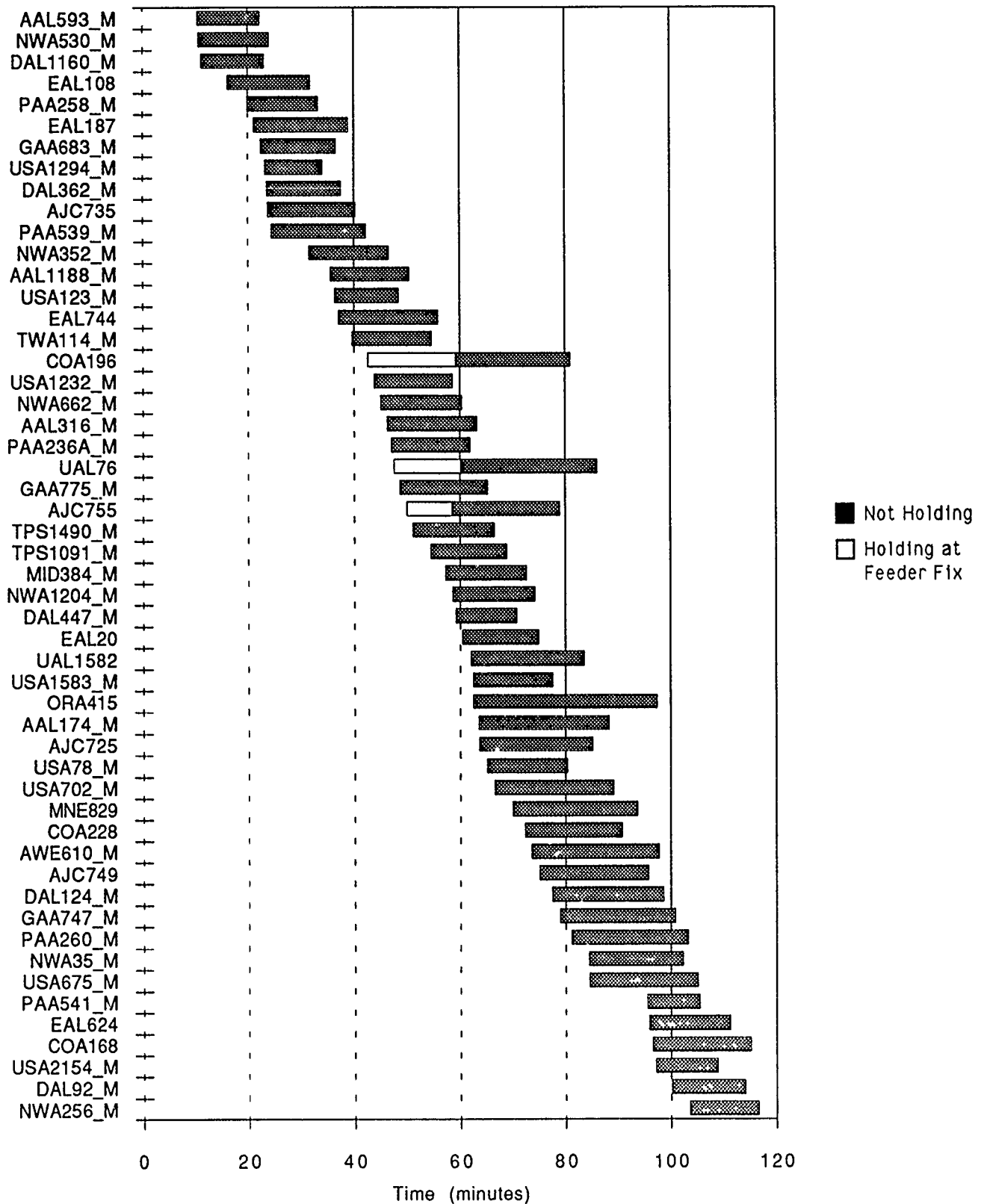

Figure D-6b. Arrival Aircraft Holding and In-flight Time Lines

Simulation Characteristics:

Airport: LGA		Percent MLS, Target: 100 Actual: 100
Arrival Runway(s): 13		Departure Runway(s): 13
No. 7	Date/Run: 4/10/90 # 1	Duration: 117 min.
No. Completed Arrivals: 56		No. Completed Departures: 47
Comments: TEB hold not necessary		

Summary of Simulation Results:

Feeder Fix	Av. Flight Time (min.)	Av. Flight Dist. (NMI)	Av. Holding Time (min.)	Min. Flight Time (min.)	Min. Flight Dist. (NMI)
ARDVOR	14.37	57.26	1.60 (1)	12.32	55.55
LIZZI	16.42	62.57	0	13.77	59.07
NESSI	18.90	56.79	0	15.38	45.92
NOBBI	20.47	57.71	0	13.27	41.57
VALRE	18.77	59.86	8.28 (1)	11.62	41.04
Wt. Av.	17.08	59.65	4.94 (2)	N/A	N/A
Arrival Rate Per Hour					
31.7					

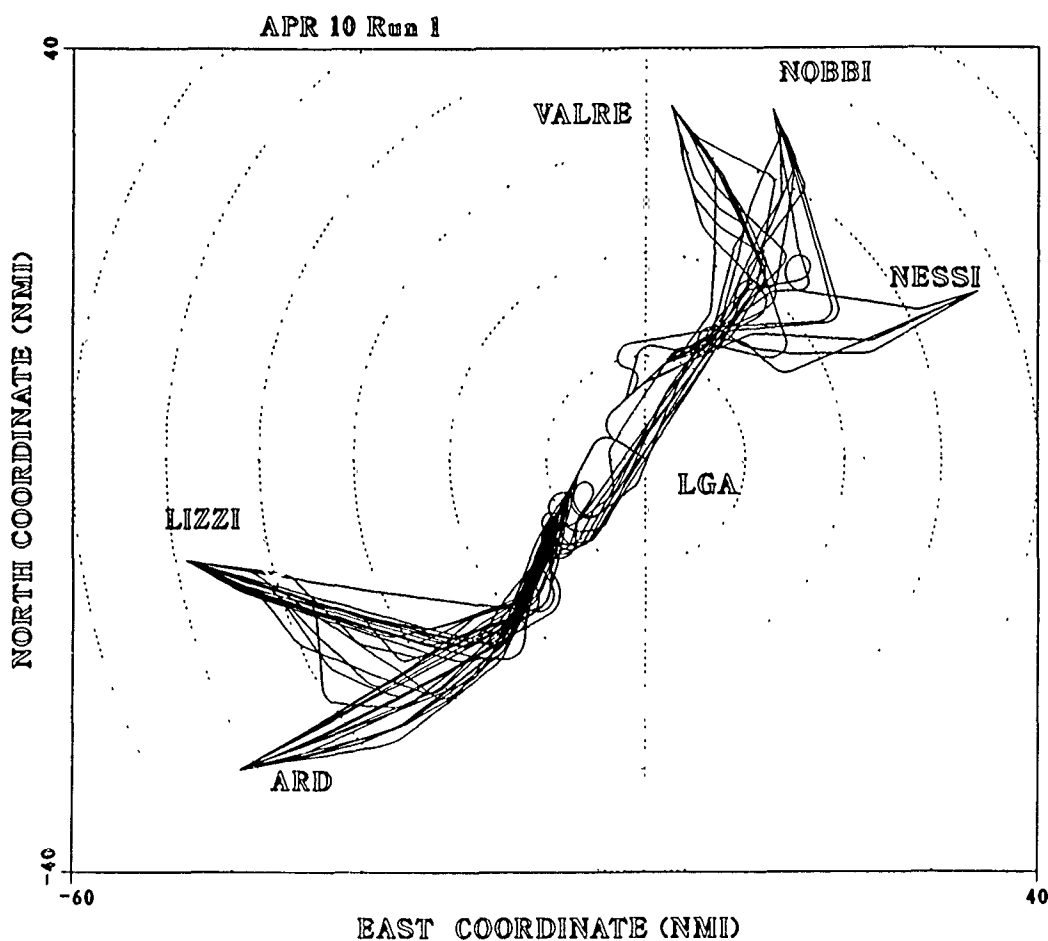

Figure D-7a. Summary Data & Arrival Aircraft Flight Tracks for No. 7

LGA MLS 13/D 13 (4/10/90 #1)

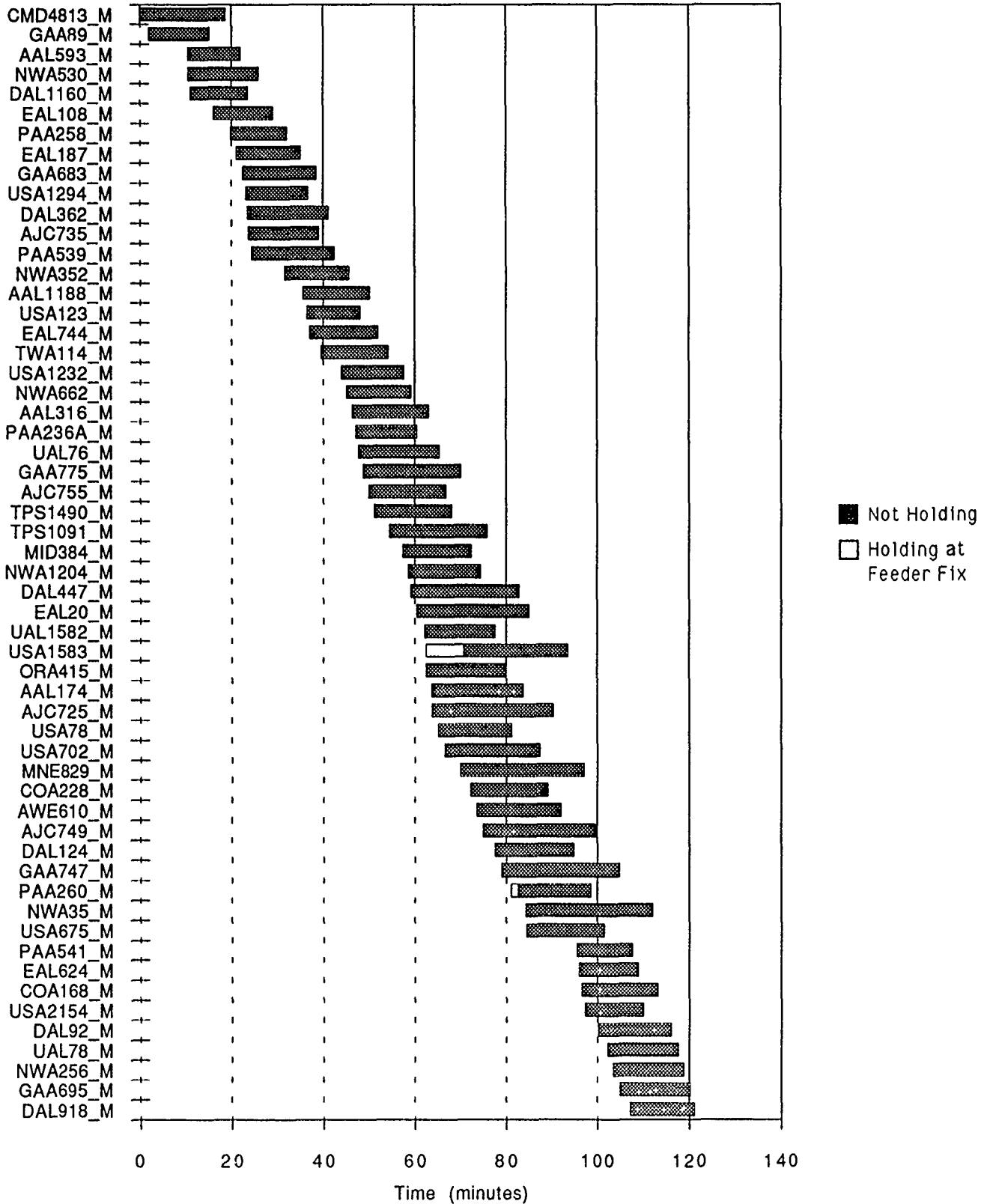

Figure D-7b. Arrival Aircraft Holding and In-flight Time Lines

Simulation Characteristics:

Airport: LGA		Percent MLS, Target: 0	Actual: 0
Arrival Runway(s): 31		Departure Runway(s): 4	
No. 8	Date/Run: 4/11/90 # 3	Duration: 112 min.	
No. Completed Arrivals: 49		No. Completed Departures: 51	
Comments:			

Summary of Simulation Results:

Feeder Fix	Av. Flight Time (min.)	Av. Flight Dist. (NMI)	Av. Holding Time (min.)	Min. Flight Time (min.)	Min. Flight Dist. (NMI)
ARDVOR	23.35	85.53	0	15.50	67.94
LIZZI	24.07	91.25	0	16.85	73.07
NESSI	20.24	55.38	0	13.23	46.27
NOBBI	18.02	54.98	5.51 (2)	12.20	44.64
VALRE	14.99	55.46	0	10.18	48.28
Wt. Av.	20.89	74.67	5.51 (2)	N/A	N/A
Arrival Rate Per Hour					
30.1					

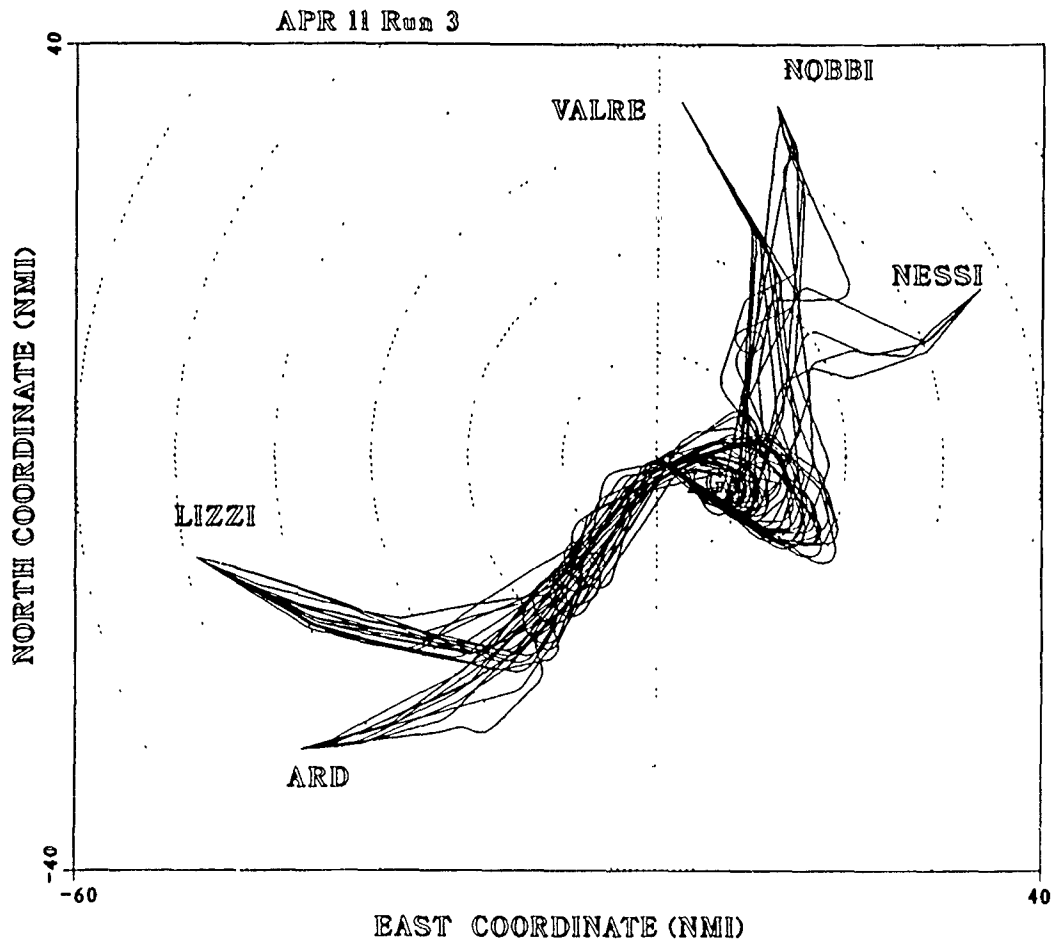

Figure D-8a. Summary Data & Arrival Aircraft Flight Tracks for No. 8

LGA ILS 31/D 04 (4/11/90 #3)

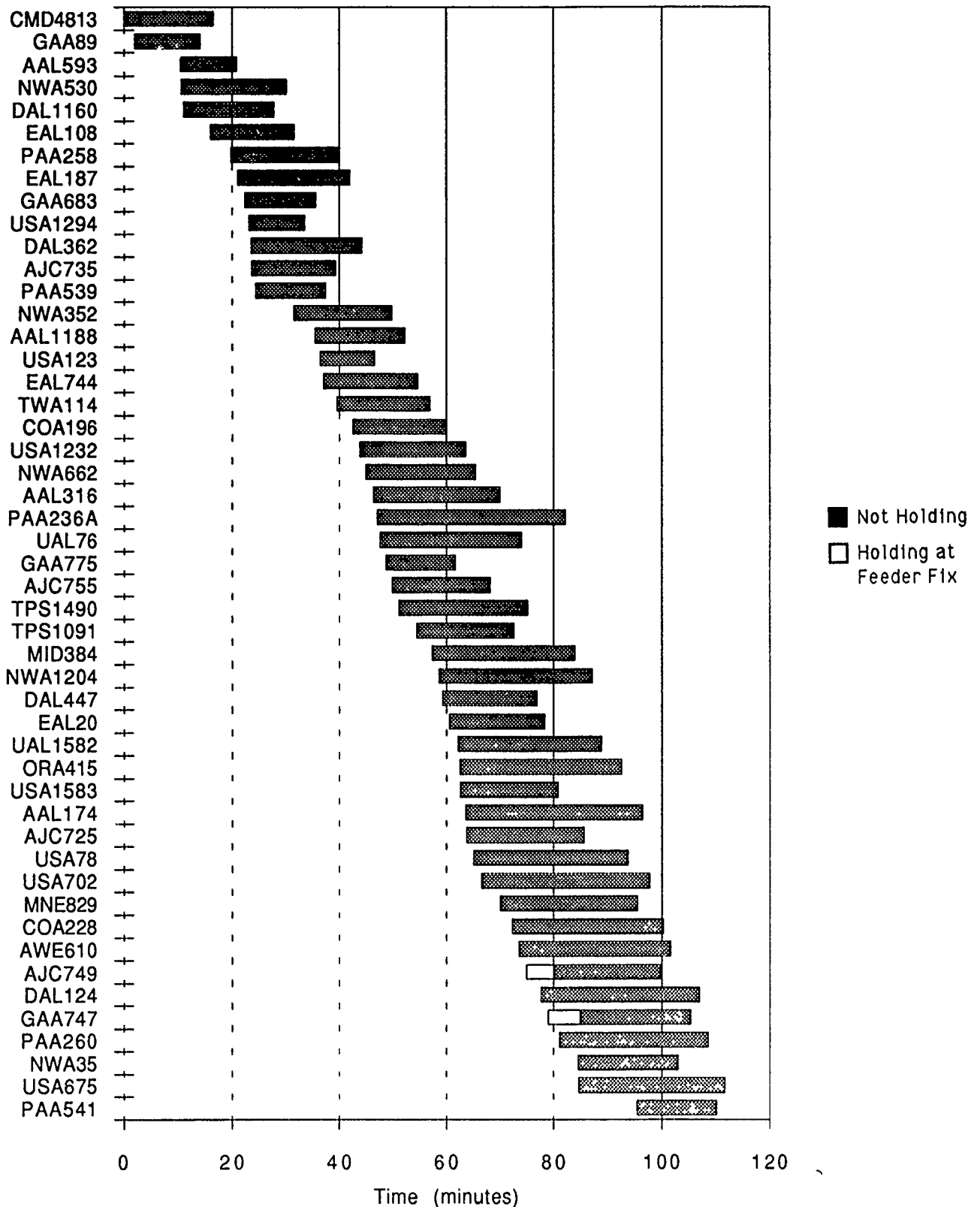

Figure D-8b. Arrival Aircraft Holding and In-flight Time Lines

Simulation Characteristics:

Airport: LGA		Percent MLS, Target: 75.0 Actual: 73.0
Arrival Runway(s): 31 & 4		Departure Runway(s): 4
No. 9	Date/Run: 4/12/90 # 3	Duration: 112 min.
No. Completed Arrivals: 51		No. Completed Departures: 41
Comments: ILS land 4, MLS land 31.		

Summary of Simulation Results:

Feeder Fix	Av. Flight Time (min.)	Av. Flight Dist. (NMI)	Av. Holding Time (min.)	Min. Flight Time (min.)	Min. Flight Dist. (NMI)
ARDVOR	13.19	52.86	0	11.25	47.30
LIZZI	14.98	61.06	0	12.43	55.23
NESSI	25.76	73.17	0	19.48	65.40
NOBBI	21.14	65.09	0	12.95	46.32
VALRE	15.59	63.65	0	10.23	47.80
Wt. Av.	16.37	61.14	0	N/A	N/A
Arrival Rate Per Hour					
31.6					

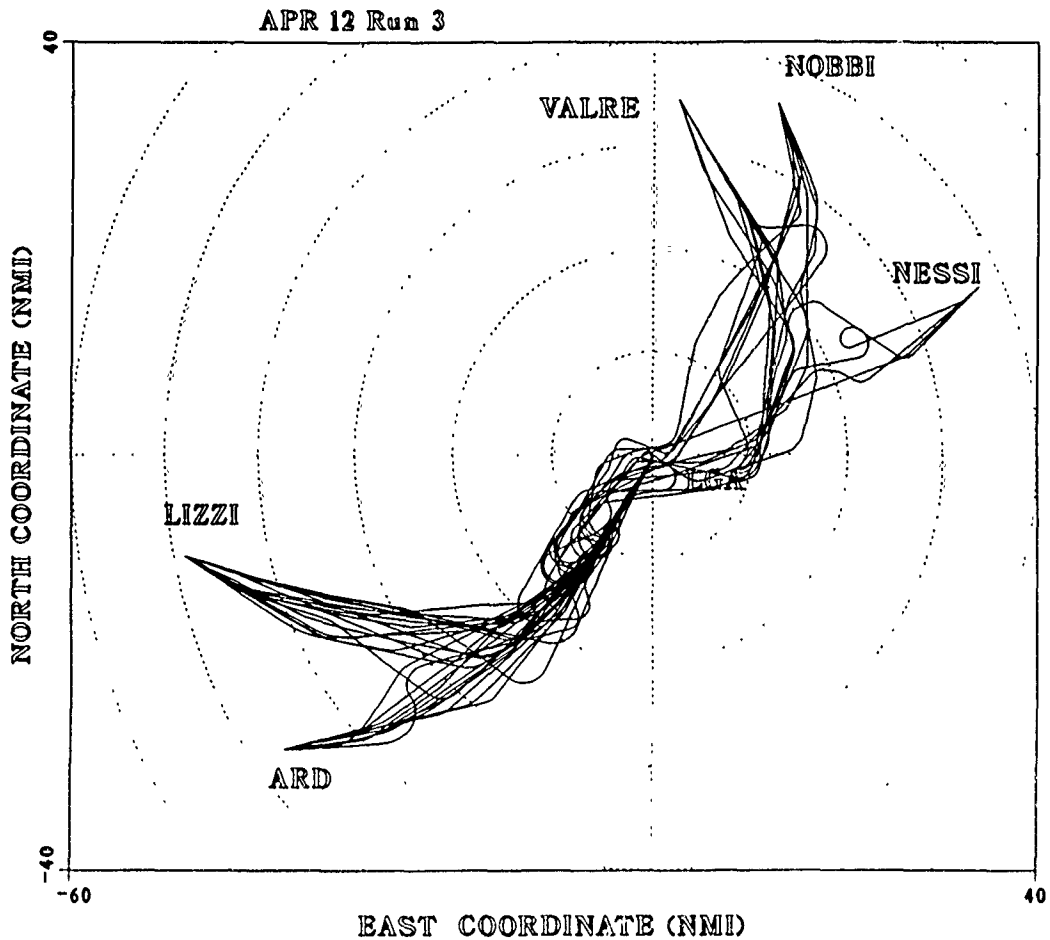

Figure D-9a. Summary Data & Arrival Aircraft Flight Tracks for No. 9

LGA ILS 04 & MLS 31/D 04 (4/12/90 #3)

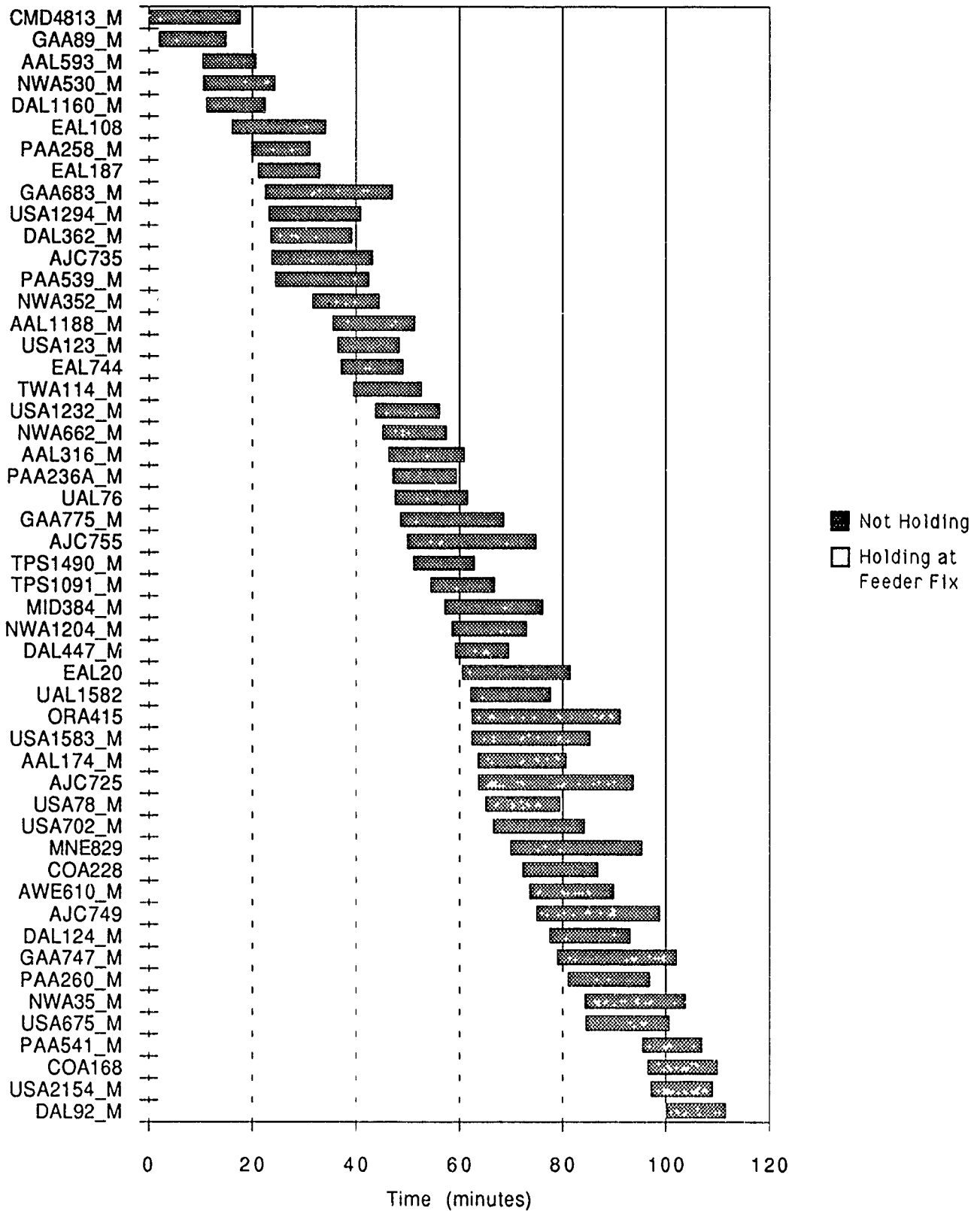

Figure D-9b. Arrival Aircraft Holding and In-flight Time Lines

Simulation Characteristics:

Airport: LGA		Percent MLS, Target: 75.0 Actual: 75.0
Arrival Runway(s): 31		Departure Runway(s): 4
No. 10	Date/Run: 4/12/90 # 2	Duration: 119 min.
No. Completed Arrivals: 52		No. Completed Departures: 54
Comments:		

Summary of Simulation Results:

Feeder Fix	Av. Flight Time (min.)	Av. Flight Dist. (NMI)	Av. Holding Time (min.)	Min. Flight Time (min.)	Min. Flight Dist. (NMI)
ARDVOR	18.69	69.46	0	12.42	51.52
LIZZI	18.77	72.31	0	12.48	56.54
NESSI	16.91	46.71	0	14.42	46.18
NOBBI	18.83	54.62	0	13.07	44.60
VALRE	14.39	53.62	0	10.93	46.16
Wt. Av.	17.78	63.70	0	N/A	N/A
Arrival Rate Per Hour					
30.5					

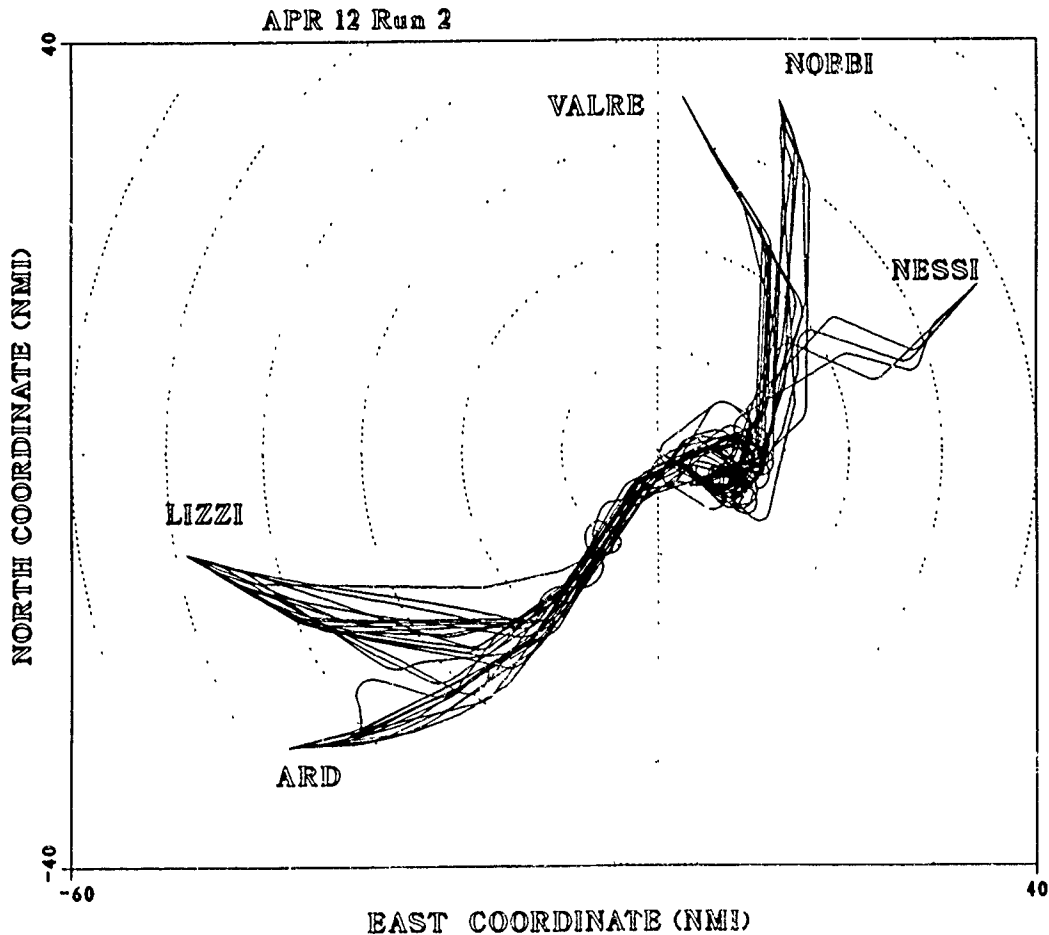

Figure D-10a. Summary Data & Arrival Aircraft Flight Tracks for No. 10

LGA ILS 31 & MLS 31/D 04 (4/12/90 #2)

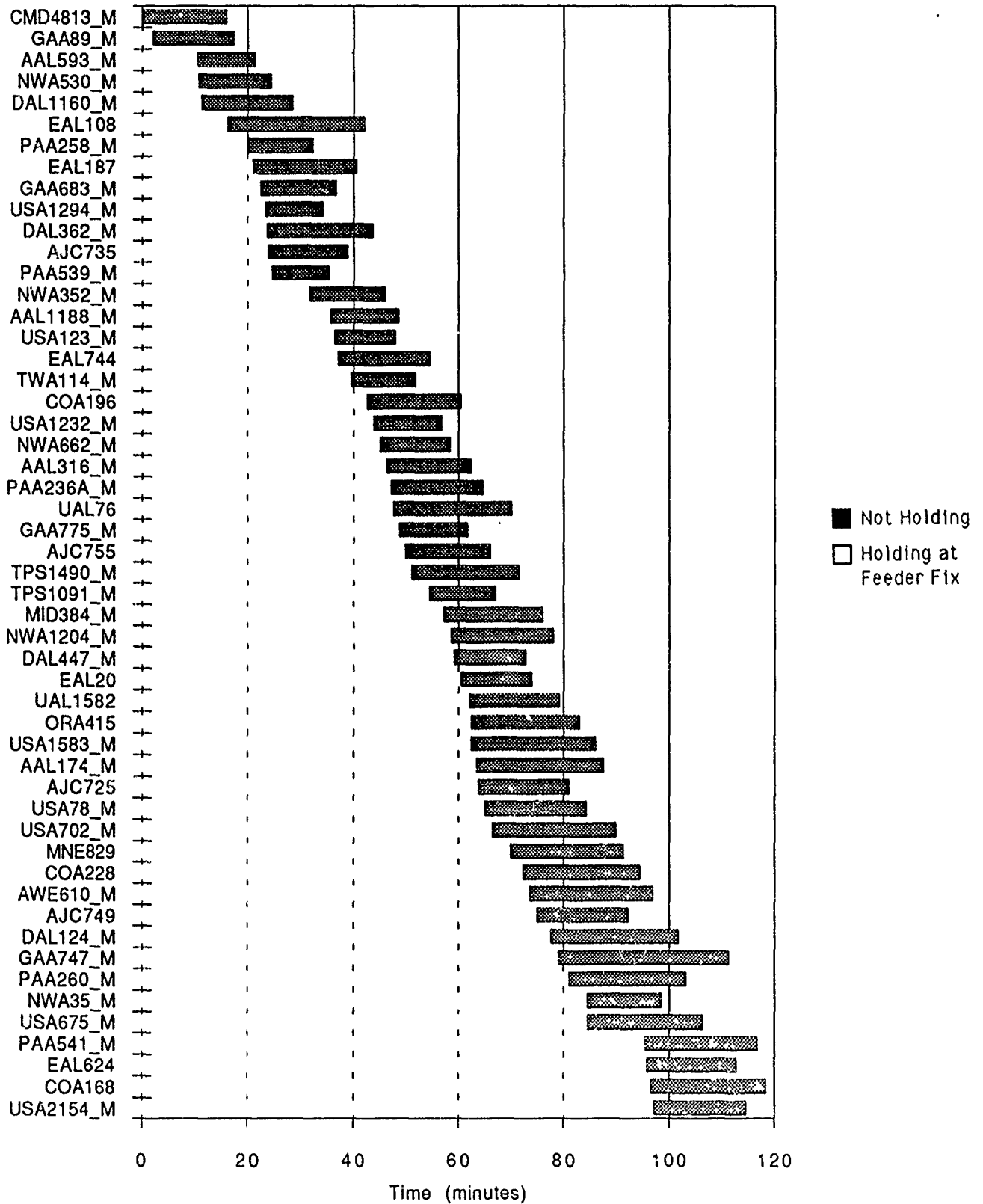

Figure D-10b. Arrival Aircraft Holding and In-flight Time Lines

Simulation Characteristics:

Airport: LGA		Percent MLS, Target: 100 Actual: 100
Arrival Runway(s): 31		Departure Runway(s): 4
No. 11	Date/Run: 4/12/90 # 1	Duration: 113 min.
No. Completed Arrivals: 53		No. Completed Departures: 50
Comments:		

Summary of Simulation Results:

Feeder Fix	Av. Flight Time (min.)	Av. Flight Dist. (NMI)	Av. Holding Time (min.)	Min. Flight Time (min.)	Min. Flight Dist. (NMI)
ARDVOR	14.62	56.65	0	11.23	50.83
LIZZI	16.67	63.84	0	12.45	57.21
NESSI	22.10	62.49	0	13.17	41.67
NOBBI	21.10	64.95	0	12.07	45.23
VALRE	18.15	68.09	0	10.35	49.64
Wt. Av.	17.44	62.92	0	N/A	N/A
Arrival Rate Per Hour					
32.3					

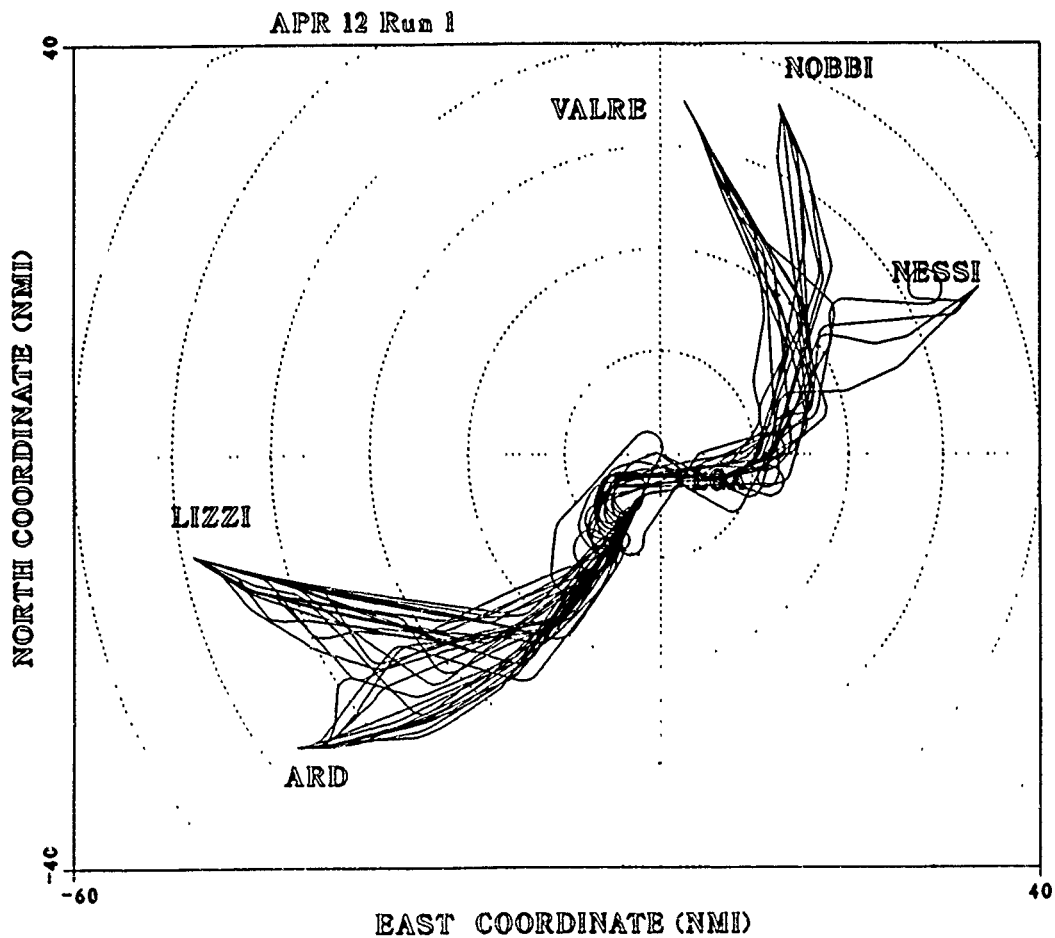

Figure D-11a. Summary Data & Arrival Aircraft Flight Tracks for No. 11

LGA MLS 31/D 04 (4/12/90 #1)

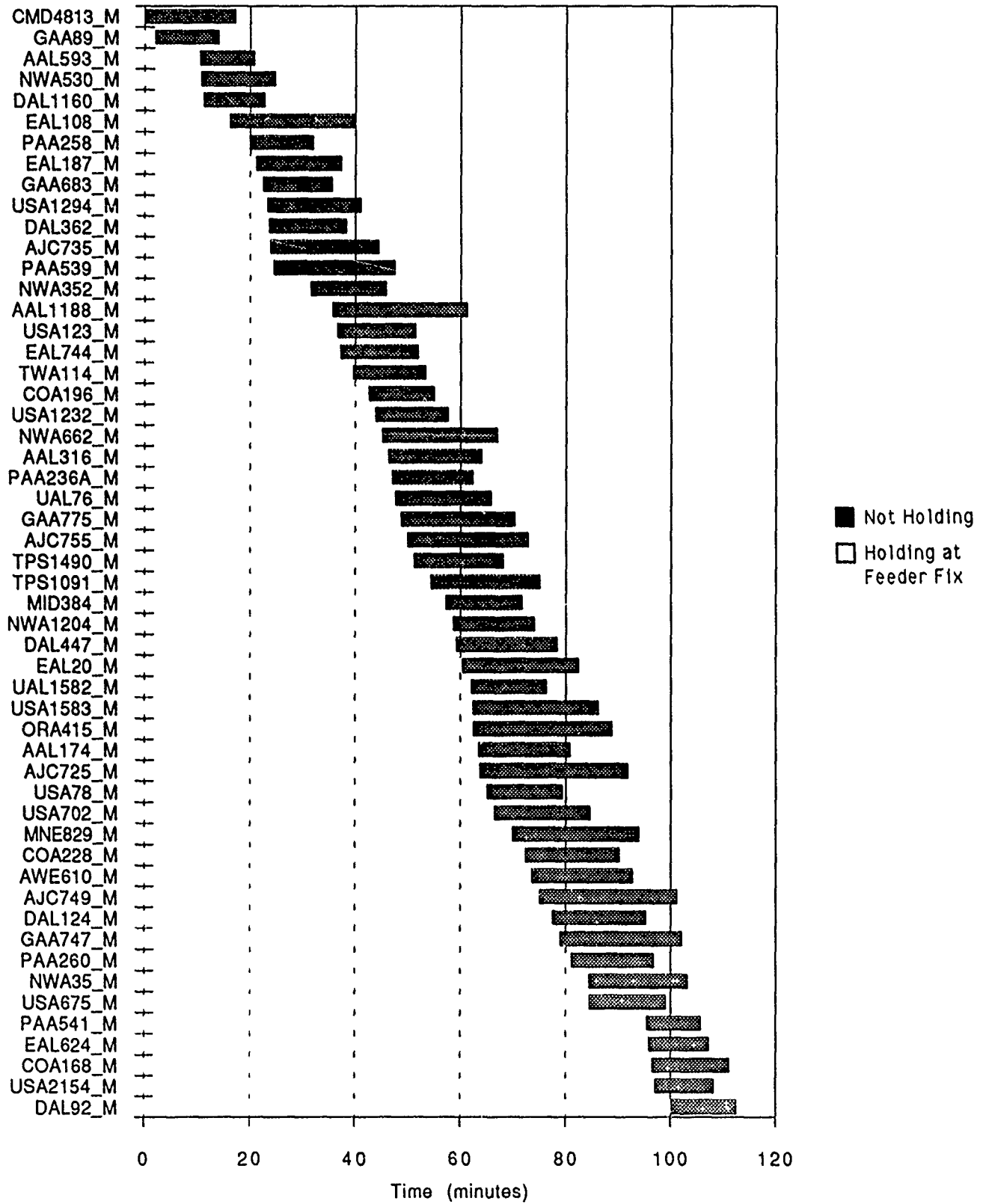

Figure D-11b. Arrival Aircraft Holding and In-flight Time Lines

Simulation Characteristics:

Airport: JFK		Percent MLS, Target: 0	Actual: 0
Arrival Runway(s): 13L		Departure Runway(s): N/A	
No. 12	Date/Run: 5/07/90 # 2	Duration: 113 min.	
No. Completed Arrivals: 55		No. Completed Departures: N/A	
Comments:			

Summary of Simulation Results:

Feeder Fix	Av. Flight Time (min.)	Av. Flight Dist. (NMI)	Av. Holding Time (min.)	Min. Flight Time (min.)	Min. Flight Dist. (NMI)
CAMRN	21.43	78.10	26.25 (6)	14.92	64.51
CCCVOR	36.20	101.63	12.78 (3)	29.23	84.33
DDXIE	27.84	77.03	31.05 (3)	14.58	54.33
ERICK	33.85	121.03	13.43 (7)	27.00	105.61
LENDY	29.56	111.51	16.41 (4)	18.60	90.09
MANTA	20.21	74.92	25.60 (1)	14.57	64.16
ZIGGI	23.43	65.15	28.25 (2)	20.67	59.11
Wt. Av.	29.50	101.13	20.41 (26)	N/A	N/A
Arrival Rate Per Hour					
33.7					

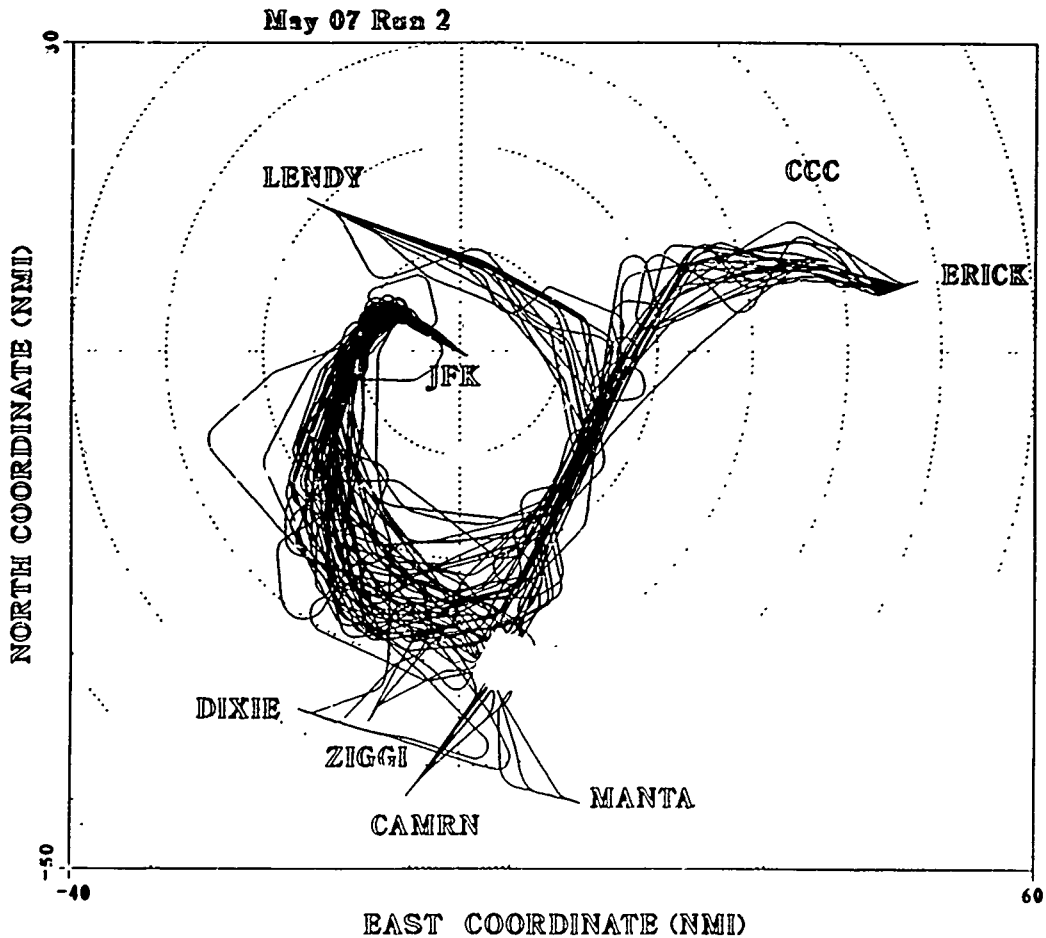

Figure D-12a. Summary Data & Arrival Aircraft Flight Tracks for No. 12

JFK ILS 13L (5/07/90 #2)

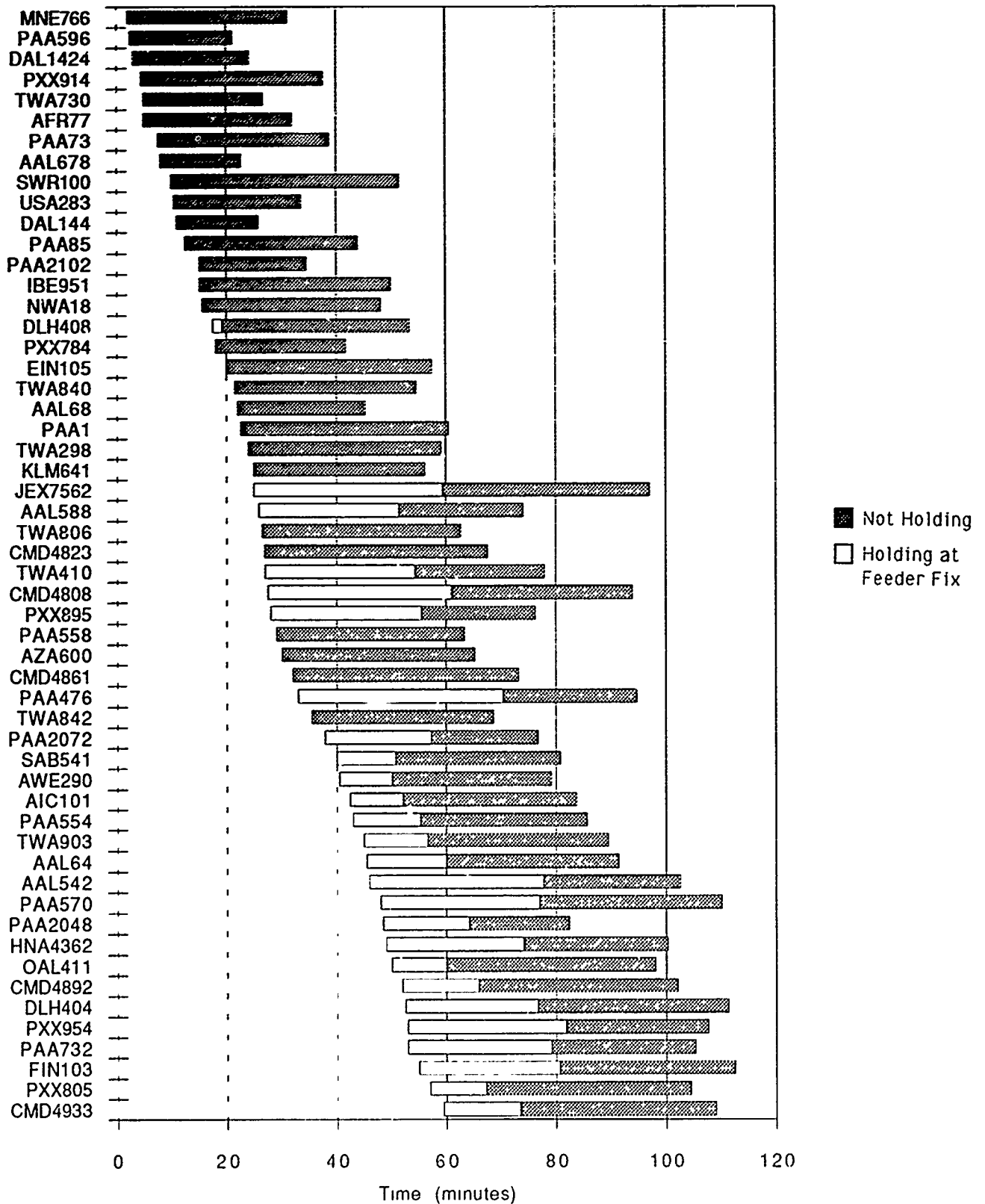

Figure D-12b. Arrival Aircraft Holding and In-flight Time Lines

Simulation Characteristics:

Airport: JFK		Percent MLS, Target: 25.0 Actual: 28.7
Arrival Runway(s): 13L & 13R		Departure Runway(s): N/A
No. 13	Date/Run: 5/07/90 # 3	Duration: 109 min.
No. Completed Arrivals: 61		No. Completed Departures: N/A
Comments: With 2 mile stagger; 13R limited to MLS		

Summary of Simulation Results:

Feeder Fix	Av. Flight Time (min.)	Av. Flight Dist. (NMI)	Av. Holding Time (min.)	Min. Flight Time (min.)	Min. Flight Dist. (NMI)
CAMRN	19.87	69.57	16.37 (4)	16.70	57.50
CCCVOR	33.67	93.86	13.63 (2)	27.92	75.00
DIXIE	21.34	56.57	11.71 (3)	16.55	42.91
ERICK	31.01	112.00	9.79 (7)	19.65	91.43
LENDY	31.40	115.88	10.80 (5)	17.72	87.01
MANTA	20.13	73.63	7.37 (1)	15.17	60.88
ZIGGI	19.92	55.25	16.41 (3)	15.70	44.48
Wt. Av.	27.92	95.41	12.27 (25)	N/A	N/A
Arrival Rate Per Hour					
39.8					

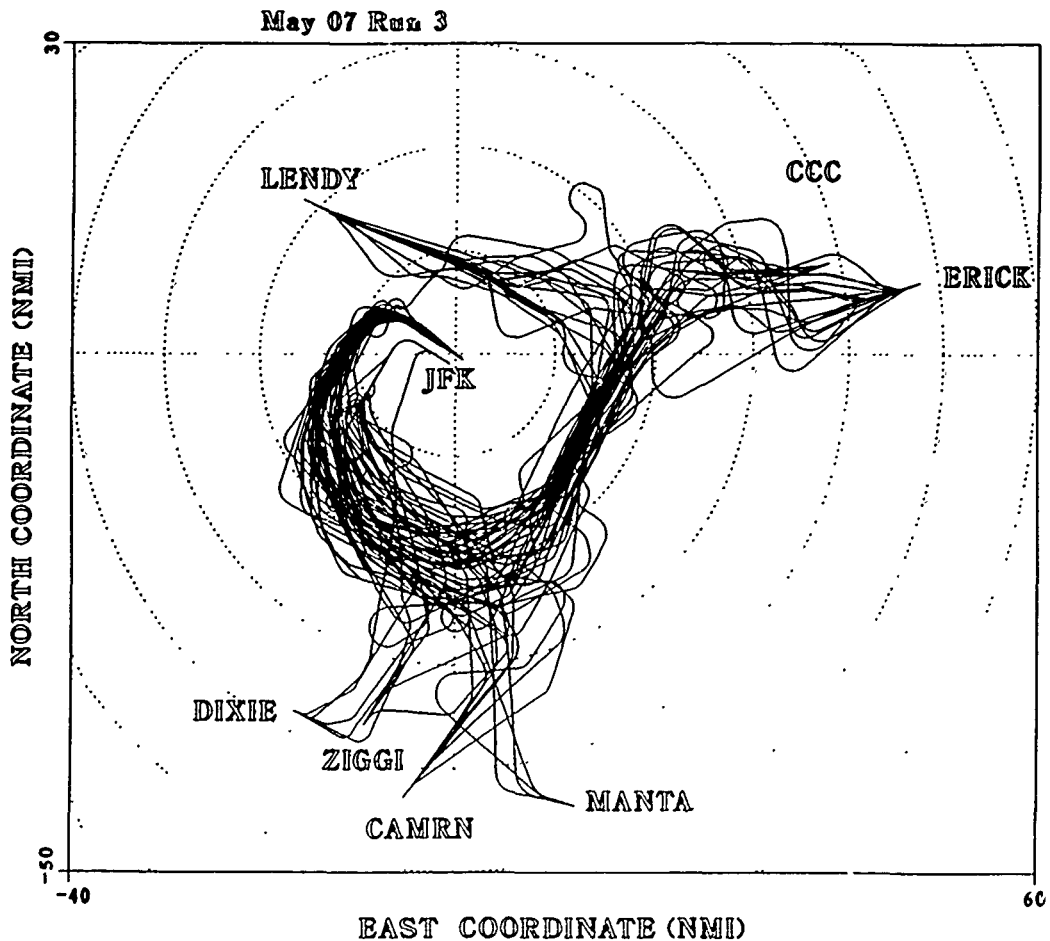

Figure D-13a. Summary Data & Arrival Aircraft Flight Tracks for No. 13

JFK ILS 13L/MLS 13R (5/07/90 #3)

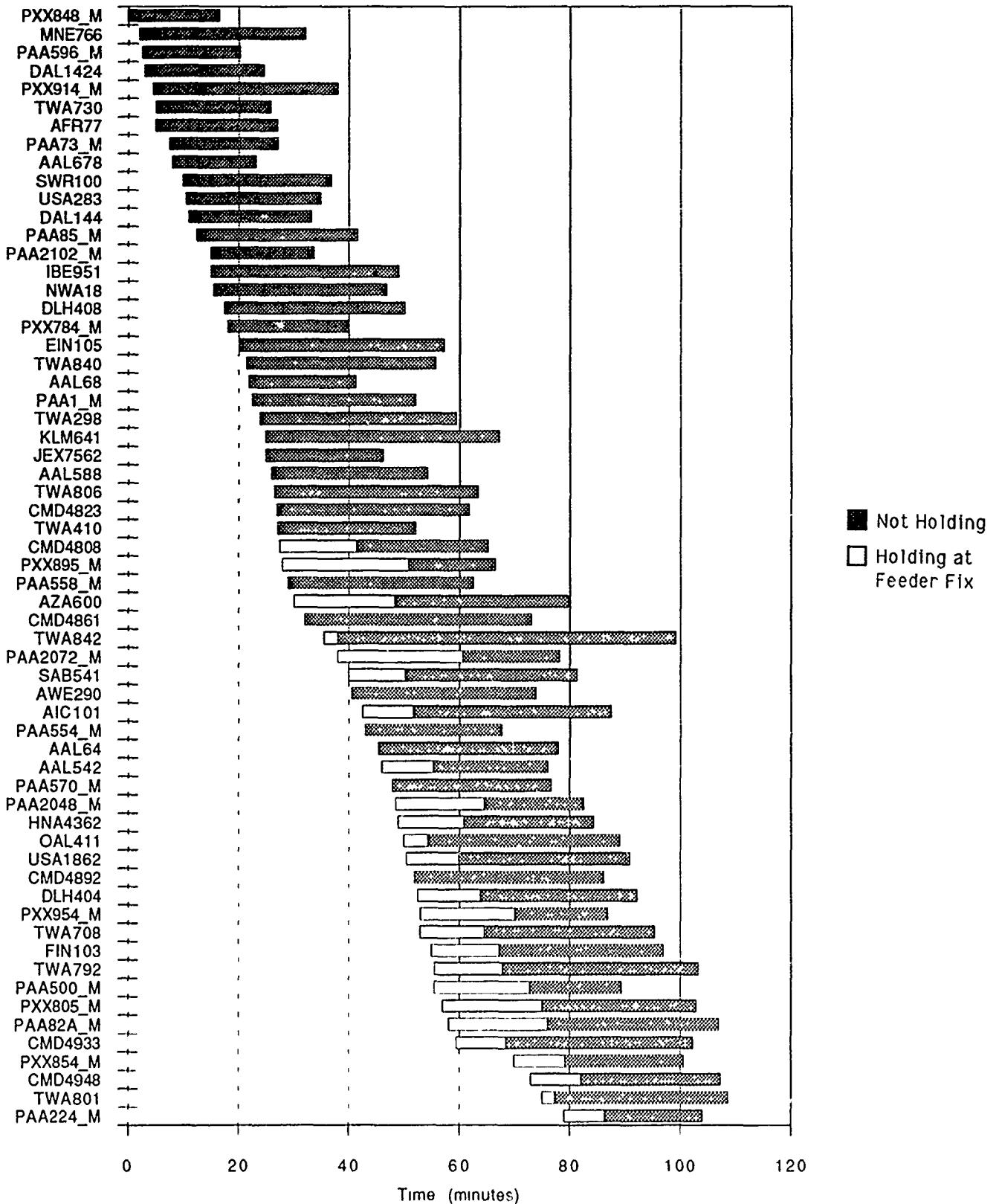

Figure D-13b. Arrival Aircraft Holding and In-flight Time Lines

Simulation Characteristics:

Airport: JFK		Percent MLS, Target: 50.0 Actual: 54.0
Arrival Runway(s): 13L & 13R		Departure Runway(s): N/A
No. 14	Date/Run: 5/10/90 # 1	Duration: 96 min.
No. Completed Arrivals: 66		No. Completed Departures: N/A
Comments: With 2 mile stagger; 13R limited to MLS		

Summary of Simulation Results:

Feeder Fix	Av. Flight Time (min.)	Av. Flight Dist. (NMI)	Av. Holding Time (min.)	Min. Flight Time (min.)	Min. Flight Dist. (NMI)
CAMRN	19.53	68.43	5.45 (1)	14.05	60.97
CCCVOR	29.33	83.13	0	25.70	71.95
DIXIE	25.03	70.92	0	12.52	44.44
ERICK	28.23	104.40	5.06 (2)	18.77	82.10
LENDY	31.46	120.82	11.83 (2)	15.75	76.31
MANTA	19.55	74.60	0	14.73	65.54
ZIGGI	22.35	62.65	0	19.55	55.88
Wt. Av.	26.83	93.48	7.84 (5)	N/A	N/A
Arrival Rate Per Hour					
41.90					

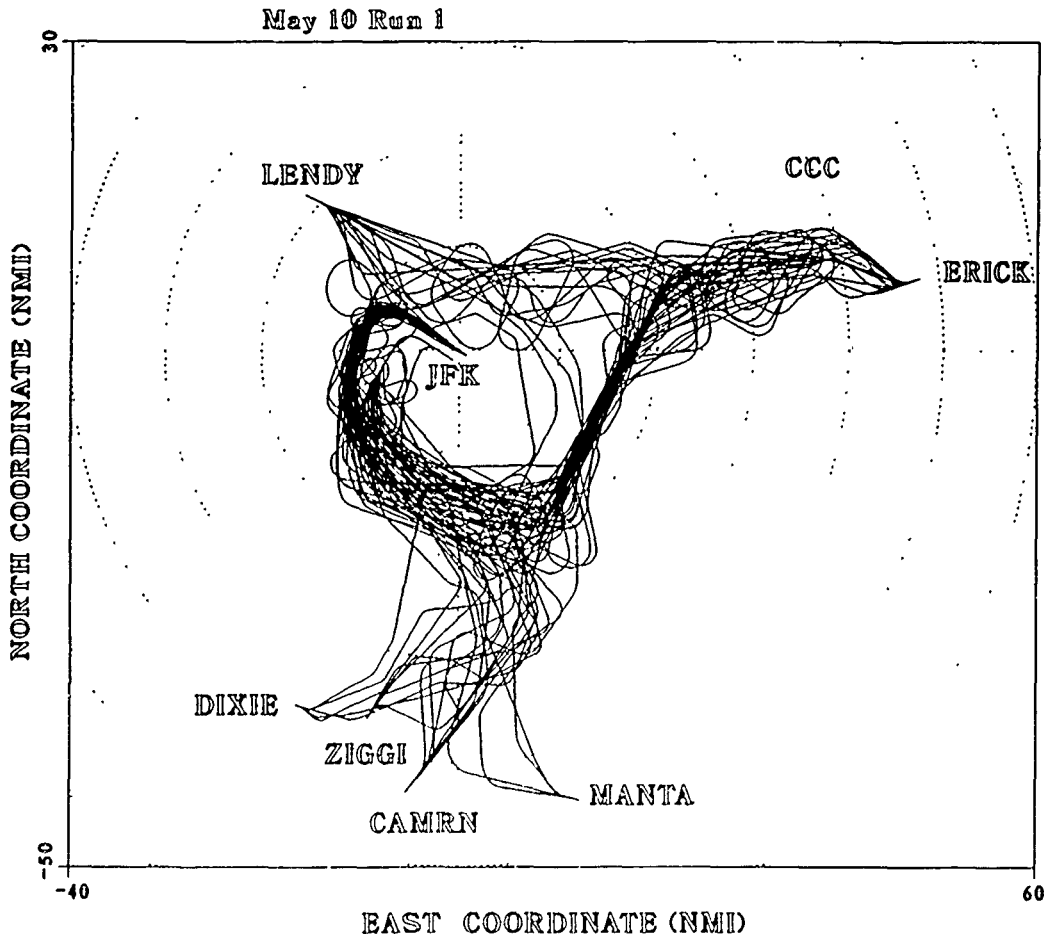

Figure D-14a. Summary Data & Arrival Aircraft Flight Tracks for No. 14

JFK ILS 13L/MLS 13R (5/10/90 #1)

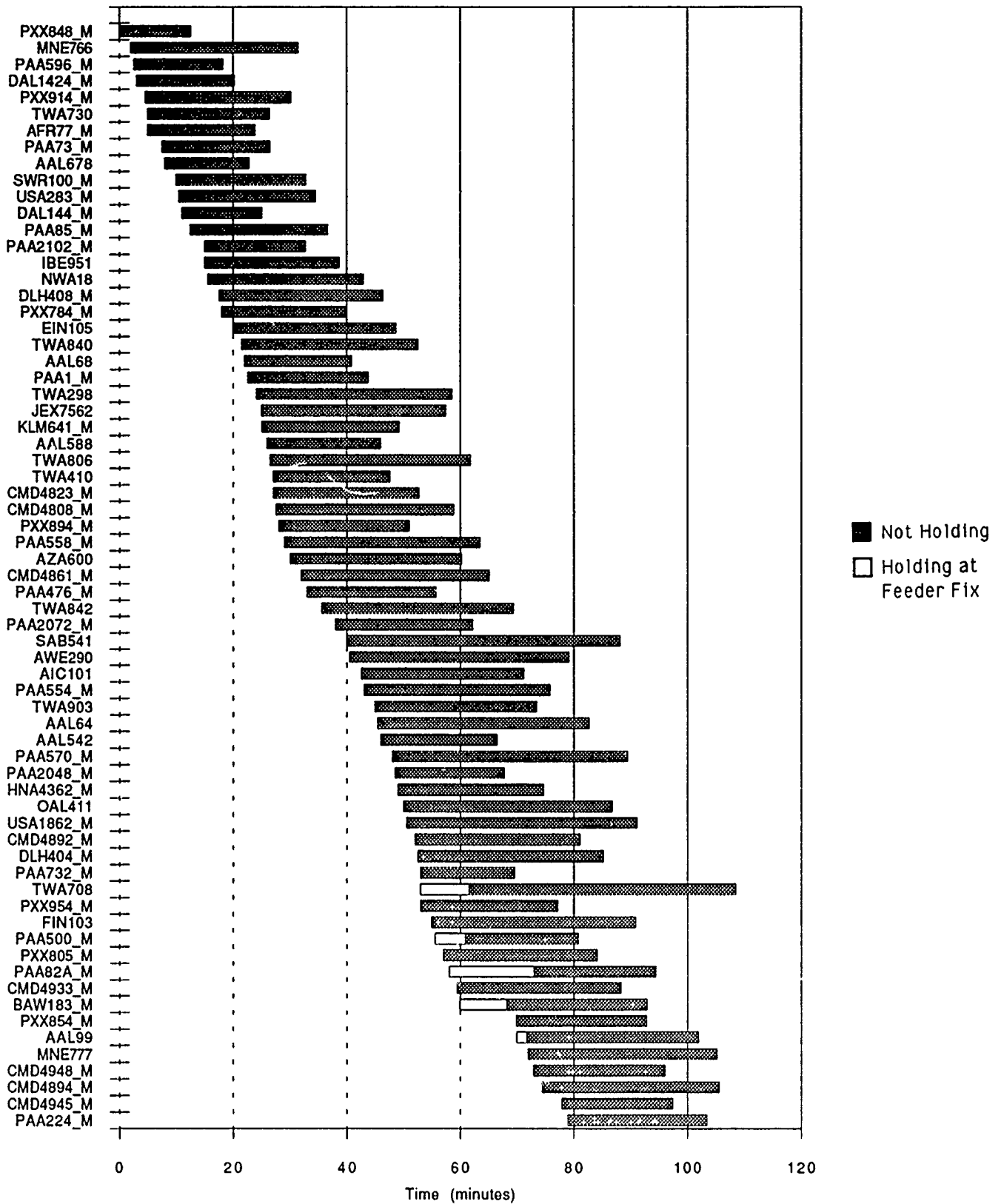

Figure D-14b. Arrival Aircraft Holding and In-flight Time Lines

Simulation Characteristics:

Airport: JFK		Percent MLS, Target: 100 Actual: 100
Arrival Runway(s): 13L & 13R		Departure Runway(s): N/A
No. 15	Date/Run: 5/08/90 # 3	Duration: 96 min.
No. Completed Arrivals: 59		No. Completed Departures: N/A
Comments: Two 13R MLS procedures		

Summary of Simulation Results:

Feeder Fix	Av. Flight Time (min.)	Av. Flight Dist. (NMI)	Av. Holding Time (min.)	Min. Flight Time (min.)	Min. Flight Dist. (NMI)
CAMRN	20.39	70.26	0	13.88	62.27
CCCVOR	27.52	76.78	0	25.52	70.60
DIXIE	23.00	66.08	0	11.78	42.61
ERICK	26.46	98.62	0	18.32	83.61
LENDY	29.05	109.18	0	16.58	82.38
MANTA	18.73	67.23	0	14.90	61.68
ZIGGI	32.09	90.09	0	19.93	57.04
Wt. Av.	26.01	90.83	0	N/A	N/A
Arrival Rate Per Hour					
42.0					

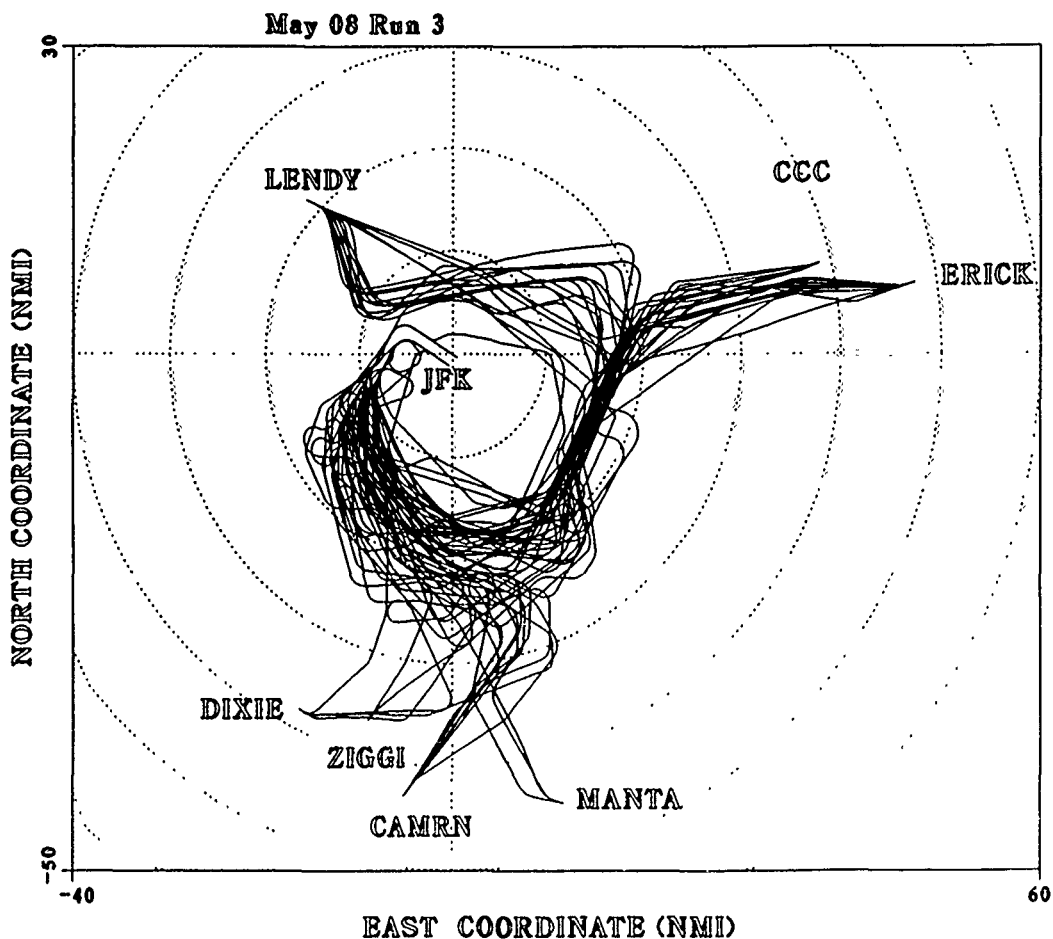

Figure D-15a. Summary Data & Arrival Aircraft Flight Tracks for No. 15

JFK MLS 13L & R (2 paths) (5/08/90 #3)

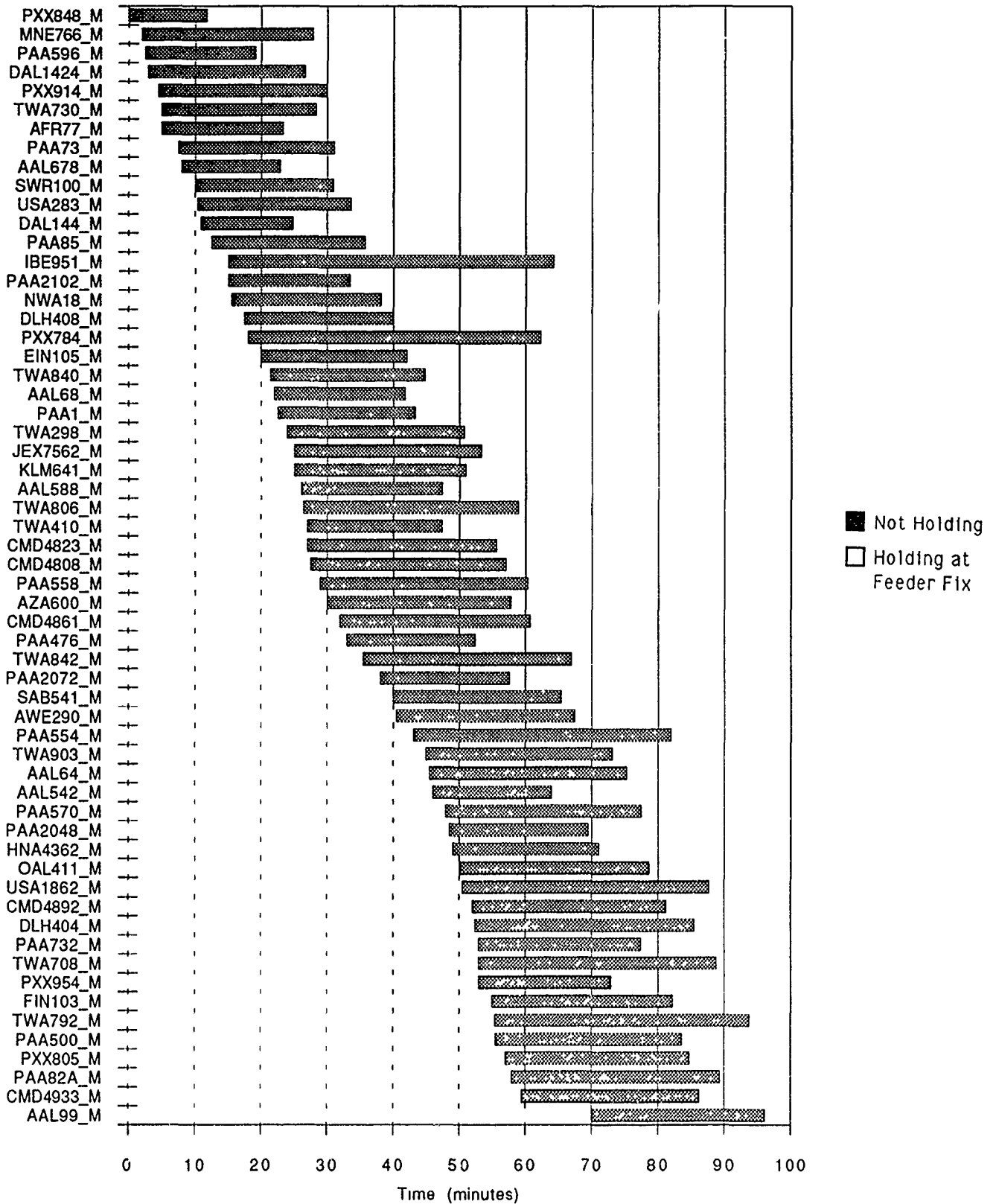

Figure D-15b. Arrival Aircraft Holding and In-flight Time Lines

Simulation Characteristics:

Airport: JFK		Percent MLS, Target: 100 Actual: 100
Arrival Runway(s): 13L & 13R		Departure Runway(s): N/A
No. 16	Date/Run: 5/10/90 # 2	Duration: 90 min.
No. Completed Arrivals: 59		No. Completed Departures: N/A
Comments: Repeat of 5/08/90 run 3. Two MLS 13R procedure.		

Summary of Simulation Results:

Feeder Fix	Av. Flight Time (min.)	Av. Flight Dist. (NMI)	Av. Holding Time (min.)	Min. Flight Time (min.)	Min. Flight Dist. (NMI)
CAMRN	21.40	74.80	0	13.55	56.25
CCCVOR	27.85	78.72	0	24.20	69.63
DIXIE	20.74	57.58	0	13.25	45.08
ERICK	26.96	99.88	0	20.67	80.66
LENDY	28.52	110.31	0	17.17	83.61
MANTA	16.52	63.39	0	14.30	62.23
ZIGGI	16.24	43.81	0	14.40	40.34
Wt. Av.	25.35	89.93	0	N/A	N/A
Arrival Rate Per Hour					
46.4					

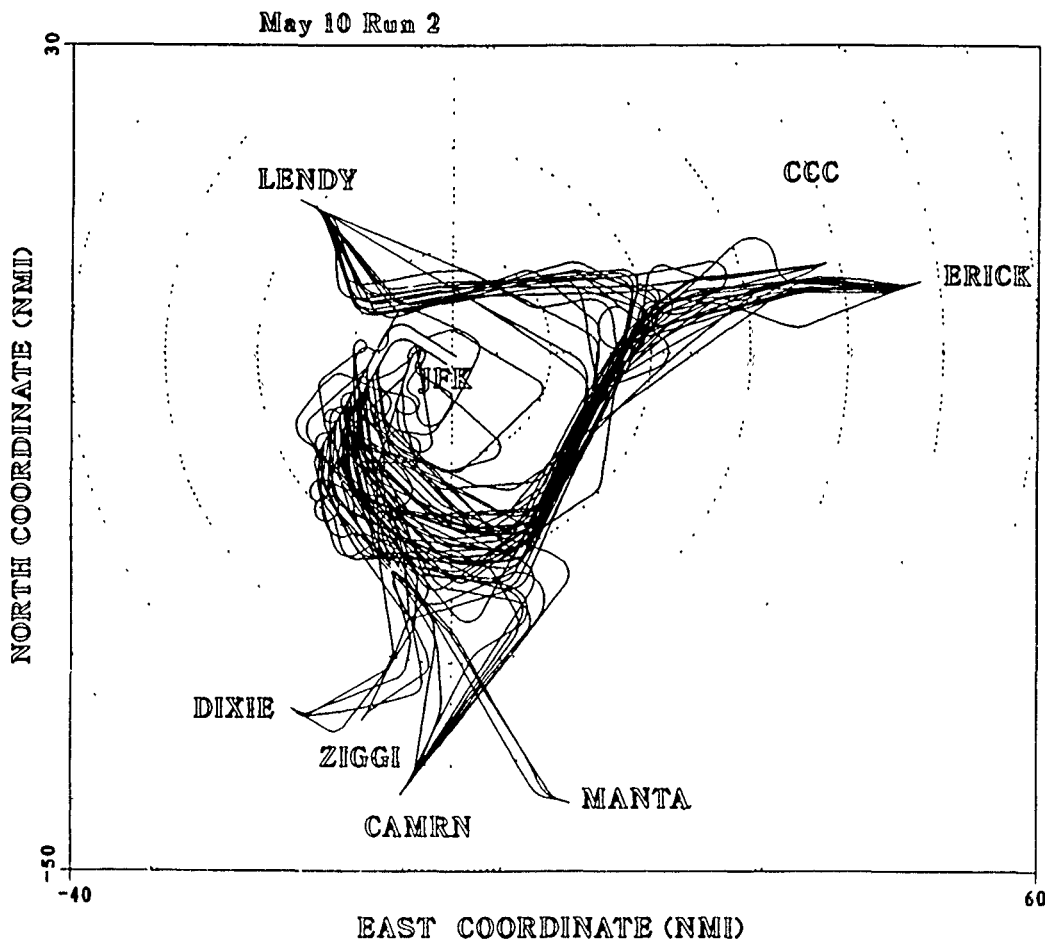

Figure D-16a. Summary Data & Arrival Aircraft Flight Tracks for No. 16

JFK MLS 13L & R (5/10/90 #2)

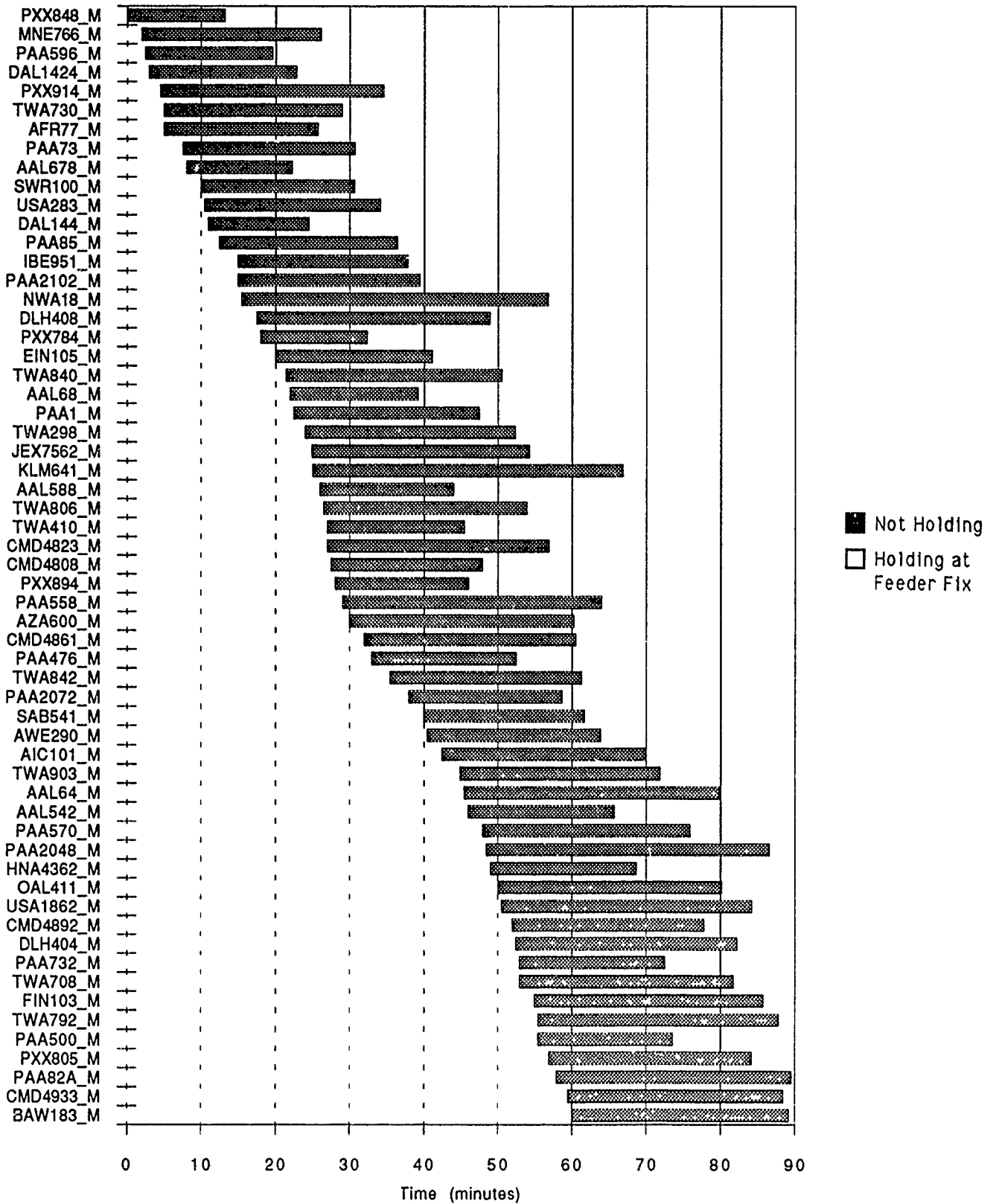

Figure D-16b. Arrival Aircraft Holding and In-flight Time Lines

Simulation Characteristics:

Airport: JFK		Percent MLS, Target: 100 Actual: 100
Arrival Runway(s): 13L & 13R		Departure Runway(s): N/A
No. 17	Date/Run: 5/11/90 # 1	Duration: 87 min.
No. Completed Arrivals: 65		No. Completed Departures: N/A
Comments: Independent operations, no stagger, new TERPS criteria; assume having precision runway monitor system		

Summary of Simulation Results:

Feeder Fix	Av. Flight Time (min.)	Av. Flight Dist. (NMI)	Av. Holding Time (min.)	Min. Flight Time (min.)	Min. Flight Dist. (NMI)
CAMRN	13.24	57.22	0	10.62	50.96
CCCVOR	23.75	67.06	0	22.45	64.28
DIXIE	16.62	47.17	0	13.65	45.62
ERICK	22.37	95.43	0	17.27	77.34
LENDY	20.67	92.06	0	14.33	71.96
MANTA	14.97	62.15	0	14.60	61.38
ZIGGI	15.82	44.18	0	15.42	43.21
Wt. Av.	19.65	78.43	0	N/A	N/A
Arrival Rate Per Hour					
53.5					

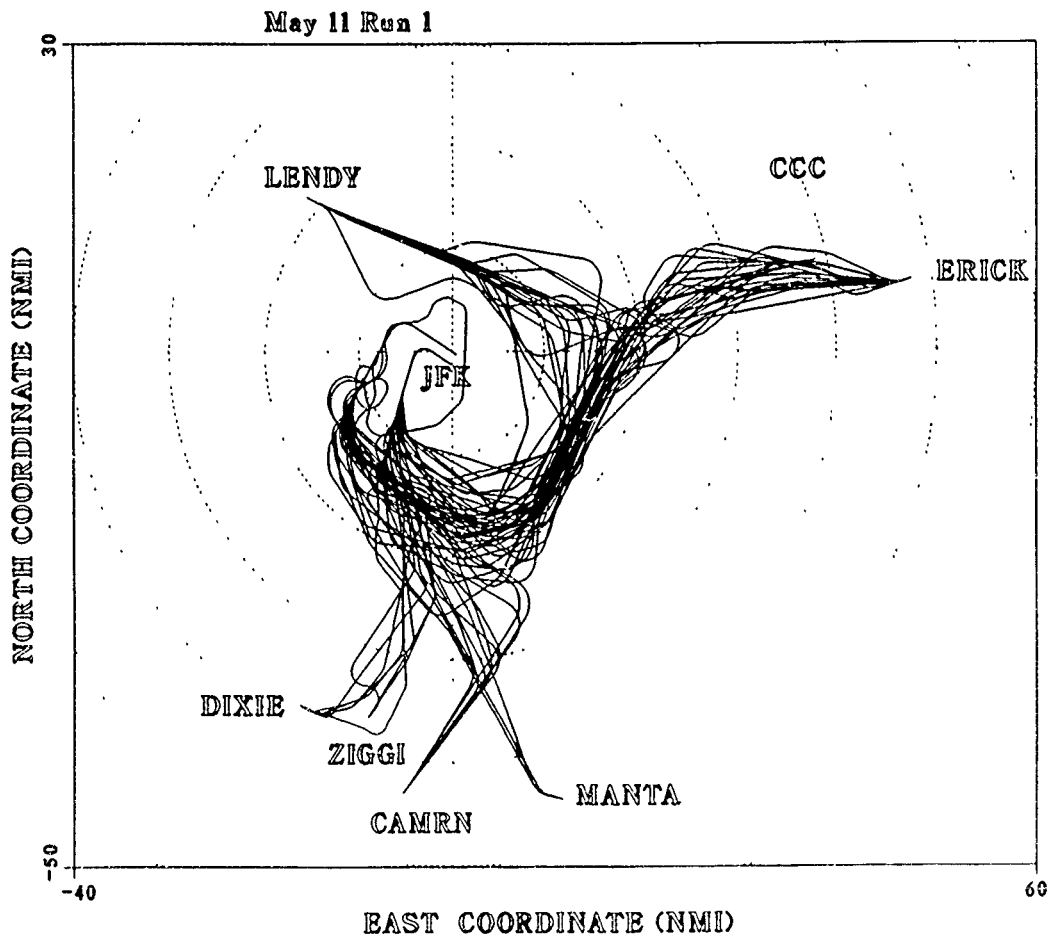

Figure D-17a. Summary Data & Arrival Aircraft Flight Tracks for No. 17

JFK MLS 13L & R (indep. op) (5/11/90 #1)

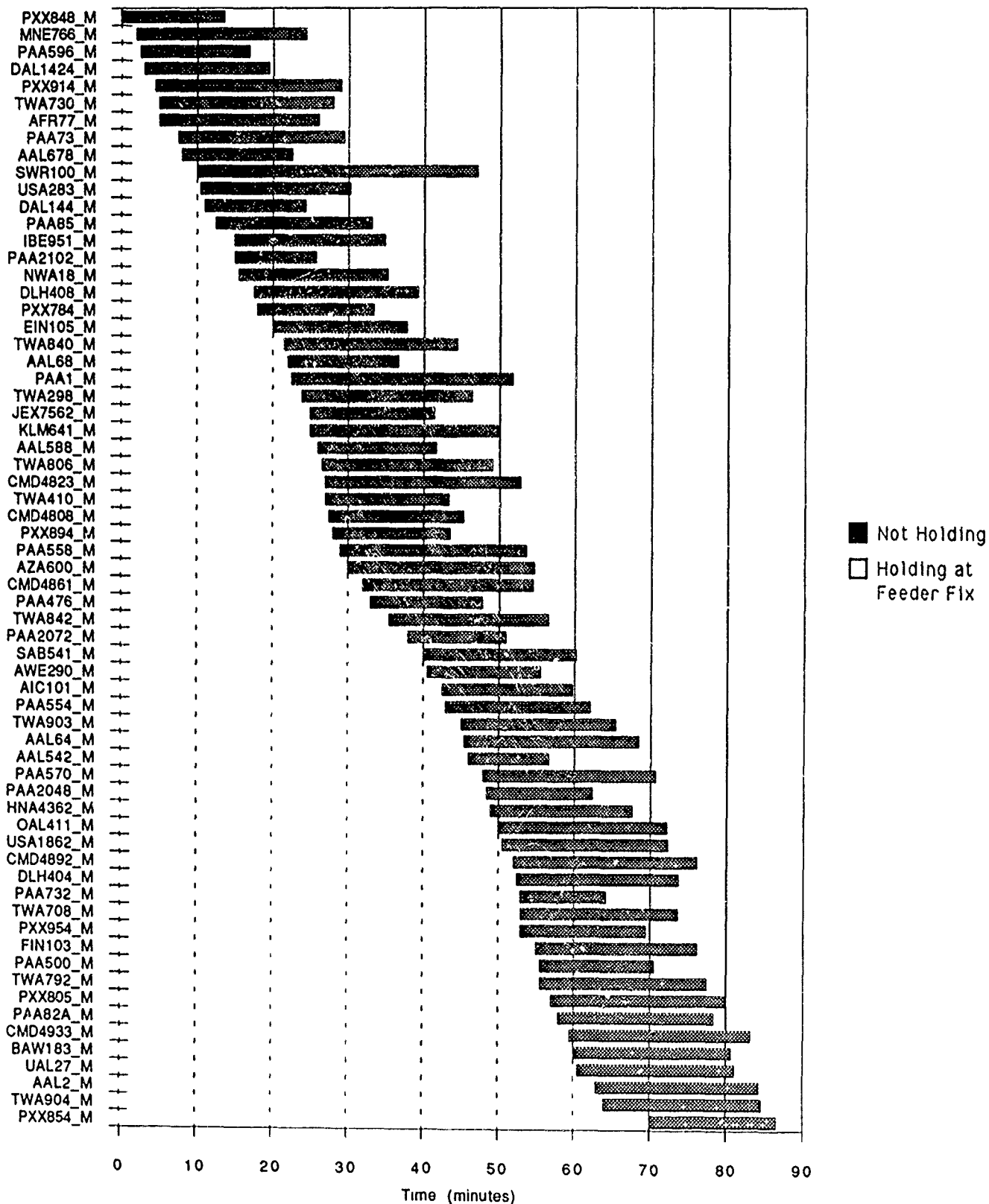

Figure D-17b. Arrival Aircraft Holding and In-flight Time Lines

Simulation Characteristics:

Airport: JFK		Percent MLS, Target: 100. Actual: 100.
Arrival Runway(s): 13L		Departure Runway(s): N/A
No. 18	Date/Run: 5/11/90 # 3	Duration: 101 min.
No. Completed Arrivals: 53		No. Completed Departures: N/A
Comments: single MLS curved procedure to 13L		

Summary of Simulation Results:

Feeder Fix	Av. Flight Time (min.)	Av. Flight Dist. (NMI)	Av. Holding Time (min.)	Min. Flight Time (min.)	Min. Flight Dist. (NMI)
CAMRN	20.01	64.97	13.79 (7)	15.50	60.95
CCCVOR	31.88	88.73	8.40 (3)	26.72	80.12
DIXIE	21.20	57.15	11.43 (3)	16.75	53.37
ERICK	30.33	106.94	11.30 (7)	25.18	96.78
LENDY	29.54	108.00	12.24 (10)	16.65	82.61
MANTA	19.11	62.03	9.81 (2)	17.20	60.33
ZIGGI	19.71	52.70	7.61 (3)	18.45	47.56
Wt. Av.	26.57	89.02	11.43 (35)	N/A	N/A
Arrival Rate Per Hour					
37.8					

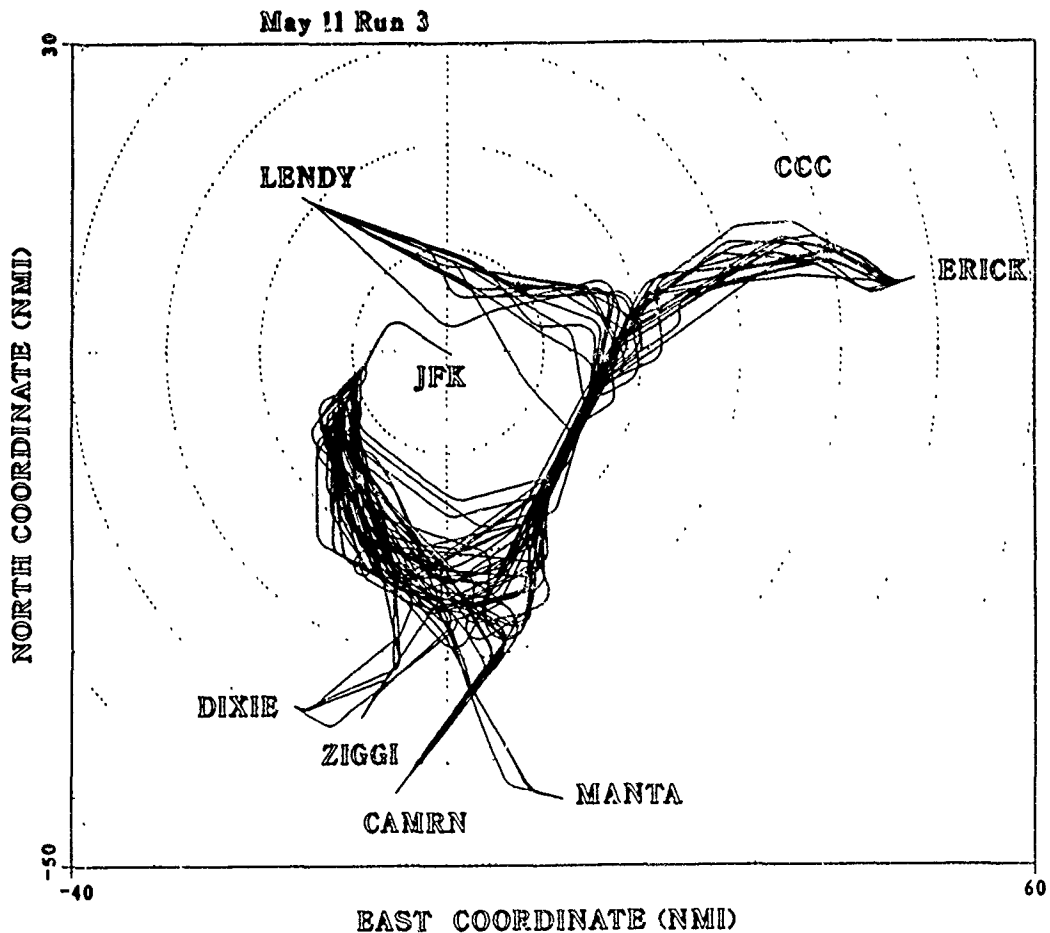

Figure D-18a. Summary Data & Arrival Aircraft Flight Tracks for No. 18

JFK MLS 13L - Single Path (5/11/90 #3)

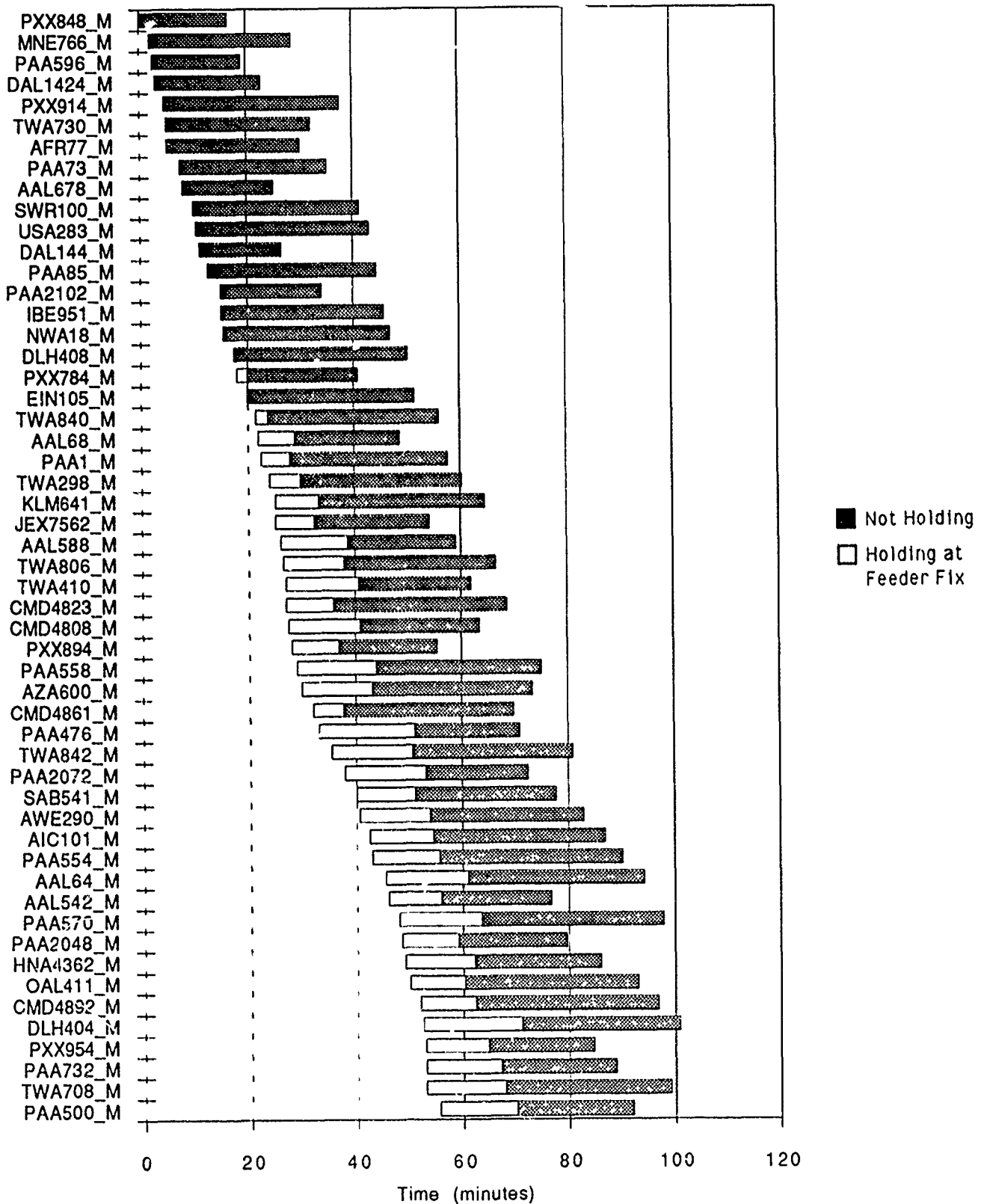

Figure D-18b. Arrival Aircraft Holding and In-flight Time Lines

Simulation Characteristics:

Airport: JFK		Percent MLS, Target: 0 Actual: 0
Arrival Runway(s): 22L & 22R		Departure Runway(s): N/A
No. 19	Date/Run: 5/09/90 # 1	Duration: 93 min.
No. Completed Arrivals: 64		No. Completed Departures: N/A
Comments:		

Summary of Simulation Results:

Feeder Fix	Av. Flight Time (min.)	Av. Flight Dist. (NMI)	Av. Holding Time (min.)	Min. Flight Time (min.)	Min. Flight Dist. (NMI)
CAMRN	20.64	72.32	9.92 (5)	18.60	67.82
CCCVOR	15.02	42.76	0	10.65	39.48
DIXIE	22.28	67.29	10.11 (2)	17.82	65.28
ERICK	14.20	53.79	0	12.45	50.60
LENDY	25.32	95.26	0	16.82	72.90
MANTA	17.77	68.05	0	16.00	63.98
ZIGGI	20.76	65.09	13.20 (2)	19.40	63.85
Wt. Av.	18.88	66.96	10.69 (9)	N/A	N/A
Arrival Rate Per Hour					
49.5					

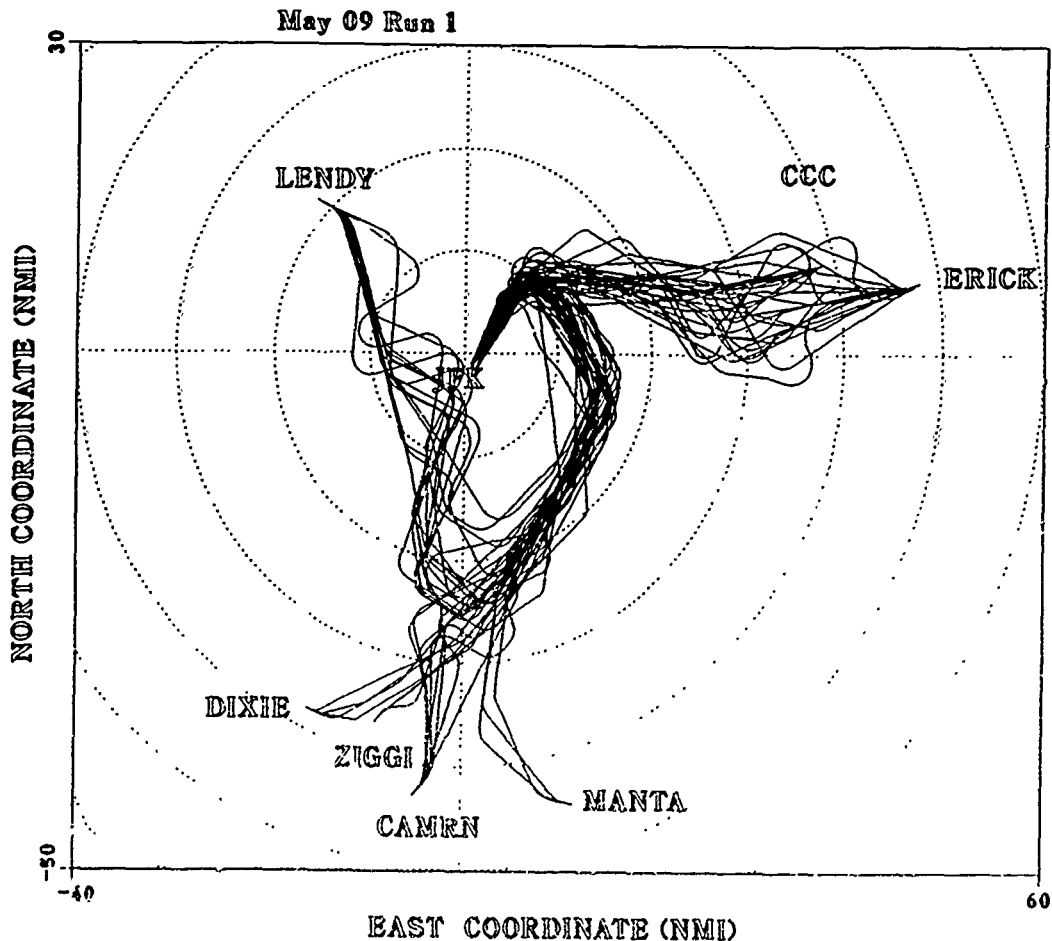

Figure D-19a. Summary Data & Arrival Aircraft Flight Tracks for No. 19

JFK ILS 22L & R (5/09/90 #1)

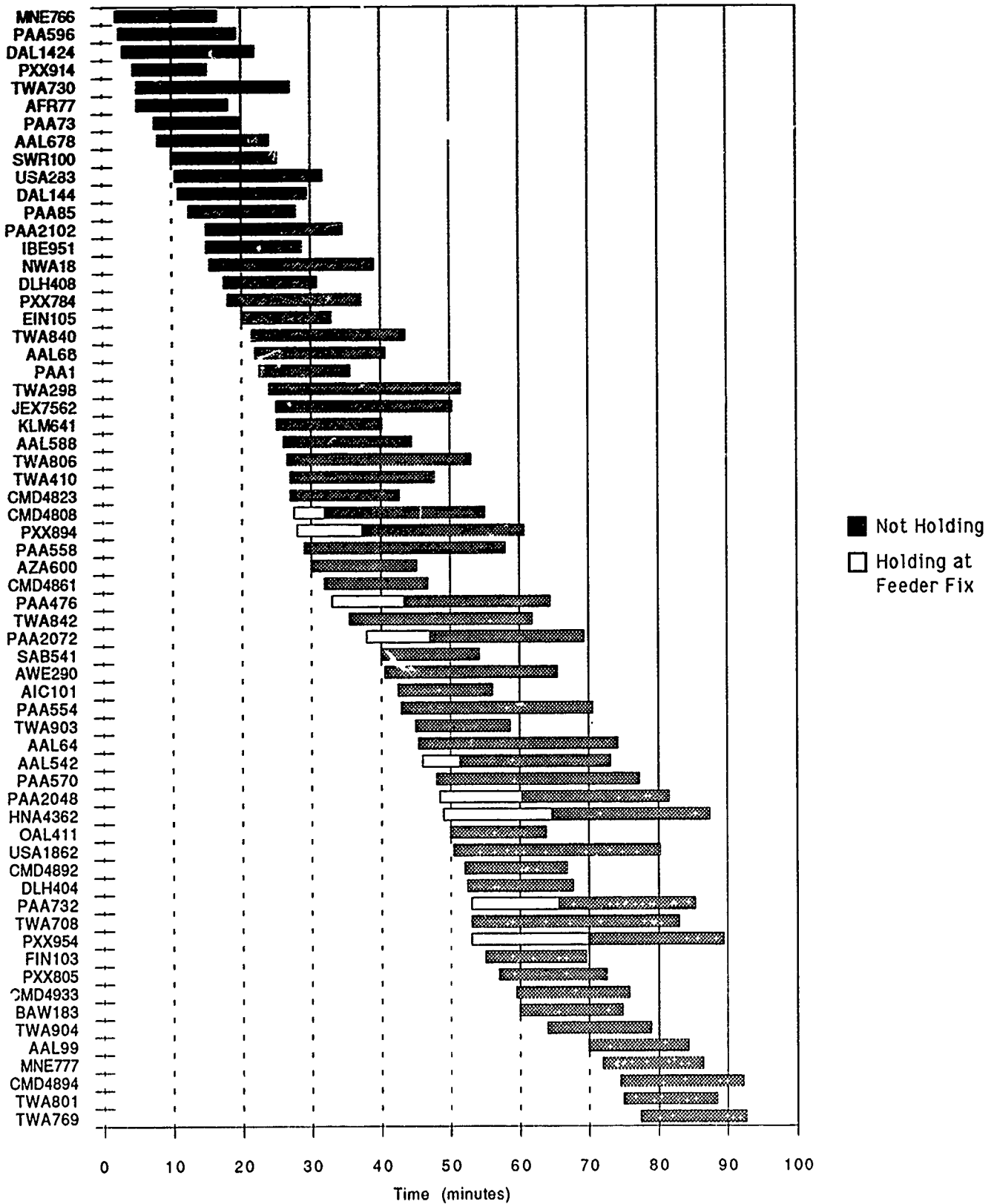

Figure D-19b. Arrival Aircraft Holding and In-flight Time Lines

JFK ILS 22L & R/MLS 13R (5/09/90 #2)

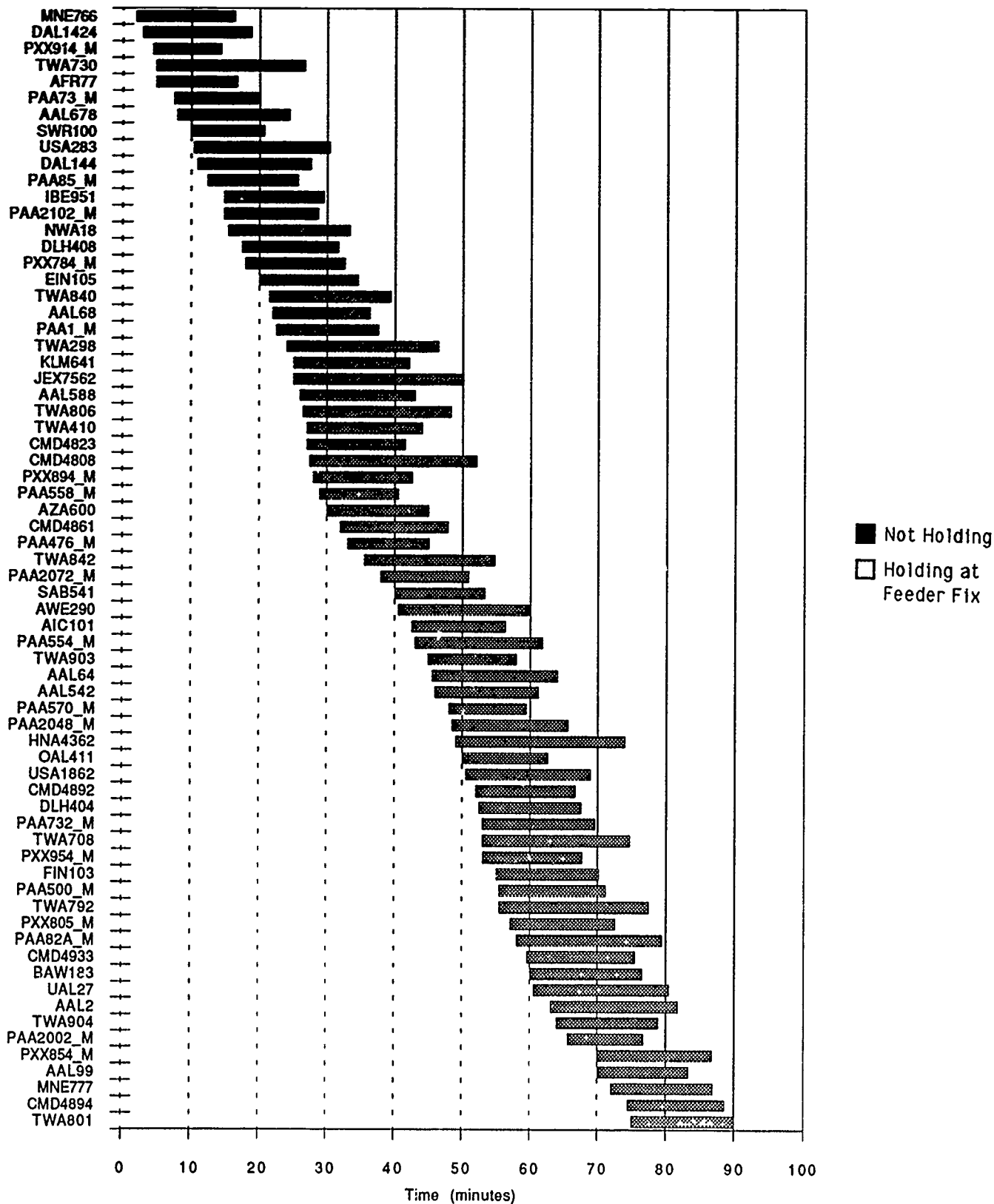

Figure D-20b. Arrival Aircraft Holding and In-flight Time Lines

JFK ILS 22L & R/MLS 13R (5/09/90 #3)

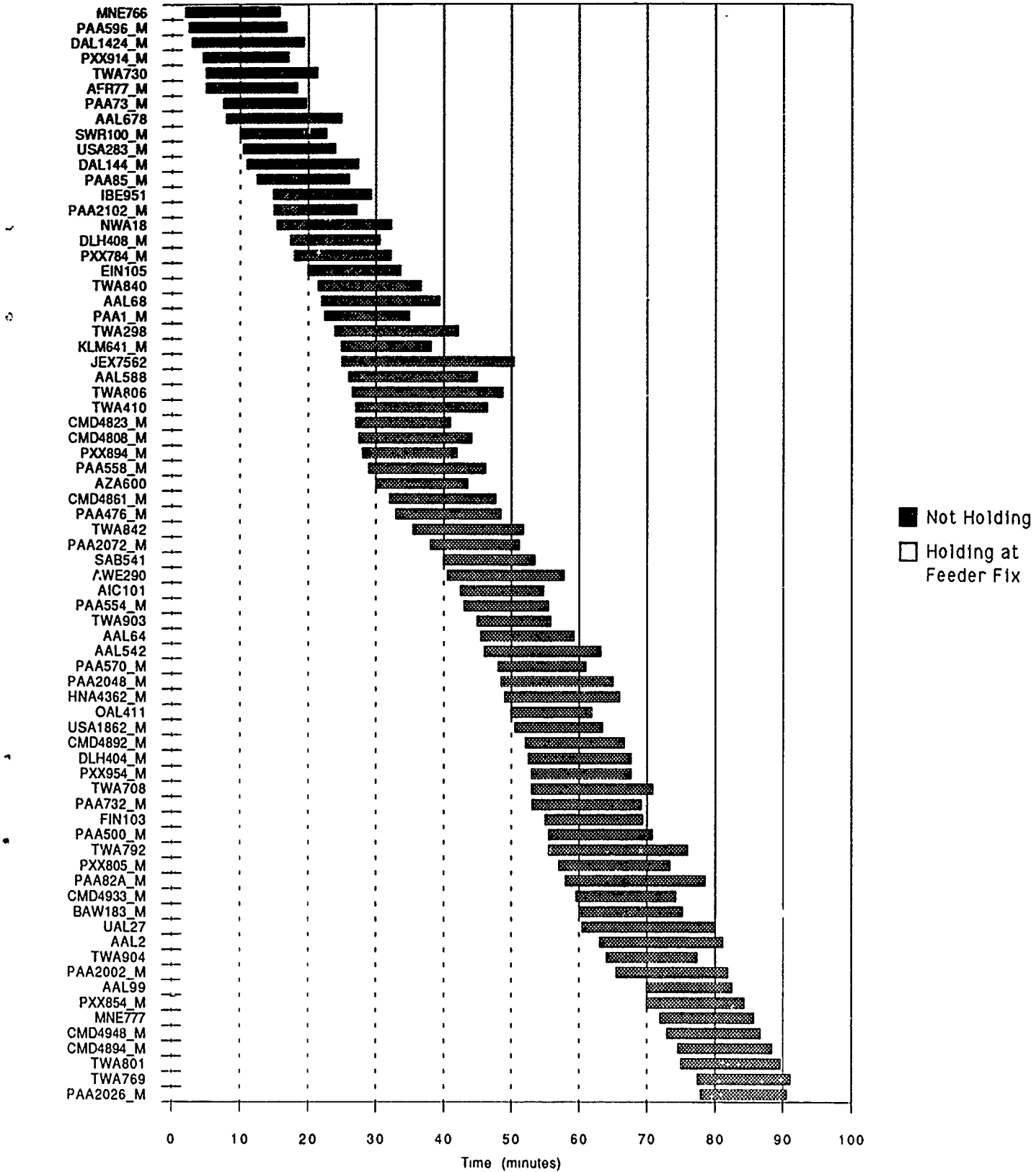

Figure D-21b. Arrival Aircraft Holding and In-flight Time Lines

JFK MLS 22L & 13R (5/10/90 #3)

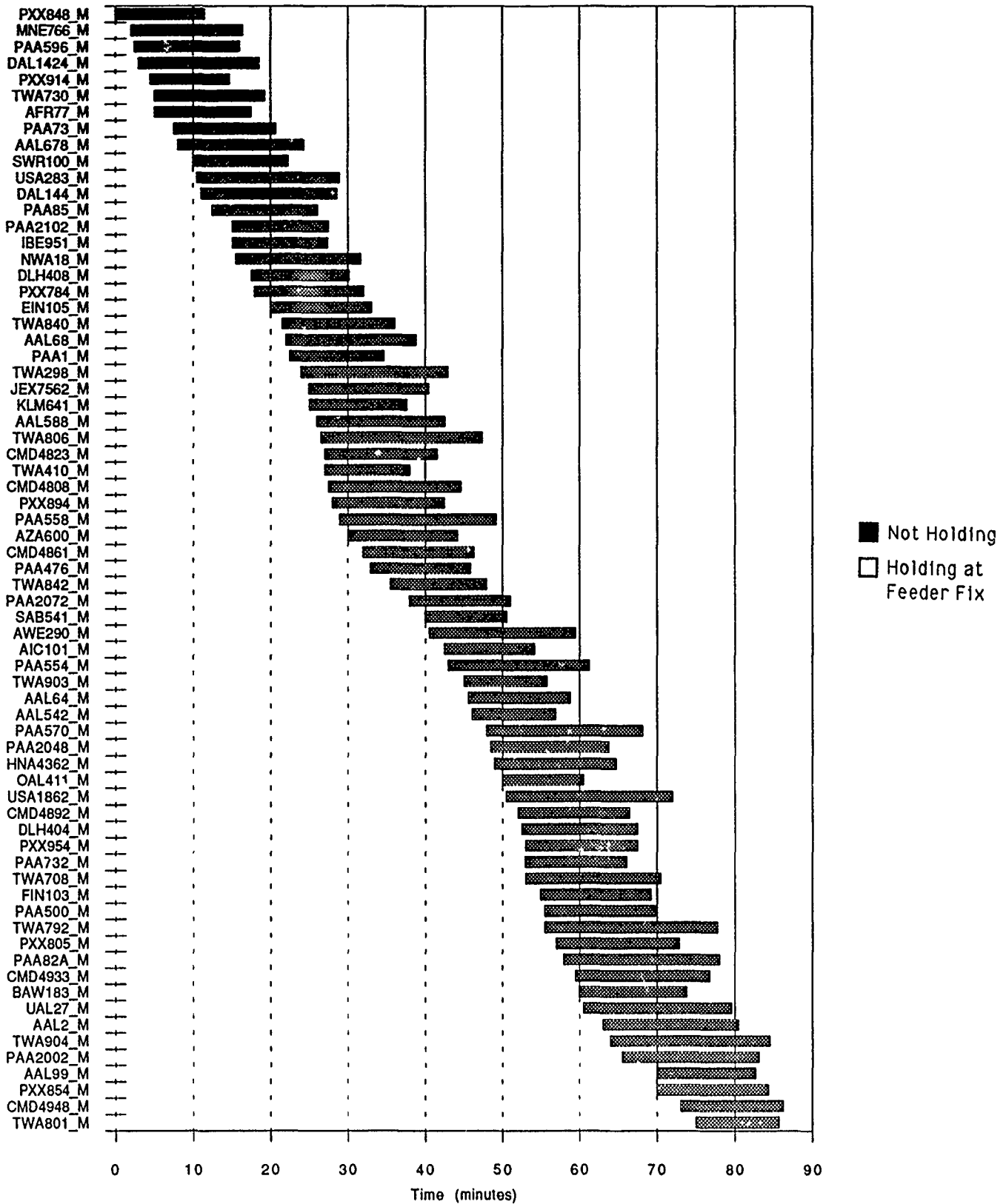

Figure D-22b. Arrival Aircraft Holding and In-flight Time Lines

EWR ILS 4R (5/14/90 #1)

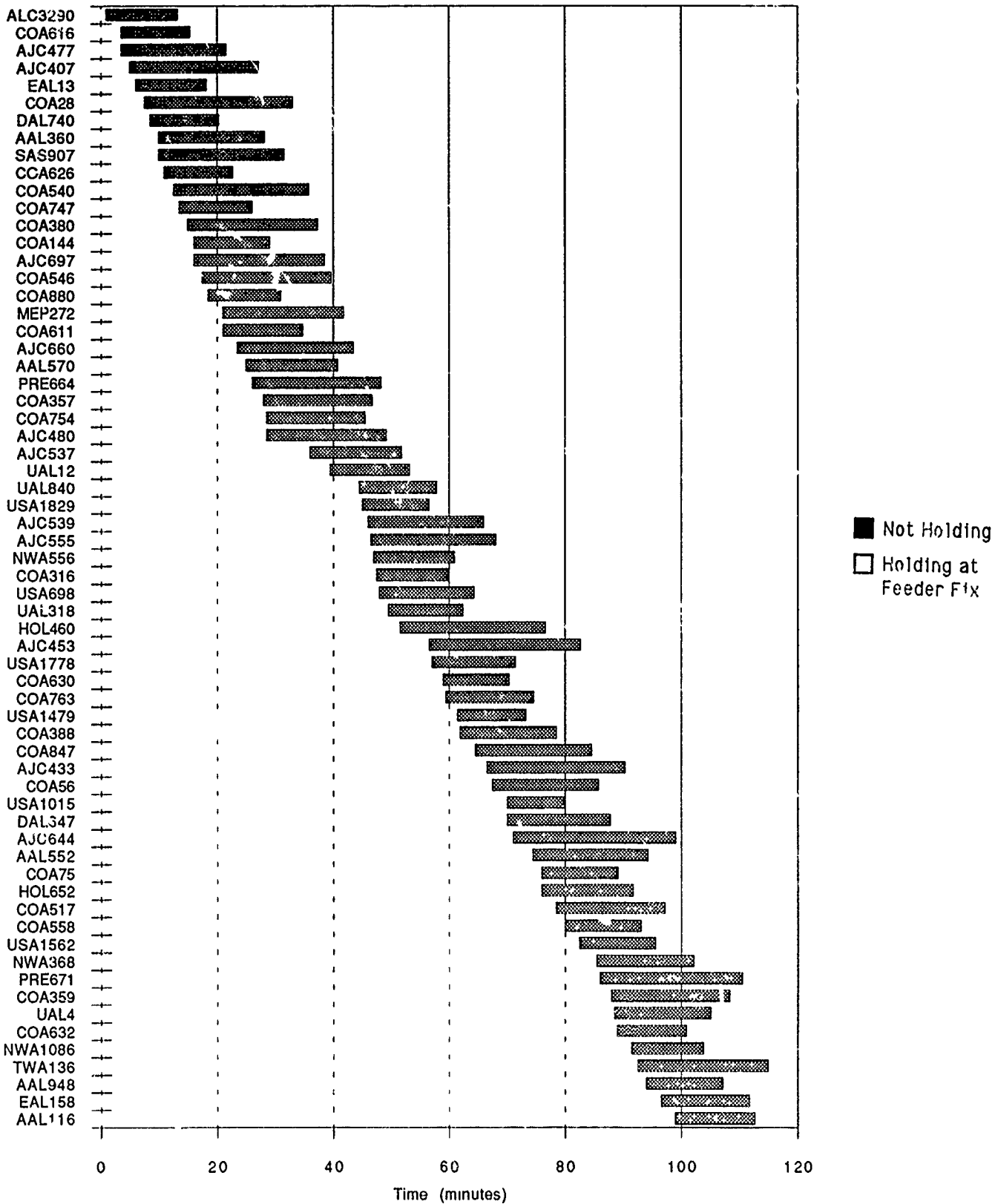

Figure D-23b. Arrival Aircraft Holding and In-flight Time Lines

Simulation Characteristics:

Airport: EWR		Percent MLS, Target: 25.0 Actual: 25.7
Arrival Runway(s): 4R & 11		Departure Runway(s): N/A
No. 24	Date/Run: 5/14/90 # 2	Duration: 113 min.
No. Completed Arrivals: 62		No. Completed Departures: N/A
Comments: MLS commuters on 11		

Summary of Simulation Results:

Feeder Fix	Av. Flight Time (min.)	Av. Flight Dist. (NMI)	Av. Holding Time (min.)	Min. Flight Time (min.)	Min. Flight Dist. (NMI)
LGA	17.14	49.28	0	14.03	41.39
METRO	13.11	43.55	0	12.80	43.17
MUGZY	17.41	58.63	0	14.98	48.90
PENNS	13.52	54.25	0	11.50	50.32
RBV	11.44	42.21	0	9.65	40.75
SHAFF	15.50	64.97	0	13.42	58.13
Wt. Av.	13.47	50.86	0	N/A	N/A
Arrival Rate Per Hour					
37.4					

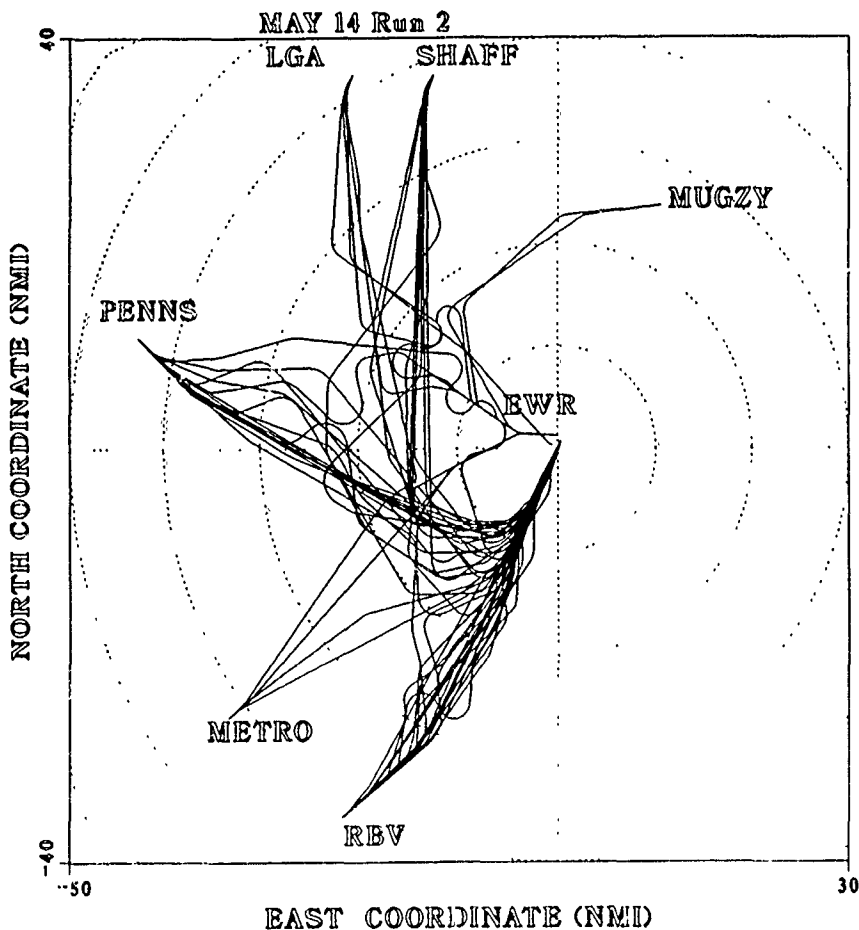

Figure D-24a. Summary Data & Arrival Aircraft Flight Tracks for No.24

EWR ILS 4R/MLS 11 (5/14/90 #2)

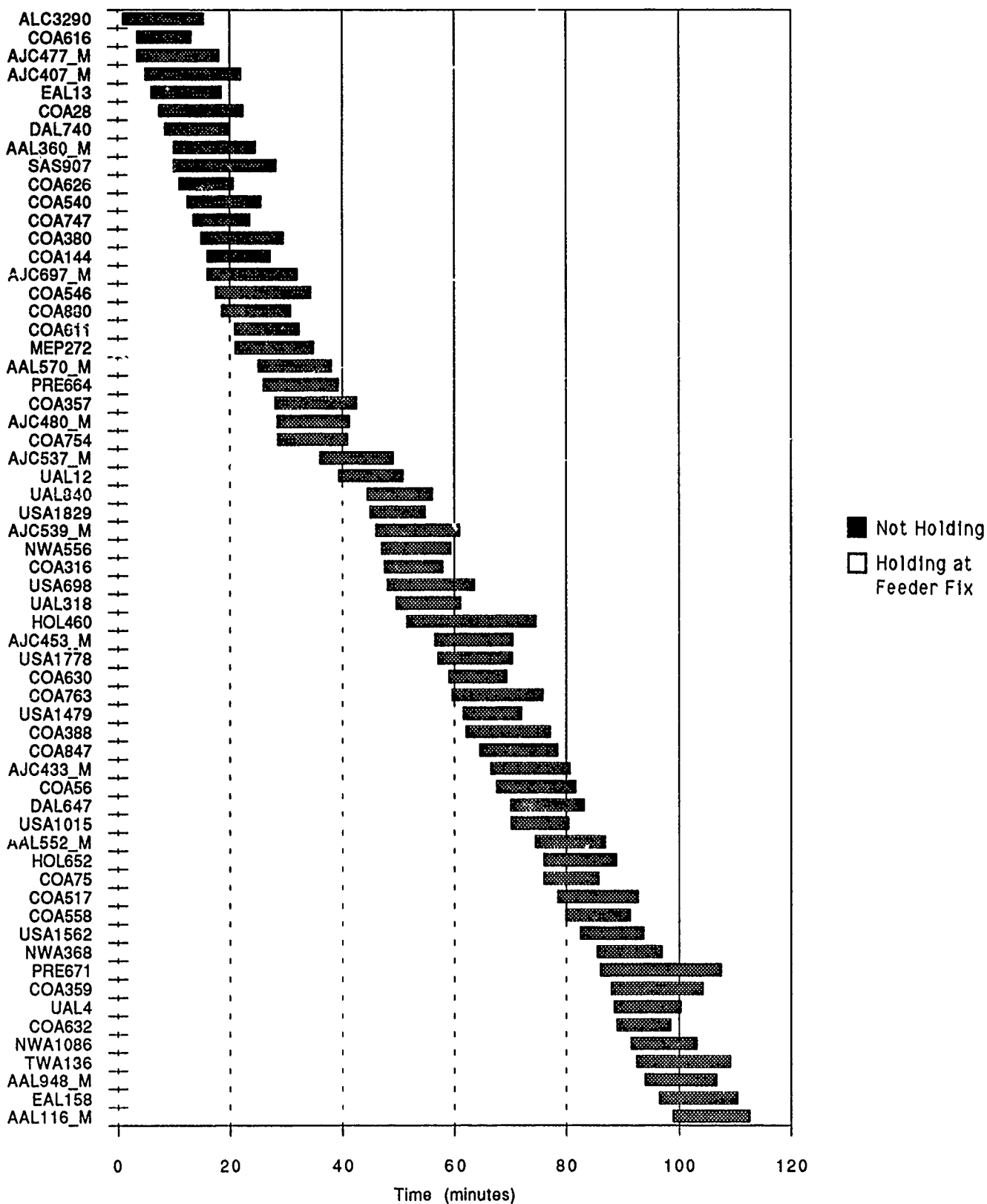

Figure D-24b. Arrival Aircraft Holding and In-flight Time Lines

Simulation Characteristics:

Airport: EWR		Percent MLS, Target: 50.0 Actual: 50.7
Arrival Runway(s): 4R & 11		Departure Runway(s): N/A
No. 25	Date/Run: 5/15/90 # 1	Duration: 105 min.
No. Completed Arrivals: 60		No. Completed Departures: N/A
Comments: MLS commuters on 11		

Summary of Simulation Results:

Feeder Fix	Av. Flight Time (min.)	Av. Flight Dist. (NMI)	Av. Holding Time (min.)	Min. Flight Time (min.)	Min. Flight Dist. (NMI)
LGA	17.45	50.88	0	14.70	42.97
METRO	14.13	44.53	0	13.15	43.39
MUGZY	13.31	45.33	0	12.50	44.74
PENNS	14.82	58.78	0	10.40	45.06
RBV	11.59	41.19	0	9.43	40.58
SHAFF	17.06	67.55	0	15.45	64.18
Wt. Av.	14.06	51.49	0	N/A	N/A
Arrival Rate Per Hour					
39.2					

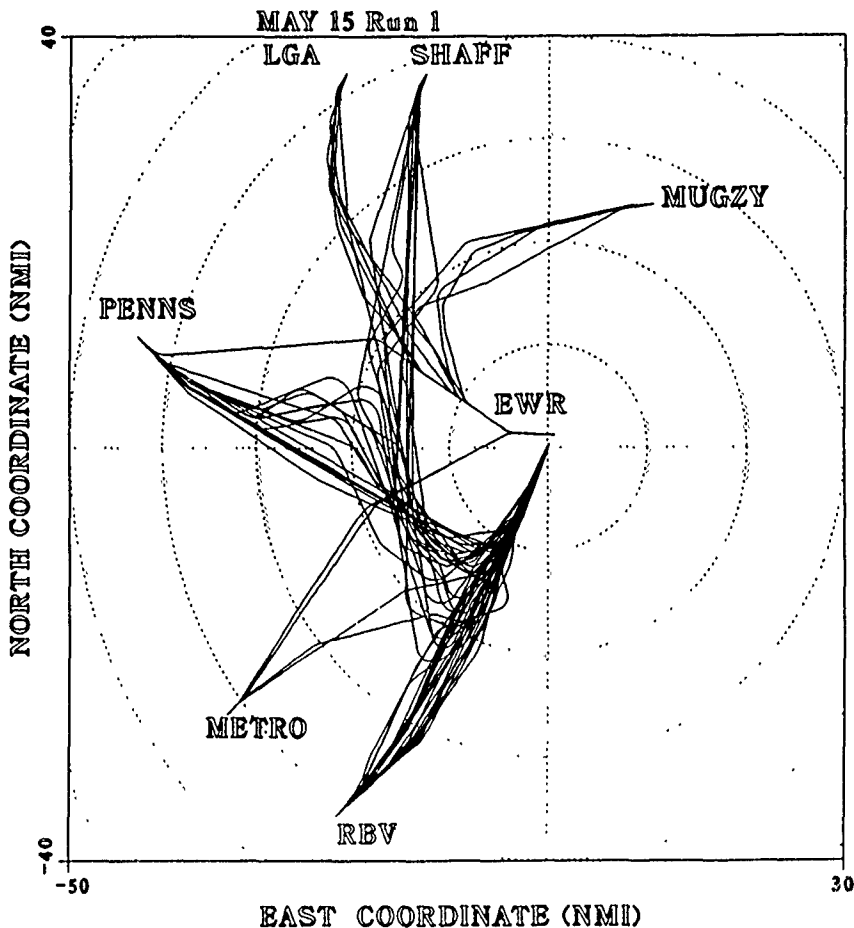

Figure D-25a. Summary Data & Arrival Aircraft Flight Tracks for No.25

EWR ILS 4R/MLS 11 (5/15/90 #1)

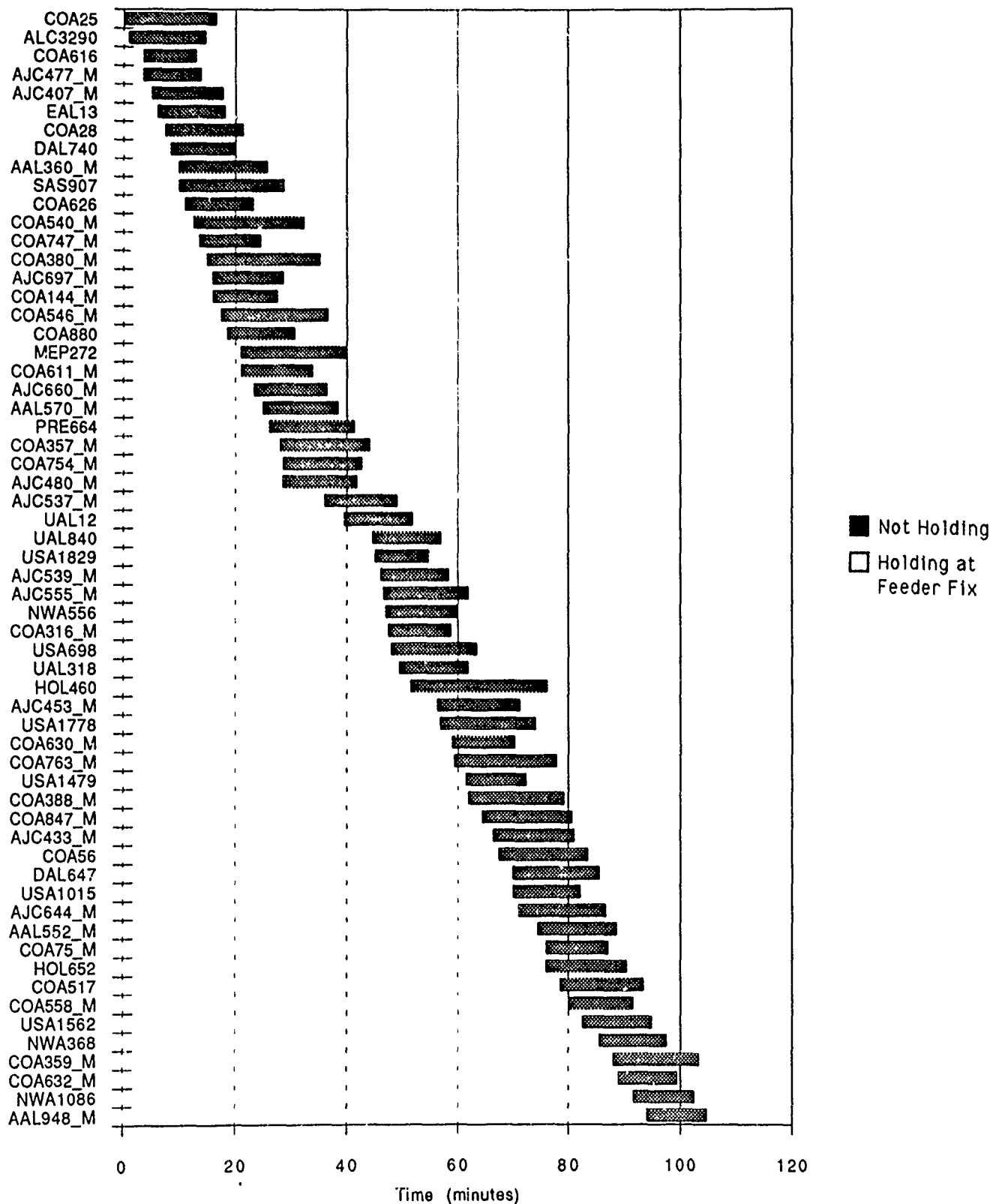

Figure D-25b. Arrival Aircraft Holding and In-flight Time Lines

Simulation Characteristics:

Airport: EWR		Percent MLS, Target: 100.0 Actual: 100.
Arrival Runway(s): 4R & 11		Departure Runway(s): N/A
No. 26	Date/Run: 5/15/90 # 2	Duration: 105 min.
No. Completed Arrivals: 55		No. Completed Departures: N/A
Comments:		

Summary of Simulation Results:

Feeder Fix	Av. Flight Time (min.)	Av. Flight Dist. (NMI)	Av. Holding Time (min.)	Min. Flight Time (min.)	Min. Flight Dist. (NMI)
LGA	13.59	40.17	0	13.23	38.74
METRO	13.04	44.29	0	12.40	43.56
MUGZY	14.10	46.88	0	12.62	45.15
PENNS	13.43	58.60	0	11.77	46.18
RBV	10.17	41.53	0	9.23	40.53
SHAFF	14.60	64.21	0	12.03	46.93
Wt. Av.	12.60	50.49	0	N/A	N/A
Arrival Rate Per Hour					
41.7					

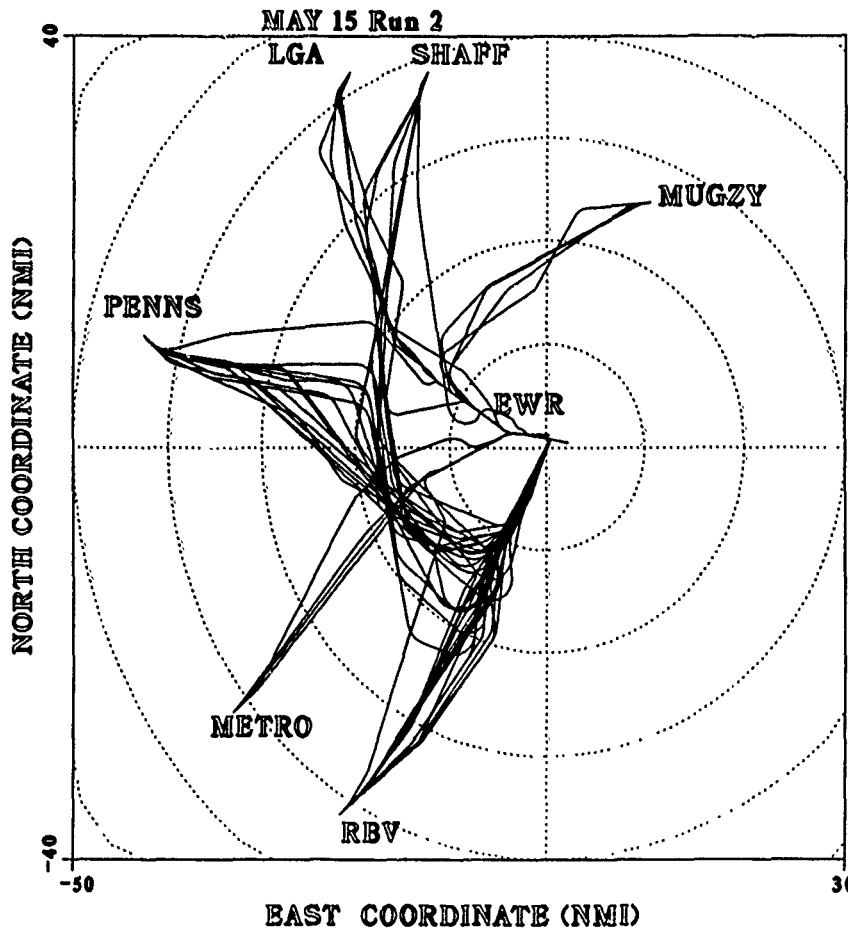

Figure D-26a. Summary Data & Arrival Aircraft Flight Tracks for No.26

EWR MLS 4R/MLS 11 (5/15/90 #2)

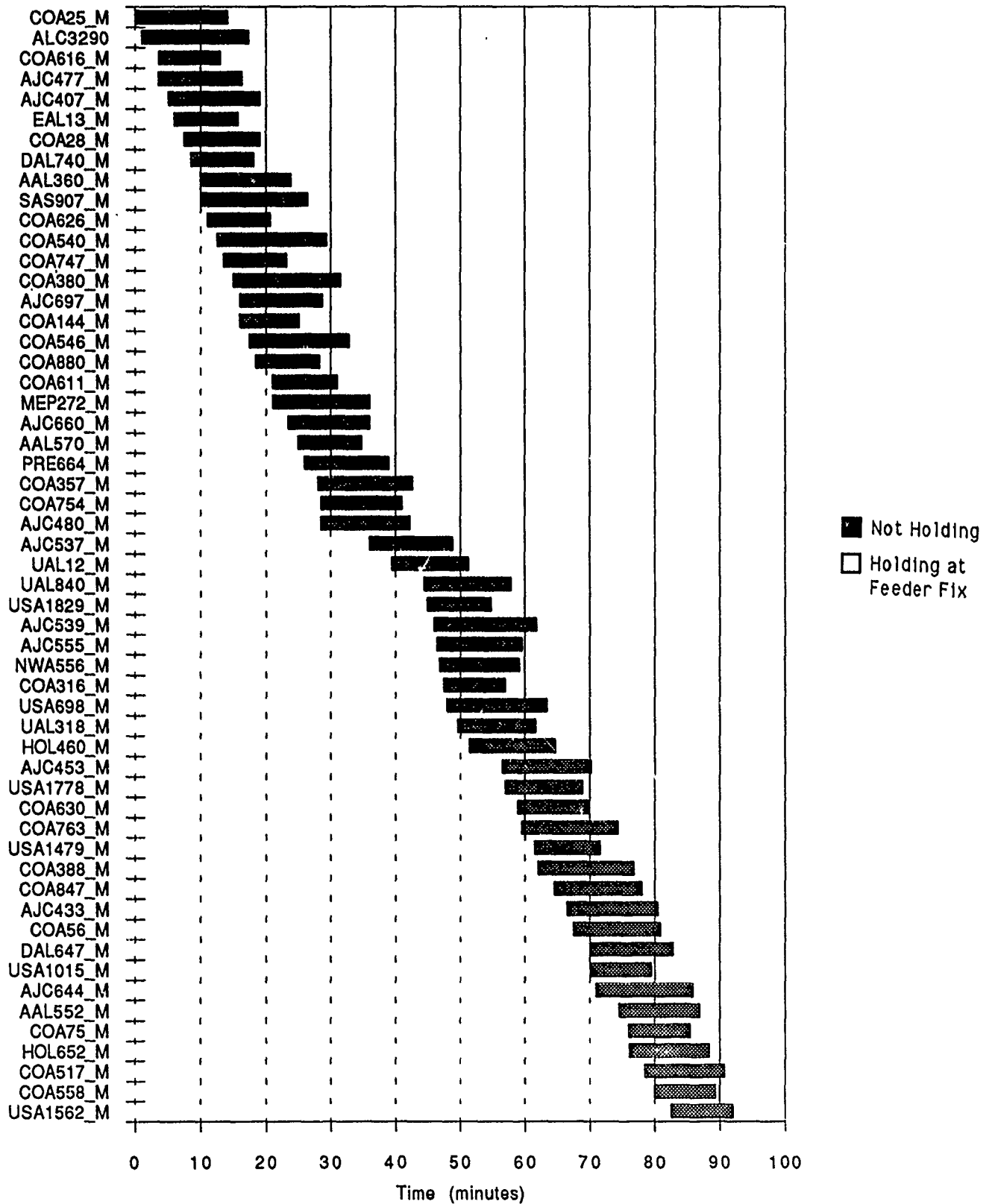

Figure D-26b. Arrival Aircraft Holding and In-flight Time Lines

Simulation Characteristics:

Airport: EWR		Percent MLS, Target: 0	Actual: 0
Arrival Runway(s): 22L		Departure Runway(s): N/A	
No. 27	Date/Run: 5/15/90 # 3	Duration: 107 min.	
No. Completed Arrivals: 58		No. Completed Departures: N/A	
Comments:			

Summary of Simulation Results:

Feeder Fix	Av. Flight Time (min.)	Av. Flight Dist. (NMI)	Av. Holding Time (min.)	Min. Flight Time (min.)	Min. Flight Dist. (NMI)
LGA	12.05	33.07	0	10.15	27.99
METRO	22.30	79.84	0	20.88	74.52
MUGZY	16.75	53.51	0	14.10	48.53
PENNS	17.59	69.46	0	13.13	57.55
RBV	21.36	86.59	0	16.52	74.83
SHAFF	13.18	47.57	0	10.25	42.16
Wt. Av.	17.86	67.56	0	N/A	N/A
Arrival Rate Per Hour					
36.9					

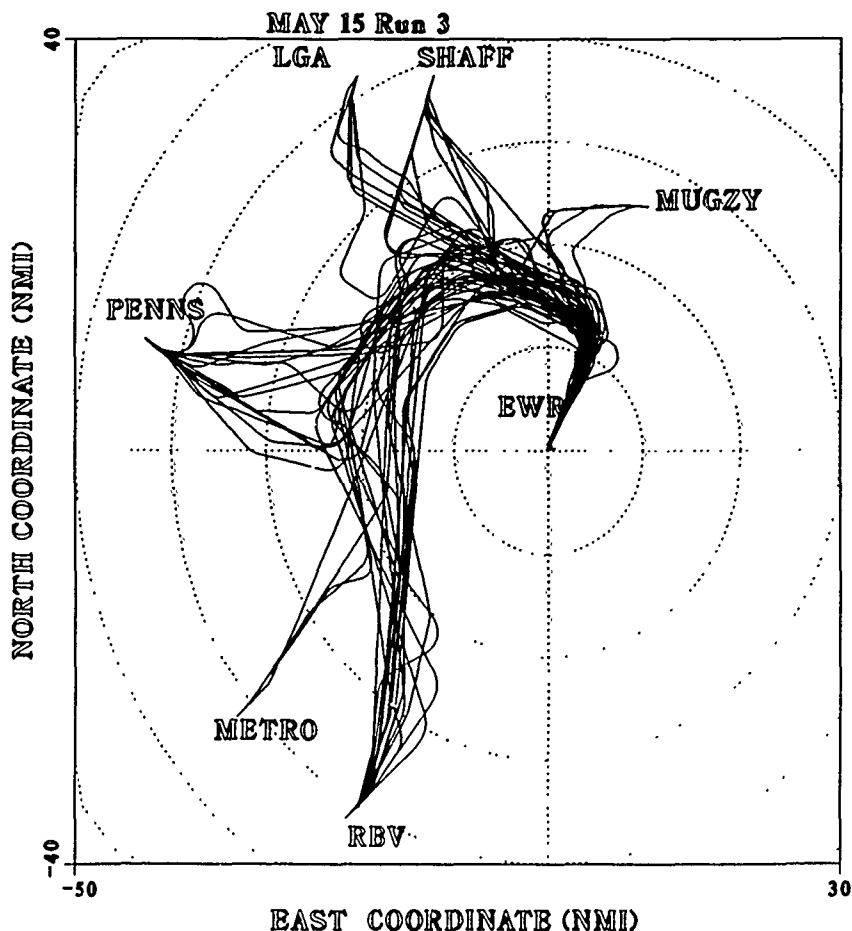

Figure D-27a. Summary Data & Arrival Aircraft Flight Tracks for No.27

EWR ILS 22L (5/15/90 #3)

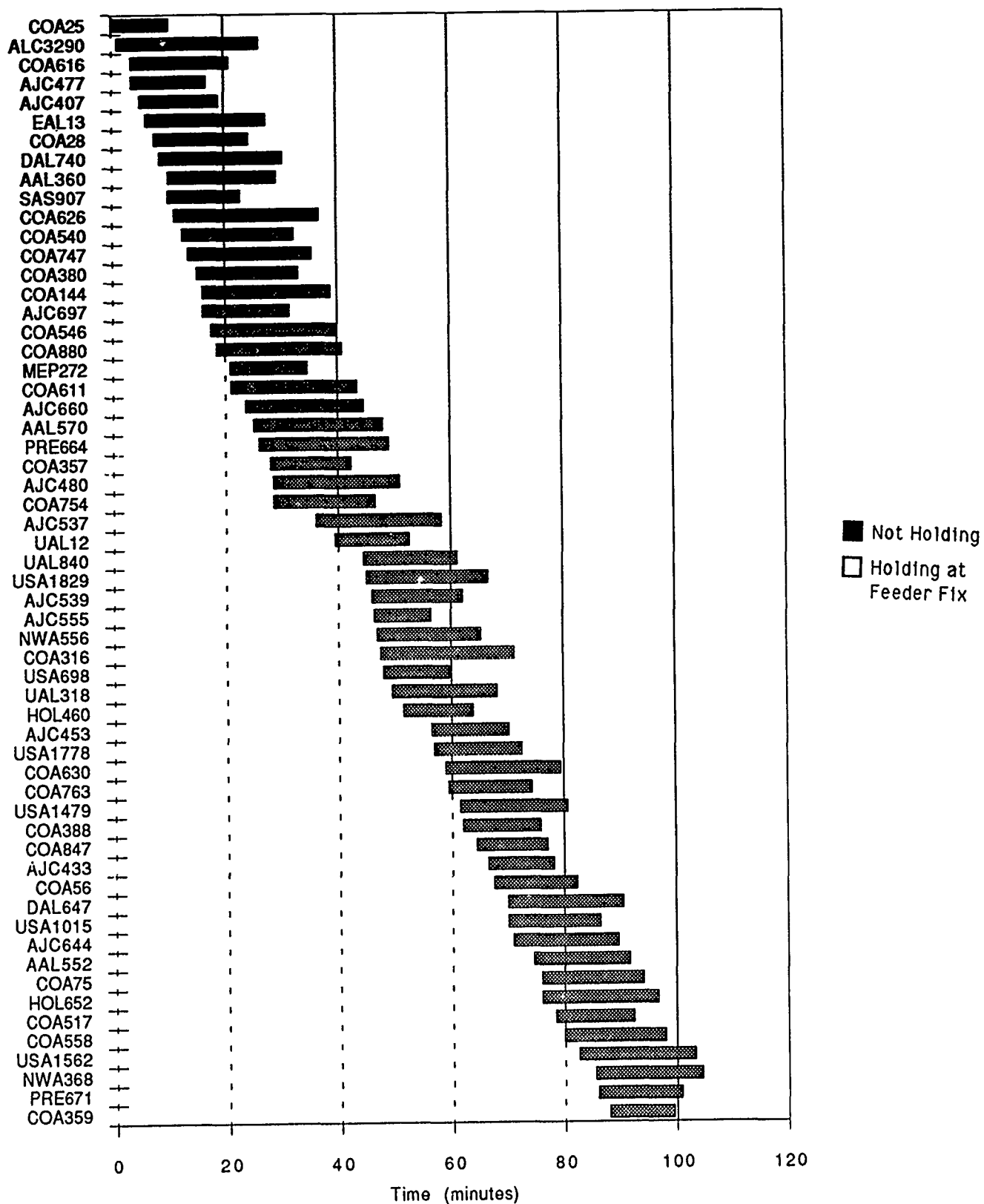

Figure D-27b. Arrival Aircraft Holding and In-flight Time Lines

Simulation Characteristics:

Airport: EWR		Percent MLS, Target: 25.0 Actual: 24.2
Arrival Runway(s): 22L & 11		Departure Runway(s): N/A
No. 28	Date/Run: 5/16/90 # 1	Duration: 103 min.
No. Completed Arrivals: 58		No. Completed Departures: N/A
Comments: MLS overflow to 11.		

Summary of Simulation Results:

Feeder Fix	Av. Flight Time (min.)	Av. Flight Dist. (NMI)	Av. Holding Time (min.)	Min. Flight Time (min.)	Min. Flight Dist. (NMI)
LGA	15.37	38.86	0	13.80	34.03
METRO	17.67	63.15	0	13.75	48.91
MUGZY	15.92	50.96	0	12.90	44.19
PENNS	16.75	65.89	0	11.65	45.09
RBV	21.33	85.73	0	16.02	74.67
SHAFF	12.39	46.25	0	9.68	40.33
Wt. Av.	17.30	65.06	0	N/A	N/A
Arrival Rate Per Hour					
37.6					

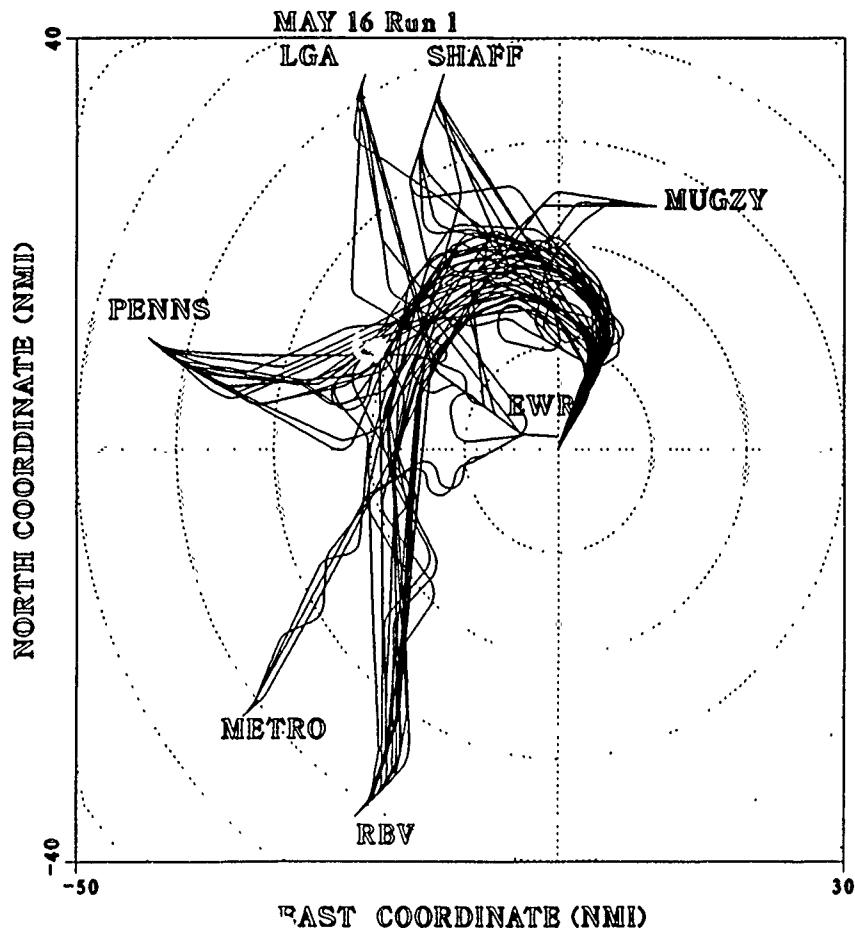

Figure D-28a. Summary Data & Arrival Aircraft Flight Tracks for No. 28

EWR ILS 22L/MLS 11 (5/16/90 #1)

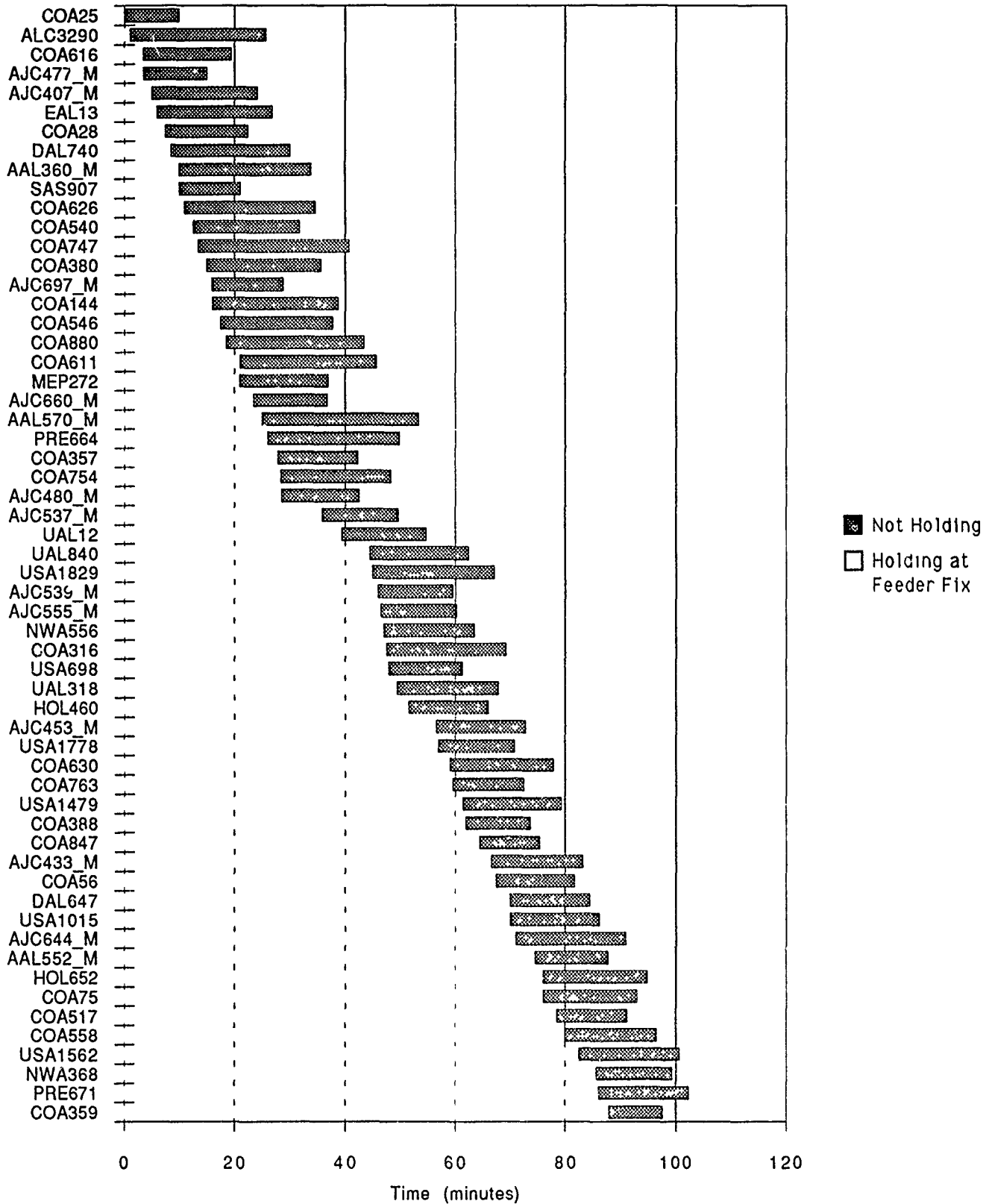

Figure D-28b. Arrival Aircraft Holding and In-flight Time Lines

Simulation Characteristics:

Airport: EWR		Percent MLS, Target: 50.0 Actual: 49.3
Arrival Runway(s): 22L & 11		Departure Runway(s): N/A
No. 29	Date/Run: 5/16/90 # 2	Duration: 106 min.
No. Completed Arrivals: 57		No. Completed Departures: N/A
Comments: MLS on 11 & ILS on 22L		

Summary of Simulation Results:

Feeder Fix	Av. Flight Time (min.)	Av. Flight Dist. (NMI)	Av. Holding Time (min.)	Min. Flight Time (min.)	Min. Flight Dist. (NMI)
LGA	12.77	32.58	0	11.60	29.78
METRO	17.17	59.17	0	12.05	44.60
MUGZY	14.67	46.19	0	13.02	42.87
PENNS	15.98	63.53	0	11.10	43.95
RBV	20.45	85.36	0	15.43	73.71
SHAFF	12.62	45.23	0	10.23	41.59
Wt. Av.	16.58	63.45	0	N/A	N/A
Arrival Rate Per Hour					
36.2					

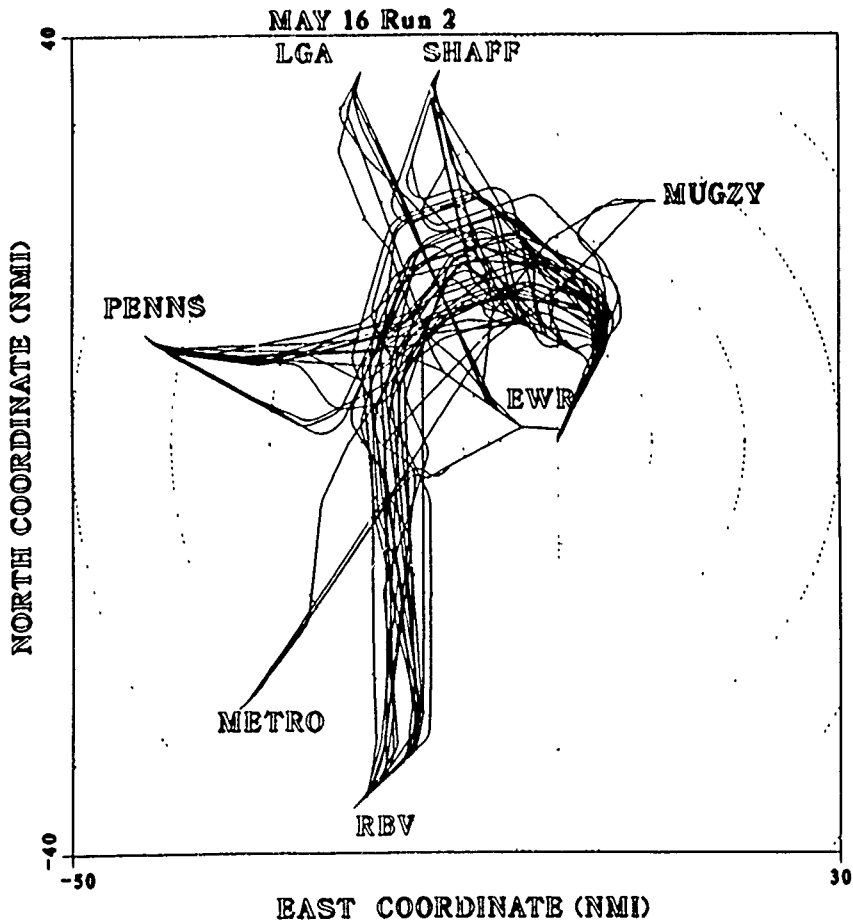

Figure D-29a. Summary Data & Arrival Aircraft Flight Tracks for No.29

EWR ILS 22L/MLS 11 (5/16/90 #2)

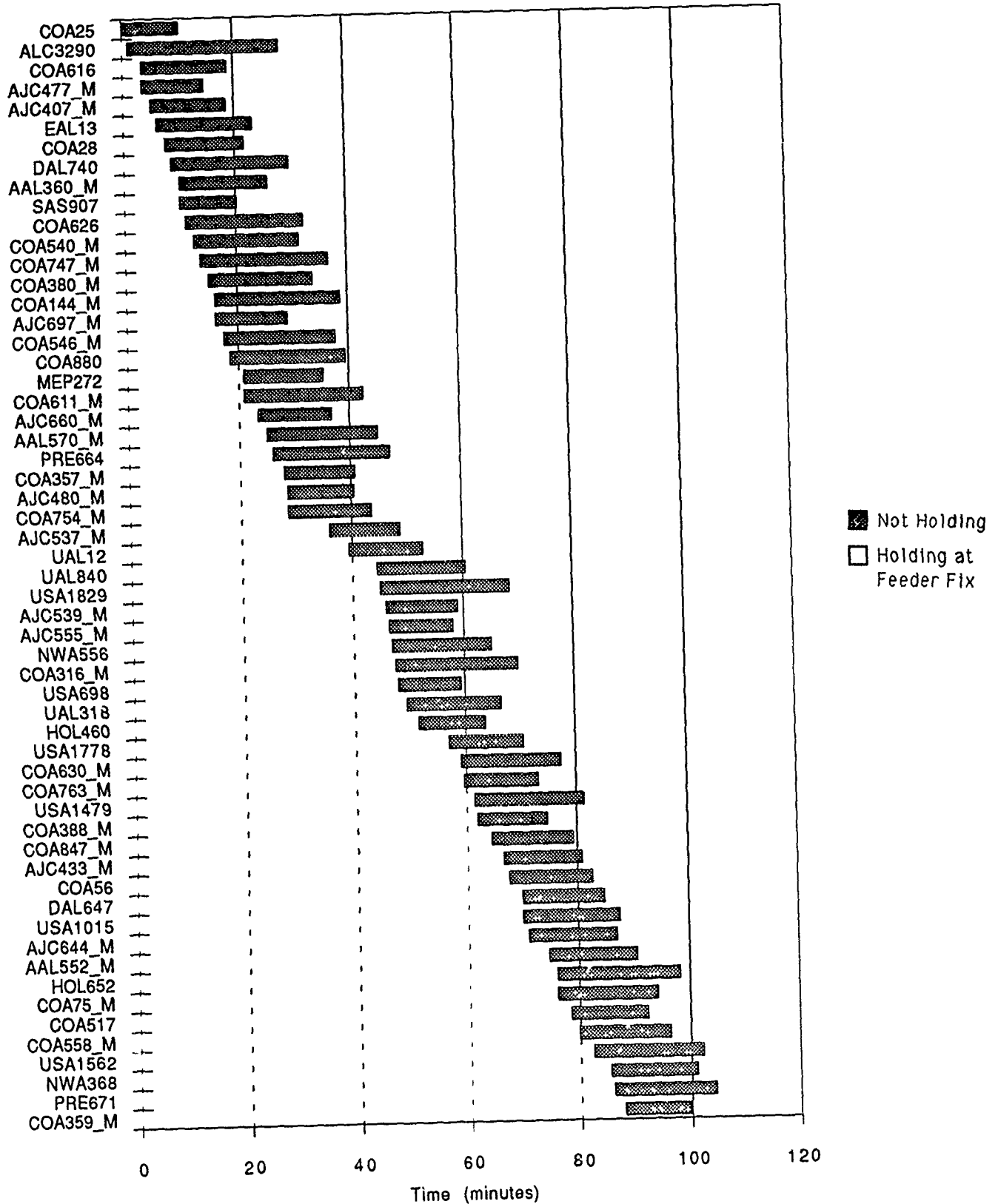

Figure D-29b. Arrival Aircraft Holding and In-flight Time Lines
D - 59

Simulation Characteristics:

Airport: EWR		Percent MLS, Target: 100 Actual: 100
Arrival Runway(s): 22L & 11		Departure Runway(s): N/A
No. 30	Date/Run: 5/17/90 # 1	Duration: 104 min.
No. Completed Arrivals: 60		No. Completed Departures: N/A
Comments:		

Summary of Simulation Results:

Feeder Fix	Av. Flight Time (min.)	Av. Flight Dist. (NMI)	Av. Holding Time (min.)	Min. Flight Time (min.)	Min. Flight Dist. (NMI)
LGA	15.03	40.11	0	12.28	33.13
METRO	13.43	44.30	0	12.85	43.97
MUGZY	14.66	44.66	0	13.43	43.91
PENNS	15.32	57.01	0	11.85	46.05
RBV	19.57	77.31	0	13.15	49.65
SHAFF	12.25	42.48	0	10.80	40.78
Wt. Av.	15.94	57.81	0	N/A	N/A
Arrival Rate Per Hour					
38.9					

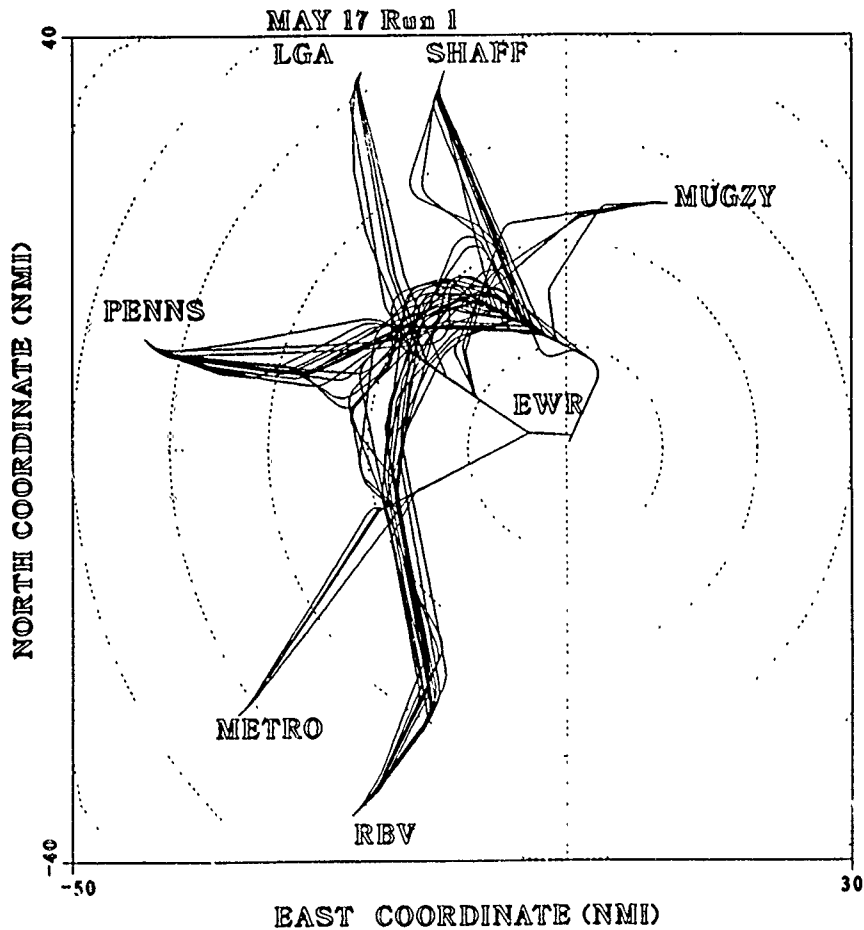

Figure D-30a. Summary Data & Arrival Aircraft Flight Tracks for No.30
D - 60

EWR MLS 22L/MLS 11 (5/17/90 #1)

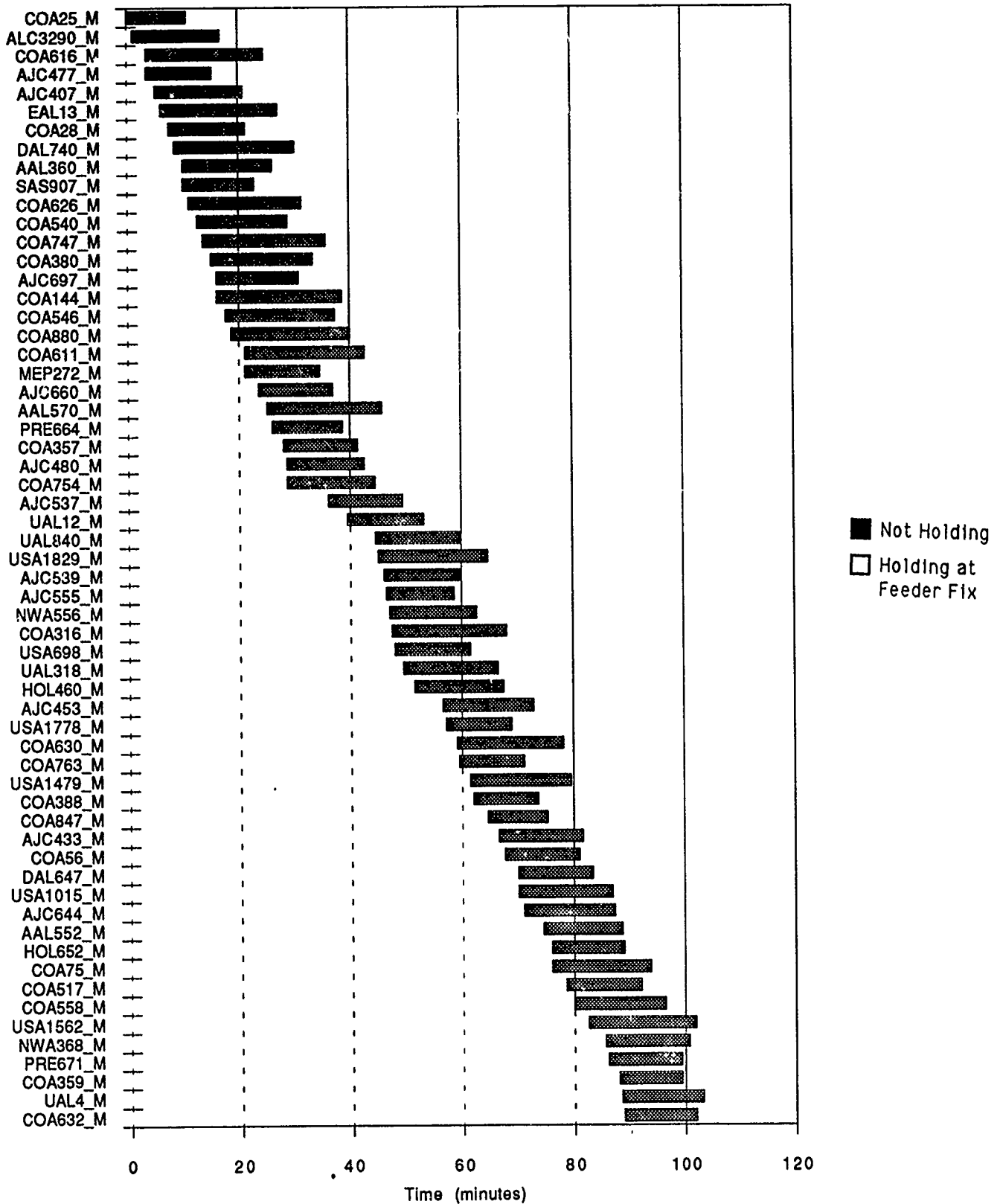

Figure D-30b. Arrival Aircraft Holding and In-flight Time Lines

Simulation Characteristics:

Airport: EWR		Percent MLS, Target: 100 Actual: 100
Arrival Runway(s): 22L & 11		Departure Runway(s): N/A
No. 31	Date/Run: 5/17/90 # 2	Duration: 80 min.
No. Completed Arrivals: 52		No. Completed Departures: N/A
Comments: Commuters on 11, heavy volume.		

Summary of Simulation Results:

Feeder Fix	Av. Flight Time (min.)	Av. Flight Dist. (NMI)	Av. Holding Time (min.)	Min. Flight Time (min.)	Min. Flight Dist. (NMI)
LGA	16.38	42.36	0	15.20	39.33
METRO	13.78	45.79	0	13.02	43.98
MUGZY	15.21	45.27	0	14.08	43.96
PENNS	17.54	61.49	0	11.35	44.22
RBV	22.27	84.45	0	15.87	53.01
SHAFF	13.70	44.88	0	10.85	40.68
Wt. Av.	17.35	60.16	0	N/A	N/A
Arrival Rate Per Hour					
45					

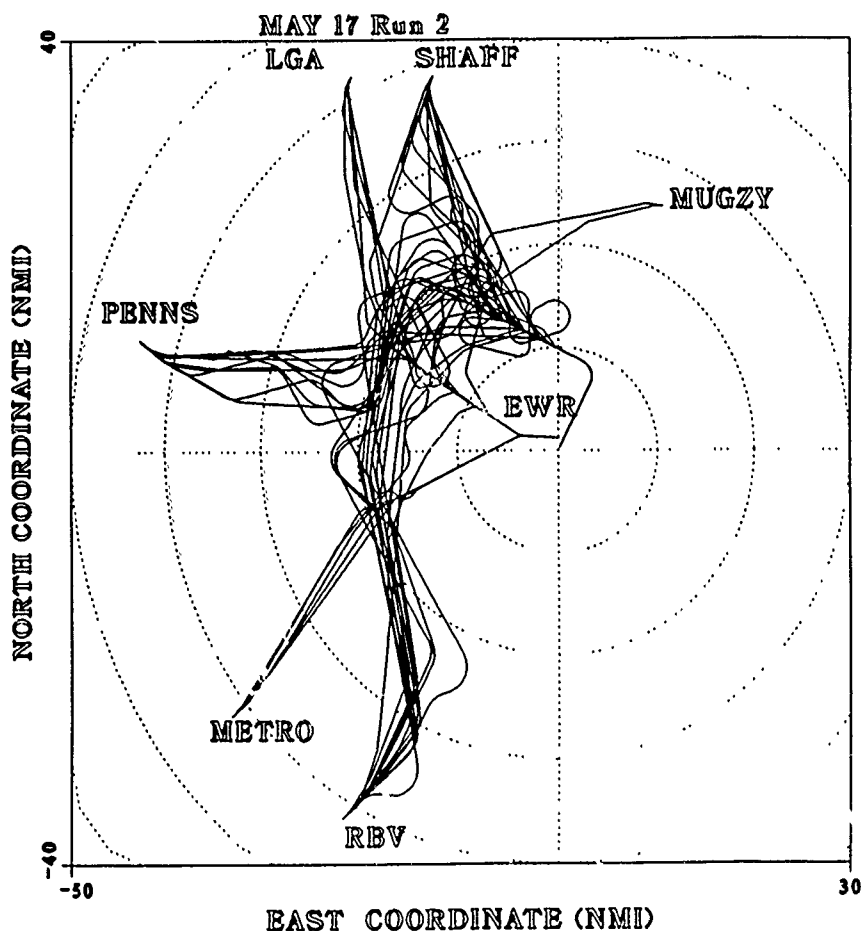

Figure D-31a. Summary Data & Arrival Aircraft Flight Tracks for No. 31

EWR MLS 22L/MLS 11 (heavy vol.) (5/17/90 #2)

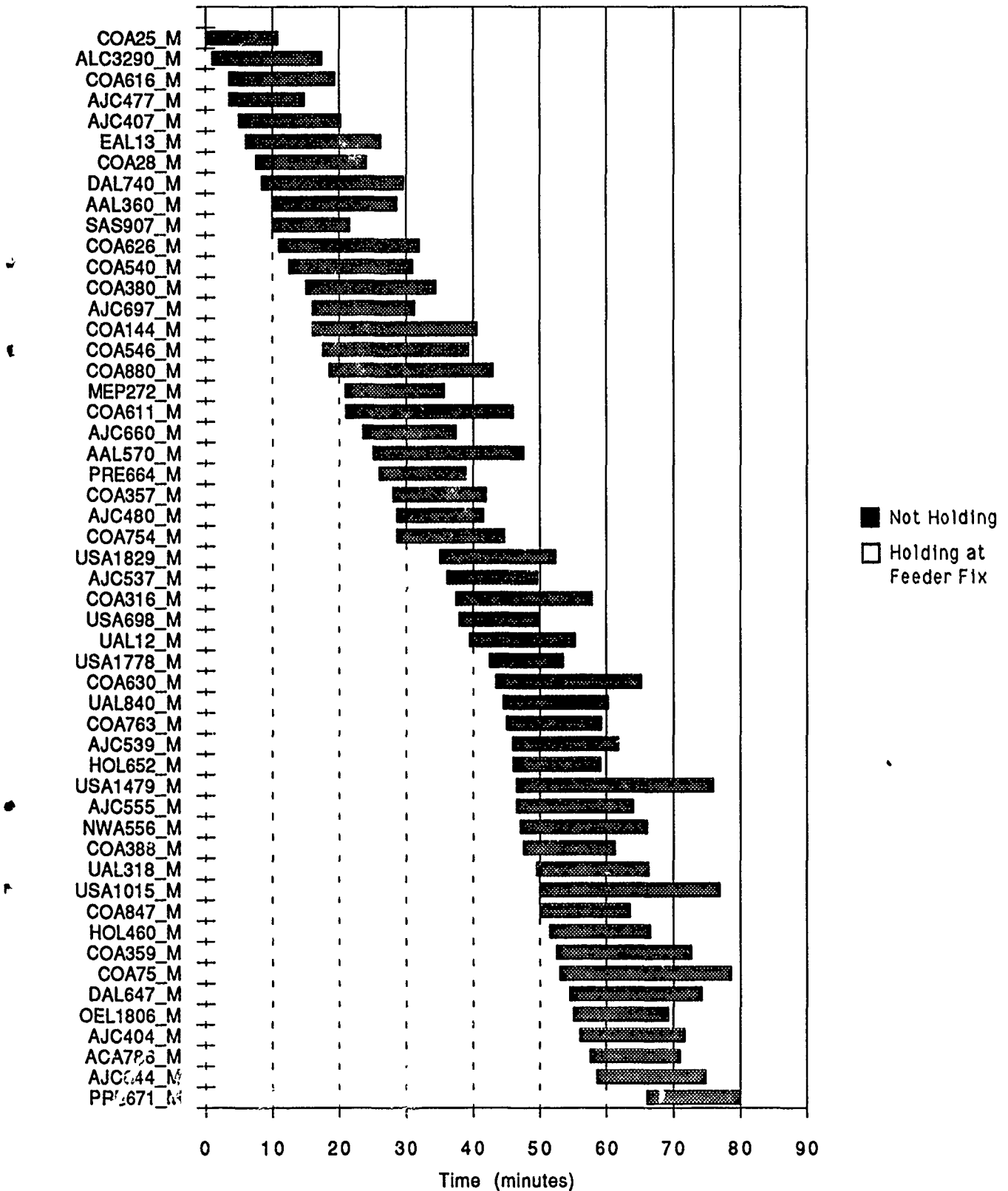

Figure D-31b. Arrival Aircraft Holding and In-flight Time Lines