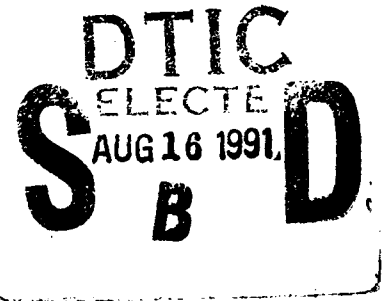




RANGE REFERENCE ATMOSPHERE  
THULE, GREENLAND

AUGUST 1991



METEOROLOGY GROUP  
**RANGE COMMANDERS COUNCIL**

- WHITE SANDS MISSILE RANGE
- KWAJALEIN MISSILE RANGE
- YUMA PROVING GROUND
- ELECTRONIC PROVING GROUND
- DUGWAY PROVING GROUND
  
- PACIFIC MISSILE TEST CENTER
- NAVAL WEAPONS CENTER
- ATLANTIC FLEET WEAPONS TRAINING FACILITY
- NAVAL AIR TEST CENTER
- NAVAL UNDERWATER SYSTEMS CENTER
  
- EASTERN SPACE AND MISSILE CENTER
- AIR FORCE DEVELOPMENT TEST CENTER
- WESTERN SPACE AND MISSILE CENTER
- CONSOLIDATED SPACE TEST CENTER
- AIR FORCE FLIGHT TEST CENTER
- AIR FORCE TACTICAL FIGHTER WEAPONS CENTER

91-07940

DISTRIBUTION STATEMENT A: APPROVED FOR PUBLIC RELEASE;  
DISTRIBUTION UNLIMITED

REPORT DOCUMENTATION PAGE

PUBLIC REPORT DOCUMENTATION SYSTEM  
REPORT DOCUMENTATION STATEMENT  
THIS REPORT IS AVAILABLE FROM  
NATIONAL AERONAUTICS AND SPACE ADMINISTRATION  
WASHINGTON, D.C. 20546-0001  
GPO : 1987 O-884-104

1. AGENCY USE ONLY (Leave blank) 2. REPORT DATE August 1991 3. REPORT TYPE AND PERIODICITY

4. TITLE AND SUBTITLE  
Range Reference Atmosphere - Thule, Greenland

6. AUTHOR(S)

7. PERFORMING ORGANIZATION NAME(S) AND ADDRESS(ES)  
Meteorology Group  
Range Commanders Council  
White Sands Missile Range, NM 88002  
RCC Document 379-91

9. SPONSORING MONITORING AGENCY NAME(S) AND ADDRESS(ES)  
Range Commanders Council  
STEWS-SA-R  
White Sands Missile Range, NM 88002  
same as block 8

11. SUPPLEMENTARY NOTES  
New document

12. DISTRIBUTION AVAILABILITY STATEMENT  
APPROVED FOR PUBLIC RELEASE: DISTRIBUTION UNLIMITED

A "reference atmosphere" is a statistical model of the earth's atmosphere, derived from upper-air observations over a specific location. The individual RRA is the authoritative source for upper-atmosphere climatology over the launch and recovery site for which it has been prepared. The RRA's are used to plan, evaluate, and establish environmental launch constraints for aerospace vehicles launched from a particular location.

range reference atmosphere, RRA, upper-atmosphere climatology 191

**DOCUMENT 379-91**

**RANGE REFERENCE ATMOSPHERE  
THULE, GREENLAND**

**AUGUST 1991**

**Prepared by**

**Range Reference Atmosphere Committee  
Meteorology Group  
Range Commanders Council**

**Published by**

**Secretariat  
Range Commanders Council  
White Sands Missile Range  
New Mexico 88002**

## PREFACE

The state of the atmosphere over national ranges and aerospace vehicle launch and recovery sites is critical not only to launch and recovery operations but to aerospace research and development as well. In the early 1960s, missile range operators recognized the need for a realistic atmospheric model that was consistently derived for each of the several major missile test ranges then in operation. Such a model, derived from climatological statistics for a given location, was developed and named a "range reference atmosphere." Even though the application has since broadened to include all aerospace launch and recovery sites, the model is still referred to as a "range reference atmosphere" or "RRA."

The first RRA (for Cape Canaveral) was prepared in 1963 by the Inter-Range Instrumentation Group (IRIG). More RRAs were produced for other ranges through 1974. Since then, improved upper-air data bases have become available not only because of an extended period of record but because of more and better rocketsonde data above 30 km. Although some improved RRAs were published in 1983 and 1984, revisions must continue, because

- aerospace technology requirements continue to change--the space shuttle program is an example;
- extended and improved upper-air data bases for most existing ranges permit development of better, more comprehensive RRAs;
- new launch and recovery sites have been opened;
- there have been significant advances in understanding the structure and physics of the upper atmosphere; and
- there have been similar advances in statistical modeling techniques, largely because of ever-larger, faster, and more sophisticated computers.

For these reasons, the Range Reference Atmosphere Committee (RRAC) was tasked by the Range Commanders Council/Meteorology Group (RCC/MG) to produce new and revised RRAs as required. The RRAC, through task MG-1, publishes RRAs for ranges specified by the RCC. An RRA as has already been mentioned, is a model of the atmosphere over a specified geographical area that delineates an aerospace vehicle launch and recovery site. The RRAs are for use by DOD and other U.S. Government users in planning, evaluating, and establishing environmental launch/recovery constraints for a specific facility and the aerospace vehicles launched and recovered there.

The RRA tasking requires using the best available upper-atmosphere data bases (rawinsonde, rocketsonde, and any other high-altitude data source) to create and publish (in standard format) a consistently derived model of wind and thermodynamic values through a cross-section of the upper atmosphere from surface to a specified height. The individual RRA serves as the authoritative source for upper-atmosphere climatology at a given launch/recovery site.

Wind statistics, insofar as practical, are modeled to be consistent with the rigorous mathematical probability properties of the multivariate normal probability theory. Thermodynamic statistics, insofar as practical, are modeled to be consistent with the hydrostatic equation, the equation of state, and related probability principles.

In keeping with the RCC's objective of standardization modeling technique, basic text and tabulation formats are the same for all RRAs. The new RRAs published in 1991 have undergone minor format changes designed to make them conform to DOD and ANSI technical publications standards. All RRAs provide mean values of thermodynamic quantities (pressure, temperature, and density) and moisture quantities (vapor pressure, virtual temperature, and dew point temperature). These values include a statistical measure for dispersion, that is, standard deviations and skewness coefficients. The properties of the bivariate normal probability distribution function are used for statistical modeling of wind.

The first RRA to be published in this new series is for Wake Island with an altitude range from 0 to 30 km. The order of priority for subsequent publications in the RRA series is

<u>Range</u>	<u>Altitude Range Required</u>
1. Nellis Range Complex, NV	0 - 30 km
2. Shemya, AK	0 - 70 km
3. Thule, GR	0 - 70 km
4. Fairbanks, AK	0 - 30 km

All final computations in this RRA series were performed by the USAF Environmental Technical Applications Center (USAFETAC) in response to taskings from the Ballistic Missile Office (BMO), HQ Air Weather Service (AWS/SYJ), and Detachment 2, Space Division.

Majors Cheryl Souders and Walter Miller, and Captains Doug Adamson and Brian Bjornson (all of USAFETAC/DNO), rewrote the software used to provide the primary tables, updated Chapters 1 through 4, and prepared the appendixes. The USAFETAC/LDE formatted and edited the text and graphics, prepared the camera-ready copy in standard DOD technical report format, and published the document as a USAFETAC project report.

The RCC/MG Range Reference Atmosphere Committee is made up of representatives from the Air Force, Army, NASA, Navy, and NOAA. The RRA committee members were

Mr. J. Lee (KMR)  
 Mr. D. Godwin (KMR)  
 Ms. J. Bailey (YPG)  
 Mr. T. O. McIntire (YPG)  
 Mr. S. W. Bieda, Jr. (EPG)  
 Mr. G. Boire (WSMC)  
 Mr. H. C. Herring (ESMC)  
 Col J. T. Madura, USAF (ESMC)  
 Maj A. F. Dye, USAF (ESMC)  
 Mr. B. F. Boyd (ESMC)  
 Mr. C. W. Fain (ESMC)  
 Maj R. Hughes, USAF (AFFTC)  
 Lt B. Hickel, USAF (AFFTC/UTTR)  
 CPO G. A. Dillie, USN (NWC)

Mr. D. R. Thornley (WSMR)  
 Mr. E. J. Keppel (AFDTC)  
 Capt R. M. Fogarty, USAF (6585th TG)  
 Lt Col T. F. Tascione, USAF (AFDTC)  
 Mr. J. Kerwin (AFDTC)  
 Lt Col R. J. Ericson, USAF (CSTC)  
 Capt W. Gibbons, USAF (TFWC)  
 Mr. L. S. Corbett (NWC)  
 Mr. J. J. Genola (NWC)  
 Mr. D. Tolzin (PMTC)  
 Lt R. Kren, USN (NATC)  
 Mr. J. Trischman (NATC)  
 Lt Col J. E. Erickson, (USAFETAC)  
 Mr. R. Olsen (WSMR), Chairman



<b>Accession For</b>	
NTIS GRA&I	<input checked="" type="checkbox"/>
DTIC TAB	<input type="checkbox"/>
Unannounced	<input type="checkbox"/>
Justification	
By _____	
Distribution/	
Availability Codes	
Dist	Avail and/or Special
A-1	

## TABLE OF CONTENTS

		<u>PAGE</u>
<b>Chapter 1 INTRODUCTION TO THE RANGE REFERENCE ATMOSPHERE (RRA)</b>		
1.1	The RRA Defined.....	1
1.2	Purpose of the RRA.....	1
1.3	Contents of the RRA.....	1
1.4	Units of Measurement Used in RRAs.....	1
1.5	RRA Quality Control.....	2
1.6	How the RRA is Organized.....	2
1.7	Conversion Units.....	3
<b>Chapter 2 WIND STATISTICS AND MODELS</b>		
2.1	General Discussion.....	7
2.2	Quality Control.....	9
2.3	Data Limitations.....	9
2.4	The Coordinate System of Statistical Parameters.....	9
2.5	Computing Statistical Parameters.....	11
2.6	Statistical Wind Models.....	11
2.6.1	Wind Component Statistics.....	11
2.6.2	The Vector Wind Model.....	12
2.6.3	Derived Distributions for Wind Statistics.....	15
2.6.3.1	The Conditional Distribution of Wind Components.....	16
2.6.3.2	Generalized Rayleigh Distribution for Wind Speed.....	17
2.6.3.3	The Derived Distribution of Wind Direction.....	18
2.6.3.4	Derived Conditional Distribution of Wind Speed Given Wind Direction.....	20
2.7	Statistical Parameters for Non-Standard Orthogonal Axes.....	22
<b>Chapter 3 THERMODYNAMICS STATISTICS AND MODELS</b>		
3.1	General Discussion.....	23
3.2	Quality Control.....	25
3.3	Data Limitations.....	25
3.4	Establishing Data Samples at Required Levels.....	25
3.4.1	Converting Geopotential Height to Geometric Altitude.....	26
3.4.2	Calculations from Rawinsonde Observations.....	26
3.4.2.1	Geopotential Height at Significant Levels.....	26
3.4.2.2	Temperature.....	27
3.4.2.3	Pressure.....	27
3.4.2.4	Dew Point Temperature.....	27
3.4.2.5	Vapor Pressure.....	28
3.4.2.6	Density.....	28
3.4.2.7	Virtual Temperature.....	28
3.4.3	Calculations from Rocketsonde Observations.....	28
3.4.3.1	Temperature.....	28
3.4.3.2	Pressure.....	28
3.4.3.3	Density.....	29

**TABLE OF CONTENTS (CONT'D)**

	<u>PAGE</u>	
3.5	Computing Statistics for Appendixes B and C.....	29
3.5.1	Stored Statistical Sums.....	29
3.5.2	Calculating Monthly Statistics.....	29
3.5.2.1	Monthly Means.....	29
3.5.2.2	Monthly Standard Deviations.....	29
3.5.2.3	Monthly Skewness Values.....	29
3.5.3	Calculating Annual Statistics.....	30
3.5.3.1	Annual Means.....	30
3.5.3.2	Annual Standard Deviations and Skewness Values.....	30
3.6	Monthly and Annual Mean Model Atmospheres.....	30
3.7	Thermodynamic Quantities Derivable from Tables.....	31
3.7.1	Mean Air Particle Speed.....	31
3.7.2	Mean Free Path.....	31
3.7.3	Mean Collision Frequency.....	32
3.7.4	Speed of Sound.....	32
3.7.5	Coefficient of Dynamic Viscosity.....	33
3.7.6	Kinematic Coefficient of Viscosity.....	33
3.7.7	Coefficient of Thermal Conductivity.....	33
3.7.8	Refractive Modulus and Refractive Index.....	33
 <b>Chapter 4 CONCLUSIONS AND RECOMMENDATIONS</b>		
4.1	Conclusions.....	35
4.2	Recommendations.....	35
 <b>BIBLIOGRAPHY.....</b>		
		37
 <b>ACRONYMS, INITIALISMS, AND ABBREVIATIONS.....</b>		
		39
 <b>PREVIOUSLY PUBLISHED RANGE REFERENCE ATMOSPHERES.....</b>		
		41
 <b>APPENDIX A - Wind Statistics Tables.....</b>		
		A-1
 <b>APPENDIX B - Thermodynamic Statistics Tables.....</b>		
		B-1
 <b>APPENDIX C - Moisture-Related Statistics Tables.....</b>		
		C-1
 <b>APPENDIX D - Hydrostatic Model Atmospheres.....</b>		
		D-1
 <b>APPENDIX E - Wind Statistics Derivable from Appendix A Tables..</b>		
		E-1
 <b>APPENDIX F - Thermodynamic Statistics Derivable from Appendix</b>		
	<b>C, D, and E Tables.....</b>	F-1
 <b>APPENDIX G - Descriptive Data.....</b>		
		G-1



## LIST OF TABLES

1-1	Conversion Units Used in RRAs.....	4
1-1	Conversion Units Used in RRAs (Cont'd).....	5
2-1	Symbols Used in Chapter 2.....	8
2-2	Values of $t$ for Standardized Normal (Univariate) Distribution for Percentiles and Interpercentile Ranges.....	13
2-3	Values of $\lambda$ for Bivariate Normal Distribution Ellipses and Circles.....	14
3-1	Primary Physical Constants Used in RRA Production.....	23
3-2	Symbols Used in Chapter 3.....	24

## LIST OF FIGURES

2-1	The Standard Meteorological Coordinate System.....	10
-----	--	----

## Chapter 1

### INTRODUCTION TO THE RANGE REFERENCE ATMOSPHERE (RRA)

#### 1.1 THE RRA DEFINED

A "reference atmosphere" is a statistical model of the earth's atmosphere, derived from upper-air observations over a specific location. The atmospheric models developed by the Range Reference Atmosphere Committee (RRAC) in response to a tasking by the Range Commanders Council/Meteorology Group (RCC/MG) and published by the Secretariat, Range Commanders Council are called "Range Reference Atmospheres" or "RRAs." The first series of RRAs was published from 1963 to 1974, and a second series was issued in 1983 and 1984.

#### 1.2 PURPOSE OF THE RRA

The individual RRA is the authoritative source for upper-atmosphere climatology over the launch and recovery site for which it has been prepared. The RRAs are used to plan, evaluate, and establish environmental launch constraints for aerospace vehicles launched from a particular location.

#### 1.3 CONTENTS OF THE RRA

The RRAs contain tabulations for monthly and annual means, standard deviations, and skewness coefficients for wind speed, pressure, temperature, density, water vapor pressure, virtual temperature, and dew point temperature. They also provide means and standard deviations for zonal and meridional wind components and the linear (product moment) correlation coefficient between wind components. Statistical values are tabulated (at the station elevation) at 1-km intervals from mean sea level (MSL) to 30 km and at 2-km intervals from 30 to 70 km. Wind statistics begin at about 10 meters above station elevation and continue at altitudes with respect to MSL thereafter. For ranges without rocketsonde measurements, RRAs terminate at 30 km; they may be extended upward, if necessary, when rocketsonde data from a nearby location can be made available.

#### 1.4 UNITS OF MEASUREMENT USED IN RRAs.

All wind speeds are in meters per second (m/s). In all cases, the skewness coefficient and the correlation coefficient between wind components are unitless. Pressure (including water vapor pressure) is in millibars (mb). Temperature and virtual temperature are in kelvin (K). Density is in grams per cubic meter (gm/m<sup>3</sup>). All altitudes are geometric in kilometers (km). All heights are geopotential also in kilometers (km). All altitudes/heights are in relation to mean sea level.

## 1.5 RRA QUALITY CONTROL

Less than 10 percent of the soundings in the data base used to calculate the RRA tables contained erroneous data. Soundings that did contain erroneous data values were eliminated from the data base. Steps taken to produce an RRA that is as error-free as possible are described below.

(1) Soundings with gaps in their pressure levels of more than 200 mb were rejected. These soundings were eliminated because some contained height values only for mandatory pressure levels; when some heights at the mandatory levels were missing, the interpolated sounding contained significant errors.

(2) An initial set of RRA statistics was computed using all the remaining soundings (that is, those that had not been rejected). This set was then used to determine data limits for temperature, pressure, U and V components of wind, density, and dew point for the 0-30 km portion and density only from 30 to 60 km (in RRAs that go that high). The lower (or upper) data limits were set at the mean value for each variable, minus (or plus) six standard deviations of that quantity. One pair of data limits was computed for each of the atmospheric variables, the month, and the data level.

(3) The first set of data limits was then used to screen the data base. All soundings that contained values outside the data limits were rejected. A new RRA was then computed using the screened data base, and the second RRA was used to generate a second set of data limits.

(4) The second set of data limits was then used to screen the data base further, and still another RRA was generated. The skewness values in this one were evaluated according to empirical criteria specified in paragraph 2.2 of this document (for winds) and in paragraph 3.2 (for thermodynamic quantities). If these criteria were satisfied, the third RRA was used to generate a final set of data limits, which were used to quality control the data base for the final version of the RRA.

(5) Occasionally, the third RRA did not satisfy all the skewness criteria, indicating that the data base still contained some erroneous values. To complete quality control, the "limits-to-RRA-to-limits" cycle was repeated (usually once or twice) until the resulting RRA satisfied the skewness criteria. When it did, a final set of data limits was generated, then used to quality control the data base and produce the final RRA.

## 1.6 HOW THE RRA IS ORGANIZED

The RRA documents are published in four chapters with Chapter 1 providing the introduction. Chapter 2, Wind Statistics and Models, describes the techniques used to produce the wind statistics given in tables A-1 through A-13 in appendix A and the probability functions used as wind models to derive several wind statistics. Chapter 3,

Statistics of Thermodynamic Quantities and Models, describes the techniques used to produce the thermodynamic and moisture-related statistics in tables B-1 through B-13 and C-1 through C-13, appendixes B and C. In addition, it describes the atmospheric thermodynamic model in tables D-1 through D-13, appendix D. Chapter 3 also contains equations used to calculate several atmospheric properties. Chapter 4 provides conclusions and recommendations. Chapters 1 through 4 are the same in each new RRA; only appendixes A-G (described next) vary from RRA to RRA.

**Appendix A** contains monthly and annual wind statistics tables that give (1) means and standard deviations of zonal and meridional wind components; (2) the linear (product moment) correlation coefficient between the two components; (3) the mean, standard deviation, and skewness coefficient of the wind speed; and (4) the number of wind observations (sample size).

**Appendix B** contains monthly and annual thermodynamic statistics tables that give (1) means, standard deviations, and skewness values of pressure, temperature, and density; and (2) the number of observations used for each of the thermodynamic quantities.

**Appendix C** contains monthly and annual moisture-related statistics tables that give (1) means, standard deviations, and skewness values of water vapor pressure, virtual temperature, and dew point; and (2) the number of observations for each of the moisture-related quantities. Statistical values for water vapor pressure and dew point terminate at or below 15 km, depending on the range's latitude. Above 15 km, statistical values of virtual temperature are considered to be the same as those of temperature.

**Appendix D** contains monthly and annual tables that give hydrostatic model atmospheres for thermodynamic variables of pressure, virtual temperature, and density. Values are derived from the monthly and annual mean virtual temperature versus altitude (geometric) using the hydrostatic equation and the equation of state. Also presented is the geopotential height corresponding to the tabulated geometric altitudes.

**Appendix E** gives range-specific examples of certain wind statistics that can be derived from the basic data in appendix A.

**Appendix F** gives tabular and graphic examples of certain pressure, density, and virtual temperature statistics that can be derived from basic data in appendixes B, C, and D.

**Appendix G** gives range-specific information such as location and data base description.

## 1.7 CONVERSION UNITS

Numerical values in the RRA are metric, as given in the International System of Units (SI, Systeme International d'Unites). Table 1-1 provides metric, U.S. Customary, and conversion units for all units used in this RRA.

TABLE 1-1. CONVERSION UNITS USED IN RRAs.

DATA TYPE	METRIC UNIT	US CUSTOMARY		CONVERSION:		To Get
		ABBR	UNIT	ABBR	Multiply By	
Ambient Temperature	degree Celsius	°C	degree Fahrenheit	°F	°F-32	°C
	kelvin	K	degree Rankine	°R	1.8	°F-32
					1.00	°F+459.67
Temperature Change	degree Celsius	°C	degree Fahrenheit	°F	1.00	°F
	kelvin	K	degree Rankine	°R	1.00	°C+273.15
					1.8	°C
Ambient Density	gram/cubic meter	gm <sup>-3</sup>	grain/cubic foot	grft <sup>-3</sup>	0.43700	grft <sup>-3</sup>
	gram/cubic centimeter	gcm <sup>-3</sup>			2.2883	gm <sup>-3</sup>
	(Absolute humidity)				10 <sup>-6</sup>	gcm <sup>-3</sup>
Vapor Concentration					4.370/10 <sup>-5</sup>	gcft <sup>-3</sup>
					2.288/10 <sup>-6</sup>	gcm <sup>-3</sup>
Windspeed	meters/second	ms <sup>-1</sup>	mile/hour	mph	2.2369	mph
			knots	knots	0.44704	ms <sup>-1</sup>
			feet/second	fts <sup>-1</sup>	1.9438	knots
					0.51444	ms <sup>-1</sup>
					0.868976	knots
					1.15078	mph
Weight	gram	g	grain	gr	3.2808	ms <sup>-1</sup>
	kilogram	kg	pound	lb	0.3048	ms <sup>-1</sup>
					0.45359237	kg
					453.59237	g
				2.20462	lb	
				15.4324	gr	
				0.06480	g	

TABLE 1-1. CONVERSION UNITS USED IN RRAS, Cont'd.

DATA TYPE	METRIC UNIT	US CUSTOMARY		CONVERSION:		To Get	
		ABBR	UNIT	Multiply	By		
Length	meter	m	feet	m	3.2808	ft	
	micron	$\mu$	inch	ft	0.3048	m	
	Angstrom unit	A			in	$2.54 \times 10^{-4}$	$\mu$
					in	$2.54 \times 10^{-8}$	A
					m	$10^{-6}$	$\mu$
					m	$10^{10}$	A
					$\mu$	$10^{-6}$	m
					$\mu$	$3.937 \times 10^{-5}$	in
			A	$10^{10}$	m		
			A	$3.937 \times 10^{-9}$	m		
Pressure	newton/square meter	newton m <sup>-2</sup>	pound force/sq in	lb in <sup>-2</sup>	$10^{-3}$	bar	
	millimeter of Mercury	mmHg	inch of Mercury	mHg	$10^3$	mb	
	bar				$10^{-2}$	mb	
	millibar	mb			$1.4504 \times 10^{-4}$	lb m <sup>-2</sup>	
	dyne/square centimeter (microbar)	dyne cm <sup>-2</sup>			$6.8948 \times 10^3$	newton m <sup>-2</sup>	
	kilogram force/square meter	kg m <sup>-2</sup>			$1.4504 \times 10^{-2}$	lb m <sup>-2</sup>	
					68.948	mb	
					$10^3$	dyne cm <sup>-2</sup>	
					$10^{-3}$	mb	
					$6.8948 \times 10^4$	dyne cm <sup>-2</sup>	
					$1.4504 \times 10^{-5}$	lb m <sup>-2</sup>	
					10.1972	kg m <sup>2</sup>	
					0.0980665	mb	
					703.0696	kg m <sup>2</sup>	
					0.0014223	lb m <sup>2</sup>	
					$2.9530 \times 10^{-2}$	mHg (32°F)	
					0.75006	mmHg (0°C)	
					25.40	mmHg (0°C)	
				1.3332	mb		
				33.8639	mb		
				1.00	newton m <sup>-2</sup>		
	pascal			Pa			

## CHAPTER 2

### WIND STATISTICS AND MODELS

#### 2.1 GENERAL DISCUSSION

One of the objectives in developing an RRA is to describe the wind field over the launch/recovery site as completely as possible with as few data tabulations as possible. With that in mind, the bivariate normal probability distribution was adopted as a statistical model for wind treated as a vector quantity at RRA data levels. Only five statistical parameters are required to completely describe this probability function; in Cartesian coordinates, these parameters are the means and standard deviations of the two orthogonal components, along with the correlation coefficient between the two components. The tables in appendix A give the five statistical parameters for the zonal and meridional (meteorological coordinate) components. The statistical properties of the bivariate normal probability distribution are used to derive many wind statistics of interest to range users. The procedure produces consistent wind statistics that are connected through rigorous mathematical probability functions. By using these functions, extensive tabulations of wind statistics are avoided. Statistical properties of the bivariate normal probability distribution presented for the vector wind statistical mode are

- wind components are univariate normally distributed;
- conditional distribution of one component, given a value of the other component, is univariate normally distributed;
- wind speed is in the form of a generalized Rayleigh distribution;
- frequency distribution of wind direction can be derived;
- conditional distribution of wind speed, given a value of wind direction (wind rose), can be derived; and
- the five tabulated wind statistical parameters, with respect to the meteorological zonal and meridional coordinate system, can be derived for any arbitrary rotation of the orthogonal axes.

The RRA provides probability distribution functions and sets of equations to derive wind statistics for the previously stated properties of the vector wind model. Examples are given in appendix E.

No attempt is made here to give the derivation of the probability functions, but the reader is referred to Smith (1976) for derivations and several applications of the probability distribution properties for wind statistics.

Symbols used in chapter 2 and their meanings are given in table 2-1.

**TABLE 2-1 Symbols Used in Chapter 2.**

$N$	The number of wind measurements in Appendix A.
$r$	A general variable for the bivariate normal probability distribution in polar coordinates.
$R$	A generalized Rayleigh variable used for derived wind speed probability distribution.
$R(U,V)$	The linear (product moment) correlation coefficient between the zonal and meridional wind components in Appendix A.
$SK(W)$	Skewness parameter for wind speed in Appendix A.
$S(U)$	The standard deviation of the zonal wind component in Appendix A.
$S(V)$	The standard deviation of the meridional wind component in Appendix A.
$S(W)$	The standard deviation of wind speed in Appendix A.
$t$	A standardized normal variate used in Table 2-1.
$U$	The zonal wind component.
$UBAR$	The mean value of the zonal wind component in Appendix A.
$V$	The meridional wind component.
$VBAR$	The mean value of the meridional wind component in Appendix A.
$W$	Wind speed or modulus of wind vector, a scalar quantity.
$WBAR$	The mean value of wind speed in Appendix A.
$X$	A general component mean value in the $[X,Y]$ coordinate system.
$Y$	A general component mean value in the $[X,Y]$ coordinate system.
$X$	A general component variable or coordinate axes.
$Y$	A general component variable or coordinate axes.
$\alpha$	(alpha) Rotation angle for the $[X,Y]$ coordinate system.
$\theta$	(theta) Wind direction in the polar coordinate system.
$\lambda$	(Lambda) A parameter in the bivariate normal probability distribution in Table 2-2.
$\xi$	(Xi) The mean value in the standardized normal probability distribution used in Table 2-1.
$\pi$	(Pi) Constant = 3.14159 .
$\rho$	(Rho) The general linear correlation coefficient between the two component variables in the $[x,y]$ coordinate system.
$\sigma_x, \sigma_y$	The general standard deviations of the $x$ and $y$ component variables in the $[x,y]$ coordinate system.



## 2.2 QUALITY CONTROL

The U and V components of wind were used to generate data limits, which were set at plus and minus six standard deviations from the mean for each of the quantities. These data limits were used to screen the wind data base, as described in paragraph 1.5. The data base was considered to be error-free if

- the skewness of the wind speed was below 4.0 at data levels where the mean wind speed was less than 15 m/s, and
- the skewness of the wind speed was below 2.5 at data levels where the mean wind speed was greater than 15 m/s.

## 2.3 DATA LIMITATIONS

For wind statistics, correlation coefficients for like and unlike wind components between altitude levels were not computed, and wind statistics with respect to altitude (profile) cannot be derived from RRA statistics. Users are referred to Smith (1976) for wind profile modeling techniques. Wind statistics as discrete altitudes are valid; all the probability distribution functions described in chapter 2 can be derived from the five wind component statistical parameters in appendix A, and the derived distributions can be considered as wind models at discrete altitudes.

Greek letters are used conventionally for population or theoretically known statistical elements, and sample estimates are denoted by English letters or with a "circumflex" ( $\hat{\alpha}$ ) over Greek letters. In Chapter 2, Greek letters are used for variances and linear correlation coefficient, while means are denoted by  $\bar{X}$  and  $\bar{Y}$  when dealing with the bivariate normal distribution. It must always be understood that appendix A contains sample estimates of statistical parameters and that they are with respect to the meteorological zonal (U) and meridional (V) coordinate systems.

## 2.4 THE COORDINATE SYSTEM OF STATISTICAL PARAMETERS

Wind is measured and recorded in terms of magnitude and direction. Wind direction is expressed in degrees clockwise from true north and is the direction from which the wind is blowing. Wind magnitude (the modulus of the vector) is the scalar quantity and is referred to as wind speed or scalar wind. A statistical description that accounts for the wind as a vector quantity is appropriate and requires a coordinate system.

For the RRA, the Standard Meteorological Coordinate System has been chosen for wind statistics, all tables of statistical parameters, and related discussions. This choice was made because the coordinate system used in aerospace and related applied fields has not always been consistent. Figure 2-1 illustrates the Standard Meteorological Coordinate System.

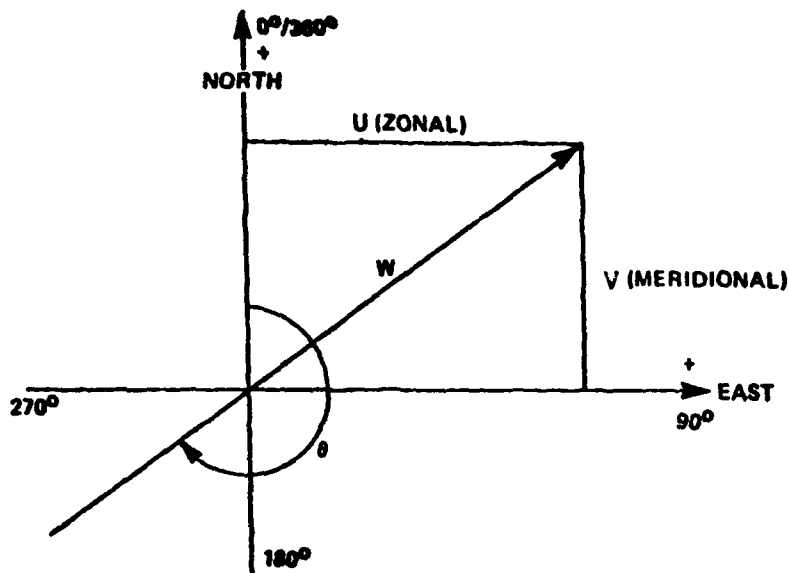


Figure 2-1. The Standard Meteorological Coordinate System.

Using Figure 2-1, the polar and Cartesian forms for the meteorological coordinate system are defined as

W wind speed, scalar wind, or magnitude of the wind vector (m/s);

$\theta$  wind direction, measured as the direction from which the wind is blowing, in degrees clockwise from true north;

U zonal wind component, positive west to east (m/s); and

V meridional wind component, positive south to north (m/s).

The components  $\theta$  and W define the polar form, and the U-V components define the Cartesian forms:

$$U = -W \sin\theta, 0 \leq \theta \leq 360^\circ \quad (1)$$

$$V = -W \cos\theta \quad (2)$$

It is helpful to note the difference between the mathematical convention for vector direction and the meteorological convention for wind direction:

$$\theta_{met} = 270 - \theta_{math} \quad (3)$$

$$\text{when } 0 \leq \theta \leq 270^\circ$$

$$\theta_{met} = 360 + (270 - \theta_{math})$$

$$\text{when } 270 \leq \theta \leq 360^\circ$$

## 2.5 COMPUTING STATISTICAL PARAMETERS

All these statistical parameters are with respect to the Standard Meteorological Coordinate System shown in figure 2-1. The wind statistical parameters in appendix A (means and standard deviations of zonal and meridional wind components, plus wind speed and the skewness parameter of wind speed) were computed using the sums technique described in subparagraph 3.5.1. In addition, a linear (product moment) correlation coefficient between the zonal and meridional wind components,  $r(u,v)$  in appendix A, was computed. This correlation coefficient is defined as

$$r(u,v) = \frac{\sum_{i=1}^n (U_i - \bar{U})(V_i - \bar{V})}{N s(u) \cdot s(v)} \quad (4)$$

## 2.6 STATISTICAL WIND MODELS

**2.6.1 Wind Component Statistics.** The univariate normal (Gaussian) probability distribution function is used to obtain wind component statistics. In generalized notations, the probability density function (pdf) is

$$F(t) = \frac{e^{-\frac{t^2}{2}}}{\sqrt{2\pi}} \quad (5)$$

where  $t = X - \frac{\xi}{\sigma}$  is the standardized variate, with  $\xi$  defining the mean and  $\sigma$  the standard deviation.

The probability distribution function (PDF) is

$$F(t) = \int_{-\infty}^t f(t) dt \quad (6)$$

Because this integral cannot be obtained in closed form, it is widely tabulated for zero mean and unit standard deviation. Selected values of  $F(t)$  are given in table 2-2. To emphasize the connotation of probability,  $F(t)$  is shown in table 2-2 as  $P\{X\}$ . The  $t$  values in table 2-2 are used as multiplier factors to the standard deviation to express the probability that a normally distributed variable ( $X$ ) is less than or equal to a given value as

$$P\{X \leq \text{mean} + t \sigma\} = \text{probability, } p \quad (7)$$

For example, when  $t = 1.6449$ , the probability that  $X$  is less than or equal to the mean plus 1.6449 standard deviations is 0.95. That value of  $X$  which is less than or equal to the mean plus 1.6449 standard deviations is called the "95th percentile value of  $X$ ." Also given in table 2-2 are the numerical values for expressing the probability that  $X$  falls in the interval  $X_1$  and  $X_2$ ; that is,

$$P\{X_1 \leq X \leq X_2\} = \text{Interpercentile Range} \quad (8)$$

where

$$X_1 = \bar{X} - t\sigma_x$$

$$X_2 = \bar{X} + t\sigma_x$$

For  $t = 1.9602$  the probability that  $X$  lies in the interval  $X_1$  and  $X_2$  is 0.95. The values of  $X_1$  and  $X_2$  in this example comprise the 95th interpercentile range.

For a normally distributed variable, the mode (most frequent value) and the median (50th percentile value) are the same as the mean value. The means and standard deviations of the zonal and meridional wind components from appendix A are used in equations 7 and 8 to compute the percentile values and interpercentile ranges of the zonal and meridional wind components. When equation 7 is illustrated on a normal graph, a straight line is formed.

**2.6.2 The Vector Wind Model.** Because wind is a vector quantity having direction and magnitude that can be expressed as two components in an orthogonal coordinate system, a probability model that describes the joint relationship is the bivariate normal probability distribution. In general component notation (shown in equation 9), the bivariate normal probability density function (BNpdf) is

$$f(X,Y) = \frac{1}{2\pi\sigma_x\sigma_y\sqrt{1-\rho^2}} \left[ \exp \frac{-1}{2(1-\rho^2)} \left\{ \frac{(X-\bar{X})^2}{\sigma_x^2} - \frac{2\rho(X-\bar{X})(Y-\bar{Y})}{\sigma_x\sigma_y} + \frac{(Y-\bar{Y})^2}{\sigma_y^2} \right\} \right] - \infty \leq X \leq \infty \& - \infty \leq Y \leq \infty \quad (9)$$

where the five parameters are  $\bar{x}, \bar{y}$ , the component means  $\sigma_x, \sigma_y$ , the component standard deviations, and  $\rho$ , the correlation coefficient between the two component variables  $X$  and  $Y$ .

For many applications there is interest in determining the probability that a point  $X, Y$  will fall within a contour of equal probability density. The exponential terms of equation 9, when set equal to a constant ( $\lambda_2$ ), give a family of ellipses depending on the value of the constant. The ellipses have a common center at the point  $\{\bar{X}, \bar{Y}\}$ . Integration of equation 9 over the region bounded by the contours of equal probability density gives

$$P(\lambda) = 1 - e^{-\frac{\lambda^2}{2(1-\rho^2)}} \quad (10)$$

Solving for  $\lambda^2$  and replacing  $P(\lambda)$  by  $p$  gives

$$\lambda^2 = -2(1-\rho^2) \ln(1-p) \quad (11)$$

Now define

$$\lambda_c = \sqrt{2} \sqrt{-\ln(1-p)} \quad (12)$$

TABLE 2-2. Values of  $t$  for Standardized Normal (Univariate) Distribution for Percentiles and Interpercentile Ranges.

$t$	$P(X)$	$X$	$P\{X_1 \leq X \leq X_2\} (\%)$
-3.0000	0.00135	$\xi - 3.0000 \sigma$	
-2.5758	0.00500	$\xi - 2.5758 \sigma$	
-2.3263	0.01000	$\xi - 2.3263 \sigma$	
-2.2365	0.01266	$\xi - 2.2365 \sigma$	
-2.0000	0.02275	$\xi - 2.0000 \sigma$	
-1.9602	0.02500	$\xi - 1.9602 \sigma$	
-1.6449	0.05000	$\xi - 1.6449 \sigma$	
-1.2816	0.10000	$\xi - 1.2816 \sigma$	
-1.0000	0.15866	$\xi - 1.0000 \sigma$	
-0.8416	0.20000	$\xi - 0.8416 \sigma$	
-0.6745	0.25000	$\xi - 0.6745 \sigma$	
-0.2533	0.40000	$\xi - 0.2533 \sigma$	
0.0000	0.50000	$\xi$	
0.2533	0.60000	$\xi + 0.2533 \sigma$	
0.6745	0.75000	$\xi + 0.6745 \sigma$	
0.8416	0.80000	$\xi + 0.8614 \sigma$	
1.0000	0.84134	$\xi + 1.0000 \sigma$	
1.2816	0.90000	$\xi + 1.2816 \sigma$	
1.6449	0.95000	$\xi + 1.6449 \sigma$	
1.9602	0.97502	$\xi + 1.9602 \sigma$	
2.0000	0.97725	$\xi + 2.0000 \sigma$	
2.2365	0.98734	$\xi + 2.2365 \sigma$	
2.3263	0.99000	$\xi + 2.3263 \sigma$	
2.5758	0.99500	$\xi + 2.5758 \sigma$	
3.0000	0.99865	$\xi + 3.0000 \sigma$	

where  $X_1 = \xi - t\sigma$   
and  $X_2 = \xi + t\sigma$

For reference and comparison,  $\lambda_p$  is shown in table 2-3 for selected values of p.

TABLE 2-3. Values of  $\lambda$  for Bivariate Normal Distribution Ellipses and Circles.

P(%)	( $\lambda_p$ --ellipse)	( $\lambda_p$ --circle)	P(%)	( $\lambda_p$ --ellipse)	( $\lambda_p$ --circle)
0.000	0.0000	0.0000	65.000	1.4490	1.0246
5.000	0.3203	0.2265	68.268	1.5151	1.0713
10.000	0.4590	0.3246	70.000	1.5518	1.0973
15.000	0.5701	0.4031	75.000	1.6651	1.1774
20.000	0.6680	0.4723	80.000	1.7941	1.2686
25.000	0.7585	0.5363	85.000	1.9479	1.3774
30.000	0.8446	0.5972	86.466	2.0000	1.4142
35.000	0.9282	0.6563	90.000	2.1460	1.5175
39.347	1.0000	0.7071	95.000	2.4477	1.7308
40.000	1.0108	0.7147	95.450	2.4860	1.7579
45.000	1.0935	0.7732	98.000	2.7971	1.9778
50.000	1.1774	0.8325	98.168	2.8284	2.0000
54.406	1.2533	0.8862	98.889	3.0000	2.1213
55.000	1.2637	0.8936	99.000	3.0348	2.1460
60.000	1.3537	0.9572	99.730	3.4393	2.4320
63.212	1.4142	1.0000	99.9877	4.2426	3.0000

The probability ellipse that contains p-percent of the wind vectors expressed in the most general form is the conic defined by

$$AX^2 + BXY + CY^2 + DX + EY + F = 0 \quad (13)$$

Where

$$A = \sigma_y^2 \quad D = 2\sigma_x\sigma_y \rho Y - 2\sigma_y^2 X = -(BY + 2AX)$$

$$B = -2\rho\sigma_x\sigma_y \quad E = 2\sigma_x\sigma_y \rho X - 2\sigma_x^2 Y = -(BX + 2CY)$$

$$C = \sigma_x^2 \quad F = AX^2 + CY^2 + BXY - AC(1 - \rho^2) \lambda_p^2$$

and

$$\lambda_p = \sqrt{2} \sqrt{-1/\pi(1-\rho)}$$

For graphic presentations, the range of the variable is important in order to arrange the scale. The largest and smallest values of X and Y for a given probability ellipse (p) are given by

$$X_{L,S} = \bar{X} \pm \sigma_x \lambda_p \quad (14)$$

$$Y_{L,S} = \bar{Y} \pm \sigma_y \lambda_p \quad (15)$$

where, as before,

$$\lambda_p = \sqrt{2} \sqrt{-1/\pi(1-\rho)}$$

Although there are several approaches to graphing the probability ellipses, the following procedure is best for electronic computer plotting. In establishing the computer plotting program, the sample estimates for  $\bar{X}$ ,  $\bar{Y}$ ,  $\sigma_x'$ ,  $\sigma_y'$ , and  $\rho$  are constants in equation 13. The user makes the choice of probability ellipses desired. Thus,  $p$  in equation 12 is programmed as a parameter. The largest and smallest values for  $X$  and  $Y$  are computed by equations 14 and 15 for the largest probability ellipses selected, which sets the graphical scale. Values of  $X$  within the range of  $X$  smallest to  $X$  largest are obtained by incrementing  $X$  between these limits. Using the quadratic equation, a solution of equation 13 is made for  $Y$  for each value of  $X$ , and plotted. The centroid  $(\bar{X}, \bar{Y})$  for the family of probability ellipses is plotted as a point. Labeling and other identification completes the plotting program.

For a given probability, equation 13 defines an ellipse that contains  $p$ -percent of the points  $X, Y$ . Since the entire area under the bivariate normal density function (equation 9) is unity, upon integration for a given probability ellipse, that given ellipse contains  $p$ -percent of the total area. In the wind statistics,  $p$ -percent of the wind vectors fall within the specified probability ellipse. From this point of view, a specified probability ellipse gives the joint probability that  $p$ -percent of the  $U-V$  components lie within the given ellipse.

When  $\sigma_x^2 = \sigma_y^2 = \sigma^2$  and  $\rho = 0$  in the bivariate normal distribution, the probability ellipses of equation 13 reduce to circles whose centers are at the means  $\bar{X}, \bar{Y}$ . The radii of the probability circles are  $\sigma_{v1} \lambda_c'$ , where

$$\sigma_{v1} = \sqrt{2\sigma^2} \quad (16)$$

$$\lambda_c = \sqrt{-1/\pi(1-\rho)} \quad (17)$$

Values for  $\lambda_c$  for selected probabilities,  $p$ , are given in table 2-3.

Because this function is simple, it can easily be graphed manually. However, the generalized plotting technique for electronic computer plotters (as shown by equation 13) can also be used.

**2.8.3 Derived Distributions for Wind Statistics.** In this section, the probability distribution functions and sets of equations are presented to derive certain probability distribution functions for wind statistics. These derived probability distributions are

- \* conditional distribution of wind components,
- \* generalized Rayleigh distribution for wind speed,
- \* distribution for wind direction, and
- \* conditional distribution of wind speed given a wind direction (wind rose).

The five required statistical parameters for these derived distributions for wind statistics are given in appendix A.

**2.6.3.1 The Conditional Distribution of Wind Components.** Given that two random variables X and Y are bivariate normally distributed, the conditional distribution  $f(Y|X)$  is read as f(Y) given X, and likewise  $f(X|Y)$  is read as f(X) given Y. The conditional probability function  $F(Y|X)$  has the mean  $(E(Y|X))$  and variance  $\sigma_{(y|x)}^2$ , where

$$E(Y|X^*) = \bar{Y} + \rho \left( \frac{\sigma_y}{\sigma_x} \right) (X^* - \bar{X}) \quad (13)$$

and

$$\sigma_{(y|x^*)}^2 = \sigma_y^2 (1 - \rho^2) \quad (19)$$

The conditional standard deviation is

$$\sigma_{(y|x^*)} = \sigma_y \sqrt{1 - \rho^2} \quad (20)$$

By interchanging the variables and parameters, the conditional distribution function for  $F(X|Y^*)$  has the conditional mean

$$E(X|Y^*) = \bar{X} + \rho \left( \frac{\sigma_x}{\sigma_y} \right) (Y^* - \bar{Y}) \quad (21)$$

conditional variance

$$\sigma_{(x|y^*)}^2 = \sigma_x^2 (1 - \rho^2) \quad (22)$$

and conditional standard deviation

$$\sigma_{(x|y^*)} = \sigma_x \sqrt{1 - \rho^2} \quad (23)$$

The preceding conditional probability distribution functions are univariate normal distributions for a (fixed) given value for one of the bivariate normal variables. Thus, the t-values given in table 2 are applicable for conditional probabilities statements. For example,

$$F(Y|X^*) = E(Y|X^*) + t \sigma_{(y|x^*)} \quad (24)$$

For  $t = 1.6449$ , there is a 95 percent chance that Y is less than or equal to  $\bar{Y} + 1.6449 \sigma_{(y|x^*)}$  given that  $X = X^*$ . In symbols, this statement reads

$$P \{ Y \leq E(Y|X^*) + 1.6449 \sigma_{(y|x^*)} | X = X^* \} = 0.9500 \quad (25)$$

Interval probability statements can also be made

$$P \{ Y_1 = E(Y|X^*) - t \sigma_{(y|x^*)} \leq Y \leq Y_2 = E(Y|X^*) + t \sigma_{(y|x^*)} | X = X^* \}$$

where  $X^*$  can take on any fixed value of X, but a convenient arrangement is to let  $X^* = \bar{X} \pm t \sigma_x$ .



The close connection of the regression function of Y on X to the conditional mean for the bivariate normal distribution is noted as

$$Y = \bar{Y} + \rho \left( \frac{\sigma_y}{\sigma_x} \right) (X - \bar{X}) \quad (26)$$

Similarly, the regression function of X on Y is

$$X = \bar{X} + \rho \left( \frac{\sigma_x}{\sigma_y} \right) (Y - \bar{Y}) \quad (27)$$

These are linear functions and express the same results as would be obtained from a least-squares regression line.

**2.6.3.2 Generalized Rayleigh Distribution for Wind Speed.** If two random variables, X and Y, are bivariate normally distributed, then the probability distribution for the modulus, R, can be derived in terms of the five parameters that define the bivariate normal distribution:

$$R = \sqrt{X^2 + Y^2} \quad (28)$$

The distribution of R, so derived, is called a generalized Rayleigh distribution, because there are no restrictions on the parameters. For applications to the RRA, the variable R is recognized as wind speed or the modulus of the wind vector.

The probability density function for R is expressed as

$$f(R) = a_0 R e^{-a_1 R^2} \left[ I_0(a_2 R^2) I_0(a_3 R) + 2 \sum_{k=1}^{\infty} I_k(a_2 R^2) I_{2k}(a_3 R) \cos 2k\psi \right] R \geq 0 \quad (29)$$

The functions  $I_0(\cdot)$ ,  $I_k(\cdot)$ , and  $I_{2k}(\cdot)$  are the modified Bessel function of the first kind for zero order, kth order, and 2kth order. The coefficients are

$$a_0 = \frac{\exp \left[ -\frac{1}{2} \left\{ \frac{\bar{X}^2}{\sigma_a^2} + \frac{\bar{Y}^2}{\sigma_b^2} \right\} \right]}{\sigma_a \sigma_b}$$

where  $\sigma_a^2$  and  $\sigma_b^2$  are the rotated variances to produce zero correlation between X and Y.  $\sigma_a$  and  $\sigma_b$  are the positive and negative roots of the following expression, the computational form of which is obtained from the determinant

$$\begin{vmatrix} \sigma_x^2 - K & \sigma_x \sigma_y \sigma \\ \sigma_x \sigma_y \sigma & \sigma_y^2 - K \end{vmatrix}$$

where  $K$  is  $\sigma^2_{(+,-)}$ , and  $\sigma_a$  and  $\sigma_b$  are analogous to the standard deviation of the major and minor axes of the bivariate normal probability ellipse

$$\sigma^2_{(+,-)} = \frac{1}{2} \left\{ \sigma_x^2 + \sigma_y^2 \pm [(\sigma_x^2 + \sigma_y^2)^2 - 4\sigma_x^2\sigma_y^2(1-\rho^2)]^{\frac{1}{2}} \right\}$$

$$a_1 = \frac{(\sigma_x^2 + \sigma_y^2)}{4(1-\rho^2)\sigma_x^2\sigma_y^2}$$

$$a_2 = \frac{[(\sigma_x^2 - \sigma_y^2)^2 + 4\rho^2\sigma_x^2\sigma_y^2]^{\frac{1}{2}}}{4(1-\rho^2)\sigma_x^2\sigma_y^2}$$

$$a_3 = \left[ \left( \frac{\bar{X}}{\sigma_x^2} \right)^2 + \left( \frac{\bar{Y}}{\sigma_y^2} \right)^2 \right]^{\frac{1}{2}}$$

and

$$\tan \Psi = \frac{\bar{Y}}{\bar{X}} \frac{\sigma_x^2}{\sigma_y^2}$$

Since this density function cannot be integrated in closed form from zero to  $R$ , numerical integration is used to obtain practical results from the probability distribution function; that is,

$$F(R) = \int_0^R f(R) dR \quad (30)$$

A number of special cases can be obtained from the general Rayleigh distribution (equation 29), the most simple of which is to let  $\sigma_x = \sigma_y = \sigma$  and  $\bar{X} = \bar{Y} = 0$  with independent variables  $X$  and  $Y$ , which gives

$$f(R) = \frac{R}{\sigma^2} e^{-\frac{R^2}{2\sigma^2}} \quad (31)$$

which is recognized as the classical Rayleigh probability density function. The density function (equation 31) can be integrated in closed form over any range of the variable  $R$ . Hence, the probability distribution function,  $F(R)$ , for equation 31 is

$$F(R) = 1 - \exp \left\{ \frac{-R^2}{2\sigma^2} \right\} \quad (32)$$

**2.6.3.3 The Derived Distribution of Wind Direction.** Considering the wind as a vector quantity and bivariate normally distributed, the wind direction can be derived. This is done by first writing the bivariate normal probability density function in polar coordinates whose variables are

$$g(r, \theta) = r d_1 e^{\frac{1}{2}(a^2 r^2 - 2br + c^2)} \quad (33)$$

**NOTE**

The expression in equation 33 (Smith, 1976) is given with respect to the mathematical convention for a vector direction where

$$a^2 = \frac{1}{(1-\rho^2)} \left[ \frac{\sin^2 \theta}{\sigma_x^2} - \frac{2\rho \cos \theta \sin \theta}{\sigma_x \sigma_y} + \frac{\cos^2 \theta}{\sigma_y^2} \right]$$

$$b = \frac{-1}{(1-\rho^2)} \left[ \frac{\bar{x} \sin \theta}{\sigma_x^2} - \frac{\rho(\bar{x} \cos \theta + \bar{y} \sin \theta)}{\sigma_x \sigma_y} + \frac{\bar{y} \cos \theta}{\sigma_y^2} \right]$$

$$c^2 = \frac{1}{(1-\rho^2)} \left[ \frac{\bar{x}^2}{\sigma_x^2} - \frac{2\rho \bar{x} \bar{y}}{\sigma_x \sigma_y} + \frac{\bar{y}^2}{\sigma_y^2} \right]$$

$$d_1 = \frac{1}{2\pi\sigma_x\sigma_y\sqrt{1-\rho^2}}$$

and  $r = \sqrt{x^2 + y^2}$  is the modulus of the vector or speed and  $\theta$  is the direction of the vector. After integrating  $g(r, \theta)$  over  $r=0$  to  $\infty$ , the probability density function  $\theta$  is

$$g(\theta) = \frac{d_1}{a^2} e^{-\frac{1}{2}c^2} \left[ 1 + \sqrt{2\pi} \left(\frac{b}{a}\right)^2 \Phi\left(\frac{b}{a}\right) \right] \quad (34)$$

where  $a^2$ ,  $b$ ,  $c^2$ , and  $d_1$  are as previously defined in equation 33, and

$$\Phi\left(\frac{b}{a}\right) \Phi(x) = \frac{1}{\sqrt{2\pi}} \int_{-\infty}^x e^{-\frac{1}{2}t^2} dt$$

is taken from tables of normal distribution functions or made available through a computer subroutine.

If desired, equation 34 can be integrated numerically over a chosen range of  $\theta$  to obtain the probability that the vector direction will lie within the chosen range; that is,

$$F(\theta) = \int_{\theta_1}^{\theta_2} g(\theta) d\theta \quad (35)$$

One application may be to obtain the probability that the wind will flow from a given quadrant or sector as onshore, for example.

**2.6.3.4 Derived Conditional Distribution of Wind Speed Given Wind Direction.** Continuing with the considerations expressed in subparagraph 2.6.3.3, the conditional probability density function (pdf) for wind speed ( $r$ ), given a specified value for the wind direction  $\theta$ , can be expressed as

$$f(r|\theta) = \frac{a^2 r e^{-\frac{1}{2}(a^2 r^2 - br)}}{1 + \sqrt{2\pi} \left(\frac{b}{a}\right) e^{\frac{1}{2}\left(\frac{b}{a}\right)^2} \Phi\left\{\frac{b}{a}\right\}} \quad (36)$$

where coefficients,  $a$  and  $b$  and the function  $\Phi\left\{\frac{b}{a}\right\}$  are as previously defined in equations 33 and 34.

From equation 36, the mode (most frequent value) of the conditional wind speed given as specified value of the wind direction is the positive solution of the quadratic equation,

$$a^2 r^2 - br - 1 = 0 \quad (37)$$

which is

$$(\tilde{r}|\theta) = \frac{1}{2a} \left[ \left(\frac{b}{a}\right) + \sqrt{4 + \left(\frac{b}{a}\right)^2} \right] \quad (38)$$

The locus of the conditional modal values of wind speed when plotted in polar form versus the given wind directions forms an ellipse.

The noncentral moment for equation 36 is expressed as

$$\mu_n' = \int_0^{\infty} r^n f(r|\theta) dr \quad (39)$$

Now the first noncentral moment is identical to the first central moment or expected value,  $E(r|\theta)$ . The integration of equation 39 for the first moment is sufficiently simple to yield practical computations, and can be expressed as

$$E(r|\theta) = \frac{\left(\frac{b}{a}\right) + \left[1 + \left(\frac{b}{a}\right)^2\right] \sqrt{2\pi} e^{\frac{1}{2}\left(\frac{b}{a}\right)^2} \Phi\left\{\frac{b}{a}\right\}}{a \left[1 + \left(\frac{b}{a}\right) \sqrt{2\pi} e^{\frac{1}{2}\left(\frac{b}{a}\right)^2} \Phi\left\{\frac{b}{a}\right\}\right]} \quad (40)$$

Equation 40, then, gives the conditional mean value of the wind speed given a specified value for the wind direction.

The integration of equation 36 for the limits  $r = 0$  to  $r = r^*$  gives the probability that the conditional wind speed is  $\leq r^*$  given a value for the wind direction,  $\theta$ . This conditional probability distribution (PDF) can be written as

$$Pr \{r \leq r^* | \theta = \theta_0\} = 1 - \left[ \frac{e^{-\frac{1}{2} r_s^2 + \sqrt{2\pi} \left(\frac{b}{a}\right) (1 - \phi(r_s))}}{e^{-\frac{1}{2} \left(\frac{b}{a}\right)^2 + \sqrt{2\pi} \left(\frac{b}{a}\right) \phi\left\{\frac{b}{a}\right\}}} \right] \quad (41)$$

where

$$r_s = \left[ a r^* - \left(\frac{b}{a}\right) \right]$$

By definition, equation 41 is an expression for a "wind rose." Empirical wind rose statistics are often tabulated or graphically illustrated given the frequency that the wind speed is not exceeded for those wind speed values which lie within assigned class intervals of wind direction. After evaluation of equation 41 for various values of wind speed,  $r^*$ , and the given wind directions,  $\theta$ , interpolations can be performed to obtain various percentile values of the conditional wind speed.

For the special case when  $b$  in equation 33 equals zero (that is, for  $\bar{x} = \bar{y} = 0$ ), the conditional modal values of wind speeds (equation 38), the conditional mean values of wind speeds (equation 40), and the fixed conditional percentile values of wind speeds (interpolated from evaluations of equation 41), when plotted in polar form versus the given wind directions, produce a family of ellipses.

For the special case when  $\bar{x} = \bar{y} = 0$ , equation 36 reduces to the following simple case:

$$Pr \{r \leq r^* | \theta = \theta_0\} = 1 - e^{-\frac{r^{*2}}{2}} \quad (42)$$

Equation 42 has special significance when related to the bivariate normal probability distribution. If  $r^*$  and  $\theta$  are measured from the centroid of the probability ellipse, then the probability that  $r \leq r^*$  is the same as the given probability ellipse. Further, solving equation 42 for  $r^*$ , gives

$$r^* = \frac{1}{\sqrt{2}} \sqrt{-2 \ln (1 - P)} \quad (43)$$

If a probability ellipse  $P$  is chosen, equation 42 gives the distance of  $r$  along any  $\theta$  from the centroid of the ellipse to the intercept of the specified probability ellipse. If there is an interest in conditional probability of winds for a given  $\theta$  relative to the monthly means, equation 43 is applicable. If it is desired to find the magnitude of the wind along any  $\theta$  relative to the monthly mean to the intercept of a given probability ellipse, equation 43 is also applicable.

## 2.7 STATISTICAL PARAMETERS FOR NON-STANDARD ORTHOGONAL AXES

The five wind statistical parameters in appendix A are given with respect to the Standard Meteorological Coordinate System (figure 2-1). That is, these parameters are for zonal and meridional components. Many range users, however, need wind statistics with respect to orthogonal axes other than west to east and south to north. For example, a user may need wind statistics with respect to a flight azimuth of  $\alpha$  degrees from true north measured clockwise. The following sets of equations are used to compute the five parameters for the new coordinate axes rotated  $\alpha$  degrees clockwise from true north.

Rotation of the means through  $\alpha$  degrees

$$\bar{X}_\alpha = \bar{X} \cos (90 - \alpha) + \bar{Y} \sin (90 - \alpha) \quad (44)$$

$$\bar{Y}_\alpha = \bar{Y} \cos (90 - \alpha) - \bar{X} \sin (90 - \alpha) \quad (45)$$

Rotation of the variances through  $\alpha$  degrees

$$\sigma_{x_\alpha}^2 = \sigma_x^2 \cos^2 (90 - \alpha) + \sigma_y^2 \sin^2 (90 - \alpha) \quad (46)$$

$$+ 2\rho\sigma_x\sigma_y \cos (90 - \alpha) \sin (90 - \alpha)$$

$$\sigma_{y_\alpha}^2 = \sigma_y^2 \cos^2 (90 - \alpha) + \sigma_x^2 \sin^2 (90 - \alpha) \quad (47)$$

$$- 2\rho\sigma_x\sigma_y \cos (90 - \alpha) \sin (90 - \alpha)$$

Rotation of the linear correlation coefficient through  $\alpha$  degrees

$$\rho_\alpha = \frac{\text{cov}(X, Y)_\alpha}{\sigma_{x_\alpha} \sigma_{y_\alpha}} \quad (48)$$

where  $\text{cov}(X, Y)_\alpha$  is the rotated covariance:

$$\begin{aligned} \text{cov}(X, Y)_\alpha &= (X, Y) [\cos^2 (90 - \alpha) - \sin^2 (90 - \alpha)] \\ &+ \cos (90 - \alpha) \sin (90 - \alpha) (\sigma_y^2 - \sigma_x^2) \end{aligned}$$

and

$$\text{cov}(X, Y) = \rho\sigma_x\sigma_y$$

By using these rotational equations, the bivariate normal distribution with respect to any desired rotated coordinates can be obtained from sample estimates that have been computed with respect to a specific axis. The marginal distributions after rotation are also normally (univariate) distributed. By using the rotational equations, computational efforts are greatly reduced to applications requiring statistics with respect to several coordinate axes. Appendix E gives examples of range-specific RRA wind statistics.

## CHAPTER 3

### THERMODYNAMICS STATISTICS AND MODELS

#### 3.1 GENERAL DISCUSSION

One of the objectives in developing the RRA was to describe the thermodynamic characteristics of the atmosphere as completely as possible with as few data tabulations as possible. With that in mind, a set of statistical variables was selected to collectively describe climatological pressure, temperature, density, dew point, virtual temperature, and water vapor pressure. Used together, these variables permit calculation of a large number of derived quantities. Some of these quantities such as the speed of sound are discussed in paragraph 3.7.

The probability distribution of each of the six thermodynamic RRA variables is described by its mean value, its standard deviation, and its skewness. Several of the thermodynamic elements (temperature, pressure, dew point, and density) have probability distributions that are close to a univariate normal distribution; the others do not. The skewness variable gives an estimate of asymmetrical departures of a probability distribution.

Hydrostatically modeled mean values of pressure and density were calculated (see appendix D) so that users can determine the departure of the actual climatology of these values from hydrostatic conditions. This was done by hydrostatically integrating the pressure from the lowest RRA data level to the RRA's termination altitude. Table 3-1 lists and explains the primary physical constants used in RRA production. Table 3-2 lists and explains the symbols used in this chapter.

TABLE 3-1. Primary Physical Constants Used in RRA Production.

$P_0$	Standard atmospheric pressure at sea level ( $1.013250 \times 10^5$ Newton/m <sup>2</sup> ) (2116.22 lb/ft <sup>2</sup> )
$\rho_0$	Standard atmospheric density at sea level ( $1.2250$ kg/m <sup>3</sup> ) (0.076474 lb/ft <sup>3</sup> )
$T_0$	Standard temperature at sea level (288.15 K) (15.0°C) (59.0°F)
$g_0$	Standard gravity at sea level at latitude 45°31'33" (9.80665 m/s <sup>2</sup> )
$s$	Sutherland's constant used in calculation of dynamic viscosity (110.4 K)
$T_i$	Ice-point temperature at $P_0$ (273.15 K)
$\beta$	Constant for calculating dynamic viscosity ( $1.458 \times 10^{-6}$ kg/sec m K <sup><math>\frac{1}{2}</math></sup> ) ( $7.3025 \times 10^{-7}$ lb/sec ft R <sup><math>\frac{1}{2}</math></sup> )
$\gamma$	Ratio of specific heat of air at constant pressure to specific heat of air at constant volume (1.4)
$C_D$	Mean effective collision diameter of air molecules ( $3.65 \times 10^{-10}$ m) ( $1.1975 \times 10^{-9}$ ft)
$N_A$	Avogadro's constant ( $6.022169 \times 10^{26}$ /kg mol) ( $2.73179 \times 10^{26}$ /lb mol)
$R^*$	Gas constant (8.31432 Joule/mol K)
$R'$	Gas constant for dry air ( $2.8704 \times 10^2$ Joule/kg K)
$M$	Molecular weight of dry air (28.966 gm/mol)

TABLE 3-2. Symbols Used In Chapter 3.

$C_s$	Speed of sound
$C_d$	Collision diameter
$E$	Vapor pressure
$g_\phi$	Gravity at latitude $\phi$
$H$	Geopotential height
$H_m$	Geopotential height at a mandatory radiosonde data level
$H_s$	Geopotential height at a significant radiosonde data level
$K_t$	Coefficient of thermal conductivity
$L$	Mean free path length
$M$	Mean molecular weight of air at sea level
$M^3q$	Monthly third moment of quantity $Q$
$n$	Refractive modulus
$N$	Refractive index
$NA$	Avogadro's constant
$Nq$	Number of values of quantity $Q$
$P$	Pressure
$P_m$	Pressure at a mandatory radiosonde data level
$P_s$	Pressure at a significant radiosonde data level
$P_h$	Hydrostatically integrated mean monthly or annual pressure
$Q$	Any tabulated RRA quantity
$R^*$	Universal gas constant
$R'$	Specific gas constant of dry air
$r, r^*$	Parameters used in converting $z$ to $h$ and vice versa
$S$	Sutherland's constant, used in the calculation of dynamic viscosity
$T$	Temperature
$T_d$	Dewpoint
$T_v$	Virtual temperature
$T_{vm}$	Virtual temperature at a mandatory radiosonde data level
$T_{vs}$	Virtual temperature at a significant radiosonde data level
$V$	Mean air particle speed
$V_c$	Mean collision frequency
$w$	Parameter used in the hydrostatic interpolation of pressure and density
$Z$	Geometric altitude
$\lambda$	Wavelength
${}^3Q$	Skewness of quantity $Q$
$B$	Constant used in the equation for viscosity
$\gamma$	Ratio of specific heat at constant pressure to specific heat at constant volume
$\eta$	Kinematic coefficient of viscosity
$\mu$	Dynamic coefficient of viscosity
$\rho$	Density
$\rho_h$	Mean monthly or annual density derived from $P_h$
$\sigma$	Standard deviation of the quantity $Q$



### 3.2 QUALITY CONTROL

Data limits derived from the following thermodynamic elements were used to screen the RRA data base: temperature, pressure, dewpoint (for the 0-30 km portion only), and density. These limits were set to plus and minus six standard deviations from the mean values of each of these quantities; they were used to screen the thermodynamic portion of the data base in accordance with procedures described in paragraph 1.5. The data base was considered to be error-free if

- (1) skewness values of pressure and temperature were between -2.5 and 2.5 at all data levels,
- (2) skewness values of density were between -3.5 and 3.5 at data levels between 0 and 30 km,
- (3) skewness values of density were between -3.0 and 3.0 at data levels between 30 and 70 km, and
- (4) skewness values of dewpoint were between -2.5 and 2.5 at all data levels with more than 10 data values.

### 3.3 DATA LIMITATIONS

Correlation coefficients between thermodynamic quantities and moisture-related quantities were not calculated at discrete altitudes, neither were any of the correlations between altitudes. As a result, valid statistical dispersion models that require a relationship between two or more of these quantities at the same altitude or between altitudes cannot be derived. Approximations for the correlation coefficients between pressure, virtual temperature, and density at discrete altitudes, however, may be obtained from the coefficients of variation as developed by Buell (1970). The coefficient of variation is the standard deviation divided by the mean. The mean values and the standard deviations are taken from appendix B. A model for the profile of monthly and annual mean pressure, virtual temperature, and density is given in appendix D and is in agreement with the respective statistical mean values. This agreement results because the physical relationships expressed by the hydrostatic equation and the equation of state were used to derive appendix D. When only the monthly or annual mean values for pressure, virtual temperature, and density are required, users should consult appendix D.

### 3.4 ESTABLISHING DATA SAMPLES AT REQUIRED LEVELS

This section describes the computational procedures used to establish data samples of the thermodynamic RRA variables at the various data levels. References are cited only when the equation given is one of many available in the literature or when it is stated in an unusual form.

**3.4.1 Converting Geopotential Height to Geometric Altitude.** Although rocketsonde observations above 30 km are recorded in terms of geometric altitude, the data can be interpolated directly to the altitude intervals shown in the tables. But radiosonde observations used to obtain tabular values below 30 km are recorded in terms of geopotential height; the conversion to geometric altitude ( $h$  to  $z$ ) is accomplished by calculating a table of geopotential heights that correspond exactly to the geometric altitudes at which the atmospheric elements are tabulated. Radiosonde observations are then interpolated to these geopotential heights. The relationship used to calculate geometric altitude from geopotential height is

$$H = (r' z) / (r' + z) \quad (49)$$

where

$$r' = g r' / 9.80665$$

and

$$r' = -2g_\phi / (\partial g_\phi / \partial z_0)$$

$g_\phi$  is sea level at latitude  $\phi$  corresponding to the proper location (List, 1968).

$$g_\phi = 9.780356 (1 + 5.2885 \times 10^{-3} \sin^2 \phi - 5.9 \times 10^{-6} \sin^2 (2\phi)) \quad (50)$$

$\frac{\partial g_\phi}{\partial z_0}$  is the rate of change of gravity at sea level. This quantity is given by

$$\frac{\partial g_\phi}{\partial z_0} = -3.085462 \times 10^{-6} \times 2.27 \times 10^{-9} \cos (2\phi) \times 2 \times 10^{-12} \cos (4\phi) \quad (51)$$

Units used for gravity are  $m/s^2$ , while the units for  $\frac{\partial g_\phi}{\partial z_0}$  are  $s^{-2}$ .

The resulting table of values of  $H$  obtained by using even increments of 2 in equation 49 is shown in appendix D. Although the values of  $H$  above 30 km were not used in the interpolation of original data, they are included for the convenience of the user.

**3.4.2 Calculations from Rawinsonde Observations.** It was necessary to interpolate information from original rawinsonde records to arrive at the geometric altitudes specified as RRA data levels. Elements for which this interpolation was required were temperature, dewpoint, and pressure. The other elements were calculated from the interpolated values at each RRA data level. These "derived" elements were water vapor pressure, density, and virtual temperature.

**3.4.2.1 Geopotential Height at Significant Levels.** Two slightly different interpolation procedures were used to obtain data from radiosonde and rocketsonde observations at the levels shown in the tables. The procedure used to interpolate radiosonde observations begins with calculations of virtual temperature at each data level in the sounding. Virtual temperature was computed by

$$T_v = T / (1 - 0.379 (e/p)) \quad (52)$$

where  $T_v$  and  $T$  are in kelvin (K) and  $e$  and  $p$  are in millibars.

Radiosonde soundings provide pressure, temperature, and dew point data recorded at "mandatory" and "significant" levels. Geopotential height data, however, is only provided for mandatory levels. Heights at the significant levels, therefore, were calculated hydrostatically, using pressure and temperature data from those levels. This procedure allows the use of most significant level data in the calculation of the RRA tables. The equation used for this process was

$$H_s = H_m + 29.2712617 * \frac{(T_m + T_s)}{2} * \ln(P_s/P_m) \quad (53)$$

where subscripts s and m denote quantities at significant and mandatory levels. This equation was not used if the difference between two adjacent mandatory levels was greater than 200 mb, and all soundings with such data gaps were rejected.

**3.4.2.2 Temperature.** Radiosonde temperatures were interpolated logarithmically with respect to pressure using the equation

$$T = T_U + (T_L - T_U) \frac{\ln p - \ln p_L}{\ln p_U - \ln p_L} \quad (54)$$

where subscripts U and L indicate values at the nearest data levels in the actual sounding above and below the interpolated level.

**3.4.2.3 Pressure.** The pressure values in each radiosonde sounding were interpolated to the RRA data levels using the equation

$$p = p_L \exp \left( \frac{H_L - H_U}{29.2712617 (0.5) (T_U + T_L)} \right) \quad (55)$$

where subscript L indicates virtual temperature, geopotential, and pressure values at the data level below and closest to the level at which data were required.

**3.4.2.4 Dew Point Temperature.** Dew point values were interpolated logarithmically with respect to pressure using the equation

$$T_d = T_{dU} + (T_{dL} - T_{dU}) \left( \frac{\ln p - \ln p_L}{\ln p_U - \ln p_L} \right) \quad (56)$$

Subscripts U and L indicate data at the nearest upper and lower data levels in a sounding.

**3.4.2.5 Vapor Pressure.** Water vapor pressure is calculated from interpolated dew point values at RRA data levels using Teten's approximation

$$e = 6.11 \text{ mb} \times 10^{7.5(T_d - 273.15) / (T_d - 35.86)} \quad (57)$$

**3.4.2.6 Density.** Density values derived from radiosonde observations were calculated at RRA data levels using the equation

$$\rho = 348.36787 p/T_v \quad (58)$$

**3.4.2.7 Virtual Temperature.** Virtual temperature values are calculated at RRA data levels for each sounding using the equation

$$T_v = T(1 - 0.379(e/p)) \quad (59)$$

where  $T_v$  and  $T$  are in K; pressure ( $p$ ) and vapor pressure ( $e$ ) are in millibars.

**3.4.3 Calculations from Rocketsonde Observations.** Rocketsonde observations used to calculate RRA table values above 30 km were recorded in terms of geometric altitude. For this reason, slightly different calculations were required to convert recorded data values to RRA data levels. Pressure, temperature, and density were interpolated to RRA data levels. Since atmospheric moisture at altitudes above 30 km is considered to be negligible, moisture-related elements (virtual temperature, water vapor pressure, and dewpoint) were not calculated. There was no interpolation across gaps in pressure or temperature data in a sounding larger than 7,000 meters. Data values at RRA levels within such a gap were set to "missing."

**3.4.3.1 Temperature.** Rocketsonde temperatures were interpolated linearly with respect to geometric altitude using the equation

$$T = T_U + (T_L - T_U) \frac{Z - Z_L}{Z_U - Z_L} \quad (60)$$

where subscript U indicates values at the nearest data level in the actual sounding above the interpolated level; L indicates values below the interpolated level.

**3.4.3.2 Pressure.** Rocketsonde pressure values were interpolated to RRA data levels using the equation

$$P = P_L \exp \left( - \frac{g_0}{R^*} \frac{M(Z - Z_L)}{T_v} \cdot W^2 \right) \quad (61)$$

where

$$T_v = \frac{T_{vU} + T_{vL}}{2} \text{ and } W = \frac{r^*}{\left( r^* + Z + \frac{Z - Z_L}{2} \right)}$$

**3.4.3.3 Density.** Rocketsonde density values were interpolated using the equation

$$\rho = \rho_L \exp \left( - \frac{g_0 M}{R^*} \frac{(Z - Z_L)}{T_v} \cdot W^2 \right) \quad (62)$$

where  $W$  is specified in subparagraph 3.4.3.2.

### 3.5 COMPUTING STATISTICS FOR APPENDIXES B AND C

Computing monthly and annual means, standard deviations, and skewness values from data at the RRA data levels was performed in two steps. First, certain statistical sums were calculated and stored as the soundings in the data base were processed. These sums were then used to calculate the monthly and annual statistics given in the RRA tables.

**3.5.1 Stored Statistical Sums.** The sums calculated were

$$\Sigma Q, \Sigma Q^2, \text{ and } \Sigma Q^3$$

where  $Q$  is any one of the quantities given in the thermodynamic part of the RRA.

**3.5.2 Calculating Monthly Statistics.** Equations 63 and 64 are used to calculate monthly standard deviations and skewness values.

**3.5.2.1 Monthly Means.** Mean monthly values of the thermodynamic RRA quantities were calculated using the equation

$$\bar{Q} = \Sigma Q / N_Q$$

where  $N_Q$  is the number of observed values of the quantity  $Q$  for a given month.

**3.5.2.2 Monthly Standard Deviations.** Monthly standard deviations of the thermodynamic RRA quantities were calculated using the equation

$$\sigma_Q = \sqrt{\frac{(N_Q \Sigma Q^2) - (\Sigma Q)^2}{N_Q \cdot (N_Q - 1)}} \quad (63)$$

**3.5.2.3 Monthly Skewness Values.** Monthly skewness values of wind speed and thermodynamic RRA quantities are calculated using the equation

$$\sigma_Q = \frac{M_3 Q}{\sigma_Q^3}$$

where  $M_{3Q}$  is the third moment of the quantity  $Q$ .  $\sigma_Q$  is its standard deviation, and

$$M_{3Q} = \left[ \frac{\sum Q^3}{N_Q} - \frac{3\sum Q \sum Q^2}{N_Q^2} + \frac{2\sum Q^3}{N_Q^3} \right] \cdot \frac{N_Q^2}{(N_Q - 1)(N_Q - 2)} \quad (64)$$

**3.5.3 Calculating Annual Statistics.** Equations 63 and 64, used to calculate monthly standard deviations and skewness values, were also used for the annual statistics.

**3.5.3.1 Annual Means.** Annual mean values of the thermodynamic RRA quantities were calculated using the equation

$$Q_{ANN} = Q_A / N_Q$$

where  $Q_A$  is the total of all observed values of  $Q$  and  $N_Q$  is the total number of observations of  $Q$ .

**3.5.3.2 Annual Standard Deviations and Skewness Values.** Annual standard deviations of the thermodynamic RRA quantities were calculated using equation 63. Annual skewness values were calculated with equation 64.

#### NOTE

Both these quantities were previously calculated with monthly statistics because of limitations in computer precision.

### 3.6 MONTHLY AND ANNUAL MEAN MODEL ATMOSPHERES

A set of modeled monthly mean and annual mean hydrostatic values of pressure and density was calculated from the lowest RRA data level (0 km, mean sea level) to 30 km, and from 30 km to 70 km. The integration from 0 to 30 km was computed independently of the integration from 30 to 70 km because of the difference in data sources. These hydrostatically modeled mean values (given in appendix D) are useful as a check on the validity of pressure and density values given in appendix B. In most cases, the values in appendixes B and D for any given data level are within 1 percent of each other. The hydrostatic pressure values in appendix D were calculated using the equation

$$p_1 = p_0 \exp \left( - \frac{0.034162 (H_1 - H_0)}{0.5 (T_n + T_w)} \right) \quad (65)$$

where,  $H_1 - H_0$  is in meters and a "0" subscript refers to values at the RRA data level immediately below the level being checked.  $p_0$  at the lowest data level is set equal to the RRA mean pressure;  $p_1$ , calculated for the next highest data level, is taken as  $p_0$  for the

level above that. This process is repeated for all the other RRA data levels. The hydrostatic density corresponding to hydrostatic pressures is calculated from these pressures and from RRA virtual temperature values using the formula

$$\rho_H = 348.36786 P_H / T_v \quad (66)$$

where  $\rho_H$  and  $P_H$  are the hydrostatic density and pressure shown in appendix D.

### 3.7 THERMODYNAMIC QUANTITIES DERIVABLE FROM TABLES

Several other quantities can be calculated from the statistics given in appendixes B and D. The equations in this section can be used to calculate approximate mean values of these quantities at each RRA data level. It is not possible, however, to infer or derive any information concerning standard deviation or skewness values of these quantities from the data in appendixes B and C.

**3.7.1 Mean Air Particle Speed.** The mean air particle speed,  $V$ , is the arithmetic average of the speeds of all air particles in the volume element being considered. For a valid average to occur, there must be a sufficient number of particles involved to represent mean conditions. The equation for  $V$  for dry air is

$$V = \sqrt{\frac{8}{\pi} \cdot \frac{R' T}{M}} \quad (67)$$

Using tabulated values, a computational form for dry air is

$$V = \sqrt{7.3094 \times 10^2 \times T} \quad (\text{m/s}) \quad (68)$$

where  $T$  is the temperature in kelvin (K) from appendix B. Equation 67, when corrected for moist air, becomes

$$V = \sqrt{\frac{8}{\pi} \cdot R' T_v} \quad (69)$$

The computational form for moist air is

$$V = \sqrt{7.3094 \cdot 10^2 \cdot T_v} \quad (\text{m/s}) \quad (70)$$

where  $T_v$  is the virtual temperature in kelvin (K) from appendix C.

**3.7.2 Mean Free Path.** The mean free path,  $L$ , is the mean value of the distance traveled by each neutral air particle, in a selected air parcel, between successive collisions with other particles in that parcel. A meaningful average requires that the selected parcel be large enough to contain a substantial number of particles. The equation for  $L$  is given by

$$L = \left( \frac{\sqrt{2}}{2\pi} \right) \left( \frac{R' T}{N_a C_d^2 P} \right) \quad (71)$$

where  $C_d$  is the effective collision diameter of the mean air molecules. The 1976 standard atmosphere value of  $3.65 \times 10^{-10}$  is valid for the range altitudes in the RRA. A computational form for moist air, using tabulated values is

$$L = 2.335 \times 10^{-7} \frac{T}{P} \text{ (meters)} \quad (72)$$

where  $T$  is the temperature in K and  $P$  is the pressure in mb, both from appendix B. A form of equation 71 to correct  $L$  for moist air is

$$L = \left( \frac{\sqrt{2}}{2\pi} \right) \frac{R' M T_v}{N_a C_d^2} \quad (73)$$

The computational form for moist air is

$$L = 2.3325 \times 10^{-7} \frac{T_v}{P} \text{ (meters)} \quad (74)$$

where  $T_v$  is the virtual temperature in K from appendix C and  $P$  is the pressure in mb from appendix B.

**3.7.3 Mean Collision Frequency.** The mean collision frequency ( $V_c$ ) is considered to be the average speed of air particles contained in an air parcel divided by the mean free path of the particles inside that parcel. Computationally, this is equivalent to

$$V_c = \frac{V}{L} \text{ (sec}^{-1}\text{)} \quad (75)$$

To determine  $V_c$  for dry air, use  $V$  and  $L$  from equations 68 and 72. To determine  $V_c$  for moist air, use  $V$  and  $L$  from equations 70 and 74.

**3.7.4 Speed of Sound.** The expression for the speed of sound ( $C_s$ ) in dry air, in (m/s) is

$$C_s = \sqrt{\frac{\gamma R' T}{M}} \quad (76)$$

To compute  $C_s$  for dry air from tabulated values, use

$$C_s = \sqrt{4.0185 \times 10^2 \times T} \text{ (m/s)} \quad (77)$$

where  $T$  is the temperature K from appendix B. One form for the speed of sound in moist air is

$$C_s = \sqrt{\gamma R' T_v} \quad (78)$$



where  $T_v$  is the virtual temperature from appendix C. A computational form for moist air is

$$C_s = \sqrt{4.0185 \times 10^2 T_v} \quad (\text{m/s}) \quad (79)$$

**3.7.5 Coefficient of Dynamic Viscosity.** The coefficient of dynamic viscosity,  $\mu$  is defined as a coefficient internal friction developed where gas regions move adjacent to each other at different velocities. The following expression is taken from the U.S. Standard Atmosphere (1976):

$$\mu = \frac{\beta \cdot T^{3/2}}{T + S} \quad (80)$$

The computational form is

$$\mu = \frac{(1.458 \times 10^{-6}) T^{3/2}}{T + 110.4} \cdot \left( \frac{\text{kg}}{\text{s} \cdot \text{m}} \right) \quad (81)$$

where  $T$  is temperature K from appendix B.

**3.7.6 Kinematic Coefficient of Viscosity.** The kinematic coefficient of viscosity, designated as  $\eta$ , is defined as the ratio of the dynamic coefficient of viscosity of a gas to its density, or

$$\eta = \mu / \rho \quad (82)$$

The computational form is

$$\eta = 1.0 \times 10^3 \mu / \rho \quad (\text{m}^2/\text{s}) \quad (83)$$

where  $\mu$  is the dynamic coefficient of viscosity from equation (81) and  $\rho$  is the density in  $\text{g m}^{-3}$  from appendix B.

**3.7.7 Coefficient of Thermal Conductivity.** The empirical expression used for the coefficient of thermal conductivity ( $K_t$ ) is given in the 1976 Standard Atmosphere as

$$K_t = \frac{2.65019 \times 10^{-3} \cdot T^{3/2}}{T + 245.4 \times 10^{-(12/T)}} \quad (\text{watts/m-deg K}) \quad (84)$$

where  $T$  is temperature K.

**3.7.8 Refractive Modulus and Refractive Index.**

The refractive modulus or refractivity (Selby and McClatchey, 1975; Smith and Weintraub, 1953) is expressed as  $N$ , where

$$N = (n - 1) \cdot 10^6 \quad (85)$$

and  $n$  is the refractive index.

For microwave frequencies below approximately 30 GHz (equivalent to wavelengths above 1 cm),  $N$ , the refractive modulus, is given by the empirical equation

$$N = 77.6 \frac{P}{T_d} + 3.73 \times 10^5 \frac{c}{T_d^2} \text{ (dimensionless)} \quad (86)$$

where  $E$  and  $P$  are in millibars and  $T$  and  $T_d$  are in K.

The following expression is valid for visible and infrared wavelengths shorter than approximately 30  $\mu\text{m}$  (0.03 mm):

$$N = 77.6 \frac{P}{T} + 0.584 \frac{P}{T^2} \text{ (dimensionless)} \quad (87)$$

where  $\lambda$  is the wavelength in microns and  $T$  is in degrees K.

The expression for  $N$  for the wavelength from 0.03 mm to 1 cm is an extremely complex function of wavelength.

## Chapter 4

### CONCLUSIONS AND RECOMMENDATIONS

#### 4.1 CONCLUSIONS

This document satisfies the technical objectives established for the Range Reference Atmosphere committee by the Range Commanders Council's Meteorology Group. Upper-air statistics and models for wind and thermodynamic quantities for the range specified have been derived through consistent uniform methods that will be used in similar publications for other ranges. This new Range Reference Atmosphere (RRA) series is an improvement over previously published RRAs. The upper-air data base is much larger and much better because more advanced statistical techniques have been employed.

In this series, a statistical measure of central tendency (mean values) and a measure of dispersion (standard deviation with respect to mean values) for monthly and annual reference periods have been consistently tabulated for all variables using data bases that have been carefully edited and quality controlled. Further, a statistical measure for symmetry (skewness coefficient which involves the third statistical moment) has been tabulated for all variables except the zonal and meridional wind components. But even with these improvements, RRA users must recognize certain limitations of the statistical tabulations. These limitations are described here to discourage misuse of the RRA.

- The wind profile structure with respect to altitude cannot be modeled from RRA statistics because inter-level and cross-level correlations were not computed.

- The profile structure with respect to altitude for any of the thermodynamic variables or quantities derivable from thermodynamic variables cannot be modeled because the prerequisite correlations were not computed. However, the profile of monthly and annual means for pressure, virtual temperature, and density given in appendix D are in agreement with the hydrostatic equation and the equation of state.

Although more extensive statistical tabulations are currently impractical, many adaptations of current statistics for specific engineering and scientific applications are envisioned as insight is gained through RRA use.

#### 4.2 RECOMMENDATIONS

The Range Reference Atmosphere Committee responsible for RRA preparation recommends that the wind and thermodynamic statistical tabulations and models in this RRA be used with confidence as a standard reference to the atmosphere over the location for which it has been prepared. It is further recommended that RRA users consult their Staff Meteorologist for assistance before attempting to apply RRA data to specific engineering projects.

## BIBLIOGRAPHY

Buell, Eugene C., "Statistical Relations in a Perfect Gas," *Journal of Applied Meteorology*, 9, pp. 729-731, 1970.

List, R.J., Ed., "Acceleration of Gravity," *Smithsonian Meteorological Tables*, Sixth Ed. Smithsonian Institution, Washington, D.C., p. 488, 1968.

Selby, J.E.A., and McClatchey, R.A., *Atmospheric Transmittance from 0.25 to 28.5  $\mu\text{m}$ -- Computer Code LOWTRAN 3*, AFCRL-TR-75-0255, Air Force Cambridge Research Laboratories, 1975.

Smith, E.K., and Weintraub, S., "The Constants in the Equation for Atmospheric Refractive Index at Radio Frequencies," *Proceedings of the Institute of Radio Engineers*, 41, 8, pp. 1035-1037, August 1953.

Smith, O.E., *Vector Wind and Vector Wind Shear Models at 0-27 km Altitude for Cape Kennedy, Florida, and Vandenberg AFB, California*, NASA TM X-73319, July 1976.

*U.S. Standard Atmosphere*, National Aeronautics and Space Administration, United States Air Force, and United States Weather Bureau; October 1976.

## ACRONYMS, INITIALISMS, AND ABBREVIATIONS (ACRINABS)

AFDTC	Air Force Development Test Center
AFFTC	Air Force Flight Test Center
AFSC	Air Force Systems Command
AFSCF	Air Force Satellite Control Facility
AWS	Air Weather Service
BMD	Ballistic Missile Division
BMO	Ballistic Missile Organization
CSTC	Consolidated Space Test Center
DoD	Department of Defense
DoE	Department of Energy
DoE/NTS	DOE/Nevada Test Site
DPG	Dugway Proving Ground
EPG	Electronic Proving Ground
ESMC	Eastern Space and Missile Center
ETR	Eastern Test Range
GL	Geophysics Laboratory
IRIG	Inter-Range Instrumentation Group
NASA	National Aeronautics and Space Administration
NASA/MSFC	NASA/Marshall Space Flight Center
NASA/WFC	NASA/Wallops Flight Center
NATC	Naval Air Test Center
NOAA	National Oceanic and Atmospheric Administration
NWC	Naval Weapons Center
PMTC	Pacific Missile Test Center
RCC/MG	Range Commanders Council/Meteorology Group
RRA	Range Reference Atmosphere
RRAC	Range Reference Atmosphere Committee
TFWC	Tactical Fighter Weapons Center
USA/NTC	U.S. Army National Training Center
USACECOM	U.S. Army Communications-Electronics Command
USAFETAC	USAF Environmental Technical Applications Center
USAKA	U.S. Army Kwajalein Atoll
UTTR	Utah Test and Training Range
WSMC	Western Space and Missile Center
WSMR	White Sands Missile Range
WTR	Western Test Range
YPG	Yuma Proving Ground
6585TG	6585th Test Group

## **PREVIOUSLY PUBLISHED RANGE REFERENCE ATMOSPHERES**

Cape Kennedy, Florida (Part I), Document 104-63, 16 April 1963  
(AD 451 780).\*

White Sands Missile Range, New Mexico (Part I), Document 104-63, 28 June 1964  
(AD 451 781).\*

Fort Churchill, Manitoba (Part I), Document 372-63, 7 August 1964  
(AD 634 727).

Eniwetok, Marshall Islands (Part I), Document 104-63, 1 September 1964  
(AD 479 264).\*

Fort Greely Missile Range, Alaska (Part I), Document 373-63, 6 October 1964  
(AD 634 726).

Eglin Gulf Test Range, Florida (Part I), Document 104-63, 25 January 1965  
(AD 472 601).\*

Point Arguello, California (Part I), Document 104-63, April 1965  
(AD 472 602).\*

Wallops Island Test Range (Part I), Document 104-63, 10 July 1965  
(AD 474 071).\*

Ascension Island, South Atlantic (Part I), Document 104-63, July 1966  
(AD 645 591).\*

Johnston Island Test Site (Part I), Document 104-63, January 1970  
(AD 782 652).\*

Lihue, Kauai, Hawaii (Part I), Document 104-63, January 1970  
(AD 782 653).\*

Cape Kennedy, Florida (Part II), Document 104-63, September 1971  
(AD 753 581).\*

White Sands Missile Range (Part II), Document 104-63, September 1971  
(AD 782 654).\*

Wallops Island Test Range (Part II), Document 104-63, September 1971.\*

Fort Greely Missile Range (Part II), Document 104-63, September 1971.\*

Edwards AFB (Part I), Document 104-63, September 1972  
(AD 782 651).\*

Kwajalein Missile Range, Marshall Islands (Part I), Document 105-63, October 1974.\*

Kwajalein Missile Range, Document 360-82, 1982  
(AD-A123424).

Cape Canaveral, Florida, Document 361-83, February 1983  
(AD-A125553).

Vandenberg AFB, California, Document 362-83, 1983  
(AD-A128125).

Dugway, Utah, Document 363-83, June 1983  
(AD-A131110).

Wallops Island Test Range, Virginia, Document 364-83, July 1983  
(AD-A131327).

White Sands Missile Range, New Mexico, Document 365-83, August 1983  
(AD-A132471).

Edwards AFB, California, Document 366-83, August 1983  
(AD-A132487).

Eglin AFB, Florida, Document 367-83, 1983  
(AD-A133506).

Taquac, Guam Island, Document 368-83, 1983  
(AD-A133618).

Point Mugu, California, Document 369-83, 1983  
(AD-A134186).

Barking Sands, Hawaii, Document 370-83, 1983  
(AD-A137406).

Ascension Island, Document 371-84, 1984  
(AD-A138470).

*\* No longer available from RCC.*

Wake Island, USAFETAC/PR-90/007, November 1990.  
(AD-Pending)

Nellis, USAFETAC/PR-90/008, December 1990  
(AD-Pending)

Shemya, USAFETAC/PR-91/003, January 1991  
(AD-Pending)

Thule, USAFETAC/PR-91/006, February 1991  
(AD-Pending)

Fairbanks, USAFETAC/PR-91/007, February 1991  
(AD-Pending)



## **APPENDIX A**

### **Thule Wind Statistics Tables**

Table A-1 through Table A-13 give statistical wind data (monthly and annual) for Thule. Data was produced as described in Chapter 2.

**TABLE A-1. January Statistical Wind Data, Thule.**

Z KM	MEAN U M/S	S.D. U M/S	R(U,V)	MEAN V M/S	S.D. V M/S	MEAN W M/S	S.D. W M/S	SKEW W	#OBS
0.000	0.00	0.00	0.0000	0.00	0.00	0.00	0.00	0.00	0.
0.059	-2.06	1.95	-0.3487	0.69	1.72	2.58	2.19	1.76	777.
1.000	-2.34	3.14	-0.3744	0.96	4.74	4.76	3.60	1.98	800.
2.000	-2.10	4.24	-0.0784	1.73	6.30	6.54	4.12	1.22	799.
3.000	-1.91	5.69	0.0081	2.45	7.59	8.30	4.91	1.03	795.
4.000	-1.75	6.93	0.0353	3.24	8.96	10.11	5.78	0.78	791.
5.000	-1.61	8.26	0.0626	3.70	10.33	11.82	6.70	0.73	787.
6.000	-1.43	9.77	0.0929	4.17	11.90	13.67	7.94	0.84	776.
7.000	-1.19	10.70	0.0890	4.49	12.64	14.77	8.80	0.94	765.
8.000	-0.73	11.29	0.1285	4.32	12.95	15.13	9.22	1.13	753.
9.000	-0.21	10.74	0.1517	3.93	12.67	14.28	9.33	1.53	734.
10.000	0.03	9.88	0.1441	3.18	11.73	12.85	8.18	1.41	697.
11.000	0.22	9.10	0.1077	2.23	10.57	11.96	7.50	1.60	665.
12.000	0.49	8.57	0.0301	0.91	9.64	11.05	6.40	1.08	636.
13.000	0.88	8.67	-0.0545	-0.14	9.47	11.11	6.48	0.82	526.
14.000	1.54	8.77	-0.1725	-1.75	9.44	11.22	6.73	0.74	454.
15.000	2.22	9.61	-0.2592	-3.12	10.06	12.13	7.80	0.85	382.
16.000	2.54	10.74	-0.2998	-5.19	10.62	13.31	9.15	0.93	247.
17.000	3.31	12.02	-0.3666	-6.51	11.91	14.92	10.79	0.95	232.
18.000	3.25	13.56	-0.4194	-8.20	13.47	16.61	12.89	0.98	167.
19.000	4.10	15.05	-0.4563	-10.04	14.55	18.14	15.02	0.97	139.
20.000	2.93	16.25	-0.4554	-11.98	16.76	20.31	16.80	0.96	103.
21.000	3.27	18.14	-0.4565	-14.49	19.62	23.34	19.65	0.91	84.
22.000	3.06	18.97	-0.3510	-15.39	21.38	24.69	21.17	0.76	70.
23.000	3.90	20.53	-0.2709	-15.64	23.34	26.50	22.72	0.69	63.
24.000	5.02	20.46	-0.0795	-15.45	24.30	27.43	22.58	0.61	48.
25.000	4.23	19.75	-0.1657	-17.81	25.94	28.10	24.44	0.76	42.
26.000	8.27	22.74	-0.3330	-21.82	30.51	34.89	27.34	0.42	26.
27.000	12.37	25.16	-0.2009	-34.93	34.03	46.93	30.22	0.06	18.
28.000	10.27	26.76	0.3748	-31.37	31.87	46.20	24.12	-0.92	11.
29.000	4.87	25.35	0.4774	-30.67	34.58	44.47	25.62	-1.06	7.
30.000	0.00	0.00	0.2490	0.00	0.00	0.00	0.00	0.00	4.
32.000	-6.42	26.94	-0.6627	-15.17	21.15	30.83	20.43	0.38	12.
34.000	-4.40	29.34	-0.6588	-18.67	29.91	36.07	26.98	0.47	15.
36.000	-3.93	31.17	-0.5339	-18.20	32.87	37.20	30.56	1.34	15.
38.000	-6.87	33.26	-0.6127	-18.07	38.34	42.13	33.06	1.04	15.
40.000	-9.75	34.90	-0.4253	-21.69	42.75	46.44	36.65	0.82	16.
42.000	-9.19	36.27	-0.3452	-16.00	39.99	43.94	34.77	1.16	16.
44.000	-6.71	37.85	-0.4534	-16.41	41.74	45.18	36.61	1.16	17.
46.000	-11.81	40.19	-0.3912	-8.19	43.43	43.13	41.82	1.59	16.
48.000	-9.00	40.88	-0.2555	-4.75	42.65	43.75	39.72	1.53	16.
50.000	-7.50	41.24	-0.2452	-4.88	40.60	43.13	37.99	1.56	16.
52.000	-4.94	40.99	-0.4017	-4.44	38.91	40.44	38.65	1.54	16.
54.000	1.38	39.64	-0.5283	-3.00	43.05	44.31	36.27	1.52	13.
56.000	1.15	38.86	-0.5385	0.46	41.17	41.00	37.30	1.61	13.
58.000	8.62	39.12	-0.5774	6.92	32.49	38.38	33.44	1.13	13.
60.000	13.00	39.96	-0.5621	8.91	34.09	42.73	32.17	0.64	11.
62.000	11.67	30.71	-0.5366	5.33	25.64	31.89	25.32	0.80	9.
64.000	7.38	32.54	-0.4617	9.75	18.46	26.25	28.44	0.83	8.
66.000	1.83	26.75	-0.4582	7.50	17.16	21.50	23.09	0.86	6.
68.000	0.00	0.00	0.2158	0.00	0.00	0.00	0.00	0.00	5.
70.000	0.00	0.00	-0.8462	0.00	0.00	0.00	0.00	0.00	3.

**TABLE A-2. February Statistical Wind Data, Thule.**

Z KM	MEAN U M/S	S.D. U M/S	R(U,V)	MEAN V M/S	S.D. V M/S	MEAN W M/S	S.D. W M/S	SKEW W	#OBS
0.000	0.00	0.00	0.0000	0.00	0.00	0.00	0.00	0.00	0.
0.059	-1.84	1.71	-0.1759	0.60	1.49	2.33	1.86	1.09	704.
1.000	-1.62	3.36	-0.3123	0.84	4.40	4.58	3.44	1.83	726.
2.000	-0.85	4.07	-0.1696	1.53	6.12	6.45	3.93	1.28	724.
3.000	-0.39	5.36	0.0090	2.33	7.60	8.22	4.94	1.14	722.
4.000	0.03	6.87	0.0712	3.20	9.34	10.24	6.31	1.31	719.
5.000	0.55	8.28	0.0650	4.22	10.94	12.07	7.79	1.43	712.
6.000	1.21	9.46	0.0871	4.95	12.24	13.67	8.83	1.45	699.
7.000	1.75	10.36	0.1026	5.57	13.18	14.67	9.98	1.54	690.
8.000	2.08	10.58	0.1224	5.30	13.11	14.68	10.00	1.52	680.
9.000	2.37	9.90	0.0940	4.32	11.94	13.41	8.83	1.36	664.
10.000	2.58	9.00	0.0618	3.41	10.57	12.14	7.96	1.44	642.
11.000	2.70	7.64	0.0167	2.37	9.50	10.96	6.44	1.14	621.
12.000	3.20	7.42	-0.0212	1.31	9.20	10.65	6.18	1.28	594.
13.000	3.54	7.83	-0.0627	0.43	9.51	10.93	6.69	1.57	536.
14.000	3.99	8.54	-0.1052	-0.65	10.17	11.75	7.39	1.37	500.
15.000	4.57	9.64	-0.1224	-2.19	10.84	12.85	8.41	1.16	437.
16.000	5.34	11.27	-0.2211	-3.87	11.43	14.45	9.58	0.87	322.
17.000	5.96	12.88	-0.2880	-5.52	12.76	16.55	10.95	0.80	315.
18.000	7.90	15.71	-0.3639	-8.80	13.67	20.17	12.87	0.61	235.
19.000	8.91	17.14	-0.4090	-10.75	15.21	22.67	14.31	0.55	222.
20.000	11.47	18.84	-0.4668	-13.75	16.61	26.63	15.51	0.37	178.
21.000	12.43	20.74	-0.4885	-15.47	17.63	29.22	16.67	0.31	163.
22.000	13.07	22.32	-0.5392	-17.37	19.27	31.58	18.46	0.38	146.
23.000	12.58	24.77	-0.5828	-18.51	20.44	33.41	20.27	0.59	127.
24.000	13.85	26.56	-0.6229	-21.04	22.38	36.69	22.10	0.55	110.
25.000	12.39	27.52	-0.6874	-22.56	24.28	38.27	23.16	0.60	95.
26.000	8.56	27.56	-0.7410	-22.19	25.68	38.17	22.68	0.09	71.
27.000	6.32	27.00	-0.6530	-23.95	26.06	38.88	22.22	-0.10	58.
28.000	9.12	25.14	-0.6463	-26.14	26.56	39.59	22.76	0.03	44.
29.000	9.37	26.21	-0.7144	-28.94	26.00	40.63	24.82	0.59	34.
30.000	1.53	28.75	-0.7418	-25.24	29.36	37.75	29.50	1.78	25.
32.000	11.13	17.97	-0.7089	-30.07	34.56	42.93	25.37	0.37	15.
34.000	7.69	13.37	-0.7627	-30.81	37.48	42.13	27.69	0.32	16.
36.000	10.65	16.53	-0.5395	-28.29	34.47	41.65	24.23	0.53	17.
38.000	8.35	14.90	-0.3125	-27.76	34.75	40.47	23.99	0.54	17.
40.000	4.76	18.42	-0.2205	-29.41	36.31	43.53	24.24	0.51	17.
42.000	5.06	19.31	-0.1748	-23.00	31.80	37.59	21.80	0.71	17.
44.000	5.76	20.70	-0.1419	-22.53	32.70	39.41	20.46	0.81	17.
46.000	2.59	19.86	0.0678	-19.47	33.70	38.71	19.14	0.23	17.
48.000	2.20	23.75	0.3605	-17.93	31.58	37.33	20.17	0.34	15.
50.000	-1.06	26.76	0.4292	-9.56	32.93	37.94	19.03	0.50	16.
52.000	0.93	31.04	0.3217	-6.20	27.79	36.27	19.10	1.69	15.
54.000	2.63	33.30	0.3469	-6.06	31.06	39.19	22.19	1.29	16.
56.000	3.20	34.90	0.0942	-0.33	27.54	35.27	25.78	1.85	15.
58.000	-1.36	21.11	0.4958	6.36	25.23	29.21	14.59	-0.03	14.
60.000	8.80	21.06	0.4107	4.87	30.43	34.33	13.95	0.37	15.
62.000	1.77	32.08	0.7484	7.46	35.48	40.54	23.78	1.16	13.
64.000	18.30	24.92	0.2068	-3.80	27.25	36.30	17.37	-0.21	10.
66.000	22.75	31.14	0.8485	1.38	16.87	33.38	23.98	1.10	8.
68.000	41.14	39.59	0.0979	-2.14	18.50	47.57	35.32	0.96	7.
70.000	53.17	41.24	-0.2079	-6.33	26.57	59.83	39.32	1.05	6.

**TABLE A-3. March Statistical Wind Data, Thule.**

Z KM	MEAN U M/S	S.D. U M/S	R(U,V)	MEAN V M/S	S.D. V M/S	MEAN W M/S	S.D. W M/S	SKEW W	#OBS
0.000	0.00	0.00	0.0000	0.00	0.00	0.00	0.00	0.00	0.
0.050	-1.93	2.03	-0.3966	0.69	1.66	2.42	2.29	1.69	734.
1.000	-2.08	3.43	-0.3332	1.06	4.65	4.79	3.71	1.90	753.
2.000	-1.12	4.62	-0.1444	1.72	6.12	6.41	4.20	1.48	753.
3.000	-0.34	6.09	-0.1167	2.17	7.39	8.06	5.02	1.20	750.
4.000	0.08	7.84	-0.0740	2.80	8.71	9.85	6.18	1.18	752.
5.000	0.58	9.29	-0.0463	3.28	9.76	11.48	7.06	1.05	747.
6.000	1.04	10.80	-0.0538	4.09	10.46	13.17	8.38	0.97	736.
7.000	1.27	12.09	-0.0765	4.76	11.21	14.38	9.43	1.15	720.
8.000	1.65	12.27	-0.0600	4.99	11.41	14.53	9.87	1.41	712.
9.000	2.15	11.24	-0.0904	4.58	10.62	13.12	9.18	1.65	701.
10.000	2.70	9.68	-0.0312	3.46	8.89	11.65	7.49	1.60	688.
11.000	3.24	8.67	-0.0095	2.24	7.83	10.68	6.14	1.15	668.
12.000	3.54	8.30	-0.0286	1.08	8.04	10.36	5.91	1.22	645.
13.000	4.19	8.30	-0.0505	-0.07	8.09	10.34	5.81	0.88	620.
14.000	4.63	8.22	-0.0252	-1.26	8.38	10.67	6.14	0.87	603.
15.000	5.23	8.39	-0.0204	-2.53	8.93	11.42	6.80	0.90	593.
16.000	5.64	8.31	0.0338	-3.72	9.55	12.20	7.55	0.95	532.
17.000	6.08	8.63	0.0570	-5.27	9.99	13.12	8.18	0.68	527.
18.000	6.41	9.01	0.0558	-6.50	10.50	14.11	8.70	0.57	508.
19.000	6.54	9.54	0.0302	-8.08	10.85	15.19	9.26	0.46	494.
20.000	6.83	10.22	-0.0254	-9.61	11.47	16.39	10.30	0.51	478.
21.000	6.85	10.78	-0.0724	-11.08	12.46	17.85	11.05	0.35	462.
22.000	6.84	11.46	-0.1218	-12.66	13.35	19.18	12.17	0.46	446.
23.000	6.90	12.08	-0.1703	-14.11	13.80	20.34	13.01	0.46	427.
24.000	6.92	12.56	-0.1995	-15.54	14.42	21.49	13.88	0.40	406.
25.000	6.58	12.92	-0.2248	-16.73	14.78	22.33	14.47	0.39	381.
26.000	6.30	13.34	-0.2629	-17.76	15.16	22.95	15.35	0.47	356.
27.000	5.62	14.12	-0.2981	-18.78	16.19	24.00	16.40	0.56	324.
28.000	5.21	13.98	-0.2869	-19.30	16.86	24.27	17.01	0.58	285.
29.000	5.03	14.30	-0.2975	-20.25	17.38	24.92	17.90	0.65	248.
30.000	3.55	14.04	-0.2775	-19.93	17.63	24.25	18.13	0.80	205.
32.000	3.71	13.81	0.6470	-7.43	21.05	20.53	16.34	1.01	17.
34.000	0.38	16.91	0.7330	-9.42	19.10	20.88	16.79	1.22	17.
36.000	0.88	19.15	0.7586	-9.59	17.44	21.82	16.20	0.80	17.
38.000	-3.37	20.38	0.6273	-9.63	18.37	23.84	16.36	0.47	19.
40.000	-3.48	20.33	0.5396	-12.57	19.08	25.43	16.79	0.55	21.
42.000	-1.57	21.80	0.5073	-11.86	20.05	25.62	18.20	0.89	21.
44.000	-2.00	22.53	0.5147	-9.52	22.72	26.29	19.88	0.79	21.
46.000	-1.43	22.93	0.5477	-6.67	21.45	25.76	18.32	1.32	21.
48.000	-2.86	22.65	0.4150	-9.76	23.27	27.10	19.94	1.10	21.
50.000	-1.90	23.77	0.4653	-8.33	25.88	29.10	20.61	1.22	21.
52.000	-0.29	26.24	0.5338	-7.29	26.37	30.86	21.12	1.34	21.
54.000	3.47	26.66	0.5549	-8.16	25.02	31.53	19.32	0.88	19.
56.000	6.50	27.96	0.4077	-1.22	18.16	28.39	17.32	1.68	18.
58.000	10.65	30.86	0.4294	7.41	16.64	28.94	22.59	1.87	17.
60.000	15.44	33.02	0.2116	8.06	17.89	33.56	23.13	1.69	16.
62.000	17.64	36.06	0.5083	9.93	19.29	35.36	27.55	1.01	14.
64.000	19.00	27.87	0.2569	7.36	22.93	34.55	21.04	0.53	11.
66.000	21.40	25.33	0.2912	2.50	32.87	39.10	23.16	0.77	10.
68.000	33.33	17.49	0.3480	13.33	18.38	40.50	14.36	0.62	6.
70.000	0.00	0.00	0.9976	0.00	0.00	0.00	0.00	0.00	3.

**TABLE A-4. April Statistical Wind Data, Thule.**

Z KM	MEAN U M/S	S.D. U M/S	R(U,V)	MEAN V M/S	S.D. V M/S	MEAN W M/S	S.D. W M/S	SKEW W	#OBS
0.000	0.00	0.00	0.0000	0.00	0.00	0.00	0.00	0.00	0.
0.059	-1.10	1.80	-0.2956	0.63	1.75	1.85	2.12	2.15	787.
1.000	-2.01	3.03	-0.3948	1.73	3.96	4.52	3.38	1.97	809.
2.000	-1.06	4.21	-0.2562	2.38	5.47	6.24	3.93	1.49	808.
3.000	-0.39	5.73	-0.2055	2.81	6.83	7.97	4.89	1.26	805.
4.000	0.12	7.32	-0.1338	3.18	8.36	9.87	6.01	1.05	804.
5.000	0.74	8.88	-0.0808	3.81	9.83	11.84	7.07	0.99	800.
6.000	1.35	10.47	-0.0355	4.49	11.46	13.92	8.29	1.04	789.
7.000	2.12	11.21	0.0119	4.67	12.02	14.67	9.00	0.97	785.
8.000	2.71	11.12	0.0365	4.54	11.48	14.21	9.03	0.96	780.
9.000	3.21	9.73	0.0412	3.94	10.12	12.52	8.12	1.06	771.
10.000	3.46	8.16	0.0165	3.30	8.57	10.83	6.75	1.20	761.
11.000	3.47	6.96	-0.0528	2.82	7.74	9.79	5.69	0.96	753.
12.000	3.81	6.34	-0.1005	2.29	7.24	9.30	5.08	0.88	743.
13.000	3.92	5.74	-0.1463	1.99	7.05	8.93	4.73	0.90	736.
14.000	3.86	5.45	-0.2107	1.75	6.78	8.52	4.60	1.10	720.
15.000	3.73	5.33	-0.2372	1.33	6.77	8.15	4.85	1.33	711.
16.000	3.53	4.98	-0.2636	1.00	6.60	7.69	4.75	1.65	663.
17.000	3.17	4.73	-0.2733	0.55	6.59	7.21	4.91	1.98	654.
18.000	2.91	4.66	-0.2534	0.18	6.80	6.98	5.26	2.13	654.
19.000	2.53	4.56	-0.2627	-0.10	6.99	6.75	5.52	2.36	640.
20.000	2.07	4.48	-0.2509	-0.32	7.14	6.46	5.80	2.58	636.
21.000	1.56	4.59	-0.1905	-0.69	7.31	6.23	5.70	2.49	605.
22.000	1.01	4.70	-0.1446	-0.89	7.37	6.15	5.49	2.38	587.
23.000	0.65	5.03	-0.1190	-1.09	7.51	6.37	5.54	2.26	570.
24.000	0.22	5.36	-0.1267	-1.34	7.72	6.69	5.62	2.14	546.
25.000	-0.39	5.43	-0.1146	-1.42	7.84	6.91	5.79	2.22	526.
26.000	-0.99	5.64	-0.0426	-1.44	8.13	7.26	5.91	1.99	506.
27.000	-1.62	6.11	0.0308	-1.53	8.53	8.04	6.25	2.01	451.
28.000	-1.95	6.15	-0.0557	-1.39	8.17	8.21	6.04	1.68	418.
29.000	-2.23	6.46	-0.0540	-1.45	8.22	8.53	6.06	1.62	381.
30.000	-2.49	6.98	-0.0643	-1.45	7.96	9.07	6.17	1.60	352.
32.000	-3.83	5.88	0.0275	1.61	4.78	7.89	3.22	0.22	18.
34.000	-3.72	7.06	0.0242	1.72	4.96	8.61	3.58	1.07	18.
36.000	-3.00	5.44	0.4330	2.39	4.59	7.00	3.53	0.78	8.
38.000	-4.61	5.92	0.4197	3.06	4.77	8.44	3.93	0.42	18.
40.000	-3.63	6.76	0.3025	3.68	6.96	9.47	5.21	0.65	19.
42.000	-3.58	8.86	0.2611	5.05	6.98	11.42	5.29	1.50	19.
44.000	-1.28	8.40	0.3878	6.39	6.61	10.00	7.54	1.30	18.
46.000	1.35	7.31	0.3899	5.20	10.05	11.55	7.12	1.03	20.
48.000	2.00	11.68	0.2122	6.70	8.45	13.90	7.64	0.85	20.
50.000	3.28	13.45	0.2090	5.72	11.39	16.28	8.90	1.10	18.
52.000	0.41	9.57	0.1497	4.94	9.57	12.59	6.15	0.19	17.
54.000	-1.63	12.30	0.3110	5.50	7.36	14.31	4.66	0.71	16.
56.000	-2.00	10.01	-0.0352	5.87	6.28	12.20	4.25	-0.30	15.
58.000	-1.46	16.16	0.1169	6.23	9.01	16.85	8.91	-0.35	13.
60.000	-2.92	15.11	-0.0649	3.75	10.37	16.92	6.93	0.15	12.
62.000	-11.13	16.45	-0.8343	9.25	9.24	20.75	10.28	1.00	8.
64.000	-6.00	21.29	-0.6860	4.38	10.18	20.13	12.72	0.42	8.
66.000	-11.83	9.26	-0.5828	13.33	14.91	21.17	12.21	1.21	6.
68.000	5.50	14.54	-0.3891	5.83	11.79	17.00	8.56	0.99	6.
70.000	0.00	0.00	-0.3957	0.00	0.00	0.00	0.00	0.00	0.

**TABLE A-5. May Statistical Wind Data, Thule.**

Z KM	MEAN U M/S	S.D. U M/S	R(U,V)	MEAN V M/S	S.D. V M/S	MEAN W M/S	S.D. W M/S	SKEW W	#OBS
0.000	0.00	0.00	0.0000	0.00	0.00	0.00	0.00	0.00	0.
0.059	-0.42	1.97	-0.4401	0.58	1.78	1.79	2.08	1.86	822.
1.000	-1.83	3.11	-0.3994	1.22	4.21	4.55	3.40	1.90	839.
2.000	-0.90	3.82	-0.2022	1.49	5.52	5.88	3.68	1.19	838.
3.000	0.01	4.86	-0.0994	1.73	6.80	7.23	4.53	1.17	835.
4.000	0.95	6.10	-0.0165	1.74	8.03	8.78	5.34	1.19	833.
5.000	1.61	7.38	0.0140	1.81	9.46	10.51	6.26	1.08	832.
6.000	2.23	8.59	0.0220	2.09	11.28	12.40	7.52	1.15	825.
7.000	2.84	9.70	0.0281	2.06	12.42	13.84	8.28	1.07	816.
8.000	3.38	10.05	0.0338	2.07	12.53	14.20	8.48	1.28	809.
9.000	3.47	9.46	0.0005	1.62	11.29	12.84	7.79	1.14	798.
10.000	3.35	7.84	-0.0009	1.40	9.32	10.70	6.49	1.19	779.
11.000	2.86	6.07	-0.0434	1.09	7.11	8.49	4.77	1.20	773.
12.000	2.43	5.22	-0.0934	0.96	6.12	7.35	4.00	1.13	755.
13.000	2.10	4.74	-0.1445	0.79	5.50	6.65	3.68	1.13	747.
14.000	1.84	4.28	-0.1252	0.58	5.06	5.97	3.31	1.17	730.
15.000	1.44	3.95	-0.1275	0.29	4.49	5.33	2.94	1.13	720.
16.000	1.07	3.78	-0.1426	0.17	4.28	5.02	2.74	0.97	701.
17.000	0.74	3.52	-0.1405	0.00	3.89	4.61	2.48	0.88	663.
18.000	0.33	3.35	-0.1255	-0.06	3.59	4.31	2.38	1.06	662.
19.000	-0.25	3.16	-0.1413	-0.07	3.38	4.05	2.25	1.25	625.
20.000	-0.83	3.04	-0.1344	-0.14	3.17	3.90	2.19	1.33	622.
21.000	-1.42	3.15	-0.0995	-0.17	3.04	3.93	2.14	1.19	608.
22.000	-1.87	3.07	-0.0878	-0.14	2.85	3.98	2.08	1.12	592.
23.000	-2.31	3.12	-0.0538	-0.08	2.79	4.21	2.15	1.05	574.
24.000	-2.69	3.24	-0.0542	0.05	2.86	4.52	2.32	1.13	555.
25.000	-3.22	3.27	-0.1029	0.11	2.73	4.80	2.32	1.01	509.
26.000	-3.71	3.46	-0.1410	0.14	2.77	5.24	2.44	0.91	484.
27.000	-4.45	3.90	-0.1078	0.28	2.74	5.81	2.72	1.08	427.
28.000	-4.70	3.92	-0.1234	0.38	2.49	5.91	2.75	1.12	379.
29.000	-4.96	4.13	-0.1743	0.45	2.64	6.26	3.07	1.47	351.
30.000	-5.30	4.43	-0.2183	0.55	2.93	6.68	3.46	1.52	31.
32.000	-7.67	5.30	0.7883	-0.20	3.30	8.20	5.45	2.16	5.
34.000	-7.13	4.52	0.6247	0.93	3.26	7.87	4.58	1.48	15.
36.000	-8.73	8.53	0.7966	1.07	4.04	9.40	8.72	2.29	15.
38.000	-10.47	13.61	0.6601	0.93	6.49	12.67	13.03	3.05	15.
40.000	-10.33	12.53	0.4148	1.53	5.97	13.20	11.23	2.83	15.
42.000	-9.88	7.46	0.1914	2.75	5.95	12.06	6.86	1.78	16.
44.000	-13.57	18.29	0.6422	4.29	7.19	16.21	18.00	3.05	14.
46.000	-17.43	27.24	0.8269	3.14	8.90	19.43	27.27	3.58	14.
48.000	-21.29	30.62	0.8556	2.57	15.04	23.93	32.45	3.45	14.
50.000	-22.40	25.07	0.9270	0.00	12.04	23.60	26.74	2.90	10.
52.000	-24.40	23.91	0.8678	0.10	10.34	25.60	24.55	2.75	10.
54.000	-30.10	39.40	0.9259	0.10	9.29	30.80	39.75	2.96	10.
56.000	-30.56	32.32	0.8259	0.11	8.65	31.33	32.71	2.79	9.
58.000	-24.13	4.58	-0.4717	6.13	4.42	25.25	4.92	-0.08	8.
60.000	-22.67	6.69	-0.2351	6.67	4.21	24.00	6.65	0.38	9.
62.000	-21.70	7.94	0.2239	6.50	6.28	23.80	6.80	0.12	10.
64.000	-20.30	11.83	-0.1947	5.90	10.58	24.30	9.68	0.64	10.
66.000	-22.00	15.45	-0.6130	8.75	7.05	27.00	9.46	0.54	8.
68.000	-21.33	8.02	-0.1072	5.33	5.43	22.33	8.09	1.04	6.
70.000	0.00	0.00	0.9912	0.00	0.00	0.00	0.00	0.00	4.

TABLE A-6. June Statistical Wind Data, Thule.

Z KM	MEAN U M/S	S.D. U M/S	R(U,V)	MEAN V M/S	S.D. V M/S	MEAN W M/S	S.D. W M/S	SKEW W	#OBS
0.000	0.00	0.00	0.0000	0.00	0.00	0.00	0.00	0.00	0.
0.059	0.27	2.23	-0.4787	0.54	2.13	2.08	2.35	1.87	752.
1.000	-1.97	3.26	-0.3945	1.31	3.94	4.40	3.40	2.09	772.
2.000	-1.15	4.14	-0.1792	1.34	5.06	5.73	3.61	1.37	772.
3.000	-0.32	5.07	-0.1200	1.19	5.98	6.71	4.25	0.96	768.
4.000	0.24	6.11	-0.1179	0.98	6.95	7.92	4.90	0.91	767.
5.000	0.74	7.34	-0.1158	0.85	8.02	9.32	5.70	0.93	765.
6.000	1.24	8.80	-0.0483	0.84	9.46	11.11	6.75	0.87	748.
7.000	1.65	10.14	-0.0287	0.80	10.73	12.79	7.59	0.87	740.
8.000	2.19	11.23	-0.0029	0.84	11.68	14.06	8.38	0.91	732.
9.000	2.31	11.04	0.0065	0.77	11.30	13.70	8.22	0.84	730.
10.000	2.18	9.18	-0.0228	0.58	9.33	11.16	7.20	1.30	727.
11.000	1.66	6.99	-0.0281	0.51	7.21	8.58	5.23	1.16	717.
12.000	1.27	5.67	-0.0645	0.50	5.81	7.06	4.23	1.27	712.
13.000	0.92	4.70	-0.0671	0.51	4.96	5.98	3.45	1.36	706.
14.000	0.55	4.16	-0.0511	0.48	4.23	5.22	2.90	1.19	696.
15.000	0.07	3.71	-0.0373	0.44	3.72	4.58	2.50	1.21	692.
16.000	-0.29	3.43	-0.0075	0.35	3.34	4.21	2.22	1.10	678.
17.000	-0.74	3.13	-0.0068	0.30	3.07	3.92	2.12	1.35	619.
18.000	-1.19	2.83	0.0860	0.31	2.82	3.63	1.88	0.88	619.
19.000	-1.68	2.65	0.1348	0.32	2.51	3.55	1.91	0.95	588.
20.000	-2.21	2.39	0.1388	0.28	2.26	3.53	1.82	0.80	584.
21.000	-2.84	2.34	0.1325	0.30	2.17	3.81	1.83	0.55	573.
22.000	-3.13	3.12	0.6449	0.36	3.36	3.96	1.78	0.37	554.
23.000	-3.60	3.40	0.6060	0.35	2.97	4.28	1.87	0.43	540.
24.000	-4.00	3.69	0.6029	0.26	2.53	4.64	1.94	0.36	517.
25.000	-4.51	2.27	0.1132	0.21	1.78	4.92	1.94	0.21	491.
26.000	-4.75	2.30	0.0734	0.29	1.71	5.12	1.93	0.28	479.
27.000	-4.98	2.61	0.0403	0.35	1.92	5.42	2.06	0.18	461.
28.000	-5.25	2.37	0.1621	0.46	1.73	5.57	2.01	0.34	381.
29.000	-5.43	2.39	0.0574	0.54	1.83	5.75	2.06	0.71	359.
30.000	-5.64	2.65	0.0612	0.59	2.04	6.05	2.25	0.13	338.
32.000	-6.08	4.57	0.2048	0.83	3.70	7.79	3.41	1.41	24.
34.000	-7.36	4.79	0.0800	1.08	2.58	8.48	3.73	1.19	25.
36.000	-6.76	4.66	-0.2881	1.72	2.53	7.80	3.80	0.61	25.
38.000	-7.38	4.18	-0.1700	1.35	3.07	8.65	2.88	0.78	26.
40.000	-8.46	5.15	-0.6052	1.96	4.02	9.85	4.79	2.22	26.
42.000	-10.92	6.95	-0.4605	1.96	3.66	12.46	5.48	2.99	26.
44.000	-13.16	9.48	0.2256	2.32	4.04	15.00	7.63	2.77	25.
46.000	-13.50	7.92	0.1721	2.08	4.82	15.00	6.44	1.61	26.
48.000	-16.67	9.20	-0.0852	4.74	5.92	19.41	6.31	1.09	27.
50.000	-18.00	10.37	-0.2119	4.69	4.37	19.96	8.44	2.97	26.
52.000	-17.24	10.24	-0.0571	4.12	4.66	18.80	9.11	2.60	25.
54.000	-21.44	12.73	-0.2237	2.96	4.95	22.67	11.83	3.24	27.
56.000	-26.74	15.72	-0.3736	4.61	6.03	28.22	14.99	2.30	23.
58.000	-26.62	13.11	-0.1166	5.29	5.57	28.90	10.12	1.34	21.
60.000	-23.00	11.79	-0.1663	5.47	5.95	25.63	8.26	0.08	19.
62.000	-26.53	9.87	0.4749	2.82	8.99	29.00	6.80	-0.52	17.
64.000	-24.86	7.51	-0.5981	1.64	10.50	26.93	7.02	-0.46	14.
66.000	-23.83	11.17	0.0472	2.50	8.27	25.33	11.34	0.10	12.
68.000	-23.80	16.95	0.0453	3.30	4.11	24.90	16.39	1.50	10.
70.000	-8.75	12.61	-0.3945	0.75	6.82	13.88	8.71	0.84	8.

**TABLE A-7. July Statistical Wind Data, Thule.**

Z KM	MEAN U M/S	S.D. U M/S	R(U,V)	MEAN V M/S	S.D. V M/S	MEAN W M/S	S.D. W M/S	SKEW W	#OBS
0.000	0.00	0.00	0.0000	0.00	0.00	0.00	0.00	0.00	0.
0.059	0.02	2.24	-0.4568	0.33	1.91	1.78	2.36	2.31	769.
1.000	-2.14	3.40	-0.2875	1.17	4.40	4.53	3.79	2.19	797.
2.000	-1.16	3.78	-0.0928	0.89	4.94	5.29	3.58	1.76	796.
3.000	-0.41	4.52	-0.0279	0.80	5.72	6.20	3.94	1.35	794.
4.000	0.11	5.41	-0.0210	0.51	6.52	7.30	4.16	1.10	794.
5.000	0.68	6.49	-0.0175	0.18	7.47	8.62	4.91	1.10	792.
6.000	1.01	7.93	-0.0101	-0.10	8.98	10.50	5.85	1.07	781.
7.000	1.35	9.44	0.0180	-0.23	10.59	12.44	6.95	1.08	777.
8.000	1.67	11.05	0.0615	-0.31	12.22	14.29	8.36	1.30	772.
9.000	1.92	11.81	0.0935	-0.41	12.90	14.97	9.24	1.32	767.
10.000	1.70	9.89	0.0362	-0.23	11.18	12.45	8.04	1.24	762.
11.000	1.22	7.65	0.0289	-0.18	8.28	9.06	6.02	1.45	755.
12.000	0.69	5.32	-0.0021	-0.11	6.22	6.92	4.42	1.29	746.
13.000	0.27	4.35	0.0364	0.04	5.04	5.55	3.36	1.04	738.
14.000	0.02	3.87	0.1244	0.18	4.56	4.68	2.85	1.19	728.
15.000	-0.31	3.37	0.1769	0.08	4.00	3.95	2.45	1.31	723.
16.000	-0.68	2.75	-0.0510	0.01	2.98	3.53	2.10	1.12	711.
17.000	-1.03	2.46	-0.0498	0.01	2.68	3.27	1.91	1.01	669.
18.000	-1.44	2.24	-0.0594	0.06	2.36	3.06	1.81	0.91	668.
19.000	-1.86	2.18	0.0677	0.10	2.31	3.06	1.80	0.91	628.
20.000	-2.39	2.03	0.1026	0.11	2.10	3.24	1.69	0.58	627.
21.000	-2.92	2.07	0.0731	0.17	2.03	3.63	1.76	0.35	625.
22.000	-3.20	2.01	0.0880	0.26	1.98	3.82	1.73	0.30	603.
23.000	-3.55	2.01	0.0914	0.33	1.93	4.10	1.76	0.34	594.
24.000	-3.84	2.13	0.0976	0.38	2.01	4.35	1.85	0.32	580.
25.000	-4.05	2.01	0.0317	0.42	1.83	4.53	1.85	0.48	558.
26.000	-4.21	2.01	0.1022	0.48	1.72	4.62	1.77	0.32	538.
27.000	-4.37	2.27	0.1141	0.48	1.86	4.83	1.98	0.62	523.
28.000	-4.54	2.04	0.1369	0.41	1.90	4.90	1.87	0.22	455.
29.000	-4.69	2.17	0.1296	0.35	2.29	5.07	2.03	0.32	423.
30.000	-4.75	2.41	-0.0770	0.24	2.37	5.27	2.29	0.42	386.
32.000	-5.50	4.43	0.3302	1.29	2.79	6.57	3.88	0.71	14.
34.000	-7.47	4.87	-0.4123	0.27	2.28	7.67	4.76	1.87	15.
36.000	-8.53	5.22	0.0270	1.41	3.41	9.18	5.05	1.52	17.
38.000	-7.88	6.58	0.5593	1.06	3.36	9.41	5.14	1.20	17.
40.000	-8.68	6.39	0.1760	1.37	2.36	10.00	4.86	0.54	19.
42.000	-10.16	4.68	0.6152	2.16	6.22	12.11	4.27	1.09	19.
44.000	-12.68	4.10	-0.1789	1.00	2.73	13.00	3.97	-1.36	19.
46.000	-14.32	5.52	0.1258	5.00	4.64	16.00	4.62	0.43	19.
48.000	-15.20	3.43	0.1052	4.65	3.88	16.40	3.07	-0.48	20.
50.000	-17.40	4.91	0.2505	4.65	3.86	18.45	4.72	0.31	20.
52.000	-19.89	5.56	-0.0575	3.56	3.88	20.56	5.79	0.16	18.
54.000	-20.83	6.36	-0.1196	4.78	3.81	21.61	6.32	0.11	18.
56.000	-21.22	8.99	-0.2985	4.67	3.76	22.17	8.69	-0.14	18.
58.000	-20.59	8.73	-0.3959	6.71	5.75	22.47	8.56	-0.29	17.
60.000	-21.93	8.75	-0.0827	5.00	7.02	23.36	8.62	0.01	14.
62.000	-28.00	14.48	0.2085	11.00	5.56	32.40	9.30	-0.93	10.
64.000	-28.75	8.55	0.5202	8.38	7.27	31.13	6.96	0.68	8.
66.000	-35.00	17.06	0.1091	-0.17	4.83	35.33	16.78	1.96	6.
68.000	-27.14	13.01	0.4901	0.14	6.62	27.57	12.97	0.74	7.
70.000	0.00	0.00	0.9210	0.00	0.00	0.00	0.00	0.00	4.



**TABLE A-8. August Statistical Wind Data, Thule.**

Z KM	MEAN U M/S	S.D. U M/S	R(U,V)	MEAN V M/S	S.D. V M/S	MEAN W M/S	S.D. W M/S	SKEW W	#OBS
0.000	0.00	0.00	0.0000	0.00	0.00	0.00	0.00	0.00	0.
0.059	-0.35	2.18	-0.4712	0.65	2.18	1.88	2.55	1.85	745.
1.000	-1.88	3.76	-0.4470	1.77	4.60	4.97	3.97	1.96	768.
2.000	-0.70	4.04	-0.1576	1.50	5.23	5.84	3.49	1.18	767.
3.000	0.00	4.91	-0.0433	1.70	5.81	6.65	3.87	0.80	767.
4.000	0.44	5.98	0.0297	1.83	6.66	7.87	4.49	0.65	766.
5.000	1.00	7.13	0.0884	1.92	7.45	9.15	5.21	0.77	762.
6.000	1.56	8.45	0.1039	2.19	8.73	10.75	6.26	0.76	750.
7.000	2.00	9.87	0.1048	2.37	10.13	12.54	7.23	0.72	742.
8.000	2.37	11.33	0.1257	2.68	11.51	14.16	8.54	0.84	736.
9.000	2.72	12.14	0.1326	2.67	12.19	14.95	9.30	1.04	730.
10.000	2.63	10.97	0.0895	2.43	10.93	13.30	8.68	1.37	722.
11.000	2.32	8.89	0.0587	1.89	8.52	10.30	6.82	1.45	710.
12.000	1.93	7.24	0.0181	1.60	6.66	8.41	5.37	1.51	699.
13.000	1.55	6.03	-0.0057	1.41	5.50	7.04	4.37	1.45	694.
14.000	1.31	5.14	-0.0128	1.14	4.56	6.02	3.55	1.23	687.
15.000	0.85	4.48	0.0175	0.84	3.92	5.22	3.09	1.24	683.
16.000	0.63	4.20	0.0013	0.80	3.57	4.75	2.84	1.23	674.
17.000	0.32	3.81	-0.0175	0.68	3.35	4.36	2.70	1.53	630.
18.000	-0.05	3.43	0.0356	0.51	3.10	3.87	2.21	1.09	630.
19.000	-0.34	3.03	0.0130	0.51	2.95	3.57	1.97	0.99	602.
20.000	-0.62	2.84	0.0308	0.50	2.98	3.32	1.76	0.65	602.
21.000	-0.97	2.72	0.0786	0.50	2.50	3.22	1.76	0.62	594.
22.000	-1.07	2.60	0.1150	0.44	2.36	3.08	1.69	0.79	587.
23.000	-1.27	2.57	0.0444	0.38	2.05	3.08	1.76	1.26	576.
24.000	-1.39	2.97	0.1633	0.37	2.11	3.05	1.68	1.03	566.
25.000	-1.53	2.50	0.0483	0.37	1.97	2.99	1.60	0.57	541.
26.000	-1.52	2.57	0.0986	0.37	2.04	3.04	1.72	0.62	525.
27.000	-1.55	2.88	0.1081	0.39	2.37	3.30	2.03	1.23	494.
28.000	-1.41	2.70	0.0777	0.26	1.88	3.06	1.75	0.61	448.
29.000	-1.40	2.80	0.0690	0.26	1.95	3.19	1.87	1.13	419.
30.000	-1.29	3.03	0.0719	0.14	2.25	3.39	1.95	0.95	389.
32.000	-3.18	3.56	0.3218	1.65	2.29	4.76	2.66	1.87	17.
34.000	-3.58	4.60	0.2233	2.32	4.08	6.21	4.02	1.09	19.
36.000	-3.21	6.15	-0.0994	2.05	2.80	6.37	4.30	1.90	19.
38.000	-3.71	5.66	0.2390	2.62	2.78	6.76	3.51	2.83	21.
40.000	-4.05	6.66	-0.2663	2.71	2.97	7.67	3.89	2.20	21.
42.000	-3.78	7.20	-0.1081	1.26	4.10	7.96	4.65	2.18	23.
44.000	-4.22	8.47	-0.2251	2.65	4.95	9.22	5.91	1.41	3.
46.000	-4.39	9.37	-0.0381	3.48	4.93	10.65	5.00	0.86	23.
48.000	-4.46	8.32	0.1992	5.04	4.81	9.83	6.04	0.31	24.
50.000	-6.22	10.12	0.3063	5.00	5.27	11.91	6.68	0.41	23.
52.000	-8.00	10.95	0.1502	4.82	4.90	14.23	4.84	0.01	22.
54.000	-10.05	11.09	-0.3434	3.33	5.72	15.10	6.15	-0.50	21.
56.000	-9.95	12.27	-0.1619	3.95	7.68	16.24	7.51	0.38	21.
58.000	-13.77	11.55	0.0045	5.50	6.01	18.00	8.01	0.47	2.
60.000	-15.32	13.20	-0.2426	7.53	6.87	20.11	9.85	0.46	19.
62.000	-12.77	13.01	-0.1119	8.38	8.14	19.85	7.71	-0.37	13.
64.000	-15.38	19.61	0.0175	6.23	6.58	21.85	14.31	2.01	13.
66.000	-13.89	12.49	-0.2222	6.00	8.92	18.33	10.75	0.67	9.
68.000	-9.13	17.13	0.1011	7.38	5.80	16.38	13.07	0.86	8.
70.000	0.00	0.00	-0.7544	0.00	0.00	0.00	0.00	0.00	3.

**TABLE A-9. September Statistical Wind Data, Thule.**

Z KM	MEAN U M/S	S.D. U M/S	R(U,V)	MEAN V M/S	S.D. V M/S	MEAN W M/S	S.D. W M/S	SKEW W	#OBS
0.000	0.00	0.00	0.0000	0.00	0.00	0.00	0.00	0.00	0.
0.059	-1.25	2.22	-0.3156	1.03	2.16	2.35	2.58	1.69	835.
1.000	-1.27	3.40	-0.2565	1.26	4.65	4.85	3.47	1.55	875.
2.000	-0.12	3.91	-0.0856	1.07	5.42	5.75	3.43	0.98	873.
3.000	0.76	4.96	-0.0768	1.43	6.08	7.01	3.87	0.71	872.
4.000	1.59	6.08	-0.0525	1.76	7.12	8.47	4.62	0.81	872.
5.000	2.41	7.37	-0.0178	1.93	8.47	10.17	5.67	0.98	869.
6.000	3.33	8.72	0.0002	2.07	10.03	12.12	6.71	0.91	859.
7.000	4.19	10.13	0.0052	2.29	11.35	13.97	7.68	1.00	848.
8.000	5.01	11.32	-0.0030	2.32	12.33	15.37	8.62	1.07	837.
9.000	5.61	11.92	-0.0249	2.16	12.48	15.44	9.28	1.28	817.
10.000	5.31	10.73	-0.0771	1.42	11.01	13.33	8.34	1.34	797.
11.000	4.73	8.59	-0.1348	0.91	8.36	10.47	6.25	1.07	784.
12.000	4.08	7.03	-0.1235	0.72	6.75	8.80	4.96	0.84	769.
13.000	3.71	5.82	-0.0732	0.56	5.78	7.77	4.38	0.89	758.
14.000	3.39	5.03	-0.0691	0.46	4.98	6.91	3.74	0.71	742.
15.000	3.06	4.52	-0.0784	0.26	4.53	6.30	3.27	0.44	733.
16.000	3.01	4.36	-0.0492	0.28	4.32	5.94	3.10	0.52	676.
17.000	2.81	4.05	-0.0643	0.27	4.07	5.51	3.04	0.73	656.
18.000	2.77	3.92	-0.0960	0.21	3.97	5.24	3.06	0.89	654.
19.000	2.67	3.70	-0.1564	0.25	3.91	4.98	2.96	0.88	635.
20.000	2.60	3.66	-0.2121	0.30	3.99	4.80	2.88	0.97	632.
21.000	2.56	3.38	-0.0061	0.45	3.54	4.69	2.94	1.24	611.
22.000	2.67	3.26	0.0145	0.60	3.43	4.62	2.91	1.14	596.
23.000	2.73	3.29	0.0491	0.80	3.51	4.70	3.02	1.19	590.
24.000	2.81	3.28	0.0803	0.95	3.64	4.85	3.04	1.12	569.
25.000	3.11	3.32	0.1490	0.97	3.65	5.04	3.10	1.11	537.
26.000	3.33	3.40	0.1961	0.99	3.87	5.33	3.20	1.02	512.
27.000	3.69	3.86	0.1493	1.06	4.19	5.79	3.45	1.02	451.
28.000	4.07	3.93	0.2549	1.24	4.23	6.02	3.55	1.09	411.
29.000	4.57	4.40	0.3935	1.23	4.60	6.50	3.71	1.11	383.
30.000	4.79	4.49	0.3169	1.16	4.54	6.98	4.04	1.22	340.
32.000	6.92	5.66	-0.4095	4.08	4.66	9.75	4.45	-0.39	12.
34.000	6.21	7.32	-0.5168	4.57	5.45	10.79	4.92	0.09	14.
36.000	8.62	6.16	-0.5058	3.54	4.82	11.46	3.67	-1.53	13.
38.000	9.85	8.17	-0.3831	5.38	5.78	13.38	6.19	0.28	13.
40.000	13.58	11.65	-0.3954	5.83	6.45	17.50	9.16	1.43	12.
42.000	14.83	9.47	-0.2578	7.00	5.74	18.50	7.05	0.02	12.
44.000	16.42	10.02	-0.2859	5.33	6.65	19.58	7.45	-0.08	12.
46.000	18.00	10.82	-0.2640	5.55	7.63	21.00	8.82	-0.17	11.
48.000	21.27	11.03	0.0231	6.55	11.14	24.73	10.72	-0.24	11.
50.000	20.42	10.20	0.4237	7.50	11.70	24.08	11.04	-0.35	12.
52.000	20.33	12.45	0.2953	8.75	13.85	25.08	14.13	0.24	12.
54.000	24.08	11.42	0.4651	8.83	13.37	27.75	13.93	-0.12	12.
56.000	26.50	19.01	0.5240	3.83	6.09	27.42	19.14	1.47	12.
58.000	19.17	13.67	0.1372	6.08	7.17	21.75	13.14	0.41	12.
60.000	22.10	20.33	-0.2838	3.90	12.19	25.50	19.86	0.78	10.
62.000	19.29	14.60	-0.7408	6.86	17.11	26.71	12.71	1.00	7.
64.000	22.00	15.61	-0.6951	5.00	19.34	27.57	18.17	1.80	7.
66.000	0.00	0.00	-0.8950	0.00	0.00	0.00	0.00	0.00	5.
68.000	0.00	0.00	-0.5692	0.00	0.00	0.00	0.00	0.00	5.
70.000	0.00	0.00	1.0000	0.00	0.00	0.00	0.00	0.00	2.

**TABLE A-10. October Statistical Wind Data, Thule.**

Z KM	MEAN U M/S	S.D. U M/S	R(U,V)	MEAN V M/S	S.D. V M/S	MEAN W M/S	S.D. W M/S	SKEW W	#OBS
0.000	0.00	0.00	0.0000	0.00	0.00	0.00	0.00	0.00	0.
0.059	-2.19	2.13	-0.1454	1.04	1.86	3.01	2.19	1.23	818.
1.000	-1.73	3.76	-0.5725	1.70	5.10	5.35	4.16	1.87	841.
2.000	-0.73	4.15	-0.3203	1.64	6.05	6.44	3.94	1.16	841.
3.000	-0.02	4.96	-0.2040	2.05	6.95	7.59	4.41	1.10	841.
4.000	0.62	6.13	-0.1643	2.63	8.38	9.12	5.31	1.18	841.
5.000	1.30	7.44	-0.1145	3.06	9.85	10.78	6.25	1.06	840.
6.000	2.11	8.61	-0.1155	3.56	11.09	12.50	7.32	0.96	830.
7.000	2.86	9.74	-0.1340	3.89	12.15	14.11	8.15	0.93	818.
8.000	3.48	10.55	-0.1359	4.24	13.28	15.30	9.13	1.18	812.
9.000	4.13	10.35	-0.1495	4.17	12.97	14.88	9.39	1.44	805.
10.000	4.49	9.41	-0.1685	3.59	10.79	13.18	8.02	1.21	794.
11.000	4.52	7.92	-0.1892	3.18	8.86	11.34	6.57	1.11	785.
12.000	4.64	6.94	-0.1965	2.84	7.95	10.29	5.59	1.05	772.
13.000	4.73	6.37	-0.1740	2.58	7.09	9.70	5.09	1.03	757.
14.000	5.02	5.83	-0.1590	2.24	6.59	9.27	4.65	0.89	742.
15.000	5.33	5.41	-0.1130	1.86	6.31	8.97	4.51	0.86	731.
16.000	5.51	5.29	-0.0806	1.55	6.08	8.83	4.43	0.71	657.
17.000	5.87	5.22	-0.0501	1.32	6.09	8.94	4.54	0.66	649.
18.000	6.35	5.33	-0.0511	1.11	6.11	9.20	4.75	0.69	601.
19.000	6.78	5.34	-0.0328	0.78	6.34	9.58	4.84	0.68	559.
20.000	7.15	5.49	-0.0002	0.50	6.50	9.93	5.02	0.83	523.
21.000	7.42	5.68	-0.0169	-0.11	6.61	10.15	5.27	0.98	462.
22.000	7.72	5.68	-0.0527	-0.34	6.76	10.53	5.17	1.05	412.
23.000	7.98	5.87	-0.0913	-0.73	7.12	10.97	5.37	1.09	376.
24.000	7.91	5.62	-0.1119	-1.02	7.35	10.90	5.51	1.54	308.
25.000	8.28	5.61	-0.1157	-1.06	7.03	11.05	5.33	1.19	256.
26.000	8.53	5.62	-0.1408	-1.57	7.37	11.35	5.66	1.26	212.
27.000	8.97	5.84	-0.1198	-2.12	7.50	11.82	5.95	1.33	174.
28.000	9.18	6.09	-0.1353	-2.28	7.53	12.06	6.11	1.50	142.
29.000	9.66	6.44	-0.1158	-2.54	8.13	12.72	6.71	1.52	125.
30.000	10.20	6.18	-0.0133	-2.73	9.44	13.89	6.70	1.30	95.
32.000	13.57	8.08	-0.4989	-16.86	20.45	24.57	18.27	0.58	7.
34.000	13.00	7.09	-0.0330	-14.25	24.44	25.75	17.69	0.66	8.
36.000	14.75	9.54	-0.0117	-14.63	23.43	26.75	17.52	0.33	8.
38.000	13.56	7.40	-0.3139	-15.00	24.21	25.67	19.21	1.40	9.
40.000	11.11	6.53	0.3503	-12.44	20.69	22.89	14.01	1.02	9.
42.000	11.11	7.42	0.2683	-16.33	23.62	25.67	17.68	0.47	9.
44.000	12.63	10.20	0.0859	-9.00	22.17	21.75	17.89	1.06	8.
46.000	9.50	10.85	0.2136	-6.63	20.00	19.63	15.38	1.43	8.
48.000	7.63	13.24	0.3722	-9.38	17.56	19.38	14.67	1.17	8.
50.000	4.25	17.25	0.3398	-9.63	13.82	20.63	11.50	0.47	8.
52.000	-0.75	20.76	-0.0583	-6.75	14.22	22.50	10.38	-0.47	8.
54.000	10.13	21.14	-0.1080	-7.13	14.32	22.13	16.15	0.78	8.
56.000	8.71	21.33	0.2510	-1.29	13.34	21.57	13.13	2.22	7.
58.000	9.00	19.22	0.0201	-6.29	18.11	25.57	9.32	1.44	7.
60.000	10.57	13.19	0.0870	-6.57	21.98	25.00	10.46	1.52	7.
62.000	17.43	21.25	0.5537	1.71	23.10	28.43	19.66	1.36	7.
64.000	0.00	0.00	0.7708	0.00	0.00	0.00	0.00	0.00	5.
66.000	0.00	0.00	0.6194	0.00	0.00	0.00	0.00	0.00	4.
68.000	0.00	0.00	-0.7683	0.00	0.00	0.00	0.00	0.00	3.
70.000	0.00	0.00	0.0000	0.00	0.00	0.00	0.00	0.00	1.

**TABLE A-11. November Statistical Wind Data, Thule.**

Z KM	MEAN U M/S	S.D. U M/S	R(U,V)	MEAN V M/S	S.D. V M/S	MEAN W M/S	S.D. W M/S	SKEW W	#OBS
0.000	0.00	0.00	0.0000	0.00	0.00	0.00	0.00	0.00	0.
0.059	-2.08	2.17	-0.2739	0.91	1.78	2.82	2.25	1.66	732.
1.000	-1.72	3.71	-0.3440	0.81	5.05	5.16	4.02	1.53	757.
2.000	-0.61	4.58	-0.1479	0.83	6.16	6.37	4.17	1.20	756.
3.000	0.24	5.51	-0.0720	1.10	6.69	7.42	4.40	1.00	719.
4.000	0.95	6.68	-0.0782	1.32	7.67	8.86	5.24	0.95	748.
5.000	1.72	8.02	-0.0548	1.73	8.71	10.49	6.01	0.77	745.
6.000	2.53	9.66	-0.0630	2.11	10.15	12.50	7.12	0.87	734.
7.000	3.08	10.61	-0.0535	2.53	10.82	13.61	7.75	0.80	722.
8.000	3.87	11.21	-0.0697	2.90	11.29	14.26	8.53	0.89	714.
9.000	4.31	10.76	-0.0780	3.00	10.61	13.58	8.44	0.98	701.
10.000	4.58	9.63	-0.0750	2.66	9.23	12.17	7.59	1.18	686.
11.000	4.97	8.52	-0.1042	2.27	8.02	11.16	6.49	0.89	672.
12.000	5.38	8.08	-0.1242	1.72	7.35	10.82	5.82	0.70	664.
13.000	6.06	7.75	-0.1589	1.32	7.21	10.91	5.60	0.53	637.
14.000	6.81	7.76	-0.1460	0.74	7.18	11.28	5.59	0.58	621.
15.000	7.47	7.91	-0.1402	0.10	7.36	11.76	5.84	0.63	602.
16.000	8.55	8.40	-0.1365	-0.54	7.65	12.79	6.23	0.57	494.
17.000	9.33	8.83	-0.1123	-1.32	8.29	13.78	6.73	0.53	493.
18.000	11.11	9.34	-0.0973	-2.33	9.14	15.62	7.45	0.62	399.
19.000	12.09	9.92	-0.0818	-3.54	9.98	17.05	8.11	0.76	385.
20.000	13.06	10.65	-0.0438	-5.34	10.60	18.82	8.38	0.36	306.
21.000	14.29	11.43	-0.0264	-6.90	11.34	20.77	8.87	0.35	258.
22.000	15.65	11.71	-0.0005	-8.90	11.96	22.70	9.37	0.30	216.
23.000	16.86	12.34	-0.0191	-11.19	11.86	24.67	9.61	0.09	176.
24.000	17.51	13.62	-0.1967	-13.22	12.26	26.57	10.46	0.48	135.
25.000	18.88	11.19	-0.0161	-14.94	12.01	27.50	9.53	0.39	111.
26.000	19.02	10.93	-0.0880	-16.68	11.62	28.54	8.84	0.47	82.
27.000	19.73	9.99	0.1124	-20.37	11.33	30.63	9.58	0.48	55.
28.000	20.26	11.71	0.0308	-22.25	12.59	32.66	11.38	0.52	37.
29.000	21.58	9.86	0.0558	-23.57	13.80	34.73	9.74	-0.26	23.
30.000	25.41	10.26	-0.0115	-24.05	18.51	39.23	10.17	1.07	12.
32.000	25.29	13.67	0.2878	-15.07	18.69	35.00	12.17	-0.24	14.
34.000	25.43	14.83	0.3470	-17.71	19.16	36.21	13.91	-0.17	14.
36.000	24.29	14.99	0.2662	-20.36	20.03	36.71	15.48	-0.44	14.
38.000	24.21	14.13	0.4062	-21.29	19.42	37.14	14.69	0.22	14.
40.000	23.15	17.25	0.1945	-22.92	20.11	37.62	17.30	0.28	13.
42.000	29.64	21.47	0.1956	-22.07	19.56	42.36	19.74	0.25	14.
44.000	29.50	23.18	-0.0543	-26.14	19.79	44.29	21.71	0.81	14.
46.000	29.64	21.38	0.1536	-27.36	23.63	44.93	24.28	0.96	14.
48.000	32.31	24.35	0.2264	-24.23	14.74	44.08	22.05	1.11	13.
50.000	27.43	26.33	0.0711	-25.71	14.31	42.64	21.60	1.12	14.
52.000	28.08	28.33	-0.0388	-26.75	22.18	45.17	26.87	1.33	12.
54.000	34.67	32.38	0.0336	-24.33	20.54	48.58	29.19	1.46	12.
56.000	46.50	40.84	0.3066	-17.00	22.71	58.58	33.21	0.76	12.
58.000	49.64	41.66	0.3601	-15.82	21.76	62.55	29.64	0.53	11.
60.000	57.10	57.66	0.0467	-14.60	18.35	72.30	40.90	0.26	10.
62.000	60.13	67.08	0.0469	-11.25	18.23	73.25	54.50	0.65	8.
64.000	35.17	52.99	0.2688	-12.83	20.87	53.33	39.38	0.81	6.
66.000	0.00	0.00	0.3764	0.00	0.00	0.00	0.00	0.00	4.
68.000	0.00	0.00	1.0000	0.00	0.00	0.00	0.00	0.00	2.
70.000	0.00	0.00	-1.0000	0.00	0.00	0.00	0.00	0.00	2.

**TABLE A-12. December Statistical Wind Data, Thule.**

Z KM	MEAN U M/S	S.D. U M/S	R(U,V)	MEAN V M/S	S.D. V M/S	MEAN W M/S	S.D. W M/S	SKEW W	#OBS
0.000	0.00	0.00	0.0000	0.00	0.00	0.00	0.00	0.00	0.
0.059	-2.18	2.02	-0.2398	0.97	1.87	2.78	2.19	1.11	814.
1.000	-2.15	3.95	-0.4243	1.14	4.80	5.14	4.26	1.90	837.
2.000	-1.44	4.72	-0.2721	2.09	6.27	6.83	4.40	1.30	834.
3.000	-0.93	5.93	-0.1848	2.89	7.51	8.58	4.69	0.84	831.
4.000	-0.48	6.98	-0.0928	3.72	8.75	10.36	5.66	0.81	831.
5.000	-0.02	8.40	-0.0756	4.31	10.40	12.31	6.76	0.76	826.
6.000	0.45	9.95	-0.0305	4.99	12.12	14.34	8.07	0.82	815.
7.000	1.07	11.07	-0.0294	5.49	13.41	15.79	9.17	1.02	802.
8.000	1.55	11.65	-0.0335	5.51	14.09	16.51	9.71	1.07	793.
9.000	1.97	11.14	-0.0872	5.23	13.41	15.57	9.60	1.29	781.
10.000	2.43	10.18	-0.1300	4.51	12.03	13.94	8.59	1.44	757.
11.000	2.75	9.04	-0.1781	3.85	10.65	12.66	7.55	1.47	728.
12.000	3.31	8.09	-0.2520	3.12	9.93	11.80	6.34	0.74	703.
13.000	3.72	7.65	-0.2584	2.66	9.67	11.48	6.01	0.57	616.
14.000	4.42	7.64	-0.2333	1.88	9.80	11.77	6.23	0.60	572.
15.000	5.33	7.91	-0.1914	1.07	10.36	12.39	6.75	0.52	501.
16.000	6.25	7.85	-0.0750	0.47	11.22	13.07	7.46	0.61	318.
17.000	7.15	8.62	-0.0380	-0.30	12.16	14.45	8.00	0.71	314.
18.000	8.16	8.91	0.1096	-1.10	13.93	16.35	8.54	0.73	213.
19.000	10.01	8.78	0.2540	-2.04	15.70	18.72	8.73	0.95	191.
20.000	10.37	9.69	0.3777	-3.47	16.36	20.22	8.36	0.96	124.
21.000	11.91	10.65	0.3935	-5.33	17.48	22.36	9.28	1.64	107.
22.000	11.34	11.32	0.3915	-8.48	17.63	23.56	8.96	0.37	91.
23.000	12.25	12.80	0.4156	-11.50	17.37	25.57	9.46	0.81	80.
24.000	14.61	12.46	0.3803	-11.44	17.88	26.92	9.46	0.59	69.
25.000	15.97	13.11	0.4148	-12.76	19.15	29.11	10.09	0.46	59.
26.000	15.89	13.88	0.4055	-12.63	20.25	29.90	10.41	0.65	41.
27.000	17.41	13.32	0.2801	-13.81	20.36	30.99	10.46	0.97	30.
28.000	20.01	10.81	0.2137	-12.01	22.80	31.83	11.85	0.93	18.
29.000	20.29	9.04	-0.2779	-10.74	21.33	30.38	10.34	-0.18	13.
30.000	17.93	9.19	-0.4762	-1.20	23.22	27.14	11.86	0.50	7.
32.000	14.33	14.73	0.1232	-10.00	16.58	23.83	14.63	0.45	12.
34.000	13.69	19.75	0.2304	-8.85	17.31	25.00	17.33	0.42	13.
36.000	11.50	20.62	0.1333	-6.21	18.01	24.50	16.62	0.68	14.
38.000	10.79	22.89	0.1057	-8.00	20.31	27.21	18.19	0.35	14.
40.000	13.27	26.30	-0.0808	-9.33	27.40	34.20	21.67	0.87	15.
42.000	11.93	29.59	-0.4016	-8.73	29.60	35.20	25.67	1.14	15.
44.000	7.79	25.59	-0.3275	-0.43	30.07	30.93	24.62	1.69	14.
46.000	10.23	26.32	-0.1932	2.62	30.06	31.46	25.25	1.73	13.
48.000	12.62	30.95	-0.3725	2.15	34.83	37.08	29.26	1.63	13.
50.000	13.54	30.60	-0.3916	-0.15	36.08	37.31	30.83	1.87	13.
52.000	14.30	34.42	-0.4136	-4.00	43.01	45.30	31.57	1.15	10.
54.000	19.80	35.96	-0.3500	-5.10	46.30	51.00	31.65	0.75	10.
56.000	13.22	32.10	-0.1956	-2.78	45.10	48.33	25.66	1.41	9.
58.000	9.89	28.27	-0.1891	-1.11	40.29	42.11	23.70	0.73	9.
60.000	21.00	28.78	-0.2645	-5.25	39.44	46.25	22.19	0.07	8.
62.000	0.00	0.00	-0.3987	0.00	0.00	0.00	0.00	0.00	5.
64.000	0.00	0.00	-0.3256	0.00	0.00	0.00	0.00	0.00	5.
66.000	0.00	0.00	-0.9951	0.00	0.00	0.00	0.00	0.00	3.
68.000	0.00	0.00	-1.0000	0.00	0.00	0.00	0.00	0.00	2.
70.000	0.00	0.00	-1.0000	0.00	0.00	0.00	0.00	0.00	2.

**TABLE A-13. Annual Statistical Wind Data, Thule.**

Z KM	MEAN U M/S	S.D. U M/S	R(U,V)	MEAN V M/S	S.D. V M/S	MEAN W M/S	S.D. W M/S	SKEW W	#OBS
0.000	0.00	0.00	0.0000	0.00	0.00	0.00	0.00	0.00	0.
0.059	-1.26	2.24	0.2171	0.73	1.88	2.31	2.30	1.64	9289.
1.000	-1.89	3.46	0.1502	1.25	4.57	4.80	3.74	1.92	9574.
2.000	-0.99	4.22	0.0621	1.52	5.75	6.14	3.90	1.33	9561.
3.000	-0.30	5.35	0.0158	1.89	6.80	7.49	4.54	1.10	9571.
4.000	0.25	6.60	-0.0107	2.24	8.05	9.06	5.45	1.11	9518.
5.000	0.82	7.94	-0.0283	2.56	9.37	10.71	6.42	1.09	9477.
6.000	1.40	9.36	-0.0408	2.95	10.83	12.56	7.55	1.07	9342.
7.000	1.94	10.51	-0.0498	3.21	11.90	13.97	8.42	1.10	9225.
8.000	2.47	11.22	-0.0575	3.26	12.49	14.74	9.02	1.16	9130.
9.000	2.86	10.97	-0.0646	2.98	12.05	14.13	8.97	1.29	8999.
10.000	2.99	9.68	-0.0726	2.45	10.45	12.32	7.87	1.37	8812.
11.000	2.92	8.15	-0.0791	1.91	8.67	10.42	6.44	1.34	8631.
12.000	2.91	7.20	-0.0746	1.42	7.68	9.33	5.61	1.16	8438.
13.000	2.96	6.72	-0.0641	1.04	7.15	8.69	5.38	1.21	8071.
14.000	3.07	6.53	-0.0399	0.59	6.93	8.32	5.47	1.35	7795.
15.000	3.11	6.60	-0.0053	0.08	6.93	8.09	5.89	1.55	7508.
16.000	3.00	6.65	0.0184	-0.28	6.81	7.78	6.22	1.81	6673.
17.000	3.11	7.09	0.0445	-0.74	7.28	8.02	7.00	1.90	6421.
18.000	2.97	7.41	0.0576	-1.08	7.50	7.91	7.63	2.12	6010.
19.000	2.97	7.88	0.0693	-1.48	8.07	8.19	8.41	2.20	5708.
20.000	2.57	8.11	0.0679	-1.78	8.33	8.09	8.86	2.37	5415.
21.000	2.23	8.58	0.0625	-2.12	8.81	8.31	9.53	2.49	5152.
22.000	1.95	8.84	0.0567	-2.39	9.33	8.44	10.04	2.61	4900.
23.000	1.62	9.18	0.0475	-2.58	9.63	8.62	10.45	2.76	4693.
24.000	1.25	9.34	0.0362	-2.69	9.98	8.73	10.78	2.91	4409.
25.000	0.86	9.22	0.0257	-2.82	10.31	8.84	10.98	3.02	4106.
26.000	0.30	8.85	0.0089	-2.67	10.26	8.68	10.66	3.04	3832.
27.000	-0.21	8.85	-0.0062	-2.74	10.70	8.93	10.88	3.16	3466.
28.000	-0.40	8.55	-0.0114	-2.58	10.53	8.77	10.60	3.18	3029.
29.000	-0.65	8.44	-0.0178	-2.42	10.42	8.73	10.38	3.45	2766.
30.000	-1.24	8.10	-0.0315	-2.05	10.01	8.59	9.87	4.10	2484.
32.000	2.24	15.20	0.0494	-6.03	18.09	17.25	17.36	1.69	177.
34.000	1.32	15.98	0.0271	-6.49	19.97	18.40	18.84	1.75	189.
36.000	1.60	16.96	0.0299	-6.22	19.80	18.73	19.10	1.93	192.
38.000	0.36	17.70	0.0061	-6.18	20.79	19.94	19.64	1.93	198.
40.000	-0.39	19.00	-0.0061	-6.72	22.69	21.77	21.08	1.96	203.
42.000	-0.06	20.56	-0.0007	-5.50	21.44	22.23	20.40	2.05	207.
44.000	-0.58	21.87	-0.0055	-4.60	22.45	23.23	21.47	2.06	202.
46.000	-1.46	22.89	-0.0080	-2.80	22.45	23.55	21.93	2.61	202.
48.000	-2.03	24.83	-0.0061	-1.62	21.95	24.81	22.10	2.62	202.
50.000	-2.35	25.12	-0.0069	-1.63	22.13	26.07	21.15	2.43	197.
52.000	-2.98	26.10	-0.0075	-1.45	22.05	26.55	21.68	2.41	186.
54.000	-2.10	29.43	-0.0046	-1.43	22.31	28.90	23.05	2.38	182.
56.000	-1.60	31.84	0.0022	0.87	20.04	29.33	23.57	2.22	172.
58.000	-1.35	29.79	0.0095	3.82	18.32	28.74	20.26	1.99	164.
60.000	1.88	33.03	-0.0103	3.51	19.52	31.07	22.63	2.11	150.
62.000	0.01	35.96	-0.0001	5.94	19.85	33.25	24.64	2.45	121.
64.000	0.79	31.55	-0.0049	3.70	19.22	31.09	20.27	1.39	105.
66.000	1.64	33.42	-0.0083	3.25	19.45	31.86	21.96	1.29	81.
68.000	5.40	32.95	-0.0151	1.54	16.92	30.33	21.63	1.37	67.
70.000	17.27	38.23	0.0229	-0.85	17.26	34.83	28.74	1.32	41.

## **APPENDIX B**

### **Thule Thermodynamics Statistics Tables**

Tables B-1 through B-13 provide thermodynamics statistics (monthly and annual) for Thule. They were prepared as described in Chapter 3.

TABLE B-1. January Thermodynamic Data, Thule.

Z KM	MEAN P MB	S.D. P MB	SKEW P	MEAN T DEG K	S.D. T DEG K	SKEW T	MEAN D G/M3	S.D. D G/M3	SKEW D	NOBS P	NOBS T	NOBS D
0.000	1008.885	13.948	0.0901	251.76	8.11	0.42	1397.01	47.82	-0.07	744.	744.	744.
0.059	1002.263	13.753	0.1451	251.71	7.97	0.45	1388.04	45.70	-0.11	758.	758.	758.
1.000	881.702	12.638	0.2352	253.49	7.44	0.43	1212.19	35.62	-0.05	786.	786.	786.
2.000	769.937	12.065	0.4272	250.89	6.71	0.48	1069.32	25.52	0.00	786.	786.	786.
3.000	671.004	11.915	0.5659	246.22	6.19	0.59	949.51	18.37	-0.06	786.	786.	786.
4.000	582.891	11.657	0.6612	240.34	6.00	0.73	845.00	14.32	-0.04	781.	781.	781.
5.000	505.056	11.482	0.7079	233.95	5.76	0.79	752.15	11.51	-0.06	781.	781.	781.
6.000	435.358	11.284	0.8451	227.45	5.45	0.92	666.83	10.13	-0.24	771.	771.	771.
7.000	373.836	10.603	0.9185	221.25	5.03	0.89	588.63	10.65	-0.59	763.	763.	763.
8.000	319.738	9.703	1.0223	216.00	4.98	0.75	515.73	12.27	-0.75	755.	755.	755.
9.000	272.880	8.961	1.1042	212.85	5.57	0.57	446.77	14.36	-0.25	737.	737.	737.
10.000	232.489	7.964	1.0427	211.79	6.17	0.46	382.61	14.33	0.45	710.	710.	710.
11.000	197.992	7.139	0.9101	211.46	6.52	0.46	326.37	12.63	1.21	679.	679.	679.
12.000	168.360	6.449	0.8398	210.78	6.66	0.61	278.36	9.86	1.54	656.	656.	656.
13.000	143.414	6.014	0.7070	210.08	7.01	0.65	237.87	7.68	1.34	591.	591.	591.
14.000	121.818	5.497	0.6699	209.02	7.40	0.72	203.03	5.89	1.03	530.	530.	530.
15.000	104.105	4.965	0.6151	208.48	7.74	0.70	173.95	5.07	0.90	476.	476.	476.
16.000	88.937	4.996	0.3938	208.24	8.54	0.56	148.74	4.53	0.77	345.	345.	345.
17.000	75.876	4.521	0.3574	207.52	8.84	0.51	127.33	3.99	0.54	316.	316.	316.
18.000	65.452	4.351	-0.0333	208.85	9.23	0.25	109.11	3.96	0.23	224.	224.	224.
19.000	56.105	3.461	0.1146	208.87	8.72	0.24	93.54	3.40	0.15	189.	189.	189.
20.000	48.965	2.908	-0.3429	211.26	8.10	-0.16	80.73	3.26	-0.27	125.	125.	125.
21.000	41.770	2.487	-0.1978	211.58	7.75	-0.41	68.76	2.82	-0.38	96.	96.	96.
22.000	35.640	2.265	-0.1397	211.19	7.87	-0.60	58.77	2.66	-0.15	83.	83.	83.
23.000	30.790	1.702	0.1216	212.03	6.39	-0.28	50.61	2.36	-0.10	72.	72.	72.
24.000	26.267	1.397	-0.4808	212.41	6.72	-0.22	43.10	2.00	-0.42	55.	55.	55.
25.000	22.536	1.166	-0.4162	212.45	7.13	-0.08	36.97	1.73	-0.78	50.	50.	50.
26.000	19.397	0.991	-0.2667	215.13	8.05	-0.29	31.44	1.61	-1.14	33.	33.	33.
27.000	16.370	0.913	-0.0109	215.05	7.41	-0.64	26.52	1.37	-0.90	20.	20.	20.
28.000	14.223	0.856	-0.6377	219.79	5.83	-0.33	22.56	1.38	-1.05	13.	13.	13.
29.000	12.073	0.772	-0.4161	220.92	7.99	0.19	19.06	1.24	-1.01	11.	11.	11.
30.000	10.522	0.538	-0.6527	223.69	8.74	0.62	16.44	1.19	-1.53	9.	9.	9.



TABLE B-1. January Thermodynamic Data, Thule, Cont'd.

Z KM	MEAN P MB	S.D. P MB	SKEW P	MEAN T DEG K	S.D. T DEG K	SKEW T	MEAN D G/M3	S.D. D G/M3	SKEW D	NOBS P	NOBS T	NOBS D
32.000	7.055	1.244	0.0760	224.86	17.61	0.11	10.88	1.60	-0.06	8.	10.	8.
34.000	5.091	1.027	0.2794	227.78	17.45	0.59	7.71	1.34	0.21	9.	13.	9.
36.000	3.803	0.816	0.2986	230.70	18.02	0.25	5.67	1.05	0.16	9.	13.	9.
38.000	2.859	0.650	0.3475	237.24	20.52	0.61	4.14	0.84	0.25	9.	13.	9.
40.000	2.135	0.498	0.5682	242.37	21.07	0.73	3.04	0.62	0.32	10.	14.	10.
42.000	1.621	0.398	0.6179	246.16	19.14	0.26	2.29	0.50	0.37	10.	14.	10.
44.000	1.201	0.319	0.7841	248.96	16.91	-0.01	1.68	0.42	0.53	11.	15.	11.
46.000	0.915	0.251	0.8466	250.83	17.48	-0.49	1.28	0.33	0.55	11.	15.	11.
48.000	0.698	0.196	0.9337	253.03	15.35	-0.67	0.97	0.26	0.55	11.	15.	11.
50.000	0.535	0.154	1.0064	255.83	13.72	-1.00	0.73	0.20	0.70	11.	15.	11.
52.000	0.411	0.119	1.0725	258.03	12.05	-0.72	0.56	0.16	0.78	11.	15.	11.
54.000	0.307	0.103	1.2364	262.80	12.44	-0.07	0.41	0.15	1.08	9.	14.	9.
56.000	0.242	0.081	1.0890	261.08	13.41	0.09	0.33	0.12	0.93	8.	12.	8.
58.000	0.185	0.061	1.1322	257.91	14.52	0.54	0.26	0.09	0.99	8.	12.	8.
60.000	0.129	0.032	1.3102	257.34	14.77	-0.02	0.18	0.05	1.63	7.	11.	7.
62.000	0.099	0.023	1.2064	256.96	15.70	-0.41	0.14	0.04	1.52	7.	10.	7.
64.000	0.076	0.018	0.9368	258.53	16.28	-0.05	0.11	0.03	1.12	6.	8.	6.
66.000	0.000	0.000	0.0000	259.33	17.86	0.51	0.00	0.00	0.00	4.	6.	4.
68.000	0.000	0.000	0.0000	0.00	0.00	0.00	0.00	0.00	0.00	3.	5.	3.
70.000	0.000	0.000	0.0000	0.00	0.00	0.00	0.00	0.00	0.00	2.	4.	2.

TABLE B-2. February Thermodynamic Data, Thule.

Z KM	MEAN P MB	S.D. P MB	MEAN T DEG K	S.D. T DEG K	MEAN D G/M3	S.D. D G/M3	SKEW D	NOBS P	NOBS T	NOBS D
0.000	1010.592	14.338	248.57	6.28	1417.00	43.48	-0.21	634.	634.	634.
0.059	1004.040	14.191	248.45	6.23	1408.48	42.48	-0.27	652.	652.	652.
1.000	881.771	12.159	250.29	6.97	1227.51	38.16	-0.68	678.	679.	679.
2.000	768.712	11.249	248.13	7.00	1079.68	29.04	-0.06	678.	678.	678.
3.000	669.006	11.018	243.94	6.57	955.69	21.47	-0.05	676.	676.	676.
4.000	580.412	10.769	238.35	6.03	848.49	15.91	-0.13	676.	676.	676.
5.000	502.332	10.633	232.27	5.59	753.53	12.18	-0.16	674.	674.	674.
6.000	432.602	10.426	226.19	5.01	666.33	9.85	0.03	659.	659.	659.
7.000	371.261	9.888	220.76	4.12	585.86	10.29	0.11	651.	651.	651.
8.000	317.537	8.888	216.47	3.70	511.06	12.70	-0.01	646.	646.	646.
9.000	271.110	7.930	214.43	4.93	440.65	15.47	0.28	631.	631.	631.
10.000	231.200	6.838	213.95	6.00	376.76	15.34	0.77	622.	622.	622.
11.000	197.182	5.871	214.10	6.23	321.08	12.59	1.24	603.	603.	603.
12.000	167.983	5.212	213.69	6.24	274.00	9.39	1.26	584.	584.	584.
13.000	143.431	4.683	213.52	6.53	234.12	7.45	0.95	538.	538.	538.
14.000	122.195	4.336	212.94	7.06	199.99	6.17	0.78	512.	512.	512.
15.000	104.435	3.814	212.65	7.66	171.18	5.54	0.53	483.	483.	483.
16.000	89.050	3.693	212.87	8.59	145.81	5.07	0.19	374.	374.	374.
17.000	76.016	3.289	212.68	9.20	124.59	4.52	0.15	360.	360.	360.
18.000	65.070	3.101	213.89	9.64	106.05	4.18	0.16	284.	284.	284.
19.000	55.563	2.817	214.07	9.96	90.47	3.66	0.04	265.	265.	265.
20.000	48.064	2.521	217.22	9.67	77.13	3.48	0.12	189.	189.	189.
21.000	41.056	2.255	217.73	9.77	65.72	3.03	-0.08	169.	169.	169.
22.000	35.209	2.072	218.55	10.12	56.16	2.86	-0.27	147.	147.	147.
23.000	30.388	1.841	220.29	9.94	48.10	2.76	-0.36	128.	128.	128.
24.000	25.958	1.766	221.43	10.55	40.87	2.48	-0.17	106.	106.	106.
25.000	22.247	1.574	221.47	10.99	35.02	2.29	-0.15	101.	101.	101.
26.000	19.299	1.488	225.15	11.07	29.90	2.22	-0.20	69.	69.	69.
27.000	16.582	1.302	226.84	11.64	25.50	1.98	-0.34	55.	55.	55.
28.000	14.331	1.161	227.45	12.08	21.97	1.74	-0.56	51.	51.	51.
29.000	12.403	0.879	228.12	13.06	18.96	1.43	-0.24	38.	38.	38.
30.000	10.811	0.611	230.72	13.81	16.33	1.21	-0.37	27.	27.	27.

TABLE B-2. February Thermodynamic Data, Thule, Cont'd.

Z KM	MEAN P MB	S.D. P MB	MEAN T DEG K	S.D. T DEG K	MEAN D G/M3	S.D. D G/M3	SKEW D	NOBS P	NOBS T	NOBS D
32.000	0.000	0.000	218.39	14.68	0.00	0.00	0.00	5.	13.	5.
34.000	0.000	0.000	220.37	15.46	0.00	0.00	0.00	5.	14.	5.
36.000	4.274	0.605	222.16	14.31	6.58	0.52	-0.31	6.	15.	6.
38.000	3.179	0.511	225.41	13.73	4.82	0.50	0.28	6.	16.	6.
40.000	2.373	0.413	230.36	12.07	3.53	0.52	0.55	6.	15.	6.
42.000	1.782	0.321	236.49	12.41	2.61	0.45	0.70	6.	15.	6.
44.000	1.342	0.244	240.29	13.72	1.95	0.31	0.76	6.	15.	6.
46.000	0.000	0.000	245.45	15.47	0.00	0.00	0.00	5.	14.	5.
48.000	0.000	0.000	249.95	17.91	0.00	0.00	0.00	5.	14.	5.
50.000	0.610	0.081	253.37	18.96	0.87	0.14	-0.01	6.	14.	6.
52.000	0.464	0.058	253.16	19.54	0.66	0.10	-0.29	6.	13.	6.
54.000	0.353	0.043	255.95	19.48	0.50	0.07	-0.39	6.	14.	6.
56.000	0.000	0.000	259.99	16.94	0.45	0.00	0.00	5.	12.	5.
58.000	0.000	0.000	259.33	14.19	0.17	0.00	0.00	5.	12.	5.
60.000	0.000	0.000	258.16	12.78	0.20	0.00	0.00	4.	12.	4.
62.000	0.000	0.000	258.74	13.47	0.83	0.00	0.00	4.	12.	4.
64.000	0.000	0.000	260.72	17.48	1.23	0.00	0.00	0.	9.	0.
66.000	0.000	0.000	262.33	18.64	1.30	0.00	0.00	0.	6.	0.
68.000	0.000	0.000	0.00	0.00	0.00	0.00	0.00	0.	3.	0.
70.000	0.000	0.000	0.00	0.00	0.00	0.00	0.00	0.	0.	0.

TABLE B-3. March Thermodynamic Data, Thule.

Z KM	MEAN P MB	S.D. P MB	SKEW P	MEAN T DEG K	S.D. T DEG K	SKEW T	MEAN D G/M3	S.D. D G/M3	SKEW D	NOBS P	NOBS T	NOBS D
0.000	1012.442	13.721	-0.1925	249.82	6.63	0.42	1412.19	46.14	-0.72	694	693	694
0.059	1005.980	13.377	-0.1666	249.74	6.43	0.59	1403.56	44.20	-0.84	712.	711.	712.
1.000	883.592	11.633	0.0267	250.53	6.37	0.37	1229.08	35.35	-0.47	747.	747.	747.
2.000	770.269	10.473	0.1586	247.72	6.12	0.12	1083.53	27.33	-0.23	746.	746.	746.
3.000	670.232	9.931	0.2146	243.56	5.63	0.13	958.85	20.45	-0.18	745.	745.	745.
4.000	581.450	9.509	0.2458	238.17	5.29	0.19	850.61	15.57	-0.21	745.	745.	745.
5.000	503.155	9.159	0.2226	232.29	4.86	0.37	754.70	12.04	-0.33	743.	743.	743.
6.000	433.376	8.818	0.2988	226.51	4.29	0.58	666.57	9.93	-0.29	730.	730.	730.
7.000	372.190	8.251	0.3280	221.62	3.82	0.41	585.10	10.62	-0.42	720.	720.	720.
8.000	318.654	7.400	0.3322	218.56	4.39	0.42	508.04	13.06	-0.30	708.	708.	708.
9.000	272.510	6.525	0.2446	218.19	5.68	0.02	435.34	13.92	0.23	693.	693.	693.
10.000	233.099	5.799	0.0993	219.25	6.34	-0.38	370.59	11.52	0.65	682.	682.	682.
11.000	199.522	5.424	-0.0372	219.92	6.59	-0.36	316.20	8.49	0.67	670.	670.	670.
12.000	170.760	5.166	-0.1311	219.88	6.90	-0.41	270.64	6.58	0.52	645.	645.	645.
13.000	146.315	4.908	-0.2411	219.89	7.20	-0.49	231.86	5.42	0.43	623.	623.	623.
14.000	125.319	4.654	-0.3139	219.90	7.49	-0.54	198.57	4.61	0.32	606.	606.	606.
15.000	107.430	4.285	-0.3447	219.93	7.64	-0.55	170.18	4.15	0.20	593.	593.	593.
16.000	92.060	4.022	-0.4613	220.03	7.74	-0.61	145.76	3.83	0.09	541.	541.	541.
17.000	78.832	3.760	-0.5022	219.96	7.84	-0.63	124.84	3.60	-0.07	538.	538.	538.
18.000	67.678	3.413	-0.5690	220.46	7.48	-0.48	106.93	3.47	-0.20	512.	512.	512.
19.000	57.953	3.122	-0.5458	220.42	7.51	-0.39	91.57	3.32	-0.36	497.	497.	497.
20.000	49.790	2.755	-0.5590	220.78	7.32	-0.20	78.54	3.18	-0.55	481.	481.	481.
21.000	42.618	2.505	-0.5329	220.79	7.45	-0.01	67.23	3.05	-0.68	457.	457.	457.
22.000	36.516	2.261	-0.5547	220.86	7.63	0.11	57.59	2.85	-0.73	448.	448.	448.
23.000	31.366	2.003	-0.6195	221.13	7.74	0.15	49.41	2.65	-0.81	429.	429.	429.
24.000	26.842	1.817	-0.5584	221.34	7.71	0.06	42.25	2.45	-0.76	404.	404.	404.
25.000	23.013	1.597	-0.4531	221.62	7.77	-0.10	36.18	2.20	-0.77	393.	393.	393.
26.000	19.788	1.419	-0.4622	222.32	7.73	-0.19	31.01	1.97	-0.82	373.	373.	373.
27.000	16.934	1.281	-0.3770	223.04	7.68	-0.21	26.45	1.79	-0.73	333.	333.	333.
28.000	14.553	1.134	-0.4206	223.82	7.54	-0.13	22.66	1.60	-0.82	306.	306.	306.
29.000	12.500	1.019	-0.3774	224.71	7.88	-0.19	19.38	1.45	-0.80	282.	282.	282.
30.000	10.851	0.824	-0.3937	225.75	7.59	0.21	16.75	1.19	-0.82	245.	245.	245.

TABLE B-3. March Thermodynamic Data, Thule, Cont'd.

Z KM	MEAN P MB	S.D. P MB	SKEWP	MEAN T DEG K	S.D. T DEG K	SKEWT	MEAN D GM/3	S.D. D GM/3	SKEWD	NOBS P	NOBS T	NOBS D
32.000	7.696	1.005	-0.1036	226.63	10.80	0.08	11.68	1.57	-0.04	13.	17.	13.
34.000	5.729	0.749	-0.1153	228.28	11.84	0.23	8.64	1.20	-0.05	13.	17.	13.
36.000	4.279	0.558	-0.1161	230.60	12.72	0.54	6.37	0.90	-0.11	13.	18.	13.
38.000	3.210	0.419	-0.0784	233.16	11.48	0.64	4.72	0.64	-0.13	13.	20.	13.
40.000	2.406	0.333	0.0835	235.66	12.05	0.43	3.49	0.46	-0.07	12.	20.	12.
42.000	1.818	0.261	0.1104	239.21	10.57	0.12	2.61	0.34	0.13	12.	20.	12.
44.000	1.378	0.207	0.1481	243.26	9.33	0.38	1.95	0.24	0.10	12.	20.	12.
46.000	1.051	0.166	0.1978	249.36	10.13	-0.37	1.46	0.19	0.03	12.	20.	12.
48.000	0.804	0.133	0.2365	252.61	8.53	-0.53	1.11	0.15	0.11	12.	20.	12.
50.000	0.616	0.107	0.2408	255.26	8.69	-0.26	0.84	0.12	0.30	12.	20.	12.
52.000	0.472	0.089	0.3076	257.77	7.69	-0.26	0.64	0.11	0.32	11.	18.	11.
54.000	0.364	0.070	0.3172	262.05	7.47	0.36	0.49	0.09	0.24	11.	18.	11.
56.000	0.281	0.055	0.3316	263.71	9.03	0.27	0.38	0.07	0.28	11.	20.	11.
58.000	0.219	0.044	0.1658	263.55	9.32	0.60	0.29	0.06	0.06	10.	18.	10.
60.000	0.169	0.034	0.1888	263.10	10.39	1.22	0.23	0.05	0.15	10.	18.	10.
62.000	0.130	0.026	0.1889	262.66	12.52	0.50	0.18	0.04	0.25	10.	18.	10.
64.000	0.101	0.021	-0.0139	262.16	12.84	0.89	0.14	0.03	-0.12	7.	12.	7.
66.000	0.078	0.015	0.0211	258.86	14.21	0.58	0.11	0.02	-0.12	7.	10.	7.
68.000	0.000	0.000	0.0000	0.00	0.00	0.00	0.00	0.00	0.00	3.	5.	3.
70.000	0.000	0.000	0.0000	0.00	0.00	0.00	0.00	0.00	0.00	0.	2.	0.

TABLE B-4. April Thermodynamic Data, Thule.

Z KM	MEAN P MB	S.D. P MB	SKEWP P	MEAN T DEG K	S.D. T DEG K	SKEWT G/M3	MEAN D G/M3	S.D. D G/M3	SKEW D	NOBS P	NOBS T	NOBS D
0.000	1017.101	11.483	0.6196	256.68	5.82	0.36	1380.67	36.25	-0.22	722.	722.	722.
0.059	1010.635	11.363	0.6314	256.53	5.77	0.34	1372.64	35.24	-0.23	736.	736.	736.
1.000	890.099	10.071	0.7426	254.97	5.82	0.25	1216.24	29.38	-0.16	782.	782.	782.
2.000	777.732	9.500	0.7883	251.78	5.72	0.00	1076.17	22.65	0.12	782.	782.	782.
3.000	678.280	9.414	0.7101	247.34	5.48	-0.13	955.39	16.79	0.32	782.	782.	782.
4.000	589.586	9.289	0.6532	241.85	5.30	-0.05	849.31	12.82	0.31	782.	782.	782.
5.000	511.276	9.216	0.5365	235.93	4.99	0.13	754.98	9.98	0.17	778.	778.	778.
6.000	441.415	9.099	0.5364	230.26	4.44	0.44	667.87	9.00	-0.05	768.	768.	768.
7.000	380.056	8.422	0.5572	225.53	3.61	0.38	587.08	10.77	-0.49	761.	761.	761.
8.000	326.356	7.395	0.6363	223.44	3.57	0.22	508.94	13.95	-0.27	758.	758.	758.
9.000	280.235	6.275	0.6646	224.39	4.36	-0.20	435.29	14.76	0.43	749.	749.	749.
10.000	240.826	5.203	0.5373	226.55	4.15	-0.66	370.48	11.74	1.15	743.	743.	743.
11.000	207.205	4.413	0.2501	227.77	3.62	-0.98	316.99	8.71	1.58	740.	740.	740.
12.000	178.346	3.810	-0.0327	228.17	3.34	-1.08	272.34	6.75	1.40	730.	730.	730.
13.000	153.563	3.302	-0.2601	228.21	3.14	-0.87	234.45	5.51	0.86	727.	727.	727.
14.000	132.202	2.903	-0.4718	227.94	2.97	-0.66	202.07	4.63	0.46	703.	703.	703.
15.000	113.787	2.554	-0.6528	227.63	2.95	-0.53	174.15	3.99	0.26	698.	698.	698.
16.000	97.985	2.244	-0.8012	227.26	3.07	-0.25	150.22	3.53	0.04	667.	667.	667.
17.000	84.257	1.973	-0.9250	226.95	3.14	-0.08	129.35	3.05	-0.25	655.	655.	655.
18.000	72.509	1.707	-0.9584	226.65	3.33	0.13	111.46	2.64	-0.56	646.	646.	646.
19.000	62.334	1.509	-1.0147	226.40	3.49	0.24	95.92	2.27	-0.68	632.	632.	632.
20.000	53.598	1.346	-1.0192	226.21	3.70	0.24	82.55	1.94	-0.85	631.	631.	631.
21.000	46.084	1.221	-1.0232	226.02	3.89	0.21	71.03	1.66	-0.95	602.	602.	602.
22.000	39.602	1.100	-0.9222	225.82	4.13	0.21	61.10	1.42	-0.98	582.	582.	582.
23.000	34.030	1.000	-0.8697	225.62	4.39	0.23	52.55	1.24	-1.04	574.	574.	574.
24.000	29.249	0.923	-0.8252	225.46	4.63	0.31	45.19	1.10	-1.04	550.	550.	550.
25.000	25.123	0.853	-0.7290	225.57	4.77	0.16	38.80	0.95	-1.06	532.	532.	532.
26.000	21.597	0.769	-0.6439	225.73	4.93	0.06	33.33	0.81	-0.97	527.	527.	527.
27.000	18.557	0.721	-0.6013	225.97	5.07	-0.01	28.61	0.73	-0.95	482.	482.	482.
28.000	15.963	0.667	-0.5569	226.43	5.15	-0.13	24.56	0.65	-0.92	457.	457.	457.
29.000	13.742	0.600	-0.4736	227.04	5.15	-0.11	21.08	0.59	-0.77	432.	432.	432.
30.000	11.798	0.551	-0.4790	227.43	5.18	-0.06	18.06	0.55	-0.69	404.	404.	404.

TABLE B-4. April Thermodynamic Data, Thule, Cont'd.

Z KM	MEAN P MB	S.D. P MB	SKEW P	MEAN T DEG K	S.D. T DEG K	SKEW T	MEAN D GM/3	S.D. D GM/3	SKEW D	NOBS P	NOBS T	NOBS D
32.000	8.789	0.326	-0.5249	232.51	11.29	1.34	13.36	0.40	0.08	11.	17.	11.
34.000	6.551	0.262	-0.6096	237.41	12.52	1.98	9.82	0.31	-0.28	11.	16.	11.
36.000	4.905	0.216	-0.5310	241.53	13.51	1.91	7.24	0.24	-0.46	11.	16.	11.
38.000	3.694	0.179	-0.4449	246.22	12.24	1.69	5.34	0.20	-0.47	11.	18.	11.
40.000	2.798	0.148	-0.3317	250.88	12.36	1.30	3.96	0.18	-0.56	11.	18.	11.
42.000	2.134	0.124	-0.1794	256.60	11.63	0.78	2.94	0.12	-0.52	11.	18.	11.
44.000	1.638	0.106	-0.0757	261.94	9.80	-0.01	2.20	0.10	-1.01	11.	18.	11.
46.000	1.248	0.118	-0.7215	266.10	8.99	-0.71	1.65	0.12	-1.15	11.	18.	11.
48.000	0.969	0.098	-0.6432	270.63	7.33	-1.08	1.25	0.10	-1.02	11.	17.	11.
50.000	0.741	0.083	-0.2435	271.16	7.59	-1.43	0.96	0.09	-0.22	9.	14.	9.
52.000	0.577	0.067	-0.2880	273.39	6.69	-1.25	0.74	0.08	0.07	9.	13.	9.
54.000	0.447	0.057	-0.1533	272.08	6.10	-0.45	0.58	0.07	0.04	8.	12.	8.
56.000	0.348	0.045	-0.1674	271.16	4.92	-0.56	0.45	0.06	-0.02	8.	12.	8.
58.000	0.271	0.036	-0.1999	269.16	3.41	-1.24	0.35	0.04	-0.10	8.	12.	8.
60.000	0.211	0.030	-0.2053	268.16	6.45	0.02	0.27	0.04	-0.11	7.	11.	7.
62.000	0.167	0.026	-0.5442	269.66	9.43	1.63	0.22	0.03	-0.32	6.	8.	6.
64.000	0.000	0.000	0.0000	262.16	6.32	-0.81	0.00	0.00	0.00	5.	7.	5.
66.000	0.000	0.000	0.0000	259.99	5.12	-0.50	0.00	0.00	0.00	4.	6.	4.
68.000	0.000	0.000	0.0000	0.00	0.00	0.00	0.00	0.00	0.00	2.	4.	2.
70.000	0.000	0.000	0.0000	0.00	0.00	0.00	0.00	0.00	0.00	0.	3.	0.

TABLE B-5. May Thermodynamic Data, Thule.

Z KM	MEAN P MB	S.D. P MB	SKEW P	MEAN T DEG K	S.D. T DEG K	SKEW T	MEAN D G/M3	S.D. D G/M3	SKEW D	NOBS P	NOBS T	NOBS D
0.000	1017.127	9.533	-0.0586	267.51	4.82	-0.02	1324.00	29.02	0.46	776.	775.	776.
0.059	1011.018	9.399	0.0032	267.33	4.80	0.00	1316.70	27.87	0.09	780.	780.	780.
1.000	894.229	8.593	-0.0148	263.27	5.71	0.40	1182.81	25.55	-0.09	823.	823.	823.
2.000	784.668	8.397	0.1162	259.60	5.67	0.30	1052.75	19.91	0.02	822.	822.	822.
3.000	687.246	8.650	0.2167	254.98	5.46	0.29	938.80	14.84	0.09	821.	821.	821.
4.000	599.781	8.838	0.2944	249.36	5.51	0.32	837.88	11.63	0.01	821.	821.	821.
5.000	522.329	8.920	0.3353	243.08	5.48	0.34	748.58	9.00	-0.01	820.	820.	820.
6.000	453.079	9.009	0.3540	236.61	5.16	0.54	667.10	7.14	-0.11	816.	816.	816.
7.000	391.666	8.811	0.4213	230.68	4.31	0.79	591.48	7.78	-0.51	809.	809.	809.
8.000	337.144	8.002	0.5863	226.48	3.55	0.51	518.65	11.84	-0.62	802.	802.	802.
9.000	290.031	6.978	0.7083	225.36	4.35	0.04	448.58	15.80	0.06	794.	794.	794.
10.000	249.295	5.662	0.7980	227.01	5.00	-0.64	382.86	15.31	0.85	776.	776.	776.
11.000	214.591	4.539	0.7250	228.49	4.11	-1.08	327.36	11.44	1.32	774.	774.	774.
12.000	184.833	3.673	0.6068	229.05	3.01	-0.86	281.19	7.90	1.21	752.	752.	752.
13.000	159.206	3.069	0.5076	228.89	2.52	-0.46	242.35	5.97	0.91	748.	748.	748.
14.000	137.139	2.622	0.4117	228.55	2.36	-0.39	209.07	4.85	0.78	731.	731.	731.
15.000	118.060	2.217	0.3094	228.16	2.25	-0.13	180.27	3.89	0.69	719.	719.	719.
16.000	101.664	1.895	0.2327	227.76	2.25	-0.12	155.51	3.22	0.67	708.	708.	708.
17.000	87.496	1.673	0.1581	227.63	2.32	0.17	133.91	2.70	0.63	682.	682.	682.
18.000	75.291	1.461	0.0831	227.52	2.36	-0.03	115.27	2.26	0.48	672.	671.	672.
19.000	64.797	1.286	-0.0029	227.54	2.40	0.02	99.21	1.86	0.51	647.	647.	647.
20.000	55.768	1.146	-0.0631	227.64	2.49	0.29	85.33	1.58	0.27	638.	637.	638.
21.000	47.998	1.031	-0.0734	227.70	2.50	0.13	73.41	1.33	0.19	610.	608.	610.
22.000	41.305	0.926	-0.0810	227.81	2.55	0.36	63.15	1.10	0.15	600.	599.	600.
23.000	35.551	0.843	-0.0420	227.91	2.56	0.27	54.33	0.96	0.06	589.	588.	589.
24.000	30.606	0.759	-0.0372	227.98	2.54	0.11	46.76	0.86	-0.07	575.	574.	575.
25.000	26.335	0.694	0.0503	228.35	2.64	0.32	40.17	0.78	-0.12	526.	526.	526.
26.000	22.680	0.619	0.0500	228.74	2.70	0.35	34.54	0.71	-0.07	515.	515.	515.
27.000	19.543	0.570	0.1001	229.32	2.84	0.67	29.68	0.67	0.09	469.	469.	469.
28.000	16.854	0.509	0.2004	230.36	2.84	0.47	25.49	0.60	0.34	429.	429.	429.
29.000	14.547	0.453	0.1865	231.53	2.90	0.26	21.88	0.53	0.17	399.	399.	399.
30.000	12.549	0.409	0.2012	232.71	3.05	0.04	18.78	0.48	0.10	372.	372.	372.



TABLE B-5. May Thermodynamic Data, Thule, Cont'd.

Z KM	MEAN P MB	S.D. P MB	SKEW P	MEAN T DEG K	S.D. T DEG K	SKEW T	MEAN D G/M3	S.D. D G/M3	SKEW D	NOBS P	NOBS T	NOBS D
32.000	9.716	0.305	0.4178	238.37	7.21	0.43	14.15	0.27	0.06	8.	14.	8.
34.000	7.345	0.268	0.8573	244.45	6.76	0.24	10.42	0.22	-0.79	8.	14.	8.
36.000	5.594	0.232	1.1132	249.95	7.32	0.29	7.75	0.20	-0.58	8.	14.	8.
38.000	4.288	0.206	1.2965	256.96	7.88	0.50	5.80	0.16	-0.89	8.	15.	8.
40.000	3.252	0.100	-0.1803	263.59	5.63	0.32	4.33	0.11	0.06	7.	14.	7.
42.000	2.498	0.100	-0.3148	269.76	7.61	0.30	3.25	0.08	0.35	8.	15.	8.
44.000	1.976	0.070	-0.9433	274.33	6.45	-0.76	2.51	0.07	-0.19	6.	12.	6.
46.000	1.548	0.058	-1.0292	278.41	6.74	-0.98	1.94	0.06	-0.89	6.	12.	6.
48.000	1.217	0.048	-1.0008	281.91	7.36	-1.33	1.50	0.05	-0.79	6.	12.	6.
50.000	0.960	0.040	-0.9005	286.71	4.30	1.62	1.17	0.04	-1.22	6.	11.	6.
52.000	0.758	0.033	-0.7766	286.89	4.36	1.17	0.93	0.03	-1.24	6.	11.	6.
54.000	0.000	0.000	0.0000	286.66	3.03	0.66	0.00	0.00	0.00	5.	10.	5.
56.000	0.000	0.000	0.0000	284.26	3.14	0.40	0.00	0.00	0.00	5.	10.	5.
58.000	0.000	0.000	0.0000	280.46	4.27	0.06	0.00	0.00	0.00	5.	10.	5.
60.000	0.000	0.000	0.0000	275.94	4.06	1.10	0.00	0.00	0.00	5.	9.	5.
62.000	0.000	0.000	0.0000	266.87	2.43	-0.12	0.00	0.00	0.00	4.	7.	4.
64.000	0.000	0.000	0.0000	260.02	2.54	-1.05	0.00	0.00	0.00	4.	7.	4.
66.000	0.000	0.000	0.0000	253.16	4.80	1.09	0.00	0.00	0.00	4.	7.	4.
68.000	0.000	0.000	0.0000	0.00	0.00	0.00	0.00	0.00	0.00	3.	5.	3.
70.000	0.000	0.000	0.0000	0.00	0.00	0.00	0.00	0.00	0.00	2.	2.	2.

TABLE B-6. June Thermodynamic Data, Thule.

Z KM	MEAN P MB	S.D. P MB	MEAN T DEG K	S.D. T DEG K	MEAN D G/M3	S.D. D G/M3	SKEW D	NOBS P	NOBS T	NOBS D
0.000	1012.394	7.651	274.73	3.39	1281.93	18.33	-0.49	778.	778.	777.
0.059	1006.737	7.811	274.53	3.34	1275.69	18.59	-0.45	780.	781.	780.
1.000	893.153	6.977	270.65	4.11	1148.07	17.63	-0.29	807.	811.	808.
2.000	786.419	6.777	266.14	4.40	1028.67	14.99	0.10	809.	810.	809.
3.000	691.106	6.855	261.28	4.37	921.02	12.14	0.24	806.	807.	806.
4.000	605.162	6.916	255.64	4.38	824.47	9.76	0.27	806.	807.	806.
5.000	528.766	6.957	249.45	4.46	738.36	8.03	0.13	806.	807.	806.
6.000	460.230	7.023	242.68	4.44	660.61	6.82	0.00	792.	792.	792.
7.000	399.298	6.899	235.80	4.17	589.93	6.28	-0.55	779.	779.	779.
8.000	344.529	6.536	229.56	3.60	522.81	7.66	-1.23	771.	770.	771.
9.000	296.763	5.919	225.89	4.09	457.81	12.27	-0.74	764.	764.	764.
10.000	255.142	4.885	227.29	5.02	391.32	13.80	0.32	761.	761.	761.
11.000	219.742	3.878	229.58	4.31	333.62	10.94	1.42	756.	756.	756.
12.000	189.411	3.111	230.54	3.11	286.29	7.34	1.53	746.	746.	746.
13.000	163.309	2.575	230.46	2.39	246.90	5.28	1.04	744.	744.	744.
14.000	140.787	2.083	230.19	2.02	213.09	4.08	0.60	733.	733.	733.
15.000	121.337	1.752	230.00	1.90	183.80	3.34	0.51	726.	726.	726.
16.000	104.587	1.487	229.85	1.79	158.53	2.74	0.30	726.	725.	726.
17.000	90.158	1.264	229.95	1.74	136.58	2.29	0.26	680.	679.	680.
18.000	77.720	1.087	230.21	1.64	117.59	1.87	0.06	676.	674.	676.
19.000	67.031	0.954	230.51	1.57	101.27	1.56	0.08	645.	643.	645.
20.000	57.794	0.817	230.83	1.48	87.19	1.27	-0.25	637.	634.	637.
21.000	49.860	0.725	231.16	1.48	75.10	1.10	-0.68	617.	614.	617.
22.000	43.009	0.646	231.42	1.47	64.71	0.89	-0.22	590.	587.	590.
23.000	37.110	0.580	231.68	1.50	55.78	0.76	-0.03	584.	581.	584.
24.000	32.022	0.521	231.97	1.60	48.08	0.66	0.03	580.	578.	580.
25.000	27.658	0.474	232.45	1.62	41.44	0.60	0.64	537.	536.	537.
26.000	23.878	0.417	233.16	1.81	35.68	0.51	0.23	526.	526.	526.
27.000	20.628	0.368	233.88	1.98	30.72	0.45	0.29	522.	521.	522.
28.000	17.845	0.331	235.27	2.03	26.43	0.40	0.02	458.	458.	458.
29.000	15.462	0.301	236.79	2.21	22.74	0.35	0.08	432.	432.	432.
30.000	13.385	0.277	238.29	2.40	19.57	0.31	0.25	399.	399.	399.

TABLE B-6. June Thermodynamic Data, Thule, Cont'd.

Z KM	MEAN P MB	S.D. P MB	SKEW P	MEAN T DEG K	S.D. T DEG K	SKEW T	MEAN D G/M3	S.D. D G/M3	SKEW D	NOBS P	NOBS T	NOBS D
32.000	10.233	0.198	-0.9419	245.33	6.25	0.71	14.60	0.20	-0.52	19.	23.	19.
34.000	7.775	0.173	-0.7913	250.49	6.51	0.63	10.86	0.17	-0.77	20.	24.	20.
36.000	5.934	0.156	-0.5308	255.08	6.59	1.06	8.13	0.14	-0.66	19.	24.	19.
38.000	4.552	0.139	-0.2789	260.92	6.89	1.17	6.10	0.12	-0.54	20.	25.	20.
40.000	3.518	0.121	-0.1540	266.40	7.01	0.98	4.61	0.10	0.01	20.	25.	20.
42.000	2.735	0.105	-0.1058	272.32	6.58	0.52	3.51	0.09	-0.15	20.	25.	20.
44.000	2.139	0.090	-0.0639	278.12	6.56	0.13	2.69	0.08	-0.37	20.	25.	20.
46.000	1.680	0.076	-0.0351	282.54	6.34	-0.74	2.08	0.07	-0.08	20.	26.	20.
48.000	1.326	0.065	-0.1962	285.35	5.93	-1.29	1.62	0.07	0.15	19.	26.	19.
50.000	1.051	0.054	-0.4480	286.83	4.71	-1.94	1.28	0.06	-0.40	17.	24.	17.
52.000	0.831	0.044	-0.4647	286.70	3.86	-1.28	1.01	0.05	-0.51	17.	24.	17.
54.000	0.654	0.034	-0.4637	285.28	3.38	0.05	0.80	0.04	-0.51	17.	24.	17.
56.000	0.514	0.028	-0.3255	283.11	3.35	-0.68	0.63	0.03	-0.61	15.	20.	15.
58.000	0.406	0.022	-0.2867	279.83	4.90	-0.66	0.50	0.03	-0.83	14.	18.	14.
60.000	0.318	0.018	0.0222	275.91	5.23	0.20	0.40	0.02	-0.67	13.	16.	13.
62.000	0.248	0.012	-0.7187	271.70	5.72	0.55	0.32	0.02	-0.76	10.	13.	10.
64.000	0.193	0.009	-0.8206	266.56	9.54	0.25	0.25	0.02	-0.91	8.	10.	8.
66.000	0.151	0.005	-0.8506	262.53	12.00	-0.01	0.20	0.02	-1.24	6.	8.	6.
68.000	0.116	0.004	0.1154	258.03	14.81	-0.51	0.16	0.01	-0.88	6.	8.	6.
70.000	0.000	0.000	0.0000	0.00	0.00	0.00	0.00	0.00	0.00	2.	4.	2.

TABLE B-7. July Thermodynamic Data, Thule.

Z KM	MEAN P MB	S.D. P MB	MEAN T DEG K	S.D. T DEG K	MEAN D G/M3	S.D. D G/M3	NOBS P	NOBS T	NOBS D
0.000	1009.911	7.606	277.85	3.40	1263.93	19.81	782.	781.	782.
0.059	1004.324	7.852	277.64	3.33	1257.67	18.84	787.	787.	787.
1.000	892.483	6.988	274.38	3.19	1131.06	13.34	823.	825.	823.
2.000	787.205	6.719	269.77	3.52	1015.23	12.09	823.	823.	823.
3.000	693.050	6.556	264.82	3.64	910.94	10.51	822.	822.	822.
4.000	608.036	6.376	259.21	3.56	816.73	8.56	822.	822.	822.
5.000	532.234	6.236	253.02	3.55	732.57	7.07	822.	822.	822.
6.000	464.242	6.219	246.27	3.65	656.61	6.11	817.	817.	817.
7.000	403.488	6.014	239.15	3.58	587.71	5.37	809.	809.	809.
8.000	348.886	5.829	232.19	3.19	523.45	5.85	805.	805.	805.
9.000	300.802	5.282	226.69	3.17	462.34	9.62	796.	796.	796.
10.000	258.624	4.348	226.02	4.94	398.90	13.68	795.	795.	795.
11.000	222.610	3.326	229.04	4.60	338.80	10.84	785.	785.	785.
12.000	191.861	2.602	230.83	2.72	289.62	6.36	779.	779.	779.
13.000	165.461	2.130	230.84	2.06	249.74	4.64	770.	770.	770.
14.000	142.712	1.763	230.71	1.87	215.52	3.69	760.	760.	760.
15.000	123.051	1.468	230.61	1.71	185.91	2.96	754.	754.	754.
16.000	106.106	1.236	230.51	1.58	160.36	2.39	753.	753.	753.
17.000	91.552	1.042	230.66	1.52	138.27	1.93	703.	702.	703.
18.000	78.956	0.896	230.91	1.44	119.11	1.56	701.	699.	701.
19.000	68.129	0.778	231.20	1.43	102.61	1.30	678.	676.	678.
20.000	58.774	0.686	231.54	1.37	88.40	1.05	673.	670.	673.
21.000	50.718	0.603	231.84	1.36	76.19	0.91	667.	664.	667.
22.000	43.769	0.545	232.06	1.41	65.69	0.76	627.	623.	627.
23.000	37.781	0.486	232.30	1.51	56.65	0.65	618.	616.	618.
24.000	32.610	0.432	232.55	1.56	48.84	0.56	614.	612.	614.
25.000	28.170	0.382	233.13	1.63	42.09	0.49	579.	578.	579.
26.000	24.342	0.342	234.04	1.59	36.23	0.42	563.	562.	563.
27.000	21.035	0.307	234.99	1.73	31.19	0.38	561.	561.	561.
28.000	18.212	0.276	236.29	1.79	26.85	0.35	497.	497.	497.
29.000	15.782	0.253	237.74	1.94	23.13	0.31	473.	473.	473.
30.000	13.672	0.221	239.21	2.19	19.91	0.26	435.	435.	435.

TABLE B-7. July Thermodynamic Data, Thule, Cont'd.

Z KM	MEAN P MB	S.D. P MB	SKEWP P	MEAN T DEG K	S.D. T DEG K	SKEW T G/M3	MEAN D G/M3	S.D. D G/M3	SKEW D	NOBS P	NOBS T	NOBS D
32.000	10.330	0.163	0.3338	246.95	4.44	2.82	14.65	0.24	0.34	12.	14.	12.
34.000	7.884	0.157	0.6227	251.56	4.58	1.68	10.96	0.17	0.20	13.	15.	13.
36.000	6.027	0.129	0.7719	256.10	3.79	0.98	8.22	0.13	1.23	14.	16.	14.
38.000	4.636	0.109	0.5651	261.10	3.59	0.16	6.20	0.12	1.37	14.	16.	14.
40.000	3.575	0.094	0.4136	265.44	4.35	0.34	4.70	0.08	1.43	15.	18.	15.
42.000	2.780	0.081	0.2441	270.69	5.22	0.27	3.58	0.06	0.75	16.	19.	16.
44.000	2.170	0.075	0.2208	275.16	5.80	-0.39	2.75	0.06	0.23	15.	18.	15.
46.000	1.701	0.065	0.2531	279.44	5.62	-1.02	2.12	0.06	-0.09	15.	18.	15.
48.000	1.335	0.055	0.3869	282.74	4.54	-0.70	1.64	0.06	0.29	16.	19.	16.
50.000	1.052	0.046	0.3590	285.00	3.06	-1.08	1.29	0.05	0.49	16.	19.	16.
52.000	0.833	0.037	0.1585	285.99	2.36	-0.47	1.02	0.04	0.40	15.	18.	15.
54.000	0.657	0.031	0.2093	285.75	3.28	-0.01	0.80	0.04	0.20	14.	17.	14.
56.000	0.514	0.020	-0.4328	284.01	4.22	-0.49	0.63	0.02	-0.46	11.	13.	11.
58.000	0.405	0.016	-0.4252	281.31	5.47	-0.30	0.50	0.02	-0.38	11.	13.	11.
60.000	0.318	0.014	-0.3196	277.49	5.85	-0.34	0.40	0.02	-0.36	10.	12.	10.
62.000	0.249	0.010	0.6950	269.83	5.45	-0.20	0.32	0.01	0.27	7.	9.	7.
64.000	0.194	0.008	0.5548	264.66	6.28	-0.17	0.25	0.01	0.56	7.	8.	7.
66.000	0.000	0.000	0.0000	259.16	5.83	1.00	0.00	0.00	0.00	5.	6.	5.
68.000	0.000	0.000	0.0000	249.16	8.69	1.33	0.00	0.00	0.00	5.	6.	5.
70.000	0.000	0.000	0.0000	0.00	0.00	0.00	0.00	0.00	0.00	2.	3.	2.

TABLE B-8. August Thermodynamic Data, Thule.

Z KM	MEAN P MB	S.D. P MB	SKEW P	MEAN T DEG K	S.D. T DEG K	SKEW T	MEAN D G/M3	S.D. D G/M3	SKEW D	NOBS P	NOBS T	NOBS D
0.000	1010.028	8.521	-0.1838	276.68	2.94	0.04	1269.35	17.46	0.08	742.	742.	742.
0.059	1004.235	8.678	-0.2445	276.48	2.89	0.07	1263.03	17.31	0.03	747.	747.	747.
1.000	891.988	7.873	-0.3309	272.27	3.20	0.18	1139.42	13.55	-0.29	785.	785.	785.
2.000	786.116	7.445	-0.0946	267.86	3.79	-0.13	1021.27	12.66	-0.02	785.	785.	785.
3.000	691.462	7.348	-0.0657	263.06	4.09	-0.23	915.02	11.06	-0.04	785.	785.	785.
4.000	606.091	7.327	-0.0391	257.38	4.23	-0.19	820.01	9.27	-0.24	785.	785.	785.
5.000	530.052	7.240	-0.0509	251.09	4.31	-0.32	735.23	7.68	-0.10	783.	783.	783.
6.000	461.815	7.284	-0.0799	244.41	4.37	-0.27	658.16	6.51	-0.28	775.	775.	775.
7.000	401.013	7.131	-0.1346	237.39	4.23	-0.07	588.45	5.80	-0.32	764.	764.	764.
8.000	346.303	6.866	-0.0513	230.48	3.62	0.20	523.43	6.41	-0.79	756.	756.	756.
9.000	298.301	6.233	0.0242	225.03	3.39	0.71	461.88	10.63	-1.42	749.	749.	749.
10.000	256.149	5.165	0.2209	223.96	5.29	0.50	398.75	15.14	-0.43	744.	744.	744.
11.000	220.157	3.977	0.2856	226.63	5.50	-0.67	338.72	13.16	0.63	733.	733.	733.
12.000	189.442	3.088	0.2083	228.48	3.94	-1.16	288.97	8.53	0.92	723.	723.	723.
13.000	163.160	2.509	0.1524	228.86	2.83	-0.69	248.41	5.68	0.47	719.	719.	719.
14.000	140.544	2.079	0.0781	228.92	2.43	-0.61	213.92	4.23	0.30	709.	709.	709.
15.000	121.053	1.759	0.0669	228.86	2.26	-0.66	184.28	3.32	0.27	704.	704.	704.
16.000	104.265	1.516	0.0580	228.82	2.10	-0.64	158.75	2.62	0.22	704.	704.	704.
17.000	89.834	1.334	0.0547	228.88	1.98	-0.46	136.73	2.11	0.18	679.	679.	679.
18.000	77.373	1.179	0.0472	228.89	1.92	-0.54	117.75	1.74	0.08	677.	677.	677.
19.000	66.657	1.045	0.0359	228.98	1.90	-0.41	101.40	1.41	0.07	649.	648.	649.
20.000	57.418	0.937	0.0016	228.98	1.92	-0.25	87.34	1.21	-0.21	646.	645.	646.
21.000	49.484	0.839	-0.0010	228.98	1.97	-0.38	75.27	1.06	-0.77	625.	624.	625.
22.000	42.624	0.757	-0.0268	229.08	1.98	-0.30	64.80	0.89	-0.32	614.	613.	614.
23.000	36.730	0.686	0.0039	229.23	2.03	-0.22	55.81	0.77	-0.07	606.	605.	606.
24.000	31.640	0.625	0.0058	229.38	2.12	-0.11	48.04	0.69	0.04	604.	603.	604.
25.000	27.277	0.572	0.0315	229.86	2.12	-0.11	41.33	0.62	0.05	572.	571.	572.
26.000	23.521	0.521	0.0546	230.53	2.21	-0.19	35.54	0.56	0.02	565.	564.	565.
27.000	20.298	0.469	0.0346	231.35	2.35	-0.17	30.56	0.50	-0.04	551.	550.	551.
28.000	17.521	0.431	0.1008	232.52	2.52	-0.04	26.25	0.46	0.05	500.	500.	500.
29.000	15.152	0.392	0.0396	233.84	2.58	-0.34	22.57	0.42	0.14	478.	477.	478.
30.000	13.090	0.361	0.0577	235.04	2.72	-0.42	19.40	0.38	0.36	434.	433.	434.

TABLE B-8. August Thermodynamic Data, Thule, Cont'd.

Z KM	MEAN P MB	S.D. P MB	SKEW P	MEAN T DEG K	S.D. T DEG K	SKEW T	MEAN D G/M3	S.D. D G/M3	SKEW D	NOBS P	NOBS T	NOBS D
32.000	9.886	0.332	-0.4258	241.53	10.28	1.11	14.27	0.40	0.72	11.	16.	11.
34.000	7.488	0.278	-0.4950	244.99	10.05	0.67	10.63	0.27	0.50	13.	18.	13.
36.000	5.696	0.241	-0.5312	249.55	10.42	0.36	7.94	0.22	0.32	13.	18.	13.
38.000	4.341	0.202	-0.3424	253.86	10.70	-0.19	5.94	0.16	-0.14	15.	20.	15.
40.000	3.336	0.177	-0.3318	258.61	10.75	-0.84	4.48	0.14	-0.26	15.	20.	15.
42.000	2.578	0.153	-0.3183	263.21	10.42	-0.88	3.39	0.12	-0.38	15.	21.	15.
44.000	2.002	0.132	-0.2874	267.84	9.93	-0.96	2.58	0.12	-0.31	15.	22.	15.
46.000	1.559	0.115	-0.1972	271.98	8.72	-1.01	1.98	0.10	-0.14	14.	22.	14.
48.000	1.220	0.096	-0.2243	274.81	7.93	-1.53	1.54	0.10	-0.01	14.	23.	14.
50.000	0.952	0.079	-0.1309	276.52	7.12	-1.67	1.19	0.09	0.19	13.	22.	13.
52.000	0.745	0.066	-0.0854	277.71	6.56	-1.03	0.93	0.08	0.44	12.	22.	12.
54.000	0.593	0.052	-0.4486	276.95	5.49	-0.35	0.74	0.06	-0.02	10.	19.	10.
56.000	0.470	0.041	-0.8773	275.16	5.44	-0.35	0.60	0.05	-0.62	9.	18.	9.
58.000	0.359	0.032	-0.7115	273.44	6.38	-0.44	0.46	0.04	-0.42	7.	18.	7.
60.000	0.284	0.026	-0.9422	270.84	6.78	-0.24	0.37	0.03	-0.61	8.	19.	8.
62.000	0.000	0.000	0.0000	267.49	6.66	0.10	0.00	0.00	0.00	5.	9.	5.
64.000	0.000	0.000	0.0000	262.53	8.75	0.33	0.00	0.00	0.00	4.	8.	4.
66.000	0.000	0.000	0.0000	0.00	0.00	0.00	0.00	0.00	0.00	2.	5.	2.
68.000	0.000	0.000	0.0000	0.00	0.00	0.00	0.00	0.00	0.00	0.	3.	0.
70.000	0.000	0.000	0.0000	0.00	0.00	0.00	0.00	0.00	0.00	0.	2.	0.

TABLE B-9. September Thermodynamic Data, Thule.

Z KM	MEAN P MB	S.D. P MB	MEAN T DEG K	S.D. T DEG K	MEAN D G/M3	S.D. D G/M3	SKEW D	NOBS P	NOBS T	NOBS D
0.000	1010.343	8.682	271.09	4.06	1296.97	21.57	0.68	803.	803.	803.
0.059	1004.373	8.354	270.89	4.01	1290.25	21.04	0.62	810.	810.	810.
1.000	889.870	8.162	266.97	4.08	1159.75	18.46	-0.51	860.	863.	862.
2.000	782.220	7.728	262.58	4.93	1037.19	16.69	0.16	863.	863.	863.
3.000	686.084	7.929	257.50	5.17	927.88	14.01	0.17	862.	862.	862.
4.000	599.570	8.114	251.65	5.26	829.89	11.31	0.21	861.	861.	861.
5.000	522.769	8.216	245.22	5.29	742.63	8.98	0.15	861.	861.	861.
6.000	453.936	8.382	238.48	5.22	663.11	7.25	-0.13	850.	850.	850.
7.000	392.699	8.339	231.70	4.88	590.45	6.62	-0.82	841.	841.	841.
8.000	337.923	7.968	225.42	4.27	522.12	8.35	-2.22	835.	834.	835.
9.000	290.340	7.308	221.39	3.99	456.79	13.16	-1.55	824.	823.	824.
10.000	248.787	6.119	221.97	5.07	390.74	15.55	0.13	816.	816.	816.
11.000	213.461	4.913	224.28	4.49	331.77	12.72	1.08	811.	811.	811.
12.000	183.385	3.996	225.54	3.21	283.35	8.47	1.11	795.	795.	795.
13.000	157.588	3.347	225.61	2.64	243.38	6.38	0.83	791.	791.	791.
14.000	135.430	2.854	225.44	2.35	209.30	5.03	0.73	767.	767.	767.
15.000	116.374	2.461	225.14	2.25	180.09	4.05	0.68	763.	763.	763.
16.000	100.091	2.137	224.80	2.30	155.12	3.30	0.59	721.	721.	721.
17.000	85.927	1.898	224.31	2.37	133.45	2.74	0.61	701.	701.	701.
18.000	73.770	1.677	223.82	2.54	114.82	2.27	0.64	696.	696.	696.
19.000	63.339	1.505	223.33	2.69	98.80	1.92	0.67	672.	672.	672.
20.000	54.341	1.352	222.81	2.89	84.96	1.61	0.66	669.	669.	669.
21.000	46.625	1.226	222.44	3.06	73.02	1.39	0.64	641.	641.	641.
22.000	39.976	1.116	222.14	3.24	62.69	1.22	0.56	627.	627.	627.
23.000	34.272	1.014	221.86	3.44	53.81	1.06	0.57	623.	623.	623.
24.000	29.399	0.926	221.74	3.64	46.18	0.96	0.46	607.	607.	607.
25.000	25.207	0.851	222.00	3.80	39.55	0.87	0.40	590.	590.	590.
26.000	21.621	0.769	222.35	3.94	33.87	0.78	0.37	583.	583.	583.
27.000	18.583	0.698	223.12	4.05	29.01	0.71	0.32	507.	507.	507.
28.000	15.958	0.636	223.93	4.26	24.82	0.64	0.29	478.	478.	478.
29.000	13.727	0.584	224.89	4.49	21.26	0.59	0.23	443.	443.	443.
30.000	11.776	0.532	225.67	4.59	18.17	0.54	0.25	417.	417.	417.



TABLE B-9. September Thermodynamic Data, Thule, Cont'd.

Z KM	MEAN P MB	S.D. P MB	SKEWP P	MEANT DEG K	S.D. T DEG K	SKEWT G/M3	MEAND G/M3	S.D. D G/M3	SKEWD D	NOBS P	NOBS T	NOBS D
32.000	7.686	2.617	-2.7946	228.06	7.16	0.02	11.77	3.96	-2.93	9.	10.	9.
34.000	5.717	1.958	-2.7344	230.16	8.02	0.44	8.62	2.91	-2.89	9.	11.	9.
36.000	4.276	1.475	-2.6648	234.80	8.81	0.66	6.32	2.14	-2.86	9.	11.	9.
38.000	3.215	1.118	-2.5821	238.52	9.00	0.73	4.67	1.58	-2.83	9.	11.	9.
40.000	2.413	0.911	-2.3471	243.56	9.75	0.54	3.41	1.25	-2.60	8.	10.	8.
42.000	1.839	0.701	-2.2625	249.06	10.30	0.58	2.54	0.94	-2.54	8.	10.	8.
44.000	1.410	0.543	-2.1744	252.46	10.13	0.54	1.92	0.72	-2.46	8.	10.	8.
46.000	1.084	0.422	-2.0966	256.16	8.01	0.44	1.46	0.55	-2.34	8.	10.	8.
48.000	0.837	0.328	-2.0268	261.46	7.51	1.64	1.11	0.42	-2.25	8.	10.	8.
50.000	0.650	0.257	-1.9546	264.36	7.33	1.04	0.85	0.33	-2.18	8.	10.	8.
52.000	0.505	0.201	-1.8954	264.06	6.79	0.35	0.66	0.26	-2.13	8.	10.	8.
54.000	0.392	0.158	-1.8335	264.76	6.88	0.57	0.51	0.20	-2.07	8.	10.	8.
56.000	0.305	0.124	-1.7689	264.36	7.69	0.55	0.40	0.16	-2.05	8.	10.	8.
58.000	0.237	0.097	-1.6945	263.86	8.27	0.24	0.31	0.12	-2.00	8.	10.	8.
60.000	0.207	0.039	-0.0153	264.02	9.10	-0.07	0.27	0.04	-0.01	7.	7.	7.
62.000	0.000	0.000	0.0000	0.00	0.00	0.00	0.00	0.00	0.00	4.	4.	4.
64.000	0.000	0.000	0.0000	0.00	0.00	0.00	0.00	0.00	0.00	3.	3.	3.
66.000	0.000	0.000	0.0000	0.00	0.00	0.00	0.00	0.00	0.00	3.	3.	3.
68.000	0.000	0.000	0.0000	0.00	0.00	0.00	0.00	0.00	0.00	3.	3.	3.
70.000	0.000	0.000	0.0000	0.00	0.00	0.00	0.00	0.00	0.00	0.	0.	0.

TABLE B-10. October Thermodynamic Data, Thule.

Z KM	MEAN P MB	S.D. P MB	MEAN T DEG K	S.D. T DEG K	MEAN D G/M3	S.D. D G/M3	SKWEW D	NOBS P	NOBS T	NOBS D
0.000	1008.894	10.395	263.34	6.20	1334.38	34.60	0.17	823.	823.	823.
0.059	1002.936	10.308	263.23	6.11	1327.02	33.14	0.15	830.	830.	830.
1.000	886.237	9.561	261.64	5.35	1179.53	23.63	0.35	851.	851.	851.
2.000	776.899	9.338	257.58	5.66	1050.53	19.76	0.13	850.	850.	850.
3.000	679.509	9.544	252.36	5.90	937.97	15.95	0.26	850.	850.	850.
4.000	592.216	9.753	246.50	6.07	837.00	12.78	0.42	850.	850.	850.
5.000	514.996	9.864	240.21	6.09	746.93	10.05	0.48	848.	848.	848.
6.000	445.753	10.056	233.64	5.88	664.69	7.94	0.30	835.	835.	835.
7.000	384.442	9.980	227.24	5.39	589.37	7.31	0.05	827.	827.	827.
8.000	329.975	9.320	221.78	4.36	518.29	9.20	-0.60	817.	817.	817.
9.000	282.845	8.480	219.34	3.73	449.32	14.17	-0.18	810.	810.	810.
10.000	242.074	7.165	220.06	4.27	385.45	15.75	0.65	805.	805.	805.
11.000	207.341	5.903	221.46	3.85	326.33	12.98	1.39	798.	798.	798.
12.000	177.645	4.849	221.75	3.16	279.15	9.50	1.65	780.	780.	780.
13.000	152.301	4.093	221.42	2.78	239.66	7.27	1.43	776.	776.	776.
14.000	130.421	3.535	220.69	2.67	205.89	5.80	1.28	759.	759.	759.
15.000	111.684	3.059	219.89	2.71	176.95	4.72	1.21	758.	758.	758.
16.000	95.645	2.698	218.92	2.80	152.20	3.90	1.08	713.	713.	713.
17.000	81.751	2.390	217.75	2.98	130.79	3.25	1.06	700.	700.	700.
18.000	69.945	2.119	216.61	3.22	112.48	2.79	0.95	670.	670.	670.
19.000	59.673	1.887	215.34	3.30	96.51	2.44	0.79	637.	636.	637.
20.000	51.043	1.620	214.39	3.24	82.92	2.09	0.65	596.	595.	596.
21.000	43.495	1.491	213.19	3.48	70.94	1.88	0.49	510.	510.	510.
22.000	37.076	1.325	212.71	3.55	60.72	1.64	0.46	468.	468.	468.
23.000	31.689	1.091	212.06	3.27	52.04	1.41	0.39	446.	445.	446.
24.000	27.088	0.969	211.98	3.23	44.51	1.25	0.24	352.	352.	352.
25.000	23.051	0.870	211.49	3.46	37.96	1.11	0.19	336.	336.	336.
26.000	19.800	0.731	211.87	3.52	32.55	0.98	0.08	255.	255.	255.
27.000	16.888	0.634	212.27	3.37	27.71	0.85	0.21	208.	208.	208.
28.000	14.402	0.569	212.64	3.60	23.59	0.73	0.24	175.	175.	175.
29.000	12.280	0.488	213.03	3.50	20.07	0.63	0.25	156.	156.	156.
30.000	10.499	0.422	213.43	3.61	17.14	0.53	0.28	144.	144.	144.

TABLE B-10. October Thermodynamic Data, Thule, Cont'd.

Z KM	MEAN P MB	S.D. P MB	SKEW P	MEAN T DEG K	S.D. T DEG K	SKEW T	MEAN D G/M3	S.D. D G/M3	SKEW D	NOBS P	NOBS T	NOBS D
32.000	7.163	0.492	-0.2904	211.30	5.27	0.03	11.85	0.62	-1.12	6.	7.	6.
34.000	5.193	0.385	-0.0759	211.16	6.07	-0.14	8.56	0.51	-0.88	6.	8.	6.
36.000	3.777	0.293	0.0636	215.03	6.81	0.83	6.14	0.44	-0.54	6.	8.	6.
38.000	2.787	0.214	-0.1374	219.60	7.43	0.34	4.43	0.31	-1.01	7.	9.	7.
40.000	2.051	0.163	0.0440	222.60	7.07	0.33	3.22	0.24	-0.65	7.	9.	7.
42.000	1.517	0.124	0.2099	226.60	7.55	-0.33	2.33	0.18	-0.38	7.	9.	7.
44.000	1.131	0.096	0.3074	232.94	8.48	-0.32	1.69	0.14	-0.12	7.	9.	7.
46.000	0.849	0.075	0.3707	238.60	8.57	0.92	1.24	0.09	0.19	7.	9.	7.
48.000	0.642	0.061	0.4155	244.16	8.93	0.91	0.92	0.07	0.14	7.	9.	7.
50.000	0.489	0.049	0.4386	252.94	8.76	0.53	0.67	0.06	0.49	7.	9.	7.
52.000	0.375	0.039	0.4677	255.83	9.91	1.06	0.51	0.04	0.27	7.	9.	7.
54.000	0.288	0.032	0.5266	257.60	10.69	0.59	0.39	0.03	0.02	7.	9.	7.
56.000	0.222	0.026	0.5691	260.83	7.19	0.39	0.30	0.03	0.37	7.	9.	7.
58.000	0.172	0.022	0.6244	263.16	8.00	-0.16	0.23	0.02	0.15	7.	9.	7.
60.000	0.128	0.014	0.9640	263.66	8.54	-1.47	0.17	0.02	0.49	6.	8.	6.
62.000	0.000	0.000	0.0000	266.02	10.07	-2.19	0.00	0.00	0.00	5.	7.	5.
64.000	0.000	0.000	0.0000	264.73	11.49	-1.71	0.00	0.00	0.00	5.	7.	5.
66.000	0.000	0.000	0.0000	261.66	14.31	-0.81	0.00	0.00	0.00	4.	6.	4.
68.000	0.000	0.000	0.0000	0.00	0.00	0.00	0.00	0.00	0.00	3.	4.	3.
70.000	0.000	0.000	0.0000	0.00	0.00	0.00	0.00	0.00	0.00	0.	0.	0.

TABLE B-11. November Thermodynamic Data, Thule.

Z KM	MEAN P MB	S.D. P MB	SKEW P	MEAN T DEG K	S.D. T DEG K	SKEW T	MEAN D G/M3	S.D. D G/M3	SKEW D	NOBS P	NOBS T	NOBS D
0.000	1009.367	12.473	0.2106	256.20	6.46	0.14	1372.86	41.67	0.06	739.	739.	739.
0.059	1003.040	12.129	0.2742	256.16	6.32	0.19	1364.42	39.95	-0.01	744.	744.	744.
1.000	883.594	11.920	-1.3823	255.69	5.48	0.36	1203.85	29.45	-0.41	776.	776.	776.
2.000	772.433	9.827	0.3960	251.88	5.30	0.46	1068.34	22.51	-0.35	775.	775.	775.
3.000	673.605	9.348	0.5276	247.13	5.02	0.43	949.59	17.52	-0.24	774.	774.	774.
4.000	585.440	8.986	0.6248	241.41	4.92	0.51	844.89	13.98	-0.20	772.	772.	772.
5.000	507.634	8.676	0.6433	235.29	4.74	0.67	751.66	11.23	-0.20	769.	769.	769.
6.000	438.004	8.481	0.7407	229.00	4.52	0.77	666.40	9.75	-0.29	761.	761.	761.
7.000	376.627	8.057	0.8394	223.14	4.10	0.71	588.03	9.67	-0.50	748.	748.	748.
8.000	322.602	7.306	0.9290	218.64	3.84	0.54	514.09	10.86	-0.58	737.	737.	737.
9.000	275.948	6.544	1.0143	217.31	4.19	0.22	442.52	13.03	0.15	724.	724.	724.
10.000	235.860	5.618	0.9615	218.18	4.47	-0.31	376.77	12.20	0.96	713.	713.	713.
11.000	201.779	4.795	0.7595	219.02	4.09	-0.75	321.05	9.69	1.66	705.	705.	705.
12.000	172.569	4.164	0.5235	218.83	4.02	-0.66	274.79	7.56	1.81	690.	690.	690.
13.000	147.689	3.689	0.3026	218.37	3.96	-0.37	235.65	5.90	1.44	666.	666.	666.
14.000	126.180	3.323	0.1383	217.44	4.25	-0.31	202.19	4.88	1.27	646.	646.	646.
15.000	107.797	2.977	-0.0754	216.40	4.60	-0.23	173.56	4.01	1.14	645.	645.	645.
16.000	92.134	2.712	-0.1774	215.40	4.88	-0.14	148.99	3.63	0.38	594.	594.	594.
17.000	78.551	2.478	-0.2756	214.03	5.27	-0.12	127.83	3.09	0.42	586.	585.	586.
18.000	67.200	2.208	-0.2731	213.40	5.58	0.35	109.71	2.70	0.48	506.	506.	506.
19.000	57.168	2.042	-0.2823	212.22	5.88	0.19	93.85	2.19	0.32	479.	479.	479.
20.000	49.051	1.708	-0.1651	212.13	5.77	0.22	80.56	1.90	0.32	392.	392.	392.
21.000	41.852	1.552	-0.0019	211.88	5.99	0.17	68.81	1.57	0.17	320.	320.	320.
22.000	35.666	1.470	0.0177	211.53	6.22	0.22	58.79	1.43	-0.06	279.	279.	279.
23.000	30.666	1.243	0.1418	211.92	6.13	0.17	50.40	1.18	-0.05	228.	228.	228.
24.000	26.160	1.242	0.1549	211.78	6.85	0.22	43.02	1.08	-0.05	156.	156.	156.
25.000	22.299	1.161	0.1741	211.39	7.46	0.55	36.72	1.01	-0.15	151.	151.	151.
26.000	19.280	1.070	0.0799	213.22	8.29	1.32	31.50	1.00	-0.45	100.	100.	100.
27.000	16.495	0.915	0.3068	212.75	6.86	0.23	26.99	0.86	0.27	79.	79.	79.
28.000	14.151	0.915	0.1771	212.86	7.50	0.18	23.13	0.86	0.19	55.	55.	55.
29.000	12.011	0.864	0.3022	211.74	7.04	0.39	19.73	0.89	0.24	45.	45.	45.
30.000	10.548	0.772	-0.3611	214.11	6.35	-0.12	17.14	0.91	-0.41	29.	29.	29.

TABLE B-11. November Thermodynamic Data, Thule, Cont'd.

Z KM	MEAN P MB	S.D. P MB	SKEW P	MEAN T DEG K	S.D. T DEG K	SKEW T	MEAN D G/M3	S.D. D G/M3	SKEW D	NOBS P	NOBS T	NOBS D
32.000	6.747	0.447	0.2570	207.01	4.43	-0.35	11.33	0.71	0.15	10.	13.	10.
34.000	4.877	0.336	0.2672	209.87	5.48	0.00	8.09	0.52	0.06	10.	14.	10.
36.000	3.547	0.254	0.1819	214.45	4.81	-0.10	5.75	0.39	0.60	10.	14.	10.
38.000	2.595	0.193	-0.0022	217.95	6.45	0.13	4.12	0.30	0.56	10.	14.	10.
40.000	1.912	0.147	-0.1969	220.95	6.64	-0.09	2.98	0.22	0.31	10.	14.	10.
42.000	1.406	0.113	-0.1261	226.45	7.85	0.27	2.15	0.18	0.22	11.	14.	11.
44.000	1.048	0.084	-0.1983	232.73	8.43	0.18	1.57	0.13	0.24	11.	14.	11.
46.000	0.788	0.064	-0.4193	241.30	13.56	2.08	1.14	0.10	0.20	11.	14.	11.
48.000	0.597	0.054	-0.2863	247.93	9.78	0.28	0.84	0.07	-0.09	10.	13.	10.
50.000	0.462	0.046	-0.2003	252.30	7.95	-0.01	0.65	0.07	0.07	11.	14.	11.
52.000	0.354	0.034	-0.2459	253.78	5.68	0.53	0.49	0.05	-0.16	11.	13.	11.
54.000	0.271	0.028	-0.0665	255.98	7.83	0.34	0.37	0.04	-0.36	9.	11.	9.
56.000	0.211	0.022	-0.1758	259.58	8.10	-1.15	0.28	0.03	-0.23	10.	12.	10.
58.000	0.162	0.018	-0.0048	261.06	10.24	-1.66	0.22	0.03	0.38	9.	10.	9.
60.000	0.126	0.014	0.1305	260.03	15.51	-1.17	0.17	0.02	0.16	7.	8.	7.
62.000	0.098	0.012	0.2530	258.87	22.79	-0.48	0.13	0.02	-0.35	6.	7.	6.
64.000	0.000	0.000	0.0000	253.99	26.48	-0.25	0.00	0.00	0.00	5.	6.	5.
66.000	0.000	0.000	0.0000	0.00	0.00	0.00	0.00	0.00	0.00	3.	4.	3.
68.000	0.000	0.000	0.0000	0.00	0.00	0.00	0.00	0.00	0.00	2.	3.	2.
70.000	0.000	0.000	0.0000	0.00	0.00	0.00	0.00	0.00	0.00	2.	2.	2.

TABLE B-12. December Thermodynamic Data, Thule.

Z KM	MEAN P MB	S.D. P MB	MEAN T DEG K	S.D. T DEG K	MEAN D G/M3	S.D. D G/M3	SKWEW D	NOBS P	NOBS T	NOBS D
0.000	1008.555	13.165	252.32	7.44	1393.20	44.16	-0.17	790.	790.	790.
0.059	1002.071	13.253	252.19	7.35	1384.93	43.42	-0.14	803.	803.	803.
1.000	881.460	11.700	253.01	7.23	1214.14	35.92	-0.02	833.	833.	833.
2.000	769.285	11.123	249.53	7.00	1074.33	27.27	0.00	832.	832.	832.
3.000	669.926	11.127	244.80	6.52	953.59	19.94	0.02	831.	831.	831.
4.000	581.490	11.032	239.05	6.24	847.56	15.04	-0.10	831.	831.	831.
5.000	503.495	10.980	233.06	5.80	752.71	11.43	-0.41	829.	829.	829.
6.000	433.845	10.855	226.99	5.34	665.88	9.46	-0.39	812.	812.	812.
7.000	372.649	10.314	221.38	4.65	586.38	10.13	-0.44	799.	799.	799.
8.000	318.809	9.327	216.82	4.04	512.25	12.29	-0.47	795.	795.	795.
9.000	272.249	8.334	214.64	4.28	442.01	14.90	0.05	787.	787.	787.
10.000	232.130	7.135	214.16	4.96	377.79	14.59	0.63	773.	773.	773.
11.000	198.031	6.088	214.25	5.09	322.15	11.77	0.92	745.	745.	745.
12.000	168.700	5.234	213.66	5.34	275.15	8.94	0.88	727.	727.	727.
13.000	143.967	4.707	212.82	5.67	235.73	7.18	0.72	676.	676.	676.
14.000	122.563	4.335	211.73	6.23	201.70	5.84	0.62	636.	636.	636.
15.000	104.516	3.879	210.62	6.89	172.92	4.99	0.08	605.	605.	605.
16.000	89.135	3.835	210.05	7.66	147.86	4.22	0.23	443.	443.	443.
17.000	75.772	3.585	208.55	8.14	126.57	3.58	0.20	426.	426.	426.
18.000	65.380	3.413	209.89	8.74	108.50	3.23	-0.13	278.	278.	278.
19.000	55.602	3.216	208.77	8.99	92.76	2.85	0.07	266.	266.	266.
20.000	48.247	3.023	210.87	9.04	79.66	2.61	-0.04	172.	172.	172.
21.000	41.301	2.949	210.75	9.07	68.20	2.54	-0.25	131.	131.	131.
22.000	35.217	2.653	209.81	9.12	58.41	2.37	-0.26	120.	120.	120.
23.000	30.643	2.246	211.20	8.39	50.49	2.25	-0.79	89.	89.	89.
24.000	26.271	2.106	211.56	8.40	43.22	2.27	-0.93	72.	72.	72.
25.000	22.551	1.765	211.26	8.34	37.16	2.01	-1.15	67.	67.	67.
26.000	19.459	1.633	211.53	8.76	32.00	1.85	-1.49	51.	51.	51.
27.000	16.558	1.697	211.49	9.04	27.20	1.97	-1.23	33.	33.	33.
28.000	14.332	1.681	213.42	8.28	23.33	2.05	-1.50	19.	19.	19.
29.000	12.040	1.556	212.73	6.54	19.69	2.07	-1.36	15.	15.	15.
30.000	10.508	1.379	214.65	3.80	17.02	2.03	-1.80	12.	12.	12.

TABLE B-12. December Thermodynamic Data, Thule, Cont'd.

Z KM	MEAN P MB	S.D. P MB	SKEW P	MEAN T DEG K	S.D. T DEG K	SKEW T	MEAN D G/M3	S.D. D G/M3	SKEW D	NOBS P	NOBS T	NOBS D
32.000	0.000	0.000	0.0000	204.53	7.13	0.13	0.00	0.00	0.00	5.	8.	5.
34.000	0.000	0.000	0.0000	208.43	9.09	-0.22	0.00	0.00	0.00	5.	11.	5.
36.000	0.000	0.000	0.0000	215.93	9.34	-0.14	0.00	0.00	0.00	5.	13.	5.
38.000	0.000	0.000	0.0000	222.78	11.04	0.76	0.00	0.00	0.00	5.	13.	5.
40.000	0.000	0.000	0.0000	230.52	11.74	1.44	0.00	0.00	0.00	5.	14.	5.
42.000	0.000	0.000	0.0000	237.52	14.38	1.03	0.00	0.00	0.00	5.	14.	5.
44.000	0.000	0.000	0.0000	243.85	16.06	1.04	0.00	0.00	0.00	5.	13.	5.
46.000	0.000	0.000	0.0000	250.49	14.74	0.85	0.00	0.00	0.00	4.	12.	4.
48.000	0.000	0.000	0.0000	256.16	14.45	0.33	0.00	0.00	0.00	4.	12.	4.
50.000	0.000	0.000	0.0000	258.58	12.04	0.52	0.00	0.00	0.00	4.	12.	4.
52.000	0.000	0.000	0.0000	261.08	10.04	-0.09	0.00	0.00	0.00	3.	12.	3.
54.000	0.000	0.000	0.0000	264.08	9.31	-0.32	0.00	0.00	0.00	3.	12.	3.
56.000	0.000	0.000	0.0000	264.16	13.11	0.22	0.00	0.00	0.00	3.	11.	3.
58.000	0.000	0.000	0.0000	262.16	19.30	0.44	0.00	0.00	0.00	3.	10.	3.
60.000	0.000	0.000	0.0000	260.03	22.03	0.30	0.00	0.00	0.00	2.	8.	2.
62.000	0.000	0.000	0.0000	257.73	18.04	0.49	0.00	0.00	0.00	2.	7.	2.
64.000	0.000	0.000	0.0000	259.33	21.70	0.33	0.00	0.00	0.00	2.	6.	2.
66.000	0.000	0.000	0.0000	0.00	0.00	0.00	0.00	0.00	0.00	0.	5.	0.
68.000	0.000	0.000	0.0000	0.00	0.00	0.00	0.00	0.00	0.00	0.	2.	0.
70.000	0.000	0.000	0.0000	0.00	0.00	0.00	0.00	0.00	0.00	0.	0.	0.

TABLE B-13. Annual Thermodynamic Data, Thule.

Z KM	MEAN P MB	S.D. P MB	SKEW P	MEAN T DEG K	S.D. T DEG K	SKEW T	MEAN D G/M3	S.D. D G/M3	SKEW D	NOBS P	NOBS T	NOBS D
0.000	1011.270	11.482	0.0880	262.61	11.89	-0.16	1343.15	64.40	0.32	9027.	9024.	9026.
0.059	1005.116	11.399	0.0587	262.40	11.81	-0.15	1335.94	63.06	0.29	9139.	9139.	9139.
1.000	887.636	11.050	-0.3765	260.87	10.03	-0.12	1185.86	43.27	0.31	9551.	9561.	9555.
2.000	777.871	11.684	-0.1858	257.20	9.48	-0.07	1054.03	31.37	0.32	9551.	9552.	9551.
3.000	680.315	12.813	-0.1338	252.48	9.22	0.01	939.05	23.02	0.25	9540.	9541.	9540.
4.000	592.991	13.598	-0.0748	246.80	9.15	0.07	837.33	17.18	0.20	9532.	9533.	9532.
5.000	515.687	14.132	-0.0452	240.63	8.98	0.15	746.80	12.55	0.14	9514.	9515.	9514.
6.000	446.535	14.548	0.0033	234.27	8.60	0.24	664.11	9.13	0.07	9386.	9386.	9386.
7.000	385.340	14.465	0.0530	228.18	7.81	0.29	588.29	8.79	-0.58	9271.	9271.	9271.
8.000	331.101	13.746	0.1106	223.16	6.81	0.09	516.78	11.92	-0.89	9185.	9183.	9185.
9.000	284.080	12.787	0.1150	220.61	6.43	-0.20	448.61	16.39	-0.30	9058.	9057.	9058.
10.000	243.407	11.507	0.0599	221.04	7.34	-0.26	383.77	16.97	0.41	8940.	8940.	8940.
11.000	208.780	10.388	-0.0412	222.47	7.84	-0.54	327.00	13.61	0.88	8799.	8799.	8799.
12.000	179.118	9.574	-0.1337	222.99	8.10	-0.72	279.80	10.22	0.67	8607.	8607.	8607.
13.000	153.966	8.734	-0.2250	223.02	8.16	-0.85	240.42	8.50	0.32	8369.	8369.	8369.
14.000	132.215	8.080	-0.2995	222.72	8.41	-0.92	206.69	7.46	0.13	8092.	8092.	8092.
15.000	113.619	7.287	-0.3291	222.45	8.60	-0.95	177.82	6.63	-0.02	7924.	7924.	7924.
16.000	98.084	6.520	-0.4887	222.81	8.46	-1.08	153.24	6.01	-0.23	7291.	7288.	7291.
17.000	84.123	5.951	-0.4825	222.35	8.88	-1.04	131.68	5.42	-0.30	7026.	7023.	7026.
18.000	72.743	5.102	-0.5804	223.08	8.37	-1.07	113.49	4.83	-0.52	6542.	6536.	6542.
19.000	62.482	4.626	-0.5607	222.91	8.67	-1.01	97.53	4.37	-0.60	6256.	6250.	6256.
20.000	54.081	3.873	-0.5888	223.74	8.04	-0.97	84.11	3.81	-0.79	5849.	5840.	5849.
21.000	46.619	3.475	-0.6429	224.10	8.03	-0.98	72.38	3.47	-0.89	5445.	5436.	5445.
22.000	40.098	3.114	-0.6588	224.17	8.23	-0.98	62.23	3.13	-0.96	5185.	5176.	5185.
23.000	34.601	2.684	-0.6244	224.57	8.02	-0.88	53.61	2.75	-1.05	4986.	4978.	4986.
24.000	29.901	2.366	-0.7300	225.24	7.81	-0.96	46.19	2.49	-1.16	4675.	4669.	4675.
25.000	25.687	2.139	-0.6636	225.44	8.12	-0.96	39.64	2.25	-1.09	4434.	4431.	4434.
26.000	22.246	1.817	-0.7077	226.62	7.75	-0.98	34.16	1.94	-1.20	4160.	4158.	4160.
27.000	19.247	1.619	-0.7800	227.74	7.67	-1.01	29.40	1.75	-1.24	3820.	3818.	3820.
28.000	16.602	1.431	-0.7551	228.83	7.71	-0.95	25.24	1.54	-1.23	3438.	3438.	3438.
29.000	14.349	1.284	-0.7485	230.03	8.00	-0.96	21.70	1.37	-1.21	3204.	3203.	3204.
30.000	12.403	1.112	-0.6351	231.21	8.10	-0.83	18.66	1.16	-1.06	2927.	2926.	2927.



TABLE B-13. Annual Thermodynamic Data, Thule, Cont'd.

Z KM	MEAN P MB	S.D. P MB	SKEWP P	MEANT DEG K	S.D. T DEG K	SKEWT G/M3	MEAND G/M3	S.D. D G/M3	SKEWD D	NOBS P	NOBS T	NOBS D
32.000	8.606	1.673	-1.1410	230.14	16.39	-0.25	12.91	1.98	-2.14	117.	162.	117.
34.000	6.464	1.357	-0.9614	233.11	17.83	-0.18	9.52	1.57	-1.79	122.	175.	122.
36.000	4.857	1.092	-0.7984	237.05	18.16	-0.13	7.03	1.24	-1.49	123.	180.	123.
38.000	3.687	0.875	-0.7002	241.92	18.64	-0.13	5.22	0.98	-1.28	127.	190.	127.
40.000	2.803	0.713	-0.5992	246.79	19.06	-0.15	3.89	0.79	-1.06	126.	191.	126.
42.000	2.148	0.579	-0.5186	252.30	19.15	-0.24	2.92	0.63	-0.91	129.	194.	129.
44.000	1.641	0.475	-0.4049	256.85	18.94	-0.25	2.19	0.52	-0.73	127.	191.	127.
46.000	1.275	0.384	-0.3618	261.94	18.44	-0.39	1.67	0.42	-0.65	124.	190.	124.
48.000	0.994	0.311	-0.3333	266.06	17.43	-0.50	1.28	0.34	-0.57	123.	190.	123.
50.000	0.765	0.254	-0.2078	268.36	16.47	-0.48	0.98	0.28	-0.41	120.	184.	120.
52.000	0.597	0.205	-0.1667	269.80	15.65	-0.50	0.76	0.23	-0.35	116.	178.	116.
54.000	0.468	0.167	-0.1662	270.75	14.31	-0.62	0.60	0.19	-0.33	107.	170.	107.
56.000	0.358	0.132	-0.0701	270.08	12.72	-0.43	0.46	0.15	-0.22	100.	159.	100.
58.000	0.278	0.105	-0.0241	268.69	12.53	-0.53	0.36	0.12	-0.15	95.	152.	95.
60.000	0.222	0.081	0.0058	266.95	12.29	-0.75	0.29	0.10	-0.06	86.	139.	86.
62.000	0.166	0.064	0.1924	264.20	12.62	-0.66	0.22	0.08	0.14	70.	111.	70.
64.000	0.131	0.051	0.1015	261.59	13.39	-0.25	0.17	0.07	0.06	56.	91.	56.
66.000	0.103	0.039	0.1173	258.88	14.85	0.01	0.14	0.05	0.09	42.	72.	42.
68.000	0.083	0.032	-0.1204	256.43	16.33	0.34	0.11	0.05	-0.12	30.	51.	30.
70.000	0.066	0.027	-0.4821	259.89	18.82	-0.12	0.09	0.04	-0.49	10.	22.	10.

## **APPENDIX C**

### **Thule Moisture-Related Statistics Tables**

Tables C-1 through C-13 provide moisture related statistics (monthly and annual, from surface to 70 km) for Thule. They were prepared as described in Chapter 3.

TABLE C-1. January Moisture-Related Data, Thule.

Z KM	VP MEAN		S.D. VP		TV MEAN		TV S.D.		SKEW TV		TD MEAN		S.D. TD		SKEW TD		NOBS		NOBS	
	MB	MB	MB	MB	K	K	K	K	K	K	K	K	K	K	VP	TV	VP	TV	VP	TV
0.000	0.777	0.664	0.664	2.3005	251.84	8.17	0.43	244.87	8.30	0.18	744.	744.								
0.059	0.769	0.650	0.650	2.3025	251.79	8.03	0.46	244.84	8.17	0.19	758.	758.								
1.000	0.844	0.590	0.590	2.0320	253.59	7.51	0.43	246.71	6.81	0.32	782.	782.								
2.000	0.584	0.421	0.421	2.4114	251.00	6.76	0.48	242.76	6.50	0.38	772.	772.								
3.000	0.354	0.244	0.244	2.1019	246.56	6.14	0.63	237.73	6.60	0.28	743.	748.								
4.000	0.211	0.145	0.145	2.2052	241.83	5.39	1.10	232.64	6.32	0.02	645.	649.								
5.000	0.146	0.113	0.113	2.2891	238.61	4.64	1.42	228.60	7.33	-0.51	359.	361.								
6.000	0.127	0.107	0.107	1.5398	237.52	4.41	0.26	226.46	8.63	-0.69	91.	91.								
7.000	0.098	0.053	0.053	1.0109	235.78	1.76	0.13	225.95	4.56	0.65	19.	19.								
8.000	0.000	0.000	0.000	0.0000	216.00	4.98	0.75	0.00	0.00	0.00	0.	0.								
9.000	0.000	0.000	0.000	0.0000	212.85	5.57	0.57	0.00	0.00	0.00	0.	0.								
10.000	0.000	0.000	0.000	0.0000	211.79	6.17	0.46	0.00	0.00	0.00	0.	0.								
11.000	0.000	0.000	0.000	0.0000	211.46	6.52	0.46	0.00	0.00	0.00	0.	0.								
12.000	0.000	0.000	0.000	0.0000	210.78	6.66	0.61	0.00	0.00	0.00	0.	0.								
13.000	0.000	0.000	0.000	0.0000	210.08	7.01	0.65	0.00	0.00	0.00	0.	0.								
14.000	0.000	0.000	0.000	0.0000	209.02	7.40	0.72	0.00	0.00	0.00	0.	0.								
15.000	0.000	0.000	0.000	0.0000	208.48	7.74	0.70	0.00	0.00	0.00	0.	0.								
16.000	0.000	0.000	0.000	0.0000	208.24	8.54	0.56	0.00	0.00	0.00	0.	0.								
17.000	0.000	0.000	0.000	0.0000	207.52	8.84	0.51	0.00	0.00	0.00	0.	0.								
18.000	0.000	0.000	0.000	0.0000	208.85	9.23	0.25	0.00	0.00	0.00	0.	0.								
19.000	0.000	0.000	0.000	0.0000	208.87	8.72	0.24	0.00	0.00	0.00	0.	0.								
20.000	0.000	0.000	0.000	0.0000	211.26	8.10	-0.16	0.00	0.00	0.00	0.	0.								
21.000	0.000	0.000	0.000	0.0000	211.58	7.75	-0.41	0.00	0.00	0.00	0.	0.								
22.000	0.000	0.000	0.000	0.0000	211.19	7.87	-0.60	0.00	0.00	0.00	0.	0.								
23.000	0.000	0.000	0.000	0.0000	212.03	6.39	-0.28	0.00	0.00	0.00	0.	0.								
24.000	0.000	0.000	0.000	0.0000	212.41	6.72	-0.22	0.00	0.00	0.00	0.	0.								
25.000	0.000	0.000	0.000	0.0000	212.45	7.13	-0.08	0.00	0.00	0.00	0.	0.								
26.000	0.000	0.000	0.000	0.0000	215.13	8.05	-0.29	0.00	0.00	0.00	0.	0.								
27.000	0.000	0.000	0.000	0.0000	215.05	7.41	-0.64	0.00	0.00	0.00	0.	0.								
28.000	0.000	0.000	0.000	0.0000	219.79	5.83	-0.33	0.00	0.00	0.00	0.	0.								
29.000	0.000	0.000	0.000	0.0000	220.92	7.99	0.19	0.00	0.00	0.00	0.	0.								
30.000	0.000	0.000	0.000	0.0000	223.69	8.74	0.62	0.00	0.00	0.00	0.	0.								

TABLE C-1. January Moisture-Related Data, Thule, Cont'd.

Z KM	VP MEAN		S.D. VP		TV MEAN		TV S.D.		SKEW TV		TD MEAN		S.D. TD		SKEW TD		NOBS		
	MB	K	MB	K	K	K	K	K	K	K	K	K	K	K	VP	TV	VP	TV	
32.000	0.000	224.86	0.000	17.61	0.11	0.00	0.00	0.00	0.00	0.00	0.00	0.00	0.00	0.00	0.00	0.00	0.00	10.	0.
34.000	0.000	227.78	0.000	17.45	0.59	0.00	0.00	0.00	0.00	0.00	0.00	0.00	0.00	0.00	0.00	0.00	0.00	13.	0.
36.000	0.000	230.70	0.000	18.02	0.25	0.00	0.00	0.00	0.00	0.00	0.00	0.00	0.00	0.00	0.00	0.00	0.00	13.	0.
38.000	0.000	237.24	0.000	20.52	0.61	0.00	0.00	0.00	0.00	0.00	0.00	0.00	0.00	0.00	0.00	0.00	0.00	13.	0.
40.000	0.000	242.37	0.000	21.07	0.73	0.00	0.00	0.00	0.00	0.00	0.00	0.00	0.00	0.00	0.00	0.00	0.00	14.	0.
42.000	0.000	246.16	0.000	19.14	0.26	0.00	0.00	0.00	0.00	0.00	0.00	0.00	0.00	0.00	0.00	0.00	0.00	14.	0.
44.000	0.000	248.96	0.000	16.91	-0.01	0.00	0.00	0.00	0.00	0.00	0.00	0.00	0.00	0.00	0.00	0.00	0.00	15.	0.
46.000	0.000	250.83	0.000	17.48	-0.49	0.00	0.00	0.00	0.00	0.00	0.00	0.00	0.00	0.00	0.00	0.00	0.00	15.	0.
48.000	0.000	253.03	0.000	15.35	-0.67	0.00	0.00	0.00	0.00	0.00	0.00	0.00	0.00	0.00	0.00	0.00	0.00	15.	0.
50.000	0.000	255.83	0.000	13.72	-1.00	0.00	0.00	0.00	0.00	0.00	0.00	0.00	0.00	0.00	0.00	0.00	0.00	15.	0.
52.000	0.000	258.03	0.000	12.05	-0.72	0.00	0.00	0.00	0.00	0.00	0.00	0.00	0.00	0.00	0.00	0.00	0.00	15.	0.
54.000	0.000	262.80	0.000	12.44	-0.07	0.00	0.00	0.00	0.00	0.00	0.00	0.00	0.00	0.00	0.00	0.00	0.00	14.	0.
56.000	0.000	261.08	0.000	13.41	0.09	0.00	0.00	0.00	0.00	0.00	0.00	0.00	0.00	0.00	0.00	0.00	0.00	12.	0.
58.000	0.000	257.91	0.000	14.52	0.54	0.00	0.00	0.00	0.00	0.00	0.00	0.00	0.00	0.00	0.00	0.00	0.00	12.	0.
60.000	0.000	257.34	0.000	14.77	-0.02	0.00	0.00	0.00	0.00	0.00	0.00	0.00	0.00	0.00	0.00	0.00	0.00	11.	0.
62.000	0.000	256.96	0.000	15.70	-0.41	0.00	0.00	0.00	0.00	0.00	0.00	0.00	0.00	0.00	0.00	0.00	0.00	10.	0.
64.000	0.000	258.53	0.000	16.28	-0.05	0.00	0.00	0.00	0.00	0.00	0.00	0.00	0.00	0.00	0.00	0.00	0.00	8.	0.
66.000	0.000	259.33	0.000	17.86	0.51	0.00	0.00	0.00	0.00	0.00	0.00	0.00	0.00	0.00	0.00	0.00	0.00	6.	0.
68.000	0.000	0.00	0.000	0.00	0.00	0.00	0.00	0.00	0.00	0.00	0.00	0.00	0.00	0.00	0.00	0.00	0.00	0.	0.
70.000	0.000	0.00	0.000	0.00	0.00	0.00	0.00	0.00	0.00	0.00	0.00	0.00	0.00	0.00	0.00	0.00	0.00	0.	0.

TABLE C-2. February Moisture-Related Data, Thule.

Z KM	VP MEAN MB	S.D. VP MB	SKEW VP	TV MEAN K	TV S.D. K	SKEW TV	TD MEAN K	S.D. TD K	SKEW TD	NOBS VP	NOBS TV	NOBS TD
0.000	0.561	0.405	1.9470	248.62	6.32	0.52	242.19	7.15	0.13	632.	634.	634.
0.059	0.551	0.397	1.9691	248.50	6.27	0.53	242.04	7.06	0.17	650.	652.	652.
1.000	0.648	0.429	1.9524	250.30	6.98	0.54	244.09	6.32	0.37	672.	673.	673.
2.000	0.504	0.348	2.1089	248.45	6.75	0.48	241.43	6.24	0.57	656.	658.	658.
3.000	0.337	0.226	1.9007	244.78	6.08	0.61	237.27	6.20	0.37	608.	610.	610.
4.000	0.213	0.138	2.0533	240.79	5.06	0.79	232.94	5.89	0.41	477.	480.	480.
5.000	0.156	0.110	1.7950	238.48	3.93	0.99	229.56	6.55	-0.11	219.	220.	220.
6.000	0.122	0.083	1.5798	236.76	2.63	1.00	226.69	7.79	-1.15	54.	54.	54.
7.000	0.000	0.000	0.0000	220.76	4.12	0.65	0.00	0.00	0.00	4.	0.	4.
8.000	0.000	0.000	0.0000	216.47	3.70	0.28	0.00	0.00	0.00	0.	0.	0.
9.000	0.000	0.000	0.0000	214.43	4.93	0.10	0.00	0.00	0.00	0.	0.	0.
10.000	0.000	0.000	0.0000	213.95	6.00	-0.01	0.00	0.00	0.00	0.	0.	0.
11.000	0.000	0.000	0.0000	214.10	6.23	-0.20	0.00	0.00	0.00	0.	0.	0.
12.000	0.000	0.000	0.0000	213.69	6.24	-0.10	0.00	0.00	0.00	0.	0.	0.
13.000	0.000	0.000	0.0000	213.52	6.53	-0.04	0.00	0.00	0.00	0.	0.	0.
14.000	0.000	0.000	0.0000	212.94	7.06	0.02	0.00	0.00	0.00	0.	0.	0.
15.000	0.000	0.000	0.0000	212.65	7.66	0.11	0.00	0.00	0.00	0.	0.	0.
16.000	0.000	0.000	0.0000	212.87	8.59	0.62	0.00	0.00	0.00	0.	0.	0.
17.000	0.000	0.000	0.0000	212.68	9.20	0.59	0.00	0.00	0.00	0.	0.	0.
18.000	0.000	0.000	0.0000	213.89	9.64	0.42	0.00	0.00	0.00	0.	0.	0.
19.000	0.000	0.000	0.0000	214.07	9.96	0.34	0.00	0.00	0.00	0.	0.	0.
20.000	0.000	0.000	0.0000	217.22	9.67	0.04	0.00	0.00	0.00	0.	0.	0.
21.000	0.000	0.000	0.0000	217.73	9.77	-0.05	0.00	0.00	0.00	0.	0.	0.
22.000	0.000	0.000	0.0000	218.55	10.12	0.00	0.00	0.00	0.00	0.	0.	0.
23.000	0.000	0.000	0.0000	220.29	9.94	0.25	0.00	0.00	0.00	0.	0.	0.
24.000	0.000	0.000	0.0000	221.43	10.55	0.16	0.00	0.00	0.00	0.	0.	0.
25.000	0.000	0.000	0.0000	221.47	10.99	0.22	0.00	0.00	0.00	0.	0.	0.
26.000	0.000	0.000	0.0000	225.15	11.07	0.21	0.00	0.00	0.00	0.	0.	0.
27.000	0.000	0.000	0.0000	226.84	11.64	0.29	0.00	0.00	0.00	0.	0.	0.
28.000	0.000	0.000	0.0000	227.45	12.08	0.25	0.00	0.00	0.00	0.	0.	0.
29.000	0.000	0.000	0.0000	228.12	13.06	0.02	0.00	0.00	0.00	0.	0.	0.
30.000	0.000	0.000	0.0000	230.72	13.81	-0.03	0.00	0.00	0.00	0.	0.	0.

TABLE C-2. February Moisture-Related Data, Thule, Cont'd.

Z KM	VP MEAN		S.D. VP		TV MEAN		TV S.D.		SKEW TV		TD MEAN		S.D. TD		NOBS		NOBS	
	MB	K	MB	K	K	K	K	K	K	K	K	K	K	K	VP	TV	VP	TV
32.000	0.000	218.39	0.000	14.68	0.84	0.00	0.00	0.00	0.00	0.00	0.00	0.00	0.00	0.00	0.	13.	0.	0.
34.000	0.000	220.37	0.000	15.46	1.14	0.00	0.00	0.00	0.00	0.00	0.00	0.00	0.00	0.00	0.	14.	0.	0.
36.000	0.000	222.16	0.000	14.31	0.82	0.00	0.00	0.00	0.00	0.00	0.00	0.00	0.00	0.00	0.	15.	0.	0.
38.000	0.000	225.41	0.000	13.73	0.55	0.00	0.00	0.00	0.00	0.00	0.00	0.00	0.00	0.00	0.	16.	0.	0.
40.000	0.000	230.36	0.000	12.07	0.15	0.00	0.00	0.00	0.00	0.00	0.00	0.00	0.00	0.00	0.	15.	0.	0.
42.000	0.000	236.49	0.000	12.41	-0.29	0.00	0.00	0.00	0.00	0.00	0.00	0.00	0.00	0.00	0.	15.	0.	0.
44.000	0.000	240.29	0.000	13.72	-0.26	0.00	0.00	0.00	0.00	0.00	0.00	0.00	0.00	0.00	0.	15.	0.	0.
46.000	0.000	245.45	0.000	15.47	-0.52	0.00	0.00	0.00	0.00	0.00	0.00	0.00	0.00	0.00	0.	14.	0.	0.
48.000	0.000	249.95	0.000	17.91	-0.73	0.00	0.00	0.00	0.00	0.00	0.00	0.00	0.00	0.00	0.	14.	0.	0.
50.000	0.000	253.37	0.000	18.96	-0.49	0.00	0.00	0.00	0.00	0.00	0.00	0.00	0.00	0.00	0.	14.	0.	0.
52.000	0.000	253.16	0.000	19.54	-0.05	0.00	0.00	0.00	0.00	0.00	0.00	0.00	0.00	0.00	0.	13.	0.	0.
54.000	0.000	255.95	0.000	19.48	-0.15	0.00	0.00	0.00	0.00	0.00	0.00	0.00	0.00	0.00	0.	14.	0.	0.
56.000	0.000	259.99	0.000	16.94	0.45	0.00	0.00	0.00	0.00	0.00	0.00	0.00	0.00	0.00	0.	12.	0.	0.
58.000	0.000	259.33	0.000	14.19	0.17	0.00	0.00	0.00	0.00	0.00	0.00	0.00	0.00	0.00	0.	12.	0.	0.
60.000	0.000	258.16	0.000	12.78	0.20	0.00	0.00	0.00	0.00	0.00	0.00	0.00	0.00	0.00	0.	12.	0.	0.
62.000	0.000	258.74	0.000	13.47	0.83	0.00	0.00	0.00	0.00	0.00	0.00	0.00	0.00	0.00	0.	12.	0.	0.
64.000	0.000	260.72	0.000	17.48	1.23	0.00	0.00	0.00	0.00	0.00	0.00	0.00	0.00	0.00	0.	9.	0.	0.
66.000	0.000	262.33	0.000	18.64	1.30	0.00	0.00	0.00	0.00	0.00	0.00	0.00	0.00	0.00	0.	6.	0.	0.
68.000	0.000	0.00	0.000	0.00	0.00	0.00	0.00	0.00	0.00	0.00	0.00	0.00	0.00	0.00	0.	0.	0.	0.
70.000	0.000	0.00	0.000	0.00	0.00	0.00	0.00	0.00	0.00	0.00	0.00	0.00	0.00	0.00	0.	0.	0.	0.

TABLE C-3. March Moisture-Related Data, Thule.

Z KM	VP MEAN MB	S.D. VP MB	TV MEAN K	S.D. TV K	SKEW TV K	TD MEAN K	S.D. TD K	SKEW TD K	NOBS VP	NOBS TV	NOBS TD
0.000	0.634	0.449	249.96	7.02	1.14	243.57	7.33	0.07	689.	694.	693.
0.059	0.625	0.442	249.88	6.80	1.27	243.45	7.20	0.16	707.	712.	711.
1.000	0.708	0.488	250.61	6.41	0.38	245.03	6.19	0.52	746.	746.	746.
2.000	0.535	0.384	247.95	5.98	0.22	241.89	6.27	0.55	728.	728.	728.
3.000	0.374	0.262	244.40	5.11	0.43	238.21	6.22	0.56	663.	663.	663.
4.000	0.225	0.158	240.16	4.31	0.59	233.23	6.03	0.59	552.	554.	554.
5.000	0.167	0.100	237.71	3.07	0.66	230.59	5.83	-0.35	240.	241.	241.
6.000	0.152	0.079	235.80	1.91	1.37	229.50	6.62	-1.79	43.	43.	43.
7.000	0.000	0.000	221.62	3.82	0.41	0.00	0.00	0.00	0.00	0.00	0.00
8.000	0.000	0.000	218.56	4.39	0.42	0.00	0.00	0.00	0.00	0.00	0.00
9.000	0.000	0.000	218.19	5.68	0.02	0.00	0.00	0.00	0.00	0.00	0.00
10.000	0.000	0.000	219.25	6.34	-0.38	0.00	0.00	0.00	0.00	0.00	0.00
11.000	0.000	0.000	219.92	6.59	-0.36	0.00	0.00	0.00	0.00	0.00	0.00
12.000	0.000	0.000	219.88	6.90	-0.41	0.00	0.00	0.00	0.00	0.00	0.00
13.000	0.000	0.000	219.89	7.20	-0.49	0.00	0.00	0.00	0.00	0.00	0.00
14.000	0.000	0.000	219.90	7.49	-0.54	0.00	0.00	0.00	0.00	0.00	0.00
15.000	0.000	0.000	219.93	7.64	-0.55	0.00	0.00	0.00	0.00	0.00	0.00
16.000	0.000	0.000	220.03	7.74	-0.61	0.00	0.00	0.00	0.00	0.00	0.00
17.000	0.000	0.000	219.96	7.84	-0.63	0.00	0.00	0.00	0.00	0.00	0.00
18.000	0.000	0.000	220.46	7.48	-0.48	0.00	0.00	0.00	0.00	0.00	0.00
19.000	0.000	0.000	220.42	7.51	-0.39	0.00	0.00	0.00	0.00	0.00	0.00
20.000	0.000	0.000	220.78	7.32	-0.20	0.00	0.00	0.00	0.00	0.00	0.00
21.000	0.000	0.000	220.79	7.45	-0.01	0.00	0.00	0.00	0.00	0.00	0.00
22.000	0.000	0.000	220.86	7.63	0.11	0.00	0.00	0.00	0.00	0.00	0.00
23.000	0.000	0.000	221.13	7.74	0.15	0.00	0.00	0.00	0.00	0.00	0.00
24.000	0.000	0.000	221.34	7.71	0.06	0.00	0.00	0.00	0.00	0.00	0.00
25.000	0.000	0.000	221.62	7.77	-0.10	0.00	0.00	0.00	0.00	0.00	0.00
26.000	0.000	0.000	222.32	7.73	-0.19	0.00	0.00	0.00	0.00	0.00	0.00
27.000	0.000	0.000	223.04	7.68	-0.21	0.00	0.00	0.00	0.00	0.00	0.00
28.000	0.000	0.000	223.82	7.54	-0.13	0.00	0.00	0.00	0.00	0.00	0.00
29.000	0.000	0.000	224.71	7.88	-0.19	0.00	0.00	0.00	0.00	0.00	0.00
30.000	0.000	0.000	225.75	7.59	0.21	0.00	0.00	0.00	0.00	0.00	0.00

TABLE C-3. March Moisture-Related Data, Thule, Cont'd.

Z	VP	S.D.	TV	TD	MEAN	TV	S.D.	SKEW	TV	TD	MEAN	S.D.	SKEW	TD	NOBS	NOBS	NOBS	NOBS
KM	MB	MB	K	K	K	K	K	K	K	K	K	K	K	K	VP	TV	TD	TD
32.000	0.000	0.000	226.63	10.80	0.08	0.00	0.00	0.00	0.00	0.00	0.00	0.00	0.00	0.00	0.	17.	0.	0.
34.000	0.000	0.000	228.28	11.84	0.23	0.00	0.00	0.00	0.00	0.00	0.00	0.00	0.00	0.00	0.	17.	0.	0.
36.000	0.000	0.000	230.60	12.72	0.54	0.00	0.00	0.00	0.00	0.00	0.00	0.00	0.00	0.00	0.	18.	0.	0.
38.000	0.000	0.000	233.16	11.48	0.64	0.00	0.00	0.00	0.00	0.00	0.00	0.00	0.00	0.00	0.	20.	0.	0.
40.000	0.000	0.000	235.66	12.05	0.43	0.00	0.00	0.00	0.00	0.00	0.00	0.00	0.00	0.00	0.	20.	0.	0.
42.000	0.000	0.000	239.21	10.57	0.12	0.00	0.00	0.00	0.00	0.00	0.00	0.00	0.00	0.00	0.	20.	0.	0.
44.000	0.000	0.000	243.26	9.33	0.38	0.00	0.00	0.00	0.00	0.00	0.00	0.00	0.00	0.00	0.	20.	0.	0.
46.000	0.000	0.000	249.36	10.13	-0.37	0.00	0.00	0.00	0.00	0.00	0.00	0.00	0.00	0.00	0.	20.	0.	0.
48.000	0.000	0.000	252.61	8.53	-0.53	0.00	0.00	0.00	0.00	0.00	0.00	0.00	0.00	0.00	0.	20.	0.	0.
50.000	0.000	0.000	255.26	8.69	-0.26	0.00	0.00	0.00	0.00	0.00	0.00	0.00	0.00	0.00	0.	20.	0.	0.
52.000	0.000	0.000	257.77	7.69	-0.26	0.00	0.00	0.00	0.00	0.00	0.00	0.00	0.00	0.00	0.	18.	0.	0.
54.000	0.000	0.000	262.05	7.47	0.36	0.00	0.00	0.00	0.00	0.00	0.00	0.00	0.00	0.00	0.	18.	0.	0.
56.000	0.000	0.000	263.71	9.03	0.27	0.00	0.00	0.00	0.00	0.00	0.00	0.00	0.00	0.00	0.	20.	0.	0.
58.000	0.000	0.000	263.55	9.32	0.60	0.00	0.00	0.00	0.00	0.00	0.00	0.00	0.00	0.00	0.	18.	0.	0.
60.000	0.000	0.000	263.10	10.39	1.22	0.00	0.00	0.00	0.00	0.00	0.00	0.00	0.00	0.00	0.	18.	0.	0.
62.000	0.000	0.000	262.66	12.52	0.50	0.00	0.00	0.00	0.00	0.00	0.00	0.00	0.00	0.00	0.	18.	0.	0.
64.000	0.000	0.000	262.16	12.84	0.89	0.00	0.00	0.00	0.00	0.00	0.00	0.00	0.00	0.00	0.	12.	0.	0.
66.000	0.000	0.000	258.86	14.21	0.58	0.00	0.00	0.00	0.00	0.00	0.00	0.00	0.00	0.00	0.	10.	0.	0.
68.000	0.000	0.000	0.00	0.00	0.00	0.00	0.00	0.00	0.00	0.00	0.00	0.00	0.00	0.00	0.	0.	0.	0.
70.000	0.000	0.000	0.00	0.00	0.00	0.00	0.00	0.00	0.00	0.00	0.00	0.00	0.00	0.00	0.	0.	0.	0.



TABLE C-4. April Moisture-Related Data, Thule.

Z KM	VP MEAN		S.D. VP		TV MEAN		TV S.D.		SKEW TV		TD MEAN		S.D. TD		SKEW TD		NOBS		NOBS	
	MB	MB	MB	MB	K	K	K	K	K	K	K	K	K	K	VP	VP	TV	TV	TD	TD
0.000	1.023	0.601	1.7160	256.77	5.87	0.37	249.34	6.22	0.19	721.	722.	0.19	721.	721.	722.	722.	722.	722.	722.	722.
0.059	1.013	0.593	1.6990	256.63	5.82	0.35	249.24	6.19	0.20	735.	736.	0.20	735.	735.	736.	736.	736.	736.	736.	736.
1.000	0.977	0.584	1.9125	255.08	5.88	0.25	248.84	5.94	0.30	779.	779.	0.30	779.	779.	779.	779.	779.	779.	779.	779.
2.000	0.704	0.482	1.9726	251.89	5.74	0.03	244.78	6.69	0.11	768.	768.	0.11	768.	768.	768.	768.	768.	768.	768.	768.
3.000	0.449	0.289	1.6114	247.70	5.23	0.06	240.13	6.43	0.02	750.	751.	0.02	750.	750.	751.	751.	751.	751.	751.	751.
4.000	0.268	0.175	1.9556	242.86	4.61	0.30	234.98	5.90	0.02	696.	696.	0.02	696.	696.	696.	696.	696.	696.	696.	696.
5.000	0.163	0.100	1.6337	238.77	3.46	0.94	230.27	5.75	-0.37	503.	503.	-0.37	503.	503.	503.	503.	503.	503.	503.	503.
6.000	0.122	0.078	1.3474	236.49	2.83	1.21	227.09	6.83	-0.98	147.	147.	-0.98	147.	147.	147.	147.	147.	147.	147.	147.
7.000	0.103	0.059	0.2123	236.51	1.59	0.89	225.45	8.04	-1.81	8.	8.	-1.81	8.	8.	8.	8.	8.	8.	8.	8.
8.000	0.000	0.000	0.0000	223.44	3.57	0.22	0.00	0.00	0.00	0.00	0.00	0.00	0.00	0.00	0.00	0.00	0.00	0.00	0.00	0.00
9.000	0.000	0.000	0.0000	224.39	4.36	-0.20	0.00	0.00	0.00	0.00	0.00	0.00	0.00	0.00	0.00	0.00	0.00	0.00	0.00	0.00
10.000	0.000	0.000	0.0000	226.55	4.15	-0.66	0.00	0.00	0.00	0.00	0.00	0.00	0.00	0.00	0.00	0.00	0.00	0.00	0.00	0.00
11.000	0.000	0.000	0.0000	227.77	3.62	-0.98	0.00	0.00	0.00	0.00	0.00	0.00	0.00	0.00	0.00	0.00	0.00	0.00	0.00	0.00
12.000	0.000	0.000	0.0000	228.17	3.34	-1.08	0.00	0.00	0.00	0.00	0.00	0.00	0.00	0.00	0.00	0.00	0.00	0.00	0.00	0.00
13.000	0.000	0.000	0.0000	228.21	3.14	-0.87	0.00	0.00	0.00	0.00	0.00	0.00	0.00	0.00	0.00	0.00	0.00	0.00	0.00	0.00
14.000	0.000	0.000	0.0000	227.94	2.97	-0.66	0.00	0.00	0.00	0.00	0.00	0.00	0.00	0.00	0.00	0.00	0.00	0.00	0.00	0.00
15.000	0.000	0.000	0.0000	227.63	2.95	-0.53	0.00	0.00	0.00	0.00	0.00	0.00	0.00	0.00	0.00	0.00	0.00	0.00	0.00	0.00
16.000	0.000	0.000	0.0000	227.26	3.07	-0.25	0.00	0.00	0.00	0.00	0.00	0.00	0.00	0.00	0.00	0.00	0.00	0.00	0.00	0.00
17.000	0.000	0.000	0.0000	226.95	3.14	-0.08	0.00	0.00	0.00	0.00	0.00	0.00	0.00	0.00	0.00	0.00	0.00	0.00	0.00	0.00
18.000	0.000	0.000	0.0000	226.65	3.33	0.13	0.00	0.00	0.00	0.00	0.00	0.00	0.00	0.00	0.00	0.00	0.00	0.00	0.00	0.00
19.000	0.000	0.000	0.0000	226.40	3.49	0.24	0.00	0.00	0.00	0.00	0.00	0.00	0.00	0.00	0.00	0.00	0.00	0.00	0.00	0.00
20.000	0.000	0.000	0.0000	226.21	3.70	0.24	0.00	0.00	0.00	0.00	0.00	0.00	0.00	0.00	0.00	0.00	0.00	0.00	0.00	0.00
21.000	0.000	0.000	0.0000	226.02	3.89	0.21	0.00	0.00	0.00	0.00	0.00	0.00	0.00	0.00	0.00	0.00	0.00	0.00	0.00	0.00
22.000	0.000	0.000	0.0000	225.82	4.13	0.21	0.00	0.00	0.00	0.00	0.00	0.00	0.00	0.00	0.00	0.00	0.00	0.00	0.00	0.00
23.000	0.000	0.000	0.0000	225.62	4.39	0.23	0.00	0.00	0.00	0.00	0.00	0.00	0.00	0.00	0.00	0.00	0.00	0.00	0.00	0.00
24.000	0.000	0.000	0.0000	225.46	4.63	0.31	0.00	0.00	0.00	0.00	0.00	0.00	0.00	0.00	0.00	0.00	0.00	0.00	0.00	0.00
25.000	0.000	0.000	0.0000	225.57	4.77	0.16	0.00	0.00	0.00	0.00	0.00	0.00	0.00	0.00	0.00	0.00	0.00	0.00	0.00	0.00
26.000	0.000	0.000	0.0000	225.73	4.93	0.06	0.00	0.00	0.00	0.00	0.00	0.00	0.00	0.00	0.00	0.00	0.00	0.00	0.00	0.00
27.000	0.000	0.000	0.0000	225.97	5.07	-0.01	0.00	0.00	0.00	0.00	0.00	0.00	0.00	0.00	0.00	0.00	0.00	0.00	0.00	0.00
28.000	0.000	0.000	0.0000	226.43	5.15	-0.13	0.00	0.00	0.00	0.00	0.00	0.00	0.00	0.00	0.00	0.00	0.00	0.00	0.00	0.00
29.000	0.000	0.000	0.0000	227.04	5.15	-0.11	0.00	0.00	0.00	0.00	0.00	0.00	0.00	0.00	0.00	0.00	0.00	0.00	0.00	0.00
30.000	0.000	0.000	0.0000	227.43	5.18	-0.06	0.00	0.00	0.00	0.00	0.00	0.00	0.00	0.00	0.00	0.00	0.00	0.00	0.00	0.00

TABLE C-4. April Moisture-Related Data, Thule, Con't.

Z KM	VP MEAN MB	S.D. VP MB	SKEW VP	TV MEAN K	TV S.D. K	SKEW TV	TD MEAN K	S.D. TD K	SKEW TD	NOBS VP	NOBS TV	NOBS TD
32.000	0.000	0.000	0.0000	232.51	11.29	1.34	0.00	0.00	0.00	0.	17.	0.
34.000	0.000	0.000	0.0000	237.41	12.52	1.98	0.00	0.00	0.00	0.	16.	0.
36.000	0.000	0.000	0.0000	241.53	13.51	1.91	0.00	0.00	0.00	0.	16.	0.
38.000	0.000	0.000	0.0000	246.22	12.24	1.69	0.00	0.00	0.00	0.	18.	0.
40.000	0.000	0.000	0.0000	250.88	12.36	1.30	0.00	0.00	0.00	0.	18.	0.
42.000	0.000	0.000	0.0000	256.60	11.63	0.78	0.00	0.00	0.00	0.	18.	0.
44.000	0.000	0.000	0.0000	261.94	9.80	-0.01	0.00	0.00	0.00	0.	18.	0.
46.000	0.000	0.000	0.0000	266.10	8.99	-0.71	0.00	0.00	0.00	0.	18.	0.
48.000	0.000	0.000	0.0000	270.63	7.33	-1.08	0.00	0.00	0.00	0.	17.	0.
50.000	0.000	0.000	0.0000	271.16	7.59	-1.43	0.00	0.00	0.00	0.	14.	0.
52.000	0.000	0.000	0.0000	273.39	6.69	-1.25	0.00	0.00	0.00	0.	13.	0.
54.000	0.000	0.000	0.0000	272.08	6.10	-0.45	0.00	0.00	0.00	0.	12.	0.
56.000	0.000	0.000	0.0000	271.16	4.92	-0.56	0.00	0.00	0.00	0.	12.	0.
58.000	0.000	0.000	0.0000	269.16	3.41	-1.24	0.00	0.00	0.00	0.	12.	0.
60.000	0.000	0.000	0.0000	268.16	6.45	0.02	0.00	0.00	0.00	0.	11.	0.
62.000	0.000	0.000	0.0000	269.66	9.43	1.63	0.00	0.00	0.00	0.	8.	0.
64.000	0.000	0.000	0.0000	262.16	6.32	-0.81	0.00	0.00	0.00	0.	7.	0.
66.000	0.000	0.000	0.0000	259.99	5.12	-0.50	0.00	0.00	0.00	0.	6.	0.
68.000	0.000	0.000	0.0000	0.00	0.00	0.00	0.00	0.00	0.00	0.	0.	0.
70.000	0.000	0.000	0.0000	0.00	0.00	0.00	0.00	0.00	0.00	0.	0.	0.

TABLE C-5. May Moisture-Related Data, Thule.

Z KM	VP MEAN		S.D. VP		TV MEAN		TV S.D.		TD MEAN		S.D. TD		NOBS		NOBS	
	MB	K	MB	K	K	K	K	K	K	K	K	K	VP	TV	VP	TV
0.000	2.576	1.270	1.1059	267.72	5.09	-0.48	260.48	6.27	-0.27	776.	776.	776.	776.	776.	776.	776.
0.059	2.531	1.235	1.1204	267.58	4.90	0.02	260.31	6.12	-0.14	780.	780.	780.	780.	780.	780.	780.
1.000	1.903	0.966	1.5114	263.48	5.78	0.40	256.83	5.91	-0.05	823.	823.	823.	823.	823.	823.	823.
2.000	1.197	0.761	1.9949	259.73	5.70	0.30	250.88	6.66	0.09	818.	818.	818.	818.	818.	818.	818.
3.000	0.791	0.548	1.9986	255.10	5.51	0.30	245.97	7.08	0.01	813.	813.	813.	813.	813.	813.	813.
4.000	0.452	0.330	1.9778	249.46	5.55	0.33	239.86	7.12	0.07	810.	810.	810.	810.	810.	810.	810.
5.000	0.253	0.184	2.1015	243.46	5.26	0.51	234.10	6.81	-0.05	783.	783.	783.	783.	783.	783.	783.
6.000	0.158	0.108	1.7970	239.40	4.17	0.88	229.54	6.97	-0.71	517.	517.	517.	517.	517.	517.	517.
7.000	0.126	0.080	1.6677	237.73	3.06	0.74	227.47	6.96	-1.24	135.	135.	135.	135.	135.	135.	135.
8.000	0.097	0.043	0.6998	234.95	3.10	0.74	226.66	3.55	-0.01	16.	16.	16.	16.	16.	16.	16.
9.000	0.000	0.000	0.0000	225.36	4.35	0.04	0.00	0.00	0.00	3.	3.	3.	3.	3.	3.	3.
10.000	0.000	0.000	0.0000	227.01	5.00	-0.64	0.00	0.00	0.00	0.	0.	0.	0.	0.	0.	0.
11.000	0.000	0.000	0.0000	228.49	4.11	-1.08	0.00	0.00	0.00	0.	0.	0.	0.	0.	0.	0.
12.000	0.000	0.000	0.0000	229.05	3.01	-0.86	0.00	0.00	0.00	0.	0.	0.	0.	0.	0.	0.
13.000	0.000	0.000	0.0000	228.89	2.52	-0.46	0.00	0.00	0.00	0.	0.	0.	0.	0.	0.	0.
14.000	0.000	0.000	0.0000	228.55	2.36	-0.39	0.00	0.00	0.00	0.	0.	0.	0.	0.	0.	0.
15.000	0.000	0.000	0.0000	228.16	2.25	-0.13	0.00	0.00	0.00	0.	0.	0.	0.	0.	0.	0.
16.000	0.000	0.000	0.0000	227.76	2.25	-0.12	0.00	0.00	0.00	0.	0.	0.	0.	0.	0.	0.
17.000	0.000	0.000	0.0000	227.63	2.32	0.17	0.00	0.00	0.00	0.	0.	0.	0.	0.	0.	0.
18.000	0.000	0.000	0.0000	227.52	2.36	-0.03	0.00	0.00	0.00	0.	0.	0.	0.	0.	0.	0.
19.000	0.000	0.000	0.0000	227.54	2.40	0.02	0.00	0.00	0.00	0.	0.	0.	0.	0.	0.	0.
20.000	0.000	0.000	0.0000	227.64	2.49	0.29	0.00	0.00	0.00	0.	0.	0.	0.	0.	0.	0.
21.000	0.000	0.000	0.0000	227.70	2.50	0.13	0.00	0.00	0.00	0.	0.	0.	0.	0.	0.	0.
22.000	0.000	0.000	0.0000	227.81	2.55	0.36	0.00	0.00	0.00	0.	0.	0.	0.	0.	0.	0.
23.000	0.000	0.000	0.0000	227.91	2.56	0.27	0.00	0.00	0.00	0.	0.	0.	0.	0.	0.	0.
24.000	0.000	0.000	0.0000	227.98	2.54	0.11	0.00	0.00	0.00	0.	0.	0.	0.	0.	0.	0.
25.000	0.000	0.000	0.0000	228.35	2.64	0.32	0.00	0.00	0.00	0.	0.	0.	0.	0.	0.	0.
26.000	0.000	0.000	0.0000	228.74	2.70	0.35	0.00	0.00	0.00	0.	0.	0.	0.	0.	0.	0.
27.000	0.000	0.000	0.0000	229.32	2.84	0.67	0.00	0.00	0.00	0.	0.	0.	0.	0.	0.	0.
28.000	0.000	0.000	0.0000	230.36	2.84	0.47	0.00	0.00	0.00	0.	0.	0.	0.	0.	0.	0.
29.000	0.000	0.000	0.0000	231.53	2.90	0.26	0.00	0.00	0.00	0.	0.	0.	0.	0.	0.	0.
30.000	0.000	0.000	0.0000	232.71	3.05	0.04	0.00	0.00	0.00	0.	0.	0.	0.	0.	0.	0.

TABLE C-5. May Moisture-Related Data, Thule, Cont'd.

Z KM	VP MEAN		S.D. VP		TV MEAN		TV S.D.		SKEW TV		TD MEAN		S.D. TD		SKEW TD		NOBS		NOBS	
	MB	MB	MB	MB	K	K	K	K	K	K	K	K	K	K	K	K	VP	TV	TV	TD
32.000	0.000	0.000	0.000	0.000	238.37	7.21	0.43	0.00	0.00	0.00	0.00	0.00	0.00	0.00	0.00	0.00	0.	14.	0.	0.
34.000	0.000	0.000	0.000	0.000	244.45	6.76	0.24	0.00	0.00	0.00	0.00	0.00	0.00	0.00	0.00	0.00	0.	14.	0.	0.
36.000	0.000	0.000	0.000	0.000	249.95	7.32	0.29	0.00	0.00	0.00	0.00	0.00	0.00	0.00	0.00	0.00	0.	14.	0.	0.
38.000	0.000	0.000	0.000	0.000	256.96	7.88	0.50	0.00	0.00	0.00	0.00	0.00	0.00	0.00	0.00	0.00	0.	15.	0.	0.
40.000	0.000	0.000	0.000	0.000	263.59	5.63	0.32	0.00	0.00	0.00	0.00	0.00	0.00	0.00	0.00	0.00	0.	14.	0.	0.
42.000	0.000	0.000	0.000	0.000	269.76	7.61	0.30	0.00	0.00	0.00	0.00	0.00	0.00	0.00	0.00	0.00	0.	15.	0.	0.
44.000	0.000	0.000	0.000	0.000	274.33	6.45	-0.76	0.00	0.00	0.00	0.00	0.00	0.00	0.00	0.00	0.00	0.	12.	0.	0.
46.000	0.000	0.000	0.000	0.000	278.41	6.74	-0.98	0.00	0.00	0.00	0.00	0.00	0.00	0.00	0.00	0.00	0.	12.	0.	0.
48.000	0.000	0.000	0.000	0.000	281.91	7.36	-1.33	0.00	0.00	0.00	0.00	0.00	0.00	0.00	0.00	0.00	0.	12.	0.	0.
50.000	0.000	0.000	0.000	0.000	286.71	4.30	1.62	0.00	0.00	0.00	0.00	0.00	0.00	0.00	0.00	0.00	0.	11.	0.	0.
52.000	0.000	0.000	0.000	0.000	286.89	4.36	1.17	0.00	0.00	0.00	0.00	0.00	0.00	0.00	0.00	0.00	0.	11.	0.	0.
54.000	0.000	0.000	0.000	0.000	286.66	3.03	0.66	0.00	0.00	0.00	0.00	0.00	0.00	0.00	0.00	0.00	0.	10.	0.	0.
56.000	0.000	0.000	0.000	0.000	284.26	3.14	0.40	0.00	0.00	0.00	0.00	0.00	0.00	0.00	0.00	0.00	0.	10.	0.	0.
58.000	0.000	0.000	0.000	0.000	280.46	4.27	0.06	0.00	0.00	0.00	0.00	0.00	0.00	0.00	0.00	0.00	0.	10.	0.	0.
60.000	0.000	0.000	0.000	0.000	275.94	4.06	1.10	0.00	0.00	0.00	0.00	0.00	0.00	0.00	0.00	0.00	0.	9.	0.	0.
62.000	0.000	0.000	0.000	0.000	266.87	2.43	-0.12	0.00	0.00	0.00	0.00	0.00	0.00	0.00	0.00	0.00	0.	7.	0.	0.
64.000	0.000	0.000	0.000	0.000	260.02	2.54	-1.05	0.00	0.00	0.00	0.00	0.00	0.00	0.00	0.00	0.00	0.	7.	0.	0.
66.000	0.000	0.000	0.000	0.000	253.16	4.80	1.09	0.00	0.00	0.00	0.00	0.00	0.00	0.00	0.00	0.00	0.	7.	0.	0.
68.000	0.000	0.000	0.000	0.000	0.00	0.00	0.00	0.00	0.00	0.00	0.00	0.00	0.00	0.00	0.00	0.00	0.	0.	0.	0.
70.000	0.000	0.000	0.000	0.000	0.00	0.00	0.00	0.00	0.00	0.00	0.00	0.00	0.00	0.00	0.00	0.00	0.	0.	0.	0.

TABLE C-6. June Moisture-Related Data, Thule.

Z	VP MEAN	S.D. VP	TV MEAN	TV S.D.	SKEW TV	TD MEAN	S.D. TD	SKEW TD	NOBS	NOBS	NOBS	NOBS
KM	MB	MB	K	K	K	K	K	K	VP	TV	VP	TD
0.000	4.457	1.187	275.18	3.44	0.74	268.49	3.79	-0.51	778.	778.	778.	778.
0.059	4.380	1.148	274.99	3.39	0.76	268.25	3.76	-0.50	780.	781.	780.	781.
1.000	3.330	1.189	271.03	4.16	0.01	264.30	4.93	-0.65	809.	809.	809.	809.
2.000	2.043	1.040	266.39	4.44	0.04	257.38	6.95	-0.71	808.	808.	808.	808.
3.000	1.281	0.786	261.47	4.41	0.05	251.27	7.85	-0.59	801.	801.	801.	801.
4.000	0.731	0.501	255.76	4.42	-0.03	244.69	8.05	-0.38	799.	800.	799.	800.
5.000	0.395	0.285	249.52	4.50	0.03	238.04	7.98	-0.40	792.	793.	792.	793.
6.000	0.211	0.153	242.93	4.32	0.36	231.98	7.39	-0.46	763.	764.	763.	764.
7.000	0.129	0.084	238.42	3.35	1.59	227.56	7.10	-0.96	424.	425.	424.	425.
8.000	0.098	0.081	236.75	3.32	2.72	223.75	8.95	-0.70	65.	65.	65.	65.
9.000	0.072	0.084	237.16	6.03	-0.06	218.91	11.35	0.15	10.	10.	10.	10.
10.000	0.047	0.057	237.97	3.02	1.80	214.91	11.18	0.56	7.	7.	7.	7.
11.000	0.000	0.000	229.58	4.31	-1.10	0.00	0.00	0.00	5.	0.	5.	0.
12.000	0.000	0.000	230.54	3.11	-1.33	0.00	0.00	0.00	3.	0.	3.	0.
13.000	0.000	0.000	230.46	2.39	-0.83	0.00	0.00	0.00	3.	0.	3.	0.
14.000	0.000	0.000	230.19	2.02	-0.67	0.00	0.00	0.00	0.	0.	0.	0.
15.000	0.000	0.000	230.00	1.90	-0.77	0.00	0.00	0.00	0.	0.	0.	0.
16.000	0.000	0.000	229.85	1.79	-0.35	0.00	0.00	0.00	0.	0.	0.	0.
17.000	0.000	0.000	229.95	1.74	-0.70	0.00	0.00	0.00	0.	0.	0.	0.
18.000	0.000	0.000	230.21	1.64	-0.52	0.00	0.00	0.00	0.	0.	0.	0.
19.000	0.000	0.000	230.51	1.57	-0.29	0.00	0.00	0.00	0.	0.	0.	0.
20.000	0.000	0.000	230.83	1.48	-0.02	0.00	0.00	0.00	0.	0.	0.	0.
21.000	0.000	0.000	231.16	1.48	0.18	0.00	0.00	0.00	0.	0.	0.	0.
22.000	0.000	0.000	231.42	1.47	0.44	0.00	0.00	0.00	0.	0.	0.	0.
23.000	0.000	0.000	231.68	1.50	0.56	0.00	0.00	0.00	0.	0.	0.	0.
24.000	0.000	0.000	231.97	1.60	0.69	0.00	0.00	0.00	0.	0.	0.	0.
25.000	0.000	0.000	232.45	1.62	0.72	0.00	0.00	0.00	0.	0.	0.	0.
26.000	0.000	0.000	233.16	1.81	0.82	0.00	0.00	0.00	0.	0.	0.	0.
27.000	0.000	0.000	233.88	1.98	0.35	0.00	0.00	0.00	0.	0.	0.	0.
28.000	0.000	0.000	235.27	2.03	0.24	0.00	0.00	0.00	0.	0.	0.	0.
29.000	0.000	0.000	236.79	2.21	-0.15	0.00	0.00	0.00	0.	0.	0.	0.
30.000	0.000	0.000	238.29	2.40	-0.72	0.00	0.00	0.00	0.	0.	0.	0.

TABLE C-6. June Moisture-Related Data, Thule, Cont'd.

Z KM	VP MEAN		S.D. VP		TV MEAN		TV S.D.		SKEW TV		TD MEAN		S.D. TD		SKEW TD		NOBS	
	MB	MB	MB	MB	K	K	K	K	K	K	K	K	K	K	VP	TV	VP	TV
32.000	0.000	0.000	0.000	0.000	245.33	6.25	0.71	0.00	0.00	0.00	0.00	0.00	0.00	0.00	0.00	0.00	23.	0.
34.000	0.000	0.000	0.000	0.000	250.49	6.51	0.63	0.00	0.00	0.00	0.00	0.00	0.00	0.00	0.00	0.00	24.	0.
36.000	0.000	0.000	0.000	0.000	255.08	6.59	1.06	0.00	0.00	0.00	0.00	0.00	0.00	0.00	0.00	0.00	24.	0.
38.000	0.000	0.000	0.000	0.000	260.92	6.89	1.17	0.00	0.00	0.00	0.00	0.00	0.00	0.00	0.00	0.00	25.	0.
40.000	0.000	0.000	0.000	0.000	266.40	7.01	0.98	0.00	0.00	0.00	0.00	0.00	0.00	0.00	0.00	0.00	25.	0.
42.000	0.000	0.000	0.000	0.000	272.32	6.58	0.52	0.00	0.00	0.00	0.00	0.00	0.00	0.00	0.00	0.00	25.	0.
44.000	0.000	0.000	0.000	0.000	278.12	6.56	0.13	0.00	0.00	0.00	0.00	0.00	0.00	0.00	0.00	0.00	25.	0.
46.000	0.000	0.000	0.000	0.000	282.54	6.34	-0.74	0.00	0.00	0.00	0.00	0.00	0.00	0.00	0.00	0.00	26.	0.
48.000	0.000	0.000	0.000	0.000	285.35	5.93	-1.29	0.00	0.00	0.00	0.00	0.00	0.00	0.00	0.00	0.00	26.	0.
50.000	0.000	0.000	0.000	0.000	286.83	4.71	-1.94	0.00	0.00	0.00	0.00	0.00	0.00	0.00	0.00	0.00	24.	0.
52.000	0.000	0.000	0.000	0.000	286.70	3.86	-1.28	0.00	0.00	0.00	0.00	0.00	0.00	0.00	0.00	0.00	24.	0.
54.000	0.000	0.000	0.000	0.000	285.28	3.38	0.05	0.00	0.00	0.00	0.00	0.00	0.00	0.00	0.00	0.00	24.	0.
56.000	0.000	0.000	0.000	0.000	283.11	3.35	-0.68	0.00	0.00	0.00	0.00	0.00	0.00	0.00	0.00	0.00	20.	0.
58.000	0.000	0.000	0.000	0.000	279.83	4.90	-0.66	0.00	0.00	0.00	0.00	0.00	0.00	0.00	0.00	0.00	18.	0.
60.000	0.000	0.000	0.000	0.000	275.91	5.23	0.20	0.00	0.00	0.00	0.00	0.00	0.00	0.00	0.00	0.00	16.	0.
62.000	0.000	0.000	0.000	0.000	271.70	5.72	0.55	0.00	0.00	0.00	0.00	0.00	0.00	0.00	0.00	0.00	13.	0.
64.000	0.000	0.000	0.000	0.000	266.56	9.54	0.25	0.00	0.00	0.00	0.00	0.00	0.00	0.00	0.00	0.00	10.	0.
66.000	0.000	0.000	0.000	0.000	262.53	12.00	-0.01	0.00	0.00	0.00	0.00	0.00	0.00	0.00	0.00	0.00	8.	0.
68.000	0.000	0.000	0.000	0.000	258.03	14.81	-0.51	0.00	0.00	0.00	0.00	0.00	0.00	0.00	0.00	0.00	8.	0.
70.000	0.000	0.000	0.000	0.000	0.00	0.00	0.00	0.00	0.00	0.00	0.00	0.00	0.00	0.00	0.00	0.00	0.	0.

TABLE C-7. July Moisture-Related Data, Thule.

Z	VP MEAN	S.D. VP	TV MEAN	TV S.D.	SKEW TV	TD MEAN	S.D. TD	NOBS	NOBS	NOBS	NOBS	NOBS	NOBS
KM	MB	MB	K	K	K	K	K	VP	VP	VP	VP	VP	TD
0.000	5.752	1.301	278.40	3.63	-0.80	272.03	3.23	782.	-0.85	782.	782.	782.	781.
0.059	5.670	1.258	278.23	3.36	0.20	271.82	3.19	787.	-0.82	787.	787.	787.	787.
1.000	4.538	1.224	274.91	3.21	0.05	268.67	3.85	825.	-0.78	825.	825.	825.	825.
2.000	2.945	1.318	270.15	3.53	-0.02	262.21	6.43	819.	-0.70	819.	819.	819.	819.
3.000	1.750	0.994	265.06	3.63	-0.12	255.01	8.03	818.	-0.77	818.	818.	818.	818.
4.000	1.019	0.645	259.38	3.57	-0.19	248.45	8.09	816.	-0.49	816.	816.	816.	816.
5.000	0.564	0.384	253.15	3.55	-0.22	241.76	8.20	810.	-0.53	810.	810.	810.	810.
6.000	0.289	0.202	246.39	3.64	-0.26	234.81	7.99	797.	-0.58	797.	797.	797.	797.
7.000	0.163	0.100	240.40	2.77	0.30	229.67	7.33	642.	-1.13	642.	642.	642.	642.
8.000	0.091	0.049	235.61	1.89	1.14	224.82	6.42	200.	-1.49	200.	200.	200.	200.
9.000	0.040	0.037	234.73	0.80	-0.57	214.93	10.18	7.	-0.11	7.	7.	7.	7.
10.000	0.000	0.000	226.02	4.94	0.27	0.00	0.00	0.	0.00	0.	0.	0.	0.
11.000	0.000	0.000	229.04	4.60	-0.86	0.00	0.00	0.	0.00	0.	0.	0.	0.
12.000	0.000	0.000	230.83	2.72	-0.66	0.00	0.00	0.	0.00	0.	0.	0.	0.
13.000	0.000	0.000	230.84	2.06	-0.29	0.00	0.00	0.	0.00	0.	0.	0.	0.
14.000	0.000	0.000	230.71	1.87	-0.17	0.00	0.00	0.	0.00	0.	0.	0.	0.
15.000	0.000	0.000	230.61	1.71	0.01	0.00	0.00	0.	0.00	0.	0.	0.	0.
16.000	0.000	0.000	230.51	1.58	0.02	0.00	0.00	0.	0.00	0.	0.	0.	0.
17.000	0.000	0.000	230.66	1.52	0.22	0.00	0.00	0.	0.00	0.	0.	0.	0.
18.000	0.000	0.000	230.91	1.44	0.29	0.00	0.00	0.	0.00	0.	0.	0.	0.
19.000	0.000	0.000	231.20	1.43	0.24	0.00	0.00	0.	0.00	0.	0.	0.	0.
20.000	0.000	0.000	231.54	1.37	0.60	0.00	0.00	0.	0.00	0.	0.	0.	0.
21.000	0.000	0.000	231.84	1.36	0.54	0.00	0.00	0.	0.00	0.	0.	0.	0.
22.000	0.000	0.000	232.06	1.41	0.80	0.00	0.00	0.	0.00	0.	0.	0.	0.
23.000	0.000	0.000	232.30	1.51	1.20	0.00	0.00	0.	0.00	0.	0.	0.	0.
24.000	0.000	0.000	232.55	1.56	0.70	0.00	0.00	0.	0.00	0.	0.	0.	0.
25.000	0.000	0.000	233.13	1.63	0.76	0.00	0.00	0.	0.00	0.	0.	0.	0.
26.000	0.000	0.000	234.04	1.59	0.33	0.00	0.00	0.	0.00	0.	0.	0.	0.
27.000	0.000	0.000	234.99	1.73	0.05	0.00	0.00	0.	0.00	0.	0.	0.	0.
28.000	0.000	0.000	236.29	1.79	-0.42	0.00	0.00	0.	0.00	0.	0.	0.	0.
29.000	0.000	0.000	237.74	1.94	-0.94	0.00	0.00	0.	0.00	0.	0.	0.	0.
30.000	0.000	0.000	239.21	2.19	-1.30	0.00	0.00	0.	0.00	0.	0.	0.	0.

TABLE C-7. July Moisture-Related Data, Thule, Cont'd

Z KM	VP MEAN MB	S.D. VP MB	TV MEAN K	SKEW VP K	TV S.D. K	SKEW TV K	TD MEAN K	S.D. TD K	SKEW TD	NOBS VP	NOBS TV	NOBS TD
32.000	0.000	0.000	246.95	0.0000	4.44	2.82	0.00	0.00	0.00	0.	14.	0.
34.000	0.000	0.000	251.56	0.0000	4.58	1.68	0.00	0.00	0.00	0.	15.	0.
36.000	0.000	0.000	256.10	0.0000	3.79	0.98	0.00	0.00	0.00	0.	16.	0.
38.000	0.000	0.000	261.10	0.0000	3.59	0.16	0.00	0.00	0.00	0.	16.	0.
40.000	0.000	0.000	265.44	0.0000	4.35	0.34	0.00	0.00	0.00	0.	18.	0.
42.000	0.000	0.000	270.69	0.0000	5.22	0.27	0.00	0.00	0.00	0.	19.	0.
44.000	0.000	0.000	275.16	0.0000	5.80	-0.39	0.00	0.00	0.00	0.	18.	0.
46.000	0.000	0.000	279.44	0.0000	5.62	-1.02	0.00	0.00	0.00	0.	18.	0.
48.000	0.000	0.000	282.74	0.0000	4.54	-0.70	0.00	0.00	0.00	0.	19.	0.
50.000	0.000	0.000	285.00	0.0000	3.06	-1.08	0.00	0.00	0.00	0.	19.	0.
52.000	0.000	0.000	285.99	0.0000	2.36	-0.47	0.00	0.00	0.00	0.	18.	0.
54.000	0.000	0.000	285.75	0.0000	3.28	-0.01	0.00	0.00	0.00	0.	17.	0.
56.000	0.000	0.000	284.01	0.0000	4.22	-0.49	0.00	0.00	0.00	0.	13.	0.
58.000	0.000	0.000	281.31	0.0000	5.47	-0.30	0.00	0.00	0.00	0.	13.	0.
60.000	0.000	0.000	277.49	0.0000	5.85	-0.34	0.00	0.00	0.00	0.	12.	0.
62.000	0.000	0.000	269.83	0.0000	5.45	-0.20	0.00	0.00	0.00	0.	9.	0.
64.000	0.000	0.000	264.66	0.0000	6.28	-0.17	0.00	0.00	0.00	0.	8.	0.
66.000	0.000	0.000	259.16	0.0000	5.83	1.00	0.00	0.00	0.00	0.	6.	0.
68.000	0.000	0.000	249.16	0.0000	8.69	1.33	0.00	0.00	0.00	0.	6.	0.
70.000	0.000	0.000	0.00	0.0000	0.00	0.00	0.00	0.00	0.00	0.	0.	0.



TABLE C-8. August Moisture-Related Data, Thule.

Z KM	VP MB	VP MEAN	S.D. MB	VP S.D.	TV MEAN	TV S.D.	SKEW K	TV SKEW	TV K	TD MEAN	TD K	S.D. TD	SKEW TD	NOBS VP	NOBS TV	NOBS TD
0.000	5.290	1.287	0.0985	277.23	3.00	0.01	270.81	3.49	-0.66	742.	742.	742.				
0.059	5.199	1.260	0.1075	277.02	2.94	0.04	270.58	3.46	-0.63	747.	747.	747.				
1.000	4.125	1.215	0.1344	272.75	3.25	0.15	267.31	4.21	-0.77	785.	785.	785.				
2.000	2.591	1.237	0.4385	268.18	3.82	-0.16	260.37	7.00	-0.88	779.	779.	779.				
3.000	1.570	0.924	0.8084	263.30	4.13	-0.25	253.59	8.27	-0.85	778.	778.	778.				
4.000	0.881	0.606	1.1769	257.54	4.27	-0.18	246.55	8.57	-0.47	781.	782.	782.				
5.000	0.484	0.354	1.2722	251.18	4.34	-0.32	239.78	8.76	-0.57	779.	779.	779.				
6.000	0.256	0.184	1.3960	244.60	4.22	-0.14	233.43	8.39	-0.80	752.	752.	752.				
7.000	0.148	0.097	1.2271	239.46	2.99	0.53	228.52	7.83	-1.11	522.	522.	522.				
8.000	0.096	0.052	0.7927	235.55	1.98	0.78	225.43	6.04	-1.32	121.	121.	121.				
9.000	0.000	0.000	0.0000	225.03	3.39	0.71	0.00	0.00	0.00	5.	5.	5.				
10.000	0.000	0.000	0.0000	223.96	5.29	0.50	0.00	0.00	0.00	0.	0.	0.				
11.000	0.000	0.000	0.0000	226.63	5.50	-0.67	0.00	0.00	0.00	0.	0.	0.				
12.000	0.000	0.000	0.0000	228.48	3.94	-1.16	0.00	0.00	0.00	0.	0.	0.				
13.000	0.000	0.000	0.0000	228.86	2.83	-0.69	0.00	0.00	0.00	0.	0.	0.				
14.000	0.000	0.000	0.0000	228.92	2.43	-0.61	0.00	0.00	0.00	0.	0.	0.				
15.000	0.000	0.000	0.0000	228.86	2.26	-0.66	0.00	0.00	0.00	0.	0.	0.				
16.000	0.000	0.000	0.0000	228.82	2.10	-0.64	0.00	0.00	0.00	0.	0.	0.				
17.000	0.000	0.000	0.0000	228.88	1.98	-0.46	0.00	0.00	0.00	0.	0.	0.				
18.000	0.000	0.000	0.0000	228.89	1.92	-0.54	0.00	0.00	0.00	0.	0.	0.				
19.000	0.000	0.000	0.0000	228.98	1.90	-0.41	0.00	0.00	0.00	0.	0.	0.				
20.000	0.000	0.000	0.0000	228.98	1.92	-0.25	0.00	0.00	0.00	0.	0.	0.				
21.000	0.000	0.000	0.0000	228.98	1.97	-0.38	0.00	0.00	0.00	0.	0.	0.				
22.000	0.000	0.000	0.0000	229.08	1.98	-0.30	0.00	0.00	0.00	0.	0.	0.				
23.000	0.000	0.000	0.0000	229.23	2.03	-0.22	0.00	0.00	0.00	0.	0.	0.				
24.000	0.000	0.000	0.0000	229.38	2.12	-0.11	0.00	0.00	0.00	0.	0.	0.				
25.000	0.000	0.000	0.0000	229.86	2.12	-0.11	0.00	0.00	0.00	0.	0.	0.				
26.000	0.000	0.000	0.0000	230.53	2.21	-0.19	0.00	0.00	0.00	0.	0.	0.				
27.000	0.000	0.000	0.0000	231.35	2.35	-0.17	0.00	0.00	0.00	0.	0.	0.				
28.000	0.000	0.000	0.0000	232.52	2.52	-0.04	0.00	0.00	0.00	0.	0.	0.				
29.000	0.000	0.000	0.0000	233.84	2.58	-0.34	0.00	0.00	0.00	0.	0.	0.				
30.000	0.000	0.000	0.0000	235.04	2.72	-0.42	0.00	0.00	0.00	0.	0.	0.				

TABLE C-8. August Moisture-Related Data, Thule, Cont'd.

Z KM	VP MEAN MB	S.D. VP MB	SKEW VP	TV MEAN K	TV S.D. K	SKEW TV	TD MEAN K	S.D. TD K	SKEW TD	NOBS VP	NOBS TV	NOBS TD
32.000	0.000	0.000	0.0000	241.53	10.28	1.11	0.00	0.00	0.00	0.	16.	0.
34.000	0.000	0.000	0.0000	244.99	10.05	0.67	0.00	0.00	0.00	0.	18.	0.
36.000	0.000	0.000	0.0000	249.55	10.42	0.36	0.00	0.00	0.00	0.	18.	0.
38.000	0.000	0.000	0.0000	253.86	10.70	-0.19	0.00	0.00	0.00	0.	20.	0.
40.000	0.000	0.000	0.0000	258.61	10.75	-0.84	0.00	0.00	0.00	0.	20.	0.
42.000	0.000	0.000	0.0000	263.21	10.42	-0.88	0.00	0.00	0.00	0.	21.	0.
44.000	0.000	0.000	0.0000	267.84	9.93	-0.96	0.00	0.00	0.00	0.	22.	0.
46.000	0.000	0.000	0.0000	271.98	8.72	-1.01	0.00	0.00	0.00	0.	22.	0.
48.000	0.000	0.000	0.0000	274.81	7.93	-1.53	0.00	0.00	0.00	0.	23.	0.
50.000	0.000	0.000	0.0000	276.52	7.12	-1.67	0.00	0.00	0.00	0.	22.	0.
52.000	0.000	0.000	0.0000	277.71	6.56	-1.03	0.00	0.00	0.00	0.	22.	0.
54.000	0.000	0.000	0.0000	276.95	5.49	-0.35	0.00	0.00	0.00	0.	19.	0.
56.000	0.000	0.000	0.0000	275.16	5.44	-0.35	0.00	0.00	0.00	0.	18.	0.
58.000	0.000	0.000	0.0000	273.44	6.38	-0.44	0.00	0.00	0.00	0.	18.	0.
60.000	0.000	0.000	0.0000	270.84	6.78	-0.24	0.00	0.00	0.00	0.	19.	0.
62.000	0.000	0.000	0.0000	267.49	6.86	0.10	0.00	0.00	0.00	0.	9.	0.
64.000	0.000	0.000	0.0000	262.53	8.75	0.33	0.00	0.00	0.00	0.	8.	0.
66.000	0.000	0.000	0.0000	0.00	0.00	0.00	0.00	0.00	0.00	0.	0.	0.
68.000	0.000	0.000	0.0000	0.00	0.00	0.00	0.00	0.00	0.00	0.	0.	0.
70.000	0.000	0.000	0.0000	0.00	0.00	0.00	0.00	0.00	0.00	0.	0.	0.

TABLE C-9. September Moisture-Related Data, Thule.

Z	VP MEAN	S.D. VP	TV MEAN	TV S.D.	SKEW TV	TD MEAN	S.D. TD	SKEW TD	NOBS	NOBS	NOBS	NOBS
KM	MB	MB	K	K	K	K	K	K	VP	TV	VP	TD
0.000	3.425	1.249	271.44	4.15	-0.60	264.60	5.12	-0.64	803.	803.	803.	803.
0.059	3.370	1.225	271.24	4.10	-0.59	264.41	5.08	-0.62	810.	810.	810.	810.
1.000	2.652	1.056	267.28	4.13	0.28	261.20	5.53	-0.77	861.	861.	861.	861.
2.000	1.699	0.934	262.82	4.97	0.13	254.96	7.22	-0.58	855.	855.	855.	855.
3.000	1.042	0.689	257.69	5.23	0.08	248.69	8.15	-0.56	852.	852.	852.	852.
4.000	0.571	0.404	251.80	5.27	0.07	241.89	8.15	-0.51	852.	852.	852.	852.
5.000	0.313	0.234	245.43	5.21	0.20	235.65	7.88	-0.43	841.	842.	842.	842.
6.000	0.180	0.132	240.39	4.36	0.60	230.17	8.11	-0.76	634.	635.	635.	635.
7.000	0.128	0.080	238.28	2.90	1.03	227.38	7.83	-1.29	197.	198.	198.	198.
8.000	0.076	0.044	235.28	2.14	2.66	223.60	5.78	-1.63	23.	23.	23.	23.
9.000	0.000	0.000	221.39	3.99	0.45	0.00	0.00	0.00	0.	0.	0.	0.
10.000	0.000	0.000	221.97	5.07	0.22	0.00	0.00	0.00	0.	0.	0.	0.
11.000	0.000	0.000	224.28	4.49	-0.67	0.00	0.00	0.00	0.	0.	0.	0.
12.000	0.000	0.000	225.54	3.21	-0.82	0.00	0.00	0.00	0.	0.	0.	0.
13.000	0.000	0.000	225.61	2.64	-0.23	0.00	0.00	0.00	0.	0.	0.	0.
14.000	0.000	0.000	225.44	2.35	-0.03	0.00	0.00	0.00	0.	0.	0.	0.
15.000	0.000	0.000	225.14	2.25	0.07	0.00	0.00	0.00	0.	0.	0.	0.
16.000	0.000	0.000	224.80	2.30	0.05	0.00	0.00	0.00	0.	0.	0.	0.
17.000	0.000	0.000	224.31	2.37	-0.07	0.00	0.00	0.00	0.	0.	0.	0.
18.000	0.000	0.000	223.82	2.54	-0.16	0.00	0.00	0.00	0.	0.	0.	0.
19.000	0.000	0.000	223.33	2.69	-0.14	0.00	0.00	0.00	0.	0.	0.	0.
20.000	0.000	0.000	222.81	2.89	-0.09	0.00	0.00	0.00	0.	0.	0.	0.
21.000	0.000	0.000	222.44	3.06	-0.05	0.00	0.00	0.00	0.	0.	0.	0.
22.000	0.000	0.000	222.14	3.24	-0.05	0.00	0.00	0.00	0.	0.	0.	0.
23.000	0.000	0.000	221.86	3.44	-0.04	0.00	0.00	0.00	0.	0.	0.	0.
24.000	0.000	0.000	221.74	3.64	0.01	0.00	0.00	0.00	0.	0.	0.	0.
25.000	0.000	0.000	222.00	3.80	-0.01	0.00	0.00	0.00	0.	0.	0.	0.
26.000	0.000	0.000	222.35	3.94	0.06	0.00	0.00	0.00	0.	0.	0.	0.
27.000	0.000	0.000	223.12	4.05	0.08	0.00	0.00	0.00	0.	0.	0.	0.
28.000	0.000	0.000	223.93	4.26	0.07	0.00	0.00	0.00	0.	0.	0.	0.
29.000	0.000	0.000	224.89	4.49	0.07	0.00	0.00	0.00	0.	0.	0.	0.
30.000	0.000	0.000	225.67	4.59	-0.12	0.00	0.00	0.00	0.	0.	0.	0.

**TABLE C-9. September Moisture-Related Data, Thule, Cont'd.**

Z KM	VP MEAN		S.D. VP		TV MEAN		TV S.D.		SKEW TV		TD MEAN		S.D. TD		SKEW TD		NOBS	
	MB	MB	MB	MB	K	K	K	K	K	K	K	K	K	K	VP	TV	TV	TD
32.000	0.000	0.000	0.000	0.000	228.06	7.16	0.02	0.00	0.00	0.00	0.00	0.00	0.00	0.00	0.	10.	0.	0.
34.000	0.000	0.000	0.000	0.000	230.16	8.02	0.44	0.00	0.00	0.00	0.00	0.00	0.00	0.00	0.	11.	0.	0.
36.000	0.000	0.000	0.000	0.000	234.80	8.81	0.66	0.00	0.00	0.00	0.00	0.00	0.00	0.00	0.	11.	0.	0.
38.000	0.000	0.000	0.000	0.000	238.52	9.00	0.73	0.00	0.00	0.00	0.00	0.00	0.00	0.00	0.	11.	0.	0.
40.000	0.000	0.000	0.000	0.000	243.56	9.75	0.54	0.00	0.00	0.00	0.00	0.00	0.00	0.00	0.	10.	0.	0.
42.000	0.000	0.000	0.000	0.000	249.06	10.30	0.58	0.00	0.00	0.00	0.00	0.00	0.00	0.00	0.	10.	0.	0.
44.000	0.000	0.000	0.000	0.000	252.46	10.13	0.54	0.00	0.00	0.00	0.00	0.00	0.00	0.00	0.	10.	0.	0.
46.000	0.000	0.000	0.000	0.000	256.16	8.01	0.44	0.00	0.00	0.00	0.00	0.00	0.00	0.00	0.	10.	0.	0.
48.000	0.000	0.000	0.000	0.000	261.46	7.51	1.64	0.00	0.00	0.00	0.00	0.00	0.00	0.00	0.	10.	0.	0.
50.000	0.000	0.000	0.000	0.000	264.36	7.33	1.04	0.00	0.00	0.00	0.00	0.00	0.00	0.00	0.	10.	0.	0.
52.000	0.000	0.000	0.000	0.000	264.06	6.79	0.35	0.00	0.00	0.00	0.00	0.00	0.00	0.00	0.	10.	0.	0.
54.000	0.000	0.000	0.000	0.000	264.76	6.88	0.57	0.00	0.00	0.00	0.00	0.00	0.00	0.00	0.	10.	0.	0.
56.000	0.000	0.000	0.000	0.000	264.36	7.69	0.55	0.00	0.00	0.00	0.00	0.00	0.00	0.00	0.	10.	0.	0.
58.000	0.000	0.000	0.000	0.000	263.86	8.27	0.24	0.00	0.00	0.00	0.00	0.00	0.00	0.00	0.	10.	0.	0.
60.000	0.000	0.000	0.000	0.000	264.02	9.10	-0.07	0.00	0.00	0.00	0.00	0.00	0.00	0.00	0.	7.	0.	0.
62.000	0.000	0.000	0.000	0.000	0.00	0.00	0.00	0.00	0.00	0.00	0.00	0.00	0.00	0.00	0.	0.	0.	0.
64.000	0.000	0.000	0.000	0.000	0.00	0.00	0.00	0.00	0.00	0.00	0.00	0.00	0.00	0.00	0.	0.	0.	0.
66.000	0.000	0.000	0.000	0.000	0.00	0.00	0.00	0.00	0.00	0.00	0.00	0.00	0.00	0.00	0.	0.	0.	0.
68.000	0.000	0.000	0.000	0.000	0.00	0.00	0.00	0.00	0.00	0.00	0.00	0.00	0.00	0.00	0.	0.	0.	0.
70.000	0.000	0.000	0.000	0.000	0.00	0.00	0.00	0.00	0.00	0.00	0.00	0.00	0.00	0.00	0.	0.	0.	0.

TABLE C-10. October Moisture-Related Data, Thule.

Z	VP	S.D.	TV	TD	S.D.	S.D.	NOBS	NOBS	NOBS	NOBS
KM	MEAN	MB	MEAN	MEAN	TD	TD	VP	TV	TD	TD
	MB		K	K	K	K	VP	TV	TD	TD
			K	K	K	K	VP	TV	TD	TD
0.000	1.983	1.067	263.54	6.29	0.00	257.02	6.74	-0.33	823.	823.
0.059	1.958	1.051	263.43	6.21	0.00	256.88	6.70	-0.30	830.	830.
1.000	1.774	0.847	261.84	5.41	0.05	255.95	6.13	-0.51	850.	850.
2.000	1.072	0.695	257.74	5.72	0.33	249.49	7.23	0.03	841.	843.
3.000	0.648	0.461	252.59	5.87	0.41	243.74	7.44	0.15	828.	834.
4.000	0.391	0.301	246.84	5.93	0.46	238.34	6.96	0.32	816.	818.
5.000	0.229	0.173	241.55	5.49	0.69	233.18	6.79	0.30	720.	725.
6.000	0.161	0.115	238.88	4.41	0.86	229.76	7.15	-0.43	350.	353.
7.000	0.156	0.108	238.38	3.16	0.20	228.84	8.29	-1.08	79.	79.
8.000	0.115	0.060	235.35	1.87	0.73	227.19	5.66	-0.71	10.	10.
9.000	0.000	0.000	219.34	3.73	0.75	0.00	0.00	0.00	0.	0.
10.000	0.000	0.000	220.06	4.27	-0.15	0.00	0.00	0.00	0.	0.
11.000	0.000	0.000	221.46	3.85	-0.83	0.00	0.00	0.00	0.	0.
12.000	0.000	0.000	221.75	3.16	-0.89	0.00	0.00	0.00	0.	0.
13.000	0.000	0.000	221.42	2.78	-0.52	0.00	0.00	0.00	0.	0.
14.000	0.000	0.000	220.69	2.67	-0.42	0.00	0.00	0.00	0.	0.
15.000	0.000	0.000	219.89	2.71	-0.41	0.00	0.00	0.00	0.	0.
16.000	0.000	0.000	218.92	2.80	-0.43	0.00	0.00	0.00	0.	0.
17.000	0.000	0.000	217.75	2.98	-0.43	0.00	0.00	0.00	0.	0.
18.000	0.000	0.000	216.61	3.22	-0.46	0.00	0.00	0.00	0.	0.
19.000	0.000	0.000	215.34	3.30	-0.42	0.00	0.00	0.00	0.	0.
20.000	0.000	0.000	214.39	3.24	-0.34	0.00	0.00	0.00	0.	0.
21.000	0.000	0.000	213.59	3.48	0.18	0.00	0.00	0.00	0.	0.
22.000	0.000	0.000	212.71	3.55	0.04	0.00	0.00	0.00	0.	0.
23.000	0.000	0.000	212.06	3.27	-0.18	0.00	0.00	0.00	0.	0.
24.000	0.000	0.000	211.98	3.23	-0.01	0.00	0.00	0.00	0.	0.
25.000	0.000	0.000	211.49	3.46	0.00	0.00	0.00	0.00	0.	0.
26.000	0.000	0.000	211.87	3.52	0.17	0.00	0.00	0.00	0.	0.
27.000	0.000	0.000	212.27	3.37	0.23	0.00	0.00	0.00	0.	0.
28.000	0.000	0.000	212.64	3.60	-0.02	0.00	0.00	0.00	0.	0.
29.000	0.000	0.000	213.03	3.50	0.11	0.00	0.00	0.00	0.	0.
30.000	0.000	0.000	213.43	3.61	-0.04	0.00	0.00	0.00	0.	0.

TABLE C-10. October Moisture-Related Data, Thule, Cont'd.

Z KM	VP MEAN		S.D. VP		TV MEAN		TV S.D.		SKEW TV		TD MEAN		S.D. TD		SKEW TD		NOBS		NOBS	
	MB	MB	MB	MB	K	K	K	K	K	K	K	K	K	K	K	K	VP	TV	VP	TV
32.000	0.000	0.000	0.000	0.000	211.30	5.27	0.03	0.00	0.00	0.00	0.00	0.00	0.00	0.00	0.00	0.00	0.	7.	0.	0.
34.000	0.000	0.000	0.000	0.000	211.16	6.07	-0.14	0.00	0.00	0.00	0.00	0.00	0.00	0.00	0.00	0.00	0.	8.	0.	0.
36.000	0.000	0.000	0.000	0.000	215.03	6.81	0.83	0.00	0.00	0.00	0.00	0.00	0.00	0.00	0.00	0.00	0.	8.	0.	0.
38.000	0.000	0.000	0.000	0.000	219.60	7.43	0.34	0.00	0.00	0.00	0.00	0.00	0.00	0.00	0.00	0.00	0.	9.	0.	0.
40.000	0.000	0.000	0.000	0.000	222.60	7.07	0.33	0.00	0.00	0.00	0.00	0.00	0.00	0.00	0.00	0.00	0.	9.	0.	0.
42.000	0.000	0.000	0.000	0.000	226.60	7.55	-0.33	0.00	0.00	0.00	0.00	0.00	0.00	0.00	0.00	0.00	0.	9.	0.	0.
44.000	0.000	0.000	0.000	0.000	232.94	8.48	-0.32	0.00	0.00	0.00	0.00	0.00	0.00	0.00	0.00	0.00	0.	9.	0.	0.
46.000	0.000	0.000	0.000	0.000	238.60	8.57	0.92	0.00	0.00	0.00	0.00	0.00	0.00	0.00	0.00	0.00	0.	9.	0.	0.
48.000	0.000	0.000	0.000	0.000	244.16	8.93	0.91	0.00	0.00	0.00	0.00	0.00	0.00	0.00	0.00	0.00	0.	9.	0.	0.
50.000	0.000	0.000	0.000	0.000	252.94	8.76	0.53	0.00	0.00	0.00	0.00	0.00	0.00	0.00	0.00	0.00	0.	9.	0.	0.
52.000	0.000	0.000	0.000	0.000	255.83	9.91	1.06	0.00	0.00	0.00	0.00	0.00	0.00	0.00	0.00	0.00	0.	9.	0.	0.
54.000	0.000	0.000	0.000	0.000	257.60	10.69	0.59	0.00	0.00	0.00	0.00	0.00	0.00	0.00	0.00	0.00	0.	9.	0.	0.
56.000	0.000	0.000	0.000	0.000	260.83	7.19	0.39	0.00	0.00	0.00	0.00	0.00	0.00	0.00	0.00	0.00	0.	9.	0.	0.
58.000	0.000	0.000	0.000	0.000	263.16	8.00	-0.16	0.00	0.00	0.00	0.00	0.00	0.00	0.00	0.00	0.00	0.	9.	0.	0.
60.000	0.000	0.000	0.000	0.000	263.66	8.54	-1.47	0.00	0.00	0.00	0.00	0.00	0.00	0.00	0.00	0.00	0.	8.	0.	0.
62.000	0.000	0.000	0.000	0.000	266.02	10.07	-2.19	0.00	0.00	0.00	0.00	0.00	0.00	0.00	0.00	0.00	0.	7.	0.	0.
64.000	0.000	0.000	0.000	0.000	264.73	11.49	-1.71	0.00	0.00	0.00	0.00	0.00	0.00	0.00	0.00	0.00	0.	7.	0.	0.
66.000	0.000	0.000	0.000	0.000	261.66	14.31	-0.81	0.00	0.00	0.00	0.00	0.00	0.00	0.00	0.00	0.00	0.	6.	0.	0.
68.000	0.000	0.000	0.000	0.000	0.00	0.00	0.00	0.00	0.00	0.00	0.00	0.00	0.00	0.00	0.00	0.00	0.	0.	0.	0.
70.000	0.000	0.000	0.000	0.000	0.00	0.00	0.00	0.00	0.00	0.00	0.00	0.00	0.00	0.00	0.00	0.00	0.	0.	0.	0.

TABLE C-11. November Moisture-Related Data, Thule.

Z	VP MEAN	S.D. VP	TV MEAN	TV S.D.	SKEW TV	TD MEAN	S.D. TD	SKEW TD	NOBS	NOBS	NOBS	NOBS
KM	MB	MB	K	K	K	K	K	K	VP	TV	VP	TD
0.000	1.100	0.699	256.31	6.51	0.16	249.75	7.20	-0.17	738.	739.	738.	739.
0.059	1.086	0.683	256.27	6.38	0.20	249.66	7.09	-0.15	743.	744.	743.	744.
1.000	1.084	0.599	255.81	5.53	0.36	250.06	6.19	-0.14	774.	775.	774.	775.
2.000	0.694	0.433	251.96	5.32	0.46	244.84	6.55	-0.20	769.	770.	769.	770.
3.000	0.422	0.265	247.28	4.93	0.53	239.62	6.61	-0.27	753.	757.	753.	757.
4.000	0.247	0.158	242.03	4.56	0.82	234.26	6.43	-0.21	706.	711.	706.	711.
5.000	0.160	0.102	238.12	3.86	1.23	230.03	6.48	-0.91	444.	447.	444.	447.
6.000	0.142	0.090	237.48	3.11	0.83	228.63	6.64	-1.05	87.	87.	87.	87.
7.000	0.135	0.041	235.84	1.65	0.45	229.56	3.03	-0.56	9.	9.	9.	9.
8.000	0.000	0.000	218.64	3.84	0.54	0.00	0.00	0.00	0.	0.	0.	0.
9.000	0.000	0.000	217.31	4.19	0.22	0.00	0.00	0.00	0.	0.	0.	0.
10.000	0.000	0.000	218.18	4.47	-0.31	0.00	0.00	0.00	0.	0.	0.	0.
11.000	0.000	0.000	219.02	4.09	-0.75	0.00	0.00	0.00	0.	0.	0.	0.
12.000	0.000	0.000	218.83	4.02	-0.66	0.00	0.00	0.00	0.	0.	0.	0.
13.000	0.000	0.000	218.37	3.96	-0.37	0.00	0.00	0.00	0.	0.	0.	0.
14.000	0.000	0.000	217.44	4.25	-0.31	0.00	0.00	0.00	0.	0.	0.	0.
15.000	0.000	0.000	216.40	4.60	-0.23	0.00	0.00	0.00	0.	0.	0.	0.
16.000	0.000	0.000	215.40	4.88	-0.14	0.00	0.00	0.00	0.	0.	0.	0.
17.000	0.000	0.000	214.03	5.27	-0.12	0.00	0.00	0.00	0.	0.	0.	0.
18.000	0.000	0.000	213.40	5.58	0.35	0.00	0.00	0.00	0.	0.	0.	0.
19.000	0.000	0.000	212.22	5.88	0.19	0.00	0.00	0.00	0.	0.	0.	0.
20.000	0.000	0.000	212.13	5.77	0.22	0.00	0.00	0.00	0.	0.	0.	0.
21.000	0.000	0.000	211.88	5.99	0.17	0.00	0.00	0.00	0.	0.	0.	0.
22.000	0.000	0.000	211.33	6.22	0.22	0.00	0.00	0.00	0.	0.	0.	0.
23.000	0.000	0.000	211.92	6.13	0.17	0.00	0.00	0.00	0.	0.	0.	0.
24.000	0.000	0.000	211.78	6.85	0.22	0.00	0.00	0.00	0.	0.	0.	0.
25.000	0.000	0.000	211.39	7.46	0.55	0.00	0.00	0.00	0.	0.	0.	0.
26.000	0.000	0.000	213.22	8.29	1.32	0.00	0.00	0.00	0.	0.	0.	0.
27.000	0.000	0.000	212.75	6.86	0.23	0.00	0.00	0.00	0.	0.	0.	0.
28.000	0.000	0.000	212.86	7.50	0.18	0.00	0.00	0.00	0.	0.	0.	0.
29.000	0.000	0.000	211.74	7.04	0.39	0.00	0.00	0.00	0.	0.	0.	0.
30.000	0.000	0.000	214.11	6.35	-0.12	0.00	0.00	0.00	0.	0.	0.	0.

TABLE C-11. November Moisture-Related Data, Thule, Cont'd.

Z KM	VP MEAN		S.D. VP		TV MEAN		TV S.D.		SKEW VP		SKEW TV		TD MEAN		S.D. TD		SKEW TD		NOBS		NOBS	
	MB	MB	MB	MB	K	K	K	K	K	K	K	K	K	K	K	K	VP	TV	VP	TV	TD	TD
32.000	0.000	0.000	0.000	0.000	207.01	4.43	-0.35	0.00	0.00	0.00	0.00	0.00	0.00	0.00	0.00	0.00	0.00	0.00	0.00	13.	0.	
34.000	0.000	0.000	0.000	0.000	209.87	5.48	0.00	0.00	0.00	0.00	0.00	0.00	0.00	0.00	0.00	0.00	0.00	0.00	0.00	14.	0.	
36.000	0.000	0.000	0.000	0.000	214.45	4.81	-0.10	0.00	0.00	0.00	0.00	0.00	0.00	0.00	0.00	0.00	0.00	0.00	0.00	14.	0.	
38.000	0.000	0.000	0.000	0.000	217.95	6.45	0.13	0.00	0.00	0.00	0.00	0.00	0.00	0.00	0.00	0.00	0.00	0.00	0.00	14.	0.	
40.000	0.000	0.000	0.000	0.000	220.95	6.64	-0.09	0.00	0.00	0.00	0.00	0.00	0.00	0.00	0.00	0.00	0.00	0.00	0.00	14.	0.	
42.000	0.000	0.000	0.000	0.000	226.45	7.85	0.27	0.00	0.00	0.00	0.00	0.00	0.00	0.00	0.00	0.00	0.00	0.00	0.00	14.	0.	
44.000	0.000	0.000	0.000	0.000	232.73	8.43	0.18	0.00	0.00	0.00	0.00	0.00	0.00	0.00	0.00	0.00	0.00	0.00	0.00	14.	0.	
46.000	0.000	0.000	0.000	0.000	241.30	13.56	2.08	0.00	0.00	0.00	0.00	0.00	0.00	0.00	0.00	0.00	0.00	0.00	0.00	14.	0.	
48.000	0.000	0.000	0.000	0.000	247.93	9.78	0.28	0.00	0.00	0.00	0.00	0.00	0.00	0.00	0.00	0.00	0.00	0.00	0.00	13.	0.	
50.000	0.000	0.000	0.000	0.000	252.30	7.95	-0.01	0.00	0.00	0.00	0.00	0.00	0.00	0.00	0.00	0.00	0.00	0.00	0.00	14.	0.	
52.000	0.000	0.000	0.000	0.000	253.78	5.68	0.53	0.00	0.00	0.00	0.00	0.00	0.00	0.00	0.00	0.00	0.00	0.00	0.00	13.	0.	
54.000	0.000	0.000	0.000	0.000	255.98	7.83	0.34	0.00	0.00	0.00	0.00	0.00	0.00	0.00	0.00	0.00	0.00	0.00	0.00	11.	0.	
56.000	0.000	0.000	0.000	0.000	259.58	8.10	-1.15	0.00	0.00	0.00	0.00	0.00	0.00	0.00	0.00	0.00	0.00	0.00	0.00	12.	0.	
58.000	0.000	0.000	0.000	0.000	261.06	10.24	-1.66	0.00	0.00	0.00	0.00	0.00	0.00	0.00	0.00	0.00	0.00	0.00	0.00	10.	0.	
60.000	0.000	0.000	0.000	0.000	260.03	15.51	-1.17	0.00	0.00	0.00	0.00	0.00	0.00	0.00	0.00	0.00	0.00	0.00	0.00	8.	0.	
62.000	0.000	0.000	0.000	0.000	258.87	22.79	-0.48	0.00	0.00	0.00	0.00	0.00	0.00	0.00	0.00	0.00	0.00	0.00	0.00	7.	0.	
64.000	0.000	0.000	0.000	0.000	253.99	26.48	-0.25	0.00	0.00	0.00	0.00	0.00	0.00	0.00	0.00	0.00	0.00	0.00	0.00	6.	0.	
66.000	0.000	0.000	0.000	0.000	0.00	0.00	0.00	0.00	0.00	0.00	0.00	0.00	0.00	0.00	0.00	0.00	0.00	0.00	0.00	0.	0.	
68.000	0.000	0.000	0.000	0.000	0.00	0.00	0.00	0.00	0.00	0.00	0.00	0.00	0.00	0.00	0.00	0.00	0.00	0.00	0.00	0.	0.	
70.000	0.000	0.000	0.000	0.000	0.00	0.00	0.00	0.00	0.00	0.00	0.00	0.00	0.00	0.00	0.00	0.00	0.00	0.00	0.00	0.	0.	



TABLE C-12. December Moisture-Related Data, Thule.

Z KM	VP MEAN		S.D. VP		TV MEAN		TV S.D.		SKEW TV		TD MEAN		S.D. TD		SKEW TD		NOBS		NOBS	
	MB	MB	K	K	K	K	K	K	K	K	K	K	K	K	K	K	VP	TV	VP	TV
0.000	0.822	0.642	2.0697	252.40	7.49	0.56	245.94	7.79	0.11	789.	790.									
0.059	0.810	0.629	2.0755	252.27	7.41	0.57	245.82	7.72	0.14	802.	803.									
1.000	0.849	0.592	1.8569	253.11	7.28	0.30	246.80	6.83	0.43	831.	832.									
2.000	0.594	0.448	2.0421	249.78	6.86	0.20	242.66	7.05	0.16	819.	819.									
3.000	0.386	0.281	1.8342	245.72	5.94	0.27	238.26	6.80	0.20	756.	757.									
4.000	0.243	0.178	2.2521	241.49	4.88	0.53	233.78	6.25	0.18	630.	630.									
5.000	0.167	0.110	2.0274	238.51	3.75	0.94	230.40	6.06	-0.26	343.	344.									
6.000	0.138	0.087	1.1638	236.88	2.85	1.05	228.32	6.73	-0.94	88.	88.									
7.000	0.125	0.053	0.4336	235.85	2.82	2.02	228.57	3.94	0.31	9.	9.									
8.000	0.000	0.000	0.0000	216.82	4.04	0.62	0.00	0.00	0.00	0.00	0.00									
9.000	0.000	0.000	0.0000	214.64	4.28	0.54	0.00	0.00	0.00	0.00	0.00									
10.000	0.000	0.000	0.0000	214.16	4.96	0.34	0.00	0.00	0.00	0.00	0.00									
11.000	0.000	0.000	0.0000	214.25	5.09	0.47	0.00	0.00	0.00	0.00	0.00									
12.000	0.000	0.000	0.0000	213.66	5.34	0.66	0.00	0.00	0.00	0.00	0.00									
13.000	0.000	0.000	0.0000	212.82	5.67	0.82	0.00	0.00	0.00	0.00	0.00									
14.000	0.000	0.000	0.0000	211.73	6.23	0.90	0.00	0.00	0.00	0.00	0.00									
15.000	0.000	0.000	0.0000	210.62	6.89	1.04	0.00	0.00	0.00	0.00	0.00									
16.000	0.000	0.000	0.0000	210.05	7.66	0.88	0.00	0.00	0.00	0.00	0.00									
17.000	0.000	0.000	0.0000	208.55	8.14	0.89	0.00	0.00	0.00	0.00	0.00									
18.000	0.000	0.000	0.0000	209.89	8.74	0.64	0.00	0.00	0.00	0.00	0.00									
19.000	0.000	0.000	0.0000	208.77	8.99	0.55	0.00	0.00	0.00	0.00	0.00									
20.000	0.000	0.000	0.0000	210.87	9.04	0.21	0.00	0.00	0.00	0.00	0.00									
21.000	0.000	0.000	0.0000	210.75	9.07	0.01	0.00	0.00	0.00	0.00	0.00									
22.000	0.000	0.000	0.0000	209.81	9.12	0.05	0.00	0.00	0.00	0.00	0.00									
23.000	0.000	0.000	0.0000	211.20	8.39	0.07	0.00	0.00	0.00	0.00	0.00									
24.000	0.000	0.000	0.0000	211.56	8.40	0.06	0.00	0.00	0.00	0.00	0.00									
25.000	0.000	0.000	0.0000	211.26	8.34	0.09	0.00	0.00	0.00	0.00	0.00									
26.000	0.000	0.000	0.0000	211.53	8.76	-0.15	0.00	0.00	0.00	0.00	0.00									
27.000	0.000	0.000	0.0000	211.49	9.04	-0.27	0.00	0.00	0.00	0.00	0.00									
28.000	0.000	0.000	0.0000	213.42	8.28	-0.71	0.00	0.00	0.00	0.00	0.00									
29.000	0.000	0.000	0.0000	212.73	6.54	-0.31	0.00	0.00	0.00	0.00	0.00									
30.000	0.000	0.000	0.0000	214.65	3.80	0.24	0.00	0.00	0.00	0.00	0.00									

**TABLE C-12. December Moisture-Related Data, Thule, Cont'd.**

Z KM	VP MEAN		S.D. VP		TV MEAN		TV S.D.		SKEW TV		TD MEAN		S.D. TD		SKEW TD		NOBS		NOBS	
	MB	MB	MB	MB	K	K	K	K	K	K	K	K	K	K	K	K	VP	TV	TV	TD
32.000	0.000	0.000	0.000	0.000	204.53	7.13	0.13	0.00	0.00	0.00	0.00	0.00	0.00	0.00	0.00	0.00	0.	8.	0.	0.
34.000	0.000	0.000	0.000	0.000	208.43	9.09	-0.22	0.00	0.00	0.00	0.00	0.00	0.00	0.00	0.00	0.00	0.	11.	0.	0.
36.000	0.000	0.000	0.000	0.000	215.93	9.34	-0.14	0.00	0.00	0.00	0.00	0.00	0.00	0.00	0.00	0.00	0.	13.	0.	0.
38.000	0.000	0.000	0.000	0.000	222.78	11.04	0.76	0.00	0.00	0.00	0.00	0.00	0.00	0.00	0.00	0.00	0.	13.	0.	0.
40.000	0.000	0.000	0.000	0.000	230.52	11.74	1.44	0.00	0.00	0.00	0.00	0.00	0.00	0.00	0.00	0.00	0.	14.	0.	0.
42.000	0.000	0.000	0.000	0.000	237.52	14.38	1.03	0.00	0.00	0.00	0.00	0.00	0.00	0.00	0.00	0.00	0.	14.	0.	0.
44.000	0.000	0.000	0.000	0.000	243.85	16.06	1.04	0.00	0.00	0.00	0.00	0.00	0.00	0.00	0.00	0.00	0.	13.	0.	0.
46.000	0.000	0.000	0.000	0.000	250.49	14.74	0.85	0.00	0.00	0.00	0.00	0.00	0.00	0.00	0.00	0.00	0.	12.	0.	0.
48.000	0.000	0.000	0.000	0.000	256.16	14.45	0.33	0.00	0.00	0.00	0.00	0.00	0.00	0.00	0.00	0.00	0.	12.	0.	0.
50.000	0.000	0.000	0.000	0.000	258.58	12.04	0.52	0.00	0.00	0.00	0.00	0.00	0.00	0.00	0.00	0.00	0.	12.	0.	0.
52.000	0.000	0.000	0.000	0.000	261.08	10.04	-0.09	0.00	0.00	0.00	0.00	0.00	0.00	0.00	0.00	0.00	0.	12.	0.	0.
54.000	0.000	0.000	0.000	0.000	264.08	9.31	-0.32	0.00	0.00	0.00	0.00	0.00	0.00	0.00	0.00	0.00	0.	12.	0.	0.
56.000	0.000	0.000	0.000	0.000	264.16	13.11	0.22	0.00	0.00	0.00	0.00	0.00	0.00	0.00	0.00	0.00	0.	11.	0.	0.
58.000	0.000	0.000	0.000	0.000	262.16	19.30	0.44	0.00	0.00	0.00	0.00	0.00	0.00	0.00	0.00	0.00	0.	10.	0.	0.
60.000	0.000	0.000	0.000	0.000	260.03	22.03	0.30	0.00	0.00	0.00	0.00	0.00	0.00	0.00	0.00	0.00	0.	8.	0.	0.
62.000	0.000	0.000	0.000	0.000	257.73	18.04	0.49	0.00	0.00	0.00	0.00	0.00	0.00	0.00	0.00	0.00	0.	7.	0.	0.
64.000	0.000	0.000	0.000	0.000	259.33	21.70	0.33	0.00	0.00	0.00	0.00	0.00	0.00	0.00	0.00	0.00	0.	6.	0.	0.
66.000	0.000	0.000	0.000	0.000	0.00	0.00	0.00	0.00	0.00	0.00	0.00	0.00	0.00	0.00	0.00	0.00	0.	0.	0.	0.
68.000	0.000	0.000	0.000	0.000	0.00	0.00	0.00	0.00	0.00	0.00	0.00	0.00	0.00	0.00	0.00	0.00	0.	0.	0.	0.
70.000	0.000	0.000	0.000	0.000	0.00	0.00	0.00	0.00	0.00	0.00	0.00	0.00	0.00	0.00	0.00	0.00	0.	0.	0.	0.

TABLE C-13. Annual Moisture-Related Data, Thule.

Z KM	VP MEAN		S.D. VP		TV MEAN		TV S.D.		SKEW TV		TD MEAN		S.D. TD		SKEW TD		NOBS		NOBS	
	MB	K	MB	K	K	K	K	K	K	K	K	K	K	K	K	K	VP	TV	VP	TV
0.000	2.422	0.8437	2.072	12.09	262.85	12.09	-0.15	256.16	12.34	-0.19	9017.	9027.	9025.							
0.059	2.374	0.8496	2.032	12.01	262.65	12.01	-0.13	255.94	12.26	-0.17	9129.	9140.	9139.							
1.000	1.988	1.0380	1.589	10.18	261.11	10.18	-0.11	254.94	10.30	-0.04	9537.	9540.	9540.							
2.000	1.288	1.5479	1.141	9.50	257.46	9.50	-0.04	249.73	9.89	0.16	9432.	9437.	9437.							
3.000	0.809	1.9049	0.758	8.97	253.07	8.97	0.08	244.49	9.57	0.21	9162.	9183.	9183.							
4.000	0.484	2.1480	0.467	8.33	248.31	8.33	0.18	239.13	9.01	0.27	8580.	8600.	8600.							
5.000	0.309	2.1296	0.280	7.04	244.66	7.04	0.21	234.91	8.48	0.01	6833.	6851.	6851.							
6.000	0.209	1.7670	0.162	5.14	242.02	5.14	0.18	231.50	8.05	-0.54	4323.	4330.	4330.							
7.000	0.145	1.3477	0.094	3.16	239.18	3.16	0.64	228.47	7.50	-1.09	2048.	2050.	2050.							
8.000	0.094	1.2984	0.055	2.28	235.71	2.28	2.06	224.89	6.65	-1.28	435.	435.	435.							
9.000	0.050	2.1129	0.059	5.79	234.11	5.79	-0.23	217.36	9.78	-0.22	25.	25.	25.							
10.000	0.047	1.4006	0.057	3.02	237.97	3.02	1.80	214.91	11.18	0.56	7.	7.	7.							
11.000	0.000	0.0000	0.000	7.84	222.47	7.84	-0.54	0.00	0.00	0.00	5.	0.	5.							
12.000	0.000	0.0000	0.000	8.10	222.99	8.10	-0.72	0.00	0.00	0.00	3.	0.	3.							
13.000	0.000	0.0000	0.000	8.16	223.02	8.16	-0.85	0.00	0.00	0.00	3.	0.	3.							
14.000	0.000	0.0000	0.000	8.41	222.72	8.41	-0.92	0.00	0.00	0.00	0.	0.	0.							
15.000	0.000	0.0000	0.000	8.60	222.45	8.60	-0.95	0.00	0.00	0.00	0.	0.	0.							
16.000	0.000	0.0000	0.000	8.46	222.81	8.46	-1.08	0.00	0.00	0.00	0.	0.	0.							
17.000	0.000	0.0000	0.000	8.88	222.35	8.88	-1.04	0.00	0.00	0.00	0.	0.	0.							
18.000	0.000	0.0000	0.000	8.37	223.08	8.37	-1.07	0.00	0.00	0.00	0.	0.	0.							
19.000	0.000	0.0000	0.000	8.67	222.91	8.67	-1.01	0.00	0.00	0.00	0.	0.	0.							
20.000	0.000	0.0000	0.000	8.04	223.74	8.04	-0.97	0.00	0.00	0.00	0.	0.	0.							
21.000	0.000	0.0000	0.000	8.03	224.10	8.03	-0.98	0.00	0.00	0.00	0.	0.	0.							
22.000	0.000	0.0000	0.000	8.23	224.17	8.23	-0.98	0.00	0.00	0.00	0.	0.	0.							
23.000	0.000	0.0000	0.000	8.02	224.57	8.02	-0.88	0.00	0.00	0.00	0.	0.	0.							
24.000	0.000	0.0000	0.000	7.81	225.24	7.81	-0.96	0.00	0.00	0.00	0.	0.	0.							
25.000	0.000	0.0000	0.000	8.12	225.44	8.12	-0.96	0.00	0.00	0.00	0.	0.	0.							
26.000	0.000	0.0000	0.000	7.75	226.62	7.75	-0.98	0.00	0.00	0.00	0.	0.	0.							
27.000	0.000	0.0000	0.000	7.67	227.74	7.67	-1.01	0.00	0.00	0.00	0.	0.	0.							
28.000	0.000	0.0000	0.000	7.71	228.83	7.71	-0.95	0.00	0.00	0.00	0.	0.	0.							
29.000	0.000	0.0000	0.000	8.00	230.03	8.00	-0.96	0.00	0.00	0.00	0.	0.	0.							
30.000	0.000	0.0000	0.000	8.10	231.21	8.10	-0.83	0.00	0.00	0.00	0.	0.	0.							

TABLE C-13. Annual Moisture-Related Data, Thule, Cont'd.

Z KM	VP MEAN		S.D. VP		TV MEAN		TV S.D.		SKEW VP		SKEW TV		TD MEAN		S.D. TD		SKEW TD		NOBS		NOBS	
	MB	MB	MB	MB	K	K	K	K	K	K	K	K	K	K	K	K	K	K	VP	TV	VP	TV
32.000	0.000	0.000	0.000	0.000	230.14	16.39	-0.25	0.00	0.00	0.00	0.00	0.00	0.00	0.00	0.00	0.00	0.00	0.	162.	0.	162.	0.
34.000	0.000	0.000	0.000	0.000	233.11	17.83	-0.18	0.00	0.00	0.00	0.00	0.00	0.00	0.00	0.00	0.00	0.00	0.	175.	0.	175.	0.
36.000	0.000	0.000	0.000	0.000	237.05	18.16	-0.13	0.00	0.00	0.00	0.00	0.00	0.00	0.00	0.00	0.00	0.00	0.	180.	0.	180.	0.
38.000	0.000	0.000	0.000	0.000	241.92	18.64	-0.13	0.00	0.00	0.00	0.00	0.00	0.00	0.00	0.00	0.00	0.00	0.	190.	0.	190.	0.
40.000	0.000	0.000	0.000	0.000	246.79	19.06	-0.15	0.00	0.00	0.00	0.00	0.00	0.00	0.00	0.00	0.00	0.00	0.	191.	0.	191.	0.
42.000	0.000	0.000	0.000	0.000	252.30	19.15	-0.24	0.00	0.00	0.00	0.00	0.00	0.00	0.00	0.00	0.00	0.00	0.	194.	0.	194.	0.
44.000	0.000	0.000	0.000	0.000	256.85	18.94	-0.25	0.00	0.00	0.00	0.00	0.00	0.00	0.00	0.00	0.00	0.00	0.	191.	0.	191.	0.
46.000	0.000	0.000	0.000	0.000	261.94	18.44	-0.39	0.00	0.00	0.00	0.00	0.00	0.00	0.00	0.00	0.00	0.00	0.	190.	0.	190.	0.
48.000	0.000	0.000	0.000	0.000	266.06	17.43	-0.50	0.00	0.00	0.00	0.00	0.00	0.00	0.00	0.00	0.00	0.00	0.	190.	0.	190.	0.
50.000	0.000	0.000	0.000	0.000	268.36	16.47	-0.48	0.00	0.00	0.00	0.00	0.00	0.00	0.00	0.00	0.00	0.00	0.	184.	0.	184.	0.
52.000	0.000	0.000	0.000	0.000	269.80	15.65	-0.50	0.00	0.00	0.00	0.00	0.00	0.00	0.00	0.00	0.00	0.00	0.	178.	0.	178.	0.
54.000	0.000	0.000	0.000	0.000	270.75	14.31	-0.62	0.00	0.00	0.00	0.00	0.00	0.00	0.00	0.00	0.00	0.00	0.	170.	0.	170.	0.
56.000	0.000	0.000	0.000	0.000	270.08	12.72	-0.43	0.00	0.00	0.00	0.00	0.00	0.00	0.00	0.00	0.00	0.00	0.	159.	0.	159.	0.
58.000	0.000	0.000	0.000	0.000	268.69	12.53	-0.53	0.00	0.00	0.00	0.00	0.00	0.00	0.00	0.00	0.00	0.00	0.	152.	0.	152.	0.
60.000	0.000	0.000	0.000	0.000	266.95	12.29	-0.75	0.00	0.00	0.00	0.00	0.00	0.00	0.00	0.00	0.00	0.00	0.	139.	0.	139.	0.
62.000	0.000	0.000	0.000	0.000	264.20	12.62	-0.66	0.00	0.00	0.00	0.00	0.00	0.00	0.00	0.00	0.00	0.00	0.	111.	0.	111.	0.
64.000	0.000	0.000	0.000	0.000	261.59	13.39	-0.25	0.00	0.00	0.00	0.00	0.00	0.00	0.00	0.00	0.00	0.00	0.	91.	0.	91.	0.
66.000	0.000	0.000	0.000	0.000	258.88	14.85	0.01	0.00	0.00	0.00	0.00	0.00	0.00	0.00	0.00	0.00	0.00	0.	72.	0.	72.	0.
68.000	0.000	0.000	0.000	0.000	256.43	16.33	0.34	0.00	0.00	0.00	0.00	0.00	0.00	0.00	0.00	0.00	0.00	0.	51.	0.	51.	0.
70.000	0.000	0.000	0.000	0.000	259.89	18.82	-0.12	0.00	0.00	0.00	0.00	0.00	0.00	0.00	0.00	0.00	0.00	0.	22.	0.	22.	0.

## **APPENDIX D**

### **Thule Hydrostatic Model Atmospheres**

Tables D-1 through D-13 provide hydrostatic model atmospheres (monthly and annual) from 0 to 70 km over Thule. They were prepared as described in Chapter 3.

**TABLE D-1. January Hydrostatic Model Atmosphere, Thule.**

Z KM	GEO. HT KM	PRESS MB	D G/M <sup>3</sup>	TV K
0.000	0.000	1008.8855	1395.6579	251.84
0.059	0.059	1002.2545	1386.7739	251.79
1.000	1.002	881.5894	1211.1230	253.59
2.000	2.005	769.8327	1068.5292	251.00
3.000	3.007	670.9116	947.9930	246.56
4.000	4.009	582.8097	839.6116	241.83
5.000	5.012	504.9842	737.3080	238.61
6.000	6.014	435.2956	638.4783	237.52
7.000	7.016	373.7821	552.2875	235.78
8.000	8.018	319.7384	470.7846	233.40
9.000	9.021	272.7927	446.4938	212.85
10.000	10.023	232.4513	382.3654	211.79
11.000	11.025	197.9602	326.1429	211.46
12.000	12.028	168.3328	278.2298	210.78
13.000	13.030	143.3902	237.7939	210.08
14.000	14.032	121.7976	203.0020	209.02
15.000	15.035	104.0875	173.9329	208.48
16.000	16.037	88.9222	148.7685	208.24
17.000	17.039	75.8638	127.3619	207.52
18.000	18.041	65.4410	109.1634	208.85
19.000	19.044	56.0961	93.5648	208.87
20.000	20.046	48.9568	80.7338	211.26
21.000	21.048	41.7630	68.7665	211.58
22.000	22.051	35.6340	58.7818	211.19
23.000	23.053	30.7853	50.5837	212.03
24.000	24.055	26.2630	43.0750	212.41
25.000	25.057	22.5324	36.9494	212.45
26.000	26.060	19.3939	31.4066	215.13
27.000	27.062	16.3674	26.5154	215.05
28.000	28.064	14.2208	22.5408	219.79
29.000	29.067	12.0709	19.0355	220.92
30.000	30.069	10.5190	16.3828	223.69
32.000	32.074	7.0508	10.9241	112.43
34.000	34.078	5.0883	7.7825	113.89
36.000	36.083	3.8010	5.7399	115.35
38.000	38.087	2.8569	4.1954	118.62
40.000	40.092	2.1337	3.0669	121.19
42.000	42.096	1.6205	2.2934	123.08
44.000	44.101	1.2001	1.6794	124.48
46.000	46.106	0.9144	1.2700	125.41
48.000	48.110	0.6978	0.9607	126.51
50.000	50.115	0.5344	0.7278	127.91
52.000	52.119	0.4103	0.5540	129.01
54.000	54.124	0.3065	0.4062	131.40
56.000	56.128	0.2420	0.3230	130.54
58.000	58.133	0.1852	0.2502	128.95
60.000	60.138	0.1291	0.1748	128.67
62.000	62.142	0.0985	0.1335	128.48
64.000	64.147	0.0759	0.1023	129.27
66.000	66.151	0.0622	0.0836	129.66
68.000	68.156	0.0433	0.0576	130.98
70.000	70.161	0.0334	0.0452	128.58

**TABLE D-2. February Hydrostatic Model Atmosphere, Thule.**

Z KM	GEO. HT KM	PRESS MB	D G/M <sup>3</sup>	TV K
0.000	0.000	1010.4378	1415.8694	248.62
0.059	0.059	1004.0319	1407.5868	248.50
1.000	1.002	881.6567	1227.1297	250.30
2.000	2.005	768.6063	1077.7540	248.45
3.000	3.007	668.9128	952.0421	244.78
4.000	4.009	580.3303	839.6569	240.79
5.000	5.012	502.2603	733.7238	238.48
6.000	6.014	432.5395	636.4563	236.76
7.000	7.016	371.2070	551.2993	234.58
8.000	8.018	317.5368	483.3671	232.31
9.000	9.021	271.0237	440.3296	214.43
10.000	10.023	231.1632	376.4203	213.95
11.000	11.025	197.1504	320.8098	214.10
12.000	12.028	167.9560	273.8249	213.69
13.000	13.030	143.4082	233.9860	213.52
14.000	14.032	122.1753	199.8910	212.94
15.000	15.035	104.4184	171.0694	212.65
16.000	16.037	89.0357	145.7154	212.87
17.000	17.039	76.0042	124.4974	212.68
18.000	18.041	65.0596	105.9668	213.89
19.000	19.044	55.5538	90.4096	214.07
20.000	20.046	48.0564	77.0743	217.22
21.000	21.048	41.0492	65.6801	217.73
22.000	22.051	35.2033	56.1171	218.55
23.000	23.053	30.3835	48.0509	220.29
24.000	24.055	25.9545	40.8355	221.43
25.000	25.057	22.2431	34.9895	221.47
26.000	26.060	19.2956	29.8567	225.15
27.000	27.062	16.5793	25.4629	226.84
28.000	28.064	14.3292	21.9480	227.45
29.000	29.067	12.4008	18.9381	228.12
30.000	30.069	10.8079	16.3196	230.72
32.000	32.074	7.9370	12.6614	109.20
34.000	34.078	5.8947	9.3188	110.19
36.000	36.083	4.2715	6.6985	111.08
38.000	38.087	3.1767	4.9098	112.70
40.000	40.092	2.3713	3.5862	115.18
42.000	42.096	1.7806	2.6231	118.25
44.000	44.101	1.3409	1.9441	120.15
46.000	46.106	1.0562	1.4991	122.72
48.000	48.110	0.7988	1.1133	124.97
50.000	50.115	0.6101	0.8389	126.69
52.000	52.119	0.4638	0.6383	126.58
54.000	54.124	0.3528	0.4803	127.97
56.000	56.128	0.2680	0.3591	130.00
58.000	58.133	0.2038	0.2738	129.66
60.000	60.138	0.1506	0.2032	129.08
62.000	62.142	0.1149	0.1547	129.37
64.000	64.147	0.0961	0.1285	130.36
66.000	66.151	0.0000	0.0000	131.16
68.000	68.156	0.0000	0.0000	132.25
70.000	70.161	0.0000	0.0000	135.08

**TABLE D-3. March Hydrostatic Model Atmosphere, Thule.**

Z KM	GEO. HT KM	PRESS MB	D G/M <sup>3</sup>	TV K
0.000	0.000	1012.4417	1411.0784	249.96
0.059	0.059	1005.9723	1402.5171	249.88
1.000	1.002	883.4782	1228.1605	250.61
2.000	2.005	770.1628	1082.1274	247.95
3.000	3.007	670.1390	955.2738	244.40
4.000	4.009	581.3674	843.3505	240.16
5.000	5.012	503.0832	737.3192	237.71
6.000	6.014	433.3134	640.1990	235.80
7.000	7.016	372.1360	552.1082	234.11
8.000	8.018	318.6542	484.9311	232.69
9.000	9.021	272.4243	434.9755	218.19
10.000	10.023	233.0627	370.3309	219.25
11.000	11.025	199.4913	316.0774	219.92
12.000	12.028	170.7334	270.5192	219.88
13.000	13.030	146.2923	231.7758	219.89
14.000	14.032	125.2993	198.5123	219.90
15.000	15.035	107.4136	170.1507	219.93
16.000	16.037	92.0459	145.7401	220.03
17.000	17.039	78.8199	124.8361	219.96
18.000	18.041	67.6678	106.9339	220.46
19.000	19.044	57.9437	91.5810	220.42
20.000	20.046	49.7819	78.5526	220.78
21.000	21.048	42.6109	67.2344	220.79
22.000	22.051	36.5100	57.5912	220.86
23.000	23.053	31.3606	49.4076	221.13
24.000	24.055	26.8382	42.2430	221.34
25.000	25.057	23.0094	36.1701	221.62
26.000	26.060	19.7852	31.0043	222.32
27.000	27.062	16.9310	26.4463	223.04
28.000	28.064	14.5510	22.6497	223.82
29.000	29.067	12.4981	19.3770	224.71
30.000	30.069	10.8473	16.7400	225.75
32.000	32.074	7.6911	11.8230	113.32
34.000	34.078	5.7258	8.7384	114.14
36.000	36.083	4.2767	6.4610	115.30
38.000	38.087	3.2084	4.7940	116.58
40.000	40.092	2.4048	3.5550	117.83
42.000	42.096	1.8170	2.6463	119.60
44.000	44.101	1.3776	1.9730	121.63
46.000	46.106	1.0503	1.4673	124.68
48.000	48.110	0.8035	1.1081	126.30
50.000	50.115	0.6158	0.8405	127.63
52.000	52.119	0.4717	0.6375	128.89
54.000	54.124	0.3637	0.4836	131.02
56.000	56.128	0.2808	0.3709	131.85
58.000	58.133	0.2191	0.2896	131.77
60.000	60.138	0.1691	0.2239	131.55
62.000	62.142	0.1303	0.1728	131.33
64.000	64.147	0.1010	0.1342	131.08
66.000	66.151	0.0778	0.1047	129.43
68.000	68.156	0.0617	0.0829	129.58
70.000	70.161	0.0383	0.0456	146.08



**TABLE D-4. April Hydrostatic Model Atmosphere, Thule.**

Z KM	GEO. HT KM	PRESS MB	D G/M <sup>3</sup>	TV K
0.000	0.000	1017.1014	1379.9866	256.77
0.059	0.059	1010.6266	1371.9788	256.63
1.000	1.002	889.9873	1215.5424	255.08
2.000	2.005	777.6268	1075.5307	251.89
3.000	3.007	678.1870	953.8547	247.70
4.000	4.009	589.5035	845.6400	242.86
5.000	5.012	511.2032	745.8926	238.77
6.000	6.014	441.3515	650.1694	236.49
7.000	7.016	380.0006	559.7507	236.51
8.000	8.018	326.3562	490.7889	234.36
9.000	9.021	280.1491	434.9597	224.39
10.000	10.023	240.7899	370.2805	226.55
11.000	11.025	207.1740	316.8766	227.77
12.000	12.028	178.3197	272.2664	228.17
13.000	13.030	153.5404	234.3912	228.21
14.000	14.032	132.1824	202.0297	227.94
15.000	15.035	113.7699	174.1212	227.63
16.000	16.037	97.9703	150.1836	227.26
17.000	17.039	84.2439	129.3224	226.95
18.000	18.041	72.4985	111.4386	226.65
19.000	19.044	62.3246	95.9037	226.40
20.000	20.046	53.5901	82.5338	226.21
21.000	21.048	46.0767	71.0232	226.02
22.000	22.051	39.5957	61.0856	225.82
23.000	23.053	34.0248	52.5386	225.62
24.000	24.055	29.2447	45.1900	225.46
25.000	25.057	25.1193	38.7958	225.57
26.000	26.060	21.5939	33.3265	225.73
27.000	27.062	18.5540	28.6054	225.97
28.000	28.064	15.9606	24.5574	226.43
29.000	29.067	13.7398	21.0833	227.04
30.000	30.069	11.7947	18.0674	227.43
32.000	32.074	8.7837	13.1610	116.26
34.000	34.078	6.5475	9.6080	118.70
36.000	36.083	4.9019	7.0703	120.77
38.000	38.087	3.6916	5.2234	123.11
40.000	40.092	2.7960	3.8826	125.44
42.000	42.096	2.1324	2.8951	128.30
44.000	44.101	1.6368	2.1770	130.97
46.000	46.106	1.2474	1.6330	133.05
48.000	48.110	0.9686	1.2469	135.32
50.000	50.115	0.7403	0.9511	135.58
52.000	52.119	0.5771	0.7354	136.70
54.000	54.124	0.4468	0.5721	136.04
56.000	56.128	0.3480	0.4472	135.58
58.000	58.133	0.2712	0.3510	134.58
60.000	60.138	0.2113	0.2746	134.08
62.000	62.142	0.1667	0.2153	134.83
64.000	64.147	0.1258	0.1672	131.08
66.000	66.151	0.0993	0.1330	130.00
68.000	68.156	0.0689	0.0917	130.83
70.000	70.161	0.0465	0.0605	133.75

**TABLE D-5. May Hydrostatic Model Atmosphere, Thule.**

Z KM	GEO. HT KM	PRESS MB	D G/M <sup>3</sup>	TV K
0.000	0.000	1017.1269	1323.5660	267.72
0.059	0.059	1011.0099	1316.2935	267.58
1.000	1.002	894.1207	1182.2200	263.48
2.000	2.005	784.5650	1052.3399	259.73
3.000	3.007	687.1546	938.4197	255.10
4.000	4.009	599.6996	837.5100	249.46
5.000	5.012	522.2562	747.3464	243.46
6.000	6.014	453.0152	659.2468	239.40
7.000	7.016	391.6094	573.8773	237.73
8.000	8.018	337.0949	499.8465	234.95
9.000	9.021	289.9886	440.6666	229.26
10.000	10.023	249.2573	382.5294	227.01
11.000	11.025	214.5592	327.1449	228.49
12.000	12.028	184.8055	281.0867	229.05
13.000	13.030	159.1822	242.2804	228.89
14.000	14.032	137.1181	209.0144	228.55
15.000	15.035	118.0420	180.2401	228.16
16.000	16.037	101.6484	155.4846	227.76
17.000	17.039	87.4826	133.8886	227.63
18.000	18.041	75.2799	115.2681	227.52
19.000	19.044	64.7876	99.1955	227.54
20.000	20.046	55.7593	85.3345	227.64
21.000	21.048	47.9908	73.4263	227.70
22.000	22.051	41.2991	63.1566	227.81
23.000	23.053	35.5454	54.3356	227.91
24.000	24.055	30.6018	46.7629	227.98
25.000	25.057	26.3314	40.1722	228.35
26.000	26.060	22.6762	34.5372	228.74
27.000	27.062	19.5399	29.6846	229.32
28.000	28.064	16.8513	25.4846	230.36
29.000	29.067	14.5450	21.8857	231.53
30.000	30.069	12.5452	18.7810	232.71
32.000	32.074	9.7104	14.1918	119.19
34.000	34.078	7.3414	10.4629	122.22
36.000	36.083	5.5914	7.7936	124.97
38.000	38.087	4.2853	5.8100	128.48
40.000	40.092	3.2503	4.2959	131.79
42.000	42.096	2.4972	3.2251	134.88
44.000	44.101	1.9752	2.5084	137.16
46.000	46.106	1.5469	1.9357	139.20
48.000	48.110	1.2166	1.5034	140.95
50.000	50.115	0.9594	1.1657	143.35
52.000	52.119	0.7573	0.9196	143.44
54.000	54.124	0.6069	0.7375	143.33
56.000	56.128	0.4786	0.5865	142.13
58.000	58.133	0.3763	0.4675	140.23
60.000	60.138	0.2949	0.3723	137.97
62.000	62.142	0.2310	0.3016	133.44
64.000	64.147	0.1790	0.2399	130.01
66.000	66.151	0.1377	0.1894	126.58
68.000	68.156	0.1069	0.1496	124.48
70.000	70.161	0.0792	0.1183	116.58

**TABLE D-6. June Hydrostatic Model Atmosphere, Thule.**

Z KM	GEO. HT KM	PRESS MB	D G/M <sup>3</sup>	TV K
0.000	0.000	1012.1724	1281.4209	275.18
0.059	0.059	1006.7298	1275.4429	274.99
1.000	1.002	893.0473	1147.9089	271.03
2.000	2.005	786.3191	1028.3373	266.39
3.000	3.007	691.0166	920.7176	261.47
4.000	4.009	605.0820	824.2229	255.76
5.000	5.012	528.6942	738.1728	249.52
6.000	6.014	460.1661	659.9211	242.93
7.000	7.016	399.2410	583.3775	238.42
8.000	8.018	344.4789	506.9112	236.75
9.000	9.021	296.7201	435.8669	237.16
10.000	10.023	255.1057	373.4631	237.97
11.000	11.025	219.7100	323.4480	236.65
12.000	12.028	189.3838	276.9478	238.23
13.000	13.030	163.2851	239.8188	237.20
14.000	14.032	140.7667	213.0423	230.19
15.000	15.035	121.3184	183.7656	230.00
16.000	16.037	104.5715	158.4968	229.85
17.000	17.039	90.1445	136.5705	229.95
18.000	18.041	77.7086	117.5964	230.21
19.000	19.044	67.0215	101.2942	230.51
20.000	20.046	57.7851	87.2143	230.83
21.000	21.048	49.8529	75.1343	231.16
22.000	22.051	43.0023	64.7366	231.42
23.000	23.053	37.1048	55.7953	231.68
24.000	24.055	32.0175	48.0857	231.97
25.000	25.057	27.6537	41.4465	232.45
26.000	26.060	23.8748	35.6738	233.16
27.000	27.062	20.6249	30.7220	233.88
28.000	28.064	17.8422	26.4207	235.27
29.000	29.067	15.4603	22.7459	236.79
30.000	30.069	13.3816	19.5641	238.29
32.000	32.074	10.2270	14.5227	122.67
34.000	34.078	7.7708	10.8076	125.25
36.000	36.083	5.9310	8.1006	127.54
38.000	38.087	4.5494	6.0744	130.46
40.000	40.092	3.5163	4.5984	133.20
42.000	42.096	2.7339	3.4975	136.16
44.000	44.101	2.1376	2.6776	139.06
46.000	46.106	1.6788	2.0700	141.27
48.000	48.110	1.3250	1.6177	142.68
50.000	50.115	1.0506	1.2761	143.41
52.000	52.119	0.8306	1.0093	143.35
54.000	54.124	0.6534	0.7979	142.64
56.000	56.128	0.5142	0.6327	141.55
58.000	58.133	0.4055	0.5049	139.91
60.000	60.138	0.3177	0.4011	137.95
62.000	62.142	0.2479	0.3178	135.85
64.000	64.147	0.1924	0.2515	133.28
66.000	66.151	0.1507	0.2000	131.27
68.000	68.156	0.1162	0.1568	129.02
70.000	70.161	0.0893	0.1176	132.20

**TABLE D-7. July Hydrostatic Model Atmosphere, Thule.**

Z KM	GEO. HT KM	PRESS MB	D G/M <sup>3</sup>	TV K
0.000	0.000	1009.9110	1263.7715	278.40
0.059	0.059	1004.3162	1257.5251	278.23
1.000	1.002	892.3793	1130.8978	274.91
2.000	2.005	787.1066	1015.0330	270.15
3.000	3.007	692.9609	910.7835	265.06
4.000	4.009	607.9571	816.5706	259.38
5.000	5.012	532.1633	732.3653	253.15
6.000	6.014	464.1785	656.3148	246.39
7.000	7.016	403.4308	584.6540	240.40
8.000	8.018	348.8359	515.8142	235.61
9.000	9.021	300.7586	446.3851	234.73
10.000	10.023	258.5857	398.5842	226.02
11.000	11.025	222.5766	338.5573	229.04
12.000	12.028	191.8324	289.5285	230.83
13.000	13.030	165.4364	249.6757	230.84
14.000	14.032	142.6909	215.4725	230.71
15.000	15.035	123.0329	185.8666	230.61
16.000	16.037	106.0906	160.3427	230.51
17.000	17.039	91.5380	138.2579	230.66
18.000	18.041	78.9441	119.1046	230.91
19.000	19.044	68.1187	102.6459	231.20
20.000	20.046	58.7652	88.4196	231.54
21.000	21.048	50.7106	76.2021	231.84
22.000	22.051	43.7629	65.6990	232.06
23.000	23.053	37.7758	56.6532	232.30
24.000	24.055	32.6051	48.8454	232.55
25.000	25.057	28.1663	42.0908	233.13
26.000	26.060	24.3382	36.2286	234.04
27.000	27.062	21.0317	31.1808	234.99
28.000	28.064	18.2094	26.8473	236.29
29.000	29.067	15.7793	23.1232	237.74
30.000	30.069	13.6678	19.9056	239.21
32.000	32.074	10.3243	14.5652	123.47
34.000	34.078	7.8800	10.9130	125.78
36.000	36.083	6.0240	8.1948	128.05
38.000	38.087	4.6336	6.1826	130.55
40.000	40.092	3.5734	4.6901	132.72
42.000	42.096	2.7782	3.5757	135.34
44.000	44.101	2.1694	2.7467	137.58
46.000	46.106	1.7006	2.1201	139.72
48.000	48.110	1.3340	1.6437	141.37
50.000	50.115	1.0519	1.2858	142.50
52.000	52.119	0.8326	1.0142	143.00
54.000	54.124	0.6569	0.8009	142.87
56.000	56.128	0.5133	0.6296	142.00
58.000	58.133	0.4046	0.5011	140.66
60.000	60.138	0.3179	0.3991	138.75
62.000	62.142	0.2490	0.3215	134.91
64.000	64.147	0.1938	0.2551	132.33
66.000	66.151	0.1526	0.2051	129.58
68.000	68.156	0.1169	0.1634	124.58
70.000	70.161	0.0897	0.1310	119.25

**TABLE D-8. August Hydrostatic Model Atmosphere, Thule.**

Z KM	GEO. HT KM	PRESS MB	D G/M <sup>3</sup>	TV K
0.000	0.000	1010.0282	1269.2669	277.23
0.059	0.059	1004.2276	1262.9333	277.02
1.000	1.002	891.8835	1139.2205	272.75
2.000	2.005	786.0165	1021.1031	268.18
3.000	3.007	691.3726	914.7977	263.30
4.000	4.009	606.0118	819.7867	257.54
5.000	5.012	529.9805	735.0684	251.18
6.000	6.014	461.7514	657.6615	244.60
7.000	7.016	400.9565	583.3500	239.46
8.000	8.018	346.2529	512.1134	235.55
9.000	9.021	298.2572	451.7341	230.02
10.000	10.023	256.1100	398.3925	223.96
11.000	11.025	220.1240	338.3871	226.63
12.000	12.028	189.4134	288.8113	228.48
13.000	13.030	163.1354	248.3346	228.86
14.000	14.032	140.5233	213.8592	228.92
15.000	15.035	121.0349	184.2435	228.86
16.000	16.037	104.2492	158.7237	228.82
17.000	17.039	89.8206	136.7178	228.88
18.000	18.041	77.3618	117.7505	228.89
19.000	19.044	66.6467	101.4022	228.98
20.000	20.046	57.4098	87.3473	228.98
21.000	21.048	49.4768	75.2775	228.98
22.000	22.051	42.6174	64.8111	229.08
23.000	23.053	36.7242	55.8142	229.23
24.000	24.055	31.6357	48.0477	229.38
25.000	25.057	27.2732	41.3369	229.86
26.000	26.060	23.5176	35.5397	230.53
27.000	27.062	20.2948	30.5611	231.35
28.000	28.064	17.5182	26.2472	232.52
29.000	29.067	15.1501	22.5716	233.84
30.000	30.069	13.0865	19.3973	235.04
32.000	32.074	9.8799	14.2506	120.77
34.000	34.078	7.4838	10.6421	122.50
36.000	36.083	5.6926	7.9472	124.77
38.000	38.087	4.3389	5.9545	126.93
40.000	40.092	3.3347	4.4923	129.30
42.000	42.096	2.5771	3.4110	131.60
44.000	44.101	2.0013	2.6031	133.92
46.000	46.106	1.5586	1.9965	135.99
48.000	48.110	1.2198	1.5464	137.41
50.000	50.115	0.9518	1.1992	138.26
52.000	52.119	0.7443	0.9338	138.85
54.000	54.124	0.5925	0.7454	138.47
56.000	56.128	0.4693	0.5942	137.58
58.000	58.133	0.3591	0.4575	136.72
60.000	60.138	0.2834	0.3645	135.42
62.000	62.142	0.2184	0.2845	133.75
64.000	64.147	0.1644	0.2182	131.27
66.000	66.151	0.1116	0.1513	128.48
68.000	68.156	0.0854	0.1156	128.58
70.000	70.161	0.0000	0.0000	131.33

**TABLE D-9. September Hydrostatic Model Atmosphere, Thule.**

Z KM	GEO. HT KM	PRESS MB	D G/M <sup>3</sup>	TV K
0.000	0.000	1010.3434	1296.7589	271.44
0.059	0.059	1004.3656	1290.0290	271.24
1.000	1.002	889.7635	1159.7472	267.28
2.000	2.005	782.1189	1036.7433	262.82
3.000	3.007	685.9935	927.4362	257.69
4.000	4.009	599.4899	829.4450	251.80
5.000	5.012	522.6970	741.9670	245.43
6.000	6.014	453.8717	657.7713	240.39
7.000	7.016	392.6428	574.0848	238.28
8.000	8.018	337.8737	500.3023	235.28
9.000	9.021	290.2964	456.8198	221.39
10.000	10.023	248.7486	390.4101	221.97
11.000	11.025	213.4280	331.5221	224.28
12.000	12.028	183.3566	283.2277	225.54
13.000	13.030	157.5646	243.3084	225.61
14.000	14.032	135.4090	209.2574	225.44
15.000	15.035	116.3560	180.0522	225.14
16.000	16.037	100.0760	155.0898	224.80
17.000	17.039	85.9137	133.4343	224.31
18.000	18.041	73.7590	114.8062	223.82
19.000	19.044	63.3296	98.7905	223.33
20.000	20.046	54.3329	84.9531	222.81
21.000	21.048	46.6183	73.0134	222.44
22.000	22.051	39.9701	62.6843	222.14
23.000	23.053	34.2666	53.8080	221.86
24.000	24.055	29.3943	46.1833	221.74
25.000	25.057	25.2034	39.5518	222.00
26.000	26.060	21.6179	33.8720	222.35
27.000	27.062	18.5802	29.0112	223.12
28.000	28.064	15.9557	24.8236	223.93
29.000	29.067	13.7252	21.2622	224.89
30.000	30.069	11.7724	18.1741	225.67
32.000	32.074	7.6817	11.7346	114.03
34.000	34.078	5.7137	8.6486	115.08
36.000	36.083	4.2740	6.3416	117.40
38.000	38.087	3.2136	4.6938	119.26
40.000	40.092	2.4115	3.4493	121.78
42.000	42.096	1.8383	2.5715	124.53
44.000	44.101	1.4092	1.9446	126.23
46.000	46.106	1.0832	1.4732	128.08
48.000	48.110	0.8361	1.1140	130.73
50.000	50.115	0.6498	0.8563	132.18
52.000	52.119	0.5047	0.6658	132.03
54.000	54.124	0.3920	0.5158	132.38
56.000	56.128	0.3046	0.4014	132.18
58.000	58.133	0.2365	0.3123	131.93
60.000	60.138	0.2072	0.2734	132.01
62.000	62.142	0.1614	0.2139	131.45
64.000	64.147	0.1156	0.1564	128.75
66.000	66.151	0.0894	0.1209	128.75
68.000	68.156	0.0689	0.0947	126.75
70.000	70.161	0.0000	0.0000	0.00

**TABLE D-10. October Hydrostatic Model Atmosphere, Thule.**

Z KM	GEO. HT KM	PRESS MB	D G/M <sup>3</sup>	TV K
0.000	0.000	1008.8935	1333.6902	263.54
0.059	0.059	1002.9280	1326.3610	263.43
1.000	1.002	886.1281	1179.0230	261.84
2.000	2.005	776.7969	1050.0003	257.74
3.000	3.007	679.4180	937.0772	252.59
4.000	4.009	592.1345	835.7113	246.84
5.000	5.012	514.9237	742.6665	241.55
6.000	6.014	445.6890	650.0073	238.88
7.000	7.016	384.3867	561.7609	238.38
8.000	8.018	329.9277	488.3890	235.35
9.000	9.021	282.8021	449.1823	219.34
10.000	10.023	242.0364	383.1824	220.06
11.000	11.025	207.3093	326.1242	221.46
12.000	12.028	177.6178	279.0437	221.75
13.000	13.030	152.2774	239.5965	221.42
14.000	14.032	130.4006	205.8472	220.69
15.000	15.035	111.6667	176.9233	219.89
16.000	16.037	95.6298	152.1795	218.92
17.000	17.039	81.7385	130.7763	217.75
18.000	18.041	69.9339	112.4789	216.61
19.000	19.044	59.6632	96.5241	215.34
20.000	20.046	51.0345	82.9309	214.39
21.000	21.048	43.4879	70.9310	213.59
22.000	22.051	37.0716	60.7169	212.71
23.000	23.053	31.6835	52.0520	212.06
24.000	24.055	27.0840	44.5124	211.98
25.000	25.057	23.0478	37.9655	211.49
26.000	26.060	19.7964	32.5525	211.87
27.000	27.062	16.8853	27.7120	212.27
28.000	28.064	14.3994	23.5911	212.64
29.000	29.067	12.2782	20.0797	213.03
30.000	30.069	10.4952	17.1316	213.43
32.000	32.074	7.1589	11.8031	105.65
34.000	34.078	5.1896	8.5621	105.58
36.000	36.083	3.7748	6.1156	107.52
38.000	38.087	2.7848	4.4179	109.80
40.000	40.092	2.0500	3.2084	111.30
42.000	42.096	1.5157	2.3302	113.30
44.000	44.101	1.1305	1.6908	116.47
46.000	46.106	0.8489	1.2395	119.30
48.000	48.110	0.6414	0.9151	122.08
50.000	50.115	0.4883	0.6725	126.47
52.000	52.119	0.3747	0.5102	127.91
54.000	54.124	0.2879	0.3894	128.80
56.000	56.128	0.2219	0.2964	130.41
58.000	58.133	0.1715	0.2271	131.58
60.000	60.138	0.1284	0.1697	131.83
62.000	62.142	0.1014	0.1328	133.01
64.000	64.147	0.0786	0.1034	132.37
66.000	66.151	0.0585	0.0778	130.83
68.000	68.156	0.0426	0.0587	126.45
70.000	70.161	0.0339	0.0442	133.58

**TABLE D-11. November Hydrostatic Model Atmosphere, Thule.**

Z KM	GEO. HT KM	PRESS MB	D G/M <sup>3</sup>	TV K
0.000	0.000	1009.3673	1371.9563	256.31
0.059	0.059	1003.0324	1363.5602	256.27
1.000	1.002	883.4831	1203.1905	255.81
2.000	2.005	772.3291	1067.9066	251.96
3.000	3.007	673.5127	948.8778	247.28
4.000	4.009	585.3576	842.5767	242.03
5.000	5.012	507.5618	742.5783	238.12
6.000	6.014	437.9409	642.4636	237.48
7.000	7.016	376.5725	556.2714	235.84
8.000	8.018	322.6022	487.2341	233.70
9.000	9.021	275.8610	442.2546	217.31
10.000	10.023	235.8229	376.5552	218.18
11.000	11.025	201.7470	320.9039	219.02
12.000	12.028	172.5421	274.6950	218.83
13.000	13.030	147.6662	235.5855	218.37
14.000	14.032	126.1607	202.1355	217.44
15.000	15.035	107.7802	173.5181	216.40
16.000	16.037	92.1192	148.9932	215.40
17.000	17.039	78.5380	127.8380	214.03
18.000	18.041	67.1890	109.6873	213.40
19.000	19.044	57.1591	93.8345	212.22
20.000	20.046	49.0434	80.5455	212.13
21.000	21.048	41.8454	68.8036	211.88
22.000	22.051	35.6602	58.7862	211.33
23.000	23.053	30.6613	50.4050	211.92
24.000	24.055	26.1560	43.0274	211.78
25.000	25.057	22.2951	36.7431	211.39
26.000	26.060	19.2769	31.4962	213.22
27.000	27.062	16.4923	27.0061	212.75
28.000	28.064	14.1486	23.1570	212.86
29.000	29.067	12.0092	19.7589	211.74
30.000	30.069	10.5449	17.1578	214.11
32.000	32.074	6.7421	11.3468	103.50
34.000	34.078	4.8736	8.0900	104.94
36.000	36.083	3.5444	5.7582	107.22
38.000	38.087	2.5936	4.1458	108.97
40.000	40.092	1.9111	3.0134	110.47
42.000	42.096	1.4049	2.1614	113.22
44.000	44.101	1.0469	1.5672	116.37
46.000	46.106	0.7879	1.1375	120.65
48.000	48.110	0.5972	0.8391	123.96
50.000	50.115	0.4619	0.6378	126.15
52.000	52.119	0.3535	0.4853	126.89
54.000	54.124	0.2705	0.3682	127.99
56.000	56.128	0.2106	0.2827	129.79
58.000	58.133	0.1623	0.2165	130.53
60.000	60.138	0.1261	0.1690	130.02
62.000	62.142	0.0982	0.1322	129.44
64.000	64.147	0.0768	0.1053	127.00
66.000	66.151	0.0580	0.0817	123.70
68.000	68.156	0.0472	0.0643	127.91
70.000	70.161	0.0368	0.0478	134.33



**TABLE D-12. December Hydrostatic Model Atmosphere, Thule.**

Z KM	GEO. HT KM	PRESS MB	D G/M <sup>3</sup>	TV K
0.000	0.000	1008.5547	1392.0751	252.40
0.059	0.059	1002.0635	1383.8305	252.27
1.000	1.002	881.3478	1213.1016	253.11
2.000	2.005	769.1800	1072.8188	249.78
3.000	3.007	669.8338	949.6773	245.72
4.000	4.009	581.4081	838.7794	241.49
5.000	5.012	503.4232	735.3312	238.51
6.000	6.014	433.7821	637.9720	236.88
7.000	7.016	372.5948	550.3826	235.85
8.000	8.018	318.7623	472.5798	232.91
9.000	9.021	272.1625	441.7566	214.64
10.000	10.023	232.0929	377.5494	214.16
11.000	11.025	197.9998	321.9654	214.25
12.000	12.028	168.6733	275.0240	213.66
13.000	13.030	143.9436	235.6371	212.82
14.000	14.032	122.5431	201.6361	211.73
15.000	15.035	104.4993	172.8506	210.62
16.000	16.037	89.1207	147.8164	210.05
17.000	17.039	75.7599	126.5569	208.55
18.000	18.041	65.3692	108.5015	209.89
19.000	19.044	55.5932	92.7696	208.77
20.000	20.046	48.2386	79.6963	210.87
21.000	21.048	41.2941	68.2614	210.75
22.000	22.051	35.2118	58.4688	209.81
23.000	23.053	30.6377	50.5390	211.20
24.000	24.055	26.2666	43.2539	211.56
25.000	25.057	22.5471	37.1822	211.26
26.000	26.060	19.4557	32.0433	211.53
27.000	27.062	16.5549	27.2705	211.49
28.000	28.064	14.3293	23.3908	213.42
29.000	29.067	12.0381	19.7142	212.73
30.000	30.069	10.5050	17.0499	214.65
32.000	32.074	5.9008	10.0509	102.27
34.000	34.078	4.2520	7.1070	104.22
36.000	36.083	3.0882	4.9826	107.96
38.000	38.087	2.2564	3.5287	111.39
40.000	40.092	1.6672	2.5197	115.26
42.000	42.096	1.2453	1.8265	118.76
44.000	44.101	0.9366	1.3380	121.93
46.000	46.106	0.7101	0.9875	125.25
48.000	48.110	0.5411	0.7359	128.08
50.000	50.115	0.4141	0.5579	129.29
52.000	52.119	0.3211	0.4285	130.54
54.000	54.124	0.2484	0.3277	132.04
56.000	56.128	0.1919	0.2530	132.08
58.000	58.133	0.1475	0.1960	131.08
60.000	60.138	0.1188	0.1592	130.02
62.000	62.142	0.0909	0.1228	128.87
64.000	64.147	0.0696	0.0935	129.66
66.000	66.151	0.0489	0.0647	131.68
68.000	68.156	0.0000	0.0000	129.33
70.000	70.161	0.0000	0.0000	135.08

**TABLE D-13. Annual Hydrostatic Model Atmosphere, Thule.**

Z KM	GEO. HT KM	PRESS MB	D G/M <sup>3</sup>	TV K
0.000	0.000	1011.2407	1340.2838	262.85
0.059	0.059	1005.1081	1333.1812	262.65
1.000	1.002	887.5266	1184.1816	261.11
2.000	2.005	777.7683	1052.4462	257.46
3.000	3.007	680.2238	936.4043	253.07
4.000	4.009	592.9102	831.8560	248.31
5.000	5.012	515.6156	734.1957	244.66
6.000	6.014	446.4720	642.6902	242.02
7.000	7.016	385.2854	561.1967	239.18
8.000	8.018	331.0531	489.2945	235.71
9.000	9.021	284.0387	422.6920	234.11
10.000	10.023	243.3721	356.2857	237.97
11.000	11.025	208.7498	307.3129	236.65
12.000	12.028	179.0926	261.8983	238.23
13.000	13.030	153.9441	226.0996	237.20
14.000	14.032	132.1958	206.7796	222.72
15.000	15.035	113.6011	177.9092	222.45
16.000	16.037	98.0689	153.3428	222.81
17.000	17.039	84.1104	131.7861	222.35
18.000	18.041	72.7317	113.5868	223.08
19.000	19.044	62.4721	97.6386	222.91
20.000	20.046	54.0724	84.1969	223.74
21.000	21.048	46.6115	72.4623	224.10
22.000	22.051	40.0919	62.3068	224.17
23.000	23.053	34.5952	53.6680	224.57
24.000	24.055	29.8960	46.2413	225.24
25.000	25.057	25.6832	39.6902	225.44
26.000	26.060	22.2425	34.1936	226.62
27.000	27.062	19.2444	29.4391	227.74
28.000	28.064	16.5996	25.2724	228.83
29.000	29.067	14.3472	21.7289	230.03
30.000	30.069	12.3992	18.6827	231.21
32.000	32.074	8.6006	13.0198	115.07
34.000	34.078	6.4603	9.6547	116.56
36.000	36.083	4.8546	7.1344	118.53
38.000	38.087	3.6846	5.3060	120.96
40.000	40.092	2.8013	3.9544	123.40
42.000	42.096	2.1466	2.9640	126.15
44.000	44.101	1.6404	2.2250	128.43
46.000	46.106	1.2739	1.6943	130.97
48.000	48.110	0.9933	1.3006	133.03
50.000	50.115	0.7647	0.9928	134.18
52.000	52.119	0.5972	0.7711	134.90
54.000	54.124	0.4677	0.6018	135.38
56.000	56.128	0.3580	0.4617	135.04
58.000	58.133	0.2777	0.3600	134.34
60.000	60.138	0.2217	0.2894	133.48
62.000	62.142	0.1659	0.2188	132.10
64.000	64.147	0.1308	0.1742	130.79
66.000	66.151	0.1026	0.1380	129.44
68.000	68.156	0.0828	0.1125	128.22
70.000	70.161	0.0657	0.0880	129.94

## APPENDIX E

### Wind Statistics Derivable from Appendix A Tables

Appendix E gives a few graphic examples of certain wind statistics that can be derived from basic data in Appendix A. These examples should help RRA users understand the functional relationships of the probability wind models and develop an appreciation for the powerful properties of the bivariate normal probability distribution function. Only a few of the many options in deriving wind statistics are illustrated here.

All illustrations for this appendix were derived for the five wind component statistical parameters from Table A-1 (January) and Table A-7 (July) for eight selected altitudes; these are: 4, 12, 20, 30, 40, 50, 60, and 70 km. Descriptions of Tables E-1 and E-2 and Figures E-1 through E-64 follow:

#### Wind Speed (Tables E-1 and E-2)

The five wind components from Appendix A are used as inputs to the generalized Rayleigh probability density function (equation 29), then integrated as indicated by equation 30 to obtain the probability distribution function for wind speed. The derived distribution functions for wind speed are shown in Tables E-1 and E-2 on the normal probability scale.

#### Frequency of Wind Direction (Figures E-1 through E-16)

The derived frequencies for wind direction shown in Figures E-1 through E-16 were obtained using the five wind component parameters from Tables A-1 and A-7 as input values in equation 35. The limits of integration (performed numerically) are over the 22.5-degree interval for each of the 16 compass points. The graphs give the percentage frequency that the wind will blow from the direction intervals.

#### Mean Wind Components and 80th Interpercentile Range of Wind Components (Figures E-17 through E-32)

Wind component means with respect to any orthogonal axis are obtained by using the zonal and meridional mean wind components in equations 44 and 45. These component means form the circle shown in Figures E-17 through E-32. The zonal and meridional wind component variances and correlation coefficients are then used in equations 46 and 47 to obtain the variances with respect to any orthogonal axis. These rotated component variances and the rotated component means are used in equation 8 to obtain the 80th interpercentile range of wind components, as shown in Figures E-17 through E-32.

#### Probability Ellipses (Figures E-33 through E-48)

Using the five wind component parameters from Tables A-1 and A-7, and  $p = 0.50$ ,  $p = 0.95$ , and  $p = 0.99$  as input values to equation 13, the wind probability ellipses shown in Figures E-33 through E-48 were produced with computer graphics, using the standard meteorological coordinate system explained in Chapter 1. Statistical inferences are, for example, that 50 percent of the wind vectors lie within the smaller ellipse, and that 99 percent lie within the outer ellipse.

### **Conditional Wind Speed Given Wind Direction (Figures E-49 through E-64)**

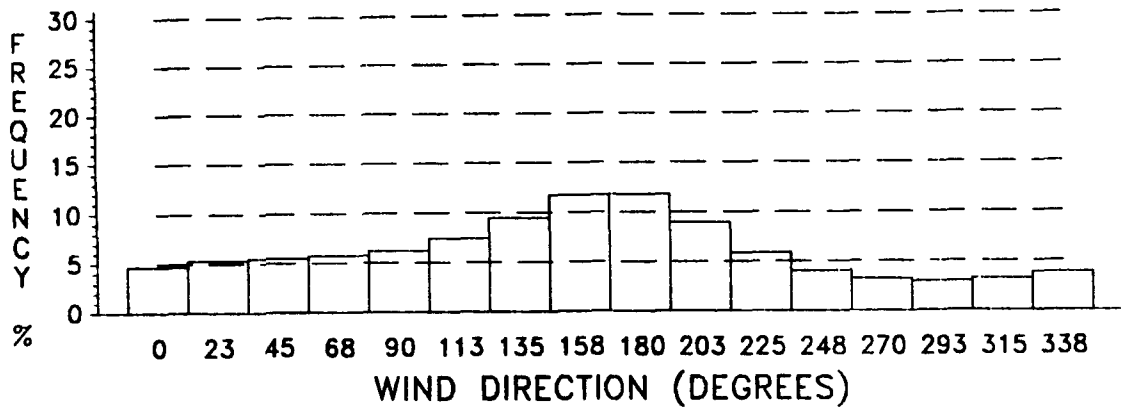
The five wind component parameters from Tables A-1 and A-7 were used to evaluate the conditional probability distribution function, equation 41. Interpolations of the conditional function are made to obtain the 5th, 15th, 50th (median), 85th, 95th, and 99th conditional percentile values of wind speed, given wind directions, are as shown in Figures E-49 through E-64. The conditional mean wind speed, given wind direction, is obtained from equation 40. The conditional mode (most probable) wind speed given wind direction is obtained from equation 38. The conditional mean wind speed and the conditional wind speed modal value, given the wind direction, are also shown. For some figures, conditional wind speed values are invalid for a given wind direction near 270 degrees (from the west); this is caused by the lack of computational precision in evaluating equations 40 and 41 when arguments for the Gaussian probability distribution have large negative values; i.e., when the coefficients (b/a) become less than -4 in these equations.

**TABLE E-1. Derived (Rayleigh) Percentiles for Windspeed (M/S), January.**

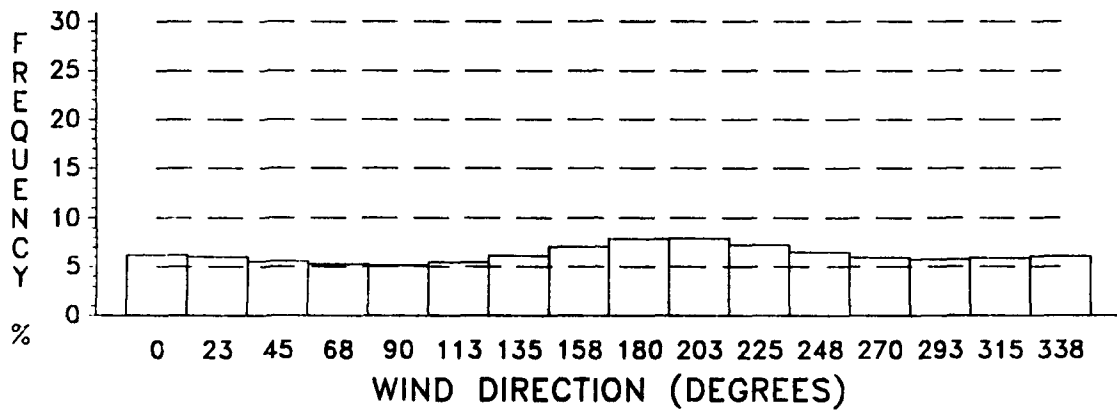
PERCENTILE	ALTITUDE (KM)							
	4 KM	12 KM	20 KM	30 KM	40 KM	50 KM	60 KM	70 KM
0.010	1.169	1.292	2.520	0.000	6.000	5.788	5.259	0.000
0.025	1.864	2.047	4.005	0.000	9.491	9.195	8.327	0.000
0.050	2.655	2.921	5.715	0.000	13.500	13.116	11.857	0.000
0.100	3.807	4.183	8.190	0.000	19.345	18.786	17.024	0.000
0.150	4.731	5.197	10.193	0.000	24.025	23.349	21.153	0.000
0.200	5.545	6.091	11.959	0.000	28.125	27.375	24.797	0.000
0.300	7.019	7.701	15.166	0.000	35.521	34.632	31.429	0.000
0.400	8.412	9.219	18.220	0.000	42.478	41.482	37.715	0.000
0.500	9.813	10.744	21.326	0.000	49.473	48.378	44.104	0.000
0.600	11.304	12.357	24.661	0.000	56.896	55.694	50.978	0.000
0.700	12.990	14.175	28.487	0.000	65.288	63.944	58.867	0.000
0.800	15.073	16.402	33.277	0.000	75.712	74.113	68.827	0.000
0.850	16.400	17.814	36.394	0.000	82.408	80.624	75.359	0.000
0.900	18.133	19.644	40.477	0.000	91.188	89.042	83.959	0.000
0.950	20.798	22.443	46.812	0.000	104.878	101.946	97.575	0.000
0.975	23.189	24.933	52.511	0.000	117.377	113.560	110.034	0.000
0.990	26.106	27.938	59.431	0.000	132.615	127.638	125.029	0.000

**TABLE E-2. Derived (Rayleigh) Percentiles for Windspeed (M/S), July.**

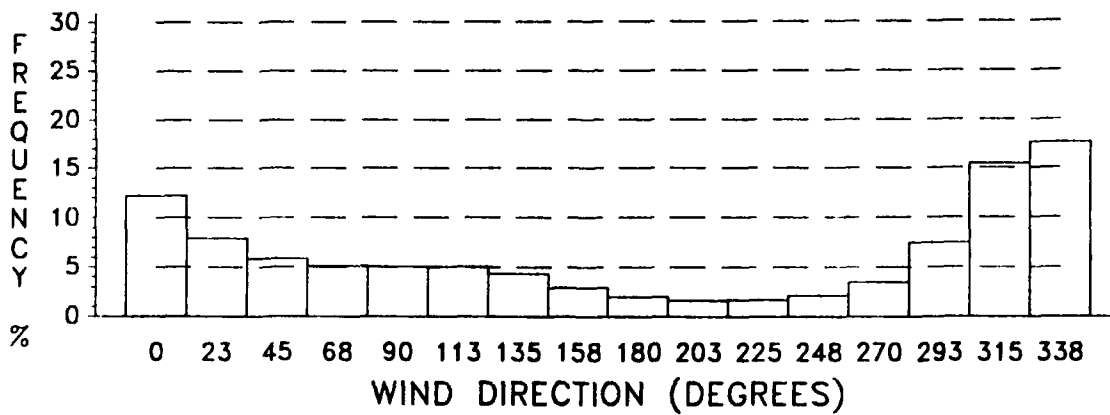
PERCENTILE	ALTITUDE (KM)							
	4 KM	12 KM	20 KM	30 KM	40 KM	50 KM	60 KM	70 KM
0.010	0.842	0.820	0.415	0.878	1.025	8.373	5.204	0.000
0.025	1.337	1.301	0.658	1.362	1.630	9.896	7.656	0.000
0.050	1.903	1.852	0.933	1.875	2.318	11.221	9.996	0.000
0.100	2.729	2.653	1.331	2.556	3.329	12.777	12.860	0.000
0.150	3.391	3.294	1.643	3.054	4.158	13.840	14.853	0.000
0.200	3.976	3.860	1.914	3.464	4.908	14.690	16.458	0.000
0.300	5.029	4.883	2.394	4.151	6.321	16.091	19.107	0.000
0.400	6.024	5.847	2.834	4.754	7.715	17.300	21.390	0.000
0.500	7.022	6.813	3.265	5.324	9.142	18.438	23.543	0.000
0.600	8.081	7.839	3.710	5.902	10.640	19.587	25.700	0.000
0.700	9.277	8.994	4.200	6.525	12.291	20.824	28.021	0.000
0.800	10.747	10.408	4.786	7.259	14.255	22.284	30.753	0.000
0.850	11.681	11.310	5.153	7.713	15.473	23.187	32.432	0.000
0.900	12.893	12.476	5.617	8.286	17.011	24.324	34.546	0.000
0.950	14.754	14.254	6.313	9.141	19.298	26.026	37.688	0.000
0.975	16.413	15.854	6.927	9.882	21.296	27.513	40.420	0.000
0.990	18.442	17.739	7.647	10.755	23.628	29.262	43.586	0.000



**Figure E-1. Wind Direction Frequency, January, 4 KM.**



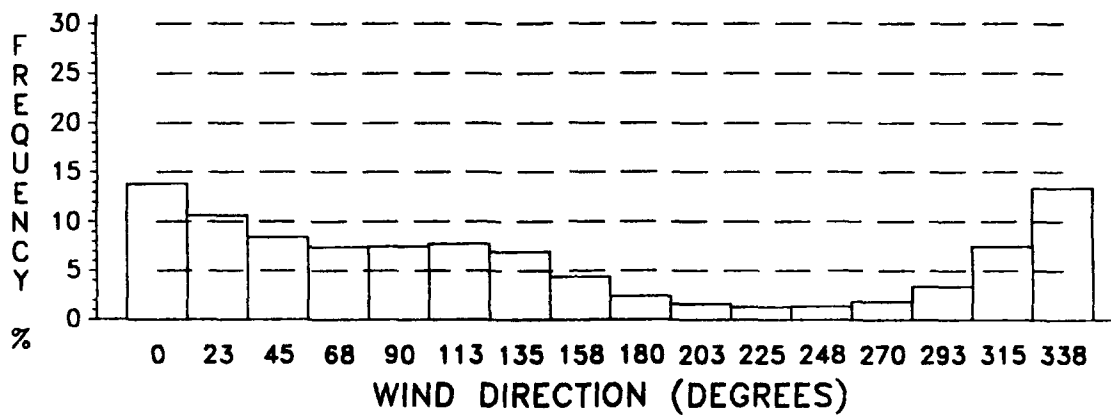
**Figure E-2. Wind Direction Frequency, January, 12 KM.**



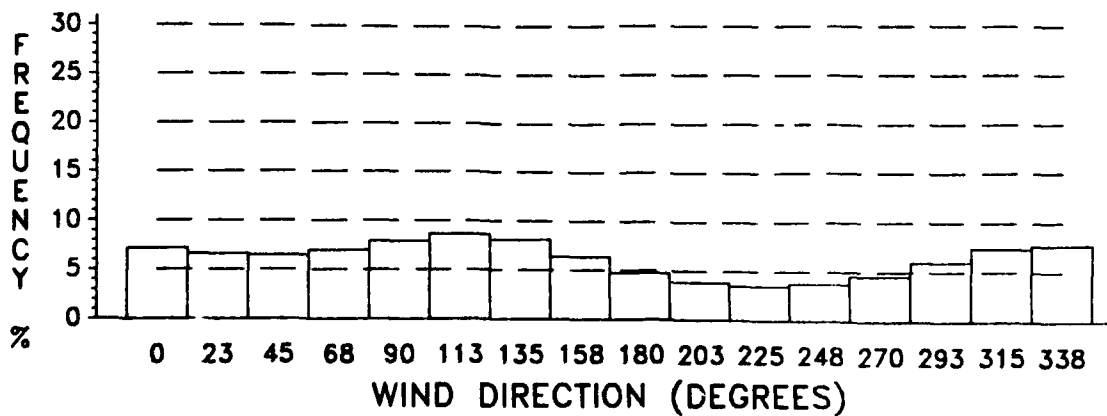
**Figure E-3. Wind Direction Frequency, January, 20 KM.**

# NO DATA AVAILABLE

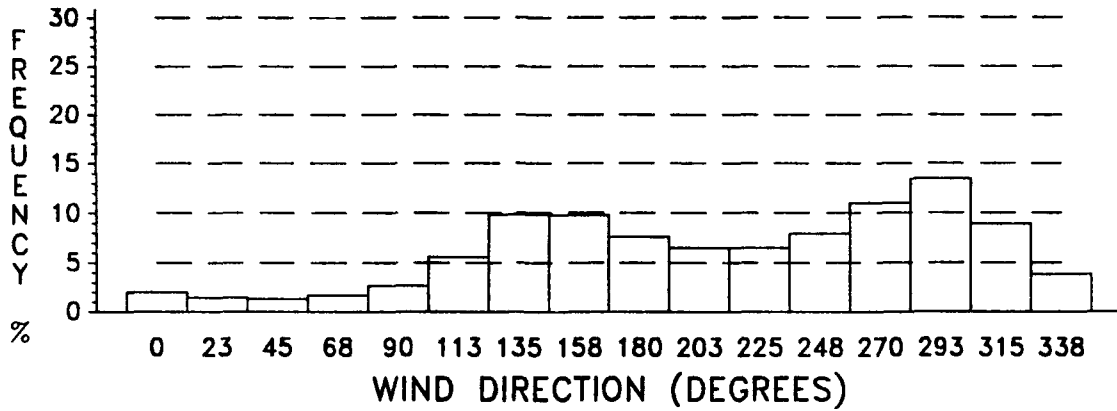
**Figure E-4. Wind Direction Frequency, January, 30 KM.**



**Figure E-5. Wind Direction Frequency, January, 40 KM.**



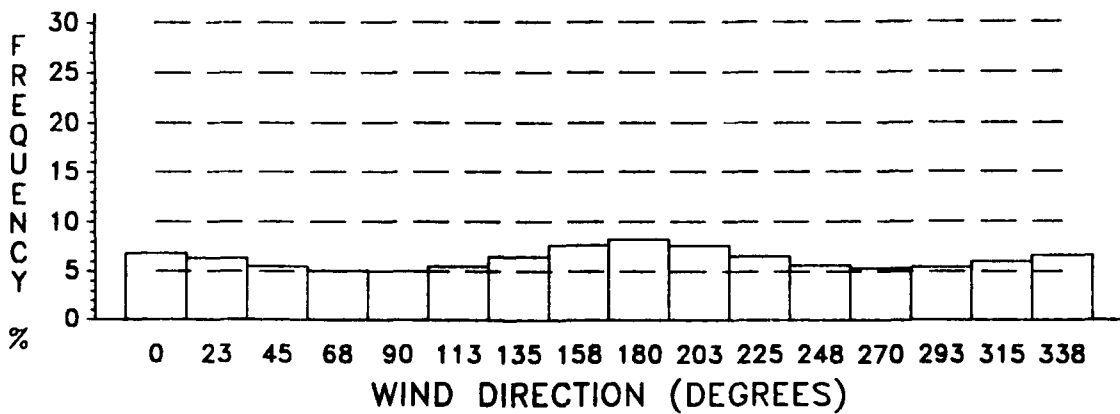
**Figure E-6. Wind Direction Frequency, January, 50 KM.**



**Figure E-7. Wind Direction Frequency, January, 60 KM.**

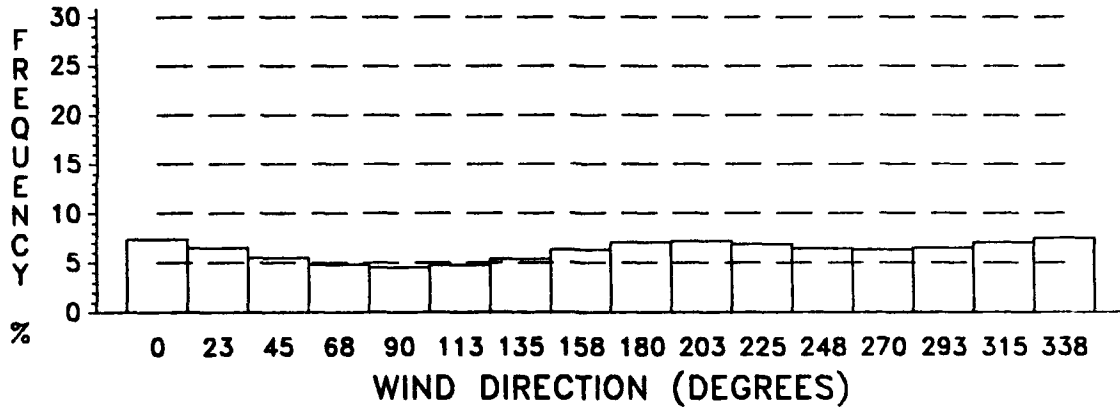
**NO DATA AVAILABLE**

**Figure E-8. Wind Direction Frequency, January, 70 KM.**

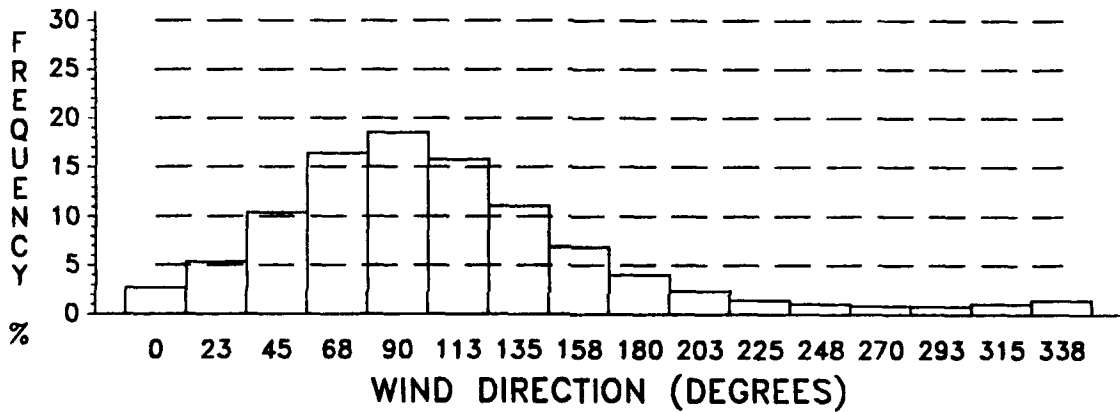


**Figure E-9. Wind Direction Frequency, July, 4 KM.**

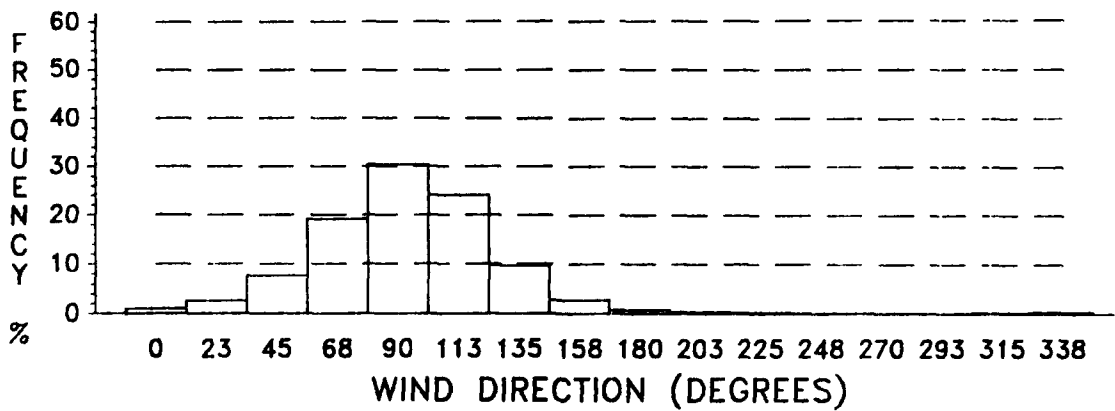




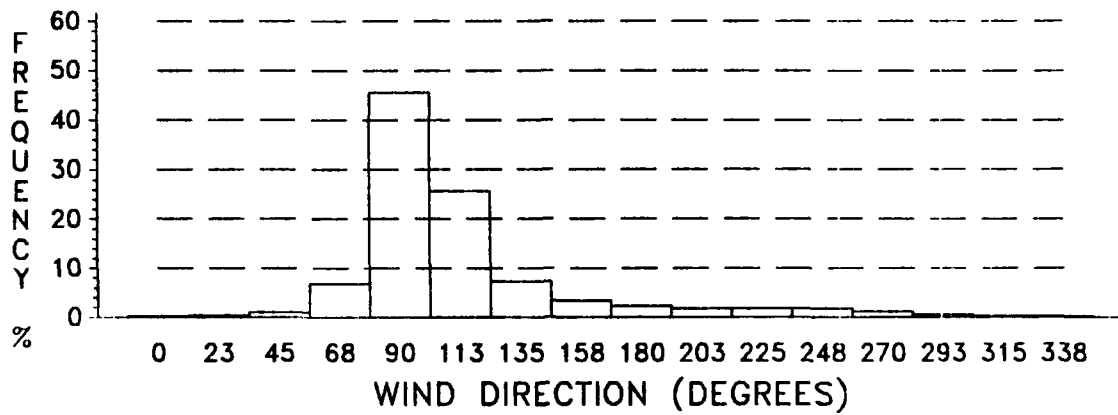
**Figure E-10. Wind Direction Frequency, July, 12 KM.**



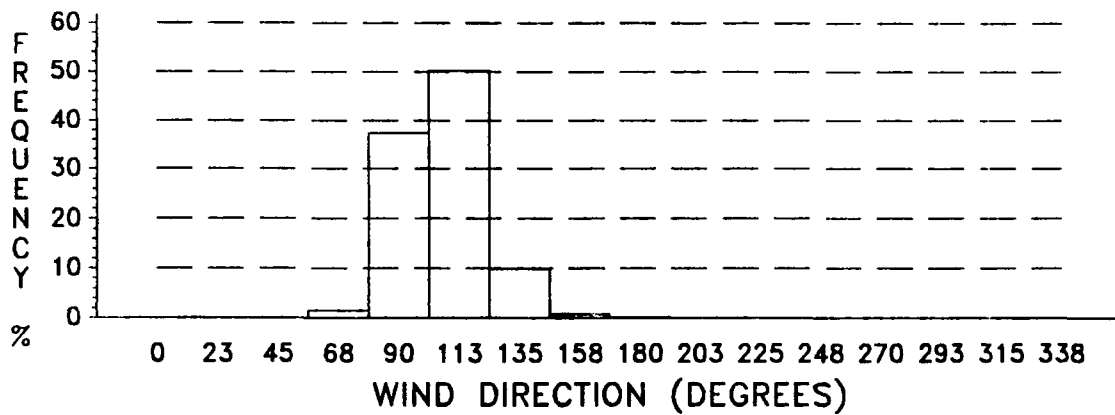
**Figure E-11. Wind Direction Frequency, July, 20 KM.**



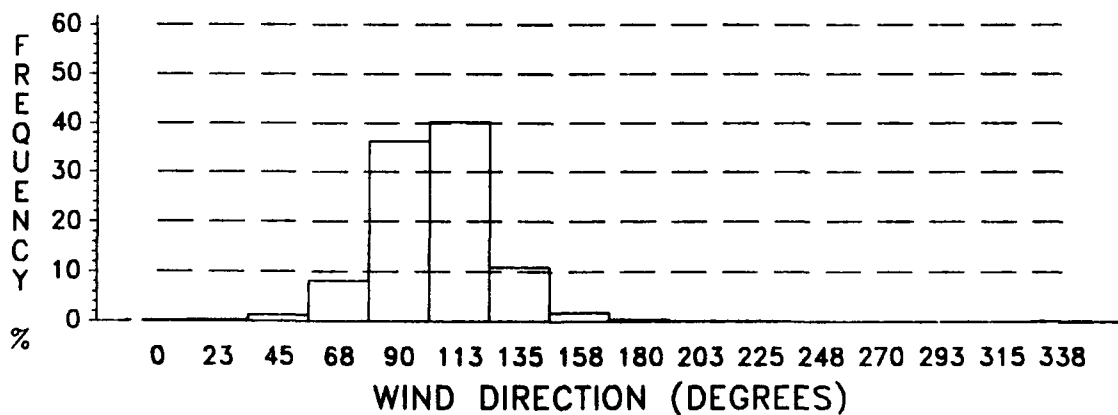
**Figure E-12. Wind Direction Frequency, July, 30 KM.**



**Figure E-13. Wind Direction Frequency, July, 40 KM.**



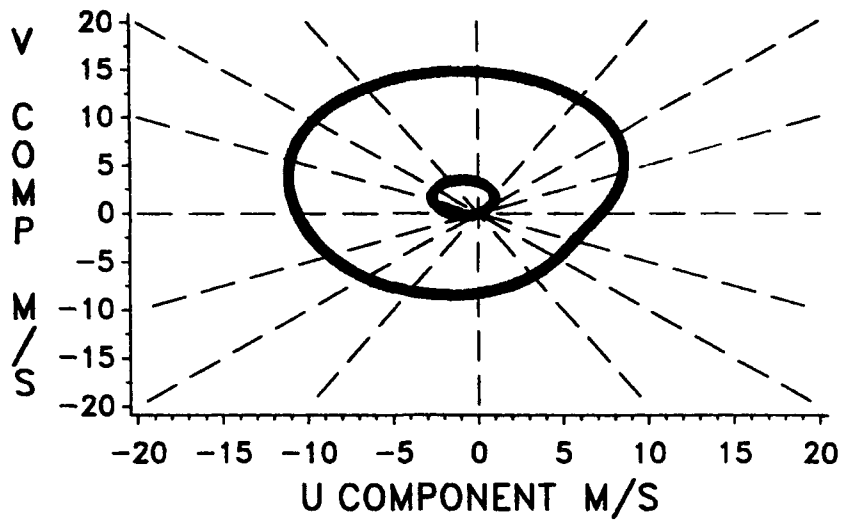
**Figure E-14. Wind Direction Frequency, July, 50 KM.**



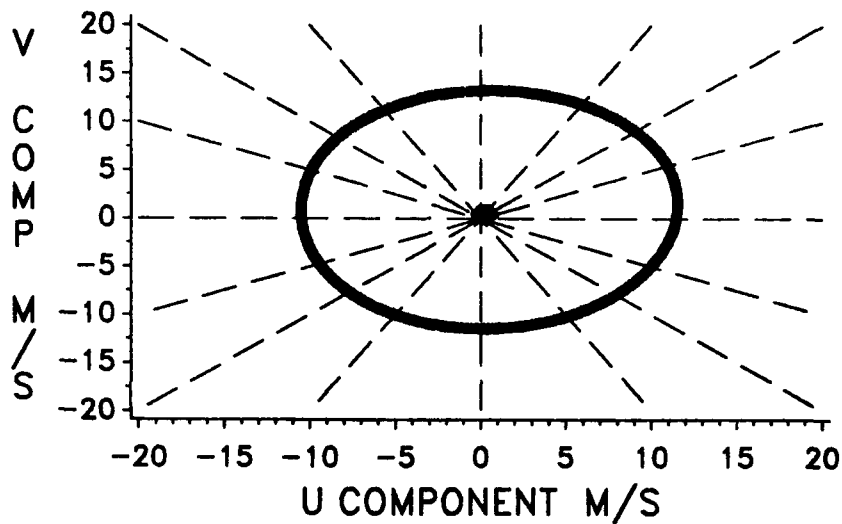
**Figure E-15. Wind Direction Frequency, July, 60 KM.**

**NO DATA AVAILABLE**

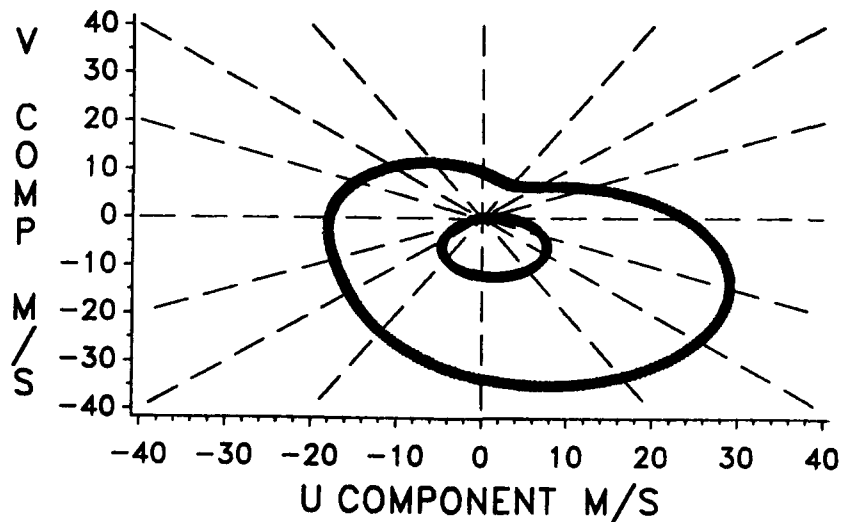
**Figure E-16. Wind Direction Frequency, July, 70 KM.**



**Figure E-17. Wind Interpercentile Range and Mean, January, 4 KM.**



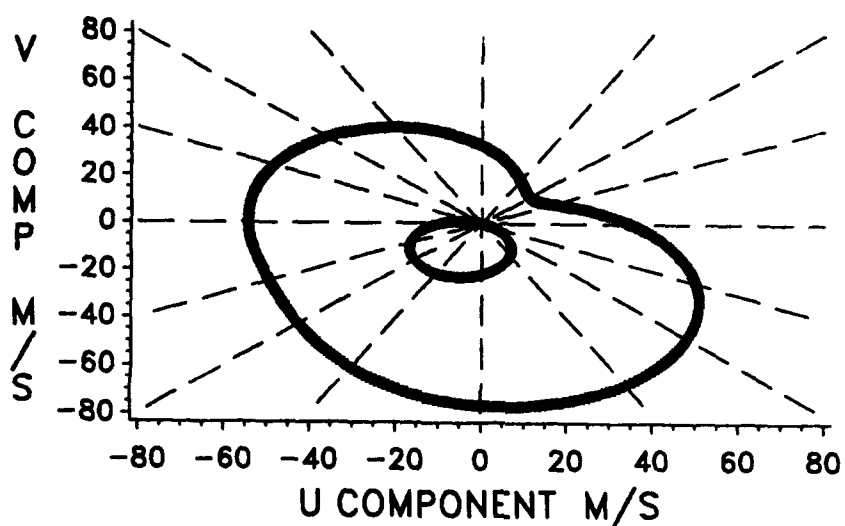
**Figure E-18. Wind Interpercentile Range and Mean, January, 12 KM.**



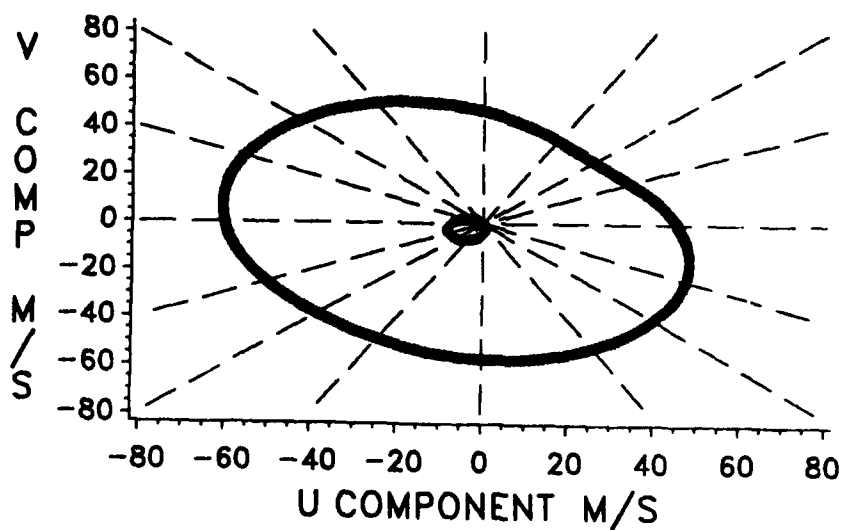
**Figure E-19. Wind Interpercentile Range and Mean, January, 20 KM.**

**NO DATA AVAILABLE**

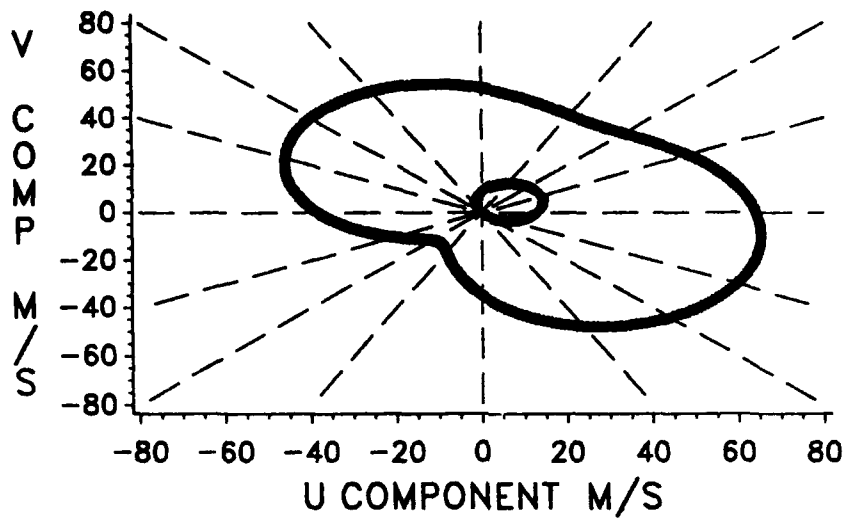
**Figure E-20. Wind Interpercentile Range and Mean, January, 30 KM.**



**Figure E-21. Wind Interpercentile Range and Mean, January, 40 KM.**



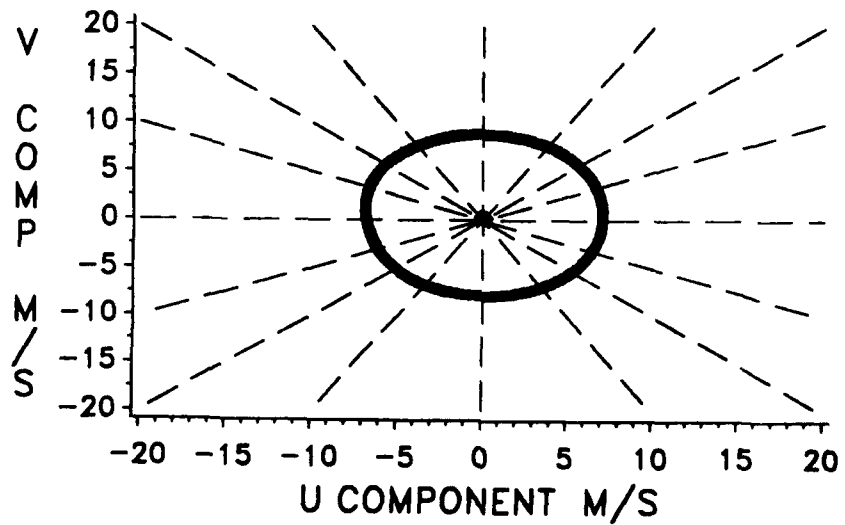
**Figure E-22. Wind Interpercentile Range and Mean, January, 50 KM.**



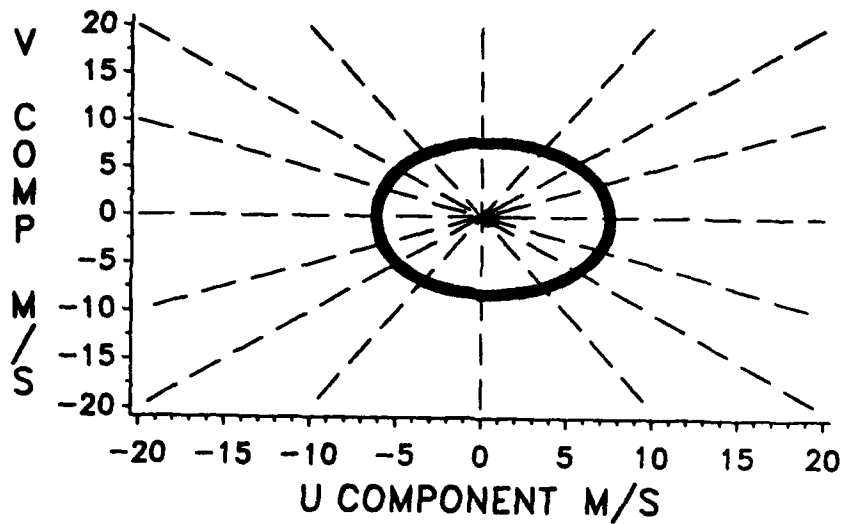
**Figure E-23. Wind Interpercentile Range and Mean, January, 60 KM.**

**NO DATA AVAILABLE**

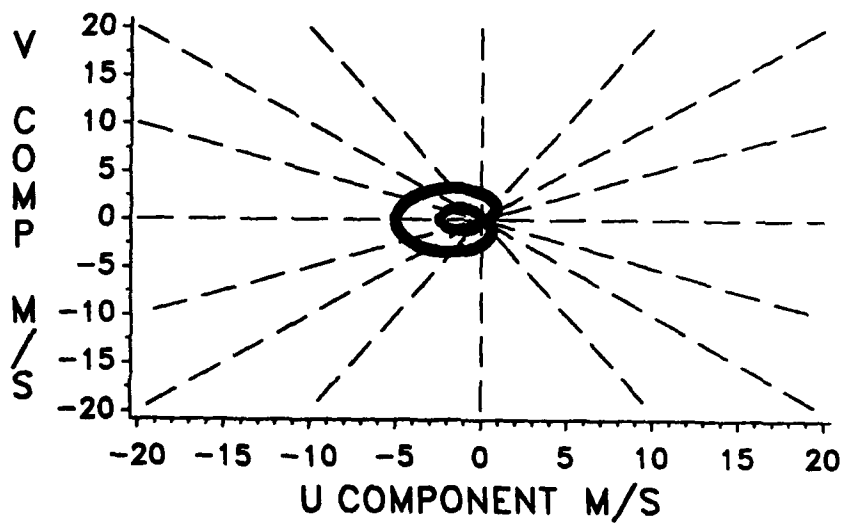
**Figure E-24. Wind Interpercentile Range and Mean, January, 70 KM.**



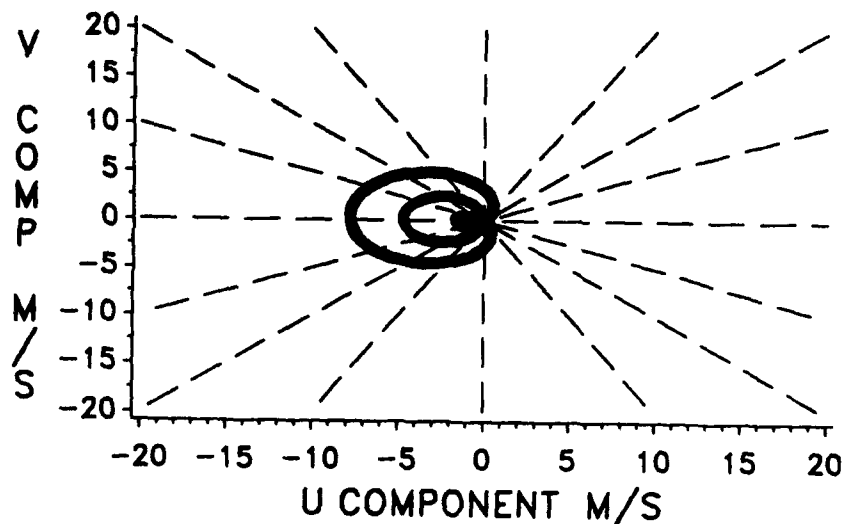
**Figure E-25. Wind Interpercentile Range and Mean, July, 4 KM.**



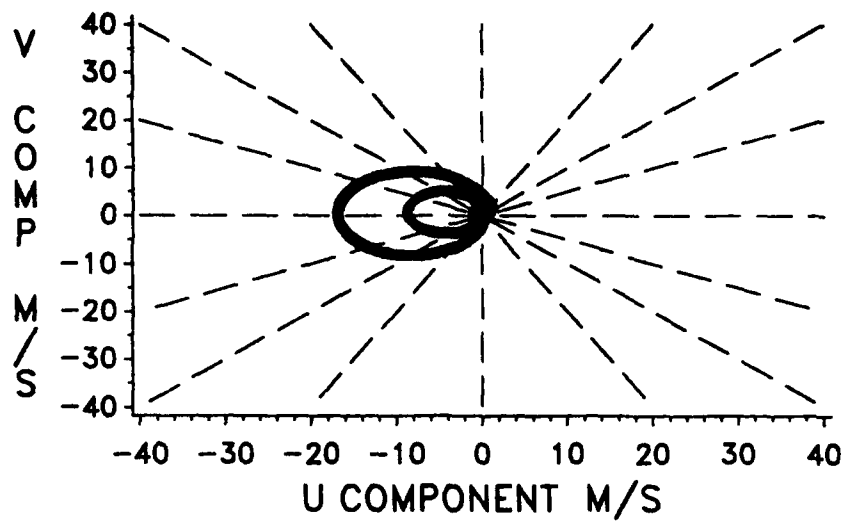
**Figure E-26. Wind Interpercentile Range and Mean, July, 12 KM.**



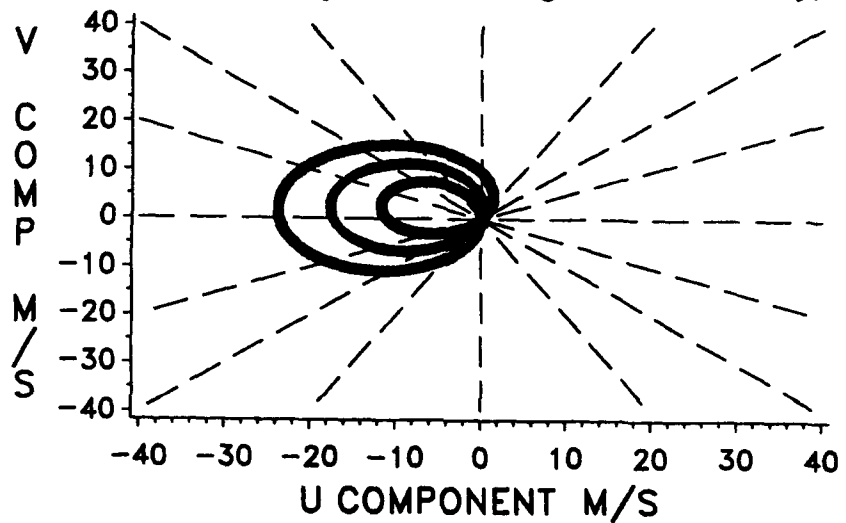
**Figure E-27. Wind Interpercentile Range and Mean, July, 20 KM.**



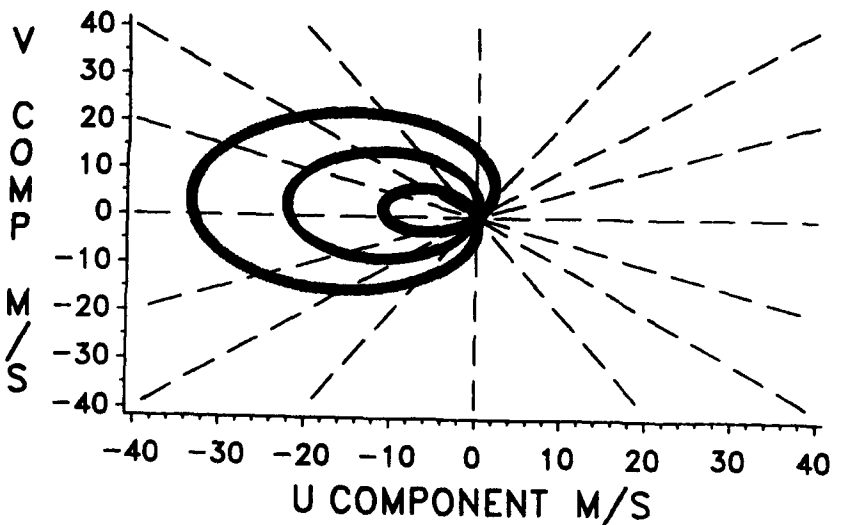
**Figure E-28. Wind Interpercentile Range and Mean, July, 30 KM.**



**Figure E-29. Wind Interpercentile Range and Mean, July, 40 KM.**



**Figure E-30. Wind Interpercentile Range and Mean, July, 50 KM.**

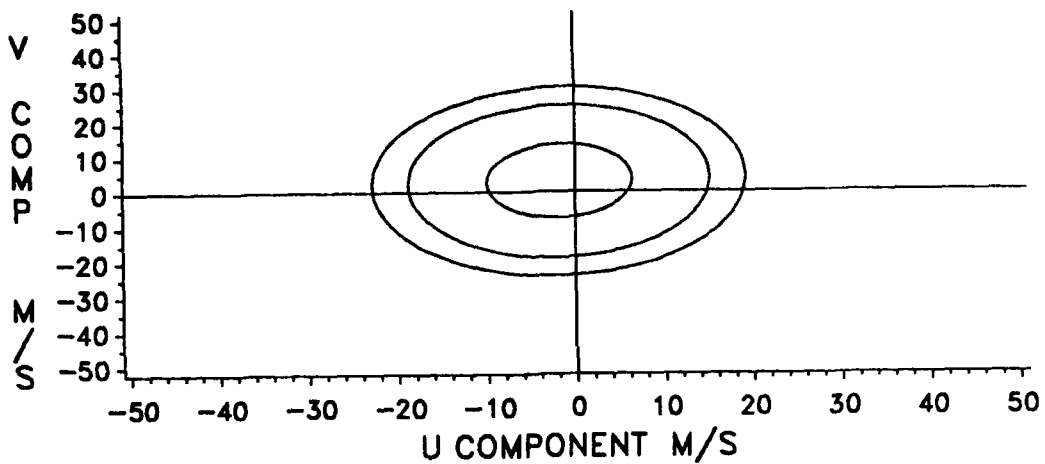


**Figure E-31. Wind Interpercentile Range and Mean, July, 60 KM.**

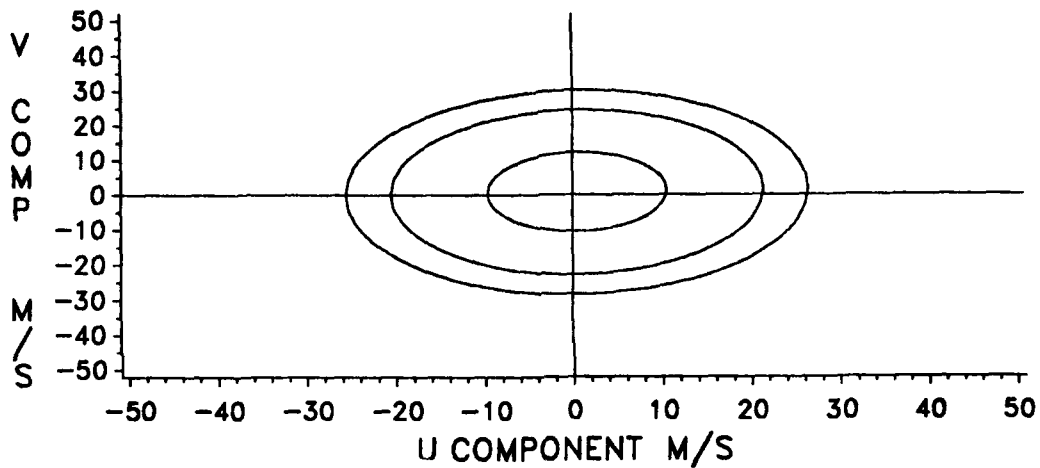


**NO DATA AVAILABLE**

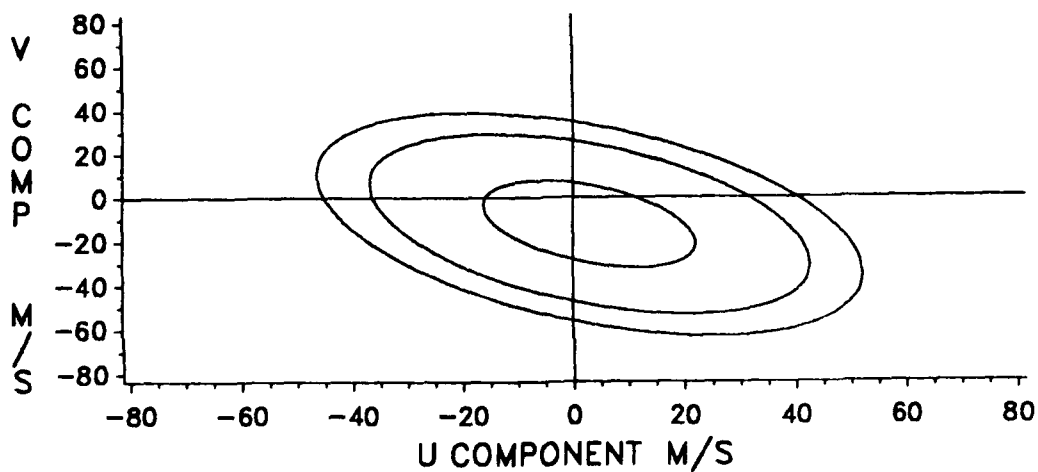
**Figure E-32. Wind Interpercentile Range and Mean, July, 70 KM.**



**Figure E-33. Wind Probability Ellipses, January, 4 KM.**



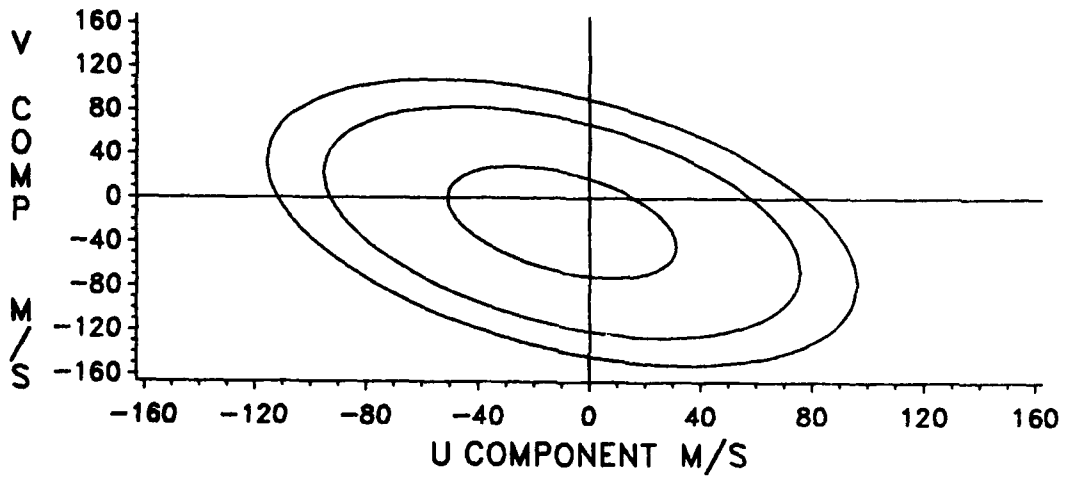
**Figure E-34. Wind Probability Ellipses, January, 12 KM.**



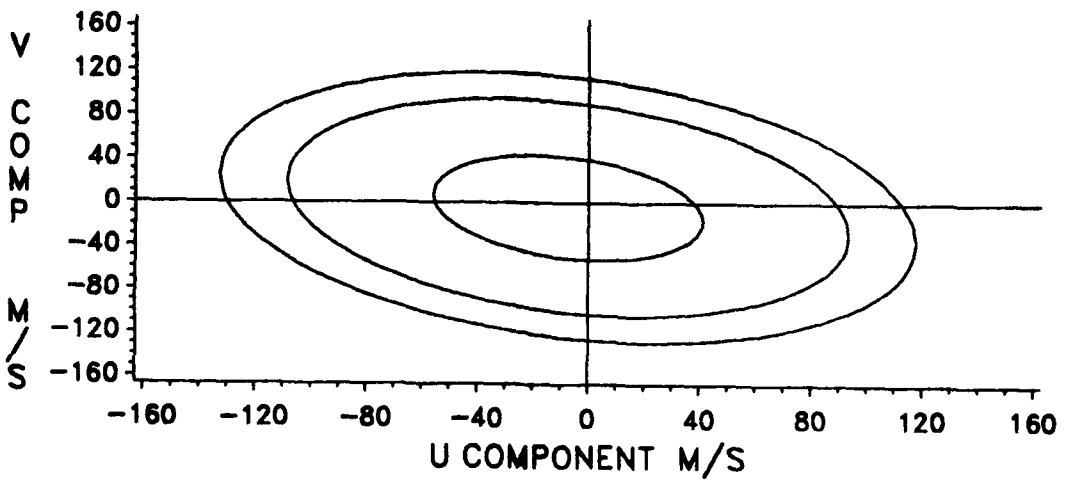
**Figure E-35. Wind Probability Ellipses, January, 20 KM.**

**NO DATA AVAILABLE**

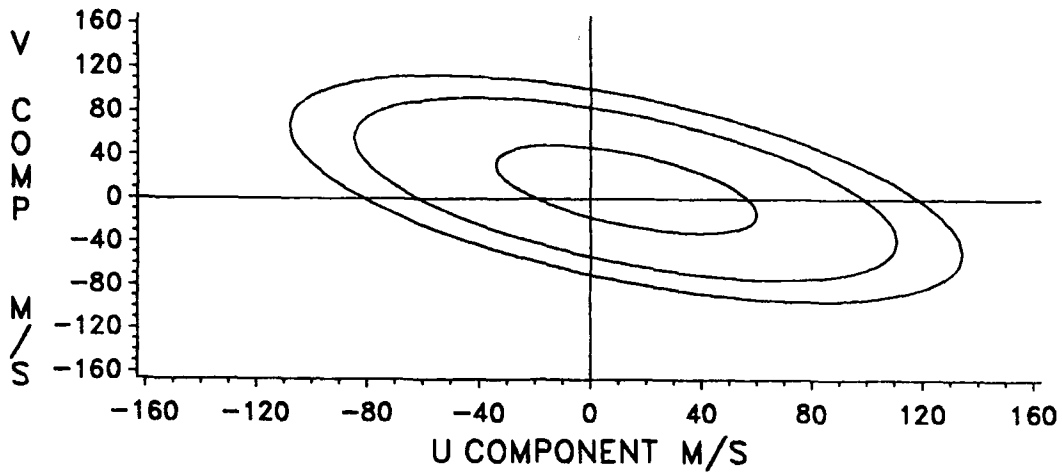
**Figure E-36. Wind Probability Ellipses, January, 30 KM.**



**Figure E-37. Wind Probability Ellipses, January, 40 KM.**



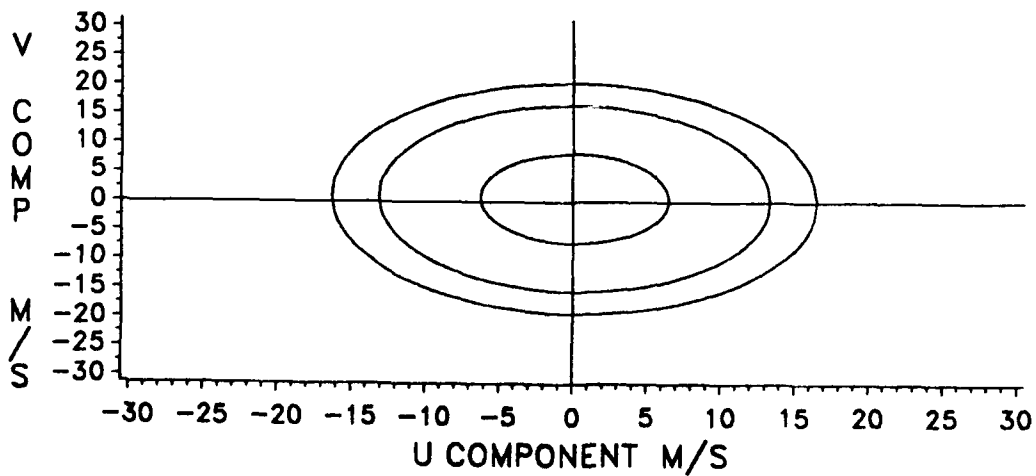
**Figure E-38. Wind Probability Ellipses, January, 50 KM.**



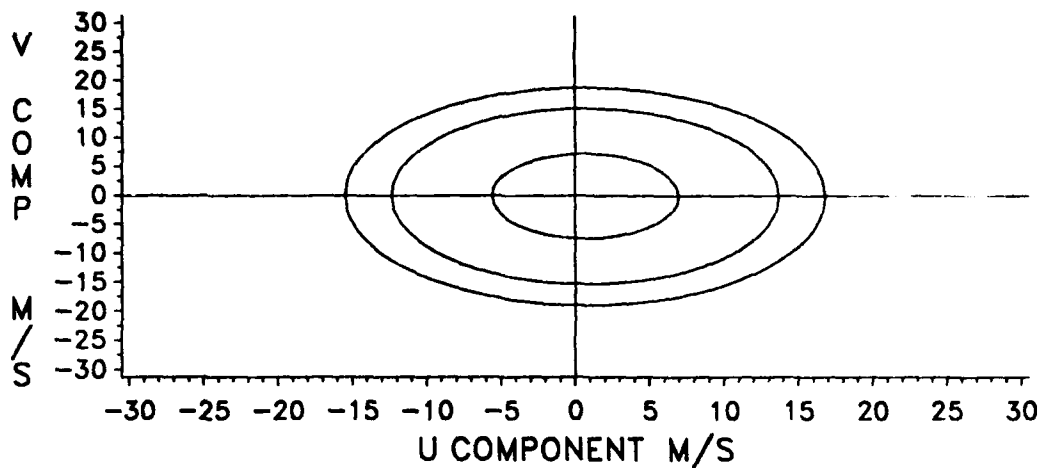
**Figure E-39. Wind Probability Ellipses, January, 60 KM.**

**NO DATA AVAILABLE**

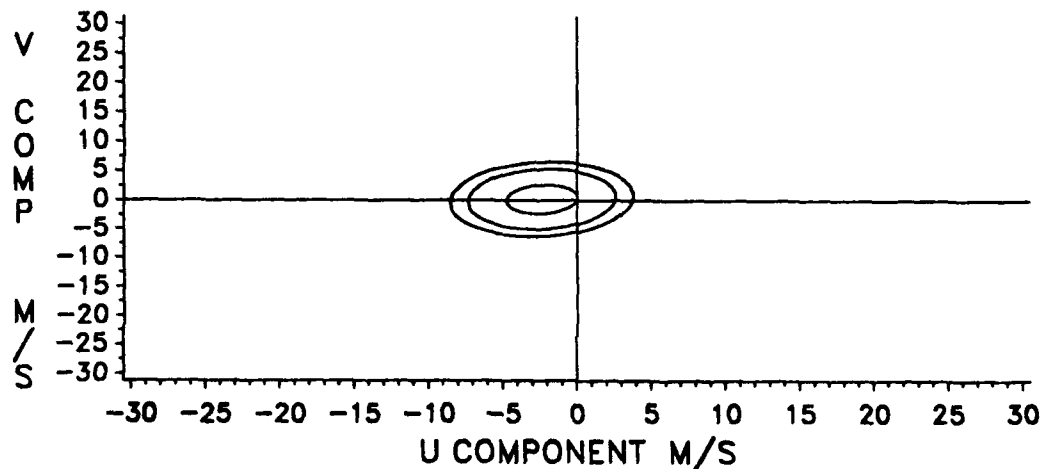
**Figure E-40. Wind Probability Ellipses, January, 70 KM.**



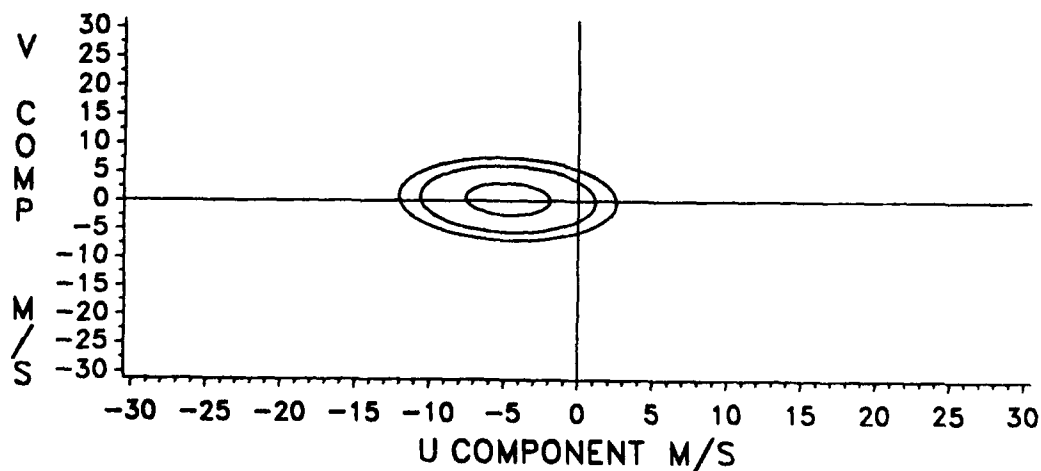
**Figure E-41. Wind Probability Ellipses, July, 4 KM.**



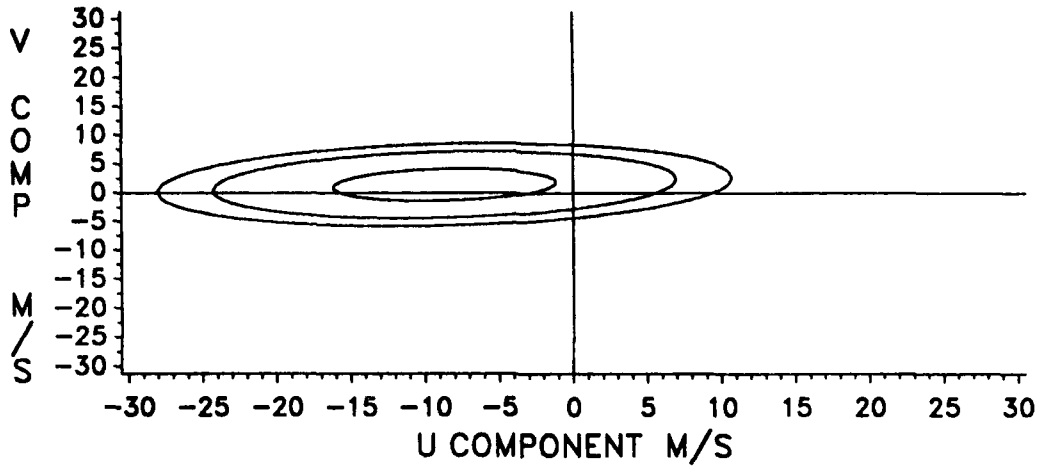
**Figure E-42. Wind Probability Ellipses, July, 12 KM.**



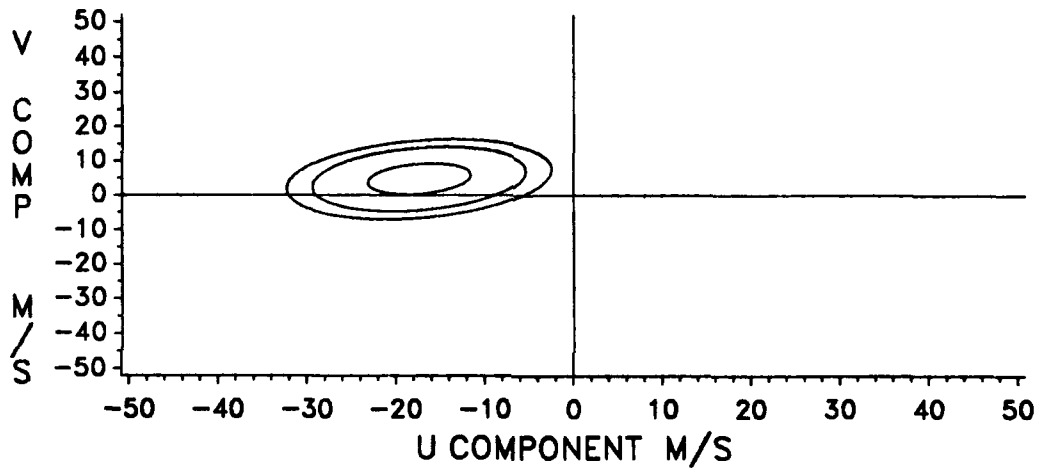
**Figure E-43. Wind Probability Ellipses, July, 20 KM.**



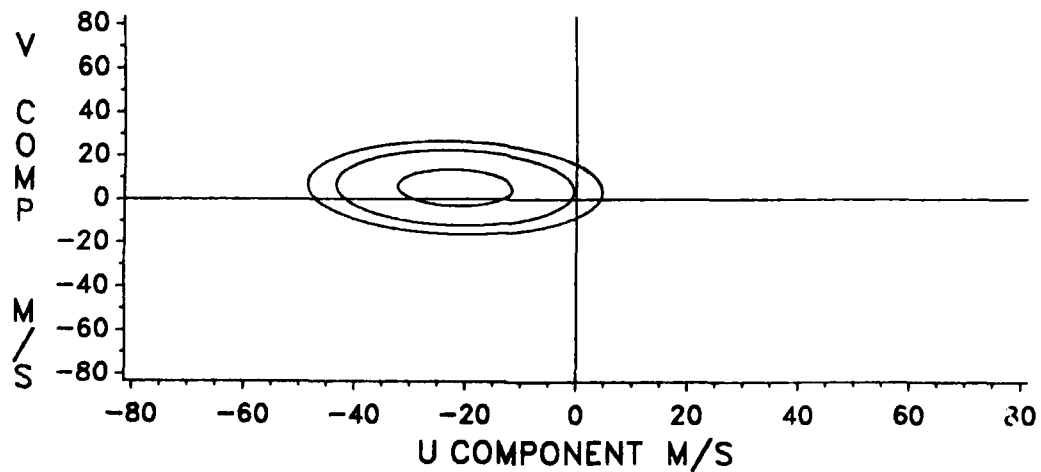
**Figure E-44. Wind Probability Ellipses, July, 30 KM.**



**Figure E-45. Wind Probability Ellipses, July, 40 KM.**



**Figure E-46. Wind Probability Ellipses, July, 50 KM.**



**Figure E-47. Wind Probability Ellipses, July 60 KM.**

**NO DATA AVAILABLE**

**Figure E-48. Wind Probability Ellipses, July, 70 KM.**

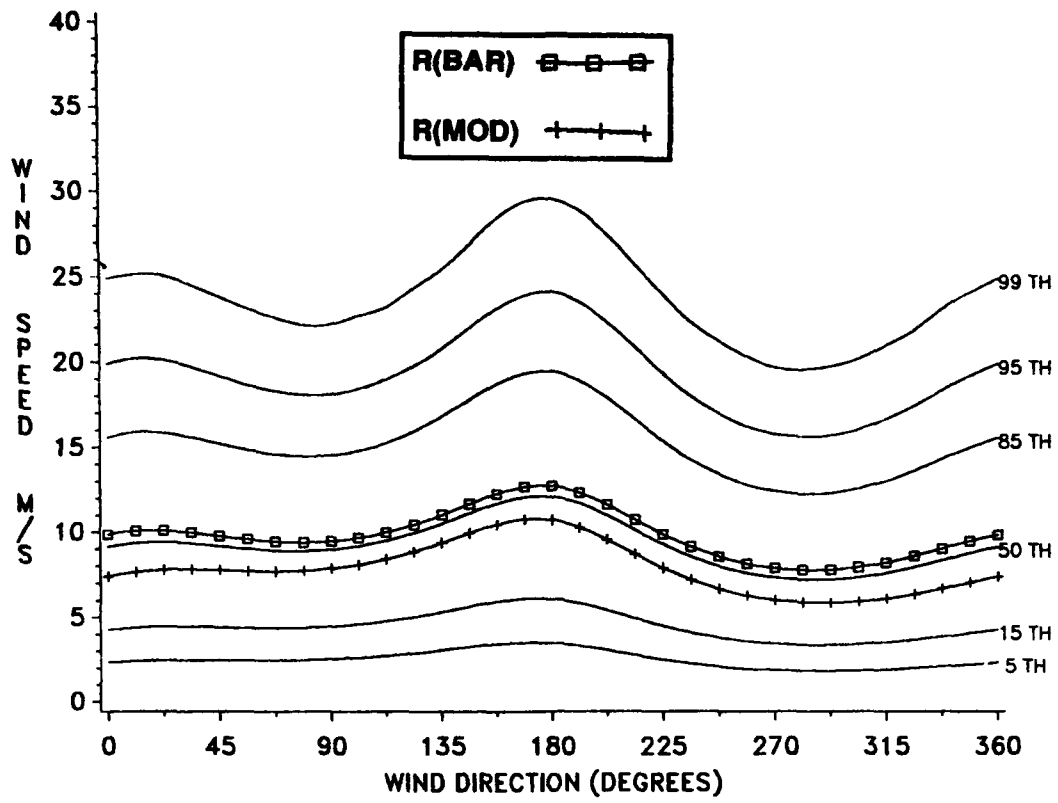


Figure E-49. Conditional Wind Speed Given Direction, January, 4 KM.

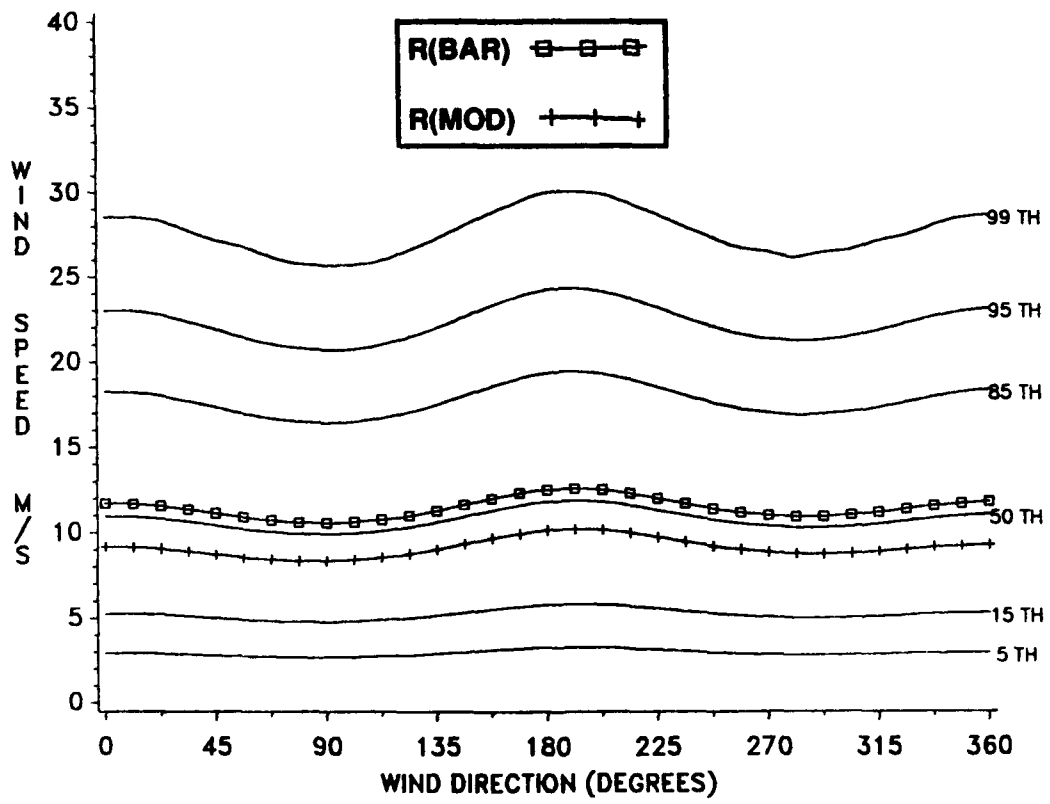
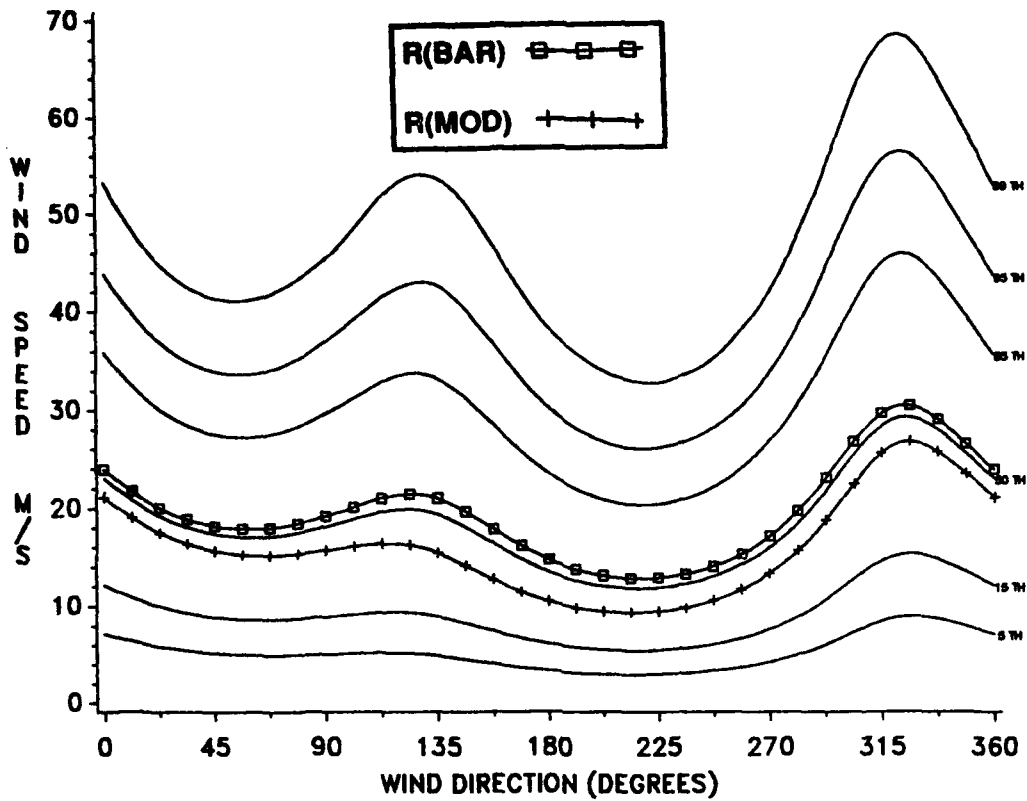


Figure E-50. Conditional Wind Speed Given Direction, January, 12 KM.





**Figure E-51. Conditional Wind Speed Given Direction, January, 20 KM.**

**NO DATA AVAILABLE**

**Figure E-52. Conditional Wind Speed Given Direction, January, 30 KM.**

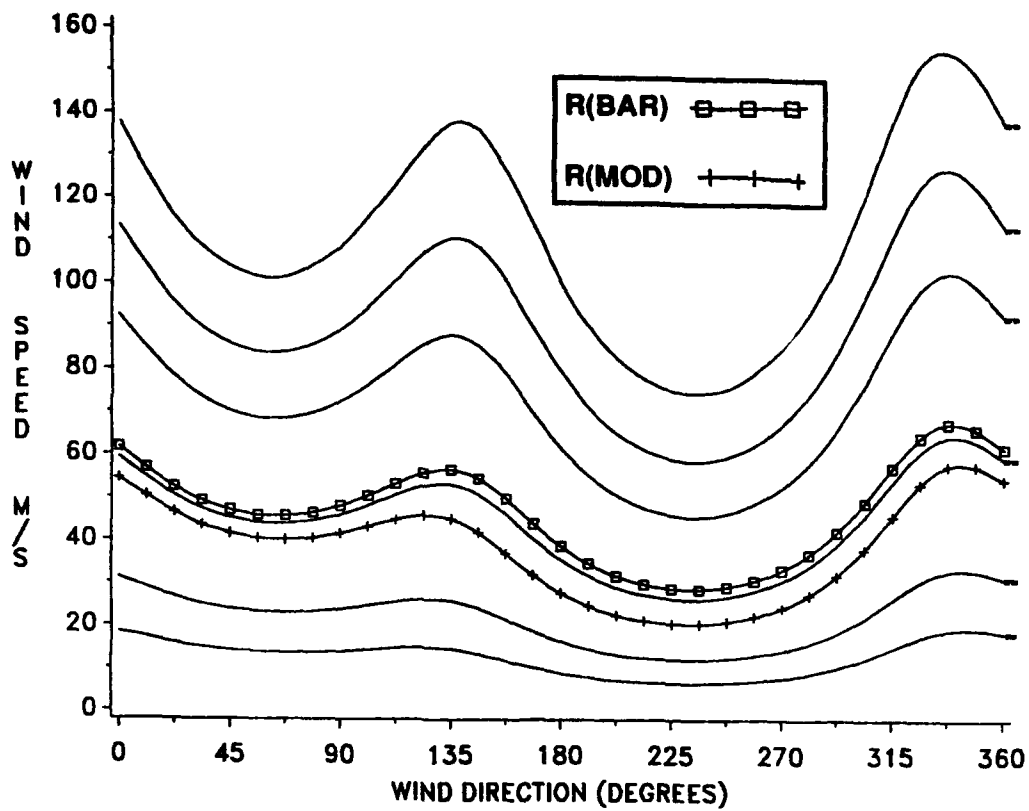


Figure E-53. Conditional Wind Speed Given Direction, January, 40 KM.

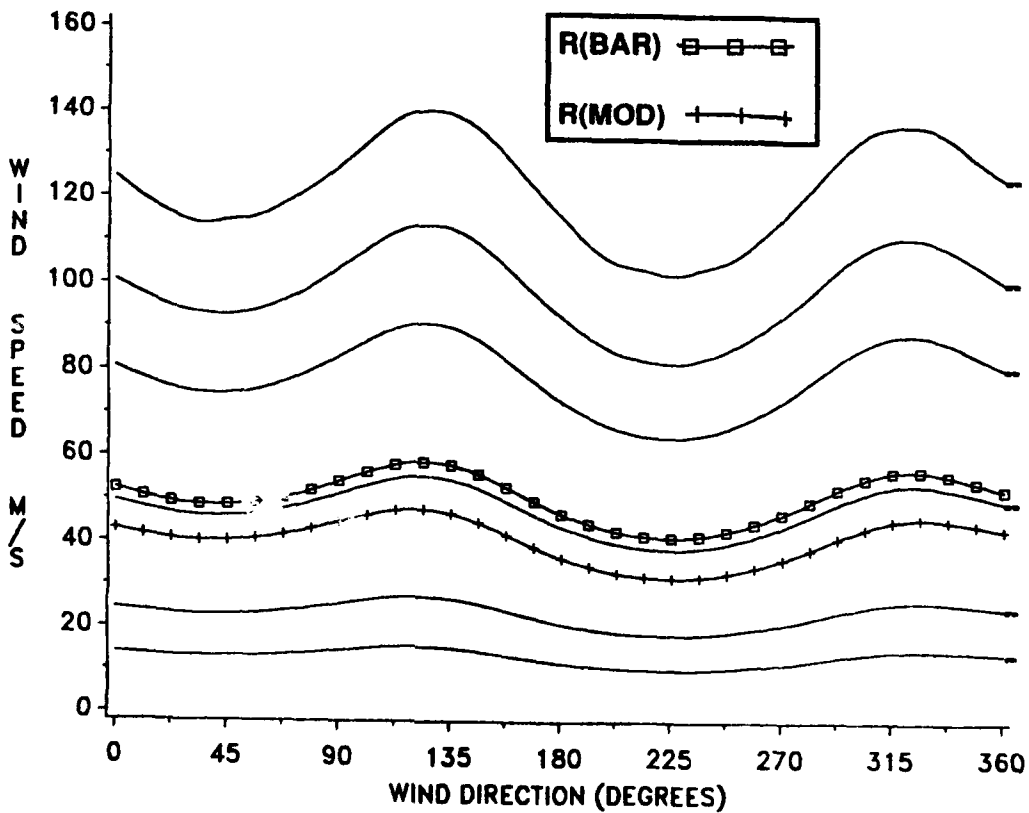
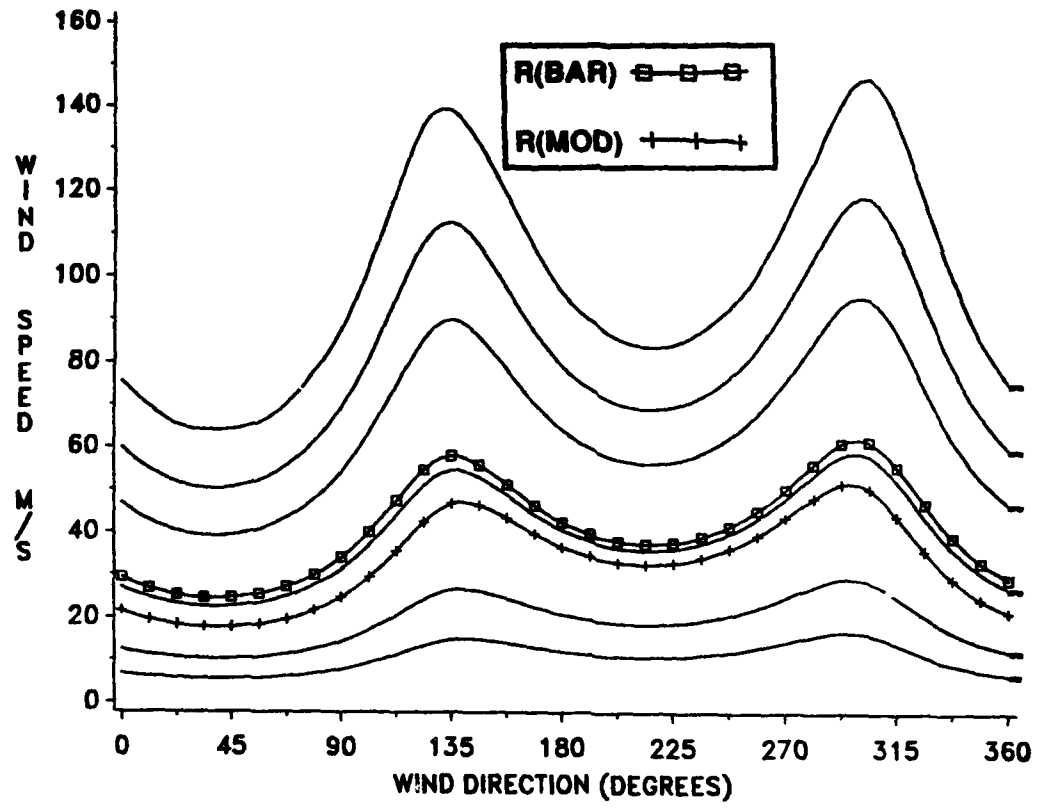


Figure E-54. Conditional Wind Speed Given Direction, January, 50 KM.



**Figure E-55. Conditional Wind Speed Given Direction, January, 60 KM.**

**NO DATA AVAILABLE**

**Figure E-56. Conditional Wind Speed Given Direction, January, 70 KM.**

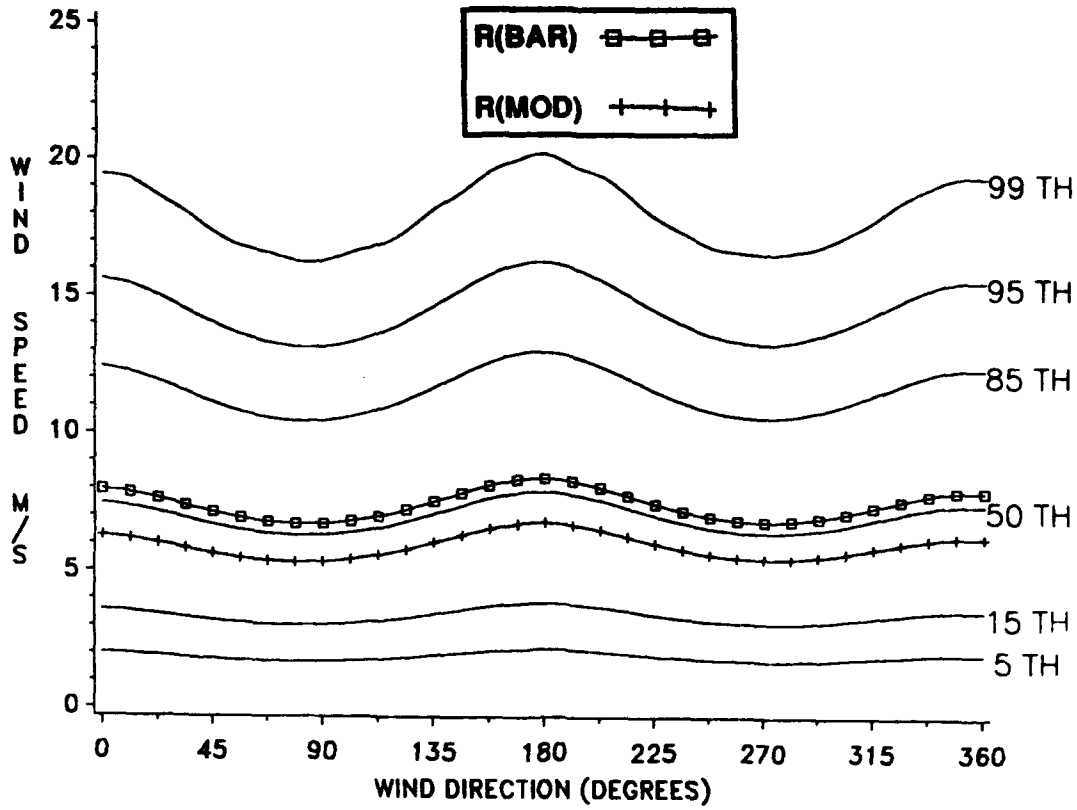


Figure E-57. Conditional Wind Speed Given Direction, July, 4 KM.

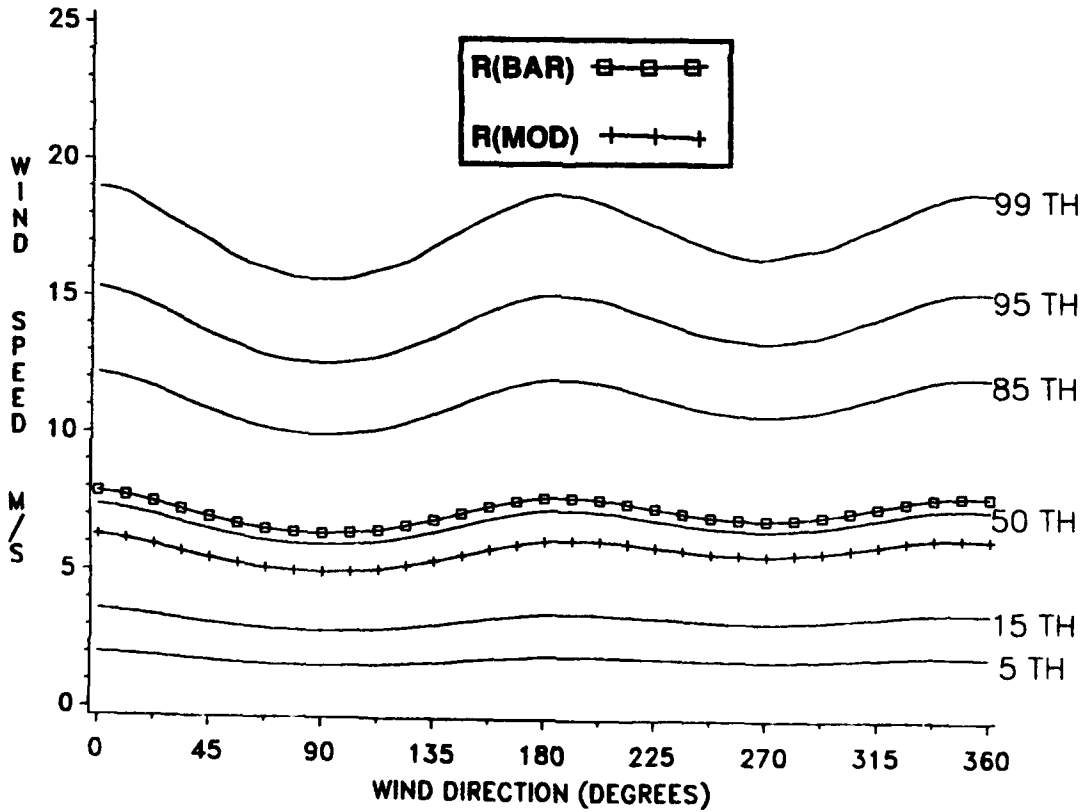


Figure E-58. Conditional Wind Speed Given Direction, July, 12 KM.

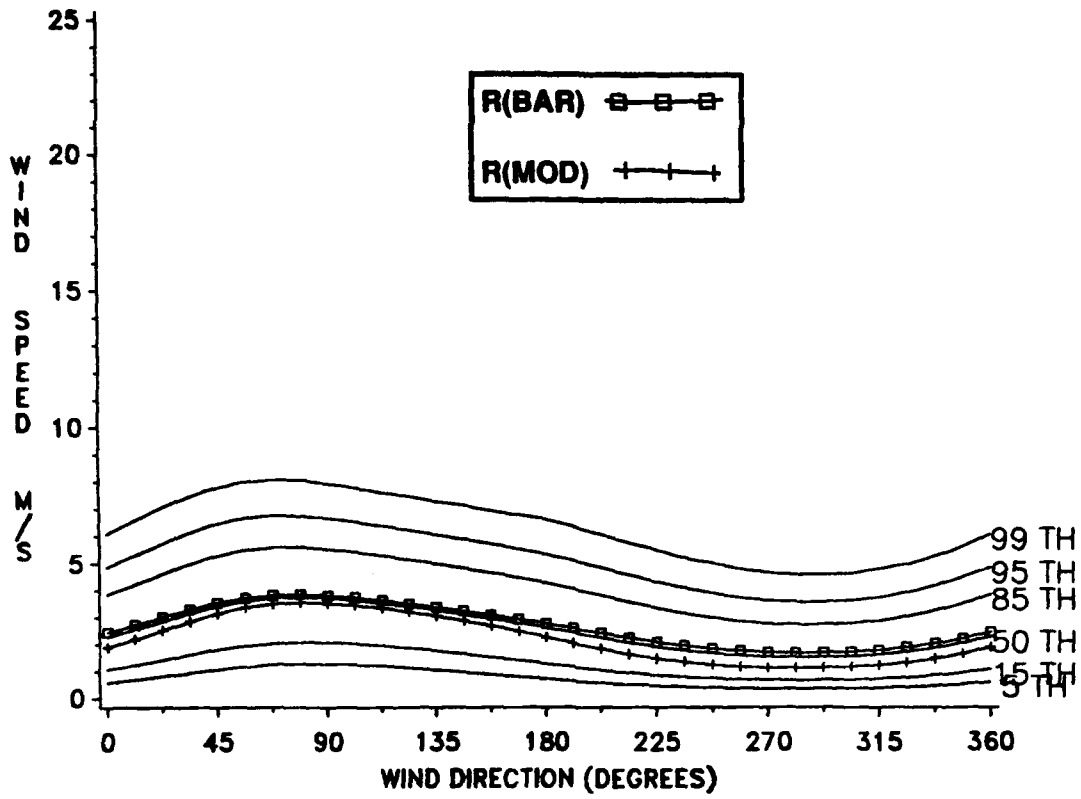


Figure E-59. Conditional Wind Speed Given Direction, July, 20 KM.

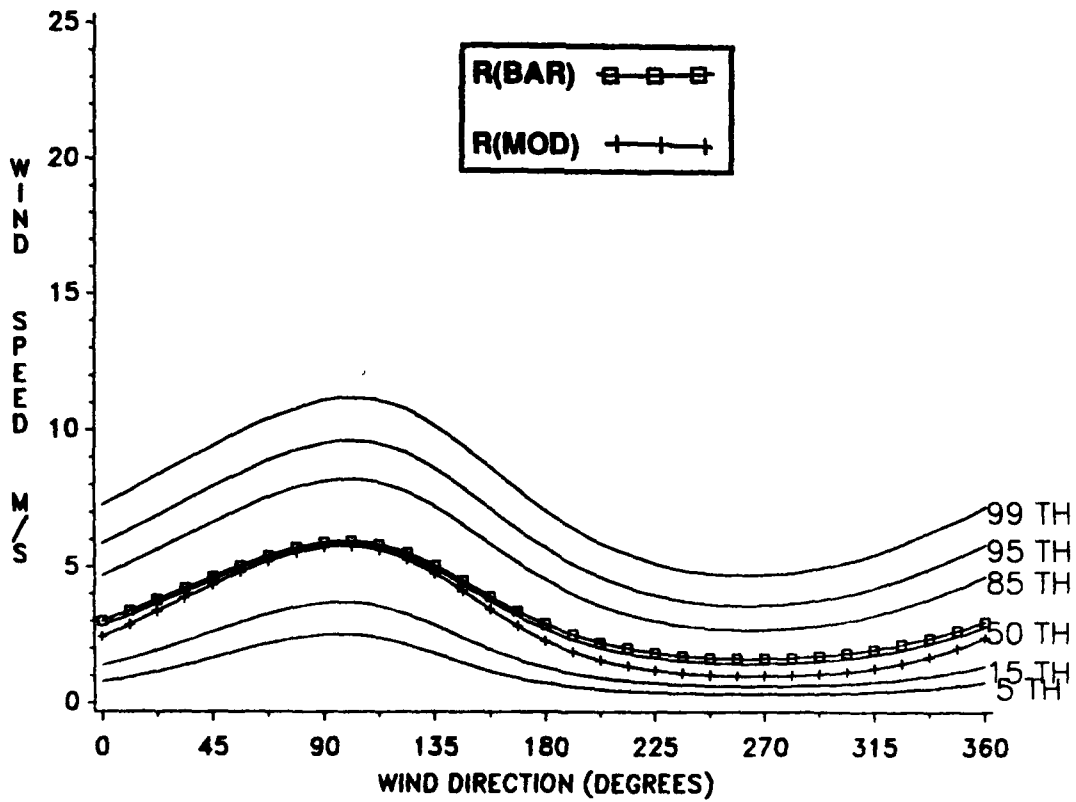


Figure E-60. Conditional Wind Speed Given Direction, July, 30 KM.

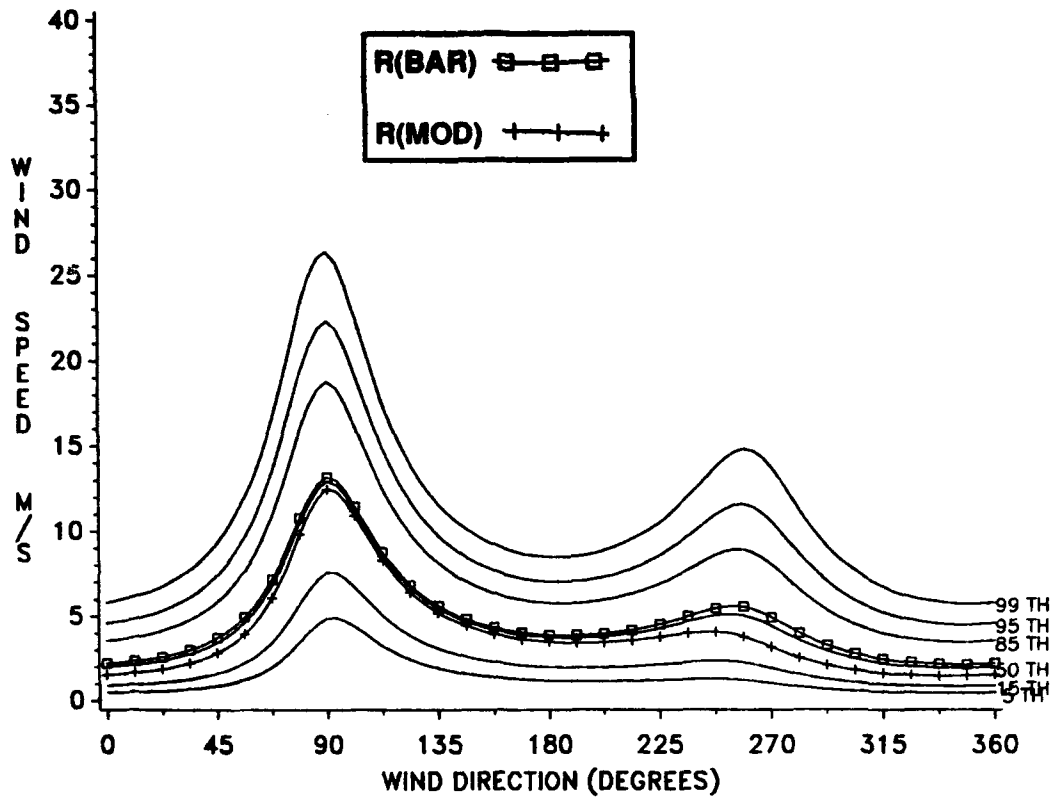


Figure E-61. Conditional Wind Speed Given Direction, July, 40 KM.

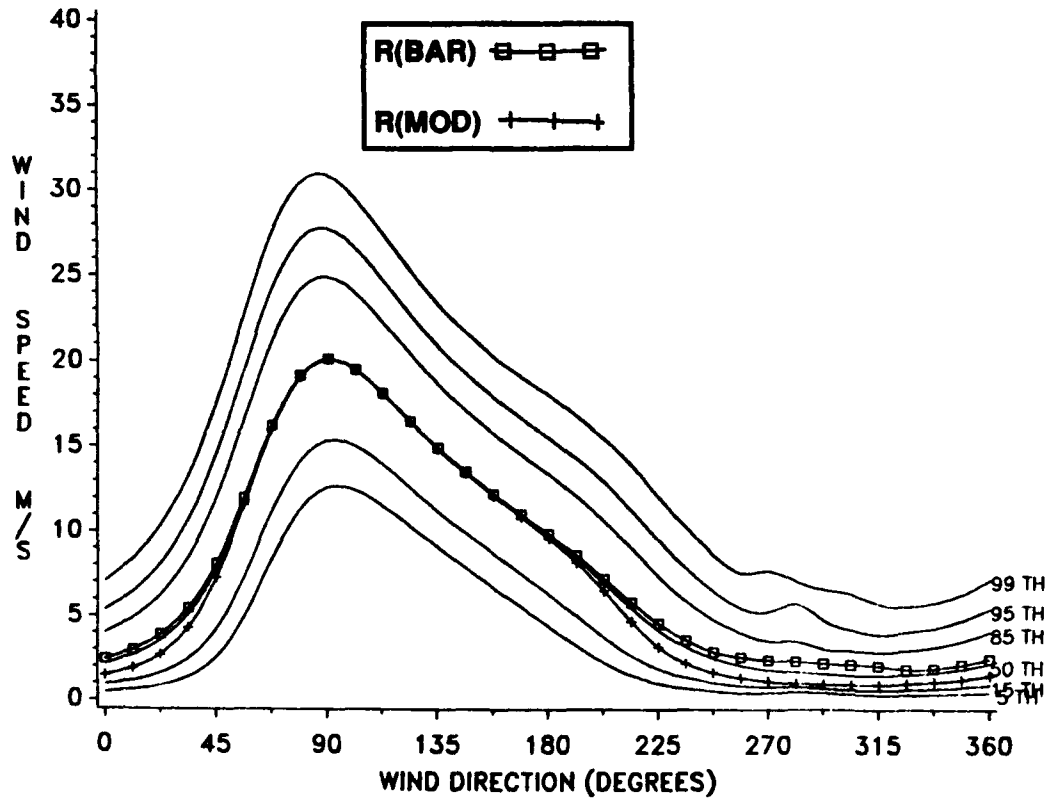
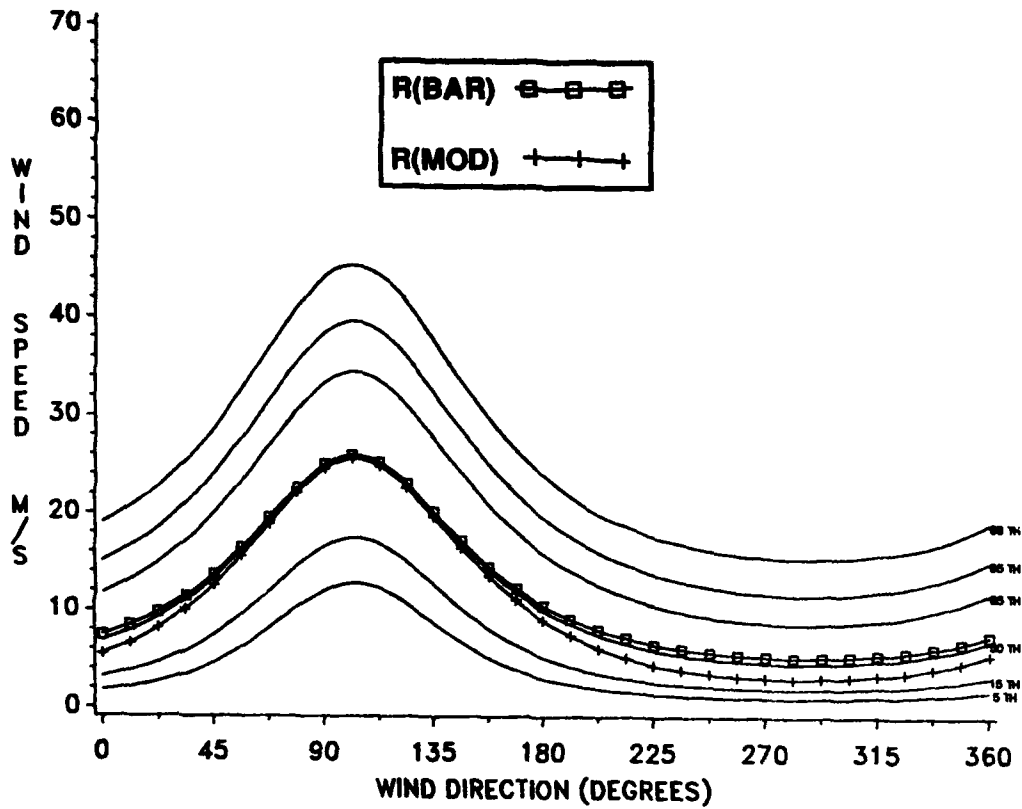


Figure E-62. Conditional Wind Speed Given Direction, July, 50 KM.



**Figure E-63. Conditional Wind Speed Given Direction, July, 60 KM.**

**NO DATA AVAILABLE**

**Figure E-64. Conditional Wind Speed Given Direction, July, 70 KM.**

## APPENDIX F

### Thermodynamic Statistics Derivable from Appendix B, C, and D Tables

This appendix gives graphic examples of certain pressure, density, and virtual temperature statistics that can be derived from basic data in Appendices B, C, and D. These examples should help RRA users in understanding and visualizing the relationships that can be inferred from data in Appendices B and D.

#### Monthly Means from the Annual Mean

The hydrostatic model values in Appendix D are used to compute monthly mean differences relative to annual mean values of pressure, density, and virtual temperature (expressed in percent), and the monthly mean difference in virtual temperature for annual mean virtual temperature (expressed in kelvin, K). Examples of these four statistics are given in Tables F-1 (January) and F-2 (July); graphic displays of the four statistics contained in these tables are then provided by Figures F-1 through F-8. The relative differences between monthly mean values (from Tables D-1 through D-12 for all months) and annual mean values (Table D-13) are illustrated in Figures F-9 and F-18 for pressure, Figures F-10 and F-12 for density, and Figures F-13 and F-14 for virtual temperature. Differences between monthly mean virtual temperature differences and annual mean virtual temperature for all months are given in Figures F-15 and F-16.

#### Coefficients of Variation and Derived Correlation Coefficients.

The coefficient of variation ( $C_v$ ) is defined as "the standard deviation with respect to the mean divided by the mean." Coefficients of variation for pressure ( $C_{vP}$ ) and density ( $C_{vD}$ ) were computed using standard deviations in Appendix B and the hydrostatic mean values in Appendix E. The coefficient of variation for temperature uses the standard deviations of virtual temperature from Appendix C to the altitude at which virtual temperature exists; above that altitude, standard deviations of temperature are from Appendix B. Mean values for virtual temperature to the altitude at which it exists and above are taken from Appendix E. No distinction is made between virtual temperature and temperature in Table F-3, Table F-4, or any of the figures.

From the coefficients of variation for pressure and temperature (virtual temperature to the altitude at which it exists), correlation coefficients between these quantities are derived using Buell's method--see Chapter 3. The three equations for the derived correlation coefficients in Tables F-3 and F-4 are:

$$R(P,T) = \frac{(C_v T)^2 + (C_v P)^2 - (C_v D)^2}{2[C_v T \cdot C_v P]} \quad (F-1)$$

$$R(P,D) = \frac{(C_v D)^2 - (C_v T)^2 + (C_v P)^2}{2[C_v D \cdot C_v P]} \quad (F-2)$$



$$R(T,D) = \frac{(C_v P)^2 - (C_v D)^2 - (C_v T)^2}{2[C_v T \cdot C_v D]} \quad (F-3)$$

To test for validity of derived correlation coefficients, all three of the following inequalities must be satisfied:

$$\begin{aligned} C_v P - (C_v D + C_v T) &< 0 \\ C_v D - (C_v T + C_v P) &< 0 \\ C_v T - (C_v P + C_v D) &< 0 \end{aligned} \quad (F-4)$$

In the examples (Tables F-3 and F-4), the numerical values from equation F-4 are usually negative, and the derived correlation test is considered valid. However, when any of the inequalities are not satisfied, "9.999" (missing) is written in the table. The rare exceptions to this test for several RRAs occur at extremely high altitudes where sample sizes for the statistical sample are small.

Statistical parameters from Table F-3 (January) and Table F-4 (July) are illustrated in Figures F-17 through F-20.

$C_v P$  values for all months are given in Figures F-21 and F-22.  $C_v D$  values are given in Figures F-23 and F-24, and  $C_v T$  values in Figures F-25 and F-26. If the abscissa on the figures for the coefficient of variation is multiplied by 100, these figures would show the percentage of random dispersion for these quantities over the month with respect to the monthly mean.

Derived correlation coefficients for all months are shown as follows: Figures F-27 and F-28 give  $R(P,D)$ ; Figures F-29 and F-30 give  $R(P,T)$ ; and Figures F-31 and F-32 give  $R(T,D)$ .

**TABLE F-1. Deltas in Percent Relative to Annual, Thule, January.**

<u>RLEVEL</u>	<u>PRESSURE</u>	<u>DENSITY</u>	<u>TEMP.</u>	<u>TMO-TANN (K)</u>
0.000	-0.233	4.132	-4.189	-11.010
0.059	-0.284	4.020	-4.135	-10.860
1.000	-0.669	2.275	-2.880	-7.520
2.000	-1.020	1.528	-2.509	-6.460
3.000	-1.369	1.238	-2.572	-6.510
4.000	-1.704	0.932	-2.610	-6.480
5.000	-2.062	0.424	-2.473	-6.050
6.000	-2.503	-0.655	-1.859	-4.500
7.000	-2.986	-1.588	-1.422	-3.400
8.000	-3.418	-3.783	-0.980	-2.310
9.000	-3.959	5.631	-9.081	-21.260
10.000	-4.487	7.320	-11.001	-26.180
11.000	-5.169	6.127	-10.644	-25.190
12.000	-6.008	6.236	-11.522	-27.450
13.000	-6.856	5.172	-11.433	-27.120
14.000	-7.866	-1.827	-6.151	-13.700
15.000	-8.375	-2.235	-6.280	-13.970
16.000	-9.327	-2.983	-6.539	-14.570
17.000	-9.804	-3.357	-6.670	-14.830
18.000	-10.024	-3.894	-6.379	-14.230
19.000	-10.206	-4.172	-6.299	-14.040
20.000	-9.461	-4.113	-5.578	-12.480
21.000	-10.402	-5.100	-5.587	-12.520
22.000	-11.119	-5.657	-5.790	-12.980
23.000	-11.013	-5.747	-5.584	-12.540
24.000	-12.152	-6.847	-5.696	-12.830
25.000	-12.268	-6.905	-5.762	-12.990
26.000	-12.807	-8.151	-5.070	-11.490
27.000	-14.950	-9.931	-5.572	-12.690
28.000	-14.330	-10.809	-3.951	-9.040
29.000	-15.866	-12.395	-3.960	-9.110
30.000	-15.164	-12.310	-3.252	-7.520
32.000	-18.020	-16.096	-2.294	-2.640
34.000	-21.237	-19.392	-2.291	-2.670
36.000	-21.703	-19.546	-2.683	-3.180
38.000	-22.464	-20.931	-1.935	-2.340
40.000	-23.832	-22.443	-1.791	-2.210
42.000	-24.509	-22.625	-2.434	-3.070
44.000	-26.841	-24.521	-3.076	-3.950
46.000	-28.220	-25.043	-4.245	-5.560
48.000	-29.749	-26.134	-4.901	-6.520
50.000	-30.116	-26.692	-4.673	-6.270
52.000	-31.296	-28.155	-4.366	-5.890
54.000	-34.467	-32.502	-2.940	-3.980
56.000	-32.402	-30.041	-3.332	-4.500
58.000	-33.309	-30.500	-4.012	-5.390
60.000	-41.768	-39.599	-3.604	-4.810
62.000	-40.627	-38.985	-2.740	-3.620
64.000	-41.972	-41.274	-1.162	-1.520
66.000	-39.376	-39.420	0.170	0.220
68.000	-47.705	-48.800	2.153	2.760
70.000	-49.163	-48.636	-1.047	-1.360

**TABLE F-2. Deltas in Percent Relative to Annual, Thule, July.**

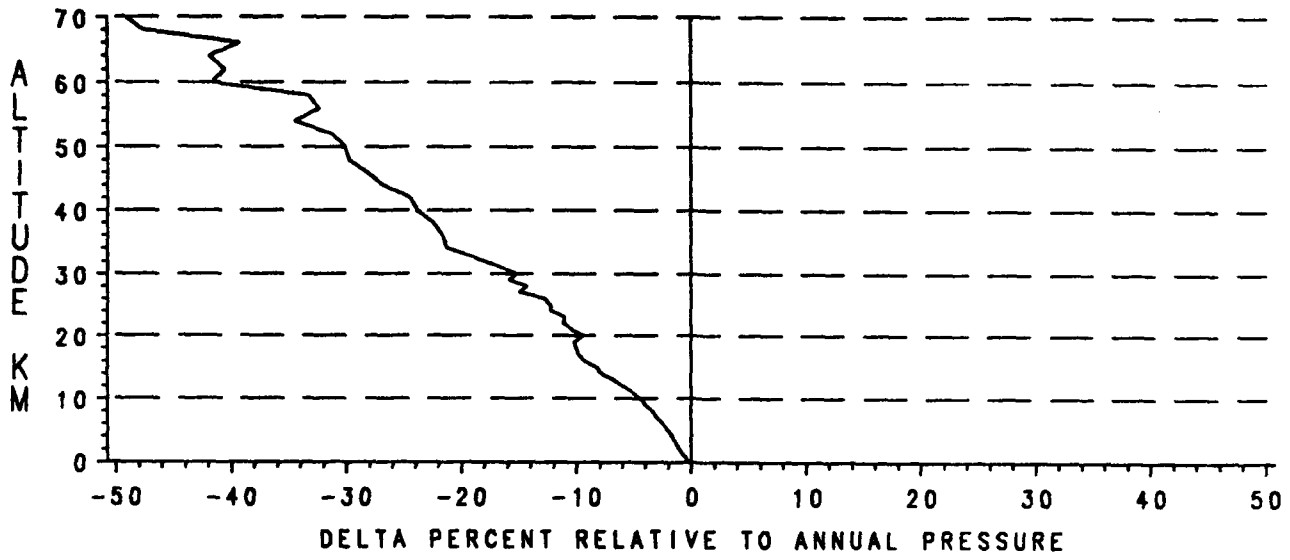
<u>RLEVEL</u>	<u>PRESSURE</u>	<u>DENSITY</u>	<u>TEMP.</u>	<u>TMO-TANN (K)</u>
0.000	-0.132	-5.709	5.916	15.550
0.059	-0.079	-5.675	5.932	15.580
1.000	0.547	-4.500	5.285	13.800
2.000	1.201	-3.555	4.929	12.690
3.000	1.872	-2.736	4.738	11.990
4.000	2.538	-1.838	4.458	11.070
5.000	3.209	-0.249	3.470	8.490
6.000	3.966	2.120	1.806	4.370
7.000	4.710	4.180	0.510	1.220
8.000	5.372	5.420	-0.042	-0.100
9.000	5.886	5.605	0.265	0.620
10.000	6.251	11.872	-5.022	-11.950
11.000	6.624	10.167	-3.216	-7.610
12.000	7.114	10.550	-3.106	-7.400
13.000	7.465	10.427	-2.681	-6.360
14.000	7.939	4.204	3.587	7.990
15.000	8.303	4.473	3.668	8.160
16.000	8.180	4.565	3.456	7.700
17.000	8.831	4.911	3.737	8.310
18.000	8.542	4.858	3.510	7.830
19.000	9.039	5.128	3.719	8.290
20.000	8.679	5.015	3.486	7.800
21.000	8.794	5.161	3.454	7.740
22.000	9.156	5.444	3.520	7.890
23.000	9.194	5.562	3.442	7.730
24.000	9.062	5.632	3.245	7.310
25.000	9.668	6.048	3.411	7.690
26.000	9.422	5.951	3.274	7.420
27.000	9.287	5.916	3.183	7.250
28.000	9.698	6.232	3.260	7.460
29.000	9.982	6.417	3.352	7.710
30.000	10.231	6.546	3.460	8.000
32.000	20.042	11.870	7.300	8.400
34.000	21.976	13.033	7.910	9.220
36.000	24.088	14.863	8.032	9.520
38.000	25.756	16.521	7.928	9.590
40.000	27.562	18.605	7.553	9.320
42.000	29.423	20.638	7.285	9.190
44.000	32.248	23.447	7.125	9.150
46.000	33.496	25.131	6.681	8.750
48.000	34.300	26.380	6.269	8.340
50.000	37.557	29.512	6.201	8.320
52.000	39.417	31.526	6.004	8.100
54.000	40.453	33.084	5.533	7.490
56.000	43.380	36.366	5.154	6.960
58.000	45.697	39.194	4.704	6.320
60.000	43.392	37.906	3.948	5.270
62.000	50.090	46.938	2.127	2.810
64.000	48.165	46.441	1.177	1.540
66.000	48.733	48.623	0.108	0.140
68.000	41.184	45.244	-2.839	-3.640
70.000	36.530	48.864	-8.227	-10.690

**TABLE F-3. Coefficients of Variation/Correlation Coefficients, January.**

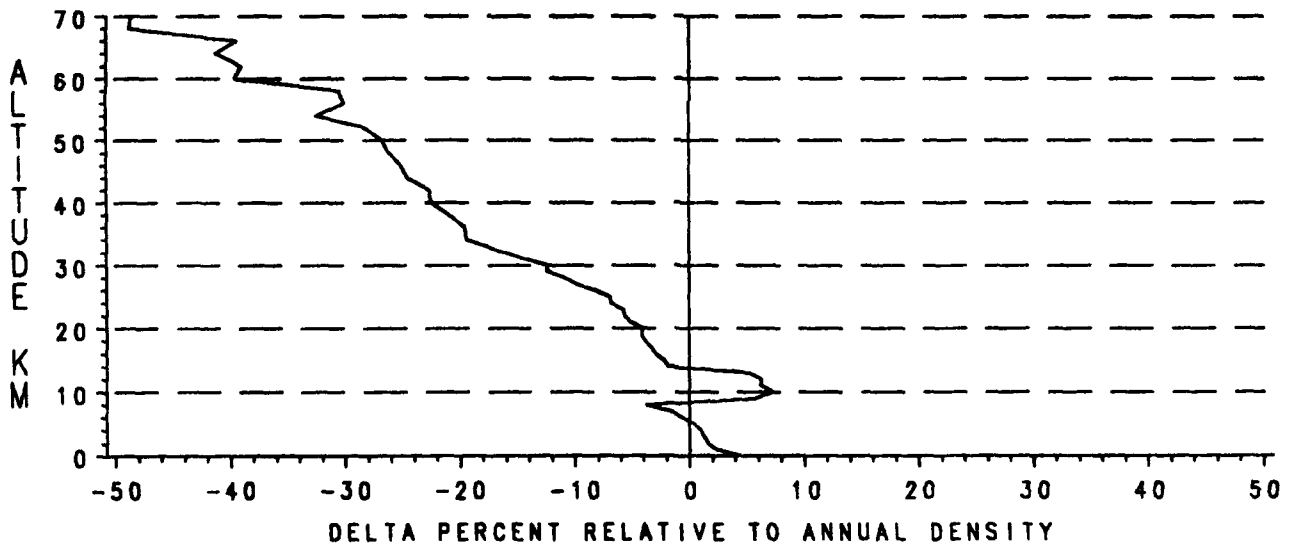
LEVEL	CVP	CVD	CVT	R(P, T)	R(P, D)	R(T, D)
0.000	0.014	0.034	0.032	0.078	0.330	-0.916
0.059	0.014	0.033	0.032	0.136	0.284	-0.911
1.000	0.014	0.029	0.029	0.256	0.229	-0.882
2.000	0.016	0.024	0.027	0.474	0.121	-0.816
3.000	0.018	0.019	0.025	0.633	0.103	-0.705
4.000	0.020	0.017	0.025	0.680	0.285	-0.510
5.000	0.023	0.016	0.024	0.737	0.539	-0.173
6.000	0.026	0.016	0.023	0.795	0.704	0.128
7.000	0.028	0.019	0.021	9.999	9.999	9.999
8.000	0.030	0.026	0.021	0.538	0.724	-0.192
9.000	0.033	0.032	0.026	0.424	0.676	-0.380
10.000	0.034	0.037	0.029	0.310	0.674	-0.494
11.000	0.036	0.039	0.031	0.338	0.662	-0.481
12.000	0.038	0.035	0.032	0.500	0.635	-0.351
13.000	0.042	0.032	0.033	0.654	0.623	-0.184
14.000	0.045	0.029	0.035	0.766	0.621	-0.028
15.000	0.048	0.029	0.037	0.792	0.628	0.022
16.000	0.056	0.030	0.041	0.849	0.702	0.219
17.000	0.060	0.031	0.043	0.864	0.728	0.283
18.000	0.066	0.036	0.044	0.861	0.784	0.359
19.000	0.062	0.036	0.042	0.821	0.755	0.245
20.000	0.059	0.040	0.038	0.739	0.769	0.138
21.000	0.060	0.041	0.037	0.735	0.796	0.174
22.000	0.064	0.045	0.037	0.714	0.817	0.179
23.000	0.055	0.047	0.030	0.537	0.838	-0.010
24.000	0.053	0.046	0.032	0.498	0.807	-0.111
25.000	0.052	0.047	0.034	0.464	0.773	-0.204
26.000	0.051	0.051	0.037	0.362	0.733	-0.369
27.000	0.056	0.052	0.034	0.424	0.797	-0.209
28.000	0.060	0.061	0.027	0.181	0.905	-0.255
29.000	0.064	0.065	0.036	0.250	0.843	-0.310
30.000	0.051	0.073	0.039	-0.284	0.857	-0.738
32.000	0.176	0.146	0.157	0.619	0.543	-0.324
34.000	0.202	0.172	0.153	0.559	0.675	-0.235
36.000	0.215	0.183	0.156	0.552	0.702	-0.206
38.000	0.228	0.200	0.173	0.529	0.680	-0.263
40.000	0.233	0.202	0.174	0.540	0.690	-0.236
42.000	0.246	0.218	0.156	0.484	0.781	-0.168
44.000	0.266	0.250	0.136	0.368	0.863	-0.152
46.000	0.274	0.260	0.139	0.356	0.865	-0.160
48.000	0.281	0.271	0.121	0.299	0.904	-0.138
50.000	0.288	0.275	0.107	0.308	0.928	-0.067
52.000	0.290	0.289	0.093	0.174	0.948	-0.149
54.000	0.336	0.369	0.095	-0.227	0.968	-0.463
56.000	0.335	0.372	0.103	-0.225	0.963	-0.479
58.000	0.329	0.360	0.113	-0.111	0.950	-0.415
60.000	0.248	0.286	0.115	-0.127	0.917	-0.511
62.000	0.234	0.300	0.122	-0.356	0.925	-0.685
64.000	0.237	0.293	0.126	-0.233	0.909	-0.618
66.000	0.000	0.000	0.138	9.999	9.999	9.999
68.000	0.000	0.000	0.000	9.999	9.999	9.999
70.000	0.000	0.000	0.000	9.999	9.999	9.999

**TABLE F-4. Coefficients of Variation/Correlation Coefficient, July.**

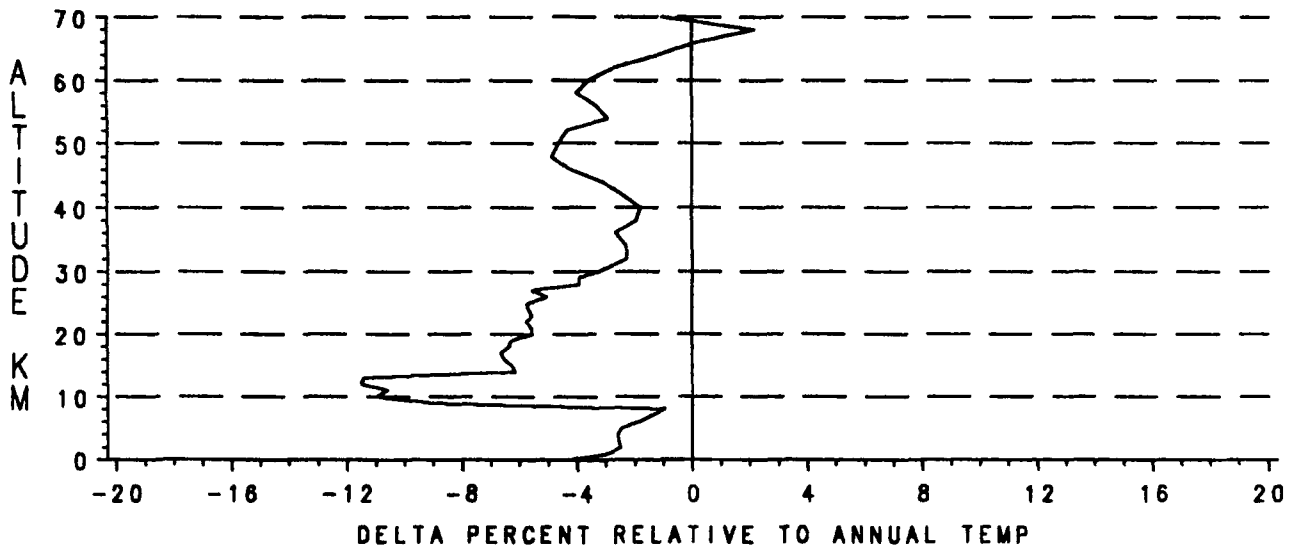
LEVEL	CVP	CVD	CVT	R(P, T)	R(P, D)	R(T, D)
0.000	0.008	0.016	0.012	-0.097	0.561	-0.878
0.059	0.008	0.015	0.012	-0.093	0.597	-0.854
1.000	0.008	0.012	0.012	0.320	0.347	-0.777
2.000	0.009	0.012	0.013	0.456	0.216	-0.770
3.000	0.009	0.012	0.014	0.555	0.161	-0.732
4.000	0.010	0.010	0.014	0.657	0.138	-0.656
5.000	0.012	0.010	0.014	0.733	0.150	-0.563
6.000	0.013	0.009	0.015	0.786	0.192	-0.456
7.000	0.015	0.009	0.015	0.788	0.635	0.024
8.000	0.017	0.011	0.014	0.802	0.906	0.474
9.000	0.018	0.022	0.014	9.999	9.999	9.999
10.000	0.017	0.034	0.022	-0.568	0.852	-0.915
11.000	0.015	0.032	0.020	-0.664	0.883	-0.937
12.000	0.014	0.022	0.012	-0.500	0.885	-0.845
13.000	0.013	0.019	0.009	-0.435	0.902	-0.782
14.000	0.012	0.017	0.008	-0.374	0.899	-0.743
15.000	0.012	0.016	0.007	-0.318	0.897	-0.704
16.000	0.012	0.015	0.007	-0.247	0.895	-0.653
17.000	0.011	0.014	0.007	-0.146	0.884	-0.591
18.000	0.011	0.013	0.006	-0.027	0.879	-0.500
19.000	0.011	0.013	0.006	0.059	0.873	-0.435
20.000	0.012	0.012	0.006	0.219	0.874	-0.283
21.000	0.012	0.012	0.006	0.238	0.879	-0.254
22.000	0.012	0.012	0.006	0.385	0.875	-0.111
23.000	0.013	0.011	0.007	0.455	0.863	-0.056
24.000	0.013	0.011	0.007	0.501	0.862	-0.006
25.000	0.014	0.012	0.007	0.513	0.857	-0.003
26.000	0.014	0.012	0.007	0.572	0.877	0.107
27.000	0.015	0.012	0.007	0.553	0.864	0.058
28.000	0.015	0.013	0.008	0.510	0.866	0.012
29.000	0.016	0.013	0.008	0.550	0.861	0.049
30.000	0.016	0.013	0.009	0.590	0.824	0.029
32.000	0.016	0.016	0.036	9.999	9.999	9.999
34.000	0.020	0.016	0.036	9.999	9.999	9.999
36.000	0.021	0.016	0.030	0.854	-0.244	-0.713
38.000	0.024	0.019	0.027	0.721	0.190	-0.543
40.000	0.026	0.017	0.033	0.856	-0.102	-0.602
42.000	0.029	0.017	0.039	0.914	-0.364	-0.710
44.000	0.035	0.022	0.042	0.856	-0.069	-0.575
46.000	0.038	0.028	0.040	0.741	0.298	-0.421
48.000	0.041	0.037	0.032	0.528	0.665	-0.283
50.000	0.044	0.039	0.021	0.459	0.871	-0.036
52.000	0.044	0.039	0.017	0.472	0.929	0.113
54.000	0.047	0.050	0.023	0.120	0.890	-0.346
56.000	0.039	0.032	0.030	0.601	0.664	-0.198
58.000	0.040	0.040	0.039	0.482	0.521	-0.497
60.000	0.044	0.050	0.042	0.325	0.606	-0.556
62.000	0.040	0.031	0.040	0.702	0.380	-0.393
64.000	0.041	0.039	0.047	0.618	0.305	-0.560
66.000	0.000	0.000	0.045	9.999	9.999	9.999
68.000	0.000	0.000	0.070	9.999	9.999	9.999
70.000	0.000	0.000	0.000	9.999	9.999	9.999



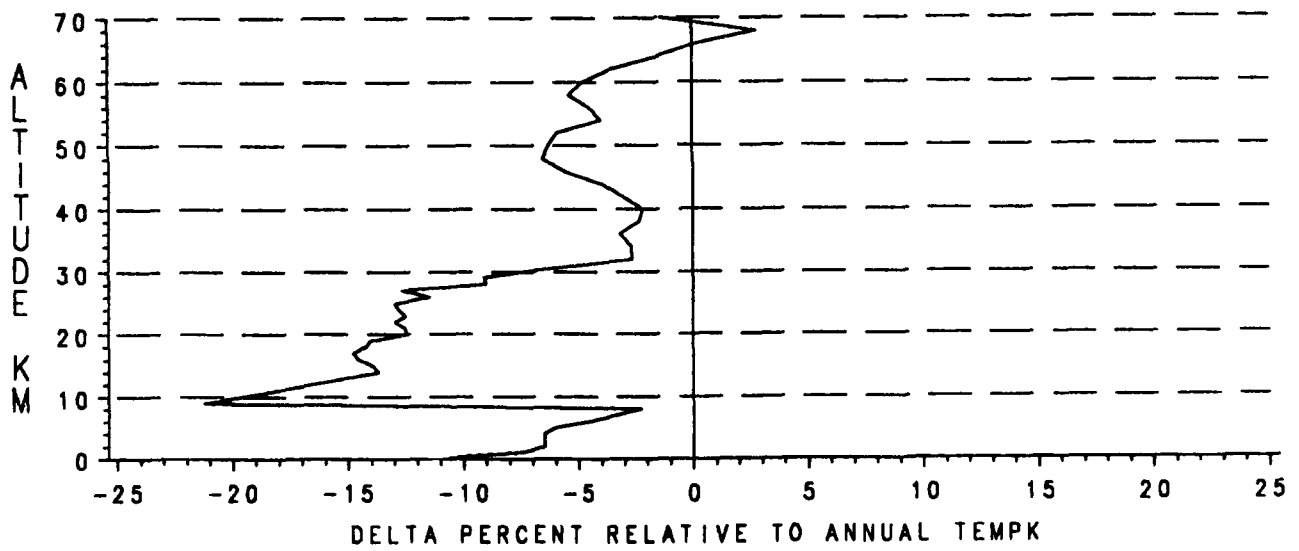
**Figure F-1. Delta Percent Relative to Annual Pressure, January**



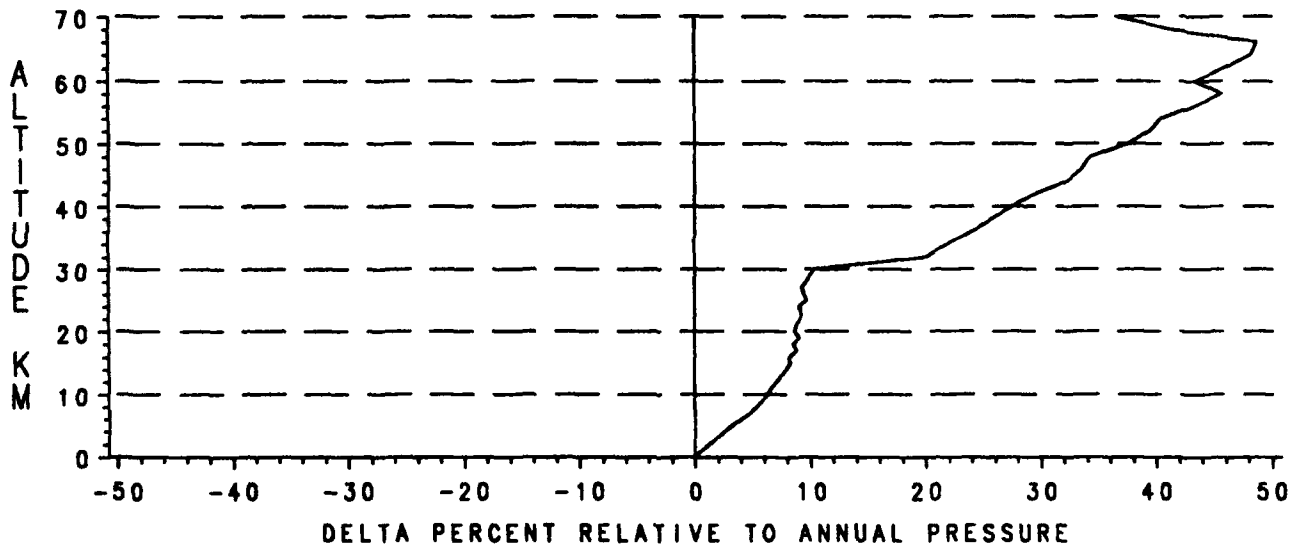
**Figure F-2. Delta Percent Relative to Annual Density, January.**



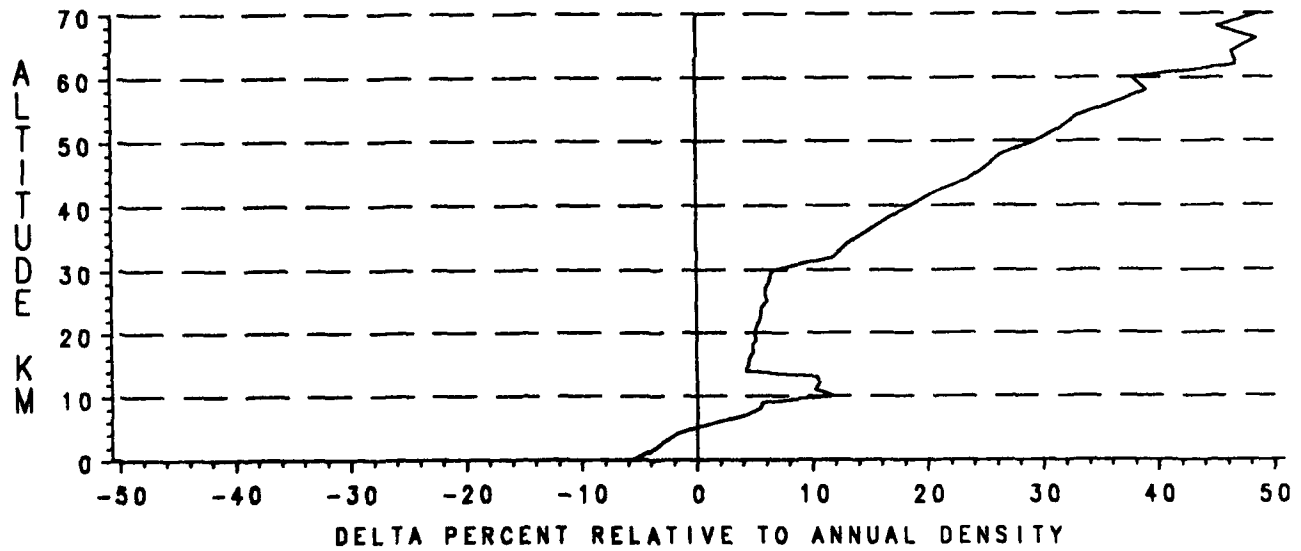
**Figure F-3. Delta Percent Relative to Annual Temperature, January**



**Figure F-4. Delta Temperature (K), January.**

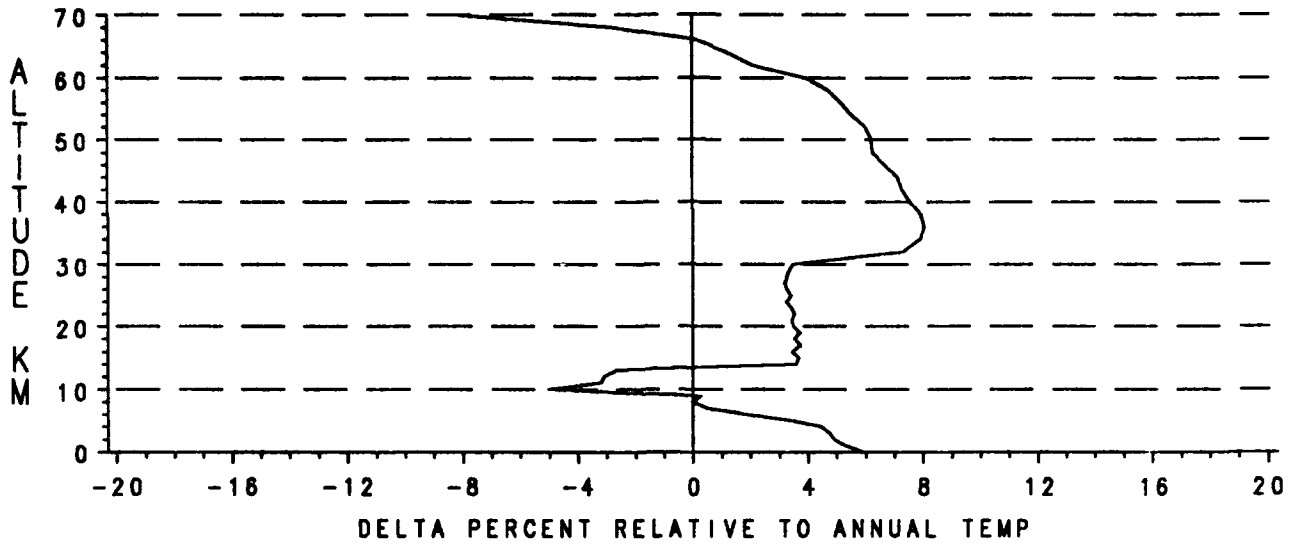


**Figure F-5. Delta Percent Relative to Annual Pressure, July.**

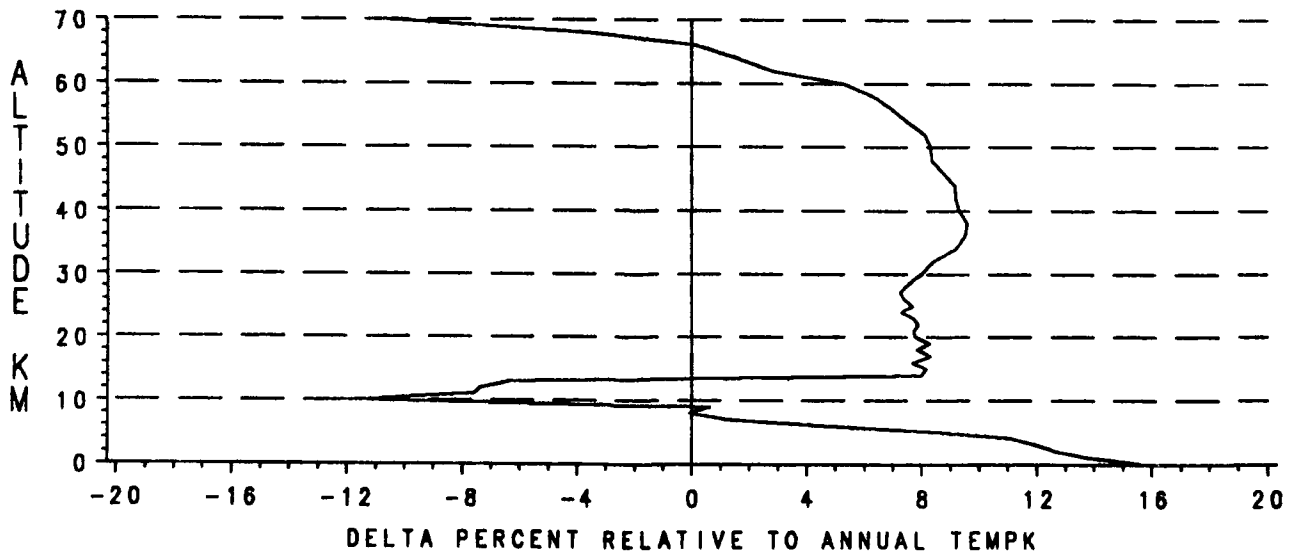


**Figure F-6. Delta Percent Relative to Annual Density, July.**

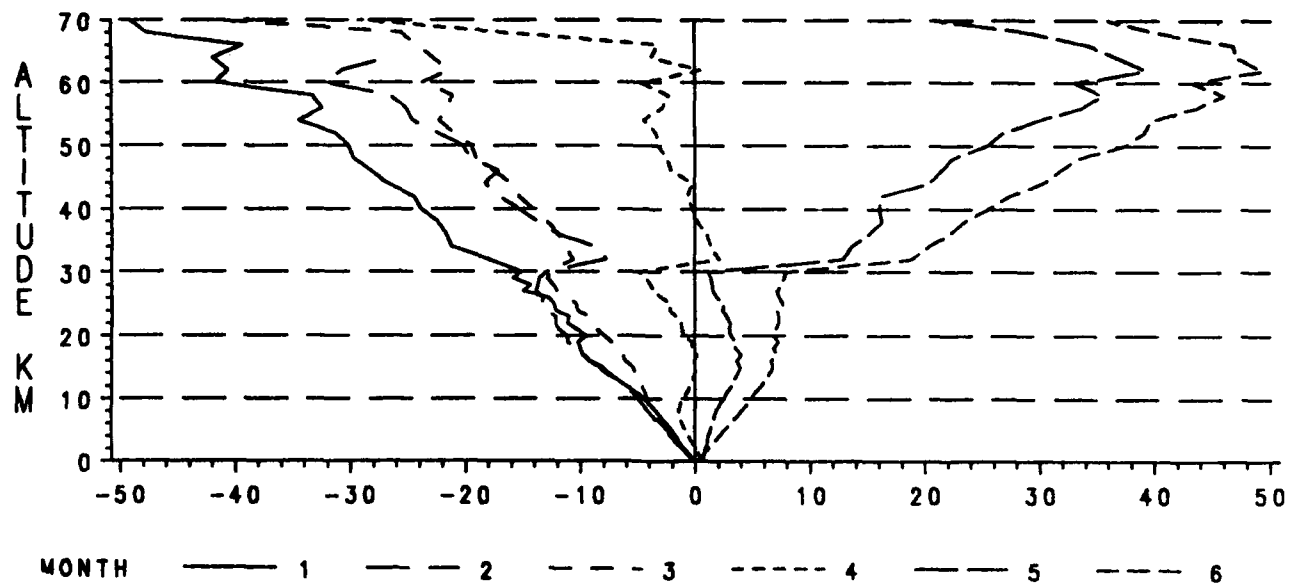




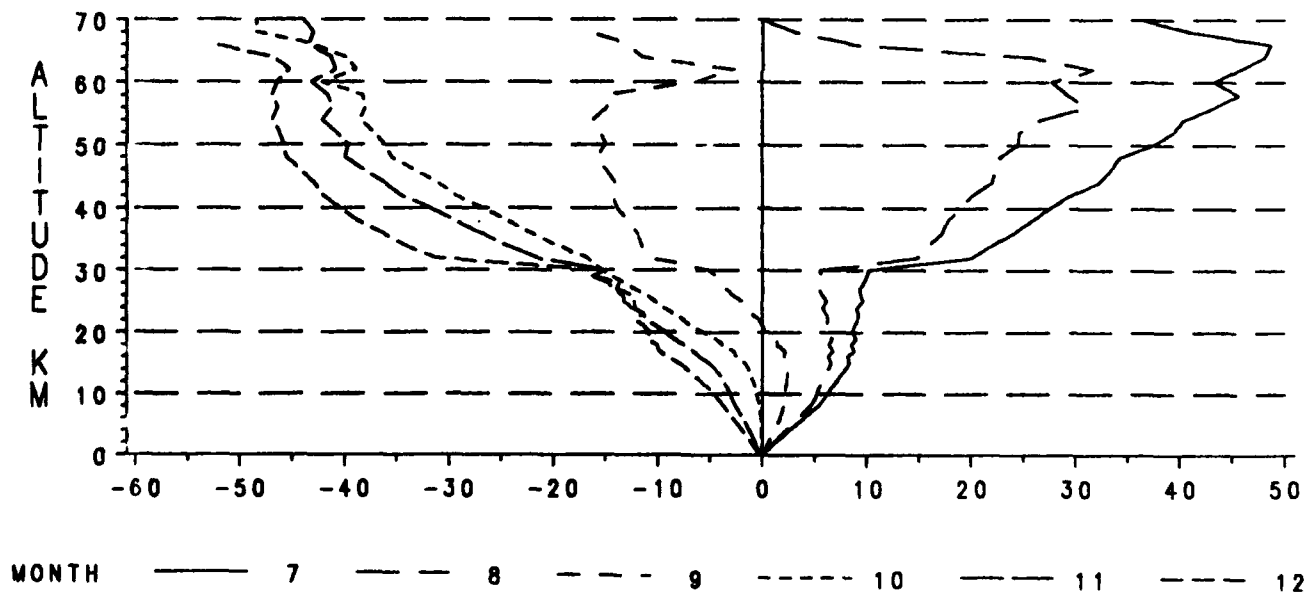
**Figure F-7. Delta Percent Relative to Annual Temperature, July.**



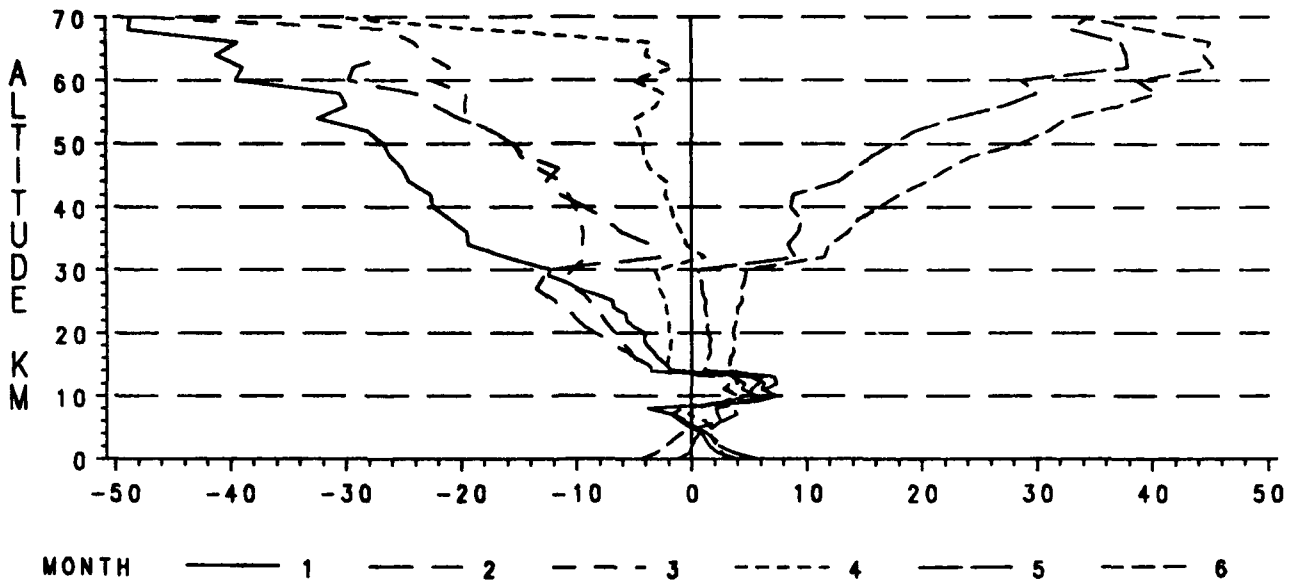
**Figure F-8. Delta Temperature (K), July.**



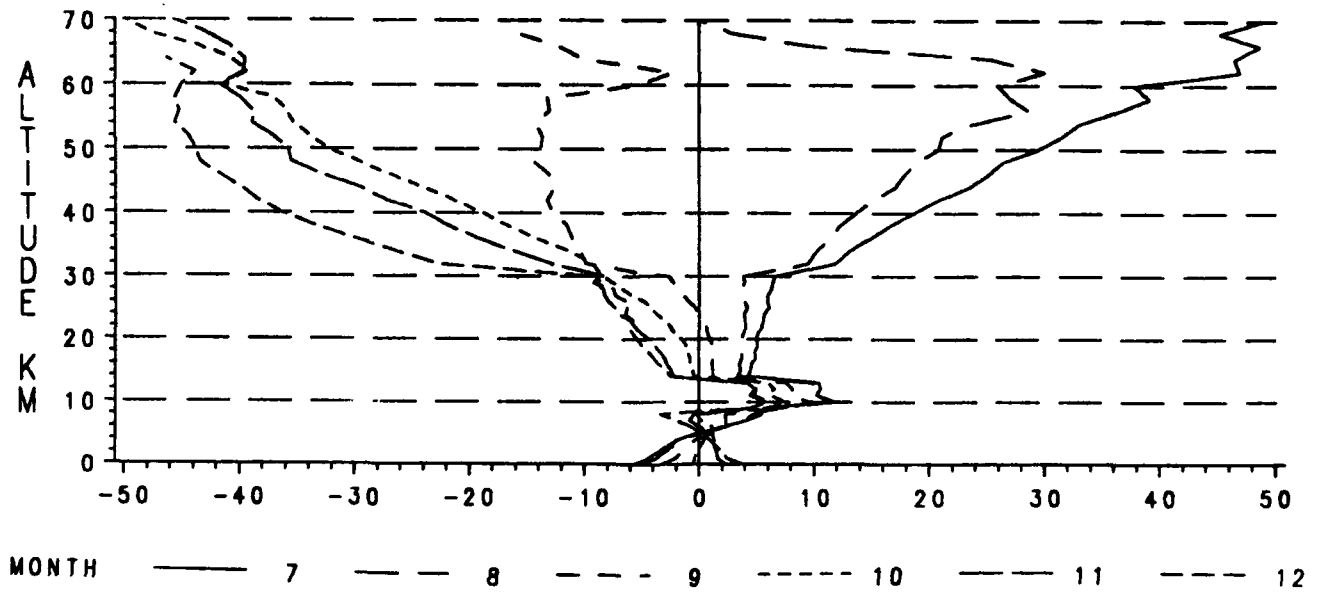
**Figure F-9. Delta Percent Relative to Annual Pressure, January-June.**



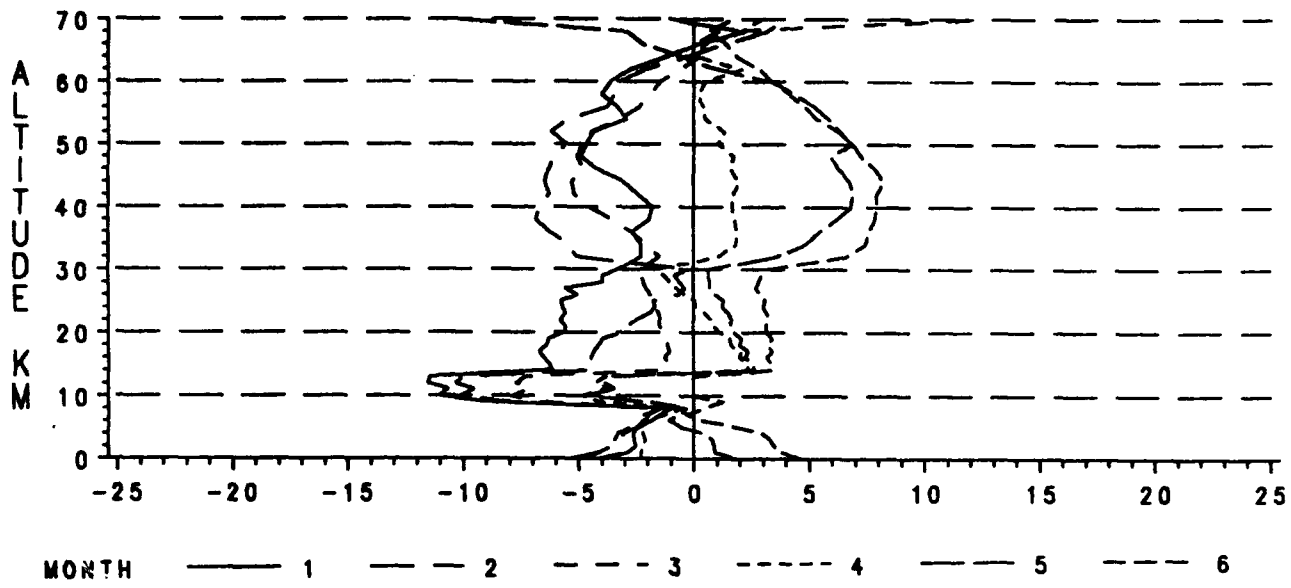
**Figure F-10. Delta Percent Relative to Annual Pressure, July-December.**



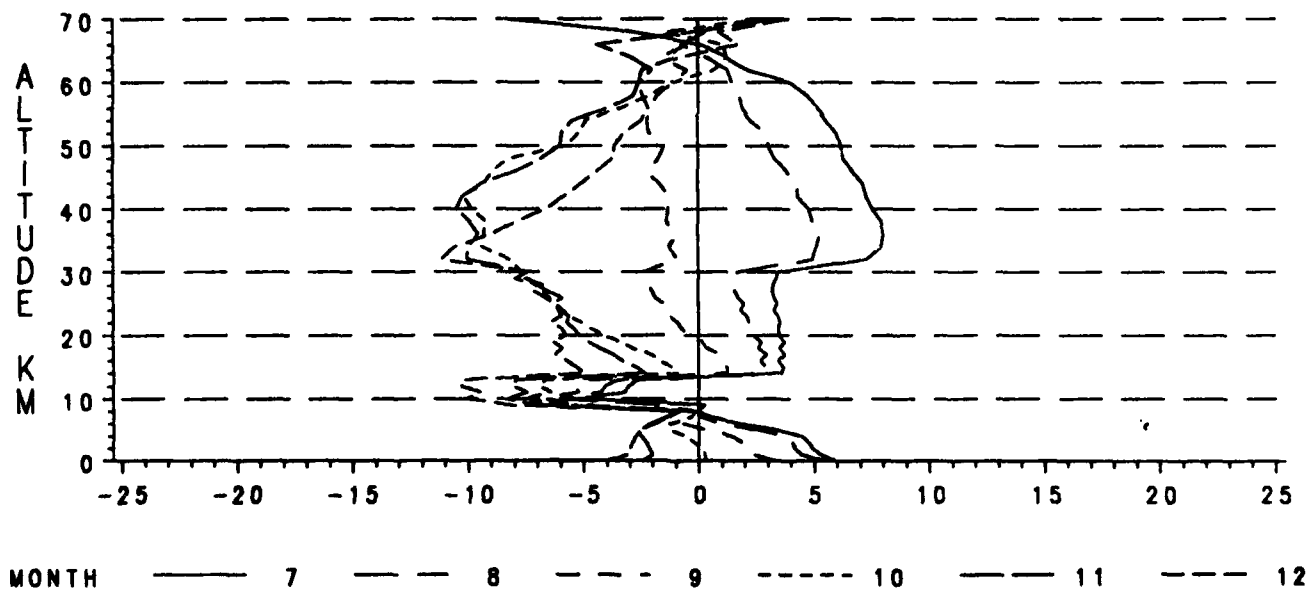
**Figure F-11. Delta Percent Relative to Annual Density, January-June.**



**Figure F-12. Delta Percent Relative to Annual Density, July-December.**



**Figure F-13. Delta Percent Relative to Annual Temperature, January-June.**



**Figure F-14. Delta Percent Relative to Annual Temperature, July-December.**

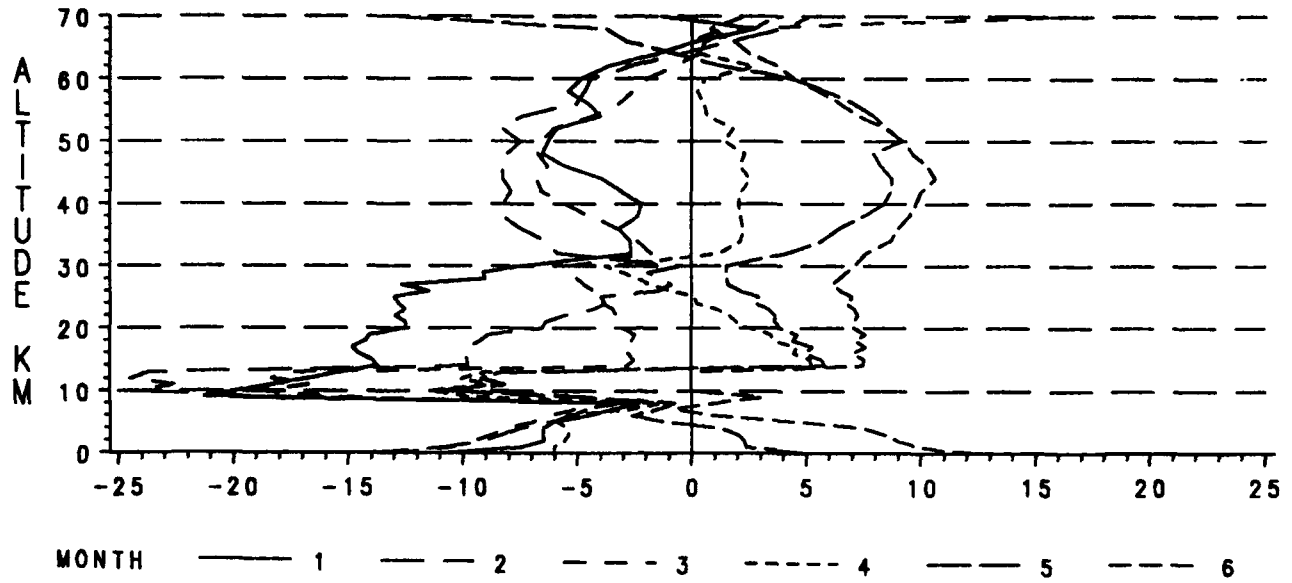


Figure F-15. Delta Temperature (K), January-June.

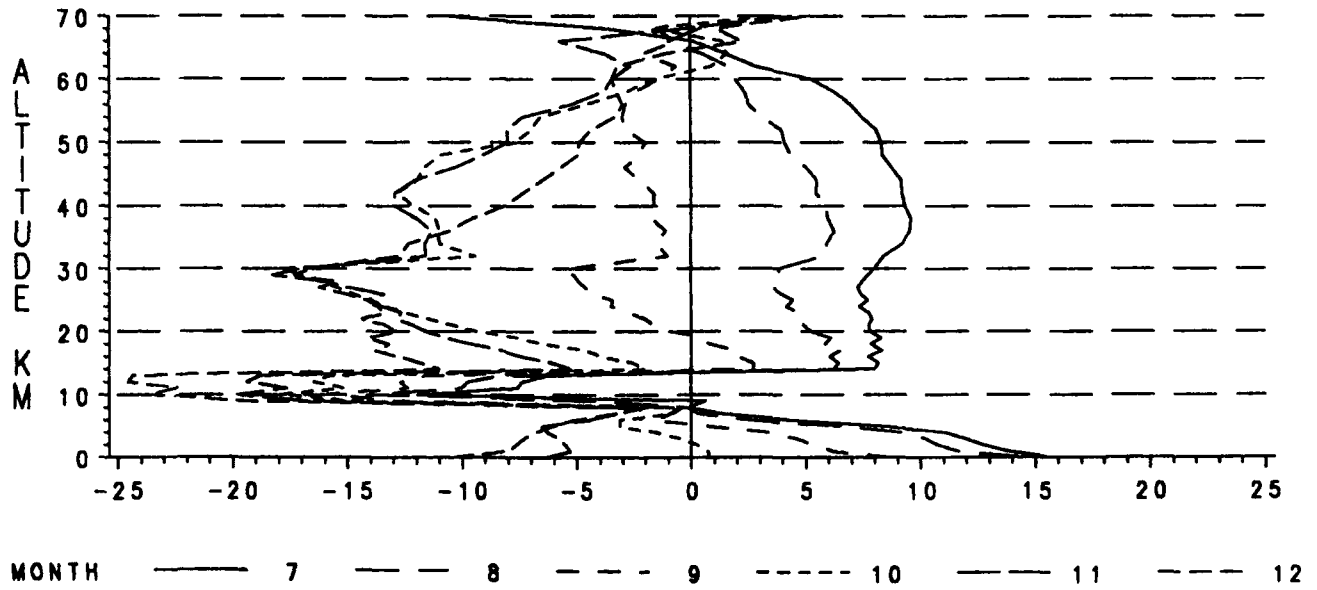
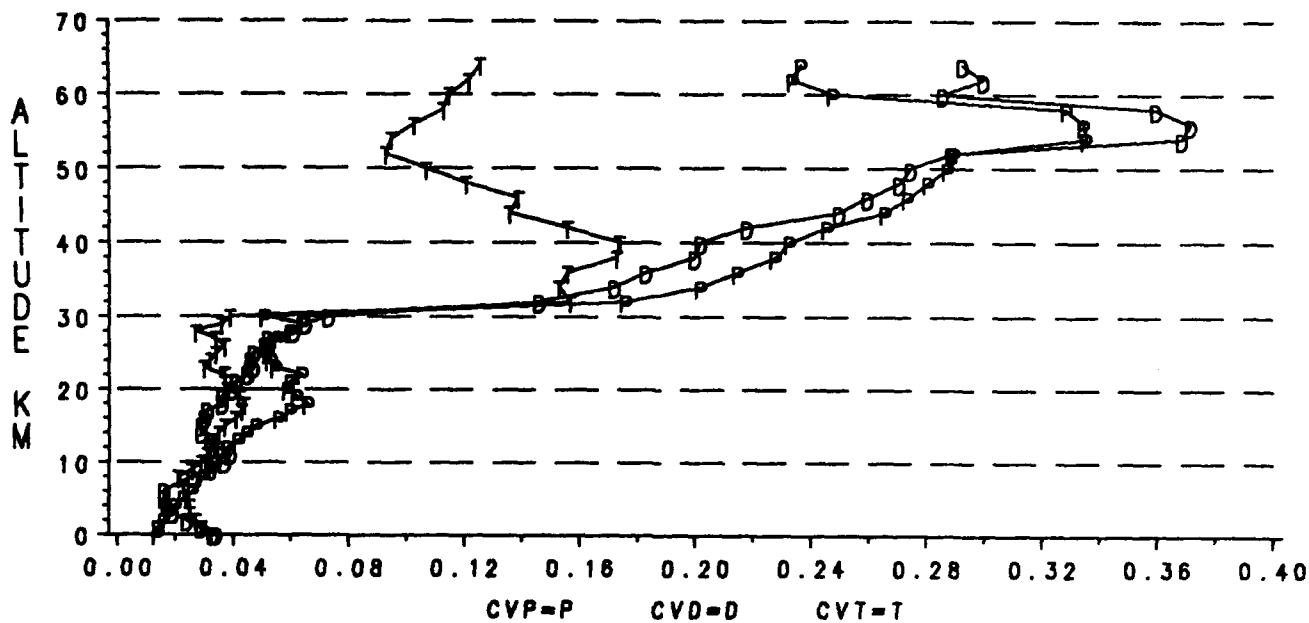
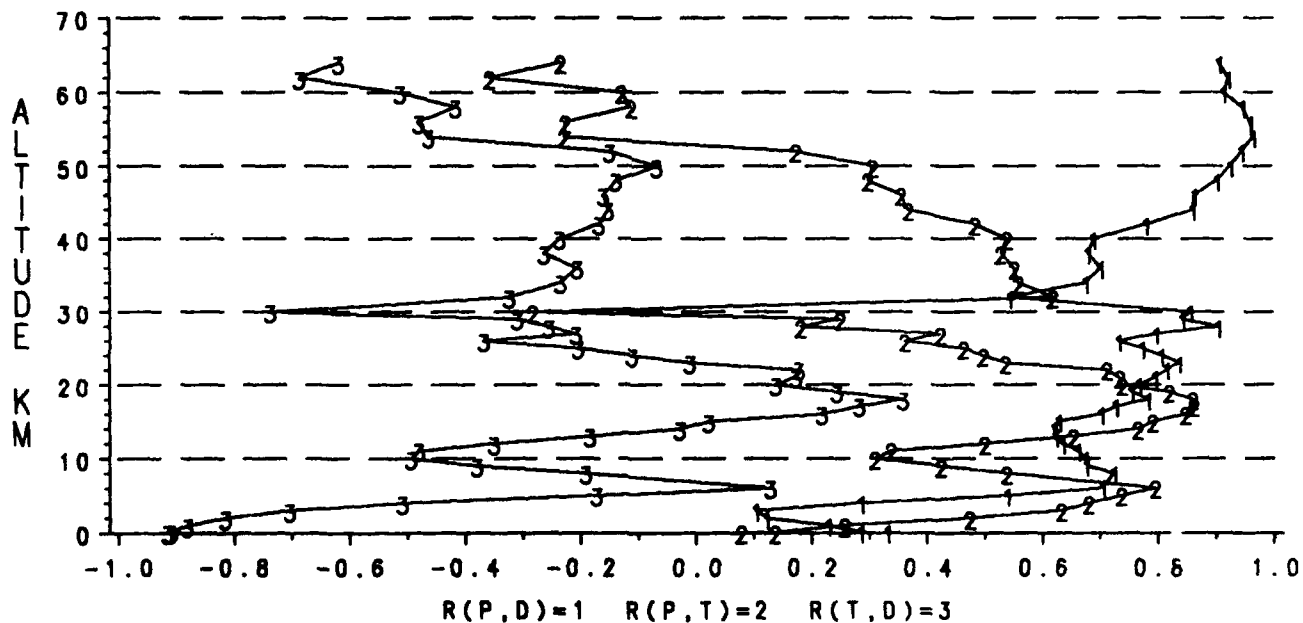


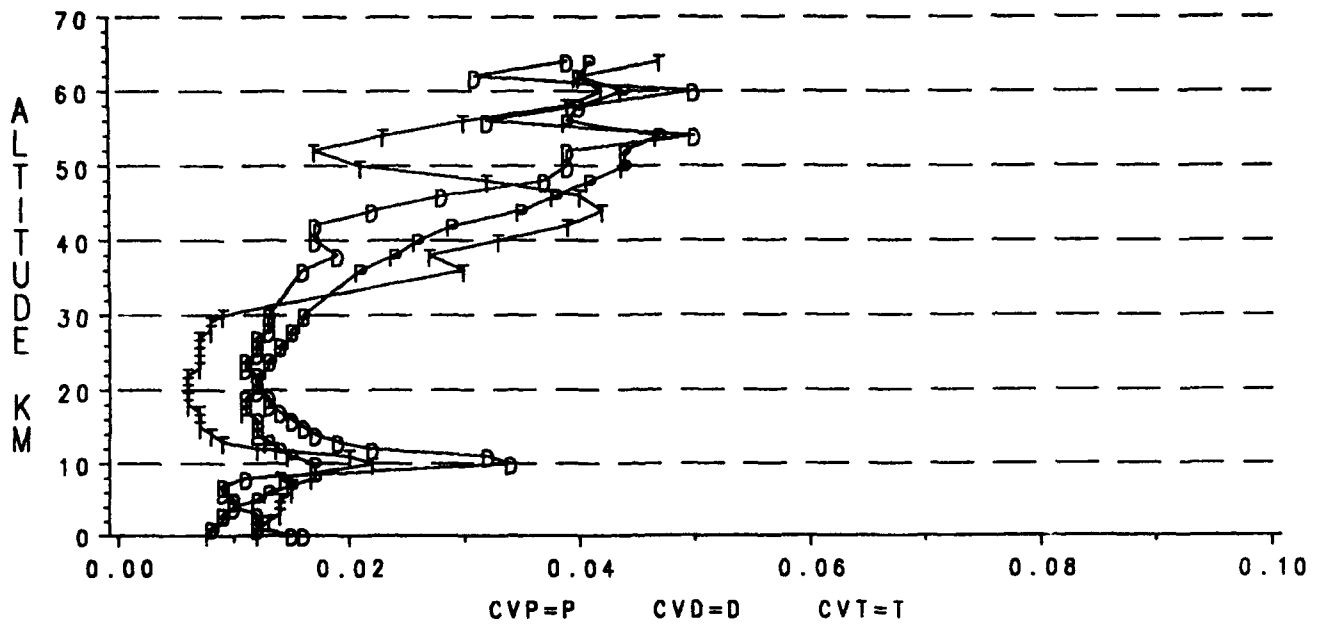
Figure F-16 Delta Temperature (K), July-December.



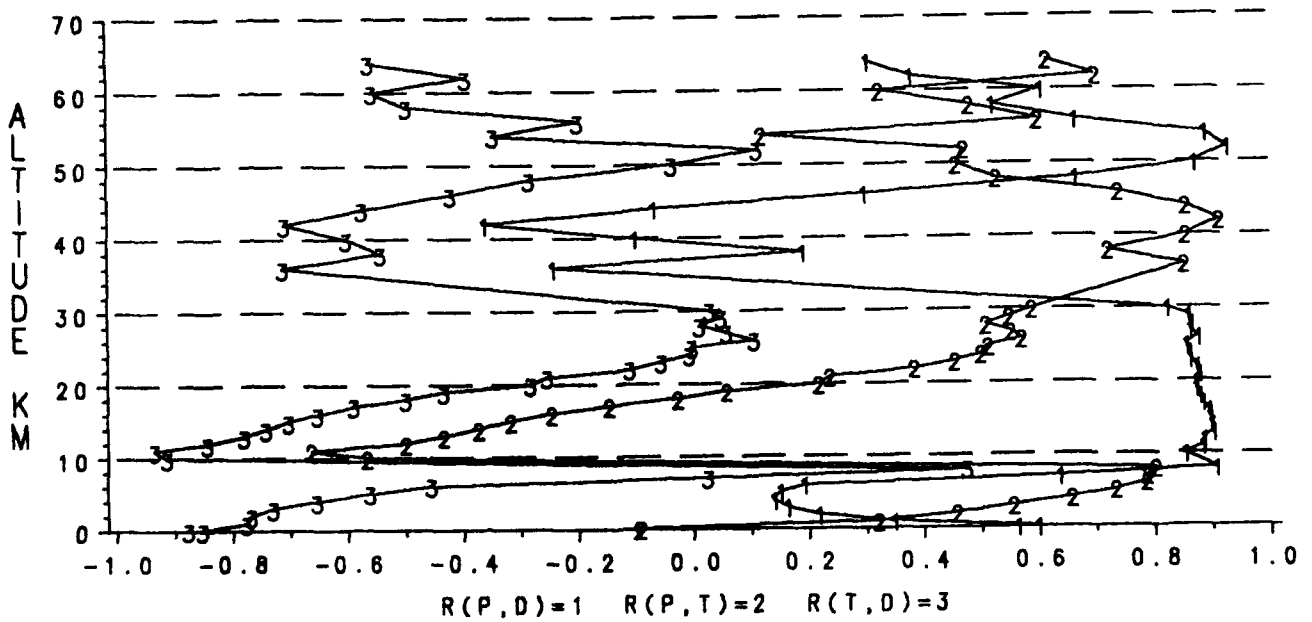
**Figure F-17. Coefficients of Variation for Pressure (P), Density (D), and Temperature (T), January.**



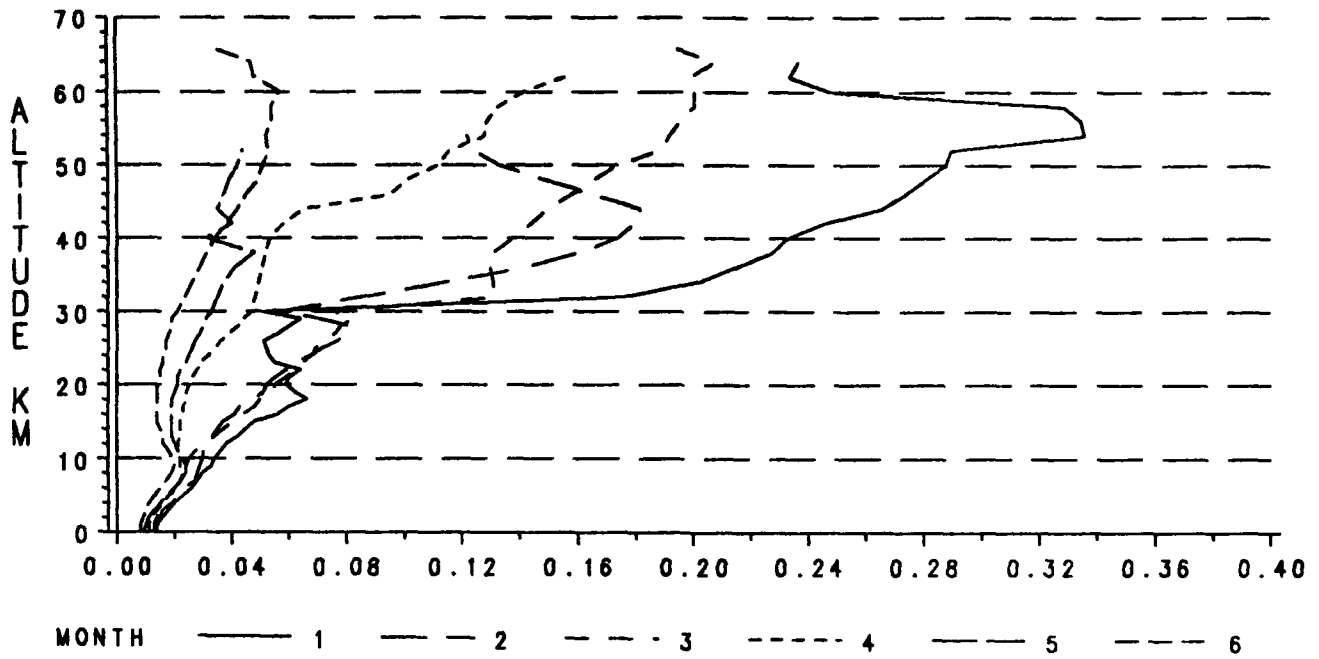
**Figure F-18. Correlation Coefficients for P&D, P&T, and T&D, January.**



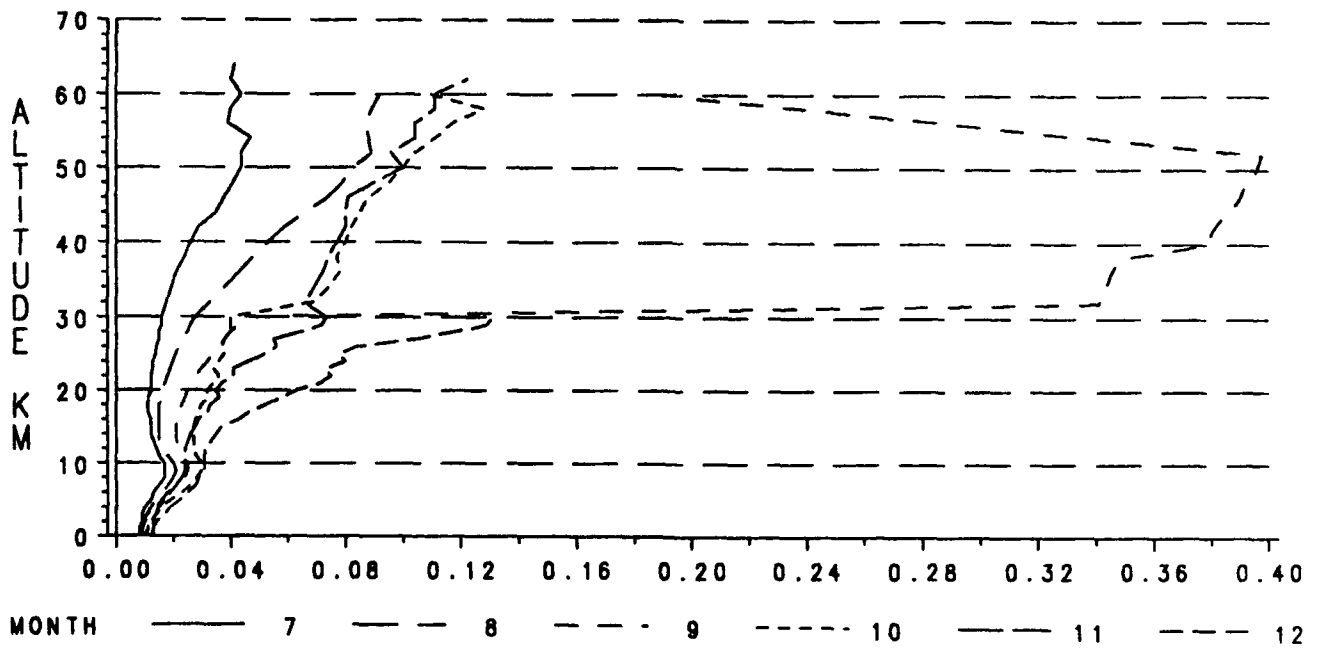
**Figure F-19. Coefficients of Variation for Pressure (P), Density (D), and Temperature (T), July.**



**Figure F-20. Correlation Coefficients for P&D, P&T, and T&D, July.**

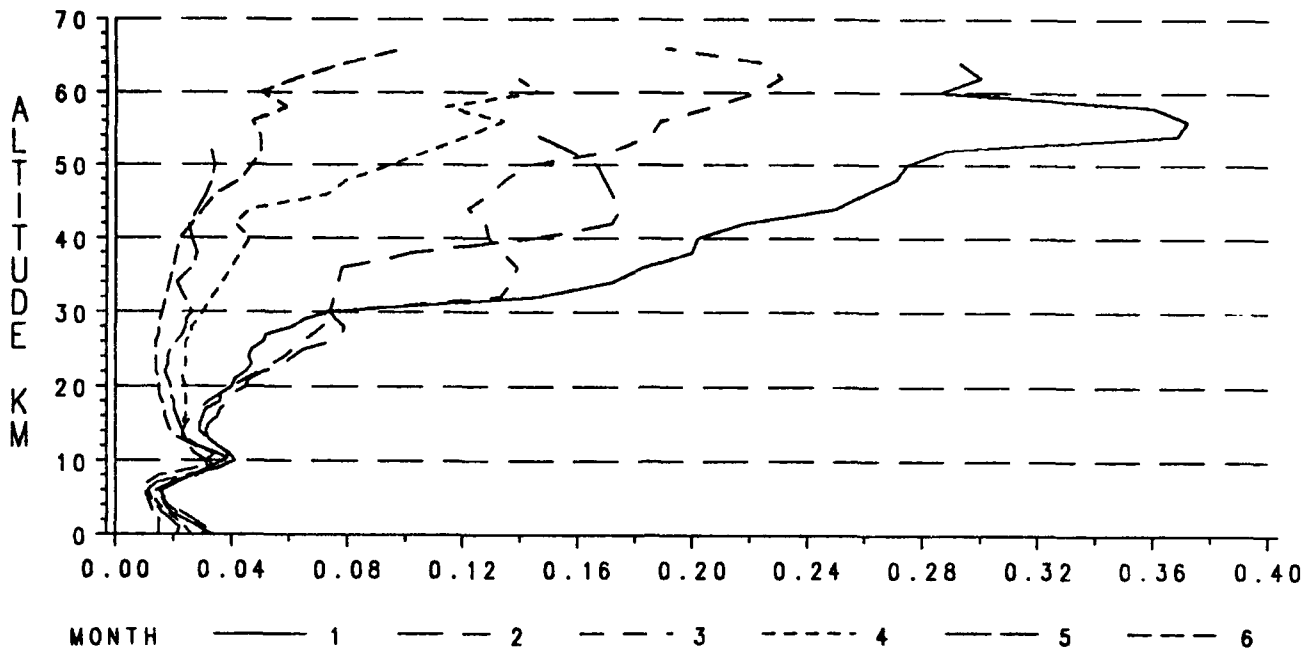


**Figure F-21. Coefficients of Variation for Pressure, January-June.**

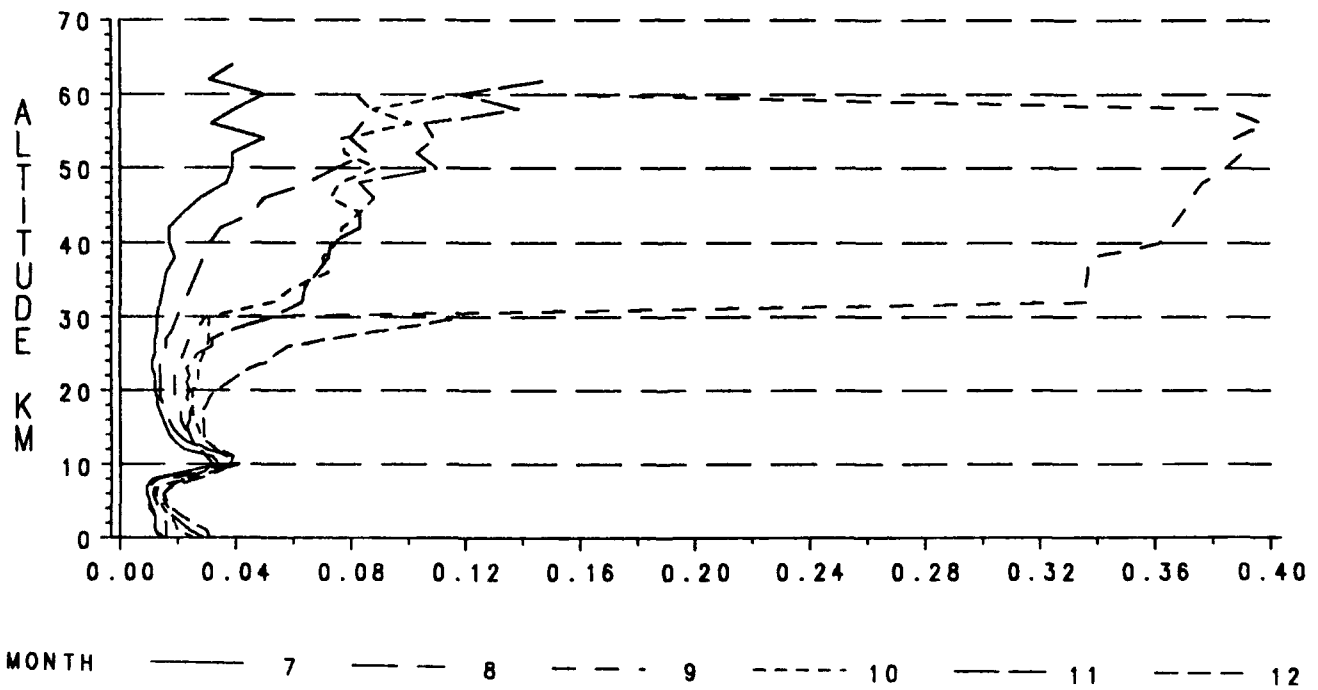


**Figure F-22. Coefficients of Variation for Pressure, July-December.**

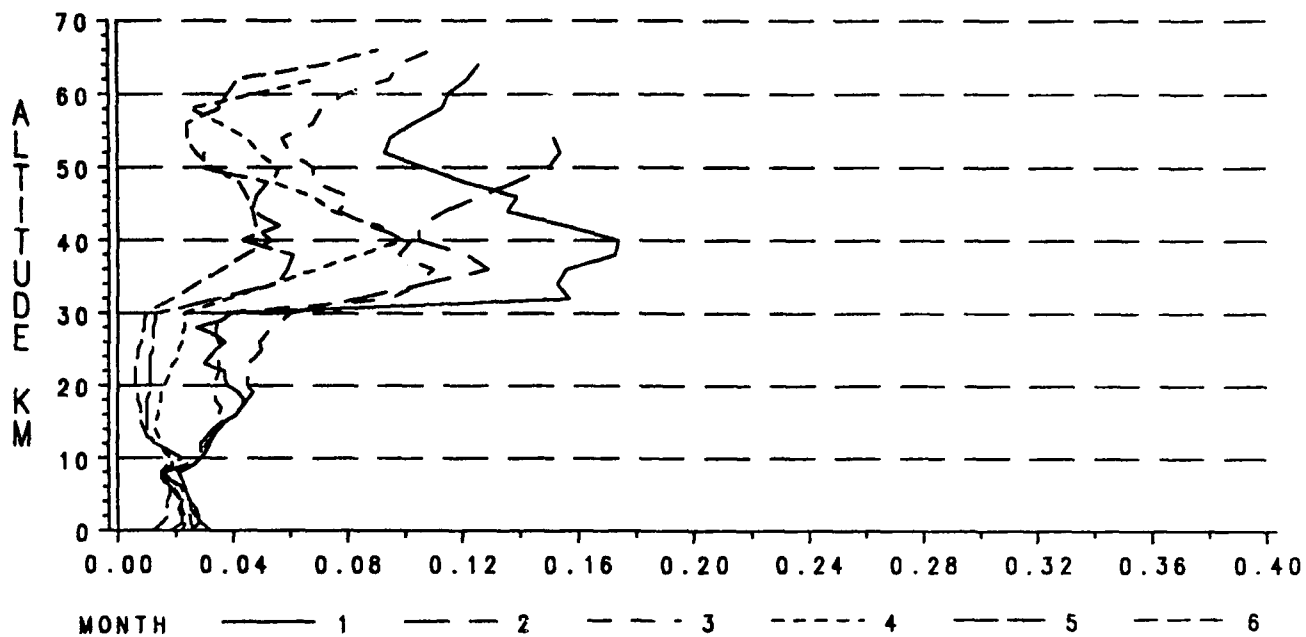




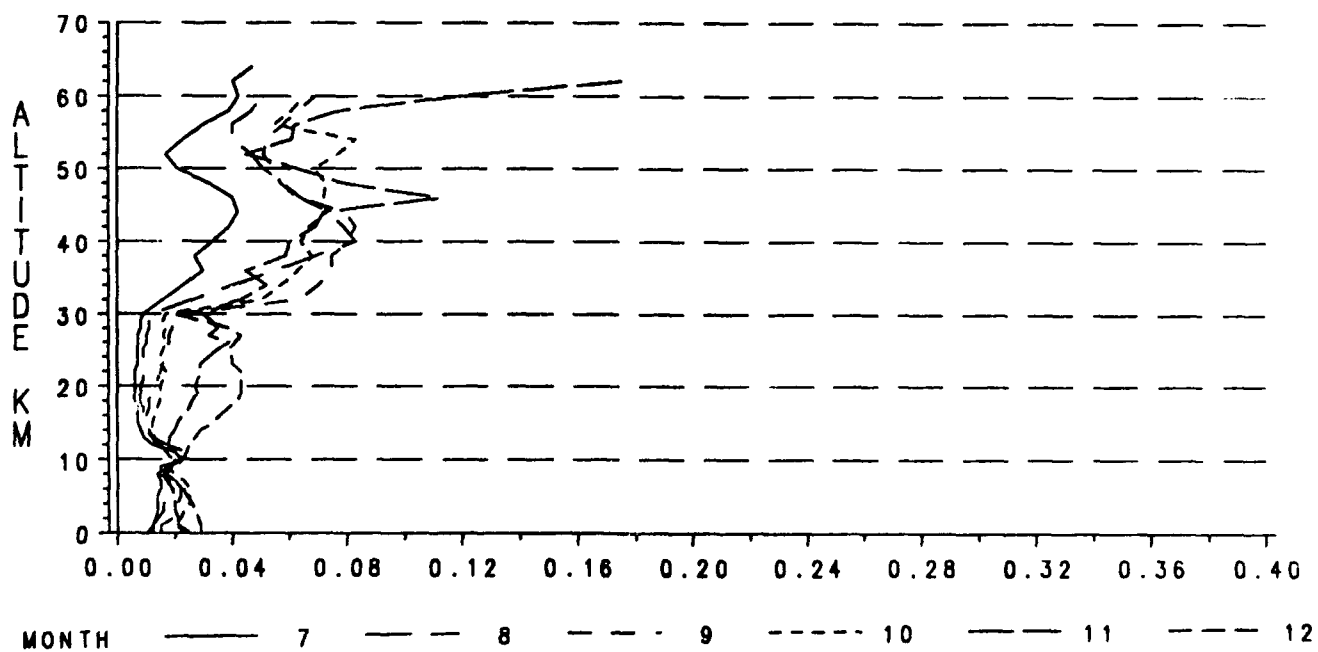
**Figure F-23. Coefficients of Variation for Density, January-June.**



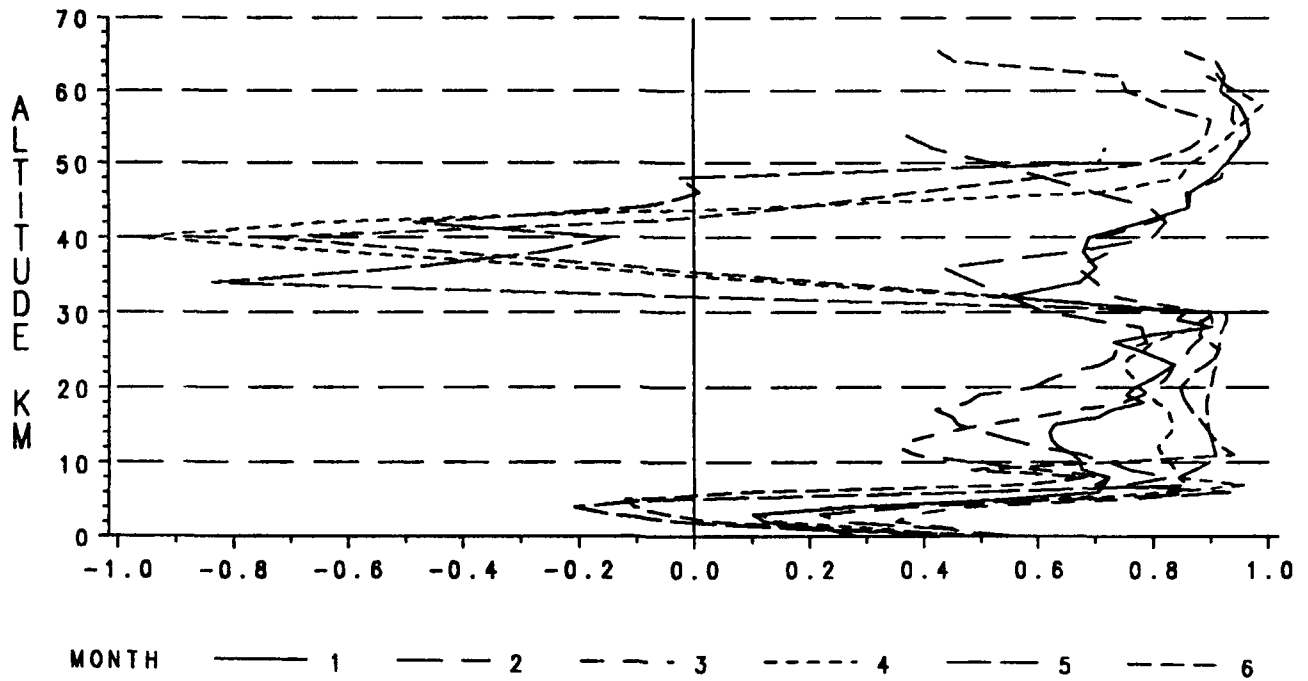
**Figure F-24. Coefficients of Variation for Density, July-December.**



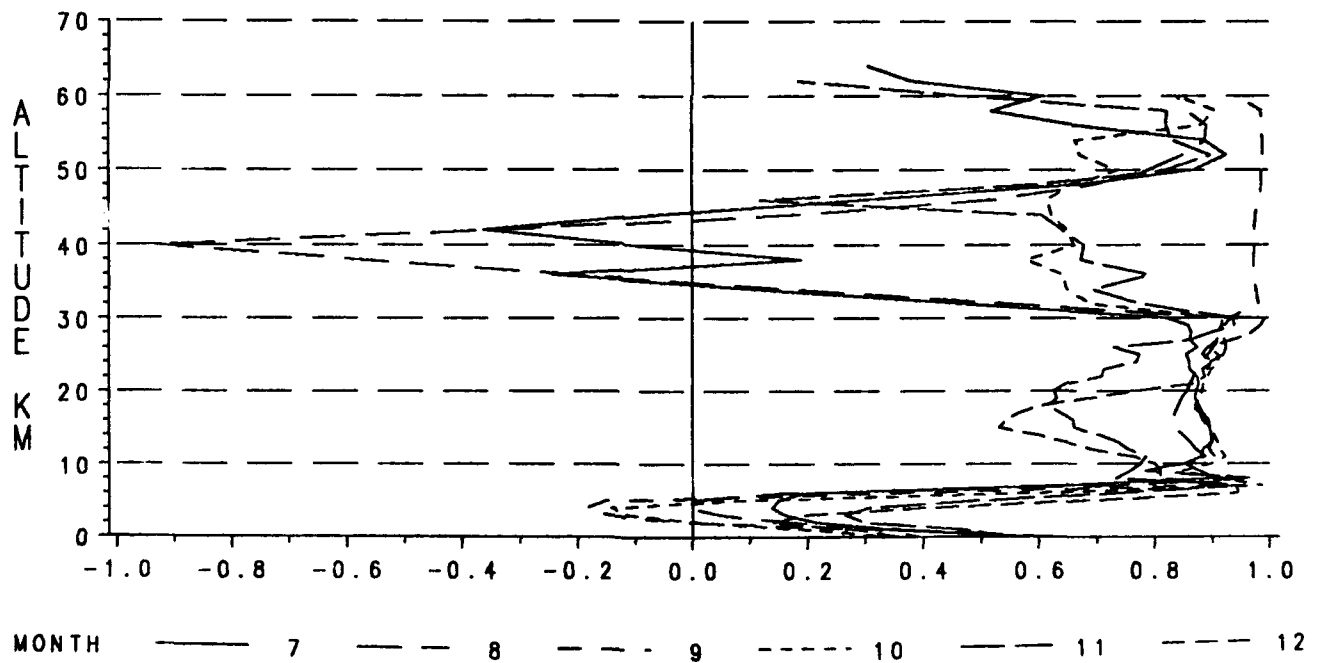
**Figure F-25. Coefficients of Variation for Temperature, January-June.**



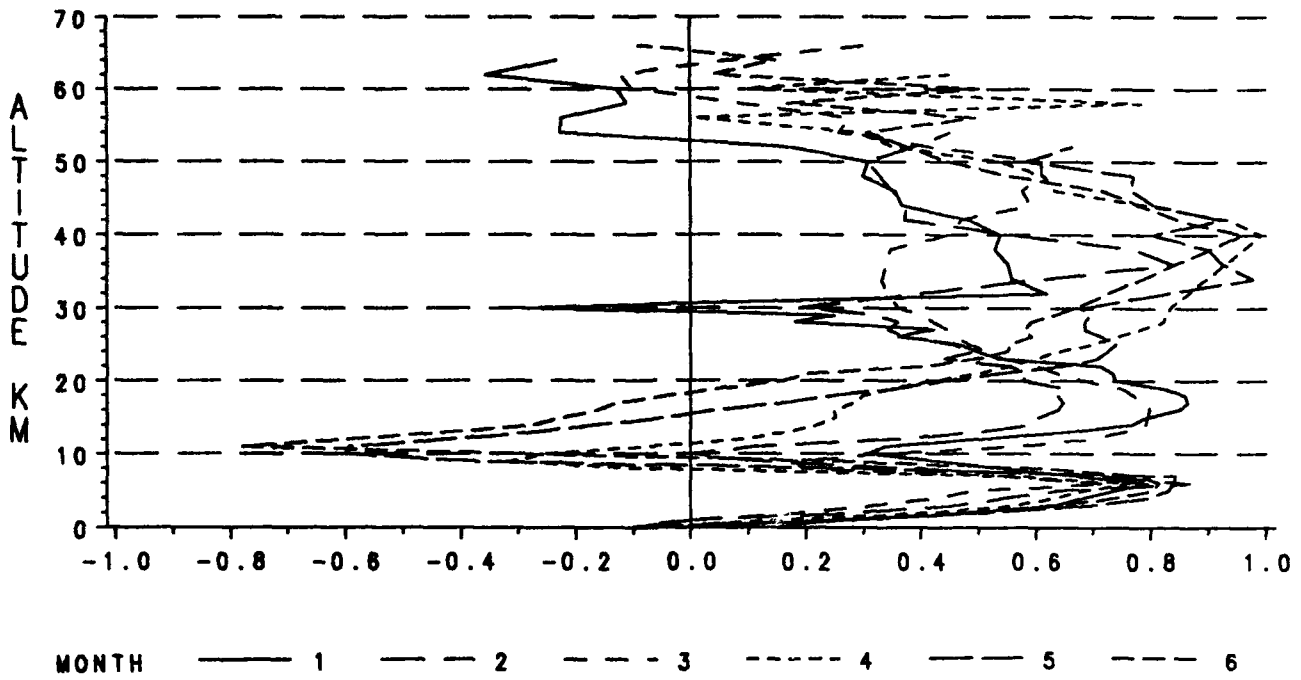
**Figure F-26. Coefficients of Variation for Temperature, July-December.**



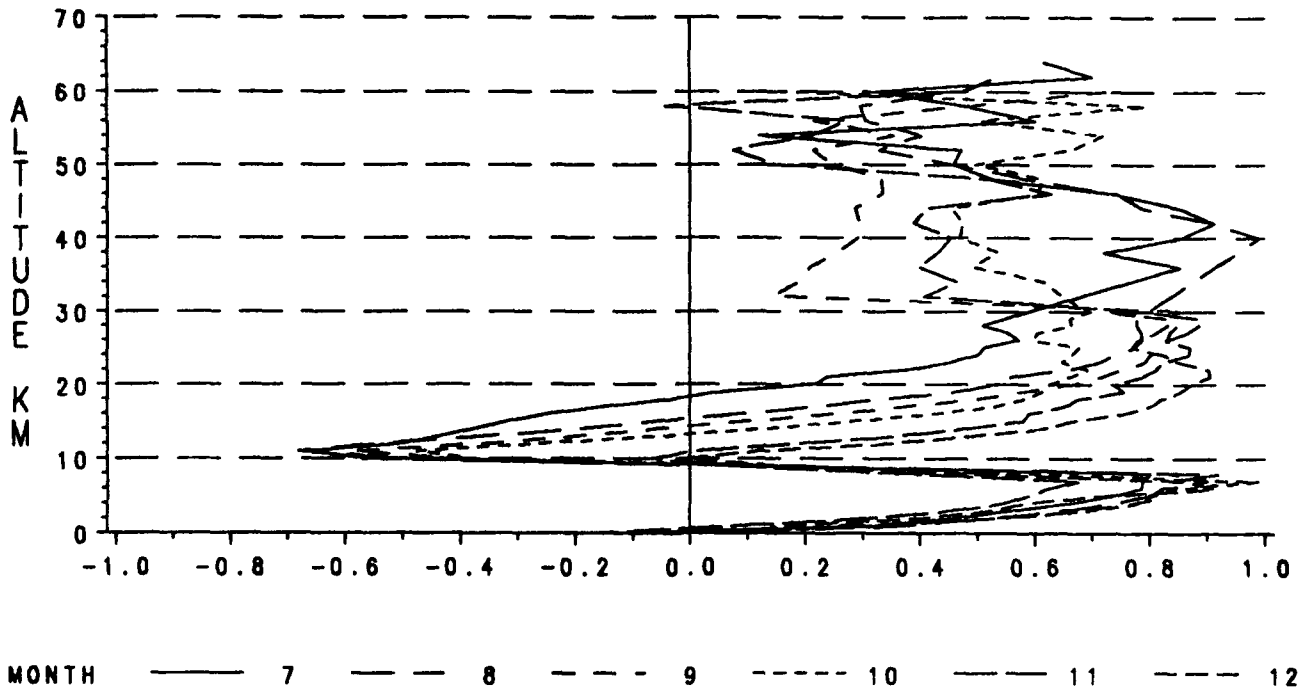
**Figure F-27. Correlation Coefficients for Pressure & Density, January-June.**



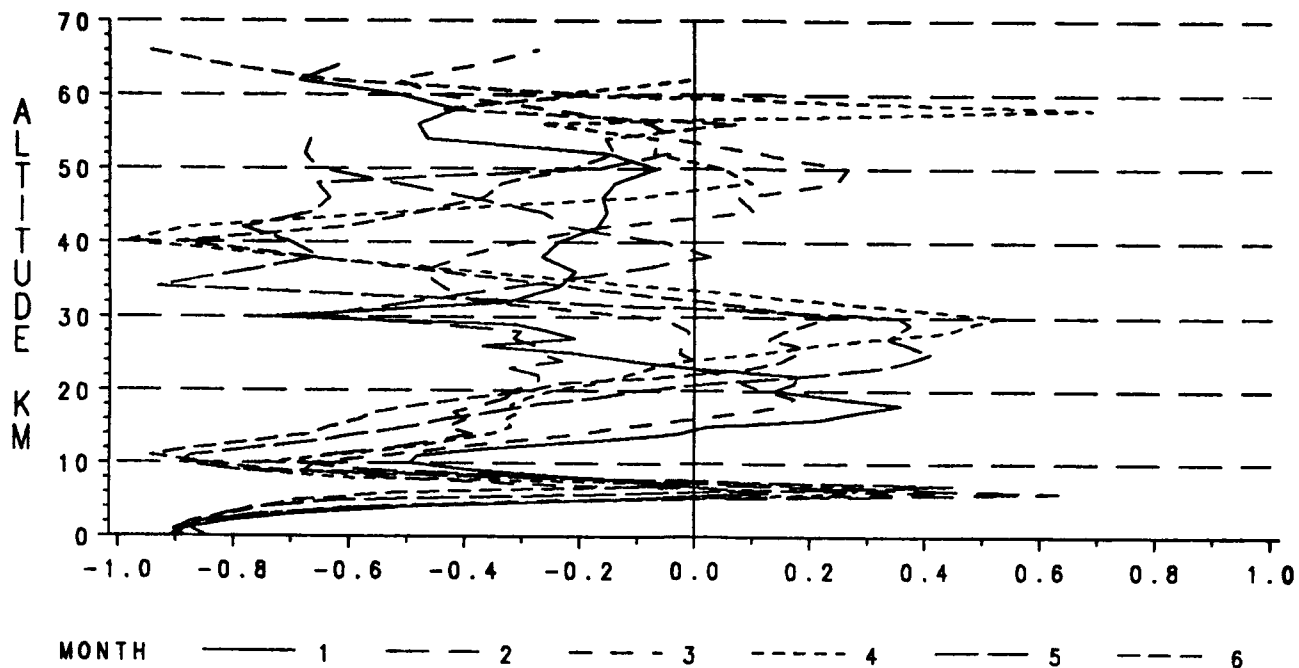
**Figure F-28. Correlation Coefficients for Pressure & Density, July-December.**



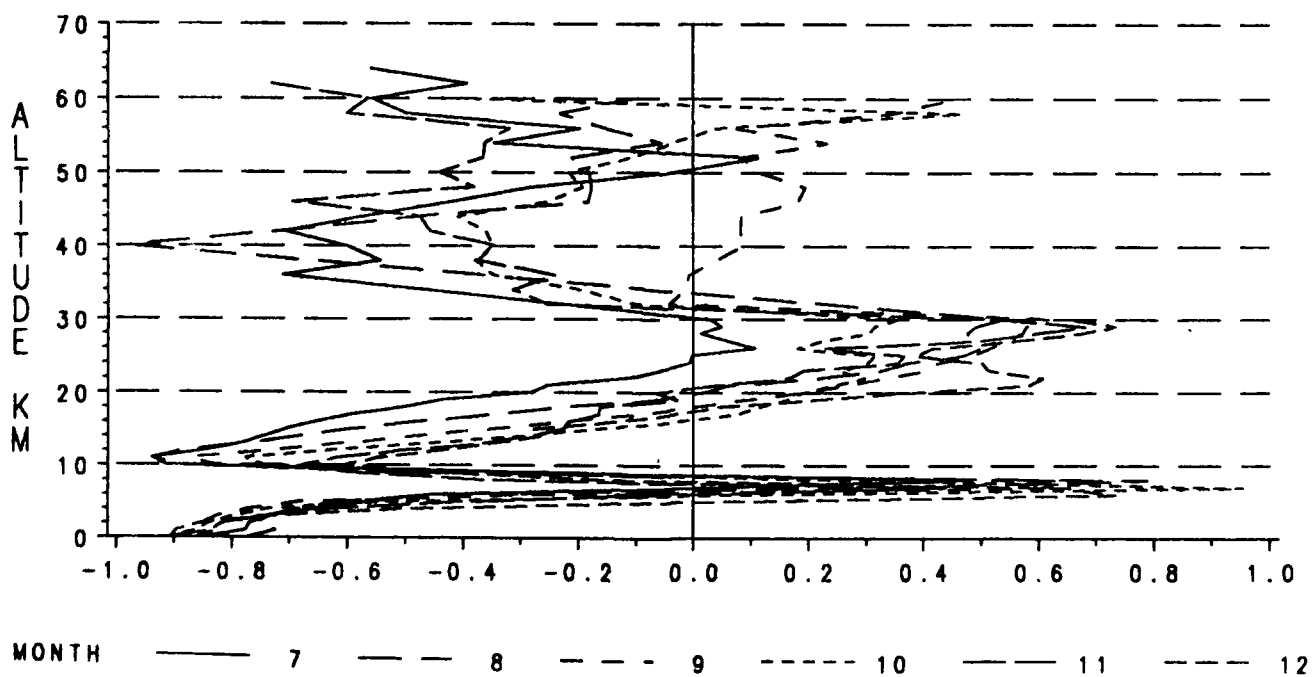
**Figure F-29. Correlation Coefficients for Pressure & Temperature, January-June.**



**Figure F-30. Correlation Coefficients for Pressure & Temperature July-December.**



**Figure F-31. Correlation Coefficients for Temperature & Density, January-June.**



**Figure F-32. Correlation Coefficients for Temperature & Density, July-December.**

## APPENDIX G

### Thule Descriptive Data

To prevent further character size reduction in the tables given in Appendices A-D, certain range-specific information for Thule has been omitted. The most important information follows:

#### Header Record 0-30 km

Table Number.....	0
Data Source (1=DATSAV, 2=WDC-A).....	1
Call Letters.....	BGTL
WMO Number.....	042020
Latitude.....	76° 31'
Direction (N or S).....	N
Longitude.....	068° 30'
Direction (E or W).....	W
Elevation in Meters.....	59
Start Period of Record (Mo-Yr).....	0173
End Period of Record (Mo-Yr).....	1286
No. of Time Windows (0,1, or 2).....	0
Start Time Window #1 (Hr-Mhz).....	0
End Time Window #1.....	0
Start Time Window #2.....	0
End Time Window #2.....	0
Date of RRA.....	0291
Altitude Range of RRA Low-Level (km).....	0
Altitude Range of RRA High-Level (km).....	30
Standard Deviation of Thermodynamics Limits.....	±6.0
Wind Limits.....	±6.0

**The following data is only required for RRAs that go to 70 km:**

Table Number.....	0
Data Source (1=DATSAV, 2=WDC-A).....	1
Call Letters.....	BGTL
WMO Number.....	042020
Latitude.....	76° 31'
Direction (N or S).....	N
Longitude.....	068° 30'
Direction (E or W).....	W
Elevation in Meters.....	59
Start Period of Record (Mo-Yr).....	0169
End Period of Record (Mo-Yr).....	0880
No. of Time Windows (0,1, or 2).....	0
Start Time Window #1 (Hr-Mhz).....	0
End Time Window #1.....	0
Start Time Window #2.....	0
End Time Window #2.....	0
Date of RRA.....	0291
Altitude Range of RRA Low-Level (km).....	32
Altitude Range of RRA High-Level (km).....	70
Standard Deviation of Thermodynamic Limits.....	±6.0
Wind Limits.....	±6.0