

2

AD-A239 508

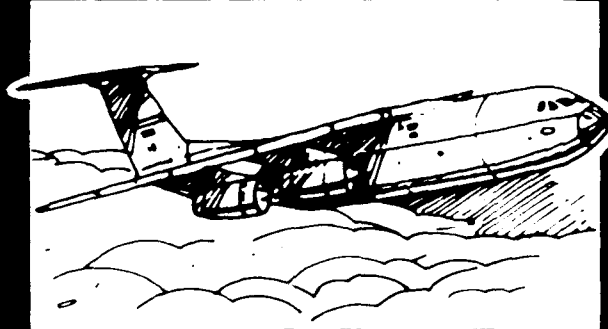
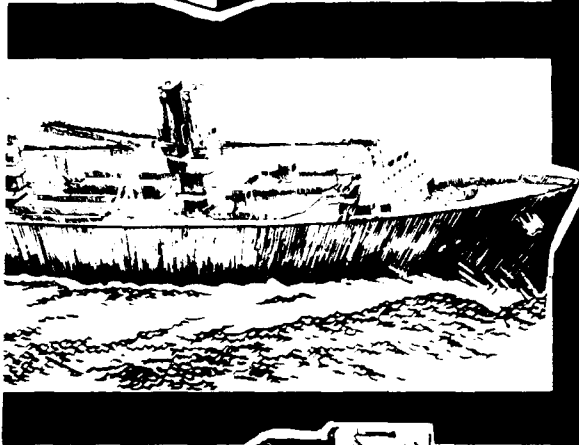
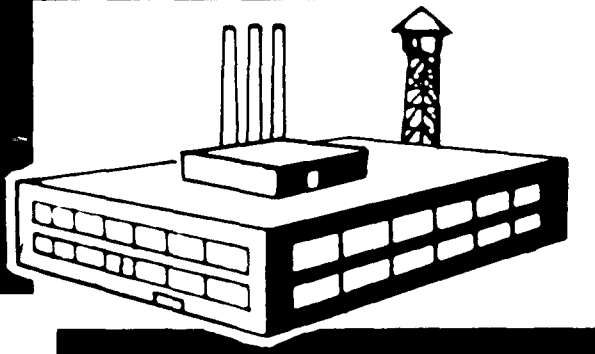

1991 CONTAINER SYSTEM HARDWARE

STATUS REPORT

Distribution is unlimited.

91-07052

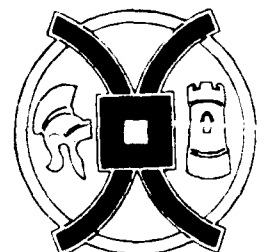

Intermodal Schematic

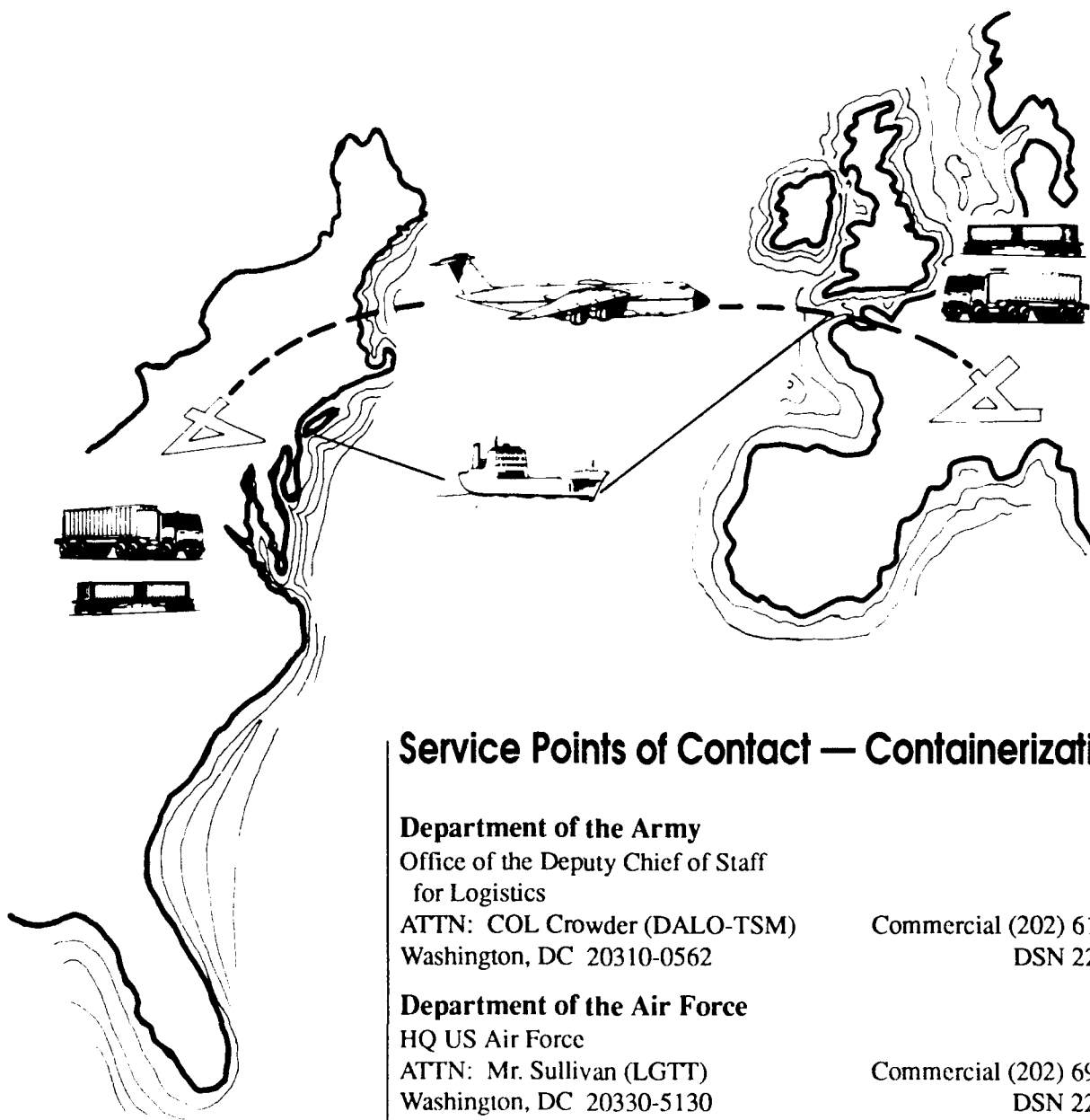

Service Points of Contact — Containerization

Department of the Army
Office of the Deputy Chief of Staff
for Logistics
ATTN: COL Crowder (DALO-TSM) Commercial (202) 614-6605
Washington, DC 20310-0562 DSN 224-6605

Department of the Air Force
HQ US Air Force
ATTN: Mr. Sullivan (LGTT) Commercial (202) 697-4742
Washington, DC 20330-5130 DSN 227-4742

U. S. Marine Corps
Commanding General
RD&A Command
ATTN: Mr. Spires (Code SSCGP) Commercial (703) 696-1064
Washington, DC 20380-0001 DSN 226-1064

Department of the Navy
Naval Supply Systems Command
ATTN: Mr. Crawmer (Code 051B) Commercial (202) 746-3991
Washington, DC 20376-5000 DSN 286-3991

Foreword

Today, virtually all of the commercial products and equipment shipped overseas, as well as by rail, are shipped using some form of intermodal container. The Merchant Marine Industry has made the transition from the breakbulk fleet of the past to the current containership fleet. Because of the Merchant Marine Industry's impact on the transportation of supplies by sea, the Department of Defense (DOD) has placed an increasing emphasis on containers to deploy and support forces in overseas contingency situations.

This publication was initiated in 1977 by the former office of the Project Manager, Army Container Oriented Distribution System, to provide information to Army activities. The Joint Intermodal Steering Group requested that the status of the other Services' containerization programs be included, beginning with the January 1979 issue. In November 1981, publication responsibility was transferred to the US Army Belvoir Research, Development and Engineering Center (BRDEC). BRDEC has published the report yearly, except for 1987 and 1988, in accordance with DOD Directive 4500.37 (Management of the DOD Intermodal Container System).

During FY90, the Containerized Ammunition/Missiles Distribution Executive Group (CAMDEG) was formed. The group's charter states that a container ammunition distribution system plan will be developed and executed. Specifically, the plan will attempt to achieve 100% containerization to customer requirements, improve blocking and bracing procedures, and reduce overall system costs.

During Operations Desert Shield/Desert Storm, some of the equipment and supplies deployed to Southwest Asia were shipped in ISO containers and handled using much of the equipment listed in this report. In addition to DOD containers, many commercial containers were leased and several procurements of containers were initiated. Retrograde of munitions and fuel equipment from Southwest Asia has revealed the need for additional types of ISO containers (side-opening, open top, etc.) which are currently being procured. The lessons learned from this large deployment will prove invaluable to DOD, enabling a larger percentage of ISO containers to be used for future rapid deployments.

Mr. Norman Fertman is the project director and Mr. William Brower is the technical coordinator for this report, both of whom may be reached at DSN 354-1143, Commercial (703) 664-1143, or FAX (703) 355-7732. Comments on this report are welcomed and may be submitted to:

Commander
US Army Belvoir RD&E Center
ATTN: STRBE-FMR
Fort Belvoir, VA 22060-5606

Comments or questions on particular pieces of equipment should be referred to the point of contact shown for that particular program.



NORMAN H. FERTMAN
Project Director
Logistics Equipment Directorate
Belvoir RD&E Center

1991 Container System Hardware

Contents

	Page
PART I. CONTAINERS	1
MILVAN—Ammunition Restraint.....	3
MILVAN—General Cargo	5
Refrigerated Container	7
Deployable Medical (DEPMED) Container	9
20' ISO Side-Opening Container.....	11
20' Shipping/Storage Container Bulk and Configured.....	13
ISO Tactical Shelter	15
Mobile Facility (MF) Program.....	17
TRICON-Shipping/Storage Container Bulk and Configured	19
Quadruple Container (QUADCON)	21
Shipping Frame, 4' x 6 ² / ₃ ' x 8'.....	23
Shipping Frame, 8' x 8' x 10'.....	25
Palletized Load System (PLS) Logistics.....	27
20' Flatrack, Project Easy ISO	29
40' Heavy Duty Flatrack	31
Load and Roll Pallet (LRP).....	33
PART II. HANDLING EQUIPMENT	35
4,000-Pound Capacity Forklift Truck	37
4,000-Pound Capacity Forklift Truck, Rough Terrain (RTFLT).....	39
Mobile Loading Ramp	41
6,000-Pound Capacity Variable Reach Rough Terrain Forklift Truck (VRRFTLT)	43
All Terrain Lifter, Articulated System (ATLAS)	45
Extendable Boom Forklift (EBFL)	47
Spreader Bars, Intermodal Container Handling	49
Top Handler, Intermodal Container Handling, Lightweight Expandable	51
Rough Terrain Container Crane (RTCC)	53
140-Ton, Truck-Mounted, Container Handling Crane	55
250-Ton, Truck-Mounted, Container Handling Crane	57
Lightweight Amphibious Container Handler (LACH)	59
Container Lifting Semitrailer	61
50,000-Pound Capacity Container Handler, Rough Terrain (RTCH)	63
20'/40' Container Sideloader	65
Palletized Load System (PLS)	67
Logistics Vehicle System	69

	Page
PART III. GROUND TRANSPORTATION EQUIPMENT	71
Chassis, Semitrailer: Coupleable, MILVAN Container Transporter	73
Semitrailer, Linehaul, Breakbulk/Container, M872 Series	75
Semitrailer, Tactical, Dual Purpose Breakbulk/ Container Transporter, 22 ¹ / ₂ -Ton, M871 Series	77
Truck Tractor, Yard Type, 4 x 2, M878A1	79
Truck Tractor, Linehaul, 6 x 4, M915 Series	81
5-Ton Truck Bed with ISO-Configured Locking Devices	83
Railway Car, Flat (Heavy Duty), 150-Ton Capacity, Domestic Service.....	85
 PART IV. LOTS, HARBOR, AND CONTAINER OFFLOADING AND TRANSFER EQUIPMENT	 87
SEASHED System	89
Floating Causeway (FC)	91
Elevated Causeway, Modular (ELCAS (M))	93
Roll-On/Roll-Off Discharge Facility (RO/RO DF)	95
Causeway Section, Powered (CSP).....	97
Causeway Ferry (CF)	99
Lighter Air Cushion Vehicle, 30 Ton (LACV-30).....	101
Pontoon Air Cushion Kit (PACK).....	103
Lighter, Amphibian, Heavy-Lift (LAMP-H)	105
Landing Craft, Utility (LCU) 2000	107
Logistics Support Vessel (LSV).....	109
Fast Logistic Ship (T-AKR) Program	111
Auxiliary Crane Ship (T-ACS).....	113
High Sea State Container Transfer System (HISEACOTS)	115
Automated All-Weather Cargo Transfer System (AACTS).....	117
Cantilevered Lift Frame (CLF)	119
 PART V. AERIAL PORT/TERMINAL EQUIPMENT	 121
Avionics Intermediate Shop (AIS) Shelter Movement	123
Elevator Loader.....	125
25,000-Pound 463L Aircraft Loader.....	127
40,000-Pound 463L Aircraft Loader.....	129
Mobile Straddle Crane	131
35-Ton Bridge Crane.....	133
 PART VI. DELETED PROGRAMS	 135
 ACRONYMS AND ABBREVIATIONS	 139

Part I

Containers

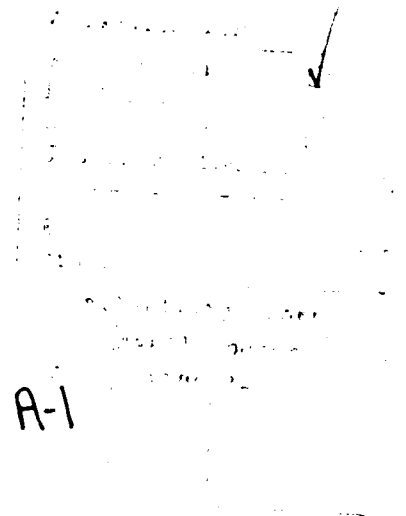

MILVAN - Ammunition Restraint

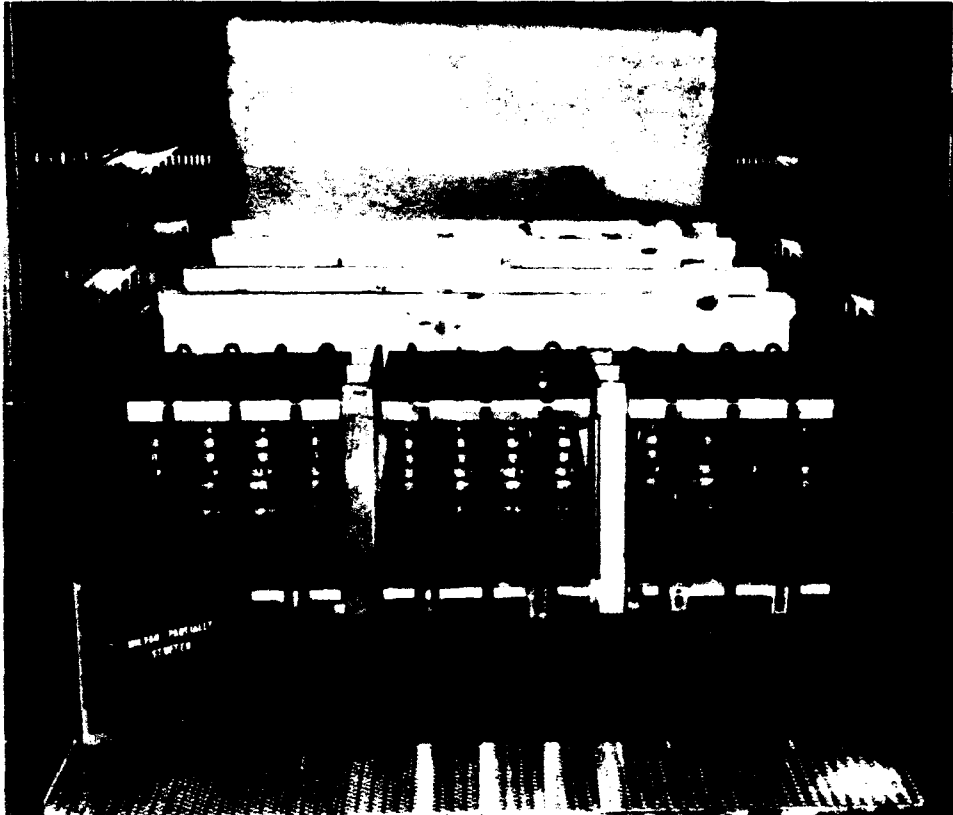

LENGTH	20'
WIDTH	8'
HEIGHT	8'
WEIGHT (EMPTY)	5,785 pounds
GROSS WEIGHT (DESIGNED)	44,800 pounds

MILVAN - Ammunition Restraint

POINT OF CONTACT

Mr. P. Barickman
US Army Belvoir RD&E Center, STRBE-FMR
Fort Belvoir, VA 22060-5606
DSN 354-4490/Commercial (703) 664-4490

ITEM DESCRIPTION

The MILVAN ammunition restraint container is a standard American National Standards Institute (ANSI)/International Organization of Standardization (ISO) container equipped with restraint hardware capable of handling approximately 20 long tons of ammunition. The restraint system consists of eight slotted steel rails permanently installed on each side wall and 25 adjustable crossbars that can be inserted in the slotted rails. Its use at full rated load has been approved by the US Coast Guard and the Association of American Railroads. The MILVAN container is 8' x 8' x 20', and weighs 5,785 pounds including 1,300 pounds for the restraint system. Some 8' x 8.5' x 20' containers have been procured and are currently in the Army inventory.

STATUS

The Army procured 4,500 MILVAN ammunition restraint containers and there are 4,241 in the present inventory. A total of 249 MILVANs, each 8' x 8.5' x 20' with composite flooring and corrosion resistant steel, were procured. The Army awarded a contract on 30 September 1989 to American Coastal Industries for 1,243 8' x 8' x 20' containers. As of 31 January 1991, 362 containers have been delivered to the Army.

PROGRAM PLAN

Monitor and provide engineering assistance during the performance period of the contract. The remaining 881 containers will be delivered before 31 August 1991.

NSNs

8' x 8' x 20': 8115-00-151-9953
8' x 8.5' x 20': 8115-01-220-9527

MILVAN - General Cargo

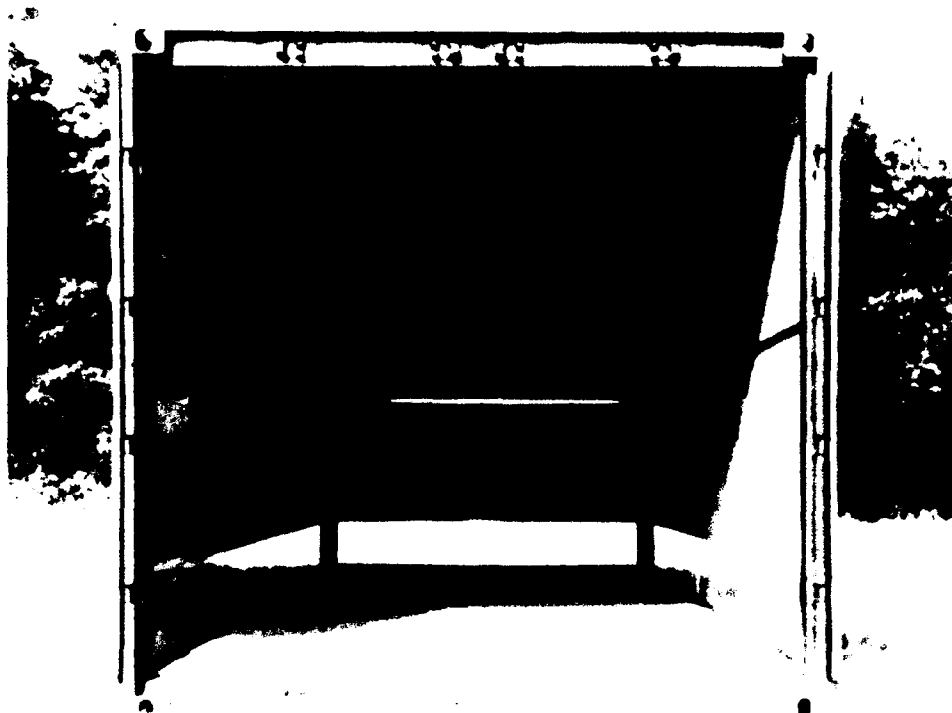

LENGTH	20'
WIDTH	8'
HEIGHT	8'
VOLUME INSIDE	1,060 cubic feet
WEIGHT (EMPTY)	4,700 pounds
GROSS WEIGHT (DESIGNED)	44,800 pounds

MILVAN - General Cargo

POINT OF CONTACT

Mr. P. Barickman
US Army Belvoir RD&E Center, STRBE-FMR
Fort Belvoir, VA 22060-5606
DSN 354-4490/Commercial (703) 664-4490

ITEM DESCRIPTION

The MILVAN provides a capability of handling up to 20 long tons of general cargo. It is used to transport and temporarily store military cargo. The MILVAN dimensions are 8' x 8' x 20', weighs 4,770 pounds when empty, and has an internal volume of 1,060 cubic feet. The MILVAN is designed to ANSI/ISO standards and procured with a military performance specification. The container is of steel construction with hardwood flooring and the walls are lined with plywood.

STATUS

The Army has procured a total of 2,200 MILVAN general cargo containers. The International Convention for Safe Containers (CSC) was ratified by the United States 3 January 1978. The US Coast Guard, as the implementing agency, issued approval to the Army for the existing MILVAN fleet on 9 November 1978. With depot participation, the container inventory was refurbished and the CSC approval plate mounted beginning in 1978.

PROGRAM PLAN

There is no current plan to procure additional quantities.

NSN

8115-00-168-2275

Refrigerated Container



LENGTH	20'
WIDTH	8'
HEIGHT	8'
TARE WEIGHT	8,000 pounds
DOOR OPENING HEIGHT	82'
DOOR OPENING WIDTH	89'

Refrigerated Container

POINT OF CONTACT

Mr. P. Barickman
US Army Belvoir RD&E Center, STRBE-FMR
Fort Belvoir, VA 22060-5606
DSN 354-4490/Commercial (703) 664-4490

ITEM DESCRIPTION

The refrigerated container provides a capability to transport, temporarily store, and distribute temperature-sensitive cargo. The container, including the refrigeration unit, is nominally 8' x 8' x 20' and weighs approximately 8,000 pounds. The unit is powered by a military standard 10kW diesel engine generator set or by an external electrical power supply. The refrigerated container is a modified commercial design and procured to a military specification. It meets all ISO requirements for intermodal shipments.

STATUS

A total of 665 containers, including 24 for the US Navy, were purchased and delivered by 1980. Approximately 225 have been deployed to Europe where they are in constant use. The Navy procured an additional 49 units in FY85.

PROGRAM PLAN

The Army Surgeon General is procuring 43 refrigerated containers and also has an additional requirement for 54 refrigerated containers. The Navy is currently procuring 20 refrigerated containers.

NSN

8115-01-015-7039

Deployable Medical (DEPMED) Containers

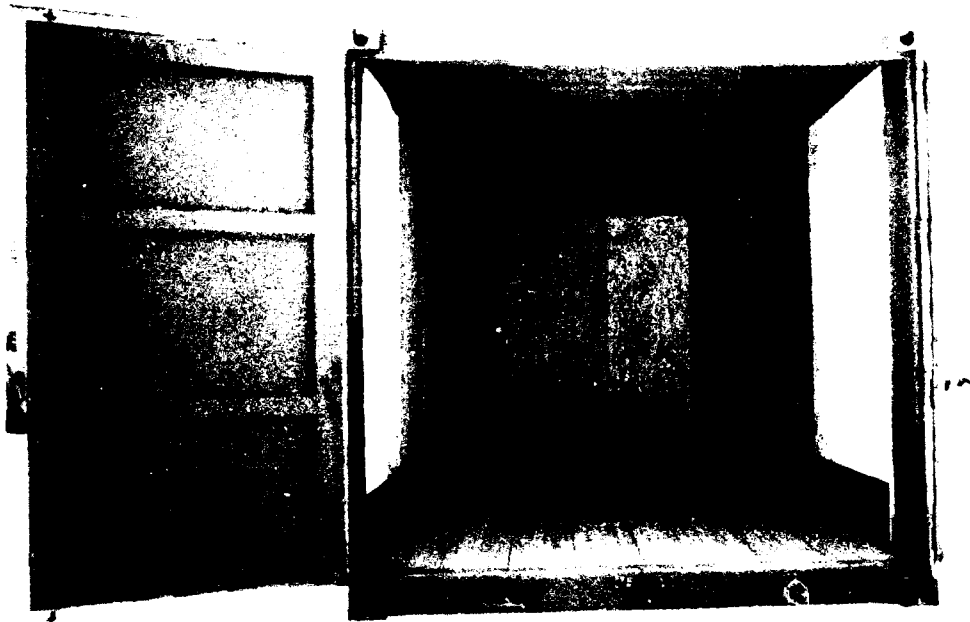

LENGTH	20'
WIDTH	8'
HEIGHT	8'
TARE WEIGHT	5,150 pounds
GROSS WEIGHT	44,800 pounds

Deployable Medical (DEPMED) Containers

POINT OF CONTACT

Mr. T. Lavin
US Army Troop Support Command, AMSTR-WH
4300 Goodfellow Blvd.
St. Louis, MO 63120-1798
DSN 693-2667/Commercial (314) 263-2667

ITEM DESCRIPTION

The DEPMED containers are used in direct support of the Surgeon General's fielding of the Deployable Medical Systems. They are used for shipping and storage of components for various operating rooms, medical support, and laboratories which comprise the Deployable Medical Systems. The DEPMED Container is an 8' x 8' x 20' ISO container with both end and side doors. The DEPMED container is designed to ANSI/ISO standards and is produced from a military performance specification. The container is constructed of steel with hardwood flooring, and the interior walls are lined with plywood.

STATUS

A contract was awarded to Mid-States Metal Lines, Grandview, MO, for 4,339 containers on 11 May 1988. A fourth year option of 1,171 containers has not been exercised on this contract. As of 31 March 1991, 1,300 containers have been delivered.

PROGRAM PLAN

Continue to receive and field the DEPMED containers.

NSN

8115-01-241-7524

20' ISO Side-Opening Container

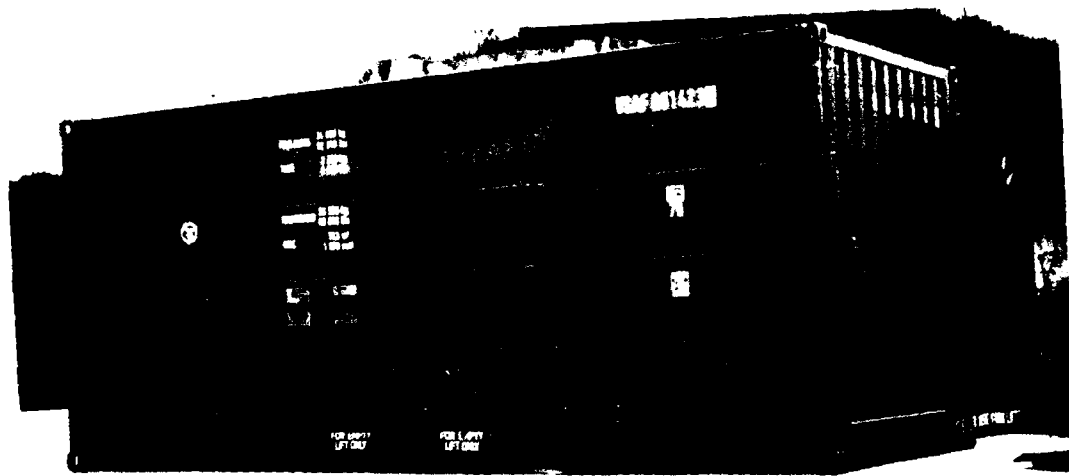

20' ISO Side-Opening Container

POINT OF CONTACT

MAJ T. Baltes
HQ, US Air Force Europe, LGWR
Ramstein AB, GE, APO New York 09094-5000
DSN 480-6688/Commercial 011-49-6371-47-6688

ITEM DESCRIPTION

The 20' ISO side-opening container is an ISO container with two double doors located on one side of the container which allows unobstructed access to its contents. The one side-opening containers are used to store and transport munitions in Europe and do not have end doors. The side-opening container was selected for ease in loading and unloading of munitions.

STATUS

The Armament Division (AD) leased 10 side-opening ISO containers of three designs:

- One side door, one end door
- Ventilated; full side access doors, one end door
- Side Doors, both sides; one end door

Three containers of each design were shipped to USAFE, PACAF, and MAC for operational testing and evaluation during FY86. Due to the urgent need to improve munitions storage and handling capability in USAFE, the process of procuring side-opening containers was initiated before the testing was complete. In FY86, HQ USAFE released a request for proposal (RFP) to purchase 20' side-opening ISO containers. A total of 1,200 side-opening containers were procured by USAFE and are being used to store and transport munitions.

PROGRAM PLAN

Continue to support the fielded containers.

NSNs

2 Fork Pockets: 8145-L900411D
4 Fork Pockets: 8145-L900412D

20' Shipping/Storage Container

(Bulk & Configured)

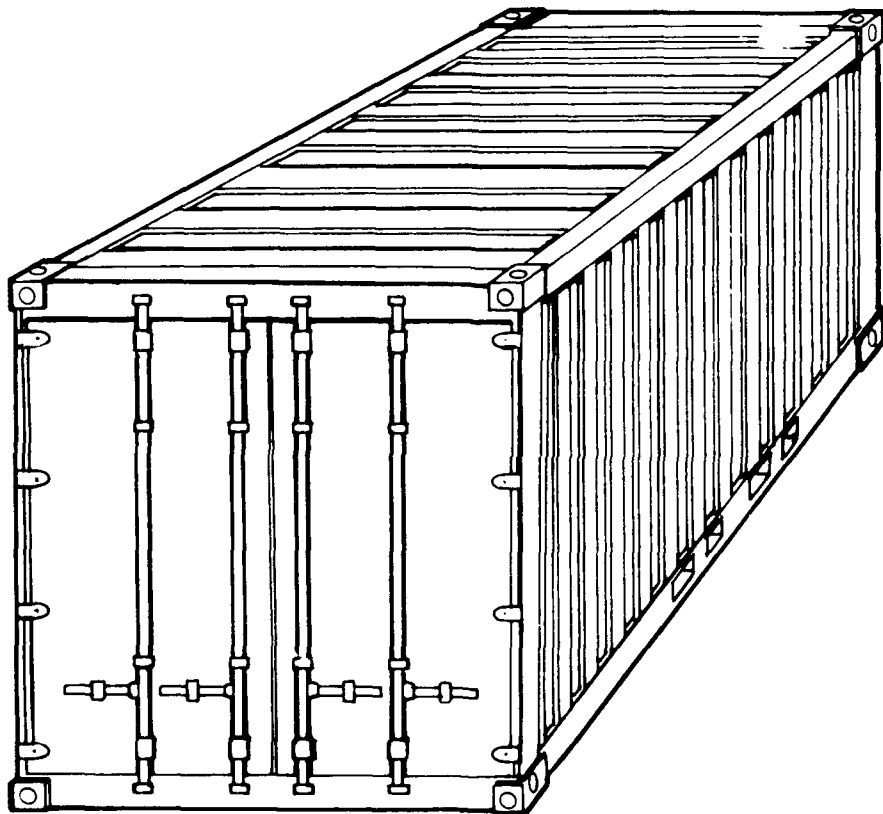

20' Shipping/Storage Container

(Bulk & Configured)

POINT OF CONTACT

Mr. J. Cannon
Naval Construction Battalion Center (CESO Code 15731)
Port Hueneme, CA 93043-5000
DSN 551-1895/Commercial 805-982-1895

ITEM DESCRIPTION

The 20' storage container is an 8' high x 8' wide x 20' long lockable, watertight, reusable container. It is of all steel construction with standard ISO corner fittings and two sets of forklift pockets for moving empty or loaded containers. Containers are designed to ISO standards. Two types of containers are being procured: bulk and configured. Configured containers may consist of cabinets with drawers or shelves, rifle racks, or a combination thereof to make up storerooms and armories. Currently, six different styles of storeroom configurations plus an armory configuration are being procured.

- Cabinets with drawers or shelves are available in three sizes: 30" wide x 27 3/4" deep
45" wide x 27 3/4" deep
60" wide x 27 3/4" deep
- Usable drawer heights range from 2" to 13"
- Shelf heights are adjustable in 1" increments.

STATUS

A contract was awarded in May 1986 to J. D. Bertolini Industries, Limited, for 1,171 bulk and 641 storeroom/armory configured containers. Deliveries began in FY89.

PROGRAM PLAN

Procurement is planned in FY91 for an additional 309 bulk and 44 storeroom configured containers.

NSNs

Bulk: 8145-01-287-8567

ISO Tactical Shelter

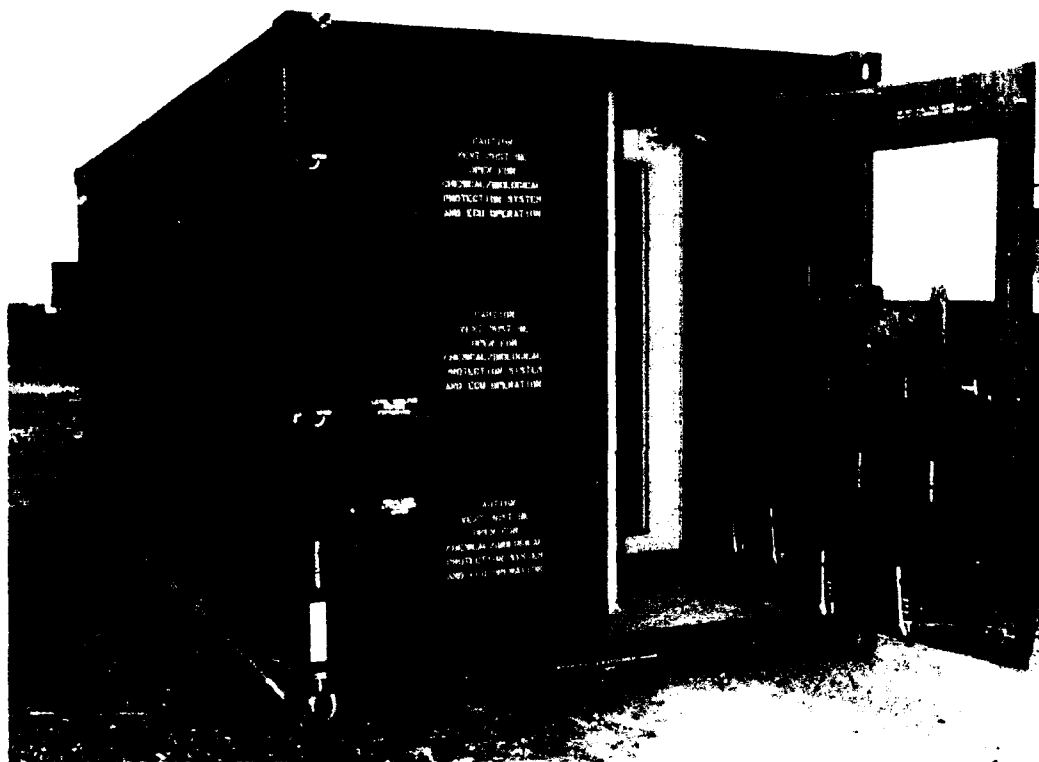
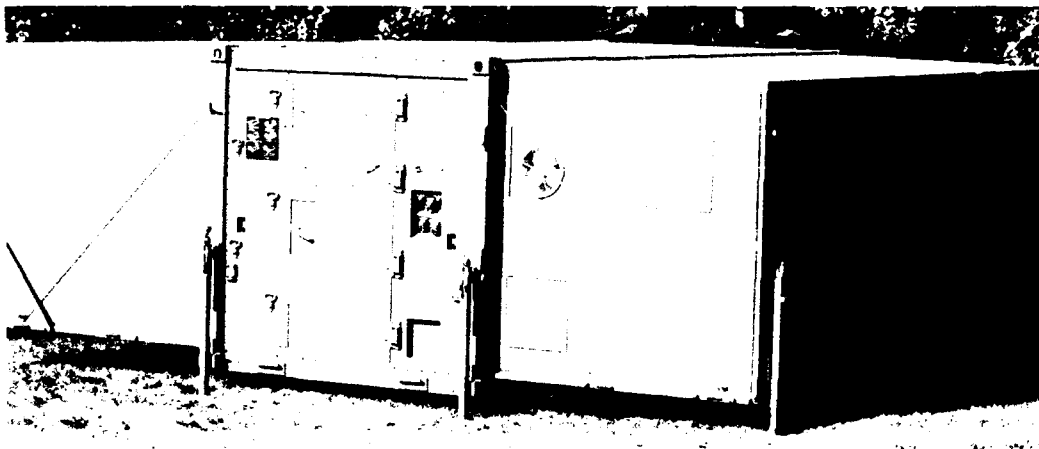

ISO Tactical Shelter

POINT OF CONTACT

Mr. A. Murphy
US Army Natick RD&E Center (STRNC-UST)
Natick, MA 01760-5017
DSN 256-5246/Commercial (508) 651-5246

ITEM DESCRIPTION

An ISO Tactical Shelter is a presized, transportable structure designed for a functional requirement and provides a live-in, work-in, or container capability. This structure can be either expandable or non-expandable and conforms to applicable ANSI/ISO container standards. All services are increasing their utilization of the shelter concept, and the impact of shelters on the transportation and material handling system will become more significant in coming years. A standard family of 20' rigid wall ISO shelters has been developed by the US Army Natick Research, Development and Engineering Center for DOD use. The shelter family includes three types:

- Non-Expandable Shelter, Tactical (11,100-pound payload)
- One-Side Expandable Shelter, Tactical (9,700-pound payload)
- Two-Side Expandable Shelter, Tactical (8,300-pound payload)

STATUS

ISO Tactical Shelters have completed development and a Technical Data Package is finalized. Two production contracts have been awarded to date: the first in April 1984 for 1,739 units, with deliveries starting in December 1985; the second in August 1988 for 722 units, with a 100% option. Completion of this second contract is anticipated in December 1991. The following quantities represent Army standard ISO shelters procured for specific new Navy, Air Force, and Army ISO sheltered systems to date:

Quantity	
ISO Tactical Shelter (Non-Expandable)	31
ISO Tactical Shelter (One-Side Expandable)	1,762
ISO Tactical Shelter (Two-Side Expandable)	1,307

PROGRAM PLAN

In addition to monitoring production contracts and fielding the Army ISO shelters, a number of enhancements to the ISO shelter are being designed to provide threat protection and to increase its functional workspace. The ISO shelter enhancement programs currently in development include Chemical/Biological (CB) Protection, Electro-Magnetic Interference (EMI) shielding, and a 1,000 square foot Modular Extendable Rigid Wall Shelter (MERWS) kit. Two enhancement programs have completed development. The CB Non-Expandable shelter Milestone III In Process Review (IPR) was completed in August 1990, and the complexing passageway Milestone III IPR was completed in November 1989.

NSNs	60 Amp	100 Amp
Non-Expandable:	5411-01-136-9837	5411-01-294-6390
One-Side Expandable:	5411-01-124-1377	5411-01-295-3433
Two-Side Expandable:	5411-01-136-9838	5411-01-294-9866

Mobile Facility (MF) Program

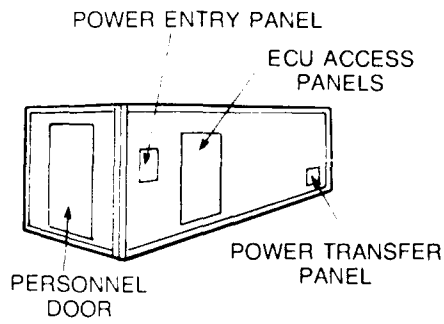

BASIC MF

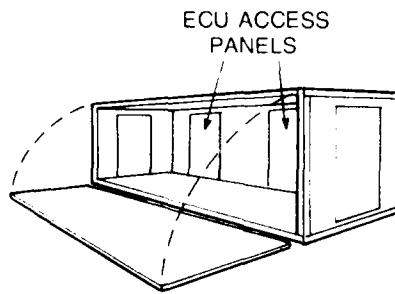

SIDE OPENING MF TYPE A

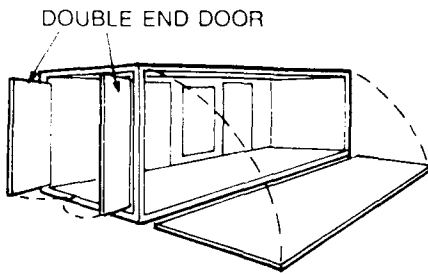

SIDE OPENING MF TYPE B (MODIFIED)

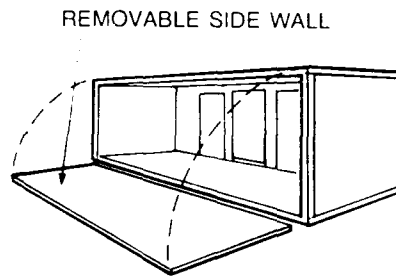

SIDE OPENING MF TYPE B

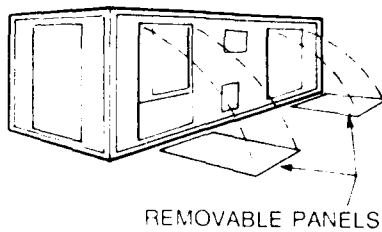

INTEGRATION UNIT

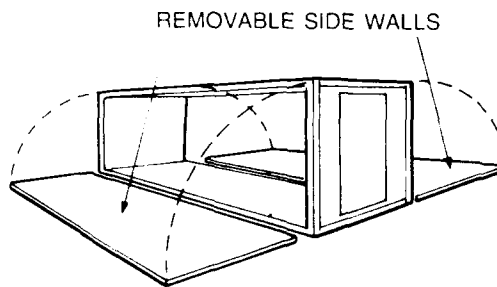

SIDE OPENING MF TYPE C

LENGTH	20'
WIDTH	8'
HEIGHT	8'

Notes:

- All meet ISO/ANSI Specifications for shipping containers
- All are Certified to meet Conference for Safe Container Requirements

Mobile Facility (MF) Program

POINTS OF CONTACT

Ms. K. Clark/MAJ K. Karlson, USMC
Naval Air Systems Command, AIR-41712A/AIR-41712B
Washington, DC 20361-4170
DSN 222-2344/Commercial (703) 692-2344

ITEM DESCRIPTION

The Naval Air Systems Command (NAVAIR) Mobile Facility (MF) Program utilizes a family of rigid walled ISO containers as habitable tactical shelters principally to contain aviation weapons system maintenance, tactical operational, logistical, and administrative functions. These shelters, referred to as MFs, are widely utilized by Navy and Marine Corps aviation units and to a lesser degree by other intraservice and interservice units within DOD. There are six MF types, all of which meet ISO 668/1161/1496 and ANSI MH5.1.1M specifications and have external dimensions of 8' wide, 8' high, and 20' long. Gross shipping weight is 20,000 pounds with a tare weight of approximately 5,200 pounds. MFs may be integrated into complexes by a variety of methods utilizing standard MF program ancillary equipment. MFs are mainly aluminum, foam, and beam construction having a 15-year service life. NAVAIR is the DOD Primary Inventory Control Activity for MFs.

STATUS

The MF Program is a mature program with procurement of ISO/ANSI specification MFs since 1975. Currently, over 5,000 MF units are in service. Recent contract awards are as follows:

Contract Number	Year	Quantity
N00140-84-3251	1984	1,308
N00140-86-5994	1986	337
N00140-87-9326	1987	874
N00140-89-SA03	1989	243
N00140-89-2812	1989	640

PROGRAM PLAN

Contracts are expected to be awarded in 1991 with total procurement quantity of all MF types to be 400.

NSN

No NSNs are assigned, although the part numbers are listed below (CAGE Code 30003):

Type MF	Part Number
Basic MF (60/400Hz)	1339AS701-1
Basic MF (60Hz only)	1339AS700-1
Integration Unit MF	1339AS900-2
Side Opening MF Type A	1339AS500-1
Side Opening MF Type B	1339AS501-1
Side Opening MF Type C	1339AS1100
Side Opening MF Type B (Modified)	1339AS1000-1

TRICON - Shipping/Storage Container

Bulk and Configured

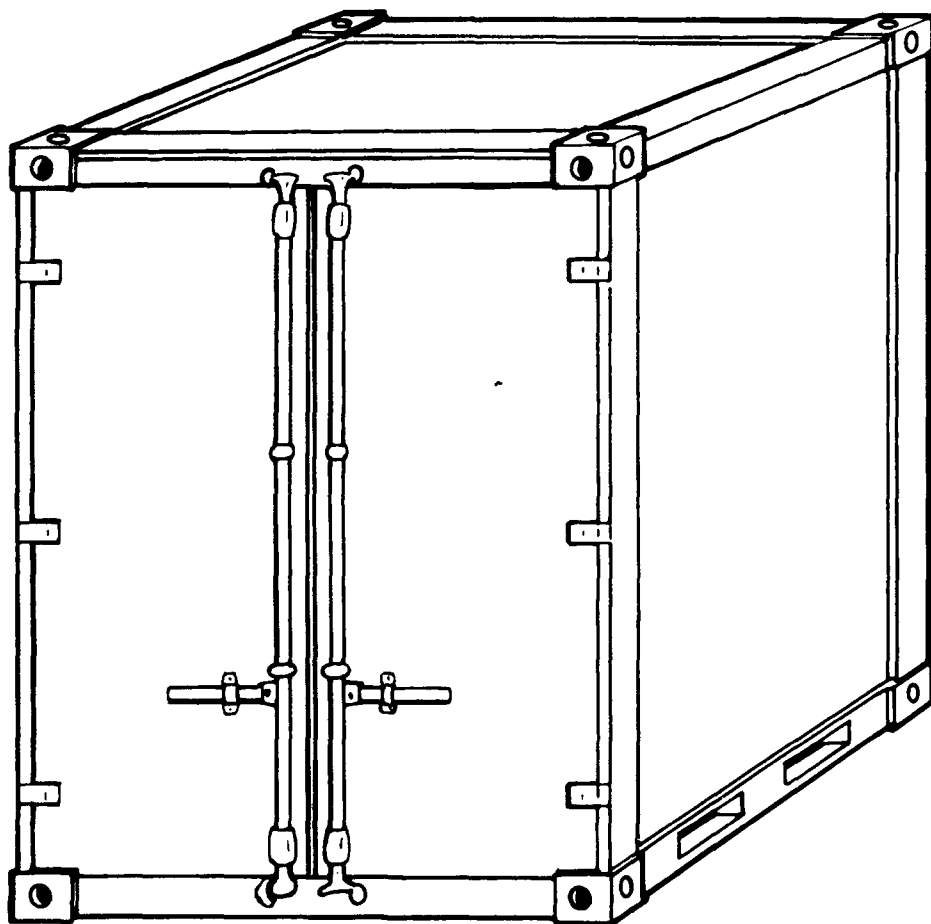

LENGTH	77.5'
WIDTH	96.0'
HEIGHT	96.0'

TRICON - Shipping/Storage Container

Bulk and Configured

POINTS OF CONTACT

Mr. J. Cannon
Naval Construction Battalion Center (CESO Code 15731)
Port Hueneme, CA 93043-5000
DSN 551-1895/Commercial (805) 982-1895

ITEM DESCRIPTION

The TRICON is an 8' high x 8' wide x 6.5' long lockable, watertight, reusable container. It is of all steel construction with standard ISO corner fittings and 3-way forklift pockets (sides and back). Two styles of containers are being procured: bulk and configured. Configured containers may consist of cabinets with drawers or shelves, rifle racks, or a combination thereof, to make up a storeroom or armory.

- Cabinets with drawers or shelves are available in five sizes: 30" wide x 22 3/4" deep
60" wide x 22 3/4" deep
30" wide x 27 3/4" deep
45" wide x 27 3/4" deep
60" wide x 27 3/4" deep
- Usable drawer heights range from 2" to 13"
- Shelf heights are adjustable in 1" increments.

Currently, three different styles of storeroom configurations, plus an armory configuration, are being procured. Three containers may be coupled together into a nominal 20' modular assembly for transport by container ships.

STATUS

A contract was awarded in May 1986 to J. D. Bertolini Industries, Limited, for 119 bulk and 243 configured containers. Deliveries began in FY89.

PROGRAM PLAN

Procurement of 367 additional 309 bulk containers is planned for FY91.

NSN

Bulk: 8145-01-287-3294

Quadruple Container (QUADCON)

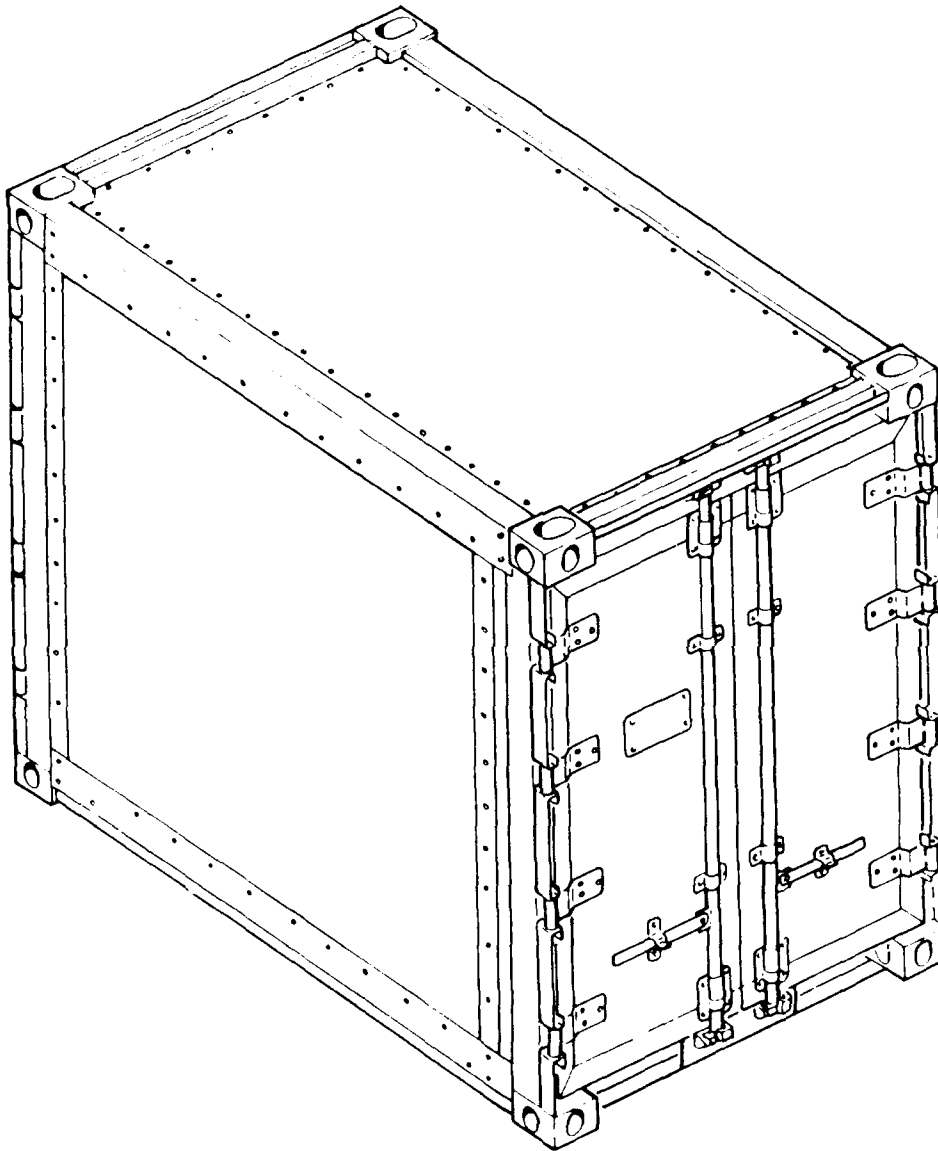

LENGTH	96.0'
WIDTH	57.5'
HEIGHT	82.0'
CARGO CAPACITY	8,000 pounds

Quadruple Container (QUADCON)

POINT OF CONTACT

Mr. J. Spires
CG, Marine Corps RD&A Command, Code SSCGP
Washington, DC 20380-0001
DSN 226-1064/Commercial (202) 696-1064

ITEM DESCRIPTION

The QUADCON is an 82" x 57.5" x 96" lockable, weatherproof, reusable, prefabricated container with a cargo capacity of 8,000 pounds. The QUADCON has a structural steel welded frame; top sides and door panels of plywood coated with a plastic laminate; and a floor of high-density plywood covered on both sides with sheet steel. It has ISO corner fittings for lifting and restraint, and for coupling QUADCONs into arrays of up to four units. The QUADCON has a tineway base to allow four-way forklift entry. An array of four QUADCONs has the same dimension (except for height) as an 8' x 8' x 20' ISO container and is compatible with the 20' cell guides of a containership.

STATUS

In November 1990, a solicitation for an improved, lighter weight QUADCON was issued. The Technical Proposals have been received for evaluation and will result in an award of a production contract (base year plus four options). This contract will produce up to 45% of the Marine Corps Acquisition Objective.

PROGRAM PLAN

Contract award is planned for 4QFY91. A follow-on contract is currently planned for FY95.

NSN

8115-01-194-4017

Shipping Frame, 4' x 6²/₃' x 8' (SIXCON)

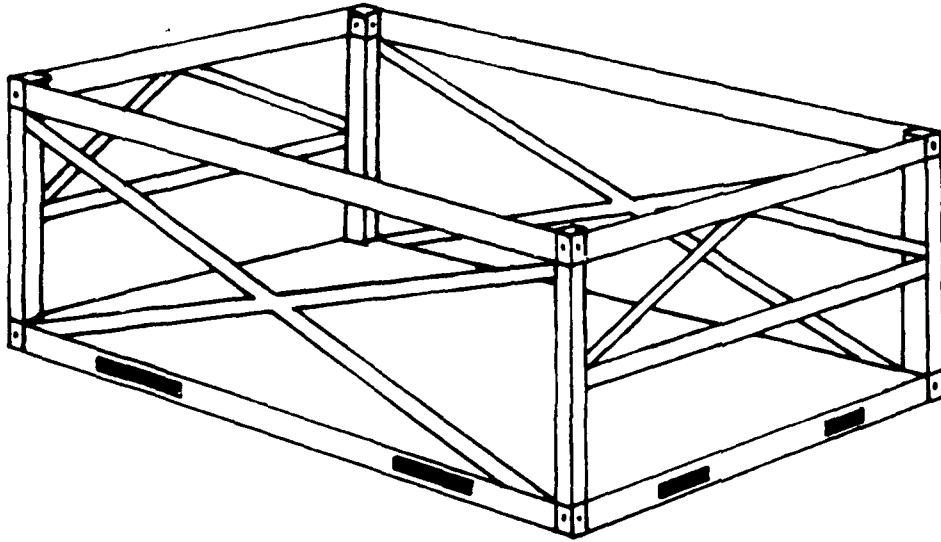

LENGTH	6 ² / ₃ '
WIDTH	8'
HEIGHT	4'
ARRAYED CONFIGURATION	8' x 8' x 20'

Shipping Frame, 4' x 6²/₃' x 8' (SIXCON)

POINT OF CONTACT

Mr. J. Spires
CG, Marine Corps RD&A Command, Code SSCGP
Washington, DC 20380-0001
DSN 226-1064/Commercial (202) 696-1064

ITEM DESCRIPTION

Reusable open top cargo carrier with four-way forklift handling capability with ISO standard corner fittings. Can be arrayed up to six, forming an 8' x 8' x 20' configuration to fit the cell of a containership. Capability objective is to provide an open container of intermediate size compatible with US Navy amphibious ships and the Merchant Fleet. The frame is used as an integral component of SIXCON fuel/water storage and pump modules though it could be used for general cargo and organizational property.

STATUS

A procurement contract for 402 shipping frames was conducted and the shipping frames are now in use with the fuel and water modules.

PROGRAM PLAN

There are no plans for future procurements since the item was for one unique application.

NSN

Not applicable.

Shipping Frame, 8' x 8' x 10'

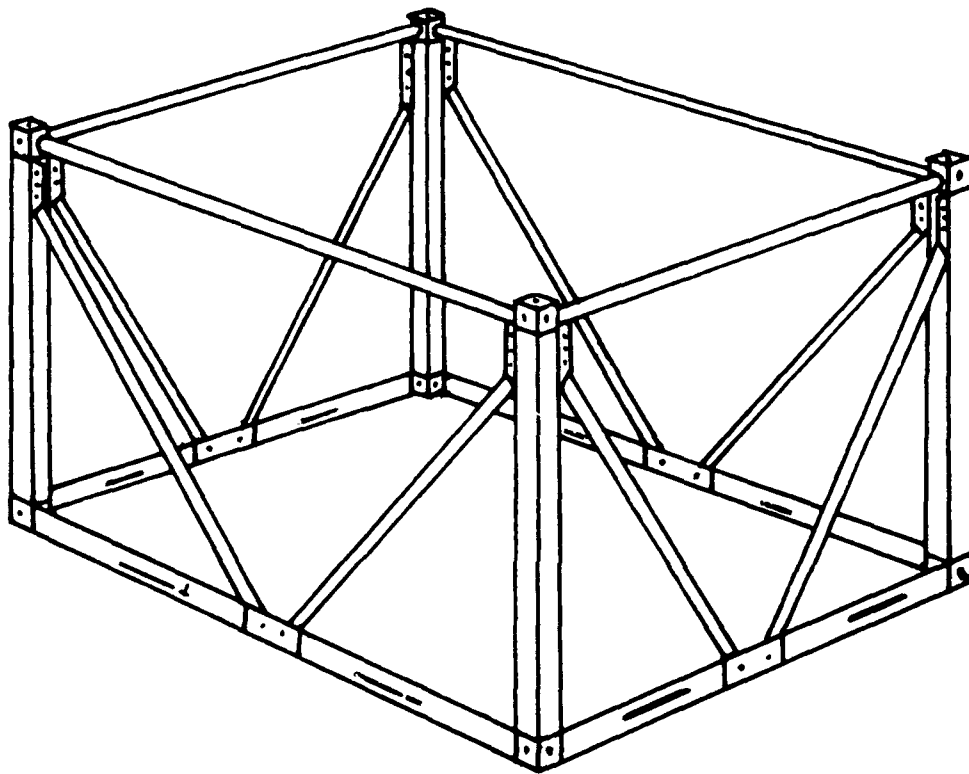

LENGTH	10'
WIDTH	8'
HEIGHT	4'
ARRAYED CONFIGURATION	8' x 8' x 20'

Shipping Frame, 8' x 8' x 10'

POINT OF CONTACT

Mr. J. Spires
CG, Marine Corps RD&A Command, Code SSCGP
Washington, DC 20380-0001
DSN 226-1064/Commercial (202) 696-1064

ITEM DESCRIPTION

An open top cargo carrier of steel construction which features a four-way forklift handling capability and standard ISO corner fittings. An array of two frames forms an 8' x 8' x 20' configuration and fits the 20' cells of a containership. The frame is used to support the mounting and movement of the reverse osmosis water purification unit (ROWPU).

STATUS

Approved for service use was obtained in May 1981. An Army contract was awarded 30 September 1983 for the procurement of 496 frames which satisfied Marine Corps requirements.

PROGRAM PLAN

There are no plans for future procurements since the item was for one unique application.

NSN

Not applicable.

Palletized Load System (PLS) Logistics

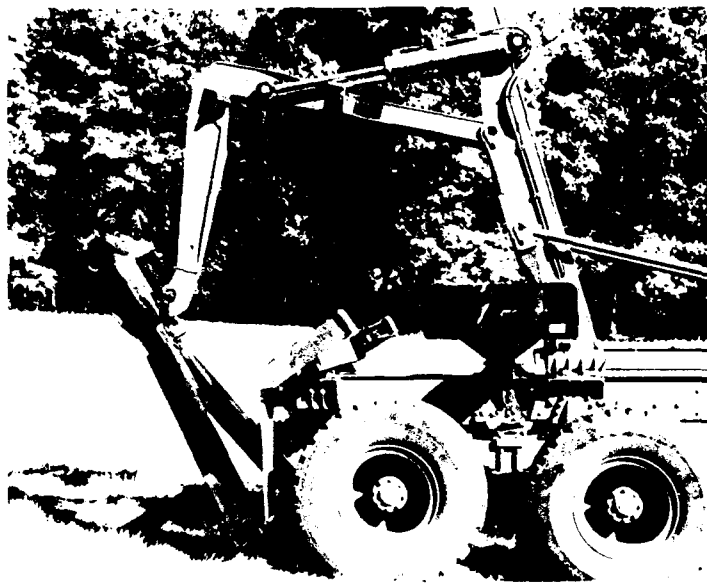

Hooklift Interface Kit (HIK)



Ammunition Container (AMCON)

Palletized Load System (PLS) Logistics

POINT OF CONTACT

Mr. D. Chesnulovitch
PM-AMMOLOG, AMCPM-AL
Picatinny Arsenal, NJ 07806-5000
DSN 880-4737/Commercial (201) 724-4737

ITEM DESCRIPTION

The present ammunition logistics system in the theater of operations must overcome material handling and transportation shortfalls associated with the delivery of Class V (ammunition) materials to combat units. Currently, two different methods are being examined to meet this need. The concept of PLS Logistics is to demonstrate a direct connectivity between PLS and strategic transportation assets.

The first concept, Hooklift Interface Kit (HIK), is a device that enables the PLS truck to directly lift, transport, and download any commercial 8' x 20' container. HIK is made up of two components: an X-frame that attaches to the hook on the PLS load handling system, and a support frame mounted to the rear of the truck.

The second concept, Ammunition Container (AMCON), is a commercial ISO flatrack design, modified to interface directly with PLS. With this design, the possibility exists for AMCONs to be loaded in CONUS and shipped to the weapon system on the battlefield without additional ammunition handling.

STATUS

A Phase I demonstration of the HIK and AMCON was completed in December 1988. Follow-on evaluations for the HIK and AMCON were completed in March 1990.

PROGRAM PLAN

At the present time, there is no Training and Doctrine Command (TRADOC) requirement for the HIK. However, further analysis being conducted by AMC (Natick RD&E Center with medical shelters and Belvoir RD&E Center with transporting ISO containers) may highlight cost effective applications in the future. Based on efforts with the AMCON, Belvoir was tasked by the PM for Heavy Tactical Vehicles to conduct an Enhanced Flatrack Program. This effort will formally assess the feasibility and cost of design alternatives to the PLS Flatrack. A program decision is planned for 1QFY93.

NSN

Not assigned.

20' Flatrack, Project Easy ISO



20' Flatrack, Project Easy ISO

POINT OF CONTACT

Mr. D. Swanick
MSD/YBAC
Eglin AFB, FL 32542-5000
DSN 872-4173/Commercial (904) 882-4173

ITEM DESCRIPTION

Project Easy ISO is the evaluation of ISO flatrack containers for transport of munitions by DOD. The flatracks increase utility in loading and downloading, use existing munitions handling equipment, and reduce costs for retrograde shipping.

STATUS

In March 1983, the Air Force Armament Division at Eglin AFB gained US Coast Guard (USCG) and Bureau of Explosives (BOE) approval for load plan drawings of 30mm ammunition loaded on a 20' x 8' x 5' 8" flatrack. The loaded flatrack was successfully shipped to Korea in June 1983. The shipment confirmed the flatrack advantages of effective cube utilization and ease of unloading with conventional munitions handling equipment.

Also in March 1983, HQ FACA completed the static test loading of 11 different air munition loads on a 20' x 8' x 8' flatrack. Drawings for these load configurations have been developed by the US Army Defense Ammunition Center and School and Load Plans have obtained USCG/BOE approval. Transportability testing of the flatrack for use on Federal Republic of Germany railroads was completed in September 1985.

The following are the drawing numbers for the approved load plans: #19487073 - MK-82; #19487074 - MK-84; #19487079 - MK-20; #19487079/1 - 30mm Ammunition on Flatrack on Trailer; #19487086 - BLU-107/B Weapon; #19487090 - AGM-88 HARM Missile; #19487092 - CBU-87/B and CBU-89/B Cluster Bombs; #19487095 - AIM-7F (SPARROW) Missile; #19487098 - AIM-9L (SIDEWINDER) Missile.

PROGRAM PLAN

Program completed.

NSN

Not assigned.

40' Heavy Duty Flatrack

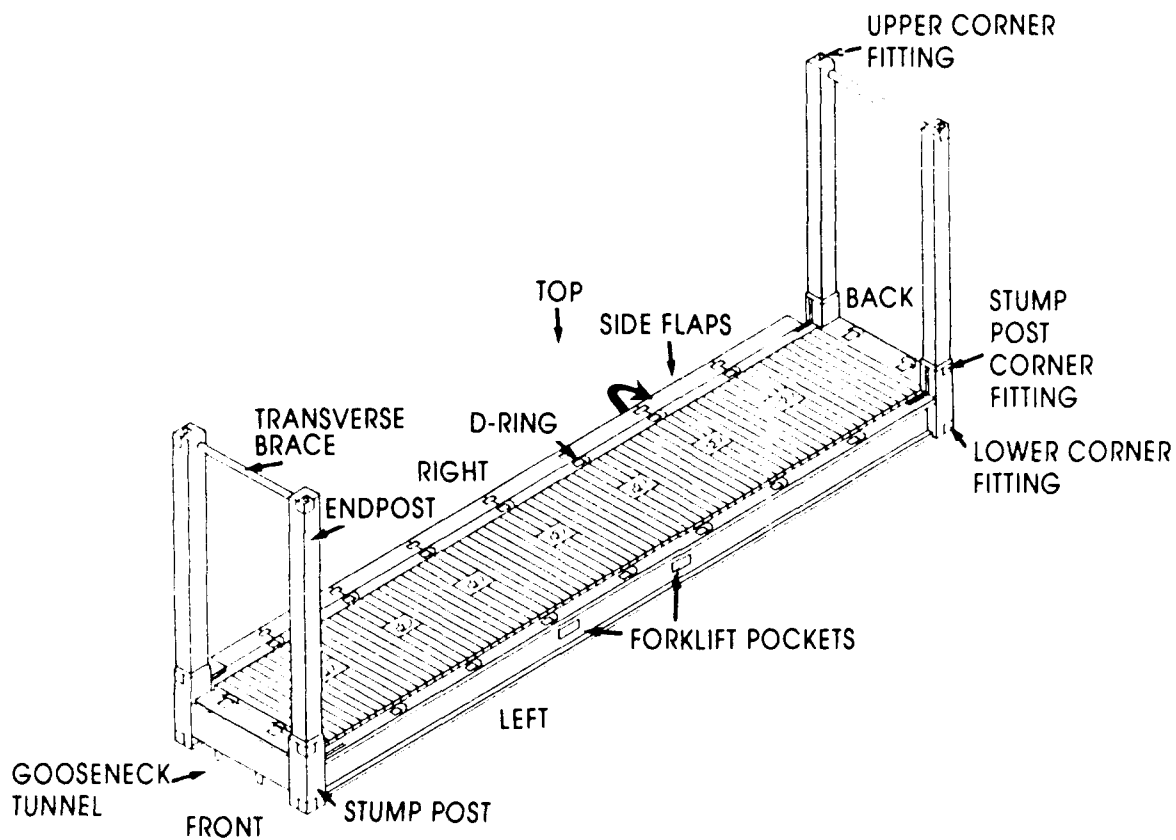

LENGTH	40'
WIDTH	8'
CLEAR HEIGHT FOR CARGO	10'6"
MAXIMUM OVERALL HEIGHT	13'

40' Heavy Duty Flatrack

POINT OF CONTACT

Mr. M. Baig
Naval Sea Systems Command, PMS-377V
Washington, DC 20362-5101
DSN 332-7881/Commercial (703) 602-7881

ITEM DESCRIPTION

The 40' heavy duty flatrack was developed to provide a breakbulk capability to containerships for the carriage of tanks and other heavy and/or oversized cargo. The 40' heavy duty flatrack is a relatively uncomplicated structural steel frame, decked over and fitted with tiedown points. There are two types of flatracks, each having a different cargo capacity. The first type of flatrack has a maximum cargo capacity of 67.2 short-tons and has telescoping corner posts which are adjustable from 8.5' to 13' for various cargo heights. The second type of flatrack has a maximum cargo capacity of 72 short-tons and has corner posts 13' high. The corner posts on both types fold down to facilitate stacking and storage. The flatracks may be inserted/removed into the container cells empty or loaded at a not-to-exceed cargo weight of 30 long-tons (67,200 pounds).

STATUS

The heavy duty flatrack was initially authorized in the FY83 budget for 223 units; the FY84 budget was for 135 units. Delivery of the 358 flatracks was completed during 2QFY86. Two contracts for the second type of flatrack were awarded during 2QFY88. As of December 1990, approximately 1,653 of the second type flatrack have been delivered for a total flatrack inventory of 2,011 units. The inventory is at three storage locations: MOT, Bayonne, NJ; NWS, Charleston, SC; and CBC, Port Hueneme, CA.

PROGRAM PLAN

No funds have been identified for the procurement of additional flatracks.

NSN

0910-LP-248-8600

Load and Roll Pallet (LRP)

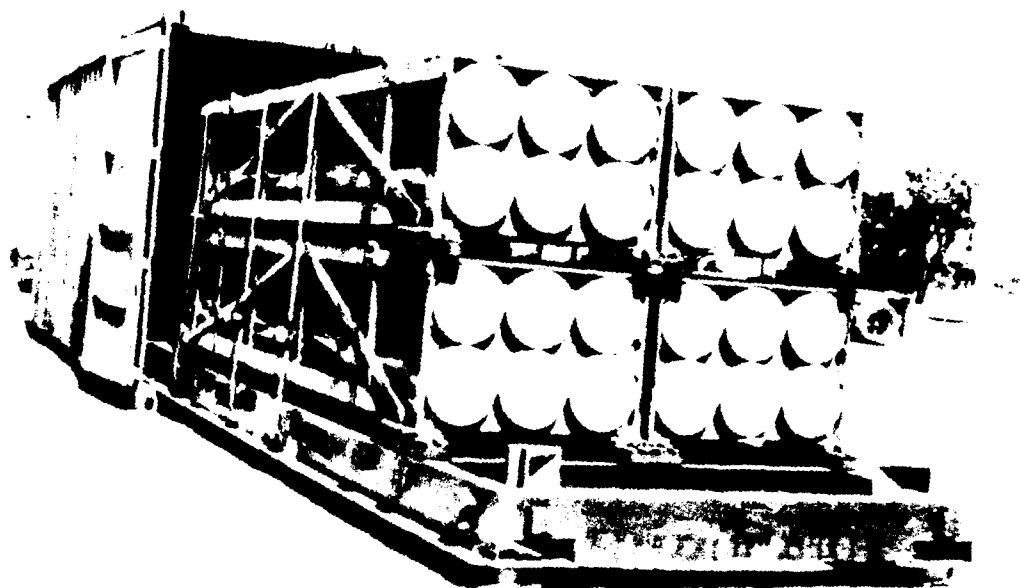

Load and Roll Pallet (LRP)

POINT OF CONTACT

Mr. D. Chesnulovitch
PM-AMMOLOG, AMCPM-AL
Picatinny Arsenal, NJ 07806-5000
DSN 880-4737/Commercial (201) 724-4737

ITEM DESCRIPTION

The Load and Roll Pallet (LRP) fits inside of a standard 20' ANSI/ISO container. The LRP allows a complete load of four Multiple Launch Rocket System (MLRS) Pods (each weighing 5,078 pounds) to be rolled out of an end opening container so they can be easily handled from the side. Two 6,000-pound capacity forklifts or one 10,000-pound capacity or larger forklift lifts up one end of the fully loaded LRP just high enough to clear the floor of the container and rolls the entire load in or out of the container. Unloading can be accomplished in approximately one-fourth of the time required using the current method of dragging the MLRS Pods out of the container.

STATUS

Testing of the LRP concept was conducted during November 1987 at Miesau Army Depot and the results were favorable. Ten LRPs were bought and delivered to the US Army Defense Ammunition Center and School in 2QFY89 for follow-on evaluation. An acquisition strategy and cost benefit analysis have also been completed.

PROGRAM PLAN

Based on the results of the acquisition strategy and cost benefit analysis, the LRP/ISO container combination should be used for shipment of MLRS and Army Tactical Missile System (ATACMS) rocket pod containers.

NSN

Not assigned.

Part II

Handling

Equipment

,000-Pound Capacity Forklift Truck



CAPACITY	4,000 pounds at 24' load center
LENGTH WITH FORKS	145'
WIDTH	45'
HEIGHT WITH ROPS	81'

4,000-Pound Capacity Forklift Truck

POINTS OF CONTACT

Mr. R. Riley
US Army Belvoir RD&E Center, STRBE-FMR
Fort Belvoir, VA 22060-5606
DSN 354-4490/Commercial (703) 664-4490

COL Kearns
Wamer Robins Air Logistics Center, WRALC/LV
Robins AFB, GA 31098-5609
DSN 468-2062/Commercial (912) 926-2062

ITEM DESCRIPTION

This forklift provides Air Force bases and Army Depots the capability to load and unload palletized cargo from ISO containers. It is a commercial type pneumatic tired forklift with a lift height of at least 144". The forklift has a capacity of 4,000 pounds at a 24" Load Center.

STATUS

The Army has an inventory of approximately 1,700 gasoline engine powered units. In FY85, the Army awarded a 5-year contract to Hyster to procure approximately 1,300 clean-burn, diesel engine powered units. DLA managed IDTC contract was awarded in July 1989, although it could not handle the Air Force requirements. DLA is currently in solicitation to meet the Air Force requirements. FY86-91 Air Force requirements are for 785 units.

PROGRAM PLAN

The Army will continue to field the forklifts. The Air Force is planning to receive deliveries beginning in August 1992.

NSN

3930-01-172-7891

4,000-Pound Capacity, Rough Terrain Forklift Truck (4K RTFLT)

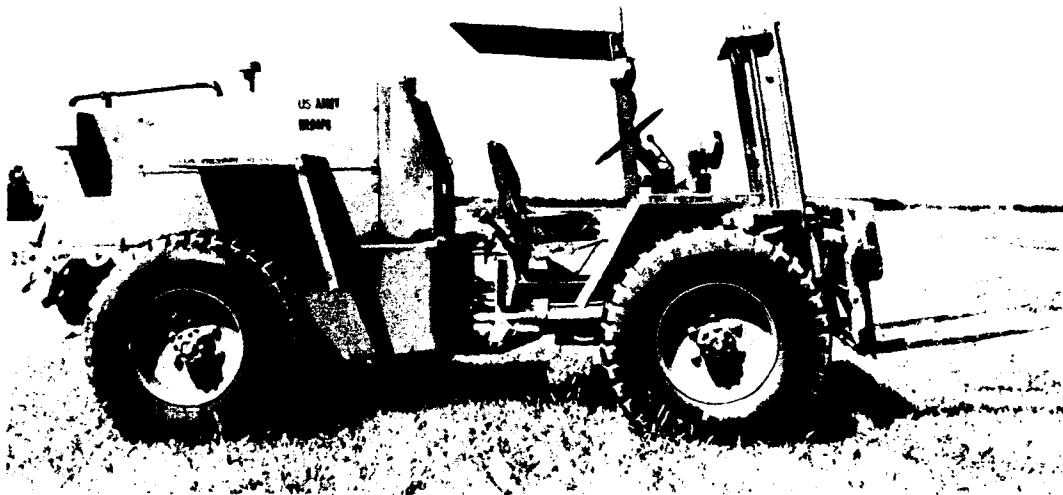

CAPACITY	4,000 pounds at 24' load center
LENGTH WITH FORKS	205'
WIDTH	79'
HEIGHT WITH ROPS	80'
WEIGHT	10,000 pounds

4,000-Pound Capacity, Rough Terrain Forklift Truck (4K RTFLT)

POINTS OF CONTACT

Mr. W. Brower
US Army Belvoir RD&E Center, STRBE-FMR
Fort Belvoir, VA 22060-5606
DSN 354-1143/Commercial (703) 664-1143

CAPT P. Tomecek
Dep CG, Marine Corps RD&A Command, SSEA
Quantico, VA 22134-5080
DSN 278-2022/Commercial (703) 640-2022

ITEM DESCRIPTION

The 4,000-Pound Capacity, Rough Terrain Forklift Truck (4K RTFLT) provides the capability of stuffing and stripping the 8' wide family of ISO containers under field conditions. The vehicle is sized to effectively operate within the ISO container including placing two pallet loads side by side and two high within the container. The vehicle weighs approximately 10,000 pounds, is 79" wide, 80" high, and 165" long, excluding forks. The vehicle is four-wheel drive for rough terrain operation and has freelif and side shift capabilities for operating within the container.

STATUS

The Army awarded a multi-year contract to J. I. Case Company during FY78. A total of 1,910 forklifts were delivered between August 1980 and July 1984. Initial fielding of 209 units was made to Korea and USAREUR. Additional fielding was made on call-up. On 29 October 1990, the Tank-Automotive Command (TACOM) awarded a multi-year contract to the Entwistle Company for a total of 714 vehicles, with options for an additional 557 vehicles. The Marine Corps bought 280 forklifts from J. I. Case Company during the mid-1970s. In FY85, the Marine Corps awarded a contract to Defense Technology (subsequently a subsidiary of Entwistle Company) for a quantity of 560 forklifts. The Marine Corps began fielding in June 1990.

PROGRAM PLAN

Perform necessary actions as required to support the fielded forklifts. First Article Testing for the Army contract is scheduled for July 1991 through February 1992 with deliveries of production vehicles beginning in May 1993.

NSNs

Army:	3930-01-076-4237
Marine Corps J. I. Case:	3930-00-415-0098
Marine Corps new:	3940-01-275-6420

Mobile Loading Ramp

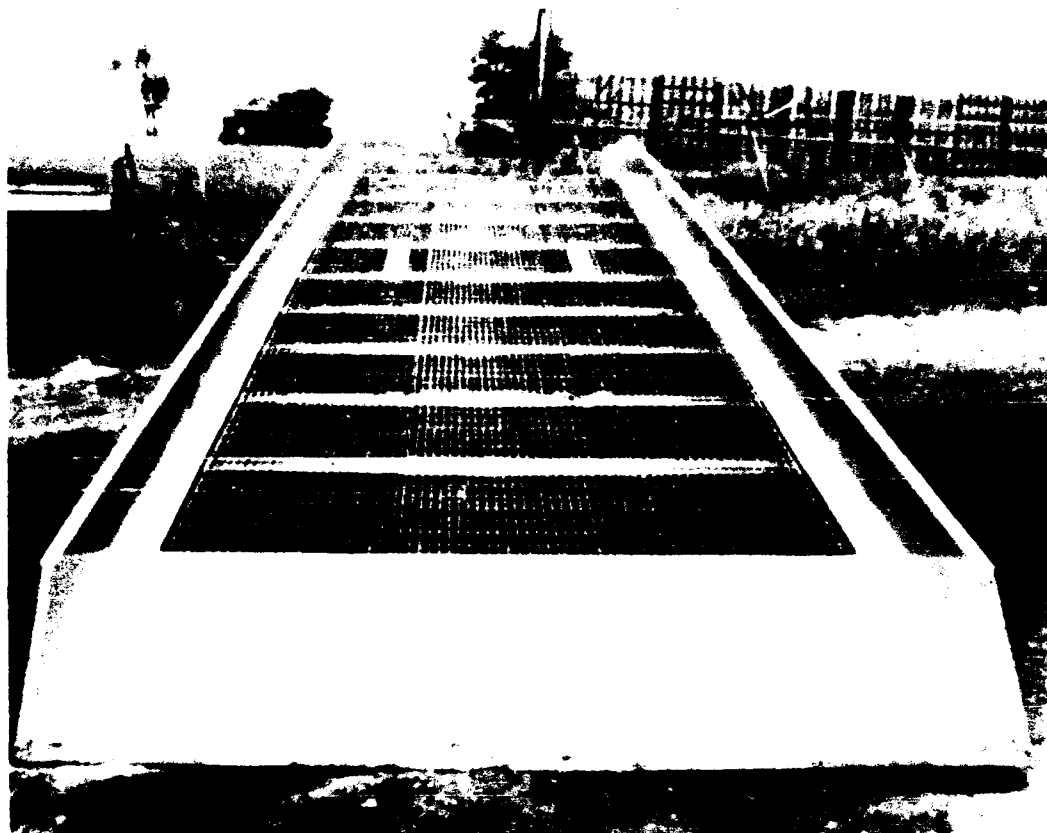

CAPACITY	16,000 pounds
LENGTH	36' including 6' level-off section
WIDTH	8' approximately
HEIGHT	adjustable from 46' to 65'
WEIGHT	6,000 pounds approximately

Mobile Loading Ramp

POINT OF CONTACT

Mr. W. Brower
US Army Belvoir RD&E Center, STRBE-FMR
Fort Belvoir, VA 22060-5606
DSN 354-1143/Commercial (703) 664-1143

ITEM DESCRIPTION

The Mobile Loading Ramp is used in conjunction with the 4,000-Pound Capacity Rough Terrain Forklift Truck for stuffing and stripping the 8' wide family of containers when the container is on a semitrailer or truck chassis. The ramp is 96" wide and 36' long, including a 6', level-off section, and weighs approximately 6,000 pounds. The bed height is adjustable from 45 to 65". The ramp is capable of safely supporting loads up to 16,000 pounds. The specification for the Mobile Loading Ramp is MIL-R-52899.

STATUS

A firm fixed price contract was awarded to Magline, Inc., for 83 commercial units. The preproduction testing was completed in March 1976. Production delivery took place as scheduled, from June 1976 through April 1977. A contract was negotiated with Magline, Inc., to increase the curb height to 12" on the 83 fielded ramps to overcome safety deficiencies. A second multi-year contract was awarded in November 1977 to Brooks and Perkins, Inc., to provide an additional quantity of 346 ramps. Under the option in the Brooks and Perkins contract, additional quantities of 346 units were procured. A two-step multi-year procurement contract was awarded to Magline, Inc., in 4QFY81 for additional ramps. A total of 828 ramps were delivered.

PROGRAM PLAN

Support fielded ramps. There are no plans for additional procurements.

NSN

3990-01-120-4015

**6,000-Pound Capacity, Variable Reach
Rough Terrain Forklift Truck (6K VRRFTLT)**



6,000-Pound Capacity, Variable Reach Rough Terrain Forklift Truck (6K VRRFTFLT)

POINT OF CONTACT

Mr. D. Krawchuk
US Army Belvoir RD&E Center, STRBE-FMR
Fort Belvoir, VA 22060-5606
DSN 354-1143/Commercial (703) 664-1143

ITEM DESCRIPTION

The 6,000-Pound Capacity, Variable Reach Rough Terrain Forklift Truck (6K VRRFTFLT) provides the capability of loading and unloading 8' x 8' x 20' MILVANs and ISO containers located on the ground or mounted on a trailer under field conditions. The 6K VRRFTFLT is specifically designed to unload the Multiple Launch Rocket System (MLRS) pods from ISO containers.

The 6K VRRFTFLT can handle 6,000 pounds at a reach of 15' and 4,000 pounds at a reach of 23.5'. The vehicle weighs 27,100 pounds, is 102" high, 100" wide, and 262" long without forks. The 6K VRRFTFLT will replace the aging fleet of 6,000-Pound Capacity Rough Terrain Forklifts.

STATUS

The Army Type Classified the 6K VRRFTFLT for use in November 1984. Tank-Automotive Command awarded a production contract in January 1988 to TRAK International for 1,686 vehicles. Two contract options have been exercised, bringing the total number of vehicles to 2,050.

PROGRAM PLAN

Production is scheduled to end during 2QFY94.

NSN

3930-01-158-0849

**All Terrain Lifter,
Articulated System (ATLAS)**

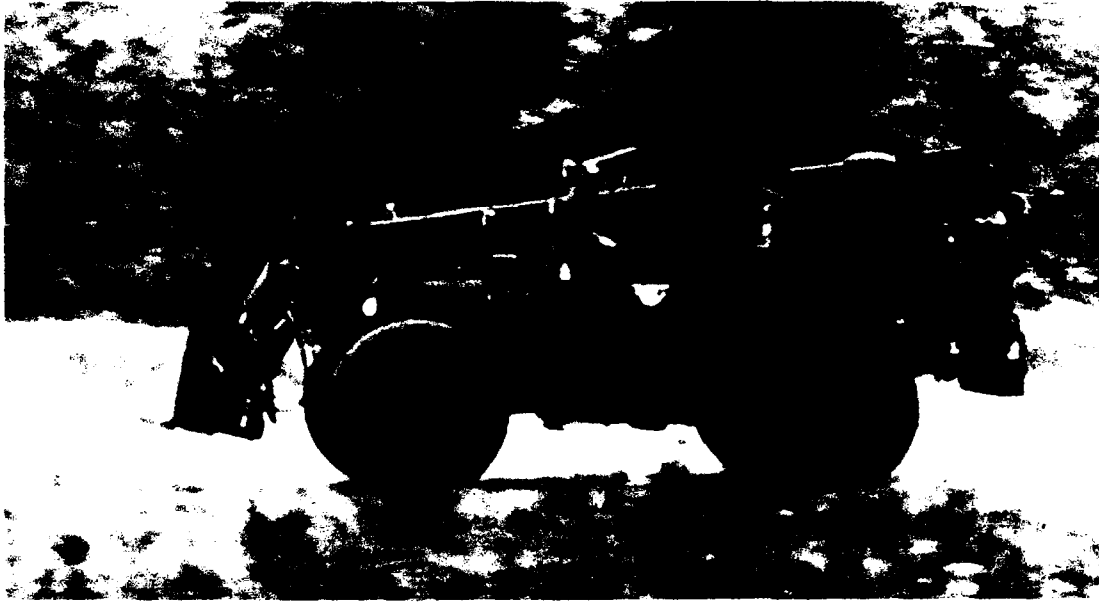

All Terrain Lifter, Articulated System (ATLAS)

POINT OF CONTACT

Mr. D. Krawchuk
US Army Belvoir RD&E Center, STRBE-FMR
Fort Belvoir, VA 22060-5606
DSN 354-1143/Commercial (703) 664-1143

ITEM DESCRIPTION

The All Terrain Lifter, Articulated System (ATLAS) is a rough terrain variable reach forklift with a maximum lift capacity of 10,000 pounds at a load center of 48" and a reach of 4'. The ATLAS also has lift capacities of 6,000 pounds at 13' and 4,000 pounds at 23.5', both with a load center of 24". These lift capacities will allow the ATLAS to load and unload 20' long ISO containers located on the ground or on a trailer up to 5' from the end of the trailer. The ATLAS is self-deployable at speeds up to 45 mph to reduce the need for organic transportation. The ATLAS will be equipped with a micro-cooling unit and provisions for the M43A1/M42 Chemical Agent Detection/Alarm System.

STATUS

The O&O Plan for the program was approved in May 1986. A contract for the Proof of Principle (POP) prototype vehicle was awarded in September 1987 to FMC Corporation. The prototype vehicle was received in July 1989 and is currently undergoing testing at Aberdeen Proving Ground, MD.

PROGRAM PLAN

Completion of the POP prototype vehicle testing is scheduled for June 1991. Award three (3) Development Prove-Out (DPO) contracts in FY93 for four (4) each DPO prototype vehicles. These vehicles will be tested at Aberdeen Proving Ground, MD, and the vehicles which complete testing will be eligible for the Production Contract which will be awarded in FY96.

NSN

Not assigned.

Extendable Boom Forklift (EBFL)



Extendable Boom Forklift (EBFL)

POINT OF CONTACT

CAPT P. Tomecek
Dep CG, Marine Corps RD&A Command, SSEA
Quantico, VA 22134-5080
DSN 278-2022/Commercial (703) 640-2022

ITEM DESCRIPTION

The Extendable Boom Forklift (EBFL) provides the Marine Corps the capability of loading and unloading 8' x 8' x 20' MILVANs and ISO containers located on the ground or trailer mounted, under field conditions. One of the main uses of the EBFL is to unload the Multiple Launch Rocket System (MLRS) pods from ISO containers.

The EBFL has two different carriages. The smaller carriage can handle 4,000 pounds at a reach of 20' and 6,000 pounds at a reach of 10', both measured to the load center. The larger carriage can handle 10,000-pound loads at a reach of 6'. The vehicle weight 25,600 pounds, is 101" high, 102" wide, and 315" long, including the carriage.

STATUS

The Marine Corps awarded a contract to LULL Corporation on 30 September 1988 for 734 EBFLs. First Article Testing was approved during August 1989 and first deliveries began in May 1990.

PROGRAM PLAN

Initial fielding of the EBFL is scheduled for 4QFY91.

NSN

3930-01-305-2111

Spreader Bars, Intermodal Container Handling

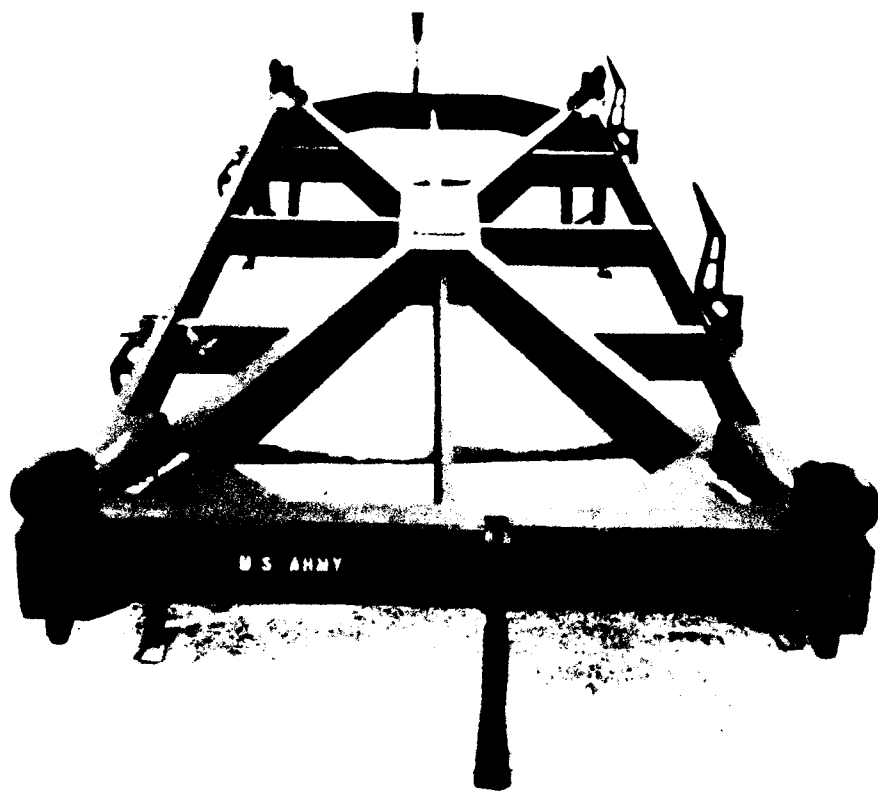

Spreader Bars, Intermodal Container Handling

POINT OF CONTACT

Mr. R. Riley
US Army Belvoir RD&E Center, STRBE-FMR
Fort Belvoir, VA 22060-5606
DSN 354-4490/Commercial (703) 664-4490

ITEM DESCRIPTION

The Spreader Bars are connected to the hook of a crane such as the Rough Terrain Container Crane or the 140-Ton Truck-Mounted Container handling Crane and are used to handle ISO and other intermodal containers. The Army has two types of the Spreader Bars. One type is for handling 20' long containers and the other type is for handling 40' long containers. Both Spreader Bar types conform to the requirements of the Military Specification MIL-S-52713. Both types are of a fixed frame design and have a manually locking frame.

STATUS

A contract was awarded in FY87 to Isometrics, Inc., for 476 20' spreaders and 154 40' spreaders. These spreaders were procured in support of the Rough Terrain Container Crane (RTCC), currently in production. First Article Testing of the spreaders was conducted in two phases: the first phase was successfully conducted at the manufacturers facilities, and the second phase was conducted in conjunction with the First Article Test for the RTCC.

PROGRAM PLAN

No additional procurement actions are scheduled.

NSNs

20': 3990-01-258-2010
40': 3990-01-258-2011

Top Handler, Intermodal Container Handling, Lightweight Expandable



Top Handler, Intermodal Container Handling, Lightweight Expandable

POINT OF CONTACT

Mr. R. Riley
US Army Belvoir RD&E Center, STRBE-FMR
Fort Belvoir, VA 22060-5606
DSN 354-4490/Commercial (703) 664-4490

ITEM DESCRIPTION

The lightweight expandable top handler is an electro/hydraulically activated top handler which can be used with the Army's 50,000-pound capacity Rough Terrain Container Handler (RTCH) for lifting and handling ISO and intermodal containers. The top handler weighs under 10,000 pounds and can be expanded longitudinally to handle 20', 35', and 40' containers. Expansion of the top handler as well as engagement/disengagement of a container can be performed by the operator from the cab of the RTCH.

STATUS

Three lightweight expandable top handlers were obtained on loan from various commercial manufacturers during FY84. Conceptual testing, conducted at Fort Belvoir, VA, was completed during FY85. Two lightweight expandable top handlers were procured during FY86 for additional testing. Concept Evaluation Program (CEP) tests were conducted at Fort Eustis, VA, during FY86. Results of the CEP tests were evaluated during FY87. The Transportation School recommended that additional CEP testing be conducted. The additional CEP testing was conducted at Fort Eustis, VA, during 4QFY88, and the test reports were published during 3QFY89. Further support for continuing the program has not been received; therefore, all work on the program ceased in FY89.

PROGRAM PLAN

Without user support, the program will remain dormant.

NSN

Not assigned.

Rough Terrain Container Crane (RTCC)

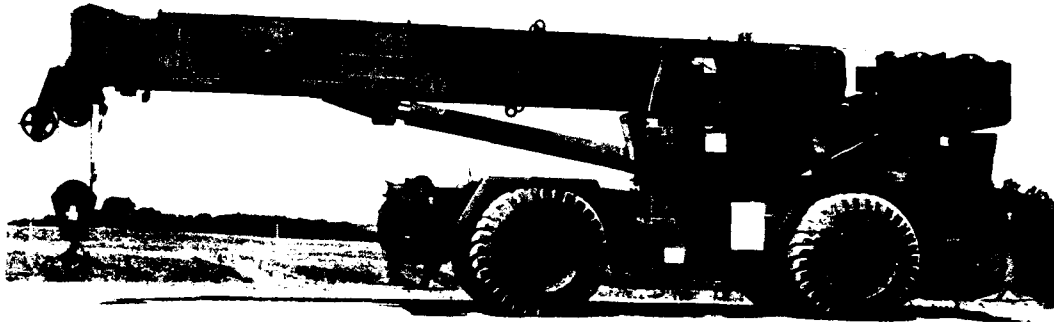

CAPACITY	44,800 pounds at 27'
LENGTH	548'
WIDTH	145'
HEIGHT	153'
WEIGHT	108,750 pounds

Rough Terrain Container Crane (RTCC)

POINT OF CONTACT

Mr. V. Batson
US Army Belvoir RD&E Center, STRBE-FMR
Fort Belvoir, VA 22060-5606
DSN 354-1143/Commercial (703) 664-1143

ITEM DESCRIPTION

The RTCC is a commercially designed truck-mounted crane. The RTCC is capable of lifting a 20' container weighing 44,800 pounds at a radius of 27' and a 35'/40' container weighing 67,200 pounds at a radius of 22'. General Support (GS) ammunition units use the RTCC "from a fixed position" for transfer of 20' ANSI/ISO containers from one mode of transportation to another or to ground/load containers from/to waiting transportation in the Theater and Corps ammunition storage areas. Transportation units use the crane to augment the 50,000-Pound Rough Terrain Container Handler in the transfer and handling of 20', 35', or 40' containers and other cargo between transportation modes and in storage areas.

STATUS

A Market Investigation was completed in FY85 and a purchase description prepared in FY86. Two candidate cranes were leased and evaluated during 3QFY85. The crane was type classified standard in August 1985, and was transitioned to the US Army Tank-Automotive Command (TACOM). A contract was awarded to Grove Manufacturing Company on 24 November 1986 for 254 vehicles. Preproduction testing was conducted 1QFY88 to 4QFY88. Initial production testing was completed 2QFY89. Delivery of the RTCC commenced during June 1989. As of December 1990, 189 RTCCs have been delivered.

PROGRAM PLAN

Continue fielding the RTCC.

NSN

3810-01-205-2716

140-Ton, Truck-Mounted, Container Handling Crane

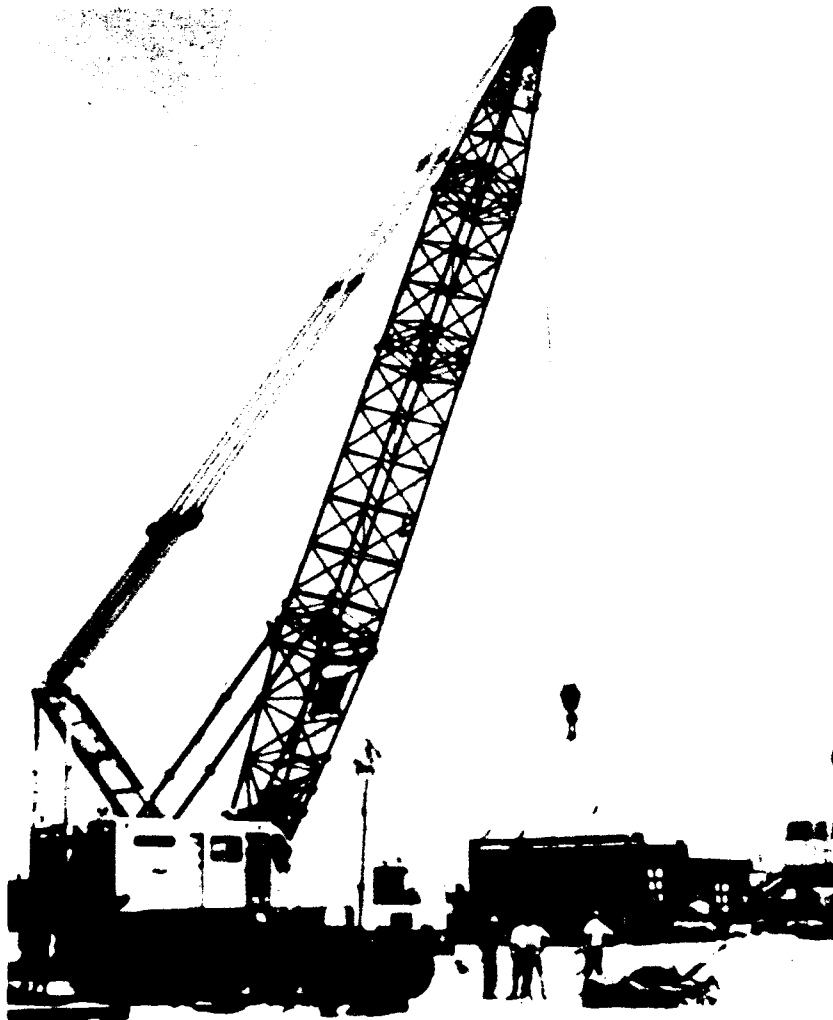

CAPACITY	140 tons approximately 12'
LENGTH WITH 50' BOOM	873.0'
WIDTH	132.5'
HEIGHT	157.8'
WEIGHT WITH 120' BOOM	195,000 pounds

140-Ton, Truck-Mounted, Container Handling Crane

POINT OF CONTACT

Mr. E. Rodrick
US Army Belvoir RD&E Center, STRBE-FMR
Fort Belvoir, VA 22060-5606
DSN 354-1143/Commercial (703) 664-1143

ITEM DESCRIPTION

The 140-ton crane is a commercial design, truck-mounted, and has 140-ton maximum capacity at a reach of 12'. It has an 8' x 4' truck chassis and a 50' basic boom which can be extended in length up to 130' with the use of various lengths of lattice boom. The crane is used in the loading and unloading of containers from ships in a fixed port operation or landing craft in a Logistics-Over-The-Shore (LOTS) operation and for handling containers in a marshalling area and terminal sites.

STATUS

A multi-year contract was awarded to FMC Corporation in September 1980 for 28 cranes. Deliveries began in January 1982 and were completed during FY85.

PROGRAM PLAN

There are no plans for additional procurements.

NSN

3950-01-027-9254

250-Ton, Truck-Mounted, Container Handling Crane

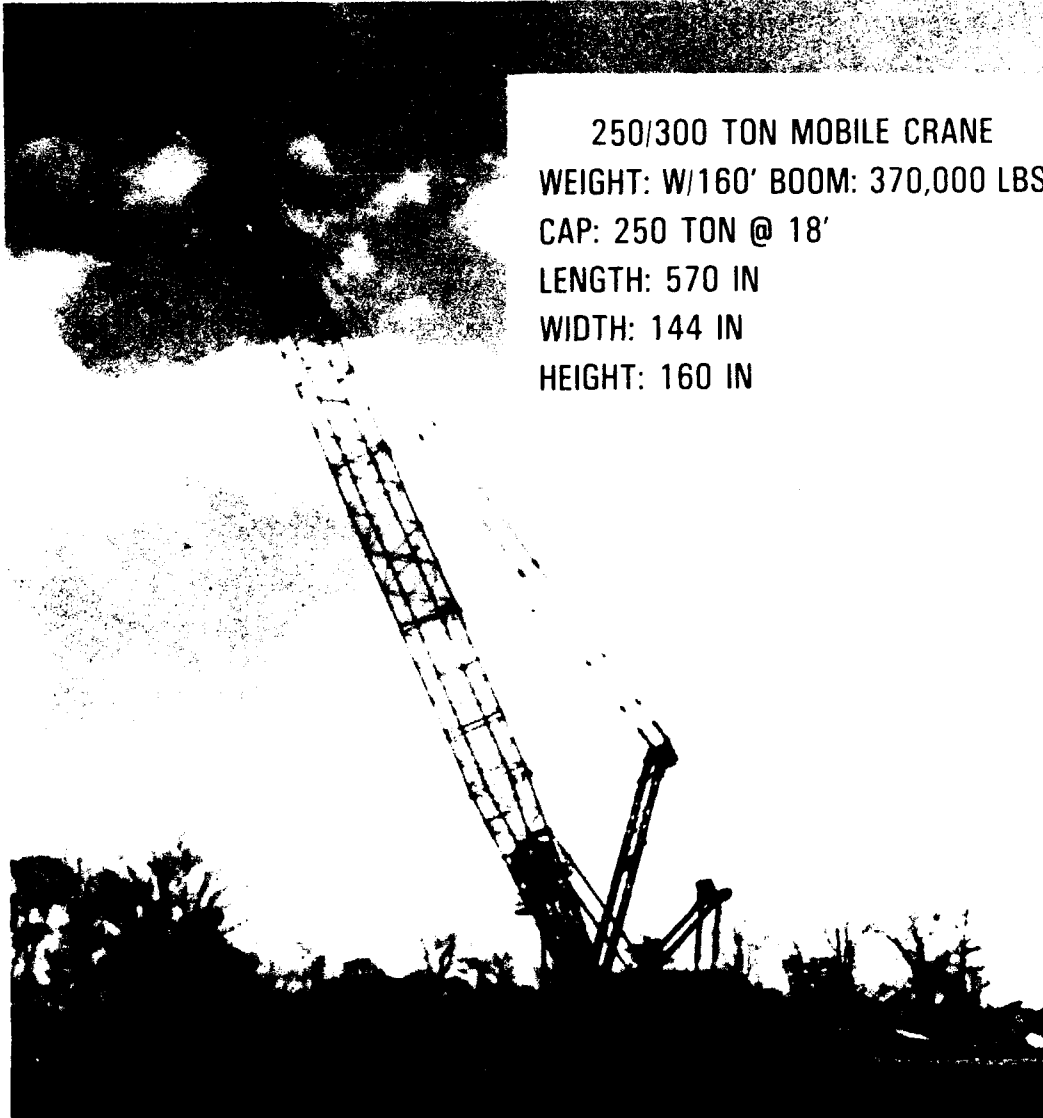

250/300 TON MOBILE CRANE
WEIGHT: W/160' BOOM: 370,000 LBS
CAP: 250 TON @ 18'
LENGTH: 570 IN
WIDTH: 144 IN
HEIGHT: 160 IN

250-Ton, Truck-Mounted, Container Handling Crane

POINT OF CONTACT

Mr. E. Rodrick
US Army Belvoir RD&E Center, STRBE-FMR
Fort Belvoir, VA 22060-5606
DSN 354-1143/Commercial (703) 664-1143

ITEM DESCRIPTION

The 250-ton crane is a commercial design, truck-mounted, and has a 250-ton maximum capacity at a reach of 18'. It has a 12' x 6' truck chassis and a 70' boom which can be extended in length up to 160' with the use of various lengths of lattice boom. The crane is used in the loading and unloading of containers from ships in a fixed port and alongside these ships on barges, piers, and floating platforms in a Logistics-Over-The-Shore (LOTS) environment. The crane is also used for the loading and unloading of containers from lighters over the beach in a LOTS environment.

STATUS

A total of eight cranes have been delivered by Hamischfeger Corporation, satisfying the Army's total requirement. A Product Improvement Program (PIP) was approved to incorporate the Rider Block Tagline System (RBTS) developed by the Navy to minimize the pendulation problem in the sea environment. A contract to design, fabricate, install, and test an RBTS prototype was awarded in FY84. An RBTS prototype unit was installed on a 250-ton crane mounted on a "B" DeLong Barge. The RBTS was successfully tested during the FY84 Joint-LOTS exercise. Due to the development of the Navy TACS Ship, development of the RBTS was terminated.

PROGRAM PLAN

There are no plans for additional procurements.

NSN

3950-01-027-9253

Lightweight Amphibious Container Handler (LACH)

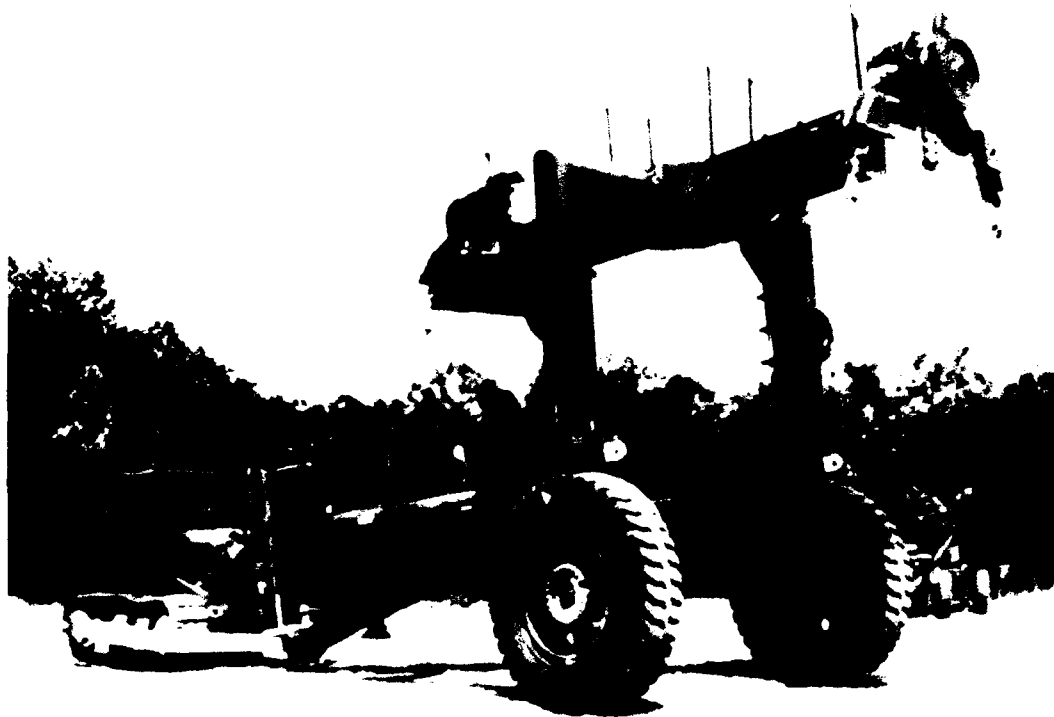

Lightweight Amphibious Container Handler (LACH)

POINT OF CONTACT

MAJ S. A. Loconto
Dep CG, Marine Corps RD&A Command, SSEA
Quantico, VA 22134-5080
DSN 278-2022/Commercial (703) 640-2022

ITEM DESCRIPTION

The LACH is a straddle-lift type, towed, two-wheel mounted, container handler. The LACH is capable of lifting and carrying containers, ramp entry into large landing craft, and loading and unloading containers onto/from cargo trailers during amphibious operations. The LACH, when propelled by its prime mover (medium size bulldozer), can be maneuvered in the surf zone in up to 5' of water with a 20' container weighing up to 50,000 pounds.

STATUS

FY81 funds were appropriated for the production procurement of 56 LACHs to complete the Marine Corps inventory objective. All LACHs have been delivered to MCLBs. Each Maritime Prepositioning Ship Squadron were equipped with four LACHs.

PROGRAM PLAN

No additional procurement actions are planned.

NSN

3920-01-143-9607

Container Lifting Semitrailer

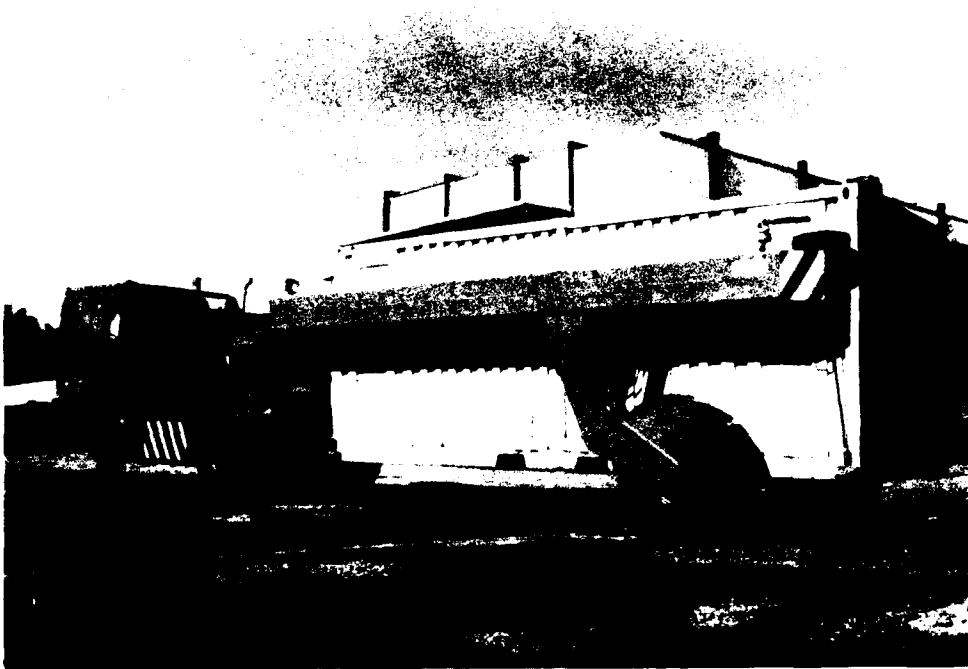

Container Lifting Semitrailer

POINT OF CONTACT

ZB-7 Hawk
6930th Civilian Support Center, AETS-SC-LS-I
APO New York 09160-0305
DSN 426-4565/Commercial 0791-45-565

ITEM DESCRIPTION

The Container Lifting Semitrailer is a U-shaped transporter which is capable of lifting a 20' long ISO container off of the ground and moving it to another location. The Container Lifting Semitrailer has guide wheels to protect the container from damage as it is backed around the container prior to loading. Quick connect couplings are attached to the lifting cables to allow for ease in lifting a container by the lower corner fittings. The container is lifted using hydraulics on the semitrailer which raise the entire frame of the semitrailer. The prime mover for the semitrailer, including hydraulics, is a specialized 4 x 2 yard tractor with a hydraulic-lift fifth wheel.

STATUS

The Container Lifting Semitrailer and prime mover were procured in early FY86 from PLAN Industries GmbH, to meet the need of moving ISO containers within the Civil Support Center. The Container Lifting Semitrailer has been in continuous use by the 2043rd Civilian Support Group, 2044th Civilian Support Group, and the 2045th Civilian Support Group (Ordnance).

PROGRAM PLAN

Support the Container Lifting Semitrailer in use.

NSN

Not assigned.

50,000-Pound Container Handler, Rough Terrain (RTCH)



CAPACITY	50,000 pounds at 48' load center
LENGTH WITH FORKS	420'
WIDTH	138'
HEIGHT	167'
WEIGHT WITHOUT TOP HANDLER	103,000 pounds
TOP HANDLER WEIGHTS:	
20'	3,800 pounds
35'	9,120 pounds
40'	9,927 pounds

50,000-Pound Container Handler, Rough Terrain (RTCH)

POINTS OF CONTACT

Mr. E. Rodrick
US Army Belvoir RD&E Center, STRBE-FMR
Fort Belvoir, VA 22060-5606
DSN 354-1143/Commercial (703) 664-1143

MAJ S. A. Loconto
Dep CG, Marine Corps RD&A Command, SSEA
Quantico, VA 22134-5080
DSN 278-2022/Commercial (703) 640-2022

COL Kearns
Werner Robins Air Logistics Center, WRALC/LV
Robins AFB, GA 31098-5609
DSN 468-2062/Commercial (912) 926-2062

ITEM DESCRIPTION

The RTCH provides a capability of handling the 8' wide family of containers weighing up to 50,000 pounds and 20', 35', and 40' long. It is capable of operating as a rough terrain truck primarily in supply holding storage and marshalling areas by selected supply, ammunition, and transportation units. The RTCH is a modified commercial design and procured to a military specification. The vehicle weighs approximately 103,000 pounds, is 138" wide, 167" high, and 35' long. Top handlers—20', 35', or 40'—are placed on the forks of the RTCH to allow for handling the three different lengths of ISO containers.

STATUS

The Army awarded a multi-year contract to the Caterpillar Tractor Company for 344 vehicles. Of this number, the Air Force procured three for use with Containerized Ammunition Distribution Systems (CADS) shipments, and the Marine Corps procured 21. Production and delivery of all vehicles have been completed. The Marine Corps increased their quantity to a total of 106 by awarding a contract for the additional RTCHs which were delivered in FY88. Ten are aboard each Maritime Prepositioning Ship Squadron. The Air Force procured and fielded nine additional vehicles in FY89.

PROGRAM PLAN

Provide support for fielded vehicles. The Air Force has an additional six vehicles scheduled for procurement and fielding in FY91.

NSNs

Army/Marine Corps: 3930-01-082-3758
Air Force: 3930-01-307-3658CT

0'/40' Container Sideloader

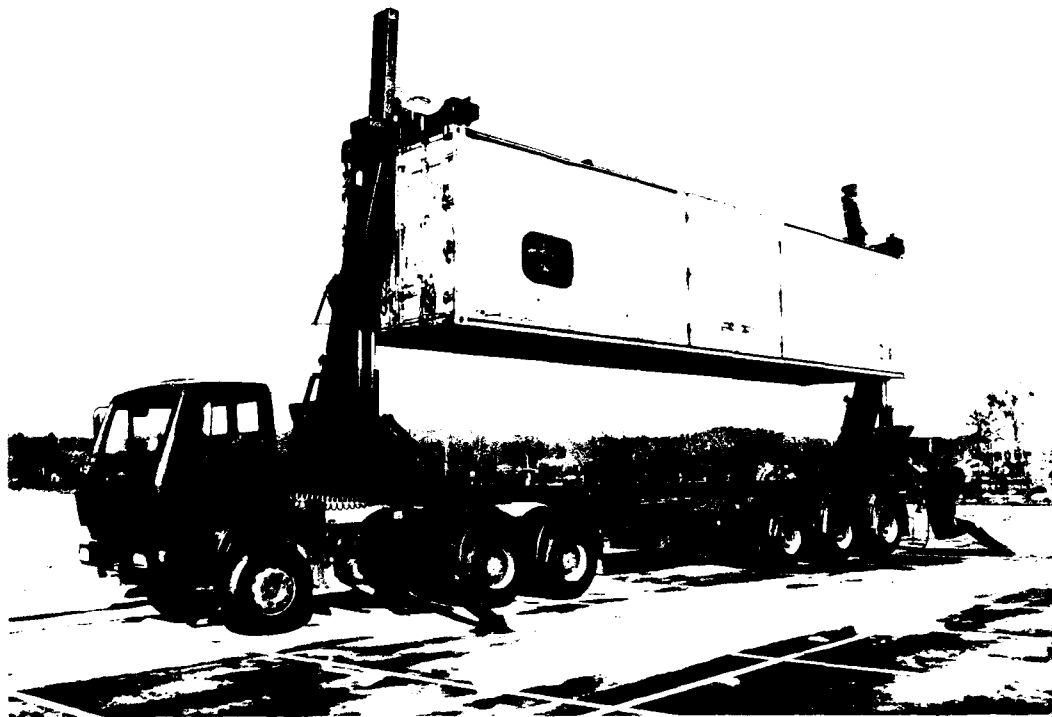

20'/40' Container Sideloader

POINT OF CONTACT

Mr. W. Allenbacher
HQ US Air Force Europe, LGTT
Ramstein AB, GE, APO New York 09094-5000
DSN 480-6321/7468/Commercial 06371-47-6321/7468

ITEM DESCRIPTION

This diesel-powered container sideloader is capable of transferring or self-loading and transporting 20' through 40' ISO containers or tactical shelters. Maximum lifting capability is 66,150 pounds, with an additional 10 percent safety factor built-in. The unit has a telescopic spreader bar for 20', 35', and 40' containers, and can also lift containers with slings. The sideloaders can transport containers within maximum road height limitations. They also have an air ride suspension making them viable to transport ISO containers carrying delicate equipment. The unit is self-deployable by road and by C-5 military airlift. An optional 26-ton tractor is used to pull the sideloader.

STATUS

Four Klaus handlers were procured by the Army for Miesau Army Ammo Depot in 1972 to meet an urgent requirement for container handling. A BeSima/Marmon handler and a Steadman handler were procured by the Army and evaluated by Belvoir RD&E Center in 1975-76. The Steadman handler was subsequently provided to ASP-1 Vilseck, Germany. In August 1978, four additional Klaus handlers with tractors were procured for Army use at ASP-1. In 1982, the Air Force successfully tested the use of a sideloader (on loan from the Army) during an Air Force Containerized Ammunition Distribution System (CADS) movement to Germany. USAFE purchased two sideloaders in early 1984 under the Productivity Investment Program. These sideloaders were used successfully to support several CADS movements in both MILVANs and SEAVANs during 1984. USAFE bought 27 additional 40' sideloaders between FY86 and FY88. The sideloaders are used throughout Europe to support CADS and ISO container movements. USAFE bought and fielded six 20' capacity sideloaders during FY90. The 20' sideloaders will enable USAFE to increase maneuverability in close areas. The Army has obtained additional sideloaders and has met its inventory objective of eighteen 20' container, 44,800-pound capacity sideloaders for use in Germany.

PROGRAM PLAN

There are no additional plans for procurement.

NSNs

40': 3810-01-228-0190CT
20': Unknown

Palletized Load System (PLS)

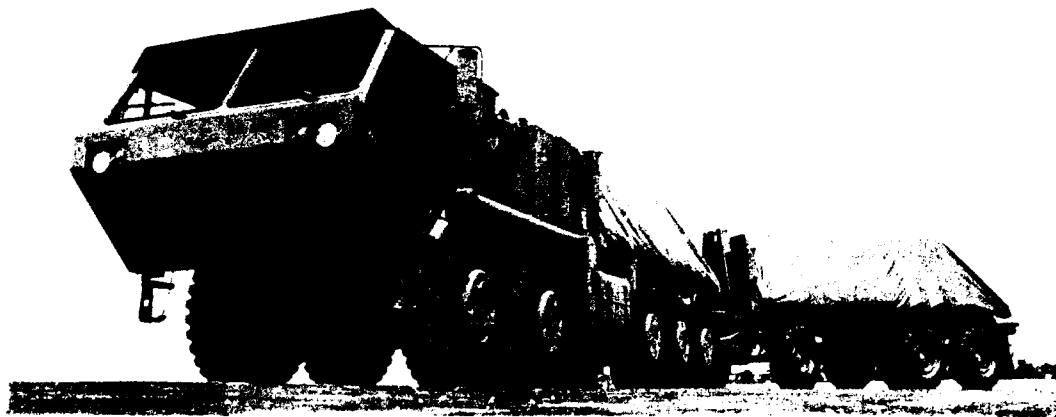
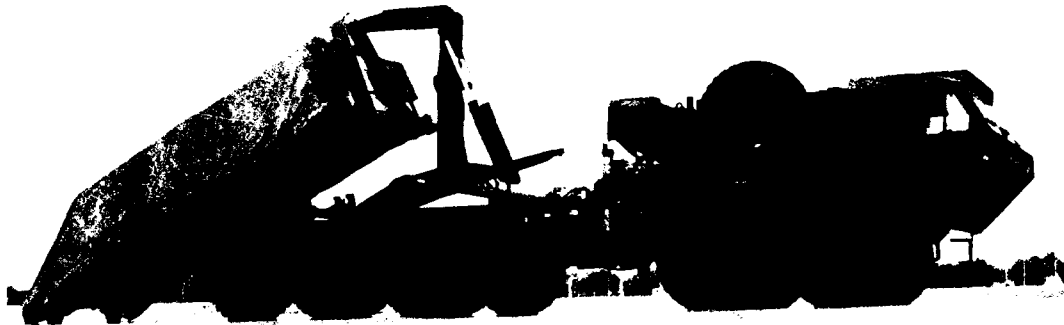

Palletized Load System (PLS)

POINT OF CONTACT

COL W. John Stoddart
US Army Tank-Automotive Command, AMCPM-TVH
Warren, MI 48397-5000
DSN 786-5800/Commercial (313) 574-5800

ITEM DESCRIPTION

The Palletized Load System (PLS) consists of a standard mobility heavy truck chassis, an integral hydraulic load handling mechanism, a compatible trailer, and a number of flatracks. The system is capable of self-loading and self-unloading the flatracks from the ground onto the truck chassis using the integral load handling system. The vehicle-mounted load handling system also has the capability to load and unload flatracks onto the companion trailer. Both the truck and the companion trailer have a 16.5-ton payload capacity.

STATUS

Three heavy (15-ton payload) PLSs were evaluated for 2 years by ADEA and the 9th ID at Fort Lewis, WA. Three additional heavy and 15 medium (7.5-ton payload) PLSs were evaluated by ADEA between 2QFY85 and 2QFY86. Under a separate program, the Tank-Automotive Command (TACOM) leased 46 PLSs of 10- and 15-ton payloads for use in Force Development Test and Evaluation (FDTE) at Fort Hood, TX, during 1QFY87. The results showed the advantages of PLS in the distribution of ammunition. In January 1989, TACOM awarded three prototype contracts to General Motors, PACCAR and Oshkosh. Competitive testing between the three contractors was conducted from September 1989 through March 1990 at Aberdeen Proving Ground (APG), MD, Yuma Proving Ground (YPG), AZ, and Fort Carson, CO. This testing involved nine trucks, six trailers, and 30 flatracks from each of the three contractors. Based on the test results, system costs, and production proposals, the Source Selection Board chose the Oshkosh vehicle over the other two competitors' vehicles. In September 1990, the Defense Acquisition Board (DAB) approved and released funds for the PLS. DAB approval provided the authorization to sign a 5-year multi-year, \$860 million contract for 2,707 PLS trucks, 1,083 trailers, and 28,272 flatracks with Oshkosh.

PROGRAM PLAN

In 3QFY91, production vehicles will undergo shakedown testing at Nevada Automotive Test Center (NATC). Production phase testing will begin in 1QFY92. It will include more than 120,000 miles of endurance testing at APG and YPG. Operational testing will be conducted at Fort Carson from December 1991 through March 1992. Upon the completion of successful testing and evaluation, the system will undergo a Milestone III review at the DAB level. The Milestone III DAB will authorize Full Rate Production with First Unit Equipment (FUE) occurring in 1QFY93.

NSNs

Truck with MHE Crane:	2320-01-304-2277
Truck:	2320-01-304-2278
Trailer:	2330-01-303-5197
Flatrack:	3990-01-307-7676

Logistics Vehicle System

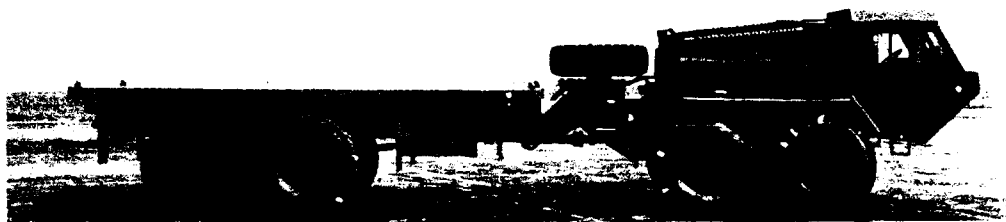

MK 48/MK 14

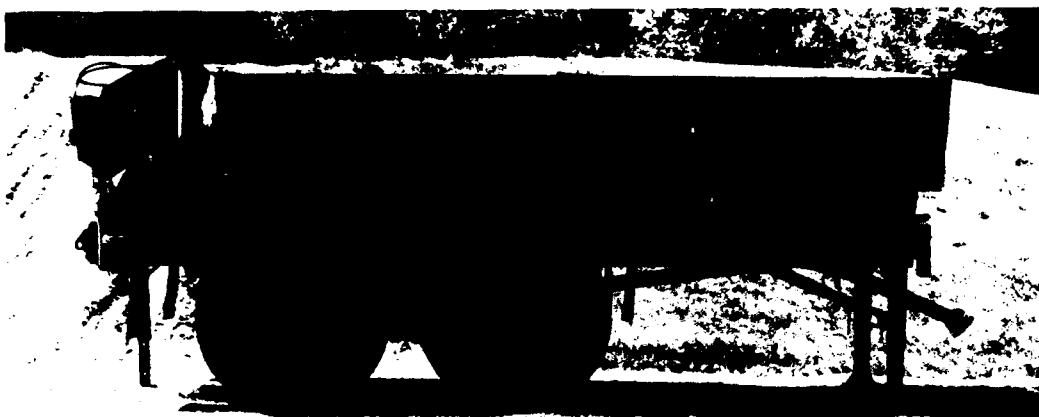

MK 17

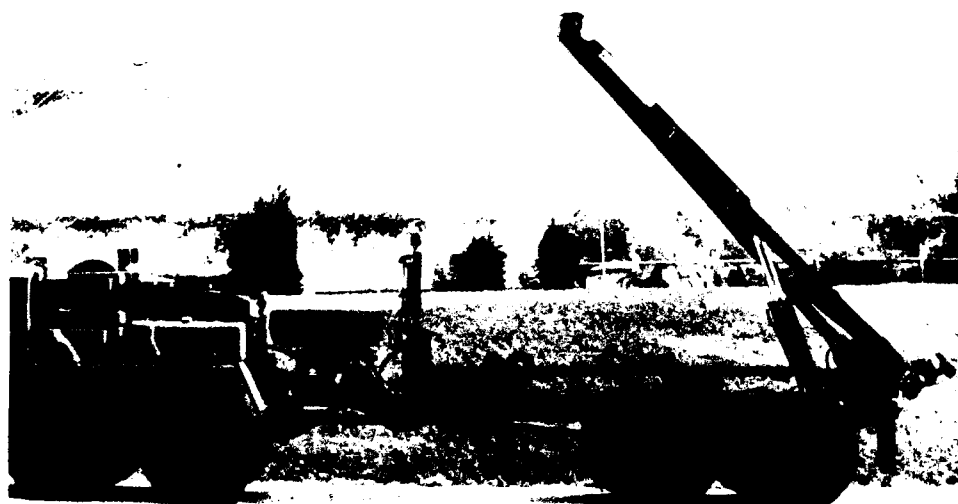

MK 18

Logistics Vehicle System

POINT OF CONTACT

MAJ J. Wozniak
Marine Corps RD&A Command, Code SSCMT
Washington, DC 20380-0001
DSN 226-1154/Commercial (202) 696-1154

ITEM DESCRIPTION

The Logistics Vehicle System consists of one front power unit (MK48) and any one of five rear body unit configurations. The MK14 Container Hauler is an ISO twist-lock equipped, 22.5-ton capacity; rear body unit designed to transport standard ISO 8' x 8' x 20' containers, shelters, and modules. The MK17 Dropside Cargo with crane is a rear body unit with an 8' x 16' loading area designed as a troop carrier as well as a carrier for fuel/water modules, and 8' x 8' x 10' shelters/containers. The MK18 Self-Loading Ribbon Bridge Transporter/Container Handler is a hydraulically powered tilt bed rear body unit designed to load/offload ISO containers, ribbon bridge components or fill material without the assistance of material handling equipment.

STATUS

Approval for service use for the MK48 Front Power Unit and MK14 Container Hauler Rear Body Unit was obtained in July 1982. Approval for the MK17 Dropside Cargo variant was obtained in August 1983. A 5-year letter contract was signed in September 1983 for 1,433 units with options extending the total to 1,686 total Logistics Vehicle Systems. The Logistics Vehicle System consisting of the MK48/14/17 began delivery to selected units in August 1985 with a subsequent initial operational capability (IOC) of March 1986. Production deliveries were completed September 1989. The MK18 R&D prototype testing commenced 3QFY88 and a Milestone III was held on 9 January 1990. Production contract award for a base quantity of 100 units occurred in February 1990; the first option for 110 units was exercised in July 1990. The maximum quantity of vehicles available under this contract, with options, is 268 units.

PROGRAM PLAN

Delivery of production vehicles commenced January 1991 and will continue at a rate of approximately 15 per month. It is anticipated that the next option calling up 110 units will occur in 4QFY91.

NSNs

MK48: 2320-01-177-5162
MK14: 2320-01-176-0469
MK17: 2320-01-176-0468
MK18: 2320-01-324-5915

●
Part III

Ground

● **Transportation**

Equipment

Chassis, Semitrailer: Coupleable, MILVAN Container Transporter

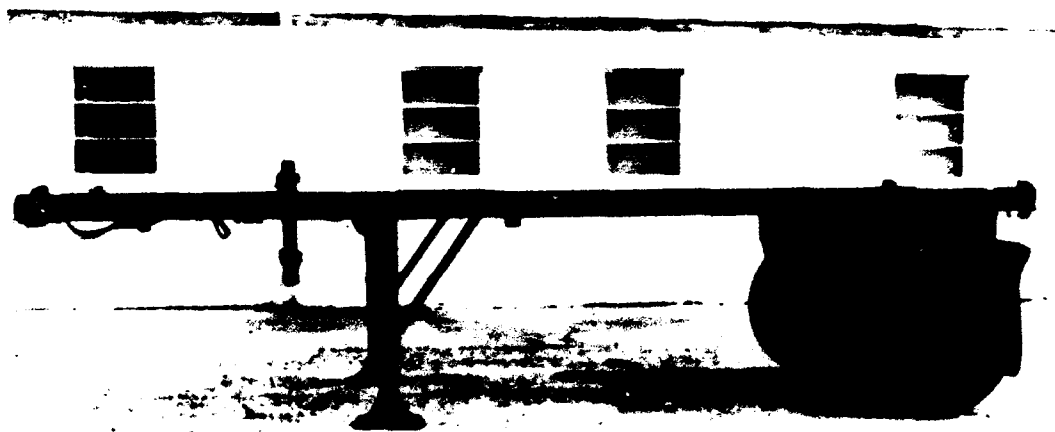

	20' UNIT SINGLE BOGIE	20' UNIT DOUBLE BOGIE	40' UNIT DOUBLE BOGIE
LENGTH	242'	242'	484'
WIDTH	96'	96'	96'
HEIGHT*	53.5'	53.5'	53.5'
WEIGHT	4,000 pounds	5,850 pounds	8,000 pounds

*Height when unloaded and supported on landing legs with deck level.

Chassis, Semitrailer: Coupleable, MILVAN Container Transporter

POINT OF CONTACT

Mr. W. Newell
US Army Tank-Automotive Command, AMSTA-FHS
Warren, MI 48397-5000
DSN 786-6677/Commercial (313) 574-6677

ITEM DESCRIPTION

The MILVAN chassis was procured to attain a military owned, centrally controlled fleet for movement of military and commercial ISO containers over primary hard surface roads principally in CONUS. The chassis consists of a 20' frame, landing gear, and single-axle bogie. The bogie is movable along the length of the frame. The frame has provisions for coupling two 20' units to form a 40' chassis, with the bogies under the rear frame to form a tandem-axle configuration. Each frame has twist locks to accept ISO containers. There is provision for lowering the twist locks flush with the top of the frame so that 40' containers can be transported on a coupled chassis. The MILVAN chassis was competitively procured from industry utilizing a military performance specification.

STATUS

The MILVAN chassis is currently deployed. From 1969-71, 5,620 were procured; 1,479 are currently in inventory. A 4-year overhaul program for 700 units was begun in FY84, and was completed in December 1989.

PROGRAM PLAN

There is no current plan to procure additional units or initiate additional overhauls.

NSN

2300-00-168-2259

Semitrailer, Linehaul, Breakbulk/Container, M872 Series

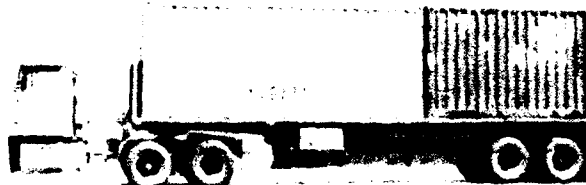
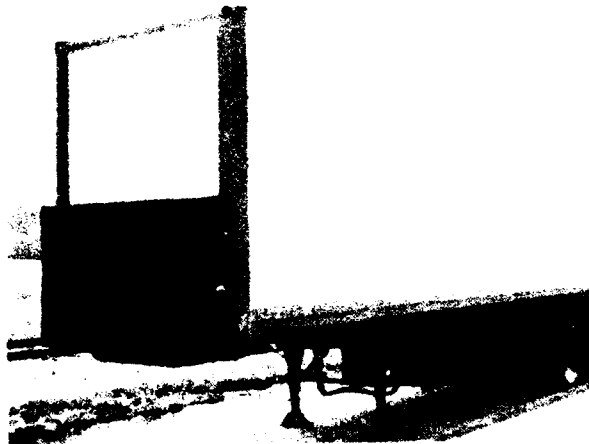

CURB WEIGHT	17,400 pounds	TIRES	10:00 X 20 tube type
RATED PAYLOAD	67,200 pounds	BRAKES	cam/air
GROSS WEIGHT	84,600 pounds	ELECTRICAL	12/24 volt
OVERALL LENGTH	489"	LANDING GEAR	hand/mechanical
OVERALL WIDTH	96"	SIDE PANEL HEIGHT	48"
PLATFORM HEIGHT	59"	CONTAINER LOCKS	20', 35', 40', 24', 5', 6 ² / ₃ ', and 10'
FIFTH WHEEL HEIGHT	50" loaded		

**Height when unloaded and supported on landing legs with deck level*

Semitrailer, Linehaul, Breakbulk/Container, M872 Series

POINT OF CONTACT

Mr. T. Miller
US Army Tank-Automotive Command, AMSTA-FTH
Warren, MI 48397-5000
DSN 786-5162/Commercial (313) 574-5162

ITEM DESCRIPTION

The M872 Series Semitrailers are commercial design flatbed semitrailers of 34-ton capacity used in the linehaul of containers, breakbulk cargo, and M113 Armored Personnel Carriers (APCs). The M915/M915A1 truck tractor is the prime mover.

STATUS

Procurement of the total requirement of 8,656 semitrailers was accomplished by five separate contracts as follows:

Model	Contractor	Quantity
M872	Theurer	1,364
M872	Southwest	1,304
M872A1	Theurer	2,713
M872A1	Heller	212
M872A2*	Theurer	125
M872A2*	Heller	125
M872A3	Southwest	<u>2,813</u>
		8,656 Total

* Model M872A2 has a tapered gooseneck configuration which has been modified by installing a saddle to the gooseneck.

All contracts are complete. All medium transportation companies have 100% fill of the M872.

PROGRAM PLAN

Provide support for fielded items.

NSNs

M872: 2330-01-039-8059
M872A1: 2330-01-109-8006

M872A2: 2330-01-119-5837
M872A3: 2330-01-142-1385

Semitrailer, Tactical, Dual Purpose Breakbulk/Container Transporter, 22 1/2-Ton, M871 Series

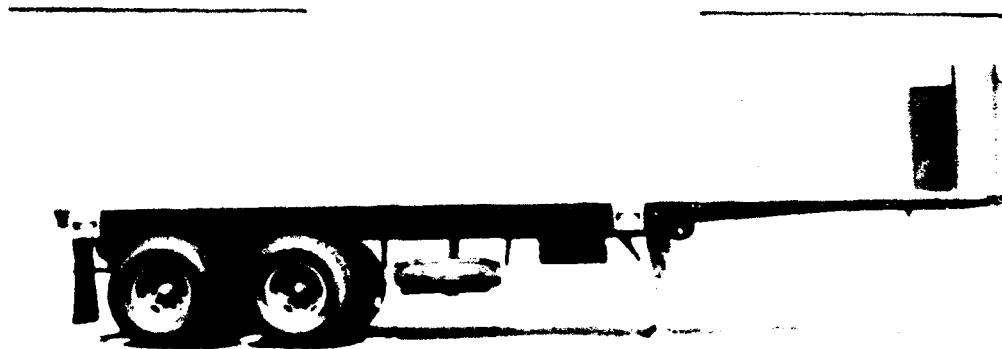

RATED PAYLOAD	44,800 pounds	TIRES	11:00 X 20
OVERALL LENGTH	358'	ELECTRICAL	12/24 volt
OVERALL WIDTH	96'	LANDING GEAR	hand/mechanical
PLATFORM HEIGHT	55**	CONTAINER LOCKS	20', 10', 6 ² / ₃ ', and 5'

***Height when unloaded and supported on landing legs with deck level*

Semitrailer, Tactical, Dual Purpose Breakbulk/Container Transporter, 22¹/₂-Ton, M871 Series

POINTS OF CONTACT

Mr. M. Musotto
US Army TACOM, SFAE-CS-TVH
Warren, MI 48397-5000
DSN 786-8065/Commercial (313) 574-8065

Mr. J. Hollern
US Army TACOM, SFAE-CS-TVH
Warren, MI 48397-5000
DSN 786-7657/Commercial (313) 574-7657

ITEM DESCRIPTION

The M871 is a commercial design tactical semitrailer whose primary application will be the delivery and retrograde of ISO containers and shelters up to 20' long, and breakbulk cargo in an overseas theater of operation between the Corps General Support Supply Activities (GSSA) and the Division Support Command (DISCOM). On occasion it may also be used to deliver containers to forward distribution points or to using units. The prime movers in these roles will be the M818, M915, and M932 truck tractors. The tactical semitrailer will also be used on the linehaul mission as a means of clearing 20' or smaller containers from the port area. The prime mover in this role will normally be the M915 linehaul tractor.

STATUS

A flatbed configuration was selected by the Logistics Center in December 1977, after consideration was given to the conflicting requirements dictated by breakbulk and container transport mission. A quantity of 3,325 trailers was procured and fielded under a 5-year multi-year contract awarded to Southwest Truck Body in March 1979. A quantity of 246 M871A1 trailers was procured and fielded under a contract awarded in May 1985 to Shoals American Industries, Inc. Deployment of the M871/M871A1 has been completed. A 3-year contract for the M871A2 was awarded in September 1988 to Dynaweld, Inc., for 1,089 units with 100% options per year. Initial Production Testing of the M871A2 was completed in September 1990 and delivery began in October 1990.

PROGRAM PLAN

FUE of the M871A2 is scheduled for January 1991.

NSNs

M871: 2330-00-122-6779
M871A1: 2330-01-226-0701
M871A2: 2330-01-294-3367

Truck Tractor, Yard Type, 4 x 2, M878A1

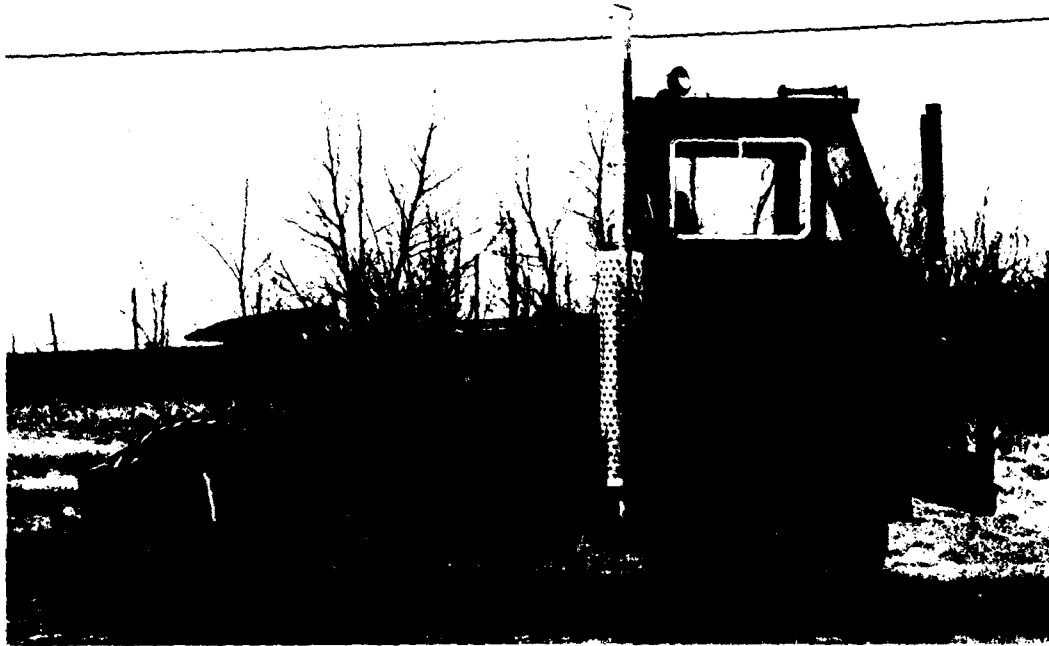

CURB WEIGHT	16,280 pounds
OVERALL LENGTH	182.5'
OVERALL WIDTH	98.125'
OVERALL HEIGHT	120'
WHEEL BASE	116'
FIFTH WHEEL HEIGHT	8' to 64'

Truck Tractor, Yard Type, 4 x 2, M878A1

POINT OF CONTACT

Mr. J. Curtis
US Army Tank-Automotive Command, AMSTA-FTM
Warren, MI 48397-5000
DSN 786-5225/Commercial (313) 574-5225

ITEM DESCRIPTION

The yard type truck tractor is primarily used to provide a capability to shuttle semitrailers loaded with containers or breakbulk cargo within fixed ports, on prepared beaches during Logistics-Over-The-Shore (LOTS) operations, and in trailer transfer areas. The vehicle is a highly maneuverable commercial tractor with an automatic locking, hydraulic-lift fifth wheel which facilitates semitrailer coupling and disengagement, and allows movement of the semitrailer/chassis without retracting the landing legs. It is capable of moving vehicles weighing between 21,000 and 60,000 pounds.

STATUS

Twenty-eight trucks were competitively procured from Ottawa Truck Company for use during Joint-Logistics-Over-The-Shore (J-LOTS) testing in 1977. Based on the favorable results of this test, 16 additional trucks were ordered. The truck passed all First Article Tests, and a third buy contract was awarded to Ottawa Truck Company for a quantity of 175 trucks. Of these 175 vehicles, 56 were issued in 1983 to fill initial CONUS requirements. A full AR 700-34 release of the M878A1 was granted in October 1985. Forty-three trucks have been deployed to USAREUR and nine deployed to Korea. Twenty-six vehicles were fielded to CONUS units in FY90, and 19 were issued in support of Operation Desert Shield/Desert Storm. The remaining vehicles are in long term storage.

PROGRAM PLAN

Continue to fully support fielded vehicles. There are no current plans for additional procurements.

NSN

2320-01-121-2102

Truck Tractor, Linehaul 6 x 4, M915 Series



Truck Tractor, Linehaul 6 x 4, M915 Series

POINT OF CONTACT

Mr. M. Musotto
US Army Tank-Automotive Command, SFAE-CS-TVH
Warren, MI 48397-5000
DSN 786-8065/Commercial (313) 574-8065

ITEM DESCRIPTION

The M915 Series tractors are military adaptations of commercial 6 x 4 tractors. The M915 is the on-road prime mover for the M872 series Breakbulk/Container Transporter Semitrailer (105,000-pound Gross Combination Weight Rating) and is used in linehaul operations from the port of debarkation to the division rear boundary. It partially replaces or augments the M818/M931 5-ton Tactical Tractor fleet. The M915 was part of a single procurement action which fielded a six-vehicle family. The other vehicles within the combined procurement were the M916 Light Equipment Transporter, M920 Medium Equipment Transporter, M917 20-Ton Dump Truck, M918 Bituminous Distributor, and M919 Concrete Mobile.

The M915A1 is a rebuy of the M915 and it has been improved to include state-of-the-art advances in heavy truck technology. It is intended for linehaul operation from the port of debarkation to the division rear boundary. While the M915A1 is used primarily with the M872 series semitrailers, it is capable of operating with a variety of military and commercial trailers.

The M915A2 is a later version of the M915A1. It has a dual purpose of being the prime mover for the M1062, a 7,500 gallon petroleum tanker, as well as the M872 semitrailers.

STATUS

Four M915s with companion M872 semitrailers satisfactorily completed Force Development Test and Evaluation (FDTE) at Fort Campbell, KY, between January and April 1979. Production was completed in June 1980 and the entire fleet of 2,498 M915 tractors has been fielded. AM General produced 2,342 M915A1s. Deployment to USAREUR, US Army Reserves, and Army National Guard was made between August 1983 and July 1984 to 37 Medium Transportation Companies.

In September 1988, a contract was awarded to Freightliner Corp. to produce the M915A2 tractor. There are 769 M915A2s on contract with options for more. Production Approval was granted to Freightliner in December 1990.

PROGRAM PLAN

First Unit Equipped (FUE) with the M915A2 tractor is scheduled for June 1991.

NSNs

M915: 2320-01-028-4395
M915A1: 2320-01-272-5029
M915A2: 2320-01-028-4396

5-Ton Truck Bed with ISO-Configured Locking Devices

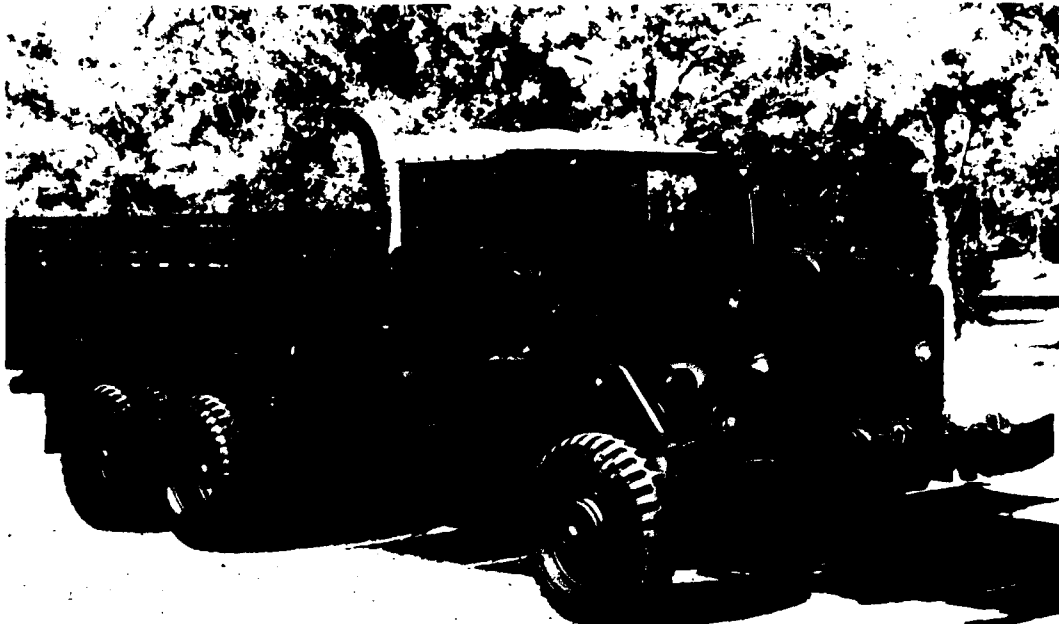

5-Ton Truck Bed with ISO-Configured Locking Devices

POINT OF CONTACT

CAPT J. H. Mayles
CG, Marine Corps RD&A Command, Code SSCMT
Washington, DC 20380-0001
DSN 226-1154/Commercial (202) 696-1154

ITEM DESCRIPTION

The ISO-configured truck bed is a modification to the cargo beds of the existing 5-ton trucks to facilitate the transport of ISO-configured containers. The 14' bed will transport two SIXCON containers while the 20' bed will transport one 20' long ISO container, two 10' long ISO containers, or four QUADCONS.

STATUS

A letter contract was awarded during June 1988. Contract was definitized on 26 March 1990 and is for a total of 1,198 5-ton truck beds; 1,182 14' beds; and 16 20' beds.

PROGRAM PLAN

Shipment of the beds will commence by 4QFY91. The truck beds will be delivered to the 5th echelon depots where the beds will be placed on the trucks during the inspect and repair program. Plans are to outfit all of the Marine Corps 5-ton trucks over the next 5 years.

NSNs

M813A1: 2320-01-329-7162
M923: 2320-01-324-5923
M922: 2320-01-324-7800

Railway Car, Flat (Heavy Duty), 150-Ton Capacity, Domestic Service



Railway Car, Flat (Heavy Duty), 150-Ton Capacity, Domestic Service

POINT OF CONTACT

Mr. H. Ranslem
US Army Belvoir RD&E Center, STRBE-FMT
Fort Belvoir, VA 22060-5606
DSN 354-5581/Commercial (703) 664-5581

ITEM DESCRIPTION

The 150-ton flat car is designed for unrestricted interchange use while transporting both oversized tracked and wheeled vehicles and multiple ANSI/ISO containers loaded with Class A explosives and other commodities. The all-steel car is equipped with integral securement systems to restrain both tracked/wheeled vehicles and ISO containers. For ISO containers, the securement system accommodates a single 40' container, three 20' containers, or a combination of both sizes. The twist locks are of the pedestal type that lock automatically when the container is set in place and release automatically when the containers are lifted. The flat car is approximately 68' long; 10' 5" wide; and is supported by two three-axle trucks. The car is designed to carry a capacity of 150 tons.

STATUS

Four production contracts yielding 574 cars have been completed. These cars have been fielded and are managed by MTMC. A contract for 40 150-ton capacity cars was awarded in FY90. These cars will be used by the Navy and will not have the same securement systems as the previous cars. These cars will be used to transport special loads using the Navy's securement system.

PROGRAM PLAN

Pending negotiations, production of the 40 cars will begin in FY91 and should be fielded by the end of FY92.

NSN

2220-01-058-6377

• **Part IV**

**LOTS, Harbor,
and Container**

• **Offloading and
Transfer**

Equipment

SEASHED System

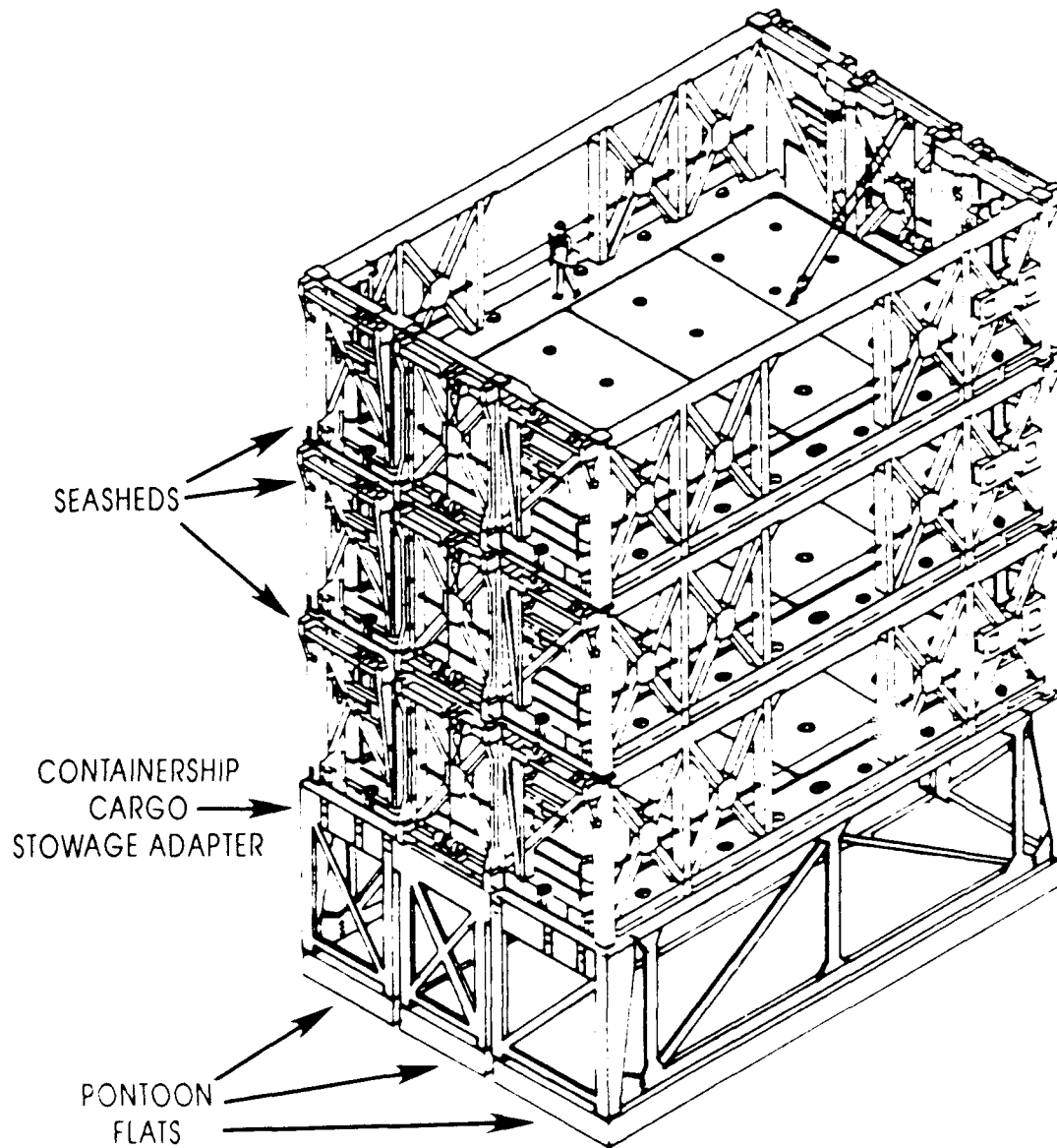

SEASHED System

POINT OF CONTACT

Mr. M. Baig
Naval Sea Systems Command, PMS 377 V
Washington, DC 20362-5101
DSN 332-7881/Commercial (703) 602-7881

ITEM DESCRIPTION

The SEASHED System consists of a stack of up to three SEASHEDs on a Containership Cargo Stowage Adapter (CCSA).

SEASHEDs are open-topped large cargo containers that fit into the container cells of a containership to provide the capability to carry large, heavy or oversized cargo such as Army and Marine Corps tanks and helicopters. Each SEASHED occupies the space of three 40' containers in width and has the overall height of 1-1/2 containers, having dimensions of 25' wide, 40' long, and 12-1/2' high. The maximum cargo capacity of each SEASHED is 220,000 pounds. Each SEASHED weighs 76,000 pounds. The floor of the SEASHED opens to allow cargo to be lowered through to the SEASHED or CCSA below. The clear opening of the floor is 30' x 18'. The CCSA has two elements—the adapter frame and three pontoon flats—which provide the same storage capability as a SEASHED. The quantity to be procured is to satisfy contingency logistics requirements for heavy lift shipment via Ready Reserve Force (RRF), US Flag, and allied containerships.

STATUS

Approximately 939 SEASHED and 359 CCSA units have been delivered as of December 1990. The current budget shows a total of 1,058 SEASHED units and 359 CCSA units. The inventory is at three storage locations: MOT, Bayonne, NJ; NWS; Charleston, SC; and Port Hueneme, CA.

PROGRAM PLAN

Continue receiving units ordered under 1989 contracts.

NSNs

SEASHED: 0910-LP-433-9400
CCSA: 0910-LP-248-8700

Floating Causeway (FC)



Floating Causeway (FC)

POINTS OF CONTACT

Mr. B. Oh
US Army Belvoir RD&E Center, STRBE-FMS
Fort Belvoir, VA 22060-5606
DSN 354-5319/Commercial (703) 664-5319

Mr. G. Walker
Naval Facilities Engineering Command, Code 061A
Alexandria, VA 22332
DSN 221-8535/Commercial (703) 325-8535

ITEM DESCRIPTION

The Floating Causeway (FC) consists of non-powered intermediate, offshore and beach end sections, and an Anchor Mooring System (AMS). It extends from the high water line out into the surf zone to a mean low water depth of 8'. The maximum working length of an FC is approximately 1,500'. The beach end sections include transition ramps from the roadway surface to the beach. The offshore end incorporates an adapter end for the discharge of cargo from displacement lighters onto the roadway. The offshore end uses the "Rhino" horn to mate with lighters, so equipped. The FC uses an AMS to retain an emplaced FC. The AMS uses large marine anchors placed perpendicular to the roadway, offshore, and dry beach anchors to secure the FC to the beach. Two Side Loadable Warping Tugs (SLWTs) are Associated Support Items of Equipment (ASIOE). The SLWTs are used to insert, retract, and tender the FC and to emplace and remove the larger AMS anchors. The FC is used as a dry bridge in the transfer of cargo (primarily rolling cargo) from displacement lighters to the shoreside logistics operation.

STATUS

The FC facility was granted Type Classification (TC) Limited Procurement Urgent (LPU) in February 1988 by HQ, DA direction. The Army FC hardware is being procured under multiple Army and Navy competitive procurement contracts, in accordance with an Interservice Support Agreement. The Army FC requirement is for four systems. This quantity is identified in the Army Watercraft Master Plan. Funding for the procurement of four FCs was from FY85 and FY86 funds. Currently, the Army has two FC systems of the Navy Lighterage (NL) configuration and two systems configured using ISO-compatible components.

PROGRAM PLAN

Army Initial Operational Capability (IOC) is expected to be 3QFY91.

NSN

1945-01-218-7268

Elevated Causeway, Modular (ELCAS (M))

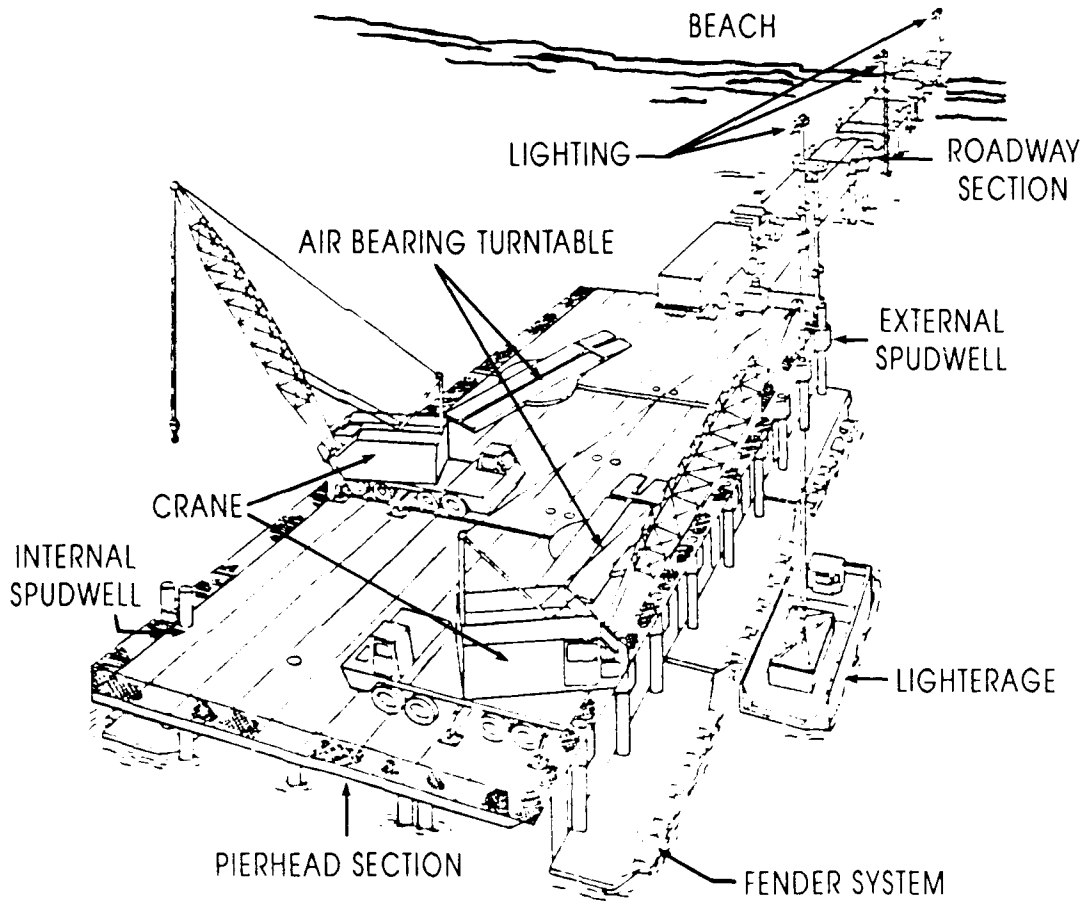

Elevated Causeway, Modular (ELCAS (M))

POINTS OF CONTACT

Mr. B. Oh
US Army Belvoir RD&E Center, STRBE-FMS
Fort Belvoir, VA 22060-5606
DSN 354-5319/Commercial (703) 664-5319

Mr. G. Walker
Naval Facilities Engineering Command, Code 061A
Alexandria, VA 22332
DSN 221-8535/Commercial (703) 325-8535

ITEM DESCRIPTION

The Elevated Causeway, Modular (ELCAS (M)) is a modular pier facility, composed of container-compatible modules, providing an interface between displacement craft carrying containers and the beach. The ELCAS (M) will have a nominal length of up to 3,000', as required, to reach a 20' water depth at the pierhead and is 15' above the mean low water level. The pierhead will be 72' wide by 240' long. The two long sides of the pierhead will have a fendering system to accommodate unscathed, lighter interface. The ELCAS (M) is constructed by erecting initial section(s) and mounting a construction crane on top of them. Subsequent sections will be cantilevered from the previously erected sections and secured in place with piles. An ELCAS (M) roadway section measures 24' x 40', consisting of three ISO pontoons, each measuring 40' x 8' x 4.5'. Emplaced on the ELCAS (M) pierhead are two vehicle turntables for truck turnarounds which are supported by air bearings. Two container-handling cranes will be stationed on the ELCAS (M) pierhead to transfer cargo from lighters to container handling vehicles for subsequent transport to shore. The constructed ELCAS (M) will be equipped with a lighting system. Side-Loadable Warping Tugs and Modular Causeways will be used to install, maintain, and retrieve the ELCAS (M) system.

STATUS

An Army Operational and Organizational (O&O) Plan for the Elevated Causeway (ELCAS) was approved by the Commanding General, TRADOC, on 9 August 1985. A draft Operational Requirement (OR) for the ELCAS (M) has been prepared by the Naval Facilities Engineering Command and Army requirements for the ELCAS (M) have been incorporated into the Navy's OR.

PROGRAM PLAN

The Army Watercraft Master Plan identifies the requirement for two ELCAS (M); however, neither system is currently funded. The Navy may procure three ELCAS (M) systems, two in FY91 and one in FY95. The first Navy ELCAS (M) is scheduled for contract award in late FY91 and will undergo operational evaluation by the Naval Amphibious Construction Battalions under direction of the Commander for Operations, Test, and Evaluation Force.

NSNs

Not assigned.

Roll-On/Roll-Off Discharge Facility (RO/RO DF)

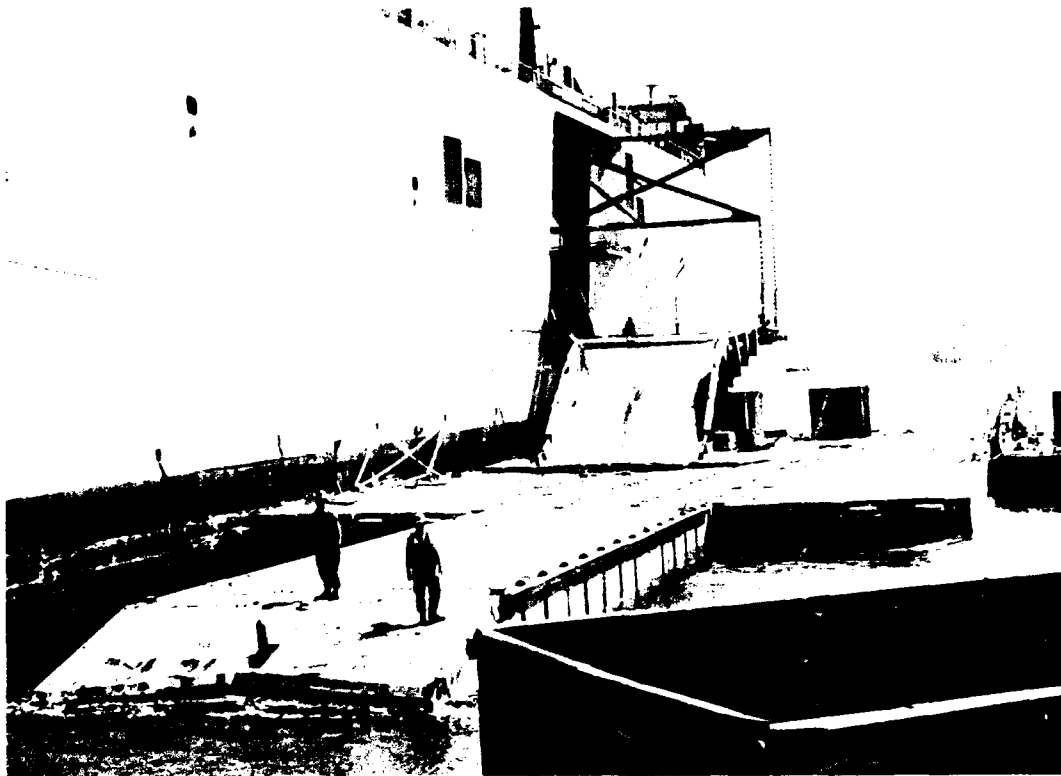

Roll-On/Roll-Off Discharge Facility (RO/RO DF)

POINTS OF CONTACT

Mr. B. Oh
US Army Belvoir RD&E Center, STRBE-FMS
Fort Belvoir, VA 22060-5606
DSN 354-5319/Commercial (703) 664-5319

Mr. G. Walker
Naval Facilities Engineering Command, Code 061A
Alexandria, VA 22332
DSN 221-8535/Commercial (703) 325-8535

Mr. T. Vaughters
David Taylor Research Center, DTRC-125
Annapolis, MD 21402-5067
DSN 281-2261/Commercial (301) 267-2261

ITEM DESCRIPTION

The Roll-On/Roll-Off Discharge Facility (RO/RO DF) consists of a RO/RO platform, a "B" or Sea End section with provisions for "Rhino" horn, a Calm Water Ramp (CWR), a fendering system, a lighting system, and an emergency anchor system. The RO/RO DF provides an interface between RO/RO ships and displacement type lighterage. It will support self-sustaining and non-self-sustaining RO/RO ships. The Platform is approximately 65' wide by 180' long. The "B" or Sea End provides an interface between the RO/RO platform and displacement craft. The CWR is used with non-self-sustaining ships. The lighting system is used during night operations and includes integral power generation and distribution. The fendering system is used to maintain position alongside a deep draft vessel being serviced and for fendering of shallow draft vessels being serviced. The emergency anchor system is used to provide a controlled drift of the assembled platform. The emergency anchor system is used during adverse weather conditions or when one ship being serviced is required to depart due to adverse enemy actions or weather conditions. The RO/RO DF is tendered by two Side Loadable Warping Tugs (SLWTs). The SLWT is an Associated Support Item of Equipment (ASIOE) for the RO/RO DF. The SLWT has a deck-mounted "A" frame and winch for hoisting/lifting and assembly of the RO/RO DF hardware and components. The SLWT also has a stern anchor.

STATUS

A RO/RO DF was granted Type Classification (TC) - Standard on 21 March 1985 at the Milestone I/III In Process Review (IPR). Three RO/RO DFs were procured through an Interservice Support Agreement (ISA) with the Navy under multiple competitive contracts and were delivered to the Army in FY89. Funding for the RO/RO DF was from FY85 and FY86 procurement funds.

PROGRAM PLAN

Army Initial Operational Capability (IOC) is expected to be 3QFY91. Five Navy RO/RO DFs will be completed in FY91.

NSN

1945-01-219-2109

Causeway Section, Powered (CSP)

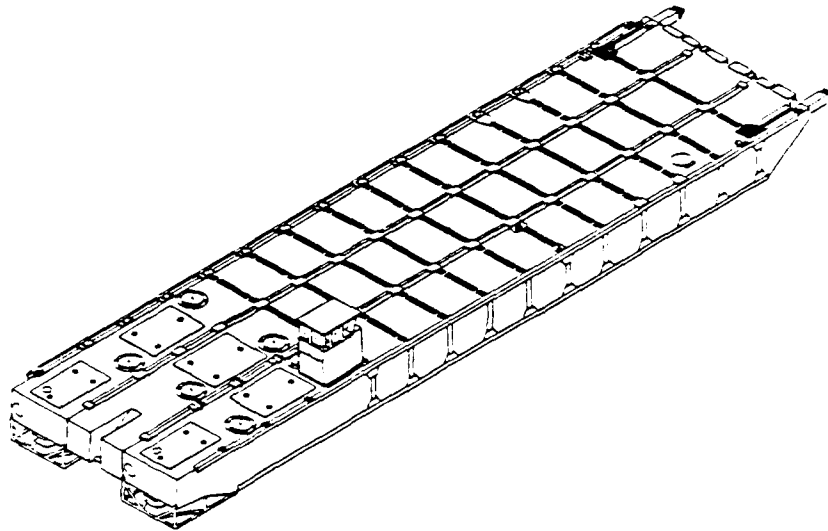

Causeway Section, Powered

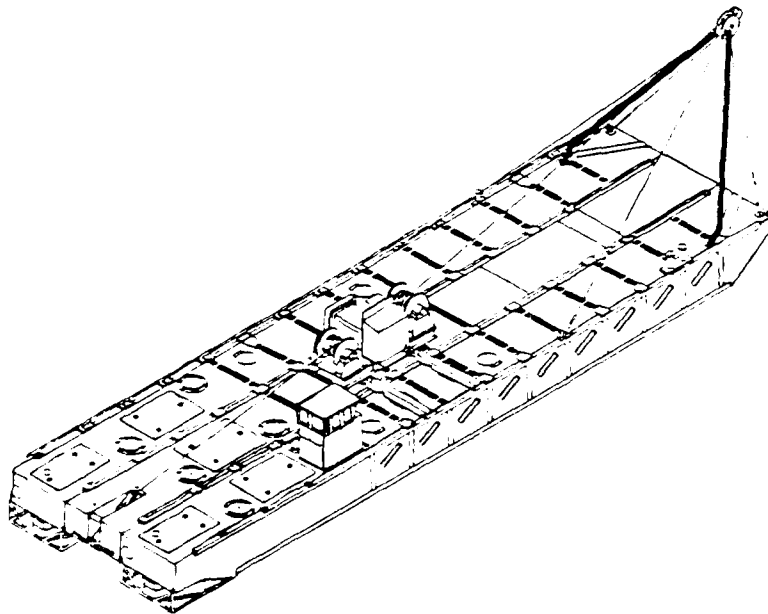

Side-Loadable Warping Tug

Causeway Section, Powered (CSP)

POINTS OF CONTACT

Mr. G. Walker
Naval Facilities Engineering Command, Code 061A
Alexandria, VA 22332
DSN 221-8535/Commercial (703) 325-8535

Mr. B. Karrh
Naval Civil Engineering Laboratory, NCEL-L65
Port Hueneme, CA 93043-5003
DSN 551-1332/Commercial (805) 982-1332

Mr. B. Oh
US Army Belvoir RD&E Center, STRBE-FMS
Fort Belvoir, VA 22060-5606
DSN 354-5319/Commercial (703) 664-5319

ITEM DESCRIPTION

The Causeway Section, Powered (CSP) Navy Lighterage (NL) version will be procured by the Army through the Navy. The NL version of the CSP and the Side Loadable Warming Tug (SLWT) are shown. The NL versions are constructed with 5' x 5' x 7' NL pontoons and three Waterjet Propulsion Assemblies. Propulsion modules consist of a drive engine and a waterjet pump system. The SLWT can be side carried on a Landing Ship Tank (LST). The CSP can carry 40 tons of cargo and is used to push Causeway Ferries. A Causeway Ferry consists of a CSP and Causeway Sections, Non Powered (CSNPs). Each CSNP carries 100 tons of cargo.

STATUS

The Navy awarded a contract in 4QFY87 to Costal Engineering and Manufacturing Co. for 37 SLWT/CSP NL version units. A contract to procure 11 additional SLWT/CSP NL version units was awarded in 4QFY89. The first delivery was received in November 1990. These contracts are for both Navy and Army requirements and include CSNPs distributed as shown below:

	Navy	Army	TOTALS
CSP/SLWT	34	14	48
CSNP	96	26	122

PROGRAM PLAN

Monitor contract and field the delivered units. Delivery of the SLWT/CSP NL version and the CSNP units will continue through 4QFY92.

NSNs

CSP: 1945-01-213-7235
SLWT: 1945-01-218-4669

Causeway Ferry (CF)

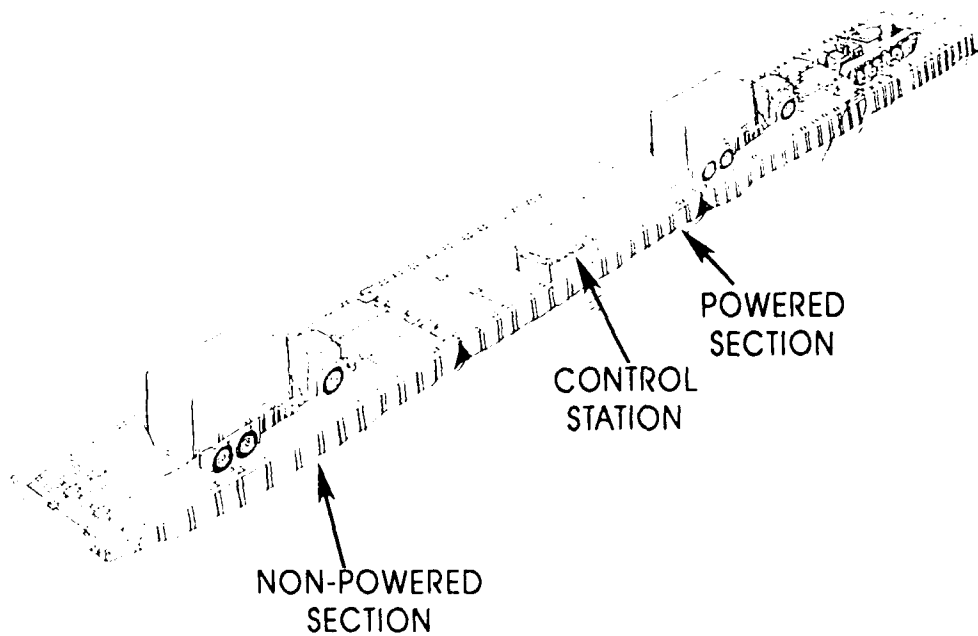
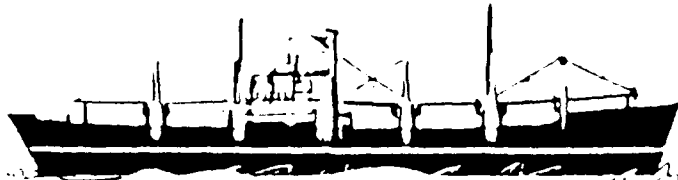

Causeway Ferry (CF)

POINT OF CONTACT

Mr. B. Oh
US Army Belvoir RD&E Center, STRBE-FMS
Fort Belvoir, VA 22060-5606
DSN 354-5319/Commercial (703) 664-5319

ITEM DESCRIPTION

The Causeway Ferry (CF) consists of a powered section, two non-powered intermediate sections, and a non-powered beach end section joined end-to-end. It has a loaded capacity of 100 short-tons per non-powered section and approximately 50 short-tons for the powered section. It carries a total cargo capacity of 350 short-tons with approximately 12" of freeboard. The powered section is composed of powered modules with internal propulsion and control components connected to non-powered modules. The CF will operate in the J-LOTS environment between RO/RO and lift-on/lift-off ships and shoreside logistics operations. Upon arrival in the operational area, the CF components will be offloaded and assembled for use. Each operational system includes pilot-to-operator, operator-to-commercial ship, and operator-to-command and control communication equipment.

STATUS

An Army Operational and Organizational (O&O) Plan has been approved for the CF.

PROGRAM PLAN

The Army will pursue a Non-Developmental Item (NDI) procurement approach for the CF. The Army requirement is for 16 CFs per the Army Watercraft Master Plan. Currently, there are six CFs funded: two in FY92 and four in FY93.

NSN

1990-01-280-3692 (NL configuration)

Lighter Air Cushion Vehicle, 30-Ton (LACV-30)

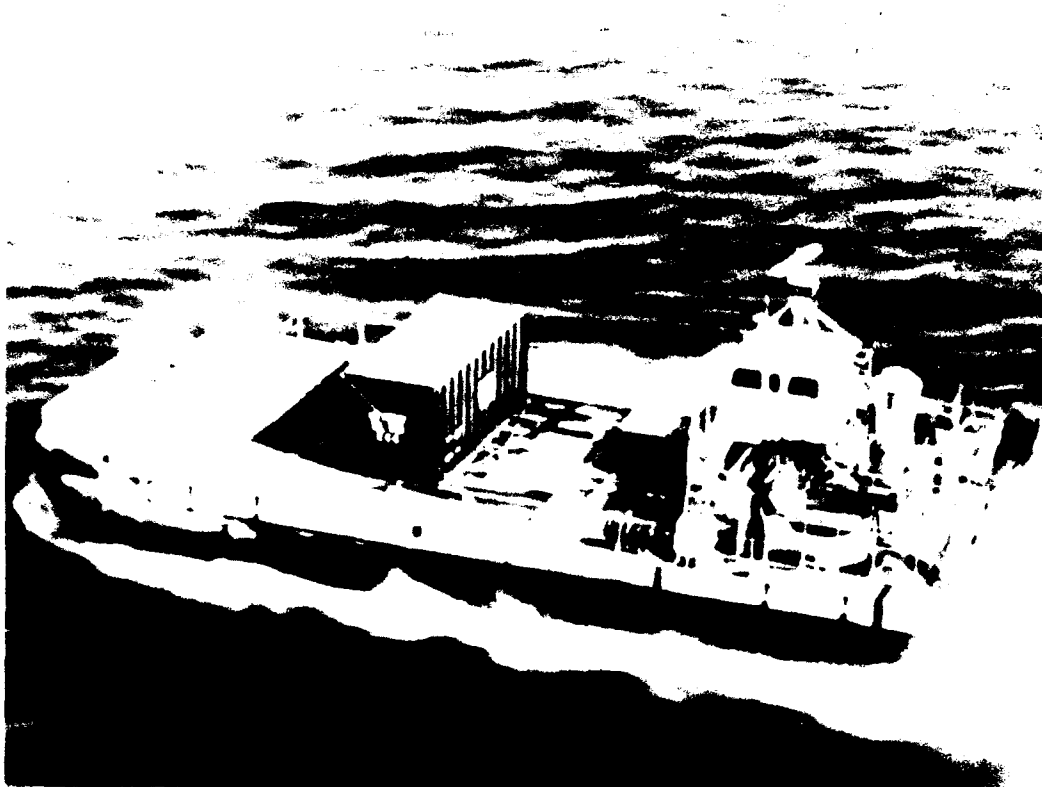

LENGTH	76' 3"	DESIGN GROSS WEIGHT	57,344 pounds
WIDTH	36' 8"	SPEED AT MAX CONTINUOUS POWER	40 mph at all-up weight
DECK LENGTH	51' 6"	ENDURANCE	approx 5 hours of LOTS with 25-ton payload
HEIGHT (HOVERING)	28' 11"	DECK WIDTH	36' 6"
CARGO DECK HEIGHT	3' 11.5"		

Lighter Air Cushion Vehicle, 30-Ton (LACV-30)

POINT OF CONTACT

Mr. J. Walter
US Army Belvoir RD&E Center, STRBE-FMD
Fort Belvoir, VA 22060-5606
DSN 354-5498/Commercial (703) 664-5498

ITEM DESCRIPTION

The LACV-30 is a military adaptation of the Bell Aerospace Company air cushion vehicle *Voyageur* and is used primarily in Logistics-Over-The-Shore (LOTS) operations. It is used to provide the logistical system with a rapid lift capability of moving cargo and equipment over water, marsh areas, beaches, ice, snow, and land. The LACV-30 provides a method of augmenting congested port facilities or replacing lost or reduced port capabilities. The LACV-30 is also intended to support secondary missions such as coastal, harbor, inland waterway operations, support of amphibious operations, ship-to-shore operations, transport operations, and search and rescue operations. The LACV-30 can negotiate Sea State 2 and 8' plunging surf.

STATUS

Two prototype craft were built and successfully passed operational and developmental tests. The LACV-30 was subsequently Type Classified. Twenty-four production craft have been built under two separate contracts with Bell Aerospace. The first 12 craft were assigned to the 331st Transportation Company and the second 12 craft to the 8th Transportation Company. All of the LACV-30s are stationed at Fort Story, VA. The last craft was delivered in 1986. There are ongoing Materiel Changes (MCs) to improve operational capabilities and maintainability.

PROGRAM PLAN

Complete MCs and retrofit all craft in the 331st and 8th Transportation Companies with the improvements. Currently, there is no planned procurement of additional LACV-30s.

NSN

2305-01-061-6230

Pontoon Air Cushion Kit (PACK)

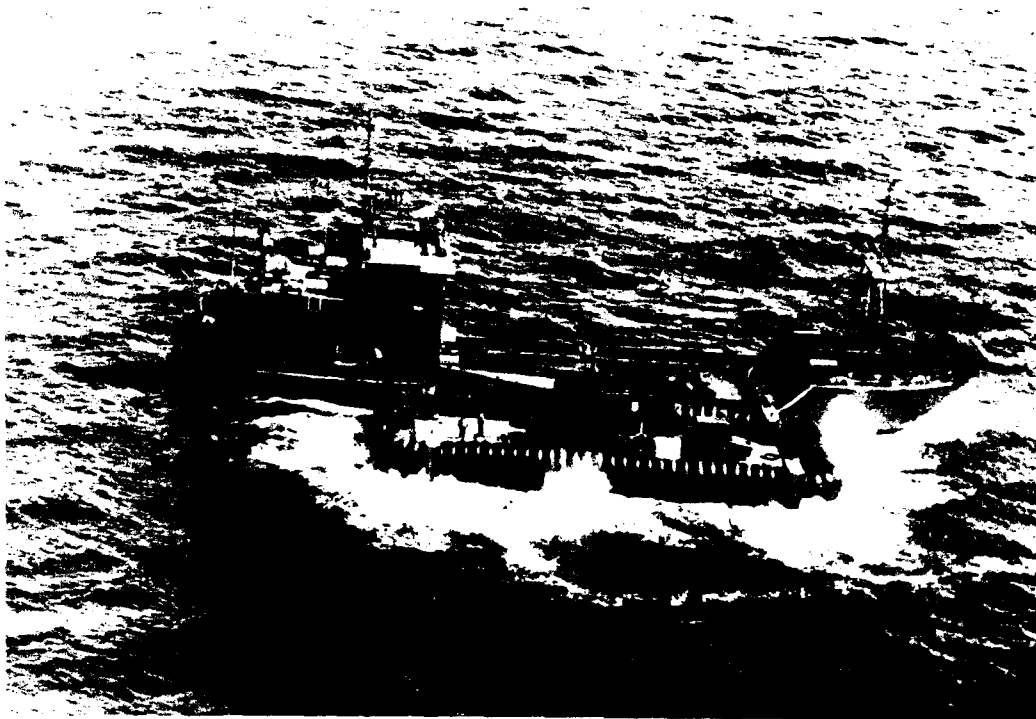

LENGTH	80.0' (hard structure) 97.0' (inflated)	BEAM	32' (hard structure) 49' (inflated)
HEIGHT	4.5' (hard structure)	HEIGHT	11' (inflated)
CUSHION HEIGHT	3.0'	CUSHION AREA	3,145 sq ft
LIGHTSHIP		CUSHION PERIPHERAL	
DISPLACEMENT	198,500 pounds	LENGTH	241'
FULL LOAD			
DISPLACEMENT	410,500 pounds		
KIT WEIGHT	32,500 pounds (without pontoons)		

Pontoon Air Cushion Kit (PACK)

POINT OF CONTACT

Mr. B. David
US Army Belvoir RD&E Center, STRBE-FMD
Fort Belvoir, VA 22060-5606
DSN 354-4266/Commercial (703) 664-4266

ITEM DESCRIPTION

The PACK consists of a lightweight peripheral skirt system with autonomous air supply units that can be attached in the field to a Modular Causeway barge (80' x 32') converting it into an air cushion supported platform capable of carrying 140 short-tons of cargo. There are two diesel engine (GM 8V-9LTA) centrifugal fan units which supply pressurized air to the skirt system. The diesel engine/fan units are skid mounted for easy deployment. The skids utilize existing attachment points on the deck of the module pontoons for fastening purposes. The PACK is supplied with "pusher knees" that can be attached to one end of the causeway section to facilitate warping operations with US Army lighters. The PACK (excluding Modular Causeway) is transportable in a 40' ISO container.

The PACK was developed by the Army Belvoir RD&E Center to provide enhanced mobility and an amphibious capability to inventory Modular Causeway sections for LOTS operations. The current Modular Causeway sections are incapable of traversing shallow beach gradients or LOTS sites that have restrictive hydrographic features (i.e., offshore sandbars, coral reefs). The Army and Navy presently utilize modular pontoons, which are bolted and welded together, to construct field-assembled causeways, causeway ferries, warping tugs, and Roll-On/Roll-Off (RO/RO) discharge platforms for use in a LOTS operation. The Army has recently acquired 40' x 8' x 4.5' modular pontoons which are ISO compatible. These modular pontoons are compatible with commercial type container handling gear and are capable of being shipped by containership. Retractable pin connectors enable fast and rigid connection of the modules.

The Army also currently does not have the amphibious capability to carry heavy, outsized cargo in a LOTS operation. The current heavy lift amphibian—the Lighter, Resupply Cargo - 60 ton (LARC-LX)—is unable to carry the Army's heaviest piece of LOTS equipment, the 140-ton capacity crane (92 short-ton tactical disassembly weight). The LARC-LX, in addition to its poor mobility over soft bottom terrains, also has a very narrow cargo well which prevents top loading of wide equipment.

STATUS

A full-scale PACK technology demonstrator was fabricated and tested in a 3-week Concept Evaluation Program (CEP) user test at Fort Eustis, VA, 25 June-13 July 1990 and at Fort Story, VA, 23-26 September 1990. The PACK was tested over water using the Landing Craft, Mechanized (LCM-8) and the Lighter, Air Cushion Vehicle-30 Ton (LACV-30) as prime movers. The PACK was tested over land using the D-7 bulldozer and the 50K Rough Terrain Container Handler (RTCH) as prime movers. The total payload carried by the PACK was 130 short-tons. A 65-ton capacity Rough Terrain Crane was loaded and off loaded from the PACK using the LACV-30's portable beach ramps.

PROGRAM PLAN

An upgraded PACK technology demonstrator will be fabricated and tested in the 1991 J-LOTS III exercise.

NSN

Not assigned.

Lighter, Amphibian, Heavy-Lift (LAMP-H)

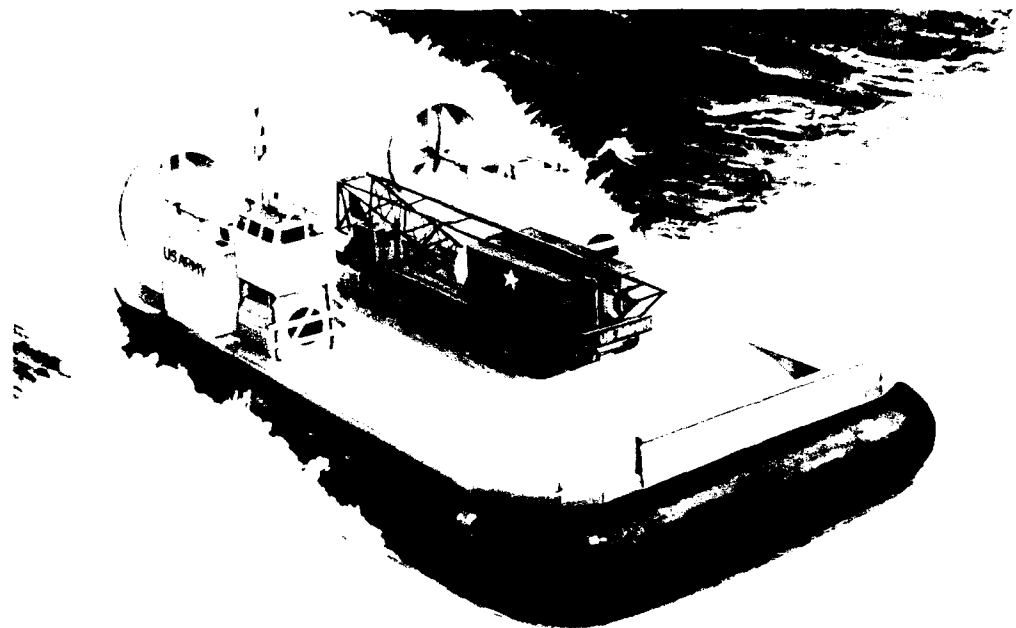

Lighter, Amphibian, Heavy-Lift (LAMP-H)

POINT OF CONTACT

Mr. R. Schmidt
US Army Belvoir RD&E Center, STRBE-FMD
Fort Belvoir, VA 22060-5606
DSN 354-4266/Commercial (703) 664-4266

ITEM DESCRIPTION

The LAMP-H is a heavy-lift air cushioned vehicle with amphibious capability, which is being developed to perform in Army Logistics-Over-The-Shore (LOTS) missions. The primary cargo will be vehicles and outsized cargo, with a secondary role of containerized cargo transfer. The craft will be capable of carrying over 100 short-tons of cargo, at speeds of 8 to 15 knots. The LAMP-H will have bow and stern ramps and an open cargo deck area, making it capable of roll-on/roll-off and easy crane loading and unloading.

STATUS

A Required Operational Capability (ROC) document was approved in August 1989. Following a successful Milestone I/II In-Process Review (December 1989), the program has transitioned into the Development/Production Prove-Out Phase.

PROGRAM PLAN

Contract award of a Development/Production Prove Out phase prototype is scheduled for 3QFY91. Testing and evaluation will be conducted during FY93 with LAMP-H craft production following. FUE is scheduled for late FY94.

NSN

Not assigned.

Landing Craft, Utility (LCU) 2000



Landing Craft, Utility (LCU) 2000

POINT OF CONTACT

Mr. J. Wersching
US Army Belvoir RD&E Center, STRBE-FMS
Fort Belvoir, VA 22060-5606
DSN 354-5971/Commercial (703) 664-5971

ITEM DESCRIPTION

The LCU 2000 is the latest in the evolution of the landing craft designs, succeeding the 1646 Class LCU and replacing the 1466 Class in the Active Army and Reserve inventories. The mission of the LCU 2000 is to provide transportation of rolling and tracked vehicles, containers, and outsized and general cargo in support of LOTS operations as well as Coastal, Harbor, and Inland (CHI) waterway missions. The LCU 2000 has an overall length of 174', a beam of 42', and a full load design draft of 8'. It is capable of carrying up to 28 20' or 12 40' ISO freight containers secured on its 2,500 square foot cargo deck, and can carry a full load of 350 short-tons. It is configured to deliver 175 short-tons through its 16' wide bow ramp to shallow 1/30 gradient beaches without exceeding a 4' bow draft. The LCU's 2 Cummins V16 turbo-charged diesels with 2,500 installed HP provides a full load speed of 10 knots, and a light delivery speed of 12 knots. The 300 HP Cummins powered Bow Thruster provides added maneuverability during docking or undocking operations. It is classed by the American Bureau of Shipping (ABS) for full ocean service and one-man engine room operations, and is built to US Coast Guard standards. LCUs are equipped with the latest navigation, communication, and electronic equipment including an automatic pilot and steering system. The LCU 2000 is capable of sustaining its crew of two warrant officers and 11 enlisted personnel for periods of up to 18 days and over 6,000 nautical miles, without refueling.

STATUS

The procurement of the LCU 2000 utilizes the Non-Developmental Item (NDI) acquisition strategy, and is managed by the Product Office for Amphibians and Watercraft (PO-AWC) with specifications prepared by the Belvoir RD&E Center. The LCU 2000 is in full production and is being constructed by Halter Marine, Inc., a division of Trinity Marine Industries, at the Moss Point Marine Shipyard, Escatawpa, MS, as part of a 5-year multi-year firm fixed price contract awarded in June 1986. The lead vessel, LCU 2001, *US Army Runnymede*, was launched on 14 August 1987 and sea trials were conducted 12-14 July 1988. Presently, 12 LCU 2000 vessels have been delivered to Fort Eustis, VA. LCUs 2013-2023 are in various stages of construction with 10 vessels to be delivered during 1992. Also, a major modification to the bow ramp is presently being evaluated. If implemented, the modification will double the length of the ramp and reduce the approach angle to 14 degrees, thus allowing loading of all major wheeled vehicles.

PROGRAM PLAN

The last LCU is presently scheduled for delivery in early 1993. Army units scheduled to receive the LCU 2000 include the 558th Marine Maintenance, 97th and 329th Transportation Companies, Fort Eustis, VA; the 481st National Guard Unit in Rio Vista, CA; the 824th National Guard Unit in Morehead City, NC; the 506th Marine Maintenance, Tacoma, WA; Panama; and Kwajalein.

NSN

1905-01-154-1191

Logistics Support Vessel (LSV)



Logistics Support Vessel (LSV)

POINT OF CONTACT

Ms. O. Martinovitch
US Army Belvoir RD&E Center, STRBE-FMS
Fort Belvoir, VA 22060-5606
DSN 354-5319/Commercial (703) 664-5319

ITEM DESCRIPTION

The LSV has the capability of intra-theater linehaul of cargo to support the unit deployment/relocation, tactical and sustained resupply to remote, undeveloped areas along coastlines and on inland waterways. Additionally, the LSV is capable of self-delivery to a theater of operations. Mission requirements include the capability to assist in discharging and backloading ships in a roll-on/roll-off or LOTS operations with its drive-through capability and of transporting heavy, outsized cargo. The vessel has a self-delivery range of 6,500 nautical miles at service speed of 11.5 knots and is capable of sustaining a crew of 29 for a minimum of 30 days. Utilizing 10,500 square feet of deck cargo space, the LSV can transport 2,000 short-tons of cargo consisting of rolling stock, general cargo or ISO containers. Principal characteristics of the LSV are: length (overall), 273'; beam (molded), 60'; beaching draft, 4' at the bow, with 900 tons of cargo distributed uniformly over the deck; twin screw diesel propulsion; 3,900 shaft HP; bow thruster; bow and stern ramps; and deck sockets to secure all types of cargo transported.

STATUS

The LSV was Type Classified Standard, Logistics Control Code (LCC) A in September 1983. After a competitive solicitation, contract for four LSVs was awarded to Moss Point Marine Shipyard, Escatawpa, MS, on 19 September 1986. The LSV was initially fielded in November 1987 and was commissioned as a US Army vessel. The original contract was later modified on 19 September 1989 to include construction of a fifth LSV. The LSVs' delivery dates are shown below:

Hull No.	Name	Delivery Date	Gaining Command
LSV-1	GEN Frank S. Besson, Jr.	November 1987	FORSCOM
LSV-2	CW3 Harold C. Clinger	February 1988	WESTCOM
LSV-3	GEN Brehon B. Sommervell	April 1988	NGB
LSV-4	LTG William B. Bunker	May 1988	FORSCOM
LSV-5	MG Charles P. Gross	January 1991	WESTCOM

PROGRAM PLAN

Continue to support the fielded vessels.

NSN

1915-01-153-8801

Fast Logistic Ship (T-AKR) Program

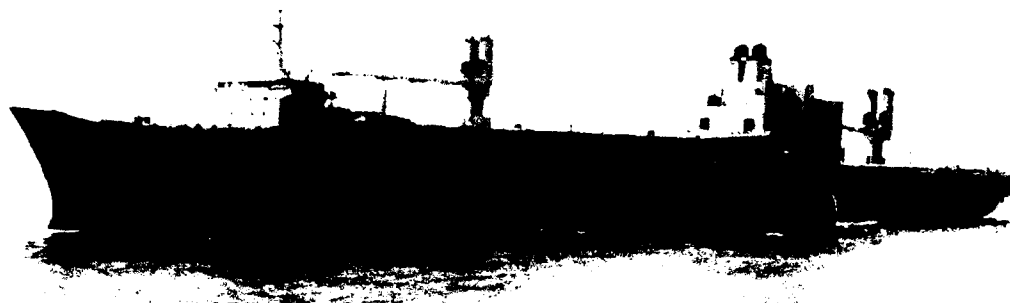

Fast Logistic Ship (T-AKR) Program

POINT OF CONTACT

Mr. M. Fink
Naval Sea Systems Command, PMS-377K
Washington, DC 20362-5101
DSN 332-0920/Commercial (703) 602-0920

ITEM DESCRIPTION

The Fast Logistic Ship (T-AKR) Program includes the procurement of eight SL-7 class high-speed containerhips and their subsequent conversion to a cargo configuration specifically designed for rapid load/unload of military vehicles and equipment, including tanks and helicopters. T-AKR ships will enhance the ability to quickly deploy military equipment and supplies from the continental United States to potential objective areas throughout the world. The conversion design includes installation of decks midship to permit roll-on/roll-off of vehicles, addition of a flight deck for helicopter operations, and retention of the existing container cells aft. The T-AKR provides the capability to transport 78 special-purpose heavy-duty flatracks in the aft part of the ship: 53 (35' long x 8' wide x 13.5' high), 22 (35' long x 8' wide x 10.5' high), 3 (35' long x 8' wide x 8.5' high), 46 containers (20' long x 8' wide x 8' high)*, and 8 SEASHEDs (35' long x 25' wide x 12.5' high). The 35' special-purpose flatracks were designed specifically for use on-board the T-AKR and are capable of carrying a maximum cargo weight of 134,400 pounds. These flatracks have been designed with hinged edge flaps installed along one side to provide the ability to span the gaps between flatracks in container cells resulting basically in a series of *'tween decks*.

STATUS

Contracts for conversion of four SL-7 ships were awarded in September 1982 to three shipyards with options for four additional ship conversions: Avondale Shipyards, Inc. (ASI) (one firm, two options); National Steel and Shipbuilding Company (two firm, one option); and Pennsylvania Shipbuilding Company (one firm, one option). The options for conversion of the remaining four ships were exercised on 31 October 1983. The eight ships have been redelivered as follows: USNS ALGOL (T-AKR 287) 6/84; USNS CAPELLA (T-AKR 293) 6/84; USNS ALTAIR (T-AKR 294) 7/84; USNS BELLATRIX (T-AKR 288) 9/84; USNS REGULUS (T-AKR 292) 8/85; USNS DENEbola (T-AKR 289) 10/85; USNS ALTAIR (T-AKR 291) 11/85; and USNS POLLUX (T-AKR 290) 3/86. Deliveries of SEASHEDs and flatracks to the eight T-AKR ships were completed in September 1984. Each T-AKR is also equipped with two 35' spreaders, two 20' spreaders, and one 40' spreader to enhance load/offload operations.

PROGRAM PLAN

Program completed. The Fast Logistic Ships are under operational control of the Military Sealift Command.

NSN

Not assigned.

* 44 containers (20' long x 8' wide x 8' high) on USNS ALGOL (T-AKR 287), USNS BELLATRIX (T-AKR 288) and USNS REGULUS (T-AKR 292).

Auxiliary Crane Ship (T-ACS)

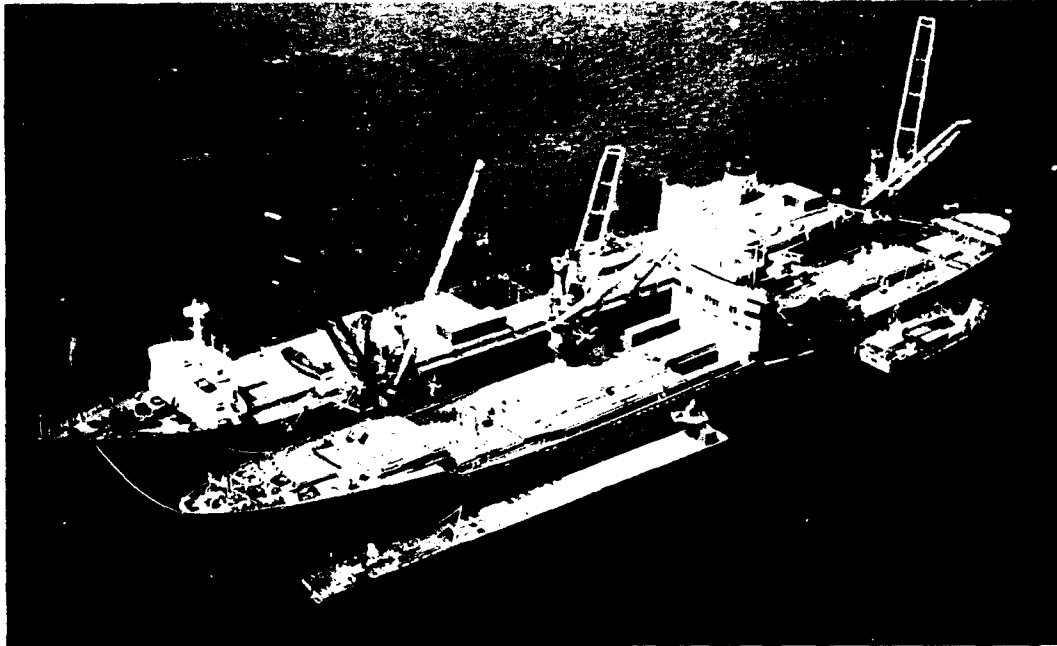

Auxiliary Crane Ship (T-ACS)

POINT OF CONTACT

Mr. M. Baig
Naval Sea Systems Command, PMS-377V
Washington, DC 20362-5101
DSN 332-7881/Commercial (703) 602-7881

ITEM DESCRIPTION

The T-ACS is a converted containership from the MARAD Reserve Force modified by the installation of twin-boom marine cranes. Auxiliary features supporting crane operation include upgraded or supplementary living quarters, upgraded messing facilities, upgraded communications suites, additional generator capacity, semi-permanent or permanent ballast, modification of some container cells to permit installation of SEASHEDs, lighterage stowage capability, and upgraded mooring and fendering capabilities.

The primary mission of the ship is to offload non-self-sustaining cargo (container) ships moored alongside with offload operations conducted at anchor, in the stream, or in an underdeveloped or damaged port. The ship also has the capability to discharge its own cargo.

The cranes on the T-ACS are evolutionary variations of the level luffing type crane already in widespread merchant service. All T-ACS classes have twin boom rotating pedestal cranes. The T-ACS 1 class has three twin cranes capable of offloading 30 long-tons with a single boom, 60 long-tons with twin booms, and 105 long-tons in tandem (four booms). The T-ACS 4 class has two twin cranes capable of offloading 30 long-tons with a single boom, 60 long-tons with twin booms, and 120 long-tons in tandem. T-ACS 7 through T-ACS 10 will have the same crane design and capability as the T-ACS 4, except T-ACS 7 and T-ACS 8 have three twin cranes.

STATUS

T-ACS 1, SS KEYSTONE STATE, began conversion in March 1983 by Bay Shipbuilding Corporation, and was delivered in May 1984. The ship successfully completed J-LOTS II exercises in October 1984. The second ship, T-ACS 2, SS GEM STATE, began conversion in September 1984 at Continental Maritime of San Francisco, Inc., and was delivered in October 1985. Dillingham Ship Repair began conversion of T-ACS 3, SS GRAND CANYON STATE, in September 1985 and delivered the ship in October 1986. The conversion contract for T-ACS 4, SS GOPHER STATE, T-ACS 5, SS FLICKERTAIL STATE, and T-ACS 6, SS CORNHUSKER STATE, was awarded to Norfolk Shipbuilding and Drydock Corporation in August 1986. Redeliveries of T-ACS 4, 5, and 6 were October 1987, February 1988, and April 1988, respectively. The conversion contract for T-ACS 7, SS DIAMOND STATE, and T-ACS 8, SS EQUALITY STATE, was awarded to Tampa Shipyards, Inc., in September 1987. T-ACS 7 and T-ACS 8 were redelivered in February 1989 and May 1989, respectively. The conversion contract for T-ACS 9, SS GREEN MOUNTAIN STATE, and T-ACS 10, SS BEAVER STATE, was awarded to Norfolk Shipbuilding and Drydock Corporation in January 1989. T-ACS 9 was redelivered in September 1990. The T-ACS 10 contract was terminated in January 1990 to allow sufficient funds to complete the conversion of T-ACS 9. T-ACS 10 underwent lay-up for a 1-year period so that the Navy could seek funding to complete the vessel. To date, no funds have been identified.

PROGRAM PLAN

The T-ACS program calls for conversion of a total of 12 ships from the MARAD Reserve Force. As directed by Congress, the Navy did not budget for T-ACS 11 and 12 in the FY91 or future budgets. MARAD is to plan for the T-ACS 11 and 12 conversions as part of the Department of Transportation (DOT) budget request.

NSN

Not assigned.

High Sea State Container Transfer System (HISEACOTS)

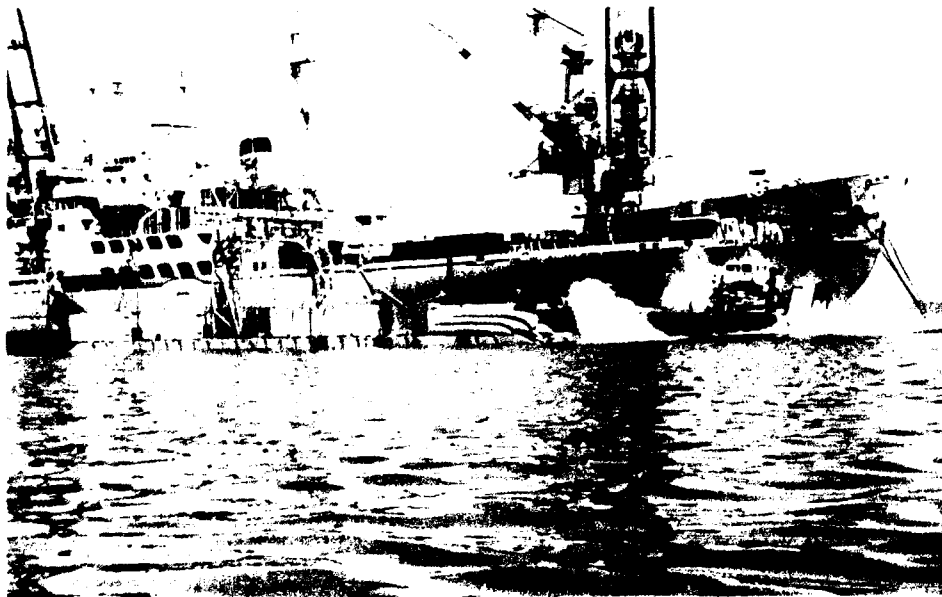
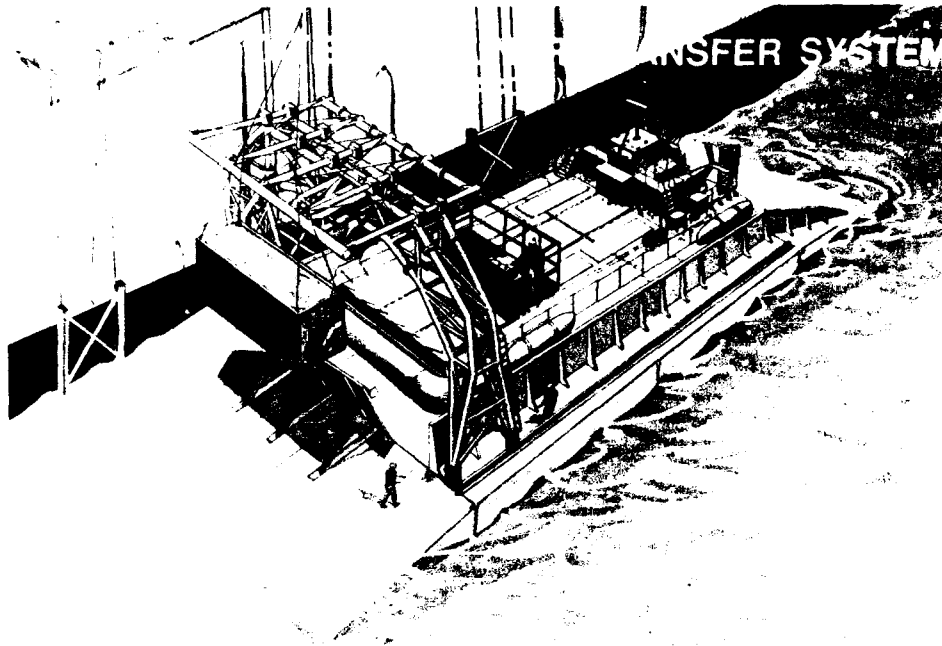

High Sea State Container Transfer System (HISEACOTS)

POINT OF CONTACT

Mr. B. David
US Army Belvoir RD&E Center, STRBE-FMD
Fort Belvoir, VA 22060-5606
DSN 354-4266/Commercial (703) 664-4266

ITEM DESCRIPTION

The HISEACOTS is a system that has been developed to stabilize the offloading/lighter interface in high Sea States (SS 3/4). The system consists of a floating platform made up of modular ISO pontoons (120' x 56'), with fore and aft ramps and batterboards to guide air cushion vehicles (i.e., US Army LACV-30) onto the platform. This platform is fitted with a specially designed gantry crane that is used to offload containers/vehicles. The gantry crane has a pendulation attenuator bar that mitigates all pendulation motions through friction forces generated at the bar by the container slings. A positive lock/spar device further reduces any heave motions present and allows the offload of eccentrically loaded containers. The HISEACOTS is designed to offload ISO containers and cargo weighing up to 50,000 pounds in SS 4.

STATUS

The HISEACOTS is currently in the concept exploration phase. A Small Business Innovation Research (SBIR) Program contract was awarded (Phase I) in 1986 for concept design. A Phase II SBIR contract was awarded in 1988 for a detailed HISEACOTS system design and additional fabrication and testing of the special gantry crane. Land based testing of the gantry crane was successfully completed April 1990. A joint Army/Navy technology demonstration of an air cushion "fly-on/fly-off" platform was completed October 1990. A Phase III SBIR contract was awarded in 1990 for: (1) a pierside demonstration of the gantry crane mounted to a modular platform and an auxiliary crane ship; (2) full-scale demonstration in the J-LOTS III exercise scheduled for May 1991.

PROGRAM PLAN

Full-scale demonstration in J-LOTS III in 3QFY91. Transition into a Development-Production Prove-Out Phase in FY93.

NSN

Not assigned.

Automated All-Weather Cargo Transfer System (AACTS)

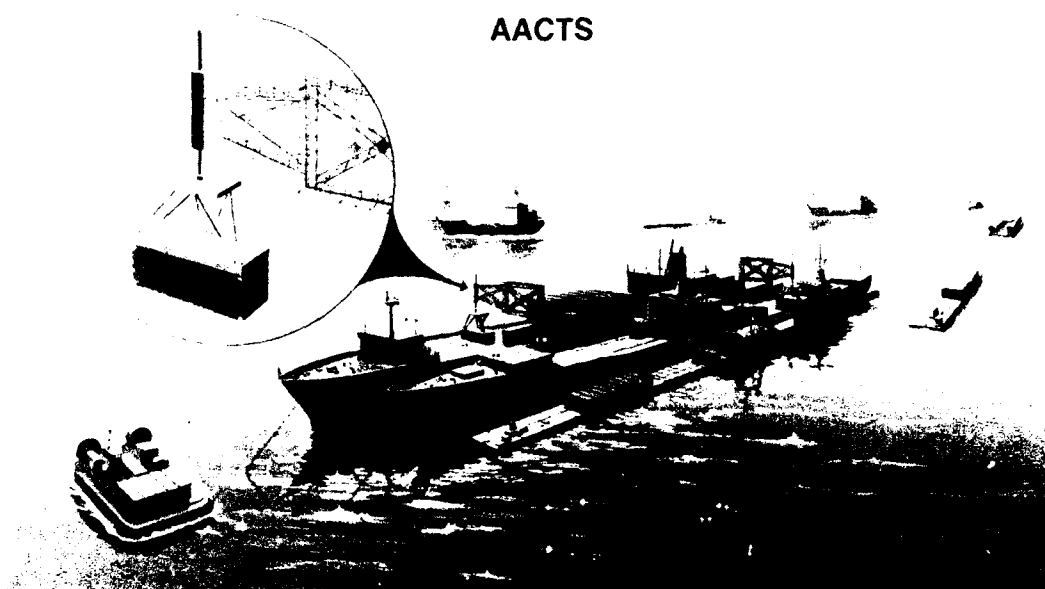

Automated All-Weather Cargo Transfer System (AACTS)

POINT OF CONTACT

Mr. W. Brower
US Army Belvoir RD&E Center, STRBE-FMR
Fort Belvoir, VA 22060-5606
DSN 354-1143/Commercial (703) 664-1143

ITEM DESCRIPTION

The AACTS is an automated system which will be used to transfer ISO containers between containerships and lighterage in stream or between lighterage and transportation assets at shoreside in support of LOTS operations. AACTS may replace the conventional cable type of cranes found shoreside such as the 140-Ton Crane or the container cranes on crane ships. AACTS consists of the following major components: (1) Cargo Manipulator Arm; (2) Intelligent Spreader Bar; (3) Master Control Computer; and (4) Berthing Modules.

The system will have the ability to identify and engage an ISO container using a built-in vision system. This system allows the container to be engaged even under conditions of severe relative motion differences between the container and the AACTS. These capabilities will allow AACTS to increase the number of containers transferred from ship-to-shore during Sea States (SS) 1 and 2 and provide the new capability to efficiently transfer containers in SS 3 and 4. In addition, personnel can be eliminated from hazardous tagline operations, thereby increasing safety.

STATUS

AACTS was established under the Small Business Innovative Research (SBIR) Program. August Design, Inc. submitted the SBIR and has been performing the effort under the SBIR Program. Phase I consisted of a feasibility study and was completed during FY87. Phase II was initiated during FY88 and completed at the end of FY90. Phase II consisted of producing a working 1/10th scale model of the Intelligent Spreader Bar, Manipulator Arm, and Motion Platform to prove the concept of picking containers autonomously from a simulated LACV-30 in SS 3 and 4 conditions.

PROGRAM PLAN

Pending funding, award a Phase III SBIR to further develop the technology explored in the Phase II SBIR.

NSN

Not assigned.

Cantilevered Lift Frame (CLF)

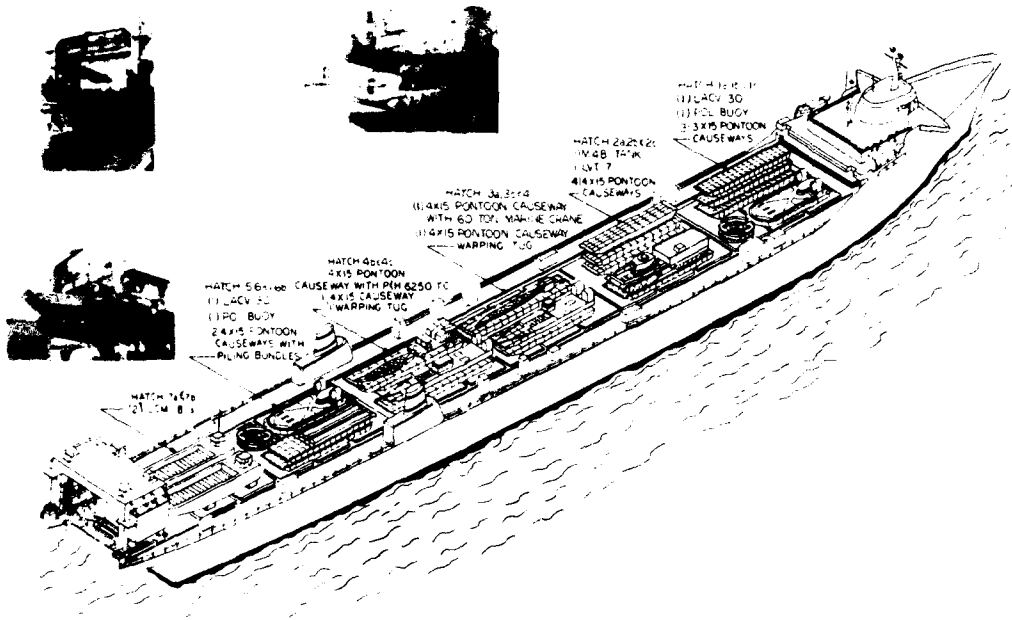

TYPICAL DECK STORAGE FOR
OUTSIDE CARGO COMPONENTS
FOR G9 LASH VESSEL

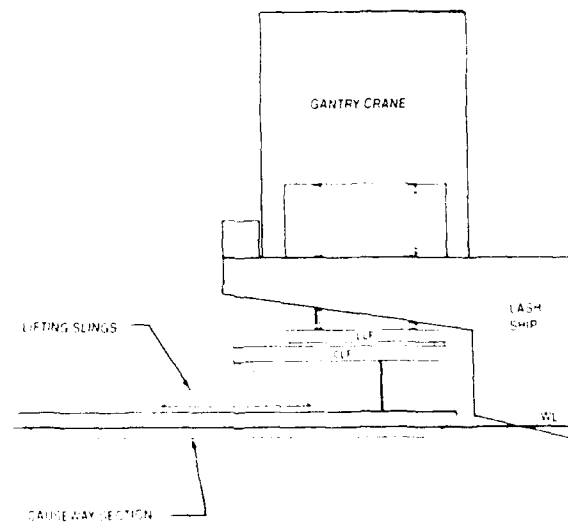

LASH CAUSEWAY LIFTING OPERATIONS

Cantilevered Lift Frame (CLF)

POINTS OF CONTACT

Mr. G. Walker
Naval Facilities Engineering Command, Code 061A
Alexandria, VA 22332
DSN 221-8535/Commercial (703) 325-8535

Mr. T. Vaughters
David Taylor Research Center, DTRC-125
Annapolis, MD 21402-5067
DSN 281-2261/Commercial (301) 267-2261

ITEM DESCRIPTION

The CLF has the capability to deploy commercial LASH vessels with heavy, oversized equipment and to offload offshore during LOTS operations. This special lifting device attaches to the LASH ship's gantry crane (designed to lift 30' x 60' barges up to 500 short-tons) and enables the lift of non-barges, eccentric loads up to 150 tons approximately 60' wide x 90' long. The frame was designed to be mated to the four lifting sockets of either the Morgan or Alliance lighter crane lifting frames. The design concept, called the *Cantilevered Lift Frame*, has been accepted as a National Defense feature by MARAD. Certification by the American Bureau of Shipping is based on the capacity of the eccentric loaded crane.

STATUS

Development has been completed to provide quick-release devices for the rigging gear to assist SS 3 offload of causeways from a LASH ship. Existing design is under procurement for a total of 14 units. Delivery began in FY81. The quick-release device was tested during LOGEX 88 on a T-ACS ship.

PROGRAM PLAN

Complete procurement of 14 units. Change rigging design if development is successful and continue procurement of device with lift beam, when available. Test quick-release devices during J-LOTS III exercise scheduled for 1991.

NSN

3950-LL-LCA-0115

Part V

Aerial

Port/Terminal

Equipment

Avionics Intermediate Shop (AIS) Shelter Movement

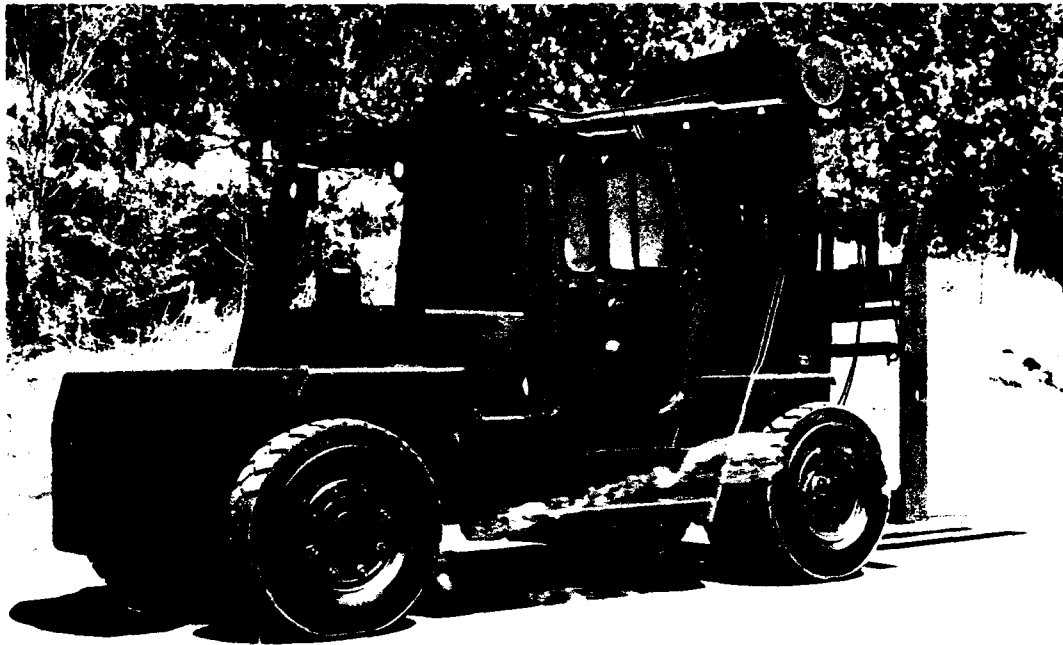

Avionics Intermediate Shop (AIS) Shelter Movement

POINT OF CONTACT

CAPT J. Wray
HQ TAC/LGTV
Langley AFB, VA 23665-5541
DSN 574-5685/Commercial (804) 764-5685

ITEM DESCRIPTION

This is a new requirement for the Avionics Intermediate Shop (AIS) Shelter Movement within the Tactical Air Command (TAC). This vehicle has a lifting capacity of 22,100 pounds at a 48" load center, utilized to handle tactical ISO shelters and ISO containers. This forklift is a commercially available vehicle and air transportable only on the C-5 Galaxy. It does not have rough terrain capability. The forklift does have a side shift carriage to aid in container/shelter handling.

STATUS

A contract for 58 units was awarded to Clark Material System Technology Company. As of January 1991, all units have been delivered with 19 received by TAC.

PROGRAM PLAN

Future procurements will convert to the C-130, C-141, and C-5 air transportable 25K forklift.

NSN

3930-01-220-3657

Elevator Loader



Elevator Loader

POINT OF CONTACT

COL L. Kearns
Warner Robins Air Logistics Center, WRALC/LV
Robins AFB, GA 31098-5609
DSN 468-2062/Commercial (912) 926-2062

ITEM DESCRIPTION

There are three models of Elevator Loaders currently in the Air Force inventory. The Cochran Model 316A has a two 463L pallet, 25,000-pound capability. The Cochran Model 316E and the Wilson have a three 463L pallet, or one air/land container, 40,000-pound capability. The Elevator Loader can also be used to load/unload rolling stock up to its capacity. It is compatible with wide-body aircraft upper deck nose doors and side doors, with maximum transfer height of 18', 6". The Elevator Loaders are transportable in C-130 aircraft. They are used at major aerial ports for efficient mechanized loading/offloading of cargo between wide-body aircraft and other materials handling equipment.

STATUS

The Air Force has 101 Elevator Loaders on hand. Fifty-nine CL3 Elevator Loaders were recently refurbished.

PROGRAM PLAN

The remaining 42 Elevator Loaders will undergo a refurbishment program beginning in 4QFY91. The Elevator Loaders will eventually be replaced by the 60,000-pound Capacity Loader which is scheduled for production delivery in 2QFY95.

NSN

3930-01-069-1026 CT

25,000-Pound 463L Aircraft Loader

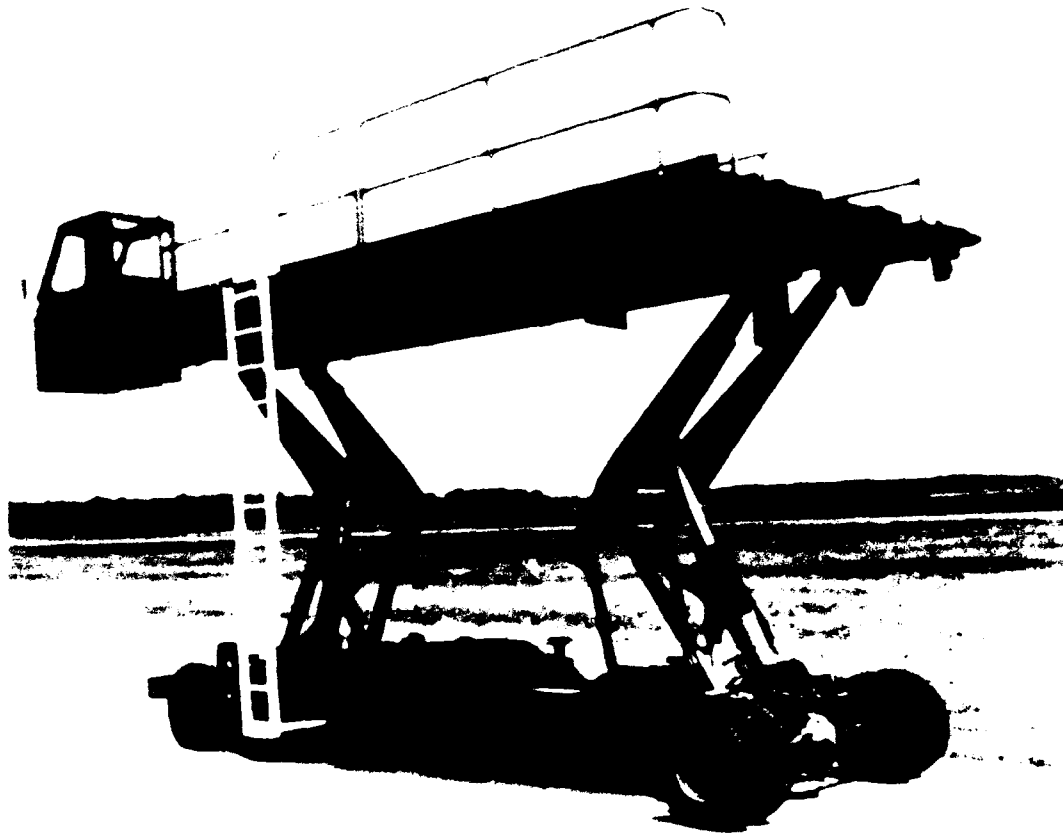

25,000-Pound 463L Aircraft Loader

POINT OF CONTACT

COL L. Keams
Warner Robins Air Logistics Center, WRALC/LV
Robins AFB, GA 31098-5609
DSN 468-2062/Commercial (912) 926-2062

ITEM DESCRIPTION

This diesel-powered loader has the capacity to transport 25,000-pound palletized aircraft loads to and from cargo aircraft. It has a platform length of 24', a width of 10', and can accommodate three 463L pallets. The 25,000-pound loader is air transportable by C-130 aircraft and available at major aerial ports. The 25,000-pound loader can accommodate ISO containers with gross weight, including 463L adapter systems, of 25,000 pounds.

STATUS

The Air Force currently has 522 units on hand. A contract was awarded 1 July 1987 for 191 additional 25,000-pound aircraft loaders with options for 49 more; start delivery date is July 1991.

PROGRAM PLAN

The inventory objective is 869 units.

NSN

3930-00-955-3293 CT

40,000-Pound 463L Aircraft Loader

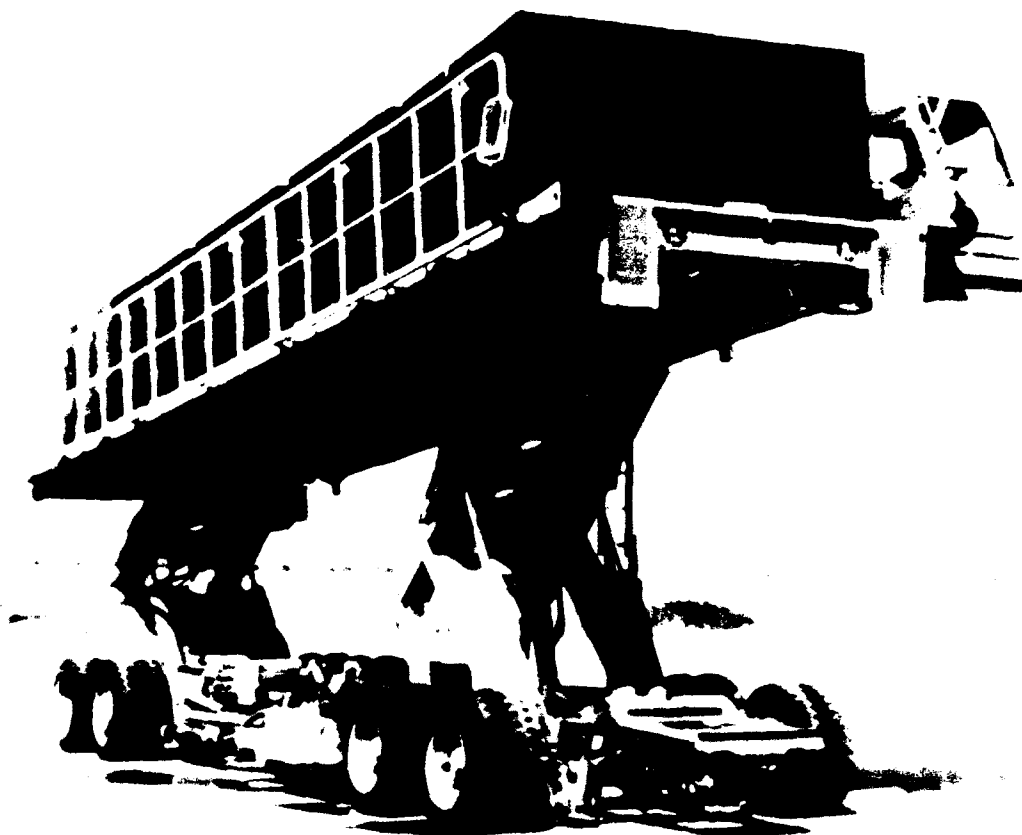

40,000-Pound 463L Aircraft Loader

POINT OF CONTACT

COL L. Keams
Warner Robins Air Logistics Center, WRALC/LV
Robins AFB, GA 31098-5609
DSN 468-2062/Commercial (912) 926-2062

ITEM DESCRIPTION

This aircraft loader has the capacity to transport 40,000-pound 463L palletized loads to and from cargo aircraft. It has a platform length of 41 $\frac{1}{2}$ ', a width of 10', and a lifting range of 3 $\frac{1}{3}$ ' to 13' at 10 FPM. The unit will accommodate five 463L pallets. The loaders are air transportable and are available at all major aerial ports. The 40,000-pound loader can also accommodate an ISO container loaded on married 463L pallets or other adapter systems.

STATUS

The Air Force has 286 40,000-pound loaders on hand.

PROGRAM PLAN

The 40,000-pound loader will be replaced by the 60,000-pound Capacity Loader which is scheduled for production delivery in 2QFY95. The 60,000-pound Capacity Loader will be air transportable, a member of the 463L Material Handling System, and capable of loading all aircraft including the C-17. A depot overhaul contract is currently in place to assure operational readiness.

NSN

3930-00-800-3929 CT

Mobile Straddle Crane

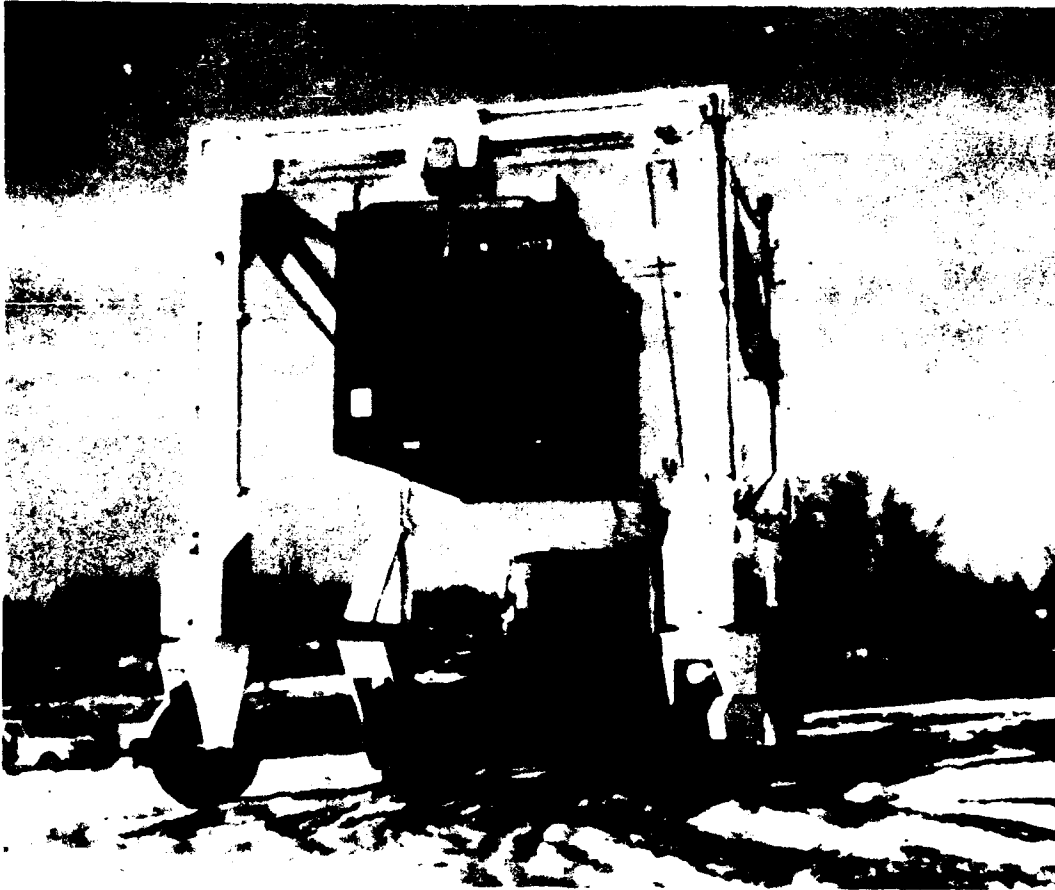

Mobile Straddle Crane

POINT OF CONTACT

MSGT D. Bowen
HQ Military Airlift Command, XORP
Scott AFB, IL 62225-5001
DSN 576-4951/Commercial (618) 256-4951

ITEM DESCRIPTION

The Mobile Straddle Crane is for use by major aerial ports to handle the movement of ISO containers and shelters by air. There are two types of Mobile Straddle Cranes: the 50K and the 75K. The Mobile Straddle Crane has the capability of lifting ISO tactical shelters, surface containers, and air/surface containers. The unit is able to operate within the confines of an aerial port and provide the capability to transfer shelters and containers from/to trailers, aerial port high-line docks, and 25K/40K aircraft loaders. The 50K Mobile Straddle Crane can handle containers weighing up to 47,000 pounds and is air transportable (disassembled) in C-130 and larger aircraft. The 75K Mobile Straddle Crane can handle 40' containers weighing up to approximately 70,000 pounds and is for use at strategic aerial ports.

STATUS

The Air Force does not have the Mobile Straddle Cranes currently assigned. The Mobile Straddle Crane has successfully completed tests to assess its military utility as a container handling system, determine its deployability by air, and assess its suitability for use in military airlift operations. The tests were conducted at Pope AFB, NC, by the USAF Airlift Center. It was also tested in Korea during a test shipment of Air Force containerized munitions. The Mobile Straddle Crane was tested at the discharge pier and during train offloading at the ammunition storage site. The test successfully demonstrated the deployability of the crane and identified constraints while working in an area not specifically designed for container operations.

The Military Airlift Command (MAC) Statement of Operational Need (SON) for a Mobile Straddle Crane was approved by the Air Force. The present airlift requirement is for 39 strategic loaders and 16 air transportable loaders. Funding was programmed for FY85-86 to satisfy this requirement. A production contract was awarded to Mi Jack during 4QFY88 to produce 16 50Ks and 39 75Ks.

PROGRAM PLAN

There is a delay in the program due to price increases during contract negotiations.

NSNs

50K: 3810-01-208-0996 CT
75K: 3810-01-208-3338 CT

35-Ton Bridge Crane

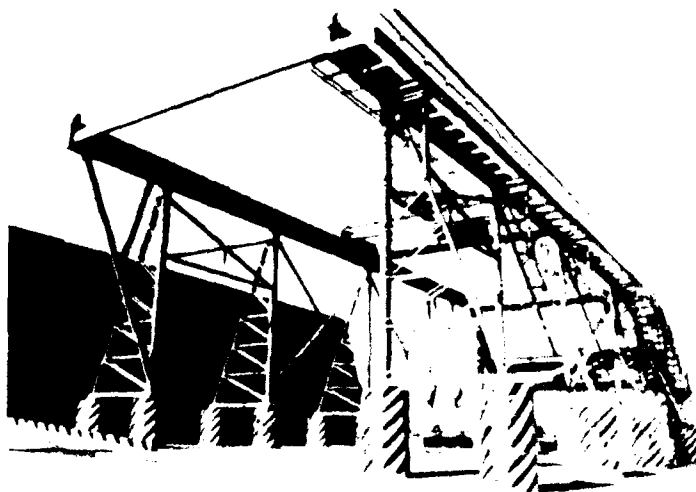
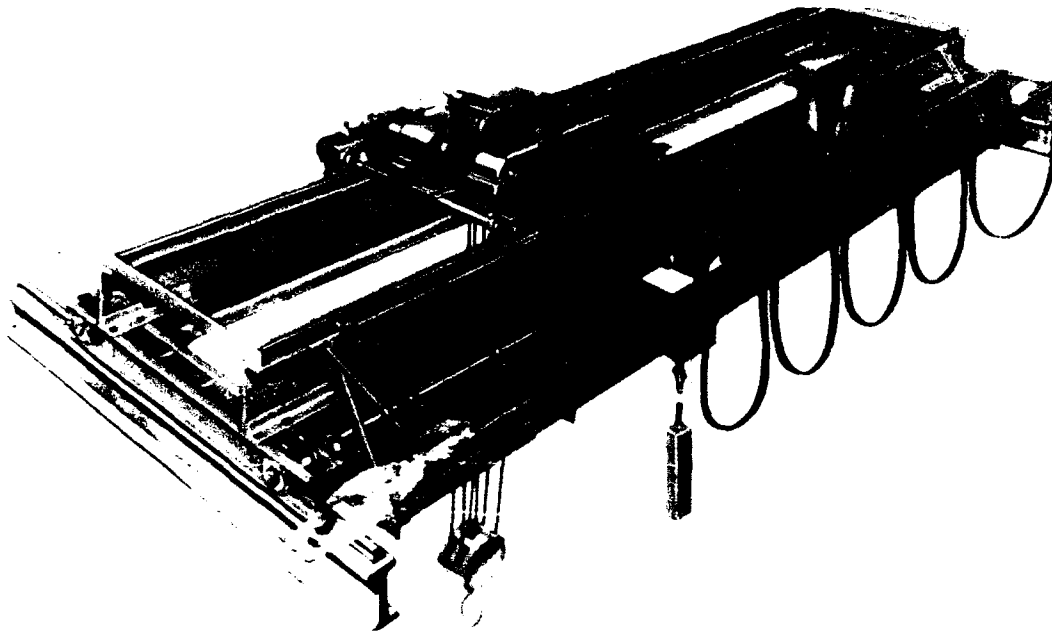

35-Ton Bridge Crane

POINT OF CONTACT

MSGT D. Bowen
HQ Military Airlift Command, XORP
Scott AFB, IL 62225-5001
DSN 576-4951/Commercial (618) 256-4951

ITEM DESCRIPTION

The 35-Ton Bridge Crane provides major aerial ports the capability to build up pallets for air drop missions and to transfer fully loaded ISO shelters, air/land and surface containers from trucks/trailers to adapter systems and aircraft loaders. The Bridge Crane is not mobile and provides the capability to support limited container movements.

STATUS

Bridge Cranes are installed at the following aerial ports: Dover, Travis, Mildenhall, Ramstein, Rhein-Main, Clark, and Kadena.

PROGRAM PLAN

Install the Bridge Cranes as new facilities are constructed.

NSN

Not applicable.

Part VI

Deleted

Programs

Over time, many programs have been added and deleted from the Container System Hardware Status Report. Listed below are the programs which have been deleted. These programs are listed under the edition of the report from which they were deleted. The programs were deleted from the report for many reasons, including: lack of funding; lack of user support; completion of the program; individual service program combined into a joint service program; or, in rare cases, the POC could not be contacted to determine the status of the program.

July 1976 Status Report

Aerocrane, Ultra Heavy, Vertical Lift
Container Handling in Terminal Operations (CHITO) Equipment
Klemp Klamp Detachable Container Clamp
Lightweight Top Lift Attachments
Logistics-Over-The-Shore (LOTS)
Ship-to-Shore Balloon Transport System (BTS)
10,000-Pound Capacity Forklift Rough Terrain
Type "B" Restraint System for Commercial Containers (Value Engineering)
Type "C" Restraint System for Commercial Containers (Foster Miller)
Type "C" Restraint System for Commercial Containers (Kappa Sys Inc)
US Coast Guard Actions

January 1977 Status Report

Automatic Air Valving Surface Effects Device (ASVSED)
Container Condensation Test
Tug, Large, Inland and Coastal
Tug, Small, Harbor and Inland Waterway

January 1978 Status Report

50,000-Pound Capacity Container Handler, Side Loader (Cochran Western)
Railcar, Modified Flatbed
300-Ton Self-Discharging, Beaching Lighter (BDL)
Type "A" Restraint System for Commercial Containers (Brooks & Perkins)
Type "B" Restraint System for Commercial Containers (Brooks & Perkins)

July 1978 Status Report

4,000-Pound Capacity Forklift Truck, Conventional

January 1979 Status Report

CCIRRS
Container Insert
Lancer Boss Sideloader

January 1980 Status Report

67,000-Pound Capacity Container Handler

July 1980 Status Report

40-Foot Platform Container, Military (Flatrack)
Mobile Port Modules

January 1982 Status Report

Aircraft Mobile Loader

January 1983 Status Report

Conventional Multi-Purpose Barges (Trans Hydro Barges)
INSERT
Navy Internal Restraint System (IRS Kit) for Commercial Containers
Pallet Container (PALCON)
Shore Side Trafficability and Storage Facility Construction
Wood Dunnaging Restraint System (Savanna)

January 1984 Status Report

Container Offloading and Transfer Systems (COTS) Relative Motion Mitigation

January 1985 Status Report

None

1986 Status Report

Barge, Knockdown, Rapid Deployable (BK)
Container Offloading and Transfer System (COTS); COD and TCDF COTS Crane Support
Container Offloading and Transfer System (COTS); Temporary Container
Discharge Facility (TDCF)

1989 Status Report

Air/Surface Intermodal General Purpose Container
Container Offloading and Transfer System (COTS), Crane on Deck (COD)
Container Offloading and Transfer System (COTS), Helicopter Offloading
50,000-Pound Capacity Depot and Terminal Container Handler, Front Loader
40-Foot Flatrack—Army
Lightweight Container Handler
Pre-Staged Ammunition Loading System (PALS)
Slip Sheets for Unstuffing Containerized Ammunition
Spreader Bars, Remote Control
Super Jack Mobile Loading System

1990 Status Report

PLS Container (COMPODS)
Rough Terrain Container Transporter (RTCT)
Temporary Container Discharge Facility (TCDF)

1991 Status Report

Basic Merchant Ship Naval Augmentation Program (MSNAP) Module
Habitability and Utility Support System (HUSS)
Modular Mobile Repair System (MMRS)
Ammunition Containerization Evaluation (Follow-On Efforts)
Crane Rotator
Containership Strike-Up System (CSUS)
463L/ISO Adapter System

Acronyms and Abbreviations

AACTS	Automated All-Weather Cargo Transfer System
ABS	American Bureau of Shipping
AD	Armament Division
AIS	Avionics Intermediate Shop
AMC	Army Materiel Command
AMCON	Ammunition Container
AMS	Anchor Mooring System
ANSI	American National Standards Institute
APC	Armored Personnel Carrier
AR	Army Regulation
ASIOE	Associated Support Items of Equipment
ASP	Ammunition Supply Point
ATLAS	All Terrain Lifter, Articulated System
ATACMS	Army Tactical Missile System
BOE	Bureau of Explosives
BRDEC	Belvoir Research, Development and Engineering Center
CADS	Containerized Ammunition Distribution System
CAMDEG	Containerized Ammunition/Missiles Distribution Executive Group
CB	Chemical/Biological
CCSA	Containership Cargo Stowage Adapter
CEP	Concept Evaluation Program
CF	Causeway Ferry
CHI	Coastal, Harbor, Inland
CLF	Cantilevered Lift Frame
CONUS	Continental United States
CSC	Convention for Safe Containers
CSNP	Causeway Sections, Non Powered
CSP	Causeway Section, Powered
CWR	Calm Water Ramp

DAB	Defense Acquisition Board
DEPMED	Deployable Medical
DISCOM	Division Support Command
DOD	Department of Defense
DOT	Department of Transportation
DPO	Development Prove-Out
DSN	Defense Switched Network (formerly Autovon)
EBFL	Extendable Boom Forklift
ELCAS (M)	Elevated Causeway, Modular
EMI	Electro-Magnetic Interference
FC	Floating Causeway
FDTE	Force Development Test and Evaluation
FUE	First Unit Equipment
FY	Fiscal Year (Oct 1 - 30 Sept)
GS	General Support
GSSA	General Support Supply Activities
HIK	Hooklift Interface Kit
HISEACOTS	High Sea State Container Transfer System
HP	Horsepower
HQ	Headquarters
Hz	Hertz
IOC	Initial Operational Capability
IPR	In Process Review
ISA	Interservice Support Agreement
ISO	International Organization of Standardization (French translation)
J-LOTS	Joint-Logistics-Over-The-Shore
K	thousand(s)
kW	kilowatt

LACH	Lightweight Amphibious Container Handler
LACV-30	Lighter Air Cushion Vehicle, 30 Ton
LAMP-H	Lighter, Amphibian, Heavy-Lift
LB	pound(s)
LC	Load Center
LCC	Logistics Control Code
LCU	Landing Craft Utility
LOTS	Logistics-Over-The-Shore
LPU	Limited Procurement Urgent
LRP	Load and Roll Pallet
LST	Landing Ship Tank
LSV	Logistics Support Vessel
MAC	Military Airlift Command
MC	Materiel Change
MERWS	Modular Extendable Rigid Wall Shelter
MF	Mobile Facility
MILVAN	Military Van
MLRS	Multiple Launch Rocket System
NATC	Nevada Automotive Test Center
NAVAIR	Naval Air Systems Command
NDI	Non-Developmental Item
NL	Navy Lighterage
NSN	National Stock Number
O&O	Operational and Organizational
OR	Operational Requirement
PACK	Pontoon Air Cushion Kit
PLS	Palletized Load System
PO-AWC	Product Office for Amphibians and Watercraft
POC	Point of Contact
POP	Proof of Principle

Q	quarter
QUADCON	Quadruple Container
RBTS	Rider Block Tagline System
RFP	Request for Proposal
ROC	Required Operational Capability
RO/RO DF	Roll-on/Roll-off Discharge Facility
ROWPU	Reverse Osmosis Water Purification Unit
RTCC	Rough Terrain Container Crane
RTCH	Rough Terrain Container Handler
RTFLT	Rough Terrain Forklift Truck
SBIR	Small Business Innovation Research
SIXCON	Six Containers
SLWT	Side Loadable Warping Tugs
SON	Statement of Operational Need
SS	Sea State
SS	Steam Ship
TAC	Tactical Air Command
TACOM	Tank-Automotive Command
T-ACS	Auxiliary Crane Ship
T-AKR	Vehicle Cargo Ship
TC	Type Classification
TRADOC	Training and Doctrine Command
TRICON	Triple Container
US	United States
USAREUR	US Army Europe
USCG	US Coast Guard
VRTFLT	Variable Reach Rough Terrain Forklift Truck