

2

Cold Regions Technical Digest  
No. 91-4, May 1991

# Automotive Batteries at Low Temperatures

Deborah Diemand

AD-A239 115  

DTIC  
AUG 01 1991

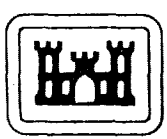

US Army Corps  
of Engineers  
Cold Regions Research &  
Engineering Laboratory

91-06671  



CRREL's *Cold Regions Technical Digests* are aimed at communicating essential technical information in condensed form to researchers, engineers, technicians, public officials and others. They convey up-to-date knowledge concerning technical problems unique to cold regions. Attention is paid to the degree of detail necessary to meet the needs of the intended audience. References to background information are included for the specialist.

USA Cold Regions Research and Engineering Laboratory  
Hanover, New Hampshire 03755-1290

---

# Automotive Batteries at Low Temperatures

Deborah Diemand

---

## Introduction

Batteries are one of the most common sources of problems for equipment operators in cold regions. Some failures, such as frozen electrolyte, are unique to cold areas, while others, such as vibration damage, are also experienced in temperate conditions but are intensified at extremely low temperatures.

Twelve-volt lead-acid batteries are almost universally used for electrical storage in automotive and construction vehicles in all areas. They are relatively inexpensive and widely available in innumerable sizes and configurations. However, their performance depends strongly on temperature. This digest will therefore deal primarily with this type of battery. Nickel-cadmium batteries are used in aircraft and in certain military applications. They have excellent low-temperature, high-discharge properties and will be briefly discussed later. Lithium batteries are probably the best low-temperature performers, but since most cannot be recharged, and all are very costly and hard to dispose of, they will not be dealt with here.

## Lead-acid batteries

*The author, a physical  
scientist, is a member  
of CRREL's Applied  
Research Branch.*

Lead-acid batteries are commonly available in 6-, 12- and 24-V configurations. Most automotive applications use 12-V batteries, while 24-V batteries are often used on heavy equipment. The military commonly uses 24-V batteries, and all vehicle functions, including engine starting, must be achievable without 120-V assistance.

1. Arrangement of plates in a cell of a typical lead-acid battery.

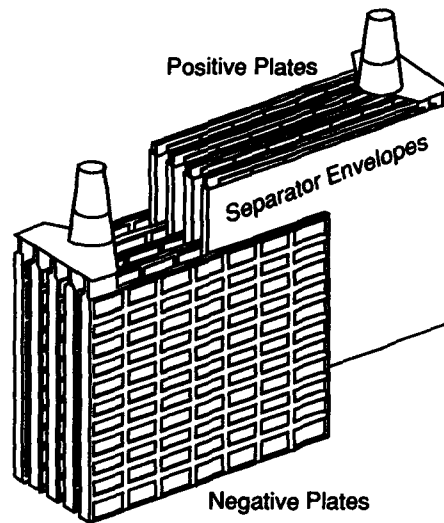

**Gross anatomy**  
Cells

Lead-acid batteries are composed of individual cells containing lead (Pb) plates at the negative electrode and lead dioxide ( $\text{PbO}_2$ ) at the positive electrode. These react with the sulfuric acid electrolyte ( $\text{H}_2\text{SO}_4$ ) to produce current when the circuit between the two electrodes is closed. The voltage developed in a fully charged cell is 2.1 V (six are connected in series in a 12-V battery). In most lead-acid batteries, each cell contains a number of positive plates interleaved between a like number of negative plates (Fig. 1), all immersed in a sulfuric acid solution. The cells are usually connected by through-partition connectors as shown in Figure 2.

Plates

Generally the plates are made by pressing a paste or slurry made of lead oxide and sulfuric acid into a lead alloy grid designed to prevent material from shedding during use. A typical lead-acid battery grid is shown in Figure 3. (Vibration, a leading cause of battery failure, can cause the active material to shed from the grid, reducing the battery's performance and potentially giving rise to internal short circuits.) The plates are then processed to produce the final positive and negative electrodes, sponge lead at the negative

electrode and  $\text{PbO}_2$  at the positive electrode in the form of a porous mass of crystals. This results in a very high effective electrode surface area, allowing the highest possible current density necessary for automotive batteries, which must

2. Assembly of the battery showing arrangement of cells and through-partition connectors.

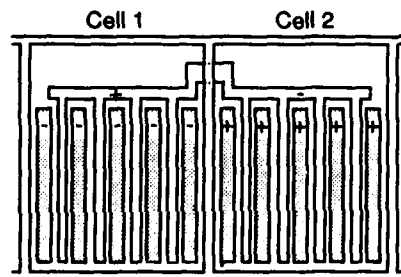

produce very high currents for short periods. The effective surface area of a typical electrode thus produced has been calculated to be about 50–150 m<sup>2</sup> per amp-hour capacity.

The use of thin plates can produce high amps in a relatively small battery, but heavy cycling will cause the plates to deteriorate. Low-quality batteries have fewer plates or thinner plates or both. In general, weight is a good quality indicator.

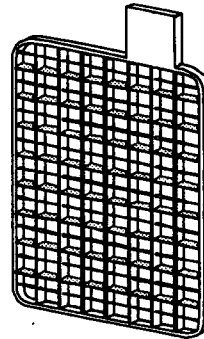

3. Typical grid in a lead-acid battery. The active material is pressed into the grid in the form of a paste or slurry and treated to produce the final electrode.

Separators are installed between the positive and negative plates to prevent short circuits and to maintain a uniform distance between them. Often these take the form of sleeves enclosing the positive plates, as shown in Figure 1. They should be highly porous, with small pore diameters and high electrical resistance. They are usually made of some sort of plastic, rubber or silicious material or a combination of these. Different grades of separators are used, and some disintegrate easily, especially in a high-vibration environment.

Urethane cases are best at low temperatures and will not become brittle down to -45°C. They will not crack if the battery freezes, and they are currently available for large batteries. Polypropylene cases, which are becoming increasingly common in automotive batteries, tend to become brittle below -30°C. Rubber cases are somewhat better but are becoming increasingly rare. At extremely low temperatures, battery cases made of hard rubber or plastic may become brittle and fracture on impact, rendering the batteries completely inoperative and possibly allowing sulfuric acid to escape.

A maintenance-free battery is very similar to the conventional type except that it is designed to minimize gassing and water loss, and the case is therefore usually sealed. Some of these are fitted with a built-in hydrometer with which the state of charge and the electrolyte level can be checked. If the electrolyte level is low and the vents cannot be removed to allow water to be added, the battery must be replaced.

A gel-cell battery contains electrolyte that has been immobilized in a silica gel or by some other means so that it can be used in any orientation.

The basic chemical reaction in all lead-acid type batteries, including maintenance-free and gel-cell batteries, is

Separators



Approved for  
 DTIC  
 Under contract  
 Justification

Per AD-A236 040  
 Distribution

Cases & Availability Order

Dist	Avail and/or
A-1	Special

Maintenance-free and gel-cell batteries

How batteries work

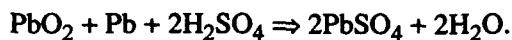

The reaction at the positive electrode in a cell during discharge is

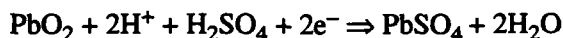

and at the negative electrode, it is

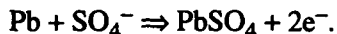

During charging the reactions reverse.

While the battery is discharging, the sulfate concentration in the electrode pores is decreased at the same time as water is formed. Thus the rate of the reaction is governed by the rate at which diffusion into the pore structure takes place. This diminishes as the temperature decreases and the electrolyte becomes increasingly viscous. It is also retarded by the formation of  $\text{PbSO}_4$ , which occupies a greater volume than the  $\text{Pb}$  or the  $\text{PbO}_2$  it replaces.

#### Terminology

The *capacity* (amp-hour rating) of the battery is its ability to deliver electric current at a given rate over a specified period. For example, a battery capable of delivering 2 amps over a 20-hour period is a 40 amp-hour battery. (The 20-hour capacity rating is commonly included in the technical information given for automotive batteries.) For any battery type, the greater the amount of active materials, the greater the capacity.

The *reserve capacity (RC)* rating is the time in minutes that a new battery can sustain a drain of 25 amps at 27°C (80°F) in the event of alternator or generator failure. The actual reserve capacity is reduced by repeated heavy cycling as shown in Figure 4.

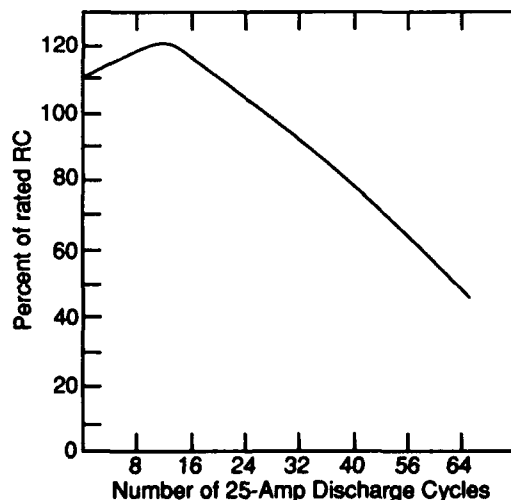

4. Reduction in reserve capacity of a typical lead-acid battery after repeated deep cycling at 27°C.

The *cold-cranking amp (CCA)* rating is the number of amperes a battery can deliver for 30 seconds at  $-18^{\circ}\text{C}$  ( $0^{\circ}\text{F}$ ) and still maintain a voltage of 1.2 per cell (7.2 V in a 12-V battery). Repeatedly draining the battery to this voltage level will shorten the battery's life. In general, the greater the surface area of the electrodes, the greater the cold-cranking rating. The CCA rating should not be confused with the battery's amp-hour rating. For an automotive lead-acid battery rated only by amp-hours, the CCA can be approximated by multiplying the amp-hour rating by 5.25.

The *cycle life* represents the number of discharge cycles a battery is capable of sustaining. The DIN cycle life tests (a frequently used German standard) involve consuming 25% of the battery capacity followed by recharging at 14.8 V to full charge. After every 24 cycles the battery's cold cranking rating is measured.

The most conspicuous battery problem in cold regions is freezing, which may crack cases and damage plates. Figure 5 shows the freezing point of sulfuric acid electrolyte at specific gravities common in automotive batteries, along with the  $\text{H}_2\text{SO}_4$  concentration they represent. A specific gravity of 1.300 is commonly used in low-temperature situations, and 1.360 in some cases. While it may at first appear counterproductive to use such a high acid concentration, it is important to remember that the acid is consumed on discharge, with concomitant formation of water which, in this case, would result in the battery's freezing point actually dropping. On the other hand, a high acid level can damage a battery, especially if it is exposed to elevated temperatures, and it may cause sulfation. This phenomenon will be discussed later.

#### Low-temperature problems

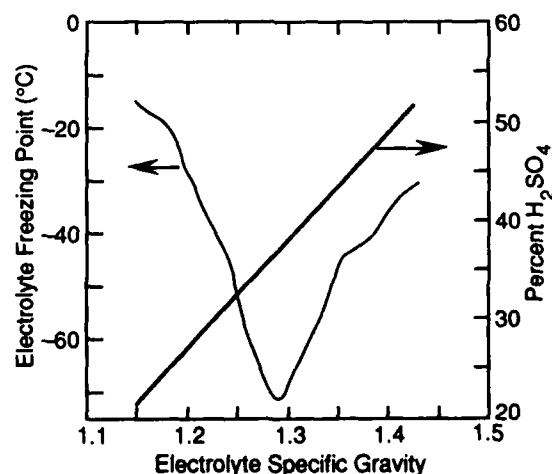

5. Freezing points of electrolyte in the range of specific gravities commonly used in lead-acid batteries. Data from Dean (1973).

6. Effect of temperature and state of charge on the specific gravity of battery electrolyte and its freezing point. (After Gardner 1985.)

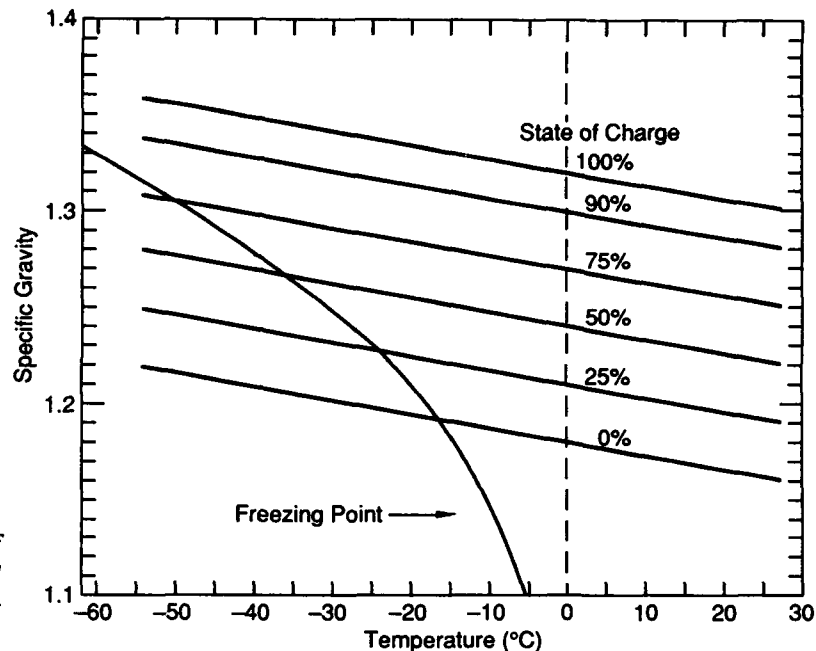

Figure 6 shows a family of curves representing hydrometer readings on a battery whose specific gravity, fully charged at 27°C (80°F), is 1.300. Note the change in electrolyte density at different temperatures and states of charge. The freezing point curve indicates that the discharged battery will freeze at about -17°C.

Other common low-temperature battery problems are:

- Cases may break not only from freezing but also from a sharp blow or from excessive vibration.
- Batteries may explode if charging is attempted when the battery is discharged and frozen.
- The amp-hour capacity and voltage under even light loads are seriously decreased.
- Charging becomes difficult and inefficient.

The last two of these difficulties arise from the greatly increased internal resistance of the battery at low temperatures. As the temperature falls, the electrolyte becomes increasingly viscous, and the chemical processes at the plate surface are not only slowed by direct temperature effects but also are hampered through slow diffusion of the reactants due to the increased viscosity of the aqueous medium. This results in a slower rate of both charging and discharging. Figure 7 shows the apparent power reduction of a fully charged battery at low-temperatures.

In terms of discharge, many cranking problems are attributable to the state of the battery cables and connectors. It is tempting to



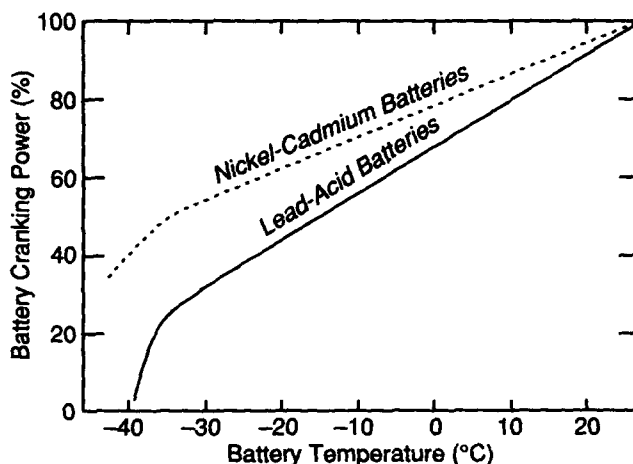

7. Apparent power reduction in fully charged batteries at low temperatures. (After U.S. Army 1989, Union Carbide 1985, Detroit Diesel 1989 and Vincent 1984.)

blame all such problems on low-temperature effects, but simple solutions sometimes apply and can easily be checked. For example, a corroded terminal may prevent proper contact with the cable connector, hindering or preventing the flow of electricity. Similarly a frayed cable can seriously increase the cable's resistance, with similar results.

Batteries must be capable of absorbing full charge to deliver maximum current and prevent rupture by freezing. The mechanical condition, electrolytic strength and charging temperature are controlling factors. The battery case and electrolyte temperatures must be from 16° to 38°C while the battery is being filled with electrolyte, and the battery temperature during charging should be above 2°C, ideally at least 10°C. However, even at -45°C charging is possible if the battery is not frozen. (The use of a trickle charger will warm the battery slightly.)

Gassing (the production of hydrogen and oxygen) becomes a problem whenever the battery is charged at a rate that causes gas generation at a higher rate than gas removal. A buildup of these gases can cause the battery to explode. In a frozen battery, gas production will take place at almost any rate of charge. For this reason a frozen battery must always be thawed before any attempt to charge it.

A low rate of charging due to low temperatures has two other adverse effects: first, subsequent starting attempts will be seriously hampered unless extra charging time is allowed, and second, the operator may be deceived as to the actual state of charge of the battery since the battery charger will indicate a very low charging current going to the battery, which would usually indicate a full charge. When a battery is in an extremely discharged state, it does

### Charging

not readily accept a high current charge. It may appear to be taking a charge, but it will only be taking the charge on the surface of the plates. In this case the battery should be charged at a very low rate for a long time, say, 25–30 hours.

Because of the importance of maintaining a battery in a good state of charge, frequent specific gravity checks are necessary. There are many ways of doing this; however, a hydrometer is probably the simplest and most reliable if compensation is made for the increased viscosity at low temperatures. In general, the specific gravity will increase 0.0007 per °C. Figure 8 shows a nomogram that can be used to determine the actual specific gravity of the battery normalized to 16°C (60°F). It is, of course, essential to know the fully charged specific gravity of the battery being measured. Otherwise a hydrometer reading is worthless.

8. Nomograph for the specific gravity of electrolyte normalized to 16°C (60°F). Extend a straight line from the measured battery temperature through the measured hydrometer reading to the normalized specific gravity scale, from which the corrected value can be read directly. In the example shown, a reading of 1.280 from a battery at -40°C yields a value of 1.240 normalized to 16°C.

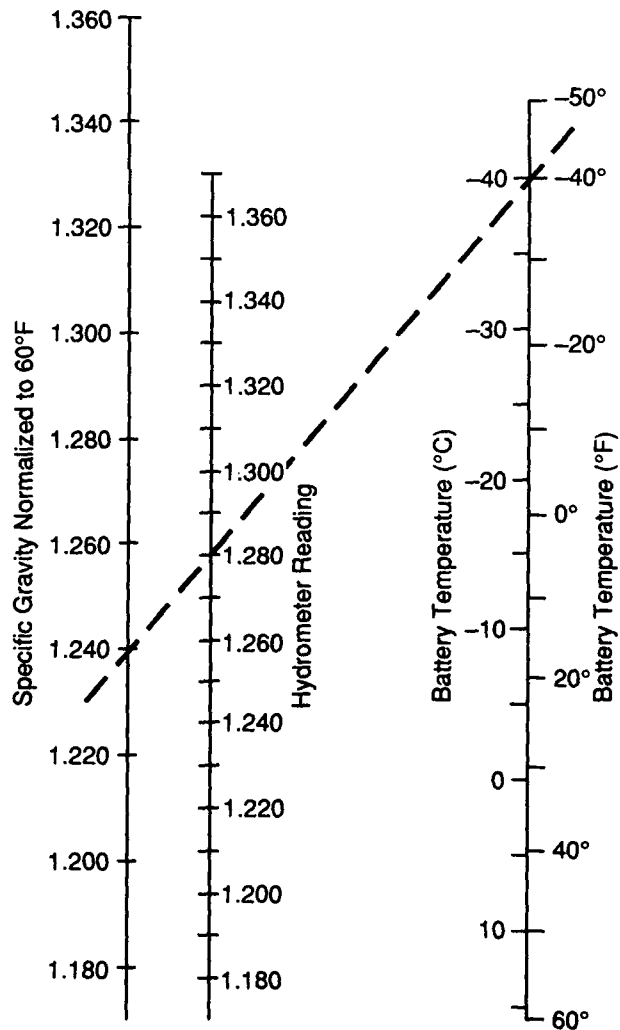

If it is not possible to tell if a maintenance-free battery is frozen, it should be heated to 2°C before charging. Batteries of this sort should never be overcharged, as this results in the loss of water, which cannot be replaced in most cases.

A method used in some Swedish vehicles appears to be highly effective in recharging the battery after starting. After the engine is started and operating normally, a 200-W battery heater, which draws power from the alternator, automatically cuts in and heats the battery to about 5°C. The heater then turns off and the battery is charged while the equipment is operating. The battery is located in the cab to ensure that it is as warm as possible.

Overcharging results from either too high a charging voltage or too high a charging current. If a battery in service appears to be losing an abnormally large amount of water, the voltage regulator should be checked. This is tricky, as it should be done with the regulator at its normal operating temperature, since these devices are usually equipped with a temperature-compensating capability. This is because the ability to accept a charge strongly depends on the temperature. For example, a half-charged battery at -18°C will accept a 10-amp charge at 17 V, while the same battery at 27°C will accept a 10-amp charge at 13.5 V, as shown in Figure 9.

Overcharging

Up to 60% of premature battery failures are reportedly due to overcharging, resulting in corrosion of the positive grid upon exposure of the bare metal to the electrolyte. The grid can become seriously weakened, and the internal resistance of the battery will increase. Overcharging can also warp the plates due to the heat generated and shedding of the active material due to excessive gas formation in the pores. In addition, excessive gassing may result in

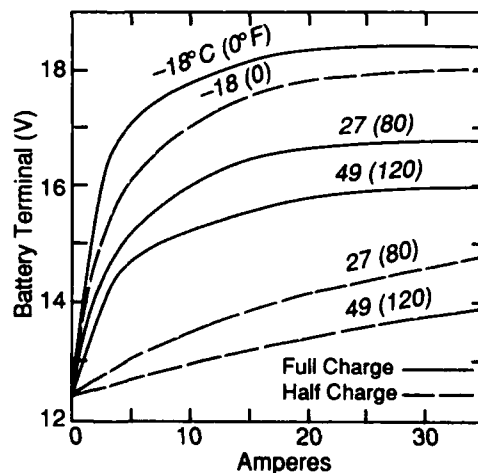

9. Rate of charge acceptance by a fully charged and a half charged lead-acid battery at various temperatures. The rate of charge acceptance of a lead-acid battery is strongly influenced by the battery's temperature. (From Battery Council International 1987.)

an abnormally high rate of water loss. This is especially serious in sealed batteries, in which the water cannot be replaced.

#### Undercharging

Undercharging results when the battery is in an almost constant state of discharge or under conditions where it is charged insufficiently for the discharge rates required. This condition can also reduce battery life through the process of sulfation, in which the lead sulfate deposit, especially on the negative electrode, is transformed through recrystallization to a dense, coarse-grained material that ultimately prevents the battery from accepting a charge. It is sometimes possible to reverse this process by slowly charging with a dilute electrolyte. Undercharging can result from slipping belts, low electrolyte level, extended idling, too low a voltage regulator setting, or a charging system incapable of handling the accessory load. Sulfation may also be caused by operation at excessively high temperatures or with too high an acid concentration.

#### *Battery care and maintenance*

A battery will last about a year at extremely low temperatures. However, once it has frozen, it will never be good again, as this bends the plates.

Furnishing heat to increase the temperature of the battery is the present solution to cold weather operations. The most common practice is to use either battery blankets or battery plates, never both. There appears to be no clear unanimity concerning which of these is preferable, although plates appear to be slightly more popular. Battery blankets, which are rated at about 80 W, wrap around the four sides of the battery and contain an insulating layer as well as a heating element. They will therefore keep the battery warm when not plugged in and may protect it to some degree from vibration damage. On the other hand, it is sometimes difficult to install on a battery in a very confined space as it is fairly bulky, and if the battery has to be removed or installed in the cold, the blanket may sustain some damage. Battery plates, on the other hand, are easily installed underneath the battery, take up very little space, and are less subject to damage. However, they may concentrate too much heat, which could damage the battery. They are rated at about 60 W. A third method that is being installed on some new vehicles is a built-in trickle charger. This is not universally well thought of, as it may boil the battery dry if it is not thermostatically controlled and the temperature rises.

The storage battery should be housed in a box insulated with material that will withstand the vibration of the equipment. The box should have some means of heating the battery and should be equipped with battery lifting handles. It is recommended that the

battery box be located within the cab, preferably under the right seat, to reduce exposure to wind chill and to avoid interference with controls. It should not, however, be exposed to excessive heat routinely, since the plates in a battery with heavy electrolyte (greater than 1.285) will deteriorate at temperatures above 38°C.

The liquid level in the cells should be checked frequently, and depending on the specific gravity of the existing fluid, either acid or cold water added. If water is added and the machine is to be left outside, the battery should be charged either by using a charger or by running the engine for about 20 minutes afterward. This will mix in the water and prevent freezing problems. In general, acid should not be added to a battery whose fluid level has become low through use. However, if the existing acid concentration is known to be low enough to run the risk of freezing, acid can be added sparingly and with care to ensure that all cells receive the same amount so that the specific gravity in all cells is the same after the acid is added. This should be done in a warm place. The battery should then be charged fully and a final check made to be sure that the density is uniform in all cells.

A battery condition indicator has been developed to replace the cumbersome hydrometer and thermometer. This instrument was needed because of the difficulty of obtaining accurate readings at -45°C while working in bulky arctic clothing. The device requires the operator simply to push a button and turn a dial to find out how much usable power there is in a battery. It does not, however, seem to be in general use.

Batteries should be stored in a cold place, say, about -15°C, although when fully charged to a specific gravity of 1.280 or greater they can be stored at -1°C indefinitely without deteriorating. Batteries, particularly those conditioned for arctic use, should not be stored in warm places. High sulfuric acid content improves electrical performance at low temperatures and lowers the freezing point but causes rapid deterioration at normal temperatures. In addition, all batteries experience some degree of self-discharge during storage. This can be greatly reduced by storing them at lower temperatures.

Storage

If a piece of equipment is to be left for a long period, it is best to remove the negative terminal, as the parasitic electrical loads in most equipment will eventually drain the battery. Most vehicles normally have a small, continuous discharge on the battery of as much as 20 milliamps due to digital clocks and other electronic devices. In addition, there may be a fault in the vehicle's electrical system that can discharge the battery even when all the accessories

are turned off. This is especially likely in extremely cold areas, where wire insulation may become brittle in the cold and crack or break away.

Batteries should be kept clean and dry, as they will slowly discharge through the film composed of dirt and small amounts of acid that tends to accumulate on the surface. The battery can be cleaned using a solution of baking soda followed by rinsing with clean water. This will also prevent corrosion of the posts. Anti-corrosion rings also reduce this problem. These felt rings, impregnated with a compound that neutralizes the acid, fit over the positive terminal beneath the connector.

*Low-temperature  
recommendations*

Use good-quality heavy-duty batteries with at least a two-year warranty period and a CCA rating that is 60–100% higher than the temperate requirement. In general the higher the cranking amps, the greater the warranty period. Deep-cycle batteries are best, as these are designed for the heavy power drain commonly experienced in low-temperature operations. Normally a 425–500 CCA battery is required in light vehicles. For low-temperature operation an 875 CCA battery is recommended. Low battery power can not only result in poor cranking performance but can also burn out the starter motor. A more powerful battery will therefore result in longer starter motor life. A new vehicle will not require as heavy a battery as an older one. It is a good idea to get the largest battery that will fit into the vehicle. Beware of a small battery with a high cranking amp rating as this implies thin plates and therefore low reserve capacity.

If standard supplied batteries are used, when fluid replacement is necessary, use acid as described earlier. The specific gravity of standard electrolyte is 1.250; a specific gravity of 1.280 or higher is recommended in cold regions, and 1.300 is commonly used. Maintenance-free batteries come from the factory with acid whose specific gravity cannot usually be changed and will probably be relatively light unless otherwise specified.

An obvious method of increasing battery power is to use additional batteries. Light vehicles should be equipped with two batteries, or a larger battery than that specified by the equipment manufacturer should be used. It is best to have an extra battery in heavy equipment. These may be installed on a vehicle in such a way that they may be used during starting if necessary, charged during operation, and not used again until difficult starting is again experienced. Slave starting—using additional batteries not installed on the vehicle—can be considered an indirect method of equipping a vehicle with additional battery power. Even though additional

batteries enable more cranking, an engine should not be cranked for longer than 30 s, and the starter should be allowed ample time to cool between starting attempts. If the engine does not start in a few attempts, other measures should be taken to improve the chances of starting.

The demands for current and voltage are most severe when the battery is capable of delivering the least power. Current delivered at  $-10^{\circ}\text{C}$  may be only 50% of that which would be produced at normal temperatures, while the amount delivered at  $-35^{\circ}\text{C}$  may be only a little over 10% of that which would be produced at room temperature (Fig. 7). At  $-40^{\circ}\text{C}$  and below, the available current is practically zero. A fully charged battery will not freeze in extremely cold climates, but a battery with specific gravity of 1.100 will freeze at about  $-10^{\circ}\text{C}$ . Figure 5 shows freezing points of electrolyte at all commonly used specific gravities. Unless the storage battery is warmed to about  $2^{\circ}\text{C}$ , it will not receive an adequate charge from the generator. In constant cold weather, storage batteries should be tested for state of charge every three days and recharged if necessary. Testing procedures for determining the state of charge and battery condition are given in Appendix A.

Generator regulator voltage should be adjusted for subzero operations as shown in Table 1. These settings are for  $-40^{\circ}\text{C}$  and are satisfactory for temperatures as low as  $-55^{\circ}\text{C}$ . No adjustments are required on regulators having automatic voltage variation.

**Table 1. Generator regulator voltages for subzero operations.**

	<i>Minimum (V)</i>	<i>Maximum (V)</i>
<i>12-V system</i>		
Open circuit	14.3	15.3
Closed circuit	14.2	15.0
<i>6-V system</i>		
Open or closed circuit	7.3	7.8

The overall construction of large-capacity nickel-cadmium (NiCd) batteries is much the same as that of the lead-acid types, with the positive and negative plates interleaved in each cell similar to those shown in Figure 1. The positive electrode contains nickel oxide [NiO(OH)], the negative electrode is cadmium (Cd), and the electrolyte is potassium hydroxide (KOH). The nominal cell voltage is about 1.2, so that 10 cells are required in a 12-V battery.

There are two types of plates commonly used, however, and both differ from their lead-acid counterparts. A *pocket plate* is made by

### **Nickel-cadmium batteries**



a. Cross section of a single channel containing active material enclosed in a nickel-plated steel envelope.



10. Pocket plate construction.

b. Several such channels connected to form a section of the plate constituting the electrode.

containing the active material in perforated, nickel-plated steel channels or pockets. A number of these channels are then assembled to form the plate. A schematic cross-section of this arrangement is shown in Figure 10. Both positive and negative plates are fabricated in this way.

A *sintered plate* is made by distributing the active materials throughout a plate cut from a mass of porous sintered nickel. Again the same technique is used for both positive and negative electrodes. Sintered plate batteries are more expensive to produce, but they have a higher power density and lower internal resistance than pocket plate types.

The overall reaction on discharge of a NiCd cell is:

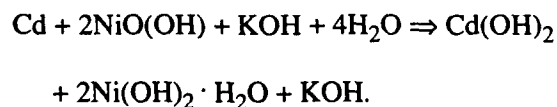

The KOH takes no part in the reaction. Thus, unlike lead-acid batteries, neither freezing temperatures nor internal resistance in NiCd batteries are affected by the state of charge. NiCd batteries do not suffer from the same problems as lead-acid batteries with regard to freezing because the electrolyte does not get diluted on discharge. The freezing temperature remains at  $-83^\circ\text{C}$  independent of the state of the battery. A fully charged lead-acid battery may freeze at  $-68^\circ\text{C}$ , but when discharged it freezes at  $9^\circ\text{C}$ . At  $-40^\circ\text{C}$  a lead-acid battery is essentially dead, while a NiCd battery can still deliver 25–30% of its rated capacity, thereby significantly decreasing the requirement for battery heating. At  $-40^\circ\text{C}$  NiCd batteries can accept a charge as readily as lead-acid batteries at  $-18^\circ\text{C}$ , and they are not damaged by overcharging.

NiCd batteries have several other advantages over lead-acid ones as well, and they are significantly more effective at low temperatures:



- They are not damaged by overcharging or undercharging, although some gas formation and water loss may occur during the former.
- They are not likely to freeze but are not damaged by freezing; a frozen battery returns to normal operation when it is thawed.
- Their discharge voltage is almost constant and self-discharge is minimal, especially at low temperatures.
- The need for battery oversizing is decreased due to the improved performance at low temperatures.
- The life expectancy of a NiCd battery in service is about three times that of a lead-acid battery (and the price is about three to four times higher).

The most prominent problems with NiCd batteries are the facilities and increased precautions required for battery recharging. A prominent drawback of NiCd batteries is cost, which is many times more than that of lead-acid batteries, but the improved performance and increased life expectancy may make their use economically feasible. A minor disadvantage of the constant electrolyte concentration is that there is no simple way to determine the state of charge. NiCd and lead-acid batteries can never be charged together, as the gases produced by these chemically dissimilar systems can combine to form toxic vapors.

#### *Disadvantages*

The float charge voltage for 12-V NiCd batteries should be about 14 V. High-rate charging should be at about 16 V. While overcharging will not cause permanent cell damage, it will cause some gassing, with associated water loss. It is therefore a good idea to check the fluid level frequently and top up when necessary with distilled or deionized water. It should not be necessary to add electrolyte. However, should this become necessary for any reason, only potassium hydroxide (KOH) should be used. Sulfuric acid must *never* be added to a NiCd battery, as the violent chemical reaction between these two compounds will destroy the battery and will likely damage the equipment and seriously injure nearby personnel.

#### *Charging*

Pocket plate batteries do not develop a charging memory. However, sintered plate batteries do, and for maximum effectiveness when charging these batteries, one must destroy this charging memory. For example, if a battery is continually called upon to deliver an average of only 25% of its capacity before it is recharged, it will eventually "memorize" this fact and become incapable of supplying the remaining 75%. Operators must discharge the bat-

teries to their lowest operating levels, then recharge them fully, then discharge them again to their lowest operating levels, then once again recharge them fully to destroy the "memory." Sintered plate batteries should be cycled in this way once per year in any case to prolong their lives. They should never be left in a discharged condition.

**Storage** Manufacturers' recommendations should be followed if possible. However, in general, pocket plate batteries can be shipped sealed and dry, with electrolyte in a separate container. In this condition they can be stored indefinitely. A fully charged battery may be stored up to a year, but if a battery in service is to be stored for longer than this, it should be fully discharged, drained and sealed. When it is returned to service, the instructions for the initial filling should be followed.

**Conclusions** There is no hard and fast rule for choosing a suitable battery for automotive equipment in extremely cold regions. In most cases, trade-offs must be made between initial cost, reliability and battery life. The provision of reliable battery power at low temperatures will cost more than it would in temperate regions for a similar application due to the need for larger or extra batteries for the same power output. NiCd batteries may be the best choice if their much higher cost is not prohibitive and if the battery's physical size is not critical, since these batteries are somewhat exotic and are not available in a wide selection of dimensions. Moreover, in a remote location, since fewer replacement batteries would be needed, shipping and disposal costs would be much reduced. On the other hand, lead-acid batteries with high specific gravity electrolyte are considerably less costly, are familiar to maintenance personnel and operators, and can be used at very low temperatures with modest heat input, especially if they are well insulated. Furthermore, if both lead-acid and NiCd batteries are used, provision must be made for separate charging and storage of the two types of batteries and their electrolytes to prevent dangerous accidents.

Many other types of electrical storage systems are in experimental or developmental stages. On the whole they are prohibitively expensive and unsuitable for automotive applications. However, it seems likely that active research in this area will result in improved solutions to the problems of energy storage and retrieval at low temperatures.

- Machine Design** (1971) Designing for 65° below, Parts I & II. January 7 and 21. **References**
- Battery Council International** (1987) *Storage Battery Technical Service Manual*. Battery Council International, 111 East Wacker Drive, Chicago, Illinois.
- Dean, J. A.** (Ed.) (1973) *Lange's Handbook of Chemistry*, Eleventh Edition. New York: McGraw-Hill Book Company.
- Detroit Diesel** (1989) Cold weather operation of Detroit diesel engines. Engineering Bulletin No. 38, Engineering Technical Data Dept., Revision No. 5.
- Gaines, R.** (1989) Things my mother never told me about batteries. *Equipment Today*, September, p. 33-34.
- Gardner, W. J.** (1985) Operating tips boost arctic diesel efficiency. *Oil & Gas Journal*, OGJ Report, June 24.
- Newton, W. S. and C. G. Makrides** (1954) Effect of climate and environment on ground support equipment. Report prepared by Corvey Engineering Co. for Wright Air Development Center, Air Research and Development Command, USAF. Wright-Patterson Air Force Base, Ohio. Technical Report 54-132.
- Stupich, T. F.** (1987) Cold regions operation of diesel vehicles with special consideration for the M113A1 armoured personnel carrier. Defence Research Establishment Suffield, Ralston, Alberta, Suffield Report No. 408.
- U.S. Army** (1989) *Operation and Maintenance of Ordnance Materiel in Cold Weather (0°F to -65°F)*, 1989. Departments of the Army and the Air Force, Washington, D.C.
- U.S. Navy** (1955) *Arctic Engineering*. Technical Publication Navdocks TP-PW-11.
- Union Carbide** (1985) *Eveready Battery Engineering Data*, Volumes I-IV. Union Carbide Corporation.
- Vincent, C. A.** (1984) *Modern Batteries—An Introduction to Electrochemical Power Sources*. Baltimore, Maryland: Edward Arnold.

**Appendix A.**  
**Lead-acid battery**  
**maintenance**  
**and testing**  
(After Battery Council  
International 1987)

Since loss of battery power for one reason or another is such a common problem in cold regions, this section is included as an aid to routine maintenance and diagnosis of battery-related problems. The procedures described below are not strictly cold-related but rather are standard methods for use in lead-acid batteries at all temperatures.

The testing procedures call for testing the battery's condition and its state of charge. The state of charge reflects the ability of the battery to store additional power. A battery showing a 100% state of charge cannot be charged any further, and attempts to do so will result in gassing and associated water loss. The battery condition is its ability to deliver useful power at its design load. A battery in poor condition (for example, heavily sulfated or damaged internally through loss of active material) can be fully charged to 12.4 V or more but will not be able to deliver its rated power.

The load test is used to determine the battery condition. To do this, a load of half the battery's CCA is applied to the fully charged battery for 15 s. If the voltage at the end of this time is below the minimum acceptable level, the battery is clearly unable to store sufficient power for its intended use. An adjustable load test is preferable to a fixed load test because the load level can be set accurately to the level desired. A fixed load tester can only be set to a range of loads, so that a battery whose 0.5 CCA level is at the upper end of the range may appear to be in good condition when it is not, while one in the lower end of the range may fail the test when it is still in acceptable condition.

The cause of an apparent loss of battery power may not be directly related to the battery itself. By checking the state of charge and battery condition, the source of the problem may be more easily identified. For example, if the battery can be shown to be in good condition, then the problem may be due to a faulty alternator, poor connections or the use of a battery too small for the application.

*Sealed batteries*

Figure 11 shows the steps in testing a sealed battery. The first step is to check for obvious damage such as damaged terminals, cracked case and so forth. Discard the battery if such damage is found.

If the battery appears to be undamaged, check the electrolyte level. Sealed batteries are designed to minimize water loss but cannot prevent it entirely. Many are designed such that it is not possible to add water. These should be discarded when the electrolyte level falls below the tops of the plates in any cell. Since it is not possible to open the sealed cover on these types of batteries to check the level or measure the specific gravity of the electrolyte, check the

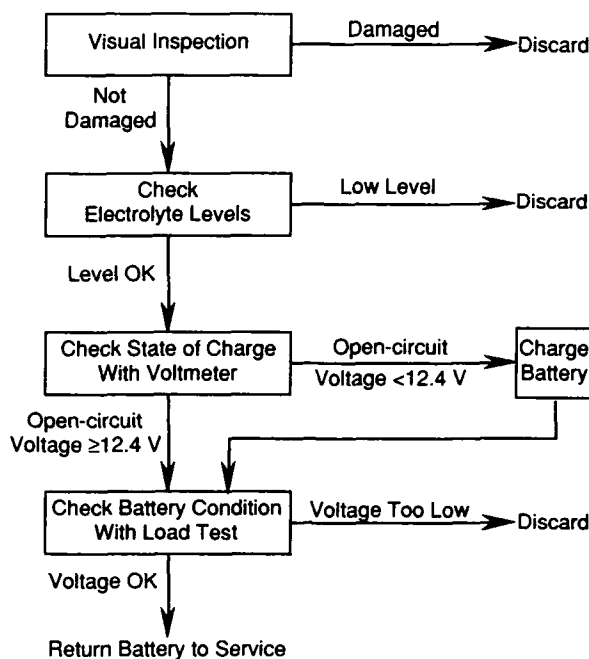

11. Test procedure for sealed batteries.

level either by observing it through the translucent plastic case or by using the built-in hydrometer, which also serves as the level indicator.

If the electrolyte level is acceptable, the state of charge in sealed batteries should be determined with an accurate voltmeter. The voltmeter should be calibrated frequently. The percentage of charge reflected by open-circuit voltage is given in Table 2. If the stabilized open-circuit voltage is 12.4 V or greater, perform the load test described below. If it is below 12.4 V, charge the battery. Never overcharge a sealed battery, as this will result in water loss. A stabilized voltage reading is assured after the battery has remained on open circuit for a minimum of 4 hours, or preferably overnight. (If a hydrometer reading can be taken, it should give a specific

**Table 2. Open-circuit voltage and state of charge (16°C).**

Open-circuit volts	State of charge (%)
12.6 or greater	100
12.4–12.6	75–100
12.2–12.4	50–75
12.0–12.2	25–50
11.7–12.0	0–25
11.7 or less	0

Table 3. Voltage chart for load test.

Electrolyte temperature		Minimum required voltage*
(°C)	(°F)	
≥21°	≥70°	9.6
16°	60°	9.5
10°	50°	9.4
4°	40°	9.3
-1°	30°	9.1
-7°	20°	8.9
-12°	10°	8.7
-18°	0°	8.5

\*Use half of these values for 6-V batteries.

gravity indicating at least a 75% charge of the electrolyte as supplied by the manufacturer. If the battery has a built-in hydrometer, follow the manufacturer's instructions.) If the state of charge cannot be determined, the battery must be charged. After charging, remove the surface charge by attaching load test leads to the terminals and applying a load equal to half of the battery's CCA rating for 15 s, or follow the manufacturer's recommendations if available.

The final step is to do a load test of battery condition. This procedure is only valid if the battery is fully or nearly fully charged. Connect the voltmeter and load test leads to the battery terminals, making sure that the load switch is in the "Off" position. Apply a load test equal to half of the battery's CCA rating. Read the voltage after 15 s with the load connected. Remove the load. Estimate or measure the battery temperature and compare the voltage reading with the voltage chart given in Table 3. If the voltage is less than the minimum specified, replace the battery. If the voltage meets or exceeds the voltage specified, return it to service.

### *Conventional batteries*

Figure 12 shows the steps in testing conventional batteries. As with sealed batteries, the first step is to check for obvious damage. Discard the battery if it is damaged.

Check the electrolyte level in conventional batteries by removing the caps and determining whether the level is above the plates in all cells. If necessary, fill all cells with distilled water to just above the tops of the separators and charge for 15 minutes at 15–25 amps to mix the water with the electrolyte.

There are two possible ways to complete the series of tests for conventional batteries. The type of equipment available should be considered before choosing the tests to be run. Whenever possible, an adjustable load tester and a hydrometer that reads in units of

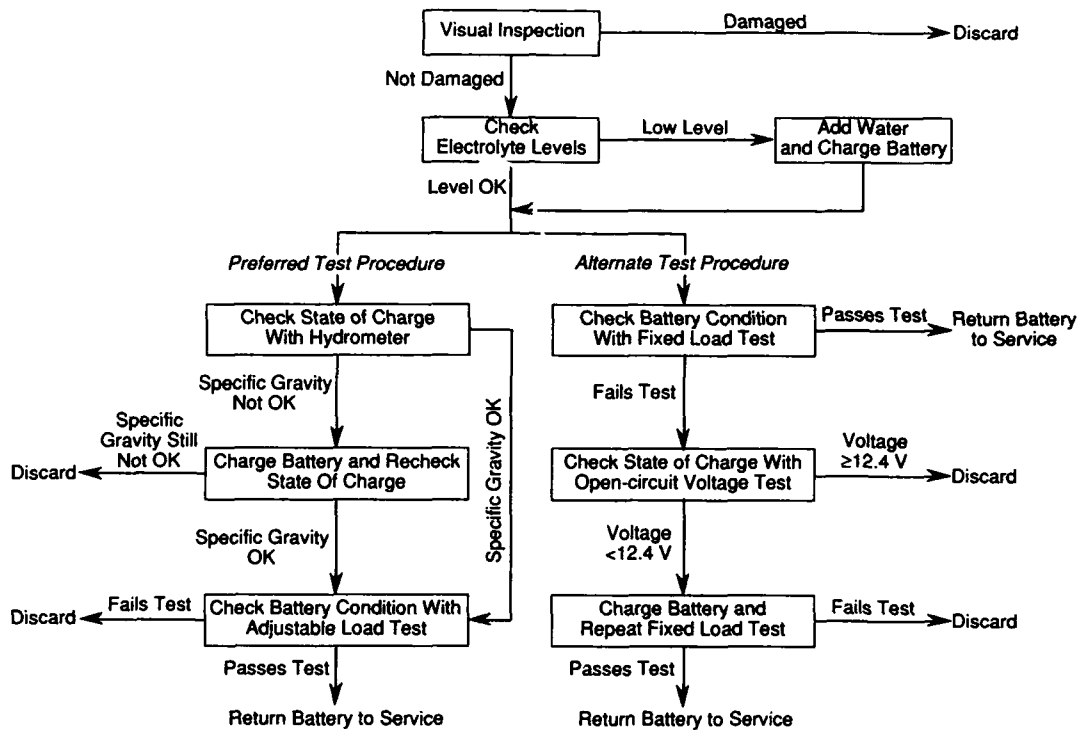

12. Test procedure for conventional batteries.

specific gravity are preferable to a fixed load tester and an open circuit voltmeter or a hydrometer that only gives an indication of the state of charge. There are also testers available that use battery resistance (or conductance) to indicate battery condition. These testers do not put a discharge load on the battery and may not discriminate all battery failure modes unless used with some means of loading the battery, such as the vehicle's starter. However, they do have the advantage of not discharging the battery appreciably, and they can be used repeatedly without recharging the battery, such as in testing the batteries on the shelf.

If the physical condition of the battery is acceptable after visual inspection, and the electrolyte is satisfactory, perform one of the following series of tests.

Use a hydrometer to check the state of charge. A hydrometer is a bulb-type glass syringe used to extract electrolyte from the cell. A glass float inside the hydrometer barrel is calibrated to read in units of specific gravity. A common range of specific gravity used on these floats is 1.160–1.325. Enough electrolyte should be drawn into the syringe so that the float lifts off the bottom of the barrel. When a reading is taken, the hydrometer is held vertically so that the

Preferred test procedure

13. Typical hydrometer.  
 Enlarged section  
 shows correct level for  
 taking a reading.  
 (After Battery Council  
 International 1987.)

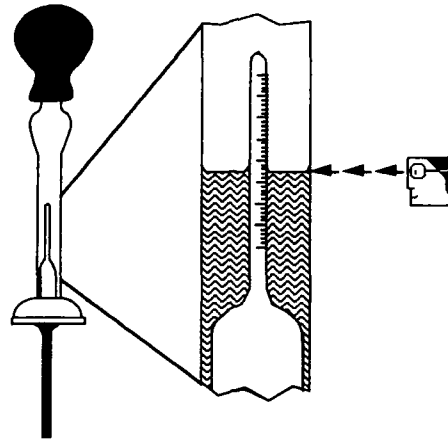

float does not touch either the sides, the bottom or the top of the barrel and the level of the electrolyte should be at eye level (Fig. 13). Disregard the curvature of the fluid against the float stem and the sides of the barrel due to surface tension. The lower the float sinks in the electrolyte, the lower the specific gravity. Measure and record the specific gravity, corrected to 60°F (15°C) of the electrolyte in each cell. The nomogram given in Figure 8 may be used. If the range (highest–lowest) is 50 points (0.050 sp. gr.) or greater or the lowest indicates less than 75% state of charge (about 1.250 in a battery with 1.300 electrolyte when fully charged), charge the battery until all cells show at least a 75% charge and the range is less than 50 points. When the specific gravity reaches a satisfactory level and range, run an adjustable load test as described below. If no amount of charging will accomplish this, discard the battery.

The adjustable load test measures the battery's condition. When available, the instrument manufacturer's instructions should be followed; otherwise the following may be used as guidelines.

1. Disconnect the battery cables starting with the ground cable.
2. Measure the temperature of a center cell. If the instrument has an integral temperature compensator, use the attached probe. Cover the battery with a wet cloth.
3. Connect the voltmeter and load test leads to the appropriate battery terminals. Make sure the terminals are free of corrosion.
4. Connect the current transducer (if necessary) to the appropriate lead.
5. Apply a test load equivalent to half of the battery's CCA rating for 15 s.



6. Read the voltage at 15 s; then remove the load.
7. Determine the minimum voltage required at the electrolyte test temperature from Table 3.
8. If the test voltage is above the minimum, return the battery to service; otherwise replace the battery.

If a hydrometer and variable load tester are not available, there is an alternate procedure, which begins with fixed load test of battery condition. Instead of a variable load, these testers measure the battery voltage under a heavy fixed load. The tester should include a selector switch or meter scale to choose among a variety of battery sizes. It should include some means of correcting for the battery temperature, either an automatic sensing circuit or a manually adjustable one.

Alternate procedure

When available, the instrument manufacturer's instructions should be followed; otherwise the following may be used as guidelines.

1. Disconnect the battery cables, starting with the ground cable.
2. Measure the temperature of a center cell and set the temperature dial on the tester or insert the automatic temperature corrector probe in the center cell. Cover the battery with a wet cloth.
3. Set the battery size selector to a range (or select a range on the meter) that will include half of the battery's CCA rating or three times the 20 amp-hour capacity of the battery.
4. Connect the voltmeter and load test leads to the appropriate battery terminals. Make sure the terminals are free of corrosion.
5. Apply the test load for 15 s.
6. Read the battery performance from the instrument meter at 15 s; then remove the load.

If the battery passed the load test, return it to service. Otherwise perform the open-circuit voltage test, which indicates the state of charge. Allow at least 10 minutes after the load test for the voltage to stabilize; then measure the open-circuit voltage. Determine the approximate state of charge from Table 2. If the state of charge is 75% or greater and the battery failed the load test, it should be replaced. If the state of charge is less than 75%, the battery should be charged and the load test repeated. If the battery passes the load test, it may be returned to service; otherwise replace it.