

2

NAVAL POSTGRADUATE SCHOOL Monterey, California

AD-A238 001



DTIC
S
JUL 11 1991
c
D

THESIS

A CIRCUIT MODEL FOR AN
INDUCTIVE STRIP
IN HOMOGENEOUS FINLINE

by

Michael L. Morua

June 1990

Thesis Advisor

Jeffrey B. Knorr

Approved for public release; distribution is unlimited.

51

91-04477



Unclassified

Security classification of this page

REPORT DOCUMENTATION PAGE

1a Report Security Classification Unclassified		1b Restrictive Markings	
2a Security Classification Authority		3 Distribution Availability of Report	
2b Declassification Downgrading Schedule		Approved for public release; distribution is unlimited.	
4 Performing Organization Report Number(s)		5 Monitoring Organization Report Number(s)	
6a Name of Performing Organization Naval Postgraduate School	6b Office Symbol (if applicable) 33	7a Name of Monitoring Organization Naval Postgraduate School	
6c Address (city, state, and ZIP code) Monterey, CA 93943-5000		7b Address (city, state, and ZIP code) Monterey, CA 93943-5000	
8a Name of Funding Sponsoring Organization	8b Office Symbol (if applicable)	9 Procurement Instrument Identification Number	
8c Address (city, state, and ZIP code)		10 Source of Funding Numbers	
		Program Element No	Project No
		Task No	Work Unit Accession No

11 Title (include security classification) **A CIRCUIT MODEL FOR AN INDUCTIVE STRIP IN HOMOGENEOUS FINLINE**

12 Personal Author(s) **Michael L. Morua**

13a Type of Report Master's Thesis	13b Time Covered From To	14 Date of Report (year, month, day) June 1990	15 Page Count 112
---------------------------------------	-----------------------------	---	----------------------

16 Supplementary Notation **The views expressed in this thesis are those of the author and do not reflect the official policy or position of the Department of Defense or the U.S. Government.**

17 Cross Codes			18 Subject Terms (continue on reverse if necessary and identify by block number) Finline, Discontinuity, Inductive, Strip.
Field	Group	Subgroup	

19 Abstract (continue on reverse if necessary and identify by block number)
This thesis describes a CAD-compatible circuit model for an infinitesimally thin inductive strip centered in homogeneous finline for $0.1 \leq \frac{h}{b} \leq 1.0$. The model is shown to predict scattering data which agrees with data computed using the spectral domain method. Results were generated for strips of length $T \geq 10$ mils in X-band. By applying the scaling principle, the model is valid for any waveguide band over the normal frequency range for the dominant TE_{10} mode.

20 Distribution Availability of Abstract <input checked="" type="checkbox"/> unclassified unlimited <input type="checkbox"/> same as report <input type="checkbox"/> DTIC users		21 Abstract Security Classification Unclassified	
22a Name of Responsible Individual Jeffrey B. Knorr		22b Telephone (include Area code) (408) 646-2815 2082	22c Office Symbol EC Ko

Approved for public release; distribution is unlimited.

A Circuit Model for an
Inductive Strip
in Homogeneous Finline

by

Michael L. Morua
Lieutenant, United States Navy
B.S., University of California, Berkeley 1982

Submitted in partial fulfillment of the
requirements for the degree of

MASTER OF SCIENCE IN ELECTRICAL ENGINEERING

from the

NAVAL POSTGRADUATE SCHOOL
June 1990

Author:

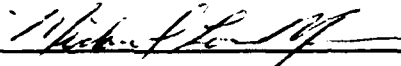

Michael L. Morua

Approved by:

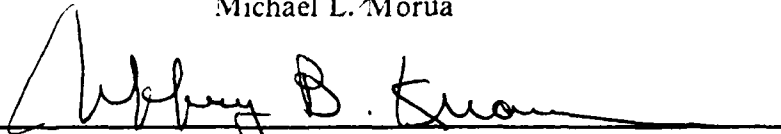

Jeffrey B. Knorr, Thesis Advisor

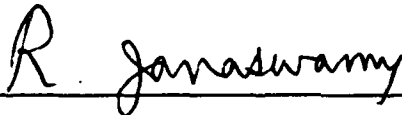

R. Janaswamy, Second Reader



John P. Powers, Chairman,
Department of Electrical and Computer Engineering

ABSTRACT

This thesis describes a CAD-compatible circuit model for an infinitesimally thin inductive strip centered in homogeneous finline for $0.1 \leq \frac{w}{b} \leq 1.0$. The model is shown to predict scattering data which agrees with data computed using the spectral domain method. Results were generated for strips of length $T \geq 10$ mils in X-band. By applying the scaling principle, the model is valid for any waveguide band over the normal frequency range for the dominant TE_{10} mode.

Accession For	
DTIC GR&I	<input checked="" type="checkbox"/>
DTIC TAB	<input type="checkbox"/>
Unannounced	<input type="checkbox"/>
Justification	
By	
Distribution/	
Availability Codes	
Dist	Avail and/or
	Special
A-1	



TABLE OF CONTENTS

I. INTRODUCTION	1
A. BACKGROUND	1
B. OBJECTIVE	1
C. RELATED WORK	2
II. A MODEL FOR HOMOGENEOUS FINLINE	4
A. CONCEPT	4
B. DETERMINING A_{eq} AND B_{eq}	4
C. ANALYTICAL EXPRESSIONS FOR A_{eq} AND B_{eq}	6
III. SCATTERING DATA FOR AN INDUCTIVE STRIP IN FINLINE	14
A. CONCEPT	14
B. SPECTRAL DOMAIN PROGRAM	14
C. MODIFICATION TO PROGRAM	15
IV. A MODEL FOR AN INDUCTIVE STRIP IN HOMOGENEOUS FINLINE	22
A. CONCEPT	22
B. CIRCUIT MODEL	25
C. RESULTS	28
V. SCALING TO OTHER WAVEGUIDE BANDS	32
A. CONCEPT	32
B. IMPLEMENTATION AND RESULTS	34
VI. SUMMARY	35
A. CONCLUSIONS	35
B. RECOMMENDATIONS	35
APPENDIX A. COMPUTER-GENERATED FINLINE DATA FOR WR(28) AND WR(90)	37

APPENDIX B. INDUCTIVE STRIP IN FINLINE MODEL	46
APPENDIX C. COMPUTER-GENERATED SCATTERING DATA FOR INDUCTIVE STRIPS	48
APPENDIX D. INDUCTANCE, CAPACITANCE, AND ERROR FOR INDUCTIVE STRIPS	70
APPENDIX E. FINLINE FILTER MODEL	81
APPENDIX F. COMPUTER-GENERATED SCATTERING DATA FOR SCALED MODEL	85
APPENDIX G. MAGNITUDE, PHASE, SMITH CHART PLOT OF SCALED MODEL AND DATA	91
APPENDIX H. ERROR FOR SCALED MODEL	97
LIST OF REFERENCES	98
INITIAL DISTRIBUTION LIST	99

LIST OF TABLES

Table 1.	Aeq AND Beq FOR WR(28), W/B = 0.01, 0.02, 0.03	37
Table 2.	Aeq AND Beq FOR WR(28), W/B = 0.04, 0.05, 0.06, 0.07	38
Table 3.	Aeq AND Beq FOR WR(28), W/B = 0.08, 0.09, 0.1, 0.2	39
Table 4.	Aeq AND Beq FOR WR(28), W/B = 0.3, 0.4, 0.5, 0.6	40
Table 5.	Aeq AND Beq FOR WR(28), W/B = 0.7, 0.8, 0.9, 1.0	41
Table 6.	Aeq AND Beq FOR WR(90), W/B = 0.01, 0.02, 0.03, 0.04	42
Table 7.	Aeq AND Beq FOR WR(90), W/B = 0.05, 0.06, 0.07, 0.08, 0.09	43
Table 8.	Aeq AND Beq FOR WR(90), W/B = 0.1, 0.2, 0.3, 0.4, 0.5	44
Table 9.	Aeq AND Beq FOR WR(90), W/B = 0.6, 0.7, 0.8, 0.9, 1.0	45
Table 10.	SCATTERING DATA FOR W/B= 1.0, T= 10, 20, 30, 40, 50, 60 MILS	48
Table 11.	SCATTERING DATA FOR W/B= 1.0, T= 70, 80, 90, 100, 200, 300, 400, 500 MILS	49
Table 12.	SCATTERING DATA FOR W/B= 0.9, T= 10, 40, 80 MILS	50
Table 13.	SCATTERING DATA FOR W/B= 0.9, T= 100, 200, 300, 400, 500 MILS	51
Table 14.	SCATTERING DATA FOR W/B= 0.8, T= 10, 20, 30, 40, 50, 60 MILS	52
Table 15.	SCATTERING DATA FOR W/B= 0.8, T= 70, 80, 90, 100, 200, 300, 400, 500 MILS	53
Table 16.	SCATTERING DATA FOR W/B= 0.7, T= 10, 40, 80 MILS	54
Table 17.	SCATTERING DATA FOR W/B= 0.7, T= 100, 200, 300, 400, 500 MILS	55
Table 18.	SCATTERING DATA FOR W/B= 0.6, T= 10, 40, 80 MILS	56
Table 19.	SCATTERING DATA FOR W/B= 0.6, T= 100, 200, 300, 400, 500 MILS	57
Table 20.	SCATTERING DATA FOR W/B= 0.5, T= 10, 20, 30, 40, 50, 60 MILS	58
Table 21.	SCATTERING DATA FOR W/B= 0.5, T= 70, 80, 90, 100, 200, 300, 400, 500 MILS	59
Table 22.	SCATTERING DATA FOR W/B= 0.4, T= 10, 40, 80 MILS	60
Table 23.	SCATTERING DATA FOR W/B= 0.4, T= 100, 200, 300, 400, 500 MILS	61
Table 24.	SCATTERING DATA FOR W/B= 0.3, T= 10, 40, 80 MILS	62

Table 25. SCATTERING DATA FOR $W/B = 0.3$, $T = 100, 200, 300, 400, 500$ MILS	63
Table 26. SCATTERING DATA FOR $W/B = 0.25$, $T = 10, 20, 30, 40, 50, 60$ MILS	64
Table 27. SCATTERING DATA FOR $W/B = 0.25$, $T = 70, 80, 90, 100, 200, 300,$ 400, 500 MILS	65
Table 28. SCATTERING DATA FOR $W/B = 0.2$, $T = 10, 20, 30, 40, 50, 60$ MILS	66
Table 29. SCATTERING DATA FOR $W/B = 0.2$, $T = 70, 80, 90, 100, 200, 300,$ 400, 500 MILS	67
Table 30. SCATTERING DATA FOR $W/B = 0.1$, $T = 10, 20, 30, 40, 50, 60$ MILS	68
Table 31. SCATTERING DATA FOR $W/B = 0.1$, $T = 70, 80, 90, 100, 200, 300,$ 400, 500 MILS	69
Table 32. INDUCTANCE, CAPACITANCE, AND ERROR FOR $W/B = 1.0$, $T = 10$ TO 500 MILS	70
Table 33. INDUCTANCE, CAPACITANCE, AND ERROR FOR $W/B = 0.9$, $T = 10$ TO 500 MILS	71
Table 34. INDUCTANCE, CAPACITANCE, AND ERROR FOR $W/B = 0.8$, $T = 10$ TO 500 MILS	72
Table 35. INDUCTANCE, CAPACITANCE, AND ERROR FOR $W/B = 0.7$, $T = 10$ TO 500 MILS	73
Table 36. INDUCTANCE, CAPACITANCE, AND ERROR FOR $W/B = 0.6$, $T = 10$ TO 500 MILS	74
Table 37. INDUCTANCE, CAPACITANCE, AND ERROR FOR $W/B = 0.5$, $T = 10$ TO 500 MILS	75
Table 38. INDUCTANCE, CAPACITANCE, AND ERROR FOR $W/B = 0.4$, $T = 10$ TO 500 MILS	76
Table 39. INDUCTANCE, CAPACITANCE, AND ERROR FOR $W/B = 0.3$, $T = 10$ TO 500 MILS	77
Table 40. INDUCTANCE, CAPACITANCE, AND ERROR FOR $W/B = 0.25$, $T = 10$ TO 500 MILS	78
Table 41. INDUCTANCE, CAPACITANCE, AND ERROR FOR $W/B = 0.2$, $T = 10$ TO 500 MILS	79
Table 42. INDUCTANCE, CAPACITANCE, AND ERROR FOR $W/B = 0.1$, $T = 10$ TO 500 MILS	80
Table 43. SCATTERING DATA FOR $WR(42)$, $W/B = 0.5$, $T = 40$ MILS	85
Table 44. SCATTERING DATA FOR $WR(28)$, $W/B = 1.0$, $T = 15$ MILS	86

Table 45. SCATTERING DATA FOR WR(19), W/B = 0.25, T = 20 MILS	87
Table 46. SCATTERING DATA FOR WR(12), W/B = 0.5, T = 3 MILS	88
Table 47. SCATTERING DATA FOR WR(8), W/B = 1.0, T = 30 MILS	89
Table 48. SCATTERING DATA FOR WR(5), W/B = 0.25, T = 2 MILS	90
Table 49. ERROR FOR WR(42), WR(28), WR(19), WR(12), WR(8), WR(5)	97

LIST OF FIGURES

Figure 1.	Cross-sectional view of a finline.	3
Figure 2.	Cut away view of an inductive strip in a finline cavity.	3
Figure 3.	Homogeneous finline and equivalent rectangular waveguide.	5
Figure 4.	MATLAB program used for elliptical curve fitting.	9
Figure 5.	A_{eq}/A vs. W/B for WR(28).	10
Figure 6.	B_{eq}/B vs. W/B for WR(28).	10
Figure 7.	A_{eq}/A vs. W/B for WR(90).	11
Figure 8.	B_{eq}/B vs. W/B for WR(90).	11
Figure 9.	Error for A_{eq}/A vs. W/B for WR(28).	12
Figure 10.	Error for B_{eq}/B vs. W/B for WR(28).	12
Figure 11.	Error for A_{eq}/A vs. W/B for WR(90).	13
Figure 12.	Error for B_{eq}/B vs. W/B for WR(90).	13
Figure 13.	Convergence of scattering data (magnitude) vs. matrix order.	17
Figure 14.	Convergence of scattering data (phase) vs. matrix order.	18
Figure 15.	Computer system time vs. matrix order and w/b	19
Figure 16.	Search routine from STRIP.	20
Figure 17.	Results from the modified version of STRIP.	21
Figure 18.	Equivalent circuit models.	23
Figure 19.	Equivalent circuit models (cont.).	24
Figure 20.	Inductance vs. Strip Length.	29
Figure 21.	Error vs. Strip Length.	30
Figure 22.	Insertion and Return Loss of Model and Actual Filter.	31
Figure 23.	Inductive Strip in Finline Model TOUCHSTONE Program.	46
Figure 24.	Inductive Strip in Finline Model TOUCHSTONE Program (cont.).	47
Figure 25.	Finline Filter Model TOUCHSTONE Program.	81
Figure 26.	Finline Filter Model TOUCHSTONE Program (cont.).	82
Figure 27.	Finline Filter Model TOUCHSTONE Program (cont.).	83
Figure 28.	Finline Filter Model TOUCHSTONE Program (cont.).	84
Figure 29.	Plots for WR(42), $W/B = 0.5$, $T = 40$ mils.	91
Figure 30.	Plots for WR(28), $W/B = 1.0$, $T = 15$ mils.	92
Figure 31.	Plots for WR(19), $W/B = 0.25$, $T = 20$ mils.	93

Figure 32. Plots for WR(12), $W/B = 0.5$, $T = 3$ mils.	94
Figure 33. Plots for WR(8), $W/B = 1.0$, $T = 30$ mils.	95
Figure 34. Plots for WR(5), $W/B = 0.25$, $T = 2$ mils.	96

ACKNOWLEDGMENTS

I would like to thank my wife, Susan, for her patience and understanding, my parents for the sense of achievement that they have always encouraged in me, and my thesis advisor, Prof. Knorr, for his support and guidance.

I. INTRODUCTION

A. BACKGROUND

Finline, in its most general form, consists of metal fins printed on a dielectric substrate which is mounted along the E-plane of a rectangular waveguide. The advantages of this structure are low-attenuation, single mode operation, containment of spurious emissions, ease of production, and compatibility with integrated circuit technology. In conjunction with the inductive strip, filters and resonators can be constructed. For these reasons, finline has been used extensively for constructing millimeter wave circuits.

The design process for microwave devices has undergone a revolutionary change since the recent development of Computer Assisted Design (CAD) programs. CAD's ability to streamline the design process and improve flexibility has saved time and money. Numerical methods can be used to generate scattering data for an inductive strip in finline, but this process is extremely slow and not suited for CAD applications. Therefore, a simple circuit model, which is compatible with existing general purpose CAD software, is required. Knorr presented such a model for the case of $\frac{w}{b} = 1.0$ in 1988 [Ref. 1]. However, prior to this thesis no such circuit model had been fully developed for the case of $\frac{w}{b} < 1.0$.

For filters, the inductive strip in finline is the basic building block. The geometry of finline and the inductive strip are illustrated in Figs. 1 and 2 on page 3. Figure 1 shows the cross-sectional view of a finline waveguide. Figure 2 shows a 3-dimensional view of an inductive strip of length T centered in a finline cavity. As Fig. 2 illustrates, the inductive strip couples two finline resonant cavities. A filter consists of a number of inductive strips joined by finline. The transfer characteristics are controlled by choosing the number and lengths of the inductive strips, and the lengths of the finline joining them. Therefore, several inductive strip circuit models can be cascaded with finline sections to model the transfer characteristics of a filter. As a result, the filter designer can have the capability of accurately determining the transfer characteristics before the filter is actually built.

B. OBJECTIVE

The objective of this thesis is to describe an equivalent circuit model for an infinitesimally thin inductive strip in homogeneous, lossless finline when $\frac{w}{b} \leq 1.0$. Homogeneous finline has no dielectric in its structure. The model is valid for $WR(90)$,

waveguide where $\frac{b}{a} = \frac{4}{9}$ and the frequency range is 8 to 12 GHz. Using the scaling principle, the model can be modified for use in other waveguide bands. If the scaling principle is violated, such as when $\frac{b}{a} = \frac{1}{2}$, the model can be used with only a slight increase in error. Furthermore, the model produces an error of less than 2.5% and is compatible with *TOUCHSTONE*, a PC-based microwave CAD program developed by *EESOF*.

C. RELATED WORK

Finline was first described by Meier in 1974 [Ref. 2]. This work discussed the advantages of finline as a transmission medium for millimeter wave integrated circuits. Under Knorr, further work on finline was conducted at the Microwave Lab of the Naval Postgraduate School. An analysis of finline using the spectral domain method was completed by Knorr and Shayda in 1980 [Ref. 3,4]. This work resulted in a Fortran program called *IMPED* which calculates the impedance and wavelength in a finline waveguide. In 1984, Kim reformulated the finline field equations to achieve better numerical stability [Ref. 5]. In 1980, Miller began work on the inductive strip in finline by experimentally measuring the scattering coefficients of various strip lengths. In 1984, Knorr and Deal completed an analysis of the inductive strip in finline using the spectral domain method. They validated their results by comparing them to Miller's experimental data [Refs. 6,7]. This work resulted in a Fortran program called *STRIP* which calculates the S_{11} and S_{12} scattering coefficients for an inductive strip in finline. In 1988, Knorr proposed a circuit model for an inductive strip in finline when $\frac{w}{b} = 1.0$ [Ref. 1: pp. 11-15]. Bush and Karaminas continued Knorr's work in order to develop a circuit model for the case when $\frac{w}{b} \leq 1.0$ [Refs. 8,9].

This thesis describes a circuit model based on data generated by *IMPED* and *STRIP* for the case when $\frac{w}{b} \leq 1.0$. The model incorporates ideas from Knorr, Bush, and Karaminas as well as original ideas. The resulting model significantly improves accuracy. Knorr discusses the evolution of this circuit model in Ref. 10.

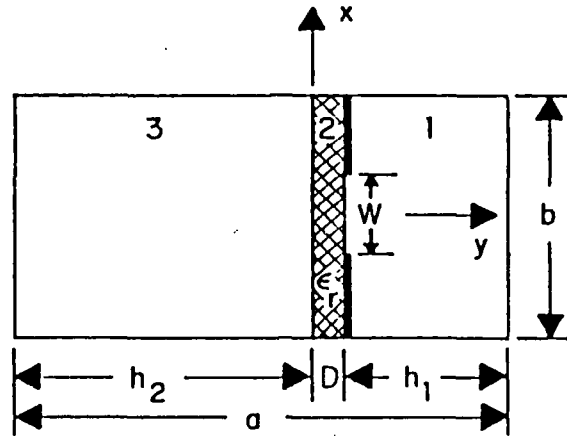

Figure 1. Cross-sectional view of a finline.: [From Ref. 1: p. 22.]

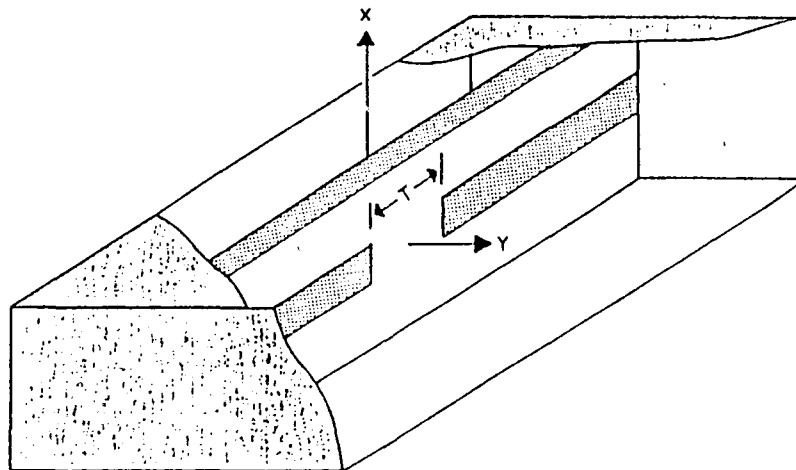

Figure 2. Cut away view of an inductive strip in a finline cavity.: [From Ref. 1: p. 22.] A metal strip of length T spans the space between the fins at the center of the cavity. The dielectric substrate is the shaded region next to the strip. The surrounding non-shaded region is metal.

II. A MODEL FOR HOMOGENEOUS FINLINE

A. CONCEPT

To model an inductive strip in finline, one must first develop a finline model. Bush describes the process of modeling homogeneous finline in Ref. 8: pp. 12-14. With $\epsilon_r = 1$, a finline is just a homogeneous cylindrical waveguide. Thus, the electrical characteristics of homogeneous finline are identical to those of a rectangular waveguide having the same wavelength and impedance. Figure 3 on page 5 compares homogeneous finline to a rectangular waveguide of width a_{eq} and height b_{eq} . Furthermore, a unique value of a_{eq} and b_{eq} exists for each finline value of $\frac{w}{b}$, where $\frac{w}{b}$ is the ratio of the fin gap to finline height.

To calculate a_{eq} and b_{eq} , the finline wavelength and impedance must be calculated numerically. *IMPED* was used for this purpose. It calculates $\frac{\lambda'}{\lambda_o}$ and Z_{ov} for various values of $\frac{w}{b}$, where λ' is the finline wavelength, λ_o is the free-space wavelength, and Z_{ov} is the finline characteristic impedance. Therefore, a finline model can be generated by: (1) using *IMPED* to determine a_{eq} and b_{eq} for various values of $\frac{w}{b}$, and (2) creating an analytical expression which describes a_{eq} and b_{eq} as a function of $\frac{w}{b}$.

B. DETERMINING A_{eq} AND B_{eq}

Equations for a_{eq} and b_{eq} can be derived from the following wavelength and impedance equations for homogeneous finline:

$$\frac{\lambda'}{\lambda_o} = \frac{1}{\sqrt{1 - \left(\frac{\lambda}{\lambda_{cf}}\right)^2}} \quad (1)$$

$$Z_{ov} = \frac{2b_{eq}}{a_{eq}} \eta_o \left(\frac{\lambda'}{\lambda_o}\right) \quad (2)$$

where λ_{cf} is the finline cutoff wavelength and η_o is the intrinsic impedance of free space [Ref. 8, pp. 15-16]. First, a_{eq} and b_{eq} are expressed in terms of the normalized equivalent width $\frac{a_{eq}}{a}$ and the normalized equivalent height $\frac{b_{eq}}{b}$. The normalized equivalent width is derived by relating a_{eq} to the finline cutoff wavelength as follows:

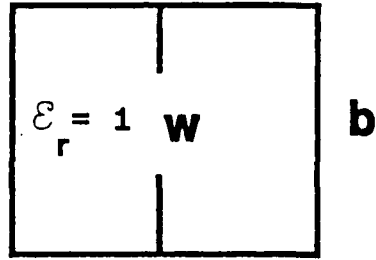

a

a)

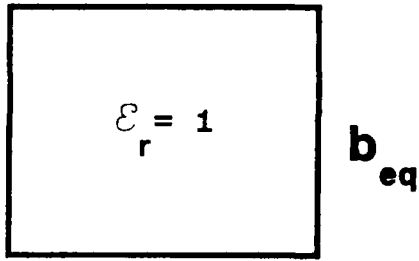

a_{eq}

b)

Figure 3. Homogeneous finline and equivalent rectangular waveguide.: a) homogeneous finline and b) equivalent rectangular waveguide of width a_{eq} and height b_{eq}

$$\frac{a_{eq}}{a} = \frac{2a_{eq}}{2a} = \frac{\lambda_{cf}}{\lambda_{cg}} \quad (3)$$

where λ_{cf} and λ_{cg} are the cutoff wavelengths of the finline and rectangular waveguides, respectively. The finline cutoff wavelength λ_{cf} can be derived from Eq. (1) and is as follows:

$$\lambda_{cf} = \frac{\lambda}{\sqrt{1 - \left(\frac{\lambda_o}{\lambda'}\right)^2}} \quad (4)$$

Combining Eqs. (3) and (4), the result is an expression for the normalized equivalent width:

$$\frac{a_{eq}}{a} = \frac{\lambda}{2a\sqrt{1 - \left(\frac{\lambda_o}{\lambda'}\right)^2}} \quad (5)$$

The normalized equivalent height is derived by rearranging Eq. (2) as follows:

$$b_{eq} = \frac{Z_{ov} a_{eq}}{2\eta_o \left(\frac{\lambda'}{\lambda_o}\right)} \quad (6)$$

Multiplying the right side by $\frac{a}{a}$ and regrouping results in the following:

$$b_{eq} = \frac{Z_{ov}}{\eta_o \left(\frac{\lambda'}{\lambda_o}\right)} \left(\frac{a_{eq} a}{2a}\right) \quad (7)$$

Normalizing b_{eq} to b , the result is an expression for the normalized equivalent height:

$$\frac{b_{eq}}{b} = \frac{Z_{ov}}{\eta_o \left(\frac{\lambda'}{\lambda_o}\right)} \left(\frac{a_{eq}}{a}\right) \left(\frac{a}{2b}\right) \quad (8)$$

IMPED was originally programmed to calculate only $\frac{\lambda'}{\lambda_o}$ and Z_{ov} . However, it has been reprogrammed to calculate $\frac{a_{eq}}{a}$ and $\frac{b_{eq}}{b}$ directly, permitting quick and accurate calculations of the data. *IMPED* was used extensively to generate data points in order to find analytical expressions for $\frac{a_{eq}}{a}$ and $\frac{b_{eq}}{b}$ as a function of $\frac{w}{b}$.

C. ANALYTICAL EXPRESSIONS FOR A_{eq} AND B_{eq}

Data from *WR(28)* and *WR(90)* waveguides were used to develop analytical expressions for $\frac{a_{eq}}{a}$ and $\frac{b_{eq}}{b}$. *WR(28)* has an aspect ratio $\frac{b}{a}$ of $\frac{1}{2}$ which is the same for all other millimeter waveguides. However, all of the experimental data was obtained

with $WR(90)$ which has an aspect ratio of $\frac{4}{9}$. For these reasons, an analytical expression was sought which was valid for both aspect ratios.

IMPED was used to calculate $\frac{a_{eq}}{a}$ and $\frac{b_{eq}}{b}$ for nineteen values of $\frac{w}{b}$. Appendix A lists the resulting *IMPED* output for $WR(28)$ and $WR(90)$. This approach ensured that sufficient data was available for an accurate curve fit. Bush was unsuccessful in his attempt to find an accurate analytical expression for $\frac{a_{eq}}{a}$ and $\frac{b_{eq}}{b}$ because he failed to use a sufficient number of data points (only 7 points at irregular intervals). After the data points were plotted, it was observed that the curves resemble the arc of an ellipse. Therefore, an elliptical curve fit was attempted.

The first step in the elliptical curve-fitting process is to start with the equation for an ellipse. The general equation for an ellipse is:

$$\frac{(x-h)^2}{b^2} + \frac{(y-k)^2}{a^2} = 1. \quad (9)$$

Solving for y results in:

$$y = k \pm \sqrt{a^2 - a^2 \frac{(x-h)^2}{b^2}} \quad (10)$$

where (h,k) is the center of the ellipse, and a, b are the major and minor axes, respectively. The positive term refers to the upper half of the ellipse, while the negative term refers to the lower half.

For $WR(28)$, Knorr discovered that the curve for $\frac{a_{eq}}{a}$ vs. $\frac{w}{b}$ resembles the arc of a unit circle with center at $(1,2)$. Using Eq. (9) with $h = 1$, $k = 2$, $a = 1$, and $b = 1$, the result is:

$$\frac{a_{eq}}{a} = 2 - \sqrt{1 - \left(1 - \frac{w}{b}\right)^2}. \quad (11)$$

Equation (10) works well for $\frac{w}{b} \geq 0.1$, but is not very accurate for values less than 0.1. Accuracy was improved by adding the following term to Eq. (10):

$$0.221 \left(1 - \frac{w}{b}\right)^{28}. \quad (12)$$

This term was found by trial and error. Its purpose is to increase $\frac{a_{eq}}{a}$ for the smaller values of $\frac{w}{b}$.

The same curve fitting method was used to find analytical expressions for $\frac{b_{eq}}{b}$ vs. $\frac{w}{b}$ for *WR(28)*, and $\frac{a_{eq}}{a}, \frac{b_{eq}}{b}$ vs. $\frac{w}{b}$ for *WR(90)*. For both waveguides, the center of the ellipse is (1, 2) for $\frac{a_{eq}}{a}$ and (1, 0.6) for $\frac{b_{eq}}{b}$. As a result, an expression for $\frac{a_{eq}}{a}$ and $\frac{b_{eq}}{b}$ in terms of $\frac{b}{a}$ involves only the lengths of the major and minor axes of the ellipse.

For a particular curve, a fit can be found by simply adjusting the lengths a and b in Eq. (9). Once an approximate fit is found, the coefficient and exponent in Eq. (12) can be adjusted to decrease the error. The curve fit is conducted on a trial-and-error basis until the error at each data point is reduced to an acceptable level. The error at each point is defined as:

$$Error = \left(\frac{|Model\ value - IMPED\ Value|}{IMPED\ Value} \right) 100. \quad (13)$$

The *MATLAB* program in Fig. 4 on page 9 was used to graph the results and determine the error.

The following equations were derived from the elliptical curve fitting process for *WR(28)* and *WR(90)*:

$$\frac{a_{eq}}{a} = 2 - \sqrt{1 - \left(\frac{2b}{a}\right)^{0.77} \left(1 - \frac{w}{b}\right)^2} + 0.221 \left(\frac{2b}{a}\right)^{-3.61} \left(1 - \frac{w}{b}\right)^{28} \quad (14)$$

$$\frac{b_{eq}}{b} = 0.6 + \sqrt{0.16 - 0.1347 \left(\frac{2b}{a}\right)^{1.35} \left(1 - \frac{w}{b}\right)^2} - 0.170 \left(\frac{2b}{a}\right)^{-1.15} \left(1 - \frac{w}{b}\right)^{10} \quad (15)$$

where $\frac{b}{a}$ is the aspect ratio and $\frac{w}{b}$ is the fin gap ratio. The error from these equations is less than 1.3% for $0.01 \leq \frac{w}{b} \leq 1.0$. Figures 5 and 6 on page 10 and Figs. 7 and 8 on page 11 show the plot of $\frac{a_{eq}}{a}$ and $\frac{b_{eq}}{b}$ vs. $\frac{w}{b}$ for *WR(28)* and *WR(90)*, respectively. The analytical equations are plotted with solid lines and the data from *IMPED* is plotted with circles. Figures 9 and 10 on page 12 and Figs. 11 and 12 on page 13 show how the error at each data point changes with $\frac{w}{b}$. The solid line in each graph merely connects the data points.

In conclusion, homogeneous finline can be modeled with just an analytical expression for $\frac{a_{eq}}{a}$ and $\frac{b_{eq}}{b}$ because these parameters define a unique finline wavelength and impedance. These analytical expressions are of an elliptical form and are functions of $\frac{w}{b}$ and $\frac{b}{a}$. As a result, finline in any waveguide with $\frac{b}{a} = \frac{1}{2}$ or $\frac{4}{9}$ can be modeled. The model can be applied to other values of $\frac{b}{a}$, but with less accuracy. Additional tests

have shown that the error only increases by a maximum of 0.3% for values of $\frac{b}{a} = 0.25$ and 0.6.

```
% MATLAB program for elliptical curve fitting

% Enter data W = w/b D = data
W = [ 0.01 0.02 0.03 0.04 0.05 0.06 0.07 0.08 0.09 0.1 0.2 0.3 0.4 ...
0.5 0.6 0.7 0.8 0.9 1.0 ];
D = [ 1.951 1.831 1.751 1.702 1.654 1.620 1.587 1.557 1.529 1.506 ...
1.343 1.248 1.175 1.120 1.078 1.047 1.022 1.005 1.000 ];

% Enter waveguide width, a, and height, b
a = 9;
b = 4;
% Enter coefficients to adjust fit m-extends curve left/right
% n-adjusts tail of curve up/down
m = 0.77;
n = -3.61;
x = 0.0:.001:1.0;
y = 2 - sqrt(1 - (2*b/a).^m.*(1-x).^2) + 0.221*(2*b/a).^n.*(1-x).^28;
y1 = 2 - sqrt(1 - (2*b/a).^m.*(1-W).^2) + 0.221*(2*b/a).^n.*(1-W).^28;
% Calculates error at each data point
p1 = (y1 - D)./D .* 100
% Plots data points and graphs function
clc
axis([ 0 1.0 1.0 2.1 ])
plot(x,y,W,D, 'o')
title('Aeq/A vs W/B for WR(90)')
xlabel(' W/B '),ylabel(' Aeq/A '),grid
pause
print
```

Figure 4. MATLAB program used for elliptical curve fitting.: Program plots data points, graphs analytical equations, and computes error at each data point.

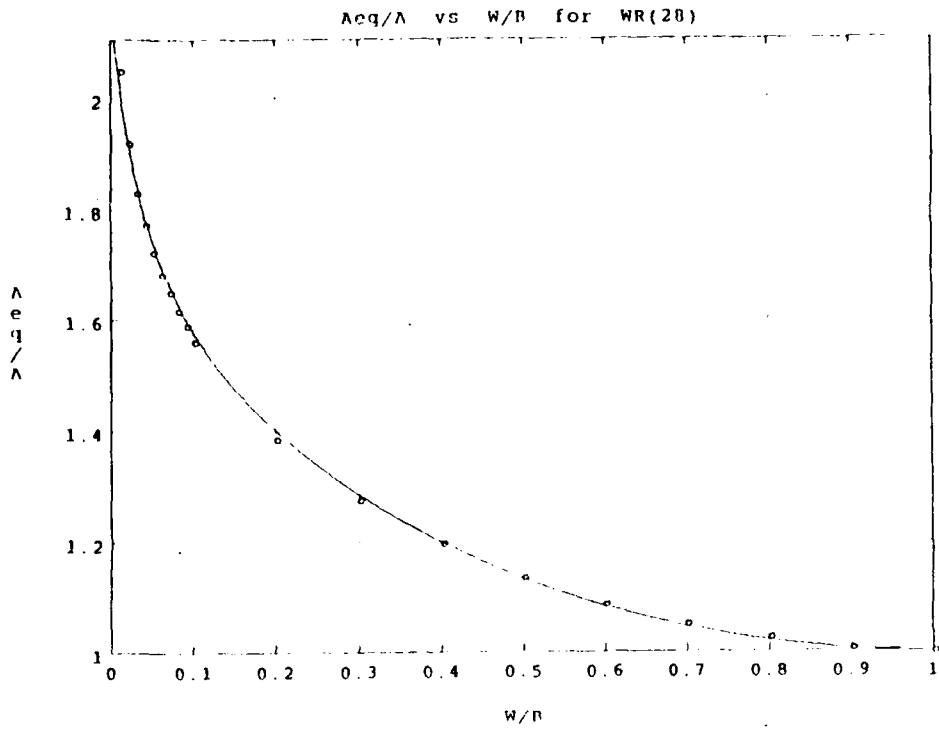

Figure 5. Aeq/A vs. W/B for WR(28).

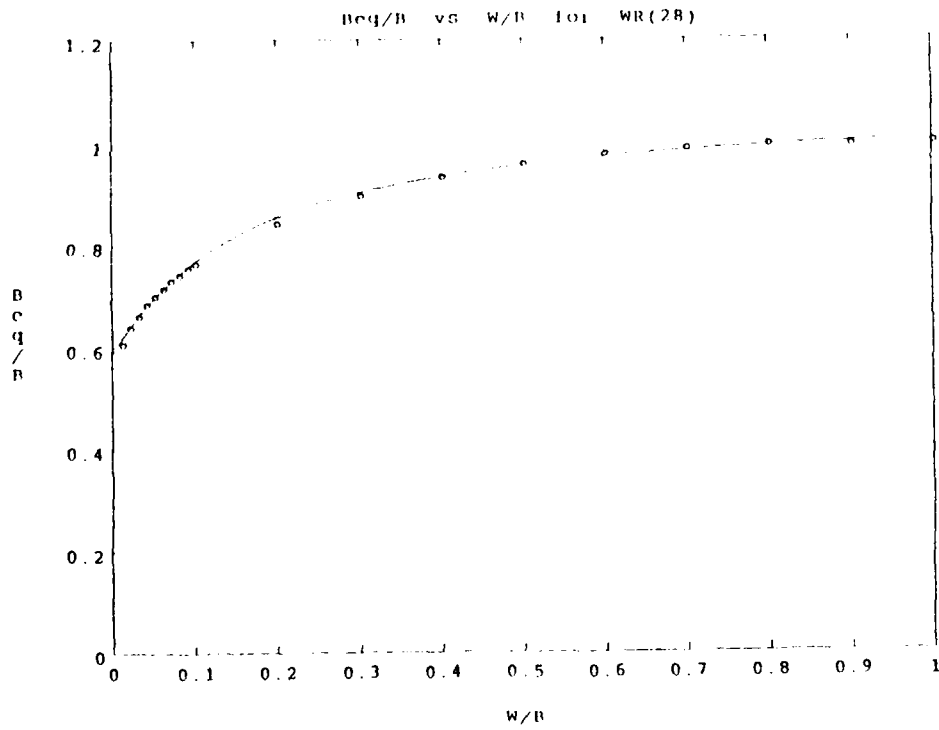

Figure 6. Beq/B vs. W/B for WR(28).

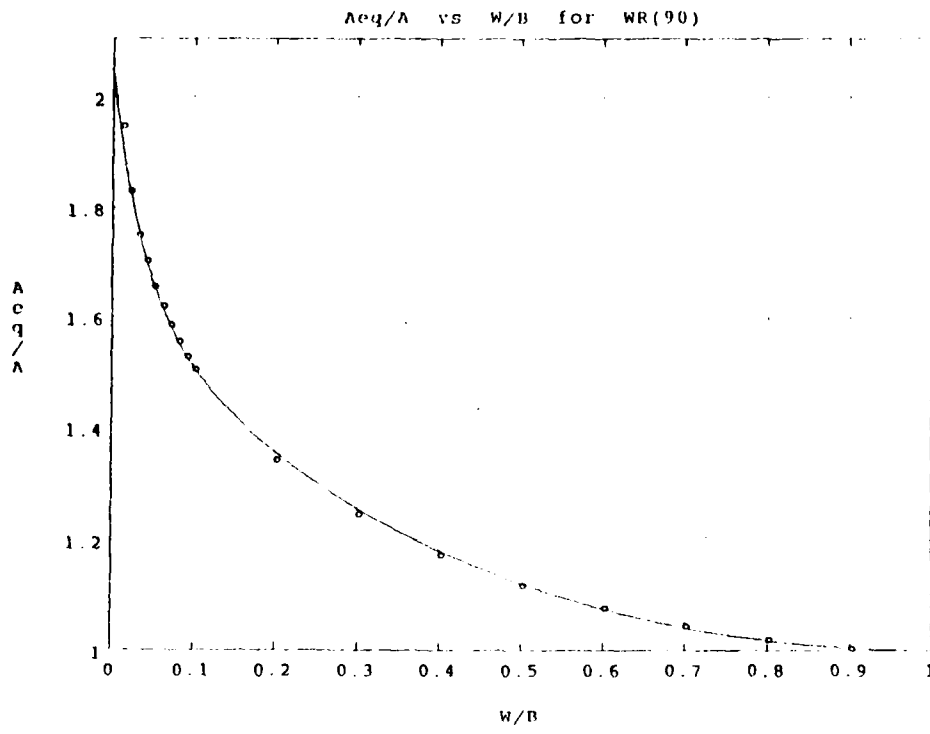

Figure 7. Aeq/A vs. W/B for WR(90).

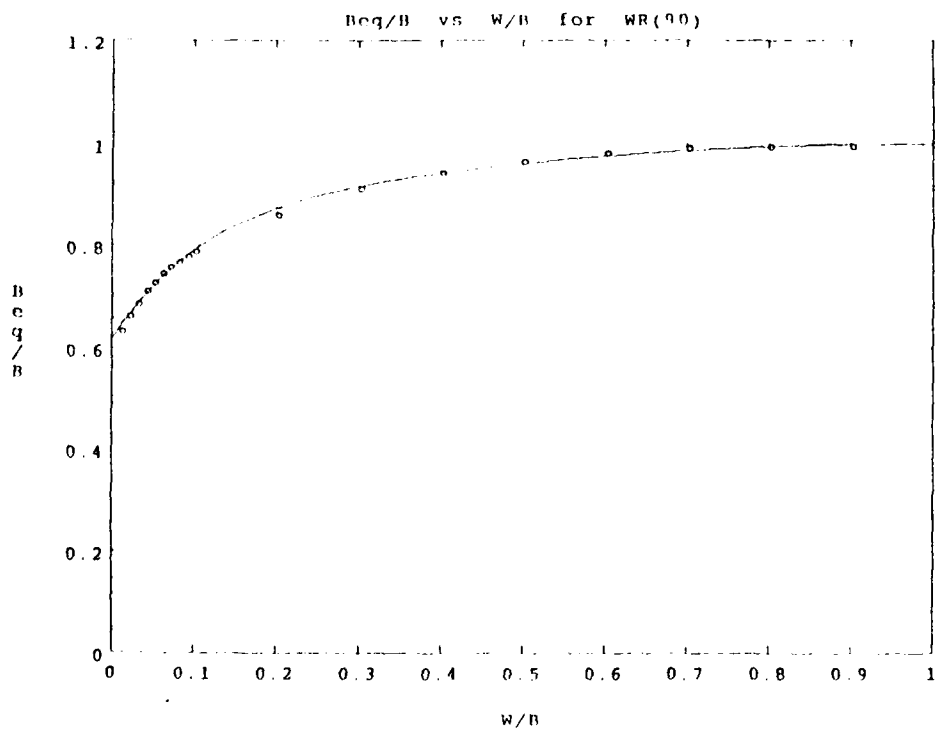

Figure 8. Beq/B vs. W/B for WR(90).

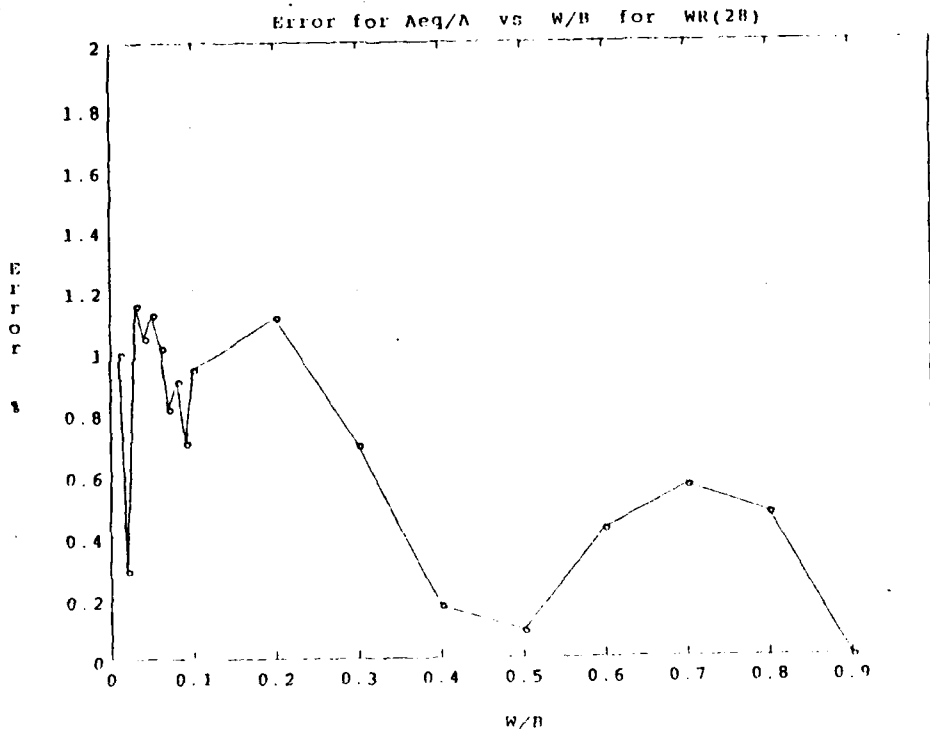

Figure 9. Error for A_{eq}/A vs. W/B for $WR(28)$.

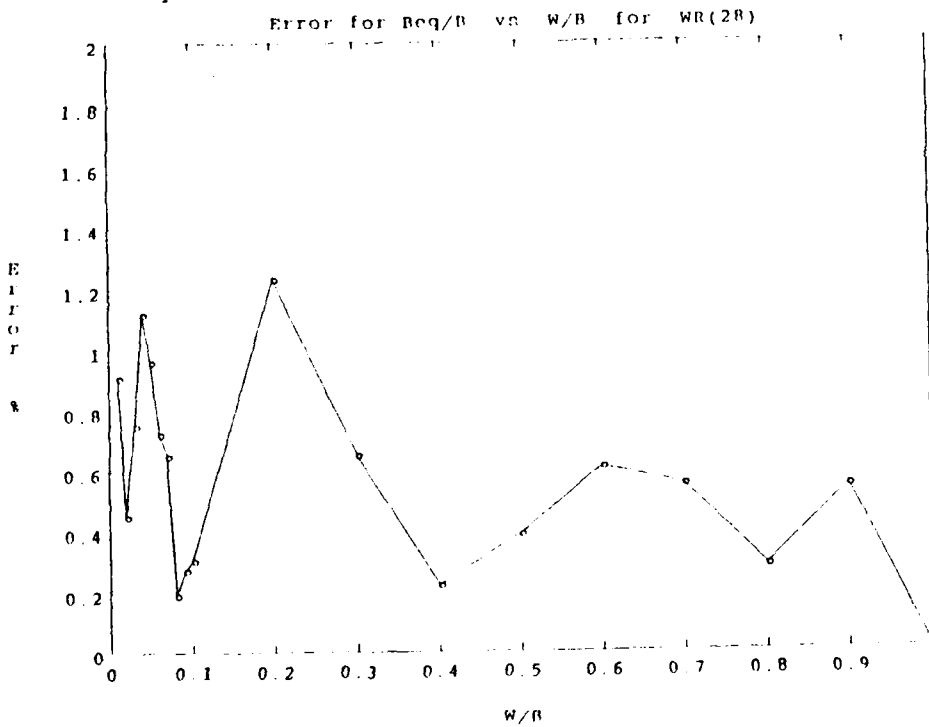

Figure 10. Error for B_{eq}/B vs. W/B for $WR(28)$.

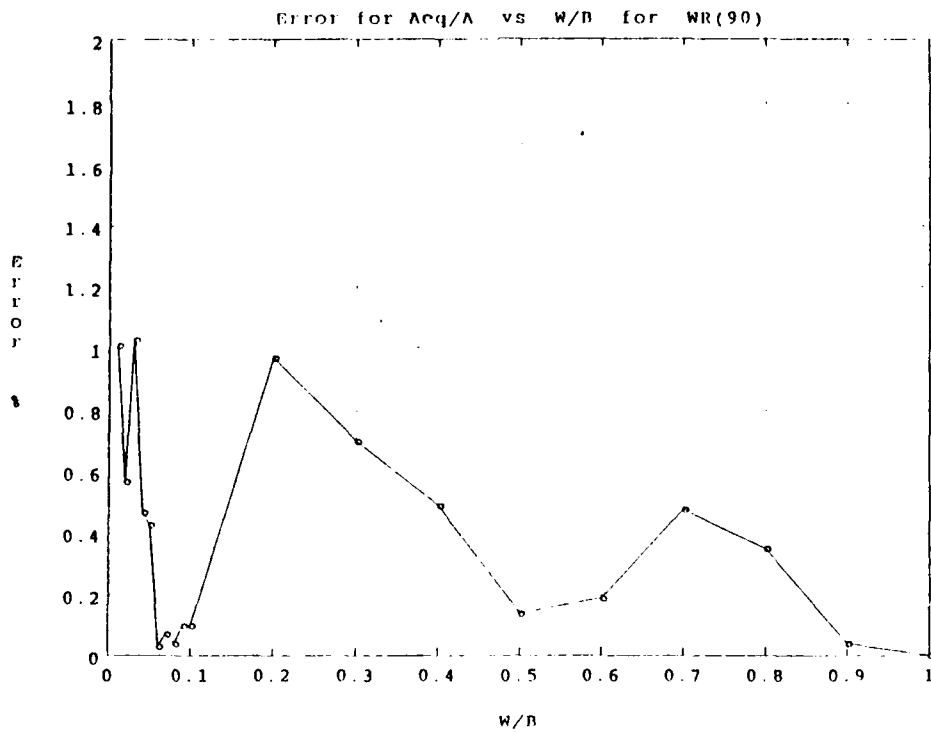

Figure 11. Error for Aeq/A vs. W/B for WR(90).

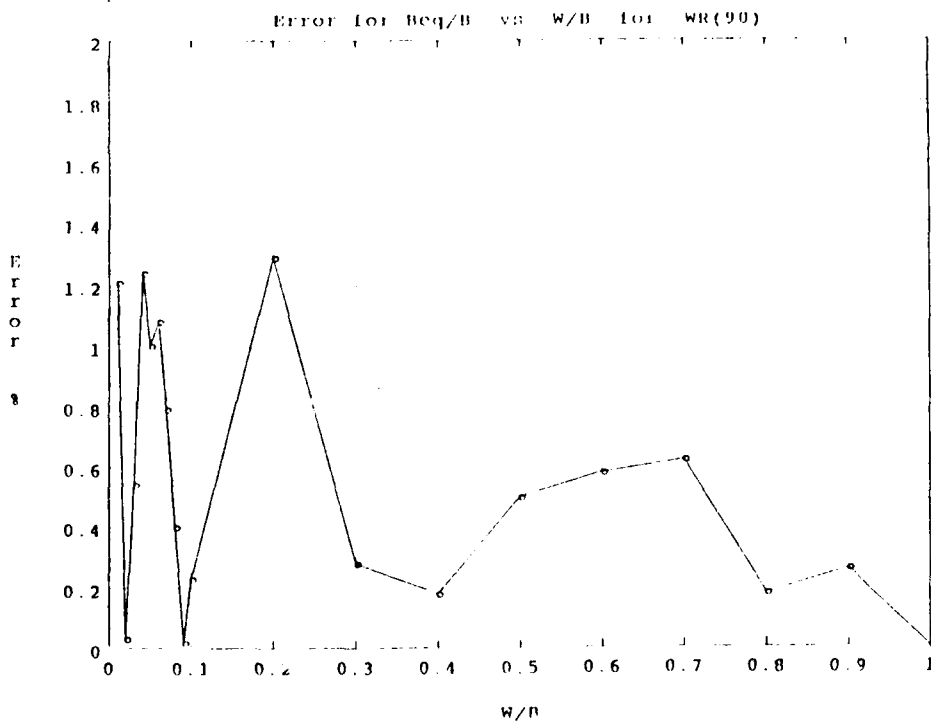

Figure 12. Error for Beq/B vs. W/B for WR(90).

III. SCATTERING DATA FOR AN INDUCTIVE STRIP IN FINLINE

A. CONCEPT

Having obtained a finline model, the next step in the development of an equivalent circuit model is to obtain accurate scattering data for various lengths of inductive strips. The scattering data can be generated either experimentally or numerically. In the latter case, *STRIP* uses the spectral domain method to accurately predict scattering data [Ref. 7: pp. 76-82]. *STRIP* was used to provide scattering data for $0.1 \leq \frac{w}{b} \leq 1.0$ and strip lengths of $10 \leq T \leq 500$ mils.

Scattering data was generated for *X*-band frequencies because measuring equipment for *WR(90)* is readily available. In addition, the comparison of *STRIP* to *X*-band experimental scattering data is well-documented [Ref. 7: pp. 83-138]. The accuracy of the circuit model can also be validated by building *X*-band filters and resonators, and comparing their insertion and return loss with that predicted by the model. This process is simpler and less time consuming than directly measuring the scattering data from the inductive strips.

B. SPECTRAL DOMAIN PROGRAM

In general, *STRIP* is a Fortran program which uses the spectral domain method to solve the field equations for an inductive strip in finline. Deal describes this method in detail in Ref. 7: pp. 62-71. In essence, the electric field is approximated by a finite summation of sines and cosines. The Fourier transform is taken because field integrals are reduced to multiplication in the spectral domain. By applying Galerkin's method, an iterative search is used to find the odd and even resonant cavity lengths which cause a matrix of inner product terms to go to zero. Next, the scattering parameters are determined by making the assumption that the inductive strip can be represented by a lossless, reciprocal, symmetric, two-port network. Using the odd and even resonant cavity lengths, the scattering parameters are calculated.

STRIP consists of two nested 'Do' loops, three embedded search routines, and seven subroutines. The first loop iterates over the strip lengths of interest for a particular value of $\frac{w}{b}$ while the second loop iterates over the frequency band of interest. Within the second loop, there are three search routines. The first one finds the normalized finline wavelength $\frac{\lambda'}{\lambda}$. This search routine consists of a modified bisectional search for the wavelength which causes the inner product of the G_{11} Dyadic Green's function and

the square of the x -component of the x -directed field to go to zero. The second and third search routines use the value of $\frac{\lambda'}{\lambda}$ to find the even and odd mode resonant cavity lengths, respectively. These search routines consist of simple bisectional searches for the cavity lengths which cause the determinant of a matrix of inner product terms to go to zero. The inner product terms consist of the G_{11} Dyadic Greens's function, the square of the x -component of the x -directed field, the m th z -component of the x -directed field, the n th z -component of the x -directed field, and the m th and n th spatial shift functions for the z -component field functions. The scattering parameters are then calculated from the even and odd mode cavity lengths. [Ref. 7: pp. 62-71]

The accuracy of *STRIP* is dependent upon the matrix order of the inner product terms which can be specified by the user. The scattering data converges as the matrix order is increased, but at the increase of computation time. Figure 13 on page 17 and Fig. 14 on page 18 show how accuracy is improved in magnitude and phase by increasing the matrix order. Most of the convergence has taken place by matrix order 10. The increased computation time is due to the increased number of matrix elements and determinant operations.

Computation time is also dependent on $\frac{w}{b}$. The limits of summation in the electric field calculations increase as $\frac{w}{b}$ decreases. Typical computation times for a VAX computer system are shown in Fig. 15 on page 19. The graph shows computer system time as matrix order and $\frac{w}{b}$ is varied. The actual run times are much larger and are dependent on computer load.

As a result, a tradeoff exists between accuracy, $\frac{w}{b}$, and computation time. *STRIP* allows data to be run in batch mode where up to 8 strip lengths and 8 data sets may be queued into the computer. However, the results may take several weeks to be completed. If computer time is expensive, the matrix order may be adjusted to give acceptable computation times. In this thesis, a matrix order of 10 was chosen as a suitable compromise between accuracy and computation time. Typical run times encountered for a single strip length for five different frequencies was 2 hours for $\frac{w}{b} = 1.0$ and 30 hours for $\frac{w}{b} = 0.1$.

C. MODIFICATION TO PROGRAM

STRIP was recently modified to run on a VAX computer vice an IBM 3033 mainframe computer. Upon testing *STRIP*, it was noticed that the program gave erroneous results for matrix orders greater than 4. Deal wrote *STRIP* to be able to handle matrix orders of up to 20. Therefore, a serious problem existed which severely limited

the accuracy of *STRIP*. After an exhaustive search, it was discovered that *STRIP* contained a routine which caused the numerical handling capabilities of the VAX to be exceeded.

The faulty routine was traced to the search routines which determine the odd and even resonant cavity lengths. These search routines take the determinant of the inner product terms for the left and right endpoints of the current search interval. For the next iteration, the search interval is moved to the left or the right, depending if the product of the left and right determinant is positive or negative, respectively. However, the object of the search routine is to drive the value of the determinant to zero. Therefore, as the determinant approaches zero, the product of the left and right determinant becomes extremely small. These small values can exceed the numerical handling capability of the computer and result in an underflow error. The error alters the search pattern and causes the search routine to converge on the wrong value.

The faulty routine was corrected by using conditional statements to determine the sign of the product rather than multiplying the two determinants outright. This technique eliminates the extremely small numbers which caused the underflow error. The program was modified as shown in Fig. 16 on page 20 and tested. The results of the test demonstrated that matrix orders greater than 4 were allowed and that results identical to Deal's could be achieved. In some cases, the results were closer to the experimental data than Deal's results, demonstrating that the original program was producing occasional underflow errors on the IBM mainframe. An example of the improved results is shown in Fig. 17 on page 21. The modified version of *STRIP* now produces the most accurate results possible under the constraints of the program.

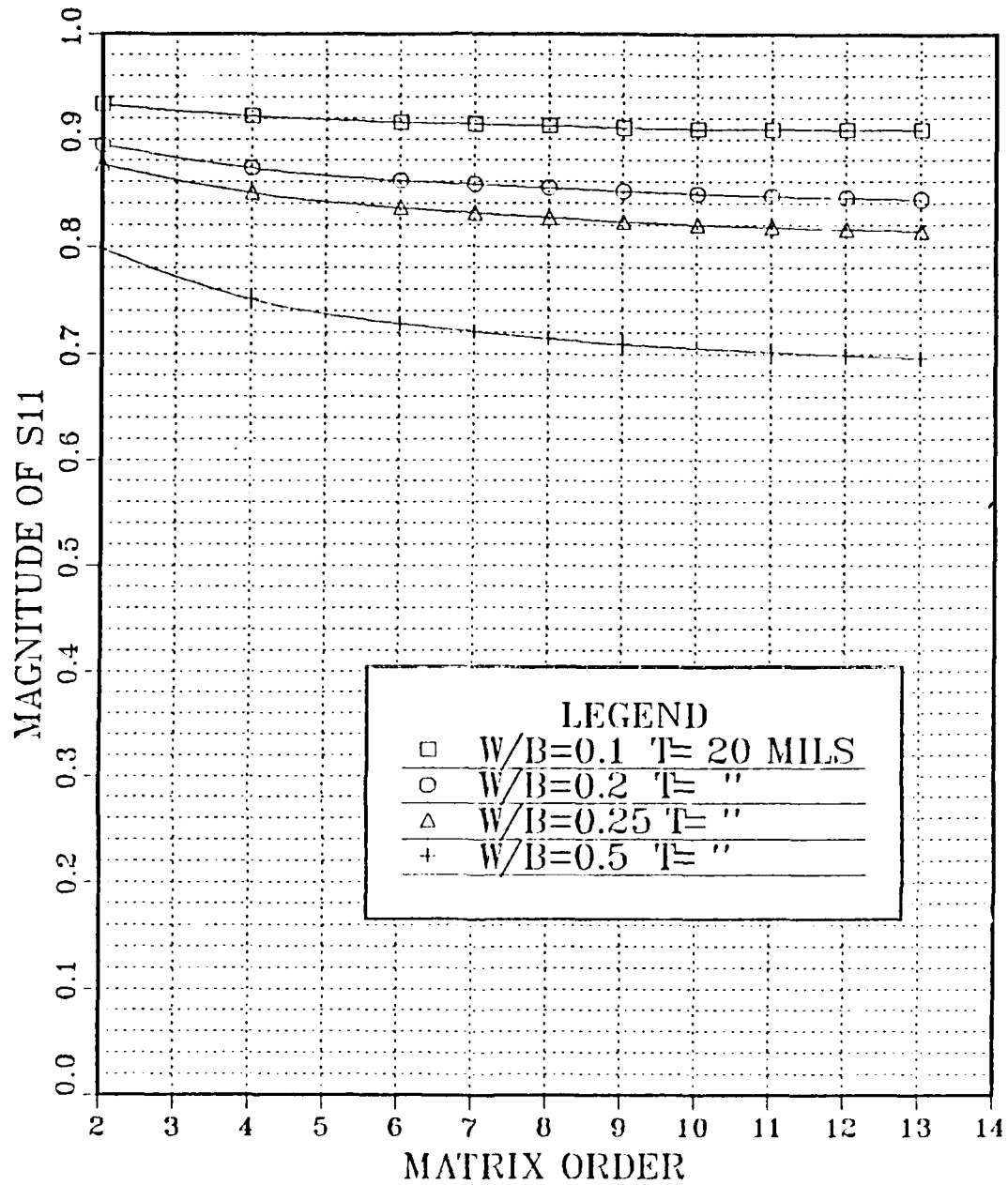

Figure 13. Convergence of scattering data (magnitude) vs. matrix order.: Scattering data from $\frac{w}{b} = 0.5, 0.25, 0.2, 0.1$ is plotted as the matrix order is varied. The solid lines merely connect the data points.

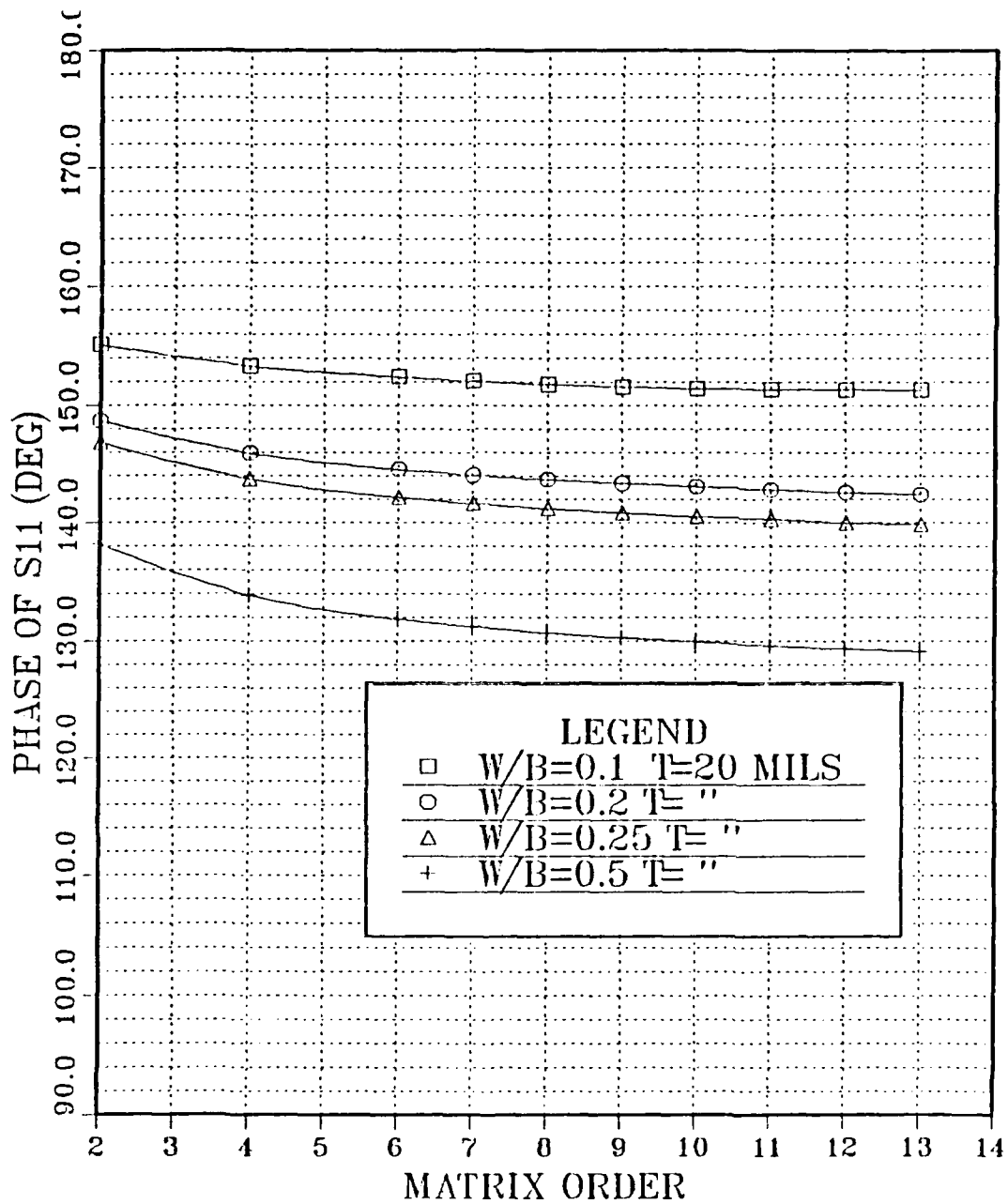

Figure 14. Convergence of scattering data (phase) vs. matrix order.: Scattering data from $\frac{w}{b} = 0.5, 0.25, 0.2, 0.1$ is plotted as the matrix order is varied. The solid lines merely connect the data points.

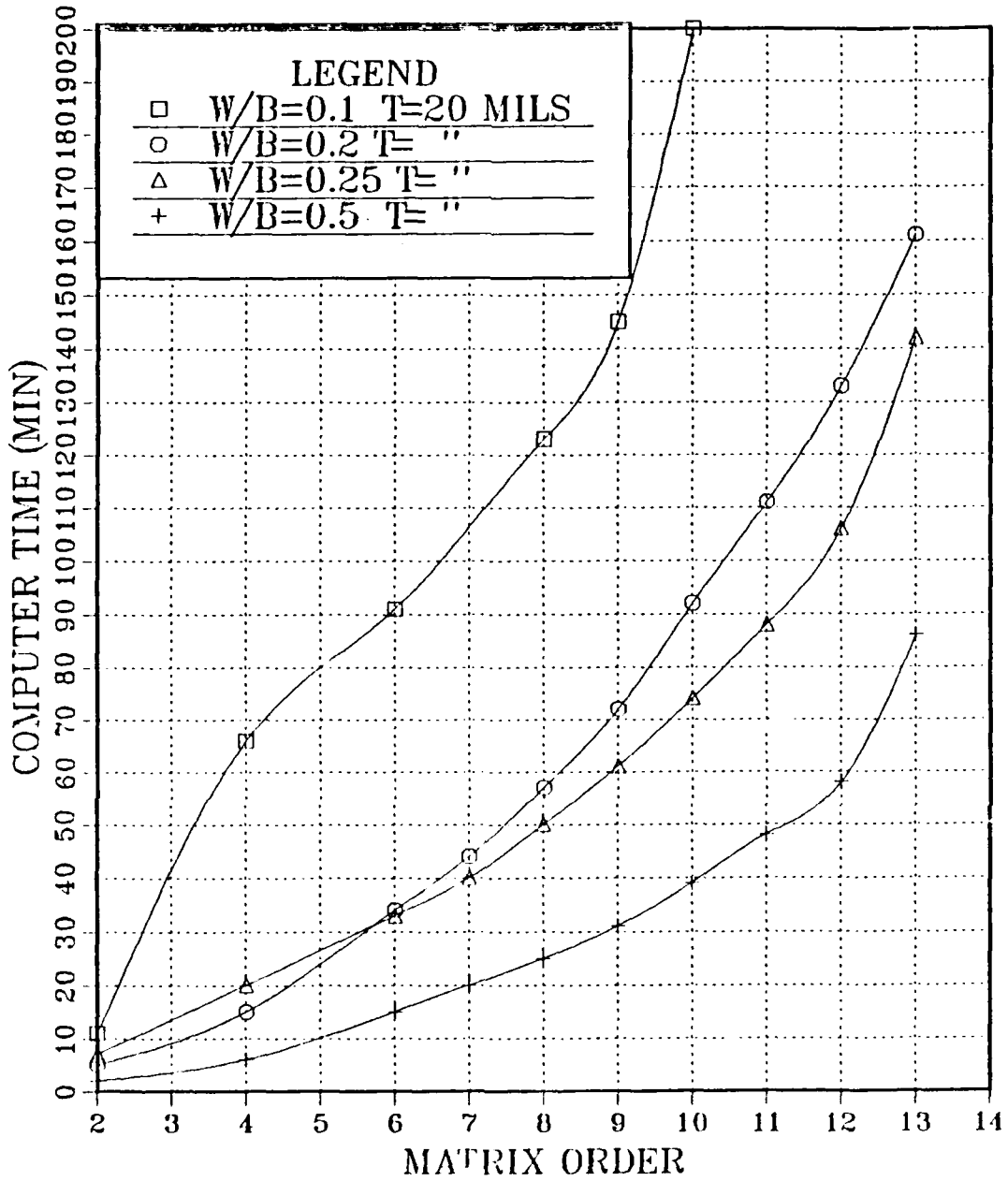

Figure 15. Computer system time vs. matrix order and w/b .: Typical system time for a VAX computer as matrix order and $\frac{w}{b}$ are varied. The solid lines merely connect the data points.

```

C    calculates determinant
CALL DTERM(ORDER,LLE,DETLE,ROWDIM)
YLE = DETLE
CALL DTERM(ORDER,LRE,DETRE,ROWDIM)
YRE = DETRE
SIGNE = YLE*YRE
IF (SIGNE.GE.0.0) XLE = XRESTE
IF (SIGNE.LT.0.0) XRE = XRESTE
EPSLNE = .5*DABS(XLE-XRE)
CONTINUE

```

a)

```

C    calculates determinant
CALL DTERM(ORDER,LLE,DETLE,ROWDIM)
YLE = DETLE
CALL DTERM(ORDER,LRE,DETRE,ROWDIM)
YRE = DETRE
IF ((YLE.LT.0.0) .AND. (YRE.LT.0.0 )) GOTO 53
IF ((YLE.GE.0.0) .AND. (YRE.GE.0.0 )) GOTO 53
XRE = XRESTE
GOTO 54
53  XLE = XRESTE
54  EPSLNE = .5*DABS(XLE-XRE)
CONTINUE

```

b)

Figure 16. Search routine from STRIP.: a) original and b) modified search routines. The modified routine uses 'IF' statements vice taking the product outright.

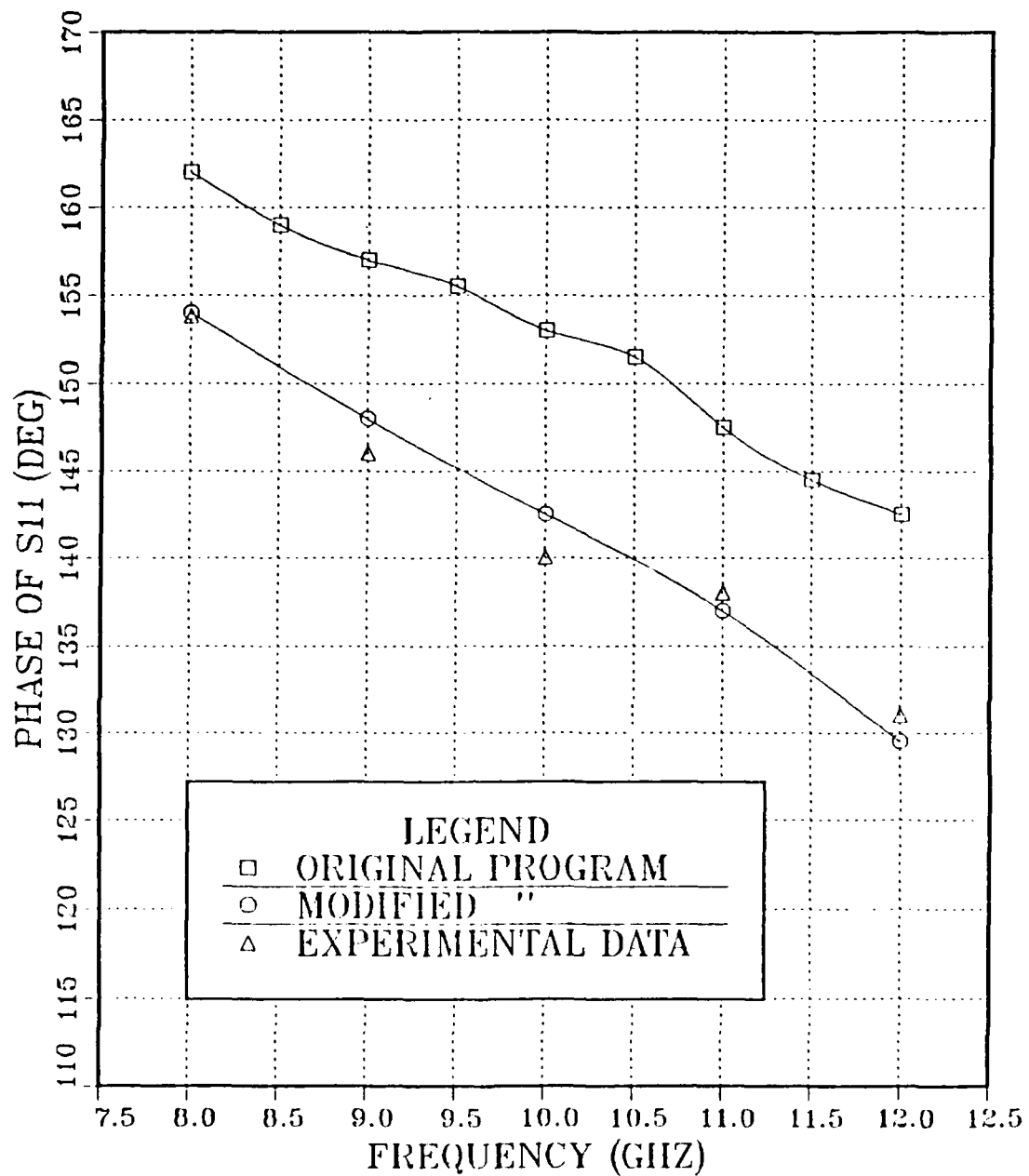

Figure 17. Results from the modified version of STRIP.: Results from the original and modified versions of STRIP are compared with the experimental data for $T = 0.05$ inch, $\frac{w}{b} = 0.25$.

IV. A MODEL FOR AN INDUCTIVE STRIP IN HOMOGENEOUS FINLINE

A. CONCEPT

Combining the finline model with accurate computer-generated strip scattering data, an equivalent circuit model for an inductive strip centered in finline can now be developed. Knorr describes three such models in Ref. 10: pp. 10-12 which are shown in Fig. 18 on page 23 and Fig. 19 on page 24. Model 1 is Knorr's original model; models 2 and 3 were created by Knorr during the experimental phase of this thesis. Model 3 is the most accurate and is the basis of this thesis.

From a physical point of view, the inductive strip in finline consists of a strip region, a discontinuity region, and a finline region. Using discrete components from *TOUCHSTONE*, one can piece together a circuit model which simulates the physical aspects of these regions. In addition, the model represents a lossless, reciprocal, symmetric, two-port network. Therefore, S_{11} completely characterizes the network behavior.

The strip region is modeled by two below-cutoff pieces of waveguide of length T , width $\frac{a}{2}$, and height b , where T is the strip length, a is the finline width, and b is the finline height. The width $\frac{a}{2}$ allows the waveguide sections to remain below cutoff so that fields from the TE_{10} mode can be reflected. It was initially assumed that the below-cutoff pieces of waveguide were of width $\frac{a_{eq}}{2}$ and height b_{eq} , so that the finline characteristics could be represented. This assumption was made in Karaminas's model [Ref. 9: p. 16]. However, it was discovered that the below-cutoff condition could not be maintained for $\frac{w}{b} < 1.0$ as T became greater than 500 mils. The result was a large dip in the magnitude and phase of S_{11} in the 11 to 12 GHz range as the TE_{10} mode propagated through the below-cutoff pieces of waveguide. These results were unsatisfactory. Consequently, $\frac{a}{2}$ and b were substituted for $\frac{a_{eq}}{2}$ and b_{eq} as the width and height of the below-cutoff sections of waveguide.

The discontinuity region is modeled by an inductor and capacitor. These discrete elements represent the higher-order mode magnetic and electric fields induced by the discontinuity. The energy is stored in the evanescent fields near the ends of the strips. As a result, the reflections from the strip region are modified by the value of inductance and capacitance. Model 1 uses only an inductor because the stored magnetic energy is the dominant effect. However, it was discovered that the addition of a small amount

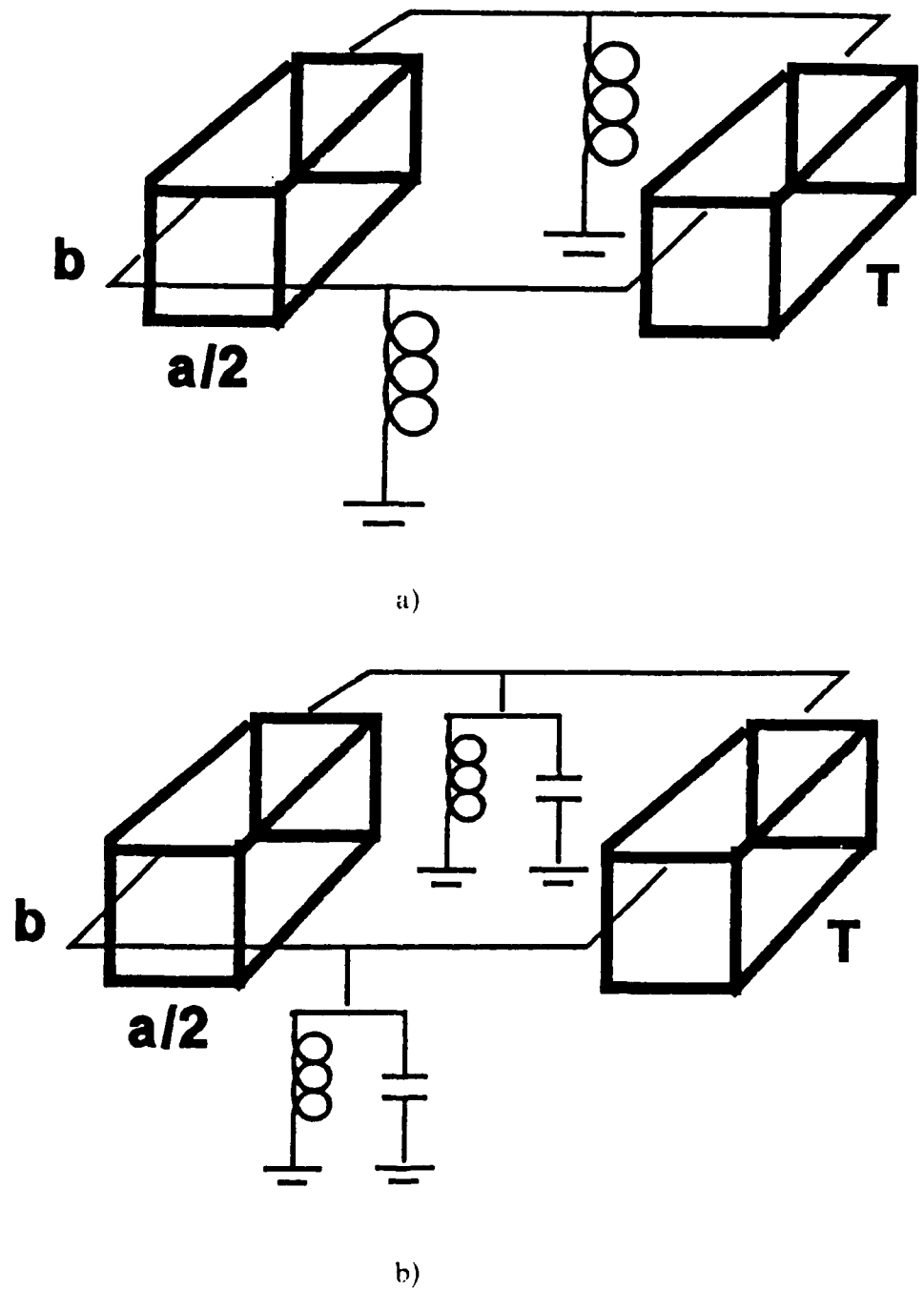

Figure 18. Equivalent circuit models.: a) Model 1 (inductance only), b) Model 2 (inductance and capacitance).

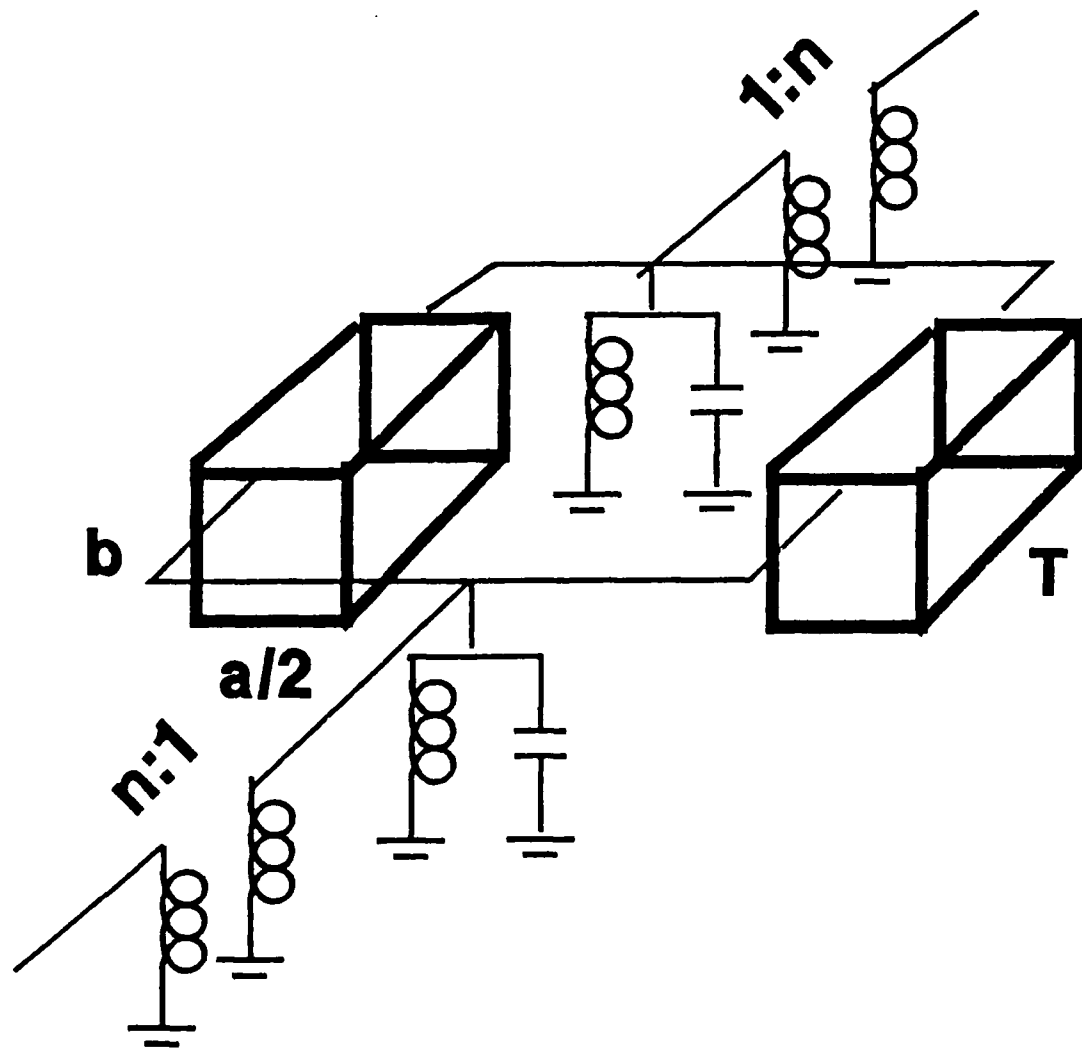

Figure 19. Equivalent circuit models (cont.): Model 3 (inductance, capacitance, and impedance transformer).

of capacitance (0.003 pF compared to 20 nH) produced a better match between the S_{11} parameters of the model and the data. Two elements also allow two degrees of freedom in which to best match the magnitude and angle of the actual scattering data.

The finline region is modeled by an ideal impedance transformer with turns ratio n which is equal to the square root of the ratio of the finline impedance to unloaded guide impedance. This impedance transformer implies that an impedance step exists between the finline and strip regions. It was discovered that the addition of this ideal transformer significantly reduced the error between the model and the data. As a result, models 1 and 2 assume that the strip is terminated in the finline impedance for $\frac{w}{b} \leq 1.0$. Model 3, on the other hand, effectively terminates the strip in the finline impedance for $\frac{w}{b} = 1.0$

B. CIRCUIT MODEL

The *TOUCHSTONE* program used to simulate the circuit model is shown in Appendix B. The program basically simulates an equivalent circuit model identical to model 3. The model inductance and capacitance equations which are valid for $WR(90)$ and $0.1 \leq \frac{w}{b} \leq 1.0$ are as follows:

$$L = A' + \frac{B' C' \ln(T)}{1 + \exp\left(\frac{T-N}{10}\right)} \text{ nH} \quad (16)$$

$$C = 0.003 \left(\frac{w}{b}\right) \text{ pF} \quad (17)$$

where

$$A' = 13.75 - 10.32 \left(1 - \frac{w}{b}\right)^{1.60}$$

$$B' = 9.46 - 6.36 \left(1 - \frac{w}{b}\right)^{3.78}$$

$$C' = 1.54 - 1.10 \left(1 - \frac{w}{b}\right)^{4.73}$$

$$N = 500 - 241 \left(1 - \frac{w}{b}\right)^{1.74}$$

The inductance and capacitance equations were developed by varying inductance and capacitance until the S_{11} parameters of the model and the data were matched. Generally, a best fit in magnitude is not always the best fit in phase. This discrepancy is greater with models 1 and 2. However with model 3, it is possible without incurring significant error to determine an inductance and capacitance which produce equal error in magnitude and phase. The error is defined as follows:

$$Error = \left(\frac{|Model\ value - STRIP\ Value|}{STRIP\ Value} \right) 100. \quad (22)$$

The matching process was completed first for $\frac{w}{b} = 1$ at fourteen different strip lengths. It was observed that the capacitance could remain fixed while the inductance was varied to match the S_{11} parameters of the strip lengths. This fact greatly simplified the matching process. Next, values of inductance and capacitance were found for $\frac{w}{b} = 0.8, 0.5, 0.25, 0.2,$ and 0.1 . Again, it was discovered that a match occurred when the capacitance remained fixed while the inductance was varied. Thus, a characteristic of the inductive strip is that its discontinuity capacitance varies only with $\frac{w}{b}$, while its discontinuity inductance varies with $\frac{w}{b}$ and T .

Another characteristic of the inductive strip is that the S_{11} parameters approach a constant value as the strip lengths become longer. This occurs because the transmission of incident signals decreases significantly at the longer strip lengths. The model then becomes similar to two inductors separated by a fixed length of cutoff waveguide. The result is total reflection with a constant phase shift. For $WR(90)$, this phenomenon occurs at 500 mils and decreases slightly as $\frac{w}{b}$ decreases. As a result, the model inductance becomes constant at long strip lengths.

The next step is to determine the relationship between inductance and strip length T for a specific value of $\frac{w}{b}$. Using a curve-fitting routine which uses linear regression to find coefficients for exponential, logarithmic, power and linear functions, the following equation was derived for the inductance:

$$L = A' + (B' - C' \ln T) \quad (23)$$

where A' is the inductance when S_{11} becomes constant, and B', C' are the coefficients from the curve-fitting routine. However, in this form, the equation does not allow the inductance to remain constant for strip lengths greater than 500 mils. To account for this fact, the inductance equation was modified as follows:

$$L = A' + \frac{B' - C' \ln(T)}{1 + \exp\left(\frac{T - N}{10}\right)} \quad (24)$$

where $N = 500$. This equation puts a break point into the curve at 500 mils where the *exp* term equals 1. For strip lengths greater than 500 mils, A' becomes dominant as the right hand terms go to zero. However, the break point occurs at lower values of T as $\frac{w}{b}$ decreases. Therefore, N needs to be described as follows:

$$N = 500 - 241\left(1 - \frac{w}{b}\right)^{1.74}. \quad (25)$$

To determine how the coefficients A' , B' , and C' vary with $\frac{w}{b}$, they must be determined for many values of $\frac{w}{b}$. As a result, coefficients were determined for $\frac{w}{b} = 0.9, 0.7, 0.6, 0.4,$ and 0.3 . This time only eight strip lengths vice fourteen were used. Accurate coefficients could still be obtained if the 8 strips were of lengths 10, 40, 80, 100, 200, 300, 400, and 500 mils. This reduction in the number of strip lengths reduced the computation time considerably. Using the same curve-fitting routine as before, an equation of the following form was found for each coefficient:

$$a = a_1 - a_2\left(1 - \frac{w}{b}\right)^{a_3} \quad (26)$$

where a_1 is the value of a when $\frac{w}{b} = 1.0$, and a_2, a_3 are the coefficients from the curve-fitting routine. The resulting equations are as follows:

$$A' = 13.75 - 10.32\left(1 - \frac{w}{b}\right)^{1.60} \quad (27)$$

$$B' = 9.46 - 6.36\left(1 - \frac{w}{b}\right)^{3.78} \quad (28)$$

$$C' = 1.54 - 1.10\left(1 - \frac{w}{b}\right)^{4.73}. \quad (29)$$

Figure 20 on page 29 compares the values from the inductance equation with that of the inductance obtained from the matching process as $\frac{w}{b}$ and T are varied. The model inductance equation increases the error by only a maximum of 0.7%.

Determining a capacitance equation was much easier. Since capacitance is independent of strip length, it is only a function of $\frac{w}{b}$. In addition, capacitance is linearly

proportional to $\frac{w}{b}$ with a value of 0.003 pF at $\frac{w}{b} = 1.0$. Therefore, the capacitance equation is as follows:

$$C = 0.003 \left(\frac{w}{b} \right). \quad (30)$$

In summary, this circuit model accounts for three important features of the inductive strip in finline: (1) inductance decreases with increasing T and decreasing $\frac{w}{b}$, (2) the inductance approaches a constant value for very large values of T , and (3) the capacitance decreases with decreasing $\frac{w}{b}$. Appendix C lists the computer-generated S_{11} coefficients for all strip lengths. Appendix D lists the values of inductance, capacitance, and maximum error obtained from the matching process and the model equations.

C. RESULTS

The best indicator of the success of a model is the error it generates. In all cases, the error is less than 2.5%. In general, the error increases with strip length, reaching a peak at 200 mils. After the peak, the error steadily decreases and becomes constant at 500 mils. The exception to this behavior is at $\frac{w}{b}$ near 1.0 where $|S_{11}|$ is so low (0.3 - 0.4) that small deviations result in large errors. Figure 21 on page 30 shows how the error from model 1 and model 3 compare for $\frac{w}{b} = 0.5$. As the graph illustrates, model 3 reduces the error by 1% to 5%.

Another way of measuring the error is to compare the insertion and return loss of an actual finline filter with that of a filter model based on the inductive strip in finline model. The filter of interest has four inductive strips and $\frac{w}{b} = 1.0$. The *TOUCHSTONE* program for such a filter is listed in Appendix E. Figure 22 on page 31 shows the insertion and return loss of the actual finline filter and the model. Comparing these results, it is clear that they closely match in shape and center frequency. However, the actual filter has dissipative losses, while the model does not. The actual filter was built by Knorr and is described in Ref. 1: pp. 15-16. This example demonstrates how valuable the inductive strip in finline model is in designing finline filters. Although testing of more finline filters is required in order to completely check accuracy, this example proves that reasonable accuracy can be obtained from the model.

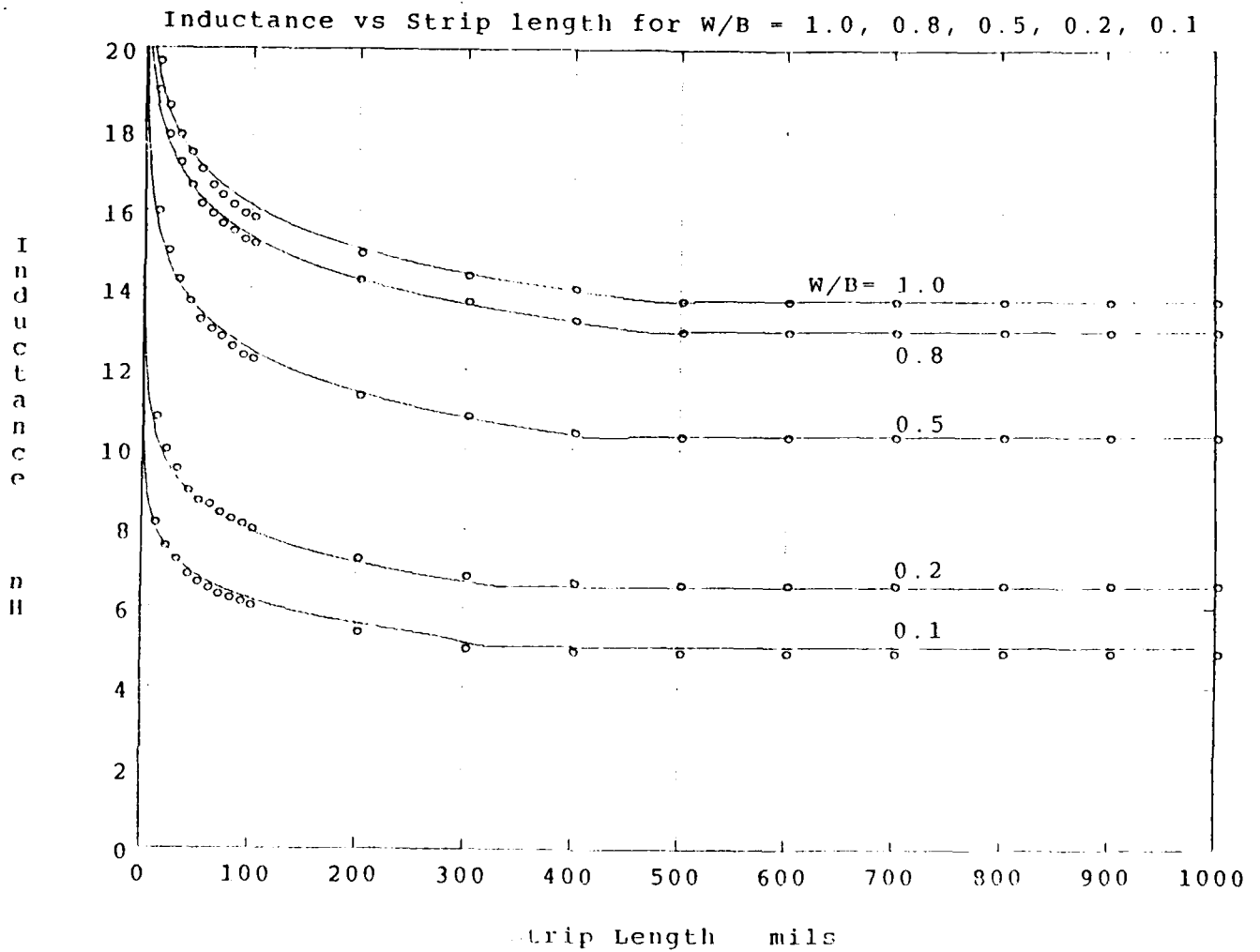

Figure 20. Inductance vs. Strip Length: The inductance given by the model equation is plotted vs. strip length. The circles indicate the actual inductance. Curves are plotted for $\frac{W}{b} = 1.0, 0.8, 0.5, 0.2,$ and 0.1 .

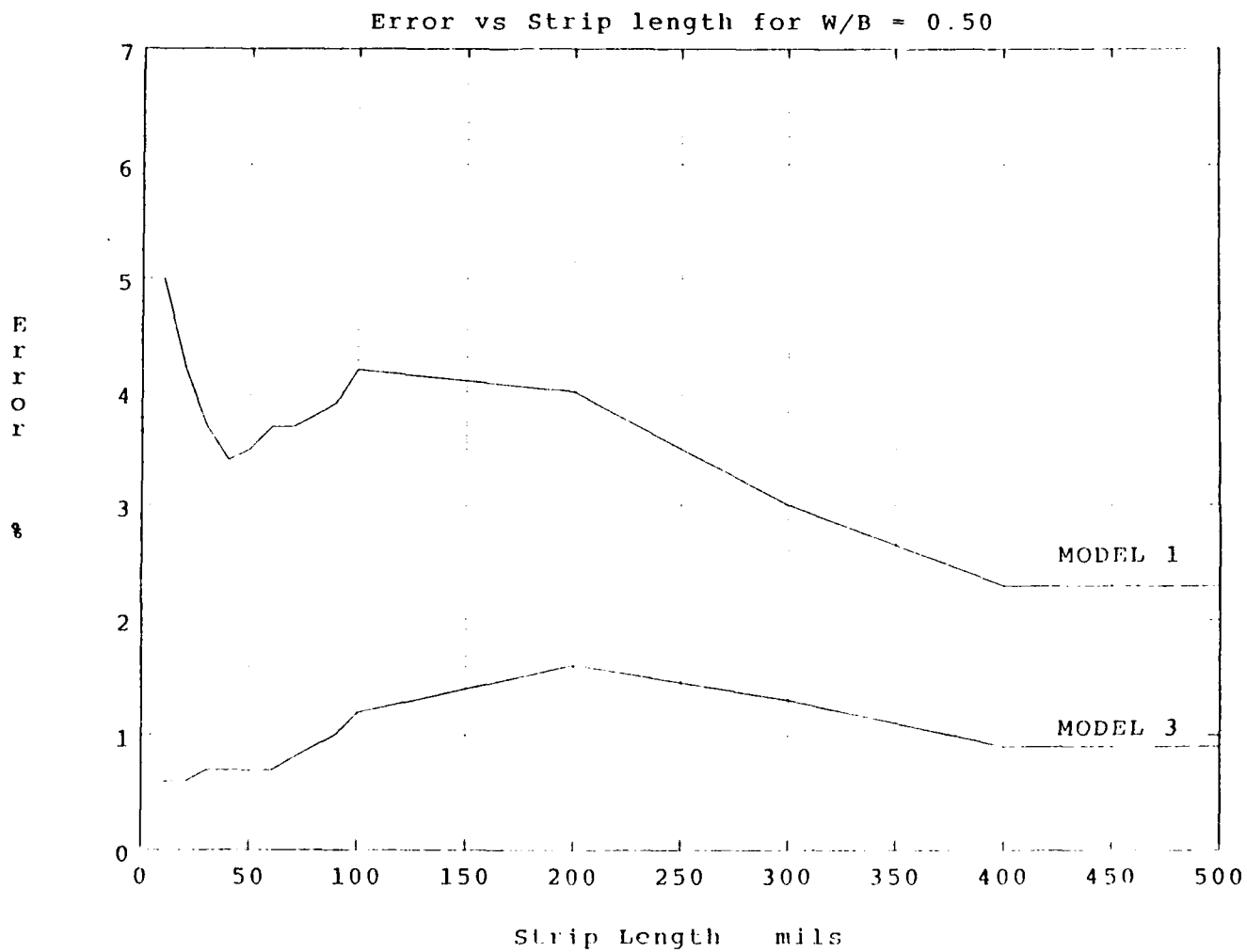
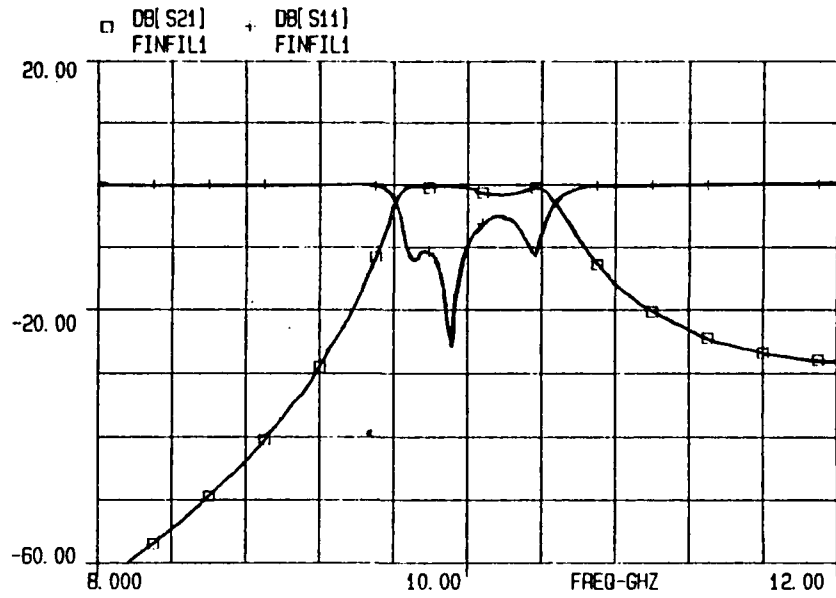
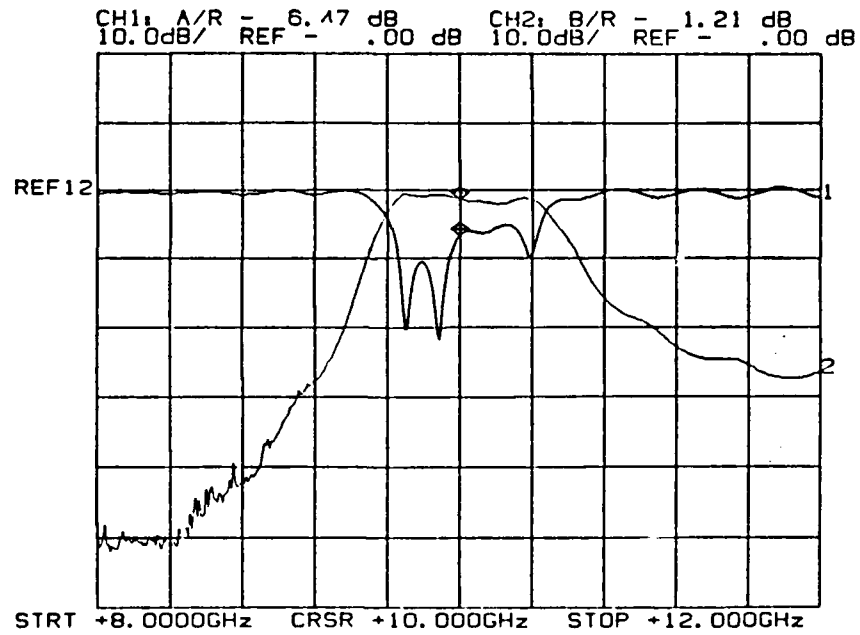

Figure 21. Error vs. Strip Length: The error vs. strip length is plotted for $\frac{W}{b} = 0.5$. The solid lines merely connect the data points.



a)



b)

Figure 22. Insertion and Return Loss of Model and Actual Filter: The insertion and return loss of a 4 strip finline filter where $\frac{w}{b} = 1.0$. a) model b) actual filter.

V. SCALING TO OTHER WAVEGUIDE BANDS

A. CONCEPT

It has been shown that the model is accurate for $WR(90)$, but it would be more useful if it could be applied to other waveguide bands. In particular, the millimeter wave frequencies are currently of high interest. In Ref. 10: pp. 14 - 16, Knorr describes a method of using the scaling principle to scale the model to various waveguide bands. The scaling principle states that when the wavelength and all dimensions are scaled by the same factor, the electrical characteristics remain unchanged.

In this application, the scaling principle requires that the normalized reactance remain constant while the structure is scaled in size. Thus, the following needs to be true:

$$\frac{\omega_c L\left(T, \frac{w}{b}\right)}{Z_{ov}} = K_l \quad (31)$$

$$\frac{1}{\omega_c C\left(\frac{w}{b}\right) Z_{ov}} = K_c \quad (32)$$

where K_l , K_c are constants, ω_c is the cutoff frequency, and $L\left(T, \frac{w}{b}\right)$, $C\left(\frac{w}{b}\right)$ are the model equations for inductance and capacitance. Since Z_{ov} is proportional to $\frac{a}{b}$, this results in the following:

$$\omega_c L\left(T, \frac{w}{b}\right) \propto \frac{b}{a} \quad (33)$$

$$\omega_c C\left(\frac{w}{b}\right) \propto \frac{a}{b}. \quad (34)$$

Moving ω_c to the right side, the following is obtained:

$$L\left(T, \frac{w}{b}\right) \propto \frac{b}{a\omega_c} \quad (35)$$

$$C\left(\frac{w}{b}\right) \propto \frac{a}{b\omega_c}. \quad (36)$$

Since $\frac{1}{\omega_c}$ is proportional to a , the result is:

$$L\left(T, \frac{w}{b}\right) \propto b \quad (37)$$

$$C\left(\frac{w}{b}\right) \propto \frac{a^2}{b}. \quad (38)$$

In addition, the scattering coefficients vary with $\frac{T}{a}$. Thus, combining these two scaling factors into the model equations results in the following:

$$L = \left(\frac{b}{400}\right) \left[A' + \frac{B' - C' \ln\left(T\left(\frac{900}{a}\right)\right)}{1 + \exp\left(\frac{T - N}{10} \left(\frac{900}{a}\right)\right)} \right] nH \quad (39)$$

$$C = \left(\frac{4}{8100}\right) \left(\frac{a^2}{b}\right) \left[0.003 \left(\frac{w}{b}\right) \right] pF. \quad (40)$$

For the case of $\frac{w}{b} = 1.0$, the electrical characteristics are independent of height b . Therefore, $\frac{b}{a}$ may change, and the model equations will predict the correct scattering coefficients. The model was tested at $\frac{w}{b} = 1.0$ as $\frac{b}{a}$ was varied from 0.1 to 0.5. The results showed that the scattering coefficients were identical in all cases, proving the independence of b . Since *TOUCHSTONE* picks the larger of the two waveguide dimensions as the a dimension, the *CAD* software limits the model to a maximum value of $\frac{b}{a} = \frac{1}{2}$ when the library element *RWG* is used.

For the case of $\frac{w}{b} < 1.0$, the electrical characteristics are dependent on height b . Therefore, $\frac{b}{a}$ will affect the scattering coefficients. This was tested by using *STRIP* to calculate scattering coefficients for $\frac{b}{a} = \frac{4}{9}$ and $\frac{3}{9}$ using *WR(90)*. The results showed that the scattering coefficients differed by no more than 0.5 degrees in phase and 0.005 in magnitude. As a result, only another 0.3% to 0.5% of error is incurred by making the assumption that the scattering coefficients are independent of $\frac{b}{a}$. For the waveguides of interest, *WR(90)* to *WR(5)*, there are only 3 different values of $\frac{b}{a}$: $\frac{b}{a} = 0.444$ for *WR(90)*, $\frac{b}{a} = 0.405$ for *WR(42)*, and $\frac{b}{a} = 0.5$ for *WR(28)* to *WR(5)*. This narrow range of $\frac{b}{a}$ values makes it reasonable to assume that the scattering coefficients are effectively independent of $\frac{b}{a}$. To measure the effect of $\frac{b}{a}$, the inductance and capacitance equations would need to be tested for a $\frac{b}{a}$ dependence. This could be done by replicating the work done for *WR(90)* with *WR(28)*. Therefore, a model would exist for $\frac{b}{a} = \frac{4}{9}$ and another for $\frac{b}{a} = \frac{1}{2}$. If there are enough similarities, the two models may be merged and a single one formed.

B. IMPLEMENTATION AND RESULTS

The model was scaled to $WR(42)$, $WR(28)$, $WR(19)$, $WR(12)$, $WR(8)$, and $WR(5)$ at various values of $\frac{w}{b}$ and strip lengths. Appendix F lists the computer-generated S_{11} coefficients. Appendix G shows the magnitude, phase, and Smith chart plots which compare the model with the data. Appendix H lists the maximum error found in each case. The results show that the model is remarkably accurate as frequency and waveguide dimensions are scaled. In addition, the error is not significantly increased by making the assumption that $\frac{b}{a}$ is constant.

In conclusion, the model's scaling ability is its most powerful feature. With it, any millimeter waveguide and any strip (with the limitation that $\frac{T}{a} \geq \frac{10}{900}$) can be represented by the model with a maximum of 2.5% error in the scattering coefficients. Furthermore, millimeter wave finline filters can be easily modeled with high accuracy in those cases where conductor thickness t is negligibly small ($\frac{t}{a} \rightarrow 0$).

VI. SUMMARY

A. CONCLUSIONS

In summary, an equivalent circuit model which describes an inductive strip in homogeneous finline has been derived which produces less than 2.5% error. The model is based on a homogeneous finline model and scattering data from a spectral domain computer program. The requirement of an accurate spectral domain program is essential in order to test the model under all conditions. In addition, the model describes most of the physical features of an inductive strip in finline. This was accomplished by carefully using curve-fitting techniques to minimize any additional error. This allows the model to work well under a variety of conditions. Good data gathered in the matching process will be wasted if accurate curve-fitting techniques are not used. The work in this thesis resulted in a range of validity for the finline model of $0.01 \leq \frac{w}{b} \leq 1.0$ and for the inductive strip in finline model of $0.1 \leq \frac{w}{b} \leq 1.0$ where $\frac{T}{a} \geq \frac{10}{900}$.

Model accuracy may be tested in two ways: (1) comparing the S_{11} parameters of the model against actual measurements or computer-generated data, and (2) comparing the insertion and return loss of a finline filter model (constructed with the inductive strip in finline model) against an actual finline filter. It is easier to experimentally measure the latter. Although the spectral domain program is more flexible, it makes many assumptions (e.g., infinitely thin strips, no loss, etc.) which may be invalid for the case in question.

Finally, the ability to scale the model is its most powerful feature. The model can be scaled to all millimeter wave frequencies and applied to the design of millimeter wave finline filters. As a result, the circuit model presented in this thesis has wide applications, yet maintains enough simplicity to generate accurate results in a matter of seconds.

B. RECOMMENDATIONS

Although this model generates very accurate results, it would be useful to investigate the following:

1. The effect of resistance in a waveguide below cutoff.
2. The effect of strips with finite metal thickness.
3. Extending the model to the case of $\frac{w}{b} < 0.1$ and $T < 10$ mils for $WR(90)$ waveguide. This will involve validating the spectral domain program under these conditions.

4. Developing a model for inhomogeneous finline and inductive strips in inhomogeneous finline.

In conclusion, other means of improving accuracy should be investigated with the eventual goal of developing a model for an inductive strip in inhomogeneous finline.

**APPENDIX A. COMPUTER-GENERATED FINLINE DATA FOR WR(28)
AND WR(90)**

Table 1. Aeq AND Beq FOR WR(28), W/B = 0.01, 0.02, 0.03: Output from IMPED. Results include $\frac{\lambda'}{\lambda}$, Z_{ov} , k_{eff} , and Z_{inf} . Frequency is in GHz and impedance is in Ohms.

Dielec Thickness D (mil) 1.0000
 Normalized H1/D = 140.0000
 Normalized H2/D = 139.0000
 waveguide height B/D = 140.0000
 septum width S/B = 0.
 nmbr of dif. W/B (max 8) 7.0000
 Dielec. cons region 1 = 1.0000
 Dielec. cons region 2 = 1.0000
 Dielec. cons region 3 = 1.0000
 Upper freq limit GHz = 40.0000
 Lower freq limit GHz = 26.0000
 Freq increment GHz = 2.0000

W / B						

0.0100						
FREQ	L"/L	Z ov	K eff	Z inf	Aeq / A	Beq / B
-----	-----	-----	-----	-----	-----	-----
26.0000	1.0900	122.0114	1.0000	111.9360	2.0386	0.6053
28.0000	1.0759	120.4365	1.0000	111.9448	2.0422	0.6064
30.0000	1.0645	119.1899	1.0000	111.9644	2.0504	0.6089
32.0000	1.0560	118.2394	1.0000	111.9647	2.0505	0.6090
34.0000	1.0504	117.5462	1.0000	111.9082	2.0273	0.6018
36.0000	1.0447	116.9043	1.0000	111.9002	2.0241	0.6008
38.0000	1.0391	116.3204	1.0000	111.9480	2.0436	0.6068
40.0000	1.0334	115.8009	1.0000	112.0585	2.0910	0.6215

W / B						

0.0200						
FREQ	L"/L	Z ov	K eff	Z inf	Aeq / A	Beq / B
-----	-----	-----	-----	-----	-----	-----
26.0000	1.1042	138.4195	1.0000	125.3613	1.9132	0.6362
28.0000	1.0872	136.3173	1.0000	125.3861	1.9198	0.6385
30.0000	1.0759	134.8417	1.0000	125.3342	1.9061	0.6337
32.0000	1.0645	133.4875	1.0000	125.3952	1.9222	0.6394
34.0000	1.0560	132.4525	1.0000	125.4235	1.9299	0.6421
36.0000	1.0504	131.6830	1.0000	125.3669	1.9147	0.6367
38.0000	1.0447	130.9847	1.0000	125.3779	1.9176	0.6377
40.0000	1.0391	130.3657	1.0000	125.4653	1.9414	0.6461

W / B						

0.0300						
FREQ	L"/L	Z ov	K eff	Z inf	Aeq / A	Beq / B
-----	-----	-----	-----	-----	-----	-----
26.0000	1.1155	152.1625	1.0000	136.4091	1.8307	0.6624
28.0000	1.0957	149.5297	1.0000	136.4730	1.8432	0.6672
30.0000	1.0815	147.6125	1.0000	136.4864	1.8458	0.6683
32.0000	1.0730	146.2971	1.0000	136.3407	1.8177	0.6574
34.0000	1.0617	144.9118	1.0000	136.4899	1.8465	0.6685
36.0000	1.0560	144.0093	1.0000	136.3670	1.8227	0.6593
38.0000	1.0504	143.1884	1.0000	136.3205	1.8139	0.6559
40.0000	1.0447	142.4600	1.0000	136.3620	1.8217	0.6589

Table 2. Aeq AND Beq FOR WR(28), W/B = 0.04, 0.05, 0.06, 0.07

W / B						
0.0400						
FREQ	L"/L	Z ov	K eff	Z inf	Aeq / A	Beq / B
26.0000	1.1240	163.5707	1.0000	145.5282	1.7768	0.6859
28.0000	1.1042	160.6853	1.0000	145.5267	1.7765	0.6858
30.0000	1.0900	158.5556	1.0000	145.4625	1.7668	0.6817
32.0000	1.0787	156.8443	1.0000	145.4029	1.7579	0.6780
34.0000	1.0674	155.3138	1.0000	145.5114	1.7742	0.6848
36.0000	1.0589	154.1307	1.0000	145.5611	1.7818	0.6880
38.0000	1.0532	153.2147	1.0000	145.4739	1.7685	0.6824
40.0000	1.0475	152.4028	1.0000	145.4851	1.7702	0.6831

W / B						
0.0500						
FREQ	L"/L	Z ov	K eff	Z inf	Aeq / A	Beq / B
26.0000	1.1325	173.8649	1.0000	153.5270	1.7284	0.7039
28.0000	1.1127	170.7288	1.0000	153.4426	1.7180	0.6992
30.0000	1.0957	168.1436	1.0000	153.4617	1.7203	0.7003
32.0000	1.0815	166.0600	1.0000	153.5434	1.7305	0.7048
34.0000	1.0730	164.5846	1.0000	153.3836	1.7108	0.6960
36.0000	1.0645	163.2634	1.0000	153.3661	1.7086	0.6951
38.0000	1.0560	162.1168	1.0000	153.5136	1.7267	0.7031
40.0000	1.0504	161.2179	1.0000	153.4852	1.7232	0.7016

W / B						
0.0600						
FREQ	L"/L	Z ov	K eff	Z inf	Aeq / A	Beq / B
26.0000	1.1410	183.3215	1.0000	160.6726	1.6848	0.7180
28.0000	1.1183	179.6601	1.0000	160.6521	1.6826	0.7170
30.0000	1.1013	176.8816	1.0000	160.6068	1.6779	0.7148
32.0000	1.0872	174.6284	1.0000	160.6252	1.6798	0.7157
34.0000	1.0759	172.8303	1.0000	160.6443	1.6818	0.7167
36.0000	1.0674	171.4026	1.0000	160.5849	1.6757	0.7138
38.0000	1.0589	170.1649	1.0000	160.7038	1.6881	0.7196
40.0000	1.0532	169.1751	1.0000	160.6279	1.6801	0.7159

W / B						
0.0700						
FREQ	L"/L	Z ov	K eff	Z inf	Aeq / A	Beq / B
26.0000	1.1495	192.2167	1.0000	167.2242	1.6451	0.7297
28.0000	1.1240	188.0161	1.0000	167.2772	1.6499	0.7321
30.0000	1.1070	185.0413	1.0000	167.1564	1.6391	0.7268
32.0000	1.0900	182.4123	1.0000	167.3491	1.6564	0.7353
34.0000	1.0787	180.4951	1.0000	167.3284	1.6545	0.7344
36.0000	1.0702	178.9581	1.0000	167.2200	1.6447	0.7296
38.0000	1.0617	177.6257	1.0000	167.3026	1.6522	0.7332
40.0000	1.0560	176.5395	1.0000	167.1709	1.6404	0.7274

Table 3. Aeq AND Beq FOR WR(28), W/B = 0.08, 0.09, 0.1, 0.2

W / B						
0.0800						
FREQ	L"/L	Z ov	K eff	Z inf	Aeq / A	Beq / B
26.0000	1.1551	200.3378	1.0000	173.4352	1.6206	0.7456
28.0000	1.1296	195.9017	1.0000	173.4196	1.6194	0.7449
30.0000	1.1098	192.4864	1.0000	173.4384	1.6209	0.7457
32.0000	1.0957	189.9177	1.0000	173.3345	1.6128	0.7415
34.0000	1.0843	187.8341	1.0000	173.2230	1.6042	0.7371
36.0000	1.0730	186.0330	1.0000	173.3723	1.6157	0.7430
38.0000	1.0645	184.6015	1.0000	173.4106	1.6187	0.7446
40.0000	1.0589	183.4131	1.0000	173.2154	1.6037	0.7368
W / B						
0.0900						
FREQ	L"/L	Z ov	K eff	Z inf	Aeq / A	Beq / B
26.0000	1.1636	208.4340	1.0000	179.1272	1.5865	0.7538
28.0000	1.1353	203.4376	1.0000	179.1926	1.5910	0.7562
30.0000	1.1155	199.8159	1.0000	179.1289	1.5866	0.7539
32.0000	1.0985	196.8669	1.0000	179.2138	1.5925	0.7570
34.0000	1.0872	194.6558	1.0000	179.0466	1.5810	0.7509
36.0000	1.0759	192.7447	1.0000	179.1546	1.5884	0.7548
38.0000	1.0674	191.2091	1.0000	179.1413	1.5875	0.7543
40.0000	1.0589	189.9335	1.0000	179.3733	1.6037	0.7630
W / B						
0.1000						
FREQ	L"/L	Z ov	K eff	Z inf	Aeq / A	Beq / B
26.0000	1.1693	215.9153	1.0000	184.6582	1.5653	0.7667
28.0000	1.1410	210.6722	1.0000	184.6442	1.5644	0.7662
30.0000	1.1211	206.8374	1.0000	184.4872	1.5549	0.7609
32.0000	1.1042	203.6966	1.0000	184.4804	1.5545	0.7607
34.0000	1.0900	201.1661	1.0000	184.5543	1.5589	0.7632
36.0000	1.0787	199.1411	1.0000	184.6142	1.5626	0.7652
38.0000	1.0702	197.4958	1.0000	184.5418	1.5582	0.7628
40.0000	1.0617	196.1254	1.0000	184.7271	1.5696	0.7691
W / B						
0.2000						
FREQ	L"/L	Z ov	K eff	Z inf	Aeq / A	Beq / B
26.0000	1.2344	283.1277	1.0000	229.3690	1.3837	0.8419
28.0000	1.1919	273.4150	1.0000	229.3912	1.3843	0.8423
30.0000	1.1608	266.2852	1.0000	229.4023	1.3846	0.8425
32.0000	1.1381	260.9028	1.0000	229.2376	1.3803	0.8393
34.0000	1.1183	256.5936	1.0000	229.4461	1.3857	0.8434
36.0000	1.1042	253.1782	1.0000	229.2940	1.3818	0.8404
38.0000	1.0900	250.4790	1.0000	229.7951	1.3948	0.8502
40.0000	1.0815	248.0957	1.0000	229.3957	1.3844	0.8424

Table 4. Aeq AND Beq FOR WR(28), W/B = 0.3, 0.4, 0.5, 0.6

W / B						
0.3000						
FREQ	L"/L	Z ov	K eff	Z inf	Aeq / A	Beq / B
26.0000	1.2938	342.5876	1.0000	264.7875	1.2784	0.8979
28.0000	1.2400	327.9518	1.0000	264.4692	1.2738	0.8936
30.0000	1.1976	317.0459	1.0000	264.7394	1.2777	0.8973
32.0000	1.1664	309.0069	1.0000	264.9147	1.2803	0.8997
34.0000	1.1438	302.8224	1.0000	264.7526	1.2779	0.8975
36.0000	1.1268	297.7991	1.0000	264.2852	1.2712	0.8911
38.0000	1.1098	293.9612	1.0000	264.8716	1.2797	0.8991
40.0000	1.0985	290.5319	1.0000	264.4800	1.2740	0.8938

W / B						
0.4000						
FREQ	L"/L	Z ov	K eff	Z inf	Aeq / A	Beq / B
26.0000	1.3589	399.7240	1.0000	294.1467	1.1980	0.9347
28.0000	1.2852	378.2077	1.0000	294.2497	1.1990	0.9358
30.0000	1.2344	363.2450	1.0000	294.2741	1.1992	0.9361
32.0000	1.1976	352.2457	1.0000	294.1320	1.1979	0.9346
34.0000	1.1693	343.8067	1.0000	294.0353	1.1970	0.9336
36.0000	1.1466	337.1990	1.0000	294.0797	1.1974	0.9341
38.0000	1.1296	331.6964	1.0000	293.6301	1.1933	0.9294
40.0000	1.1127	327.8269	1.0000	294.6345	1.2026	0.9399

W / B						
0.5000						
FREQ	L"/L	Z ov	K eff	Z inf	Aeq / A	Beq / B
26.0000	1.4269	454.8902	1.0000	318.8041	1.1372	0.9617
28.0000	1.3363	425.6771	1.0000	318.5534	1.1356	0.9596
30.0000	1.2740	405.6564	1.0000	318.4101	1.1347	0.9584
32.0000	1.2287	391.1611	1.0000	318.3497	1.1343	0.9579
34.0000	1.1947	380.2219	1.0000	318.2448	1.1336	0.9570
36.0000	1.1664	372.0155	1.0000	318.9325	1.1380	0.9628
38.0000	1.1466	365.0417	1.0000	318.3620	1.1344	0.9580
40.0000	1.1296	359.4962	1.0000	318.2396	1.1336	0.9569

W / B						
0.6000						
FREQ	L"/L	Z ov	K eff	Z inf	Aeq / A	Beq / B
26.0000	1.4976	507.6295	1.0000	338.9548	1.0897	0.9798
28.0000	1.3844	469.1109	1.0000	338.8541	1.0892	0.9790
30.0000	1.3080	443.6118	1.0000	339.1593	1.0907	0.9812
32.0000	1.2570	425.5640	1.0000	338.5494	1.0878	0.9769
34.0000	1.2174	412.1272	1.0000	338.5329	1.0877	0.9767
36.0000	1.1863	401.9366	1.0000	338.8283	1.0891	0.9785
38.0000	1.1636	393.3824	1.0000	338.0710	1.0855	0.9734
40.0000	1.1438	386.8616	1.0000	338.2267	1.0862	0.9745

Table 5. Aeq AND Beq FOR WR(28), W/B = 0.7, 0.8, 0.9, 1.0

W / B						
0.7000						
FREQ	L"/L	Z ov	K eff	Z inf	Aeq / A	Beq / B
26.0000	1.5712	556.8206	1.0000	354.3851	1.0517	0.9886
28.0000	1.4325	507.7754	1.0000	354.4616	1.0520	0.9891
30.0000	1.3448	476.4986	1.0000	354.3336	1.0515	0.9883
32.0000	1.2825	454.8299	1.0000	354.6436	1.0527	0.9903
34.0000	1.2372	439.0472	1.0000	354.8696	1.0535	0.9917
36.0000	1.2032	426.9690	1.0000	354.8498	1.0535	0.9916
38.0000	1.1778	417.0474	1.0000	354.1015	1.0506	0.9868
40.0000	1.1551	409.8824	1.0000	354.8407	1.0534	0.9915

W / B						
0.8000						
FREQ	L"/L	Z ov	K eff	Z inf	Aeq / A	Beq / B
26.0000	1.6335	598.4049	1.0000	366.3317	1.0259	0.9969
28.0000	1.4750	539.7807	1.0000	365.9564	1.0247	0.9947
30.0000	1.3731	503.0155	1.0000	366.3408	1.0259	0.9969
32.0000	1.3051	478.0200	1.0000	366.2585	1.0257	0.9965
34.0000	1.2570	459.6460	1.0000	365.6626	1.0238	0.9930
36.0000	1.2174	446.4958	1.0000	366.7641	1.0273	0.9994
38.0000	1.1891	435.5678	1.0000	366.3050	1.0258	0.9967
40.0000	1.1664	426.6892	1.0000	365.8049	1.0242	0.9938

W / B						
0.9000						
FREQ	L"/L	Z ov	K eff	Z inf	Aeq / A	Beq / B
26.0000	1.6930	631.4192	1.0000	372.9696	1.0053	0.9946
28.0000	1.5090	563.0791	1.0000	373.1583	1.0058	0.9956
30.0000	1.3986	521.7743	1.0000	373.0804	1.0056	0.9952
32.0000	1.3250	493.8659	1.0000	372.7405	1.0047	0.9934
34.0000	1.2712	473.8665	1.0000	372.7782	1.0048	0.9936
36.0000	1.2315	458.6316	1.0000	372.4032	1.0038	0.9915
38.0000	1.2004	446.8446	1.0000	372.2440	1.0033	0.9907
40.0000	1.1749	437.8122	1.0000	372.6278	1.0044	0.9927

W / B						
1.0000						
FREQ	L"/L	Z ov	K eff	Z inf	Aeq / A	Beq / B
26.0000	1.7099	644.6556	1.0000	377.0059	1.0000	1.0001
28.0000	1.5203	573.1610	1.0000	377.0107	1.0001	1.0001
30.0000	1.4070	530.1048	1.0000	376.7492	0.9994	0.9987
32.0000	1.3306	501.1732	1.0000	376.6463	0.9991	0.9982
34.0000	1.2740	480.8591	1.0000	377.4386	1.0012	1.0024
36.0000	1.2344	465.0375	1.0000	376.7388	0.9993	0.9987
38.0000	1.2032	452.7038	1.0000	376.2377	0.9980	0.9960
40.0000	1.1778	443.1579	1.0000	376.2711	0.9981	0.9962

Table 6. Aeq AND Beq FOR WR(90), W/B = 0.01, 0.02, 0.03, 0.04

Dielec Thickness D (mil) 1.0000
 Normalized H1/D - 449.0000
 Normalized H2/D - 450.0000
 waveguide height B/D - 400.0000
 septum width S/B - 0.
 nmr of dif. W/B (max 8) 6.0000
 Dielec. cons region 1 - 1.0000
 Dielec. cons region 2 - 1.0000
 Dielec. cons region 3 - 1.0000
 Upper freq limit GHz - 12.0000
 Lower freq limit GHz - 8.0000
 Freq increment GHz - 1.0000

W / B						
0.0100						
FREQ	L"/L	Z ov	K eff	Z inf	Aeq / A	Beq / B
8.0000	1.1013	119.9015	1.0000	108.8694	1.9576	0.6360
9.0000	1.0787	117.3959	1.0000	108.8321	1.9446	0.6315
10.0000	1.0617	115.5738	1.0000	108.8569	1.9532	0.6345
11.0000	1.0504	114.3300	1.0000	108.8462	1.9495	0.6332
12.0000	1.0419	113.4013	1.0000	108.8421	1.9480	0.6327
W / B						
0.0200						
FREQ	L"/L	Z ov	K eff	Z inf	Aeq / A	Beq / B
8.0000	1.1183	135.8013	1.0000	121.4336	1.8322	0.6639
9.0000	1.0900	132.3641	1.0000	121.4338	1.8322	0.6640
10.0000	1.0702	130.0040	1.0000	121.4769	1.8421	0.6678
11.0000	1.0589	128.4977	1.0000	121.3533	1.8142	0.6570
12.0000	1.0475	127.2242	1.0000	121.4493	1.8358	0.6653
W / B						
0.0300						
FREQ	L"/L	Z ov	K eff	Z inf	Aeq / A	Beq / B
8.0000	1.1296	148.8423	1.0000	131.7608	1.7634	0.6933
9.0000	1.0985	144.7279	1.0000	131.7501	1.7616	0.6926
10.0000	1.0787	142.0432	1.0000	131.6815	1.7501	0.6877
11.0000	1.0645	140.1118	1.0000	131.6180	1.7397	0.6833
12.0000	1.0532	138.6385	1.0000	131.6341	1.7423	0.6844
W / B						
0.0400						
FREQ	L"/L	Z ov	K eff	Z inf	Aeq / A	Beq / B
8.0000	1.1410	159.8889	1.0000	140.1350	1.7035	0.7124
9.0000	1.1070	155.0981	1.0000	140.1074	1.6998	0.7107
10.0000	1.0843	151.9012	1.0000	140.0852	1.6969	0.7094
11.0000	1.0674	149.5963	1.0000	140.1548	1.7061	0.7136
12.0000	1.0560	147.9698	1.0000	140.1174	1.7011	0.7113

Table 7. Aeq AND Beq FOR WR(90), W/B = 0.05, 0.06, 0.07, 0.08, 0.09

W / B						
0.0500						
FREQ	L"/L	Z ov	K eff	Z inf	Aeq / A	Beq / B
8.0000	1.1523	169.8614	1.0000	147.4126	1.6508	0.7262
9.0000	1.1127	164.1416	1.0000	147.5223	1.6628	0.7320
10.0000	1.0900	160.6626	1.0000	147.3955	1.6490	0.7253
11.0000	1.0730	158.1199	1.0000	147.3589	1.6451	0.7234
12.0000	1.0589	156.2027	1.0000	147.5245	1.6631	0.7321

W / B						
0.0600						
FREQ	L"/L	Z ov	K eff	Z inf	Aeq / A	Beq / B
8.0000	1.1608	178.7356	1.0000	153.9792	1.6153	0.7422
9.0000	1.1211	172.5986	1.0000	153.9480	1.6125	0.7408
10.0000	1.0928	168.4105	1.0000	154.1033	1.6268	0.7481
11.0000	1.0759	165.6826	1.0000	154.0006	1.6173	0.7432
12.0000	1.0617	163.6221	1.0000	154.1128	1.6277	0.7486

W / B						
0.0700						
FREQ	L"/L	Z ov	K eff	Z inf	Aeq / A	Beq / B
8.0000	1.1693	187.0554	1.0000	159.9762	1.5827	0.7556
9.0000	1.1268	180.2519	1.0000	159.9666	1.5819	0.7552
10.0000	1.0985	175.7720	1.0000	160.0105	1.5854	0.7570
11.0000	1.0787	172.6772	1.0000	160.0808	1.5910	0.7600
12.0000	1.0645	170.4609	1.0000	160.1272	1.5947	0.7620

W / B						
0.0800						
FREQ	L"/L	Z ov	K eff	Z inf	Aeq / A	Beq / B
8.0000	1.1778	194.9232	1.0000	165.5030	1.5526	0.7668
9.0000	1.1325	187.4415	1.0000	165.5155	1.5535	0.7673
10.0000	1.1042	182.6614	1.0000	165.4296	1.5476	0.7640
11.0000	1.0815	179.2047	1.0000	165.6973	1.5662	0.7744
12.0000	1.0674	176.8261	1.0000	165.6660	1.5639	0.7732

W / B						
0.0900						
FREQ	L"/L	Z ov	K eff	Z inf	Aeq / A	Beq / B
8.0000	1.1834	202.1476	1.0000	170.8159	1.5338	0.7818
9.0000	1.1381	194.2826	1.0000	170.7030	1.5269	0.7778
10.0000	1.1070	189.0214	1.0000	170.7518	1.5298	0.7795
11.0000	1.0872	185.4672	1.0000	170.5948	1.5203	0.7740
12.0000	1.0702	182.8288	1.0000	170.8369	1.5351	0.7826

Table 8. Aeq AND Beq FOR WR(90), W/B = 0.1, 0.2, 0.3, 0.4, 0.5

W / B						
0.1000						
FREQ	L"/L	Z ov	K eff	Z inf	Aeq / A	Beq / B
8.0000	1.1919	209.3881	1.0000	175.6735	1.5073	0.7902
9.0000	1.1438	200.8223	1.0000	175.5757	1.5020	0.7869
10.0000	1.1098	195.0781	1.0000	175.7737	1.5128	0.7935
11.0000	1.0900	191.3220	1.0000	175.5231	1.4991	0.7852
12.0000	1.0730	188.5158	1.0000	175.6861	1.5080	0.7906
W / B						
0.2000						
FREQ	L"/L	Z ov	K eff	Z inf	Aeq / A	Beq / B
8.0000	1.2627	271.5700	1.0000	215.0737	1.3434	0.8622
9.0000	1.1891	255.9433	1.0000	215.2439	1.3475	0.8655
10.0000	1.1466	246.5003	1.0000	214.9791	1.3411	0.8603
11.0000	1.1155	240.0435	1.0000	215.1917	1.3462	0.8645
12.0000	1.0957	235.4061	1.0000	214.8509	1.3330	0.8579
W / B						
0.3000						
FREQ	L"/L	Z ov	K eff	Z inf	Aeq / A	Beq / B
8.0000	1.3278	325.5548	1.0000	245.1855	1.2468	0.9122
9.0000	1.2315	302.1625	1.0000	245.3523	1.2491	0.9146
10.0000	1.1749	288.3362	1.0000	245.4068	1.2499	0.9153
11.0000	1.1381	279.2545	1.0000	245.3620	1.2493	0.9147
12.0000	1.1127	272.8339	1.0000	245.2096	1.2471	0.9126
W / B						
0.4000						
FREQ	L"/L	Z ov	K eff	Z inf	Aeq / A	Beq / B
8.0000	1.3957	376.2543	1.0000	269.5759	1.1757	0.9458
9.0000	1.2740	343.5753	1.0000	269.6810	1.1767	0.9470
10.0000	1.2061	324.8664	1.0000	269.3597	1.1737	0.9435
11.0000	1.1608	312.7967	1.0000	269.4716	1.1748	0.9447
12.0000	1.1296	304.5048	1.0000	269.5591	1.1756	0.9456
W / B						
0.5000						
FREQ	L"/L	Z ov	K eff	Z inf	Aeq / A	Beq / B
8.0000	1.4665	424.5219	1.0000	289.4908	1.1214	0.9687
9.0000	1.3165	381.0219	1.0000	289.4276	1.1210	0.9692
10.0000	1.2344	356.9354	1.0000	289.1626	1.1193	0.9658
11.0000	1.1806	341.9166	1.0000	289.6143	1.1222	0.9699
12.0000	1.1466	331.2670	1.0000	288.9062	1.1176	0.9635

Table 9. Aeq AND Beq FOR WR(90), W/B = 0.6, 0.7, 0.8, 0.9, 1.0

W / B						
0.6000						
FREQ	L"/L	Z ov	K eff	Z inf	Aeq / A	Beq / B
8.0000	1.5401	470.1929	1.0000	305.3017	1.0785	0.9826
9.0000	1.3561	414.2647	1.0000	305.4832	1.0794	0.9840
10.0000	1.2599	384.7084	1.0000	305.3598	1.0788	0.9830
11.0000	1.2004	366.4448	1.0000	305.2669	1.0783	0.9823
12.0000	1.1608	354.0174	1.0000	304.9828	1.0769	0.9801
W / B						
0.7000						
FREQ	L"/L	Z ov	K eff	Z inf	Aeq / A	Beq / B
8.0000	1.6109	511.6850	1.0000	317.6471	1.0462	0.9917
9.0000	1.3929	442.8350	1.0000	317.9240	1.0473	0.9937
10.0000	1.2825	407.9390	1.0000	318.0815	1.0480	0.9948
11.0000	1.2174	386.6221	1.0000	317.5822	1.0459	0.9913
12.0000	1.1721	372.3983	1.0000	318.1452	1.0483	0.9952
W / B						
0.8000						
FREQ	L"/L	Z ov	K eff	Z inf	Aeq / A	Beq / B
8.0000	1.6760	547.3323	1.0000	326.5771	1.0221	0.9961
9.0000	1.4269	465.9814	1.0000	326.5772	1.0221	0.9961
10.0000	1.3051	425.8634	1.0000	326.2961	1.0211	0.9943
11.0000	1.2315	402.1650	1.0000	326.5530	1.0220	0.9959
12.0000	1.1834	386.6313	1.0000	326.7057	1.0225	0.9969
W / B						
0.9000						
FREQ	L"/L	Z ov	K eff	Z inf	Aeq / A	Beq / B
8.0000	1.7297	574.4741	1.0000	332.1140	1.0052	0.9963
9.0000	1.4523	482.4052	1.0000	332.1571	1.0054	0.9965
10.0000	1.3193	438.4726	1.0000	332.3530	1.0060	0.9977
11.0000	1.2429	412.4967	1.0000	331.8909	1.0045	0.9949
12.0000	1.1919	395.7210	1.0000	332.0041	1.0049	0.9956
W / B						
1.0000						
FREQ	L"/L	Z ov	K eff	Z inf	Aeq / A	Beq / B
8.0000	1.7467	585.5476	1.0000	335.2243	1.0004	1.0007
9.0000	1.4608	489.3806	1.0000	335.0011	1.0001	0.9998
10.0000	1.3250	444.1296	1.0000	335.2025	1.0002	1.0005
11.0000	1.2457	417.6120	1.0000	335.2430	1.0004	1.0008
12.0000	1.1947	400.0270	1.0000	334.8216	0.9993	0.9984

APPENDIX B. INDUCTIVE STRIP IN FINLINE MODEL

```

! FILE: FINTEST.CKTS

! USER:      MIKE MORUA
! DATE:      22 MAY 90
! CIRCUIT:   MODEL OF INDUCTIVE STRIP IN HOMOGENEOUS FINLINE
!           FOR 0.1 <= W/b <= 1.0, 10 <= T <= 500 MILS,
!           AND STRIP CENTERED. MODEL SCALES TO ALL WAVEGUIDE
!           BANDS.

! COMMENT:   S-PARAMETERS FOR THE STRIPS ARE IN DATA FILES
!           AND WERE TAKEN FROM STRIP SPECTRAL DOMAIN PROGRAM.

DIM
  FREQ GHZ
  RES OH
  IND NH
  CAP PF
  LNG MIL
  TIME PS
  COND /OH
  ANG DEG

VAR
  A = 900
  B = 400
  Wovb = 1.0
  T = 100
  pi = 3.14159

EQN
  Tov2 = T/2

! FINLINE MODEL
  M = 2*B/A
  N = 1-Wovb
  Aov2 = A/2
  Aeq1 = 2 - (1 - M**0.77 * N**2)**0.5
  Aeq2 = 0.221 * (1/M)**3.61 * N**28
  Aeq = (Aeq1 + Aeq2)*A

  Beq1 = 0.6 + (0.16 - 0.1347 * M**1.35 * N**2)**0.5
  Beq2 = -0.17 * (1/M)**1.15 * N**10
  Beq = (Beq1 + Beq2)*B

! IMPEDANCE TRANSFORMER
  Lamda = (30000/2.54)/FREQ
  LpovL1 = 1/(1-(Lamda/(2*Aeq))**2)**0.5
  LpovL2 = 1/(1-(Lamda/(2*A))**2)**0.5
  Z1 = 120*pi*(2*Beq/Aeq)*LpovL1
  Z2 = 120*pi*(2*B/A)*LpovL2
  X1 = (Z1/Z2)**0.5

! INDUCTANCE COEFFICIENTS
  A1 = 13.75 - 10.32*(1 - Wovb)**1.60
  B1 = 9.46 - 6.36*(1 - Wovb)**3.78
  C1 = 1.54 - 1.10*(1 - Wovb)**4.73

```

Figure 23. Inductive Strip in Finline Model TOUCHSTONE Program.

```

! INDUCTANCE EQUATION
Tp = 900*T/A
N1 = 500 - 241*(1-Wovb)**1.74
L1 = B1 - C1*ln(Tp)
L2 = 1 + exp((T - N1)*90/A)
L = (B/400)*(A1 + (L1/L2))

! CAPACITANCE EQUATION
C = (4/8100)*(A**2/B)*(Wovb*0.003)

CKT

! HALF LENGTH OF WAVEGUIDE BELOW CUTOFF W/ CAP AND IND
CAP 1 0 C`C
IND 1 0 L`L
RWG 1 2 A`Aov2 B`B L`Tov2 ER=1.0 RHO=1
DEF2P 1 2 STRIP

! COMPLETE CIRCUIT MODEL
XFER 1 2 0 0 N`X1
STRIP 2 3
STRIP 2 3
STRIP 4 3
STRIP 4 3
XFER 5 4 0 0 N`X1
DEF2P 1 5 STRIPMOD

! EXPERIMENTAL OR COMPUTER GENERATED DATA
S2PA 1 2 0 W100T10.S2P ! FILE NAME
DEF2P 1 2 STRIPDAT

! WEDGE TERMINATION
RWGT 1 A`Aeq B`Beq ER=1 RHO=1
DEF1P 1 WEDGE

TERM
STRIPMOD WEDGE WEDGE
PROC

OUT
STRIPMOD S11 SC2
STRIPMOD MAG[S11] GR1
STRIPMOD ANG[S11] GR1A
STRIPDAT S11 SC2
STRIPDAT MAG[S11] GR1
STRIPDAT ANG[S11] GR1A

FREQ
SWEEP 8.0 12.0 0.5

GRID !SET UP GRID SCALING
RANGE 7 13 1
GR1 0.00 1.00 0.05
GR1A 90 180 5.0

```

Figure 24. Inductive Strip in Finline Model TOUCHSTONE Program (cont.).

APPENDIX C. COMPUTER-GENERATED SCATTERING DATA FOR INDUCTIVE STRIPS

Table 10. SCATTERING DATA FOR W/B = 1.0, T = 10, 20, 30, 40, 50, 60 MILS

Dielec Thickness D (mil) 100.0000
 Normalized H1/D - 4.5000
 Normalized H2/D - 3.5000
 waveguide height B/D - 4.0000
 fin gap width W/B - 1.0000
 number of dif. T/D - 8.0000
 Dielec. cons region 1 - 1.0000
 Dielec. cons region 2 - 1.0000
 Dielec. cons region 3 - 1.0000
 Upper freq limit GHz - 12.0000
 Lower freq limit GHz - 8.0000
 Freq increment GHz - 1.0000
 Matrix order - 10.0000

FREQUENCY	S11 Mag.	S11 Phase	S12 Mag.	S12 Phase	T OVER D
8.0000	0.7440	136.9688	0.6681	46.9688	0.1000
9.0000	0.6033	125.3672	0.7975	35.3672	0.1000
10.0000	0.5046	118.1426	0.8634	28.1426	0.1000
11.0000	0.4323	113.0274	0.9017	23.0274	0.1000
12.0000	0.3767	109.0196	0.9263	19.0196	0.1000
FREQUENCY	S11 Mag.	S11 Phase	S12 Mag.	S12 Phase	T OVER D
8.0000	0.7872	139.5528	0.6167	49.5528	0.2000
9.0000	0.6590	127.6875	0.7522	37.6875	0.2000
10.0000	0.5622	119.9356	0.8270	29.9356	0.2000
11.0000	0.4878	114.1876	0.8729	24.1875	0.2000
12.0000	0.4306	109.5469	0.9025	19.5469	0.2000
FREQUENCY	S11 Mag.	S11 Phase	S12 Mag.	S12 Phase	T OVER D
8.0000	0.8190	141.3458	0.5738	51.3457	0.3000
9.0000	0.7021	129.3750	0.7121	39.3750	0.3000
10.0000	0.6099	121.2012	0.7925	31.2012	0.3000
11.0000	0.5353	114.9258	0.8447	24.9258	0.3000
12.0000	0.4749	109.6524	0.8800	19.6524	0.3000
FREQUENCY	S11 Mag.	S11 Phase	S12 Mag.	S12 Phase	T OVER D
8.0000	0.8440	142.7696	0.5363	52.7696	0.4000
9.0000	0.7379	130.8516	0.6750	40.8516	0.4000
10.0000	0.6492	122.2032	0.7606	32.2032	0.4000
11.0000	0.5751	115.3477	0.8181	25.3477	0.4000
12.0000	0.5117	109.4415	0.8591	19.4415	0.4000
FREQUENCY	S11 Mag.	S11 Phase	S12 Mag.	S12 Phase	T OVER D
8.0000	0.8651	144.0352	0.5017	54.0352	0.5000
9.0000	0.7693	132.0117	0.6389	42.0118	0.5000
10.0000	0.6835	122.9415	0.7299	32.9415	0.5000
11.0000	0.6099	115.6114	0.7925	25.6114	0.5000
12.0000	0.5453	109.1778	0.8382	19.1778	0.5000
FREQUENCY	S11 Mag.	S11 Phase	S12 Mag.	S12 Phase	T OVER D
8.0000	0.8829	145.0899	0.4695	55.0899	0.6000
9.0000	0.7951	132.9083	0.6065	42.9082	0.6000
10.0000	0.7138	123.5742	0.7004	33.5743	0.6000
11.0000	0.6408	115.7696	0.7677	25.7696	0.6000
12.0000	0.5743	108.8614	0.8186	18.8614	0.6000

Table 11. SCATTERING DATA FOR W/B= 1.0, T= 70, 80, 90, 100, 200, 300, 400, 500 MILS

FREQUENCY	S11 Mag.	S11 Phase	S12 Mag.	S12 Phase	T OVER D
8.0000	0.8980	145.9337	0.4400	55.9337	0.7000
9.0000	0.8174	133.6993	0.5761	43.6993	0.7000
10.0000	0.7410	124.0489	0.6716	34.0489	0.7000
11.0000	0.6686	115.8750	0.7436	25.8750	0.7000
12.0000	0.6026	108.4395	0.7981	18.4395	0.7000
FREQUENCY	S11 Mag.	S11 Phase	S12 Mag.	S12 Phase	T OVER D
8.0000	0.9106	146.6719	0.4134	56.6719	0.8000
9.0000	0.8371	134.3321	0.5471	44.3321	0.8000
10.0000	0.7640	124.4708	0.6452	34.4707	0.8000
11.0000	0.6942	115.8750	0.7198	25.8750	0.8000
12.0000	0.6273	108.0176	0.7788	18.0176	0.8000
FREQUENCY	S11 Mag.	S11 Phase	S12 Mag.	S12 Phase	T OVER D
8.0000	0.9213	147.2520	0.3889	57.2520	0.9000
9.0000	0.8547	134.9649	0.5191	44.9649	0.9000
10.0000	0.7855	124.8399	0.6189	34.8399	0.9000
11.0000	0.7170	115.8223	0.6971	25.8223	0.9000
12.0000	0.6499	107.5958	0.7600	17.5957	0.9000
FREQUENCY	S11 Mag.	S11 Phase	S12 Mag.	S12 Phase	T OVER D
8.0000	0.9310	147.7794	0.3650	57.7794	1.0000
9.0000	0.8701	135.4395	0.4929	45.4395	1.0000
10.0000	0.8050	125.1035	0.5932	35.1035	1.0000
11.0000	0.7385	115.8223	0.6743	25.8223	1.0000
12.0000	0.6713	107.1212	0.7412	17.1211	1.0000
FREQUENCY	S11 Mag.	S11 Phase	S12 Mag.	S12 Phase	T OVER D
8.0000	0.9790	150.4688	0.2038	60.4688	2.0000
9.0000	0.9553	138.0762	0.2956	48.0762	2.0000
10.0000	0.9223	126.5274	0.3864	36.5274	2.0000
11.0000	0.8777	115.0313	0.4792	25.0313	2.0000
12.0000	0.8195	103.0078	0.5730	13.0079	2.0000
FREQUENCY	S11 Mag.	S11 Phase	S12 Mag.	S12 Phase	T OVER D
8.0000	0.9934	151.2071	0.1148	61.2071	3.0000
9.0000	0.9843	138.8673	0.1767	48.8672	3.0000
10.0000	0.9688	127.0020	0.2477	37.0020	3.0000
11.0000	0.9426	114.4512	0.3340	24.4512	3.0000
12.0000	0.8988	100.3711	0.4383	10.3711	3.0000
FREQUENCY	S11 Mag.	S11 Phase	S12 Mag.	S12 Phase	T OVER D
8.0000	0.9978	151.4708	0.0662	61.4708	4.0000
9.0000	0.9943	139.1309	0.1066	49.1309	4.0000
10.0000	0.9874	127.1602	0.1586	37.1602	4.0000
11.0000	0.9730	114.0821	0.2308	24.0821	4.0000
12.0000	0.9426	98.7364	0.3340	8.7364	4.0000
FREQUENCY	S11 Mag.	S11 Phase	S12 Mag.	S12 Phase	T OVER D
8.0000	0.9993	151.5235	0.0377	61.5235	5.0000
9.0000	0.9979	139.2364	0.0644	49.2364	5.0000
10.0000	0.9949	127.2129	0.1011	37.2129	5.0000
11.0000	0.9875	113.9239	0.1576	23.9239	5.0000
12.0000	0.9674	97.8926	0.2531	7.8926	5.0000

Table 12. SCATTERING DATA FOR W/B = 0.9, T = 10, 40, 80 MILS

Dielec Thickness D (mil) 100.0000
 Normalized H1/D = 4.5000
 Normalized H2/D = 3.5000
 waveguide height B/D = 4.0000
 fin gap width W/B = 0.9000
 number of dif. T/D = 8.0000
 Dielec. cons region 1 = 1.0000
 Dielec. cons region 2 = 1.0000
 Dielec. cons region 3 = 1.0000
 Upper freq limit GHz = 12.0000
 Lower freq limit GHz = 8.0000
 Freq increment GHz = 1.0000
 Matrix order = 10.0000

FREQUENCY	S11 Mag.	S11 Phase	S12 Mag.	S12 Phase	T OVER D
8.0000	0.7538	137.4961	0.6571	47.4961	0.1000
9.0000	0.6186	126.4746	0.7857	36.4747	0.1000
10.0000	0.5220	118.9864	0.8530	28.9864	0.1000
11.0000	0.4471	114.2930	0.8945	24.2930	0.1000
12.0000	0.3929	109.8106	0.9196	19.8106	0.1000

FREQUENCY	S11 Mag.	S11 Phase	S12 Mag.	S12 Phase	T OVER D
8.0000	0.8504	143.1387	0.5262	53.1387	0.4000
9.0000	0.7489	131.8008	0.6626	41.8008	0.4000
10.0000	0.6638	122.9942	0.7479	32.9942	0.4000
11.0000	0.5885	116.6133	0.8085	26.6133	0.4000
12.0000	0.5259	110.2852	0.8505	20.2852	0.4000

FREQUENCY	S11 Mag.	S11 Phase	S12 Mag.	S12 Phase	T OVER D
8.0000	0.9140	146.8301	0.4058	56.8301	0.8000
9.0000	0.8440	135.1758	0.5363	45.1758	0.8000
10.0000	0.7746	125.2090	0.6325	35.2090	0.8000
11.0000	0.7047	117.1407	0.7095	27.1407	0.8000
12.0000	0.6387	108.8614	0.7695	18.8614	0.8000

Table 13. SCATTERING DATA FOR W/B= 0.9, T= 100, 200, 300, 400, 500 MILS

FREQUENCY	S11 Mag.	S11 Phase	S12 Mag.	S12 Phase	T OVER D
8.0000	0.9333	147.8321	0.3590	57.8321	1.0000
9.0000	0.8759	136.2305	0.4825	46.2305	1.0000
10.0000	0.8137	125.7364	0.5813	35.7364	1.0000
11.0000	0.7477	117.0352	0.6640	27.0352	1.0000
12.0000	0.6822	107.9649	0.7312	17.9649	1.0000

FREQUENCY	S11 Mag.	S11 Phase	S12 Mag.	S12 Phase	T OVER D
8.0000	0.9799	150.4161	0.1993	60.4161	2.0000
9.0000	0.9575	138.7090	0.2885	48.7090	2.0000
10.0000	0.9262	127.1075	0.3770	37.1075	2.0000
11.0000	0.8829	116.2969	0.4695	26.2969	2.0000
12.0000	0.8263	104.0098	0.5632	14.0098	2.0000

FREQUENCY	S11 Mag.	S11 Phase	S12 Mag.	S12 Phase	T OVER D
8.0000	0.9935	151.1544	0.1139	61.1543	3.0000
9.0000	0.9847	139.4473	0.1740	49.4473	3.0000
10.0000	0.9702	127.5294	0.2424	37.5294	3.0000
11.0000	0.9450	115.7169	0.3271	25.7168	3.0000
12.0000	0.9024	101.3731	0.4309	11.3731	3.0000

FREQUENCY	S11 Mag.	S11 Phase	S12 Mag.	S12 Phase	T OVER D
8.0000	0.9979	151.3653	0.0644	61.3653	4.0000
9.0000	0.9946	139.7110	0.1038	49.7110	4.0000
10.0000	0.9879	127.6876	0.1549	37.6875	4.0000
11.0000	0.9743	115.3477	0.2254	25.3477	4.0000
12.0000	0.9447	99.8438	0.3279	9.8438	4.0000

FREQUENCY	S11 Mag.	S11 Phase	S12 Mag.	S12 Phase	T OVER D
8.0000	0.9993	151.4707	0.0368	61.4707	5.0000
9.0000	0.9980	139.7637	0.0625	49.7637	5.0000
10.0000	0.9952	127.6876	0.0983	37.6875	5.0000
11.0000	0.9879	115.2422	0.1549	25.2422	5.0000
12.0000	0.9688	98.9473	0.2477	8.9473	5.0000

Table 14. SCATTERING DATA FOR W/B = 0.8, T = 10, 20, 30, 40, 50, 60 MILS

Dielec Thickness D (mil) 100.0000
 Normalized H1/D = 4.5000
 Normalized H2/D = 3.5000
 waveguide height B/D = 4.0000
 fin gap width W/B = 0.8000
 number of dif. T/D = 8.0000
 Dielec. cons region 1 = 1.0000
 Dielec. cons region 2 = 1.0000
 Dielec. cons region 3 = 1.0000
 Upper freq limit GHz = 12.0000
 Lower freq limit GHz = 8.0000
 Freq increment GHz = 1.0000
 Matrix order = 10.0000

FREQUENCY	S11 Mag.	S11 Phase	S12 Mag.	S12 Phase	T OVER D
8.0000	0.7675	138.8145	0.6410	48.8145	0.1000
9.0000	0.6429	127.8458	0.7660	37.8457	0.1000
10.0000	0.5469	121.2012	0.8372	31.2012	0.1000
11.0000	0.4749	115.5587	0.8800	25.5586	0.1000
12.0000	0.4173	111.5508	0.9088	21.5508	0.1000

FREQUENCY	S11 Mag.	S11 Phase	S12 Mag.	S12 Phase	T OVER D
8.0000	0.8078	141.1876	0.5895	51.1876	0.2000
9.0000	0.6955	130.1133	0.7185	40.1133	0.2000
10.0000	0.6033	123.0469	0.7975	33.0469	0.2000
11.0000	0.5314	116.7715	0.8471	26.7715	0.2000
12.0000	0.4700	112.1836	0.8826	22.1836	0.2000

FREQUENCY	S11 Mag.	S11 Phase	S12 Mag.	S12 Phase	T OVER D
8.0000	0.8365	142.8223	0.5479	52.8223	0.3000
9.0000	0.7354	131.6954	0.6777	41.6954	0.3000
10.0000	0.6478	124.3126	0.7618	34.3126	0.3000
11.0000	0.5766	117.5626	0.8171	27.5626	0.3000
12.0000	0.5141	112.3419	0.8577	22.3418	0.3000

FREQUENCY	S11 Mag.	S11 Phase	S12 Mag.	S12 Phase	T OVER D
8.0000	0.8595	144.1407	0.5112	54.1407	0.4000
9.0000	0.7681	133.0664	0.6403	43.0665	0.4000
10.0000	0.6862	125.2618	0.7274	35.2618	0.4000
11.0000	0.6150	117.9845	0.7885	27.9844	0.4000
12.0000	0.5499	112.2364	0.8352	22.2364	0.4000

FREQUENCY	S11 Mag.	S11 Phase	S12 Mag.	S12 Phase	T OVER D
8.0000	0.8786	145.1953	0.4776	55.1954	0.5000
9.0000	0.7968	134.1211	0.6043	44.1211	0.5000
10.0000	0.7177	126.0001	0.6964	36.0000	0.5000
11.0000	0.6471	118.2481	0.7624	28.2481	0.5000
12.0000	0.5833	112.0255	0.8123	22.0254	0.5000

FREQUENCY	S11 Mag.	S11 Phase	S12 Mag.	S12 Phase	T OVER D
8.0000	0.8947	146.1446	0.4466	56.1446	0.6000
9.0000	0.8195	134.9649	0.5730	44.9649	0.6000
10.0000	0.7453	126.5274	0.6668	36.5274	0.6000
11.0000	0.6768	118.4063	0.7362	28.4063	0.6000
12.0000	0.6114	111.7090	0.7914	21.7090	0.6000

Table 15. SCATTERING DATA FOR W/B= 0.8, T= 70, 80, 90, 100, 200, 300, 400, 500 MILS

FREQUENCY	S11 Mag.	S11 Phase	S12 Mag.	S12 Phase	T OVER D
8.0000	0.9087	146.9356	0.4175	56.9356	0.7000
9.0000	0.8401	135.5977	0.5425	45.5977	0.7000
10.0000	0.7699	127.0020	0.6382	37.0020	0.7000
11.0000	0.7028	118.4590	0.7114	28.4590	0.7000
12.0000	0.6372	111.2872	0.7707	21.2872	0.7000
FREQUENCY	S11 Mag.	S11 Phase	S12 Mag.	S12 Phase	T OVER D
8.0000	0.9198	147.5684	0.3923	57.5684	0.8000
9.0000	0.8571	136.1778	0.5152	46.1778	0.8000
10.0000	0.7917	127.4239	0.6109	37.4239	0.8000
11.0000	0.7266	118.5117	0.6871	28.5117	0.8000
12.0000	0.6603	110.9180	0.7510	20.9180	0.8000
FREQUENCY	S11 Mag.	S11 Phase	S12 Mag.	S12 Phase	T OVER D
8.0000	0.9296	148.0957	0.3685	58.0957	0.9000
9.0000	0.8728	136.7052	0.4881	46.7051	0.9000
10.0000	0.8110	127.6876	0.5851	37.6875	0.9000
11.0000	0.7477	118.5117	0.6640	28.5117	0.9000
12.0000	0.6822	110.4962	0.7312	20.4961	0.9000
FREQUENCY	S11 Mag.	S11 Phase	S12 Mag.	S12 Phase	T OVER D
8.0000	0.9376	148.5176	0.3478	58.5176	1.0000
9.0000	0.8864	137.1797	0.4630	47.1797	1.0000
10.0000	0.8284	127.9512	0.5602	37.9512	1.0000
11.0000	0.7675	118.4590	0.6410	28.4590	1.0000
12.0000	0.7021	110.0743	0.7121	20.0743	1.0000
FREQUENCY	S11 Mag.	S11 Phase	S12 Mag.	S12 Phase	T OVER D
8.0000	0.9814	150.8380	0.1921	60.8379	2.0000
9.0000	0.9611	139.3419	0.2762	49.3419	2.0000
10.0000	0.9327	129.1641	0.3608	39.1641	2.0000
11.0000	0.8927	117.7207	0.4507	27.7207	2.0000
12.0000	0.8381	106.2774	0.5456	16.2774	2.0000
FREQUENCY	S11 Mag.	S11 Phase	S12 Mag.	S12 Phase	T OVER D
8.0000	0.9940	151.5235	0.1093	61.5235	3.0000
9.0000	0.9862	140.0274	0.1658	50.0274	3.0000
10.0000	0.9730	129.4805	0.2308	39.4805	3.0000
11.0000	0.9500	117.1407	0.3122	27.1407	3.0000
12.0000	0.9090	103.8516	0.4167	13.8516	3.0000
FREQUENCY	S11 Mag.	S11 Phase	S12 Mag.	S12 Phase	T OVER D
8.0000	0.9980	151.6817	0.0625	61.6817	4.0000
9.0000	0.9951	140.2911	0.0992	50.2911	4.0000
10.0000	0.9890	129.5860	0.1476	39.5860	4.0000
11.0000	0.9765	116.8770	0.2155	26.8770	4.0000
12.0000	0.9489	102.3751	0.3157	12.3750	4.0000
FREQUENCY	S11 Mag.	S11 Phase	S12 Mag.	S12 Phase	T OVER D
8.0000	0.9994	151.7344	0.0359	61.7344	5.0000
9.0000	0.9982	140.3438	0.0598	50.3438	5.0000
10.0000	0.9956	129.6387	0.0937	39.6387	5.0000
11.0000	0.9890	116.7188	0.1476	26.7188	5.0000
12.0000	0.9708	101.5313	0.2397	11.5313	5.0000

Table 16. SCATTERING DATA FOR W/B = 0.7, T = 10, 40, 80 MILS

Dielec Thickness D (mil) 100.0000
 Normalized H1/D = 4.5000
 Normalized H2/D = 3.5000
 waveguide height B/D = 4.0000
 fin gap width W/B = 0.7000
 number of dif. T/D = 8.0000
 Dielec. cons region 1 = 1.0000
 Dielec. cons region 2 = 1.0000
 Dielec. cons region 3 = 1.0000
 Upper freq limit GHz = 12.0000
 Lower freq limit GHz = 8.0000
 Freq increment GHz = 1.0000
 Matrix order = 10.0000

FREQUENCY	S11 Mag.	S11 Phase	S12 Mag.	S12 Phase	T OVER D
8.0000	0.7832	140.2383	0.6217	50.2383	0.1000
9.0000	0.6700	130.2188	0.7424	40.2188	0.1000
10.0000	0.5781	123.2578	0.8160	33.2578	0.1000
11.0000	0.5062	117.5098	0.8624	27.5098	0.1000
12.0000	0.4455	113.5547	0.8953	23.5547	0.1000

FREQUENCY	S11 Mag.	S11 Phase	S12 Mag.	S12 Phase	T OVER D
8.0000	0.8705	145.4063	0.4921	55.4063	0.4000
9.0000	0.7895	135.3340	0.6138	45.3340	0.4000
10.0000	0.7138	127.3712	0.7003	37.3711	0.4000
11.0000	0.6450	120.1993	0.7642	30.1992	0.4000
12.0000	0.5803	114.5567	0.8144	24.5567	0.4000

FREQUENCY	S11 Mag.	S11 Phase	S12 Mag.	S12 Phase	T OVER D
8.0000	0.9269	148.5176	0.3753	58.5176	0.8000
9.0000	0.8719	138.2872	0.4897	48.2872	0.8000
10.0000	0.8131	129.3750	0.5821	39.3750	0.8000
11.0000	0.7514	120.8321	0.6599	30.8321	0.8000
12.0000	0.6869	113.3965	0.7268	23.3965	0.8000

Table 17. SCATTERING DATA FOR W/B= 0.7, T= 100, 200, 300, 400, 500 MILS

FREQUENCY	S11 Mag.	S11 Phase	S12 Mag.	S12 Phase	T OVER D
8.0000	0.9435	149.4142	0.3314	59.4141	1.0000
9.0000	0.8984	139.1309	0.4392	49.1309	1.0000
10.0000	0.8470	129.9024	0.5316	39.9024	1.0000
11.0000	0.7900	120.8321	0.6131	30.8321	1.0000
12.0000	0.7266	112.6055	0.6871	22.6055	1.0000
FREQUENCY	S11 Mag.	S11 Phase	S12 Mag.	S12 Phase	T OVER D
8.0000	0.9831	151.4708	0.1830	61.4708	2.0000
9.0000	0.9658	141.0821	0.2593	51.0821	2.0000
10.0000	0.9407	131.0098	0.3392	41.0098	2.0000
11.0000	0.9048	120.1466	0.4259	30.1465	2.0000
12.0000	0.8528	109.1251	0.5222	19.1250	2.0000
FREQUENCY	S11 Mag.	S11 Phase	S12 Mag.	S12 Phase	T OVER D
8.0000	0.9945	151.9981	0.1047	61.9981	3.0000
9.0000	0.9879	141.6094	0.1549	51.6094	3.0000
10.0000	0.9763	131.2735	0.2164	41.2735	3.0000
11.0000	0.9556	119.5665	0.2947	29.5665	3.0000
12.0000	0.9184	106.8575	0.3957	16.8575	3.0000
FREQUENCY	S11 Mag.	S11 Phase	S12 Mag.	S12 Phase	T OVER D
8.0000	0.9982	152.1563	0.0598	62.1563	4.0000
9.0000	0.9957	141.8204	0.0928	51.8204	4.0000
10.0000	0.9905	131.3262	0.1376	41.3262	4.0000
11.0000	0.9794	119.2501	0.2020	29.2500	4.0000
12.0000	0.9540	105.5391	0.3000	15.5391	4.0000
FREQUENCY	S11 Mag.	S11 Phase	S12 Mag.	S12 Phase	T OVER D
8.0000	0.9994	152.2618	0.0340	62.2617	5.0000
9.0000	0.9985	141.8731	0.0552	51.8731	5.0000
10.0000	0.9962	131.3790	0.0873	41.3790	5.0000
11.0000	0.9904	119.1446	0.1385	29.1446	5.0000
12.0000	0.9736	104.7481	0.2281	14.7481	5.0000

Table 18. SCATTERING DATA FOR W/B= 0.6, T= 10, 40, 80 MILS

Dielec Thickness D (mil) 100.0000
 Normalized H1/D = 4.5000
 Normalized H2/D = 3.5000
 waveguide height B/D = 4.0000
 fin gap width W/B = 0.6000
 number of dif. T/D = 8.0000
 Dielec. cons region 1 = 1.0000
 Dielec. cons region 2 = 1.0000
 Dielec. cons region 3 = 1.0000
 Upper freq limit GHz = 12.0000
 Lower freq limit GHz = 8.0000
 Freq increment GHz = 1.0000
 Matrix order = 10.0000

FREQUENCY	S11 Mag.	S11 Phase	S12 Mag.	S12 Phase	T OVER D
8.0000	0.8001	141.8204	0.5999	51.8203	0.1000
9.0000	0.6988	132.3809	0.7153	42.3809	0.1000
10.0000	0.6135	125.3672	0.7897	35.3672	0.1000
11.0000	0.5415	119.8828	0.8407	29.8829	0.1000
12.0000	0.4814	115.4532	0.8765	25.4532	0.1000

FREQUENCY	S11 Mag.	S11 Phase	S12 Mag.	S12 Phase	T OVER D
8.0000	0.8834	146.7247	0.4687	56.7247	0.4000
9.0000	0.8126	137.3380	0.5828	47.3379	0.4000
10.0000	0.7446	129.5333	0.6675	39.5332	0.4000
11.0000	0.6788	122.7832	0.7343	32.7832	0.4000
12.0000	0.6164	116.7188	0.7874	26.7188	0.4000

FREQUENCY	S11 Mag.	S11 Phase	S12 Mag.	S12 Phase	T OVER D
8.0000	0.9346	149.6251	0.3556	59.6251	0.8000
9.0000	0.8885	140.0801	0.4589	50.0801	0.8000
10.0000	0.8365	131.5372	0.5479	41.5372	0.8000
11.0000	0.7804	123.5216	0.6253	33.5215	0.8000
12.0000	0.7189	115.7696	0.6951	25.7695	0.8000

Table 19. SCATTERING DATA FOR W/B= 0.6, T= 100, 200, 300, 400, 500 MILS

FREQUENCY	S11 Mag.	S11 Phase	S12 Mag.	S12 Phase	T OVER D
8.0000	0.9494	150.3633	0.3140	60.3633	1.0000
9.0000	0.9121	140.8712	0.4100	50.8711	1.0000
10.0000	0.8669	132.0117	0.4985	42.0118	1.0000
11.0000	0.8147	123.5215	0.5798	33.5215	1.0000
12.0000	0.7556	115.0840	0.6550	25.0840	1.0000
FREQUENCY	S11 Mag.	S11 Phase	S12 Mag.	S12 Phase	T OVER D
8.0000	0.9851	152.1036	0.1722	62.1036	2.0000
9.0000	0.9708	142.4532	0.2397	52.4532	2.0000
10.0000	0.9494	132.9610	0.3140	42.9610	2.0000
11.0000	0.9180	122.9415	0.3965	32.9415	2.0000
12.0000	0.8710	111.9200	0.4913	21.9200	2.0000
FREQUENCY	S11 Mag.	S11 Phase	S12 Mag.	S12 Phase	T OVER D
8.0000	0.9952	152.5255	0.0974	62.5254	3.0000
9.0000	0.9897	142.9278	0.1431	52.9278	3.0000
10.0000	0.9799	133.1192	0.1993	43.1192	3.0000
11.0000	0.9621	122.4668	0.2726	32.4668	3.0000
12.0000	0.9283	109.9161	0.3719	19.9161	3.0000
FREQUENCY	S11 Mag.	S11 Phase	S12 Mag.	S12 Phase	T OVER D
8.0000	0.9985	152.7364	0.0552	62.7364	4.0000
9.0000	0.9963	143.0860	0.0855	53.0860	4.0000
10.0000	0.9919	133.2247	0.1267	43.2247	4.0000
11.0000	0.9824	122.1505	0.1867	32.1504	4.0000
12.0000	0.9598	108.7032	0.2806	18.7032	4.0000
FREQUENCY	S11 Mag.	S11 Phase	S12 Mag.	S12 Phase	T OVER D
8.0000	0.9995	152.7364	0.0313	62.7364	5.0000
9.0000	0.9987	143.1387	0.0515	53.1387	5.0000
10.0000	0.9967	133.2247	0.0809	43.2247	5.0000
11.0000	0.9917	122.0450	0.1285	32.0450	5.0000
12.0000	0.9771	107.9649	0.2128	17.9649	5.0000

Table 20. SCATTERING DATA FOR W/B = 0.5, T = 10, 20, 30, 40, 50, 60 MILS

Dielec Thickness D (mil) 100.0000
 Normalized H1/D = 4.5000
 Normalized H2/D = 3.5000
 waveguide height B/D = 4.0000
 fin gap width W/B = 0.5000
 number of dif. T/D = 8.0000
 Dielec. cons region 1 = 1.0000
 Dielec. cons region 2 = 1.0000
 Dielec. cons region 3 = 1.0000
 Upper freq limit GHz = 12.0000
 Lower freq limit GHz = 8.0000
 Freq increment GHz = 1.0000
 Matrix order = 10.0000

FREQUENCY	S11 Mag.	S11 Phase	S12 Mag.	S12 Phase	T OVER D
8.0000	0.8206	143.4024	0.5715	53.4024	0.1000
9.0000	0.7316	134.8594	0.6817	44.8594	0.1000
10.0000	0.6527	127.9512	0.7576	37.9512	0.1000
11.0000	0.5818	122.8887	0.8133	32.8887	0.1000
12.0000	0.5212	117.9844	0.8534	27.9844	0.1000

FREQUENCY	S11 Mag.	S11 Phase	S12 Mag.	S12 Phase	T OVER D
8.0000	0.8552	145.5645	0.5183	55.5645	0.2000
9.0000	0.7775	137.0743	0.6289	47.0743	0.2000
10.0000	0.7054	129.9551	0.7088	39.9551	0.2000
11.0000	0.6372	124.4708	0.7707	34.4707	0.2000
12.0000	0.5773	118.9864	0.8165	28.9864	0.2000

FREQUENCY	S11 Mag.	S11 Phase	S12 Mag.	S12 Phase	T OVER D
8.0000	0.8786	146.9884	0.4776	56.9883	0.3000
9.0000	0.8110	138.5509	0.5851	48.5508	0.3000
10.0000	0.7453	131.2735	0.6668	41.2735	0.3000
11.0000	0.6808	125.4727	0.7324	35.4727	0.3000
12.0000	0.6208	119.4610	0.7840	29.4610	0.3000

FREQUENCY	S11 Mag.	S11 Phase	S12 Mag.	S12 Phase	T OVER D
8.0000	0.8972	148.0431	0.4416	58.0430	0.4000
9.0000	0.8381	139.7110	0.5456	49.7110	0.4000
10.0000	0.7780	132.2754	0.6282	42.2754	0.4000
11.0000	0.7157	126.0528	0.6984	36.0528	0.4000
12.0000	0.6562	119.5664	0.7546	29.5664	0.4000

FREQUENCY	S11 Mag.	S11 Phase	S12 Mag.	S12 Phase	T OVER D
8.0000	0.9125	148.9395	0.4092	58.9395	0.5000
9.0000	0.8599	140.6075	0.5104	50.6075	0.5000
10.0000	0.8039	132.9083	0.5947	42.9083	0.5000
11.0000	0.7453	126.4219	0.6668	36.4219	0.5000
12.0000	0.6862	119.5664	0.7274	29.5664	0.5000

FREQUENCY	S11 Mag.	S11 Phase	S12 Mag.	S12 Phase	T OVER D
8.0000	0.9248	149.6778	0.3804	59.6778	0.6000
9.0000	0.8781	141.2403	0.4784	51.2403	0.6000
10.0000	0.8258	133.3829	0.5640	43.3828	0.6000
11.0000	0.7699	126.6856	0.6382	36.6856	0.6000
12.0000	0.7112	119.3555	0.7030	29.3555	0.6000

Table 21. SCATTERING DATA FOR W/B = 0.5, T = 70, 80, 90, 100, 200, 300, 400, 500 MILS

FREQUENCY	S11 Mag.	S11 Phase	S12 Mag.	S12 Phase	T OVER D
8.0000	0.9350	150.2051	0.3547	60.2051	0.7000
9.0000	0.8927	141.7677	0.4507	51.7676	0.7000
10.0000	0.8450	133.8048	0.5347	43.8047	0.7000
11.0000	0.7917	126.7911	0.6109	36.7911	0.7000
12.0000	0.7335	119.1973	0.6797	29.1973	0.7000
FREQUENCY	S11 Mag.	S11 Phase	S12 Mag.	S12 Phase	T OVER D
8.0000	0.9435	150.5743	0.3314	60.5743	0.8000
9.0000	0.9056	142.1895	0.4242	52.1895	0.8000
10.0000	0.8613	134.1211	0.5080	44.1211	0.8000
11.0000	0.8099	126.8438	0.5865	36.8438	0.8000
12.0000	0.7538	118.9337	0.6571	28.9336	0.8000
FREQUENCY	S11 Mag.	S11 Phase	S12 Mag.	S12 Phase	T OVER D
8.0000	0.9506	150.9961	0.3105	60.9961	0.9000
9.0000	0.9106	142.5586	0.3999	52.5586	0.9000
10.0000	0.8759	134.3321	0.4825	44.3321	0.9000
11.0000	0.8274	126.8965	0.5617	36.8965	0.9000
12.0000	0.7716	118.6172	0.6361	28.6172	0.9000
FREQUENCY	S11 Mag.	S11 Phase	S12 Mag.	S12 Phase	T OVER D
8.0000	0.9567	151.3126	0.2912	61.3125	1.0000
9.0000	0.9262	142.8223	0.3770	52.8223	1.0000
10.0000	0.8881	134.5430	0.4597	44.5430	1.0000
11.0000	0.8416	126.8965	0.5402	36.8965	1.0000
12.0000	0.7872	118.3536	0.6167	28.3535	1.0000
FREQUENCY	S11 Mag.	S11 Phase	S12 Mag.	S12 Phase	T OVER D
8.0000	0.9874	152.6837	0.1586	62.6837	2.0000
9.0000	0.9759	144.2462	0.2182	54.2461	2.0000
10.0000	0.9585	135.3340	0.2850	45.3340	2.0000
11.0000	0.9313	126.4220	0.3642	36.4219	2.0000
12.0000	0.8897	115.5587	0.4564	25.5586	2.0000
FREQUENCY	S11 Mag.	S11 Phase	S12 Mag.	S12 Phase	T OVER D
8.0000	0.9960	153.1055	0.0892	63.1055	3.0000
9.0000	0.9916	144.5626	0.1294	54.5625	3.0000
10.0000	0.9838	135.4395	0.1794	45.4395	3.0000
11.0000	0.9686	125.8946	0.2486	35.8946	3.0000
12.0000	0.9391	113.7657	0.3435	23.7657	3.0000
FREQUENCY	S11 Mag.	S11 Phase	S12 Mag.	S12 Phase	T OVER D
8.0000	0.9987	153.2110	0.0506	63.2110	4.0000
9.0000	0.9970	144.7208	0.0772	54.7207	4.0000
10.0000	0.9934	135.4922	0.1148	45.4922	4.0000
11.0000	0.9854	125.7364	0.1704	35.7364	4.0000
12.0000	0.9658	112.7110	0.2593	22.7110	4.0000
FREQUENCY	S11 Mag.	S11 Phase	S12 Mag.	S12 Phase	T OVER D
8.0000	0.9996	153.2637	0.0294	63.2637	5.0000
9.0000	0.9989	144.7208	0.0460	54.7207	5.0000
10.0000	0.9974	135.4922	0.0726	45.4922	5.0000
11.0000	0.9932	125.5782	0.1166	35.5782	5.0000
12.0000	0.9805	112.0782	0.1966	22.0782	5.0000

Table 22. SCATTERING DATA FOR W/B= 0.4, T= 10, 40, 80 MILS

Dielec Thickness D (mil) 100.0000
 Normalized H1/D - 4.5000
 Normalized H2/D - 3.5000
 waveguide height B/D - 4.0000
 fin gap width W/B - 0.4000
 number of dif. T/D - 8.0000
 Dielec. cons region 1 - 1.0000
 Dielec. cons region 2 - 1.0000
 Dielec. cons region 3 - 1.0000
 Upper freq limit GHz - 12.0000
 Lower freq limit GHz - 8.0000
 Freq increment GHz - 1.0000
 Matrix order - 10.0000

FREQUENCY	S11 Mag.	S11 Phase	S12 Mag.	S12 Phase	T OVER D
8.0000	0.8435	145.7755	0.5371	55.7754	0.1000
9.0000	0.7681	138.2344	0.6403	48.2344	0.1000
10.0000	0.6968	131.4844	0.7172	41.4844	0.1000
11.0000	0.6308	126.2110	0.7759	36.2110	0.1000
12.0000	0.5690	121.5704	0.8223	31.5704	0.1000

FREQUENCY	S11 Mag.	S11 Phase	S12 Mag.	S12 Phase	T OVER D
8.0000	0.9128	150.0469	0.4083	60.0469	0.4000
9.0000	0.8651	142.8751	0.5017	52.8750	0.4000
10.0000	0.8131	135.7032	0.5821	45.7032	0.4000
11.0000	0.7586	129.4805	0.6515	39.4805	0.4000
12.0000	0.7001	123.5215	0.7140	33.5215	0.4000

FREQUENCY	S11 Mag.	S11 Phase	S12 Mag.	S12 Phase	T OVER D
8.0000	0.9531	152.3145	0.3026	62.3145	0.8000
9.0000	0.9231	145.0899	0.3847	55.0899	0.8000
10.0000	0.8868	137.4434	0.4622	47.4434	0.8000
11.0000	0.8430	130.3243	0.5378	40.3243	0.8000
12.0000	0.7906	123.0997	0.6123	33.0996	0.8000

Table 23. SCATTERING DATA FOR W/B = 0.4, T = 100, 200, 300, 400, 500 MILS

FREQUENCY	S11 Mag.	S11 Phase	S12 Mag.	S12 Phase	T OVER D
8.0000	0.9643	152.8946	0.2646	62.8946	1.0000
9.0000	0.9404	145.6172	0.3401	55.6172	1.0000
10.0000	0.9098	137.8125	0.4150	47.8125	1.0000
11.0000	0.8705	130.4297	0.4921	40.4297	1.0000
12.0000	0.8211	122.5723	0.5708	32.5723	1.0000
FREQUENCY	S11 Mag.	S11 Phase	S12 Mag.	S12 Phase	T OVER D
8.0000	0.9897	154.0020	0.1431	64.0020	2.0000
9.0000	0.9810	146.7247	0.1939	56.7247	2.0000
10.0000	0.9672	138.4454	0.2540	48.4454	2.0000
11.0000	0.9450	129.9551	0.3271	39.9551	2.0000
12.0000	0.9083	120.1993	0.4184	30.1993	2.0000
FREQUENCY	S11 Mag.	S11 Phase	S12 Mag.	S12 Phase	T OVER D
8.0000	0.9968	154.2657	0.0800	64.2657	3.0000
9.0000	0.9935	146.9356	0.1139	56.9356	3.0000
10.0000	0.9872	138.4981	0.1595	48.4981	3.0000
11.0000	0.9751	129.5860	0.2218	39.5860	3.0000
12.0000	0.9497	118.6700	0.3131	28.6700	3.0000
FREQUENCY	S11 Mag.	S11 Phase	S12 Mag.	S12 Phase	T OVER D
8.0000	0.9990	154.3712	0.0451	64.3711	4.0000
9.0000	0.9977	147.0410	0.0681	57.0411	4.0000
10.0000	0.9950	138.5508	0.1002	48.5508	4.0000
11.0000	0.9885	129.3750	0.1513	39.3750	4.0000
12.0000	0.9717	117.7735	0.2361	27.7735	4.0000
FREQUENCY	S11 Mag.	S11 Phase	S12 Mag.	S12 Phase	T OVER D
8.0000	0.9996	154.3712	0.0267	64.3711	5.0000
9.0000	0.9992	147.0410	0.0405	57.0411	5.0000
10.0000	0.9980	138.5509	0.0635	48.5508	5.0000
11.0000	0.9947	129.3224	0.1029	39.3223	5.0000
12.0000	0.9839	117.2461	0.1785	27.2461	5.0000

Table 24. SCATTERING DATA FOR W/B = 0.3, T = 10, 40, 80 MILS

Dielec Thickness D (mil) 100.0000
 Normalized H1/D = 4.5000
 Normalized H2/D = 3.5000
 waveguide height B/D = 4.0000
 fin gap width W/B = 0.3000
 number of dif. T/D = 8.0000
 Dielec. cons region 1 = 1.0000
 Dielec. cons region 2 = 1.0000
 Dielec. cons region 3 = 1.0000
 Upper freq limit GHz = 12.0000
 Lower freq limit GHz = 8.0000
 Freq increment GHz = 1.0000
 Matrix order = 10.0000

FREQUENCY	S11 Mag.	S11 Phase	S12 Mag.	S12 Phase	T OVER D
8.0000	0.8714	148.7813	0.4905	58.7813	0.1000
9.0000	0.8105	142.2950	0.5858	52.2950	0.1000
10.0000	0.7489	136.3360	0.6626	46.3360	0.1000
11.0000	0.6875	130.8516	0.7261	40.8516	0.1000
12.0000	0.6287	125.8419	0.7777	35.8418	0.1000

FREQUENCY	S11 Mag.	S11 Phase	S12 Mag.	S12 Phase	T OVER D
8.0000	0.9307	152.5782	0.3659	62.5782	0.4000
9.0000	0.8939	146.4610	0.4482	56.4610	0.4000
10.0000	0.8518	140.3438	0.5238	50.3438	0.4000
11.0000	0.8045	134.1211	0.5940	44.1211	0.4000
12.0000	0.7514	128.0040	0.6599	38.0040	0.4000

FREQUENCY	S11 Mag.	S11 Phase	S12 Mag.	S12 Phase	T OVER D
8.0000	0.9634	154.3712	0.2682	64.3712	0.8000
9.0000	0.9413	148.3067	0.3375	58.3067	0.8000
10.0000	0.9128	141.8204	0.4083	51.8204	0.8000
11.0000	0.8768	134.9649	0.4808	44.9649	0.8000
12.0000	0.8304	127.7403	0.5571	37.7403	0.8000

Table 25. SCATTERING DATA FOR W/B= 0.3, T= 100, 200, 300, 400, 500 MILS

<u>FREQUENCY</u>	<u>S11 Mag.</u>	<u>S11 Phase</u>	<u>S12 Mag.</u>	<u>S12 Phase</u>	<u>T OVER D</u>
8.0000	0.9726	154.7930	0.2326	64.7930	1.0000
9.0000	0.9548	148.7286	0.2973	58.7286	1.0000
10.0000	0.9313	142.1368	0.3642	52.1368	1.0000
11.0000	0.8992	135.0176	0.4375	45.0176	1.0000
12.0000	0.8561	127.3184	0.5167	37.3184	1.0000

<u>FREQUENCY</u>	<u>S11 Mag.</u>	<u>S11 Phase</u>	<u>S12 Mag.</u>	<u>S12 Phase</u>	<u>T OVER D</u>
8.0000	0.9923	155.6368	0.1239	65.6368	2.0000
9.0000	0.9858	149.5196	0.1676	59.5196	2.0000
10.0000	0.9757	142.6114	0.2191	52.6114	2.0000
11.0000	0.9580	134.7012	0.2868	44.7012	2.0000
12.0000	0.9279	125.3673	0.3727	35.3672	2.0000

<u>FREQUENCY</u>	<u>S11 Mag.</u>	<u>S11 Phase</u>	<u>S12 Mag.</u>	<u>S12 Phase</u>	<u>T OVER D</u>
8.0000	0.9976	155.8477	0.0690	65.8477	3.0000
9.0000	0.9952	149.7305	0.0983	59.7305	3.0000
10.0000	0.9906	142.6641	0.1367	52.6641	3.0000
11.0000	0.9812	134.4376	0.1930	44.4375	3.0000
12.0000	0.9606	124.1544	0.2779	34.1543	3.0000

<u>FREQUENCY</u>	<u>S11 Mag.</u>	<u>S11 Phase</u>	<u>S12 Mag.</u>	<u>S12 Phase</u>	<u>T OVER D</u>
8.0000	0.9992	155.9532	0.0396	65.9532	4.0000
9.0000	0.9983	149.7833	0.0589	59.7832	4.0000
10.0000	0.9962	142.6641	0.0873	52.6641	4.0000
11.0000	0.9914	134.2266	0.1312	44.2266	4.0000
12.0000	0.9779	123.3633	0.2092	33.3633	4.0000

<u>FREQUENCY</u>	<u>S11 Mag.</u>	<u>S11 Phase</u>	<u>S12 Mag.</u>	<u>S12 Phase</u>	<u>T OVER D</u>
8.0000	0.9997	155.9532	0.0230	65.9532	5.0000
9.0000	0.9994	149.7833	0.0350	59.7832	5.0000
10.0000	0.9985	142.6641	0.0543	52.6641	5.0000
11.0000	0.9959	134.1739	0.0901	44.1739	5.0000
12.0000	0.9876	122.9415	0.1567	32.9415	5.0000

Table 26. SCATTERING DATA FOR W/B= 0.25, T= 10, 20, 30, 40, 50, 60 MILS

Dielec Thickness D (mil) 100.0000
 Normalized H1/D - 4.5000
 Normalized H2/D - 3.5000
 waveguide height B/D - 4.0000
 fin gap width W/B - 0.2500
 number of dif. T/D - 5.0000
 Dielec. cons region 1 - 1.0000
 Dielec. cons region 2 - 1.0000
 Dielec. cons region 3 - 1.0000
 Upper freq limit GHz - 12.0000
 Lower freq limit GHz - 8.0000
 Freq increment GHz - 1.0000
 Matrix order - 10.0000

FREQUENCY	S11 Mag.	S11 Phase	S12 Mag.	S12 Phase	T OVER D
8.0000	0.8872	150.7852	0.4614	60.7852	0.1000
9.0000	0.8345	144.2989	0.5510	54.2989	0.1000
10.0000	0.7792	138.7090	0.6268	48.7090	0.1000
11.0000	0.7221	133.5410	0.6918	43.5410	0.1000
12.0000	0.6652	128.3731	0.7467	38.3731	0.1000

FREQUENCY	S11 Mag.	S11 Phase	S12 Mag.	S12 Phase	T OVER D
8.0000	0.9117	152.5255	0.4108	62.5255	0.2000
9.0000	0.8683	146.0919	0.4961	56.0918	0.2000
10.0000	0.8201	140.5020	0.5723	50.5020	0.2000
11.0000	0.7693	135.1758	0.6389	45.1758	0.2000
12.0000	0.7151	129.6915	0.6990	39.6914	0.2000

FREQUENCY	S11 Mag.	S11 Phase	S12 Mag.	S12 Phase	T OVER D
8.0000	0.9279	153.5274	0.3727	63.5274	0.3000
9.0000	0.8914	147.3048	0.4532	57.3047	0.3000
10.0000	0.8499	141.7149	0.5269	51.7149	0.3000
11.0000	0.8034	136.2305	0.5955	46.2305	0.3000
12.0000	0.7520	130.3770	0.6592	40.3770	0.3000

FREQUENCY	S11 Mag.	S11 Phase	S12 Mag.	S12 Phase	T OVER D
8.0000	0.9398	154.2657	0.3418	64.2657	0.4000
9.0000	0.9090	148.1485	0.4167	58.1485	0.4000
10.0000	0.8728	142.5060	0.4881	52.5059	0.4000
11.0000	0.8299	136.7578	0.5579	46.7579	0.4000
12.0000	0.7804	130.5880	0.6253	40.5879	0.4000

FREQUENCY	S11 Mag.	S11 Phase	S12 Mag.	S12 Phase	T OVER D
8.0000	0.9497	154.8458	0.3131	64.8457	0.5000
9.0000	0.9234	148.7286	0.3838	58.7286	0.5000
10.0000	0.8902	142.9278	0.4556	52.9278	0.5000
11.0000	0.8504	137.1270	0.5262	47.1270	0.5000
12.0000	0.8034	130.6407	0.5955	40.6407	0.5000

FREQUENCY	S11 Mag.	S11 Phase	S12 Mag.	S12 Phase	T OVER D
8.0000	0.9577	155.3204	0.2876	65.3204	0.6000
9.0000	0.9340	149.0977	0.3573	59.0977	0.6000
10.0000	0.9044	143.2970	0.4267	53.2969	0.6000
11.0000	0.8674	137.3380	0.4977	47.3379	0.6000
12.0000	0.8227	130.6407	0.5685	40.6407	0.6000

Table 27. SCATTERING DATA FOR W/B = 0.25, T = 70, 80, 90, 100, 200, 300, 400, 500 MILS

FREQUENCY	S11 Mag.	S11 Phase	S12 Mag.	S12 Phase	T OVER D
8.0000	0.9639	155.6368	0.2664	65.6368	0.7000
9.0000	0.9429	149.4142	0.3331	59.4141	0.7000
10.0000	0.9162	143.6661	0.4007	53.6661	0.7000
11.0000	0.8821	137.4962	0.4711	47.4962	0.7000
12.0000	0.8381	130.5352	0.5456	40.5352	0.7000
FREQUENCY	S11 Mag.	S11 Phase	S12 Mag.	S12 Phase	T OVER D
8.0000	0.9691	155.8477	0.2468	65.8477	0.8000
9.0000	0.9506	149.7305	0.3105	59.7305	0.8000
10.0000	0.9259	143.8243	0.3779	53.8243	0.8000
11.0000	0.8943	137.5489	0.4474	47.5489	0.8000
12.0000	0.8523	130.3770	0.5230	40.3770	0.8000
FREQUENCY	S11 Mag.	S11 Phase	S12 Mag.	S12 Phase	T OVER D
8.0000	0.9730	156.0587	0.2308	66.0586	0.9000
9.0000	0.9567	149.9414	0.2912	59.9415	0.9000
10.0000	0.9343	143.9825	0.3565	53.9825	0.9000
11.0000	0.9044	137.6016	0.4267	47.6016	0.9000
12.0000	0.8641	130.2188	0.5033	40.2188	0.9000
FREQUENCY	S11 Mag.	S11 Phase	S12 Mag.	S12 Phase	T OVER D
8.0000	0.9765	156.2169	0.2155	66.2169	1.0000
9.0000	0.9621	150.0997	0.2726	60.0997	1.0000
10.0000	0.9420	144.0880	0.3357	54.0880	1.0000
11.0000	0.9136	137.6016	0.4066	47.6016	1.0000
12.0000	0.8750	130.0079	0.4841	40.0079	1.0000
FREQUENCY	S11 Mag.	S11 Phase	S12 Mag.	S12 Phase	T OVER D
8.0000	0.9935	156.9551	0.1139	66.9551	2.0000
9.0000	0.9884	150.7325	0.1522	60.7325	2.0000
10.0000	0.9796	144.5098	0.2011	54.5098	2.0000
11.0000	0.9646	137.3380	0.2638	47.3379	2.0000
12.0000	0.9379	128.3204	0.3470	38.3204	2.0000
FREQUENCY	S11 Mag.	S11 Phase	S12 Mag.	S12 Phase	T OVER D
8.0000	0.9980	157.1133	0.0635	67.1133	3.0000
9.0000	0.9960	150.8907	0.0892	60.8907	3.0000
10.0000	0.9922	144.5098	0.1248	54.5098	3.0000
11.0000	0.9841	137.0215	0.1776	47.0215	3.0000
12.0000	0.9663	127.1602	0.2575	37.1602	3.0000
FREQUENCY	S11 Mag.	S11 Phase	S12 Mag.	S12 Phase	T OVER D
8.0000	0.9994	157.1133	0.0359	67.1133	4.0000
9.0000	0.9986	150.9434	0.0534	60.9434	4.0000
10.0000	0.9969	144.5098	0.0791	54.5098	4.0000
11.0000	0.9927	136.8633	0.1203	46.8633	4.0000
12.0000	0.9810	126.4747	0.1939	36.4747	4.0000
FREQUENCY	S11 Mag.	S11 Phase	S12 Mag.	S12 Phase	T OVER D
8.0000	0.9998	157.1661	0.0202	67.1661	5.0000
9.0000	0.9995	150.9434	0.0313	60.9434	5.0000
10.0000	0.9988	144.5098	0.0497	54.5098	5.0000
11.0000	0.9966	136.8106	0.0827	46.8106	5.0000
12.0000	0.9893	126.1055	0.1458	36.1055	5.0000

Table 28. SCATTERING DATA FOR W/B = 0.2, T = 10, 20, 30, 40, 50, 60 MILS

Dielec Thickness D (mil) 100.0000
 Normalized H1/D = 4.5000
 Normalized H2/D = 3.5000
 waveguide height B/D = 4.0000
 fin gap width W/B = 0.2000
 number of dif. T/D = 8.0000
 Dielec. cons region 1 = 1.0000
 Dielec. cons region 2 = 1.0000
 Dielec. cons region 3 = 1.0000
 Upper freq limit GHz = 12.0000
 Lower freq limit GHz = 8.0000
 Freq increment GHz = 1.0000
 Matrix order = 10.0000

FREQUENCY	S11 Mag.	S11 Phase	S12 Mag.	S12 Phase	T OVER D
8.0000	0.9044	153.2110	0.4267	63.2110	0.1000
9.0000	0.8604	147.3047	0.5096	57.3047	0.1000
10.0000	0.8121	141.3985	0.5836	51.3985	0.1000
11.0000	0.7598	136.6524	0.6501	46.6524	0.1000
12.0000	0.7060	131.3789	0.7082	41.3789	0.1000

FREQUENCY	S11 Mag.	S11 Phase	S12 Mag.	S12 Phase	T OVER D
8.0000	0.9255	154.7403	0.3787	64.7403	0.2000
9.0000	0.8893	148.9395	0.4573	58.9395	0.2000
10.0000	0.8489	143.0860	0.5285	53.0860	0.2000
11.0000	0.8028	138.1817	0.5962	48.1817	0.2000
12.0000	0.7526	132.6446	0.6585	42.6446	0.2000

FREQUENCY	S11 Mag.	S11 Phase	S12 Mag.	S12 Phase	T OVER D
8.0000	0.9395	155.5840	0.3427	65.5840	0.3000
9.0000	0.9090	149.9414	0.4167	59.9415	0.3000
10.0000	0.8746	144.0880	0.4849	54.0880	0.3000
11.0000	0.8335	139.1309	0.5525	49.1309	0.3000
12.0000	0.7866	133.2774	0.6174	43.2774	0.3000

FREQUENCY	S11 Mag.	S11 Phase	S12 Mag.	S12 Phase	T OVER D
8.0000	0.9500	156.2696	0.3122	66.2696	0.4000
9.0000	0.9245	150.6798	0.3813	60.6797	0.4000
10.0000	0.8943	144.8262	0.4474	54.8262	0.4000
11.0000	0.8561	139.6583	0.5167	49.6583	0.4000
12.0000	0.8121	133.4883	0.5836	43.4883	0.4000

FREQUENCY	S11 Mag.	S11 Phase	S12 Mag.	S12 Phase	T OVER D
8.0000	0.9583	156.7969	0.2859	66.7969	0.5000
9.0000	0.9366	151.2071	0.3504	61.2071	0.5000
10.0000	0.9090	145.1953	0.4167	55.1954	0.5000
11.0000	0.8741	139.9219	0.4857	49.9219	0.5000
12.0000	0.8320	133.5938	0.5548	43.5938	0.5000

FREQUENCY	S11 Mag.	S11 Phase	S12 Mag.	S12 Phase	T OVER D
8.0000	0.9651	157.1661	0.2620	67.1661	0.6000
9.0000	0.9456	151.5762	0.3253	61.5762	0.6000
10.0000	0.9209	145.5118	0.3898	55.5118	0.6000
11.0000	0.8893	140.1856	0.4573	50.1856	0.6000
12.0000	0.8484	133.5411	0.5293	43.5411	0.6000

Table 29. SCATTERING DATA FOR W/B= 0.2, T= 70, 80, 90, 100, 200, 300, 400, 500 MILS

FREQUENCY	S11 Mag.	S11 Phase	S12 Mag.	S12 Phase	T OVER D
8.0000	0.9702	157.3770	0.2424	67.3770	0.7000
9.0000	0.9528	151.8399	0.3035	61.8399	0.7000
10.0000	0.9310	145.7755	0.3650	55.7754	0.7000
11.0000	0.9016	140.2911	0.4325	50.2911	0.7000
12.0000	0.8627	133.4356	0.5057	43.4356	0.7000
FREQUENCY	S11 Mag.	S11 Phase	S12 Mag.	S12 Phase	T OVER D
8.0000	0.9743	157.6407	0.2254	67.6407	0.8000
9.0000	0.9593	152.0508	0.2823	62.0508	0.8000
10.0000	0.9395	145.9864	0.3427	55.9864	0.8000
11.0000	0.9117	140.2911	0.4108	50.2911	0.8000
12.0000	0.8746	133.3301	0.4849	43.3301	0.8000
FREQUENCY	S11 Mag.	S11 Phase	S12 Mag.	S12 Phase	T OVER D
8.0000	0.9777	157.7989	0.2101	67.7989	0.9000
9.0000	0.9646	152.2090	0.2638	62.2090	0.9000
10.0000	0.9462	146.0919	0.3236	56.0918	0.9000
11.0000	0.9209	140.3438	0.3898	50.3438	0.9000
12.0000	0.8847	133.1719	0.4662	43.1719	0.9000
FREQUENCY	S11 Mag.	S11 Phase	S12 Mag.	S12 Phase	T OVER D
8.0000	0.9807	157.9044	0.1957	67.9043	1.0000
9.0000	0.9691	152.3672	0.2468	62.3672	1.0000
10.0000	0.9523	146.1446	0.3052	56.1446	1.0000
11.0000	0.9283	140.3966	0.3719	50.3965	1.0000
12.0000	0.8943	133.0137	0.4474	43.0137	1.0000
FREQUENCY	S11 Mag.	S11 Phase	S12 Mag.	S12 Phase	T OVER D
8.0000	0.9946	158.4844	0.1038	68.4844	2.0000
9.0000	0.9905	152.8419	0.1376	62.8418	2.0000
10.0000	0.9834	146.5137	0.1812	56.5137	2.0000
11.0000	0.9711	140.0801	0.2388	50.0801	2.0000
12.0000	0.9477	131.4844	0.3192	41.4844	2.0000
FREQUENCY	S11 Mag.	S11 Phase	S12 Mag.	S12 Phase	T OVER D
8.0000	0.9983	158.5899	0.0580	68.5899	3.0000
9.0000	0.9968	153.0001	0.0800	63.0000	3.0000
10.0000	0.9937	146.5137	0.1121	56.5137	3.0000
11.0000	0.9869	139.8692	0.1613	49.8692	3.0000
12.0000	0.9715	130.4825	0.2370	40.4825	3.0000
FREQUENCY	S11 Mag.	S11 Phase	S12 Mag.	S12 Phase	T OVER D
8.0000	0.9995	158.6426	0.0331	68.6426	4.0000
9.0000	0.9989	153.0528	0.0478	63.0528	4.0000
10.0000	0.9975	146.4610	0.0708	56.4610	4.0000
11.0000	0.9940	139.7110	0.1093	49.7110	4.0000
12.0000	0.9839	129.9024	0.1785	39.9024	4.0000
FREQUENCY	S11 Mag.	S11 Phase	S12 Mag.	S12 Phase	T OVER D
8.0000	0.9998	158.6426	0.0184	68.6426	5.0000
9.0000	0.9996	153.0000	0.0285	63.0000	5.0000
10.0000	0.9990	146.4610	0.0451	56.4610	5.0000
11.0000	0.9972	139.6583	0.0754	49.6583	5.0000
12.0000	0.9909	129.5860	0.1349	39.5860	5.0000

Table 30. SCATTERING DATA FOR W/B = 0.1, T = 10, 20, 30, 40, 50, 60 MILS

Dielec Thickness D (mil) 100.0000
 Normalized H1/D = 4.5000
 Normalized H2/D = 3.5000
 waveguide height B/D = 4.0000
 fin gap width W/B = 0.1000
 number of dif. T/D = 8.0000
 Dielec. cons region 1 = 1.0000
 Dielec. cons region 2 = 1.0000
 Dielec. cons region 3 = 1.0000
 Upper freq limit GHz = 12.0000
 Lower freq limit GHz = 8.0000
 Freq increment GHz = 1.0000
 Matrix order = 10.0000

FREQUENCY	S11 Mag.	S11 Phase	S12 Mag.	S12 Phase	T OVER D
8.0000	0.9429	158.6954	0.3331	68.6953	0.1000
9.0000	0.9177	154.0020	0.3974	64.0020	0.1000
10.0000	0.8864	150.2579	0.4630	60.2578	0.1000
11.0000	0.8504	145.1426	0.5262	55.1426	0.1000
12.0000	0.8072	140.8184	0.5903	50.8184	0.1000

FREQUENCY	S11 Mag.	S11 Phase	S12 Mag.	S12 Phase	T OVER D
8.0000	0.9564	159.6973	0.2920	69.6973	0.2000
9.0000	0.9359	155.1094	0.3522	65.1094	0.2000
10.0000	0.9098	151.4180	0.4150	61.4180	0.2000
11.0000	0.8790	146.1974	0.4768	56.1973	0.2000
12.0000	0.8401	141.7149	0.5425	51.7149	0.2000

FREQUENCY	S11 Mag.	S11 Phase	S12 Mag.	S12 Phase	T OVER D
8.0000	0.9646	160.2247	0.2638	70.2247	0.3000
9.0000	0.9474	155.6895	0.3201	65.6895	0.3000
10.0000	0.9259	152.0508	0.3779	62.0508	0.3000
11.0000	0.8988	146.8829	0.4383	56.8829	0.3000
12.0000	0.8637	142.1895	0.5041	52.1895	0.3000

FREQUENCY	S11 Mag.	S11 Phase	S12 Mag.	S12 Phase	T OVER D
8.0000	0.9708	160.5938	0.2397	70.5938	0.4000
9.0000	0.9567	156.1641	0.2912	66.1641	0.4000
10.0000	0.9382	152.5255	0.3461	62.5255	0.4000
11.0000	0.9136	147.1993	0.4066	57.1993	0.4000
12.0000	0.8799	142.2950	0.4752	52.2950	0.4000

FREQUENCY	S11 Mag.	S11 Phase	S12 Mag.	S12 Phase	T OVER D
8.0000	0.9759	160.9102	0.2182	70.9102	0.5000
9.0000	0.9639	156.4805	0.2664	66.4805	0.5000
10.0000	0.9471	152.7891	0.3210	62.7891	0.5000
11.0000	0.9248	147.3575	0.3804	57.3575	0.5000
12.0000	0.8935	142.2950	0.4491	52.2950	0.5000

FREQUENCY	S11 Mag.	S11 Phase	S12 Mag.	S12 Phase	T OVER D
8.0000	0.9799	161.1739	0.1993	71.1739	0.6000
9.0000	0.9691	156.6915	0.2468	66.6915	0.6000
10.0000	0.9542	152.9473	0.2991	62.9473	0.6000
11.0000	0.9340	147.5157	0.3573	57.5157	0.6000
12.0000	0.9044	142.3477	0.4267	52.3477	0.6000

Table 31. SCATTERING DATA FOR W/B= 0.1, T= 70, 80, 90, 100, 200, 300, 400, 500 MILS

FREQUENCY	S11 Mag.	S11 Phase	S12 Mag.	S12 Phase	T OVER D
8.0000	0.9828	161.2794	0.1848	71.2793	0.7000
9.0000	0.9732	156.8497	0.2299	66.8497	0.7000
10.0000	0.9598	153.1055	0.2806	63.1055	0.7000
11.0000	0.9413	147.5684	0.3375	57.5684	0.7000
12.0000	0.9132	142.1895	0.4075	52.1895	0.7000
FREQUENCY	S11 Mag.	S11 Phase	S12 Mag.	S12 Phase	T OVER D
8.0000	0.9851	161.3848	0.1722	71.3848	0.8000
9.0000	0.9769	156.9551	0.2137	66.9551	0.8000
10.0000	0.9651	153.1583	0.2620	63.1582	0.8000
11.0000	0.9480	147.5684	0.3183	57.5684	0.8000
12.0000	0.9213	142.0840	0.3889	52.0840	0.8000
FREQUENCY	S11 Mag.	S11 Phase	S12 Mag.	S12 Phase	T OVER D
8.0000	0.9872	161.4903	0.1595	71.4903	0.9000
9.0000	0.9799	157.0606	0.1993	67.0606	0.9000
10.0000	0.9691	153.2110	0.2468	63.2110	0.9000
11.0000	0.9531	147.5684	0.3026	57.5684	0.9000
12.0000	0.9276	141.9786	0.3736	51.9786	0.9000
FREQUENCY	S11 Mag.	S11 Phase	S12 Mag.	S12 Phase	T OVER D
8.0000	0.9889	161.5958	0.1486	71.5957	1.0000
9.0000	0.9826	157.1133	0.1858	67.1133	1.0000
10.0000	0.9726	153.3165	0.2326	63.3164	1.0000
11.0000	0.9577	147.6212	0.2876	57.6211	1.0000
12.0000	0.9337	141.8731	0.3582	51.8731	1.0000
FREQUENCY	S11 Mag.	S11 Phase	S12 Mag.	S12 Phase	T OVER D
8.0000	0.9969	161.8594	0.0782	71.8594	2.0000
9.0000	0.9947	157.3770	0.1029	67.3770	2.0000
10.0000	0.9906	153.4219	0.1367	63.4219	2.0000
11.0000	0.9831	147.3575	0.1830	57.3575	2.0000
12.0000	0.9672	140.7657	0.2540	50.7657	2.0000
FREQUENCY	S11 Mag.	S11 Phase	S12 Mag.	S12 Phase	T OVER D
8.0000	0.9991	161.9649	0.0432	71.9649	3.0000
9.0000	0.9982	157.4297	0.0598	67.4297	3.0000
10.0000	0.9963	153.4219	0.0855	63.4219	3.0000
11.0000	0.9923	147.1993	0.1239	57.1993	3.0000
12.0000	0.9821	140.0801	0.1885	50.0801	3.0000
FREQUENCY	S11 Mag.	S11 Phase	S12 Mag.	S12 Phase	T OVER D
8.0000	0.9997	161.9649	0.0248	71.9649	4.0000
9.0000	0.9994	157.4297	0.0359	67.4297	4.0000
10.0000	0.9985	153.4219	0.0543	63.4219	4.0000
11.0000	0.9965	147.0938	0.0837	57.0938	4.0000
12.0000	0.9901	139.7110	0.1404	49.7110	4.0000
FREQUENCY	S11 Mag.	S11 Phase	S12 Mag.	S12 Phase	T OVER D
8.0000	0.9999	161.9649	0.0138	71.9649	5.0000
9.0000	0.9998	157.4297	0.0212	67.4297	5.0000
10.0000	0.9994	153.4219	0.0340	63.4219	5.0000
11.0000	0.9984	147.0410	0.0570	57.0411	5.0000
12.0000	0.9944	139.5001	0.1056	49.5001	5.0000

**APPENDIX D. INDUCTANCE, CAPACITANCE, AND ERROR FOR
INDUCTIVE STRIPS**

**Table 32. INDUCTANCE, CAPACITANCE, AND ERROR FOR $W/B = 1.0$,
 $T = 10$ TO 500 MILS:** Listed are the discontinuity inductance and
capacitance associated with each inductive strip. Results were obtained
from the matching process and the model. The error listed is the maxi-
mum error in S_{11} .

Strip Length (mils)	Inductance (nH) (Matching)	Max Error (%)	Inductance (nH) (Model)	Max Error (%)
10	19.70	2.4	19.66	2.4
20	18.60	2.0	18.60	2.0
30	17.90	1.5	17.97	1.9
40	17.45	1.2	17.53	1.6
50	17.05	0.8	17.19	1.3
60	16.65	0.8	16.90	1.1
70	16.40	0.7	16.67	1.2
80	16.15	0.9	16.46	1.3
90	15.95	1.0	16.28	1.4
100	15.85	1.0	16.11	1.4
200	14.95	1.3	15.05	1.5
300	14.40	1.2	14.43	1.2
400	14.05	0.9	13.98	1.0
500	13.75	0.8	13.69	0.7
Capactance (pF)	0.0030			

Table 33. INDUCTANCE, CAPACITANCE, AND ERROR FOR W/B= 0.9,
T= 10 TO 500 MILS

Strip Length (mils)	Inductance (nH) (Matching)	Max Error (%)	Inductance (nH) (Model)	Max Error (%)
10	19.50	1.7	19.40	2.1
40	17.25	0.6	17.27	0.6
80	16.05	0.8	16.20	1.0
100	15.70	1.0	15.86	1.2
200	14.80	1.5	14.79	1.5
300	14.20	1.4	14.17	1.4
400	13.87	1.0	13.72	1.1
500	13.50	0.6	13.45	0.6
Capacitance (pF)	0.0027			

Table 34. INDUCTANCE, CAPACITANCE, AND ERROR FOR W/B= 0.8,
T= 10 TO 500 MILS

Strip Length (mils)	Inductance (nH) (Matching)	Max Error (%)	Inductance (nH) (Model)	Max Error (%)
10	19.00	1.2	18.86	1.6
20	17.90	0.8	17.80	1.3
30	17.20	0.6	17.17	0.6
40	16.65	0.4	16.73	0.6
50	16.20	0.4	16.39	0.7
60	15.95	0.6	16.11	0.9
70	15.70	0.7	15.87	1.0
80	15.50	0.9	15.66	1.1
90	15.30	1.0	15.48	1.2
100	15.20	1.1	15.32	1.3
200	14.25	1.6	14.25	1.6
300	13.70	1.4	13.63	1.4
400	13.25	1.0	13.19	1.1
500	12.95	0.7	12.94	0.7
Capacitance (pF)	0.0024			

Table 35. INDUCTANCE, CAPACITANCE, AND ERROR FOR W/B= 0.7,
T= 10 TO 500 MILS

Strip Length (mils)	Inductance (nH) (Matching)	Max Error (%)	Inductance (nH) (Model)	Max Error (%)
10	18.20	0.5	18.10	0.8
40	15.80	0.5	15.97	0.7
80	14.70	0.9	14.91	1.2
100	14.35	1.1	14.56	1.3
200	13.50	1.6	13.50	1.6
300	12.90	1.4	12.88	1.4
400	12.45	1.0	12.43	1.0
500	12.10	0.6	12.24	0.8
Capacitance (pF)	0.0021			

**Table 36. INDUCTANCE, CAPACITANCE, AND ERROR FOR W/B= 0.6,
T= 10 TO 500 MILS**

Strip Length (mils)	Inductance (nH) (Matching)	Max Error (%)	Inductance (nH) (Model)	Max Error (%)
10	17.20	0.3	17.12	0.6
40	14.80	0.3	15.00	1.0
80	13.75	0.8	13.94	1.1
100	13.45	1.0	13.60	1.3
200	12.50	1.5	12.55	1.5
300	12.00	1.4	11.93	1.4
400	11.55	0.9	11.49	0.9
500	11.30	0.6	11.37	0.6
Capacitance (pF)	0.0018			

**Table 37. INDUCTANCE, CAPACITANCE, AND ERROR FOR W/B= 0.5,
T= 10 TO 500 MILS**

Strip Length (mils)	Inductance (nH) (Matching)	Max Error (%)	Inductance (nH) (Model)	Max Error (%)
10	16.00	0.6	15.89	1.2
20	15.00	0.6	14.85	0.8
30	14.25	0.7	14.25	1.0
40	13.70	0.7	13.81	1.0
50	13.25	0.7	13.48	1.1
60	13.00	0.7	13.21	1.1
70	12.80	0.8	12.98	1.1
80	12.55	0.9	12.78	1.2
90	12.35	1.0	12.60	1.3
100	12.25	1.1	12.44	1.4
200	11.35	1.6	11.40	1.7
300	10.85	1.3	10.80	1.4
400	10.45	0.9	10.36	0.9
500	10.35	0.9	10.35	0.9
Capacitance (pF)	0.0015			

**Table 38. INDUCTANCE, CAPACITANCE, AND ERROR FOR W/B= 0.4,
T= 10 TO 500 MILS**

Strip Length (mils)	Inductance (nH) (Matching)	Max Error (%)	Inductance (nH) (Model)	Max Error (%)
10	14.65	0.8	14.41	1.8
40	12.45	0.9	12.41	1.0
80	11.35	0.9	11.41	1.0
100	11.00	1.1	11.09	1.2
200	10.20	1.5	10.09	1.7
300	9.65	1.3	9.51	1.4
400	9.35	1.0	9.14	1.2
500	9.30	1.0	9.19	1.1
Capacitance (pF)	0.0012			

**Table 39. INDUCTANCE, CAPACITANCE, AND ERROR FOR W/B= 0.3,
T= 10 TO 500 MILS**

Strip Length (mils)	Inductance (nH) (Matching)	Max Error (%)	Inductance (nH) (Model)	Max Error (%)
10	13.00	1.1	12.65	1.9
40	10.95	1.1	10.80	1.2
80	9.90	1.2	9.87	1.2
100	9.60	1.3	9.57	1.3
200	8.75	1.6	8.65	1.7
300	8.25	1.2	8.10	1.4
400	8.10	1.2	7.91	1.4
500	8.05	1.3	7.91	1.3
Capacitance (pF)	0.0009			

**Table 40. INDUCTANCE, CAPACITANCE, AND ERROR FOR W/B= 0.25,
T= 10 TO 500 MILS**

Strip Length (mils)	Inductance (nH) (Matching)	Max Error (%)	Inductance (nH) (Model)	Max Error (%)
10	11.95	1.0	11.66	1.8
20	11.05	1.0	10.79	1.5
30	10.50	1.1	10.27	1.3
40	10.05	1.0	9.91	1.2
50	9.75	0.9	9.63	1.1
60	9.45	0.9	9.40	1.0
70	9.25	1.1	9.21	1.2
80	9.10	1.1	9.04	1.3
90	8.95	1.3	8.89	1.4
100	8.85	1.4	8.76	1.5
200	8.00	1.6	7.89	1.7
300	7.55	1.2	7.38	1.3
400	7.40	1.2	7.23	1.3
500	7.35	1.2	7.24	1.3
Capacitance (pF)	0.00075			

Table 41. INDUCTANCE, CAPACITANCE, AND ERROR FOR W/B= 0.2,
T= 10 TO 500 MILS

Strip Length (mils)	Inductance (nH) (Matching)	Max Error (%)	Inductance (nH) (Model)	Max Error (%)
10	10.80	1.0	10.59	1.4
20	10.00	0.9	9.79	1.2
30	9.50	1.0	9.32	1.2
40	8.95	1.1	8.98	1.0
50	8.70	1.1	8.73	1.0
60	8.60	0.9	8.51	1.2
70	8.40	1.0	8.34	1.2
80	8.25	1.1	8.18	1.1
90	8.10	1.2	8.04	1.4
100	8.00	1.3	7.92	1.6
200	7.25	1.5	7.12	1.7
300	6.80	1.2	6.65	1.3
400	6.65	1.0	6.53	1.2
500	6.60	1.1	6.53	1.1
Capacitance (pF)	0.0006			

**Table 42. INDUCTANCE, CAPACITANCE, AND ERROR FOR W/B= 0.1,
T= 10 TO 500 MILS**

Strip Length (mils)	Inductance (nH) (Matching)	Max Error (%)	Inductance (nH) (Model)	Max Error (%)
10	8.15	1.0	8.21	1.3
20	7.55	1.0	7.61	1.0
30	7.20	1.0	7.26	1.1
40	6.85	1.0	7.00	1.3
50	6.65	1.1	6.81	1.4
60	6.50	1.2	6.65	1.5
70	6.35	1.3	6.52	1.6
80	6.25	1.4	6.40	1.7
90	6.15	1.4	6.30	1.8
100	6.05	1.5	6.21	1.9
200	5.40	1.4	5.60	1.9
300	5.00	1.0	5.14	1.3
400	4.95	1.1	5.03	1.2
500	4.90	1.1	5.03	1.3
Capacitance (pF)	0.0003			

APPENDIX E. FINLINE FILTER MODEL

```
! FILE: FINFIL.CKT

! USER:      MIKE MORUA
! DATE:      22 MAY 90
! CIRCUIT:   FINLINE FILTER MODEL WHICH IS BASED ON INDUCTIVE STRIP
!            IN HOMOGENEOUS FINLINE MODEL.  VALID FOR
!            0.1 <= W/b <= 1.0, 10 <= (900T/A) <= 500 MILS,
!            AND STRIPS CENTERED.  MODEL SCALES TO ALL WAVEGUIDE
!            BANDS.

! COMMENT:   THIS CIRCUIT FILE IS A SIMULATION OF A THREE SECTION
!            4 STRIP SYMMETRIC FINLINE FILTER.

DIM
  FREQ GHZ
  RES OH
  IND NH
  CAP PF
  LNG MIL
  TIME PS
  COND /OH
  ANG DEG

VAR
  A = 900
  B = 400
  Wovb = 1.00
  T1 = 90      ! STRIP LENGTHS
  T2 = 250
  T3 = 240
  T4 = 90
  R1 = 558     ! FINLINE LENGTHS
  R2 = 540
  R3 = 540

  pi = 3.14159

EQN
  Lg1 = T1/2
  Lg2 = T2/2
  Lg3 = T3/2
  Lg4 = T4/2

! FINLINE MODEL
  M = 2*B/A
  N = 1-Wovb
  Aov2 = A/2
  Aeq1 = 2 - (1 - M**0.77 * N**2)**0.5
  Aeq2 = 0.221 * (1/M)**3.61 * N**28
  Aeq = (Aeq1 + Aeq2)*A

  Beq1 = 0.6 + (0.16 - 0.1347 * M**1.35 * N**2)**0.5
  Beq2 = -0.17 * (1/M)**1.15 * N**10
  Beq = (Beq1 + Beq2)*B
```

Figure 25. Finline Filter Model TOUCHSTONE Program.

```

! IMPEDANCE TRANSFORMER
Lamda = (30000/2.54)/FREQ
LpovL1 = 1/(1-(Lamda/(2*Aeq))**2)**0.5
LpovL2 = 1/(1-(Lamda/(2*A))**2)**0.5
Z1 = 120*pi*(2*Beq/Aeq)*LpovL1
Z2 = 120*pi*(2*B/A)*LpovL2
X1 = (Z1/Z2)**0.5

! INDUCTANCE COEFFICIENTS
A1 = 13.75 - 10.32*(1 - Wovb)**1.60
B1 = 9.46 - 6.36*(1 - Wovb)**3.78
C1 = 1.54 - 1.10*(1 - Wovb)**4.73
N1 = 500 - 241*(1-Wovb)**1.74

! INDUCTANCE EQUATIONS
! 1ST INDUCTOR
Tp1 = 900*T1/A
L11 = B1 - C1*ln(Tp1)
L21 = 1 + exp((T1 - N1)*90/A)
Ld1 = (B/400)*(A1 + (L11/L21))
! 2ND INDUCTOR
Tp2 = 900*T2/A
L12 = B1 - C1*ln(Tp2)
L22 = 1 + exp((T2 - N1)*90/A)
Ld2 = (B/400)*(A1 + (L12/L22))
! 3RD INDUCTOR
Tp3 = 900*T3/A
L13 = B1 - C1*ln(Tp3)
L23 = 1 + exp((T3 - N1)*90/A)
Ld3 = (B/400)*(A1 + (L13/L23))
! 4TH INDUCTOR
Tp4 = 900*T4/A
L14 = B1 - C1*ln(Tp4)
L24 = 1 + exp((T4 - N1)*90/A)
Ld4 = (B/400)*(A1 + (L14/L24))

! CAPACITANCE EQUATION
C = (4/8100)*(A**2/B)*(Wovb*0.003)

CKT
RWG 1 2 A`Aov2 B`B L`Lg1 ER=1 RHO=1
IND 1 0 L`Ld1
CAP 1 0 C`C
DEF2P 1 2 A

! 1ST STRIP
XFER 1 2 0 0 N`X1
A 2 3
A 2 3
A 4 3
A 4 3
XFER 5 4 0 0 N`X1
DEF2P 1 5 STRIP1

RWG 1 2 A`Aov2 B`B L`Lg2 ER=1 RHO=1
IND 1 0 L`Ld2
CAP 1 0 C`C
DEF2P 1 2 B

```

Figure 26. Finline Filter Model TOUCHSTONE Program (cont.).

```

! 2ND STRIP
XFER 1 2 0 0 N`X1
B 2 3
B 2 3
B 4 3
B 4 3
XFER 5 4 0 0 N`X1
DEF2P 1 5 STRIP2

RWG 1 2 A`Aov2 B`B L`Lg3 ER=1 RHO=1
IND 1 0 L`Ld3
CAP 1 0 C`C
DEF2P 1 2 C

! 3RD STRIP
XFER 1 2 0 0 N`X1
C 2 3
C 2 3
C 4 3
C 4 3
XFER 5 4 0 0 N`X1
DEF2P 1 5 STRIP3

RWG 1 2 A`Aov2 B`B L`Lg4 ER=1 RHO=1
IND 1 0 L`Ld4
CAP 1 0 C`C
DEF2P 1 2 D

! 4TH STRIP
XFER 1 2 0 0 N`X1
D 2 3
D 2 3
D 4 3
D 4 3
XFER 5 4 0 0 N`X1
DEF2P 1 5 STRIP4

! FINLINE LENGTHS
RWG 1 2 A`Aeq B`Beq L`R1 ER=1 RHO=1
DEF2P 1 2 RES1

RWG 1 2 A`Aeq B`Beq L`R2 ER=1 RHO=1
DEF2P 1 2 RES2

RWG 1 2 A`Aeq B`Beq L`R3 ER=1 RHO=1
DEF2P 1 2 RES3

RWGT 1 A`Aeq B`Beq ER=1 RHO=1
DEF1P 1 WEDGE

```

Figure 27. Finline Filter Model TOUCHSTONE Program (cont.).

```
! FINLINE FILTER MODEL
STRIP1 1 2
RES1 2 3
STRIP2 3 4
RES2 4 5
STRIP3 5 6
RES3 6 7
STRIP4 7 8
DEF2P 1 8 FINFIL1

TERM
FINFIL1 WEDGE WEDGE

PROC

OUT
FINFIL1 DB[S21] GR1
FINFIL1 DB[S11] GR1

FREQ
SWEEP 8 12 .1
SWEEP 9.5 10.5 .01

GRID
RANGE 8 12 0.4
GR1 -60 20 10
```

Figure 28. Finline Filter Model TOUCHSTONE Program (cont.).

APPENDIX F. COMPUTER-GENERATED SCATTERING DATA FOR SCALED MODEL

Table 43. SCATTERING DATA FOR WR(42), W/B= 0.5, T= 40 MILS

```

Dielec Thickness D (mil) 10.0000
Normalized H1/D -        21.0000
Normalized H2/D -        20.0000
waveguide height B/D -   17.0000
fin gap width W/B -      0.5000
number of dif. T/D -     1.0000
Dielec. cons region 1 -   1.0000
Dielec. cons region 2 -   1.0000
Dielec. cons region 3 -   1.0000
Upper freq limit GHz -    26.0000
Lower freq limit GHz -    18.0000
Freq increment GHz -      1.0000
Matrix order -           10.0000
1st t/d value            4.0000
2nd t/d value            0.
3rd t/d value            0.
4th t/d value            0.
5th t/d value            0.
6th t/d value            0.
7th t/d value            0.
8th t/d value            0.
    
```

FREQUENCY	S11 Mag.	S11 Phase	S12 Mag.	S12 Phase	T OVER D
18.0000	0.9333	147.4102	0.3590	57.4102	4.0000
19.0000	0.9162	143.3496	0.4007	53.3497	4.0000
20.0000	0.8968	139.9747	0.4425	49.9747	4.0000
21.0000	0.8773	135.8614	0.4800	45.8614	4.0000
22.0000	0.8552	132.2754	0.5183	42.2754	4.0000
23.0000	0.8310	128.7422	0.5563	38.7423	4.0000
24.0000	0.8061	124.8926	0.5917	34.8926	4.0000
26.0000	0.7514	118.0899	0.6599	28.0899	4.0000

Table 44. SCATTERING DATA FOR WR(28), W/B= 1.0, T= 15 MILS

Dielec Thickness D (mil) 10.0000
 Normalized H1/D = 14.0000
 Normalized H2/D = 13.0000
 waveguide height B/D = 14.0000
 fin gap width W/B = 1.0000
 number of dif. T/D = 1.0000
 Dielec. cons region 1 = 1.0000
 Dielec. cons region 2 = 1.0000
 Dielec. cons region 3 = 1.0000
 Upper freq limit GHz = 40.1000
 Lower freq limit GHz = 26.1000
 Freq increment GHz = 2.0000
 Matrix order = 10.0000
 1st t/d value 1.5000
 2nd t/d value 0.
 3rd t/d value 0.
 4th t/d value 0.
 5th t/d value 0.
 6th t/d value 0.
 7th t/d value 0.
 8th t/d value 0.

FREQUENCY	S11 Mag.	S11 Phase	S12 Mag.	S12 Phase	T OVER D
26.1000	0.8494	141.7676	0.5277	51.7676	1.5000
28.1000	0.7883	134.1739	0.6152	44.1739	1.5000
30.1000	0.7316	128.3203	0.6817	38.3204	1.5000
32.1000	0.6795	122.6251	0.7337	32.6250	1.5000
34.1000	0.6323	117.8790	0.7748	27.8790	1.5000
36.1000	0.5878	114.1348	0.8090	24.1348	1.5000
38.1000	0.5476	110.2852	0.8367	20.2852	1.5000

Table 45. SCATTERING DATA FOR WR(19), W/B= 0.25, T= 20 MILS

Dielec Thickness D (mil) 10.0000
 Normalized H1/D - 9.4000
 Normalized H2/D - 8.4000
 waveguide height B/D - 9.4000
 fin gap width W/B - 0.2500
 number of dif. T/D - 1.0000
 Dielec. cons region 1 - 1.0000
 Dielec. cons region 2 - 1.0000
 Dielec. cons region 3 - 1.0000
 Upper freq limit GHz - 60.0000
 Lower freq limit GHz - 40.0000
 Freq increment GHz - 2.0000
 Matrix order - 10.0000
 1st t/d value 2.0000
 2nd t/d value 0.
 3rd t/d value 0.
 4th t/d value 0.
 5th t/d value 0.
 6th t/d value 0.
 7th t/d value 0.
 8th t/d value 0.

FREQUENCY	S11 Mag.	S11 Phase	S12 Mag.	S12 Phase	T OVER D
40.0000	0.9706	154.0020	0.2406	64.0020	2.0000
42.0000	0.9643	151.1016	0.2646	61.1016	2.0000
44.0000	0.9572	148.9922	0.2894	58.9922	2.0000
46.0000	0.9491	146.4083	0.3148	56.4082	2.0000
48.0000	0.9401	143.8770	0.3409	53.8770	2.0000
50.0000	0.9296	141.2403	0.3685	51.2403	2.0000
52.0000	0.9177	138.2872	0.3974	48.2872	2.0000
54.0000	0.9036	135.7032	0.4284	45.7032	2.0000
56.0000	0.8876	132.4864	0.4605	42.4864	2.0000
58.0000	0.8701	129.5333	0.4929	39.5332	2.0000
60.0000	0.8484	126.6856	0.5293	36.6856	2.0000

Table 46. SCATTERING DATA FOR WR(12), W/B= 0.5, T= 3 MILS

Dielec Thickness D (mil) 10.0000
 Normalized H1/D = 6.1000
 Normalized H2/D = 5.1000
 waveguide height B/D = 6.1000
 fin gap width W/B = 0.5000
 number of dif. T/D = 1.0000
 Dielec. cons region 1 = 1.0000
 Dielec. cons region 2 = 1.0000
 Dielec. cons region 3 = 1.0000
 Upper freq limit GHz = 90.0000
 Lower freq limit GHz = 60.0000
 Freq increment GHz = 3.0000
 Matrix order = 10.0000
 1st t/d value 0.3000
 2nd t/d value 0.
 3rd t/d value 0.
 4th t/d value 0.
 5th t/d value 0.
 6th t/d value 0.
 7th t/d value 0.
 8th t/d value 0.

FREQUENCY	S11 Mag.	S11 Phase	S12 Mag.	S12 Phase	T OVER D
60.0000	0.8480	144.5625	0.5301	54.5625	0.3000
63.0000	0.8174	141.0821	0.5761	51.0821	0.3000
66.0000	0.7872	137.8653	0.6167	47.8653	0.3000
69.0000	0.7586	134.6485	0.6515	44.6485	0.3000
72.0000	0.7297	131.9590	0.6837	41.9590	0.3000
75.0000	0.7014	129.4278	0.7127	39.4278	0.3000
78.0000	0.6754	126.6328	0.7374	36.6328	0.3000
81.0000	0.6485	124.7872	0.7612	34.7872	0.3000
84.0000	0.6237	122.3087	0.7817	32.3086	0.3000
87.0000	0.5996	120.4630	0.8003	30.4629	0.3000
90.0000	0.5758	118.4590	0.8176	28.4590	0.3000

Table 47. SCATTERING DATA FOR WR(8), W/B = 1.0, T = 30 MILS

Dielec Thickness D (mil) 10.0000
 Normalized H1/D = 4.0000
 Normalized H2/D = 3.0000
 waveguide height B/D = 4.0000
 fin gap width W/B = 1.0000
 number of dif. T/D = 1.0000
 Dielec. cons region 1 = 1.0000
 Dielec. cons region 2 = 1.0000
 Dielec. cons region 3 = 1.0000
 Upper freq limit GHz = 140.0000
 Lower freq limit GHz = 90.0000
 Freq increment GHz = 5.0000
 Matrix order = 10.0000
 1st t/d value 3.0000
 2nd t/d value 0.
 3rd t/d value 0.
 4th t/d value 0.
 5th t/d value 0.
 6th t/d value 0.
 7th t/d value 0.
 8th t/d value 0.

FREQUENCY	S11 Mag.	S11 Phase	S12 Mag.	S12 Phase	T OVER D
90.0000	0.9956	151.3653	0.0937	61.3653	3.0000
95.0000	0.9933	145.6700	0.1157	55.6700	3.0000
100.0000	0.9901	140.0274	0.1404	50.0274	3.0000
105.0000	0.9862	134.8595	0.1658	44.8594	3.0000
110.0000	0.9808	130.0079	0.1948	40.0079	3.0000
115.0000	0.9741	124.0489	0.2263	34.0489	3.0000
120.0000	0.9653	118.6172	0.2611	28.6172	3.0000
125.0000	0.9540	112.5001	0.3000	22.5001	3.0000
130.0000	0.9382	106.5411	0.3461	16.5411	3.0000
135.0000	0.9184	99.6856	0.3957	9.6856	3.0000
140.0000	0.8914	92.3555	0.4532	2.3555	3.0000

Table 48. SCATTERING DATA FOR WR(5), W/B= 0.25, T= 2 MILS

Dielec Thickness D (mil) 10.0000
 Normalized H1/D - 2.5500
 Normalized H2/D - 1.5500
 waveguide height B/D - 2.5500
 fin gap width W/B - 0.2500
 number of dif. T/D - 1.0000
 Dielec. cons region 1 - 1.0000
 Dielec. cons region 2 - 1.0000
 Dielec. cons region 3 - 1.0000
 Upper freq limit GHz - 220.0000
 Lower freq limit GHz - 140.0000
 Freq increment GHz - 10.0000
 Matrix order - 10.0000
 1st t/d value 0.2000
 2nd t/d value 0.
 3rd t/d value 0.
 4th t/d value 0.
 5th t/d value 0.
 6th t/d value 0.
 7th t/d value 0.
 8th t/d value 0.

FREQUENCY	S11 Mag.	S11 Phase	S12 Mag.	S12 Phase	T OVER D
140.0000	0.9350	153.6856	0.3547	63.6856	0.2000
150.0000	0.9169	150.7325	0.3991	60.7325	0.2000
160.0000	0.8976	147.5684	0.4408	57.5684	0.2000
170.0000	0.8764	143.6661	0.4816	53.6661	0.2000
180.0000	0.8538	140.6602	0.5207	50.6602	0.2000
190.0000	0.8294	137.3380	0.5586	47.3379	0.2000
200.0000	0.8028	134.0685	0.5962	44.0684	0.2000
210.0000	0.7734	131.4317	0.6339	41.4317	0.2000
220.0000	0.7440	127.7930	0.6681	37.7930	0.2000

APPENDIX G. MAGNITUDE, PHASE, SMITH CHART PLOT OF SCALED MODEL AND DATA

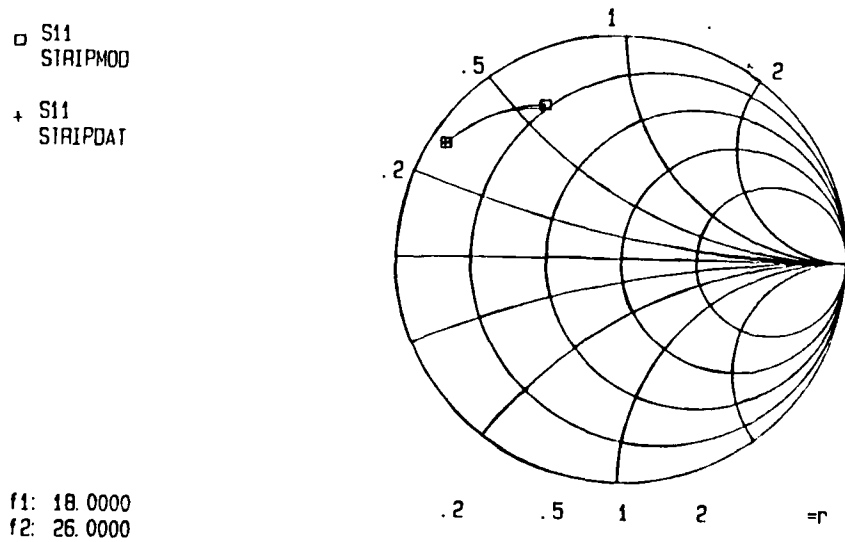
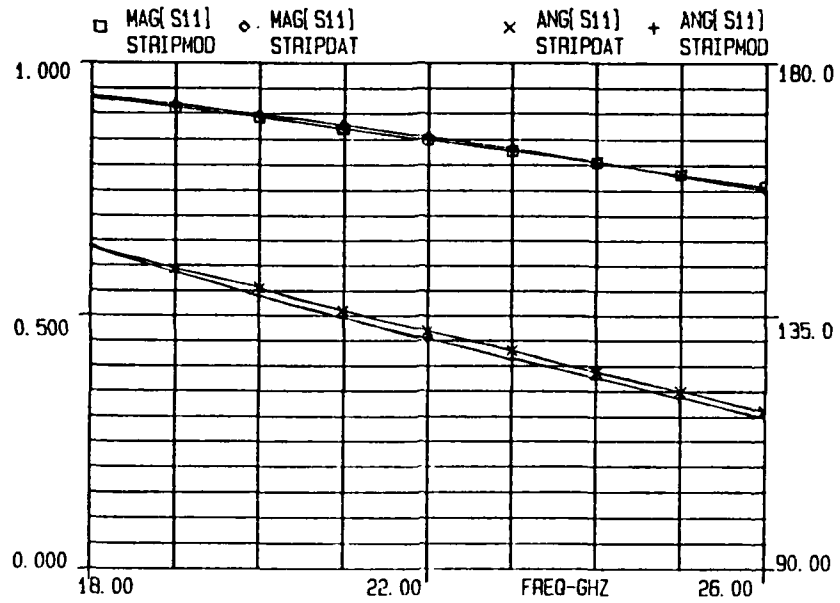

Figure 29. Plots for WR(42), W/B= 0.5, T= 40 mils.

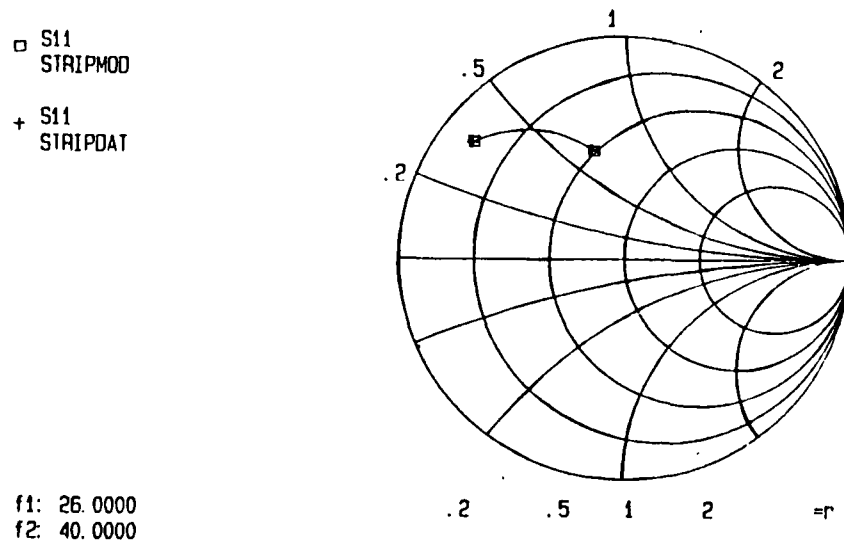
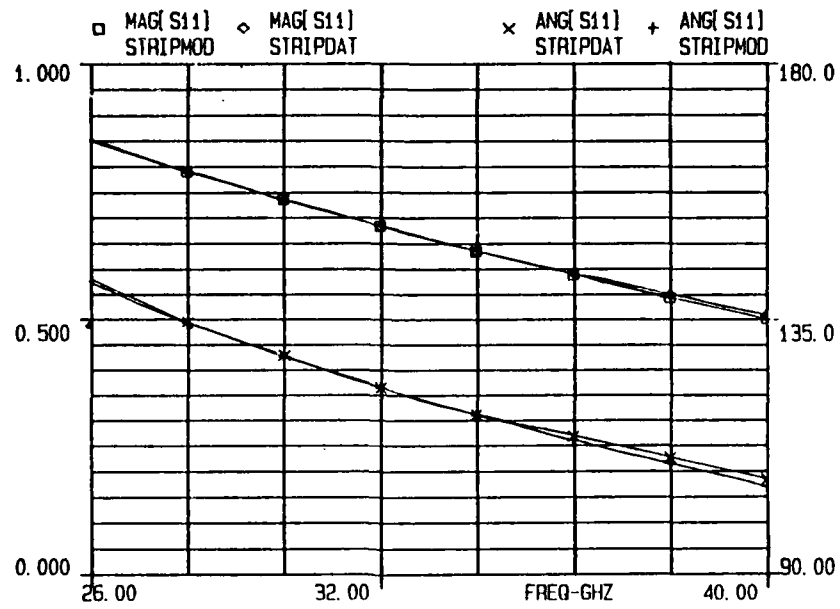
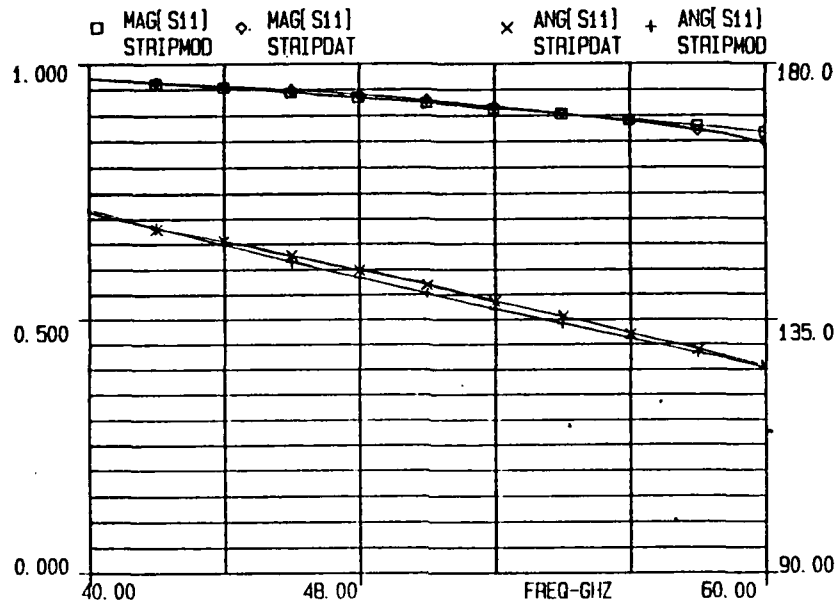
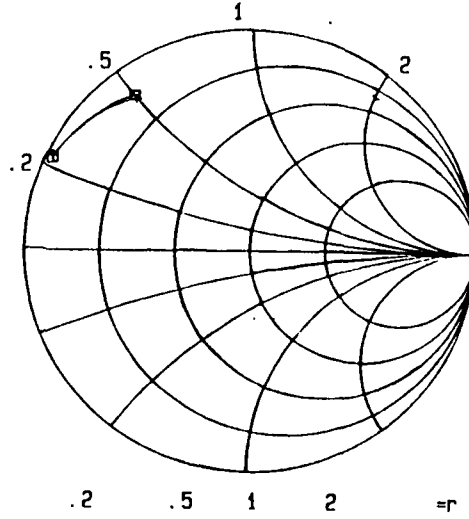

Figure 30. Plots for WR(28), W/B = 1.0, T = 15 mils.



□ S11 STRIPMOD
 + S11 STRIPDAT



f1: 40.0000
 f2: 60.0000

Figure 31. Plots for WR(19), W/B = 0.25, T = 20 mils.

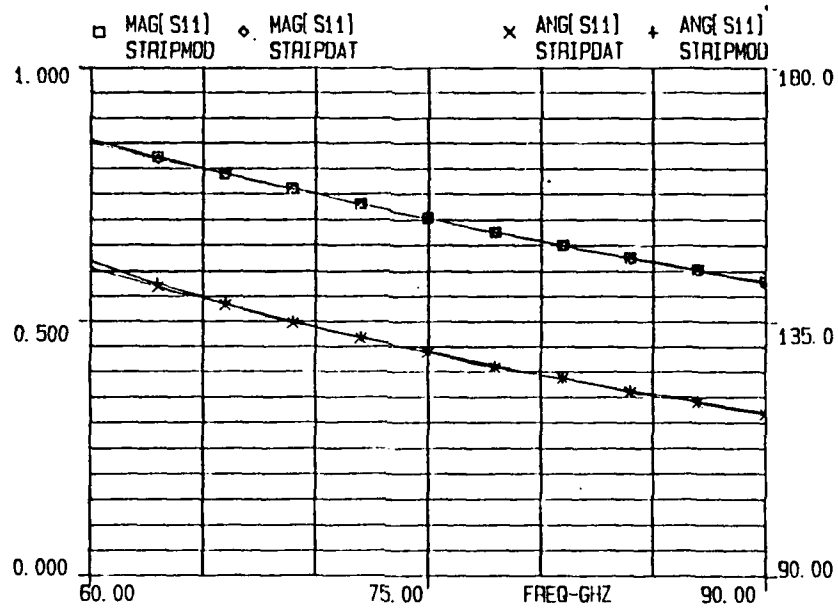

□ S11 STRIPMOD
 + S11 STRIPDAT

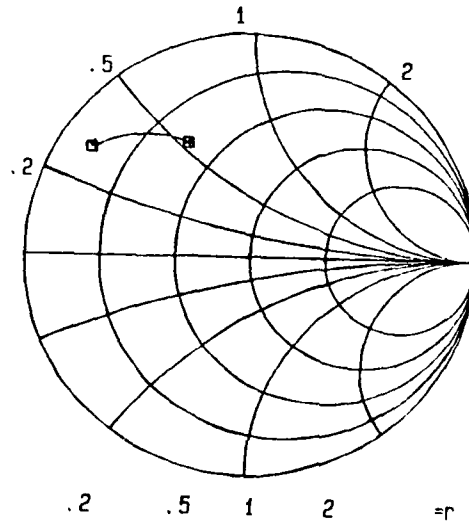

f1: 60.0000
 f2: 90.0000

Figure 32. Plots for WR(12), W/B = 0.5, T = 3 mils.

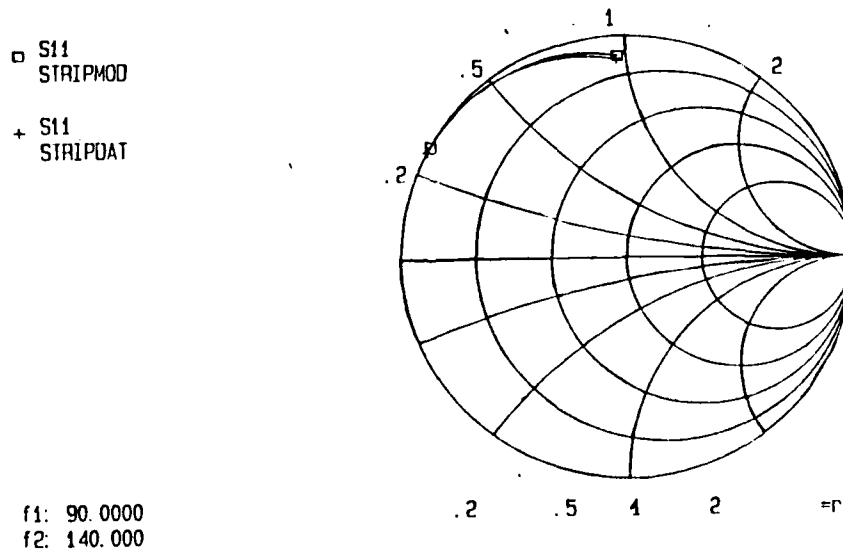
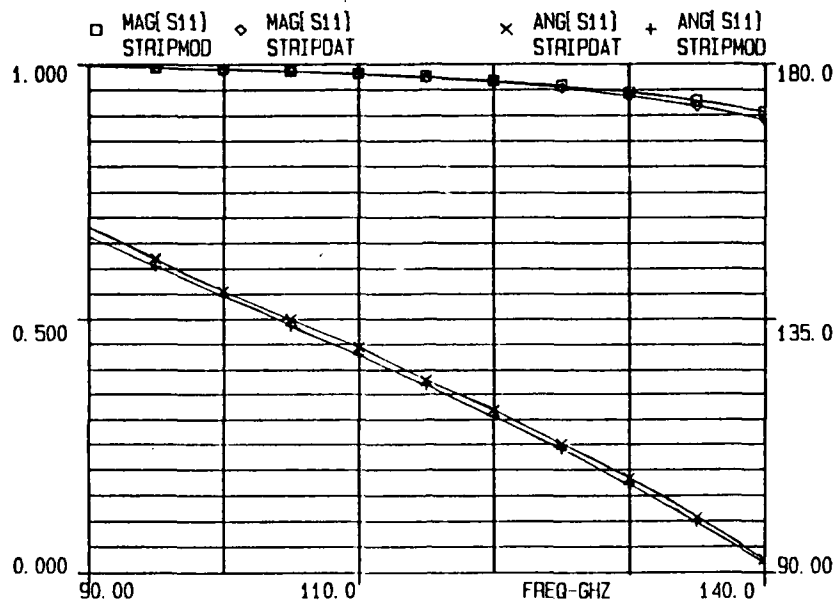

Figure 33. Plots for WR(8), W/B = 1.0, T = 30 mils.

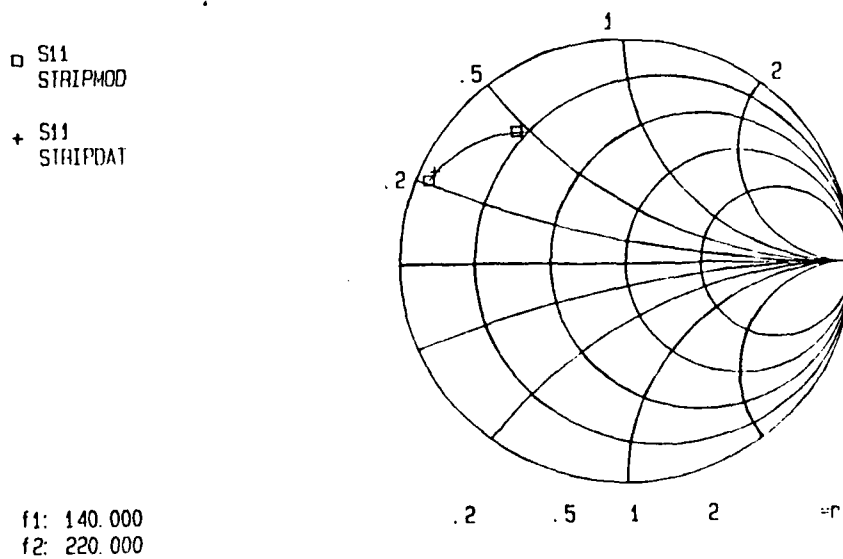
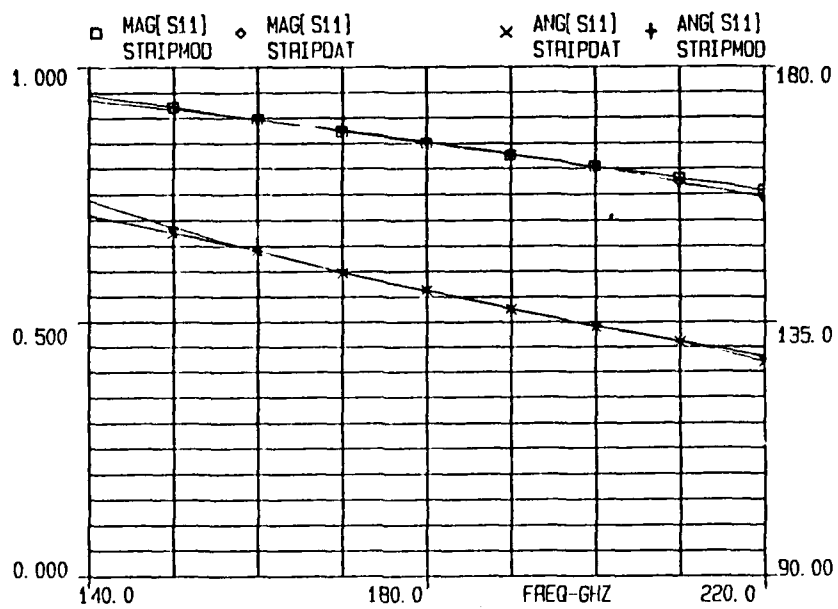

Figure 34. Plots for WR(5), W/B = 0.25, T = 2 mils.

APPENDIX H. ERROR FOR SCALED MODEL

Table 49. ERROR FOR WR(42), WR(28), WR(19), WR(12), WR(8), WR(5): The error listed is the maximum error in S_{11} .

Waveguide Type	Freq (GHz)	W/B	Strip Length (mils)	Max Error (%)
WR(42)	16-26	0.5	40	1.2
WR(28)	26-40	1.0	15	1.4
WR(19)	40-60	0.25	20	2.2
WR(12)	60-90	0.5	3	0.7
WR(8)	90-140	1.0	30	1.8
WR(5)	140-220	0.25	2	1.8

LIST OF REFERENCES

1. Knorr, J. B., *A CAD model for the inductive strip in finline*, Technical report NPS 62-88-013, Naval Postgraduate School, Monterey, CA, Aug. 1988.
2. Meier, P. J., *Integrated fin-line millimeter components*, IEEE Trans. Microwave Theory and Tech., vol. MTT-22, pp. 1209-1216, Dec. 1974.
3. Knorr, J. B. and Shayda, P. M., *Millimeter-wave fin-line characteristics*, IEEE Trans. Microwave Theory and Tech., vol. MTT-28, pp. 737-742, Jul. 1980.
4. Shayda, P. M., *Spectral domain analysis of finline*, M.S. thesis, Naval Postgraduate School, Monterey, CA, Dec. 1979.
5. Kim, B., *A computation of fin-line impedance*, M.S. thesis, Naval Postgraduate School, Monterey, CA, Dec. 1984.
6. Knorr, J. B. and Deal, J. C., *Scattering coefficients of an inductive strip in a fin-line: theory and experiment*, IEEE Trans. Microwave Theory and Tech., vol. MTT-33, pp. 1011-1017, Oct. 1985.
7. Deal, J. C., *Numerical computation of the scattering coefficients of an inductive strip in a fin-line*, M.S. thesis, Naval Postgraduate School, Monterey, CA, Mar. 1984.
8. Bush, T., *An equivalent rectangular waveguide model for finline*, M.S. thesis, Naval Postgraduate School, Monterey, CA, Dec. 1989.
9. Karaminas, G., *Circuit models for inductive strips in fin-line*, M.S. thesis, Naval Postgraduate School, Monterey, CA, Dec. 1989.
10. Knorr, J. B., *CAD models for inductive strips in homogeneous finline: the methodology*, Technical report NPS 62-90-007, Naval Postgraduate School, Monterey, CA, Mar. 1990.

INITIAL DISTRIBUTION LIST

	No. Copies
1. Defense Technical Information Center Cameron Station Alexandria, VA 22304-6145	2
2. Library, Code 0142 Naval Postgraduate School Monterey, CA 93943-5002	2
3. Chairman, Code EC Department of Electrical and Computer Engineering Naval Postgraduate School Monterey, California 93943-5000	1
4. Professor Jeffrey B. Knorr, Code EC/Ko Department of Electrical and Computer Engineering Naval Postgraduate School Monterey, California 93943-5000	4
5. R. Janaswamy, Code EC/Js Department of Electrical and Computer Engineering Naval Postgraduate School Monterey, California 93943-5000	1
6. Commanding Officer Microwave Millimeter Wave Branch (Attn: Dave Rubin, Code 753) Naval Ocean Systems Center San Diego, California 92152	1
7. Commanding Officer RF Development Section (Attn: Joe Mosko, Code 35203) Naval Weapons Center China Lake, California 93555	1
8. LT Michael L. Morua, USN 40134 Davis St. Fremont, California 94538	4