

AD-A235 305



2

IMPROVED POINT ANALYSIS MODEL  
(IPAM)  
USERS GUIDE

FEBRUARY 1991

DTIC  
ELECTE  
APR 25 1991  
S E D

APPROVED FOR PUBLIC RELEASE;  
DISTRIBUTION IS UNLIMITED



AIR FORCE GLOBAL WEATHER CENTRAL  
Offutt Air Force Base, Nebraska 68113-5000

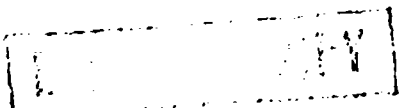

91 4 25 006

## REVIEW AND APPROVAL STATEMENT

This publication approved for public release. There is no objection to unlimited distribution of this document to the public at large, or by the Defense Technical Information Center (DTIC) to the National Technical Information Service (NTIS)

  
JAMES A. PHILLIPS, Colonel, USAF  
Chief, Operations Division

FOR THE COMMANDER

  
KEITH C. ROSS, Colonel, USAF  
Vice Commander

## REPORT DOCUMENTATION PAGE

2. Report Date: February 1991
3. Report Type: Technical Note
4. Title: Improved Point Analysis Model (IPAM) Users Guide
7. Performing Organization Name: Air Force Global Weather Central (AFGWC/DOP), Offutt AFB, NE 68113-5000
8. Performing Organization Report Number: AFGWC/TN-91/001
11. Supplementary Notes: Updates, but does not replace, AFGWC-TM-78-003 (AD-A063648).
12. Distribution/Availability Statement: Approved for public release; distribution is unlimited
13. Abstract: The Air Force Global Weather Central (AFGWC) and the USAF Environmental Technical Applications Center (USAFETAC) have provided vertical meteorological profiles to military organizations, government agencies, and DoD contractors for a number of years. These products are called "Point Analyses," or "PAs." The contents of a PA let customers use applicable meteorological information to assess and evaluate their own data with respect to the state of the atmosphere at a specific place and time. The capabilities of the PA have recently been improved to accomodate new meteorological databases, new data sources, updated or new climatological data fields and models, and sophisticated methemathical techniques that enhance the accuracy and reliability of the data profile. The improved product is known as the "Improved Point Analysis Model," or "IPAM." This users guide describes the IPAM in detail, explaining its capabilities and limitations in sufficient depth to allow customers to use and apply the data to their own purposes.
14. Subject Terms: METEOROLOGY, CLIMATOLOGY, MODELS, MATHEMATICAL MODELS, ATMOSPHERE MODELS, PROFILES, TRANSMISSIVITY, LINE OF SIGHT, CLOUD, AEROSOLS, REFRACTIVE INDEX, TEMPERATURE, MOISTURE

15. Number of Pages: 201
17. Security Classification of Report: Unclassified
18. Security Classification of this Page: Unclassified
19. Security Classification of Abstract: Unclassified
20. Limitation of Abstract: UL

|                      |                                     |
|----------------------|-------------------------------------|
| <b>Accession For</b> |                                     |
| NTIS GRA&I           | <input checked="" type="checkbox"/> |
| DTIC TAB             | <input checked="" type="checkbox"/> |
| Unannounced          | <input type="checkbox"/>            |
| Justification        |                                     |
| By _____             |                                     |
| Distribution/        |                                     |
| Availability Codes   |                                     |
| Dist                 | Avail and/or<br>Special             |
| A-1                  |                                     |

# IPAM USER'S GUIDE

## TABLE OF CONTENTS

|                  |   | <b>PAGE</b> |
|------------------|---|-------------|
| <b>SECTION 1</b> | <b>GENERAL</b>  | <b>1-1</b>  |
| 1.1              | Purpose of the IPAM User's Guide                                      | 1-1         |
| 1.2              | Project References  | 1-2         |
| 1.3              | Terms and Abbreviations   | 1-5         |
| 1.4              | Security  | 1-5         |
| <br>             |   |             |
| <b>SECTION 2</b> | <b>CAPABILITIES AND IMPROVEMENTS</b>                                  | <b>2-1</b>  |
| 2.1              | IPAM Accuracy   | 2-1         |
| 2.2              | Improved Exploitation of Data Base<br>Information Content             | 2-3         |
| 2.3              | Improved Upper Air Estimates  | 2-3         |
| 2.4              | Improved Pseudo-Surface Observation                                   | 2-4         |
| 2.5              | Improved Model Flexibility  | 2-4         |
| 2.6              | Alternate Temperature and Moisture<br>Profiles                        | 2-4         |
| 2.7              | Aerosol Parameters  | 2-5         |
| 2.8              | Surface Weather History   | 2-5         |
| 2.9              | Slant Path Capabilities   | 2-5         |
| 2.10             | Moisture Parameter Comparison   | 2-5         |
| 2.11             | Optimum Interpolation Profile   | 2-6         |
| 2.12             | Cloud Depiction Moisture Consistency                                  | 2-6         |
| 2.13             | Calculation of Precipitable Water                                     | 2-6         |
| 2.14             | Refractive Index  | 2-6         |
| <br>             |   |             |
| <b>SECTION 3</b> | <b>GENERAL INFORMATION ON IPAM INPUTS,<br/>PROCESSING, AND OUTPUT</b> | <b>3-1</b>  |
| 3.1              | Paragraph A - Point Analysis Site<br>Identification                   | 3-1         |
| 3.1.1            | Input for IPAM Site Identification                                    | 3-1         |
| 3.1.2            | Description of Site Identification<br>Output                          | 3-2         |
| 3.2              | Paragraph B - Date and Time   | 3-3         |
| 3.2.1            | Input for IPAM Date and Time  | 3-3         |

TABLE OF CONTENTS (Continued)

|         |  | <u>PAGE</u> |
|---------|--|-------------|
| 3.2.2   | Output for Paragraph B - Date<br>and Time  | 3-3         |
| 3.3     | Paragraph C - Cloud Cover  | 3-3         |
| 3.3.1   | Organizational Data Bases Used<br>for Paragraph C                                | 3-4         |
| 3.3.2   | Construction of Cloud Depiction  | 3-4         |
| 3.3.3   | Description of Paragraph C Output  | 3-5         |
| 3.4     | Paragraph D - Site Pseudo-Surface<br>Observation                                 | 3-6         |
| 3.4.1   | Organizational Data Bases Used   | 3-9         |
| 3.4.2   | Construction of the Pseudo-Surface<br>Observation                                | 3-9         |
| 3.5     | Paragraph E - Precipitable Water   | 3-12        |
| 3.5.1   | Organizational Data Bases Used   | 3-15        |
| 3.5.2   | Construction of Precipitable Water<br>Profile                                    | 3-15        |
| 3.6     | Paragraph F - Winds, Temperature,<br>Absolute Humidity, Density, and<br>Pressure | 3-15        |
| 3.6.1   | Organizational Data Bases Used   | 3-16        |
| 3.6.2   | Construction of RAOBVP   | 3-16        |
| 3.7     | Paragraph G - Remarks  | 3-20        |
| 3.7.1   | Organizational Data Bases Used   | 3-20        |
| 3.7.2   | Construction of Remarks Paragraph  | 3-20        |
| 3.7.2.1 | Closest RAOB Summary   | 3-20        |
| 3.7.2.2 | Surface Observation Table  | 3-23        |
| 3.7.2.3 | SESS Data  | 3-25        |
| 3.7.2.4 | SSM/I Parameters   | 3-32        |
| 3.7.2.5 | Data Source/Weight/<br>Correlation Table   | 3-32        |
| 3.7.2.6 | Other Remarks  | 3-33        |
| 3.8     | Paragraph H - Aerosol Parameters and VPI<br>Data for LOWTRAN Inputs              | 3-35        |

TABLE OF CONTENTS (Continued)

|           |  | <u>PAGE</u> |
|-----------|--|-------------|
| 3.8.1     | Organizational Data Bases Used   | 3-36        |
| 3.8.2     | Construction of Aerosol Parameters<br>and VPI  | 3-36        |
| 3.8.3     | Decode Values and Interpretation<br>of Some Aerosol Profile<br>Parameters                                      | 3-39        |
| 3.9       | Paragraph I - Optimum Interpolation Data<br>for Winds, Temperature, Absolute<br>Humidity, Density and Pressure | 3-44        |
| 3.9.1     | Organizational Data Bases Used   | 3-44        |
| 3.9.2     | Construction of an OIVP  | 3-44        |
| 3.10      | Paragraph J - 24-Hour Surface Weather<br>History   | 3-46        |
| 3.10.1    | Organizational Data Bases Used   | 3-46        |
| 3.10.2    | Construction of the Surface Weather<br>History   | 3-46        |
| 3.10.3    | Decode and Interpretation of<br>Selected Surface Weather History<br>Parameters                                 | 3-50        |
| 3.11      | Paragraph K - Refractive Index   | 3-54        |
| 3.11.1    | Input for the Refractive Index   | 3-54        |
| 3.11.2    | Description of Refractive Index Output   | 3-54        |
| SECTION 4 | IPAM Products  | 4-1         |
| 4.1       | IPAM Request Procedures and AUTODIN<br>Message Formats   | 4-1         |
| 4.1.1     | Message Input via AUTODIN  | 4-3         |
| 4.1.2     | Request Via AWN  | 4-3         |
| 4.1.3     | Customer Inputs and Default Options  | 4-5         |
| 4.1.4     | Data Item Relationships  | 4-15        |
| 4.2       | Paragraph Relationships  | 4-16        |
| 4.2.1     | If Paragraph C is Requested  | 4-16        |
| 4.2.2     | If Paragraph D is Requested  | 4-17        |
| 4.2.3     | If Paragraph E is Requested  | 4-19        |

# IPAM USER'S GUIDE

## TABLE OF CONTENTS (Continued)

|       |  | <u>PAGE</u> |
|-------|--|-------------|
| 4.2.4 | If Paragraph F is Requested                                  | 4-19        |
| 4.2.5 | Options Affecting Contents of<br>Paragraph G                 | 4-20        |
| 4.2.6 | If Paragraph H is Requested                                  | 4-20        |
| 4.2.7 | If Paragraph I is Requested                                  | 4-20        |
| 4.2.8 | If Paragraph J is Requested                                  | 4-22        |
| 4.2.9 | If Paragraph K is Requested                                  | 4-22        |
| 4.3   | Analyst Quality Control of an IPAM Data<br>Profile           | 4-22        |
| 4.3.1 | Paragraphs Which are Quality Controlled                      | 4-23        |
| 4.3.2 | Increased Time of Turn-Around                                | 4-23        |
| 4.3.3 | Disparities in IPAM Output                                   | 4-24        |
| 4.4   | IPAM Requests - Handling Policies                            | 4-24        |
| 4.4.1 | AFGWC IPAM Processing and Turn-Around<br>Time Procedures     | 4-25        |
| 4.4.2 | USAFETAC IPAM Processing and Turn-<br>Around Time Procedures | 4-27        |

## LIST OF ATTACHMENTS

### ATTACHMENT

|    |   |       |
|----|---|-------|
| 1  | Terms and Abbreviations                       | A1-1  |
| 2  | Optimum Interpolation in IPAM                 | A2-1  |
| 3  | RAOB Vertical Profile (RAOBVP)                | A3-1  |
| 4  | OIVP - Optimum Interpolation Vertical Profile | A4-1  |
| 5  | RAOBVP versus OIVP                            | A5-1  |
| 6  | Precipitable Water Content                    | A6-1  |
| 7  | Construction of the Cloud Depiction           | A7-1  |
| 8  | Slant Path Capabilities                       | A8-1  |
| 9  | ROCOB Data                                    | A9-1  |
| 10 | Moisture Parameter Comparison                 | A10-1 |
| 11 | RAOBVP Search Logic                           | A11-1 |
| 12 | Specific/Absolute Humidity                    | A12-1 |
| 13 | Aerosol Parameters                            | A13-1 |

TABLE OF CONTENTS (Continued)

PAGE

LIST OF ATTACHMENTS (Continued)

|    |   |       |
|----|---|-------|
| 14 | Groves/MSIS Model                           | A14-1 |
| 15 | Cubic Spline Technique                      | A15-1 |
| 16 | Data Weight/Correlation Schemes             | A16-1 |
| 17 | Alternate Temperature and Moisture Profiles | A17-1 |
| 18 | Quality Indices                             | A18-1 |
| 19 | HIRAS                                       | A19-1 |
| 20 | Upper Air Climatology                       | A20-1 |
| 21 | Refractive Index                            | A21-1 |
| 22 | Line-of-Sight Capabilities                  | A22-1 |

LIST OF FIGURES

FIGURE

|     |   |      |
|-----|---|------|
| 3-1 | Sample Output for Paragraph C - Cloud Cover   | 3-7  |
| 3-2 | Sample IPAM Output for Paragraph E -<br>Precipitable Water Content  | 3-16 |
| 3-3 | Sample Output for Paragraph F - Winds,<br>Temperature, Absolute Humidity, Density,<br>and Pressure            | 3-19 |
| 3-4 | Paragraph G - Remarks (Sample Output)   | 3-21 |
| 3-5 | Example of SSM/I Parameters   | 3-32 |
| 3-6 | Example of Data Source Weight Table   | 3-34 |
| 3-7 | Sample Output for Paragraph H - Aerosol<br>Parameters and Vertical Profile Information                        | 3-40 |
| 3-8 | Sample Output for Paragraph I - OI Data for<br>Winds, Temperature, Absolute Humidity,<br>Density and Pressure | 3-47 |
| 3-9 | Sample Output for Paragraph J - Surface<br>Weather History  | 3-49 |



**TABLE OF CONTENTS (Continued)**

**PAGE**

**LIST OF FIGURES (Continued)**

|          |  |       |
|----------|--|-------|
| 3-10     | Sample Output for Paragraph K - Refraction<br>Index Profile  | 3-52  |
| 4-1      | Formatted AUTODIN Request Message  | 4-2   |
| 4-2      | Sample 105-18 Support Assistance<br>Request Sent to USAFETAC   | 4-4   |
| 4-3      | AFGWC IPAM Request Template  | 4-6   |
| 4-4      | USAFETAC IPAM Request Template   | 4-9   |
| A3-1     | Sample Final Output of the RAOBVP Analysis<br>Profile  | A3-3  |
| A6-1     | Data Base Level Relationships to Calculation<br>of Precipitable Water Content for a 500<br>Ft. AGL Layer | A6-3  |
| A8-1     | Slant Path Trigonometry  | A8-6  |
| A9-1     | Case Situations Using ROCOB Data and<br>Groves/MSIS Model for Vertical Profiles<br>Above 100K Feet       | A9-3  |
| A15-1    | Cubic Spline Data  | A15-4 |
| A18-1    | Determination of Analyst Quality Control<br>Based on Requestor Input and<br>Quality Index Thresholds     | A18-4 |
| A22-1a/b | Sample Slant Path/Sample Line-of-Sight   | A22-3 |

**LIST OF TABLES**

**TABLE**

|     |   |      |
|-----|---|------|
| 2-1 | PA versus IPAM Comparison Chart   | 2-2  |
| 3-1 | Cloud Types for IPAM Paragraph D Output                                     | 3-10 |
| 3-2 | Present Weather Contractions and Their<br>Equivalent in WMO Code 4677WW     | 3-13 |
| 3-3 | Past Weather Contractions in WMO Code 4561                                  | 3-25 |
| 3-4 | Low Level Cloud Codes and Their Equivalent<br>Descriptions in WMO Code 0513 | 3-26 |

TABLE OF CONTENTS (Continued)

PAGE

LIST OF TABLES (Continued)

|       |  |       |
|-------|--|-------|
| 3-5   | Middle Level Cloud Codes and Their<br>Equivalent Descriptions in WMO Code 0515   | 3-28  |
| 3-6   | High Level Cloud Codes and Their Equivalent<br>Descriptions in WMO Code 0509   | 3-30  |
| 4-1   | IPAM AUTODIN User's Data Items   | 4-13  |
| 4-2   | Data Item Relationships  | 4-17  |
| 4-3   | IPAM Paragraph Output Selection and Other<br>Paragraph Choices   | 4-21  |
| A2-1  | User IPAM Request Options Which Can Involve<br>Optimum Interpolation   | A2-10 |
| A8-1  | Slant Path Subpoint Distances (nm) for<br>Selected Elevation Angles and Profile<br>Heights                                 | A8-7  |
| A9-1  | ROCOB Stations   | A9-2  |
| A10-1 | Sample Quality Thresholds and Quality<br>Indexes with Corresponding Selection of<br>VPI or Pseudo-Surface Observation Data | A10-2 |
| A13-1 | IHAZE/AIHAZE Decision Table  | A13-2 |
| A17-1 | Standard Temperature Errors ( $^{\circ}$ K)  | A17-3 |

## SECTION 1 GENERAL

### 1.1 Purpose of the IPAM User's Guide

The Air Force Global Weather Central (AFGWC) and the United States Air Force Environmental Technical Applications Center (USAFETAC) provide vertical profiles of meteorological data for the atmosphere to numerous military organizations, government agencies, and Department of Defense (DoD) contractors. This product has been called the Point Analysis (PA). The contents of the PA permits customers to use applicable meteorological information to support, assess and evaluate their own data and decision-making with respect to atmospheric conditions at a specific time and place.

Recently, the capabilities of the PA have been enhanced and improved to accommodate new meteorological data bases, new data sources, updated or new climatological data fields and models, and sophisticated mathematical techniques to enhance the accuracy and reliability of the data profile. These enhancements were made in a project entitled the Improved Point Analysis Model (IPAM).

This IPAM User's Guide describes the IPAM product in extensive detail. Its capabilities and limitations are explained so that the Users of the IPAM product will comprehend the nature and content of the atmospheric profile information in the product, when the data are applied to their own studies and applications.

This User's Guide updates and replaces the IPAM User's Guide, dated 12 July 1989, and updates but does not replace AFGWC Technical Memo 78-003, Point Analysis User's Guide, dated 30 September 1978. If Users intend to request vertical profiles from USAFETAC for dates prior to 1 January 1985, the PA software and output formats described in AFGWC Technical

Memo 78-003 will be used. Thus, some Users may need to keep the 1978 document. The type of data base information needed to support IPAM is not available nor can it be constructed for dates prior to 1 January 1985.

This IPAM User's Guide concerns itself with the fundamental inputs and information necessary for Users to understand the IPAM product. This document will not attempt to detail any applications for IPAM data or restate in any depth technical information already published in widely accepted and readily available reference material, e.g., Geophysics Laboratory (GL) Technical Reports, AFGWC Technical Reports/Memos.

## 1.2 Project References

The IPAM project has taken several years to design, code and implement. Pertinent references which User's may wish to consult for further information and understanding of the IPAM product are listed as follows:

- a. AFGWC Technical Memo 78-003, Point Analysis User's Guide, 30 September 1978;
- b. AFGWC TN 88/001 - The Automated Real Time Cloud Analysis Model, March 1988;
- c. High Resolution Analysis System - HIRAS Upper Air Users Manual, June 1986;
- d. AFGWC TSIN Office Note 84-1: Cholesky Method for Solving a Series of Linear Equations;
- e. AFGWC TN 79/003 - Map Projections and Grid Systems for Meteorological Applications, March 1981;
- f. Bergman, K.H., (May 1979), "Multivariate Analysis of Temperatures and Wind Using Optimum Interpolation",

Office Note 200, National Meteorological Center, NWS, NOAA, Washington, D.C., 37 pp.

- g. McPherson, R.D., (1980), "Theory of optimum interpolation", Office Note 217, National Meteorological Center, NWS, NOAA, Washington, D.C., 33 pp;
- h. McPherson, R.D., (1982), "Optimum interpolation: basic formulation and characteristics", Office Note 265, National Meteorological Center, NWS, NOAA, Washington, D.C., 14 pp;
- i. McPherson, R.D., (1982), "Optimum Interpolation: Practical Aspects of Operational Application", Office Note 266, National Meteorological Center, NWS, NOAA, Washington, D.C., 27 pp;
- j. AWS Tech Note - 86/001: AFGWC's Advanced Weather Analysis and Prediction System, June 1986;
- k. AFGL TR-83-0187: Atmospheric Transmittance/Radiance Computer Code - LOWTRAN 6, 1 August 1983;
- l. AFGL TR-83-0079: Variability of Atmospheric Density in the Middle Atmosphere, March 1983;
- m. AFGL TR-85-0129: A Global Reference Atmosphere from 15 to 80 Km, May 1985;
- n. Collins, W.G., (1983), "Vertical Interpolation of Heights and Temperatures for Model Input and Output," Office Note 282, National Meteorological Center, NWS, NOAA, Washington, D.C., 41 pp;
- o. Journal of Applied Meteorology, "On Some Properties of Correlation Functions Used in OI Schemes", July 1985.

- p. AWSR 105-18, The AWS Support System, 1 December 1986;
- q. Hedin, A.E., "A Revised Thermospheric Model Based on Mass Spectrometer and Incoherent Scatter Data: MSIS-83", *Journal of Geophysical Research*, Vol. 88, No. A12, Pages 10,170 - 10,188, December 1, 1983;
- r. Gerald V. Groves, "Atmospheric Structure Variations, Modeling of Atmospheric Structure 70-130KM", Air Force Office of Scientific Research, Grant No. AFOSR 84-0045, 27 April 1987;
- s. Bergman, K.H., (1979), "Multivariate analysis of temperature and winds using optimum interpolation", Monthly Weather Review 107:1423-1444;
- t. Eliassen, A., (1954), "Provisional report on calculation of spatial covariance and autocorrelation of the pressure field", Rapport No. 5, Videnskaps-Akademie Institute for Vaer-Ogklimaforskning, Oslo, Norway. Reprinted in Dynamic Meteorology: Data Assimilation Methods, L. Bengtsson, M. Ghil, and E. Kallen, eds., Applied Mathematical Sciences, V36, Springer-Verlag, New York, 1981;
- u. Gandin, L.S., (1963), "Objective analysis of meteorological fields", Isdat., Leningrad (Israel Program for Scientific Translations, Jerusalem, 1965, 242 pp.);
- v. McPherson, R.D., Bergman, K.H., Kistler, R.E., Rasch, G.E., and Gordon, D.S., (1979), "The NMC operational Global Data Assimilation System", Monthly Weather Review, 107:1445-1461; and
- w. The AFGWC High Resolution Analysis System (HIRAS), AFGWC Tech Note 9124B, 11 June 1986.

- x. NVALUE User's Manual, May 1981, Attachment 4 to Task Order Specification Request, 29 August, 1989.

### Terms and Abbreviations

A listing of applicable terms, acronyms, and abbreviations used in conjunction with this User's Guide documentation is presented in Attachment 1.

### Security

Requests for IPAM data are sent to AFGWC or USAFETAC via AUTODIN, AWN, or secure/dedicated communication lines. USAFETAC may also receive requests by letter in accordance with Air Weather Service Regulation 105-18. The classification of any IPAM product is the same as the classification of the request. The analysts and the computers handle each request in accordance with the stated security classification. While the meteorological data are normally unclassified, the total output of the IPAM product will be classified the same as the request message because of an association of date, time, place, and requestor for the data profile, unless different instructions are stated by the customer. The user also has the capability of establishing declassification and review instructions.

Within this document users will be made aware of an IPAM output message option called sanitization. When the user selects this option, certain output information is not printed or transmitted, and the resultant output message is not classified, even though the request message was classified. When specific parameters can be affected by the sanitization option, that feature is discussed. Slant path and Line-of-sight features cannot be requested with the sanitization option. Examples of suppressed information include latitude and longitude values, WMO region and station numbers, and station call letters. Slant path or

line-of-sight PAs cannot be run if the sanitization option is selected.



## SECTION 2

### CAPABILITIES AND IMPROVEMENTS

The Point Analysis (PA) program has provided meteorological information to varied customers for more than two decades. As customer applications for the data became more demanding, it became necessary to develop an Improved Point Analysis Model (IPAM) to meet client agency needs. The IPAM takes full advantage of current AFGWC data bases, (e.g., HIRAS, NUAV, RTNEPH), new/updated climatic models, (e.g., Groves-MSIS, OZONE), and better mathematical techniques, e.g., Optimum Interpolation (OI), applied to meteorological data. Further, IPAM provides new tailored support for the LOWTRAN model, developed by the Air Force Geophysics Laboratory (AFGL), by including aerosol parameter information.

Because of the anticipated increase in the number of requests for the Point Analysis product, more automation was built into the product production cycle. Also, IPAM customers have more options to select or criteria to establish for the information they receive in these atmospheric data analyses.

In the categorical comparison Table 2-1, an overview of the primary outputs of the old PA profile and the new IPAM product is presented. The details of the IPAM product are explained more fully as you read further in this User's Guide.

#### 2.1. Improved Point Analysis Model Accuracy

Model accuracy has been improved by the use of higher resolution and more accurate data bases. The upper air data base now provides upper air observations which have been more carefully validated by the New Upper Air Validator (NUAV). The High Resolution Upper Air Analysis System (HIRAS)

TABLE 2-1. PA versus IPAM Comparison Chart

| <u>PA Output</u>  | <u>Para</u> | <u>IPAM Output</u>  |
|---|-------------|---|
| Site or Lat/Lon   | A           | Site or Lat/Lon   |
| Time and Date   | B           | Time and Date   |
| Gridded Cloud Depiction   | C           | Gridded Cloud Depiction   |
| Surface Weather Data  | D           | Surface Weather Data  |
| RAOB-Based  | E           | RAOB- or OI-Based   |
| Precipitable Water<br>Profile   |             | Precipitable Water<br>Profile   |
| Meteorological Data<br>Profile<br>(Wind, Temperature,<br>Pressure, Density,<br>Absolute Humidity) | F           | Meteorological Data<br>Profile<br>(Wind, Temperature,<br>Pressure, Density,<br>Absolute Humidity)                                   |
| Remarks<br>(RAOB, Surface<br>Information)   | G           | Remarks<br>(RAOB, Surface Information,<br>Quality Indexes, Data<br>Source Weight Table, Slant<br>Path, and Moisture<br>Consistency) |
|   | H           | Aerosol Parameters  |
|   | I           | OI Meteorological Data<br>Profile (Wind, Temperature,<br>Pressure, Density, Absolute<br>Humidity)                                   |
|   | J           | 24-HR Surface Weather History   |
|   | K           | Refractive Index  |

benefits from the increased accuracy of validated observations. The improved resolution of HIRAS decreases interpolation errors in point analysis. Also, improved cloud modeling enhanced the accuracy of the Real Time Nephanalysis (RTNEPH) data.

Use of all the available data is made possible through new time and space statistical interpolation capabilities. The statistical interpolation weighs observational data based on source, distance and timeliness, and sensor type. This method provides a true analysis for the PA time and location, and a method for determining the quality of the analysis based on the type, source, and timeliness of the observational information used to build the PA.

## 2.2 Improved Exploitation of Data Base Information Content

HIRAS error fields are used to implement statistical interpolation techniques and to provide a quality index.

The data type indicators aid statistical interpolation, and can help resolve internal inconsistencies between point analysis paragraphs.

For RAOB-based profiles, information regarding the radiosonde observation time, location, and completeness will help STAFFMETS interpret PA representativeness.

Climatology and HIRAS-like buddy-checking are used for data validation.

## 2.3 Improved Upper Air Estimates

The Groves/MSIS-83 density model has been incorporated to improve estimates of upper air meteorological variables in regions where observational data are not available, e.g., 100,000 to 400,000 feet. Rocket Observation (ROCOB) data are

merged when and where available with the Groves/MSIS-83 model using a cubic spline technique. ROCOB winds are used above 100,000 feet when they are available.

#### 2.4 Improved Pseudo-Surface Observation

Optimum Interpolation (OI) techniques have been employed to improve the representativeness of the pseudo-surface observation. The data can also undergo a moisture consistency check with other data in the IPAM output at the request of the user or as a result of analyst quality control.

#### 2.5 Improved Model Flexibility

The IPAM is designed to support a variety of customers and applications. A wide range of data selection criteria has been used to preclude the use of questionable data and to tailor the data used for the customer and the application. The ability to select or suppress any IPAM output paragraph (with the exception of paragraphs A and G) is available by customer and application, or on request. Customers may specify RAOB-based production or OI-based production. Responsiveness varies from a totally automated mode for high-volume, fast-response requirements, to a mode with a deliberate, extensive, interactive quality control step with reruns as required for customers desiring close quality control. In the totally automated mode, automated quality control is provided through data quality indexes and automated data validation techniques.

#### 2.6 Alternate Temperature and Moisture Profiles

Alternate temperature and moisture profiles based on estimated standard deviations are provided as quality indicators. These alternate profile values define the range of values plus or minus one standard deviation from the analysis profile. This information is the best available

answer to customer requirements for knowledge of product accuracy. Experience and customer-tailoring of quality information is necessary to optimize the value of this feature.

### 2.7 Aerosol Parameters

Aerosol parameter values as well as alternate values are provided as input to the AFGL transmissivity model LOWTRAN. Climatological OZONE data are also provided. Air Weather Service's (AWS) meteorological data and expertise should improve the estimation of these LOWTRAN parameters.

### 2.8 Surface Weather History

The Surface Weather History is provided to enable a better evaluation of the Earth's surface emissivity. It is provided for all locations. The data provide information for surface-based weather parameters and cover a 24 hour period with observations at 3 hour intervals.

### 2.9 Line-of-sight Capabilities

IPAM provides for a line-of-sight data profile. This option offers a more accurate IPAM profile for user applications by estimating data along the actual path of interest in place of the vertical profile at a specified location. The path may be defined between any two points at different latitudes, longitudes, and elevations up to 400,000 feet above ground level.

### 2.10 Moisture Parameter Comparison

IPAM provides a comparison between the cloud amounts obtained from the RTNEPH data base and the dewpoint depression computed from the vertical profile. The moisture consistency can be forced so that the cloud amounts and the dewpoint

depression agree when the user requests moisture consistency in the output.

#### 2.11 Optimum Interpolation Profile

The Optimum Interpolation (OI) technique is employed against data base information to provide the most representative and most consistent meteorological data profile. The data produced by the OI technique are particularly effective over data sparse areas of the world. The OI profile is strongly recommended over the RAOB-based profile as the routine profile of choice for IPAM users.

#### 2.12 Cloud Depiction Moisture Consistency

To obtain a more totally consistent IPAM output, an option is available whereby the user can elect to have the IPAM programs force moisture consistency within the output of Paragraph D (Pseudo-Surface Observation), Paragraph H (Aerosol Parameters) and the OI Vertical Profile or RAOB-based Profile (Paragraph I or F). Based on user-established threshold values, one parameter is selected as better, and the remaining information is adjusted to conform to the value(s) of the better parameter.

#### 2.13 Calculation of Precipitable Water

The calculation of Precipitable Water Content (PWC) in the IPAM profile is improved because of the use of OI-based data. PWC calculations have also been made possible along a slant path profile.

#### 2.14 Refractive Index

IPAM provides for a refractive index profile. Using data from other profiles produced by IPAM, profiles of radio and optical index of refraction are constructed.

## SECTION 3

## GENERAL INFORMATION ON IPAM INPUTS, PROCESSING AND OUTPUT

The following paragraphs provide detailed explanations and information concerning the content of the IPAM product. It is explained by sequential paragraph designations A through K as in the IPAM output. The discussion includes: 1) formats and definitions for paragraph outputs; 2) examples of output data; 3) the types of data bases needed to develop paragraph information; 4) general comments on how IPAM programs develop the output data; and, 5) information tables to decode specific data output.

### 3.1 Paragraph A - Point Analysis Site Identification

Paragraph A of the IPAM output identifies the site or location of the IPAM output.

#### 3.1.1 Input for IPAM Site Identification

The site identification for the IPAM event comes from the request message input, e.g., Awn message, AUTODIN message or 105-18 request. There are two methods of identification for the IPAM event site. Typically, the location is identified by its latitude and longitude. However, there is an option for customers to use a Point Analysis Identifier (PAID), whereby site locations can be encoded by a 6-character field. Input designators for the 6-character field are the user's choice.

The PAID is useful when a user wants to use the sanitization option for the final IPAM output. When the sanitization output is selected, the PAID appears in the output for Paragraph A. Otherwise, the latitude and longitude of the IPAM event site comprise the output of Paragraph A.

3.1.2 Description of Site Identification Output

When the PAID feature is used as part of the IPAM request, the output for Paragraph A would appear as follows:

```
A.  SITE      C
      or
A.  SITE 123456
```

Using the latitude and longitude option, site identification in Paragraph A is identified by the following format:

```
A.  SITE      sXX.XX sYYY.YY
```

where,

XX.XX = latitude;

YYY.YY = longitude; and

s = the sign plus (+) or minus (-)

where,

+ = North latitude and East longitude; and

- = South latitude and West longitude.

NOTES: (1) Latitude and longitude are expressed in whole degrees with hundredths of a degree to the right of the decimal point.

(2) Only the minus (-) sign is printed for latitude and longitude in the output. No sign preceding the latitude or longitude means it is a positive (+) value.



### 3.2 Paragraph B - Date and Time

Paragraph B specifies the time and date of the event for which IPAM data are provided.

#### 3.2.1 Input for IPAM Date and Time

The IPAM event time and date are extracted from the customers request.

#### 3.2.2 Output for Paragraph B - Date and Time

The format for the time and date is as follows:

B. TIME TTTTZ DD MMM YY

where,

TTTT = Greenwich Mean Time or Z Time;

Z = an indicator for Zulu Time;

DD = the day of the month;

MMM = a three letter abbreviation for the calendar month; and

YY = the tens and unit digits of the calendar year.

Paragraph information is left blank when the sanitization option is used.

### 3.3 Paragraph C - Cloud Cover

Paragraph C displays a gridded depiction of cloud layer and total sky cover amounts in eighths of coverage over and

surrounding the latitude and longitude of the event site specified in the IPAM data request.

### 3.3.1 Organizational Data Bases Used for Paragraph C

Cloud cover is obtained from the synoptic Real Time Nephanalysis (RTNEPH) closest to the event time. Synoptic data times for the RTNEPH data base are 0000Z plus every 3 hours for both the northern and southern hemisphere, i.e., 00Z, 03Z, 06Z, 09Z, 12Z, etc.. If an IPAM profile is needed for an event time of 1 July 1989 at 1035Z, the RTNEPH analysis used in the cloud depiction is 1200Z on 1 July 1989.

If the required RTNEPH data cycle is missing, then a substitute data cycle is sought. IPAM program logic searches for the first available RTNEPH data base up to 24 hours prior to the required data cycle. If no data cycle is found, then the program logic searches for the first available RTNEPH data base cycle up to 24 hours after the required data base time. If no RTNEPH data are found, the IPAM request terminates, and the analyst is advised of the problem with the missing RTNEPH data. The analyst then advises the user.

### 3.3.2 Construction of Cloud Depiction

The cloud depiction comes from the RTNEPH analysis which is an automated analysis of clouds on a hemispheric scale. The RTNEPH produces up to four layers of clouds for a specified grid point by analyzing satellite data, surface observations, aircraft reports, and cross-checking against valid observational parameters. Exact details of the RTNEPH analysis are found in reference 1.2.b.

### 3.3.3 Description of Paragraph C Output

The format for the initial line in Paragraph C is as follows:

C. CLOUD COVER - (LLLL)

where LLLL represents the total number of lines contained in Paragraph C. The line count begins with the line labeled "C. CLOUD COVER" and ends with the last line of data. The line count does not include the two blank lines at the end of Paragraph C that precede Paragraph D.

A statement specifying the exact synoptic RTNEPH analysis time and date for the data displayed is included at the start of Paragraph C. A sample message would read "(RTNEPH for 1200Z 01/07/89 USED IN CLOUD DEPICTION)", where the date is listed as day/month/year. When the user invokes the sanitization option, the date and time information is suppressed.

The center point of the dotted grid in Paragraph C is the actual latitude and longitude of the IPAM data request point. The top of the grid is toward the North Pole or the South Pole depending on the hemisphere of the IPAM request location. The blocks of information are as presented in the following format and example:

|         |     |          |     |
|---------|-----|----------|-----|
| Format: | H   | Example: | 4   |
|         | M T |          | 3 6 |
|         | L   |          | 2   |

The data depict the cloud analysis information from the RTNEPH grid points surrounding the IPAM event site. The cloud description at each displayed grid point shows High (H), Middle (M), and Low (L) cloud layer amounts as well as the Total (T) cloud cover amount, and each is expressed in

eighths of sky coverage. Each grid point is the center of a 25nm grid box. The grid display contains a minimum of a 75nm radius of cloud information surrounding the location site.

In the preceding example the cloud amounts represent 4/8s sky coverage of high clouds, 3/8s coverage of middle clouds, and 2/8s coverage of low clouds. The total sky cover for all the cloud layers is 6/8s for this sample grid point.

A sample of Paragraph C output is shown in Figure 3-1. Additional information on the construction of the cloud depiction data is contained in Attachment 7.

#### 3.4 Paragraph D - Site Pseudo-Surface Observation

For a given IPAM request point a pseudo-surface observation is constructed which contains data for surface visibility, cloud layers, cloud types, total cloud coverage, surface winds and present weather. The pseudo-surface observation is constructed from data analyzed for the RTNEPH grid point nearest to the PA point. RTNEPH grid terrain heights serve as the baseline for information presented in AGL unless the request message specifically provides a surface height for the given latitude and longitude. User specified station heights are used when provided in the message request.

The output format for the pseudo-surface observation is as follows:

```
VSBY vv.vv NM x/8 ct bbb/ttt x/8 ct bbb/ttt
      x/8 ct bbb/ttt x/8 ct bbb/ttt
TOTAL CLOUD COVERAGE IS T/8
WIND dddfffGfff PRESENT WEATHER
```

C. CLOUD COVER - (0048)

(RTNEPH FOR 1200Z ON 19/05/88 USED IN CLOUD DEPICTION)

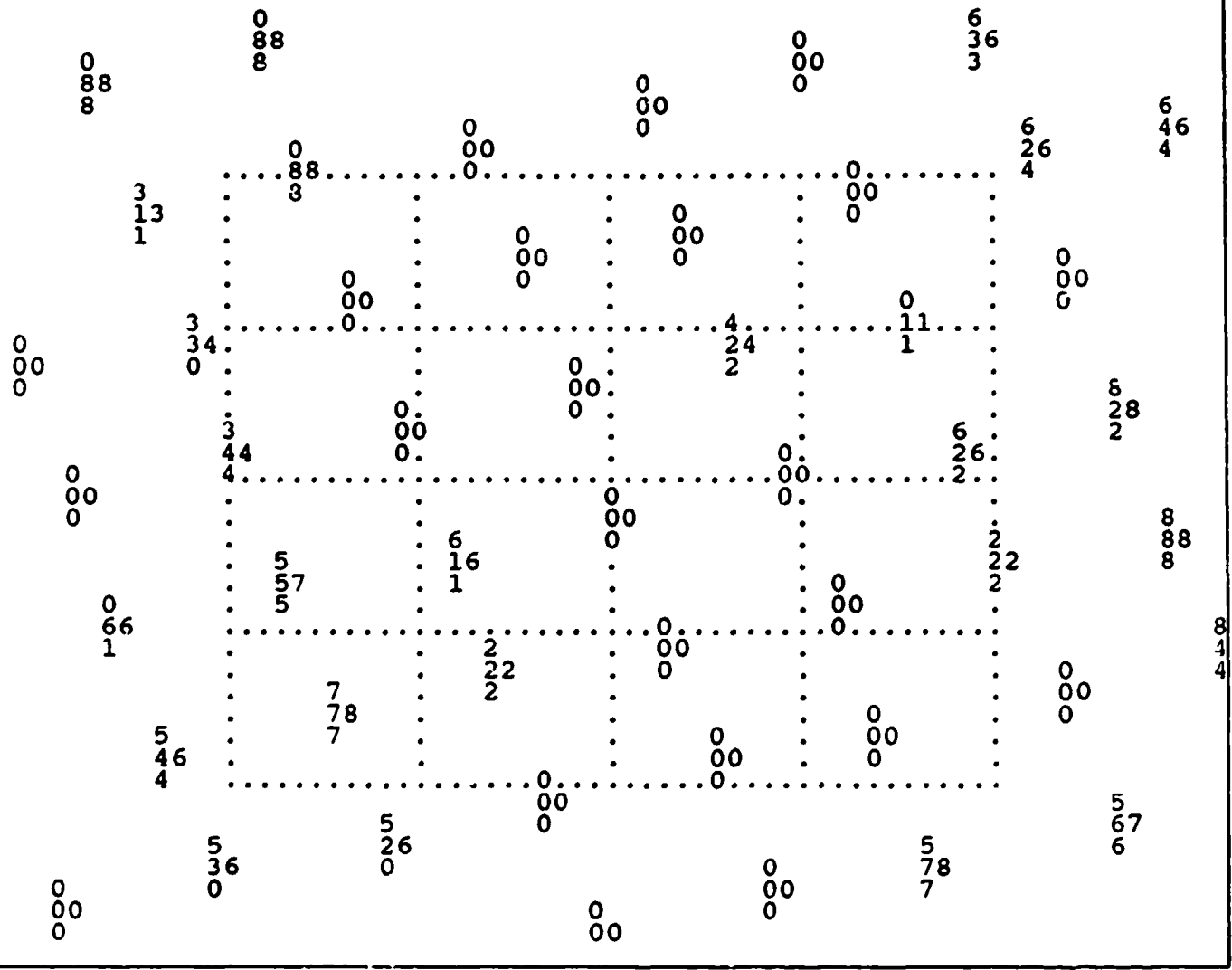

Figure 3-1. Sample Output for Paragraph C - Cloud Cover

where,

- VSBY - signifies the visibility value follows;
- vv.vv = the surface visibility expressed to hundredths of a nautical mile;
- NM - signifies the visibility is stated in nautical miles;
- x/8 = the value for the cloud layer amount expressed in eighths;
- ct = the cloud type;
- bbb = the analyzed cloud layer base in hundreds of feet from RTNEPH;
- ttt = the analyzed cloud layer top in hundreds of feet from RTNEPH;
- TOTAL  
CLOUD  
COVERAGE
- IS - a label which signifies the analyzed RTNEPH total cloud cover follows;
- T/8 = the total sky cloud cover expressed in eighths;
- WIND - signifies the analyzed wind value follows;
- ddd = the wind direction expressed in whole degrees, and calm wind is entered as 000;
- fff = the wind speed expressed in knots;

G - indicates the gust speed follows, when it exists;

fff = the wind speed gust expressed in knots; and

PRESENT

WEATHER = the type of present weather determined for the RTNEPH grid point from analyzed surface weather observations.

A sample pseudo-surface observation follows:

```
VSBY 10.00 NM 2/8 SC 020/040 3/8 AC 110/140
  5/8 CS 280/350 0/8 ** ***/***
TOTAL CLOUD COVERAGE IS 7/8
WIND 240020G026 CLD SAME
```

Note: The asterisk (\*) indicates no data for that entry.

Note: The entry 999 is used to indicate data missing from the data base.

#### 3.4.1 Organizational Data Bases Used

The following data bases are used to construct Paragraph D of the IPAM output: RTNEPH and the Surface Regions Data Base.

#### 3.4.2 Construction of the Pseudo-Surface Observation

The following details expand the user's understanding of the data in the pseudo-surface observation.

a. Visibility. The visibility value (nm) for Paragraph D is selected from the RTNEPH data base grid point closest to the IPAM event site.

b. Cloud Data. Cloud types and cloud layer bases and tops are extracted from the RTNEPH grid point nearest the IPAM analysis point for the closest synoptic RTNEPH analysis time. The cloud bases and tops are expressed in hundreds of feet AGL, e.g., 004 is 400 feet AGL; 080 is 8,000 feet AGL; and 310 is 31,000 feet AGL.

A maximum of 4 cloud layers is output in the pseudo-surface observation. This corresponds to the capabilities of RTNEPH which produces cloud data for up to four cloud layers for any given grid point.

The valid cloud type definitions are as shown in Table 3-1.

TABLE 3-1. CLOUD TYPES FOR IPAM PARAGRAPH D OUTPUT.

| <u>Abbreviation</u> | <u>Cloud Type</u>      |
|---------------------|------------------------|
| CB                  | Cumulonimbus           |
| ST                  | Stratus                |
| SC                  | Stratocumulus          |
| CU                  | Cumulus                |
| AS                  | Altostratus            |
| NS                  | Nimbostratus           |
| AC                  | Alto cumulus           |
| CS                  | Cirrostratus           |
| CC                  | Cirrocumulus           |
| CI                  | Cirrus                 |
| UN                  | Unknown                |
| **                  | No Data for this Entry |



c. Surface Wind. Surface wind direction and speed can be obtained from two sources. In most cases these data come from an OI analysis of wind data from surface observations surrounding the IPAM event site. If a RAOB vertical profile is selected and the RAOB location is within 6 nautical miles of the IPAM event site, then the surface wind direction and speed from the RAOB data profile are used. (Note: 360 degrees represents a North wind, not 000 degrees).

d. Surface Wind Gust. The wind gust is calculated for the pseudo-surface observation using the following criteria:

A1) Then gust equals 1.3 times wind speed,

A2) Otherwise, gust equals 0.

Example #1:

$20 \text{ knots} \times (.3) = 6 \text{ knots (Criteria A)}$

$\text{Gust} = 1.3 \times 20 \text{ knots} = 26 \text{ knots (Criteria A1)}$

Example #2:

$11 \text{ knots} \times (.3) = 3.3 \text{ knots (Criteria A)}$

$\text{Gust} = 0 \text{ (Criteria A1)}$

Using these criteria for calculating the wind gust for a pseudo-surface observation, the minimum wind speed must be 17 knots in order for any gust to be reported.

e. Present Weather. The Present Weather information is developed in the RTNEPH analysis cycle. Information for a specific grid point is determined from the present weather

reported at the surrounding surface observation sites. Standard entries are up to 12 characters in length and in accordance with WMO Code 4677WW as shown in Table 3-2.

### 3.5 Paragraph E - Precipitable Water

Paragraph E provides precipitable water amounts expressed in centimeters (cm) for specified layers of the atmosphere at the IPAM site. The output layers are in varying increments above ground level (AGL) as herein specified:

Sfc - 8000 ft AGL expressed in 1000 ft layers  
8000 - 20000 ft AGL expressed in 2000 ft layers  
20000 - 50000 ft AGL expressed in 5000 ft layers  
50000 - 100000 ft AGL expressed in 10000 ft layers

The calculated value for precipitable water is written in the format:

X.XXEstu

where,

X.XX = the precipitable water amount;  
E - signifies an exponential value to the base 10;  
s = a sign for (+) or (-);  
t = the tens value of the exponent; and  
u = the unit value of the exponent.

**TABLE 3-2. PRESENT WEATHER CONTRACTIONS AND THEIR  
EQUIVALENT IN WMO CODE 4677WW.**

| <u>Contraction</u> | <u>WMO</u> | <u>Contraction</u> | <u>WMO</u> |
|--------------------|------------|--------------------|------------|
|                    |            | RAIN SHWRS         | 25         |
| CLD DCRSG          | 01         | RN/SNW SHWR        | 26         |
| CLD SAME           | 02         | RN/HAIL MXD        | 27         |
| CLD BLDG           | 03         | FOG/ICE FOG        | 28         |
| SMOKE              | 04         | THUNDERSTORM       | 29         |
| HAZE               | 05         | DCRSG MDUST        | 30         |
| DUST               | 06         | MOD DUST           | 31         |
| BLWG DUST          | 07         | INCRSG MDUST       | 32         |
| DUST DEVILS        | 08         | DCRSG SDUST        | 33         |
| DUST STORM         | 09         | SVR DUST           | 34         |
| MIST               | 10         | INCRSG SDUST       | 35         |
| PCHY GRN FOG       | 11         | MD DRFTG SNW       | 36         |
| GROUND FOG         | 12         | HV DRFTG SNW       | 37         |
| LTG SEEN           | 13         | MOD BLWG SNW       | 38         |
| VIRGA              | 14         | HVY BLWG SNW       | 39         |
| DISTANT PRCP       | 15         | DSTNT FOG          | 40         |
| CLOSE PRCP         | 16         | PTCHY FOG          | 41         |
| THNDR HEARD        | 17         | SKY/DC FOG         | 42         |
| SQUALLS            | 18         | NOSKY/DC FOG       | 43         |
| FUNNEL CLD         | 19         | SKY FOG            | 44         |
| DRZL/SNW GRN       | 20         | NOSKY FOG          | 45         |
| RAIN               | 21         | SKY/IN FOG         | 46         |
| SNOW               | 22         | NOSKY/IN FOG       | 47         |
| RN/SNW/ICEPL       | 23         | SKY/RM FOG         | 48         |
| FRZG PRCP          | 24         | NOSKY/RM FOG       | 49         |

TABLE 3-2. PRESENT WEATHER CONTRACTIONS AND THEIR  
EQUIVALENT IN WMO CODE 4677WW (Continued)

| <u>Contraction</u> | <u>WMO</u> | <u>Contraction</u> | <u>WMO</u> |
|--------------------|------------|--------------------|------------|
| LGT INT DRZL       | 50         | HVY CON SNOW       | 75         |
| LGT CON DRZL       | 51         | ICE CRYSTALS       | 76         |
| MOD INT DRZL       | 52         | SNOW GRAINS        | 77         |
| MOD CON DRZL       | 53         | ISLTD CRYSTL       | 78         |
| HVY INT DRZL       | 54         | ICE PELLETS        | 79         |
| HVY CON DRZL       | 55         | LT RAIN SHWR       | 80         |
| LGT FRZ DRZL       | 56         | MDH RAIN SHW       | 81         |
| MOD FRZ DRZL       | 57         | SVR RAIN SHW       | 82         |
| LT DRZL+RAIN       | 58         | LT RAIN+SNOW       | 83         |
| MD DRZL+RAIN       | 59         | MD RAIN+SNOW       | 84         |
| LGT INT RAIN       | 60         | LT SNOW SHWR       | 85         |
| LGT CON RAIN       | 61         | MDH SNW SHWR       | 86         |
| MOD INT RAIN       | 62         | LT SNOW PLT        | 87         |
| MOD CON RAIN       | 63         | MDH SNOW PLT       | 88         |
| HVY INT RAIN       | 64         | LT HAIL SHWR       | 89         |
| HVY CON RAIN       | 65         | MDH HAIL SHW       | 90         |
| LGT FRZ RAIN       | 66         | LT RAIN OBT        | 91         |
| MOD FRZ RAIN       | 67         | MDH RAIN OBT       | 92         |
| LT RAIN+SNOW       | 68         | LT SNOW OBT        | 93         |
| MD RAIN+SNOW       | 69         | MDH SNOW OBT       | 94         |
| LGT INT SNOW       | 70         | THDSTM+RAIN        | 95         |
| LGT CON SNOW       | 71         | THDSTM+RN+HL       | 96         |
| MOD INT SNOW       | 72         | HVY THDSTM         | 97         |
| MOD CON SNOW       | 73         | THDSTM+DUST        | 98         |
| HVY INT SNOW       | 74         | HV THDSTM+HL       | 99         |

Figure 3-2 is a sample output for paragraph E of the IPAM profile. The first data entry SFC - 1M 4.71E-01 represents .471 centimeters of precipitable water in the layer from the surface to 1000 feet AGL. (NOTE: M stands for a factor of 1000).

### 3.5.1 Organizational Data Bases Used

The data bases used to develop Paragraph E output include HIRAS, the Surface Data Base, and the Upper Air data bases.

### 3.5.2 Construction of Precipitable Water Profile

In Paragraph E, the precipitable water values are constructed with data from the RAOB nearest to the PA point, from HIRAS analysis fields, and the observational data using the Optimum Interpolation method. A choice is exercised by the client in the IPAM Data Request. Analysis fields are used when RAOB data are not available or not considered representative. Precipitable water values can only be calculated when moisture data are available either in the RAOB or in the analysis fields.

Details describing the method of calculation for Precipitable Water Content are provided in Attachment 6.

### 3.6 Paragraph F - Winds, Temperature, Absolute Humidity, Density, and Pressure

Paragraph F provides analytic data at a specified height AGL/MSL at the IPAM point for the following parameters:

Figure 3-2. Sample IPAM Output for Paragraph E-  
Precipitable Water Content

E. PRECIPITABLE WATER (CM) -

|                      |                       |                    |
|----------------------|-----------------------|--------------------|
| SFC - 1M FT 4.71E-01 | 10M - 12M FT 2.54E-01 | 40M - 45M 5.28E-04 |
| 1M - 2M FT 5.11E-01  | 12M - 14M FT 8.94E-02 | 45M - 50M 1.45E-04 |
| 2M - 3M FT 4.38E-01  | 14M - 16M FT 2.07E-02 | 50M - 60M 1.97E-04 |
| 3M - 4M FT 3.85E-01  | 16M - 18M FT 3.19E-02 | 60M - 70M 1.21E-04 |
| 4M - 5M FT 3.36E-01  | 18M - 20M FT 5.97E-02 | 70M - 80M 7.39E-05 |
| 5M - 6M FT 3.01E-01  | 20M - 25M FT 1.37E-01 | 80M - 90M 4.48E-05 |
| 6M - 7M FT 2.84E-01  | 25M - 30M FT 6.80E-02 | 90M -100M 2.79E-05 |
| 7M - 8M FT 2.52E-01  | 30M - 35M FT 1.35E-02 |                    |
| 8M - 10M FT 3.57E-01 | 35M - 40M FT 2.79E-03 |                    |

Wind Direction [degrees];

Wind Speed [meters per second (m/sec)];

Temperature [degrees Centigrade ( $^{\circ}$ C)];

Absolute Humidity [grams per cubic meter ( $\text{gm}/\text{m}^3$ )];

Density [grams per cubic centimeter ( $\text{gm}/\text{cm}^3$ )]; and

Pressure [millibars (mb)]

### 3.6.1 Organizational Data Bases Used

The data bases used to develop Paragraph F output include HIRAS and the Upper Air data bases.

### 3.6.2 Construction of RAOBVP

The values of the parameters in this IPAM paragraph are calculated from data obtained from the closest RAOB or analysis fields in the data base. The levels for output in feet AGL are as follows:

Sfc - 8000 ft AGL shown in 1000 ft levels  
8000 - 20000 ft AGL shown in 2000 ft levels  
20000 - 50000 ft AGL shown in 5000 ft levels  
50000 - 100000 ft AGL shown in 10000 ft levels  
100000 - 400000 ft AGL shown in 20000 ft levels

Output can also be selected to be shown in meters as follows:

Sfc - 3000 m AGL shown in 300 m levels  
3000 - 6000 m AGL shown in 600 m levels  
6000 - 15000 m AGL shown in 1500 m levels  
15000 - 30000 m AGL shown in 3000 m levles  
30000 - 120000 m AGL shown in 6000 m levles

The output format for paragraph F is as follows:

hhhM ddd sss sTTT g.gggEstu d.dddEstu ppp.pp

where,

hhh = the height of the level, in thousands of feet(M) or hundreds of meters or listed as SFC for surface information;

ddd = the wind direction expressed in degrees;

sss = the wind speed in meters per second;

s = a sign for (+) or (-), (only (-) is printed);

TTT = the temperature in degrees Centigrade;

g.ggg = the absolute humidity expressed in grams per cubic meter;

- E = an exponential value to the base 10;
- t = the tens value of the exponent to the base 10;
- u = the units value of the exponent to the base 10;
- d.ddd = the density value expressed in grams per cubic centimeter; and
- ppp.pp = the pressure, expressed to hundredths of a millibar, for this level.

Figure 3-3. gives a sample output for paragraph F.

Unless RAOB data go exceptionally high in the atmosphere, some data are not available above 100,000 feet AGL. Specifically, wind direction, wind speed, and absolute humidity are no longer calculated above 100,000 feet AGL. All mandatory level winds must be present before a RAOB will be considered suitable.

Above 100,000 feet AGL the Groves-MSIS model will determine density, temperature and some pressure values. The available data will be shown for heights up to 400,000 feet AGL. Details on the Groves-MSIS model are found in Attachment 14.

When ROCOB data are available, the validated data will be used to provide detailed data for the wind, temperature, moisture, density and pressure values in the IPAM profile. ROCOB wind data is used above 100,000 ft AGL only if the ROCOB begins below 100,000 ft AGL.

For those levels where data are not available, the asterisk (\*) is used to fill in the profile entry.



| F. WINDS, TEMPERATURE, ABS HUMIDITY, DENSITY, PRESSURE - |       |         |         |           |           |        |
|--|-------|---------|---------|-----------|-----------|--------|
| HEIGHT   | DIR   | SPEED   | TEMP    | ABS HUM   | DEN       | PRES   |
| F AGL  | (DEG) | (M/SEC) | (DEG C) | (GM/M3)   | (GM/CM3)  | (MB)   |
| SFC  | 179.  | 3.      | 15.     | 1.023E+01 | 1.186E-03 | 987.00 |
| 1M   | 196.  | 6.      | 21.     | 1.099E+01 | 1.119E-03 | 952.00 |
| 2M   | 216.  | 10.     | 21.     | 1.153E+01 | 1.081E-03 | 917.00 |
| 3M   | 226.  | 10.     | 18.     | 9.689E+00 | 1.054E-03 | 887.00 |
| 4M   | 230.  | 10.     | 17.     | 8.447E+00 | 1.022E-03 | 856.00 |
| 5M   | 225.  | 11.     | 16.     | 7.053E+00 | 9.911E-04 | 826.00 |
| 6M   | 218.  | 11.     | 13.     | 6.851E+00 | 9.644E-04 | 797.00 |
| 7M   | 213.  | 10.     | 11.     | 6.585E+00 | 9.374E-04 | 769.00 |
| 8M   | 210.  | 9.      | 10.     | 4.918E+00 | 9.092E-04 | 740.00 |
| 10M  | 203.  | 8.      | 5.      | 3.411E+00 | 8.602E-04 | 687.00 |
| 12M  | 190.  | 8.      | 0.      | 2.397E+00 | 8.118E-04 | 637.00 |
| 14M  | 197.  | 10.     | -3.     | 3.119E-01 | 7.593E-04 | 590.00 |
| 16M  | 204.  | 11.     | -7.     | 1.867E-01 | 7.155E-04 | 546.00 |
| 18M  | 210.  | 12.     | -11.    | 6.846E-01 | 6.718E-04 | 507.00 |
| 20M  | 217.  | 11.     | -14.    | 6.459E-01 | 6.287E-04 | 467.00 |
| 25M  | 231.  | 7.      | -25.    | 6.278E-01 | 5.344E-04 | 381.00 |
| 30M  | 232.  | 3.      | -37.    | 1.213E-01 | 4.526E-04 | 307.00 |
| 35M  | 66.   | 2.      | -50.    | 2.606E-02 | 3.817E-04 | 245.00 |
| 40M  | 359.  | 5.      | -62.    | 5.247E-03 | 3.183E-04 | 193.00 |
| 45M  | 301.  | 5.      | -61.    | 7.942E-03 | 2.493E-04 | 151.00 |
| 50M  | 341.  | 3.      | -61.    | 5.794E-04 | 1.931E-04 | 118.00 |
| 60M  | 68.   | 5.      | -60.    | 3.546E-04 | 1.182E-04 | 72.00  |
| 70M  | 85.   | 7.      | -55.    | 2.134E-04 | 7.114E-05 | 44.00  |
| 80M  | 76.   | 6.      | -55.    | 1.316E-04 | 4.385E-05 | 27.00  |
| 90M  | 89.   | 4.      | -46.    | 7.921E-05 | 2.640E-05 | 17.00  |
| 100M   | 215.  | 1.      | -38.    | 4.816E-05 | 1.605E-05 | 11.00  |
| 120M   | ****  | ****    | -26.    | *****     | 9.003E-06 | 6.70   |
| 140M   | ****  | ****    | -9.     | *****     | 3.145E-06 | 2.38   |
| 160M   | ****  | ****    | -2.     | *****     | 1.425E-06 | 1.11   |
| 180M   | ****  | ****    | -8.     | *****     | 6.817E-07 | 0.52   |
| 200M   | ****  | ****    | -28.    | *****     | 3.328E-07 | 0.23   |
| 220M   | ****  | ****    | -57.    | *****     | 1.557E-07 | 0.10   |
| 240M   | ****  | ****    | -85.    | *****     | 6.499E-08 | 0.04   |
| 260M   | ****  | ****    | -103.   | *****     | 2.301E-08 | 0.01   |
| 280M   | ****  | ****    | -108.   | *****     | 7.003E-09 | *****  |
| 300M   | ****  | ****    | -99.    | *****     | 1.998E-09 | *****  |
| 320M   | ****  | ****    | -76.    | *****     | 5.927E-10 | *****  |
| 340M   | ****  | ****    | -39.    | *****     | 1.961E-10 | *****  |
| 360M   | ****  | ****    | 10.     | *****     | 7.447E-11 | *****  |
| 380M   | ****  | ****    | 70.     | *****     | 3.237E-11 | *****  |
| 400M   | ****  | ****    | 142.    | *****     | 1.590E-11 | *****  |

Figure 3-3. Sample Output for Paragraph F - Winds, Temperature, Absolute Humidity, Density, and Pressure.

### 3.7 Paragraph G - Remarks

Paragraph G contains varied information and remarks which enhance the user's overall understanding of the IPAM output. Figure 3-4 contains sample remark data which are explained in detail in the remainder of this section.

#### 3.7.1 Organizational Data Bases Used

The data bases used to develop Paragraph G output include the Upper Air, Surface, HIRAS, SESS, and SSM/I data bases.

#### 3.7.2 Construction of Remarks Paragraph

The initial line in paragraph G uses the following format:

G. REMARKS - (LLLL)

where,

LLLL represents the total number of lines contained in Paragraph G. This total includes the title line for Paragraph G, down to the last line with data. It does not include the two blank lines which precede Paragraph H.

The exact contents of paragraph G vary depending upon the type of IPAM profile provided.

##### 3.7.2.1 Closest RAOB Summary

When a RAOB vertical profile is requested, there will be several remarks directly related to the RAOB-based information. These remarks include:

## G. REMARKS - (0038)

DISTANCE AND BEARING TO NEAREST RAOB -- 15.0 NM AT 170.0 DEG

RAOB STATION NUMBER -- 725530

RAOB SITE ELEVATION -- 1312 FT

EVENT SITE ELEVATION -- 675 FT (USER SUPPLIED)

SOME ANALYSIS FIELDS DATA USED TO FILL IN 15 STANDARD PRESSURE LEVELS

NO HIRAS ANALYSIS USED ABOVE HIGHEST RAOB LEVEL.

RAOB BASE TIME -- 1200Z

| SURFACE OBSERVATIONS                          | 1             | 2         | 3         | 4         |
|---|---------------|-----------|-----------|-----------|
| BLOCK/STATION NUMBER                          | 72549         | 72553     | 72551     | 72557     |
| CALL LETTERS                                  | FOD           | OVN       | LNK       | SUX       |
| ZULU TIME                                     | 1200Z         | 1200Z     | 1200Z     | 1200Z     |
| BEARING (DEG)                                 | 55            | 178       | 215       | 342       |
| DISTANCE (NM)                                 | 99            | 15        | 56        | 49        |
| WIND DIRECTION (DEG)                          | 130           | 160       | 160       | 120       |
| WIND SPEED (KTS)                              | 9             | 9         | 7         | 9         |
| SEA LEVEL PRESSURE (MB)                       |               | 1010.2    | 1009.8    | 1010.1    |
| 3-HRLY PRES CHANGE (MB)                       |               | + 0.2     |           | + 0.3     |
| ALTIMETER SETTING (IN)                        |               | 29.86     | 29.85     | 29.85     |
| VISIBILITY (NM)                               |               | 10.3      | 13.0      | 16.2      |
| 6-HR PRECIPITATION (IN)                       |               |           |           |           |
| TEMPERATURE (DEG C)                           | 18            | 19        | 18        | 17        |
| DEWPOINT (DEG C)                              | 7             | 11        | 14        | 11        |
| PRESENT WEATHER                               |               |           |           |           |
| PAST WEATHER                                  |               |           |           |           |
| CLOUDS:                                       |               |           |           |           |
| LOW, MID, HIGH TYPES                          | MIS, MIS, MIS | 0, 0, CS8 | 0, 0, CI1 | 0, 0, CI2 |
| REPORT CLOUD LAYERS<br>(COVER, TYPE, X100 FT) |               |           |           |           |
| TOTAL COVERAGE                                |               | 6/8       | 7/8       | 4/8       |
| CEILING (X 100FT)                             |               |           |           |           |

MF=116. F=102. A= 29.

MOISTURE QUALITY INDEX = 4.81  
 TEMPERATURE QUALITY INDEX = 3.44

Figure 3-4. Paragraph G - Remarks (Sample Output)

Distance and bearing to the nearest RAOB, stated as -- XXX.X NM at YYY.Y degrees;

RAOB Station Number -- stated as rrnnnr, where rr is the WMO Block Number, and nnnn is the station number; if message sanitization is requested, this information is not provided in the out).

RAOB site elevation -- stated as hhhh Ft, where hhhh is the station elevation height above sea level;

Event Site Elevation -- stated as hhhh Ft, where hhhh is height above sea level of the IPAM site. NOTE: This is a user supplied value, or it is extracted from the terrain data base. Due to the deficiencies of the current terrain elevation data base, user specified site elevations are highly recommended.

Remarks relating to the resultant IPAM profile will include such statements as:

"SOME ANALYSIS FIELDS DATA USED TO FILL IN XX STANDARD PRESSURE LEVELS", where XX is the number of levels requiring analysis data;

"NO HIRAS ANALYSIS FIELDS USED ABOVE THE HIGHEST RAOB LEVEL";

"RAOB BASE TIME -- TTTTZ", where TTTTZ is the Zulu Time of the RAOB used for the event profile; and

An optional message "ROCOB DATA USED IN THE PRODUCTION OF THIS VERTICAL PROFILE" indicates that actual ROCOB data were merged with the RAOB data.

### 3.7.2.2 Surface Observation Table

Information for the four closest surface observations to the event site is also listed in paragraph G. The data in these surface observations include:

WMO Block and Station Number -- stated as rrnnnn, where rr is the WMO Block Number, and nnnn is the station number, e.g., 725510; if the message sanitization option is used, this entry is left blank in the output message;

Station Call Letters -- stated as llll, where llll are ICAO or airways code letter identifiers for the surface observation station, e.g., LNK or RJTY; if the message sanitization option is used, this entry is left blank in the output message;

Zulu Time -- stated as TTTTZ, where TTTT is the Greenwich Mean Time hour of the surface observation, e.g., 1200Z;

Bearing in degrees from Event Site -- e.g., 55;

Distance in nautical miles from Event Site -- e.g., 12;

Surface Wind Direction in degrees -- e.g., 120;

Surface Wind Speed in knots -- e.g., 16;

Sea Level Pressure to tenths of a millibar -- e.g., 1012.7;

3-Hour Pressure Change to tenths of a millibar - e.g., +0.4;

Altimeter Setting to hundredths of an inch -- e.g., 29.86;

Visibility expressed to tenths of a nautical mile -- e.g., 12.4;

6-Hour Precipitation expressed to hundredths of an inch -- e.g., .76;

Temperature expressed in degrees Centigrade -- e.g., 18, -7;

Dewpoint expressed in degrees Centigrade -- e.g., 7, -2;

Present Weather -- A twelve-character field using the contractions previously shown in Table 3-2 for WMO Code 4677WW; and, up to six present weather codes may be printed;

Past Weather -- A twelve-character field using the contractions shown in Table 3-3, Past Weather Contractions in WMO Code 4561; and, up to four past weather codes may be printed; and

Clouds (to include Low, Middle and High Types) -- e.g., CU3, AC7, CS8, which are decoded as LLl, MMm, HHh, where LL, MM, and HH are the types of clouds as shown previously in Table 3-1, and l, m, and h are further breakouts of cloud types according to Tables 3-4, 3-5, and 3-6, which are cloud descriptions according to WMO codes. Additional cloud data include:

Report Cloud Layers --

Total Coverage expressed in eighths of coverage -- e.g., 6/8

TABLE 3-3. PAST WEATHER CONTRACTIONS IN WHO CODE 4561

|     |     |      |
|-----|-----|------|
| LT  | 1/2 | CLDY |
| PRT | 1/2 | CLDY |
| GT  | 1/2 | CLDY |

DUSTSTORM

FOG

DRIZZLE

RAIN

SNOW

SHOWERS

and not reported (blank) if missing

Ceiling expressed in hundreds of feet -- e.g., 40, which is 4000 feet.

### 3.7.2.3 SESS Data

Next, Solar Data appear in the remarks section. These data include values for MF, F and A, where:

MF = Mean 90 day 10.7 cm flux

F = 10.7 cm daily flux; and

A = Three-Hourly Planetary Geomagnetic Index

A sample output would read "MF=116. F=102. A=29."

TABLE 3-4. LOW LEVEL CLOUD CODES AND THEIR EQUIVALENT DESCRIPTIONS  
IN WMO CODE 0513

| Code | <u>Figure</u> | <u>Cloud Descriptions</u>   |
|------|---------------|---|
| 0    |               | No Stratocumulus, Stratus, Cumulus or Cumulonimbus.   |
| 1    |               | Cumulus with little vertical extent and seemingly flattened, or ragged Cumulus other than of bad weather*, or both.   |
| 2    |               | Cumulus of moderate or strong vertical extent, generally with protuberances in the form of domes or towers, either accompanied or not by other Cumulus or by Stratocumulus, all having their bases at the same level. |
| 3    |               | Cumulonimbus the summits of which, at least partially, lack sharp outlines, but are neither clearly fibrous (cirriform) nor in the form of an anvil; Cumulus, Stratocumulus or Stratus may also be present.           |
| 4    |               | Stratocumulus formed by the spreading out of Cumulus; Cumulus may also be present.  |
| 5    |               | Stratocumulus not resulting from the spreading out of Cumulus.  |
| 6    |               | Stratus in a more or less continuous sheet or layer, or in ragged shreds, or both, but no Stratus fractus of bad weather.*  |

\* "Bad weather" denotes the conditions which generally exist during precipitation and a short time before and after.



TABLE 3-4. LOW LEVEL CLOUD CODES AND THEIR EQUIVALENT DESCRIPTIONS  
IN WMO CODE 0513 (Continued)

| Code | <u>Figure</u> | <u>Cloud Descriptions</u>  |
|------|---------------|--|
| 7    |               | Stratus fractus of bad weather* or Cumulus fractus of bad weather, or both (pannus), usually below Altostratus or Nimbostratus.  |
| 8    |               | Cumulus and Stratocumulus other than that formed from the spreading out of Cumulus; the base of the Cumulus is at a different level from that of the Stratocumulus.  |
| 9    |               | Cumulonimbus, the upper part of which is clearly fibrous (cirriform), often in the form of an anvil; either accompanied or not by Cumulonimbus without anvil or fibrous upper part, Cumulus, Stratocumulus, Stratus or pannus. |
| /    |               | Stratocumulus, Stratus, Cumulus and Cumulonimbus invisible owing to darkness, fog, blowing dust or sand, or other similar phenomena.   |
| MIS  |               | Data are Missing or Unknown.   |

\* "Bad weather" denotes the conditions which generally exist during precipitation and a short time before and after.

TABLE 3-5. MIDDLE LEVEL CLOUD CODES AND THEIR EQUIVALENT DESCRIPTIONS  
IN WMO CODE 0515

| Code | <u>Figure</u> | <u>Cloud Descriptions</u>  |
|------|---------------|--|
| 0    |               | No Altocumulus, Altostratus or Nimbostratus.   |
| 1    |               | Altostratus, the greater part of which is semi-transparent; through this part the sun or moon may be weakly visible, as through ground glass.  |
| 2    |               | Altostratus, the greater part of which is sufficiently dense to hide the sun or moon, or Nimbostratus.   |
| 3    |               | Altocumulus, the greater part of which is semi-transparent; the various elements of the cloud change only slowly and are all at a single level.  |
| 4    |               | Patches (often in the form of almonds or fishes) of Altocumulus, the greater part of which is semi-transparent; the clouds occur at one or more levels and the elements are continually changing in appearance.    |
| 5    |               | Semi-transparent Altocumulus in bands, or Altocumulus in one or more fairly continuous layers (semi-transparent or opaque), progressively invading the sky; these Altocumulus clouds generally thicken as a whole. |

TABLE 3-5. MIDDLE LEVEL CLOUD CODES AND THEIR EQUIVALENT DESCRIPTIONS  
IN WMO CODE 0515 (Continued)

| Code | <u>Figure</u>   | <u>Cloud Descriptions</u> |
|------|---|---------------------------|
| 6    | Altocumulus resulting from the spreading out of Cumulus (or Cumulonimbus).  |                           |
| 7    | Altocumulus in two or more layers, usually opaque in places and not progressively invading the sky; or opaque layer of Altocumulus, not progressively invading the sky; or Altocumulus together with Altostratus or Nimbostratus. |                           |
| 8    | Altocumulus with sprouting in the form of small towers or battlements, or Altocumulus having the appearance of cumuliform tufts.  |                           |
| 9    | Altocumulus of a chaotic sky, generally at several levels.  |                           |
| /    | Altocumulus, Altostratus and Nimbostratus invisible owing to darkness, fog, blowing dust or sand, or other similar phenomena, or more often because of the presence of a continuous layer of lower clouds.                        |                           |
| MIS  | Data are Missing or Unknown.  |                           |

TABLE 3-6. HIGH LEVEL CLOUD CODES AND THEIR EQUIVALENT DESCRIPTIONS  
IN WMO CODE 0509

| <u>Code</u> | <u>Cloud Descriptions</u>  |
|-------------|--|
| 0           | No Cirrus, Cirrocumulus or Cirrostratus.   |
| 1           | Cirrus in the form of filaments, strands or hooks, not progressively invading the sky.   |
| 2           | Dense Cirrus, in patches or entangled sheaves, which usually do not increase and sometimes seem to be the remains of the upper part of a Cumulonimbus; or Cirrus with sproutings in the form of small turrets or battlements, or Cirrus having the appearance of cumuliform tufts.                         |
| 3           | Dense Cirrus, often in the form of an anvil, being the remains of the upper parts of Cumulonimbus.   |
| 4           | Cirrus in the form of hooks or of filaments, or both, progressively invading the sky; they generally become denser as a whole.   |
| 5           | Cirrus (often in bands converging towards one point or two opposite points of the horizon) and Cirrostratus, or Cirrostratus alone; in either case, they are progressively invading the sky, and generally growing denser as a whole, but the continuous veil does not reach 45 degrees above the horizon. |

**TABLE 3-6. HIGH LEVEL CLOUD CODES AND THEIR EQUIVALENT DESCRIPTIONS  
IN WMO CODE 0509 (Continued)**

| Code | <u>Figure</u> | <u>Cloud Descriptions</u>  |
|------|---------------|--|
| 6    |               | Cirrus (often in bands converging towards one point or two opposite points of the horizon) and Cirrostratus, or Cirrostratus alone; in either case, they are progressively invading the sky, and generally growing denser as a whole; the continuous veil extends more than 45 degrees above the horizon, without the sky being totally covered. |
| 7    |               | Veil of Cirrostratus covering the celestial dome.  |
| 8    |               | Cirrostratus not progressively invading the sky and not completely covering the celestial dome.  |
| 9    |               | Cirrocumulus alone, or Cirrocumulus accompanied by Cirrus or Cirrostratus, or both, but Cirrocumulus is predominant.   |
| /    |               | Cirrus, Cirrocumulus and Cirrostratus invisible owing to darkness, fog, blowing dust or sand, or other similar phenomena, or more often because of the presence of a continuous layer of lower clouds.   |
| MIS  |               | Data are Missing or Unknown.   |

#### 3.7.2.4 SSM/I Parameters

The REMARKS section may contain an SSM/I Parameters table. The SSM/I data is based on the IPAM latitude and longitude requested. Sample output is provided in Figure 3-5.

| SSM/I Parameters     |               |
|----------------------|---------------|
| EDR Surface Type:    | VEGETATION    |
| Surface Temperature: | 298 DEGREES K |
| Ice Age:             | (N/A)         |
| Ice Concentration:   | (N/A)         |
| Cloud Water:         | 3.1 KG/M*M    |
| Liquid Water:        | 3.5 KG/M*M    |
| Rain Rate:           | 25 MM/HR      |
| Ice Edge Flag:       | No Edge       |

Figure 3-5. Example of SSM/I Parameters

#### 3.7.2.5 Data Source/Weight/Correlation Table

Another table that may appear in the Remarks section is the Data Source Weight Table. This table indicates the source of weather data in Paragraph I or F, e.g., PIBAL, RAOB, or satellite data. The Table provides a weighting factor and a correlation coefficient for the resultant data. Details on these weighting factors and correlation coefficients are found in Attachment 16. The format for this information is as follows, and a sample output for the Data Source Weight Table is provided in Figure 3-6:

## DATA SOURCE WEIGHT TABLE:

| LEVEL  | WIND          | TEMP          | ABS HUM       | HGT           |
|--------|---------------|---------------|---------------|---------------|
| FT/AGL | SRC/WGT/CORR  | SRC/WGT/CORR  | SRC/WGT/CORR  | SRC/WGT/CORR  |
| ff.fff | XXX/w.ww/c.cc | XXX/w.ww/c.cc | XXX/w.ww/c.cc | XXX/w.ww/c.cc |

where,

ff.fff = Height of data analysis (x1000) in feet or meters above ground level or MSL;

XXX = The source (SRC) of the IPAM data, e.g., PBL - PIBAL; RAB - RAOB;  
SAT - Satellite; AIR - Aircraft; or  
ROC - Rocket Observation;

w.ww = The data weight (WGT) factor (Values range from 0 to 1); and

c.cc = The correlation coefficient (CORR) for the data to its surrounding data base information (Values range from 0 to 1).

A dash (-) in the SRC column indicates no observational data were available for that level, and only HIRAS data were used. The WGT and CORR columns, therefore, are then zero filled.

### 3.7.2.6 Other Remarks

The next remarks are values for the Moisture Quality Index and the Temperature Quality Index. Sample remark entries are as follows:

MOISTURE QUALITY INDEX = 4.81  
TEMPERATURE QUALITY INDEX = 3.44

## DATA SOURCE WEIGHT TABLE:

| LEVEL  | WIND          | TEMP          | ABS HUM       | HGT           |
|--------|---------------|---------------|---------------|---------------|
| FT/AGL | SRC/WGT/CORR  | SRC/WGT/CORR  | SRC/WGT/CORR  | SRC/WGT/CORR  |
| SFC    | PBL/0.29/0.71 | RAB/0.24/0.72 | RAB/0.35/0.74 | RAB/0.18/0.75 |
| 0.167  | PBL/0.34/0.76 | RAB/0.34/0.78 | RAB/0.43/0.80 | RAB/0.29/0.80 |
| 0.966  | PBL/0.42/0.82 | RAB/0.22/0.82 | RAB/0.33/0.76 | SAT/0.28/0.86 |
| 1.764  | PBL/0.36/0.78 | RAB/0.47/0.90 | RAB/0.54/0.90 | RAB/0.37/0.91 |
| 2.609  | PBL/0.35/0.86 | RAB/0.38/0.73 | RAB/0.45/0.75 | RAB/0.32/0.74 |
| 3.439  | PBL/0.29/0.92 | RAB/0.22/0.75 | RAB/0.29/0.75 | RAB/0.12/0.58 |
| 4.269  | PBL/0.29/0.93 | RAB/0.33/0.93 | RAB/0.43/0.93 | RAB/0.18/0.93 |
| 5.085  | PBL/0.26/0.87 | RAB/0.49/0.84 | RAB/0.54/0.84 | RAB/0.42/0.84 |
| 5.900  | PBL/0.20/0.81 | RAB/0.35/0.81 | RAB/0.41/0.71 | RAB/0.31/0.70 |
| 6.745  | PBL/0.22/0.74 | RAB/0.56/0.93 | RAB/0.68/0.93 | RAB/0.36/0.93 |
| 7.547  | PBL/0.27/0.80 | RAB/0.49/0.92 | RAB/0.58/0.92 | RAB/0.40/0.92 |
| 9.150  | PBL/0.20/0.84 | RAB/0.28/0.84 | RAB/0.36/0.84 | RAB/0.17/0.84 |
| 10.772 | PBL/0.20/0.78 | RAB/0.33/0.73 | RAB/0.38/0.69 | RAB/0.30/0.69 |
| 12.399 | PBL/0.33/0.92 | RAB/0.21/0.86 | RAB/0.25/0.71 | RAB/0.21/0.71 |
| 14.035 | PBL/0.24/0.76 | RAB/0.36/0.76 | RAB/0.40/0.76 | RAB/0.33/0.76 |
| 15.686 | PBL/0.21/0.74 | RAB/0.49/0.74 | RAB/0.56/0.76 | RAB/0.39/0.75 |
| 19.030 | PBL/0.18/0.84 | RAB/0.27/0.73 | RAB/0.33/0.73 | RAB/0.13/0.73 |
| 22.306 | PBL/0.23/0.93 | RAB/0.57/0.81 | RAB/0.63/0.81 | RAB/0.36/0.81 |
| 25.569 | PBL/0.19/0.87 | RAB/0.42/0.78 | RAB/0.48/0.78 | RAB/0.29/0.78 |
| 28.822 | PBL/0.12/0.78 | RAB/0.33/0.70 | RAB/0.36/0.70 | RAB/0.19/0.70 |
| 32.120 | PBL/0.16/0.78 | RAB/0.27/0.69 | - /0.00/0.00  | RAB/0.20/0.69 |
| 40.311 | PBL/0.15/0.70 | RAB/0.21/0.47 | - /0.00/0.00  | RAB/0.11/0.53 |
| 41.812 | PBL/0.13/0.71 | RAB/0.29/0.69 | - /0.00/0.00  | RAB/0.18/0.70 |
| 48.542 | PBL/0.15/0.75 | RAB/0.53/0.66 | - /0.00/0.00  | RAB/0.18/0.64 |
| 56.843 | PBL/0.19/0.73 | RAB/0.60/0.85 | - /0.00/0.00  | RAB/0.16/0.84 |
| 64.982 | PBL/0.22/0.68 | RAB/0.28/0.54 | - /0.00/0.00  | RAB/0.04/0.47 |

Figure 3-6. Example of Data Source Weight Table



These indices are further detailed in Attachment 18.

When a slant path IPAM profile is selected, the remarks section contains information on the slant path azimuth expressed in degrees and the slant path elevation angle expressed in degrees. Sample remark entries are as follows:

SLANT PATH AZIMUTH = 135.0  
SLANT PATH ELEVATION = 45.0

For further details on the slant path profile, see Attachment 8.

Further, when moisture consistency is accomplished, one of the two following messages appears in Paragraph G, Remarks:

- 1) "MOISTURE CONSISTENCY WAS ACHIEVED BY ADJUSTING PARAGRAPH D"; or
- 2) "MOISTURE CONSISTENCY WAS ACHIEVED BY ADJUSTING VERTICAL PROFILE", i.e., that is Paragraph F/I or H depending on user request.

Details concerning the Moisture Consistency Comparison are found in Attachment 10.

When a line-of-sight IPAM profile is selected, the latitude and longitude of the subpoints will be included in the REMARKS section. Slant path and line-of-sight PAs cannot be run if the sanitization option is selected.

### 3.8 Paragraph H - Aerosol Parameters and Vertical Profile Information (VPI) Data for LOWTRAN Inputs

Paragraph H is designed to provide input parameters and information for the LOWTRAN Model. The paragraph provides coded information for the history of air parcels, seasonal

data, visibility (visual range), ozone information, and the state of the atmosphere due to volcanic activity. In addition, data are provided for levels of the atmosphere as well as for latitude and longitude subpoints when slant path profiles are requested. For detailed explanations concerning more specific information on LOWTRAN models and assumptions, users are referred to the Air Force Geophysics Laboratory, TR-83-0187, 1 August 1983.

### 3.8.1 Organizational Data Bases Used

The data bases used to develop the Paragraph H output include the Surface, Upper Air, HIRAS, Terrain, Stratospheric (Volcanic), Aerosol Index, and Ozone data bases.

### 3.8.2 Construction of Aerosol Parameters and VPI

The format for the output of Paragraph H is as follows. The first line is formatted as such:

"VERTICAL PROFILE INFORMATION"LLHCCSVv:M<sub>3</sub>QQv<sub>a</sub>v<sub>a</sub>H<sub>a</sub>C<sub>a</sub>C<sub>a</sub>

where,

- LL = number of levels in aerosol profile
- H = Primary Boundary Layer Aerosol Parameter
- CC = Describes whether Air Parcel is Maritime or Not
- S = Value showing seasonal dependence of the profiles for Tropospheric and Stratospheric Aerosols
- V = Profile and Extinction Type for Stratospheric Aerosols
- vv = Surface Meteorological Visibility Range
- M<sub>3</sub> = Ozone Profile
- QQ = Quality Index showing how well Primary Boundary Layer Parameter fits the Aerosol

## Model

$v_a v_a$  = Alternate Surface Meteorological Visibility Range

$H_a$  = Alternate Value for Boundary Layer Aerosol Parameter

$C_a C_a$  = Alternate Description whether Air Parcel is Maritime or Not

CC and  $C_a C_a$  only have values when  $H = 3$ . See Section 3.8.3 for further details.

At the end of this paragraph is an example of output for the first data line of output in Paragraph H. Note that leading zeros are shown as blank spaces, e.g., 02 is printed as 2. Also, parameters with no calculated value are shown with blank spaces, e.g., CC.

VERTICAL PROFILE INFORMATION351--10193-9-62--

The remainder of Paragraph H is formatted as follows:

hhhhh pppp sTTTT qqqq AHAZ sT<sub>a</sub>T<sub>a</sub>T<sub>a</sub> q<sub>a</sub>q<sub>a</sub>q<sub>a</sub>q<sub>a</sub>

AHAZ<sub>a</sub>sXXXXYYYYY Z.ZZZ

where,

hhhhh = height of the level in hundredths of a kilometer, e.g., 20 = .2km, 10000 = 100km, and always with respect to MSL. Negative values are possible when the IPAM event site elevation is below sea level;

pppp = pressure to tenths of a millibar at this specified height in the atmospheric profile, e.g., 9864 = 986.4mb;

s = the sign for plus (+) or minus (-) for the Temperature. Only the (-) is printed;

TTTT = the Temperature to tenths of a degree

Centigrade, e.g., 107 = 10.7°C,  
-483 = -48.3°C;

qqqq = the water vapor density in hundredths of a gram/cm<sup>3</sup>, e.g., 1023 = 10.23 gm/cm<sup>3</sup>. This value is never less than zero;

AHAZ = Normalized Aerosol Number Density (Not yet in IPAM);

T<sub>a</sub>T<sub>a</sub>T<sub>a</sub> = the alternate profile temperature to tenths of a degree Centigrade, e.g., 125 = 12.5°C, -547 = -54.7°C;

q<sub>a</sub>q<sub>a</sub>q<sub>a</sub>q<sub>a</sub> = the alternate water vapor density in hundredths of a gram/cm<sup>3</sup>, e.g., 967 = 9.67 gm/cm<sup>3</sup>. This value is never less than zero;

AHAZ<sub>a</sub> = Alternate Normalized Aerosol Number Density (Not yet in IPAM);

s = the plus (+) or minus (-) sign associated with the latitude. Plus (+) is North, and minus (-) is South. Only the (-) is printed;

XXXX = latitude in hundredths of a degree for the subpoint when the slant path option has been selected, e.g., 4162 = 41.62; and,

YYYYY = longitude in hundredths of a degree for the subpoint when the slant path option has been selected. Values range from 00000 to 35999, e.g., 26344 = 263.44 degrees longitude (See following Note).

Z.ZZZ = Ozone day-night ratio in parts per million by volume.

Note: The frame of reference for this longitude value is 0 at the Greenwich Meridian, 90 at 90°E, 180 at 180°E, 270 at 90°W. Values range from 00000 to 35999, e.g., 26397 is 96.03°W.

If the message sanitization option is selected, all references to latitude and longitude are omitted from the output message.

The height values are always provided in MSL in the following increments:

SFC - 2.5 km in .25 km increments  
2.5 km - 5.0 km in .50 km increments  
5.0 km - 10.0 km in 1 km increments  
10.0 km - 30.0 km in 2.5 km increments  
30.0 km - 50.0 km in 5.0 km increments  
50.0 km - 100.0 km in 25 km increments

The first line of vertical profile data output is for the surface. The number of levels reported in the profile depends upon the surface elevation of the IPAM event site.

Figure 3-7 indicates sample output for Paragraph H.

### 3.8.3 Decode Values and Interpretation of Some Aerosol Profile Parameters

The contents of this section detail the coded values for specified elements in Paragraph H.

#### a. Season

There are two values for Season in the IPAM output:

1 = Spring/Summer  
2 = Fall/Winter

The seasonal values are based on latitude and calendar considerations.

Figure 3-7. Sample Output for Paragraph H -  
Aerosol Parameters and Vertical Profile Information

```

H. AEROSOL PARAMETERS
VERTICAL PROFILE INFORMATION351 10193 9 62

 20 9870 153 1023 164 917 416226397 X.XXX
 25 9813 152 992 161 912 416226397 X.XXX
 50 9523 213 1093 222 1005 416226397 X.XXX
 75 9242 206 1183 214 1110 416226397 X.XXX
100 8984 184 1020 195 919 416126398 X.XXX
125 8730 179 920 191 794 416126398 X.XXX
150 8482 171 810 177 764 416126398 X.XXX
175 8234 158 691 167 631 416126398 X.XXX
200 7993 135 711 144 655 416126399 X.XXX
225 7766 119 699 125 664 416126399 X.XXX
250 7534 106 487 113 457 416126399 X.XXX
300 7088 64 421 74 382 416029399 X.XXX
350 6663 28 296 39 253 416029400 X.XXX
400 6259 -6 143 2 117 416029400 X.XXX
450 5876 -28 25 -16 1 415926401 X.XXX
500 5516 -66 0 -54 0 415926401 X.XXX
600 4858 -125 59 -111 35 415826402 X.XXX
700 4255 -187 28 -177 21 415826403 X.XXX
800 3711 -267 57 -257 50 415726404 X.XXX
900 3221 -339 16 -328 15 415626404 X.XXX
1000 2788 -465 6 -453 0 415626405 X.XXX
1250 1899 -628 0 -612 0 415426407 X.XXX
1500 1263 -631 0 -616 0 415326410 X.XXX
1750 845 -627 0 -618 0 415126412 X.XXX
2000 566 -577 0 -559 0 414926414 X.XXX
2250 381 -573 0 -555 0 414826416 X.XXX
2500 258 -532 0 -508 0 414626418 X.XXX
2750 176 -456 0 -428 0 414526420 X.XXX
3000 120 -407 0 -383 0 414326422 X.XXX
3500 65 -294 0 -272 0 414026426 X.XXX
4000 46 -179 0 -154 0 413726430 X.XXX
4500 18 -51 0 -5 0 413426435 X.XXX
5000 9 -17 0 43 0 413126439 X.XXX
7500 1 -915 0 -824 0 411526459 X.XXX
10000 1 -625 0 -504 0 410026479 X.XXX

```

If the IPAM latitude request point is < 20 degrees, then Season is always coded as 1, Spring/Summer.

If the IPAM latitude request point is > 70 degrees, then Season is always coded as 2, Fall/Winter.

If the IPAM latitude request point is in the middle latitudes, 20 to 70 degrees, in the Northern Hemisphere, and the month is March through August, then the Season Value is 1, Spring/Summer. For the months of September through February, the Season Value is 2, Fall/Winter.

If the IPAM latitude request value is in the middle latitudes, 20 to 70 degrees, in the Southern Hemisphere, and the month is September through February, then the Season Value is 1, Spring/Summer. For the months of March through August, the Season Value is 2, Fall/Winter.

b. Boundary Layer Aerosol Profile

Conditions for the boundary layer are established and coded for values of H as follows:

- 1 = Rural - Continental area not under the influence of urban industrial sources
- 2 = Urban - Continental area under the direct influence of urban industrial sources or stagnant polluted air masses
- 3 = Navy maritime - Open Ocean
- 4 = Maritime - Coast region with prevailing wind from ocean
- 5 = Tropospheric - Continental area within an exceptionally clean air mass, e.g., visibility  $\geq 40$  km.
- 6 = Fog

c. Air Mass Character

When the request point for an IPAM profile is in the open ocean, i.e., the Boundary Layer Aerosol Profile Value, H, equals 3, then the character of the air mass is further evaluated.

It is evaluated with respect to the number of days since the air parcel left land. The integer value for the air mass character code, CC, is determined from the following equation:

$$CC = 9 * e^{-(t/4)} + 1$$

where,

e = the base for natural logarithms;

t = the number of days since the parcel left land; and

only the integer value of the term  $9 * e^{-(t/4)}$  is used.

For example, when: t = 0, CC = 10

t = 1, CC = 8

t = 4, CC = 4

d. Stratospheric Index for Volcanic Activity

When volcanic eruptions occur around the world, particulate matter is spewed into the atmosphere and can remain suspended for extended periods of time, and they are diffused and dispersed by the winds. These particles can affect the transmissivity or electro-optic quality of the atmosphere. This stratospheric index (V) is coded as follows:

- 1 = Normal background
- 2 = Moderate, aged 10 to 24 weeks
- 3 = High, fresh 1 to 9 weeks
- 4 = High, aged 10 to 24 weeks
- 5 = Moderate, fresh 1 to 9 weeks
- 6 = Moderate, background 25 to 149 weeks
- 7 = High, background 25 to 99 weeks



8 = Extreme, fresh 1 to 9 weeks

e. Ozone Profile

The Ozone Profile ( $M_3$ ) of the atmosphere is coded according to latitude and season. It represents a climatological composite profile of Ozone.

The values of  $M_3$  are coded as follows:

1 = Tropical location, latitude  $< 20^\circ$

2 = Mid-latitude ( $20^\circ - 70^\circ$ ), summer

3 = Mid-latitude ( $20^\circ - 70^\circ$ ), winter

4 = Subarctic latitude  $> 70^\circ$ , summer

5 = Subarctic latitude  $> 70^\circ$ , winter

6 = U.S. Standard

f. Alternate Temperature Profile

The alternate temperature profile is based on adding a set of estimated temperature error values to the analyzed temperatures at the indicated levels. Details on calculating the temperature error values are found in Attachment 17.

g. Alternate Moisture Profile

The alternate moisture profile is based on subtracting a set of estimated moisture errors from the analyzed

values of the absolute humidity for an indicated level. Details on calculating and applying these moisture error values are found in Attachment 17.

3.9 Paragraph I - Optimum Interpolation Data for Winds, Temperature, Absolute Humidity, Density and Pressure

Paragraph I provides analytic data at specified heights in feet or meters with respect to AGL or MSL at the IPAM point for the following parameters:

Wind Direction [degrees];  
Wind Speed [meters per second (m/sec)];  
Temperature [degrees Centigrade ( $^{\circ}\text{C}$ )];  
Absolute Humidity [grams per cubic meter ( $\text{gm}/\text{m}^3$ )];  
Density [grams per cubic centimeter ( $\text{gm}/\text{cm}^3$ )]; and  
Pressure [millibars (mb)].

3.9.1 Organizational Data Bases Used

The data bases used to develop Paragraph I output include the HIRAS, Upper Air, Surface, Aircraft, and Sensor Error data bases.

3.9.2 Construction of an OIVP

The values of the parameters in this IPAM paragraph are calculated from analysis data in the data base. The levels for output in feet AGL are as follows:

Sfc - 8000 ft AGL shown in 1000 ft levels  
8000 - 20000 ft AGL shown in 2000 ft levels  
20000 - 50000 ft AGL shown in 5000 ft levels  
50000 - 100000 ft AGL shown in 10000 ft levels  
100000 - 400000 ft AGL shown in 20000 ft levels

Output can be selected to be shown in meters as follows:

Sfc - 3000 m AGL shown in 300 m levels  
3000 - 6000 m AGL shown in 600 m levels  
6000 - 15000 m AGL shown in 1500 m levels  
15000 - 30000 m AGL shown in 3000 m levels  
30000 - 120000 m AGL shown in 6000 m levels

The output format for paragraph I is as follows:

hhhM ddd sss sTTT g.gggEstu d.dddEstu ppp.pp

where,

hhh = the height of the level, expressed in thousands of feet (M) or hundreds of meters (H) or listed as SFC for surface information;

ddd = the wind direction expressed in degrees;

sss = the wind speed in meters per second;

s = a sign for (+) or (-), (only (-) is printed);

TTT = the temperature in degrees Centigrade;

g.ggg = the absolute humidity expressed in grams per cubic meter;

E = an exponential value to the base 10;

t = the tens value of the exponent to the base 10;

u = the units value of the exponent to the base 10;

d.ddd = the density value expressed in grams per cubic centimeter; and

ppp.pp = the pressure, expressed to hundredths of a millibar, for this level.

Figure 3-8 gives a sample output for paragraph I.

Above 100,000 feet AGL the Groves-MSIS model will determine density, temperature and some pressure values. The available data will be shown for heights up to 400,000 feet AGL. Details on the Groves-MSIS model are found in Attachment 14.

When ROCOB data are available, the validated data will be used to provide detailed data for the wind, temperature, moisture, density and pressure values in the IPAM profile.

For those levels where data are not available, the asterisk (\*) is used to fill in the profile entry.

### 3.10 Paragraph J - 24-Hour Surface Weather History

Paragraph J presents a 24 hour coded weather history for the event site. The data are presented at 3-hour intervals starting with the hour nearest the event time and ending 24 hours later. Thus, 9 observational data sets are presented.

#### 3.10.1 Organizational Data Bases Used

The data bases used to develop Paragraph J output include the Surface, RTNEPH, HIRAS, and Snow data bases.

#### 3.10.2 Construction of the Surface Weather History

The surface history data are coded as follows:

YYJJJhhmbbb<sub>x</sub>cv<sub>x</sub>th<sub>x</sub>tcvpto pppp sTT sDddssaaa

Figure 3-8. Sample Output for Paragraph I -  
 OI Data for Winds, Temperature, Absolute Humidity,  
 Density and Pressure

I. WINDS, TEMPERATURE, ABS HUMIDITY, DENSITY, PRESSURE -

| HEIGHT<br>F AGL | DIR<br>(DEG) | SPEED<br>(M/SEC) | TEMP<br>(DEG C) | ABS HUM<br>(GM/M3) | DEN<br>(GM/CM3) | PRES<br>(MB) |
|-----------------|--------------|------------------|-----------------|--------------------|-----------------|--------------|
| SFC             | 179.         | 3.               | 15.             | 1.023E+01          | 1.186E-03       | 987.00       |
| 1M              | 196.         | 6.               | 21.             | 1.099E+01          | 1.119E-03       | 952.00       |
| 2M              | 216.         | 10.              | 21.             | 1.153E+01          | 1.081E-03       | 917.00       |
| 3M              | 226.         | 10.              | 18.             | 9.689E+00          | 1.054E-03       | 887.00       |
| 4M              | 230.         | 10.              | 17.             | 8.447E+00          | 1.022E-03       | 856.00       |
| 5M              | 225.         | 11.              | 16.             | 7.053E+00          | 9.911E-04       | 826.00       |
| 6M              | 218.         | 11.              | 13.             | 6.851E+00          | 9.644E-04       | 797.00       |
| 7M              | 213.         | 10.              | 11.             | 6.585E+00          | 9.374E-04       | 769.00       |
| 8M              | 210.         | 9.               | 10.             | 4.918E+00          | 9.092E-04       | 740.00       |
| 10M             | 203.         | 8.               | 5.              | 3.411E+00          | 8.602E-04       | 687.00       |
| 12M             | 190.         | 8.               | 0.              | 2.397E+00          | 8.118E-04       | 637.00       |
| 14M             | 197.         | 10.              | -3.             | 3.119E-01          | 7.593E-04       | 590.00       |
| 16M             | 204.         | 11.              | -7.             | 1.867E-01          | 7.155E-04       | 546.00       |
| 18M             | 210.         | 12.              | -11.            | 6.846E-01          | 6.718E-04       | 507.00       |
| 20M             | 217.         | 11.              | -14.            | 6.459E-01          | 6.287E-04       | 467.00       |
| 25M             | 231.         | 7.               | -25.            | 6.278E-01          | 5.344E-04       | 381.00       |
| 30M             | 232.         | 3.               | -37.            | 1.213E-01          | 4.526E-04       | 307.00       |
| 35M             | 66.          | 2.               | -50.            | 2.606E-02          | 3.817E-04       | 245.00       |
| 40M             | 359.         | 5.               | -62.            | 5.247E-03          | 3.183E-04       | 193.00       |
| 45M             | 301.         | 5.               | -61.            | 7.942E-03          | 2.493E-04       | 151.00       |
| 50M             | 341.         | 3.               | -61.            | 5.794E-04          | 1.931E-04       | 118.00       |
| 60M             | 68.          | 5.               | -60.            | 3.546E-04          | 1.182E-04       | 72.00        |
| 70M             | 85.          | 7.               | -55.            | 2.134E-04          | 7.114E-05       | 44.00        |
| 80M             | 76.          | 6.               | -55.            | 1.316E-04          | 4.385E-05       | 27.00        |
| 90M             | 89.          | 4.               | -46.            | 7.921E-05          | 2.640E-05       | 17.00        |
| 100M            | 215.         | 1.               | -38.            | 4.816E-05          | 1.605E-05       | 11.00        |
| 120M            | ****         | ****             | -26.            | *****              | 9.003E-06       | 6.70         |
| 140M            | ****         | ****             | -9.             | *****              | 3.145E-06       | 2.38         |
| 160M            | ****         | ****             | -2.             | *****              | 1.425E-06       | 1.11         |
| 180M            | ****         | ****             | -8.             | *****              | 6.817E-07       | 0.52         |
| 200M            | ****         | ****             | -28.            | *****              | 3.328E-07       | 0.23         |
| 220M            | ****         | ****             | -57.            | *****              | 1.557E-07       | 0.10         |
| 240M            | ****         | ****             | -85.            | *****              | 6.499E-08       | 0.04         |
| 260M            | ****         | ****             | -103.           | *****              | 2.301E-08       | 0.01         |
| 280M            | ****         | ****             | -108.           | *****              | 7.003E-09       | *****        |
| 300M            | ****         | ****             | -99.            | *****              | 1.998E-09       | *****        |
| 320M            | ****         | ****             | -76.            | *****              | 5.927E-10       | *****        |
| 340M            | ****         | ****             | -39.            | *****              | 1.961E-10       | *****        |
| 360M            | ****         | ****             | 10.             | *****              | 7.447E-11       | *****        |
| 380M            | ****         | ****             | 70              | *****              | 3.237E-11       | *****        |
| 400M            | ****         | ****             | 142.            | *****              | 1.590E-11       | *****        |

where,

- YY = last two digits of calendar year, e.g. 89 is 1989;
- JJJ = Julian Day of the year, e.g., 1-366;
- hh = Zulu hour of the day, e.g. 00-23;
- mm = Zulu minutes of the Zulu time hour, e.g., 00-59;

bbb = cloud base value in hundreds of meters AGL;

cv = cloud coverage, to nearest ten percent, e.g., multiply value by 10;

th = thickness of cloud layer in hundreds of meters;

x = 1st, 2nd, 3rd and 4th cloud layer;  
(NOTE: the 'bbbcvth' group is repeated four times, and it is zero filled when no cloud layer values are present. x is not a print position);

tc = total cloud coverage in percent, and 99 means 100% coverage;

vv = Visibility in kilometers, e.g., 19;

pt = Precipitation type;

o = Obscuration to visibility;

pppp = Pressure to tenths of a millibar, e.g. 9873 is 987.3 millibars;

s = plus or minus sign for Temperature and Dewpoint values, but only minus sign is printed;

TT = Temperature in degrees Centigrade, e.g., 22, -3;

DD = Dew Point in degrees Centigrade, e.g., 12, -7;

dd = Wind direction in tens of degrees, e.g., 18 is 180 degrees;

sss = Wind speed in meters/sec; and,

aaa = Alternate wind speed in meters/sec.

Note: The date and time entries are suppressed when the user selects the sanitization option.

Following the surface weather history there are three values presented in the following format:

$T_h T_h$   $T_1 T_1$  SSS

where,

- $T_h T_h$  = the maximum 24-hour surface temperature in degrees Centigrade;
- $T_l T_l$  = the minimum 24-hour surface temperature in degrees Centigrade; and,
- SSS = Snow Depth expressed in inches.

Figure 3-9 is a sample output for Paragraph J, Surface Weather History.

---

Figure 3-9. Sample Output for Paragraph J -  
Surface Weather History

---

J. SURFACE WEATHER HISTORY

24 HOUR SURFACE WEATHER HISTORY

|   |      |    |            |
|---|------|----|------------|
| 88139120000000000000000000000000000000000019000 | 9870 | 15 | 918003004  |
| 8813909000780309000000000000000000000002519000  | 9875 | 22 | 1518008010 |
| 8813906000780309000000000000000000000002524000  | 9876 | 25 | 1718009011 |
| 8813903000780309000000000000000000000002524000  | 9871 | 27 | 1517011014 |
| 881390000078012100000000000000000000001224000   | 9866 | 29 | 1317013016 |
| 8813821000780809000000000000000000000007524000  | 9877 | 25 | 1017014018 |
| 8813818000780809000000000000000000000007524000  | 9890 | 21 | 818015019  |
| 88138150003003100520520058103800000009924000    | 9890 | 19 | 1018014018 |
| 8813812000330310078080900000000000000007524000  | 9889 | 16 | 1118013016 |
| 29  | 15   | 0  |            |

---

### 3.10.3 Decode and Interpretation of Selected Surface Weather History Parameters

Several items in the 24 hour Surface Weather History require specific information in order for the customer to properly decode the data. This information is explained in the following paragraphs.

#### a. Cloud Bases.

The value for cloud bases in the Surface Weather History is expressed in hundreds of meters AGL. An entry of 999 means the data are missing.

#### b. Cloud Layer Thickness.

This is a value for cloud layer thickness ranging from 00 to 99. Multiplying the value by 100 will provide the cloud layer thickness in meters. Thickness values will not exceed 9900 meters thick, so for any cloud layer that is actually greater than 9900 meters thick, the coded value will be listed as 99, and the calculated thickness value will only be 9900 meters.

#### c. Precipitation Type.

This is an alphabetic code which appears when precipitation has occurred. Only the following letter combinations are used:

|                    |                   |
|--------------------|-------------------|
| R - Rain           | SW - Snow Shower  |
| S - Snow           | A - Hail          |
| RS - Rain and Snow | BS - Blowing Snow |
| ZR - Freezing Rain | IC - Ice Crystals |
| RW - Rain Shower   | IP - Ice Pellets  |

Note: Drizzle is listed as Rain.



d. Obscuration to Visibility.

When non-precipitation weather phenomena have occurred, the following obscuration phenomena are listed:

- K - Smoke
- H - Haze
- D - Dust/Sand
- F - Fog
- I - Fog Depositing Rime Ice

e. Alternate Wind Speed.

The last entry for the surface weather history observation is a value called the alternate wind speed. The value is a factor that equates to a positive standard deviation of the wind speed value.

The value for the alternate wind speed is calculated as follows:

If the existing data base wind speed for an IPAM event point is less than 3.33 m/sec, then the alternate wind speed is calculated as:

$$aaa = \text{wind speed} + 1$$

If the existing data base wind speed for an IPAM event point is 3.33 m/sec or greater, then the alternate wind speed is calculated as:

$$aaa = \text{wind speed} * 1.3$$

Figure 3-10. Sample Output for Paragraph K-  
Refractive Index Profile

| K. REFRACTIVE INDEX PROFILE |           |          |           |              |            |                |                  |                |        |
|-----------------------------|-----------|----------|-----------|--------------|------------|----------------|------------------|----------------|--------|
| PRESS<br>MB                 | HGT<br>FT | WD<br>DG | WS<br>M/S | TEMP<br>DG C | RH<br>PRCT | RADIO<br>INDEX | OPTICAL<br>INDEX | REFRC<br>DELTA | COND   |
| 1020.0                      | 0         | 320      | 2         | 4.24         | 90         |                |                  |                |        |
| 983.0                       | 1000      | 356      | 2         | 10.11        | 25         | 305.2          | 1.000305         | -27.2009       | SUPER  |
| 947.7                       | 2000      | 70       | 1         | 9.42         | 14         | 278.0          | 1.000278         | -10.7483       | NORMAL |
| 913.4                       | 3000      | 200      | 2         | 8.16         | 10         | 267.3          | 1.000267         | - 7.3337       | NORMAL |
| 879.7                       | 4000      | 230      | 4         | 6.22         | 10         | 259.9          | 1.000260         | - 5.4439       | NORMAL |
| 847.6                       | 5000      | 260      | 4         | 4.37         | 11         | 254.5          | 1.000254         | - 2.8748       | NORMAL |
| 816.8                       | 6000      | 305      | 6         | 3.93         | 21         | 251.6          | 1.000252         | - 5.1909       | NORMAL |
| 786.8                       | 7000      | 300      | 8         | 4.89         | 14         | 246.4          | 1.000246         | - 9.2377       | NORMAL |
| 757.9                       | 8000      | 301      | 9         | 5.27         | 10         | 237.2          | 1.000237         | - 7.5683       | NORMAL |
| 729.6                       | 9000      | 305      | 10        | 3.53         | 9          | 229.6          | 1.000230         | - 5.1403       | NORM.  |
| 702.7                       | 10000     | 305      | 13        | 1.82         | 9          | 224.5          | 1.000224         | - 4.6507       | NORMAL |
| 676.6                       | 11000     | 311      | 14        | - .27        | 11         | 219.8          | 1.000220         | - 3.9719       | NORMAL |
| 650.6                       | 12000     | 315      | 16        | - 2.20       | 14         | 215.9          | 1.000216         | - 3.8409       | NORMAL |
| 625.9                       | 13000     | 315      | 17        | - 4.53       | 17         | 212.0          | 1.000212         | - 3.7079       | NORMAL |
| 601.8                       | 14000     | 315      | 20        | - 6.70       | 22         | 208.3          | 1.000208         | - 3.5788       | NORMAL |
| 578.7                       | 15000     | 310      | 20        | - 8.83       | 27         | 204.7          | 1.000205         | - 3.3992       | NORMAL |
| 557.0                       | 16000     | 305      | 20        | -10.96       | 34         | 201.3          | 1.000201         | - 4.3131       | NORMAL |
| 535.3                       | 17000     | 305      | 22        | -12.92       | 29         | 197.0          | 1.000197         | - 5.3160       | NORMAL |
| 514.3                       | 18000     | 305      | 23        | -14.88       | 19         | 191.7          | 1.000192         | - 5.0047       | NORMAL |
| 493.9                       | 19000     | 305      | 25        | -16.83       | 14         | 186.7          | 1.000187         | - 4.8198       | NORMAL |
| 474.1                       | 20000     | 305      | 26        | -18.74       | 11         | 181.6          | 1.000182         | - 4.5453       | NORMAL |
| 455.0                       | 21000     | 300      | 27        | -20.65       | 9          | 177.3          | 1.000177         | - 4.1855       | NORMAL |
| 436.6                       | 22000     | 295      | 28        | -22.57       | 6          | 173.2          | 1.000173         | - 3.8143       | NORMAL |
| 418.8                       | 23000     | 290      | 29        | -25.01       | 11         | 169.3          | 1.000169         | - 3.0198       | NORMAL |
| 401.6                       | 24000     | 286      | 31        | -27.65       | 27         | 166.3          | 1.000166         | - 3.0674       | NORMAL |
| 384.4                       | 25000     | 285      | 30        | -30.34       | 31         | 163.2          | 1.000163         | - 3.3497       | NORMAL |

Figure 3-10. Sample Output for Paragraph K -  
Refractive Index Profile (Continued)

| K. REFRACTIVE INDEX PROFILE |           |          |           |              |            |                |                  |          |               |
|-----------------------------|-----------|----------|-----------|--------------|------------|----------------|------------------|----------|---------------|
| PRESS<br>MB                 | HGT<br>FT | WD<br>DG | WS<br>M/S | TEMP<br>DG C | RH<br>PRCT | RADIO<br>INDEX | OPTICAL<br>INDEX | DELTA    | REFRC<br>COND |
| 368.3                       | 26000     | 283      | 31        | -33.04       | 32         | 159.9          | 1.000160         | - 3.2544 | NORMAL        |
| 352.6                       | 27000     | 280      | 33        | -35.73       | 34         | 156.6          | 1.000157         | - 3.1925 | NORMAL        |
| 337.6                       | 28000     | 278      | 34        | -38.39       | 33         | 153.5          | 1.000153         | - 3.2271 | NORMAL        |
| 322.8                       | 29000     | 275      | 35        | -41.00       | 28         | 150.2          | 1.000150         | - 3.2998 | NORMAL        |
| 308.3                       | 30000     | 275      | 33        | -43.68       | 23         | 146.9          | 1.000147         | - 3.1165 | NORMAL        |
| 294.7                       | 31000     | 275      | 32        | -46.14       | 22         | 143.8          | 1.000144         | - 3.1148 | NORMAL        |
| 281.5                       | 32000     | 275      | 33        | -48.37       | 25         | 140.7          | 1.000141         | - 3.2145 | NORMAL        |
| 268.7                       | 33000     | 275      | 34        | -50.61       | 28         | 137.5          | 1.000137         | - 3.1709 | NORMAL        |
| 256.4                       | 34000     | 275      | 35        | -52.84       | 32         | 134.3          | 1.000134         | - 3.1343 | NORMAL        |
| 244.5                       | 35000     | 275      | 36        | -55.07       | 36         | 131.2          | 1.000131         | - 3.0973 | NORMAL        |
| 233.1                       | 36000     | 273      | 36        | -57.34       | 42         | 128.1          | 1.000128         | - 3.1627 | NORMAL        |
| 221.4                       | 37000     | 270      | 37        | -59.61       | 48         | 124.9          | 1.000125         | - 3.1212 | NORMAL        |
| 210.9                       | 38000     | 273      | 42        | -61.82       | 56         | 121.8          | 1.000122         | - 2.9640 | NORMAL        |
| 200.8                       | 39000     | 275      | 48        | -64.03       | 65         | 118.8          | 1.000119         | - 2.8387 | NORMAL        |
| 191.4                       | 40000     | 275      | 49        | -62.82       | 47         | 116.0          | 1.000116         | - 4.5888 | NORMAL        |
| 182.2                       | 41000     | 275      | 48        | -61.48       | 34         | 111.4          | 1.000111         | - 3.9531 | NORMAL        |
| 176.2                       | 42000     | 274      | 47        | -60.28       | 26         | 107.4          | 1.000107         | - 3.6974 | NORMAL        |
| 167.8                       | 43000     | 273      | 46        | -60.45       | 22         | 103.8          | 1.000104         | - 3.4622 | NORMAL        |
| 159.8                       | 44000     | 272      | 45        | -60.65       | 20         | 100.3          | 1.000100         | - 3.8707 | NORMAL        |
| 149.8                       | 45000     | 270      | 44        | -60.88       | 17         | 96.4           | 1.000096         | - 3.7483 | NORMAL        |
| 142.7                       | 46000     | 270      | 42        | -61.53       | 16         | 92.7           | 1.000093         | - 2.9065 | NORMAL        |
| 135.9                       | 47000     | 270      | 40        | -62.18       | 15         | 89.8           | 1.000090         | - 2.8235 | NORMAL        |
| 129.4                       | 48000     | 270      | 39        | -62.84       | 14         | 86.9           | 1.000087         | - 2.7426 | NORMAL        |
| 123.1                       | 49000     | 270      | 37        | -63.49       | 13         | 84.2           | 1.000084         | - 2.6554 | NORMAL        |
| 117.2                       | 50000     | 270      | 35        | -64.14       | 0          | 81.5           | 1.000082         | - 2.5785 | NORMAL        |
| 111.6                       | 51000     | 270      | 35        | -64.81       | 0          | 79.0           | 1.000079         | - 2.5084 | NORMAL        |

### 3.11 Paragraph K - Refractive Index

Paragraph K provides profiles of radio and optical indices of refraction.

#### 3.11.1 Input for the Refractive Index

The data are calculated from previously constructed vertical profiles.

#### 3.11.2 Description of Refractive Index Output

The data are presented in heights in feet up to 100000 feet, in intervals from 500 to 2500 feet. The height and interval are determined by the user.

The format for the refractive index is as follows:

```
pppp.p hhhhhh ddd sss TT.TT rrr RRR.R o.oooooo DDD.DDDD AAAA
```

where,

|          |   |  |
|----------|---|--|
| pppp.p   | = | pressure of the level in millibars                                       |
| hhhhh    | = | height of the level, in feet   |
| ddd      | = | wind direction in degrees  |
| sss      | = | wind velocity in meters per second                                       |
| TT.TT    | = | temperature in degrees Centigrade  |
| rrr      | = | relative humidity  |
| RRR.R    | = | the radio index  |
| o.oooooo | = | the optical index  |
| DDD.DDDD | = | the difference between the radio indices at the level and the next level |
| AAAAA    | = | the Refractive Condition   |

## SECTION 4

### IPAM PRODUCTS

This section provides IPAM users with pertinent information on AUTODIN message formats, AWN formats, and organizational operating procedures. This information is essential to requesting and obtaining the IPAM product in an expedient manner, taking full advantage of the totally automated request capabilities, and understanding the quality control capabilities available to ensure the best possible meteorological product for every user's need.

#### 4.1 IPAM Request Procedures and AUTODIN Message Formats

Requestors of IPAM information can send information requests to either AFGWC or USAFETAC.

##### a. AFGWC

Requests to AFGWC must be in the form of an AUTODIN message that is accurately and rigidly formatted to be automatically read and validated by the computer system. Figure 4-1 shows a sample formatted AUTODIN request message directed to AFGWC. The message address must be: AFGWC/IPAM/POINT ANALYSIS SUMMARY OFFUTT AFB NE. The ROUTING INDICATOR RHWAAI may be included in the special instruction block to assist communications personnel in expediting the message. The format for the message contents is explained in Section 4.1.1.

##### b. USAFETAC

For Secret, Confidential or Unclassified IPAM data profiles, requests to USAFETAC/DO may be by letter or AUTODIN message. In addition to the request information, formatted as in Figure 4-1, customers must also supply required information in accordance with AWSR 105-18 for

|                   |                               |            |       |        |      |                           |  |
|-------------------|-------------------------------|------------|-------|--------|------|---------------------------|--|
| JOINT MESSAGEFORM |                               |            |       |        |      | UNCLASSIFIED              |  |
| PRIO              | 375 RELEASE TIME              | PRECEDENCE | CLASS | TRACAP | REP  | PRIORITY                  |  |
| 03                | 133200Z                       | MAY 89     | RR    | RR     | UUUU | (SUPPLIED BY COMM CENTER) |  |
| 0000              | MESSAGE HANDLING INSTRUCTIONS |            |       |        |      |                           |  |

FROM: 9MM/D0

TO AFGMC/IPAM/POINT ANALYSIS SUMMARY/  
OPFUTT A7B NE//

1=001,4=KAGAR1,5=15,6=23,7=N,8=120,9=34,10=E,11=21,12=23  
 13=21,14=10,15=86,16=KLAX02,17=A,18=Y,20=4,21=1,22=8000,  
 23=Y,24=N,25=Y,26=AGL,27=FT,28=300,42=N,44=Y,48=N,49=Y,  
 50=N,51=Y,52=Y,53=Y,54=Y,55=Y,56=Y,58=Y,59=N,60=Y,61=Y,  
 62=Y,63=Y,64=N,89=25,90=25,92=N.

0000

|  |   |
|--|---|
| SENDER NAME TITLE OFFICE SYMBOL PHONE<br><b>JEFFREY KAPOLKA, CAPT</b><br><b>9MM/D00,576-1234</b> | SPECIAL INSTRUCTIONS<br><b>ROUTING IDENTIFIER IS</b><br><b>RHUUAAI FOR AFGMC POINT ANALYSIS</b> |
| SENDER NAME TITLE OFFICE SYMBOL PHONE<br><b>P.E. NICHOLS CAPT 9MM/D00</b><br>576-1234            | SECURITY CLASSIFICATION<br><b>UNCLASSIFIED</b>  |
| DATE TIME GROUP<br><b>133200Z MAY 89</b>   |   |

30 173/2

FORM 37 1 FEB 79

4 U 3 000

Figure 4-1. Formatted AUTODIN Request Message

support assistance requests. See Figure 4-2 for an example of an IPAM 105-18 request being sent to USAFETAC. For IPAM data profiles in support of Special Strategic Programs (SSP), the user must submit the request to HQ AWS/XTJ.

#### 4.1.1 Message Input Via AUTODIN

When an IPAM message request is submitted to AFGWC, the format described in Figure 4-1 must be adhered to in order for the request to be validated by the computer. If the message is rejected, the Customer is contacted to clarify the discrepancies. The Customer must list the data items as shown in Figure 4-1 and follow these general rules:

- (1) The format for requesting a data item is:

Data Item Number, followed by an = sign, followed by the desired value, followed by a comma, e.g.  
8=21,;

- (2) Data Item information must continue across the message line and no entry can exceed column 80;
- (3) Data Item information must not be split across two lines; and
- (4) The final Data Item must be followed by a period.
- (5) Leading zeros for any Data Item field are not required, e.g., a surface height of 70 ft AGL is entered as 70 not 0070.

#### 4.1.2 Request Via AWN

Request for IPAM to be output over the AWN must be made by one of the following methods:

---

FROM: 4WW/DOO (TSgt Kinney, AV 259-2551)

SUBJECT: Routine SAR-Request for Point Analysis (PA) in IPAM Format

TO: USAFETAC/DO

1. PA in IPAM Format for Cape Canaveral.
  2.
    - a. 22nd Air Force.
    - b. USAF 1-1; AWS 2.
  3.
    - a. Mail.
    - b. 4WW/DO Falcon AFB, CO 80821-5000
    - c. Magnetic tape and two paper copies
  4. NA; Unclassified.
  5. Capt Metcalf  
4WW/DO  
Falcon AFB, CO 80821-5000  
AV 259-2551; Commercial 719-555-3543
  6. Point Analysis in IPAM Format for the Date, Time, and Location provided.
  7. 1=001, 4=XMR, 5=28, 6=28, 7=N, 8=80, 9=30, 10=W, 11=12, 12=56,  
13=10, 14=08, 15=89, 16=Y, 18=4, 19=1, 20=3, 21=N, 22=Y,  
23=Y, 24=AGL, 25=MT, 26=500, 40=N, 42=Y, 46=N, 47=Y, 48=N, 49=Y,  
50=Y, 51=Y, 52=Y, 53=Y, 54=Y, 56=N, 57=Y, 58=Y, 59=Y, 60=Y,  
61=Y, 62=N, 87=30, 88=30, 90=Y, 91=1200, 92=650.
  8. -10. NA.
  11. 1 Sep 89.
  12. NA.
  13. Remarks as required.
- 

Figure 4-2.

Sample 105-18 Support Assistance Request Sent to USAFETAC



- (1) Via AFR 105-18 request
- (2) Via AUTODIN request
- (3) Via telephone to AFGWC/WFO

#### 4.1.3 Customer Inputs and Default Options

It is imperative the requestors of the IPAM product fully comprehend the concept of the AFGWC and USAFETAC templates.

These templates control the information that dictates the IPAM profile that clients receive. The AFGWC template is shown in Figure 4-3, and the USAFETAC template is shown in Figure 4-4,. The only difference between the two templates concerns an AUTODIN or In-House destination of the IPAM product, as reflected in Data Items 16 and 17 of the AFGWC template.

IPAM requestors have two options to follow when submitting IPAM requests.

Option 1. All template information as described in Table 4-1 must be submitted with each IPAM profile request.

Option 2. IPAM clients can establish a routine default file for data information which will in turn reduce the required content of message requests. Only those data item numbers with a D suffix as shown in Table 4-1 can be included in the default file. This default file must be established with AFGWC/DO or USAFETAC/DO in order to be implemented. Each customer number established will have a corresponding set of default options. If the client needs to change the status of the default file for a specific request, simply include the change in the request message. This will be incorporated into the data selections only for this individual request. It is

| 1. DATA ITEM NUMBER | 2. DATA ITEM | 3. ITEM NAME | 4. ITEM DESCRIPTION                                    | 5. RANGE OF VALUES                                  |
|---------------------|--------------|--------------|--|---|
| 1                   | DDD          | CUSTNO       | CUSTOMER NUMBER  | 0-200   |
| 2                   | D            | PAREQT       | PA REQUEST TYPE  | 1 THRU 7  |
| 3                   | DDD          | JOBNO        | JOB NUMBER   | 0-400   |
| 4                   | IDIDID       | PAID         | PA IDENTIFIER  | 1-6 CHAR  |
| 5                   | DD           | PALATD       | PA LATITUDE DEGREES                                    | 0-90  |
| 6                   | MM           | PALATM       | PA LATITUDE MINUTES                                    | 0-59  |
| 7                   | K            | PALATK       | PA LATITUDE KEY  | N/S   |
| 8                   | DDD          | PALOND       | PA LONGITUDE DEGREES                                   | 0-180   |
| 9                   | M            | PALONM       | PA LONGITUDE MINUTES                                   | 0-59  |
| 10                  | K            | PALONK       | PA LONGITUDE KEY                                       | E/W   |
| 11                  | HH           | PAZH         | PA ZULU HOUR   | 0-23  |
| 12                  | MM           | PAZM         | PA ZULU MINUTE   | 0-59  |
| 13                  | DD           | PADA         | PA DAY DEPENDS ON MO                                   | DEPENDS   |
| 14                  | MM           | PAMO         | PA MONTH   | 1-12  |
| 15                  | YY           | PAYR         | PA YEAR LESS 1900                                      | 85-99   |
| 16                  | IDIDID       | MANDST       | MANDATORY DESTINATION                                  | 1-6 CHAR  |
| 17                  | D            | AORI         | AUTODIN OR IN-HOUSE                                    | A OR I  |
| 18                  | D            | Y            | MANQC  | ENABLE MANUAL QC/EDIT?                              |
| 19                  | N            | FRCCON       | FORCE MOISTURE CONSIST.                                | Y,N   |
| 20                  | D            | 4            | MSGPRI   | MESSAGE PRIORITY                                    |
| 21                  | D            | D            | PACLAS   | SECURITY CLASSIFICATION                             |
| 22                  | 9999         | SFCHT        | SURFACE HEIGHT OF PA (METERS)                          | -350 TO 8840  |
| 23                  | D            | Y            | SANIT  | SANITIZATION FLAG                                   |
| 24                  | DD           | N            | NEPH   | CLOUD DEPICTION FLAG                                |
| 25                  | DD           | Y            | VPI  | DO A VPI? FLAG                                      |
| 26                  | DD           | AGL          | MSLAGL   | MSL OR AGL FLAG                                     |
| 27                  | D            | FT           | METMTR   | FEET OR METERS FLAG                                 |
| 28                  | 400          | MXSRC        | MAX SEARCH RADIUS (NM)                                 | 100-2000  |
| 29                  | N            | ADDLEV       | ADDITIONAL LEVELS FLAG                                 | Y,N   |
| 30                  | 00           | NPADD        | NUMBER OF LEVELS TO ADD                                | 0-11  |
| 31                  | 000000       | PLADD (1)    | ARRAY OF PRESSURE LEVELS TO ADD IN TENTHS OF MILLIBARS | 0-11000   |
| 32                  | 000000       | PLADD (2)    |  |   |
| 33                  | 000000       | PLADD (3)    |  |   |
| 34                  | 000000       | PLADD (4)    |  |   |
| 35                  | 000000       | PLADD (5)    |  |   |
| 36                  | 000000       | PLADD (6)    |  |   |
| 37                  | 000000       | PLADD (7)    |  |   |
| 38                  | 000000       | PLADD (8)    |  |   |
| 39                  | 000000       | PLADD (9)    |  |   |
| 40                  | 000000       | PLADD (10)   |  |   |
| 41                  | 000000       | PLADD (11)   |  |   |
| 42                  | D            | N            | RAOBVP   | DO A RAOB VP? FLAG                                  |
| 43                  | D            | 0            | ROMIT  | # OF RAOB STNS OMITTED                              |
| 44                  | D            | Y            | RMILEV   | ADD ANALYSIS DATA? FLAG                             |
| 45                  | N            | N            | RSPORD   | WMO# SPECIFIED(S), WMO#'S DELETED(D) OR NEITHER (N) |
| 46                  | N            | CHPRES       | CHANGE SUITABLE RAOB PRESSURE FLAG                     | Y,N   |
| 47                  | 000          | RABPRS       | SUITABLE RAOB PRESSURE                                 | 100-900   |
| 48                  | N            | USANLY       | USE ANALYSIS ONLY                                      | Y,N   |
| 49                  | D            | Y            | OIYN   | DO AN OIVP? FLAG                                    |
| 50                  | DD           | N            | FGONLY   | FIRST GUESS ONLY FLAG                               |
| 51                  | D            | Y            | URAOB  | USE RAOBS? FLAG                                     |
| 52                  | D            | Y            | UPIBAL   | USE PIBALS? FLAG                                    |
| 53                  | D            | Y            | USAT   | USE SATELLITE? FLAG                                 |
| 54                  | D            | Y            | UPIREP   | USE PIREPS? FLAG                                    |
| 55                  | D            | Y            | USFC   | USE SURFACE REPORTS? FLAG                           |
| 56                  | D            | Y            | UROCOB   | USE ROCOBS? FLAG                                    |
| 57                  | D            | 0            | OIOMIT   | # OF WMO#S TO OMIT                                  |
| 58                  | D            | Y            | OIPARF   | OI IN PARA F? FLAG                                  |
| 59                  | D            | N            | DATAWT   | PRINT DATAWT TABLE? FLAG                            |

Figure 4-3. AFGWC IPAM Request Template

| 1. DATA ITEM NUMBER | 2. DATA ITEM | 3. ITEM NAME | 4. ITEM DESCRIPTION   | 5. RANGE OF VALUES |
|---------------------|--------------|--------------|---|--------------------|
| 60 D                | Y            | PARAE        | PWC IN PARA E? FLAG   | Y,N                |
| 61 D                | Y            | PSEUOB       | PSEUDO SFC OB?  | Y,N                |
| 62 D                | Y            | SFCOBT       | SURFACE OB TABLE?   | Y,N                |
| 63 D                | N            | SFCHIS       | SURFACE WEATHER HISTORY?  | Y,N                |
| 64 D                | N            | AEROSL       | AEROSOL PARAMETER INPUTS?   | Y,N                |
| 65                  | N            | AUTDIN       | TRANSMIT VIA AUTODIN?   | Y,N                |
| 66                  | 0            | NAUT         | NO. OF AUTODIN ADDRESSES  | 0-9                |
| 67                  | 000000       | AUTADR (1)   | ARRAY OF<br>AUTODIN<br>ADDRESSES<br>EXCLUDING<br>MANDST             | 6ASCII<br>CHAR     |
| 68                  | 000000       | AUTADR (2)   |   |                    |
| 69                  | 000000       | AUTADR (3)   |   |                    |
| 70                  | 000000       | AUTADR (4)   |   |                    |
| 71                  | 000000       | AUTADR (5)   |   |                    |
| 72                  | 000000       | AUTADR (6)   |   |                    |
| 73                  | 000000       | AUTADR (7)   |   |                    |
| 74                  | 000000       | AUTADR (8)   |   |                    |
| 75                  | 000000       | AUTADR (9)   |   |                    |
| 76                  | N            | SYSTEM       | OUTPUT TO SYSTEM DEVICES?   | Y,N                |
| 77                  | 0            | NSYS         | NO. OF SYSTEM DEVICES   | 0-9                |
| 78                  | 000000       | ASCIID (1)   | ARRAY OF<br>ASCII SYSTEM<br>DEVICE ADDRESSES<br>EXCLUDING<br>MANDST | 6ASCII<br>CHAR     |
| 79                  | 000000       | ASCIID (2)   |   |                    |
| 80                  | 000000       | ASCIID (3)   |   |                    |
| 81                  | 000000       | ASCIID (4)   |   |                    |
| 82                  | 000000       | ASCIID (5)   |   |                    |
| 83                  | 000000       | ASCIID (6)   |   |                    |
| 84                  | 000000       | ASCIID (7)   |   |                    |
| 85                  | 000000       | ASCIID (8)   |   |                    |
| 86                  | 000000       | ASCIID (9)   |   |                    |
| 87                  | N            | RDCOR        | READ NEW CORR COEFFS . LAG  | Y,N                |
| 88                  | 010          | FMIN         | MIN CORRELATION WT*100  | 0-100              |
| 89 D                | 25           | MOSTQT       | MOISTURE QUALITY<br>THRESHOLD*10                                    | 0-50               |
| 90 D                | 25           | TEMPQT       | TEMPERATURE QUALITY<br>THRESHOLD*10                                 | 0-50               |
| 91                  | 0            | DIAGPR       | FOR MAIN. PROG. ONLY  | 0-4                |
| 92 D                | N            | SLANT        | SLANT PATH? FLAG  | Y,N                |
| 93 D                | 0000         | AZMUTH       | SLANT PATH AZIMUTH*10   | 1-3600             |
| 94 D                | 000          | ELEVAT       | SLANT PATH ELEVATION*10   | 0-900              |
| 95 D                | N            | HRZPTH       | HORIZONTAL PATH? FLAG   | Y,N                |
| 96 D                | DD           | ENDLTD       | ENDING LATITUDE DEGREES   | 0-90               |
| 97 D                | MM           | ENDLTM       | ENDING LATITUDE MINUTES   | 0-59               |
| 98 D                | K            | ENDLTK       | ENDING LATITUDE KEY   | N/S                |
| 99 D                | DDD          | ENDLND       | ENDING LONGITUDE DEGREES  | 0-180              |
| 100 D               | MM           | ENDLNM       | ENDING LONGITUDE MINUTES  | 0-59               |
| 101 D               | K            | ENDLNK       | ENDING LONGITUDE KEY  | E/W                |
| 102 D               | 000000       | BEGALT       | BEGINNING POINT ALTITUDE  | 400000 MX          |
| 103 D               | 000000       | ENDALI       | ENDING PT. ALTITUDE   | 400000 MX          |
| 104 D               | R            | DECREV       | DECLASSIFICATION/ REVIEW  | D,R                |
| 105 D               | DD           | DRDAY        | DECLAS./REVIEW DAY  | 1-31               |
| 106 D               | MM           | DRMON        | DECLAS./REVIEW MONTH  | 1-12               |
| 107 D               | YY           | DRYEAR       | DECLAS./REVIEW YEAR   | 90-99              |
| 108 D               | N            | NVALUE       | REFRACTIVE INDEX?   | Y,N                |
| 109 D               | 500          | HGHTRI       | HEIGHT ENCR. RI PROFILE   | 500-2500           |
| 110 D               | 50000        | KTOP         | TOP OF THE NVALUE PROFILE   | 0-100000           |
| 111 D               | N            | SSMINF       | DMSP SSM/I DATA?  | Y,N                |
| 112 D               | N            | AWN          | TRANSMIT USING AWN ADDR?  | Y,N                |
| 113 D               | 0            | NAWN         | NO. OF AWN ADDRESSES  | 0-3                |
| 114 D               | 0000         | AWNADR (1)   | ARRAY OF<br>AWN ADDRESSES   | 4ASCII<br>CHAR     |
| 115 D               | 0000         | AWNADR (2)   |   |                    |
| 116 D               | 0000         | AWNADR (3)   |   |                    |

Figure 4-3. AFGWC IPAM Request Template (Continued)

| TABLE OF OBS REPORTS TO OMIT IN OIVP PROCESSING |                 |               |                  |             |                        |                    |
|---|-----------------|---------------|------------------|-------------|------------------------|--------------------|
| WMO#<br>OIWMOD                                  | MONTH<br>OIMODL | DAY<br>OIDADL | ZULUHR<br>OIZUDL | REPORT<br># | ELEMENT<br>DESCRIPTION | RANGE OF<br>VALUES |
| 000000  | 00              | 00            | 00               | 1           | OIWMOD-ARRAY OF WMO#S  | 000000             |
| 000000  | 00              | 00            | 00               | 2           | TO DELETE              | -999999            |
| 000000  | 00              | 00            | 00               | 3           |                        |                    |
| 000000  | 00              | 00            | 00               | 4           | OIMODL-ARRAY OF MONTHS | 0-12               |
| 000000  | 00              | 00            | 00               | 5           | TO DELETE              |                    |
| 000000  | 00              | 00            | 00               | 6           |                        |                    |
| 000000  | 00              | 00            | 00               | 7           | OIDADL-ARRAY OF THE    | DEPENDS            |
| 000000  | 00              | 00            | 00               | 8           | DAY TO OMIT            | ON MONTH           |
| 000000  | 00              | 00            | 00               | 9           |                        |                    |
| 000000  | 00              | 00            | 00               | 10          | OIZUDL-ARRAY OF THE    | 0-23               |
| 000000  | 00              | 00            | 00               | 11          | ZULU HOUR TO           |                    |
| 000000  | 00              | 00            | 00               | 12          | OMIT                   |                    |
| 000000  | 00              | 00            | 00               | 13          | TO DELETE ALL OBS FROM |                    |
| 000000  | 00              | 00            | 00               | 14          | STATION I,             |                    |
| 000000  | 00              | 00            | 00               | 15          | SET OIMODL(I)=99       |                    |
| 000000  | 00              | 00            | 00               | 16          |                        |                    |
| 000000  | 00              | 00            | 00               | 17          |                        |                    |
| 000000  | 00              | 00            | 00               | 18          |                        |                    |
| 000000  | 00              | 00            | 00               | 19          |                        |                    |
| 000000  | 00              | 00            | 00               | 20          |                        |                    |

| TABLE OF RAOB REPORTS TO OMIT OR SPECIFY IN RAOB PROCESSING |       |     |        |             |                        |                    |
|---|-------|-----|--------|-------------|------------------------|--------------------|
| WMO#  | MONTH | DAY | ZULUHR | REPORT<br># | ELEMENT<br>DESCRIPTION | RANGE OF<br>VALUES |
| 000000  | 00    | 00  | 00     | 1           | FILL IN THIS TABLE,    |                    |
| 000000  | 00    | 00  | 00     | 2           | FOR RAOB OMISSIONS,    |                    |
| 000000  | 00    | 00  | 00     | 3           | OR RAOB SPECIFIED,     | AS ABOVE           |
| 000000  | 00    | 00  | 00     | 4           | AS YOU DO ABOVE        |                    |
| 000000  | 00    | 00  | 00     | 5           | FOR OI OMISSIONS.      |                    |

Figure 4-3. AFGWC IPAM Request Template (Continued)

| 1. DATA ITEM NUMBER | 2. DATA ITEM | 3. ITEM NAME | 4. ITEM DESCRIPTION  | 5. RANGE OF VALUES                                     |
|---------------------|--------------|--------------|----------------------|--|
| 1                   | DDD          | CUSTNO       | CUSTOMER NUMBER      | 0-200  |
| 2                   | D            | PAREQT       | PA REQUEST TYPE      | 1 THRU 7   |
| 3                   | DDD          | JOBNO        | JOB NUMBER           | 0-400  |
| 4                   | IDIDID       | PAID         | PA IDENTIFIER        | 1-6 CHAR   |
| 5                   | DD           | PALATD       | PA LATITUDE DEGREES  | 0-90   |
| 6                   | MM           | PALATM       | PA LATITUDE MINUTES  | 0-59   |
| 7                   | K            | PALATK       | PA LATITUDE KEY      | N/S  |
| 8                   | DDD          | PALOND       | PA LONGITUDE DEGREES | 0-180  |
| 9                   | M            | PALONM       | PA LONGITUDE MINUTES | 0-59   |
| 10                  | K            | PALONK       | PA LONGITUDE KEY     | E/W  |
| 11                  | HH           | PAZH         | PA ZULU HOUR         | 0-23   |
| 12                  | MM           | PAZM         | PA ZULU MINUTE       | 0-59   |
| 13                  | DD           | PADA         | PA DAY DEPENDS ON MO | DEPENDS  |
| 14                  | MM           | PAMO         | PA MONTH             | 1-12   |
| 15                  | YY           | PAYR         | PA YEAR LESS 1900    | 85-99  |
| 16                  | D            | Y            | MANQC                | ENABLE MANUAL QC/EDIT?                                 |
| 17                  | D            | N            | FRCCON               | FORCE MOISTURE CONSIST.                                |
| 18                  | D            | 4            | MSGPRI               | MESSAGE PRIORITY                                       |
| 19                  | D            | D            | PACLAS               | SECURITY CLASSIFICATION                                |
| 20                  |              | 9999         | SFCHT                | SURFACE HEIGHT OF PA (METERS)                          |
| 21                  | D            | Y            | SANIT                | SANITIZATION FLAG                                      |
| 22                  | D            | N            | NEPH                 | CLOUD DEPICTION FLAG                                   |
| 23                  | D            | Y            | VPI                  | DO A VPI? FLAG   |
| 24                  | D            | AGL          | MSLAGL               | MSL OR AGL FLAG  |
| 25                  | D            | FT           | METMTR               | FEET OR METERS FLAG                                    |
| 26                  |              | 400          | MXSRC                | MAX SEARCH RADIUS (NM)                                 |
| 27                  |              | N            | ADDLEV               | ADDITIONAL LEVELS FLAG                                 |
| 28                  |              | 00           | NPADD                | NUMBER OF LEVELS TO ADD                                |
| 29                  |              | 000000       | PLADD (1)            | ARRAY OF PRESSURE LEVELS TO ADD IN TENTHS OF MILLIBARS |
| 30                  |              | 000000       | PLADD (2)            |  |
| 31                  |              | 000000       | PLADD (3)            |  |
| 32                  |              | 000000       | PLADD (4)            |  |
| 33                  |              | 000000       | PLADD (5)            |  |
| 34                  |              | 000000       | PLADD (6)            |  |
| 35                  |              | 000000       | PLADD (7)            |  |
| 36                  |              | 000000       | PLADD (8)            |  |
| 37                  |              | 000000       | PLADD (9)            |  |
| 38                  |              | 000000       | PLADD (10)           |  |
| 39                  |              | 000000       | PLADD (11)           |  |
| 40                  | D            | N            | RAOBVP               | DO A RAOB VP? FLAG                                     |
| 41                  |              | 0            | ROMIT                | # OF RAOB STNS OMITTED                                 |
| 42                  | D            | Y            | RMILEV               | ADD ANALYSIS DATA? FLAG                                |
| 43                  |              | N            | RSPORD               | WMO# SPECIFIED(S), WMO#'S DELETED(D) OR NEITHER (N)    |
| 44                  |              | N            | CHPRES               | CHANGE SUITABLE RAOB PRESSURE FLAG                     |
| 45                  |              | 000          | RABPRS               | SUITABLE RAOB PRESSURE                                 |
| 46                  |              | N            | USANLY               | USE ANALYSIS ONLY                                      |
| 47                  | D            | Y            | OIYN                 | DO AN OIVP? FLAG                                       |
| 48                  | D            | N            | FGONLY               | FIRST GUESS ONLY FLAG                                  |
| 49                  | D            | Y            | URAOB                | USE RAOBS? FLAG  |
| 50                  | D            | Y            | UPIBAL               | USE PIBALS? FLAG                                       |
| 51                  | D            | Y            | USAT                 | USE SATELLITE? FLAG                                    |
| 52                  | D            | Y            | UPIREP               | USE PIREPS? FLAG                                       |
| 53                  | D            | Y            | USFC                 | USE SURFACE REPORTS? FLAG                              |
| 54                  | D            | Y            | UROCOB               | USE ROCOBS? FLAG                                       |
| 55                  |              | 0            | OIOMIT               | # OF WMO#S TO OMIT                                     |
| 56                  | D            | Y            | OIPARF               | OI IN PARA F? FLAG                                     |
| 57                  | D            | N            | DATAWT               | PRINT DATAWT TABLE? FLAG                               |

Figure 4-4. USAFETAC IPAM Request Template

| 1. DATA<br>ITEM<br>NUMBER | 2. DATA<br>ITEM | 3. ITEM<br>NAME | 4. ITEM<br>DESCRIPTION                                  | 5. RANGE<br>OF<br>VALUES |
|---------------------------|-----------------|-----------------|---|--------------------------|
| 58 D                      | Y               | PARAE           | PWC IN PARA E? FLAG                                     | Y,N                      |
| 59 D                      | Y               | PSEUOB          | PSEUDO SFC OB?  | Y,N                      |
| 60 D                      | Y               | SFCOBT          | SURFACE OB TABLE?                                       | Y,N                      |
| 61 D                      | N               | SFCHIS          | SURFACE WEATHER HISTORY?                                | Y,N                      |
| 62 D                      | N               | AEROSL          | AEROSOL PARAMETER INPUTS?                               | Y,N                      |
| 63                        | N               | AUTDIN          | TRANSMIT VIA AUTODIN?                                   | Y,N                      |
| 64                        | 0               | NAUT            | NO. OF AUTODIN ADDRESSES                                | 0-9                      |
| 65                        | 000000          | AUTADR (1)      | ARRAY OF<br>AUTODIN<br>ADDRESSES<br>EXCLUDING<br>MANDST | 6ASCII<br>CHAR           |
| 66                        | 000000          | AUTADR (2)      |   |                          |
| 67                        | 000000          | AUTADR (3)      |   |                          |
| 68                        | 000000          | AUTADR (4)      |   |                          |
| 69                        | 000000          | AUTADR (5)      |   |                          |
| 70                        | 000000          | AUTADR (6)      |   |                          |
| 71                        | 000000          | AUTADR (7)      |   |                          |
| 72                        | 000000          | AUTADR (8)      |   |                          |
| 73                        | 000000          | AUTADR (9)      |   |                          |
| 74                        | 000000          | AUTADR (10)     |   |                          |
| 75                        | N               | RDCOR           | READ NEW CORR COEFFS FLAG                               | Y,N                      |
| 76                        | 010             | FMIN            | MIN CORRELATION WT*100                                  | 0-100                    |
| 77 D                      | 25              | MOSTQT          | MOISTURE QUALITY<br>THRESHOLD*10                        | 0-50                     |
| 78 D                      | 25              | TEMPQT          | TEMPERATURE QUALITY<br>THRESHOLD*10                     | 0-50                     |
| 79                        | 0               | DIAGPR          | FOR MAIN. PROG. ONLY                                    | 0-4                      |
| 80 D                      | N               | SLANT           | SLANT PATH? FLAG  | Y,N                      |
| 81 D                      | 0000            | AZMUTH          | SLANT PATH AZIMUTH*10                                   | 1-3600                   |
| 82 D                      | 000             | ELEVAT          | SLANT PATH ELEVATION*10                                 | 0-900                    |
| 83 D                      | N               | HRZPTH          | HORIZONTAL PATH? FLAG                                   | Y,N                      |
| 84 D                      | DD              | ENDLTD          | END LATITUDE DEGREES                                    | 0-90                     |
| 85 D                      | MM              | ENDLTM          | END LATITUDE MINUTES                                    | 0-59                     |
| 86 D                      | K               | ENDLTK          | END LATITUDE KEY  | N/S                      |
| 87 D                      | DDD             | ENDLND          | END LONGITUDE DEGREES                                   | 0-180                    |
| 88 D                      | MM              | ENDLNM          | END LONGITUDE MINUTES                                   | 0-59                     |
| 89 D                      | K               | ENDLNK          | END LONGITUDE KEY                                       | E/W                      |
| 90 D                      | 000000          | BEGALT          | BEGINNING PT. ALTITUDE                                  | 400000MAX                |
| 91 D                      | 000000          | ENDALT          | ENDING PT. ALTITUDE                                     | 400000MAX                |
| 92 D                      | R               | DECREV          | DECLASSIFICATION/REVIEW                                 | D,R                      |
| 93 D                      | DD              | DRDAY           | DECLAS./REVIEW DAY                                      | 1-31                     |
| 94 D                      | MM              | DRMON           | DECLAS./REVIEW MONTH                                    | 1-12                     |
| 95 D                      | YY              | DRYEAR          | DECLAS./REVIEW YEAR                                     | 90-99                    |
| 96 D                      | N               | NVALUE          | REFRACTIVE INDEX?                                       | Y,N                      |
| 97 D                      | 500             | HGHTRI          | HEIGHT ENCR. RI PROFILE                                 | 500-2500                 |
| 98 D                      | 50000           | KTOP            | TOP OF THE NVALUE PROFILE                               | 0-100000                 |
| 99 D                      | N               | SSMINF          | DMSP SSM/I DATA?  | Y,N                      |

Figure 4-4. USAFETAC IPAM Request Template (Continued)

TABLE OF OBS REPORTS TO OMIT IN OIVP PROCESSING

| WMO#<br>OIWMOD | MONTH<br>OIMODL | DAY<br>OIDADL | ZULUHR<br>OIZUDL | REPORT<br># | ELEMENT<br>DESCRIPTION | RANGE OF<br>VALUES |
|----------------|-----------------|---------------|------------------|-------------|------------------------|--------------------|
| 000000         | 00              | 00            | 00               | 1           | OIWMOD-ARRAY OF WMO#S  | 000000             |
| 000000         | 00              | 00            | 00               | 2           | TO DELETE              | -999999            |
| 000000         | 00              | 00            | 00               | 3           |                        |                    |
| 000000         | 00              | 00            | 00               | 4           | OIMODL-ARRAY OF MONTHS | 0-12               |
| 000000         | 00              | 00            | 00               | 5           | TO DELETE              |                    |
| 000000         | 00              | 00            | 00               | 6           |                        |                    |
| 000000         | 00              | 00            | 00               | 7           | OIDADL-ARRAY OF THE    | DEPENDS            |
| 000000         | 00              | 00            | 00               | 8           | DAY TO OMIT            | ON MONTH           |
| 000000         | 00              | 00            | 00               | 9           |                        |                    |
| 000000         | 00              | 00            | 00               | 10          | OIZUDL-ARRAY OF THE    | 0-23               |
| 000000         | 00              | 00            | 00               | 11          | ZULU HOUR TO           |                    |
| 000000         | 00              | 00            | 00               | 12          | OMIT                   |                    |
| 000000         | 00              | 00            | 00               | 13          | TO DELETE ALL OBS FROM |                    |
| 000000         | 00              | 00            | 00               | 14          | STATION I,             |                    |
| 000000         | 00              | 00            | 00               | 15          | SET OIMODL(I)=99       |                    |
| 000000         | 00              | 00            | 00               | 16          |                        |                    |
| 000000         | 00              | 00            | 00               | 17          |                        |                    |
| 000000         | 00              | 00            | 00               | 18          |                        |                    |
| 000000         | 00              | 00            | 00               | 19          |                        |                    |
| 000000         | 00              | 00            | 00               | 20          |                        |                    |

TABLE OF RAOB REPORTS TO OMIT OR SPECIFY IN RAOB PROCESSING

| WMO#   | MONTH | DAY | ZULUHR | REPORT<br># | ELEMENT<br>DESCRIPTION | RANGE OF<br>VALUES |
|--------|-------|-----|--------|-------------|------------------------|--------------------|
| 000000 | 00    | 00  | 00     | 1           | FILL IN THIS TABLE,    |                    |
| 000000 | 00    | 00  | 00     | 2           | FOR RAOB OMISSIONS,    |                    |
| 000000 | 00    | 00  | 00     | 3           | OR RAOB SPECIFIED,     | AS ABOVE           |
| 000000 | 00    | 00  | 00     | 4           | AS YOU DO ABOVE        |                    |
| 000000 | 00    | 00  | 00     | 5           | FOR OI OMISSIONS.      |                    |

Figure 4-4. USAFETAC IPAM Request Template (Continued)

recommended that Data Item 92/80, Slant Path, regularly be set to 'NO' in the default file, because it requires further values on azimuth and elevation angles which will change with virtually every request for a slant path profile. This type of changeable information needs to be in the individual IPAM profile requests.

At USAFETAC: If the analysts working to satisfy a request cannot determine what the client has requested, a default value will be used, if possible. Otherwise, the request will be returned to the client for clarification.

Changes to defaults or information on IPAM surface height or a slant path profile must be included in the input message request.

Further explanations of data item values in Table 4-1 follow; note that the item numbers are presented with respect to AFGWC/USAFETAC template numbers unless specified otherwise.

- a) Item 16 (AFGWC only). This is the User's 6-character AUTODIN Routing Key.
  
- b) Item 18/16. Selection for manual quality control.

Y = Always send IPAM profile to Analyst for Quality Control;

N = Never send IPAM profile to Analyst for Quality Control;

A = Have Analyst Quality Control as needed;

V = Quality Control if Temperature Quality Index < 1.5, or Moisture Quality Index < 1.5;

C = Quality Control if Moisture Parameter Comparison Fails; and, Control;



TABLE 4-1. IPAM AUTODIN User's Data Items

| 1. DATA ITEM NUMBER AFGWC/USAFETAC | 2. DATA ITEM | 3. ITEM NAME | 4. ITEM DESCRIPTION              | 5. RANGE OF VALUES |
|------------------------------------|--------------|--------------|----------------------------------|--------------------|
| 1/1                                | DDD          | CUSTNO       | CUSTOMER NUMBER                  | 0-200              |
| 4/4                                | IDIDID       | PAID         | PA IDENTIFIER                    | 1-6CHAR            |
| 5/5                                | DD           | PALATD       | PA LATITUDE DEGREES              | 0-90               |
| 6/6                                | MM           | PALATM       | PA LATITUDE MINUTES              | 0-59               |
| 7/7                                | K            | PALATK       | PA LATITUDE KEY                  | N/S                |
| 8/8                                | DDD          | PALOND       | PA LONGITUDE DEGREES             | 0-180              |
| 9/9                                | MM           | PALONM       | PA LONGITUDE MINUTES             | 0-59               |
| 10/10                              | K            | PALONK       | PA LONGITUDE KEY                 | E/W                |
| 11/11                              | HH           | PAZH         | PA ZULU HOUR                     | 0-23               |
| 12/12                              | MM           | PAZM         | PA ZULU MINUTES                  | 0-59               |
| 13/13                              | DD           | PADA         | PA DAY DEPENDS ON MONTH          | DEPENDS            |
| 14/14                              | MM           | PAMO         | PA MONTH                         | 1-12               |
| 15/15                              | YY           | PAYR         | PA YEAR LESS 1900                | 85-99              |
| 16/N/A                             | IDIDID       | MANDST       | MANDATORY DESTINATION            | 1-6CHAR            |
| 17/N/A                             | D            | AORI         | AUTODIN OR IN-HOUSE              | A OR I             |
| 18/16 D                            | Y            | MANQC        | ENABLE MANUAL QC/EDIT?           | Y,N,A,V,C,B        |
| 19/17 D                            | N            | FRCCON       | FORCE MOISTURE CONSIST.          | Y,N                |
| 20/18 D                            | 4            | MSGPRI       | MESSAGE PRIORITY                 | 2-4                |
| 21/19 D                            | D            | PACLAS       | SECURITY CLASSIFICATION          | 1-5                |
| 22/20                              | 9999         | SFCHT        | SURFACE HEIGHT OF PA (METERS)    | -350 TO 8840       |
| 23/21 D                            | Y            | SANIT        | SANITIZATION FLAG                | Y,N                |
| 24/22 D                            | N            | NEPH         | CLOUD DEPICTION FLAG             | Y,N                |
| 25/23 D                            | Y            | VPI          | DO A VPI? FLAG                   | Y,N                |
| 26/24 D                            | AGL          | MSLAGL       | MSL OR AGL FLAG                  | MSL,AGL            |
| 27/25 D                            | FT           | FETMTR       | FEET OR METERS FLAG              | FT,MT              |
| 28/26                              | 400          | MXSRC        | MAX SEARCH RADIUS (NM)           | 100-2000           |
| 42/40 D                            | N            | RAOBVP       | DO A RAOB VP? FLAG               | Y,N                |
| 44/42 D                            | Y            | RMILEV       | ADD ANALYSIS DATA? FLAG          | Y,N                |
| 48/46                              | N            | USANLY       | USE ANALYSIS ONLY                | Y,N                |
| 49/47 D                            | Y            | OIYN         | DO AN OIVP? FLAG                 | Y,N                |
| 50/48 D                            | N            | FGONLY       | FIRST GUESS ONLY FLAG            | Y,N                |
| 51/49 D                            | Y            | URAOB        | USE RAOBS? FLAG                  | Y,N                |
| 52/50 D                            | Y            | UPIBAL       | USE PIBALS? FLAG                 | Y,N                |
| 53/51 D                            | Y            | USAT         | USE SATELLITE? FLAG              | Y,N                |
| 54/52 D                            | Y            | UPIREP       | USE PIREPS? FLAG                 | Y,N                |
| 55/53 D                            | Y            | USFC         | USE SURFACE REPORTS? FLAG        | Y,N                |
| 56/54 D                            | Y            | UROCOB       | USE ROCOBS? FLAG                 | Y,N                |
| 58/56 D                            | Y            | OIPARF       | OI IN PARA F? FLAG               | Y,N                |
| 59/57 D                            | N            | DATAWT       | PRINT DATAWT TABLE? FLAG         | Y,N                |
| 60/58 D                            | Y            | PARAE        | PWC IN PARA E? FLAG              | Y,N                |
| 61/59 D                            | Y            | PSEUOB       | PSEUDO SFC OB?                   | Y,N                |
| 62/60 D                            | Y            | SFCOBT       | SURFACE OB TABLE                 | Y,N                |
| 63/61 D                            | N            | SFCHIS       | SURFACE WEATHER HISTORY?         | Y,N                |
| 64/62 D                            | N            | AEROSL       | AEROSOL PARAMETER INPUTS?        | Y,N                |
| 89/77 D                            | 25           | MOSTQT       | MOISTURE QUALITY THRESHOLD*10    | 0-50               |
| 90/78 D                            | 25           | TEMPQT       | TEMPERATURE QUALITY THRESHOLD*10 | 0-50               |
| 92/80 D                            | N            | SLANT        | SLANT PATH? FLAG                 | Y,N                |
| 93/81                              | 0000         | AZMUTH       | SLANT PATH AZIMUTH*10            | 0001-3600          |
| 94/82                              | 000          | ELEVAT       | SLANT PATH ELEVATION*10          | 100-900            |
| 95/83                              | N            | HRZPTH       | HORIZONTAL PATH? FLAG            | Y,N                |
| 96/84                              | DD           | END!TD       | END LATITUDE DEGREES             | 0-90               |

TABLE 4-1. IPAM AUTODIN User's Data Items (Continued)

| 1. DATA ITEM NUMBER AFGWC/USAFETAC | 2. DATA ITEM | 3. ITEM NAME | 4. ITEM DESCRIPTION       | 5. RANGE OF VALUES |
|------------------------------------|--------------|--------------|---------------------------|--------------------|
| 97/85                              | MM           | ENDLTM       | END LATITUDE MINUTES      | 0-59               |
| 98/86                              | K            | ENDLTK       | END LATITUDE KEY          | N/S                |
| 99/87                              | DDD          | ENDLND       | END LONGITUDE DEGREES     | 0-180              |
| 100/88                             | MM           | ENDLNM       | END LONGITUDE MINUTES     | 0-59               |
| 101/89                             | K            | ENDLNK       | END LONGITUDE KEY         | E/W                |
| 102/90                             | 000000       | BEGALT       | BEGINNING PT. ALTITUDE    | 400000MAX          |
| 103/91                             | 000000       | ENDALT       | ENDING PT. ALTITUDE       | 400000MAX          |
| 104/92                             | R            | DECREV       | DECLASSIFICATION/REVIEW   | D, R               |
| 105/93                             | DD           | DRDAY        | DECLAS./REVIEW DAY        | 1-31               |
| 106/94                             | MM           | DRMON        | DECLAS./REVIEW MONTH      | 1-12               |
| 107/95                             | YY           | DRYEAR       | DECLAS./REVIEW YEAR       | 90-99              |
| 108/96                             | N            | NVALUE       | REFRACTIVE INDEX?         | Y, N               |
| 109/97                             | 500          | HGHTRI       | HEIGHT ENCR. RI PROFILE   | 500-2500           |
| 110/98                             | 50000        | KTOP         | TOP OF THE NVALUE PROFILE | 0-100000           |
| 111/99                             | N            | SSMINF       | DMSP SSM/I DATA?          | Y, N               |
| 112                                | N            | AWN          | TRANSMIT USING AWN ADDR?  | Y, N               |
| 113                                | G            | NAWN         | NO. OF AWN ADDRESSES      | 0-3                |
| 114                                | 0000         | AWNADR(1)    | ARRAY OF                  | 4ASCII             |
| 115                                | 0000         | AWNADR(2)    | AWN ADDRESSES             | CHAR               |
| 116                                |              | AWNADR(3)    |                           |                    |

B = Quality Control if either the Temperature Quality Index or Moisture Quality Index < 1.5, and the Moisture Parameter Comparison Check fails.

c) Item 19/17. Selection for forcing the moisture consistency between profiles.

Y = YES

N = NO

d) Item 20/18. The values for message priority are as follows:

2 = Operational Immediate

3 = Priority

4 = Routine

e) Item 21/19. The values for message classification are as follows:

- 1 = Unclassified
- 2 = Unclassified EFTO
- 3 = Confidential
- 4 = Secret
- 5 = No Secret

f) Item 22/20. The surface height if not supplied by the requestor defaults to 9999 (missing data). Then, a smoothed surface height will be estimated by interpolating the system 1/8 mesh (25 nm) gridded terrain field. Due to the deficiencies of the current terrain elevation data base, user specified site elements are highly recommended.

When customer default options are established, as explained in Section 4.1.2, IPAM Requests directed to AFGWC need only include Data Items 1, and 4-17, while requests to USAFETAC would only require Data Items 1, and 4-15. The text of such a request to AFGWC would be as follows:

1=001,4=KAGAR2,5=23,6=30,7=N,8=121,9=22,10=W,  
11=22,12=0,13=21,14=3,15=87,16=KLAX21,17=A.

#### 4.1.4 Data Item Relationships

In order to expedite the execution of an IPAM request, it is important for the requestors of the IPAM product to ensure consistency in their request with respect to IPAM program logic. There are eight data item relationships listed in Table 4-2. Presently, these numbers indicate AFGWC/USAFETAC data item numbers with respect to the processing templates (Figures 4-3 and 4-4). By ensuring that the default file, if any, and the message request do not violate any of these relationships, the IPAM request will not be "rejected" forcing an analyst to intervene and seek clarifications or correct the message input.

## 4.2 Paragraph Relationships

The standard output of the AFGWC and USAFETAC templates provides the following information in an IPAM profile.

Paragraph A - Site Information or Latitude and Longitude of the event location

Paragraph B - Date and Time of the Event

Paragraph D - Pseudo-Surface Observation

Paragraph E - Precipitable Water Profile

Paragraph F - OI- or RAOB-based data Profile for Wind, Temperature, Absolute Humidity, Density, and Pressure

Paragraph G - Remarks

There are some specific relationships for paragraph output. These relationships are really based on the Data Item relationships described in Table 4-2 and discussed in Paragraph 4.1.3. Table 4-3 summarizes the paragraph outputs and other possible paragraph output choices.

Paragraphs 4.2.1 through 4.2.7 serve as a quick reference of IPAM request do's and dont's and contain reminders for developing IPAM requests which will execute properly with minimum questions about user needs.

### 4.2.1 If Paragraph C is Requested

If Paragraph C, Cloud Depiction, is needed by the user, then Data Item 24 at AFGWC or Data Item 22 at USAFETAC must read

TABLE 4-2. DATA ITEM RELATIONSHIPS

1. At least one of the following flags must be = Y:
  - A. VPI (Data Item 25/23, DO A VPI);
  - B. NEPH (Data Item 24/22, CLOUD DEPICTION FLAG);
  - C. SFCHIS (Data Item 63/61, SURFACE WEATHER HISTORY);
  - D. PSEUOB (Data Item 61/59, PSEUDO SURFACE OBS); or
  - E. AEROSL (Data Item 64/62, AEROSOL PARAMETER INPUTS).
  
2. Only one of the following flags may be set to "Y":
  - A. RAOBVP (Data Item 42/40, DO A RAOB VP? FLAG);
  - B. OIYN (Data Item 49/47, DO AN OIVP? FLAG); or
  - C. AEROSL (Data Item 64/62 AEROSOL PARAMETER INPUTS?).
  
3. If VPI (Data Item 25/23, DO A VPI) = Y, then either RAOBVP (Data Item 42/40, DO A RAOB VP) or OIYN (Data Item 49/47, DO AN OIVP) must be = Y.

NEPH = Y. In conjunction with selecting Paragraph C, the user may select Paragraphs D, E, J, and K and one of either Paragraphs F, I or H to comprise the final IPAM profile.

#### 4.2.2 If Paragraph D is Requested

If Paragraph D, Pseudo-Surface Observation, is needed in the output by the user, then Data Item 61 at AFGWC or Data Item 59 at USAFETAC must read PSEUOB = Y. In conjunction with selecting Paragraph D, the user may select Paragraphs C, E, J, and K and one of either Paragraphs F, I, or H to comprise the final IPAM profile.

TABLE 4-2. DATA ITEM RELATIONSHIPS (Continued)

4. If OIPARF (Data Item 58/56, OI IN PARA F? FLAG) is set to "Y", then OIYN (Data Item 49/47, DO AN OIVP? FLAG) must be set to "Y".
5. If PARAE (Data Item 60/58, PWC IN PARA E? FLAG) is set to "Y", then OIYN (Data Item 49/47, DO AN OIVP? FLAG), RAOBVP (Data Item 42/40, DO A RAOB VP? FLAG), or AEROSL (Data Item 64/62, AEROSOL PARAMETER INPUTS?) must be set to "Y".
6. If DATAWT (Data Item 59/57, PRINT DATAWT TABLE) is set to "Y", then OIYN (Data Item 49/47, DO AN OIVP? FLAG), AEROSL (Data Item 64/62, AEROSOL PARAMETER INPUTS?) or SFCHIS (Data Item 63/61, SURFACE WEATHER HISTORY) must be set to "Y".
7. If SFCOBT (Data Item 62/60, SURFACE OB TABLE?) is set to "Y", then PSEUOB (Data Item 61/59, PSEUDO SURFACE OB) must be set to "Y".
8. If SLANT (Data Item 92/80, SLANT PATH? FLAG) is set to "Y", then AZMUTH (Data Item 93/81, SLANT PATH AZIMUTH\*10) and ELEVAT (Data Item 94/82, SLANT PATH ELEVATION\*10) must not be set to zero. Data items 95/83 through 103/91 must be set to the default values.
9. If HRZPTH (Data Item 95/83, HORIZONTAL PATH? FLAG) is set to "Y", then ENDLTK (Data Item 98/86, ENDING LATITUDE KEY) must be set to N/S. Also, Data items 92/80 through 94/82 must be set to the default values.

4.2.3 If Paragraph E is Requested

If Paragraph E, Precipitable Water Content, is required in the final IPAM output by the user, then Data Item 60 at AFGWC or Data Item 58 at USAFETAC must read PARAE = Y. In conjunction with Paragraph E, the user may select Paragraphs C, D, J, and K and must select one of either Paragraphs F, I or H to comprise the final IPAM profile.

4.2.4 If Paragraph F is Requested

If Paragraph F, Meteorological Data Profile, is needed in the final IPAM output and is to contain OIVP data, then the Data Items in the request message must be set = Y as follows:

At AFGWCAt USAFETAC

|              |        |              |
|--------------|--------|--------------|
| Data Item 25 | VPI    | Data Item 23 |
| Data Item 49 | OIYN   | Data Item 47 |
| Data Item 58 | OIPARF | Data Item 56 |

If Paragraph F is needed in the final output and is to contain RAOBVP data, then the following Data Items in the Request message must be set = Y as follows:

At AFGWCAt USAFETAC

|              |        |              |
|--------------|--------|--------------|
| Data Item 25 | VPI    | Data Item 23 |
| Data Item 42 | RAOBVP | Data Item 40 |

In conjunction with Paragraph F, the user may only select Paragraphs C, D, E, J, and K to complete the final IPAM profile.

#### 4.2.5 Options Affecting Contents of Paragraph G

Paragraph G is always printed. There is no Data Item that will prevent Paragraph G output. This paragraph will contain any pertinent messages generated by the IPAM program. The user can add to the information in Paragraph G by requesting the following data items. The Data Weight Table is printed in the Paragraph G if Data Item 59 at AFGWC or Data Item 57 at USAFETAC reads DATAWT = Y. The Surface Observation Table is printed in Paragraph G if Data Item 62 at AFGWC or Data Item 60 at USAFETAC reads SFCOBT = Y. SESS data are always included in the output of Paragraph G. If no actual SESS data are available, default values are used, and the following message appears in Paragraph G, "SESS DATA NOT AVAILABLE; DEFAULTS USED: F=120., MF=120., A=10." SSM/I data are printed in Paragraph G if Data Item 111 at AFGWC or Data Item 99 at USAFETAC reads SSMINF = Y. In conjunction with Paragraph G, the user may select paragraphs C, D, E, and J and one of either F, I or H to comprise the final IPAM profile. Slant path or line-of-sight PAs cannot be run if the sanitization option is selected.

#### 4.2.6 If Paragraph H is Requested

If Paragraph H, Aerosol Profile, is requested by the user, then Data Item 64 at AFGWC or Data Item 62 at USAFETAC must read AERSOL = Y. In conjunction with Paragraph H, the user may select only Paragraphs C, D, E, J and K to comprise the final IPAM output.

#### 4.2.7 If Paragraph I is Requested

If Paragraph I, Meteorological Data Profile, is requested by the IPAM User, i.e., Data Item 49/47, Do an OIVP = Y, then Data Item 58 at AFGWC or Data Item 56 at USAFETAC must read



**TABLE 4-3. IPAM Paragraph Output Selection and Other Paragraph Choices**

|  |   | <u>Other Paragraph Output Choices</u> |   |   |             |   |             |             |   |   |
|--|---|---------------------------------------|---|---|-------------|---|-------------|-------------|---|---|
|  |   | C                                     | D | E | F           | G | H           | I           | J | K |
| <u>User Selection for Paragraph Output</u> | C | -                                     | Y | Y | F/I<br>or H | A | F/I<br>or H | F/I<br>or H | Y | Y |
|  | D | Y                                     | - | Y | F/I<br>or H | A | F/I<br>or H | F/I<br>or H | Y | Y |
|  | E | Y                                     | Y | - | F/I<br>or H | A | F/I<br>or H | F/I<br>or H | Y | Y |
|  | F | Y                                     | Y | Y | -           | A | N           | N           | Y | Y |
|  | G | Y                                     | Y | Y | F/I<br>or H | A | F/I<br>or H | F/I<br>or H | Y | Y |
|  | H | Y                                     | Y | Y | N           | A | -           | N           | Y | Y |
|  | I | Y                                     | Y | Y | N           | A | N           | -           | Y | Y |
|  | J | Y                                     | Y | Y | F/I<br>or H | A | F/I<br>or H | F/I<br>or H | - | Y |
|  | K | Y                                     | Y | Y | F/I<br>or H | A | F/I<br>or H | F/I<br>or H | Y | - |

**Legend** Y = Paragraph Output may be selected  
 N = Paragraph Output cannot be selected  
 A = Paragraph automatically included in output, but certain data item selections add to contents

OIPARF = N. This option simply prints the OI vertical profile output normally found in Paragraph F in the Paragraph I position. In conjunction with Paragraph I, the user may select only Paragraphs C, D, E, J, and K to comprise the final IPAM output.

#### 4.2.8 If Paragraph J is Requested

If Paragraph J, Surface Weather History, is requested by the

IPAM user, then Data Item 63 at AFGWC or Data Item 61 at USAFETAC must read SFCHIS = Y. In conjunction with Paragraph J, the user may select output from Paragraphs C, D, E, and K and one of either F, H, or I to comprise the final IPAM output.

#### 4.2.9 If Paragraph K is Requested

If Paragraph K, Refractive Index, is requested by the user, then Data Item 108 at AFGWC or Data Item 96 at USAFETAC must read NVALUE = Y. In conjunction with Paragraph K, the user may select Paragraphs C, D, E, and J, and one of either F, I, or H to comprise the final IPAM profile.

#### 4.3 Analyst Quality Control of an IPAM Data Profile

Manual quality control of an IPAM data profile request is dependent on analyst workload at AFGWC and USAFETAC. In most cases analysts will perform the quality control requested to ensure the meteorological soundness of the output data. During periods of heavy workload, quality control may be limited, and automated quality control procedures will be relied upon when necessary to expedite request processing.

#### 4.3.1 Paragraphs Which Are Quality Controlled

When quality control is requested for an IPAM product or automated quality control threshold values are met, an analyst is required to review the IPAM output and perform quality control as needed. Quality Control can be performed on Paragraphs D, F/I, H and J.

#### 4.3.2 Increased Time of Turn-Around

The turn-around time for IPAM data requests can be influenced by several factors. First, the data base required to support the request must be available to use. For near real-time requests (particularly to AFGWC) this can be significant, especially if the message request time precedes the time of the supporting data base. For example, a user needs an IPAM profile for 1 July 1989 at 1035Z and sends the request at 1100Z. The supporting data base is 1 July 1989 at 1200Z. The data have not yet started to be collected. So, the message will have to enter the queue and await the availability of all the necessary data bases. Since part of the queue ordering is based on the required data base time, subsequent requests could bump a specific request down in the queue. The older a data base required to support a request at AFGWC, the more likely the request will move toward the top of the queue. Remember, AFGWC will run IPAM requests for messages received up to 24 hours after actual event time.

A request sent to AFGWC that can no longer be supported will be passed to USAFETAC. At that point, the request will be governed by policies and procedures employed at USAFETAC.

When manual quality control is requested or occurs, some additional turn-around time is required. If the analyst

determines a rerun is required, again some time is added to the overall turn-around time.

When a line-of-sight PA is requested, the user can expect a considerable increase in turn-around time. The line-of-sight is a very complex process that is not unlike running multiple PAs. Due to the increased CPU time needed, the user may also expect line-of-sight requests to be held until off-peak periods to minimize impacts to other operations requiring computer resources.

#### 4.3.3 Disparities in IPAM Output

Because of the varied data bases, data manipulations and assumptions made in compiling an IPAM profile, it is possible that some inconsistencies can arise within the total data profile.

One inconsistency that can arise is in the moisture and cloud data depicted in the output. For example, the cloud information in the Pseudo-Surface Observation may not properly be reflected in the moisture data contained in the OI profile shown in Paragraph F/I or in the Aerosol profile in Paragraph H. To minimize this problem, the user can request that the Force Moisture Consistency option be turned on (See Attachment 10 for details). The result of forcing moisture consistency will minimize disparities between cloud data and moisture profile data.

#### 4.4 IPAM Requests - Handling Policies

Some IPAM clients need IPAM data in near real-time or within a certain number of hours after issuing the request. Yet other agencies request the IPAM data for post-analysis work,

perhaps months or even years after the event time. As a result of these varying requests and the different operating missions of AFGWC and USAFETAC, there are established policies which will determine which organization processes the IPAM request. In general, AFGWC deal with real-time data bases from zero to 48 hours old. USAFETAC possesses a quality assured climatic data base, e.g., data more than 48 hours old. Most requests are based on client need, urgency and where the data base is active. The current policy in force concerning IPAM data requests are presented in the following subparagraphs.

#### 4.4.1 AFGWC IPAM Processing and Turn-Around Time Procedures

AFGWC's ability to process an IPAM profile request is generally only limited by the availability of supporting data bases. AFGWC only maintains active on-line data bases that are up to 48 hours old.

Turn-around time for any given IPAM request may be a matter of minutes or many hours. Turn-around time is a function of the event time in the IPAM request, the availability of supporting data bases, and the level of effort for any analyst quality control required to deliver the IPAM product.

The IPAM production control program requires for all IPAM requests that 2 or 3 HIRAS data bases be available in order to complete the IPAM profile. To execute an IPAM request, request time. Normally, two consecutive HIRAS data bases are sufficient to bracket an IPAM event time. For example, if the IPAM event time is 1 July at 0001Z, then HIRAS data bases for 1 July at 0000Z and 0600Z are needed to execute the IPAM request. However, if the IPAM event time is the same as the HIRAS data base, e.g., 1 July 0000Z, then three HIRAS data bases are needed to bracket the IPAM event time.

Specifically, the 30 June 1800Z and the 1 July 0000Z and 0600Z HIRAS data bases would be necessary to execute an IPAM profile for a 1 July 0000Z IPAM event time.

Turn-around time is directly affected by the availability of data bases for use by application programs. Let's say a user specifies the need for an IPAM data profile for a 1 July 0001Z event and submits the request to arrive 1 July 0200Z.

The HIRAS data base cycles needed to support this request are 1 July 0000Z and 0600Z. The 1 July 0600Z HIRAS data base becomes available for use by application programs at approximately 1000Z. Thus, the IPAM request waits in the IPAM request queue until such time as the appropriate data bases become available for use.

AFGWC maintains the key HIRAS and RTNEPH data bases up to 48 hours after valid analysis time. Thus, the worst case HIRAS data bases must be available and bracket the IPAM scenario with respect to timelines for AFGWC to fulfill an IPAM data request are as follows:

AFGWC receives an IPAM data request for Day 'X' at 0000Z. The message is received at Day 'X+1' at 0000Z, i.e., 24 hours after event time. Part of the output required to satisfy the request is the Surface Weather History which requires data for Day 'X-1' at 0000Z. Thus, the request is at the limit of AFGWC's on-line and available data bases, e.g., Day X-1 at 0000Z to Day X+1 at 0000Z. Anytime after this point, data needed to be used to satisfy an IPAM request might not be available on-line at AFGWC. Thus, the policy was established that AFGWC would respond to IPAM requests received up to 24 hours after event time. Since the AFGWC system relies on automated processing, lack of necessary data bases would cause program errors, and create too much manual intervention to assess such problems. Therefore,

requests requiring data bases more than 48 hours old must be directed to USAFETAC.

When quality control of the IPAM output is requested by the user, this will add to the overall turn-around time for a given IPAM request. The amount of time may vary depending on the amount of quality control to be done or the need to rerun the profile.

#### 4.4.2 USAFETAC IPAM Processing and Turn-Around Time Procedures

USAFETAC will complete all valid IPAM requests and make every effort to meet the customer's requested need-by date.

USAFETAC can process any IPAM request with an event date of 1 January 85 to the present. Any request with an event date prior to 1 January 85 will be done using the old PA software, and it will be output in the old PA format. This restriction is caused by the nonavailability of HIRAS error fields, which are necessary for IPAM processing, and other data base conversion problems.

##### a. Limitations

Because of limitations in manpower and computer resources (particularly in the unclassified and collateral classified mode), there may be occasions when a request is delayed because of higher priority requests, lack of required data, etc. Since the same team of analysts processes all IPAM requests (SSP, collateral classified, and unclassified), heavy workload in one particular classification affects production in the other request classifications.

b. Turn-Around Time

Turn-around times are dependent upon total workload at or above the IPAM request project priority, the number of IPAM or PA profiles in the request, the method used to deliver the final product, the availability of required data, and the classification of the request. Specific details follow.

(1) Unclassified Requests.

Normal turn-around times for a small unclassified request of six or less IPAM data profiles is two weeks. Add one workday to send the final output to the customer using AUTODIN, or five workdays to send the final output by first class mail. Add an additional week for each increase of six (or less) IPAM data profiles in a request, e.g., three weeks plus transmission time for a request with 7 to 12 data requests; four weeks plus transmission time for a request with 13 to 18 data requests, etc.

(2) Collateral Classified Requests.

Normal turn-around time for a small classified request of six or less IPAM data profiles is one week. Add one workday to send the final output to the customer using AUTODIN, or five workdays to send the final output by first class mail. Add an additional week for each increase of six (or less) IPAM data profiles in a request.

(3) SSP Requests.

(a) For customers with secure communications capability. Normal turn-around time is 24 hours after receipt of the request, if the



IPAM event data time required to produce the profile are available in an on-line data base. For data times not available in the on-line data base, USAFETAC must perform time-consuming data loads, which may delay the request anywhere from one to two weeks, (longer if many IPAM or PA profiles are requested).

- (b) For customers without secure communications capability. Users need to contact Hqs AWS/XJT for distribution information and procedures for delivery of classified SSP information.

If the final output can be downgraded to collateral classified or unclassified (by using the sanitization option, i.e., removing all references to location and date/times), then the shipment methods and timelines described for unclassified and collateral IPAM data profiles can be used. Note that the additional handling of listings (versus mailing electronically) reduces production efficiency by 40 percent.

ATTACHMENT 1  
TERMS AND ABBREVIATIONS

The contents of this attachment are provided in two parts. Part A shows a listing of terms, acronyms and abbreviations associated primarily with the text portion of this User's Guide. Part B provides a consolidated listing of the abbreviations associated with the IPAM output data formats and equations that are presented in the text. There is a slight amount of duplication in the two listings.

PART A

|                   |  |
|-------------------|--|
| A                 | Three-Hourly Planetary Geomagnetic Index   |
| AAHAZE            | Alternate Normalized Aerosol Number Density  |
| Absolute Humidity | The mass of water vapor per volume of air  |
| Abs Hum           | Absolute Humidity  |
| AFGL              | Air Force Geophysics Laboratory  |
| AFGWC             | Air Force Global Weather Central   |
| AGL               | Above Ground Level   |
| AHAZE             | Normalized Aerosol Number Density  |
| AICSTL            | Alternate Profile Value for ICSTL  |
| AIHAZE            | Alternate Profile Value for IHAZE  |
| ALTVIS            | Alternate Surface Meteorological Visibility Range  |
| AUTODIN           | Automated Digital Network  |
| AWS               | Air Weather Service  |
| AWSR              | Air Weather Service Regulation   |
| buddy checking    | Comparison of observed data against surrounding observational data to ensure the value is representative and within a prescribed statistical bound |
| C                 | Centigrade   |
| cm                | centimeter   |
| cubic spline      | Mathematical technique to mesh data from two different sources   |

## default

|             |  |
|-------------|--|
| option      | A data flag or value which can be changed from a standard setting or value to a new setting or value   |
| deg         | degree   |
| °C          | Degrees Centigrade   |
| DoD         | Department of Defense  |
| EFTO        | Encrypt for Transmission Only  |
| emissivity  | The ratio of radiation intensity from a surface to the radiation at the same wavelength from a black body at the same temperature                    |
| F           | 10.7 cm Daily Flux   |
| ft          | Feet   |
| GL          | Geophysics Laboratory  |
| Groves-MSIS | Upper Atmosphere Density Model   |
| High Clouds | Clouds more than 20,000 ft AGL   |
| HIRAS       | High Resolution Analysis System  |
| HR          | Hour   |
| ICAO        | International Civilian Airlines Organization   |
| ICSTL       | Describes Whether Air Parcel is Maritime or Not  |
| IHAZE       | Primary Boundary Layer Aerosol Parameter   |
| Info        | Information  |
| IPAM        | Improved Point Analysis Model  |
| ISEASN      | Value Showing Seasonal Dependence of the Profiles for Tropospheric and Stratospheric Aerosols  |
| IVULCN      | Profile and Extinction Type for Stratospheric Aerosols   |
| Julian Day  | Sequential number for the day of the Year, where January 1st is day 001 and December 31st is day 365/366 depending on the occurrence of a leap year. |
| K           | Degrees Kelvin   |
| kg          | kilogram   |
| Km          | Kilometers   |
| Lat         | Latitude   |
| Lon         | Longitude  |
| Low Clouds  | Clouds less than 6,500 ft AGL  |
| LOWTRAN     | AFGL Atmospheric Transmissivity Model  |
| m           | meter  |
| mb          | millibar   |

|                      |   |
|----------------------|---|
| MEB                  | Moisture Error Bound  |
| MF                   | Mean 90-day 10.7 cm Flux  |
| Middle Clouds        | Clouds 6,500 to 20,000 ft AGL   |
| mixing ratio         | Ratio of mass of water vapor to mass of dry air   |
| nm                   | nautical mile   |
| NMC                  | National Meteorological Center  |
| NOAA                 | National Oceanographic and Atmospheric<br>Administration  |
| NUAV                 | New Upper Air Validator   |
| NWS                  | National Weather Service  |
| OI                   | Optimum Interpolation   |
| OIVP                 | Optimum Interpolation Vertical Profile  |
| P                    | Pressure in millibars   |
| PA                   | Point Analysis  |
| PAID                 | Point Analysis Identifier   |
| Pibal                | Upper Air Balloon to measure winds  |
| Pres                 | Pressure  |
| PWC                  | Precipitable Water Content  |
| QC                   | Quality Control   |
| QIHAZE               | Quality Index Showing How Well IHAZE fits the Aerosol<br>Model  |
| RAOB                 | Radiosonde Observation  |
| ROCOB                | Rocketsonde Observation   |
| RTNEPH               | Real Time Nephanalysis  |
| Sanitization         | Capability to ensure an IPAM output message is<br>unclassified, even though the request is classified |
| sec                  | second  |
| SESS                 | Space Environmental Support System  |
| Sfc                  | Surface   |
| Sigma                | Standard Deviation  |
| Slant Path           | Straight Line-of-Site Path from Point A to Point B  |
| Specific<br>Humidity | Ratio of the mass of water vapor to the mass of moist<br>air  |
| SSP                  | Special Strategic Programs  |
| STAFFMETS            | Staff Meteorologists  |
| TEB                  | Temperature Error Bound   |

|              |   |
|--------------|---|
| Temp         | Temperature   |
| template     | A list of required and optional information needed to execute an IPAM Message request at AFGWC or USAFETAC  |
| TN           | Technical Note  |
| TR           | Technical Report  |
| u            | Ordinate value of the vector wind component   |
| USAF         | United States Air Force   |
| USAFETAC     | USAF Environmental Technical Applications Center  |
| User         | Agency which receives and applies the IPAM Output   |
| v            | Abscissa value of the vector wind component   |
| VIS          | Surface Meteorological Visibility Range   |
| visual range | The distance, under daylight conditions, at which the apparent contrast between a specified type of target and its background becomes just equal to the threshold contrast of an observer; to be distinguished from the night visual range. The visual range is a function of the atmospheric extinction coefficient, the albedo and visual angle of the target, and the observer's threshold contrast at the moment of observation. Only in the so-called meteorological range does one have a visibility figure dependent only upon the extinction coefficient. |
| VPI          | Vertical Profile Information  |
| Wgt          | Weight  |
| WMO          | World Meteorological Organization   |
| WX           | Weather   |
| Z            | Zulu or Greenwich Mean Time (GMT)   |

### PART B

|                   |   |   |
|-------------------|---|---|
| A                 | = | Three Hourly Planetary Geomagnetic Index    |
| aaa               | = | Alternate Wind Speed                        |
| AHAZ              | = | Normalized Aerosol Number Density           |
| AHAZ <sub>a</sub> | = | Alternate Normalized Aerosol Number Density |
| AIR               | = | Aircraft Observation                        |
| bbb               | = | Cloud Layer Bases (in hundreds of feet)     |

|                      |   |  |
|----------------------|---|--|
| CC                   | = | Describes Whether Air Parcel is Maritime or Not  |
| $C_a C_a$            | = | Alternate Description Whether Air Parcel is Maritime or Not                            |
| cc                   | = | Air Mass Code  |
| c.cc                 | = | Correlation Coefficient for IPAM Source Data   |
| CMAXM                | = | $\text{MAX}(\text{FB}(i,j) * \text{WT}(i,j))$ for moisture                             |
| CMEANM               | = | Mean value of $\text{FB}(i,j)$ for moisture  |
| CMEANT               | = | Mean value of $\text{FB}(i,j)$ for temperature   |
| CORR                 | = | Correlation  |
| CWMAXT               | = | $\text{MAX}(\text{FB}(i,j) * \text{WT}(i,j))$ for temperature                          |
| ct                   | = | Cloud Type   |
| cv                   | = | Cloud Coverage   |
| d                    | = | Distance in nautical miles   |
| D                    | = | Difference in Height Between Two Layers of Clouds                                      |
| DD                   | = | Day of the Month   |
| DD                   | = | Dewpoint   |
| dd                   | = | Wind Direction in Tens of Degrees  |
| ddd                  | = | Wind Direction in Degrees  |
| d.ddd                | = | Density in Grams per Cubic Centimeter  |
| DEG                  | = | Degree   |
| DEG C                | = | Degrees Centigrade   |
| E                    | = | Exponential Indicator to the Base 10   |
| e                    | = | The Base for Natural Logarithms  |
| $\overline{e_i e_j}$ | = | Covariance of the observational instrument error at a point with that at another point |
| F                    | = | 10.7 cm Daily Flux   |
| FA                   | = | $\overline{f_i f_j} + \overline{e_i e_j}$  |
| F AGL                | = | Feet Above Ground Level  |
| FB                   | = | $\overline{f_g f_i}$   |
| $\text{FB}(i,j)$     | = | Correlation of $i$ observation residual and $j$ analysis level residual                |

|                      |   |  |
|----------------------|---|--|
| $\overline{f_g f_i}$ | = | Modeled covariance of the first guess error residual at a point with the residual error at another point |
| $\overline{f_i f_j}$ | = | Modeled covariance of the residual at a point with the residual at another point                         |
| fff                  | = | Wind Speed in Knots  |
| FINMEB               | = | Specific Humidity Error Value  |
| G                    | = | Indicator for Wind Gusts   |
| $\overline{g}$       | = | Average acceleration due to gravity  |
| gm                   | = | Gram   |
| g.ggg                | = | Absolute Humidity in Grams per Cubic Meter   |
| H                    | = | High Cloud Amount  |
| H                    | = | Primary Boundary Layer Aerosol Parameter   |
| H <sub>a</sub>       | = | Alternate Value for Boundary Layer Aerosol Parameter   |
| hh                   | = | Hour   |
| HHh                  | = | High Cloud Type  |
| hhh                  | = | Height of a Level  |
| hhhh                 | = | Station Elevation Height   |
| hhhhh                | = | Height of a Level  |
| IN                   | = | Inches   |
| JJJ                  | = | Julian Day of the Year   |
| K                    | = | Thousands of feet  |
| KTS                  | = | Knots  |
| L                    | = | Low Cloud Amount   |
| LL                   | = | Number of Levels in Aerosol Profile  |
| LLl                  | = | Low Cloud Type   |
| LLLL                 | = | Number of Lines in IPAM Message Paragraph  |
| llll                 | = | Station Call Letters   |
| M                    | = | Middle Cloud Amount  |
| M                    | = | Thousands (When Referring to Height)   |
| m                    | = | Meter  |
| M <sub>3</sub>       | = | Ozone Profile  |
| mb                   | = | Millibar   |
| MEB(j)               | = | Moisture Error Bound for a level   |
| MEBAVE               | = | Average Moisture Error Bound Value   |

|   |   |   |
|---|---|---|
| MEBMAX  | = | Maximum Moisture Error Bound Value  |
| MF  | = | Mean 90-day 10.7 cm Flux  |
| MIS   | = | Missing   |
| mm  | = | Zulu minutes of the Zulu time hour  |
| MMM   | = | Three Letter Abbreviation for Calendar Month  |
| MMm   | = | Middle Cloud Type   |
| NM  | = | Nautical Mile   |
| nnnn  | = | WMO Station Number  |
| NVALUE  | = | Refractive Index Value  |
| o   | = | Obscuration to Visibility   |
| P   | = | Pressure at a specified level   |
| PBL   | = | Pilot Balloon Observation   |
| ppp.p   | = | Pressure to Tenths of a Millibar  |
| ppp.pp  | = | Pressure to Hundredths of a Millibar  |
| pppp  | = | Pressure to Tenths of a Millibar  |
| pt  | = | Precipitation Type  |
| q   | = | Specific Humidity   |
| Q <sub>alt</sub>  | = | Alternate Profile Moisture Value  |
| Q <sub>i</sub>  | = | Moisture Value for a specific level   |
| QITEMP  | = | Temperature Quality Index   |
| QISH  | = | Moisture Quality Index  |
| QQ  | = | Quality Index Showing How Well Primary Boundary Layer<br>Aerosol Parameter Fits the Aerosol Model |
| qqqq  | = | Water Vapor Density   |
| q <sub>a</sub> q <sub>a</sub> q <sub>a</sub> q <sub>a</sub> | = | Alternate Water Vapor Density   |
| R   | = | Gas Constant  |
| R   | = | Scale Factor to determine cloud layer coverage  |
| RAB   | = | Radiosonde Observation  |
| rho (ρ)   | = | Density   |
| ROC   | = | Rocket Observation  |
| rr  | = | WMO Block Number  |
| S   | = | Value Showing Seasonal Dependence of the Profiles for<br>Tropospheric and Stratospheric Aerosols  |
| SSS   | = | Snow Depth in Inches  |
| s   | = | Sign (+) for plus or (-) for minus  |
| SAT   | = | Satellite Observation   |
| SAR   | = | Support Assistance Request  |



|  |   |  |
|--|---|--|
| sec  | = | Second   |
| sigma  | = | Standard Deviation                                     |
| sin  | = | Sine of an angle                                       |
| SPHUM  | = | Specific Humidity Analysis Value                       |
| SRC  | = | Source   |
| sss  | = | Wind Speed in Meters per second                        |
| T  | = | Total Clouds in Eights at RTNEPH Grid Point            |
| t  | = | Tens Digit   |
| t  | = | Number of Hours Since an Air Parcel Left Land          |
| T <sub>alt</sub>                             | = | Alternate Profile Temperature                          |
| Tan  | = | Tangent of an angle                                    |
| T <sub>i</sub>                               | = | Temperature for a specific level                       |
| T <sub>v</sub>                               | = | Virtual Temperature                                    |
| T/8  | = | Total Clouds in Eighths at RTNEPH Grid Point           |
| tc   | = | Total Cloud  |
| th   | = | Thickness  |
| T <sub>h</sub> T <sub>h</sub>                | = | Maximum 24 Hour Temperature                            |
| T <sub>l</sub> T <sub>l</sub>                | = | Minimum 24 Hour Temperature                            |
| TTT  | = | Temperature in Degrees Centigrade                      |
| T <sub>a</sub> T <sub>a</sub> T <sub>a</sub> | = | Alternate Temperature to Tenths of a Degree Centigrade |
| TEB(j)                                       | = | Temperature Error Bound for a level                    |
| TEBAVE                                       | = | Average of Temperature Error Values                    |
| TEBMAX                                       | = | Maximum Value in Temperature Data Set                  |
| TEE(j)                                       | = | Interpolated temperature error value for a level       |
| ttt  | = | Cloud Layer Top in hundreds of feet                    |
| TTTT   | = | Time (Zulu)  |
| TTTT   | = | Temperature to tenths of a Degree Centigrade           |
| u  | = | Unit Digit   |
| V  | = | Profile and Extinction Type for Stratospheric Aerosols |
| vv   | = | Surface Meteorological Visibility Range                |
| V <sub>a</sub> V <sub>a</sub>                | = | Alternate Surface Meteorological Visibility Range      |
| VSBY   | = | Visibility   |
| vv.vv  | = | Visibility   |
| w  | = | Mixing Ratio   |
| $\bar{w}$                                    | = | Average Mixing Ratio                                   |
| w <sub>j</sub>                               | = | Weight value   |

|         |   |  |
|---------|---|--|
| ww      | = | Present Weather  |
| w.ww    | = | Weight Factor for IPAM Source Data                       |
| WGT     | = | Weight   |
| WT      | = | $w_j$  |
| WT(i,j) | = | Weight of i observation residual for analysis at j level |
| x       | = | Number of Cloud Layers                                   |
| x/8     | = | Cloud Layer Amount in Eighths                            |
| X.XX    | = | Precipitable Water Amount in Centimeters                 |
| XX.XX   | = | Latitude   |
| XXX     | = | Source of IPAM Data                                      |
| XXX.X   | = | Distance to Nearest RAOB                                 |
| XXXX    | = | Latitude in Hundredths of a Degree                       |
| X 100   | = | Times One Hundred  |
| YY      | = | Calendar Year (Tens and Unit Digits)                     |
| YYY.Y   | = | Bearing of Nearest RAOB                                  |
| YYY.YY  | = | Longitude  |
| YYYYY   | = | Longitude in Hundredths of a Degree                      |
| Z       | = | Zulu Time Indicator                                      |

ATTACHMENT 2  
OPTIMUM INTERPOLATION IN IPAM

At the core of the upgrade from the early Point Analysis (PA) capability to the Improved Point Analysis Model (IPAM) was the transition from the PA's reliance on a single radiosonde observation (RAOB) in the vicinity of the analysis point to the application of the Optimum Interpolation (OI) method. In this attachment, the motivation for use of the OI method is presented, as well as a discussion of the nature of the CI scheme used in IPAM.

Background Information:

Prior to the development of the IPAM capabilities, point analyses (PAs) produced at AFGWC and USAFETAC relied upon the availability of radiosonde observations (RAOBs) in the vicinity of the analysis point to represent the condition of the atmosphere. Originally a strictly manual analysis, the RAOB-based approach suffered from several fundamental limitations, including the following:

- 1) Displacement in space. The PA method was forced to assume that the RAOB selected as the basis for the analysis provided an accurate representation of atmospheric conditions at the location of the point for which the analysis was desired. However, the atmosphere is highly non-homogeneous in all dimensions, so that the correlation between conditions at the RAOB site and the analysis point falls rapidly as their separation distance increases.
  
- 2) Displacement in time. Similarly, the PA method was forced to assume that the selected RAOB profile was representative of conditions at the analysis point at the time desired for the analysis. However, atmospheric conditions vary significantly with time, so that the correlation between conditions at the RAOB site and the analysis site is reduced by the time

difference between the RAOB data time and the desired analysis time.

- 3) Non-verticality of RAOB profile. RAOB soundings are obtained by sensor packages borne aloft by buoyant balloons. The sounding path is thus affected by the vertical profile of winds at and near the RAOB site. As these profiles are not routinely predictable, it is necessary to assume that the RAOB ascent represents a vertical profile above the RAOB site. However, the actual RAOB trajectory may cover a horizontal distance on the order of 100 Km from the point of release. Due to the horizontal variability of the atmospheric conditions, the correlation of the RAOB profile with actual conditions above the RAOB site degrades as the altitude increases.
  
- 4) Quality of RAOB data. As the PA method relied entirely on the data provided by a single RAOB profile, no objective method existed to identify and adjust or reject faulty data within the RAOB. Quality control depended primarily on the meteorological experience and judgement of the analyst responsible for the point analysis.

All these limitations of the RAOB-based approach are overcome by the application of the optimum interpolation (OI) method of analysis of meteorological fields.

The theory of optimum interpolation (also called statistical interpolation) was first introduced by Eliassen (1954). L. Gandin (1963) of the Soviet Union developed the technique and is credited with its subsequent widespread use. The National Meteorological Center (NMC) used Gandin's work along with the optimum interpolation theory described by Bergman (1979) as the basis for the NMC Global Data Assimilation System (McPherson et al, 1979). The formulation of the NMC optimum interpolation model is described by McPherson (1980,

1982). This technology was transferred to AFGWC to form the basis of the High Resolution Analysis System (HIRAS) and the OI component of the Improved Point Analysis Model (IPAM). AFGWC Tech Note 9124B (1986) provides an excellent summary of the OI method as applied to the AFGWC HIRAS. All the aforementioned references are listed on pages A2-8 and A2-9 of this attachment, as well as in Section 1.2.

#### Data Used:

To support the OI analysis used in IPAM, the following data bases and support files are used at AFGWC and USAFETAC:

- 1) HIRAS gridded data base - provides the first-guess analysis and error fields used in the OI method;
- 2) Upper-air Regions data base - provides the observational data from radiosondes (RAOBS), pilot balloons (PIBALS), satellite soundings, and rocket observations (ROCOBS);
- 3) Surface Regions data base - provides the observational data from surface reporting stations and ships;
- 4) Aircraft observations data base - provides the observational data from aircraft; and
- 5) File of sensor error tables - provide the profiles of estimated instrument errors associated with each type of meteorological observation included in items 2 through 4 above.

#### Procedures to Analyze Data:

In general terms, the optimum interpolation (OI) method provides a statistical analysis of meteorological observations throughout an area surrounding a point for which an analysis is desired. The object of

the analysis is to determine a "best fit" value at the analysis point on the basis of the surrounding observational data and the first-guess field. The key technical considerations used in the analysis are the following:

- 1) All observations within the specified radius of the analysis point are considered for the analysis. Their relative significance to the analysis is determined by a combination of correlation factors, including the horizontal and vertical separation between the observation point and the desired analysis point, and the difference between the time of the observation and the desired time of the analysis. After all the observational data within the search radius have been correlated in this manner, they are ranked by total correlation, and only a specified number of the highest correlated observations are used for the final analysis. Typically, the top 50 observations are selected from the ranked set.
  
- 2) Each observation is checked for values out of the probable range. This is a two-stage process. The first stage (the gross-check) tests each observational datum against a climatological range, and rejects the observation if its value is outside that range. This eliminates outliers with extreme values due to reporting errors or other anomalous conditions. In the second stage, if an observation passes the gross check but is found to deviate from the climatological mean by more than a specified threshold value, it is tested against other observations in the area. This test (the buddy-check) is accomplished by performing a complete OI analysis at the location of that observation, using all data in the area except the suspected observation. If the resulting analyzed value at the point of the suspected observation differs from the observation by more than a specified limit, the observation is rejected.

- 3) The analysis is performed on the basis of "observation residuals". The OI method requires that the analysis be performed on variables which are calculated from the difference between the observational value at a given point and the first-guess field at that point. In IPAM, the first-guess field is provided by the HIRAS data base. For a given observation at an arbitrary location, it is necessary to interpolate the HIRAS gridded fields in space and time to obtain the best possible estimate of the first-guess value at the location and time of the observation. For this reason, it is necessary in IPAM to access HIRAS data bases with valid times both before and after the time of the observation, and to obtain values from the four HIRAS grid points surrounding the location of the observation. For each HIRAS time-cycle, the gridded HIRAS field values are first vertically interpolated to the pressure-level of the observation. A bilinear horizontal interpolation is then performed to the location of the observation, and, finally, a linear time interpolation is made to the time of the observation. The resulting value represents the first-guess value at the observation location and time. The difference between this value and the observation value is taken as the observation residual for the remainder of the analysis.
- 4) In IPAM, the OI analysis is performed directly on the following meteorological variables: height; U-wind component; V-wind component; temperature; and, specific humidity. All analyses in IPAM are univariate, i.e., the OI analysis for each of the stated variables is performed independently of all other variables. For each analysis variable, a separate OI analysis is performed at each pressure level required to form the vertical profile. In IPAM, a total of 50 levels may

be specified for analysis, thus requiring a total of 250 separate OI analyses (5 analysis variables X 50 levels) to complete the profile.

- 5) The crux of the OI analysis is the solution of a system of linear equations involving the weights and correlations of the observation residuals in order to minimize the analysis error terms. For details of this procedure, References 4 and 7, shown near the end of this attachment, are recommended. The result of this calculation is a final analyzed residual value for the particular analysis variable, at the location, level, and time of the desired analysis.
- 6) The final step in the OI process is to construct the final analysis value. This is performed simply by adding the final analyzed residual value (calculated in procedure 5 above) to the first-guess value at the analysis point.

#### Results of the Analysis:

The basic result of the IPAM OI analysis is the vertical (or slant-path) profile of meteorological variables reported in IPAM Paragraph I (Optimum Interpolation).

In addition, the OI analysis provides indicators of the quality of the analysis by means of Quality Indices (QI) and the data source-weight table. These indicators are reported in IPAM Paragraph G (Remarks).

#### Advantages:

The IPAM implementation of the OI analysis method offers a number of very significant advantages over the RAOB-based point analysis method, including the following:



- 1) OI does not depend on the proximity of a RAOB site relative to the location of the analysis point;
- 2) The OI method is protected from invalid data by gross-checks, buddy-checks, and the basic controlled use of all available observational data in the area;
- 3) OI results are interpolated in space and time to the analysis point;
- 4) OI provides the capability for profiles along a non-vertical (slant) path;
- 5) OI takes maximum advantage of the data bases at AFGWC and USAFETAC;
- 6) OI incorporates satellite sounding data over otherwise data-sparse regions; and
- 7) OI provides indicators of the quality of the analysis by virtue of Quality Indices and the data source-weight table.

Dependencies:

The IPAM application of the OI method described herein is entirely dependent upon the availability and quality of the HIRAS data base. The IPAM OI model will operate satisfactorily in the "first-guess only" mode, in which no observational data are considered. In this configuration, the final result will simply represent the HIRAS fields, interpolated to the location, levels, and time specified for the vertical analysis profile.

For basic functionality, the IPAM OI model requires at least one HIRAS data cycle earlier than the specified analysis time and at least one HIRAS data cycle later than the specified analysis time. The IPAM OI

model can be run in "first-guess only" mode with a single HIRAS data cycle, if the specified analysis time exactly matches the valid time of the available HIRAS cycle.

In the total absence of HIRAS data bases, the IPAM OI model will not function.

#### References:

The following list provides references for the literature describing the Optimum Interpolation Scheme. These references constitute the primary source materials used in the development of the OI capabilities for the IPAM program.

1. Bergman, K.H., (1979), "Multivariate analysis of temperature and winds using optimum interpolation", Monthly Weather Review 107:1423-1444.
2. Eliassen, A., (1954), "Provisional report on calculation of spatial covaria and autocorrelation of the pressure field", Rapport No. 5, Videnskaps-Akademie Institute for Vaer-Ogklimaforskning, Oslo, Norway. Reprinted in Dynamic Meteorology: Data Assimilation Methods, L. Bengtsson, M. Ghil, and E. Kallen, eds. Applied Mathematical Sciences, V36, Springer-Verlag, New York, 1981.
3. Gandin, L. S., (1963), "Objective analysis of meteorological fields", Isdat., Leningrad (Israel Program for Scientific Translations, Jerusalem, 1965, 242 pp.)
4. McPherson, R. D., (1980), "Theory of optimum interpolation," Office Note 217, National Meteorological Center, NWS, NOAA, Washington, D.C., 33 pp.

5. McPherson, R. D., (1982), "Optimum interpolation: basic formulation and characteristics", Office Note 265, National Meteorological Center, NWS, NOAA, Washington, D.C., 14 pp.
6. McPherson, R. D., K. H. Bergman, R. E. Kistler, G. E. Rasch, and D. S. Gordon, (1979), "The NMC operational Global Data Assimilation System", Monthly Weather Review, 107:1445-1461.
7. The AFGWC High Resolution Analysis System (HIRAS), AFGWC Tech Note 9124B, 11 June 1986.

### Miscellaneous:

#### 1) Equations/algorithms

For a detailed explanation of the mathematical methods used in the OI analysis, the reader should consult the references.

#### 2) Client options

The data items listed in Table A2-1 represent those options which can be related to the OI methodology. They are available to the IPAM user via selections in the request templates as described in Section 4 of this User's Guide. Thus, the User can selectively choose the data which are to be considered for a specific analysis. If there is some concern that certain data may not be suitable for the final analysis profile, the User can simply set the appropriate data item equal to "N" in the request sent to AFGWC or USAFETAC.

TABLE A2-1.

## User IPAM Request Options Which Can Involve Optimum Interpolation

| <u>DATA</u><br><u>ITEM</u> | <u>DESCRIPTION</u>                   | <u>RANGE OF</u><br><u>VALUES</u> |
|----------------------------|--------------------------------------|----------------------------------|
| VPI                        | DO A VERTICAL PROFILE? FLAG          | Y,N                              |
| OIYN                       | DO AN OI VERTICAL PROFILE? FLAG      | Y,N                              |
| FGONLY                     | FIRST GUESS ONLY FLAG                | Y,N                              |
| URAOB                      | USE RAOBS? FLAG                      | Y,N                              |
| UPIBAL                     | USE PIBALS? FLAG                     | Y,N                              |
| USAT                       | USE SATELLITES? FLAG                 | Y,N                              |
| UPIREP                     | USE PILOT REPORTS? FLAG              | Y,N                              |
| USFC                       | USE SURFACE REPORTS? FLAG            | Y,N                              |
| UROCOB                     | USE ROCKET OBSERVATIONS? FLAG        | Y,N                              |
| OIPARF                     | OI IN PARAGRAPH F? FLAG              | Y,N                              |
| DATAWT                     | PRINT DATA SOURCE-WEIGHT TABLE? FLAG | Y,N                              |
| SLANT                      | SLANT PATH? FLAG                     | Y,N                              |
| AZMUTH                     | SLANT PATH AZIMUTH*10                | 0001-3600                        |
| ELEVAT                     | SLANT PATH ELEVATION*10              | 100-900                          |
| HRZPTH                     | HORIZONTAL PATH? FLAG                | Y,N                              |
| ENLTD                      | ENDING LATITUDE DEGREES              | 0-90                             |
| ENLTM                      | ENDING LATITUDE MINUTES              | 0-59                             |
| ENLTK                      | ENDING LATITUDE KEY                  | N/S                              |
| ENLND                      | ENDING LONGITUDE DEGREES             | 0-180                            |
| ENLNM                      | ENDING LONGITUDE MINUTES             | 0-59                             |
| ENLNK                      | ENDING LONGITUDE KEY                 | E/W                              |
| BEGALT                     | BEGINNING POINT ALTITUDE             | 400000 MAX                       |
| ENDALT                     | ENDING POINT ALTITUDE                | 400000 MAX                       |

**ATTACHMENT 3**  
**RAOB VERTICAL PROFILE (RAOVBP)**

The RAOB Vertical Profile is a vertical profile of actual and analyzed atmospheric data based on a single "best" RAOB sounding. The vertical profile consists of height (surface to 400,000 feet), wind (surface to 100,000 feet), temperature (surface to 400,000 feet), absolute humidity (surface to 100,000 feet), density (surface to 400,000 feet), and pressure (surface to 0 mb) data for predetermined levels. Output heights in meters may also be selected. These predetermined levels are described in Section 3.6.2. The levels may be in AGL or MSL depending on user specification. The RAOB analysis profile is developed using the following procedures:

- a. The upper air data base is searched to identify RAOBs to use as a skeletal structure for a vertical profile. The first step in constructing a vertical profile is to search the data base for a suitable sounding. A suitable sounding is defined as follows:
  - (1) occurs within 15 hours of the requested IPAM event time;
  - (2) is located within a specified radius, i.e., 400nm, of the IPAM event latitude and longitude (NOTE: User can select a radius of 100 to 2000 nm in the AUTODIN message or 105-18 request. The 400 nm radius is the preferred radius to satisfy user requests);
  - (3) contains at least four values of dewpoint depression; and
  - (4) contains a pressure level at least as high as a specified pressure level. This pressure level is specified in the request template by the IPAM analyst; and
  - (5) winds at all mandatory levels are present.

If no suitable sounding is identified, and the user has specified that analysis fields should be used, the data in the HIRAS

analysis fields are used for the skeletal structure. If the user has specified that analysis fields are not to be used, the IPAM run terminates with an appropriate error message.

The surface elevation is a critical value to the interpolation and extrapolation schemes used to obtain values for any missing profile data. If, for any reason, the surface elevation is missing and the value cannot be interpolated from the terrain data base, then the RAOB is reclassified as unsuitable, and another search is conducted for a suitable RAOB.

- b. The HIRAS analysis fields are used to fill in missing data at the mandatory levels of the skeletal profile. Values for missing mandatory levels in the skeletal profile are obtained through bilinear interpolation of the HIRAS analysis fields. The combination of HIRAS analysis fields with the skeletal profile is called the "basic RAOB profile".
- c. The RAOB profile is completed by using interpolation and extrapolation techniques and methods to obtain values for the remaining data levels. The final RAOB vertical profile may have missing data at other than mandatory RAOB levels. If analysis fields are not used, data also may be missing at mandatory RAOB levels. The IPAM program will not abort due to missing data at mandatory levels. ROCOB data and the Groves/MSIS technique are used to complete the profile to 400,000 feet.

Figure A3-1 shows a sample output of the RAOBVP, which appears in Paragraph F of the IPAM output.

| F. WINDS,<br>HEIGHT<br>F MSL | TEMPERATURE<br>DIR<br>(DEG) | ABS SPEED<br>(M/SEC) | HUMIDITY,<br>TEMP<br>(DEG C) | DENSITY,<br>ABS HUM<br>(GM/M3) | PRESSURE -<br>DEN<br>(GM/CM3) | PRES<br>(MB) |
|------------------------------|-----------------------------|----------------------|------------------------------|--------------------------------|-------------------------------|--------------|
| 0M                           | 0.                          | 0.                   | 4.                           | 5.933E+00                      | 1.261E-03                     | 1008.0       |
| 1M                           | 318.                        | 4.                   | 3.                           | 5.203E+00                      | 1.222E-03                     | 971.0        |
| 2M                           | 318.                        | 5.                   | 2.                           | 4.507E+00                      | 1.183E-03                     | 935.0        |
| 3M                           | 318.                        | 6.                   | 0.                           | 3.902E+00                      | 1.145E-03                     | 901.0        |
| 4M                           | 318.                        | 6.                   | -1.                          | 3.377E+00                      | 1.108E-03                     | 867.0        |
| 5M                           | 317.                        | 7.                   | -3.                          | 3.335E+00                      | 1.072E-03                     | 834.0        |
| 6M                           | 315.                        | 8.                   | -5.                          | 3.358E+00                      | 1.038E-03                     | 802.0        |
| 7M                           | 313.                        | 9.                   | -6.                          | 3.021E+00                      | 1.006E-03                     | 771.0        |
| 8M                           | 311.                        | 9.                   | -8.                          | 2.727E+00                      | 9.731E-04                     | 742.0        |
| 10M                          | 310.                        | 11.                  | -11.                         | 2.171E+00                      | 9.105E-04                     | 686.0        |
| 12M                          | 313.                        | 14.                  | -13.                         | 1.402E+00                      | 8.471E-04                     | 633.0        |
| 14M                          | 314.                        | 16.                  | -17.                         | 9.523E-01                      | 7.924E-04                     | 584.0        |
| 16M                          | 315.                        | 19.                  | -20.                         | 7.485E-01                      | 7.414E-04                     | 538.0        |
| 18M                          | 316.                        | 21.                  | -22.                         | 6.860E-01                      | 6.893E-04                     | 496.0        |
| 20M                          | 320.                        | 23.                  | -27.                         | 4.502E-01                      | 6.458E-04                     | 456.0        |
| 25M                          | 327.                        | 28.                  | -39.                         | 1.239E-01                      | 5.466E-04                     | 368.0        |
| 30M                          | 334.                        | 30.                  | -52.                         | 2.396E-02                      | 4.604E-04                     | 293.0        |
| 35M                          | 334.                        | 23.                  | -56.                         | 2.310E-03                      | 3.703E-04                     | 230.0        |
| 40M                          | 322.                        | 14.                  | -51.                         | 8.572E-04                      | 2.857E-04                     | 182.0        |
| 45M                          | 306.                        | 9.                   | -50.                         | 6.750E-04                      | 2.250E-04                     | 144.0        |
| 50M                          | 310.                        | 8.                   | -50.                         | 5.345E-04                      | 1.782E-04                     | 114.0        |
| 60M                          | 24.                         | 3.                   | -49.                         | 3.352E-04                      | 1.121E-04                     | 72.0         |
| 70M                          | 132.                        | 6.                   | -50.                         | 2.124E-04                      | 7.081E-05                     | 45.0         |
| 80M                          | 149.                        | 9.                   | -47.                         | 1.319E-04                      | 4.397E-05                     | 29.0         |
| 90M                          | 148.                        | 11.                  | -45.                         | 8.312E-05                      | 2.771E-05                     | 18.0         |
| 100M                         | 115.                        | 8.                   | -39.                         | 5.197E-05                      | 1.732E-05                     | 12.0         |
| 120M                         | ****                        | ****                 | -21.                         | *****                          | 9.471E-06                     | 7.1          |
| 140M                         | ****                        | ****                 | 0.                           | *****                          | 3.235E-06                     | 2.5          |
| 160M                         | ****                        | ****                 | 6.                           | *****                          | 1.505E-06                     | 1.2          |
| 180M                         | ****                        | ****                 | -1.                          | *****                          | 7.348E-07                     | 0.5          |
| 200M                         | ****                        | ****                 | -19.                         | *****                          | 3.603E-07                     | 0.2          |
| 220M                         | ****                        | ****                 | -46.                         | *****                          | 1.739E-07                     | 0.1          |
| 240M                         | ****                        | ****                 | -77.                         | *****                          | 7.682E-08                     | 0.0          |
| 260M                         | ****                        | ****                 | -103.                        | *****                          | 2.899E-08                     | 0.0          |
| 280M                         | ****                        | ****                 | -115.                        | *****                          | 8.971E-09                     | *****        |
| 300M                         | ****                        | ****                 | -111.                        | *****                          | 2.446E-09                     | *****        |
| 320M                         | ****                        | ****                 | -91.                         | *****                          | 6.651E-10                     | *****        |
| 340M                         | ****                        | ****                 | -54.                         | *****                          | 2.002E-10                     | *****        |
| 360M                         | ****                        | ****                 | 1.                           | *****                          | 7.052E-11                     | *****        |
| 380M                         | ****                        | ****                 | 66.                          | *****                          | 2.963E-11                     | *****        |
| 400M                         | ****                        | ****                 | 130.                         | *****                          | 1.463E-11                     | *****        |

Figure A3-1. Sample Final Output of the RAOBVP Analysis Profile

## ATTACHMENT 4

## OIVP - OPTIMUM INTERPOLATION VERTICAL PROFILE

The objective of this attachment is to provide the IPAM user with a general discussion on the procedures used to produce the Optimum Interpolation Vertical Profile (OIVP) for the IPAM Final Output.

The OIVP is built using observation data, Upper Air (PIBAL, RAOB, ROCOB, Satellite), Aircraft, and Surface data, and the HIRAS data base. Optimum Interpolation (OI) is performed at the pressure surfaces required to build a profile from the surface to 400,000 feet.

Observations are collected from the data base that are located within a specified search area surrounding the IPAM point and are within the range of + or - six hours from the IPAM event time. For the search area the default value is 400 nautical miles. The maximum search area is a request template data item which the user can change via the AUTODIN message or 105-18 request to suit the needs of each individual IPAM request. If slant path is requested, the search area is automatically expanded in the direction of the slant path analysis to ensure enough data are available to include the slant path subpoints (see Attachment 8).

When all the data are collected, the best correlated observations are saved. Observations are accepted which have the highest correlation to the IPAM event location and time, and pass the minimum threshold value established by the analyst for inclusion. The number of observations kept is limited to a maximum of 50 each for surface, aircraft, and upper air observations.

Rocket observation data above 100,000 feet are collected, if available, and used in the extended profile (see Attachment 9).

HIRAS analysis and error data are extracted from the data base surrounding the analysis point in space and time. If slant path analysis is requested, all interpolations are performed along the slant path. The extracted HIRAS analysis and error values are



interpolated to the IPAM location, time, and output levels for use as a first guess. The first guess analysis and error values surrounding the observation locations are interpolated to the observation locations, levels and times. Residuals, the difference between the analysis first guess value at an observation's location, level, and time, and the observation's data value, are calculated.

To perform an OIVP analysis for the IPAM point, the following procedures occur:

1. Data selection criteria are applied to observations, discarding any observations requested to be omitted. Up to 20 WMO numbers may be omitted. The user may specify station numbers to omit from analysis by including the station number information in a separate communication to AFGWC or within the request sent to USAFETAC. The analyst makes the appropriate entry into the IPAM request template.
2. Buddy checking, comparing questionable observations with good observations that surround them, is done on questionable data. Buddy-checking of data is done automatically within the IPAM program runstreams.
3. The OI analysis is performed using the first guess data as a basis and a weighted average based on correlations of surrounding observations.

The final analyzed profile is created, including weights and quality index profiles. The profile is converted from pressure surfaces to height surfaces (AGL/MSL), and moisture is added to the profile above the 300mb level if observational data are not provided above this level. Density is computed for each level using the ideal gas law.

The vertical profile is extended from 100,000 feet to the 400,000 foot level using a combination of the Groves/MSIS model (see Attachment 14), ROCOB data (see Attachment 9), when available, and the Cubic Spline Technique (see Attachment 15) to connect two different data

sources. If the Aerosol Parameter profile is requested, the IPAM profile is extended to only 100,000 meters.

An input file is produced for calculation of Precipitable Water Content, Paragraph E. This file contains data for the 500 foot profile or the 250 meter profile if the Aerosol Parameters profile is requested. This profile contains pressure, mixing ratio, and the average acceleration due to gravity for use by the Precipitable Water module.

The temperature and moisture error bounds are determined using a weighted average. The alternate temperature and moisture error bounds are produced using a weighted average. The alternate temperature and moisture profile for each output level is produced. The Quality Indicators (see Attachment 18) for temperature and moisture are calculated.

The OI technique supports the following IPAM output paragraphs for the production of a vertical profile:

1. Paragraph H, the Aerosol Parameters profile containing alternate temperature and moisture profiles, quality indicators, and other OI data;
2. Paragraph D, the Pseudo-Surface Observation, specifically the wind data analyzed from surface observations;
3. Paragraph E, Amounts of Precipitable Water;
4. Paragraph I, Detailed Wind, Temperature, Absolute Humidity, Density, and Pressure data;
5. Paragraph J, Surface Weather History;
6. The SDHS-Profile containing the SDHS upper air plot profile and alternate temperature and moisture profiles produced for AFGWC only; and

7. Paragraph K, Refractive Index.

**ATTACHMENT 5**  
**RAOB vs OIVP**

The IPAM system offers the user two primary choices to calculate a vertical profile of atmospheric data for a specific date, time, and location anywhere on Earth. The methods are: 1) the Optimum Interpolation Vertical Profile (OIVP); and, 2) the RAOB Vertical Profile (RAOBVP), a method based on the use of a single radiosonde observation in the vicinity of the analysis point of interest. In this attachment, the differences between those two methods are summarized, along with the relative advantages and disadvantages of each method.

Background Information:

The original method for obtaining a vertical atmospheric data profile centered on using a representative RAOB as the foundation for the Point Analysis product. Data from analysis fields were used to supplement the profile as needed. Over the years technical application needs have changed, and there is a need to provide the best and most reliable data to users. Thus, the Optimum Interpolation method was applied to available meteorological data to improve the overall capabilities of the vertical data profile or the Point Analysis. The format and basic contents of the long-used Point Analysis product has been preserved in the Improved Point Analysis Model product, primarily to support the specialized mission requirements of specific customers. The output of the IPAM has been expanded to meet new requirements.

The capability to obtain a RAOB-based profile using the IPAM system was retained in order to preserve the format and content of the original Point Analysis in support of specialized mission requirements of certain customers. When point analysis requests sent to USAFETAC require the use of archived data prior to 1 January 1985, the output will be created using the old PA model, as the IPAM model cannot be applied to data prior to 1 January 1985.

Advantages and Disadvantages:

In some circumstances the RAOB-based method will provide a more appropriate and accurate vertical data profile than the OI method. On the other hand, the OI method offers significant advantages for applications in which the desired analysis point is remote from any RAOB soundings, or in case the desired analysis time is significantly different from release times for RAOB stations in the vicinity. Discussions on these and other significant advantages and disadvantages between RAOBVP and OIVP follow.

One of the key differences between the RAOBVP and OIVP methods is the absence in RAOBVP of any method for interpolation of the atmospheric conditions to the location and time for which the analysis is desired. In RAOBVP, it is necessary to assume that the conditions reported by the RAOB profile are generally representative of the area, and that they are, therefore, appropriate for the analysis point. Obviously, the validity of this assumption degrades as the separation in time and space between the RAOB site and the analysis point increases.

While OIVP is preferred for IPAM requests, there may be special situations in which a RAOBVP is preferable. Consider an application in which a point analysis is desired for the time and location of a research-oriented missile test launch, and a RAOB sounding is made simultaneously with the missile launch. In such a case, assuming typical quality of the RAOB sounding, the RAOB-based profile provides the actual "in situ" measurements at the time and location of the launch. Errors normally introduced in the OI analysis as a result of interpolation in time and space are absent, except to the extent that any missing RAOB levels are filled in with interpolated HIRAS data, remembering also that the HIRAS analysis is a product of the OI method. Even so, an OIVP for this missile launch site will heavily use the available RAOB profile data, and the OIVP can still overall be the best data profile.

Conversely, the OI method is the advantageous choice for analyses over traditionally data-sparse areas such as oceans, deserts, polar regions, and undeveloped areas of the southern hemisphere. In addition, the OI method does not rely on any single observation, but makes use of all available observations in an area surrounding the analysis point to arrive at the best possible profile at the analysis point. In this way, inaccuracies in individual observations are compensated by the "best fit" process implicit in the OIVP method of analysis.

OIVP also offers a significant advantage over RAOBVP in its capability to provide profiles along either vertical or non-vertical (slant) paths through the atmosphere. In the case of the vertical profile, this is a subtle advantage. OIVP provides a truly vertical profile, while the RAOB, by virtue of its balloon-borne sensing technique, follows an irregular trajectory depending on local wind conditions. Thus, the RAOB's actual profile is never truly vertical.

As noted, OIVP can provide profiles along slant paths through the atmosphere. For such profiles, the OI analyses are performed at the locations of points where the slant path intersects the constant pressure surfaces corresponding to the pressure levels specified for the point analysis. This capability increases in significance as the slant path elevation angle (the angle above horizontal) approaches tangency to the local horizontal plane. In this configuration, the horizontal displacement between the origin of the slant path at the surface and its intersections with high-altitude pressure surfaces may be sufficiently large that the high-level profile points are under the influence of different weather patterns from the low-level profile points. The horizontal displacement factor may be even more pronounced for line-of-sight. The OI method is easily applicable along the slant path. No comparable method exists for adjustment of RAOB-based profiles relative to slant paths.

To provide some sense of the areal distribution of atmospheric conditions, RAOBVP tests all available RAOBs within the specified search radius from the analysis point. All RAOBs satisfying the criteria for acceptability are then ranked by objective scoring criteria, and the top five from the resultant ranking are saved. The top-ranked RAOB forms the basis for the actual profile reported, and the remaining four RAOBs are reported as "alternate RAOBs". There is no corresponding function in OIVP.

Both RAOBVP and OIVP use the same methods for extension of the reported profile to the IPAM upper limit of 400,000 feet. If either the OIVP profile or the RAOB-based profile fails to reach or surpass 100,000 feet, an extrapolation model is used to extend the profile to 100,000 feet. In all cases, a high-level model combining climatology and photo-chemical process modeling is used to further extend the profile from 100,000 to 400,000 feet. Above 100,000 feet, only temperature, pressure, and density are reported, and valid RAOB wind data when available above 100,000 feet AGL/MSL.

Because of the overall improvement to the analyzed meteorological data bases and the numerous advantages of the OI methodology, Users of IPAM are strongly urged to select the OIVP option for obtaining atmospheric data profiles. In a vast majority of cases, OIVP should provide the best possible data for analytical applications of the data. When situations warrant, the selection of the RAOBVP should be made because of the known proximity and timing of RAOB information. The important key is for users to know and understand the data choices available and to select the most appropriate option to fit the requirement.

**ATTACHMENT 6**  
**PRECIPITABLE WATER CONTENT**

The purpose of this attachment is to provide the user with the definition of precipitable water and an explanation on how it is calculated for the IPAM output.

Precipitable Water is defined as the depth of water (cm) that can be precipitated out of a column of air one centimeter square for a specified layer.

The data in the AFGWC and USAFETAC data bases used to calculate the precipitable water content (PWC) are interpolated to 500 foot increments from the surface to 100,000 feet AGL at the event site.

PWC is calculated for a layer (from height  $z_{j-1}$  to height  $z_j$ ,  $j > 1$ ) from the following equation:

$$PWC_{j-1} = \frac{\left[ \frac{w_{j-1}}{1 + w_{j-1}} + \frac{w_j}{1 + w_j} \right] * .5 * (P_{j-1} - P_j)}{\bar{g} \sin(D)}$$

where,  $w$  equals the mixing ratio at a specific level, and the term

$$\left[ \frac{w_{j-1}}{1 + w_{j-1}} + \frac{w_j}{1 + w_j} \right] * .5$$

is the average mixing ratio ( $\bar{w}$ ) for the layer  $j-1$  to  $j$ ;



$P$  equals the pressure at a specified level, and  
 $(P_{j-1} - P_j)$  is the difference in pressure at  
the top and bottom of the layer;

$\bar{g}$  is the average acceleration due to gravity for the  
layer; and,

$\sin(D)$  is the sine of the slant path elevation angle. If  
the request for an IPAM profile is a routine request,  
i.e., no slant path, then the  $\sin(D)$  is automatically  
set to 1 or the sine of  $90^\circ$ .

The foregoing equation for PWC can then be written as:

$$PWC_{j-1} = \frac{\bar{w}_{j-1} * (P_{j-1} - P_j)}{\bar{g} \sin(D)}$$

Now, the meteorological information available from the various AFGWC and USAFETAC data bases do not conveniently have levels at 500 feet AGL at an IPAM profile point. Therefore, the calculations for PWC for a specific layer consist of average information for the actual data base levels that comprise a given 500 ft AGL layer. Figure A6-1 depicts a typical relationship for data base levels with respect to a 500 ft AGL layer for the IPAM event site.

Calculations of  $\bar{w}$ , the average mixing ratio, are made for each existing data base layer. Then, each portion of the PWC from each data base layer is determined, and the sum of these values equal the total PWC for a 500 ft AGL layer. The equation to calculate the PWC for a 500 ft AGL layer as shown in Figure A6-1 is as follows:

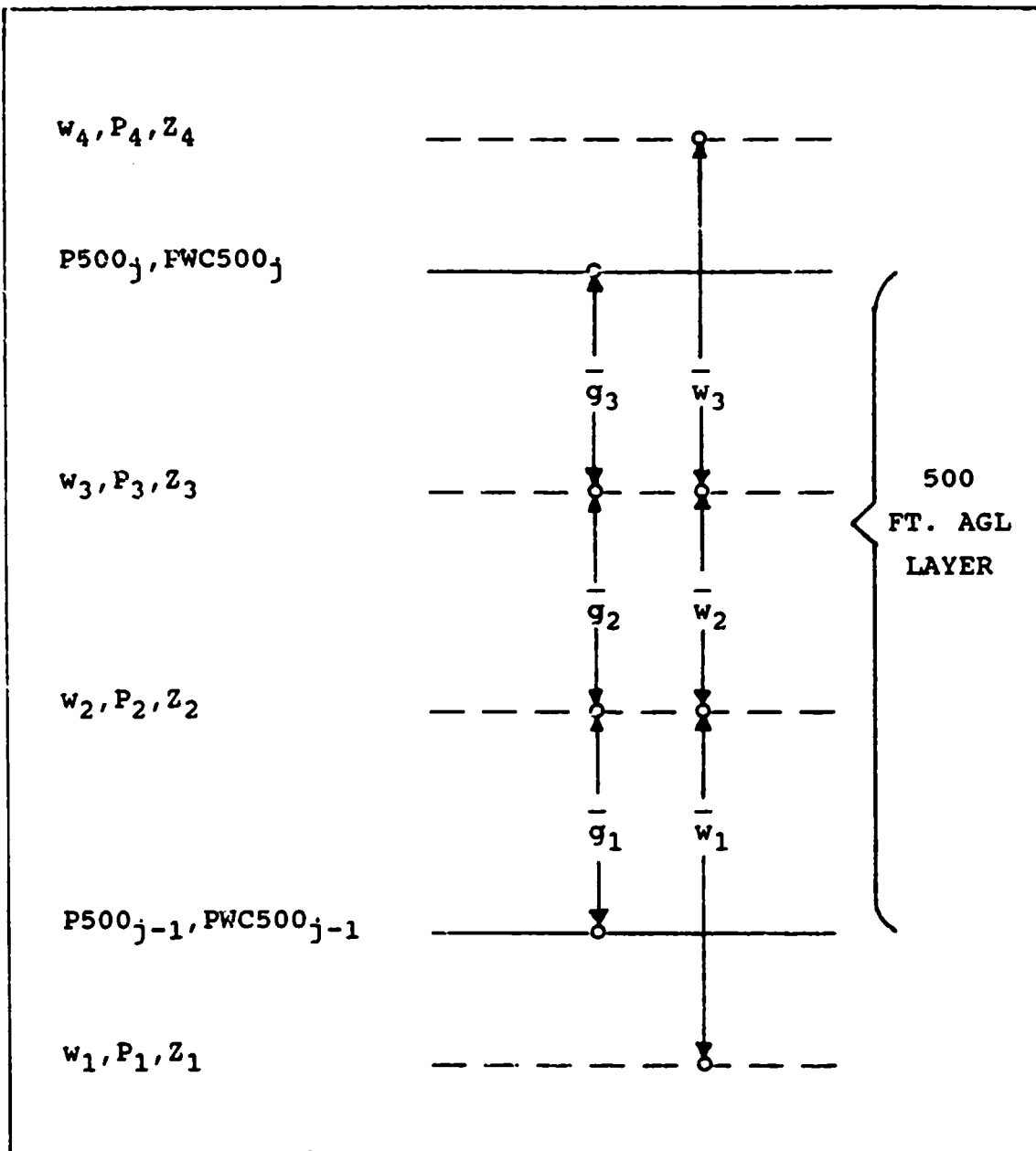

Figure A6-1.  
 Data Base Level Relationships to Calculation  
 of PWC For a 500 Ft. AGL Layer

$$\begin{aligned}
 \text{PWC}_{j-1} = & \frac{\bar{w}_1 * (P_{500j-1} - P_2)}{\bar{g}_1 \sin(D)} + \frac{\bar{w}_2 * (P_2 - P_3)}{\bar{g}_2 \sin(D)} \\
 & + \frac{\bar{w}_3 * (P_3 - P_{500j})}{\bar{g}_3 \sin(D)}
 \end{aligned}$$

The layers needed to calculate PWC for a 500 ft AGL layer may be a portion of one data base layer or parts/all data base layers. The number of terms in the previous PWC equation depends totally upon the level information available in the data base.

For the output of Paragraph E, the resultant precipitable water values are summed for the appropriate number of layers in the specified range. For the Surface to 1000 foot AGL layer, two analyzed precipitable water values are summed for the message output, i.e., the SFC to 500 Ft AGL layer and the 500 Ft AGL to 1000 Ft AGL layer. For the 50,000 Ft AGL to 60,000 Ft AGL layer a total of 20 increments, 500 feet each, are summed to obtain the PWC value for this layer. Finally, if the user should require a total precipitable water content for the entire profile, this value can be obtained by summing all the PWC layer values specified in Paragraph E.

The IPAM programs that calculate the PWC output for Paragraph E use the event site as the baseline point for calculations. For slant path calculations, the event site remains the baseline for PWC calculations. The slant path through the atmosphere is compensated for by the sine value in the denominator of the PWC equation. In essence, the line-of-sight through the layer is increased for angles less than  $90^\circ$ , and the PWC value for the slant path is increased accordingly.

There are some other calculations in the IPAM profile that actually use the latitude and longitude of slant path subpoints to calculate or determine certain parameters. However, this is not the case for Paragraph E and the calculation of precipitable water for slant path profiles. Since the profile for PWC only goes from the surface to 100,000 Ft AGL, and the slant path can only be calculated to a minimum  $10^{\circ}$  elevation angle, the furthest distance away from the event site for the 100,000 Ft AGL level is about 94 nm (see Table A8-1, Attachment 8, page A8-7).

ATTACHMENT 7  
CONSTRUCTION OF THE CLOUD DEPICTION

The purpose of this attachment is to provide the IPAM user with a general discussion on the procedure used to produce the Gridded Cloud Depiction of the IPAM Final Output.

A Gridded Cloud Depiction is provided for the area surrounding the input point. The cloud depiction displays values of low, middle, high and total cloud amounts in eighths of coverage. These values are displayed at the grid points of a polar stereographic projection (data grid) and displayed for a map scale of 1:1,875,000. The data grid is true at 60°N or 60°S latitude (where the data grid spacing is approximately 25nm). The data grid size increases as it approaches the equator, and it decreases in size as it approaches a pole. The display is centered on the input point and covers a square area with sides equal to six times the grid spacing at the input point.

Since the data grid size varies as the cloud depiction nears the equator, a line counter was added to the header of Paragraph C indicating how many lines are in the cloud depiction. The line counter reflects the total number of lines in the paragraph, including the paragraph heading and any internal blank lines, except for the two blank lines preceding the next paragraph.

Data for the Gridded Cloud Depiction are extracted from the Real Time Nephanalysis (RTNEPH) data base. Cloud coverages are extracted in percents. Surface heights are extracted from the Fixed Field data base. The Gridded Cloud Depiction is built using the following procedures:

- a. Access the RTNEPH data base and obtain the cloud amount, cloud type, cloud base, and cloud top of the four floating RTNEPH data base layers. RTNEPH data are obtained from a square area with sides equal to six times the grid spacing at the input point;

- b. The four floating RTNEPH layers are then converted into low (0-6000 Ft. AGL), middle (6000-20000 Ft. AGL), and high (above 20000 Ft. AGL) cloud categories. This is accomplished by grouping the floating layers into low, middle, and high layer groups; then the layers within a group are combined. First, the two lowest layers in a group are combined. Then, the next layer up is combined into the result of the first combination, and so on until all the layers of a group are combined into a final result for the group. If a cloud layer crosses more than one category, its coverage is combined in each of the crossed categories.

The process of combining two layers, or of combining a resultant layer combination with the next layer up, uses a dimensionless stacking factor, R. An R equal to zero indicates that the clouds in the next layer up are all stacked directly above the clouds below. R equal to one indicates that the clouds in the next layer up are totally random in relation to the clouds below.

The difference in height between two layers (D) is used to determine R. If D is less than 610 meters, R is set at zero. For D greater than 610 meters,

$$R = \frac{D-610}{6100.}$$

The equation used to determine the total cloud coverage for the combination of any two layers is:

$$T = \text{MAX} + (1-\text{MAX})(\text{MIN})R.$$

where T is the resultant total cloud layer coverage, MAX is the larger of the two coverages, and MIN is the smaller of the two coverages;

- c. Cloud coverages are converted from percentages back to eighths of clouds using the following conversions:

| <u>Percentage of<br/>Cloud Layer Coverage</u> | <u>Equivalent<br/>Coverage in Eighths</u> |
|---|---|
| 0   | 0   |
| 1 - 19  | 1   |
| 20 - 32                                       | 2   |
| 33 - 44                                       | 3   |
| 45 - 57                                       | 4   |
| 58 - 69                                       | 5   |
| 70 - 82                                       | 6   |
| 83 - 93                                       | 7   |
| 94 - 100                                      | 8   |

- d. A reference grid (equally spaced in Earth distance) is then superimposed on the data grid. The reference grid is always 100 nautical miles on a side with grid spacing of 25 nautical miles. It is centered on the input point and squared to the printed page. In the northern hemisphere, north is towards the top of the grid. In the southern hemisphere, south is at the top of the grid. The cloud coverage amounts in eighths are plotted top to bottom, high through low, respectively. The total cloud amount is plotted to the right of the middle cloud amount. See page 3-5 for an example.

**ATTACHMENT 8**  
**SLANT PATH CAPABILITIES**

The objective of this attachment is to provide the user of the IPAM Point Analysis a general description of the Slant Path Capabilities of the IPAM system.

The IPAM system provides a slant path, line of sight point analysis. This option improves the accuracy of the Point Analysis by estimating data along the actual path of interest of the profile. Calculations of the slant path subpoints take into account the curvature of the Earth.

The user may designate in the IPAM template a request for a slant path vertical profile by entering: a "Y" for the Slant Path Flag, SLANT; the desired Slant Path Azimuth\*10, AZMUTH; and, the desired Slant Path Elevation Angle\*10, ELEVAT. Both the Slant Path Azimuth and the Elevation Angle can be expressed to tenths of a degree. The Slant Path Azimuth should be valued from 1-3600, where 3600 is due North, 1800 is due South, 900 is due East and 2700 is due West. The Slant Path Elevation Angle should be set between 100 (10 degree elevation angle) and 900 (90 degree elevation angle).

Optimum Interpolation Profile

If a Slant Path is requested for an Optimum Interpolation (OI) profile (Paragraph I or F), the observation data collected for the interpolation are extracted from a larger area than that for a vertical profile. The area is automatically extended in the direction of the Slant Path Azimuth. This is to ensure that the observation data collected are representative of the entire Slant Path profile.

For any OI vertical profile location, only the fifty best-correlated observations of each of the following types are kept: Surface Observations; Upper Air Observations (RAOBs, PIBALS, ROCOBs, and Satellite); and Aircraft Observations. For the Slant Path OI profile, the fifty best-correlated Surface Observations with respect to the IPAM input latitude and longitude are kept. The fifty best-correlated



Upper Air and Aircraft Observations with respect to the latitude and longitude subpoint of the 50,000 foot level for the slant path profile are kept. Note that the 50,000 foot level is the mid-point of the 100,000 foot profile.

Additionally, HIRAS data are collected for the OI Vertical Profile. The HIRAS data for the Slant Path profile are collected at each profile level based on latitude and longitude subpoints along the slant path.

After the data have been collected for the Slant Path profile, the values are interpolated at each profile level, again based on latitude and longitude subpoints along the slant path.

Above 100,000 feet, for a normal OI Vertical Profile, the profile levels are calculated by the Groves-MSIS model unless ROCOB data are available, in which case, the ROCOB data are used. For a Slant Path profile, the profile levels are calculated in much the same way--If ROCOB data are available, they are used; otherwise, the Groves-MSIS model data are used. The profile level values are obtained from the Groves-MSIS model based on latitude and longitude subpoints along the Slant Path.

Note that when an OI Slant Path profile is requested, even though the profile values are calculated along the Slant Path, the latitude and longitude subpoints along the Slant Path are not part of the IPAM Final Output of Paragraphs I or F.

#### Aerosol Parameters Profile

When an Aerosol Parameter profile (Paragraph H) is requested, it must be a request separate from RAOBVP and OI vertical profiles. When requesting a slant path calculation for the Aerosol Parameter profile, the same criteria are used as those to select and calculate data for a routine slant path OI profile.

If a Slant Path is requested for an Aerosol Parameter profile (Paragraph H), the observation data collected for the interpolation are extracted from a larger area than that for a vertical profile. The area is automatically extended in the direction of the Slant Path Azimuth. This is to ensure that the observation data collected are representative of the entire Slant Path profile.

For any Aerosol Parameter profile location, only the fifty best-correlated observations of each of the following types are kept: Surface Observations; Upper Air Observations (RAOBs, PIBALS, ROCOBs, and Satellite); and Aircraft Observations. For the Slant Path Aerosol Parameter profile, the fifty best-correlated Surface Observations with respect to the IPAM input latitude and longitude are kept. The fifty best-correlated Upper Air and Aircraft Observations with respect to the latitude and longitude subpoint of the 50,000 foot level for the slant path profile are kept. Note that the 50,000 foot level is the mid-point of the 100,000 foot profile.

Additionally, HIRAS data are collected for the Aerosol Parameter Profile. The HIRAS data for the Slant Path profile are collected at each profile level based on latitude and longitude subpoints along the slant path.

After the data have been collected for the Slant Path profile, the values are interpolated at each profile level, again based on latitude and longitude subpoints along the slant path.

Above 100,000 feet, for an Aerosol Parameter Profile, the profile levels are calculated by the Groves-MSIS model unless ROCOB data are available, in which case, the ROCOB data are used. For a Slant Path profile, the profile levels are calculated in much the same way--If ROCOB data are available, they are used; otherwise, the Groves-MSIS model data are used. The profile level values are obtained from the Groves-MSIS model based on latitude and longitude subpoints along the Slant Path.

In contrast to the Final Output of the OI Slant Path profile, the Aerosol Parameters profile Final Output (Paragraph H) contains the latitude and longitude of the subpoints along the Slant Path. The latitudes\*100 range from -9000 to 9000, and the longitudes\*100 range from 0 to 35999. If the sanitization flag, SANIT, is set to "Y", the latitudes and longitudes are left blank in the output message.

### Miscellaneous

No Slant Path Capability exists for the RAOB-based profile.

If, in addition to an OI or Aerosol Parameters Slant Path profile, the Precipitable Water Content (PWC) of the profile is also requested, the PWC will be calculated along the Slant Path. The Final Output of the PWC appears in Paragraph E of the IPAM Final Output.

A Moisture Parameters Comparison is not performed between the Slant Path profile and the RTNEPH Cloud Amounts if the Slant Path elevation angle is less than  $45^{\circ}$ .

If a Slant Path profile is requested, Paragraph G of the IPAM Final Output contains the Slant Path Azimuth and the Slant Path elevation angle.

It is also important to note that for identical IPAM data requests for an OI profile and an Aerosol Parameter profile, the user cannot obtain a 1 to 1 data match for the levels in Paragraph H and the levels in Paragraph F or I, except by chance. The paragraphs serve different purposes, and there is no intent to have these paragraphs reflect identical height values. Pressure is a common element in these output paragraphs, and that can allow for some integration of data in these paragraphs.

A brief discussion on the distance of the slant path subpoint from the actual IPAM event site may be helpful to the user. The distances along the slant path profile may necessitate an increase in the data area search radius, especially for low elevation angle situations. In

contrast, the distances of the slant path subpoints from the event site may not be as far as one might think.

Figure A8-1 provides graphic details on slant path trigonometry, and Table A8-1 identifies an envelope of distances of the subpoints from the event site for selected elevation angles. The figure and table do not account for Earth curvature, and they are only provided to demonstrate to the User approximate distances of the slant path subpoints from the IPAM event location. Earth curvature is accounted for in slant path calculations to acquire the correct latitude and longitude subpoints.

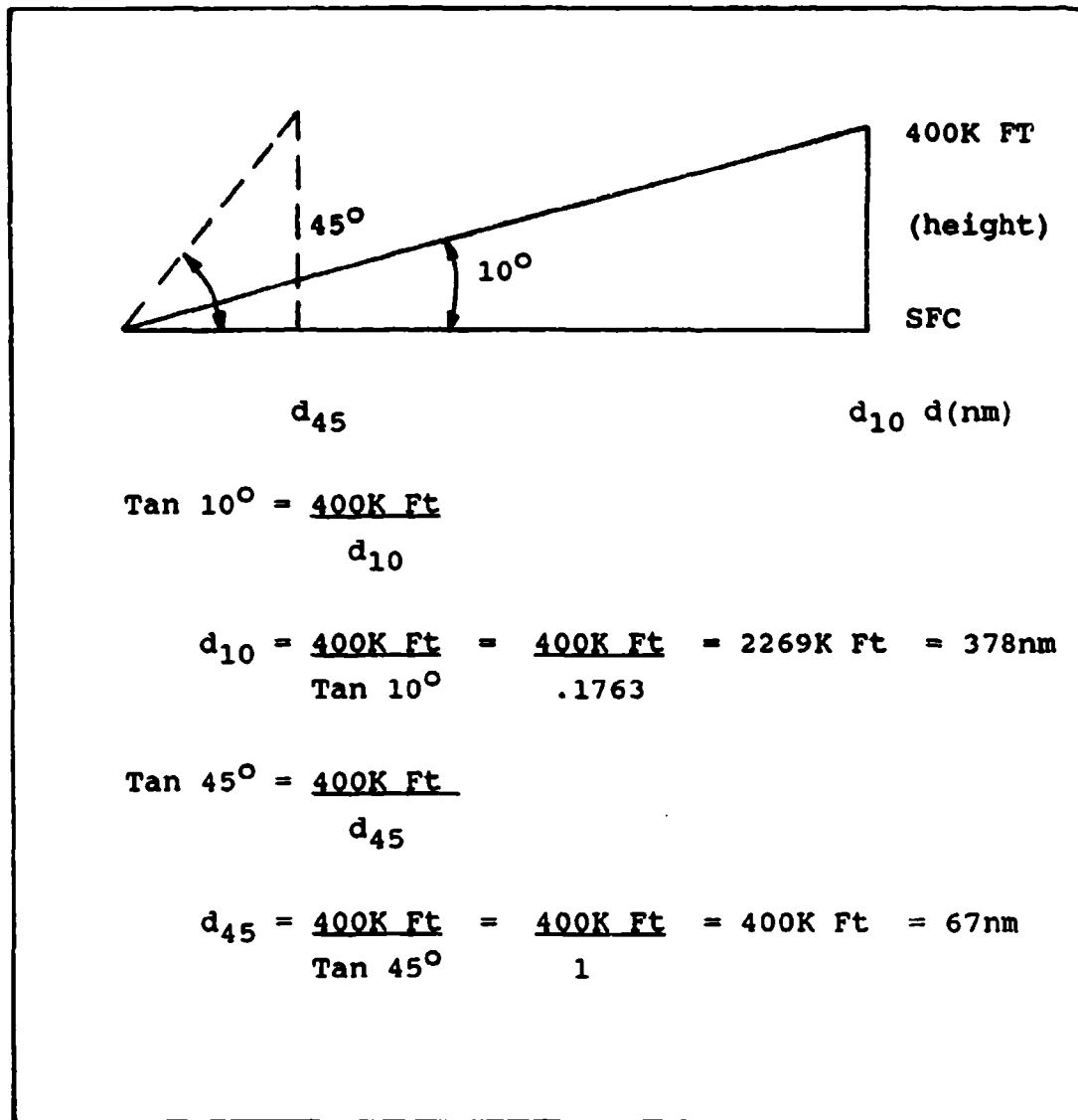

Figure A8-1. Slant Path Trigonometry

**TABLE A8-1. Slant Path Subpoint Distances (nm) for Selected Elevation Angles and Profile Heights**

| Height Above Sfc<br>(K Ft) | 50 | 100 | 200 | 300 | 400 |
|----------------------------|----|-----|-----|-----|-----|
| Elevation Angle            |    |     |     |     |     |
| 10°                        | 47 | 94  | 189 | 283 | 378 |
| 45°                        | 8  | 17  | 33  | 50  | 67  |
| 80°                        | 1  | 3   | 6   | 9   | 12  |

## ATTACHMENT 9

## ROCOB DATA

The objective of this attachment is to provide the IPAM user with a general discussion on the use and availability of Rocket Observation (ROCOB) data in the IPAM profile.

ROCOB data are extracted from the Upper Air Data Base. Data collected below 100K feet are treated as upper air observation data. For an OI run, a well correlated ROCOB will be found in the Data Source Weight Table in Paragraph G when the Data Items DATAWT (print data weight table) and UROCOB (use ROCOBs) are set to 'Y' in the IPAM data request. For a RAOBVP run, the message 'ROCOB DATA USED IN THE PRODUCTION OF THIS VERTICAL PROFILE' will be present in Paragraph G when a ROCOB with usable data is found which corresponds to the best RAOB.

ROCOB data above 100K feet are treated and used as observational data rather than climatological data for the Improved Point Analysis Model. ROCOBs are flagged within 400 nautical miles of the IPAM location and + or - 48 hours of the IPAM time. For an OI run with slant path requested, ROCOBs are flagged for availability when they are within 400 nautical miles of the subpoints for the 400K Feet and 100K Feet levels of the profile. ROCOB data are first quality controlled for the validity of the density values. If the density measurements are out of range from anticipated values, the data are no longer considered valid. Data which pass this initial check undergo further quality control for the values of temperature and pressure.

ROCOB wind data are used above 100K feet and treated as observational data. However, in order for the ROCOB wind data to be considered valid and usable, the available ROCOB data must begin below 100,000 feet. If the available ROCOB data begins above 100,000 feet, the ROCOB winds are considered unusable.

Rocketsonde observation sites are limited in number. There are 18 known stations. Their WMO station numbers are shown in Table A9-1.

TABLE A9-1. ROCOB STATIONS

| <u>WMO</u><br><u>STATION #</u> | <u>STATION LOCATION</u>         | <u>Lat</u> | <u>Lon</u> |
|--------------------------------|---------------------------------|------------|------------|
| 042020                         | Thule AB, Greenland             | 7632N      | 6845W      |
| 200460                         | Heysa Island, Russia            | 8037N      | 5803E      |
| 345600                         | Volgograd, Russia               | 4841N      | 4421E      |
| 475130                         | Ryori, Japan                    | 3902N      | 14150E     |
| 619020                         | Wide Awake Field, Ascension Is. | 0758S      | 1424W      |
| 701920                         | Chatanika/Poker Flats, AK       | 6507N      | 14729W     |
| 704143                         | Shemya, AK                      | 5243N      | 17406E     |
| 711240                         | Primrose Lane, Canada           | 5445N      | 11003E     |
| 719130                         | Churchill, Canada               | 5845N      | 9404W      |
| 722690                         | White Sands Test Range, NM      | 3223N      | 10629W     |
| 723910                         | Pt. Magu NAS, CA                | 3407N      | 11907W     |
| 724020                         | Wallops Island, VA              | 3751N      | 07529W     |
| 747940                         | Cape Canaveral AFS, FL          | 2828N      | 08033W     |
| 788010                         | Fort Sherman, Panama            | 0920N      | 7959W      |
| 788610                         | Antigua                         | 1701N      | 6147W      |
| 895420                         | Molodezhnaya, Russia            | 6740S      | 4551E      |
| 911620                         | Barking Sands/Kauai             | 2202N      | 15947W     |
| 913660                         | Kwajalein/Bucholz, Marshall Is. | 0844N      | 16744E     |

There are multiple cases to consider when ROCOB data are available above 100K feet. Figure A9-1 depicts cases where the Groves model data are needed in conjunction with ROCOB data to develop the Vertical

Profile above 100K feet. In all cases, the Spline function (reference Attachment 15) is used to smoothly interpolate between data from different sources.



Details of the 7 cases associated with ROCOB data and the use of the Groves/MSIS model data cited in Figure A9-1 follow.

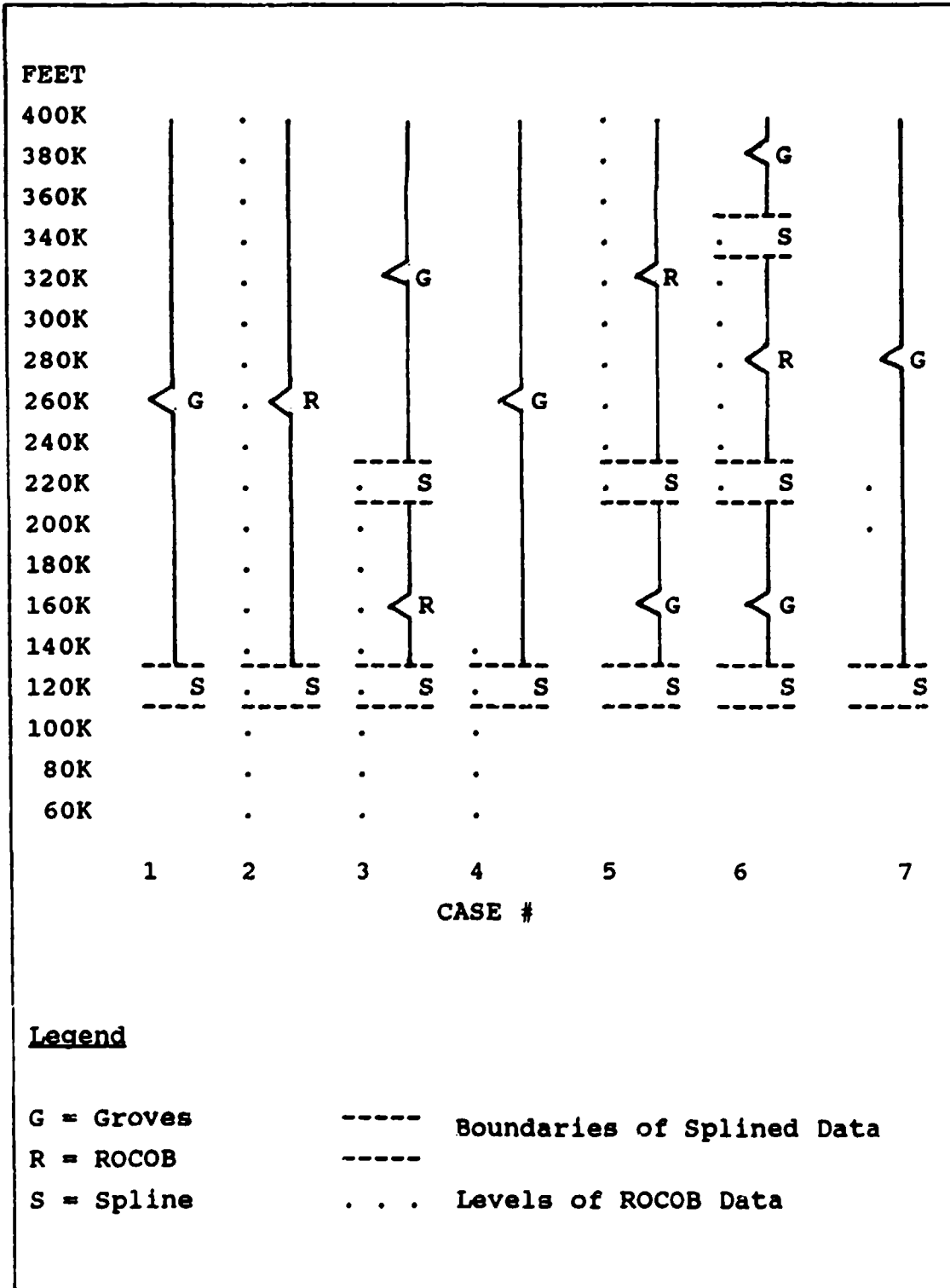

Figure A9-1.

Case Situations Using ROCOB Data and Groves/MSIS  
Model for Vertical Profiles Above 100K Feet

- #1. No usable ROCOB exists. Data produced from the Groves/MSIS model are used from 130K feet to 400K feet, and the data are Splined from the top of the data profile (100K Ft) to Groves Model inputs (130K Ft).
- #2. A usable ROCOB exists. It begins at or below 130K feet and extends up to or above 400K feet. ROCOB data are used from 130K feet to 400K feet, and the Spline function is used to interpolate smoothly between the top of the data profile (100K Ft) and the ROCOB data at 130K feet. ROCOB winds are used only if the ROCOB begins below 100k feet.
- #3. A usable ROCOB exists. It begins below 130K feet and ends below 400K feet. ROCOB data are used from 130K feet to the top level of available data, and Groves/MSIS model data are used from the top of the ROCOB to 400K feet. Data are Splined in the transition from ROCOB data to Groves/MSIS model data as well as from the top of the data profile (100K Ft) and the ROCOB data at 130K Ft. ROCOB winds are used only if the ROCOB begins below 100k feet.
- #4. An unusable ROCOB exists. It begins below 130K feet and ends at or below 140K feet. Data from Groves are used from 130K feet to 400K feet, and the data are Splined from the top of the data profile (100K Ft) to Groves Model data (130K Ft).
- #5. A usable ROCOB exists. It begins above 130K feet and extends up to or above 400K feet. Groves data are used from 130K feet to the start of the ROCOB data, and the ROCOB data are used from its starting point to 400K feet. Data are Splined in the transition from Groves/MSIS model data to ROCOB data.
- #6. A usable ROCOB exists. It begins above 130K feet and ends below 400K feet. Data from Groves are used from 130K feet to the start of the ROCOB data, and from the top of the ROCOB to 400K feet. ROCOB data are used for the levels available. Data are Splined from the Groves/MSIS model data to ROCOB data and vice versa.

- #7. An unusable ROCOB exists. It begins at 200K feet and ends at 220K feet. Data from Groves are used from 130K feet to 400K feet, and the data are Splined from the top of the data profile (100K Ft) to Groves Model data (130K Ft).

**ATTACHMENT 10**  
**MOISTURE PARAMETER COMPARISON**

The objective of this attachment is to provide the user of the IPAM Profile a general description of the program logic and procedures for the Moisture Consistency Comparison.

The Moisture Consistency Comparison is implemented when the Pseudo-Surface Observation (Paragraph D) is requested with either the Optimum Interpolation Vertical Profile, the RAOB Vertical Profile, or the Aerosol Parameter Profile, and the appropriate quality control Data Item is selected in the IPAM request.

The Moisture Consistency Comparison compares the selected Vertical Profile to the Pseudo-Surface Observation Cloud Amounts. Any inconsistencies between the moisture parameters and cloud data are noted, then a determination is made as to which data source is the better of the two. The selection is based on a comparison between the temperature and moisture quality indexes of the Vertical Profile and the temperature and moisture quality thresholds set by the user or the analyst. The threshold range is 0 to 5.0 and is set based on the user's or the analyst's assessment of the data's accuracy. If either index is less than its corresponding threshold, the Pseudo-Surface Observation is determined to be better. Otherwise, the Vertical Profile is selected as the better of the data sources. Obviously, a higher threshold increases the probability that the Pseudo-Surface Observation will be deemed better. Likewise, a lower threshold increases the chances that the Vertical Profile will be found better. Table A10-1 shows combinations of thresholds and indexes and the result of those combinations.

When inconsistencies are found and one source is determined to be better, the user can request the moisture consistency be forced. This is accomplished by setting the Force Moisture Consistency Data Item equal to 'Y' in the profile request.

**TABLE A10-1.**  
**Sample Quality Thresholds and Quality Indexes**  
**with Corresponding Selection of VPI or**  
**Pseudo-Surface Observation Data**

| Sample Quality Thresholds |          | Sample Quality Indexes |          | Results                              |
|---------------------------|----------|------------------------|----------|--------------------------------------|
| Temperature               | Moisture | Temperature            | Moisture |                                      |
| 2.5                       | 2.5      | 3.0                    | 3.5      | Vertical Profile is Better           |
| 2.0                       | 2.5      | 3.0                    | 2.0*     | Pseudo-Surface Observation is Better |
| 2.0                       | 3.0      | 1.7*                   | 3.1      | Pseudo-Surface Observation is Better |
| 2.0                       | 2.0      | 1.8*                   | 1.9*     | Pseudo-Surface Observation is Better |

\* Index that causes Pseudo Surface Observation to be deemed better.

When the request is made, the module to force the moisture consistency, is called during the run. The inaccurate data source is changed to agree with the values of the data source deemed to be better.

### Moisture Consistency and the Optimum Interpolation Profile

The control record and the Optimum Interpolation profile are collected. The Pseudo-Surface Observation is collected, and the cloud bases and tops are identified. Cloud Amounts are also identified. Any overlapping layers in the Pseudo-Surface Observation then have their bases, tops, and amounts adjusted to create new layers which do not overlap. In the following example, layer 1 has a base of 8000, a top of 14000, and  $\frac{5}{8}$  cloud coverage. Layer 2 has a base of 12000, a top of 20000, and  $\frac{2}{8}$  cloud coverage.

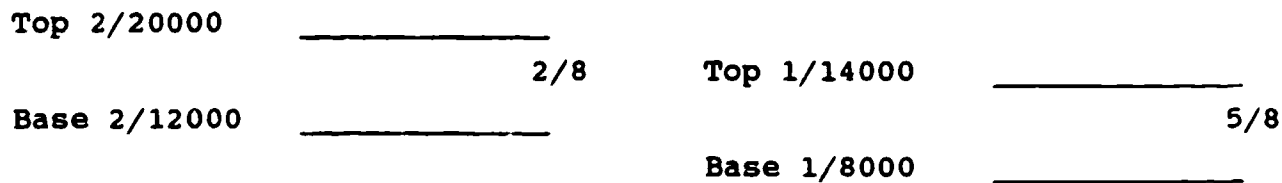

The layers are converted to three layers. Where the layers overlap, the third layer is created. The cloud coverage of the created layer is the sum of the coverages of the original layers that overlap. In this case, the coverage of the created layer is  $\frac{7}{8}$ .

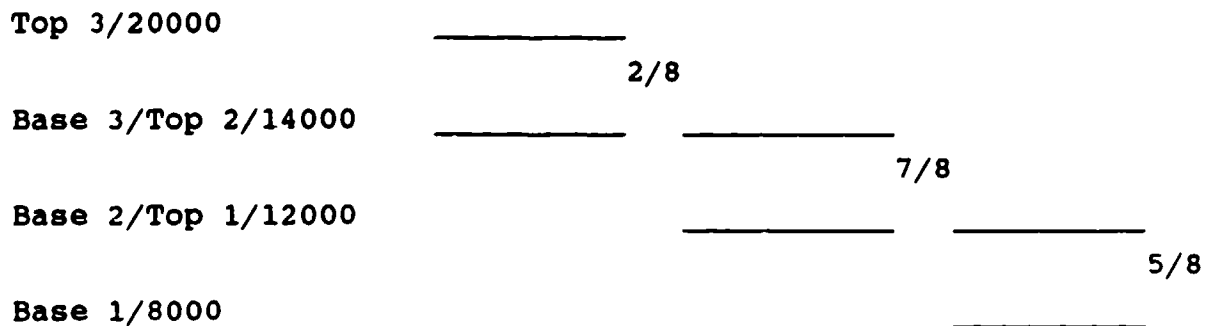

Next, Dewpoint Depressions are computed from the OI profile data and compared to the Cloud Amounts. If no inconsistency is found with the

Pseudo-Surface Observation, a message is sent to the analyst stating there is consistency between the profile and the Cloud Amounts.

If an inconsistency is found, quality control is needed, and a message is sent to the analyst stating the inconsistency and the levels at which any inconsistencies occur. The temperature and moisture quality indexes are compared to the temperature and moisture quality thresholds. If either index is less than the threshold, a message is sent to the analyst stating the Pseudo-Surface Observation Cloud Amounts are better. Otherwise, a message is sent to the analyst stating the Vertical Profile is better. Then the analyst decides whether to force consistency.

#### Moisture Consistency and the RAOB-Based Profile

This process is identical to that for the Optimum Interpolation profile except as noted:

1. The RAOB-Based profile is used; and,
2. If the nearest RAOB is determined to be outside of a 25nm radius of the IPAM event site, the Pseudo-Surface Observation Cloud Amounts are assumed to be better.

#### Moisture Consistency and the Aerosol Parameters Profile

This process is identical to that of the Optimum Interpolation profile except that the Aerosol Parameters profile is used.

#### Forcing The Moisture Consistency

If there is an inconsistency between the Vertical Profile and the Pseudo-Surface Observation Cloud Amounts, they can be forced to be consistent. This is accomplished by adjusting either the Vertical Profile, or the Cloud Amounts, depending on which is better. As mentioned before, to force the consistency, the Force Moisture Consistency Flag is set to 'Y' in the profile request. When the

consistency is forced, either the Vertical Profile and the Precipitable Water Content Input File are changed to match the Pseudo-Surface Observation Cloud Amounts, or the Pseudo-Surface Observation Cloud Amounts are changed to match the Vertical Profile. The determination is based on which data source is judged better.

When the Vertical Profile and Precipitable Water Content Input File are to be changed to match the Pseudo-Surface Observation, the following items occur:

1. Dewpoint depressions for the Vertical Profile are adjusted to match the corresponding Cloud Amount;
2. The absolute humidity values are recomputed;
3. The Vertical Profile with adjusted values is output to Paragraph I or F if the Optimum Interpolation Profile is used, or to Paragraph F if the RAOB-Based Profile is used. Paragraph G will contain a message, "MOISTURE CONSISTENCY WAS ACHIEVED BY ADJUSTING VERTICAL PROFILE";
4. The Precipitable Water Content Input File is collected;
5. The mixing ratio and absolute humidity values are recomputed;
6. The Precipitable Water Content is computed from the adjusted values and output to Paragraph E;
7. If the run is using the Aerosol Parameter profile, the following items also occur:
  - a. The Aerosol Parameter profile is compared to the Pseudo-Surface Observation Cloud Layers;



- b. If a Cloud Layer exists between two profile levels, a new level is interpolated at the midpoint of the Cloud Layer;
- c. Each new level is merged with the original profile, and all necessary values for the new level are interpolated and calculated from the original profile values; and
- d. The profile with merged levels is output to Paragraph H.

When the Pseudo-Surface Observation Cloud Amounts are to be changed to match the Vertical Profile, the following items occur:

1. The Vertical Profile is compared to the Pseudo-Surface Observation Cloud Layers. Dewpoint Depressions of levels that fall within a Cloud Layer are added together, and an average dewpoint depression for the layer is computed;
2. The Cloud Amount of the layer is changed based on the average dewpoint depression computed from Vertical Profile levels. (NOTE: If a Cloud Layer happens to fall between two Vertical profile levels, the layer is left as is.);
3. The adjusted Pseudo-Surface Observation is output to Paragraph D; a message is written to Paragraph G, "MOISTURE CONSISTENCY WAS ACHIEVED BY ADJUSTING PARAGRAPH D";
4. If more than one Cloud Layer exists, the Pseudo-Surface Observation Total Cloud Coverage is recomputed and is output to Paragraph D; and
5. If the Surface Weather History is used, the Pseudo-Surface Observation that corresponds to the event time is collected with cloud amounts expressed as percents. The Cloud Amounts are adjusted to match the Vertical Profile, and they are recomputed in percent and output to Paragraph J. Finally,

the Total Cloud Coverage is recomputed in percent and is output to Paragraph J.

ATTACHMENT 11  
RAOBVP SEARCH LOGIC

The purpose of this attachment is to explain how the IPAM program interprets user request parameters in combination with analyst controlled data and searches for the best suitable RAOB to provide a RAOB-based vertical profile. This "best" RAOB serves as the basis for the paragraph F final output.

1. Request Parameters Affecting RAOBVP Search Logic

A number of Data Item parameters in the IPAM request template affect the RAOB search logic. These are, in alphabetical order, MXSRC, RABPRS, RMILEV, ROMIT, RSPORL, and USANLY. Most of these parameters cannot be directly specified by the user in the request message. The user has to contact AFGWC by separate communication, e.g., AUTODIN message or telephone call, or inform USAFETAC within the written request to tell the analyst of any specific needs with regard to the RAOB search logic.

- a. MXSRC - This is the maximum search radius used to find RAOBs for the final data profile. Any suitable RAOB must lie within the number of nautical miles of the IPAM analysis point. This search radius is established at 400 nm by AFGWC/USAFETAC unless specifically requested otherwise by the user.
- b. RABPRS - This is the required RAOB top pressure, and may be specified between 100 mb and 900 mb. No RAOB is suitable unless its least pressure (greatest height) is less than RABPRS. This is not a user-defined option; it is established by AFGWC/USAFETAC. If the user needs to specify, so state to AFGWC or USAFETAC by required communication.

- c. RMILEV - If missing mandatory levels in the RAOB are to be replaced by analytic (HIRAS) data, the user must specify RMILEV = Y in the IPAM data request.
- d. ROMIT - The number, between 0 and 5, of RAOBs to be omitted from consideration. If ROMIT is greater than 0, then RSPORD must be D, and the omitted RAOBs must be specified by WMO, hour, day, and month in the table at the bottom of the request template. The user must specify any specific requirements to exclude WMO RAOB stations from the selection process.
- e. RSPORD - Equal to S, N, or D. Indicates whether the requestor is specifying a RAOB (S), deleting 1 to 5 RAOBs (D), or neither (N). This is an analyst responsibility in response to any stated user needs or known data deficiencies.
- f. USANLY - If the user desires an analysis-only run, the Data Item USANLY in the IPAM request message must be set = Y. The result is, no RAOB is searched for or used.

## 2. RAOB Search Logic

The following steps are used to identify suitable RAOBs, selecting the best and 4 alternates, to respond to the user control options selected, and to prepare a suitable RAOBVP:

- a. If Use Analysis Fields Only (USANLY = Y) is requested, the RAOB search is not done.
- b. When one specific station is sought for the RAOB profile, the analyst sets the RSPORD Data Item = S. If the RAOB is not within 24 hours of the IPAM event time and within the maximum search radius of the IPAM point, a message is issued

to the analyst explaining that the RAOB was not suitable. At this point the program stops. The analyst will have to contact the requestor for different instructions.

- c. When no specific RAOB is requested for the IPAM profile, the IPAM program searches for RAOBs within the maximum search radius specified. When no RAOBs are found, the possibilities are: (1) the user has requested the use of analysis fields, then a profile is produced using HIRAS analysis fields data; or (2) the user has not requested the use of analysis fields, then a program error message is sent to the analyst. The analyst will then have to contact the user to discuss remaining options in order to obtain an IPAM profile.
- d. Determine the suitability of all RAOBs collected. An individual RAOB is suitable for a RAOBVP analysis: if the RAOB time is within 15 hours of the IPAM time; the RAOB location is within the maximum search radius of the IPAM point; the RAOB top pressure is less than the value specified for Data Item RABPRS; and, at least 4 RAOB levels report moisture.
- e. The next step in the selection logic is to evaluate each suitable RAOB collected by giving it a score based upon five factors:
  - (1) distance to the PA point;
  - (2) time difference between RAOB time and IPAM event time;
  - (3) height of the highest RAOB level; and
  - (4) similarity of the RAOB base temperature to the closest surface station temperature
  - (5) winds must be present at all mandatory levels.

- f. The final procedure in the development of a RAOB-based vertical profile is to rank the five suitable RAOBs according to scores. The highest scored RAOB is the one used for the profile. The other four are termed "alternate RAOBs" and could be used if it were determined that a rerun is needed.

**ATTACHMENT 12**  
**SPECIFIC/ABSOLUTE HUMIDITY**

Specific humidity is defined as the ratio of the mass of water vapor to the mass of moist air. Absolute humidity is defined as the mass of water vapor per volume of air that it occupies.

When data are extracted from the various computerized data bases for IPAM applications, the moisture values are in terms of specific humidity. When using specific humidity for data calculations, it has been determined to be a somewhat unstable parameter, not always yielding reasonable results. Therefore, where appropriate for calculation purposes in the IPAM computations, specific humidity is converted to mixing ratio before any calculations are done.

Mixing ratio is defined as the ratio of the mass of water vapor to the mass of dry air. To translate from specific humidity to mixing ratio, the following formula applies:

$$w = \frac{q}{1 - q} \quad (1)$$

where,

q = specific humidity

w = mixing ratio.

To convert from mixing ratio to specific humidity, use the following formula:

$$q = \frac{w}{1 + w} \quad (2)$$

Formulae (1) and (2) assume w and q are both in gm/gm. If w or q are in gm/kg (or any other unit), they must be converted to gm/gm, or they will not work properly.

Once specific humidity is converted to a mixing ratio, the density and absolute humidity can be obtained for each required level in the IPAM output profile. Density is obtained from the equation of state:

$$\rho = \frac{P}{RT_v} \quad (3)$$

where,

- $\rho$  = Density (gm/cm<sup>3</sup>)
- P = Pressure (mb)
- R = Gas Constant
- T<sub>v</sub> = Virtual Temperature (°K).

Absolute humidity is obtained from the following equation:

$$\rho_v = \rho q \quad (4)$$

or

$$\rho_v = 1,000,000 * \frac{w}{1 + w} \quad (4)$$

where,

- $\rho_v$  = absolute humidity (gm/meter\*\*3)
- $\rho$  = Density (gm/cm<sup>3</sup>)
- w = mixing ratio (gm/gm)
- 1,000,000 = the conversion factor for cm<sup>3</sup> to m<sup>3</sup>



**ATTACHMENT 13**  
**AEROSOL PARAMETERS**

Aerosol parameters are factors which are used in the calculation of atmospheric transmittance and absorption. Such parameters include boundary layer aerosol parameter, ozone and volcanic extinction.

IPAM programs calculate or determine the following aerosol parameters:

- IHAZE - Primary Boundary Layer Aerosol Parameter
- AIHAZE - Alternate Profile Value for IHAZE
- ICSTL - Describes whether air parcel is maritime or not
- AICSTL - Alternate Profile Value for ICSTL
- ISEASN - Value showing seasonal dependence of the profiles for tropospheric and stratospheric aerosols
- IVULCN - Profile and extinction type for stratospheric aerosols
- VIS - Surface meteorological visibility range
- M<sub>3</sub> - Ozone profile
- ALTVIS - Alternate surface meteorological visibility range
- QIHAZE - Quality Index showing how well IHAZE fits the aerosol model

Associated with these parameters is an atmospheric profile containing the following information: Height in meters above MSL; Pressure in millibars; Temperature in degrees Kelvin; Absolute Humidity in gms/m<sup>3</sup>; AHAZE, Normalized Aerosol Number Density (not done at present); AAHAZE, Alternate Normalized Aerosol Number Density (not done at present); Alternate Temperature in degrees Kelvin; Alternate Absolute Humidity in gms/m<sup>3</sup>; Ozone climatological data; and Subpoint latitudes and longitudes, when a slant path is requested.

IHAZE and AIHAZE are calculated via a decision table as shown in TABLE A13-1.

The factors that make up IHAZE and AIHAZE are visibility, the aerosol industrial id (industrial area yes/no), geography code (over water

TABLE A13-1. IHAZE/AIHAZE DECISION TABLE

| Vsby (Miles) |     |      |     | Indus-trial Area |    | Terrain (Geog-Code) |       | Hours Since Land |           | IHAZE | Alt IHAZE |
|--------------|-----|------|-----|------------------|----|---------------------|-------|------------------|-----------|-------|-----------|
| <2*          | 2-5 | 5-30 | 30+ | Yes              | No | Land                | Ocean | <3               | 3 or More |       |           |
| X            |     |      |     | X                |    | X                   |       |                  | N/A       | 6     | 2         |
|              | X   |      |     | X                |    | X                   |       |                  | N/A       | 2     | 6         |
|              |     | X    |     | X                |    | X                   |       |                  | N/A       | 2     | 1         |
|              |     |      | X   | X                |    | X                   |       |                  | N/A       | 2     | 1         |
| X            |     |      |     |                  | X  | X                   |       |                  | N/A       | 6     | 1         |
|              | X   |      |     |                  | X  | X                   |       |                  | N/A       | 1     | 6         |
|              |     | X    |     |                  | X  | X                   |       |                  | N/A       | 1     | 2         |
|              |     |      | X   |                  | X  | X                   |       |                  | N/A       | 1     | 5         |
| X            |     |      |     | N/A              |    |                     | X     | X                |           | 6     | 3         |
|              | X   |      |     | N/A              |    |                     | X     | X                |           | 3     | 6         |
|              |     | X    |     | N/A              |    |                     | X     | X                |           | 3     | 1         |
|              |     |      | X   | N/A              |    |                     | X     | X                |           | 3     | 5         |
| X            |     |      |     | N/A              |    |                     | X     |                  | X         | 6     | 4         |
|              | X   |      |     | N/A              |    |                     | X     |                  | X         | 3     | 6         |
|              |     | X    |     | N/A              |    |                     | X     |                  | X         | 3     | 4         |
|              |     |      | X   | N/A              |    |                     | X     |                  | X         | 3     | 4         |

NOTE: IF THE PRESENT WEATHER CODE INDICATES FOG, USE A VISIBILITY VALUE <2 MILES IN THIS TABLE TO SET IHAZE AND ALT-IHAZE

IHAZE AND ALT-IHAZE VALUES:

1. RURAL
2. INDUSTRIAL URBAN
3. NAVY MARITIME
4. MARITIME
5. TROPOSPHERIC
6. FOG

yes/no), and the number of hours since an air parcel was over land.

Visual Range (Visibility) is calculated from surrounding observations. The aerosol industrial id, geography code, and the number of hours since land come from the terrain data base.

ICSTL and AICSTL are only calculated when IHAZE or AIHAZE = 3. It is calculated from the following equation:

$$ICSTL = [ 9e^{(-t/4)} + 1 ]$$

where,

e = the base for natural logarithms

t = the number of hours since an air parcel was over land

NOTE: ICSTL is CC and AICSTL is  $C_a C_a$  as described in paragraph 3.8.3.c of this User's Guide.

To avoid AICSTL being equal to zero the following applies:

If ICSTL = 1, then AICSTL = ICSTL + 1.

In all other cases AICSTL = ICSTL - 1.

VIS, ALTVIS and QIHAZE are calculated via statistical methods.

Alternate profile temperatures ( $T_{alt}$ ) and moisture values ( $Q_{alt}$ ) are calculated by setting:

$$(T_{alt})_i = T_i + (\sigma_T)_i$$

and

$$(Q_{alt})_i = \max (Q_i - (\sigma_Q)_i, 0)$$

where,

sigma is a standard deviation value, and the maximum function (max) guarantees  $Q_i \geq 0$ .

NOTE: The moisture profile contains no values less than zero.

**ATTACHMENT 14**  
**GROVES/MSIS MODEL**

The objective of this attachment is to provide the user of the IPAM profile a general description of the program logic and procedures for the Groves/MSIS climatological model.

The Groves/MSIS model is a highly complex climatology model that combines three models for the atmospheric height regions 18-70 KM, 70-130KM and above 130KM to provide a single model from 18KM upwards. The Groves/MSIS model is an empirical model of temperature, density, and atmospheric composition, and it results from the analysis of data obtained from rocket flights, satellite platforms, and incoherent scatter radars. Some data included in the resultant model were obtained during periods of high solar activity. It is completely beyond the scope of this User's Guide to detail the complexities of the Groves/MSIS model. Those users requiring further technical details are directed to References 1.2.q and 1.2.r in Section 1 of this document. The following information highlights items that users should be aware of, in general, about the Groves/MSIS model and its use in the IPAM profile.

For IPAM the Groves model is used from 130K Feet to 400K Feet (45KM to 100KM for aerosol) to produce temperature, density and pressure data.

The sole user inputs affecting the Groves model output are the location and Julian Hour of the IPAM request. Based on the event time Julian Hour, the values for the solar flux, mean flux and the AP index are collected, and these values are used directly in the Groves/MSIS model calculations.

The Groves model subroutines provide the only usable data for the IPAM profile above 130K feet (45KM for aerosol profiles) unless ROCOB data are available. In the event a slant path profile is requested for OIVP, the Groves model is executed multiple times using locations on

the slant path corresponding to mandatory height levels above 130K Feet as input.

The output from the Groves model can be found in Paragraphs F or I (140K Feet to 400K Feet) and Paragraph H (45KM to 100KM).

**ATTACHMENT 15**  
**CUBIC SPLINE TECHNIQUE**

The objective of this attachment is to provide the IPAM user a general description of the program logic and procedures for the cubic spline technique.

The cubic spline technique is a mathematical method used to smoothly connect data from two different sources in the IPAM profile. It is a purely mathematical model in which data from both sources are employed to create an interpolation approximated by a cubic polynomial.

The cubic spline model is based on the mechanical spline used by draftsmen. This device consists of flexible strips of wood or plastic, secured at the points of interpolation. A detailed description can be found in any comprehensive numerical analysis text book.

The basic principle of the mathematical model is to find the value of the coefficients a, b, c, and d in the following polynomial equation:

$$f(x) = ax^3 + bx^2 + cx + d$$

The solution of these coefficients is accomplished by using four known points of data, i.e., four equations and four unknowns. Once the equation is found, it is a simple procedure to solve for any unknown points by plugging in the value of x in the above equation and solving for f(x). The spline technique is used only for interpolation between end points, not for extrapolation.

The cubic spline technique is employed in the development of the OIVP, RAOBVP and Aerosol Profiles. In all instances, it is used to smoothly connect the data at the top of the profile (100K Feet for OIVP and RAOB, and 30km for aerosol parameters) to the climatological data produced by the Groves/MSIS model, or to ROCOB data when it is available. The cubic spline technique is also used to connect climatological data and ROCOB data.

The cubic spline technique is implemented in the following manner:

To spline from the OIVP or RAOBVP profile to the Groves/MSIS model or ROCOB data, the top two levels of the OIVP or RAOBVP, i.e., 90K and 100K Feet (25km and 30km in the case of aerosol parameters) and the lowest 2 levels of the Groves/MSIS model, i.e., 130K and 140K Feet (45km and 50km for aerosol parameters), or the ROCOB data are used as input to produce the interpolated data for the 110K and 120K Ft levels (35km and 40km in the case of the aerosol profiles). Note: The 110K and 130K Feet levels are not reported in the final profile output.

As mentioned before, the cubic spline technique is also used to smoothly interpolate between ROCOB data and the Groves Model data. This situation occurs anytime there is usable ROCOB data which does not extend up to 400K Ft (100km for aerosol parameters) or down to 130K Feet (45km for aerosol parameters). For example, if there is usable ROCOB data which extends from 200K to 400K Feet, the 200K and 210K Feet levels would be replaced by data calculated using the cubic spline technique. (Note: The 210K Feet level is not reported in the final output). The input data to the cubic spline calculations in this example would be the 180K and 190K Feet levels from the Groves/MSIS model and 220K and 230K Feet levels from the ROCOB data.

Data calculated by the cubic spline method are found in paragraphs F, I or H in the IPAM output, but it carries no special label. The data at the 120K level of the RAOBVP and OIVP outputs in paragraphs F or I will always be calculated by the cubic spline method. Similarly, in Paragraph H, data at the 35 and 40km levels will be the result of the cubic spline calculations. When ROCOB data are used, the level just above and just below the actual ROCOB data will be the result of cubic spline calculations, unless the ROCOB data extend to 400K Feet or higher. Then, just the bottom of the ROCOB undergoes the cubic spline technique.

An example obtained from an actual OIVP run contains the following input data, where 'x' is the height and  $f(x)$  is the temperature in the aforementioned polynomial equation:

| Height (K Ft) | Temperature ( $^{\circ}$ K) | Data Source  |
|---------------|-----------------------------|--------------|
| 90            | 221.0                       | OIVP         |
| 100           | 226.6                       | OIVP         |
| 110           | -----                       | Cubic Spline |
| 120           | -----                       | Cubic Spline |
| 130           | 249.7                       | Groves Model |
| 140           | 257.1                       | Groves Model |

The values determined for the temperature at 110K Feet and 120K Feet by the cubic spline method are 230.9 and 237.3 degrees Kelvin respectively. The result is displayed in graphic form in Figure A15-1.



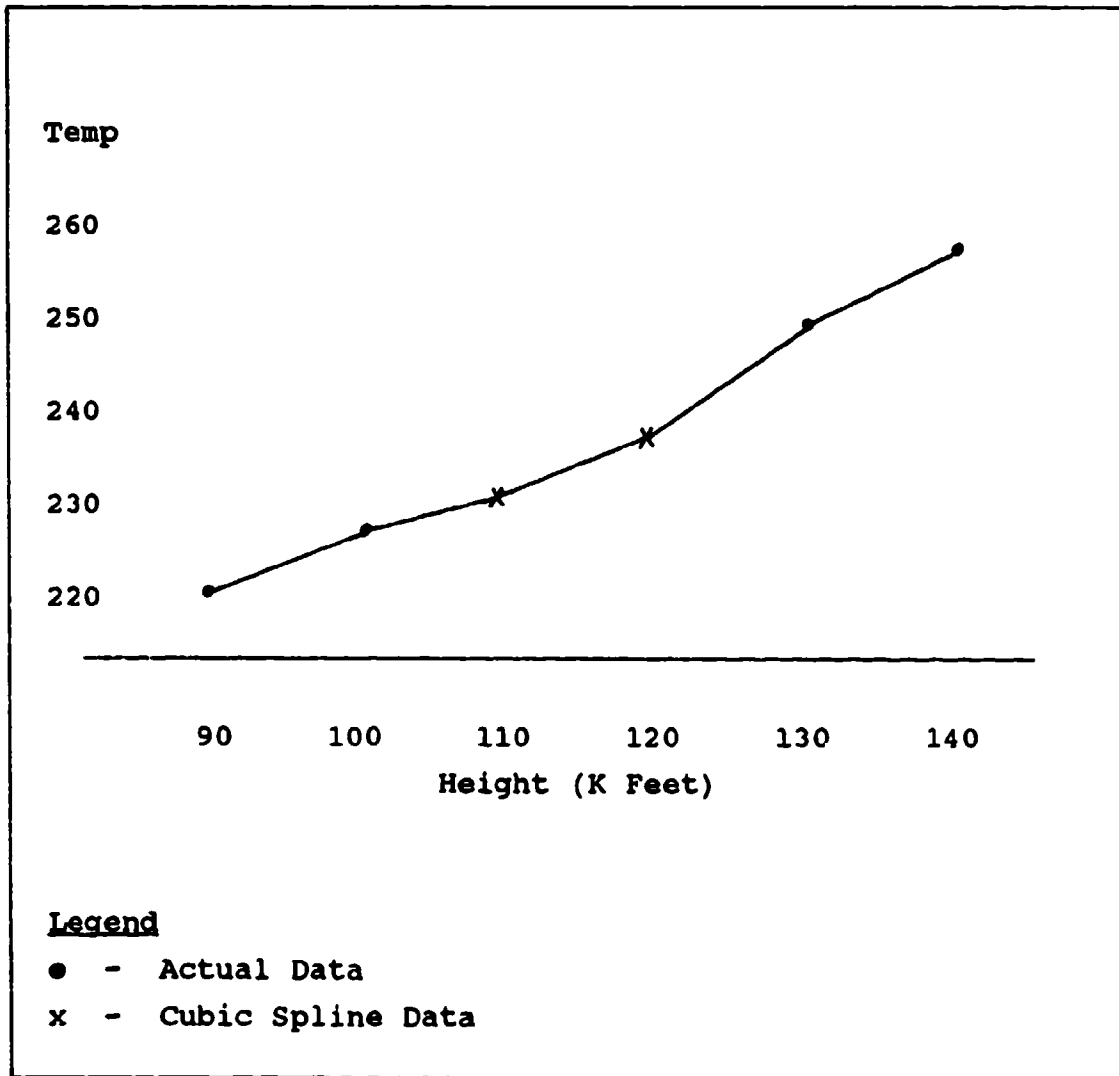

Figure A15-1. Cubic Spline Data

**ATTACHMENT 16**  
**DATA WEIGHT/CORRELATION SCHEMES**

The objective of this attachment is to provide the user of the IPAM Profile a general description of the program logic and procedures for the Data Source Weight Table.

The Data Source Weight Table shows the source of the best correlated observation ("SRC") used for the OI profile at each height level for each variable type. The abbreviations are deciphered as follows:

|     |           |
|-----|-----------|
| --- | None Used |
| PBL | PIBAL     |
| AIR | Aircraft  |
| SFC | Surface   |
| RAB | RAOB      |
| SAT | Satellite |
| ROC | ROCOB     |
| GOE | Goes Wind |

If no observation was used for a certain height level, the OI profile originates from either first guess data or extrapolations at that height level.

The numbers accompanying each type are the weight (WGT) and correlation (CORR) of the observation. The weight of the observation is the number (WT) resulting from the solution of the OI matrix equation, which is described below.

$$\sum_{j=1}^N \underbrace{[f_1 f_j + e_1 e_j]}_{\text{FA}} \underbrace{w_j}_{\text{WT}} = \underbrace{f_g f_1}_{\text{FB}}$$

where:

(FA)  $f_i f_j$  is the modeled covariance of the residual at point  $(x_i, y_i, p_i)$  with the residual at point  $(x_j, y_j, p_j)$ ;

$e_i e_j$  is the covariance of the observational instrument error at point  $(x_i, y_i, p_i)$  with that at  $(x_j, y_j, p_j)$ ;

(FB)  $f_g f_i$  is the modeled covariance of the first guess error residual at the analysis point with the residual error at the point  $(x_i, y_i, p_i)$ ;

(WT)  $w_j$  is the set of weights which is to be solved; and

$N$  is the number of observations being used around each analysis point.

The correlation is defined as the modeled covariance of the first guess error residual (residual = observation - first guess) at the analysis point with the residual error at the observation point (FB in the above formula).

The user has the ability to display the height array in any of four ways: FT/AGL, FT/MSL, MT/AGL, MT/MSL, by using the FETMTR and MSLAGL flags in the request template.

If FT (feet) is selected, the heights are displayed in thousands of feet; if MT (meters) is selected, heights are in hundreds of meters. When "AGL" is selected, the first height level is always designated as "SFC", meaning surface.

## ATTACHMENT 17

## ALTERNATE TEMPERATURE AND MOISTURE PROFILES

The purpose of this attachment is to provide the user of the IPAM output a general discussion on the procedure used to produce the alternate temperature and water vapor density (absolute humidity) profiles found in Paragraph H of the IPAM Final Output.

The Alternate Temperature and Moisture Profiles based on estimated standard deviations are provided as quality indicators. The Alternate Profiles define the range plus or minus one standard deviation, from the Analysis Profile. This information is the best available answer to customer requirements for knowledge of product accuracy.

ALTERNATE TEMPERATURE PROFILE

The Alternate Temperature Profile is produced by adding an array of estimated temperature errors to the temperature profile. These temperature error bounds below 100,000 feet AGL are calculated as follows:

1. Interpolated temperature error values are produced by applying error growth, and maximum and minimum factors to temperature errors extracted from the HIRAS data base. If data observations were used to produce the temperature value at any profile level, the error value at that level is also multiplied by a factor produced by the Cholesky method; and
2. These interpolated temperature error values are then used in a regression equation to produce the array of estimated temperature errors (which are then added to the temperature profile to produce the Alternate Temperature Profile). The Temperature Error Bounds (TEB) are calculated for the j'th profile level.

$$TEB(j) = TEE(j) * (1 - 1/2 * CMEANT) * (1 - 1/2 * CWMAXT)$$

where: TEE(j) is the interpolated temperature error value for the j'th profile level.

$$CWMAXT = \text{MAX}(\text{FB}(i,j) * \text{WT}(i,j))$$

where, (FB(i,j) is the correlation of the i'th observation residual to the j'th level analysis residual; and WT(i,j) is the weight given the i'th observation residual for the analysis at level j.

CMEANT = mean value of FB(i,j) from i = 1 to the number of observations.

If the number of observations is zero, the following method is used instead:

$$\text{TEB}(j) = \text{TEE}(j).$$

Above 100,000 feet AGL, the temperature error bounds are calculated as follows:

1. If a ROCOB is present at that level:

$$\text{TEB}(j) = \text{TEBCOR} * \text{ROCTIE} + (1 - \text{TEBCOR}) * \text{TEBPH}(j)$$

where: TEBCOR is the product of the temporal, vertical, and horizontal correlations between the ROCOB and the PA point;

ROCTIE is the ROCOB instrument error, set at 4 degrees Kelvin; and

TEBPH(j) is a standard temperature error for level j (See Table A17-1). These temperature errors are based on the Groves/MSIS Model and represent climatological temperature errors.

2. If a ROCOB is not present at that level, Groves data are used, and the temperature error bounds are calculated by the following method:

$$TEB(j) = TEBPH(j).$$

3. The spline function is then used to smooth the resulting temperature error bound values to the temperature error bound values below 100,000 feet AGL.

TABLE A17-1. Standard Temperature Errors ( $^{\circ}$ K)

| Height (km) | TEBPH ( $^{\circ}$ K) |
|-------------|-----------------------|
| 30          | 2.95                  |
| 35          | 3.55                  |
| 40          | 4.15                  |
| 45          | 4.67                  |
| 50          | 6.02                  |
| 75          | 9.09                  |
| 100         | 12.15                 |

#### ALTERNATE MOISTURE PROFILE

The production of the Alternate Moisture Profile is not as straight forward as the production of the Alternate Temperature Profile. The moisture data extracted from the HIRAS data base are specific humidity values, however, the primary and alternate profiles found in the final output are absolute humidity values. The production of these primary and alternate profiles occurs as follows:

1. All interpolations for the primary profile are performed using mixing ratio values which are calculated from the specific humidity data. The final mixing ratio profile is then converted to absolute humidity to form the primary moisture profile;
2. The Moisture Error Bounds (MEB) are based on specific humidity and are calculated as follows:
  - a). Interpolated moisture error values are produced by applying error growth, and maximum and minimum factors to standard specific humidity errors. These standard specific humidity errors are used due to the fact that the HIRAS data base contains only relative humidity errors. If data observations were used to produce the moisture value at any profile level, the error value at that level is also multiplied by a factor produced by the Cholesky method; and
  - b). These interpolated moisture error values are then used in a regression equation to produce the array of estimated specific humidity errors. The Moisture Error Bounds are calculated for the j'th profile level:

$$MEB(j) = MEE(j) * (1 - 1/2 * CMEANM) * (1 - 1/2 * CWMAXM)$$

where,

MEE(j) is the interpolated moisture error value for the j'th profile level.

$$CWMAXM = \text{MAX}(\text{FB}(i,j) * \text{WT}(i,j))$$

where,

(FB(i,j) is the correlation of the i'th observation residual to the j'th level analysis residual. WT(i,j) is the weight given the i'th observation residual for the analysis at level j.

CMEANM = mean value of FB(i,j) from i = 1 to the number of observations.

If the number of observations is zero, the following method is used instead:

$$MEB(j) = MEE(j).$$

3. The final mixing ratio profile values are converted back to specific humidity, and an alternate specific humidity profile is obtained by subtracting the Moisture Error Bounds from the specific humidity value at each profile level; and,
4. The alternate specific humidity profile is then converted to form an alternate mixing ratio profile. This alternate mixing ratio profile is then converted to absolute humidity to produce the alternate moisture profile found in the final output.

Note that the Moisture Profile does not extend above 100,000 feet AGL, and therefore, the Moisture Error Bounds are not calculated above 100,000 feet AGL.



**ATTACHMENT 18**  
**QUALITY INDICES AND STATISTICS**

The purpose of this attachment is to describe to the IPAM User how the moisture and temperature quality indices are determined. These indices are listed in Paragraph G of the IPAM profile output. Also contained in this attachment is a discussion on the quality statistics file.

A Quality Index is a number between 0.00 and 5.00. The temperature quality index is based on the temperature errors, and the moisture quality index is based on specific humidity errors. These quality indices are part of the remarks output shown in Paragraph G of the IPAM output whenever a vertical profile, e.g., RAOBVP, OIVP or Aerosol Parameters, or a slant path profile, e.g., OI- or Aerosol-based, is requested.

The method of obtaining the temperature and specific humidity errors for each profile level for an aerosol based profile is explained in Attachment 17 of this User's Guide. The temperature and specific humidity errors for each profile level of an OI-based profile are obtained in the same manner.

The temperature and specific humidity errors for each level of a RAOB-based vertical profile are calculated as a weighted average between the instrument error for the most significant data source and a climatological error value. Attachment 20 of this User's Guide describes how these climatological error values were obtained. Note that the error values for the profiles are never part of the final IPAM output. However, in the case of an Aerosol-based profile, these error values are used to create the alternate profiles.

After the temperature and moisture error values are obtained, the quality indices are calculated. The temperature quality index (QITEMP) is calculated using the following formula:

$$QITEMP = 5. - .25*TEBMAX - .5*TEBAVE$$

where,

TEBMAX = the maximum value within the Temperature Error data set; and,

TEBAVE = is the average of the Temperature Error Values.

The moisture quality index (QISH) is calculated using the following formula:

$$QISH = 5. - MEBMAX - MEBAVE$$

where,

MEBMAX is the maximum of:

$$\frac{(FINMEB(I) * SPHUM(I))}{(FINMEB(I) + SPHUM(I))}$$

and I = 1 to top specific humidity level;

where,

FINMEB(I) is the specific humidity error value of the Ith profile level and SPHUM(I) is the specific humidity analysis value for the Ith profile level; and,

MEBAVE is the average of the sum of:

$$\frac{(FINMEB(I) * SPHUM(I))}{(FINMEB(I) + SPHUM(I))}$$

for I = 1 to the top of the specific humidity levels.

After the quality control indices have been calculated, the values are used to determine if the profile has passed/failed the quality checks.

If either quality index is less than 1.5, the profile is assumed to be of questionable quality. The values of the quality indices, the result of the moisture parameter comparison (see Attachment 10 of this User's Guide), plus IPAM request information for quality control dictate what happens next in the handling and processing of the IPAM profile output.

The IPAM requestor has several options to obtain quality control of the IPAM output. In addition, the IPAM programs will also set flags to request quality control. The user requests and the system flags have to be compatible to ensure quality control takes place in some instances.

The IPAM requestor establishes quality control requirements by setting the MANQC data item in the request to Y, N, A, V, C, or B. These options are:

- Y - Always send IPAM profile to Analyst for Quality Control;
- N - Never send IPAM profile to Analyst for Quality Control;
- A - Have Analyst Quality Control as needed;
- V - Quality Control if Temperature Quality Index < 1.5 or Moisture Quality Index < 1.5;
- C - Quality Control if Moisture Parameter Comparison quality check fails (see Attachment 10 of this User's Guide); and
- B - Quality Control if either Temperature Quality Index or Moisture Quality Index < 1.5. and the Moisture Parameter Comparison quality check fails.

Figure A18-1 helps the user understand when Quality Control of an IPAM profile will be done by an analyst.

| IPAM Quality Index Options<br>(Automated Program Flags)       |  |   |   |  |
|---|--|---|---|--|
| Requestor Input<br>for Quality Control<br>(Data Item - MANQC) | All<br>Quality<br>Checks<br>Meet<br>Thresholds | Only<br>Vertical<br>Profile<br>Quality<br>Check<br>Failed | Only<br>Moisture<br>Parameter<br>Comparison<br>Quality<br>Check<br>Failed | Both<br>Vertical<br>Profile<br>and<br>Moisture<br>Comparison<br>Checks<br>Failed |
| Y   | QC   | QC  | QC  | QC   |
| N   | None   | None  | None  | None   |
| A   | None   | QC  | QC  | QC   |
| V   | None   | QC  | None  | QC   |
| C   | None   | None  | QC  | QC   |
| B   | None   | None  | None  | QC   |

Legend: QC - Quality Control Performed by Analyst  
None - No Quality Control Performed

NOTE: Vertical Profile Quality Check fails if either QITEMP or QISH is < 1.5.

Figure A18-1.  
Determination of Analyst Quality Control  
Based on Requestor Input and Quality Index Thresholds

The quality indices are also used in the actual moisture parameter comparison process. If a vertical profile or slant path profile with an elevation angle greater than 45° is requested along with a request for a pseudo-surface observation, a moisture comparison is performed. If either quality index is less than the corresponding quality control threshold established by the user in the request, the cloud amounts in the pseudo-surface observation are assumed to be better data, and the vertical profile is adjusted accordingly. For more information concerning the moisture parameter comparison, refer to Attachment 10 in this User's Guide.

IPAM compiles statistics on the quality of IPAM products. During each IPAM run, if quality threshold is exceeded by a quality index, a flag is set indicating a threshold was exceeded. An array of 12 flags is maintained by each PA run. The array is a 4 x 3 array as follows:

| Index exceeding threshold | Original Run | 1st Rerun | 2nd Rerun |
|---------------------------|--------------|-----------|-----------|
| Temperature               |              |           |           |
| Maximum                   | X            | X         | X         |
| Temperature               |              |           |           |
| Average                   | X            | X         | X         |
| Moisture                  |              |           |           |
| Maximum                   | X            | X         | X         |
| Moisture                  |              |           |           |
| Average                   | X            | X         | X         |

X=Flag. Flag will be set to "0" at start, and set to "1" when threshold is exceeded.

Figure A18-2.  
Quality Statistics Array Configuration

The Audit program will total the statistics for each customer for each day. The totals are kept for 45 days.

NOTE: If either threshold is changed, the statistics for that day will be inaccurate.

(3) Using the following height increments and statistical software, climatological errors for temperature and specific humidity for each upper-air station were determined.

- a. 100 ft. increments for the Planetary Boundary Layer;
- b. 1000 ft. increments for the Troposphere Layer; and,
- c. 2000 ft. increments for the Stratosphere Layer.

The incremental standard deviations are combined and averaged to produce an error for each layer, then combined and averaged to produce seasonal climatological errors for each layer. Finally, the seasonal errors for each station in a latitudinal band are combined and averaged to produce climatological errors for temperature and specific humidity based on season, latitude and height.

The results contribute to the development of the alternate temperature and moisture profiles.

## ATTACHMENT 19

## HIRAS

The HIRAS (High Resolution Analysis System) database is a gridded co-ordinate system, based on latitude and longitude, for meteorological data. Users can find a detailed description of HIRAS in Reference 1.2.c.

In OIVP, HIRAS analysis values and error values are used as the basis for the IPAM first guess. In RAOBVP, HIRAS analysis values are used to calculate data for the final RAOB profile. When the user requests a RAOB-based Vertical Profile, data from HIRAS can be used to fill in any missing data.

When the user requests an Optimum Interpolation Vertical Profile (OIVP), the analysis values and error values for the HIRAS grid points are used, and they serve as the basis for the IPAM data profile.

ATTACHMENT 20  
UPPER AIR CLIMATOLOGY

The purpose of this attachment is to provide the user with information concerning the development of Climatological Temperature and Specific Humidity Errors, which are used to develop the Alternate Temperature and Moisture Profiles described in Attachment 17.

The error values were developed and categorized by the variables of season, latitude and atmospheric layers. Details on each variable follow.

a. Season

Seasonal errors were developed for Winter, Summer and Spring/Fall according to the months and hemisphere shown below:

| <u>Season</u> | <u>N.H. Months</u>     | <u>S.H. Months</u>     |
|---------------|------------------------|------------------------|
| Winter        | Dec - Feb              | Jun - Aug              |
| Summer        | Jun - Aug              | Dec - Feb              |
| Fall/Spring   | Mar - May<br>Sep - Nov | Sep - Nov<br>Mar - May |

b. Latitude

The error categories were further refined by latitude bands as follows:

- (1) Tropics: 20°N to 20°S;
- (2) Mid-Latitudes: 20°N - 60°N; 20°S - 60°S; and,
- (3) Polar: 60°N - 90°N; 60°S - 90°S



c. Atmospheric Layers:

Finally, the errors were further delineated by layers as follows:

(1) Planetary Boundary Layer:

Surface to 1999 feet;

(2) Troposphere Layer:

2000 feet to the tropopause; and,

(3) Stratosphere Layer:

Above the tropopause.

The methodology to calculate the climatological errors for temperature and specific humidity is described in the following paragraphs.

- (1) For each latitudinal band 20 upper-air RAOB stations were selected. The stations were chosen in such a manner that all possible air mass types for that band would be included. All stations used had at least a 10-year period of record for the data, i.e., daily 0000Z and 1200Z upper-air RAOBS were available for 10 consecutive years (1979-1988); many stations had a 15 year period of record.
- (2) A seasonal tropopause height for each latitudinal band was determined. First, the monthly average tropopause height for each upper-air station was calculated using statistical software. Then the monthly average heights were combined and averaged to produce three seasonal tropopause heights. Finally, the seasonal averages for the 20 stations in each band were averaged to produce an average tropopause height for each latitudinal band, based on the seasons previously identified.

(3) Using the following height increments and statistical software, climatological errors for temperature and specific humidity for each upper-air station were determined:

- a. 100 ft. increments for the Planetary Boundary Layer;
- b. 1000 ft. increments for the Troposphere Layer; and,
- c. 2000 ft. increments for the Stratosphere Layer.

The incremental standard deviations are combined and averaged to produce an error for each layer, then combined and averaged to produce seasonal climatological errors for each layer. Finally, the seasonal errors for each station in a latitudinal band are combined and averaged to produce climatological errors for temperature and specific humidity based on season, latitude and height.

The results contribute to the development of the alternate temperature and moisture profiles.

**ATTACHMENT 21**  
**REFRACTIVE INDEX**

The purpose of this attachment is to provide the user with information concerning the development of the Refractive Index profile, or NVALUE. The profile is output in Paragraph K.

The refractive index is based upon the NVALUE program that is operational at AFGWC. It allows for the creation of profiles of radio and optical indices. The electromagnetic spectrum ranges from  $3 \times 10^{-5} \mu$  (Gamma rays) to  $3 \times 10^6 \mu$  (Very High Frequency). The visual band extends from  $.4 \mu$  (violet) to  $.7 \mu$  (red). The formulae used to create the Refractive Index profile were extracted directly from the AFGWC NVALUE program. Actually, the AFGWC NVALUE code is very similar to the code used in the IPAM, so the IPAM and NVALUE compliment each other well. The NVALUE User's Manual may be a good source to find out more about the actual AFGWC NVALUE code, if desired.

The Refractive Index profile can be requested by setting NVALUE to "Y" in the request template. This will trigger modules in OI DRV R or RAOBVP, whichever is appropriate, to create the profile. The user can request a profile up to 100000 feet by modifying KTOP in the request template, and increments of 500, 1000, 1500, 2000, or 2500 feet can be chosen by modifying HGHTRI. The default values are 50000 and 500, respectively.

The NVALUE modules extract pressure, heights, wind direction and speed, temperature, and absolute humidity from the 500 foot profile to build the Refractive Index profile. The output includes all of the above except the absolute humidity is converted to relative humidity. Also included in the output is the Radio Index, Optical Index, Delta, which is the difference in radio indices at that level and the next level, and a description of the Refractive Condition.

The Radio and Optical indices are computed using the formulae extracted from the AFGWC code. The Refractive Condition is determined by the size of Delta as follows:

| If | <u>DELTA</u> | then | <u>REFRACTIVE CONDITION</u> |
|----|--------------|------|-----------------------------|
|    | .GE. 0       |      | Subrefractive               |
|    | .LT. 0       |      |                             |
|    | and          |      |                             |
|    | .GE. -24     |      | Normal                      |
|    | .LE. -24     |      |                             |
|    | and          |      |                             |
|    | .GT. -48     |      | Super Refractive            |
|    | .LE. -48     |      | Trapping                    |

Sample output of the Refractive Index profile, Paragraph K, is in Section 3.

**ATTACHMENT 22**  
**LINE-OF-SIGHT CAPABILITIES**

The purpose of this attachment is to provide the user with information describing the line-of-sight capabilities of the IPAM system.

The line-of-sight capability, also known as the horizontal path capability, provided by the IPAM system is similar in concept to the slant path capability described in Attachment 8. The slant path allows for a PA analysis along a path at an angle from the vertical. Line-of-sight analysis are alike in that they involve paths away from the vertical an expanded data collection area is required. However, there are also some significant differences between slant path and line-of-sight.

The user requests a line-of-sight by setting the HRZPTH flag to "Y" in the request template. At this time, other key inputs are required. They are

|        |   |
|--------|---|
| ENDLTD | Ending latitude degrees                         |
| ENDLTM | Ending latitude minutes                         |
| ENDLNK | Ending latitude key                             |
| ENDLND | Ending longitude degrees                        |
| ENDLNM | Ending longitude minutes                        |
| ENDLNK | Ending longitude key                            |
| BEGALT | Beginning point altitude<br>(maximum, 400000ft) |
| ENDALT | Ending point altitude<br>(maximum, 400000ft)    |

It is easily apparent that the line-of-sight path does not need to begin at the surface like the slant path. In fact, the entire path is above the surface.

In a worst case scenario for a line-of-sight, where BEGALT and ENDALT are both set at 400000ft, the result can be a very lengthy profile. Because of memory limitations in the system, lengthy line-of-sight, although they are still part of the same run. The line-of-sight code determines where the lowest point on the path occurs. This is where the path will be split into two separate PAs.

The low point is also important in the creation of output profiles for long line-of-sights. The levels in the outputs will be organized in a high-low-high fashion. In other words, the profile will begin at the beginning point and decrease to the low point, then it will begin to increase to the ending point.

Not all line-of-sights will be sufficiently lengthy to warrant splitting it into two PAs. Many will be short enough to be completed as one PA. However, the BEGALT and ENDALT will determine how the output will be organized. If the BEGALT is lower than the ENDALT, then the output will be produced in increasing order of levels. If the BEGALT is higher than the ENDALT, the output will be produced in decreasing order. Also, it is still possible to have a single line-of-sight output in a high-low-high format, similar to the double line-of-sight described earlier.

Line-of-sight PAs may sometimes intersect with the surface. In this case, the profile will be created from the BEGALT to the surface. If the path re-emerges on the other side of the globe, the profile will continue from the surface at that latitude and longitude, and continue to the ENDALT. For example, in the following diagram, the profile will be created for segments A-B and C-D. No profile will be created for segment B-C since it is below the surface.

Other sample line-of-sight possibilities are as follows. To note differences between slant paths and line-of-sights, refer to the sample of a line-of-sight. Figure A8-1.

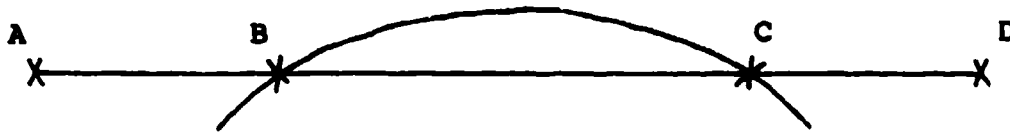

When the above situation occurs, a message will be written to Paragraph G, REMARKS, stating that the PA intersects the earth.

It is important to note that the line-of-sight requires significantly more CPU time than the slant path due to the increased data requirements and extra processing to determine subpoints. Because of this, the user can expect greater turn around time, especially during peak production hours. The following diagrams show a sample slant path versus a sample line-of-sight.

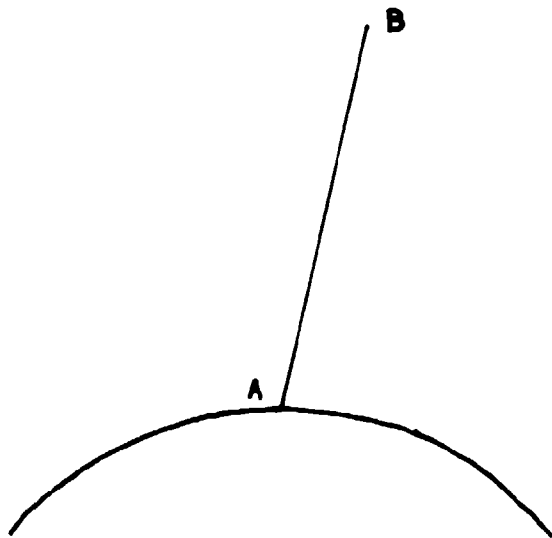

Figure 22-1a.  
Sample Slant Path

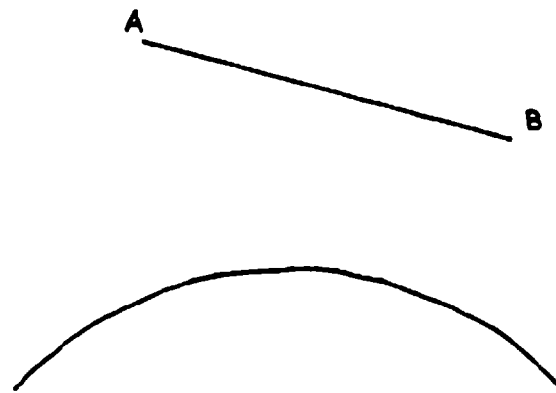

Figure 22-1b.  
Sample Line-of-Sight

## DISTRIBUTION

|  |    |
|--|----|
| AWS/DO, Scott AFB, IL 62225-5008 .....   | 1  |
| AWS/XTJ, Scott AFB, IL 62225-5008 .....  | 1  |
| AWS/XTXA, Scott AFB, IL 62225-5008 .....   | 1  |
| OL A, HQ AWS, Buckley ANG Base, Aurora, CO 80011-9599.....                                       | 1  |
| SSD/MWA, PO Box 92960, Los Angeles, CA 90009-2960.....   | 1  |
| Det 1, HQ AWS, Pentagon, Washington, DC 20330-6560.....  | 5  |
| Det 2, HQ AWS, Pentagon, Washington, DC 20330-5054.....  | 3  |
| Det 3, HQ AWS, PO Box 3430, Onizuka AFB, CA 94088-3430.....                                      | 1  |
| 1WW/DO/DN Hickam AFB, HI 96853-5000 .....  | 2  |
| 11WS/DON, Elmendorf AFB, AK 99506-5000.....  | 1  |
| 20WS/DON, APO San Francisco 96328-5000.....  | 1  |
| 30WS/DON, APO San Francisco 96301-0420.....  | 1  |
| 2WW/DO/DN, APO New York 09094-5000.....  | 2  |
| 7WS/DON, APO New York 09403-5000.....  | 1  |
| 28WS/DON, APO New York 09127-5000.....   | 1  |
| 31WS/DON, APO New York 09136-5000.....   | 1  |
| 3WW/DO/DN, Offutt AFB, NE 68113-5000.....  | 2  |
| 9WS/DON, March AFB, CA 92518-5000.....   | 1  |
| 24WS/DON, Randolph AFB, TX 78150-5000.....   | 1  |
| 26WS/DON, Barksdale AFB, LA 71110-5002.....  | 1  |
| 4WW/DO/DN, Peterson AFB, CO 80914-5000.....  | 2  |
| 2WS/DR, Andrews AFB, MD 20334-5000.....  | 20 |
| 5WW/DO/DN, Langley AFB, VA 23665-5000.....   | 4  |
| 1WS/DON, MacDill AFB, FL 33608-5000.....   | 1  |
| 3WS/DON, Shaw AFB, SC 29152-5000.....  | 1  |
| 5WS/DON, Ft McPherson, GA 30330-5000.....  | 1  |
| 25WS/DON, Bergstrom AFB, TX 78743-5000.....  | 1  |
| AFGWC/SDSL, Offutt AFB, NE 68113-5000.....   | 25 |
| OL-A, AFGWC, FLENUMOCEANCEN, Monterey, CA 93943-5005.....  | 1  |
| OL-B, AFGWC/R/E/S2, 325 Broadway, Boulder, CO 80303-3328.....                                    | 1  |
| OL-C, AFGWC, NOAA/NESDIS Liaison E/SPI, Federal Bldg 4, Rm 0304, Washington, DC 20233-0001.....  | 1  |
| USAFETAC, Scott AFB, IL 62225-5438.....  | 6  |
| OL-A, USAFETAC, Asheville, NC 28801-2723.....  | 2  |
| 7WW/DN, Scott AFB, IL 62225-5008.....  | 2  |
| 6WS/DON, Hurlburt Field, FL 32544-5000.....  | 1  |
| 15WS/DON, McGuire AFB, NJ 08641-5002.....  | 1  |
| 17WS/DON, Travis AFB, CA 94535-5986.....   | 1  |
| 3350 TCHTG/TTGU-W, Stop 62, Chanute AFB, IL 61868-5000.....                                      | 2  |
| 3395 TCHTG/TTKO-W, Keesler AFB, MS 39534-5000.....   | 2  |
| AFIT/CIR, Wright-Patterson AFB, OH 45433-6583.....   | 1  |
| NAVOCEANO (Rusty Russum), Stennis Space Ctr, MS 39522-5001.....                                  | 2  |
| Maury Oceanographic Library (NOC), Code XJL, Stennis Space Ctr, MS 39529-5001.....               | 1  |
| FLENUMOCEANCEN, Monterey, CA 93943-5006.....   | 1  |
| NOARL West, Monterey, CA 93943-5006.....   | 1  |
| Naval Research Laboratory, Code 4323, Washington, DC 20375.....                                  | 1  |
| Naval Postgraduate School, Chmn, Dept of Meteorology, Code 63, Monterey, CA 93943-5000.....      | 1  |
| Dept of Commerce/NOAA/MASC Library MC5 (Jean Bankhead), 325 Broadway, Boulder, CO 80303.....     | 2  |
| OFCM, Suite 300, 6010 Executive Blvd, Rockville, MD 20852.....                                   | 1  |
| NOAA Library-EOC4WSC4, Attn: ACQ, 6009 Executive Blvd, Rockville MD 20852.....                   | 1  |
| NOAA/NESDIS (Attn: Nancy Everson, E/RA22), World Weather Bldg, Rm 703, Washington, DC 20233..... | 1  |



|   |     |
|---|-----|
| NOAA/NBSDIS (Attn: Capt Taylor), FB #4, Rm 0308, Suitland, MD 20746 .....                           | 1   |
| GLLY, Hanscom AFB, MA 01731-5000 .....  | 1   |
| GL Library, Attn: SULLR, Stop 29, Hanscom AFB, MA 01731-5000 .....                                  | 1   |
| Atmospheric Sciences Laboratory (SLCAS-AT-AB), Aberdeen Proving Grounds, MD 21005-5001 .....        | 1   |
| Atmospheric Sciences Laboratory (SLCAS-AS-I 310-2c), White Sands Missile Range, NM 88002-5501 ..... | 1   |
| Army Missile Command, ATTN: AMSMI-RD-TE-F, Redstone Arsenal, AL 35898-5250 .....                    | 1   |
| Army Test & Eval Cmd, ATTN: AMSTB-TC-AM (RE) TCOM Met Team, Redstone Arsenal, AL 35898-8052 .....   | 1   |
| Commandor and Director, U.S. Army CEETL, Attn: GL-AE, Fort Belvoir, VA 22060-5546 .....             | 1   |
| Technical Library, Dugway Proving Ground, Dugway, UT 84022-5000 .....                               | 1   |
| NCDC Library (D542X2), Federal Building, Asheville, NC 28801-2723 .....                             | 1   |
| NIST Pubs Production, Rm A-405, Admin Bldg, Gaithersburg, MD 20899 .....                            | 1   |
| DTIC-FDAC, Cameron Station, Alexandria, VA 22304-6145 .....   | 2   |
| AUL/LSE, Maxwell AFB, AL 36112-5564 .....   | 1   |
| AWSTL, Scott AFB, IL 62225-5438 .....   | 100 |



DEPARTMENT OF THE AIR FORCE  
HEADQUARTERS AIR FORCE GLOBAL WEATHER CENTRAL  
OFFUTT AIR FORCE BASE NEBRASKA 68113-5000

91-16

ERRATA

REPLY TO DOP (Capt P. Thompson, DSN 271-5985)  
ATTN OF:

10 May 1991

SUBJECT: Correction to AFGWC/TN-91/001, Improved Point Analysis Model (IPAM) Users  
Guide, dated February 1991

TO: See Distribution

In para 3.8.2., page 3-38, the units for the parameters "qqqq" and "q<sub>a</sub>q<sub>a</sub>q<sub>a</sub>" were erroneously reported as gm/cm<sup>3</sup>. The units are, in fact, gm/m<sup>3</sup>. Please note the correct units and file this letter as a reference. If you have any questions, please contact Capt Pat Thompson.

*Bruce D. Springer*

BRUCE D. SPRINGER, Lt Col, USAF  
Chief, Programs Acquisitions Branch

1 Atch  
Distribution

AD A 235 305

DISTRIBUTION

AWS/DOO, Scott AFB, IL 62225-5008  
AWS/DOS, Scott AFB, IL 62225-5008  
AWS/KTX, Scott AFB, IL 62225-5008  
OL-A, HQ AWS, Buckley ANG Base, Aurora, CO 80011-9599  
SSD/MWA, PO Box 92960, Los Angeles, CA 90009-2960  
Det 1, HQ AWS, Pentagon, Washington D. C., 20330-6560  
Det 2, HQ AWS, Pentagon, Washington D. C., 20330-5054  
Det 3, HQ AWS, P. O. Box 3430, Onizuka AFB, CA 94088-3430  
1WW/DO/DN, Hickam AFB, HI 96853-5000  
11WS/DON, Elmendorf AFB, AK 99506-5000  
20WS/DON, APO San Francisco 96328-5000  
30WS/DON, APO San Francisco 96301-0420  
2WW/DO/DN, APO New York 09403-5000  
7WS/DON, APO New York 09403-5000  
28WS/DON, APO New York 09127-5000  
31WS/DON, APO New York 09136-5000  
3WW/DO/DN, Offutt AFB, NE 68113-5000  
9WS/DON, March AFB, CA 92518-5000  
24WS/DON, Randolph AFB, TX 78150-5000  
26WS/DON, Barksdale AFB, LA 71110-5000  
4WW/DO/DN, Peterson AFB, CO 80914-5000  
2WS/DR, Andrews AFB, MD 20334-5000  
5WW/DO/DN, Langley AFB, VA 23665-5000  
1WS/DON, MacDill AFB, FL 33608-5000  
3WS/DON, Shaw AFB, SC 29152-5000  
5WS/DON, Ft McPherson, GA 30330-5000  
25WS/DON, Bergstrom AFB, TX 78743-5000  
AFGWC/SDSL, Offutt AFB, NE 68113-5000  
OL-A, AFGWC, FLENUMOCEANCEN, Monterey, CA 93943-5005  
OL-B, AFGWC/R/E/S2, 325 Broadway, Boulder, CO 80303 4-3328  
OL-C, AFGWC, NOAA/NESDIS Liaison E/SPI, Federal Bldg 4, Rm 0304,  
Washington D. C., 20233-0001  
USAFETAC, Scott AFB, IL 62225-5438  
OL-A, USAFETAC, Asheville, NC 28801-2723  
7WW/DN, Scott AFB, IL 62225-5008  
6WS/DON, Hurlburt Field, FL 32544-5000  
15WS/DON, McGuire AFB, NJ 08641-5000  
17WS/DON, Travis AFB, CA 94535-5986  
3350 TCHTG/TTGU-W, Stop 62, Chanute AFB, IL 61868-5000  
3395 TCHTG/TTGU-W, Keesler AFB, MS 39534-5000  
AFIT/CIR, Wright-Patterson AFB, OH 45433-6583  
NAVOCEANO (Rusty Russum), Stennis Space Center, MS 39522-5001  
Maurv Oceanographic Library (NOC), Code XJL, Stennis Space Center, MS  
39529-5001  
FLENUMOCEANCEN, Monterey, CA 93943-5006

NOARL West, Monterey, CA 93943-5006

Naval Research Laboratory, Code 4323, Washington D. C., 20375

Naval Postgraduate School, Chmn, Dept of Meteorology, Code 63, Monterey, CA  
93943-5000

Dept of Commerce/NOAA/MASC Library MC5 (Jean Bankhead), 325 Broadway, Boulder,  
CO 80303

OFCM, Suite 300, 6010 Executive Blvd, Rockville, MD 20852

NOAA Library-EOC42SC4, ATTN: ACQ, 6009 Executive Blvd, Rockville, MD 20852

NOAA/NESDIS (ATTN: Nancy Everson, E/RA22), World Weather Building, Room 703,  
Washington D. C. 20233

PL/LY, Hanscom AFB, MA 01731-5000

PL Library, ATTN: SULLR, Stop 29, Hanscom AFB, MA 01731-5000

Atmospheric Sciences Laboratory (SLCAS-AT-AB), Aberdeen Proving Grounds, MD  
21005-5001

Atmospheric Sciences Laboratory (SLCAS-AS-I 310-2c), White Sands Missile  
Range, NM 88002-5501

Army Missile Command, ATTN: AMSMI-RD-TE-F, Redstone Arsenal, AL 35898-5250

Army Test and Evaluation Command, ATTN: AMSTE-TC-AM (RE) TCOM Met Team,  
Redstone Arsenal, AL 35898-8052

Commander and Director, U. S. Army CEETL, ATTN: GL-AE, Fort Belvoir, VA  
22060-5546

Technical Library, Dugway Proving Ground, Dugway, UT 84022-5000

NCDC Library (D542X2), Federal Building, Asheville, NC 28801-2723

NIST Pubs Production, Rm A-405, Admin Bldg, Gaithersburg, MD 20899

DTIC-FDAC, Cameron Station, Alexandria, VA 22304-6145

AUL/LSE, Maxwell AFB, AL 36112-5564

AWSTL, Scott AFB, IL 62225-5438

**END**

**FILMED**

**DATE:**

7-91

**DTIC**