

DTIC FILE COPY



AD-A232 813

RANGE REFERENCE ATMOSPHERE

SHEMYA

USAFETAC



JANUARY 1991

DTIC  
ELECTE  
MAR 14 1991  
S E D

APPROVED FOR PUBLIC RELEASE;  
DISTRIBUTION IS UNLIMITED

USAF  
ENVIRONMENTAL TECHNICAL  
APPLICATIONS CENTER


Scott Air Force Base, Illinois, 62225-5438

91 3 12 125


## REVIEW AND APPROVAL STATEMENT

USAFETAC/PR-91/003, *Range Reference Atmosphere, Shemya*, January 1991, is approved for public release. There is no objection to unlimited distribution of this document to the public at large, or by the Defense Technical Information Center (DTIC) to the National Technical Information Service (NTIS).

This document has been reviewed and is approved for publication.

  
PATRICK J. BREITLING  
Chief Scientist

FOR THE COMMANDER

  
WALTER S. BURGMANN  
Scientific and Technical Information  
Program Manager  
28 December 1990

## REPORT DOCUMENTATION PAGE

2. Report Date: January 1991
3. Report Type: Range Reference Atmosphere (RRA)
4. Title and Subtitle: Range Reference Atmosphere, Shemya
7. Performing Organization Name and Address: USAF Environmental Technical Applications Center (USAFETAC), Scott AFB, IL 62225-5438
8. Performing Organization Report Number: USAFETAC/PR-91/003
12. Distribution/Availability Statement: Approved for public release; distribution is unlimited.
13. Abstract: This range reference atmosphere (RRA) is a statistical model (derived from upper-air observations) of the atmosphere from 0 to 70 km over the Shemya range complex. The RRA provides tabulations of monthly and annual means, standard deviations, and skewness coefficients for wind speed, pressure, temperature, density, water vapor pressure, virtual temperature, and dew point temperature. It also gives means and standard deviation for the zonal and meridional wind components and hydrostatic model atmosphere. Methodology is included, along with graphic displays of wind statistics that can be derived from the wind data.
14. Subject Terms: CLIMATOLOGY, UPPER-AIR CLIMATOLOGY, UPPER ATMOSPHERE, ATMOSPHERIC SOUNDINGS, STATISTICAL DATA, STATISTICAL ANALYSIS, HYDROSTATIC MODEL ATMOSPHERES, MISSILE RANGES, LAUNCHING SITES, SHEMA, wind, atmospheric pressure, atmospheric density, air temperature, dew point temperature, atmospheric moisture, range reference atmosphere.
15. Number of Pages: 164
17. Security Classification of Report: Unclassified
18. Security Classification of this Page: Unclassified
19. Security Classification of Abstract: Unclassified
20. Limitation of Abstract: UL

Standard Form 298

<b>Accession For</b>	
NTIS GRA&I	<input checked="" type="checkbox"/>
DTIC TAB	<input type="checkbox"/>
Unannounced	<input type="checkbox"/>
Justification	
By _____	
Distribution/	
Availability Codes	
Dist	Avail and/or Special
A-1	



# TABLE OF CONTENTS

	Page
<b>Chapter 1 INTRODUCTION TO THE RANGE REFERENCE ATMOSPHERE (RRA)</b>	
1.1 The RRA Defined.....	1
1.2 Purpose of the RRA.....	1
1.3 Contents of the RRA.....	1
1.4 Units of Measurement Used in RRAs.....	1
1.5 RRA Quality Control.....	1
1.6 How the RRA is Organized.....	2
1.7 Conversion Units.....	2
<b>Chapter 2 WIND STATISTICS AND MODELS</b>	
2.1 General Discussion.....	5
2.2 Quality Control.....	7
2.3 Data Limitations.....	7
2.4 The Coordinate System of Statistical Parameters.....	7
2.5 Computing Statistical Parameters.....	8
2.6 Statistical Wind Models.....	8
2.6.1 Wind Component Statistics.....	8
2.6.2 The Vector Wind Model.....	8
2.6.3 Derived Distributions for Wind Statistics.....	12
2.6.3.1 The Conditional Distribution of Wind Components.....	13
2.6.3.2 Generalized Rayleigh Distribution for Wind Speed.....	14
2.6.3.3 The Derived Distribution of Wind Direction.....	15
2.6.3.4 Derived Conditional Distribution of Wind Speed Given Wind Direction.....	16
2.7 Statistical Parameters for Non-Standard Orthogonal Axes.....	18
<b>Chapter 3 THERMODYNAMIC STATISTICS AND MODELS</b>	
3.1 General Discussion.....	19
3.2 Quality Control.....	21
3.3 Data Limitations.....	21
3.4 Establishing Data Samples at Required Levels.....	21
3.4.1 Converting Geopotential Height to Geometric Altitude.....	21
3.4.2 Calculations from Rawinsonde Observations.....	22
3.4.2.1 Geopotential Height at Significant Levels.....	22
3.4.2.2 Temperature.....	22
3.4.2.3 Pressure.....	23
3.4.2.4 Dew Point Temperature.....	23
3.4.2.5 Vapor Pressure.....	23
3.4.2.6 Density.....	23
3.4.2.7 Virtual Temperature.....	23
3.4.3 Calculations from Rocketsonde Observations.....	23
3.4.3.1 Temperature.....	23
3.4.3.2 Pressure.....	24
3.4.3.3 Density.....	24
3.5 Computing Statistics for Appendices B and C.....	24
3.5.1 Stored Statistical Sums.....	24
3.5.2 Calculating Monthly Statistics.....	24
3.5.2.1 Monthly Means.....	24
3.5.2.2 Monthly Standard Deviations.....	24
3.5.2.3 Monthly Skewness Values.....	24
3.5.3 Calculating Annual Statistics.....	25

<b>Chapter 3</b>	<b>THERMODYNAMIC STATISTICS AND MODELS, Cont'd.</b>	
3.5.3.1	Annual Means.....	25
3.5.3.2	Annual Standard Deviations and Skewness Values.....	25
3.6	Monthly and Annual Mean Model Atmospheres.....	25
3.7	Thermodynamic Quantities Derivable from Tables.....	25
3.7.1	Mean Air Particle Speed.....	26
3.7.2	Mean Free Path.....	26
3.7.3	Mean Collision Frequency.....	27
3.7.4	Speed of Sound.....	27
3.7.5	Coefficient of Dynamic Viscosity.....	27
3.7.6	Kinematic Coefficient of Viscosity.....	27
3.7.7	Coefficient of Thermal Conductivity.....	28
3.7.8	Refractive Modulus and Refractive Index.....	28
<b>Chapter 4</b>	<b>CONCLUSIONS AND RECOMMENDATIONS</b>	
4.1	Conclusions.....	29
4.2	Recommendations.....	29
<b>BIBLIOGRAPHY</b> .....		<b>30</b>
<b>PREVIOUSLY PUBLISHED RANGE REFERENCE ATMOSPHERES</b> .....		<b>31</b>
<b>ACRONYMS, INITIALISMS, AND ABBREVIATIONS (ACRINABs)</b> .....		<b>34</b>
<b>APPENDIX A Shemya Wind Statistics Tables</b> .....		<b>A-1</b>
<b>APPENDIX B Shemya Thermodynamic Statistics Tables</b> .....		<b>B-1</b>
<b>APPENDIX C Shemya Moisture-Related Statistics Tables</b> .....		<b>C-1</b>
<b>APPENDIX D Shemya Hydrostatic Model Atmospheres</b> .....		<b>D-1</b>
<b>APPENDIX E Wind Statistics Derivable from Appendix A Tables</b> .....		<b>E-1</b>
<b>APPENDIX F Thermodynamic Statistics Derivable from Appendix C, D, and E Tables</b> .....		<b>F-1</b>
<b>APPENDIX G Shemya Descriptive Data</b> .....		<b>G-1</b>

## PREFACE

The state of the atmosphere over national ranges and aerospace vehicle launch and/or recovery sites is critical not only to launch and recovery operations, but to aerospace research and development, as well. In the early 1960s, missile range operators recognized the need for a realistic atmospheric model that was consistently derived for each of the several major missile test ranges then in operation. Such a model, derived from climatological statistics for a given location, was developed and named a "range reference atmosphere." Even though the application has since broadened to include all aerospace launch and/or recovery sites, the model is still referred to as a "range reference atmosphere," or "RRA."

The first RRA (for Cape Canaveral) was prepared in 1963 by the Inter-Range Instrumentation Group (IRIG). More RRAs were produced for other ranges through 1974. Since then, improved upper-air databases have become available not only because of an extended period of record, but because of more and better rocketsonde data above 30 km. Although some improved RRAs were published in 1983 and 1984, revisions must continue, because:

- Aerospace technology requirements continue to change--the space shuttle program is an example.
- Extended and improved upper-air databases for most existing ranges permit development of better, more comprehensive RRAs.
- New launch and recovery sites have been opened.
- There have been significant advances in understanding the structure and physics of the upper atmosphere.
- There have been similar advances in statistical modeling techniques, largely because of ever-larger, faster, and more sophisticated computers.

For these reasons, the Range Reference Atmosphere Committee (RRAC) was tasked by the Range Commander's Council/Meteorology Group (RCC/MG) to produce new and revised RRAs, as required. The RRAC, through Task MG-1, publishes RRAs for ranges specified by the RCC. An RRA, as has already been mentioned, is a model of the atmosphere over a specified geographical area that delineates an aerospace vehicle launch and/or recovery site. RRAs are for use by DoD and other U.S. Government users in planning, evaluating, and establishing environmental launch/recovery constraints for a specific facility and the aerospace vehicles launched and/or recovered there.

The RRA tasking requires using the best available upper-atmosphere databases (rawinsonde, rocketsonde, and any other high-altitude data source) to create and publish (in standard format) a consistently derived model of wind and thermodynamic values through a cross-section of the upper atmosphere from surface to a specified height. The individual RRA serves as the authoritative source for upper-atmosphere climatology at a given launch/recovery site.

Wind statistics, insofar as practical, are modeled to be consistent with the rigorous mathematical probability properties of the multivariate normal probability theory. Thermodynamic statistics, insofar as practical, are modeled to be consistent with the hydrostatic equation, the equation of state, and related probability principles.

In keeping with the RCC's objective of standardization, modeling technique, basic text, and tabulation formats are the same for all RRAs. RRAs published in 1990 have undergone minor format changes designed to make them conform to DoD and ANSI technical publications standards. All RRAs provide mean values of thermodynamic quantities (pressure, temperature, and density) and moisture quantities (vapor pressure, virtual temperature, and dew point temperature). These values include a statistical measure for the dispersion: that is, standard deviations and skewness coefficients. The properties of the bivariate normal probability distribution function are used for statistical modeling of wind.

The first RRA to be published in this new (1990) series was for the Wake Island Missile Range, with an altitude range from 0 to 30 km. The order of priority for subsequent publications in the RRA series is:

<u>Range</u>	<u>Altitude Range Required</u>
1. Nellis Range Complex, NV	0 - 30 km
2. Shemya, AK	0 - 70 km
3. Thule, GR	0 - 70 km
4. Fairbanks, AK	0 - 30 km

All final computations in this RRA series were performed by the USAF Environmental Technical Applications Center (USAFETAC) in response to taskings from the Ballistic Missile Office (BMO), HQ Air Weather Service (AWS/SYJ), and Detachment 2, Space Division.

Majors Cheryl Souders and Walter Miller, and Capts Doug Adamson and Brian Bjornson (all of USAFETAC/DNO), rewrote the software used to provide the primary tables, updated Chapters 1 through 4, and prepared the appendices. USAFETAC/LDE formatted and edited the text and graphics, prepared the camera-ready copy in standard DoD technical report format, and published the document as a USAFETAC project report.

The RRC/MG Range Reference Atmosphere Committee is made up of representatives from the Air Force, Army, NASA, Navy, and NOAA. The RRA committee members were:

Mr J. Lee (USAKA)	Mr D.R. Thornley (WSMR)
Mr D. Godwin (USAKA)	Mr E.J. Keppel (MSD)
Ms J. Bailey (YPG)	Capt R.M. Fogarty, USAF (6535th TG)
Mr T.O. McIntire (YPG)	Lt Col T.F. Tascione, USAF (MSD)
Mr S.W. Bieda, Jr. (EPG)	Mr J. Kerwin (MSD)
Mr G. Boire (WSMC)	Lt Col R.J. Ericson, USAF (CSTC)
Mr H.C. Herring (ESMC)	Capt W. Gibbons, USAF (TFWC)
Col J.T. Madura, USAF (ESMC)	Mr L.S. Corbett (NWC)
Maj A.F. Dye, USAF (ESMC)	Mr J.J. Genola (NWC)
Mr B.F. Boyd (ESMC)	Mr D. Tolzin (PMTC)
Mr C.W. Fain (ESMC)	Lt R. Kren, USN (NATC)
Maj R. Hughes USAF (AFFTC)	Mr J. Trischman (NATC)
Lt B. Hickel, USAF (AFFTC/UTTR)	Lt Col J.E. Erickson, (USAFETAC)
CPO G.A. Dillie, USN (NWC)	Mr R. Olsen (WSMR), Chairman

## Chapter 1

### INTRODUCTION TO THE THE RANGE REFERENCE ATMOSPHERE (RRA)

#### 1.1 THE RRA DEFINED.

A "reference atmosphere" is a statistical model of the earth's atmosphere, derived from upper-air observations over a specific location. The atmospheric models developed by the Range Reference Atmosphere Committee (RRAC) in response to a tasking by the Range Commander's Council/Meteorology Group (RCC/MG) and published by the Secretariat, Range Commander's Council (RCC) are called "Range Reference Atmospheres," or "RRAs." The first series of RRAs was published from 1963 to 1974, and a second series was issued in 1983 and 1984.

#### 1.2 PURPOSE OF THE RRA.

The individual RRA is the authoritative source for upper-atmosphere climatology over the launch and/or recovery site for which it has been prepared. RRAs are used to plan, evaluate, and establish environmental launch constraints for aerospace vehicles launched from a particular location.

#### 1.3 CONTENTS OF THE RRA.

RRAs contain tabulations for monthly and annual means, standard deviations, and skewness coefficients for wind speed, pressure, temperature, density, water vapor pressure, virtual temperature, and dew point temperature. They also provide means and standard deviations for zonal and meridional wind components and the linear (product moment) correlation coefficient between wind components. Statistical values are tabulated (at the station elevation) at 1-km intervals from sea level (MSL) to 30 km and at 2-km intervals from 30 to 70 km. Wind statistics begin at about 10 meters above station elevation, and continue at altitudes with respect to MSL thereafter. For ranges without rocketsonde measurements, RRAs terminate at 30 km; they may be extended upward, if necessary, when rocketsonde data from a nearby location can be made available.

#### 1.4 UNITS OF MEASUREMENT USED IN RRAs.

All wind speeds are in meters per second (m/s). In all cases, the skewness coefficient and the correlation coefficient between wind components are unitless. Pressure (including water vapor pressure) is in millibars (mb). Temperature and virtual temperature are in kelvin (K). Density is in grams per cubic meter ( $g/m^3$ ). All altitudes are geometric, in kilometers (km). All heights are geopotential, also in kilometers (km). All altitudes/heights are in relation to mean sea level.

#### 1.5 RRA QUALITY CONTROL.

Less than 10 percent of the soundings in the database used to calculate the RRA tables contained erroneous data. Soundings that did contain erroneous values data were eliminated from the database. Steps taken to produce an RRA that is as error-free as possible are described below:

(1) Soundings with gaps in their pressure levels of more than 200 mb were rejected. These soundings were eliminated because some contained height values only for mandatory pressure levels; when some heights at the mandatory levels were missing, the interpolated sounding contained significant errors.

(2) An initial set of RRA statistics was computed using all the remaining soundings (i.e., those that had not been rejected). This set was then used to determine data limits for temperature, pressure, U and V components of wind, density, and dew point for the 0-30 km portion, and density only from 30 to 60 km (in RRAs that go that high). The lower (or upper) data limits were set at the mean value for each variable, minus (or plus) six standard deviations of that quantity. One pair of data limits was computed for each of the atmospheric variables, the month, and the data level.

(3) The first set of data limits was then used to screen the database. All soundings that contained values outside the data limits were rejected. A new RRA was then computed using the screened database, and the second RRA was used to generate a second set of data limits.



(4) The second set of data limits was then used to screen the database further, and still another RRA was generated. The skewness values in this one were evaluated according to empirical criteria specified in Section 2.2 of this document (for winds) and in Section 3.2 (for thermodynamic quantities). If these criteria were satisfied, the third RRA was used to generate a final set of data limits, which were used to quality control the database for the final version of the RRA.

(5) Occasionally, the third RRA did not satisfy all the skewness criteria, indicating that the database still contained some erroneous values. To complete quality control, the "limits-to-RRA-to-limits" cycle was repeated (usually once or twice) until the resulting RRA satisfied the skewness criteria. When it did, a final set of data limits was generated, then used to quality control the database and produce the final RRA.

## 1.6 HOW THE RRA IS ORGANIZED.

RRA documents are published in four chapters, with Chapter 1 providing the introduction. Chapter 2, "Wind Statistics and Models," describes the techniques used to produce the wind statistics given in Table A-1 through A-13, Appendix A; it also describes the probability functions used as wind models to derive several wind statistics. Chapter 3, "Statistics of Thermodynamic Quantities and Models," describes the techniques used to produce the thermodynamic and moisture-related statistics in Tables B-1 through B-13 and C-1 through C-13, Appendices B and C. It also describes the atmospheric thermodynamic model in Tables D-1 through D-13, Appendix D. Chapter 4 also contains equations used to calculate several atmospheric properties. Chapter 4 provides conclusions and recommendations. Chapters 1-4 are the same in each new RRA; only Appendices A-G (described below) vary from RRA to RRA.

**Appendix A** contains monthly and annual wind statistics tables that give: (1) means and standard deviations of zonal and meridional wind components, (2) the linear (product moment) correlation coefficient between the two components, (3) the mean, standard deviation and skewness coefficient of the wind speed, and (4) the number of wind observations (sample size).

**Appendix B** contains monthly and annual thermodynamic statistics tables that give: (1) means, standard deviations, and skewness values of pressure, temperature, and density; and (2) the number of observations used for each of the thermodynamic quantities.

**Appendix C** contains monthly and annual moisture-related statistics tables that give: (1) means, standard deviations, and skewness values of water vapor pressure, virtual temperature, and dewpoint; and (2) the number of observations for each of the moisture-related quantities. Statistical values for water vapor pressure and dewpoint terminate at or below 15 km, depending on the range's latitude. Above 15 km, statistical values of virtual temperature are considered to be the same as those of temperature.

**Appendix D** contains monthly and annual tables that give hydrostatic model atmospheres for thermodynamic variables of pressure, virtual temperature, and density. Values are derived from the monthly and annual mean virtual temperature versus altitude (geometric) using the hydrostatic equation and the equation of state. Also presented is the geopotential height corresponding to the tabulated geometric altitudes.

**Appendix E** gives range-specific examples of certain wind statistics that can be derived from the basic data in Appendix A.

**Appendix F** gives tabular and graphic examples of certain pressure, density, and virtual temperature statistics that can be derived from basic data in Appendices B, C, and D.

**Appendix G** gives range-specific information such as location and database description.

## 1.7 CONVERSION UNITS.

Numerical values in the RRA are metric, as given in the International System of Units (SI, *Système International d'Unités*). Table 1-1 provides metric, U.S. Customary, and conversion units for all units used in this RRA.

TABLE 1-1. CONVERSION UNITS USED IN RRAS.

DATA TYPE	METRIC UNIT	US CUSTOMARY		CONVERSION:		To Get
		ABBR	UNIT	ABBR	Multiply By	
Ambient Temperature	degree Celsius	°C	degree Fahrenheit	°F	0.5556	°C
	kelvin	K	degree Rankine	°R	1.8°	°F-32
					1.00°	°F+459.67
Temperature Change	degree Celsius	°C	degree Fahrenheit	°F	0.5556	°C
	kelvin	K	degree Rankine	°R	1.8°	°F/°R
					0.5556	Chg °C/K
Ambient Density	gram/cubic meter	gm <sup>-3</sup>	grain/cubic foot	grft <sup>-3</sup>	0.43700	grft <sup>-3</sup>
	gram/cubic centimeter	gcm <sup>-3</sup>			2.2883	gm <sup>-3</sup>
	(Absolute humidity)				10 <sup>-6</sup>	gcm <sup>-3</sup>
Vapor Concentration					4.370/10 <sup>-3</sup>	gcft <sup>-3</sup>
					2.288/10 <sup>-6</sup>	gcm <sup>-3</sup>
Windspeed	meters/second	ms <sup>-1</sup>	mile/hour	mph	2.2369	mph
			knots	knots	0.44704°	ms <sup>-1</sup>
			feet/second	fts <sup>-1</sup>	1.9438	knots
					0.51444	ms <sup>-1</sup>
					0.868976	knots
					1.15078	mph
Weight	gram	g	grain	gr	0.45359237°	kg
	kilogram	kg	pound	lb	453.59237°	g
					2.20462	lb
				15.4324	gr	
				0.06480	g	

TABLE 1-1. CONVERSION UNITS USED IN RRAS, Cont'd.

DATA TYPE	METRIC UNIT	US CUSTOMARY UNIT		CONVERSION:		To Get	
		ABBR	UNIT	Multiply	By		
Length	meter	m	feet	m	3.2808	ft	
	micron	$\mu$	inch	ft	0.3048	m	
	Angstrom unit		A		in	$2.54 \times 10^{11}$	$\mu$
					in	$2.54 \times 10^{10}$	A
					m	$10^{-6}$	$\mu$
					m	$10^{-10}$	A
					$\mu$	$10^{-6}$	m
			$\mu$	$3.937 \times 10^{-3}$	in		
			A	$10^{10}$	m		
			A	$3.937 \times 10^{-9}$	m		
Pressure	newton/square meter		newton m <sup>-2</sup>	lb in <sup>-2</sup>	$10^{-3}$	bar	
					$10^3$	mb	
	millimeter of Mercury	mmHg	inch of Mercury	newton m <sup>-2</sup>	$10^{-2}$	mb	
				newton m <sup>-2</sup>	$1.4504 \times 10^{-4}$	lb m <sup>-2</sup>	
				lb in <sup>-2</sup>	$6.8948 \times 10^3$	newton m <sup>-2</sup>	
	bar			mb	$1.4504 \times 10^{-2}$	lb m <sup>-2</sup>	
	millibar			lbin <sup>-2</sup>	68.948	mb	
	dyne/square centimeter (microbar)	dyne cm <sup>-2</sup>		mb	$10^3$	dyne cm <sup>-2</sup>	
	kilogram force/square meter	kg m <sup>-2</sup>		mb	$10^{-3}$	dyne cm <sup>-2</sup>	
				dyne cm <sup>-2</sup>	$10^{-3}$	mb	
				lb in <sup>-2</sup>	$6.8948 \times 10^4$	dyne cm <sup>-2</sup>	
				dyne cm <sup>-2</sup>	$1.4504 \times 10^{-5}$	lb m <sup>-2</sup>	
				mb	10.1972	kg m <sup>-2</sup>	
				kg m <sup>-2</sup>	0.0980665	mb	
				lb m <sup>-2</sup>	703.0696	kg m <sup>-2</sup>	
				kg m <sup>-2</sup>	0.0014223	lb m <sup>-2</sup>	
				mb	$2.9530 \times 10^{-2}$	mmHg (32°F)	
			mb	0.75006	mmHg (0°C)		
			mmHg	25.40	mmHg (0°C)		
			mmHg	1.3332	mb		
			mmHg (321)	33.8639	mb		
			Pa	1.00	newton m <sup>-2</sup>		

## WIND STATISTICS AND MODELS

### 2.1 GENERAL DISCUSSION.

One of the objectives in developing an RRA is to describe the wind field over the launch/recovery site as completely as possible with as few data tabulations as possible. With that in mind, the bivariate normal probability distribution was adopted as a statistical model for wind treated as a vector quantity at RRA data levels. Only five statistical parameters are required to completely describe this probability function; in Cartesian coordinates, these parameters are the means and standard deviations of the two orthogonal components, along with the correlation coefficient between the two components. The tables in Appendix A give the five statistical parameters for the zonal and meridional (meteorological coordinate) components. The statistical properties of the bivariate normal probability distribution are used to derive many wind statistics of interest to range users. The procedure produces consistent wind statistics that are connected through rigorous mathematical probability functions. By using these functions, extensive tabulations of wind statistics are avoided. Statistical properties of the bivariate normal probability distribution presented for the vector wind statistical model are:

- Wind components are univariate normally distributed.
- Conditional distribution of one component, given a value of the other component, is univariate normally distributed.
- Wind speed is in the form of a generalized Rayleigh distribution.
- Frequency distribution of wind direction can be derived.
- Conditional distribution of wind speed, given a value of wind direction (wind rose), can be derived.
- The five tabulated wind statistical parameters that are with respect to the meteorological zonal and meridional coordinate system can be derived for any arbitrary rotation of the orthogonal axes.

The RRA provides probability distribution functions and sets of equations to derive wind statistics for the previously stated properties of the vector wind model; examples are given in Appendix E.

No attempt is made here to give the derivation of the probability functions, but the reader is referred to Smith (1976) for derivations and several applications of the probability distribution properties for wind statistics.

Symbols used in Chapter 2, and their meanings, are given in Table 2-1, next page.

**TABLE 2-1 Symbols Used in Chapter 2.**

$N$	The number of wind measurements in Appendix A.
$r$	A general variable for the bivariate normal probability distribution in polar coordinates.
$R$	A generalized Rayleigh variable used for derived wind speed probability distribution.
$R(U,V)$	The linear (product moment) correlation coefficient between the zonal and meridional wind components in Appendix A.
$SK(W)$	Skewness parameter for wind speed in Appendix A.
$S(U)$	The standard deviation of the zonal wind component in Appendix A.
$S(V)$	The standard deviation of the meridional wind component in Appendix A.
$S(W)$	The standard deviation of wind speed in Appendix A.
$z$	A standardized normal variate used in Table 2-1.
$U$	The zonal wind component.
$UBAR$	The mean value of the zonal wind component in Appendix A.
$V$	The meridional wind component.
$VBAR$	The mean value of the meridional wind component in Appendix A.
$W$	Wind speed or modulus of wind vector, a scalar quantity.
$WBAR$	The mean value of wind speed in Appendix A.
$X$	A general component mean value in the $[X,Y]$ coordinate system.
$Y$	A general component mean value in the $[X,Y]$ coordinate system.
$X$	A general component variable or coordinate axes.
$Y$	A general component variable or coordinate axes.
$\alpha$	(alpha) Rotation angle for the $[X,Y]$ coordinate system.
$\theta$	(theta) Wind direction in the polar coordinate system.
$\lambda$	(Lambda) A parameter in the bivariate normal probability distribution in Table 2-2.
$\xi$	(Xi) The mean value in the standardized normal probability distribution used in Table 2-1.
$\pi$	(Pi) Constant = 3.14159 .
$\rho$	(Rho) The general linear correlation coefficient between the two component variables in the $[x,y]$ coordinate system.
$\sigma_x, \sigma_y$	The general standard deviations of the $x$ and $y$ component variables in the $[x,y]$ coordinate system.

## 2.2 QUALITY CONTROL.

The U and V components of wind were used to generate data limits, which were set at plus and minus six standard deviations from the mean for each of the quantities. These data limits were used to screen the wind database, as described in Paragraph 1.5. The database was considered to be error-free if:

- The skewness of the wind speed was below 4.0 at data levels where the mean wind speed was less than 15 m/s, and
- The skewness of the wind speed was below 2.5 at data levels where the mean wind speed was greater than 15 m/s.

## 2.3 DATA LIMITATIONS.

For wind statistics, correlation coefficients for like and unlike wind components between altitude levels were not computed, and wind statistics with respect to altitude (profile) cannot be derived from RRA statistics; users are referred to Smith (1976) for wind profile modeling techniques. Wind statistics at discrete altitudes are valid; all the probability distribution functions described in Chapter 2 can be derived from the five wind component statistical parameters in Appendix A and the derived distributions can be considered as wind models at discrete altitudes.

Greek letters are used conventionally for population or theoretically known statistical elements, and sample estimates are denoted by English letters or with a "hat" ( $\hat{\ } \wedge$ ) over Greek letters. In Chapter 2, Greek letters are used for variances and linear correlation coefficient, while means are denoted by  $\bar{X}$  and  $\bar{Y}$  when dealing with the bivariate normal distribution. It must always be understood that Appendix A contains sample estimates of statistical parameters, and that they are with respect to the meteorological zonal (U) and meridional (V) coordinate systems.

## 2.4 THE COORDINATE SYSTEM OF STATISTICAL PARAMETERS.

Wind is measured and recorded in terms of magnitude and direction. Wind direction is expressed in degrees clockwise from true north, and is the direction from which the wind is blowing. Wind magnitude (the modulus of the vector) is the scalar quantity, and is referred to as wind speed or scalar wind. A statistical description that accounts for the wind as a vector quantity is appropriate and requires a coordinate system.

For the RRA, the Standard Meteorological Coordinate System has been chosen for wind statistics, all tables of statistical parameters, and related discussions. This choice was made because the coordinate system used in aerospace and related applied fields has not always been consistent. Figure 2-1 illustrates the Standard Meteorological Coordinate System.

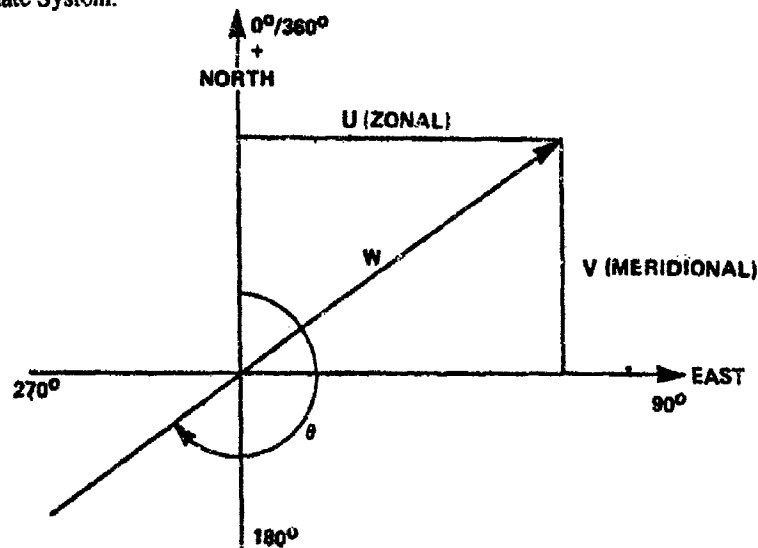


Figure 2-1. The Standard Meteorological Coordinate System.

Using Figure 2.1, the polar and Cartesian forms for the meteorological coordinate system are defined as follows:

$W$  wind speed, scalar wind, or magnitude of the wind vector (m/s).

$\theta$  wind direction, measured as the direction *from which* the wind is blowing, in degrees clockwise from true north.

$U$  zonal wind component, positive west to east (m/s).

$V$  meridional wind component, positive south to north (m/s).

The components  $\theta$  and  $W$  define the polar form, and the  $U$ - $V$  components define the Cartesian forms:

$$U = -W \sin\theta, \quad 0 \leq \theta \leq 360^\circ \quad (1)$$

$$V = -W \cos\theta \quad (2)$$

It is helpful to note the difference between the *mathematical* convention for *vector* direction and the *meteorological* convention for *wind* direction:

$$\theta_{met} = 270 - \theta_{math} \quad (3)$$

$$\text{when } 0 \leq \theta \leq 270^\circ$$

$$\theta_{met} = 360 + (270 - \theta_{math})$$

$$\text{when } 270 \leq \theta \leq 360^\circ$$

## 2.5 COMPUTING STATISTICAL PARAMETERS.

All these statistical parameters are with respect to the Standard Meteorological Coordinate System shown in Figure 2-1. The wind statistical parameters in Appendix A (means and standard deviations of zonal and meridional wind components, plus wind speed and the skewness parameter of wind speed) were computed using the sums technique described in Paragraph 3.5.1. In addition, a linear (product moment) correlation coefficient between the zonal and meridional wind components,  $r(u,v)$  in Appendix A, was computed. This correlation coefficient is defined as:

$$r(u,v) = \frac{\sum_{i=1}^n (U_i - \bar{U})(V_i - \bar{V})}{N s(u) \cdot s(v)} \quad (4)$$

## 2.6 STATISTICAL WIND MODELS.

### 2.6.1 Wind Component Statistics.

The univariate normal (Gaussian) probability distribution function is used to obtain wind component statistics. In generalized notations, the probability density function (*pdf*) is:

$$F(T) = \frac{e^{-\frac{t^2}{2}}}{\sqrt{2\pi}} \quad (5)$$

where  $t = X - \frac{\xi}{\sigma_x}$  is the standardized variate, with  $\xi$  defining the mean and  $\sigma$  the standard deviation.

The probability distribution function (PDF) is:

$$F(t) = \int_{-\infty}^t f(t) dt \quad (6)$$

Because this integral cannot be obtained in closed form, it is widely tabulated for zero mean and unit standard deviation. Selected values of  $F(t)$  are given in Table 2-2, next page. To emphasize the connotation of probability,  $F(t)$  is shown in Table 2-2 as  $P\{X\}$ . The  $t$  values in Table 2-2 are used as multiplier factors to the standard deviation to express the probability that a normally distributed variable ( $X$ ) is less than or equal to a given value as:

$$P\{X \leq \text{mean} + t \sigma_x\} = \text{probability, } p \quad (7)$$

For example, when  $t = 1.6449$ , the probability that  $X$  is less than or equal to the mean plus 1.6449 standard deviations is 0.95. That value of  $X$  which is less than or equal to the mean plus 1.6449 standard deviations is called the "95th percentile value of  $X$ ." Also given in Table 2-2 are the numerical values for expressing the probability that  $X$  falls in the interval  $X_1$  and  $X_2$ ; i.e.,

$$P\{X_1 \leq X \leq X_2\} = \text{Interpercentile Range} \quad (8)$$

where

$$X_1 = \bar{X} - t \sigma_x$$

$$X_2 = \bar{X} + t \sigma_x$$

For  $t = 1.9602$  the probability that  $X$  lies in the interval  $X_1$  and  $X_2$  is 0.95. The values of  $X_1$  and  $X_2$  in this example comprise the 95th interpercentile range.

For a normally distributed variable, the mode (most frequent value) and the median (50th percentile value) are the same as the mean value. The means and standard deviations of the zonal and meridional wind components from Appendix A are used in equations 7 and 8 to compute the percentile values and interpercentile ranges of the zonal and meridional wind components. When equation 7 is illustrated on a normal probability graph, a straight line is formed.

### 2.6.2 The Vector Wind Model.

Because wind is a vector quantity having direction and magnitude that can be expressed as two components in an orthogonal coordinate system, a probability model that describes the joint relationship is the bivariate normal probability distribution. In general component notation (shown by equation 9, below), the bivariate normal probability density function (BNpdf) is:

$$f(X,Y) = \frac{1}{2\pi\sigma_x\sigma_y\sqrt{1-\rho^2}} \left[ \exp \frac{-1}{2(1-\rho^2)} \left\{ \frac{(X-\bar{X})^2}{\sigma_x^2} - \frac{2\rho(X-\bar{X})(Y-\bar{Y})}{\sigma_x\sigma_y} + \frac{(Y-\bar{Y})^2}{\sigma_y^2} \right\} \right] \quad -\infty \leq X \leq \infty \ \& \ -\infty \leq Y \leq \infty$$

where the five parameters are  $\bar{X}, \bar{Y}$ , the component means  $\sigma_x, \sigma_y$ , the component standard deviations, and  $\rho$ , the correlation coefficient between the two component variables  $X$  and  $Y$ .

For many applications, there is interest in determining the probability that a point  $\{X,Y\}$  will fall within a contour of equal probability density. The exponential terms of equation 9, when set equal to a constant ( $\lambda_2$ ), give a family of ellipses depending on the value of the constant. The ellipses have a common center at the point  $\{\bar{X}, \bar{Y}\}$ . Integration of equation 9 over the region bounded by the contours of equal probability density gives:



**TABLE 2-2. Values of  $t$  for Standardized Normal (Univariate) Distribution for Percentiles and Interpercentile Ranges.**

$t$	$P(X)$	$X$	$P\{X_1 \leq X \leq X_2\} (\%)$
-3.0000	0.00135	$\xi - 3.0000 \sigma$	
-2.5758	0.00500	$\xi - 2.5758 \sigma$	
-2.3263	0.01000	$\xi - 2.3263 \sigma$	
-2.2365	0.01266	$\xi - 2.2365 \sigma$	
-2.0000	0.02275	$\xi - 2.0000 \sigma$	
-1.9602	0.02500	$\xi - 1.9602 \sigma$	
-1.6449	0.05000	$\xi - 1.6449 \sigma$	
-1.2816	0.10000	$\xi - 1.2816 \sigma$	
-1.0000	0.15866	$\xi - 1.0000 \sigma$	
-0.8416	0.20000	$\xi - 0.8416 \sigma$	
-0.6745	0.25000	$\xi - 0.6745 \sigma$	
-0.2533	0.40000	$\xi - 0.2533 \sigma$	
0.0000	0.50000	$\xi$	
0.2533	0.60000	$\xi + 0.2533 \sigma$	
0.6745	0.75000	$\xi + 0.6745 \sigma$	
0.8416	0.80000	$\xi + 0.8414 \sigma$	
1.0000	0.84134	$\xi + 1.0000 \sigma$	
1.2816	0.90000	$\xi + 1.2816 \sigma$	
1.6449	0.95000	$\xi + 1.6449 \sigma$	
1.9602	0.97502	$\xi + 1.9602 \sigma$	
2.0000	0.97725	$\xi + 2.0000 \sigma$	
2.2365	0.98734	$\xi + 2.2365 \sigma$	
2.3263	0.99000	$\xi + 2.3263 \sigma$	
2.5758	0.99500	$\xi + 2.5758 \sigma$	
3.0000	0.99865	$\xi + 3.0000 \sigma$	

where  $X_1 = \xi - t\sigma$   
 and  $X_2 = \xi + t\sigma$

$$P(\lambda) = 1 - e^{-\frac{\lambda^2}{2(1-p^2)}} \quad (10)$$

Solving for  $\lambda^2$  and replacing  $P(\lambda)$  by  $p$  gives:

$$\lambda^2 = -2(1-p^2) \ln(1-p) \quad (11)$$

Now define:

$$\lambda_e = \sqrt{2} \sqrt{-\ln(1-p)} \quad (12)$$

For reference and comparison,  $\lambda_e$  is shown in Table 2-3 for selected values of  $p$ .

**TABLE 2-3. Values of  $\lambda$  for Bivariate Normal Distribution Ellipses and Circles.**

$P(\%)$	$(\lambda_e\text{--ellipse})$	$(\lambda_e\text{--circle})$	$P(\%)$	$(\lambda_e\text{--ellipse})$	$(\lambda_e\text{--circle})$
0.000	0.0000	0.0000	65.000	1.4490	1.0246
5.000	0.3203	0.2265	68.268	1.5151	1.0713
10.000	0.4590	0.3246	70.000	1.5518	1.0973
15.000	0.5701	0.4031	75.000	1.6651	1.1774
20.000	0.6680	0.4723	80.000	1.7941	1.2686
25.000	0.7585	0.5363	85.000	1.9479	1.3774
30.000	0.8446	0.5972	86.466	2.0000	1.4142
35.000	0.9282	0.6563	90.000	2.1460	1.5175
39.347	1.0000	0.7071	95.000	2.4477	1.7308
40.000	1.0108	0.7147	95.450	2.4860	1.7579
45.000	1.0935	0.7732	98.000	2.7971	1.9778
50.000	1.1774	0.8325	98.168	2.8284	2.0000
54.406	1.2533	0.8862	98.889	3.0000	2.1213
55.000	1.2637	0.8936	99.000	3.0348	2.1460
60.000	1.3537	0.9572	99.730	3.4393	2.4320
63.212	1.4142	1.0000	99.9877	4.2426	3.0000

The probability ellipse that contains  $p$ -percent of the wind vectors expressed in the most general form is the conic defined by:

$$AX^2 + BXY + CY^2 + DX + EY + F = 0 \quad (13)$$

Where:

$$A = \sigma_y^2 \quad D = 2\sigma_x\sigma_y \rho Y - 2\sigma_y^2 X = -(B Y + 2A X)$$

$$B = -2\rho\sigma_x\sigma_y \quad E = 2\sigma_x\sigma_y \rho X - 2\sigma_x^2 Y = -(B X + 2C Y)$$

$$C = \sigma_x^2 \quad F = AX^2 + CY^2 + BXY - AC(1-p^2)\lambda_e^2$$

and  $\lambda_e = \sqrt{2} \sqrt{-\ln(1-p)}$

For graphic presentations, the range of the variable is important in order to arrange the scale. The largest and smallest values of  $X$  and  $Y$  for a given probability ellipse ( $p$ ) are given by:

$$X_{L,S} = \bar{X} \pm \sigma_x \lambda_c \quad (14)$$

$$Y_{L,S} = \bar{Y} \pm \sigma_y \lambda_c \quad (15)$$

where, as before,

$$\lambda_c = \sqrt{2} \sqrt{-1/n (1-p)}$$

Although there are several approaches to graphing the probability ellipses, the following procedure is best for electronic computer plotting. In establishing the computer plotting program, the sample estimates for  $\bar{X}$ ,  $\bar{Y}$ ,  $\sigma_x$ ,  $\sigma_y$ , and  $\rho$  are constants in equation 13. The user makes the choice of probability ellipses desired. Thus,  $p$  in equation 12 is programmed as a parameter. The largest and smallest values for  $X$  and  $Y$  are computed by equations 14 and 15 for the largest probability ellipse selected. This sets the graphical scale. Values of  $X$  within the range of  $X$  smallest to  $X$  largest are obtained by incrementing  $X$  between these limits. Using the quadratic equation, a solution of equation 13 is made for  $Y$  for each value of  $X$ , and plotted. The centroid ( $\bar{X}$ ,  $\bar{Y}$ ) for the family of probability ellipses is plotted as a point. Labeling and other identification completes the plotting program.

For a given probability, equation 13 defines an ellipse that contains  $p$ -percent of the points  $X, Y$ . Since the entire area under the bivariate normal density function (equation 9) is unity, upon integration for a given probability ellipse, that given ellipse contains  $p$ -percent of the total area. In the wind statistics  $p$ -percent of the wind vectors fall within the specified probability ellipse. From this point of view, a specified probability ellipse gives the joint probability that  $p$ -percent of the  $U-V$  components lie within the given ellipse.

When  $\sigma_x^2 = \sigma_y^2 = \sigma^2$  and  $\rho = 0$  in the bivariate normal distribution, the probability ellipses of equation 13 reduce to circles whose centers are at the means  $\bar{X}, \bar{Y}$ . The radii of the probability circles are  $\sigma_{V1} \lambda_c$ , where:

$$\sigma_{V1} = \sqrt{2}\sigma \quad (16)$$

and

$$\lambda_c = \sqrt{-1/n (1-p)} \quad (17)$$

Values for  $\lambda_c$  for selected probabilities,  $p$ , are given in Table 2-3.

Because this function is simple, it can easily be graphed manually. However, the generalized plotting technique for electronic computer plotters (as shown by equation 13) can also be used.

### 2.6.3 Derived Distributions for Wind Statistics.

In this section, the probability distribution functions and sets of equations are presented to derive certain probability distribution functions for wind statistics. These derived probability distributions are:

- Conditional distribution of wind components
- Generalized Rayleigh distribution for wind speed
- Distribution for wind direction
- Conditional distribution of wind speed given a wind direction (wind rose).

The five required statistical parameters for these derived distributions for wind statistics are given in Appendix A.

### 2.6.3.1 The Conditional Distribution of Wind Components.

Given that two random variables  $X$  and  $Y$  are bivariate normally distributed, the conditional distribution  $f(Y|X)$  is read as  $f(Y)$  given  $X$ , and likewise  $f(X|Y)$  is read as  $f(X)$  given  $Y$ . The conditional probability function  $F(Y|X)$  has the mean  $E(Y|X)$  and variance  $\sigma^2_{(y|x)}$ , where:

$$E(Y|X^*) = \bar{Y} + \rho \left( \frac{\sigma_y}{\sigma_x} \right) (X^* - \bar{X}) \quad (18)$$

and

$$\sigma^2_{(y|x^*)} = \sigma_y^2 (1 - \rho^2) \quad (19)$$

The conditional standard deviation is:

$$\sigma_{(y|x^*)} = \sigma_y \sqrt{1 - \rho^2} \quad (20)$$

By interchanging the variables and parameters, the conditional distribution function for  $F(X|Y^*)$  has the conditional mean:

$$E(X|Y^*) = \bar{X} + \rho \left( \frac{\sigma_x}{\sigma_y} \right) (Y^* - \bar{Y}) \quad (21)$$

conditional variance:

$$\sigma^2_{(x|y^*)} = \sigma_x^2 (1 - \rho^2) \quad (22)$$

and conditional standard deviation:

$$\sigma_{(x|y^*)} = \sigma_x \sqrt{1 - \rho^2} \quad (23)$$

The preceding conditional probability distribution functions are univariate normal distributions for a (fixed) given value for one of the bivariate normal variables. Thus, the  $t$ -values given in Table 2 are applicable for conditional probabilities statements. For example,

$$F(Y|X^*) = E(Y|X^*) + t \sigma_{(y|x^*)} \quad (24)$$

For  $t = 1.6449$ , there is a 95 percent chance that  $Y$  is less than or equal to  $\bar{Y} + 1.6449 \sigma_{(y|x^*)}$  given that  $X = X^*$ . In symbols, this statement reads:

$$P \{ Y \leq E(Y|X^*) + 1.6449 \sigma_{(y|x^*)} | X = X^* \} = 0.9500 \quad (25)$$

Interval probability statements can also be made:

$$P \{ Y_1 = E(Y|X^*) - t \sigma_{(y|x^*)} \leq Y \leq Y_2 = E(Y|X^*) + t \sigma_y | X = X^* \}$$

where  $X^*$  can take on any fixed value of  $X$ , but a convenient arrangement is to let  $X^* = \bar{X} \pm t \sigma_x$ .

The close connection of the regression function of  $Y$  on  $X$  to the conditional mean for the bivariate normal distribution is noted:

$$Y = \bar{Y} + \rho \left( \frac{\sigma_y}{\sigma_x} \right) (X - \bar{X}) \quad (26)$$

Similarly, the regression function of  $X$  on  $Y$  is:

$$X = \bar{X} + \rho \left( \frac{\sigma_x}{\sigma_y} \right) (Y - \bar{Y}) \quad (27)$$

These are linear functions and express the same results as would be obtained from a least-squares regression line.

### 2.5.3.2 Generalized Rayleigh Distribution for Wind Speed.

If two random variables,  $X$  and  $Y$ , are bivariate normally distributed, then the probability distribution for the modulus,  $R$ , can be derived in terms of the five parameters that define the bivariate normal distribution:

$$R = \sqrt{X^2 + Y^2} \quad (28)$$

The distribution of  $R$  so derived is called a generalized Rayleigh distribution because there are no restrictions on the parameters. For applications to the RRA, the variable  $R$  is recognized as wind speed or the modulus of the wind vector.

The probability density function for  $R$  is expressed as:

$$f(R) = a_0 R e^{-a_1 R^2} \left[ I_0(a_2 R^2) I_0(a_3 R) + 2 \sum_{k=1}^{\infty} I_k(a_2 R^2) I_{2k}(a_3 R) \cos 2k\psi \right] \quad R \geq 0 \quad (29)$$

The functions  $I_0(\cdot)$ ,  $I_k(\cdot)$ , and  $I_{2k}(\cdot)$  are the modified Bessel function of the first kind for zero order,  $k$ th order, and  $2k$ th order. The coefficients are:

$$a_0 = \frac{\exp \left[ -\frac{1}{2} \left\{ \frac{\bar{X}^2}{\sigma_a^2} + \frac{\bar{Y}^2}{\sigma_b^2} \right\} \right]}{\sigma_a \sigma_b}$$

where  $\sigma_a^2$  and  $\sigma_b^2$  are the rotated variances to produce zero correlation between  $X$  and  $Y$ .  $\sigma_a$  and  $\sigma_b$  are the positive and negative roots of the following expression, the computational form of which is obtained from the determinant:

$$\begin{vmatrix} \sigma_x^2 - K & \sigma_x \sigma_y \rho \\ \sigma_x \sigma_y \rho & \sigma_y^2 - K \end{vmatrix}$$

where  $K$  is  $\sigma_{(x,y)}^2$ , and  $\sigma_a$  and  $\sigma_b$  are analogous to the standard deviation of the major and minor axes of the bivariate normal probability ellipse:

$$\sigma_{(x,y)}^2 = \frac{1}{2} \left\{ \sigma_x^2 + \sigma_y^2 \pm \left[ (\sigma_x^2 + \sigma_y^2)^2 - 4\sigma_x^2 \sigma_y^2 (1 - \rho^2) \right]^{1/2} \right\}$$

$$a_1 = \frac{(\sigma_x^2 + \sigma_y^2)}{4(1-\rho^2)\sigma_x^2\sigma_y^2}$$

$$a_2 = \frac{[(\sigma_x^2 - \sigma_y^2)^2 + 4\rho^2\sigma_x^2\sigma_y^2]^{\frac{1}{2}}}{4(1-\rho^2)\sigma_x^2\sigma_y^2}$$

$$a_3 = \left[ \left( \frac{\bar{X}}{\sigma_a^2} \right)^2 + \left( \frac{\bar{Y}}{\sigma_b^2} \right)^2 \right]^{\frac{1}{2}}$$

and

$$\tan \psi = \frac{\bar{Y}}{\bar{X}} \frac{\sigma_a^2}{\sigma_b^2}$$

Since this density function cannot be integrated in closed form from zero to  $R$ , numerical integration is used to obtain practical results from the probability distribution function; i.e.,

$$F(R) = \int_0^R f(R) dR \quad (30)$$

A number of special cases can be obtained from the general Rayleigh distribution (equation 29), the most simple of which is to let  $\sigma_x = \sigma_y = \sigma$  and  $\bar{X} = \bar{Y} = 0$  with independent variables  $X$  and  $Y$ . This gives:

$$f(R) = \frac{R}{\sigma^2} e^{-\frac{R^2}{2\sigma^2}} \quad (31)$$

which is recognized as the classical Rayleigh probability density function. The density function (equation 31) can be integrated in closed form over any range of the variable  $R$ . Hence, the probability distribution function,  $F(R)$ , for equation 31 is:

$$F(R) = 1 - \exp \left\{ -\frac{R^2}{2\sigma^2} \right\} \quad (32)$$

### 2.6.3.3 The Derived Distribution of Wind Direction.

Considering the wind as a vector quantity and bivariate normally distributed, the wind direction can be derived. This is done by first writing the bivariate normal probability density function in polar coordinates whose variables are:

$$g(r, \theta) = r d_1 e^{\frac{1}{2}(a^2 r^2 - 2br + c^2)} \quad (33)$$

NOTE: The expression in equation 33 (Smith, 1976) is given with respect to the mathematical convention for a vector direction, where:

$$a^2 = \frac{1}{(1-\rho^2)} \left[ \frac{\sin^2 \theta}{\sigma_x^2} - \frac{2\rho \cos \theta \sin \theta}{\sigma_x \sigma_y} + \frac{\cos^2 \theta}{\sigma_y^2} \right]$$

$$b = \frac{-1}{(1-\rho^2)} \left[ \frac{\bar{x} \sin \theta}{\sigma_x^2} - \frac{\rho(\bar{x} \cos \theta + \bar{y} \sin \theta)}{\sigma_x \sigma_y} + \frac{\bar{y} \cos \theta}{\sigma_y^2} \right]$$

$$c^2 = \frac{1}{(1-\rho^2)} \left[ \frac{x^2}{\sigma_x^2} - \frac{2\rho xy}{\sigma_x \sigma_y} + \frac{y^2}{\sigma_y^2} \right]$$

$$d_1 = \frac{1}{2\pi\sigma_x\sigma_y\sqrt{1-\rho^2}}$$

and  $r = \sqrt{x^2 + y^2}$  is the modulus of the vector or speed and  $\theta$  is the direction of the vector. After integrating  $g(r, \theta)$  over  $r = 0$  to  $\infty$ , the probability density function is  $\theta$  is:

$$g(\theta) = \frac{d_1}{a^2} e^{-\frac{1}{2}c^2} \left[ 1 + \sqrt{2\pi} \left(\frac{b}{a}\right)^2 \Phi\left(\frac{b}{a}\right) \right] \quad (34)$$

where  $a^2$ ,  $b$ ,  $c^2$ , and  $d_1$  are as previously defined in equation 33, and

$$\Phi\left(\frac{b}{a}\right) = \frac{1}{\sqrt{2\pi}} \int_{-\infty}^{\frac{b}{a}} e^{-\frac{1}{2}t^2} dt$$

is taken from tables of normal distribution functions or made available through a computer subroutine.

If desired, equation 34 can be integrated numerically over a chosen range of  $\theta$  to obtain the probability that the vector direction will lie within the chosen range; i.e.,

$$F(\theta) = \int_{\theta_1}^{\theta_2} g(\theta) d\theta \quad (35)$$

One application may be to obtain the probability that the wind will flow from a given quadrant or sector as, for example, onshore.

#### 2.6.3.4 Derived Conditional Distribution of Wind Speed Given Wind Direction.

Continuing with the considerations expressed in Paragraph 2.6.3.3, the conditional probability density function (pdf) for wind speed ( $r$ ), given a specified value for the wind direction  $\theta$ , can be expressed as:

$$f(r|\theta) = \frac{a^2 r e^{-\frac{1}{2}(a^2 r^2 - br)}}{1 + \sqrt{2\pi} \left(\frac{b}{a}\right)^2 e^{\frac{1}{2}\left(\frac{b}{a}\right)^2} \Phi\left\{\frac{b}{a}\right\}} \quad (36)$$

where coefficients,  $a$  and  $b$  and the function  $\Phi\left\{\frac{b}{a}\right\}$  are as previously defined in equations 33 and 34.

From equation 36, the mode (most frequent value) of the conditional wind speed given a specified value of the wind direction is the positive solution of the quadratic equation,

$$a^2 r^2 - br - 1 = 0 \quad (37)$$

which is:

$$(\bar{r}|\theta) = \frac{1}{2a} \left[ \left( \frac{b}{a} \right) + \sqrt{4 + \left( \frac{b}{a} \right)^2} \right] \quad (38)$$

The locus of the conditional modal values of wind speed when plotted in polar form versus the given wind directions forms an ellipse.

The noncentral moment for equation 36 is expressed as:

$$\mu'_n = \int_0^{\infty} r^n f(r|\theta) dr \quad (39)$$

Now the first noncentral moment is identical to the first central moment or expected value,  $E(r|\theta)$ . The integration of equation 39 for the first moment is sufficiently simple to yield practical computations, and can be expressed as:

$$E(r|\theta) = \frac{\left( \frac{b}{a} \right) + \left[ 1 + \left( \frac{b}{a} \right)^2 \right] \sqrt{2\pi} e^{\frac{1}{2} \left( \frac{b}{a} \right)^2} \Phi \left\{ \frac{b}{a} \right\}}{a \left[ 1 + \left( \frac{b}{a} \right)^2 \sqrt{2\pi} e^{\frac{1}{2} \left( \frac{b}{a} \right)^2} \Phi \left\{ \frac{b}{a} \right\} \right]} \quad (40)$$

Equation 40, then, gives the conditional mean value of the wind speed given a specified value for the wind direction.

The integration of equation 36 for the limits  $r=0$  to  $r=r^*$  gives the probability that the conditional wind speed is  $\leq r^*$  given a value for the wind direction,  $\theta$ . This conditional probability distribution (PDF) can be written as:

$$Pr \{ r \leq r^* | \theta = \theta_0 \} = 1 - \left[ \frac{e^{-\frac{1}{2} r_s^2 + \sqrt{2\pi} \left( \frac{b}{a} \right) (1 - \Phi(r_s))}}{e^{-\frac{1}{2} \left( \frac{b}{a} \right)^2 + \sqrt{2\pi} \left( \frac{b}{a} \right) \Phi \left\{ \frac{b}{a} \right\}}} \right] \quad (41)$$

where:  $r_s = \left[ a r^* - \left( \frac{b}{a} \right) \right]$

By definition, equation 41 is an expression for a "wind rose." Empirical wind rose statistics are often tabulated or graphically illustrated giving the frequency that the wind speed is not exceeded for those wind speed values which lie within assigned class intervals of wind direction. After evaluation of equation 41 for various values of wind speed,  $r^*$ , and the given wind directions,  $\theta$ , interpolations can be performed to obtain various percentile values of the conditional wind speed.

For the special case when  $h$  in equation 33 equals zero (i.e., for  $\bar{x} = \bar{y} = 0$ ), the conditional modal values of wind speeds (equation 38), the conditional mean values of wind speeds (equation 40), and the fixed conditional percentile values of wind speeds (interpolated from evaluations of equation 41), when plotted in polar form versus the given wind directions, produce a family of ellipses.

For the special case when  $\bar{x} = \bar{y} = 0$ , equation 36 reduces to the following simple case:

$$Pr \{ r \leq r^* | \theta = \theta_0 \} = 1 - e^{-\frac{a^2 r^{*2}}{2}} \quad (42)$$



Equation 42 has special significance when related to the bivariate normal probability distribution. If  $r^*$  and  $\theta$  are measured from the centroid of the probability ellipse, then the probability that  $r \leq r^*$  is the same as the given probability ellipse. Further, solving equation 42 for  $r^*$ , gives:

$$r^* = \frac{1}{2} \sqrt{-2 \ln (1 - P)} \quad (43)$$

If a probability ellipse  $P$  is chosen, equation 42 gives the distance of  $r$  along any  $\theta$  from the centroid of the ellipse to the intercept of the specified probability ellipse. If there is an interest in conditional probability of winds for a given  $\theta$  relative to the monthly means, equation 43 is applicable. If it is desired to find the magnitude of the wind along any  $\theta$  relative to the monthly mean to the intercept of a given probability ellipse, equation 43 is also applicable.

### 2.7 Statistical Parameters for Non-Standard Orthogonal Axes.

The five wind statistical parameters in Appendix A are given with respect to the Standard Meteorological Coordinate System (Figure 2-1). That is, these parameters are for zonal and meridional components. Many range users, however, need wind statistics with respect to orthogonal axes other than west to east and south to north. For example, a user may need wind statistics with respect to a flight azimuth of  $\alpha$  degrees from true north measured clockwise. The following sets of equations are used to compute the five parameters for the new coordinate axes rotated  $\alpha$  degrees clockwise from true north.

Rotation of the means through  $\alpha$  degrees:

$$\bar{X}_\alpha = \bar{X} \cos (90 - \alpha) + \bar{Y} \sin (90 - \alpha) \quad (44)$$

$$\bar{Y}_\alpha = \bar{Y} \cos (90 - \alpha) - \bar{X} \sin (90 - \alpha) \quad (45)$$

Rotation of the variances through  $\alpha$  degrees:

$$\sigma_{x_\alpha}^2 = \sigma_x^2 \cos^2 (90 - \alpha) + \sigma_y^2 \sin^2 (90 - \alpha) + 2\rho\sigma_x\sigma_y \cos (90 - \alpha) \sin (90 - \alpha) \quad (46)$$

$$\sigma_{y_\alpha}^2 = \sigma_y^2 \cos^2 (90 - \alpha) + \sigma_x^2 \sin^2 (90 - \alpha) - 2\rho\sigma_x\sigma_y \cos (90 - \alpha) \sin (90 - \alpha) \quad (47)$$

Rotation of the linear correlation coefficient through  $\alpha$  degrees:

$$\rho_\alpha = \frac{\text{cov}(X, Y)_\alpha}{\sigma_{x_\alpha} \sigma_{y_\alpha}} \quad (48)$$

where  $\text{cov}(X, Y)_\alpha$  is the rotated covariance:

$$\text{cov}(X, Y)_\alpha = (X, Y) [\cos^2 (90 - \alpha) - \sin^2 (90 - \alpha)] + \cos (90 - \alpha) \sin (90 - \alpha) (\sigma_y^2 - \sigma_x^2)$$

and

$$\text{cov}(X, Y) = \rho\sigma_x\sigma_y$$

By using these rotational equations, the bivariate normal distribution with respect to any desired rotated coordinates can be obtained from sample estimates that have been computed with respect to a specific axis. The marginal distributions after rotation are also normally (univariate) distributed. By using the rotational equations, computational efforts are greatly reduced for applications requiring statistics with respect to several coordinate axes.

Appendix E gives examples of range-specific RRA wind statistics.

## Chapter 3

### THERMODYNAMICS STATISTICS AND MODELS

#### 3.1 GENERAL DISCUSSION.

One of the objectives in developing the RRA was to describe the thermodynamic characteristics of the atmosphere as completely as possible with as few data tabulations as possible. With that in mind, a set of statistical variables was selected to collectively describe climatological pressure, temperature, density, dew point, virtual temperature, and water vapor pressure. Used together, these variables permit calculation of a large number of derived quantities. Some of these quantities (such as the speed of sound) are discussed in Paragraph 3.7.

The probability distribution of each of the six thermodynamic RRA variables is described by its mean value, its standard deviation, and its skewness. Several of the thermodynamic elements (temperature, pressure, dew point, and density) have probability distributions that are close to a univariate normal distribution; the others do not. The skewness variable gives an estimate of the asymmetrical departures of a probability distribution.

Hydrostatically modeled mean values of pressure and density were calculated (see Appendix D) so that users can determine the departure of the actual climatology of these values from hydrostatic conditions. This was done by hydrostatically integrating the pressure from the lowest RRA data level to the RRA's termination altitude. Table 3-1 lists and explains the primary physical constants used in RRA production. Table 3-2 lists and explains the symbols used in this chapter.

TABLE 3-1. Primary Physical Constants Used in RRA Production.

$P_0$	Standard atmospheric pressure at sea level ( $1.013250 \times 10^5$ Newton/m <sup>2</sup> ) (2116.22 lb/ft <sup>2</sup> )
$\rho_0$	Standard atmospheric density at sea level ( $1.2250$ kg/m <sup>3</sup> ) (0.076474 lb/ft <sup>3</sup> )
$T_0$	Standard temperature at sea level (288.15 K) (15.0°C) (59.0°F)
$g_0$	Standard gravity at sea level at latitude 45°31'33" ( $9.80665$ m/s <sup>2</sup> )
$\nu$	Sutherland's constant used in calculation of dynamic viscosity (110.4 K)
$T_i$	Ice-point temperature at $P_0$ (273.15 K)
$\beta$	Constant for calculating dynamic viscosity ( $1.458 \times 10^{-6}$ kg/sec m K <sup><math>\frac{1}{2}</math></sup> ) ( $7.3025 \times 10^{-7}$ lb/sec ft R <sup><math>\frac{1}{2}</math></sup> )
$\gamma$	Ratio of specific heat of air at constant pressure to specific heat of air at constant volume (1.4)
$C_D$	Mean effective collision diameter of air molecules ( $3.65 \times 10^{-10}$ m) ( $1.1975 \times 10^{-9}$ ft)
$N_A$	Avogadro's constant ( $6.022169 \times 10^{26}$ /kg mol) ( $2.73179 \times 10^{26}$ /lb mol)
$R^*$	Gas constant (8.31432 Joule/mol K)
$R'$	Gas constant for dry air ( $2.8704 \times 10^2$ Joule/kg K)
$M$	Molecular weight of dry air (28.966 g/mol)

**TABLE 3-2. Symbols Used in Chapter 3.**

$C_s$	Speed of sound
$C_d$	Collision diameter
$E$	Vapor pressure
$g_\phi$	Gravity at latitude $\phi$
$H$	Geopotential height
$H_m$	Geopotential height at a mandatory radiosonde data level
$H_s$	Geopotential height at a significant radiosonde data level
$K_t$	Coefficient of thermal conductivity
$L$	Mean free path length
$M$	Mean molecular weight of air at sea level
$M3q$	Monthly third moment of quantity $Q$
$n$	Refractive modulus
$N$	Refractive index
$NA$	Avogadro's constant
$Nq$	Number of values of quantity $Q$
$P$	Pressure
$P_m$	Pressure at a mandatory radiosonde data level
$P_s$	Pressure at a significant radiosonde data level
$P_h$	Hydrostatically integrated mean monthly or annual pressure
$Q$	Any tabulated RRA quantity
$R^*$	Universal gas constant
$R'$	Specific gas constant of dry air
$r, r^*$	Parameters used in converting $z$ to $h$ and vice versa
$S$	Sutherland's constant, used in the calculation of dynamic viscosity
$T$	Temperature
$T_d$	Dewpoint
$T_v$	Virtual temperature
$T_{vm}$	Virtual temperature at a mandatory radiosonde data level
$T_{vs}$	Virtual temperature at a significant radiosonde data level
$V$	Mean air particle speed Mean collision frequency
$w$	Parameter used in the hydrostatic interpolation of pressure and density
$Z$	Geometric altitude
$X$	Wavelength
$^aQ$	Skewness of quantity $Q$
$B$	Constant used in the equation for viscosity
$\gamma$	Ratio of specific heat at constant pressure to specific heat at constant volume
$\eta$	Kinematic coefficient of viscosity
$\mu$	Dynamic coefficient of viscosity
$\rho$	Density
$\rho_h$	Mean monthly or annual density derived from $P_h$
$\sigma$	Standard deviation of the quantity $Q$

### 3.2 QUALITY CONTROL.

Data limits derived from the following thermodynamic elements were used to screen the RRA database: temperature, pressure, dewpoint (for the 0-30 km portion only), and density. These limits were set to plus and minus six standard deviations from the mean values of each of these quantities; they were then used to screen the thermodynamic portion of the database IAW procedures described in Paragraph 1.5. The database was considered to be error-free if:

- (1) Skewness values of pressure and temperature were between -2.5 and 2.5 at all data levels.
- (2) Skewness values of density were between -3.5 and 3.5 at data levels between 0 and 30 km.
- (3) Skewness values of density were between -3.0 and 3.0 at data levels between 30 and 70 km.
- (4) Skewness values of dewpoint were between -2.5 and 2.5 at all data levels with more than 10 data values.

### 3.3 DATA LIMITATIONS.

Correlation coefficients between thermodynamic quantities and moisture-related quantities were not calculated at discrete altitudes; neither were any of the correlations between altitudes. As a result, valid statistical dispersion models that require relationship between two or more of these quantities at the same altitude or between altitudes cannot be derived. Approximations for the correlation coefficients between pressure, virtual temperature, and density at discrete altitudes, however, may be obtained from the coefficients of variation as developed by Buell (1970). The coefficient of variation is the standard deviation divided by the mean. The mean values and the standard deviations are taken from Appendix B. A model for the profile of monthly and annual mean pressure, virtual temperature, and density is given in Appendix D, and is in excellent agreement with the respective statistical mean values. This agreement results because the physical relationships expressed by the hydrostatic equation and the equation of state were used to derive Appendix D. When only the monthly or annual mean values for pressure, virtual temperature, and density are required, users should consult Appendix D.

### 3.4 ESTABLISHING DATA SAMPLES AT REQUIRED LEVELS.

This section describes the computational procedures used to establish data samples of the thermodynamic RRA variables at the various data levels. References are cited only when the equation given is one of many available in the literature or when it is stated in an unusual form.

#### 3.4.1 Converting Geopotential Height to Geometric Altitude.

Although rocketsonde observations above 30 km are recorded in terms of geometric altitude, the data can be interpolated directly to the altitude intervals shown in the tables. But radiosonde observations used to obtain tabular values below 30 km are recorded in terms of geopotential height; the conversion to geometric altitude ( $h$  to  $z$ ) is accomplished by calculating a table of geopotential heights that correspond exactly to the geometric altitudes at which the atmospheric elements are tabulated. Radiosonde observations are then interpolated to these geopotential heights. The relationship used to calculate geometric altitude from geopotential height is:

$$H = (r' z) / (r' + z) \quad (49)$$

where  $r' = g r^* / 9.80665$

and  $r^* = -2g_\phi / (\partial g_\phi / \partial z_0)$

$g_\phi$  is sea level at latitude  $\phi$  corresponding to the proper location (List, 1968).

$$g_\phi = 9.780356 (1 + 5.2885 \times 10^{-3} \sin^2 \phi - 5.9 \times 10^{-6} \sin^2 (2\phi)) \quad (50)$$

$\frac{\partial g_{\phi}}{\partial z_0}$  is the rate of change of gravity at sea level. This quantity is given by:

$$\frac{\partial g_{\phi}}{\partial z_0} = -3.085462 \times 10^{-6} \times 2.27 \times 10^{-9} \cos(2\phi) \times 2 \times 10^{-12} \cos(4\phi) \quad (51)$$

Units used for gravity are  $m/s^2$ , while the units for  $\frac{\partial g_{\phi}}{\partial z_0}$  are  $s^{-2}$ .

The resulting table of values of H obtained by using even increments of 2 in equation 49 is shown in Appendix D. Although the values of H above 30 km were not used in the interpolation of original data, they are included for the convenience of the user.

### 3.4.2 Calculations from Rawinsonde Observations.

It was necessary to interpolate information from original rawinsonde records to arrive at the geometric altitudes specified as RRA data levels. Elements for which this interpolation was required were temperature, dewpoint, and pressure. The other elements were calculated from the interpolated values at each RRA data level. These "derived" elements were water vapor pressure, density, and virtual temperature.

#### 3.4.2.1 Geopotential Height at Significant Levels.

Two slightly different interpolation procedures were used to obtain data from radiosonde and rocketsonde observations at the levels shown in the tables. The procedure used to interpolate radiosonde observations begins with calculations of virtual temperature at each data level in the sounding. Virtual temperature was computed by:

$$T_v = T / (1 - 0.379 (e/p)) \quad (52)$$

where  $T_v$  and  $T$  are in kelvin (K) and  $e$  and  $p$  are in millibars.

Radiosonde soundings provide pressure, temperature, and dew point data recorded at "mandatory" and "significant" levels. Geopotential height data, however, is only provided for mandatory levels. Heights at the significant levels, therefore, were calculated hydrostatically, using pressure and temperature data from those levels. This procedure allows the use of most significant level data in the calculation of the RRA tables. The equation used for this process was:

$$H_s = H_m + 29.2712617 + \frac{(T_{vs} + T_{vm})}{2} * \ln(P_s/P_m) \quad (53)$$

where subscripts  $s$  and  $m$  denote quantities at significant and mandatory levels. This equation was not used if the difference between two adjacent mandatory levels was greater than 200 mb, and all soundings with such data gaps were rejected.

#### 3.4.2.2 Temperature.

Radiosonde temperatures were interpolated logarithmically with respect to pressure using the equation:

$$T = T_U + (T_L - T_U) \frac{\ln p - \ln p_L}{\ln p_U - \ln p_L} \quad (54)$$

where subscripts  $U$  and  $L$  indicate values at the nearest data levels in the actual sounding above and below the interpolated level.

### 3.4.2.3 Pressure.

The pressure values in each radiosonde sounding were interpolated to the RRA data levels using the equation:

$$p = p_L \exp \left( \frac{H_L - H_U}{29.2712617 (0.5) (T_{vU} + T_{vL})} \right) \quad (55)$$

where subscript  $L$  indicates virtual temperature, geopotential, and pressure values at the data level below and closest to the level at which data were required.

### 3.4.2.4 Dew Point Temperature.

Dew point values were interpolated logarithmically with respect to pressure using the equation:

$$T_d = T_{dU} + (T_{dL} - T_{dU}) \left( \frac{\ln p - \ln p_L}{\ln p_U - \ln p_L} \right) \quad (56)$$

Subscripts  $U$  and  $L$  indicate data at the nearest upper and lower data levels in a sounding.

### 3.4.2.5 Vapor Pressure.

Water vapor pressure is calculated from interpolated dew point values at RRA data levels using Tetens' approximation:

$$e = 6.11 \text{ mb} \times 10^{7.5(T_d - 273.15) / (T_d - 35.86)} \quad (57)$$

### 3.4.2.6 Density.

Density values derived from radiosonde observations were calculated at RRA data levels using the equation:

$$\rho = 348.36787 p/T_v \quad (58)$$

### 3.4.2.7 Virtual Temperature.

Virtual temperature values are calculated at RRA data levels for each sounding using the equation:

$$T_v = T / (1 - 0.379(e/p)) \quad (59)$$

where  $T_v$  and  $T$  are in K; pressure ( $p$ ) and vapor pressure ( $e$ ) are in millibars.

## 3.4.3 Calculations from Rocketsonde Observations.

Rocketsonde observations used to calculate RRA table values above 30 km were recorded in terms of geometric altitude. For this reason, slightly different calculations were required to convert recorded data values to RRA data levels. Pressure, temperature, and density were interpolated to RRA data levels. Since atmospheric moisture at altitudes above 30 km is considered to be negligible, moisture-related elements (virtual temperature, water vapor pressure, and dewpoint) were not calculated. There was no interpolation across gaps in pressure or temperature data in a sounding larger than 7,000 meters. Data values at RRA levels within such a gap were set to "missing."

### 3.4.3.1 Temperature.

Rocketsonde temperatures were interpolated linearly with respect to geometric altitude using the equation:

$$T = T_U + (T_L - T_U) \frac{Z - Z_L}{Z_U - Z_L} \quad (60)$$

where subscript  $U$  indicates values at the nearest data level in the actual sounding above the interpolated level;  $L$  indicates values below the interpolated level.

### 3.4.3.2 Pressure.

Rocketsonde pressure values were interpolated to RRA data levels using the equation:

$$P = P_L \exp \left( - \frac{g_0}{R^*} \frac{M (Z - Z_L)}{T_v} \cdot W^2 \right) \quad (61)$$

where

$$T_v = \frac{T_{vU} + T_{vL}}{2} \text{ and } W = \frac{r^*}{\left( r^* + Z + \frac{Z - Z_L}{2} \right)}$$

### 3.4.3.3 Density.

Rocketsonde density values were interpolated using the equation:

$$\rho = \rho_L \exp \left( - \frac{g_0 M}{R^*} \frac{(Z - Z_L)}{T_v} \cdot W^2 \right) \quad (62)$$

where  $W$  is specified in 3.4.3.2.

## 3.5 COMPUTING STATISTICS FOR APPENDICES B AND C.

Computing monthly and annual means, standard deviations, and skewness values from data at the RRA data levels was in two steps. First, certain statistical sums were calculated and stored as the soundings in the database were processed. These sums were then used to calculate the monthly and annual statistics given in the RRA tables.

### 3.5.1 Stored Statistical Sums.

The sums that were calculated were:

$$\Sigma Q, \Sigma Q^2, \text{ and } \Sigma Q^3$$

where  $Q$  is any one of the quantities given in the thermodynamic part of the RRA.

### 3.5.2 Calculating Monthly Statistics.

#### 3.5.2.1 Monthly Means.

Mean monthly values of the thermodynamic RRA quantities were calculated using the equation:

$$\bar{Q} = \Sigma Q / N_Q$$

where  $N_Q$  is the number of observed values of the quantity  $Q$  for a given month.

#### 3.5.2.2 Monthly Standard Deviations.

Monthly standard deviations of the thermodynamic RRA quantities were calculated using the equation:

$$\sigma_Q = \sqrt{\frac{(N_Q \Sigma Q^2) - (\Sigma Q)^2}{N_Q \cdot (N_Q - 1)}} \quad (63)$$

#### 3.5.2.3 Monthly Skewness Values.

Monthly skewness values of wind speed and thermodynamic RRA quantities are calculated using the equation:

$$\sigma_Q = \frac{M_3 Q}{\sigma_Q^3}$$

where  $M_3Q$  is the third moment of the quantity  $Q$ ,  $\sigma_Q$  is its standard deviation, and

$$M_{3Q} = \left[ \frac{\sum Q^3}{N_Q} - \frac{3\sum Q \sum Q^2}{N_Q^2} + \frac{2\sum Q^3}{N_Q^3} \right] \cdot \frac{N_Q^2}{(N_Q - 1)(N_Q - 2)} \quad (64)$$

### 3.5.3 Calculating Annual Statistics.

Equations 63 and 64, used to calculate monthly values of standard deviations and skewness values, were also used for the annual statistics.

#### 3.5.3.1 Annual Means.

Annual mean values of the thermodynamic RRA quantities were calculated using the equation:

$$Q_{ANN} = Q_A / N_Q$$

where  $Q_A$  is the total of all observed values of  $Q$  and  $N_Q$  is the total number of observations of  $Q$ .

#### 3.5.3.2 Annual Standard Deviations and Skewness Values.

Annual standard deviations of the thermodynamic RRA quantities were calculated using equation 63; annual skewness values were calculated with equation 64. NOTE: Both these quantities were previously calculated with monthly statistics due to limitations in computer precision.

## 3.6 MONTHLY AND ANNUAL MEAN MODEL ATMOSPHERES.

A set of modeled monthly mean and annual mean hydrostatic values of pressure and density was calculated from the lowest RRA data level (0 km, mean sea level) to 30 km, and from 30 km to 70 km. The integration from 0 to 30 km was computed independently of the integration from 30 to 70 km because of the difference in data sources. These hydrostatically modeled mean values (given in Appendix D) are useful as a check on the validity of pressure and density values given in Appendix B. In most cases, the values in Appendices B and D for any given data level are within 1 percent of each other. The hydrostatic pressure values in Appendix D were calculated using the equation:

$$p_1 = p_0 \exp \left( - \frac{0.034162 (H_1 - H_0)}{0.5 (T_{v1} + T_w)} \right) \quad (65)$$

where,  $H_1 - H_0$  is in meters and a "0" subscript refers to values at the RRA data level immediately below the level being checked.  $p_0$  at the lowest data level is set equal to the RRA mean pressure;  $p_1$ , calculated for the next highest data level, is taken as  $p_0$  for the level above that. This process is repeated for all the other RRA data levels. The hydrostatic density corresponding to hydrostatic pressures is calculated from these pressures and from RRA virtual temperature values using the formula:

$$\rho_H = 348.36786 P_H / T_v \quad (66)$$

where  $\rho_H$  and  $P_H$  are the hydrostatic density and pressure shown in Appendix D.

## 3.7 THERMODYNAMIC QUANTITIES DERIVABLE FROM TABLES.

Several other quantities can be calculated from the statistics given in Appendices B and D. The equations in this section can be used to calculate approximate mean values of these quantities at each RRA data level. It is not possible, however, to infer or derive any information concerning standard deviation or skewness values of these quantities from the data in Appendices B and C.



### 3.7.1 Mean Air Particle Speed.

The mean air particle speed, "V", is the arithmetic average of the speeds of all air particles in the volume element being considered. For a valid average to occur, there must be a sufficient number of particles involved to represent mean conditions. The equation for "V" for dry air is:

$$V = \sqrt{\frac{8}{\pi} \cdot \frac{R \cdot T}{M}} \quad (67)$$

A computational form for dry air, using tabulated values, is:

$$V = \sqrt{7.3094 \times 10^2 \times T} \quad (\text{m/s}) \quad (68)$$

where  $T$  is the temperature in kelvin (K) from Appendix B. Equation 67, when corrected for moist air, becomes:

$$V = \sqrt{\frac{8}{\pi} \cdot R \cdot T_v} \quad (69)$$

The computational form for moist air is:

$$V = \sqrt{7.3094 \cdot 10^2 \cdot T_v} \quad (\text{m/s}) \quad (70)$$

where  $T_v$  is the virtual temperature in kelvin (K) from Appendix C.

### 3.7.2 Mean Free Path.

The mean free path, "L" is the mean value of the distance traveled by each neutral air particle, in a selected air parcel, between successive collisions with other particles in that parcel. A meaningful average requires that the selected parcel be large enough to contain a substantial number of particles. The equation for  $L$  is given by:

$$L = \left( \frac{\sqrt{2}}{2\pi} \right) \left( \frac{R \cdot T}{N_a \cdot C_d^2 \cdot P} \right) \quad (71)$$

where  $C_d$  is the effective collision diameter of the mean air molecules. The 1976 standard atmosphere value of  $3.65 \times 10^{10}$  is valid for the range of altitudes in the RRA. A computational form for moist air, using tabulated values, is:

$$L = 2.335 \times 10^{-7} \frac{T}{P} \quad (\text{meters}) \quad (72)$$

where  $T$  is the temperature in K and  $P$  is the pressure in mb, both from Appendix B. A form of equation 71 to correct  $L$  for moist air is:

$$L = \left( \frac{\sqrt{2}}{2\pi} \right) \frac{R \cdot M \cdot T_v}{N_a \cdot C_d^2} \quad (73)$$

The computational form for moist air is:

$$L = 2.3325 \times 10^{-7} \frac{T_v}{P} \quad (\text{meters}) \quad (74)$$

where  $T_v$  is the virtual temperature in K from Appendix C and  $P$  is the pressure in mb from Appendix B.

### 3.7.3 Mean Collision Frequency.

The mean collision frequency ( $V_c$ ) is considered to be the average speed of air particles contained in an air parcel divided by the mean free path of the particles inside that parcel. Computationally, this is equivalent to:

$$V_c = \frac{V}{L} \text{ (sec}^{-1}\text{)} \quad (75)$$

To determine  $V_c$  for dry air, use  $V$  and  $L$  from equations 68 and 72. To determine  $V_c$  for moist air, use  $V$  and  $L$  from equations 70 and 74.

### 3.7.4 Speed of Sound.

The expression for the speed of sound ( $C_s$ ) in dry air, in (m/s) is:

$$C_s = \sqrt{\frac{\gamma R^* T}{M}} \quad (76)$$

To compute  $C_s$  for dry air from tabulated values, use:

$$C_s = \sqrt{4.0185 \times 10^2 \times T} \text{ (m/s)} \quad (77)$$

where  $T$  is the temperature K from Appendix B. One form for the speed of sound in moist air is:

$$C_s = \sqrt{\gamma R^* T_v} \quad (78)$$

where  $T_v$  is the virtual temperature from Appendix C. A computational form for moist air is:

$$C_s = \sqrt{4.0185 \times 10^2 T_v} \text{ (m/s)} \quad (79)$$

### 3.7.5 Coefficient of Dynamic Viscosity.

The coefficient of dynamic viscosity,  $\mu$ , is defined as a coefficient of internal friction developed where gas regions move adjacent to each other at different velocities. The following expression is taken from the U.S. Standard Atmosphere (1976):

$$\mu = \frac{\beta \cdot T^{3/2}}{T + S} \quad (80)$$

The computational form is:

$$\mu = \frac{(1.458 \times 10^{-6}) T^{3/2}}{T + 110.4} \cdot \left( \frac{\text{kg}}{\text{s} \cdot \text{m}} \right) \quad (81)$$

where  $T$  is temperature K from Appendix B.

### 3.7.6 Kinematic Coefficient of Viscosity.

The kinematic coefficient of viscosity, designated as  $\eta$ , is defined as the ratio of the dynamic coefficient of viscosity of a gas to its density, or:

$$\eta = \mu/\rho \quad (82)$$

The computational form is:

$$\eta = 1.0 \times 10^3 \mu / \rho \quad , \quad (m^2/s) \quad (83)$$

where  $\mu$  is the dynamic coefficient of viscosity from equation (81) and  $\rho$  is the density in  $g\ m^{-3}$  from Appendix B.

### 3.7.7 Coefficient of Thermal Conductivity.

The empirical expression used for the coefficient of thermal conductivity ( $K_t$ ) is given in the 1976 Standard Atmosphere as:

$$K_t = \frac{2.65019 \times 10^{-3} \cdot T^{0.72}}{T + 245.4 \times 10^{-(12/T)}} \quad , \quad (\text{watts/m-deg K}) \quad (84)$$

where  $T$  is temperature K.

### 3.7.8 Refractive Modulus and Refractive Index.

The refractive modulus or refractivity (Seiby and McClatchey, 1975; Smith and Weintraub, 1953), is expressed as  $N$ , where:

$$N = (n - 1) \cdot 10^6 \quad (85)$$

and  $n$  is the refractive index.

For microwave frequencies below approximately 30 GHz (equivalent to wavelengths above 1 cm),  $N$ , the refractive modulus, is given by the empirical equation:

$$N = 77.6 \frac{P}{T_d} + 3.73 \times 10^5 \frac{e}{T_d^2} \quad (\text{dimensionless}) \quad (86)$$

where  $E$  and  $P$  are in millibars and  $T$  and  $T_d$  are in K.

The following expression is valid for visible and infrared wavelengths shorter than approximately 30  $\mu\text{m}$  (0.03 mm):

$$N = 77.6 \frac{P}{T} + 0.584 \frac{P}{T^2} \quad (\text{dimensionless}) \quad (87)$$

where  $\lambda$  is the wavelength in microns and  $T$  is in degrees K.

The expression for  $N$  for the wavelength from 0.03 mm to 1 cm is an extremely complex function of wavelength.

## Chapter 4

### CONCLUSIONS AND RECOMMENDATIONS

#### 4.1 CONCLUSIONS.

This document satisfies the technical objectives established for the Range Reference Atmosphere committee by the Range Commanders Council Meteorology Group. Upper-air statistics and models for wind and thermodynamic quantities for the range specified have been derived through consistent and uniform methods that will be used in similar publications for other ranges. This new Range Reference Atmosphere (RRA) series is an improvement over previously published RRAs for several reasons: for one, the upper-air database is much larger and much better. For another, more advanced statistical techniques have been developed.

In this series, a statistical measure of central tendency (mean values) and a measure of dispersion (standard deviation with respect to mean values) for monthly and annual reference periods have been consistently tabulated for all variables, using databases that have been carefully edited and quality controlled. Further, a statistical measure for symmetry (skewness coefficient which involves the third statistical moment) has been tabulated for all variables except the zonal and meridional wind components. But even with these improvements, RRA users must recognize certain limitations of the statistical tabulations; these limitations are described here to discourage misuse of the RRA.

- The wind profile structure with respect to altitude cannot be modeled from RRA statistics because inter-level and cross-level correlations were not computed.

- The profile structure with respect to altitude for any of the thermodynamic variables or any quantities derivable from thermodynamic variables cannot be modeled because the prerequisite correlations were not computed. However, the profile of monthly and annual means for pressure, virtual temperature, and density given in Appendix D are in agreement with the hydrostatic equation and the equation of state.

Although more extensive statistical tabulations are currently impractical, many adaptations of current statistics for specific engineering and scientific applications are envisioned as insight is gained through RRA use.

#### 4.2. RECOMMENDATIONS.

The agency responsible for RRA preparation recommends that the wind and thermodynamic statistical tabulations and models in this RRA be used with confidence as a standard reference to the atmosphere over the location for which it has been prepared. It is further recommended that RRA users consult their Staff Meteorologist for assistance before attempting to apply RRA data to specific engineering projects.

## BIBLIOGRAPHY

Buell, Eugene C., "Statistical Relations in a Perfect Gas," *Journal of Applied Meteorology*, 9, pp. 729-731, 1970.

List, R.J., Ed., "Acceleration of Gravity," *Smithsonian Meteorological Tables*, Sixth Ed. Smithsonian Institution, Washington, D.C., P. 488, 1968.

Selby, J.E.A., and McClatchey, R.A., *Atmospheric Transmittance from 0.25 to 28.5  $\mu\text{m}$ -- Computer Code LOWTRAN 3*, AFCRL-TR-75-0255, Air Force Cambridge Research Laboratories, 1975.

Smith, E.K., and Weintraub, S., "The Constants in the Equation for Atmospheric Refractive Index at Radio Frequencies," *Proceedings of the Institute of Radio Engineers*, 41, 8, pp. 1035-1037, August 1953.

Smith, O.E., *Vector Wind and Vector Wind Shear Models at 0-27 km Altitude for Cape Kennedy, Florida, and Vandenberg AFB, California*, NASA TM X-73319, July 1976.

*U.S. Standard Atmosphere*, National Aeronautics and Space Administration, United States Air Force, and United States Weather Bureau, October 1976.

## PREVIOUSLY PUBLISHED RANGE REFERENCE ATMOSPHERES

Capt Kennedy, Florida (Part I), Document 104-63, 16 April 1963  
(AD 451 780).\*

White Sands Missile Range, New Mexico (Part I), Document 104-63, 28 June 1964  
(AD 451 781).\*

Fort Churchill, Manitoba (Part I), Document 372-63, 7 August 1964  
(AD 634 727).

Eniwetok, Marshall Islands (Part I), Document 104-63, 1 September 1964  
(AD 479 264).\*

Fort Greely Missile Range, Alaska (Part I), Document 373-63, 6 October 1964  
(AD 634 726).

Eglin Gulf Test Range, Florida (Part I), Document 104-63, 25 January 1965  
(AD 472 601).\*

Point Arguello, California (Part I), Document 104-63, April 1965  
(AD 472 602).\*

Wallops Island Test Range (Part I), Document 104-63, 10 July 1965  
(AD 474 071).\*

Ascension Island, South Atlantic (Part I), Document 104-63, July 1966  
(AD 645 591).\*

Johnston Island Test Site (Part I), Document 104-63, January 1970  
(AD 782 652).\*

Lihue, Kauai, Hawaii (Part I), Document 104-63, January 1970  
(AD 782 653).\*

Cape Kennedy, Florida (Part II), Document 104-63, September 1971  
(AD 753 581).\*

White Sands Missile Range (Part II), Document 104-63, September 1971  
(AD 782 654).\*

Wallops Island Test Range (Part II), Document 104-63, September 1971.\*

Fort Greely Missile Range (Part II), Document 104-63, September 1971.\*

Edwards AFB (Part I), Document 104-63, September 1972  
(AD 782 651).\*

Kwajalein Missile Range, Marshall Islands (Part I), Document 105-63, October 1974.\*

Kwajalein Missile Range, Document 360-82, 1982  
(AD-A123424).

Cape Canaveral, Florida, Document 361-83, February 1983  
(AD-A125553).

Vandenberg AFB, California, Document 362-83, 1983  
(AD-A128125).

Dugway, Utah, Document 363-83, June 1983  
(AD-A131110).

Wallops Island Test Range, Virginia, Document 364-83, July 1983  
(AD-A131327).

White Sands Missile Range, New Mexico, Document 365-83, August 1983  
(AD-A132471).

Edwards AFB, California, Document 366-83, August 1983  
(AD-A132487).

Eglin AFB, Florida, Document 367-83, 1983  
(AD-A133506).

Taquac, Guam Island, Document 368-83, 1983  
(AD-A133618).

Point Mugu, California, Document 369-83, 1983  
(AD-A134186).

Barking Sands, Hawaii, Document 370-83, 1983  
(AD-A137406).

Ascension Island, Document 371-84, 1984  
(AD-A138470).

*\* No longer available from RCC.*

Wake Island, USAFETAC/PR-90/007, November 1990.  
(AD-Pending)

Nellis, USAFETAC/PR-90/008, December 1990  
(AD-Pending)

Shemya, USAFETAC/PR-91/003, January 1991  
(AD-Pending)



## **ACRONYMS, INITIALISMS, AND ABBREVIATIONS (ACRINABS)**

<b>AD</b>	<b>Armament Division</b>
<b>AFFTC</b>	<b>Air Force Flight Test Center</b>
<b>AFSC</b>	<b>Air Force Systems Command</b>
<b>AFSCF</b>	<b>Air Force Satellite Control Facility</b>
<b>AFTFWC</b>	<b>Air Force Tactical Fighter Weapons Center</b>
<b>AWS</b>	<b>Air Weather Service</b>
<b>BMD</b>	<b>Ballistic Missile Division</b>
<b>CSTC</b>	<b>Consolidated Space Test Center</b>
<b>DOD</b>	<b>Department of Defense</b>
<b>DOE</b>	<b>Department of Energy</b>
<b>DOE/NTS</b>	<b>DOE/Nevada Test Site</b>
<b>DPG</b>	<b>Dugway Proving Ground</b>
<b>EPG</b>	<b>Electronic Proving Ground</b>
<b>ESMC</b>	<b>Eastern Space and Missile Center</b>
<b>ETR</b>	<b>Eastern Test Range</b>
<b>GL</b>	<b>Geophysics Laboratory</b>
<b>KMR</b>	<b>Kwajalein Missile Range</b>
<b>NASA</b>	<b>National Aeronautics and Space Administration</b>
<b>NASA/MSFC</b>	<b>NASA/Marshall Space Flight Center</b>
<b>NASA/WFC</b>	<b>NASA/Wallops Flight Center</b>
<b>NATC</b>	<b>Naval Air Test Center</b>
<b>NOAA</b>	<b>National Oceanic and Atmospheric Administration</b>
<b>NWC</b>	<b>Naval Weapons Center</b>
<b>PMTC</b>	<b>Pacific Missile Test Center</b>
<b>SAMTO</b>	<b>Space and Missile Test Organization</b>
<b>TFWC</b>	<b>Tactical Fighter Weapons Center</b>
<b>TSCF</b>	<b>Targeting Systems Characterization Facility</b>
<b>USA/DTA</b>	<b>U.S. Army/Desert Test Center</b>
<b>USAECOM</b>	<b>U.S. Army Electronics Command</b>
<b>USAFETAC</b>	<b>USAF Environmental Technical Applications Center</b>
<b>USAKA</b>	<b>U.S. Army Kwajalein Atoll</b>
<b>UTTR</b>	<b>Utah Test and Training Range</b>
<b>WSMC</b>	<b>Western Space and Missile Center</b>
<b>WSMR</b>	<b>White Sands Missile Range</b>
<b>WTR</b>	<b>Western Test Range</b>
<b>YPG</b>	<b>Yuma Proving Ground</b>
<b>6585TG</b>	<b>6585th Test Group</b>

## **APPENDIX A**

### **Shemya Wind Statistics Tables**

Table A-1 through Table A-13 give statistical wind data (monthly and annual) for Shemya. Data was produced as described in Chapter 2.

TABLE A-1. January Statistical Wind Data, Shemya.

Z KM	MEAN U M/S	S.D. U M/S	R(U,V)	MEAN V M/S	S.D. V M/S	MEAN W M/S	S.D. W M/S	SKEW W	#OBS
0.000	0.00	0.00	0.0000	0.00	0.00	0.00	0.00	0.00	0.
0.039	-1.17	6.59	0.2129	-1.02	6.64	8.29	4.59	0.58	671.
1.000	-2.17	9.91	-0.0411	0.26	8.47	11.47	6.00	0.78	727.
2.000	-1.60	9.76	-0.0315	1.02	8.36	11.17	6.05	0.86	725.
3.000	-0.91	9.96	-0.0330	1.75	8.68	11.69	6.45	0.88	725.
4.000	-0.27	10.77	-0.0129	2.37	9.34	12.55	7.16	0.94	724.
5.000	0.22	12.26	-0.0284	3.14	10.18	13.97	8.27	1.14	719.
6.000	0.83	13.98	-0.0530	4.00	11.51	15.88	9.60	1.15	706.
7.000	1.68	15.75	-0.0594	5.07	12.79	17.93	10.87	1.20	699.
8.000	2.35	16.45	-0.0563	5.82	13.31	18.61	11.85	1.21	694.
9.000	3.89	15.95	-0.0592	6.32	12.45	17.96	11.90	1.31	686.
10.000	4.90	14.06	-0.0998	6.56	11.13	16.06	10.41	1.47	674.
11.000	5.58	11.29	-0.1042	6.81	9.25	14.53	8.90	1.52	654.
12.000	6.43	10.03	-0.0769	7.11	8.09	14.07	7.73	1.19	642.
13.000	7.38	9.44	-0.0018	7.48	7.46	14.06	7.57	1.13	638.
14.000	7.91	9.19	0.0284	7.60	7.42	14.33	7.36	1.03	631.
15.000	7.92	8.85	0.0455	7.79	7.31	14.22	7.27	0.89	617.
16.000	8.03	8.90	0.1056	7.77	7.20	14.18	7.39	0.75	547.
17.000	7.88	8.94	0.1387	7.83	7.31	14.04	7.70	0.86	544.
18.000	7.76	8.90	0.2148	7.66	7.55	13.70	8.20	1.05	543.
19.000	7.43	9.18	0.2651	7.70	7.77	13.52	8.73	1.35	538.
20.000	7.00	9.71	0.3091	7.51	7.57	13.20	9.08	1.29	534.
21.000	6.59	9.92	0.2926	7.01	7.41	12.85	8.99	1.25	515.
22.000	5.83	10.42	0.2884	6.37	7.49	12.55	9.03	1.39	502.
23.000	5.17	11.09	0.2399	6.33	7.57	12.70	9.25	1.55	489.
24.000	4.82	12.09	0.2382	6.19	8.42	13.38	9.97	1.81	474.
25.000	4.24	12.72	0.1964	5.80	8.60	13.74	9.91	1.79	462.
26.000	3.39	13.71	0.1451	5.36	9.21	14.33	10.35	1.87	446.
27.000	2.85	14.58	0.0869	4.82	9.91	15.21	10.50	1.55	411.
28.000	2.06	15.64	0.0816	4.28	10.70	16.13	10.99	1.62	383.
29.000	1.14	16.20	0.0080	3.90	10.91	16.73	10.83	1.27	346.
30.000	-0.14	16.84	-0.0005	3.40	11.85	17.53	11.28	1.23	309.
32.000	0.95	20.34	-0.2215	-1.80	12.80	19.90	12.83	1.23	20.
34.000	0.81	24.79	-0.2170	-2.00	15.00	23.86	15.35	1.18	21.
36.000	2.86	28.32	-0.1771	-2.05	17.92	28.05	17.63	0.72	22.
38.000	3.09	30.71	-0.1559	-3.59	22.43	31.86	20.09	0.75	22.
40.000	3.41	33.89	-0.0372	-6.45	22.74	35.18	20.66	0.14	22.
42.000	4.10	34.96	0.0281	-8.57	28.52	40.43	20.07	0.12	21.
44.000	4.85	39.36	0.2634	-10.20	32.40	45.60	23.13	0.04	20.
46.000	6.65	44.67	0.3547	-11.45	33.78	50.10	26.41	0.41	20.
48.000	14.18	43.27	-0.0625	-8.00	30.71	48.00	25.37	0.21	17.
50.000	20.27	50.35	0.0438	-8.93	35.97	56.20	30.88	0.20	15.
52.000	32.23	58.48	0.2336	-10.08	25.77	61.69	34.20	0.24	13.
54.000	28.08	68.82	0.6965	-12.50	26.80	68.08	37.50	0.09	12.
56.000	28.86	53.22	0.4120	-12.00	22.27	55.29	30.63	0.21	7.
58.000	0.00	0.00	0.0000	0.00	0.00	0.00	0.00	0.00	3.
60.000	0.00	0.00	0.0000	0.00	0.00	0.00	0.00	0.00	1.
62.000	0.00	0.00	0.0000	0.00	0.00	0.00	0.00	0.00	0.
64.000	0.00	0.00	0.0000	0.00	0.00	0.00	0.00	0.00	0.
66.000	0.00	0.00	0.0000	0.00	0.00	0.00	0.00	0.00	0.
68.000	0.00	0.00	0.0000	0.00	0.00	0.00	0.00	0.00	0.
70.000	0.00	0.00	0.0000	0.00	0.00	0.00	0.00	0.00	0.

TABLE A-2. February Statistical Wind Data, Shemya.

Z KM	MEAN U M/S	S.D. U M/S	R(U,V)	MEAN V M/S	S.D. V M/S	MEAN W M/S	S.D. W M/S	SKEW W	#OBS
0.000	0.00	0.00	0.0000	0.00	0.00	0.00	0.00	0.00	0.
0.039	-2.22	6.13	0.1712	-1.49	7.17	8.65	4.59	0.69	65.
1.000	-2.82	9.22	-0.0069	0.21	9.51	11.86	6.53	1.04	606.
2.000	-1.86	8.97	0.0008	0.80	9.57	11.54	6.55	1.06	604.
3.000	-0.84	9.55	0.0087	1.49	10.08	12.02	7.15	1.49	601.
4.000	-0.30	10.49	0.0079	2.39	10.67	12.81	8.09	1.19	600.
5.000	0.59	11.76	-0.0327	3.09	11.20	13.87	9.00	1.13	597.
6.000	1.11	13.29	-0.0619	4.21	12.25	15.51	10.23	1.18	584.
7.000	1.78	14.98	-0.1209	5.14	13.41	17.21	11.17	1.16	577.
8.000	2.70	16.04	-0.0984	6.23	13.92	18.32	12.68	1.45	570.
9.000	4.05	16.11	-0.0388	7.08	13.24	18.11	13.16	1.69	564.
10.000	5.19	14.73	-0.0316	7.08	11.83	16.78	12.32	1.96	542.
11.000	5.81	12.30	-0.0254	6.86	10.51	14.82	9.91	1.77	524.
12.000	6.08	10.79	-0.0126	7.36	9.06	13.58	7.97	1.40	510.
13.000	6.44	9.84	-0.0498	7.39	8.45	13.46	7.81	1.63	501.
14.000	6.90	9.24	-0.0691	7.51	8.04	13.41	7.30	1.08	488.
15.000	7.05	9.10	-0.0462	7.44	7.87	13.44	7.39	1.40	478.
16.000	6.98	8.78	-0.0458	7.77	8.11	13.48	7.36	1.46	421.
17.000	6.44	7.92	-0.0923	7.61	7.66	12.68	6.61	0.91	416.
18.000	5.87	7.64	-0.0614	7.39	7.72	12.18	6.52	0.80	414.
19.000	5.05	7.88	0.0019	7.07	7.55	11.51	6.75	1.19	401.
20.000	4.30	7.75	0.0160	6.65	7.26	10.83	6.44	1.27	394.
21.000	3.26	7.81	0.0477	6.32	6.97	10.25	6.15	1.38	384.
22.000	2.40	8.04	0.0580	6.09	7.02	10.15	6.04	1.52	378.
23.000	1.65	8.26	0.1201	5.98	7.11	10.19	6.06	1.70	373.
24.000	1.08	9.03	0.1966	5.67	6.35	10.69	6.37	1.68	359.
25.000	-0.08	9.09	0.2233	5.18	6.45	10.80	5.84	1.61	342.
26.000	-1.27	9.47	0.2093	4.88	6.82	11.21	5.96	1.42	327.
27.000	-2.38	10.17	0.1629	4.56	7.66	12.05	6.54	1.41	300.
28.000	-3.32	11.06	0.1206	4.16	8.04	12.88	7.00	1.30	278.
29.000	-4.03	11.78	0.1283	3.96	8.89	14.03	7.23	0.90	242.
30.000	-3.98	13.61	0.0290	4.44	9.62	15.67	8.17	0.82	211.
32.000	-7.48	15.79	0.3004	5.17	8.62	17.24	9.98	1.09	29.
34.000	-10.17	19.58	0.1792	5.66	9.66	21.21	12.40	0.69	29.
36.000	-10.60	24.12	0.1508	4.73	12.22	25.63	13.96	0.30	30.
38.000	-13.40	25.21	0.0397	3.83	13.79	28.17	14.41	0.75	30.
40.000	-13.20	28.66	0.0409	1.67	15.68	31.13	15.64	0.88	30.
42.000	-12.93	31.56	-0.1218	-0.50	15.78	33.50	15.88	0.74	30.
44.000	-13.59	30.59	-0.3081	-2.72	16.81	33.72	15.57	0.84	32.
46.000	-11.47	31.04	-0.0925	-7.66	16.31	34.38	16.51	0.52	32.
48.000	-5.77	32.94	-0.1372	-8.50	17.14	32.27	20.30	0.48	30.
50.000	-2.56	33.43	-0.2451	-5.59	20.32	32.44	21.78	0.65	27.
52.000	-2.67	33.31	0.1288	-10.57	19.27	34.00	19.63	0.86	21.
54.000	2.10	39.92	-0.1182	-6.60	20.56	35.10	26.58	1.50	10.
56.000	-6.00	37.69	-0.7076	-19.17	24.96	41.67	20.97	-0.76	6.
58.000	0.00	0.00	0.0000	0.00	0.00	0.00	0.00	0.00	2.
60.000	0.00	0.00	0.0000	0.00	0.00	0.00	0.00	0.00	1.
62.000	0.00	0.00	0.0000	0.00	0.00	0.00	0.00	0.00	1.
64.000	0.00	0.00	0.0000	0.00	0.00	0.00	0.00	0.00	1.
66.000	0.00	0.00	0.0000	0.00	0.00	0.00	0.00	0.00	0.
68.000	0.00	0.00	0.0000	0.00	0.00	0.00	0.00	0.00	0.
70.000	0.00	0.00	0.0000	0.00	0.00	0.00	0.00	0.00	0.

**TABLE A-3. March Statistical Wind Data, Shemya.**

Z KM	MEAN U M/S	S.D. U M/S	R(U,V)	MEAN V M/S	S.D. V M/S	MEAN W M/S	S.D. W M/S	SKEW W	#OBS
0.000	0.00	0.00	0.0000	0.00	0.00	0.00	0.00	0.00	0.
0.039	0.11	6.35	0.2929	-1.45	7.37	8.56	4.83	0.59	676.
1.000	0.43	9.28	0.1481	-0.37	9.21	11.48	6.27	0.73	732.
2.000	1.15	9.17	0.2063	0.49	8.96	11.22	6.33	0.89	732.
3.000	2.15	9.60	0.1891	1.25	9.20	11.70	6.79	1.10	730.
4.000	3.37	10.77	0.1715	2.32	10.22	13.14	8.02	1.35	729.
5.000	4.36	12.11	0.1171	3.36	11.48	15.03	9.13	1.06	726.
6.000	5.53	14.16	0.0866	4.24	13.62	17.20	10.60	0.93	716.
7.000	6.85	15.91	0.0759	4.99	14.14	19.56	11.91	0.77	706.
8.000	8.36	17.59	0.1187	6.15	15.44	21.38	14.08	1.15	699.
9.000	9.52	17.71	0.1215	6.75	14.70	21.21	14.69	1.28	695.
10.000	9.89	15.81	0.2083	7.13	13.62	19.50	14.25	1.58	659.
11.000	10.08	14.46	0.1707	6.85	11.38	17.3	11.99	1.66	638.
12.000	9.44	12.08	0.1164	6.81	9.60	16.35	10.29	1.22	625.
13.000	9.05	11.42	0.1489	7.10	8.97	15.63	9.22	1.02	618.
14.000	8.46	10.55	0.1145	7.30	8.02	15.08	8.54	1.03	612.
15.000	7.73	10.26	0.1256	7.37	7.50	14.32	7.76	0.93	604.
16.000	6.57	9.06	0.0932	6.92	6.54	13.00	6.85	0.71	548.
17.000	5.60	9.08	0.1270	6.93	6.07	12.34	6.81	1.28	541.
18.000	4.75	8.83	0.2385	6.93	6.04	11.68	6.95	1.38	540.
19.000	3.61	7.91	0.2404	6.48	5.56	10.47	6.22	1.50	525.
20.000	2.48	7.60	0.2039	6.07	5.15	9.74	5.68	1.23	514.
21.000	1.30	7.50	0.1969	5.89	4.83	9.29	5.45	1.46	499.
22.000	0.27	7.20	0.1492	5.57	4.47	8.91	4.85	1.09	489.
23.000	-0.85	7.17	0.1277	5.20	4.80	8.47	4.79	1.13	480.
24.000	-1.97	7.25	0.0481	4.94	4.99	8.75	5.40	1.38	464.
25.000	-2.75	7.42	0.0854	4.87	5.77	9.00	5.32	0.98	446.
26.000	-3.48	7.93	0.0377	4.39	5.86	9.45	6.27	1.52	426.
27.000	-4.42	8.27	0.0404	3.96	5.95	9.76	6.10	0.96	385.
28.000	-5.13	8.59	0.0682	3.64	7.16	10.31	6.19	0.93	352.
29.000	-5.65	9.04	-0.0155	3.22	6.49	10.96	6.77	1.15	312.
30.000	-6.06	9.58	-0.1048	3.29	6.96	11.57	7.32	1.11	261.
32.000	-8.33	10.12	-0.1554	3.23	8.17	13.90	7.17	0.62	30.
34.000	-7.39	12.85	0.0177	3.74	9.95	16.16	8.10	0.38	31.
36.000	-6.59	14.48	-0.0942	3.19	11.95	17.66	9.09	0.22	32.
38.000	-6.03	15.65	-0.1155	3.25	13.61	18.13	11.82	0.28	32.
40.000	-2.71	16.82	-0.1745	2.50	14.78	19.29	11.52	0.40	34.
42.000	-0.29	20.20	-0.1078	1.09	13.74	21.24	11.67	0.31	34.
44.000	0.94	23.21	-0.0417	0.06	17.95	24.94	15.03	1.11	35.
46.000	4.56	24.18	0.0481	-0.15	19.97	27.00	15.96	1.01	34.
48.000	4.12	28.52	0.1434	-1.09	19.10	30.24	16.18	0.39	34.
50.000	6.67	25.77	0.0965	-3.64	18.47	28.30	15.34	0.44	33.
52.000	10.89	27.87	-0.0267	-4.93	18.47	30.71	16.98	0.75	28.
54.000	10.05	31.19	0.0504	-7.63	19.37	34.37	16.44	-0.25	19.
56.000	11.45	33.08	0.0124	-8.18	13.87	34.55	14.30	-0.13	11.
58.000	0.00	0.00	0.0000	0.00	0.00	0.00	0.00	0.00	3.
60.000	0.00	0.00	0.0000	0.00	0.00	0.00	0.00	0.00	0.
62.000	0.00	0.00	0.0000	0.00	0.00	0.00	0.00	0.00	0.
64.000	0.00	0.00	0.0000	0.00	0.00	0.00	0.00	0.00	0.
66.000	0.00	0.00	0.0000	0.00	0.00	0.00	0.00	0.00	0.
68.000	0.00	0.00	0.0000	0.00	0.00	0.00	0.00	0.00	0.
70.000	0.00	0.00	0.0000	0.00	0.00	0.00	0.00	0.00	0.

TABLE A-4. April Statistical Wind Data, Shemya.

Z KM	MEAN U M/S	S.D. U M/S	R(U,V)	MEAN V M/S	S.D. V M/S	MEAN W M/S	S.D. W M/S	SKEW W	#OBS
0.000	0.00	0.00	0.0000	0.00	0.00	0.00	0.00	0.00	0.
0.039	1.32	6.07	0.1556	0.47	7.04	8.23	4.52	0.78	638.
1.000	3.05	8.95	0.0200	0.78	8.51	11.15	6.16	0.75	694.
2.000	4.27	8.79	0.0329	0.65	8.62	11.55	6.05	0.66	694.
3.000	5.39	9.61	0.0178	0.64	9.16	12.69	6.67	0.91	693.
4.000	6.65	10.58	0.0227	0.69	10.18	14.34	7.36	0.80	693.
5.000	8.18	12.24	0.0378	0.60	11.82	16.63	8.94	0.79	692.
6.000	9.68	14.14	0.0306	0.46	13.08	18.81	10.50	0.76	677.
7.000	11.34	16.07	0.0094	0.49	14.83	21.41	12.17	0.75	671.
8.000	13.47	18.05	-0.0204	0.66	16.23	23.81	14.27	0.80	667.
9.000	15.37	18.62	-0.0408	0.93	16.65	24.91	15.49	0.94	660.
10.000	16.18	17.25	-0.0626	1.23	16.26	24.30	15.32	0.94	634.
11.000	16.04	14.68	-0.0459	1.39	14.15	22.22	13.44	1.06	611.
12.000	15.23	13.11	-0.0790	1.54	12.33	20.17	12.28	1.65	593.
13.000	13.70	10.63	-0.0447	1.80	10.68	17.70	9.17	1.00	588.
14.000	12.51	9.88	-0.0413	2.23	9.37	16.00	8.31	1.10	581.
15.000	11.53	9.19	-0.0128	2.49	8.54	14.55	7.90	1.17	578.
16.000	10.09	8.56	0.0096	2.45	8.10	13.04	7.20	1.16	533.
17.000	8.50	8.05	0.0352	2.51	7.56	11.37	6.65	1.50	509.
18.000	6.93	7.52	0.0831	2.67	6.84	9.54	5.89	1.55	508.
19.000	5.64	6.85	-0.0511	2.41	5.96	8.16	4.76	0.99	501.
20.000	4.01	6.37	-0.0752	2.30	5.07	7.00	4.02	1.09	495.
21.000	3.11	5.62	-0.0573	2.18	4.59	6.31	3.76	1.05	486.
22.000	1.85	5.53	0.0056	2.00	3.88	5.64	3.21	1.08	474.
23.000	1.35	5.48	-0.0570	1.71	3.43	5.38	2.92	0.79	464.
24.000	0.93	5.87	-0.0286	1.46	3.44	5.50	3.23	0.97	448.
25.000	0.50	6.25	-0.1330	1.09	3.63	5.96	3.34	1.00	428.
26.000	0.04	6.52	-0.1681	0.78	4.02	6.29	3.58	0.80	410.
27.000	0.01	7.06	-0.1953	0.61	3.92	6.50	3.82	0.84	378.
28.000	-0.10	7.20	-0.2555	0.23	4.20	7.03	4.12	1.16	348.
29.000	-0.38	8.55	-0.2435	0.08	4.29	7.57	4.35	1.21	298.
30.000	-0.91	8.06	-0.3427	-0.07	4.44	7.87	4.82	1.48	250.
32.000	-1.96	8.09	-0.5004	0.27	5.26	8.27	5.20	1.09	26.
34.000	-2.30	9.03	-0.3414	-0.96	6.31	9.93	5.11	0.44	27.
36.000	-1.56	9.34	-0.1446	-0.19	6.03	9.85	5.19	1.28	27.
38.000	0.71	11.59	-0.2891	-1.39	6.15	11.07	6.85	1.11	28.
40.000	0.30	11.46	-0.2273	0.07	6.98	11.53	6.60	1.19	30.
42.000	2.91	12.98	-0.0936	-0.06	6.43	12.34	7.72	0.69	32.
44.000	3.91	14.92	0.3629	0.82	8.05	14.94	8.68	0.75	33.
46.000	3.75	15.12	0.1966	3.25	9.15	16.72	6.98	0.35	32.
48.000	3.70	19.08	0.0030	4.37	9.91	18.59	11.75	0.88	27.
50.000	2.68	20.19	0.1519	3.04	8.86	17.88	12.99	1.02	25.
52.000	-4.43	26.47	-0.1269	2.05	11.38	20.57	20.16	2.11	21.
54.000	-7.80	20.62	0.5867	1.00	14.06	21.07	14.63	1.19	15.
56.000	-9.17	20.03	0.1553	2.17	8.82	19.00	12.25	1.65	6.
58.000	0.00	0.00	0.0000	0.00	0.00	0.00	0.00	0.00	3.
60.000	0.00	0.00	0.0000	0.00	0.00	0.00	0.00	0.00	2.
62.000	0.00	0.00	0.0000	0.00	0.00	0.00	0.00	0.00	0.
64.000	0.00	0.00	0.0000	0.00	0.00	0.00	0.00	0.00	0.
66.000	0.00	0.00	0.0000	0.00	0.00	0.00	0.00	0.00	0.
68.000	0.00	0.00	0.0000	0.00	0.00	0.00	0.00	0.00	0.
70.000	0.00	0.00	0.0000	0.00	0.00	0.00	0.00	0.00	0.

TABLE A-5. May Statistical Wind Data, Shemya.

Z KM	MEAN U M/S	S.D. U M/S	R(U,V)	MEAN V M/S	S.D. V M/S	MEAN W M/S	S.D. W M/S	SKEW W	#OBS
0.000	0.00	0.00	0.0000	0.00	0.00	0.00	0.00	0.00	0.
0.039	1.02	4.94	0.0456	-0.84	6.04	7.00	3.69	0.61	701.
1.000	2.15	7.15	-0.0096	-0.92	7.89	9.49	5.35	0.90	761.
2.000	2.86	7.63	0.0091	-1.30	8.04	10.14	5.47	0.73	760.
3.000	4.20	8.55	-0.0174	-1.40	8.66	11.34	6.26	0.87	759.
4.000	5.76	9.50	-0.0331	-1.48	9.35	12.71	7.17	0.99	759.
5.000	7.27	10.64	-0.0496	-1.67	10.51	14.24	8.21	0.90	758.
6.000	8.48	11.96	-0.1006	-1.69	11.42	16.01	9.58	0.99	749.
7.000	10.24	13.77	-0.1132	-1.82	13.02	18.43	11.29	0.95	748.
8.000	12.00	15.62	-0.0960	-1.80	14.66	20.75	13.25	1.09	739.
9.000	13.70	16.31	-0.0472	-1.75	14.88	21.86	14.13	1.13	734.
10.000	14.79	15.48	-0.0532	-1.38	14.00	21.31	14.20	1.16	719.
11.000	15.21	14.51	-0.0830	-1.36	12.50	19.79	13.31	1.16	693.
12.000	13.52	11.44	-0.1079	-1.24	10.73	17.28	11.46	1.39	687.
13.000	12.06	9.48	-0.0969	-0.86	9.02	14.90	9.32	1.25	685.
14.000	10.41	8.86	-0.0257	-0.64	7.99	12.93	8.03	1.21	678.
15.000	8.80	7.44	-0.0557	-0.48	6.83	10.86	6.82	1.21	675.
16.000	7.24	6.42	-0.0324	-0.23	5.83	9.21	6.19	1.47	660.
17.000	6.03	5.73	-0.0176	-0.12	5.15	8.04	5.57	1.95	603.
18.000	4.50	4.95	0.0765	0.22	4.60	6.61	4.72	1.90	602.
19.000	2.97	5.37	0.0376	0.42	4.34	5.25	3.52	1.81	586.
20.000	1.59	3.85	0.1145	0.50	3.47	4.30	2.56	1.32	582.
21.000	0.19	3.79	0.0579	0.62	3.20	3.83	2.44	2.21	571.
22.000	-0.59	3.93	0.1025	0.70	2.97	3.91	2.35	1.75	563.
23.000	-1.45	3.84	0.1099	0.83	2.74	4.04	2.24	1.28	556.
24.000	-1.94	4.03	0.0605	0.89	2.61	4.18	2.31	1.19	536.
25.000	-2.45	3.86	0.1564	0.86	2.76	4.54	2.39	0.69	520.
26.000	-2.68	3.89	0.0548	0.70	2.78	4.90	2.55	0.82	490.
27.000	-2.74	4.27	0.0620	0.74	2.94	5.17	2.84	0.77	439.
28.000	-2.72	4.80	0.1264	0.56	3.46	5.63	3.32	1.66	406.
29.000	-3.03	5.02	0.0293	0.43	3.36	6.01	3.11	1.34	350.
30.000	-3.14	5.24	-0.0269	0.43	3.67	6.34	3.26	1.10	303.
32.000	-4.76	5.98	0.4540	2.38	3.28	7.43	4.03	0.28	21.
34.000	-5.29	6.84	0.1584	1.58	3.17	8.04	4.59	0.62	24.
36.000	-5.42	6.76	-0.1216	2.33	3.42	8.38	4.54	0.47	24.
38.000	-5.58	6.41	0.2754	2.67	3.66	8.50	4.32	0.73	24.
40.000	-5.50	7.06	-0.0287	2.17	3.00	8.17	4.99	0.75	24.
42.000	-5.25	7.51	-0.2111	2.33	4.03	9.00	4.94	0.67	24.
44.000	-6.00	5.95	0.1944	0.71	5.79	9.29	4.18	0.07	24.
46.000	-6.96	8.51	0.2149	1.96	4.27	10.35	5.54	0.70	26.
48.000	-10.96	15.96	-0.7294	7.26	11.21	15.83	17.23	3.38	23.
50.000	-8.71	9.24	0.1113	5.52	8.16	14.14	7.22	0.83	21.
52.000	-13.00	10.49	0.3871	-1.00	7.57	16.53	7.78	0.58	17.
54.000	-18.33	15.84	-0.5409	3.89	25.43	27.22	21.60	2.45	9.
56.000	0.00	0.00	0.0000	0.00	0.00	0.00	0.00	0.00	2.
58.000	0.00	0.00	0.0000	0.00	0.00	0.00	0.00	0.00	0.
60.000	0.00	0.00	0.0000	0.00	0.00	0.00	0.00	0.00	0.
62.000	0.00	0.00	0.0000	0.00	0.00	0.00	0.00	0.00	1.
64.000	0.00	0.00	0.0000	0.00	0.00	0.00	0.00	0.00	1.
66.000	0.00	0.00	0.0000	0.00	0.00	0.00	0.00	0.00	1.
68.000	0.00	0.00	0.0000	0.00	0.00	0.00	0.00	0.00	1.
70.000	0.00	0.00	0.0000	0.00	0.00	0.00	0.00	0.00	0.

**TABLE A-6. June Statistical Wind Data, Shemya.**

Z KM	MEAN U M/S	S.D. U M/S	R(U,V)	MEAN V M/S	S.D. V M/S	MEAN W M/S	S.D. W M/S	SKEW W	#OBS
0.000	0.00	0.00	0.0000	0.00	0.00	0.00	0.00	0.00	0.
0.039	0.93	4.38	0.1239	0.02	5.31	6.18	3.18	0.63	628.
1.000	1.57	7.02	0.0669	-0.30	7.40	9.06	4.94	0.99	675.
2.000	1.98	7.91	0.0604	-0.68	8.11	10.05	5.63	1.28	675.
3.000	2.66	8.63	0.0948	-1.19	8.67	11.05	5.99	1.15	674.
4.000	3.52	9.22	0.0632	-1.68	9.26	12.02	6.42	1.02	672.
5.000	4.55	10.59	0.0124	-2.08	10.11	13.28	7.02	0.93	669.
6.000	5.38	11.95	0.0193	-2.58	11.24	14.89	8.11	0.97	663.
7.000	6.02	12.90	0.0521	-2.82	12.91	16.59	9.12	1.04	661.
8.000	6.65	14.17	0.0903	-3.36	13.45	18.28	10.13	0.98	648.
9.000	7.40	15.40	0.1444	-3.11	14.57	19.68	11.24	0.85	642.
10.000	8.64	15.65	0.1577	-2.87	14.47	19.77	12.07	1.07	638.
11.000	9.14	14.34	0.1659	-2.54	13.30	17.96	12.23	1.63	623.
12.000	8.84	11.50	0.1360	-1.81	10.19	14.84	9.86	1.62	614.
13.000	7.60	8.83	0.1555	-1.61	8.42	12.19	7.78	1.42	611.
14.000	6.40	7.21	0.1268	-1.18	6.86	9.91	6.56	1.65	608.
15.000	5.20	5.85	0.1605	-0.77	5.66	8.14	5.25	1.59	605.
16.000	3.65	4.72	0.1444	-0.56	4.73	6.14	3.78	1.17	601.
17.000	2.51	4.32	0.1462	-0.43	4.24	5.14	3.09	1.21	538.
18.000	0.93	3.82	0.1519	-0.18	3.75	4.07	2.66	1.56	536.
19.000	-0.67	2.99	0.0824	0.22	2.79	3.31	2.09	1.47	530.
20.000	-1.99	2.93	-0.0399	0.36	2.53	3.39	2.01	1.18	528.
21.000	-3.19	2.87	-0.0151	0.53	2.30	3.97	2.19	1.06	519.
22.000	-4.26	2.65	0.0565	0.69	2.16	4.75	2.09	0.69	508.
23.000	-5.22	2.52	0.0039	0.68	2.02	5.65	2.14	0.36	502.
24.000	-5.94	2.65	-0.0981	0.64	1.98	6.37	2.44	0.87	491.
25.000	-6.54	2.71	-0.0624	0.71	2.30	6.86	2.29	0.29	471.
26.000	-7.10	2.71	-0.0091	0.76	1.84	7.48	2.41	0.31	453.
27.000	-7.63	2.76	0.0660	0.84	1.98	7.99	2.58	0.09	420.
28.000	-8.24	2.94	0.0741	0.78	1.98	8.60	2.68	0.13	399.
29.000	-8.73	2.93	0.1363	0.87	2.23	9.12	2.68	0.11	354.
30.000	-9.32	3.32	0.1327	0.83	2.23	9.69	3.12	0.11	300.
32.000	-12.68	2.60	0.3099	1.95	3.26	13.16	2.59	-0.19	19.
34.000	-13.29	3.39	-0.1850	2.05	2.77	13.71	3.65	-0.35	21.
36.000	-13.83	4.01	-0.0601	1.30	2.49	14.00	3.93	-0.30	23.
38.000	-16.00	3.34	0.0147	0.91	2.78	16.26	3.52	-0.22	23.
40.000	-17.43	3.70	-0.2355	1.14	4.46	17.95	3.96	0.20	21.
42.000	-18.24	5.99	0.3234	4.48	7.00	20.05	5.74	-0.60	21.
44.000	-21.52	7.33	-0.5243	3.14	4.60	22.10	7.67	0.56	21.
46.000	-24.18	7.88	0.1420	2.14	7.13	25.27	7.72	0.53	22.
48.000	-26.40	6.08	0.1368	2.95	10.35	28.15	7.85	1.18	20.
50.000	-33.40	15.00	0.6418	-0.85	29.41	38.05	27.33	3.50	20.
52.000	-27.94	9.45	-0.0257	4.69	7.04	29.38	9.03	-0.20	16.
54.000	-30.42	7.56	-0.0564	12.83	13.60	35.17	9.21	-0.80	12.
56.000	0.00	0.00	0.0000	0.00	0.00	0.00	0.00	0.00	5.
58.000	0.00	0.00	0.0000	0.00	0.00	0.00	0.00	0.00	2.
60.000	0.00	0.00	0.0000	0.00	0.00	0.00	0.00	0.00	2.
62.000	0.00	0.00	0.0000	0.00	0.00	0.00	0.00	0.00	2.
64.000	0.00	0.00	0.0000	0.00	0.00	0.00	0.00	0.00	2.
66.000	0.00	0.00	0.0000	0.00	0.00	0.00	0.00	0.00	1.
68.000	0.00	0.00	0.0000	0.00	0.00	0.00	0.00	0.00	1.
70.000	0.00	0.00	0.0000	0.00	0.00	0.00	0.00	0.00	0.



TABLE A-7. July Statistical Wind Data, Shemya.

Z KM	MEAN U M/S	S.D. U M/S	R(U,V)	MEAN V M/S	S.D. V M/S	MEAN W M/S	S.D. W M/S	SKEW W	#OBS
0.000	0.00	0.00	0.0000	0.00	0.00	0.00	0.00	0.00	0.
0.039	1.01	3.83	0.2026	1.09	4.83	5.50	3.16	0.51	709.
1.000	2.62	6.85	0.1358	0.85	6.58	8.44	5.14	1.11	766.
2.000	3.43	7.30	0.1299	0.21	7.04	9.26	5.37	1.17	763.
3.000	4.45	7.83	0.1631	-0.23	7.76	10.33	5.88	1.24	763.
4.000	5.77	8.41	0.1452	-0.39	8.08	11.46	6.16	1.03	760.
5.000	6.95	9.14	0.1593	-0.76	8.98	12.74	6.84	0.77	759.
6.000	8.18	10.20	0.1520	-1.11	10.01	14.42	8.02	0.99	743.
7.000	9.48	11.04	0.1468	-1.37	11.17	16.00	9.06	0.88	738.
8.000	11.10	12.41	0.1580	-1.59	12.61	18.04	10.63	0.95	733.
9.000	12.38	13.66	0.1338	-2.15	13.71	19.95	11.58	0.85	728.
10.000	13.76	14.61	0.1510	-2.36	14.92	21.68	12.68	0.79	716.
11.000	14.42	15.04	0.1862	-2.33	15.74	21.78	13.15	0.88	696.
12.000	13.97	14.39	0.2154	-2.08	13.90	19.66	12.80	1.16	678.
13.000	11.76	11.16	0.1473	-1.75	11.06	16.34	10.49	1.26	675.
14.000	9.57	8.58	0.1432	-1.45	8.94	13.26	8.45	1.27	666.
15.000	7.29	6.99	0.1170	-1.36	7.22	10.53	6.71	1.41	661.
16.000	5.24	6.04	0.2147	-1.08	6.40	8.09	5.03	1.14	653.
17.000	3.34	4.59	0.1988	-0.64	5.41	6.20	3.89	1.32	583.
18.000	1.47	4.00	0.3212	-0.29	4.67	4.60	2.86	1.50	582.
19.000	-0.41	3.26	0.2740	-0.20	3.74	3.64	2.46	1.79	565.
20.000	-1.93	2.77	0.2268	0.06	3.16	3.69	2.28	1.43	563.
21.000	-3.24	2.50	0.1914	0.12	2.68	4.20	2.11	1.35	559.
22.000	-4.58	2.41	0.1949	0.11	2.15	5.13	2.09	1.56	545.
23.000	-5.66	2.28	0.4073	0.28	2.41	6.13	1.87	1.17	536.
24.000	-6.67	2.71	0.3818	0.33	2.41	7.00	2.00	0.67	526.
25.000	-7.15	2.37	0.2240	0.41	2.05	7.59	1.88	0.72	501.
26.000	-8.04	2.40	0.2991	0.39	2.11	8.36	2.00	0.39	483.
27.000	-8.81	2.39	0.1189	0.48	2.05	9.10	2.22	0.18	456.
28.000	-9.20	2.46	0.0163	0.52	2.02	9.50	2.18	-0.10	405.
29.000	-9.87	2.24	0.0387	0.50	1.88	10.07	2.20	0.07	367.
30.000	-10.55	2.39	0.1555	0.31	2.04	10.75	2.37	0.44	332.
32.000	-12.54	3.55	0.0918	1.15	2.58	12.77	3.61	0.12	13.
34.000	-14.36	2.44	-0.5103	2.79	3.47	14.86	3.01	0.52	14.
36.000	-14.93	3.20	0.0785	1.64	2.56	15.29	3.17	0.25	14.
38.000	-18.06	3.82	0.1260	1.94	3.45	18.44	3.98	-0.80	16.
40.000	-20.15	2.96	-0.4247	4.05	5.23	21.00	3.21	-0.75	20.
42.000	-23.67	6.57	-0.2905	4.00	4.22	24.29	6.81	1.10	21.
44.000	-25.59	8.72	-0.3897	4.14	4.03	26.23	8.83	2.16	22.
46.000	-28.76	6.83	-0.0588	1.14	12.03	30.67	8.88	0.95	21.
48.000	-32.67	7.42	-0.4665	6.11	6.59	33.72	8.35	0.75	18.
50.000	-36.29	10.48	-0.1999	5.00	9.22	37.53	10.92	-0.15	17.
52.000	-40.50	9.10	0.0293	4.42	10.07	41.67	9.32	-0.60	12.
54.000	-41.43	9.78	-0.4923	13.71	8.20	44.43	10.53	-0.66	7.
56.000	-43.67	13.68	-0.6740	9.50	8.53	45.17	14.80	0.03	6.
58.000	0.00	0.00	0.0000	0.00	0.00	0.00	0.00	0.00	3.
60.000	0.00	0.00	0.0000	0.00	0.00	0.00	0.00	0.00	3.
62.000	0.00	0.00	0.0000	0.00	0.00	0.00	0.00	0.00	2.
64.000	0.00	0.00	0.0000	0.00	0.00	0.00	0.00	0.00	2.
66.000	0.00	0.00	0.0000	0.00	0.00	0.00	0.00	0.00	2.
68.000	0.00	0.00	0.0000	0.00	0.00	0.00	0.00	0.00	1.
70.000	0.00	0.00	0.0000	0.00	0.00	0.00	0.00	0.00	0.

TABLE A-8. August Statistical Wind Data, Shemya.

Z KM	MEAN U M/S	S.D. U M/S	R(U,V)	MEAN V M/S	S.D. V M/S	MEAN W M/S	S.D. W M/S	SKEW W	#OBS
0.000	0.00	0.00	0.0000	0.00	0.00	0.00	0.00	0.00	0.
0.039	1.40	4.09	0.1444	1.26	5.44	6.22	3.35	0.77	693.
1.000	3.58	7.27	0.1012	1.12	7.43	9.64	5.39	0.83	750.
2.000	4.40	7.79	0.0976	0.99	7.66	10.35	5.70	0.86	750.
3.000	5.58	8.18	0.1180	0.87	8.08	11.28	6.06	0.73	749.
4.000	7.05	8.94	0.1231	0.86	8.49	12.61	6.59	0.52	746.
5.000	8.33	10.08	0.1150	0.84	9.33	14.27	7.41	0.54	746.
6.000	9.72	11.27	0.1278	0.75	10.44	16.19	8.30	0.68	728.
7.000	11.20	12.93	0.1317	0.76	11.90	18.33	9.51	0.72	723.
8.000	12.93	14.75	0.1029	0.68	13.54	20.98	11.30	0.86	714.
9.000	14.90	16.90	0.1037	0.26	15.33	23.87	13.13	0.99	707.
10.000	16.37	17.74	0.0590	0.43	16.67	25.63	14.26	0.78	703.
11.000	17.50	17.51	-0.0035	0.48	17.05	26.07	14.94	0.93	685.
12.000	17.19	16.00	-0.0092	0.05	15.01	24.09	14.00	1.00	669.
13.000	14.97	13.32	-0.0562	0.11	13.02	20.78	11.78	0.93	661.
14.000	12.91	11.01	-0.0464	-0.05	11.13	17.78	9.75	0.98	655.
15.000	10.66	9.19	0.0180	0.08	9.39	14.81	8.17	1.05	649.
16.000	8.29	7.40	-0.0258	-0.17	7.31	11.59	6.50	1.04	638.
17.000	6.32	5.99	0.0617	0.06	6.43	9.23	5.10	1.14	583.
18.000	4.43	5.44	0.1269	0.15	5.16	7.23	4.25	1.99	583.
19.000	2.78	4.61	0.1619	0.35	4.56	5.54	3.73	2.07	572.
20.000	1.40	4.15	0.2050	0.47	3.61	4.50	2.88	1.65	569.
21.000	-0.21	3.93	0.3378	0.47	3.04	3.85	2.45	1.42	556.
22.000	-1.18	3.37	0.3622	0.51	2.62	3.93	2.10	0.80	545.
23.000	-2.04	3.63	0.3952	0.63	2.54	4.22	2.06	0.77	534.
24.000	-2.82	4.04	0.5344	0.63	3.63	4.45	2.20	0.67	518.
25.000	-3.41	3.61	0.2524	0.44	2.26	4.77	2.29	0.56	495.
26.000	-3.95	3.63	0.3701	0.43	2.24	5.24	2.37	0.51	474.
27.000	-4.17	3.87	0.3211	0.45	2.61	5.63	2.76	0.69	447.
28.000	-4.28	3.87	0.2336	0.36	2.55	5.60	2.68	0.70	412.
29.000	-4.55	3.82	0.2506	0.42	2.73	5.71	2.42	0.25	362.
30.000	-4.75	4.19	0.3500	0.29	3.24	5.95	2.89	1.10	323.
32.000	-6.26	4.46	-0.4646	1.83	2.25	7.00	4.27	0.31	23.
34.000	-6.58	4.16	-0.4095	0.96	2.44	7.21	3.73	-0.41	24.
36.000	-8.33	4.33	-0.2525	1.75	2.86	9.00	4.08	-0.59	24.
38.000	-7.58	5.27	-0.2374	2.50	2.81	8.71	5.03	-0.09	24.
40.000	-10.52	6.24	-0.2720	0.64	3.65	11.24	5.76	-0.06	25.
42.000	-12.84	7.52	0.0859	1.84	4.04	14.28	6.23	-0.57	25.
44.000	-14.76	7.28	-0.2219	4.76	4.53	16.48	6.58	-0.18	25.
46.000	-15.61	9.44	0.0834	3.57	6.18	17.39	8.59	0.12	23.
48.000	-17.21	8.68	0.2044	7.32	10.90	21.00	10.08	0.82	19.
50.000	-18.31	10.57	0.0885	5.31	4.81	20.44	9.08	-0.55	16.
52.000	-24.25	10.96	-0.6148	4.92	7.49	25.92	10.82	0.17	12.
54.000	-20.67	22.25	-0.8897	5.22	20.52	34.11	11.48	1.27	9.
56.000	-36.17	6.74	0.0568	19.67	12.89	42.17	9.91	0.81	6.
58.000	0.00	0.00	0.0000	0.00	0.00	0.00	0.00	0.00	4.
60.000	0.00	0.00	0.0000	0.00	0.00	0.00	0.00	0.00	4.
62.000	0.00	0.00	0.0000	0.00	0.00	0.00	0.00	0.00	1.
64.000	0.00	0.00	0.0000	0.00	0.00	0.00	0.00	0.00	0.
66.000	0.00	0.00	0.0000	0.00	0.00	0.00	0.00	0.00	0.
68.000	0.00	0.00	0.0000	0.00	0.00	0.00	0.00	0.00	0.
70.000	0.00	0.00	0.0000	0.00	0.00	0.00	0.00	0.00	0.

**TABLE A-9. September Statistical Wind Data, Shemya.**

Z KM	MEAN U M/S	S.D. U M/S	R(U,V)	MEAN V M/S	S.D. V M/S	MEAN W M/S	S.D. W M/S	SKEW W	#OBS
0.000	0.00	0.00	0.0000	0.00	0.00	0.00	0.00	0.00	0.
0.039	1.50	4.70	0.0913	-0.18	5.99	6.76	3.81	0.87	632.
1.000	3.12	7.77	-0.0111	-1.23	8.21	10.13	5.72	0.85	704.
2.000	3.69	7.72	0.0504	-1.71	8.12	10.52	5.60	0.88	702.
3.000	4.70	8.05	0.0459	-1.74	8.51	11.38	5.72	0.75	702.
4.000	6.09	8.78	0.0525	-1.83	9.05	12.60	6.36	0.83	702.
5.000	7.41	9.38	0.0416	-1.82	9.98	13.88	7.28	0.81	700.
6.000	8.84	10.65	0.0243	-1.71	11.28	15.68	8.69	0.92	685.
7.000	10.39	12.42	-0.0237	-1.88	12.95	17.96	10.51	1.06	682.
8.000	12.35	14.64	-0.0389	-1.83	14.60	20.57	12.63	1.15	676.
9.000	14.74	16.52	-0.0621	-1.68	16.71	23.54	14.75	1.00	669.
10.000	16.91	17.33	-0.0759	-1.27	17.29	25.25	15.77	1.05	662.
11.000	18.28	16.48	-0.0812	-0.92	16.37	25.08	15.65	1.12	644.
12.000	18.56	14.80	-0.0339	-0.44	15.11	23.87	14.91	1.29	637.
13.000	17.24	12.07	-0.0629	-0.51	12.76	21.42	12.13	1.22	629.
14.000	15.83	9.98	-0.1070	-0.66	10.94	19.20	10.09	1.15	617.
15.000	14.18	8.57	-0.0573	-0.40	9.84	17.09	8.93	1.42	612.
16.000	12.21	7.50	-0.0199	-0.02	8.41	14.61	7.51	1.20	604.
17.000	10.29	6.21	-0.0275	0.07	6.97	12.25	6.10	1.44	553.
18.000	8.70	5.52	-0.0269	0.16	6.00	10.33	5.22	1.57	552.
19.000	7.48	5.49	-0.0796	0.50	5.09	8.56	4.20	1.26	547.
20.000	6.08	4.74	-0.1425	0.77	4.24	7.19	3.61	1.21	543.
21.000	5.09	4.70	-0.0897	0.98	3.83	6.28	3.51	1.15	530.
22.000	4.57	4.38	-0.1789	1.18	3.64	5.98	3.22	1.10	520.
23.000	3.99	4.38	-0.1912	1.13	3.50	5.68	3.22	1.54	509.
24.000	3.38	4.66	-0.1186	0.93	3.38	5.33	3.43	1.72	494.
25.000	3.40	4.85	0.0048	0.86	3.23	5.51	3.68	1.99	475.
26.000	3.50	5.03	0.0262	0.56	3.12	5.55	3.51	1.40	454.
27.000	3.41	5.16	0.1220	0.31	3.03	5.51	3.41	0.93	408.
28.000	3.03	5.30	0.1166	0.06	2.97	5.68	3.71	1.50	378.
29.000	3.17	5.14	0.0923	-0.01	2.91	5.73	3.48	0.91	336.
30.000	2.96	5.62	0.0098	0.01	3.13	5.76	3.71	1.04	299.
32.000	3.83	4.94	0.4280	0.83	2.37	5.58	3.36	0.51	24.
34.000	4.32	5.28	0.1994	0.64	3.16	6.32	3.89	1.05	25.
36.000	5.32	6.51	0.3383	0.16	3.89	7.80	4.99	0.29	25.
38.000	4.56	7.01	-0.0192	0.40	3.59	7.36	5.25	1.12	25.
40.000	7.58	8.56	-0.0060	0.31	4.36	10.19	6.84	0.94	26.
42.000	9.35	8.83	-0.0599	1.00	5.37	11.85	7.11	0.39	26.
44.000	9.88	9.47	-0.1016	-0.52	5.57	12.48	7.82	0.24	25.
46.000	11.26	11.60	-0.1402	1.33	6.66	14.70	9.33	0.19	27.
48.000	12.15	15.15	-0.2709	0.38	8.26	18.23	10.37	0.34	26.
50.000	11.45	14.43	-0.4800	0.05	6.85	16.00	10.85	0.68	22.
52.000	7.47	14.33	0.0201	5.35	8.92	16.35	9.80	0.40	17.
54.000	10.60	13.58	0.8223	5.90	8.45	16.40	10.71	0.30	10.
56.000	0.00	0.00	0.0000	0.00	0.00	0.00	0.00	0.00	5.
58.000	0.00	0.00	0.0000	0.00	0.00	0.00	0.00	0.00	3.
60.000	0.00	0.00	0.0000	0.00	0.00	0.00	0.00	0.00	1.
62.000	0.00	0.00	0.0000	0.00	0.00	0.00	0.00	0.00	1.
64.000	0.00	0.00	0.0000	0.00	0.00	0.00	0.00	0.00	1.
66.000	0.00	0.00	0.0000	0.00	0.00	0.00	0.00	0.00	0.
68.000	0.00	0.00	0.0000	0.00	0.00	0.00	0.00	0.00	0.
70.000	0.00	0.00	0.0000	0.00	0.00	0.00	0.00	0.00	0.

TABLE A-10. October Statistical Wind Data, Shemya.

Z KM	MEAN U M/S	S.D. U M/S	R(U,V)	MEAN V M/S	S.D. V M/S	MEAN W M/S	S.D. W M/S	SKEW W	#OBS
0.000	0.00	0.00	0.0000	0.00	0.00	0.00	0.00	0.00	0.
0.039	1.18	5.57	0.1189	0.49	6.43	7.45	4.29	0.74	674.
1.000	3.35	8.89	0.0140	0.28	8.66	11.26	6.19	0.85	739.
2.000	4.59	8.82	0.0429	0.09	8.64	11.53	6.37	0.93	737.
3.000	5.98	8.94	0.0621	0.11	8.91	12.28	6.64	0.92	737.
4.000	7.64	9.68	0.0945	0.14	9.78	13.90	7.36	0.91	737.
5.000	9.49	11.20	0.0955	0.00	11.51	16.14	8.75	0.86	733.
6.000	11.66	13.04	0.1133	0.16	13.20	18.82	10.30	0.66	709.
7.000	13.94	15.04	0.0980	0.60	14.85	21.85	12.78	0.89	705.
8.000	16.74	16.48	0.0455	1.02	16.31	24.65	14.53	0.82	692.
9.000	19.29	17.41	0.0250	1.30	17.18	26.83	15.86	0.82	685.
10.000	22.04	17.87	0.0405	1.43	17.45	28.47	17.34	1.01	666.
11.000	23.20	16.64	0.0759	1.73	16.49	28.38	16.85	1.13	643.
12.000	22.64	14.59	0.0943	1.59	14.55	26.74	14.97	1.33	631.
13.000	21.90	12.84	0.1413	1.77	13.26	25.21	12.95	1.24	625.
14.000	20.55	10.70	0.1192	1.74	11.39	23.33	11.19	1.10	609.
15.000	18.94	9.52	0.1142	1.83	9.60	21.18	9.79	1.09	597.
16.000	16.87	8.32	0.1432	2.13	8.40	18.88	8.49	1.11	565.
17.000	15.12	8.59	0.2476	2.12	7.57	17.18	8.30	1.69	504.
18.000	13.48	8.40	0.2344	2.10	6.98	15.55	7.97	1.53	503.
19.000	12.35	8.07	0.2225	2.09	6.33	14.19	7.79	1.73	495.
20.000	11.11	7.47	0.2635	2.22	6.04	12.85	7.44	1.85	491.
21.000	10.37	7.61	0.3044	2.28	5.69	12.13	7.47	1.76	485.
22.000	9.23	7.77	0.2601	2.08	4.94	10.92	7.41	1.76	477.
23.000	8.26	7.79	0.3284	1.93	4.73	10.02	6.96	1.64	461.
24.000	7.85	9.12	0.3072	1.65	5.22	10.01	8.00	1.72	436.
25.000	7.17	9.07	0.3159	1.15	4.63	9.74	7.84	1.53	419.
26.000	6.29	9.64	0.2278	0.52	4.59	9.52	7.95	1.71	408.
27.000	6.34	10.08	0.1948	0.27	4.72	9.77	8.28	1.78	377.
28.000	6.37	10.94	0.2397	0.24	5.19	10.24	9.07	1.84	365.
29.000	6.26	10.18	0.0679	-0.44	5.04	10.09	8.15	1.69	325.
30.000	6.70	10.78	0.0560	-0.98	5.25	10.66	8.70	1.67	281.
32.000	5.67	12.11	-0.5253	-0.86	5.93	11.05	9.49	1.71	21.
34.000	7.50	15.37	-0.4213	-2.55	8.45	13.73	13.19	1.22	22.
36.000	8.48	17.62	-0.4824	-3.43	8.59	16.39	13.90	1.08	23.
38.000	11.59	18.46	-0.3667	-4.14	8.60	17.50	15.96	1.46	22.
40.000	13.95	18.39	-0.3051	-4.09	7.69	19.32	14.99	1.27	22.
42.000	17.42	19.54	-0.4229	-6.58	8.32	21.83	17.56	1.18	24.
44.000	19.71	18.11	-0.3162	-5.63	10.93	24.21	16.67	0.90	24.
46.000	20.23	17.39	0.0970	-3.32	9.16	22.77	16.84	1.19	22.
48.000	20.23	12.25	0.1083	-3.09	8.45	22.32	11.63	0.45	22.
50.000	21.29	13.84	0.5369	-11.47	11.71	28.00	10.63	0.49	17.
52.000	18.50	12.63	-0.0081	-12.42	13.80	25.92	12.75	-0.11	12.
54.000	22.13	17.44	-0.3734	-7.25	11.42	27.50	14.56	0.51	8.
56.000	0.00	0.00	0.0000	0.00	0.00	0.00	0.00	0.00	1.
58.000	0.00	0.00	0.0000	0.00	0.00	0.00	0.00	0.00	1.
60.000	0.00	0.00	0.0000	0.00	0.00	0.00	0.00	0.00	1.
62.000	0.00	0.00	0.0000	0.00	0.00	0.00	0.00	0.00	1.
64.000	0.00	0.00	0.0000	0.00	0.00	0.00	0.00	0.00	1.
66.000	0.00	0.00	0.0000	0.00	0.00	0.00	0.00	0.00	1.
68.000	0.00	0.00	0.0000	0.00	0.00	0.00	0.00	0.00	1.
70.000	0.00	0.00	0.0000	0.00	0.00	0.00	0.00	0.00	0.

TABLE A-11. November Statistical Wind Data, Shemya.

Z KM	MEAN U M/S	S.D. U M/S	R(U,V)	MEAN V M/S	S.D. V M/S	MEAN W M/S	S.D. W M/S	SKEW W	#OBS
0.000	0.00	0.00	0.0000	0.00	0.00	0.00	0.00	0.00	0.
0.039	2.89	6.38	0.0424	0.69	7.29	8.95	4.74	0.52	623.
1.000	5.29	10.13	-0.0008	0.86	9.93	13.36	7.16	0.98	704.
2.000	6.35	10.27	0.0156	0.92	9.95	13.81	7.40	1.19	703.
3.000	7.23	10.50	0.0158	1.26	10.19	14.57	7.45	0.92	702.
4.000	8.59	11.39	-0.0047	1.75	11.21	16.11	8.52	0.87	701.
5.000	9.99	12.82	-0.0367	2.34	12.32	17.83	9.59	0.64	697.
6.000	11.12	14.27	-0.0353	2.87	13.54	19.82	11.20	0.69	686.
7.000	12.60	16.14	-0.0553	3.46	15.02	22.13	12.89	0.72	681.
8.000	14.04	17.95	-0.0686	4.19	16.37	24.32	14.61	0.84	670.
9.000	15.65	18.28	-0.1144	4.73	16.60	25.22	15.52	0.88	660.
10.000	17.25	17.67	-0.1116	4.62	15.95	25.13	15.93	1.19	632.
11.000	17.74	15.45	-0.1016	4.76	14.12	23.95	14.19	1.20	617.
12.000	17.37	13.27	-0.1546	4.56	12.12	22.29	12.18	1.21	605.
13.000	17.50	12.06	-0.0982	4.74	10.66	21.55	11.10	1.11	592.
14.000	16.87	11.27	-0.1344	4.85	9.66	20.72	10.07	1.12	582.
15.000	16.28	10.62	-0.1693	4.88	8.99	19.64	8.88	0.92	565.
16.000	15.94	10.43	-0.2385	5.39	8.40	19.26	8.82	1.03	510.
17.000	14.99	9.68	-0.1864	5.14	7.30	17.94	8.20	1.01	493.
18.000	13.99	9.75	-0.1501	5.02	7.07	17.03	8.71	1.56	489.
19.000	13.48	10.15	-0.0371	5.10	6.82	16.53	9.16	1.43	480.
20.000	12.16	9.88	-0.0944	4.98	6.37	15.22	8.89	1.23	474.
21.000	11.94	9.96	-0.0919	4.73	6.23	14.64	9.41	1.27	468.
22.000	10.93	10.30	0.0402	4.77	6.20	14.06	9.42	1.29	453.
23.000	10.59	10.60	0.0892	4.10	6.19	13.86	9.35	1.39	442.
24.000	9.79	11.33	0.0943	3.70	6.58	13.67	9.71	1.57	424.
25.000	9.31	12.18	0.0717	3.28	6.96	13.92	10.01	1.80	406.
26.000	8.54	13.53	0.0930	2.49	7.44	14.25	10.69	1.88	383.
27.000	8.84	13.54	0.1338	2.07	8.50	15.17	10.37	1.61	329.
28.000	8.51	14.19	0.1382	1.66	9.15	15.71	10.62	1.64	302.
29.000	9.11	16.20	0.0586	1.49	9.64	16.35	10.28	1.58	256.
30.000	8.87	16.04	0.2069	0.87	9.54	17.47	11.02	1.36	223.
32.000	4.05	16.10	-0.0586	2.18	7.27	14.27	10.91	2.21	22.
34.000	3.59	16.19	0.0298	1.27	8.94	16.18	9.01	1.49	22.
36.000	5.83	16.59	-0.0912	0.00	8.65	16.04	10.76	1.38	23.
38.000	9.17	19.06	-0.0092	-0.63	9.84	19.50	12.24	1.45	24.
40.000	11.04	19.26	-0.1240	-1.46	11.53	20.67	13.86	0.87	24.
42.000	9.56	21.78	-0.0619	-1.33	12.76	22.11	14.89	0.99	27.
44.000	11.69	24.31	0.1712	1.08	15.22	25.08	17.66	1.11	26.
46.000	13.09	23.02	0.3842	2.14	16.08	25.45	16.88	1.05	22.
48.000	16.84	27.66	0.2408	2.68	17.71	30.84	19.51	1.09	19.
50.000	17.13	30.66	0.6040	0.40	25.90	37.73	20.20	0.24	15.
52.000	19.92	30.78	0.6007	3.38	24.89	37.38	22.39	0.00	13.
54.000	20.00	32.77	0.7674	0.23	23.58	37.46	23.33	0.71	13.
56.000	21.00	29.50	0.5820	-0.50	29.86	37.10	26.69	0.96	10.
58.000	0.00	0.00	0.0000	0.00	0.00	0.00	0.00	0.00	5.
60.000	0.00	0.00	0.0000	0.00	0.00	0.00	0.00	0.00	2.
62.000	0.00	0.00	0.0000	0.00	0.00	0.00	0.00	0.00	2.
64.000	0.00	0.00	0.0000	0.00	0.00	0.00	0.00	0.00	2.
66.000	0.00	0.00	0.0000	0.00	0.00	0.00	0.00	0.00	2.
68.000	0.00	0.00	0.0000	0.00	0.00	0.00	0.00	0.00	1.
70.000	0.00	0.00	0.0000	0.00	0.00	0.00	0.00	0.00	0.

TABLE A-12. December Statistical Wind Data, Shemya.

Z KM	MEAN U M/S	S.D. U M/S	R(U,V)	MEAN V M/S	S.D. V M/S	MEAN W M/S	S.D. W M/S	SKEW W	#OBS
0.000	0.00	0.00	0.0000	0.00	0.00	0.00	0.00	0.00	0.
0.039	1.08	6.80	0.2105	-0.83	7.27	8.80	4.85	0.58	673.
1.000	1.86	10.78	0.0695	-0.24	9.12	12.48	6.56	0.70	737.
2.000	2.56	10.50	0.0836	0.38	9.16	12.55	6.56	0.74	737.
3.000	3.58	11.19	0.1456	1.23	9.44	13.17	6.74	0.62	735.
4.000	4.57	12.38	0.1230	1.82	9.95	14.43	8.25	1.18	734.
5.000	5.43	14.15	0.1144	2.56	10.97	16.14	9.79	1.24	731.
6.000	6.37	15.93	0.0725	3.28	12.36	18.09	11.41	1.22	710.
7.000	8.15	18.28	0.0882	4.02	14.26	20.38	13.21	1.36	701.
8.000	9.61	19.64	0.0881	4.94	15.03	21.68	14.62	1.40	693.
9.000	10.82	18.26	0.0119	5.27	14.51	21.73	14.70	1.23	686.
10.000	11.83	16.56	0.0320	5.74	12.94	20.58	13.82	1.33	669.
11.000	12.16	14.14	0.0635	5.95	11.00	18.94	12.05	1.45	662.
12.000	12.62	12.38	0.0604	6.26	9.45	18.17	10.52	1.25	654.
13.000	13.19	11.64	0.0696	6.84	9.00	18.14	10.39	1.40	649.
14.000	13.88	11.17	0.1186	7.19	8.46	18.17	9.58	1.24	637.
15.000	14.06	10.73	0.1381	7.38	7.88	17.92	9.06	1.06	629.
16.000	14.00	10.64	0.1748	7.60	7.52	18.00	9.18	1.28	573.
17.000	13.73	10.29	0.1926	7.71	7.15	17.63	8.98	1.31	565.
18.000	13.65	10.32	0.1833	8.11	7.13	17.57	8.79	1.08	563.
19.000	13.56	10.35	0.2460	8.36	6.81	17.65	9.28	1.19	553.
20.000	13.10	10.84	0.2316	8.28	6.79	17.51	9.85	1.40	549.
21.000	12.71	11.48	0.1987	8.24	7.24	17.57	10.24	1.38	535.
22.000	12.37	12.46	0.2418	8.26	7.32	17.61	10.94	1.52	528.
23.000	12.03	13.31	0.1970	8.20	7.64	17.57	11.09	1.49	510.
24.000	11.85	14.07	0.1906	8.34	8.34	17.95	11.47	1.46	492.
25.000	11.85	14.74	0.1012	8.24	8.81	18.63	11.40	1.32	467.
26.000	11.98	15.74	0.0250	7.72	9.58	19.58	12.62	1.40	441.
27.000	12.55	17.29	0.0128	6.63	10.14	20.43	13.62	1.52	397.
28.000	12.13	17.75	-0.0114	5.80	11.25	20.80	13.76	1.32	362.
29.000	12.83	19.97	0.0161	5.12	12.36	22.42	15.45	1.41	309.
30.000	12.05	21.13	0.0189	4.40	12.73	22.81	15.87	1.75	268.
32.000	12.48	26.32	-0.0244	5.60	15.37	27.48	18.26	0.98	25.
34.000	13.15	27.73	-0.1603	2.54	15.15	28.50	18.48	1.02	26.
36.000	13.23	28.86	-0.3767	0.46	16.65	29.73	19.24	0.57	26.
38.000	13.58	28.98	-0.4156	-3.19	18.44	32.38	17.09	0.39	26.
40.000	15.71	29.36	-0.3018	-4.29	21.50	34.50	18.93	0.20	24.
42.000	19.91	30.59	-0.0972	-8.13	25.81	38.96	22.14	0.04	23.
44.000	25.68	36.50	-0.1438	-14.64	26.01	46.32	25.91	0.46	25.
46.000	27.27	34.66	0.0793	-14.35	27.94	45.77	28.02	0.51	26.
48.000	25.48	36.34	0.0583	-15.96	26.16	46.40	26.42	0.44	25.
50.000	22.39	41.43	-0.0088	-12.17	31.47	50.91	26.27	0.53	23.
52.000	22.56	33.17	0.2693	-5.78	30.34	44.22	22.92	0.12	18.
54.000	16.18	32.71	-0.0431	-2.73	28.85	40.27	20.09	0.25	11.
56.000	0.00	0.00	0.0000	0.00	0.00	0.00	0.00	0.00	4.
58.000	0.00	0.00	0.0000	0.00	0.00	0.00	0.00	0.00	1.
60.000	0.00	0.00	0.0000	0.00	0.00	0.00	0.00	0.00	0.
62.000	0.00	0.00	0.0000	0.00	0.00	0.00	0.00	0.00	0.
64.000	0.00	0.00	0.0000	0.00	0.00	0.00	0.00	0.00	0.
66.000	0.00	0.00	0.0000	0.00	0.00	0.00	0.00	0.00	0.
68.000	0.00	0.00	0.0000	0.00	0.00	0.00	0.00	0.00	0.
70.000	0.00	0.00	0.0000	0.00	0.00	0.00	0.00	0.00	0.

TABLE A-13. Annual Statistical Wind Data, Shemya.

Z KM	MEAN U M/S	S.D. U M/S	R(U,V)	MEAN V M/S	S.D. V M/S	MEAN W M/S	S.D. W M/S	SKEW W	#OBS
0.000	0.00	0.00	0.0000	0.00	0.00	0.00	0.00	0.00	0.
0.039	0.78	5.69	0.0028	-0.13	6.50	7.52	4.32	0.80	7883.
1.000	1.90	8.95	-0.0027	0.11	8.46	10.79	6.13	0.94	8595.
2.000	2.71	9.06	-0.0052	0.15	8.57	11.12	6.21	1.01	8582.
3.000	3.75	9.55	-0.0141	0.32	9.01	11.94	6.57	1.00	8570.
4.000	4.95	10.47	-0.0271	0.56	9.76	13.22	7.41	1.05	8557.
5.000	6.15	11.61	-0.0369	0.77	10.89	14.84	8.52	1.00	8527.
6.000	7.34	13.40	-0.0461	1.03	12.27	16.78	9.90	1.00	8356.
7.000	8.75	15.15	-0.0557	1.33	13.76	18.99	11.45	1.05	8292.
8.000	10.32	16.76	-0.0691	1.69	15.04	20.97	13.16	1.12	8195.
9.000	11.94	17.39	-0.0842	1.91	15.54	22.11	14.18	1.11	8116.
10.000	13.28	16.99	-0.1058	2.07	15.31	22.11	14.60	1.22	7914.
11.000	13.90	15.70	-0.1366	2.19	14.22	21.01	13.92	1.32	7690.
12.000	13.61	13.87	-0.1850	2.35	12.48	19.36	12.54	1.46	7545.
13.000	12.82	12.00	-0.2503	2.58	11.03	17.56	10.82	1.33	7472.
14.000	11.89	10.71	-0.3097	2.74	9.82	16.17	9.59	1.22	7364.
15.000	10.79	9.80	-0.3572	2.87	8.87	14.66	8.71	1.17	7270.
16.000	9.49	9.08	-0.3725	2.86	8.06	13.07	8.16	1.21	6853.
17.000	8.30	8.65	-0.3993	3.08	7.42	11.85	7.78	1.39	6432.
18.000	7.09	8.52	-0.3796	3.18	7.01	10.67	7.75	1.53	6415.
19.000	5.99	8.60	-0.3467	3.24	6.55	9.70	7.80	1.77	6293.
20.000	4.81	8.52	-0.3008	3.22	6.07	8.96	7.61	1.98	6236.
21.000	3.84	8.78	-0.2383	3.15	5.81	8.60	7.57	2.15	6107.
22.000	2.92	9.02	-0.1791	3.07	5.58	8.49	7.43	2.43	5982.
23.000	2.13	9.32	-0.1226	2.97	5.54	8.51	7.28	2.58	5856.
24.000	1.47	9.87	-0.0733	2.84	5.78	8.78	7.62	2.63	5662.
25.000	0.96	10.15	-0.0430	2.64	5.84	9.10	7.61	2.60	5432.
26.000	0.40	10.53	-0.0144	2.33	6.03	9.52	8.02	2.74	5195.
27.000	0.03	11.27	-0.0009	2.05	6.26	9.99	8.30	2.67	4747.
28.000	-0.32	11.69	0.0073	1.77	6.70	10.45	8.59	2.54	4390.
29.000	-0.64	12.44	0.0116	1.54	6.88	10.96	8.87	2.62	3857.
30.000	-1.04	12.89	0.0150	1.34	7.22	11.54	9.34	2.58	3360.
32.000	-1.96	14.97	0.0333	2.02	7.97	13.30	10.82	2.21	273.
34.000	-2.24	16.80	0.0215	1.43	8.88	15.05	11.84	1.91	286.
36.000	-1.91	18.57	0.0099	0.96	9.98	16.67	13.04	1.61	293.
38.000	-1.82	20.04	0.0026	0.33	11.41	18.23	14.22	1.48	296.
40.000	-1.40	21.46	-0.0009	-0.17	12.36	19.86	14.81	1.35	302.
42.000	-0.55	23.54	-0.0013	-0.76	13.90	22.08	16.02	1.28	308.
44.000	-0.12	26.25	-0.0004	-1.46	15.87	24.79	18.05	1.46	312.
46.000	0.49	27.45	0.0018	-1.74	17.26	26.29	18.93	1.53	307.
48.000	1.18	29.43	0.0020	-0.86	17.41	28.42	19.02	1.23	280.
50.000	0.59	31.59	0.0019	-2.10	20.42	30.63	21.84	1.58	251.
52.000	0.72	33.05	0.0024	-1.98	18.03	31.20	21.03	1.27	200.
54.000	1.09	36.63	0.0004	-0.30	20.57	35.08	22.97	1.39	135.
56.000	-4.00	40.02	-0.0055	-1.09	20.06	38.28	23.21	1.64	69.
58.000	-3.67	41.62	0.0082	2.23	24.83	43.23	20.76	1.22	30.
60.000	-16.65	42.20	0.2496	13.71	23.02	47.12	20.71	-0.49	17.
62.000	-20.64	41.71	0.1796	6.18	18.73	41.82	26.02	-0.05	11.
64.000	-21.20	38.44	0.1940	5.20	16.43	36.00	29.28	0.36	10.
66.000	-32.14	41.41	0.8188	17.43	19.28	45.86	35.04	0.92	7.
68.000	0.00	0.00	0.0000	0.00	0.00	0.00	0.00	0.00	5.
70.000	0.00	0.00	0.0000	0.00	0.00	0.00	0.00	0.00	0.

## APPENDIX B

### Shemya Thermodynamics Statistics Tables

Tables B-1 through B-13 provide thermodynamics statistics (monthly and annual) for Shemya. They were prepared as described in Chapter 3.



TABLE B-1. January Thermodynamic Data, Shemya.

Z KM	MEAN P MB	S.D. P MB	SKEW P	MEAN T DEG K	S.D. T DEG K	SKEW T	MEAN D GMS	S.D. D GMS	SKEW D	NOBS P	NOBS T	NOBS D
0.000	997.918	14.982	-0.2494	273.04	2.16	-0.49	1271.38	23.27	0.15	709.	708.	709.
0.039	993.548	14.849	-0.2610	272.81	2.20	-0.46	1266.69	22.15	-0.45	714.	714.	714.
1.000	877.051	23.143	-4.9549	265.35	3.45	-0.12	1150.05	29.24	-3.04	737.	737.	737.
2.000	772.018	11.917	-0.0101	259.39	4.70	0.66	1036.44	20.14	-0.21	736.	736.	736.
3.000	675.825	11.370	0.2066	253.51	5.58	0.49	928.61	17.19	-0.13	734.	734.	734.
4.000	589.302	11.095	0.3976	247.13	6.17	0.38	830.75	14.40	-0.03	734.	734.	734.
5.000	512.576	10.930	0.4879	240.43	6.48	0.29	742.78	12.32	-0.12	734.	734.	734.
6.000	443.785	11.053	0.5394	233.77	6.36	0.40	661.41	9.96	-0.39	718.	718.	718.
7.000	382.820	10.795	0.6057	227.49	5.74	0.54	586.27	9.45	-0.57	715.	715.	715.
8.000	328.761	9.991	0.7088	222.33	4.69	0.37	515.15	11.92	-0.64	707.	707.	707.
9.000	281.860	9.028	0.8057	219.65	4.52	-0.04	447.20	16.24	-0.10	703.	703.	703.
10.000	241.330	7.596	0.8844	219.95	5.50	-0.15	382.58	17.81	0.51	696.	696.	696.
11.000	206.760	6.187	0.8271	221.97	5.35	-0.53	324.77	14.97	1.09	685.	685.	685.
12.000	177.326	5.049	0.7184	223.94	4.40	-0.36	276.00	10.48	1.09	660.	660.	660.
13.000	152.260	4.261	0.6292	225.12	3.73	-0.18	235.69	7.83	0.82	657.	657.	657.
14.000	130.822	3.619	0.5835	225.79	3.53	-0.20	201.89	6.50	0.69	648.	648.	648.
15.000	112.444	3.117	0.5297	226.30	3.36	-0.12	173.14	5.49	0.58	643.	643.	643.
16.000	96.880	2.667	0.4844	226.55	3.34	0.07	149.01	4.76	0.42	575.	575.	575.
17.000	83.304	2.279	0.4747	226.54	3.43	0.32	128.13	4.01	0.22	567.	567.	567.
18.000	71.631	1.963	0.4964	226.47	3.69	0.46	110.21	3.38	0.07	562.	562.	562.
19.000	61.605	1.727	0.5480	226.38	3.72	0.38	94.80	2.80	0.01	553.	552.	553.
20.000	52.970	1.521	0.6035	226.29	3.90	0.25	81.54	2.27	-0.08	552.	551.	552.
21.000	45.574	1.368	0.6401	226.36	4.04	0.20	70.13	1.85	-0.09	528.	527.	528.
22.000	39.195	1.232	0.6732	226.39	4.34	0.15	60.30	1.55	-0.10	521.	520.	521.
23.000	33.707	1.127	0.6995	226.71	4.84	0.27	51.79	1.32	-0.06	512.	512.	512.
24.000	29.004	1.028	0.7171	227.06	5.07	0.08	44.50	1.12	0.12	490.	490.	490.
25.000	24.958	0.957	0.6941	227.33	5.41	0.01	38.24	0.98	0.35	478.	478.	478.
26.000	21.479	0.879	0.7003	227.64	5.81	-0.05	32.87	0.89	0.48	473.	473.	473.
27.000	18.506	0.806	0.7128	228.05	6.02	-0.12	28.26	0.79	0.75	431.	431.	431.
28.000	15.944	0.752	0.6636	228.41	6.26	-0.20	24.31	0.73	0.95	410.	410.	410.
29.000	13.748	0.694	0.6386	229.09	6.50	-0.09	20.90	0.67	0.84	382.	382.	382.
30.000	11.810	0.602	0.1524	229.13	6.73	-0.12	17.95	0.59	0.30	354.	354.	354.

TABLE B-1. January Thermodynamic Data, Shemya, Cont'd.

Z KM	MEAN P MB	S.D. P MB	SKEWP P	MEAN T DEG K	S.D. T DEG K	MEAN D G/M3	S.D. D G/M3	SKFWD D	NOBS P	NOBS T	NOBS D
32.000	8.992	0.521	-0.2842	230.86	8.67	13.52	0.40	-0.39	18.	20.	18.
34.000	6.715	0.451	-0.2778	232.40	8.18	10.05	0.40	-0.38	18.	21.	18.
36.000	5.026	0.374	-0.2900	235.02	8.24	7.44	0.37	-0.07	19.	22.	19.
38.000	3.774	0.312	-0.3113	236.34	8.59	5.56	0.33	-0.19	19.	22.	19.
40.000	2.843	0.258	-0.2724	240.11	9.66	4.13	0.28	-0.26	19.	22.	19.
42.000	2.146	0.219	-0.1763	240.54	11.12	3.10	0.25	-0.21	18.	21.	18.
44.000	1.626	0.183	-0.1113	243.11	11.82	2.32	0.22	-0.06	17.	20.	17.
46.000	1.218	0.135	-0.1923	243.79	11.22	1.73	0.18	-0.21	16.	19.	16.
48.000	0.928	0.118	-0.1740	243.85	12.69	1.33	0.16	-0.22	13.	16.	13.
50.000	0.695	0.092	0.1269	243.59	9.91	1.00	0.13	-0.13	12.	14.	12.
52.000	0.507	0.064	0.3352	243.91	9.11	0.73	0.09	0.04	10.	12.	10.
54.000	0.391	0.043	0.3259	240.26	4.86	0.57	0.07	0.21	10.	10.	10.
56.000	0.000	0.000	0.0000	0.00	0.00	0.00	0.00	0.00	4.	4.	4.
58.000	0.000	0.000	0.0000	0.00	0.00	0.00	0.00	0.00	2.	2.	2.
60.000	0.000	0.000	0.0000	0.00	0.00	0.00	0.00	0.00	0.	0.	0.
62.000	0.000	0.000	0.0000	0.00	0.00	0.00	0.00	0.00	0.	0.	0.
64.000	0.000	0.000	0.0000	0.00	0.00	0.00	0.00	0.00	0.	0.	0.
66.000	0.000	0.000	0.0000	0.00	0.00	0.00	0.00	0.00	0.	0.	0.
68.000	0.000	0.000	0.0000	0.00	0.00	0.00	0.00	0.00	0.	0.	0.
70.000	0.000	0.000	0.0000	0.00	0.00	0.00	0.00	0.00	0.	0.	0.

TABLE B-2. February Thermodynamic Data, Shemya.

Z KM	MEAN P MB	S.D. P MB	SKEW P	MEAN T DEG K	S.D. T DEG K	SKEW T	MEAN D GMS	S.D. D GMS	SKEW D	NOBS P	NOBS T	NOBS D
0.000	1000.235	15.305	-0.1246	273.07	2.24	-0.32	1273.97	21.95	-0.46	613.	613.	613.
0.039	995.805	15.157	-0.1403	272.84	2.26	-0.31	1269.45	21.80	-0.47	616.	616.	616.
1.000	879.616	20.932	-4.8842	265.39	3.84	0.55	1153.34	28.20	-2.80	639.	639.	639.
2.000	773.602	12.350	0.1911	259.46	5.01	0.81	1038.24	20.93	-0.26	639.	639.	639.
3.000	677.232	11.823	0.4025	253.74	5.65	0.73	929.65	17.56	-0.26	639.	639.	639.
4.000	590.616	11.457	0.5726	247.43	6.03	0.66	831.57	14.74	-0.34	639.	639.	639.
5.000	513.856	11.194	0.6881	240.91	6.41	0.61	743.13	12.40	-0.36	639.	639.	639.
6.000	445.077	11.222	0.7322	234.29	6.44	0.58	661.86	10.41	-0.43	627.	627.	627.
7.000	384.022	11.047	0.7752	227.94	6.15	0.59	586.96	9.95	-0.55	621.	621.	621.
8.000	329.889	10.378	0.8437	222.53	5.36	0.52	516.45	11.51	-0.50	617.	617.	617.
9.000	282.823	9.477	0.9074	219.74	4.77	0.39	448.51	15.57	0.00	614.	614.	614.
10.000	242.266	8.135	0.9179	220.14	5.56	0.02	383.70	17.97	0.64	594.	594.	594.
11.000	207.446	6.666	0.8893	221.82	5.89	-0.57	326.12	16.05	1.20	586.	586.	586.
12.000	178.008	5.564	0.7507	223.89	4.91	-0.67	277.14	11.53	1.25	567.	567.	567.
13.000	152.879	4.717	0.6444	224.99	4.31	-0.50	236.81	9.04	1.03	564.	564.	564.
14.000	131.354	4.011	0.5436	225.48	4.29	-0.49	203.03	7.78	0.95	550.	550.	550.
15.000	112.875	3.398	0.4145	225.71	4.50	-0.52	174.30	6.91	0.93	547.	547.	547.
16.000	97.208	2.926	0.2087	225.83	4.85	-0.49	150.05	6.20	0.72	476.	476.	476.
17.000	83.492	2.447	0.1103	225.80	5.14	-0.26	128.89	5.20	0.52	463.	463.	463.
18.000	71.775	2.071	0.0089	225.69	5.24	-0.11	110.86	4.26	0.34	461.	461.	461.
19.000	61.693	1.800	-0.0747	225.55	5.20	-0.01	95.33	3.45	0.22	449.	449.	449.
20.000	53.028	1.564	-0.0907	225.51	5.20	0.06	81.95	2.79	0.11	443.	443.	443.
21.000	45.573	1.366	-0.0891	225.41	5.30	0.09	70.46	2.23	-0.03	429.	429.	429.
22.000	39.178	1.231	-0.0576	225.38	5.36	0.03	60.57	1.79	0.02	417.	417.	417.
23.000	33.653	1.119	-0.0301	225.48	5.53	0.06	52.00	1.46	-0.03	411.	411.	411.
24.000	28.943	1.024	-0.0271	225.70	5.69	0.09	44.68	1.20	-0.10	396.	396.	396.
25.000	24.870	0.954	0.0117	225.94	5.84	0.13	38.34	1.03	-0.16	382.	382.	382.
26.000	21.388	0.875	0.0963	226.38	6.23	0.12	32.91	0.90	-0.20	378.	378.	378.
27.000	18.412	0.820	0.0974	226.83	6.58	0.13	28.27	0.78	-0.22	336.	336.	336.
28.000	15.857	0.751	0.2286	227.45	6.93	0.11	24.28	0.70	-0.06	313.	313.	313.
29.000	13.676	0.699	0.2787	228.24	7.35	0.04	20.87	0.63	0.01	289.	289.	289.
30.000	11.768	0.656	0.3458	228.91	7.65	0.12	17.90	0.59	0.09	267.	267.	267.

TABLE B-2. February Thermodynamic Data, Shemya, Cont'd.

Z KM	MEAN P MB	S.D. P MB	SKEW P	MEAN T DEG K	S.D. T DEG K	SKEW T	MEAN D GM3	S.D. D GM3	SKEW D	NOBS P	NOBS T	NOBS D
32.000	9.158	0.524	-1.2266	233.85	7.94	-0.36	13.62	0.53	-1.47	26.	29.	26.
34.000	6.872	0.446	-1.0673	235.99	9.05	-0.35	10.11	0.42	-1.44	26.	29.	26.
36.000	5.173	0.382	-0.9560	238.19	9.66	-0.34	7.53	0.37	-1.08	26.	30.	26.
38.000	3.502	0.322	-0.9366	239.63	9.59	-0.59	5.65	0.32	-0.49	26.	30.	26.
40.000	2.919	0.271	-0.9412	240.88	8.84	-0.34	4.25	0.31	-0.73	25.	29.	25.
42.000	2.232	0.220	-0.9464	241.82	9.70	-0.57	3.20	0.25	-0.62	25.	29.	25.
44.000	1.667	0.191	-0.8891	243.43	10.84	-0.51	2.38	0.21	-0.87	26.	30.	26.
46.000	1.264	0.157	-0.8535	244.88	10.81	-0.54	1.79	0.19	-0.89	25.	29.	25.
48.000	0.964	0.127	-0.9333	245.66	10.50	-0.56	1.37	0.17	-0.71	23.	26.	23.
50.000	0.719	0.103	-0.7692	247.92	9.97	-0.77	1.01	0.13	-0.74	19.	21.	19.
52.000	0.547	0.081	-0.7890	246.69	10.32	0.01	0.78	0.11	-0.39	15.	17.	15.
54.000	0.401	0.062	-0.6297	247.86	8.38	-0.78	0.57	0.08	-0.84	8.	10.	8.
56.000	0.000	0.000	0.0000	0.00	0.00	0.00	0.00	0.00	0.00	4.	4.	4.
58.000	0.000	0.000	0.0000	0.00	0.00	0.00	0.00	0.00	0.00	2.	2.	2.
60.000	0.000	0.000	0.0000	0.00	0.00	0.00	0.00	0.00	0.00	0.	0.	0.
62.000	0.000	0.000	0.0000	0.00	0.00	0.00	0.00	0.00	0.00	0.	0.	0.
64.000	0.000	0.000	0.0000	0.00	0.00	0.00	0.00	0.00	0.00	0.	0.	0.
66.000	0.000	0.000	0.0000	0.00	0.00	0.00	0.00	0.00	0.00	0.	0.	0.
68.000	0.000	0.000	0.0000	0.00	0.00	0.00	0.00	0.00	0.00	0.	0.	0.
70.000	0.000	0.000	0.0000	0.00	0.00	0.00	0.00	0.00	0.00	0.	0.	0.

TABLE B-3. March Thermodynamic Data, Shemya.

Z KM	MEAN P MB	S.D. P MB	SKEW P	MEAN T DEG K	S.D. T DEG K	SKEW T	MEAN D G/M3	S.D. D G/M3	SKEW D	NOBS P	NOBS T	NOBS D
0.000	1001.318	13.269	0.0098	273.54	2.08	-0.69	1273.08	22.38	0.13	747.	747.	747.
0.039	996.912	13.309	0.0227	273.30	2.09	-0.68	1268.65	22.41	0.14	749.	749.	749.
1.000	880.562	19.912	-5.7483	265.49	3.10	-0.27	1154.06	28.59	-2.53	769.	769.	769.
2.000	774.602	9.916	0.0965	259.51	4.00	0.29	1039.33	20.85	0.01	769.	769.	769.
3.000	678.191	9.019	0.1856	253.91	4.80	0.35	930.33	18.42	0.09	769.	769.	769.
4.000	591.530	8.469	0.2983	247.89	5.47	0.28	831.33	16.08	0.13	769.	769.	769.
5.000	514.805	8.228	0.3888	241.67	5.90	0.23	742.24	13.85	0.15	768.	768.	768.
6.000	445.974	8.349	0.4385	235.22	5.97	0.26	660.63	11.31	0.19	753.	753.	753.
7.000	385.070	8.337	0.4912	229.18	5.54	0.37	585.43	9.46	0.18	744.	744.	744.
8.000	331.067	7.826	0.5885	224.15	4.71	0.40	514.62	10.19	-0.39	741.	741.	741.
9.000	284.157	7.096	0.6677	221.49	4.66	0.20	447.10	13.69	-0.14	736.	736.	736.
10.000	243.545	6.018	0.6733	221.94	5.37	0.04	382.56	15.03	0.54	714.	714.	714.
11.000	208.806	4.861	0.5299	223.46	5.17	-0.47	325.74	12.52	1.27	703.	703.	703.
12.000	179.336	4.024	0.3104	224.67	4.43	-0.66	278.20	9.01	1.39	671.	671.	671.
13.000	154.046	3.409	0.1620	225.27	3.78	-0.36	238.30	6.67	0.93	666.	666.	666.
14.000	132.382	2.927	0.0602	225.45	3.61	-0.31	204.60	5.49	0.61	654.	654.	654.
15.000	113.753	2.525	-0.0046	225.42	3.56	-0.34	175.84	4.76	0.38	652.	652.	652.
16.000	97.822	2.218	-0.0819	225.35	3.62	-0.12	151.26	4.12	0.09	607.	607.	607.
17.000	84.025	1.916	-0.0827	225.28	3.49	0.21	129.96	3.38	-0.09	595.	595.	595.
18.000	72.199	1.668	-0.0732	225.20	3.47	0.39	111.71	2.84	-0.16	592.	592.	592.
19.000	62.038	1.472	-0.0415	225.04	3.43	0.41	96.05	2.35	-0.21	572.	572.	572.
20.000	53.309	1.288	0.0399	224.93	3.31	0.50	82.57	1.97	-0.29	570.	570.	570.
21.000	45.813	1.152	0.1127	224.82	3.26	0.55	71.00	1.64	-0.36	551.	551.	551.
22.000	39.353	1.025	0.2352	224.76	3.35	0.54	61.00	1.40	-0.50	538.	538.	538.
23.000	33.800	0.921	0.3494	224.72	3.53	0.51	52.40	1.21	-0.62	533.	533.	533.
24.000	29.035	0.831	0.4543	224.83	3.74	0.44	44.99	1.06	-0.64	514.	514.	514.
25.000	24.952	0.757	0.5034	225.06	4.07	0.45	38.62	0.93	-0.58	501.	501.	501.
26.000	21.439	0.691	0.5995	225.37	4.55	0.41	33.14	0.83	-0.55	496.	496.	496.
27.000	18.452	0.626	0.6868	225.76	4.87	0.36	28.47	0.72	-0.16	433.	433.	433.
28.000	15.883	0.570	0.8473	226.39	5.23	0.36	24.44	0.63	-0.05	400.	400.	400.
29.000	13.676	0.522	0.8551	227.11	5.60	0.37	20.98	0.56	-0.01	367.	367.	367.
30.000	11.771	0.472	0.9917	227.89	5.82	0.38	17.99	0.49	0.19	327.	327.	327.

TABLE B-3. March Thermodynamic Data, Shemya, Cont'd.

Z KM	MEAN P MB	S.D. P MB	SKEW P	MEAN T DEG K	S.D. T DEG K	SKEW T	MEAN D G/M3	S.D. D G/M3	SKEW D	NOBS P	NOBS T	NOBS D
32.000	8.777	0.421	0.0890	228.64	7.67	0.59	13.39	0.41	0.61	25.	29.	25.
34.000	6.540	0.353	0.0506	231.22	7.70	0.56	9.85	0.33	0.28	26.	31.	26.
36.000	4.889	0.304	0.1065	234.63	7.27	0.64	7.26	0.31	0.07	25.	30.	25.
38.000	3.675	0.250	0.1813	237.69	6.77	0.26	5.37	0.28	0.12	25.	30.	25.
40.000	2.765	0.206	0.2098	241.82	7.83	-0.59	3.97	0.25	0.38	26.	32.	26.
42.000	2.099	0.168	0.1339	246.19	7.25	-0.57	2.96	0.21	0.33	25.	31.	25.
44.000	1.603	0.131	-0.0082	249.32	7.42	-0.96	2.24	0.18	0.17	26.	32.	26.
46.000	1.227	0.102	-0.0634	253.63	7.24	-0.76	1.68	0.14	0.14	26.	32.	26.
48.000	0.957	0.078	0.0534	256.10	6.62	-0.58	1.30	0.11	0.28	26.	32.	26.
50.000	0.742	0.062	-0.2357	256.16	6.80	-0.88	1.00	0.09	0.22	24.	31.	24.
52.000	0.568	0.049	-0.5133	256.23	7.72	-1.68	0.77	0.07	0.03	20.	27.	20.
54.000	0.440	0.040	-0.6601	255.41	7.17	-0.91	0.60	0.06	-0.09	8.	12.	8.
56.000	0.000	0.000	0.0000	258.30	6.67	-0.66	0.00	0.00	0.00	5.	7.	5.
58.000	0.000	0.000	0.0000	0.00	0.00	0.00	0.00	0.00	0.00	2.	2.	2.
60.000	0.000	0.000	0.0000	0.00	0.00	0.00	0.00	0.00	0.00	0.	0.	0.
62.000	0.000	0.000	0.0000	0.00	0.00	0.00	0.00	0.00	0.00	0.	0.	0.
64.000	0.000	0.000	0.0000	0.00	0.00	0.00	0.00	0.00	0.00	0.	0.	0.
66.000	0.000	0.000	0.0000	0.00	0.00	0.00	0.00	0.00	0.00	0.	0.	0.
68.000	0.000	0.000	0.0000	0.00	0.00	0.00	0.00	0.00	0.00	0.	0.	0.
70.000	0.000	0.000	0.0000	0.00	0.00	0.00	0.00	0.00	0.00	0.	0.	0.

TABLE B-4. April Thermodynamic Data, Shemya.

Z KM	MEAN P MB	S.D. P MB	SKEW P	MEAN T DEG K	S.D. T DEG K	SKEW T	MEAN D GMS	S.D. D GMS	SKEW D	NOBS P	NOBS T	NOBS D
0.000	1008.976	13.807	-0.2691	274.88	1.54	-0.56	1276.35	20.18	-0.14	711.	710.	711.
0.039	1004.501	13.741	-0.2815	274.66	1.56	-0.54	1271.75	20.09	-0.14	713.	712.	713.
1.000	889.380	12.974	-1.0340	267.74	3.71	1.21	1155.02	25.72	-2.48	727.	729.	729.
2.000	782.280	11.001	-0.0915	263.00	4.88	0.78	1035.54	19.75	-0.37	730.	730.	730.
3.000	686.334	10.512	0.0907	258.09	5.52	0.47	926.13	17.01	-0.27	730.	730.	730.
4.000	600.040	10.189	0.2292	252.31	5.82	0.28	828.40	14.40	-0.16	729.	729.	729.
5.000	523.377	10.024	0.3187	246.17	6.05	0.30	740.67	12.49	-0.21	729.	729.	729.
6.000	454.753	10.008	0.3750	239.59	6.10	0.44	661.26	10.74	-0.19	723.	723.	723.
7.000	393.722	9.840	0.4188	233.09	5.93	0.54	588.49	9.76	-0.21	718.	718.	718.
8.000	339.189	9.331	0.5541	227.29	5.39	0.55	519.94	10.68	-0.51	713.	713.	713.
9.000	291.670	8.592	0.6553	223.19	4.86	0.22	455.39	13.94	-0.39	708.	708.	708.
10.000	250.178	7.388	0.7954	221.41	5.26	-0.06	393.92	16.63	0.10	693.	693.	693.
11.000	214.258	5.998	0.9302	221.58	5.79	-0.38	337.21	16.01	0.69	671.	671.	671.
12.000	183.687	4.803	0.9118	222.26	5.30	-0.70	288.17	12.66	1.21	647.	647.	647.
13.000	157.507	3.876	0.7762	222.54	4.44	-0.75	246.71	9.27	1.23	646.	646.	646.
14.000	135.071	3.150	0.7053	222.46	3.90	-0.36	211.62	7.07	0.98	632.	632.	632.
15.000	115.817	2.587	0.5848	222.30	3.77	-0.27	181.57	5.83	0.93	630.	630.	630.
16.000	99.412	2.172	0.4215	222.25	3.83	-0.17	155.89	5.04	0.82	588.	588.	588.
17.000	85.150	1.769	0.3956	222.38	3.75	-0.13	133.45	4.08	0.85	559.	559.	559.
18.000	73.026	1.463	0.3646	222.39	3.66	0.07	114.43	3.25	0.73	556.	556.	556.
19.000	62.630	1.234	0.3724	222.39	3.54	0.28	98.13	2.62	0.57	552.	552.	552.
20.000	53.705	1.058	0.4159	222.30	3.43	0.56	84.18	2.07	0.42	547.	547.	547.
21.000	46.066	0.918	0.5203	222.25	3.43	0.72	72.22	1.63	0.25	527.	527.	527.
22.000	39.493	0.812	0.6495	222.18	3.33	0.67	61.93	1.31	0.17	521.	521.	521.
23.000	33.862	0.726	0.7624	222.17	3.33	0.75	53.10	1.06	0.07	514.	514.	514.
24.000	29.052	0.655	0.8683	222.32	3.47	0.73	45.52	0.87	0.07	494.	494.	494.
25.000	24.910	0.591	0.9049	222.45	3.57	0.69	39.01	0.71	0.04	472.	472.	472.
26.000	21.364	0.543	0.9965	222.69	3.73	0.69	33.42	0.60	0.02	468.	468.	468.
27.000	18.338	0.499	1.0469	223.19	3.82	0.80	28.62	0.52	0.10	418.	418.	418.
28.000	15.763	0.467	1.0694	223.99	4.05	0.74	24.51	0.48	0.27	390.	390.	390.
29.000	13.546	0.417	1.1191	224.84	4.09	0.85	20.98	0.41	0.72	353.	353.	353.
30.000	11.636	0.387	1.1636	225.67	4.29	0.74	17.96	0.39	0.76	320.	320.	320.

TABLE B-4. April Thermodynamic Data, Shemya, Cont'd.

Z KM	MEAN P MB	S.D. P MB	SKEW P	MEAN T DEG K	S.D. T DEG K	SKEW T	MEAN D G/M3	S.D. D G/M3	SKEW D	NOBS P	NOBS T	NOBS D
32.000	8.763	0.229	0.5114	228.39	4.94	-0.18	13.36	0.32	0.70	22.	26.	22.
34.000	6.532	0.190	0.3652	233.12	6.03	-0.17	9.74	0.25	0.68	23.	26.	23.
36.000	4.907	0.167	0.3172	239.24	7.25	0.00	7.12	0.17	0.98	23.	26.	23.
38.000	3.716	0.142	0.3356	245.68	7.74	-0.33	5.25	0.16	0.75	24.	27.	24.
40.000	2.829	0.121	0.3705	251.64	7.86	-0.49	3.90	0.12	0.29	26.	29.	26.
42.000	2.174	0.101	0.3607	258.06	7.42	-0.82	2.93	0.11	0.14	28.	30.	28.
44.000	1.680	0.082	0.3073	262.29	8.19	-0.62	2.23	0.10	0.38	29.	31.	29.
46.000	1.298	0.064	0.1998	265.63	7.90	-1.10	1.70	0.08	0.17	28.	30.	28.
48.000	1.004	0.046	-0.0607	266.78	6.12	-1.15	1.31	0.06	-0.21	22.	24.	22.
50.000	0.779	0.029	-0.2942	268.25	4.19	-0.59	1.01	0.04	-0.20	20.	22.	20.
52.000	0.606	0.027	-0.1827	267.96	4.16	0.06	0.79	0.04	-0.50	14.	15.	14.
54.000	0.469	0.020	0.2337	268.78	5.39	0.45	0.61	0.03	-0.34	12.	13.	12.
56.000	0.000	0.000	0.0000	0.00	0.00	0.00	0.00	0.00	0.00	4.	4.	4.
58.000	0.000	0.000	0.0000	0.00	0.00	0.00	0.00	0.00	0.00	3.	3.	3.
60.000	0.000	0.000	0.0000	0.00	0.00	0.00	0.00	0.00	0.00	2.	2.	2.
62.000	0.000	0.000	0.0000	0.00	0.00	0.00	0.00	0.00	0.00	0.	0.	0.
64.000	0.000	0.000	0.0000	0.00	0.00	0.00	0.00	0.00	0.00	0.	0.	0.
66.000	0.000	0.000	0.0000	0.00	0.00	0.00	0.00	0.00	0.00	0.	0.	0.
68.000	0.000	0.000	0.0000	0.00	0.00	0.00	0.00	0.00	0.00	0.	0.	0.
70.000	0.000	0.000	0.0000	0.00	0.00	0.00	0.00	0.00	0.00	0.	0.	0.



TABLE B-5. May Thermodynamic Data, Shemya.

Z KM	MEAN P MB	S.D. P MB	MEAN T DEG K	S.D. T DEG K	SKEW T G/M3	MEAN D G/M3	S.D. D G/M3	SKEW D	NOBS P	NOBS T	NOBS D
0.000	1010.063	10.868	276.69	1.42	-0.10	1269.03	16.18	0.61	757.	755.	756.
0.039	1005.689	10.819	276.52	1.43	-0.13	1264.14	15.11	-0.48	758.	758.	758.
1.000	889.704	20.634	270.67	3.68	0.73	1143.30	27.38	-4.60	780.	780.	780.
2.000	785.402	9.063	267.07	4.38	0.29	1023.58	15.36	-0.10	779.	779.	779.
3.000	690.594	8.835	262.64	4.55	0.03	915.49	12.80	-0.15	778.	778.	778.
4.000	605.158	8.650	257.17	4.70	0.02	819.52	10.89	-0.32	778.	778.	778.
5.000	529.215	8.473	251.01	4.91	0.06	734.36	9.58	-0.49	778.	778.	778.
6.000	461.175	8.437	244.44	5.20	0.20	657.23	8.75	-0.62	767.	767.	767.
7.000	400.377	8.194	237.59	5.35	0.43	587.07	8.38	-0.75	762.	762.	762.
8.000	345.801	7.905	231.01	5.11	0.65	521.52	8.77	-1.02	759.	759.	759.
9.000	297.989	7.342	225.95	4.66	0.62	459.54	11.40	-0.85	754.	754.	754.
10.000	255.920	6.375	223.62	4.89	0.13	398.93	14.49	-0.16	748.	748.	748.
11.000	219.682	5.204	223.41	5.61	-0.37	342.89	14.72	0.47	726.	726.	726.
12.000	188.602	4.092	223.77	5.41	-0.93	293.89	12.23	1.07	705.	705.	705.
13.000	161.883	3.212	223.80	4.38	-1.05	252.13	8.76	1.25	702.	702.	702.
14.000	138.928	2.595	223.39	3.60	-0.81	216.74	6.37	1.12	693.	693.	693.
15.000	119.180	2.124	222.76	3.17	-0.54	186.44	4.89	0.88	692.	692.	692.
16.000	102.264	1.743	222.29	2.97	-0.28	160.31	3.85	0.88	685.	685.	685.
17.000	87.693	1.477	222.02	2.75	-0.17	137.62	3.02	0.84	625.	625.	625.
18.000	75.185	1.261	221.91	2.67	-0.02	118.04	2.37	0.70	625.	625.	625.
19.000	64.470	1.107	222.15	2.61	0.50	101.11	1.88	0.49	609.	609.	609.
20.000	55.288	0.976	222.44	2.60	0.63	86.59	1.51	0.39	604.	604.	604.
21.000	47.433	0.871	222.75	2.52	0.88	74.19	1.22	0.27	587.	587.	587.
22.000	40.700	0.792	223.09	2.50	1.03	63.56	1.01	0.25	580.	580.	580.
23.000	34.924	0.718	223.48	2.51	1.21	54.44	0.85	0.21	576.	576.	576.
24.000	29.980	0.637	223.95	2.46	0.84	46.63	0.73	0.19	557.	557.	557.
25.000	25.759	0.587	224.72	2.49	0.75	39.92	0.64	0.22	536.	536.	536.
26.000	22.127	0.527	225.57	2.69	0.66	34.16	0.57	0.19	526.	526.	526.
27.000	19.027	0.488	226.64	2.75	0.32	29.23	0.51	0.44	476.	476.	476.
28.000	16.386	0.445	227.99	3.13	0.77	25.04	0.45	0.44	435.	435.	435.
29.000	14.118	0.414	229.35	3.27	0.18	21.44	0.42	0.60	399.	399.	399.
30.000	12.168	0.362	231.07	3.66	0.00	18.34	0.38	0.44	356.	356.	356.

TABLE B-5. May Thermodynamic Data, Shemya, Cont'd.

Z KM	MEAN P MB	S.D. P MB	SKEW P	MEAN T DEG K	S.D. T DEG K	SKEW T	MEAN D G/M3	S.D. D G/M3	SKEW D	NOBS P	NOBS T	NOBS D
32.000	9.266	0.284	0.0936	235.31	5.63	0.09	13.66	0.35	-0.05	17.	20.	17.
34.000	6.988	0.229	0.1465	240.75	6.24	-0.35	10.06	0.28	-0.30	19.	22.	19.
36.000	5.300	0.193	0.1751	246.07	7.61	-0.47	7.46	0.23	-0.03	19.	22.	19.
38.000	4.049	0.165	0.2565	252.39	7.31	-0.47	5.55	0.16	-0.22	19.	22.	19.
40.000	3.113	0.140	0.3177	258.07	7.49	-0.79	4.17	0.14	-0.01	19.	22.	19.
42.000	2.403	0.120	0.3522	262.54	6.40	-1.01	3.17	0.11	0.55	18.	21.	18.
44.000	1.878	0.094	0.1852	268.11	4.60	-1.65	2.43	0.11	-0.02	18.	21.	18.
46.000	1.456	0.081	-0.1030	270.77	3.82	-0.54	1.87	0.10	-0.30	20.	23.	20.
48.000	1.139	0.052	-0.2137	273.00	4.00	0.52	1.45	0.07	-0.17	16.	19.	16.
50.000	0.886	0.042	0.0056	272.88	4.23	1.03	1.13	0.04	-0.19	15.	18.	15.
52.000	0.698	0.031	-0.0168	273.47	4.01	0.90	0.89	0.03	-0.30	12.	13.	12.
54.000	0.000	0.000	0.0000	270.66	2.66	0.14	0.00	0.00	0.00	5.	6.	5.
56.000	0.000	0.000	0.0000	0.00	0.00	0.00	0.00	0.00	0.00	0.	0.	0.
58.000	0.000	0.000	0.0000	0.00	0.00	0.00	0.00	0.00	0.00	0.	0.	0.
60.000	0.000	0.000	0.0000	0.00	0.00	0.00	0.00	0.00	0.00	0.	0.	0.
62.000	0.000	0.000	0.0000	0.00	0.00	0.00	0.00	0.00	0.00	0.	0.	0.
64.000	0.000	0.000	0.0000	0.00	0.00	0.00	0.00	0.00	0.00	0.	0.	0.
66.000	0.000	0.000	0.0000	0.00	0.00	0.00	0.00	0.00	0.00	0.	0.	0.
68.000	0.000	0.000	0.0000	0.00	0.00	0.00	0.00	0.00	0.00	0.	0.	0.
70.000	0.000	0.000	0.0000	0.00	0.00	0.00	0.00	0.00	0.00	0.	0.	0.

TABLE B-6. June Thermodynamic Data, Shemya.

Z KM	MEAN P MB	S.D. P MB	SKEW P	MEAN T DEG K	S.D. T DEG K	SKEW T	MEAN D G/M3	S.D. D G/M3	SKEW D	NOBS P	NOBS T	NOBS P
0.060	1010.689	8.374	-0.0586	278.68	1.39	0.13	1259.68	12.15	-0.08	704.	704.	704.
0.039	1006.399	8.422	-0.0448	278.58	1.38	0.11	1254.84	12.06	-0.08	704.	704.	704.
1.000	893.741	7.649	-0.0238	275.91	4.15	0.43	1124.00	26.75	-4.89	725.	731.	731.
2.000	789.347	7.324	0.0611	272.65	4.38	0.02	1006.99	14.61	0.00	731.	731.	731.
3.000	695.922	7.224	0.1211	267.95	4.37	-0.12	903.81	12.00	-0.04	730.	730.	730.
4.000	611.537	7.255	0.1760	262.54	4.54	-0.09	810.96	10.12	-0.17	730.	730.	730.
5.000	536.233	7.213	0.1643	256.48	4.71	-0.14	728.12	8.61	-0.22	729.	729.	729.
6.000	468.682	7.364	0.1123	249.75	4.95	-0.10	653.65	7.20	-0.31	717.	717.	717.
7.000	408.100	7.275	0.0714	242.64	5.13	-0.02	585.91	6.54	-0.47	717.	717.	717.
8.000	353.579	7.287	0.0536	235.33	5.05	0.14	523.43	6.06	-0.73	710.	710.	710.
9.000	305.311	6.999	0.1054	228.67	4.57	0.32	465.16	8.00	-1.17	701.	701.	701.
10.000	262.533	6.321	0.2302	224.49	4.39	0.41	407.54	12.05	-0.79	698.	698.	698.
11.000	225.422	5.288	0.3517	223.24	5.46	0.07	352.08	14.36	0.01	681.	681.	681.
12.000	193.469	4.187	0.3649	223.87	5.46	-0.55	301.33	12.52	0.75	668.	668.	668.
13.000	166.073	3.277	0.2529	224.43	4.15	-0.80	257.92	8.62	0.88	664.	664.	664.
14.000	142.604	2.666	0.1668	224.10	3.29	-0.54	221.75	6.27	0.65	662.	662.	662.
15.000	122.385	2.190	0.1188	223.48	2.83	-0.50	190.82	4.85	0.52	660.	660.	660.
16.000	105.030	1.813	0.0943	222.96	2.60	-0.20	164.14	3.82	0.33	660.	660.	660.
17.000	90.098	1.551	0.1247	222.89	2.37	-0.16	140.84	3.02	0.25	592.	592.	592.
18.000	77.301	1.324	0.1760	223.11	2.17	-0.05	120.71	2.39	0.15	591.	591.	591.
19.000	66.326	1.132	0.2427	223.44	2.07	0.09	103.41	1.91	0.11	582.	582.	582.
20.000	56.929	0.983	0.3118	223.74	1.97	0.33	88.64	1.57	0.05	581.	581.	581.
21.000	48.879	0.855	0.4014	224.15	2.00	0.53	75.98	1.30	0.07	574.	574.	574.
22.000	41.989	0.744	0.2695	224.65	1.96	0.45	65.11	1.07	0.09	566.	566.	566.
23.000	36.070	0.662	0.3129	225.22	2.03	0.44	55.80	0.90	0.16	560.	560.	560.
24.000	30.996	0.590	0.3644	225.93	2.11	0.25	47.79	0.76	0.23	557.	557.	557.
25.000	26.679	0.529	0.3823	227.12	2.16	0.31	40.92	0.65	0.19	518.	518.	518.
26.000	22.967	0.479	0.4105	228.44	2.31	0.17	35.02	0.58	0.11	515.	515.	515.
27.000	19.784	0.434	0.4198	229.97	2.60	0.41	29.97	0.51	0.16	486.	486.	486.
28.000	17.073	0.397	0.4781	231.52	2.60	-0.10	25.69	0.45	0.23	458.	458.	458.
29.000	14.748	0.365	0.5456	233.24	2.89	-0.32	22.02	0.41	0.14	418.	418.	418.
30.000	12.737	0.335	0.4573	234.88	3.15	-0.68	18.89	0.38	0.22	381.	381.	381.

TABLE B-6. June Thermodynamic Data, Shemya, Cont'd.

Z KM	MEAN P MB	S.D. P MB	SKEW P	MEAN T DEG K	S.D. T DEG K	SKEW T	MEAN D G/M3	S.D. D G/M3	SKEW D	NOBS P	NOBS T	NOBS P
32.000	9.829	0.180	-0.7225	240.21	2.74	0.37	14.26	0.22	-0.73	15.	19.	15.
34.000	7.428	0.151	-0.3232	243.96	4.54	-0.22	10.59	0.19	-0.80	15.	20.	15.
36.000	5.638	0.134	0.1268	248.92	5.84	-0.18	7.86	0.15	-0.74	16.	21.	16.
38.000	4.312	0.117	0.3614	253.92	5.32	-0.49	5.90	0.11	-0.48	16.	21.	16.
40.000	3.323	0.105	0.3438	260.36	5.37	-0.33	4.43	0.09	0.06	15.	20.	15.
42.000	2.574	0.090	0.3998	265.21	5.98	-0.86	3.37	0.08	-0.43	15.	20.	15.
44.000	1.993	0.071	0.4416	269.06	4.82	-1.18	2.57	0.07	0.71	14.	20.	14.
46.000	1.563	0.065	0.3021	272.64	4.77	-0.39	1.99	0.06	0.58	15.	21.	15.
48.000	1.215	0.072	-0.9265	274.79	3.52	-0.60	1.53	0.08	-0.93	13.	19.	13.
50.000	0.948	0.059	-0.8298	275.66	2.73	0.60	1.20	0.07	-0.61	12.	18.	12.
52.000	0.737	0.043	-1.0888	275.43	2.28	0.41	0.93	0.05	-1.33	11.	15.	11.
54.000	0.586	0.028	0.3828	273.16	2.45	-1.31	0.75	0.03	0.72	6.	9.	6.
56.000	0.000	0.000	0.0000	0.00	0.00	0.00	0.00	0.00	0.00	2.	3.	2.
58.000	0.000	0.000	0.0000	0.00	0.00	0.00	0.00	0.00	0.00	0.	2.	0.
60.000	0.000	0.000	0.0000	0.00	0.00	0.00	0.00	0.00	0.00	0.	2.	0.
62.000	0.000	0.000	0.0000	0.00	0.00	0.00	0.00	0.00	0.00	0.	2.	0.
64.000	0.000	0.000	0.0000	0.00	0.00	0.00	0.00	0.00	0.00	0.	2.	0.
66.000	0.000	0.000	0.0000	0.00	0.00	0.00	0.00	0.00	0.00	0.	0.	0.
68.000	0.000	0.000	0.0000	0.00	0.00	0.00	0.00	0.00	0.00	0.	0.	0.
70.000	0.000	0.000	0.0000	0.00	0.00	0.00	0.00	0.00	0.00	0.	0.	0.

TABLE B-7. July Thermodynamic Data, Shemya.

Z KM	MEAN P MB	S.D. P MB	MEANT DEG K	S.D. Y DEG K	MEAN D G/M3	SKEW T G/M3	S.D. D G/M3	SKEW D	NOBS P	NOBS T	NOBS D
0.000	1013.473	7.792	281.17	1.52	1251.08	0.08	11.35	-0.10	717.	716.	716.
0.039	1009.129	7.665	281.12	1.51	1246.03	0.11	11.12	-0.10	720.	720.	720.
1.000	895.759	20.290	260.10	4.10	1110.73	0.19	26.76	-4.93	751.	751.	751.
2.000	794.407	6.825	277.52	3.91	994.98	-0.06	15.01	0.01	750.	750.	750.
3.000	702.034	6.638	273.13	3.95	894.06	-0.07	10.67	-0.05	750.	750.	750.
4.000	618.570	6.649	267.84	4.01	803.77	-0.13	8.79	-0.13	750.	750.	750.
5.000	543.830	6.610	262.04	4.19	722.57	-0.08	7.69	-0.18	750.	750.	750.
6.000	476.794	6.731	255.66	4.54	649.45	-0.02	6.86	-0.15	744.	744.	744.
7.000	416.371	6.653	248.76	4.94	582.99	0.03	6.32	-0.21	737.	737.	737.
8.000	362.114	6.668	241.56	5.25	522.20	0.17	6.04	-0.43	727.	727.	727.
9.000	313.733	6.548	234.26	5.17	466.58	0.34	6.08	-1.06	724.	724.	724.
10.000	270.625	6.309	227.86	4.66	413.80	0.38	7.96	-1.63	720.	720.	720.
11.000	232.711	5.646	223.44	4.57	362.96	0.46	11.05	-0.94	691.	691.	691.
12.000	199.663	4.706	222.29	5.18	313.16	0.07	12.82	0.04	680.	680.	680.
13.000	171.175	3.683	222.58	4.78	268.12	-0.52	10.63	0.62	669.	669.	669.
14.000	146.827	2.863	222.40	4.02	230.12	-0.52	8.00	0.66	664.	664.	664.
15.000	125.864	2.241	221.95	3.65	197.65	-0.43	6.19	0.58	659.	659.	659.
16.000	107.899	1.761	221.67	3.39	169.63	-0.39	4.79	0.51	658.	658.	658.
17.000	92.488	1.401	221.96	3.11	145.20	-0.20	3.64	0.41	592.	592.	592.
18.000	79.308	1.150	222.41	2.80	124.25	-0.24	2.77	0.58	590.	590.	590.
19.000	68.039	0.966	222.93	2.56	106.34	-0.14	2.13	1.09	581.	581.	581.
20.000	58.380	0.754	223.48	2.33	91.01	0.02	1.52	-0.02	578.	578.	578.
21.000	50.113	0.647	224.06	2.28	77.92	0.06	1.17	-0.06	572.	572.	572.
22.000	43.060	0.574	224.83	2.18	66.72	0.33	0.93	-0.04	553.	553.	553.
23.000	37.002	0.514	225.66	2.19	57.13	0.46	0.75	0.03	547.	547.	547.
24.000	31.803	0.466	226.64	2.27	48.89	0.63	0.63	0.10	545.	545.	545.
25.000	27.378	0.428	227.82	2.24	41.86	0.51	0.54	0.06	508.	508.	508.
26.000	23.576	0.389	229.14	2.41	35.84	0.03	0.46	0.24	496.	496.	496.
27.000	20.314	0.358	230.67	2.51	30.68	0.42	0.41	0.37	483.	483.	483.
28.000	17.535	0.328	232.02	2.63	26.32	0.11	0.36	0.44	434.	434.	434.
29.000	15.147	0.284	233.50	2.72	22.60	-0.51	0.32	0.33	408.	408.	408.
30.000	13.093	0.266	235.03	2.96	19.40	-0.64	0.29	0.35	363.	363.	363.

TABLE B-7. July Thermodynamic Data, Shemya, Cont'd.

Z KM	MEAN P MB	S.D. P MB	SKEW P	MEAN T DEG K	S.D. T DEG K	SKEW T	MEAN D G/M3	S.D. D G/M3	SKEW D	NOBS P	NOBS T	NOBS D
32.000	10.046	0.244	0.2354	239.85	6.24	0.18	14.53	0.16	0.08	11.	13.	11.
34.000	7.613	0.228	0.1770	244.37	6.57	0.26	10.82	0.13	-0.41	12.	14.	12.
36.000	5.794	0.219	0.2570	249.23	8.58	0.27	8.07	0.11	0.58	12.	14.	12.
38.000	4.430	0.200	0.2843	254.41	8.89	0.22	6.04	0.11	-0.40	14.	16.	14.
40.000	3.415	0.167	0.2582	261.01	8.05	-0.31	4.54	0.11	0.50	17.	20.	17.
42.000	2.646	0.146	0.2076	264.30	7.81	-0.53	3.46	0.12	0.49	17.	21.	17.
44.000	2.053	0.121	0.2344	267.75	6.59	-0.62	2.66	0.12	0.56	18.	22.	18.
46.000	1.599	0.107	0.1770	270.16	4.81	-0.86	2.05	0.11	0.56	16.	20.	16.
48.000	1.232	0.078	0.1426	272.66	4.20	-0.56	1.57	0.09	0.81	14.	18.	14.
50.000	0.968	0.061	0.1821	273.85	3.79	-0.54	1.23	0.07	1.06	10.	13.	10.
52.000	0.737	0.037	-1.6187	273.16	3.33	0.00	0.94	0.04	-1.55	7.	10.	7.
54.000	0.000	0.000	0.0000	272.02	2.61	0.45	0.00	0.00	0.00	5.	7.	5.
56.000	0.000	0.000	0.0000	269.99	3.37	0.92	0.00	0.00	0.00	4.	6.	4.
58.000	0.000	0.000	0.0000	0.00	0.00	0.00	0.00	0.00	0.00	3.	3.	3.
60.000	0.000	0.000	0.0000	0.00	0.00	0.00	0.00	0.00	0.00	3.	3.	3.
62.000	0.000	0.000	0.0000	0.00	0.00	0.00	0.00	0.00	0.00	2.	2.	2.
64.000	0.000	0.000	0.0000	0.00	0.00	0.00	0.00	0.00	0.00	2.	2.	2.
66.000	0.000	0.000	0.0000	0.00	0.00	0.00	0.00	0.00	0.00	0.	0.	0.
68.000	0.000	0.000	0.0000	0.00	0.00	0.00	0.00	0.00	0.00	0.	0.	0.
70.000	0.000	0.000	0.0000	0.00	0.00	0.00	0.00	0.00	0.00	0.	0.	0.

TABLE B-8. August Thermodynamic Data, Shemya.

Z KM	MEAN P MB	S.D. P MB	SKEW P	MEAN T DEG K	S.D. T DEG K	SKEW T	MEAN D G/M3	S.D. D G/M3	SKEW D	NOBS P	NOBS T	NOBS D
0.000	1010.385	9.439	-0.1480	282.90	1.36	0.81	1239.37	13.83	1.03	700.	698.	700.
0.039	1006.143	9.245	-0.1572	282.80	1.34	0.81	1234.61	13.49	1.03	701.	699.	701.
1.000	893.131	22.055	-7.3005	280.70	4.27	0.17	1104.69	28.62	-4.51	736.	736.	736.
2.000	792.520	8.161	-0.0214	277.53	4.32	0.00	992.40	14.49	0.08	736.	736.	736.
3.000	700.391	7.926	0.0900	273.08	4.43	-0.01	892.07	11.94	-0.09	735.	735.	735.
4.000	617.095	7.937	0.1633	267.86	4.65	-0.10	801.80	10.15	-0.11	733.	733.	733.
5.000	542.530	7.891	0.1941	262.08	4.98	-0.10	720.75	8.95	-0.33	733.	733.	733.
6.000	475.690	8.002	0.1790	255.73	5.44	-0.05	647.79	8.23	-0.54	719.	719.	719.
7.000	415.476	7.917	0.1522	248.88	5.94	0.07	581.48	7.51	-0.82	716.	716.	716.
8.000	361.348	7.952	0.1466	241.76	6.22	0.30	520.70	6.86	-1.17	708.	708.	708.
9.000	313.170	7.822	0.1447	234.70	5.96	0.15	464.75	6.95	-1.44	704.	703.	704.
10.000	270.256	7.566	0.2478	228.95	5.11	0.26	411.13	9.14	-1.22	697.	696.	697.
11.000	232.582	6.824	0.4028	225.65	4.73	-0.05	359.09	12.58	-0.38	680.	679.	680.
12.000	199.814	5.685	0.3970	223.88	5.09	-0.30	311.17	13.52	0.22	668.	668.	668.
13.000	171.410	4.606	0.3987	222.88	4.82	-0.60	268.15	11.92	0.69	658.	658.	658.
14.000	147.030	3.638	0.2354	221.70	4.61	-0.80	231.22	9.84	0.85	653.	653.	653.
15.000	125.913	2.825	0.0083	220.73	4.48	-0.79	198.86	7.88	0.87	646.	646.	646.
16.000	107.844	2.211	-0.2880	220.27	4.00	-0.59	170.65	5.95	0.64	644.	644.	644.
17.000	92.353	1.758	-0.6504	220.33	3.60	-0.48	146.08	4.49	0.51	592.	592.	592.
18.000	79.104	1.431	-0.9540	220.77	3.23	-0.25	124.86	3.33	0.42	590.	590.	590.
19.000	67.791	1.184	-1.2501	221.42	2.97	-0.02	106.68	2.50	0.17	578.	578.	578.
20.000	58.113	1.019	-1.3204	221.98	2.75	0.22	91.21	1.91	-0.13	573.	573.	573.
21.000	49.825	0.873	-1.4260	222.55	2.60	0.35	77.99	1.55	-1.07	566.	565.	566.
22.000	42.769	0.777	-1.3856	223.34	2.49	0.43	66.70	1.22	-1.12	551.	550.	551.
23.000	36.715	0.689	-1.3937	224.12	2.48	0.62	57.07	0.99	-1.18	537.	537.	537.
24.000	31.520	0.619	-1.2536	224.98	2.44	0.40	48.81	0.81	-1.50	530.	530.	530.
25.000	27.094	0.556	-1.1971	226.12	2.42	0.45	41.74	0.68	-1.76	500.	500.	500.
26.000	23.305	0.504	-1.0340	227.32	2.50	0.24	35.71	0.60	-1.75	495.	495.	495.
27.000	20.068	0.463	-0.9804	228.71	2.57	0.14	30.57	0.52	-1.65	470.	470.	470.
28.000	17.301	0.421	-1.0246	229.94	2.48	0.47	26.21	0.46	-1.60	428.	427.	428.
29.000	14.924	0.387	-0.9833	231.23	2.59	0.21	22.49	0.42	-1.25	392.	391.	392.
30.000	12.883	0.346	-1.2259	232.62	2.73	-0.01	19.30	0.38	-1.38	352.	351.	352.

TABLE B-8. August Thermodynamic Data, Shemya, Cont'd.

Z KM	MEAN P MB	S.D. P MB	SKEWP P	MEAN T DEG K	S.D. T DEG K	SKEWT G/M3	MEAN D G/M3	S.D. D G/M3	SKEWD D	NOBS P	NOBS T	NOBS D
32.000	9.833	0.189	0.3762	236.03	3.83	1.19	14.50	0.23	-0.16	20.	23.	20.
34.000	7.394	0.166	0.8301	239.99	4.19	0.44	10.71	0.15	-0.57	21.	24.	21.
36.000	5.596	0.148	1.0805	244.58	5.30	1.09	7.95	0.12	-1.01	21.	24.	21.
38.000	4.261	0.133	1.2917	249.91	5.14	0.46	5.93	0.11	-0.25	21.	24.	21.
40.000	3.264	0.113	1.4591	255.08	5.52	-0.43	4.44	0.12	-0.08	21.	25.	21.
42.000	2.516	0.098	1.4108	260.03	5.70	-0.33	3.36	0.09	1.06	20.	24.	20.
44.000	1.944	0.081	1.4603	264.24	5.69	0.03	2.55	0.09	1.42	20.	24.	20.
46.000	1.516	0.068	1.1659	268.16	5.50	-0.54	1.96	0.08	1.78	18.	22.	18.
48.000	1.176	0.046	0.1306	269.44	4.46	-1.51	1.52	0.05	0.34	14.	18.	14.
50.000	0.916	0.038	0.1418	270.63	3.64	-0.60	1.18	0.04	0.10	12.	15.	12.
52.000	0.709	0.028	-0.4452	271.08	2.23	0.59	0.91	0.04	0.20	9.	12.	9.
54.000	0.549	0.022	-1.0529	268.28	1.81	0.34	0.71	0.03	-0.28	6.	8.	6.
56.000	0.000	0.000	0.0000	265.83	4.41	0.63	0.00	0.00	0.00	4.	6.	4.
58.000	0.000	0.000	0.0000	0.00	0.00	0.00	0.00	0.00	0.00	3.	4.	3.
60.000	0.000	0.000	0.0000	0.00	0.00	0.00	0.00	0.00	0.00	3.	4.	3.
62.000	0.000	0.000	0.0000	0.00	0.00	0.00	0.00	0.00	0.00	0.	0.	0.
64.000	0.000	0.000	0.0000	0.00	0.00	0.00	0.00	0.00	0.00	0.	0.	0.
66.000	0.000	0.000	0.0000	0.00	0.00	0.00	0.00	0.00	0.00	0.	0.	0.
68.000	0.000	0.000	0.0000	0.00	0.00	0.00	0.00	0.00	0.00	0.	0.	0.
70.000	0.000	0.000	0.0000	0.00	0.00	0.00	0.00	0.00	0.00	0.	0.	0.



TABLE B-9. September Thermodynamic Data, Shemya.

Z KM	MEAN P MB	S.D. P MB	SKEWP P	MEANT DEG K	S.D. T DEG K	SKEWT G/M3	MEAN D G/M3	S.D. D G/M3	SKEWD P	NOBS P	NOBS T	NOBS D
0.000	1011.361	11.113	-0.4261	282.36	1.61	-0.52	1243.35	15.74	-0.24	681.	681.	681.
0.039	1007.086	11.078	-0.4334	282.18	1.61	-0.53	1238.96	15.65	-0.26	683.	683.	683.
1.000	893.369	20.443	-7.2163	275.98	3.49	0.76	1124.94	26.19	-4.35	706.	706.	706.
2.000	790.413	9.048	-0.3809	272.01	4.22	0.48	1010.95	16.03	-0.53	706.	706.	706.
3.000	696.609	8.600	-0.2969	267.20	4.64	0.22	907.45	13.58	-0.43	705.	705.	705.
4.000	611.870	8.473	-0.1584	261.60	4.94	0.13	814.45	11.59	-0.48	705.	705.	705.
5.000	536.208	8.353	-0.0689	255.33	5.39	0.11	731.42	10.28	-0.45	705.	705.	705.
6.000	468.435	8.510	-0.0448	248.62	5.79	0.11	656.32	9.03	-0.48	696.	696.	696.
7.000	407.611	8.435	-0.0375	241.54	6.11	0.18	587.91	7.85	-0.58	693.	693.	693.
8.000	352.988	8.527	-0.0154	234.62	6.18	0.27	524.16	7.19	-0.57	685.	685.	685.
9.000	304.726	8.222	0.0576	228.48	5.81	0.41	464.67	8.82	-0.93	684.	684.	684.
10.000	261.994	7.561	0.2003	224.58	5.04	0.31	406.53	12.59	-0.66	681.	681.	681.
11.000	225.015	6.554	0.3181	223.21	5.12	-0.05	351.42	14.43	-0.07	662.	662.	662.
12.000	193.086	5.422	0.3676	222.97	5.06	-0.39	301.93	13.40	0.52	653.	653.	653.
13.000	165.587	4.347	0.3351	222.55	4.54	-0.63	259.38	10.79	0.71	650.	650.	650.
14.000	142.020	3.489	0.2964	221.92	4.36	-0.73	223.09	8.87	0.76	636.	636.	636.
15.000	121.693	2.767	0.2245	221.35	4.22	-0.72	191.65	7.19	0.70	633.	633.	633.
16.000	104.281	2.208	0.1833	221.00	4.02	-0.71	164.47	5.69	0.61	633.	633.	633.
17.000	89.315	1.806	0.1833	221.03	3.63	-0.62	140.83	4.36	0.41	560.	560.	560.
18.000	76.524	1.487	0.2678	221.11	3.24	-0.25	120.60	3.31	0.16	560.	560.	560.
19.000	65.578	1.250	0.4206	221.29	3.06	0.01	103.26	2.59	-0.03	548.	548.	548.
20.000	56.198	1.068	0.6175	221.43	2.91	0.24	88.43	2.02	-0.11	544.	544.	544.
21.000	48.170	0.918	0.8207	221.66	2.83	0.49	75.71	1.59	-0.19	534.	534.	534.
22.000	41.300	0.807	0.9757	222.05	2.81	0.63	64.80	1.28	-0.14	526.	526.	526.
23.000	35.414	0.718	1.1661	222.51	2.86	0.61	55.45	1.07	0.01	518.	518.	518.
24.000	30.385	0.640	1.3358	223.12	2.95	0.68	47.44	0.90	0.22	509.	509.	509.
25.000	26.078	0.580	1.4274	223.88	2.90	0.78	40.58	0.74	0.35	488.	488.	488.
26.000	22.390	0.522	1.5050	224.67	2.90	0.74	34.72	0.62	0.55	481.	481.	481.
27.000	19.236	0.471	1.5659	225.53	2.98	0.87	29.71	0.52	0.86	446.	446.	446.
28.000	16.530	0.431	1.7379	226.38	3.03	0.88	25.44	0.47	1.09	417.	417.	417.
29.000	14.232	0.391	1.7970	227.35	3.18	0.76	21.80	0.41	1.26	382.	382.	382.
30.000	12.240	0.360	2.0493	228.29	3.42	0.66	18.68	0.37	1.51	339.	339.	339.

TABLE B-9. September Thermodynamic Data, Shemya, Cont'd.

Z KM	MEAN P MB	S.D. P MB	SKEW P	MEAN T DEG K	S.D. T DEG K	SKEW T	MEAN D G/M3	S.D. D G/M3	SKEW D	NOBS P	NOBS T	NOBS D
32.000	9.232	0.203	-0.5357	230.55	3.50	-0.83	13.97	0.27	0.59	20.	23.	20.
34.000	6.923	0.206	0.2570	234.28	4.37	-0.53	10.30	0.22	0.20	21.	24.	21.
36.000	5.200	0.177	0.1867	238.24	4.85	-0.31	7.61	0.17	0.43	21.	24.	21.
38.000	3.920	0.153	0.2524	243.40	5.07	-0.46	5.62	0.14	0.22	22.	25.	22.
40.000	2.977	0.132	0.2709	247.88	6.28	0.31	4.18	0.11	-0.33	22.	25.	22.
42.000	2.277	0.116	0.2147	252.87	6.17	-0.43	3.14	0.09	0.24	21.	24.	21.
44.000	1.741	0.102	0.3205	256.89	6.33	-0.72	2.36	0.09	0.64	19.	22.	19.
46.000	1.342	0.086	0.2946	260.68	5.55	-0.26	1.79	0.08	0.30	19.	23.	19.
48.000	1.042	0.069	0.1039	263.30	4.70	-0.56	1.38	0.07	0.21	19.	22.	19.
50.000	0.807	0.060	0.1402	263.99	3.84	-0.64	1.07	0.07	-0.04	15.	18.	15.
52.000	0.615	0.046	-0.3326	263.24	4.58	0.41	0.81	0.06	-0.26	10.	12.	10.
54.000	0.472	0.035	-1.4937	260.28	5.00	-0.09	0.63	0.04	-1.80	7.	8.	7.
56.000	0.000	0.000	0.0000	0.00	0.00	0.00	0.00	0.00	0.00	3.	4.	3.
58.000	0.000	0.000	0.0000	0.00	0.00	0.00	0.00	0.00	0.00	2.	2.	2.
60.000	0.000	0.000	0.0000	0.00	0.00	0.00	0.00	0.00	0.00	0.	0.	0.
62.000	0.000	0.000	0.0000	0.00	0.00	0.00	0.00	0.00	0.00	0.	0.	0.
64.000	0.000	0.000	0.0000	0.00	0.00	0.00	0.00	0.00	0.00	0.	0.	0.
66.000	0.000	0.000	0.0000	0.00	0.00	0.00	0.00	0.00	0.00	0.	0.	0.
68.000	0.000	0.000	0.0000	0.00	0.00	0.00	0.00	0.00	0.00	0.	0.	0.
70.000	0.000	0.000	0.0000	0.00	0.00	0.00	0.00	0.00	0.00	0.	0.	0.

TABLE B-10. October Thermodynamic Data, Shemya.

Z KM	MEAN P MB	S.D. P MB	SKEWP	MEAN T DEG K	S.D. T DEG K	MEAN D G/M3	S.D. D G/M3	SKEWD	NOBS P	NOBS T	NOBS D
0.000	1009.594	12.515	-0.2182	279.71	1.95	1254.16	18.77	0.51	742.	740.	742.
0.039	1005.221	12.456	-0.2149	279.50	1.96	1249.56	17.86	-0.14	742.	741.	742.
1.000	891.989	11.320	-0.1818	272.41	3.37	1137.78	20.77	-2.40	760.	763.	762.
2.000	786.161	10.354	0.0224	267.50	4.60	1022.86	17.38	-0.38	761.	762.	761.
3.000	691.362	9.938	0.1772	262.65	5.12	916.57	14.59	-0.35	759.	760.	759.
4.000	605.784	9.762	0.3130	256.84	5.53	821.51	12.75	-0.40	758.	759.	758.
5.000	529.625	9.649	0.3821	250.53	5.92	736.47	11.23	-0.45	757.	758.	757.
6.000	461.453	9.698	0.4179	243.89	6.24	659.22	9.90	-0.56	742.	743.	742.
7.000	400.577	9.617	0.3905	237.11	6.52	588.71	9.07	-0.59	737.	738.	737.
8.000	345.886	9.495	0.4778	230.61	6.49	522.67	8.90	-0.63	730.	731.	730.
9.000	297.957	8.982	0.5306	225.34	5.95	460.72	11.20	-0.64	725.	725.	725.
10.000	255.823	8.152	0.6808	222.50	5.59	400.73	14.22	-0.27	714.	714.	714.
11.000	219.348	7.074	0.8254	221.74	5.21	344.84	14.75	0.33	693.	693.	693.
12.000	187.999	5.902	0.8955	221.67	4.55	295.65	13.14	0.86	676.	676.	676.
13.000	161.110	4.815	0.8692	221.34	4.11	253.73	10.89	1.11	673.	673.	673.
14.000	138.013	3.872	0.8272	220.94	3.95	217.74	9.00	1.17	659.	659.	659.
15.000	118.184	3.100	0.7189	220.71	3.82	186.65	7.33	1.16	650.	650.	650.
16.000	101.339	2.483	0.5838	220.52	3.83	160.18	6.01	1.06	624.	624.	624.
17.000	86.772	2.074	0.4725	220.58	3.60	137.10	4.83	0.99	566.	566.	566.
18.000	74.306	1.694	0.3975	220.50	3.33	117.44	3.74	0.84	564.	564.	564.
19.000	63.647	1.412	0.3276	220.56	3.18	100.56	2.94	0.66	548.	548.	548.
20.000	54.510	1.186	0.3008	220.72	3.09	86.06	2.33	0.49	547.	547.	547.
21.000	46.704	1.020	0.2857	220.86	2.99	73.68	1.87	0.29	530.	530.	530.
22.000	40.024	0.883	0.3512	221.23	3.01	63.04	1.53	0.23	523.	523.	523.
23.000	34.296	0.769	0.4148	221.69	2.96	53.90	1.26	0.11	521.	521.	521.
24.000	29.408	0.681	0.4767	222.08	2.83	46.13	1.03	0.02	496.	496.	496.
25.000	25.220	0.608	0.5626	222.60	2.85	39.47	0.87	-0.01	479.	479.	479.
26.000	21.633	0.538	0.6420	223.11	3.01	33.78	0.75	-0.03	476.	476.	476.
27.000	18.589	0.479	0.7803	223.65	3.19	28.95	0.64	0.07	430.	430.	430.
28.000	15.966	0.437	0.8691	224.14	3.36	24.81	0.55	0.30	415.	415.	415.
29.000	13.714	0.399	0.9896	224.76	3.52	21.26	0.49	0.34	397.	397.	397.
30.000	11.776	0.349	0.9842	225.38	3.66	18.20	0.43	0.36	376.	376.	376.

TABLE B-10. October Thermodynamic Data, Shemya, Cont'd.

Z KM	MEAN P MB	S.D. P MB	SKEW P	MEAN T DEG K	S.D. T DEG K	SKEW T	MEAN D GMS	S.D. D GMS	SKEW D	NOBS P	NOBS T	NOBS D
32.000	8.841	0.248	0.0268	227.21	4.28	0.48	13.56	0.31	-0.21	20.	21.	20.
34.000	6.558	0.217	0.1231	229.52	5.36	0.15	9.95	0.27	-0.15	21.	22.	21.
36.000	4.898	0.184	0.1728	232.51	6.46	0.17	7.34	0.21	-0.43	22.	23.	22.
38.000	3.676	0.158	0.2841	235.87	5.68	-0.14	5.43	0.17	-0.27	20.	21.	20.
40.000	2.755	0.123	0.1499	237.97	6.49	0.04	4.04	0.11	0.00	20.	21.	20.
42.000	2.076	0.108	0.3176	242.34	6.44	0.07	2.99	0.11	-0.56	19.	22.	19.
44.000	1.578	0.088	0.4280	247.16	6.93	0.23	2.23	0.09	0.08	19.	22.	19.
46.000	1.209	0.073	0.2044	251.40	5.49	-0.11	1.68	0.08	0.08	18.	21.	18.
48.000	0.944	0.060	-0.2081	254.11	7.19	-0.03	1.29	0.08	0.19	17.	21.	17.
50.000	0.721	0.052	0.0554	253.45	6.54	-0.71	0.99	0.06	0.42	12.	17.	12.
52.000	0.550	0.039	-0.1124	253.58	4.60	1.00	0.75	0.06	0.25	10.	12.	10.
54.000	0.420	0.031	-0.0165	253.87	4.92	-0.55	0.58	0.05	0.69	7.	7.	7.
56.000	0.000	0.000	0.0000	0.00	0.00	0.00	0.00	0.00	0.00	0.	0.	0.
58.000	0.000	0.000	0.0000	0.00	0.00	0.00	0.00	0.00	0.00	0.	0.	0.
60.000	0.000	0.000	0.0000	0.00	0.00	0.00	0.00	0.00	0.00	0.	0.	0.
62.000	0.000	0.000	0.0000	0.00	0.00	0.00	0.00	0.00	0.00	0.	0.	0.
64.000	0.000	0.000	0.0000	0.00	0.00	0.00	0.00	0.00	0.00	0.	0.	0.
66.000	0.000	0.000	0.0000	0.00	0.00	0.00	0.00	0.00	0.00	0.	0.	0.
68.000	0.000	0.000	0.0000	0.00	0.00	0.00	0.00	0.00	0.00	0.	0.	0.
70.000	0.000	0.000	0.0000	0.00	0.00	0.00	0.00	0.00	0.00	0.	0.	0.

TABLE B-11. November Thermodynamic Data, Shemya.

Z KM	MEAN P MB	S.D. P MB	SKEW P	MEAN T DEG K	S.D. T DEG K	SKEW T	MEAN D G/M3	S.D. D G/M3	SKEW D	NOBS P	NOBS T	NOBS D
0.000	1001.953	14.182	-0.2458	276.38	1.98	-0.19	1260.20	20.68	-0.14	667.	667.	667.
0.039	997.472	14.231	-0.2258	276.13	1.99	-0.18	1255.71	20.71	-0.14	668.	668.	668.
1.000	883.490	14.703	-1.9813	268.73	3.12	0.20	1142.88	24.39	-2.08	689.	691.	691.
2.000	777.618	11.364	-0.0359	262.96	4.39	0.79	1029.44	19.36	-0.49	691.	691.	691.
3.000	682.057	10.748	0.1477	257.26	5.30	0.53	923.36	17.07	-0.48	691.	691.	691.
4.000	595.953	10.409	0.3224	251.02	6.00	0.42	827.03	14.95	-0.50	690.	690.	690.
5.000	519.463	10.191	0.4218	244.44	6.42	0.38	740.40	12.90	-0.53	688.	688.	688.
6.000	450.927	10.277	0.4571	237.82	6.49	0.46	660.64	10.92	-0.63	681.	681.	681.
7.000	389.939	10.168	0.4891	231.30	6.22	0.56	587.37	9.76	-0.68	672.	672.	672.
8.000	335.594	9.655	0.5872	225.71	5.64	0.75	518.02	11.02	-0.65	664.	664.	664.
9.000	288.299	8.850	0.6559	222.21	4.94	0.69	452.12	14.50	-0.24	659.	659.	659.
10.000	247.191	7.617	0.7399	221.18	5.36	0.14	389.64	16.91	0.29	634.	634.	634.
11.000	211.716	6.246	0.8071	221.55	5.28	-0.31	333.20	15.33	0.84	621.	621.	621.
12.000	181.473	5.065	0.7621	222.28	4.63	-0.61	284.61	12.10	1.20	604.	604.	604.
13.000	155.590	4.138	0.6737	222.44	3.98	-0.56	243.80	9.24	1.14	601.	601.	601.
14.000	133.433	3.420	0.5826	222.55	3.59	-0.36	208.95	7.24	0.99	582.	582.	582.
15.000	114.430	2.859	0.4987	222.42	3.57	-0.24	179.29	5.88	0.84	581.	581.	581.
16.000	98.227	2.446	0.4019	222.63	3.37	-0.16	153.75	4.81	0.76	536.	536.	536.
17.000	84.178	2.070	0.3971	222.68	3.39	0.02	131.73	3.92	0.74	516.	516.	516.
18.000	72.217	1.771	0.3268	222.53	3.45	0.15	113.08	3.28	0.64	512.	512.	512.
19.000	61.947	1.539	0.2784	222.48	3.64	0.27	97.02	2.77	0.63	494.	494.	494.
20.000	53.126	1.327	0.2443	222.34	3.63	0.11	83.23	2.35	0.43	490.	489.	490.
21.000	45.585	1.141	0.3254	222.41	3.72	0.18	71.39	1.95	0.30	477.	476.	477.
22.000	39.101	0.998	0.3688	222.35	3.81	0.17	61.26	1.61	0.31	471.	470.	471.
23.000	33.525	0.889	0.3885	222.35	4.10	0.21	52.54	1.37	0.11	466.	466.	466.
24.000	28.769	0.794	0.4715	222.54	4.29	0.14	45.04	1.20	0.04	437.	437.	437.
25.000	24.655	0.699	0.4288	222.58	4.46	0.21	38.60	1.02	0.02	424.	424.	424.
26.000	21.155	0.619	0.5281	222.64	4.83	0.22	33.11	0.88	-0.03	420.	420.	420.
27.000	18.179	0.576	0.4801	223.08	5.04	0.08	28.39	0.77	0.07	356.	356.	356.
28.000	15.620	0.499	0.2800	223.49	5.33	0.27	24.35	0.66	-0.09	332.	332.	332.
29.000	13.411	0.470	0.2619	223.71	5.49	-0.14	20.89	0.58	0.00	297.	297.	297.
30.000	11.511	0.435	0.2557	223.94	5.72	-0.33	17.91	0.52	0.07	281.	281.	281.

TABLE B-11. November Thermodynamic Data, Shemya, Cont'd.

Z KIA	MEAN P MB	S.D. P MB	SKEW P	MEAN T DEG K	S.D. T DEG K	SKEW T	MEAN D GMS	S.D. D GMS	SKEW D	NOBS P	NOBS T	NOBS D
32.000	8.706	0.397	-0.3786	224.52	6.31	-1.00	13.51	0.51	-0.52	22.	22.	22.
34.000	6.445	0.326	-0.3827	226.02	7.77	-0.45	9.94	0.43	-0.02	22.	22.	22.
36.000	4.783	0.261	-0.3803	228.42	8.35	-0.20	7.30	0.36	0.10	23.	25.	23.
38.000	3.554	0.213	-0.2187	231.87	8.00	-0.26	5.34	0.30	0.09	24.	24.	24.
40.000	2.661	0.172	-0.1834	234.74	8.59	-0.15	3.95	0.23	-0.07	24.	24.	24.
42.000	2.003	0.135	-0.1826	239.62	8.56	-0.20	2.91	0.19	-0.07	25.	26.	25.
44.000	1.508	0.111	-0.0267	244.33	9.36	-0.31	2.15	0.15	-0.18	23.	24.	23.
46.000	1.151	0.090	-0.1024	247.71	9.33	0.01	1.62	0.12	-0.25	20.	20.	20.
48.000	0.877	0.077	-0.0118	251.44	8.78	0.48	1.21	0.09	0.05	18.	18.	18.
50.000	0.676	0.059	0.1043	253.93	10.04	0.71	0.93	0.06	0.49	13.	13.	13.
52.000	0.519	0.050	0.1277	256.83	9.46	0.66	0.70	0.06	0.06	12.	12.	12.
54.000	0.403	0.042	0.0131	259.66	13.94	0.51	0.54	0.06	-0.11	10.	10.	10.
56.000	0.312	0.030	0.5042	262.03	13.50	-0.45	0.42	0.04	-0.34	7.	8.	7.
58.000	0.000	0.000	0.0000	0.00	0.00	0.00	0.00	0.00	0.00	4.	4.	4.
60.000	0.000	0.000	0.0000	0.00	0.00	0.00	0.00	0.00	0.00	2.	2.	2.
62.000	0.000	0.000	0.0000	0.00	0.00	0.00	0.00	0.00	0.00	2.	0.	2.
64.000	0.000	0.000	0.0000	0.00	0.00	0.00	0.00	0.00	0.00	2.	2.	2.
66.000	0.000	0.000	0.0000	0.00	0.00	0.00	0.00	0.00	0.00	2.	2.	2.
68.000	0.000	0.000	0.0000	0.00	0.00	0.00	0.00	0.00	0.00	0.	0.	0.
70.000	0.000	0.000	0.0000	0.00	0.00	0.00	0.00	0.00	0.00	0.	0.	0.

TABLE B-12. December Thermodynamic Data, Shemya.

Z KM	MEAN P MB	S.D. P MB	SKEW P	MEAN T DEG K	S.D. T DEG K	SKEW T	MEAN D G/M3	S.D. D G/M3	SKEW D	NOBS P	NOBS T	NOBS D
0.000	997.919	15.646	-0.1241	274.07	2.04	-0.61	1266.14	23.72	-0.11	701.	701.	701.
0.039	993.463	15.575	-0.1201	273.83	2.05	-0.58	1261.65	23.64	-0.12	703.	703.	703.
1.000	877.860	21.387	-4.7868	266.32	3.10	0.09	1166.83	28.75	-2.56	726.	726.	726.
2.000	772.522	12.043	0.0743	260.23	4.25	0.51	1033.62	21.16	-0.18	726.	726.	726.
3.000	676.588	11.128	0.2645	254.40	5.13	0.42	926.33	18.05	-0.19	725.	725.	725.
4.000	590.250	10.633	0.4327	247.97	5.71	0.34	829.24	15.49	-0.31	725.	725.	725.
5.000	513.613	10.225	0.5307	241.29	6.07	0.28	741.64	13.28	-0.30	723.	723.	723.
6.000	444.913	10.175	0.5626	234.69	6.09	0.27	660.52	11.36	-0.30	708.	708.	708.
7.000	383.928	9.877	0.6023	228.34	5.54	0.28	585.80	10.27	-0.19	697.	697.	697.
8.000	329.893	9.104	0.6520	223.36	4.57	0.20	514.57	11.79	-0.32	689.	689.	689.
9.000	283.007	8.174	0.7170	220.75	4.42	0.24	446.80	15.61	-0.02	682.	682.	682.
10.000	242.500	6.802	0.7505	220.56	5.23	0.07	383.35	16.98	0.48	669.	669.	669.
11.000	207.775	5.452	0.7323	221.88	5.35	-0.46	326.52	14.33	0.88	662.	662.	662.
12.000	178.220	4.409	0.6561	223.07	4.70	-0.45	278.49	10.56	0.90	656.	656.	656.
13.000	152.926	3.651	0.6066	223.60	4.24	-0.24	238.37	8.02	0.71	651.	651.	651.
14.000	131.261	3.051	0.5487	223.92	4.09	-0.18	204.29	6.47	0.65	638.	638.	638.
15.000	112.674	2.568	0.4409	224.18	4.17	-0.25	175.15	5.35	0.57	636.	636.	636.
16.000	96.788	2.235	0.4089	224.54	3.95	-0.45	150.21	4.42	0.52	581.	581.	581.
17.000	83.103	1.902	0.3393	224.64	3.98	-0.53	128.91	3.74	0.43	573.	573.	573.
18.000	71.382	1.641	0.2853	224.62	4.17	-0.27	110.74	3.17	0.20	570.	570.	570.
19.000	61.317	1.445	0.2482	224.67	4.33	-0.52	95.11	2.73	0.00	554.	554.	554.
20.000	52.673	1.260	0.2525	224.69	4.55	-0.49	81.69	2.30	-0.10	552.	552.	552.
21.000	45.248	1.115	0.1799	224.84	4.83	-0.66	70.13	1.88	-0.08	540.	540.	540.
22.000	38.890	1.000	0.1165	225.08	5.09	-0.66	60.21	1.58	-0.15	531.	531.	531.
23.000	33.409	0.905	-0.0323	225.19	5.49	-0.66	51.70	1.32	-0.22	529.	529.	529.
24.000	28.716	0.836	-0.1307	225.43	5.82	-0.59	44.39	1.13	-0.10	496.	496.	496.
25.000	24.685	0.778	-0.2699	225.61	6.12	-0.62	38.12	0.94	-0.07	485.	485.	485.
26.000	21.222	0.722	-0.3847	225.77	6.51	-0.59	32.75	0.81	0.02	479.	479.	479.
27.000	18.251	0.668	-0.3202	225.65	6.90	-0.41	28.18	0.71	0.15	422.	422.	422.
28.000	15.683	0.616	-0.5206	225.50	7.22	-0.34	24.23	0.60	0.01	392.	392.	392.
29.000	13.511	0.568	-0.6003	225.95	7.39	-0.23	20.83	0.55	-0.02	346.	346.	346.
30.000	11.626	0.517	-0.5472	226.06	7.67	-0.12	17.91	0.49	-0.25	317.	317.	317.

TABLE B-12. December Thermodynamic Data, Shemya, Cont'd.

Z KM	MEAN P MB	S.D. P MB	SKEW P	MEAN T DEG K	S.D. T DEG K	SKEW T	MEAN D G/M3	S.D. D G/M3	SKEW D	NOBS P	NOBS T	NOBS D
32.000	8.824	0.614	-0.7761	227.04	10.34	-0.37	13.51	0.52	-1.06	22.	25.	22.
34.000	6.551	0.535	-0.6424	226.31	11.32	0.20	10.06	0.49	-0.98	22.	26.	22.
36.000	4.864	0.459	-0.4496	227.78	10.56	0.48	7.42	0.47	-1.28	22.	26.	22.
38.000	3.599	0.372	-0.2253	228.52	10.48	0.83	5.47	0.43	-0.76	21.	25.	21.
40.000	2.643	0.291	-0.1392	229.21	10.09	0.51	4.01	0.37	-0.41	18.	22.	18.
42.000	1.971	0.229	-0.0565	230.89	9.98	-0.04	2.97	0.32	-0.29	18.	22.	18.
44.000	1.455	0.162	-0.2716	233.21	11.13	-0.32	2.17	0.22	-0.34	17.	22.	17.
46.000	1.099	0.126	-0.3303	239.03	12.98	0.38	1.60	0.18	-0.17	18.	24.	18.
48.000	0.831	0.099	-0.2310	240.61	11.76	0.02	1.20	0.14	-0.61	18.	22.	18.
50.000	0.623	0.078	-0.0957	245.86	11.49	0.15	0.88	0.12	-0.33	15.	20.	15.
52.000	0.473	0.060	0.1748	250.69	12.37	-1.08	0.66	0.09	-0.02	14.	15.	14.
54.000	0.378	0.043	-0.0687	249.36	15.05	-0.51	0.53	0.06	-0.53	9.	10.	9.
56.000	0.000	0.000	0.0000	0.00	0.00	0.00	0.00	0.00	0.00	0.	0.	0.
58.000	0.000	0.000	0.0000	0.00	0.00	0.00	0.00	0.00	0.00	0.	0.	0.
60.000	0.000	0.000	0.0000	0.00	0.00	0.00	0.00	0.00	0.00	0.	0.	0.
62.000	0.000	0.000	0.0000	0.00	0.00	0.00	0.00	0.00	0.00	0.	0.	0.
64.000	0.000	0.000	0.0000	0.00	0.00	0.00	0.00	0.00	0.00	0.	0.	0.
66.000	0.000	0.000	0.0000	0.00	0.00	0.00	0.00	0.00	0.00	0.	0.	0.
68.000	0.000	0.000	0.0000	0.00	0.00	0.00	0.00	0.00	0.00	0.	0.	0.
70.000	0.000	0.000	0.0000	0.00	0.00	0.00	0.00	0.00	0.00	0.	0.	0.



TABLE B-13. Annual Thermodynamic Data, Shemya.

Z KM	MEAN P MB	S.D. P MB	SKEWP	MEAN T DEGK	S.D. T DEGK	SKEWT	MEAN D GM3	S.D. D GM3	SKEWD	NOBS P	NOBS T	NOBS D
0.000	1006.250	13.653	-0.5603	277.23	3.92	0.05	1261.49	22.15	0.28	8449.	8440.	8447.
0.039	1001.869	13.620	-0.5645	277.04	3.96	0.04	1256.85	21.89	0.16	8471.	8467.	8471.
1.000	887.234	19.710	-5.3930	271.29	6.56	0.48	1137.17	31.54	-2.27	8758.	8758.	8757.
2.000	782.693	12.778	-0.3772	266.65	7.96	0.29	1021.87	24.09	0.02	8754.	8755.	8754.
3.000	687.897	13.319	-0.2320	261.56	8.65	0.15	916.00	20.18	0.09	8745.	8746.	8745.
4.000	602.454	13.939	-0.1148	255.73	9.20	0.08	820.73	16.64	0.11	8740.	8741.	8740.
5.000	526.437	14.373	-0.0512	249.47	9.59	0.07	735.28	13.63	0.07	8733.	8734.	8733.
6.000	458.329	14.915	-0.0176	242.92	9.73	0.13	657.43	10.69	-0.08	8595.	8596.	8595.
7.000	397.556	14.998	0.0034	236.29	9.47	0.26	586.18	9.00	-0.32	8529.	8530.	8529.
8.000	343.214	14.692	0.0885	230.14	8.62	0.46	519.50	10.03	-0.85	8450.	8451.	8450.
9.000	295.594	13.903	0.1582	225.46	7.12	0.51	456.67	14.41	-0.77	8394.	8393.	8394.
10.000	253.942	12.575	0.2535	223.17	5.88	0.09	396.48	18.44	-0.32	8258.	8257.	8258.
11.000	217.802	10.990	0.3330	222.77	5.42	-0.29	340.80	19.38	0.18	8061.	8060.	8061.
12.000	186.924	9.356	0.3336	223.22	5.02	-0.49	291.96	17.53	0.54	7855.	7855.	7855.
13.000	160.357	7.862	0.3035	223.45	4.45	-0.59	250.17	14.68	0.59	7801.	7801.	7801.
14.000	137.638	6.625	0.2654	223.32	4.21	-0.49	214.86	12.49	0.52	7671.	7671.	7671.
15.000	118.063	5.534	0.2283	223.08	4.19	-0.38	184.50	10.63	0.42	7629.	7629.	7629.
16.000	101.522	4.592	0.1473	222.88	4.16	-0.20	158.80	8.92	0.28	7267.	7267.	7267.
17.000	86.947	3.857	0.1769	222.96	4.05	0.01	135.94	7.38	0.23	6800.	6800.	6800.
18.000	74.598	3.235	0.1729	223.01	3.94	0.27	116.59	6.01	0.14	6773.	6773.	6773.
19.000	64.016	2.739	0.1663	223.15	3.82	0.35	99.98	4.91	0.09	6620.	6619.	6620.
20.000	54.931	2.326	0.1649	223.29	3.74	0.41	85.73	4.01	0.04	6581.	6579.	6581.
21.000	47.163	1.989	0.1585	223.49	3.74	0.39	73.53	3.29	0.01	6415.	6412.	6415.
22.000	40.486	1.719	0.1748	223.77	3.77	0.33	63.04	2.70	0.01	6298.	6295.	6298.
23.000	34.751	1.498	0.1798	224.11	3.93	0.31	54.02	2.24	0.01	6224.	6224.	6224.
24.000	29.865	1.309	0.1587	224.57	4.07	0.20	46.33	1.86	-0.01	6021.	6020.	6021.
25.000	25.646	1.161	0.1628	225.14	4.28	0.06	39.68	1.54	0.01	5771.	5769.	5771.
26.000	22.039	1.032	0.1699	225.78	4.65	-0.07	34.00	1.29	0.02	5703.	5702.	5703.
27.000	18.986	0.924	0.1388	226.62	4.96	-0.17	29.18	1.08	0.03	5187.	5184.	5187.
28.000	16.338	0.829	0.1493	227.42	5.31	-0.25	25.02	0.92	0.08	4824.	4823.	4824.
29.000	14.080	0.749	0.1364	228.40	5.67	-0.28	21.47	0.80	0.10	4430.	4428.	4430.
30.000	12.116	0.678	0.1222	229.27	6.11	-0.31	18.40	0.70	0.11	4033.	4032.	4033.

TABLE B-13. Annual Thermodynamic Data, Shemya, Cont'd.

Z KM	MEAN P MB	S.D. P MB	SKEW P	MEAN T DEG K	S.D. T DEG K	SKEW T	MEAN D G/M3	S.D. D G/M3	SKEW D	NOBS P	NOBS T	NOBS D
32.000	9.124	0.559	-0.1482	231.39	7.89	-0.28	13.73	0.54	-0.21	238.	270.	238.
34.000	6.828	0.478	-0.1324	234.30	9.09	-0.34	16.14	0.45	-0.26	246.	281.	246.
36.000	5.129	0.407	-0.1079	237.95	10.12	-0.18	7.49	0.38	-0.34	249.	285.	249.
38.000	3.874	0.349	-0.0584	241.89	11.05	-0.20	5.57	0.33	-0.29	251.	287.	251.
40.000	2.940	0.300	0.0112	246.24	12.41	-0.23	4.15	0.28	-0.22	252.	291.	252.
42.000	2.240	0.255	0.0589	250.02	13.21	-0.34	3.11	0.25	-0.16	249.	291.	249.
44.000	1.713	0.216	0.0562	253.80	13.88	-0.51	2.34	0.21	-0.11	246.	290.	246.
46.000	1.317	0.190	0.0857	257.18	13.80	-0.60	1.78	0.18	-0.07	239.	284.	239.
48.000	1.012	0.145	0.0020	258.83	13.67	-0.68	1.36	0.15	-0.15	213.	255.	213.
50.000	0.780	0.120	-0.0057	260.14	12.88	-0.60	1.04	0.13	-0.22	179.	220.	179.
52.000	0.595	0.098	-0.0088	260.31	12.57	-0.66	0.79	0.11	-0.29	144.	172.	144.
54.000	0.455	0.076	0.2178	259.30	12.77	-0.57	0.61	0.09	0.00	93.	110.	93.
56.000	0.351	0.061	0.2379	260.05	12.24	-0.79	0.47	0.07	0.24	37.	46.	37.
58.000	0.276	0.048	0.1702	258.24	11.74	-1.16	0.37	0.06	0.26	21.	24.	21.
60.000	0.240	0.029	-0.7160	258.39	5.46	-0.21	0.32	0.04	-0.59	10.	13.	10.
62.000	0.000	0.000	0.0000	0.00	0.00	0.00	0.00	0.00	0.00	4.	4.	4.
64.000	0.000	0.000	0.0000	244.99	5.67	-0.36	0.00	0.00	0.00	4.	6.	4.
66.000	0.000	0.000	0.0000	0.00	0.00	0.00	0.00	0.00	0.00	2.	2.	2.
68.000	0.000	0.000	0.0000	0.00	0.00	0.00	0.00	0.00	0.00	0.	0.	0.
70.000	0.000	0.000	0.0000	0.00	0.00	0.00	0.00	0.00	0.00	0.	0.	0.

## APPENDIX C

### Shemya Moisture-Related Statistics Tables

Tables C-1 through C-13 provide moisture related statistics (monthly and annual, from surface to 30 km) for Shemya. They were prepared as described in Chapter 3.

TABLE C-1. January Moisture-Related Data, Shemya.

Z	VP MEAN	S.D. VP	TV MEAN	TV S.D.	SKEW TV	TD MEAN	S.D. TD	NOBS	NOBS	NOBS	NOBS
KM	MB	MB	K	K	K	K	K	VP	TV	VP	TV
								TD	TD	TD	TD
0.000	4.521	1.280	273.51	2.27	-0.46	268.60	3.99	-0.59	709.	708.	708.
0.039	4.440	1.261	273.27	2.30	-0.43	268.34	4.00	-0.55	714.	714.	714.
1.000	2.933	1.036	265.67	3.52	-0.17	262.64	5.16	-1.27	735.	735.	735.
2.000	1.374	0.878	259.54	4.72	0.62	252.14	7.57	-0.27	731.	731.	731.
3.000	0.696	0.587	253.61	5.55	0.47	243.54	8.60	-0.05	724.	724.	724.
4.000	0.379	0.344	247.30	6.04	0.44	236.66	9.15	-0.27	719.	719.	719.
5.000	0.227	0.202	242.30	5.41	0.57	231.54	9.19	-0.54	597.	597.	597.
6.000	0.162	0.120	239.57	4.17	0.60	228.75	8.75	-0.94	306.	306.	306.
7.000	0.109	0.077	237.95	2.62	0.78	224.87	8.96	-0.85	78.	78.	78.
8.000	0.070	0.052	235.37	1.82	0.45	220.24	10.68	-0.88	7.	7.	7.
9.000	0.000	0.000	219.65	4.52	-0.04	0.00	0.00	0.00	0.00	0.00	0.00
10.000	0.000	0.000	219.95	5.50	-0.15	0.00	0.00	0.00	0.00	0.00	0.00
11.000	0.000	0.000	221.97	5.35	-0.53	0.00	0.00	0.00	0.00	0.00	0.00
12.000	0.000	0.000	223.94	4.40	-0.36	0.00	0.00	0.00	0.00	0.00	0.00
13.000	0.000	0.000	225.12	3.73	-0.18	0.00	0.00	0.00	0.00	0.00	0.00
14.000	0.000	0.000	225.79	3.53	-0.20	0.00	0.00	0.00	0.00	0.00	0.00
15.000	0.000	0.000	226.30	3.36	-0.12	0.00	0.00	0.00	0.00	0.00	0.00
16.000	0.000	0.000	226.55	3.34	0.07	0.00	0.00	0.00	0.00	0.00	0.00
17.000	0.000	0.000	226.54	3.43	0.32	0.00	0.00	0.00	0.00	0.00	0.00
18.000	0.000	0.000	226.47	3.69	0.46	0.00	0.00	0.00	0.00	0.00	0.00
19.000	0.000	0.000	226.38	3.72	0.38	0.00	0.00	0.00	0.00	0.00	0.00
20.000	0.000	0.000	226.29	3.90	0.25	0.00	0.00	0.00	0.00	0.00	0.00
21.000	0.000	0.000	226.36	4.04	0.20	0.00	0.00	0.00	0.00	0.00	0.00
22.000	0.000	0.000	226.39	4.34	0.15	0.00	0.00	0.00	0.00	0.00	0.00
23.000	0.000	0.000	226.71	4.84	0.27	0.00	0.00	0.00	0.00	0.00	0.00
24.000	0.000	0.000	227.06	5.07	0.08	0.00	0.00	0.00	0.00	0.00	0.00
25.000	0.000	0.000	227.33	5.41	0.01	0.00	0.00	0.00	0.00	0.00	0.00
26.000	0.000	0.000	227.64	5.81	-0.05	0.00	0.00	0.00	0.00	0.00	0.00
27.000	0.000	0.000	228.05	6.02	-0.12	0.00	0.00	0.00	0.00	0.00	0.00
28.000	0.000	0.000	228.41	6.26	-0.20	0.00	0.00	0.00	0.00	0.00	0.00
29.000	0.000	0.000	229.09	6.50	-0.09	0.00	0.00	0.00	0.00	0.00	0.00
30.000	0.000	0.000	229.13	6.73	-0.12	0.00	0.00	0.00	0.00	0.00	0.00

TABLE C-2. February Moisture-Related Data, Shemya.

Z	VP	S.D.	TV	S.D.	TD	VP	S.D.	TV	S.D.	TD	VP	S.D.	TD	VP	S.D.	TD
KM	MB	MB	K	K	K	K	K	K	K	K	K	K	K	K	K	K
0.000	4.435	1.385	0.2325	273.53	2.36	-0.29	268.22	4.36	-0.37	613.	613.	613.	613.	613.	613.	613.
0.039	4.345	1.361	0.2497	273.29	2.38	-0.27	267.95	4.35	-0.34	616.	616.	616.	616.	616.	616.	616.
1.000	2.903	1.187	1.3155	265.72	3.94	0.55	262.43	5.26	-0.53	639.	639.	639.	639.	639.	639.	639.
2.000	1.418	0.943	1.5272	259.64	5.08	0.81	252.36	7.90	-0.33	636.	636.	636.	636.	636.	636.	636.
3.000	0.755	0.668	2.1564	253.88	5.71	0.74	244.21	8.96	-0.03	634.	634.	634.	634.	634.	634.	634.
4.000	0.404	0.405	2.4169	247.52	6.07	0.68	237.24	9.01	0.16	634.	634.	634.	634.	634.	634.	634.
5.000	0.234	0.249	2.6215	242.14	5.95	0.77	231.33	9.64	-0.24	553.	553.	553.	553.	553.	553.	553.
6.000	0.171	0.145	1.8635	240.31	4.63	0.80	228.86	9.76	-0.61	259.	259.	259.	259.	259.	259.	259.
7.000	0.153	0.125	2.1794	238.43	3.44	0.98	228.02	9.07	-0.94	89.	89.	89.	89.	89.	89.	89.
8.000	0.167	0.078	-0.5596	237.34	2.62	0.54	229.95	8.58	-2.53	11.	11.	11.	11.	11.	11.	11.
9.000	0.000	0.000	0.0000	219.74	4.77	0.39	0.00	0.00	0.00	0.	0.	0.	0.	0.	0.	0.
10.000	0.000	0.000	0.0000	220.14	5.56	0.02	0.00	0.00	0.00	0.	0.	0.	0.	0.	0.	0.
11.000	0.000	0.000	0.0000	221.82	5.89	-0.57	0.00	0.00	0.00	0.	0.	0.	0.	0.	0.	0.
12.000	0.000	0.000	0.0000	223.89	4.91	-0.67	0.00	0.00	0.00	0.	0.	0.	0.	0.	0.	0.
13.000	0.000	0.000	0.0000	224.99	4.31	-0.50	0.00	0.00	0.00	0.	0.	0.	0.	0.	0.	0.
14.000	0.000	0.000	0.0000	225.48	4.29	-0.49	0.00	0.00	0.00	0.	0.	0.	0.	0.	0.	0.
15.000	0.000	0.000	0.0000	225.71	4.50	-0.52	0.00	0.00	0.00	0.	0.	0.	0.	0.	0.	0.
16.000	0.000	0.000	0.0000	225.83	4.89	-0.49	0.00	0.00	0.00	0.	0.	0.	0.	0.	0.	0.
17.000	0.000	0.000	0.0000	225.80	5.14	-0.26	0.00	0.00	0.00	0.	0.	0.	0.	0.	0.	0.
18.000	0.000	0.000	0.0000	225.69	5.24	-0.11	0.00	0.00	0.00	0.	0.	0.	0.	0.	0.	0.
19.000	0.000	0.000	0.0000	225.55	5.20	-0.01	0.00	0.00	0.00	0.	0.	0.	0.	0.	0.	0.
20.000	0.000	0.000	0.0000	225.51	5.20	0.06	0.00	0.00	0.00	0.	0.	0.	0.	0.	0.	0.
21.000	0.000	0.000	0.0000	225.41	5.30	0.09	0.00	0.00	0.00	0.	0.	0.	0.	0.	0.	0.
22.000	0.000	0.000	0.0000	225.38	5.36	0.03	0.00	0.00	0.00	0.	0.	0.	0.	0.	0.	0.
23.000	0.000	0.000	0.0000	225.48	5.53	0.06	0.00	0.00	0.00	0.	0.	0.	0.	0.	0.	0.
24.000	0.000	0.000	0.0000	225.70	5.69	0.09	0.00	0.00	0.00	0.	0.	0.	0.	0.	0.	0.
25.000	0.000	0.000	0.0000	225.94	5.84	0.13	0.00	0.00	0.00	0.	0.	0.	0.	0.	0.	0.
26.000	0.000	0.000	0.0000	226.38	6.23	0.12	0.00	0.00	0.00	0.	0.	0.	0.	0.	0.	0.
27.000	0.000	0.000	0.0000	226.83	6.58	0.13	0.00	0.00	0.00	0.	0.	0.	0.	0.	0.	0.
28.000	0.000	0.000	0.0000	227.45	6.93	0.11	0.00	0.00	0.00	0.	0.	0.	0.	0.	0.	0.
29.000	0.000	0.000	0.0000	228.24	7.35	0.04	0.00	0.00	0.00	0.	0.	0.	0.	0.	0.	0.
30.000	0.000	0.000	0.0000	228.91	7.65	0.12	0.00	0.00	0.00	0.	0.	0.	0.	0.	0.	0.

TABLE C-3. March Moisture-Related Data, Shemya.

Z	VP MEAN	S.D. VP	TV MEAN	TV S.D.	SKEW TV	TD MEAN	S.D. TD	SKEW TD	NOBS VP	NOBS TV	NOBS TD
KM	MB	MB	K	K	K	K	K	K	VP	TV	TD
0.000	4.659	1.322	274.03	2.18	-0.65	268.96	4.14	-0.84	747.	747.	747.
0.039	4.564	1.297	273.78	2.19	-0.65	268.68	4.13	-0.81	749.	749.	749.
1.000	2.999	1.019	265.84	3.19	-0.24	263.02	4.99	-1.51	769.	769.	767.
2.000	1.443	0.902	259.69	4.07	0.31	252.60	8.01	-0.58	766.	766.	766.
3.000	0.801	0.663	254.03	4.87	0.36	244.98	8.94	-0.12	758.	758.	758.
4.000	0.453	0.427	248.06	5.45	0.34	238.30	9.46	-0.17	755.	755.	755.
5.000	0.256	0.253	242.72	5.26	0.55	232.30	9.57	-0.34	690.	690.	690.
6.000	0.177	0.153	239.69	4.20	0.76	228.81	9.70	-0.62	384.	384.	384.
7.000	0.163	0.105	238.65	2.86	0.39	228.98	8.89	-1.27	98.	98.	98.
8.000	0.112	0.060	235.21	2.40	-1.17	226.04	8.53	-1.79	16.	16.	16.
9.000	0.000	0.000	221.49	4.66	0.20	0.00	0.00	0.00	0.	0.	0.
10.000	0.000	0.000	221.94	5.37	0.04	0.00	0.00	0.00	0.	0.	0.
11.000	0.000	0.000	223.46	5.17	-0.47	0.00	0.00	0.00	0.	0.	0.
12.000	0.000	0.000	224.67	4.43	-0.66	0.00	0.00	0.00	0.	0.	0.
13.000	0.000	0.000	225.27	3.78	-0.36	0.00	0.00	0.00	0.	0.	0.
14.000	0.000	0.000	225.45	3.61	-0.31	0.00	0.00	0.00	0.	0.	0.
15.000	0.000	0.000	225.42	3.56	-0.34	0.00	0.00	0.00	0.	0.	0.
16.000	0.000	0.000	225.35	3.62	-0.12	0.00	0.00	0.00	0.	0.	0.
17.000	0.000	0.000	225.28	3.49	0.21	0.00	0.00	0.00	0.	0.	0.
18.000	0.000	0.000	225.20	3.47	0.39	0.00	0.00	0.00	0.	0.	0.
19.000	0.000	0.000	225.04	3.43	0.41	0.00	0.00	0.00	0.	0.	0.
20.000	0.000	0.000	224.93	3.31	0.50	0.00	0.00	0.00	0.	0.	0.
21.000	0.000	0.000	224.82	3.26	0.55	0.00	0.00	0.00	0.	0.	0.
22.000	0.000	0.000	224.76	3.35	0.54	0.00	0.00	0.00	0.	0.	0.
23.000	0.000	0.000	224.72	3.53	0.51	0.00	0.00	0.00	0.	0.	0.
24.000	0.000	0.000	224.83	3.74	0.44	0.00	0.00	0.00	0.	0.	0.
25.000	0.000	0.000	225.06	4.07	0.45	0.00	0.00	0.00	0.	0.	0.
26.000	0.000	0.000	225.37	4.55	0.41	0.00	0.00	0.00	0.	0.	0.
27.000	0.000	0.000	225.76	4.87	0.36	0.00	0.00	0.00	0.	0.	0.
28.000	0.000	0.000	226.39	5.23	0.36	0.00	0.00	0.00	0.	0.	0.
29.000	0.000	0.000	227.11	5.60	0.37	0.00	0.00	0.00	0.	0.	0.
30.000	0.000	0.000	227.89	5.82	0.38	0.00	0.00	0.00	0.	0.	0.

TABLE C-4. April Moisture-Related Data, Shemya.

Z	VP	VP	S.D.	TV	TV	TV	S.D.	S.D.	NOBS	NOBS	NOBS	NOBS
KM	MEAN	MEAN	VP	MEAN	MEAN	MEAN	VP	VP	VP	VP	VP	VP
	MB	K	MB	K	K	K	K	K	K	K	K	K
0.000	5.192	275.40	1.338	1.70	-0.98	270.51	3.86	-1.10	711.	711.	711.	710.
0.039	5.087	275.17	1.322	1.72	-0.91	270.23	3.87	-1.05	713.	713.	713.	712.
1.000	3.424	268.10	1.360	3.92	0.70	264.49	5.63	-1.20	729.	729.	729.	728.
2.000	1.816	263.25	1.315	4.98	0.79	254.73	9.01	-0.28	728.	728.	728.	728.
3.000	1.048	258.24	0.928	5.57	0.49	247.30	10.10	-0.13	725.	725.	725.	725.
4.000	0.578	252.39	0.587	5.87	0.30	240.14	10.46	-0.07	726.	726.	726.	726.
5.000	0.316	246.36	0.357	6.01	0.35	233.41	10.71	-0.01	714.	715.	715.	715.
6.000	0.197	241.56	0.229	5.24	0.74	228.38	10.96	-0.15	571.	571.	571.	571.
7.000	0.163	239.46	0.157	4.29	0.55	226.82	11.30	-0.52	250.	250.	250.	250.
8.000	0.137	238.07	0.096	2.86	0.32	226.31	10.63	-1.03	67.	67.	67.	67.
9.000	0.102	235.09	0.041	0.84	0.09	225.82	7.58	-2.77	10.	10.	10.	10.
10.000	0.000	221.41	0.000	5.26	-0.06	0.00	0.00	0.00	0.	0.	0.	0.
11.000	0.000	221.58	0.000	5.79	-0.38	0.00	0.00	0.00	0.	0.	0.	0.
12.000	0.000	222.26	0.000	5.30	-0.70	0.00	0.00	0.00	0.	0.	0.	0.
13.000	0.000	222.54	0.000	4.44	-0.75	0.00	0.00	0.00	0.	0.	0.	0.
14.000	0.000	222.46	0.000	3.90	-0.36	0.00	0.00	0.00	0.	0.	0.	0.
15.000	0.000	222.30	0.000	3.77	-0.27	0.00	0.00	0.00	0.	0.	0.	0.
16.000	0.000	222.25	0.000	3.83	-0.17	0.00	0.00	0.00	0.	0.	0.	0.
17.000	0.000	222.38	0.000	3.75	-0.13	0.00	0.00	0.00	0.	0.	0.	0.
18.000	0.000	222.39	0.000	3.66	0.07	0.00	0.00	0.00	0.	0.	0.	0.
19.000	0.000	222.39	0.000	3.54	0.28	0.00	0.00	0.00	0.	0.	0.	0.
20.000	0.000	222.30	0.000	3.43	0.56	0.00	0.00	0.00	0.	0.	0.	0.
21.000	0.000	222.25	0.000	3.43	0.72	0.00	0.00	0.00	0.	0.	0.	0.
22.000	0.000	222.18	0.000	3.33	0.67	0.00	0.00	0.00	0.	0.	0.	0.
23.000	0.000	222.17	0.000	3.33	0.75	0.00	0.00	0.00	0.	0.	0.	0.
24.000	0.000	222.32	0.000	3.47	0.73	0.00	0.00	0.00	0.	0.	0.	0.
25.000	0.000	222.45	0.000	3.57	0.69	0.00	0.00	0.00	0.	0.	0.	0.
26.000	0.000	222.69	0.000	3.73	0.69	0.00	0.00	0.00	0.	0.	0.	0.
27.000	0.000	223.19	0.000	3.82	0.80	0.00	0.00	0.00	0.	0.	0.	0.
28.000	0.000	223.99	0.000	4.05	0.74	0.00	0.00	0.00	0.	0.	0.	0.
29.000	0.000	224.84	0.000	4.09	0.85	0.00	0.00	0.00	0.	0.	0.	0.
30.000	0.000	225.67	0.000	4.29	0.74	0.00	0.00	0.00	0.	0.	0.	0.

TABLE C-5. May Moisture-Related Data, Shemya.

Z	VP MEAN	S.D. VP	TV MEAN	TV S.D.	SKREW TV	TD MEAN	S.D. TD	SKREW TD	NOBS VP	NOBS TV	NOBS TD
KM	MB	MB	K	K	K	K	K	K	VP	TV	TD
0.000	6.126	1.358	277.32	1.50	-0.17	272.98	3.17	-1.11	757.	755.	752.
0.039	6.029	1.315	277.15	1.50	-0.19	272.72	3.18	-1.07	758.	758.	755.
1.000	3.976	1.469	271.12	3.76	0.73	266.39	5.92	-1.62	777.	777.	777.
2.000	2.269	1.386	267.35	4.44	0.29	257.84	8.70	-0.63	778.	778.	778.
3.000	1.357	1.040	262.83	4.60	0.04	250.64	10.04	-0.38	772.	772.	772.
4.000	0.751	0.692	257.29	4.73	0.03	243.19	10.46	-0.08	771.	771.	771.
5.000	0.412	0.410	251.13	4.89	0.11	236.36	10.70	-0.10	769.	769.	769.
6.000	0.229	0.247	244.75	5.02	0.36	230.22	10.69	-0.05	739.	740.	740.
7.000	0.145	0.150	240.33	4.23	1.00	225.63	11.31	-0.20	501.	504.	504.
8.000	0.111	0.108	237.96	3.60	1.30	223.32	11.30	-0.33	166.	167.	167.
9.000	0.075	0.095	235.98	4.12	-0.84	219.66	10.90	0.13	38.	38.	38.
10.000	0.046	0.059	233.95	5.96	-2.61	214.97	10.78	0.51	10.	10.	10.
11.000	0.000	0.000	223.41	5.61	-0.37	0.00	0.00	0.00	3.	0.	3.
12.000	0.000	0.000	223.77	5.41	-0.93	0.00	0.00	0.00	0.	0.	0.
13.000	0.000	0.000	223.80	4.38	-1.05	0.00	0.00	0.00	0.	0.	0.
14.000	0.000	0.000	223.39	3.60	-0.81	0.00	0.00	0.00	0.	0.	0.
15.000	0.000	0.000	222.76	3.17	-0.54	0.00	0.00	0.00	0.	0.	0.
16.000	0.000	0.000	222.29	2.97	-0.28	0.00	0.00	0.00	0.	0.	0.
17.000	0.000	0.000	222.02	2.75	-0.17	0.00	0.00	0.00	0.	0.	0.
18.000	0.000	0.000	221.91	2.67	-0.02	0.00	0.00	0.00	0.	0.	0.
19.000	0.000	0.000	222.15	2.61	0.50	0.00	0.00	0.00	0.	0.	0.
20.000	0.000	0.000	222.44	2.60	0.63	0.00	0.00	0.00	0.	0.	0.
21.000	0.000	0.000	222.75	2.52	0.88	0.00	0.00	0.00	0.	0.	0.
22.000	0.000	0.000	223.09	2.50	1.03	0.00	0.00	0.00	0.	0.	0.
23.000	0.000	0.000	223.48	2.51	1.21	0.00	0.00	0.00	0.	0.	0.
24.000	0.000	0.000	223.95	2.46	0.84	0.00	0.00	0.00	0.	0.	0.
25.000	0.000	0.000	224.72	2.49	0.75	0.00	0.00	0.00	0.	0.	0.
26.000	0.000	0.000	225.57	2.69	0.66	0.00	0.00	0.00	0.	0.	0.
27.000	0.000	0.000	226.64	2.75	0.32	0.00	0.00	0.00	0.	0.	0.
28.000	0.000	0.000	227.99	3.13	0.77	0.00	0.00	0.00	0.	0.	0.
29.000	0.000	0.000	229.35	3.27	0.18	0.00	0.00	0.00	0.	0.	0.
30.000	0.000	0.000	231.07	3.66	0.00	0.00	0.00	0.00	0.	0.	0.



TABLE C-6. June Moisture-Related Data, Shemya.

Z	VP	S.D.	TV	TV	TV	S.D.	SK	TV	TD	MEAN	S.D.	TD	NOBS	NOBS	NOBS
KM	MB	MB	VP	VP	VP	K	K	K	K	K	K	K	VP	TV	TD
0.000	7.995	1.080	-0.2430	279.51	1.46	0.11	276.80	2.00	-0.80	700.	704.	700.			
0.039	7.882	1.086	-0.2237	279.40	1.45	0.08	276.59	2.03	-0.76	700.	704.	700.			
1.000	5.499	2.330	0.6637	276.56	4.26	0.44	270.46	6.59	-1.03	731.	731.	731.			
2.000	3.657	2.084	0.6385	273.13	4.47	0.02	264.03	8.67	-0.66	731.	731.	731.			
3.000	2.307	1.521	0.7059	268.28	4.43	-0.13	257.44	9.82	-0.57	725.	725.	725.			
4.000	1.220	1.037	1.2520	262.73	4.58	-0.09	248.80	10.60	-0.11	725.	725.	725.			
5.000	0.679	0.645	1.5361	256.59	4.74	-0.14	241.68	10.91	-0.06	721.	721.	721.			
6.000	0.356	0.358	1.7790	249.88	4.89	-0.08	234.82	10.71	-0.04	702.	703.	703.			
7.000	0.181	0.189	1.8657	243.26	4.60	0.18	227.71	11.16	-0.17	658.	660.	660.			
8.000	0.117	0.118	1.7926	238.84	3.47	0.74	223.70	11.08	-0.31	357.	358.	358.			
9.000	0.099	0.083	0.8329	236.52	2.85	-0.06	222.77	10.59	-0.52	77.	77.	77.			
10.000	0.044	0.057	0.8952	235.23	1.67	0.70	213.12	11.91	0.79	9.	9.	9.			
11.000	0.000	0.000	0.0000	223.24	5.46	0.07	0.00	0.00	0.00	3.	0.	3.			
12.000	0.000	0.000	0.0000	223.87	5.46	-0.65	0.00	0.00	0.00	0.	0.	0.			
13.000	0.000	0.000	0.0000	224.43	4.15	-0.80	0.00	0.00	0.00	0.	0.	0.			
14.000	0.000	0.000	0.0000	224.10	3.29	-0.54	0.00	0.00	0.00	0.	0.	0.			
15.000	0.000	0.000	0.0000	223.48	2.83	-0.50	0.00	0.00	0.00	0.	0.	0.			
16.000	0.000	0.000	0.0000	222.96	2.60	-0.20	0.00	0.00	0.00	0.	0.	0.			
17.000	0.000	0.000	0.0000	222.89	2.37	-0.16	0.00	0.00	0.00	0.	0.	0.			
18.000	0.000	0.000	0.0000	223.11	2.17	-0.05	0.00	0.00	0.00	0.	0.	0.			
19.000	0.000	0.000	0.0000	223.44	2.07	0.09	0.00	0.00	0.00	0.	0.	0.			
20.000	0.000	0.000	0.0000	223.74	1.97	0.33	0.00	0.00	0.00	0.	0.	0.			
21.000	0.000	0.000	0.0000	224.15	2.00	0.53	0.00	0.00	0.00	0.	0.	0.			
22.000	0.000	0.000	0.0000	224.65	1.96	0.45	0.00	0.00	0.00	0.	0.	0.			
23.000	0.000	0.000	0.0000	225.22	2.03	0.44	0.00	0.00	0.00	0.	0.	0.			
24.000	0.000	0.000	0.0000	225.93	2.11	0.25	0.00	0.00	0.00	0.	0.	0.			
25.000	0.000	0.000	0.0000	227.12	2.16	0.31	0.00	0.00	0.00	0.	0.	0.			
26.000	0.000	0.000	0.0000	228.44	2.31	0.17	0.00	0.00	0.00	0.	0.	0.			
27.000	0.000	0.000	0.0000	229.97	2.60	0.41	0.00	0.00	0.00	0.	0.	0.			
28.000	0.000	0.000	0.0000	231.52	2.60	-0.10	0.00	0.00	0.00	0.	0.	0.			
29.000	0.000	0.000	0.0000	233.24	2.89	-0.32	0.00	0.00	0.00	0.	0.	0.			
30.000	0.000	0.000	0.0000	234.88	3.15	-0.68	0.00	0.00	0.00	0.	0.	0.			

TABLE C-7. July Moisture-Related Data, Shemya.

Z	VP	S.D.	TV	TV	SKEW	TV	TD	MEAN	S.D.	TD	SKEW	TD	VP	NOBS	TV	NOBS	TD
KM	MB	MB	K	K	K	K	K	K	K	K	K	K	K	VP	TV	TV	TD
0.000	9.868	1.218	-0.2175	282.21	1.62	0.07	279.84	1.85	-0.65	712.	716.	712.	716.	712.	716.	712.	716.
0.039	9.749	1.216	-0.2221	282.14	1.61	0.09	279.67	1.87	-0.65	716.	720.	716.	720.	716.	720.	716.	720.
1.000	7.443	3.131	0.7364	280.99	4.29	0.24	274.70	6.50	-0.81	750.	750.	750.	750.	750.	750.	750.	750.
2.000	5.051	2.801	0.5362	278.18	4.04	-0.01	268.29	8.89	-0.71	746.	746.	746.	746.	746.	746.	746.	746.
3.000	3.083	2.106	0.6960	273.58	4.04	-0.07	260.88	10.17	-0.39	746.	746.	746.	746.	746.	746.	746.	746.
4.000	1.778	1.460	1.0123	268.11	4.07	-0.11	253.21	10.87	-0.09	746.	746.	746.	746.	746.	746.	746.	746.
5.000	1.041	0.995	1.3367	262.22	4.26	-0.05	246.15	11.41	0.05	742.	742.	742.	742.	742.	742.	742.	742.
6.000	0.610	0.654	1.6454	255.77	4.62	0.02	239.65	11.63	0.15	733.	733.	733.	733.	733.	733.	733.	733.
7.000	0.342	0.378	1.6296	248.84	4.93	0.09	232.05	12.14	0.00	717.	717.	717.	717.	717.	717.	717.	717.
8.000	0.191	0.211	1.6677	242.36	4.86	0.24	227.30	12.02	-0.12	633.	633.	633.	633.	633.	633.	633.	633.
9.000	0.125	0.118	1.3683	238.64	3.29	0.58	224.14	11.38	-0.43	339.	339.	339.	339.	339.	339.	339.	339.
10.000	0.105	0.064	-0.0857	236.32	1.69	0.35	224.65	9.47	-1.20	61.	61.	61.	61.	61.	61.	61.	61.
11.000	0.000	0.000	0.0000	223.44	4.57	0.46	0.00	0.00	0.00	0.00	0.00	0.00	0.00	0.00	0.00	0.00	0.00
12.000	0.000	0.000	0.0000	222.29	5.18	0.07	0.00	0.00	0.00	0.00	0.00	0.00	0.00	0.00	0.00	0.00	0.00
13.000	0.000	0.000	0.0000	222.58	4.78	-0.52	0.00	0.00	0.00	0.00	0.00	0.00	0.00	0.00	0.00	0.00	0.00
14.000	0.000	0.000	0.0000	222.40	4.02	-0.52	0.00	0.00	0.00	0.00	0.00	0.00	0.00	0.00	0.00	0.00	0.00
15.000	0.000	0.000	0.0000	221.95	3.65	-0.43	0.00	0.00	0.00	0.00	0.00	0.00	0.00	0.00	0.00	0.00	0.00
16.000	0.000	0.000	0.0000	221.67	3.39	-0.39	0.00	0.00	0.00	0.00	0.00	0.00	0.00	0.00	0.00	0.00	0.00
17.000	0.000	0.000	0.0000	221.96	3.11	-0.20	0.00	0.00	0.00	0.00	0.00	0.00	0.00	0.00	0.00	0.00	0.00
18.000	0.000	0.000	0.0000	222.41	2.80	-0.24	0.00	0.00	0.00	0.00	0.00	0.00	0.00	0.00	0.00	0.00	0.00
19.000	0.000	0.000	0.0000	222.93	2.56	-0.14	0.00	0.00	0.00	0.00	0.00	0.00	0.00	0.00	0.00	0.00	0.00
20.000	0.000	0.000	0.0000	223.48	2.33	0.02	0.00	0.00	0.00	0.00	0.00	0.00	0.00	0.00	0.00	0.00	0.00
21.000	0.000	0.000	0.0000	224.06	2.28	0.06	0.00	0.00	0.00	0.00	0.00	0.00	0.00	0.00	0.00	0.00	0.00
22.000	0.000	0.000	0.0000	224.83	2.18	0.33	0.00	0.00	0.00	0.00	0.00	0.00	0.00	0.00	0.00	0.00	0.00
23.000	0.000	0.000	0.0000	225.66	2.19	0.46	0.00	0.00	0.00	0.00	0.00	0.00	0.00	0.00	0.00	0.00	0.00
24.000	0.000	0.000	0.0000	226.64	2.27	0.63	0.00	0.00	0.00	0.00	0.00	0.00	0.00	0.00	0.00	0.00	0.00
25.000	0.000	0.000	0.0000	227.82	2.24	0.51	0.00	0.00	0.00	0.00	0.00	0.00	0.00	0.00	0.00	0.00	0.00
26.000	0.000	0.000	0.0000	229.14	2.41	0.03	0.00	0.00	0.00	0.00	0.00	0.00	0.00	0.00	0.00	0.00	0.00
27.000	0.000	0.000	0.0000	230.67	2.51	0.42	0.00	0.00	0.00	0.00	0.00	0.00	0.00	0.00	0.00	0.00	0.00
28.000	0.000	0.000	0.0000	232.02	2.63	0.11	0.00	0.00	0.00	0.00	0.00	0.00	0.00	0.00	0.00	0.00	0.00
29.000	0.000	0.000	0.0000	233.50	2.72	-0.51	0.00	0.00	0.00	0.00	0.00	0.00	0.00	0.00	0.00	0.00	0.00
30.000	0.000	0.000	0.0000	235.03	2.96	-0.64	0.00	0.00	0.00	0.00	0.00	0.00	0.00	0.00	0.00	0.00	0.00

TABLE C-8. August Moisture-Related Data, Shemya.

Z	VP MEAN	S.D. VP	TV MEAN	TV S.D.	SKEW TV	TD MEAN	S.D. TD	SKEW TD	NOBS	NOBS	NOBS	NOBS
KM	MB	MB	K	K	K	K	K	K	VP	TV	VP	TD
0.000	11.105	1.121	284.07	1.44	0.81	281.62	1.55	-0.48	692.	698.	692.	693.
0.039	10.962	1.135	283.96	1.43	0.82	281.42	1.59	-0.51	693.	699.	693.	694.
1.000	8.328	3.289	281.69	4.52	0.23	276.40	6.28	-1.00	732.	732.	732.	732.
2.000	5.455	2.934	278.26	4.50	0.03	269.42	8.79	-0.80	734.	734.	734.	734.
3.000	3.250	2.277	273.59	4.57	-0.01	261.28	10.71	-0.44	727.	727.	727.	727.
4.000	1.840	1.566	268.17	4.76	-0.09	253.36	11.23	-0.08	726.	726.	726.	726.
5.000	1.076	1.047	262.29	5.08	-0.08	246.33	11.70	0.01	725.	725.	725.	725.
6.000	0.631	0.701	255.85	5.54	-0.03	239.31	12.52	0.09	712.	712.	712.	712.
7.000	0.349	0.415	248.99	5.96	0.18	232.59	12.84	0.10	704.	705.	704.	705.
8.000	0.188	0.224	242.96	5.67	0.65	226.53	12.67	0.05	598.	599.	598.	599.
9.000	0.131	0.126	239.47	4.44	2.44	224.71	11.59	-0.19	357.	358.	357.	358.
10.000	0.086	0.072	237.29	5.17	6.44	221.91	11.73	0.37	104.	105.	104.	105.
11.000	0.421	1.599	237.41	12.59	3.66	214.64	17.77	2.73	16.	16.	16.	16.
12.000	0.000	0.000	223.88	5.09	-0.30	0.00	0.00	0.00	2.	0.	2.	0.
13.000	0.000	0.000	222.88	4.82	-0.60	0.00	0.00	0.00	0.	0.	0.	0.
14.000	0.000	0.000	221.70	4.61	-0.80	0.00	0.00	0.00	0.	0.	0.	0.
15.000	0.000	0.000	220.73	4.48	-0.79	0.00	0.00	0.00	0.	0.	0.	0.
16.000	0.000	0.000	220.27	4.00	-0.59	0.00	0.00	0.00	0.	0.	0.	0.
17.000	0.000	0.000	220.33	3.60	-0.48	0.00	0.00	0.00	0.	0.	0.	0.
18.000	0.000	0.000	220.77	3.23	-0.25	0.00	0.00	0.00	0.	0.	0.	0.
19.000	0.000	0.000	221.42	2.97	-0.02	0.00	0.00	0.00	0.	0.	0.	0.
20.000	0.000	0.000	221.98	2.75	0.22	0.00	0.00	0.00	0.	0.	0.	0.
21.000	0.000	0.000	222.55	2.60	0.35	0.00	0.00	0.00	0.	0.	0.	0.
22.000	0.000	0.000	223.34	2.49	0.43	0.00	0.00	0.00	0.	0.	0.	0.
23.000	0.000	0.000	224.12	2.48	0.62	0.00	0.00	0.00	0.	0.	0.	0.
24.000	0.000	0.000	224.98	2.44	0.40	0.00	0.00	0.00	0.	0.	0.	0.
25.000	0.000	0.000	226.12	2.42	0.45	0.00	0.00	0.00	0.	0.	0.	0.
26.000	0.000	0.000	227.32	2.50	0.24	0.00	0.00	0.00	0.	0.	0.	0.
27.000	0.000	0.000	228.71	2.57	0.14	0.00	0.00	0.00	0.	0.	0.	0.
28.000	0.000	0.000	229.94	2.48	0.47	0.00	0.00	0.00	0.	0.	0.	0.
29.000	0.000	0.000	231.23	2.59	0.21	0.00	0.00	0.00	0.	0.	0.	0.
30.000	0.000	0.000	232.62	2.73	-0.01	0.00	0.00	0.00	0.	0.	0.	0.

TABLE C-9. September Moisture-Related Data, Shemya.

Z	VP	S.D.	TV	TD	MEAN	S.D.	SK	VP	TD	MEAN	S.D.	SK	VP	TD	NOBS	NOBS	NOBS	NOBS	
KM	MB	MB	K	K	K	K	K	K	K	K	K	K	K	K	TV	VP	TD	TV	TD
0.000	9.616	1.862	-1.0531	283.37	1.74	-0.50	279.48	2.64	-0.72	681.	675.								
0.039	9.425	1.837	-1.0060	283.18	1.74	-0.50	279.19	2.66	-0.70	683.	677.								
1.000	5.974	2.230	1.0116	276.68	3.64	0.82	271.97	5.68	-1.27	706.	704.								
2.000	3.152	2.080	1.3011	272.41	4.32	0.55	261.76	9.06	-0.38	704.	704.								
3.000	1.877	1.537	1.5225	267.44	4.70	0.26	254.27	10.30	-0.16	701.	701.								
4.000	1.055	1.047	1.9826	251.75	5.00	0.16	246.67	10.80	0.10	701.	701.								
5.000	0.628	0.708	2.1898	255.43	5.44	0.14	240.24	11.18	0.18	699.	699.								
6.000	0.362	0.448	2.3431	248.78	5.74	0.18	233.83	11.51	0.17	686.	686.								
7.000	0.205	0.259	2.3718	243.03	5.16	0.67	227.76	11.98	-0.05	593.	593.								
8.000	0.144	0.156	1.6478	239.50	4.42	0.68	224.93	11.68	-0.22	324.	324.								
9.000	0.114	0.090	0.5255	237.80	2.83	0.05	223.92	11.16	-0.73	114.	114.								
10.000	0.066	0.058	0.4433	235.35	1.84	1.63	218.75	10.93	-0.32	18.	18.								
11.000	0.000	0.000	0.0000	223.21	5.12	-0.05	0.00	0.00	0.00	4.	4.								
12.000	0.000	0.000	0.0000	222.97	5.06	-0.39	0.00	0.00	0.00	0.	0.								
13.000	0.000	0.000	0.0000	222.55	4.54	-0.63	0.00	0.00	0.00	0.	0.								
14.000	0.000	0.000	0.0000	221.92	4.36	-0.73	0.00	0.00	0.00	0.	0.								
15.000	0.000	0.000	0.0000	221.35	4.22	-0.72	0.00	0.00	0.00	0.	0.								
16.000	0.000	0.000	0.0000	221.00	4.02	-0.71	0.00	0.00	0.00	0.	0.								
17.000	0.000	0.000	0.0000	221.03	3.63	-0.62	0.00	0.00	0.00	0.	0.								
18.000	0.000	0.000	0.0000	221.11	3.24	-0.25	0.00	0.00	0.00	0.	0.								
19.000	0.000	0.000	0.0000	221.29	3.06	0.01	0.00	0.00	0.00	0.	0.								
20.000	0.000	0.000	0.0000	221.43	2.91	0.24	0.00	0.00	0.00	0.	0.								
21.000	0.000	0.000	0.0000	221.66	2.83	0.49	0.00	0.00	0.00	0.	0.								
22.000	0.000	0.000	0.0000	222.05	2.81	0.63	0.00	0.00	0.00	0.	0.								
23.000	0.000	0.000	0.0000	222.51	2.86	0.61	0.00	0.00	0.00	0.	0.								
24.000	0.000	0.000	0.0000	223.12	2.95	0.68	0.00	0.00	0.00	0.	0.								
25.000	0.000	0.000	0.0000	223.88	2.90	0.78	0.00	0.00	0.00	0.	0.								
26.000	0.000	0.000	0.0000	224.67	2.90	0.74	0.00	0.00	0.00	0.	0.								
27.000	0.000	0.000	0.0000	225.53	2.98	0.87	0.00	0.00	0.00	0.	0.								
28.000	0.000	0.000	0.0000	226.38	3.03	0.88	0.00	0.00	0.00	0.	0.								
29.000	0.000	0.000	0.0000	227.35	3.18	0.76	0.00	0.00	0.00	0.	0.								
30.000	0.000	0.000	0.0000	228.29	3.42	0.66	0.00	0.00	0.00	0.	0.								

TABLE C-10. October Moisture-Related Data, Shemya.

Z	VP MEAN	S.D. VP	TV MEAN	TV S.D.	SKEW TV	TD MEAN	S.D. TD	SKEW TD	NOES	NOBS	NOBS
KM	MB	MB	K	K	K	K	K	K	VP	TV	TD
0.000	7.575	1.891	280.49	2.15	-0.71	275.86	3.57	-0.73	742.	741.	737.
0.039	7.425	1.848	280.26	2.16	-0.68	275.56	3.58	-0.70	742.	742.	738.
1.000	4.844	1.682	272.98	3.48	1.00	269.33	4.81	-1.00	762.	762.	760.
2.000	2.393	1.673	267.81	4.70	0.80	258.11	9.29	-0.47	761.	761.	761.
3.000	1.315	1.159	262.77	5.14	0.49	249.74	10.48	-0.11	752.	752.	752.
4.000	0.746	0.755	256.92	5.58	0.38	242.73	10.96	-0.04	752.	753.	753.
5.000	0.424	0.476	250.60	5.90	0.37	236.04	11.50	-0.02	748.	750.	750.
6.000	0.248	0.301	244.52	5.86	0.58	230.01	11.70	-0.06	688.	688.	688.
7.000	0.187	0.214	241.05	5.10	0.79	227.32	11.81	-0.24	428.	428.	428.
8.000	0.147	0.150	239.49	4.16	0.49	224.84	12.22	-0.29	172.	172.	172.
9.000	0.119	0.090	237.84	2.91	0.78	225.01	10.26	-0.75	64.	64.	64.
10.000	0.059	0.095	237.53	4.52	-0.54	216.12	10.90	0.97	12.	12.	12.
11.000	0.000	0.000	221.74	5.21	-0.06	0.00	0.00	0.00	4.	4.	4.
12.000	0.000	0.000	221.67	4.55	-0.38	0.00	0.00	0.00	0.	0.	0.
13.000	0.000	0.000	221.34	4.11	-0.64	0.00	0.00	0.00	0.	0.	0.
14.000	0.000	0.000	220.94	3.95	-0.60	0.00	0.00	0.00	0.	0.	0.
15.000	0.000	0.000	220.71	3.82	-0.65	0.00	0.00	0.00	0.	0.	0.
16.000	0.000	0.000	220.52	3.83	-0.65	0.00	0.00	0.00	0.	0.	0.
17.000	0.000	0.000	220.58	3.60	-0.78	0.00	0.00	0.00	0.	0.	0.
18.000	0.000	0.000	220.50	3.33	-0.58	0.00	0.00	0.00	0.	0.	0.
19.000	0.000	0.000	220.56	3.18	-0.30	0.00	0.00	0.00	0.	0.	0.
20.000	0.000	0.000	220.72	3.09	-0.06	0.00	0.00	0.00	0.	0.	0.
21.000	0.000	0.000	220.86	2.99	-0.07	0.00	0.00	0.00	0.	0.	0.
22.000	0.000	0.000	221.23	3.01	0.07	0.00	0.00	0.00	0.	0.	0.
23.000	0.000	0.000	221.69	2.96	0.11	0.00	0.00	0.00	0.	0.	0.
24.000	0.000	0.000	222.08	2.83	0.27	0.00	0.00	0.00	0.	0.	0.
25.000	0.000	0.000	222.60	2.85	0.35	0.00	0.00	0.00	0.	0.	0.
26.000	0.000	0.000	223.11	3.01	0.41	0.00	0.00	0.00	0.	0.	0.
27.000	0.000	0.000	223.65	3.19	0.50	0.00	0.00	0.00	0.	0.	0.
28.000	0.000	0.000	224.14	3.36	0.44	0.00	0.00	0.00	0.	0.	0.
29.000	0.000	0.000	224.76	3.52	0.45	0.00	0.00	0.00	0.	0.	0.
30.000	0.000	0.000	225.38	3.66	0.37	0.00	0.00	0.00	0.	0.	0.

TABLE C-11. November Moisture-Related Data, Shemya.

Z	VP	VP	S.D.	VP	TV	TV	TV	S.D.	SK	TV	TD	MEAN	S.D.	TD	NOBS	NOBS	NOBS	NOBS	
KM	MB	MB	MB	VP	VP	VP	VP	VP	VP	VP	VP	VP	VP	VP	VP	VP	VP	VP	TD
0.000	5.900	1.587	1.587	-0.0986	276.99	276.99	2.10	-0.14	272.32	3.79	-0.73	667.	667.	667.	667.	667.	667.	667.	663.
0.039	5.779	1.560	1.560	-0.0707	276.74	276.74	2.11	-0.13	272.03	3.79	-0.70	668.	668.	668.	668.	668.	668.	668.	664.
1.000	3.790	1.315	1.315	0.9370	269.16	269.16	3.24	0.24	266.01	4.93	-1.13	691.	691.	691.	691.	691.	691.	691.	691.
2.000	1.896	1.208	1.208	1.4481	263.20	263.20	4.47	0.81	255.79	8.24	-0.54	689.	689.	689.	689.	689.	689.	689.	690.
3.000	0.989	0.860	0.860	2.0962	257.36	257.36	5.37	0.55	247.03	9.53	-0.21	681.	681.	681.	681.	681.	681.	681.	681.
4.000	0.557	0.573	0.573	2.3751	251.14	251.14	6.08	0.42	239.97	10.04	0.01	679.	679.	679.	679.	679.	679.	679.	679.
5.000	0.316	0.368	0.368	2.5774	244.83	244.83	6.32	0.43	233.25	10.77	-0.03	654.	654.	654.	654.	654.	654.	654.	654.
6.000	0.210	0.237	0.237	2.5193	241.32	241.32	5.07	0.76	229.12	11.12	-0.32	436.	436.	436.	436.	436.	436.	436.	436.
7.000	0.169	0.162	0.162	1.7641	239.14	239.14	3.96	1.00	227.04	11.75	-0.63	178.	178.	178.	178.	178.	178.	178.	178.
8.000	0.135	0.117	0.117	0.9955	237.23	237.23	3.22	0.66	224.62	12.42	-0.63	50.	50.	50.	50.	50.	50.	50.	50.
9.000	0.105	0.061	0.061	-0.6829	235.28	235.28	3.90	-2.04	224.40	10.88	-1.76	10.	10.	10.	10.	10.	10.	10.	10.
10.000	0.000	0.000	0.000	0.0000	221.18	221.18	5.36	0.14	0.00	0.00	0.00	2.	2.	2.	2.	2.	2.	2.	2.
11.000	0.000	0.000	0.000	0.0000	221.55	221.55	5.28	-0.31	0.00	0.00	0.00	2.	2.	2.	2.	2.	2.	2.	2.
12.000	0.000	0.000	0.000	0.0000	222.28	222.28	4.63	-0.61	0.00	0.00	0.00	0.	0.	0.	0.	0.	0.	0.	0.
13.000	0.000	0.000	0.000	0.0000	222.44	222.44	3.98	-0.56	0.00	0.00	0.00	0.	0.	0.	0.	0.	0.	0.	0.
14.000	0.000	0.000	0.000	0.0000	222.55	222.55	3.69	-0.36	0.00	0.00	0.00	0.	0.	0.	0.	0.	0.	0.	0.
15.000	0.000	0.000	0.000	0.0000	222.42	222.42	3.57	-0.24	0.00	0.00	0.00	0.	0.	0.	0.	0.	0.	0.	0.
16.000	0.000	0.000	0.000	0.0000	222.63	222.63	3.37	-0.16	0.00	0.00	0.00	0.	0.	0.	0.	0.	0.	0.	0.
17.000	0.000	0.000	0.000	0.0000	222.68	222.68	3.39	0.02	0.00	0.00	0.00	0.	0.	0.	0.	0.	0.	0.	0.
18.000	0.000	0.000	0.000	0.0000	222.53	222.53	3.45	0.15	0.00	0.00	0.00	0.	0.	0.	0.	0.	0.	0.	0.
19.000	0.000	0.000	0.000	0.0000	222.48	222.48	3.64	0.27	0.00	0.00	0.00	0.	0.	0.	0.	0.	0.	0.	0.
20.000	0.000	0.000	0.000	0.0000	222.34	222.34	3.63	0.11	0.00	0.00	0.00	0.	0.	0.	0.	0.	0.	0.	0.
21.000	0.000	0.000	0.000	0.0000	222.41	222.41	3.72	0.18	0.00	0.00	0.00	0.	0.	0.	0.	0.	0.	0.	0.
22.000	0.000	0.000	0.000	0.0000	222.35	222.35	3.81	0.17	0.00	0.00	0.00	0.	0.	0.	0.	0.	0.	0.	0.
23.000	0.000	0.000	0.000	0.0000	222.35	222.35	4.10	0.21	0.00	0.00	0.00	0.	0.	0.	0.	0.	0.	0.	0.
24.000	0.000	0.000	0.000	0.0000	222.54	222.54	4.29	0.14	0.00	0.00	0.00	0.	0.	0.	0.	0.	0.	0.	0.
25.000	0.000	0.000	0.000	0.0000	222.58	222.58	4.46	0.21	0.00	0.00	0.00	0.	0.	0.	0.	0.	0.	0.	0.
26.000	0.000	0.000	0.000	0.0000	222.64	222.64	4.83	0.22	0.00	0.00	0.00	0.	0.	0.	0.	0.	0.	0.	0.
27.000	0.000	0.000	0.000	0.0000	223.08	223.08	5.04	0.08	0.00	0.00	0.00	0.	0.	0.	0.	0.	0.	0.	0.
28.000	0.000	0.000	0.000	0.0300	223.49	223.49	5.33	0.27	0.00	0.00	0.00	0.	0.	0.	0.	0.	0.	0.	0.
29.000	0.000	0.000	0.000	0.0000	223.71	223.71	5.49	-0.14	0.00	0.00	0.00	0.	0.	0.	0.	0.	0.	0.	0.
30.000	0.000	0.000	0.000	0.0000	223.94	223.94	5.72	-0.33	0.00	0.00	0.00	0.	0.	0.	0.	0.	0.	0.	0.

TABLE C-12. December Moisture-Related Data, Shemya.

Z	VP MEAN	S.D. VP	TV MEAN	TV S.D.	SKEW TV	TD MEAN	S.D. TD	SKEW TD	NOBS VP	NOBS TV	NOBS TD
KM	MB	MB	K	K	K	K	K	K	VP	TV	TD
0.000	4.965	1.418	274.59	2.15	-0.55	269.87	4.05	-0.69	701.	701.	699.
0.039	4.864	1.395	274.34	2.17	-0.52	269.58	4.05	-0.66	703.	703.	701.
1.000	3.197	1.083	266.69	3.20	0.12	263.87	4.63	-0.9.	726.	726.	726.
2.000	1.549	0.929	260.43	4.32	0.51	253.61	7.68	-0.56	724.	724.	724.
3.000	0.795	0.622	254.53	5.19	0.41	244.97	8.96	0.	720.	720.	720.
4.000	0.425	0.378	248.04	5.74	0.34	237.86	9.18	-0.22	719.	719.	719.
5.000	0.229	0.203	242.46	5.48	0.40	231.57	9.39	-0.42	633.	633.	633.
6.000	0.155	0.123	239.74	3.90	0.50	228.06	9.01	-0.69	338.	338.	338.
7.000	0.112	0.081	237.16	2.69	1.20	224.58	10.24	-1.12	96.	96.	96.
8.000	0.061	0.069	236.59	3.42	1.01	216.57	12.62	0.16	7.	7.	7.
9.000	0.000	0.000	220.75	4.42	0.24	0.00	0.00	0.00	0.	0.	0.
10.000	0.000	0.000	220.56	5.23	0.07	0.00	0.00	0.00	0.	0.	0.
11.000	0.000	0.000	221.88	5.35	-0.46	0.00	0.00	0.00	0.	0.	0.
12.000	0.000	0.000	223.07	4.70	-0.45	0.00	0.00	0.00	0.	0.	0.
13.000	0.000	0.000	223.60	4.24	-0.24	0.00	0.00	0.00	0.	0.	0.
14.000	0.000	0.000	223.92	4.09	-0.18	0.00	0.00	0.00	0.	0.	0.
15.000	0.000	0.000	224.18	4.17	-0.25	0.00	0.00	0.00	0.	0.	0.
16.000	0.000	0.000	224.54	3.95	-0.45	0.00	0.00	0.00	0.	0.	0.
17.000	0.000	0.000	224.64	3.98	-0.53	0.00	0.00	0.00	0.	0.	0.
18.000	0.000	0.000	224.62	4.17	-0.27	0.00	0.00	0.00	0.	0.	0.
19.000	0.000	0.000	224.67	4.33	-0.52	0.00	0.00	0.00	0.	0.	0.
20.000	0.000	0.000	224.69	4.55	-0.49	0.00	0.00	0.00	0.	0.	0.
21.000	0.000	0.000	224.84	4.83	-0.66	0.00	0.00	0.00	0.	0.	0.
22.000	0.000	0.000	225.08	5.09	-0.66	0.00	0.00	0.00	0.	0.	0.
23.000	0.000	0.000	225.19	5.49	-0.66	0.00	0.00	0.00	0.	0.	0.
24.000	0.000	0.000	225.43	5.82	-0.59	0.00	0.00	0.00	0.	0.	0.
25.000	0.000	0.000	225.61	6.12	-0.62	0.00	0.00	0.00	0.	0.	0.
26.000	0.000	0.000	225.77	6.51	-0.59	0.00	0.00	0.00	0.	0.	0.
27.000	0.000	0.000	225.65	6.90	-0.41	0.00	0.00	0.00	0.	0.	0.
28.000	0.000	0.000	225.50	7.22	-0.34	0.00	0.00	0.00	0.	0.	0.
29.000	0.000	0.000	225.95	7.39	-0.23	0.00	0.00	0.00	0.	0.	0.
30.000	0.000	0.000	226.06	7.67	-0.12	0.00	0.00	0.00	0.	0.	0.

TABLE C-13. Annual Moisture-Related Data, Shemya.

Z	VP MEAN	S.D. VP	TV MEAN	TV S.D.	SKEW TV	TD MEAN	S.D. TD	SKEW TD	NOBS	NOBS	NOBS	NOBS
KM	MB	MB	K	K	K	K	K	K	VP	TV	VP	TV
0.000	6.834	2.648	277.94	4.18	0.07	273.77	5.68	-0.37	8432.	8442.	8432.	8409.
0.039	6.716	2.619	277.75	4.22	0.06	273.51	5.71	-0.35	8455.	8469.	8455.	8436.
1.000	4.624	2.612	271.82	6.81	0.49	267.69	7.24	-0.18	8747.	8747.	8747.	8739.
2.000	2.637	2.215	266.99	8.15	0.31	258.46	10.34	-0.08	8728.	8730.	8728.	8730.
3.000	1.533	1.560	261.78	8.79	0.16	250.61	11.54	0.06	8665.	8665.	8665.	8665.
4.000	0.855	1.006	255.91	9.26	0.10	243.26	11.73	0.16	8653.	8655.	8653.	8655.
5.000	0.501	0.652	250.38	9.09	0.16	236.99	11.91	0.13	8243.	8249.	8243.	8249.
6.000	0.329	0.439	246.65	7.75	0.35	232.56	11.79	0.08	6554.	6558.	6554.	6558.
7.000	0.229	0.287	243.70	6.22	0.54	228.93	12.02	-0.07	4390.	4396.	4390.	4396.
8.000	0.160	0.183	240.76	5.04	0.77	225.67	11.99	-0.14	2408.	2411.	2408.	2411.
9.000	0.121	0.113	238.46	3.82	1.61	224.12	11.27	-0.37	1009.	1010.	1009.	1010.
10.000	0.084	0.071	236.63	4.17	5.75	221.37	11.29	0.01	216.	217.	216.	217.
11.000	0.221	1.131	236.35	8.87	5.10	211.80	13.93	3.12	32.	32.	32.	32.
12.000	0.000	0.000	223.22	5.02	-0.49	0.00	0.00	0.00	2.	0.	2.	0.
13.000	0.000	0.000	223.45	4.45	-0.59	0.00	0.00	0.00	0.	0.	0.	0.
14.000	0.000	0.000	223.32	4.21	-0.49	0.00	0.00	0.00	0.	0.	0.	0.
15.000	0.000	0.000	223.08	4.19	-0.38	0.00	0.00	0.00	0.	0.	0.	0.
16.000	0.000	0.000	222.88	4.16	-0.20	0.00	0.00	0.00	0.	0.	0.	0.
17.000	0.000	0.000	222.96	4.05	0.01	0.00	0.00	0.00	0.	0.	0.	0.
18.000	0.000	0.000	223.01	3.94	0.27	0.00	0.00	0.00	0.	0.	0.	0.
19.000	0.000	0.000	223.15	3.82	0.35	0.00	0.00	0.00	0.	0.	0.	0.
20.000	0.000	0.000	223.29	3.74	0.41	0.00	0.00	0.00	0.	0.	0.	0.
21.000	0.000	0.000	223.49	3.74	0.39	0.00	0.00	0.00	0.	0.	0.	0.
22.000	0.000	0.000	223.77	3.77	0.33	0.00	0.00	0.00	0.	0.	0.	0.
23.000	0.000	0.000	224.11	3.93	0.31	0.00	0.00	0.00	0.	0.	0.	0.
24.000	0.000	0.000	224.57	4.07	0.20	0.00	0.00	0.00	0.	0.	0.	0.
25.000	0.000	0.000	225.14	4.28	0.06	0.00	0.00	0.00	0.	0.	0.	0.
26.000	0.000	0.000	225.78	4.65	-0.07	0.00	0.00	0.00	0.	0.	0.	0.
27.000	0.000	0.000	226.62	4.96	-0.17	0.00	0.00	0.00	0.	0.	0.	0.
28.000	0.000	0.000	227.42	5.31	-0.25	0.00	0.00	0.00	0.	0.	0.	0.
29.000	0.000	0.000	228.40	5.67	-0.28	0.00	0.00	0.00	0.	0.	0.	0.
30.000	0.000	0.000	229.27	6.11	-0.31	0.00	0.00	0.00	0.	0.	0.	0.



## APPENDIX D

### Shemya Hydrostatic Model Atmospheres

Tables D-1 through D-13 provide hydrostatic model atmospheres (monthly and annual) from 0 to 70 km over Shemya. They were prepared as described in Chapter 3.

**TABLE D-1. January Hydrostatic Model Atmosphere, Shemya.**

Z KM	GEO. HT KM	PRESS MB	D G/M <sup>3</sup>	TV K
0.000	0.000	997.9180	1271.0947	273.51
0.039	0.039	993.5428	1266.6454	273.27
1.000	1.001	876.9437	1149.9643	265.67
2.000	2.001	771.9170	1036.1560	259.54
3.000	3.002	675.7352	928.2713	253.61
4.000	4.003	589.2213	830.0640	247.30
5.000	5.003	512.5040	736.8765	242.30
6.000	6.004	443.7217	645.2694	239.57
7.000	7.005	382.7649	560.4103	237.95
8.000	8.005	328.7131	486.5514	235.37
9.000	9.006	281.8181	426.9817	219.65
10.000	10.006	241.2921	382.1932	219.95
11.000	11.007	206.7285	324.4581	221.97
12.000	12.008	177.2990	275.8299	223.94
13.000	13.008	152.2365	235.5935	225.12
14.000	14.009	130.8018	201.8232	225.79
15.000	15.010	112.4269	173.0818	226.30
16.000	16.010	96.8657	148.9583	226.55
17.000	17.011	83.2917	128.0869	226.54
18.000	18.012	71.6203	110.1732	226.47
19.000	19.012	61.5956	94.7903	226.38
20.000	20.013	52.9625	81.5385	226.29
21.000	21.014	45.5675	70.1319	226.36
22.000	22.014	39.1887	60.3072	226.39
23.000	23.015	33.7021	51.7898	226.71
24.000	24.016	29.0001	44.4957	227.06
25.000	25.016	24.9538	38.2413	227.33
26.000	26.017	21.4763	32.8679	227.64
27.000	27.017	18.5033	28.2663	228.05
28.000	28.018	15.9413	24.3144	228.41
29.000	29.019	13.7464	20.9045	229.09
30.000	30.019	11.8066	17.9515	229.13
32.000	32.021	8.9865	13.5613	115.43
34.000	34.022	6.7109	10.0602	116.20
36.000	36.023	5.0228	7.4455	117.51
38.000	38.025	3.7721	5.5603	118.17
40.000	40.026	2.8411	4.1222	120.06
42.000	42.027	2.1445	3.1060	120.27
44.000	44.028	1.6250	2.3286	121.55
46.000	46.030	1.2169	1.7389	121.90
48.000	48.031	0.9271	1.3245	121.92
50.000	50.032	0.6948	0.9937	121.79
52.000	52.033	0.5063	0.7232	121.95
54.000	54.035	0.3907	0.5666	120.13
56.000	56.036	0.2888	0.4186	120.20
58.000	58.037	0.2176	0.3169	119.58
60.000	60.038	0.1439	0.2012	124.58
62.000	62.040	0.0000	0.0000	0.00
64.000	64.041	0.0000	0.0000	0.00
66.000	66.042	0.0000	0.0000	0.00
68.000	68.044	0.0000	0.0000	0.00
70.000	70.046	0.0000	0.0000	0.00

**TABLE D-2. February Hydrostatic Model Atmosphere, Shemya.**

Z KM	GEO. HT KM	PRESS MB	D G/M <sup>3</sup>	TV K
0.000	0.000	1000.2349	1273.9457	273.53
0.039	0.039	995.8003	1269.4171	273.29
1.000	1.001	879.5084	1153.1242	265.72
2.000	2.001	773.5009	1037.8598	259.64
3.000	3.002	677.1418	929.1847	253.88
4.000	4.003	590.5358	831.1619	247.52
5.000	5.003	513.7844	739.2170	242.14
6.000	6.004	445.0138	645.1414	240.31
7.000	7.005	383.9676	561.0419	238.43
8.000	8.005	329.8419	484.1547	237.34
9.000	9.006	282.7812	448.3274	219.74
10.000	10.006	242.2289	383.3334	220.14
11.000	11.007	207.4143	325.7610	221.82
12.000	12.008	177.9806	276.9423	223.89
13.000	13.008	152.8562	236.6848	224.99
14.000	14.009	131.3344	202.9210	225.48
15.000	15.010	112.8580	174.1961	225.71
16.000	16.010	97.1935	149.9379	225.83
17.000	17.011	83.4798	128.7975	225.80
18.000	18.012	71.7644	110.7797	225.69
19.000	19.012	61.6837	95.2782	225.55
20.000	20.013	53.0202	81.9090	225.51
21.000	21.014	45.5663	70.4252	225.41
22.000	22.014	39.1718	60.5492	225.38
23.000	23.015	33.6479	51.9885	225.48
24.000	24.016	28.9383	44.6683	225.70
25.000	25.016	24.8661	38.3419	225.94
26.000	26.017	21.3843	32.9097	226.38
27.000	27.017	18.4094	28.2745	226.83
28.000	28.018	15.8548	24.2845	227.45
29.000	29.019	13.6737	20.8714	228.24
30.000	30.019	11.7646	17.9052	228.91
32.000	32.021	9.1528	13.6357	116.92
34.000	34.022	6.8681	10.1392	117.99
36.000	36.023	5.1704	7.5622	119.10
38.000	38.025	3.9002	5.6704	119.81
40.000	40.026	2.9476	4.2630	120.44
42.000	42.027	2.2305	3.2134	120.91
44.000	44.028	1.6660	2.3844	121.71
46.000	46.030	1.2636	1.7976	122.44
48.000	48.031	0.9631	1.3659	122.83
50.000	50.032	0.7190	1.0103	123.96
52.000	52.033	0.5466	0.7720	123.34
54.000	54.035	0.4004	0.5628	123.93
56.000	56.036	0.2957	0.4290	120.08
58.000	58.037	0.2385	0.3460	120.08
60.000	60.038	0.1949	0.2792	121.58
62.000	62.040	0.1468	0.2175	117.58
64.000	64.041	0.1107	0.1620	119.08
66.000	66.042	0.0000	0.0000	0.00
68.000	68.044	0.0000	0.0000	0.00
70.000	0.000	0.0000	0.0000	0.00

**TABLE D-3. March Hydrostatic Model Atmosphere, Shemya.**

Z KM	GEO. HT KM	PRESS MB	D G/M <sup>3</sup>	TV K
0.000	0.000	1001.3185	1273.0321	274.03
0.039	0.039	996.9070	1268.5745	273.78
1.000	1.001	880.4547	1153.8428	265.84
2.000	2.001	774.5012	1039.0188	259.69
3.000	3.002	678.1007	929.9631	254.03
4.000	4.003	591.4498	830.6537	248.06
5.000	5.003	514.7331	738.8135	242.72
6.000	6.004	445.9110	648.1305	239.69
7.000	7.005	385.0154	562.0390	238.65
8.000	8.005	331.0197	490.2943	235.21
9.000	9.006	284.1145	446.8827	221.49
10.000	10.006	243.5071	382.2298	221.94
11.000	11.007	208.7742	325.4811	223.46
12.000	12.008	179.3084	278.0400	224.67
13.000	13.008	154.0230	238.2023	225.27
14.000	14.009	132.3623	204.5328	225.45
15.000	15.010	113.7361	175.7799	225.42
16.000	16.010	97.8071	151.2070	225.35
17.000	17.011	84.0118	129.9173	225.28
18.000	18.012	72.1882	111.6728	225.20
19.000	19.012	62.0282	96.0250	225.04
20.000	20.013	53.3008	82.5566	224.93
21.000	21.014	45.8065	70.9826	224.82
22.000	22.014	39.3466	60.9894	224.76
23.000	23.015	33.7950	52.3914	224.72
24.000	24.016	29.0302	44.9839	224.83
25.000	25.016	24.9487	38.6189	225.06
26.000	26.017	21.4357	33.1352	225.37
27.000	27.017	18.4487	28.4688	225.76
28.000	28.018	15.8806	24.4376	226.39
29.000	29.019	13.6737	20.9749	227.11
30.000	30.019	11.7671	17.9886	227.89
32.000	32.021	8.7718	13.3655	114.32
34.000	34.022	6.5360	9.8478	115.61
36.000	36.023	4.8866	7.2558	117.31
38.000	38.025	3.6727	5.3831	118.85
40.000	40.026	2.7637	3.9817	120.91
42.000	42.027	2.0979	2.9687	123.10
44.000	44.028	1.6024	2.2392	124.66
46.000	46.030	1.2266	1.6849	126.81
48.000	48.031	0.9569	1.3017	128.05
50.000	50.032	0.7411	1.0079	128.08
52.000	52.033	0.5676	0.7717	128.12
54.000	54.035	0.4397	0.5998	127.70
56.000	56.036	0.3272	0.4413	129.15
58.000	58.037	0.2524	0.3473	126.58
60.000	60.038	0.0000	0.0000	0.00
62.000	62.040	0.0000	0.0000	0.00
64.000	64.041	0.0000	0.0000	0.00
66.000	66.042	0.0000	0.0000	0.00
68.000	68.044	0.0000	0.0000	0.00
70.000	0.000	0.0000	0.0000	0.00

**TABLE D-4. April Hydrostatic Model Atmosphere, Shemya.**

Z KM	GEO. HT KM	PRESS MB	D G/M <sup>3</sup>	TV K
0.000	0.000	1008.9765	1276.3642	275.40
0.039	0.039	1004.4958	1271.7373	275.17
1.000	1.001	889.2720	1155.5613	268.10
2.000	2.001	782.1790	1035.1281	263.25
3.000	3.002	686.2437	925.7855	258.24
4.000	4.003	599.9592	828.1503	252.39
5.000	5.003	523.3048	740.0227	246.36
6.000	6.004	454.6890	655.7600	241.56
7.000	7.005	393.6659	572.7354	239.46
8.000	8.005	339.1406	496.2837	238.07
9.000	9.006	291.6276	432.1601	235.09
10.000	10.006	250.1405	393.5893	221.41
11.000	11.007	214.2249	336.8143	221.58
12.000	12.008	183.6583	287.8797	222.26
13.000	13.008	157.4826	246.5383	222.54
14.000	14.009	135.0501	211.4980	222.46
15.000	15.010	115.7992	181.4785	222.30
16.000	16.010	99.3964	155.8055	222.25
17.000	17.011	85.1370	133.3790	222.38
18.000	18.012	73.0152	114.3794	222.39
19.000	19.012	62.6208	98.0972	222.39
20.000	20.013	53.6969	84.1517	222.30
21.000	21.014	46.0586	72.1991	222.25
22.000	22.014	39.4870	61.9162	222.18
23.000	23.015	33.8565	53.0891	222.17
24.000	24.016	29.0476	45.5182	222.32
25.000	25.016	24.9061	39.0054	222.45
26.000	26.017	21.3610	33.4178	222.69
27.000	27.017	18.3347	28.6188	223.19
28.000	28.018	15.7609	24.5135	223.99
29.000	29.019	13.5444	20.9863	224.84
30.000	30.019	11.6321	17.9574	225.67
32.000	32.021	8.7577	13.3589	114.20
34.000	34.022	6.5277	9.7552	116.56
36.000	36.023	4.9046	7.1423	119.62
38.000	38.025	3.7144	5.2672	122.84
40.000	40.026	2.8276	3.9147	125.82
42.000	42.027	2.1733	2.9339	129.03
44.000	44.028	1.6793	2.2306	131.14
46.000	46.030	1.2971	1.7012	132.81
48.000	48.031	1.0031	1.3099	133.39
50.000	50.032	0.7786	1.0112	134.13
52.000	52.033	0.6058	0.7877	133.98
54.000	54.035	0.4687	0.6075	134.39
56.000	56.036	0.3540	0.4549	135.58
58.000	58.037	0.2745	0.3575	133.75
60.000	60.038	0.2167	0.2874	131.33
62.000	62.040	0.0000	0.0000	0.00
64.000	64.041	0.0000	0.0000	0.00
66.000	66.042	0.0000	0.0000	0.00
68.000	68.044	0.0000	0.0000	0.00
70.000	0.000	0.0000	0.0000	0.00

**TABLE D-5. May Hydrostatic Model Atmosphere, Shemya.**

Z KM	GEO. HT KM	PRESS MB	D G/M <sup>3</sup>	TV K
0.000	0.000	1010.0626	1268.8822	277.32
0.039	0.039	1005.6838	1264.1603	277.15
1.000	1.001	889.5971	1143.1154	271.12
2.000	2.001	785.3022	1023.3264	267.35
3.000	3.002	690.5047	915.2705	262.83
4.000	4.003	605.0782	819.2947	257.29
5.000	5.003	529.1435	734.0580	251.13
6.000	6.004	461.1113	656.3520	244.75
7.000	7.005	400.3207	580.3129	240.33
8.000	8.005	345.7519	506.1890	237.96
9.000	9.006	297.9460	439.8626	235.98
10.000	10.006	255.8828	381.0428	233.95
11.000	11.007	219.6498	325.8767	234.82
12.000	12.008	188.5737	293.5907	223.77
13.000	13.008	161.8579	251.9581	223.80
14.000	14.009	138.9070	216.6317	223.39
15.000	15.010	119.1619	186.3661	222.76
16.000	16.010	102.2482	160.2517	222.29
17.000	17.011	87.6798	137.5824	222.02
18.000	18.012	75.1734	118.0146	221.91
19.000	19.012	64.4597	101.0891	222.15
20.000	20.013	55.2791	86.5763	222.44
21.000	21.014	47.4258	74.1754	222.75
22.000	22.014	40.6939	63.5499	223.09
23.000	23.015	34.9190	54.4358	223.48
24.000	24.016	29.9755	46.6302	223.95
25.000	25.016	25.7550	39.9274	224.72
26.000	26.017	22.1234	34.1694	225.57
27.000	27.017	19.0244	29.2438	226.64
28.000	28.018	16.3840	25.0354	227.99
29.000	29.019	14.1159	21.4423	229.35
30.000	30.019	12.1641	18.3401	231.07
32.000	32.021	9.2607	13.7108	117.65
34.000	34.022	6.9840	10.1064	120.38
36.000	36.023	5.2974	7.5000	123.03
38.000	38.025	4.0467	5.5859	126.19
40.000	40.026	3.1114	4.2003	129.03
42.000	42.027	2.4020	3.1873	131.27
44.000	44.028	1.8774	2.4395	134.06
46.000	46.030	1.4554	1.8726	135.38
48.000	48.031	1.1386	1.4530	136.50
50.000	50.032	0.8858	1.1309	136.44
52.000	52.033	0.6977	0.8889	136.73
54.000	54.035	0.5406	0.6958	135.33
56.000	56.036	0.4278	0.5599	133.08
58.000	58.037	0.0000	0.0000	0.00
60.000	60.038	0.0000	0.0000	0.00
62.000	62.040	0.0000	0.0000	0.00
64.000	64.041	0.0000	0.0000	0.00
66.000	66.042	0.0000	0.0000	0.00
68.000	68.044	0.0000	0.0000	0.00
70.000	0.000	0.0000	0.0000	0.00

**TABLE D-6. June Hydrostatic Model Atmosphere, Shemya.**

Z KM	GEO. HT KM	PRESS MB	D G/M <sup>3</sup>	TV K
0.000	0.000	1010.6891	1259.7156	279.51
0.039	0.039	1006.3941	1254.8640	279.40
1.000	1.001	893.6358	1125.7350	276.56
2.000	2.001	789.2492	1006.7090	273.13
3.000	3.002	695.8346	903.6009	268.28
4.000	4.003	611.4581	810.7996	262.73
5.000	5.003	536.1625	727.9702	256.59
6.000	6.004	468.6183	653.3599	249.88
7.000	7.005	408.0433	584.3692	243.26
8.000	8.005	353.5293	515.6772	238.84
9.000	9.006	305.2668	449.6420	236.52
10.000	10.006	262.4945	388.7594	235.23
11.000	11.007	225.3888	333.9551	235.13
12.000	12.008	193.440	301.025	223.87
13.000	13.008	166.0476	257.7571	224.43
14.000	14.009	142.5825	221.6532	224.10
15.000	15.010	122.3660	190.7546	223.48
16.000	16.010	105.0135	164.0885	222.96
17.000	17.011	90.0847	140.8068	222.89
18.000	18.012	77.2890	120.6875	223.11
19.000	19.012	66.3154	103.3976	223.44
20.000	20.013	56.9200	88.6292	223.74
21.000	21.014	48.8716	75.9600	224.15
22.000	22.014	41.9825	65.1052	224.65
23.000	23.015	36.0647	55.7871	225.22
24.000	24.016	30.9910	47.7879	225.93
25.000	25.016	26.6753	40.9179	227.12
26.000	26.017	22.9635	35.0204	228.44
27.000	27.017	19.7812	29.9673	229.97
28.000	28.018	17.0706	25.6875	231.52
29.000	29.019	14.7459	22.0257	233.24
30.000	30.019	12.7333	18.8862	234.88
32.000	32.021	9.8235	14.2471	120.11
34.000	34.022	7.4240	10.6018	121.98
36.000	36.023	5.6354	7.8871	124.46
38.000	38.025	4.3100	5.9134	126.96
40.000	40.026	3.3217	4.4447	130.18
42.000	42.027	2.5724	3.3792	132.60
44.000	44.028	1.9920	2.5793	134.53
46.000	46.030	1.5626	1.9968	136.32
48.000	48.031	1.2145	1.5397	137.40
50.000	50.032	0.9478	1.1978	137.83
52.000	52.033	0.7364	0.9314	137.71
54.000	54.035	0.5856	0.7468	136.58
56.000	56.036	0.4332	0.5649	133.58
58.000	58.037	0.3385	0.4516	130.58
60.000	60.038	0.2599	0.3569	126.83
62.000	62.040	0.1981	0.2815	122.58
64.000	64.041	0.1500	0.2190	119.33
66.000	66.042	0.0000	0.0000	113.08
68.000	68.044	0.0000	0.0000	0.00
70.000	0.000	0.0000	0.0000	0.00

TABLE D-7. July Hydrostatic Model Atmosphere, Shemya.

Z KM	GEO. HT KM	PRESS MB	D GM <sup>3</sup>	TV K
0.000	0.000	1013.4725	1251.1254	282.21
0.039	0.039	1009.1244	1246.0430	282.14
1.000	1.001	895.6544	1110.4865	280.99
2.000	2.001	794.3098	994.7631	278.18
3.000	3.002	701.9466	893.8798	273.58
4.000	4.003	618.4919	803.6654	268.11
5.000	5.003	543.7595	722.4396	262.22
6.000	6.004	476.7314	649.3646	255.77
7.000	7.005	416.3148	582.8465	248.84
8.000	8.005	362.0635	520.4470	242.36
9.000	9.006	313.6887	457.9389	238.64
10.000	10.006	270.5858	398.9048	236.32
11.000	11.007	232.6767	362.7803	223.44
12.000	12.008	199.6328	312.8705	222.29
13.000	13.008	171.1492	267.8825	222.58
14.000	14.009	146.8040	229.9622	222.40
15.000	15.010	125.8445	197.5357	221.95
16.000	16.010	107.8823	169.5534	221.67
17.000	17.011	92.4736	145.1437	221.96
18.000	18.012	79.2963	124.2111	222.41
19.000	19.012	68.0286	106.3132	222.93
20.000	20.013	58.3706	90.9953	223.48
21.000	21.014	50.1051	77.9064	224.06
22.000	22.014	43.0535	66.7128	224.83
23.000	23.015	36.9966	57.1167	225.66
24.000	24.016	31.7985	48.8800	226.64
25.000	25.016	27.3734	41.8594	227.82
26.000	26.017	23.5729	35.8398	229.14
27.000	27.017	20.3115	30.6767	230.67
28.000	28.018	17.5320	26.3243	232.02
29.000	29.019	15.1448	22.5958	233.50
30.000	30.019	13.0887	19.4015	235.03
32.000	32.021	10.0399	14.5829	119.93
34.000	34.022	7.6083	10.8465	122.19
36.000	36.023	5.7908	8.0946	124.62
38.000	38.025	4.4275	6.0629	127.20
40.000	40.026	3.4136	4.5563	130.50
42.000	42.027	2.6442	3.4854	132.15
44.000	44.028	2.0517	2.6695	133.80
46.000	46.030	1.5981	2.0608	135.08
48.000	48.031	1.2317	1.5737	136.33
50.000	50.032	0.9675	1.2302	136.93
52.000	52.033	0.7369	0.9398	136.58
54.000	54.035	0.5502	0.7302	136.01
56.000	56.036	0.4372	0.5641	135.00
58.000	58.037	0.3375	0.4440	132.41
60.000	60.038	0.2614	0.3500	130.08
62.000	62.040	0.1966	0.2695	127.08
64.000	64.041	0.1503	0.2127	123.08
66.000	66.042	0.1171	0.1743	117.08
68.000	68.044	0.0000	0.0000	0.00
70.000	0.000	0.0000	0.0000	0.00



**TABLE D-8. August Hydrostatic Model Atmosphere, Shemya.**

Z KM	GEO. HT KM	PRESS MB	D G/M <sup>3</sup>	TV K
0.000	0.000	1010.3854	1239.1542	284.07
0.039	0.039	1006.1379	1234.3910	283.96
1.000	1.001	893.0274	1104.4671	281.69
2.000	2.001	792.4231	992.1210	278.26
3.000	3.002	700.3039	891.7533	273.59
4.000	4.003	617.0172	801.5660	268.17
5.000	5.003	542.4600	720.5252	262.29
6.000	6.004	475.6276	647.6360	255.85
7.000	7.005	415.4199	581.2563	248.99
8.000	8.005	361.2978	518.0612	242.96
9.000	9.006	313.1252	455.5453	239.47
10.000	10.006	270.2169	396.7300	237.29
11.000	11.007	232.5484	341.2521	237.41
12.000	12.008	199.7850	302.5573	230.04
13.000	13.008	171.3839	267.8957	222.88
14.000	14.009	147.0076	231.0058	221.70
15.000	15.010	125.8937	198.6997	220.73
16.000	16.010	107.8275	170.5435	220.27
17.000	17.011	92.3384	146.0073	220.33
18.000	18.012	79.0915	124.8083	220.77
19.000	19.012	67.7805	106.6466	221.42
20.000	20.013	58.1043	91.1898	221.98
21.000	21.014	49.8174	77.9846	222.55
22.000	22.014	42.7622	66.7047	223.34
23.000	23.015	36.7089	57.0622	224.12
24.000	24.016	31.5150	48.8005	224.98
25.000	25.016	27.0903	41.7380	226.12
26.000	26.017	23.3019	35.7114	227.32
27.000	27.017	20.0653	30.5648	228.71
28.000	28.018	17.2984	26.2085	229.94
29.000	29.019	14.9215	22.4818	231.23
30.000	30.019	12.8789	19.2879	232.62
32.000	32.021	9.8271	14.5049	118.01
34.000	34.022	7.3903	10.7280	120.00
36.000	36.023	5.5928	7.9665	122.29
38.000	38.025	4.2588	5.9369	124.95
40.000	40.026	3.2626	4.4560	127.54
42.000	42.027	2.5149	3.3694	130.02
44.000	44.028	1.9425	2.5611	132.12
46.000	46.030	1.5151	1.9684	134.08
48.000	48.031	1.1752	1.5195	134.72
50.000	50.032	0.9159	1.1791	135.31
52.000	52.033	0.7087	0.9108	135.54
54.000	54.035	0.5492	0.7132	134.14
56.000	56.036	0.4337	0.5684	132.91
58.000	58.037	0.3381	0.4489	131.20
60.000	60.038	0.2603	0.3550	127.70
62.000	62.040	0.2023	0.2840	124.08
64.000	64.041	0.0000	0.0000	0.00
66.000	66.042	0.0000	0.0000	0.00
68.000	68.044	0.0000	0.0000	0.00
70.000	0.000	0.0000	0.0000	0.00

**TABLE D-9. September Hydrostatic Model Atmosphere, Shemya.**

Z KM	GEO. HT KM	PRESS MB	D G/M <sup>3</sup>	TV K
0.000	0.000	1011.3611	1243.3877	283.37
0.039	0.039	1007.0816	1238.9694	283.18
1.000	1.001	893.2640	1124.7663	276.68
2.000	2.001	790.3145	1010.7206	272.41
3.000	3.002	696.5207	907.3243	267.44
4.000	4.003	611.7907	814.2680	261.75
5.000	5.003	536.1371	731.2301	255.43
6.000	6.004	468.3711	655.8905	248.78
7.000	7.005	407.5547	584.2413	243.03
8.000	8.005	352.9379	513.3974	239.50
9.000	9.006	304.6819	446.3664	237.80
10.000	10.006	261.9560	387.7732	235.35
11.000	11.007	224.9824	333.4297	235.07
12.000	12.008	193.0574	301.6469	222.97
13.000	13.008	165.5615	259.1695	222.55
14.000	14.009	141.9978	222.9209	221.92
15.000	15.010	121.6740	191.5057	221.35
16.000	16.010	104.2645	164.3643	221.00
17.000	17.011	89.3014	140.7534	221.03
18.000	18.012	76.5121	120.5542	221.11
19.000	19.012	65.5682	103.2261	221.29
20.000	20.013	56.1893	88.4058	221.43
21.000	21.014	48.1626	75.6958	221.66
22.000	22.014	41.2938	64.7871	222.05
23.000	23.015	35.4083	55.4376	222.51
24.000	24.016	30.3804	47.4374	223.12
25.000	25.016	26.0743	40.5751	223.88
26.000	26.017	22.3864	34.7139	224.67
27.000	27.017	19.2327	29.7093	225.53
28.000	28.018	16.5272	25.4343	226.38
29.000	29.019	14.2301	21.8061	227.35
30.000	30.019	12.2362	18.6731	228.29
32.000	32.021	9.2269	13.9426	115.28
34.000	34.022	6.9187	10.2882	117.14
36.000	36.023	5.1966	7.5990	119.12
38.000	38.025	3.9181	5.6080	121.70
40.000	40.026	2.9756	4.1821	123.94
42.000	42.027	2.2756	3.1352	126.43
44.000	44.028	1.7399	2.3596	128.44
46.000	46.030	1.3411	1.7923	130.34
48.000	48.031	1.0414	1.3780	131.65
50.000	50.032	0.8070	1.0650	132.00
52.000	52.033	0.6144	0.8130	131.62
54.000	54.035	0.4720	0.6318	130.14
56.000	56.036	0.3459	0.4659	129.33
58.000	58.037	0.2676	0.3590	129.83
60.000	60.038	0.1848	0.2523	127.58
62.000	62.040	0.1415	0.1995	123.58
64.000	64.041	0.1077	0.1537	122.08
66.000	66.042	0.0000	0.0000	0.00
68.000	68.044	0.0000	0.0000	0.00
70.000	0.000	0.0000	0.0000	0.00

**TABLE D-10. October Hydrostatic Model Atmosphere, Shemya.**

Z KM	GEO. HT KM	PRESS MB	D G/M <sup>3</sup>	TV K
0.000	0.000	1009.5938	1253.9896	280.49
0.039	0.039	1005.2162	1249.5381	280.26
1.000	1.001	891.8826	1138.2221	272.98
2.000	2.001	786.0616	1022.5680	267.81
3.000	3.002	691.2732	916.4865	262.77
4.000	4.003	605.7047	821.3474	256.92
5.000	5.003	529.5550	736.1833	250.60
6.000	6.004	461.3897	657.3824	244.52
7.000	7.005	400.5201	578.8650	241.05
8.000	8.005	345.8364	503.0908	239.49
9.000	9.006	297.9146	436.3747	237.84
10.000	10.006	255.7860	375.1529	237.53
11.000	11.007	219.3165	323.8651	235.92
12.000	12.008	187.9713	295.4201	221.67
13.000	13.008	161.0851	253.5387	221.34
14.000	14.009	137.9920	217.5904	220.94
15.000	15.010	118.1656	186.5195	220.71
16.000	16.010	101.3232	160.0761	220.52
17.000	17.011	86.7583	137.0282	220.58
18.000	18.012	74.2942	117.3812	220.50
19.000	19.012	63.6367	100.5187	220.56
20.000	20.013	54.5018	86.0270	220.72
21.000	21.014	46.6967	73.6603	220.86
22.000	22.014	40.0175	63.0167	221.23
23.000	23.015	34.2909	53.8889	221.69
24.000	24.016	29.4033	46.1258	222.08
25.000	25.016	25.2160	39.4641	222.60
26.000	26.017	21.6295	33.7741	223.11
27.000	27.017	18.5860	28.9514	223.65
28.000	28.018	15.9631	24.8119	224.14
29.000	29.019	13.7123	21.2540	224.76
30.000	30.019	11.7728	18.1982	225.38
32.000	32.021	8.8355	13.5477	113.60
34.000	34.022	6.5543	9.9485	114.76
36.000	36.023	4.8953	7.3351	116.25
38.000	38.025	3.6738	5.4262	117.94
40.000	40.026	2.7535	4.0311	118.98
42.000	42.027	2.0746	2.9823	121.17
44.000	44.028	1.5767	2.2224	123.58
46.000	46.030	1.2088	1.6751	125.70
48.000	48.031	0.9439	1.2941	127.06
50.000	50.032	0.7204	0.9902	126.73
52.000	52.033	0.5497	0.7552	126.79
54.000	54.035	0.4195	0.5757	126.94
56.000	56.036	0.2983	0.4106	126.58
58.000	58.037	0.2294	0.3120	128.08
60.000	60.038	0.1765	0.2401	128.08
62.000	62.040	0.1351	0.1912	123.08
64.000	64.041	0.1027	0.1442	124.08
66.000	66.042	0.0779	0.1158	117.08
68.000	68.044	0.0580	0.0917	110.08
70.000	0.000	0.0000	0.0000	0.00

**TABLE D-11. November Hydrostatic Model Atmosphere, Shemya.**

Z KM	GEO. HT KM	PRESS MB	D G/M <sup>3</sup>	TV K
0.000	0.000	1001.9531	1260.2002	276.99
0.039	0.039	997.4668	1255.6843	276.74
1.000	1.001	883.3835	1143.3812	269.16
2.000	2.001	777.5177	1029.1623	265.20
3.000	3.002	681.9672	923.1785	257.36
4.000	4.003	595.875	826.6099	251.14
5.000	5.003	519.3912	739.0711	244.83
6.000	6.004	450.8639	650.8911	241.32
7.000	7.005	389.8831	567.9867	239.14
8.000	8.005	335.5463	492.7718	237.23
9.000	9.006	288.2571	426.8222	235.28
10.000	10.006	247.1548	362.3781	237.61
11.000	11.007	211.6855	313.2669	235.41
12.000	12.008	181.4454	284.3861	222.22
13.000	13.008	155.5661	243.6507	222.44
14.000	14.009	133.4127	208.8448	222.55
15.000	15.010	114.4124	179.2098	222.42
16.000	16.010	98.2118	153.6863	222.63
17.000	17.011	84.1652	131.6785	222.68
18.000	18.012	72.2057	113.0440	222.53
19.000	19.012	61.9377	96.9885	222.48
20.000	20.013	53.1180	83.2312	222.34
21.000	21.014	45.5779	71.3939	222.41
22.000	22.014	39.0948	61.2561	222.35
23.000	23.015	33.5195	52.5193	222.35
24.000	24.016	28.7642	45.0303	222.54
25.000	25.016	24.6516	38.5851	222.58
26.000	26.017	21.1522	33.0983	222.64
27.000	27.017	18.1761	28.3855	223.08
28.000	28.018	15.6172	24.3445	223.49
29.000	29.019	13.4094	20.8829	223.71
30.000	30.019	11.5079	17.9024	223.94
32.000	32.021	8.7007	13.5006	112.26
34.000	34.022	6.4407	9.9275	113.01
36.000	36.023	4.7800	7.2904	114.21
38.000	38.025	3.5517	5.3364	115.93
40.000	40.026	2.6590	3.9462	117.37
42.000	42.027	2.0016	2.9101	119.81
44.000	44.028	1.5075	2.1496	122.16
46.000	46.030	1.1505	1.6181	123.85
48.000	48.031	0.8763	1.2141	125.72
50.000	50.032	0.6755	0.9267	126.96
52.000	52.033	0.5189	0.7039	128.41
54.000	54.035	0.4030	0.5407	129.83
56.000	56.036	0.3123	0.4152	131.02
58.000	58.037	0.2462	0.3285	130.58
60.000	60.038	0.2011	0.2672	131.08
62.000	62.040	0.1553	0.2103	128.58
64.000	64.041	0.1192	0.1661	125.08
66.000	66.042	0.0908	0.1309	120.83
68.000	68.044	0.0746	0.1105	117.58
70.000	0.000	0.0000	0.0000	0.00

TABLE D-12. December Hydrostatic Model Atmosphere, Shemya.

Z KM	GEO. HT KM	PRESS MB	D G/M <sup>3</sup>	TV K
0.000	0.000	997.9191	1266.1042	274.59
0.039	0.039	993.4582	1261.5955	274.34
1.000	1.001	877.7533	1146.6509	266.69
2.000	2.001	772.4221	1033.3034	260.43
3.000	3.002	676.4983	925.9430	254.53
4.000	4.003	590.1692	828.9106	248.04
5.000	5.003	513.5416	737.9075	242.46
6.000	6.004	444.8502	646.4518	239.74
7.000	7.005	383.8734	563.8908	237.16
8.000	8.005	329.8459	485.6958	236.59
9.000	9.006	282.9643	446.5749	220.75
10.000	10.006	242.4621	382.9784	220.56
11.000	11.007	207.7425	326.1866	221.88
12.000	12.008	178.1924	278.2899	223.07
13.000	13.008	152.9030	238.2377	223.60
14.000	14.009	131.2406	204.1875	223.92
15.000	15.010	112.6567	175.0701	224.18
16.000	16.010	96.7729	150.1492	224.54
17.000	17.011	83.0901	128.8584	224.64
18.000	18.012	71.3716	110.6965	224.62
19.000	19.012	61.3073	95.0651	224.67
20.000	20.013	52.6652	81.6573	224.69
21.000	21.014	45.2409	70.0997	224.84
22.000	22.014	38.8841	60.1852	225.08
23.000	23.015	33.4034	51.6771	225.19
24.000	24.016	28.7118	44.3721	225.43
25.000	25.016	24.6810	38.1112	225.61
26.000	26.017	21.2191	32.7427	225.77
27.000	27.017	18.2482	28.1738	225.65
28.000	28.018	15.6803	24.2246	225.50
29.000	29.019	13.5092	20.8297	225.95
30.000	30.019	11.6227	17.9119	226.06
32.000	32.021	8.8186	13.5318	113.52
34.000	34.022	6.5468	10.0781	113.16
36.000	36.023	4.8616	7.4358	113.89
38.000	38.025	3.5970	5.4837	114.26
40.000	40.026	2.6416	4.0151	114.60
42.000	42.027	1.9703	2.9730	115.44
44.000	44.028	1.4540	2.1721	116.60
46.000	46.030	1.0985	1.6010	119.52
48.000	48.031	0.8302	1.2021	120.31
50.000	50.032	0.6222	0.8817	122.93
52.000	52.033	0.4726	0.6567	125.35
54.000	54.035	0.3781	0.5282	124.68
56.000	56.036	0.2346	0.3105	131.58
58.000	58.037	0.0000	0.0000	0.00
60.000	60.038	0.0000	0.0000	0.00
62.000	62.040	0.0000	0.0000	0.00
64.000	64.041	0.0000	0.0000	0.00
66.000	66.042	0.0000	0.0000	0.00
68.000	68.044	0.0000	0.0000	0.00
70.000	0.000	0.0000	0.0000	0.00

**TABLE D-13. Annual Hydrostatic Model Atmosphere, Shemya.**

Z KM	GEO. HT KM	PRESS MB	D G/M <sup>3</sup>	TV K
0.000	0.000	1006.2500	1261.2783	277.94
0.039	0.039	1001.8640	1256.6662	277.75
1.000	1.001	887.1281	1136.9859	271.82
2.000	2.001	782.5938	1021.1634	266.99
3.000	3.002	687.8079	915.3402	261.78
4.000	4.003	602.3748	820.0530	255.91
5.000	5.003	526.3657	732.4034	250.38
6.000	6.004	458.2658	647.2701	246.65
7.000	7.005	397.5008	568.2610	243.70
8.000	8.005	343.1656	496.5643	240.76
9.000	9.006	295.5517	431.7953	238.46
10.000	10.006	253.9058	373.8165	236.63
11.000	11.007	217.7707	320.9986	236.35
12.000	12.008	186.8966	283.0390	230.04
13.000	13.008	160.3327	249.9750	223.45
14.000	14.009	137.6171	214.6836	223.32
15.000	15.010	118.0449	184.3510	223.08
16.000	16.010	101.5060	158.6668	222.88
17.000	17.011	86.9336	135.8357	222.96
18.000	18.012	74.5867	116.5165	223.01
19.000	19.012	64.0067	99.9261	223.15
20.000	20.013	54.9227	85.6906	223.29
21.000	21.014	47.1562	73.5089	223.49
22.000	22.014	40.4794	63.0223	223.77
23.000	23.015	34.7456	54.0128	224.11
24.000	24.016	29.8606	46.3234	224.57
25.000	25.016	25.6421	39.6784	225.14
26.000	26.017	22.0361	34.0017	225.78
27.000	27.017	18.9829	29.1819	226.62
28.000	28.018	16.3357	25.0242	227.42
29.000	29.019	14.0774	21.4729	228.40
30.000	30.019	12.1125	18.4057	229.27
32.000	32.021	9.1182	13.7287	115.69
34.000	34.022	6.8238	10.1463	117.15
36.000	36.023	5.1257	7.5045	118.98
38.000	38.025	3.8715	5.5761	120.94
40.000	40.026	2.9382	4.1570	123.12
42.000	42.027	2.2387	3.1195	125.01
44.000	44.028	1.7121	2.3502	126.90
46.000	46.030	1.3167	1.7836	128.59
48.000	48.031	1.0113	1.3612	129.41
50.000	50.032	0.7796	1.0440	130.07
52.000	52.033	0.5944	0.7955	130.16
54.000	54.035	0.4547	0.6109	129.65
56.000	56.036	0.3504	0.4694	130.03
58.000	58.037	0.2756	0.3718	129.12
60.000	60.038	0.2400	0.3236	129.20
62.000	62.040	0.1759	0.2455	124.83
64.000	64.041	0.1348	0.1917	122.50
66.000	66.042	0.0908	0.1309	120.83
68.000	68.044	0.0699	0.1043	116.75
70.000	0.000	0.0000	0.0000	0.00

## APPENDIX E

### Wind Statistics Derivable from Appendix A Tables

Appendix E gives a few graphic examples of certain wind statistics that can be derived from basic data in Appendix A. These examples should help RRA users understand the functional relationships of the probability wind models and develop an appreciation for the powerful properties of the bivariate normal probability distribution function. Only a few of the many options in deriving wind statistics are illustrated here.

All illustrations for this appendix were derived for the five wind component statistical parameters from Table A-1 (January) and Table A-7 (July) for eight selected altitudes; these are: 4, 12, 20, 30, 40, 50, 60, and 70 km. Descriptions of Tables E-1 and E-2 and Figures E-1 through E-64 follow:

#### **Wind Speed (Tables E-1 and E-2)**

The five wind components from Appendix A are used as inputs to the generalized Rayleigh probability density function (equation 29), then integrated as indicated by equation 30 to obtain the probability distribution function for wind speed. The derived distribution functions for wind speed are shown in Tables E-1 and E-2 on the normal probability scale.

#### **Frequency of Wind Direction (Figures E-1 through E-16)**

The derived frequencies for wind direction shown in Figures E-1 through E-16 were obtained using the five wind component parameters from Tables A-1 and A-7 as input values in equation 35. The limits of integration (performed numerically) are over the 22.5-degree interval for each of the 16 compass points. The graphs give the percentage frequency that the wind will blow from the direction intervals.

#### **Mean Wind Components and 80th Interpercentile Range of Wind Components (Figures E-17 through E-32)**

Wind component means with respect to any orthogonal axis are obtained by using the zonal and meridional mean wind components in equations 44 and 45. These component means form the circle shown in Figures E-17 through E-32. The zonal and meridional wind component variances and correlation coefficients are then used in equations 46 and 47 to obtain the variances with respect to any orthogonal axis. These rotated component variances and the rotated component means are used in equation 8 to obtain the 80th interpercentile range of wind components, as shown in Figures E-17 through E-32.

#### **Probability Ellipses (Figures E-33 through E-48)**

Using the five wind component parameters from Tables A-1 and A-7, and  $p = 0.50$ ,  $p = 0.95$ , and  $p = 0.99$  as input values to equation 13, the wind probability ellipses shown in Figures E-33 through E-48 were produced with computer graphics, using the standard meteorological coordinate system explained in Chapter 1. Statistical inferences are, for example, that 50 percent of the wind vectors lie within the smaller ellipse, and that 99 percent lie within the outer ellipse.

### **Conditional Wind Speed Given Wind Direction (Figures E-49 through E-64)**

The five wind component parameters from Tables A-1 and A-7 were used to evaluate the conditional probability distribution function, equation 41. Interpolations of the conditional function are made to obtain the 5th, 15th, 50th (median), 85th, 95th, and 99th conditional percentile values of wind speed, given wind directions, are as shown in Figures E-49 through E-64. The conditional mean wind speed, given wind direction, is obtained from equation 40. The conditional mode (most probable) wind speed given wind direction is obtained from equation 38. The conditional mean wind speed and the conditional wind speed modal value, given the wind direction, are also shown. For some figures, conditional wind speed values are invalid for a given wind direction near 270 degrees (from the west); this is caused by the lack of computational precision in evaluating equations 40 and 41 when arguments for the Gaussian probability distribution have large negative values; i.e., when the coefficients (b/a) become less than -4 in these equations.

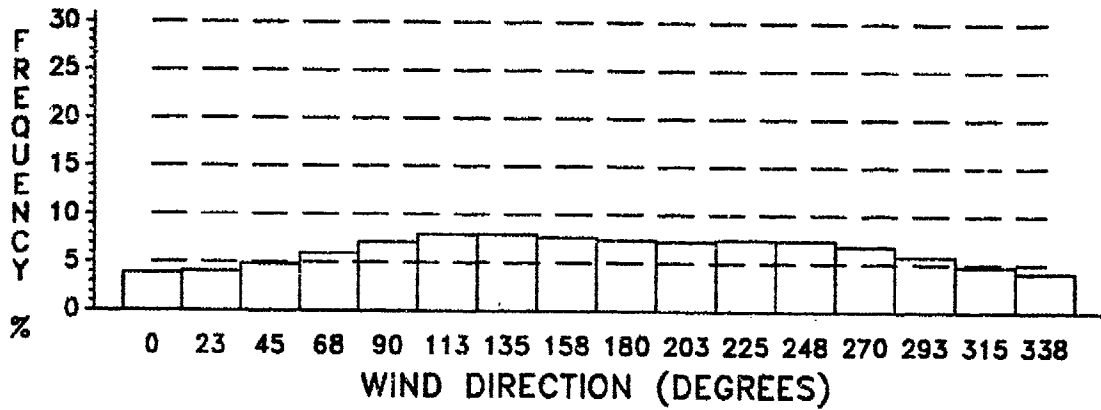


**TABLE E-1. Derived (Rayleigh) Percentiles for Windspeed (M/S), January.**

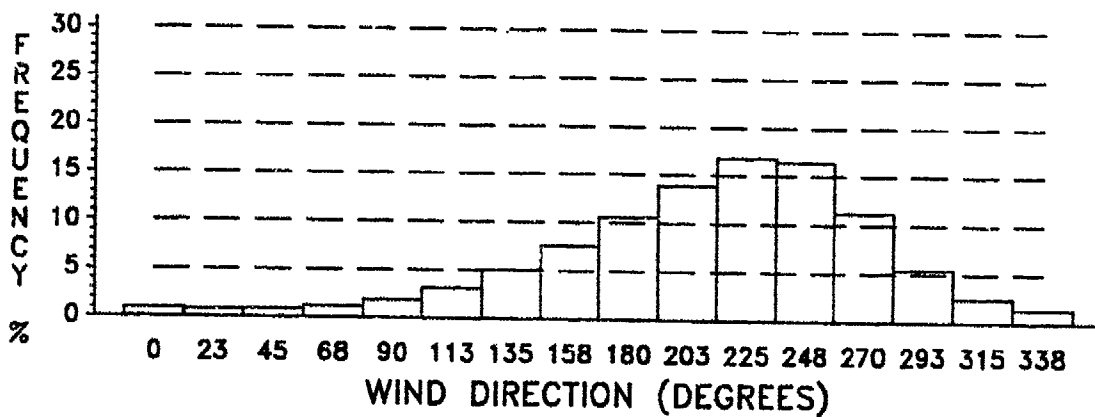
PERCENTILE	ALTITUDE (KM)							
	4 KM	12 KM	20 KM	30 KM	40 KM	50 KM	60 KM	70 KM
0.010	1.450	1.746	1.595	2.034	4.035	6.379	0.000	0.000
0.025	2.294	2.774	2.518	3.245	6.384	10.127	0.000	0.000
0.050	3.263	3.942	3.588	4.618	9.096	14.436	0.000	0.000
0.100	4.679	5.618	5.148	6.628	13.049	20.730	0.000	0.000
0.150	5.812	6.938	6.393	8.234	16.225	25.766	0.000	0.000
0.200	6.812	8.088	7.494	9.655	19.020	30.214	0.000	0.000
0.300	8.616	10.119	9.484	12.227	24.105	38.300	0.000	0.000
0.400	10.312	11.985	11.362	14.661	28.926	45.937	0.000	0.000
0.500	12.015	13.819	13.257	17.115	33.797	53.673	0.000	0.000
0.600	13.816	15.723	15.272	19.730	39.007	61.926	0.000	0.000
0.700	15.844	17.817	17.545	22.693	44.936	71.312	0.000	0.000
0.800	18.329	20.344	20.340	26.363	52.296	82.986	0.000	0.000
0.850	19.909	21.923	22.117	28.720	57.062	90.480	0.000	0.000
0.900	21.948	23.942	24.408	31.793	63.278	100.307	0.000	0.000
0.950	25.056	26.996	27.874	36.547	72.933	115.491	0.000	0.000
0.975	27.828	29.708	30.949	40.837	81.718	129.228	0.000	0.000
0.990	31.130	32.896	34.575	46.034	92.493	145.661	0.000	0.000

**TABLE E-2. Derived (Rayleigh) Percentiles for Windspeed (M/S), July.**

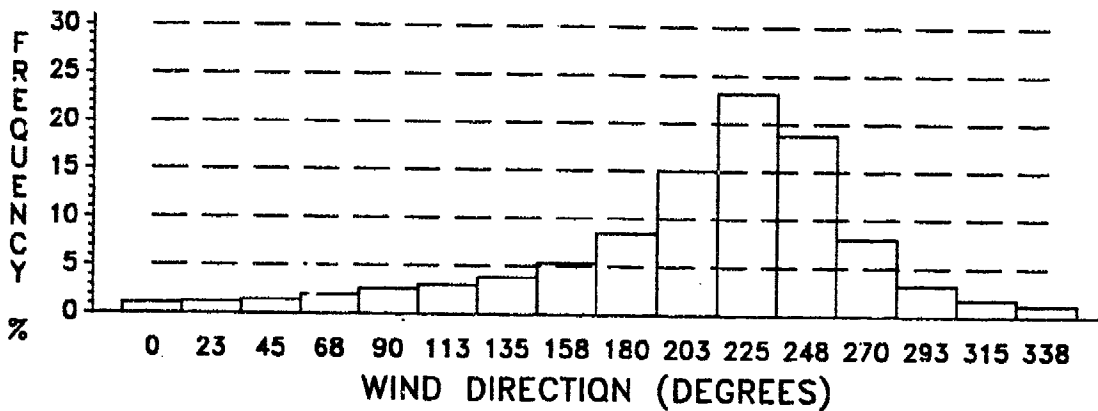
PERCENTILE	ALTITUDE (KM)							
	4 KM	12 KM	20 KM	30 KM	40 KM	50 KM	60 KM	70 KM
0.010	1.314	2.603	0.469	5.320	13.817	13.884	0.000	0.000
0.025	2.085	4.111	0.747	6.164	14.878	17.503	0.000	0.000
0.050	2.970	5.337	1.063	6.888	15.804	20.663	0.000	0.000
0.100	4.257	8.347	1.522	7.732	16.891	24.350	0.000	0.000
0.150	5.284	10.330	1.888	8.301	17.640	26.869	0.000	0.000
0.200	6.188	12.066	2.211	8.755	18.245	28.881	0.000	0.000
0.300	7.817	15.154	2.790	9.498	19.249	32.177	0.000	0.000
0.400	9.348	18.021	3.332	10.134	20.131	35.003	0.000	0.000
0.500	10.879	20.851	3.873	10.730	20.974	37.660	0.000	0.000
0.600	12.497	23.811	4.444	11.327	21.838	40.320	0.000	0.000
0.700	14.308	27.086	5.081	11.967	22.790	43.184	0.000	0.000
0.800	16.519	31.052	5.859	12.718	23.940	46.538	0.000	0.000
0.850	17.917	33.542	6.352	13.179	24.666	48.607	0.000	0.000
0.900	19.724	36.728	6.984	13.762	25.602	51.206	0.000	0.000
0.950	22.464	41.574	7.951	14.625	27.038	55.083	0.000	0.000
0.975	24.890	45.859	8.821	15.371	28.331	58.441	0.000	0.000
0.990	27.817	50.975	9.850	16.255	29.876	62.383	0.000	0.000



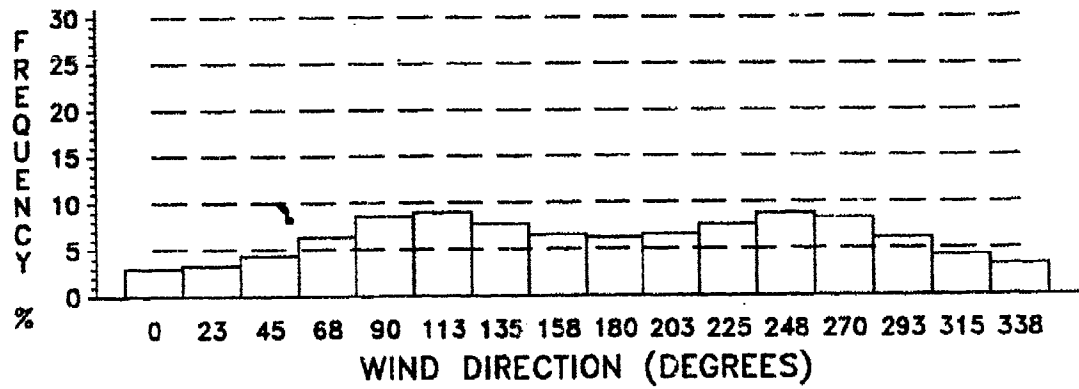
**Figure E-1. Wind Direction Frequency, January, 4 KM.**



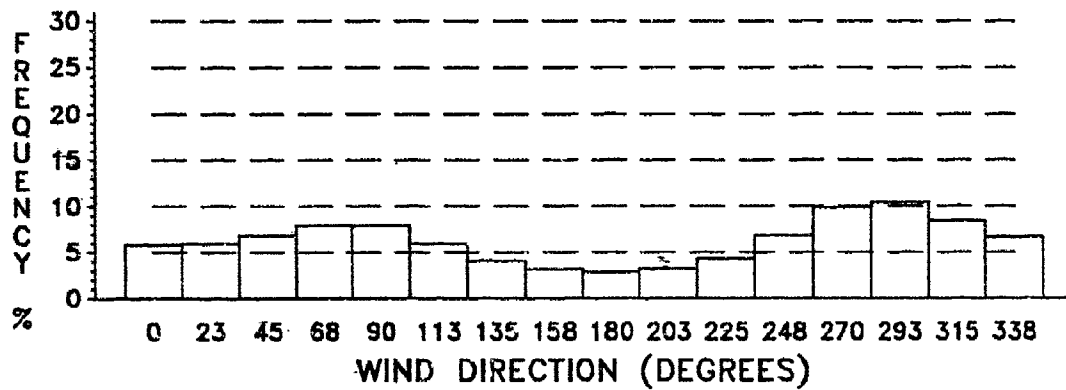
**Figure E-2. Wind Direction Frequency, January, 12 KM.**



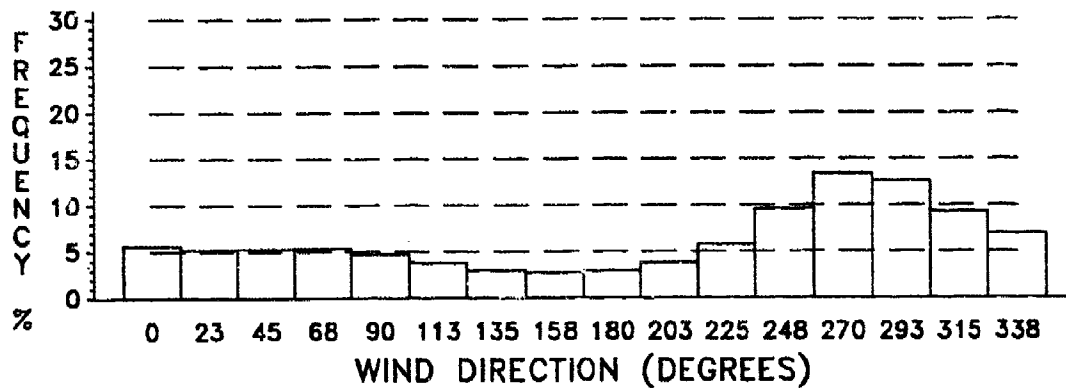
**Figure E-3. Wind Direction Frequency, January, 20 KM.**



**Figure E-4. Wind Direction Frequency, January, 30 KM.**



**Figure E-5. Wind Direction Frequency, January, 40 KM.**



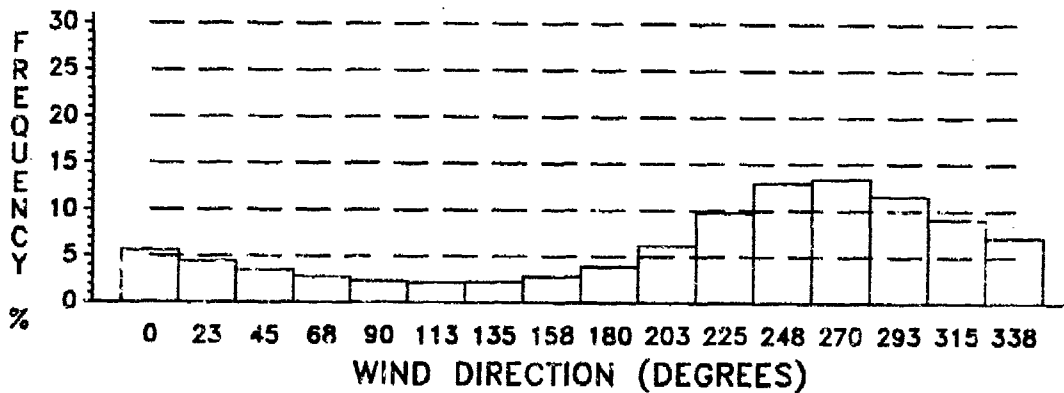
**Figure E-6. Wind Direction Frequency, January, 50 KM.**

**NO DATA AVAILABLE**

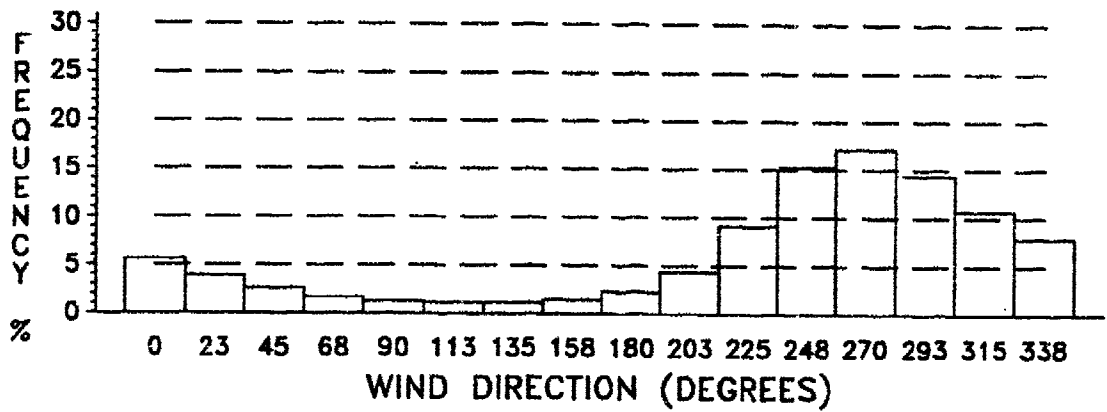
**Figure E-7. Wind Direction Frequency, January, 60 KM.**

**NO DATA AVAILABLE**

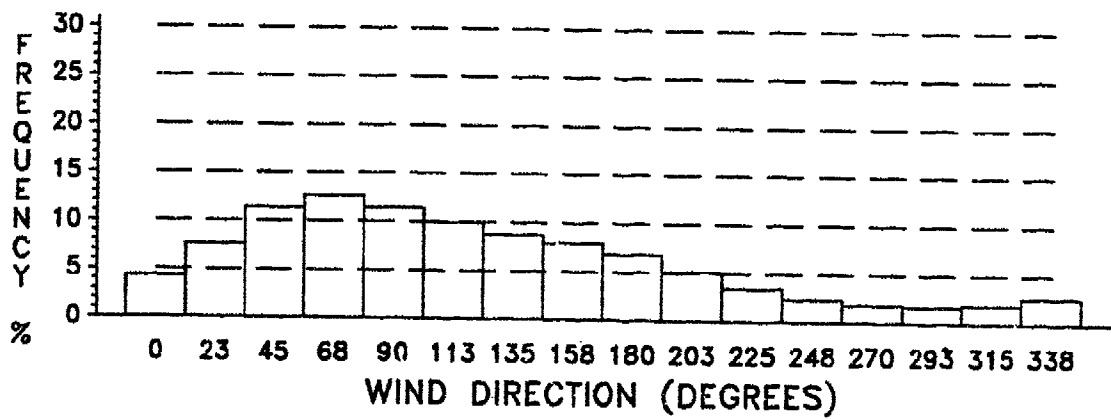
**Figure E-8. Wind Direction Frequency, January, 70 KM.**



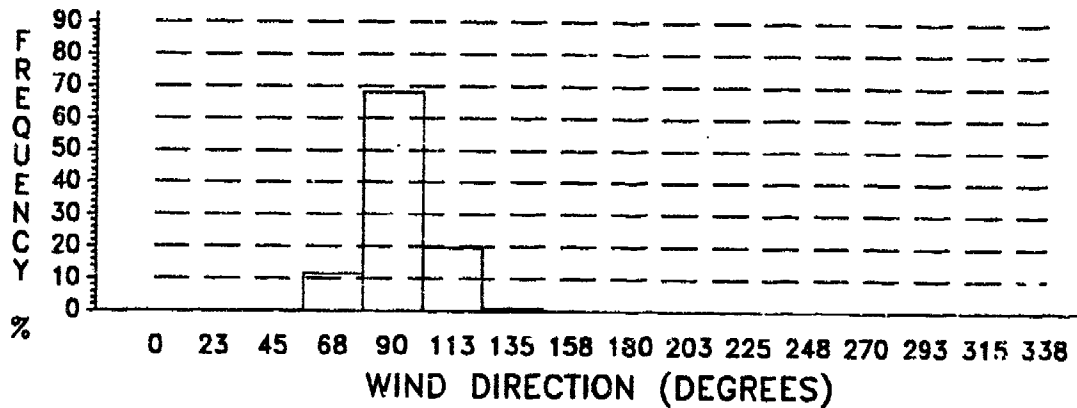
**Figure E-9. Wind Direction Frequency, July, 4 KM.**



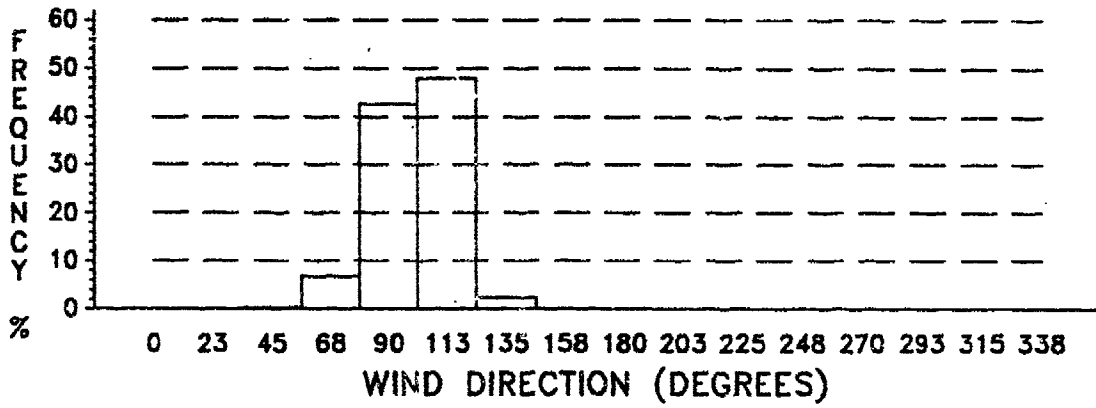
**Figure E-10. Wind Direction Frequency, July, 12 KM.**



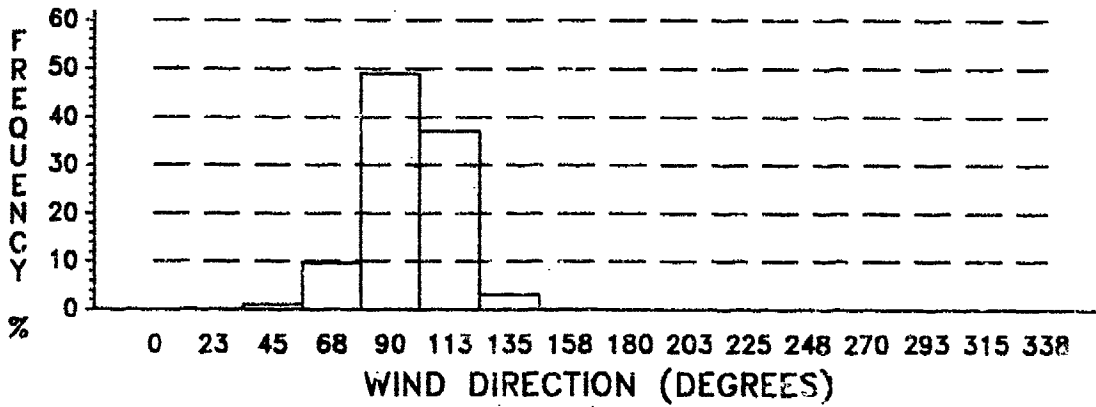
**Figure E-11. Wind Direction Frequency, July, 20 KM.**



**Figure E-12. Wind Direction Frequency, July, 30 KM.**



**Figure E-13. Wind Direction Frequency, July, 40 KM.**



**Figure E-14. Wind Direction Frequency, July, 50 KM.**

**NO DATA AVAILABLE**

**Figure E-15. Wind Direction Frequency, July, 60 KM.**

**NO DATA AVAILABLE**

**Figure E-16. Wind Direction Frequency, July, 70 KM.**

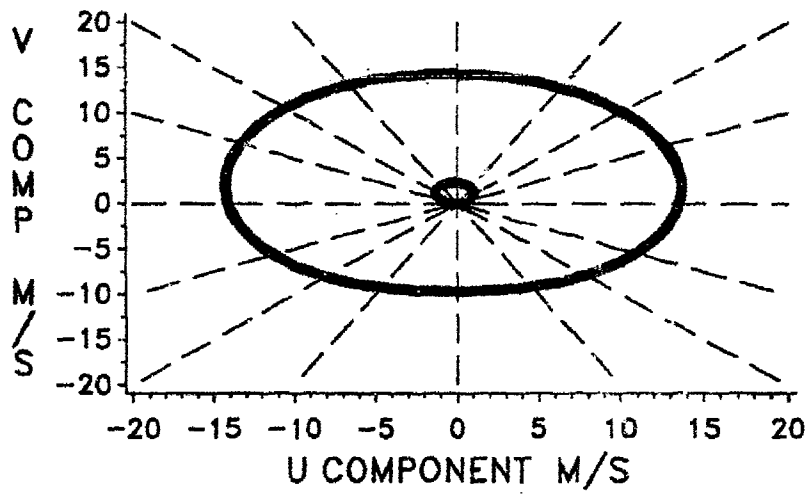


Figure E-17. Wind Interpercentile Range and Mean, January, 4 KM.

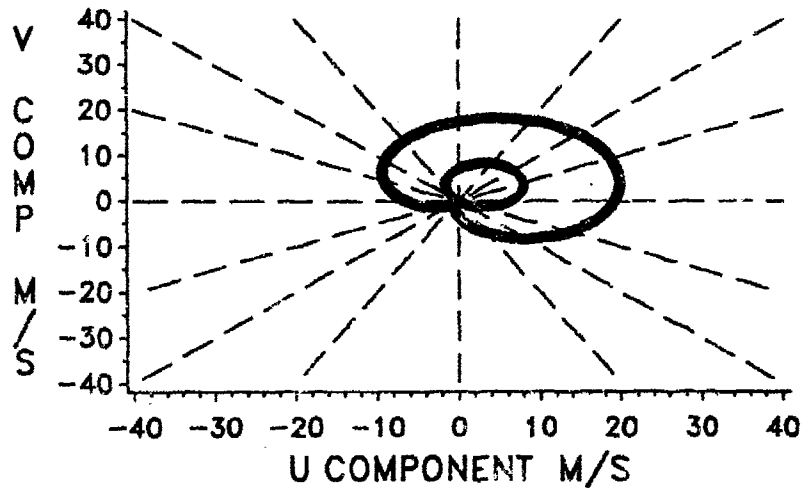


Figure E-18. Wind Interpercentile Range and Mean, January, 12 KM.

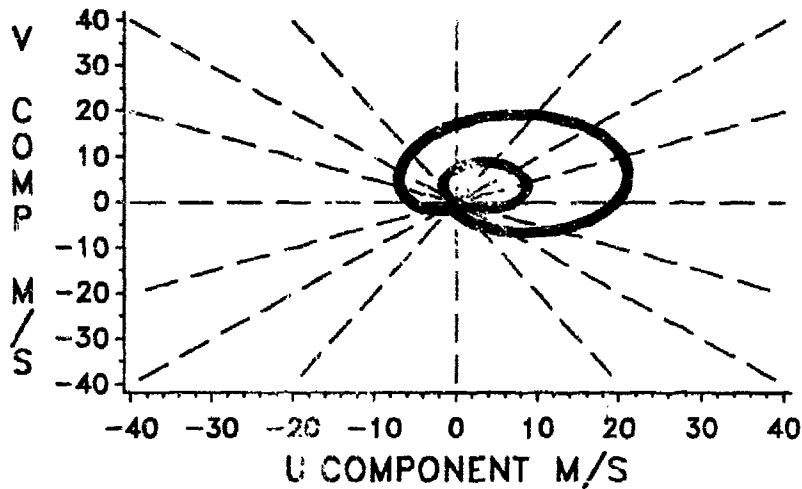


Figure E-19. Wind Interpercentile Range and Mean, January, 20 KM.



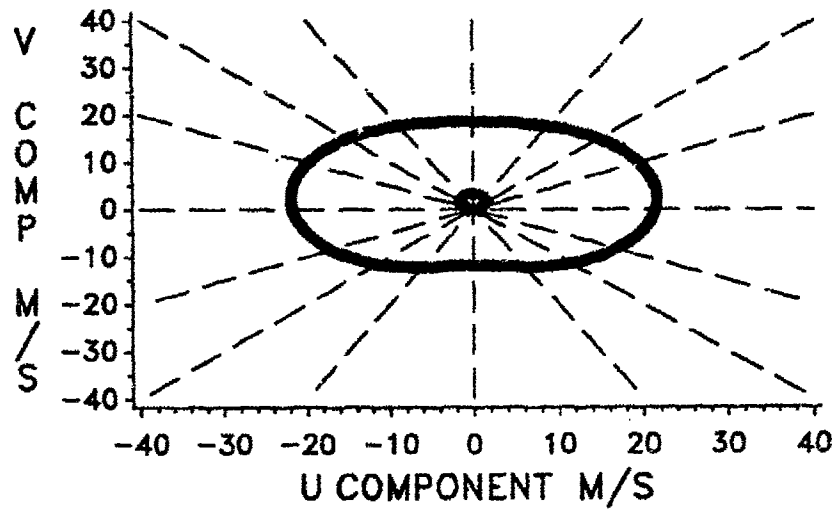


Figure E-20. Wind Interpercentile Range and Mean, January, 30 KM.

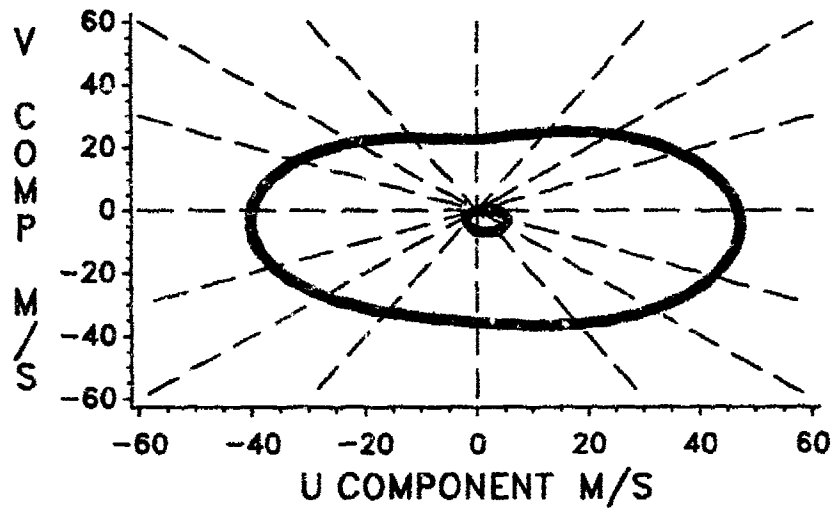


Figure E-21. Wind Interpercentile Range and Mean, January, 40 KM.

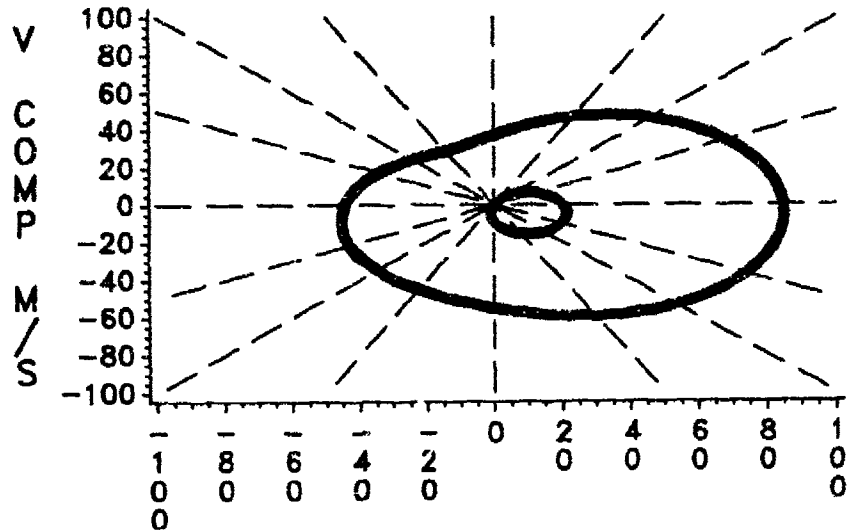


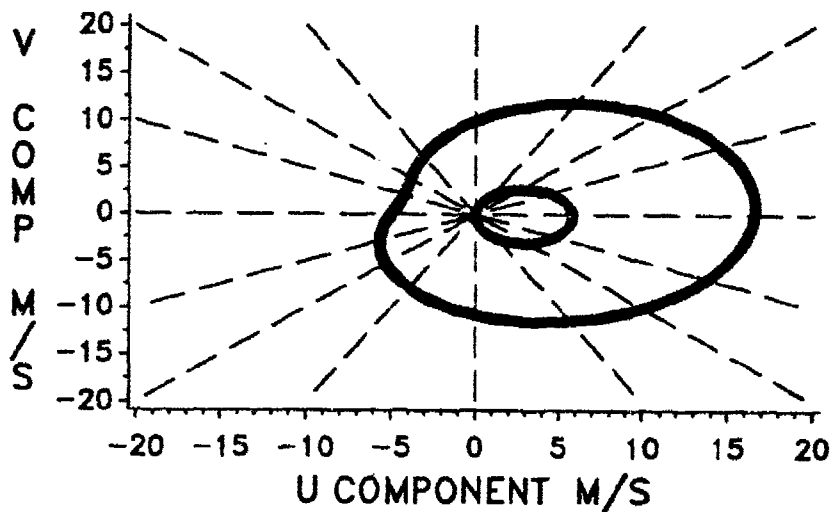
Figure E-22. Wind Interpercentile Range and Mean, January, 50 KM.

**NO DATA AVAILABLE**

**Figure E-23. Wind Interpercentile Range and Mean, January, 60 KM.**

**NO DATA AVAILABLE**

**Figure E-24. Wind Interpercentile Range and Mean, January, 70 KM.**



**Figure E-25. Wind Interpercentile Range and Mean, July, 4 KM.**

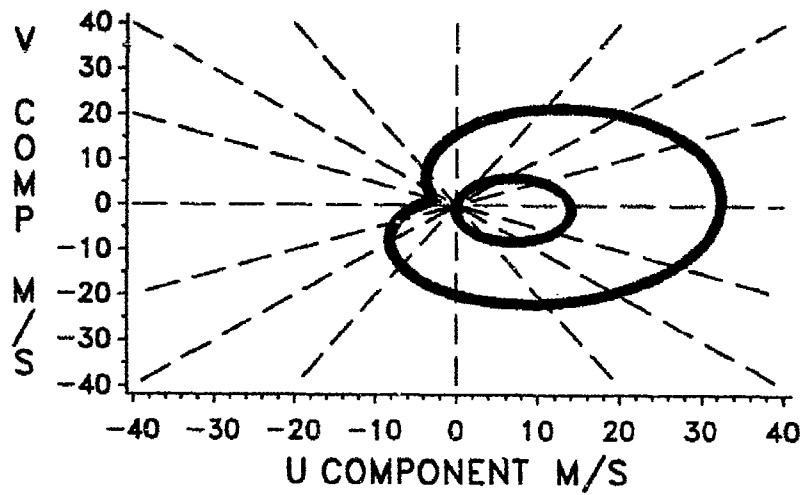


Figure E-26. Wind Interpercentile Range and Mean, July, 12 KM.

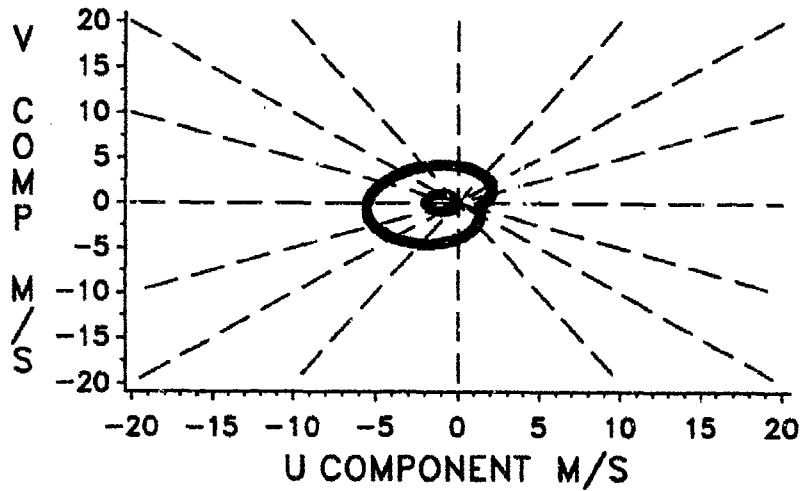


Figure E-27. Wind Interpercentile Range and Mean, July, 20 KM.

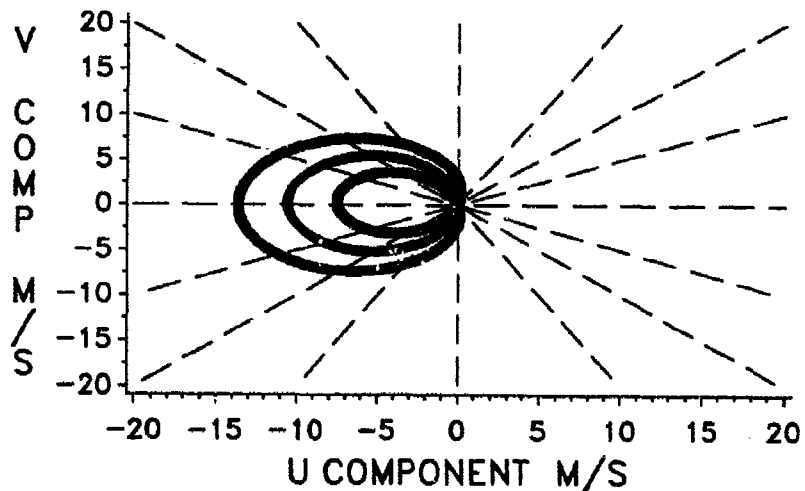
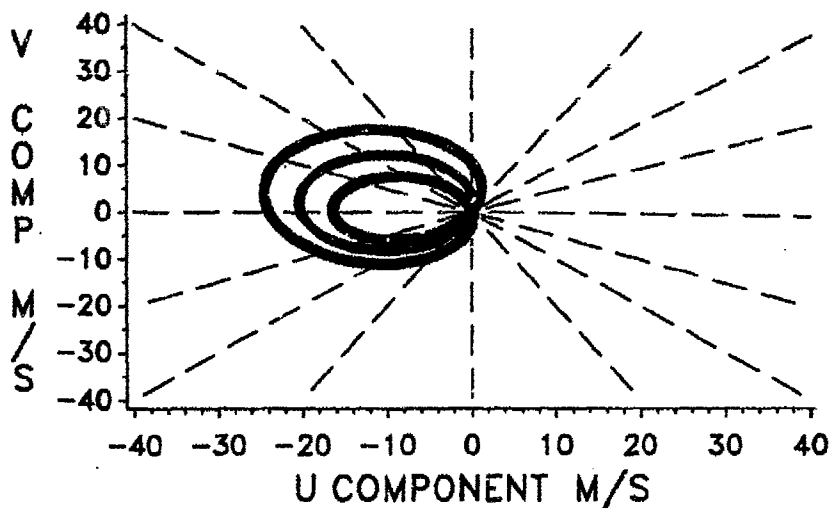
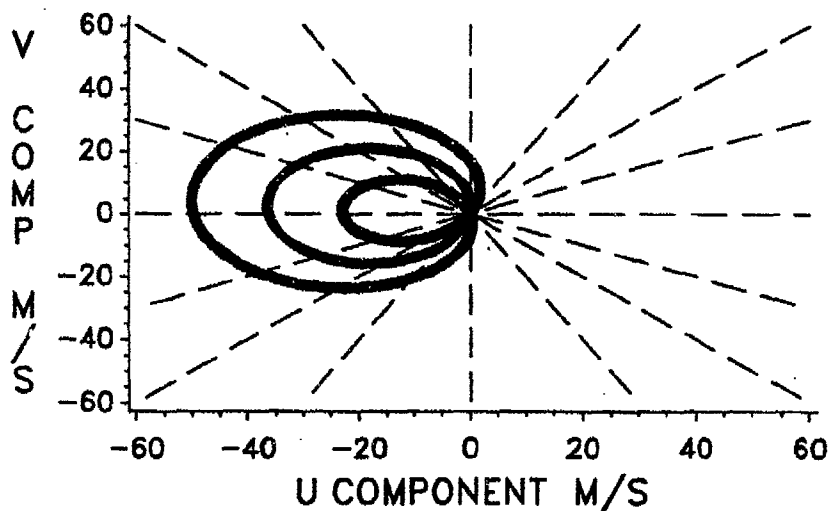


Figure E-28. Wind Interpercentile Range and Mean, July, 30 KM.



**Figure E-29. Wind Interpercentile Range and Mean, July, 40 KM.**



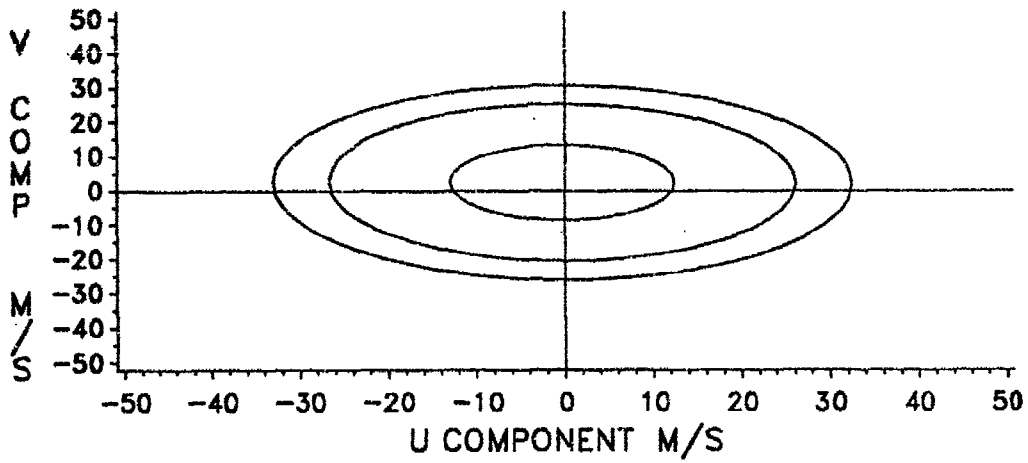
**Figure E-30. Wind Interpercentile Range and Mean, July, 50 KM.**

**NO DATA AVAILABLE**

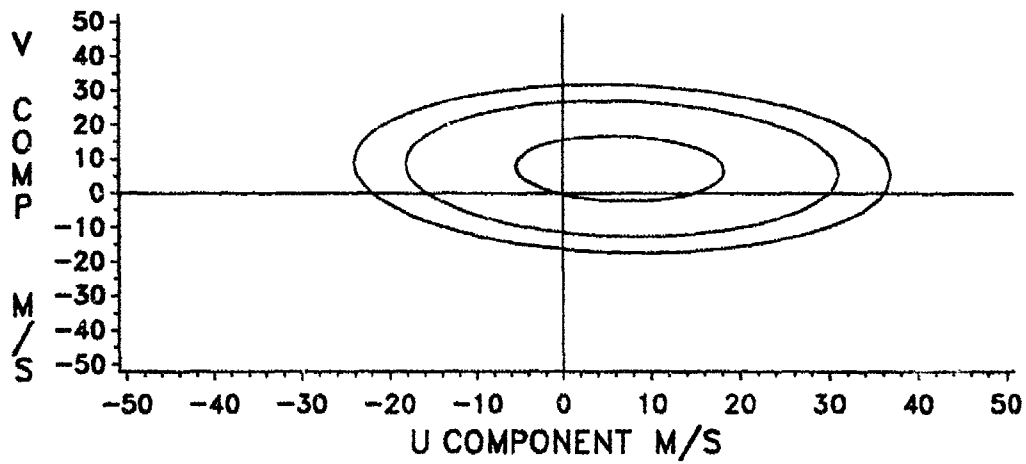
**Figure E-31. Wind Interpercentile Range and Mean, July, 60 KM.**

**NO DATA AVAILABLE**

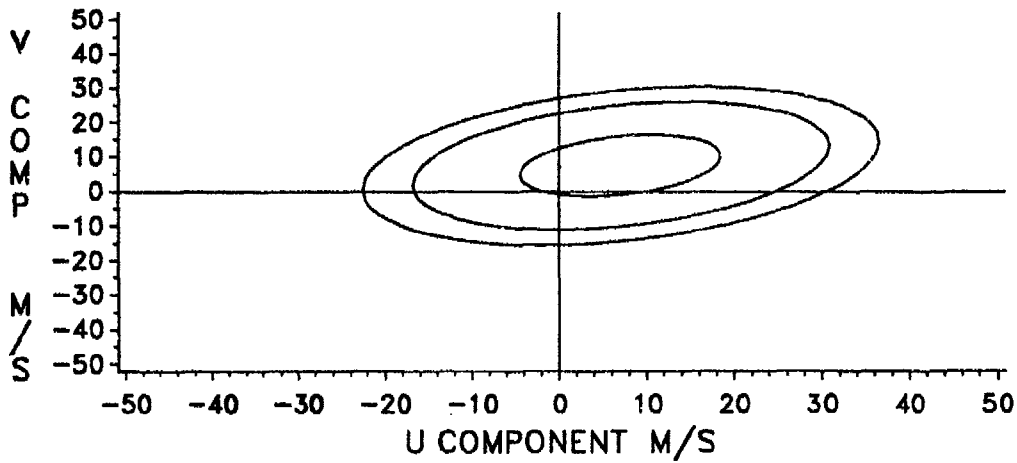
**Figure E-32. Wind Interpercentile Range and Mean, July, 70 KM.**



**Figure E-33. Wind Probability Ellipses, January, 4 KM.**



**Figure E-34. Wind Probability Ellipses, January, 12 KM.**



**Figure E-35. Wind Probability Ellipses, January, 20 KM.**

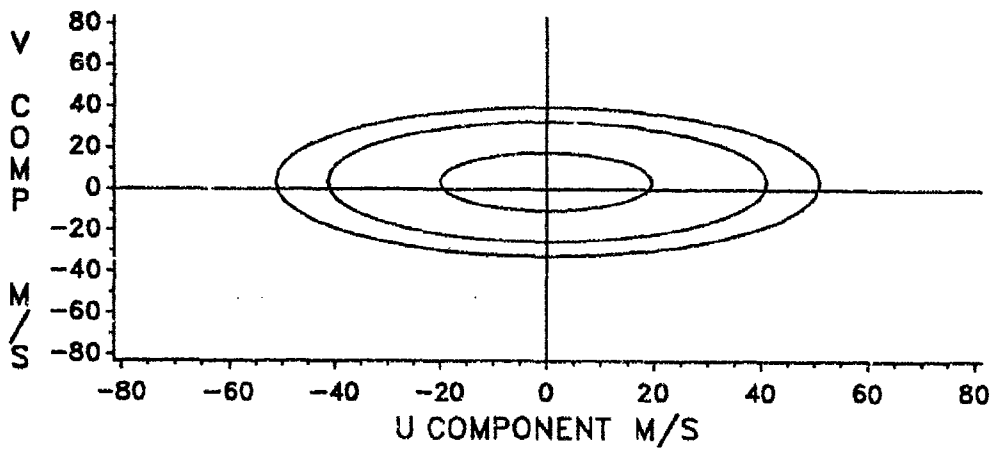


Figure E-36. Wind Probability Ellipses, January, 30 KM.

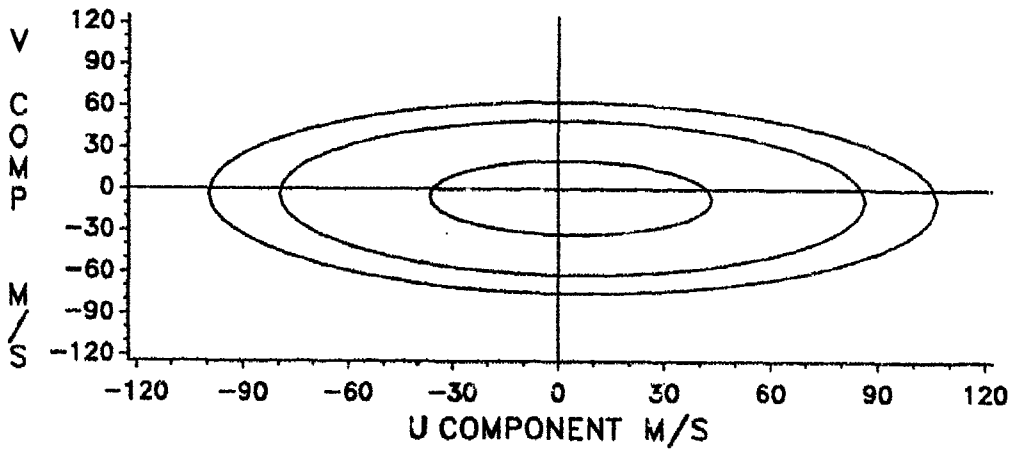


Figure E-37. Wind Probability Ellipses, January, 40 KM.

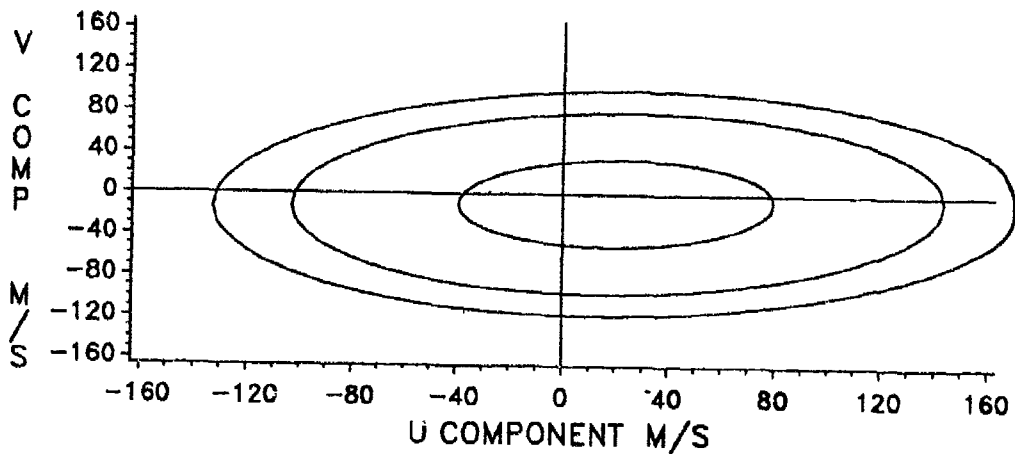


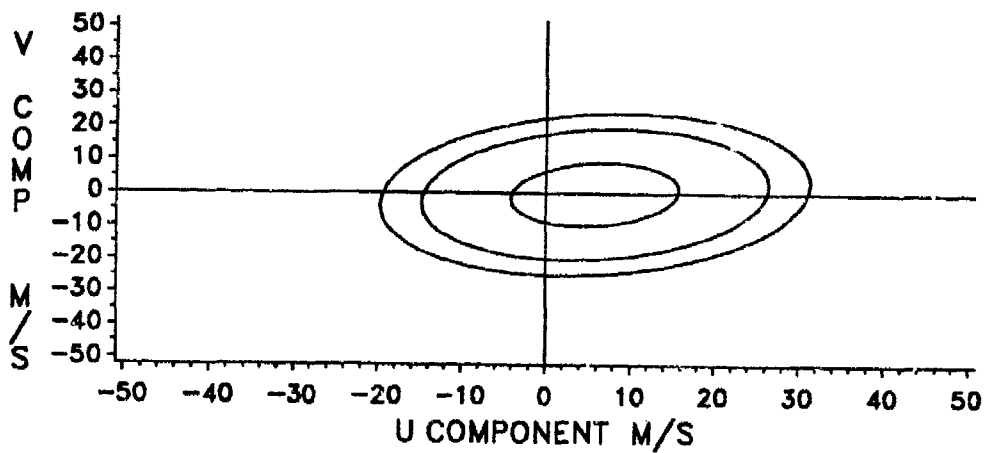
Figure E-38. Wind Probability Ellipses, January, 50 KM.

**NO DATA AVAILABLE**

**Figure E-39. Wind Probability Ellipses, January, 60 KM.**

**NO DATA AVAILABLE**

**Figure E-40. Wind Probability Ellipses, January, 70 KM.**



**Figure E-41. Wind Probability Ellipses, July, 4 KM.**



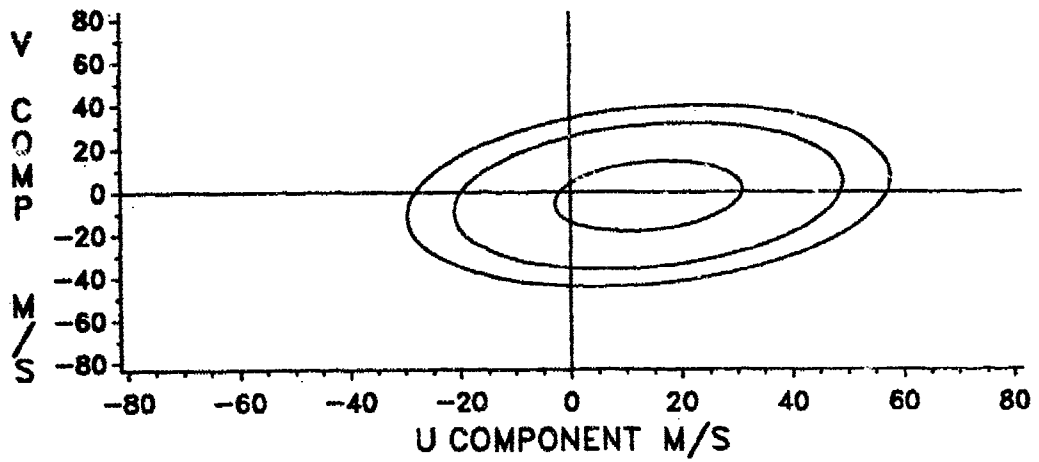


Figure E-42. Wind Probability Ellipses, July, 12 KM.

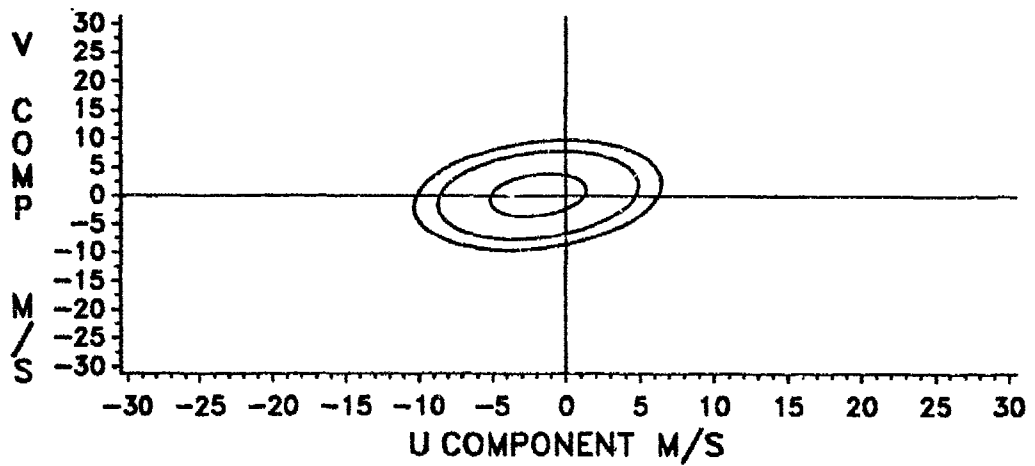


Figure E-43. Wind Probability Ellipses, July, 20 KM.

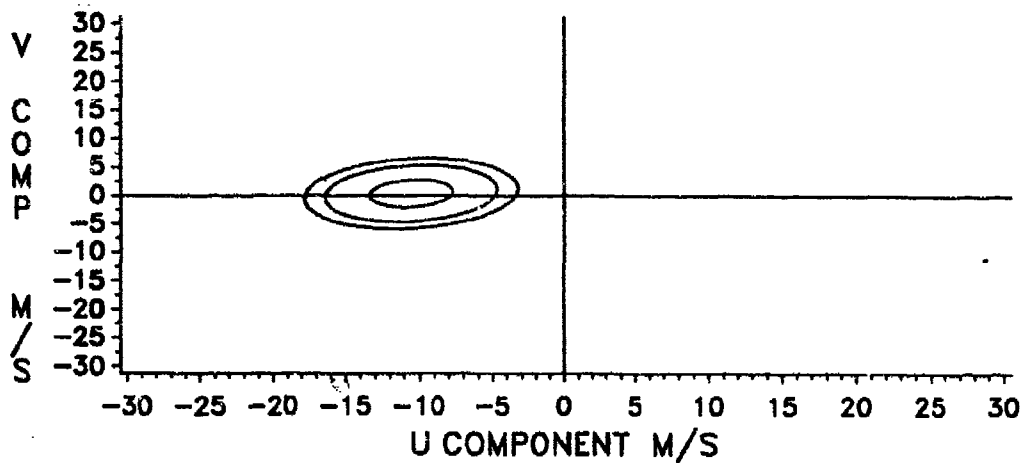
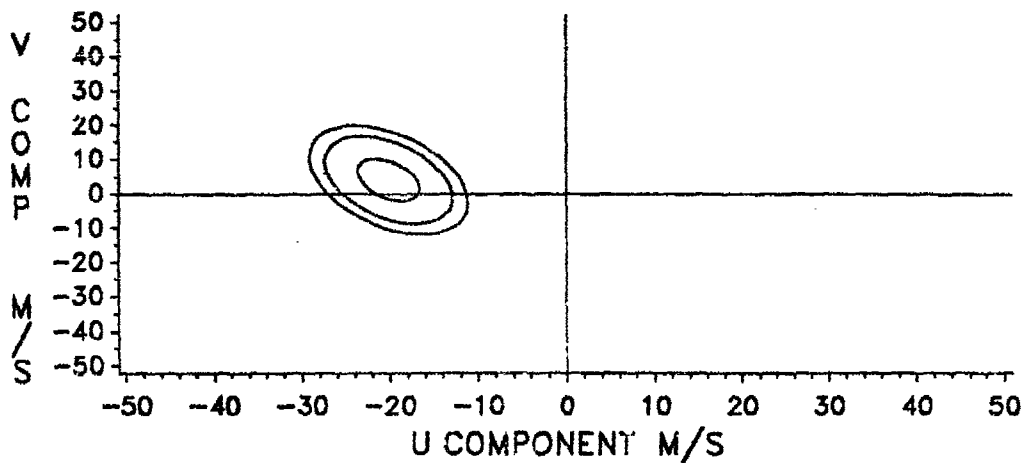
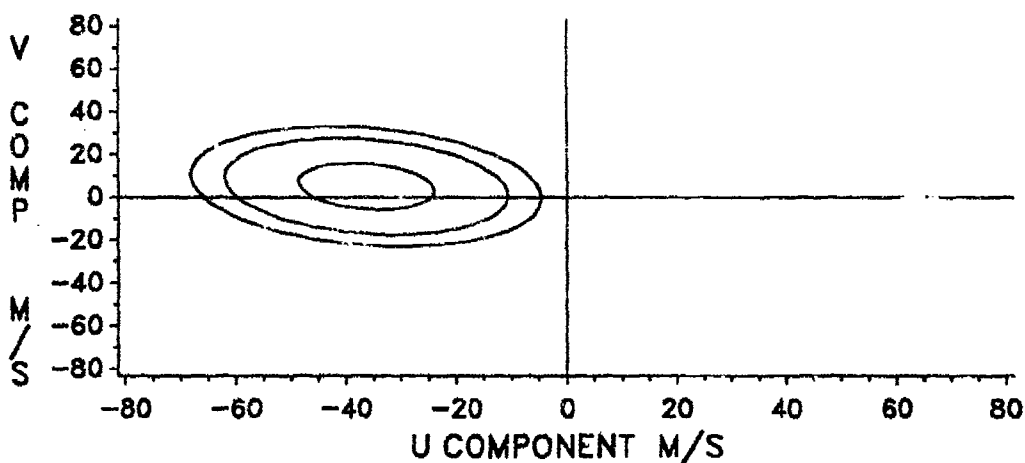


Figure E-44. Wind Probability Ellipses, July, 30 KM.



**Figure E-45. Wind Probability Ellipses, July, 40 KM.**



**Figure E-46. Wind Probability Ellipses, July, 50 KM.**

**NO DATA AVAILABLE**

**Figure E-47. Wind Probability Ellipses, July 60 KM.**

**NO DATA AVAILABLE**

**Figure E-48. Wind Probability Ellipses, July, 70 KM.**

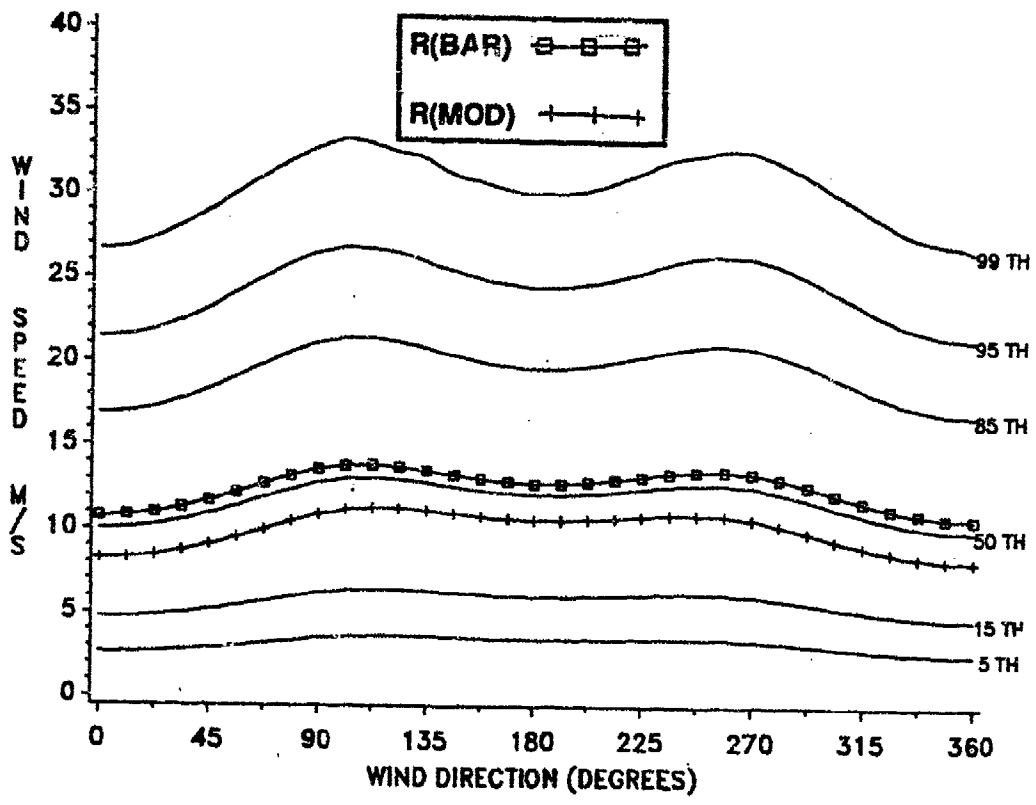


Figure E-49. Conditional Wind Speed Given Direction, January, 4 KM.

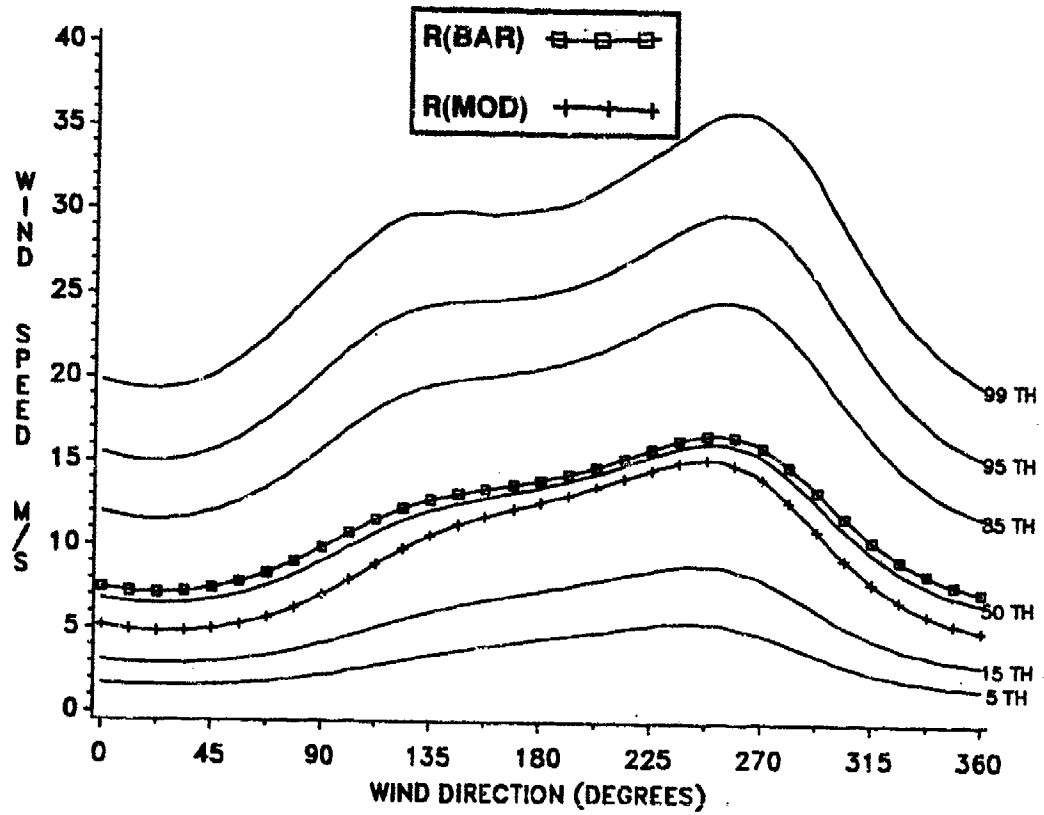


Figure E-50. Conditional Wind Speed Given Direction, January, 12 KM.

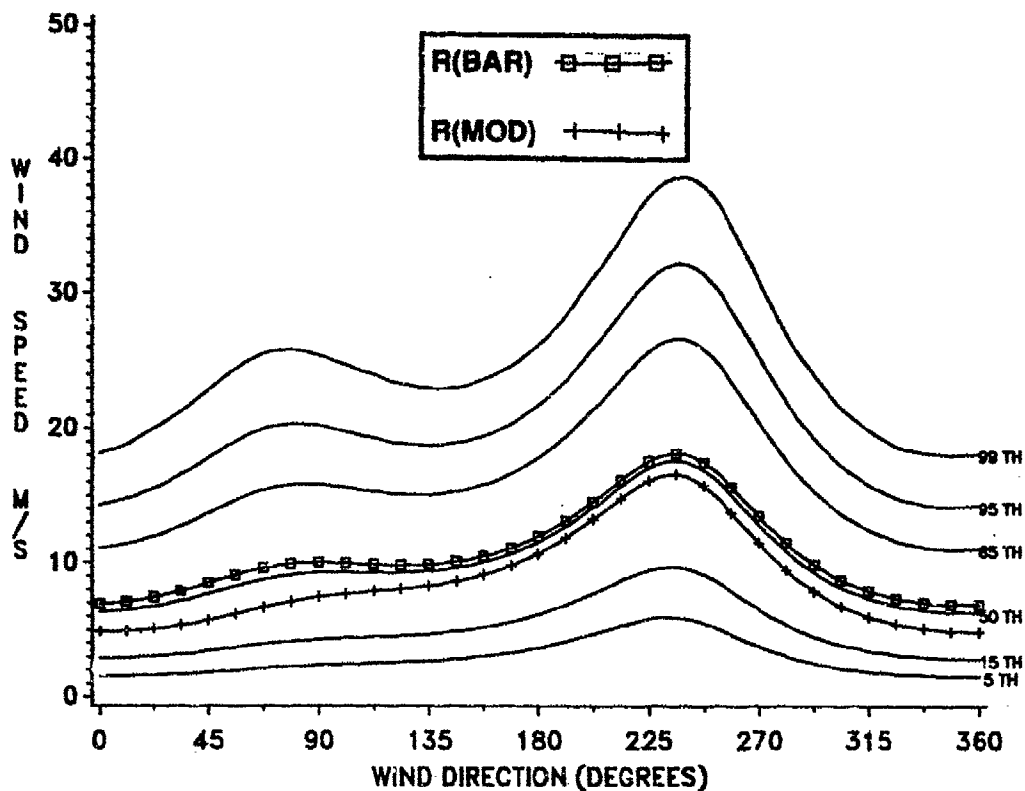


Figure E-51. Conditional Wind Speed Given Direction, January, 20 KM.

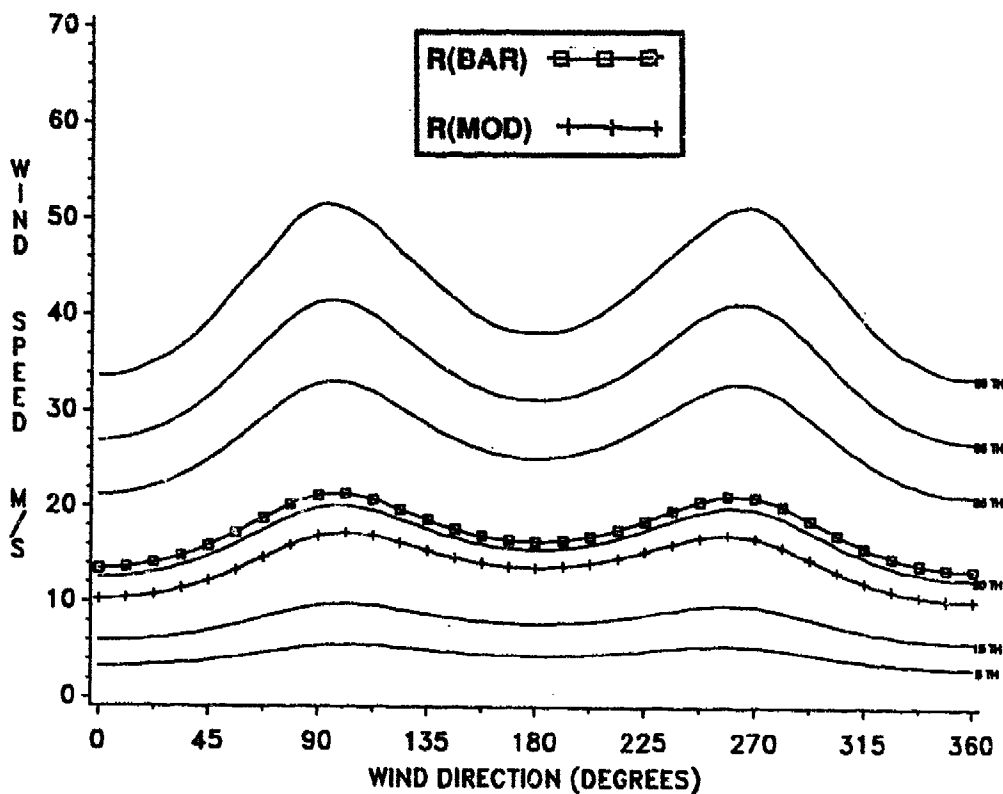


Figure E-52. Conditional Wind Speed Given Direction, January, 30 KM.

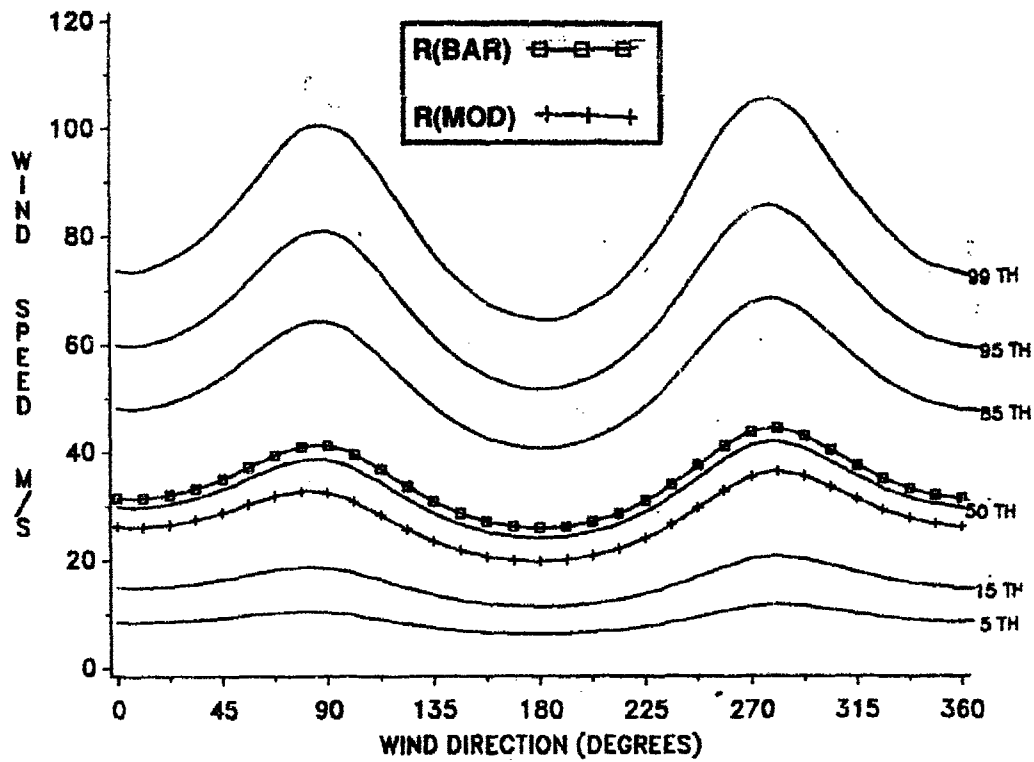


Figure E-53. Conditional Wind Speed Given Direction, January, 40 KM.

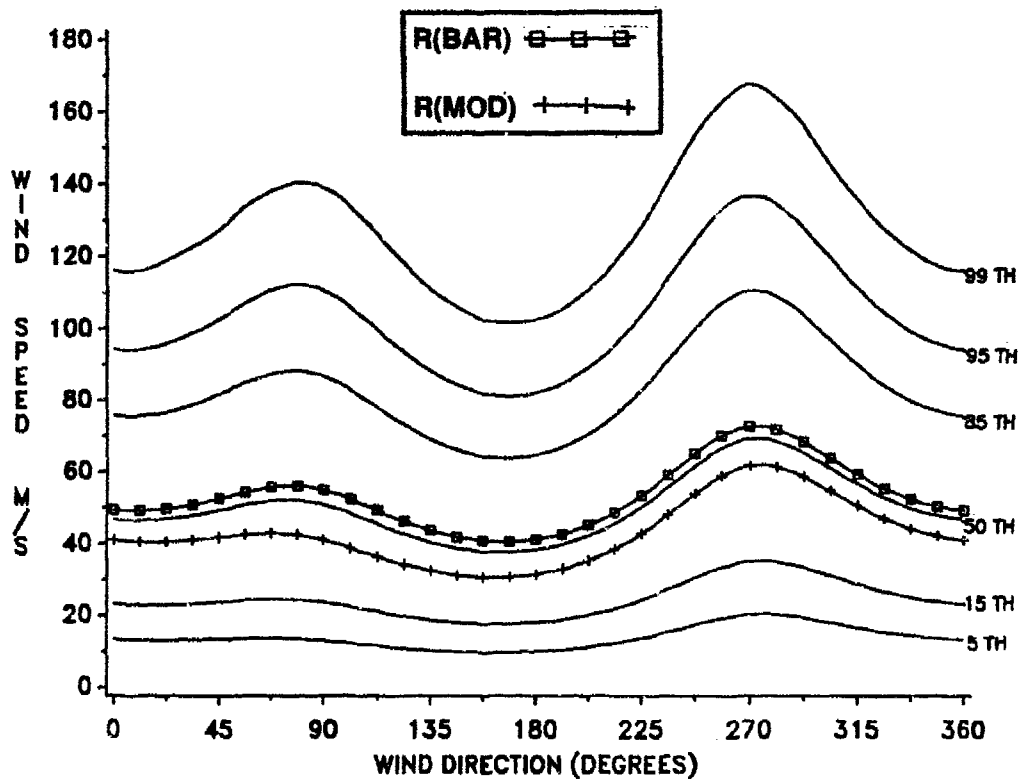


Figure E-54. Conditional Wind Speed Given Direction, January, 50 KM.

**NO DATA AVAILABLE**

**Figure E-55. Conditional Wind Speed Given Direction, January, 60 KM.**

**NO DATA AVAILABLE**

**Figure E-56. Conditional Wind Speed Given Direction, January, 70 KM.**

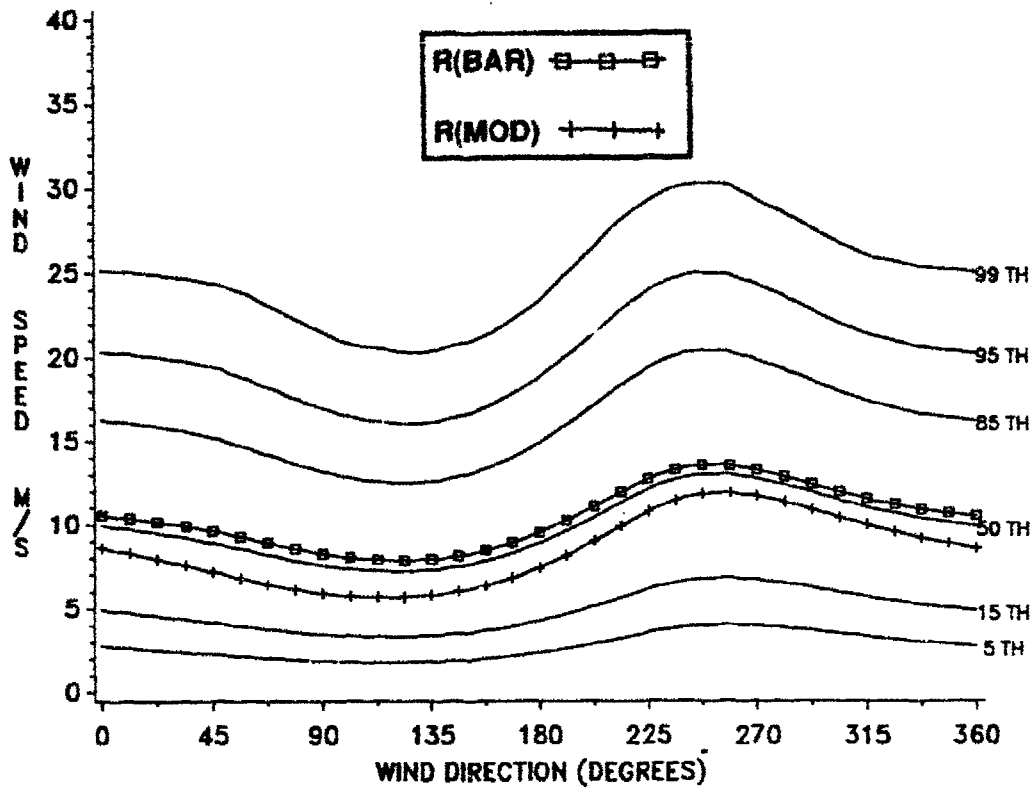


Figure E-57. Conditional Wind Speed Given Direction, July, 4 KM.

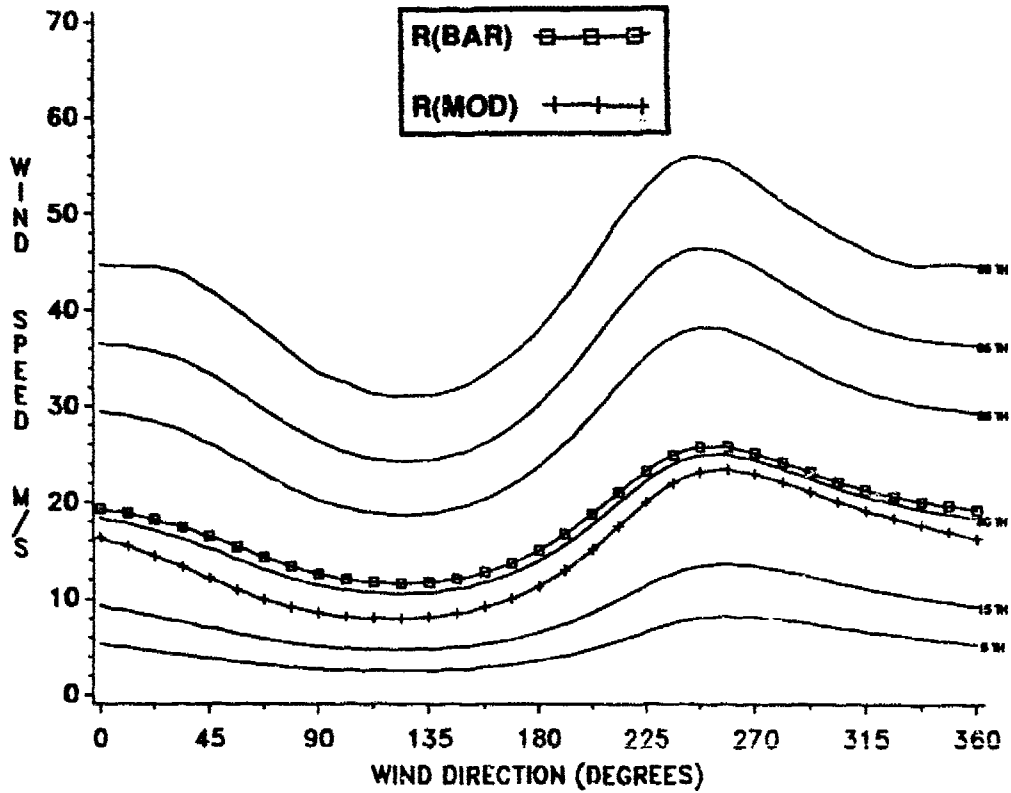


Figure E-58. Conditional Wind Speed Given Direction, July, 12 KM.



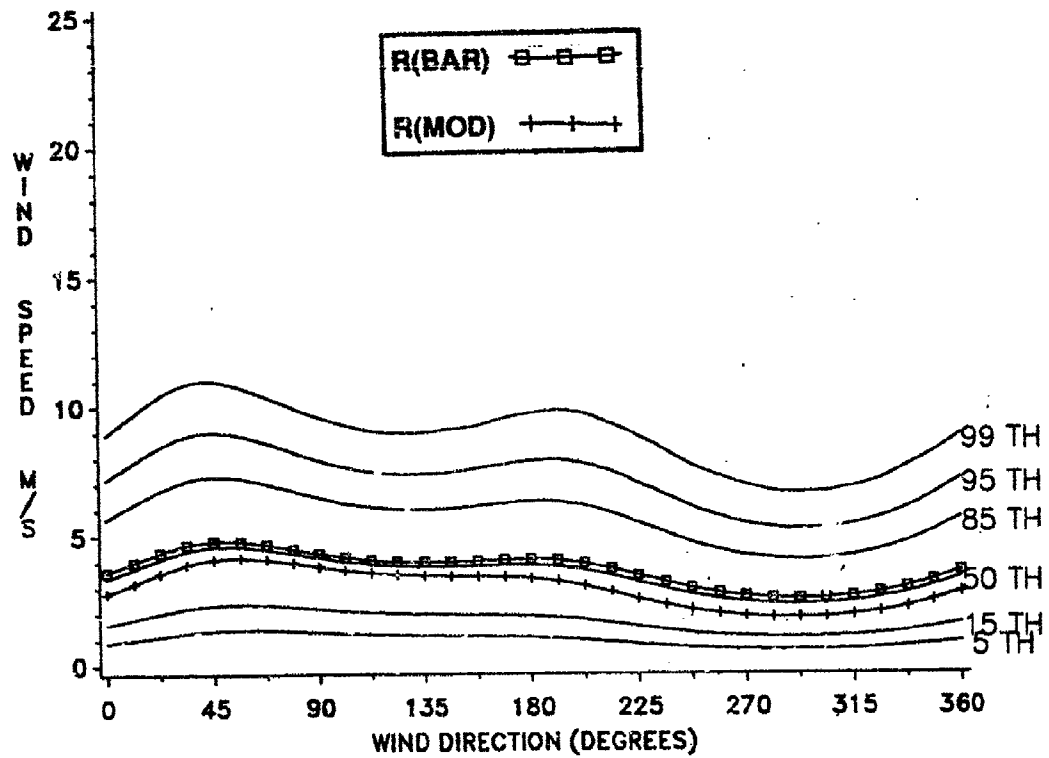


Figure E-59. Conditional Wind Speed Given Direction, July, 20 KM.

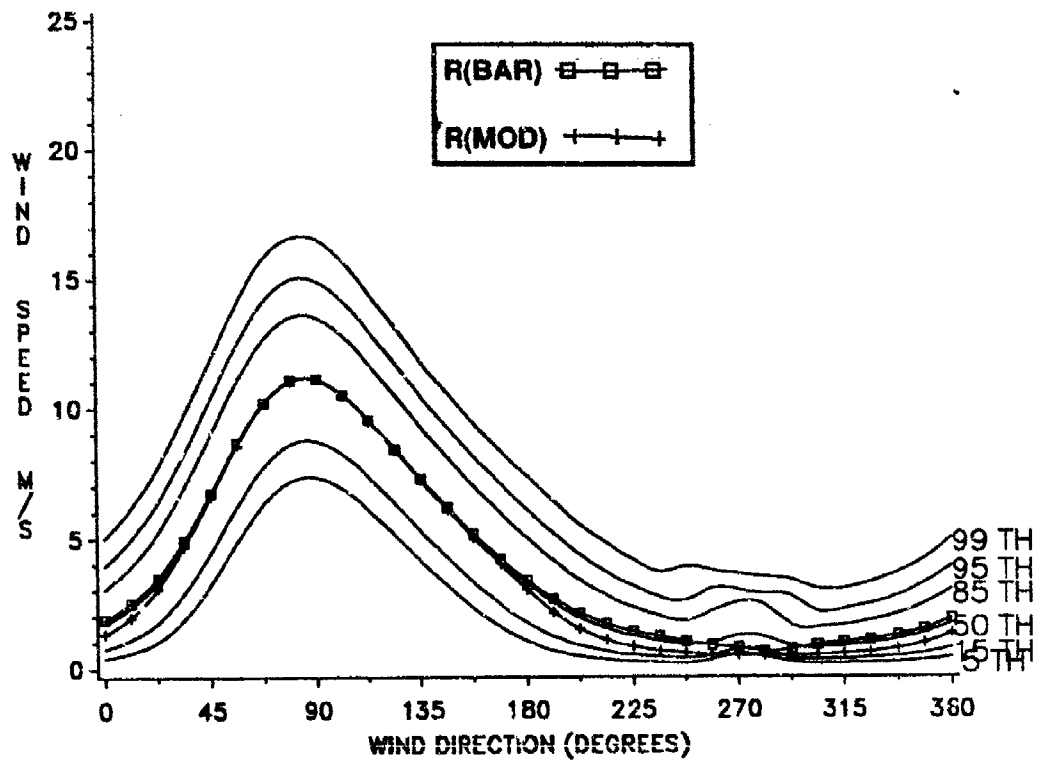


Figure E-60. Conditional Wind Speed Given Direction, July, 30 KM.

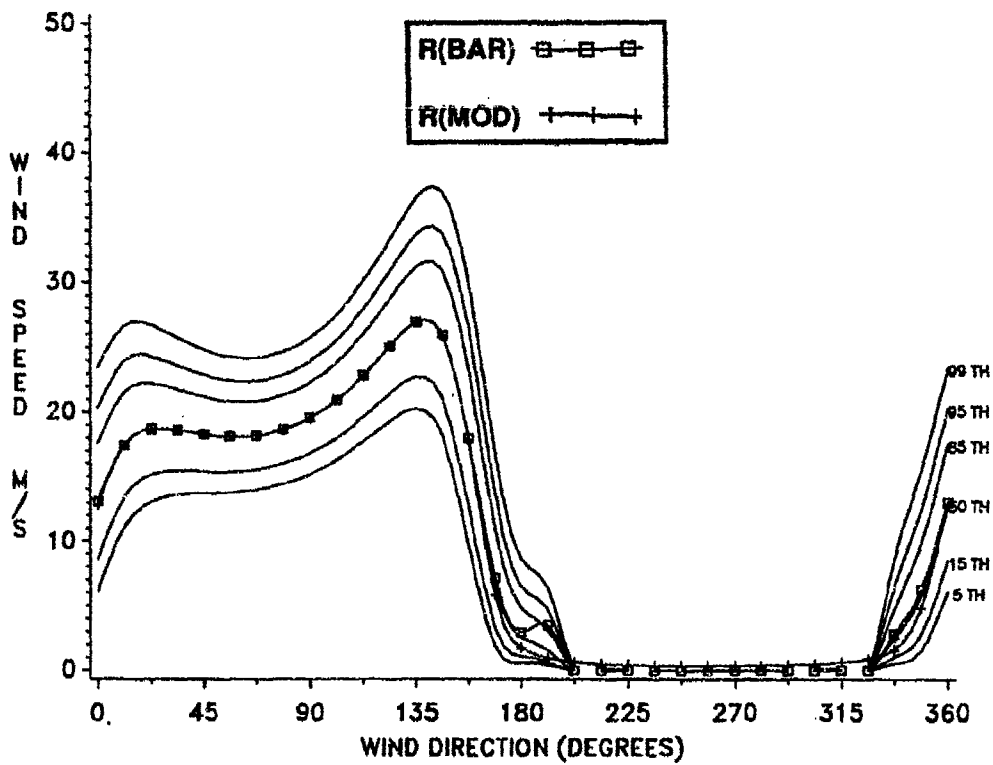


Figure E-61. Conditional Wind Speed Given Direction, July, 40 KM.

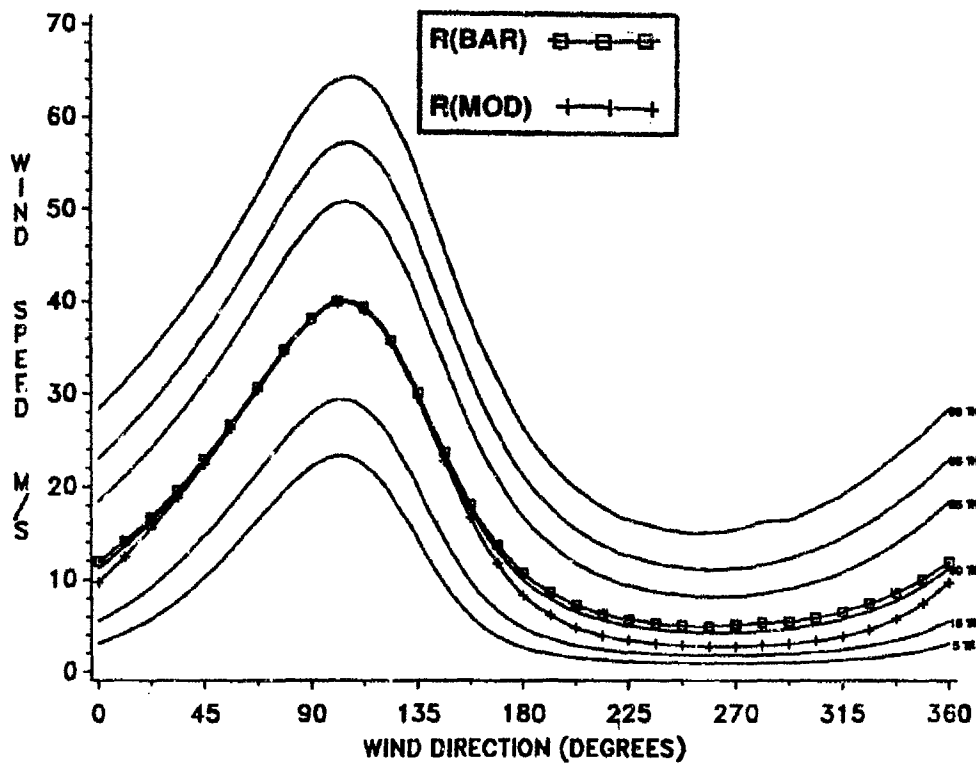


Figure E-62. Conditional Wind Speed Given Direction, July, 50 KM.

**NO DATA AVAILABLE**

**Figure E-63. Conditional Wind Speed Given Direction, July, 60 KM.**

**NO DATA AVAILABLE**

**Figure E-64. Conditional Wind Speed Given Direction, July, 70 KM.**

## APPENDIX F

### Thermodynamic Statistics Derivable from Appendix B, C, and D Tables

This appendix gives graphic examples of certain pressure, density, and virtual temperature statistics that can be derived from basic data in Appendices B, C, and D. These examples should help RRA users in understanding and visualizing the relationships that can be inferred from data in Appendices B and D.

#### Monthly Means from the Annual Mean

The hydrostatic model values in Appendix D are used to compute monthly mean differences relative to annual mean values of pressure, density, and virtual temperature (expressed in percent), and the monthly mean difference in virtual temperature for annual mean virtual temperature (expressed in kelvin, K). Examples of these four statistics are given in Tables F-1 (January) and F-2 (July); graphic displays of the four statistics contained in these tables are then provided by Figures F-1 through F-8. The relative differences between monthly mean values (from Tables D-1 through D-12 for all months) and annual mean values (Table D-13) are illustrated in Figures F-9 and F-18 for pressure, Figures F-10 and F-12 for density, and Figures F-13 and F-14 for virtual temperature. Differences between monthly mean virtual temperature differences and annual mean virtual temperature for all months are given in Figures F-15 and F-16.

#### Coefficients of Variation and Derived Correlation Coefficients.

The coefficient of variation ( $C_V$ ) is defined as "the standard deviation with respect to the mean divided by the mean." Coefficients of variation for pressure ( $C_{VP}$ ) and density ( $C_{VD}$ ) were computed using standard deviations in Appendix B and the hydrostatic mean values in Appendix E. The coefficient of variation for temperature uses the standard deviations of virtual temperature from Appendix C to the altitude at which virtual temperature exists; above that altitude, standard deviations of temperature are from Appendix B. Mean values for virtual temperature to the altitude at which it exists and above are taken from Appendix E. No distinction is made between virtual temperature and temperature in Table F-3, Table F-4, or any of the figures.

From the coefficients of variation for pressure and temperature (virtual temperature to the altitude at which it exists), correlation coefficients between these quantities are derived using Buell's method--see Chapter 3. The three equations for the derived correlation coefficients in Tables F-3 and F-4 are:

$$R(P,T) = \frac{(C_V T)^2 + (C_V P)^2 - (C_V D)^2}{2[C_V T \cdot C_V P]} \quad (F-1)$$

$$R(P,D) = \frac{(C_V D)^2 - (C_V T)^2 + (C_V P)^2}{2[C_V D \cdot C_V P]} \quad (F-2)$$

$$R(T,D) = \frac{(C_v P)^2 - (C_v D)^2 - (C_v T)^2}{2[C_v T \cdot C_v D]} \quad (F-3)$$

To test for validity of derived correlation coefficients, all three of the following inequalities must be satisfied:

$$\begin{aligned} C_v P - (C_v D + C_v T) &< 0 \\ C_v D - (C_v T + C_v P) &< 0 \\ C_v T - (C_v P + C_v D) &< 0 \end{aligned} \quad (F-4)$$

In the examples (Tables F-3 and F-4), the numerical values from equation F-4 are usually negative, and the derived correlation test is considered valid. However, when any of the inequalities are not satisfied, "9.999" (missing) is written in the table. The rare exceptions to this test for several RRAs occur at extremely high altitudes where sample sizes for the statistical sample are small.

Statistical parameters from Table F-3 (January) and Table F-4 (July) are illustrated in Figures F-17 through F-20.

$C_v P$  values for all months are given in Figures F-21 and F-22.  $C_v D$  values are given in Figures F-23 and F-24, and  $C_v T$  values in Figures F-25 and F-26. If the abscissa on the figures for the coefficient of variation is multiplied by 100, these figures would show the percentage of random dispersion for these quantities over the month with respect to the monthly mean.

Derived correlation coefficients for all months are shown as follows: Figures F-27 and F-28 give  $R(P,D)$ ; Figures F-29 and F-30 give  $R(P,T)$ ; and Figures F-31 and F-32 give  $R(T,D)$ .

**TABLE F-1. Deltas in Percent Relative to Annual, Shemya, January.**

<u>RLEVEL</u>	<u>PRESSURE</u>	<u>DENSITY</u>	<u>TEMP.</u>	<u>TMO-TANN (K)</u>
0.000	-0.828	0.778	-1.594	-4.430
0.039	-0.831	0.794	-1.613	-4.480
1.000	-1.148	1.141	-2.263	-6.150
2.000	-1.364	1.468	-2.790	-7.450
3.000	-1.755	1.413	-3.121	-8.170
4.000	-2.184	1.221	-3.364	-8.610
5.000	-2.633	0.611	-3.227	-8.080
6.000	-3.174	-0.309	-2.870	-7.080
7.000	-3.707	-1.382	-2.359	-5.750
8.000	-4.211	-2.016	-2.239	-5.390
9.000	-4.647	3.517	-7.888	-18.810
10.000	-4.968	2.241	-7.049	-16.680
11.000	-5.071	1.078	-6.084	-14.380
12.000	-5.135	-2.547	-2.652	-6.100
13.000	-5.050	-5.753	0.747	1.670
14.000	-4.952	-5.990	1.106	2.470
15.000	-4.759	-6.113	1.443	3.220
16.000	-4.571	-6.119	1.647	3.670
17.000	-4.189	-5.705	1.606	3.580
18.000	-3.977	-5.444	1.552	3.460
19.000	-3.767	-5.140	1.447	3.230
20.000	-3.569	-4.845	1.344	3.000
21.000	-3.369	-4.594	1.284	2.870
22.000	-3.189	-4.308	1.171	2.620
23.000	-3.003	-4.116	1.160	2.600
24.000	-2.882	-3.946	1.109	2.490
25.000	-2.684	-3.622	0.973	2.190
26.000	-2.540	-3.335	0.824	1.860
27.000	-2.526	-3.138	0.631	1.430
28.000	-2.414	-2.836	0.435	0.990
29.000	-2.351	-2.647	0.302	0.690
30.000	-2.525	-2.468	-0.061	-0.140
32.000	-1.444	-1.219	-0.225	-0.260
34.000	-1.654	-0.849	-0.811	-0.950
36.000	-2.008	-0.786	-1.236	-1.470
38.000	-2.567	-0.283	-2.290	-2.770
40.000	-3.305	-0.837	-2.485	-3.060
42.000	-4.208	-0.433	-3.792	-4.740
44.000	-5.087	-0.919	-4.216	-5.350
46.000	-7.580	-2.506	-5.203	-6.690
48.000	-8.326	-2.696	-5.788	-7.490
50.000	-10.877	-4.818	-6.366	-8.280
52.000	-14.822	-9.089	-6.308	-8.210
54.000	-14.075	-7.252	-7.343	-9.520
56.000	-17.580	-10.822	-7.560	-9.830
58.000	-21.045	-14.766	-7.388	-9.540
60.000	-40.042	-37.824	-3.576	-4.620
62.000	0.000	0.000	0.000	0.000
64.000	0.000	0.000	0.000	0.000
66.000	0.000	0.000	0.000	0.000
68.000	0.000	0.000	0.000	0.000
70.000	0.000	0.000	0.000	0.000

**TABLE F-2. Deltas in Percent Relative to Annual, Shemya, July.**

<u>RLEVEL</u>	<u>PRESSURE</u>	<u>DENSITY</u>	<u>TEMP.</u>	<u>TMO-TANN (K)</u>
0.000	0.718	-0.805	1.536	4.270
0.039	0.725	-0.845	1.581	4.390
1.000	0.961	-2.331	3.374	9.170
2.000	1.497	-2.585	4.191	11.190
3.000	2.056	-2.345	4.508	11.800
4.000	2.676	-1.998	4.767	12.200
5.000	3.305	-1.360	4.729	11.840
6.000	4.029	0.324	3.698	9.120
7.000	4.733	2.567	2.109	5.140
8.000	5.507	4.810	0.665	1.600
9.000	6.137	6.055	0.075	0.180
10.000	6.569	6.711	-0.131	-0.310
11.000	6.845	13.016	-5.462	-12.910
12.000	6.815	10.540	-3.369	-7.750
13.000	6.746	7.164	-0.389	-0.870
14.000	6.676	7.117	-0.412	-0.920
15.000	6.607	7.152	-0.507	-1.130
16.000	6.282	6.861	-0.543	-1.210
17.000	6.373	6.852	-0.449	-1.000
18.000	6.314	6.604	-0.269	-0.600
19.000	6.284	6.392	-0.099	-0.220
20.000	6.278	6.191	0.085	0.190
21.000	6.253	5.982	0.255	0.570
22.000	6.359	5.856	0.474	1.060
23.000	6.478	5.747	0.692	1.550
24.000	6.490	5.519	0.922	2.070
25.000	6.752	5.497	1.190	2.680
26.000	6.974	5.406	1.488	3.360
27.000	6.999	5.122	1.787	4.050
28.000	7.323	5.195	2.023	4.600
29.000	7.582	5.229	2.233	5.100
30.000	8.059	5.410	2.512	5.760
32.000	10.108	6.222	3.665	4.240
34.000	11.497	6.901	4.302	5.040
36.000	12.976	7.863	4.740	5.640
38.000	14.361	8.730	5.176	6.260
40.000	16.180	9.605	5.994	7.380
42.000	18.113	11.729	5.712	7.140
44.000	19.835	13.586	5.500	6.980
46.000	21.372	15.542	5.047	6.490
48.000	21.794	15.611	5.347	6.920
50.000	24.102	17.893	5.274	6.860
52.000	23.974	18.140	4.932	6.420
54.000	25.401	19.529	4.906	6.360
56.000	24.772	20.175	3.822	4.970
58.000	22.460	19.419	2.548	3.290
60.000	8.917	8.158	0.681	0.880
62.000	11.768	9.776	1.802	2.250
64.000	11.499	10.955	0.473	0.580
66.000	28.965	33.155	-3.104	-3.750
68.000	0.000	0.000	0.000	0.000
70.000	0.000	0.000	0.000	0.000

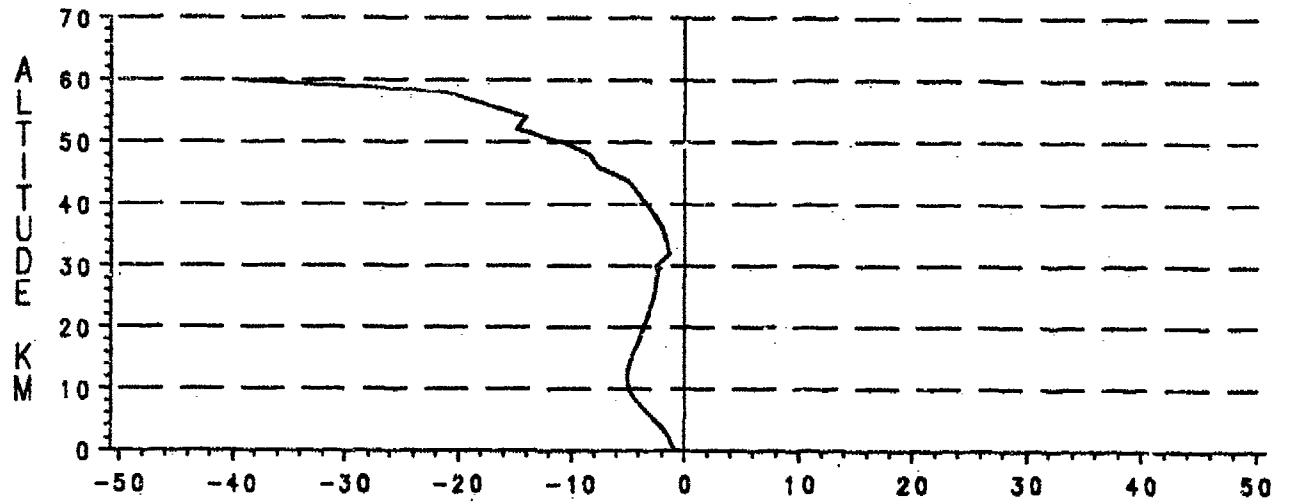
**TABLE F-3. Coefficients of Variation/Correlation Coefficients, January.**

LEVEL	CVP	CVD	CVT	R(P,T)	R(P,D)	R(T,D)
0.000	0.015	0.018	0.008	-0.164	0.894	-0.588
0.039	0.015	0.017	0.008	-0.046	0.877	-0.521
1.000	0.026	0.025	0.013	0.322	0.870	-0.186
2.000	0.015	0.019	0.018	0.341	0.476	-0.665
3.000	0.017	0.019	0.022	0.569	0.236	-0.665
4.000	0.019	0.017	0.025	0.707	0.090	-0.641
5.000	0.021	0.017	0.027	0.708	0.331	-0.433
6.000	0.025	0.015	0.027	0.790	0.723	0.148
7.000	0.028	0.017	0.024	9.999	9.999	9.999
8.000	0.030	0.024	0.020	0.816	0.983	0.696
9.000	0.032	0.036	0.021	0.098	0.826	-0.480
10.000	0.031	0.047	0.025	-0.353	0.865	-0.775
11.000	0.030	0.046	0.024	-0.452	0.885	-0.816
12.000	0.028	0.038	0.020	-0.220	0.863	-0.682
13.000	0.028	0.033	0.017	-0.050	0.867	-0.541
14.000	0.028	0.032	0.016	-0.032	0.874	-0.513
15.000	0.028	0.032	0.015	-0.021	0.884	-0.486
16.000	0.028	0.032	0.015	-0.056	0.888	-0.510
17.000	0.027	0.031	0.015	-0.003	0.875	-0.486
18.000	0.027	0.031	0.016	0.085	0.848	-0.456
19.000	0.028	0.030	0.016	0.199	0.838	-0.367
20.000	0.029	0.028	0.017	0.350	0.815	-0.258
21.000	0.030	0.026	0.018	0.489	0.807	-0.120
22.000	0.031	0.026	0.019	0.577	0.793	-0.040
23.000	0.033	0.025	0.021	0.647	0.770	0.012
24.000	0.035	0.025	0.022	0.708	0.780	0.111
25.000	0.038	0.026	0.024	0.756	0.794	0.203
26.000	0.041	0.027	0.026	0.763	0.793	0.210
27.000	0.044	0.028	0.026	0.788	0.814	0.284
28.000	0.047	0.030	0.027	0.802	0.839	0.348
29.000	0.050	0.032	0.028	0.812	0.856	0.394
30.000	0.051	0.033	0.029	0.795	0.841	0.340
32.000	0.058	0.029	0.075	0.934	-0.412	-0.711
34.000	0.067	0.040	0.070	0.834	0.214	-0.361
36.000	0.074	0.050	0.070	0.765	0.418	-0.264
38.000	0.083	0.059	0.073	0.715	0.517	-0.228
40.000	0.091	0.068	0.080	0.692	0.518	-0.260
42.000	0.102	0.080	0.092	0.662	0.508	-0.309
44.000	0.113	0.094	0.097	0.603	0.571	-0.310
46.000	0.111	0.104	0.092	0.493	0.634	-0.361
48.000	0.127	0.121	0.104	0.470	0.649	-0.367
50.000	0.132	0.131	0.081	0.327	0.809	-0.291
52.000	0.126	0.124	0.075	0.322	0.823	-0.274
54.000	0.110	0.124	0.040	-0.170	0.947	-0.479
56.000	0.000	0.000	0.000	9.999	9.999	9.999
58.000	0.000	0.000	0.000	9.999	9.999	9.999
60.000	0.000	0.000	0.000	9.999	9.999	9.999
62.000	0.000	0.000	0.000	9.999	9.999	9.999
64.000	0.000	0.000	0.000	9.999	9.999	9.999
66.000	0.000	0.000	0.000	9.999	9.999	9.999
68.000	0.000	0.000	0.000	9.999	9.999	9.999
70.000	0.000	0.000	0.000	9.999	9.999	9.999

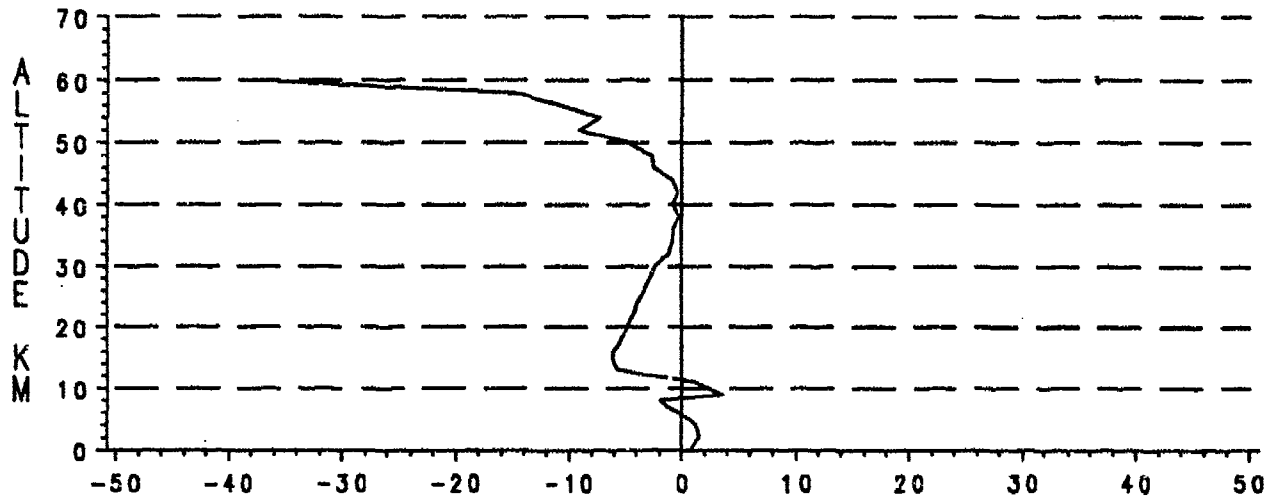


**TABLE F-4. Coefficients of Variation/Correlation Coefficient, July.**

LEVEL	CVP	CVD	CVT	R(P, T)	R(P, D)	R(T, D)
0.000	0.008	0.009	0.005	0.111	0.777	-0.539
0.039	0.008	0.009	0.005	0.122	0.773	-0.535
1.000	0.023	0.024	0.015	0.239	0.788	-0.409
2.000	0.009	0.013	0.014	0.456	0.151	-0.811
3.000	0.009	0.012	0.014	0.591	0.061	-0.769
4.000	0.011	0.011	0.015	0.694	0.020	-0.706
5.000	0.012	0.011	0.016	0.755	-0.011	-0.663
6.000	0.014	0.011	0.018	0.812	-0.051	-0.625
7.000	0.016	0.011	0.020	0.837	-0.056	-0.593
8.000	0.018	0.012	0.022	0.821	0.168	-0.425
9.000	0.021	0.013	0.022	0.781	0.761	0.190
10.000	0.023	0.020	0.020	0.590	0.957	0.330
11.000	0.024	0.030	0.020	0.080	0.743	-0.608
12.000	0.024	0.041	0.023	-0.528	0.876	-0.873
13.000	0.022	0.040	0.021	-0.704	0.923	-0.923
14.000	0.020	0.035	0.018	-0.714	0.931	-0.920
15.000	0.018	0.031	0.016	-0.673	0.922	-0.907
16.000	0.016	0.028	0.015	-0.596	0.901	-0.886
17.000	0.015	0.025	0.014	-0.478	0.871	-0.848
18.000	0.015	0.022	0.013	-0.352	0.849	-0.793
19.000	0.014	0.020	0.011	-0.208	0.828	-0.721
20.000	0.013	0.017	0.010	-0.013	0.781	-0.634
21.000	0.013	0.015	0.010	0.170	0.744	-0.531
22.000	0.013	0.014	0.010	0.299	0.748	-0.409
23.000	0.014	0.013	0.010	0.426	0.743	-0.289
24.000	0.015	0.013	0.010	0.507	0.743	-0.200
25.000	0.016	0.013	0.010	0.568	0.779	-0.073
26.000	0.017	0.013	0.011	0.629	0.771	-0.011
27.000	0.018	0.013	0.011	0.653	0.787	0.047
28.000	0.019	0.014	0.011	0.687	0.798	0.111
29.000	0.019	0.014	0.012	0.656	0.784	0.047
30.000	0.020	0.015	0.013	0.680	0.786	0.082
32.000	0.024	0.011	0.052	9.999	9.999	9.999
34.000	0.030	0.012	0.054	9.999	9.999	9.999
36.000	0.038	0.014	0.069	9.999	9.999	9.999
38.000	0.045	0.018	0.070	9.999	9.999	9.999
40.000	0.049	0.024	0.062	0.930	-0.351	-0.670
42.000	0.055	0.034	0.059	0.821	0.195	-0.400
44.000	0.059	0.045	0.049	0.668	0.580	-0.218
46.000	0.067	0.053	0.036	0.609	0.848	0.096
48.000	0.063	0.057	0.031	0.433	0.874	-0.059
50.000	0.063	0.057	0.028	0.432	0.898	-0.008
52.000	0.050	0.043	0.024	0.533	0.875	0.055
54.000	0.000	0.000	0.019	9.999	9.999	9.999
56.000	0.000	0.000	0.025	9.999	9.999	9.999
58.000	0.000	0.000	0.000	9.999	9.999	9.999
60.000	0.000	0.000	0.000	9.999	9.999	9.999
62.000	0.000	0.000	0.000	9.999	9.999	9.999
64.000	0.000	0.000	0.000	9.999	9.999	9.999
66.000	0.000	0.000	0.000	9.999	9.999	9.999
68.000	0.000	0.000	0.000	9.999	9.999	9.999
70.000	0.000	0.000	0.000	9.999	9.999	9.999



**Figure F-1. Delta Percent Relative to Annual Pressure, January**



**Figure F-2. Delta Percent Relative to Annual Density, January.**

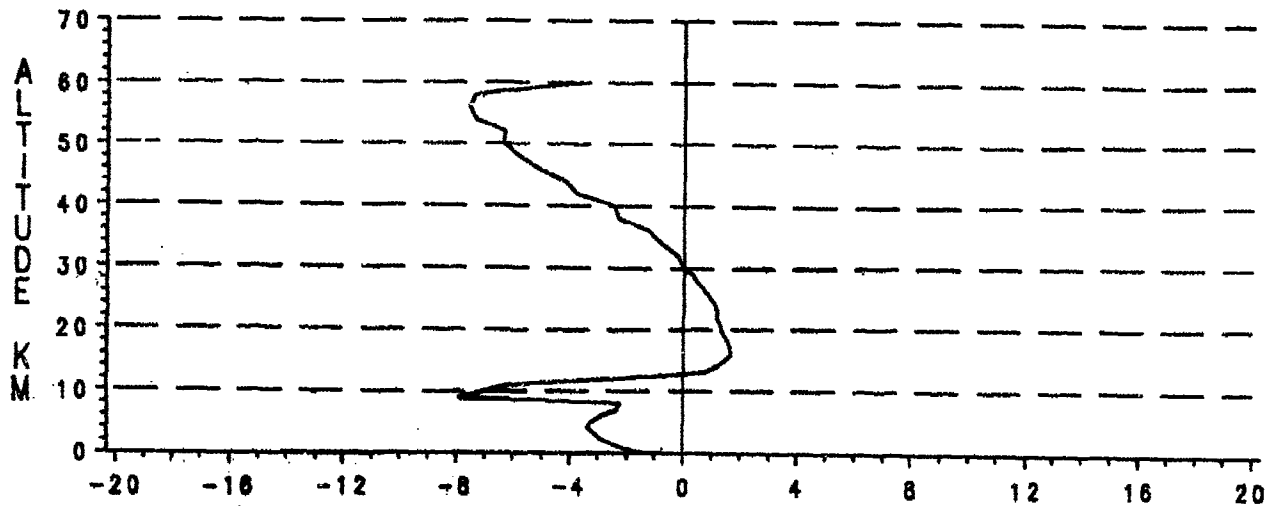


Figure F-3. Delta Percent Relative to Annual Temperature, January

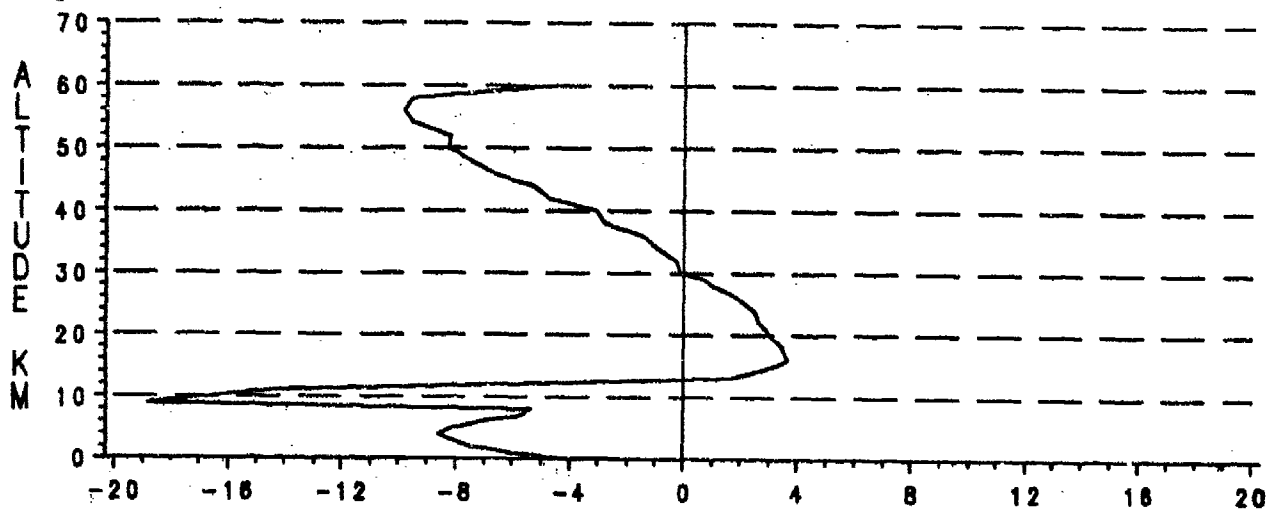
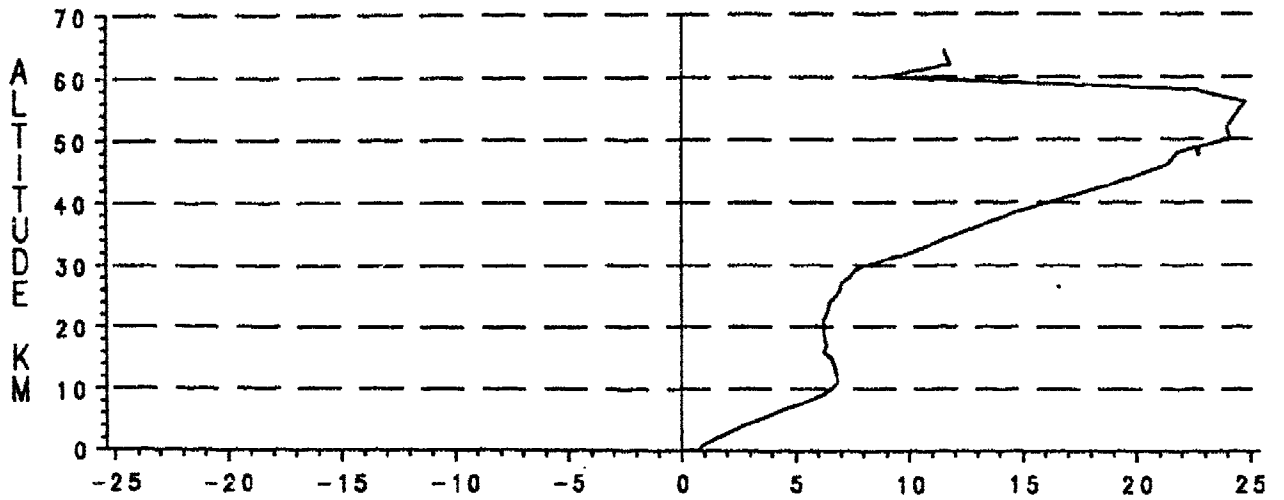
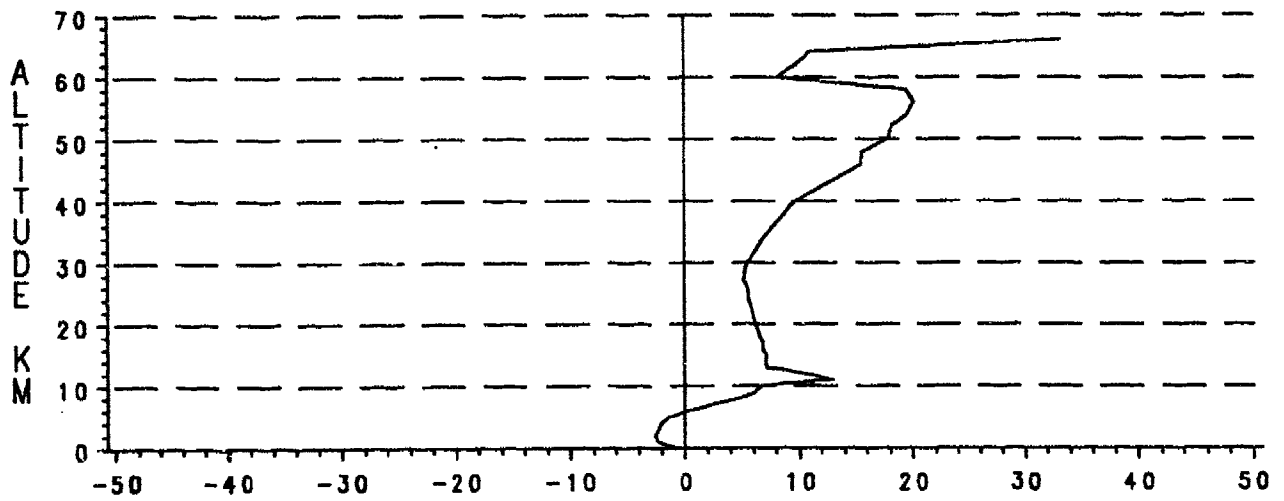


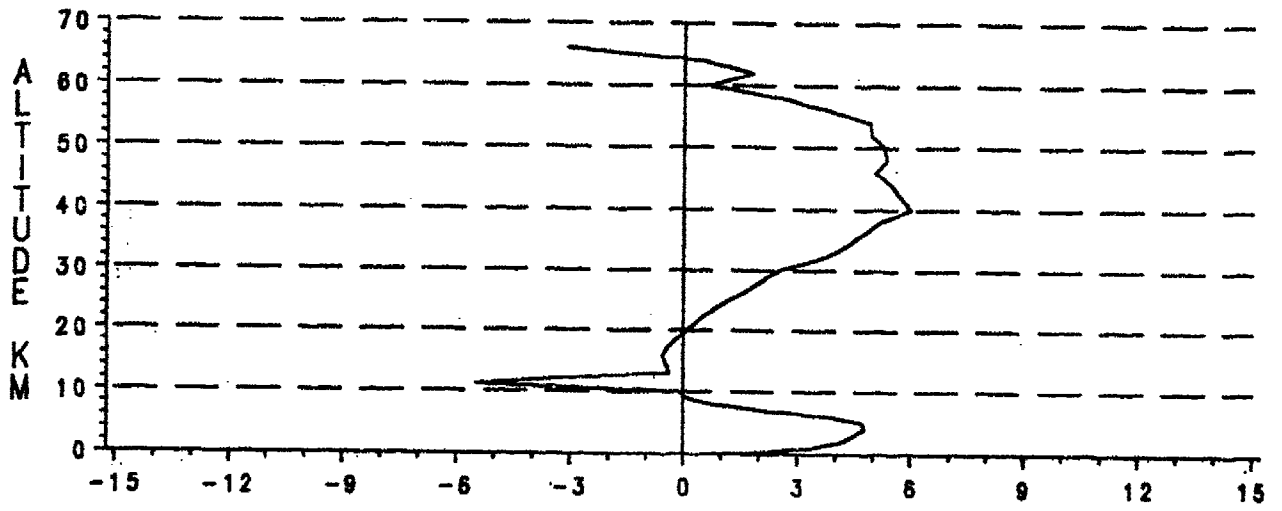
Figure F-4. Delta Temperature (K), January.



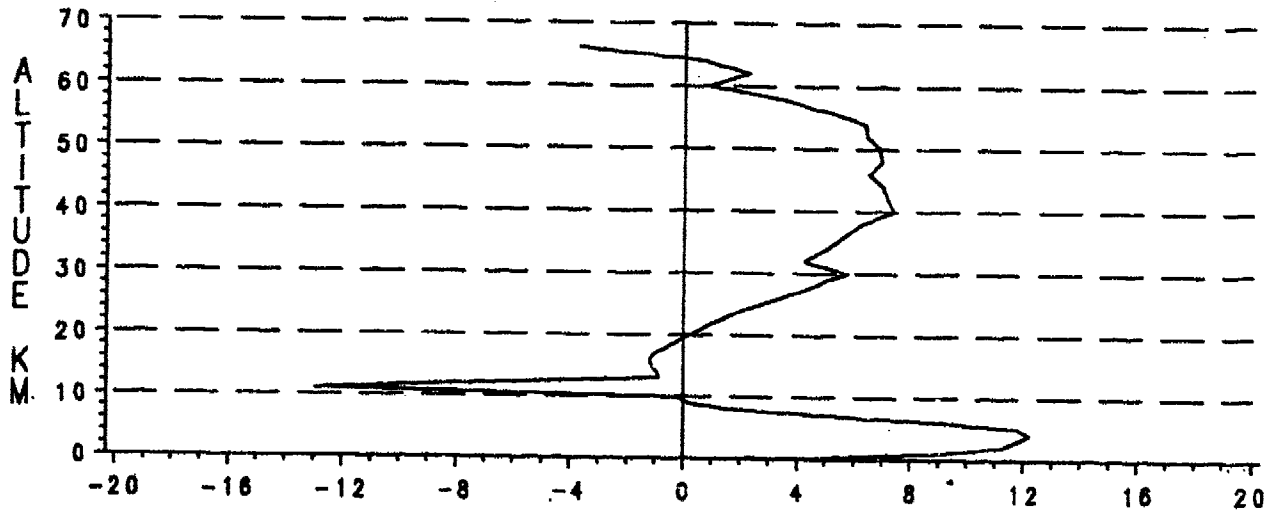
**Figure F-5. Delta Percent Relative to Annual Pressure, July.**



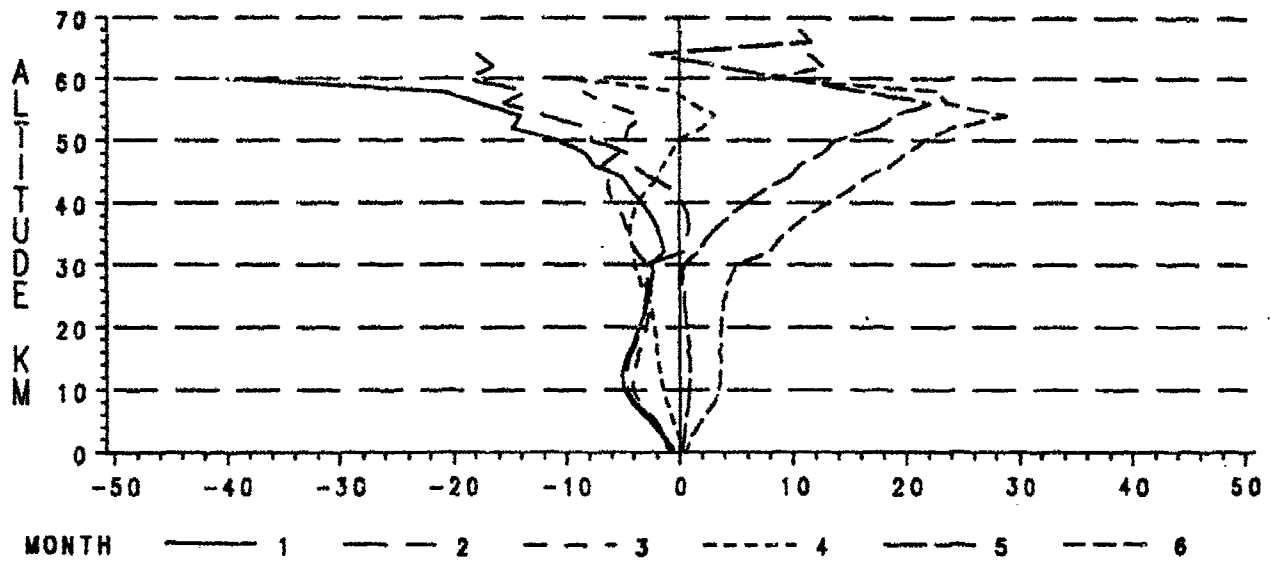
**Figure F-6. Delta Percent Relative to Annual Density, July.**



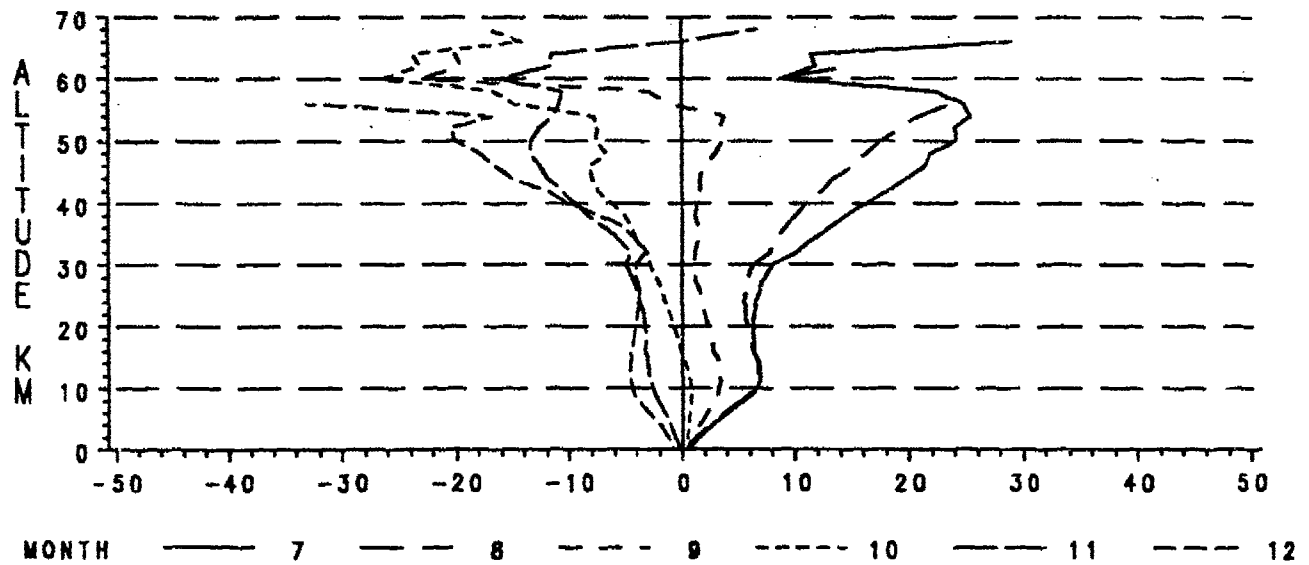
**Figure F-7. Delta Percent Relative to Annual Temperature, July.**



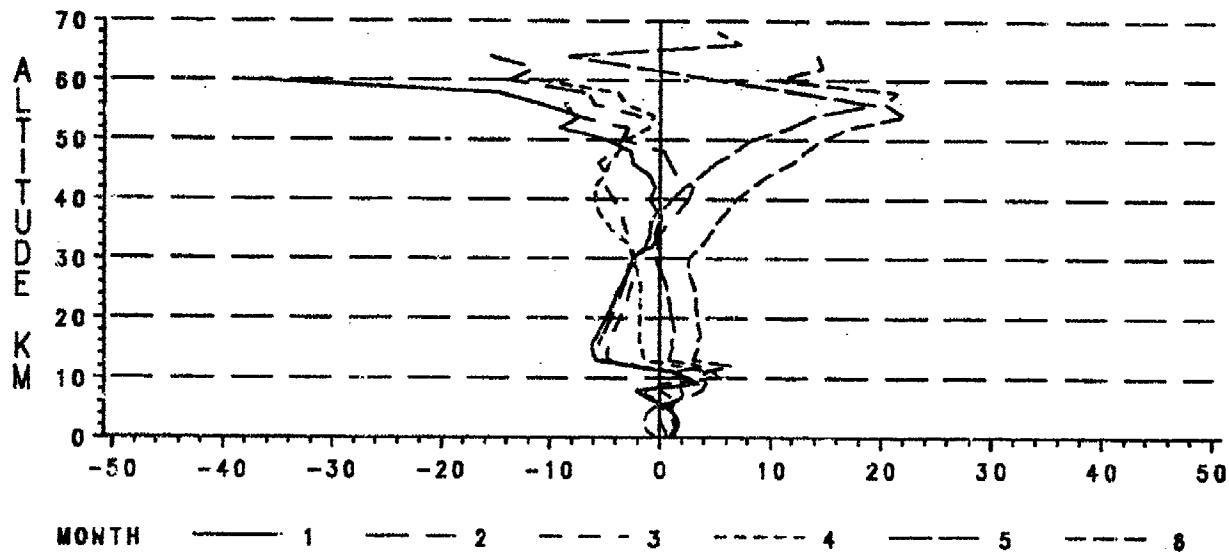
**Figure F-8. Delta Temperature (K), July.**



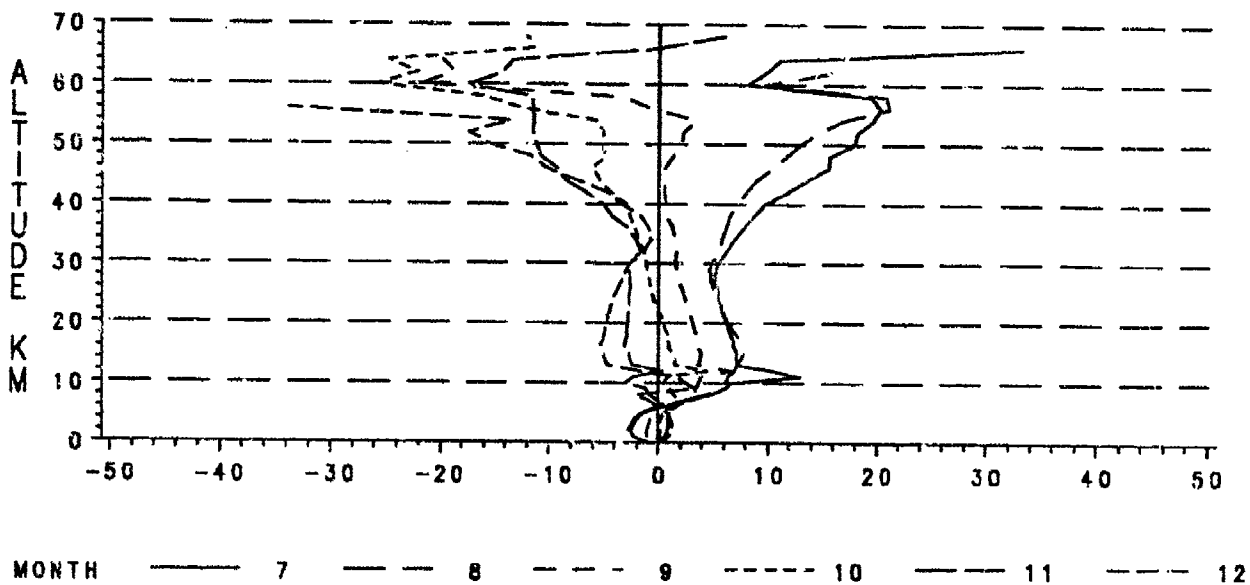
**Figure F-9. Delta Percent Relative to Annual Pressure, January-June.**



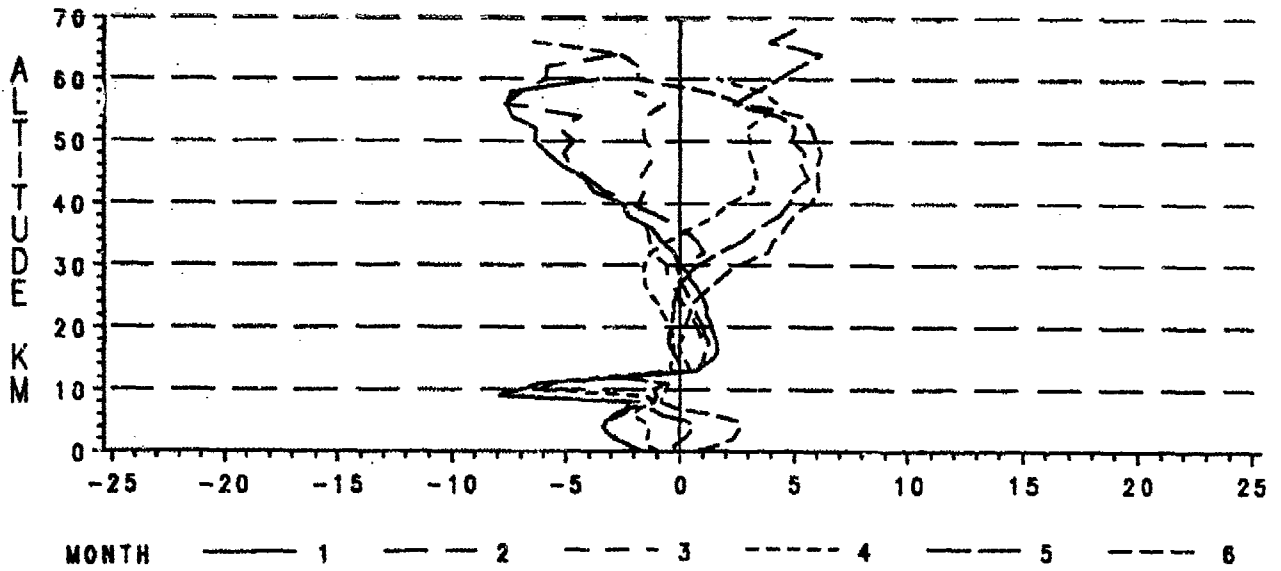
**Figure F-10. Delta Percent Relative to Annual Pressure, July-December.**



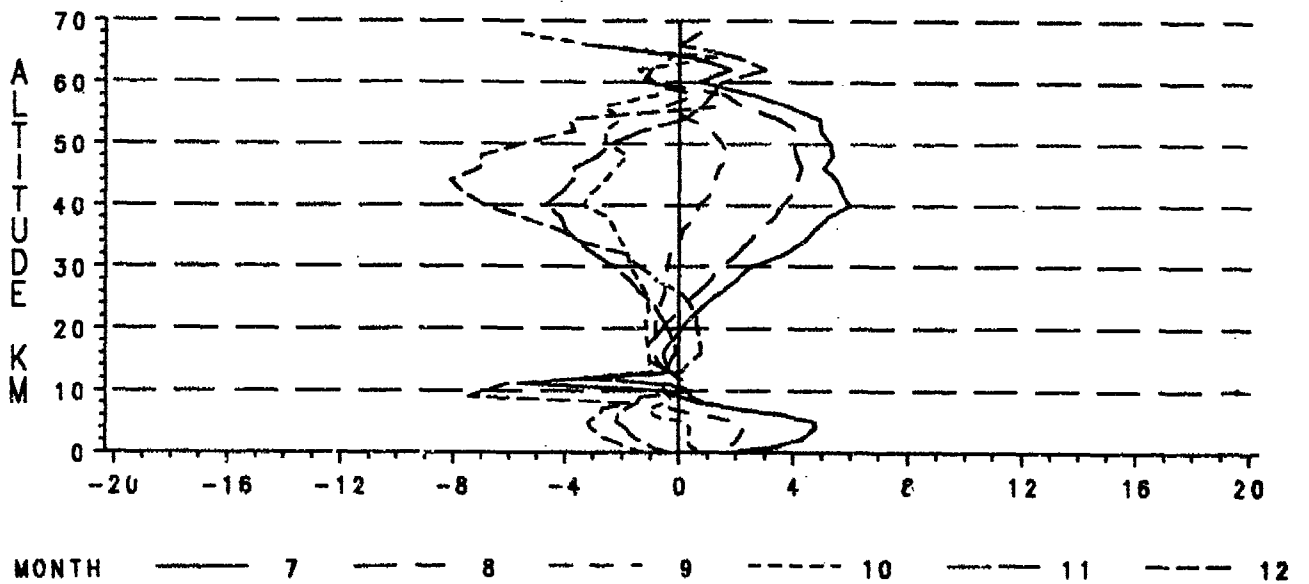
**Figure F-11. Delta Percent Relative to Annual Density, January-June.**



**Figure F-12. Delta Percent Relative to Annual Density, July-December.**

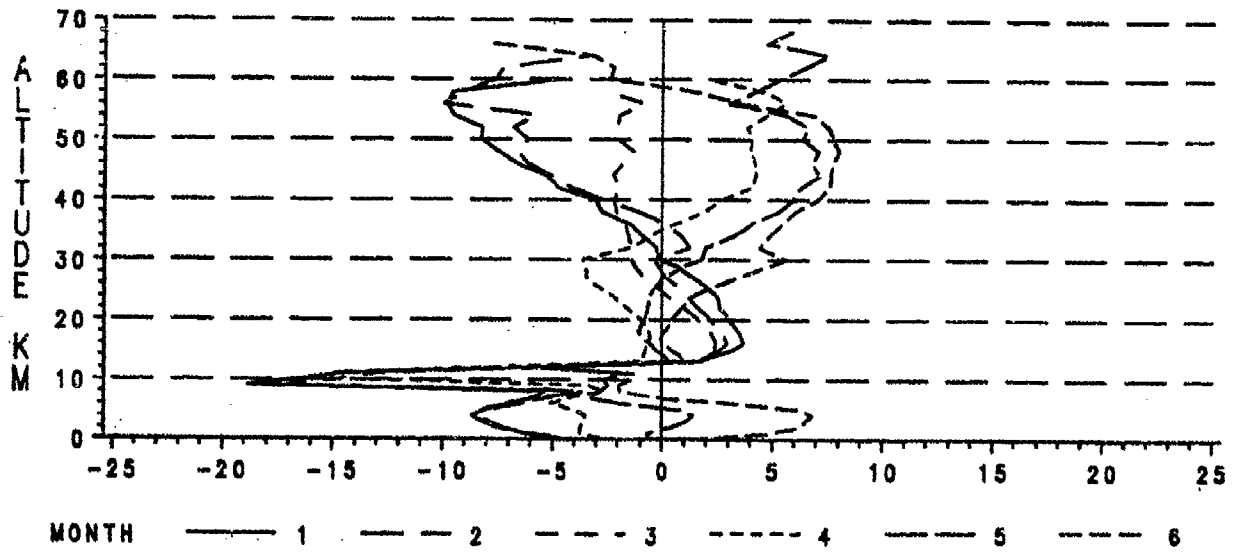


**Figure F-13. Delta Percent Relative to Annual Temperature, January-June.**

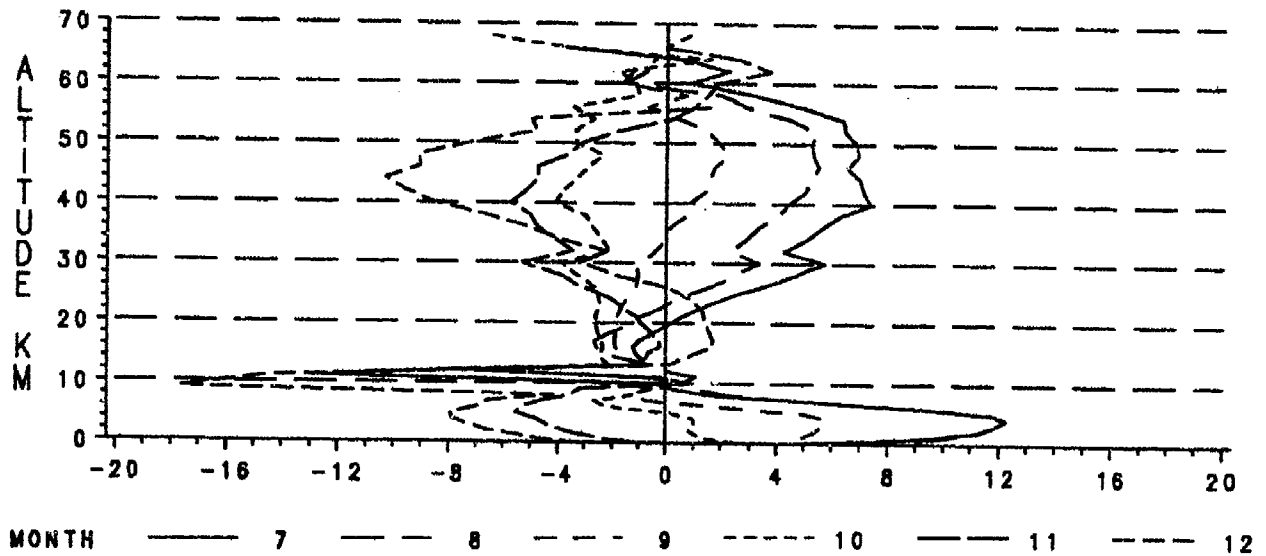


**Figure F-14. Delta Percent Relative to Annual Temperature, July-December.**





**Figure F-15. Delta Temperature (K), January-June.**



**Figure F-16 Delta Temperature (K), July-December.**

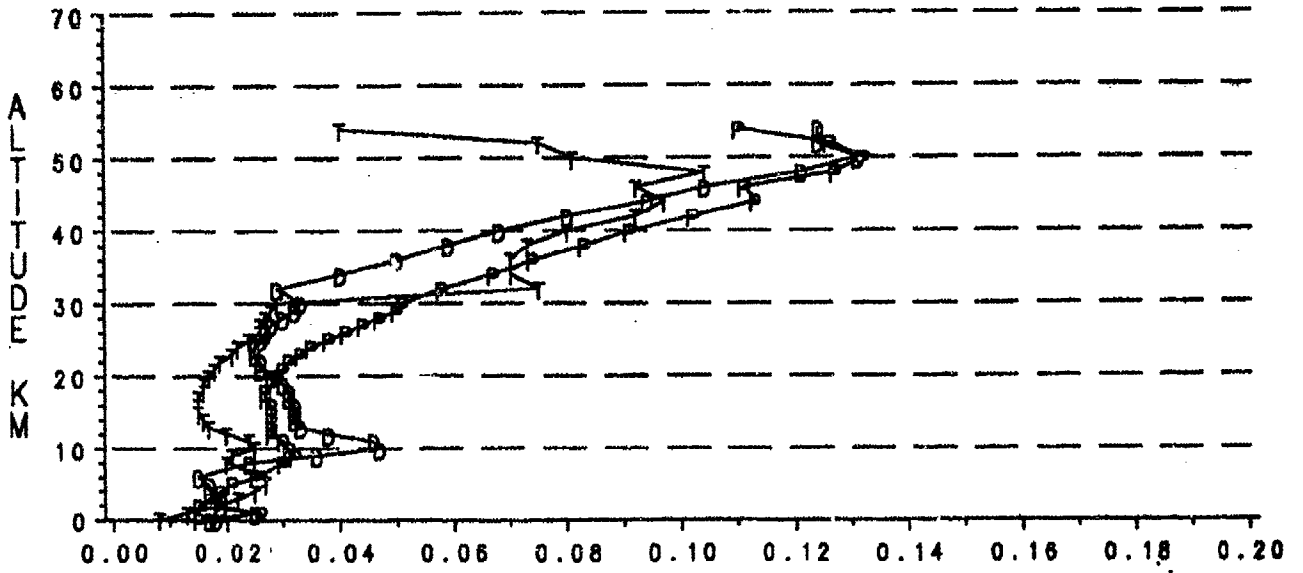


Figure F-17. Coefficients of Variation for Pressure (P), Density (D), and Temperature (T), January.

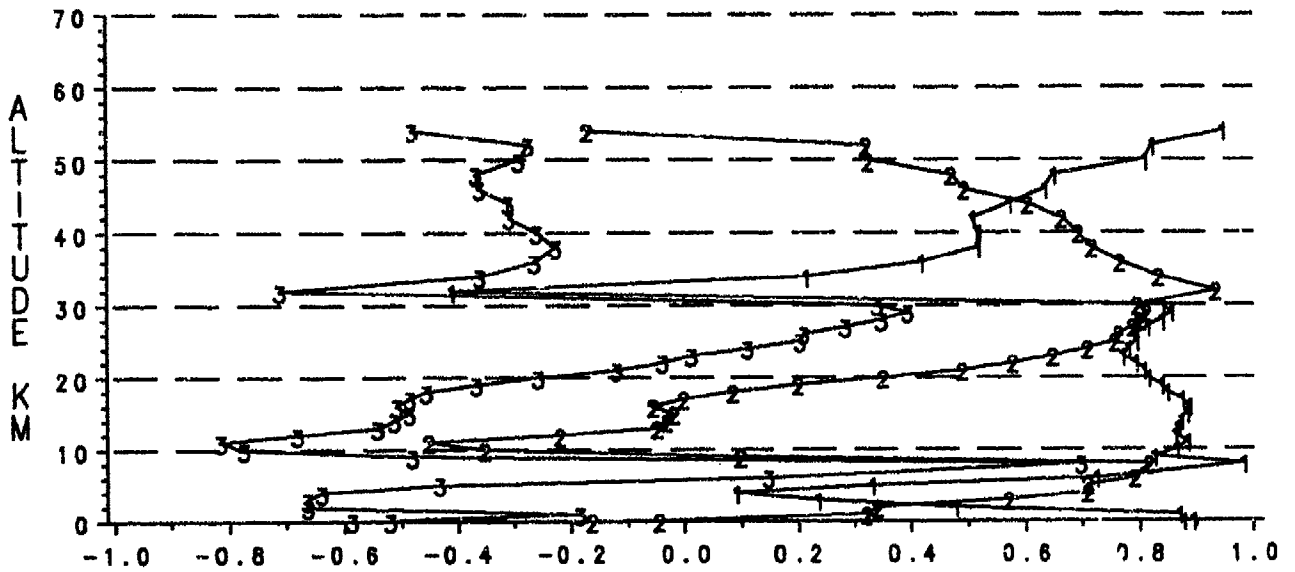


Figure F-18. Correlation Coefficients for P&D, P&T, and T&D, January.

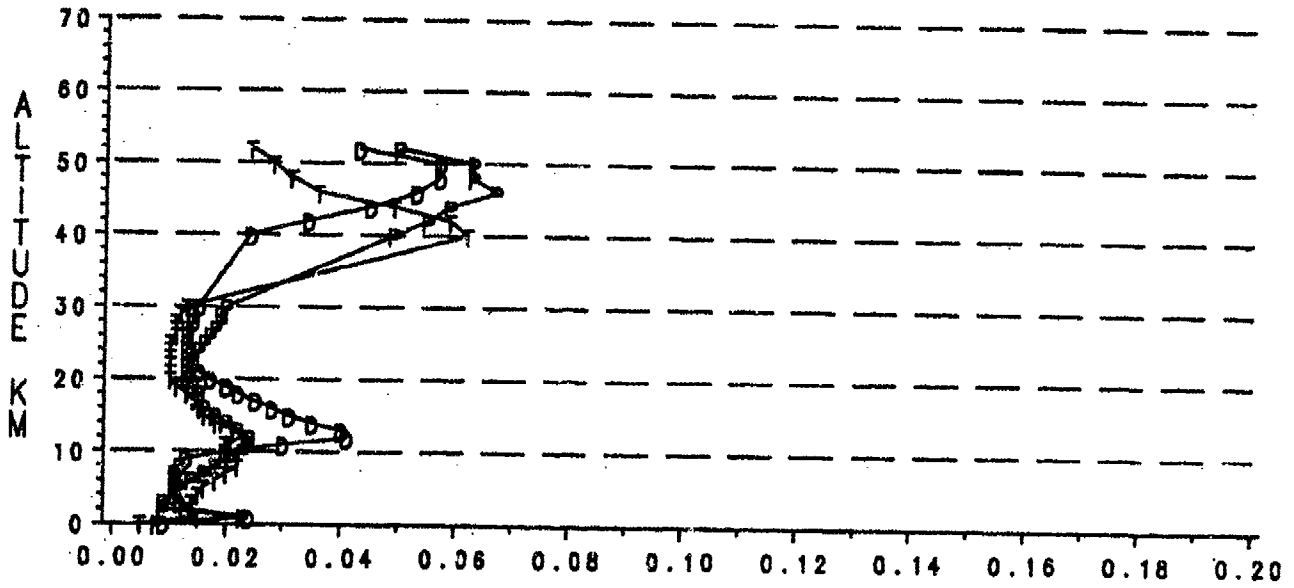


Figure F-19. Coefficients of Variation for Pressure (P), Density (D), and Temperature (T), July.

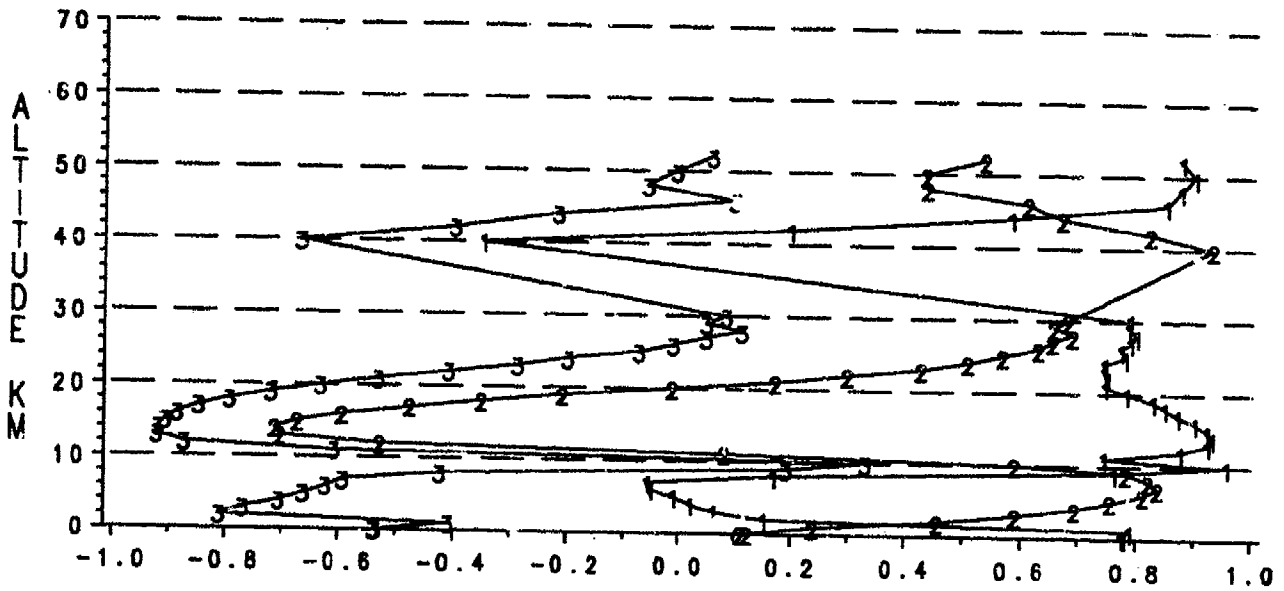


Figure F-20. Correlation Coefficients for P&D, P&T, and T&D, July.

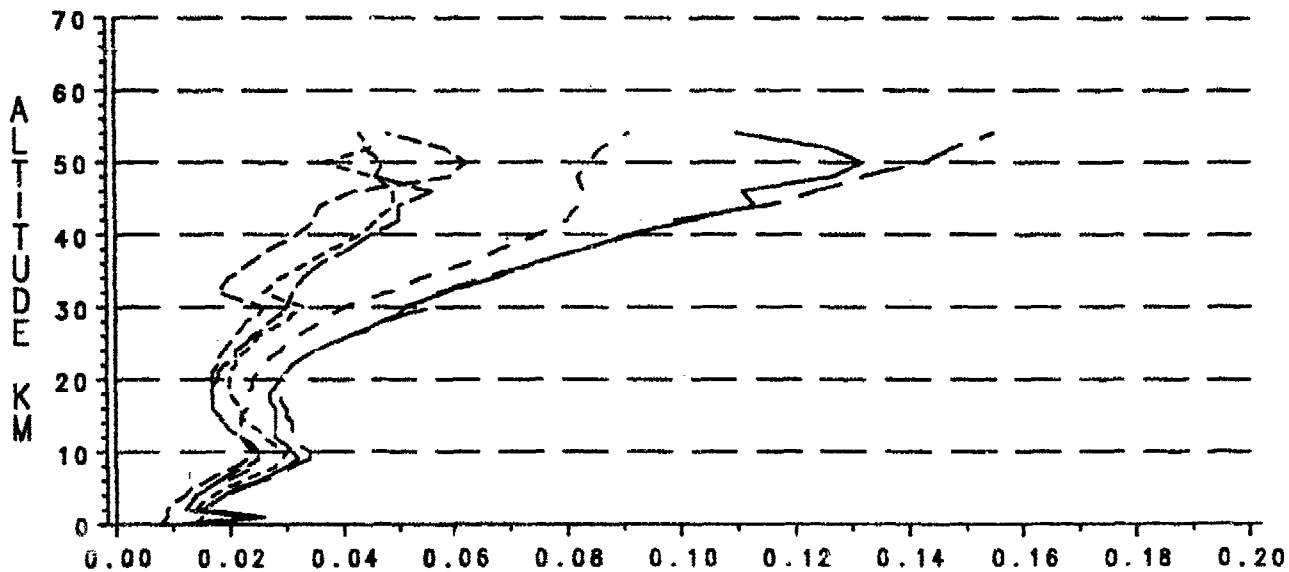


Figure F-21. Coefficients of Variation for Pressure, January-June.

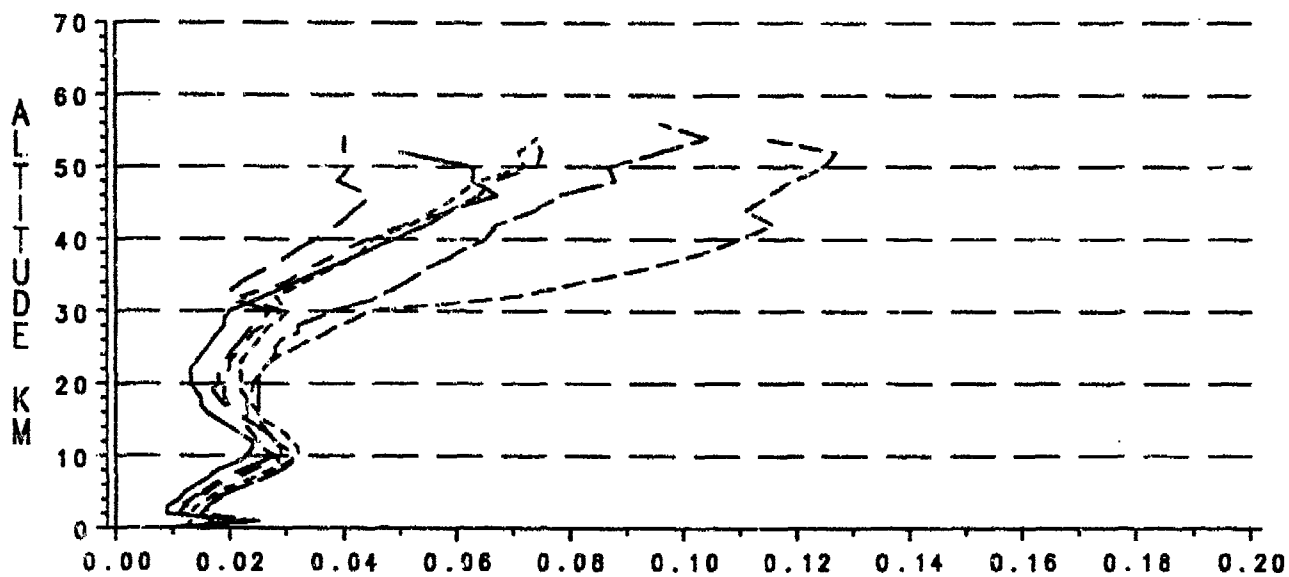
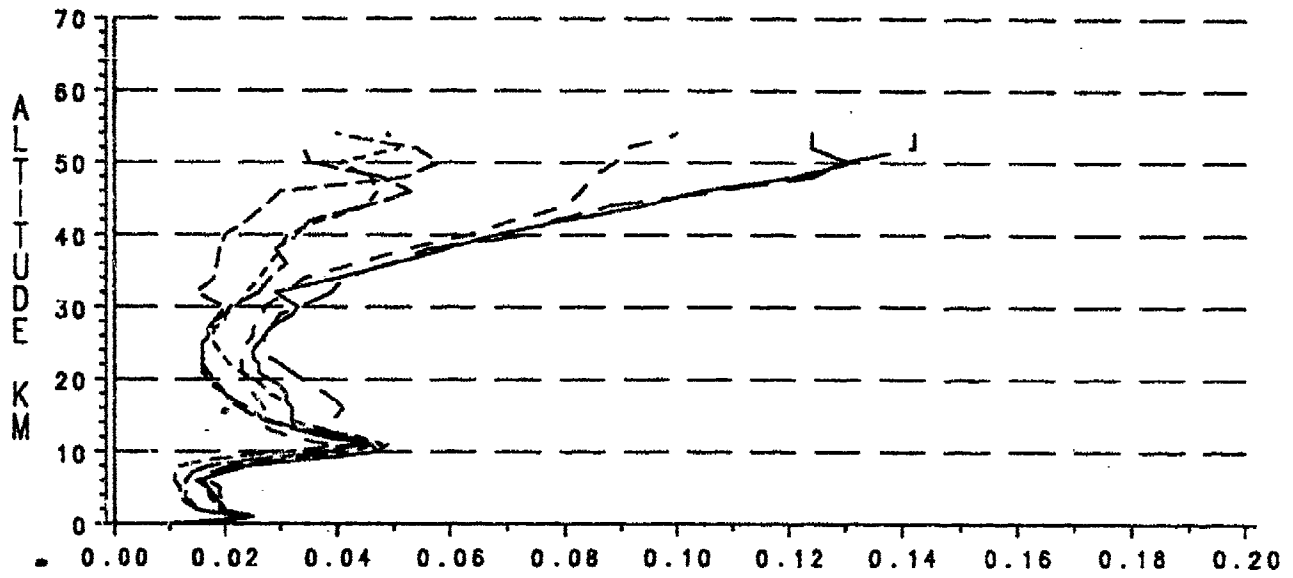
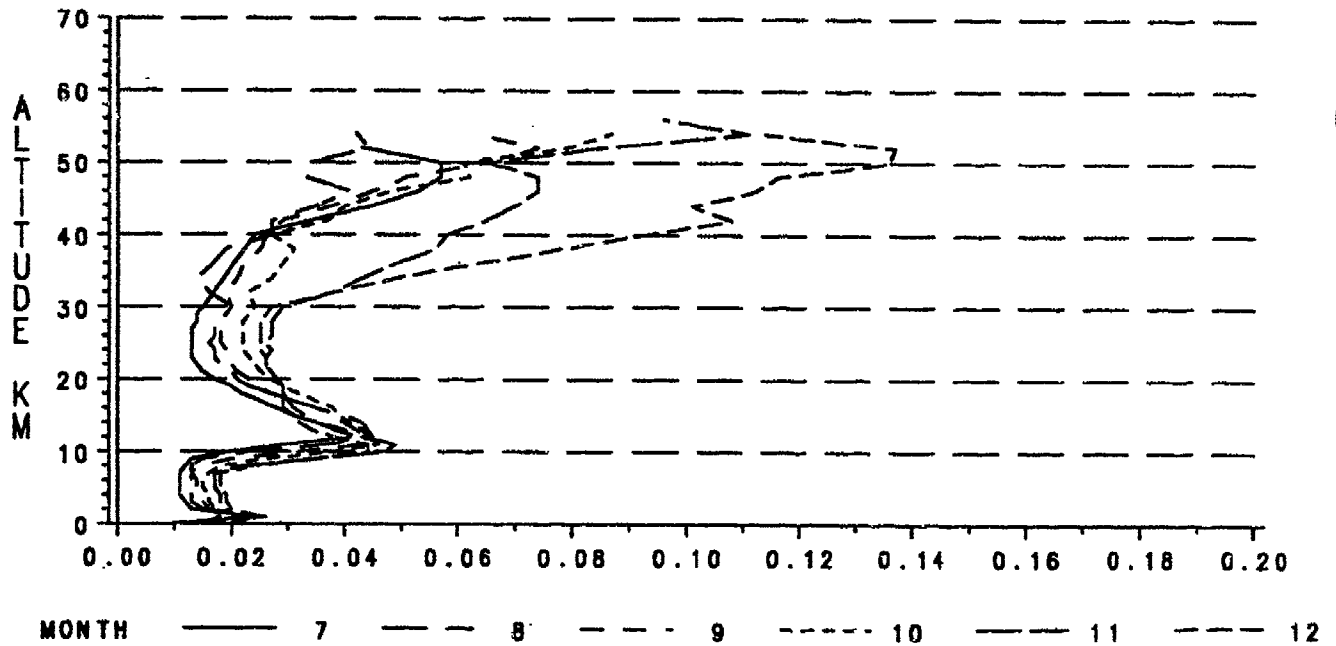


Figure F-22. Coefficients of Variation for Pressure, July-December.



**Figure F-23. Coefficients of Variation for Density, January-June.**



**Figure F-24. Coefficients of Variation for Density, July-December.**

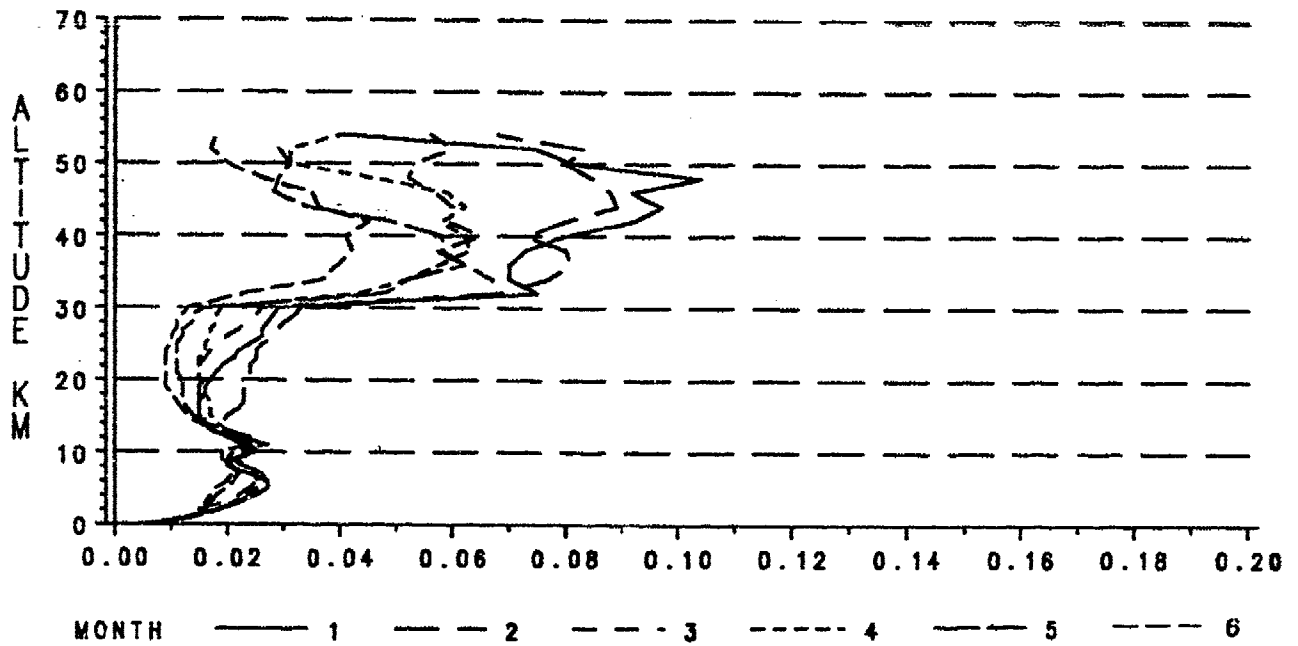


Figure F-25. Coefficients of Variation for Temperature, January-June.

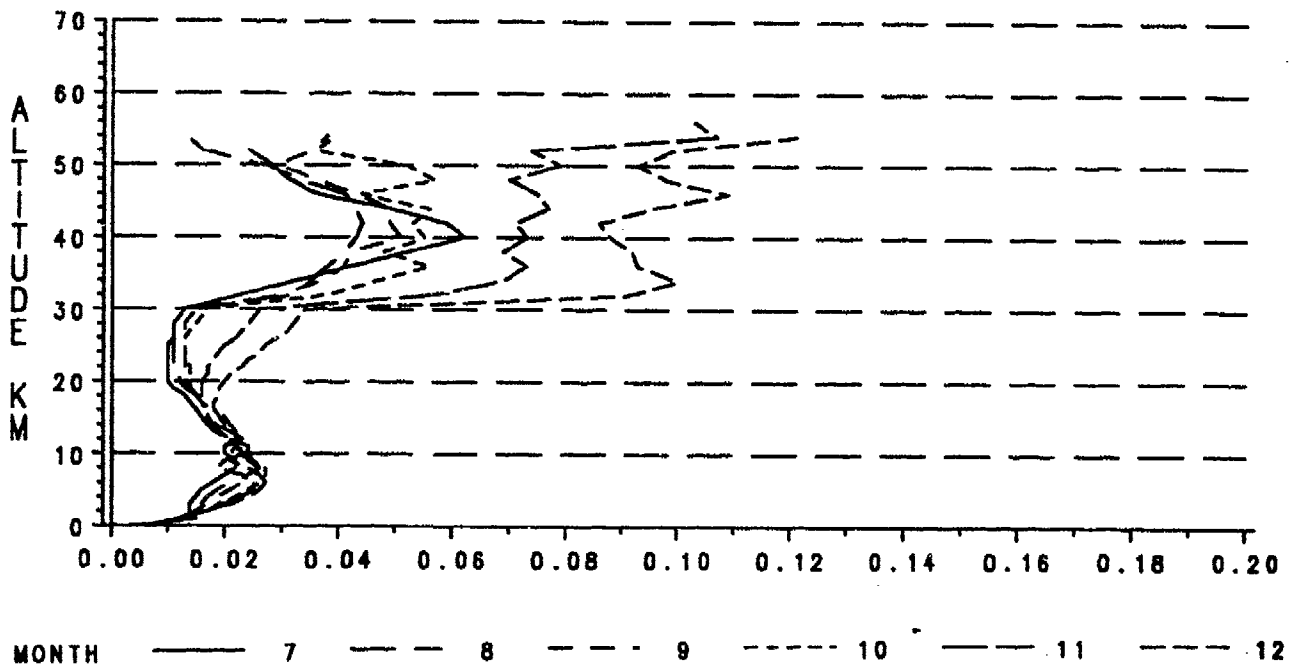
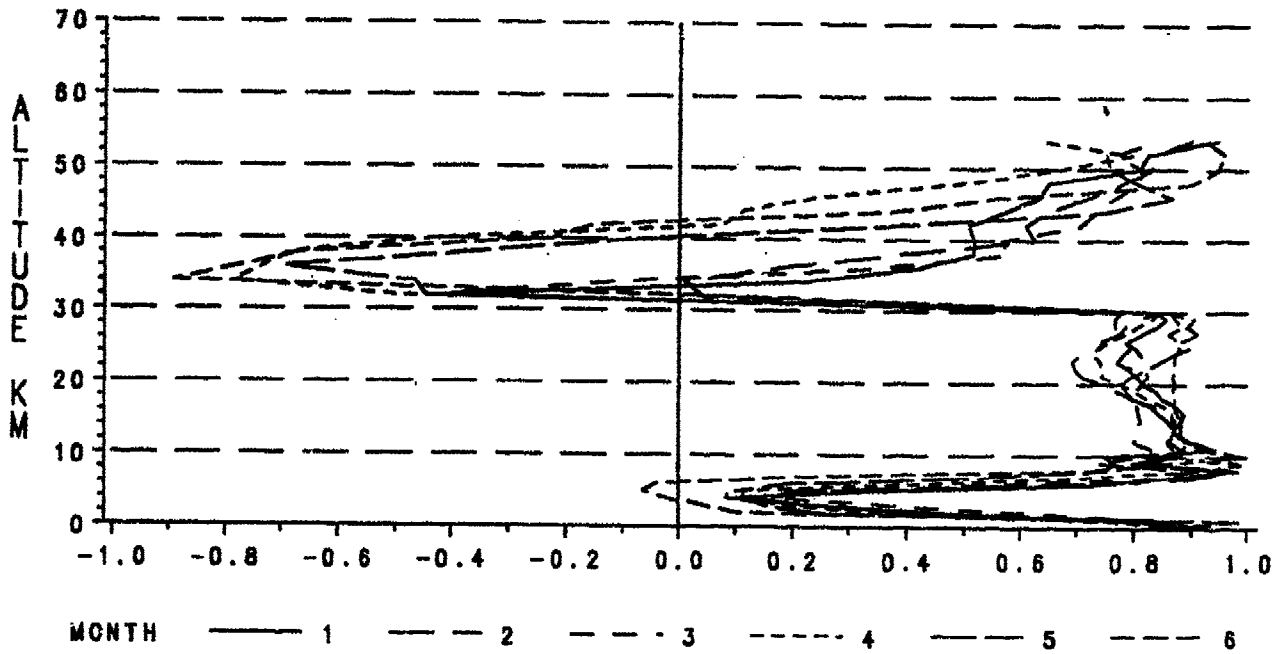
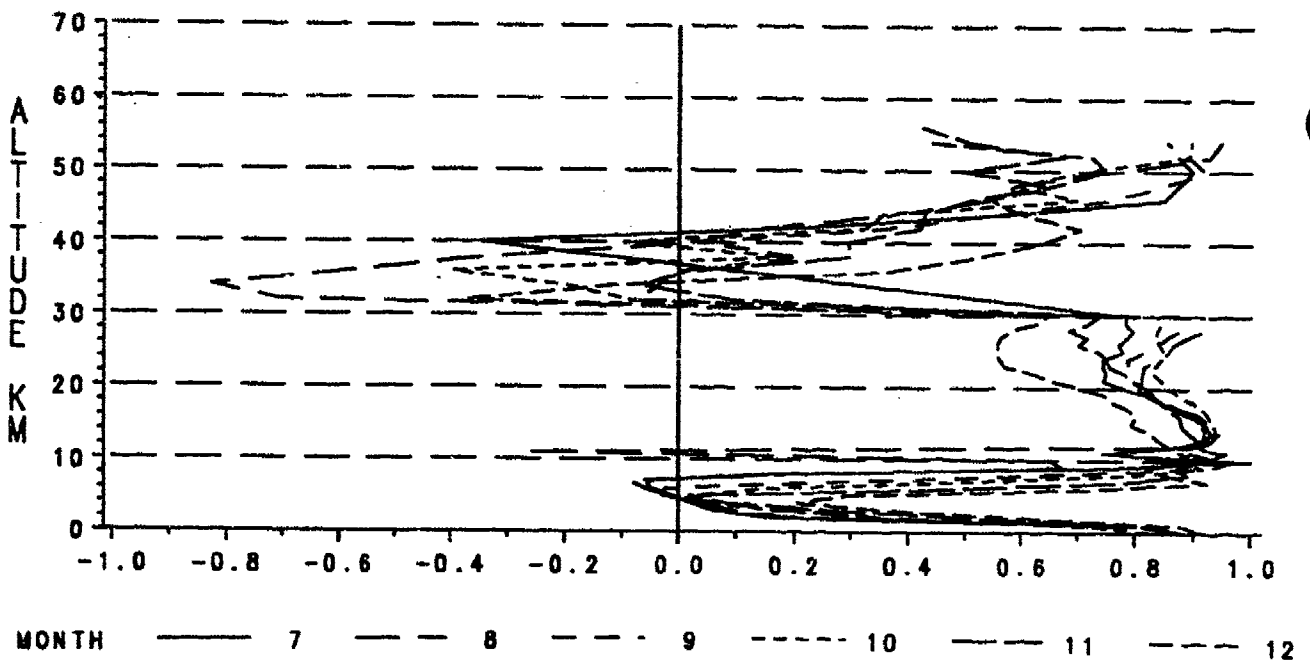


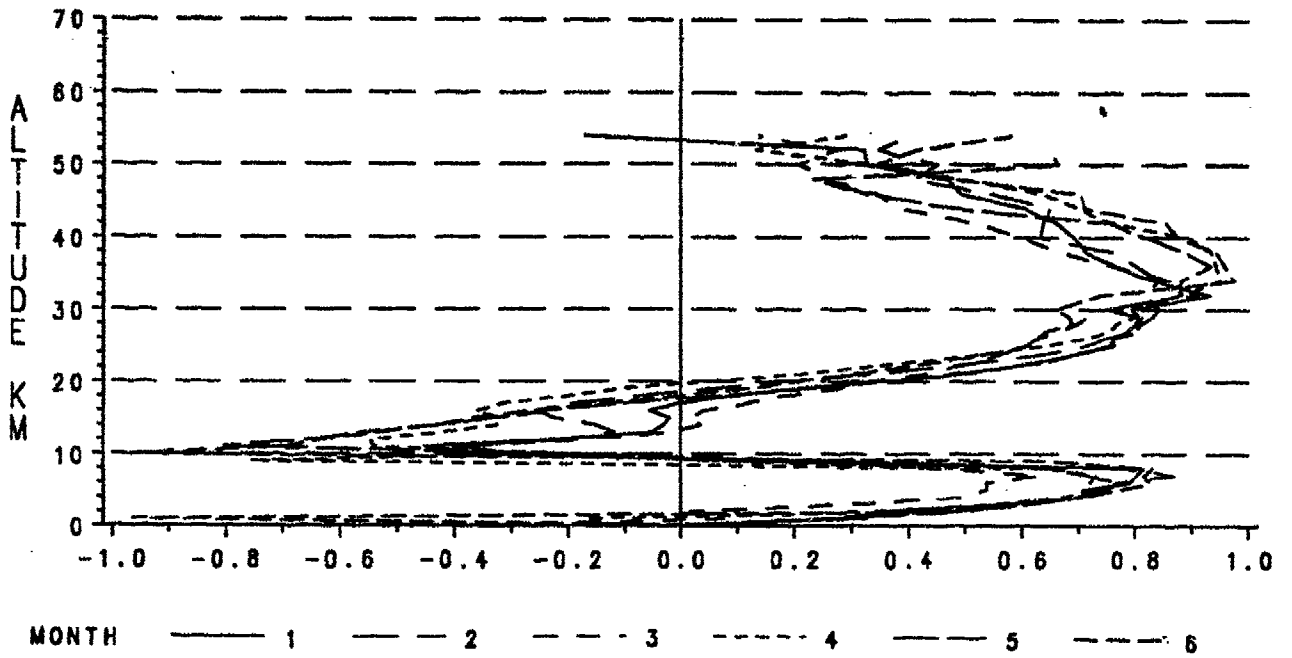
Figure F-26. Coefficients of Variation for Temperature, July-December.



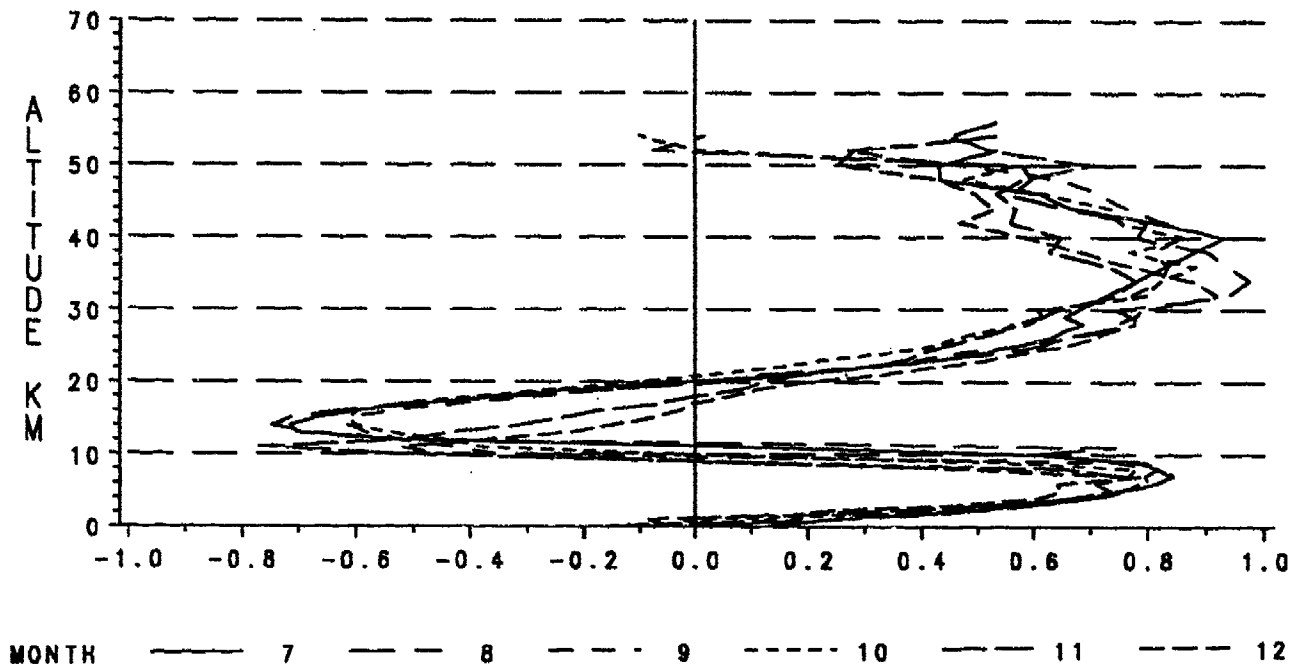
**Figure F-27. Correlation Coefficients for Pressure & Density, January-June.**



**Figure F-28. Correlation Coefficients for Pressure & Density, July-December.**



**Figure F-29. Correlation Coefficients for Pressure & Temperature, January-June.**



**Figure F-30. Correlation Coefficients for Pressure & Temperature July-December.**



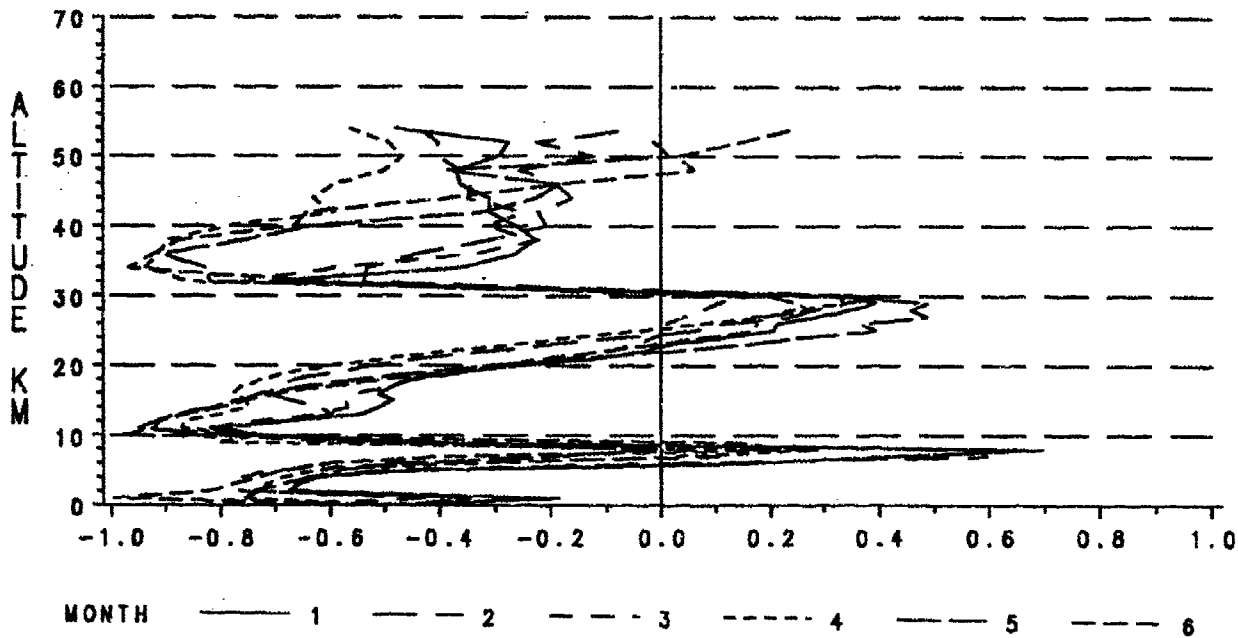


Figure F-31. Correlation Coefficients for Temperature & Density, January-June.

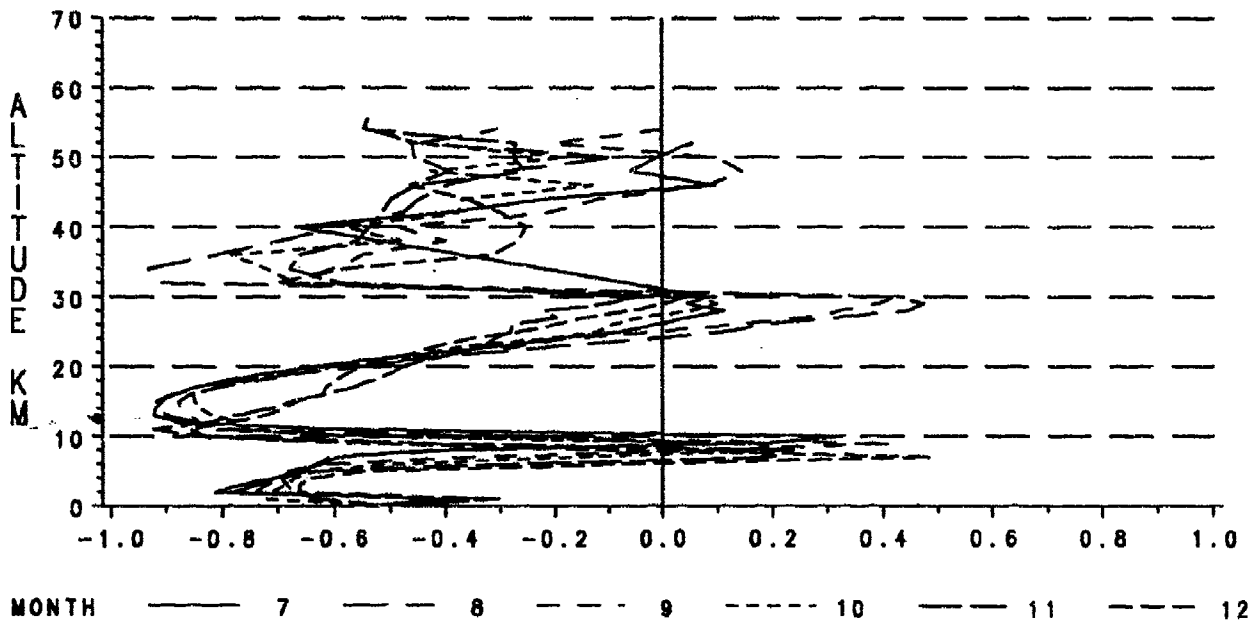


Figure F-32. Correlation Coefficients for Temperature & Density, July-December.

## APPENDIX G

### SHEMYA Descriptive Data

To prevent further character size reduction in the tables given in Appendices A-D, certain range-specific information for Shemya has been omitted. The most important information follows:

#### Header Record 0-30 km

Table Number.....	0
Data Source (1=DATSAV, 2=WDC-A).....	1
Call Letters.....	PASY
WMO Number.....	704140
Latitude.....	52° 43'
Direction (N or S).....	N
Longitude.....	174° 07'
Direction (E or W).....	E
Elevation in Meters.....	30
Start Period of Record (Mo-Yr).....	0173
End Period of Record (Mo-Yr).....	1286
No. of Time Windows (0,1, or 2).....	0
Start Time Window #1 (Hr-Mhz).....	0
End Time Window #1.....	0
Start Time Window #2.....	0
End Time Window #2.....	0
Date of RRA.....	0191
Altitude Range of RRA Low-Level (km).....	0
Altitude Range of RRA High-Level (km).....	30
Standard Deviation of Thermodynamics Limits.....	±6.0
Wind Limits.....	±6.0

**The following data is only required for RRAs that go to 70 km:**

Table Number..... 0  
Data Source (1=DATSAV, 2=WDC-A)..... 1  
Call Letters..... PASY  
WMO Number..... 704140  
Latitude..... 52° 43'  
Direction (N or S)..... N  
Longitude..... 174° 07'  
Direction (E or W)..... E  
Elevation in Meters..... 30  
Start Period of Record (Mo-Yr)..... 0575  
End Period of Record (Mo-Yr)..... 1285  
No. of Time Windows (0,1, or 2)..... 0  
Start Time Window #1 (Hr-Mhz)..... 0  
End Time Window #1..... 0  
Start Time Window #2..... 0  
End Time Window #2..... 0  
Date of RRA..... 0191  
Altitude Range of RRA Low-Level (km)..... 32  
Altitude Range of RRA High-Level (km)..... 70  
Standard Deviation of Thermodynamic Limits..... ±6.0  
Wind Limits..... ±6.0

## DISTRIBUTION

AWS/DO, Scott AFB, IL 62225-5008 .....	1
AWS/XT, Scott AFB, IL 62225-5008 .....	1
AWS/XTJ, Scott AFB, IL 62225-5008 .....	1
SD/CWDA, PO Box 92960, Los Angeles, CA 90009-2960 .....	1
Det 1, HQ AWS, Pentagon, Washington, DC 20330-6560 .....	1
Det 2, HQ AWS, Pentagon, Washington, DC 20330-5054 .....	1
Det 3, HQ AWS, PO Box 3430, Onizuka AFB, CA 94088-3430 .....	1
1WW/DN, Hickam AFB, HI 96853-5000 .....	3
11WS/DON, Elmendorf AFB, AK 99506-5000 .....	1
20WS/DON, APO San Francisco 96328-5000 .....	1
30WS/DON, APO San Francisco 96301-0420 .....	1
2WW/DN, APO New York 09094-5000 .....	1
3WW/DN, Offutt AFB, NE 68113-5000 .....	2
4WW/DN, Peterson AFB, CO 80914-5000 .....	2
2WS/DON, Andrews AFB, MD 20334-5000 .....	20
5WW/DN, Langley AFB, VA 23665-5000 .....	2
AFGWC/SDSL, Offutt AFB, NE 68113-5000 .....	2
USAFETAC, Scott AFB, IL 62225-5438 .....	5
7WW/DN, Scott AFB, IL 62225-5008 .....	1
6WS/DON Hurlburt Field, FL 32544-5000 .....	1
17WS/DON, Travis AFB, CA 94535-5986 .....	1
3350 TCHTG/TTGU-W, Stop 62, Chanute AFB, IL 61868-5000 .....	1
3395 TCHTG/TTKO, Keesler AFB, MS 39534-5000 .....	1
USCINCPAC (J37), Box 13, Camp H.M. Smith, HI 96861-5025 .....	1
NAVOCEANCOMDET, Federal Building, Asheville, NC 28801-2723 .....	1
NAVOCEANCOMDET, Patuxent River NAS, MD 20670-5103 .....	1
NAVOCEANCOMFAC, Stennis Space Ctr, MS 39529-5002 .....	1
NAVOCEANCOMFAC, NAS North Island, San Diego, CA 92135-5130 .....	1
COMNAVOCEANCOM, Code N312, Stennis Space Ctr, MS 39529-5000 .....	2
COMNAVOCEANCOM (Capt Brown, Code N332), Stennis Space Ctr, MS 39529-5001 .....	1
NAVOCEANO, Code 9220 (Tony Ortolano), Stennis Space Ctr, MS 39529-5001 .....	1
FLENUMOCEANCEN, Monterey, CA 93943-5006 .....	1
NOARL West, Monterey, CA 93943-5006 .....	1
Naval Research Laboratory, Code 4323, Washington, DC 20375 .....	1
Naval Western Oceanography Ctr, Box 113, Attn: Tech Library, Pearl Harbor, HI 96860-5000 .....	1
Naval Oceanography Command Ctr, COMNAVMAR Box 12, FPO San Francisco, CA 96630-5000 .....	1
Pacific Missile Test Center, Geophysics Division, Code 3253, Pt Mugu, CA 93042-5000 .....	1
NOAA Library-EOC4WSC4, Attn: ACQ, 6009 Executive Blvd, Rockville, MD 20852 .....	1
NOAA/NESDIS (Attn: Nancy Everson, E/RA22), World Weather Bldg, Rm 703, Washington, DC 20233 .....	1
GL/LY, Hanscom AFB, MA 01731-5000 .....	1
GL Library, Attn: SULLR, Stop 29, Hanscom AFB, MA 01731-5000 .....	1
Atmospheric Sciences Laboratory (SLCAS-AT-AB) Aberdeen Proving Grounds, MD 21005-5001 .....	1
Atmospheric Sciences Laboratory, (SCLAS-AS-I), White Sands Missile Range, NM 88002-5501 .....	1
U.S. Army Missile Command, ATTN: AMSMI-RD-TE-F, Redstone Arsenal, AL 35898-5250 .....	1
Technical Library, Dugway Proving Ground, Dugway, UT 84022-5000 .....	1
NCDC Library (D542X2), Federal Building, Asheville, NC 28801-2723 .....	1
DTIC-FDAC, Cameron Station, Alexandria, VA 22304-6145 .....	2
AUL/LSE, Maxwell AFB, AL 36112-5564 .....	1
AWSTL, Scott AFB, IL 62225-5438 .....	50