

AD-A231 926

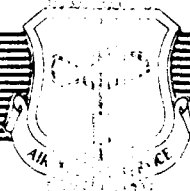

RANGE REFERENCE ATMOSPHERE

NELLIS

DTIC
ELECTE
FEB 12 1991
S B D

DECEMBER 1990

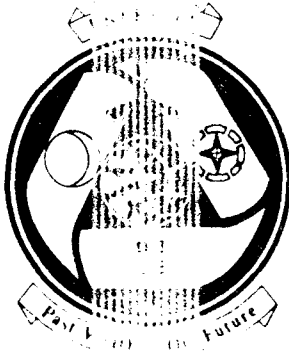

APPROVED FOR PUBLIC RELEASE;
DISTRIBUTION IS UNLIMITED

USAF
ENVIRONMENTAL TECHNICAL
APPLICATIONS CENTER

Scott Air Force Base, Illinois, 62225-5438

91 2 11 188

REVIEW AND APPROVAL STATEMENT

USAFETAC/PR-90/008, *Range Reference Atmosphere, Nellis*, December 1990, is approved for public release. There is no objection to unlimited distribution of this document to the public at large, or by the Defense Technical Information Center (DTIC) to the National Technical Information Service (NTIS).

This document has been reviewed and is approved for publication.

PATRICK J. BREITLING
Chief Scientist

FOR THE COMMANDER

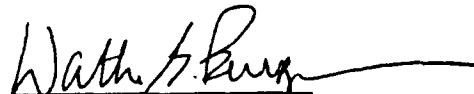
WALTER S. BURGMANN
Scientific and Technical Information
Program Manager
18 December 1990

REPORT DOCUMENTATION PAGE

2. Report Date: December 1990
3. Report Type: Range Reference Atmosphere (RRA)
4. Title and Subtitle: Range Reference Atmosphere, Nellis
7. Performing Organization Name and Address: USAF Environmental Technical Applications Center (USAFETAC), Scott AFB, IL 62225-5438
8. Performing Organization Report Number: USAFETAC/PR-90/008
12. Distribution/Availability Statement: Approved for public release; distribution is unlimited.
13. Abstract: This range reference atmosphere (RRA) is a statistical model (derived from upper-air observations) of the atmosphere from 0 to 30 km over the Nellis range complex. The data used to create this document was from Desert Rock (KDRA), about 50 NM west of Nellis AFB. The RRA provides tabulations of monthly and annual means, standard deviations, and skewness coefficients for wind speed, pressure, temperature, density, water vapor pressure, virtual temperature, and dew point temperature. It also gives means and standard deviation for the zonal and meridional wind components and hydrostatic model atmosphere. Methodology is included, along with graphic displays of wind statistics that can be derived from the wind data.
14. Subject Terms: CLIMATOLOGY, UPPER-AIR CLIMATOLOGY, UPPER ATMOSPHERE, ATMOSPHERIC SOUNDINGS, STATISTICAL DATA, STATISTICAL ANALYSIS, HYDROSTATIC MODEL ATMOSPHERES, MISSILE RANGES, LAUNCHING SITES, NELLIS, wind, atmospheric pressure, atmospheric density, air temperature, dew point temperature, atmospheric moisture, range reference atmosphere.
15. Number of Pages: 150
17. Security Classification of Report: Unclassified
18. Security Classification of this Page: Unclassified
19. Security Classification of Abstract: Unclassified
20. Limitation of Abstract: UL

Standard Form 298

TABLE OF CONTENTS

	Page
Chapter 1 INTRODUCTION TO THE RANGE REFERENCE ATMOSPHERE (RRA)	
1.1 The RRA Defined.....	1
1.2 Purpose of the RRA.....	1
1.3 Contents of the RRA.....	1
1.4 Units of Measurement Used in RRAs.....	1
1.5 RRA Quality Control.....	1
1.6 How the RRA is Organized.....	2
1.7 Conversion Units.....	2
 Chapter 2 WIND STATISTICS AND MODELS	
2.1 General Discussion.....	5
2.2 Quality Control.....	7
2.3 Data Limitations.....	7
2.4 The Coordinate System of Statistical Parameters.....	7
2.5 Computing Statistical Parameters.....	8
2.6 Statistical Wind Models.....	8
2.6.1 Wind Component Statistics.....	8
2.6.2 The Vector Wind Model.....	8
2.6.3 Derived Distributions for Wind Statistics.....	12
2.6.3.1 The Conditional Distribution of Wind Components.....	13
2.6.3.2 Generalized Rayleigh Distribution for Wind Speed.....	14
2.6.3.3 The Derived Distribution of Wind Direction.....	15
2.6.3.4 Derived Conditional Distribution of Wind Speed Given Wind Direction.....	16
2.7 Statistical Parameters for Non-Standard Orthogonal Axes.....	18
 Chapter 3 THERMODYNAMIC STATISTICS AND MODELS	
3.1 General Discussion.....	19
3.2 Quality Control.....	21
3.3 Data Limitations.....	21
3.4 Establishing Data Samples at Required Levels.....	21
3.4.1 Converting Geopotential Height to Geometric Altitude.....	21
3.4.2 Calculations from Rawinsonde Observations.....	22
3.4.2.1 Geopotential Height at Significant Levels.....	22
3.4.2.2 Temperature.....	22
3.4.2.3 Pressure.....	23
3.4.2.4 Dew Point Temperature.....	23
3.4.2.5 Vapor Pressure.....	23
3.4.2.6 Density.....	23
3.4.2.7 Virtual Temperature.....	23
3.4.3 Calculations from Rocketsonde Observations.....	23
3.4.3.1 Temperature.....	23
3.4.3.2 Pressure.....	24
3.4.3.3 Density.....	24
3.5 Computing Statistics for Appendices B and C.....	24
3.5.1 Stored Statistical Sums.....	24
3.5.2 Calculating Monthly Statistics.....	24
3.5.2.1 Monthly Means.....	24
3.5.2.2 Monthly Standard Deviations.....	24
3.5.2.3 Monthly Skewness Values.....	24
3.5.3 Calculating Annual Statistics.....	25

Chapter 3 THERMODYNAMIC STATISTICS AND MODELS, Cont'd.	
3.5.3.1 Annual Means.....	25
3.5.3.2 Annual Standard Deviations and Skewness Values.....	25
3.6 Monthly and Annual Mean Model Atmospheres.....	25
3.7 Thermodynamic Quantities Derivable from Tables.....	25
3.7.1 Mean Air Particle Speed.....	26
3.7.2 Mean Free Path.....	26
3.7.3 Mean Collision Frequency.....	27
3.7.4 Speed of Sound.....	27
3.7.5 Coefficient of Dynamic Viscosity.....	27
3.7.6 Kinematic Coefficient of Viscosity.....	27
3.7.7 Coefficient of Thermal Conductivity.....	28
3.7.8 Refractive Modulus and Refractive Index.....	28
Chapter 4 CONCLUSIONS AND RECOMMENDATIONS	
4.1 Conclusions.....	29
4.2 Recommendations.....	29
BIBLIOGRAPHY.....	30
PREVIOUSLY PUBLISHED RANGE REFERENCE ATMOSPHERES.....	31
ACRONYMS, INITIALISMS, AND ABBREVIATIONS (ACRINABs).....	34
APPENDIX A Nellis Wind Statistics Tables.....	A-1
APPENDIX B Nellis Thermodynamic Statistics Tables.....	B-1
APPENDIX C Nellis Moisture-Related Statistics Tables.....	C-1
APPENDIX D Nellis Hydrostatic Model Atmospheres.....	D-1
APPENDIX E Wind Statistics Derivable from Appendix A Tables.....	E-1
APPENDIX F Thermodynamic Statistics Derivable from Appendix C, D, and E Tables.....	F-1
APPENDIX G Nellis Descriptive Data.....	G-1



Accession For	
NTIS GRA&I	<input checked="" type="checkbox"/>
DTIC TAB	<input type="checkbox"/>
Unannounced	<input type="checkbox"/>
Justification	
By.....	
Distribution/.....	
Availability Codes	
Dist.	Avail and/or Special
A-1	

PREFACE

The state of the atmosphere over national ranges and aerospace vehicle launch and/or recovery sites is critical not only to launch and recovery operations, but to aerospace research and development, as well. In the early 1960s, missile range operators recognized the need for a realistic atmospheric model that was consistently derived for each of the several major missile test ranges then in operation. Such a model, derived from climatological statistics for a given location, was developed and named a "range reference atmosphere." Even though the application has since broadened to include all aerospace launch and/or recovery sites, the model is still referred to as a "range reference atmosphere," or "RRA."

The first RRA (for Cape Canaveral) was prepared in 1963 by the Inter-Range Instrumentation Group (IRIG). More RRAs were produced for other ranges through 1974. Since then, improved upper-air databases have become available not only because of an extended period of record, but because of more and better rocketsonde data above 30 km. Although some improved RRAs were published in 1983 and 1984, revisions must continue, because:

- Aerospace technology requirements continue to change--the space shuttle program is an example.
- Extended and improved upper-air databases for most existing ranges permit development of better, more comprehensive RRAs.
- New launch and recovery sites have been opened.
- There have been significant advances in understanding the structure and physics of the upper atmosphere.
- There have been similar advances in statistical modeling techniques, largely because of ever-larger, faster, and more sophisticated computers.

For these reasons, the Range Reference Atmosphere Committee (RRAC) was tasked by the Range Commander's Council/Meteorology Group (RCC/MG) to produce new and revised RRAs, as required. The RRAC, through Task MG-1, publishes RRAs for ranges specified by the RCC. An RRA, as has already been mentioned, is a model of the atmosphere over a specified geographical area that delineates an aerospace vehicle launch and/or recovery site. RRAs are for use by DoD and other U.S. Government users in planning, evaluating, and establishing environmental launch/recovery constraints for a specific facility and the aerospace vehicles launched and/or recovered there.

The RRA tasking requires using the best available upper-atmosphere databases (rawinsonde, rocketsonde, and any other high-altitude data source) to create and publish (in standard format) a consistently derived model of wind and thermodynamic values through a cross-section of the upper atmosphere from surface to a specified height. The individual RRA serves as the authoritative source for upper-atmosphere climatology at a given launch/recovery site.

Wind statistics, insofar as practical, are modeled to be consistent with the rigorous mathematical probability properties of the multivariate normal probability theory. Thermodynamic statistics, insofar as practical, are modeled to be consistent with the hydrostatic equation, the equation of state, and related probability principles.

In keeping with the RCC's objective of standardization, modeling technique, basic text, and tabulation formats are the same for all RRAs. RRAs published in 1990 have undergone minor format changes designed to make them conform to DoD and ANSI technical publications standards. All RRAs provide mean values of thermodynamic quantities (pressure, temperature, and density) and moisture quantities (vapor pressure, virtual temperature, and dew point temperature). These values include a statistical measure for the dispersion: that is, standard deviations and skewness coefficients. The properties of the bivariate normal probability distribution function are used for statistical modeling of wind.

The first RRA to be published in this new (1990) series was for the Wake Island Missile Range, with an altitude range from 0 to 30 km. The order of priority for subsequent publications in the RRA series is:

<u>Range</u>	<u>Altitude Range Required</u>
1. Nellis Range Complex, NV	0 - 30 km
2. Shemya, AK	0 - 70 km
3. Thule, GR	0 - 70 km
4. Fairbanks, AK	0 - 30 km

All final computations in this RRA series were performed by the USAF Environmental Technical Applications Center (USAFETAC) in response to taskings from the Ballistic Missile Office (BMO), HQ Air Weather Service (AWS/SYJ), and Detachment 2, Space Division.

Majors Cheryl Souders and Walter Miller, and Capts Doug Adamson and Brian Bjornson (all of USAFETAC/DNO), rewrote the software used to provide the primary tables, updated Chapters 1 through 4, and prepared the appendices. USAFETAC/LDE formatted and edited the text and graphics, prepared the camera-ready copy in standard DoD technical report format, and published the document as a USAFETAC project report.

The RRC/MG Range Reference Atmosphere Committee is made up of representatives from the Air Force, Army, NASA, Navy, and NOAA. The RRA committee members were:

Mr J. Lee (USAKA)	Mr D.R. Thornley (WSMR)
Mr D. Godwin (USAKA)	Mr E.J. Keppel (MSD)
Ms J. Bailey (YPG)	Capt R.M. Fogarty, USAF (6585th TG)
Mr T.O. McIntire (YPG)	Lt Col T.F. Tascione, USAF (MSD)
Mr S.W. Bieda, Jr. (EPG)	Mr J. Kerwin (MSD)
Mr G. Boire (WSMC)	Lt Col R.J. Ericson, USAF (CSTC)
Mr H.C. Herring (ESMC)	Capt W. Gibbons, USAF (TFWC)
Col J.T. Madura, USAF (ESMC)	Mr L.S. Corbett (NWC)
Maj A.F. Dye, USAF (ESMC)	Mr J.J. Genola (NWC)
Mr B.F. Boyd (ESMC)	Mr D. Tolzin (PMTC)
Mr C.W. Fain (ESMC)	Lt R. Kren, USN (NATC)
Maj R. Hughes USAF (AFFTC)	Mr J. Trischman (NATC)
Lt B. Hickel, USAF (AFFTC/UTTR)	Lt Col J.E. Erickson, (USAFETAC)
CPO G.A. Dillie, USN (NWC)	Mr R. Olsen (WSMR), Chairman

Chapter 1

INTRODUCTION TO THE THE RANGE REFERENCE ATMOSPHERE (RRA)

1.1 THE RRA DEFINED.

A "reference atmosphere" is a statistical model of the earth's atmosphere, derived from upper-air observations over a specific location. The atmospheric models developed by the Range Reference Atmosphere Committee (RRAC) in response to a tasking by the Range Commander's Council/Meteorology Group (RCC/MG) and published by the Secretariat, Range Commander's Council (RCC) are called "Range Reference Atmospheres," or "RRAs." The first series of RRAs was published from 1963 to 1974, and a second series was issued in 1983 and 1984.

1.2 PURPOSE OF THE RRA.

The individual RRA is the authoritative source for upper-atmosphere climatology over the launch and/or recovery site for which it has been prepared. RRAs are used to plan, evaluate, and establish environmental launch constraints for aerospace vehicles launched from a particular location.

1.3 CONTENTS OF THE RRA.

RRAs contain tabulations for monthly and annual means, standard deviations, and skewness coefficients for wind speed, pressure, temperature, density, water vapor pressure, virtual temperature, and dew point temperature. They also provide means and standard deviations for zonal and meridional wind components and the linear (product moment) correlation coefficient between wind components. Statistical values are tabulated (at the station elevation) at 1-km intervals from sea level (MSL) to 30 km and at 2-km intervals from 30 to 70 km. Wind statistics begin at about 10 meters above station elevation, and continue at altitudes with respect to MSL thereafter. For ranges without rocketsonde measurements, RRAs terminate at 30 km; they may be extended upward, if necessary, when rocketsonde data from a nearby location can be made available.

1.4 UNITS OF MEASUREMENT USED IN RRAs.

All wind speeds are in meters per second (m/s). In all cases, the skewness coefficient and the correlation coefficient between wind components are unitless. Pressure (including water vapor pressure) is in millibars (mb). Temperature and virtual temperature are in kelvin (K). Density is in grams per cubic meter (gm/m^3). All altitudes are geometric, in kilometers (km). All heights are geopotential, also in kilometers (km). All altitudes/heights are in relation to mean sea level.

1.5 RRA QUALITY CONTROL.

Less than 10 percent of the soundings in the database used to calculate the RRA tables contained erroneous data. Soundings that did contain erroneous values data were eliminated from the database. Steps taken to produce an RRA that is as error-free as possible are described below:

(1) Soundings with gaps in their pressure levels of more than 200 mb were rejected. These soundings were eliminated because some contained height values only for mandatory pressure levels; when some heights at the mandatory levels were missing, the interpolated sounding contained significant errors.

(2) An initial set of RRA statistics was computed using all the remaining soundings (i.e., those that had not been rejected). This set was then used to determine data limits for temperature, pressure, U and V components of wind, density, and dew point for the 0-30 km portion, and density only from 30 to 60 km (in RRAs that go that high). The lower (or upper) data limits were set at the mean value for each variable, minus (or plus) six standard deviations of that quantity. One pair of data limits was computed for each of the atmospheric variables, the month, and the data level.

(3) The first set of data limits was then used to screen the database. All soundings that contained values outside the data limits were rejected. A new RRA was then computed using the screened database, and the second RRA was used to generate a second set of data limits.

(4) The second set of data limits was then used to screen the database further, and still another RRA was generated. The skewness values in this one were evaluated according to empirical criteria specified in Section 2.2 of this document (for winds) and in Section 3.2 (for thermodynamic quantities). If these criteria were satisfied, the third RRA was used to generate a final set of data limits, which were used to quality control the database for the final version of the RRA.

(5) Occasionally, the third RRA did not satisfy all the skewness criteria, indicating that the database still contained some erroneous values. To complete quality control, the "limits-to-RRA-to-limits" cycle was repeated (usually once or twice) until the resulting RRA satisfied the skewness criteria. When it did, a final set of data limits was generated, then used to quality control the database and produce the final RRA.

1.6 HOW THE RRA IS ORGANIZED.

RRA documents are published in four chapters, with Chapter 1 providing the introduction. Chapter 2, "Wind Statistics and Models," describes the techniques used to produce the wind statistics given in Table A-1 through A-13, Appendix A; it also describes the probability functions used as wind models to derive several wind statistics. Chapter 3, "Statistics of Thermodynamic Quantities and Models," describes the techniques used to produce the thermodynamic and moisture-related statistics in Tables B-1 through B-13 and C-1 through C-13, Appendices B and C. It also describes the atmospheric thermodynamic model in Tables D-1 through D-13, Appendix D. Chapter 3 also contains equations used to calculate several atmospheric properties. Chapter 4 provides conclusions and recommendations. Chapters 1-4 are the same in each new RRA; only Appendices A-G (described below) vary from RRA to RRA.

Appendix A contains monthly and annual wind statistics tables that give: (1) means and standard deviations of zonal and meridional wind components, (2) the linear (product moment) correlation coefficient between the two components, (3) the mean, standard deviation and skewness coefficient of the wind speed, and (4) the number of wind observations (*sample size*).

Appendix B contains monthly and annual thermodynamic statistics tables that give: (1) means, standard deviations, and skewness values of pressure, temperature, and density; and (2) the number of observations used for each of the thermodynamic quantities.

Appendix C contains monthly and annual moisture-related statistics tables that give: (1) means, standard deviations, and skewness values of water vapor pressure, virtual temperature, and dewpoint; and (2) the number of observations for each of the moisture-related quantities. Statistical values for water vapor pressure and dewpoint terminate at or below 15 km, depending on the range's latitude. Above 15 km, statistical values of virtual temperature are considered to be the same as those of temperature.

Appendix D contains monthly and annual tables that give hydrostatic model atmospheres for thermodynamic variables of pressure, virtual temperature, and density. Values are derived from the monthly and annual mean virtual temperature versus altitude (*geometric*) using the hydrostatic equation and the equation of state. Also presented is the geopotential height corresponding to the tabulated geometric altitudes.

Appendix E gives range-specific examples of certain wind statistics that can be derived from the basic data in Appendix A.

Appendix F gives tabular and graphic examples of certain pressure, density, and virtual temperature statistics that can be derived from basic data in Appendices B, C, and D.

Appendix G gives range-specific information such as location and database description.

1.7 CONVERSION UNITS.

Numerical values in the RRA are metric, as given in the International System of Units (SI, *Système International d'Unités*). Table 1-1 provides metric, U.S. Customary, and conversion units for all units used in this RRA.

TABLE 1-1. CONVERSION UNITS USED IN RRAS.

DATA TYPE	METRIC		US CUSTOMARY		CONVERSION:		To Get
	UNIT	ABBR	UNIT	ABBR	Multiply	By	
Ambient Temperature	degree Celsius	°C	degree Fahrenheit	°F	°F-32	0.5556	°C
	kelvin	K	degree Rankine	°R	°C	1.8	°F-32
					°R	1.00	°F+459.67
					°R-459.67	1.00	°F
Temperature Change	degree Celsius	°C	degree Fahrenheit	°F	K	1.00	°C+273.15
	kelvin	K	degree Rankine	°R	K-273.15	1.00	°C
					°C or K	1.8	chg °F/°R
					K or °R	0.5556	Chg °C/K
Ambient Density	gram/cubic meter	gm ⁻³	grain/cubic foot	grft ⁻³	gm ⁻³	0.43700	grft ⁻³
	gram/cubic centimeter	gcm ⁻³			grft ⁻³	2.2883	gm ⁻³
					gm ⁻³	10 ⁻⁶	gcm ⁻³
					gcm ⁻³	4.370/10 ⁻⁵	gcft ⁻³
Vapor Concentration (Absolute humidity)					grft ⁻³	2.288/10 ⁻⁶	gcm ⁻³
Windspeed	meters/second	ms ⁻¹	mile/hour	mph	ms ⁻¹	2.2369	mph
			knots	knots	mph	0.44704	ms ⁻¹
			feet/second	fts ⁻¹	ms ⁻¹	1.9438	knots
					knots	0.51444	ms ⁻¹
					mph	0.868976	knots
					knots	1.15078	mph
					ms ⁻¹	3.2808	ms ⁻¹
					fts ⁻¹	0.3048	ms ⁻¹
Weight	gram	g	grain	gr	lb	0.45359237	kg
	kilogram	kg	pound	lb	lb	453.59237	g
					kg	2.20462	lb
					g	15.4324	gr
				gr	0.06480	g	

TABLE 1-1. CONVERSION UNITS USED IN RRAS, Cont'd.

DATA TYPE	METRIC UNIT	US CUSTOMARY UNIT	ABBR	ABBR	CONVERSION:			To Get
					Multiply	By		
Length	meter	feet	m	ft	m	3.2808		ft
	micron	inch	μ	in	ft	0.3048		m
	Angstrom unit			in	in	2.54×10^{-4}		μ
				in	in	2.54×10^{-8}		A
			m	m	m	10^{+6}		μ
			m	m	m	10^{+10}		A
			μ	μ	μ	10^{-6}		m
			μ	μ	μ	3.937×10^{-5}		in
		A	A	A	10^{+0}		m	
		A	A	A	3.937×10^{-9}		m	
Pressure	newton/square meter	newton m ⁻² pound force/sq in	newton m ⁻²	lb in ⁻²	mb	10^{-3}		bar
	millimeter of Mercury	mmHg	mmHg	mHg	bar	10^3		mb
	bar	bar	bar	mHg	newton m ⁻²	10^{-2}		mb
	millibar	mb	mb	inch of Mercury	newton m ⁻²	1.4504×10^{-4}		lb m ⁻²
	dynes/square centimeter (microbar)	dyne cm ⁻²	dyne cm ⁻²		lb in ⁻²	6.8948×10^3		newton m ⁻²
	kilogram force/square meter	kg m ⁻²	kg m ⁻²		lb m ⁻²	1.4504×10^{-2}		lb m ⁻²
			bar		mb	68.948		mb
			mb		lbin ⁻²	10^3		dyne cm ⁻²
			dyne cm ⁻²		mb	10^{-3}		mb
			kg m ⁻²		dyne cm ⁻²	10^{-3}		dyne cm ⁻²
			kg m ⁻²		lb in ⁻²	6.8948×10^4		dyne cm ⁻²
			kg m ⁻²		dyne cm ²	1.4504×10^{-5}		lb m ⁻²
			kg m ⁻²		mb	10.1972		kg m ²
			kg m ⁻²		kg m ⁻²	0.0980665		mb
			kg m ⁻²		lb m ⁻²	703.0696		kg m ²
			kg m ⁻²		kg m ⁻²	0.0014223		lb m ²
			kg m ⁻²		mb	2.9530×10^{-2}		mHg (32°F)
		kg m ⁻²		mb	0.75006		mmHg (0°C)	
		kg m ⁻²		mHg	25.40		mmHg (0°C)	
		kg m ⁻²		mmHg	1.3332		mb	
		kg m ⁻²		mmHg (321)	33.8639		mb	
		kg m ⁻²		Pa	1.00		newton m ⁻²	

Chapter 2

WIND STATISTICS AND MODELS

2.1 GENERAL DISCUSSION.

One of the objectives in developing an RRA is to describe the wind field over the launch/recovery site as completely as possible with as few data tabulations as possible. With that in mind, the bivariate normal probability distribution was adopted as a statistical model for wind treated as a vector quantity at RRA data levels. Only five statistical parameters are required to completely describe this probability function; in Cartesian coordinates, these parameters are the means and standard deviations of the two orthogonal components, along with the correlation coefficient between the two components. The tables in Appendix A give the five statistical parameters for the zonal and meridional (meteorological coordinate) components. The statistical properties of the bivariate normal probability distribution are used to derive many wind statistics of interest to range users. The procedure produces consistent wind statistics that are connected through rigorous mathematical probability functions. By using these functions, extensive tabulations of wind statistics are avoided. Statistical properties of the bivariate normal probability distribution presented for the vector wind statistical model are:

- Wind components are univariate normally distributed.
- Conditional distribution of one component, given a value of the other component, is univariate normally distributed.
- Wind speed is in the form of a generalized Rayleigh distribution.
- Frequency distribution of wind direction can be derived.
- Conditional distribution of wind speed, given a value of wind direction (wind rose), can be derived.
- The five tabulated wind statistical parameters that are with respect to the meteorological zonal and meridional coordinate system can be derived for any arbitrary rotation of the orthogonal axes.

The RRA provides probability distribution functions and sets of equations to derive wind statistics for the previously stated properties of the vector wind model; examples are given in Appendix E.

No attempt is made here to give the derivation of the probability functions, but the reader is referred to Smith (1976) for derivations and several applications of the probability distribution properties for wind statistics.

Symbols used in Chapter 2, and their meanings, are given in Table 2-1, next page.

TABLE 2-1 Symbols Used In Chapter 2.

N	The number of wind measurements in Appendix A.
r	A general variable for the bivariate normal probability distribution in polar coordinates.
R	A generalized Rayleigh variable used for derived wind speed probability distribution.
$R(U,V)$	The linear (product moment) correlation coefficient between the zonal and meridional wind components in Appendix A.
$SK(W)$	Skewness parameter for wind speed in Appendix A.
$S(U)$	The standard deviation of the zonal wind component in Appendix A.
$S(V)$	The standard deviation of the meridional wind component in Appendix A.
$S(W)$	The standard deviation of wind speed in Appendix A.
t	A standardized normal variate used in Table 2-1.
U	The zonal wind component.
$U\overline{BAR}$	The mean value of the zonal wind component in Appendix A.
V	The meridional wind component.
$V\overline{BAR}$	The mean value of the meridional wind component in Appendix A.
W	Wind speed or modulus of wind vector, a scalar quantity.
$W\overline{BAR}$	The mean value of wind speed in Appendix A.
X	A general component mean value in the $[X,Y]$ coordinate system.
Y	A general component mean value in the $[X,Y]$ coordinate system.
\bar{X}	A general component variable or coordinate axes.
\bar{Y}	A general component variable or coordinate axes.
α	(alpha) Rotation angle for the $[X,Y]$ coordinate system.
θ	(theta) Wind direction in the polar coordinate system.
λ	(Lambda) A parameter in the bivariate normal probability distribution in Table 2-2.
ξ	(xi) The mean value in the standardized normal probability distribution used in Table 2-1.
π	(Pi) Constant = 3.14159.
ρ	(Rho) The general linear correlation coefficient between the two component variables in the $[x,y]$ coordinate system.
σ_x, σ_y	The general standard deviations of the x and y component variables in the $[x,y]$ coordinate system.

2.2 QUALITY CONTROL.

The U and V components of wind were used to generate data limits, which were set at plus and minus six standard deviations from the mean for each of the quantities. These data limits were used to screen the wind database, as described in Paragraph 1.5. The database was considered to be error-free if:

- The skewness of the wind speed was below 4.0 at data levels where the mean wind speed was less than 15 m/s, and
- The skewness of the wind speed was below 2.5 at data levels where the mean wind speed was greater than 15 m/s.

2.3 DATA LIMITATIONS.

For wind statistics, correlation coefficients for like and unlike wind components between altitude levels were not computed, and wind statistics with respect to altitude (profile) cannot be derived from RRA statistics; users are referred to Smith (1976) for wind profile modeling techniques. Wind statistics at discrete altitudes are valid; all the probability distribution functions described in Chapter 2 can be derived from the five wind component statistical parameters in Appendix A and the derived distributions can be considered as wind models at discrete altitudes.

Greek letters are used conventionally for population or theoretically known statistical elements, and sample estimates are denoted by English letters or with a "hat" ($\hat{\ } \wedge$) over Greek letters. In Chapter 2, Greek letters are used for variances and linear correlation coefficient, while means are denoted by \bar{X} and \bar{Y} when dealing with the bivariate normal distribution. It must always be understood that Appendix A contains sample estimates of statistical parameters, and that they are with respect to the meteorological zonal (U) and meridional (V) coordinate systems.

2.4 THE COORDINATE SYSTEM OF STATISTICAL PARAMETERS.

Wind is measured and recorded in terms of magnitude and direction. Wind direction is expressed in degrees clockwise from true north, and is the direction from which the wind is blowing. Wind magnitude (the modulus of the vector) is the scalar quantity, and is referred to as wind speed or scalar wind. A statistical description that accounts for the wind as a vector quantity is appropriate and requires a coordinate system.

For the RRA, the Standard Meteorological Coordinate System has been chosen for wind statistics, all tables of statistical parameters, and related discussions. This choice was made because the coordinate system used in aerospace and related applied fields has not always been consistent. Figure 2-1 illustrates the Standard Meteorological Coordinate System.

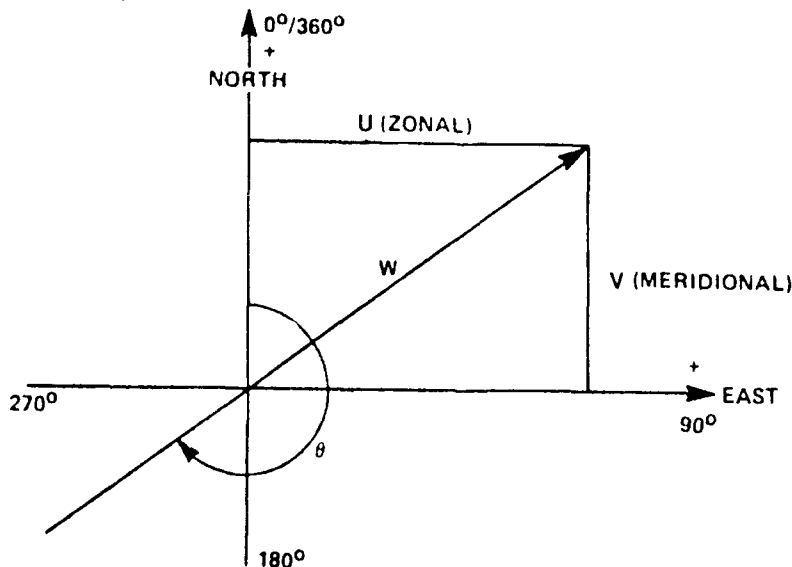

Figure 2-1. The Standard Meteorological Coordinate System.

Using Figure 2.1, the polar and Cartesian forms for the meteorological coordinate system are defined as follows:

W wind speed, scalar wind, or magnitude of the wind vector (m/s).

θ wind direction, measured as the direction *from which* the wind is blowing, in degrees clockwise from true north.

U zonal wind component, positive west to east (m/s).

V meridional wind component, positive south to north (m/s).

The components θ and W define the polar form, and the U - V components define the Cartesian forms:

$$U = -W \sin\theta, \quad 0 \leq \theta \leq 360^\circ \quad (1)$$

$$V = -W \cos\theta \quad (2)$$

It is helpful to note the difference between the *mathematical* convention for *vector* direction and the *meteorological* convention for *wind* direction:

$$\theta_{met} = 270 - \theta_{math} \quad (3)$$

$$\text{when } 0 \leq \theta \leq 270^\circ$$

$$\theta_{met} = 360 + (270 - \theta_{math})$$

$$\text{when } 270 \leq \theta \leq 360^\circ$$

2.5 COMPUTING STATISTICAL PARAMETERS.

All these statistical parameters are with respect to the Standard Meteorological Coordinate System shown in Figure 2-1. The wind statistical parameters in Appendix A (means and standard deviations of zonal and meridional wind components, plus wind speed and the skewness parameter of wind speed) were computed using the sums technique described in Paragraph 3.5.1. In addition, a linear (product moment) correlation coefficient between the zonal and meridional wind components, $r(u,v)$ in Appendix A, was computed. This correlation coefficient is defined as:

$$r(u,v) = \frac{\sum_{i=1}^n (U_i - \bar{U})(V_i - \bar{V})}{N s(u) \cdot s(v)} \quad (4)$$

2.6 STATISTICAL WIND MODELS.

2.6.1 Wind Component Statistics.

The univariate normal (Gaussian) probability distribution function is used to obtain wind component statistics. In generalized notations, the probability density function (*pdf*) is:

$$F(T) = \frac{e^{-\frac{t^2}{2}}}{\sqrt{2\pi}} \quad (5)$$

where $t = X - \frac{\xi}{\sigma}$ is the standardized variate, with ξ defining the mean and σ the standard deviation.

The probability distribution function (*PDF*) is:

$$F(t) = \int_{-\infty}^t f(t) dt \quad (6)$$

Because this integral cannot be obtained in closed form, it is widely tabulated for zero mean and unit standard deviation. Selected values of $F(t)$ are given in Table 2-2, next page. To emphasize the connotation of probability, $F(t)$ is shown in Table 2-2 as $P\{X\}$. The t values in Table 2-2 are used as multiplier factors to the standard deviation to express the probability that a normally distributed variable (X) is less than or equal to a given value as:

$$P\{X \leq \text{mean} + t \sigma_x\} = \text{probability, } p \quad (7)$$

For example, when $t = 1.6449$, the probability that X is less than or equal to the mean plus 1.6449 standard deviations is 0.95. That value of X which is less than or equal to the mean plus 1.6449 standard deviations is called the "95th percentile value of X ." Also given in Table 2-2 are the numerical values for expressing the probability that X falls in the interval X_1 and X_2 ; i.e.,

$$P\{X_1 \leq X \leq X_2\} = \text{Interpercentile Range} \quad (8)$$

where

$$\begin{aligned} X_1 &= \bar{X} - t \sigma_x \\ X_2 &= \bar{X} + t \sigma_x \end{aligned}$$

For $t = 1.9602$ the probability that X lies in the interval X_1 and X_2 is 0.95. The values of X_1 and X_2 in this example comprise the 95th interpercentile range.

For a normally distributed variable, the mode (most frequent value) and the median (50th percentile value) are the same as the mean value. The means and standard deviations of the zonal and meridional wind components from Appendix A are used in equations 7 and 8 to compute the percentile values and interpercentile ranges of the zonal and meridional wind components. When equation 7 is illustrated on a normal probability graph, a straight line is formed.

2.6.2 The Vector Wind Model.

Because wind is a vector quantity having direction and magnitude that can be expressed as two components in an orthogonal coordinate system, a probability model that describes the joint relationship is the bivariate normal probability distribution. In general component notation (shown by equation 9, below), the bivariate normal probability density function (*BNpdf*) is:

$$f(X, Y) = \frac{1}{2\pi\sigma_x\sigma_y\sqrt{1-\rho^2}} \left[\exp \frac{-1}{2(1-\rho^2)} \left\{ \frac{(X-\bar{X})^2}{\sigma_x^2} - \frac{2\rho(X-\bar{X})(Y-\bar{Y})}{\sigma_x\sigma_y} + \frac{(Y-\bar{Y})^2}{\sigma_y^2} \right\} \right] \quad -\infty \leq X \leq \infty \ \& \ -\infty \leq Y \leq \infty$$

where the five parameters are \bar{x}, \bar{y} , the component means σ_x, σ_y , the component standard deviations, and ρ , the correlation coefficient between the two component variables X and Y .

For many applications, there is interest in determining the probability that a point $\{X, Y\}$ will fall within a contour of equal probability density. The exponential terms of equation 9, when set equal to a constant (λ_2), give a family of ellipses depending on the value of the constant. The ellipses have a common center at the point $\{\bar{X}, \bar{Y}\}$. Integration of equation 9 over the region bounded by the contours of equal probability density gives:

TABLE 2-2. Values of t for Standardized Normal (Univariate) Distribution for Percentiles and Interpercentile Ranges.

t	$P(X)$	X	$P\{X_1 \leq X \leq X_2\} (\%)$
-3.0000	0.00135	$\xi - 3.0000 \sigma$	
-2.5758	0.00500	$\xi - 2.5758 \sigma$	
-2.3263	0.01000	$\xi - 2.3263 \sigma$	
-2.2365	0.01266	$\xi - 2.2365 \sigma$	
-2.0000	0.02275	$\xi - 2.0000 \sigma$	
-1.9602	0.02500	$\xi - 1.9602 \sigma$	
-1.6449	0.05000	$\xi - 1.6449 \sigma$	
-1.2816	0.10000	$\xi - 1.2816 \sigma$	
-1.0000	0.15866	$\xi - 1.0000 \sigma$	
-0.8416	0.20000	$\xi - 0.8416 \sigma$	
-0.6745	0.25000	$\xi - 0.6745 \sigma$	
-0.2533	0.40000	$\xi - 0.2533 \sigma$	
0.0000	0.50000	ξ	
0.2533	0.60000	$\xi + 0.2533 \sigma$	
0.6745	0.75000	$\xi + 0.6745 \sigma$	
0.8416	0.80000	$\xi + 0.8614 \sigma$	
1.0000	0.84134	$\xi + 1.0000 \sigma$	
1.2816	0.90000	$\xi + 1.2816 \sigma$	
1.6449	0.95000	$\xi + 1.6449 \sigma$	
1.9602	0.97502	$\xi + 1.9602 \sigma$	
2.0000	0.97725	$\xi + 2.0000 \sigma$	
2.2365	0.98734	$\xi + 2.2365 \sigma$	
2.3263	0.99000	$\xi + 2.3263 \sigma$	
2.5758	0.99500	$\xi + 2.5758 \sigma$	
3.0000	0.99865	$\xi + 3.0000 \sigma$	

where $X_1 = \xi - t\sigma$
 and $X_2 = \xi + t\sigma$

$$P(\lambda) = 1 - e^{-\frac{\lambda^2}{2(1-\rho^2)}} \quad (10)$$

Solving for λ^2 and replacing $P(\lambda)$ by p gives:

$$\lambda^2 = -2(1-\rho^2) \ln(1-p) \quad (11)$$

Now define:

$$\lambda_e = \sqrt{2} \sqrt{-1 \ln(1-p)} \quad (12)$$

For reference and comparison, λ_e is shown in Table 2-3 for selected values of p .

TABLE 2-3. Values of λ for Bivariate Normal Distribution Ellipses and Circles.

$P(\%)$	$(\lambda_e \text{--ellipse})$	$(\lambda_c \text{--circle})$	$P(\%)$	$(\lambda_e \text{--ellipse})$	$(\lambda_c \text{--circle})$
0.000	0.0000	0.0000	65.000	1.4490	1.0246
5.000	0.3203	0.2265	68.268	1.5151	1.0713
10.000	0.4590	0.3246	70.000	1.5518	1.0973
15.000	0.5701	0.4031	75.000	1.6651	1.1774
20.000	0.6680	0.4723	80.000	1.7941	1.2686
25.000	0.7585	0.5363	85.000	1.9479	1.3774
30.000	0.8446	0.5972	86.466	2.0000	1.4142
35.000	0.9282	0.6563	90.000	2.1460	1.5175
39.347	1.0000	0.7071	95.000	2.4477	1.7308
40.000	1.0108	0.7147	95.450	2.4860	1.7579
45.000	1.0935	0.7732	98.000	2.7971	1.9778
50.000	1.1774	0.8325	98.168	2.8284	2.0000
54.406	1.2533	0.8862	98.889	3.0000	2.1213
55.000	1.2637	0.8936	99.000	3.0348	2.1460
60.000	1.3537	0.9572	99.730	3.4393	2.4320
63.212	1.4142	1.0000	99.9877	4.2426	3.0000

The probability ellipse that contains p -percent of the wind vectors expressed in the most general form is the conic defined by:

$$AX^2 + BXY + CY^2 + DX + EY + F = 0 \quad (13)$$

Where:

$$A = \sigma_x^2 \quad D = 2\sigma_x \sigma_y \rho Y - 2\sigma_y^2 X = -(B Y + 2A X)$$

$$B = -2\rho\sigma_x \sigma_y \quad E = 2\sigma_x \sigma_y \rho X - 2\sigma_x^2 Y = -(B X + 2C Y)$$

$$C = \sigma_y^2 \quad F = A X^2 + C Y^2 + B X Y - AC (1 - \rho^2) \lambda_e^2$$

and $\lambda_e = \sqrt{2} \sqrt{-1 \ln(1-p)}$

For graphic presentations, the range of the variable is important in order to arrange the scale. The largest and smallest values of X and Y for a given probability ellipse (p) are given by:

$$X_{L,S} = \bar{X} \pm \sigma_x \lambda_e \quad (14)$$

$$Y_{L,S} = \bar{Y} \pm \sigma_y \lambda_e \quad (15)$$

where, as before,

$$\lambda_e = \sqrt{2} \sqrt{-1n(1-\rho)}$$

Although there are several approaches to graphing the probability ellipses, the following procedure is best for electronic computer plotting. In establishing the computer plotting program, the sample estimates for \bar{X} , \bar{Y} , σ_x , σ_y , and ρ are constants in equation 13. The user makes the choice of probability ellipses desired. Thus, p in equation 12 is programmed as a parameter. The largest and smallest values for X and Y are computed by equations 14 and 15 for the largest probability ellipse selected. This sets the graphical scale. Values of X within the range of X smallest to X largest are obtained by incrementing X between these limits. Using the quadratic equation, a solution of equation 13 is made for Y for each value of X , and plotted. The centroid (\bar{X}, \bar{Y}) for the family of probability ellipses is plotted as a point. Labeling and other identification completes the plotting program.

For a given probability, equation 13 defines an ellipse that contains p -percent of the points X, Y . Since the entire area under the bivariate normal density function (equation 9) is unity, upon integration for a given probability ellipse, that given ellipse contains p -percent of the total area. In the wind statistics p -percent of the wind vectors fall within the specified probability ellipse. From this point of view, a specified probability ellipse gives the joint probability that p -percent of the $U-V$ components lie within the given ellipse.

When $\sigma_x^2 = \sigma_y^2 = \sigma^2$ and $\rho = 0$ in the bivariate normal distribution, the probability ellipses of equation 13 reduce to circles whose centers are at the means \bar{X}, \bar{Y} . The radii of the probability circles are $\sigma_{v1} \lambda_c$, where:

$$\sigma_{v1} = \sqrt{2}\sigma^2 \quad (16)$$

and

$$\lambda_c = \sqrt{-1n(1-p)} \quad (17)$$

Values for λ_c for selected probabilities, p , are given in Table 2-3.

Because this function is simple, it can easily be graphed manually. However, the generalized plotting technique for electronic computer plotters (as shown by equation 13) can be also be used.

2.6.3 Derived Distributions for Wind Statistics.

In this section, the probability distribution functions and sets of equations are presented to derive certain probability distribution functions for wind statistics. These derived probability distributions are:

- Conditional distribution of wind components
- Generalized Rayleigh distribution for wind speed
- Distribution for wind direction
- Conditional distribution of wind speed given a wind direction (wind rose).

The five required statistical parameters for these derived distributions for wind statistics are given in Appendix A.

2.6.3.1 The Conditional Distribution of Wind Components.

Given that two random variables X and Y are bivariate normally distributed, the conditional distribution $f(Y|X)$ is read as $f(Y)$ given X , and likewise $f(X|Y)$ is read as $f(X)$ given Y . The conditional probability function $F(Y|X)$ has the mean $E(Y|X)$ and variance $\sigma^2_{(y|x)}$, where:

$$E(Y|X^*) = \bar{Y} + \rho \left(\frac{\sigma_y}{\sigma_x} \right) (X^* - \bar{X}) \quad (18)$$

and

$$\sigma^2_{(y|x^*)} = \sigma_y^2 (1 - \rho^2) \quad (19)$$

The conditional standard deviation is:

$$\sigma_{(y|x^*)} = \sigma_y \sqrt{1 - \rho^2} \quad (20)$$

By interchanging the variables and parameters, the conditional distribution function for $F(X|Y^*)$ has the conditional mean:

$$E(X|Y^*) = \bar{X} + \rho \left(\frac{\sigma_x}{\sigma_y} \right) (Y^* - \bar{Y}) \quad (21)$$

conditional variance:

$$\sigma^2_{(x|y^*)} = \sigma_x^2 (1 - \rho^2) \quad (22)$$

and conditional standard deviation:

$$\sigma_{(x|y^*)} = \sigma_x \sqrt{1 - \rho^2} \quad (23)$$

The preceding conditional probability distribution functions are univariate normal distributions for a (fixed) given value for one of the bivariate normal variables. Thus, the t -values given in Table 2 are applicable for conditional probabilities statements. For example,

$$F(Y|X^*) = E(Y|X^*) + t \sigma_{(y|x^*)} \quad (24)$$

For $t = 1.6449$, there is a 95 percent chance that Y is less than or equal to $\bar{Y} + 1.6449 \sigma_{(y|x^*)}$ given that $X = X^*$. In symbols, this statement reads:

$$P \{ Y \leq E(Y|X^*) + 1.6449 \sigma_{(y|x^*)} | X = X^* \} = 0.9500 \quad (25)$$

Interval probability statements can also be made:

$$P \{ Y_1 = E(Y|X^*) - t \sigma_{(y|x^*)} \leq Y \leq Y_2 = E(Y|X^*) + t \sigma_y | X = X^* \}$$

where X^* can take on any fixed value of X , but a convenient arrangement is to let $X^* = \bar{X} \pm t \sigma_x$.

The close connection of the regression function of Y on X to the conditional mean for the bivariate normal distribution is noted:

$$Y = \bar{Y} + \rho \left(\frac{\sigma_y}{\sigma_x} \right) (X - \bar{X}) \quad (26)$$

Similarly, the regression function of X on Y is:

$$X = \bar{X} + \rho \left(\frac{\sigma_x}{\sigma_y} \right) (Y - \bar{Y}) \quad (27)$$

These are linear functions and express the same results as would be obtained from a least-squares regression line.

2.6.3.2 Generalized Rayleigh Distribution for Wind Speed.

If two random variables, X and Y , are bivariate normally distributed, then the probability distribution for the modulus, R , can be derived in terms of the five parameters that define the bivariate normal distribution:

$$R = \sqrt{X^2 + Y^2} \quad (28)$$

The distribution of R so derived is called a generalized Rayleigh distribution because there are no restrictions on the parameters. For applications to the RRA, the variable R is recognized as wind speed or the modulus of the wind vector.

The probability density function for R is expressed as:

$$f(R) = a_0 R e^{-a_1 R^2} \left[I_0(a_2 R^2) I_0(a_3 R) + 2 \sum_{k=1}^{\infty} I_k(a_2 R^2) I_{2k}(a_2 R) \cos 2k\psi \right] \quad R \geq 0 \quad (29)$$

The functions $I_0(\cdot)$, $I_k(\cdot)$, and $I_{2k}(\cdot)$ are the modified Bessel function of the first kind for zero order, k th order, and $2k$ th order. The coefficients are:

$$a_0 = \frac{\exp \left[-\frac{1}{2} \left\{ \frac{\bar{X}^2}{\sigma_a^2} + \frac{\bar{Y}^2}{\sigma_b^2} \right\} \right]}{\sigma_a \sigma_b}$$

where σ_a^2 and σ_b^2 are the rotated variances to produce zero correlation between X and Y . σ_a and σ_b are the positive and negative roots of the following expression, the computational form of which is obtained from the determinant:

$$\begin{vmatrix} \sigma_x^2 - K & \sigma_x \sigma_y \sigma \\ \sigma_x \sigma_y \sigma & \sigma_y^2 - K \end{vmatrix}$$

where K is $\sigma_{(x,y)}^2$, and σ_a and σ_b are analogous to the standard deviation of the major and minor axes of the bivariate normal probability ellipse:

$$\sigma_{(x,y)}^2 = \frac{1}{2} \left\{ \sigma_x^2 + \sigma_y^2 \pm \left[(\sigma_x^2 + \sigma_y^2)^2 - 4\sigma_x^2 \sigma_y^2 (1 - \rho^2) \right]^{1/2} \right\}$$

$$a_1 = \frac{(\sigma_x^2 + \sigma_y^2)}{4(1 - \rho^2) \sigma_x^2 \sigma_y^2}$$

$$a_2 = \frac{[(\sigma_x^2 - \sigma_y^2)^2 + 4\rho^2 \sigma_x^2 \sigma_y^2]^{\frac{1}{2}}}{4(1 - \rho^2) \sigma_x^2 \sigma_y^2}$$

$$a_3 = \left[\left(\frac{\bar{X}}{\sigma_a^2} \right)^2 + \left(\frac{\bar{Y}}{\sigma_b^2} \right)^2 \right]^{\frac{1}{2}}$$

and

$$\tan \psi = \frac{\bar{Y}}{\bar{X}} \frac{\sigma_a^2}{\sigma_b^2}$$

Since this density function cannot be integrated in closed form from zero to R , numerical integration is used to obtain practical results from the probability distribution function; i.e.,

$$F(R) = \int_0^R f(R) dR \quad (30)$$

A number of special cases can be obtained from the general Rayleigh distribution (equation 29), the most simple of which is to let $\sigma_x \equiv \sigma_y = \sigma$ and $\bar{X} = \bar{Y} = 0$ with independent variables X and Y . This gives:

$$f(R) = \frac{R}{\sigma^2} e^{-\frac{R^2}{2\sigma^2}} \quad (31)$$

which is recognized as the classical Rayleigh probability density function. The density function (equation 31) can be integrated in closed form over any range of the variable R . Hence, the probability distribution function, $F(R)$, for equation 31 is:

$$F(R) = 1 - \exp \left\{ \frac{-R^2}{2\sigma^2} \right\} \quad (32)$$

2.6.3.3 The Derived Distribution of Wind Direction.

Considering the wind as a vector quantity and bivariate normally distributed, the wind direction can be derived. This is done by first writing the bivariate normal probability density function in polar coordinates whose variables are:

$$g(r, \theta) = r d_1 e^{\frac{1}{2}(a^2 r^2 - 2br + c^2)} \quad (33)$$

NOTE: The expression in equation 33 (Smith, 1976) is given with respect to the mathematical convention for a vector direction, where:

$$a^2 = \frac{1}{(1 - \rho^2)} \left[\frac{\sin^2 \theta}{\sigma_x^2} - \frac{2\rho \cos \theta \sin \theta}{\sigma_x \sigma_y} + \frac{\cos^2 \theta}{\sigma_y^2} \right]$$

$$b = \frac{-1}{(1 - \rho^2)} \left[\frac{\bar{x} \sin \theta}{\sigma_x^2} - \frac{\rho(\bar{x} \cos \theta + \bar{y} \sin \theta)}{\sigma_x \sigma_y} + \frac{\bar{y} \cos \theta}{\sigma_y^2} \right]$$

$$c^2 = \frac{1}{(1-\rho^2)} \left[\frac{\bar{x}^2}{\sigma_x^2} - \frac{2\rho xy}{\sigma_x \sigma_y} + \frac{\bar{y}^2}{\sigma_y^2} \right]$$

$$d_1 = \frac{1}{2\pi\sigma_x\sigma_y\sqrt{1-\rho^2}}$$

and $r = \sqrt{x^2 + y^2}$ is the modulus of the vector or speed and θ is the direction of the vector. After integrating $g(r, \theta)$ over $r = 0$ to ∞ , the probability density function is θ is:

$$g(\theta) = \frac{d_1}{a^2} e^{-\frac{1}{2}c^2} \left[1 + \sqrt{2\pi} \left(\frac{b}{a}\right)^2 \Phi\left(\frac{b}{a}\right) \right] \quad (34)$$

where a^2 , b , c^2 , and d_1 are as previously defined in equation 33, and

$$\Phi\left(\frac{b}{a}\right) = \frac{1}{\sqrt{2\pi}} \int_{-\infty}^{\frac{b}{a}} e^{-\frac{1}{2}t^2} dt$$

is taken from tables of normal distribution functions or made available through a computer subroutine.

If desired, equation 34 can be integrated numerically over a chosen range of θ to obtain the probability that the vector direction will lie within the chosen range; i.e.,

$$F(\theta) = \int_{\theta_2}^{\theta_1} g(\theta) d\theta \quad (35)$$

One application may be to obtain the probability that the wind will flow from a given quadrant or sector as, for example, onshore.

2.6.3.4 Derived Conditional Distribution of Wind Speed Given Wind Direction.

Continuing with the considerations expressed in Paragraph 2.6.3.3, the conditional probability density function (pdf) for wind speed (r), given a specified value for the wind direction θ , can be expressed as:

$$f(r|\theta) = \frac{a^2 r e^{-\frac{1}{2}(a^2 r^2 - br)}}{1 + \sqrt{2\pi} \left(\frac{b}{a}\right)^2 e^{\frac{1}{2}\left(\frac{b}{a}\right)^2} \Phi\left\{\frac{b}{a}\right\}} \quad (36)$$

where coefficients, a and b and the function $\Phi\left\{\frac{b}{a}\right\}$ are as previously defined in equations 33 and 34.

From equation 36, the mode (most frequent value) of the conditional wind speed given a specified value of the wind direction is the positive solution of the quadratic equation,

$$a^2 r^2 - br - 1 = 0 \quad (37)$$

which is:

$$(\bar{r} | \theta) = \frac{1}{2a} \left[\left(\frac{b}{a} \right) + \sqrt{4 + \left(\frac{b}{a} \right)^2} \right] \quad (38)$$

The locus of the conditional modal values of wind speed when plotted in polar form versus the given wind directions forms an ellipse.

The noncentral moment for equation 36 is expressed as:

$$\mu_n' = \int_0^{\infty} r^n f(r | \theta) dr \quad (39)$$

Now the first noncentral moment is identical to the first central moment or expected value, $E(r | \theta)$. The integration of equation 39 for the first moment is sufficiently simple to yield practical computations, and can be expressed as:

$$E(r | \theta) = \frac{\left(\frac{b}{a} \right) + \left[1 + \left(\frac{b}{a} \right)^2 \right] \sqrt{2\pi} e^{\frac{1}{2} \left(\frac{b}{a} \right)^2} \Phi \left\{ \frac{b}{a} \right\}}{a \left[1 + \left(\frac{b}{a} \right) \sqrt{2\pi} e^{\frac{1}{2} \left(\frac{b}{a} \right)^2} \Phi \left\{ \frac{b}{a} \right\} \right]} \quad (40)$$

Equation 40, then, gives the conditional mean value of the wind speed given a specified value for the wind direction.

The integration of equation 36 for the limits $r=0$ to $r=r^*$ gives the probability that the conditional wind speed is $\leq r^*$ given a value for the wind direction, θ . This conditional probability distribution (PDF) can be written as:

$$Pr \{ r \leq r^* | \theta = \theta_0 \} = 1 - \left[\frac{e^{-\frac{1}{2} r_s^2 + \sqrt{2\pi} \left(\frac{b}{a} \right) \{1 - \Phi(r_s)\}}}{e^{-\frac{1}{2} \left(\frac{b}{a} \right)^2 + \sqrt{2\pi} \left(\frac{b}{a} \right) \Phi \left\{ \frac{b}{a} \right\}}} \right] \quad (41)$$

where: $r_s = \left[a r^* - \left(\frac{b}{a} \right) \right]$

By definition, equation 41 is an expression for a "wind rose." Empirical wind rose statistics are often tabulated or graphically illustrated giving the frequency that the wind speed is not exceeded for those wind speed values which lie within assigned class intervals of wind direction. After evaluation of equation 41 for various values of wind speed, r^* , and the given wind directions, θ , interpolations can be performed to obtain various percentile values of the conditional wind speed.

For the special case when b in equation 33 equals zero (i.e., for $\bar{x} \equiv \bar{y} = 0$), the conditional modal values of wind speeds (equation 38), the conditional mean values of wind speeds (equation 40), and the fixed conditional percentile values of wind speeds (interpolated from evaluations of equation 41), when plotted in polar form versus the given wind directions, produce a family of ellipses.

For the special case when $\bar{x} = \bar{y} = 0$, equation 36 reduces to the following simple case:

$$Pr \{ r \leq r^* | \theta = \theta_0 \} = 1 - e^{-\frac{a^2 r^{*2}}{2}} \quad (42)$$

Equation 42 has special significance when related to the bivariate normal probability distribution. If r^* and θ are measured from the centroid of the probability ellipse, then the probability that $r \leq r^*$ is the same as the given probability ellipse. Further, solving equation 42 for r^* , gives:

$$r^* = \frac{1}{2} \sqrt{-2 \ln(1-P)} \quad (43)$$

If a probability ellipse P is chosen, equation 42 gives the distance of r along any θ from the centroid of the ellipse to the intercept of the specified probability ellipse. If there is an interest in conditional probability of winds for a given θ relative to the monthly means, equation 43 is applicable. If it is desired to find the magnitude of the wind along any θ relative to the monthly mean to the intercept of a given probability ellipse, equation 43 is also applicable.

2.7 Statistical Parameters for Non-Standard Orthogonal Axes.

The five wind statistical parameters in Appendix A are given with respect to the Standard Meteorological Coordinate System (Figure 2-1). That is, these parameters are for zonal and meridional components. Many range users, however, need wind statistics with respect to orthogonal axes other than west to east and south to north. For example, a user may need wind statistics with respect to a flight azimuth of α degrees from true north measured clockwise. The following sets of equations are used to compute the five parameters for the new coordinate axes rotated α degrees clockwise from true north.

Rotation of the means through α degrees:

$$\bar{X}_\alpha = \bar{X} \cos(90 - \alpha) + \bar{Y} \sin(90 - \alpha) \quad (44)$$

$$\bar{Y}_\alpha = \bar{Y} \cos(90 - \alpha) - \bar{X} \sin(90 - \alpha) \quad (45)$$

Rotation of the variances through α degrees:

$$\begin{aligned} \sigma_{x_\alpha}^2 &= \sigma_x^2 \cos^2(90 - \alpha) + \sigma_y^2 \sin^2(90 - \alpha) \\ &\quad + 2\rho\sigma_x\sigma_y \cos(90 - \alpha) \sin(90 - \alpha) \end{aligned} \quad (46)$$

$$\begin{aligned} \sigma_{y_\alpha}^2 &= \sigma_y^2 \cos^2(90 - \alpha) + \sigma_x^2 \sin^2(90 - \alpha) \\ &\quad - 2\rho\sigma_x\sigma_y \cos(90 - \alpha) \sin(90 - \alpha) \end{aligned} \quad (47)$$

Rotation of the linear correlation coefficient through α degrees:

$$\rho_\alpha = \frac{\text{cov}(X, Y)_\alpha}{\sigma_{x_\alpha} \sigma_{y_\alpha}} \quad (48)$$

where $\text{cov}(X, Y)_\alpha$ is the rotated covariance:

$$\begin{aligned} \text{cov}(X, Y)_\alpha &= \text{cov}(X, Y) [\cos^2(90 - \alpha) - \sin^2(90 - \alpha)] \\ &\quad + \cos(90 - \alpha) \sin(90 - \alpha) (\sigma_x^2 - \sigma_y^2) \end{aligned}$$

and

$$\text{cov}(X, Y) = \rho\sigma_x\sigma_y$$

By using these rotational equations, the bivariate normal distribution with respect to any desired rotated coordinates can be obtained from sample estimates that have been computed with respect to a specific axis. The marginal distributions after rotation are also normally (univariate) distributed. By using the rotational equations, computational efforts are greatly reduced for applications requiring statistics with respect to several coordinate axes.

Appendix E gives examples of range-specific RRA wind statistics.

Chapter 3

THERMODYNAMICS STATISTICS AND MODELS

3.1 GENERAL DISCUSSION.

One of the objectives in developing the RRA was to describe the thermodynamic characteristics of the atmosphere as completely as possible with as few data tabulations as possible. With that in mind, a set of statistical variables was selected to collectively describe climatological pressure, temperature, density, dew point, virtual temperature, and water vapor pressure. Used together, these variables permit calculation of a large number of derived quantities. Some of these quantities (such as the speed of sound) are discussed in Paragraph 3.7.

The probability distribution of each of the six thermodynamic RRA variables is described by its mean value, its standard deviation, and its skewness. Several of the thermodynamic elements (temperature, pressure, dew point, and density) have probability distributions that are close to a univariate normal distribution; the others do not. The skewness variable gives an estimate of the asymmetrical departures of a probability distribution.

Hydrostatically modeled mean values of pressure and density were calculated (see Appendix D) so that users can determine the departure of the actual climatology of these values from hydrostatic conditions. This was done by hydrostatically integrating the pressure from the lowest RRA data level to the RRA's termination altitude. Table 3-1 lists and explains the primary physical constants used in RRA production. Table 3-2 lists and explains the symbols used in this chapter.

TABLE 3-1. Primary Physical Constants Used in RRA Production.

P_0	Standard atmospheric pressure at sea level (1.013250×10^5 Newton/m ²) (2116.22 lb/ft ²)
ρ_0	Standard atmospheric density at sea level (1.2250 kg/m ³) (0.076474 lb/ft ³)
T_0	Standard temperature at sea level (288.15 K) (15.0°C) (59.0°F)
g_0	Standard gravity at sea level at latitude 45°31'33" (9.80665 m/s ²)
s	Sutherland's constant used in calculation of dynamic viscosity (110.4 K)
T_i	Ice-point temperature at P_0 (273.15 K)
β	Constant for calculating dynamic viscosity (1.458×10^{-6} kg/sec m K ^{1/2}) (7.3025×10^{-7} lb/sec ft R ^{1/2})
γ	Ratio of specific heat of air at constant pressure to specific heat of air at constant volume (1.4)
C_D	Mean effective collision diameter of air molecules (3.65×10^{-10} m) (1.1975×10^{-9} ft)
N_a	Avogadro's constant (6.022169×10^{26} /kg mol) (2.73179×10^{26} /lb mol)
R^*	Gas constant (8.31432 Joule/mol K)
R	Gas constant for dry air (2.8704×10^2 Joule/kg K)
M	Molecular weight of dry air (28.966 gm/mol)

TABLE 3-2. Symbols Used in Chapter 3.

C_s	Speed of sound
C_d	Collision diameter
E	Vapor pressure
g_ϕ	Gravity at latitude ϕ
H	Geopotential height
H_m	Geopotential height at a mandatory radiosonde data level
H_s	Geopotential height at a significant radiosonde data level
K_z	Coefficient of thermal conductivity
l	Mean free path length
M	Mean molecular weight of air at sea level
M^3q	Monthly third moment of quantity Q
n	Refractive modulus
N	Refractive index
N_A	Avogadro's constant
N_q	Number of values of quantity Q
P	Pressure
P_m	Pressure at a mandatory radiosonde data level
P_s	Pressure at a significant radiosonde data level
P_z	Hydrostatically integrated mean monthly or annual pressure
Q	Any tabulated RRA quantity
R^*	Universal gas constant
R	Specific gas constant of dry air
r, r^*	Parameters used in converting z to h and vice versa
S	Sutherland's constant, used in the calculation of dynamic viscosity
T	Temperature
T_d	Dewpoint
T_v	Virtual temperature
$T_{v,m}$	Virtual temperature at a mandatory radiosonde data level
$T_{v,s}$	Virtual temperature at a significant radiosonde data level
V	Mean air particle speed
	Mean collision frequency
w	Parameter used in the hydrostatic interpolation of pressure and density
Z	Geometric altitude
λ	Wavelength
3Q	Skewness of quantity Q
B	Constant used in the equation for viscosity
γ	Ratio of specific heat at constant pressure to specific heat at constant volume
ν	Kinematic coefficient of viscosity
μ	Dynamic coefficient of viscosity
ρ	Density
ρ_h	Mean monthly or annual density derived from P/h
σ	Standard deviation of the quantity Q

3.2 QUALITY CONTROL.

Data limits derived from the following thermodynamic elements were used to screen the RRA database: temperature, pressure, dewpoint (for the 0-30 km portion only), and density. These limits were set to plus and minus six standard deviations from the mean values of each of these quantities; they were then used to screen the thermodynamic portion of the database IAW procedures described in Paragraph 1.5. The database was considered to be error-free if:

- (1) Skewness values of pressure and temperature were between -2.5 and 2.5 at all data levels.
- (2) Skewness values of density were between -3.5 and 3.5 at data levels between 0 and 30 km.
- (3) Skewness values of density were between -3.0 and 3.0 at data levels between 30 and 70 km.
- (4) Skewness values of dewpoint were between -2.5 and 2.5 at all data levels with more than 10 data values.

3.3 DATA LIMITATIONS.

Correlation coefficients between thermodynamic quantities and moisture-related quantities were not calculated at discrete altitudes; neither were any of the correlations between altitudes. As a result, valid statistical dispersion models that require relationship between two or more of these quantities at the same altitude or between altitudes cannot be derived. Approximations for the correlation coefficients between pressure, virtual temperature, and density at discrete altitudes, however, may be obtained from the coefficients of variation as developed by Buell (1970). The coefficient of variation is the standard deviation divided by the mean. The mean values and the standard deviations are taken from Appendix B. A model for the profile of monthly and annual mean pressure, virtual temperature, and density is given in Appendix D, and is in excellent agreement with the respective statistical mean values. This agreement results because the physical relationships expressed by the hydrostatic equation and the equation of state were used to derive Appendix D. When only the monthly or annual mean values for pressure, virtual temperature, and density are required, users should consult Appendix D.

3.4 ESTABLISHING DATA SAMPLES AT REQUIRED LEVELS.

This section describes the computational procedures used to establish data samples of the thermodynamic RRA variables at the various data levels. References are cited only when the equation given is one of many available in the literature or when it is stated in an unusual form.

3.4.1 Converting Geopotential Height to Geometric Altitude.

Although rocketsonde observations above 30 km are recorded in terms of geometric altitude, the data can be interpolated directly to the altitude intervals shown in the tables. But radiosonde observations used to obtain tabular values below 30 km are recorded in terms of geopotential height; the conversion to geometric altitude (h to z) is accomplished by calculating a table of geopotential heights that correspond exactly to the geometric altitudes at which the atmospheric elements are tabulated. Radiosonde observations are then interpolated to these geopotential heights. The relationship used to calculate geometric altitude from geopotential height is:

$$H = (r^* z) / (r^* + z) \quad (49)$$

where $r = g r^* / 9.80665$

and $r^* = 2g_0 / (\partial g_0 / \partial z_0)$

g_0 is sea level at latitude ϕ corresponding to the proper location (List, 1968).

$$g_0 = 9.780356 (1 + 5.2885 \times 10^{-3} \sin^2 \phi - 5.9 \times 10^{-6} \sin^2 (2\phi)) \quad (50)$$

$\frac{\partial g_0}{\partial z_0}$ is the rate of change of gravity at sea level. This quantity is given by:

$$\frac{\partial g_0}{\partial z_0} = -3.085462 \times 10^{-6} \times 2.27 \times 10^{-9} \cos(2\phi) \times 2 \times 10^{-12} \cos(4\phi) \quad (51)$$

Units used for gravity are m/s^2 , while the units for $\frac{\partial g_0}{\partial z_0}$ are s^{-2} .

The resulting table of values of H obtained by using even increments of 2 in equation 49 is shown in Appendix D. Although the values of H above 30 km were not used in the interpolation of original data, they are included for the convenience of the user.

3.4.2 Calculations from Rawinsonde Observations.

It was necessary to interpolate information from original rawinsonde records to arrive at the geometric altitudes specified as RRA data levels. Elements for which this interpolation was required were temperature, dewpoint, and pressure. The other elements were calculated from the interpolated values at each RRA data level. These "derived" elements were water vapor pressure, density, and virtual temperature.

3.4.2.1 Geopotential Height at Significant Levels.

Two slightly different interpolation procedures were used to obtain data from radiosonde and rocketsonde observations at the levels shown in the tables. The procedure used to interpolate radiosonde observations begins with calculations of virtual temperature at each data level in the sounding. Virtual temperature was computed by:

$$T_v = T / (1 - 0.379(e/p)) \quad (52)$$

where T_v and T are in kelvin (K) and e and p are in millibars.

Radiosonde soundings provide pressure, temperature, and dew point data recorded at "mandatory" and "significant" levels. Geopotential height data, however, is only provided for mandatory levels. Heights at the significant levels, therefore, were calculated hydrostatically, using pressure and temperature data from those levels. This procedure allows the use of most significant level data in the calculation of the RRA tables. The equation used for this process was:

$$H_s = H_m + 29.2712617 * \frac{(T_{vs} + T_{vm})}{2} * \ln(P_s/P_m) \quad (53)$$

where subscripts s and m denote quantities at significant and mandatory levels. This equation was not used if the difference between two adjacent mandatory levels was greater than 200 mb, and all soundings with such data gaps were rejected.

3.4.2.2 Temperature.

Radiosonde temperatures were interpolated logarithmically with respect to pressure using the equation:

$$T = T_U + (T_L - T_U) \frac{\ln p - \ln p_L}{\ln p_U - \ln p_L} \quad (54)$$

where subscripts U and L indicate values at the nearest data levels in the actual sounding above and below the interpolated level.

3.4.2.3 Pressure.

The pressure values in each radiosonde sounding were interpolated to the RRA data levels using the equation:

$$p = p_L \exp \left(\frac{H_L - H_U}{29.2712617 (0.5) (T_{v_U} + T_{v_L})} \right) \quad (55)$$

where subscript L indicates virtual temperature, geopotential, and pressure values at the data level below and closest to the level at which data were required.

3.4.2.4 Dew Point Temperature.

Dew point values were interpolated logarithmically with respect to pressure using the equation:

$$T_d = T_{dU} + (T_{dL} - T_{dU}) \left(\frac{\ln p - \ln p_L}{\ln p_U - \ln p_L} \right) \quad (56)$$

Subscripts U and L indicate data at the nearest upper and lower data levels in a sounding.

3.4.2.5 Vapor Pressure.

Water vapor pressure is calculated from interpolated dew point values at RRA data levels using Tetten's approximation:

$$e = 6.11 \text{ mb} \times 10^{7.5(T_d - 273.15) / (T_d - 35.86)} \quad (57)$$

3.4.2.6 Density.

Density values derived from radiosonde observations were calculated at RRA data levels using the equation:

$$\rho = 348.36787 p / T_v \quad (58)$$

3.4.2.7 Virtual Temperature.

Virtual temperature values are calculated at RRA data levels for each sounding using the equation:

$$T_v = T / (1 - 0.379(e/p)) \quad (59)$$

where T_v and T are in K; pressure (p) and vapor pressure (e) are in millibars.

3.4.3 Calculations from Rocketsonde Observations.

Rocketsonde observations used to calculate RRA table values above 30 km were recorded in terms of geometric altitude. For this reason, slightly different calculations were required to convert recorded data values to RRA data levels. Pressure, temperature, and density were interpolated to RRA data levels. Since atmospheric moisture at altitudes above 30 km is considered to be negligible, moisture-related elements (virtual temperature, water vapor pressure, and dewpoint) were not calculated. There was no interpolation across gaps in pressure or temperature data in a sounding larger than 7,000 meters. Data values at RRA levels within such a gap were set to "missing."

3.4.3.1 Temperature.

Rocketsonde temperatures were interpolated linearly with respect to geometric altitude using the equation:

$$T = T_U + (T_L - T_U) \frac{Z - Z_L}{Z_U - Z_L} \quad (60)$$

where subscript U indicates values at the nearest data level in the actual sounding above the interpolated level; L indicates values below the interpolated level.

3.4.3.2 Pressure.

Rocketsonde pressure values were interpolated to RRA data levels using the equation:

$$P = P_L \exp \left(- \frac{g_0}{R^*} \frac{M (Z - Z_L)}{T_v} \cdot W^2 \right) \quad (61)$$

where

$$T_v = \frac{T_{vU} + T_{vL}}{2} \text{ and } W = \frac{r^*}{\left(r^* + Z + \frac{Z - Z_L}{2} \right)}$$

3.4.3.3 Density.

Rocketsonde density values were interpolated using the equation:

$$\rho = \rho_L \exp \left(- \frac{g_0 M}{R^*} \frac{(Z - Z_L)}{T_v} \cdot W^2 \right) \quad (62)$$

where W is specified in 3.4.3.2.

3.5 COMPUTING STATISTICS FOR APPENDICES B AND C.

Computing monthly and annual means, standard deviations, and skewness values from data at the RRA data levels was in two steps. First, certain statistical sums were calculated and stored as the soundings in the database were processed. These sums were then used to calculate the monthly and annual statistics given in the RRA tables.

3.5.1 Stored Statistical Sums.

The sums that were calculated were:

$$\Sigma Q, \Sigma Q^2, \text{ and } \Sigma Q^3$$

where Q is any one of the quantities given in the thermodynamic part of the RRA.

3.5.2 Calculating Monthly Statistics.

3.5.2.1 Monthly Means.

Mean monthly values of the thermodynamic RRA quantities were calculated using the equation:

$$\bar{Q} = \Sigma Q / N_Q$$

where N_Q is the number of observed values of the quantity Q for a given month.

3.5.2.2 Monthly Standard Deviations.

Monthly standard deviations of the thermodynamic RRA quantities were calculated using the equation:

$$\sigma_Q = \sqrt{\frac{(N_Q \Sigma Q^2) - (\Sigma Q)^2}{N_Q \cdot (N_Q - 1)}} \quad (63)$$

3.5.2.3 Monthly Skewness Values.

Monthly skewness values of wind speed and thermodynamic RRA quantities are calculated using the equation:

$$\sigma_Q = \frac{M_3 Q}{\sigma_Q^3}$$

where M_{3Q} is the third moment of the quantity Q , σ_Q is its standard deviation, and

$$M_{3Q} = \left[\frac{\sum Q^3}{N_Q} - \frac{3\sum Q \sum Q^2}{N_Q^2} + \frac{2\sum Q^3}{N_Q^3} \right] \cdot \frac{N_Q^2}{(N_Q - 1)(N_Q - 2)} \quad (64)$$

3.5.3 Calculating Annual Statistics.

Equations 63 and 64, used to calculate monthly values of standard deviations and skewness values, were also used for the annual statistics.

3.5.3.1 Annual Means.

Annual mean values of the thermodynamic RRA quantities were calculated using the equation:

$$Q_{ANN} = Q_A / N_Q$$

where Q_A is the total of all observed values of Q and N_Q is the total number of observations of Q .

3.5.3.2 Annual Standard Deviations and Skewness Values.

Annual standard deviations of the thermodynamic RRA quantities were calculated using equation 63; annual skewness values were calculated with equation 64. **NOTE:** Both these quantities were previously calculated with monthly statistics due to limitations in computer precision.

3.6 MONTHLY AND ANNUAL MEAN MODEL ATMOSPHERES.

A set of modeled monthly mean and annual mean hydrostatic values of pressure and density was calculated from the lowest RRA data level (0 km, mean sea level) to 30 km, and from 30 km to 70 km. The integration from 0 to 30 km was computed independently of the integration from 30 to 70 km because of the difference in data sources. These hydrostatically modeled mean values (given in Appendix D) are useful as a check on the validity of pressure and density values given in Appendix B. In most cases, the values in Appendices B and D for any given data level are within 1 percent of each other. The hydrostatic pressure values in Appendix D were calculated using the equation:

$$p_1 = p_0 \exp \left(- \frac{0.034162 (H_1 - H_0)}{0.5 (T_{v_1} + T_{v_0})} \right) \quad (65)$$

where, $H_1 - H_0$ is in meters and a "0" subscript refers to values at the RRA data level immediately below the level being checked. p_0 at the lowest data level is set equal to the RRA mean pressure; p_1 , calculated for the next highest data level, is taken as p_0 for the level above that. This process is repeated for all the other RRA data levels. The hydrostatic density corresponding to hydrostatic pressures is calculated from these pressures and from RRA virtual temperature values using the formula:

$$\rho_H = 348.36786 P_H / T_v \quad (66)$$

where ρ_H and P_H are the hydrostatic density and pressure shown in Appendix D.

3.7 THERMODYNAMIC QUANTITIES DERIVABLE FROM TABLES.

Several other quantities can be calculated from the statistics given in Appendices B and D. The equations in this section can be used to calculate approximate mean values of these quantities at each RRA data level. It is not possible, however, to infer or derive any information concerning standard deviation or skewness values of these quantities from the data in Appendices B and C.

3.7.1 Mean Air Particle Speed.

The mean air particle speed, "V", is the arithmetic average of the speeds of all air particles in the volume element being considered. For a valid average to occur, there must be a sufficient number of particles involved to represent mean conditions. The equation for "V" for dry air is:

$$V = \sqrt{\frac{8}{\pi} \cdot \frac{R^* T}{M}} \quad (67)$$

A computational form for dry air, using tabulated values, is:

$$V = \sqrt{7.3094 \times 10^2 \times T} \quad (\text{m/s}) \quad (68)$$

where T is the temperature in kelvin (K) from Appendix B. Equation 67, when corrected for moist air, becomes:

$$V = \sqrt{\frac{8}{\pi} \cdot R^* T_v} \quad (69)$$

The computational form for moist air is:

$$V = \sqrt{7.3094 \cdot 10^2 \cdot T_v} \quad (\text{m/s}) \quad (70)$$

where T_v is the virtual temperature in kelvin (K) from Appendix C.

3.7.2 Mean Free Path.

The mean free path, "L" is the mean value of the distance traveled by each neutral air particle, in a selected air parcel, between successive collisions with other particles in that parcel. A meaningful average requires that the selected parcel be large enough to contain a substantial number of particles. The equation for L is given by:

$$L = \left(\frac{\sqrt{2}}{2\pi} \right) \left(\frac{R^* T}{N_a C_d^2 P} \right) \quad (71)$$

where C_d is the effective collision diameter of the mean air molecules. The 1976 standard atmosphere value of 3.65×10^{-10} is valid for the range of altitudes in the RRA. A computational form for moist air, using tabulated values, is:

$$L = 2.335 \times 10^{-7} \frac{T}{P} \quad (\text{meters}) \quad (72)$$

where T is the temperature in K and P is the pressure in mb, both from Appendix B. A form of equation 71 to correct L for moist air is:

$$L = \left(\frac{\sqrt{2}}{2\pi} \right) \frac{R^* M T_v}{N_a C_d^2} \quad (73)$$

The computational form for moist air is:

$$L = 2.3325 \times 10^{-7} \frac{T_v}{P} \quad (\text{meters}) \quad (74)$$

where T_v is the virtual temperature in K from Appendix C and P is the pressure in mb from Appendix B.

3.7.3 Mean Collision Frequency.

The mean collision frequency (V_c) is considered to be the average speed of air particles contained in an air parcel divided by the mean free path of the particles inside that parcel. Computationally, this is equivalent to:

$$V_c = \frac{V}{L} \text{ (sec}^{-1}\text{)} \quad (75)$$

To determine V_c for dry air, use V and L from equations 68 and 72. To determine V_c for moist air, use V and L from equations 70 and 74.

3.7.4 Speed of Sound.

The expression for the speed of sound (C_s) in dry air, in (m/s) is:

$$C_s = \sqrt{\frac{\gamma R^* T}{M}} \quad (76)$$

To compute C_s for dry air from tabulated values, use:

$$C_s = \sqrt{4.0185 \times 10^2 \times T} \text{ (m/s)} \quad (77)$$

where T is the temperature K from Appendix B. One form for the speed of sound in moist air is:

$$C_s \approx \sqrt{\gamma R^* T_v} \quad (78)$$

where T_v is the virtual temperature from Appendix C. A computational form for moist air is:

$$C_s \approx \sqrt{4.0185 \times 10^2 T_v} \text{ (m/s)} \quad (79)$$

3.7.5 Coefficient of Dynamic Viscosity.

The coefficient of dynamic viscosity, μ , is defined as a coefficient of internal friction developed where gas regions move adjacent to each other at different velocities. The following expression is taken from the U.S. Standard Atmosphere (1976):

$$\mu = \frac{\beta \cdot T^{3/2}}{T + S} \quad (80)$$

The computational form is:

$$\mu = \frac{(1.458 \times 10^{-6}) T^{3/2}}{T + 110.4} \cdot \left(\frac{\text{kg}}{\text{s} \cdot \text{m}} \right) \quad (81)$$

where T is temperature K from Appendix B.

3.7.6 Kinematic Coefficient of Viscosity.

The kinematic coefficient of viscosity, designated as η , is defined as the ratio of the dynamic coefficient of viscosity of a gas to its density, or:

$$\eta = \mu/\rho \quad (82)$$

The computational form is:

$$\eta = 1.0 \times 10^3 \mu/\rho \quad , \quad (m^2/s) \quad (83)$$

where μ is the dynamic coefficient of viscosity from equation (81) and ρ is the density in $g\ m^{-3}$ from Appendix B.

3.7.7 Coefficient of Thermal Conductivity.

The empirical expression used for the coefficient of thermal conductivity (K_t) is given in the 1976 Standard Atmosphere as:

$$K_t = \frac{2.65019 \times 10^{-3} \cdot T^{3/2}}{T + 245.4 \times 10^{-(12/T)}} \quad , \quad (\text{watts/m-deg K}) \quad (84)$$

where T is temperature K.

3.7.8 Refractive Modulus and Refractive Index.

The refractive modulus or refractivity (Selby and McClatchey, 1975; Smith and Weintraub, 1953), is expressed as N , where:

$$N = (n - 1) \cdot 10^6 \quad (85)$$

and n is the refractive index.

For microwave frequencies below approximately 30 GHz (equivalent to wavelengths above 1 cm), N , the refractive modulus, is given by the empirical equation:

$$N = 77.6 \frac{P}{T_d} + 3.73 \times 10^5 \frac{e}{T^2} \quad (\text{dimensionless}) \quad (86)$$

where E and P are in millibars and T and T_d are in K.

The following expression is valid for visible and infrared wavelengths shorter than approximately 30 μm (0.03 mm):

$$N = 77.6 \frac{P}{T} + 0.584 \frac{P}{T\lambda} \quad (\text{dimensionless}) \quad (87)$$

where λ is the wavelength in microns and T is in degrees K.

The expression for N for the wavelength from 0.03 mm to 1 cm is an extremely complex function of wavelength.

Chapter 4

CONCLUSIONS AND RECOMMENDATIONS

4.1 CONCLUSIONS.

This document satisfies the technical objectives established for the Range Reference Atmosphere committee by the Range Commanders Council Meteorology Group. Upper-air statistics and models for wind and thermodynamic quantities for the range specified have been derived through consistent and uniform methods that will be used in similar publications for other ranges. This new Range Reference Atmosphere (RRA) series is an improvement over previously published RRAs for several reasons: for one, the upper-air database is much larger and much better. For another, more advanced statistical techniques have been developed.

In this series, a statistical measure of central tendency (mean values) and a measure of dispersion (standard deviation with respect to mean values) for monthly and annual reference periods have been consistently tabulated for all variables, using databases that have been carefully edited and quality controlled. Further, a statistical measure for symmetry (skewness coefficient which involves the third statistical moment) has been tabulated for all variables except the zonal and meridional wind components. But even with these improvements, RRA users must recognize certain limitations of the statistical tabulations; these limitations are described here to discourage misuse of the RRA.

- The wind profile structure with respect to altitude cannot be modeled from RRA statistics because inter-level and cross-level correlations were not computed.
- The profile structure with respect to altitude for any of the thermodynamic variables or any quantities derivable from thermodynamic variables cannot be modeled because the prerequisite correlations were not computed. However, the profile of monthly and annual means for pressure, virtual temperature, and density given in Appendix D are in agreement with the hydrostatic equation and the equation of state.

Although more extensive statistical tabulations are currently impractical, many adaptations of current statistics for specific engineering and scientific applications are envisioned as insight is gained through RRA use.

4.2. RECOMMENDATIONS.

The agency responsible for RRA preparation recommends that the wind and thermodynamic statistical tabulations and models in this RRA be used with confidence as a standard reference to the atmosphere over the location for which it has been prepared. It is further recommended that RRA users consult their Staff Meteorologist for assistance before attempting to apply RRA data to specific engineering projects.

BIBLIOGRAPHY

- Buell, Eugene C., "Statistical Relations in a Perfect Gas," *Journal of Applied Meteorology*, 9, pp. 729-731, 1970.
- List, R.J., Ed., "Acceleration of Gravity," *Smithsonian Meteorological Tables*, Sixth Ed. Smithsonian Institution, Washington, D.C., P. 488, 1968.
- Selby, J.E.A., and McClatchey, R.A., *Atmospheric Transmittance from 0.25 to 28.5 μm -- Computer Code LOWTRAN 3*, AFCRL-TR-75-0255, Air Force Cambridge Research Laboratories, 1975.
- Smith, E.K., and Weintraub, S., "The Constants in the Equation for Atmospheric Refractive Index at Radio Frequencies," *Proceedings of the Institute of Radio Engineers*, 41, 8, pp. 1035-1037, August 1953.
- Smith, O.E., *Vector Wind and Vector Wind Shear Models at 0-27 km Altitude for Cape Kennedy, Florida, and Vandenberg AFB, California*, NASA TM X-73319, July 1976.
- U.S. Standard Atmosphere*, National Aeronautics and Space Administration, United States Air Force, and United States Weather Bureau, October 1976.

PREVIOUSLY PUBLISHED RANGE REFERENCE ATMOSPHERES

- Capt Kennedy, Florida (Part I), Document 104-63, 16 April 1963
(AD 451 780).*
- White Sands Missile Range, New Mexico (Part I), Document 104-63, 28 June 1964
(AD 451 781).*
- Fort Churchill, Manitoba (Part I), Document 372-63, 7 August 1964
(AD 634 727).
- Eniwetok, Marshall Islands (Part I), Document 104-63, 1 September 1964
(AD 479 264).*
- Fort Greely Missile Range, Alaska (Part I), Document 373-63, 6 October 1964
(AD 634 726).
- Eglin Gulf Test Range, Florida (Part I), Document 104-63, 25 January 1965
(AD 472 601).*
- Point Arguello, California (Part I), Document 104-63, April 1965
(AD 472 602).*
- Wallops Island Test Range (Part I), Document 104-63, 10 July 1965
(AD 474 071).*
- Ascension Island, South Atlantic (Part I), Document 104-63, July 1966
(AD 645 591).*
- Johnston Island Test Site (Part I), Document 104-63, January 1970
(AD 782 652).*
- Lihue, Kauai, Hawaii (Part I), Document 104-63, January 1970
(AD 782 653).*
- Cape Kennedy, Florida (Part II), Document 104-63, September 1971
(AD 753 581).*
- White Sands Missile Range (Part II), Document 104-63, September 1971
(AD 782 654).*
- Wallops Island Test Range (Part II), Document 104-63, September 1971.*
- Fort Greely Missile Range (Part II), Document 104-63, September 1971.*

Edwards AFB (Part I), Document 104-63, September 1972
(AD 782 651).*

Kwajalein Missile Range, Marshall Islands (Part I), Document 105-63, October 1974.*

Kwajalein Missile Range, Document 360-82, 1982
(AD-A123424).

Cape Canaveral, Florida, Document 361-83, February 1983
(AD-A125553).

Vandenberg AFB, California, Document 362-83, 1983
(AD-A128125).

Dugway, Utah, Document 363-83, June 1983
(AD-A131110).

Wallops Island Test Range, Virginia, Document 364-83, July 1983
(AD-A131327).

White Sands Missile Range, New Mexico, Document 365-83, August 1983
(AD-A132471).

Edwards AFB, California, Document 366-83, August 1983
(AD-A132487).

Eglin AFB, Florida, Document 367-83, 1983
(AD-A133506).

Taquac, Guam Island, Document 368-83, 1983
(AD-A133618).

Point Mugu, California, Document 369-83, 1983
(AD-A134186).

Barking Sands, Hawaii, Document 370-83, 1983
(AD-A137406).

Ascension Island, Document 371-84, 1984
(AD-A138470).

Wake Island, USAFETAC/PR-90/007, November 1990.
(AD-Pending)

Nellis, USAFETAC/PR-90/008, December 1990
(AD-Pending)

** No longer available from RCC.*

ACRONYMS, INITIALISMS, AND ABBREVIATIONS (ACRINABS)

AD	Armament Division
AFFTC	Air Force Flight Test Center
AFSC	Air Force Systems Command
AFSCF	Air Force Satellite Control Facility
AFTFWC	Air Force Tactical Fighter Weapons Center
AWS	Air Weather Service
BMD	Ballistic Missile Division
CSTC	Consolidated Space Test Center
DOD	Department of Defense
DOE	Department of Energy
DOE/NTS	DOE/Nevada Test Site
DPG	Dugway Proving Ground
EPG	Electronic Proving Ground
ESMC	Eastern Space and Missile Center
ETR	Eastern Test Range
GL	Geophysics Laboratory
KMR	Kwajalein Missile Range
NASA	National Aeronautics and Space Administration
NASA/MSFC	NASA/Marshall Space Flight Center
NASA/WFC	NASA/Wallops Flight Center
NATC	Naval Air Test Center
NOAA	National Oceanic and Atmospheric Administration
NWC	Naval Weapons Center
PMTC	Pacific Missile Test Center
SAMTO	Space and Missile Test Organization
TFWC	Tactical Fighter Weapons Center
TSCF	Targeting Systems Characterization Facility
USA/DTA	U.S. Army/Desert Test Center
USAECOM	U.S. Army Electronics Command
USAFETAC	USAF Environmental Technical Applications Center
USAKA	U.S. Army Kwajalein Atoll
UTTR	Utah Test and Training Range
WSMC	Western Space and Missile Center
WSMR	White Sands Missile Range
WTR	Western Test Range
YPG	Yuma Proving Ground
6585TG	6585th Test Group

APPENDIX A

Nellis Wind Statistics Tables

Table A-1 through Table A-13 give statistical wind data (monthly and annual) for Nellis. Data was produced as described in Chapter 2.

TABLE A-1. January Statistical Wind Data, Nellis.

Z KM	MEAN U M/S	S.D. U M/S	R(U,V)	MEAN V M/S	S.D. V M/S	MEAN W M/S	S.D. W M/S	SKEW W	#OBS
0.000	0.00	0.00	0.0000	0.00	0.00	0.00	0.00	0.00	0
1.000	0.00	0.00	0.0000	0.00	0.00	0.00	0.00	0.00	0.
1.007	-1.47	2.92	0.3876	-0.26	3.55	4.13	2.51	0.75	495.
2.000	-0.71	4.69	0.6013	0.09	6.66	6.89	4.14	0.86	550.
3.000	2.13	6.93	0.4681	-1.28	8.05	9.50	5.34	0.66	47.
4.000	4.96	8.44	0.3158	-2.68	8.92	11.87	6.43	0.67	540.
5.000	7.51	9.62	0.2097	-3.48	10.48	14.50	7.76	0.58	524.
6.000	9.45	11.49	0.2127	-3.93	11.94	17.19	9.13	0.64	510.
7.000	11.31	13.10	0.2457	-4.07	13.66	19.78	10.52	0.68	475.
8.000	12.85	14.71	0.2670	-4.74	15.37	22.41	11.72	0.68	469.
9.000	14.27	16.24	0.2833	-5.22	16.56	24.84	12.29	0.53	462.
10.000	15.58	16.95	0.2726	-6.04	17.01	26.37	12.62	0.52	453.
11.000	17.38	16.85	0.2679	-6.48	16.34	27.13	12.56	0.70	441.
12.000	18.48	14.94	0.2884	-6.20	14.32	25.95	11.60	0.52	436.
13.000	19.36	12.91	0.2539	-5.42	12.28	24.61	10.75	0.81	435.
14.000	18.61	10.83	0.1821	-4.94	10.81	22.66	9.55	0.72	434.
15.000	16.79	9.41	0.1715	-4.41	9.12	20.05	8.42	0.74	432.
16.000	14.60	8.24	0.1433	-3.88	7.47	17.18	7.52	0.91	432.
17.000	12.21	7.21	0.0780	-3.36	6.30	14.35	6.80	1.26	409.
18.000	9.40	6.84	0.0053	-3.24	5.24	11.45	6.47	1.58	409.
19.000	6.76	6.99	0.0007	-3.42	4.53	9.42	6.17	1.81	404.
20.000	4.08	7.33	0.0099	-3.53	4.08	8.00	5.14	1.21	400.
21.000	2.03	8.08	-0.0153	-3.67	4.01	8.28	4.71	0.96	398.
22.000	0.54	9.24	-0.0179	-3.86	4.00	9.27	4.87	1.17	387.
23.000	-0.67	9.98	0.0786	-3.97	4.18	10.35	5.09	0.72	380.
24.000	-1.17	11.30	0.2189	-4.19	4.55	11.57	5.76	0.51	373.
25.000	-1.16	12.77	0.3194	-4.23	5.23	12.85	6.64	0.64	356.
26.000	-0.79	14.66	0.4375	-4.26	6.14	14.44	7.90	0.67	341.
27.000	-0.15	16.34	0.4853	-4.33	7.19	16.01	8.97	0.60	308.
28.000	0.22	18.37	0.5005	-4.42	8.08	17.75	10.31	0.77	273.
29.000	-0.26	19.89	0.5542	-4.32	8.79	18.69	11.86	0.99	212.
30.000	-0.17	22.29	0.5049	-4.60	9.12	20.28	13.71	1.17	173.

TABLE A-2. February Statistical Wind Data, Nellis.

Z KM	MEAN U M/S	S.D. U M/S	R(U,V)	MEAN V M/S	S.D. V M/S	MEAN W M/S	S.D. W M/S	SKEW W	#OBS
0.000	0.00	0.00	0.0000	0.00	0.00	0.00	0.00	0.00	0.
1.000	0.00	0.00	0.0000	0.00	0.00	0.00	0.00	0.00	0.
1.007	-0.57	3.19	0.4803	0.05	4.02	4.24	2.93	1.04	458.
2.000	0.64	4.64	0.5795	1.16	7.07	7.09	4.79	1.13	509.
3.000	3.71	6.14	0.4509	-0.66	8.02	9.28	5.48	0.93	507.
4.000	7.06	7.22	0.2727	-2.19	8.78	11.82	6.63	0.74	501.
5.000	9.67	8.47	0.2081	-3.29	10.21	14.98	7.46	0.65	494.
6.000	11.78	9.78	0.1549	-3.94	11.79	17.66	8.76	0.76	475.
7.000	14.46	10.77	0.1054	-4.68	13.34	20.67	9.84	0.75	432.
8.000	16.59	11.96	0.0610	-5.65	14.69	23.39	10.87	0.49	426.
9.000	18.71	13.23	0.0904	-6.25	16.06	26.04	11.98	0.46	425.
10.000	21.03	13.85	0.0814	-6.89	16.70	28.38	12.42	0.28	423.
11.000	22.94	14.11	0.0587	-7.26	16.79	29.87	12.93	0.40	421.
12.000	23.30	11.96	0.0833	-6.71	14.63	28.66	11.09	0.37	417.
13.000	23.53	10.23	0.1124	-5.90	12.73	27.58	9.70	0.45	412.
14.000	22.00	9.48	0.1087	-5.06	11.26	25.38	9.06	0.64	412.
15.000	19.79	8.48	0.0930	-4.30	9.63	22.50	8.26	0.82	409.
16.000	16.85	7.35	0.0855	-3.33	8.00	19.00	7.20	0.68	405.
17.000	13.99	7.08	0.0030	-3.09	6.93	15.95	6.99	0.77	386.
18.000	10.88	6.87	-0.1051	-2.74	5.94	12.68	6.89	0.98	385.
19.000	7.93	6.62	-0.1026	-2.78	4.86	10.02	6.13	1.16	374.
20.000	4.91	6.90	-0.1246	-2.58	4.36	8.18	5.51	1.53	374.
21.000	2.53	7.30	-0.0784	-2.57	4.03	7.64	4.90	1.77	365.
22.000	0.68	7.73	-0.1221	-2.80	3.72	7.88	4.43	1.71	352.
23.000	-0.97	8.17	-0.1380	-2.73	3.87	8.40	4.40	1.37	348.
24.000	-1.93	9.20	-0.0487	-2.65	4.06	9.28	5.07	0.92	340.
25.000	-2.16	10.40	0.0151	-2.88	4.76	10.39	5.95	0.96	327.
26.000	-2.26	11.68	0.0983	-3.20	5.11	11.49	6.73	0.60	310.
27.000	-2.09	13.45	0.1243	-3.54	5.94	13.24	7.56	0.64	266.
28.000	-2.71	15.12	0.1993	-3.52	6.51	14.70	8.58	0.71	233.
29.000	-2.24	18.03	0.2758	-3.81	6.50	16.72	10.29	1.12	185.
30.000	-1.81	18.98	0.3974	-3.79	6.61	17.73	10.26	0.75	144.

TABLE A-3. March Statistical Wind Data, Nellis.

Z KM	MEAN U M/S	S.D. U M/S	R(U,V)	MEAN V M/S	S.D. V M/S	MEAN W M/S	S.D. W M/S	SKEW W	#OBS
0.000	0.00	0.00	0.0000	0.00	0.00	0.00	0.00	0.00	0.
1.000	0.00	0.00	0.0000	0.00	0.00	0.00	0.00	0.00	0.
1.007	0.30	3.28	0.5578	0.74	4.29	4.54	3.03	1.05	493.
2.000	1.44	4.14	0.4453	1.66	6.91	7.04	4.48	0.97	553.
3.000	3.61	5.32	0.3033	0.12	7.63	8.58	5.08	0.73	548.
4.000	6.52	6.83	0.1800	-1.17	9.07	11.38	6.55	0.81	543.
5.000	9.40	8.53	0.0934	-1.88	10.99	14.72	8.29	0.89	530.
6.000	12.07	10.47	0.0513	-2.13	12.89	18.02	10.05	1.04	516.
7.000	14.07	12.09	0.0316	-2.03	14.40	20.87	10.94	0.79	475.
8.000	16.30	13.28	0.0714	-2.12	16.00	23.61	12.02	0.57	470.
9.000	18.12	14.35	0.0543	-3.05	17.30	26.13	12.61	0.40	458.
10.000	20.64	15.11	0.0650	-2.83	17.67	28.17	13.42	0.43	453.
11.000	22.48	14.51	0.0799	-2.79	16.85	28.72	13.49	0.53	446.
12.000	23.45	12.81	0.0965	-1.44	14.36	27.81	12.16	0.52	439.
13.000	23.51	11.08	0.1275	-0.64	12.45	26.72	10.80	0.55	437.
14.000	22.07	9.57	0.0926	0.02	10.79	24.68	9.26	0.62	435.
15.000	19.91	8.04	0.0810	0.14	9.45	22.11	7.82	0.71	434.
16.000	17.16	7.53	0.1205	0.31	8.12	19.06	7.34	0.88	432.
17.000	14.34	6.83	0.1103	0.47	6.76	15.94	6.62	1.15	411.
18.000	11.31	6.24	0.1251	0.53	5.57	12.63	6.21	1.40	411.
19.000	8.54	5.99	0.1854	0.29	4.57	9.78	5.83	1.70	404.
20.000	5.87	6.12	0.2230	-0.10	3.86	7.59	5.39	2.21	400.
21.000	3.90	6.38	0.1936	-0.45	3.36	6.42	4.44	1.91	394.
22.000	2.38	6.56	0.2234	-0.72	3.11	6.13	3.84	1.88	387.
23.000	1.19	7.14	0.2315	-0.95	3.06	6.38	3.92	1.51	385.
24.000	0.74	7.92	0.2193	-1.11	3.07	6.96	5.04	1.86	367.
25.000	0.69	8.86	0.2576	-1.05	3.32	7.85	5.41	1.57	350.
26.000	0.75	10.17	0.3159	-1.00	3.80	9.06	6.10	1.08	337.
27.000	1.84	11.95	0.4071	-1.32	4.00	10.64	7.10	0.98	290.
28.000	3.35	13.32	0.4738	-1.16	4.28	11.88	8.17	0.98	267.
29.000	5.01	15.20	0.5233	-0.61	4.84	13.78	9.45	0.82	206.
30.000	7.84	17.43	0.5291	0.04	5.52	16.51	11.03	0.63	150.

TABLE A-4. April Statistical Wind Data, Nellis.

Z KM	MEAN U M/S	S.D. U M/S	R(U,V)	MEAN V M/S	S.D. V M/S	MEAN W M/S	S.D. W M/S	SKEW W	#OBS
0.000	0.00	0.00	0.0000	0.00	0.00	0.00	0.00	0.00	0.
1.000	0.00	0.00	0.0000	0.00	0.00	0.00	0.00	0.00	0.
1.007	0.52	3.36	0.5409	0.86	4.37	4.79	2.91	0.61	509.
2.000	1.64	4.53	0.4050	2.09	6.72	7.20	4.18	0.96	546.
3.000	3.06	5.49	0.1987	1.17	7.33	8.14	4.95	1.21	544.
4.000	5.65	7.42	0.0101	-0.11	8.87	11.03	6.62	1.18	530.
5.000	8.54	9.41	0.0021	-1.06	10.51	14.21	8.41	0.91	520.
6.000	10.85	10.79	0.0389	-1.41	12.29	17.07	9.77	0.76	513.
7.000	13.30	12.63	0.0690	-1.81	14.39	20.44	11.32	0.74	478.
8.000	15.19	13.76	0.1137	-1.99	16.00	23.06	12.15	0.66	472.
9.000	16.90	14.78	0.1539	-2.28	17.04	25.18	12.84	0.52	468.
10.000	18.92	15.69	0.1824	-2.49	17.28	26.99	13.42	0.60	462.
11.000	20.10	15.39	0.1911	-2.61	16.85	27.72	12.74	0.34	456.
12.000	20.77	14.36	0.2327	-1.73	14.98	26.97	11.68	0.44	452.
13.000	20.17	12.25	0.2500	-0.75	12.62	24.71	10.28	0.35	448.
14.000	19.23	10.84	0.2688	0.13	10.44	22.56	9.34	0.39	447.
15.000	17.43	9.60	0.2173	0.41	9.01	20.12	8.50	0.39	445.
16.000	14.89	8.43	0.1709	0.86	7.47	17.02	7.73	0.50	442.
17.000	12.78	7.45	0.1725	1.17	6.47	14.64	6.89	0.62	411.
18.000	10.19	6.67	0.1651	1.22	5.60	11.91	6.26	0.90	411.
19.000	7.57	6.13	0.2163	1.11	4.73	9.31	5.63	1.25	410.
20.000	5.37	5.55	0.2727	0.85	4.04	7.18	5.02	1.67	406.
21.000	3.59	5.48	0.2967	0.47	3.74	5.89	4.73	1.81	399.
22.000	2.82	5.53	0.3286	-0.01	3.49	5.64	4.35	1.84	393.
23.000	2.13	5.69	0.3250	-0.35	3.37	5.65	4.05	1.71	390.
24.000	2.02	6.01	0.3062	-0.39	3.35	5.71	4.33	1.77	376.
25.000	2.80	6.40	0.3162	-0.45	3.41	6.23	4.65	1.79	363.
26.000	3.58	6.73	0.3251	-0.64	3.50	6.68	5.10	1.66	345.
27.000	4.97	6.96	0.3160	-0.76	3.71	7.51	5.57	1.56	316.
28.000	6.12	6.67	0.2160	-0.67	3.83	8.13	5.55	1.44	286.
29.000	7.43	6.84	0.1966	-0.82	4.08	9.19	5.89	1.60	251.
30.000	8.36	7.52	0.2038	-0.73	4.65	10.31	6.49	1.76	202.

TABLE A-5. May Statistical Wind Data, Nellis.

Z KM	MEAN U M/S	S.D. U M/S	R(U,V)	MEAN V M/S	S.D. V M/S	MEAN W M/S	S.D. W M/S	SKEW W	#OBS
0.000	0.00	0.00	0.0000	0.00	0.00	0.00	0.00	0.00	0.
1.000	0.00	0.00	0.0000	0.00	0.00	0.00	0.00	0.00	0.
1.007	0.71	3.23	0.5725	1.05	4.00	4.42	2.90	0.93	502.
2.000	1.98	3.51	0.4957	2.58	5.64	6.39	3.73	1.04	530.
3.000	2.31	3.88	0.2359	2.10	5.90	6.56	4.05	1.13	529.
4.000	3.68	5.42	0.0460	1.24	6.72	8.20	4.73	0.89	527.
5.000	6.13	7.76	-0.0004	0.07	8.22	10.89	6.81	1.27	520.
6.000	8.25	9.48	-0.0397	-0.46	9.26	13.15	8.41	1.34	515.
7.000	10.06	10.60	0.0538	-0.79	10.47	15.41	9.28	0.97	474.
8.000	11.63	11.96	0.1130	-1.14	11.88	17.71	10.34	0.92	469.
9.000	13.12	13.17	0.1166	-1.41	13.18	19.92	11.12	0.68	466.
10.000	14.69	14.17	0.1456	-1.82	14.32	21.96	11.93	0.61	464.
11.000	15.88	14.43	0.2073	-2.00	14.64	23.03	12.17	0.65	461.
12.000	16.78	14.06	0.2221	-1.47	13.53	23.00	11.60	0.71	458.
13.000	16.12	11.89	0.2453	-0.91	11.46	20.88	9.84	0.84	455.
14.000	14.87	9.82	0.1870	-0.18	9.17	18.18	8.42	1.20	455.
15.000	12.95	8.38	0.1692	0.42	7.43	15.43	7.44	1.44	454.
16.000	10.47	7.06	0.0917	0.88	6.17	12.32	6.32	1.33	454.
17.000	8.06	5.92	0.0907	0.85	5.08	9.86	5.41	1.88	425.
18.000	5.46	5.18	0.0845	0.64	4.07	7.10	3.77	1.75	425.
19.000	2.91	4.90	0.0701	0.34	3.32	5.00	3.07	1.64	419.
20.000	0.86	4.63	0.0104	0.11	2.75	3.84	2.09	1.05	419.
21.000	-0.74	4.51	-0.0156	-0.19	2.40	3.47	2.12	1.28	415.
22.000	-1.36	4.34	-0.0516	-0.37	2.27	3.51	2.11	1.11	412.
23.000	-1.72	4.40	-0.0808	-0.52	2.30	3.71	2.24	0.83	407.
24.000	-1.70	4.71	-0.0486	-0.56	2.48	3.79	2.20	0.93	396.
25.000	-1.59	4.07	-0.0105	-0.72	2.37	3.87	2.23	0.61	376.
26.000	-1.38	4.39	-0.0639	-0.63	2.48	4.19	2.40	1.00	364.
27.000	-0.91	4.70	-0.0157	-0.63	2.66	4.43	2.73	1.59	341.
28.000	-0.30	5.22	0.0022	-0.46	2.86	4.85	2.93	1.43	310.
29.000	-0.02	5.58	0.0480	-0.37	2.97	5.17	3.04	1.27	271.
30.000	0.19	6.06	0.0398	-0.39	3.00	5.55	3.21	0.95	234.

TABLE A-6. June Statistical Wind Data, Nellis.

Z KM	MEAN U M/S	S.D. U M/S	R(U,V)	MEAN V M/S	S.D. V M/S	MEAN W M/S	S.D. W M/S	SKEW W	#OBS
0.000	0.00	0.00	0.0000	0.00	0.00	0.00	0.00	0.00	0.
1.000	0.00	0.00	0.0000	0.00	0.00	0.00	0.00	0.00	0.
1.007	1.31	3.15	0.6179	1.75	4.21	4.88	2.93	0.60	566.
2.000	2.45	3.39	0.5970	4.42	5.41	7.21	3.77	0.60	587.
3.000	2.42	3.79	0.3528	4.09	5.60	7.12	4.18	1.02	587.
4.000	3.27	5.26	0.1513	3.52	6.09	8.01	4.60	0.90	583.
5.000	5.69	6.64	0.0833	3.10	7.02	10.08	5.81	1.04	574.
6.000	8.12	7.88	0.0710	2.94	8.13	12.30	7.17	0.99	571.
7.000	10.29	8.90	0.1173	3.18	9.36	14.51	8.50	1.00	527.
8.000	12.27	10.32	0.1550	3.60	10.69	16.87	9.98	1.01	526.
9.000	13.98	11.45	0.1689	3.96	11.76	18.98	10.95	0.85	525.
10.000	15.66	12.75	0.2482	4.26	12.66	21.10	11.86	0.83	522.
11.000	16.90	13.15	0.2768	4.77	13.26	22.67	11.95	0.63	513.
12.000	18.20	12.85	0.2692	5.14	13.22	23.55	11.92	0.47	512.
13.000	18.42	11.62	0.2595	5.69	11.91	23.05	10.81	0.32	508.
14.000	16.99	9.51	0.2211	5.69	10.14	20.78	9.06	0.39	503.
15.000	14.00	7.39	0.2113	5.01	8.16	17.11	7.02	0.26	502.
16.000	10.02	5.72	0.1735	3.94	6.02	12.45	5.45	0.64	498.
17.000	6.40	4.68	0.1114	2.94	4.65	8.69	4.18	1.17	473.
18.000	3.12	4.10	0.1269	2.15	3.66	5.78	3.34	1.74	473.
19.000	-0.08	3.81	0.2342	1.24	2.94	4.09	2.49	1.28	469.
20.000	-2.34	3.65	0.2929	0.57	2.48	4.41	2.25	1.04	466.
21.000	-3.99	3.32	0.1932	0.12	2.11	5.06	2.39	0.55	464.
22.000	-5.41	2.98	0.1493	-0.09	1.89	6.04	2.27	0.14	461.
23.000	-6.51	3.00	0.0608	-0.17	1.86	7.00	2.42	-0.09	456.
24.000	-7.15	3.43	0.1476	-0.30	1.93	7.61	2.95	0.08	451.
25.000	-7.73	3.35	0.0821	-0.36	1.94	8.12	2.98	0.13	438.
26.000	-8.34	3.52	0.0614	-0.41	1.88	8.71	3.14	0.17	425.
27.000	-8.72	3.81	0.0709	0.02	2.16	9.14	3.42	-0.04	399.
28.000	-9.04	4.26	0.2296	-0.03	2.36	9.37	3.26	-0.04	365.
29.000	-9.50	3.84	0.1461	-0.13	2.45	9.97	3.40	0.09	319.
30.000	-9.98	4.03	0.1466	0.01	2.30	10.42	3.54	0.23	269.

TABLE A-7. July Statistical Wind Data, Nellis.

Z KM	MEAN U M/S	S.D. U M/S	R(U,V)	MEAN V M/S	S.D. V M/S	MEAN W M/S	S.D. W M/S	SKEW W	#OBS
0.000	0.00	0.00	0.0000	0.00	0.00	0.00	0.00	0.00	0.
1.000	0.00	0.00	0.0000	0.00	0.00	0.00	0.00	0.00	0.
1.007	1.06	3.25	0.5830	1.88	3.58	4.46	2.85	0.64	598.
2.000	2.44	2.72	0.4827	5.03	4.07	6.54	3.53	0.56	615.
3.000	1.58	3.29	0.4621	4.97	4.52	6.55	3.95	0.99	614.
4.000	1.36	4.37	0.3286	4.67	4.44	6.84	3.95	1.06	610.
5.000	2.46	5.31	0.2388	4.56	5.06	7.86	4.33	1.00	600.
6.000	4.06	5.95	0.1996	4.54	5.61	8.93	4.92	0.74	595.
7.000	6.03	6.97	0.1985	5.27	6.33	10.75	6.10	0.85	560.
8.000	7.51	7.75	0.1716	5.81	7.35	12.50	6.93	0.59	548.
9.000	8.88	8.63	0.1806	6.63	8.40	14.29	7.98	0.81	547.
10.000	10.22	9.41	0.0829	7.87	9.16	16.13	8.35	0.52	545.
11.000	11.71	10.16	0.0717	9.10	9.96	18.28	9.39	0.81	544.
12.000	12.61	10.26	0.1050	9.38	10.24	19.00	9.79	0.63	541.
13.000	12.66	10.37	0.1598	8.88	10.12	18.64	10.06	0.69	540.
14.000	11.19	9.19	0.2008	7.60	9.08	16.39	9.02	0.72	539.
15.000	8.14	7.25	0.1880	5.97	7.16	12.59	6.87	0.53	539.
16.000	4.12	5.25	0.1859	4.50	5.51	8.50	4.78	0.74	537.
17.000	1.09	4.24	0.1797	3.25	4.02	5.99	3.17	0.82	503.
18.000	-1.53	3.32	0.2594	2.22	3.09	4.73	2.33	0.38	503.
19.000	-3.95	2.79	0.2782	1.16	2.49	5.13	2.15	0.50	503.
20.000	-6.09	2.25	0.2314	0.49	2.06	6.53	2.00	-0.11	501.
21.000	-7.92	2.45	0.1205	0.14	1.98	8.20	2.32	-0.30	499.
22.000	-9.11	2.19	0.0721	-0.08	1.87	9.32	2.10	-0.28	492.
23.000	-10.43	2.26	0.0620	-0.24	1.78	10.60	2.18	-0.17	489.
24.000	-11.71	2.42	0.0981	-0.19	1.86	11.87	2.34	-0.17	480.
25.000	-12.56	2.57	0.1804	-0.14	1.88	12.73	2.43	-0.33	463.
26.000	-13.36	2.62	0.1640	-0.21	2.00	13.55	2.46	-0.41	451.
27.000	-14.24	2.80	0.0780	-0.05	2.09	14.42	2.67	-0.45	428.
28.000	-14.94	2.67	0.1049	0.18	2.15	15.11	2.55	-0.76	374.
29.000	-15.54	2.80	0.1614	0.04	2.32	15.74	2.66	-0.71	338.
30.000	-16.47	3.07	0.1564	0.06	2.48	16.69	2.91	-0.44	293.

TABLE A-8. August Statistical Wind Data, Nellis.

Z KM	MEAN U M/S	S.D. U M/S	R(U,V)	MEAN V M/S	S.D. V M/S	MEAN W M/S	S.D. W M/S	SKEW W	#OBS
0.000	0.00	0.00	0.0000	0.00	0.00	0.00	0.00	0.00	0.
1.000	0.00	0.00	0.0000	0.00	0.00	0.00	0.00	0.00	0.
1.007	0.94	2.96	0.5594	1.94	3.36	4.11	2.79	0.65	548.
2.000	2.39	2.65	0.4657	5.02	3.79	6.38	3.41	0.33	567.
3.000	1.39	3.48	0.4111	4.73	4.14	6.39	3.56	0.83	567.
4.000	0.97	4.38	0.2695	4.46	4.44	6.86	3.55	0.76	566.
5.000	2.38	5.22	0.1967	4.20	5.09	7.82	3.90	0.69	562.
6.000	3.90	5.86	0.1717	4.03	5.69	8.86	4.42	0.55	559.
7.000	5.60	6.48	0.1838	4.63	6.24	10.36	5.11	0.65	547.
8.000	7.20	7.22	0.1572	5.55	6.88	12.06	6.05	0.52	547.
9.000	8.83	7.93	0.0978	6.76	7.84	14.12	6.95	0.50	545.
10.000	10.60	8.98	0.0285	8.51	8.80	16.73	7.94	0.47	544.
11.000	12.25	9.91	-0.0212	10.16	9.96	19.33	8.76	0.30	543.
12.000	13.53	10.48	-0.0633	11.51	10.82	21.33	9.35	0.31	540.
13.000	13.72	10.06	-0.0319	11.17	10.41	21.02	8.99	0.28	539.
14.000	12.36	8.69	0.0040	9.26	8.23	18.07	7.41	0.26	538.
15.000	9.42	7.09	-0.0294	7.17	6.42	14.03	5.89	0.21	534.
16.000	5.31	5.21	-0.0137	5.06	4.94	9.30	4.33	0.61	532.
17.000	2.30	4.14	0.0218	3.53	3.72	6.29	2.84	0.58	483.
18.000	-0.36	3.67	0.1346	2.20	2.76	4.61	2.01	0.30	483.
19.000	-2.90	3.18	0.1652	1.09	2.49	4.57	2.23	0.60	483.
20.000	-4.79	2.59	0.1783	0.45	2.04	5.43	2.15	-0.07	482.
21.000	-6.28	2.63	0.0564	0.07	1.99	6.67	2.40	-0.09	481.
22.000	-7.60	2.23	0.1316	-0.11	1.75	7.82	2.15	-0.13	479.
23.000	-8.92	2.25	0.0498	-0.37	1.69	9.09	2.21	-0.18	475.
24.000	-10.27	2.60	0.0030	-0.39	1.87	10.46	2.56	-0.26	468.
25.000	-11.11	2.63	0.0043	-0.21	1.96	11.30	2.59	-0.28	455.
26.000	-11.80	2.77	0.0383	-0.19	1.90	11.96	2.72	-0.25	438.
27.000	-12.57	3.12	0.0605	-0.16	2.09	12.76	3.06	-0.08	414.
28.000	-13.18	3.14	0.0327	-0.05	1.93	13.33	3.09	-0.20	396.
29.000	-13.74	3.27	0.0936	0.05	2.07	13.90	3.25	-0.18	355.
30.000	-14.16	3.73	0.1223	-0.01	2.31	14.41	3.46	-0.27	310.

TABLE A-9. September Statistical Wind Data, Nellis.

Z KM	MEAN U M/S	S.D. U M/S	R(U,V)	MEAN V M/S	S.D. V M/S	MEAN W M/S	S.D. W M/S	SKEW W	#OBS
0.000	0.00	0.00	0.0000	0.00	0.00	0.00	0.00	0.00	0.
1.000	0.00	0.00	0.0000	0.00	0.00	0.00	0.00	0.00	0.
1.007	0.53	2.99	0.5313	1.54	3.70	4.22	2.72	0.74	512.
2.000	1.67	3.27	0.5671	4.28	5.03	6.54	3.79	0.69	550.
3.000	2.01	3.76	0.4068	4.44	5.89	7.27	4.45	0.85	549.
4.000	3.19	5.21	0.2579	3.88	6.34	8.22	4.99	0.75	545.
5.000	4.99	6.65	0.1709	3.43	7.15	9.82	5.95	0.70	541.
6.000	6.75	7.89	0.1777	3.50	8.32	11.68	7.26	0.88	539.
7.000	8.87	9.32	0.2118	3.84	9.80	14.07	8.84	0.99	529.
8.000	10.77	10.57	0.2409	4.18	11.33	16.37	10.27	1.00	526.
9.000	12.41	11.31	0.2518	4.49	12.67	18.58	10.83	0.88	523.
10.000	14.34	11.81	0.2752	4.60	13.63	20.67	11.17	0.57	523.
11.000	16.41	11.78	0.2681	5.12	13.34	22.13	11.06	0.47	522.
12.000	17.71	11.34	0.2361	5.47	12.49	22.69	10.62	0.31	520.
13.000	18.27	10.54	0.1895	5.60	11.03	22.29	10.02	0.33	517.
14.000	17.30	9.13	0.1445	5.21	9.44	20.56	8.73	0.12	514.
15.000	14.49	7.52	0.1441	4.45	7.75	17.15	7.20	0.20	511.
16.000	10.78	6.31	0.1400	3.23	6.23	12.96	6.10	0.52	510.
17.000	7.50	5.65	0.1753	2.16	5.35	9.63	5.35	1.03	472.
18.000	4.38	4.85	0.2468	1.27	4.38	6.63	4.12	1.65	472.
19.000	1.77	4.53	0.3234	0.48	3.67	4.80	3.24	1.65	465.
20.000	0.27	4.39	0.3361	0.14	3.11	4.43	2.78	1.56	465.
21.000	-1.04	4.01	0.1981	-0.16	2.56	4.22	2.44	1.38	462.
22.000	-1.95	4.06	0.2436	-0.27	2.36	4.55	2.27	0.55	458.
23.000	-2.73	4.29	0.2194	-0.37	2.25	5.05	2.34	0.27	451.
24.000	-3.29	4.52	0.1847	-0.30	2.22	5.37	2.72	0.30	447.
25.000	-3.67	4.62	0.1685	-0.08	2.10	5.59	2.82	0.28	430.
26.000	-4.11	4.74	0.1383	-0.07	2.09	5.91	2.97	0.29	422.
27.000	-4.22	4.91	0.1304	0.02	2.20	6.06	3.16	0.36	389.
28.000	-4.09	5.25	0.2442	0.11	2.33	6.23	3.29	0.42	369.
29.000	-4.00	5.61	0.3382	0.05	2.46	6.51	3.34	0.61	321.
30.000	-3.79	6.05	0.3658	-0.01	2.58	6.65	3.64	0.56	277.

TABLE A-10. October Statistical Wind Data, Nellis.

Z KM	MEAN U M/S	S.D. U M/S	R(U,V)	MEAN V M/S	S.D. V M/S	MEAN W M/S	S.D. W M/S	SKEW W	#OBS
0.000	0.00	0.00	0.0000	0.00	0.00	0.00	0.00	0.00	0.
1.000	0.00	0.00	0.0000	0.00	0.00	0.00	0.00	0.00	0.
1.007	-0.19	2.98	0.5963	0.44	3.69	3.88	2.77	1.04	569.
2.000	0.22	4.07	0.5563	1.11	5.77	5.77	4.22	1.50	600.
3.000	0.82	5.06	0.3743	0.31	6.43	6.93	4.42	1.07	600.
4.000	2.84	6.76	0.2324	-0.67	7.35	8.80	5.53	0.99	595.
5.000	4.96	8.50	0.1229	-1.31	8.65	11.08	7.10	1.11	586.
6.000	6.81	10.23	0.1294	-1.98	10.60	13.74	8.85	1.17	580.
7.000	8.67	11.97	0.1372	-2.36	12.84	16.45	10.84	1.26	545.
8.000	10.01	13.27	0.1645	-2.16	13.46	18.28	11.30	0.98	538.
9.000	11.45	14.21	0.1921	-2.08	14.82	20.21	12.17	0.81	535.
10.000	13.26	15.14	0.2561	-1.93	15.67	22.32	12.47	0.55	528.
11.000	15.08	15.03	0.2405	-1.90	15.40	23.16	12.51	0.48	526.
12.000	16.12	14.04	0.2219	-1.45	14.07	22.80	11.70	0.37	521.
13.000	16.23	13.15	0.2096	-1.21	12.22	21.56	11.04	0.50	514.
14.000	14.82	10.89	0.1781	-1.06	10.16	18.79	9.43	0.41	512.
15.000	13.22	9.63	0.1286	-0.68	8.48	16.33	8.55	0.79	506.
16.000	11.12	8.02	0.1834	-0.39	6.94	13.59	7.18	0.72	504.
17.000	9.27	6.90	0.2331	-0.42	5.85	11.48	6.00	0.85	457.
18.000	6.90	6.05	0.2732	-0.45	4.90	9.11	5.03	1.25	457.
19.000	5.04	5.60	0.3178	-0.42	4.54	7.64	4.37	1.60	454.
20.000	3.72	5.17	0.3226	-0.82	3.72	6.38	3.30	1.27	453.
21.000	2.93	5.10	0.2913	-0.85	3.49	5.87	3.59	1.76	450.
22.000	3.10	4.90	0.3727	-0.70	3.14	5.71	2.95	0.97	446.
23.000	3.74	4.92	0.3128	-0.64	3.02	6.05	3.33	1.48	439.
24.000	4.66	5.23	0.2496	-0.35	2.95	6.48	3.98	1.24	425.
25.000	6.12	5.12	0.3070	-0.11	2.92	7.38	4.20	0.79	407.
26.000	8.00	5.29	0.2714	0.25	2.98	8.87	4.72	0.41	395.
27.000	9.70	5.88	0.2041	0.41	3.07	10.46	5.37	0.25	373.
28.000	10.89	6.42	0.2795	0.63	3.19	11.70	5.77	0.29	347.
29.000	12.25	6.85	0.2695	0.99	3.37	13.06	6.22	0.29	303.
30.000	13.84	7.21	0.2596	1.54	3.62	14.67	6.62	0.19	256.

TABLE A-11. November Statistical Wind Data, Nellis.

Z KM	MEAN U M/S	S.D. U M/S	R(U,V)	MEAN V M/S	S.D. V M/S	MEAN W M/S	S.D. W M/S	SKEW W	#OBS
0.000	0.00	0.00	0.0000	0.00	0.00	0.00	0.00	0.00	0.
1.000	0.00	0.00	0.0000	0.00	0.00	0.00	0.00	0.00	0.
1.007	-0.66	2.87	0.4699	0.55	3.74	3.92	2.76	1.12	550.
2.000	0.47	4.49	0.5765	1.57	7.07	7.29	4.43	0.96	578.
3.000	3.97	6.34	0.4247	-0.27	8.37	9.85	5.38	0.88	575.
4.000	7.70	7.79	0.2271	-2.09	9.63	13.05	6.83	0.59	570.
5.000	10.78	9.44	0.1478	-2.99	11.79	16.71	8.61	0.52	558.
6.000	13.17	10.68	0.1174	-3.54	13.82	19.81	9.92	0.58	552.
7.000	15.17	12.30	0.1219	-3.70	15.75	22.72	11.24	0.56	525.
8.000	16.92	13.02	0.1519	-4.21	17.41	25.17	11.93	0.49	513.
9.000	18.86	13.51	0.1655	-4.53	18.69	27.46	12.37	0.32	504.
10.000	20.68	13.86	0.2035	-5.29	19.23	29.33	12.50	0.18	495.
11.000	22.16	14.42	0.2282	-5.80	18.64	30.33	12.63	0.17	484.
12.000	23.14	13.65	0.2282	-5.41	17.30	30.19	11.76	0.18	481.
13.000	22.60	12.41	0.2356	-4.36	15.31	28.36	10.63	0.32	476.
14.000	21.11	10.84	0.2473	-3.85	13.14	25.69	9.50	0.43	472.
15.000	19.08	9.11	0.2760	-3.06	11.15	22.67	8.17	0.43	469.
16.000	16.50	7.94	0.2728	-2.44	9.25	19.28	7.40	0.53	468.
17.000	13.94	7.03	0.2746	-1.97	7.93	16.22	6.88	0.95	437.
18.000	11.12	6.32	0.2416	-1.66	6.59	12.95	6.48	1.39	437.
19.000	8.77	5.88	0.2332	-1.64	5.52	10.41	6.02	1.85	434.
20.000	6.97	5.75	0.2069	-1.61	4.59	8.54	5.68	2.14	434.
21.000	5.58	5.90	0.1752	-1.47	3.98	7.33	5.48	2.17	430.
22.000	5.04	6.04	0.1761	-1.32	3.56	6.96	5.27	2.22	423.
23.000	4.78	6.32	0.1574	-1.11	3.39	6.97	5.18	2.02	420.
24.000	4.88	7.24	0.2266	-0.73	3.41	7.47	5.70	1.92	410.
25.000	5.48	8.04	0.2834	-0.52	3.52	8.19	5.84	1.67	396.
26.000	5.91	8.89	0.3009	-0.46	3.77	9.02	6.85	1.76	381.
27.000	7.16	10.37	0.3162	-0.35	3.97	10.61	7.88	1.53	354.
28.000	8.66	11.44	0.3794	-0.10	4.51	12.35	8.57	1.20	321.
29.000	10.24	12.88	0.4392	0.12	5.36	14.24	9.81	1.14	264.
30.000	11.73	14.51	0.3632	-0.22	6.43	16.11	11.38	1.22	211.

TABLE A-12. December Statistical Wind Data, Nellis.

Z KM	MEAN U M/S	S.D. U M/S	R(U,V)	MEAN V M/S	S.D. V M/S	MEAN W M/S	S.D. W M/S	SKEW W	#OBS
0.000	0.00	0.00	0.0000	0.00	0.00	0.00	0.00	0.00	0.
1.000	0.00	0.00	0.0000	0.00	0.00	0.00	0.00	0.00	0.
1.007	-1.10	2.66	0.2542	-0.10	3.20	3.54	2.44	1.12	586.
2.000	-0.08	4.36	0.4932	0.28	6.30	6.58	3.93	0.89	614.
3.000	3.43	6.65	0.2835	-1.26	7.91	9.59	5.30	0.75	610.
4.000	6.76	8.10	0.1462	-2.86	9.24	12.56	6.85	0.78	600.
5.000	9.29	9.76	0.0780	-3.84	10.95	15.57	8.58	0.77	586.
6.000	11.33	11.27	0.0865	-4.00	12.57	18.11	10.05	0.77	563.
7.000	12.71	12.75	0.1577	-4.54	14.21	20.49	11.23	0.73	536.
8.000	14.51	13.97	0.1820	-5.15	15.61	22.92	12.24	0.75	524.
9.000	16.56	15.31	0.1936	-5.60	16.89	25.67	12.88	0.56	518.
10.000	18.55	16.40	0.1839	-6.07	17.29	27.82	13.21	0.48	511.
11.000	20.40	16.37	0.1847	-6.66	16.49	28.77	13.12	0.43	504.
12.000	21.02	14.96	0.1778	-6.60	14.68	27.77	12.36	0.45	497.
13.000	20.79	13.22	0.1710	-5.71	13.41	26.24	11.40	0.46	492.
14.000	19.56	11.03	0.1867	-5.20	11.60	23.81	9.94	0.40	489.
15.000	17.73	9.46	0.2208	-4.70	10.18	21.36	8.56	0.43	487.
16.000	15.29	8.37	0.2168	-4.38	8.66	18.42	7.64	0.67	485.
17.000	12.84	7.46	0.2467	-4.03	7.54	15.67	6.40	0.72	448.
18.000	10.20	7.08	0.2029	-3.66	6.31	12.85	5.99	0.98	448.
19.000	7.55	6.83	0.1641	-3.65	5.40	10.51	5.46	1.24	441.
20.000	5.26	6.86	0.1771	-3.45	4.72	8.93	4.89	1.42	435.
21.000	3.80	7.33	0.1193	-3.51	4.69	8.58	4.91	1.31	428.
22.000	2.70	7.91	0.0961	-3.66	4.55	8.69	4.94	1.33	425.
23.000	1.84	9.07	0.1191	-3.76	4.61	9.48	5.56	1.37	412.
24.000	1.81	10.31	0.1840	-3.62	5.18	10.41	6.40	1.14	403.
25.000	3.04	12.09	0.2422	-3.64	5.76	12.07	7.48	1.26	389.
26.000	4.03	13.74	0.2093	-3.82	6.32	13.82	8.25	0.93	374.
27.000	5.76	15.74	0.2392	-3.90	6.93	15.89	9.53	0.82	346.
28.000	7.84	17.70	0.2725	-3.69	7.24	17.98	10.80	0.72	305.
29.000	10.03	19.72	0.2670	-3.48	8.44	20.36	12.54	0.78	252.
30.000	12.28	21.97	0.3624	-2.89	10.15	23.11	14.46	1.11	185.

TABLE A-13. Annual Statistical Wind Data, Nellis.

Z KM	MEAN U M/S	S.D. U M/S	R(U,V)	MEAN V M/S	S.D. V M/S	MEAN W M/S	S.D. W M/S	SKEW W	#OBS
0.000	0.00	0.00	0.0000	0.00	0.00	0.00	0.00	0.00	0.
1.000	0.00	0.00	0.0000	0.00	0.00	0.00	0.00	0.00	0.
1.007	0.13	3.19	-0.0093	0.89	3.88	4.25	2.82	0.86	6386.
2.000	1.21	4.06	-0.1185	2.46	6.19	6.74	4.06	0.95	6799.
3.000	2.52	5.25	-0.1050	1.57	7.16	7.97	4.88	1.01	6777.
4.000	4.45	6.91	-0.0429	0.54	8.17	9.85	6.11	1.05	6710.
5.000	6.74	8.51	0.0115	-0.14	9.58	12.28	7.67	1.05	6595.
6.000	8.77	9.91	0.0343	-0.43	11.00	14.59	9.13	1.07	6488.
7.000	10.73	11.23	0.0327	-0.43	12.57	17.04	10.45	1.00	6103.
8.000	12.48	12.38	0.0336	-0.47	13.97	19.32	11.45	0.98	6028.
9.000	14.15	13.41	0.0319	-0.46	15.25	21.54	12.20	0.73	5976.
10.000	15.97	14.25	0.0250	-0.36	16.06	23.57	12.63	0.63	5923.
11.000	17.58	14.37	0.0110	-0.14	16.13	24.84	12.60	0.58	5861.
12.000	18.54	13.47	-0.0398	0.44	15.07	24.78	11.76	0.48	5814.
13.000	18.56	12.17	-0.1035	0.91	13.46	23.63	10.77	0.48	5773.
14.000	17.28	10.58	-0.1351	0.95	11.51	21.28	9.54	0.50	5750.
15.000	14.99	9.26	-0.1336	0.79	9.62	18.24	8.41	0.60	5722.
16.000	11.96	8.32	-0.1018	0.55	7.81	14.67	7.60	0.79	5699.
17.000	9.27	7.69	-0.0474	0.26	6.49	11.82	6.84	1.06	5315.
18.000	6.47	7.19	0.0051	-0.03	5.35	9.17	6.05	1.47	5314.
19.000	3.86	6.95	0.0538	-0.44	4.52	7.41	5.22	1.85	5260.
20.000	1.7	6.78	0.0480	-0.73	3.86	6.56	4.36	2.11	5235.
21.000	0.08	6.90	0.0032	-0.94	3.54	6.46	4.14	1.75	5185.
22.000	-0.96	7.17	-0.0442	-1.09	3.34	6.80	4.01	1.54	5115.
23.000	-1.81	7.68	-0.0850	-1.19	3.30	7.42	4.26	1.23	5052.
24.000	-2.26	8.55	-0.0885	-1.15	3.44	8.13	4.93	1.08	4936.
25.000	-2.20	9.51	-0.0696	-1.11	3.69	8.92	5.44	1.17	4750.
26.000	-2.08	10.61	-0.0551	-1.12	3.98	9.83	6.09	1.15	4583.
27.000	-1.68	11.97	-0.0343	-1.07	4.36	10.90	6.87	1.18	4224.
28.000	-1.22	13.20	-0.0183	-0.92	4.62	11.82	7.57	1.32	3848.
29.000	-0.94	14.47	-0.0104	-0.79	4.93	12.81	8.41	1.56	3277.
30.000	-0.75	15.75	-0.0058	-0.65	5.31	13.82	9.27	1.77	2704.

APPENDIX B

Nellis Thermodynamics Statistics Tables

Tables B-1 through B-13 provide thermodynamics statistics (monthly and annual) for Nellis. They were prepared as described in Chapter 3.

TABLE B-1. January Thermodynamic Data, Nellis.

Z KM	MEAN P MB	S.D. P MB	SKEW P	MEAN T DEG K	S.D. T DEG K	SKEW T	MEAN D G/M3	S.D. D G/M3	SKEW D	NOBS P	NOBS T	NOBS D
0.000	1019.691	8.241	-0.1298	284.19	9.83	0.15	1248.59	50.18	0.05	392.	392.	392.
1.000	903.834	5.924	-0.3673	280.91	6.08	0.15	1119.16	25.75	0.10	482.	482.	482.
1.007	903.056	5.914	-0.3690	280.88	6.07	0.15	1118.34	25.64	0.10	482.	482.	482.
2.000	799.566	5.699	-0.5330	276.11	4.92	-0.29	1007.50	16.06	0.61	483.	483.	483.
3.000	705.984	6.026	-0.5330	271.24	5.37	-0.54	906.02	13.17	0.64	483.	483.	483.
4.000	621.374	6.642	-0.5702	265.66	5.47	-0.77	814.44	10.39	0.86	483.	483.	483.
5.000	545.595	7.131	-0.6268	259.23	5.51	-0.87	733.01	8.21	0.75	482.	482.	482.
6.000	477.632	7.632	-0.6827	252.30	5.58	-0.95	659.40	6.58	0.51	480.	480.	480.
7.000	416.314	7.722	-0.7420	245.08	5.30	-0.80	591.72	5.18	0.12	478.	478.	478.
8.000	361.298	7.670	-0.7334	237.66	4.70	-0.51	529.57	5.56	-0.90	475.	475.	475.
9.000	312.311	7.351	-0.6418	230.30	4.08	-0.23	472.41	7.15	-1.72	473.	473.	473.
10.000	268.622	6.724	-0.5030	223.56	3.60	0.03	418.62	9.77	-1.66	473.	473.	473.
11.000	230.211	5.862	-0.3510	218.60	4.36	0.90	367.04	12.55	-1.12	467.	467.	467.
12.000	196.800	4.811	-0.2344	216.65	5.62	0.45	316.74	13.40	-0.32	465.	465.	465.
13.000	168.048	3.815	-0.1755	216.54	5.24	-0.41	270.58	10.76	0.12	465.	465.	465.
14.000	143.484	3.082	-0.1200	215.75	3.97	-0.16	231.81	7.86	-0.06	464.	464.	464.
15.000	122.296	2.432	-0.1284	213.53	3.64	0.25	199.62	6.43	-0.13	462.	462.	462.
16.000	104.184	1.912	-0.1391	211.25	3.88	0.24	171.89	5.58	-0.13	462.	462.	462.
17.000	88.546	1.489	-0.1905	210.08	3.82	0.09	146.89	4.37	-0.04	437.	437.	437.
18.000	75.262	1.184	-0.2115	209.90	3.85	-0.15	124.96	3.34	-0.01	434.	434.	434.
19.000	64.000	0.999	-0.2810	210.63	3.81	-0.36	105.88	2.46	0.06	427.	427.	427.
20.000	54.437	0.880	-0.3157	211.53	3.82	-0.41	89.67	1.75	-0.07	424.	424.	424.
21.000	46.358	0.806	-0.3953	212.45	3.89	-0.48	76.03	1.25	0.07	414.	414.	414.
22.000	39.507	0.764	-0.4752	213.51	4.11	-0.37	64.46	1.00	-0.04	406.	406.	406.
23.000	33.667	0.729	-0.5012	214.51	4.18	-0.42	54.68	0.83	-0.04	400.	400.	400.
24.000	28.740	0.674	-0.4819	215.55	4.22	-0.45	46.45	0.73	-0.11	384.	384.	384.
25.000	24.537	0.629	-0.4476	216.50	4.32	-0.58	39.48	0.70	-0.35	379.	379.	379.
26.000	20.976	0.574	-0.4175	217.74	4.28	-0.47	33.56	0.67	-0.82	368.	368.	368.
27.000	17.961	0.520	-0.4424	218.91	4.26	-0.57	28.58	0.63	-0.63	338.	338.	338.
28.000	15.394	0.467	-0.4314	220.15	4.47	-0.36	24.36	0.61	-0.70	301.	301.	301.
29.000	13.225	0.405	-0.3577	221.49	4.69	-0.45	20.80	0.56	-0.79	247.	247.	247.
30.000	11.376	0.365	-0.4344	223.31	5.07	-0.53	17.75	0.53	-0.79	209.	209.	209.

TABLE B-2. February Thermodynamic Data, Nellis.

Z KM	MEAN P MB	S.D. P MB	MEAN T DEG K	S.D. T DEG K	SKEW T G/M3	MEAN D G/M3	S.D. D G/M3	SKEW D	NOBS P	NOBS T	NOBS D
0.000	1018.323	7.840	284.45	10.21	0.28	1245.64	51.86	-0.05	325.	325.	325.
1.000	902.521	5.199	282.35	6.84	0.10	1111.99	28.30	0.12	446.	446.	446.
1.007	901.751	5.188	282.31	6.81	0.10	1111.19	28.18	0.12	446.	446.	446.
2.000	798.693	5.126	276.75	5.01	-0.25	1004.15	16.01	0.38	446.	446.	446.
3.000	705.351	5.589	271.12	5.12	-0.46	905.62	12.52	0.56	446.	446.	446.
4.000	620.710	6.188	265.31	5.02	-0.65	814.65	9.56	0.66	446.	446.	446.
5.000	544.921	6.648	258.73	5.04	-0.54	733.49	7.66	0.28	445.	445.	445.
6.000	476.899	7.036	251.58	5.12	-0.52	660.25	6.28	0.07	443.	443.	443.
7.000	415.517	7.093	244.16	5.00	-0.40	592.79	5.06	-0.25	441.	441.	441.
8.000	360.419	7.135	236.50	4.72	-0.15	530.87	4.58	-0.89	440.	440.	440.
9.000	311.321	6.925	229.05	4.25	-0.02	473.49	6.02	-1.54	439.	439.	439.
10.000	267.536	6.424	222.27	3.77	0.38	419.36	8.70	-1.52	438.	438.	438.
11.000	229.030	5.637	217.01	4.41	0.99	367.82	11.88	-0.97	437.	437.	437.
12.000	195.597	4.670	215.45	5.82	0.27	316.58	13.26	-0.18	435.	435.	435.
13.000	166.925	3.729	216.27	5.20	-0.69	269.10	10.49	0.47	431.	431.	431.
14.000	142.517	3.012	215.85	3.96	-0.50	230.13	7.70	0.36	428.	428.	428.
15.000	121.512	2.386	214.03	3.53	-0.26	197.87	6.36	0.36	427.	427.	427.
16.000	103.565	1.870	212.21	3.77	-0.24	170.10	5.38	0.36	426.	426.	426.
17.000	88.119	1.466	210.96	4.10	-0.34	145.59	4.53	0.43	410.	410.	410.
18.000	74.932	1.156	210.67	4.05	-0.32	123.96	3.49	0.43	407.	407.	407.
19.000	63.765	0.935	211.49	3.76	-0.33	105.07	2.46	0.50	394.	394.	394.
20.000	54.269	0.804	212.41	3.46	-0.30	89.03	1.74	0.33	392.	392.	392.
21.000	46.238	0.722	213.40	3.29	-0.18	75.49	1.26	0.07	383.	383.	383.
22.000	39.443	0.643	214.57	3.24	-0.20	64.04	0.95	-0.02	372.	372.	372.
23.000	33.654	0.595	215.68	3.03	-0.28	54.36	0.74	-0.34	366.	366.	366.
24.000	28.747	0.540	216.84	2.99	-0.25	46.19	0.64	-0.31	354.	354.	354.
25.000	24.578	0.499	217.94	2.95	-0.43	39.29	0.60	-0.68	349.	349.	349.
26.000	21.030	0.441	219.26	2.87	-0.47	33.42	0.54	-0.73	342.	342.	342.
27.000	18.023	0.376	220.45	2.96	-0.84	28.48	0.49	-1.09	301.	301.	301.
28.000	15.461	0.339	221.61	3.20	-0.68	24.31	0.45	-1.33	269.	269.	269.
29.000	13.276	0.307	222.91	3.22	-0.23	20.75	0.41	-1.41	227.	227.	227.
30.000	11.395	0.272	224.26	3.31	0.18	17.70	0.37	-0.86	187.	187.	187.

TABLE B-3. March Thermodynamic Data, Nellis.

Z KM	MEAN P MB	S.D. P MB	SKEWP P	MEANT DEG K	S.D. T DEG K	SKEWT T	MEAND G/M3	S.D. D G/M3	SKEWD D	NOBS P	NOBS T	NOBS D
0.000	1014.100	7.491	-0.1777	285.34	7.60	0.83	1235.32	38.51	-0.45	297.	297.	297.
1.000	899.600	5.368	-0.3222	284.54	6.46	0.29	1099.51	25.13	-0.06	491.	491.	491.
1.007	898.829	5.363	-0.3281	284.51	6.39	0.32	1098.69	24.90	-0.08	491.	491.	491.
2.000	796.508	5.381	-0.3963	277.66	4.43	0.31	997.85	13.29	-0.21	491.	491.	491.
3.000	703.595	5.620	-0.3078	270.34	4.27	0.11	905.66	10.47	0.06	491.	491.	491.
4.000	618.920	6.020	-0.2529	264.09	4.46	-0.22	815.97	8.88	0.29	490.	490.	490.
5.000	543.007	6.255	-0.2103	257.54	4.66	-0.35	734.30	7.62	0.23	490.	490.	490.
6.000	474.852	6.552	-0.2258	250.48	66	-0.44	660.32	6.20	-0.07	489.	489.	489.
7.000	413.496	6.564	-0.2544	242.99	6.64	-0.40	592.76	5.44	-0.44	486.	486.	486.
8.000	358.447	6.578	-0.2861	235.50	4.37	-0.35	530.23	5.37	-0.79	486.	486.	486.
9.000	309.476	6.323	-0.2099	228.30	3.79	-0.17	472.24	6.50	-1.34	483.	483.	483.
10.000	265.878	5.731	-0.1293	222.14	3.26	0.22	417.00	9.15	-1.17	479.	479.	479.
11.000	227.673	4.893	0.0129	217.90	4.26	0.68	364.18	12.01	-0.66	477.	477.	477.
12.000	194.582	3.915	0.1181	216.77	5.76	-0.02	313.02	12.72	0.11	475.	475.	475.
13.000	166.197	3.012	0.1520	217.08	5.33	-0.60	266.93	9.89	0.50	475.	475.	475.
14.000	141.978	2.386	0.1892	216.69	3.92	-0.54	228.36	6.70	0.27	471.	471.	471.
15.000	121.143	1.868	0.1912	215.03	3.46	-0.16	196.34	5.37	0.15	470.	470.	470.
16.000	103.329	1.451	0.2084	213.24	3.58	-0.04	168.87	4.58	0.21	469.	469.	469.
17.000	88.029	1.132	0.2004	212.33	3.77	0.00	144.49	3.80	0.27	441.	441.	441.
18.000	74.936	0.877	0.1844	211.99	3.54	-0.19	123.19	2.92	0.25	439.	439.	439.
19.000	63.823	0.715	0.1664	212.48	3.00	0.08	104.66	2.01	-0.02	431.	431.	431.
20.000	54.360	0.602	0.2329	213.13	2.76	0.08	88.87	1.43	0.15	429.	429.	429.
21.000	46.345	0.526	0.2445	213.89	2.57	-0.06	75.49	1.07	0.15	419.	419.	419.
22.000	39.527	0.473	0.2945	214.60	2.49	-0.02	64.18	0.81	0.24	409.	409.	409.
23.000	33.719	0.436	0.3349	215.61	2.43	0.01	54.49	0.64	0.02	403.	403.	403.
24.000	28.790	0.401	0.3629	216.63	2.48	-0.19	46.30	0.57	-0.07	386.	386.	386.
25.000	24.611	0.371	0.2718	217.73	2.69	-0.17	39.38	0.50	-0.27	377.	377.	377.
26.000	21.053	0.335	0.3600	219.15	2.64	0.13	33.47	0.45	-0.41	366.	366.	366.
27.000	18.054	0.304	0.3056	220.67	2.85	0.09	28.50	0.41	-0.34	324.	324.	324.
28.000	15.484	0.281	0.2617	222.23	3.19	0.59	24.27	0.38	-0.26	296.	296.	296.
29.000	13.294	0.255	0.4288	223.96	3.54	0.63	20.68	0.35	-0.29	245.	245.	245.
30.000	11.407	0.245	0.4008	225.76	3.74	0.35	17.60	0.33	-0.17	203.	203.	203.

TABLE B-4. April Thermodynamic Data, Nellis.

Z KM	MEAN P MB	S.D. P MB	SKEW P	MEAN T DEG K	S.D. T DEG K	SKEW T	MEAN D G/M3	S.D. D G/M3	SKEW D	NOBS P	NOBS T	NOBS D
0.000	1012.319	6.436	0.0674	289.15	8.51	0.85	1217.49	40.65	-0.56	288.	288.	288.
1.000	899.086	4.358	0.1735	288.75	7.27	0.22	1083.29	27.89	-0.07	477.	477.	477.
1.007	898.333	4.348	0.1739	288.71	7.24	0.21	1082.52	27.82	-0.06	477.	477.	477.
2.000	797.344	4.411	-0.1660	281.70	5.38	-0.18	984.83	16.75	0.20	477.	477.	477.
3.000	705.540	4.925	-0.3405	273.68	5.05	-0.42	897.19	12.81	0.42	476.	476.	476.
4.000	621.550	5.552	-0.4586	266.86	5.04	-0.85	810.94	10.20	0.90	476.	476.	476.
5.000	546.081	6.054	-0.5958	260.41	5.08	-1.11	730.35	8.16	1.03	476.	476.	476.
6.000	478.270	6.553	-0.7144	253.31	5.19	-1.24	657.67	6.71	0.87	475.	475.	475.
7.000	417.092	6.695	-0.8522	246.03	5.01	-1.31	590.55	5.47	0.60	475.	475.	475.
8.000	362.246	6.674	-0.9042	238.64	4.35	-1.08	528.78	5.04	-0.49	472.	472.	472.
9.000	313.381	6.415	-0.8775	231.33	3.49	-0.59	471.93	6.50	-1.44	472.	472.	472.
10.000	269.679	5.838	-0.7399	224.41	2.97	0.05	418.67	8.82	-1.74	469.	469.	469.
11.000	231.161	5.036	-0.5509	218.41	3.53	1.04	368.82	10.78	-1.48	467.	467.	467.
12.000	197.497	4.108	-0.3871	214.75	4.88	0.75	320.61	11.94	-0.78	464.	464.	464.
13.000	168.384	3.176	-0.2819	214.52	5.32	-0.05	273.68	10.52	-0.08	463.	463.	463.
14.000	143.615	2.471	-0.2280	214.71	4.03	-0.26	233.13	7.32	0.02	462.	462.	462.
15.000	122.409	1.917	-0.2113	213.69	3.41	0.30	199.64	5.51	-0.27	459.	459.	459.
16.000	104.314	1.500	-0.1423	212.71	3.34	0.43	170.90	4.44	-0.31	459.	459.	459.
17.000	88.819	1.188	-0.0739	212.26	3.37	0.23	145.82	3.51	-0.21	425.	425.	425.
18.000	75.612	0.955	0.0276	212.41	3.27	-0.07	124.05	2.73	-0.11	425.	425.	425.
19.000	64.422	0.789	0.0796	213.16	3.20	0.08	105.31	2.12	-0.15	418.	418.	418.
20.000	54.898	0.677	0.1007	213.89	2.82	0.15	89.42	1.53	-0.13	417.	417.	417.
21.000	46.827	0.598	0.1047	214.79	2.55	0.07	75.96	1.12	0.00	410.	410.	410.
22.000	39.979	0.538	0.1006	215.97	2.40	-0.02	64.49	0.87	-0.08	401.	401.	401.
23.000	34.144	0.487	0.0650	217.31	2.33	-0.07	54.74	0.71	-0.18	397.	397.	397.
24.000	29.180	0.445	0.0818	218.51	2.27	-0.04	46.52	0.58	-0.29	386.	386.	386.
25.000	24.979	0.401	0.0223	220.11	2.40	-0.07	39.54	0.53	-0.44	376.	376.	376.
26.000	21.388	0.367	-0.0137	221.77	2.73	0.25	33.60	0.49	-0.37	367.	367.	367.
27.000	18.356	0.338	-0.0019	223.42	2.85	0.17	28.63	0.44	-0.27	324.	324.	324.
28.000	15.778	0.315	-0.0480	225.13	3.02	0.32	24.41	0.40	-0.25	300.	300.	300.
29.000	13.571	0.285	-0.0368	227.02	3.19	0.20	20.82	0.35	-0.26	262.	262.	262.
30.000	11.660	0.252	-0.1234	228.83	3.07	0.03	17.75	0.31	-0.17	224.	224.	224.

TABLE B-5. May Thermodynamic Data, Nellis.

Z KM	MEAN P MB	S.D. P MB	SKEWP	MEAN T DEG K	S.D. T DEG K	MEAN D G/M3	S.D. D G/M3	SKEWD	NOBS P	NOBS T	NOBS D
0.000	1008.083	5.737	0.0071	295.67	10.00	1185.58	43.98	-0.61	306.	306.	306.
1.000	897.438	3.575	-0.0254	294.35	7.72	1060.34	28.35	-0.01	473.	473.	473.
1.007	896.712	3.568	-0.0337	294.30	7.69	1059.67	28.26	-0.01	473.	473.	473.
2.000	797.708	3.759	-0.4485	287.22	5.46	965.93	16.54	0.32	473.	473.	473.
3.000	707.523	4.366	-0.5766	278.73	5.07	883.04	12.40	0.32	473.	473.	473.
4.000	624.681	5.034	-0.5947	271.11	4.72	801.91	9.35	0.46	473.	473.	473.
5.000	549.951	5.468	-0.6398	264.34	4.46	724.37	7.16	0.56	473.	473.	473.
6.000	482.728	5.871	-0.6850	257.39	4.54	653.17	5.91	0.26	472.	472.	472.
7.000	421.888	5.931	-0.7753	250.16	4.58	587.44	5.07	-0.26	469.	469.	469.
8.000	367.152	5.983	-0.7705	242.59	4.24	527.21	4.41	-0.95	469.	469.	469.
9.000	318.325	5.771	-0.7678	234.90	3.73	472.08	4.98	-2.26	468.	468.	468.
10.000	274.645	5.522	-0.5282	227.55	3.29	420.48	6.55	-2.71	468.	468.	468.
11.000	235.883	4.972	-0.3166	221.04	3.14	371.80	8.41	-1.94	465.	465.	465.
12.000	201.796	4.201	-0.1178	216.31	4.07	325.15	10.19	-1.07	464.	464.	464.
13.000	172.172	3.371	0.0218	214.39	4.96	279.98	10.34	-0.23	462.	462.	462.
14.000	146.833	2.599	0.0650	214.21	4.72	238.96	8.44	0.37	461.	461.	461.
15.000	125.105	1.997	0.0364	213.61	3.79	204.12	6.02	0.30	459.	459.	459.
16.000	106.589	1.559	0.0423	212.48	3.49	174.82	4.64	0.16	459.	459.	459.
17.000	90.798	1.225	0.0782	211.92	3.42	149.31	3.69	0.04	428.	428.	428.
18.000	77.282	0.972	0.0893	211.97	3.27	127.05	2.92	0.08	427.	427.	427.
19.000	65.809	0.788	0.0329	212.78	2.84	107.77	2.10	0.14	422.	422.	422.
20.000	56.082	0.669	0.0601	214.07	2.59	91.28	1.48	0.10	420.	420.	420.
21.000	47.846	0.580	0.0579	215.75	2.36	77.26	1.02	0.05	415.	415.	415.
22.000	40.898	0.529	0.0623	217.39	2.25	65.54	0.76	-0.08	413.	413.	413.
23.000	34.967	0.489	0.0724	219.11	2.17	55.60	0.58	-0.11	411.	411.	411.
24.000	29.916	0.448	0.0678	220.86	2.24	47.19	0.49	0.02	400.	400.	400.
25.000	25.659	0.409	0.0098	222.55	2.25	40.16	0.42	-0.05	383.	383.	383.
26.000	22.014	0.379	-0.0151	224.37	2.32	34.18	0.40	-0.01	376.	376.	376.
27.000	18.914	0.347	-0.0097	226.17	2.38	29.13	0.38	0.02	353.	353.	353.
28.000	16.278	0.318	0.0110	227.97	2.50	24.88	0.34	0.07	321.	321.	321.
29.000	14.020	0.292	-0.0448	229.78	2.56	21.25	0.32	0.04	300.	300.	300.
30.000	12.076	0.264	-0.0133	231.59	2.50	18.16	0.28	0.04	259.	259.	259.

TABLE B-6. June Thermodynamic Data, Nellis.

Z KM	MEAN P MB	S.D. P MB	SKEW P	MEAN T DEG K	S.D. T DEG K	SKEW T	MEAN D G/M3	S.D. D G/M3	SKEW D	NOBS P	NOBS T	NOBS D
0.000	1006.684	5.474	0.0373	301.31	10.91	0.64	1162.43	46.21	-0.44	356.	356.	356.
1.000	898.198	3.247	-0.289	299.66	7.52	0.07	1042.22	27.11	0.02	516.	516.	516.
1.007	897.324	3.140	-0.1348	299.59	7.48	0.07	1041.42	26.97	0.02	516.	516.	516.
2.000	800.145	3.326	-0.5405	292.75	4.43	-0.48	950.14	13.13	0.49	528.	528.	528.
3.000	711.302	3.727	-0.6085	284.22	4.02	-0.43	870.39	9.71	0.43	528.	528.	528.
4.000	629.473	4.083	-0.5595	276.41	3.70	-0.57	792.38	7.50	0.43	528.	528.	528.
5.000	555.493	4.370	-0.6175	269.23	3.47	-0.83	718.22	5.93	0.66	528.	528.	528.
6.000	488.964	4.646	-0.6503	262.25	3.30	-0.89	649.23	4.71	-0.05	527.	527.	527.
7.000	428.287	4.591	-0.6839	255.02	3.25	-0.80	584.90	4.18	-0.46	526.	526.	526.
8.000	373.794	4.636	-0.6634	247.47	3.21	-0.62	526.10	3.66	-0.53	524.	524.	524.
9.000	324.854	4.441	-0.6445	239.78	3.14	-0.45	471.93	3.59	-0.78	523.	523.	523.
10.000	281.311	4.385	-0.5840	232.26	2.96	-0.42	421.94	3.92	-1.64	522.	522.	522.
11.000	242.299	4.107	-0.4935	225.14	2.85	-0.31	374.93	4.96	-1.75	518.	518.	518.
12.000	207.713	3.634	-0.4248	219.24	3.10	0.26	330.09	6.37	-1.33	517.	517.	517.
13.000	177.510	3.122	-0.3263	215.51	3.62	0.20	287.03	7.57	-0.57	514.	514.	514.
14.000	151.412	2.551	-0.2955	213.44	3.71	-0.17	247.24	7.21	-0.16	513.	513.	513.
15.000	128.869	1.986	-0.2933	211.45	3.72	-0.04	212.41	6.28	-0.09	512.	512.	512.
16.000	109.591	1.505	-0.2900	209.90	3.75	0.07	181.98	5.10	-0.17	512.	512.	512.
17.000	93.182	1.154	-0.2724	209.14	3.48	0.29	155.27	3.83	-0.32	478.	478.	478.
18.000	79.175	0.916	-0.1737	210.13	3.01	0.29	131.29	2.66	-0.35	478.	478.	478.
19.000	67.363	0.763	-0.0519	212.27	2.48	0.06	110.56	1.72	-0.40	476.	476.	476.
20.000	57.410	0.671	0.0357	214.38	2.19	-0.01	93.30	1.22	-0.22	474.	474.	474.
21.000	48.981	0.600	0.0379	216.31	1.96	0.06	78.88	0.89	-0.15	464.	464.	464.
22.000	41.889	0.549	0.0774	218.17	1.84	-0.01	66.89	0.73	-0.14	464.	464.	464.
23.000	35.836	0.500	0.1126	219.99	1.82	0.03	56.74	0.62	-0.02	457.	457.	457.
24.000	30.672	0.454	0.1607	221.83	1.81	-0.19	48.17	0.56	0.02	455.	455.	455.
25.000	26.335	0.409	0.1352	223.77	1.84	-0.18	40.99	0.49	-0.01	442.	442.	442.
26.000	22.616	0.373	0.1182	225.56	1.94	-0.03	34.93	0.44	0.03	437.	437.	437.
27.000	19.451	0.330	0.1253	227.35	1.91	-0.02	29.80	0.40	-0.03	409.	409.	409.
28.000	16.751	0.296	0.1391	229.06	1.93	-0.04	25.47	0.36	-0.15	375.	375.	375.
29.000	14.438	0.271	0.1480	230.78	2.04	-0.20	21.79	0.32	0.06	338.	338.	338.
30.000	12.453	0.248	0.1151	232.51	2.16	-0.07	18.65	0.29	0.01	292.	292.	292.

TABLE B-7. July Thermodynamic Data, Nellis.

Z KM	MEAN P MB	S.D. P MB	SKEW P	MEAN T DEG K	S.D. T DEG K	SKEW T	MEAN D G/M3	S.D. D G/M3	SKEW D	NOBS P	NOBS T	NOBS D
0.000	1006.989	4.991	-0.2812	304.67	10.59	0.61	1147.77	43.93	-0.42	396.	396.	396.
1.000	899.885	2.511	-0.0158	302.45	7.04	0.06	1033.20	24.78	0.02	550.	550.	550.
1.007	899.120	2.521	0.0127	302.39	7.00	0.06	1032.51	24.64	0.01	550.	550.	550.
2.000	802.661	2.255	-0.5448	295.61	3.48	-0.47	943.00	10.58	0.42	558.	558.	558.
3.000	714.370	2.408	-0.7024	287.14	2.92	-0.48	864.42	7.34	0.44	558.	558.	558.
4.000	633.161	2.689	-0.7484	279.27	2.42	-0.71	788.22	5.14	0.46	557.	557.	557.
5.000	559.549	2.822	-0.7128	272.09	2.15	-0.70	715.46	4.12	-0.04	556.	556.	556.
6.000	493.227	2.822	-0.8402	265.33	2.05	-0.65	647.14	3.83	-0.06	555.	555.	555.
7.000	432.728	2.773	-0.9996	258.55	2.24	-0.78	582.86	3.66	0.21	553.	552.	553.
8.000	378.482	2.794	-1.1269	251.44	2.42	-1.08	524.27	3.32	0.30	547.	547.	547.
9.000	329.602	2.732	-1.2090	244.04	2.48	-0.62	470.45	3.20	-0.02	544.	544.	544.
10.000	286.251	2.729	-1.2040	236.55	2.48	-0.56	421.54	3.07	-0.68	543.	543.	543.
11.000	247.259	2.652	-1.1073	229.32	2.43	-0.32	375.64	3.19	-1.51	542.	542.	542.
12.000	212.425	2.418	-1.0453	222.66	2.32	-0.03	332.38	3.49	-1.45	542.	542.	542.
13.000	181.826	2.155	-0.9169	216.72	2.27	0.17	292.31	4.39	-1.23	540.	540.	540.
14.000	155.089	1.818	-0.7488	211.52	2.73	0.86	255.47	4.86	-1.38	540.	540.	540.
15.000	131.767	1.471	-0.4805	207.78	3.14	1.11	220.98	4.77	-1.19	539.	539.	539.
16.000	111.745	1.147	-0.1835	206.37	3.22	0.94	188.69	4.05	-0.87	539.	539.	539.
17.000	94.776	0.905	-0.0149	207.22	2.73	0.63	159.36	2.76	-0.57	499.	499.	499.
18.000	80.447	0.768	0.0586	209.27	2.40	0.28	133.94	1.88	-0.42	497.	497.	497.
19.000	68.412	0.664	0.0984	212.08	1.93	0.27	112.38	1.28	-0.18	497.	497.	497.
20.000	58.316	0.605	0.1191	214.61	1.72	0.16	94.67	0.95	-0.12	496.	496.	496.
21.000	49.750	0.542	0.1759	216.76	1.69	0.16	79.96	0.75	-0.01	494.	494.	494.
22.000	42.569	0.495	0.1556	218.75	1.80	0.35	67.79	0.65	-0.15	489.	489.	489.
23.000	36.437	0.455	0.1747	220.50	1.70	0.28	57.57	0.57	0.01	485.	485.	485.
24.000	31.201	0.417	0.1711	222.17	1.72	0.04	48.92	0.48	0.01	484.	484.	484.
25.000	26.784	0.373	0.1257	223.91	1.75	0.04	41.67	0.42	-0.05	463.	463.	463.
26.000	23.008	0.344	0.1465	225.65	1.84	0.04	35.52	0.38	-0.01	456.	456.	456.
27.000	19.785	0.309	0.1142	227.35	1.99	0.03	30.31	0.34	0.04	433.	433.	433.
28.000	17.043	0.286	0.1355	228.95	2.05	0.02	25.94	0.31	0.01	398.	398.	398.
29.000	14.693	0.262	0.1568	230.59	2.27	-0.26	22.20	0.30	0.22	366.	366.	366.
30.000	12.665	0.235	0.1736	232.09	2.26	-0.14	19.01	0.27	0.01	321.	321.	321.

TABLE B-8. August Thermodynamic Data, Nellis.

Z KM	MEAN P MB	S.D. P MB	SKEW P	MEAN T DEG K	S.D. T DEG K	SKEW T	MEAN D G/M3	S.D. D G/M3	SKEW D	NOBS P	NOBS T	NOBS D
0.000	1008.026	5.359	-0.1204	304.68	10.62	0.48	1148.03	43.74	-0.28	414.	414.	414.
1.000	900.706	3.233	0.1783	301.78	7.05	0.08	1035.96	24.90	0.00	543.	543.	543.
1.007	899.442	2.701	-0.1983	301.69	6.99	0.08	1034.83	24.67	-0.02	543.	543.	543.
2.000	803.212	2.794	0.2674	295.03	3.64	-0.27	945.26	11.26	0.22	551.	551.	551.
3.000	714.687	2.748	0.2722	286.51	3.08	-0.12	866.51	8.08	0.13	551.	551.	551.
4.000	633.285	2.921	0.1319	278.69	2.49	-0.27	789.95	5.75	0.28	551.	551.	551.
5.000	559.517	2.962	0.0748	271.63	2.15	-0.43	716.63	4.31	0.24	551.	551.	551.
6.000	493.126	2.992	0.0205	264.96	2.09	-0.46	647.87	4.02	0.01	549.	549.	549.
7.000	432.575	2.920	-0.1854	258.16	2.23	-0.65	583.50	3.52	0.23	546.	546.	546.
8.000	378.262	2.944	-0.3567	250.95	2.48	-0.55	524.99	3.30	0.10	546.	546.	546.
9.000	329.328	2.929	-0.4378	243.47	2.77	-0.37	471.17	3.07	-0.25	544.	544.	544.
10.000	285.864	2.943	-0.5690	236.03	2.87	-0.39	421.90	2.78	-0.25	543.	543.	543.
11.000	246.854	2.925	-0.5633	228.93	2.86	-0.52	375.65	2.80	-0.58	543.	543.	543.
12.000	212.056	2.733	-0.5734	222.45	2.42	-0.34	332.09	3.12	-0.87	542.	542.	542.
13.000	181.497	2.471	-0.4869	216.78	2.05	0.37	291.69	4.42	-1.02	539.	539.	539.
14.000	154.840	2.072	-0.3512	211.89	2.56	0.71	254.62	5.30	-0.99	538.	538.	538.
15.000	131.593	1.650	-0.0878	208.28	3.36	0.85	220.18	5.38	-0.81	534.	534.	534.
16.000	111.630	1.265	0.1589	206.64	3.58	0.56	188.26	4.55	-0.50	532.	532.	532.
17.000	94.661	0.988	0.3698	207.57	3.00	0.44	158.90	3.09	-0.31	492.	492.	492.
18.000	80.381	0.823	0.4260	209.79	2.38	0.07	133.49	2.05	0.04	486.	486.	486.
19.000	68.374	0.701	0.4319	212.52	1.98	0.00	112.09	1.44	0.03	483.	483.	483.
20.000	58.295	0.617	0.3506	214.78	1.74	0.11	94.55	1.04	0.20	482.	482.	482.
21.000	49.742	0.552	0.4135	216.79	1.63	0.07	79.93	0.82	0.48	481.	481.	481.
22.000	42.557	0.499	0.4043	218.46	1.56	0.01	67.86	0.70	0.41	480.	480.	480.
23.000	36.419	0.457	0.4611	220.07	1.54	-0.02	57.65	0.59	0.64	476.	476.	476.
24.000	31.176	0.417	0.4591	221.71	1.63	0.05	48.98	0.51	0.78	475.	475.	475.
25.000	26.749	0.379	0.4475	223.28	1.70	0.10	41.73	0.44	1.00	453.	453.	453.
26.000	22.968	0.346	0.4548	224.89	1.86	0.19	35.58	0.40	0.80	449.	449.	449.
27.000	19.742	0.314	0.4332	226.37	2.01	0.34	30.37	0.35	0.80	422.	422.	422.
28.000	16.989	0.287	0.4152	227.70	2.07	0.29	25.99	0.31	0.65	401.	401.	401.
29.000	14.630	0.267	0.4414	229.01	2.24	0.13	22.25	0.28	0.58	375.	375.	375.
30.000	12.601	0.244	0.4150	230.29	2.39	0.02	19.06	0.25	0.54	330.	330.	330.

TABLE B-9. September Thermodynamic Data, Nellis.

Z KM	MEAN P MB	S.D. P MB	SKEWP	MEAN T DEG K	S.D. T DEG K	SKEWT	MEAN D G/M3	S.D. D G/M3	SKEWD	NOBS P	NOBS T	NOBS D
0.000	1009.296	6.369	0.3181	300.39	11.36	0.46	1167.56	49.11	-0.23	371.	371.	371.
1.000	900.221	3.948	0.3561	297.73	7.46	-0.03	1050.47	27.29	0.17	506.	506.	506.
1.007	898.947	3.384	-0.3248	297.63	7.41	-0.03	1049.30	26.97	0.15	506.	506.	506.
2.000	801.310	4.053	-0.3015	290.90	4.95	-0.80	957.06	14.80	0.82	532.	532.	532.
3.000	711.827	4.465	-0.6830	282.50	4.37	-0.92	875.82	10.51	0.92	532.	532.	532.
4.000	629.723	4.955	-0.8566	275.30	3.74	-1.18	795.63	7.45	0.99	532.	532.	532.
5.000	555.520	5.119	-0.9901	268.81	3.62	-1.24	719.29	6.14	0.87	532.	532.	532.
6.000	488.820	5.224	-1.1206	262.27	3.69	-1.12	648.98	5.12	0.44	531.	531.	531.
7.000	428.220	5.217	-1.1463	255.30	3.73	-0.97	584.18	4.26	0.15	530.	530.	530.
8.000	373.796	5.216	-1.1274	247.92	3.72	-0.74	525.17	4.09	-0.33	529.	529.	529.
9.000	324.945	5.017	-1.0704	240.36	3.55	-0.29	470.91	4.24	-0.61	528.	528.	528.
10.000	281.511	4.918	-0.9524	233.14	3.44	-0.02	420.64	4.98	-1.60	527.	527.	527.
11.000	242.663	4.591	-0.7850	226.43	3.44	-0.10	373.37	6.04	-1.72	526.	526.	526.
12.000	208.235	4.071	-0.6554	220.91	3.30	-0.25	328.44	6.84	-1.33	526.	526.	526.
13.000	178.060	3.533	-0.5520	216.42	2.88	-0.11	286.68	7.06	-0.83	524.	524.	524.
14.000	151.947	2.934	-0.5078	212.79	2.98	0.48	248.83	7.17	-0.59	524.	524.	524.
15.000	129.195	2.321	-0.4790	209.62	3.72	0.27	214.82	6.88	-0.34	518.	518.	518.
16.000	109.706	1.762	-0.4801	207.70	4.07	0.05	184.11	5.93	-0.24	518.	518.	518.
17.000	93.110	1.322	-0.4517	207.94	3.79	0.34	156.06	4.47	-0.47	480.	480.	480.
18.000	79.063	1.019	-0.3552	209.73	3.16	0.72	131.37	3.09	-0.70	477.	477.	477.
19.000	67.241	0.813	-0.2365	211.92	2.56	0.39	110.56	2.10	-0.64	475.	475.	475.
20.000	57.291	0.683	-0.1543	214.04	2.10	0.06	93.25	1.47	-0.49	472.	472.	472.
21.000	48.862	0.580	-0.0567	215.93	1.87	-0.01	78.84	1.09	-0.34	466.	466.	466.
22.000	41.773	0.518	-0.0320	217.60	1.76	-0.13	66.88	0.83	-0.28	462.	462.	462.
23.000	35.723	0.462	0.0235	219.26	1.79	-0.01	56.76	0.65	-0.22	458.	458.	458.
24.000	30.569	0.410	0.0664	220.94	1.89	0.00	48.20	0.56	-0.33	452.	452.	452.
25.000	26.213	0.368	0.1172	222.40	1.89	0.15	41.06	0.47	-0.25	436.	436.	436.
26.000	22.492	0.335	0.1037	223.82	1.88	0.27	35.00	0.39	-0.17	432.	432.	432.
27.000	19.308	0.306	0.1371	225.13	1.93	0.08	29.88	0.35	-0.10	409.	409.	409.
28.000	16.606	0.279	0.2054	226.29	2.09	-0.05	25.56	0.31	-0.08	385.	385.	385.
29.000	14.288	0.258	0.1893	227.44	2.34	0.00	21.88	0.27	-0.01	353.	353.	353.
30.000	12.294	0.232	0.2285	228.45	2.35	0.07	18.75	0.24	0.15	308.	308.	308.

TABLE B-10. October Thermodynamic Data, Nellis.

Z KM	MEAN P MB	S.D. P MB	SKEWP P	MEANT DEG K	S.D. T DEG K	SKEWT G/M3	MEAND G/M3	S.D. D G/M3	SKEWD D	NOBS P	NOBS T	NOBS D
0.000	1014.249	7.072	-0.0913	292.71	11.82	0.55	1205.78	53.96	-0.32	373.	373.	373.
1.000	901.824	4.567	-0.3293	291.18	7.67	0.20	1077.12	29.18	0.03	539.	539.	539.
1.007	900.879	4.354	-0.3932	291.11	7.61	0.19	1076.20	29.16	0.03	539.	539.	539.
2.000	800.992	4.596	-0.3901	285.18	5.28	0.03	976.72	16.09	0.28	543.	543.	543.
3.000	709.844	5.015	-0.2990	277.60	4.84	-0.23	889.51	11.69	0.41	543.	543.	543.
4.000	626.687	5.525	-0.2844	271.52	4.50	-0.70	803.39	8.59	0.61	543.	543.	543.
5.000	551.834	5.856	-0.3497	265.34	4.37	-0.74	724.14	6.71	0.49	543.	543.	543.
6.000	484.685	6.180	-0.4293	258.55	4.30	-0.75	652.86	5.61	0.00	542.	542.	542.
7.000	423.792	6.122	-0.5006	251.28	4.21	-0.79	587.41	4.93	-0.20	542.	542.	542.
8.000	369.075	6.106	-0.5341	243.73	4.08	-0.78	527.46	4.46	-0.40	541.	541.	541.
9.000	320.188	5.841	-0.5882	236.19	3.72	-0.56	472.22	4.96	-1.02	538.	538.	538.
10.000	276.588	5.580	-0.4440	229.29	3.17	0.32	420.22	6.55	-1.37	535.	535.	535.
11.000	237.880	5.031	-0.3002	223.20	3.37	0.43	371.34	8.50	-1.33	534.	534.	534.
12.000	203.830	4.294	-0.1500	218.77	3.78	0.29	324.69	9.12	-0.88	533.	533.	533.
13.000	174.074	3.586	0.0236	215.45	3.95	-0.09	281.59	8.73	-0.43	531.	531.	531.
14.000	148.491	2.934	0.1209	212.83	3.70	0.04	243.16	7.61	-0.19	529.	529.	529.
15.000	126.257	2.313	0.2144	210.30	3.65	0.24	209.24	6.54	-0.07	525.	525.	525.
16.000	107.277	1.796	0.2708	208.55	3.73	0.29	179.28	5.48	0.01	525.	525.	525.
17.000	91.113	1.402	0.2658	208.22	3.82	0.21	152.51	4.49	0.13	470.	470.	470.
18.000	77.358	1.092	0.2455	209.23	3.44	0.17	128.84	3.27	0.21	469.	469.	469.
19.000	65.769	0.879	0.2449	210.70	2.90	0.17	108.76	2.27	0.25	465.	465.	465.
20.000	55.956	0.740	0.2177	212.24	2.50	0.18	91.86	1.60	0.33	463.	463.	463.
21.000	47.665	0.633	0.2356	213.60	2.12	0.15	77.75	1.20	0.23	459.	459.	459.
22.000	40.663	0.557	0.2680	215.09	1.97	0.21	65.87	0.94	0.16	455.	455.	455.
23.000	34.706	0.489	0.2935	216.66	2.03	0.17	55.81	0.78	0.04	451.	451.	451.
24.000	29.658	0.436	0.3045	218.24	2.10	0.15	47.35	0.64	0.06	438.	438.	438.
25.000	25.388	0.391	0.2922	219.78	2.01	-0.15	40.24	0.53	-0.05	421.	421.	421.
26.000	21.741	0.354	0.2672	221.30	2.20	-0.29	34.23	0.47	0.06	417.	417.	417.
27.000	18.654	0.317	0.2379	222.71	2.18	-0.29	29.18	0.40	0.04	386.	386.	386.
28.000	16.013	0.283	0.2042	223.89	2.33	-0.10	24.91	0.35	-0.02	367.	367.	367.
29.000	13.758	0.264	0.2351	224.98	2.57	0.15	21.30	0.30	0.09	329.	329.	329.
30.000	11.822	0.233	0.2749	225.96	2.61	0.05	18.23	0.26	0.13	300.	300.	300.

TABLE B-11. November Thermodynamic Data, Nellis.

Z KM	MEAN P MB	S.D. P MB	SKEWP P	MEANT DEG K	S.D. T DEG K	MEAND G/M3	SKEWT T	S.D. D G/M3	SKEWD D	NOBS P	NOBS T	NOBS D
0.000	1016.961	8.159	-0.1735	286.73	10.70	1234.58	0.34	53.02	-0.12	418.	418.	418.
1.000	902.413	5.408	-0.4747	284.18	6.96	1104.74	0.25	28.62	-0.02	538.	538.	538.
1.007	901.647	5.400	-0.4742	284.15	6.93	1103.95	0.25	28.52	-0.02	538.	538.	538.
2.000	799.330	5.100	-0.6945	278.84	5.12	997.31	-0.11	17.07	0.30	538.	538.	538.
3.000	706.659	5.397	-0.6503	273.68	5.31	898.69	-0.35	13.66	0.41	538.	538.	538.
4.000	622.723	5.973	-0.6136	267.98	5.44	809.11	-0.62	11.03	0.69	538.	538.	538.
5.000	547.399	6.505	-0.6254	261.66	5.42	728.57	-0.75	8.73	0.77	537.	537.	537.
6.000	479.793	6.994	-0.6405	254.79	5.47	655.87	-0.80	7.07	0.67	536.	536.	536.
7.000	418.760	7.131	-0.6759	247.59	5.29	589.14	-0.83	5.60	0.36	533.	533.	533.
8.000	364.011	7.123	-0.6777	240.41	4.59	527.42	-0.48	5.16	-0.56	531.	531.	531.
9.000	315.206	6.825	-0.6209	233.18	3.89	470.90	-0.18	6.48	-1.67	529.	529.	529.
10.000	271.715	6.336	-0.4363	226.51	3.49	417.92	0.33	8.76	-1.64	526.	526.	526.
11.000	233.255	5.606	-0.2639	220.91	3.98	367.95	0.60	10.85	-1.13	522.	522.	522.
12.000	199.603	4.707	-0.1122	216.99	4.95	320.65	0.36	11.60	-0.66	522.	522.	522.
13.000	170.332	3.825	0.0212	214.79	4.85	276.45	0.11	10.26	-0.26	519.	519.	519.
14.000	145.225	3.103	0.1074	212.86	4.30	237.82	0.29	8.50	-0.10	516.	516.	516.
15.000	123.520	2.386	0.1017	210.75	4.21	204.31	0.43	7.12	0.01	513.	513.	513.
16.000	105.002	1.821	0.0835	209.07	4.36	175.08	0.35	6.04	0.10	513.	513.	513.
17.000	89.204	1.376	0.0394	208.38	4.04	149.21	-0.10	4.62	0.23	468.	468.	468.
18.000	75.731	1.058	-0.0422	208.91	3.30	126.33	-0.04	3.17	0.15	468.	468.	468.
19.000	64.357	0.845	-0.1416	210.12	2.61	106.72	0.17	2.16	0.02	465.	465.	465.
20.000	54.726	0.703	-0.2194	211.36	2.26	90.21	-0.04	1.59	0.05	465.	465.	465.
21.000	46.600	0.594	-0.2877	212.62	2.06	76.36	-0.08	1.17	-0.14	457.	457.	457.
22.000	39.719	0.521	-0.2774	213.94	2.12	64.68	-0.14	0.95	-0.37	450.	450.	450.
23.000	33.875	0.458	-0.2887	215.46	2.06	54.77	-0.16	0.75	-0.53	447.	447.	447.
24.000	28.917	0.409	-0.2765	216.81	2.22	46.46	0.06	0.62	-0.75	432.	432.	432.
25.000	24.721	0.368	-0.2396	218.03	2.55	39.50	0.23	0.57	-1.02	422.	422.	422.
26.000	21.138	0.335	-0.2029	219.17	2.88	33.60	0.56	0.51	-1.51	420.	420.	420.
27.000	18.113	0.298	-0.0635	220.30	3.06	28.64	0.90	0.44	-1.59	387.	387.	387.
28.000	15.523	0.280	-0.0465	221.47	3.27	24.42	1.02	0.39	-1.42	353.	353.	353.
29.000	13.314	0.263	-0.0369	222.83	3.75	20.82	1.38	0.39	-1.40	308.	308.	308.
30.000	11.433	0.234	0.0067	224.11	3.85	17.77	1.36	0.34	-1.10	266.	266.	266.

TABLE B-12. December Thermodynamic Data, Nellis.

Z KM	MEAN P MB	S.D. P MB	SKEW P	MEAN T DEG K	S.D. T DEG K	SKEW T	MEAN D G/M3	S.D. D G/M3	SKEW D	NOBS P	NOBS T	NOBS D
0.000	1020.485	7.671	-0.2167	283.43	10.55	0.11	1253.38	53.73	0.08	473.	473.	473.
1.000	904.101	5.414	-0.6868	280.67	6.19	0.25	1120.54	25.97	0.02	542.	542.	542.
1.007	903.319	5.417	-0.6900	280.66	6.18	0.25	1119.70	25.87	0.02	542.	542.	542.
2.000	799.908	5.392	-0.6527	276.85	4.80	-0.45	1005.27	15.01	0.86	545.	545.	545.
3.000	706.627	5.848	-0.5712	272.48	5.46	-0.80	902.70	13.37	1.08	545.	545.	545.
4.000	622.221	6.540	-0.6142	266.73	5.56	-0.86	812.28	10.59	1.07	544.	544.	544.
5.000	546.659	7.028	-0.6900	260.40	5.38	-0.97	731.10	8.07	0.81	543.	543.	543.
6.000	478.930	7.441	-0.7234	253.47	5.30	-0.99	658.09	6.68	0.26	542.	542.	542.
7.000	417.706	7.458	-0.7848	246.20	5.10	-0.82	590.97	5.65	-0.29	541.	541.	541.
8.000	362.778	7.381	-0.7667	238.86	4.61	-0.40	529.05	5.84	-1.08	540.	540.	540.
9.000	313.857	7.048	-0.6688	231.65	4.05	0.06	472.00	7.57	-1.97	538.	538.	538.
10.000	270.199	6.465	-0.4566	225.02	3.75	0.42	418.37	9.62	-1.80	537.	537.	537.
11.000	231.764	5.685	-0.2462	219.58	4.36	0.70	367.84	11.55	-1.22	534.	534.	534.
12.000	198.193	4.740	-0.0589	216.46	5.14	0.40	319.20	12.28	-0.52	534.	534.	534.
13.000	169.106	3.793	0.0819	214.80	5.26	-0.03	274.49	10.96	-0.07	530.	530.	530.
14.000	144.205	3.027	0.1557	213.47	4.49	-0.10	235.49	8.47	0.06	526.	526.	526.
15.000	122.718	2.346	0.1609	211.54	4.06	0.09	202.21	6.80	0.14	523.	523.	523.
16.000	104.386	1.818	0.1295	209.75	4.00	0.09	173.47	5.70	0.18	522.	522.	522.
17.000	88.680	1.404	0.1055	208.77	3.89	-0.10	148.06	4.59	0.28	482.	482.	482.
18.000	75.277	1.065	0.0486	208.57	3.60	-0.17	125.79	3.44	0.33	480.	480.	480.
19.000	63.949	0.851	-0.0515	209.59	3.22	0.11	106.33	2.37	0.23	472.	472.	472.
20.000	54.350	0.717	-0.0615	210.63	3.02	0.05	89.91	1.67	0.18	470.	470.	470.
21.000	46.261	0.618	0.0707	211.68	3.03	0.26	76.15	1.23	0.10	452.	452.	452.
22.000	39.404	0.560	0.1715	212.81	3.16	0.25	64.51	0.97	-0.07	446.	446.	446.
23.000	33.575	0.520	0.2106	214.01	3.27	0.25	54.66	0.75	-0.09	441.	441.	441.
24.000	29.638	0.483	0.2475	215.14	3.41	0.28	46.37	0.60	-0.20	421.	421.	421.
25.000	24.452	0.458	0.2527	216.27	3.39	0.20	39.39	0.51	-0.16	412.	412.	412.
26.000	20.879	0.430	0.2771	217.31	3.51	0.19	33.47	0.48	-0.11	406.	406.	406.
27.000	17.876	0.400	0.2544	218.40	3.56	0.28	28.51	0.45	-0.10	364.	364.	364.
28.000	15.305	0.371	0.2232	219.41	3.74	0.29	24.30	0.45	-0.14	331.	331.	331.
29.000	13.109	0.350	0.2641	220.21	3.83	0.33	20.73	0.45	-0.02	285.	285.	285.
30.000	11.217	0.318	0.3310	221.30	4.09	0.48	17.66	0.43	0.04	236.	236.	236.

TABLE B-13. Annual Thermodynamic Data, Nellis.

Z KM	MEAN P MB	S.D. P MB	SKEWP P	MEANT DEG K	S.D. T DEG K	SKEWT G/M3	MEAND G/M3	S.D. D G/M3	SKEWD	NOBS P	NOBS T	NOBS D
0.000	1013.131	8.501	0.3146	292.80	13.18	0.38	1204.36	62.41	-0.04	4409.	4409.	4409.
1.000	900.841	4.933	0.0960	290.91	10.65	0.19	1077.48	41.71	0.01	6103.	6103.	6103.
1.007	899.965	4.851	0.1063	290.86	10.61	0.19	1076.63	41.65	0.01	6103.	6103.	6103.
2.000	799.886	4.839	-0.6421	284.82	8.70	-0.02	977.08	28.12	0.10	6165.	6165.	6165.
3.000	708.784	5.962	-0.6132	277.69	7.60	-0.18	888.17	19.28	0.20	6164.	6164.	6164.
4.000	625.605	7.141	-0.5365	270.98	6.90	-0.42	803.64	13.27	0.44	6161.	6161.	6161.
5.000	550.727	7.951	-0.5210	264.35	6.67	-0.55	725.43	9.69	0.57	6156.	6156.	6156.
6.000	483.459	8.641	-0.5279	257.47	6.77	-0.57	654.01	7.51	0.48	6141.	6141.	6141.
7.000	422.513	8.886	-0.5336	250.30	6.86	-0.46	588.01	5.99	0.26	6120.	6119.	6120.
8.000	367.805	9.085	-0.4974	242.90	6.73	-0.26	527.49	5.05	-0.26	6100.	6100.	6100.
9.000	318.893	8.950	-0.4472	235.47	6.42	-0.05	471.77	5.57	-1.56	6079.	6079.	6079.
10.000	275.324	8.793	-0.3036	228.48	5.95	0.10	419.77	7.41	-2.10	6060.	6060.	6060.
11.000	236.669	8.246	-0.1660	222.43	5.52	0.05	370.68	9.84	-1.68	6032.	6032.	6032.
12.000	202.683	7.363	-0.0435	218.26	5.08	-0.21	323.60	11.78	-1.02	6019.	6019.	6019.
13.000	173.128	6.366	0.0797	215.78	4.45	-0.31	279.65	12.27	-0.44	5993.	5993.	5993.
14.000	147.718	5.331	0.1347	213.73	4.09	0.11	240.93	11.60	-0.05	5972.	5972.	5972.
15.000	125.730	4.326	0.1684	211.49	4.30	0.14	207.28	10.30	0.13	5941.	5941.	5941.
16.000	106.932	3.447	0.1726	209.84	4.39	0.10	177.67	8.50	0.14	5936.	5936.	5936.
17.000	90.865	2.789	0.1753	209.47	4.03	0.16	151.21	6.50	0.05	5510.	5510.	5510.
18.000	77.211	2.297	0.2032	210.16	3.50	0.07	128.04	4.71	-0.03	5487.	5487.	5487.
19.000	65.692	1.937	0.2092	211.63	3.08	-0.17	108.15	3.38	-0.07	5425.	5425.	5425.
20.000	55.940	1.691	0.2223	213.11	2.96	-0.44	91.45	2.53	-0.03	5404.	5404.	5404.
21.000	47.696	1.479	0.2076	214.55	3.02	-0.56	77.44	1.95	0.03	5314.	5314.	5314.
22.000	40.734	1.331	0.1909	215.99	3.19	-0.60	65.69	1.62	0.09	5247.	5247.	5247.
23.000	34.793	1.199	0.1702	217.45	3.32	-0.64	55.73	1.38	0.16	5192.	5192.	5192.
24.000	29.757	1.072	0.1357	218.93	3.53	-0.63	47.34	1.18	0.18	5067.	5067.	5067.
25.000	25.475	0.973	0.1113	220.34	3.77	-0.64	40.27	1.04	0.14	4913.	4913.	4913.
26.000	21.830	0.882	0.1001	221.83	3.99	-0.55	34.27	0.94	0.09	4836.	4836.	4836.
27.000	18.750	0.789	0.0597	223.33	4.19	-0.54	29.24	0.83	0.04	4450.	4450.	4450.
28.000	16.116	0.713	0.0345	224.75	4.41	-0.50	24.97	0.76	-0.02	4097.	4097.	4097.
29.000	13.879	0.642	-0.0051	226.29	4.64	-0.48	21.36	0.69	-0.08	3635.	3635.	3635.
30.000	11.944	0.575	-0.0289	227.77	4.76	-0.50	18.26	0.63	-0.12	3135.	3135.	3135.

APPENDIX C

Nellis Moisture-Related Statistics Tables

Tables C-1 through C-13 provide moisture related statistics (monthly and annual) for Nellis. They were prepared as described in Chapter 3.

TABLE C-1. January Moisture-Related Data, Nellis.

Z	VP MEAN	S.D. VP	TV MEAN	TV S.D.	SKEW TV	TD MEAN	S.D. TD	NOBS	NOBS	NOBS	NOBS
KM	MB	MB	K	K	K	K	K	VP	TV	VP	TV
								SKEW TD		SKEW TD	
0.000	6.725	3.138	284.87	9.90	0.13	273.19	6.50	-0.17	392.	-0.17	392.
1.000	4.702	1.953	281.40	6.33	-0.19	268.66	5.43	0.02	482.	0.02	482.
1.007	4.691	1.938	281.44	6.13	0.12	268.60	5.44	0.02	482.	0.02	482.
2.000	3.302	1.722	276.54	4.95	-0.34	263.33	7.09	-0.31	483.	-0.31	483.
3.000	2.007	1.291	271.54	5.38	-0.56	256.24	8.60	-0.27	482.	-0.27	482.
4.000	1.171	0.902	265.85	5.50	-0.78	249.17	9.28	-0.04	483.	-0.04	483.
5.000	0.696	0.591	259.35	5.54	-0.88	242.91	9.74	-0.14	482.	-0.14	482.
6.000	0.407	0.347	252.43	5.53	-0.90	237.03	9.80	-0.20	479.	-0.20	479.
7.000	0.225	0.196	245.77	4.54	-0.48	230.88	10.03	-0.41	455.	-0.41	455.
8.000	0.125	0.100	239.47	3.19	0.16	225.74	9.38	-0.62	365.	-0.62	365.
9.000	0.079	0.055	235.56	1.64	0.96	222.15	8.52	-0.86	99.	-0.86	99.
10.000	0.000	0.000	223.56	3.60	0.03	0.00	0.00	0.00	0.	0.00	0.
11.000	0.000	0.000	218.60	4.36	0.90	0.00	0.00	0.00	0.	0.00	0.
12.000	0.000	0.000	216.65	5.62	0.45	0.00	0.00	0.00	0.	0.00	0.
13.000	0.000	0.000	216.54	5.24	-0.41	0.00	0.00	0.00	0.	0.00	0.
14.000	0.000	0.000	215.75	3.97	-0.16	0.00	0.00	0.00	0.	0.00	0.
15.000	0.000	0.000	213.53	3.64	0.25	0.00	0.00	0.00	0.	0.00	0.
16.000	0.000	0.000	211.25	3.88	0.24	0.00	0.00	0.00	0.	0.00	0.
17.000	0.000	0.000	210.08	3.82	0.09	0.00	0.00	0.00	0.	0.00	0.
18.000	0.000	0.000	209.90	3.85	-0.15	0.00	0.00	0.00	0.	0.00	0.
19.000	0.000	0.000	210.63	3.81	-0.36	0.00	0.00	0.00	0.	0.00	0.
20.000	0.000	0.000	211.53	3.82	-0.41	0.00	0.00	0.00	0.	0.00	0.
21.000	0.000	0.000	212.45	3.89	-0.48	0.00	0.00	0.00	0.	0.00	0.
22.000	0.000	0.000	213.51	4.11	-0.37	0.00	0.00	0.00	0.	0.00	0.
23.000	0.000	0.000	214.51	4.18	-0.42	0.00	0.00	0.00	0.	0.00	0.
24.000	0.000	0.000	215.55	4.22	-0.45	0.00	0.00	0.00	0.	0.00	0.
25.000	0.000	0.000	216.50	4.32	-0.58	0.00	0.00	0.00	0.	0.00	0.
26.000	0.000	0.000	217.74	4.28	-0.47	0.00	0.00	0.00	0.	0.00	0.
27.000	0.000	0.000	218.91	4.26	-0.57	0.00	0.00	0.00	0.	0.00	0.
28.000	0.000	0.000	220.15	4.47	-0.36	0.00	0.00	0.00	0.	0.00	0.
29.000	0.000	0.000	221.49	4.69	-0.45	0.00	0.00	0.00	0.	0.00	0.
30.000	0.000	0.000	223.31	5.07	-0.53	0.00	0.00	0.00	0.	0.00	0.

TABLE C-2. February Moisture-Related Data, Nellis.

Z	VP	S.D.	TV	TD	S.D.	S.D.	TD	VP	NOBS	NOBS	NOBS	NOBS
KM	MB	MB	MEAN	MEAN	TV	S.D.	TD	VP	VP	TV	TV	TD
			K	K	K	K	K	K	K	K	K	K
0.000	7.183	3.296	0.9112	285.20	10.30	0.27	274.15	6.56	-0.31	325.	325.	324.
1.000	4.762	2.034	0.5964	282.69	7.62	-0.88	268.64	6.14	-0.77	446.	446.	445.
1.007	4.776	2.002	0.6552	282.88	6.88	0.08	268.74	5.80	-0.26	446.	446.	446.
2.000	3.153	1.645	0.7845	277.17	5.06	-0.26	262.67	7.34	-0.57	446.	446.	446.
3.000	1.960	1.272	0.7517	271.41	5.16	-0.48	255.77	9.05	-0.44	443.	443.	443.
4.000	1.100	0.850	1.0959	265.48	5.05	-0.65	248.45	9.27	-0.04	444.	444.	444.
5.000	0.676	0.594	1.5093	258.84	5.07	-0.53	242.39	9.90	-0.05	444.	444.	444.
6.000	0.417	0.375	1.6186	251.67	5.15	-0.51	237.07	10.14	-0.24	441.	441.	441.
7.000	0.234	0.198	1.4836	244.65	4.48	-0.01	231.53	9.75	-0.56	423.	423.	423.
8.000	0.138	0.100	1.2423	238.77	3.26	0.58	227.47	8.21	-0.83	311.	311.	311.
9.000	0.098	0.052	1.1235	235.76	1.89	1.18	225.47	6.50	-1.71	59.	59.	59.
10.000	0.000	0.000	0.0000	222.27	3.77	0.38	0.00	0.00	0.00	0.	0.	0.
11.000	0.000	0.000	0.0000	217.01	4.41	0.99	0.00	0.00	0.00	0.	0.	0.
12.000	0.000	0.000	0.0000	215.45	5.82	0.27	0.00	0.00	0.00	0.	0.	0.
13.000	0.000	0.000	0.0000	216.27	5.20	-0.69	0.00	0.00	0.00	0.	0.	0.
14.000	0.000	0.000	0.0000	215.85	3.96	-0.50	0.00	0.00	0.00	0.	0.	0.
15.000	0.000	0.000	0.0000	214.03	3.53	-0.26	0.00	0.00	0.00	0.	0.	0.
16.000	0.000	0.000	0.0000	212.21	3.77	-0.24	0.00	0.00	0.00	0.	0.	0.
17.000	0.000	0.000	0.0000	210.96	4.10	-0.34	0.00	0.00	0.00	0.	0.	0.
18.000	0.000	0.000	0.0000	210.67	4.05	-0.32	0.00	0.00	0.00	0.	0.	0.
19.000	0.000	0.000	0.0000	211.49	3.76	-0.33	0.00	0.00	0.00	0.	0.	0.
20.000	0.000	0.000	0.0000	212.41	3.46	-0.30	0.00	0.00	0.00	0.	0.	0.
21.000	0.000	0.000	0.0000	213.40	3.29	-0.18	0.00	0.00	0.00	0.	0.	0.
22.000	0.000	0.000	0.0000	214.57	3.24	-0.20	0.00	0.00	0.00	0.	0.	0.
23.000	0.000	0.000	0.0000	215.68	3.03	-0.28	0.00	0.00	0.00	0.	0.	0.
24.000	0.000	0.000	0.0000	216.84	2.99	-0.25	0.00	0.00	0.00	0.	0.	0.
25.000	0.000	0.000	0.0000	217.94	2.95	-0.43	0.00	0.00	0.00	0.	0.	0.
26.000	0.000	0.000	0.0000	219.26	2.87	-0.47	0.00	0.00	0.00	0.	0.	0.
27.000	0.000	0.000	0.0000	220.45	2.96	-0.84	0.00	0.00	0.00	0.	0.	0.
28.000	0.000	0.000	0.0000	221.61	3.20	-0.68	0.00	0.00	0.00	0.	0.	0.
29.000	0.000	0.000	0.0000	222.91	3.22	-0.23	0.00	0.00	0.00	0.	0.	0.
30.000	0.000	0.000	0.0000	224.26	3.31	0.18	0.00	0.00	0.00	0.	0.	0.

TABLE C-3. March Moisture-Related Data, Nellis.

Z KM	VP MEAN		S.D. VP		TV MEAN		TV S.D.		SKEW TV		TD MEAN		S.D. TD		SKEW TD		NOBS		NOBS	
	MB	MB	MB	VP	K	K	K	K	K	K	K	K	K	K	VP	TV	VP	TV	TV	TD
0.000	8.220	2.914	0.2917	286.18	7.64	0.79	276.43	5.51	-0.65	297.	297.	297.	5.51	-0.65	297.	297.	297.	297.	297.	297.
1.000	5.267	1.931	0.2505	285.10	6.74	-0.33	270.29	5.24	-0.38	491.	491.	491.	5.24	-0.38	491.	491.	491.	491.	491.	491.
1.007	5.264	1.916	0.2751	285.14	6.39	0.31	270.27	5.25	-0.38	491.	491.	491.	5.25	-0.38	491.	491.	491.	491.	491.	491.
2.000	3.538	1.487	0.2550	278.10	4.42	0.29	264.68	6.15	-0.68	490.	490.	490.	6.15	-0.68	490.	490.	490.	490.	490.	490.
3.000	2.338	1.147	0.2286	270.66	4.27	0.09	258.85	7.63	-1.02	490.	490.	490.	7.63	-1.02	490.	490.	490.	490.	490.	490.
4.000	1.181	0.835	0.8554	264.28	4.46	-0.22	249.48	9.23	-0.33	488.	488.	488.	9.23	-0.33	488.	488.	488.	488.	488.	488.
5.000	0.629	0.521	1.3590	257.68	4.67	-0.36	241.96	9.47	-0.15	488.	488.	488.	9.47	-0.15	488.	488.	488.	488.	488.	488.
6.000	0.346	0.299	1.6453	250.56	4.69	-0.44	235.60	9.37	-0.23	488.	488.	488.	9.37	-0.23	488.	488.	488.	488.	488.	488.
7.000	0.190	0.160	1.4747	243.37	4.30	-0.21	229.76	9.29	-0.53	472.	472.	472.	9.29	-0.53	472.	472.	472.	472.	472.	472.
8.000	0.111	0.085	1.1398	237.88	2.73	0.47	225.00	8.82	-0.74	320.	320.	320.	8.82	-0.74	320.	320.	320.	320.	320.	320.
9.000	0.082	0.048	0.2783	234.47	1.26	2.25	223.04	8.14	-1.46	41.	41.	41.	8.14	-1.46	41.	41.	41.	41.	41.	41.
10.000	0.000	0.000	0.0000	222.14	3.26	0.22	0.00	0.00	0.00	0.00	0.00	0.00	0.00	0.00	0.00	0.00	0.00	0.00	0.00	0.00
11.000	0.000	0.000	0.0000	217.90	4.26	0.68	0.00	0.00	0.00	0.00	0.00	0.00	0.00	0.00	0.00	0.00	0.00	0.00	0.00	0.00
12.000	0.000	0.000	0.0000	216.77	5.76	-0.02	0.00	0.00	0.00	0.00	0.00	0.00	0.00	0.00	0.00	0.00	0.00	0.00	0.00	0.00
13.000	0.000	0.000	0.0000	217.08	5.33	-0.60	0.00	0.00	0.00	0.00	0.00	0.00	0.00	0.00	0.00	0.00	0.00	0.00	0.00	0.00
14.000	0.000	0.000	0.0000	216.69	3.92	-0.54	0.00	0.00	0.00	0.00	0.00	0.00	0.00	0.00	0.00	0.00	0.00	0.00	0.00	0.00
15.000	0.000	0.000	0.0000	215.03	3.46	-0.16	0.00	0.00	0.00	0.00	0.00	0.00	0.00	0.00	0.00	0.00	0.00	0.00	0.00	0.00
16.000	0.000	0.000	0.0000	213.24	3.58	-0.04	0.00	0.00	0.00	0.00	0.00	0.00	0.00	0.00	0.00	0.00	0.00	0.00	0.00	0.00
17.000	0.000	0.000	0.0000	212.33	3.77	0.00	0.00	0.00	0.00	0.00	0.00	0.00	0.00	0.00	0.00	0.00	0.00	0.00	0.00	0.00
18.000	0.000	0.000	0.0000	211.99	3.54	-0.19	0.00	0.00	0.00	0.00	0.00	0.00	0.00	0.00	0.00	0.00	0.00	0.00	0.00	0.00
19.000	0.000	0.000	0.0000	212.48	3.00	0.08	0.00	0.00	0.00	0.00	0.00	0.00	0.00	0.00	0.00	0.00	0.00	0.00	0.00	0.00
20.000	0.000	0.000	0.0000	213.13	2.76	0.08	0.00	0.00	0.00	0.00	0.00	0.00	0.00	0.00	0.00	0.00	0.00	0.00	0.00	0.00
21.000	0.000	0.000	0.0000	213.89	2.57	-0.06	0.00	0.00	0.00	0.00	0.00	0.00	0.00	0.00	0.00	0.00	0.00	0.00	0.00	0.00
22.000	0.000	0.000	0.0000	214.60	2.49	-0.02	0.00	0.00	0.00	0.00	0.00	0.00	0.00	0.00	0.00	0.00	0.00	0.00	0.00	0.00
23.000	0.000	0.000	0.0000	215.61	2.43	0.01	0.00	0.00	0.00	0.00	0.00	0.00	0.00	0.00	0.00	0.00	0.00	0.00	0.00	0.00
24.000	0.000	0.000	0.0000	216.63	2.48	-0.19	0.00	0.00	0.00	0.00	0.00	0.00	0.00	0.00	0.00	0.00	0.00	0.00	0.00	0.00
25.000	0.000	0.000	0.0000	217.73	2.69	-0.17	0.00	0.00	0.00	0.00	0.00	0.00	0.00	0.00	0.00	0.00	0.00	0.00	0.00	0.00
26.000	0.000	0.000	0.0000	219.15	2.64	0.13	0.00	0.00	0.00	0.00	0.00	0.00	0.00	0.00	0.00	0.00	0.00	0.00	0.00	0.00
27.000	0.000	0.000	0.0000	220.67	2.85	0.09	0.00	0.00	0.00	0.00	0.00	0.00	0.00	0.00	0.00	0.00	0.00	0.00	0.00	0.00
28.000	0.000	0.000	0.0000	222.23	3.19	0.59	0.00	0.00	0.00	0.00	0.00	0.00	0.00	0.00	0.00	0.00	0.00	0.00	0.00	0.00
29.000	0.000	0.000	0.0000	223.96	3.54	0.63	0.00	0.00	0.00	0.00	0.00	0.00	0.00	0.00	0.00	0.00	0.00	0.00	0.00	0.00
30.000	0.000	0.000	0.0000	225.76	3.74	0.35	0.00	0.00	0.00	0.00	0.00	0.00	0.00	0.00	0.00	0.00	0.00	0.00	0.00	0.00

TABLE C-4. April Moisture-Related Data, Nellis.

Z KM	VP MEAN		S.D. VP		TV MEAN		TV S.D.		SKEW TV		TD MEAN		S.D. TD		SKEW TD		NOBS		NOBS	
	MB	MB	MB	MB	K	K	K	K	K	K	K	K	K	K	VP	VP	TV	TV	TD	TD
0.000	7.323	3.089	0.8483	289.89	8.53	0.83	274.53	6.24	-0.65	288.	288.									
1.000	4.645	1.817	0.7602	289.32	7.27	0.21	268.53	5.56	-0.34	476.	476.									
1.007	4.629	1.805	0.7591	289.28	7.26	0.21	268.51	5.55	-0.34	476.	476.									
2.000	3.248	1.366	0.8526	282.14	5.41	-0.19	263.72	5.63	-0.38	477.	477.									
3.000	2.322	1.124	0.7489	274.02	5.09	-0.42	259.09	6.63	-0.61	476.	476.									
4.000	1.270	0.825	1.0801	267.07	5.05	-0.86	251.03	7.90	-0.18	476.	476.									
5.000	0.642	0.517	1.6564	260.52	5.09	-1.12	242.75	8.43	0.09	476.	476.									
6.000	0.365	0.304	1.6279	253.43	5.14	-1.21	236.55	8.74	-0.13	474.	474.									
7.000	0.217	0.174	1.2541	246.62	4.12	-0.83	231.10	9.28	-0.50	459.	459.									
8.000	0.120	0.086	1.0113	239.88	2.90	0.02	225.92	8.56	-0.77	395.	395.									
9.000	0.074	0.044	0.5413	235.26	1.41	0.84	222.33	7.37	-1.23	121.	121.									
10.000	0.000	0.000	0.0000	224.41	2.97	0.05	0.00	0.00	0.00	0.	0.									
11.000	0.000	0.000	0.0000	218.41	3.53	1.04	0.00	0.00	0.00	0.	0.									
12.000	0.000	0.000	0.0000	214.75	4.88	0.75	0.00	0.00	0.00	0.	0.									
13.000	0.000	0.000	0.0000	214.52	5.32	-0.05	0.00	0.00	0.00	0.	0.									
14.000	0.000	0.000	0.0000	214.71	4.03	-0.26	0.00	0.00	0.00	0.	0.									
15.000	0.000	0.000	0.0000	213.69	3.41	0.30	0.00	0.00	0.00	0.	0.									
16.000	0.000	0.000	0.0000	212.71	3.34	0.43	0.00	0.00	0.00	0.	0.									
17.000	0.000	0.000	0.0000	212.26	3.37	0.23	0.00	0.00	0.00	0.	0.									
18.000	0.000	0.000	0.0000	212.41	3.27	-0.07	0.00	0.00	0.00	0.	0.									
19.000	0.000	0.000	0.0000	213.16	3.20	0.08	0.00	0.00	0.00	0.	0.									
20.000	0.000	0.000	0.0000	213.89	2.82	0.15	0.00	0.00	0.00	0.	0.									
21.000	0.000	0.000	0.0000	214.79	2.55	0.07	0.00	0.00	0.00	0.	0.									
22.000	0.000	0.000	0.0000	215.97	2.40	-0.02	0.00	0.00	0.00	0.	0.									
23.000	0.000	0.000	0.0000	217.31	2.33	-0.07	0.00	0.00	0.00	0.	0.									
24.000	0.000	0.000	0.0000	218.51	2.27	-0.04	0.00	0.00	0.00	0.	0.									
25.000	0.000	0.000	0.0000	220.11	2.40	-0.07	0.00	0.00	0.00	0.	0.									
26.000	0.000	0.000	0.0000	221.77	2.73	0.25	0.00	0.00	0.00	0.	0.									
27.000	0.000	0.000	0.0000	223.42	2.85	0.17	0.00	0.00	0.00	0.	0.									
28.000	0.000	0.000	0.0000	225.13	3.02	0.32	0.00	0.00	0.00	0.	0.									
29.000	0.000	0.000	0.0000	227.02	3.19	0.20	0.00	0.00	0.00	0.	0.									
30.000	0.000	0.000	0.0000	228.83	3.07	0.03	0.00	0.00	0.00	0.	0.									

TABLE C-5. May Moisture-Related Data, Nellis.

Z	VP MEAN	S.D. VP	TV MEAN	TV S.D.	SKEW TV	TD MEAN	S.D. TD	NOBS	NOBS	NOBS	NOBS
KM	MB	MB	K	K	K	K	K	VP	TV	TV	TD
								TD			
0.000	8.213	4.241	296.53	9.96	0.84	275.52	7.87	-0.52	306.	306.	306.
1.000	5.639	2.313	295.05	7.70	0.14	271.09	5.41	0.01	473.	473.	473.
1.007	5.627	2.306	295.00	7.68	0.14	271.09	5.40	0.01	473.	473.	473.
2.000	4.153	1.781	287.79	5.51	-0.29	266.91	5.67	-0.18	473.	473.	473.
3.000	3.119	1.294	279.19	5.10	-0.35	263.13	5.92	-0.77	473.	473.	473.
4.000	1.954	1.096	271.43	4.75	-0.56	256.36	7.89	-0.50	473.	473.	473.
5.000	0.975	0.781	264.52	4.48	-0.85	246.93	9.37	0.04	473.	473.	473.
6.000	0.497	0.421	257.49	4.55	-1.03	239.55	9.11	-0.05	472.	472.	472.
7.000	0.255	0.218	250.29	4.45	-0.88	232.66	8.98	-0.15	467.	467.	467.
8.000	0.138	0.111	243.20	3.61	-0.27	226.88	8.75	-0.35	434.	434.	434.
9.000	0.077	0.052	237.16	2.24	0.42	222.07	8.24	-0.87	292.	292.	292.
10.000	0.037	0.031	234.54	0.66	-0.03	214.57	9.62	-0.16	11.	11.	11.
11.000	0.000	0.000	221.04	3.14	0.46	0.00	0.00	0.00	0.	0.	0.
12.000	0.000	0.000	216.31	4.07	0.80	0.00	0.00	0.00	0.	0.	0.
13.000	0.000	0.000	214.39	4.96	0.25	0.00	0.00	0.00	0.	0.	0.
14.000	0.000	0.000	214.21	4.72	-0.42	0.00	0.00	0.00	0.	0.	0.
15.000	0.000	0.000	213.61	3.79	-0.37	0.00	0.00	0.00	0.	0.	0.
16.000	0.000	0.000	212.48	3.49	-0.25	0.00	0.00	0.00	0.	0.	0.
17.000	0.000	0.000	211.92	3.42	-0.03	0.00	0.00	0.00	0.	0.	0.
18.000	0.000	0.000	211.97	3.27	0.04	0.00	0.00	0.00	0.	0.	0.
19.000	0.000	0.000	212.78	2.84	-0.05	0.00	0.00	0.00	0.	0.	0.
20.000	0.000	0.000	214.07	2.59	0.01	0.00	0.00	0.00	0.	0.	0.
21.000	0.000	0.000	215.75	2.36	-0.04	0.00	0.00	0.00	0.	0.	0.
22.000	0.000	0.000	217.39	2.25	-0.19	0.00	0.00	0.00	0.	0.	0.
23.000	0.000	0.000	219.11	2.17	-0.29	0.00	0.00	0.00	0.	0.	0.
24.000	0.000	0.000	220.86	2.24	-0.29	0.00	0.00	0.00	0.	0.	0.
25.000	0.000	0.000	222.55	2.25	-0.27	0.00	0.00	0.00	0.	0.	0.
26.000	0.000	0.000	224.37	2.32	-0.10	0.00	0.00	0.00	0.	0.	0.
27.000	0.000	0.000	226.17	2.38	-0.24	0.00	0.00	0.00	0.	0.	0.
28.000	0.000	0.000	227.97	2.50	-0.09	0.00	0.00	0.00	0.	0.	0.
29.000	0.000	0.000	229.78	2.56	0.07	0.00	0.00	0.00	0.	0.	0.
30.000	0.000	0.000	231.59	2.50	0.26	0.00	0.00	0.00	0.	0.	0.

TABLE C-6. June Moisture-Related Data, Nellis.

Z KM	VP MEAN		S.D. VP		TV MEAN		TV S.D.		SKEW TV		TD MEAN		S.D. TD		SKEW TD		NOBS		NOBS	
	MB	K	MB	K	K	K	K	K	K	K	K	K	K	K	K	K	VP	TV	VP	TV
0.000	7.158	302.04	4.079	10.92	0.6811	0.60	273.01	9.10	-0.56	356.	356.	-0.15	514.	514.	514.	514.	514.	514.	514.	514.
1.000	5.843	300.43	2.312	7.64	0.5737	0.10	271.56	5.56	-0.15	514.	514.	-0.15	514.	514.	514.	514.	514.	514.	514.	514.
1.007	5.830	300.36	2.304	7.62	0.5741	0.10	271.55	5.55	-0.15	514.	514.	-0.19	528.	528.	528.	528.	528.	528.	528.	528.
2.000	4.897	293.43	1.846	4.54	0.5379	-0.44	269.29	5.20	-0.51	528.	528.	-0.38	527.	527.	527.	527.	527.	527.	527.	527.
3.000	3.437	284.74	1.469	4.08	0.2934	-0.41	264.29	6.12	-0.38	527.	527.	0.06	527.	527.	527.	527.	527.	527.	527.	527.
4.000	2.246	276.78	1.216	3.74	0.4780	-0.56	258.26	7.49	-0.38	527.	527.	0.21	526.	526.	526.	526.	526.	526.	526.	526.
5.000	1.278	269.47	0.963	3.50	1.1371	-0.84	250.42	8.89	0.06	527.	527.	0.08	525.	525.	525.	525.	525.	525.	525.	525.
6.000	0.669	262.39	0.594	3.32	1.5738	-0.90	242.55	9.26	0.08	525.	525.	-0.15	515.	515.	515.	515.	515.	515.	515.	515.
7.000	0.359	255.10	0.320	3.27	1.8117	-0.81	236.19	8.80	-0.48	498.	498.	-0.76	175.	175.	175.	175.	175.	175.	175.	175.
8.000	0.200	247.58	0.171	3.19	1.6556	-0.64	230.45	8.67	0.00	0.	0.	0.00	0.	0.	0.	0.	0.	0.	0.	0.
9.000	0.102	240.14	0.081	2.77	1.3738	-0.08	224.29	8.42	0.00	0.	0.	0.00	0.	0.	0.	0.	0.	0.	0.	0.
10.000	0.057	235.20	0.040	1.44	0.7536	0.67	219.42	8.33	0.00	0.	0.	0.00	0.	0.	0.	0.	0.	0.	0.	0.
11.000	0.000	225.14	0.000	2.85	0.0000	-0.31	0.00	0.00	0.00	0.	0.	0.00	0.	0.	0.	0.	0.	0.	0.	0.
12.000	0.000	219.24	0.000	3.10	0.0000	0.26	0.00	0.00	0.00	0.	0.	0.00	0.	0.	0.	0.	0.	0.	0.	0.
13.000	0.000	215.51	0.000	3.62	0.0000	0.20	0.00	0.00	0.00	0.	0.	0.00	0.	0.	0.	0.	0.	0.	0.	0.
14.000	0.000	213.44	0.000	3.71	0.0000	-0.17	0.00	0.00	0.00	0.	0.	0.00	0.	0.	0.	0.	0.	0.	0.	0.
15.000	0.000	211.45	0.000	3.72	0.0000	-0.04	0.00	0.00	0.00	0.	0.	0.00	0.	0.	0.	0.	0.	0.	0.	0.
16.000	0.000	209.90	0.000	3.75	0.0000	0.07	0.00	0.00	0.00	0.	0.	0.00	0.	0.	0.	0.	0.	0.	0.	0.
17.000	0.000	209.14	0.000	3.48	0.0000	0.29	0.00	0.00	0.00	0.	0.	0.00	0.	0.	0.	0.	0.	0.	0.	0.
18.000	0.000	210.13	0.000	3.01	0.0000	0.29	0.00	0.00	0.00	0.	0.	0.00	0.	0.	0.	0.	0.	0.	0.	0.
19.000	0.000	212.27	0.000	2.48	0.0000	0.06	0.00	0.00	0.00	0.	0.	0.00	0.	0.	0.	0.	0.	0.	0.	0.
20.000	0.000	214.38	0.000	2.19	0.0000	-0.01	0.00	0.00	0.00	0.	0.	0.00	0.	0.	0.	0.	0.	0.	0.	0.
21.000	0.000	216.31	0.000	1.96	0.0000	0.06	0.00	0.00	0.00	0.	0.	0.00	0.	0.	0.	0.	0.	0.	0.	0.
22.000	0.000	218.17	0.000	1.84	0.0000	-0.01	0.00	0.00	0.00	0.	0.	0.00	0.	0.	0.	0.	0.	0.	0.	0.
23.000	0.000	219.99	0.000	1.82	0.0000	0.03	0.00	0.00	0.00	0.	0.	0.00	0.	0.	0.	0.	0.	0.	0.	0.
24.000	0.000	221.83	0.000	1.81	0.0000	-0.19	0.00	0.00	0.00	0.	0.	0.00	0.	0.	0.	0.	0.	0.	0.	0.
25.000	0.000	223.77	0.000	1.84	0.0000	-0.18	0.00	0.00	0.00	0.	0.	0.00	0.	0.	0.	0.	0.	0.	0.	0.
26.000	0.000	225.56	0.000	1.94	0.0000	-0.03	0.00	0.00	0.00	0.	0.	0.00	0.	0.	0.	0.	0.	0.	0.	0.
27.000	0.000	227.35	0.000	1.91	0.0000	-0.02	0.00	0.00	0.00	0.	0.	0.00	0.	0.	0.	0.	0.	0.	0.	0.
28.000	0.000	229.06	0.000	1.93	0.0000	-0.04	0.00	0.00	0.00	0.	0.	0.00	0.	0.	0.	0.	0.	0.	0.	0.
29.000	0.000	230.78	0.000	2.04	0.0000	-0.20	0.00	0.00	0.00	0.	0.	0.00	0.	0.	0.	0.	0.	0.	0.	0.
30.000	0.000	232.51	0.000	2.16	0.0000	-0.07	0.00	0.00	0.00	0.	0.	0.00	0.	0.	0.	0.	0.	0.	0.	0.

TABLE C-7. July Moisture-Related Data, Nellis.

Z KM	VP MEAN MB	S.D. VP MB	SKEW VP	TV MEAN K	TV S.D. K	SKEW TV K	TD MEAN K	S.D. TD K	SKEW TD	NOBS VP	NOBS TV	NOBS TD
0.000	11.924	8.402	0.8708	305.96	10.61	0.52	279.29	11.00	-0.05	396.	396.	396.
1.000	8.819	4.606	0.9339	303.59	7.03	0.04	276.72	7.43	0.32	549.	550.	550.
1.007	8.802	4.594	0.9330	303.53	7.02	0.04	276.71	7.43	0.32	549.	550.	550.
2.000	6.816	2.846	0.7819	296.56	3.46	-0.39	273.64	5.70	0.14	558.	558.	558.
3.000	5.129	2.333	0.4910	287.92	2.91	-0.46	269.42	6.62	-0.38	558.	558.	558.
4.000	3.453	1.958	0.3376	279.85	2.40	-0.75	263.33	8.40	-0.36	557.	557.	557.
5.000	2.033	1.484	0.6487	272.46	2.12	-0.83	255.62	9.75	-0.02	556.	556.	556.
6.000	1.047	0.918	0.9871	265.52	2.12	-1.03	246.99	10.26	0.23	555.	555.	555.
7.000	0.516	0.472	1.2863	258.64	2.32	-1.09	239.44	9.56	0.27	553.	553.	553.
8.000	0.262	0.245	1.4224	251.50	2.44	-1.08	232.46	9.38	0.17	546.	546.	546.
9.000	0.133	0.120	1.3645	244.08	2.48	-0.62	226.12	9.07	-0.06	543.	543.	543.
10.000	0.065	0.054	0.9519	237.18	1.91	0.13	219.76	9.04	-0.32	467.	467.	467.
11.000	0.036	0.035	0.6416	234.90	2.27	0.72	214.45	9.66	-0.03	11.	11.	11.
12.000	0.000	0.000	0.0000	222.66	2.32	-0.03	0.00	0.00	0.00	0.	0.	0.
13.000	0.000	0.000	0.0000	216.72	2.27	0.17	0.00	0.00	0.00	0.	0.	0.
14.000	0.000	0.000	0.0000	211.52	2.73	0.86	0.00	0.00	0.00	0.	0.	0.
15.000	0.000	0.000	0.0000	207.78	3.14	1.11	0.00	0.00	0.00	0.	0.	0.
16.000	0.000	0.000	0.0000	206.37	3.22	0.94	0.00	0.00	0.00	0.	0.	0.
17.000	0.000	0.000	0.0000	207.22	2.73	0.63	0.00	0.00	0.00	0.	0.	0.
18.000	0.000	0.000	0.0000	209.27	2.40	0.28	0.00	0.00	0.00	0.	0.	0.
19.000	0.000	0.000	0.0000	212.08	1.93	0.27	0.00	0.00	0.00	0.	0.	0.
20.000	0.000	0.000	0.0000	214.61	1.72	0.16	0.00	0.00	0.00	0.	0.	0.
21.000	0.000	0.000	0.0000	216.76	1.69	0.16	0.00	0.00	0.00	0.	0.	0.
22.000	0.000	0.000	0.0000	218.75	1.80	0.35	0.00	0.00	0.00	0.	0.	0.
23.000	0.000	0.000	0.0000	220.50	1.70	0.28	0.00	0.00	0.00	0.	0.	0.
24.000	0.000	0.000	0.0000	222.17	1.72	0.04	0.00	0.00	0.00	0.	0.	0.
25.000	0.000	0.000	0.0000	223.91	1.75	0.04	0.00	0.00	0.00	0.	0.	0.
26.000	0.000	0.000	0.0000	225.65	1.84	0.04	0.00	0.00	0.00	0.	0.	0.
27.000	0.000	0.000	0.0000	227.35	1.99	0.03	0.00	0.00	0.00	0.	0.	0.
28.000	0.000	0.000	0.0000	228.95	2.05	0.02	0.00	0.00	0.00	0.	0.	0.
29.000	0.000	0.000	0.0000	230.59	2.27	-0.26	0.00	0.00	0.00	0.	0.	0.
30.000	0.000	0.000	0.0000	232.09	2.26	-0.14	0.00	0.00	0.00	0.	0.	0.

TABLE C-8. August Moisture-Related Data, Nellis.

Z	VP MEAN	S.D. VP	TV MEAN	TV S.D.	SKEW TV	TD MEAN	S.D. TD	SKEW TD	NOBS	NOBS	NOBS	NOBS
KM	MB	MB	K	K	K	K	K	K	VP	TV	VP	TD
0.000	14.001	8.120	306.21	10.55	0.39	282.48	10.05	-0.45	414.	414.	414.	414.
1.000	10.011	4.768	303.05	6.95	0.06	278.60	7.27	-0.20	543.	543.	543.	543.
1.007	9.982	4.756	302.95	6.92	0.06	278.57	7.28	-0.20	543.	543.	543.	543.
2.000	7.416	3.050	296.06	3.54	-0.17	274.80	5.83	-0.04	551.	551.	551.	551.
3.000	5.574	2.437	287.36	3.04	-0.11	270.57	6.68	-0.57	551.	551.	551.	551.
4.000	3.652	1.974	279.29	2.50	-0.31	264.20	8.21	-0.50	551.	551.	551.	551.
5.000	2.005	1.442	272.00	2.16	-0.51	255.63	9.44	-0.04	551.	551.	551.	551.
6.000	1.012	0.884	265.17	2.11	-0.48	246.90	9.84	0.21	549.	549.	549.	549.
7.000	0.483	0.450	258.27	2.26	-0.62	239.04	9.06	0.29	546.	546.	546.	546.
8.000	0.260	0.238	251.03	2.48	-0.53	232.66	9.03	0.11	544.	544.	544.	544.
9.000	0.139	0.119	243.52	2.76	-0.36	226.97	8.58	-0.19	541.	541.	541.	541.
10.000	0.076	0.061	237.24	1.98	0.34	221.48	8.79	-0.50	400.	400.	400.	400.
11.000	0.038	0.041	234.04	0.69	1.14	213.43	10.31	0.32	19.	19.	19.	19.
12.000	0.000	0.000	222.45	2.42	-0.34	0.00	0.00	0.00	0.	0.	0.	0.
13.000	0.000	0.000	216.78	2.05	0.37	0.00	0.00	0.00	0.	0.	0.	0.
14.000	0.000	0.000	211.89	2.56	0.71	0.00	0.00	0.00	0.	0.	0.	0.
15.000	0.000	0.000	208.28	3.36	0.85	0.00	0.00	0.00	0.	0.	0.	0.
16.000	0.000	0.000	206.64	3.58	0.56	0.00	0.00	0.00	0.	0.	0.	0.
17.000	0.000	0.000	207.57	3.00	0.44	0.00	0.00	0.00	0.	0.	0.	0.
18.000	0.000	0.000	209.79	2.38	0.07	0.00	0.00	0.00	0.	0.	0.	0.
19.000	0.000	0.000	212.52	1.98	0.00	0.00	0.00	0.00	0.	0.	0.	0.
20.000	0.000	0.000	214.78	1.74	0.11	0.00	0.00	0.00	0.	0.	0.	0.
21.000	0.000	0.000	216.79	1.63	0.07	0.00	0.00	0.00	0.	0.	0.	0.
22.000	0.000	0.000	218.46	1.56	0.01	0.00	0.00	0.00	0.	0.	0.	0.
23.000	0.000	0.000	220.07	1.54	-0.02	0.00	0.00	0.00	0.	0.	0.	0.
24.000	0.000	0.000	221.71	1.63	0.05	0.00	0.00	0.00	0.	0.	0.	0.
25.000	0.000	0.000	223.28	1.70	0.10	0.00	0.00	0.00	0.	0.	0.	0.
26.000	0.000	0.000	224.89	1.86	0.19	0.00	0.00	0.00	0.	0.	0.	0.
27.000	0.000	0.000	226.37	2.01	0.34	0.00	0.00	0.00	0.	0.	0.	0.
28.000	0.000	0.000	227.70	2.07	0.29	0.00	0.00	0.00	0.	0.	0.	0.
29.000	0.000	0.000	229.01	2.24	0.13	0.00	0.00	0.00	0.	0.	0.	0.
30.000	0.000	0.000	230.29	2.39	0.02	0.00	0.00	0.00	0.	0.	0.	0.

TABLE C-9. September Moisture-Related Data, Nellis.

Z KM	VP MEAN		S.D. VP		TV MEAN		TV S.D.		SKEW TV		TD MEAN		S.D. TD		SKEW TD		NOBS	
	MB	MB	MB	MB	K	K	K	K	K	K	K	K	K	K	VP	TV	VP	TV
0.000	10.863	6.018	0.6131	301.56	11.39	0.40	278.96	9.48	-0.66	371.	371.							
1.000	8.042	3.409	0.7087	298.73	7.46	-0.06	275.81	6.28	-0.30	506.	506.							
1.007	8.016	3.391	0.6932	298.64	7.44	-0.06	275.78	6.28	-0.31	506.	506.							
2.000	6.195	2.378	0.6182	291.75	5.03	-0.81	272.40	5.60	-0.47	532.	532.							
3.000	4.595	1.960	0.3957	283.19	4.45	-0.91	268.02	6.56	-0.89	532.	532.							
4.000	2.741	1.579	0.5906	275.76	3.79	-1.18	260.41	8.30	-0.51	532.	532.							
5.000	1.441	1.090	1.1638	269.07	3.63	-1.27	251.77	9.04	0.00	532.	532.							
6.000	0.702	0.565	1.6136	262.42	3.70	-1.13	243.71	8.49	0.09	530.	530.							
7.000	0.362	0.278	1.7434	255.38	3.75	-0.97	237.11	7.95	-0.06	526.	528.							
8.000	0.207	0.158	1.8264	248.03	3.67	-0.68	231.45	7.79	-0.33	523.	523.							
9.000	0.108	0.079	1.8933	240.75	3.25	-0.11	225.67	7.37	-0.63	501.	502.							
10.000	0.063	0.044	1.0230	236.37	1.88	0.43	220.53	7.84	-0.73	223.	223.							
11.000	0.000	0.000	0.0000	226.43	3.44	-0.10	0.00	0.00	0.00	2.	2.							
12.000	0.000	0.000	0.0000	220.91	3.30	-0.25	0.00	0.00	0.00	0.	0.							
13.000	0.000	0.000	0.0000	216.42	2.88	-0.11	0.00	0.00	0.00	0.	0.							
14.000	0.000	0.000	0.0000	212.79	2.98	0.48	0.00	0.00	0.00	0.	0.							
15.000	0.000	0.000	0.0000	209.62	3.72	0.27	0.00	0.00	0.00	0.	0.							
16.000	0.000	0.000	0.0000	207.70	4.07	0.05	0.00	0.00	0.00	0.	0.							
17.000	0.000	0.000	0.0000	207.94	3.79	0.34	0.00	0.00	0.00	0.	0.							
18.000	0.000	0.000	0.0000	209.73	3.16	0.72	0.00	0.00	0.00	0.	0.							
19.000	0.000	0.000	0.0000	211.92	2.56	0.39	0.00	0.00	0.00	0.	0.							
20.000	0.000	0.000	0.0000	214.04	2.10	0.06	0.00	0.00	0.00	0.	0.							
21.000	0.000	0.000	0.0000	215.93	1.87	-0.01	0.00	0.00	0.00	0.	0.							
22.000	0.000	0.000	0.0000	217.60	1.76	-0.13	0.00	0.00	0.00	0.	0.							
23.000	0.000	0.000	0.0000	219.26	1.79	-0.01	0.00	0.00	0.00	0.	0.							
24.000	0.000	0.000	0.0000	220.94	1.89	0.00	0.00	0.00	0.00	0.	0.							
25.000	0.000	0.000	0.0000	222.40	1.89	0.15	0.00	0.00	0.00	0.	0.							
26.000	0.000	0.000	0.0000	223.82	1.88	0.27	0.00	0.00	0.00	0.	0.							
27.000	0.000	0.000	0.0000	225.13	1.93	0.08	0.00	0.00	0.00	0.	0.							
28.000	0.000	0.000	0.0000	226.29	2.09	-0.05	0.00	0.00	0.00	0.	0.							
29.000	0.000	0.000	0.0000	227.44	2.34	0.00	0.00	0.00	0.00	0.	0.							
30.000	0.000	0.000	0.0000	228.45	2.35	0.07	0.00	0.00	0.00	0.	0.							

TABLE C-10. October Moisture-Related Data, Nellis.

Z KM	VP MEAN		S.D. VP		TV MEAN		TV S.D.		SKEW TV		TD MEAN		S.D. TD		SKEW TD		NOBS		NOBS	
	MB	KB	MB	KB	K	K	K	K	K	K	K	K	K	K	VP	TV	VP	TV	TD	TD
0.000	7.673		3.914		293.52	11.83	0.52	0.52	274.61	7.64	-0.33	373.	373.							
1.000	5.768		2.386		291.82	7.91	-0.17	271.29	5.87	-0.43	539.	539.								
1.007	5.766		2.368		291.82	7.64	0.17	271.34	5.70	-0.13	539.	539.								
2.000	4.433		1.785		285.78	5.35	0.03	267.79	5.75	-0.51	543.	543.								
3.000	3.107		1.423		278.08	4.86	-0.24	262.64	7.22	-1.01	542.	542.								
4.000	1.652		1.008		271.79	4.51	-0.70	254.14	8.09	-0.30	542.	542.								
5.000	0.911		0.660		265.51	4.38	-0.76	246.96	8.06	0.05	543.	543.								
6.000	0.545		0.423		258.65	4.31	-0.76	240.96	8.58	-0.09	542.	542.								
7.000	0.307		0.250		251.38	4.16	-0.72	234.87	8.58	-0.21	541.	541.								
8.000	0.171		0.135		244.09	3.60	-0.20	229.22	8.50	-0.45	523.	523.								
9.000	0.094		0.066		237.58	2.65	0.55	224.13	7.78	-0.86	418.	418.								
10.000	0.064		0.047		235.27	1.50	0.68	220.30	8.42	-0.71	48.	48.								
11.000	0.000		0.000		223.20	3.37	0.43	0.00	0.00	0.00	0.	0.								
12.000	0.000		0.000		218.77	3.78	0.29	0.00	0.00	0.00	0.	0.								
13.000	0.000		0.000		215.45	3.95	-0.09	0.00	0.00	0.00	0.	0.								
14.000	0.000		0.000		212.83	3.70	0.04	0.00	0.00	0.00	0.	0.								
15.000	0.000		0.000		210.30	3.65	0.24	0.00	0.00	0.00	0.	0.								
16.000	0.000		0.000		208.55	3.73	0.29	0.00	0.00	0.00	0.	0.								
17.000	0.000		0.000		208.22	3.82	0.21	0.00	0.00	0.00	0.	0.								
18.000	0.000		0.000		209.23	3.44	0.17	0.00	0.00	0.00	0.	0.								
19.000	0.000		0.000		210.70	2.90	0.17	0.00	0.00	0.00	0.	0.								
20.000	0.000		0.000		212.24	2.50	0.18	0.00	0.00	0.00	0.	0.								
21.000	0.000		0.000		213.60	2.12	0.15	0.00	0.00	0.00	0.	0.								
22.000	0.000		0.000		215.09	1.97	0.21	0.00	0.00	0.00	0.	0.								
23.000	0.000		0.000		216.66	2.03	0.17	0.00	0.00	0.00	0.	0.								
24.000	0.000		0.000		218.24	2.10	0.15	0.00	0.00	0.00	0.	0.								
25.000	0.000		0.000		219.78	2.01	-0.15	0.00	0.00	0.00	0.	0.								
26.000	0.000		0.000		221.30	2.20	-0.29	0.00	0.00	0.00	0.	0.								
27.000	0.000		0.000		222.71	2.18	-0.29	0.00	0.00	0.00	0.	0.								
28.000	0.000		0.000		223.89	2.33	-0.10	0.00	0.00	0.00	0.	0.								
29.000	0.000		0.000		224.98	2.57	0.15	0.00	0.00	0.00	0.	0.								
30.000	0.000		0.000		225.96	2.61	0.05	0.00	0.00	0.00	0.	0.								

TABLE C-11. November Moisture-Related Data, Nellis.

Z KM	VP MEAN		S.D. VP		TV MEAN		TV S.D.		SKEW TV		TD MEAN		S.D. TD		SKEW TD		NOBS		NOBS	
	MB	MB	MB	VP	K	K	K	K	K	K	K	K	K	K	VP	TV	VP	TV	VP	TV
0.000	6.412	3.569	1.4446	287.39	10.75	0.32	271.86	8.26	-0.82	418.	418.									
1.000	4.667	2.173	0.9720	284.74	6.99	0.24	268.19	6.44	-0.39	538.	538.									
1.007	4.653	2.165	0.9715	284.70	6.97	0.24	268.16	6.43	-0.39	538.	538.									
2.000	3.419	1.663	0.7052	279.29	5.16	-0.11	263.97	6.69	-0.35	538.	538.									
3.000	2.208	1.298	0.6390	274.00	5.32	-0.36	257.73	8.16	-0.45	538.	538.									
4.000	1.252	0.879	1.1099	268.19	5.46	-0.62	250.52	8.45	-0.12	538.	538.									
5.000	0.785	0.600	1.2875	261.80	5.45	-0.75	244.80	9.03	-0.22	537.	537.									
6.000	0.492	0.392	1.1137	254.89	5.50	-0.80	239.30	9.66	-0.37	536.	536.									
7.000	0.283	0.229	1.2553	247.97	4.81	-0.48	233.58	9.67	-0.58	522.	522.									
8.000	0.153	0.115	1.1488	241.34	3.77	0.04	227.92	9.24	-0.82	471.	471.									
9.000	0.094	0.054	0.6799	236.62	2.07	0.47	224.69	7.17	-1.36	240.	240.									
10.000	0.037	0.023	0.0100	235.60	2.37	1.09	215.50	8.46	-0.31	11.	11.									
11.000	0.000	0.000	0.0000	220.91	3.98	0.60	0.00	0.00	0.00	0.	0.									
12.000	0.000	0.000	0.0000	216.99	4.95	0.36	0.00	0.00	0.00	0.	0.									
13.000	0.000	0.030	0.0000	214.79	4.85	0.11	0.00	0.00	0.00	0.	0.									
14.000	0.000	0.000	0.0000	212.86	4.30	0.29	0.00	0.00	0.00	0.	0.									
15.000	0.000	0.000	0.0000	210.75	4.21	0.43	0.00	0.00	0.00	0.	0.									
16.000	0.000	0.100	0.0000	209.07	4.36	0.35	0.00	0.00	0.00	0.	0.									
17.000	0.000	0.000	0.0000	208.38	4.04	-0.10	0.00	0.00	0.00	0.	0.									
18.000	0.000	0.000	0.0000	208.91	3.30	-0.04	0.00	0.00	0.00	0.	0.									
19.000	0.000	0.000	0.0000	210.12	2.61	0.17	0.00	0.00	0.00	0.	0.									
20.000	0.000	0.000	0.0000	211.36	2.26	-0.04	0.00	0.00	0.00	0.	0.									
21.000	0.000	0.000	0.0000	212.62	2.06	-0.08	0.00	0.00	0.00	0.	0.									
22.000	0.000	0.000	0.0000	213.94	2.12	-0.14	0.00	0.00	0.00	0.	0.									
23.000	0.000	0.000	0.0000	215.46	2.06	-0.16	0.00	0.00	0.00	0.	0.									
24.000	0.000	0.000	0.0000	216.81	2.22	0.06	0.00	0.00	0.00	0.	0.									
25.000	0.000	0.000	0.0000	218.03	2.55	0.23	0.00	0.00	0.00	0.	0.									
26.000	0.000	0.000	0.0000	219.17	2.88	0.56	0.00	0.00	0.00	0.	0.									
27.000	0.000	0.000	0.0000	220.30	3.06	0.90	0.00	0.00	0.00	0.	0.									
28.000	0.000	0.000	0.0000	221.47	3.27	1.02	0.00	0.00	0.00	0.	0.									
29.000	0.000	0.000	0.0000	222.83	3.75	1.38	0.00	0.00	0.00	0.	0.									
30.000	0.000	0.000	0.0000	224.11	3.85	1.36	0.00	0.00	0.00	0.	0.									

TABLE C-12. December Moisture-Related Data, Nellis.

Z	VP	S.D.	TV	TV	TV	S.D.	S.D.	S.D.	NOBS	NOBS	NOBS
KM	MEAN	MB	MEAN	MEAN	MEAN	VP	VP	VP	VP	TV	TD
	MB		K	K	K	K	K	K	VP	TV	TD
0.000	6.144	3.065	1.3231	284.07	10.60	0.09	271.86	6.69	473.	473.	472.
1.000	4.472	1.843	0.6228	281.21	6.23	0.22	267.88	5.74	542.	542.	542.
1.007	4.458	1.836	0.6237	281.18	6.22	0.22	267.85	5.74	542.	542.	542.
2.000	3.205	1.650	0.5679	277.27	4.83	-0.50	262.94	7.12	545.	545.	545.
3.000	1.993	1.250	0.7923	272.78	5.48	-0.82	256.26	8.45	545.	545.	545.
4.000	1.171	0.881	1.0689	266.92	5.58	-0.87	249.28	9.16	544.	544.	544.
5.000	0.717	0.614	1.3809	260.53	5.41	-0.97	243.19	9.73	543.	543.	543.
6.000	0.456	0.393	1.4159	253.70	5.11	-0.85	238.26	9.81	538.	538.	538.
7.000	0.258	0.224	1.4863	246.59	4.61	-0.41	232.43	9.80	529.	529.	529.
8.000	0.143	0.111	1.4969	240.25	3.53	0.23	227.39	8.94	444.	444.	444.
9.000	0.096	0.064	1.1117	236.39	2.24	0.23	224.65	7.47	162.	162.	162.
10.000	0.041	0.026	-0.2502	235.72	0.92	-0.07	217.30	7.43	8.	8.	8.
11.000	0.000	0.000	0.0000	219.58	4.36	0.70	0.00	0.00	0.00	0.00	0.00
12.000	0.000	0.000	0.0000	216.46	5.14	0.40	0.00	0.00	0.00	0.00	0.00
13.000	0.000	0.000	0.0000	214.80	5.26	-0.03	0.00	0.00	0.00	0.00	0.00
14.000	0.000	0.000	0.0000	213.47	4.49	-0.10	0.00	0.00	0.00	0.00	0.00
15.000	0.000	0.000	0.0000	211.54	4.06	0.09	0.00	0.00	0.00	0.00	0.00
16.000	0.000	0.000	0.0000	209.75	4.00	0.09	0.00	0.00	0.00	0.00	0.00
17.000	0.000	0.000	0.0000	208.77	3.89	-0.10	0.00	0.00	0.00	0.00	0.00
18.000	0.000	0.000	0.0000	208.57	3.60	-0.17	0.00	0.00	0.00	0.00	0.00
19.000	0.000	0.000	0.0000	209.59	3.22	0.11	0.00	0.00	0.00	0.00	0.00
20.000	0.000	0.000	0.0000	210.63	3.02	0.05	0.00	0.00	0.00	0.00	0.00
21.000	0.000	0.000	0.0000	211.68	3.03	0.26	0.00	0.00	0.00	0.00	0.00
22.000	0.000	0.000	0.0000	212.81	3.16	0.25	0.00	0.00	0.00	0.00	0.00
23.000	0.000	0.000	0.0000	214.01	3.27	0.25	0.00	0.00	0.00	0.00	0.00
24.000	0.000	0.000	0.0000	215.14	3.41	0.28	0.00	0.00	0.00	0.00	0.00
25.000	0.000	0.000	0.0000	216.27	3.39	0.20	0.00	0.00	0.00	0.00	0.00
26.000	0.000	0.000	0.0000	217.31	3.51	0.19	0.00	0.00	0.00	0.00	0.00
27.000	0.000	0.000	0.0000	218.40	3.56	0.28	0.00	0.00	0.00	0.00	0.00
28.000	0.000	0.000	0.0000	219.41	3.74	0.29	0.00	0.00	0.00	0.00	0.00
29.000	0.000	0.000	0.0000	220.21	3.83	0.33	0.00	0.00	0.00	0.00	0.00
30.000	0.000	0.000	0.0070	221.30	4.09	0.48	0.00	0.00	0.00	0.00	0.00

TABLE C-13. Annual Moisture-Related Data, Nellis.

Z KM	VP MEAN		S.D. VP		TV MEAN		TV S.D.		SKEW TV		TD MEAN		S.D. TD		SKEW TD		NOBS		NOBS		NOBS		
	MB	MB	MB	MB	K	K	K	K	K	K	K	K	K	K	K	K	VP	TV	TV	TV	TV	TD	
0.000	9.523	5.530	1.6634	293.69	13.35	0.36	275.47	8.79	-0.04	4409.	8.79	-0.04	4409.	8.79	-0.04	4409.	4409.	4409.	4409.	4409.	4409.	4409.	4407.
1.000	6.107	3.381	1.6379	291.64	10.92	0.11	271.54	7.06	0.17	6099.	7.06	0.17	6099.	7.06	0.17	6099.	6103.	6103.	6103.	6103.	6103.	6103.	6098.
1.007	6.095	3.366	1.6440	291.62	10.79	0.19	271.53	7.02	0.22	6099.	7.02	0.22	6099.	7.02	0.22	6099.	6103.	6103.	6103.	6103.	6103.	6103.	6101.
2.000	4.544	2.529	1.1972	285.44	8.89	-0.01	267.36	7.50	-0.27	6164.	7.50	-0.27	6164.	7.50	-0.27	6164.	6164.	6164.	6164.	6164.	6164.	6164.	6164.
3.000	3.201	2.037	1.0849	278.18	7.76	-0.16	262.04	8.98	-0.49	6158.	8.98	-0.49	6158.	8.98	-0.49	6158.	6158.	6158.	6158.	6158.	6158.	6158.	6158.
4.000	1.940	1.546	1.3118	271.31	7.03	-0.40	254.78	10.16	-0.17	6155.	10.16	-0.17	6155.	10.16	-0.17	6155.	6155.	6155.	6155.	6155.	6155.	6155.	6155.
5.000	1.088	1.030	1.7685	264.56	6.75	-0.54	247.34	10.47	0.03	6152.	10.47	0.03	6152.	10.47	0.03	6152.	6152.	6152.	6152.	6152.	6152.	6152.	6152.
6.000	0.591	0.589	2.1081	257.61	6.78	-0.54	240.57	10.16	-0.01	6130.	10.16	-0.01	6130.	10.16	-0.01	6130.	6130.	6130.	6130.	6130.	6130.	6130.	6130.
7.000	0.314	0.305	2.2640	250.66	6.52	-0.29	234.26	9.74	-0.24	6018.	9.74	-0.24	6018.	9.74	-0.24	6018.	6020.	6020.	6020.	6020.	6020.	6020.	6020.
8.000	0.177	0.164	2.2025	244.33	5.66	0.03	228.95	9.14	-0.36	5391.	9.14	-0.36	5391.	9.14	-0.36	5391.	5391.	5391.	5391.	5391.	5391.	5391.	5391.
9.000	0.107	0.099	1.8922	239.95	4.00	0.17	224.90	8.26	-0.49	3515.	8.26	-0.49	3515.	8.26	-0.49	3515.	3515.	3515.	3515.	3515.	3515.	3515.	3516.
10.000	0.067	0.053	1.1237	236.70	2.00	0.36	220.28	8.70	-0.48	1343.	8.70	-0.48	1343.	8.70	-0.48	1343.	1343.	1343.	1343.	1343.	1343.	1343.	1343.
11.000	0.036	0.038	1.1012	234.35	1.47	1.67	213.49	9.77	0.25	32.	9.77	0.25	32.	9.77	0.25	32.	32.	32.	32.	32.	32.	32.	32.
12.000	0.000	0.000	0.0000	218.26	5.08	-0.21	0.00	0.00	0.00	0.00	0.00	0.00	0.00	0.00	0.00	0.00	0.00	0.00	0.00	0.00	0.00	0.00	0.00
13.000	0.000	0.000	0.0000	215.78	4.45	-0.31	0.00	0.00	0.00	0.00	0.00	0.00	0.00	0.00	0.00	0.00	0.00	0.00	0.00	0.00	0.00	0.00	0.00
14.000	0.000	0.000	0.0000	213.73	4.09	0.11	0.00	0.00	0.00	0.00	0.00	0.00	0.00	0.00	0.00	0.00	0.00	0.00	0.00	0.00	0.00	0.00	0.00
15.000	0.000	0.000	0.0000	211.49	4.30	0.14	0.00	0.00	0.00	0.00	0.00	0.00	0.00	0.00	0.00	0.00	0.00	0.00	0.00	0.00	0.00	0.00	0.00
16.000	0.000	0.000	0.0000	209.84	4.39	0.10	0.00	0.00	0.00	0.00	0.00	0.00	0.00	0.00	0.00	0.00	0.00	0.00	0.00	0.00	0.00	0.00	0.00
17.000	0.000	0.000	0.0000	209.47	4.03	0.16	0.00	0.00	0.00	0.00	0.00	0.00	0.00	0.00	0.00	0.00	0.00	0.00	0.00	0.00	0.00	0.00	0.00
18.000	0.000	0.000	0.0000	210.16	3.50	0.07	0.00	0.00	0.00	0.00	0.00	0.00	0.00	0.00	0.00	0.00	0.00	0.00	0.00	0.00	0.00	0.00	0.00
19.000	0.000	0.000	0.0000	211.63	3.08	-0.17	0.00	0.00	0.00	0.00	0.00	0.00	0.00	0.00	0.00	0.00	0.00	0.00	0.00	0.00	0.00	0.00	0.00
20.000	0.000	0.000	0.0000	213.11	2.96	-0.44	0.00	0.00	0.00	0.00	0.00	0.00	0.00	0.00	0.00	0.00	0.00	0.00	0.00	0.00	0.00	0.00	0.00
21.000	0.000	0.000	0.0000	214.55	3.02	-0.56	0.00	0.00	0.00	0.00	0.00	0.00	0.00	0.00	0.00	0.00	0.00	0.00	0.00	0.00	0.00	0.00	0.00
22.000	0.000	0.000	0.0000	215.99	3.19	-0.60	0.00	0.00	0.00	0.00	0.00	0.00	0.00	0.00	0.00	0.00	0.00	0.00	0.00	0.00	0.00	0.00	0.00
23.000	0.000	0.000	0.0000	217.45	3.32	-0.64	0.00	0.00	0.00	0.00	0.00	0.00	0.00	0.00	0.00	0.00	0.00	0.00	0.00	0.00	0.00	0.00	0.00
24.000	0.000	0.000	0.0000	218.93	3.53	-0.63	0.00	0.00	0.00	0.00	0.00	0.00	0.00	0.00	0.00	0.00	0.00	0.00	0.00	0.00	0.00	0.00	0.00
25.000	0.000	0.000	0.0000	220.34	3.77	-0.64	0.00	0.00	0.00	0.00	0.00	0.00	0.00	0.00	0.00	0.00	0.00	0.00	0.00	0.00	0.00	0.00	0.00
26.000	0.000	0.000	0.0000	221.83	3.99	-0.55	0.00	0.00	0.00	0.00	0.00	0.00	0.00	0.00	0.00	0.00	0.00	0.00	0.00	0.00	0.00	0.00	0.00
27.000	0.000	0.000	0.0000	223.33	4.19	-0.54	0.00	0.00	0.00	0.00	0.00	0.00	0.00	0.00	0.00	0.00	0.00	0.00	0.00	0.00	0.00	0.00	0.00
28.000	0.000	0.000	0.0000	224.75	4.41	-0.50	0.00	0.00	0.00	0.00	0.00	0.00	0.00	0.00	0.00	0.00	0.00	0.00	0.00	0.00	0.00	0.00	0.00
29.000	0.000	0.000	0.0000	226.29	4.64	-0.48	0.00	0.00	0.00	0.00	0.00	0.00	0.00	0.00	0.00	0.00	0.00	0.00	0.00	0.00	0.00	0.00	0.00
30.000	0.000	0.000	0.0000	227.77	4.76	-0.50	0.00	0.00	0.00	0.00	0.00	0.00	0.00	0.00	0.00	0.00	0.00	0.00	0.00	0.00	0.00	0.00	0.00

APPENDIX D

Nellis Hydrostatic Model Atmospheres

Tables D-1 through D-13 provide hydrostatic model atmospheres (monthly and annual) from 0 to 30 km over Nellis. They were prepared as described in Chapter 3.

TABLE D-1. January Hydrostatic Model Atmosphere, Nellis.

Z KM	GEO. HT KM	PRESS MB	D G/M ³	TV K
0.000	0.000	1019.6911	1247.0576	284.87
1.000	0.999	903.8348	1118.9778	281.40
1.007	1.006	902.9464	1117.7261	281.44
2.000	1.998	799.4678	1007.1643	276.54
3.000	2.998	705.8961	905.6743	271.54
4.000	3.997	621.2950	814.1843	265.85
5.000	4.996	545.5237	732.7905	259.35
6.000	5.995	477.5684	659.1123	252.43
7.000	6.994	416.2574	590.0635	245.77
8.000	7.994	361.2471	525.5449	239.47
9.000	8.993	312.2661	461.8239	235.56
10.000	9.992	268.5816	418.5371	223.56
11.000	10.991	230.1756	366.8352	218.60
12.000	11.990	196.7687	316.4070	216.65
13.000	12.989	168.0210	270.3268	216.54
14.000	13.989	143.4610	231.6576	215.75
15.000	14.988	122.2764	199.5017	213.53
16.000	15.987	104.1672	171.7847	211.25
17.000	16.986	88.5321	146.8132	210.08
18.000	17.985	75.2502	124.8951	209.90
19.000	18.985	63.9901	105.8417	210.63
20.000	19.984	54.4278	89.6402	211.53
21.000	20.983	46.3507	76.0090	212.45
22.000	21.982	39.5006	64.4515	213.51
23.000	22.981	33.6619	54.6711	214.51
24.000	23.980	28.7353	46.4428	215.55
25.000	24.980	24.5333	39.4787	216.50
26.000	25.979	20.9731	33.5568	217.74
27.000	26.978	17.9578	28.5784	218.91
28.000	27.977	15.3916	24.3565	220.15
29.000	28.976	13.2231	20.7987	221.49
30.000	29.976	11.3721	17.7416	223.31

TABLE D-2. February Hydrostatic Model Atmosphere, Nellis.

Z KM	GEO. HT KM	PRESS MB	D G/M ³	TV K
0.000	0.000	1018.3234	1243.9452	285.20
1.000	0.999	902.5216	1112.2462	282.69
1.007	1.006	901.6420	1110.4373	282.88
2.000	1.998	798.5957	1003.7957	277.17
3.000	2.998	705.2631	905.2783	271.41
4.000	3.997	620.6314	814.4531	265.48
5.000	4.996	544.8500	733.3273	258.84
6.000	5.995	476.8356	660.0758	251.67
7.000	6.994	415.4601	591.6090	244.65
8.000	7.994	360.3682	525.7939	238.77
9.000	8.993	311.2759	459.9731	235.76
10.000	9.992	267.4960	419.2778	222.27
11.000	10.991	228.9944	367.6283	217.01
12.000	11.990	195.5664	316.2338	215.45
13.000	12.989	166.8987	268.8568	216.27
14.000	13.989	142.4945	229.9877	215.85
15.000	14.988	121.4931	197.7596	214.03
16.000	15.987	103.5487	169.9918	212.21
17.000	16.986	88.1051	145.4971	210.96
18.000	17.985	74.9203	123.8950	210.67
19.000	18.985	63.7549	105.0207	211.49
20.000	19.984	54.2601	88.9940	212.41
21.000	20.983	46.2307	75.4728	213.40
22.000	21.982	39.4367	64.0307	214.57
23.000	22.981	33.6490	54.3514	215.68
24.000	23.980	28.7424	46.1789	216.84
25.000	24.980	24.5744	39.2826	217.94
26.000	25.979	21.0265	33.4086	219.26
27.000	26.978	18.0201	28.4777	220.45
28.000	27.977	15.4582	24.3015	221.61
29.000	28.976	13.2737	20.7450	222.91
30.000	29.976	11.3917	17.6969	224.26

TABLE D-3. March Hydrostatic Model Atmosphere, Nellis.

Z KM	GEO. HT KM	PRESS MB	D G/M ³	TV K
0.000	0.000	1014.1003	1234.5122	286.18
1.000	0.999	899.6005	1099.2907	285.10
1.007	1.006	898.7208	1098.0696	285.14
2.000	1.998	796.4112	997.6733	278.10
3.000	2.998	703.5070	905.5203	270.66
4.000	3.997	618.8408	815.7649	264.28
5.000	4.996	542.9363	734.0604	257.68
6.000	5.995	474.7878	660.1654	250.56
7.000	6.994	413.4389	591.8405	243.37
8.000	7.994	358.3957	524.8762	237.88
9.000	8.993	309.4311	459.7570	234.47
10.000	9.992	265.8379	416.9131	222.14
11.000	10.991	227.6374	363.9537	217.90
12.000	11.990	194.5518	312.6791	216.77
13.000	12.989	166.1705	266.6818	217.08
14.000	13.989	141.9560	228.2260	216.69
15.000	14.988	121.1234	196.2431	215.03
16.000	15.987	103.3121	168.7857	213.24
17.000	16.986	88.0147	144.4143	212.33
18.000	17.985	74.9237	123.1321	211.99
19.000	18.985	63.8132	104.6304	212.48
20.000	19.984	54.3510	88.8438	213.13
21.000	20.983	46.3375	75.4743	213.89
22.000	21.982	39.5204	64.1588	214.60
23.000	22.981	33.7133	54.4750	215.61
24.000	23.980	28.7851	46.2929	216.63
25.000	24.980	24.6073	39.3741	217.73
26.000	25.979	21.0497	33.4633	219.15
27.000	26.978	18.0509	28.4974	220.67
28.000	27.977	15.4921	24.2707	222.23
29.000	28.976	13.2918	20.6761	223.96
30.000	29.976	11.4034	17.5972	225.76

TABLE D-4. April Hydrostatic Model Atmosphere, Nellis.

Z KM	GEO. HT KM	PRESS MB	D G/M ³	TV K
0.000	0.000	1012.3194	1216.5879	289.89
1.000	0.999	899.0871	1082.6493	289.32
1.007	1.006	898.2267	1081.7562	289.28
2.000	1.998	797.2490	984.4452	282.14
3.000	2.998	705.4531	896.8954	274.02
4.000	3.997	621.4714	810.6966	267.07
5.000	4.996	546.0102	730.1463	260.52
6.000	5.995	478.2068	657.3891	253.43
7.000	6.994	417.0353	589.1108	246.62
8.000	7.994	362.1951	526.0147	239.88
9.000	8.993	313.3363	463.9979	235.26
10.000	9.992	269.6386	418.5951	224.41
11.000	10.991	231.1252	368.6620	218.41
12.000	11.990	197.4654	320.3438	214.75
13.000	12.989	168.3572	273.4150	214.52
14.000	13.989	143.5921	232.9848	214.71
15.000	14.988	122.3894	199.5366	213.69
16.000	15.987	104.2975	170.8206	212.71
17.000	16.986	88.8048	145.7564	212.26
18.000	17.985	75.5996	123.9944	212.41
19.000	18.985	64.4122	105.2721	213.16
20.000	19.984	54.8895	89.4035	213.89
21.000	20.983	46.8194	75.9392	214.79
22.000	21.982	39.9722	64.4807	215.97
23.000	22.981	34.1387	54.7288	217.31
24.000	23.980	29.1757	46.5170	218.51
25.000	24.980	24.9748	39.5296	220.11
26.000	25.979	21.3847	33.5935	221.77
27.000	26.978	18.3537	28.6195	223.42
28.000	27.977	15.7756	24.4125	225.13
29.000	28.976	13.5689	20.8230	227.02
30.000	29.976	11.6563	17.7463	228.83

TABLE D-5. May Hydrostatic Model Atmosphere, Nellis.

Z KM	GEO. HT KM	PRESS MB	D G/M ³	TV K
0.000	0.000	1008.0833	1184.3793	296.53
1.000	0.999	897.4384	1059.6443	295.05
1.007	1.006	896.6083	1058.8662	295.00
2.000	1.998	797.6146	965.5542	287.79
3.000	2.998	707.4376	882.7571	279.19
4.000	3.997	624.6033	801.6915	271.43
5.000	4.996	549.8811	724.2132	264.52
6.000	5.995	482.6646	653.0340	257.49
7.000	6.994	421.8314	587.1521	250.29
8.000	7.994	367.1010	525.8607	243.20
9.000	8.993	318.2796	467.5562	237.16
10.000	9.992	274.6053	407.8883	234.54
11.000	10.991	235.8472	371.7148	221.04
12.000	11.990	201.7642	324.9630	216.31
13.000	12.989	172.1448	279.7353	214.39
14.000	13.989	146.8094	238.7670	214.21
15.000	14.988	125.0848	204.0045	213.61
16.000	15.987	106.5718	174.7362	212.48
17.000	16.986	90.7838	149.2434	211.92
18.000	17.985	77.2700	126.9966	211.97
19.000	18.985	65.7982	107.7329	212.78
20.000	19.984	56.0727	91.2556	214.07
21.000	20.983	47.8379	77.2471	215.75
22.000	21.982	40.8919	65.5325	217.39
23.000	22.981	34.9612	55.5883	219.11
24.000	23.980	29.9119	47.1828	220.86
25.000	24.980	25.6553	40.1611	222.55
26.000	25.979	22.0105	34.1768	224.37
27.000	26.978	18.9113	29.1298	226.17
28.000	27.977	16.2751	24.8713	227.97
29.000	28.976	14.0182	21.2539	229.78
30.000	29.976	12.0721	18.1605	231.59

TABLE D-6. June Hydrostatic Model Atmosphere, Nellis.

Z KM	GEO. HT KM	PRESS MB	D G/M ³	TV K
0.000	0.000	1006.6837	1161.1521	302.04
1.000	0.999	898.1988	1041.5760	300.43
1.007	1.006	897.2213	1040.6753	300.36
2.000	1.998	800.0531	949.8742	293.43
3.000	2.998	711.2185	870.1947	284.74
4.000	3.997	629.3964	792.2160	276.78
5.000	4.996	555.4234	718.0855	269.47
6.000	5.995	488.9012	649.1309	262.39
7.000	6.994	428.2306	584.8147	255.10
8.000	7.994	373.7435	525.9165	247.58
9.000	8.993	324.8088	471.2259	240.14
10.000	9.992	281.2709	416.6161	235.20
11.000	10.991	242.2629	374.8826	225.14
12.000	11.990	207.6807	330.0125	219.24
13.000	12.989	177.4817	286.9051	215.51
14.000	13.989	151.3882	247.1056	213.44
15.000	14.988	128.8479	212.2853	211.45
16.000	15.987	109.5733	181.8661	209.90
17.000	16.986	93.1668	155.1943	209.14
18.000	17.985	79.1620	131.2444	210.13
19.000	18.985	67.3519	110.5375	212.27
20.000	19.984	57.4012	93.2819	214.38
21.000	20.983	48.9731	78.8760	216.31
22.000	21.982	41.8829	66.8799	218.17
23.000	22.981	35.8301	56.7412	219.99
24.000	23.980	30.6673	48.1623	221.83
25.000	24.980	26.3306	40.9940	223.77
26.000	25.979	22.6128	34.9262	225.56
27.000	26.978	19.4477	29.8008	227.35
28.000	27.977	16.7487	25.4732	229.06
29.000	28.976	14.4360	21.7920	230.78
30.000	29.976	12.4491	18.6533	232.51

TABLE D-7. July Hydrostatic Model Atmosphere, Nellis.

Z KM	GEO. HT KM	PRESS MB	D G/M ³	TV K
0.000	0.000	1006.9894	1146.6211	305.96
1.000	0.999	899.8860	1032.6690	303.59
1.007	1.006	899.0186	1031.8735	303.53
2.000	1.998	802.5696	942.8218	296.56
3.000	2.998	714.2866	864.2921	287.92
4.000	3.997	633.0849	788.1207	279.85
5.000	4.996	559.4796	715.3792	272.46
6.000	5.995	493.1648	647.0621	265.52
7.000	6.994	432.6713	582.7907	258.64
8.000	7.994	378.4316	524.2049	251.50
9.000	8.993	329.5564	470.3848	244.08
10.000	9.992	286.2106	420.4005	237.18
11.000	10.991	247.2235	366.6635	234.90
12.000	11.990	212.3934	332.3269	222.66
13.000	12.989	181.7977	292.2481	216.72
14.000	13.989	155.0642	255.3969	211.52
15.000	14.988	131.7455	220.8968	207.78
16.000	15.987	111.7269	188.6073	206.37
17.000	16.986	94.7599	159.3123	207.22
18.000	17.985	80.4339	133.9051	209.27
19.000	18.985	68.4010	112.3641	212.08
20.000	19.984	58.3066	94.6494	214.61
21.000	20.983	49.7421	79.9455	216.76
22.000	21.982	42.5618	67.7839	218.75
23.000	22.981	36.4312	57.5606	220.50
24.000	23.980	31.1966	48.9191	222.17
25.000	24.980	26.7799	41.6672	223.91
26.000	25.979	23.0044	35.5168	225.65
27.000	26.978	19.7818	30.3124	227.35
28.000	27.977	17.0402	25.9294	228.95
29.000	28.976	14.6904	22.1944	230.59
30.000	29.976	12.6614	19.0055	232.09

TABLE D-8. August Hydrostatic Model Atmosphere, Nellis.

Z KM	GEO. HT KM	PRESS MB	D G/M ³	TV K
0.000	0.000	1008.0256	1146.8692	306.21
1.000	0.999	900.7066	1035.4380	303.05
1.007	1.006	899.3405	1034.1990	302.95
2.000	1.998	803.1205	945.0663	296.06
3.000	2.998	714.6033	866.3698	287.36
4.000	3.997	633.2090	789.8457	279.29
5.000	4.996	559.4481	716.5457	272.00
6.000	5.995	493.0628	647.8027	265.17
7.000	6.994	432.5181	583.4286	258.27
8.000	7.994	378.2118	524.8839	251.03
9.000	8.993	329.2825	471.0719	243.52
10.000	9.992	285.8239	419.7316	237.24
11.000	10.991	246.8184	367.3992	234.04
12.000	11.990	212.0242	332.0527	222.45
13.000	12.989	181.4692	291.6414	216.78
14.000	13.989	154.8157	254.5427	211.89
15.000	14.988	131.5719	220.0784	208.28
16.000	15.987	111.6117	188.1680	206.64
17.000	16.986	94.6452	158.8516	207.57
18.000	17.985	80.3675	133.4613	209.79
19.000	18.985	68.3627	112.0674	212.52
20.000	19.984	58.2859	94.5409	214.78
21.000	20.983	49.7345	79.9221	216.79
22.000	21.982	42.5500	67.8552	218.46
23.000	22.981	36.4130	57.6435	220.07
24.000	23.980	31.1710	48.9802	221.71
25.000	24.980	26.7447	41.7292	223.28
26.000	25.979	22.9642	35.5748	224.89
27.000	26.978	19.7387	30.3779	226.37
28.000	27.977	16.9860	25.9889	227.70
29.000	28.976	14.6274	22.2523	229.01
30.000	29.976	12.5972	19.0570	230.29

TABLE D-9. September Hydrostatic Model Atmosphere, Nellis.

Z KM	GEO. HT KM	PRESS MB	D G/M ³	TV K
0.000	0.000	1009.2957	1166.0282	301.56
1.000	0.999	900.2221	1049.8397	298.73
1.007	1.006	898.8437	1048.5662	298.64
2.000	1.998	801.2171	956.7482	291.75
3.000	2.998	711.7420	875.6017	283.19
4.000	3.997	629.6457	795.4797	275.76
5.000	4.996	555.4503	719.1750	269.07
6.000	5.995	488.7572	648.8648	262.42
7.000	6.994	428.1639	584.0953	255.38
8.000	7.994	373.7450	524.9625	248.03
9.000	8.993	324.8991	470.1563	240.75
10.000	9.992	281.4709	414.8507	236.37
11.000	10.991	242.6273	360.9504	234.18
12.000	11.990	208.2034	328.3513	220.91
13.000	12.989	178.0319	286.5911	216.42
14.000	13.989	151.9224	248.7243	212.79
15.000	14.988	129.1737	214.6883	209.62
16.000	15.987	109.6878	183.9818	207.70
17.000	16.986	93.0949	155.9733	207.94
18.000	17.985	79.0498	131.3103	209.73
19.000	18.985	67.2306	110.5251	211.92
20.000	19.984	57.2821	93.2350	214.04
21.000	20.983	48.8543	78.8231	215.93
22.000	21.982	41.7662	66.8686	217.60
23.000	22.981	35.7178	56.7526	219.26
24.000	23.980	30.5643	48.1943	220.94
25.000	24.980	26.2088	41.0554	222.40
26.000	25.979	22.4885	35.0040	223.82
27.000	26.978	19.3049	29.8743	225.13
28.000	27.977	16.6037	25.5619	226.29
29.000	28.976	14.2857	21.8824	227.44
30.000	29.976	12.2905	18.7429	228.45

TABLE D-10. October Hydrostatic Model Atmosphere, Nellis.

Z KM	GEO. HT KM	PRESS MB	D G/M ³	TV K
0.000	0.000	1014.2491	1203.8255	293.52
1.000	0.999	901.8252	1076.6443	291.82
1.007	1.006	900.7736	1075.3767	291.82
2.000	1.998	800.8971	976.3585	285.78
3.000	2.998	709.7579	889.2044	278.08
4.000	3.997	626.6097	803.1901	271.79
5.000	4.996	551.7638	723.9950	265.51
6.000	5.995	484.6218	652.7419	258.65
7.000	6.994	423.7357	587.2407	251.38
8.000	7.994	369.0244	526.6910	244.09
9.000	8.993	320.1422	469.4467	237.58
10.000	9.992	276.5477	409.4996	235.27
11.000	10.991	237.8449	371.2359	223.20
12.000	11.990	203.7985	324.5490	218.77
13.000	12.989	174.0470	281.4329	215.45
14.000	13.989	148.4669	243.0232	212.83
15.000	14.988	126.2364	209.1241	210.30
16.000	15.987	107.2599	179.1766	208.55
17.000	16.986	91.0983	152.4235	208.22
18.000	17.985	77.3449	128.7821	209.23
19.000	18.985	65.7581	108.7266	210.70
20.000	19.984	55.9465	91.8350	212.24
21.000	20.983	47.6575	77.7309	213.60
22.000	21.982	40.6562	65.8509	215.09
23.000	22.981	34.7005	55.7965	216.66
24.000	23.980	29.6536	47.3361	218.24
25.000	24.980	25.3839	40.2375	219.78
26.000	25.979	21.7379	34.2211	221.30
27.000	26.978	18.6513	29.1759	222.71
28.000	27.977	16.0101	24.9120	223.89
29.000	28.976	13.7560	21.3013	224.98
30.000	29.976	11.8188	18.2217	225.96

TABLE D-11. November Hydrostatic Model Atmosphere, Nellis.

Z KM	GEO. HT KM	PRESS MB	D G/M ³	TV K
0.000	0.000	1016.9615	1232.7749	287.39
1.000	0.999	902.4134	1104.1156	284.74
1.007	1.006	901.5385	1103.1906	284.70
2.000	1.998	799.2332	996.9408	279.29
3.000	2.998	706.5717	898.3767	274.00
4.000	3.997	622.6450	808.8348	268.19
5.000	4.996	547.3289	728.3519	261.80
6.000	5.995	479.7301	655.6903	254.89
7.000	6.994	418.7028	588.2539	247.97
8.000	7.994	363.9607	525.3920	241.34
9.000	8.993	315.1610	464.0317	236.62
10.000	9.992	271.6761	401.7311	235.60
11.000	10.991	233.2205	367.7897	220.91
12.000	11.990	199.5720	320.4118	216.99
13.000	12.989	170.3047	276.2335	214.79
14.000	13.989	145.2022	237.6543	212.86
15.000	14.988	123.5004	204.1565	210.75
16.000	15.987	104.9845	174.9391	209.07
17.000	16.986	89.1897	149.1142	208.38
18.000	17.985	75.7186	126.2724	208.91
19.000	18.985	64.3465	106.6878	210.12
20.000	19.984	54.7176	90.1902	211.36
21.000	20.983	46.5923	76.3442	212.62
22.000	21.982	39.7130	64.6696	213.94
23.000	22.981	33.8698	54.7661	215.46
24.000	23.980	28.9123	46.4571	216.81
25.000	24.980	24.7167	39.4942	218.03
26.000	25.979	21.1346	33.5939	219.17
27.000	26.978	18.1104	28.6402	220.30
28.000	27.977	15.5205	24.4150	221.47
29.000	28.976	13.3119	20.8122	222.83
30.000	29.976	11.4296	17.7675	224.11

TABLE D-12. December Hydrostatic Model Atmosphere, Nellis.

Z KM	GEO. HT KM	PRESS MB	D G/M ³	TV K
0.000	0.000	1020.4846	1251.5015	284.07
1.000	0.999	904.1017	1120.0529	281.21
1.007	1.006	903.2093	1119.0651	281.18
2.000	1.998	799.8099	1004.9454	277.27
3.000	2.998	706.5395	902.3788	272.78
4.000	3.997	622.1421	812.0096	266.92
5.000	4.996	546.5886	730.9006	260.53
6.000	5.995	478.8665	657.5896	253.70
7.000	6.994	417.6487	590.0478	246.59
8.000	7.994	362.7275	525.9792	240.25
9.000	8.993	313.8119	462.4806	236.39
10.000	9.992	270.1600	399.2758	235.72
11.000	10.991	231.7293	367.6570	219.58
12.000	11.990	198.1620	318.9286	216.46
13.000	12.989	169.0795	274.2309	214.80
14.000	13.989	144.1816	235.3062	213.47
15.000	14.988	122.6979	202.0742	211.54
16.000	15.987	104.3687	173.3510	209.75
17.000	16.986	88.6658	147.9595	208.77
18.000	17.985	75.2648	125.7152	208.57
19.000	18.985	63.9383	106.2816	209.59
20.000	19.984	54.3407	89.8810	210.63
21.000	20.983	46.2538	76.1238	211.68
22.000	21.982	39.3981	64.4978	212.81
23.000	22.981	33.5697	54.6475	214.01
24.000	23.980	28.6339	46.3677	215.14
25.000	24.980	24.4481	39.3823	216.27
26.000	25.979	20.8760	33.4680	217.31
27.000	26.978	17.8730	28.5104	218.40
28.000	27.977	15.3027	24.2982	219.41
29.000	28.976	13.1067	20.7354	220.21
30.000	29.976	11.2139	17.6536	221.30

TABLE D-13. Annual Hydrostatic Model Atmosphere, Nellis.

Z KM	GEO. HT KM	PRESS MB	D G/M ³	TV K
0.000	0.000	1013.1313	1201.7952	293.69
1.000	0.999	900.8420	1076.1218	291.64
1.007	1.006	899.8594	1075.0252	291.62
2.000	1.998	799.7914	976.1532	285.44
3.000	2.998	708.6985	887.5602	278.18
4.000	3.997	625.5273	803.2364	271.31
5.000	4.996	550.6571	725.1383	264.56
6.000	5.995	483.3957	655.7187	257.61
7.000	6.994	422.4560	587.1582	250.66
8.000	7.994	367.7538	524.3619	244.33
9.000	8.993	318.8478	462.9279	239.95
10.000	9.992	275.2841	405.1813	236.70
11.000	10.991	236.6350	351.7864	234.35
12.000	11.990	202.6529	323.4745	218.26
13.000	12.989	173.1004	279.4796	215.78
14.000	13.989	147.6945	240.7392	213.73
15.000	14.988	125.7097	207.0820	211.49
16.000	15.987	106.9148	177.4998	209.84
17.000	16.986	90.8507	151.1015	209.47
18.000	17.985	77.1980	127.9713	210.16
19.000	18.985	65.6818	108.1246	211.63
20.000	19.984	55.9307	91.4332	213.11
21.000	20.983	47.6888	77.4350	214.55
22.000	21.982	40.7273	65.6911	215.99
23.000	22.981	34.7877	55.7337	217.45
24.000	23.980	29.7521	47.3449	218.93
25.000	24.980	25.4707	40.2724	220.34
26.000	25.979	21.8263	34.2783	221.83
27.000	26.978	18.7469	29.2439	223.33
28.000	27.977	16.1135	24.9775	224.75
29.000	28.976	13.8767	21.3636	226.29
30.000	29.976	11.9407	18.2637	227.77

APPENDIX E

Wind Statistics Derivable from Appendix A Tables

Appendix E gives a few graphic examples of certain wind statistics that can be derived from basic data in Appendix A. These examples should help RRA users understand the functional relationships of the probability wind models and develop an appreciation for the powerful properties of the bivariate normal probability distribution function. Only a few of the many options in deriving wind statistics are illustrated here.

All illustrations for this appendix were derived for the five wind component statistical parameters from Table A-1 (January) and Table A-7 (July) for nine selected altitudes; these are: 2, 4, 8, 12, 16, 20, 24, 28, and 30 km. Descriptions of Tables E-1 and E-2 and Figures E-1 through E-72 follow:

Wind Speed (Tables E-1 and E-2)

The five wind components from Appendix A are used as inputs to the generalized Rayleigh probability density function (equation 29), then integrated as indicated by equation 30 to obtain the probability distribution function for wind speed. The derived distribution functions for wind speed are shown in Tables E-1 and E-2 on the normal probability scale.

Frequency of Wind Direction (Figures E-1 through E-18)

The derived frequencies for wind direction shown in Figures E-5 through E-20 were obtained using the five wind component parameters from Tables A-1 and A-7 as input values in equation 35. The limits of integration (performed numerically) are over the 22.5-degree interval for each of the 16 compass points. The graphs give the percentage frequency that the wind will blow from the direction intervals.

Mean Wind Components and 80th Interpercentile Range of Wind Components (Figures E-19 through E-36)

Wind component means with respect to any orthogonal axis are obtained by using the zonal and meridional mean wind components in equations 44 and 45. These component means form the circle shown in Figures E-19 through E-36. The zonal and meridional wind component variances and correlation coefficients are then used in equations 46 and 47 to obtain the variances with respect to any orthogonal axis. These rotated component variances and the rotated component means are used in equation 8 to obtain the 80th interpercentile range of wind components, as shown in Figures E-19 through E-36.

Probability Ellipses (Figures E-37 through E-54)

Using the five wind component parameters from Tables A-1 and A-7, and $p = 0.50$, $p = 0.95$, and $p = 0.99$ as input values to equation 13, the wind probability ellipses shown in Figures E-37 through E-54 were produced with computer graphics, using the standard meteorological coordinate system explained in Chapter 1. Statistical inferences are, for example, that 50 percent of the wind vectors lie within the smaller ellipse, and that 99 percent lie within the outer ellipse.

Conditional Wind Speed Given Wind Direction (Figures E-55 through E-72)

The five wind component parameters from Tables A-1 and A-7 were used to evaluate the conditional probability distribution function, equation 41. Interpolations of the conditional function are made to obtain the 5th, 15th, 50th (median), 85th, 95th, and 99th conditional percentile values of wind speed, given wind directions, are as shown in Figures E-55 through E-72. The conditional mean wind speed, given wind direction, is obtained from equation 40. The conditional mode (most probable) wind speed given wind direction is obtained from equation 38. The conditional mean wind speed and the conditional wind speed modal value, given the wind direction, are also shown. For some figures, conditional wind speed values are invalid for a given wind direction near 270 degrees (from the west); this is caused by the lack of computational precision in evaluating equations 40 and 41 when arguments for the Gaussian probability distribution have large negative values; i.e., when the coefficients (b/a) become less than -4 in these equations.

TABLE E-1. Derived (Rayleigh) Percentiles for Windspeed (M/S), January.

PERCENTILE	ALTITUDE (KM)								
	2 KM	4 KM	8 KM	12 KM	16 KM	20 KM	24 KM	28 KM	30 KM
0.010	0.720	1.396	2.745	3.521	2.746	1.014	1.242	1.768	2.036
0.025	1.140	2.211	4.357	5.534	4.270	1.608	1.972	2.810	3.232
0.050	1.624	3.142	6.177	7.789	5.914	2.281	2.795	4.018	4.624
0.100	2.335	4.492	8.791	10.936	8.109	3.257	3.991	5.786	6.669
0.150	2.912	5.574	10.861	13.341	9.708	4.030	4.943	7.222	8.332
0.200	3.431	6.523	12.669	15.379	11.032	4.708	5.779	8.497	9.826
0.300	4.384	8.216	15.867	18.899	13.250	5.922	7.285	10.853	12.605
0.400	5.313	9.799	18.808	22.058	15.200	7.058	8.716	13.154	15.351
0.500	6.281	11.372	21.705	25.109	17.054	8.198	10.184	15.573	18.270
0.600	7.352	13.025	24.718	28.238	18.934	9.413	11.788	18.272	21.572
0.700	8.616	14.867	28.046	31.662	20.971	10.796	13.675	21.508	25.547
0.800	10.253	17.106	32.040	35.747	23.382	12.531	16.131	25.718	30.728
0.850	11.335	18.519	34.553	38.305	24.870	13.655	17.761	28.513	34.161
0.900	12.768	20.338	37.757	41.565	26.757	15.134	19.936	32.203	38.650
0.950	15.013	23.131	42.641	46.522	29.563	17.448	23.355	37.943	45.659
0.975	17.057	25.645	46.976	50.926	32.040	19.553	26.473	43.111	51.949
0.990	19.512	28.625	52.217	56.289	34.917	22.076	30.218	49.224	59.343

TABLE E-2. Derived (Rayleigh) Percentiles for Windspeed (M/S), July.

PERCENTILE	ALTITUDE (KM)								
	2 KM	4 KM	8 KM	12 KM	16 KM	20 KM	24 KM	28 KM	30 KM
0.010	0.668	0.803	1.494	2.481	0.992	1.828	6.273	8.928	9.578
0.025	1.065	1.272	2.365	3.904	1.574	2.485	7.136	9.896	10.686
0.050	1.522	1.808	3.361	5.528	2.241	3.080	7.884	10.713	11.632
0.100	2.206	2.589	4.805	7.845	3.210	3.796	8.750	11.670	12.725
0.150	2.768	3.211	5.953	9.642	3.985	4.293	9.337	12.318	13.470
0.200	3.277	3.759	6.962	11.193	4.667	4.692	9.807	12.835	14.063
0.300	4.229	4.744	8.770	13.898	5.895	5.348	10.570	13.676	15.029
0.400	5.155	5.668	10.457	16.361	7.045	5.916	11.221	14.392	15.851
0.500	6.102	6.593	12.131	18.747	8.194	6.453	11.832	15.066	16.625
0.600	7.103	7.571	13.883	21.196	9.407	6.994	12.442	15.736	17.399
0.700	8.212	8.670	15.828	23.874	10.760	7.578	13.095	16.456	18.226
0.800	9.543	10.017	18.178	27.059	12.406	8.269	13.863	17.302	19.200
0.850	10.369	10.873	19.650	29.034	13.441	8.695	14.334	17.821	19.796
0.900	11.415	11.974	21.523	31.540	14.762	9.233	14.926	18.472	20.544
0.950	12.974	13.654	24.339	35.276	16.765	10.037	15.799	19.430	21.655
0.975	14.337	15.155	26.837	38.581	18.541	10.751	16.565	20.270	22.625
0.990	15.957	16.956	29.819	42.461	20.628	11.602	17.464	21.262	23.777

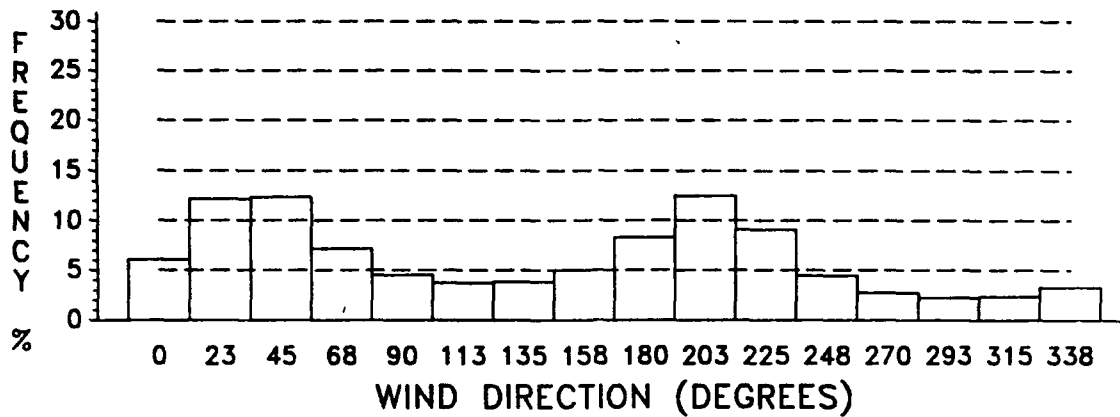

Figure E-1. Wind Direction Frequency, January, 2 KM.

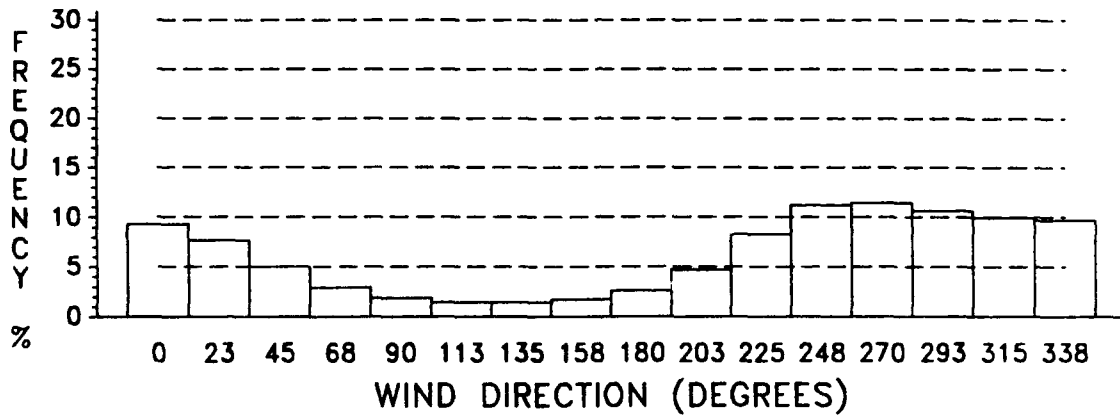

Figure E-2. Wind Direction Frequency, January, 4 KM.

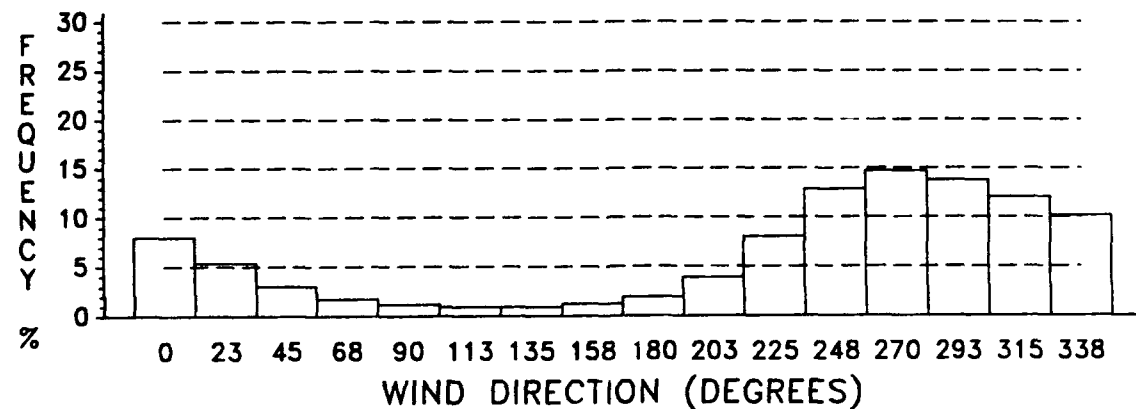

Figure E-3. Wind Direction Frequency, January, 8 KM.

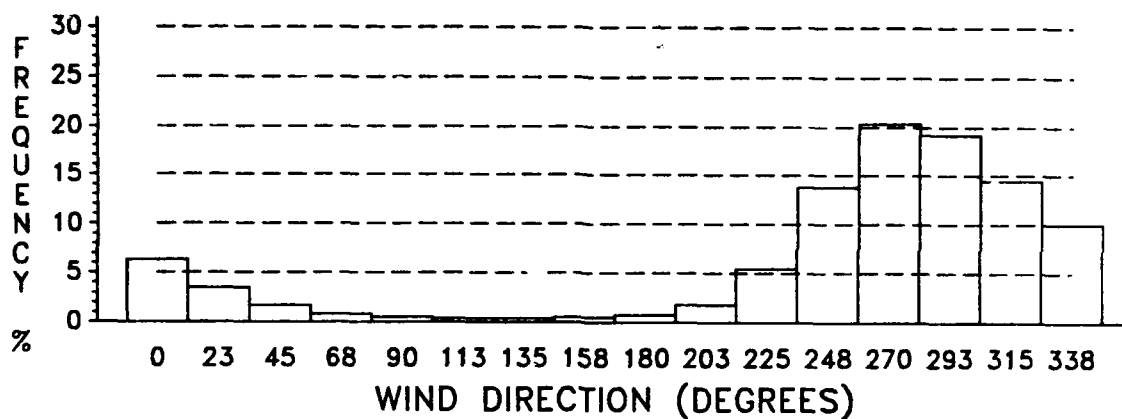

Figure E-4. Wind Direction Frequency, January, 12 KM.

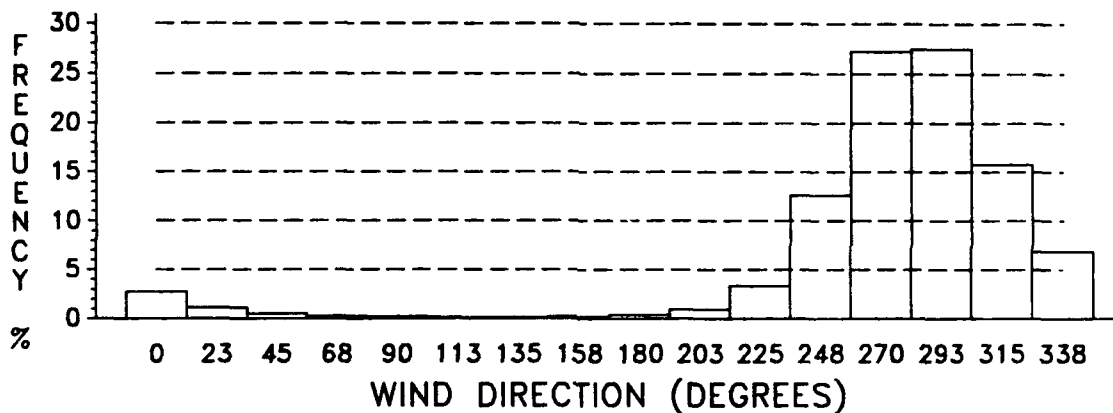

Figure E-5. Wind Direction Frequency, January, 16 KM.

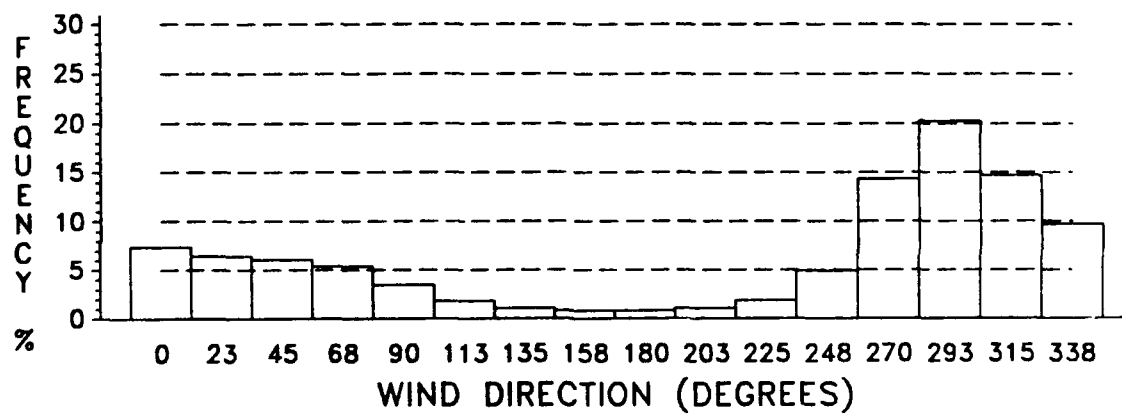

Figure E-6. Wind Direction Frequency, January, 20 KM.

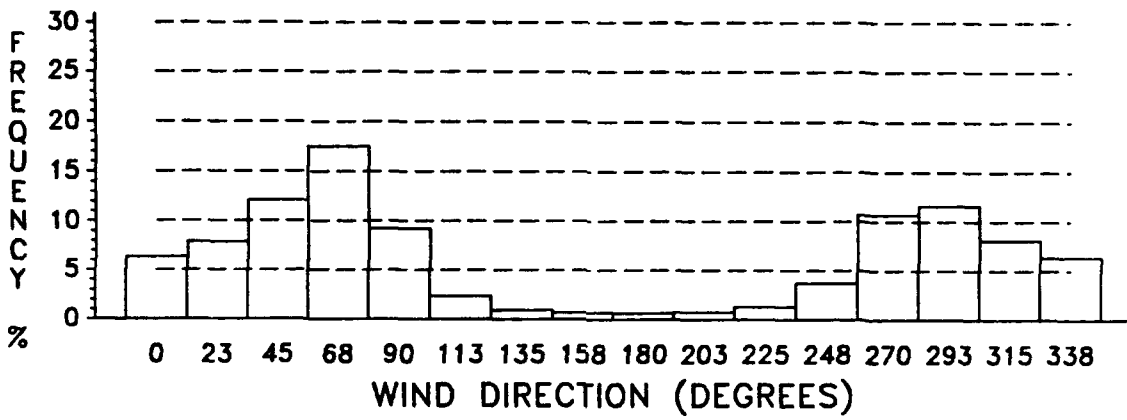

Figure E-7. Wind Direction Frequency, January, 24 KM.

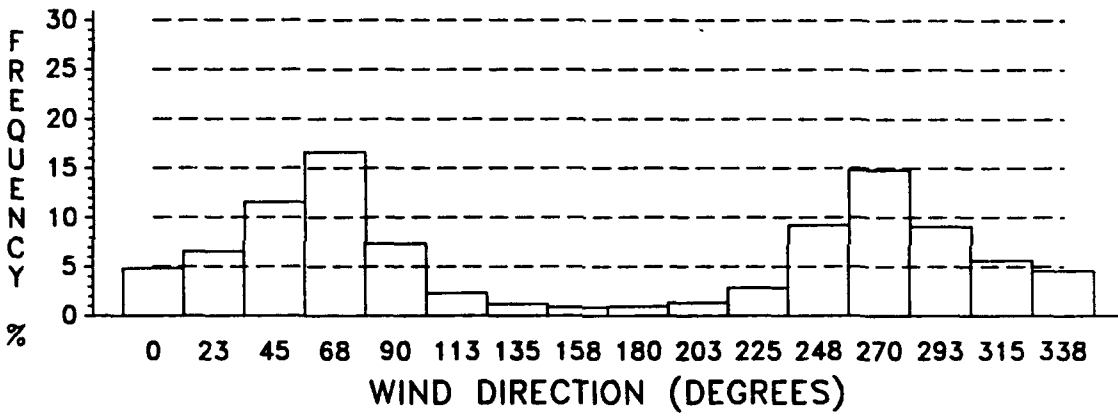

Figure E-8. Wind Direction Frequency, January, 28 KM.

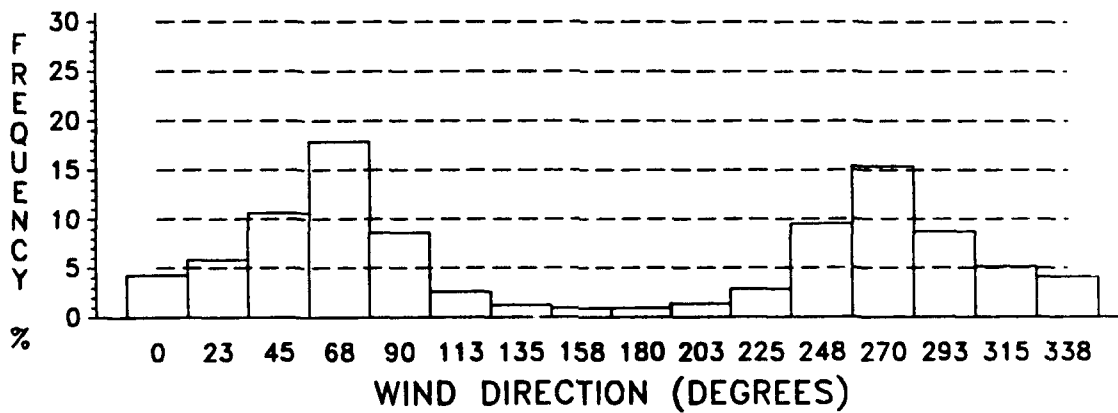

Figure E-9. Wind Direction Frequency, January, 30 KM.

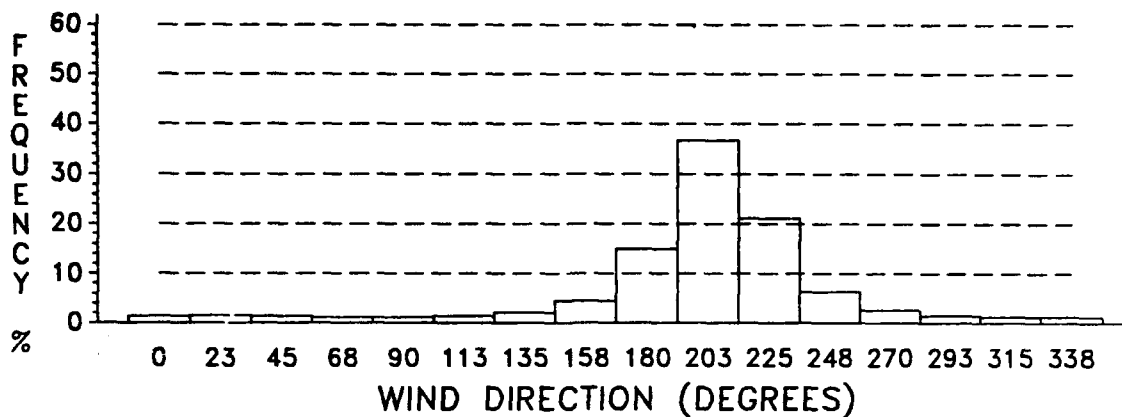

Figure E-10. Wind Direction Frequency, July, 2 KM.

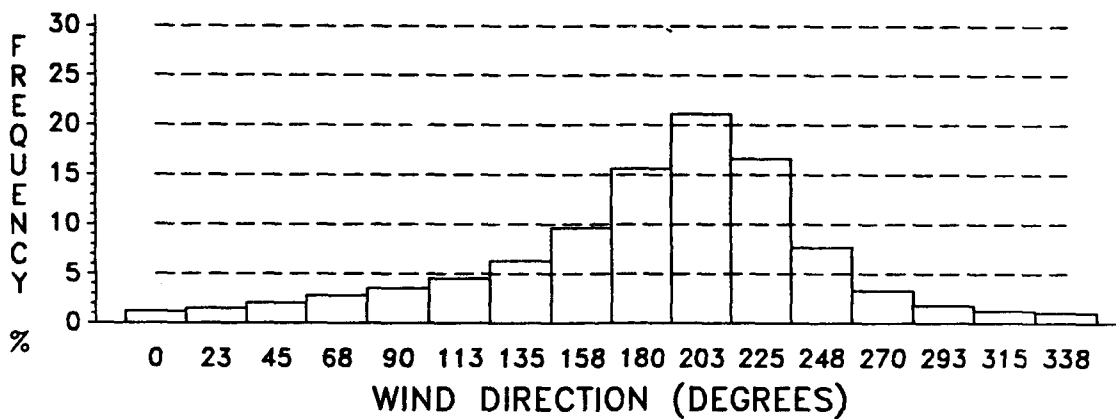

Figure E-11. Wind Direction Frequency, July, 4 KM.

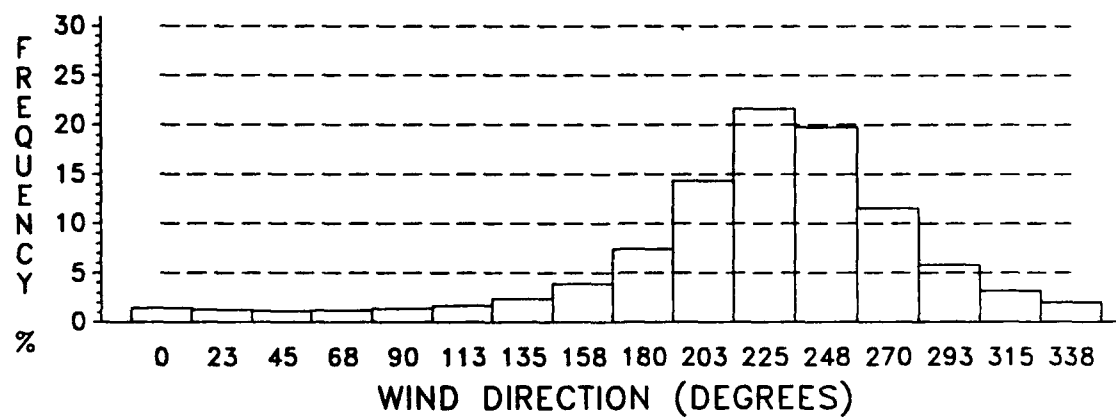

Figure E-12. Wind Direction Frequency, July, 8 KM.

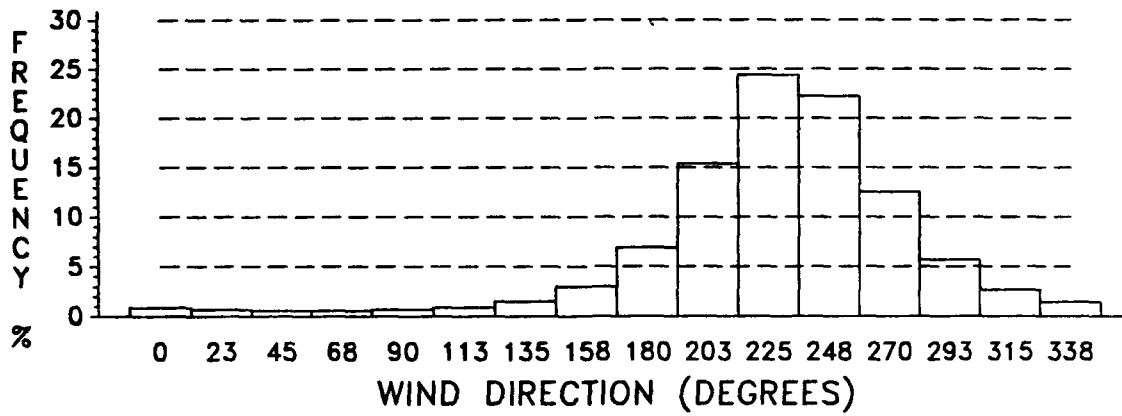

Figure E-13. Wind Direction Frequency, July, 12 KM.

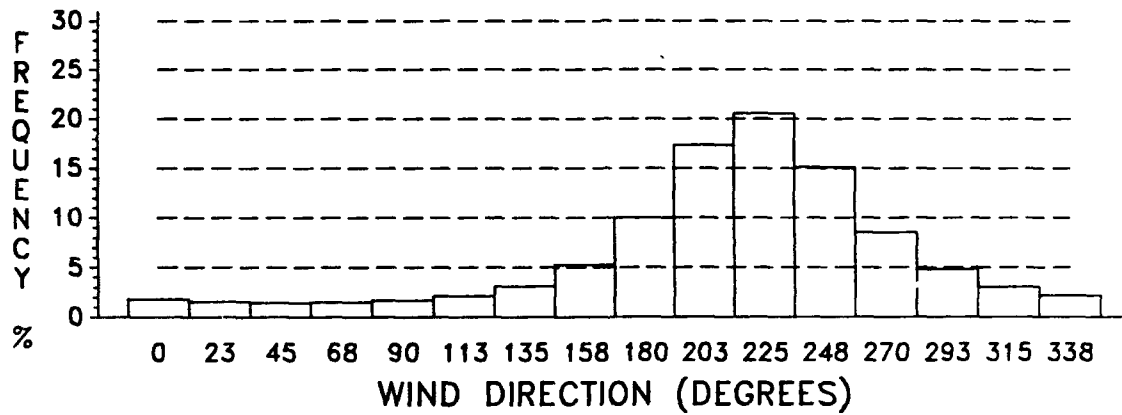

Figure E-14. Wind Direction Frequency, July, 16 KM.

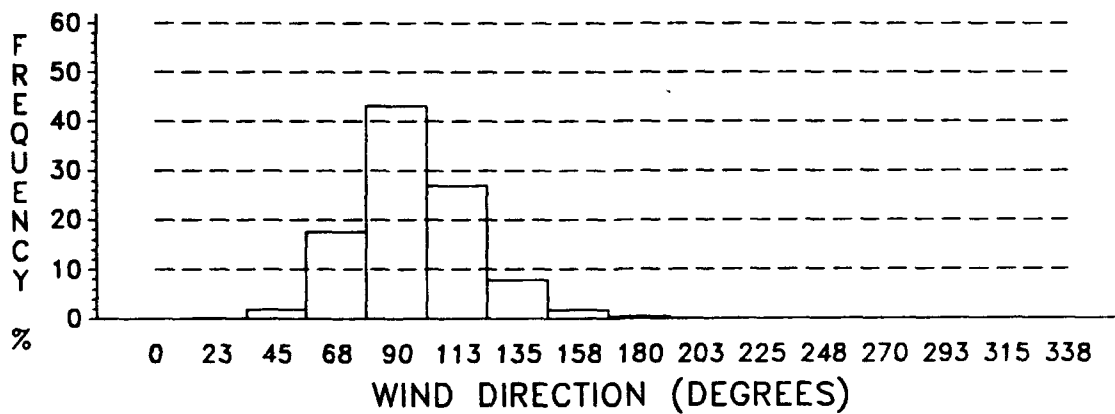

Figure E-15. Wind Direction Frequency, July, 20 KM.

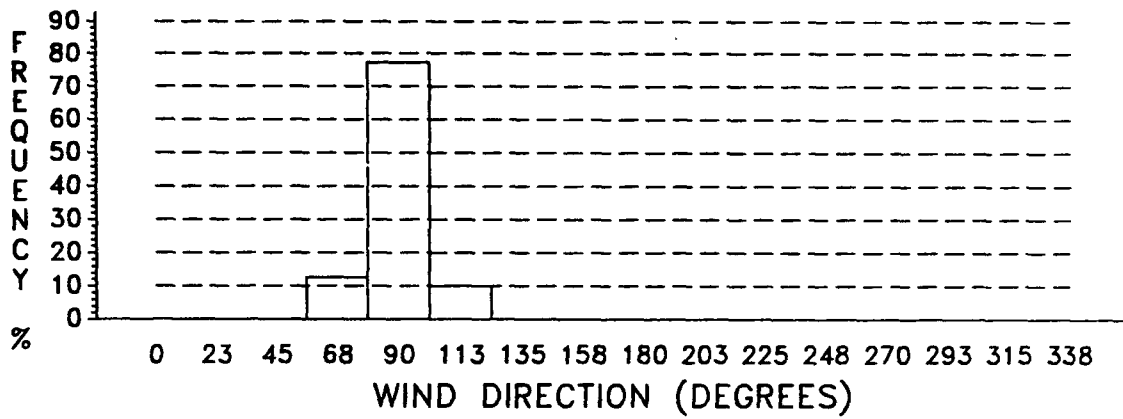

Figure E-16. Wind Direction Frequency, July, 24 KM.

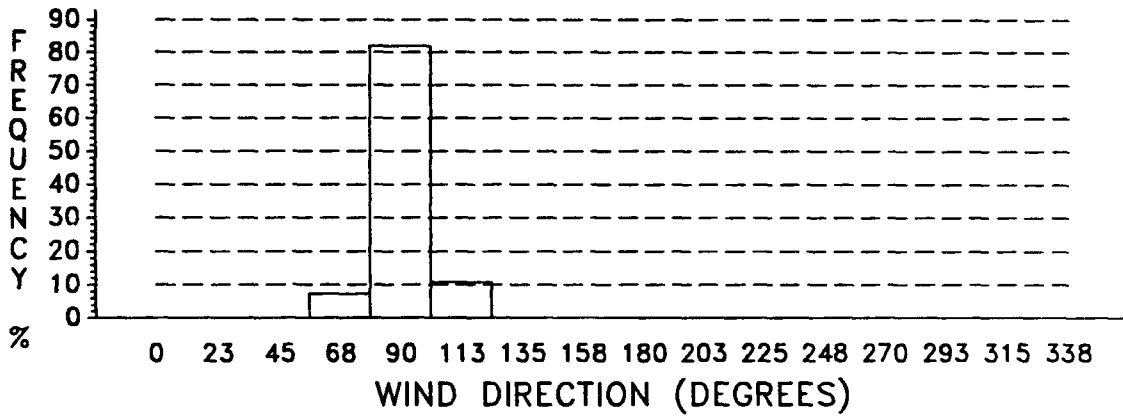

Figure E-17. Wind Direction Frequency, July, 28 KM.

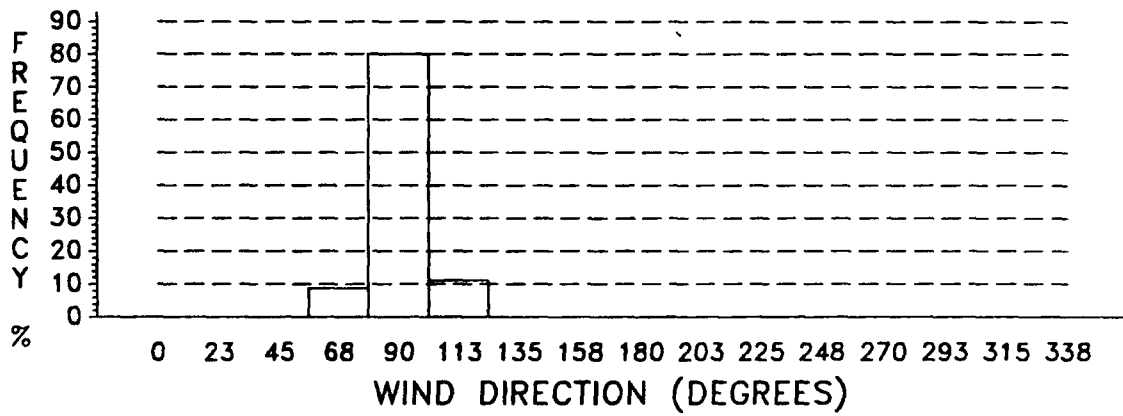

Figure E-18. Wind Direction Frequency, July, 30 KM.

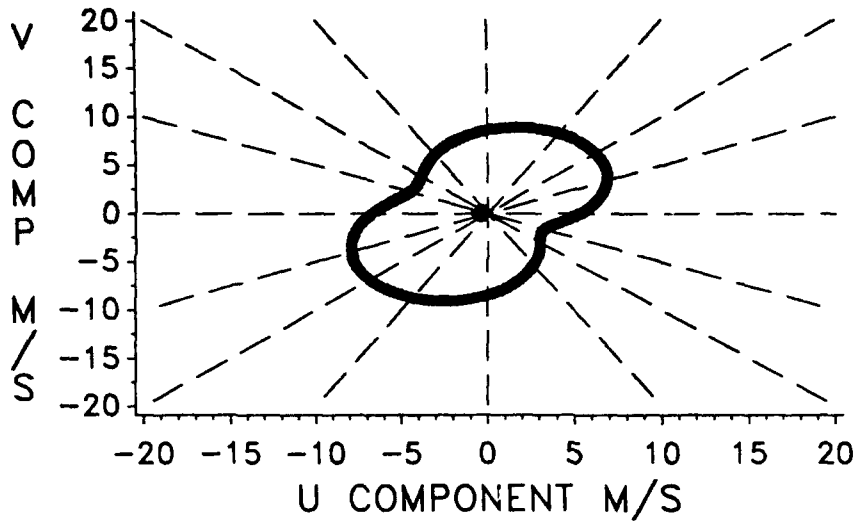

Figure E-19. Wind Interpercentile Range and Mean, January, 2 KM.

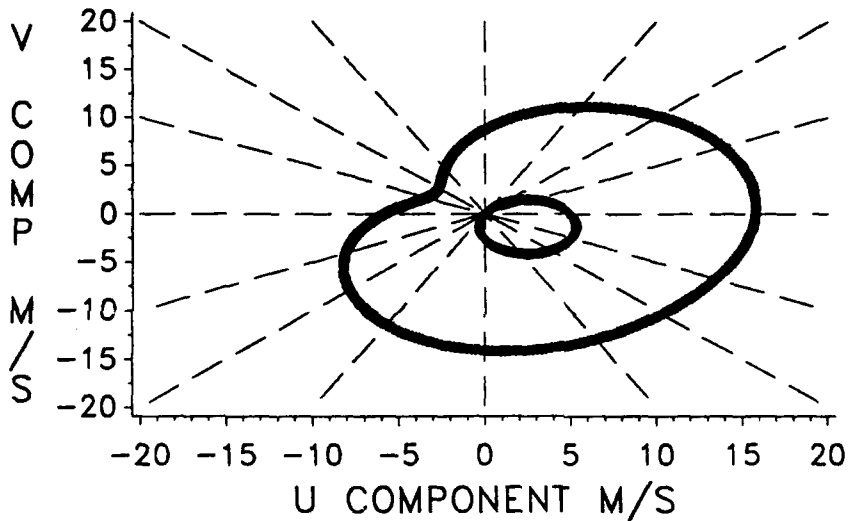

Figure E-20. Wind interpercentile Range and Mean, January, 4 KM.

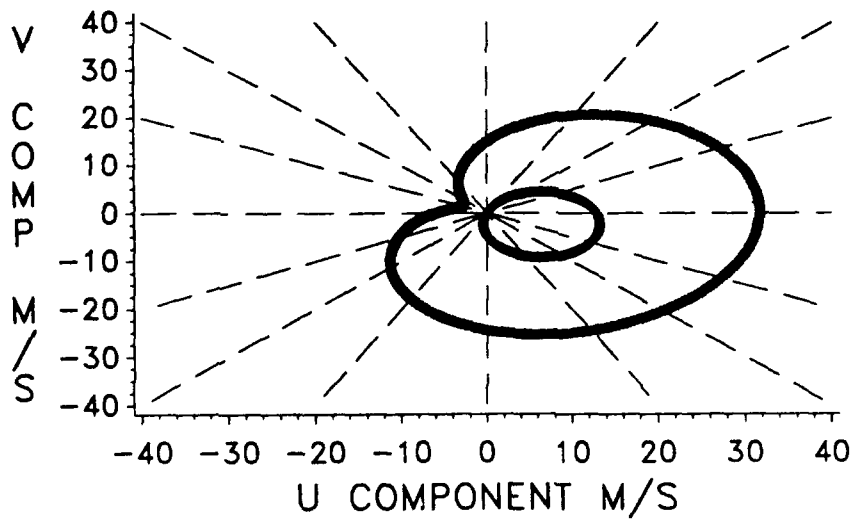

Figure E-21. Wind Interpercentile Range and Mean, January, 8 KM.

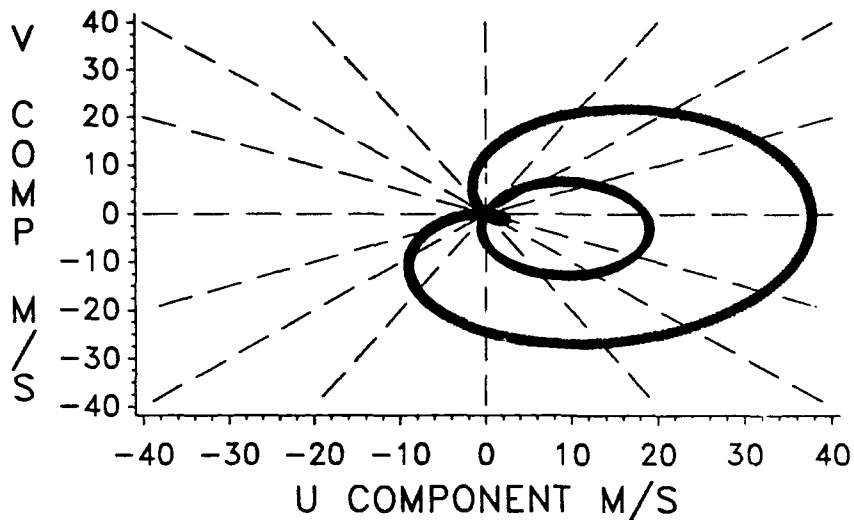

Figure E-22. Wind Interpercentile Range and Mean, January, 12 KM.

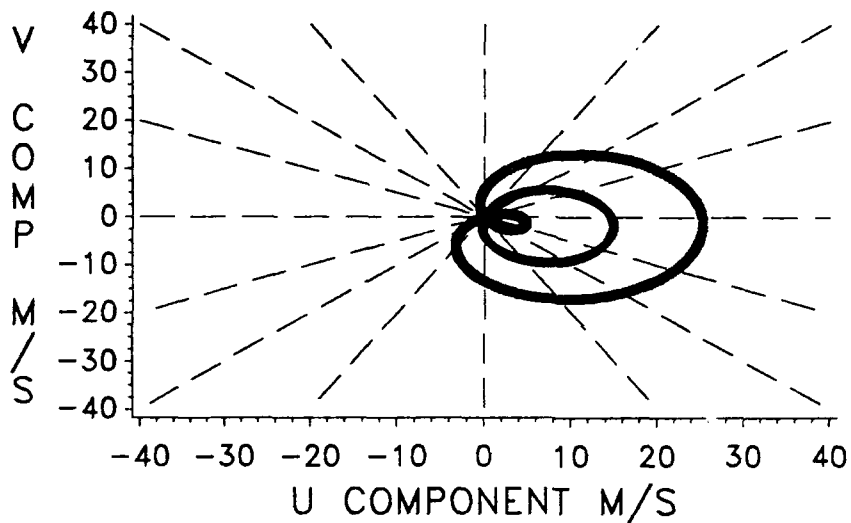

Figure E-23. Wind Interpercentile Range and Mean, January, 16 KM.

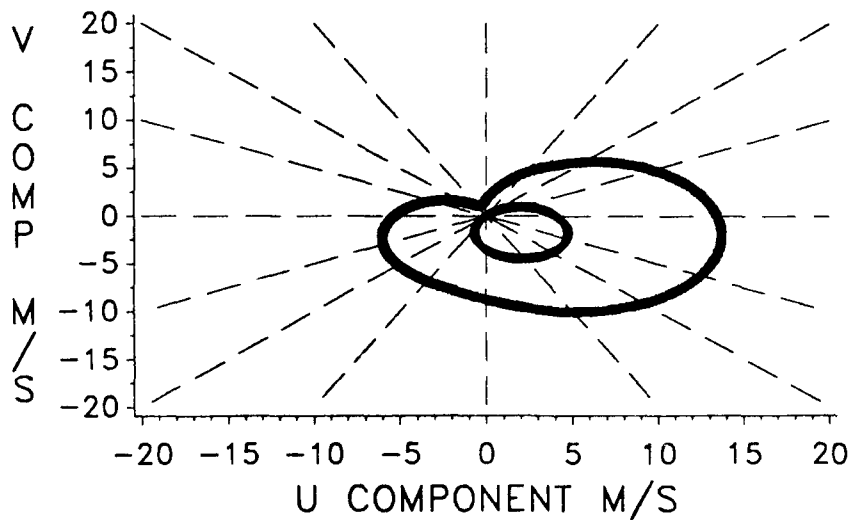

Figure E-24. Wind Interpercentile Range and Mean, January, 20 KM.

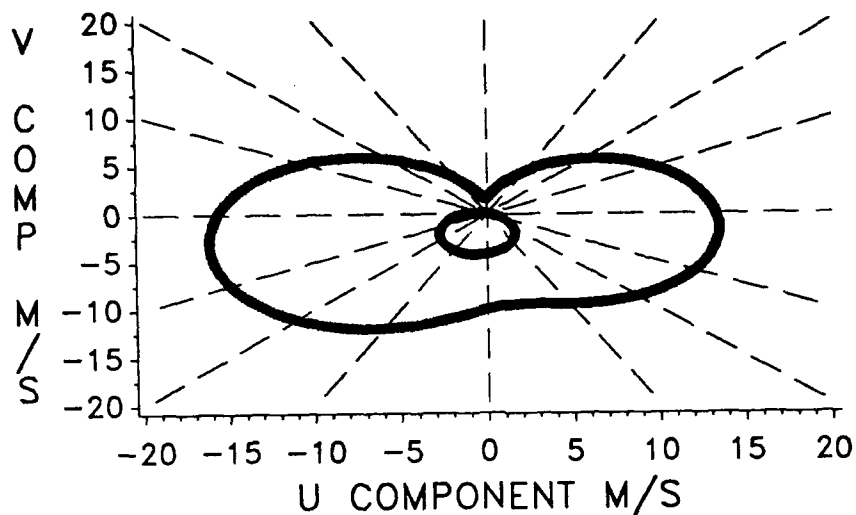

Figure E-25. Wind Interpercentile Range and Mean, January, 24 KM.

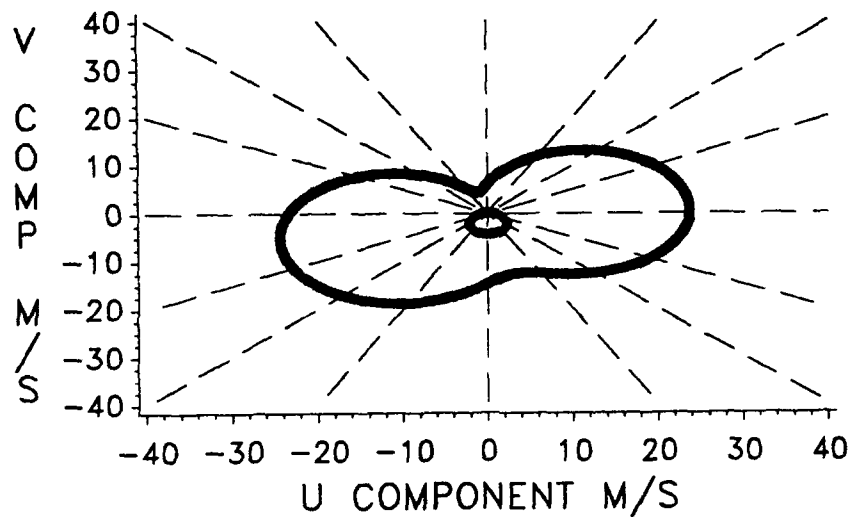

Figure E-26. Wind Interpercentile Range and Mean, January, 28 KM.

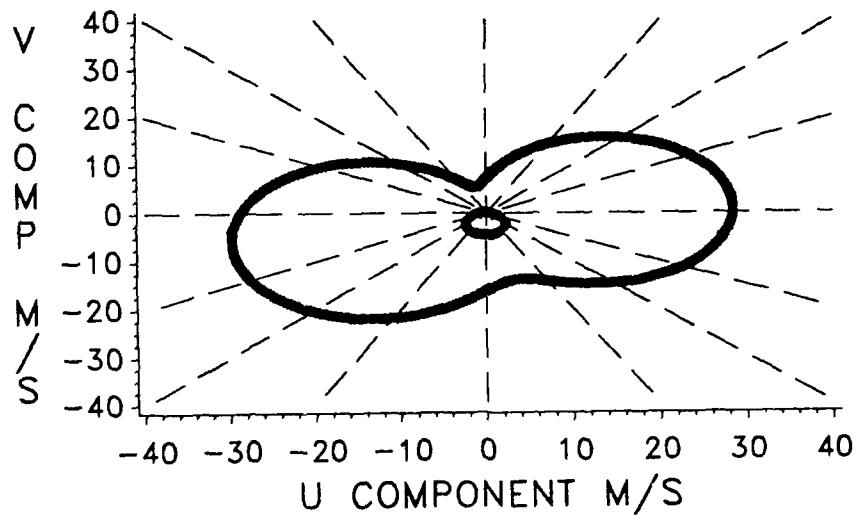

Figure E-27. Wind Interpercentile Range and Mean, January, 30 KM.

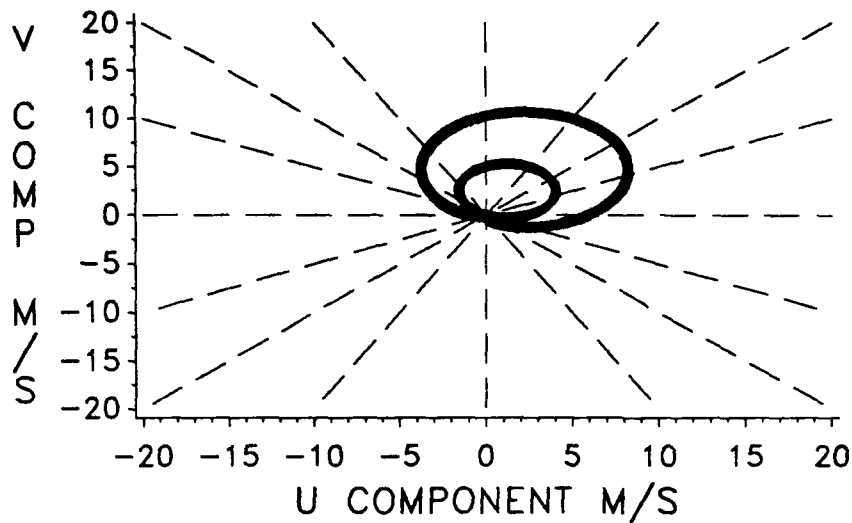

Figure E-28. Wind Interpercentile Range and Mean, July, 2 KM.

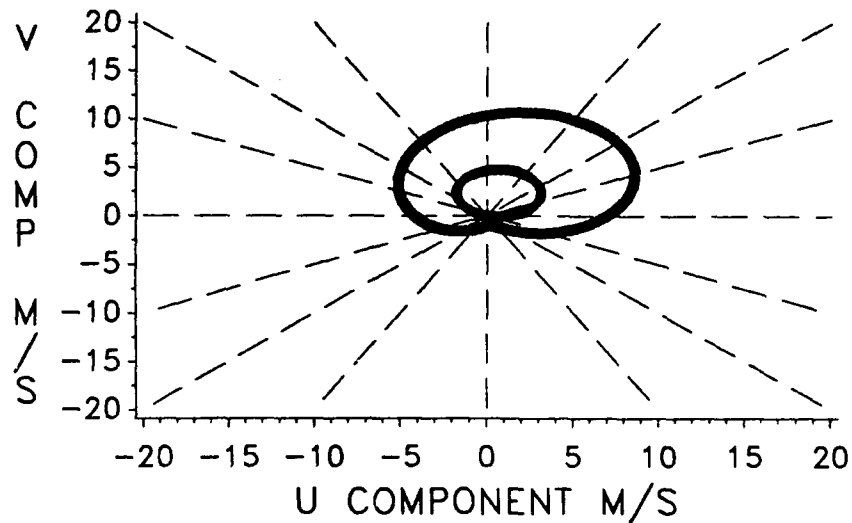

Figure E-29. Wind Interpercentile Range and Mean, July, 4 KM.

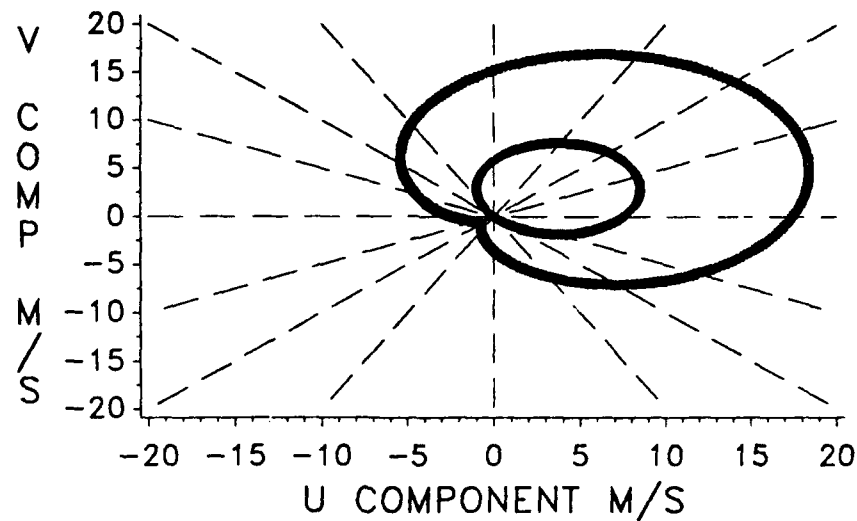

Figure E-30. Wind Interpercentile Range and Mean, July, 8 KM.

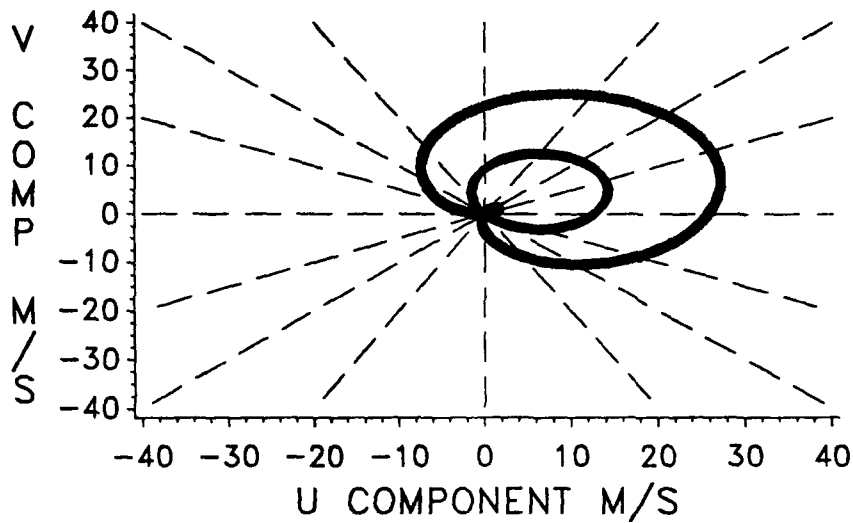

Figure E-31. Wind Interpercentile Range and Mean, July, 12 KM.

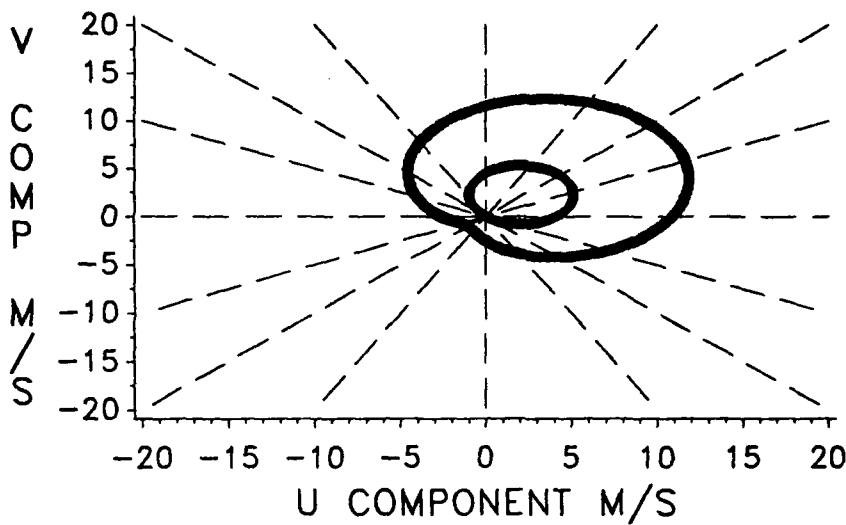

Figure E-32. Wind Interpercentile Range and Mean, July, 16 KM.

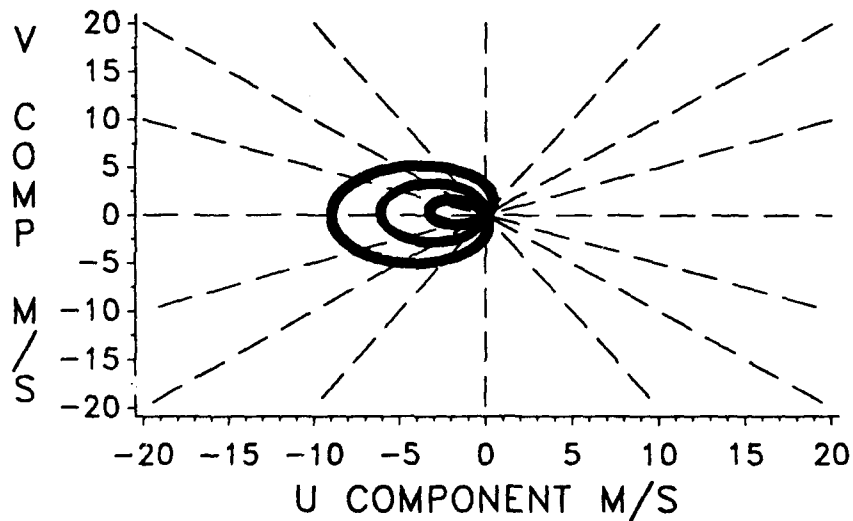

Figure E-33. Wind Interpercentile Range and Mean, July, 20 KM.

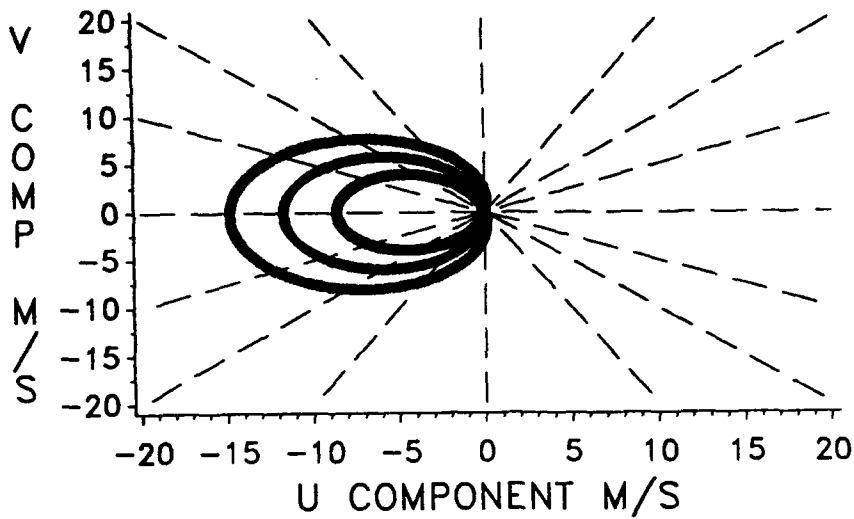

Figure E-34. Wind Interpercentile Range and Mean, July, 24 KM.

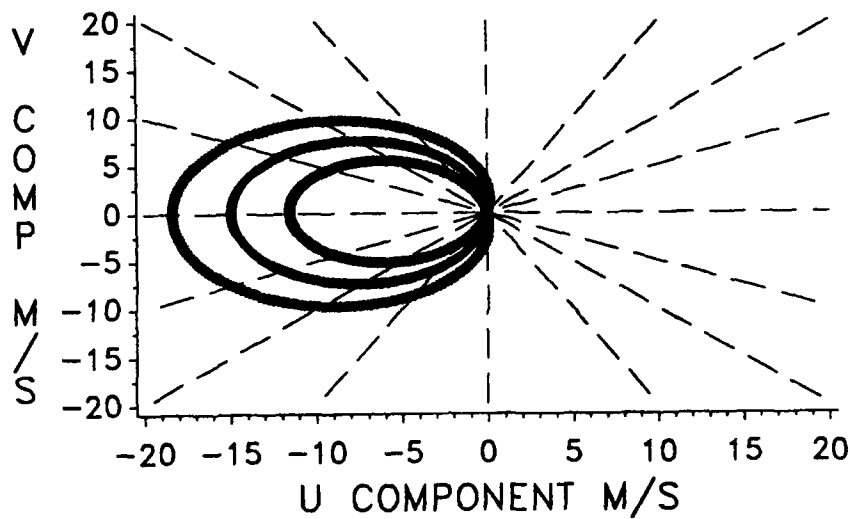

Figure E-35. Wind Interpercentile Range and Mean, July, 28 KM.

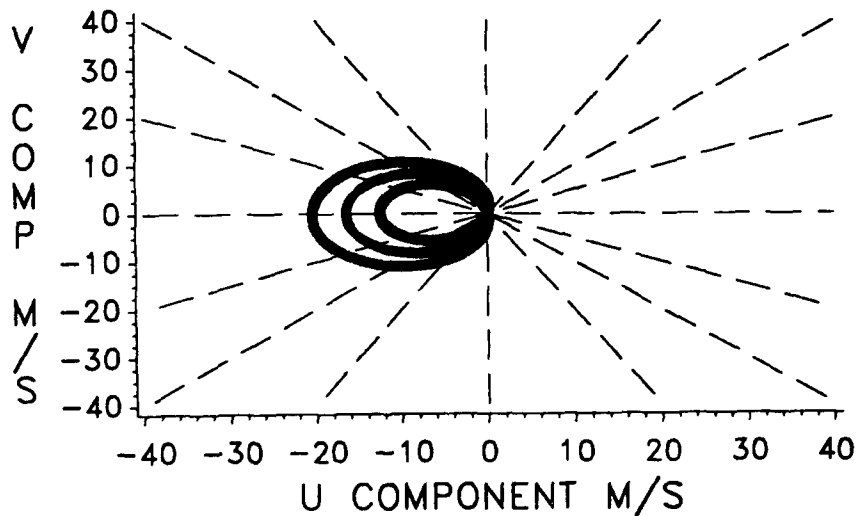

Figure E-36. Wind Interpercentile Range and Mean, July, 30 KM.

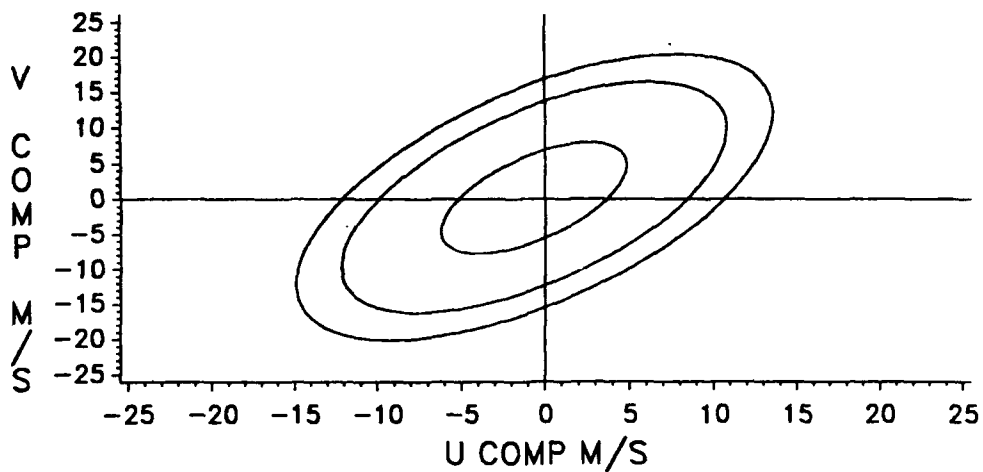

Figure E-37. Wind Probability Ellipses, January, 2 KM.

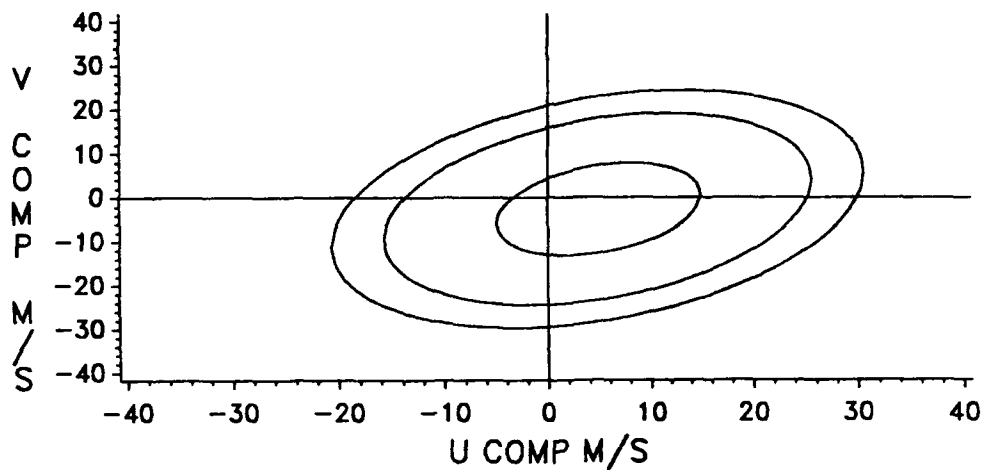

Figure E-38. Wind Probability Ellipses, January, 4 KM.

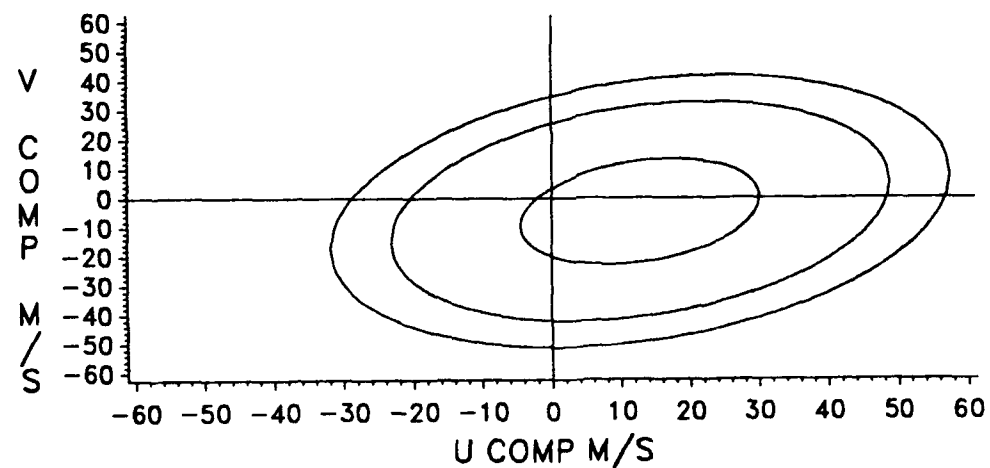

Figure E-39. Wind Probability Ellipses, January, 8 KM.

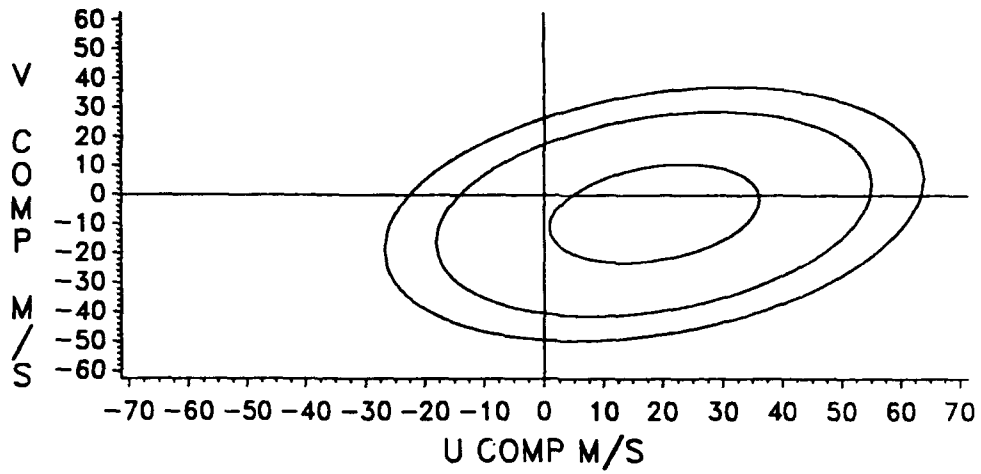

Figure E-40. Wind Probability Ellipses, January, 12 KM.

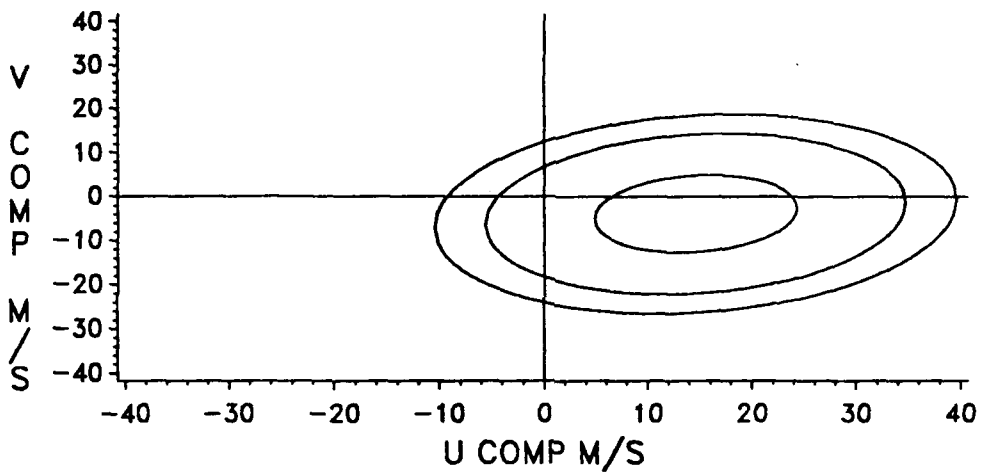

Figure E-41. Wind Probability Ellipses, January, 16 KM.

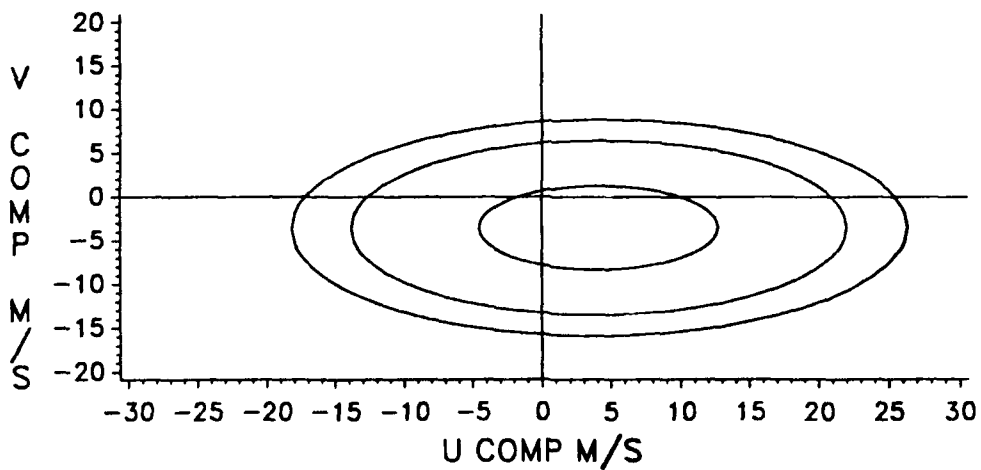

Figure E-42. Wind Probability Ellipses, January, 20 KM.

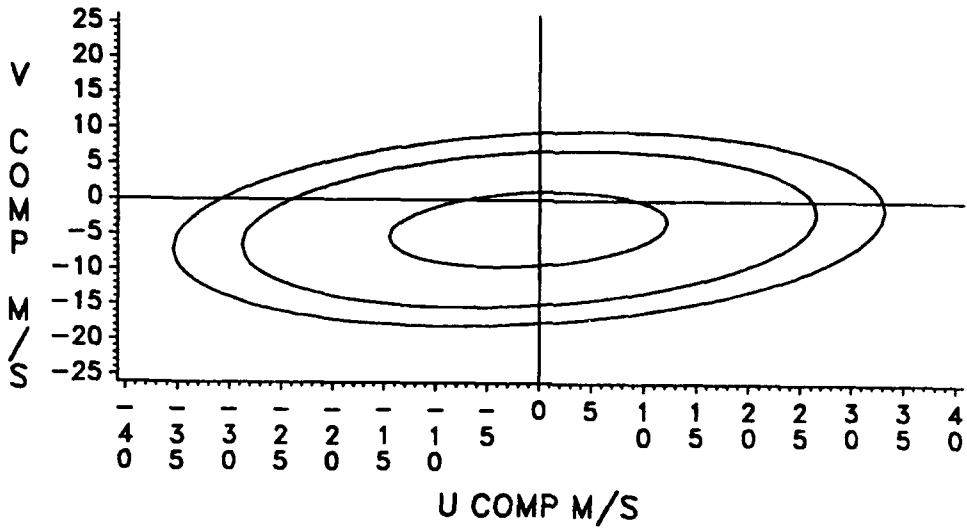

Figure E-43. Wind Probability Ellipses, January, 24 KM.

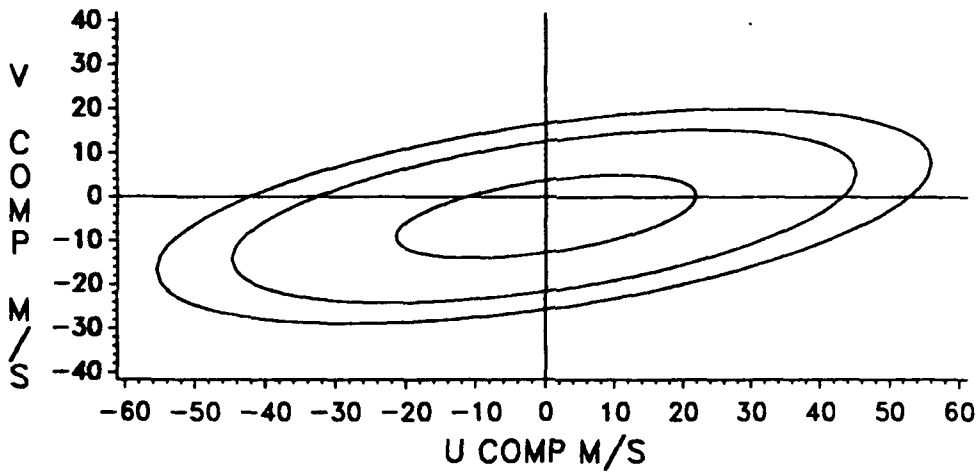

Figure E-44. Wind Probability Ellipses, January, 28 KM.

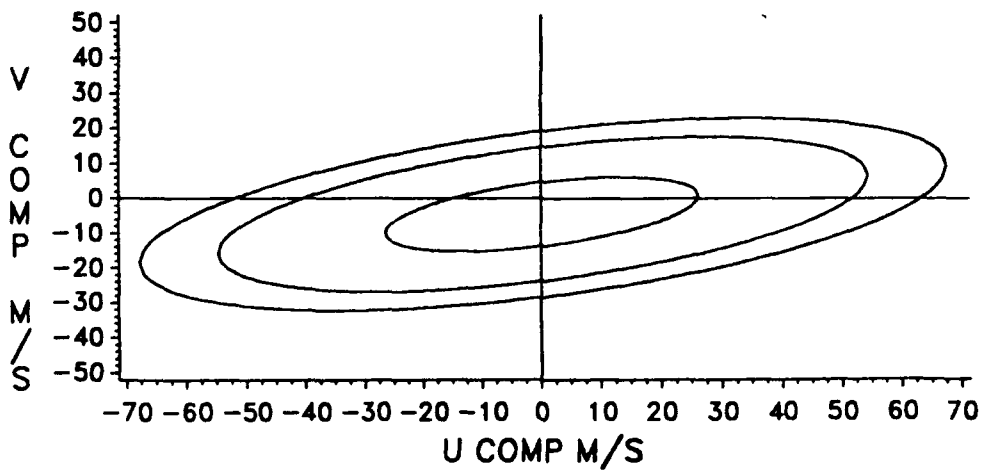

Figure E-45. Wind Probability Ellipses, January, 30 KM.

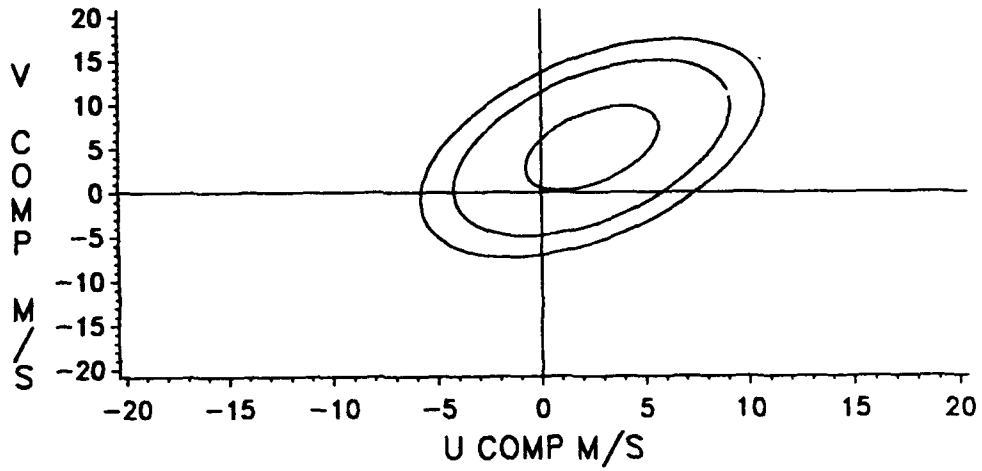

Figure E-46. Wind Probability Ellipses, July, 2 KM.

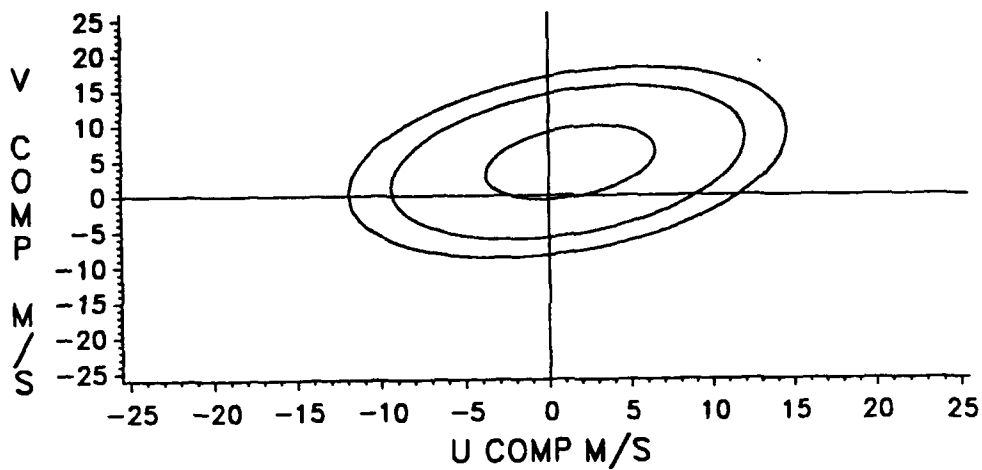

Figure E-47. Wind Probability Ellipses, July, 4 KM.

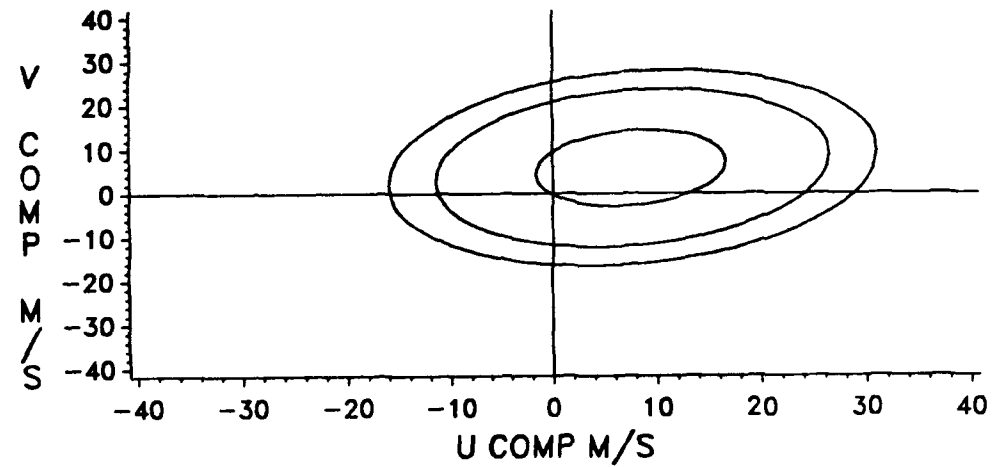

Figure E-48. Wind Probability Ellipses, July, 8 KM.

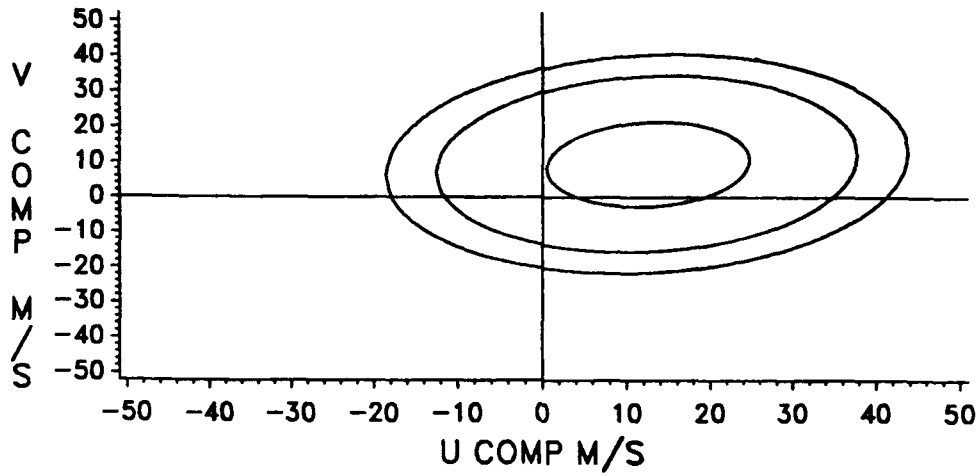

Figure E-49. Wind Probability Ellipses, July, 12 KM.

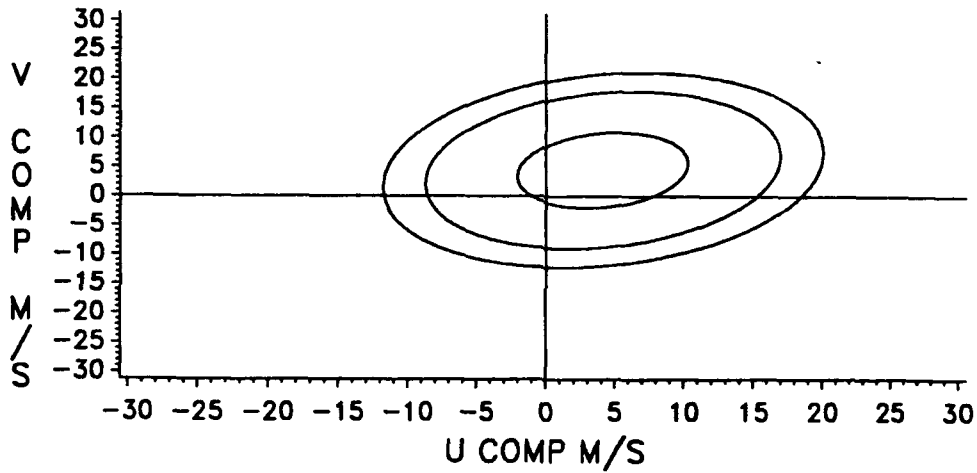

Figure E-50. Wind Probability Ellipses, July, 16 KM.

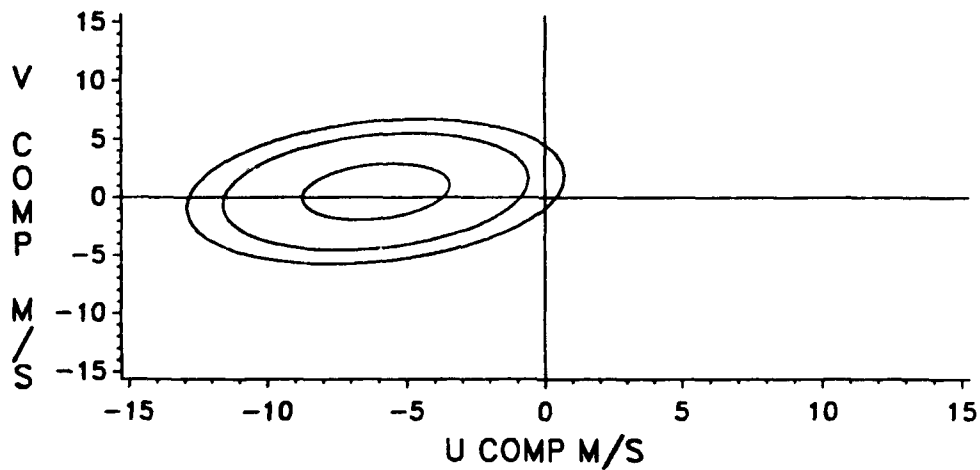

Figure E-51. Wind Probability Ellipses, July, 20 KM.

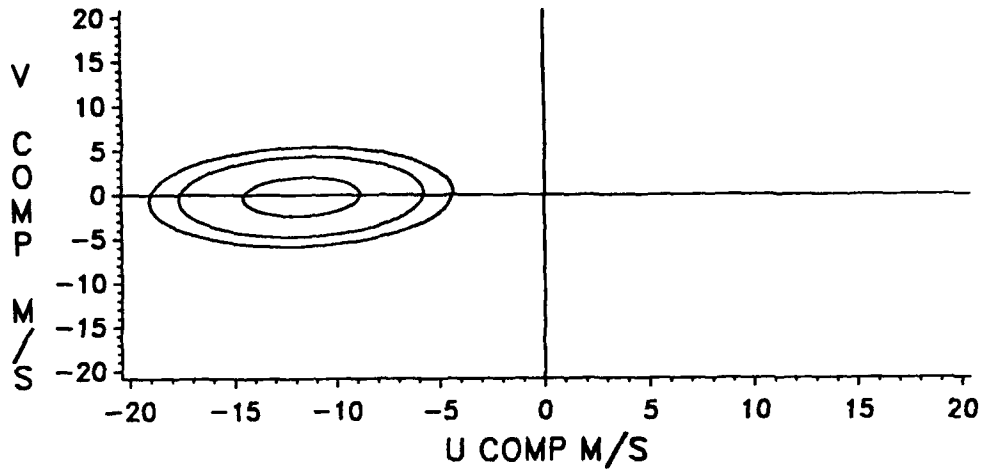

Figure E-52. Wind Probability Ellipses, July, 24 KM.

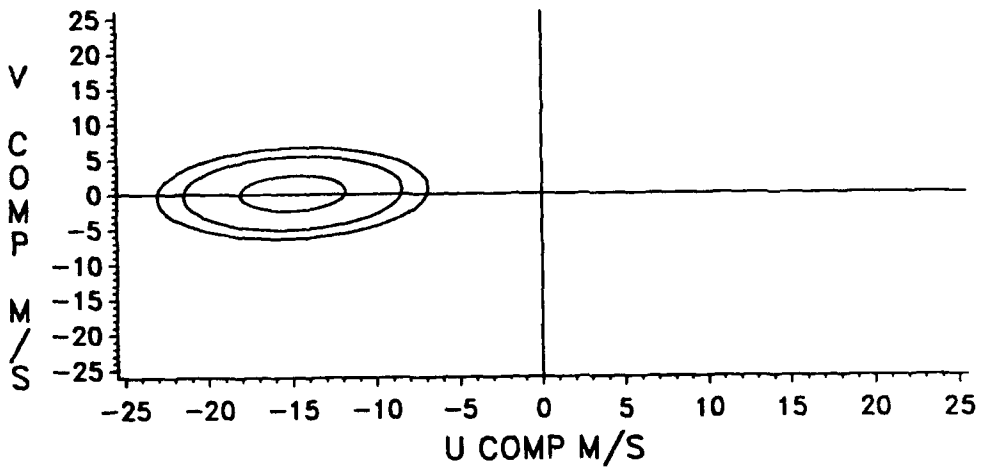

Figure E-53. Wind Probability Ellipses, July, 28 KM.

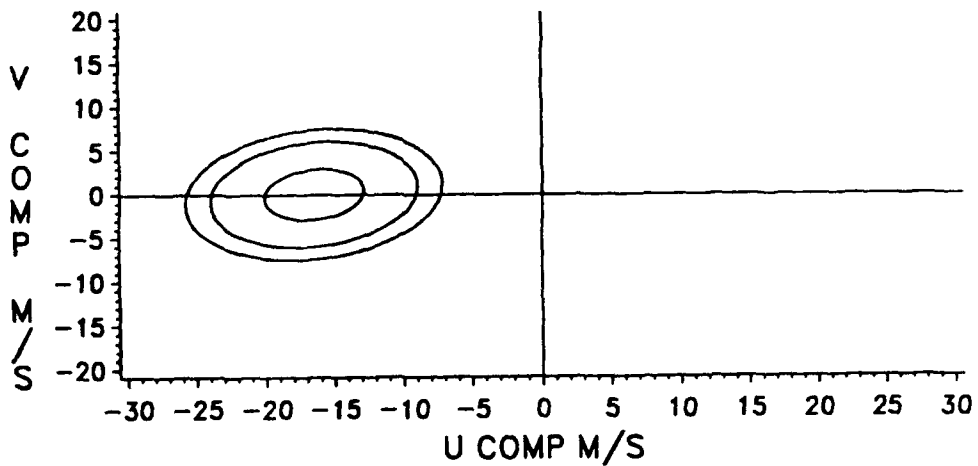

Figure E-54. Wind Probability Ellipses, July, 30 KM.

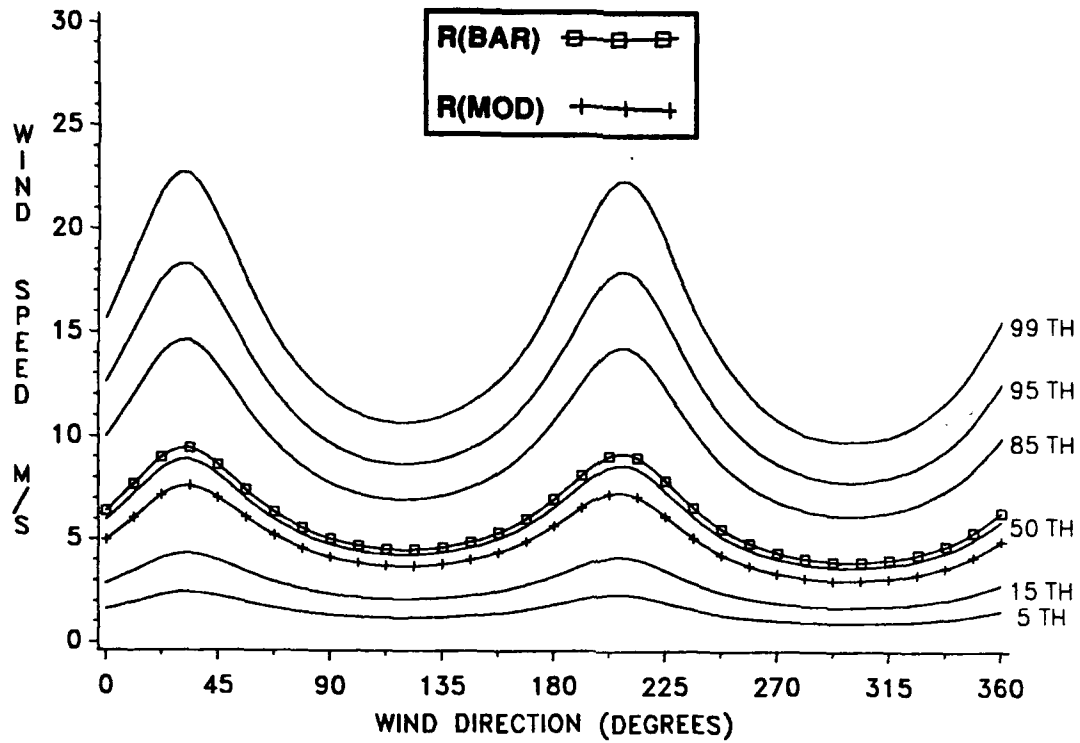

Figure E-55. Conditional Wind Speed Given Direction, January, 2 KM.

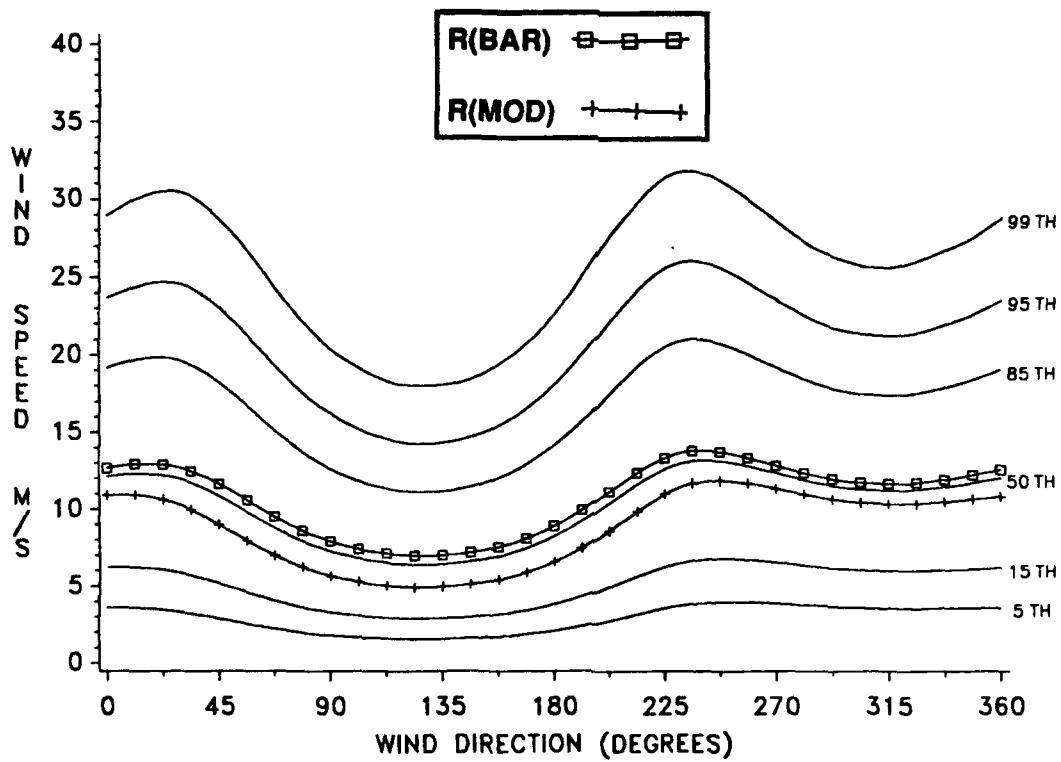

Figure E-56. Conditional Wind Speed Given Direction, January, 4 KM.

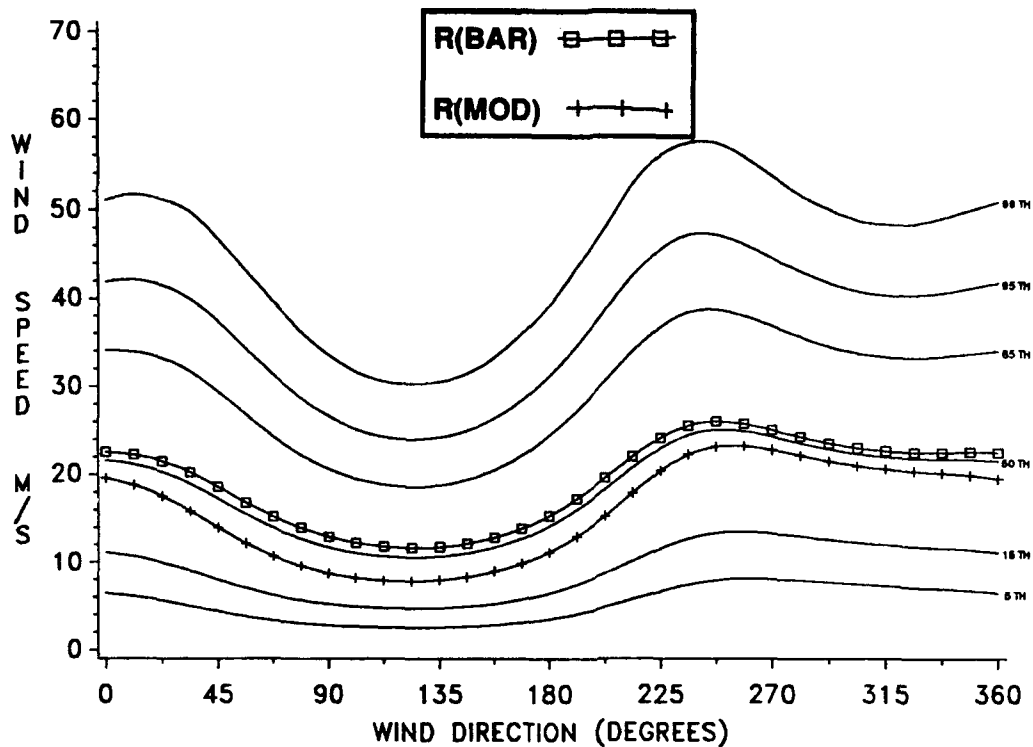

Figure E-57. Conditional Wind Speed Given Direction, January, 8 KM.

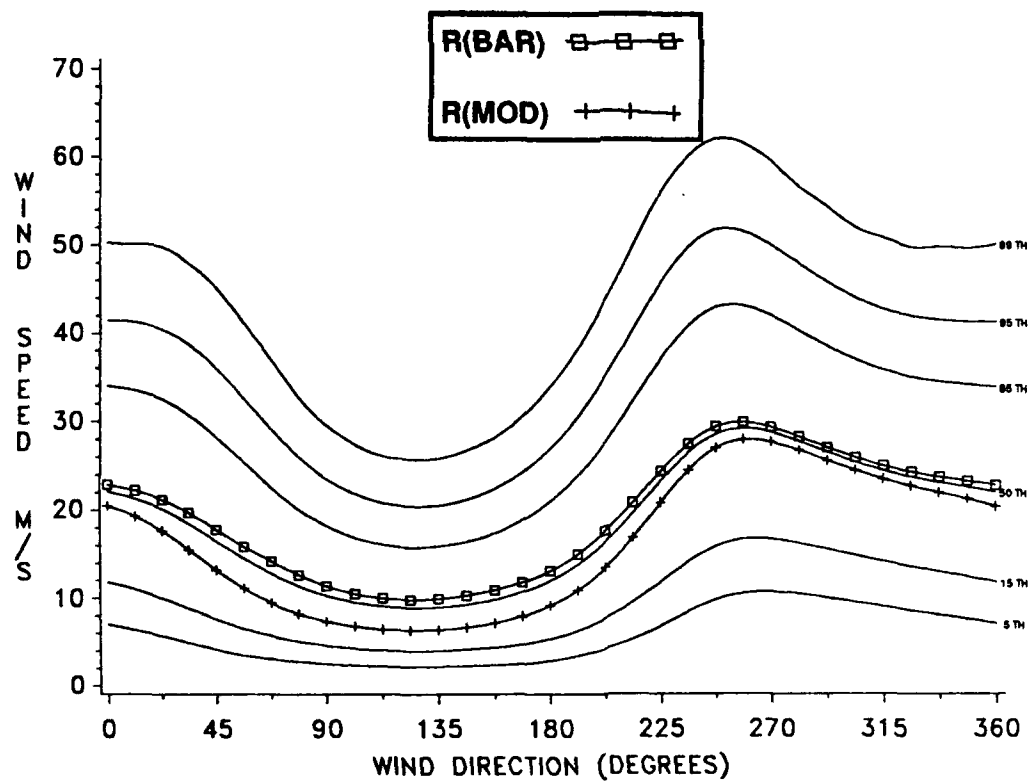

Figure E-58. Conditional Wind Speed Given Direction, January, 12 KM.

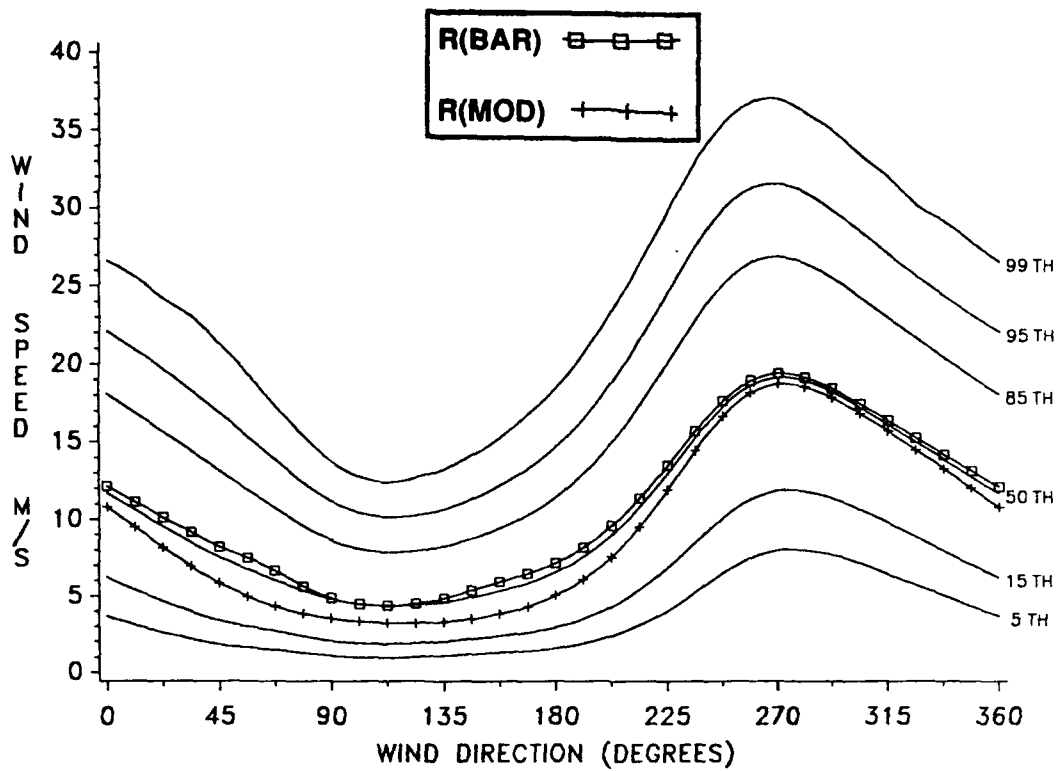

Figure E-59. Conditional Wind Speed Given Direction, January, 16 KM.

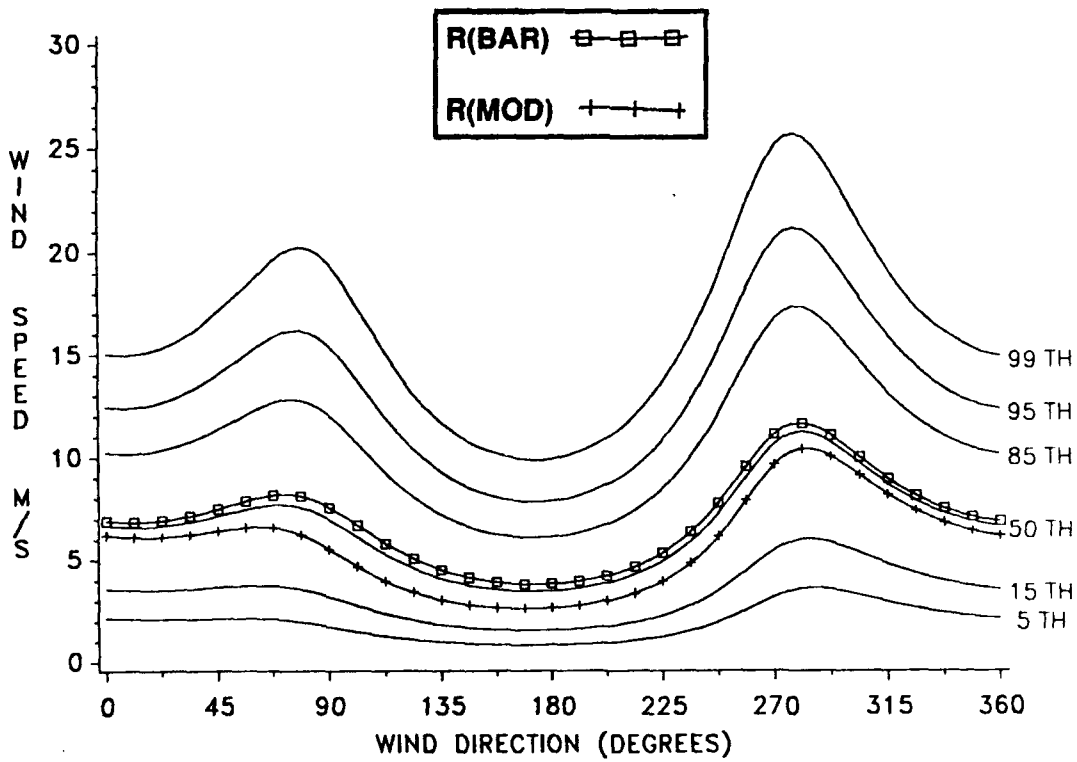

Figure E-60. Conditional Wind Speed Given Direction, January, 20 KM.

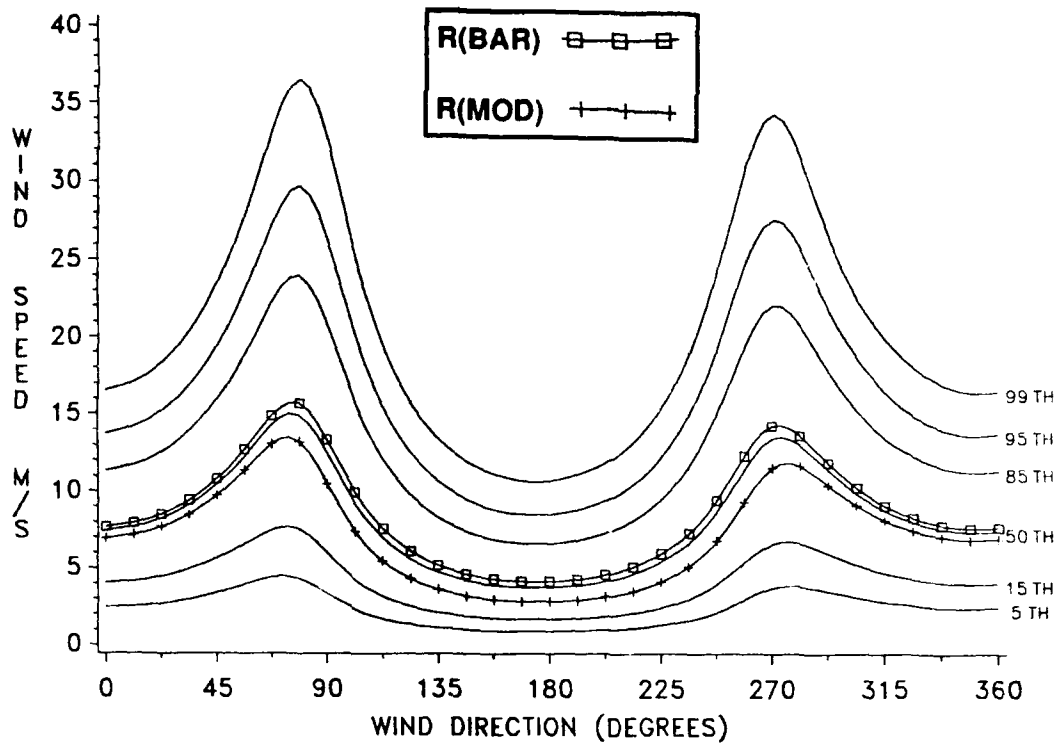

Figure E-61. Conditional Wind Speed Given Direction, January, 24 KM.

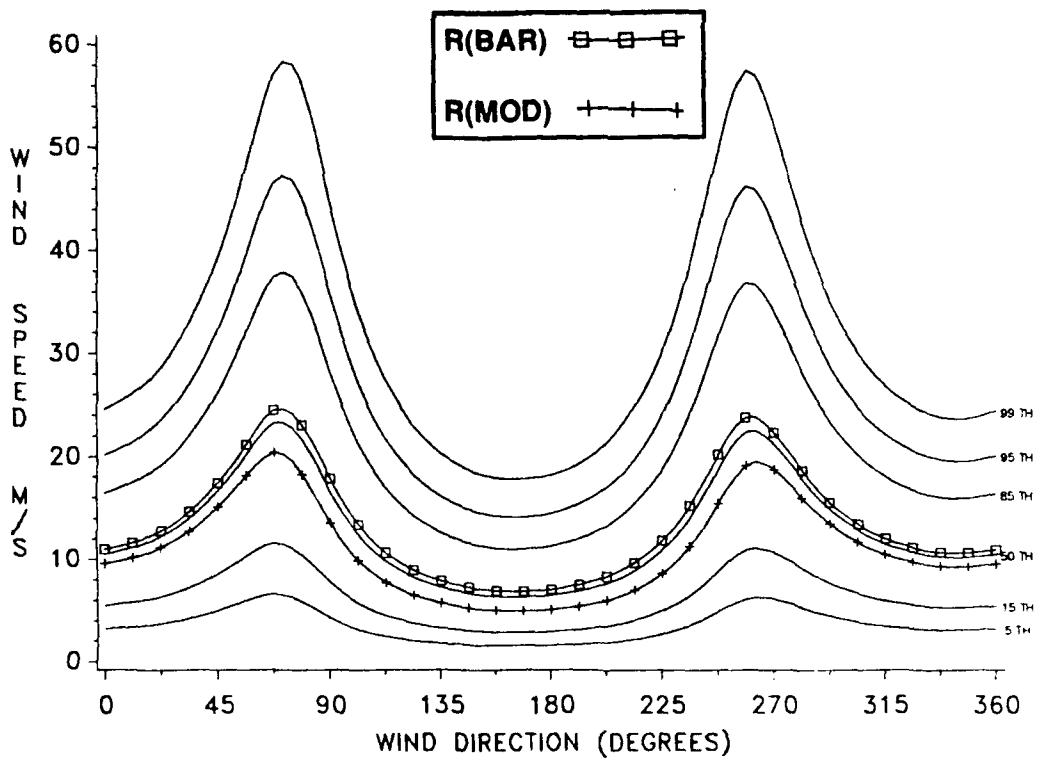

Figure E-62. Conditional Wind Speed Given Direction, January, 28 KM.

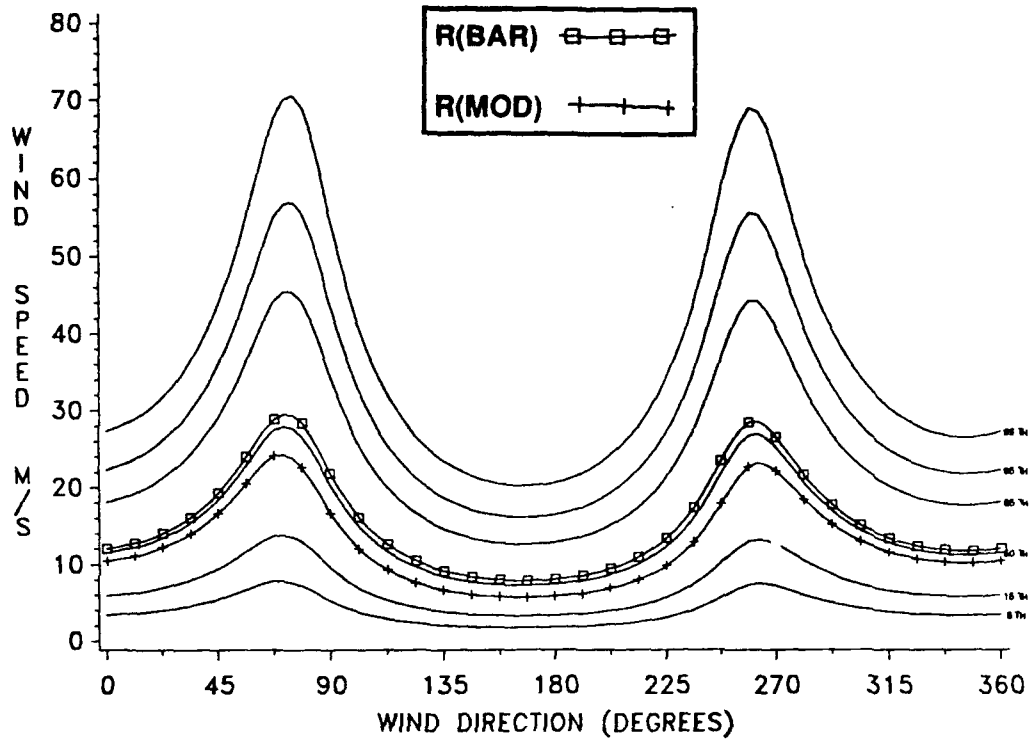

Figure E-63. Conditional Wind Speed Given Direction, January, 30 KM.

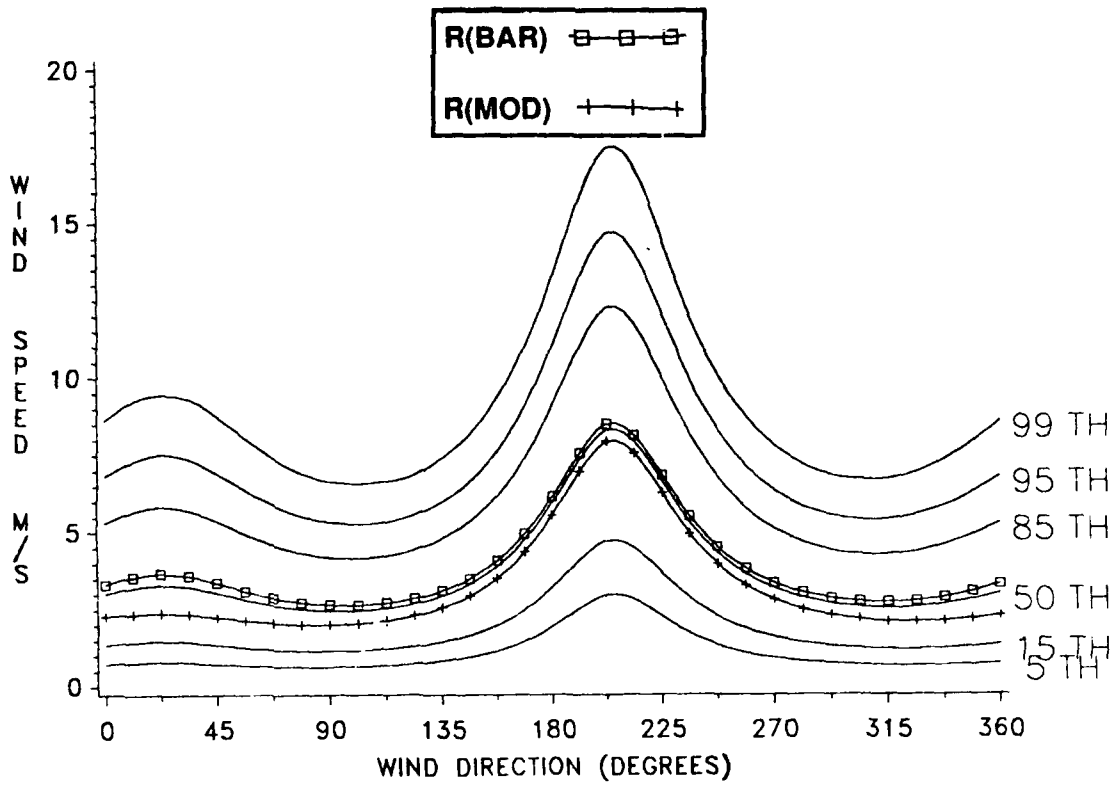

Figure E-64. Conditional Wind Speed Given Direction, July, 2 KM.

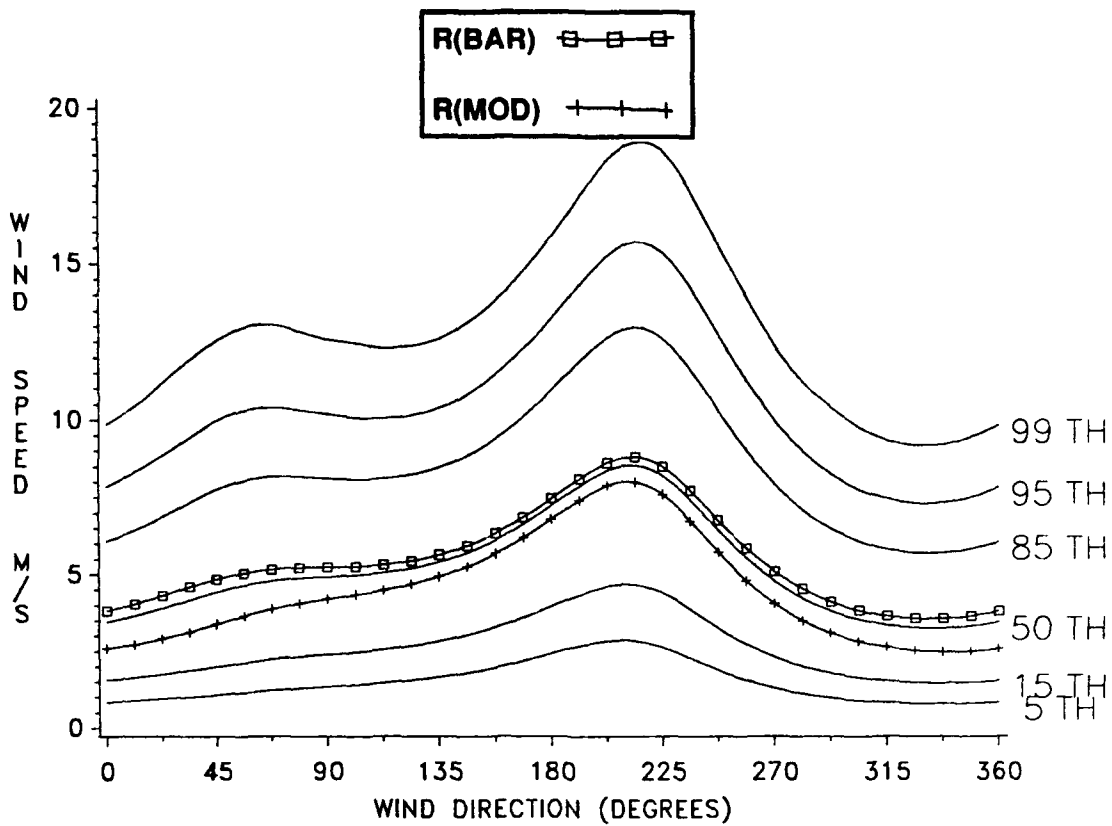

Figure E-65. Conditional Wind Speed Given Direction, July, 4 KM.

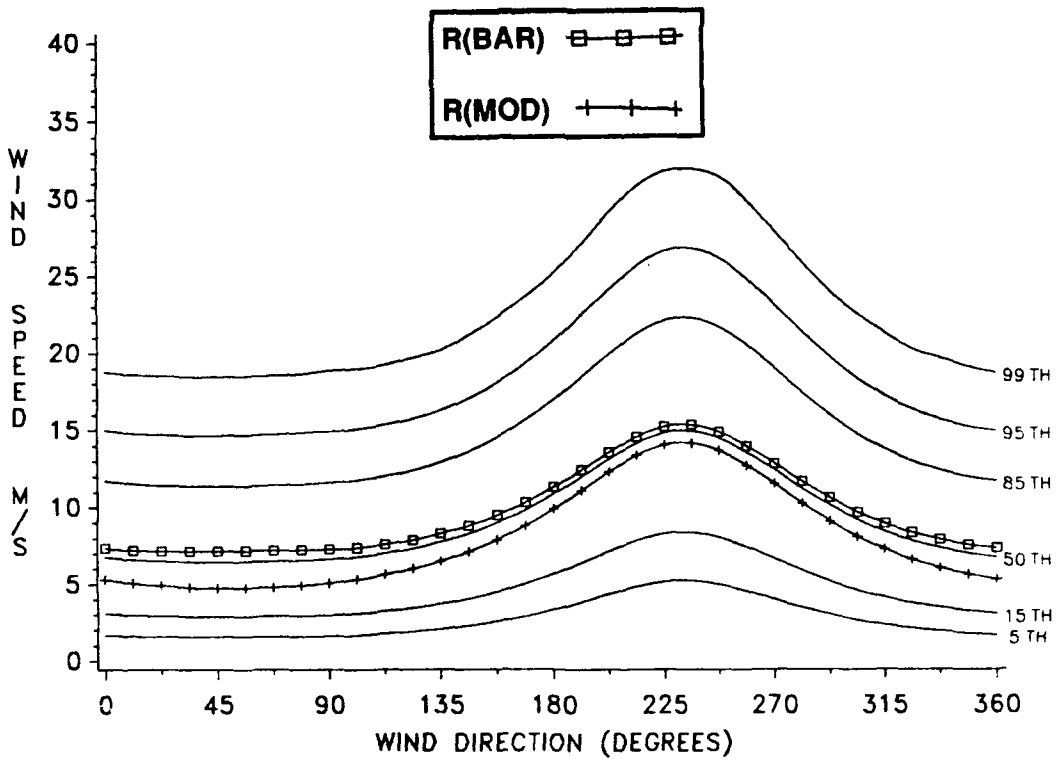

Figure E-66. Conditional Wind Speed Given Direction, July, 8 KM.

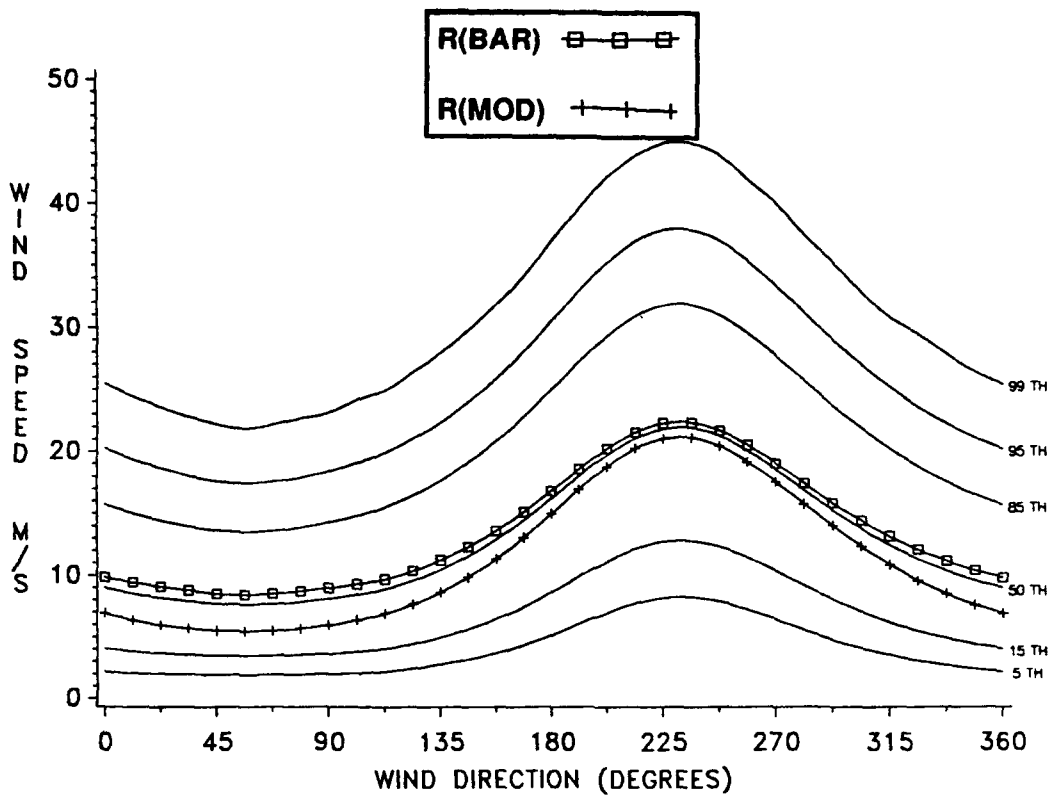

Figure E-67. Conditional Wind Speed Given Direction, July, 12 KM.

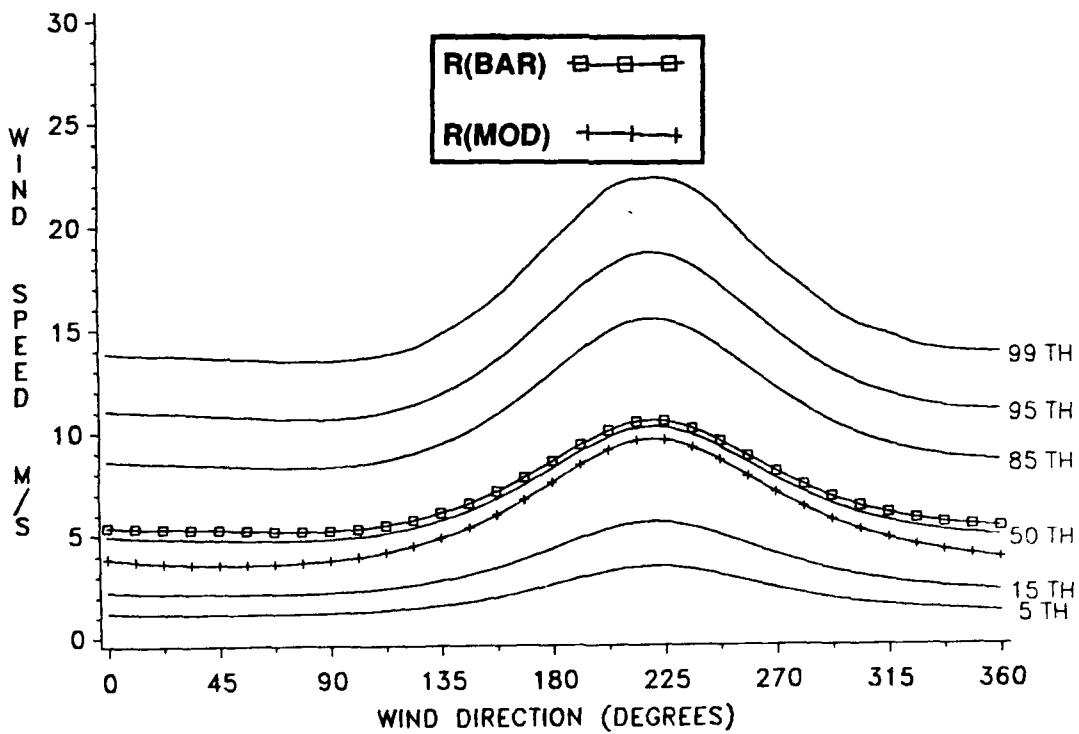

Figure E-68. Conditional Wind Speed Given Direction, July, 16 KM.

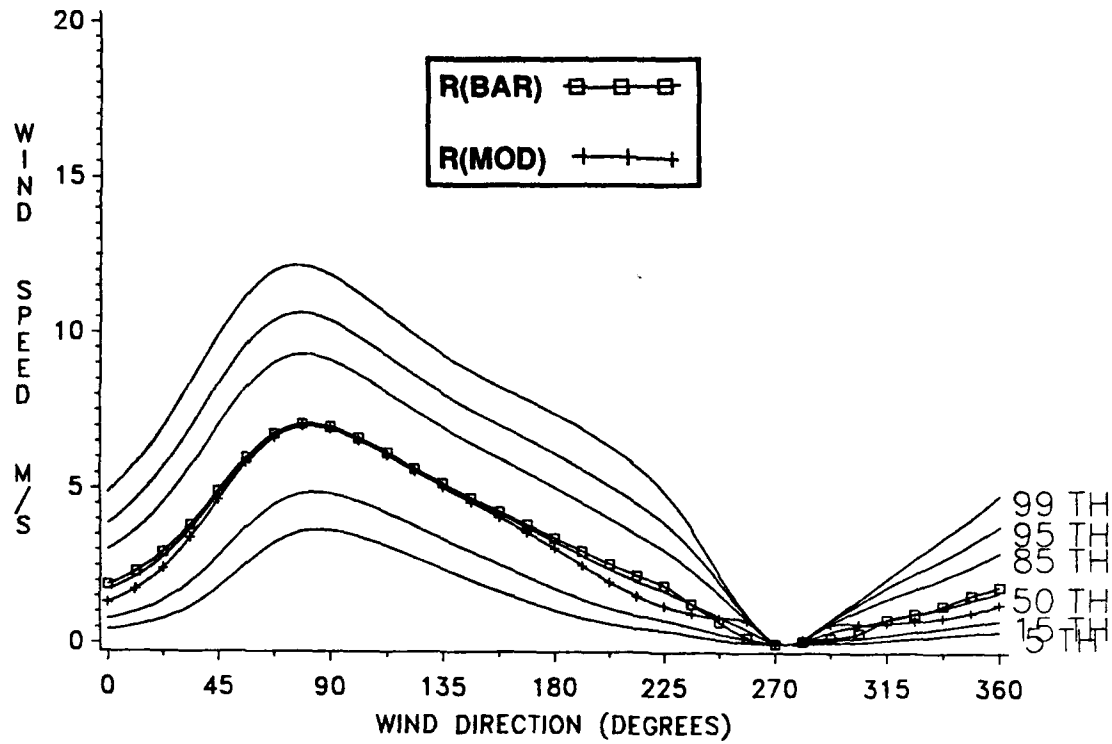

Figure E-69. Conditional Wind Speed Given Direction, July, 20 KM.

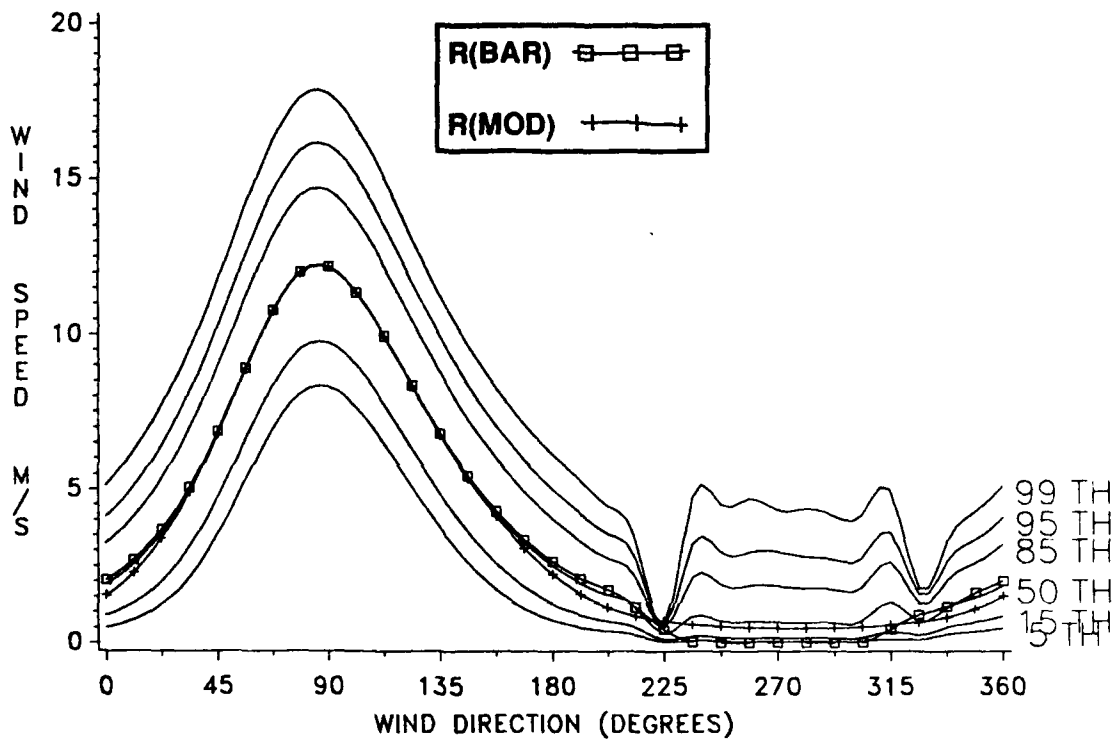

Figure E-70. Conditional Wind Speed Given Direction, July, 24 KM.

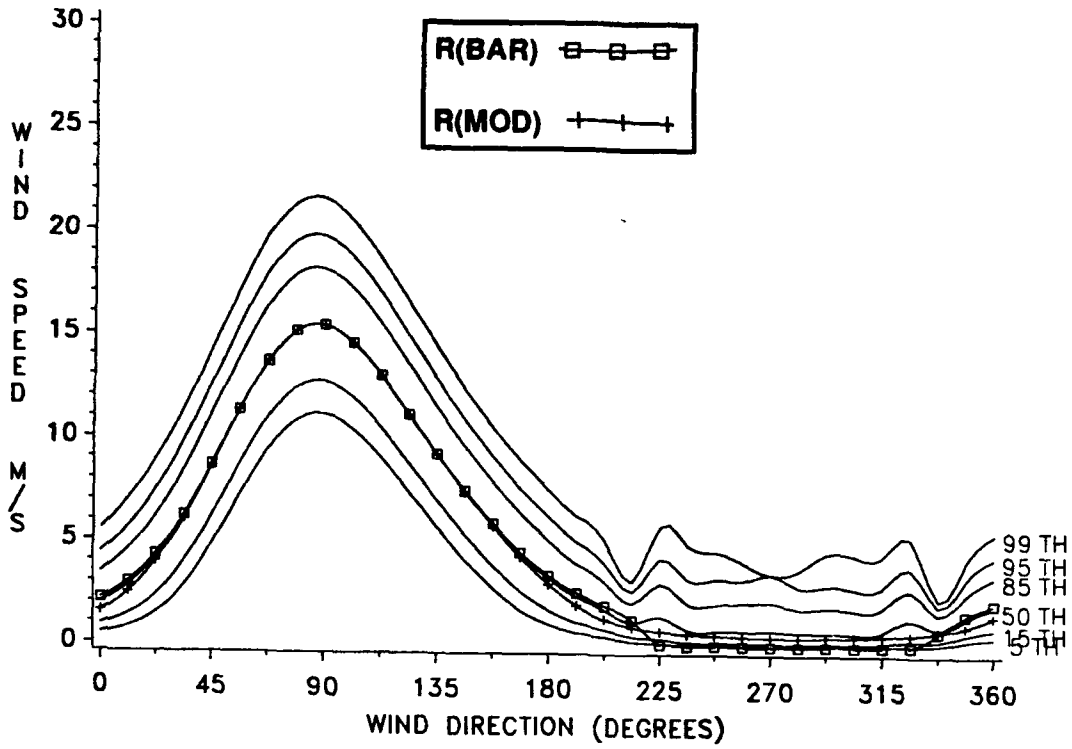

Figure E-71. Conditional Wind Speed Given Direction, July, 28 KM.

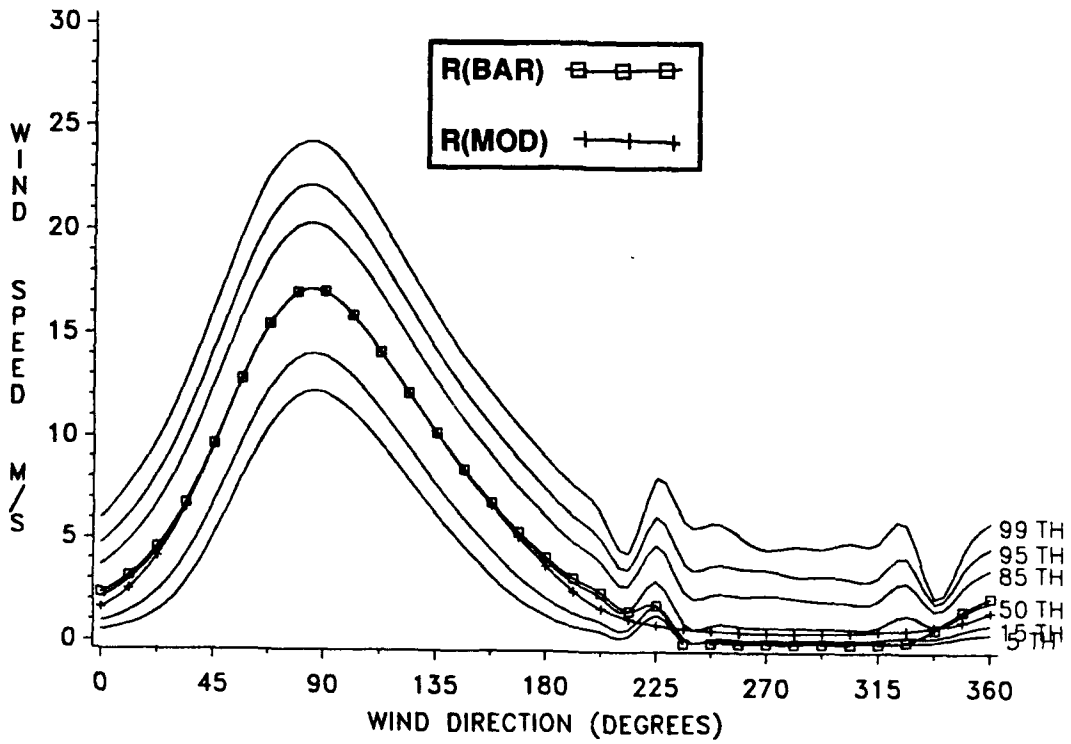

Figure E-72. Conditional Wind Speed Given Direction, July, 30 KM.

APPENDIX F

Thermodynamic Statistics Derivable from Appendix B, C, and D Tables

This appendix gives graphic examples of certain pressure, density, and virtual temperature statistics that can be derived from basic data in Appendices B, C, and D. These examples should help RRA users in understanding and visualizing the relationships that can be inferred from data in Appendices B and D.

Monthly Means from the Annual Mean

The hydrostatic model values in Appendix D are used to compute monthly mean differences relative to annual mean values of pressure, density, and virtual temperature (expressed in percent), and the monthly mean difference in virtual temperature for annual mean virtual temperature (expressed in kelvin, K). Examples of these four statistics are given in Tables F-1 (January) and F-2 (July); graphic displays of the four statistics contained in these tables are then provided by Figures F-1 through F-8. The relative differences between monthly mean values (from Tables D-1 through D-12 for all months) and annual mean values (Table D-13) are illustrated in Figures F-9 and F-18 for pressure, Figures F-10 and F-12 for density, and Figures F-13 and F-14 for virtual temperature. Differences between monthly mean virtual temperature differences and annual mean virtual temperature for all months are given in Figures F-15 and F-16.

Coefficients of Variation and Derived Correlation Coefficients.

The coefficient of variation (C_v) is defined as "the standard deviation with respect to the mean divided by the mean." Coefficients of variation for pressure ($C_v P$) and density ($C_v D$) were computed using standard deviations in Appendix B and the hydrostatic mean values in Appendix E. The coefficient of variation for temperature uses the standard deviations of virtual temperature from Appendix C to the altitude at which virtual temperature exists; above that altitude, standard deviations of temperature are from Appendix B. Mean values for virtual temperature to the altitude at which it exists and above are taken from Appendix E. No distinction is made between virtual temperature and temperature in Table F-3, Table F-4, or any of the figures.

From the coefficients of variation for pressure and temperature (virtual temperature to the altitude at which it exists), correlation coefficients between these quantities are derived using Buell's method--see Chapter 3. The three equations for the derived correlation coefficients in Tables F-3 and F-4 are:

$$R(P,T) = \frac{(C_v T)^2 + (C_v P)^2 - (C_v D)^2}{2[C_v T \cdot C_v P]} \quad (F-1)$$

$$R(P,D) = \frac{(C_v D)^2 - (C_v T)^2 + (C_v P)^2}{2[C_v D \cdot C_v P]} \quad (F-2)$$

$$R(T,D) = \frac{(C_v P)^2 - (C_v D)^2 - (C_v T)^2}{2[C_v T \cdot C_v D]} \quad (F-3)$$

To test for validity of derived correlation coefficients, all three of the following inequalities must be satisfied:

$$\begin{aligned} C_v P - (C_v D + C_v T) &< 0 \\ C_v D - (C_v T + C_v P) &< 0 \\ C_v T - (C_v P + C_v D) &< 0 \end{aligned} \quad (F-4)$$

In the examples (Tables F-3 and F-4), the numerical values from equation F-4 are usually negative, and the derived correlation test is considered valid. However, when any of the inequalities are not satisfied, "9.999" (missing) is written in the table. The rare exceptions to this test for several RRAs occur at extremely high altitudes where sample sizes for the statistical sample are small.

Statistical parameters from Table F-3 (January) and Table F-4 (July) are illustrated in Figures F-17 through F-20.

$C_v P$ values for all months are given in Figures F-21 and F-22. $C_v D$ values are given in Figures F-23 and F-24, and $C_v T$ values in Figures F-25 and F-26. If the abscissa on the figures for the coefficient of variation is multiplied by 100, these figures would show the percentage of random dispersion for these quantities over the month with respect to the monthly mean.

Derived correlation coefficients for all months are shown as follows: Figures F-27 and F-28 give $R(P,D)$; Figures F-29 and F-30 give $R(P,T)$; and Figures F-31 and F-32 give $R(T,D)$.

TABLE F-1. Deltas in Percent Relative to Annual, Nellis, January.

<u>RLEVEL</u>	<u>PRESSURE</u>	<u>DENSITY</u>	<u>TEMP.</u>	<u>TMO-TANN (K)</u>
0.000	0.784	4.893	-3.917	-11.670
1.000	0.333	3.975	-3.501	-10.210
1.007	0.344	3.978	-3.494	-10.190
2.000	-0.039	3.176	-3.115	-8.890
3.000	-0.394	2.040	-2.383	-6.630
4.000	-0.675	1.363	-2.009	-5.450
5.000	-0.931	1.056	-1.966	-5.200
6.000	-1.205	0.826	-2.015	-5.190
7.000	-1.467	0.497	-1.951	-4.890
8.000	-1.770	0.229	-1.993	-4.870
9.000	-2.065	-0.235	-1.834	-4.400
10.000	-2.436	3.296	-5.551	-13.140
11.000	-2.732	4.276	-6.721	-15.750
12.000	-2.905	-2.185	-0.738	-1.610
13.000	-2.938	-3.276	0.348	0.750
14.000	-2.869	-3.775	0.945	2.020
15.000	-2.733	-3.663	0.965	2.040
16.000	-2.572	-3.222	0.672	1.410
17.000	-2.553	-2.838	0.291	0.610
18.000	-2.524	-2.404	-0.124	-0.260
19.000	-2.576	-2.112	-0.473	-1.000
20.000	-2.688	-1.961	-0.741	-1.580
21.000	-2.807	-1.842	-0.983	-2.110
22.000	-3.014	-1.889	-1.148	-2.480
23.000	-3.238	-1.908	-1.352	-2.940
24.000	-3.419	-1.906	-1.544	-3.380
25.000	-3.683	-1.973	-1.747	-3.850
26.000	-3.911	-2.106	-1.844	-4.090
27.000	-4.211	-2.277	-1.975	-4.410
28.000	-4.483	-2.489	-2.047	-4.600
29.000	-4.713	-2.646	-2.121	-4.800
30.000	-4.762	-2.859	-1.958	-4.460

TABLE F-2. Deltas in Percent Relative to Annual, Nellis, July.

<u>RLEVEL</u>	<u>PRESSURE</u>	<u>DENSITY</u>	<u>TEMP.</u>	<u>TMO-TANN (K)</u>
0.000	-0.581	-4.637	4.253	12.670
1.000	-0.105	-4.022	4.081	11.900
1.007	-0.093	-4.009	4.081	11.900
2.000	0.348	-3.413	3.896	11.120
3.000	0.789	-2.621	3.501	9.740
4.000	1.209	-1.881	3.152	8.550
5.000	1.602	-1.347	2.990	7.910
6.000	2.020	-1.018	3.066	7.900
7.000	2.418	-0.743	3.188	7.990
8.000	2.903	-0.028	2.934	7.170
9.000	3.357	1.612	1.717	4.120
10.000	3.966	3.751	0.207	0.490
11.000	4.473	4.227	0.235	0.550
12.000	4.801	2.731	2.016	4.400
13.000	5.021	4.567	0.436	0.940
14.000	4.987	6.086	-1.034	-2.210
15.000	4.800	6.669	-1.754	-3.710
16.000	4.499	6.255	-1.654	-3.470
17.000	4.302	5.433	-1.074	-2.250
18.000	4.191	4.636	-0.423	-0.890
19.000	4.139	3.920	0.213	0.450
20.000	4.247	3.517	0.709	1.510
21.000	4.305	3.242	1.025	2.200
22.000	4.509	3.195	1.273	2.750
23.000	4.725	3.281	1.398	3.040
24.000	4.853	3.325	1.480	3.240
25.000	5.138	3.461	1.620	3.570
26.000	5.396	3.612	1.722	3.820
27.000	5.519	3.653	1.800	4.020
28.000	5.751	3.814	1.864	4.190
29.000	5.863	3.891	1.900	4.300
30.000	6.036	4.062	1.897	4.3200

TABLE F-3. Coefficients of Variation/Correlation Coefficients, January.

<u>LEVEL</u>	<u>CVP</u>	<u>CVD</u>	<u>CVT</u>	<u>R (P, T)</u>	<u>R (P, D)</u>	<u>R (T, D)</u>
0.000	0.008	0.040	0.035	-0.478	0.622	-0.985
1.000	0.007	0.023	0.022	0.066	0.220	-0.959
1.007	0.007	0.023	0.022	-0.031	0.315	-0.958
2.000	0.007	0.016	0.018	0.458	-0.067	-0.918
3.000	0.009	0.015	0.020	0.751	-0.436	-0.922
4.000	0.011	0.013	0.021	0.858	-0.553	-0.903
5.000	0.013	0.011	0.021	0.898	-0.546	-0.859
6.000	0.016	0.010	0.022	0.908	-0.391	-0.741
7.000	0.019	0.009	0.022	0.888	0.246	-0.229
8.000	0.021	0.011	0.020	0.913	0.858	0.573
9.000	0.024	0.015	0.017	9.999	9.999	9.999
10.000	0.025	0.023	0.016	0.423	0.781	-0.236
11.000	0.025	0.034	0.020	-0.122	0.816	-0.674
12.000	0.024	0.042	0.026	-0.412	0.830	-0.850
13.000	0.023	0.040	0.024	-0.440	0.838	-0.859
14.000	0.021	0.034	0.018	-0.444	0.874	-0.823
15.000	0.020	0.032	0.017	-0.520	0.892	-0.850
16.000	0.018	0.032	0.018	-0.565	0.884	-0.885
17.000	0.017	0.030	0.018	-0.445	0.837	-0.863
18.000	0.016	0.027	0.018	-0.227	0.744	-0.820
19.000	0.016	0.023	0.018	0.054	0.629	-0.742
20.000	0.016	0.020	0.018	0.353	0.501	-0.632
21.000	0.017	0.016	0.018	0.577	0.415	-0.504
22.000	0.019	0.016	0.019	0.677	0.407	-0.397
23.000	0.022	0.015	0.019	0.732	0.486	-0.239
24.000	0.023	0.016	0.020	0.747	0.561	-0.130
25.000	0.026	0.018	0.020	0.724	0.633	-0.078
26.000	0.027	0.020	0.020	0.685	0.698	-0.046
27.000	0.029	0.022	0.019	0.649	0.741	-0.030
28.000	0.030	0.025	0.020	0.573	0.747	-0.117
29.000	0.031	0.027	0.021	0.510	0.736	-0.206
30.000	0.032	0.030	0.023	0.448	0.734	-0.278

TABLE F-4. Coefficients of Variation/Correlation Coefficient, July.

<u>LEVEL</u>	<u>CVP</u>	<u>CVD</u>	<u>CVT</u>	<u>R (P, T)</u>	<u>R (P, D)</u>	<u>R (T, D)</u>
0.000	0.005	0.043	0.038	-0.916	0.934	-0.999
1.000	0.003	0.024	0.024	-0.277	0.381	-0.994
1.007	0.003	0.024	0.023	-0.212	0.322	-0.993
2.000	0.003	0.011	0.012	0.269	-0.028	-0.971
3.000	0.003	0.008	0.010	0.608	-0.326	-0.949
4.000	0.004	0.007	0.009	0.671	-0.231	-0.876
5.000	0.005	0.006	0.008	0.675	-0.040	-0.764
6.000	0.006	0.006	0.008	0.673	0.060	-0.699
7.000	0.006	0.006	0.009	0.717	-0.007	-0.702
8.000	0.007	0.006	0.010	0.758	0.007	-0.648
9.000	0.008	0.007	0.010	0.748	0.103	-0.583
10.000	0.010	0.007	0.010	0.672	0.569	-0.227
11.000	0.011	0.009	0.010	0.640	0.522	-0.321
12.000	0.011	0.011	0.010	0.540	0.546	-0.410
13.000	0.012	0.015	0.010	0.099	0.720	-0.619
14.000	0.012	0.019	0.013	-0.192	0.746	-0.796
15.000	0.011	0.022	0.015	-0.336	0.752	-0.873
16.000	0.010	0.021	0.016	-0.350	0.733	-0.894
17.000	0.010	0.017	0.013	-0.141	0.658	-0.838
18.000	0.010	0.014	0.011	0.117	0.585	-0.737
19.000	0.010	0.011	0.009	0.268	0.638	-0.571
20.000	0.010	0.010	0.008	0.428	0.692	-0.356
21.000	0.011	0.009	0.008	0.539	0.714	-0.206
22.000	0.012	0.010	0.008	0.583	0.717	-0.148
23.000	0.012	0.010	0.008	0.612	0.788	-0.005
24.000	0.013	0.010	0.008	0.688	0.820	0.148
25.000	0.014	0.010	0.008	0.705	0.835	0.199
26.000	0.015	0.011	0.008	0.720	0.849	0.244
27.000	0.016	0.011	0.009	0.712	0.837	0.212
28.000	0.017	0.012	0.009	0.728	0.858	0.274
29.000	0.018	0.014	0.010	0.666	0.841	0.158
30.000	0.019	0.014	0.010	0.657	0.856	0.173

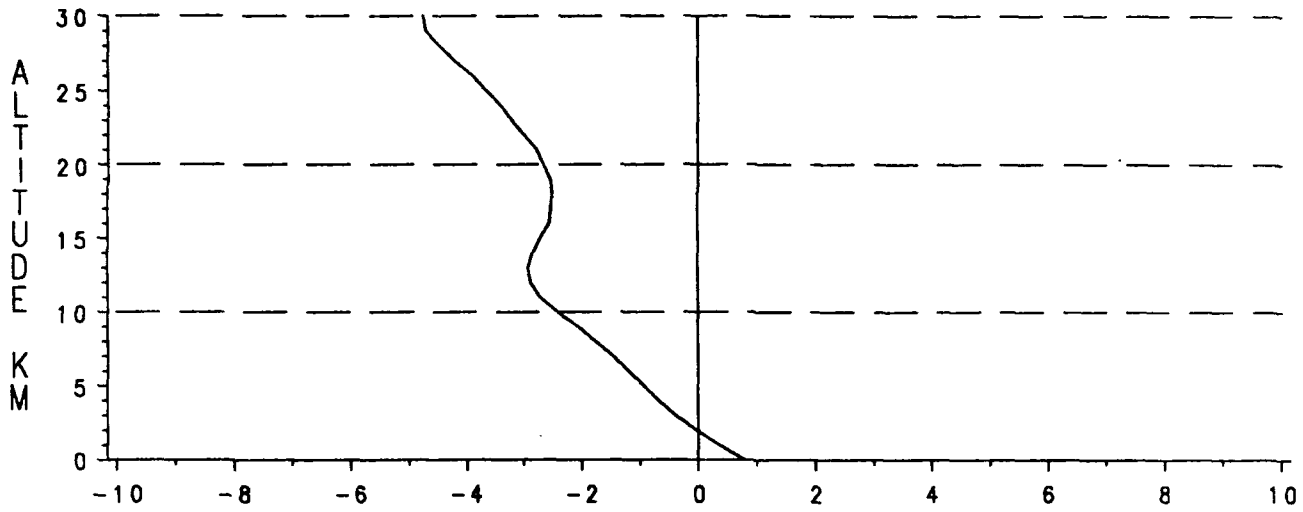

Figure F-1. Delta Percent Relative to Annual Pressure, January.

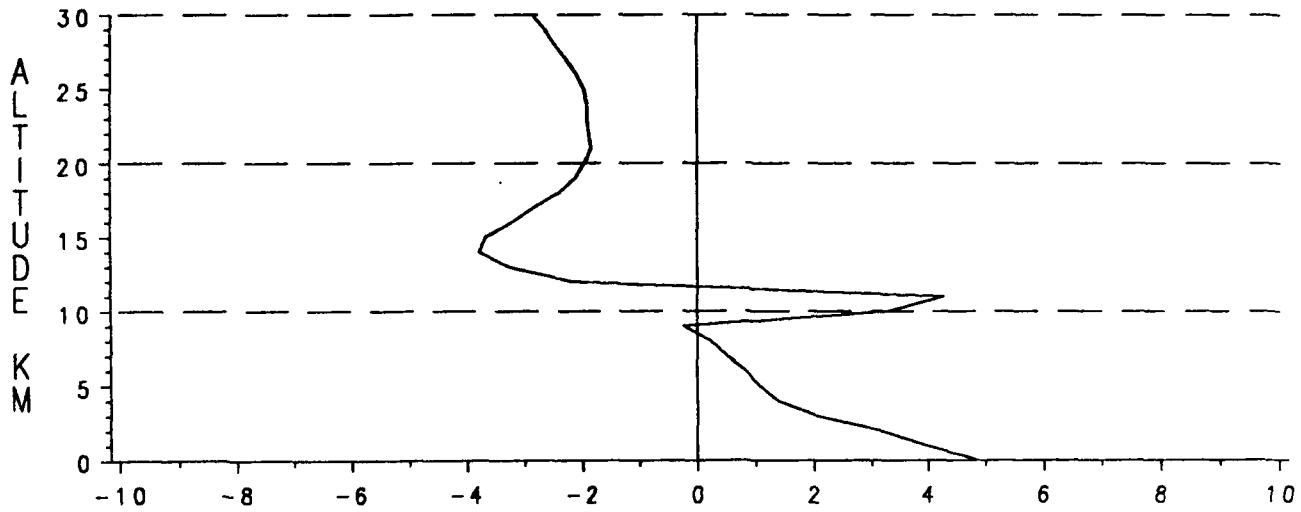

Figure F-2. Delta Percent Relative to Annual Density, January.

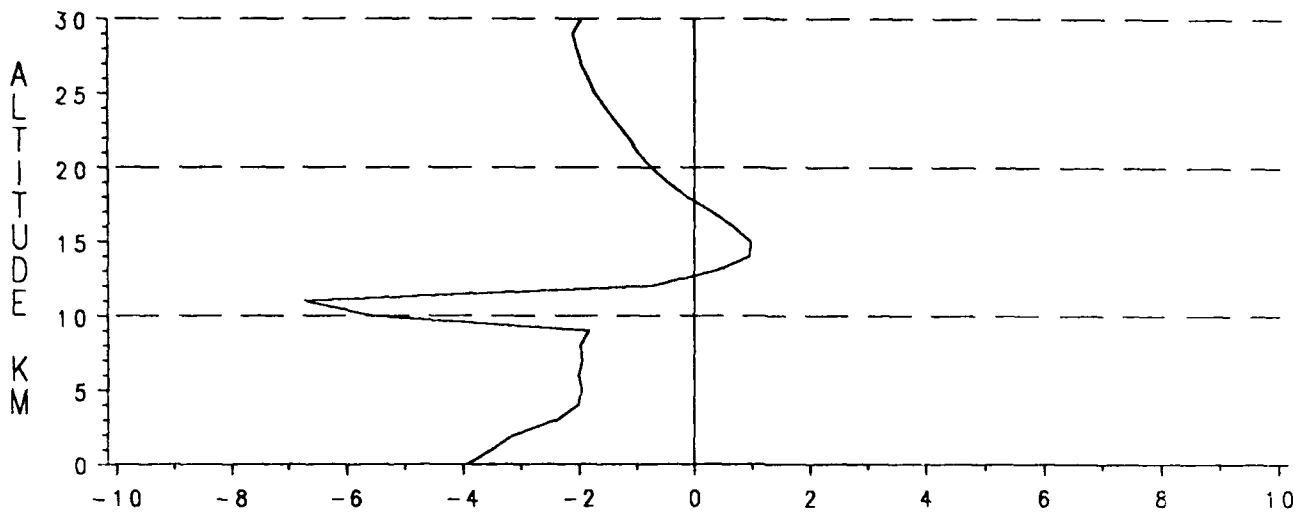

Figure F-3. Delta Percent Relative to Annual Temperature, January.

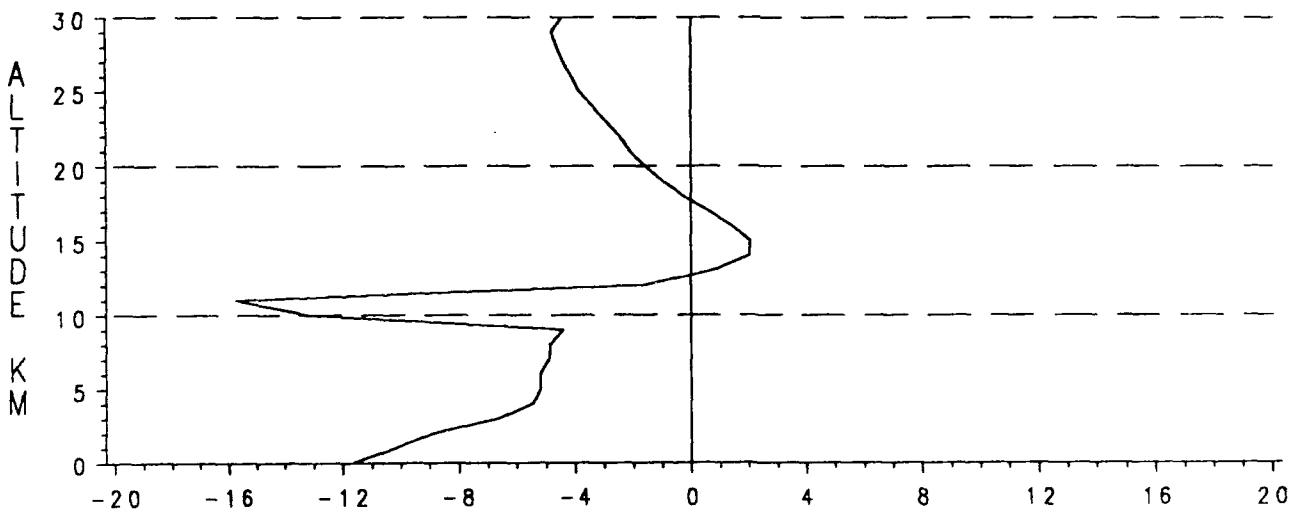

Figure F-4. Delta Temperature (K), January.

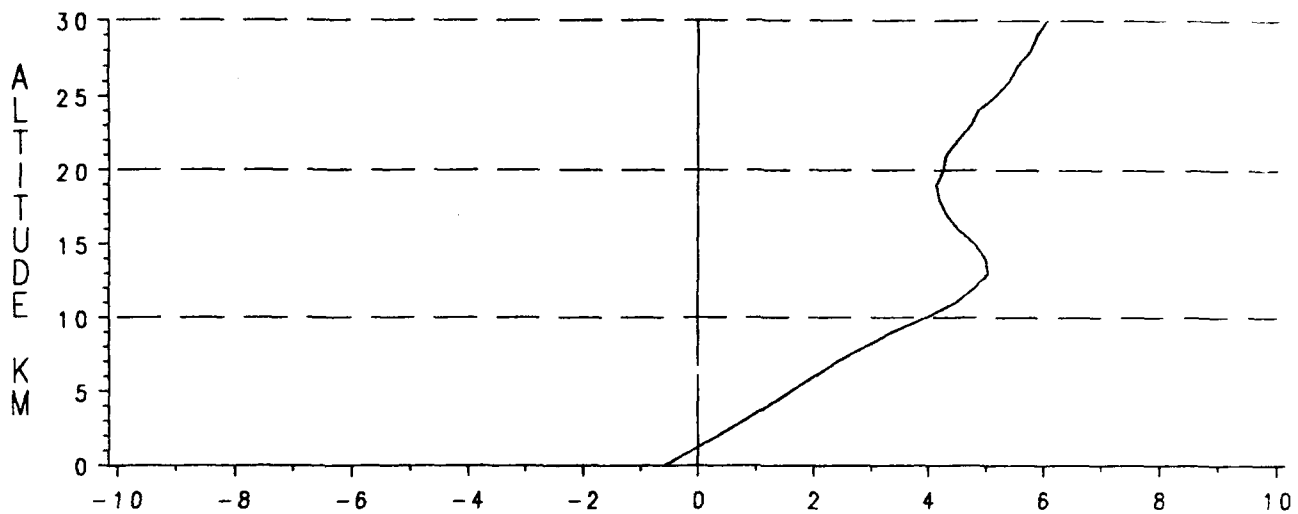

Figure F-5. Delta Percent Relative to Annual Pressure, July.

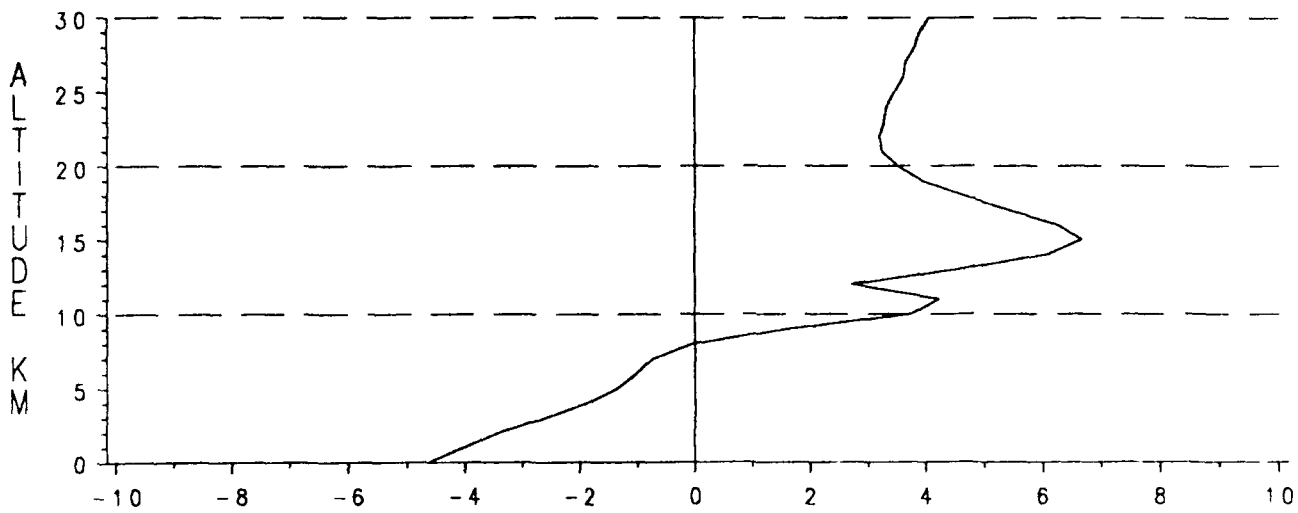

Figure F-6. Delta Percent Relative to Annual Density, July.

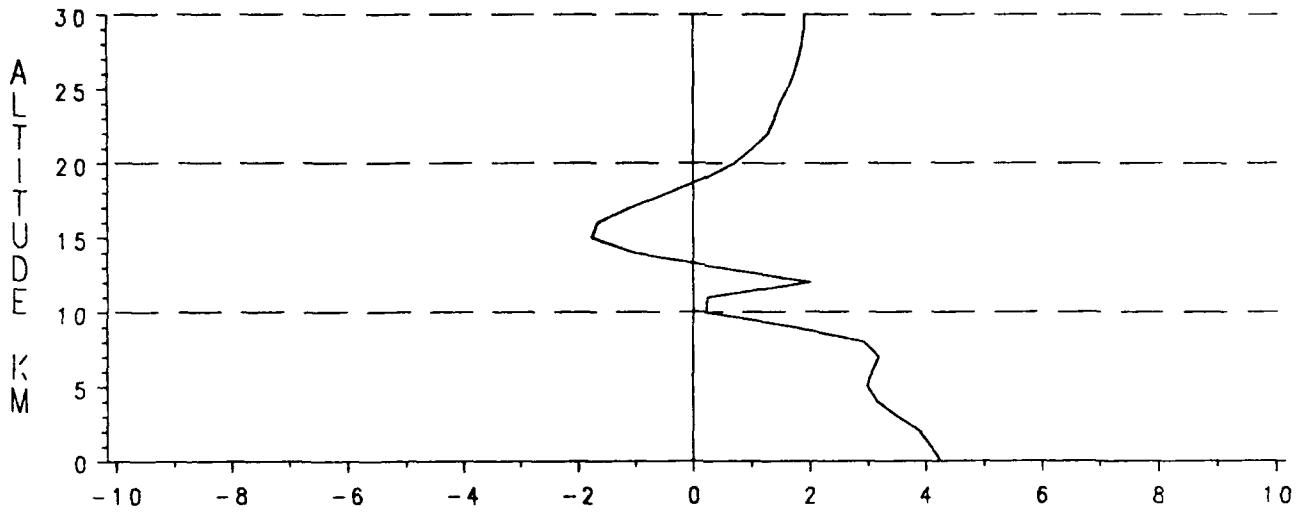

Figure F-7. Delta Percent Relative to Annual Temperature, July.

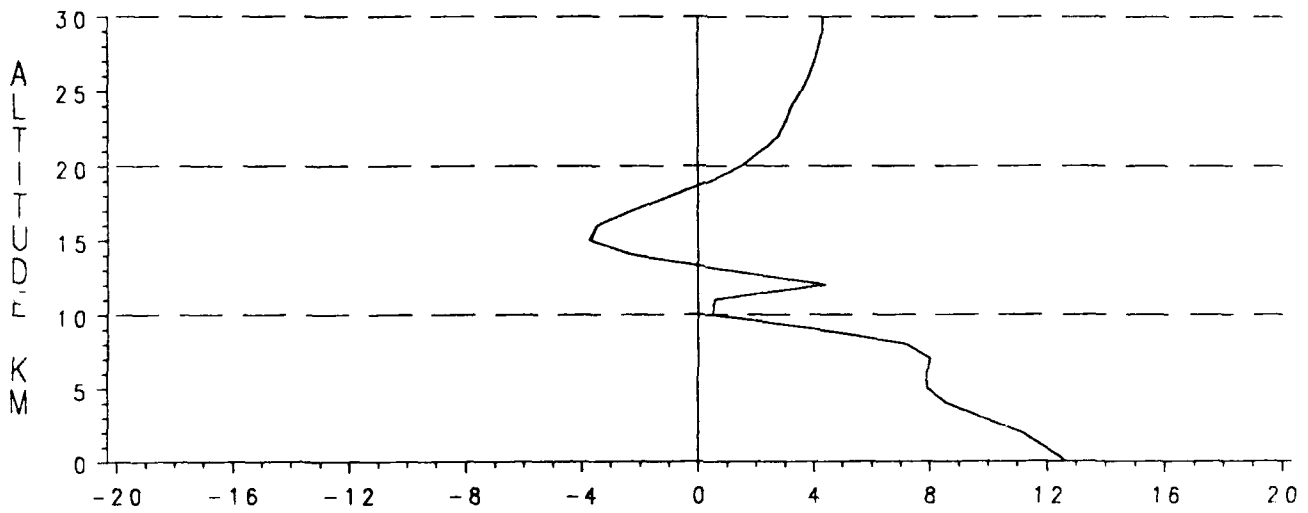

Figure F-8. Delta Temperature (K), July.

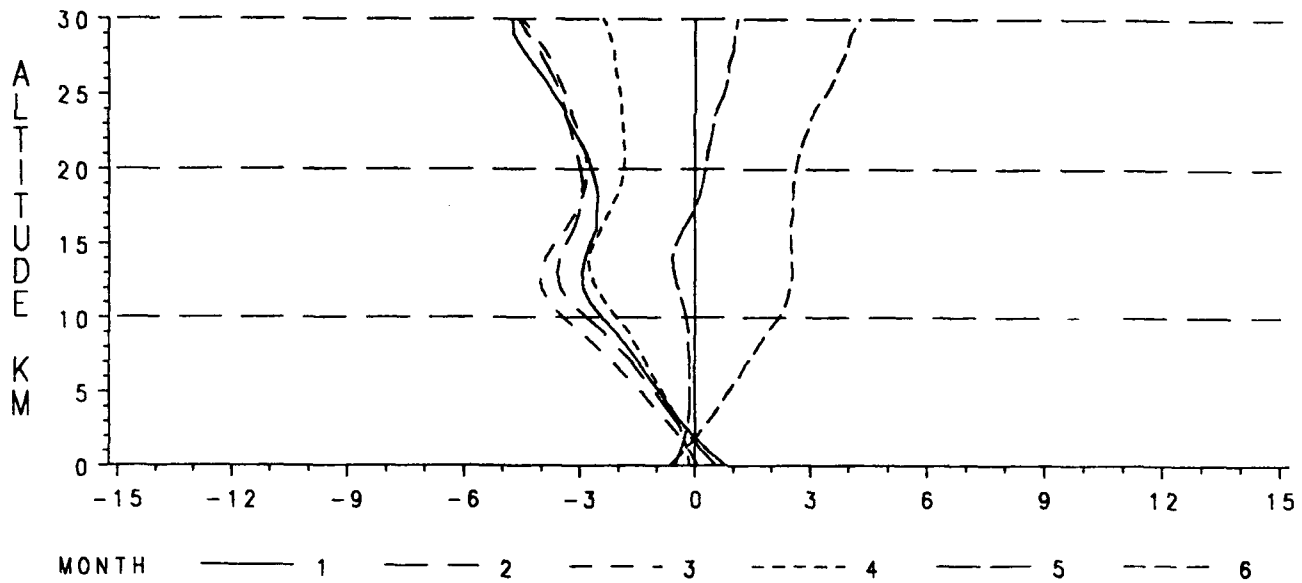

Figure F-9. Delta Percent Relative to Annual Pressure, January-June.

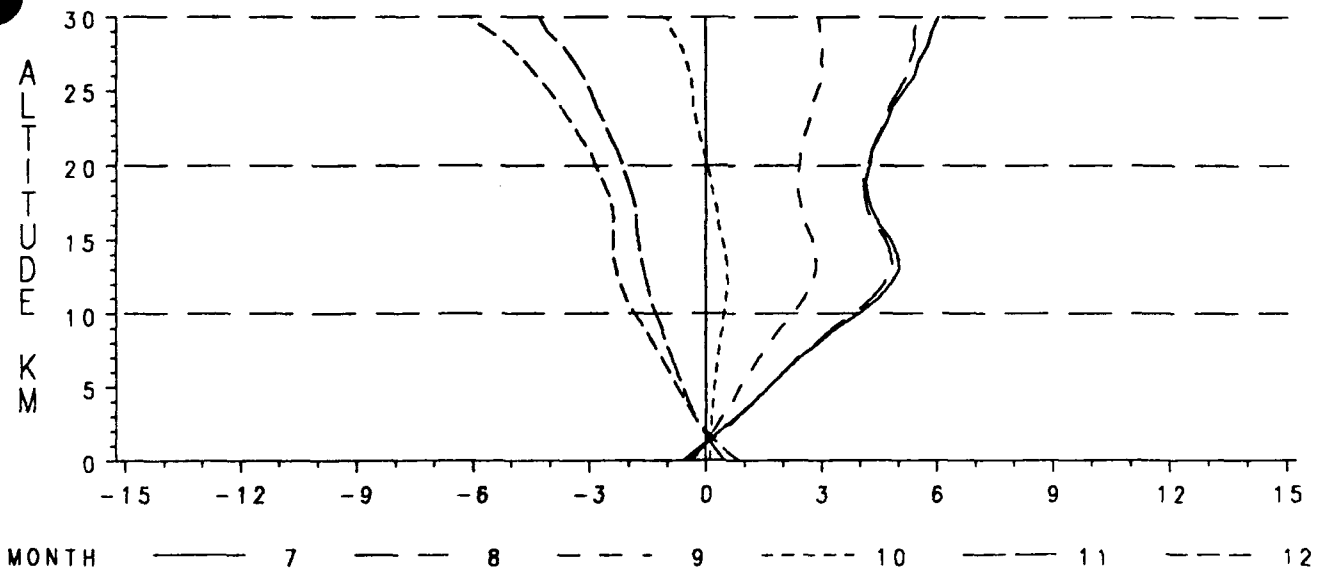

Figure F-10. Delta Percent Relative to Annual Pressure, July-December.

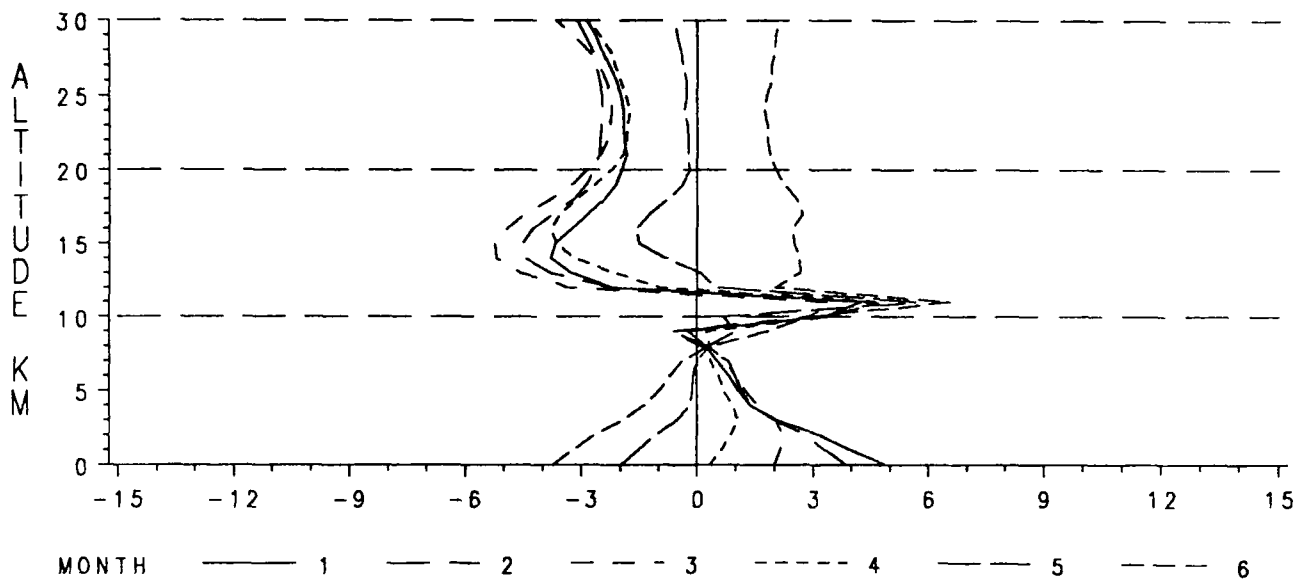

Figure F-11. Delta Percent Relative to Annual Density, January-June.

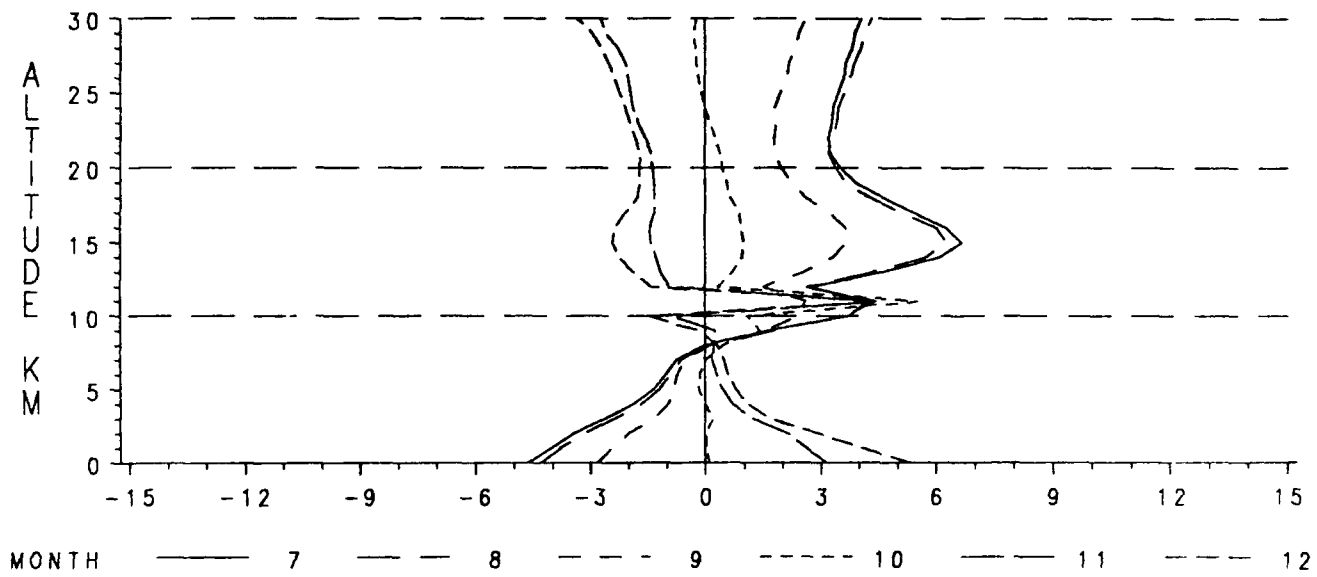

Figure F-12. Delta Percent Relative to Annual Density, July-December.

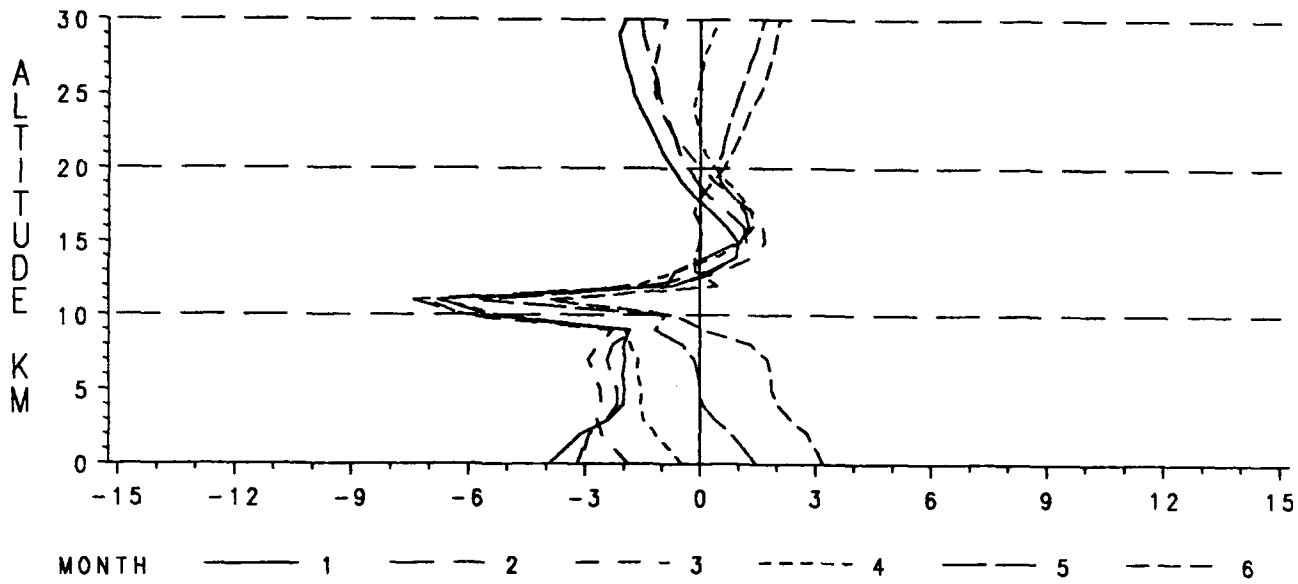

Figure F-13. Delta Percent Relative to Annual Temperature, January-June.

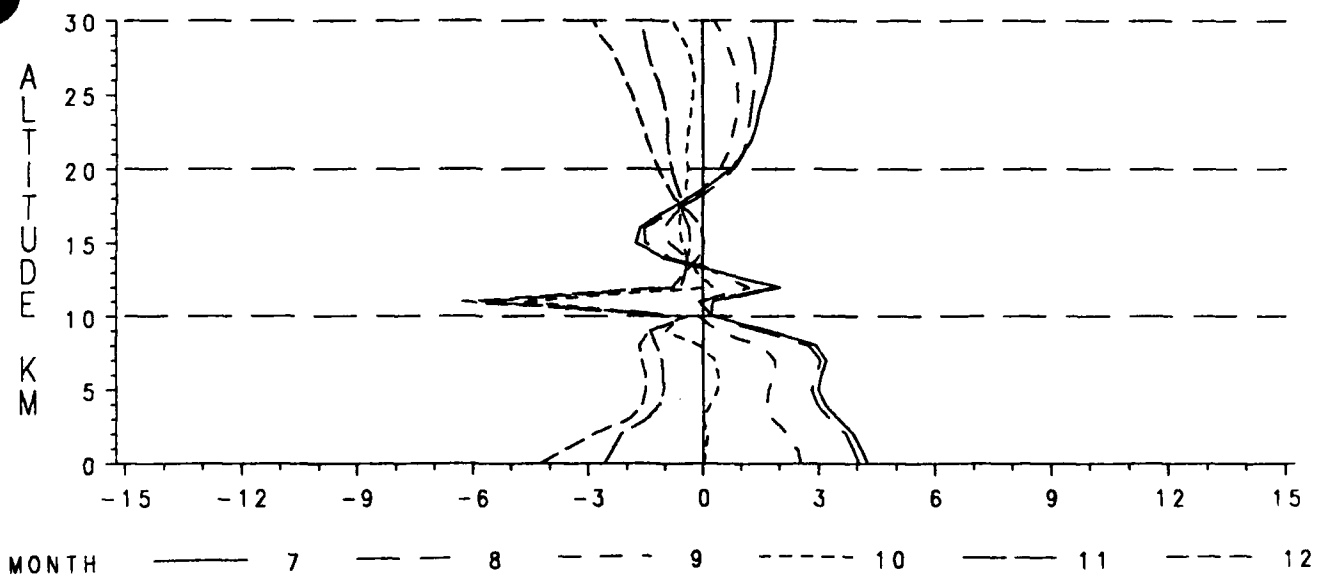

Figure F-14. Delta Percent Relative to Annual Temperature, July-December.

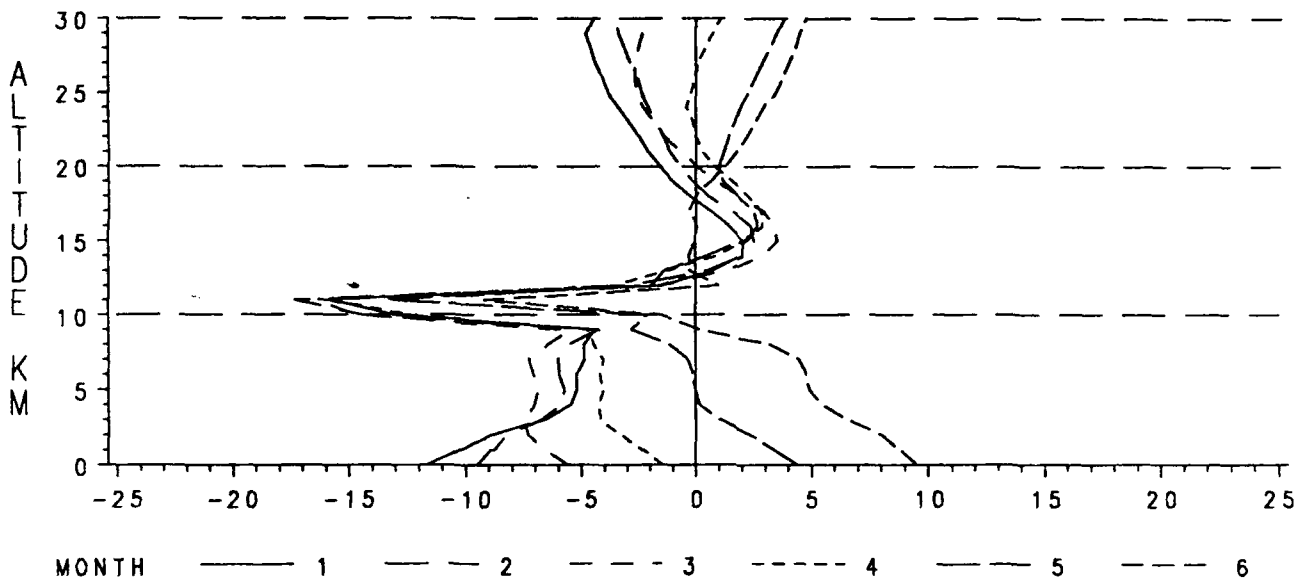

Figure F-15. Delta Temperature (K), January-June.

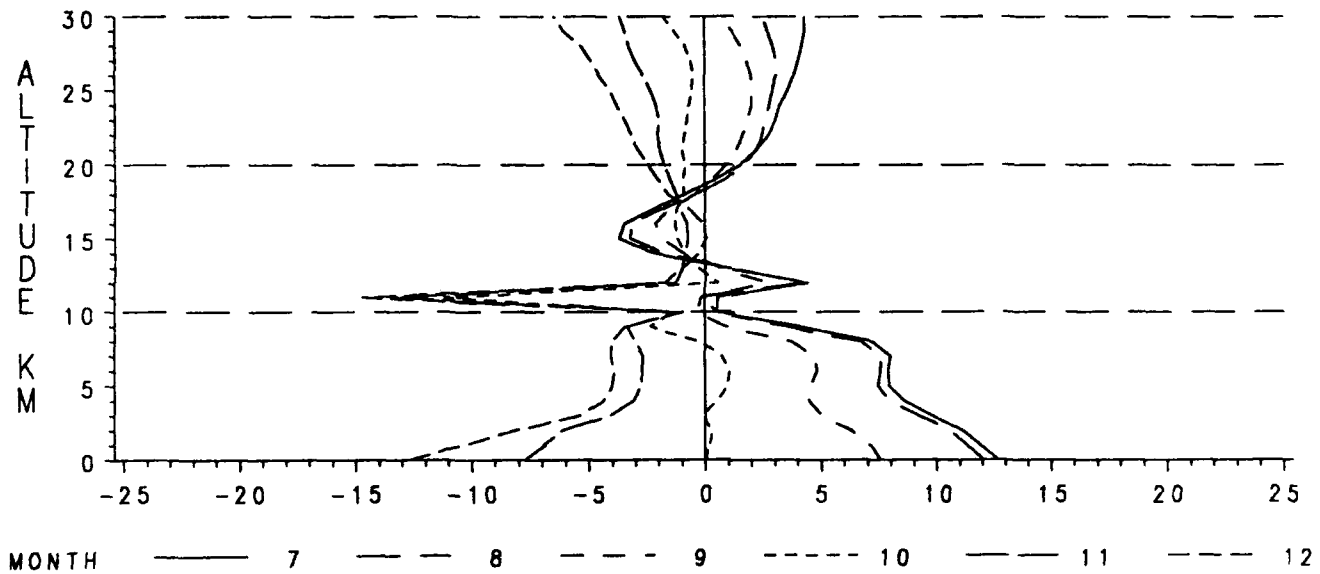

Figure F-16 Delta Temperature (K), July-December.

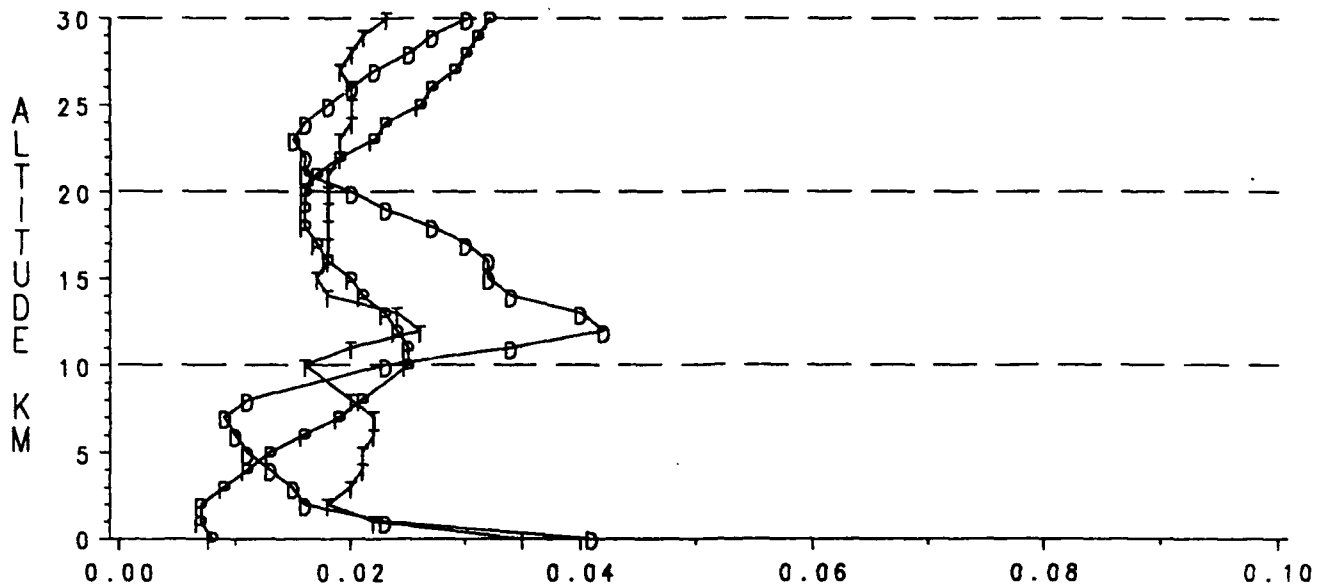

Figure F-17. Coefficients of Variation for Pressure (P), Density (D), and Temperature (T), January.

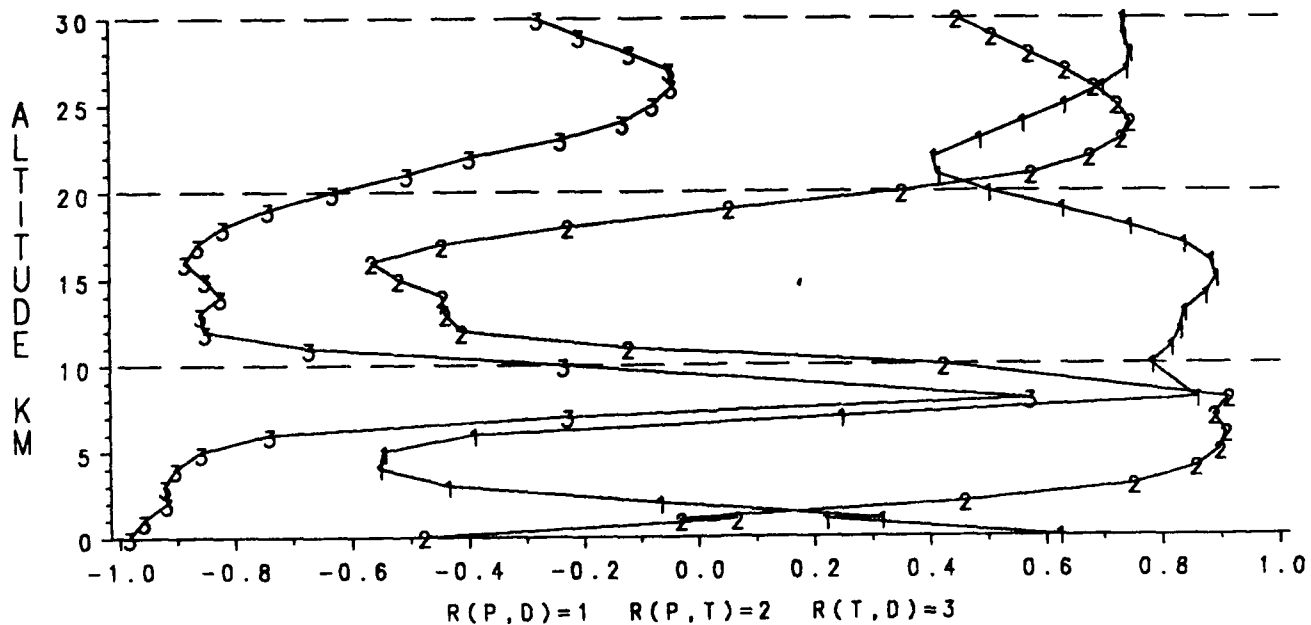

Figure F-18. Correlation Coefficients for P&D, P&T, and T&D, January.

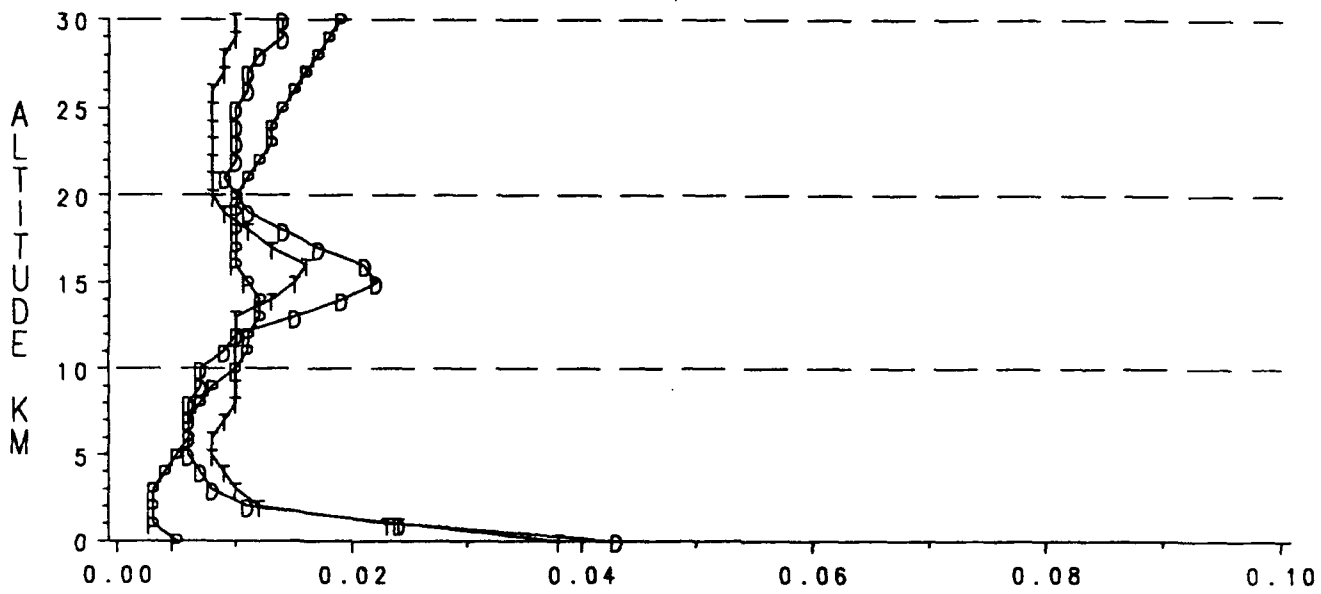

Figure F-19. Coefficients of Variation for Pressure (P), Density (D), and Temperature (T), July.

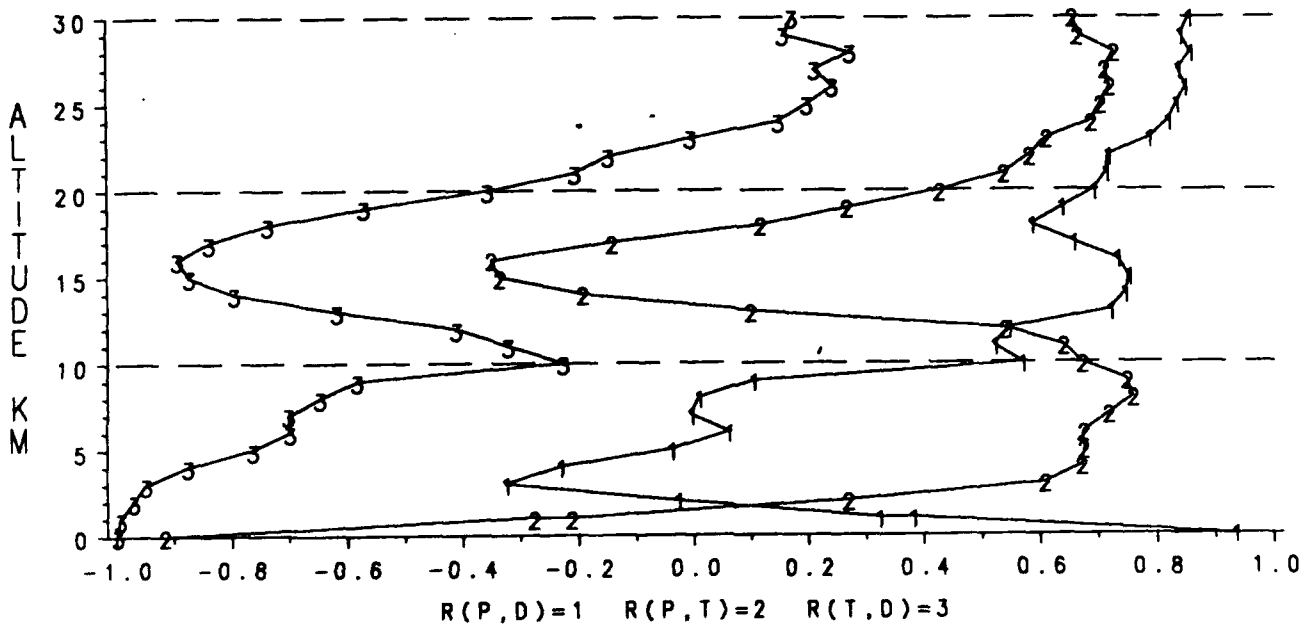

Figure F-20. Correlation Coefficients for P&D, P&T, and T&D, July.

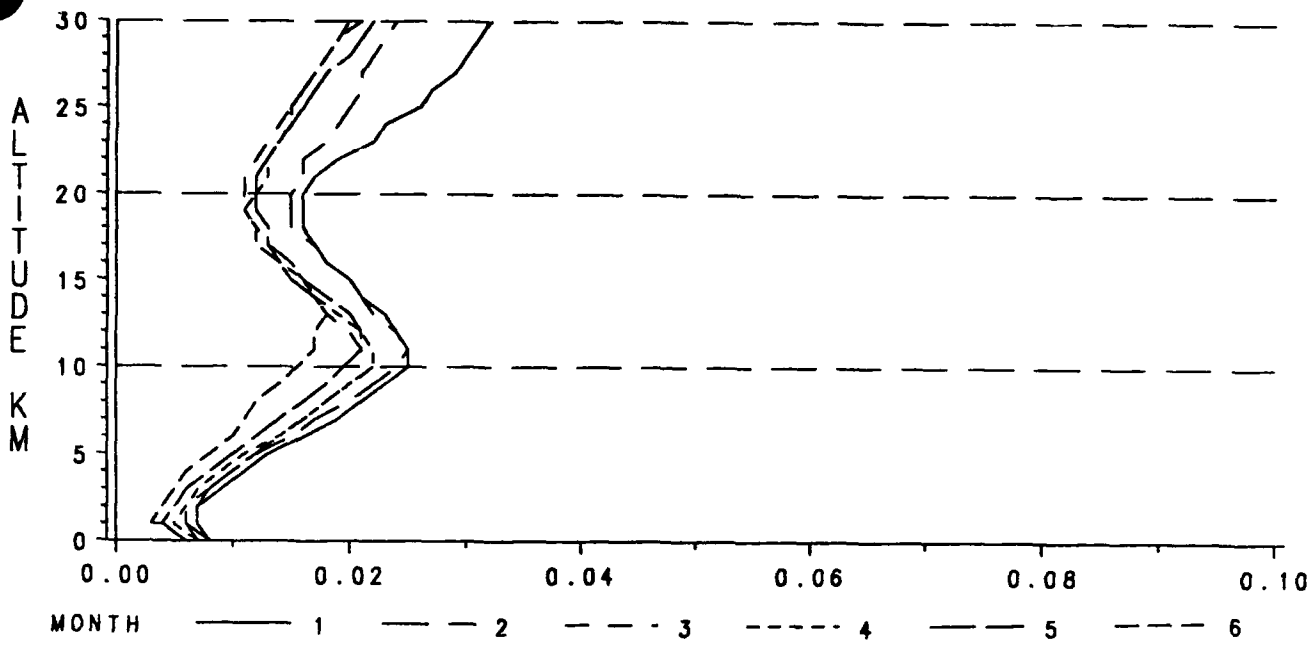

Figure F-21. Coefficients of Variation for Pressure, January-June.

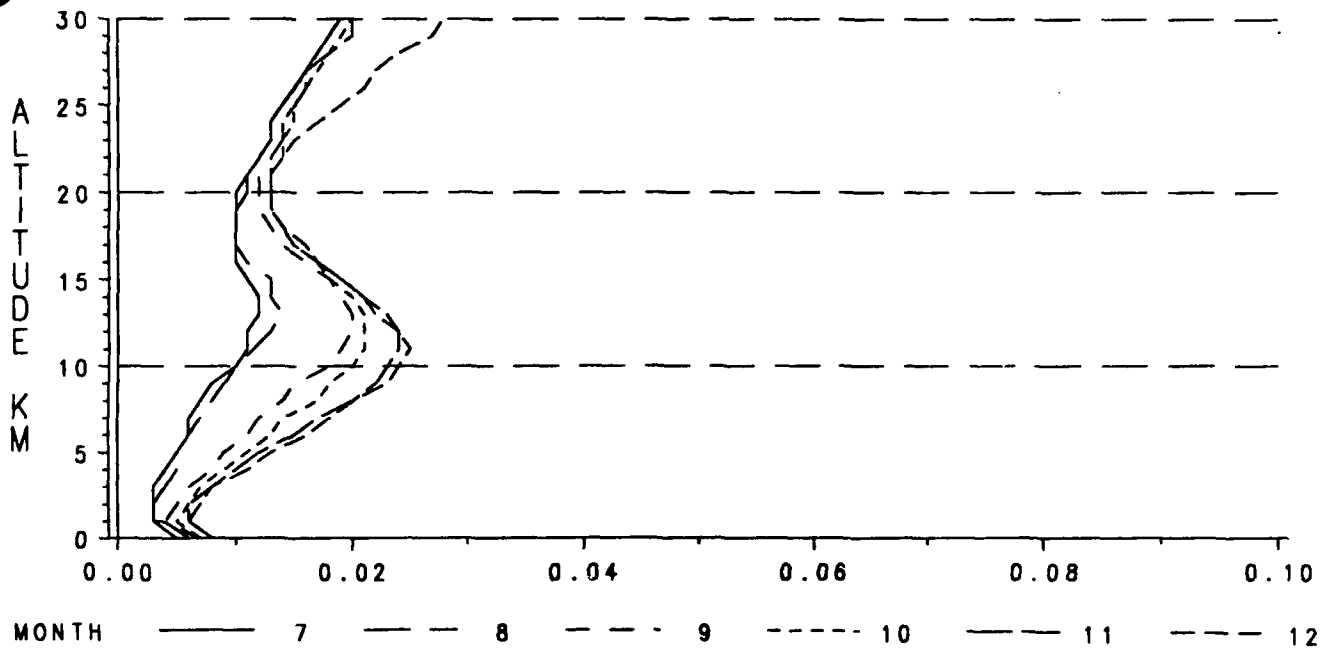

Figure F-22. Coefficients of Variation for Pressure, July-December.

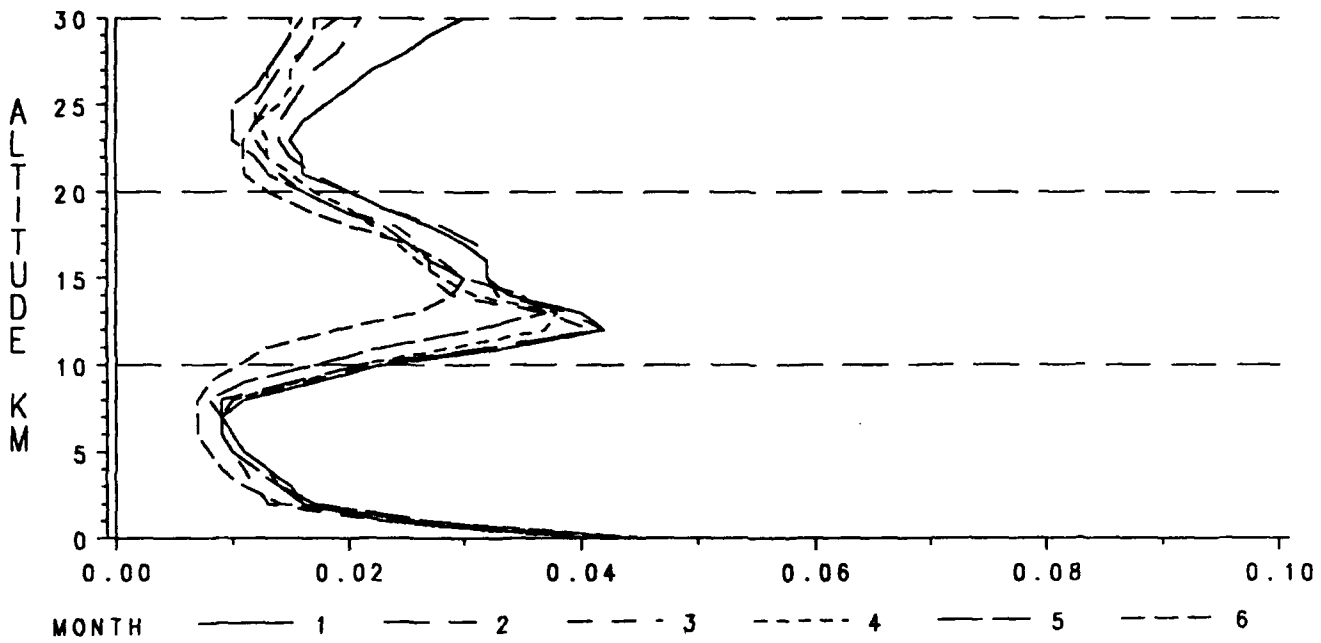

Figure F-23. Coefficients of Variation for Density, January-June.

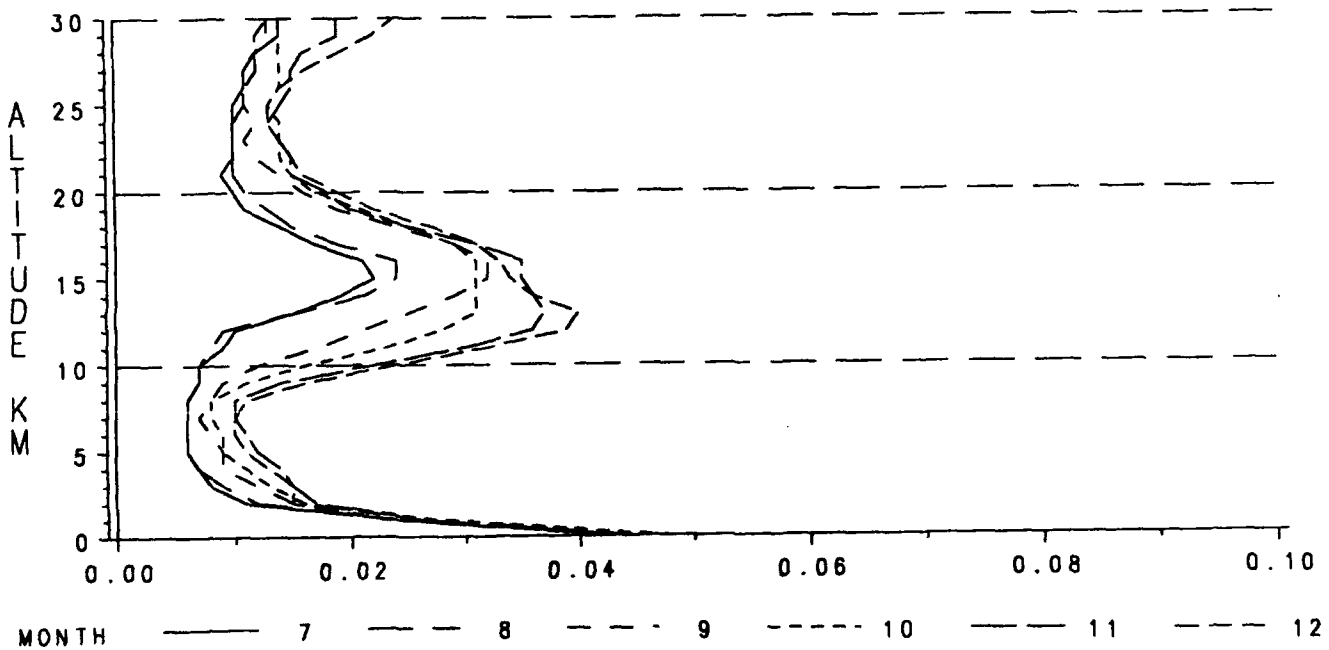

Figure F-24. Coefficients of Variation for Density, July-December.

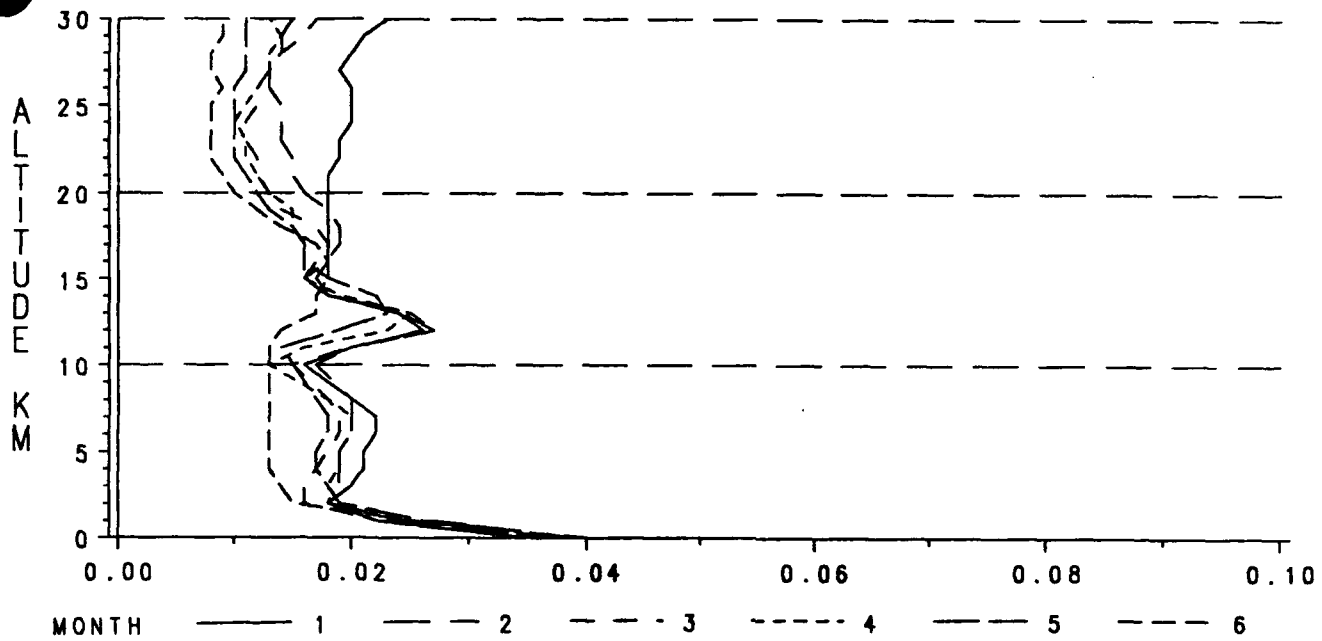

Figure F-25. Coefficients of Variation for Temperature, January-June.

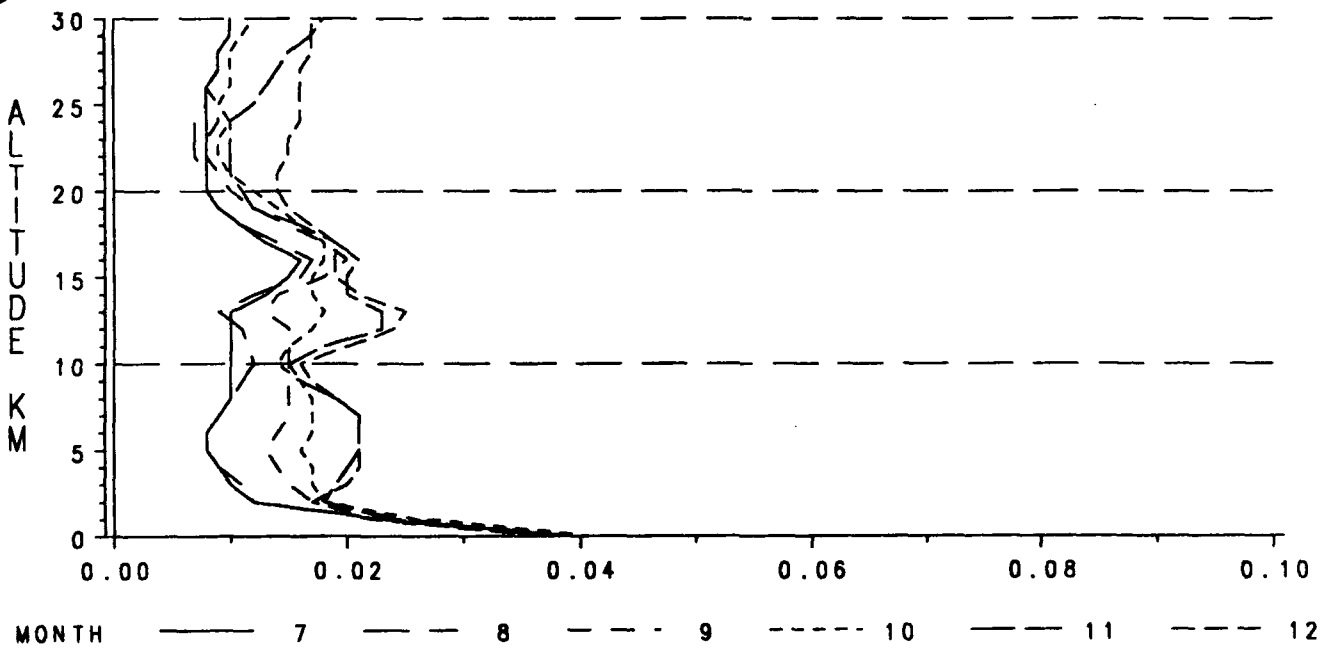

Figure F-26. Coefficients of Variation for Temperature, July-December.

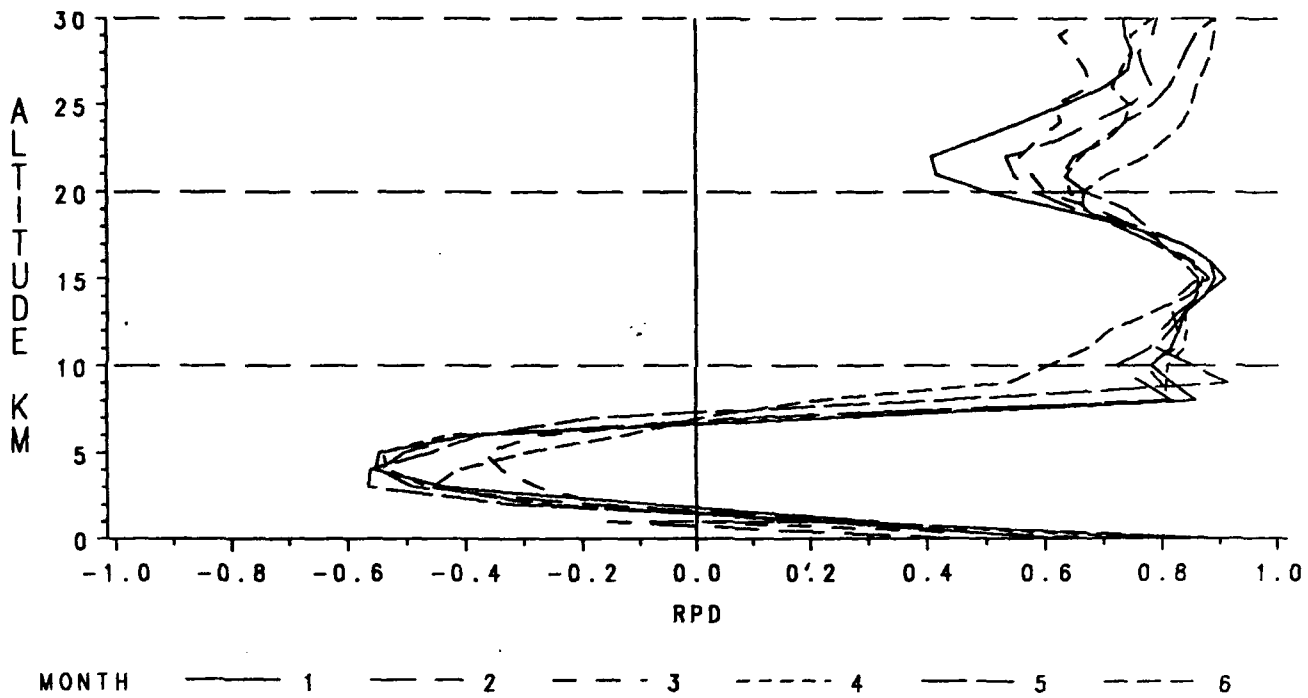

Figure F-27. Correlation Coefficients for Pressure & Density, January-June.

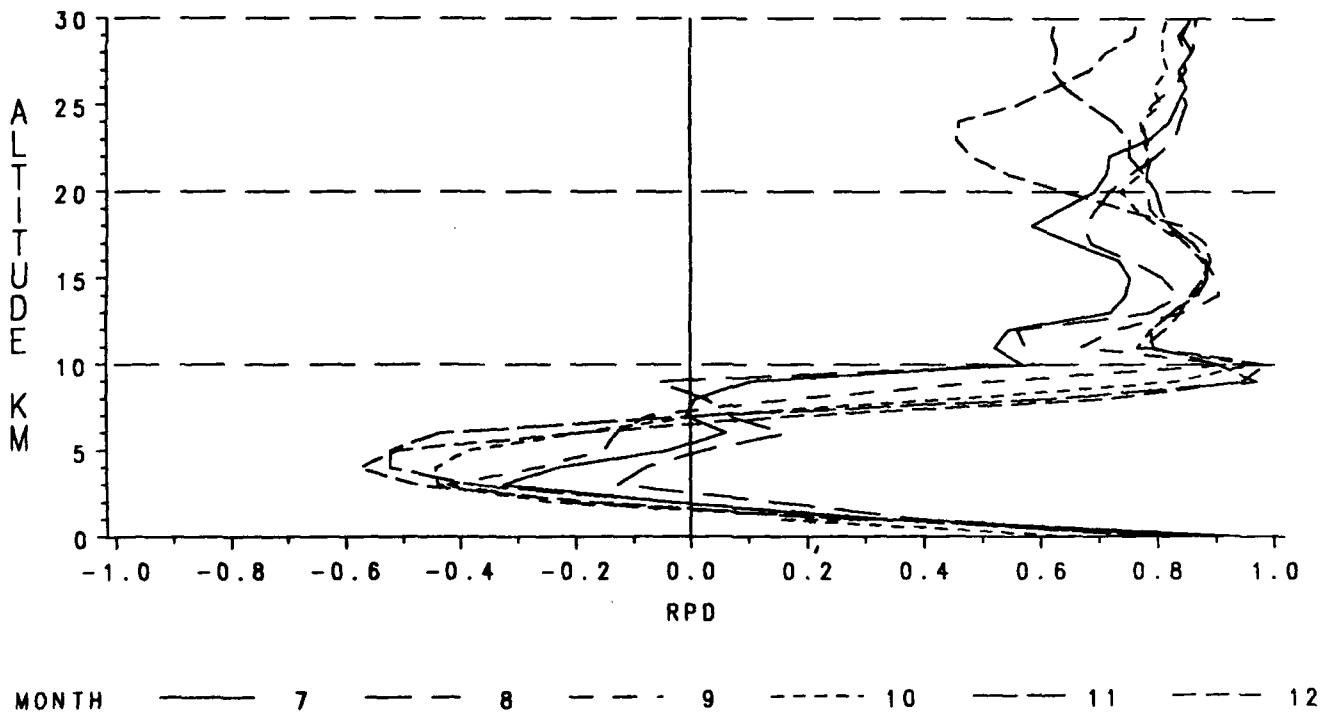

Figure F-28. Correlation Coefficients for Pressure & Density, July-December.

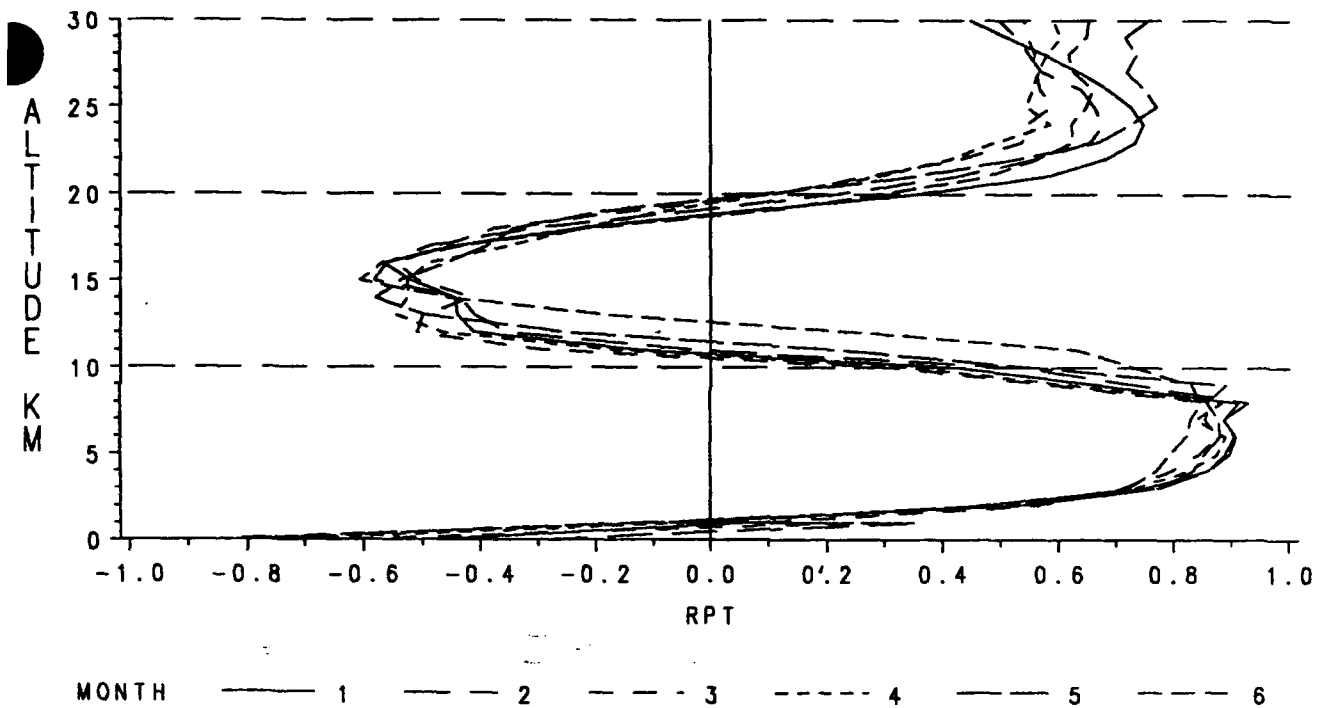

Figure F-29. Correlation Coefficients for Pressure & Temperature, January-June.

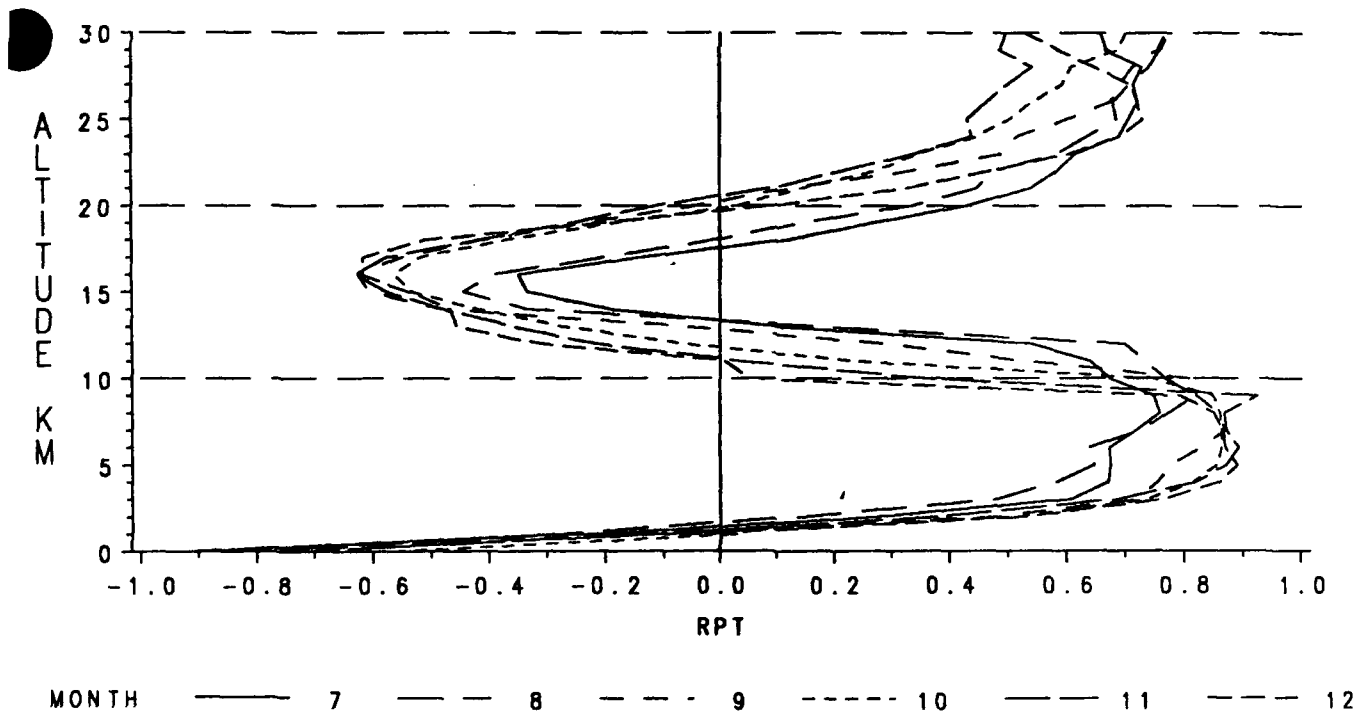

Figure F-30. Correlation Coefficients for Pressure & Temperature July-December.

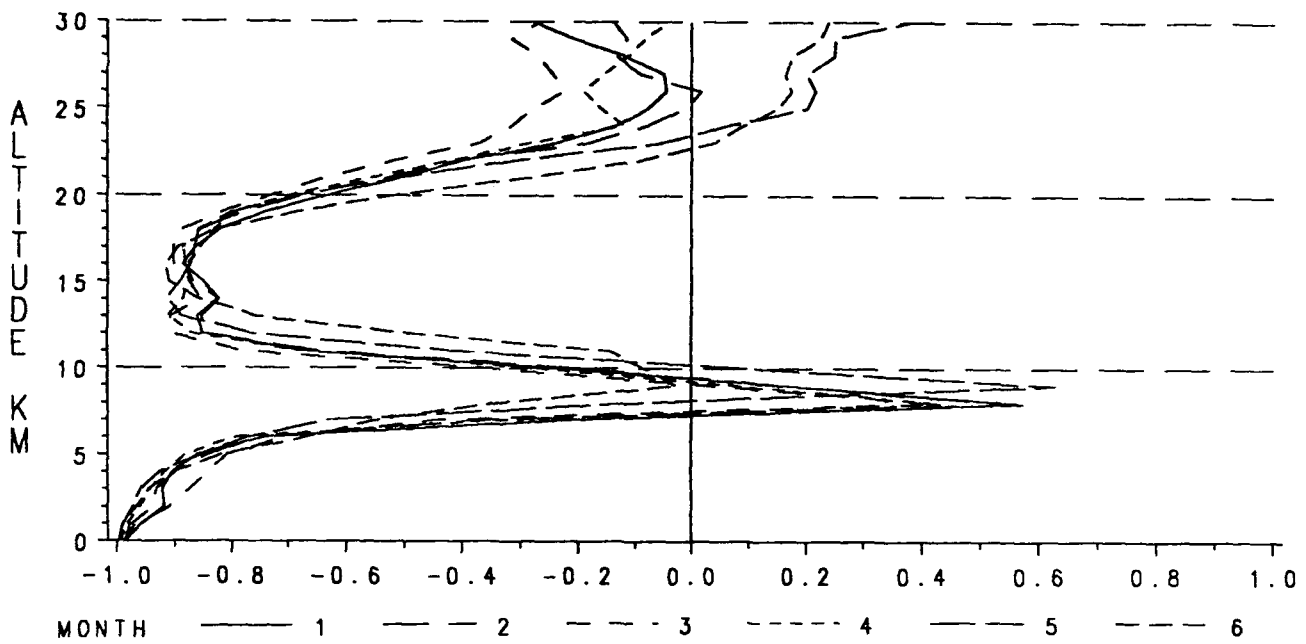

Figure F-31. Correlation Coefficients for Temperature & Density, January-June.

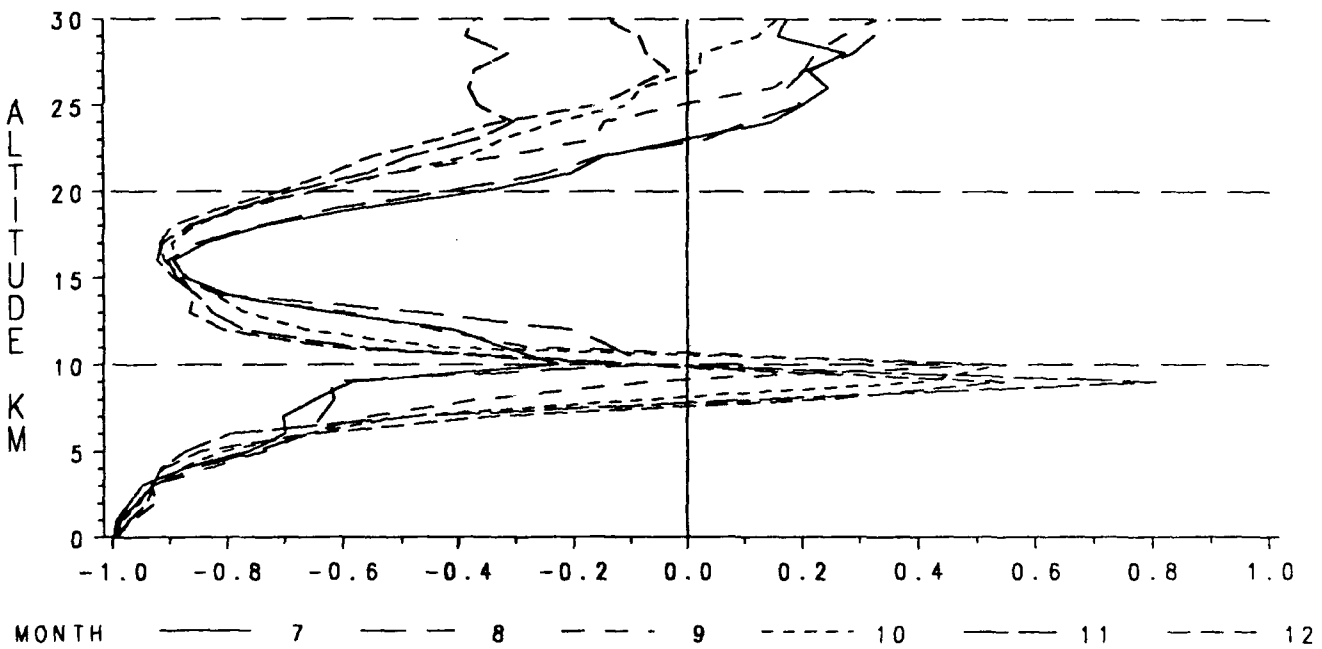

Figure F-32. Correlation Coefficients for Temperature & Density, July-December.

APPENDIX G

NELLIS (Desert Rock) Descriptive Data

To prevent further character size reduction in the tables given in Appendices A-D, certain range-specific information for Desert Rock has been omitted. The most important information follows:

Header Record 0-30 km

Table Number.....	0
Data Source (1=DATSAV, 2=WDC-A).....	1
Call Letters.....	KDRA
WMO Number.....	723870
Latitude.....	36° 37'
Direction (N or S).....	N
Longitude.....	116° 01'
Direction (E or W).....	W
Elevation in Meters.....	1,009
Start Period of Record (Mo-Yr).....	678
End Period of Record (Mo-Yr).....	1286
No. of Time Windows (0,1, or 2).....	0
Start Time Window #1 (Hr-Mhz).....	0
End Time Window #1.....	0
Start Time Window #2.....	0
End Time Window #2.....	0
Date of RRA.....	1290
Altitude Range of RRA Low-Level (km).....	0
Altitude Range of RRA High-Level (km).....	30
Standard Deviation of Thermodynamics Limits.....	±6.0
Wind Limits.....	±6.0

The following data is only required for RRAs that go to 70 km:

Table Number
Data Source (1=DATSAV, 2=WDC-A)
Call Letters
WMO Number
Latitude
Direction (N or S)
Longitude
Direction (E or W)
Elevation in Meters
Start Period of Record (Mo-Yr)
End Period of Record (Mo-Yr)
No. of Time Windows (0,1, or 2)
Start Time Window #1 (Hr-Mnz)
End Time Window #1
Start Time Window #2
End Time Window #2
Date of RRA
Altitude Range of RRA Low-Level (km)
Altitude Range of RRA High-Level (km)
Standard Deviation of Thermodynamic Limits
Wind Limits

DISTRIBUTION

AWS/DO, Scott AFB, IL 62225-5008	1
AWS/XT, Scott AFB, IL 62225-5008.....	1
AWS/XTJ, Scott AFB, IL 62225-5008	1
SD/CWDA, PO Box 92960, Los Angeles, CA 90009-2960	1
Det 1, HQ AWS, Pentagon, Washington, DC 20330-6560.....	1
Det 2, HQ AWS, Pentagon, Washington, DC 20330-5054.....	1
Det 3, HQ AWS, PO Box 3430, Onizuka AFB, CA 94088-3430.....	1
1WW/DN, Hickam AFB, HI 96853-5000.....	3
11WS/DON, Elmendorf AFB, AK 99506-5000.....	1
20WS/DON, APO San Francisco 96328-5000.....	1
30WS/DON, APO San Francisco 96301-0420.....	1
2WW/DN, APO New York 09094-5000.....	1
3WW/DN, Offutt AFB, NE 68113-5000.....	2
4WW/DN, Peterson AFB, CO 80914-5000	2
2WS/DON, Andrews AFB, MD 20334-5000.....	20
5WW/DN, Langley AFB, VA 23665-5000.....	2
AFGWC/SDSL, Offutt AFB, NE 68113-5000.....	2
USAFETAC, Scott AFB, IL 62225-5438.....	5
7WW/DN, Scott AFB, IL 62225-5008.....	1
6WS/DON Hurlburt Field, FL 32544-5000.....	1
17WS/DON, Travis AFB, CA 94535-5986.....	1
3350 TCHTG/TTGU-W, Stop 62, Chanute AFB, IL 61868-5000.....	1
3395 TCHTG/TTKO, Keesler AFB, MS 39534-5000.....	1
USCINCPAC (J37), Box 13, Camp H.M. Smith, HI 96861-5025.....	1
NAVOCEANCOMDET, Federal Building, Asheville, NC 28801-2723.....	1
NAVOCEANCOMDET, Patuxent River NAS, MD 20670-5103	1
NAVOCEANCOMFAC, Stennis Space Ctr, MS 39529-5002	1
NAVOCEANCOMFAC, NAS North Island, San Diego, CA 92135-5130	1
COMNAVOCEANCOM, Code N312, Stennis Space Ctr, MS 39529-5000.....	2
COMNAVOCEANCOM (Capt Brown, Code N332), Stennis Space Ctr, MS 39529-5001.....	1
NAVOCEANO, Code 9220 (Tony Ortolano), Stennis Space Ctr, MS 39529-5001.....	1
FLENUMOCEANCEN, Monterey, CA 93943-5006.....	1
NOARL West, Monterey, CA 93943-5006.....	1
Naval Research Laboratory, Code 4323, Washington, DC 20375.....	1
Naval Western Oceanography Ctr, Box 113, Attn: Tech Library, Pearl Harbor, HI 96860-5000	1
Naval Oceanography Command Ctr, COMNAVMAR Box 12, FPO San Francisco, CA 96630-5000	1
Pacific Missile Test Center, Geophysics Division, Code 3253, Pt Mugu, CA 93042-5000	1
NOAA Library-EOC4WSC4, Attn: ACQ, 6009 Executive Blvd, Rockville, MD 20852	1
NOAA/NESDIS (Attn: Nancy Everson, E/RA22), World Weather Bldg, Rm 703, Washington, DC 20233	1
GL/LY, Hanscom AFB, MA 01731-5000.....	1
GL Library, Attn: SULLR, Stop 29, Hanscom AFB, MA 01731-5000	1
Atmospheric Sciences Laboratory, Attn: SLCAS-AT-AB, Aberdeen Proving Grounds, MD 21005-5001	1
Atmospheric Sciences Laboratory, White Sands Missile Range, NM 88002-5501	1
U.S. Army Missile Command, ATTN: AMSMI-RD-TE-F, Redstone Arsenal, AL 35898-5250.....	1
Technical Library, Dugway Proving Ground, Dugway, UT 84022-5000.....	1
NCDC Library (D542X2), Federal Building, Asheville, NC 28801-2723.....	1
DTIC-FDAC, Cameron Station, Alexandria, VA 22304-6145	2
AUL/LSE, Maxwell AFB, AL 36112-5564	1
AWSTL, Scott AFB, IL 62225-5438	50