

DTIC FILE COPY

Corrected version--destroy all others

2

AD-A231 715



RANGE REFERENCE ATMOSPHERE

WAKE ISLAND

DTIC
ELECTE
FEB 12 1991
S B D

NOVEMBER 1990

(Corrected and reissued January 1991)



APPROVED FOR PUBLIC RELEASE;
DISTRIBUTION IS UNLIMITED

USAF
ENVIRONMENTAL TECHNICAL
APPLICATIONS CENTER

Scott Air Force Base, Illinois, 62225-5438

91 2 11 189

REVIEW AND APPROVAL STATEMENT

USAFETAC/PR-90/007, *Range Reference Atmosphere, Wake Island*, November 1990, is approved for public release. There is no objection to unlimited distribution of this document to the public at large, or by the Defense Technical Information Center (DTIC) to the National Technical Information Service (NTIS).

This document has been reviewed and is approved for publication.

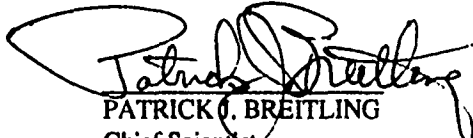
PATRICK O. BREITLING
Chief Scientist

FOR THE COMMANDER

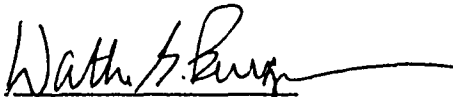
WALTER S. BURGMANN
Scientific and Technical Information
Program Manager
20 November 1990

NOTE: This corrected version of the original USAFETAC/PR-90/007, November 1990, was distributed in January 1991--destroy all copies of the original document.

REPORT DOCUMENTATION PAGE

2. Report Date: November 1990
3. Report Type: Range Reference Atmosphere (RRA)
4. Title and Subtitle: Range Reference Atmosphere, Wake Island
7. Performing Organization Name and Address: USAF Environmental Technical Applications Center (USAFETAC), Scott AFB, IL 62225-5438
8. Performing Organization Report Number: USAFETAC/PR-90/007
11. Supplementary Notes: A "corrected version" was distributed in January 1991--destroy all other copies.
12. Distribution/Availability Statement: Approved for public release; distribution is unlimited.
13. Abstract: This range reference atmosphere (RRA) is a statistical model (derived from upper-air observations) of the atmosphere from 0 to 30 km over Wake Island. It provides tabulations of monthly and annual means, standard deviations, and skewness coefficients for wind speed, pressure, temperature, density, water vapor pressure, virtual temperature, and dew point temperature. It also gives means and standard deviation for the zonal and meridional wind components and hydrostatic model atmosphere. Methodology is included, along with graphic displays of wind statistics that can be derived from the wind data.
14. Subject Terms: CLIMATOLOGY, UPPER-AIR CLIMATOLOGY, UPPER ATMOSPHERE, ATMOSPHERIC SOUNDINGS, STATISTICAL DATA, STATISTICAL ANALYSIS, HYDROSTATIC MODEL ATMOSPHERES, MISSILE RANGES, LAUNCHING SITES, WAKE ISLAND, wind, atmospheric pressure, atmospheric density, air temperature, dew point temperature, atmospheric moisture, range reference atmosphere.
15. Number of Pages: 150
17. Security Classification of Report: Unclassified
18. Security Classification of this Page: Unclassified
19. Security Classification of Abstract: Unclassified
20. Limitation of Abstract: UL

Standard Form 298

TABLE OF CONTENTS

	Page
Chapter 1 INTRODUCTION TO THE RANGE REFERENCE ATMOSPHERE (RRA)	
1.1 The RRA Defined.....	1
1.2 Purpose of the RRA.....	1
1.3 Contents of the RRA.....	1
1.4 Units of Measurement Used in RRAs.....	1
1.5 RRA Quality Control.....	1
1.6 How the RRA is Organized.....	2
1.7 Conversion Units.....	2
Chapter 2 WIND STATISTICS AND MODELS	
2.1 General Discussion.....	5
2.2 Quality Control.....	7
2.3 Data Limitations.....	7
2.4 The Coordinate System of Statistical Parameters.....	7
2.5 Computing Statistical Parameters.....	8
2.6 Statistical Wind Models.....	8
2.6.1 Wind Component Statistics.....	8
2.6.2 The Vector Wind Model.....	8
2.6.3 Derived Distributions for Wind Statistics.....	12
2.6.3.1 The Conditional Distribution of Wind Components.....	13
2.6.3.2 Generalized Rayleigh Distribution for Wind Speed.....	14
2.6.3.3 The Derived Distribution of Wind Direction.....	15
2.6.3.4 Derived Conditional Distribution of Wind Speed Given Wind Direction.....	16
2.7 Statistical Parameters for Non-Standard Orthogonal Axes.....	18
Chapter 3 THERMODYNAMIC STATISTICS AND MODELS	
3.1 General Discussion.....	19
3.2 Quality Control.....	21
3.3 Data Limitations.....	21
3.4 Establishing Data Samples at Required Levels.....	21
3.4.1 Converting Geopotential Height to Geometric Altitude.....	21
3.4.2 Calculations from Rawinsonde Observations.....	22
3.4.2.1 Geopotential Height at Significant Levels.....	22
3.4.2.2 Temperature.....	22
3.4.2.3 Pressure.....	23
3.4.2.4 Dew Point Temperature.....	23
3.4.2.5 Vapor Pressure.....	23
3.4.2.6 Density.....	23
3.4.2.7 Virtual Temperature.....	23
3.4.3 Calculations from Rocketsonde Observations.....	23
3.4.3.1 Temperature.....	23
3.4.3.2 Pressure.....	24
3.4.3.3 Density.....	24
3.5 Computing Statistics for Appendices B and C.....	24
3.5.1 Stored Statistical Sums.....	24
3.5.2 Calculating Monthly Statistics.....	24
3.5.2.1 Monthly Means.....	24
3.5.2.2 Monthly Standard Deviations.....	24
3.5.2.3 Monthly Skewness Values.....	24
3.5.3 Calculating Annual Statistics.....	25

Chapter 3 THERMODYNAMIC STATISTICS AND MODELS, Cont'd.

3.5.3.1 Annual Means.....25
 3.5.3.2 Annual Standard Deviations and Skewness Values25
 3.6 Monthly and Annual Mean Model Atmospheres25
 3.7 Thermodynamic Quantities Derivable from Tables25
 3.7.1 Mean Air Particle Speed.....26
 3.7.2 Mean Free Path.....26
 3.7.3 Mean Collision Frequency27
 3.7.4 Speed of Sound.....27
 3.7.5 Coefficient of Dynamic Viscosity27
 3.7.6 Kinematic Coefficient of Viscosity27
 3.7.7 Coefficient of Thermal Conductivity28
 3.7.8 Refractive Modulus and Refractive Index.....28

Chapter 4 CONCLUSIONS AND RECOMMENDATIONS

4.1 Conclusions29
 4.2 Recommendations29

BIBLIOGRAPHY30

PREVIOUSLY PUBLISHED RANGE REFERENCE ATMOSPHERES31

ACRONYMS, INITIALISMS, AND ABBREVIATIONS (ACRINABs).....33

APPENDIX A Wake Island Wind Statistics Tables A-1

APPENDIX B Wake Island Thermodynamic Statistics Tables.....B-1

APPENDIX C Wake Island Moisture-Related Statistics Tables.....C-1

APPENDIX D Wake Island Hydrostatic Model Atmospheres D-1

APPENDIX E Wind Statistics Derivable from Appendix A TablesE-1

APPENDIX F Thermodynamic Statistics Derivable from Appendix C, D, and E Tables.....F-1

APPENDIX G Wake Island Descriptive Data..... G-1



Accession For	
NTIS GRA&I	<input checked="" type="checkbox"/>
DTIC TAB	<input type="checkbox"/>
Unannounced	<input type="checkbox"/>
Justification	
By _____	
Distribution/	
Availability Codes	
Dist	Avail and/or Special
A-1	

PREFACE

The state of the atmosphere over national ranges and aerospace vehicle launch and/or recovery sites is critical not only to launch and recovery operations, but to aerospace research and development, as well. In the early 1960s, missile range operators recognized the need for a realistic atmospheric model that was consistently derived for each of the several major missile test ranges then in operation. Such a model, derived from climatological statistics for a given location, was developed and named a "range reference atmosphere." Even though the application has since broadened to include all aerospace launch and/or recovery sites, the model is still referred to as a "range reference atmosphere," or "RRA."

The first RRA (for Cape Canaveral) was prepared in 1963 by the Inter-Range Instrumentation Group (IRIG). More RRAs were produced for other ranges through 1974. Since then, improved upper-air databases have become available not only because of an extended period of record, but because of more and better rocketsonde data above 30 km. Although some improved RRAs were published in 1983 and 1984, revisions must continue, because:

- Aerospace technology requirements continue to change--the space shuttle program is an example.
- Extended and improved upper-air databases for most existing ranges permit development of better, more comprehensive RRAs.
- New launch and recovery sites have been opened.
- There have been significant advances in understanding the structure and physics of the upper atmosphere.
- There have been similar advances in statistical modeling techniques, largely because of ever-larger, faster, and more sophisticated computers.

For these reasons, the Range Reference Atmosphere Committee (RRAC) was tasked by the Range Commander's Council/Meteorology Group (RCC/MG) to produce new and revised RRAs, as required. The RRAC, through Task MG-1, publishes RRAs for ranges specified by the RCC. An RRA, as has already been mentioned, is a model of the atmosphere over a specified geographical area that delineates an aerospace vehicle launch and/or recovery site. RRAs are for use by DoD and other U.S. Government users in planning, evaluating, and establishing environmental launch/recovery constraints for a specific facility and the aerospace vehicles launched and/or recovered there.

The RRA tasking requires using the best available upper-atmosphere databases (rawinsonde, rocketsonde, and any other high-altitude data source) to create and publish (in standard format) a consistently derived model of wind and thermodynamic values through a cross-section of the upper atmosphere from surface to a specified height. The individual RRA serves as the authoritative source for upper-atmosphere climatology at a given launch/recovery site.

Wind statistics, insofar as practical, are modeled to be consistent with the rigorous mathematical probability properties of the multivariate normal probability theory. Thermodynamic statistics, insofar as practical, are modeled to be consistent with the hydrostatic equation, the equation of state, and related probability principles.

In keeping with the RCC's objective of standardization, modeling technique, basic text, and tabulation formats are the same for all RRAs. RRAs published in 1990 have undergone minor format changes designed to make them conform to DoD and ANSI technical publications standards. All RRAs provide mean values of thermodynamic quantities (pressure, temperature, and density) and moisture quantities (vapor pressure, virtual temperature, and dew point temperature). These values include a statistical measure for the dispersion: that is, standard deviations and skewness coefficients. The properties of the bivariate normal probability distribution function are used for statistical modeling of wind.

The first RRA to be published in this new (1990) series is for the Wake Island Missile Range, with an altitude range from 0 to 30 km. The order of priority for subsequent publications in the RRA series is:

<u>Range</u>	<u>Altitude Range Required</u>
1. Nellis Range Complex, NV	0 - 30 km
2. Shemya, AK	0 - 70 km
3. Thule, GR	0 - 70 km
4. Fairbanks, AK	0 - 30 km

All final computations in this RRA series were performed by the USAF Environmental Technical Applications Center (USAFETAC) in response to taskings from the Ballistic Missile Office (BMO), HQ Air Weather Service (AWS/SYJ), and Detachment 2, Space Division.

Majors Cheryl Souders and Walter Miller, and Capts Doug Adamson and Brian Bjornson (all of USAFETAC/DNO), rewrote the software used to provide the primary tables, updated Chapters 1 through 4, and prepared the appendices. USAFETAC/LDE formatted and edited the text and graphics, prepared the camera-ready copy in standard DoD technical report format, and published the document as a USAFETAC project report.

The RRC/MG Range Reference Atmosphere Committee is made up of representatives from the Air Force, Army, NASA, Navy, and NOAA. The RRA committee members were:

Mr J. Lee (USAKA)	Mr D.R. Thornley (WSMR)
Mr D. Godwin (USAKA)	Mr E.J. Keppel (MSD)
Ms J. Bailey (YPG)	Capt R.M. Fogarty, USAF (6585th TG)
Mr T.O. McIntire (YPG)	Lt Col T.F. Tascione, USAF (MSD)
Mr S.W. Bieda, Jr. (EPG)	Mr J. Kerwin (MSD)
Mr G. Boire (WSMC)	Lt Col R.J. Ericson, USAF (CSTC)
Mr H.C. Herring (ESMC)	Capt W. Gibbons, USAF (TFWC)
Col J.T. Madura, USAF (ESMC)	Mr L.S. Corbett (NWC)
Maj A.F. Dye, USAF (ESMC)	Mr J.J. Genola (NWC)
Mr B.F. Boyd (ESMC)	Mr D. Tolzin (PMTC)
Mr C.W. Fain (ESMC)	Lt R. Kren, USN (NATC)
Maj R. Hughes USAF (AFFTC)	Mr J. Trischman (NATC)
Lt B. Hickel, USAF (AFFTC/UTTR)	Lt Col J.E. Erickson, (USAFETAC)
CPO G.A. Dillie, USN (NWC)	Mr R. Olsen (WSMR), Chairman

Chapter 1

INTRODUCTION TO THE THE RANGE REFERENCE ATMOSPHERE (RRA)

1.1 THE RRA DEFINED.

A "reference atmosphere" is a statistical model of the earth's atmosphere, derived from upper-air observations over a specific location. The atmospheric models developed by the Range Reference Atmosphere Committee (RRAC) in response to a tasking by the Range Commander's Council/Meteorology Group (RCC/MG) and published by the Secretariat, Range Commander's Council (RCC) are called "Range Reference Atmospheres," or "RRAs." The first series of RRAs was published from 1963 to 1974, and a second series was issued in 1983 and 1984.

1.2 PURPOSE OF THE RRA.

The individual RRA is the authoritative source for upper-atmosphere climatology over the launch and/or recovery site for which it has been prepared. RRAs are used to plan, evaluate, and establish environmental launch constraints for aerospace vehicles launched from a particular location.

1.3 CONTENTS OF THE RRA.

RRAs contain tabulations for monthly and annual means, standard deviations, and skewness coefficients for wind speed, pressure, temperature, density, water vapor pressure, virtual temperature, and dew point temperature. They also provide means and standard deviations for zonal and meridional wind components and the linear (product moment) correlation coefficient between wind components. Statistical values are tabulated (at the station elevation) at 1-km intervals from sea level (MSL) to 30 km and at 2-km intervals from 30 to 70 km. Wind statistics begin at about 10 meters above station elevation, and continue at altitudes with respect to MSL thereafter. For ranges without rocketsonde measurements, RRAs terminate at 30 km; they may be extended upward, if necessary, when rocketsonde data from a nearby location can be made available.

1.4 UNITS OF MEASUREMENT USED IN RRAs.

All wind speeds are in meters per second (m/s). In all cases, the skewness coefficient and the correlation coefficient between wind components are unitless. Pressure (including water vapor pressure) is in millibars (mb). Temperature and virtual temperature are in kelvin (K). Density is in grams per cubic meter (gm/m^3). All altitudes are geometric, in kilometers (km). All heights are geopotential, also in kilometers (km). All altitudes/heights are in relation to mean sea level.

1.5 RRA QUALITY CONTROL.

Less than 10 percent of the soundings in the database used to calculate the RRA tables contained erroneous data. Soundings that did contain erroneous values data were eliminated from the database. Steps taken to produce an RRA that is as error-free as possible are described below:

(1) Soundings with gaps in their pressure levels of more than 200 mb were rejected. These soundings were eliminated because some contained height values only for mandatory pressure levels; when some heights at the mandatory levels were missing, the interpolated sounding contained significant errors.

(2) An initial set of RRA statistics was computed using all the remaining soundings (i.e., those that had not been rejected). This set was then used to determine data limits for temperature, pressure, U and V components of wind, density, and dew point for the 0-30 km portion, and density only from 30 to 60 km (in RRAs that go that high). The lower (or upper) data limits were set at the mean value for each variable, minus (or plus) six standard deviations of that quantity. One pair of data limits was computed for each of the atmospheric variables, the month, and the data level.

(3) The first set of data limits was then used to screen the database. All soundings that contained values outside the data limits were rejected. A new RRA was then computed using the screened database, and the second RRA was used to generate a second set of data limits.

(4) The second set of data limits was then used to screen the database further, and still another RRA was generated. The skewness values in this one were evaluated according to empirical criteria specified in Section 2.2 of this document (for winds) and in Section 3.2 (for thermodynamic quantities). If these criteria were satisfied, the third RRA was used to generate a final set of data limits, which were used to quality control the database for the final version of the RRA.

(5) Occasionally, the third RRA did not satisfy all the skewness criteria, indicating that the database still contained some erroneous values. To complete quality control, the "limits-to-RRA-to-limits" cycle was repeated (usually once or twice) until the resulting RRA satisfied the skewness criteria. When it did, a final set of data limits was generated, then used to quality control the database and produce the final RRA.

1.6 HOW THE RRA IS ORGANIZED.

RRA documents are published in four chapters, with Chapter 1 providing the introduction. Chapter 2, "Wind Statistics and Models," describes the techniques used to produce the wind statistics given in Table A-1 through A-13, Appendix A; it also describes the probability functions used as wind models to derive several wind statistics. Chapter 3, "Statistics of Thermodynamic Quantities and Models," describes the techniques used to produce the thermodynamic and moisture-related statistics in Tables B-1 through B-13 and C-1 through C-13, Appendices B and C. It also describes the atmospheric thermodynamic model in Tables D-1 through D-13, Appendix D. Chapter 3 also contains equations used to calculate several atmospheric properties. Chapter 4 provides conclusions and recommendations. Chapters 1-4 are the same in each new RRA; only Appendices A-G (described below) vary from RRA to RRA.

Appendix A contains monthly and annual wind statistics tables that give: (1) means and standard deviations of zonal and meridional wind components, (2) the linear (product moment) correlation coefficient between the two components, (3) the mean, standard deviation and skewness coefficient of the wind speed, and (4) the number of wind observations (sample size).

Appendix B contains monthly and annual thermodynamic statistics tables that give: (1) means, standard deviations, and skewness values of pressure, temperature, and density; and (2) the number of observations used for each of the thermodynamic quantities.

Appendix C contains monthly and annual moisture-related statistics tables that give: (1) means, standard deviations, and skewness values of water vapor pressure, virtual temperature, and dewpoint; and (2) the number of observations for each of the moisture-related quantities. Statistical values for water vapor pressure and dewpoint terminate at or below 15 km, depending on the range's latitude. Above 15 km, statistical values of virtual temperature are considered to be the same as those of temperature.

Appendix D contains monthly and annual tables that give hydrostatic model atmospheres for thermodynamic variables of pressure, virtual temperature, and density. Values are derived from the monthly and annual mean virtual temperature versus altitude (geometric) using the hydrostatic equation and the equation of state. Also presented is the geopotential height corresponding to the tabulated geometric altitudes.

Appendix E gives range-specific examples of certain wind statistics that can be derived from the basic data in Appendix A.

Appendix F gives tabular and graphic examples of certain pressure, density, and virtual temperature statistics that can be derived from basic data in Appendices B, C, and D.

Appendix G gives range-specific information such as location and database description.

1.7 CONVERSION UNITS.

Numerical values in the RRA are metric, as given in the International System of Units (SI, Systeme International d'Unites). Table 1-1 provides metric, U.S. Customary, and conversion units for all units used in this RRA.

TABLE 1-1. CONVERSION UNITS USED IN RRAS.

DATA TYPE	METRIC UNIT	ABBR	US CUSTOMARY UNIT	ABBR	CONVERSION:		To Get
					Multiply	By	
Ambient Temperature	degree Celsius	°C	degree Fahrenheit	°F	°F-32	0.5556	°C
	kelvin	K	degree Rankine	°R	°C	1.8	°F-32
					°R	1.00	°F+459.67
					°R-459.67	1.00	°F
Temperature Change	degree Celsius	°C	degree Fahrenheit	°F	K	1.00	°C+273.15
	kelvin	K	degree Rankine	°R	K-273.15	1.00	°C
					°C or K	1.8	chg °F/°R
					K or °R	0.5556	Chg °C/K
Ambient Density	gram/cubic meter	gm ⁻³	grain/cubic foot	grft ⁻³	gm ⁻³	0.43700	grft ⁻³
	gram/cubic centimeter	gcm ⁻³			grft ⁻³	2.2883	gm ⁻³
Vapor Concentration (Absolute humidity)					gm ⁻³	10 ⁻⁶	gcm ⁻³
					gcm ⁻³	4.370/10 ⁻⁵	gcft ⁻³
					grft ⁻³	2.288/10 ⁻⁶	gcm ⁻³
Windspeed	meters/second	ms ⁻¹	mile/hour	mph	ms ⁻¹	2.2369	mph
			knots	knots	mph	0.44704	ms ⁻¹
			feet/second	fts ⁻¹	ms ⁻¹	1.9438	knots
					knots	0.51444	ms ⁻¹
					mph	0.868976	knots
					knots	1.15078	mph
				ms ⁻¹	3.2808	ms ⁻¹	
				fts ⁻¹	0.3048	ms ⁻¹	
Weight	gram	g	grain	gr	lb	0.45359237	kg
	kilogram	kg	pound	lb	lb	453.59237	g
					kg	2.20462	lb
					g	15.4324	gr
				gr	0.06480	g	

TABLE 1-1. CONVERSION UNITS USED IN FRAS, Cont'd.

DATA TYPE	METRIC UNIT	ABBR	US CUSTOMARY UNIT	ABBR	CONVERSION:		To Get	
					Multiply	By		
Length	meter	m	feet	ft	m	3.2808	ft	
	micron	μ	inch	in	m	0.3048	m	
	Angstrom unit	A	A			μ	2.54×10^{-4}	μ
						A	2.54×10^{-8}	A
						m	10^{-6}	m
						m	10^{-10}	A
						μ	10^{-6}	m
	μ	3.937×10^{-5}	in					
	A	10^{10}	m					
	A	3.937×10^{-9}	m					
Pressure	newton/square meter		newton m ⁻²	pound force/sq in	lb in ⁻²	10^{-3}	bar	
						10^3	mb	
	millimeter of Mercury		mmHg	inch of Mercury	mHg	newton m ⁻²	10^{-2}	mb
						newton m ⁻²	1.4504×10^{-4}	lb m ⁻²
	bar		bar			lb in ⁻²	6.8948×10^3	newton m ⁻²
						mb	1.4504×10^{-2}	lb m ⁻²
	millibar		mb			lb in ⁻²	68.948	mb
						dyne cm ⁻²	10^3	dyne cm ⁻²
	dyne/square centimeter (microbar)		dyne cm ⁻²			dyne cm ⁻²	10^{-3}	mb
						kg m ⁻²	6.8348×10^4	dyne cm ⁻²
	kilogram force/square meter		kg m ⁻²			lb in ⁻²	1.4504×10^{-5}	lb m ⁻²
						kg m ⁻²	10.1972	kg m ²
	pascal		Pa			kg m ⁻²	0.0980665	mb
						lb m ⁻²	703.0696	kg m ²
						kg m ⁻²	0.0014223	lb m ²
						mb	2.9530×10^{-2}	mHg (32°F)
						mb	0.75006	mmHg (0°C)
mHg						25.40	mmHg (0°C)	
mmHg						1.3332	mb	
mHg (321)	33.8639	mb						
			Pa	1.00	newton. m ⁻²			

Chapter 2

WIND STATISTICS AND MODELS

2.1 GENERAL DISCUSSION.

One of the objectives in developing an RRA is to describe the wind field over the launch/recovery site as completely as possible with as few data tabulations as possible. With that in mind, the bivariate normal probability distribution was adopted as a statistical model for wind treated as a vector quantity at RRA data levels. Only five statistical parameters are required to completely describe this probability function; in Cartesian coordinates, these parameters are the means and standard deviations of the two orthogonal components, along with the correlation coefficient between the two components. The tables in Appendix A give the five statistical parameters for the zonal and meridional (meteorological coordinate) components. The statistical properties of the bivariate normal probability distribution are used to derive many wind statistics of interest to range users. The procedure produces consistent wind statistics that are connected through rigorous mathematical probability functions. By using these functions, extensive tabulations of wind statistics are avoided. Statistical properties of the bivariate normal probability distribution presented for the vector wind statistical model are:

- Wind components are univariate normally distributed.
- Conditional distribution of one component, given a value of the other component, is univariate normally distributed.
- Wind speed is in the form of a generalized Rayleigh distribution.
- Frequency distribution of wind direction can be derived.
- Conditional distribution of wind speed, given a value of wind direction (wind rose), can be derived.
- The five tabulated wind statistical parameters that are with respect to the meteorological zonal and meridional coordinate system can be derived for any arbitrary rotation of the orthogonal axes.

The RRA provides probability distribution functions and sets of equations to derive wind statistics for the previously stated properties of the vector wind model; examples are given in Appendix E.

No attempt is made here to give the derivation of the probability functions, but the reader is referred to Smith (1976) for derivations and several applications of the probability distribution properties for wind statistics.

Symbols used in Chapter 2, and their meanings, are given in Table 2 1, next page.

TABLE 2-1 Symbols Used In Chapter 2.

N	The number of wind measurements in Appendix A.
r	A general variable for the bivariate normal probability distribution in polar coordinates.
R	A generalized Rayleigh variable used for derived wind speed probability distribution.
$R(U,V)$	The linear (product moment) correlation coefficient between the zonal and meridional wind components in Appendix A.
$SK(W)$	Skewness parameter for wind speed in Appendix A.
$S(U)$	The standard deviation of the zonal wind component in Appendix A.
$S(V)$	The standard deviation of the meridional wind component in Appendix A.
$S(W)$	The standard deviation of wind speed in Appendix A.
t	A standardized normal variate used in Table 2-1.
U	The zonal wind component.
$UBAR$	The mean value of the zonal wind component in Appendix A.
V	The meridional wind component.
$VBAR$	The mean value of the meridional wind component in Appendix A.
W	Wind speed or modulus of wind vector, a scalar quantity.
$WBAR$	The mean value of wind speed in Appendix A.
X	A general component mean value in the $[X,Y]$ coordinate system.
Y	A general component mean value in the $[X,Y]$ coordinate system.
\bar{X}	A general component variable or coordinate axes.
\bar{Y}	A general component variable or coordinate axes.
α	(alpha) Rotation angle for the $[X,Y]$ coordinate system.
θ	(theta) Wind direction in the polar coordinate system.
λ	(Lambda) A parameter in the bivariate normal probability distribution in Table 2-2.
ξ	(Xi) The mean value in the standardized normal probability distribution used in Table 2-1.
π	(Pi) Constant = 3.14159 .
ρ	(Rho) The general linear correlation coefficient between the two component variables in the $[x,y]$ coordinate system.
σ_x, σ_y	The general standard deviations of the x and y component variables in the $[x,y]$ coordinate system.

2.2 QUALITY CONTROL.

The U and V components of wind were used to generate data limits, which were set at plus and minus six standard deviations from the mean for each of the quantities. These data limits were used to screen the wind database, as described in Paragraph 1.5. The database was considered to be error-free if:

- The skewness of the wind speed was below 4.0 at data levels where the mean wind speed was less than 15 m/s, and
- The skewness of the wind speed was below 2.5 at data levels where the mean wind speed was greater than 15 m/s.

2.3 DATA LIMITATIONS.

For wind statistics, correlation coefficients for like and unlike wind components between altitude levels were not computed, and wind statistics with respect to altitude (profile) cannot be derived from RRA statistics; users are referred to Smith (1976) for wind profile modeling techniques. Wind statistics at discrete altitudes are valid; all the probability distribution functions described in Chapter 2 can be derived from the five wind component statistical parameters in Appendix A and the derived distributions can be considered as wind models at discrete altitudes.

Greek letters are used conventionally for population or theoretically known statistical elements, and sample estimates are denoted by English letters or with a "hat" ($\hat{}$) over Greek letters. In Chapter 2, Greek letters are used for variances and linear correlation coefficient, while means are denoted by \bar{X} and \bar{Y} when dealing with the bivariate normal distribution. It must always be understood that Appendix A contains sample estimates of statistical parameters, and that they are with respect to the meteorological zonal (U) and meridional (V) coordinate systems.

2.4 THE COORDINATE SYSTEM OF STATISTICAL PARAMETERS.

Wind is measured and recorded in terms of magnitude and direction. Wind direction is expressed in degrees clockwise from true north, and is the direction from which the wind is blowing. Wind magnitude (the modulus of the vector) is the scalar quantity, and is referred to as wind speed or scalar wind. A statistical description that accounts for the wind as a vector quantity is appropriate and requires a coordinate system.

For the RRA, the Standard Meteorological Coordinate System has been chosen for wind statistics, all tables of statistical parameters, and related discussions. This choice was made because the coordinate system used in aerospace and related applied fields has not always been consistent. Figure 2-1 illustrates the Standard Meteorological Coordinate System.

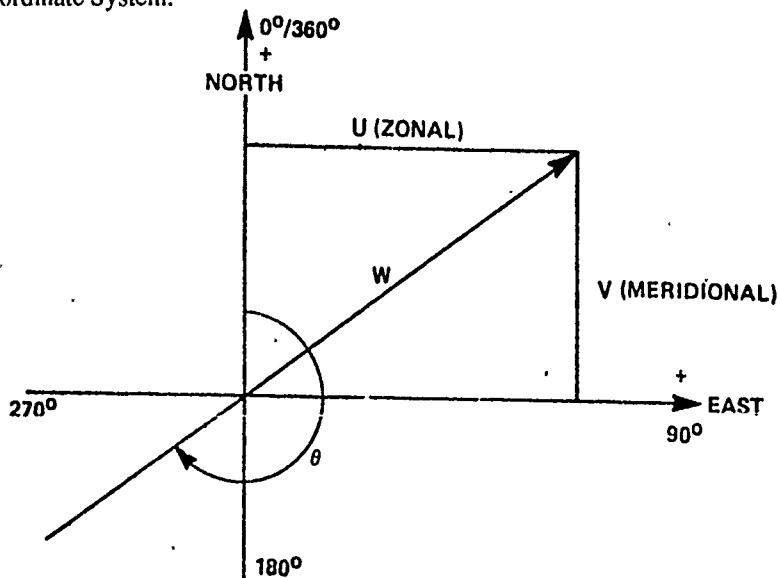

Figure 2-1. The Standard Meteorological Coordinate System.

Using Figure 2.1, the polar and Cartesian forms for the meteorological coordinate system are defined as follows:

W wind speed, scalar wind, or magnitude of the wind vector (m/s).

θ wind direction, measured as the direction *from which* the wind is blowing, in degrees clockwise from true north.

U zonal wind component, positive west to east (m/s).

V meridional wind component, positive south to north (m/s).

The components θ and W define the polar form, and the U - V components define the Cartesian forms:

$$U = -W \sin\theta, \quad 0 \leq \theta \leq 360^\circ \quad (1)$$

$$V = -W \cos\theta \quad (2)$$

It is helpful to note the difference between the *mathematical* convention for *vector* direction and the *meteorological* convention for *wind* direction:

$$\theta_{met} = 270 - \theta_{math} \quad (3)$$

$$\text{when } 0 \leq \theta \leq 270^\circ$$

$$\theta_{met} = 360 + (270 - \theta_{math})$$

$$\text{when } 270 \leq \theta \leq 360^\circ$$

2.5 COMPUTING STATISTICAL PARAMETERS.

All these statistical parameters are with respect to the Standard Meteorological Coordinate System shown in Figure 2-1. The wind statistical parameters in Appendix A (means and standard deviations of zonal and meridional wind components, plus wind speed and the skewness parameter of wind speed) were computed using the sums technique described in Paragraph 3.5.1. In addition, a linear (product moment) correlation coefficient between the zonal and meridional wind components, $r(u,v)$ in Appendix A, was computed. This correlation coefficient is defined as:

$$r(u,v) = \frac{\sum_{i=1}^n (U_i - \bar{U})(V_i - \bar{V})}{N s(u) \cdot s(v)} \quad (4)$$

2.6 STATISTICAL WIND MODELS.

2.6.1 Wind Component Statistics.

The univariate normal (Gaussian) probability distribution function is used to obtain wind component statistics. In generalized notations, the probability density function (*pdf*) is:

$$F(t) = \frac{e^{-\frac{t^2}{2}}}{\sqrt{2\pi}} \quad (5)$$

where $t = X - \frac{\xi}{\sigma_x}$ is the standardized variate, with ξ defining the mean and σ the standard deviation.

The probability distribution function (PDF) is:

$$F(t) = \int_{-\infty}^t f(t) dt \quad (6)$$

Because this integral cannot be obtained in closed form, it is widely tabulated for zero mean and unit standard deviation. Selected values of $F(t)$ are given in Table 2-2, next page. To emphasize the connotation of probability, $F(t)$ is shown in Table 2-2 as $P\{X\}$. The t values in Table 2-2 are used as multiplier factors to the standard deviation to express the probability that a normally distributed variable (X) is less than or equal to a given value as:

$$P\{X \leq \text{mean} + t \sigma_x\} = \text{probability, } p \quad (7)$$

For example, when $t = 1.6449$, the probability that X is less than or equal to the mean plus 1.6449 standard deviations is 0.95. That value of X which is less than or equal to the mean plus 1.6449 standard deviations is called the "95th percentile value of X ." Also given in Table 2-2 are the numerical values for expressing the probability that X falls in the interval X_1 and X_2 ; i.e.,

$$P\{X_1 \leq X \leq X_2\} = \text{Interpercentile Range} \quad (8)$$

where

$$\begin{aligned} X_1 &= \bar{X} - t \sigma_x \\ X_2 &= \bar{X} + t \sigma_x \end{aligned}$$

For $t = 1.9602$ the probability that X lies in the interval X_1 and X_2 is 0.95. The values of X_1 and X_2 in this example comprise the 95th interpercentile range.

For a normally distributed variable, the mode (most frequent value) and the median (50th percentile value) are the same as the mean value. The means and standard deviations of the zonal and meridional wind components from Appendix A are used in equations 7 and 8 to compute the percentile values and interpercentile ranges of the zonal and meridional wind components. When equation 7 is illustrated on a normal probability graph, a straight line is formed.

2.6.2 The Vector Wind Model.

Because wind is a vector quantity having direction and magnitude that can be expressed as two components in an orthogonal coordinate system, a probability model that describes the joint relationship is the bivariate normal probability distribution. In general component notation (shown by equation 9, below), the bivariate normal probability density function (BNpdf) is:

$$f(X,Y) = \frac{1}{2\pi\sigma_x\sigma_y\sqrt{1-\rho^2}} \left[\exp \frac{-1}{2(1-\rho^2)} \left\{ \frac{(X-\bar{X})^2}{\sigma_x^2} - \frac{2\rho(X-\bar{X})(Y-\bar{Y})}{\sigma_x\sigma_y} + \frac{(Y-\bar{Y})^2}{\sigma_y^2} \right\} \right] -\infty \leq X \leq \infty \text{ \& } -\infty \leq Y \leq \infty$$

where the five parameters are \bar{x}, \bar{y} , the component means σ_x, σ_y , the component standard deviations, and ρ , the correlation coefficient between the two component variables X and Y .

For many applications, there is interest in determining the probability that a point $\{X,Y\}$ will fall within a contour of equal probability density. The exponential terms of equation 9, when set equal to a constant (λ_2), give a family of ellipses depending on the value of the constant. The ellipses have a common center at the point $\{\bar{X}, \bar{Y}\}$. Integration of equation 9 over the region bounded by the contours of equal probability density gives:

TABLE 2-2. Values of t for Standardized Normal (Univariate) Distribution for Percentiles and Interpercentile Ranges.

t	$P(X)$	X	$P\{X_1 \leq X \leq X_2\} (\%)$
-3.0000	0.00135	$\xi - 3.0000 \sigma$	
-2.5758	0.00500	$\xi - 2.5758 \sigma$	
-2.3263	0.01000	$\xi - 2.3263 \sigma$	
-2.2365	0.01266	$\xi - 2.2365 \sigma$	
-2.0000	0.02275	$\xi - 2.0000 \sigma$	
-1.9602	0.02500	$\xi - 1.9602 \sigma$	
-1.6449	0.05000	$\xi - 1.6449 \sigma$	
-1.2816	0.10000	$\xi - 1.2816 \sigma$	
-1.0000	0.15866	$\xi - 1.0000 \sigma$	
-0.8416	0.20000	$\xi - 0.8416 \sigma$	
-0.6745	0.25000	$\xi - 0.6745 \sigma$	
-0.2533	0.40000	$\xi - 0.2533 \sigma$	
0.0000	0.50000	ξ	
0.2533	0.60000	$\xi + 0.2533 \sigma$	
0.6745	0.75000	$\xi + 0.6745 \sigma$	
0.8416	0.80000	$\xi + 0.8614 \sigma$	
1.0000	0.84134	$\xi + 1.0000 \sigma$	
1.2816	0.90000	$\xi + 1.2816 \sigma$	
1.6449	0.95000	$\xi + 1.6449 \sigma$	
1.9602	0.97502	$\xi + 1.9602 \sigma$	
2.0000	0.97725	$\xi + 2.0000 \sigma$	
2.2365	0.98734	$\xi + 2.2365 \sigma$	
2.3263	0.99000	$\xi + 2.3263 \sigma$	
2.5758	0.99500	$\xi + 2.5758 \sigma$	
3.0000	0.99865	$\xi + 3.0000 \sigma$	

where $X_1 = \xi - t\sigma$
 and $X_2 = \xi + t\sigma$

$$P(\lambda) = 1 - e^{\frac{-\lambda^2}{2(1-\rho^2)}} \quad (10)$$

Solving for λ^2 and replacing $P(\lambda)$ by p gives:

$$\lambda^2 = -2(1-\rho^2) \ln(1-p) \quad (11)$$

Now define:

$$\lambda_e = \sqrt{2} \sqrt{-\ln(1-p)} \quad (12)$$

For reference and comparison, λ_e is shown in Table 2-3 for selected values of p .

TABLE 2-3. Values of λ for Bivariate Normal Distribution Ellipses and Circles.

$P(\%)$	$(\lambda_e\text{--ellipse})$	$(\lambda_e\text{--circle})$	$P(\%)$	$(\lambda_e\text{--ellipse})$	$(\lambda_e\text{--circle})$
0.000	0.0000	0.0000	65.000	1.4490	1.0246
5.000	0.3203	0.2265	68.268	1.5151	1.0713
10.000	0.4590	0.3246	70.000	1.5518	1.0973
15.000	0.5701	0.4031	75.000	1.6651	1.1774
20.000	0.6680	0.4723	80.000	1.7941	1.2686
25.000	0.7585	0.5363	85.000	1.9479	1.3774
30.000	0.8446	0.5972	86.466	2.0000	1.4142
35.000	0.9282	0.6563	90.000	2.1460	1.5175
39.347	1.0000	0.7071	95.000	2.4477	1.7308
40.000	1.0108	0.7147	95.450	2.4860	1.7579
45.000	1.0935	0.7732	98.000	2.7971	1.9778
50.000	1.1774	0.8325	98.168	2.8284	2.0000
54.406	1.2533	0.8862	98.889	3.0000	2.1213
55.000	1.2637	0.8936	99.000	3.0348	2.1460
60.000	1.3537	0.9572	99.730	3.4393	2.4320
63.212	1.4142	1.0000	99.9877	4.2426	3.0000

The probability ellipse that contains p -percent of the wind vectors expressed in the most general form is the conic defined by:

$$AX^2 + BXY + CY^2 + DX + EY + F = 0 \quad (13)$$

Where:

$$A = \sigma_y^2 \quad D = 2\sigma_x\sigma_y \rho Y - 2\sigma_y^2 X = -(B Y + 2A X)$$

$$B = -2\rho\sigma_x\sigma_y \quad E = 2\sigma_x\sigma_y \rho X - 2\sigma_x^2 Y = -(B X + 2C Y)$$

$$C = \sigma_x^2 \quad F = A X^2 + C Y^2 + B X Y - AC (1 - \rho^2) \lambda_e^2$$

and $\lambda_e = \sqrt{2} \sqrt{-\ln(1-p)}$

For graphic presentations, the range of the variable is important in order to arrange the scale. The largest and smallest values of X and Y for a given probability ellipse (p) are given by:

$$X_{L,S} = \bar{X} \pm \sigma_x \lambda_e \quad (14)$$

$$Y_{L,S} = \bar{Y} \pm \sigma_y \lambda_e \quad (15)$$

where, as before,

$$\lambda_e = \sqrt{2} \sqrt{-1n(1-p)}$$

Although there are several approaches to graphing the probability ellipses, the following procedure is best for electronic computer plotting. In establishing the computer plotting program, the sample estimates for \bar{X} , \bar{Y} , σ_x , σ_y , and ρ are constants in equation 13. The user makes the choice of probability ellipses desired. Thus, p in equation 12 is programmed as a parameter. The largest and smallest values for X and Y are computed by equations 14 and 15 for the largest probability ellipse selected. This sets the graphical scale. Values of X within the range of X smallest to X largest are obtained by incrementing X between these limits. Using the quadratic equation, a solution of equation 13 is made for Y for each value of X , and plotted. The centroid (\bar{X}, \bar{Y}) for the family of probability ellipses is plotted as a point. Labeling and other identification completes the plotting program.

For a given probability, equation 13 defines an ellipse that contains p -percent of the points X, Y . Since the entire area under the bivariate normal density function (equation 9) is unity, upon integration for a given probability ellipse, that given ellipse contains p -percent of the total area. In the wind statistics p -percent of the wind vectors fall within the specified probability ellipse. From this point of view, a specified probability ellipse gives the joint probability that p -percent of the $U-V$ components lie within the given ellipse.

When $\sigma_x^2 = \sigma_y^2 = \sigma^2$ and $\rho = 0$ in the bivariate normal distribution, the probability ellipses of equation 13 reduce to circles whose centers are at the means \bar{X}, \bar{Y} . The radii of the probability circles are $\sigma_{v1} \lambda_c$, where:

$$\sigma_{v1} = \sqrt{2}\sigma^2 \quad (16)$$

and

$$\lambda_c = \sqrt{-1n(1-p)} \quad (17)$$

Values for λ_c for selected probabilities, p , are given in Table 2-3.

Because this function is simple, it can easily be graphed manually. However, the generalized plotting technique for electronic computer plotters (as shown by equation 13) can be also be used.

2.6.3 Derived Distributions for Wind Statistics.

In this section, the probability distribution functions and sets of equations are presented to derive certain probability distribution functions for wind statistics. These derived probability distributions are:

- Conditional distribution of wind components
- Generalized Rayleigh distribution for wind speed
- Distribution for wind direction
- Conditional distribution of wind speed given a wind direction (wind rose).

The five required statistical parameters for these derived distributions for wind statistics are given in Appendix A.

2.6.3.1 The Conditional Distribution of Wind Components.

Given that two random variables X and Y are bivariate normally distributed, the conditional distribution $f(Y|X)$ is read as $f(Y)$ given X , and likewise $f(X|Y)$ is read as $f(X)$ given Y . The conditional probability function $F(Y|X)$ has the mean $E(Y|X)$ and variance $\sigma^2_{(Y|X)}$, where:

$$E(Y|X^*) = \bar{Y} + \rho \left(\frac{\sigma_y}{\sigma_x} \right) (X^* - \bar{X}) \quad (18)$$

and

$$\sigma^2_{(Y|X^*)} = \sigma_y^2 (1 - \rho^2) \quad (19)$$

The conditional standard deviation is:

$$\sigma_{(Y|X^*)} = \sigma_y \sqrt{1 - \rho^2} \quad (20)$$

By interchanging the variables and parameters, the conditional distribution function for $F(X|Y^*)$ has the conditional mean:

$$E(X|Y^*) = \bar{X} + \rho \left(\frac{\sigma_x}{\sigma_y} \right) (Y^* - \bar{Y}) \quad (21)$$

conditional variance:

$$\sigma^2_{(X|Y^*)} = \sigma_x^2 (1 - \rho^2) \quad (22)$$

and conditional standard deviation:

$$\sigma_{(X|Y^*)} = \sigma_x \sqrt{1 - \rho^2} \quad (23)$$

The preceding conditional probability distribution functions are univariate normal distributions for a (fixed) given value for one of the bivariate normal variables. Thus, the t -values given in Table 2 are applicable for conditional probabilities statements. For example,

$$F(Y|X^*) = E(Y|X^*) + t \sigma_{(Y|X^*)} \quad (24)$$

For $t = 1.6449$, there is a 95 percent chance that Y is less than or equal to $\bar{Y} + 1.6449 \sigma_{(Y|X^*)}$ given that $X = X^*$. In symbols, this statement reads:

$$P \{ Y \leq E(Y|X^*) + 1.6449 \sigma_{(Y|X^*)} | X = X^* \} = 0.9500 \quad (25)$$

Interval probability statements can also be made:

$$P \{ Y_1 = E(Y|X^*) - t \sigma_{(Y|X^*)} \leq Y \leq Y_2 = E(Y|X^*) + t \sigma_{(Y|X^*)} | X = X^* \}$$

where X^* can take on any fixed value of X , but a convenient arrangement is to let $X^* = \bar{X} \pm t \sigma_x$.

The close connection of the regression function of Y on X to the conditional mean for the bivariate normal distribution is noted:

$$Y = \bar{Y} + \rho \left(\frac{\sigma_y}{\sigma_x} \right) (X - \bar{X}) \quad (26)$$

Similarly, the regression function of X on Y is:

$$X = \bar{X} + \rho \left(\frac{\sigma_x}{\sigma_y} \right) (Y - \bar{Y}) \quad (27)$$

These are linear functions and express the same results as would be obtained from a least-squares regression line.

2.6.3.2 Generalized Rayleigh Distribution for Wind Speed.

If two random variables, X and Y , are bivariate normally distributed, then the probability distribution for the modulus, R , can be derived in terms of the five parameters that define the bivariate normal distribution:

$$R = \sqrt{X^2 + Y^2} \quad (28)$$

The distribution of R so derived is called a generalized Rayleigh distribution because there are no restrictions on the parameters. For applications to the RRA, the variable R is recognized as wind speed or the modulus of the wind vector.

The probability density function for R is expressed as:

$$f(R) = a_0 R e^{-a_1 R^2} \left[I_0(a_2 R^2) I_0(a_3 R) + 2 \sum_{k=1}^{\infty} I_k(a_2 R^2) I_{2k}(a_3 R) \cos 2k\psi \right] \quad R \geq 0 \quad (29)$$

The functions $I_0(\cdot)$, $I_k(\cdot)$, and $I_{2k}(\cdot)$ are the modified Bessel function of the first kind for zero order, k th order, and $2k$ th order. The coefficients are:

$$a_0 = \frac{\exp \left[-\frac{1}{2} \left\{ \frac{\bar{X}^2}{\sigma_a^2} + \frac{\bar{Y}^2}{\sigma_b^2} \right\} \right]}{\sigma_a \sigma_b}$$

where σ_a^2 and σ_b^2 are the rotated variances to produce zero correlation between X and Y . σ_a and σ_b are the positive and negative roots of the following expression, the computational form of which is obtained from the determinant:

$$\begin{vmatrix} \sigma_x^2 - K & \sigma_x \sigma_y \sigma \\ \sigma_x \sigma_y \sigma & \sigma_y^2 - K \end{vmatrix}$$

where K is $\sigma_{(+, -)}^2$, and σ_a and σ_b are analogous to the standard deviation of the major and minor axes of the bivariate normal probability ellipse:

$$\sigma_{(+, -)}^2 = \frac{1}{2} \left\{ \sigma_x^2 + \sigma_y^2 \pm \left[(\sigma_x^2 + \sigma_y^2)^2 - 4\sigma_x^2 \sigma_y^2 (1 - \rho^2) \right]^{\frac{1}{2}} \right\}$$

$$a_1 = \frac{(\sigma_x^2 + \sigma_y^2)}{4(1 - \rho^2) \sigma_x^2 \sigma_y^2}$$

$$a_2 = \frac{[(\sigma_x^2 - \sigma_y^2)^2 + 4\rho^2 \sigma_x^2 \sigma_y^2]^{\frac{1}{2}}}{4(1 - \rho^2) \sigma_x^2 \sigma_y^2}$$

$$a_3 = \left[\left(\frac{\bar{X}}{\sigma_x^2} \right)^2 + \left(\frac{\bar{Y}}{\sigma_y^2} \right)^2 \right]^{\frac{1}{2}}$$

and

$$\tan \psi = \frac{\bar{Y}}{\bar{X}} \frac{\sigma_x^2}{\sigma_y^2}$$

Since this density function cannot be integrated in closed form from zero to R , numerical integration is used to obtain practical results from the probability distribution function; i.e.,

$$F(R) = \int_0^{R^*} f(R) dR \quad (30)$$

A number of special cases can be obtained from the general Rayleigh distribution (equation 29), the most simple of which is to let $\sigma_x \equiv \sigma_y = \sigma$ and $\bar{X} = \bar{Y} = 0$ with independent variables X and Y . This gives:

$$f(R) = \frac{R}{\sigma^2} e^{-\frac{R^2}{2\sigma^2}} \quad (31)$$

which is recognized as the classical Rayleigh probability density function. The density function (equation 31) can be integrated in closed form over any range of the variable R . Hence, the probability distribution function, $F(R)$, for equation 31 is:

$$F(R) = 1 - \exp \left\{ \frac{-R^2}{2\sigma^2} \right\} \quad (32)$$

2.6.3.3 The Derived Distribution of Wind Direction.

Considering the wind as a vector quantity and bivariate normally distributed, the wind direction can be derived. This is done by first writing the bivariate normal probability density function in polar coordinates whose variables are:

$$g(r, \theta) = r d_1 e^{\frac{1}{2}(a^2 r^2 - 2br + c^2)} \quad (33)$$

NOTE: The expression in equation 33 (Smith, 1976) is given with respect to the mathematical convention for a vector direction, where:

$$a^2 = \frac{1}{(1 - \rho^2)} \left[\frac{\sin^2 \theta}{\sigma_x^2} - \frac{2\rho \cos \theta \sin \theta}{\sigma_x \sigma_y} + \frac{\cos^2 \theta}{\sigma_y^2} \right]$$

$$b = \frac{-1}{(1 - \rho^2)} \left[\frac{\bar{x} \sin \theta}{\sigma_x^2} - \frac{\rho(\bar{x} \cos \theta + \bar{y} \sin \theta)}{\sigma_x \sigma_y} + \frac{\bar{y} \cos \theta}{\sigma_y^2} \right]$$

$$c^2 = \frac{1}{(1-\rho^2)} \left[\frac{\bar{x}^2}{\sigma_x^2} - \frac{2\rho xy}{\sigma_x \sigma_y} + \frac{y^2}{\sigma_y^2} \right]$$

$$d_1 = \frac{1}{2\pi\sigma_x\sigma_y\sqrt{1-\rho^2}}$$

and $r = \sqrt{x^2 + y^2}$ is the modulus of the vector or speed and θ is the direction of the vector. After integrating $g(r, \theta)$ over $r = 0$ to ∞ , the probability density function is θ is:

$$g(\theta) = \frac{d_1}{a^2} e^{-\frac{1}{2}c^2} \left[1 + \sqrt{2\pi} \left(\frac{b}{a}\right)^2 \Phi\left(\frac{b}{a}\right) \right] \quad (34)$$

where a^2 , b , c^2 , and d_1 are as previously defined in equation 33, and

$$\Phi\left(\frac{b}{a}\right) = \Phi(x) = \frac{1}{\sqrt{2\pi}} \int_{-\infty}^x e^{-\frac{1}{2}t^2} dt$$

is taken from tables of normal distribution functions or made available through a computer subroutine.

If desired, equation 34 can be integrated numerically over a chosen range of θ to obtain the probability that the vector direction will lie within the chosen range; i.e.,

$$F(\theta) = \int_{\theta_2}^{\theta_1} g(\theta) d\theta \quad (35)$$

One application may be to obtain the probability that the wind will flow from a given quadrant or sector as, for example, onshore.

2.6.3.4 Derived Conditional Distribution of Wind Speed Given Wind Direction.

Continuing with the considerations expressed in Paragraph 2.6.3.3, the conditional probability density function (pdf) for wind speed (r), given a specified value for the wind direction θ , can be expressed as:

$$f(r|\theta) = \frac{a^2 r e^{-\frac{1}{2}(a^2 r^2 - br)}}{1 + \sqrt{2\pi} \left(\frac{b}{a}\right)^2 e^{\frac{1}{2}\left(\frac{b}{a}\right)^2} \Phi\left\{\frac{b}{a}\right\}} \quad (36)$$

where coefficients, a and b and the function $\Phi\left\{\frac{b}{a}\right\}$ are as previously defined in equations 33 and 34.

From equation 36, the mode (most frequent value) of the conditional wind speed given a specified value of the wind direction is the positive solution of the quadratic equation,

$$a^2 r^2 - br - 1 = 0 \quad (37)$$

which is:

$$(\bar{r} | \theta) = \frac{1}{2a} \left[\left(\frac{b}{a} \right) + \sqrt{4 + \left(\frac{b}{a} \right)^2} \right] \quad (38)$$

The locus of the conditional modal values of wind speed when plotted in polar form versus the given wind directions forms an ellipse.

The noncentral moment for equation 36 is expressed as:

$$\mu_n = \int_0^{\infty} r^n f(r | \theta) dr \quad (39)$$

Now the first noncentral moment is identical to the first central moment or expected value, $E(r | \theta)$. The integration of equation 39 for the first moment is sufficiently simple to yield practical computations, and can be expressed as:

$$E(r | \theta) = \frac{\left(\frac{b}{a} \right) + \left[1 + \left(\frac{b}{a} \right)^2 \right] \sqrt{2\pi} e^{\frac{1}{2} \left(\frac{b}{a} \right)^2} \Phi \left\{ \frac{b}{a} \right\}}{a \left[1 + \left(\frac{b}{a} \right)^2 \sqrt{2\pi} e^{\frac{1}{2} \left(\frac{b}{a} \right)^2} \Phi \left\{ \frac{b}{a} \right\} \right]} \quad (40)$$

Equation 40, then, gives the conditional mean value of the wind speed given a specified value for the wind direction.

The integration of equation 36 for the limits $r=0$ to $r=r^*$ gives the probability that the conditional wind speed is $\leq r^*$ given a value for the wind direction, θ . This conditional probability distribution (PDF) can be written as:

$$Pr \{ r \leq r^* | \theta = \theta_0 \} = 1 - \left[\frac{e^{-\frac{1}{2} r_s^2 + \sqrt{2\pi} \left(\frac{b}{a} \right) (1 - \Phi(r_s))}}{e^{-\frac{1}{2} \left(\frac{b}{a} \right)^2 + \sqrt{2\pi} \left(\frac{b}{a} \right) \Phi \left\{ \frac{b}{a} \right\}}} \right] \quad (41)$$

where: $r_s = \left[a r^* - \left(\frac{b}{a} \right) \right]$

By definition, equation 41 is an expression for a "wind rose." Empirical wind rose statistics are often tabulated or graphically illustrated giving the frequency that the wind speed is not exceeded for those wind speed values which lie within assigned class intervals of wind direction. After evaluation of equation 41 for various values of wind speed, r^* , and the given wind directions, θ , interpolations can be performed to obtain various percentile values of the conditional wind speed.

For the special case when h in equation 33 equals zero (i.e., for $\bar{x} \equiv \bar{y} = 0$), the conditional modal values of wind speeds (equation 38), the conditional mean values of wind speeds (equation 40), and the fixed conditional percentile values of wind speeds (interpolated from evaluations of equation 41), when plotted in polar form versus the given wind directions, produce a family of ellipses.

For the special case when $\bar{x} = \bar{y} = 0$, equation 36 reduces to the following simple case:

$$Pr \{ r \leq r^* | \theta = \theta_0 \} = 1 - e^{-\frac{\sigma^2 r^{*2}}{2}} \quad (42)$$

Equation 42 has special significance when related to the bivariate normal probability distribution. If r^* and θ are measured from the centroid of the probability ellipse, then the probability that $r \leq r^*$ is the same as the given probability ellipse. Further, solving equation 42 for r^* , gives:

$$r^* = \frac{1}{2} \sqrt{-2 \ln (1 - P)} \quad (43)$$

If a probability ellipse P is chosen, equation 42 gives the distance of r along any θ from the centroid of the ellipse to the intercept of the specified probability ellipse. If there is an interest in conditional probability of winds for a given θ relative to the monthly means, equation 43 is applicable. If it is desired to find the magnitude of the wind along any θ relative to the monthly mean to the intercept of a given probability ellipse, equation 43 is also applicable.

2.7 Statistical Parameters for Non-Standard Orthogonal Axes.

The five wind statistical parameters in Appendix A are given with respect to the Standard Meteorological Coordinate System (Figure 2-1). That is, these parameters are for zonal and meridional components. Many range users, however, need wind statistics with respect to orthogonal axes other than west to east and south to north. For example, a user may need wind statistics with respect to a flight azimuth of α degrees from true north measured clockwise. The following sets of equations are used to compute the five parameters for the new coordinate axes rotated α degrees clockwise from true north.

Rotation of the means through α degrees:

$$\bar{X}_\alpha = \bar{X} \cos (90 - \alpha) + \bar{Y} \sin (90 - \alpha) \quad (44)$$

$$\bar{Y}_\alpha = \bar{Y} \cos (90 - \alpha) - \bar{X} \sin (90 - \alpha) \quad (45)$$

Rotation of the variances through α degrees:

$$\begin{aligned} \sigma_{x_\alpha}^2 &= \sigma_x^2 \cos^2 (90 - \alpha) + \sigma_y^2 \sin^2 (90 - \alpha) \\ &\quad + 2\rho\sigma_x\sigma_y \cos (90 - \alpha) \sin (90 - \alpha) \end{aligned} \quad (46)$$

$$\begin{aligned} \sigma_{y_\alpha}^2 &= \sigma_y^2 \cos^2 (90 - \alpha) + \sigma_x^2 \sin^2 (90 - \alpha) \\ &\quad - 2\rho\sigma_x\sigma_y \cos (90 - \alpha) \sin (90 - \alpha) \end{aligned} \quad (47)$$

Rotation of the linear correlation coefficient through α degrees:

$$\rho_\alpha = \frac{\text{cov}(X, Y)_\alpha}{\sigma_{x_\alpha} \sigma_{y_\alpha}} \quad (48)$$

where $\text{cov}(X, Y)_\alpha$ is the rotated covariance:

$$\begin{aligned} \text{cov}(X, Y)_\alpha &= (X, Y) [\cos^2 (90 - \alpha) - \sin^2 (90 - \alpha)] \\ &\quad + \cos (90 - \alpha) \sin (90 - \alpha) (\sigma_y^2 - \sigma_x^2) \end{aligned}$$

and

$$\text{cov}(X, Y) = \rho\sigma_x\sigma_y$$

By using these rotational equations, the bivariate normal distribution with respect to any desired rotated coordinates can be obtained from sample estimates that have been computed with respect to a specific axis. The marginal distributions after rotation are also normally (univariate) distributed. By using the rotational equations, computational efforts are greatly reduced for applications requiring statistics with respect to several coordinate axes.

Appendix E gives examples of range-specific RRA wind statistics.

Chapter 3

THERMODYNAMICS STATISTICS AND MODELS

3.1 GENERAL DISCUSSION.

One of the objectives in developing the RRA was to describe the thermodynamic characteristics of the atmosphere as completely as possible with as few data tabulations as possible. With that in mind, a set of statistical variables was selected to collectively describe climatological pressure, temperature, density, dew point, virtual temperature, and water vapor pressure. Used together, these variables permit calculation of a large number of derived quantities. Some of these quantities (such as the speed of sound) are discussed in Paragraph 3.7.

The probability distribution of each of the six thermodynamic RRA variables is described by its mean value, its standard deviation, and its skewness. Several of the thermodynamic elements (temperature, pressure, dew point, and density) have probability distributions that are close to a univariate normal distribution; the others do not. The skewness variable gives an estimate of the asymmetrical departures of a probability distribution.

Hydrostatically modeled mean values of pressure and density were calculated (see Appendix D) so that users can determine the departure of the actual climatology of these values from hydrostatic conditions. This was done by hydrostatically integrating the pressure from the lowest RRA data level to the RRA's termination altitude. Table 3-1 lists and explains the primary physical constants used in RRA production. Table 3-2 lists and explains the symbols used in this chapter.

TABLE 3-1. Primary Physical Constants Used in RRA Production.

P_0	Standard atmospheric pressure at sea lev. (1.013250 X 10 ⁵ Newton/m ²) (2116.22 lb/ft ²)
ρ_0	Standard atmospheric density at sea level (1.2250 kg/m ³) (0.076474 lb/ft ³)
T_0	Standard temperature at sea level (288.15 K) (15.0 ⁰ C) (59.0 ⁰ F)
g_0	Standard gravity at sea level at latitude 45 ⁰ 31'33" (9.80665 m/s ²)
s	Sutherland's constant used in calculation of dynamic viscosity (110.4 K)
T_i	Ice-point temperature at P_0 (273.15 K)
β	Constant for calculating dynamic viscosity (1.458 x 10 ⁻⁶ kg/sec m K ^{1/2}) (7.3025 x 10 ⁻⁷ lb/sec ft R ^{1/2})
γ	Ratio of specific heat of air at constant pressure to specific heat of air at constant volume (1.4)
C_D	Mean effective collision diameter of air molecules (3.65 x 10 ⁻¹⁰ m) (1.1975 x 10 ⁻⁹ ft)
N_a	Avogadro's constant (6.022169 x 10 ²⁶ /kg mol) (2.73179 x 10 ²⁶ /lb mol)
R^*	Gas constant (8.31432 Joule/mol K)
R'	Gas constant for dry air (2.8704 x 10 ² Joule/kg K)
M	Molecular weight of dry air (28.966 gm/mol)

TABLE 3-2. Symbols Used in Chapter 3.

C_s	Speed of sound
C_d	Collision diameter
E	Vapor pressure
g_ϕ	Gravity at latitude ϕ
H	Geopotential height
H_m	Geopotential height at a mandatory radiosonde data level
H_s	Geopotential height at a significant radiosonde data level
K_t	Coefficient of thermal conductivity
L	Mean free path length
M	Mean molecular weight of air at sea level
$M3q$	Monthly third moment of quantity Q
n	Refractive modulus
N	Refractive index
NA	Avogadro's constant
Nq	Number of values of quantity Q
P	Pressure
P_m	Pressure at a mandatory radiosonde data level
P_s	Pressure at a significant radiosonde data level
P_h	Hydrostatically integrated mean monthly or annual pressure
Q	Any tabulated RRA quantity
R^*	Universal gas constant
R'	Specific gas constant of dry air
r', r^*	Parameters used in converting z to h and vice versa
S	Sutherland's constant, used in the calculation of dynamic viscosity
T	Temperature
T_d	Dewpoint
T_v	Virtual temperature
T_{vm}	Virtual temperature at a mandatory radiosonde data level
T_{vs}	Virtual temperature at a significant radiosonde data level
V	Mean air particle speed
V_c	Mean collision frequency
w	Parameter used in the hydrostatic interpolation of pressure and density
Z	Geometric altitude
X	Wavelength
${}^{\alpha}Q$	Skewness of quantity Q
B	Constant used in the equation for viscosity
γ	Ratio of specific heat at constant pressure to specific heat at constant volume
η	Kinematic coefficient of viscosity
μ	Dynamic coefficient of viscosity
ρ	Density
ρ_h	Mean monthly or annual density derived from P_h
σ	Standard deviation of the quantity Q

3.2 QUALITY CONTROL.

Data limits derived from the following thermodynamic elements were used to screen the RRA database: temperature, pressure, dewpoint (for the 0-30 km portion only), and density. These limits were set to plus and minus six standard deviations from the mean values of each of these quantities; they were then used to screen the thermodynamic portion of the database IAW procedures described in Paragraph 1.5. The database was considered to be error-free if:

- (1) Skewness values of pressure and temperature were between -2.5 and 2.5 at all data levels.
- (2) Skewness values of density were between -3.5 and 3.5 at data levels between 0 and 30 km.
- (3) Skewness values of density were between -3.0 and 3.0 at data levels between 30 and 70 km.
- (4) Skewness values of dewpoint were between -2.5 and 2.5 at all data levels with more than 10 data values.

3.3 DATA LIMITATIONS.

Correlation coefficients between thermodynamic quantities and moisture-related quantities were not calculated at discrete altitudes; neither were any of the correlations between altitudes. As a result, valid statistical dispersion models that require relationship between two or more of these quantities at the same altitude or between altitudes cannot be derived. Approximations for the correlation coefficients between pressure, virtual temperature, and density at discrete altitudes, however, may be obtained from the coefficients of variation as developed by Buell (1970). The coefficient of variation is the standard deviation divided by the mean. The mean values and the standard deviations are taken from Appendix B. A model for the profile of monthly and annual mean pressure, virtual temperature, and density is given in Appendix D, and is in excellent agreement with the respective statistical mean values. This agreement results because the physical relationships expressed by the hydrostatic equation and the equation of state were used to derive Appendix D. When only the monthly or annual mean values for pressure, virtual temperature, and density are required, users should consult Appendix D.

3.4 ESTABLISHING DATA SAMPLES AT REQUIRED LEVELS.

This section describes the computational procedures to establish data samples of the thermodynamic RRA variables at the various data levels. References are given to the equation given is one of many available in the literature or when it is stated in an unusual form.

3.4.1 Converting Geopotential Height to Geometric Altitude.

Although rocketsonde observations are recorded in terms of geometric altitude, the data can be interpolated directly to the altitude intervals shown in the tables. But radiosonde observations used to obtain tabular values below 30 km are recorded in terms of geopotential height; the conversion to geometric altitude (h to z) is accomplished by calculating a table of geopotential heights that correspond exactly to the geometric altitudes at which the atmospheric elements are tabulated. Radiosonde observations are then interpolated to these geopotential heights. The relationship used to calculate geometric altitude from geopotential height is:

$$H = (r^* z) / (r^* + z) \quad (49)$$

where $r^* = g r^* / 9.80665$

and $r^* = -2g_\phi / (\partial g_\phi / \partial z_\phi)$

g_ϕ is sea level at latitude ϕ corresponding to the proper location (List, 1968).

$$g_\phi = 9.780356 (1 + 5.2885 \times 10^{-3} \sin^2 \phi - 5.9 \times 10^{-6} \sin^2 (2\phi)) \quad (50)$$

$\frac{\partial g_\phi}{\partial z_0}$ is the rate of change of gravity at sea level. This quantity is given by:

$$\frac{\partial g_\phi}{\partial z_0} = -3.085462 \times 10^{-6} \times 2.27 \times 10^{-9} \cos(2\phi) \times 2 \times 10^{-12} \cos(4\phi) \quad (51)$$

Units used for gravity are m/s^2 , while the units for $\frac{\partial g_\phi}{\partial z_0}$ are s^{-2} .

The resulting table of values of H obtained by using even increments of 2 in equation 49 is shown in Appendix D. Although the values of H above 30 km were not used in the interpolation of original data, they are included for the convenience of the user.

3.4.2 Calculations from Rawinsonde Observations.

It was necessary to interpolate information from original rawinsonde records to arrive at the geometric altitudes specified as RRA data levels. Elements for which this interpolation was required were temperature, dewpoint, and pressure. The other elements were calculated from the interpolated values at each RRA data level. These "derived" elements were water vapor pressure, density, and virtual temperature.

3.4.2.1 Geopotential Height at Significant Levels.

Two slightly different interpolation procedures were used to obtain data from radiosonde and rocketsonde observations at the levels shown in the tables. The procedure used to interpolate radiosonde observations begins with calculations of virtual temperature at each data level in the sounding. Virtual temperature was computed by:

$$T_v = T / (1. - 0.379 (e/p)) \quad (52)$$

where T_v and T are in kelvin (K) and e and p are in millibars.

Radiosonde soundings provide pressure, temperature, and dew point data recorded at "mandatory" and "significant" levels. Geopotential height data, however, is only provided for mandatory levels. Heights at the significant levels, therefore, were calculated hydrostatically, using pressure and temperature data from those levels. This procedure allows the use of most significant level data in the calculation of the RRA tables. The equation used for this process was:

$$H_s = H_m + 29.2712617 * \frac{(T_{vs} + T_{vm})}{2} * \ln(P_s/P_m) \quad (53)$$

where subscripts s and m denote quantities at significant and mandatory levels. This equation was not used if the difference between two adjacent mandatory levels was greater than 200 mb, and all soundings with such data gaps were rejected.

3.4.2.2 Temperature.

Radiosonde temperatures were interpolated logarithmically with respect to pressure using the equation:

$$T = T_U + (T_L - T_U) \frac{\ln p - \ln p_L}{\ln p_U - \ln p_L} \quad (54)$$

where subscripts U and L indicate values at the nearest data levels in the actual sounding above and below the interpolated level.

3.4.2.3 Pressure.

The pressure values in each radiosonde sounding were interpolated to the RRA data levels using the equation:

$$p = p_L \exp \left(\frac{H_L - H_U}{29.2712617 (0.5) (T_{vU} + T_{vL})} \right) \quad (55)$$

where subscript L indicates virtual temperature, geopotential, and pressure values at the data level below and closest to the level at which data were required.

3.4.2.4 Dew Point Temperature.

Dew point values were interpolated logarithmically with respect to pressure using the equation:

$$T_d = T_{dU} + (T_{dL} - T_{dU}) \left(\frac{\ln p - \ln p_L}{\ln p_U - \ln p_L} \right) \quad (56)$$

Subscripts U and L indicate data at the nearest upper and lower data levels in a sounding.

3.4.2.5 Vapor Pressure.

Water vapor pressure is calculated from interpolated dew point values at RRA data levels using Teten's approximation:

$$e = 6.11 \text{ mb} \times 10^{7.5(T_d - 273.15) / (T_d - 35.86)} \quad (57)$$

3.4.2.6 Density.

Density values derived from radiosonde observations were calculated at RRA data levels using the equation:

$$\rho = 348.36787 p / T_v \quad (58)$$

3.4.2.7 Virtual Temperature.

Virtual temperature values are calculated at RRA data levels for each sounding using the equation:

$$T_v = T / (1 - 0.379(e/p)) \quad (59)$$

where T_v and T are in K; pressure (p) and vapor pressure (e) are in millibars.

3.4.3 Calculations from Rocketsonde Observations.

Rocketsonde observations used to calculate RRA table values above 30 km were recorded in terms of geometric altitude. For this reason, slightly different calculations were required to convert recorded data values to RRA data levels. Pressure, temperature, and density were interpolated to RRA data levels. Since atmospheric moisture at altitudes above 30 km is considered to be negligible, moisture-related elements (virtual temperature, water vapor pressure, and dewpoint) were not calculated. There was no interpolation across gaps in pressure or temperature data in a sounding larger than 7,000 meters. Data values at RRA levels within such a gap were set to "missing."

3.4.3.1 Temperature.

Rocketsonde temperatures were interpolated linearly with respect to geometric altitude using the equation:

$$T = T_U + (T_L - T_U) \frac{Z - Z_L}{Z_U - Z_L} \quad (60)$$

where subscript U indicates values at the nearest data level in the actual sounding above the interpolated level: L indicates values below the interpolated level.

3.4.3.2 Pressure.

Rocketsonde pressure values were interpolated to RRA data levels using the equation:

$$P = P_L \exp \left(- \frac{g_0}{R^*} \frac{M (Z - Z_L)}{T_v} \cdot W^2 \right) \quad (61)$$

where

$$T_v = \frac{T_{vU} + T_{vL}}{2} \text{ and } W = \frac{r^*}{\left(r^* + Z + \frac{Z - Z_L}{2} \right)}$$

3.4.3.3 Density.

Rocketsonde density values were interpolated using the equation:

$$\rho = \rho_L \exp \left(- \frac{g_0 M}{R^*} \frac{(Z - Z_L)}{T_v} \cdot W^2 \right) \quad (62)$$

where W is specified in 3.4.3.2.

3.5 COMPUTING STATISTICS FOR APPENDICES B AND C.

Computing monthly and annual means, standard deviations, and skewness values from data at the RRA data levels was in two steps. First, certain statistical sums were calculated and stored as the soundings in the database were processed. These sums were then used to calculate the monthly and annual statistics given in the RRA tables.

3.5.1 Stored Statistical Sums.

The sums that were calculated were:

$$\Sigma Q, \Sigma Q^2, \text{ and } \Sigma Q^3$$

where Q is any one of the quantities given in the thermodynamic part of the RRA.

3.5.2 Calculating Monthly Statistics.

3.5.2.1 Monthly Means.

Mean monthly values of the thermodynamic RRA quantities were calculated using the equation:

$$\bar{Q} = \Sigma Q / N_Q$$

where N_Q is the number of observed values of the quantity Q for a given month.

3.5.2.2 Monthly Standard Deviations.

Monthly standard deviations of the thermodynamic RRA quantities were calculated using the equation:

$$\sigma_Q = \sqrt{\frac{(N_Q \Sigma Q^2) - (\Sigma Q)^2}{N_Q \cdot (N_Q - 1)}} \quad (63)$$

3.5.2.3 Monthly Skewness Values.

Monthly skewness values of wind speed and thermodynamic RRA quantities are calculated using the equation:

$$\sigma_Q = \frac{M_3 Q}{\sigma_Q^3}$$

where M_{3Q} is the third moment of the quantity Q , σ_Q is its standard deviation, and

$$M_{3Q} = \left[\frac{\sum Q^3}{N_Q} - \frac{3\sum Q \sum Q^2}{N_Q^2} + \frac{2\sum Q^3}{N_Q^3} \right] \cdot \frac{N_Q^2}{(N_Q - 1)(N_Q - 2)} \quad (64)$$

3.5.3 Calculating Annual Statistics.

Equations 63 and 64, used to calculate monthly values of standard deviations and skewness values, were also used for the annual statistics.

3.5.3.1 Annual Means.

Annual mean values of the thermodynamic RRA quantities were calculated using the equation:

$$Q_{ANN} = Q_A / N_Q$$

where Q_A is the total of all observed values of Q and N_Q is the total number of observations of Q .

3.5.3.2 Annual Standard Deviations and Skewness Values.

Annual standard deviations of the thermodynamic RRA quantities were calculated using equation 63; annual skewness values were calculated with equation 64. NOTE: Both these quantities were previously calculated with monthly statistics due to limitations in computer precision.

3.6 MONTHLY AND ANNUAL MEAN MODEL ATMOSPHERES.

A set of modeled monthly mean and annual mean hydrostatic values of pressure and density was calculated from the lowest RRA data level (0 km, mean sea level) to 30 km, and from 30 km to 70 km. The integration from 0 to 30 km was computed independently of the integration from 30 to 70 km because of the difference in data sources. These hydrostatically modeled mean values (given in Appendix D) are useful as a check on the validity of pressure and density values given in Appendix B. In most cases, the values in Appendices B and D for any given data level are within 1 percent of each other. The hydrostatic pressure values in Appendix D were calculated using the equation:

$$p_1 = p_0 \exp \left(- \frac{0.034162 (H_1 - H_0)}{0.5 (T_{v_1} + T_{v_0})} \right) \quad (65)$$

where, $H_1 - H_0$ is in meters and a "0" subscript refers to values at the RRA data level immediately below the level being checked. p_0 at the lowest data level is set equal to the RRA mean pressure; p_1 , calculated for the next highest data level, is taken as p_0 for the level above that. This process is repeated for all the other RRA data levels. The hydrostatic density corresponding to hydrostatic pressures is calculated from these pressures and from RRA virtual temperature values using the formula:

$$\rho_H = 348.36786 P_H / T_v \quad (66)$$

where ρ_H and P_H are the hydrostatic density and pressure shown in Appendix D.

3.7 THERMODYNAMIC QUANTITIES DERIVABLE FROM TABLES.

Several other quantities can be calculated from the statistics given in Appendices B and D. The equations in this section can be used to calculate approximate mean values of these quantities at each RRA data level. It is not possible, however, to infer or derive any information concerning standard deviation or skewness values of these quantities from the data in Appendices B and C.

3.7.1 Mean Air Particle Speed.

The mean air particle speed, "V", is the arithmetic average of the speeds of all air particles in the volume element being considered. For a valid average to occur, there must be a sufficient number of particles involved to represent mean conditions. The equation for "V" for dry air is:

$$V = \sqrt{\frac{8}{\pi} \cdot \frac{R^* T}{M}} \quad (67)$$

A computational form for dry air, using tabulated values, is:

$$V = \sqrt{7.3094 \times 10^2 \times T} \quad (\text{m/s}) \quad (68)$$

where T is the temperature in kelvin (K) from Appendix B. Equation 67, when corrected for moist air, becomes:

$$V = \sqrt{\frac{8}{\pi} \cdot R^* T_v} \quad (69)$$

The computational form for moist air is:

$$V = \sqrt{7.3094 \cdot 10^2 \cdot T_v} \quad (\text{m/s}) \quad (70)$$

where T_v is the virtual temperature in kelvin (K) from Appendix C.

3.7.2 Mean Free Path.

The mean free path, "L" is the mean value of the distance traveled by each neutral air particle, in a selected air parcel, between successive collisions with other particles in that parcel. A meaningful average requires that the selected parcel be large enough to contain a substantial number of particles. The equation for L is given by:

$$L = \left(\frac{\sqrt{2}}{2\pi}\right) \left(\frac{R^* T}{N_a C_d^2 P}\right) \quad (71)$$

where C_d is the effective collision diameter of the mean air molecules. The 1976 standard atmosphere value of 3.65×10^{-10} is valid for the range of altitudes in the RRA. A computational form for moist air, using tabulated values, is:

$$L = 2.335 \times 10^{-7} \frac{T}{P} \quad (\text{meters}) \quad (72)$$

where T is the temperature in K and P is the pressure in mb, both from Appendix B. A form of equation 71 to correct L for moist air is:

$$L = \left(\frac{\sqrt{2}}{2\pi}\right) \frac{R^* M T_v}{N_a C_d^2} \quad (73)$$

The computational form for moist air is:

$$L = 2.3325 \times 10^{-7} \frac{T_v}{P} \quad (\text{meters}) \quad (74)$$

where T_v is the virtual temperature in K from Appendix C and P is the pressure in mb from Appendix B.

3.7.3 Mean Collision Frequency.

The mean collision frequency (V_c) is considered to be the average speed of air particles contained in an air parcel divided by the mean free path of the particles inside that parcel. Computationally, this is equivalent to:

$$V_c = \frac{V}{L} \text{ (sec}^{-1}\text{)} \quad (75)$$

To determine V_c for dry air, use V and L from equations 68 and 72. To determine V_c for moist air, use V' and L from equations 70 and 74.

3.7.4 Speed of Sound.

The expression for the speed of sound (C_s) in dry air, in (m/s) is:

$$C_s = \sqrt{\frac{\gamma R^* T}{M}} \quad (76)$$

To compute C_s for dry air from tabulated values, use:

$$C_s = \sqrt{4.0185 \times 10^2 \times T} \text{ (m/s)} \quad (77)$$

where T is the temperature K from Appendix B. One form for the speed of sound in moist air is:

$$C_s = \sqrt{\gamma R^* T_v} \quad (78)$$

where T_v is the virtual temperature from Appendix C. A computational form for moist air is:

$$C_s = \sqrt{4.0185 \times 10^2 T_v} \text{ (m/s)} \quad (79)$$

3.7.5 Coefficient of Dynamic Viscosity.

The coefficient of dynamic viscosity, μ , is defined as a coefficient of internal friction developed where gas regions move adjacent to each other at different velocities. The following expression is taken from the U.S. Standard Atmosphere (1976):

$$\mu = \frac{\beta \cdot T^{3/2}}{T + S} \quad (80)$$

The computational form is:

$$\mu = \frac{(1.458 \times 10^{-6}) T^{3/2}}{T + 110.4} , \left(\frac{\text{kg}}{\text{s} \cdot \text{m}} \right) \quad (81)$$

where T is temperature K from Appendix B.

3.7.6 Kinematic Coefficient of Viscosity.

The kinematic coefficient of viscosity, designated as η , is defined as the ratio of the dynamic coefficient of viscosity of a gas to its density, or:

$$\eta = \mu/\rho \quad (82)$$

The computational form is:

$$\eta = 1.0 \times 10^3 \mu/\rho \quad , \quad (m^2/s) \quad (83)$$

where μ is the dynamic coefficient of viscosity from equation (81) and ρ is the density in $g\ m^{-3}$ from Appendix B.

3.7.7 Coefficient of Thermal Conductivity.

The empirical expression used for the coefficient of thermal conductivity (K_t) is given in the 1976 Standard Atmosphere as:

$$K_t = \frac{2.65019 \times 10^{-3} \cdot T^{3/2}}{T + 245.4 \times 10^{-(12/T)}} \quad , \quad (\text{watts/m-deg K}) \quad (84)$$

where T is temperature K.

3.7.8 Refractive Modulus and Refractive Index.

The refractive modulus or refractivity (Selby and McClatchey, 1975; Smith and Weintraub, 1953), is expressed as N , where:

$$N = (n - 1) \cdot 10^6 \quad (85)$$

and n is the refractive index.

For microwave frequencies below approximately 30 GHz (equivalent to wavelengths above 1 cm), N , the refractive modulus, is given by the empirical equation:

$$N = 77.6 \frac{P}{T_d} + 3.73 \times 10^5 \frac{e}{T^2} \quad (\text{dimensionless}) \quad (86)$$

where E and P are in millibars and T and T_d are in K.

The following expression is valid for visible and infrared wavelengths shorter than approximately 30 μm (0.03 mm):

$$N = 77.6 \frac{P}{T} + 0.584 \frac{P}{T\lambda} \quad (\text{diminsionless}) \quad (87)$$

where λ is the wavelength in microns and T is in degrees K.

The expression for N for the wavelength from 0.03 mm to 1 cm is an extremely complex function of wavelength.

Chapter 4

CONCLUSIONS AND RECOMMENDATIONS

4.1 CONCLUSIONS.

This document satisfies the technical objectives established for the Range Reference Atmosphere committee by the Range Commanders Council Meteorology Group. Upper-air statistics and models for wind and thermodynamic quantities for the range specified have been derived through consistent and uniform methods that will be used in similar publications for other ranges. This new Range Reference Atmosphere (RRA) series is an improvement over previously published RRAs for several reasons: for one, the upper-air database is much larger and much better. For another, more advanced statistical techniques have been developed.

In this series, a statistical measure of central tendency (mean values) and a measure of dispersion (standard deviation with respect to mean values) for monthly and annual reference periods have been consistently tabulated for all variables, using databases that have been carefully edited and quality controlled. Further, a statistical measure for symmetry (skewness coefficient which involves the third statistical moment) has been tabulated for all variables except the zonal and meridional wind components. But even with these improvements, RRA users must recognize certain limitations of the statistical tabulations; these limitations are described here to discourage misuse of the RRA.

- The wind profile structure with respect to altitude cannot be modeled from RRA statistics because inter-level and cross-level correlations were not computed.

- The profile structure with respect to altitude for any of the thermodynamic variables or any quantities derivable from thermodynamic variables cannot be modeled because the prerequisite correlations were not computed. However, the profile of monthly and annual means for pressure, virtual temperature, and density given in Appendix D are in agreement with the hydrostatic equation and the equation of state.

Although more extensive statistical tabulations are currently impractical, many adaptations of current statistics for specific engineering and scientific applications are envisioned as insight is gained through RRA use.

4.2. RECOMMENDATIONS.

The agency responsible for RRA preparation recommends that the wind and thermodynamic statistical tabulations and models in this RRA be used with confidence as a standard reference to the atmosphere over the location for which it has been prepared. It is further recommended that RRA users consult their Staff Meteorologist for assistance before attempting to apply RRA data to specific engineering projects.

BIBLIOGRAPHY

- Buell, Eugene C., "Statistical Relations in a Perfect Gas," *Journal of Applied Meteorology*, 9, pp. 729-731, 1970.
- List, R.J., Ed., "Acceleration of Gravity," *Smithsonian Meteorological Tables*, Sixth Ed. Smithsonian Institution, Washington, D.C., P. 488, 1968.
- Selby, J.E.A., and McClatchey, R.A., *Atmospheric Transmittance from 0.25 to 28.5 μ m - Computer Code LOWTRAN 3*, AFCRL-TR-75-0255, Air Force Cambridge Research Laboratories, 1975.
- Smith, E.K., and Weintraub, S., "The Constants in the Equation for Atmospheric Refractive Index at Radio Frequencies" *Proceedings of the Institute of Radio Engineers*, 41, 8, pp. 1035-1037, August 1953.
- Smith, O.E., *Vector Wind and Vector Wind Shear Models at 0-27 km Altitude for Cape Kennedy, Florida, and Vandenberg AFB, California*, NASA TM X-73319, July 1976.
- U.S. Standard Atmosphere*, National Aeronautics and Space Administration, United States Air Force, and United States Weather Bureau, October 1976.

PREVIOUSLY PUBLISHED RANGE REFERENCE ATMOSPHERES

Capt Kennedy, Florida (Part I), Document 104-63, April 16 1963
(AD 451 780).*

White Sands Missile Range, New Mexico (Part I), Document 104-63, 28 June 1964
(AD 451 781).*

Fort Churchill, Manitoba (Part I), Document 372-63, 7 August 1964
(AD 634 727).

Eniwetok, Marshall Islands (Part I), Document 104-63, 1 September 1964
(AD 479 264).*

Fort Greely Missile Range, Alaska (Part I), Document 373-63, 6 October 1964
(AD 634 726).

Eglin Gulf Test Range, Florida (Part I), Document 104-63, 25 January 1965
(AD 472 601).*

Point Arguello, California (Part I), Document 104-63, April 1965
(AD 472 602).*

Wallops Island Test Range (Part I), Document 104-63, 10 July 1965
(AD 474 071).*

Ascension Island, South Atlantic (Part I), Document 104-63, July 1966
(AD 645 591).*

Johnston Island Test Site (Part I), Document 104-63, January 1970
(AD 782 652).*

Lihue, Kauai, Hawaii (Part I), Document 104-63, January 1970
(AD 782 653).*

Cape Kennedy, Florida (Part II), Document 104-63, September 1971
(AD 753 581).*

White Sands Missile Range (Part II), Document 104-63, September 1971
(AD 782 654).*

Wallops Island Test Range (Part II), Document 104-63, September 1971.*

Fort Greely Missile Range (Part II), Document 104-63, September 1971.*

Edwards AFB (Part I), Document 104-63, September 1972
(AD 782 651).*

Kwajalein Missile Range, Marshall Islands (Part I), Document 105-63, October 1974.*

Kwajalein Missile Range, Document 360-82, 1982
(AD-A123424).

Cape Canaveral, Florida, Document 361-83, February 1983
(AD-A125553).

Vandenberg AFB, California, Document 362-83, 1983
(AD-A128125).

Dugway, Utah, Document 363-83, June 1983
(AD-A131110).

Wallops Island Test Range, Virginia, Document 364-83, July 1983
(AD-A131327).

White Sands Missile Range, New Mexico, Document 365-83, August 1983
(AD-A132471).

Edwards AFB, California, Document 366-83, August 1983
(AD-A132487).

Eglin AFB, Florida, Document 367-83, 1983
(AD-A133506).

Taquac, Guam Island, Document 368-83, 1983
(AD-A133618).

Point Mugu, California, Document 369-83, 1983
(AD-A134186).

Barking Sands, Hawaii, Document 370-83, 1983
(AD-A137406).

Ascension Island, Document 371-84, 1984
(AD-A138470).

Wake Island, USAFETAC/PR-90/007), November 1990.
(AD-Pending)

* No longer available from RCC.

ACRONYMS, INITIALISMS, AND ABBREVIATIONS (ACRINABS)

AD	Armament Division
AFFTC	Air Force Flight Test Center
AFSC	Air Force Systems Command
AFSCF	Air Force Satellite Control Facility
AFTFWC	Air Force Tactical Fighter Weapons Center
AWS	Air Weather Service
BMD	Ballistic Missile Division
BMO	Ballistic Missile Office (now BSD)
BSD	Ballistic Systems Division (formerly BMO)
CSTC	Consolidated Space Test Center
DOD	Department of Defense
DOE	Department of Energy
DOE/NTS	DOE/Nevada Test Site
DPG	Dugway Proving Ground
EPG	Electronic Proving Ground
ESMC	Eastern Space and Missile Center
ETR	Eastern Test Range
GL	Geophysics Laboratory
IRIG	Inter-Range Instrumentation Group
KMR	Kwajalein Missile Range
MSD	Munitions Systems Division
NASA	National Aeronautics and Space Administration
NASA/MSFC	NASA/Marshall Space Flight Center
NASA/WFC	NASA/Wallops Flight Center
NATC	Naval Air Test Center
NOAA	National Oceanic and Atmospheric Administration
NWC	Naval Weapons Center
PMTC	Pacific Missile Test Center
RCC/MG	Range Commanders Council/Meteorology Group
RRA	Range Reference Atmosphere
RRAC	Range Reference Atmosphere Committee
SAMTO	Space and Missile Test Organization
TFWC	Tactical Fighter Weapons Center
TSCF	Targeting Systems Characterization Facility
USA/DTA	U.S. Army/Desert Test Center
USAECOM	U.S. Army Electronics Command
USAFETAC	USAF Environmental Technical Applications Center
USAKA	U.S. Army Kwajalein Atoll
UTTR	Utah Test and Training Range
WSMC	Western Space and Missile Center
WSMR	White Sands Missile Range
WTR	Western Test Range
YPG	Yuma Proving Ground
6585TG	6585th Test Group

APPENDIX A

Wake Island Wind Statistics Tables

Table A-1 through table A-13 give statistical wind data (monthly and annual) for Wake Island. Data was produced as described in Chapter 2.

TABLE A-1. January Statistical Wind Data, Wake Island.

Z KM	MEAN U M/S	S.D. U M/S	R(U,V)	MEAN V M/S	S.D. V M/S	MEAN W M/S	S.D. W M/S	SKEW W	#OBS
0.000	0.00	0.00	0.0000	0.00	0.00	0.00	0.00	0.00	0.
0.005	-3.49	4.17	0.2936	-1.05	3.77	6.08	2.81	0.55	886.
1.000	-3.27	5.72	0.1186	-0.45	4.39	7.02	3.69	0.83	869.
2.000	-0.54	6.33	0.1305	0.02	4.22	6.65	3.74	1.18	859.
3.000	2.77	6.97	0.1446	-0.56	4.42	7.62	4.24	0.77	850.
4.000	5.22	7.40	0.1788	-0.93	4.60	8.95	4.88	0.67	846.
5.000	7.14	7.61	0.1628	-0.89	5.00	10.35	5.26	0.67	844.
6.000	8.81	7.75	0.1242	-1.33	6.04	11.85	5.95	0.69	843.
7.000	10.47	8.05	0.0282	-2.01	6.72	13.52	6.38	0.71	839.
8.000	11.83	8.48	0.0381	-2.62	6.95	14.82	6.88	0.78	837.
9.000	13.18	9.24	0.0672	-3.25	7.40	15.97	7.61	0.85	837.
10.000	14.10	8.86	0.0447	-3.71	7.55	16.81	8.09	0.98	836.
11.000	14.89	8.89	-0.0305	-3.82	7.68	17.41	8.11	0.92	834.
12.000	15.32	8.88	-0.0999	-3.53	7.45	17.66	7.99	0.85	833.
13.000	15.12	8.77	-0.0871	-2.81	7.21	17.35	8.02	0.84	830.
14.000	14.59	8.69	-0.0263	-1.88	7.13	16.79	7.80	0.88	824.
15.000	13.03	8.20	-0.0223	-0.97	6.55	15.16	7.15	0.63	822.
16.000	9.70	7.59	-0.1004	0.05	5.72	12.13	6.10	0.68	804.
17.000	6.40	7.02	-0.1744	0.53	5.07	9.59	4.93	0.86	760.
18.000	1.75	6.05	-0.1751	0.62	3.85	6.60	3.35	1.08	760.
19.000	-0.75	5.02	-0.1233	0.35	2.93	5.22	2.57	0.50	742.
20.000	-1.84	4.25	-0.0644	0.12	2.41	4.60	2.47	0.99	731.
21.000	-2.52	3.80	-0.0295	0.06	2.50	4.55	2.52	0.64	713.
22.000	-3.34	3.83	0.0048	0.07	2.31	4.87	2.72	0.82	704.
23.000	-3.84	4.54	-0.0393	0.03	2.48	5.49	3.38	1.24	692.
24.000	-3.96	5.15	-0.0486	0.03	2.85	6.05	3.70	1.30	674.
25.000	-3.81	5.89	0.0256	0.22	3.14	6.63	3.89	1.39	658.
26.000	-3.45	6.57	0.0600	0.32	3.66	7.12	4.22	1.21	645.
27.000	-2.46	7.22	0.0501	0.29	3.88	7.33	4.41	1.02	615.
28.000	-1.56	7.57	0.0600	0.11	3.62	7.39	4.26	1.10	579.
29.000	-0.73	8.05	0.0720	0.00	3.65	7.81	4.18	0.83	541.
30.000	0.20	8.97	0.0290	-0.22	4.09	8.65	4.72	0.77	489.

TABLE A-2. February Statistical Wind Data, Wake Island.

Z KM	MEAN U M/S	S.D. U M/S	R(U,V)	MEAN V M/S	S.D. V M/S	MEAN W M/S	S.D. W M/S	SKEW W	#OBS
0.000	0.00	0.00	0.0000	0.00	0.00	0.00	0.00	0.00	0.
0.005	-3.91	3.62	0.3216	-1.12	3.62	5.93	2.74	0.64	812.
1.000	-3.68	4.80	0.1133	-0.23	3.87	6.34	3.37	0.88	796.
2.000	-1.10	5.21	0.0320	0.18	3.48	5.55	3.11	1.02	785.
3.000	1.80	5.82	-0.0424	-0.19	3.59	6.18	3.43	0.92	780.
4.000	4.86	6.21	0.0299	-0.58	4.10	7.80	4.29	0.70	775.
5.000	7.43	6.41	0.0779	-0.85	5.01	9.88	4.94	0.56	773.
6.000	9.70	6.54	0.0341	-1.56	5.81	12.00	5.39	0.37	771.
7.000	11.82	6.95	0.0122	-2.39	6.41	13.99	6.25	0.44	769.
8.000	13.93	7.42	0.0194	-3.04	7.01	16.12	6.90	0.31	765.
9.000	15.89	8.00	0.0008	-3.78	7.78	18.21	7.72	0.28	764.
10.000	17.49	8.35	-0.0281	-4.17	8.42	19.77	8.56	0.47	762.
11.000	18.77	8.81	0.0091	-4.00	8.79	20.97	9.12	0.51	761.
12.000	19.19	9.13	0.0102	-3.27	8.73	21.31	9.19	0.37	760.
13.000	19.21	9.29	0.0173	-2.33	8.25	21.11	9.12	0.32	757.
14.000	18.21	8.57	-0.0369	-1.28	8.15	20.12	8.25	0.18	756.
15.000	15.76	8.00	-0.0723	-0.34	7.49	17.77	7.27	0.20	755.
16.000	11.72	7.21	-0.1799	0.17	6.58	13.91	6.25	0.43	741.
17.000	8.01	6.45	-0.2152	0.23	5.71	10.61	5.06	0.55	708.
18.000	3.32	5.51	-0.1318	0.32	3.93	6.72	3.43	0.93	708.
19.000	0.77	4.73	-0.0454	0.15	2.87	5.01	2.48	0.61	697.
20.000	-0.77	4.57	0.0699	0.10	2.71	4.72	2.55	0.68	693.
21.000	-1.92	4.65	0.1818	-0.04	2.74	4.92	2.92	1.04	685.
22.000	-2.92	4.63	0.1232	-0.14	2.42	5.20	2.95	0.93	677.
23.000	-3.56	5.10	0.0283	-0.17	2.43	5.80	3.30	1.01	670.
24.000	-3.74	5.52	-0.0521	-0.20	2.73	6.27	3.55	0.98	660.
25.000	-3.47	6.05	-0.0701	-0.04	2.98	6.64	3.65	1.20	647.
26.000	-2.74	6.71	0.0071	0.14	3.46	6.95	4.04	1.27	634.
27.000	-1.02	7.70	0.0845	0.25	3.65	7.48	4.20	0.97	614.
28.000	-0.12	8.28	0.1243	0.32	3.63	7.91	4.38	1.06	579.
29.000	0.59	9.07	0.2041	0.34	3.77	8.42	5.09	1.33	552.
30.000	1.04	9.99	0.1810	0.31	3.97	9.05	5.90	1.46	492.

TABLE A-3. March Statistical Wind Data, Wake Island.

Z KM	MEAN U M/S	S.D. U M/S	R(U,V)	MEAN V M/S	S.D. V M/S	MEAN W M/S	S.D. W M/S	SKEW W	#OBS
0.000	0.00	0.00	0.0000	0.00	0.00	0.00	0.00	0.00	0.
0.005	-5.00	3.75	0.3213	-1.36	3.54	6.76	2.76	0.26	898.
1.000	-5.85	5.17	0.1931	-0.14	3.51	7.74	3.67	0.35	877.
2.000	-3.58	5.69	0.0420	0.17	3.08	6.49	3.53	0.73	868.
3.000	-1.16	6.15	0.1229	-0.18	3.22	6.18	3.37	0.95	862.
4.000	1.38	6.34	0.1564	-0.42	3.50	6.37	3.74	1.01	861.
5.000	4.07	6.81	0.2367	-1.10	4.28	7.90	4.46	0.80	860.
6.000	6.80	7.22	0.2813	-1.88	5.43	10.30	5.04	0.42	857.
7.000	9.48	7.57	0.2906	-2.84	6.32	12.75	5.69	0.37	847.
8.000	12.08	8.08	0.2230	-3.74	7.48	15.37	6.69	0.33	842.
9.000	14.97	8.96	0.2097	-4.49	8.16	18.20	7.74	0.27	840.
10.000	17.11	9.27	0.1989	-5.08	8.54	20.18	8.38	0.22	835.
11.000	18.81	9.84	0.1989	-5.08	9.04	21.78	9.15	0.28	833.
12.000	19.66	10.17	0.1642	-4.57	9.14	22.38	9.66	0.36	831.
13.000	19.64	10.23	0.1519	-3.69	8.76	22.04	9.71	0.37	829.
14.000	18.58	9.74	0.1018	-2.92	8.13	20.74	9.20	0.29	828.
15.000	15.87	8.83	0.0464	-2.32	7.00	17.92	7.94	0.27	821.
16.000	11.95	7.93	0.0221	-1.87	6.02	14.19	6.62	0.28	807.
17.000	8.28	7.26	0.0345	-1.21	4.93	10.81	5.48	0.75	768.
18.000	3.70	6.45	0.0433	-0.52	3.62	7.09	4.09	1.23	771.
19.000	0.87	5.78	-0.0464	-0.30	2.97	5.52	3.30	1.33	755.
20.000	-0.95	5.06	-0.0405	-0.23	2.71	5.00	2.79	0.95	744.
21.000	-2.54	4.61	-0.0387	-0.20	2.88	5.15	2.80	0.68	734.
22.000	-3.35	4.32	-0.0004	-0.15	2.46	5.28	2.73	0.51	718.
23.000	-2.95	4.74	0.0117	0.04	2.34	5.67	3.18	0.77	707.
24.000	-4.05	5.16	0.0061	0.12	2.60	5.95	3.54	1.02	690.
25.000	-3.84	5.38	-0.0512	0.25	2.90	6.21	3.68	1.16	677.
26.000	-3.49	5.96	-0.0057	0.40	3.43	6.64	3.93	0.99	666.
27.000	-2.65	6.75	0.1310	0.55	3.78	7.14	4.02	0.85	62..
28.000	-1.88	7.47	0.1808	0.75	3.68	7.58	3.98	0.84	598.
29.000	-0.94	8.21	0.1700	0.85	3.77	8.09	4.19	0.82	562.
30.000	-0.16	8.77	0.2097	0.83	4.06	8.49	4.68	0.81	511.

TABLE A-4. April Statistical Wind Data, Wake Island.

Z KM	MEAN U M/S	S.D. U M/S	R(U,V)	MEAN V M/S	S.D. V M/S	MEAN W M/S	S.D. W M/S	SKEW W	#OBS
0.000	0.00	0.00	0.0000	0.00	0.00	0.00	0.00	0.00	0.
0.005	-6.62	2.94	0.3613	-1.59	2.89	7.52	2.60	0.26	876.
1.000	-8.07	3.86	0.1785	-0.25	2.92	8.82	3.30	-0.04	853.
2.000	-5.95	4.28	0.0196	0.15	2.82	7.20	3.14	0.18	838.
3.000	-4.22	4.72	-0.0189	-0.50	3.02	6.38	2.96	0.26	838.
4.000	-2.51	4.92	0.0580	-1.07	3.09	5.63	3.09	0.94	836.
5.000	-0.68	5.44	0.1297	-1.52	3.42	5.69	3.26	1.14	832.
6.000	1.35	6.31	0.1289	-2.32	4.02	6.65	3.93	1.04	828.
7.000	3.69	7.14	0.1440	-2.93	4.73	8.35	4.77	0.86	827.
8.000	6.25	8.04	0.1833	-3.44	5.66	10.60	5.55	0.76	826.
9.000	9.72	9.43	0.1985	-4.11	7.05	14.03	6.92	0.63	824.
10.000	13.58	10.59	0.3047	-4.21	8.30	17.70	7.98	0.39	817.
11.000	17.52	11.76	0.3803	-4.18	9.47	21.48	9.14	0.37	814.
12.000	20.90	12.37	0.4214	-3.98	10.80	24.74	10.00	0.28	813.
13.000	21.93	12.36	0.3856	-3.85	10.27	25.32	10.04	0.28	809.
14.000	20.50	11.37	0.3534	-3.94	8.54	23.30	9.17	0.42	805.
15.000	16.68	9.60	0.2754	-4.15	6.46	19.01	7.67	0.70	792.
16.000	11.58	8.10	0.2106	-4.04	5.60	14.23	6.15	0.56	781.
17.000	7.27	6.87	0.1909	-3.34	4.66	10.52	4.72	0.83	736.
18.000	2.29	5.64	0.0952	-2.24	3.60	6.61	3.36	1.01	738.
19.000	-0.74	4.50	0.0324	-1.37	2.86	4.96	2.49	0.73	731.
20.000	-2.50	3.84	0.0619	-0.63	2.46	4.71	2.29	0.49	729.
21.000	-4.00	3.79	0.0347	-0.09	2.50	5.41	2.70	0.32	721.
22.000	-5.19	3.90	0.0371	0.15	2.24	6.18	3.01	0.38	707.
23.000	-6.14	4.54	0.0244	0.23	2.45	7.15	3.64	0.39	693.
24.000	-6.76	5.19	0.0662	0.20	2.64	7.91	4.13	0.29	679.
25.000	-7.03	5.86	0.0400	0.32	2.77	8.47	4.44	0.30	661.
26.000	-7.10	6.53	0.0846	0.29	3.17	8.94	4.82	0.15	647.
27.000	-7.25	7.22	0.1110	0.06	3.36	9.42	5.22	0.31	608.
28.000	-7.14	7.37	0.0831	0.00	3.15	9.44	5.11	0.47	572.
29.000	-7.21	7.71	0.0000	0.06	3.34	9.80	5.15	0.55	529.
30.000	-7.23	8.12	-0.0046	0.11	3.62	10.13	5.35	0.52	482.

TABLE A-5. May Statistical Wind Data, Wake Island.

Z KM	MEAN U M/S	S.D. U M/S	R(U,V)	MEAN V M/S	S.D. V M/S	MEAN W M/S	S.D. W M/S	SKEW W	#OBS
0.000	0.00	0.00	0.0000	0.00	0.00	0.00	0.00	0.00	0.
0.005	-5.69	2.83	0.4489	-0.59	2.32	6.41	2.25	0.20	895.
1.000	-6.97	3.77	0.1995	0.39	2.42	7.75	2.96	-0.20	871.
2.000	-5.70	4.18	0.0500	0.35	2.54	6.93	2.92	0.09	867.
3.000	-4.59	4.53	0.0134	-0.14	2.68	6.33	2.97	0.22	863.
4.000	-3.43	4.54	0.0682	-0.54	2.73	5.62	2.92	0.50	863.
5.000	-2.48	4.90	0.0846	-0.83	3.13	5.63	2.99	0.55	862.
6.000	-1.45	5.56	0.1412	-1.17	3.96	6.17	3.46	0.83	861.
7.000	-0.31	6.51	0.1629	-1.60	4.60	7.15	3.88	0.88	858.
8.000	1.18	7.74	0.2055	-1.98	5.39	8.53	4.62	0.96	855.
9.000	3.01	9.39	0.2533	-2.38	6.40	10.44	5.91	0.95	852.
10.000	5.66	11.18	0.3525	-2.48	7.16	12.67	7.32	0.90	848.
11.000	8.31	13.32	0.4156	-2.75	8.20	15.39	9.17	0.84	846.
12.000	11.32	14.88	0.4335	-2.80	9.13	18.19	10.48	0.75	845.
13.000	13.05	15.26	0.4206	-3.01	9.31	19.53	10.83	0.64	842.
14.000	13.28	14.44	0.3699	-3.38	8.70	19.05	10.44	0.58	837.
15.000	10.14	11.41	0.3424	-3.48	6.91	15.17	7.91	0.74	830.
16.000	5.89	8.65	0.2716	-3.19	5.37	10.88	5.47	0.71	816.
17.000	2.53	7.00	0.2096	-2.81	4.06	8.10	3.77	0.66	779.
18.000	-1.42	5.20	0.0977	-1.91	3.00	5.85	2.72	0.46	783.
19.000	-4.33	4.15	-0.0093	-0.97	2.37	5.80	2.80	0.41	769.
20.000	-6.73	3.32	-0.0461	-0.30	2.12	7.19	3.02	0.06	761.
21.000	-8.72	3.44	0.0622	-0.06	2.28	9.06	3.31	0.18	750.
22.000	-10.08	3.27	0.0009	0.06	2.00	10.30	3.20	0.09	742.
23.000	-11.35	3.76	0.0396	0.04	2.36	11.63	3.64	0.09	734.
24.000	-12.36	4.31	0.0455	0.15	2.57	12.67	4.18	0.07	725.
25.000	-13.15	4.43	0.0509	0.36	2.50	13.43	4.30	0.04	706.
26.000	-13.77	4.82	0.0967	0.28	2.77	14.11	4.62	-0.03	684.
27.000	-14.43	5.40	0.1122	0.27	2.82	14.77	5.21	-0.03	638.
28.000	-14.67	5.56	0.0530	0.20	2.63	14.99	5.33	-0.01	605.
29.000	-14.92	5.87	-0.0028	0.23	2.57	15.24	5.60	0.04	573.
30.000	-15.44	6.28	-0.0178	0.19	2.89	15.84	5.95	0.11	529.

TABLE A-6. June Statistical Wind Data, Wake Island.

Z KM	MEAN U M/S	S.D. U M/S	R(U,V)	MEAN V M/S	S.D. V M/S	MEAN W M/S	S.D. W M/S	SKEW W	#OBS
0.000	0.00	0.00	0.0000	0.00	0.00	0.00	0.00	0.00	0.
0.005	-5.38	2.83	0.4799	-0.40	2.10	6.08	2.11	0.07	830.
1.000	-6.88	3.47	0.2424	0.61	2.16	7.56	2.72	-0.25	811.
2.000	-6.12	3.48	0.1030	0.40	2.30	6.87	2.79	0.02	806.
3.000	-5.52	3.79	0.1128	-0.08	2.71	6.59	2.97	0.33	803.
4.000	-4.91	3.86	0.0720	-0.34	2.95	6.30	2.85	0.40	802.
5.000	-4.65	4.14	-0.0077	-0.59	3.53	6.56	2.93	0.42	800.
6.000	-4.19	4.48	0.0174	-0.80	4.34	6.89	3.09	0.48	799.
7.000	-3.90	4.88	0.0557	-1.20	5.20	7.45	3.48	0.48	792.
8.000	-3.29	5.78	0.0862	-1.54	6.29	8.23	4.28	0.67	788.
9.000	-2.37	7.31	0.1343	-1.92	7.44	9.46	5.34	0.92	785.
10.000	-1.15	8.67	0.2419	-2.18	8.40	10.71	6.09	0.88	782.
11.000	0.38	10.14	0.3219	-2.46	9.57	12.40	6.83	0.90	781.
12.000	2.32	11.92	0.4112	-2.70	10.66	14.44	7.72	0.85	779.
13.000	3.60	13.18	0.4313	-2.72	10.50	15.37	8.24	0.78	775.
14.000	3.50	12.95	0.4378	-2.85	9.32	14.40	8.20	0.95	773.
15.000	1.22	10.20	0.3409	-2.75	7.36	11.18	6.50	1.01	768.
16.000	-2.06	6.98	0.2809	-2.37	5.29	8.03	4.70	0.91	763.
17.000	-4.72	5.11	0.1806	-1.91	3.54	7.16	3.64	0.79	732.
18.000	-7.78	3.69	0.0184	-1.12	2.37	8.39	3.25	0.35	733.
19.000	-10.06	3.27	-0.0191	-0.66	1.94	10.30	3.17	0.37	727.
20.000	-12.54	3.04	-0.0463	-0.27	1.93	12.70	2.99	0.10	721.
21.000	-14.65	3.29	0.0078	-0.16	2.07	14.80	3.25	0.02	710.
22.000	-15.95	3.13	-0.0794	0.04	2.03	16.09	3.10	0.10	707.
23.000	-17.18	3.31	-0.0262	0.18	2.36	17.35	3.28	-0.09	690.
24.000	-18.32	3.60	0.0164	0.17	2.68	18.52	3.56	-0.19	677.
25.000	-19.44	3.71	0.0616	0.13	2.47	19.60	3.69	0.01	662.
26.000	-20.23	3.98	0.0679	0.21	2.75	20.42	3.94	-0.09	645.
27.000	-21.03	4.41	0.0607	0.21	2.92	21.24	4.38	-0.40	607.
28.000	-21.45	4.24	0.0836	0.08	2.61	21.61	4.21	-0.36	570.
29.000	-21.97	4.32	0.0641	0.07	2.77	22.15	4.29	-0.23	528.
30.000	-22.46	4.71	-0.0165	0.04	3.18	22.70	4.63	-0.24	474.

TABLE A-7. July Statistical Wind Data, Wake Island.

Z KM	MEAN U M/S	S.D. U M/S	R(U,V)	MEAN V M/S	S.D. V M/S	MEAN W M/S	S.D. W M/S	SKEW W	#OBS
0.000	0.00	0.00	0.0000	0.00	0.00	0.00	0.00	0.00	0.
0.005	-4.96	2.85	0.3984	0.42	2.22	5.80	2.05	0.48	854.
1.000	-6.69	3.78	0.2115	1.30	2.49	7.72	2.70	0.39	847.
2.000	-5.88	3.84	0.2144	0.93	2.58	7.04	2.59	0.09	851.
3.000	-5.03	3.94	0.1972	0.48	2.81	6.46	2.68	0.20	851.
4.000	-4.10	4.16	0.2325	0.08	3.12	5.96	2.88	0.44	851.
5.000	-3.36	4.35	0.2423	-0.25	3.49	5.74	3.08	0.56	850.
6.000	-2.64	4.66	0.2377	-0.74	3.96	5.87	3.22	0.73	850.
7.000	-2.15	4.90	0.2296	-1.40	4.36	6.11	3.49	0.81	850.
8.000	-1.48	5.56	0.1914	-2.00	4.93	6.82	3.86	0.92	849.
9.000	-0.90	6.59	0.1808	-2.79	6.14	8.28	4.60	0.89	846.
10.000	-0.20	7.96	0.2393	-3.34	7.08	9.83	5.28	0.90	845.
11.000	0.49	9.63	0.2846	-3.77	8.48	11.80	6.30	0.82	841.
12.000	1.29	11.76	0.3299	-4.38	9.75	14.06	7.51	0.69	640.
13.000	1.75	12.83	0.3514	-4.92	10.20	15.20	8.05	0.57	834.
14.000	1.46	12.24	0.3466	-4.96	9.37	14.41	7.53	0.48	830.
15.000	-1.05	9.34	0.3057	-4.21	6.70	10.80	5.86	0.75	819.
16.000	-4.91	5.90	0.2415	-2.91	3.89	7.84	4.58	0.63	807.
17.000	-7.98	3.94	0.2164	-2.03	2.52	8.68	3.78	0.37	773.
18.000	-11.65	2.80	0.0331	-0.96	1.96	11.86	2.76	0.15	773.
19.000	-14.35	2.43	-0.0292	-0.54	1.86	14.48	2.43	-0.01	765.
20.000	-16.70	2.47	-0.0626	-0.20	1.86	16.80	2.47	0.19	760.
21.000	-18.73	2.98	0.0682	-0.16	2.22	18.87	2.96	-0.12	754.
22.000	-19.86	3.00	-0.0602	0.06	2.04	19.97	2.95	-0.21	749.
23.000	-20.94	3.24	-0.0588	0.36	2.18	21.06	3.22	-0.22	735.
24.000	-22.03	3.54	-0.0621	0.39	2.57	22.19	3.51	0.06	722.
25.000	-23.21	3.61	-0.0760	0.41	2.53	23.36	3.58	0.07	689.
26.000	-24.17	3.94	-0.0350	0.26	2.86	24.34	3.90	0.07	673.
27.000	-25.55	4.17	-0.0194	0.19	3.13	25.75	4.16	0.24	636.
28.000	-26.17	4.25	-0.0241	0.15	2.64	26.31	4.23	0.11	591.
29.000	-26.74	4.50	0.0207	0.19	2.79	26.89	4.47	0.19	542.
30.000	-27.29	4.50	0.0239	0.25	2.91	27.45	4.47	-0.13	495.

TABLE A-8. August Statistical Wind Data, Wake Island.

Z KM	MEAN U M/S	S.D. U M/S	R(U,V)	MEAN V M/S	S.D. V M/S	MEAN W M/S	S.D. W M/S	SKEW W	#OBS
0.000	0.00	0.00	0.0000	0.00	0.00	0.00	0.00	0.00	0.
0.005	-4.43	3.20	0.4426	0.56	2.62	5.65	2.29	0.85	852.
1.000	-5.57	4.69	0.3521	1.55	3.00	7.39	3.12	0.96	845.
2.000	-4.74	4.67	0.3135	1.20	2.86	6.68	3.05	1.02	847.
3.000	-3.90	4.57	0.2995	0.80	3.16	6.11	2.96	0.95	848.
4.000	-2.79	4.56	0.3382	0.45	3.36	5.54	3.06	1.11	847.
5.000	-1.94	4.70	0.3091	0.15	3.65	5.43	3.12	1.09	846.
6.000	-1.10	4.81	0.3226	-0.18	4.02	5.46	3.16	1.01	842.
7.000	-0.38	4.77	0.3018	-0.72	4.39	5.74	3.12	0.84	839.
8.000	0.43	5.34	0.2830	-1.14	4.95	6.47	3.55	0.74	835.
9.000	1.43	6.49	0.2838	-1.63	5.97	7.93	4.42	0.76	832.
10.000	2.50	7.71	0.2923	-2.20	6.90	9.52	5.23	0.72	831.
11.000	3.60	9.17	0.2753	-2.81	8.19	11.46	6.36	0.73	830.
12.000	5.01	10.81	0.2734	-3.47	9.58	13.76	7.51	0.81	827.
13.000	6.04	11.96	0.2713	-4.01	10.02	15.11	8.22	0.81	826.
14.000	5.23	11.81	0.2379	-4.46	9.77	14.59	8.31	0.86	820.
15.000	1.08	9.08	0.2518	-3.69	7.65	10.60	6.58	1.24	814.
16.000	-3.85	5.93	0.2265	-2.26	4.59	7.34	4.71	1.23	798.
17.000	-7.63	4.01	0.2126	-1.47	2.63	8.34	3.72	0.49	754.
18.000	-11.72	3.09	0.0528	-0.90	1.81	11.91	3.01	-0.15	755.
19.000	-14.51	3.01	-0.0251	-0.49	1.71	14.64	2.89	-0.18	741.
20.000	-16.68	2.83	0.0166	-0.35	1.89	16.80	2.82	0.04	735.
21.000	-18.62	3.19	0.0154	0.03	2.26	18.76	3.19	-0.07	725.
22.000	-19.77	3.16	-0.0638	0.17	2.05	19.89	3.12	-0.05	716.
23.000	-20.95	3.33	-0.0059	0.26	2.29	21.09	3.29	0.02	705.
24.000	-22.01	3.74	0.0707	0.35	2.64	22.18	3.66	-0.08	695.
25.000	-23.20	3.63	-0.0426	0.31	2.36	23.32	3.60	-0.12	668.
26.000	-24.31	3.75	0.0234	0.24	2.59	24.45	3.73	-0.07	647.
27.000	-25.75	4.08	0.0992	0.26	2.78	25.91	4.04	-0.15	618.
28.000	-26.49	3.97	0.0066	0.26	2.49	26.61	3.96	-0.04	569.
29.000	-27.40	4.32	-0.0475	0.14	2.59	27.52	4.31	0.05	522.
30.000	-28.10	4.55	-0.0801	0.22	3.26	28.29	4.56	-0.11	469.

TABLE A-9. September Statistical Wind Data, Wake Island.

Z KM	MEAN U M/S	S.D. U M/S	R(U,V)	MEAN V M/S	S.D. V M/S	MEAN W M/S	S.D. W M/S	SKEW W	#OBS
0.000	0.00	0.00	0.0000	0.00	0.00	0.00	0.00	0.00	0.
0.005	-4.60	2.90	0.2287	-0.25	2.44	5.54	2.10	0.15	810.
1.000	-6.43	4.09	-0.0087	0.44	2.70	7.48	3.09	0.20	807.
2.000	-5.79	4.00	-0.0187	0.42	2.70	6.91	3.03	0.25	809.
3.000	-5.21	4.03	0.0373	0.28	2.90	6.50	3.11	0.37	809.
4.000	-4.79	4.00	0.1115	0.13	3.19	6.27	3.12	0.33	808.
5.000	-4.30	4.14	0.1584	-0.04	3.49	6.16	3.14	0.49	808.
6.000	-3.94	4.52	0.1722	-0.34	3.98	6.38	3.34	0.71	806.
7.000	-3.45	4.91	0.2013	-0.73	4.34	6.52	3.43	0.74	800.
8.000	-2.48	5.59	0.2350	-1.11	4.88	6.88	3.69	0.88	797.
9.000	-1.10	6.94	0.2808	-1.42	5.77	7.92	4.68	0.95	796.
10.000	0.42	8.10	0.3170	-1.69	6.73	9.21	5.38	0.71	787.
11.000	1.77	9.61	0.2863	-1.99	7.89	10.97	6.41	0.60	783.
12.000	3.15	10.75	0.2396	-2.39	8.97	12.64	7.19	0.62	780.
13.000	3.41	11.07	0.2009	-3.00	8.95	13.01	7.35	0.66	776.
14.000	2.03	9.95	0.1845	-3.22	8.29	11.69	6.72	0.84	772.
15.000	-1.59	7.30	0.2196	-2.83	6.35	8.81	5.16	1.34	766.
16.000	-5.02	5.22	0.1770	-2.48	4.42	7.54	4.43	1.06	755.
17.000	-7.45	3.80	0.0732	-1.78	2.90	8.23	3.51	0.77	715.
18.000	-10.03	3.11	-0.0855	-0.95	2.35	10.33	2.82	0.18	715.
19.000	-12.07	3.18	-0.1300	-0.46	1.93	12.18	2.90	-0.09	703.
20.000	-13.93	3.48	-0.1250	-0.08	2.04	14.02	3.15	-0.05	698.
21.000	-15.66	3.88	-0.1570	0.02	2.41	15.79	3.54	-0.08	686.
22.000	-16.70	3.33	-0.1865	0.20	2.29	16.80	3.52	-0.12	677.
23.000	-17.73	4.01	-0.1589	0.36	2.32	17.82	3.70	-0.24	667.
24.000	-18.79	4.21	-0.1296	0.28	2.67	18.92	3.94	-0.17	651.
25.000	-19.87	4.24	-0.1196	0.14	2.36	19.95	3.99	-0.17	630.
26.000	-21.01	4.42	-0.1024	0.27	2.62	21.12	4.17	-0.10	614.
27.000	-22.29	4.77	-0.0758	0.20	2.89	22.42	4.54	-0.29	580.
28.000	-22.84	4.83	-0.1111	0.22	2.74	22.94	4.59	-0.32	540.
29.000	-23.25	5.23	-0.0997	0.31	2.88	23.37	5.00	-0.26	497.
30.000	-23.67	5.63	-0.1032	0.43	3.43	23.92	5.63	0.07	445.

TABLE A-10. October Statistical Wind Data, Wake Island.

Z KM	MEAN U M/S	S.D. U M/S	R(U,V)	MEAN V M/S	S.D. V M/S	MEAN W M/S	S.D. W M/S	S'KEW W	#OBS
0.000	0.00	0.00	0.0000	0.00	0.00	0.00	0.00	0.00	0.
0.005	-6.01	3.05	0.3075	-0.83	2.19	6.69	2.48	0.19	839.
1.000	-7.84	4.25	0.0775	0.14	2.87	8.69	3.51	-0.08	834.
2.000	-6.89	4.50	0.0912	0.32	2.91	8.01	3.50	0.10	836.
3.000	-6.47	4.64	0.0927	-0.05	3.12	7.81	3.51	0.29	836.
4.000	-6.15	4.95	0.0963	-0.30	3.48	7.82	3.65	0.37	835.
5.000	-6.19	5.40	0.0500	-0.58	4.22	8.40	3.89	0.33	834.
6.000	-6.36	6.03	-0.0064	-0.85	4.98	9.13	4.35	0.47	829.
7.000	-6.10	6.67	0.0233	-1.30	5.61	9.53	4.89	0.73	827.
8.000	-5.31	7.51	0.0776	-1.77	6.29	9.85	5.51	0.78	823.
9.000	-4.05	8.52	0.1300	-2.27	7.11	10.49	5.88	0.86	821.
10.000	-2.78	9.58	0.2184	-2.61	7.88	11.34	6.29	0.88	817.
11.000	-1.54	10.80	0.2423	-3.13	8.91	12.63	6.96	0.74	817.
12.000	-0.31	11.54	0.2402	-3.59	9.66	13.50	7.56	0.68	814.
13.000	-0.32	11.79	0.2231	-4.30	9.43	13.59	7.85	0.93	812.
14.000	-1.42	11.09	0.1647	-4.67	8.47	12.80	7.38	1.01	808.
15.000	-3.69	9.11	0.0863	-4.44	6.86	10.99	6.51	1.00	805.
16.000	-5.76	7.37	-0.0037	-3.74	5.05	9.70	5.73	1.01	785.
17.000	-6.69	5.93	-0.0281	-2.90	3.87	8.84	5.00	1.07	719.
18.000	-7.73	4.22	0.0448	-1.51	2.88	8.55	3.86	0.81	718.
19.000	-8.54	3.51	0.0161	-0.76	2.37	8.95	3.36	0.47	702.
20.000	-9.62	3.36	-0.0033	-0.31	2.26	9.93	3.23	0.56	697.
21.000	-10.93	3.72	0.0020	-0.12	2.34	11.20	3.65	0.22	690.
22.000	-11.75	3.74	0.0240	0.05	2.10	11.96	3.68	0.30	679.
23.000	-12.67	4.07	-0.0187	0.23	2.41	12.93	3.97	0.12	671.
24.000	-13.54	4.44	-0.0443	0.20	2.43	13.80	4.31	0.04	661.
25.000	-14.40	4.48	-0.0408	0.30	2.56	14.66	4.37	0.07	644.
26.000	-14.96	4.94	0.0130	0.19	2.72	15.26	4.76	0.10	626.
27.000	-15.39	5.68	0.0144	0.17	2.82	15.72	5.47	-0.13	596.
28.000	-15.00	5.96	0.0229	0.31	2.63	15.38	5.58	-0.03	561.
29.000	-14.20	6.60	-0.0204	0.19	2.74	14.67	6.12	0.01	514.
30.000	-13.25	7.68	-0.1088	0.01	3.27	14.18	6.65	0.00	461.

TABLE A-11. November Statistical Wind Data, Wake Island.

Z KM	MEAN U M/S	S.D. U M/S	R(U,V)	MEAN V M/S	S.D. V M/S	MEAN W M/S	S.D. W M/S	SKREW W	#OBS
0.000	0.00	0.00	0.0000	0.00	0.00	0.00	0.00	0.00	0.
0.005	-6.91	2.69	0.1998	-1.74	2.68	7.64	2.60	0.12	833.
1.000	-8.87	3.74	0.0306	-0.96	3.27	9.63	3.39	0.25	830.
2.000	-7.69	4.09	-0.0274	-0.68	3.26	8.66	3.48	0.46	832.
3.000	-6.56	4.40	-0.0510	-1.05	3.50	7.97	3.49	0.42	831.
4.000	-6.00	4.83	-0.0148	-1.30	3.96	7.92	3.61	0.52	831.
5.000	-5.61	5.32	-0.0054	-1.74	4.66	8.30	3.95	0.67	831.
6.000	-5.00	6.11	-0.0071	-2.44	5.65	8.90	4.58	0.79	828.
7.000	-4.21	6.71	0.0680	-2.97	6.19	9.24	4.94	1.01	825.
8.000	-3.30	7.39	0.0827	-3.61	7.03	9.90	5.46	1.03	822.
9.000	-2.29	8.47	0.1200	-4.39	8.07	11.13	6.13	0.95	821.
10.000	-0.98	9.47	0.1622	-5.02	8.80	12.22	6.62	1.04	815.
11.000	0.17	10.48	0.2103	-5.24	9.29	13.16	7.10	0.94	814.
12.000	1.20	10.98	0.2363	-5.43	9.43	13.57	7.49	0.81	810.
13.000	1.57	11.09	0.2345	-5.72	9.09	13.50	7.63	0.93	807.
14.000	0.82	10.32	0.1730	-5.53	7.98	12.35	6.99	0.84	803.
15.000	-0.82	9.24	0.0782	-4.92	6.59	10.68	6.29	0.76	796.
16.000	-2.89	7.53	0.0095	-4.22	5.26	9.18	5.14	0.89	779.
17.000	-4.53	6.32	-0.0800	-3.43	4.36	8.52	4.31	0.81	733.
18.000	-6.51	5.06	-0.0887	-2.10	3.50	8.34	3.88	0.62	734.
19.000	-7.13	4.22	-0.0585	-1.09	2.64	7.99	3.60	0.47	719.
20.000	-6.66	3.56	0.0270	-0.52	2.25	7.27	3.09	0.44	716.
21.000	-6.48	4.06	0.0654	-0.28	2.51	7.26	3.48	0.54	709.
22.000	-6.84	3.71	0.0195	0.01	2.30	7.41	3.29	0.48	693.
23.000	-7.11	4.04	0.1057	0.31	2.59	7.83	3.51	0.52	682.
24.000	-7.29	4.82	0.1187	0.38	2.84	8.28	3.98	0.56	670.
25.000	-7.04	5.54	0.1077	0.34	2.77	8.40	4.18	0.66	656.
26.000	-6.56	6.44	0.0822	0.09	3.01	8.57	4.47	0.74	639.
27.000	-5.27	7.45	0.0932	0.13	3.37	8.51	4.70	0.75	609.
28.000	-3.52	8.20	0.2286	0.34	3.41	8.18	4.93	1.37	576.
29.000	-1.87	9.30	0.2864	0.21	3.61	8.57	5.44	1.57	542.
30.000	-0.29	10.39	0.2701	0.05	3.98	9.14	6.35	1.54	498.

TABLE A-12. December Statistical Wind Data, Wake Island.

Z KM	MEAN U M/S	S.D. U M/S	R(U,V)	MEAN V M/S	S.D. V M/S	MEAN W M/S	S.D. W M/S	SKEW W	#OBS
0.000	0.00	0.00	0.0000	0.00	0.00	0.00	0.00	0.00	0.
0.005	-5.74	3.56	0.3485	-1.41	2.99	6.88	3.02	0.36	859.
1.000	-7.02	4.88	0.1865	-0.49	3.42	8.31	4.00	0.37	853.
2.000	-5.31	5.38	0.0108	-0.08	3.39	7.28	3.97	0.52	856.
3.000	-3.38	5.65	-0.0179	-0.48	3.67	6.63	3.61	0.87	856.
4.000	-1.88	6.12	0.0580	-0.84	4.12	6.66	3.78	0.98	856.
5.000	-0.46	6.89	0.0819	-1.45	4.77	7.38	4.24	1.10	854.
6.000	0.91	7.79	0.0548	-1.95	5.94	8.45	5.39	1.52	852.
7.000	2.13	8.07	0.0431	-2.49	6.74	9.30	5.90	1.50	851.
8.000	3.53	8.46	0.0543	-3.25	7.44	10.24	6.70	1.57	847.
9.000	4.91	8.82	0.0363	-3.77	7.85	11.17	7.26	1.33	844.
10.000	5.99	9.33	0.0405	-4.25	8.19	12.02	7.97	1.72	839.
11.000	7.16	9.75	0.0486	-4.52	8.61	13.03	8.44	1.55	839.
12.000	8.07	10.24	0.0557	-4.57	8.62	13.74	8.74	1.41	838.
13.000	8.28	10.14	0.0686	-4.16	7.72	13.41	8.26	1.24	833.
14.000	8.09	9.83	0.0679	-3.42	7.02	12.71	7.83	1.23	828.
15.000	6.52	8.83	0.0136	-2.77	6.24	11.04	6.71	1.01	821.
16.000	3.71	7.82	-0.0285	-1.81	5.26	8.70	5.48	1.19	809.
17.000	0.73	7.04	-0.0506	-1.02	4.74	7.41	4.32	1.35	770.
18.000	-2.93	5.93	-0.0935	-0.14	3.89	6.69	3.77	0.92	771.
19.000	-4.41	4.74	-0.0384	0.11	2.97	6.25	3.42	0.68	758.
20.000	-4.33	3.96	0.1064	0.17	2.49	5.60	3.04	0.63	753.
21.000	-3.92	3.98	0.0386	0.01	2.55	5.25	3.07	0.83	740.
22.000	-4.19	3.81	0.0277	0.10	2.54	5.41	3.05	1.07	726.
23.000	-4.26	4.36	0.0537	0.22	2.86	5.78	3.47	1.47	705.
24.000	-4.15	4.86	0.0151	0.12	3.24	6.09	3.77	1.44	684.
25.000	-3.91	5.61	0.1157	0.29	3.36	6.28	4.32	1.80	668.
26.000	-3.54	6.63	0.1609	0.42	3.60	6.74	4.92	1.93	653.
27.000	-2.71	8.05	0.1593	0.36	3.89	7.40	5.71	2.06	616.
28.000	-1.89	9.37	0.1419	0.46	3.39	7.90	6.37	2.14	591.
29.000	-1.14	10.81	0.1334	0.33	3.66	9.01	7.10	1.86	552.
30.000	-0.25	12.15	0.1427	0.14	4.29	10.22	7.84	1.52	506.

TABLE A-13. Annual Statistical Wind Data, Wake Island.

Z KM	MEAN U M/S	S.D. U M/S	R(U,V)	MEAN V M/S	S.D. V M/S	MEAN W M/S	S.D. W M/S	SKEW W	#OBS
0.000	0.00	0.00	0.0000	0.00	0.00	0.00	0.00	0.00	0.
0.005	-5.23	3.38	-0.4145	-0.78	2.93	6.42	2.59	0.42	10244.
1.000	-6.43	4.68	0.0669	0.16	3.23	7.88	3.42	0.35	10093.
2.000	-4.94	5.15	0.0877	0.28	3.09	7.03	3.34	0.55	10054.
3.000	-3.46	5.80	-0.0250	-0.14	3.30	6.73	3.36	0.67	10027.
4.000	-2.11	6.44	-0.0430	-0.47	3.59	6.73	3.69	0.90	10011.
5.000	-0.93	7.19	-0.0255	-0.81	4.14	7.27	4.17	1.00	9994.
6.000	0.23	8.01	0.0074	-1.30	4.96	8.16	4.87	1.07	9966.
7.000	1.41	8.79	0.0540	-1.88	5.60	9.12	5.54	1.11	9924.
8.000	2.77	9.64	0.1107	-2.44	6.33	10.30	6.33	1.08	9886.
9.000	4.35	10.76	0.1696	-3.02	7.21	11.92	7.25	0.98	9862.
10.000	5.97	11.67	0.2206	-3.42	7.93	13.48	8.01	0.96	9814.
11.000	7.52	12.75	0.2465	-3.65	8.74	15.19	8.77	0.88	9 93.
12.000	8.93	13.59	0.2611	-3.73	9.40	16.66	9.36	0.80	9770.
13.000	9.44	13.91	0.2738	-3.72	9.24	17.04	9.50	0.76	9730.
14.000	8.75	13.37	0.2733	-3.56	8.52	16.09	9.00	0.75	9684.
15.000	6.11	11.80	0.2290	-3.09	6.98	13.26	7.62	0.80	9609.
16.000	2.52	10.08	0.1098	-2.40	5.46	10.30	6.06	0.83	9445.
17.000	-0.45	8.81	-0.0207	-1.76	4.37	8.90	4.55	0.92	8947.
18.000	-4.04	7.47	-0.1573	-0.95	3.27	8.24	3.94	0.47	8959.
19.000	-6.27	6.86	-0.1805	-0.50	2.54	8.44	4.61	0.42	8809.
20.000	-7.78	6.84	-0.1040	-0.21	2.29	9.12	5.40	0.46	8738.
21.000	-9.08	7.27	-0.0425	-0.08	2.45	10.10	6.22	0.43	8617.
22.000	-10.04	7.36	0.0315	0.05	2.24	10.82	6.53	0.39	8495.
23.000	-10.85	7.80	0.0990	0.17	2.43	11.67	6.92	0.33	8351.
24.000	-11.48	8.40	0.0928	0.18	2.71	12.46	7.35	0.30	8188.
25.000	-11.88	9.09	0.1215	0.25	2.74	13.09	7.72	0.29	7966.
26.000	-12.11	9.92	0.1035	0.26	3.08	13.72	8.12	0.27	7773.
27.000	-12.13	11.18	0.0807	0.25	3.30	14.41	8.66	0.29	7366.
28.000	-11.79	11.96	0.0855	0.27	3.09	14.61	8.82	0.34	6931.
29.000	-11.7	12.86	0.0682	0.25	3.22	14.99	9.03	0.38	6454.
30.000	-11.17	13.77	0.0442	0.20	3.62	15.52	9.32	0.35	5851.

APPENDIX B

Wake Island Thermodynamics Statistics Tables

Tables B-1 through B-13 provide thermodynamics statistics (monthly and annual) for Wake Island. They were prepared as described in Chapter 3.

TABLE B-1. January Thermodynamic Data, Wake Island.

Z KM	MEAN P MB	S.D. P MB	SKEWP	MEAN T DEG K	S.D. T DEG K	SKEWT	MEAN D G/M3	S.D. D G/M3	SKEWD	NOBS P	NOBS T	NOBS D
0.000	1015.400	2.910	-0.8052	298.51	1.44	-0.20	1174.47	7.73	0.22	846.	845.	845.
0.005	1014.836	2.908	-0.8039	298.51	1.43	-0.15	1173.95	7.69	0.21	846.	845.	845.
1.000	904.593	2.386	-0.5523	290.25	1.57	-0.30	1078.72	7.34	0.06	846.	846.	846.
2.000	804.057	2.112	-0.6036	286.68	2.55	-0.41	973.90	8.18	0.48	845.	845.	845.
3.000	713.597	2.014	-0.6032	283.75	1.99	-0.49	874.83	5.52	0.36	845.	845.	845.
4.000	631.795	1.997	-0.5603	278.92	1.76	-0.37	788.40	4.40	0.13	843.	843.	843.
5.000	558.232	1.953	-0.5210	273.20	1.73	-0.30	711.44	3.95	0.01	843.	843.	843.
6.000	492.477	1.938	-0.5844	267.09	1.85	-0.37	642.12	4.04	0.02	843.	843.	843.
7.000	432.436	1.852	-0.5471	260.78	2.00	-0.45	577.62	3.88	-0.09	841.	841.	841.
8.000	378.730	1.839	-0.5773	254.25	1.99	-0.82	518.95	3.48	0.28	839.	839.	839.
9.000	330.377	1.762	-0.6468	247.14	1.85	-0.83	465.67	2.90	0.43	839.	839.	839.
10.000	287.435	1.736	-0.6505	239.76	1.63	-0.47	417.63	2.57	-0.16	838.	838.	838.
11.000	248.814	1.654	-0.6025	232.18	1.54	-0.14	373.34	2.25	-0.59	837.	837.	837.
12.000	213.996	1.507	-0.4385	224.36	1.47	-0.31	332.28	1.94	-0.92	836.	836.	836.
13.000	183.204	1.439	-0.3448	216.57	1.50	-0.26	294.70	1.88	-1.00	834.	834.	834.
14.000	156.149	1.300	-0.2702	208.89	1.64	-0.08	260.41	1.88	-1.20	831.	831.	831.
15.000	132.054	1.216	-0.1774	201.77	1.65	-0.06	228.01	1.99	-0.95	825.	825.	825.
16.000	111.233	1.083	-0.1191	195.49	1.85	0.02	198.23	2.08	-0.74	821.	821.	821.
17.000	93.374	0.986	-0.0791	191.45	2.35	0.16	169.93	2.49	-0.35	782.	782.	782.
18.000	78.142	0.843	0.1148	192.02	2.80	0.18	141.79	2.42	-0.34	771.	771.	771.
19.000	65.627	0.708	0.3062	197.93	2.83	0.09	115.53	1.99	-0.32	746.	746.	746.
20.000	55.393	0.618	0.4050	204.51	2.65	-0.17	94.38	1.53	-0.10	738.	738.	738.
21.000	46.950	0.528	0.3926	209.04	2.35	0.20	78.25	1.10	-0.16	713.	713.	713.
22.000	39.949	0.474	0.4107	212.22	2.43	0.21	65.57	0.91	-0.23	701.	700.	701.
23.000	34.030	0.433	0.4199	214.79	2.46	-0.05	55.19	0.69	0.09	695.	695.	695.
24.000	29.028	0.388	0.3896	217.01	2.46	-0.07	46.60	0.58	0.31	672.	672.	672.
25.000	24.832	0.357	0.3819	218.97	2.40	-0.15	39.50	0.51	0.25	661.	661.	661.
26.000	21.252	0.325	0.3182	220.93	2.39	-0.02	33.51	0.44	0.02	657.	657.	657.
27.000	18.230	0.292	0.2106	222.66	2.35	0.14	28.52	0.38	-0.06	619.	619.	619.
28.000	15.651	0.266	0.1692	224.29	2.44	0.32	24.31	0.35	-0.09	592.	592.	592.
29.000	13.450	0.240	0.1894	225.86	2.60	0.03	20.74	0.32	0.00	561.	561.	561.
30.000	11.560	0.215	0.1178	227.48	2.79	0.04	17.70	0.29	0.18	537.	537.	537.

TABLE B-2. February Thermodynamic Data, Wake Island.

Z KM	MEAN P MB	S.D. P MB	SKEW P	MEAN T DEG K	S.D. T DEG K	SKEW T	MEAN D G/M3	S.D. D G/M3	SKEW D	NOBS P	NOBS T	NOBS D
0.000	1016.054	2.658	-0.5521	298.32	1.47	-0.05	1175.99	7.60	-0.51	767.	768.	768.
0.005	1015.484	2.663	-0.5556	298.32	1.46	-0.05	1175.50	7.57	-0.54	768.	769.	769.
1.000	905.090	2.173	-0.1231	290.08	1.39	-0.34	1080.12	6.40	0.40	769.	769.	769.
2.000	804.359	1.959	-0.2353	285.81	2.19	0.08	977.11	6.93	0.45	769.	769.	769.
3.000	713.611	1.872	-0.2223	282.91	2.06	-0.03	877.47	5.70	0.04	769.	769.	769.
4.000	631.629	1.896	-0.2287	278.22	2.14	-0.28	790.30	5.40	0.13	768.	768.	768.
5.000	557.954	1.929	-0.3044	272.56	2.31	-0.33	712.81	5.07	0.04	768.	768.	768.
6.000	492.007	2.066	-0.3962	266.51	2.41	-0.59	642.94	4.61	0.25	766.	766.	766.
7.000	431.951	2.105	-0.5462	260.19	2.42	-0.87	578.24	4.07	0.39	765.	765.	765.
8.000	378.195	2.193	-0.6180	253.58	2.50	-1.38	519.53	4.00	0.33	764.	764.	764.
9.000	329.779	2.156	-0.7662	246.59	2.38	-1.71	465.89	3.42	0.29	762.	762.	762.
10.000	286.813	2.149	-0.9316	239.34	2.02	-1.83	417.46	2.92	-0.41	760.	760.	760.
11.000	248.401	2.068	-1.0116	231.92	1.75	-1.22	372.83	2.76	-1.20	759.	759.	759.
12.000	213.448	1.843	-0.9764	224.16	1.44	-0.24	331.72	2.55	-1.51	759.	759.	759.
13.000	182.703	1.709	-0.8704	216.37	1.37	0.25	294.17	2.56	-1.38	757.	757.	757.
14.000	155.710	1.485	-0.7810	208.70	1.43	0.55	259.92	2.42	-1.61	756.	756.	756.
15.000	131.668	1.310	-0.6007	201.65	1.53	0.51	227.46	2.49	-1.64	754.	753.	754.
16.000	110.924	1.112	-0.3910	195.59	1.79	0.63	197.57	2.59	-1.23	753.	752.	753.
17.000	93.135	0.961	-0.1473	192.26	2.44	0.47	168.79	2.82	-0.46	717.	717.	717.
18.000	78.014	0.796	0.0982	193.20	2.56	-0.06	140.70	2.41	-0.10	714.	714.	714.
19.000	65.550	0.652	0.3485	198.26	2.62	0.02	115.20	1.96	-0.06	692.	692.	692.
20.000	55.324	0.556	0.4114	204.15	2.59	0.06	94.42	1.51	0.01	690.	690.	690.
21.000	46.883	0.475	0.3926	208.34	2.53	0.10	78.40	1.15	0.05	677.	677.	677.
22.000	39.870	0.422	0.3422	211.44	2.57	0.00	65.70	0.90	0.22	669.	669.	669.
23.000	33.944	0.383	0.2651	214.16	2.50	-0.19	55.22	0.69	0.36	663.	663.	663.
24.000	28.950	0.347	0.2091	216.77	2.29	-0.20	46.53	0.55	0.52	650.	650.	650.
25.000	24.760	0.315	0.1591	218.95	2.25	-0.14	39.40	0.48	0.26	641.	641.	641.
26.000	21.192	0.288	0.1199	221.15	2.30	-0.36	33.38	0.43	-0.12	638.	638.	638.
27.000	18.177	0.261	0.1043	223.24	2.45	-0.33	28.37	0.39	-0.16	600.	600.	600.
28.000	15.616	0.238	0.0868	225.05	2.67	-0.08	24.17	0.35	0.02	593.	593.	593.
29.000	13.424	0.218	0.0448	226.90	3.00	0.14	20.61	0.31	0.08	568.	568.	568.
30.000	11.550	0.198	0.0537	228.59	3.12	0.17	17.60	0.27	0.14	551.	551.	551.

TABLE B-3. March Thermodynamic Data, Wake Island.

Z KM	MEAN P MB	S.D. P MB	SKEWP P	MEAN T DEG K	S.D. T DEG K	SKEWT T	MEAN D G/M3	S.D. D G/M3	SKEWD D	NOBS P	NOBS T	NOBS D
0.000	1016.731	2.455	-0.1670	298.74	1.41	-0.22	1174.72	6.88	0.48	855.	854.	854.
0.005	1016.165	2.443	-0.1799	298.74	1.40	-0.21	1174.16	6.82	0.48	855.	854.	854.
1.000	905.791	2.181	-0.3568	290.56	1.23	-0.72	1078.96	5.81	0.69	854.	854.	854.
2.000	805.116	1.972	-0.4241	285.94	1.69	-0.01	977.39	5.45	0.21	854.	854.	854.
3.000	714.245	1.863	-0.4340	282.39	1.88	-0.35	879.71	5.05	0.24	854.	854.	854.
4.000	631.991	1.969	-0.6009	277.61	2.09	-0.28	792.39	4.98	0.06	854.	854.	854.
5.000	558.157	2.016	-0.6572	272.21	2.22	-0.31	713.99	4.68	0.01	854.	854.	854.
6.000	492.135	2.126	-0.6460	266.19	2.38	-0.36	643.87	4.62	-0.06	854.	854.	854.
7.000	431.971	2.111	-0.6827	259.80	2.35	-0.54	579.14	4.18	-0.02	847.	847.	847.
8.000	378.125	2.147	-0.6689	253.17	2.38	-0.69	520.26	4.04	-0.07	845.	845.	845.
9.000	329.655	2.082	-0.7377	246.25	2.37	-0.99	466.35	3.75	0.03	843.	843.	843.
10.000	286.653	2.073	-0.7548	239.00	2.11	-0.94	417.83	3.28	-0.11	840.	840.	840.
11.000	248.037	1.961	-0.7420	231.69	1.72	-0.65	372.96	2.89	-0.51	836.	836.	836.
12.000	213.284	1.725	-0.6280	224.04	1.49	-0.17	331.66	2.60	-0.95	833.	833.	833.
13.000	182.550	1.593	-0.5440	216.38	1.45	0.04	293.90	2.60	-1.00	830.	830.	830.
14.000	155.593	1.378	-0.4252	208.86	1.57	0.20	259.53	2.54	-1.07	830.	830.	830.
15.000	131.603	1.224	-0.2776	202.15	1.68	0.41	226.81	2.62	-0.97	823.	823.	823.
16.000	110.922	1.034	-0.1445	196.32	2.04	0.41	196.86	2.68	-0.64	821.	821.	821.
17.000	93.204	0.872	-0.0490	192.91	2.53	0.34	168.34	2.74	-0.34	777.	777.	777.
18.000	78.107	0.721	0.0702	193.67	2.70	0.13	140.53	2.43	-0.04	766.	766.	766.
19.000	65.648	0.600	0.1968	198.54	2.69	0.12	115.21	1.89	-0.08	741.	741.	741.
20.000	55.415	0.520	0.2657	204.26	2.46	-0.07	94.53	1.38	0.19	738.	738.	738.
21.000	46.964	0.450	0.3705	208.82	2.24	0.13	78.37	1.01	0.38	721.	721.	721.
22.000	39.950	0.412	0.4398	211.98	2.34	0.06	65.67	0.84	0.45	710.	710.	710.
23.000	34.036	0.375	0.4540	214.82	2.49	0.06	55.19	0.71	0.44	704.	704.	704.
24.000	29.037	0.342	0.4591	217.52	2.49	0.16	46.51	0.55	0.06	680.	680.	680.
25.000	24.851	0.314	0.3920	219.85	2.37	0.22	39.38	0.47	0.02	666.	666.	666.
26.000	21.285	0.288	0.3865	222.11	2.32	0.03	33.38	0.41	0.34	663.	663.	663.
27.000	18.272	0.260	0.3736	224.42	2.45	-0.06	28.36	0.35	0.21	623.	623.	623.
28.000	15.709	0.239	0.2650	226.58	2.74	0.03	24.16	0.31	0.29	599.	599.	599.
29.000	13.522	0.220	0.1631	228.63	3.01	0.10	20.61	0.29	0.20	568.	568.	568.
30.000	11.642	0.202	0.0994	230.48	3.23	-0.08	17.60	0.27	0.19	551.	551.	551.

TABLE B-4. April Thermodynamic Data, Wake Island.

Z KM	MEAN P MB	S.D. P MB	SKWEP	MEAN T DEG K	S.D. T DEG K	SKWET	MEAN D G/M3	S.D. D G/M3	SKWED	NOBS P	NOBS T	NOBS D
0.000	1016.762	2.040	-1.5509	299.09	1.48	-0.07	1172.98	6.74	-0.13	822.	823.	823.
0.005	1016.155	2.143	-2.0834	299.10	1.48	-0.06	1172.46	6.77	-0.14	825.	826.	826.
1.000	906.000	1.755	-0.8986	290.88	1.17	-0.55	1077.76	5.03	0.35	826.	826.	826.
2.000	805.416	1.663	-0.9683	286.07	1.57	-0.34	977.04	5.12	0.23	826.	826.	826.
3.000	714.528	1.576	-0.9065	282.25	1.60	-0.25	880.38	4.42	0.05	826.	826.	826.
4.000	632.245	1.633	-0.8474	277.41	1.71	-0.25	793.23	4.30	0.12	826.	826.	826.
5.000	558.289	1.638	-0.7297	271.73	1.80	-0.21	715.33	3.87	0.15	826.	826.	826.
6.000	492.085	1.696	-0.6210	265.46	1.83	-0.38	645.55	3.50	0.18	826.	826.	826.
7.000	431.711	1.717	-0.5340	258.63	1.96	-0.34	581.40	3.29	0.06	822.	822.	822.
8.000	377.611	1.797	-0.4465	251.45	2.04	-0.24	523.11	3.01	-0.06	820.	820.	820.
9.000	328.844	1.807	-0.3459	244.05	2.09	-0.01	469.39	2.78	-0.41	819.	819.	819.
10.000	285.635	1.842	-0.3335	236.68	2.25	-0.04	420.42	3.04	-0.77	812.	812.	812.
11.000	246.750	1.858	-0.2543	229.47	2.37	-0.14	374.62	2.98	-0.64	810.	810.	810.
12.000	211.955	1.738	-0.2358	222.33	2.16	-0.41	332.13	2.71	-0.56	807.	807.	807.
13.000	181.251	1.637	-0.1615	215.48	1.92	-0.29	293.05	2.80	-0.76	805.	805.	805.
14.000	154.454	1.435	-0.1180	208.94	1.99	-0.09	257.52	3.12	-0.73	801.	800.	801.
15.000	130.712	1.255	-0.0652	203.21	2.29	0.14	224.09	3.31	-0.32	792.	791.	792.
16.000	110.315	1.054	-0.0781	198.39	2.69	0.43	193.74	3.19	-0.06	787.	787.	787.
17.000	92.869	0.875	-0.1157	195.68	2.75	0.00	165.35	2.90	0.01	742.	741.	742.
18.000	78.013	0.730	0.1131	196.03	2.92	0.32	138.67	2.41	-0.26	737.	737.	737.
19.000	65.695	0.611	0.3937	200.58	2.72	0.15	114.12	1.84	-0.13	713.	713.	713.
20.000	55.551	0.531	0.4145	206.32	2.59	0.09	93.81	1.42	0.12	710.	710.	710.
21.000	47.158	0.463	0.3942	210.61	2.09	-0.01	78.01	0.94	0.24	700.	700.	700.
22.000	40.175	0.422	0.3767	213.78	2.11	-0.05	65.47	0.79	0.13	691.	691.	691.
23.000	34.268	0.380	0.3975	216.66	2.21	-0.18	55.10	0.65	0.24	685.	685.	685.
24.000	29.283	0.337	0.3869	219.39	2.20	-0.11	46.50	0.52	0.28	658.	658.	658.
25.000	25.102	0.312	0.3062	221.83	2.21	0.15	39.42	0.43	0.16	648.	648.	648.
26.000	21.529	0.287	0.2173	224.31	2.12	0.59	33.43	0.38	0.10	642.	641.	642.
27.000	18.506	0.258	0.2242	226.64	2.33	0.54	28.44	0.35	0.28	593.	593.	593.
28.000	15.937	0.235	0.1422	228.71	2.43	0.20	24.28	0.31	0.25	576.	576.	576.
29.000	13.735	0.215	0.0825	230.73	2.38	-0.01	20.74	0.28	0.09	542.	542.	542.
30.000	11.839	0.192	0.0679	232.57	2.30	-0.23	17.74	0.24	0.07	505.	505.	505.

TABLE B-5. May Thermodynamic Data, Wake Island.

Z KM	MEAN P MB	S.D. P MB	SKEWP	MEAN T DEG K	S.D. T DEG K	SKEWT	MEAN D G/M3	S.D. D G/M3	SKEWD	NOBS P	NOBS T	NOBS D
0.000	1016.158	1.981	-1.3754	300.07	1.50	0.18	1167.90	6.79	-0.47	852.	853.	853.
0.005	1015.572	1.985	-1.4319	300.07	1.50	0.18	1167.33	6.72	-0.51	854.	855.	855.
1.000	905.838	1.690	-0.5588	291.87	1.05	-0.35	1073.50	4.51	0.13	855.	855.	855.
2.000	805.612	1.602	-0.7055	286.90	1.28	-0.45	973.90	4.33	0.29	855.	855.	855.
3.000	714.966	1.510	-0.6644	282.80	1.45	0.03	878.83	4.21	-0.31	855.	855.	855.
4.000	632.830	1.483	-0.4068	277.96	1.54	-0.04	792.24	3.99	-0.19	855.	855.	855.
5.000	558.944	1.446	-0.2236	272.24	1.62	-0.03	714.76	3.73	-0.12	855.	855.	855.
6.000	492.781	1.491	-0.0825	266.12	1.70	-0.07	644.83	3.41	-0.12	855.	855.	855.
7.000	432.488	1.515	-0.0330	259.41	1.78	-0.13	580.65	3.02	0.14	854.	854.	854.
8.000	378.458	1.616	-0.0416	252.34	1.86	-0.15	522.41	2.77	0.30	852.	852.	852.
9.000	329.720	1.637	-0.0283	244.82	1.87	-0.11	469.15	2.37	0.36	850.	850.	850.
10.000	286.494	1.653	-0.0243	237.06	1.82	-0.08	421.00	2.06	0.00	846.	846.	846.
11.000	247.502	1.676	-0.0150	229.29	1.79	-0.04	376.05	1.97	-0.41	844.	844.	844.
12.000	212.512	1.566	-0.0248	221.62	1.77	-0.02	334.06	2.08	-0.78	842.	842.	842.
13.000	181.630	1.488	0.0333	214.34	1.89	0.27	295.21	2.58	-0.87	840.	840.	840.
14.000	154.613	1.347	0.0472	207.74	2.19	0.35	259.30	3.05	-0.58	839.	839.	839.
15.000	130.801	1.196	0.1122	202.60	2.42	0.19	224.94	3.22	-0.13	831.	831.	831.
16.000	110.381	1.016	0.1380	198.95	2.45	0.02	193.31	2.95	0.07	828.	828.	828.
17.000	92.990	0.860	0.2113	197.51	2.66	-0.10	164.05	2.76	0.26	783.	783.	783.
18.000	78.290	0.717	0.2876	199.15	2.85	-0.16	136.98	2.36	0.27	776.	776.	776.
19.000	66.094	0.604	0.2903	203.90	2.69	-0.38	112.94	1.72	0.29	760.	760.	760.
20.000	56.023	0.535	0.3037	208.66	2.02	-0.20	93.54	1.19	-0.05	757.	757.	757.
21.000	47.615	0.454	0.3661	212.08	1.75	-0.03	78.22	0.86	0.10	738.	738.	738.
22.000	40.611	0.406	0.3930	214.98	1.87	0.01	65.81	0.71	0.28	726.	726.	726.
23.000	34.674	0.367	0.3840	217.80	1.82	0.01	55.47	0.61	0.29	721.	721.	721.
24.000	29.638	0.328	0.3826	220.42	1.82	-0.11	46.84	0.52	0.10	707.	707.	707.
25.000	25.425	0.293	0.3098	222.76	1.83	0.06	39.76	0.43	0.18	693.	693.	693.
26.000	21.817	0.264	0.3188	225.04	1.78	0.05	33.78	0.37	0.36	691.	691.	691.
27.000	18.756	0.234	0.258.	227.13	1.82	0.12	28.77	0.32	0.30	635.	635.	635.
28.000	16.155	0.212	0.1892	229.07	1.98	0.09	24.57	0.28	0.12	602.	602.	602.
29.000	13.929	0.191	0.1698	230.80	2.12	-0.31	21.02	0.26	0.20	575.	575.	575.
30.000	12.014	0.170	0.1608	232.40	2.15	-0.20	18.01	0.22	0.18	554.	554.	554.

TABLE B-6. June Thermodynamic Data, Wake Island.

Z KM	MEAN P MB	S.D. P MB	SKEWP	MEAN T DEG K	S.D. T DEG K	SKEWT	MEAN D G/M3	S.D. D G/M3	SKEWD	NOBS P	NOBS T	NOBS D
0.000	1015.456	1.722	-2.7860	300.91	1.36	0.23	1163.25	5.88	-0.01	804.	804.	804.
0.005	1014.861	1.716	-2.7498	300.91	1.36	0.22	1162.73	5.77	-0.10	811.	811.	811.
1.000	905.590	1.346	-0.6833	292.83	0.78	-0.35	1069.39	3.45	0.37	811.	811.	811.
2.000	805.702	1.252	-0.6792	287.66	1.05	0.27	971.11	3.37	0.07	811.	811.	811.
3.000	715.280	1.200	-0.5948	283.37	1.31	0.14	877.25	3.32	-0.06	811.	811.	811.
4.000	633.232	1.243	-0.4361	278.09	1.53	0.00	792.16	3.66	0.05	810.	810.	810.
5.000	559.396	1.296	-0.3473	272.52	1.66	-0.08	714.49	3.64	0.15	810.	810.	810.
6.000	493.214	1.374	-0.2998	266.55	1.70	-0.29	644.21	3.31	0.26	809.	809.	809.
7.000	433.029	1.404	-0.2542	260.12	1.74	-0.57	579.75	3.03	0.55	807.	807.	807.
8.000	379.045	1.509	-0.2315	253.10	1.82	-0.66	521.63	2.69	0.59	799.	799.	799.
9.000	330.351	1.540	-0.2865	245.55	1.86	-0.76	468.64	2.28	0.68	796.	796.	796.
10.000	287.172	1.608	-0.4305	237.70	1.84	-0.58	420.86	1.86	0.06	792.	792.	792.
11.000	248.186	1.657	-0.4283	229.64	1.76	-0.40	376.50	1.62	-0.29	791.	791.	791.
12.000	213.111	1.557	-0.3257	221.72	1.62	-0.13	334.84	1.86	-1.32	789.	789.	789.
13.000	182.128	1.467	-0.1437	214.16	1.79	0.08	296.28	2.56	-1.78	786.	786.	786.
14.000	154.998	1.302	0.0069	207.22	2.21	0.55	260.60	3.15	-1.48	786.	786.	786.
15.000	131.110	1.151	0.1695	201.93	2.72	0.61	226.23	3.54	-0.82	778.	778.	778.
16.000	110.627	0.975	0.1965	199.10	2.92	0.61	193.61	3.40	-0.33	778.	778.	778.
17.000	93.272	0.818	0.1582	199.75	2.64	-0.02	162.67	2.70	-0.02	750.	749.	750.
18.000	78.720	0.694	0.1693	202.62	2.18	0.09	135.36	1.79	0.12	743.	743.	743.
19.000	66.608	0.593	0.2564	206.19	1.95	0.00	112.55	1.39	0.10	725.	725.	725.
20.000	56.534	0.524	0.3292	209.60	1.71	-0.13	93.97	1.04	0.01	721.	721.	721.
21.000	48.080	0.453	0.4313	212.77	1.70	0.14	78.73	0.84	-0.13	710.	710.	710.
22.000	41.031	0.404	0.5353	215.41	1.83	0.24	66.36	0.72	-0.19	705.	705.	705.
23.000	35.040	0.367	0.5990	217.91	1.83	0.11	56.02	0.57	0.10	701.	701.	701.
24.000	29.955	0.332	0.6287	220.41	1.88	-0.05	47.34	0.50	-0.06	680.	680.	680.
25.000	25.693	0.300	0.6353	222.66	1.87	0.21	40.19	0.43	-0.05	662.	662.	662.
26.000	22.046	0.268	0.5902	224.79	1.85	0.26	34.16	0.36	0.21	656.	656.	656.
27.000	18.945	0.240	0.6062	226.66	1.90	0.31	29.12	0.33	0.54	615.	615.	615.
28.000	16.315	0.217	0.5676	228.30	1.95	0.00	24.89	0.30	0.61	590.	590.	590.
29.000	14.059	0.197	0.5625	229.92	2.06	0.02	21.30	0.28	0.72	556.	556.	556.
30.000	12.111	0.173	0.4581	231.34	2.14	0.03	18.24	0.22	0.46	510.	510.	510.

TABLE B-7. July Thermodynamic Data, Wake Island.

Z KM	MEAN F MB	S.D. P MB	SKEWP P	MEAN T DEG K	S.D. T DEG K	SKEW T	MEAN D G/M3	S.D. D G/M3	SKEW D	NOBS P	NOBS T	NOBS D
0.000	1014.452	1.791	-1.4033	301.49	1.48	0.04	1159.20	6.24	0.09	849.	849.	849.
0.005	1013.867	1.784	-1.3892	301.49	1.48	0.04	1158.68	6.17	0.06	851.	851.	851.
1.000	904.905	1.549	-0.9474	293.45	0.74	-0.12	1065.66	3.68	-0.44	851.	851.	851.
2.000	805.266	1.386	-0.7720	287.95	1.01	0.32	968.88	3.70	-0.40	851.	851.	851.
3.000	715.014	1.285	-0.5173	283.20	1.21	-0.16	876.62	3.47	0.28	851.	851.	851.
4.000	633.025	1.332	-0.2414	277.74	1.29	0.23	792.42	3.18	-0.12	851.	851.	851.
5.000	559.146	1.318	-0.0536	271.95	1.35	0.13	715.29	3.10	-0.06	851.	851.	851.
6.000	492.862	1.304	0.0039	266.10	1.51	0.06	644.67	3.13	-0.03	850.	850.	850.
7.000	432.687	1.334	0.0821	259.85	1.65	-0.04	579.76	2.92	0.11	850.	850.	850.
8.000	378.724	1.407	0.0791	253.06	1.76	-0.08	521.21	2.64	0.01	849.	849.	849.
9.000	330.119	1.460	0.0307	245.72	1.84	-0.21	467.96	2.23	0.08	847.	847.	847.
10.000	286.937	1.525	-0.0276	237.94	1.87	-0.26	420.09	1.86	-0.07	845.	845.	845.
11.000	248.022	1.614	-0.0895	229.83	1.88	-0.17	375.94	1.56	-0.39	844.	844.	844.
12.000	212.972	1.549	-0.0664	221.64	1.81	-0.14	334.75	1.51	-1.18	840.	840.	840.
13.000	181.995	1.505	0.0164	213.77	1.83	0.19	296.60	1.97	-1.49	838.	838.	838.
14.000	154.835	1.388	0.0869	206.67	2.09	0.50	261.01	2.85	-1.19	836.	836.	836.
15.000	130.973	1.197	0.2412	201.92	2.77	0.43	226.00	3.86	-0.57	824.	824.	824.
16.000	110.551	0.973	0.3746	200.31	3.38	-0.15	192.32	4.03	0.17	822.	822.	822.
17.000	93.340	0.781	0.3547	201.96	2.47	-0.22	161.03	2.57	0.52	778.	778.	778.
18.000	78.916	0.662	0.3545	204.51	1.84	-0.19	134.44	1.55	0.31	775.	775.	775.
19.000	66.848	0.564	0.4003	207.40	1.68	0.28	112.29	1.11	0.06	762.	762.	762.
20.000	56.786	0.515	0.4833	210.25	1.50	0.15	94.09	0.86	0.05	758.	757.	757.
21.000	48.315	0.464	0.7046	212.99	1.62	0.10	79.02	0.72	0.28	744.	743.	743.
22.000	41.234	0.442	1.2852	215.46	1.70	0.01	66.66	0.60	0.17	739.	738.	738.
23.000	35.210	0.378	0.3951	217.83	1.74	0.04	56.30	0.52	0.06	736.	736.	737.
24.000	30.093	0.344	0.4145	220.07	1.96	-0.02	47.64	0.46	0.20	722.	722.	723.
25.000	25.805	0.313	0.3537	222.10	1.99	0.17	40.48	0.41	0.56	697.	697.	698.
26.000	22.136	0.287	0.3978	224.15	2.07	0.19	34.41	0.36	0.22	691.	691.	691.
27.000	19.009	0.262	0.3529	225.72	2.08	-0.07	29.34	0.31	0.31	634.	635.	634.
28.000	16.364	0.241	0.2969	227.22	2.11	-0.13	25.08	0.28	0.25	605.	606.	605.
29.000	14.091	0.241	1.5808	228.77	2.21	-0.04	21.46	0.25	0.26	574.	573.	573.
30.000	12.141	0.218	1.3790	230.12	2.45	-0.09	18.37	0.23	0.32	534.	533.	533.

TABLE B-8. August Thermodynamic Data, Wake Island.

Z KM	MEAN P MB	S.D. P MB	SKEW P	MEAN T DEG K	S.D. T DEG K	SKEW T	MEAN D G/M3	S.D. D G/M3	SKEW D	NOBS P	NOBS T	NOBS D
0.000	1013.620	2.497	-2.0856	301.37	1.45	-0.23	1158.44	6.34	0.15	845.	845.	845.
0.005	1013.024	2.497	-2.0878	301.37	1.45	-0.23	1157.89	6.30	0.15	845.	845.	845.
1.000	904.247	2.141	-1.8444	293.73	0.76	0.01	1063.65	4.26	-0.66	845.	844.	845.
2.000	804.822	1.888	-1.8173	288.28	1.05	0.42	966.90	4.35	-0.76	845.	845.	845.
3.000	714.740	1.665	-1.5808	283.44	1.20	0.07	875.17	4.06	-0.89	845.	844.	845.
4.000	632.879	1.554	-1.0570	277.91	1.26	0.09	791.41	3.77	-0.95	845.	845.	845.
5.000	559.137	1.425	-0.6330	272.13	1.32	0.03	714.59	3.62	-0.98	843.	843.	843.
6.000	492.865	1.335	-0.2437	266.27	1.48	0.05	644.12	3.60	-0.86	842.	842.	842.
7.000	432.755	1.277	-0.1772	260.06	1.64	-0.03	579.32	3.41	-0.69	839.	839.	839.
8.000	378.879	1.319	-0.2269	253.39	1.87	0.09	520.69	3.23	-0.77	836.	836.	836.
9.000	330.333	1.377	-0.2816	246.10	2.03	0.08	467.52	2.82	-0.69	834.	834.	834.
10.000	287.149	1.447	-0.3823	238.33	2.11	0.09	419.69	2.41	-0.71	832.	832.	832.
11.000	248.241	1.551	-0.3464	230.21	2.11	0.24	375.66	1.95	-1.04	830.	830.	830.
12.000	213.194	1.517	-0.2284	221.96	1.93	0.32	334.61	1.65	-1.26	826.	826.	826.
13.000	182.223	1.485	-0.1097	214.01	1.89	0.29	296.63	2.05	-1.31	824.	824.	824.
14.000	155.049	1.361	-0.0058	206.81	2.10	0.53	261.20	2.88	-1.34	822.	822.	822.
15.000	131.181	1.161	0.0927	201.94	2.71	0.56	226.35	3.86	-0.56	814.	814.	814.
16.000	110.732	0.918	0.1199	200.55	3.49	-0.23	192.42	4.20	0.44	811.	811.	811.
17.000	93.503	0.734	0.1425	202.35	2.74	-0.69	161.01	2.61	0.89	766.	766.	766.
18.000	79.056	0.637	0.2966	204.66	2.11	-0.22	134.60	1.58	0.57	763.	763.	763.
19.000	66.998	0.558	0.3607	207.49	1.78	0.14	112.49	1.08	0.41	743.	743.	743.
20.000	56.906	0.512	0.4342	210.10	1.75	-0.19	94.36	0.90	0.31	735.	735.	735.
21.000	48.406	0.458	0.4593	212.68	1.69	-0.11	79.29	0.72	0.15	718.	718.	718.
22.000	41.295	0.420	0.4041	214.91	1.73	0.00	66.94	0.62	0.11	710.	710.	710.
23.000	35.251	0.385	0.4143	217.10	1.80	0.04	56.56	0.53	0.17	705.	705.	705.
24.000	30.121	0.346	0.4238	219.32	1.97	-0.05	47.84	0.48	0.13	695.	694.	695.
25.000	25.812	0.321	0.3667	221.29	2.01	0.19	40.64	0.40	0.07	665.	665.	665.
26.000	22.129	0.299	0.4329	223.15	2.10	0.17	34.55	0.35	0.05	662.	662.	662.
27.000	19.000	0.268	0.3673	224.86	2.16	0.10	29.43	0.32	0.14	612.	612.	612.
28.000	16.337	0.249	0.3113	226.41	2.27	-0.10	25.14	0.29	0.07	588.	588.	588.
29.000	14.057	0.228	0.2726	227.98	2.32	-0.02	21.48	0.26	0.21	551.	551.	551.
30.000	12.109	0.207	0.2900	229.54	2.49	-0.14	18.37	0.24	0.12	516.	516.	516.

TABLE B-9. September Thermodynamic Data, Wake Island.

Z KM	MEAN ρ MB	S.D. P MB	SKEWP	MEANT DEGK	S.D. T DEGK	SKEWT	MEAND G/M ³	S.D. D G/M ³	SKEWD	NOBS P	NOBS T	NOBS D
0.000	1013.763	2.088	-1.9887	301.76	1.37	-0.28	1156.96	6.24	0.44	807.	806.	807.
0.005	1013.176	2.092	-1.9789	301.77	1.35	-0.18	1156.42	6.15	0.39	807.	806.	807.
1.000	904.487	1.622	-0.6602	293.93	0.74	-0.30	1063.25	3.84	-0.27	807.	807.	807.
2.000	805.070	1.434	-0.6515	288.42	0.99	0.20	966.80	3.72	-0.41	806.	806.	806.
3.000	714.987	1.306	-0.5384	283.66	1.17	-0.20	875.00	3.58	-0.24	806.	806.	806.
4.000	633.126	1.305	-0.4321	278.13	1.23	-0.18	791.32	3.32	-0.18	806.	806.	806.
5.000	559.333	1.282	-0.2967	272.25	1.31	-0.20	714.76	3.10	-0.03	806.	806.	806.
6.000	493.100	1.229	-0.2295	266.39	1.41	-0.07	644.32	2.98	-0.02	806.	806.	806.
7.000	432.941	1.233	-0.2411	260.07	1.54	-0.21	579.66	2.83	0.08	801.	801.	801.
8.000	379.012	1.303	-0.2886	253.20	1.64	-0.38	521.32	2.60	0.27	796.	796.	796.
9.000	330.382	1.354	-0.2866	245.83	1.74	-0.37	468.12	2.27	0.27	794.	794.	794.
10.000	287.188	1.381	-0.3275	238.09	1.77	-0.19	420.19	1.97	0.15	790.	790.	790.
11.000	248.260	1.449	-0.3111	230.09	1.76	-0.06	375.89	1.73	-0.42	787.	787.	787.
12.000	213.224	1.391	-0.2446	222.06	1.66	0.19	334.51	1.73	-1.32	785.	785.	785.
13.000	182.275	1.346	-0.1413	214.34	1.65	0.29	296.25	2.21	-1.18	782.	781.	782.
14.000	155.134	1.214	-0.0271	207.25	1.96	0.11	260.76	2.82	-0.77	781.	780.	781.
15.000	131.236	1.054	0.1249	202.01	2.37	0.22	226.35	3.19	-0.23	775.	775.	775.
16.000	110.734	0.881	0.2663	199.03	2.71	0.11	193.87	3.21	0.09	771.	771.	771.
17.000	93.356	0.748	0.4896	199.64	2.81	0.01	162.94	2.59	0.14	735.	735.	735.
18.000	78.788	0.665	0.5522	202.58	2.31	-0.22	135.50	1.60	0.43	728.	728.	728.
19.000	66.672	0.598	0.5142	206.19	1.92	0.10	112.66	1.15	0.72	710.	710.	710.
20.000	56.581	0.547	0.5397	209.32	1.78	0.12	94.17	0.92	0.11	707.	707.	707.
21.000	48.108	0.489	0.5513	212.13	1.69	0.01	79.01	0.73	0.41	692.	692.	692.
22.000	41.022	0.449	0.5177	214.54	1.81	0.15	66.62	0.64	0.26	683.	683.	683.
23.000	35.007	0.412	0.5056	216.86	1.94	0.30	56.24	0.56	0.46	678.	678.	678.
24.000	29.917	0.374	0.4748	219.17	2.19	0.34	47.54	0.52	0.55	659.	659.	659.
25.000	25.627	0.345	0.5296	221.02	2.07	0.36	40.39	0.44	0.37	642.	642.	642.
26.000	21.963	0.315	0.5358	222.92	2.10	0.31	34.32	0.40	0.34	640.	640.	640.
27.000	18.868	0.281	0.5717	224.88	2.10	0.49	29.23	0.35	0.19	586.	586.	586.
28.000	16.252	0.257	0.5884	226.62	2.35	0.44	24.95	0.33	0.15	571.	571.	571.
29.000	13.967	0.232	0.7306	228.32	2.45	0.21	21.31	0.29	0.27	531.	531.	531.
30.000	12.024	0.204	0.6360	229.80	2.59	0.11	18.23	0.25	0.42	502.	502.	502.

TABLE B-10. October Thermodynamic Data, Wake Island.

Z KM	MEAN P MB	S.D. P MB	MEAN T DEG K	S.D. T DEG K	MEAN D GM/3	S.D. D GM/3	MEAN D GM/3	SKEW T	SKEW D	NOBS P	NOBS T	NOBS D
0.000	1014.560	1.830	301.47	1.36	1159.19	5.94	1159.19	-0.12	0.07	834.	834.	834.
0.005	1013.981	1.832	301.48	1.34	1158.67	5.84	1158.67	0.01	-0.04	835.	835.	835.
1.000	905.070	1.510	293.51	0.87	1065.65	3.77	1065.65	-0.74	0.42	835.	835.	835.
2.000	805.491	1.454	288.36	1.24	968.06	3.76	968.06	-0.41	0.15	834.	834.	834.
3.000	715.310	1.441	283.80	1.36	875.51	3.51	875.51	-0.16	-0.14	834.	834.	834.
4.000	633.442	1.469	278.48	1.45	791.08	3.44	791.08	-0.36	0.06	833.	833.	833.
5.000	559.696	1.487	272.84	1.62	713.89	3.45	713.89	-0.19	-0.06	832.	832.	832.
6.000	493.527	1.514	266.69	1.65	644.25	3.20	644.25	-0.29	0.11	830.	830.	830.
7.000	433.295	1.518	260.09	1.68	580.13	2.90	580.13	-0.26	0.01	828.	828.	828.
8.000	379.335	1.597	253.00	1.86	522.20	2.83	522.20	-0.12	0.02	825.	825.	825.
9.000	330.635	1.643	245.53	1.98	469.06	2.50	469.06	-0.11	0.13	823.	823.	823.
10.000	287.364	1.674	237.86	1.97	420.85	2.08	420.85	-0.07	-0.08	821.	821.	821.
11.000	248.395	1.712	230.02	1.89	376.20	1.82	376.20	-0.12	-0.24	820.	820.	820.
12.000	213.367	1.626	222.31	1.83	334.36	1.94	334.36	-0.26	-0.78	820.	820.	820.
13.000	182.433	1.558	214.91	1.80	295.73	2.43	295.73	0.08	-0.82	815.	815.	815.
14.000	155.344	1.396	208.07	1.88	260.10	2.83	260.10	0.19	-0.70	815.	815.	815.
15.000	131.407	1.226	202.46	1.99	226.13	2.96	226.13	0.38	-0.36	810.	810.	810.
16.000	110.842	1.015	197.96	2.21	195.09	2.94	195.09	0.11	-0.23	808.	808.	808.
17.000	93.308	0.836	196.35	2.73	165.59	3.03	165.59	0.43	-0.22	764.	764.	764.
18.000	78.513	0.658	199.03	3.15	137.45	2.63	137.45	0.13	0.05	756.	756.	756.
19.000	66.284	0.546	203.94	2.43	113.24	1.54	113.24	0.01	-0.04	726.	726.	726.
20.000	56.169	0.492	208.02	2.11	94.07	1.07	94.07	-0.13	-0.17	725.	725.	725.
21.000	47.721	0.438	211.43	1.90	78.63	0.81	78.63	0.03	-0.09	703.	703.	703.
22.000	40.677	0.397	214.32	2.07	66.12	0.71	66.12	0.15	-0.10	694.	694.	694.
23.000	34.708	0.366	216.86	2.08	55.76	0.58	55.76	-0.06	-0.01	691.	691.	691.
24.000	29.655	0.336	219.16	2.13	47.14	0.49	47.14	-0.01	0.08	680.	680.	680.
25.000	25.405	0.308	221.18	2.09	40.02	0.45	40.02	-0.18	-0.11	667.	667.	667.
26.000	21.778	0.281	223.20	2.22	33.99	0.39	33.99	-0.29	0.11	666.	666.	666.
27.000	18.700	0.252	225.34	2.18	28.91	0.33	28.91	-0.21	-0.06	627.	627.	627.
28.000	16.038	0.232	227.18	2.37	24.67	0.30	24.67	-0.09	-0.18	600.	600.	600.
29.000	13.850	0.210	228.94	2.42	21.08	0.27	21.08	-0.06	-0.05	563.	563.	563.
30.000	11.933	0.191	230.66	2.56	18.02	0.24	18.02	-0.04	-0.54	528.	528.	528.

TABLE E-11. November Thermodynamic Data, Wake Island.

Z KM	MEAN P MB	S.D. P MB	MEAN T DEG K	S.D. T DEG K	MEAN D GM/3	S.D. D GM/3	SKEW P	SKEW T	SKEW D	NOBS P	NOBS T	NOBS D
0.000	1015.207	1.887	300.42	1.34	1164.99	6.08	-1.4021	0.00	0.61	824.	822.	823.
0.005	1014.626	1.871	300.42	1.36	1164.49	6.13	-1.4057	-0.14	0.83	826.	824.	825.
1.000	905.253	1.711	292.51	1.14	1069.04	4.91	-0.9597	-0.47	0.19	826.	826.	826.
2.000	805.426	1.622	288.26	1.71	969.19	5.02	-0.7505	-0.16	0.51	826.	826.	826.
3.000	715.221	1.599	284.30	1.72	874.47	4.32	-0.6553	-0.23	0.21	825.	825.	825.
4.000	633.389	1.620	279.01	1.81	789.79	4.32	-0.5268	-0.30	0.10	825.	825.	825.
5.000	559.735	1.621	273.32	1.80	712.86	3.98	-0.4941	-0.47	0.27	825.	825.	825.
6.000	493.765	1.702	267.15	1.78	643.57	3.51	-0.6010	-0.45	0.19	824.	824.	824.
7.000	433.571	1.685	250.51	1.77	579.62	3.09	-0.5455	-0.58	0.32	820.	820.	820.
8.000	379.648	1.683	253.40	1.77	521.85	2.90	-0.5045	-0.44	0.13	815.	815.	815.
9.000	330.942	1.636	245.95	1.76	468.72	2.50	-0.4352	-0.33	-0.13	813.	813.	813.
10.000	287.747	1.649	238.31	1.74	420.63	2.31	-0.4279	-0.25	-0.39	808.	808.	808.
11.000	248.820	1.627	230.72	1.74	375.70	2.18	-0.4138	-0.29	-0.69	808.	808.	808.
12.000	213.830	1.524	223.76	1.66	333.81	2.08	-0.3105	-0.41	-1.18	806.	806.	806.
13.000	182.944	1.445	215.76	1.63	295.39	2.28	-0.2617	-0.37	-0.99	801.	801.	801.
14.000	155.855	1.288	208.68	1.54	260.19	2.35	-0.2405	-0.24	-0.72	801.	801.	801.
15.000	131.853	1.135	202.44	1.71	226.91	2.62	-0.1414	0.03	-0.54	793.	793.	793.
16.000	111.183	0.939	197.14	2.01	196.49	2.65	-0.0106	0.35	-0.43	789.	789.	789.
17.000	93.506	0.790	194.08	2.33	167.86	2.51	0.1123	0.32	-0.29	746.	746.	746.
18.000	78.464	0.658	195.10	2.82	140.13	2.82	0.1413	0.47	-0.24	735.	735.	735.
19.000	66.028	0.569	200.13	3.05	114.96	1.81	0.0335	0.07	0.13	716.	716.	716.
20.000	55.811	0.526	206.02	2.57	94.41	1.20	0.0507	-0.07	0.52	712.	711.	712.
21.000	47.379	0.480	210.47	2.15	78.43	0.83	0.0478	0.29	0.11	694.	693.	694.
22.000	40.356	0.449	213.02	2.30	65.81	0.72	0.1310	0.27	-0.08	688.	688.	688.
23.000	34.414	0.417	216.45	2.42	55.39	0.59	0.1718	0.03	-0.27	679.	679.	679.
24.000	29.398	0.382	218.87	2.39	46.80	0.53	0.2237	-0.10	-0.05	658.	658.	658.
25.000	25.177	0.350	220.91	2.17	39.71	0.47	0.1987	-0.21	-0.11	648.	648.	648.
26.000	21.580	0.325	222.87	2.53	33.73	0.41	0.2648	-0.15	-0.10	648.	648.	648.
27.000	18.532	0.296	224.83	2.67	28.72	0.36	0.2481	-0.19	-0.02	611.	611.	611.
28.000	15.934	0.273	226.51	2.83	24.51	0.32	0.1659	-0.35	0.03	593.	593.	593.
29.000	13.707	0.250	228.16	3.00	20.93	0.31	0.0866	-0.28	-0.05	562.	562.	562.
30.000	11.801	0.228	229.83	3.21	17.89	0.28	0.0068	-0.43	-0.18	539.	539.	539.

TABLE B-12. December Thermodynamic Data, Wake Island.

Z KM	MEAN:P MB	S.D. P mB	SKEWP P	MEAN T DEG K	S.D. T DEG K	SKEWT G/M3	MEAN D G/M3	S.D. D G/M3	SKEWD D	NOBS P	NOBS T	NOBS D
0.000	1015.997	2.327	-0.3077	299.43	1.35	-0.12	1170.88	6.66	0.35	856.	856.	856.
0.005	1015.428	2.324	-0.3196	299.44	1.31	0.17	1170.30	6.47	0.17	857.	857.	857.
1.000	905.482	1.987	-0.0901	291.26	1.30	-0.20	1075.57	5.82	0.25	857.	857.	857.
2.000	805.218	1.813	-0.1726	287.56	2.37	-0.39	972.15	7.30	0.65	855.	855.	855.
3.000	714.869	1.793	-0.2884	284.42	2.03	-0.80	874.29	5.32	0.65	855.	855.	855.
4.000	633.059	1.848	-0.5158	279.37	2.00	-1.60	788.75	4.75	0.65	854.	854.	854.
5.000	559.464	1.915	-0.6972	273.51	2.01	-1.14	712.19	4.21	0.78	854.	854.	854.
6.000	493.619	2.004	-0.9340	267.39	1.79	-0.79	642.97	3.59	0.45	853.	851.	853.
7.000	433.447	1.963	-1.1072	260.72	1.77	-0.92	579.10	3.19	0.48	851.	849.	851.
8.000	379.600	1.981	-1.2462	253.69	1.87	-0.94	521.44	3.15	0.08	846.	845.	846.
9.000	330.955	1.894	-1.3234	246.44	1.80	-0.78	467.82	2.91	-0.14	844.	844.	844.
10.000	287.858	1.848	-1.2862	238.91	1.72	-0.49	419.73	2.69	-0.74	840.	840.	840.
11.000	249.023	1.768	-1.1795	231.28	1.70	-0.41	375.09	2.46	-1.14	838.	838.	838.
12.000	214.060	1.620	-1.0029	223.61	1.58	-0.52	333.50	2.25	-1.37	835.	835.	835.
13.000	183.172	1.525	-0.8599	216.09	1.54	0.00	295.31	2.39	-1.49	833.	833.	833.
14.000	156.076	1.347	-0.7544	208.71	1.66	0.62	260.51	2.54	-1.59	832.	831.	832.
15.000	132.021	1.173	-0.4586	201.92	1.82	0.73	227.77	2.63	-1.38	820.	819.	820.
16.000	111.245	0.998	-0.2505	196.03	2.09	0.62	197.69	2.63	-1.00	819.	818.	819.
17.000	93.429	0.886	-0.0456	192.34	2.47	0.47	169.24	2.64	-0.37	789.	789.	789.
18.000	78.250	0.760	0.1474	192.89	2.64	0.38	141.34	2.23	-0.39	779.	778.	779.
19.000	65.740	0.648	0.3710	198.24	2.87	0.14	115.55	1.87	0.03	757.	757.	757.
20.000	55.506	0.583	0.4012	204.92	2.54	-0.13	94.37	1.37	0.23	751.	751.	751.
21.000	47.076	0.511	0.4005	209.85	2.22	0.34	78.15	1.00	0.08	734.	734.	734.
22.000	40.083	0.463	0.4169	213.31	2.30	0.04	65.47	0.80	0.10	724.	724.	724.
23.000	34.178	0.429	0.4206	216.10	2.40	0.29	55.10	0.65	0.19	717.	717.	717.
24.000	29.188	0.391	0.4087	218.60	2.58	-0.24	40.52	0.57	0.36	688.	688.	688.
25.000	24.992	0.365	0.3137	220.54	2.69	-0.19	39.48	0.51	0.21	674.	674.	674.
26.000	21.411	0.337	0.2686	222.17	2.92	-0.28	33.57	0.45	0.24	672.	672.	672.
27.000	18.369	0.308	0.2623	223.74	3.01	-0.38	28.60	0.41	0.11	624.	624.	624.
28.000	15.786	0.287	0.2935	225.29	3.16	-0.29	24.41	0.37	0.19	606.	606.	606.
29.000	13.572	0.265	0.3085	226.74	3.32	-0.28	20.85	0.34	0.38	583.	583.	583.
30.000	11.674	0.241	0.2659	228.41	3.50	-0.25	17.81	0.32	0.26	561.	561.	561.

TABLE B-13. Annual Thermodynamic Data, Wake Island.

Z KM	MEAN P MB	S.D. P MB	MEAN T DEG K	S.D. T DEG K	MEAN D G/M3	S.D. D G/M3	SKWEW D	NOBS P	NOBS T	NOBS D
0.000	1015.346	2.436	300.14	1.87	1166.57	9.49	0.17	9961.	9959.	9961.
0.005	1014.765	2.441	300.14	1.86	1166.03	9.45	0.16	9980.	9978.	9980.
1.000	905.998	1.941	292.08	1.75	1071.83	7.89	0.40	9982.	9981.	9982.
2.000	805.333	1.764	287.33	1.90	971.86	6.54	0.61	9977.	9977.	9977.
3.000	714.701	1.709	283.36	1.74	876.63	4.88	0.14	9976.	9975.	9976.
4.000	632.724	1.740	278.24	1.77	791.13	4.42	-0.06	9970.	9970.	9970.
5.000	558.962	1.739	272.54	1.84	713.87	4.08	-0.09	9967.	9967.	9967.
6.000	492.873	1.772	266.49	1.88	643.96	3.76	-0.07	9958.	9956.	9958.
7.000	432.697	1.764	260.02	1.95	579.54	3.48	-0.06	9925.	9923.	9925.
8.000	378.786	1.818	253.13	2.07	521.21	3.35	-0.15	9886.	9885.	9886.
9.000	330.775	1.805	245.83	2.12	467.86	3.02	-0.25	9864.	9864.	9864.
10.000	287.038	1.821	238.25	2.10	419.70	2.76	-0.62	9824.	9824.	9824.
11.000	248.288	1.819	230.53	2.08	375.07	2.56	-0.98	9804.	9804.	9804.
12.000	213.246	1.699	222.74	1.99	333.53	2.41	-1.12	9778.	9778.	9778.
13.000	182.375	1.621	215.18	1.97	295.27	2.61	-1.06	9745.	9744.	9745.
14.000	155.317	1.458	208.04	2.05	260.09	2.88	-1.01	9730.	9727.	9730.
15.000	131.385	1.271	202.17	2.22	226.42	3.25	-0.73	9639.	9636.	9639.
16.000	110.808	1.045	197.91	3.05	195.09	3.73	-0.43	9608.	9606.	9608.
17.000	93.275	0.869	196.35	4.53	165.57	4.11	-0.05	9129.	9127.	9129.
18.000	78.441	0.794	197.96	5.24	138.12	3.41	0.18	9043.	9042.	9043.
19.000	66.152	0.785	202.42	4.44	113.89	2.08	0.41	8791.	8791.	8791.
20.000	56.004	0.776	207.19	3.20	94.18	1.25	0.14	8742.	8740.	8741.
21.000	47.558	0.718	210.95	2.56	78.54	0.98	-0.11	8544.	8540.	8543.
22.000	40.526	0.664	213.85	2.47	66.02	0.90	-0.10	8440.	8437.	8439.
23.000	34.568	0.606	216.46	2.47	55.63	0.80	0.04	8375.	8373.	8376.
24.000	29.529	0.545	218.91	2.50	46.99	0.71	0.11	8149.	8148.	8150.
25.000	25.294	0.494	221.02	2.51	39.87	0.63	0.08	7964.	7963.	7965.
26.000	21.680	0.447	223.08	2.58	33.86	0.57	0.06	7926.	7924.	7926.
27.000	18.614	0.398	225.01	2.67	28.82	0.51	0.05	7379.	7378.	7379.
28.000	16.010	0.361	226.77	2.83	24.60	0.46	0.05	7115.	7115.	7115.
29.000	13.778	0.327	228.47	2.99	21.01	0.42	0.04	6734.	6731.	6733.
30.000	11.862	0.294	230.08	3.12	17.96	0.38	-0.01	6388.	6386.	6387.

APPENDIX C

Wake Island Moisture-Related Statistics Tables

Tables C-1 through C-13 provide moisture related statistics (monthly and annual) for Wake Island. They were prepared as described in Chapter 3.

TABLE C-1. January Moisture-Related Data, Wake Island.

Z	VP MEAN	S.D. VP	TV MEAN	TV S.D.	SKEW TV	TD MEAN	S.D. TD	SKEW TD	NOBS VP	NOBS TV	NOBS TD
KM	MB	MB	K	K	K	K	K	K	VP	TV	TD
0.000	23.602	3.591	301.18	1.64	-0.27	293.16	2.56	-0.93	846.	845.	845.
0.005	23.539	3.588	301.16	1.63	-0.26	293.12	2.57	-0.92	846.	845.	845.
1.000	15.530	2.888	292.15	1.72	-0.33	286.47	3.14	-1.47	844.	844.	843.
2.000	7.045	4.267	287.63	2.39	-0.67	272.39	9.67	-0.23	845.	845.	845.
3.000	2.813	2.330	284.17	1.89	-0.44	260.21	8.17	1.08	845.	845.	845.
4.000	1.532	1.383	279.18	1.73	-0.37	253.12	7.07	1.65	842.	842.	842.
5.000	0.875	0.834	273.37	1.71	-0.29	246.86	6.57	1.90	841.	842.	842.
6.000	0.487	0.474	267.19	1.84	-0.37	240.56	6.69	1.84	836.	841.	841.
7.000	0.249	0.222	260.83	1.96	-0.60	234.30	6.53	1.83	825.	838.	838.
8.000	0.135	0.144	254.27	1.98	-0.91	227.70	6.49	1.69	833.	838.	838.
9.000	0.062	0.066	247.15	1.85	-0.87	220.61	6.48	1.54	828.	835.	835.
10.000	0.032	0.041	239.79	1.60	-0.50	213.78	7.18	1.32	802.	803.	803.
11.000	0.025	0.025	234.15	0.91	1.22	211.38	8.46	0.34	126.	126.	126.
12.000	0.000	0.000	224.36	1.47	-0.31	0.00	0.00	0.00	0.	0.	0.
13.000	0.000	0.000	216.57	1.50	-0.26	0.00	0.00	0.00	0.	0.	0.
14.000	0.000	0.000	208.29	1.64	-0.08	0.00	0.00	0.00	0.	0.	0.
15.000	0.000	0.000	201.77	1.65	-0.06	0.00	0.00	0.00	0.	0.	0.
16.000	0.000	0.000	195.49	1.85	0.02	0.00	0.00	0.00	0.	0.	0.
17.000	0.000	0.000	191.45	2.35	0.16	0.00	0.00	0.00	0.	0.	0.
18.000	0.000	0.000	192.02	2.80	0.18	0.00	0.00	0.00	0.	0.	0.
19.000	0.000	0.000	197.93	2.83	0.09	0.00	0.00	0.00	0.	0.	0.
20.000	0.000	0.000	204.51	2.65	-0.17	0.00	0.00	0.00	0.	0.	0.
21.000	0.000	0.000	209.04	2.35	0.20	0.00	0.00	0.00	0.	0.	0.
22.000	0.000	0.000	212.22	2.43	0.21	0.00	0.00	0.00	0.	0.	0.
23.000	0.000	0.000	214.79	2.46	-0.05	0.00	0.00	0.00	0.	0.	0.
24.000	0.000	0.000	217.01	2.46	-0.07	0.00	0.00	0.00	0.	0.	0.
25.000	0.000	0.000	218.97	2.40	-0.15	0.00	0.00	0.00	0.	0.	0.
26.000	0.000	0.000	220.93	2.39	-0.02	0.00	0.00	0.00	0.	0.	0.
27.000	0.000	0.000	222.66	2.35	0.14	0.00	0.00	0.00	0.	0.	0.
28.000	0.000	0.000	224.29	2.44	0.32	0.00	0.00	0.00	0.	0.	0.
29.000	0.000	0.000	225.86	2.60	0.03	0.00	0.00	0.00	0.	0.	0.
30.000	0.000	0.000	227.48	2.79	0.04	0.00	0.00	0.00	0.	0.	0.

TABLE C-2. February Moisture-Related Data, Wake Island.

Z KM	VP MEAN MB	S.D. VP MB	SKEW VP	TV MEAN K	TV S.D. K	SKEW TV	TD MEAN K	S.D. TD K	Sr W TD	NOBS VP	NOBS TV	NOBS TD
0.000	23.328	3.305	-0.8616	300.97	1.64	-0.11	293.03	2.26	-0.79	768.	767.	765.
0.005	23.281	3.234	-0.6875	300.93	1.63	-0.10	292.99	2.27	-0.79	768.	768.	766.
1.000	15.180	2.715	-0.5581	291.93	1.51	-0.45	286.13	3.00	-1.20	767.	767.	767.
2.000	7.272	3.919	0.0438	286.80	2.03	-0.24	273.21	9.21	-0.55	768.	768.	768.
3.000	2.747	2.340	1.8243	283.33	1.92	0.04	259.82	8.25	1.14	767.	767.	767.
4.000	1.342	1.106	3.1577	278.44	2.10	-0.24	252.07	6.22	1.77	767.	767.	767.
5.000	0.691	0.439	2.7753	272.70	2.29	-0.34	245.60	5.81	1.81	755.	767.	767.
6.000	0.399	0.304	3.1675	266.60	2.41	-0.60	239.39	5.92	1.76	755.	764.	764.
7.000	0.212	0.158	2.8940	260.24	2.42	-0.88	233.13	5.93	1.62	751.	763.	763.
8.000	0.104	0.081	2.7276	253.61	2.50	-1.38	226.35	5.78	1.53	751.	762.	762.
9.000	0.054	0.056	3.1080	246.60	2.39	-1.71	219.58	6.01	1.45	756.	760.	760.
10.000	0.026	0.030	2.4307	239.57	1.54	-0.66	212.80	6.37	1.50	704.	706.	706.
11.000	0.015	0.017	1.9528	234.13	0.69	1.01	208.18	7.18	1.40	79.	80.	80.
12.000	0.000	0.000	0.0000	224.16	1.44	-0.24	0.00	0.00	0.00	0.	0.	0.
13.000	0.000	0.000	0.0000	216.37	1.37	0.25	0.00	0.00	0.00	0.	0.	0.
14.000	0.000	0.000	0.0000	208.70	1.43	0.55	0.00	0.00	0.00	0.	0.	0.
15.000	0.000	0.000	0.0000	201.65	1.53	0.51	0.00	0.00	0.00	0.	0.	0.
16.000	0.000	0.000	0.0000	195.59	1.79	0.63	0.00	0.00	0.00	0.	0.	0.
17.000	0.000	0.000	0.0000	192.26	2.44	0.47	0.00	0.00	0.00	0.	0.	0.
18.000	0.000	0.000	0.0000	193.20	2.56	-0.06	0.00	0.00	0.00	0.	0.	0.
19.000	0.000	0.000	0.0000	198.26	2.62	0.02	0.00	0.00	0.00	0.	0.	0.
20.000	0.000	0.000	0.0000	204.15	2.59	0.06	0.00	0.00	0.00	0.	0.	0.
21.000	0.000	0.000	0.0000	208.34	2.53	0.10	0.00	0.00	0.00	0.	0.	0.
22.000	0.000	0.000	0.0000	211.44	2.57	0.00	0.00	0.00	0.00	0.	0.	0.
23.000	0.000	0.000	0.0000	214.16	2.50	-0.19	0.00	0.00	0.00	0.	0.	0.
24.000	0.000	0.000	0.0000	216.77	2.29	-0.20	0.00	0.00	0.00	0.	0.	0.
25.000	0.000	0.000	0.0000	218.95	2.25	-0.14	0.00	0.00	0.00	0.	0.	0.
26.000	0.000	0.000	0.0000	221.15	2.30	-0.36	0.00	0.00	0.00	0.	0.	0.
27.000	0.000	0.000	0.0000	223.24	2.45	-0.33	0.00	0.00	0.00	0.	0.	0.
28.000	0.000	0.000	0.0000	225.05	2.67	-0.08	0.00	0.00	0.00	0.	0.	0.
29.000	0.000	0.000	0.0000	226.90	3.00	0.14	0.00	0.00	0.00	0.	0.	0.
30.000	0.000	0.000	0.0000	228.59	3.12	0.17	0.00	0.00	0.00	0.	0.	0.

TABLE C-3. March Moisture-Related Data, Wake Island.

Z	VP	S.D.	TV	TD	S.D.	S.D.	NOBS	NOBS	NOBS	NOBS	
KM	MEAN	MB	MEAN	MEAN	TD	TD	VP	TV	TD	TD	
	MB		K	K	K	K					
0.000	24.623	3.035	301.53	1.54	-0.35	293.94	1.94	-1.00	850.	849.	846.
0.005	24.532	2.967	301.50	1.53	-0.35	293.91	1.95	-1.00	854.	854.	851.
1.000	15.743	2.684	292.48	1.33	-0.78	286.83	2.61	-1.09	845.	845.	839.
2.000	7.736	3.872	286.97	1.57	-0.45	274.35	8.77	-0.71	849.	849.	849.
3.000	3.074	2.495	282.84	1.75	-0.42	260.99	8.97	0.74	849.	849.	849.
4.000	1.502	1.337	277.86	2.03	-0.26	252.74	7.40	1.40	849.	849.	849.
5.000	0.757	0.640	272.35	2.20	-0.28	245.71	6.26	1.78	848.	852.	852.
6.000	0.428	0.386	266.29	2.38	-0.35	239.41	6.30	1.68	849.	852.	852.
7.000	0.218	0.185	259.87	2.34	-0.52	232.96	6.09	1.64	836.	844.	844.
8.000	0.114	0.105	253.22	2.38	-0.69	226.56	6.34	1.55	831.	839.	839.
9.000	0.056	0.054	246.27	2.37	-1.00	219.98	6.56	1.33	829.	838.	838.
10.000	0.028	0.033	239.25	1.84	-0.55	213.20	7.07	1.29	744.	750.	750.
11.000	0.018	0.024	233.86	0.60	0.80	209.31	7.71	0.93	75.	75.	75.
12.000	0.000	0.000	224.04	1.49	-0.17	0.00	0.00	0.00	0.	0.	0.
13.000	0.000	0.000	216.38	1.45	0.04	0.00	0.00	0.00	0.	0.	0.
14.000	0.000	0.000	208.86	1.57	0.20	0.00	0.00	0.00	0.	0.	0.
15.000	0.000	0.000	202.15	1.68	0.41	0.00	0.00	0.00	0.	0.	0.
16.000	0.000	0.000	196.32	2.04	0.41	0.00	0.00	0.00	0.	0.	0.
17.000	0.000	0.000	192.91	2.53	0.34	0.00	0.00	0.00	0.	0.	0.
18.000	0.000	0.000	193.67	2.70	0.13	0.00	0.00	0.00	0.	0.	0.
19.000	0.000	0.000	198.54	2.69	0.12	0.00	0.00	0.00	0.	0.	0.
20.000	0.000	0.000	204.26	2.46	-0.07	0.00	0.00	0.00	0.	0.	0.
21.000	0.000	0.000	208.82	2.24	0.13	0.00	0.00	0.00	0.	0.	0.
22.000	0.000	0.000	211.98	2.34	0.06	0.00	0.00	0.00	0.	0.	0.
23.000	0.000	0.000	214.82	2.49	0.06	0.00	0.00	0.00	0.	0.	0.
24.000	0.000	0.000	217.52	2.49	0.16	0.00	0.00	0.00	0.	0.	0.
25.000	0.000	0.000	219.85	2.37	0.22	0.00	0.00	0.00	0.	0.	0.
26.000	0.000	0.000	222.11	2.32	0.03	0.00	0.00	0.00	0.	0.	0.
27.000	0.000	0.000	224.42	2.45	-0.06	0.00	0.00	0.00	0.	0.	0.
28.000	0.000	0.000	226.58	2.74	0.03	0.00	0.00	0.00	0.	0.	0.
29.000	0.000	0.000	228.63	3.01	0.10	0.00	0.00	0.00	0.	0.	0.
30.000	0.000	0.000	230.48	3.23	-0.08	0.00	0.00	0.00	0.	0.	0.

TABLE C-4. April Moisture-Related Data, Wake Island.

Z KM	VP MEAN MB	S.D. VP MB	SKEW VP	TV MEAN K	TV S.D. K	SKEW TV K	TD MEAN K	S.D. TD K	SKEW TD	NOBS VP	NOBS TV	NOBS TD
0.000	25.253	2.820	-0.8559	301.96	1.63	-0.23	294.30	1.93	-1.25	821.	821.	821.
0.005	25.180	2.812	-0.8516	301.92	1.63	-0.22	294.27	1.93	-1.25	824.	824.	824.
1.000	16.194	2.632	-0.7763	292.86	1.30	-0.58	287.18	2.71	-1.28	823.	823.	822.
2.000	8.303	3.893	-0.1933	287.19	1.54	-0.65	275.52	8.53	-0.89	824.	824.	824.
3.000	3.361	2.736	1.1223	282.76	1.46	-0.33	261.81	9.62	0.58	822.	822.	822.
4.000	1.617	1.518	2.1318	277.68	1.64	-0.21	253.18	8.05	1.33	825.	825.	825.
5.000	0.387	0.926	2.7061	271.90	1.76	-0.18	246.29	7.48	1.68	825.	825.	825.
6.000	0.479	0.547	2.9514	265.56	1.83	-0.37	239.40	7.39	1.74	823.	823.	823.
7.000	0.245	0.321	3.3931	258.69	1.95	-0.34	232.31	7.24	1.88	820.	820.	820.
8.000	0.128	0.176	2.9679	251.49	2.03	-0.23	225.54	7.69	1.62	815.	815.	815.
9.000	0.063	0.092	2.6163	244.06	2.10	-0.01	218.49	8.17	1.46	814.	814.	814.
10.000	0.031	0.047	2.2290	237.22	1.90	0.27	211.81	8.51	1.37	669.	669.	669.
11.000	0.035	0.030	0.8497	233.65	0.57	1.38	214.99	9.13	-0.43	11.	11.	11.
12.000	0.000	0.000	0.0000	222.33	2.16	-0.41	0.00	0.00	0.00	0.	0.	0.
13.000	0.000	0.000	0.0000	215.48	1.92	-0.29	0.00	0.00	0.00	0.	0.	0.
14.000	0.000	0.000	0.0000	208.94	1.99	-0.09	0.00	0.00	0.00	0.	0.	0.
15.000	0.000	0.000	0.0000	203.21	2.29	0.14	0.00	0.00	0.00	0.	0.	0.
16.000	0.000	0.000	0.0000	198.39	2.69	0.43	0.00	0.00	0.00	0.	0.	0.
17.000	0.000	0.000	0.0000	195.68	2.75	0.00	0.00	0.00	0.00	0.	0.	0.
18.000	0.000	0.000	0.0000	196.03	2.92	0.32	0.00	0.00	0.00	0.	0.	0.
19.000	0.000	0.000	0.0000	200.58	2.72	0.15	0.00	0.00	0.00	0.	0.	0.
20.000	0.000	0.000	0.0000	206.32	2.59	0.09	0.00	0.00	0.00	0.	0.	0.
21.000	0.000	0.000	0.0000	210.61	2.09	-0.01	0.00	0.00	0.00	0.	0.	0.
22.000	0.000	0.000	0.0000	213.78	2.11	-0.05	0.00	0.00	0.00	0.	0.	0.
23.000	0.000	0.000	0.0000	216.66	2.21	-0.18	0.00	0.00	0.00	0.	0.	0.
24.000	0.000	0.000	0.0000	219.39	2.20	-0.11	0.00	0.00	0.00	0.	0.	0.
25.000	0.000	0.000	0.0000	221.83	2.21	0.15	0.00	0.00	0.00	0.	0.	0.
26.000	0.000	0.000	0.0000	224.31	2.12	0.59	0.00	0.00	0.00	0.	0.	0.
27.000	0.000	0.000	0.0000	226.64	2.33	0.54	0.00	0.00	0.00	0.	0.	0.
28.000	0.000	0.000	0.0000	228.71	2.43	0.20	0.00	0.00	0.00	0.	0.	0.
29.000	0.000	0.000	0.0000	230.73	2.38	-0.01	0.00	0.00	0.00	0.	0.	0.
30.000	0.000	0.000	0.0000	232.57	2.30	-0.23	0.00	0.00	0.00	0.	0.	0.

TABLE C-5. May Moisture-Related Data, Wake Island.

Z KM	VP MEAN		S.D. VP		TV MEAN		TV S.D.		SKEW TV		TD MEAN		S.D. TD		SKEW TD		NOBS		NOBS	
	MB	MB	MB	MB	K	K	K	K	K	K	K	K	K	K	K	K	VP	TV	VP	TV
0.000	26.770	2.540	-0.5093	302.84	3.00	-5.39	295.28	1.61	-0.85	839.	839.									
0.005	26.692	2.539	-0.5039	303.07	1.65	0.09	295.25	1.61	-0.84	849.	849.									
1.000	17.170	2.707	-1.0715	293.98	1.17	-0.41	288.12	2.64	-1.57	848.	846.									
2.000	9.716	3.683	-0.4498	288.20	1.31	-0.73	278.06	7.24	-1.25	845.	845.									
3.000	4.153	2.754	0.6329	283.43	1.35	-0.02	265.17	9.26	0.04	847.	847.									
4.000	1.919	1.565	1.5799	278.29	1.47	0.00	255.41	8.25	0.82	848.	848.									
5.000	1.047	0.986	2.0805	272.43	1.59	-0.03	248.10	7.97	1.18	850.	850.									
6.000	0.558	0.606	2.4870	266.23	1.70	-0.06	240.83	7.89	1.42	850.	850.									
7.000	0.318	0.378	2.4301	259.48	1.79	-0.12	234.50	8.20	1.35	850.	850.									
8.000	0.165	0.218	2.4204	252.38	1.86	-0.15	227.42	8.49	1.36	844.	844.									
9.000	0.080	0.113	2.2831	244.84	1.87	-0.10	220.12	8.83	1.26	839.	839.									
10.000	0.038	0.056	2.0285	237.25	1.70	0.12	212.85	9.34	1.16	750.	750.									
11.000	0.000	0.000	0.0000	229.29	1.79	-0.04	0.00	0.00	0.00	5.	5.									
12.000	0.000	0.000	0.0000	221.62	1.77	-0.02	0.00	0.00	0.00	0.	0.									
13.000	0.000	0.000	0.0000	214.34	1.89	0.27	0.00	0.00	0.00	0.	0.									
14.000	0.000	0.000	0.0000	207.74	2.19	0.35	0.00	0.00	0.00	0.	0.									
15.000	0.000	0.000	0.0000	202.60	2.42	0.19	0.00	0.00	0.00	0.	0.									
16.000	0.000	0.000	0.0000	198.95	2.45	0.02	0.00	0.00	0.00	0.	0.									
17.000	0.000	0.000	0.0000	197.51	2.66	-0.10	0.00	0.00	0.00	0.	0.									
18.000	0.000	0.000	0.0000	199.15	2.85	-0.16	0.00	0.00	0.00	0.	0.									
19.000	0.000	0.000	0.0000	203.90	2.69	-0.38	0.00	0.00	0.00	0.	0.									
20.000	0.000	0.000	0.0000	208.66	2.02	-0.20	0.00	0.00	0.00	0.	0.									
21.000	0.000	0.000	0.0000	212.08	1.75	-0.03	0.00	0.00	0.00	0.	0.									
22.000	0.000	0.000	0.0000	214.98	1.87	0.01	0.00	0.00	0.00	0.	0.									
23.000	0.000	0.000	0.0000	217.80	1.82	0.01	0.00	0.00	0.00	0.	0.									
24.000	0.000	0.000	0.0000	220.42	1.82	-0.11	0.00	0.00	0.00	0.	0.									
25.000	0.000	0.000	0.0000	222.76	1.83	0.06	0.00	0.00	0.00	0.	0.									
26.000	0.000	0.000	0.0000	225.04	1.78	0.05	0.00	0.00	0.00	0.	0.									
27.000	0.000	0.000	0.0000	227.13	1.82	0.12	0.00	0.00	0.00	0.	0.									
28.000	0.000	0.000	0.0000	229.07	1.98	0.09	0.00	0.00	0.00	0.	0.									
29.000	0.000	0.000	0.0000	230.80	2.12	-0.31	0.00	0.00	0.00	0.	0.									
30.000	0.000	0.000	0.0000	232.40	2.15	-0.20	0.00	0.00	0.00	0.	0.									

TABLE C-6. June Moisture-Related Data, Wake Island.

Z KM	VP MEAN MB	S.D. VP MB	SKEW VP	TV MEAN		TV S.D.		SKEW TV		TD MEAN		S.D. TD		SKEW TD		NOBS VP	NOBS TV	NOBS TD
				K	K	K	K	K	K	K	K	K	K					
0.000	28.271	2.028	-0.1103	303.84	3.00	-5.95	296.21	1.19	-0.30	793.	804.	793.						
0.005	28.210	2.037	-0.0878	304.09	1.45	0.25	296.19	1.20	-0.29	802.	804.	802.						
1.000	17.997	2.526	-0.7930	295.04	0.85	-0.37	288.88	2.33	-1.26	798.	798.	797.						
2.000	10.275	3.561	-0.5851	289.05	0.97	0.00	279.44	6.56	-1.45	801.	801.	801.						
3.000	4.572	2.840	0.5794	284.06	1.18	0.11	266.72	8.89	-0.07	806.	806.	806.						
4.000	2.369	1.789	1.2025	278.49	1.43	0.04	257.94	8.72	0.45	808.	808.	808.						
5.000	1.281	1.135	1.6680	272.76	1.61	-0.07	250.27	8.53	0.82	808.	808.	808.						
6.000	0.810	0.776	1.4626	266.72	1.67	-0.30	244.39	9.28	0.71	804.	804.	804.						
7.000	0.421	0.419	1.6260	260.21	1.74	-0.57	237.47	8.76	0.76	802.	802.	802.						
8.000	0.206	0.227	1.7813	253.15	1.82	-0.66	229.86	8.79	0.87	793.	793.	793.						
9.000	0.098	0.119	1.8420	245.58	1.85	-0.75	222.40	8.96	0.89	790.	790.	790.						
10.000	0.045	0.057	1.6710	237.92	1.59	-0.02	214.76	9.39	0.84	698.	698.	698.						
11.000	0.041	0.038	0.3186	233.77	0.53	1.11	214.57	10.74	-0.08	13.	13.	13.						
12.000	0.000	0.000	0.0000	221.72	1.62	-0.13	0.00	0.00	0.00	0.	0.	0.						
13.000	0.000	0.000	0.0000	214.16	1.79	0.08	0.00	0.00	0.00	0.	0.	0.						
14.000	0.000	0.000	0.0000	207.22	2.21	0.55	0.00	0.00	0.00	0.	0.	0.						
15.000	0.000	0.000	0.0000	201.93	2.72	0.61	0.00	0.00	0.00	0.	0.	0.						
16.000	0.000	0.000	0.0000	199.10	2.92	0.61	0.00	0.00	0.00	0.	0.	0.						
17.000	0.000	0.000	0.0000	199.75	2.64	-0.02	0.00	0.00	0.00	0.	0.	0.						
18.000	0.000	0.000	0.0000	202.62	2.18	0.09	0.00	0.00	0.00	0.	0.	0.						
19.000	0.000	0.000	0.0000	206.19	1.95	0.00	0.00	0.00	0.00	0.	0.	0.						
20.000	0.000	0.000	0.0000	209.60	1.71	-0.13	0.00	0.00	0.00	0.	0.	0.						
21.000	0.000	0.000	0.0000	212.77	1.70	0.14	0.00	0.00	0.00	0.	0.	0.						
22.000	0.000	0.000	0.0000	215.41	1.83	0.24	0.00	0.00	0.00	0.	0.	0.						
23.000	0.000	0.000	0.0000	217.91	1.83	0.11	0.00	0.00	0.00	0.	0.	0.						
24.000	0.000	0.000	0.0000	220.41	1.88	-0.05	0.00	0.00	0.00	0.	0.	0.						
25.000	0.000	0.000	0.0000	222.66	1.87	0.21	0.00	0.00	0.00	0.	0.	0.						
26.000	0.000	0.000	0.0000	224.79	1.85	0.26	0.00	0.00	0.00	0.	0.	0.						
27.000	0.000	0.000	0.0000	226.66	1.90	0.31	0.00	0.00	0.00	0.	0.	0.						
28.000	0.000	0.000	0.0000	228.30	1.95	0.00	0.00	0.00	0.00	0.	0.	0.						
29.000	0.000	0.000	0.0000	229.92	2.06	0.02	0.00	0.00	0.00	0.	0.	0.						
30.000	0.000	0.000	0.0000	231.34	2.14	0.03	0.00	0.00	0.00	0.	0.	0.						

TABLE C-7. July Moisture-Related Data, Wake Island

Z	VP MEAN	S.D. VP	TV MEAN	TV S.D.	SKREW TV	TD MEAN	S.D. TD	NOBS	NOBS	NOBS	NOBS
KM	MB	MB	K	K	K	K	K	VP	TV	VP	TD
0.000	29.642	2.000	304.88	1.56	-0.01	296.99	1.14	840.	844.	840.	840.
0.005	29.570	1.997	304.84	1.56	0.00	296.98	1.14	845.	849.	845.	845.
1.000	19.224	2.301	295.83	0.84	0.08	289.93	1.98	848.	848.	848.	848.
2.000	11.805	2.825	289.55	1.01	0.10	282.08	4.40	846.	846.	846.	846.
3.000	6.364	2.637	284.15	1.16	-0.36	272.30	7.19	845.	845.	845.	845.
4.000	3.430	1.932	278.31	1.22	0.16	263.22	8.50	844.	844.	844.	844.
5.000	2.064	1.388	272.33	1.32	0.10	256.25	9.13	847.	847.	847.	847.
6.000	1.224	0.953	266.34	1.52	0.03	249.23	10.06	841.	841.	841.	841.
7.000	0.680	0.584	260.00	1.67	-0.04	242.19	10.24	841.	841.	841.	841.
8.000	0.342	0.322	253.14	1.78	-0.08	234.42	10.45	840.	840.	840.	840.
9.000	0.155	0.157	245.76	1.86	-0.20	226.29	10.35	838.	838.	838.	838.
10.000	0.068	0.070	238.10	1.74	-0.02	218.49	10.54	752.	752.	752.	752.
11.000	0.029	0.031	233.49	1.39	-3.63	211.69	10.02	20.	20.	20.	20.
12.000	0.000	0.000	221.64	1.81	-0.14	0.00	0.00	0.	0.	0.	0.
13.000	0.000	0.000	213.77	1.83	0.19	0.00	0.00	0.	0.	0.	0.
14.000	0.000	0.000	206.67	2.09	0.50	0.00	0.00	0.	0.	0.	0.
15.000	0.000	0.000	201.92	2.77	0.43	0.00	0.00	0.	0.	0.	0.
16.000	0.000	0.000	200.31	3.38	-0.15	0.00	0.00	0.	0.	0.	0.
17.000	0.000	0.000	201.96	2.47	-0.22	0.00	0.00	0.	0.	0.	0.
18.000	0.000	0.000	204.51	1.84	-0.19	0.00	0.00	0.	0.	0.	0.
19.000	0.000	0.000	207.40	1.68	0.28	0.00	0.00	0.	0.	0.	0.
20.000	0.000	0.000	210.25	1.50	0.15	0.00	0.00	0.	0.	0.	0.
21.000	0.000	0.000	212.99	1.62	0.10	0.00	0.00	0.	0.	0.	0.
22.000	0.000	0.000	215.46	1.70	0.01	0.00	0.00	0.	0.	0.	0.
23.000	0.000	0.000	217.83	1.74	0.04	0.00	0.00	0.	0.	0.	0.
24.000	0.000	0.000	220.07	1.96	-0.02	0.00	0.00	0.	0.	0.	0.
25.000	0.000	0.000	222.10	1.99	0.17	0.00	0.00	0.	0.	0.	0.
26.000	0.000	0.000	224.15	2.07	0.19	0.00	0.00	0.	0.	0.	0.
27.000	0.000	0.000	225.72	2.08	-0.07	0.00	0.00	0.	0.	0.	0.
28.000	0.000	0.000	227.22	2.11	-0.13	0.00	0.00	0.	0.	0.	0.
29.000	0.000	0.000	228.77	2.21	-0.04	0.00	0.00	0.	0.	0.	0.
30.000	0.000	0.000	230.12	2.45	-0.09	0.00	0.00	0.	0.	0.	0.

TABLE C-8. August Moisture-Related Data, Wake Island.

Z KM	VP MEAN MB	S.D. VP MB	SKREW VP	TV MEAN K	TV S.D. K	SKREW TV K	TD MEAN K	S.D. TD K	SKREW TD	NOBS VP	NOBS TV	NOBS TD
0.000	30.103	2.227	-0.0817	304.83	1.55	-0.27	297.24	1.24	-0.35	840.	840.	840.
0.005	30.045	2.218	-0.0800	304.79	1.55	-0.27	297.24	1.24	-0.34	845.	845.	845.
1.000	19.673	2.351	-0.6811	296.17	0.88	0.41	290.33	1.92	-0.91	841.	842.	839.
2.000	12.528	2.543	-1.0322	289.99	1.06	0.40	283.20	3.45	-1.82	840.	840.	837.
3.000	7.118	2.539	-0.4037	284.52	1.19	0.47	274.19	6.37	-1.39	837.	837.	837.
4.000	4.121	2.094	0.1401	278.59	1.24	0.16	265.93	8.02	-0.65	841.	841.	841.
5.000	2.485	1.586	0.4533	272.60	1.33	0.05	258.57	9.33	-0.36	837.	837.	837.
6.000	1.493	1.089	0.5917	266.58	1.53	0.09	251.68	10.23	-0.27	833.	834.	834.
7.000	0.813	0.651	0.7635	260.25	1.68	0.03	244.35	10.29	-0.14	830.	830.	830.
8.000	0.415	0.369	0.8700	253.50	1.90	0.12	236.46	10.76	-0.04	829.	829.	829.
9.000	0.196	0.180	0.8844	246.15	2.04	0.08	228.77	10.63	-0.06	829.	829.	829.
10.000	0.089	0.082	0.8003	238.47	2.01	0.36	221.10	10.83	-0.15	766.	766.	766.
11.000	0.073	0.038	-0.4783	234.41	0.90	0.78	222.05	8.25	-1.47	60.	60.	60.
12.000	0.000	0.000	0.0000	221.96	1.93	0.32	0.00	0.00	0.00	0.	0.	0.
13.000	0.000	0.000	0.0000	214.01	1.89	0.29	0.00	0.00	0.00	0.	0.	0.
14.000	0.000	0.000	0.0000	206.81	2.10	0.53	0.50	0.00	0.00	0.	0.	0.
15.000	0.000	0.000	0.0000	201.94	2.71	0.56	0.00	0.00	0.00	0.	0.	0.
16.000	0.000	0.000	0.0000	200.55	3.49	-0.23	0.00	0.00	0.00	0.	0.	0.
17.000	0.000	0.000	0.0000	202.35	2.74	-0.69	0.00	0.00	0.00	0.	0.	0.
18.000	0.000	0.000	0.0000	204.66	2.11	-0.22	0.00	0.00	0.00	0.	0.	0.
19.000	0.000	0.000	0.0000	207.49	1.78	0.14	0.00	0.00	0.00	0.	0.	0.
20.000	0.000	0.000	0.0000	210.10	1.75	-0.19	0.00	0.00	0.00	0.	0.	0.
21.000	0.000	0.000	0.0000	212.68	1.69	-0.11	0.00	0.00	0.00	0.	0.	0.
22.000	0.000	0.000	0.0000	214.91	1.73	0.00	0.00	0.00	0.00	0.	0.	0.
23.000	0.000	0.000	0.0000	217.10	1.80	0.04	0.00	0.50	0.00	0.	0.	0.
24.000	0.000	0.000	0.0000	219.32	1.97	-0.05	0.00	0.00	0.00	0.	0.	0.
25.000	0.000	0.000	0.0000	221.29	2.01	0.19	0.00	0.00	0.00	0.	0.	0.
26.000	0.000	0.000	0.0000	223.15	2.10	0.17	0.00	0.00	0.00	0.	0.	0.
27.000	0.000	0.000	0.0000	224.86	2.16	0.10	0.00	0.00	0.00	0.	0.	0.
28.000	0.000	0.000	0.0000	226.41	2.27	-0.10	0.00	0.00	0.00	0.	0.	0.
29.000	0.000	0.000	0.0000	227.98	2.32	-0.02	0.00	0.00	0.00	0.	0.	0.
30.000	0.000	0.000	0.0000	229.54	2.49	-0.14	0.00	0.00	0.00	0.	0.	0.

TABLE C-9. September Moisture-Related Data, Wake Island.

Z KM	VP MEAN MB	S.D. VP MB	SKEW VP	TV MEAN K	TV S.D. K	SKEW TV K	TD MEAN K	S.D. TD K	SKEW TD	NOBS VP	NOBS TV	NOBS TD
0.000	30.592	2.254	0.0021	305.25	1.54	-1.29	297.51	1.24	-0.22	802.	805.	802.
0.005	30.534	2.245	0.0015	305.22	1.52	-1.25	297.51	1.24	-0.23	804.	807.	804.
1.000	19.583	2.587	-0.6950	296.36	0.85	-0.25	290.22	2.19	-1.21	804.	804.	803.
2.000	12.307	2.631	-0.8559	290.10	1.01	0.10	282.85	3.75	-1.86	804.	804.	803.
3.000	6.658	2.396	-0.2643	284.67	1.13	-0.14	273.32	6.06	-1.11	804.	804.	804.
4.000	3.611	1.908	0.2945	278.73	1.17	-0.17	264.17	7.96	-0.50	804.	804.	804.
5.000	2.008	1.408	0.7987	272.62	1.29	-0.22	255.86	9.08	-0.03	804.	804.	804.
6.000	1.090	0.921	1.0009	266.61	1.41	-0.10	247.74	9.93	0.20	802.	802.	802.
7.000	0.570	0.535	1.2421	260.19	1.54	-0.25	240.30	9.75	0.37	799.	799.	799.
8.000	0.313	0.318	1.1966	253.28	1.65	-0.38	233.31	10.34	0.38	793.	793.	793.
9.000	0.149	0.158	1.2597	245.87	1.76	-0.36	225.81	10.29	0.35	790.	790.	790.
10.000	0.070	0.072	1.0546	238.27	1.66	0.03	218.80	10.36	0.17	727.	727.	727.
11.000	0.056	0.046	0.4749	233.91	0.75	1.45	217.94	10.44	-0.52	27.	27.	27.
12.000	0.000	0.000	0.0000	222.06	1.66	0.19	0.00	0.00	0.00	0.	0.	0.
13.000	0.000	0.000	0.0000	214.34	1.65	0.29	0.00	0.00	0.00	0.	0.	0.
14.000	0.000	0.000	0.0000	207.25	1.96	0.11	0.00	0.00	0.00	0.	0.	0.
15.000	0.000	0.000	0.0000	202.01	2.37	0.22	0.00	0.00	0.00	0.	0.	0.
16.000	0.000	0.000	0.0000	199.03	2.71	0.11	0.00	0.00	0.00	0.	0.	0.
17.000	0.000	0.000	0.0000	199.64	2.81	0.01	0.00	0.00	0.00	0.	0.	0.
18.000	0.000	0.000	0.0000	202.58	2.31	-0.22	0.00	0.00	0.00	0.	0.	0.
19.000	0.000	0.000	0.0000	206.19	1.92	0.10	0.00	0.00	0.00	0.	0.	0.
20.000	0.000	0.000	0.0000	209.32	1.78	0.12	0.00	0.00	0.00	0.	0.	0.
21.000	0.000	0.000	0.0000	212.13	1.69	0.01	0.00	0.00	0.00	0.	0.	0.
22.000	0.000	0.000	0.0000	214.54	1.81	0.15	0.00	0.00	0.00	0.	0.	0.
23.000	0.000	0.000	0.0000	216.86	1.94	0.30	0.00	0.00	0.00	0.	0.	0.
24.000	0.000	0.000	0.0000	219.17	2.19	0.34	0.00	0.00	0.00	0.	0.	0.
25.000	0.000	0.000	0.0000	221.02	2.07	0.36	0.00	0.00	0.00	0.	0.	0.
26.000	0.000	0.000	0.0000	222.92	2.10	0.31	0.00	0.00	0.00	0.	0.	0.
27.000	0.000	0.000	0.0000	224.88	2.10	0.49	0.00	0.00	0.00	0.	0.	0.
28.000	0.000	0.000	0.0000	226.62	2.35	0.44	0.00	0.00	0.00	0.	0.	0.
29.000	0.000	0.000	0.0000	228.32	2.45	0.21	0.00	0.00	0.00	0.	0.	0.
30.000	0.000	0.000	0.0000	229.80	2.59	0.11	0.00	0.00	0.00	0.	0.	0.

TABLE C-10. October Moisture-Related Data, Wake Island.

Z KM	VP MEAN		S.D. VP		TV MEAN		TV S.D.		SKEW TV		TD MEAN		S.D. TD		SKEW TD		NOBS		NOBS	
	MB	MB	MB	MB	K	K	K	K	K	K	K	K	K	K	K	K	VP	TV	VP	TV
0.000	29.343	2.416	-0.2501	304.91	1.47	-0.11	297.15	1.37	-0.53	831.	831.									
0.005	29.379	2.407	-0.2539	304.88	1.45	0.01	297.14	1.37	-0.54	834.	834.									
1.000	19.226	2.905	-1.3856	295.88	1.00	-0.88	290.00	2.26	-1.10	832.	825.									
2.000	11.152	3.595	-0.6553	289.87	1.21	-0.71	280.78	6.13	-1.57	831.	831.									
3.000	5.496	3.043	0.1978	284.64	1.26	-0.30	269.41	8.83	-0.41	830.	830.									
4.000	2.348	2.014	0.7812	278.95	1.34	-0.1	260.16	9.20	0.15	830.	830.									
5.000	1.581	1.377	1.2812	273.13	1.54	-0.20	252.34	9.40	0.57	830.	830.									
6.000	0.913	0.891	1.4670	266.87	1.62	-0.31	245.48	9.66	0.66	826.	826.									
7.000	0.493	0.527	1.6628	260.20	1.68	-0.25	238.44	9.63	0.74	823.	823.									
8.000	0.287	0.307	1.4260	253.06	1.88	-0.11	232.38	10.19	0.49	820.	820.									
9.000	0.157	0.164	1.1757	245.56	1.99	-0.10	226.17	10.64	0.25	816.	816.									
10.000	0.072	0.073	1.0297	238.06	1.85	0.07	218.90	10.67	0.10	736.	736.									
11.000	0.049	0.039	0.1391	233.71	0.91	-2.59	216.63	10.18	-0.40	29.	29.									
12.000	0.000	0.000	0.0000	222.31	1.83	-0.26	0.00	0.00	0.00	0.	0.									
13.000	0.000	0.000	0.0000	214.91	1.80	0.08	0.00	0.00	0.00	0.	0.									
14.000	0.000	0.000	0.0000	208.07	1.88	0.19	0.00	0.00	0.00	0.	0.									
15.000	0.000	0.000	0.0000	202.46	1.99	0.38	0.00	0.00	0.00	0.	0.									
16.000	0.000	0.000	0.0000	197.96	2.21	0.11	0.00	0.00	0.00	0.	0.									
17.000	0.000	0.000	0.0000	196.35	2.73	0.43	0.00	0.00	0.00	0.	0.									
18.000	0.000	0.000	0.0000	199.03	3.15	0.13	0.00	0.00	0.00	0.	0.									
19.000	0.000	0.000	0.0000	203.94	2.43	0.01	0.00	0.00	0.00	0.	0.									
20.000	0.000	0.000	0.0000	208.02	2.11	-0.13	0.00	0.00	0.00	0.	0.									
21.000	0.000	0.000	0.0000	211.43	1.90	0.03	0.00	0.00	0.00	0.	0.									
22.000	0.000	0.000	0.0000	214.32	2.07	0.15	0.00	0.00	0.00	0.	0.									
23.000	0.000	0.000	0.0000	216.86	2.08	-0.06	0.00	0.00	0.00	0.	0.									
24.000	0.000	0.000	0.0000	219.16	2.13	-0.01	0.00	0.00	0.00	0.	0.									
25.000	0.000	0.000	0.0000	221.18	2.09	-0.18	0.00	0.00	0.00	0.	0.									
26.000	0.000	0.000	0.0000	223.20	2.22	-0.29	0.00	0.00	0.00	0.	0.									
27.000	0.000	0.000	0.0000	225.34	2.18	-0.21	0.00	0.00	0.00	0.	0.									
28.000	0.000	0.000	0.0000	227.18	2.37	-0.09	0.00	0.00	0.00	0.	0.									
29.000	0.000	0.000	0.0000	228.94	2.42	-0.06	0.00	0.00	0.00	0.	0.									
30.000	0.000	0.000	0.0000	230.66	2.56	-0.04	0.00	0.00	0.00	0.	0.									

TABLE C-11. November Moisture-Related Data, Wake Island.

Z KM	VP MEAN		S.D. VP		TV MEAN		TV S.D.		SKEW VP		SKEW TV		TD MEAN		S.D. TD		SKEW TD		NOBS		NOBS		NOBS		
	MB	K	MB	K	K	K	K	K	K	K	K	K	K	K	K	K	K	K	VP	TV	VP	TV	VP	TV	TD
0.000	27.870		2.880		303.59		1.50		-0.60		295.94		1.76		-0.83		818.		818.		818.		818.		818.
0.005	27.800		2.889		303.56		1.50		-0.60		295.91		1.78		-0.82		823.		823.		823.		823.		823.
1.000	18.311		2.898		294.77		1.29		-0.49		289.08		2.74		-1.47		922.		922.		922.		922.		922.
2.000	9.271		4.555		289.52		1.55		-0.73		276.92		8.92		-0.73		821.		821.		821.		821.		821.
3.000	4.229		2.964		284.94		1.54		-0.35		265.29		9.29		0.26		820.		820.		820.		820.		820.
4.000	2.289		1.861		279.40		1.68		-0.29		257.33		8.78		0.71		819.		819.		819.		819.		819.
5.000	1.221		1.142		273.55		1.74		-0.51		249.64		8.25		1.11		819.		819.		819.		819.		819.
6.000	0.680		0.718		267.29		1.76		-0.48		242.83		8.30		1.19		814.		814.		814.		814.		814.
7.000	0.374		0.438		260.60		1.76		-0.61		236.15		8.35		1.26		811.		811.		811.		811.		811.
8.000	0.199		0.240		253.45		1.76		-0.44		229.35		8.72		1.09		805.		805.		805.		805.		805.
9.000	0.095		0.115		245.98		1.76		-0.32		222.33		8.71		0.90		805.		805.		805.		805.		805.
10.000	0.045		0.054		238.41		1.67		-0.06		215.11		9.18		0.74		751.		751.		751.		751.		751.
11.000	0.025		0.020		233.89		0.61		0.92		207.37		7.13		1.60		46.		46.		46.		46.		46.
12.000	0.000		0.000		223.16		1.66		-0.41		0.00		0.00		0.00		0.		0.		0.		0.		0.
13.000	0.000		0.000		215.76		1.63		-0.37		0.00		0.00		0.00		0.		0.		0.		0.		0.
14.000	0.000		0.000		208.68		1.54		-0.24		0.00		0.00		0.00		0.		0.		0.		0.		0.
15.000	0.000		0.000		202.44		1.71		0.03		0.00		0.00		0.00		0.		0.		0.		0.		0.
16.000	0.000		0.000		197.14		2.01		0.35		0.00		0.00		0.00		0.		0.		0.		0.		0.
17.000	0.000		0.000		194.08		2.33		0.32		0.00		0.00		0.00		0.		0.		0.		0.		0.
18.000	0.000		0.000		195.10		2.82		0.47		0.00		0.00		0.00		0.		0.		0.		0.		0.
19.000	0.000		0.000		200.13		3.05		0.07		0.00		0.00		0.00		0.		0.		0.		0.		0.
20.000	0.000		0.000		206.02		2.57		-0.07		0.00		0.00		0.00		0.		0.		0.		0.		0.
21.000	0.000		0.000		210.47		2.15		0.29		0.00		0.00		0.00		0.		0.		0.		0.		0.
22.000	0.000		0.000		213.62		2.30		0.27		0.00		0.00		0.00		0.		0.		0.		0.		0.
23.000	0.000		0.000		216.45		2.42		0.03		0.00		0.00		0.00		0.		0.		0.		0.		0.
24.000	0.000		0.000		218.87		2.39		-0.10		0.00		0.00		0.00		0.		0.		0.		0.		0.
25.000	0.000		0.000		220.91		2.47		-0.21		0.00		0.00		0.00		0.		0.		0.		0.		0.
26.000	0.000		0.000		222.87		2.53		-0.15		0.00		0.00		0.00		0.		0.		0.		0.		0.
27.000	0.000		0.000		224.83		2.67		-0.19		0.00		0.00		0.00		0.		0.		0.		0.		0.
28.000	0.000		0.000		226.51		2.83		-0.35		0.00		0.00		0.00		0.		0.		0.		0.		0.
29.000	0.000		0.000		228.16		3.00		-0.28		0.00		0.00		0.00		0.		0.		0.		0.		0.
30.000	0.000		0.000		229.83		3.21		-0.43		0.00		0.00		0.00		0.		0.		0.		0.		0.

TABLE C-12. December Moisture-Related Data, Wake Island.

Z KM	VP MB	VP MEAN	S.D. VP MB	SKEW VP	TV MEAN K	TV S.D. K	SKEW TV K	TD MEAN K	S.D. TD K	SKEW TD	NOBS VP	NOBS TV	NOBS TD
0.000	25.159	3.861	-1.6218	302.30	1.50	-0.16	294.35	2.23	-0.88	856.	851.	848.	
0.005	25.262	3.373	-0.6347	302.28	1.46	0.06	294.30	2.24	-0.87	854.	856.	853.	
1.000	16.536	2.868	-0.6842	293.28	1.43	-0.25	287.52	2.82	-1.27	855.	855.	852.	
2.000	7.434	4.363	0.3033	288.57	2.18	-0.62	273.33	9.35	-0.23	850.	850.	850.	
3.000	2.871	2.324	1.8886	284.86	1.92	-0.79	260.63	7.91	1.14	852.	852.	852.	
4.000	1.492	1.257	2.8955	279.62	1.94	-1.01	253.15	6.54	1.71	851.	851.	851.	
5.000	0.848	0.741	3.0787	273.68	1.98	-1.16	246.73	6.30	1.77	849.	850.	850.	
6.000	0.454	0.399	3.1109	267.45	1.88	-1.24	240.23	6.25	1.85	844.	850.	850.	
7.000	0.259	0.256	2.9514	260.75	1.87	-1.49	233.92	6.39	1.62	848.	849.	849.	
8.000	0.125	0.124	2.5474	253.71	1.91	-1.13	226.98	6.41	1.58	837.	842.	842.	
9.000	0.060	0.068	2.4927	246.46	1.80	-0.78	219.84	6.57	1.51	839.	840.	840.	
10.000	0.027	0.033	2.1099	238.97	1.67	-0.34	212.57	6.88	1.43	794.	795.	795.	
11.000	0.022	0.024	0.9649	233.90	0.62	1.57	209.94	8.57	0.72	71.	71.	71.	
12.000	0.000	0.000	0.0000	223.61	1.58	-0.52	0.00	0.00	0.00	0.	0.	0.	
13.000	0.000	0.000	0.0000	216.09	1.54	0.00	0.00	0.00	0.00	0.	0.	0.	
14.000	0.000	0.000	0.0000	208.71	1.66	0.62	0.00	0.00	0.00	0.	0.	0.	
15.000	0.000	0.000	0.0000	201.92	1.82	0.73	0.00	0.00	0.00	0.	0.	0.	
16.000	0.000	0.000	0.0000	196.03	2.09	0.62	0.00	0.00	0.00	0.	0.	0.	
17.000	0.000	0.000	0.0000	192.34	2.47	0.47	0.00	0.00	0.00	0.	0.	0.	
18.000	0.000	0.000	0.0000	192.89	2.64	0.38	0.00	0.00	0.00	0.	0.	0.	
19.000	0.000	0.000	0.0000	198.24	2.87	0.14	0.00	0.00	0.00	0.	0.	0.	
20.000	0.000	0.000	0.0000	204.92	2.54	-0.13	0.00	0.00	0.00	0.	0.	0.	
21.000	0.000	0.000	0.0000	209.85	2.22	-0.34	0.00	0.00	0.00	0.	0.	0.	
22.000	0.000	0.000	0.0000	213.31	2.30	0.04	0.00	0.00	0.00	0.	0.	0.	
23.000	0.000	0.000	0.0000	216.10	2.40	-0.29	0.00	0.00	0.00	0.	0.	0.	
24.000	0.000	0.000	0.0000	218.60	2.58	-0.24	0.00	0.00	0.00	0.	0.	0.	
25.000	0.000	0.000	0.0000	220.54	2.69	-0.19	0.00	0.00	0.00	0.	0.	0.	
26.000	0.000	0.000	0.0000	222.17	2.92	-0.28	0.00	0.00	0.00	0.	0.	0.	
27.000	0.000	0.000	0.0000	223.74	3.01	-0.38	0.00	0.00	0.00	0.	0.	0.	
28.000	0.000	0.000	0.0000	225.29	3.16	-0.29	0.00	0.00	0.00	0.	0.	0.	
29.000	0.000	0.000	0.0000	226.74	3.32	-0.28	0.00	0.00	0.00	0.	0.	0.	
30.000	0.000	0.000	0.0000	228.41	3.50	-0.25	0.00	0.00	0.00	0.	0.	0.	

TABLE C-13. Annual Moisture-Related Data, Wake Island.

Z KM	VP MEAN MB	S.D. VP MB	SKEW VP	TV MEAN K	TV S.D. K	SKEW TV K	TD MEAN K	S.D. TD K	SKEW TD	NOBS VP	NOBS TV	NOBS TD
0.000	27.096	3.786	-0.7639	303.18	2.41	-1.90	295.43	2.36	-0.98	9904.	9928.	9888.
0.005	27.053	3.723	-0.6140	303.19	2.16	-0.17	295.41	2.37	-0.98	9948.	9962.	9941.
1.000	17.536	3.121	-0.5967	294.23	1.99	-0.51	288.40	2.95	-1.16	9927.	9928.	9903.
2.000	9.555	4.178	-0.4079	288.62	1.95	-0.79	277.68	8.39	-1.09	9924.	9924.	9920.
3.000	4.456	3.039	0.5612	284.03	1.68	-0.36	265.83	9.76	0.03	9924.	9924.	9924.
4.000	2.341	1.909	1.1992	278.63	1.71	-0.26	257.38	9.24	0.55	9928.	9928.	9928.
5.000	1.314	1.241	1.6756	272.78	1.80	-0.28	250.19	9.06	0.85	9913.	9931.	9931.
6.000	0.752	0.795	1.8589	266.64	1.88	-0.41	243.43	9.25	0.94	9877.	9901.	9901.
7.000	0.405	0.461	2.0450	260.11	1.96	-0.53	236.67	9.08	1.00	9836.	9870.	9870.
8.000	0.211	0.258	2.0569	253.19	2.08	-0.54	229.70	9.22	0.97	9791.	9820.	9820.
9.000	0.102	0.129	1.9859	245.86	2.13	-0.50	222.54	9.26	0.89	9773.	9794.	9794.
10.000	0.048	0.060	1.7288	238.46	1.91	-0.10	215.37	9.47	0.77	8893.	8903.	8903.
11.000	0.030	0.033	1.2490	234.00	0.81	0.08	211.97	9.43	0.45	562.	563.	563.
12.000	0.000	0.000	0.0000	222.74	1.99	-0.23	0.00	0.00	0.00	0.	0.	0.
13.000	0.000	0.000	0.0000	215.18	1.97	-0.14	0.00	0.00	0.00	0.	0.	0.
14.000	0.000	0.000	0.0000	208.04	2.05	-0.01	0.00	0.00	0.00	0.	0.	0.
15.000	0.000	0.000	0.0000	202.17	2.22	0.41	0.00	0.00	0.00	0.	0.	0.
16.000	0.000	0.000	0.0000	197.91	3.05	0.56	0.00	0.00	0.00	0.	0.	0.
17.000	0.000	0.000	0.0000	196.35	4.53	0.22	0.00	0.00	0.00	0.	0.	0.
18.000	0.000	0.000	0.0000	197.96	5.24	0.04	0.00	0.00	0.00	0.	0.	0.
19.000	0.000	0.000	0.0000	202.42	4.44	-0.17	0.00	0.00	0.00	0.	0.	0.
20.000	0.000	0.000	0.0000	207.19	3.20	-0.38	0.00	0.00	0.00	0.	0.	0.
21.000	0.000	0.000	0.0000	210.95	2.56	-0.36	0.00	0.00	0.00	0.	0.	0.
22.000	0.000	0.000	0.0000	213.85	2.47	-0.30	0.00	0.00	0.00	0.	0.	0.
23.000	0.000	0.000	0.0000	216.46	2.47	-0.36	0.00	0.00	0.00	0.	0.	0.
24.000	0.000	0.000	0.0000	218.91	2.50	-0.27	0.00	0.00	0.00	0.	0.	0.
25.000	0.000	0.000	0.0000	221.02	2.51	-0.20	0.00	0.00	0.00	0.	0.	0.
26.000	0.000	0.000	0.0000	223.08	2.58	-0.23	0.00	0.00	0.00	0.	0.	0.
27.000	0.000	0.000	0.0000	225.01	2.67	-0.23	0.00	0.00	0.00	0.	0.	0.
28.000	0.000	0.000	0.0000	226.77	2.83	-0.23	0.00	0.00	0.00	0.	0.	0.
29.000	0.000	0.000	0.0000	228.47	2.99	-0.26	0.00	0.00	0.00	0.	0.	0.
30.000	0.000	0.000	0.0000	230.08	3.12	-0.30	0.00	0.00	0.00	0.	0.	0.

APPENDIX D

Wake Island Hydrostatic Model Atmospheres

Tables D-1 through D-13 provide hydrostatic model atmospheres (monthly and annual) from 0 to 30 km over Wake Island. They were prepared as described in Chapter 3.

TABLE D-1. January Hydrostatic Model Atmosphere, Wake Island.

Z KM	GEO. HT KM	PRESS MB	D G/M ³	TV K
0.000	0.000	1015.4004	1174.5248	301.18
0.005	0.005	1014.8351	1173.9717	301.16
1.000	0.998	904.4898	1078.5807	292.15
2.000	1.996	803.9629	973.7695	287.63
3.000	2.994	713.5116	874.7305	284.17
4.000	3.992	631.7186	788.3164	279.18
5.000	4.989	558.1832	711.3581	273.37
6.000	5.987	492.4146	642.0497	267.19
7.000	6.985	432.4298	577.5778	260.83
8.000	7.983	378.7296	518.9009	254.27
9.000	8.981	330.3321	465.6330	247.15
10.000	9.979	287.3952	417.5467	239.79
11.000	10.977	248.7780	370.1531	234.15
12.000	11.975	213.9640	332.2477	224.36
13.000	12.973	183.1760	294.6581	216.57
14.000	13.970	156.1243	260.3766	208.89
15.000	14.968	132.0321	227.9733	201.77
16.000	15.966	111.2140	198.1988	195.49
17.000	16.964	93.3576	169.8869	191.45
18.000	17.962	78.1279	141.7472	192.02
19.000	18.960	65.6157	115.4930	197.93
20.000	19.958	55.3836	94.3483	204.51
21.000	20.956	46.9423	78.2349	209.04
22.000	21.953	39.9420	65.5705	212.22
23.000	22.951	34.0249	55.1864	214.79
24.000	23.949	29.0237	46.5947	217.01
25.000	24.947	24.0282	39.5011	216.97
26.000	25.945	21.2491	33.5073	220.93
27.000	26.943	18.2276	28.5196	222.66
28.000	27.941	15.6481	24.3057	224.29
29.000	28.939	13.4475	20.7421	225.86
30.000	29.937	11.5563	17.6983	227.48

TABLE D-2. February Hydrostatic Model Atmosphere, Wake Island.

Z KM	GEO. HT KM	PRESS MB	D G/M ³	TV K
0.000	0.000	1015.9608	1176.0269	300.97
0.005	0.005	1015.4838	1175.6148	300.93
1.000	0.998	904.9863	1079.9892	291.93
2.000	1.996	804.2647	976.9709	286.80
3.000	2.994	713.5261	877.3538	283.33
4.000	3.992	631.5524	790.1939	278.44
5.000	4.989	557.8848	712.7295	272.70
6.000	5.987	491.9446	642.8679	266.60
7.000	6.985	431.8952	578.1849	260.24
8.000	7.983	378.1445	519.4658	253.61
9.000	8.981	329.7337	465.8268	246.60
10.000	9.979	286.7727	417.0195	239.57
11.000	10.977	248.1652	369.2719	234.13
12.000	11.975	213.4159	331.6849	224.16
13.000	12.973	182.6745	294.1332	216.37
14.000	13.970	155.6848	259.8905	208.70
15.000	14.968	131.6463	227.4383	201.65
16.000	15.966	110.9050	197.5420	195.59
17.000	16.964	93.1186	168.7315	192.26
18.000	17.962	78.0001	140.6510	193.20
19.000	18.960	65.5386	115.1648	198.26
20.000	19.958	55.3150	94.3935	204.15
21.000	20.956	46.8756	78.3834	208.34
22.000	21.953	39.8639	65.6834	211.44
23.000	22.951	33.9386	55.2094	214.16
24.000	23.949	28.9450	46.5184	216.77
25.000	24.947	24.7565	39.3922	218.95
26.000	25.945	21.1892	33.3803	221.15
27.000	26.943	18.1739	28.3618	223.24
28.000	27.941	15.6131	24.1698	225.05
29.000	28.939	13.4217	20.6074	226.90
30.000	29.937	11.5461	17.5972	228.59

TABLE D-3. March Hydrostatic Model Atmosphere, Wake Island.

Z KM	GEO. HT KM	PRESS MB	D G/M ³	TV K
0.000	0.000	1016.7306	1174.7270	301.53
0.005	0.005	1016.1643	1174.1808	301.50
1.000	0.998	905.6880	1078.7839	292.48
2.000	1.996	805.0209	977.2863	286.97
3.000	2.994	714.1593	879.6479	282.84
4.000	3.992	631.9139	792.3032	277.86
5.000	4.989	558.0879	713.8826	272.35
6.000	5.987	492.0725	643.7706	266.29
7.000	6.985	431.9150	579.0273	259.87
8.000	7.983	378.0744	520.1681	253.22
9.000	8.981	329.6099	466.2712	246.27
10.000	9.979	286.6132	417.3518	239.25
11.000	10.977	248.0012	369.4458	233.86
12.000	11.975	213.2525	331.6161	224.04
13.000	12.973	182.5216	293.8680	216.38
14.000	13.970	155.5686	259.4952	208.86
15.000	14.968	131.5816	226.7711	202.15
16.000	15.966	110.9032	196.8089	196.32
17.000	16.964	93.1873	168.2901	192.91
18.000	17.962	78.0931	140.4791	193.67
19.000	18.960	65.6370	115.1724	198.54
20.000	19.958	55.4054	94.5009	204.26
21.000	20.956	46.9565	78.3404	208.82
22.000	21.953	39.9437	65.6463	211.98
23.000	22.951	34.0204	55.1725	214.82
24.000	23.949	29.0325	46.4986	217.52
25.000	24.947	24.8473	39.3745	219.85
26.000	25.945	21.2813	33.3799	222.11
27.000	26.943	18.2696	28.3618	224.42
28.000	27.941	15.7063	24.1496	226.58
29.000	28.939	13.5196	20.6011	228.63
30.000	29.937	11.6383	17.5920	230.48

TABLE D-4. April Hydrostatic Model Atmosphere, Wake Island.

Z KM	GEO. HT KM	PRESS MB	D G/M ³	TV K
0.000	0.000	1016.7047	1173.0151	301.96
0.005	0.005	1016.1545	1172.5147	301.92
1.000	0.998	905.8966	1077.6277	292.86
2.000	1.996	805.3210	976.9238	287.19
3.000	2.994	714.4429	880.2673	282.76
4.000	3.992	632.1683	793.1454	277.68
5.000	4.989	558.2197	715.2477	271.90
6.000	5.987	492.0228	645.4722	265.56
7.000	6.985	431.6548	581.3247	258.69
8.000	7.983	377.5608	523.0318	251.49
9.000	8.981	328.7986	469.3410	244.06
10.000	9.979	285.5949	419.4198	237.22
11.000	10.977	246.7139	367.8567	233.65
12.000	11.975	211.9232	332.0829	222.33
13.000	12.973	181.2223	292.9959	215.48
14.000	13.970	154.4294	257.4910	208.94
15.000	14.968	130.6904	224.0552	203.21
16.000	15.966	110.2964	193.6876	198.39
17.000	16.964	92.8525	165.3091	195.68
18.000	17.962	77.9990	138.6204	196.03
19.000	18.960	65.6838	114.0873	200.58
20.000	19.958	55.5420	93.7845	206.32
21.000	20.956	47.1503	77.9932	210.61
22.000	21.953	40.1689	65.4609	213.78
23.000	22.951	34.2627	55.0931	216.66
24.000	23.949	29.2781	46.4923	219.39
25.000	24.947	25.0978	39.4165	221.83
26.000	25.945	21.5257	33.4320	224.31
27.000	26.943	18.5033	28.4422	226.64
28.000	27.941	15.9351	24.2733	228.71
29.000	28.939	13.7330	20.7355	230.73
30.000	29.937	11.8355	17.7296	232.57

TABLE D-5. May Hydrostatic Model Atmosphere, Wake Island.

Z KM	GEO. HT KM	PRESS MB	D G/M ³	TV K
0.000	0.000	1016.0829	1168.9047	302.84
0.005	0.005	1015.5709	1167.4150	303.07
1.000	0.998	905.7350	1073.3367	293.98
2.000	1.996	805.5179	973.7412	288.20
3.000	2.994	714.8810	878.7162	283.43
4.000	3.992	632.7535	792.1389	278.29
5.000	4.989	558.8750	714.6898	272.43
6.000	5.987	492.7188	644.7651	266.23
7.000	6.985	432.4322	580.5897	259.48
8.000	7.983	378.4071	522.3464	252.38
9.000	8.981	329.6749	469.0924	244.84
10.000	9.979	286.4533	420.6323	237.25
11.000	10.977	247.4666	369.5700	233.28
12.000	11.975	212.4798	334.0144	221.62
13.000	12.973	181.6014	295.1685	214.34
14.000	13.970	154.5881	259.2506	207.74
15.000	14.968	130.7789	224.8855	202.60
16.000	15.966	110.3624	193.2530	198.95
17.000	16.964	92.9737	163.9972	197.51
18.000	17.962	78.2762	136.9330	199.15
19.000	18.960	66.0825	112.9106	203.90
20.000	19.958	56.0139	93.5217	208.66
21.000	20.956	47.6071	78.2058	212.08
22.000	21.953	40.6048	65.8003	214.98
23.000	22.951	34.6680	55.4536	217.80
24.000	23.949	29.6333	46.8359	220.42
25.000	24.947	25.4206	39.7564	222.76
26.000	25.945	21.8136	33.7703	225.04
27.000	26.943	18.7532	28.7647	227.13
28.000	27.941	16.1526	24.5662	229.07
29.000	28.939	13.9273	21.0228	230.80
30.000	29.937	12.0107	18.0047	232.40

TABLE D-6. June Hydrostatic Model Atmosphere, Wake Island.

Z KM	GEO. HT KM	PRESS MB	D G/M ³	TV K
0.000	0.000	1015.4556	1164.3054	303.84
0.005	0.005	1014.8601	1162.6678	304.09
1.000	0.998	905.4872	1069.2117	295.04
2.000	1.996	805.6077	970.9670	289.05
3.000	2.994	715.1948	877.1562	284.06
4.000	3.992	633.1557	792.0677	278.49
5.000	4.989	559.3271	714.4043	272.76
6.000	5.987	493.1513	644.1470	266.72
7.000	6.985	432.9730	579.6873	260.21
8.000	7.983	378.9951	521.5694	253.15
9.000	8.981	330.3056	468.5721	245.58
10.000	9.979	287.1315	420.4438	237.92
11.000	10.977	248.1500	369.8076	233.77
12.000	11.975	213.0790	334.8057	221.72
13.000	12.973	182.0999	296.2312	214.16
14.000	13.970	154.9726	260.5495	207.22
15.000	14.968	131.0883	226.1622	201.93
16.000	15.966	110.6086	193.5408	199.10
17.000	16.964	93.2559	162.6438	199.75
18.000	17.962	78.7066	135.3256	202.62
19.000	18.960	66.5968	112.5254	206.19
20.000	19.958	56.5249	93.9529	209.60
21.000	20.956	48.0721	78.7104	212.77
22.000	21.953	41.0241	66.3489	215.41
23.000	22.951	35.0343	56.0115	217.91
24.000	23.949	29.9503	47.3394	220.41
25.000	24.947	25.6889	40.1935	222.66
26.000	25.945	22.0427	34.1622	224.79
27.000	26.943	18.9423	29.1145	226.66
28.000	27.941	16.3130	24.8938	228.30
29.000	28.939	14.0565	21.2994	229.92
30.000	29.937	12.1078	18.2338	231.34

TABLE D-7. July Hydrostatic Model Atmosphere, Wake Island.

Z KM	GEO. HT KM	PRESS MB	D G/M ³	TV K
0.000	0.000	1014.4520	1159.2115	304.88
0.005	0.005	1013.8666	1158.6870	304.84
1.000	0.998	904.8030	1065.5520	295.83
2.000	1.996	805.1725	968.7706	289.55
3.000	2.994	714.9286	876.5296	284.15
4.000	3.992	632.9484	792.3176	278.31
5.000	4.989	559.0772	715.2138	272.33
6.000	5.987	492.7999	644.5904	266.34
7.000	6.985	432.6313	579.6923	260.00
8.000	7.983	378.6742	521.1505	253.14
9.000	8.981	330.0737	467.9011	245.76
10.000	9.979	286.8965	419.7865	238.10
11.000	10.977	247.9857	370.0161	233.49
12.000	11.975	212.9405	334.7089	221.64
13.000	12.973	181.9664	296.5578	213.77
14.000	13.970	154.8097	260.9621	206.67
15.000	14.968	130.9508	225.9337	201.92
16.000	15.966	110.5320	192.2364	200.31
17.000	16.964	93.3240	160.9826	201.96
18.000	17.962	78.9029	134.4108	204.51
19.000	18.960	66.8364	112.2703	207.40
20.000	19.958	56.7764	94.0775	210.25
21.000	20.956	48.3067	79.0131	212.99
22.000	21.953	41.2277	66.6612	215.46
23.000	22.951	35.2041	56.3043	217.83
24.000	23.949	30.0878	47.6303	220.07
25.000	24.947	25.8015	40.4717	222.10
25.000	25.945	22.1322	34.3985	224.15
27.000	26.943	19.0061	29.3351	225.72
28.000	27.941	16.3612	25.0858	227.22
29.000	28.939	14.0890	21.4556	228.77
30.000	29.937	12.1374	18.3754	230.12

TABLE D-8. August Hydrostatic Model Atmosphere, Wake Island.

Z KM	GEO. HT KM	PRESS MB	D G/M ³	TV K
0.000	0.000	1013.6096	1158.4451	304.83
0.005	0.005	1013.0231	1157.9123	304.79
1.000	0.998	904.1446	1063.5262	296.17
2.000	1.996	804.7285	966.7744	289.99
3.000	2.994	714.6554	875.0554	284.52
4.000	3.992	632.8026	791.3283	278.59
5.000	4.989	559.0677	714.4963	272.60
6.000	5.987	492.8028	644.0227	266.58
7.000	6.985	432.6987	579.2428	260.25
8.000	7.983	378.8288	520.6308	253.50
9.000	8.981	330.2880	467.4753	246.15
10.000	9.979	287.1085	419.4334	238.47
11.000	10.977	248.2054	368.8933	234.41
12.000	11.975	213.1626	334.5750	221.96
13.000	12.973	182.1944	296.5850	214.01
14.000	13.970	155.0242	261.1465	206.81
15.000	14.968	131.1593	226.2764	201.94
16.000	15.966	110.7134	192.3219	200.55
17.000	16.964	93.4876	160.9578	202.35
18.000	17.962	79.0523	134.5674	204.66
19.000	18.960	66.9866	112.4749	207.49
20.000	19.958	56.8966	94.3468	210.10
21.000	20.956	48.3983	79.2783	212.68
22.000	21.953	41.2885	66.9313	214.91
23.000	22.951	35.2456	56.5583	217.10
24.000	23.949	30.1166	47.8391	219.32
25.000	24.947	25.8085	40.6317	221.29
26.000	25.945	22.1261	34.5426	223.15
27.000	26.943	18.9966	29.4319	224.86
28.000	27.941	16.3346	25.1341	226.41
29.000	28.939	14.0549	21.4779	227.98
30.000	29.937	12.1057	18.3730	229.54

TABLE D-9. September Hydrostatic Model Atmosphere, Wake Island.

Z KM	GEO. HT KM	PRESS MB	D G/M ³	TV K
0.000	0.000	1013.7632	1156.9955	305.25
0.005	0.005	1013.1754	1156.4474	305.22
1.000	0.998	904.3853	1063.1385	296.36
2.000	1.996	804.9763	966.7012	290.10
3.000	2.994	714.9020	874.9200	284.67
4.000	3.992	633.0492	791.2348	278.73
5.000	4.989	559.2636	714.6935	272.62
6.000	5.987	493.0378	644.2547	266.61
7.000	6.985	432.8852	579.6050	260.19
8.000	7.963	378.9621	521.2669	253.28
9.000	8.981	330.3370	468.0641	245.87
10.000	9.979	287.1480	419.8520	238.27
11.000	10.977	248.2245	369.6993	233.91
12.000	11.975	213.1921	334.4678	222.06
13.000	12.973	182.2463	296.2254	214.34
14.000	13.970	155.1094	260.7301	207.25
15.000	14.968	131.2140	226.2916	202.01
16.000	15.966	110.7152	193.8000	199.03
17.000	16.964	93.3397	162.8849	199.64
18.000	17.962	78.7746	135.4688	202.58
19.000	18.960	66.6613	112.6351	206.19
20.000	19.958	56.5713	94.1570	209.32
21.000	20.956	48.1005	78.9971	212.13
22.000	21.953	41.0157	66.6051	214.54
23.000	22.951	35.0015	56.2297	216.86
24.000	23.949	29.9122	47.5475	219.17
25.000	24.947	25.6228	40.3879	221.02
26.000	25.945	21.9599	34.3197	222.92
27.000	26.943	18.8656	29.2271	224.88
28.000	27.941	16.2298	24.9500	226.62
29.000	28.939	13.9646	21.3079	228.32
30.000	29.937	12.0201	18.2225	229.80

TABLE D-10. October Hydrostatic Model Atmosphere, Wake Island.

Z KM	GEO. HT KM	PRESS MB	D G/M ³	TV K
0.000	0.000	1014.5602	1159.2119	304.91
0.005	0.005	1013.9803	1158.6816	304.88
1.000	0.998	904.9674	1065.5460	295.88
2.000	1.996	805.3973	967.9602	289.87
3.000	2.994	715.2247	875.4097	284.64
4.000	3.992	633.3652	791.0073	278.95
5.000	4.989	559.6268	713.8211	273.13
6.000	5.987	493.4644	644.1811	266.87
7.000	6.985	433.2389	580.0733	260.20
8.000	7.983	379.2843	522.1489	253.06
9.000	8.981	330.5893	469.0100	245.56
10.000	9.979	287.3238	420.4784	238.06
11.000	10.977	248.3595	370.2193	233.71
12.000	11.975	213.3348	334.3149	222.31
13.000	12.973	182.4048	295.6836	214.91
14.000	13.970	155.3186	260.0533	208.07
15.000	14.968	131.3850	226.0836	202.46
16.000	15.966	110.8236	195.0355	197.96
17.000	16.964	93.2921	165.5310	196.35
18.000	17.962	78.4990	137.4020	199.03
19.000	18.960	66.2729	113.2117	203.94
20.000	19.958	56.1594	94.0540	208.02
21.000	20.956	47.7134	78.6213	211.43
22.000	21.953	40.6701	66.1106	214.32
23.000	22.951	34.7026	55.7503	216.86
24.000	23.949	29.6508	47.1331	219.16
25.000	24.947	25.4010	40.0102	221.18
26.000	25.945	21.7744	33.9868	223.20
27.000	26.943	18.6972	28.9065	225.34
28.000	27.941	16.0861	24.6679	227.18
29.000	28.939	13.8482	21.0732	228.94
30.000	29.937	11.9296	18.0179	230.66

TABLE D-11. November Hydrostatic Model Atmosphere, Wake Island.

Z KM	GEO. HT KM	PRESS MB	D G/M ³	TV K
0.000	0.000	1015.2070	1164.9882	303.59
0.005	0.005	1014.6253	1164.4592	303.56
1.000	0.998	905.1607	1069.8048	294.77
2.000	1.996	805.3316	969.0574	289.52
3.000	2.994	715.1366	874.3634	284.94
4.000	3.992	633.3128	789.6878	279.40
5.000	4.989	559.6660	712.7672	273.55
6.000	5.987	493.7024	643.4938	267.29
7.000	6.985	433.5154	579.5433	260.60
8.000	7.983	379.5978	521.7750	253.45
9.000	8.981	330.8965	468.6538	245.98
10.000	9.979	287.7068	420.4229	238.41
11.000	10.977	248.7836	370.5689	233.89
12.000	11.975	213.7976	333.7710	223.16
13.000	12.973	182.9152	295.3500	215.76
14.000	13.970	155.8299	260.1494	208.68
15.000	14.968	131.8307	226.8700	202.44
16.000	15.966	111.1639	196.4446	197.14
17.000	16.964	93.4897	167.8171	194.08
18.000	17.962	78.4502	140.0881	195.10
19.000	18.960	66.0164	114.9205	200.13
20.000	19.958	55.8120	94.3783	206.02
21.000	20.956	47.3715	78.4125	210.47
22.000	21.953	40.3493	65.8037	213.62
23.000	22.951	34.4088	55.3834	216.45
24.000	23.949	29.3937	46.7866	218.87
25.000	24.947	25.1729	39.6993	220.91
26.000	25.945	21.5771	33.7293	222.87
27.000	26.943	18.5288	28.7117	224.83
28.000	27.941	15.9318	24.5036	226.51
29.000	28.939	13.7047	20.9259	228.16
30.000	29.937	11.7972	17.8830	229.33

TABLE D-12. December Hydrostatic Model Atmosphere, Wake Island.

Z KM	GEO. HT KM	PRESS MB	D G/M ³	TV K
0.000	0.000	1015.9974	1170.8696	302.30
0.005	0.005	1015.4277	1170.3058	302.28
1.000	0.998	905.3787	1075.4735	293.28
2.000	1.996	805.1233	972.0062	288.57
3.000	2.994	714.7845	874.1872	284.86
4.000	3.992	632.9829	788.6419	279.62
5.000	4.989	559.3949	712.0929	273.68
6.000	5.987	493.5567	642.9146	267.45
7.000	6.985	433.3913	579.0495	260.75
8.000	7.983	379.5495	521.1807	253.71
9.000	8.981	330.9100	467.7610	246.46
10.000	9.979	287.8176	419.5919	238.97
11.000	10.977	248.9868	370.8474	233.90
12.000	11.975	214.0276	333.4577	223.61
13.000	12.973	183.1440	295.2725	216.09
14.000	13.970	156.0509	260.4827	208.71
15.000	14.968	131.9987	227.7434	201.92
16.000	15.966	111.2258	197.6659	196.03
17.000	16.964	93.4121	169.1963	192.34
18.000	17.962	78.2361	141.3063	192.89
19.000	18.960	65.7287	115.5117	198.24
20.000	19.958	55.4969	94.3483	204.92
21.000	20.956	47.0679	78.1406	209.85
22.000	21.953	40.0766	65.4537	213.31
23.000	22.951	34.1725	55.0899	216.10
24.000	23.949	29.1838	46.5108	218.60
25.000	24.947	24.9878	39.4733	220.54
26.000	25.945	21.4073	33.5693	222.17
27.000	26.943	18.3664	28.5979	223.74
28.000	27.941	15.7839	24.4082	225.29
29.000	28.939	13.5702	20.8507	225.74
30.000	29.937	11.6708	17.8012	228.41

TABLE D-13. Annual Hydrostatic Model Atmosphere, Wake Island.

Z KM	GEO. HT KM	PRESS MB	D G/M ³	TV K
0.000	0.000	1015.3280	1166.7242	303.18
0.005	0.005	1014.7648	1166.0230	303.19
1.000	0.998	905.0955	1071.6690	294.23
2.000	1.996	805.0387	971.7194	288.62
3.000	2.994	714.6163	876.5215	284.03
4.000	3.992	632.6475	791.0313	278.63
5.000	4.989	558.8930	713.7841	272.78
6.000	5.987	492.8106	643.8802	266.64
7.000	6.985	432.6412	579.4707	260.11
8.000	7.983	378.7355	521.1373	253.19
9.000	8.981	330.1300	467.7993	245.86
10.000	9.979	286.9977	419.2940	238.46
11.000	10.977	248.1524	369.4553	234.00
12.000	11.975	213.2146	333.4794	222.74
13.000	12.973	182.3471	295.2270	215.18
14.000	13.970	155.2924	260.0479	208.04
15.000	14.968	131.3633	226.3707	202.17
16.000	15.966	110.7891	195.0228	197.91
17.000	16.964	93.2586	165.4645	196.35
18.000	17.962	78.4277	138.0211	197.96
19.000	18.960	66.1410	113.8369	202.42
20.000	19.958	55.9946	94.1523	207.19
21.000	20.956	47.5506	78.5299	210.95
22.000	21.953	40.5193	66.0108	213.85
23.000	22.951	34.5621	55.6257	216.46
24.000	23.949	29.5240	46.9852	218.91
25.000	24.947	25.2897	39.8631	221.02
26.000	25.945	21.6763	33.8520	223.08
27.000	26.943	18.6116	28.8160	225.01
28.000	27.941	16.0073	24.5923	226.77
29.000	28.939	13.7764	21.0069	228.47
30.000	29.937	11.8587	17.5559	230.08

APPENDIX E

Wind Statistics Derivable from Appendix A Tables

Appendix E gives a few graphic examples of certain wind statistics that can be derived from basic data in Appendix A. These examples should help RRA users understand the functional relationships of the probability wind model and develop an appreciation for the powerful properties of the bivariate normal probability distribution function. Only a few of the many options in deriving wind statistics are illustrated here.

All illustrations for this appendix were derived for the five wind component statistical parameters from Table A-1 (January) and Table A-7 (July) for nine selected altitudes; these are: 2, 4, 8, 12, 16, 20, 24, 28, and 30 km. Descriptions of Tables E-1 and E-2 and Figures E-1 through E-72 follow:

Wind Speed (Tables E-1 and E-2)

The five wind components from Appendix A are used as inputs to the generalized Rayleigh probability density function (equation 29), then integrated as indicated by equation 30 to obtain the probability distribution function for wind speed. The derived distribution functions for wind speed are shown in Tables E-1 and E-2 on the normal probability scale.

Frequency of Wind Direction (Figures E-1 through E-18)

The derived frequencies for wind direction shown in Figures E-5 through E-20 were obtained using the five wind component parameters from Tables A-1 and A-7 as input values in equation 35. The limits of integration (performed numerically) are over the 22.5-degree interval for each of the 16 compass points. The graphs give the percentage frequency that the wind will blow from the direction intervals.

Mean Wind Components and 80th Interpercentile Range of Wind Components (Figures E-19 through E-36)

Wind component means with respect to any orthogonal axis are obtained by using the zonal and meridional mean wind components in equations 44 and 45. These component means form the circle shown in Figures E-19 through E-36. The zonal and meridional wind component variances and correlation coefficients are then used in equations 46 and 47 to obtain the variances with respect to any orthogonal axis. These rotated component variances and the rotated component means are used in equation 8 to obtain the 80th interpercentile range of wind components, as shown in Figures E-19 through E-36.

Probability Ellipses (Figures E-37 through E-54)

Using the five wind component parameters from Tables A-1 and A-7, and $p = 0.50$, $p = 0.95$, and $p = 0.99$ as input values to equation 13, the wind probability ellipses shown in Figures E-37 through E-54 were produced with computer graphics, using the standard meteorological coordinate system explained in Chapter 1. Statistical inferences are, for example, that 50 percent of the wind vectors lie within the smaller ellipse, and that 99 percent lie within the outer ellipse.

Conditional Wind Speed Given Wind Direction (Figures E-55 through E-72)

The five wind component parameters from Tables A-1 and A-7 were used to evaluate the conditional probability distribution function, equation 41. Interpolations of the conditional function are made to obtain the 5th, 15th, 50th (median), 85th, 95th, and 99th conditional percentile values of wind speed, given wind directions, are as shown in Figures E-55 through E-72. The conditional mean wind speed, given wind direction, is obtained from equation 40. The conditional mode (most probable) wind speed given wind direction is obtained from equation 38. The conditional mean wind speed and the conditional wind speed modal value, given the wind direction, are also shown. For some figures, conditional wind speed values are invalid for a given wind direction near 270 degrees (from the west); this is caused by the lack of computational precision in evaluating equations 40 and 41 when arguments for the Gaussian probability distribution have large negative values; i.e., when the coefficients (b/a) become less than -4 in these equations.

TABLE E-1. Derived (Rayleigh) Percentiles for Windspeed (M/S), January.

ALTITUDE (KM)									
PERCENTILE	2 KM	4 KM	8 KM	12 KM	16 KM	20 KM	24 KM	28 KM	30 KM
0.010	0.731	0.954	1.846	2.452	1.412	0.476	0.626	0.755	0.860
0.025	1.160	1.515	2.932	3.866	2.241	0.754	0.997	1.194	1.368
0.050	1.653	2.160	4.154	5.438	3.186	1.075	1.426	1.701	1.948
0.100	2.372	3.101	5.905	7.646	4.560	1.546	2.052	2.445	2.803
0.150	2.952	3.864	7.270	9.328	5.650	1.926	2.564	3.051	3.498
0.200	3.463	4.540	8.447	10.750	6.612	2.266	3.022	3.591	4.119
0.300	4.392	5.777	10.514	13.186	8.330	2.886	3.869	4.589	5.266
0.400	5.275	6.956	12.405	15.359	9.937	3.484	4.694	5.558	6.386
0.500	6.171	8.165	14.244	17.441	11.530	4.103	5.555	6.568	7.553
0.600	7.134	9.472	16.138	19.559	13.198	4.777	6.499	7.684	8.849
0.700	8.233	10.979	18.219	21.854	15.047	5.563	7.601	9.000	10.378
0.800	9.608	12.874	20.696	24.574	17.277	6.565	8.993	10.702	12.361
0.850	10.500	14.104	22.239	26.251	18.669	7.223	9.892	11.824	13.669
0.900	11.669	15.708	24.190	28.365	20.438	8.091	11.052	13.311	15.404
0.950	13.494	18.177	27.121	31.519	23.097	9.440	12.821	15.645	18.122
0.975	15.161	20.393	29.696	34.279	25.440	10.673	14.388	17.748	20.564
0.990	17.198	23.017	32.728	37.514	28.212	12.124	16.240	20.279	23.491

TABLE E-2. Derived (Rayleigh) Percentiles for Windspeed (M/S), July.

ALTITUDE (KM)									
PERCENTILE	2 KM	4 KM	8 KM	12 KM	16 KM	20 KM	24 KM	28 KM	30 KM
0.010	0.886	0.656	0.770	1.572	0.860	11.035	13.919	16.338	16.909
0.025	1.402	1.039	1.228	2.502	1.369	11.946	15.216	17.908	18.561
0.050	1.978	1.478	1.746	3.563	1.950	12.714	16.325	19.237	19.961
0.100	2.789	2.117	2.506	5.115	2.802	13.602	17.598	20.767	21.589
0.150	3.414	2.631	3.113	6.353	3.491	14.208	18.467	21.808	22.691
0.200	3.950	3.084	3.649	7.446	4.100	14.689	19.156	22.637	23.568
0.300	4.884	3.906	4.619	9.418	5.214	15.471	20.279	23.987	24.998
0.400	5.736	4.683	5.536	11.281	6.283	16.137	21.233	25.134	26.212
0.500	6.569	5.465	6.459	13.154	7.369	16.763	22.132	26.211	27.355
0.600	7.430	6.298	7.441	15.139	8.541	17.386	23.026	27.284	28.491
0.700	8.381	7.240	8.550	17.382	9.879	18.054	23.984	28.434	29.707
0.800	9.522	8.401	9.915	20.141	11.538	18.838	25.109	29.784	31.138
0.850	10.232	9.137	10.789	21.913	12.596	19.319	25.801	30.609	32.016
0.900	11.136	10.084	11.920	24.212	13.964	19.920	26.665	31.646	33.113
0.950	12.487	11.534	13.663	27.763	16.029	20.811	27.943	33.177	34.737
0.975	13.667	12.818	15.233	30.982	17.861	21.591	29.058	34.507	36.155
0.990	15.076	14.345	17.118	34.883	20.034	22.495	30.376	36.092	37.824

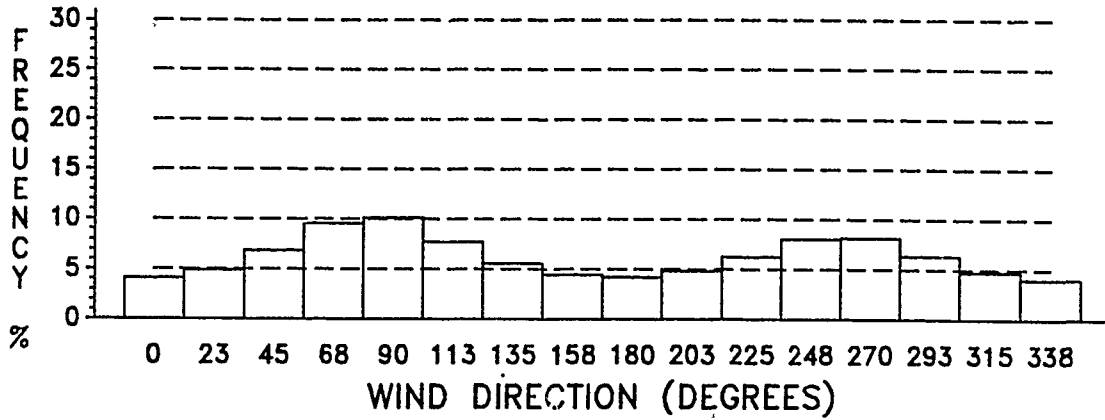

Figure E-1. Wind Direction Frequency, January, 2 KM.

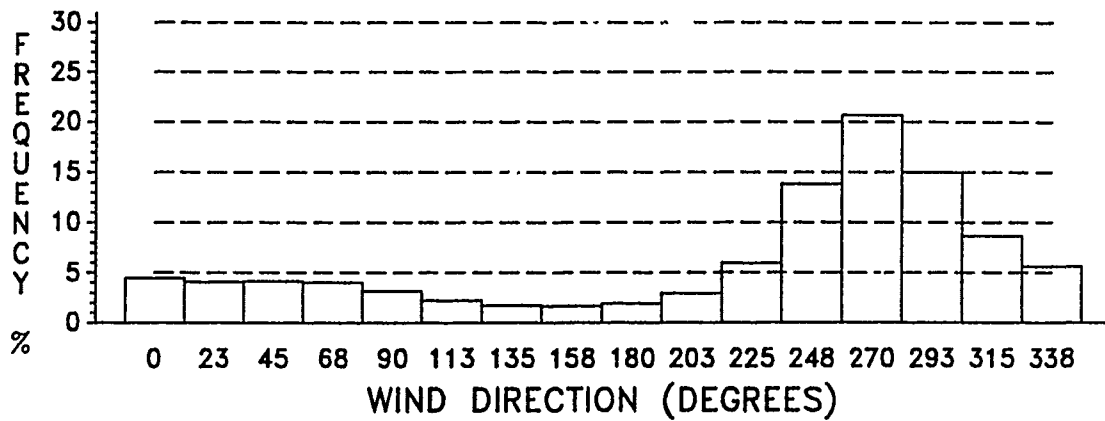

Figure E-2. Wind Direction Frequency, January, 4 KM.

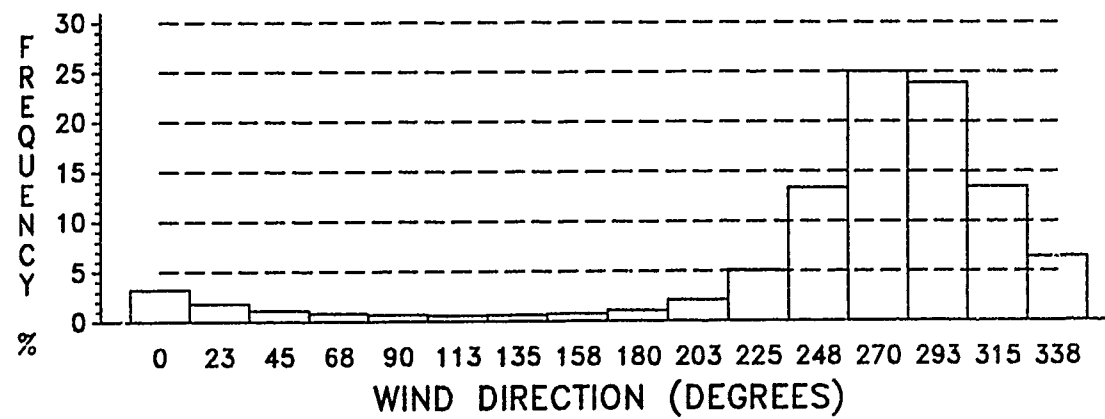

Figure E-3. Wind Direction Frequency, January, 8 KM.

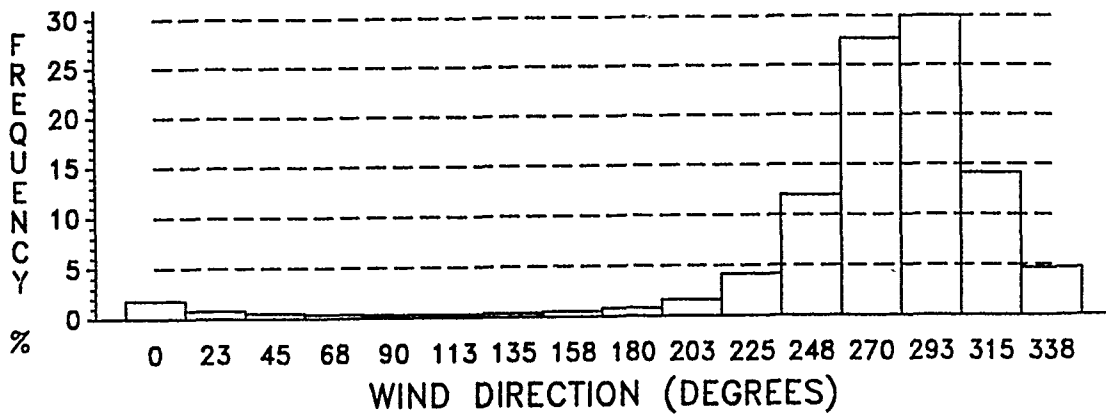

Figure E-4. Wind Direction Frequency, January, 12 KM.

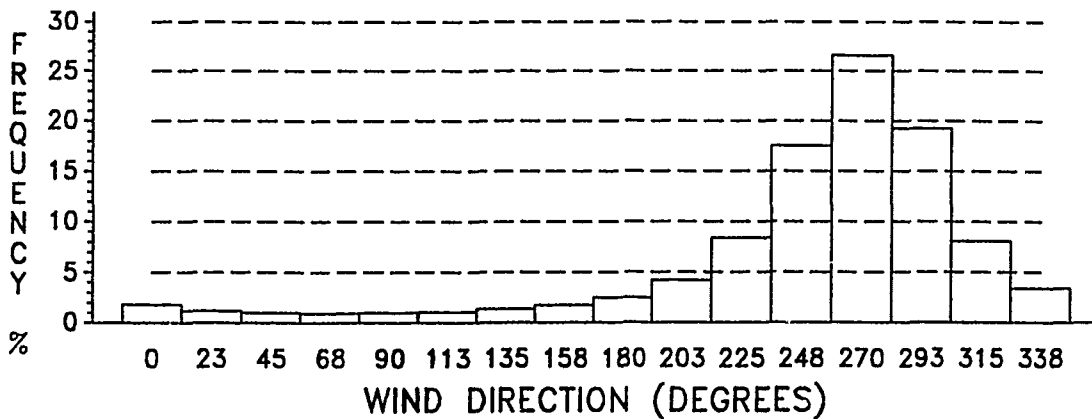

Figure E-5. Wind Direction Frequency, January, 16 KM.

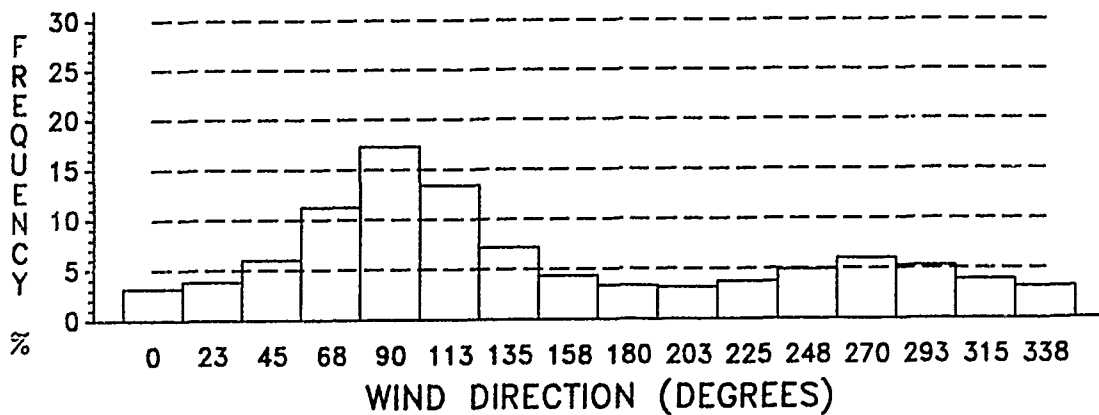

Figure E-6. Wind Direction Frequency, January, 20 KM.

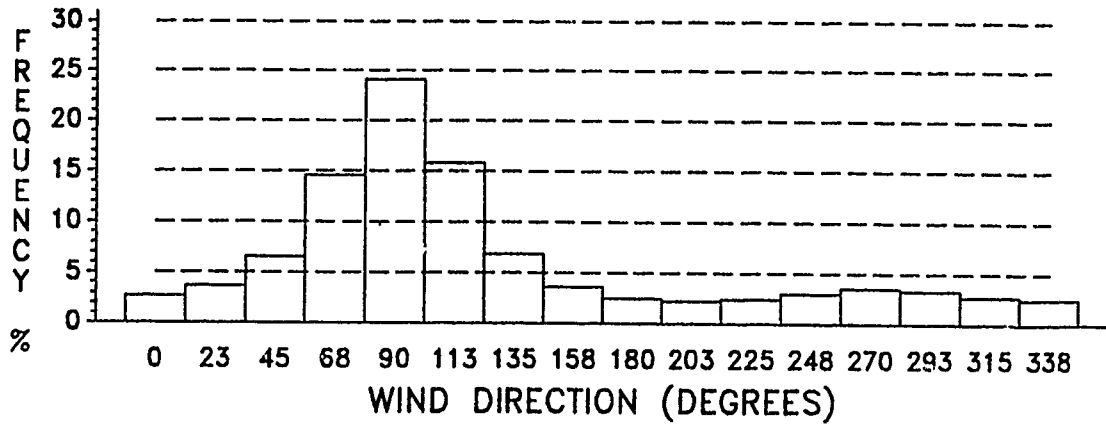

Figure E-7. Wind Direction Frequency, January, 24 KM.

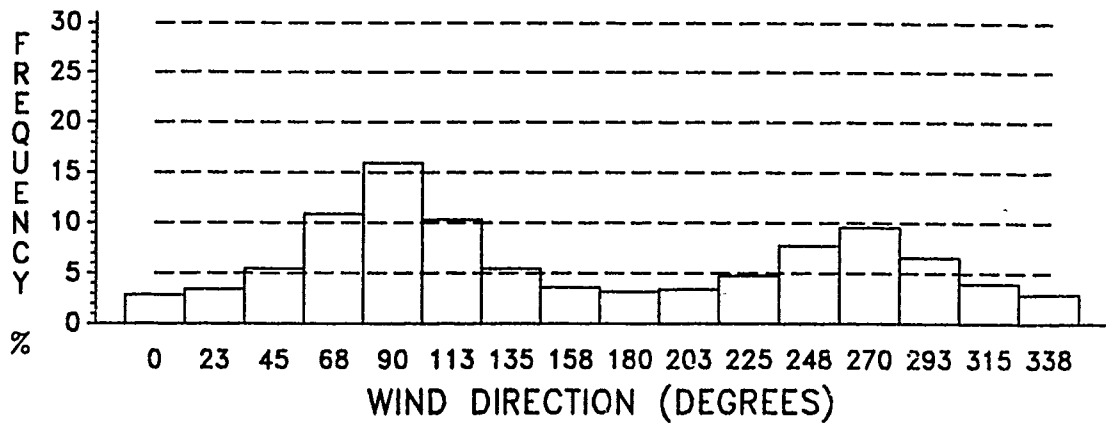

Figure E-8. Wind Direction Frequency, January, 28 KM.

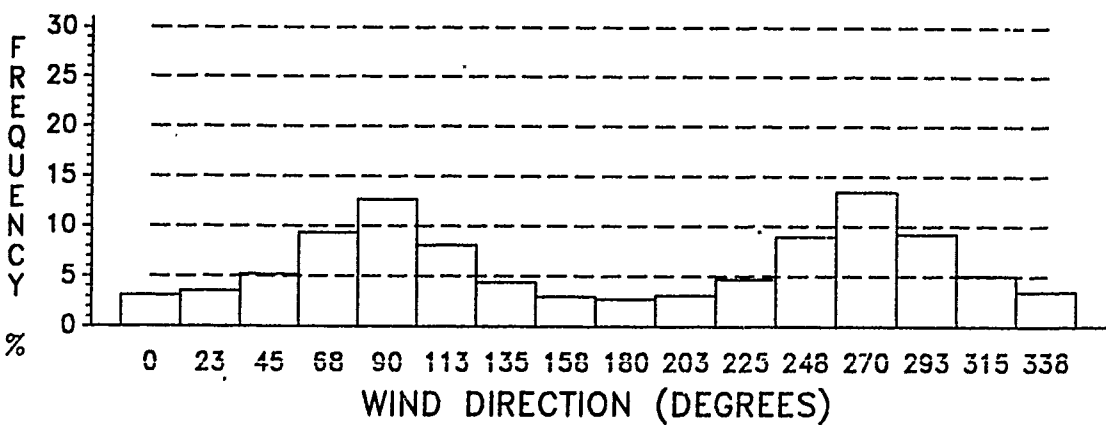

Figure E-9. Wind Direction Frequency, January, 30 KM.

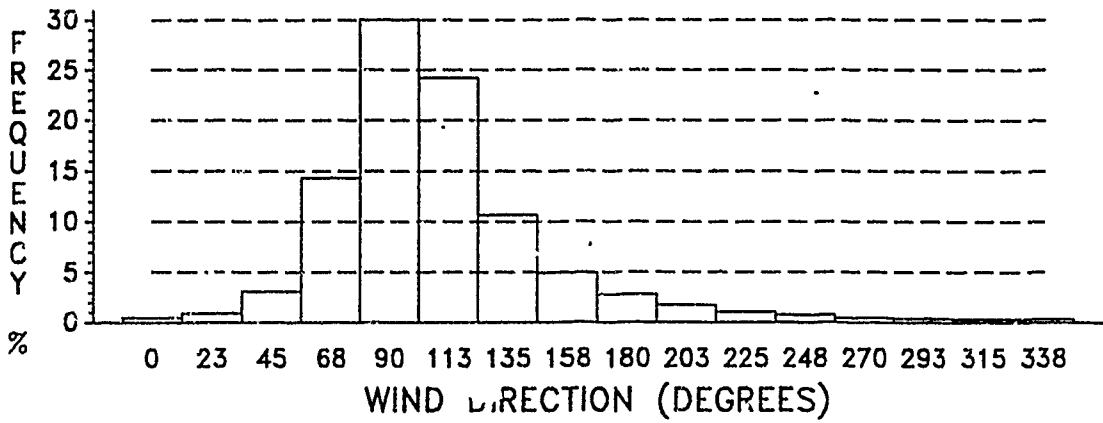

Figure E-10. Wind Direction Frequency, July, 2 KM.

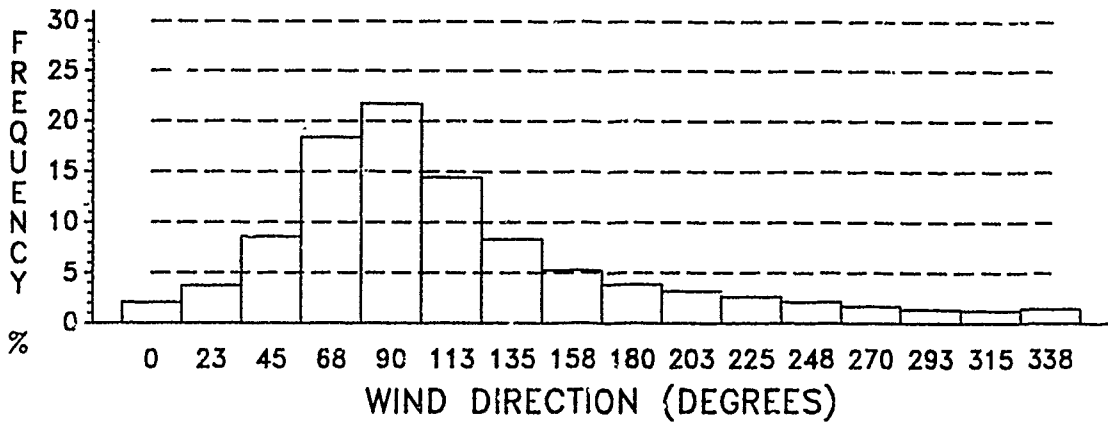

Figure E-11. Wind Direction Frequency, July, 4 KM.

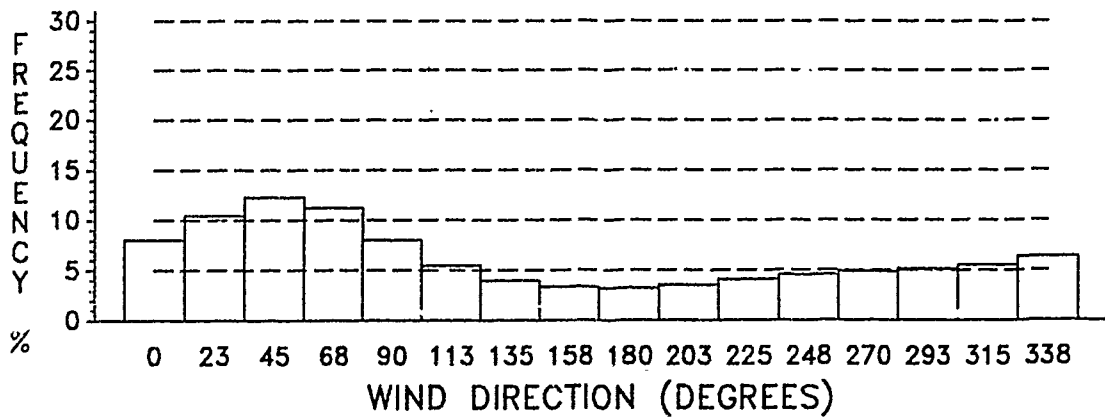

Figure E-12. Wind Direction Frequency, July, 8 KM.

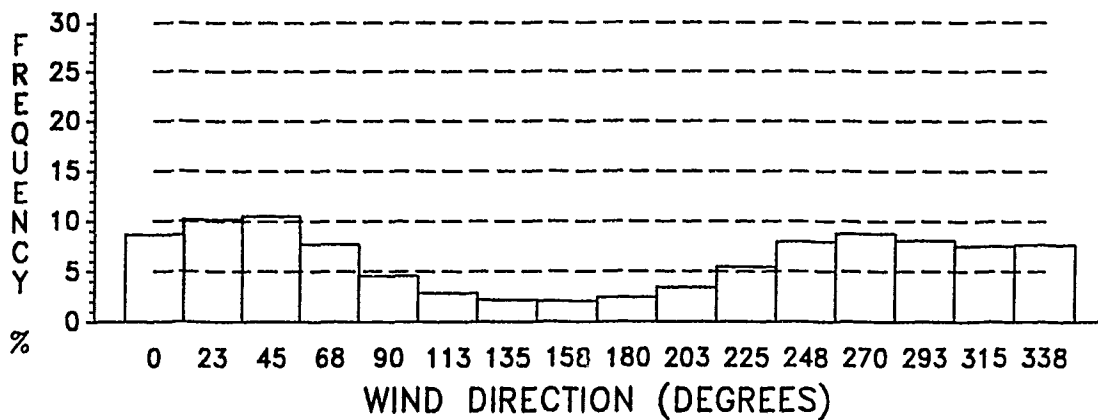

Figure E-13. Wind Direction Frequency, July, 12 KM.

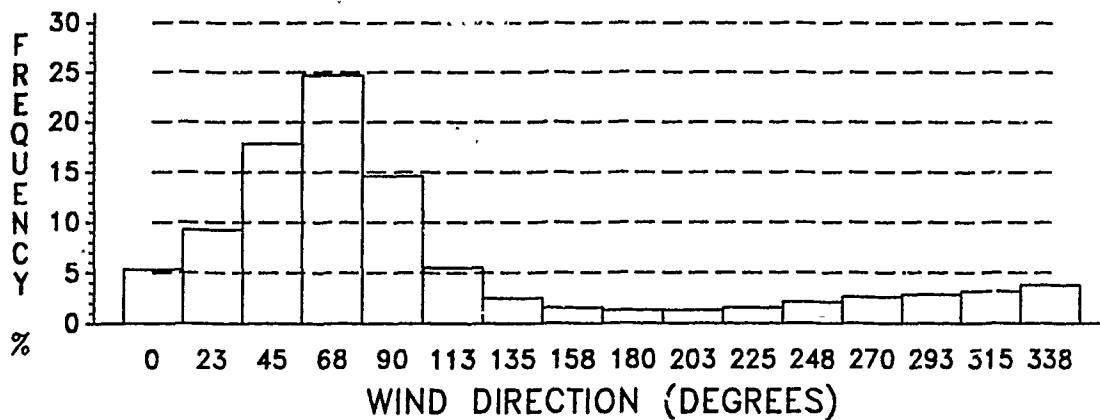

Figure E-14. Wind Direction Frequency, July, 16 KM.

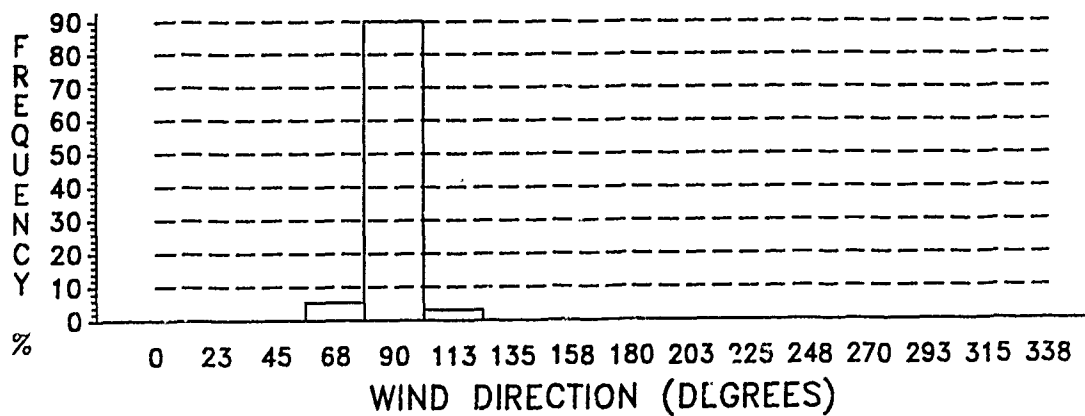

Figure E-15. Wind Direction Frequency, July, 20 KM.

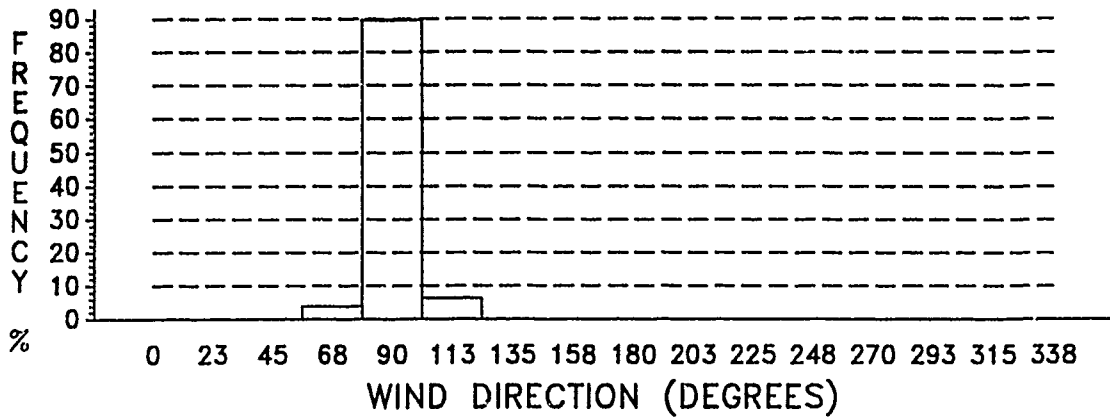

Figure E-16. Wind Direction Frequency, July, 24 KM.

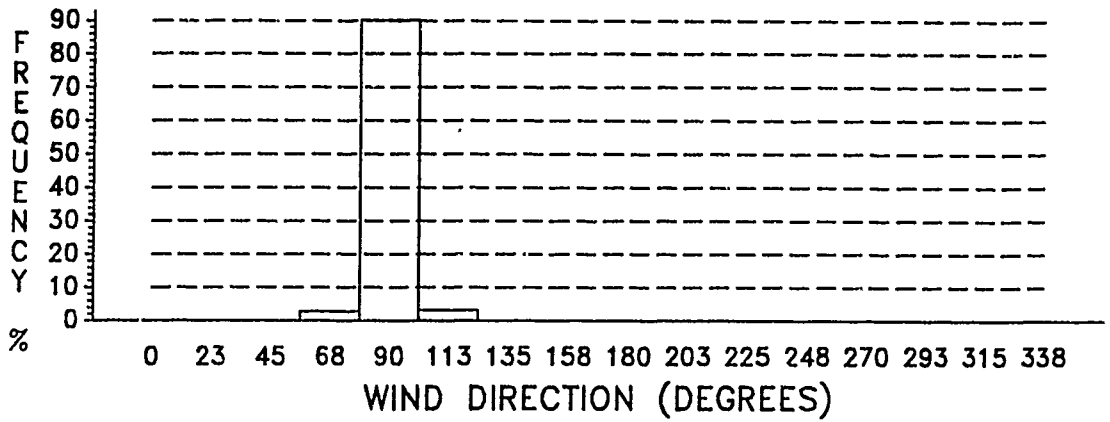

Figure E-17. Wind Direction Frequency, July, 28 KM.

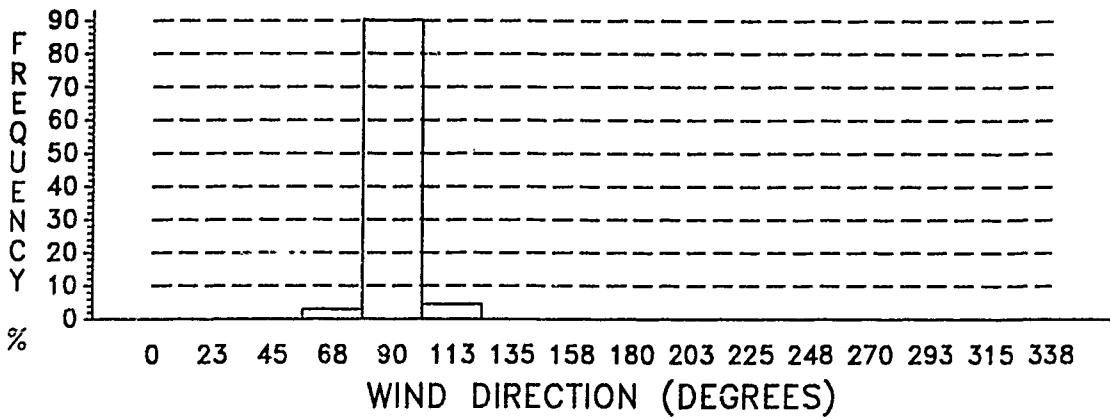

Figure E-18. Wind Direction Frequency, July, 30 KM.

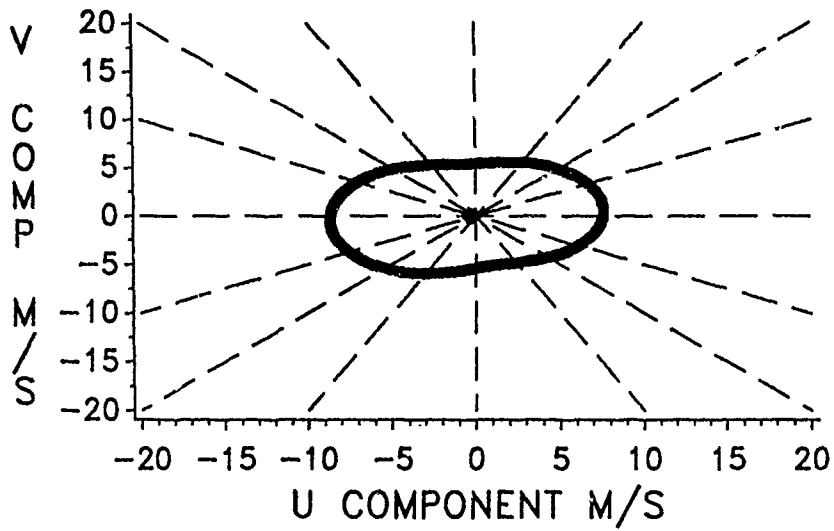

Figure E-19. Wind Interpercentile Range and Mean, January, 2 KM.

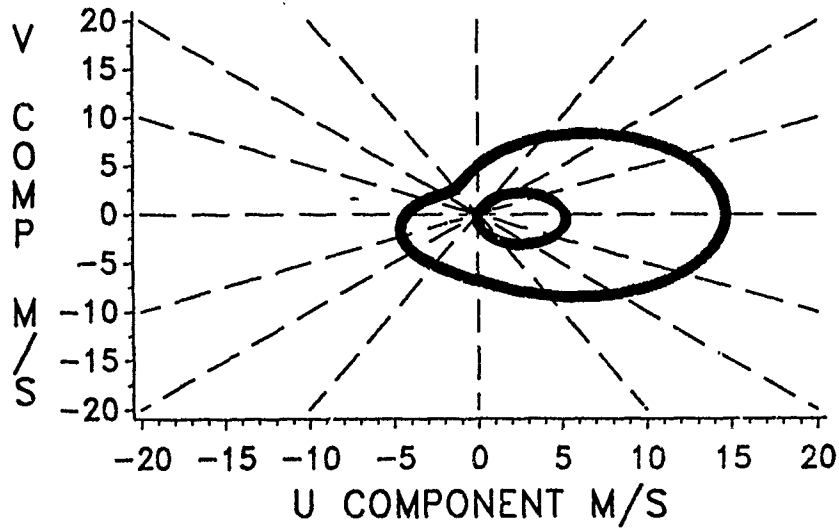

Figure E-20. Wind Interpercentile Range and Mean, January, 4 KM.

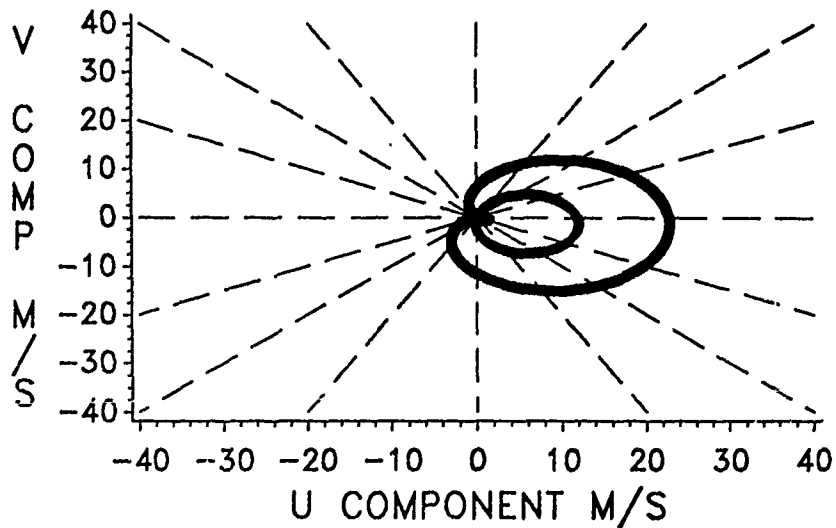

Figure E-21. Wind Interpercentile Range and Mean, January, 8 KM.

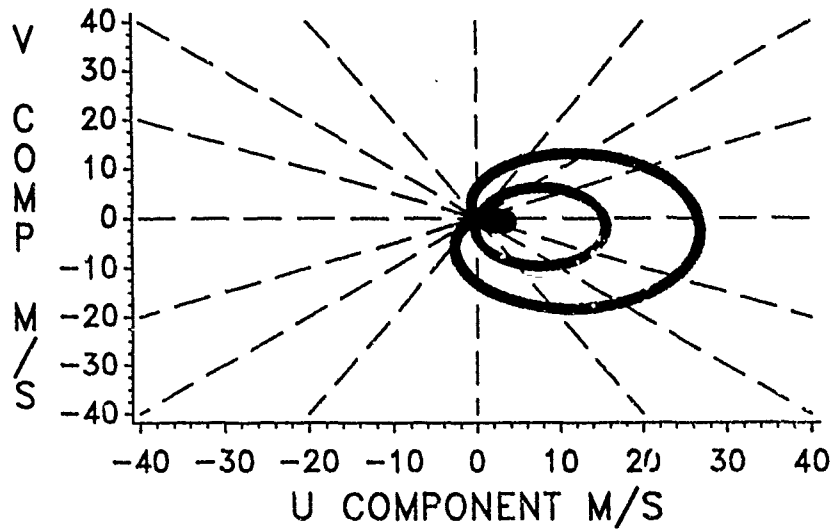

Figure E-22. Wind Interpercentile Range and Mean, January, 12 KM.

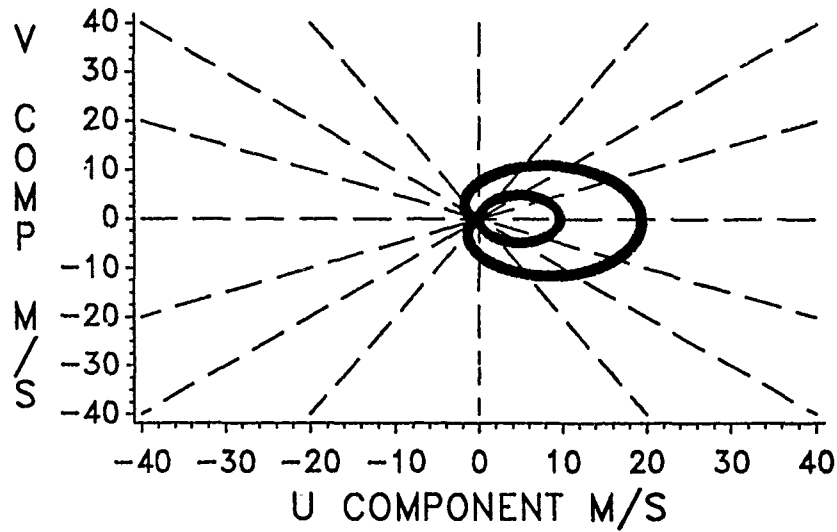

Figure E-23. Wind Interpercentile Range and Mean, January, 16 KM.

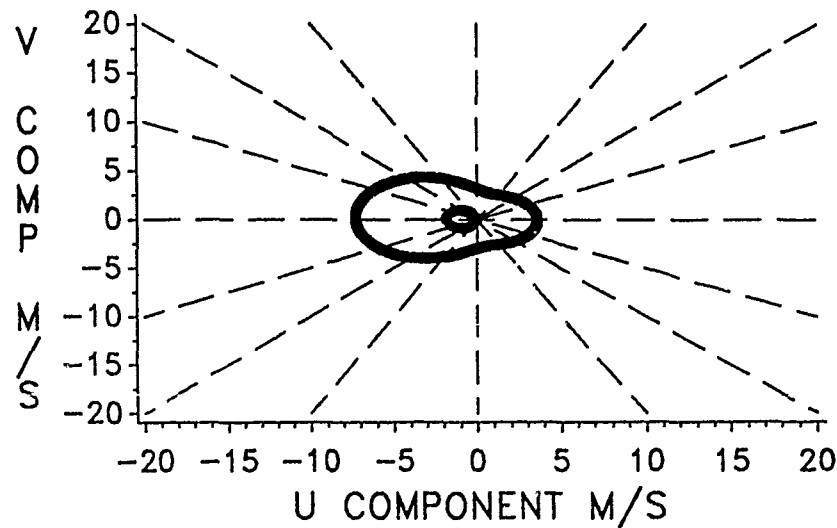

Figure E-24. Wind Interpercentile Range and Mean, January, 20 KM.

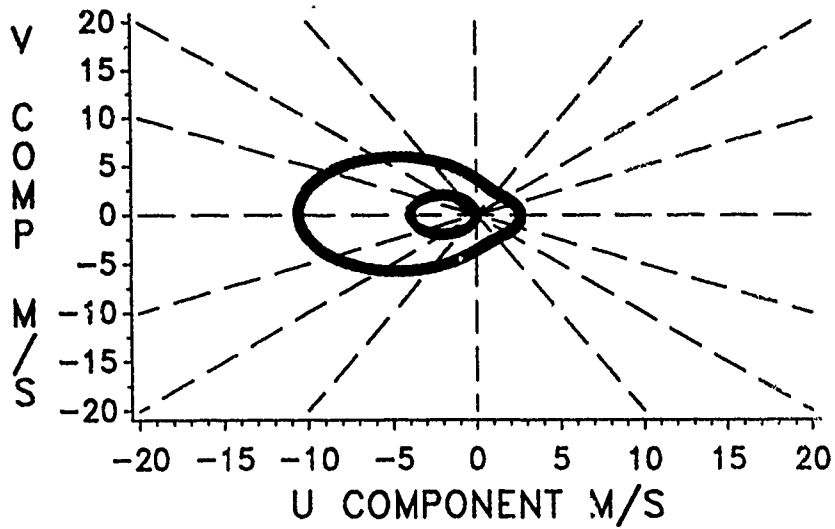

Figure E-25. Wind Interpercentile Range and Mean, January, 24 KM.

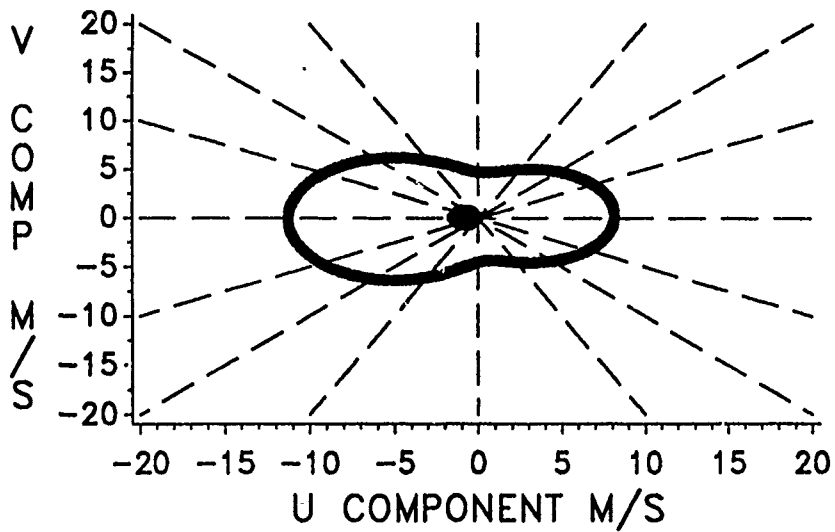

Figure E-26. Wind Interpercentile Range and Mean, January, 28 KM.

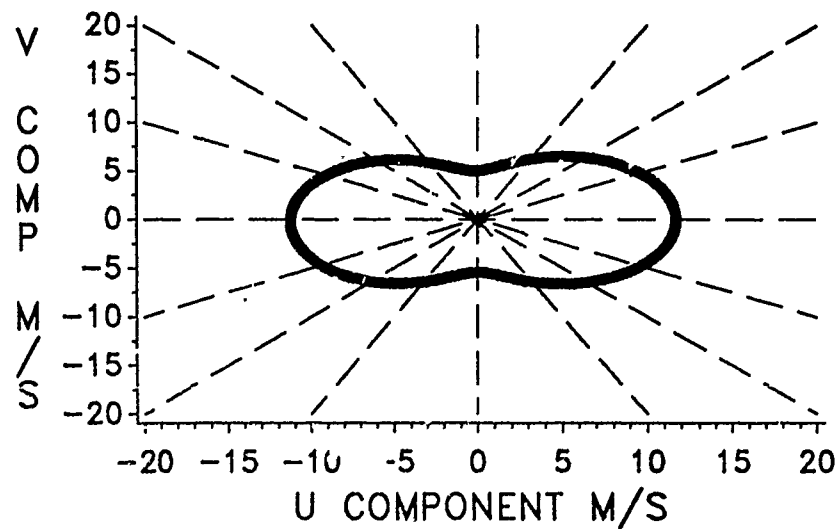

Figure E-27. Wind Interpercentile Range and Mean, January, 30 KM.

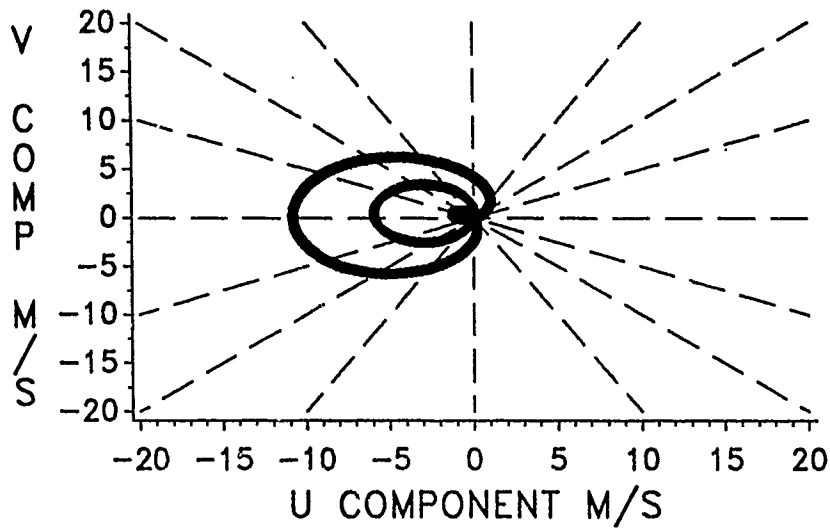

Figure E-28. Wind Interpercentile Range and Mean, July, 2 KM.

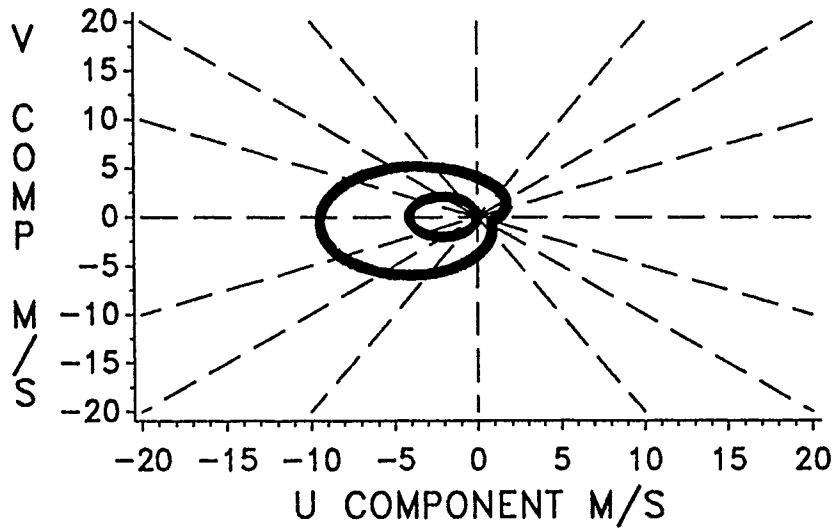

Figure E-29. Wind Interpercentile Range and Mean, July, 4 KM.

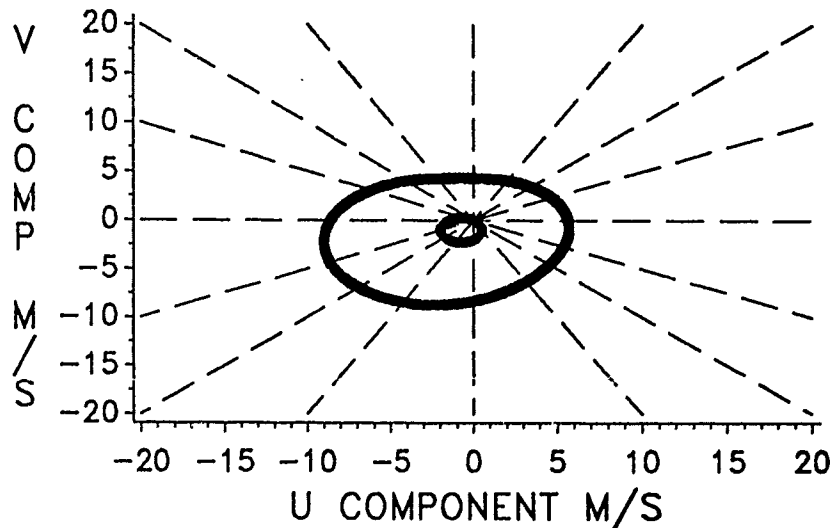

Figure E-30. Wind Interpercentile Range and Mean, July, 8 KM.

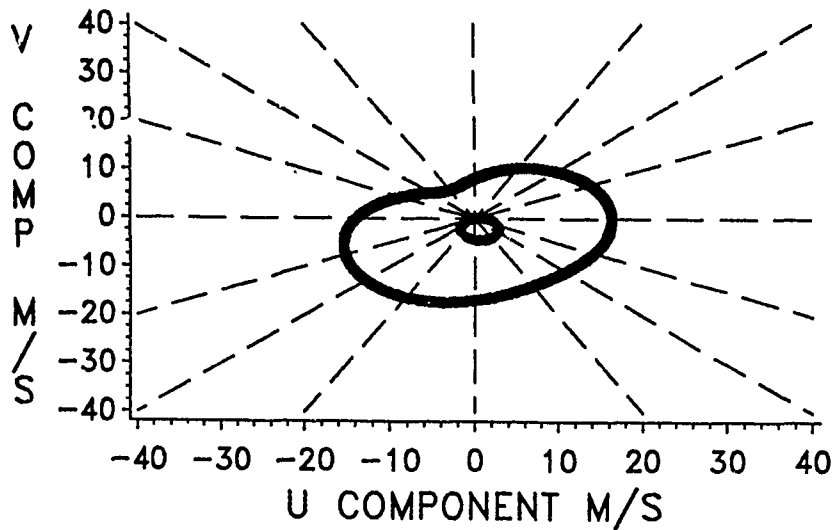

Figure E-31. Wind Interpercentile Range and Mean, July, 12 KM.

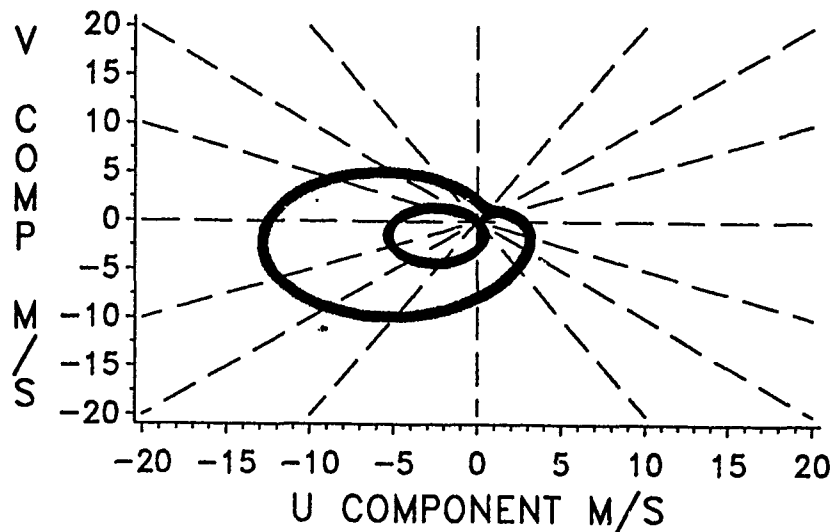

Figure E-32. Wind Interpercentile Range and Mean, July, 16 KM.

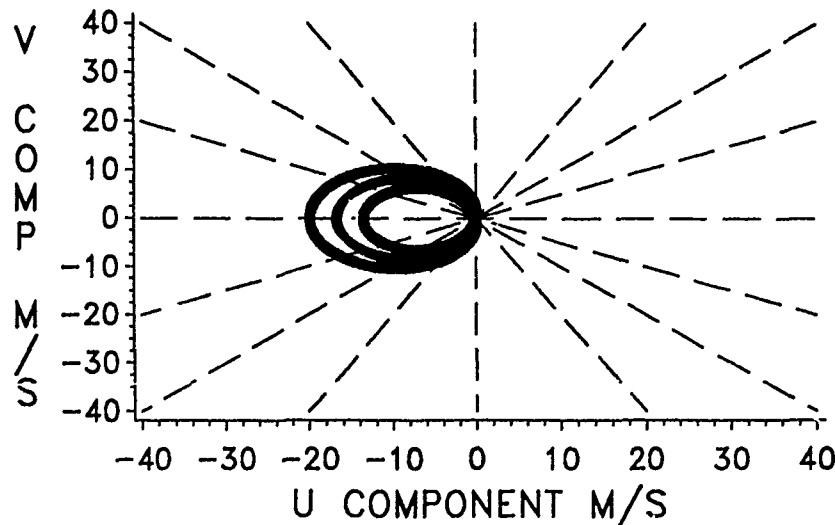

Figure E-33. Wind Interpercentile Range and Mean, July, 20 KM.

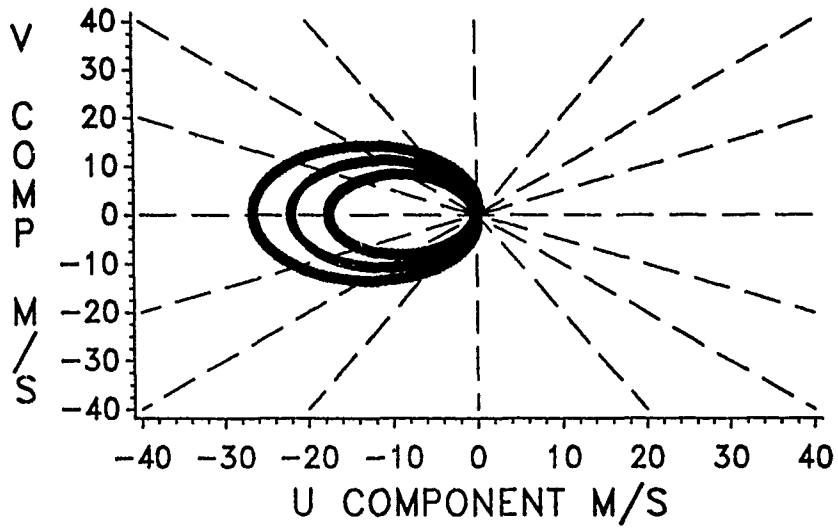

Figure E-34. Wind Interpercentile Range and Mean, July, 24 KM.

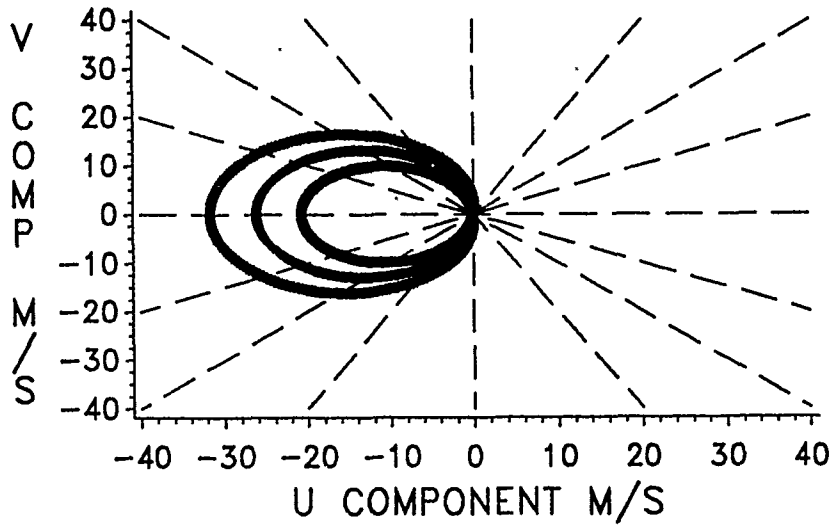

Figure E-35. Wind Interpercentile Range and Mean, July, 28 KM.

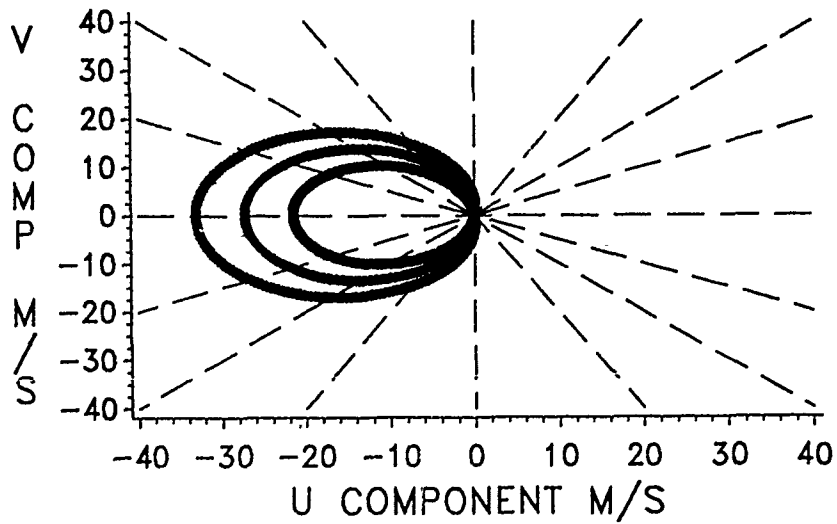

Figure E-36. Wind Interpercentile Range and Mean, July, 30 KM.

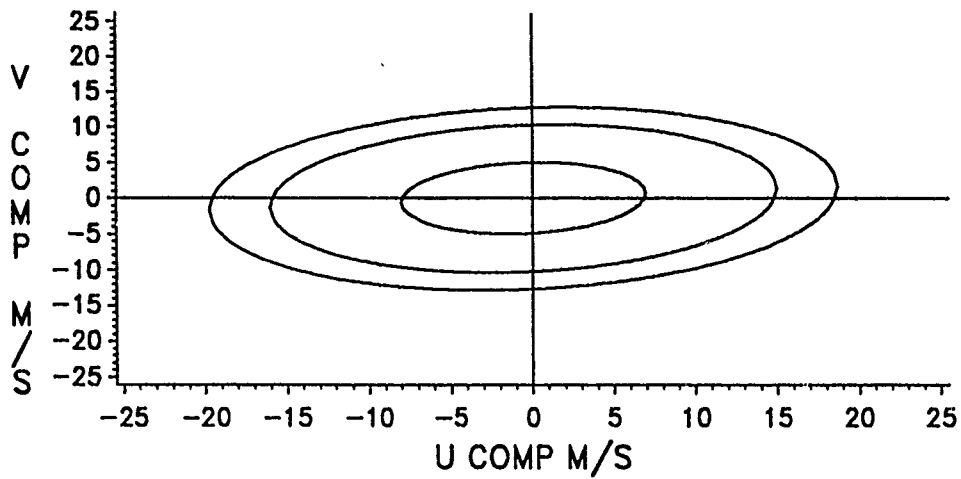

Figure E-37. Wind Probability Ellipses, January, 2 KM.

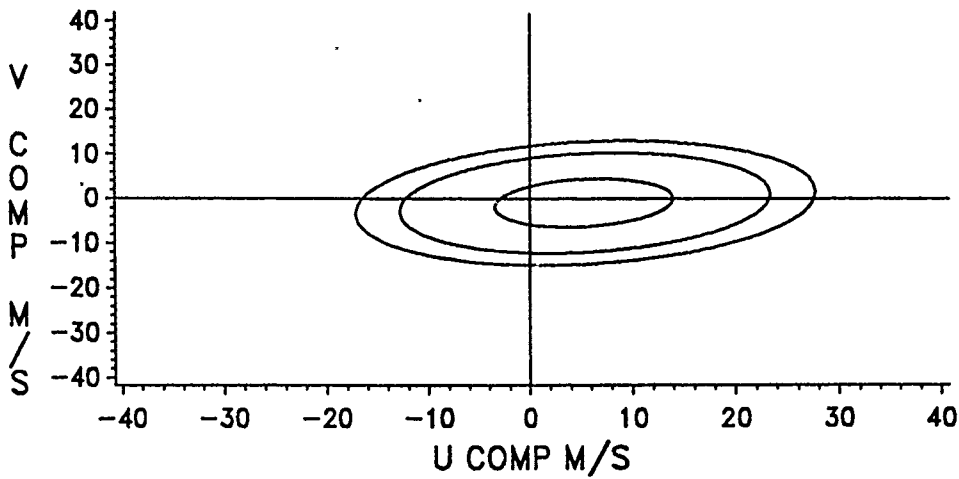

Figure E-38. Wind Probability Ellipses, January, 4 KM.

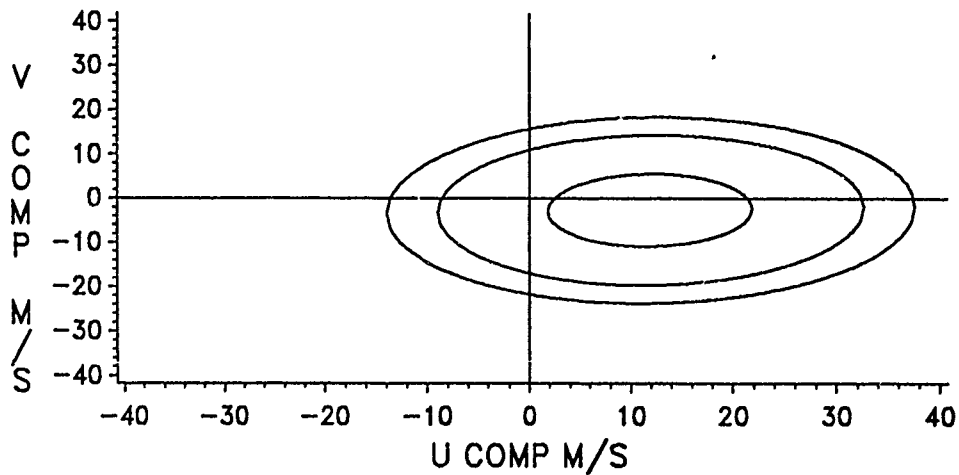

Figure E-39. Wind Probability Ellipses, January, 8 KM.

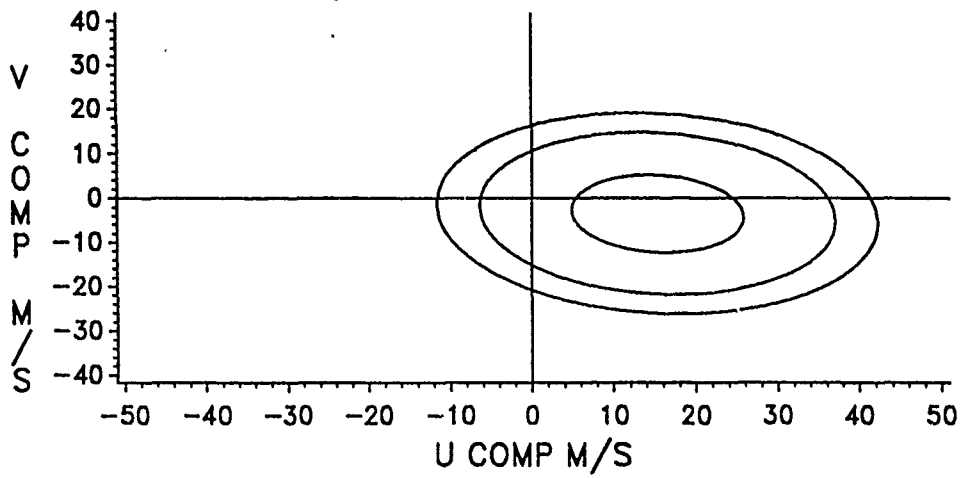

Figure E-40. Wind Probability Ellipses, January, 12 KM.

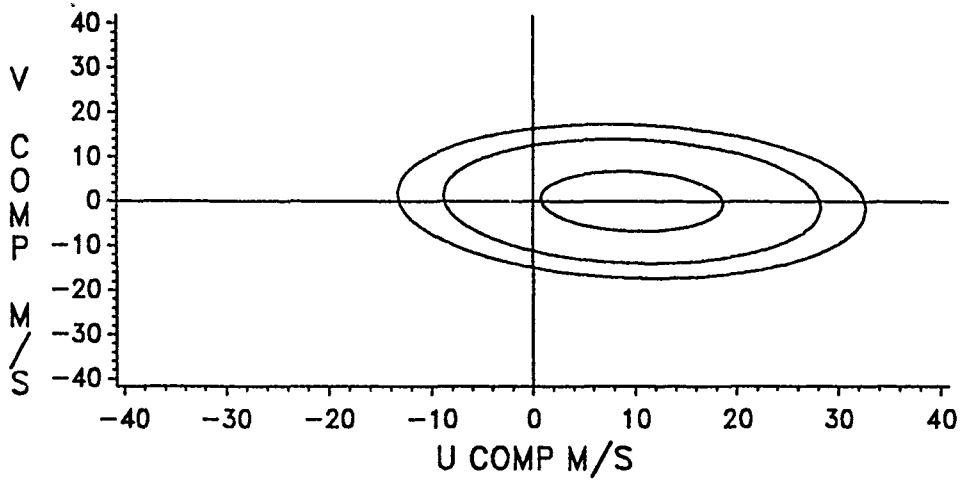

Figure E-41. Wind Probability Ellipses, January, 16 KM.

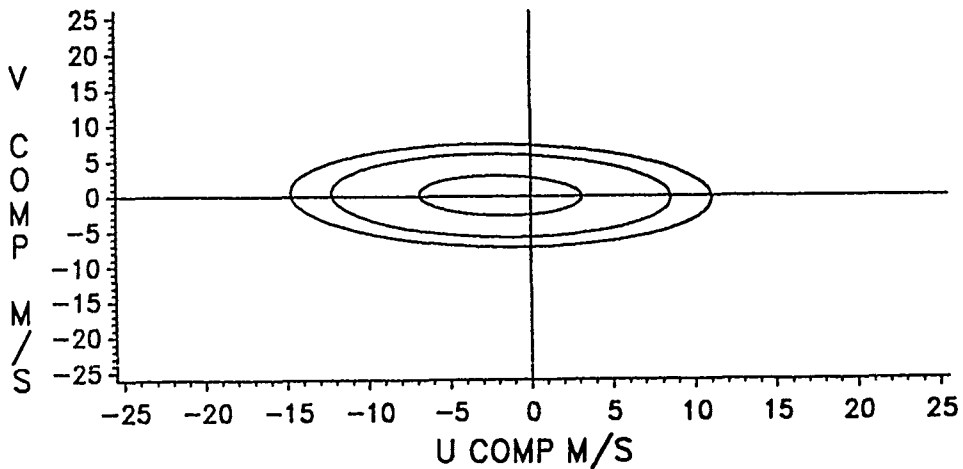

Figure E-42. Wind Probability Ellipses, January, 20 KM.

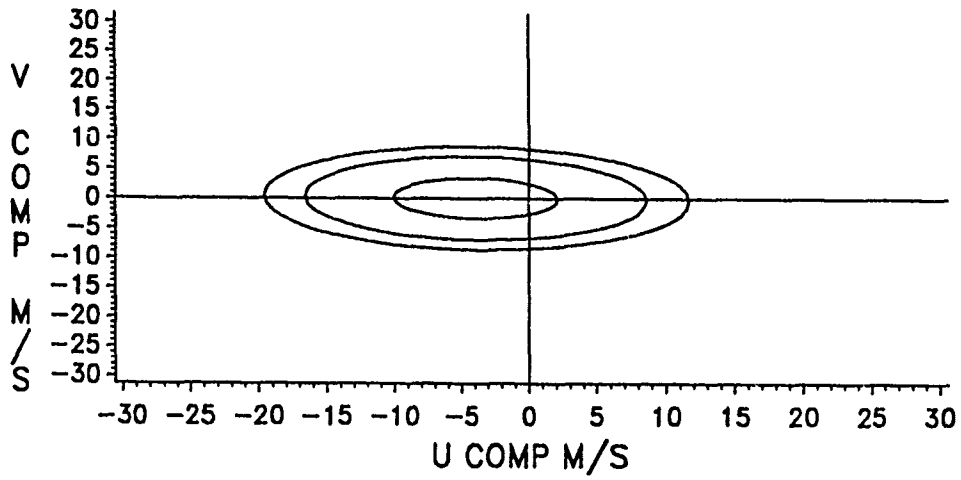

Figure E-43. Wind Probability Ellipses, January, 24 KM.

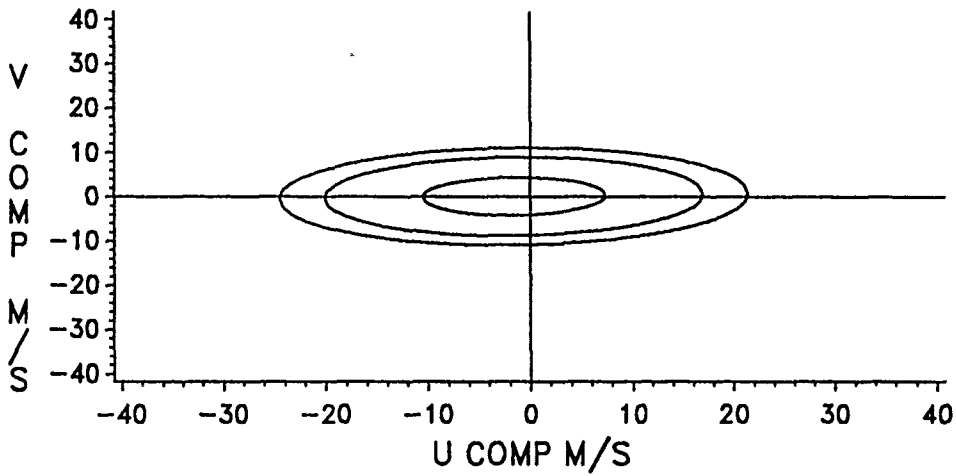

Figure E-44. Wind Probability Ellipses, January, 28 KM.

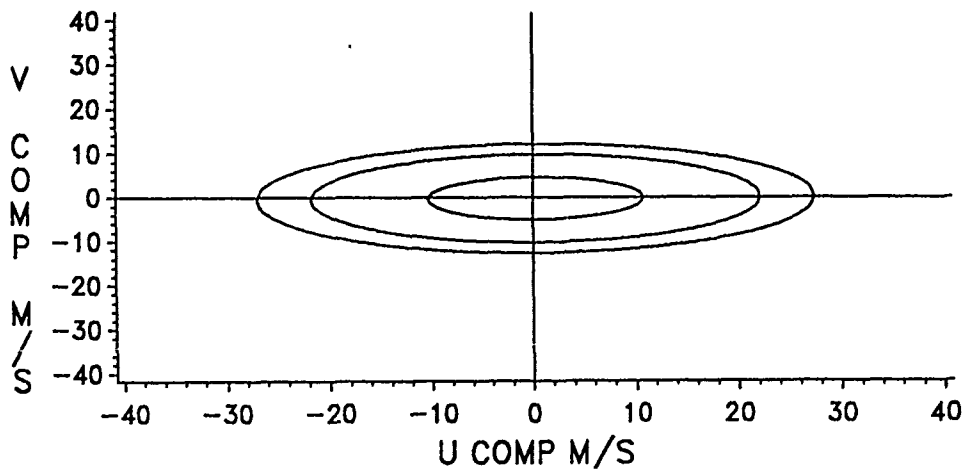

Figure E-45. Wind Probability Ellipses, January, 30 KM.

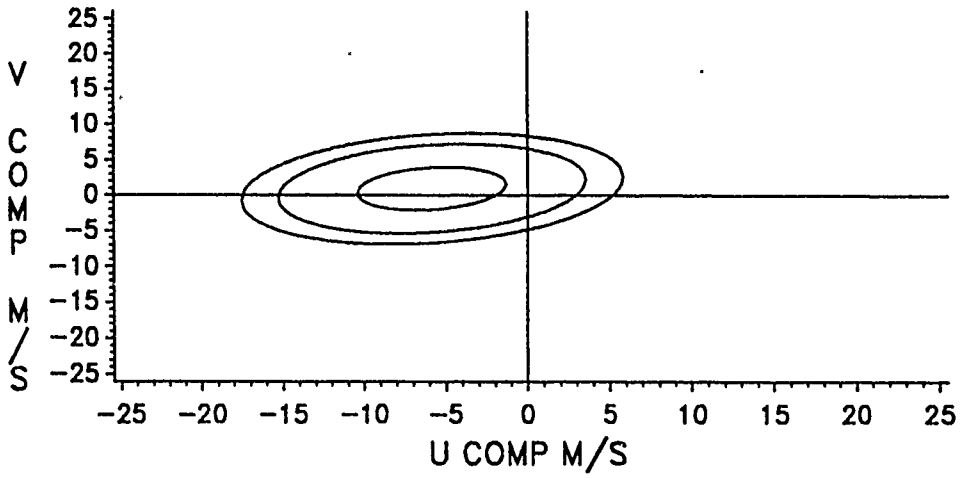

Figure E-46. Wind Probability Ellipses, July, 2 KM.

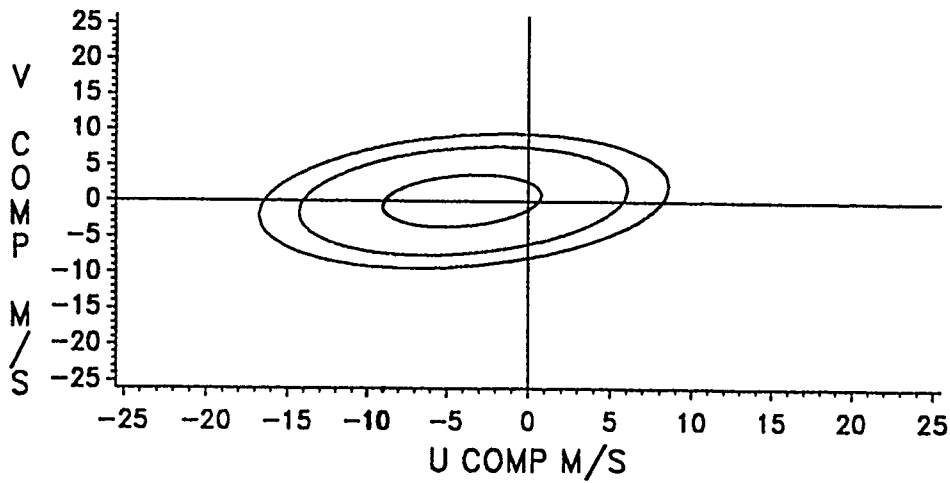

Figure E-47. Wind Probability Ellipses, July, 4 KM.

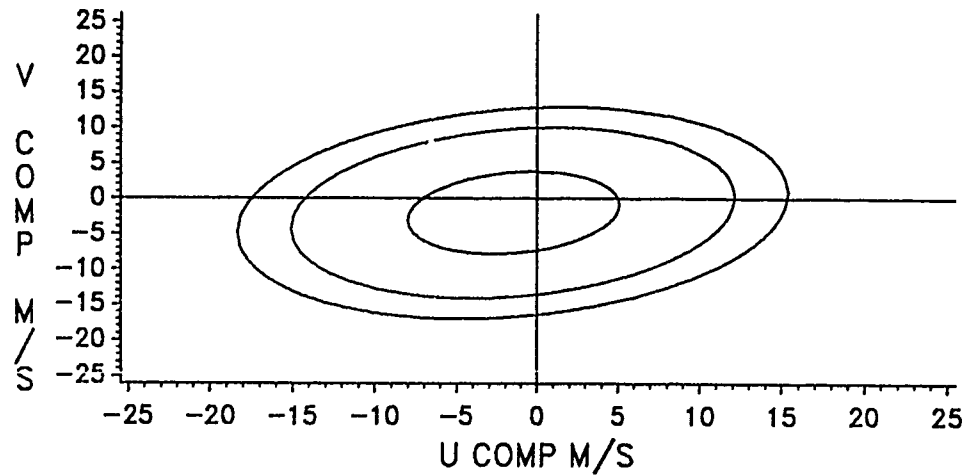

Figure E-48. Wind Probability Ellipses, July, 8 KM.

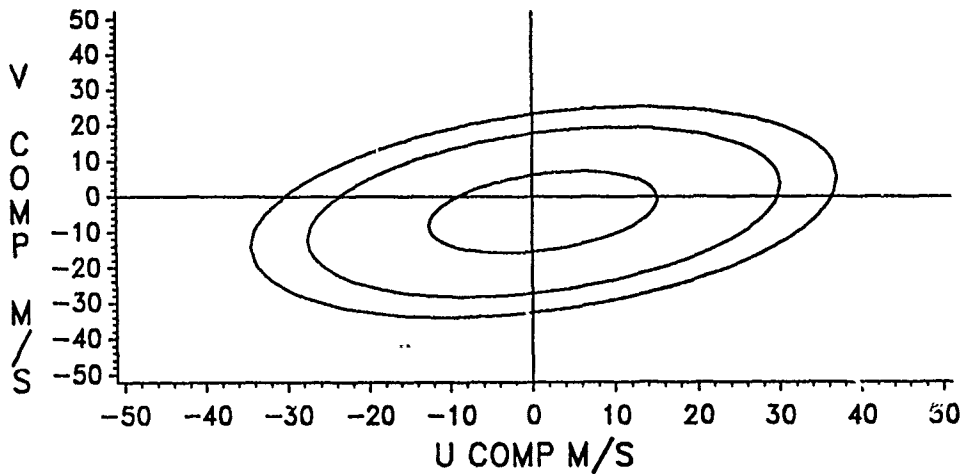

Figure E-49. Wind Probability Ellipses, July, 12 KM.

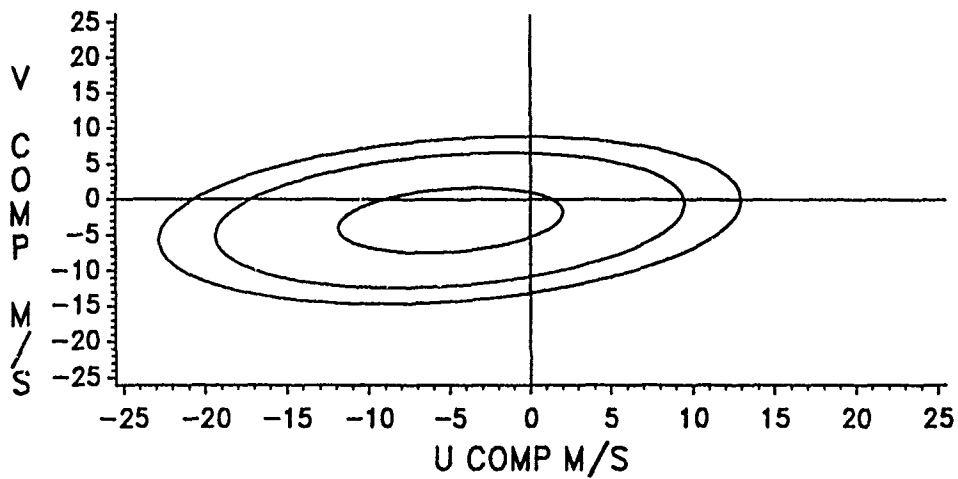

Figure E-50. Wind Probability Ellipses, July, 16 KM.

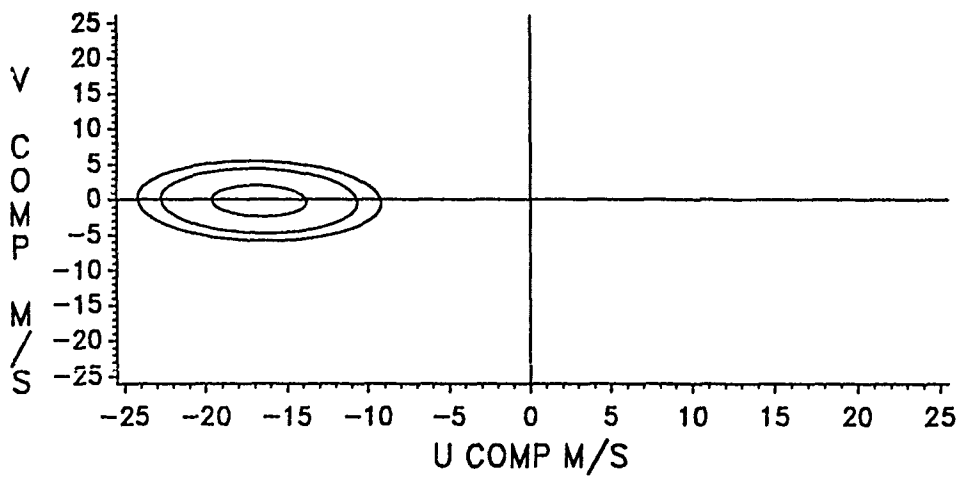

Figure E-51. Wind Probability Ellipses, July, 20 KM.

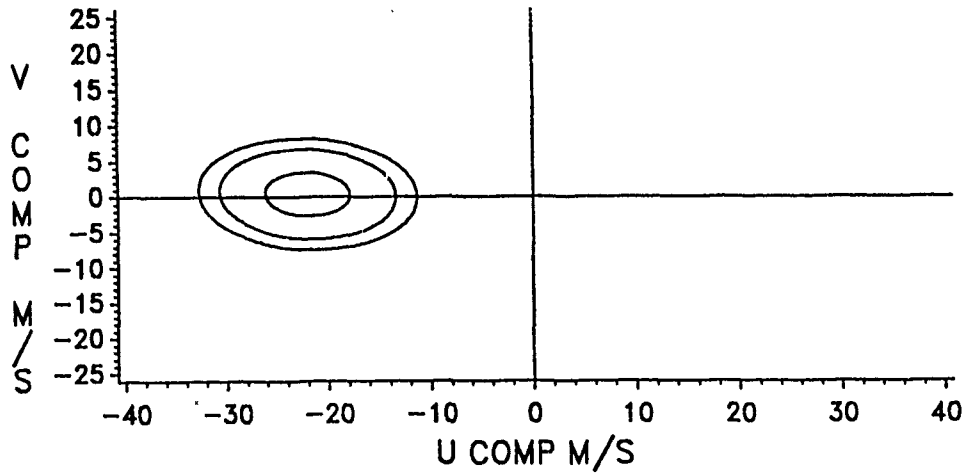

Figure E-52. Wind Probability Ellipses, July, 24 KM.

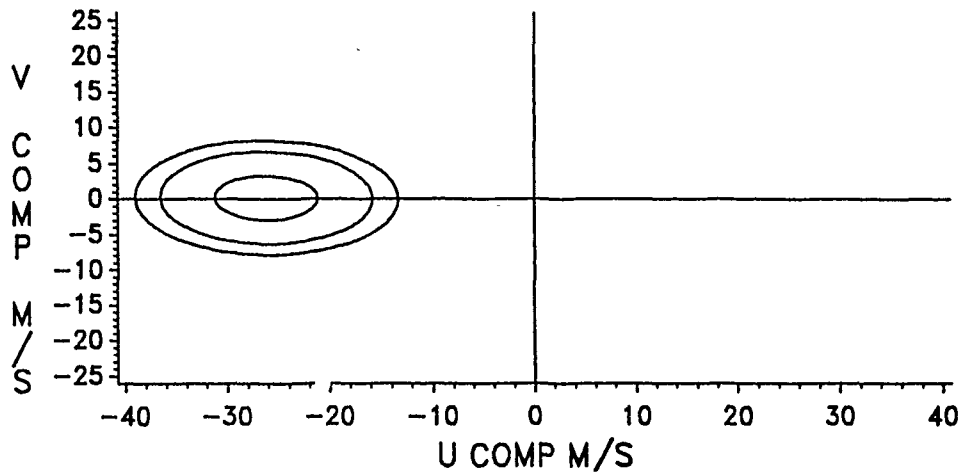

Figure E-53. Wind Probability Ellipses, July, 28 KM.

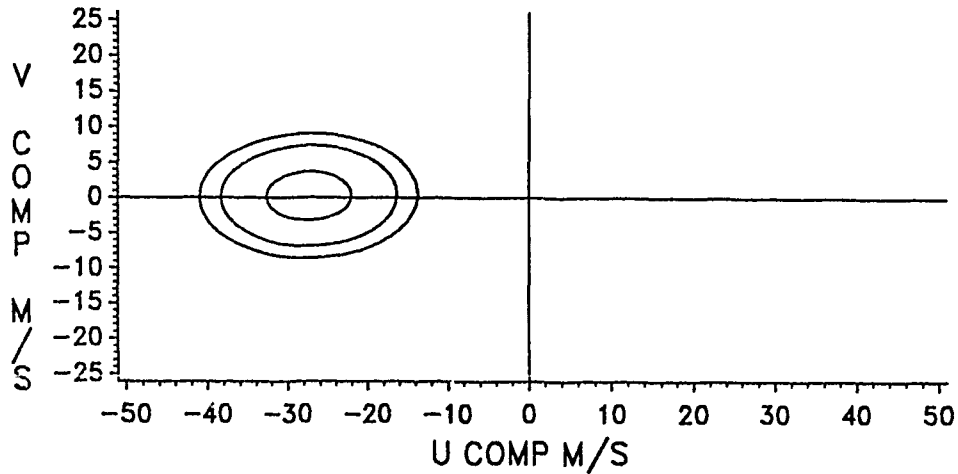

Figure E-54. Wind Probability Ellipses, July, 30 KM.

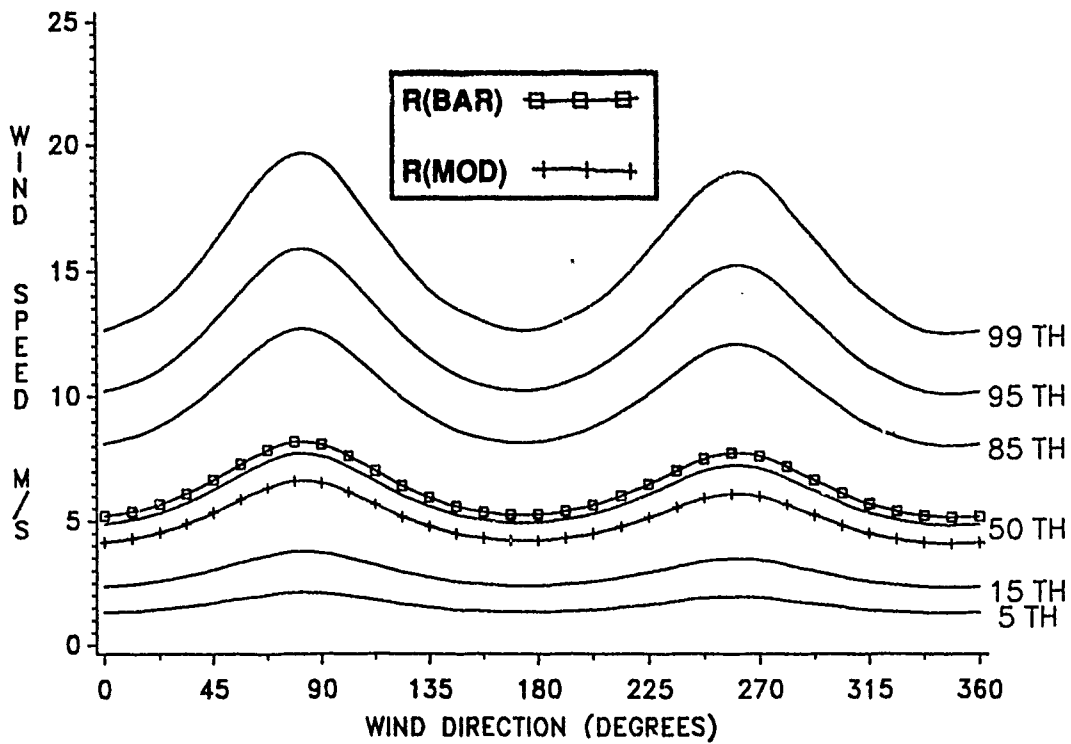

Figure E-55. Conditional Wind Speed Given Direction, January, 2 KM.

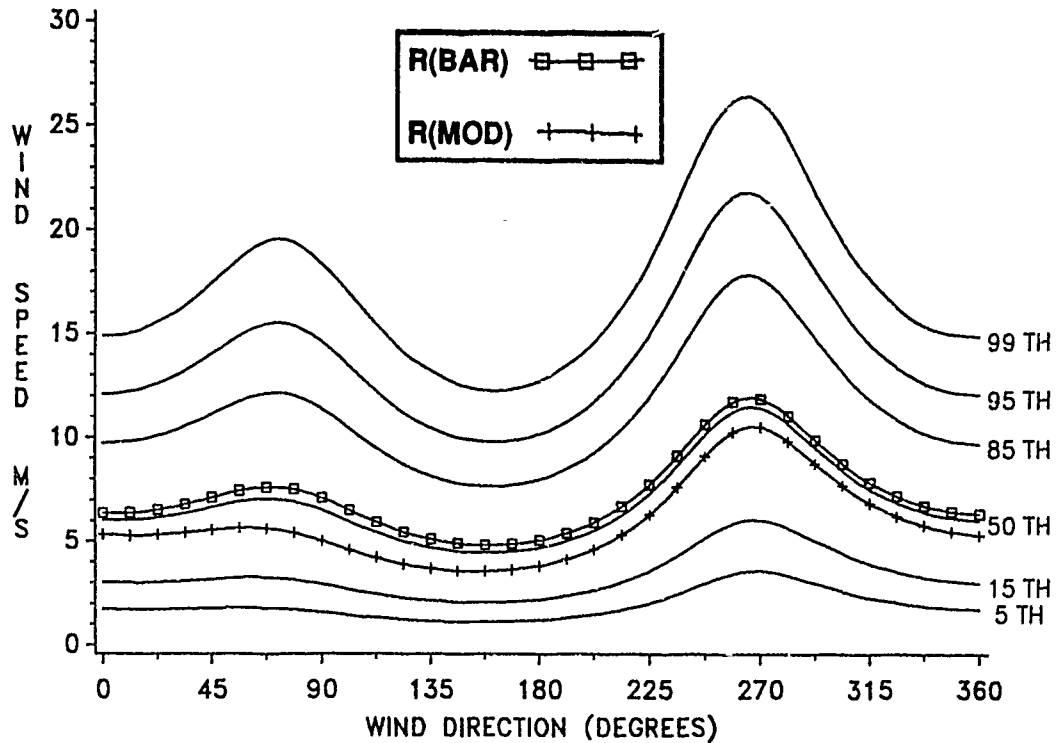

Figure E-56. Conditional Wind Speed Given Direction, January, 4 KM.

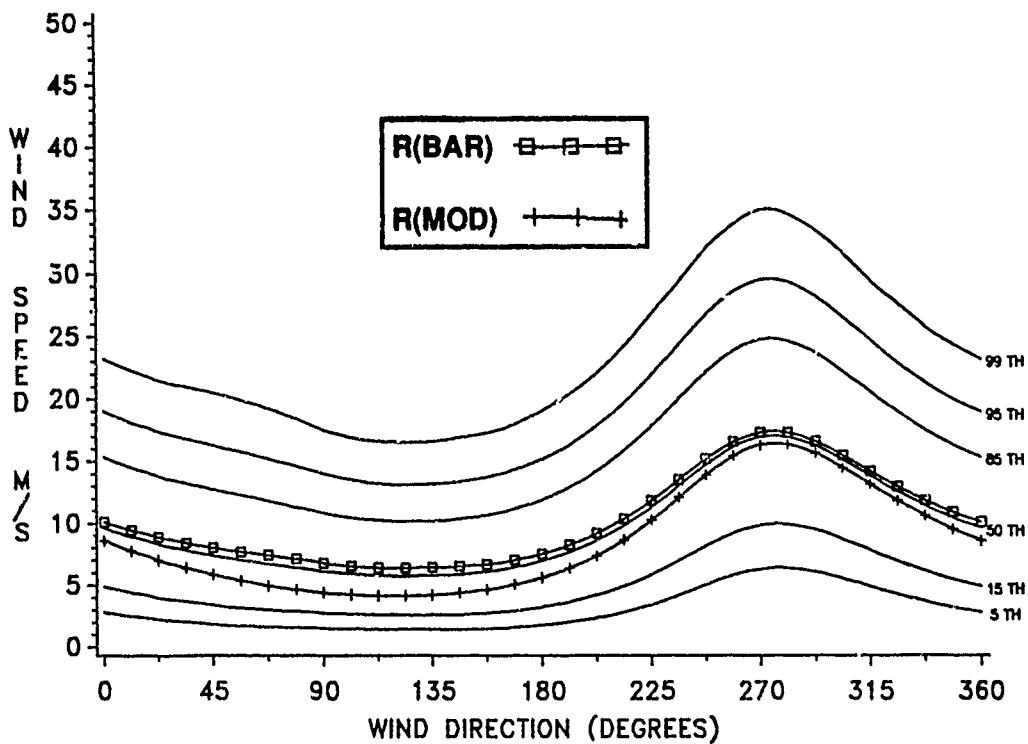

Figure E-57. Conditional Wind Speed Given Direction, January, 8 KM.

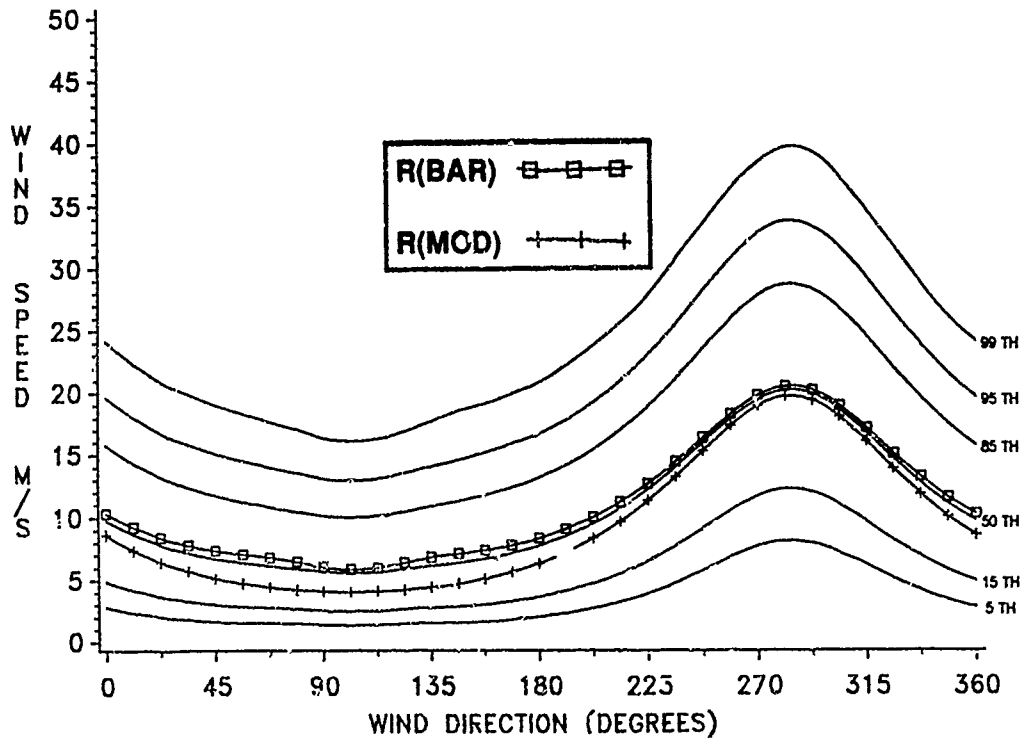

Figure E-58. Conditional Wind Speed Given Direction, January, 12 KM.

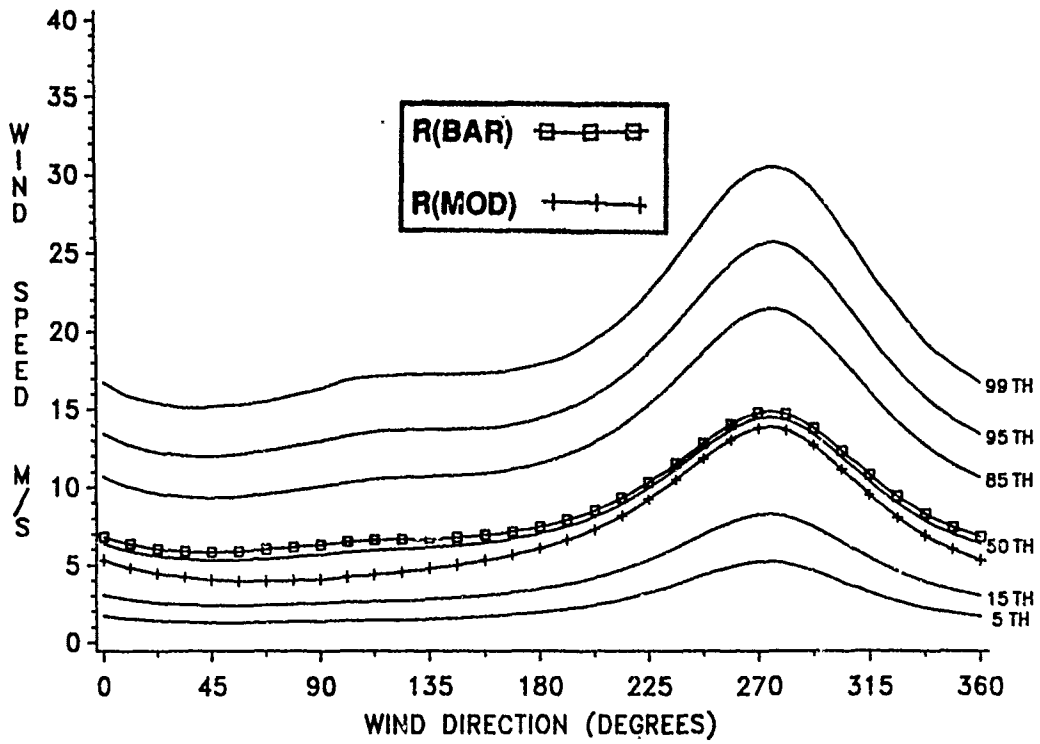

Figure E-59. Conditional Wind Speed Given Direction, January, 16 KM.

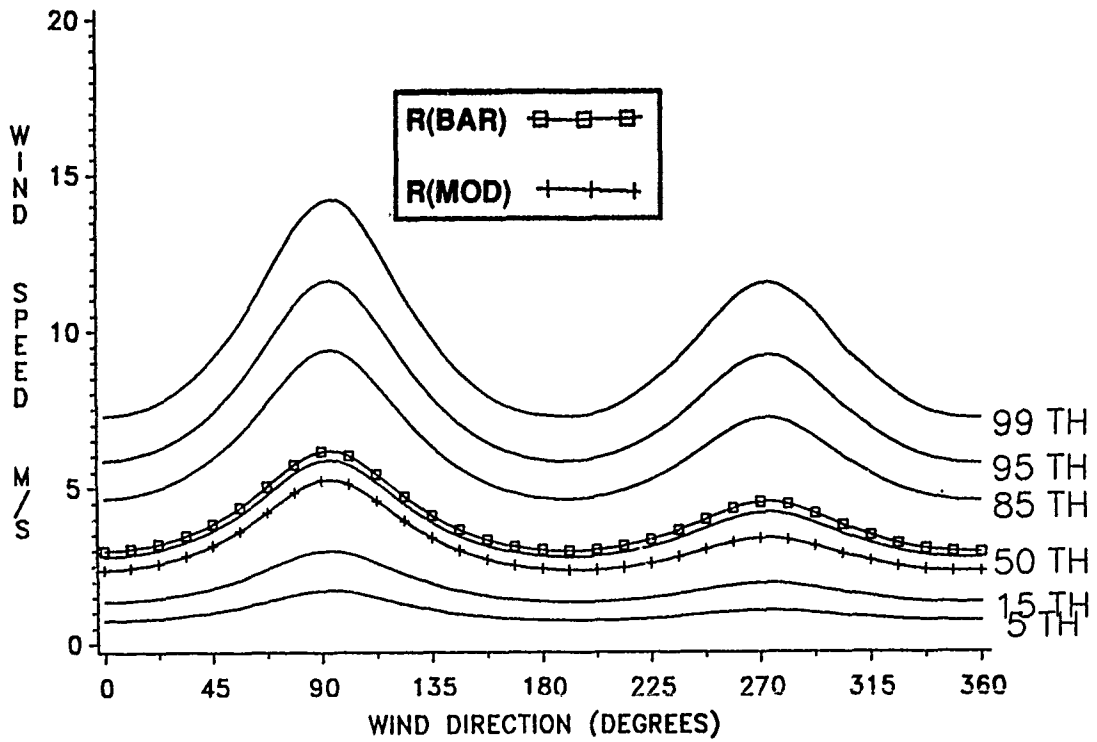

Figure E-60. Conditional Wind Speed Given Direction, January, 20 KM.

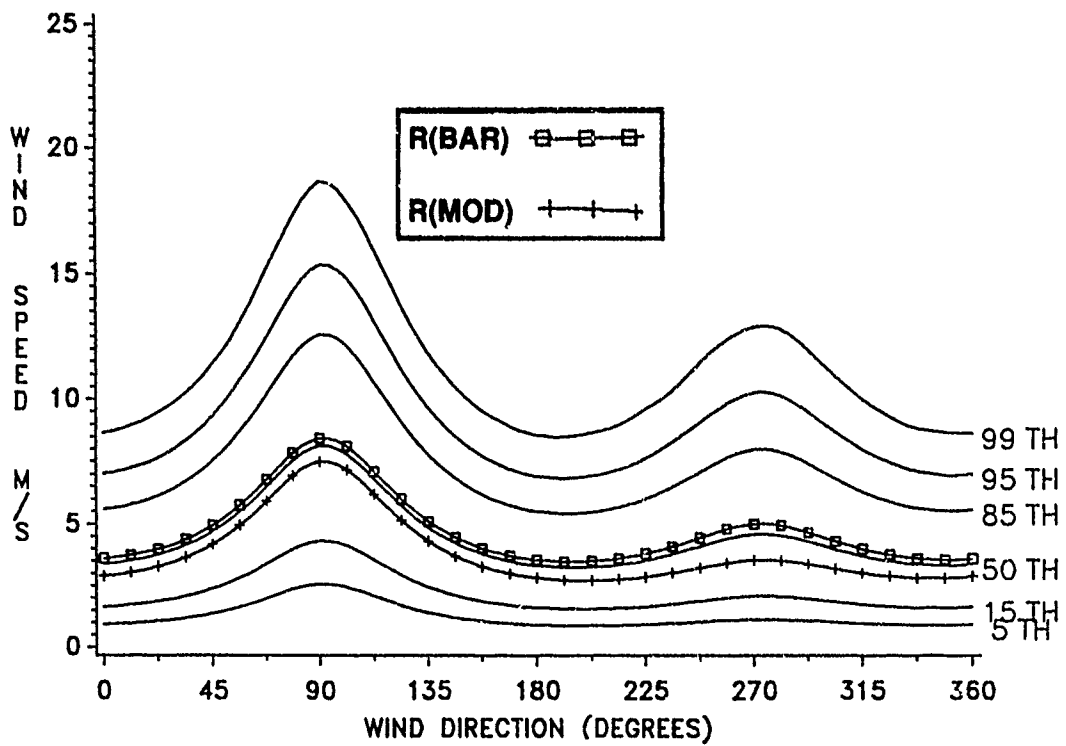

Figure E-61. Conditional Wind Speed Given Direction, January, 24 KM.

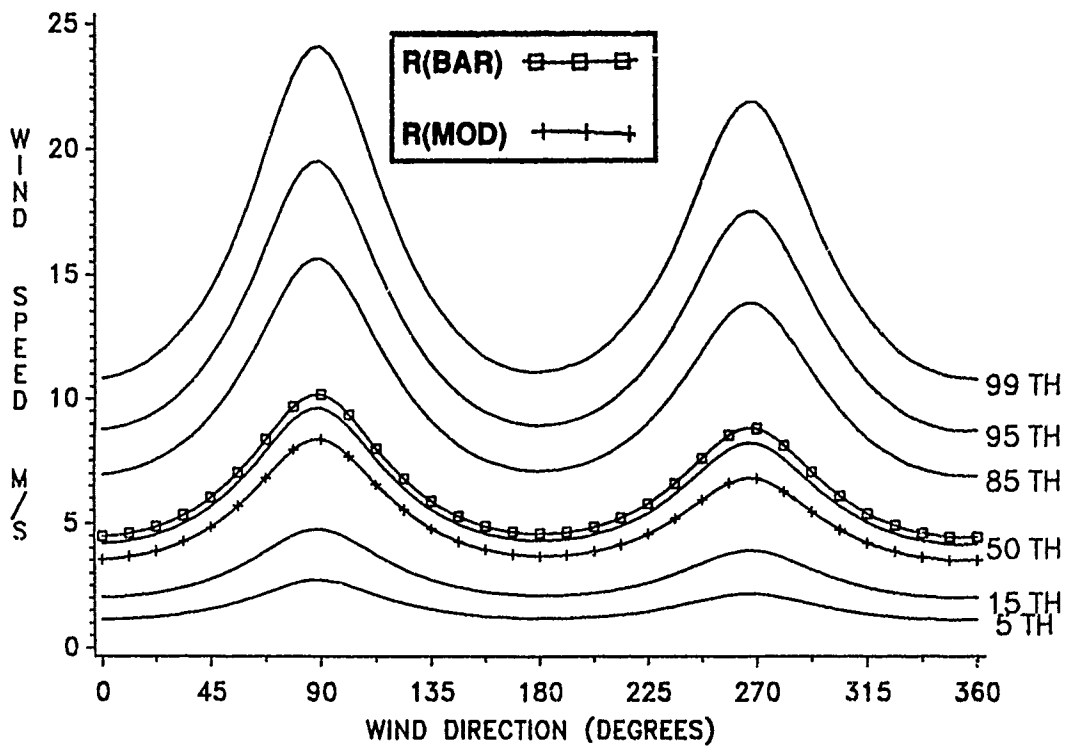

Figure E-62. Conditional Wind Speed Given Direction, January, 28 KM.

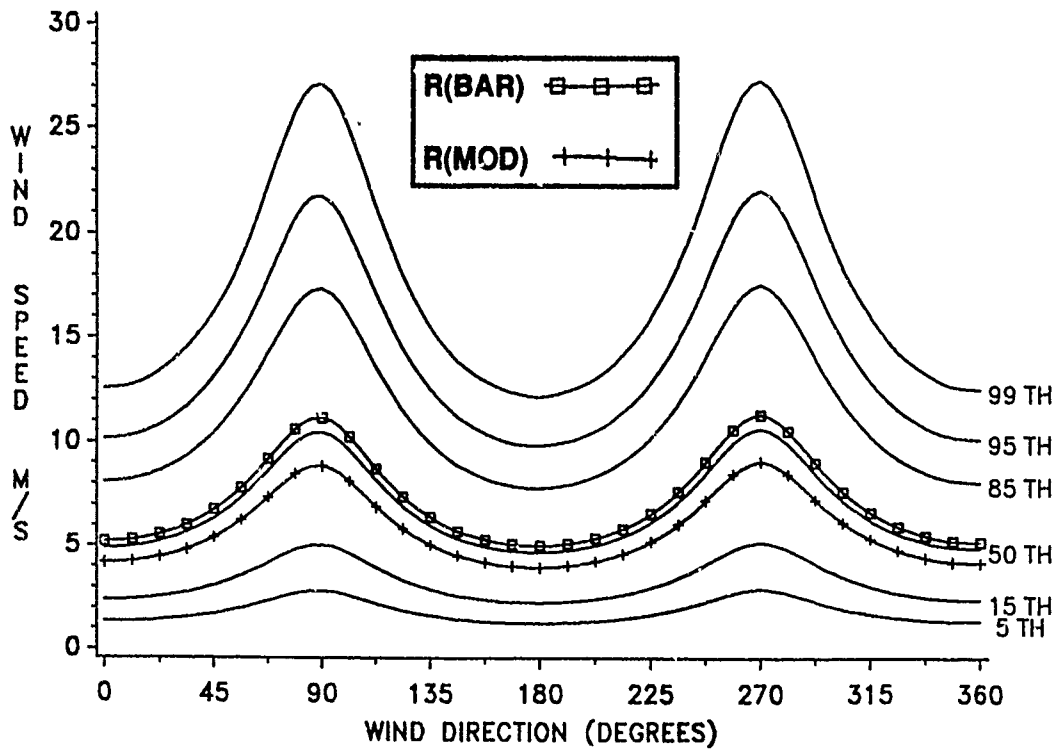

Figure E-63. Conditional Wind Speed Given Direction, January, 30 KM.

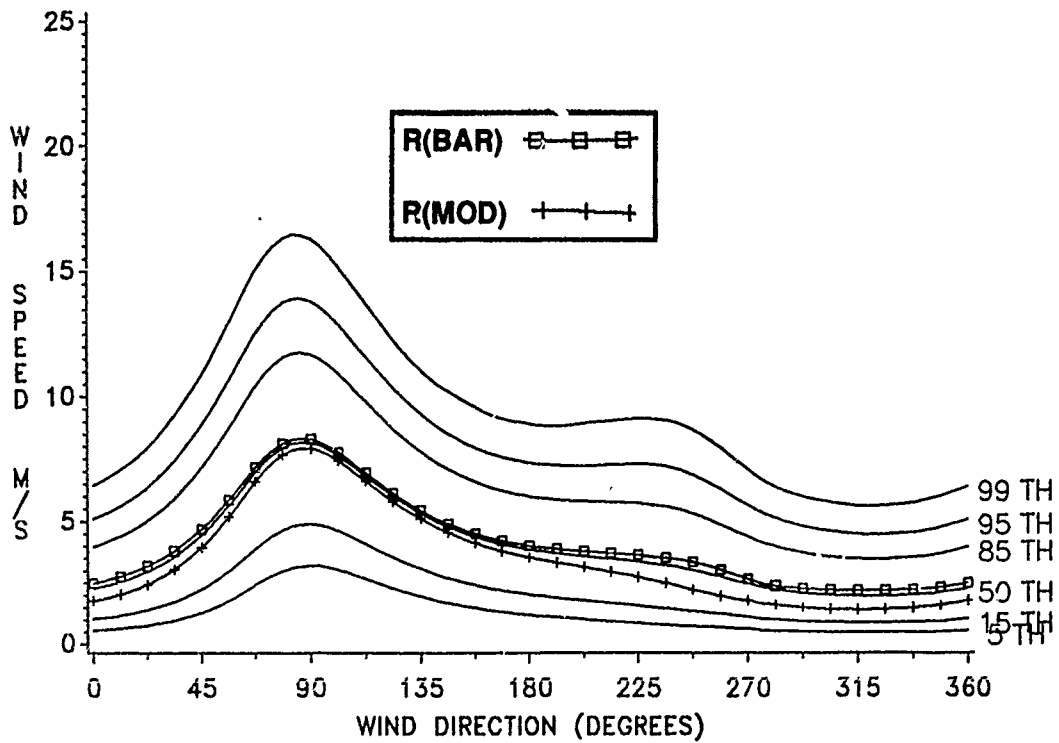

Figure E-64. Conditional Wind Speed Given Direction, July, 2 KM.

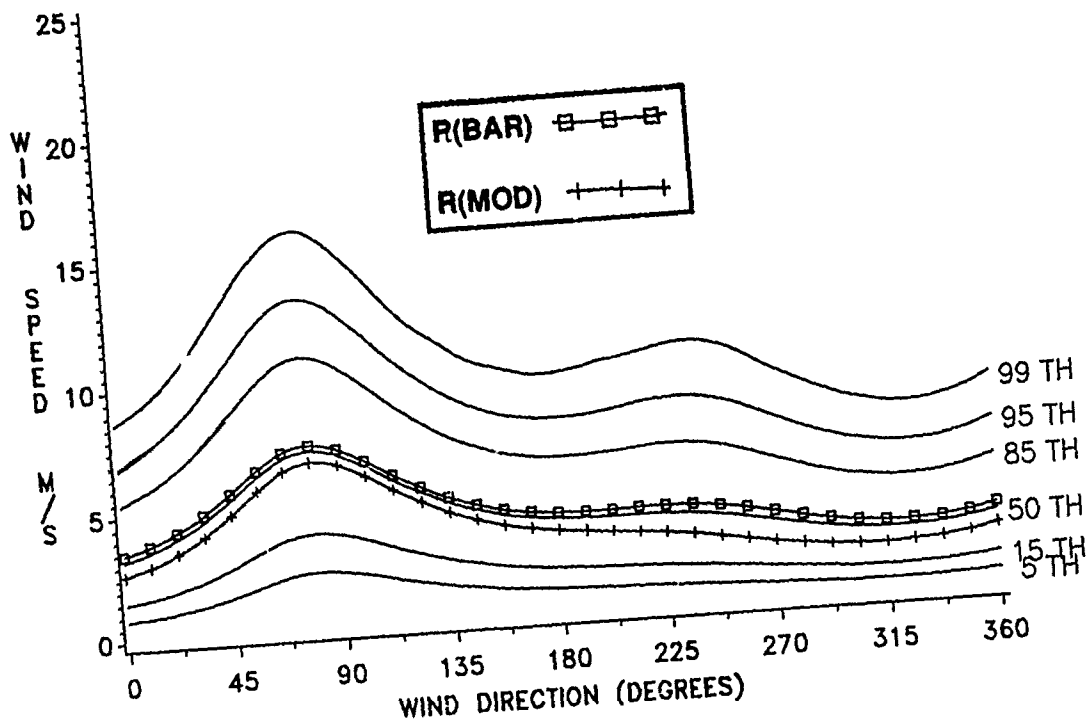

Figure E-65. Conditional Wind Speed Given Direction, July, 4 KM.

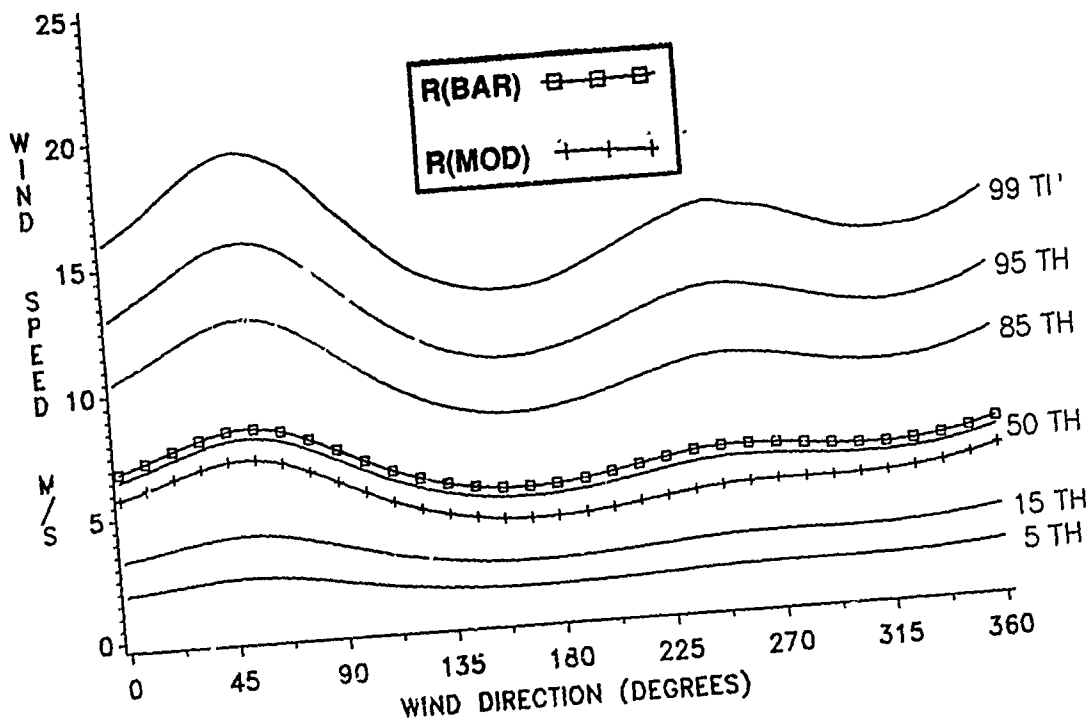

Figure E-66. Conditional Wind Speed Given Direction, July, 8 KM.

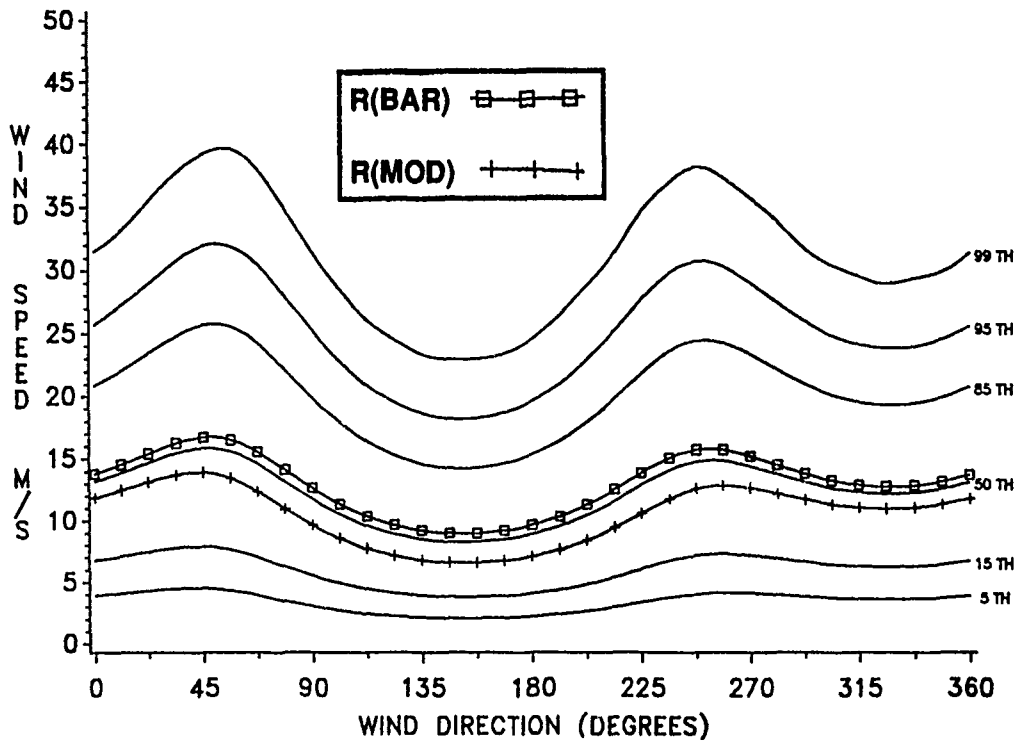

Figure E-67. Conditional Wind Speed Given Direction, July, 12 KM.

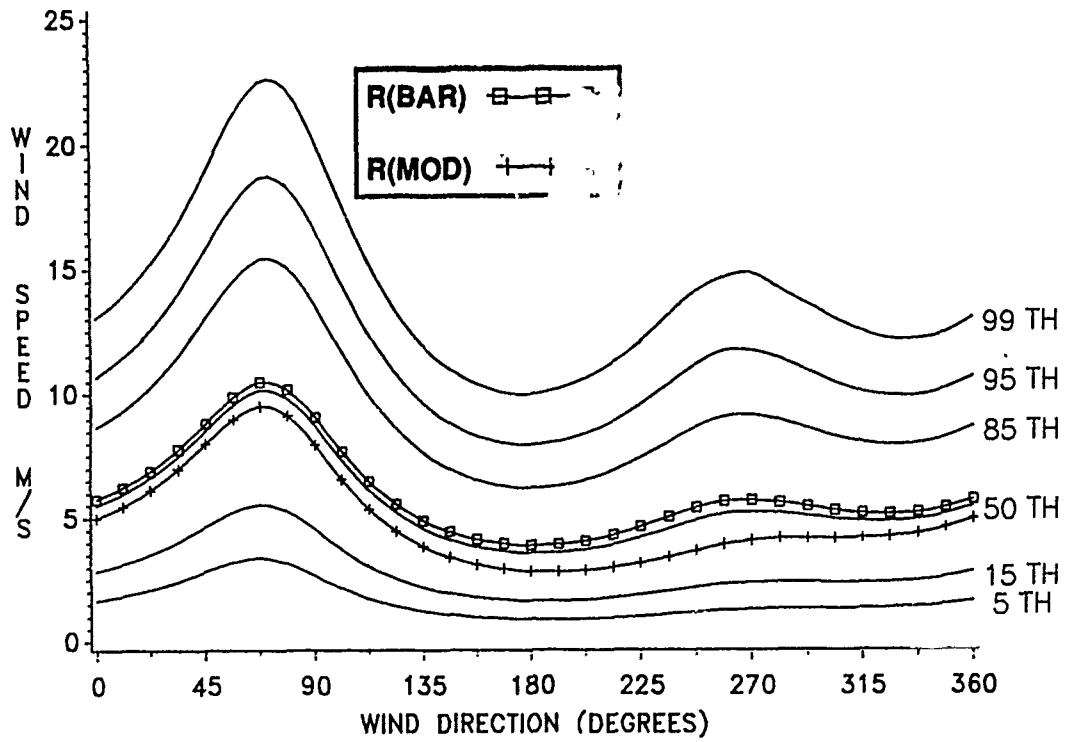

Figure E-68. Conditional Wind Speed Given Direction, July, 16 KM.

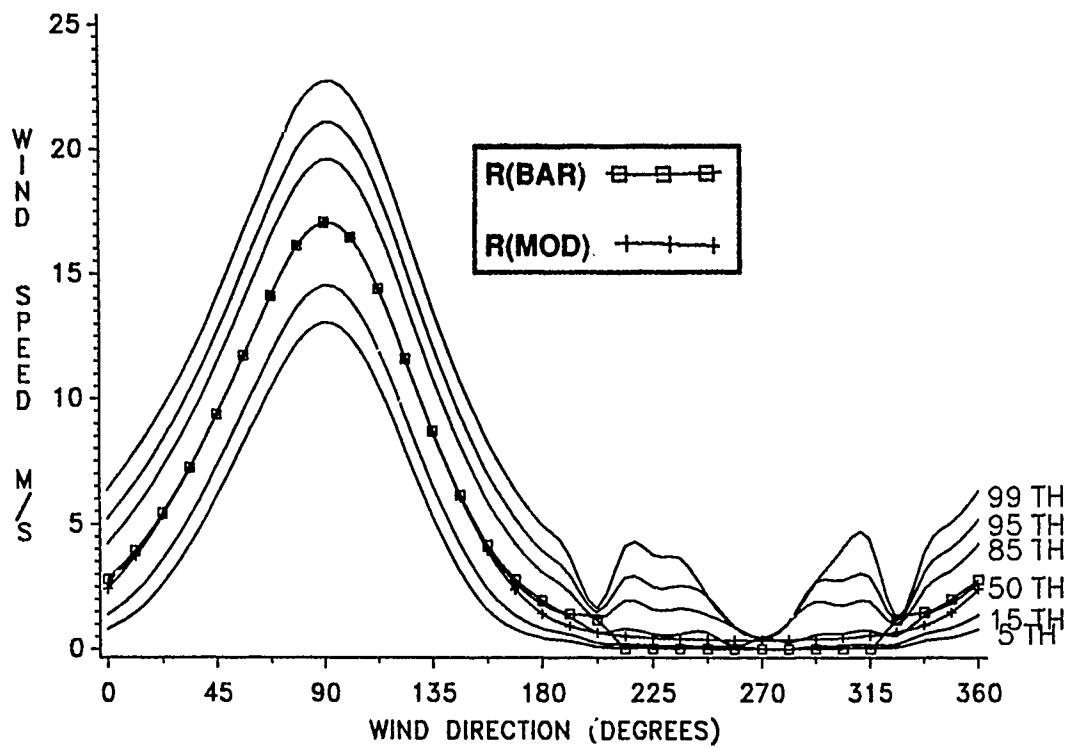

Figure E-69. Conditional Wind Speed Given Direction, July, 20 KM.

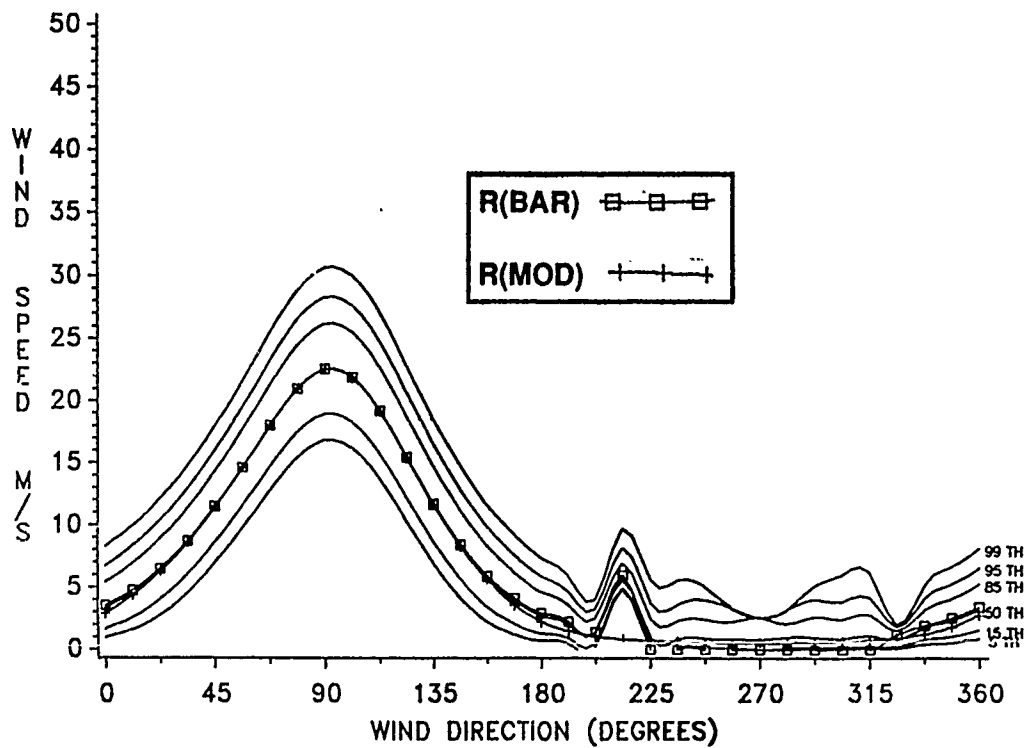

Figure E-70. Conditional Wind Speed Given Direction, July, 24 KM.

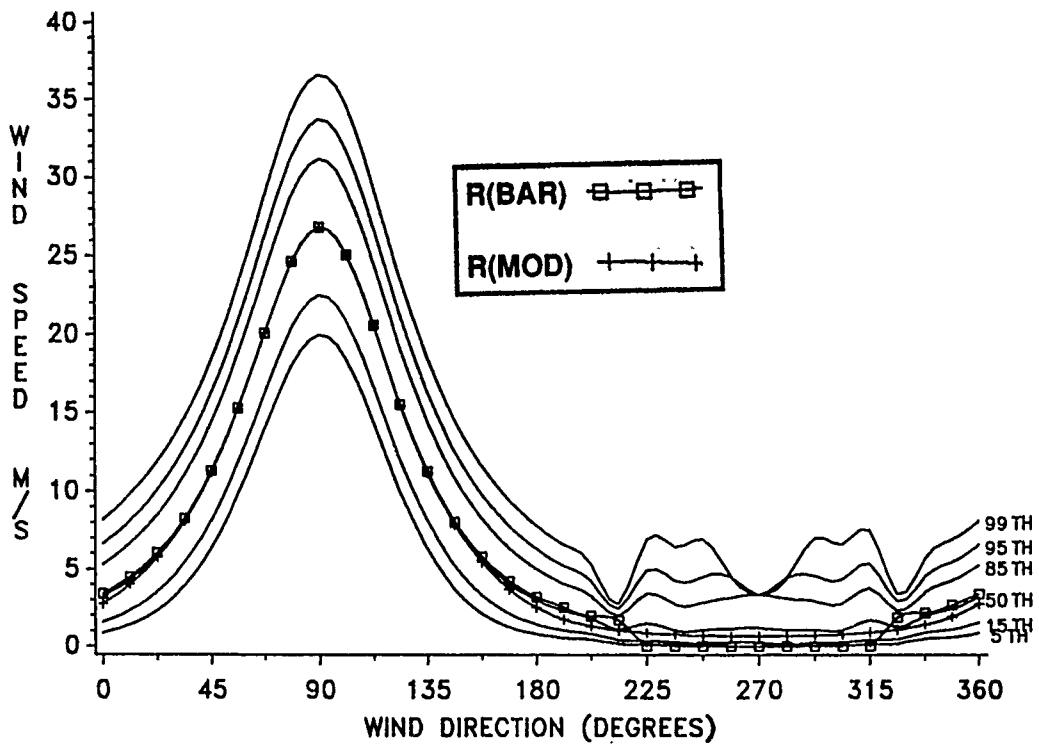

Figure E-71. Conditional Wind Speed Given Direction, July, 28 KM.

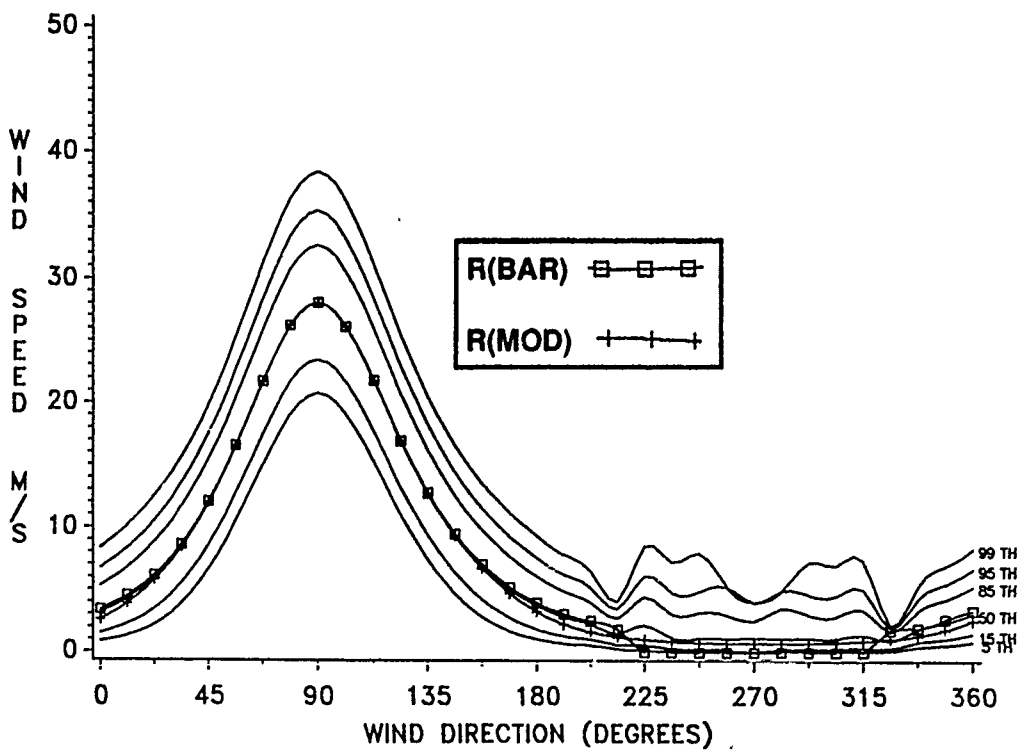

Figure E-72. Conditional Wind Speed Given Direction, July, 30 KM.

APPENDIX F

Thermodynamic Statistics Derivable from Appendix B, C, and D Tables

This appendix gives graphic examples of certain pressure, density, and virtual temperature statistics that can be derived from basic data in Appendices B, C, and D. These examples should help RRA users in understanding and visualizing the relationships that can be inferred from data in Appendices B and D.

Monthly Means from the Annual Mean

The hydrostatic model values in Appendix D are used to compute monthly mean differences relative to annual mean values of pressure, density, and virtual temperature (expressed in percent), and the monthly mean difference in virtual temperature for annual mean virtual temperature (expressed in kelvin, K). Examples of these four statistics are given in Tables F-1 (January) and F-2 (July); graphic displays of the four statistics contained in these tables are then provided by Figures F-1 through F-8. The relative differences between monthly mean values (from Tables D-1 through D-12 for all months) and annual mean values (Table D-13) are illustrated in Figures F-9 and F-18 for pressure, Figures F-10 and F-12 for density, and Figures F-13 and F-14 for virtual temperature. Differences between monthly mean virtual temperature differences and annual mean virtual temperature for all months are given in Figures F-15 and F-16.

Coefficients of Variation and Derived Correlation Coefficients.

The coefficient of variation (C_v) is defined as "the standard deviation with respect to the mean divided by the mean." Coefficients of variation for pressure (C_vP) and density (C_vD) were computed using standard deviations in Appendix B and the hydrostatic mean values in Appendix E. The coefficient of variation for temperature uses the standard deviations of virtual temperature from Appendix C to the altitude at which virtual temperature exists; above that altitude, standard deviations of temperature are from Appendix B. Mean values for virtual temperature to the altitude at which it exists and above are taken from Appendix E. No distinction is made between virtual temperature and temperature in Table F-3, Table F-4, or any of the figures.

From the coefficients of variation for pressure and temperature (virtual temperature to the altitude at which it exists), correlation coefficients between these quantities are derived using Buell's method--see Chapter 3. The three equations for the derived correlation coefficients in Tables F-3 and F-4 are:

$$R(P,T) = \frac{(C_vT)^2 + (C_vP)^2 - (C_vD)^2}{2[C_vT \cdot C_vP]} \quad (F-1)$$

$$R(P,D) = \frac{(C_vD)^2 - (C_vT)^2 + (C_vP)^2}{2[C_vD \cdot C_vP]} \quad (F-2)$$

$$R(T,D) = \frac{(C_V P)^2 - (C_V D)^2 - (C_V T)^2}{2[C_V T \cdot C_V D]} \quad (F-3)$$

To test for validity of derived correlation coefficients, all three of the following inequalities must be satisfied:

$$\begin{aligned} C_V P - (C_V D + C_V T) &< 0 \\ C_V D - (C_V T + C_V P) &< 0 \\ C_V T - (C_V P + C_V D) &< 0 \end{aligned} \quad (F-4)$$

In the examples (Tables F-3 and F-4), the numerical values from equation F-4 are all negative, and the derived correlation test is considered valid. The rare exceptions to this test for several RRAs occur at extremely high altitudes where sample sizes for the statistical sample are small.

Statistical parameters from Table F-3 (January) and Table F-4 (July) are illustrated in Figures F-17 through F-20.

$C_V P$ values for all months are given in Figures F-21 and F-22. $C_V D$ values are given in Figures F-23 and F-24, and $C_V T$ values in Figures F-25 and F-26. If the abscissa on the figures for the coefficient of variation is multiplied by 100, these figures would show the percentage of random dispersion for these quantities over the month with respect to the monthly mean.

Derived correlation coefficients for all months are shown as follows: Figures F-27 and F-28 give $R(P,D)$; Figures F-29 and F-30 give $R(P,T)$; and Figures F-31 and F-32 give $R(T,D)$.

TABLE F-1. Deltas in Percent Relative to Annual, January.

<u>RLEVEL</u>	<u>PRESSURE</u>	<u>DENSITY</u>	<u>TEMP.</u>	<u>TMO-TANN (K)</u>
0.000	0.007	0.669	-0.660	-2.000
0.005	0.007	0.682	-0.670	-2.030
1.000	-0.067	0.645	-0.707	-2.080
2.000	-0.134	0.211	-0.343	-0.990
3.000	-0.155	-0.204	0.049	0.140
4.000	-0.147	-0.343	0.197	0.550
5.000	-0.127	-0.340	0.216	0.590
6.000	-0.080	-0.284	0.206	0.550
7.000	-0.049	-0.327	0.277	0.720
8.000	-0.002	-0.429	0.427	1.080
9.000	0.061	-0.463	0.525	1.290
10.000	0.138	-0.417	0.558	1.330
11.000	0.252	0.189	0.064	0.150
12.000	0.351	-0.369	0.727	1.620
13.000	0.455	-0.193	0.646	1.390
14.000	0.536	0.126	0.409	0.850
15.000	0.509	0.708	-0.198	-0.400
16.000	0.384	1.629	-1.223	-2.420
17.000	0.106	2.673	-2.496	-4.900
18.000	-0.382	2.700	-3.001	-5.940
19.000	-0.794	1.455	-2.218	-4.490
20.000	-1.091	0.208	-1.294	-2.680
21.000	-1.279	-0.376	-0.905	-1.910
22.000	-1.425	-0.667	-0.762	-1.630
23.000	-1.554	-0.790	-0.772	-1.670
24.000	-1.695	-0.831	-0.868	-1.900
25.000	-1.825	-0.908	-0.928	-2.050
26.000	-1.971	-1.018	-0.964	-2.150
27.000	-2.063	-1.029	-1.044	-2.350
28.000	-2.244	-1.165	-1.094	-2.480
29.000	-2.387	-1.261	-1.142	-2.610
30.000	-2.550	-1.435	-1.130	-2.600

TABLE F-2. Deltas in Percent Relative to Annual Wake Island, July.

<u>RLEVEL</u>	<u>PRESSURE</u>	<u>DENSITY</u>	<u>TEMP.</u>	<u>TMO-TANN (K)</u>
0.000	-0.086	-0.644	0.561	1.700
0.005	-0.089	-0.629	0.544	1.650
1.000	-0.032	-0.571	0.544	1.600
2.000	0.017	-0.303	0.322	0.930
3.000	0.044	0.001	0.042	0.120
4.000	0.048	0.163	-0.115	-0.320
5.000	0.033	0.200	-0.165	-0.450
6.000	-0.002	0.110	-0.112	-0.300
7.000	-0.002	0.038	-0.042	-0.110
8.000	-0.016	0.003	-0.020	-0.050
9.000	-0.017	0.022	-0.041	-0.100
10.000	-0.035	0.118	-0.151	-0.360
11.000	-0.067	0.152	-0.218	-0.510
12.000	-0.129	0.369	-0.494	-1.100
13.000	-0.209	0.451	-0.655	-1.410
14.000	-0.311	0.352	-0.659	-1.370
15.000	-0.314	-0.193	-0.124	-0.250
16.000	-0.232	-1.429	1.213	2.400
17.000	0.070	-2.709	2.857	5.610
18.000	0.606	-2.616	3.309	6.550
19.000	1.051	-1.376	2.460	4.980
20.000	1.396	-0.079	1.477	3.060
21.000	1.590	0.615	0.967	2.040
22.000	1.748	0.985	0.753	1.610
23.000	1.858	1.220	0.633	1.370
24.000	1.910	1.373	0.530	1.160
25.000	2.024	1.527	0.489	1.080
26.000	2.103	1.614	0.480	1.070
27.000	2.120	1.801	0.316	0.710
28.000	2.211	2.007	0.198	0.450
29.000	2.269	2.136	0.131	0.300
30.000	2.350	2.336	0.017	0.040

TABLE F-3. Coefficients of Variation/Correlation Coefficients, January.

<u>LEVEL</u>	<u>CVP</u>	<u>CVD</u>	<u>CVT</u>	<u>R(P,T)</u>	<u>R(P,D)</u>	<u>R(T,D)</u>
0.000	0.003	0.007	0.005	-0.175	0.580	-0.903
0.005	0.003	0.007	0.005	-0.174	0.581	-0.902
1.000	0.003	0.007	0.005	-0.151	0.518	-0.924
2.000	0.003	0.008	0.009	0.123	0.191	-0.951
3.000	0.003	0.006	0.007	0.330	0.100	-0.906
4.000	0.003	0.006	0.006	0.440	0.078	-0.861
5.000	0.003	0.006	0.006	0.469	0.102	-0.831
6.000	0.004	0.006	0.007	0.430	0.155	-0.825
7.000	0.004	0.007	0.008	0.461	0.122	-0.825
8.000	0.005	0.007	0.008	0.519	0.122	-0.785
9.000	0.005	0.006	0.007	0.572	0.169	-0.712
10.000	0.006	0.006	0.007	0.535	0.401	-0.559
11.000	0.007	0.006	0.007	0.433	0.817	-0.166
12.000	0.007	0.006	0.007	0.633	0.496	-0.358
13.000	0.008	0.006	0.007	0.634	0.543	-0.305
14.000	0.008	0.007	0.008	0.603	0.498	-0.392
15.000	0.009	0.009	0.008	0.501	0.586	-0.408
16.000	0.010	0.010	0.009	0.403	0.565	-0.528
17.000	0.011	0.015	0.012	0.183	0.568	-0.706
18.000	0.011	0.017	0.015	0.119	0.530	-0.779
19.000	0.011	0.017	0.014	0.078	0.562	-0.781
20.000	0.011	0.016	0.013	0.102	0.607	-0.729
21.000	0.011	0.014	0.011	0.218	0.625	-0.625
22.000	0.012	0.014	0.011	0.292	0.614	-0.575
23.000	0.013	0.013	0.011	0.469	0.588	-0.438
24.000	0.013	0.012	0.011	0.502	0.616	-0.371
25.000	0.014	0.013	0.011	0.508	0.682	-0.283
26.000	0.015	0.013	0.011	0.539	0.720	-0.195
27.000	0.016	0.013	0.011	0.563	0.756	-0.115
28.000	0.017	0.014	0.011	0.541	0.772	-0.117
29.000	0.018	0.015	0.012	0.518	0.770	-0.146
30.000	0.019	0.016	0.012	0.500	0.761	-0.181

TABLE F-4. Coefficients of Variation/Correlation Coefficient, July.

<u>LEVEL</u>	<u>CVP</u>	<u>CVD</u>	<u>CVT</u>	<u>R(P,T)</u>	<u>R(P,D)</u>	<u>R(T,D)</u>
0.000	0.002	0.005	0.005	0.018	0.311	-0.945
0.005	0.002	0.005	0.005	0.052	0.281	-0.944
1.000	0.002	0.003	0.003	-0.096	0.575	-0.870
2.000	0.002	0.004	0.003	0.045	0.409	-0.893
3.000	0.002	0.004	0.004	0.288	0.157	-0.901
4.000	0.002	0.004	0.005	0.408	0.078	-0.878
5.000	0.002	0.004	0.005	0.449	0.042	-0.874
6.000	0.003	0.005	0.006	0.530	-0.077	-0.887
7.000	0.003	0.005	0.006	0.641	-0.205	-0.883
8.000	0.004	0.005	0.007	0.719	-0.265	-0.860
9.000	0.004	0.005	0.007	0.808	-0.356	-0.838
10.000	0.005	0.004	0.008	0.798	-0.117	-0.692
11.000	0.007	0.004	0.008	0.775	0.450	-0.216
12.000	0.007	0.005	0.008	0.835	0.100	-0.463
13.000	0.008	0.007	0.009	0.689	0.357	-0.431
14.000	0.009	0.011	0.010	0.350	0.497	-0.639
15.000	0.009	0.017	0.014	-0.080	0.600	-0.846
16.000	0.009	0.021	0.017	-0.260	0.629	-0.914
17.000	0.008	0.016	0.012	-0.172	0.656	-0.856
18.000	0.008	0.012	0.009	0.122	0.633	-0.692
19.000	0.008	0.010	0.008	0.286	0.619	-0.575
20.000	0.009	0.009	0.007	0.383	0.693	-0.400
21.000	0.010	0.009	0.008	0.459	0.671	-0.351
22.000	0.011	0.009	0.008	0.569	0.693	-0.199
23.000	0.011	0.009	0.008	0.547	0.690	-0.229
24.000	0.011	0.010	0.009	0.573	0.655	-0.243
25.000	0.012	0.010	0.009	0.574	0.690	-0.197
26.000	0.013	0.010	0.009	0.601	0.709	-0.138
27.000	0.014	0.011	0.009	0.643	0.744	-0.034
28.000	0.015	0.011	0.009	0.653	0.776	0.030
29.000	0.017	0.012	0.010	0.757	0.840	0.282
30.000	0.018	0.013	0.011	0.730	0.814	0.197

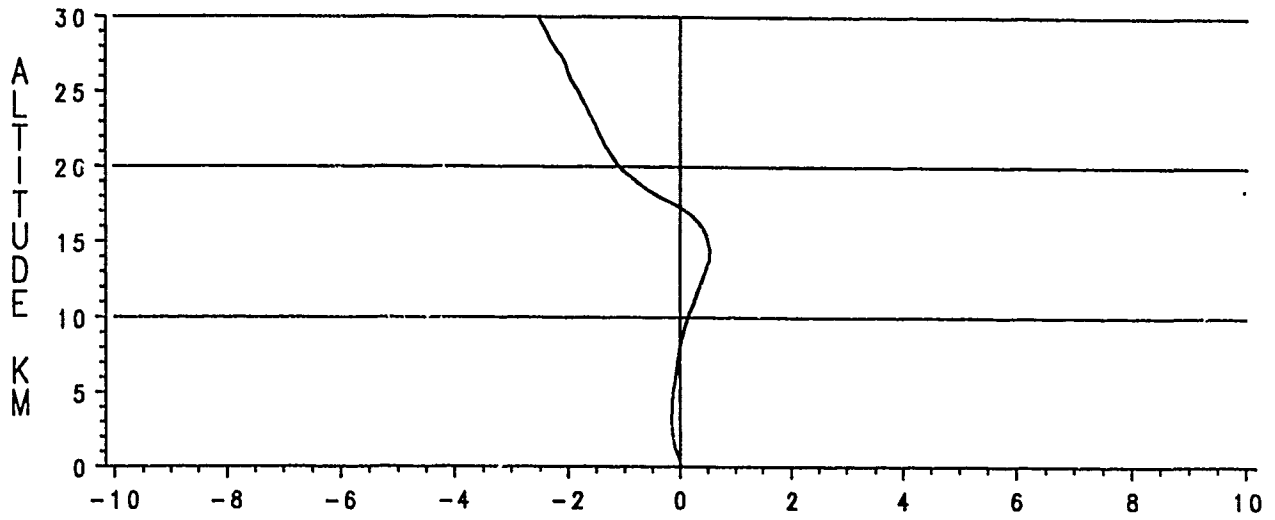

Figure F-1. Delta Percent Relative to Annual Pressure, January.

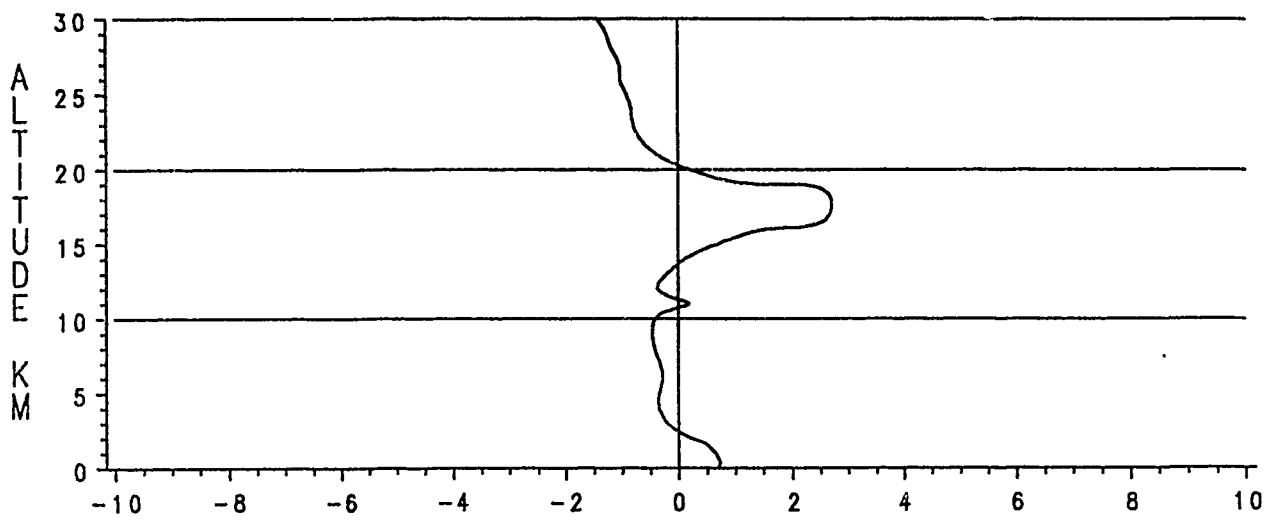

Figure F-2. Delta Percent Relative to Annual Density, January.

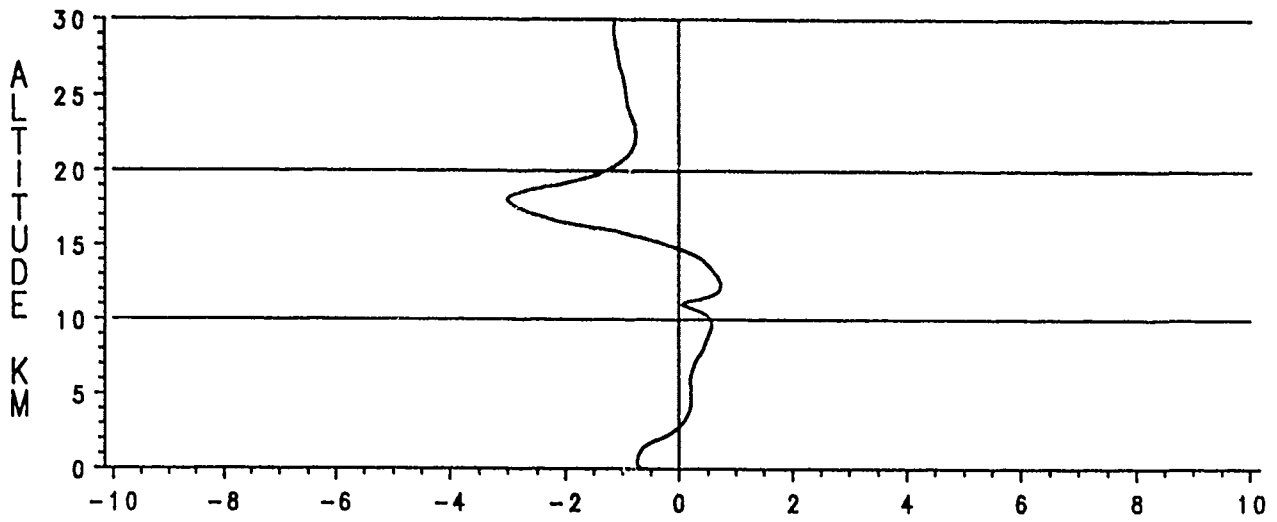

Figure F-3. Delta Percent Relative to Annual Temperature, January.

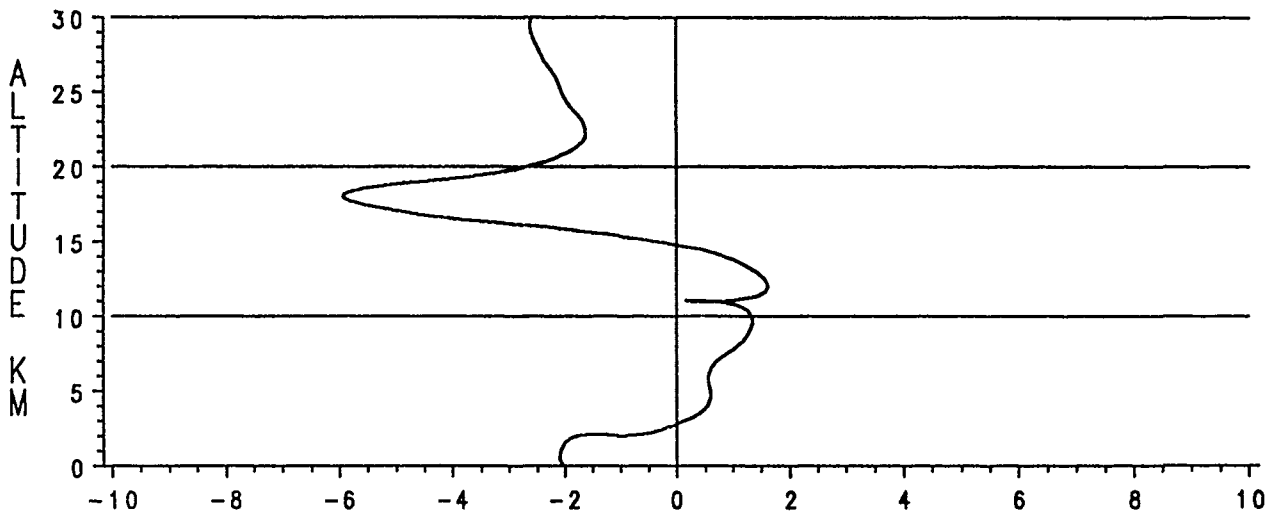

Figure F-4. Delta Temperature (K), January.

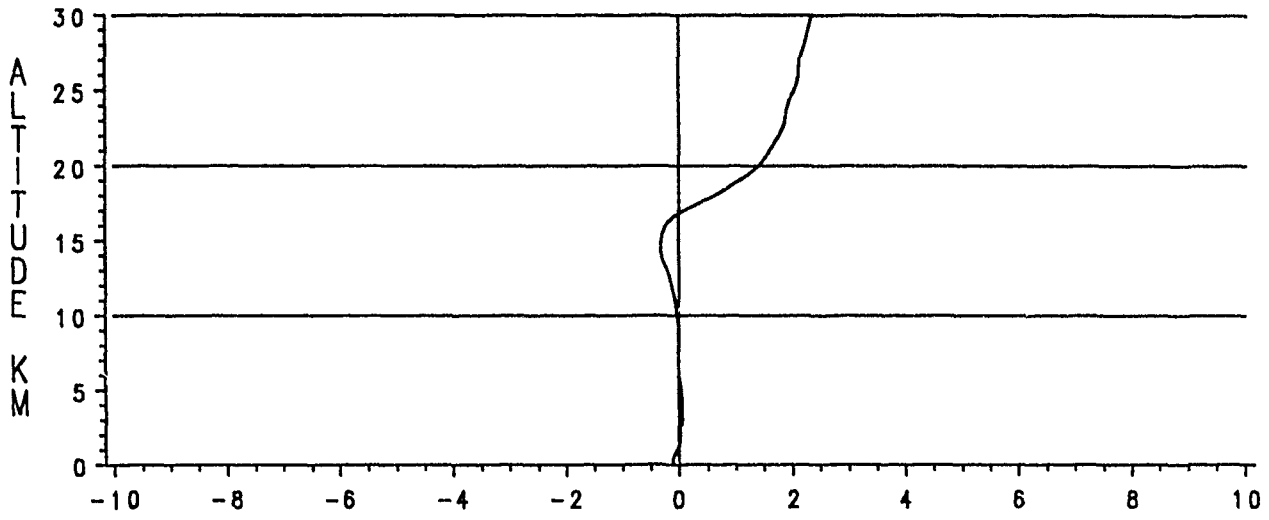

Figure F-5. Delta Percent Relative to Annual Pressure, July.

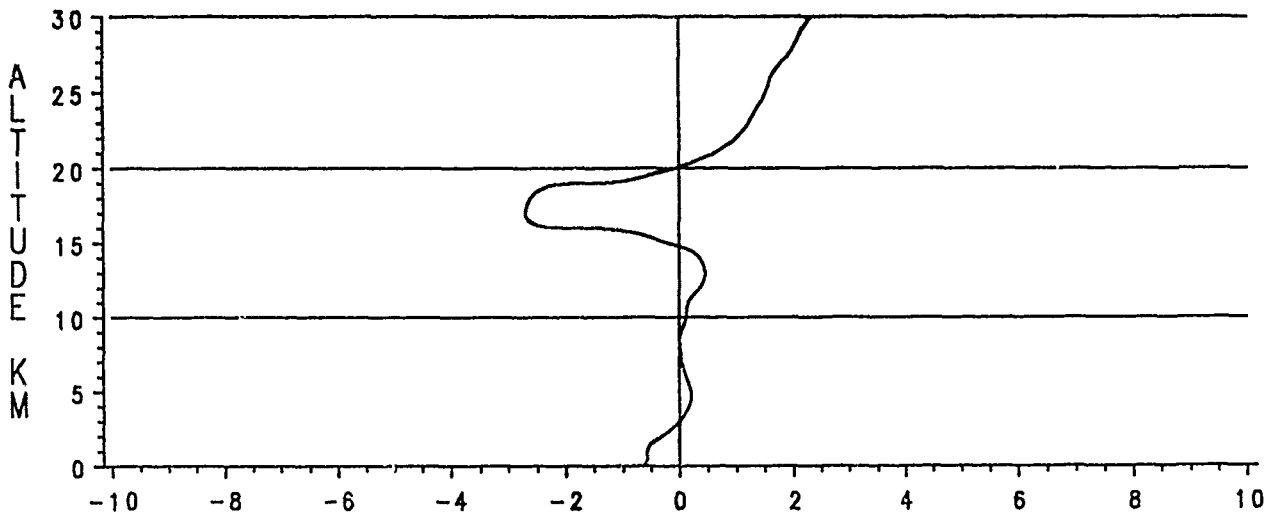

Figure F-6. Delta Percent Relative to Annual Density, July.

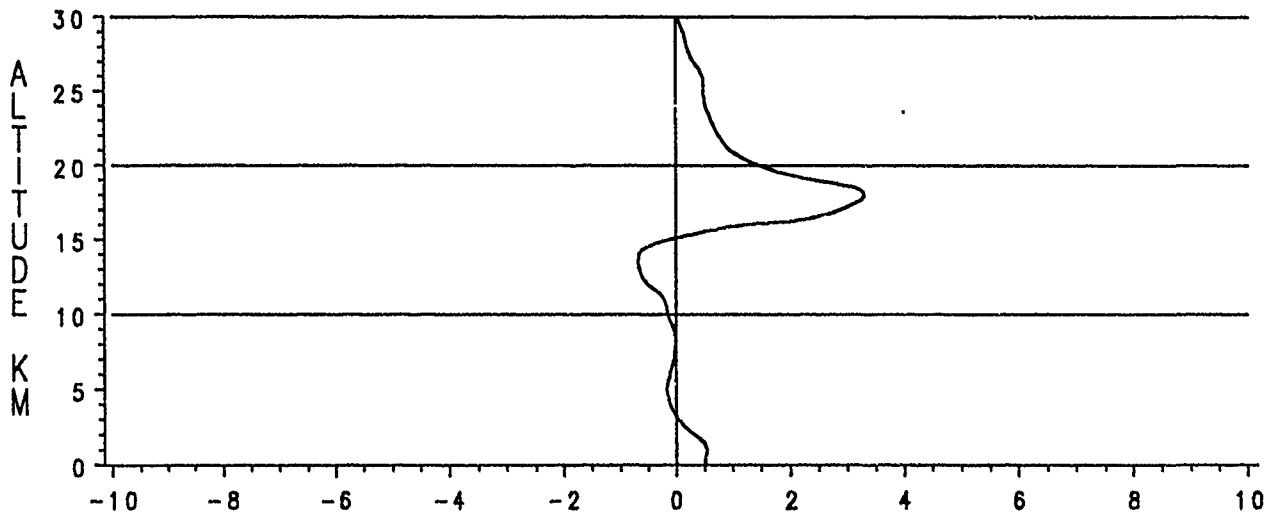

Figure F-7. Delta Percent Relative to Annual Temperature, July.

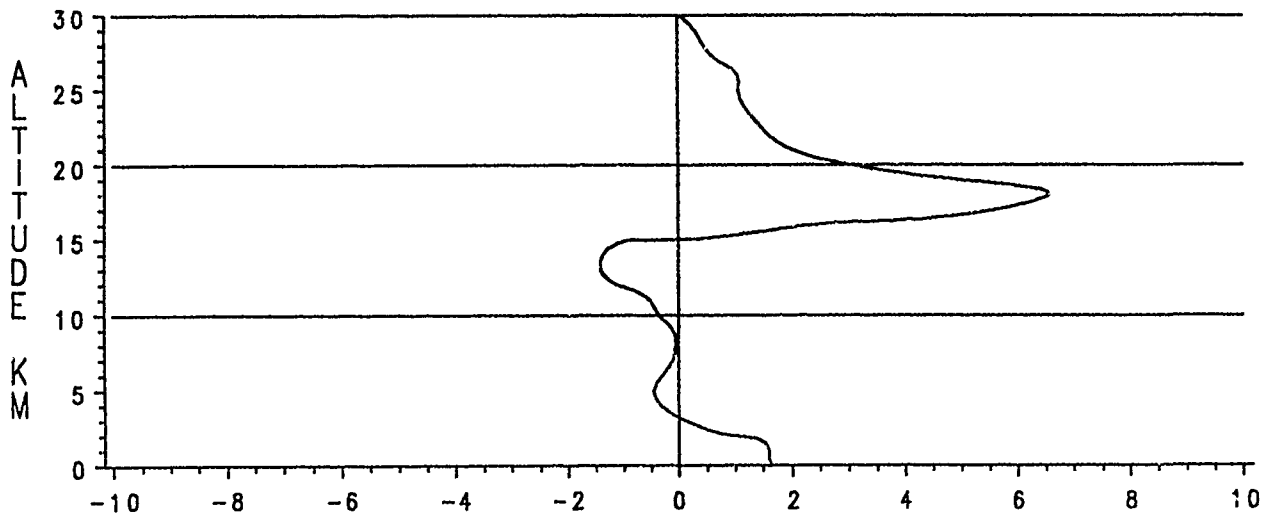

Figure F-8. Delta Temperature (K), July.

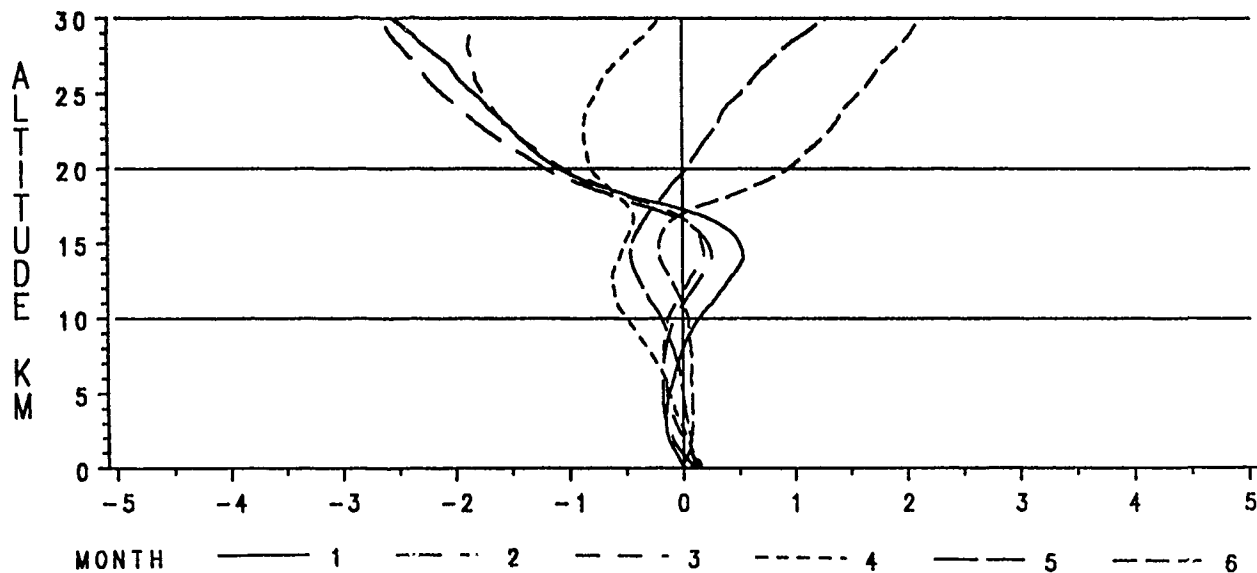

Figure F-9. Delta Percent Relative to Annual Pressure, January-June.

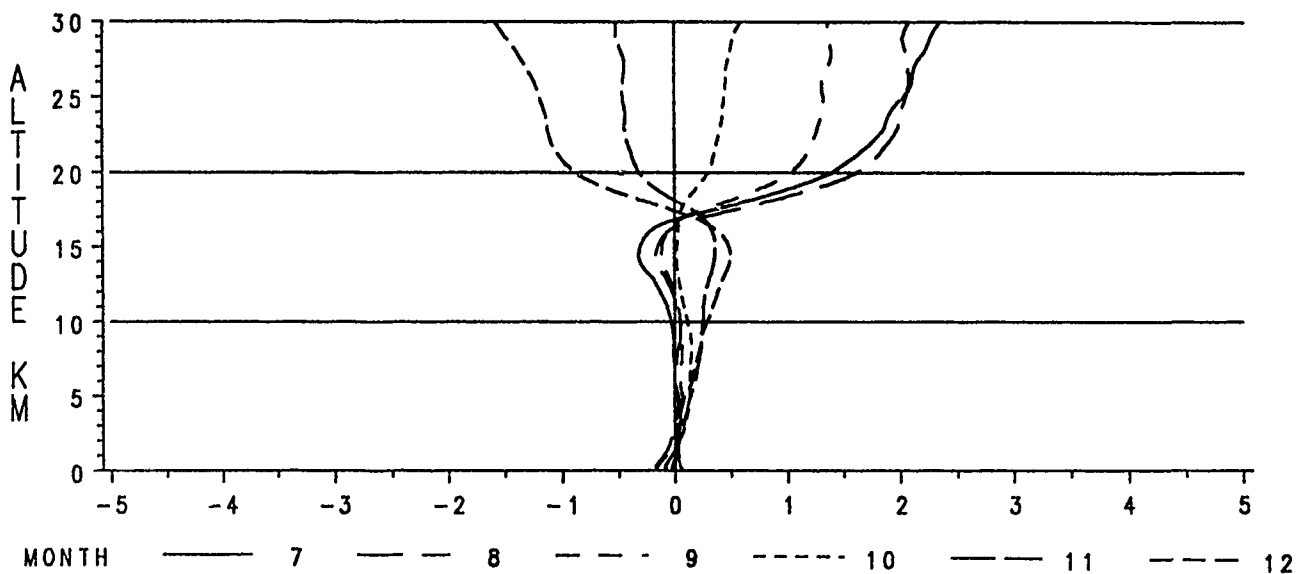

Figure F-10. Delta Percent Relative to Annual Pressure, July-December.

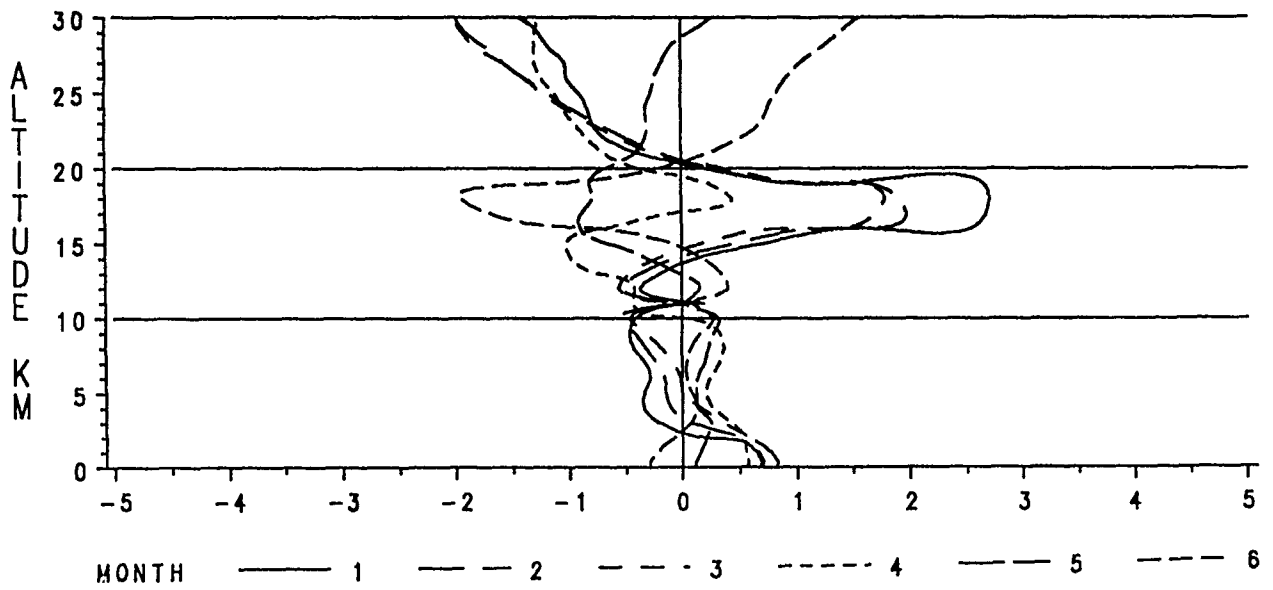

Figure F-11. Delta Percent Relative to Annual Density, January-June.

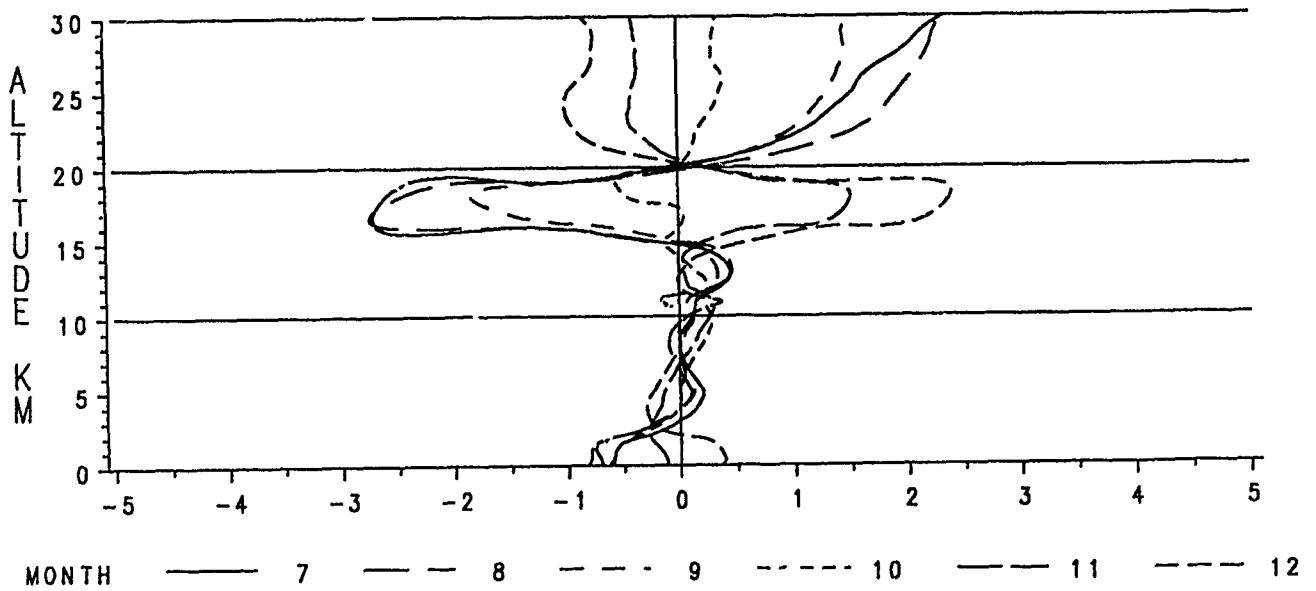

Figure F-12. Delta Percent Relative to Annual Density, July-December.

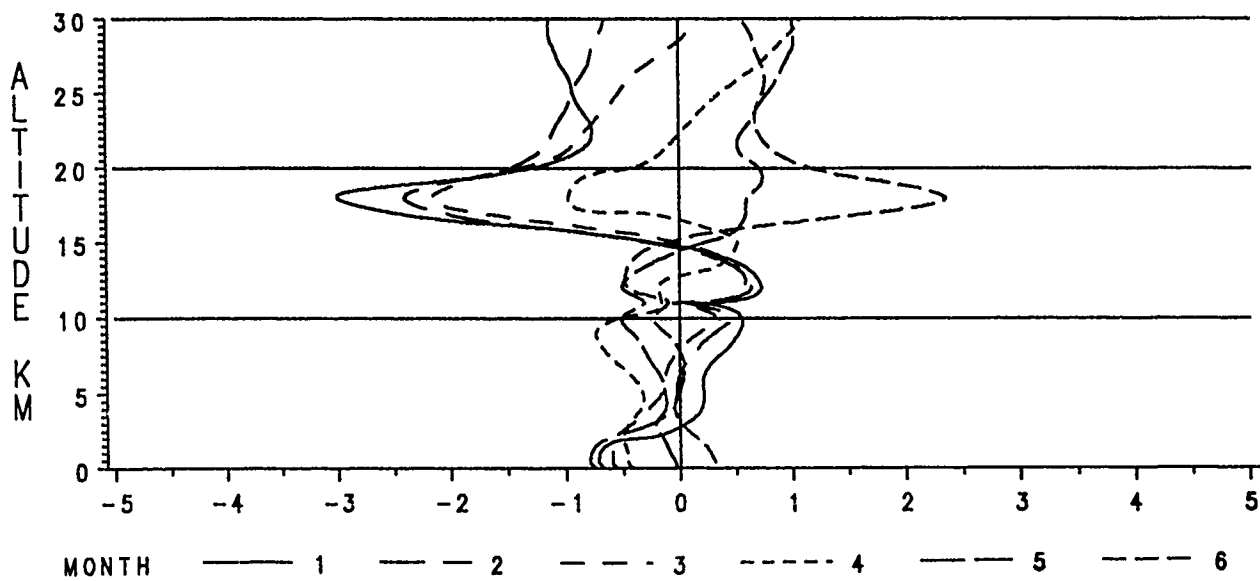

Figure F-13. Delta Percent Relative to Annual Temperature, January-June.

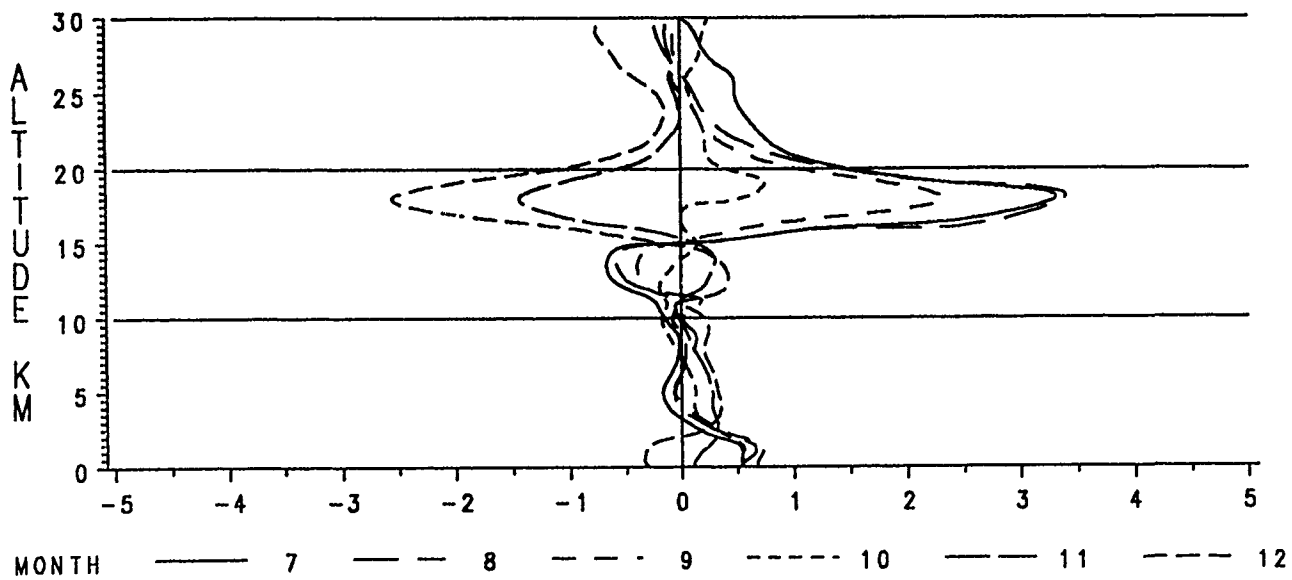

Figure F-14. Delta Percent Relative to Annual Temperature, July-December.

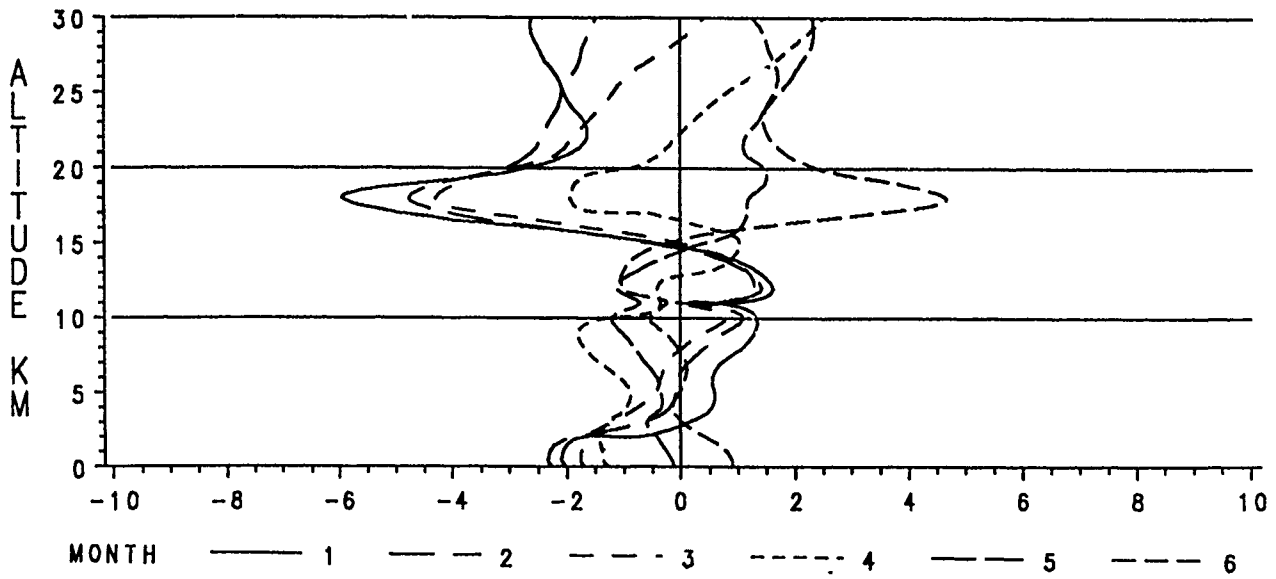

Figure F-15. Delta Temperature (K), January-June.

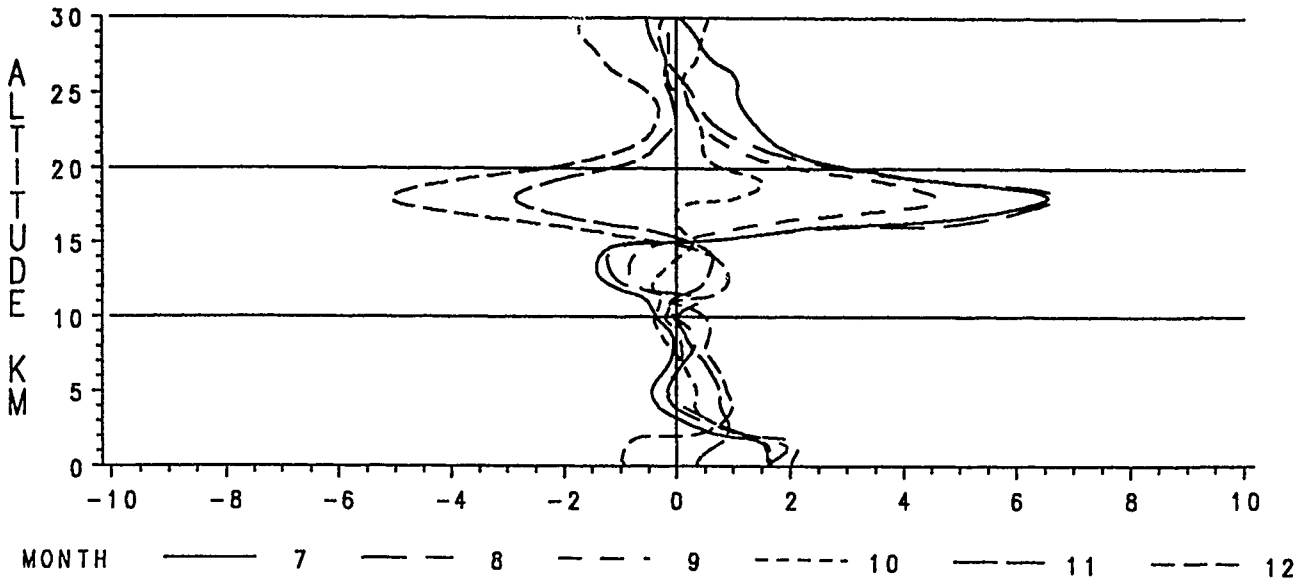

Figure F-16 Delta Temperature (K), July-December.

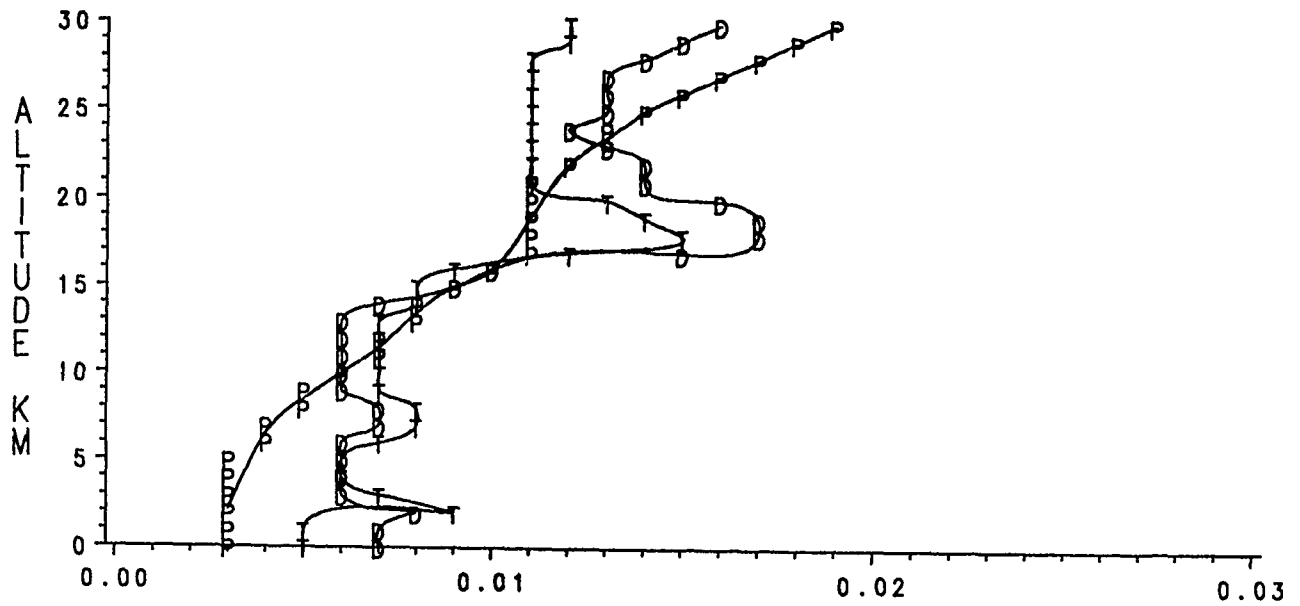

Figure F-17. Coefficients of Variation for Pressure (P), Density (D), and Temperature (T), January.

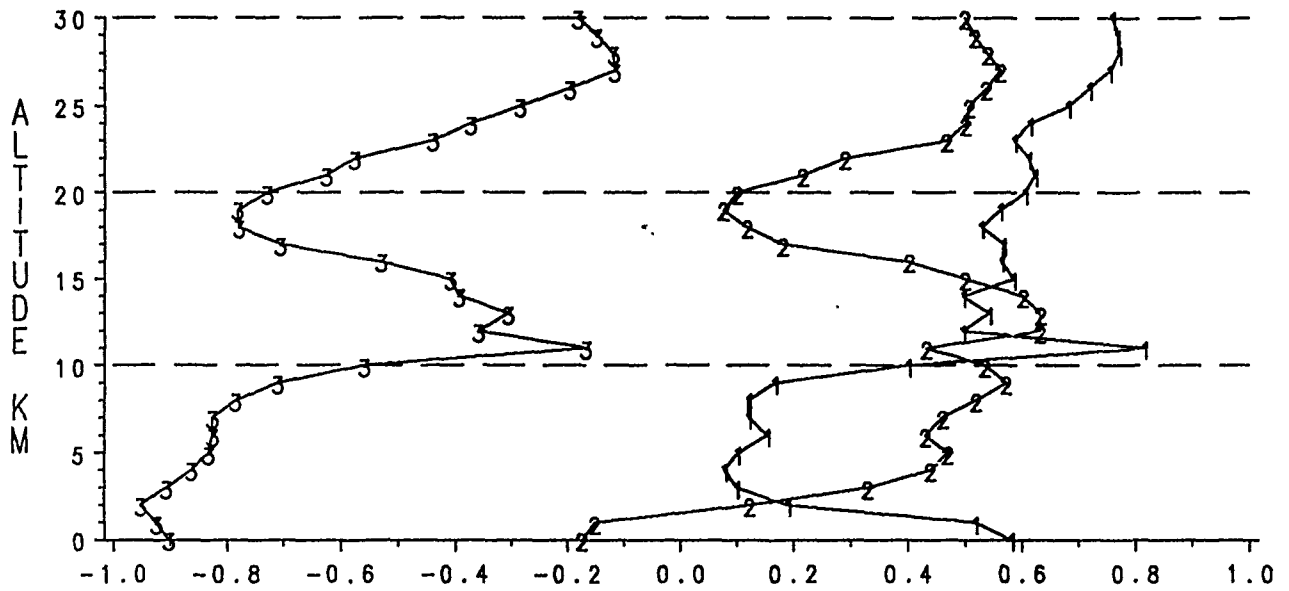

Figure F-18. Correlation Coefficients for P&D, P&T, and T&D, January.

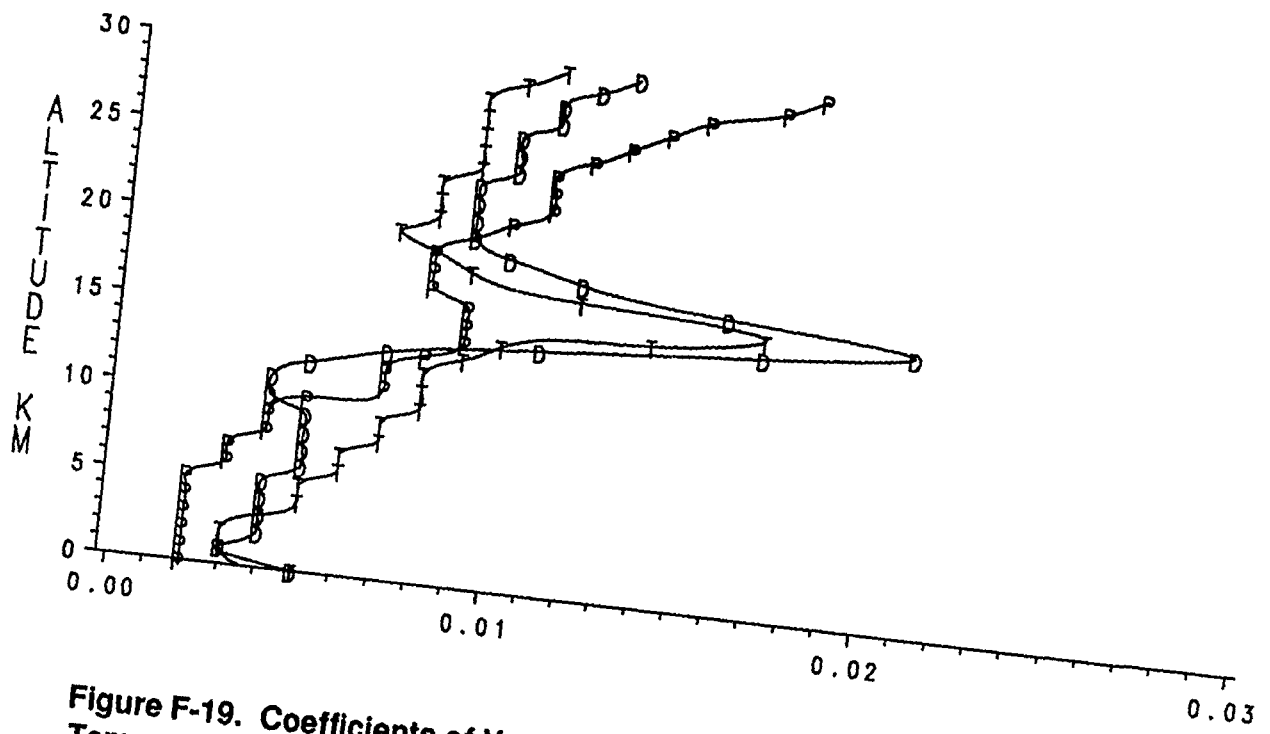

Figure F-19. Coefficients of Variation for Pressure (P), Density (D), and Temperature (T), July.

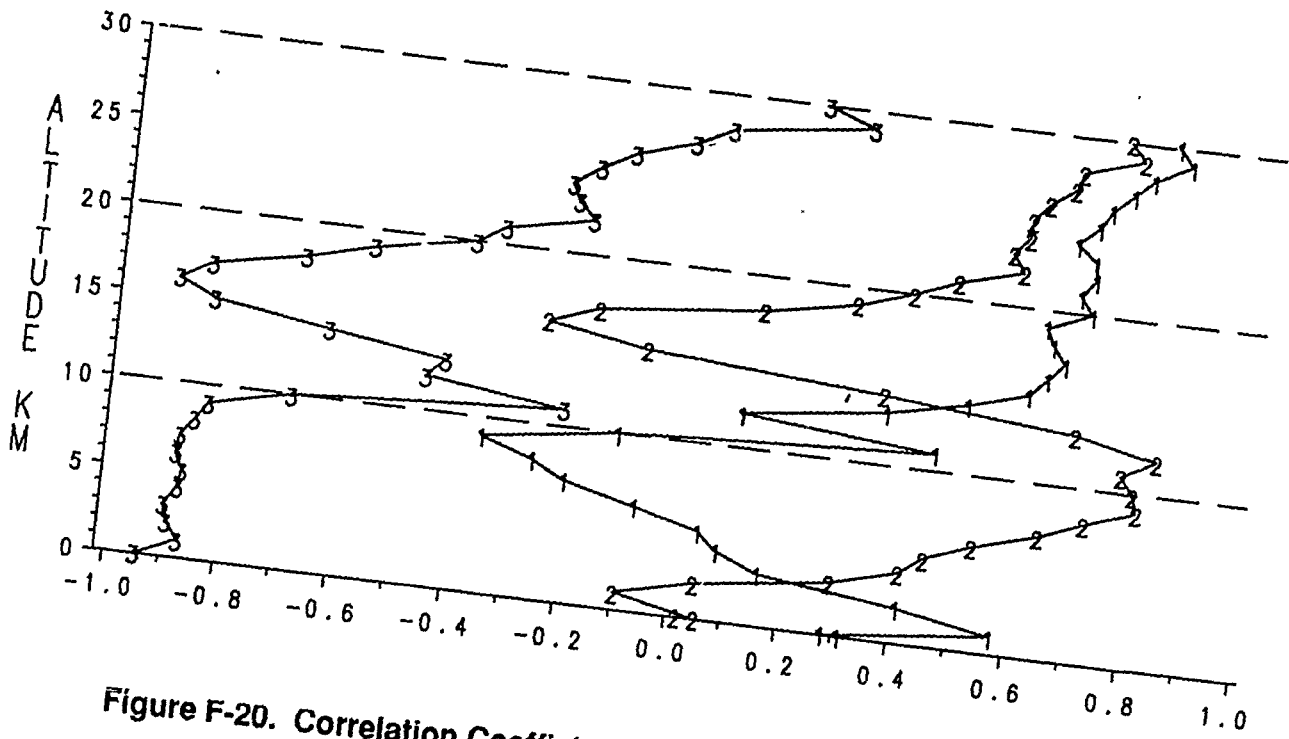

Figure F-20. Correlation Coefficients for P&D, P&T, and T&D, July.

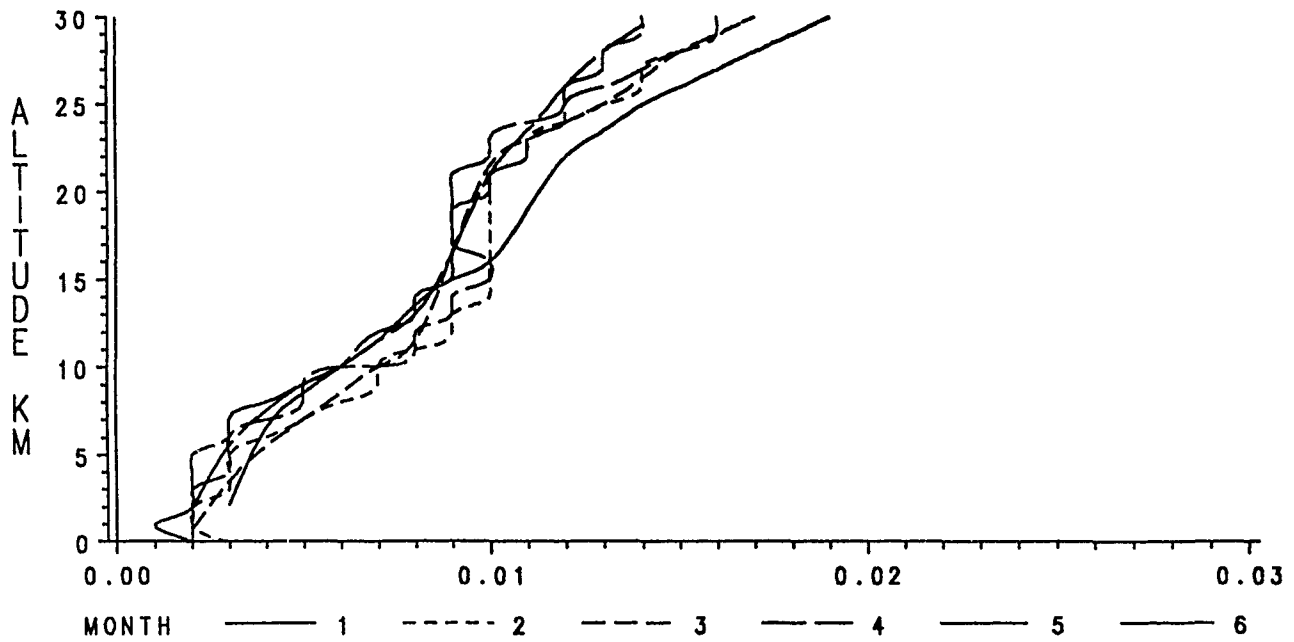

Figure F-21. Coefficients of Variation for Pressure, January-June.

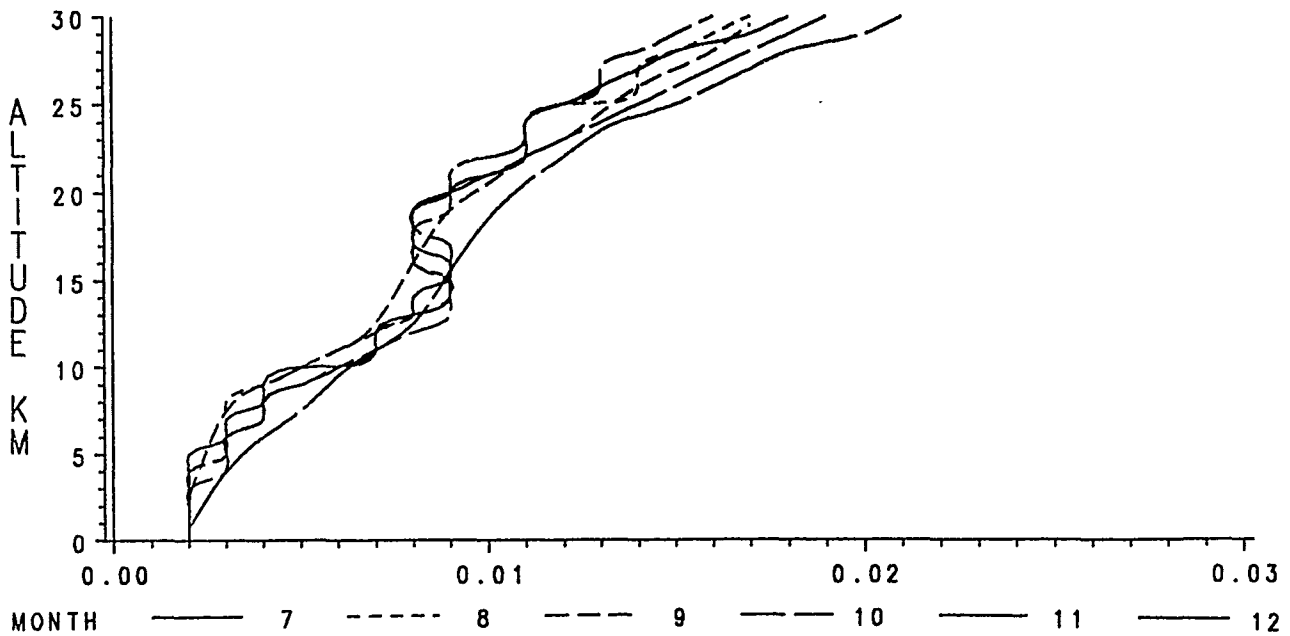

Figure F-22. Coefficients of Variation for Pressure, July-December.

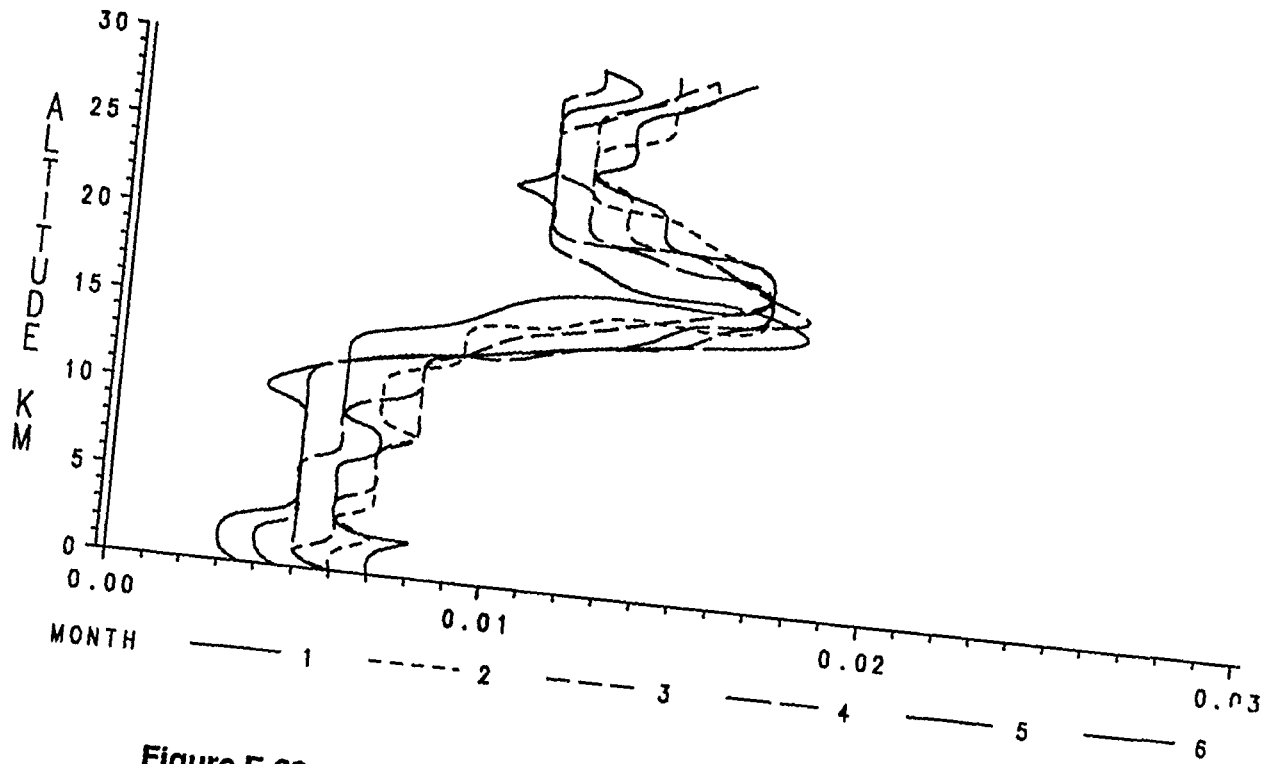

Figure F-23. Coefficients of Variation for Density, January-June.

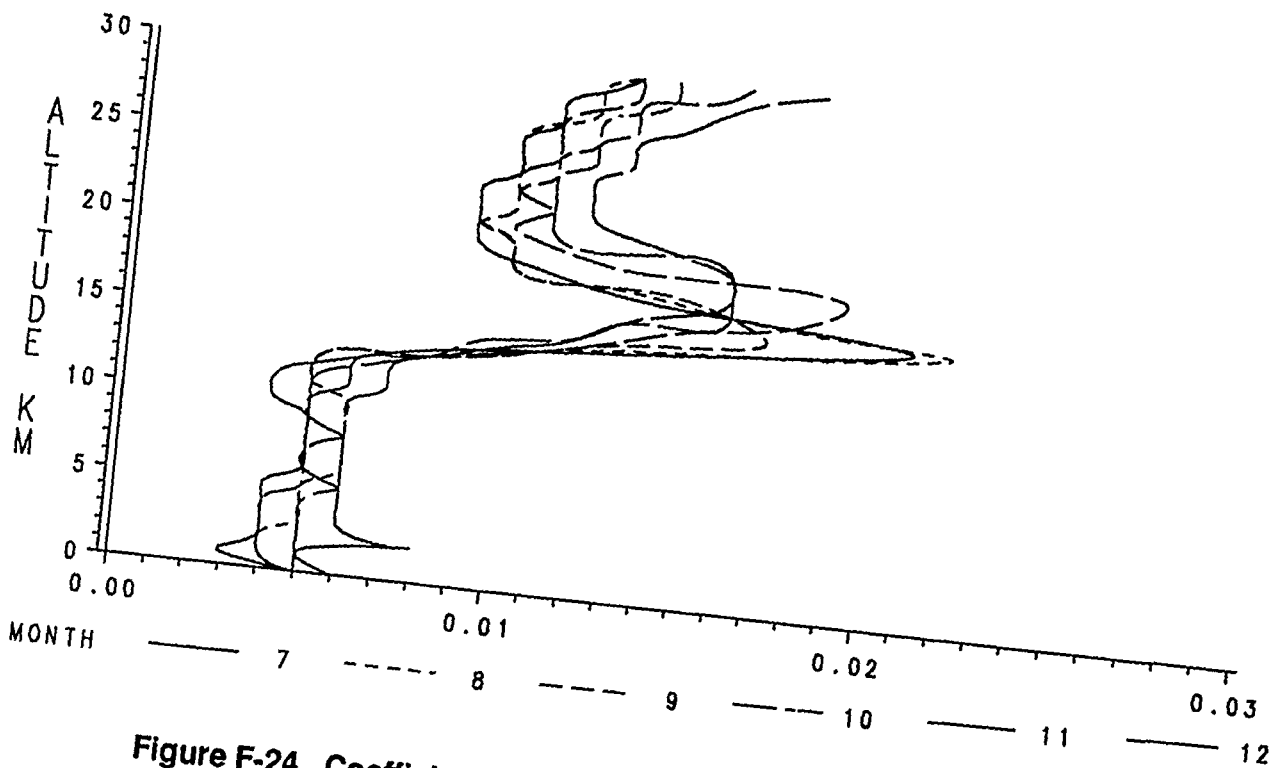

Figure F-24. Coefficients of Variation for Density, July-December.

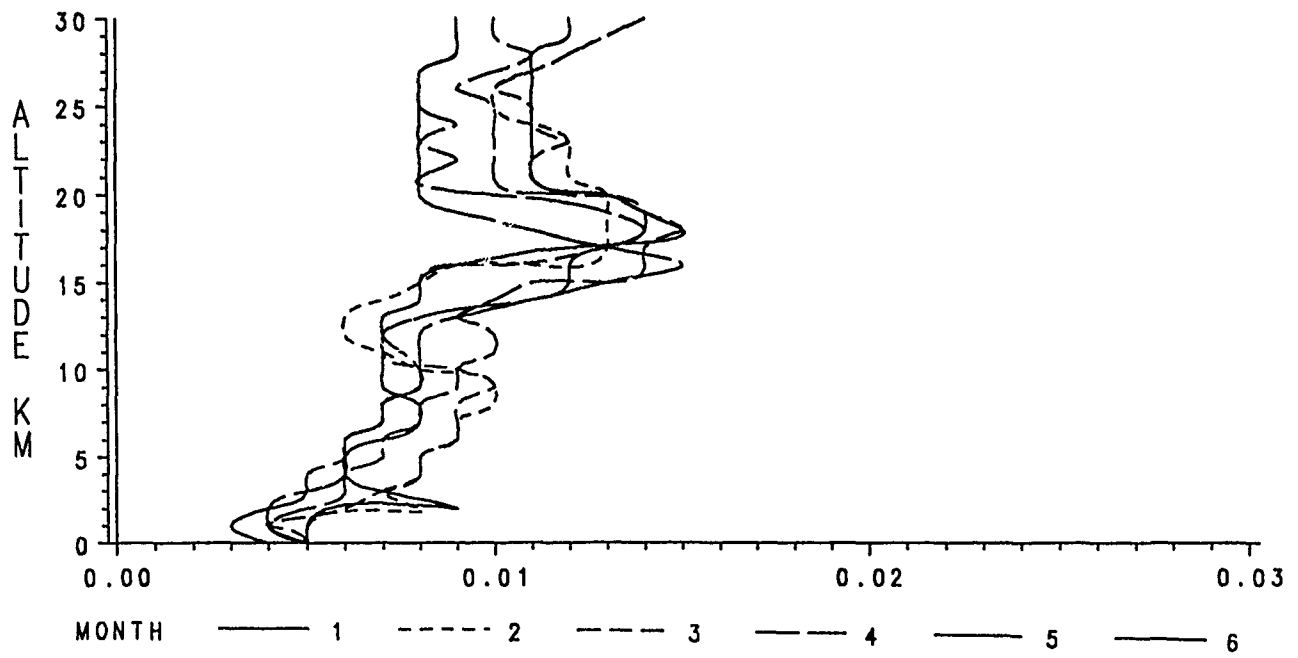

Figure F-25. Coefficients of Variation for Temperature, January-June.

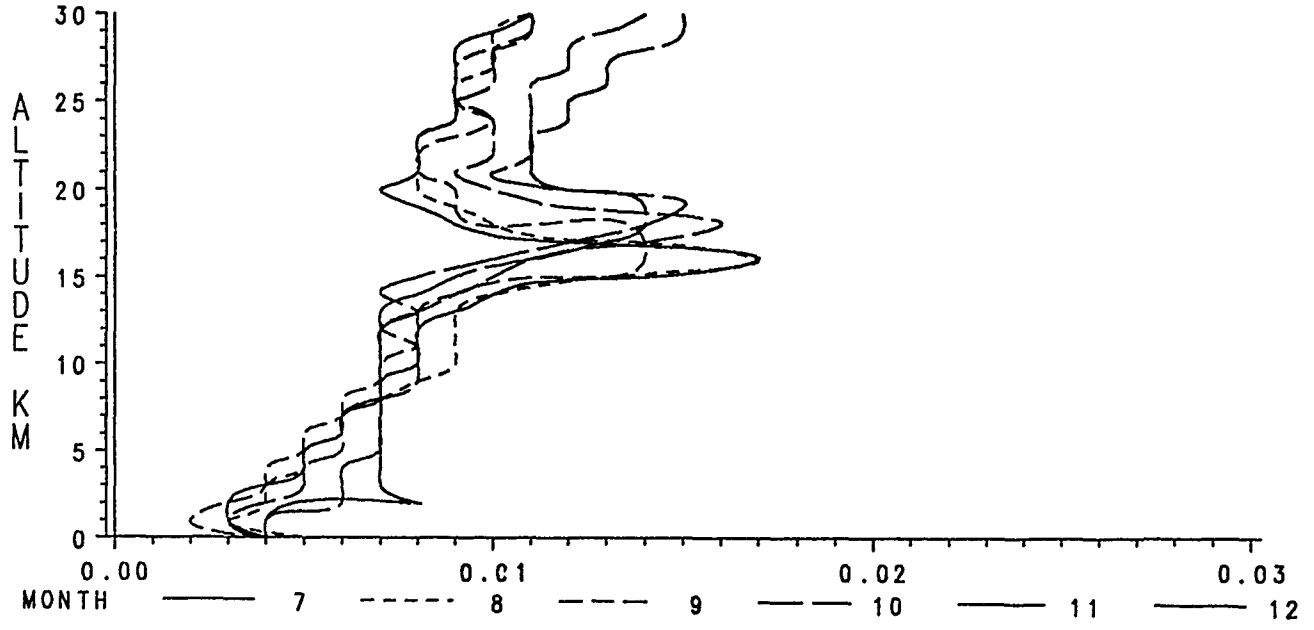

Figure F-26. Coefficients of Variation for Temperature, July-December.

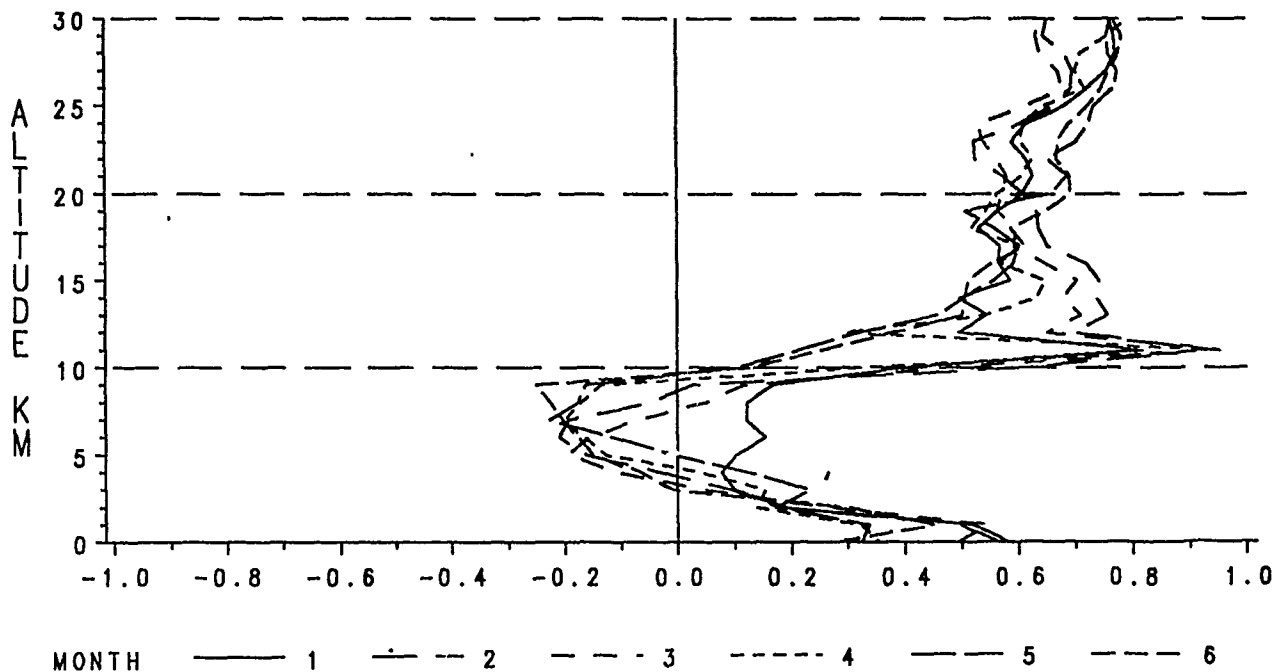

Figure F-27. Correlation Coefficients for Pressure & Density, January-June.

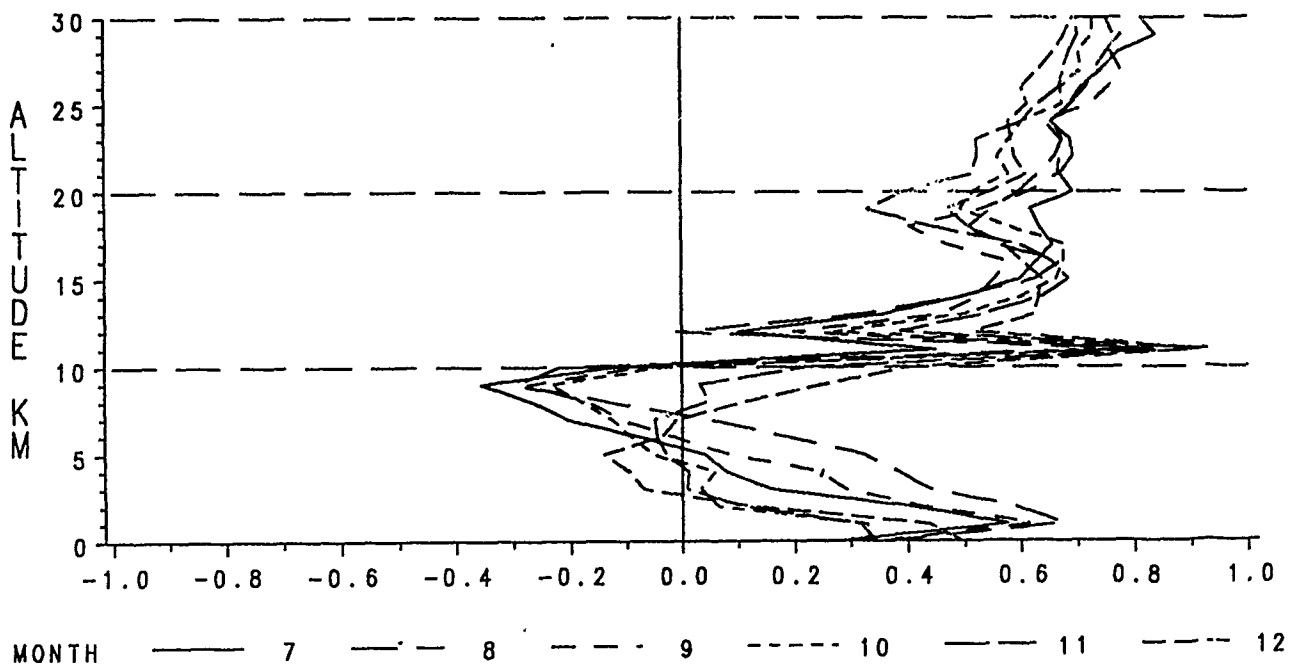

Figure F-28. Correlation Coefficients for Pressure & Density, July-December.

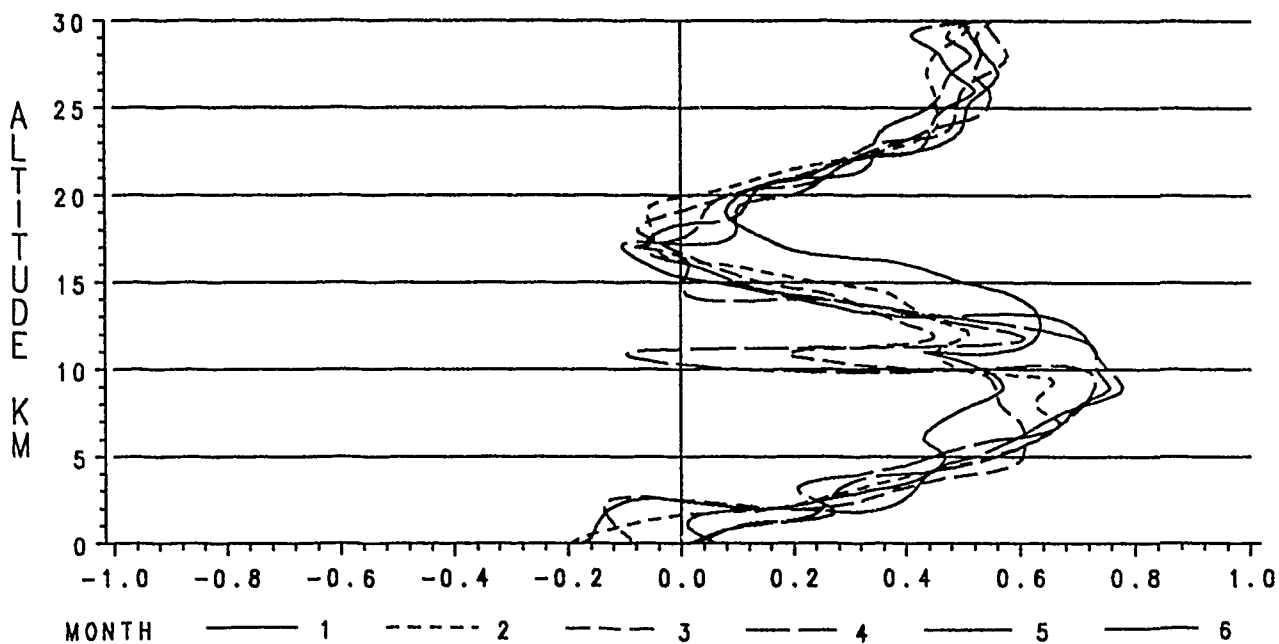

Figure F-29. Correlation Coefficients for Pressure & Temperature, January-June.

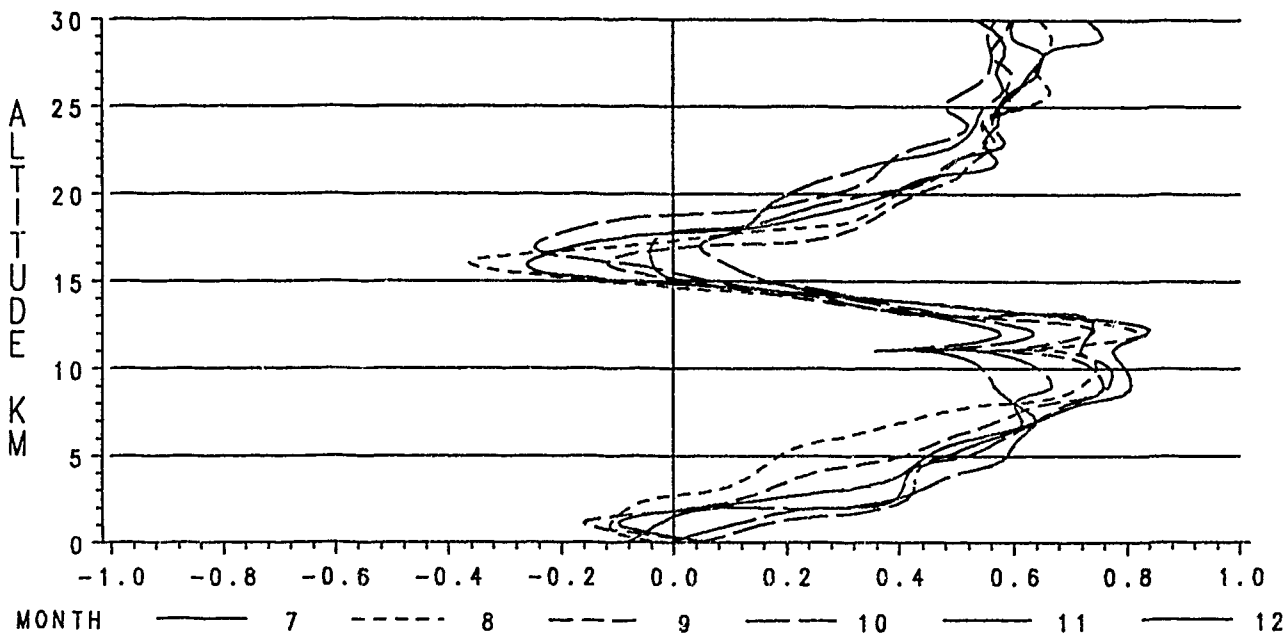

Figure F-30. Correlation Coefficients for Pressure & Temperature July-December.

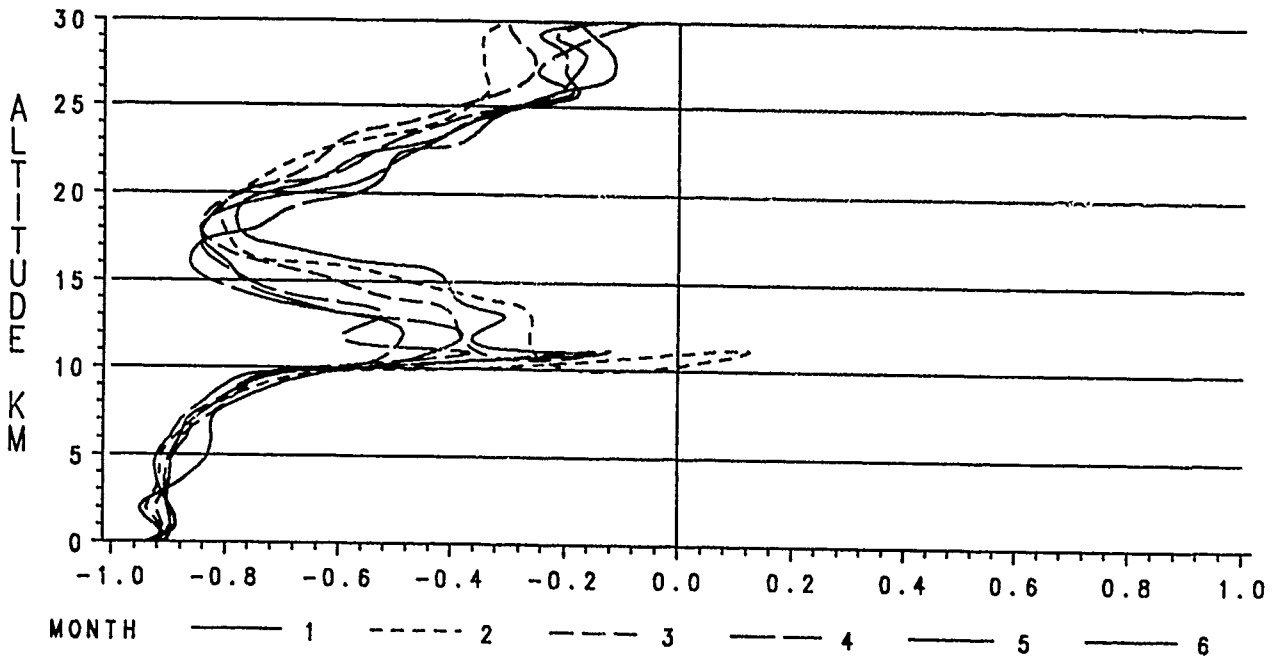

Figure F-31. Correlation Coefficients for Temperature & Density, January-June.

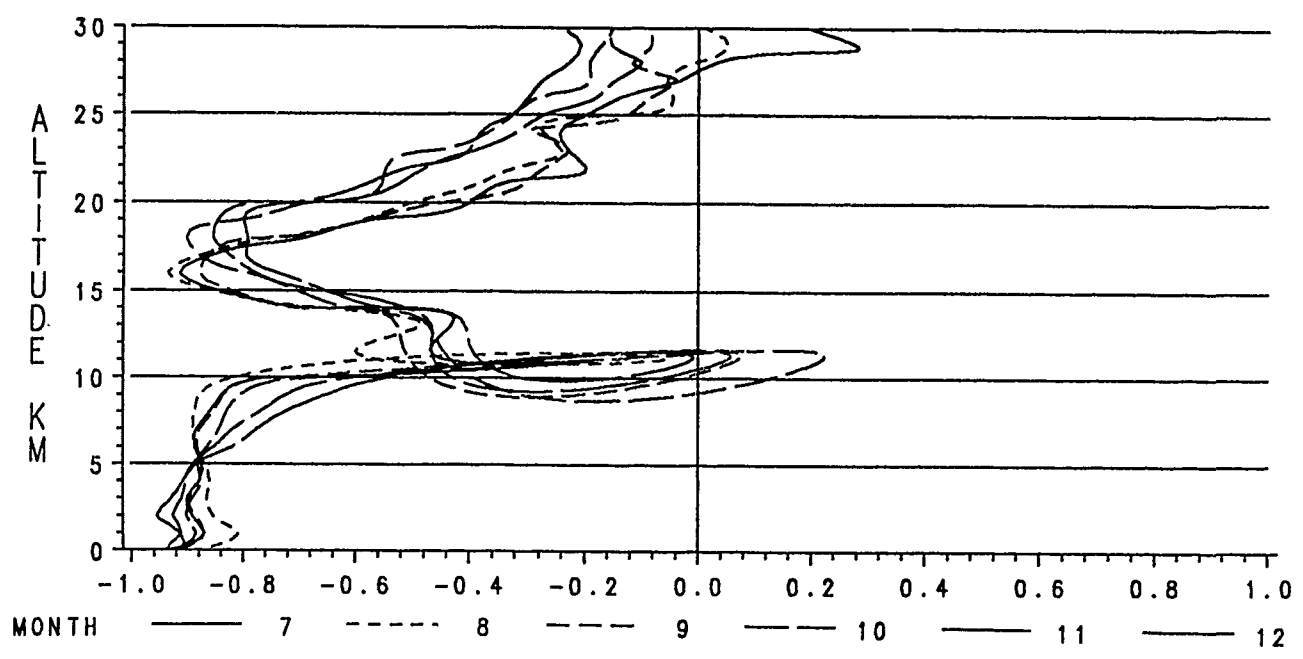

Figure F-32. Correlation Coefficients for Temperature & Density, July-December.

APPENDIX G

Wake Island Descriptive Data

To prevent further character size reduction in the tables given in Appendices A-D, certain range-specific information for Wake Island has been omitted. The most important information follows:

Header Record 0-30 km

Table Number.....	0
Data Source (1=DATSAV, 2=WDC-A).....	1
Call Letters.....	PWAK
WMO Number.....	912450
Latitude.....	79 17
Direction (N or S).....	N
Longitude.....	166 39
Direction (E or W).....	E
Elevation in Meters.....	4
Start Period of Record (Mo-Yr).....	173
End Period of Record (Mo-Yr).....	1287
No. of Time Windows (0,1, or 2).....	0
Start Time Window #1 (Hr-Mnz).....	0
End Time Window #1.....	0
Start Time Window #2.....	0
End Time Window #2.....	0
Date of RRA.....	989
Altitude Range of RRA Low-Level (km).....	0
Altitude Range of RRA High-Level (km).....	30
Standard Deviation of Thermodynamics Limits.....	±6.0
Wind Limits.....	±6.0

The following data is only required for RRAs that go to 70 km:

Table Number
Data Source (1=DATSAV, 2=WDC-A)
Call Letters
WMO Number
Latitude
Direction (N or S)
Longitude
Direction (E or W)
Elevation in Meters
Start Period of Record (Mo-Yr)
End Period of Record (Mo-Yr)
No. of Time Windows (0,1, or 2)
Start Time Window #1 (Hr-Mnz)
End Time Window #1
Start Time Window #2
End Time Window #2
Date of RRA
Altitude Range of RRA Low-Level (km)
Altitude Range of RRA High-Level (km)
Standard Deviation of Thermodynamic Limits
Wind Limits

DISTRIBUTION

AWS/DO, Scott AFB, IL 62225-5008	1
AWS/XT, Scott AFB, IL 62225-5008	1
AWS/XTJ, Scott AFB, IL 62225-5008	1
SD/CWDA, PO Box 92960, Los Angeles, CA 90009-2960	1
Det 1, HQ AWS, Pentagon, Washington, DC 20330-6560	1
Det 2, HQ AWS, Pentagon, Washington, DC 20330-5054	1
Det 3, HQ AWS, PO Box 3430, Onizuka AFB, CA 94088-3430	1
1WW/DN, Hickam AFB, HI 96853-5000	3
11WS/DON, Elmendorf AFB, AK 99506-5000	1
20WS/DON, APO San Francisco 96328-5000	1
30WS/DON, APO San Francisco 96301-0420	1
2WW/DN, APO New York 09094-5000	1
3WW/DN, Offutt AFB, NE 68113-5000	2
4WW/DN, Peterson AFB, CO 80914-5000	2
2WS/DON, Andrews AFB, MD 20334-5000	20
5WW/DN, Langley AFB, VA 23665-5000	2
AFGWC/SDSL, Offutt AFB, NE 68113-5000	2
USAFETAC, Scott AFB, IL 62225-5438	5
7WW/DN, Scott AFB, IL 62225-5008	1
6WS/DON Hurlburt Field, FL 32544-5000	1
17WS/DON, Travis AFB, CA 94535-5986	1
3350 TCHTG/TTGU-W, Stop 62, Chanute AFB, IL 61868-5000	1
3395 TCHTG/TTKO, Keesler AFB, MS 39534-5000	1
USCINCPAC (J37), Box 13, Camp H.M. Smith, HI 96861-5025	1
NAVOCEANCOMDET, Federal Building, Asheville, NC 28801-2723	1
NAVOCEANCOMDET, Patuxent River NAS, MD 20670-5103	1
NAVOCEANCOMFAC, Stennis Space Ctr, MS 39529-5002	1
NAVOCEANCOMFAC, NAS North Island, San Diego, CA 92135-5130	1
COMNAVOCEANCOM, Code N312, Stennis Space Ctr, MS 39529-5000	2
COMNAVOCEANCOM (Capt Brown, Code N332), Stennis Space Ctr, MS 39529-5001	1
NAVOCEANO, Code 9220 (Tony Ortolano), Stennis Space Ctr, MS 39529-5001	1
FLENUMOCEANCEN, Monterey, CA 93943-5006	1
NOARL West, Monterey, CA 93943-5006	1
Naval Research Laboratory, Code 4323, Washington, DC 20375	1
Naval Western Oceanography Ctr, Box 113, Attn: Tech Library, Pearl Harbor, HI 96860-5000	1
Naval Oceanography Command Ctr, COMNAVMAR Box 12, FPO San Francisco, CA 96630-5000	1
Pacific Missile Test Center, Geophysics Division, Code 3253, Pt Mugu, CA 93042-5000	1
NOAA Library-EOC4WSC4, Attn: ACQ, 6009 Executive Blvd, Rockville, MD 20852	1
NOAA/NESDIS (Attn: Nancy Everson, E/RA22), World Weather Bldg, Rm 703, Washington, DC 20233	1
GL/LY, Hanscom AFB, MA 01731-5000	1
GL Library, Attn: SULLR, Stop 29, Hanscom AFB, MA 01731-5000	1
Atmospheric Sciences Laboratory, Attn: SLCAS-AT-AB, Aberdeen Proving Grounds, MD 21005-5001	1
Atmospheric Sciences Laboratory, White Sands Missile Range, NM 88002-5501	1
U.S. Army Missile Command, ATTN: AMSMI-RD-TE-F, Redstone Arsenal, AL 35898-5250	1
Technical Library, Dugway Proving Ground, Dugway, UT 84022-5000	1
NCDC Library (D542X2), Federal Building, Asheville, NC 28801-2723	1
DTIC-FDAC, Cameron Station, Alexandria, VA 22304-6145	2
AUL/LSE, Maxwell AFB, AL 36112-5564	1
AWSTL, Scott AFB, IL 62225-5438	50