

STANDARD COPY

2

DOT/FAA/RD-90/16

Evaluation of Rotorwash Characteristics for Tiltrotor and Tiltwing Aircraft in Hovering Flight

Research and Development Service
Washington, D.C. 20591

Research and Development Service
Federal Aviation Administration
Washington, D.C. 20591

AD-A231 236

December 1990

Final Report

DTIC
ELECTE
FEB 21 1991
S B D

This document is available to the public through the National Technical Information Service, Springfield, Virginia 22161.



U.S. Department of Transportation
Federal Aviation Administration

91 2 19 224

NOTICE

This document is disseminated under the sponsorship of the U.S. Department of Transportation in the interest of information exchange. The United States Government assumes no liability for the contents or use thereof.

Technical Report Documentation Page

1. Report No. DOT/FAA/RD-90/16	2. Government Accession No.	3. Recipient's Catalog No.	
4. Title and Subtitle Evaluation of Rotorwash Characteristics for Tiltrotor and Tiltwing Aircraft in Hovering Flight		5. Report Date December 1990	
		6. Performing Organization Code	
7. Author (s) Samuel W. Ferguson, EMA		8. Performing Organization Report No. SCT 90RR-18	
9. Performing Organization Name and Address Systems Control Technology, Inc. 1611 North Kent Street, Suite 910 Arlington, Virginia 22209		10. Work Unit No. (TRAIS)	
		11. Contract or Grant No. DTFA01-87-C-00014	
12. Sponsoring Agency Name and Address U.S. Department of Transportation Federal Aviation Administration 800 Independence Avenue, S.W. Washington, D.C. 20591		13. Type Report and Period Covered Final Report	
		14. Sponsoring Agency Code ARD-30	
15. Supplementary Notes 1. Work was performed under Subcontract No. T-2608 by EMA, Mansfield, TX 2. ARD-30 - Vertical Flight Program Office			
16. Abstract The rotorwash characteristics of eleven different types of tiltrotor and tiltwing aircraft in hovering flight are presented for comparison purposes. Rotorwash characteristics that have been quantified include the mean and peak outwash velocity profiles off the left wing position (azimuth = 270 degrees) and nose position (azimuth = 0 degrees). Maximum values from each of the peak velocity and peak dynamic pressure profiles are also presented as a function of distance from the rotorcraft along both the 0 and 270 degree azimuths. Calculated personnel overturning forces are presented along both azimuths for a six foot tall person. All documented results were calculated with the ROTWASH analysis program. Flight test data, as correlated with the analysis program, are presented for the XV-15 tiltrotor and the CL-84 tiltwing. These hover characteristics do not represent the worst case scenario characteristics which would be expected at a vertiport. Scenarios involving ambient winds and maneuvering flight near hover generate higher rotorwash velocities. Unfortunately, the identification and prediction of worst case scenario results for comparison purposes is not presently possible. A companion report, entitled "Rotorwash Computer Model - Users Guide," DOT/FAA/RD-90/25, discusses the ROTWASH analysis program. This computer program is used to predict rotorwash characteristics of helicopter, tiltrotor, and tiltwing aircraft. The program also has the capability to analyze several different types of rotorwash related hazards which might be encountered in a vertiport environment. A second companion report, entitled "Analysis of Rotorwash Mishaps," DOT/FAA/RD-90/17, uses the ROTWASH program to analyse rotorwash induced mishaps in an effort to determine threshold levels at which rotorwash presents a potential hazard.			
17. Key Words Rotor Downwash, VSTOL, Tiltwing, Rotorcraft, Tiltwing		18. Distribution Statement This document is available to the public through the National Technical Information Service, Springfield, Virginia 22161.	
19. Security Classif. (of this report) Unclassified	20. Security Classif. (of this page) Unclassified	21. No of Pages 263	22. Price

TABLE OF CONTENTS

	<u>Page</u>
List of Figures	iv
List of Tables	xiii
List of Acronyms	xv
1.0 Introduction	1
2.0 Analysis Approach	3
3.0 Correlation of Flight Test Data with the ROTWASH Mathematical Model	7
3.1 Bell XV-15 Tiltrotor Correlation	7
3.2 Canadair CL-84 Tiltwing Correlation	32
4.0 Analysis of Tiltrotor and Tiltwing Configurations	45
4.1 Peak Profile Velocity and Dynamic Pressure Comparisons Along the 270 Degree Azimuth	45
4.2 Peak Profile Velocity and Dynamic Pressure Comparisons Along the 0 Degree Azimuth or Interaction Plane	51
4.3 Personnel Overturning Force Comparisons	56
5.0 Conclusions and Recommendations	63
References	67
Appendix A Bell XV-15 Aircraft and Rotorwash Data ...	A-1
Appendix B Bell/Boeing MV-22 Aircraft and Rotorwash Data	B-1
Appendix C Bell/Boeing/NASA CTR-22C/D Aircraft and Rotorwash Data	C-1
Appendix D Bell/Boeing/NASA CTR-800 Aircraft and Rotorwash Data	D-1
Appendix E Bell/Boeing/NASA CTR-1900 Aircraft and Rotorwash Data	E-1
Appendix F Bell/Boeing/NASA CTR-7500 Aircraft and Rotorwash Data	F-1
Appendix G Magnum Tiltrotor Aircraft and Rotorwash Data	G-1
Appendix H Eurofar Tiltrotor Aircraft and Rotorwash Data	H-1
Appendix I Canadair CL-84 Aircraft and Rotorwash Data	I-1
Appendix J Ishida TW-68 Aircraft and Rotorwash Data	J-1



For	
&I	<input checked="" type="checkbox"/>
ed	<input type="checkbox"/>
ion	<input type="checkbox"/>

Distribution/	
Availability Codes	
Dist	Avail and/or Special
A-1	

LIST OF FIGURES

		<u>Page</u>
Figure 1	Time Series Stripouts of Bell XV-15 Downwash Wind Velocity Magnitudes in Hover	8
Figure 2	Power Spectral Density of the Bell XV-15 Time Series Presented in Figure 1	9
Figure 3	Examples of Bell XV-15 Mean and Peak Outwash Velocity Profiles in a Zero Wind Hover	10
Figure 4	Three-View Drawing of the Bell XV-15	11
Figure 5	XV-15 Flight Test Data Measurement Locations	13
Figure 6	XV-15 Mean/Peak Velocity Profile Correlation Along the 270 Degree Azimuth Radial at a Wheel Height of 25 Feet and an Average Gross Weight of 12,475 Pounds	15
Figure 7	Bell XV-15 Downwash Flow Field Velocity Vectors in the Vertical Plane at a 25 Foot Hover Along the 270 Degree Azimuth	18
Figure 8	XV-15 Mean/Peak Velocity Profile Correlation Along the 270 Degree Azimuth Radial at Three Wheel Heights for an Average Gross Weight of 12,555 Pounds	19
Figure 9	XV-15 Mean/Peak Velocity Profile Correlation Along the 0 Degree Azimuth Radial at a Wheel Height of 25 Feet and an Average Gross Weight of 12,475 Pounds	22
Figure 10	XV-15 Mean/Peak Velocity Profile Correlation Along the 180 Degree Azimuth Radial at a Wheel Height of 25 Feet and an Average Gross Weight of 12,475 Pounds	25
Figure 11	XV-15 Mean/Peak Velocity Profile Correlation Along the 0 Degree Azimuth Radial at Three Wheel Heights for an Average Gross Weight of 12,555 Pounds	28
Figure 12	XV-15 Mean/Peak Velocity Profile Correlation Along the 180 Degree Azimuth Radial at Three Wheel Heights for an Average Gross Weight of 12,555 Pounds	30

	<u>Page</u>
Figure 13 Three-View Drawing of the Canadair CL-84	33
Figure 14 CL-84 Mean Velocity Profile Correlation Along the 270 Degree Azimuth Radial at a Wheel Height of 40 feet and an Average Gross Weight of 11,540 Pounds	35
Figure 15 CL-84 Mean Velocity Profile Correlation Along the 0 and 180 Degree Azimuth Radials at a Wheel Height of 40 feet and an Average Gross Weight of 11,540 Pounds	37
Figure 16 CL-84 Mean Velocity Profile Correlation Along the 270 Degree Azimuth Radial at a Wheel Height of 25 feet and an Average Gross Weight of 11,270 Pounds	40
Figure 17 CL-84 Mean Velocity Profile Correlation Along the 0 and 180 Degree Azimuth Radials at a Wheel Height of 25 feet and an Average Gross Weight of 11,270 Pounds	42
Figure 18 Peak Profile Velocity and Dynamic Pressure Comparisons for the Small Tiltrotor Aircraft Configurations Along the 270 Degree Azimuth ..	46
Figure 19 Peak Profile Velocity and Dynamic Pressure Comparisons for Several Bell/Boeing MV-22 Configurations Along the 270 Degree Azimuth ..	47
Figure 20 Peak Profile Velocity and Dynamic Pressure Comparisons for the Large Tiltrotor Aircraft Configurations Along the 270 Degree Azimuth ..	48
Figure 21 Peak Profile Velocity and Dynamic Pressure Comparisons for the Small Tiltwing Aircraft Configurations Along the 270 Degree Azimuth ..	49
Figure 22 Peak Profile Velocity and Dynamic Pressure Comparisons for the Small Tiltrotor Aircraft Configurations Along the 0 Degree Azimuth	52
Figure 23 Peak Profile Velocity and Dynamic Pressure Comparisons for Several Bell/Boeing MV-22 Configurations Along the 0 Degree Azimuth	53
Figure 24 Peak Profile Velocity and Dynamic Pressure Comparisons for the Large Tiltrotor Aircraft Configurations Along the 0 Degree Azimuth	54

	<u>Page</u>
Figure 25 Peak Profile Velocity and Dynamic Pressure Comparisons for the Small Tiltwing Aircraft Configurations Along the 0 Degree Azimuth	55
Figure 26 Capabilities of Test Subjects to Walk or Move Forward Under Various Amounts of Horizontal Restraint Loads Applied at a Position of 3 Feet Above Ground Level	57
Figure 27 Personnel Overturning Forces for Small Tiltrotor Configurations	58
Figure 28 Personnel Overturning Forces for Various MV-22 Tiltrotor Configurations	60
Figure 29 Personnel Overturning Forces for Large Tiltrotor Configurations	61
Figure 30 Personnel Overturning Forces for Small Tiltwing Configurations	62
Figure A-1 Three-View Drawing of the Bell XV-15	A-2
Figure A-2 Bell XV-15 Mean and Peak Velocity Profiles for Eight 270 Degree Azimuth Radial Stations at a Wheel Height of 20 Feet and a Gross Weight of 13,000 Pounds	A-4
Figure A-3 Bell XV-15 Mean and Peak Velocity Profiles for Eight 0 Degree Azimuth Radial Stations at a Wheel Height of 20 Feet and a Gross Weight of 13,000 Pounds	A-8
Figure A-4 Bell XV-15 Peak Velocity and Dynamic Pressure as a Function of Distance from Rotor Center (270 Degree Azimuth)	A-12
Figure A-5 Bell XV-15 Peak Velocity and Dynamic Pressure as a Function of Distance Along the Interaction Plane (0 Degree Azimuth) ..	A-13
Figure A-6 Bell XV-15 Overturning Force as a Function of Distance from Rotor Center (270 Degree Azimuth)	A-14
Figure A-7 Bell XV-15 Overturning Force as a Function of Distance Along the Interaction Plane (0 Degree Azimuth)	A-15
Figure B-1 Three-View Drawing of the Bell MV-22	B-2

	<u>Page</u>
Figure B-2 Bell/Boeing MV-22 Mean and Peak Velocity Profiles for Eight 270 Degree Azimuth Radial Stations at a Wheel Height of 5 Feet and a Gross Weight of 40,000 Pounds ...	B-4
Figure B-3 Bell/Boeing MV-22 Mean and Peak Velocity Profiles for Eight 270 Degree Azimuth Radial Stations at a Wheel Height of 30 Feet and a Gross Weight of 40,000 Pounds ...	B-8
Figure B-4 Bell/Boeing MV-22 Mean and Peak Velocity Profiles for Eight 270 Degree Azimuth Radial Stations at a Wheel Height of 5 Feet and a Gross Weight of 47,500 Pounds ..	B-12
Figure B-5 Bell/Boeing MV-22 Mean and Peak Velocity Profiles for Eight 270 Degree Azimuth Radial Stations at a Wheel Height of 30 Feet and a Gross Weight of 47,500 Pounds ..	B-16
Figure B-6 Bell/Boeing MV-22 Mean and Peak Velocity Profiles for Nine 0 Degree Azimuth Radial Stations at a Wheel Height of 5 Feet and a Gross Weight of 40,000 Pounds	B-20
Figure B-7 Bell/Boeing MV-22 Mean and Peak Velocity Profiles for Nine 0 Degree Azimuth Radial Stations at a Wheel Height of 30 Feet and a Gross Weight of 40,000 Pounds	B-25
Figure B-8 Bell/Boeing MV-22 Mean and Peak Velocity Profiles for Nine 0 Degree Azimuth Radial Stations at a Wheel Height of 5 Feet and a Gross Weight of 47,500 Pounds	B-30
Figure B-9 Bell/Boeing MV-22 Mean and Peak Velocity Profiles for Nine 0 Degree Azimuth Radial Stations at a Wheel Height of 30 Feet and a Gross Weight of 47,500 Pounds	B-35
Figure B-10 Bell/Boeing MV-22 Peak Rotorwash Velocity and Dynamic Pressure as a ..Function of Distance from the Rotor Center (270 Degree Azimuth)	B-40
Figure B-11 Bell/Boeing MV-22 Peak Rotorwash Velocity and Dynamic Pressure as a Function of Distance Along the Interaction Plane (0 Degree Azimuth)	B-41

	<u>Page</u>
Figure B-12 Bell/Boeing MV-22 Overturning Force as a Function of Distance from the Rotor Center (270 Degree Azimuth)	B-42
Figure B-13 Bell/Boeing MV-22 Overturning Force as a Function of Distance Along the Interaction Plane (0 Degree Azimuth)	B-43
Figure C-1 Three-View Drawing of the CTR-22C/D	C-2
Figure C-2 CTR-22C/D Mean and Peak Velocity Profiles for Eight 270 Degree Azimuth Radial Stations at a Wheel Height of 30 Feet and a Gross Weight of 51,670 Pounds	C-5
Figure C-3 CTR-22C/D Mean and Peak Velocity Profiles for Nine 0 Degree Azimuth Radial Stations at a Wheel Height of 30 Feet and a Gross Weight of 51,670 Pounds	C-9
Figure C-4 CTR-22C/D Peak Rotorwash Velocity and Dynamic Pressure as a Function of Distance from the Rotor Center (270 Degree Azimuth)	C-14
Figure C-5 CTR-22C/D Peak Rotorwash Velocity and Dynamic Pressure as a Function of Distance Along the Interaction Plane (0 Degree Azimuth)	C-15
Figure C-6 CTR-22C/D Overturning Force as a Function of Distance from the Rotor Center (270 Degree Azimuth)	C-16
Figure C-7 CTR-22C/D Overturning Force as a Function of Distance Along the Interaction Plane (0 Degree Azimuth)	C-17
Figure D-1 Three-View Drawing of the CTR-800	D-2
Figure D-2 CTR-800 Mean and Peak Velocity Profiles for Eight 270 Degree Azimuth Radial Stations at a Wheel Height of 20 Feet and a Gross Weight of 15,750 Pounds	D-4
Figure D-3 CTR-800 Mean and Peak Velocity Profiles for Eight 0 Degree Azimuth Radial Stations at a Wheel Height of 20 Feet and a Gross Weight of 15,750 Pounds	D-8

	<u>Page</u>
Figure D-4 CTR-800 Peak Rotorwash Velocity and Dynamic Pressure as a Function of Distance from the Rotor Center (270 Degree Azimuth)	D-12
Figure D-5 CTR-800 Peak Rotorwash Velocity and Dynamic Pressure as a Function of Distance Along the Interaction Plane (0 Degree Azimuth)	D-13
Figure D-6 CTR-800 Overturning Force as a Function of Distance from the Rotor Center (270 Degree Azimuth)	D-14
Figure D-7 CTR-800 Overturning Force as a Function of Distance Along the Interaction Plane (0 Degree Azimuth)	D-15
Figure E-1 Three-View Drawing of the CTR-1900	E-2
Figure E-2 CTR-1900 Mean and Peak Velocity Profiles for Eight 270 Degree Azimuth Radial Stations at a Wheel Height of 30 Feet and a Gross Weight of 22,800 Pounds	E-4
Figure E-3 CTR-1900 Mean and Peak Velocity Profiles for Nine 0 Degree Azimuth Radial Stations at a Wheel Height of 30 Feet and a Gross Weight of 22,800 Pounds	E-8
Figure E-4 CTR-1900 Peak Rotorwash Velocity and Dynamic Pressure as a Function of Distance from the Rotor Center (270 Degree Azimuth)	E-13
Figure E-5 CTR-1900 Peak Rotorwash Velocity and Dynamic Pressure as a Function of Distance Along the Interaction Plane (0 Degree Azimuth)	E-14
Figure E-6 CTR-1900 Overturning Force as a Function of Distance from the Rotor Center (270 Degree Azimuth)	E-15
Figure E-7 CTR-1900 Overturning Force as a Function of Distance Along the Interaction Plane (0 Degree Azimuth)	E-16
Figure F-1 Three-View Drawing of the CTR-7500	F-2

	<u>Page</u>
Figure F-2 CTR-7500 Mean and Peak Velocity Profiles for Seven 270 Degree Azimuth Radial Stations at a Wheel Height of 30 Feet and a Gross Weight of 79,820 Pounds	F-4
Figure F-3 CTR-7500 Mean and Peak Velocity Profiles for Eight 0 Degree Azimuth Radial Stations at a Wheel Height of 30 Feet and a Gross Weight of 79,820 Pounds	F-8
Figure F-4 CTR-7500 Peak Rotorwash Velocity and Dynamic Pressure as a Function of Distance from the Rotor Center (270 Degree Azimuth)	F-12
Figure F-5 CTR-7500 Peak Rotorwash Velocity and Dynamic Pressure as a Function of Distance Along the Interaction Plane (0 Degree Azimuth)	F-13
Figure F-6 CTR-7500 Overturning Force as a Function of Distance from the Rotor Center (270 Degree Azimuth)	F-14
Figure F-7 CTR-7500 Overturning Force as a Function of Distance Along the Interaction Plane (0 Degree Azimuth)	F-15
Figure G-1 Three-View Drawing of the MAGNUM Tiltrotor .	G-2
Figure G-2 MAGNUM Tiltrotor Mean and Peak Velocity Profiles for Eight 270 Degree Azimuth Radial Stations at a Wheel Height of 20 Feet and a Gross Weight of 16,500 Pounds ...	G-4
Figure G-3 MAGNUM Tiltrotor Mean and Peak Velocity Profiles for Eight 0 Degree Azimuth Radial Stations at a Wheel Height of 20 Feet and a Gross Weight of 16,500 Pounds	G-8
Figure G-4 MAGNUM Tiltrotor Peak Rotorwash Velocity and Dynamic Pressure as a Function of Distance from the Rotor Center (270 Degree Azimuth)	G-12
Figure G-5 MAGNUM Tiltrotor Peak Rotorwash Velocity and Dynamic Pressure as a Function of Distance Along the Interaction Plane (0 Degree Azimuth)	G-13

	<u>Page</u>
Figure G-6 MAGNUM Tiltrotor Overturning Force as a Function of Distance from the Rotor Center (270 Degree Azimuth)	G-14
Figure G-7 MAGNUM Tiltrotor Overturning Force as a Function of Distance Along the Interaction Plane (0 Degree Azimuth)	G-15
Figure H-1 Three-View Drawing of the EUROFAR Tiltrotor	H-2
Figure H-2 EUROFAR Tiltrotor Mean and Peak Velocity Profiles for Eight 270 Degree Azimuth Radial Stations at a Wheel Height of 30 Feet and a Gross Weight of 30,089 Pounds ...	H-4
Figure H-3 EUROFAR Tiltrotor Mean and Peak Velocity Profiles for Nine 0 Degree Azimuth Radial Stations at a Wheel Height of 30 Feet and a Gross Weight of 30,089 Pounds	H-8
Figure H-4 EUROFAR Tiltrotor Peak Rotorwash Velocity and Dynamic Pressure as a Function of Distance from the Rotor Center (270 Degree Azimuth)	H-13
Figure H-5 EUROFAR Tiltrotor Peak Rotorwash Velocity and Dynamic Pressure as a Function of Distance Along the Interaction Plane (0 Degree Azimuth)	H-14
Figure H-6 EUROFAR Tiltrotor Overturning Force as a Function of Distance from the Rotor Center (270 Degree Azimuth)	H-15
Figure H-7 EUROFAR Tiltrotor Overturning Force as a Function of Distance Along the Interaction Plane (0 Degree Azimuth)	H-16
Figure I-1 Three-View Drawing of the Canadair CL-84 ...	I-2
Figure I-2 Canadair CL-84 Mean and Peak Velocity Profiles for Eight 270 Degree Azimuth Radial Stations at a Wheel Height of 15 Feet and a Gross Weight of 12,200 Pounds ...	I-4
Figure I-3 Canadair CL-84 Mean and Peak Velocity Profiles for Eight 0 Degree Azimuth Radial Stations at a Wheel Height of 15 Feet and a Gross Weight of 12,200 Pounds	I-8

	<u>Page</u>
Figure I-4 Canadair CL-84 Peak Rotorwash Velocity and Dynamic Pressure as a Function of Distance from the Rotor Center (270 Degree Azimuth)	I-12
Figure I-5 Canadair CL-84 Peak Rotorwash Velocity and Dynamic Pressure as a Function of Distance Along the Interaction Plane (0 Degree Azimuth)	I-13
Figure I-6 Canadair CL-84 Overturning Force as a Function of Distance from the Rotor Center (270 Degree Azimuth)	I-14
Figure I-7 Canadair CL-84 Overturning Force as a Function of Distance Along the Interaction Plane (0 Degree Azimuth)	I-15
Figure J-1 Three-View Drawing of the Ishida TW-68	J-2
Figure J-2 Ishida TW-68 Mean and Peak Velocity Profiles for Eight 270 Degree Azimuth Radial Stations at a Wheel Height of 15 Feet and a Gross Weight of 12,500 Pounds ...	J-4
Figure J-3 Ishida TW-68 Mean and Peak Velocity Profiles for Eight 0 Degree Azimuth Radial Stations at a Wheel Height of 15 Feet and a Gross Weight of 12,500 Pounds	J-8
Figure J-4 Ishida TW-68 Peak Rotorwash Velocity and Dynamic Pressure as a Function of Distance from the Rotor Center (270 Degree Azimuth)	J-12
Figure J-5 Ishida TW-68 Peak Rotorwash Velocity and Dynamic Pressure as a Function of Distance Along the Interaction Plane (0 Degree Azimuth)	J-13
Figure J-6 Ishida TW-68 Overturning Force as a Function of Distance from the Rotor Center (270 Degree Azimuth)	J-14
Figure J-7 Ishida TW-68 Overturning Force as a Function of Distance Along the Interaction Plane (0 Degree Azimuth)	J-15

LIST OF TABLES

	<u>Page</u>
Table 1 Tiltrotor and Tiltwing Configurations Analyzed in this Study	4
Table 2 Test Matrix for XV-15 Flight Test/ Mathematical Model Data Correlation	14
Table 3 Test Matrix for CL-84 Flight Test/ Mathematical Model Data Correlation	34
Table A-1 XV-15 ROTWASH Input Data	A-1
Table A-2 XV-15 Rotorwash Evaluation Matrix	A-3
Table B-1 MV-22 ROTWASH Input Data	B-1
Table B-2 MV-22 Rotorwash Evaluation Matrix	B-3
Table C-1 CTR-22C/D ROTWASH Input Data	C-1
Table C-2 CTR-22C/D Rotorwash Evaluation Matrix	C-4
Table D-1 CTR-800 ROTWASH Input Data	D-1
Table D-2 CTR-800 Rotorwash Evaluation Matrix	D-3
Table E-1 CTR-1900 ROTWASH Input Data	E-1
Table E-2 CTR-1900 Rotorwash Evaluation Matrix	E-3
Table F-1 CTR-7500 ROTWASH Input Data	F-1
Table F-2 CTR-7500 Rotorwash Evaluation Matrix	F-3
Table G-1 MAGNUM Tiltrotor ROTWASH Input Data	G-1
Table G-2 MAGNUM Tiltrotor Rotorwash Evaluation Matrix	G-3
Table H-1 EUROFAR Tiltrotor ROTWASH Input Data	H-1
Table H-2 EUROFAR Tiltrotor Rotorwash Evaluation Matrix	H-3
Table I-1 CL-84 ROTWASH Input Data	I-1
Table I-2 CL-84 Rotorwash Evaluation Matrix	I-3

	<u>Page</u>
Table J-1 TW-68 ROTWASH Input Data	J-1
Table J-2 TW-68 Rotorwash Evaluation Matrix	J-3

LIST OF ACRONYMS

AGL	Above ground level
DAIP	Distance along the interaction plane, feet
DFAC	Distance from aircraft center, feet
DFRC	Distance from the rotor center, feet
DMAV	Dual Mode Air Vehicle Corporation
DOT	Department of Transportation
GW	Gross weight, pounds
HAGL	Rotor or sensor height above ground level, feet
Hz	Hertz, cycles per second
NASA	National Aeronautics and Space Administration
PSF	Pounds per square foot
ROTHAZ	Rotorwash and Hazard Analysis Program
ROTWASH	Rotorwash Analysis Program
VTOL	Vertical takeoff and landing
WAGL	Wheel height above ground level, feet

1.0 INTRODUCTION

The introduction of tiltrotor and tiltwing aircraft into the U.S. air transportation system will create unique opportunities for passenger growth. One of the most important growth opportunities will involve regular flight operations into and out of vertiports. However, this type of operation will have certain limitations. As an example, when rotorcraft are flown in a confined area or in close proximity to personnel and other aircraft, a potential exists for rotorwash related accidents. These types of safety related issues will influence the vertiport design process as well as operational procedures as a function of vertiport size. Fortunately, with careful planning, the undesirable effects associated with these types of issues can usually be minimized.

The objective of this report is to model and analyze the hover rotorwash flow field characteristics of tiltrotor and tiltwing aircraft in close proximity to the ground. The aircraft analyzed in this study that have been flight tested include the Bell XV-15 (tiltrotor), Bell/Boeing MV-22 (tiltrotor), and the Canadair CL-84 (tiltwing). Proposed tiltrotors included in the analysis include the Bell/Boeing/NASA CTR-22, CTR-800, CTR-1900, and CTR-7500 configurations; the Magnum tiltrotor; and the Eurofar tiltrotor. The only proposed tiltwing which is analyzed is the Ishida TW-68. Any determination of whether or not the rotorwash characteristics for any specific type of rotorcraft are necessarily more hazardous than another is specifically omitted as an objective. This is because each operational characteristic of a vertiport scenario must be fully defined before any potentially hazardous situations can be analyzed. Rotorwash velocity profile data presented in this report do provide a foundation for this type of analysis. Several examples of analyses for potentially hazardous situations involving helicopters and two types of generic tiltrotors are presented in reference 1.

The objectives of this report are accomplished through use of the ROTWASH analysis program. A detailed description of the mathematical model used in the computer program is provided in reference 1. Correlation of calculated results with Bell XV-15 and Canadair CL-84 flight test data is also provided. This correlation effort provides increased confidence in the quality of the predicted results for the other aircraft configurations which have been analyzed.

2.0 ANALYSIS APPROACH

The tiltrotor and tiltwing rotorwash flow field characteristics evaluated in this report are the result of a multi-step process. This process includes:

1. an improvement of analytical tools,
2. a review and correlation of analytical tools with available flight test data,
3. definition of candidate tiltrotor and tiltwing configurations for analysis, and
4. an analysis and evaluation of the rotorwash flow field characteristics of candidate configurations.

The first step in the analysis process was initiated in the mid 1980's with the development of the ROTHAZ analysis methodology and its associated FORTRAN 77 software. This Department of Transportation (DOT) sponsored project involved an analysis of both helicopter and tiltrotor aircraft; results are described in reference 1. This methodology has been improved during 1989 and 1990 and is documented in reference 2. The associated software has also been significantly modified and is now referred to as the ROTWASH analysis program. This version of the analysis software has been used to provide the results presented in this report.

As a result of the availability of the improved software and the intervening time period since the publishing of reference 1, it was determined that a review of all available flight test data was desirable for this analysis effort. The main objective of this step was to identify new sources of flight test data (post 1986) for correlation with the ROTWASH program. This review led to the discovery of several new reports documenting rotorwash flight test data for helicopters; however, no new sources of data for tiltrotor or tiltwing aircraft were identified. Flight test data reports for the Bell XV-15 (reference 3) and the Canadair CL-84 (references 4 through 6), as originally identified in reference 1, are still the only known sources of tiltrotor and tiltwing flight test data. Discussions with the U.S. Navy did reveal that limited Bell/Boeing MV-22 rotorwash flight test data should be available sometime in 1990. A much more complete flight test evaluation of the aircraft is planned for early 1991. Documented results should be available soon thereafter in a format similar to those presented for the Bell XV-15 in reference 3.

Rotorwash flight test data for the XV-15 and CL-84 were correlated with output from the ROTWASH analysis software subsequent to the data review process. This subject is discussed in detail in section 3.0 of this report.

Upon completion of the correlation effort, candidate tiltrotor and tiltwing configurations were defined for analysis. These configurations were defined using several sources of data and include aircraft which have flown as well as conceptual configurations. A list of these configurations is tabulated below in table 1.

TABLE 1 TILTROTOR AND TILTWING CONFIGURATIONS ANALYZED IN THIS STUDY

<u>Tiltrotor</u>	<u>Tiltwing</u>
Flight Tested:	
Bell XV-15	Canadair CL-84
Bell/Boeing MV-22	
Planned:	
Bell/Boeing CTR-22A/B	Ishida TW-68
Bell/Boeing/NASA CTR-22C/D	
Bell/Boeing/NASA CTR-800	
Bell/Boeing/NASA CTR-1900	
Bell/Boeing/NASA CTR-7500	
Magnum Tiltrotor	
Eurofar Tiltrotor	

Details and three-view drawings of each configuration are presented in appendices A through J.

The analysis of each configuration was conducted for a minimum of one specific wheel height above ground (WAGL) and one gross weight (GW) for zero wind conditions. It should be noted, based on very limited flight test data (see reference 1), that the zero wind condition is probably not the most critical condition from an accident analysis viewpoint. However, simple analyses indicate that the zero wind condition is close to the critical condition, and for purposes of comparing different tiltrotor or tiltwing aircraft this constraint is a logical choice. During the analysis, it was also determined that some of the configurations are so similar in geometry that the predicted rotorwash characteristics are almost identical at the same gross weight. In these cases, the different gross weights that were evaluated are applicable to other similar configurations. One example involves the MV-22, CTR-22A/B, and CTR-22C/D configurations. Rotorwash characteristics as

predicted by the ROTWASH program are primarily a function of gross weight, rotor radius, rotor separation distance, and height above ground. For each of these V-22 variant configurations, the rotor radius and rotor separation distance are virtually constant. If gross weight is varied at a constant wheel height above ground, then the predicted rotorwash characteristics are for all practical purposes interchangeable for the usually minor changes in fuselage configuration. Therefore, data generated for these configurations at 40,000, 47,500, and 51,670 pounds gross weight can be applied to any one of the other configurations. A similar situation exists for the XV-15, Magnum Tiltrotor, and CTR-800 configurations, since each of these aircraft use the same basic wing and rotor components. Differences in the maximum gross weights of the rotorcraft in both of these situations can be attributed to differences in the available installed power.

At the beginning of the analysis, it was planned that both a maximum and a minimum gross weight would be evaluated for each candidate configuration. This goal was not achieved because over one-half of the configurations had no clearly defined minimum practical gross weight. However, the fact that this goal was not accomplished is believed to have a minimal impact on the usefulness of the analysis effort. This statement results from the safety requirement that the design of, and procedures used at, each vertiport be based on the maximum gross weight of the largest rotorcraft configurations using the vertiport. Pilots and personnel involved in the operation of the vertiport cannot be expected to always know the gross weight of a particular aircraft and understand its impact on the strength of the associated rotorwash flow field.

All data generated in the analysis of the table 1 configurations is provided in several formats for use with future vertiport or hazard analysis efforts. These formats include graphs of:

1. outwash velocity profiles as a function of height above ground level (HAGL),
2. peak velocity and dynamic pressure as a function of distance from the aircraft, and
3. overturning force as a function of distance from the aircraft (as defined for a six foot tall person).

Data are presented in each format for each of the configurations both in front of the aircraft (distance along the interaction plane (DAIP), 0 degree azimuth) and out the left wing (distance from the rotor center (DFRC), 270 degree

azimuth). These data presentation azimuth conventions are based on previous work involving helicopters. The reader can assume for this study that no differences exist for predicted results out either the left or right wing or for results either in front of or aft of the aircraft, as long as the distances from the center of the rotor are the same.

3.0 CORRELATION OF FLIGHT TEST DATA WITH THE ROTWASH MATHEMATICAL MODEL

The usefulness of any predictive methodology or mathematical model is defined by its ability to accurately predict test cases. This statement is particularly true when a complex problem is analyzed using a methodology which must be based on a simplified mathematical description of the problem. The prediction of rotorwash flow field characteristics is an example of this type of problem.

A tiltrotor outwash flow field across the ground can be characterized as an unsteady or stochastic yet periodic flow field. In reference 3, this flow field is characterized for the XV-15 as being "composed of strong low frequency periodic components"; however, upon analysis of eight different power spectra, the same frequency components were not always present. In general, frequency components varied from 0.2 to 29.5 Hz with most of the energy below 1.3 Hz. Typically, peak velocity pulses occurred at 3 to 6 second intervals with an "average to peak to trough to average" duration of 0.5 to 0.6 seconds. Examples of time history and power spectral density graphs for the measured Bell XV-15 data are presented as figures 1 and 2 (reproduced from reference 3).

The outwash flow field, as mathematically modeled in the ROTWASH analysis program, is based upon momentum theory and steady flow assumptions. Initially, the program calculates a steady mean velocity profile for a specified helicopter, tiltrotor, or tiltwing configuration using momentum theory. Empirical corrections are then applied to the calculated mean velocity profile to account for the periodic nature of rotorwash and to enable prediction of a corresponding peak velocity profile. Examples of calculated XV-15 profile velocity data from the analysis are presented in figure 3 (distance from the rotor (DFRC) is 15.6 feet). Rotorwash flow field interaction effects are also calculated using empirical techniques in the plane perpendicular to and halfway along the line connecting the centers of the two rotors. This plane is also called the "interaction plane." Since mathematical model equations contained in the analysis are complex, it is recommended that the reader refer to references 1 and 2 for details.

3.1 BELL XV-15 TILTROTOR CORRELATION

The Bell XV-15 is a two-seat tiltrotor concept demonstrator aircraft and was first flown in 1977. The gross weight range of the aircraft for vertical takeoff operation varies between approximately 12,000 and 13,800 pounds. A three-view drawing of the XV-15 is provided as figure 4 for reference purposes.

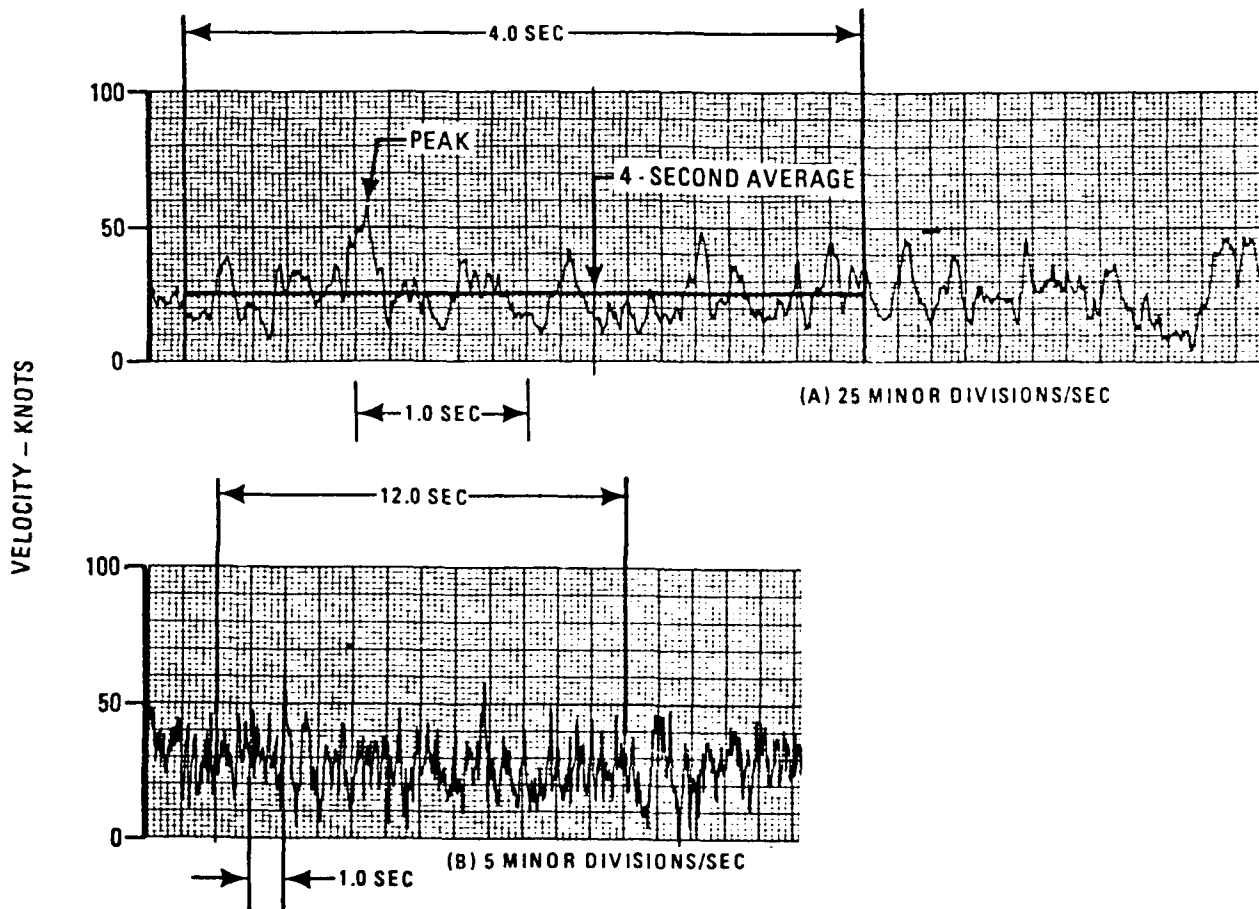

Note: Charts A and B represent horizontal velocity measured at 2 feet AGL while the aircraft was hovering at 12 feet WAGL at a 270 degree relative bearing to the instrumentation.

FIGURE 1 TIME SERIES STRIPOUTS OF BELL XV-15 DOWNWASH WIND VELOCITY MAGNITUDES IN HOVER (Source: See reference 3.)

POWER SPECTRAL DENSITY

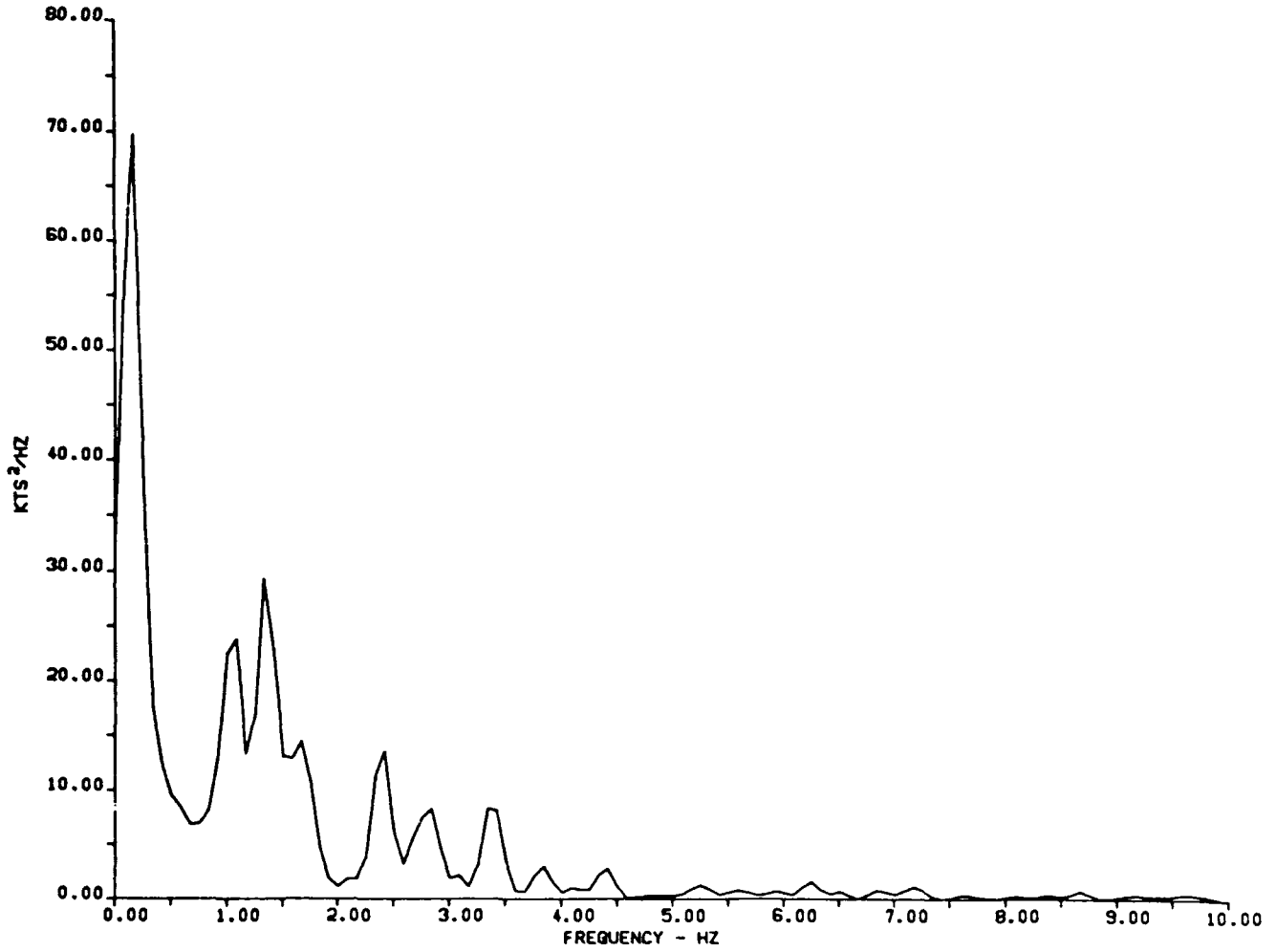

FIGURE 2 POWER SPECTRAL DENSITY OF THE BELL XV-15
TIME SERIES PRESENTED IN FIGURE 1 (Source:
See reference 3.)

BELL XV-15 TILTROTOR
GW = 12555 LB, WAGL = 50 FT
AZIMUTH = 270 DEG, DFAC = 31.7 FT (DFRC = 15.6 FT)

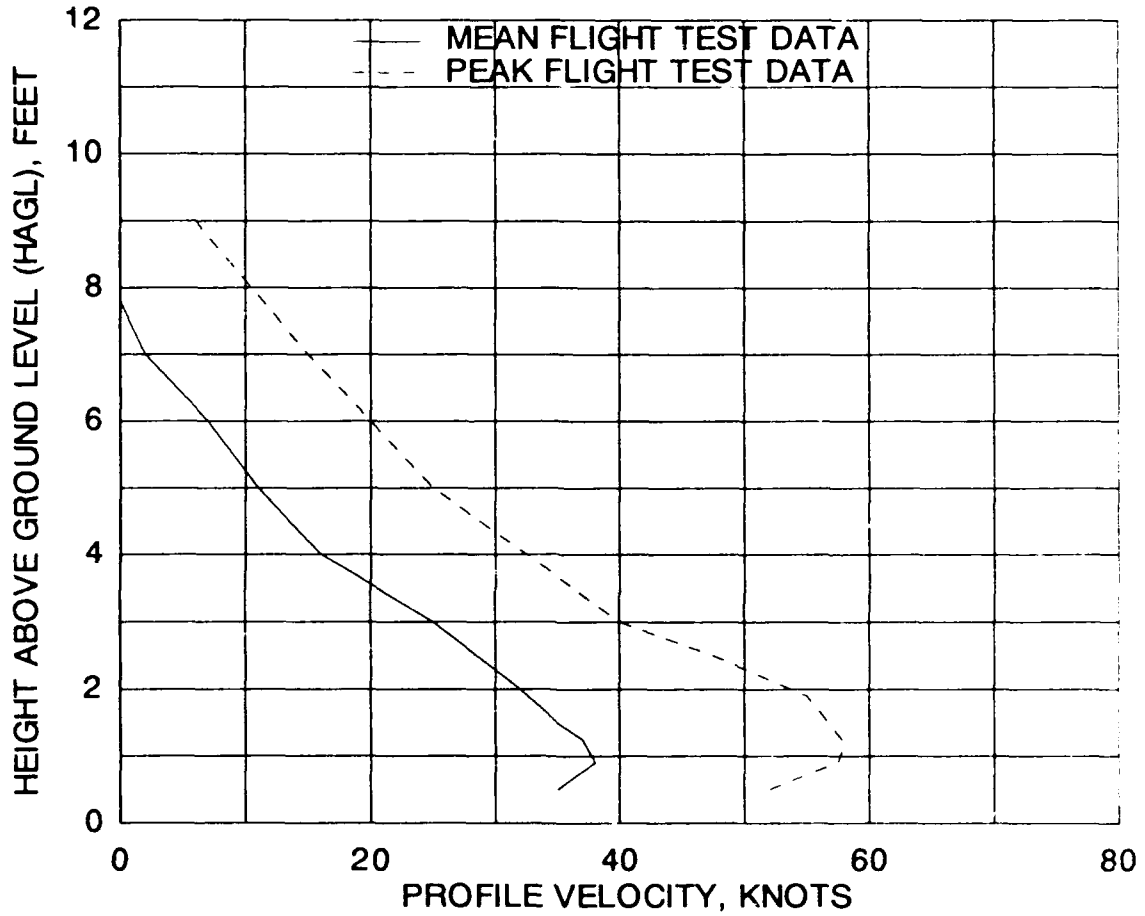

FIGURE 3 EXAMPLES OF BELL XV-15 MEAN AND PEAK OUTWASH VELOCITY PROFILES IN A ZERO WIND HOVER

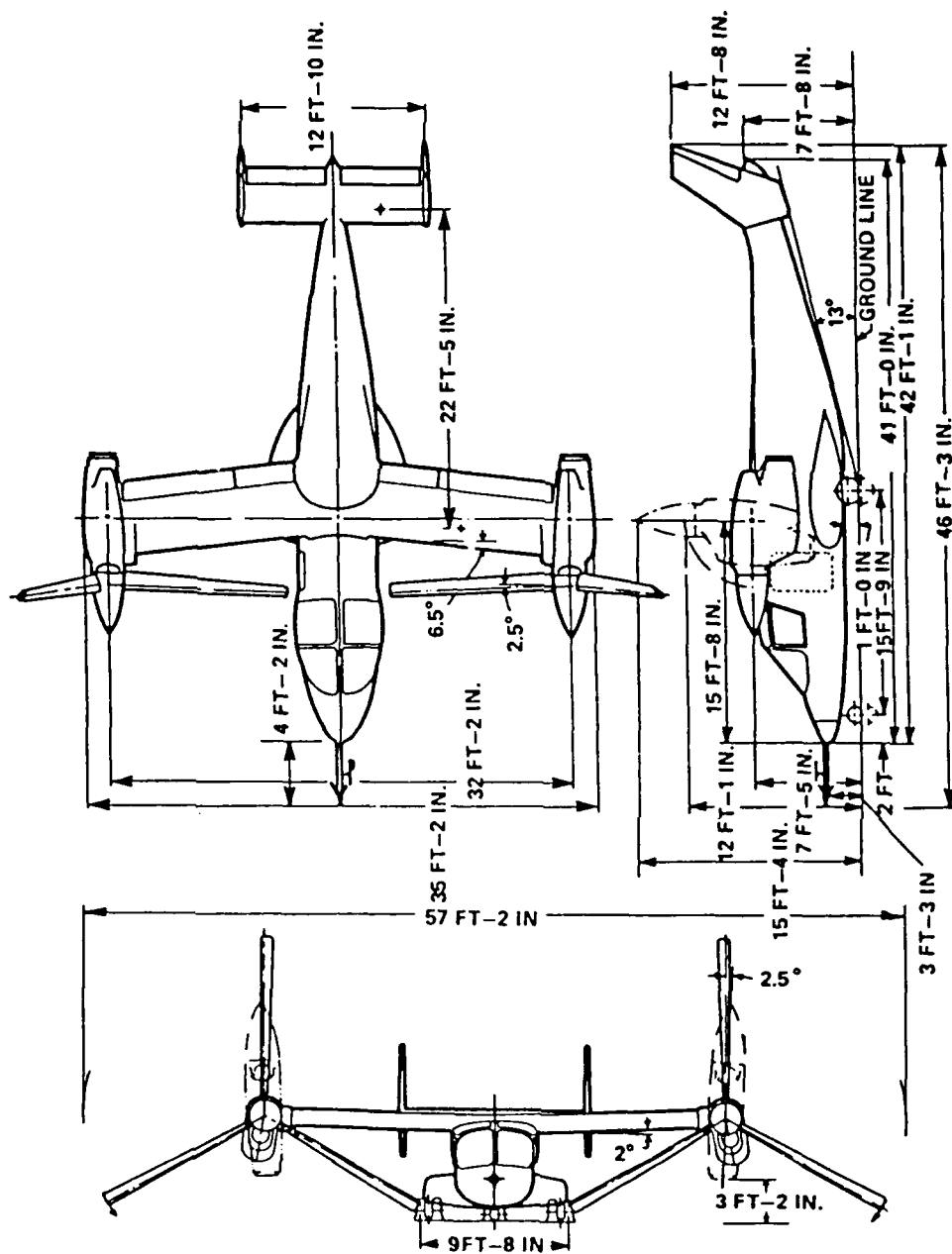

FIGURE 4 THREE-VIEW DRAWING OF THE BELL XV-15

XV-15 flight test data used in the correlation analysis were obtained from reference 3. These data were obtained at azimuths of 0, 180, and 270 degrees with respect to the nose of the aircraft (or forward, rear, and left side respectively). A minimum of six stations was evaluated along each azimuth. The distances defining these stations varied from 26.1 to 91.1 feet from the aircraft. Each of these locations is defined with respect to the XV-15 in figure 5. Data at three wheel heights above ground level (WAGL) were obtained at the station position 15.6 feet from the center of the rotor for each azimuth. Winds were less than 2 knots during the testing and significant variations in gross weight were not evaluated. Table 2 presents a matrix of the points tested which were available in reference 3 for correlation with output from the ROTWASH program.

Correlation of XV-15 flight test and calculated data, as a function of distance from the rotor center (DFRC), is presented along the 270 degree azimuth in figure 6. These data are for a gross weight of approximately 12,475 pounds at a WAGL of 25.0 feet, which corresponds to a rotor height of 37.5 feet. In the majority of the comparisons, the correlation results indicate that the ROTWASH analysis methodology predicts mean and peak profile velocities (from 0 to 9 feet AGL) to within 5 knots of the measured flight test data. (Any statistical comparison of these results would be meaningless due to the nature of the data, i.e. the flight test peak velocity profile is composed of the peak velocities measured at each height above ground over a long period of time. Therefore, this profile does not represent an "average" peak velocity profile at any one specific point in time.) The height above ground of the maximum profile velocity is generally calculated to be lower than the measured position, except in the far field. This effect is not totally unexpected however. At present, the ROTWASH model does not contain a detailed boundary layer model. Also, mean reverse flow velocities, as seen in the measured data very close to the rotor, are not predicted at heights above ground level (HAGL) greater than 5 to 7 feet. These velocities are due to vorticity and, at very low wheel heights, a tendency for rotor recirculation. Both of these effects are not modeled. Figure 7, reproduced from reference 3, provides direction of flow information for these portions of the flow field.

Correlation of measured and calculated data for a variation in WAGL of 2, 25, and 50 feet at the 15.6 foot position is presented in figure 8. These results compare quite well at the 25 and 50 foot wheel heights. However, at the 2 foot wheel height, equivalent velocities along the calculated profiles are approximately 1 foot lower than those along the measured profiles. Unfortunately, another radial location farther out from the rotor was not provided

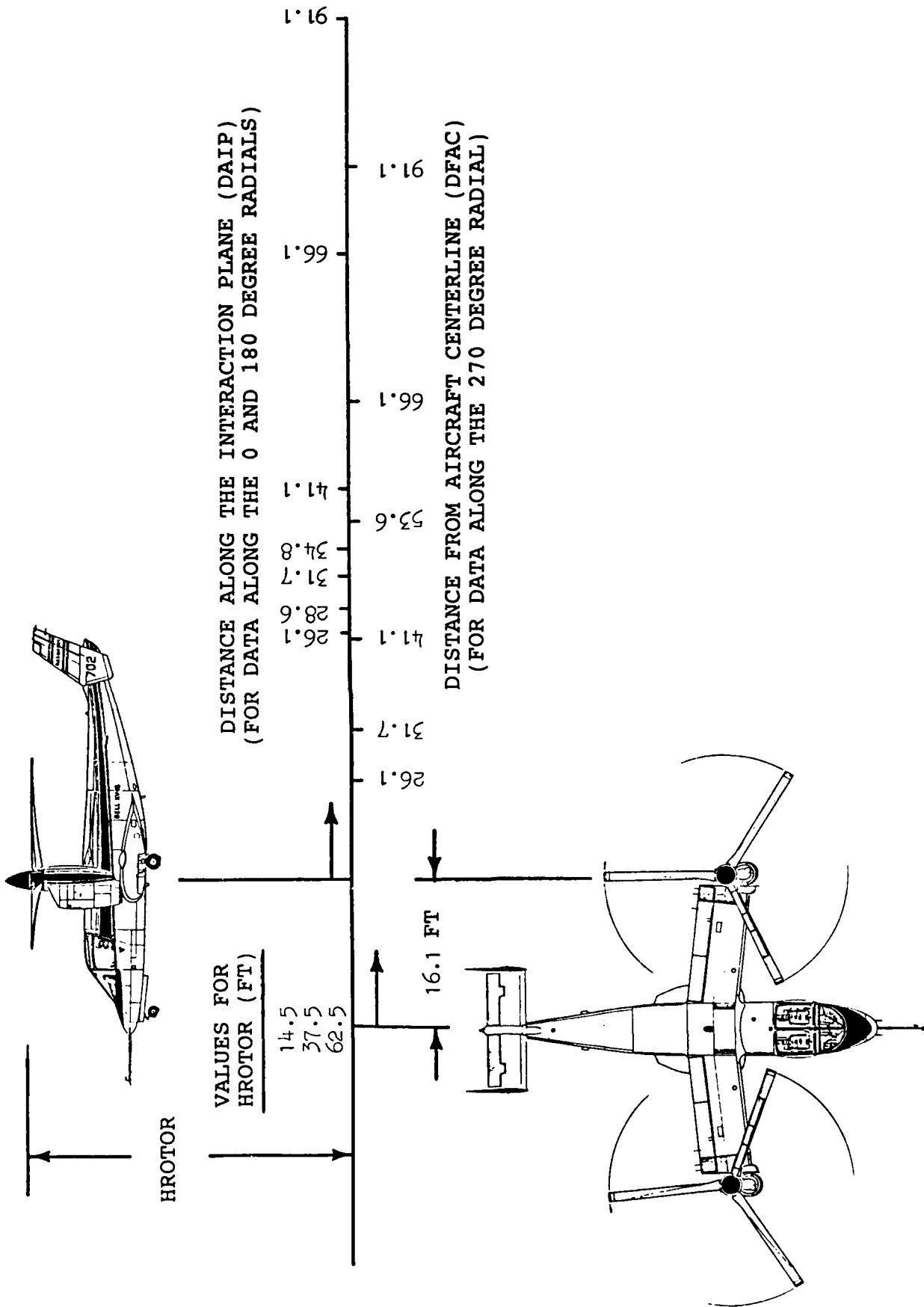

FIGURE 5 XV-15 FLIGHT TEST DATA MEASUREMENT LOCATIONS

TABLE 2 TEST MATRIX FOR XV-15 FLIGHT TEST/
MATHEMATICAL MODEL DATA CORRELATION

Figure Number	Gross Weight ¹ , lb	Wheel Height, ft	Azimuth Angle, deg	Distance From the Rotor Center (DFRC) or Distance Along the Interaction Plane (DAIP) ² , ft
6	12,475	25	270	10,15.6,25,37.5,50,75
8	12,555	2,25,50	270	15.6
9	12,475	25	0	26.1,31.7,34.8,41.1,66.1,99.1
10	12,475	25	180	26.1,28.6,31.7,41.1,66.1,99.1
11	12,555	2,25,50	0	31.7
12	12,555	2,25,50	180	31.7

Notes:

- (1) Even though care has been taken to calculate realistic average gross weights, the values are average values that could vary between 12,030 and 13,000 pounds at the extremes. Disk loadings are 12.71 PSF at 12,475 pounds and 12.79 PSF at 12,555 pounds.
- (2) The values of DFRC are applicable along only the 270 degree azimuth, whereas the values for DAIP are valid along only the 0 and 180 degree azimuths.
- (3) Atmospheric density ratio varied between 0.98 and 1.01 during testing.

BELL XV-15 TILTROTOR
 GW = 12475 LB, WAGL = 25 FT
 AZIMUTH = 270 DEG, DFAC = 26.1 FT (DFRC = 10.0 FT)

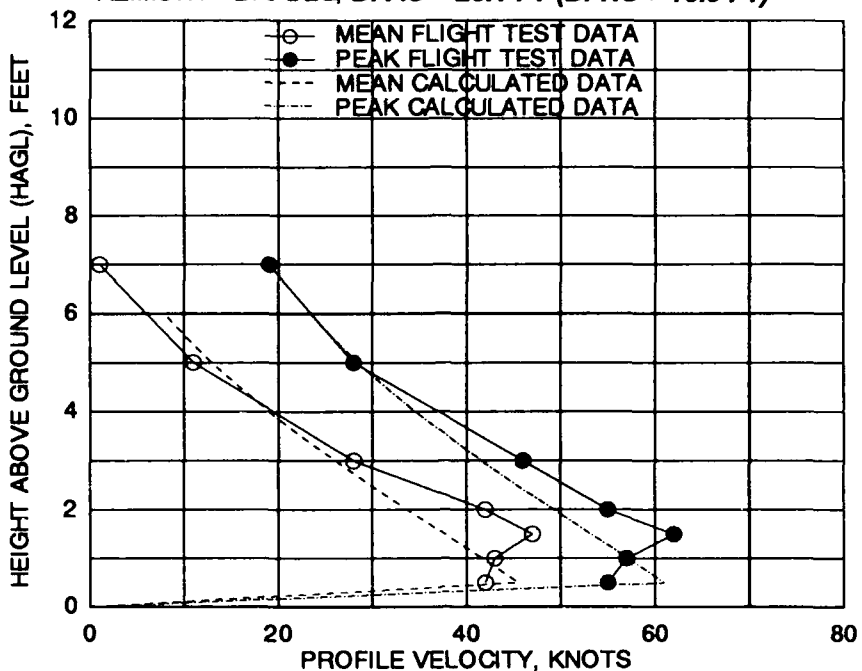

BELL XV-15 TILTROTOR
 GW = 12475 LB, WAGL = 25 FT
 AZIMUTH = 270 DEG, DFAC = 31.7 FT (DFRC = 15.6 FT)

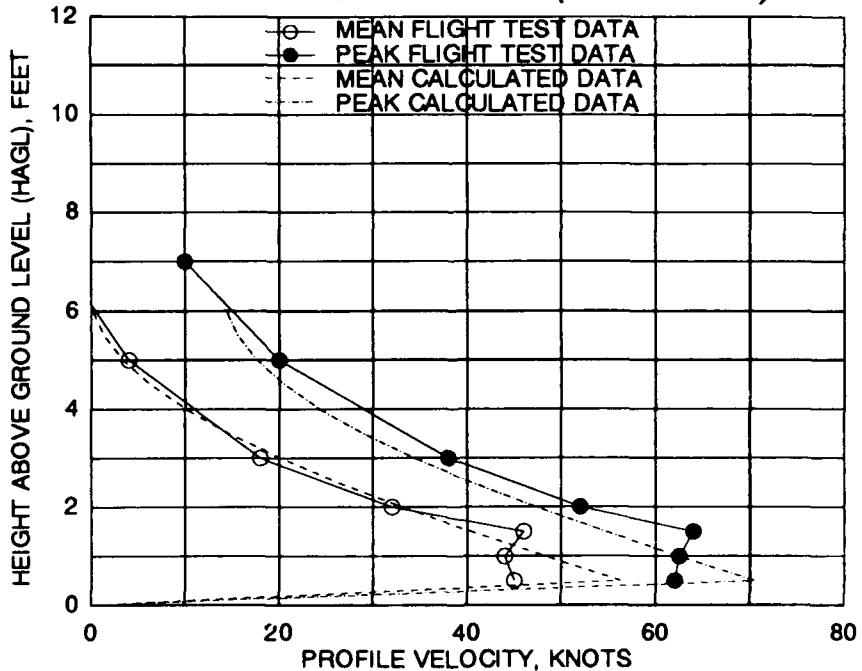
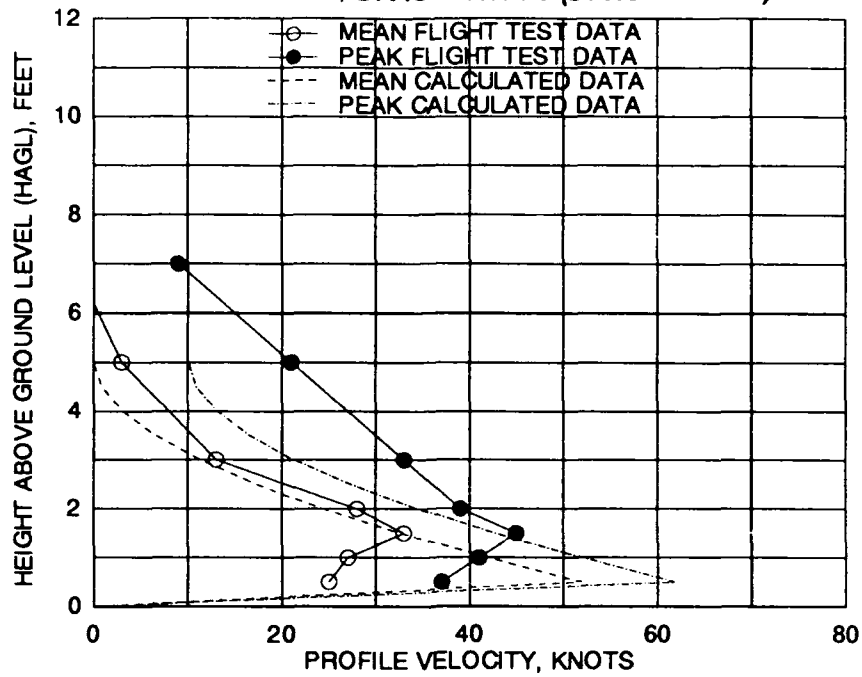

FIGURE 6 XV-15 MEAN/PEAK VELOCITY PROFILE CORRELATION ALONG THE 270 DEGREE AZIMUTH RADIAL AT A WHEEL HEIGHT OF 25 FEET AND AN AVERAGE GROSS WEIGHT OF 12,475 POUNDS

BELL XV-15 TILTROTOR
 GW = 12475 LB, WAGL = 25 FT
 AZIMUTH = 270 DEG, DFAC = 41.1 FT (DFRC = 25.0 FT)



BELL XV-15 TILTROTOR
 GW = 12475 LB, WAGL = 25 FT
 AZIMUTH = 270 DEG, DFAC = 53.6 FT (DFRC = 37.5 FT)

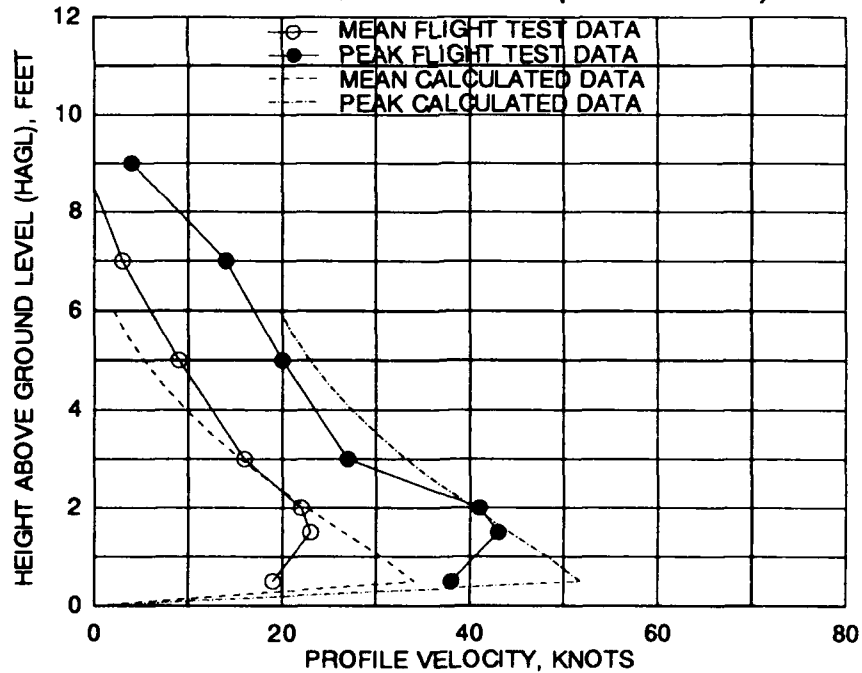
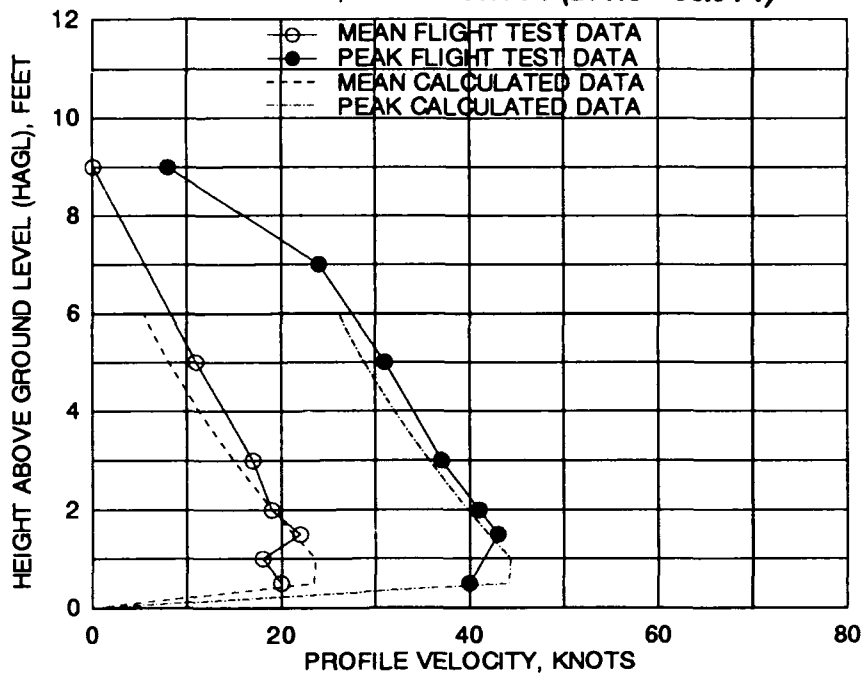

FIGURE 6 XV-15 MEAN/PEAK VELOCITY PROFILE CORRELATION ALONG THE 270 DEGREE AZIMUTH RADIAL AT A WHEEL HEIGHT OF 25 FEET AND AN AVERAGE GROSS WEIGHT OF 12,475 POUNDS (Continued)

BELL XV-15 TILTROTOR
 GW = 12475 LB, WAGL = 25 FT
 AZIMUTH = 270 DEG, DFAC = 66.1 FT (DFRC = 50.0 FT)



BELL XV-15 TILTROTOR
 GW = 12475 LB, WAGL = 25 FT
 AZIMUTH = 270 DEG, DFAC = 91.1 FT (DFRC = 75.0 FT)

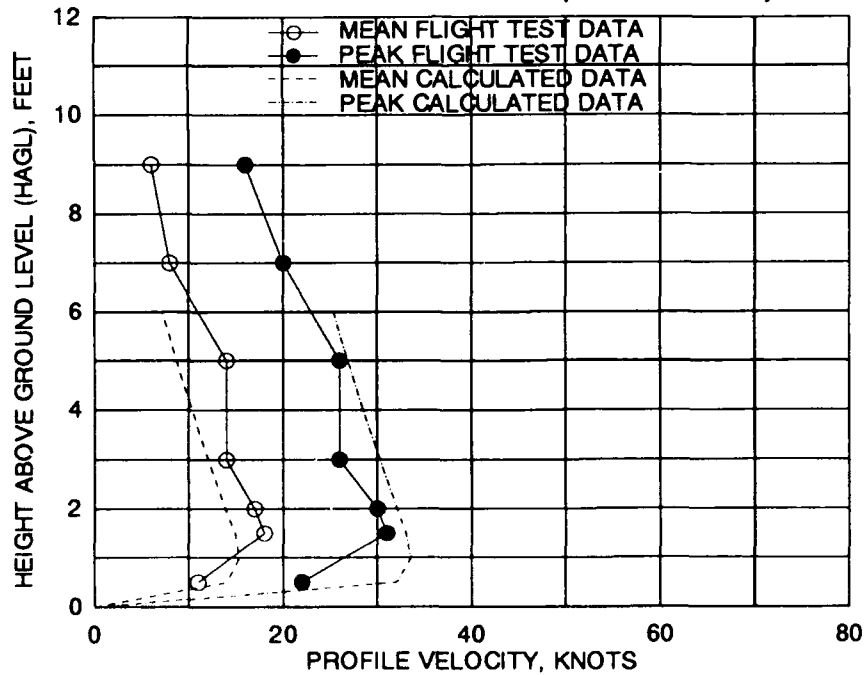

FIGURE 6 XV-15 MEAN/PEAK VELOCITY PROFILE CORRELATION ALONG THE 270 DEGREE AZIMUTH RADIAL AT A WHEEL HEIGHT OF 25 FEET AND AN AVERAGE GROSS WEIGHT OF 12,475 POUNDS (Concluded)

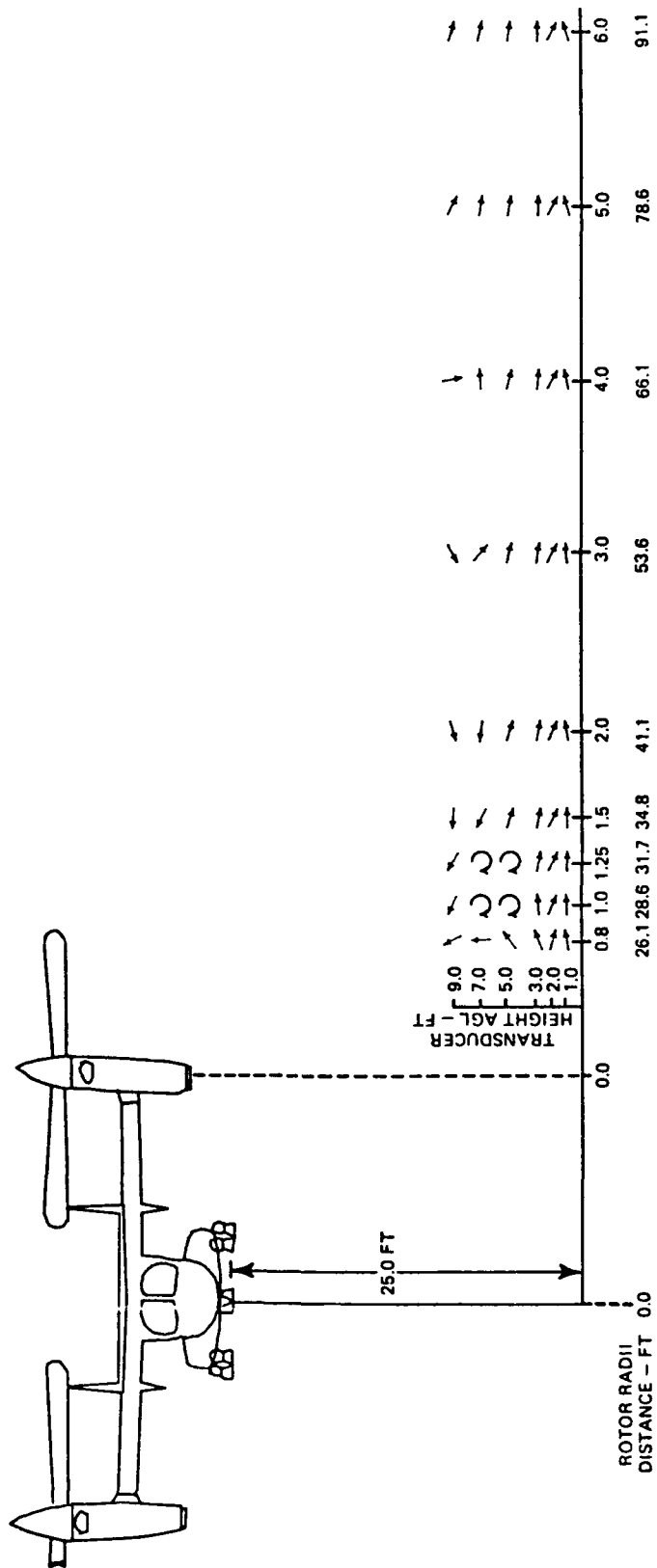
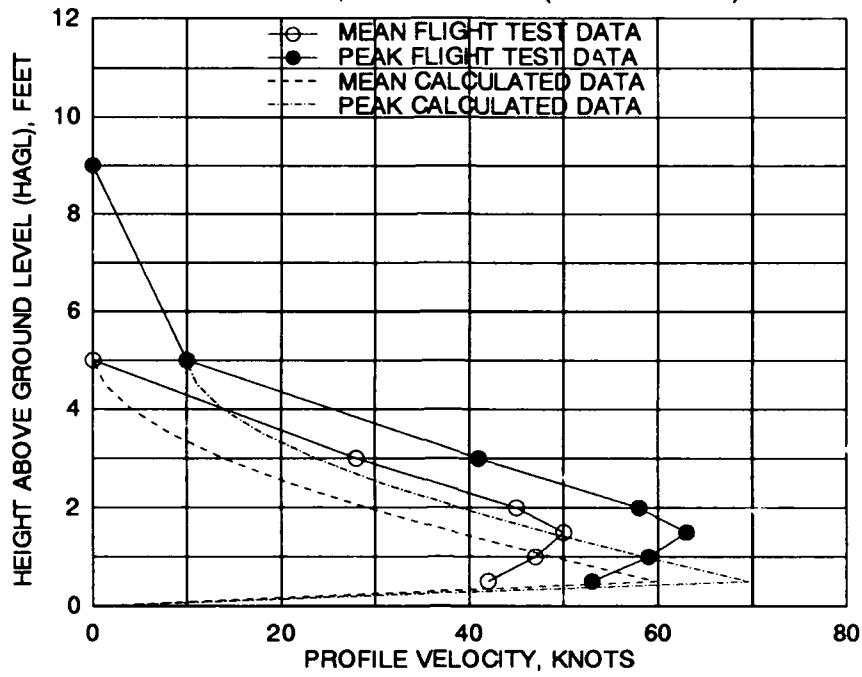

FIGURE 7 BELL XV-15 DOWNWASH FLOW FIELD VELOCITY VECTORS IN THE VERTICAL PLANE AT A 25 FOOT HOVER ALONG THE 270 DEGREE AZIMUTH (Source: See reference 3.)

BELL XV-15 TILTROTOR
 GW = 12555 LB, WAGL = 2 FT
 AZIMUTH = 270 DEG, DFAC = 31.7 FT (DFRC = 15.6 FT)



BELL XV-15 TILTROTOR
 GW = 12555 LB, WAGL = 25 FT
 AZIMUTH = 270 DEG, DFAC = 31.7 FT (DFRC = 15.6 FT)

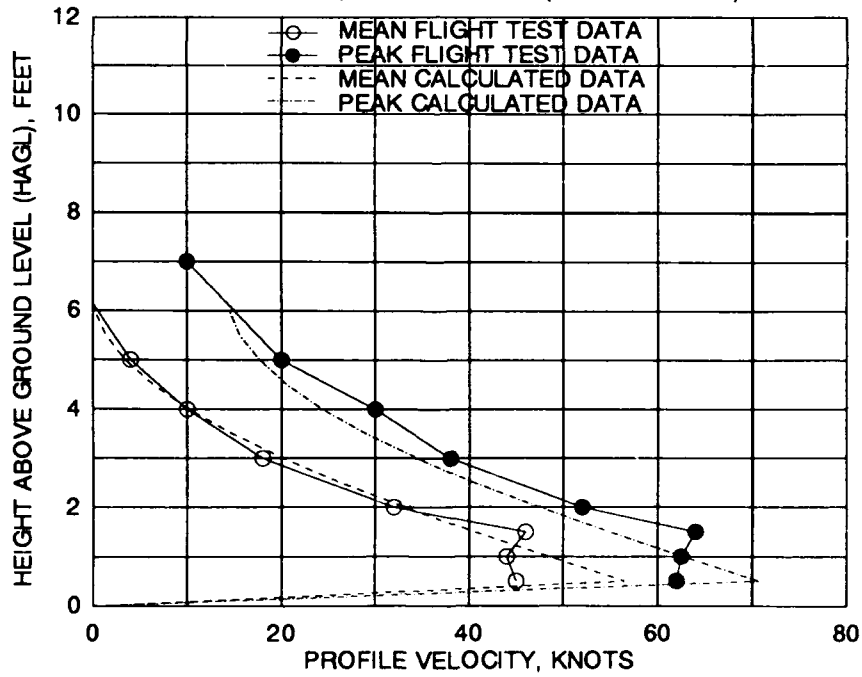

FIGURE 8 XV-15 MEAN/PEAK VELOCITY PROFILE CORRELATION ALONG THE 270 DEGREE AZIMUTH RADIAL AT THREE WHEEL HEIGHTS FOR AN AVERAGE GROSS WEIGHT OF 12,555 POUNDS

BELL XV-15 TILTROTOR
 GW = 12555 LB, **WAGL = 50 FT**
 AZIMUTH = 270 DEG, DFAC = 31.7 FT (DFRC = 15.6 FT)

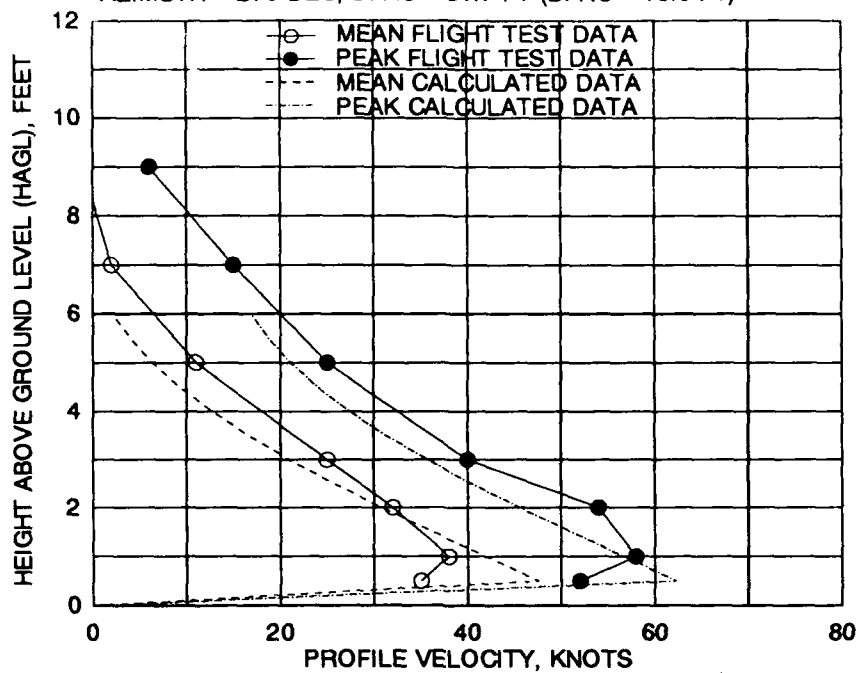

FIGURE 8 XV-15 MEAN/PEAK VELOCITY PROFILE CORRELATION ALONG THE 270 DEGREE AZIMUTH RADIAL AT THREE WHEEL HEIGHTS FOR AN AVERAGE GROSS WEIGHT OF 12,555 POUNDS (Concluded)

in reference 3 for correlation with the variation in WAGL. A second measurement location would have been very desirable, since at low altitude the 15.6 foot location is in very close proximity to the rotor tip.

Correlation of results along the interaction plane (the plane perpendicular to and one-half the distance between the two rotors, or out the aircraft centerline) is presented in figures 9 and 10 for the 0 and 180 degree azimuths, respectively. It is important to note that the ROTWASH mathematical model does not take into account any fuselage characteristics which might affect results along these azimuths. The program predicts symmetry in the flow field for a zero wind hover at all positions equidistant from the line connecting the rotors. However, this assumption is not necessarily validated by flight test data. A comparison of flight test velocity profiles at each of the interaction plane stations, particularly the 41.1, 66.1, and 91.1 foot positions, indicates that a distinct difference exists in the shape of the profiles. The reason for these differences is unknown at this time. Data correlated along the 0 degree azimuth indicate that the mathematical model closely predicts (or slightly overpredicts) the measured XV-15 velocity profiles. Likewise, a comparison of data along the 180 degree azimuth indicates a similar overprediction of velocity profiles, particularly at low profile heights, out to station positions slightly greater than 41.1 feet. At the 66.1 and 91.1 foot positions, correlation of the peak profiles is quite good, but the mean profiles are somewhat underpredicted.

Correlation for both the 0 and 180 degree azimuths as a function of WAGL is provided in figures 11 and 12. Data were acquired at only one position along both of these azimuths. This position was at 31.7 feet from the center of the XV-15. In most cases, the magnitudes of the average calculated profile velocities compare quite well with measured velocities. However, the shapes of the predicted and measured profiles do not compare as closely as would be desired, particularly at positions above 5 feet HAGL.

Overall, for the intended purposes correlation of Bell XV-15 data appears quite good. This is especially true when one considers that the theory used in the mathematical model contains simplifications which limit its ability to predict many of the details of the measured velocity profiles. It must also be noted that limitations and errors which are not documented do exist in the procedures, instrumentation, and data reduction processes involved in measuring the flight test data. It is hoped that the availability of MV-22 data in the near future will significantly increase the size of the available data base. This should provide guidance for improving various components of the mathematical model.

BELL XV-15 TILTROTOR
 GW = 12475 LB, WAGL = 25 FT
 AZIMUTH = 0 DEG, DAIP = 26.1 FT

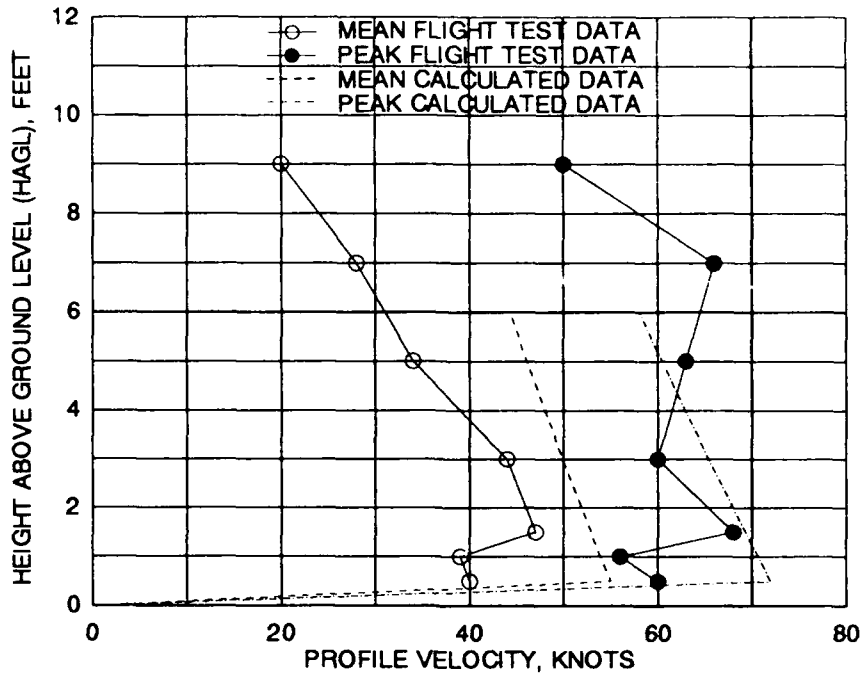

BELL XV-15 TILTROTOR
 GW = 12475 LB, WAGL = 25 FT
 AZIMUTH = 0 DEG, DAIP = 31.7 FT

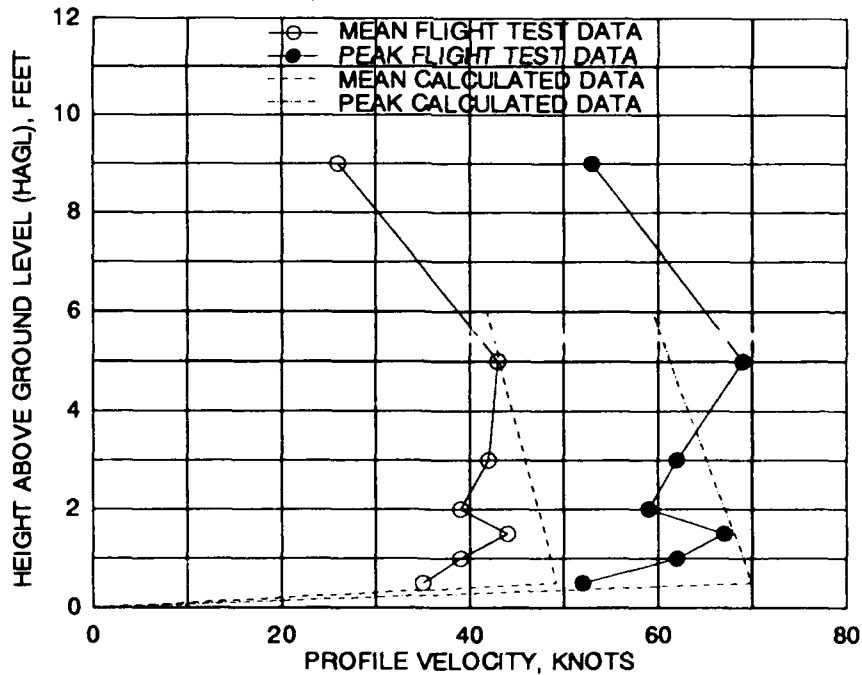
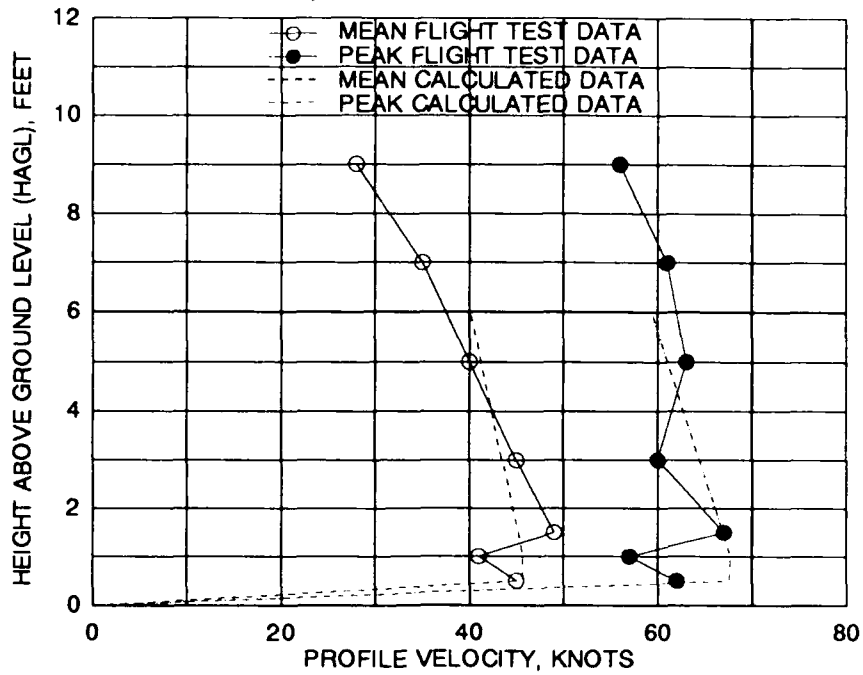

FIGURE 9 XV-15 MEAN/PEAK VELOCITY PROFILE CORRELATION ALONG THE 0 DEGREE AZIMUTH RADIAL AT A WHEEL HEIGHT OF 25 FEET AND AN AVERAGE GROSS WEIGHT OF 12,475 POUNDS

BELL XV-15 TILTROTOR
 GW = 12475 LB, WAGL = 25 FT
 AZIMUTH = 0 DEG, DAIP = 34.8 FT



BELL XV-15 TILTROTOR
 GW = 12475 LB, WAGL = 25 FT
 AZIMUTH = 0 DEG, DAIP = 41.1 FT

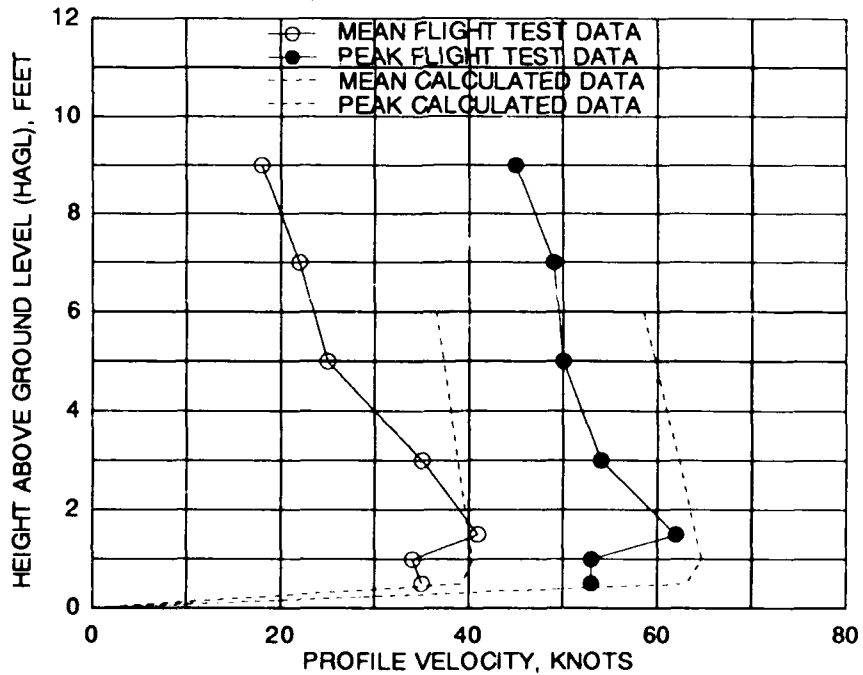
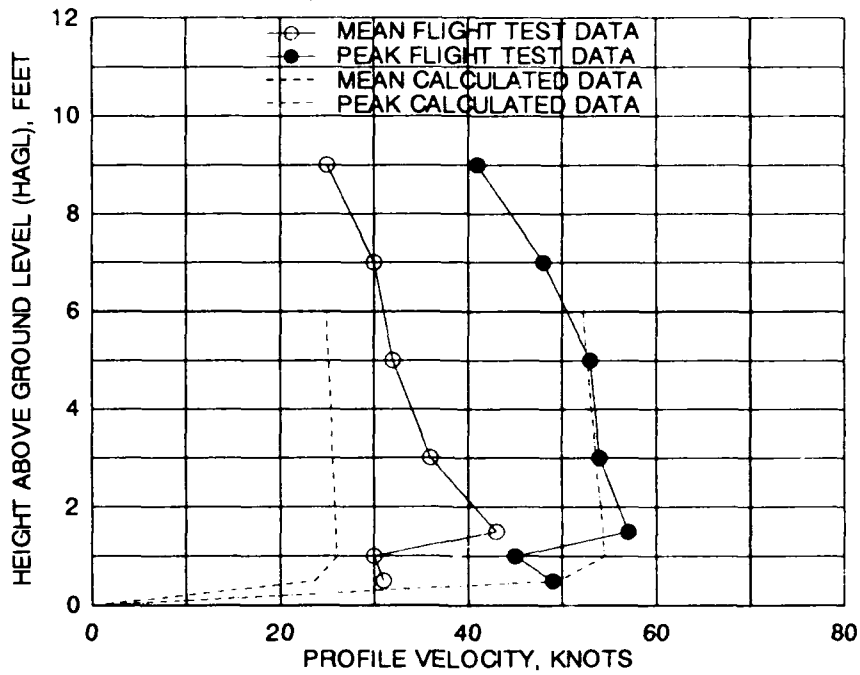

FIGURE 9 XV-15 MEAN/PEAK VELOCITY PROFILE CORRELATION ALONG THE 0 DEGREE AZIMUTH RADIAL AT A WHEEL HEIGHT OF 25 FEET AND AN AVERAGE GROSS WEIGHT OF 12,475 POUNDS (Continued)

BELL XV-15 TILTROTOR
 GW = 12475 LB, WAGL = 25 FT
 AZIMUTH = 0 DEG, DAIP = 66.1 FT



BELL XV-15 TILTROTOR
 GW = 12475 LB, WAGL = 25 FT
 AZIMUTH = 0 DEG, DAIP = 91.1 FT

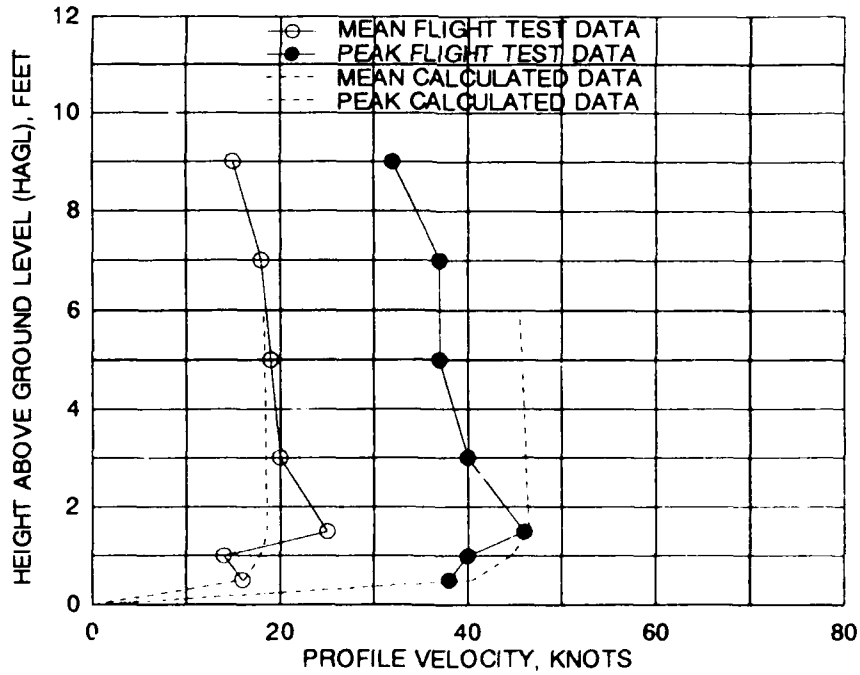
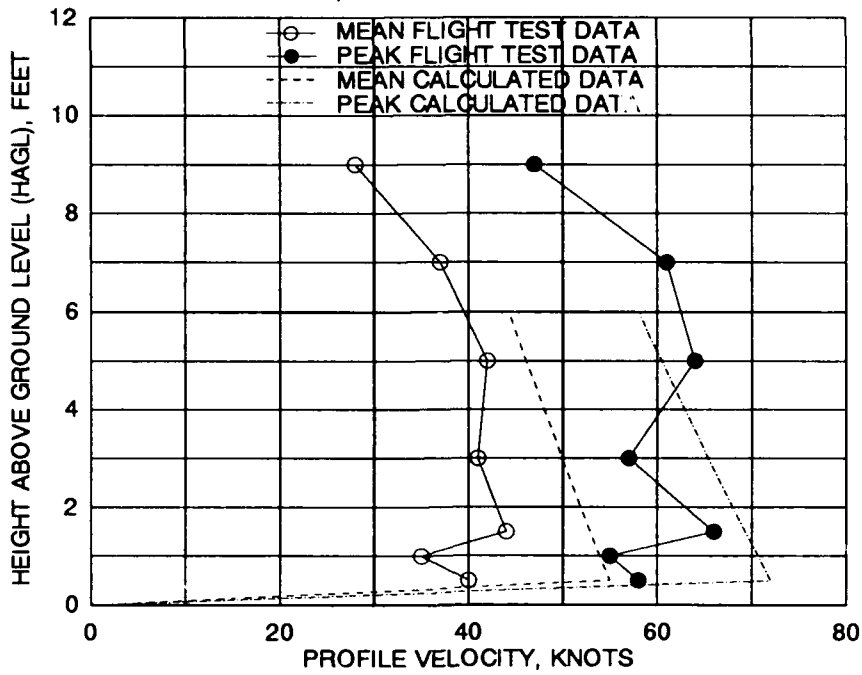

FIGURE 9 XV-15 MEAN/PEAK VELOCITY PROFILE CORRELATION ALONG THE 0 DEGREE AZIMUTH RADIAL AT A WHEEL HEIGHT OF 25 FEET AND AN AVERAGE GROSS WEIGHT OF 12,475 POUNDS (Concluded)

BELL XV-15 TILTROTOR
 GW = 12475 LB, WAGL = 25 FT
 AZIMUTH = 180 DEG, DAIP = 26.1 FT



BELL XV-15 TILTROTOR
 GW = 12475 LB, WAGL = 25 FT
 AZIMUTH = 180 DEG, DAIP = 28.6 FT

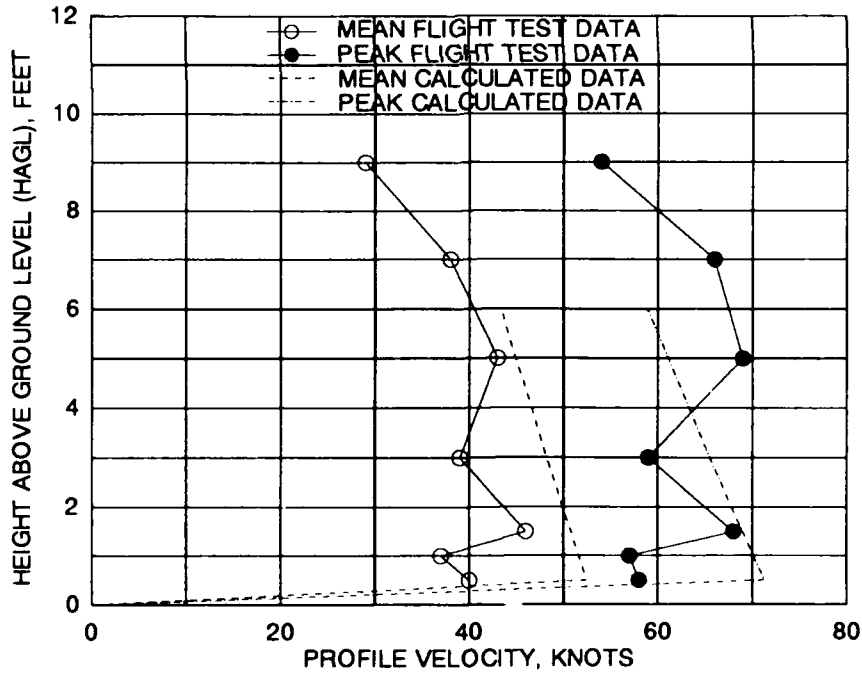
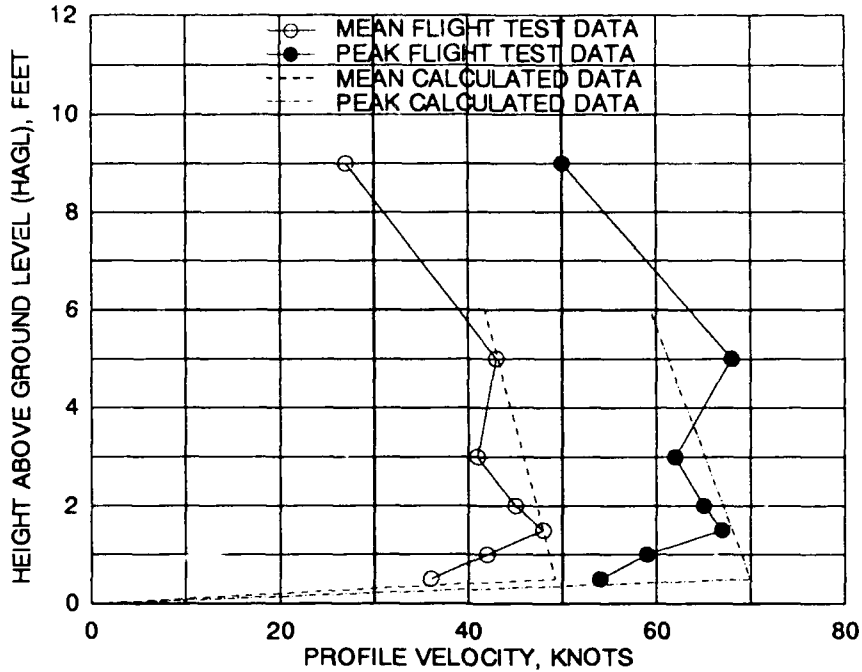

FIGURE 10 XV-15 MEAN/PEAK VELOCITY PROFILE CORRELATION ALONG THE 180 DEGREE AZIMUTH RADIAL AT A WHEEL HEIGHT OF 25 FEET AND AN AVERAGE GROSS WEIGHT OF 12,475 POUNDS

BELL XV-15 TILTROTOR
 GW = 12475 LB, WAGL = 25 FT
 AZIMUTH = 180 DEG, *DAIP* = 31.7 FT



BELL XV-15 TILTROTOR
 GW = 12475 LB, WAGL = 25 FT
 AZIMUTH = 180 DEG, *DAIP* = 41.1 FT

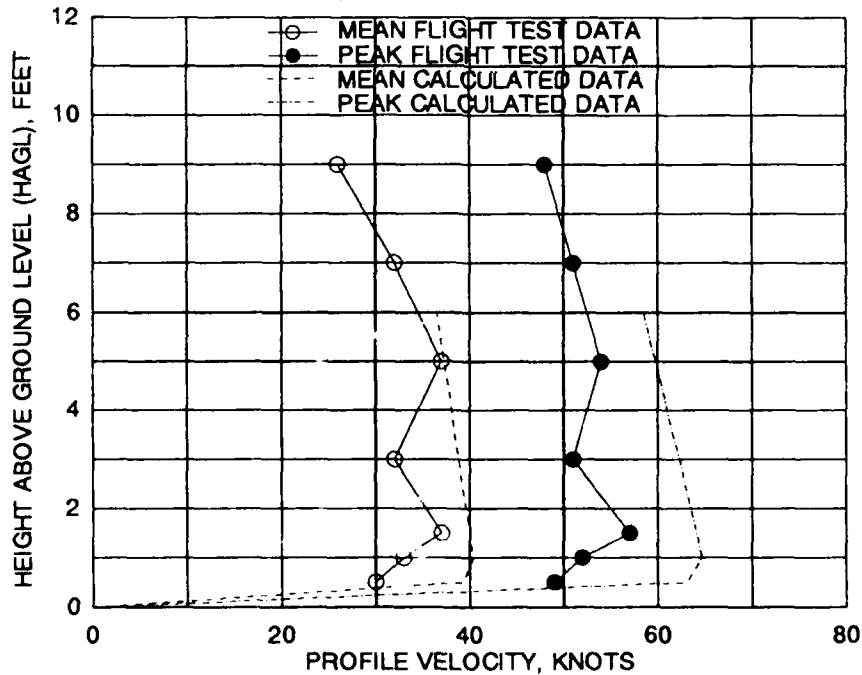
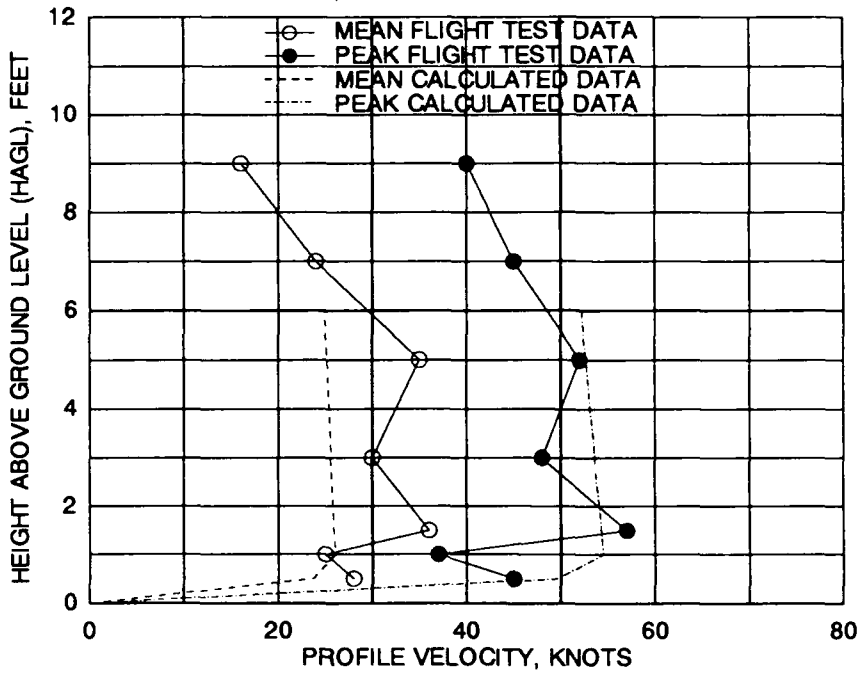

FIGURE 10 XV-15 MEAN/PEAK VELOCITY PROFILE CORRELATION ALONG THE 180 DEGREE AZIMUTH RADIAL AT A WHEEL HEIGHT OF 25 FEET AND AN AVERAGE GROSS WEIGHT OF 12,475 POUNDS (Continued)

BELL XV-15 TILTROTOR
 GW = 12475 LB, WAGL = 25 FT
 AZIMUTH = 180 DEG, DAIP = 66.1 FT



BELL XV-15 TILTROTOR
 GW = 12475 LB, WAGL = 25 FT
 AZIMUTH = 180 DEG, DAIP = 91.1 FT

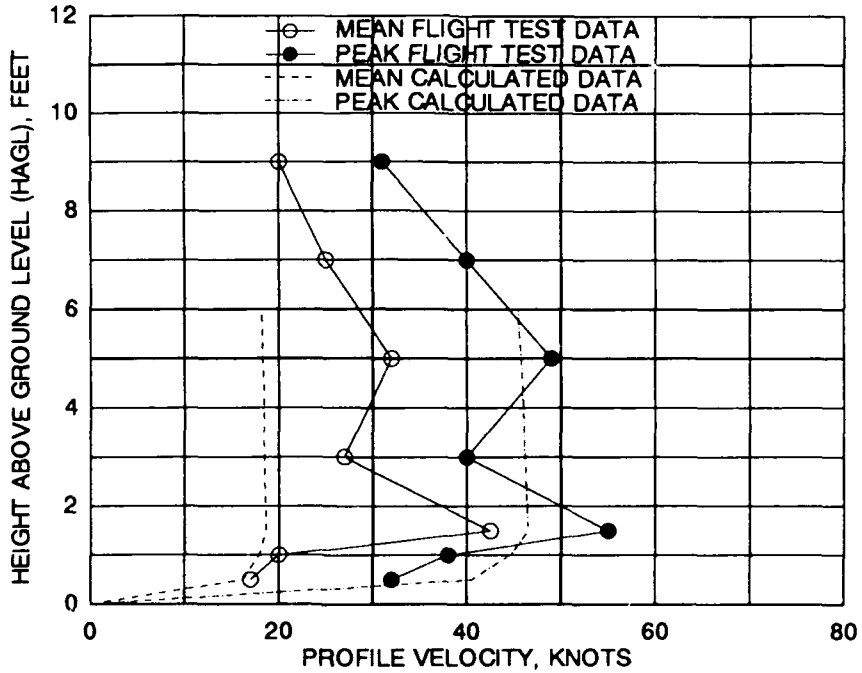
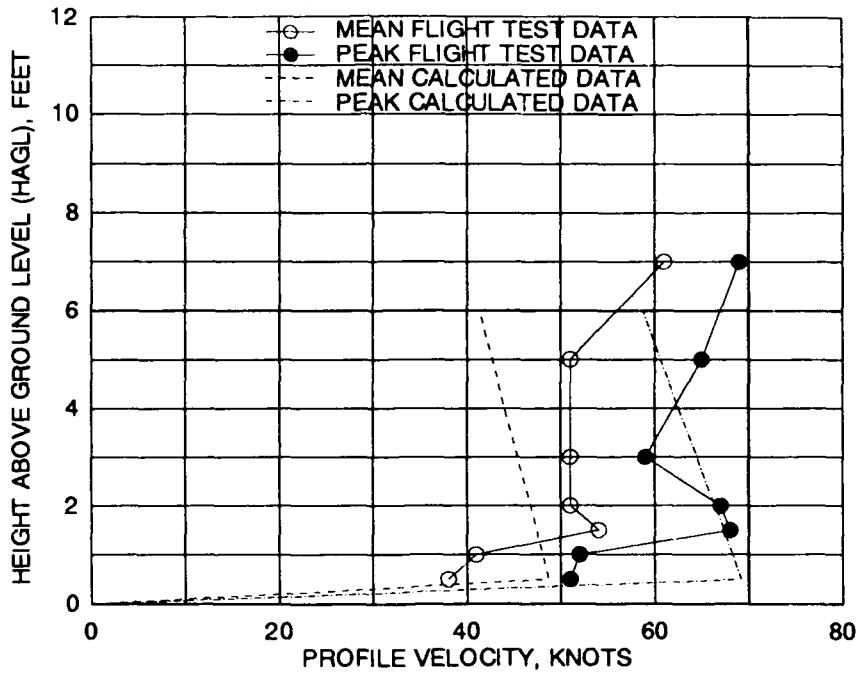

FIGURE 10 XV-15 MEAN/PEAK VELOCITY PROFILE CORRELATION ALONG THE 180 DEGREE AZIMUTH RADIAL AT A WHEEL HEIGHT OF 25 FEET AND AN AVERAGE GROSS WEIGHT OF 12,475 POUNDS (Concluded)

BELL XV-15 TILTROTOR
 GW = 12555 LB, **WAGL = 2 FT**
 AZIMUTH = 0 DEG, DAIP = 31.7 FT



BELL XV-15 TILTROTOR
 GW = 12555 LB, **WAGL = 25 FT**
 AZIMUTH = 0 DEG, DAIP = 31.7 FT

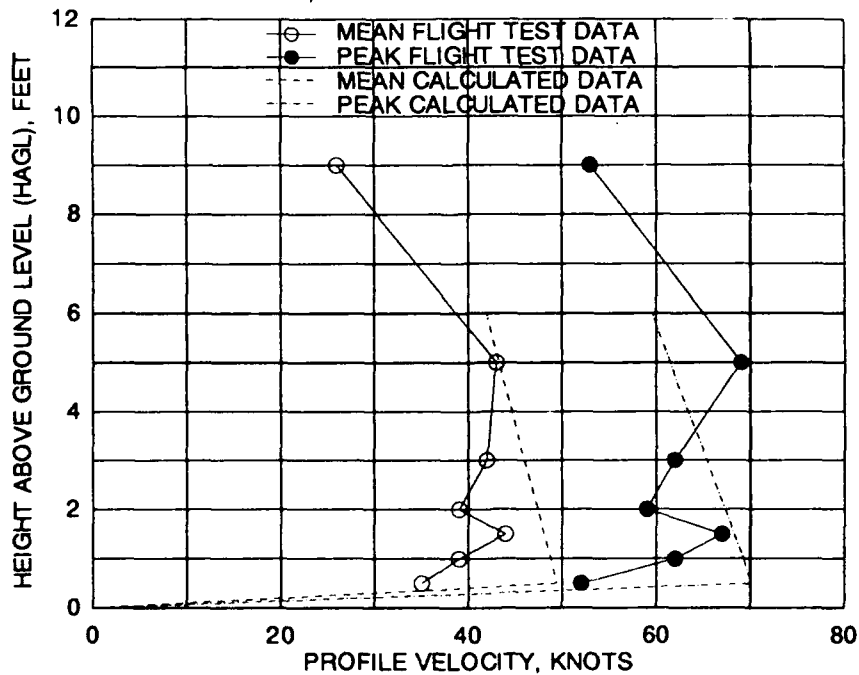

FIGURE 11 XV-15 MEAN/PEAK VELOCITY PROFILE CORRELATION ALONG THE 0 DEGREE AZIMUTH RADIAL AT THREE WHEEL HEIGHTS FOR AN AVERAGE GROSS WEIGHT OF 12,555 POUNDS

BELL XV-15 TILTROTOR
 GW = 12555 LB, WAGL = 50 FT
 AZIMUTH = 0 DEG, DAIP = 31.7 FT

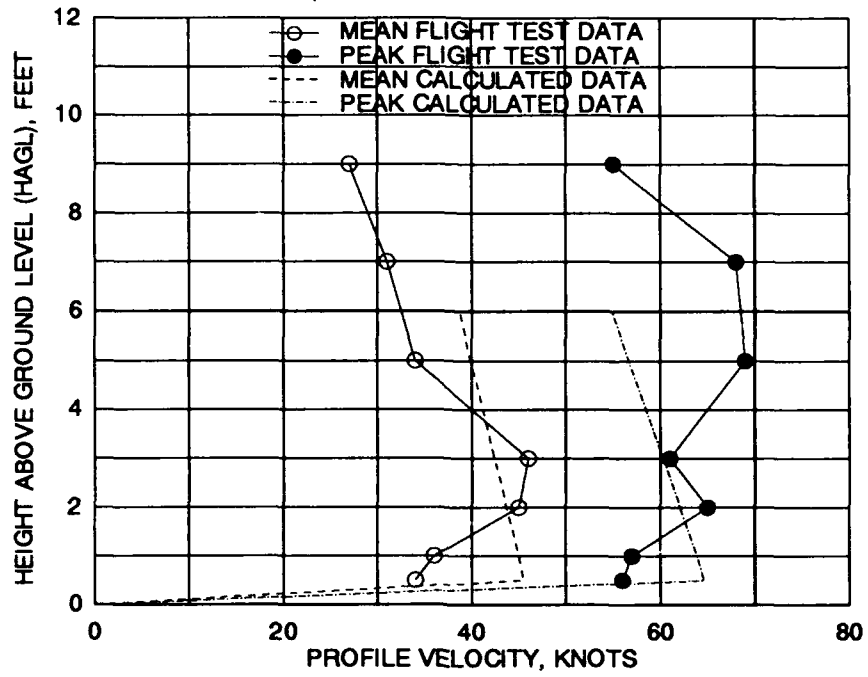
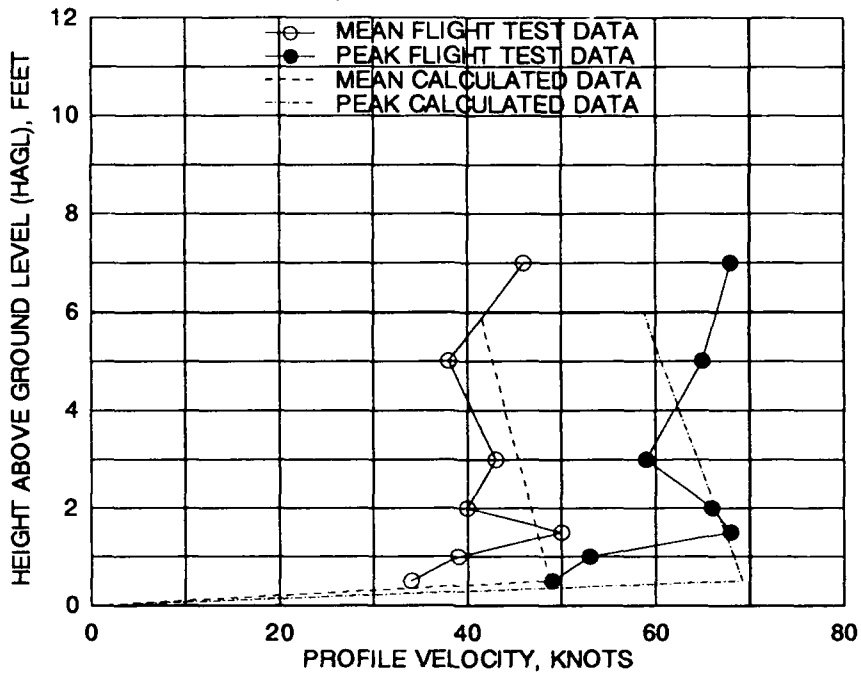

FIGURE 11 XV-15 MEAN/PEAK VELOCITY PROFILE CORRELATION ALONG THE 0 DEGREE AZIMUTH RADIAL AT THREE WHEEL HEIGHTS FOR AN AVERAGE GROSS WEIGHT OF 12,555 POUNDS (Concluded)

BELL XV-15 TILTROTOR
 GW = 12555 LB, WAGL = 2 FT
 AZIMUTH = 180 DEG, DAIP = 31.7 FT



BELL XV-15 TILTROTOR
 GW = 12555 LB, WAGL = 25 FT
 AZIMUTH = 180 DEG, DAIP = 31.7 FT

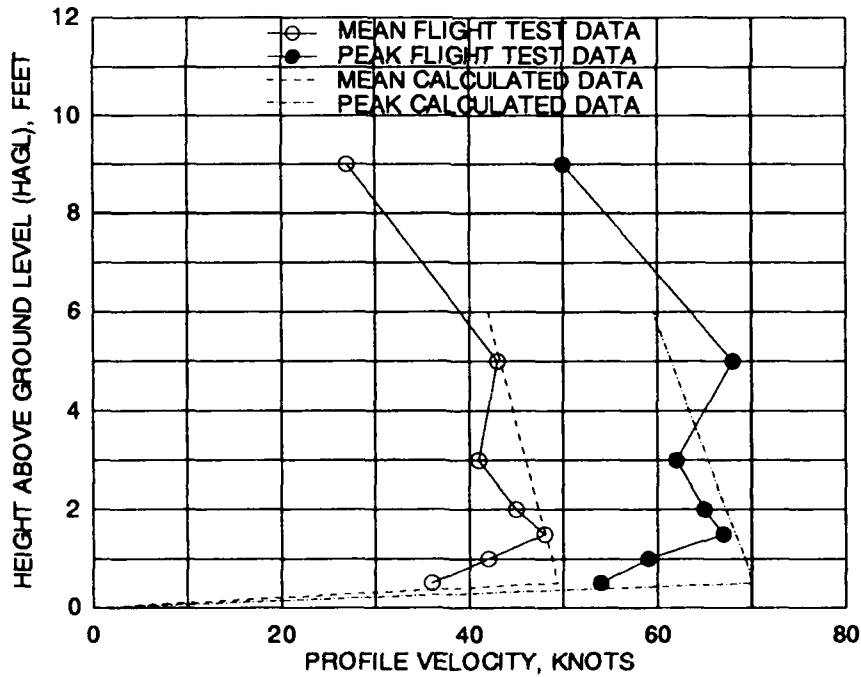

FIGURE 12 XV-15 MEAN/PEAK VELOCITY PROFILE CORRELATION ALONG THE 180 DEGREE AZIMUTH RADIAL AT THREE WHEEL HEIGHTS FOR AN AVERAGE GROSS WEIGHT OF 12,555 POUNDS

BELL XV-15 TILTROTOR
 GW = 12555 LB, **WAGL = 50 FT**
 AZIMUTH = 180 DEG, DAIP = 31.7 FT

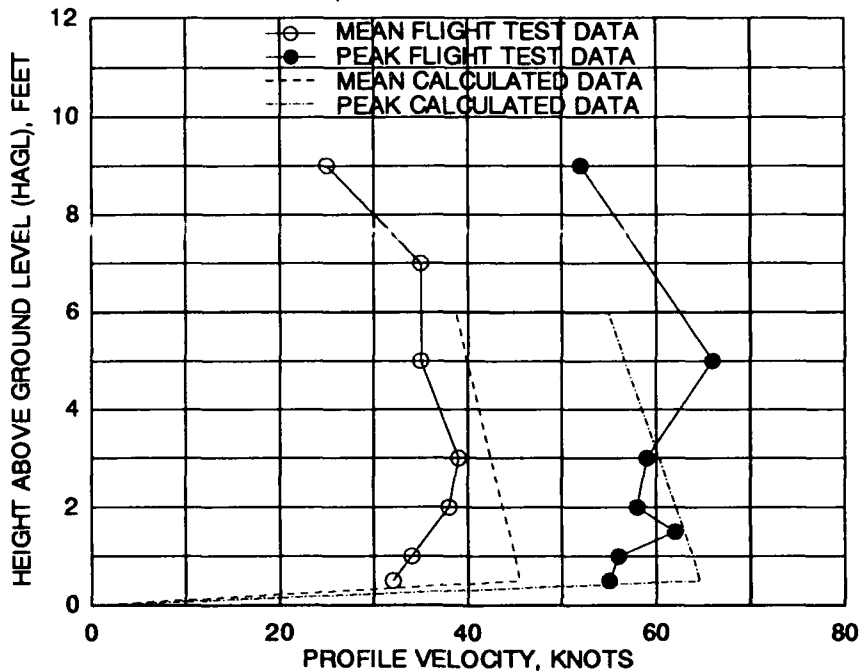

FIGURE 12 XV-15 MEAN/PEAK VELOCITY PROFILE CORRELATION ALONG THE 180 DEGREE AZIMUTH RADIAL AT THREE WHEEL HEIGHTS FOR AN AVERAGE GROSS WEIGHT OF 12,555 POUNDS (Concluded)

3.2 CANADAIR CL-84 TILTWING CORRELATION

The Canadair CL-84 is a two-seat tiltwing concept demonstrator aircraft which was first flown in 1965. The typical gross weight range of the aircraft for vertical takeoff operation varies between approximately 11,000 and 12,000 pounds. A three-view drawing of the CL-84 is provided as figure 13 for reference purposes.

CL-84 flight test data used in the correlation analysis were obtained from reference 4. Four heights above ground level at three station positions were measured along the 0, 180, and 270 degree azimuths with respect to the nose of the tiltwing. Measured station positions were 20, 40, and 80 feet from the center of the aircraft. Sensor heights were 1.0, 2.0, 4.0, and 6.0 feet AGL. Data from the three station positions were also obtained for two wheel heights, 25 and 40 feet WAGL. Unfortunately, only mean velocity profile data are presented in the report. During testing, winds were reported as 2 to 4 knots at the 40 foot wheel height. At 25 feet WAGL, winds were reported as 7 to 8 knots. Table 3 presents a matrix of the points tested which were available in reference 4 for correlation with output from the ROTWASH program.

CL-84 rotorwash test data are also documented in references 5 and 6. However, unlike the data in reference 4, these data were not obtained with an ion-beam deflection anemometer. Therefore, as based on experience documented in detail in reference 1, no attempt was made to correlate these data with the ROTWASH program.

Correlation of flight test and calculated data as a function of DFRC is presented along the 270 degree azimuth in figure 14. These data are for a gross weight of approximately 11,540 pounds at a WAGL of 40 feet, which corresponds to a rotor height of 55.2 feet. At a station position of 9.7 feet, the maximum predicted mean velocity, at between 0.5 and 1.0 feet, is less than that of the measured value by 15 to 20 knots. This underprediction of the maximum mean velocity is not totally expected, however. At this station position, the rotor tip is located approximately 50 feet above and 2.7 feet laterally from the sensor. This same effect was observed in section 3.1 for the XV-15. At the 40 and 80 feet station positions (DFRC values of 29.7 and 69.7 feet respectively), correlation is quite good. Only one calculated velocity value is not within 5 knots of its corresponding measured value. This value is at 40 feet at 6.0 feet AGL. When considering the trends of the other measured data, it is certainly possible that this measured point could be a bad point.

Data along the interaction plane for the same configuration are presented in figure 15. When these data

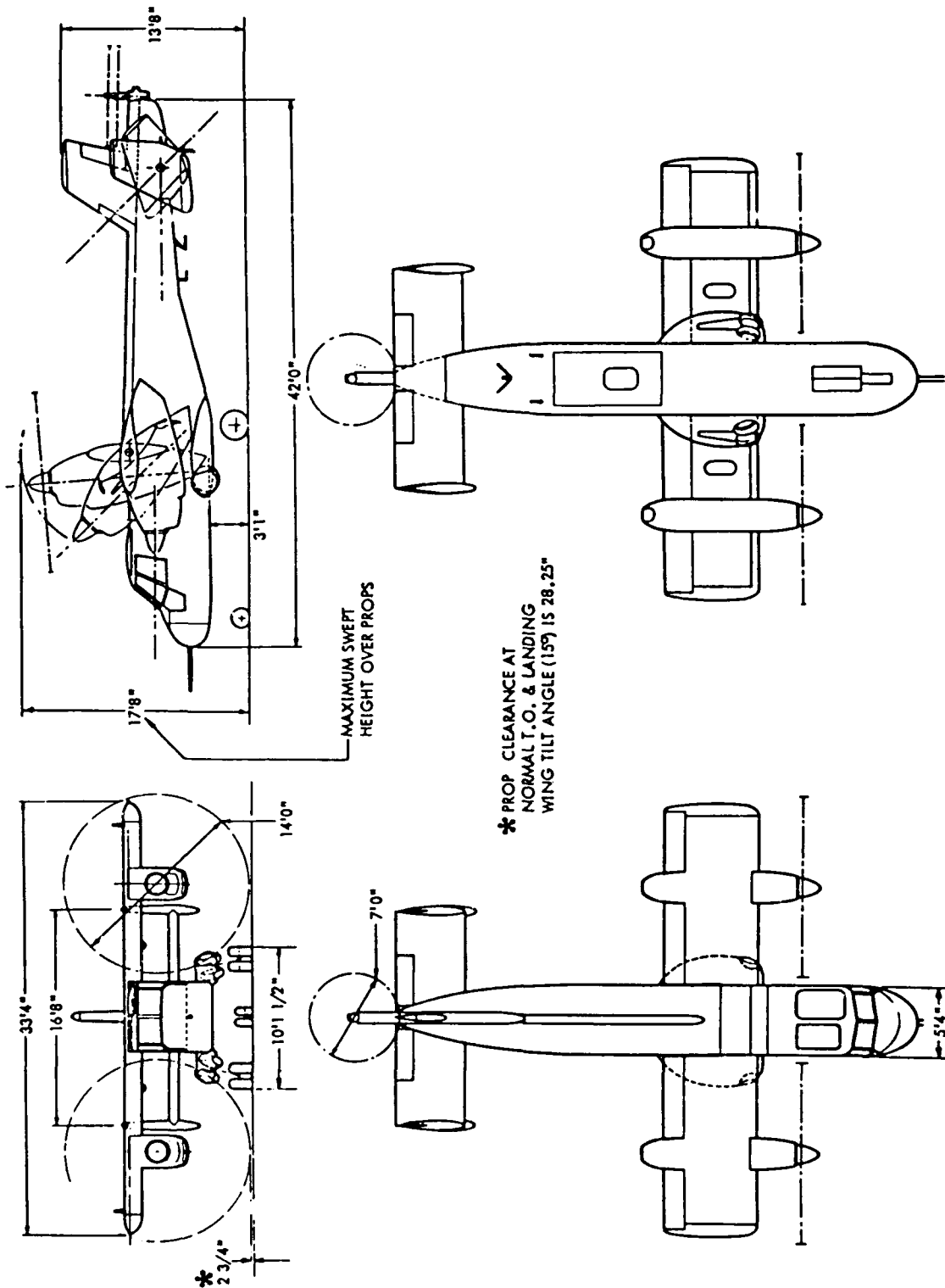

FIGURE 13 THREE-VIEW DRAWING OF THE CANADAIR CL-84

TABLE 3 TEST MATRIX FOR CL-84 FLIGHT TEST/
MATHEMATICAL MODEL DATA CORRELATION

Figure Number	Gross Weight ¹ , lb	Wheel Height, ft	Azimuth Angle, deg	Distance From the Rotor Center (DFRC) or Distance along the Interaction Plane (DAIP) ² , ft
14	11,540	40	270	9.7, 29.7, 69.7
15	11,540	40	0,180	20, 40, 80
16	11,270	25	270	9.7, 29.7, 69.7
17	11,270	25	0,180	20, 40, 80

Notes:

- (1) Even though care has been taken to calculate realistic average gross weights, actual gross weight values could vary between 11,000 and 12,000 pounds at the extremes. Disk loadings are 37.48 PSF at 11,540 pounds and 36.61 PSF at 11,270 pounds.
- (2) The values of DFRC are applicable along only the 270 degree azimuth, whereas the values for DAIP are valid along only the 0 and 180 degree azimuths.
- (3) Atmospheric density ratio, ambient windspeed/direction, wing incidence, and fuselage pitch attitude are either undefined or poorly defined with respect to the presented data.

CANADAIR CL-84 TILTWING
 GW = 11540 LB, WAGL = 40 FT
 AZIMUTH = 270 DEG, DFAC = 20.0 FT (DFRC = 9.7 FT)

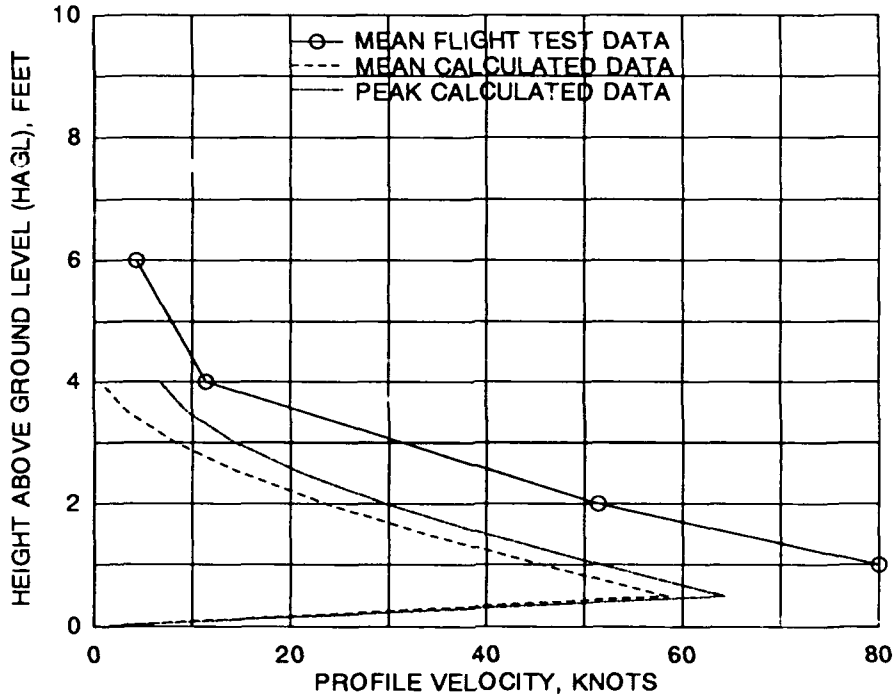

CANADAIR CL-84 TILTWING
 GW = 11540 LB, WAGL = 40 FT
 AZIMUTH = 270 DEG, DFAC = 40.0 FT (DFRC = 29.7 FT)

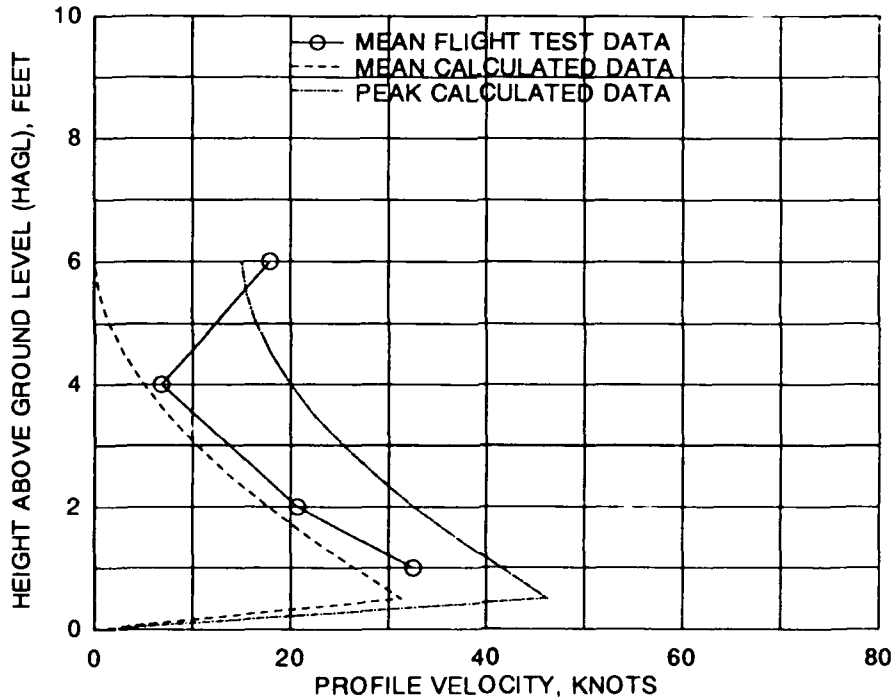

FIGURE 14 CL-84 MEAN VELOCITY PROFILE CORRELATION ALONG THE 270 DEGREE AZIMUTH RADIAL AT A WHEEL HEIGHT OF 40 FEET AND AN AVERAGE GROSS WEIGHT OF 11,540 POUNDS

CANADAIR CL-84 TILTWING
GW = 11540 LB, WAGL = 40 FT
AZIMUTH = 270 DEG, DFAC = 80.0 FT (DFRC = 69.7 FT)

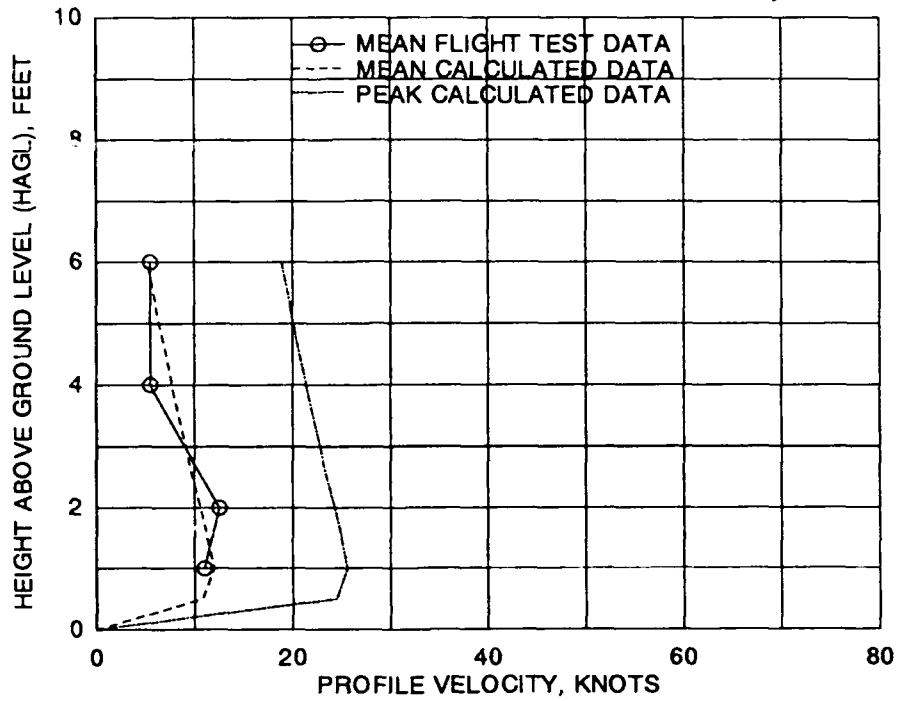
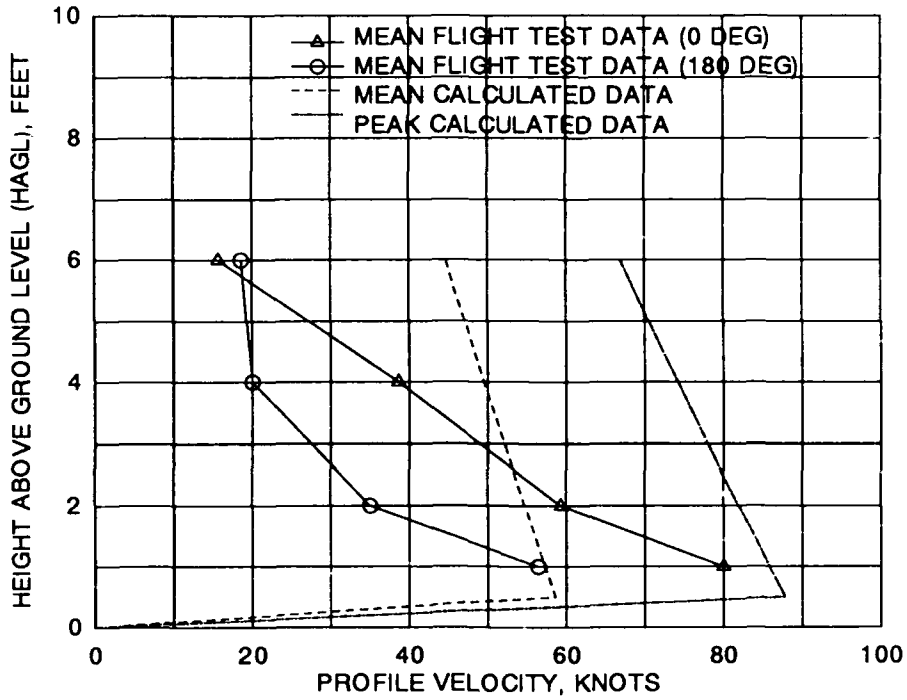

FIGURE 14 CL-84 MEAN VELOCITY PROFILE CORRELATION ALONG THE 270 DEGREE AZIMUTH RADIAL AT A WHEEL HEIGHT OF 40 FEET AND AN AVERAGE GROSS WEIGHT OF 11,540 POUNDS (Concluded)

CANADAIR CL-84 TILTWING
 GW = 11540 LB, WAGL = 40 FT
 AZIMUTH = 0/180 DEG, DAIP = 20.0 FT



CANADAIR CL-84 TILTWING
 GW = 11540 LB, WAGL = 40 FT
 AZIMUTH = 0/180 DEG, DAIP = 40.0 FT

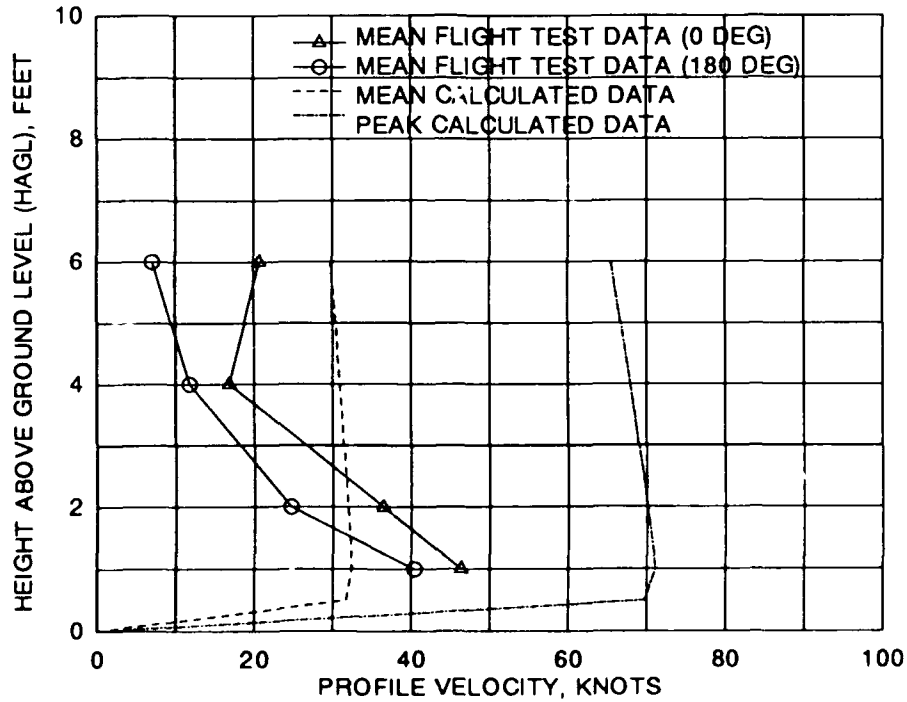

FIGURE 15 CL-84 MEAN VELOCITY PROFILE CORRELATION ALONG THE 0 AND 180 DEGREE AZIMUTH RADIALS AT A WHEEL HEIGHT OF 40 FEET AND AN AVERAGE GROSS WEIGHT OF 11,540 POUNDS

CANADAIR CL-84 TILTWING
 GW = 11540 LB, WAGL = 40 FT
 AZIMUTH = 0/180 DEG, DAIP = 80.0 FT

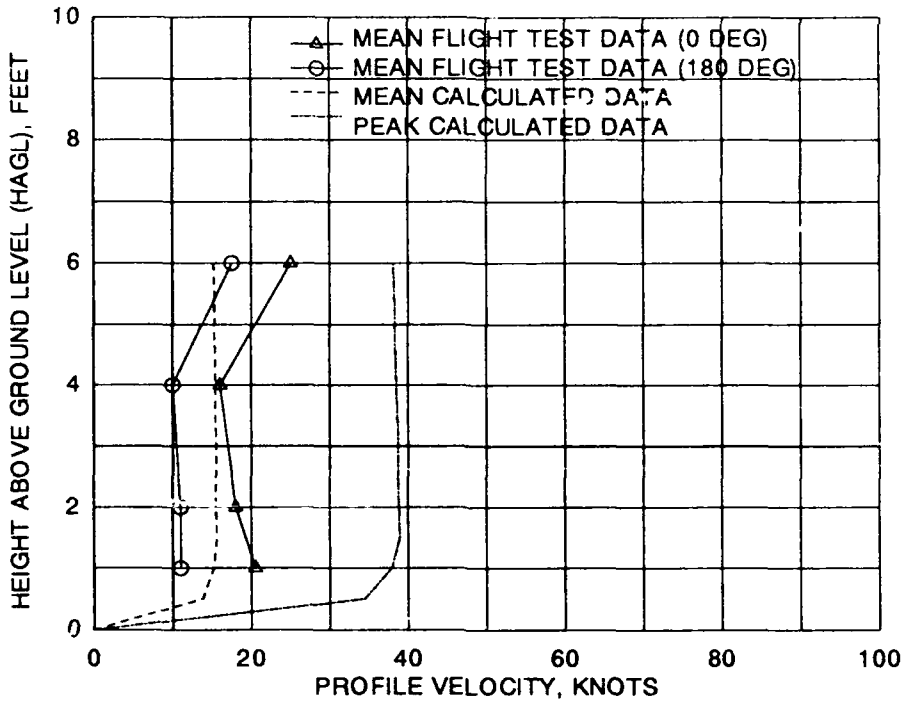

FIGURE 15 CL-84 MEAN VELOCITY PROFILE CORRELATION ALONG THE 0 AND 180 DEGREE AZIMUTH RADIALS AT A WHEEL HEIGHT OF 40 FEET AND AN AVERAGE GROSS WEIGHT OF 11,540 POUNDS (Concluded)

are compared with one another, 0 versus 180 degrees, it is interesting to observe the large differences in the values for the same station positions. Theoretically, the measured values would be expected to be quite similar. In some cases, measured velocities differ by as much as 25 knots. Average differences are usually between 5 and 10 knots. Possible causes for these velocity variations can be attributed to the aft fuselage configuration, pitch control tail rotor, and the combinations of trim wing incidence and fuselage pitch attitude which were used (which were not documented in the report). Two other important parameters, the ambient wind azimuth and the atmospheric density ratio, were also not documented in the report. However, any flow field effects due to these two parameters should have equally affected data along both azimuths. When compared at the 20 foot station position, calculated profile velocities at 3 to 6 feet HAGL overpredict the measured velocity data. At the 40 foot position, correlation is improved; however, calculated mean profile velocities below 2.0 feet are underpredicted and velocities above 3 feet are overpredicted by 10 to 15 knots. Calculated mean velocity data at 80 feet compare quite well with the measured data. At this position, the calculated data plot almost directly between the 0 and 180 degree measured data.

Data measured at a wheel height of 25 feet along all three azimuths are presented in figures 16 and 17. Along the 270 degree azimuth, as presented in figure 16, calculated data do not correlate with measured data as well as they did at the higher wheel height. At 20 feet DAIP, results are very similar to those at 40 feet HAGL. At 40 and 80 feet, calculated velocities continue to be less than measured velocities. Possible reasons for the degraded correlation could include weaknesses in the ROTWASH analysis model (such as corrections for high disk loading rotorcraft in ground effect). However, as mentioned previously, values for several important parameters are also unknown and not factored into the analysis. The ambient wind during measurement of these data was reported as 7 to 8 knots, and the azimuth of the wind vector with respect to the sensor azimuth was not reported. This effect, based upon limited data presented in reference 1, could be significant enough to shift the complete velocity profile by up to approximately 15 knots. Other unknown parameters are discussed in the previous paragraph.

Along both the 0 and 180 degree azimuths, trends along the 270 degree azimuth are repeated. Calculated mean velocities tend to be 10 to 20 knots less than the measured velocities. The reported crosswinds complicate correlation of these data, because the wing incidence has to be varied to maintain trim over the ground reference position (from 88 to 96 degrees along the 0 and 180 degree azimuths respectively, 90 degrees is vertical). Since corresponding

CANADAIR CL-84 TILTWING
 GW = 11270 LB, WAGL = 25 FT
 AZIMUTH = 270 DEG, DFAC = 20.0 FT (DFRC = 9.7 FT)

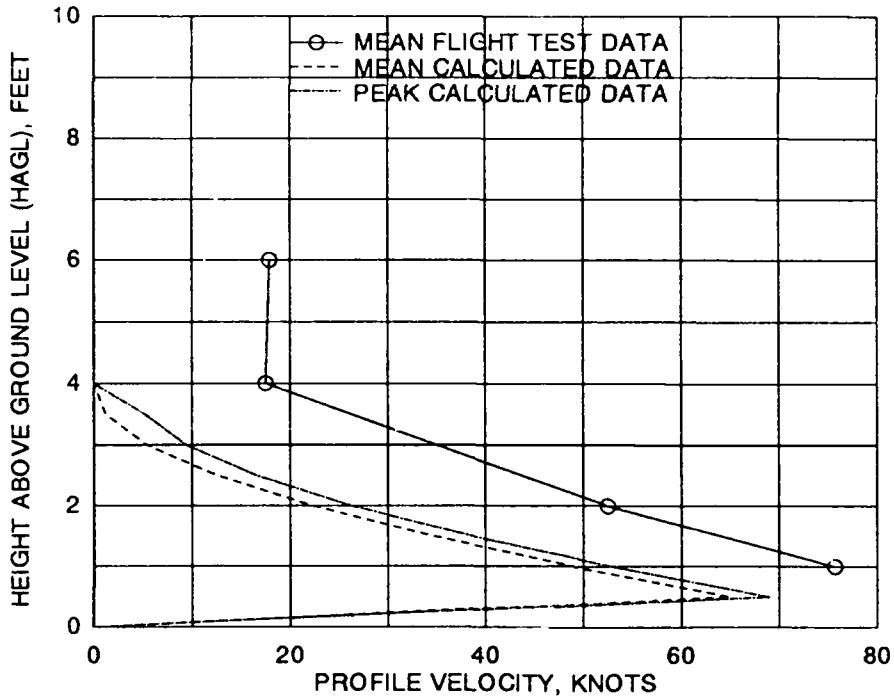

CANADAIR CL-84 TILTWING
 GW = 11270 LB, WAGL = 25 FT
 AZIMUTH = 270 DEG, DFAC = 40.0 FT (DFRC = 29.7 FT)

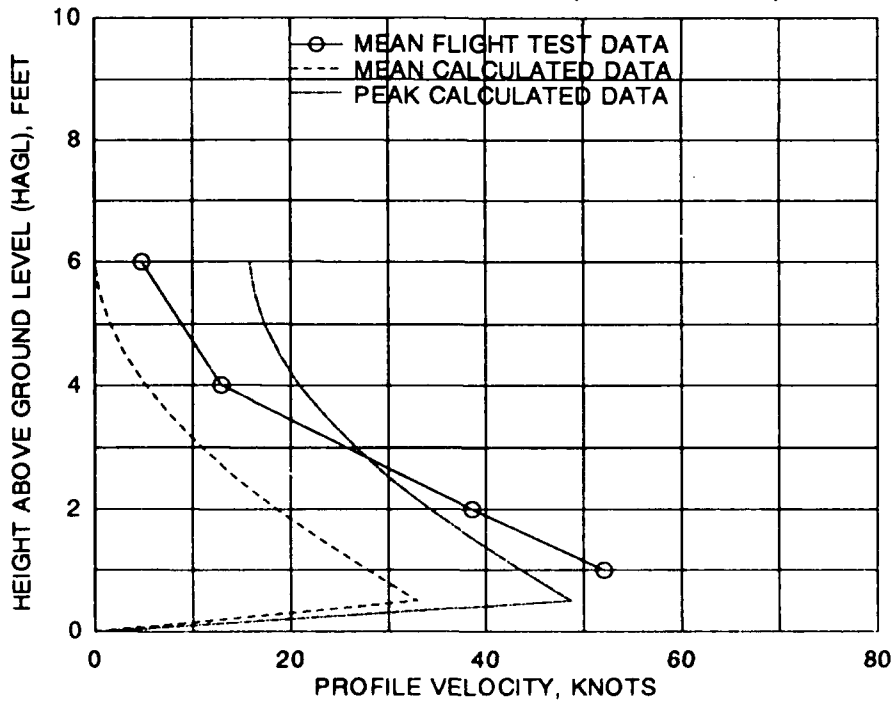

FIGURE 16 CL-84 MEAN VELOCITY PROFILE CORRELATION ALONG THE 270 DEGREE AZIMUTH RADIAL AT A WHEEL HEIGHT OF 25 FEET AND AN AVERAGE GROSS WEIGHT OF 11,270 POUNDS

CANADAIR CL-84 TILTWING
GW = 11270 LB, WAGL = 25 FT
AZIMUTH = 270 DEG, DFAC = 80.0 FT (DFRC = 69.7 FT)

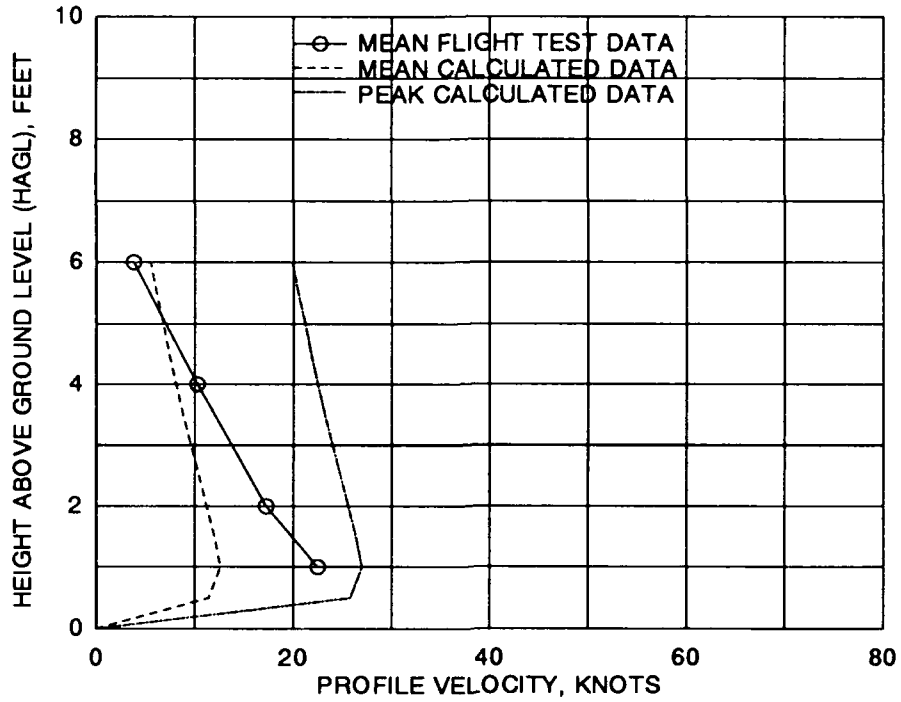
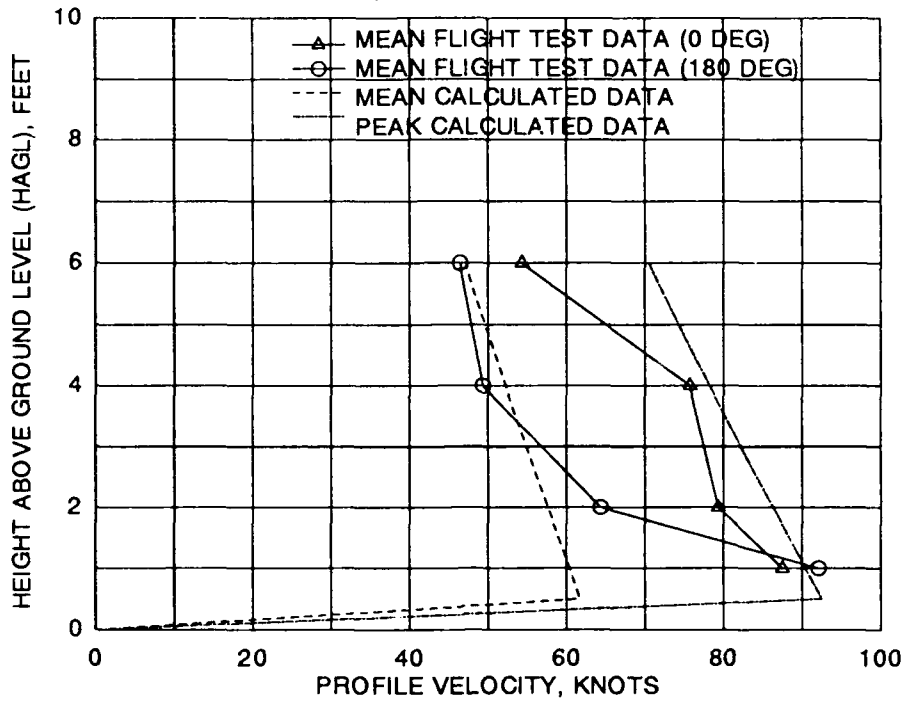

FIGURE 16 CL-84 MEAN VELOCITY PROFILE CORRELATION ALONG THE 270 DEGREE AZIMUTH RADIAL AT A WHEEL HEIGHT OF 25 FEET AND AN AVERAGE GROSS WEIGHT OF 11,270 POUNDS (Concluded)

CANADAIR CL-84 TILTWING
 GW = 11270 LB, WAGL = 25 FT
 AZIMUTH = 0/180 DEG, *DAIP* = 20.0 FT



CANADAIR CL-84 TILTWING
 GW = 11270 LB, WAGL = 25 FT
 AZIMUTH = 0/180 DEG, *DAIP* = 40.0 FT

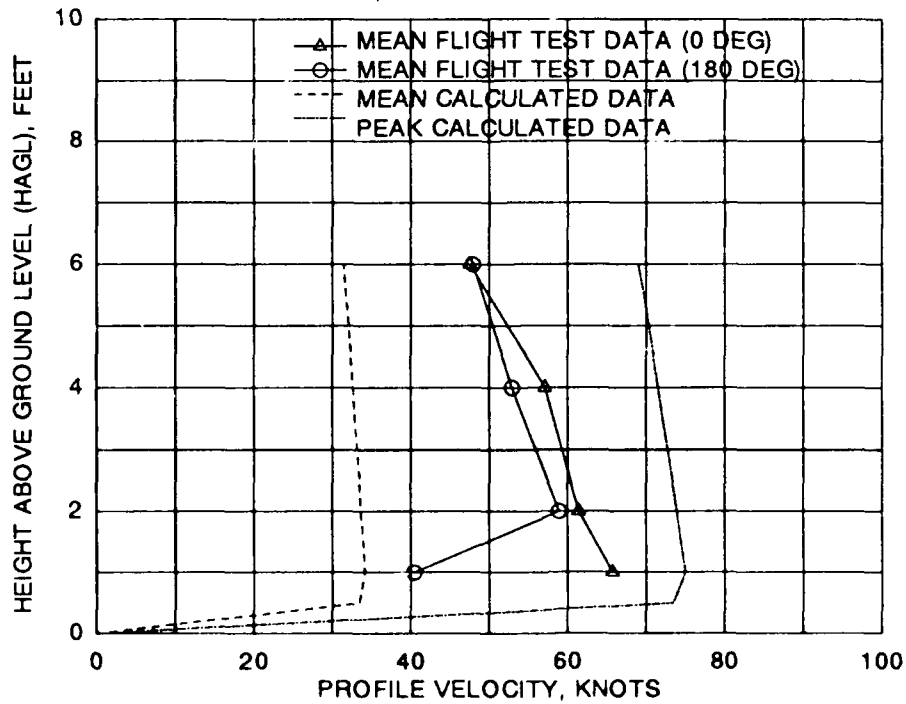

FIGURE 17 CL-84 MEAN VELOCITY PROFILE CORRELATION ALONG THE 0 AND 180 DEGREE AZIMUTH RADIALS AT A WHEEL HEIGHT OF 25 FEET AND AN AVERAGE GROSS WEIGHT OF 11,270 POUNDS

CANADAIR CL-84 TILTWING
 GW = 11270 LB, WAGL = 25 FT
 AZIMUTH = 0/180 DEG, *DAIP* = 80.0 FT

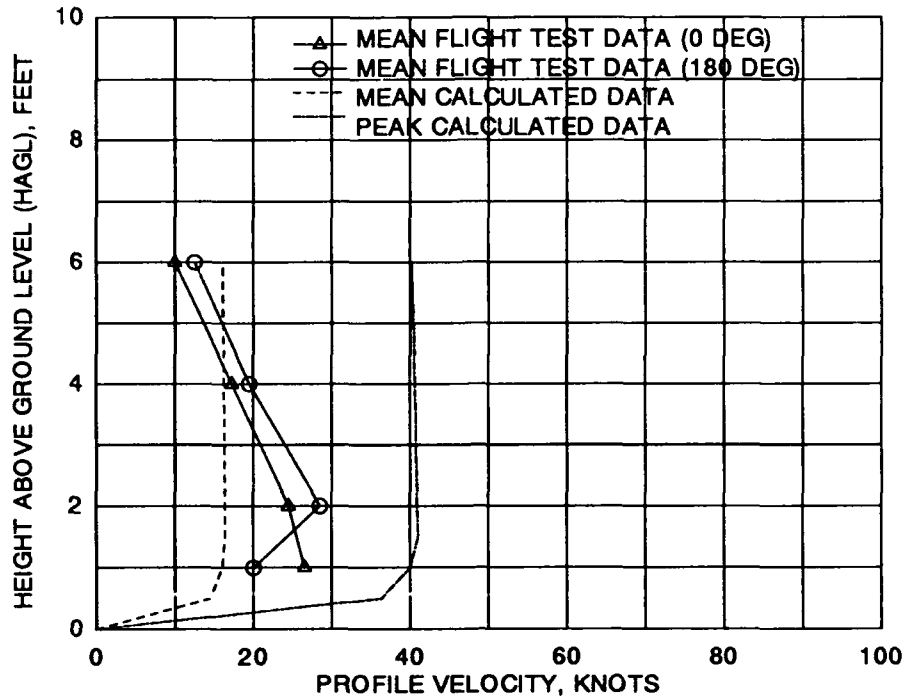

FIGURE 17 CL-84 MEAN VELOCITY PROFILE CORRELATION ALONG THE 0 AND 180 DEGREE AZIMUTH RADIALS AT A WHEEL HEIGHT OF 25 FEET AND AN AVERAGE GROSS WEIGHT OF 11,270 POUNDS (Concluded)

values for trim pitch attitude are not reported with the wing incidence data, it is not possible to estimate the angle of the induced velocity vector with respect to the ground plane (which does not have to be perpendicular to the ground when influenced by the wind and partially trimmed by the pitch axis tail rotor).

In summary, if only the 40 foot wheel height data are taken into consideration, CL-84 correlation results are fairly impressive. Unfortunately, this is not the case and the poorer correlation at 25 feet WAGL must be taken into account in any final evaluation. However, significant uncertainties do exist at this lower wheel height for the values of several important parameters which are required as input to the ROTWASH program. These uncertainties make it virtually impossible to determine whether or not weaknesses in the mathematical model are the primary cause for the poor correlation results.

4.0 ANALYSIS OF TILTROTOR AND TILTWING CONFIGURATIONS

Eleven tiltrotor and tiltwing configurations, as listed in table 1, were chosen for analysis in this study. Rotorwash characteristics for each of the configurations are summarized in this section. In most instances, as noted in section 2.0, only the maximum VTOL gross weight was evaluated. General background information and the majority of the supporting rotorwash data graphs for each configuration are presented in the 11 appendices. Tabulations of the input data values used with the ROTWASH program are also provided in each appendix for reference purposes.

In evaluating rotorwash characteristics of the various configurations, numerous parameters could have been chosen for comparison purposes. Following an evaluation of several of these different parameters, it was determined that three would be used for the general comparisons presented in this report. These three parameters are profile peak velocity, profile peak dynamic pressure, and personnel overturning force as functions of either the distance from the aircraft center (DFAC at 270 degrees) or the distance along the interaction plane (DAIP at 0 and 180 degrees). Supporting detailed data, for both the individual mean and peak velocity profiles, were also generated for each case, and these data may also be compared. However, the position specific nature of these data make it very difficult to compare more than one or two cases at a time. As a result, these data are presented only in the appendices, and it is left up to the reader to make any direct comparisons. To aid the reader, summary tables are provided in the front of the 11 appendices for all of the individual velocity profiles that are plotted. For data along the 270 degree azimuth, both the DFAC and DFRC reference positions are tabulated on each graph to enable quicker comparisons of the data.

4.1 PEAK PROFILE VELOCITY AND DYNAMIC PRESSURE COMPARISONS ALONG THE 270 DEGREE AZIMUTH

Peak profile velocity and dynamic pressure data for the 11 configurations as a function of DFAC along the 270 degree azimuth are presented in figures 18 through 21. The DFAC reference is used for the comparisons, because the DFRC measurement does not convey any information on the relative differences in tiltrotor or tiltwing size. This is because the wing span is not included in the calculation. The advantage of the DFAC reference is that it provides the vertiport designer with information based on the centerline of the aircraft and the landing area simultaneously. This ensures that critical vertiport dimensions are sized out correctly for safety. The DFRC measurement guides designers

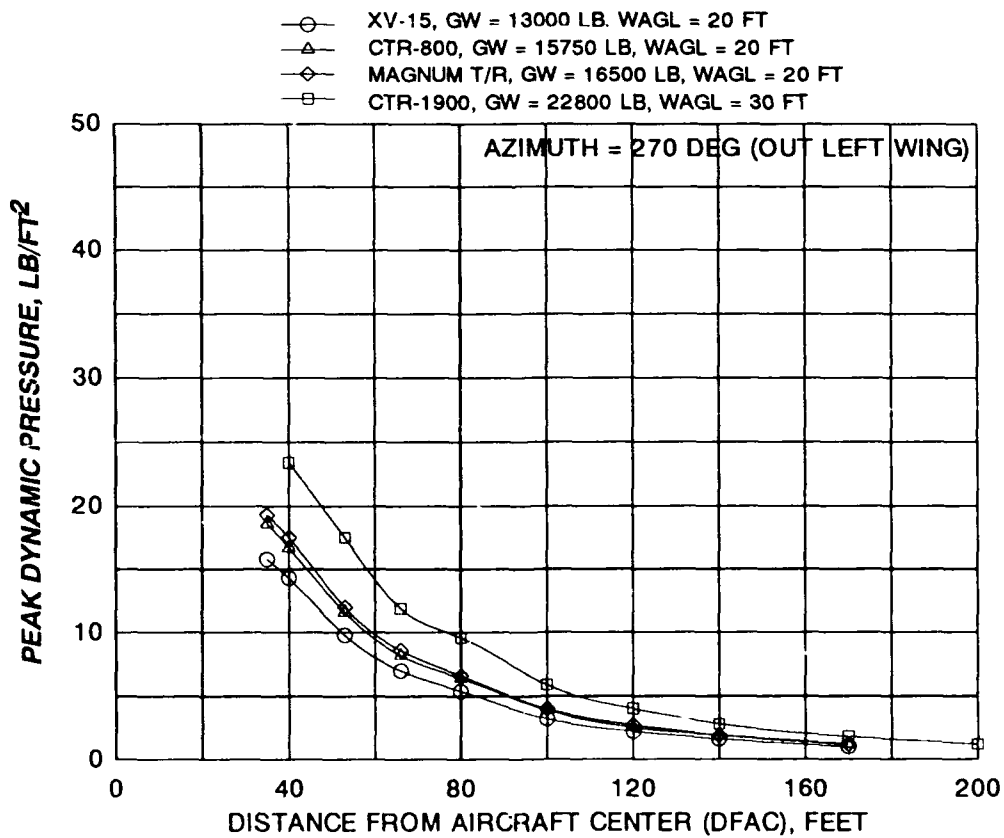
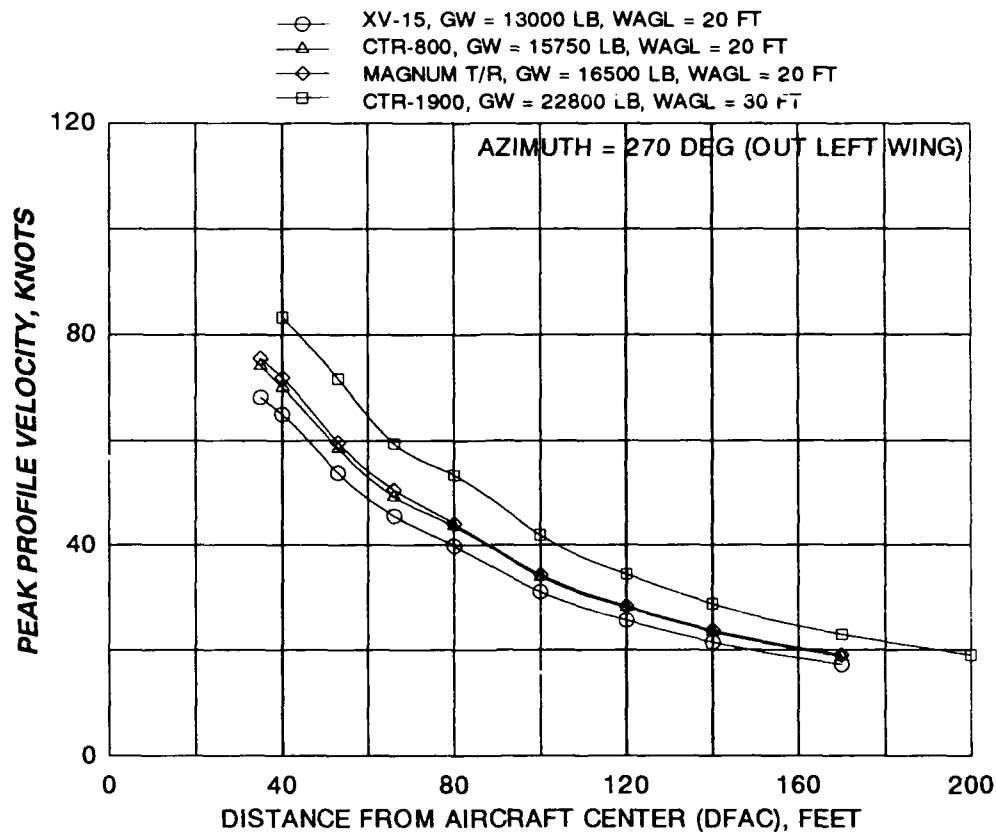

FIGURE 18 PEAK PROFILE VELOCITY AND DYNAMIC PRESSURE COMPARISONS FOR THE SMALL TILTROTOR AIRCRAFT CONFIGURATIONS ALONG THE 270 DEGREE AZIMUTH

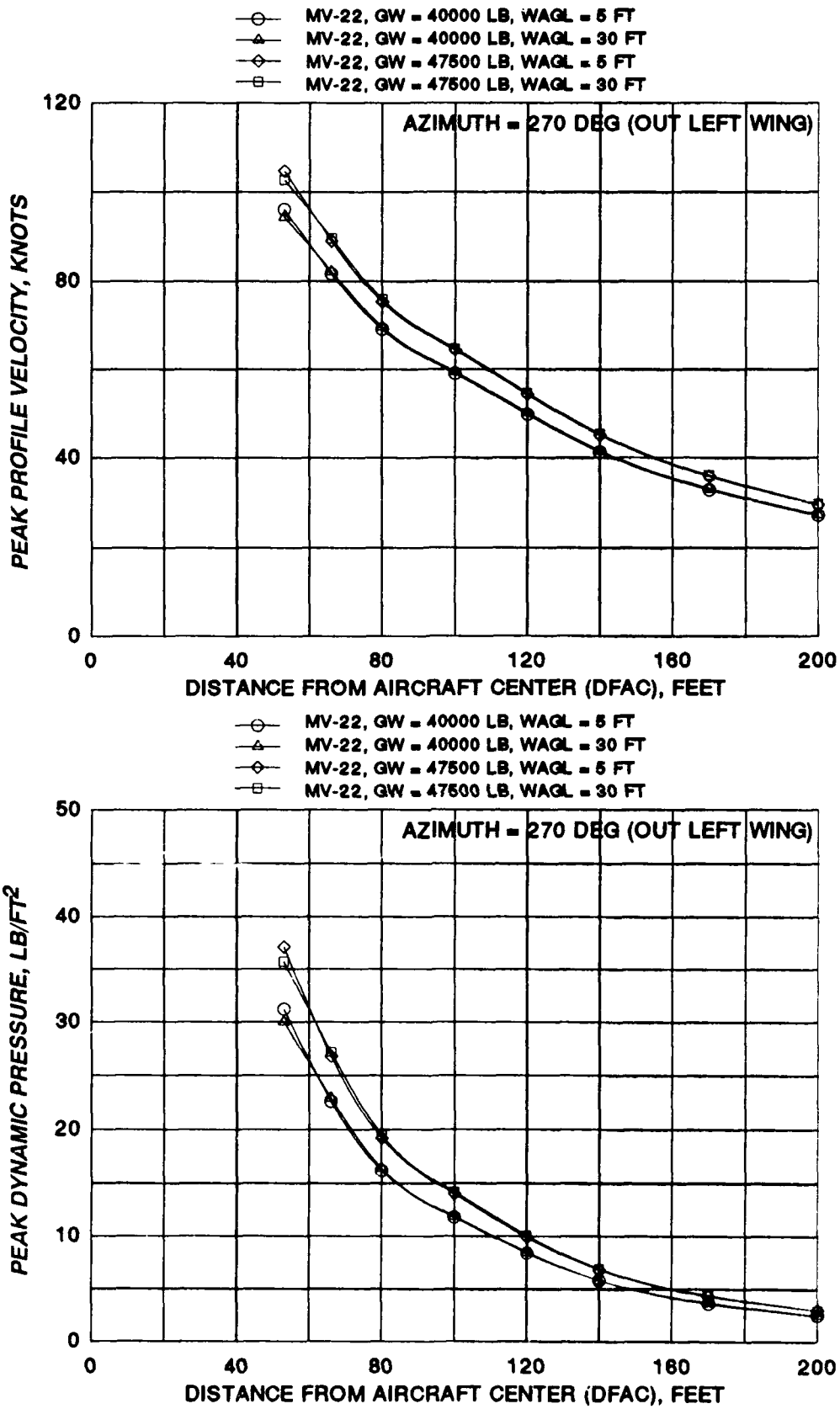

FIGURE 19 PEAK PROFILE VELOCITY AND DYNAMIC PRESSURE COMPARISONS FOR SEVERAL BELL/BOEING MV-22 CONFIGURATIONS ALONG THE 270 DEGREE AZIMUTH

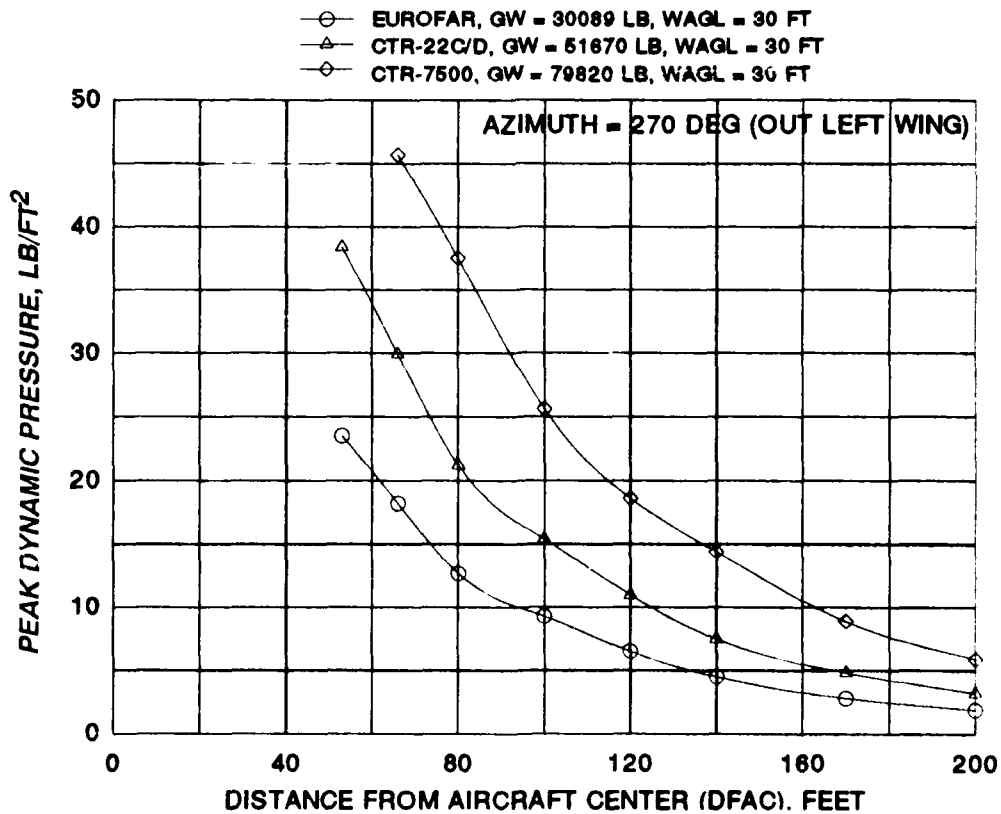
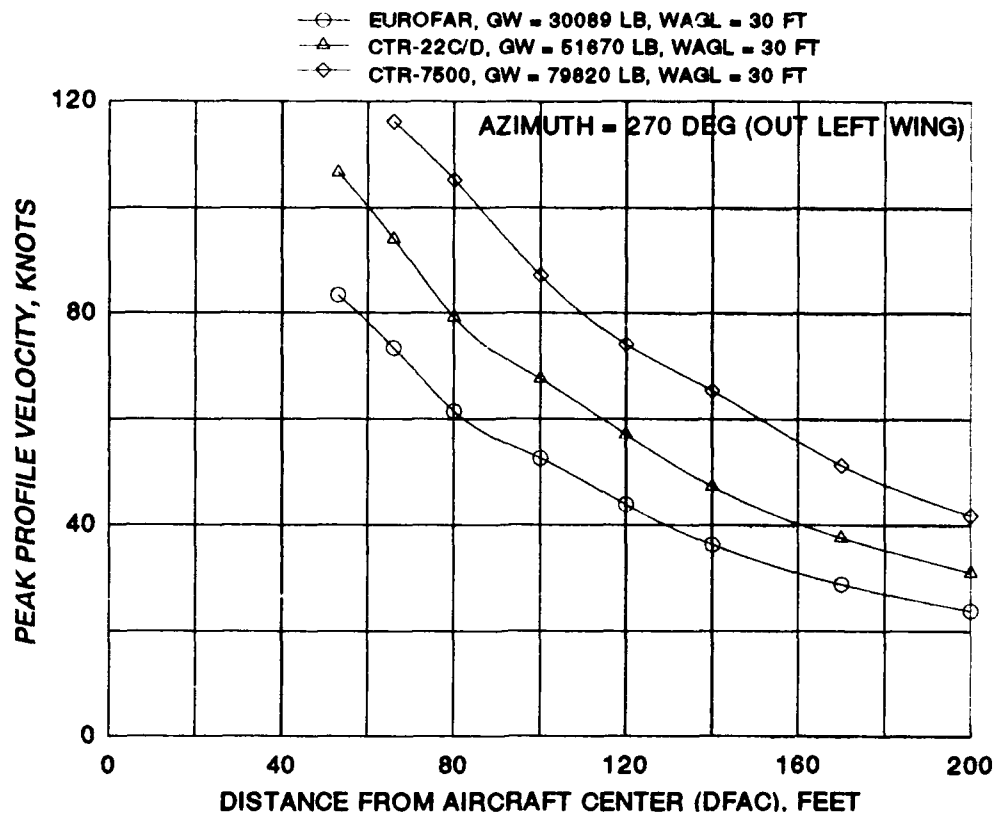

FIGURE 20 PEAK PROFILE VELOCITY AND DYNAMIC PRESSURE COMPARISONS FOR THE LARGE TILTROTOR AIRCRAFT CONFIGURATIONS ALONG THE 270 DEGREE AZIMUTH

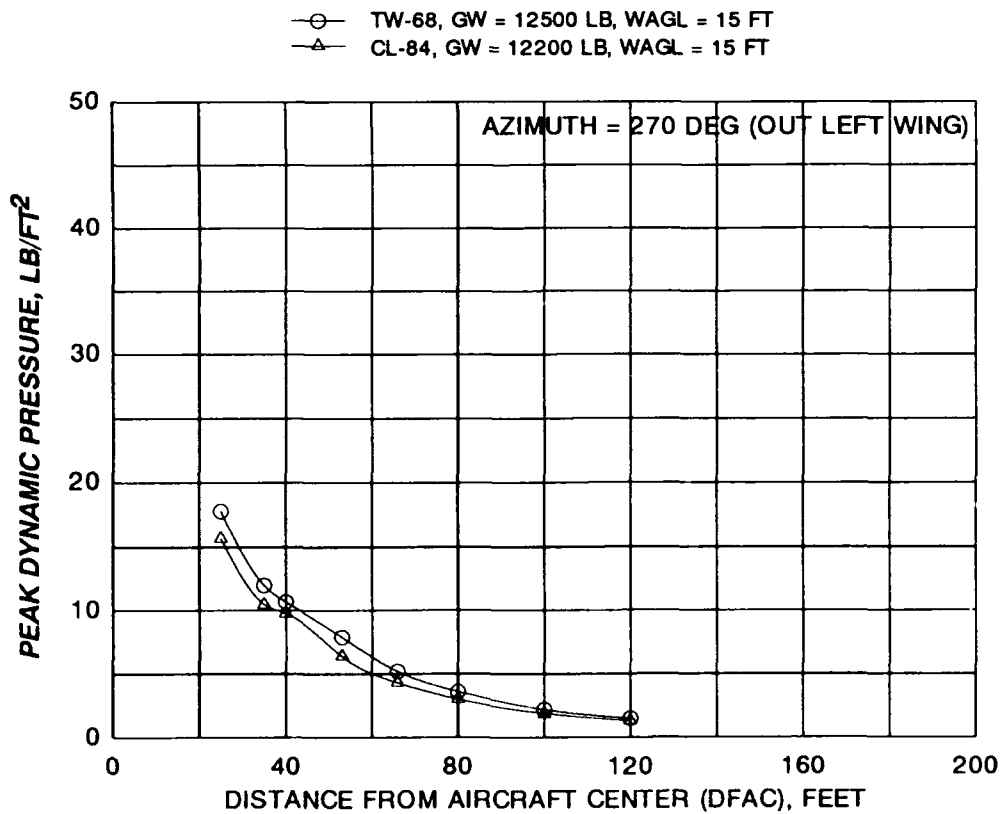
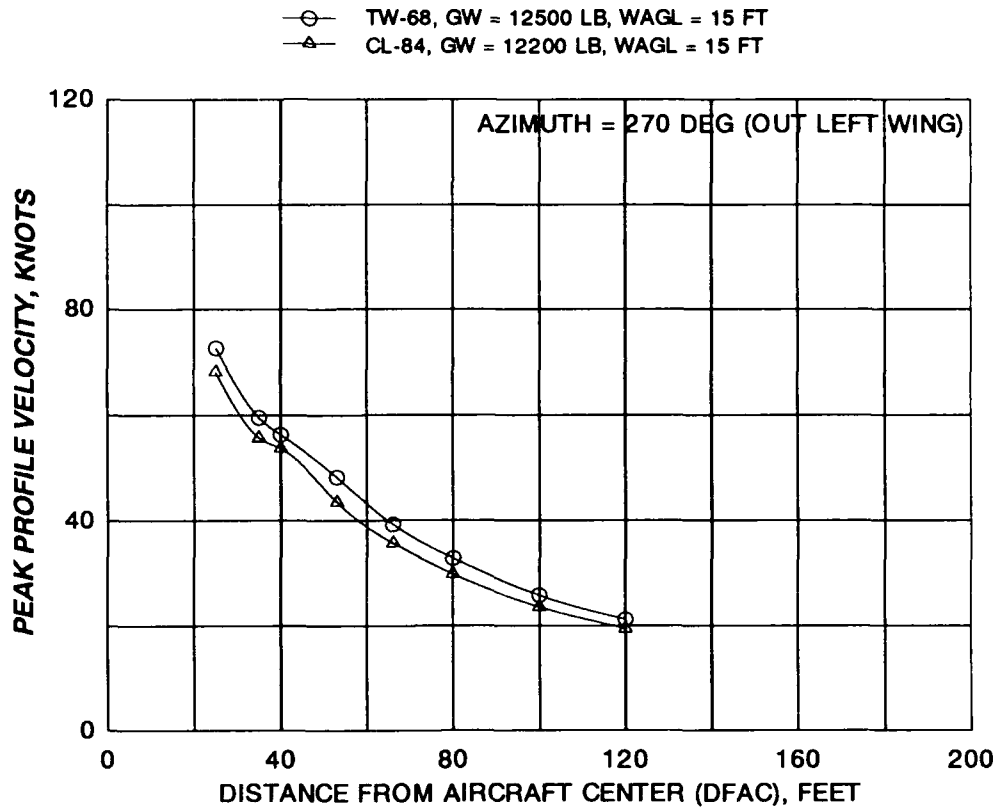

FIGURE 21 PEAK PROFILE VELOCITY AND DYNAMIC PRESSURE COMPARISONS FOR THE SMALL TILTWING AIRCRAFT CONFIGURATIONS ALONG THE 270 DEGREE AZIMUTH

interested in only distances from the rotorwash generating source itself. Since both reference positions are important, data presented in figures 18 through 21 are also presented toward the back of each appendix using the DFRC reference point.

Peak profile velocity and dynamic pressure data for the small tiltrotor configurations, the XV-15, CTR-800, MAGNUM Tiltrotor, and CTR-1900, are presented in figure 18. Peak profile velocities vary from approximately 65 to 85 knots at a DFAC of 40 feet to less than 20 knots at between 160 and 200 feet. Peak profile dynamic pressures for the same distances vary from 15 to 23 PSF down to about 2 PSF. Unfortunately, labels of "good" or "bad" can not be directly associated with these parameters. This is because the analysis of any type of potential hazard requires considerably more information before any determination can be made. However, it is possible to generalize from the work of reference 1 and conclude that for most situations, the rotorwash levels from these configurations are no more hazardous than levels from most types of medium size helicopters commonly in use today.

Data for the Bell/Boeing MV-22 are presented in figure 19 for four combinations of gross weight and wheel height. It is important to note that the gross weight range, 40,000 to 47,500 pounds, also includes the commercial CTR-22A/B configurations as defined by reference 7. Since the geometry of these two configurations is also the same as the MV-22, the graphs are appropriate for analysis of either configuration. Peak profile velocities for the MV-22 are approximately 100 knots and could increase by 10 to 20 knots with light cross winds. Peak profile dynamic pressures exceed 35 PSF. At DFAC values of 200 feet, values of peak velocity and dynamic pressure are 1.5 to 2.0 times those of the smaller tiltrotor aircraft. It is interesting to note from these data that peak values varied little with wheel height when within one rotor diameter of the ground. This observation was tested with several of the other tiltrotor configurations. As a result, the MV-22 test matrix was the only matrix varying wheel height. All of the other tiltrotor configurations were evaluated at only one wheel height, that being a WAGL rounded off to a 5 foot increment which produced the highest values of rotorwash velocity. The potential of the MV-22 for generating hazardous levels of rotorwash is obviously significant. In section 4.3, this potential will be discussed with respect to personnel overturning force. Hopefully, data will also be available in the very near future for correlation of the MV-22 results presented herein at the 40,000 pound gross weight.

Peak velocity and dynamic pressure data for the larger tiltrotor aircraft, the Eurofar Tiltrotor, CTR-22C/D, and CTR-7500, are presented in figure 20. MV-22 data would have

been included in this graph had there been room. Peak profile velocities vary from 85 to 120 knots at 50 feet and from 25 to 40 knots at 200 feet. Peak profile dynamic pressures at the same distances range from 25 to 50 PSF and 2 to 6 PSF respectively. These levels of peak velocity and dynamic pressure, usually at 1 to 2 feet HAGL, indicate that the velocity profiles as a whole (up to 10+ feet HAGL) can be very hazardous out to distances well past 100 feet (DFAC).

CL-84 and TW-68 tiltwing results are presented in figure 21. Peak profile velocities and dynamic pressures for these configurations are comparable with those predicted for the small tiltrotors. Therefore, along the 270 degree azimuth, these aircraft will probably not create any significant problems. However, a note of caution should be injected with respect to ground erosion. The higher disk loadings of the tiltwings with respect to the similiar weight tiltrotors may result in ground pressures (directly under the rotors) which will tend to entrain surface material much more readily. This type of hazard will need to be reviewed independently of the rotorwash velocity profile effects as a function of the surface type (i.e. grass, concrete, asphalt, etc).

4.2 PEAK PROFILE VELOCITY AND DYNAMIC PRESSURE COMPARISONS ALONG THE 0 DEGREE AZIMUTH OR INTERACTION PLANE

Peak profile velocity and dynamic pressure data for the 11 configurations along the 0 degree azimuth or interaction plane are presented in figures 22 through 25. While the peak profile velocities are generally not significantly greater than those along the 270 degree azimuth, the variation in velocity along the profiles (in HAGL) is more constant. The reader is referred to the appendices for examples of this behavior. This characteristic results in a dramatically increased potential for rotorwash hazards along the interaction plane when compared with the 270 degree azimuth. Even the small tiltrotor and tiltwing configurations can generate potentially hazardous levels of rotorwash along this axis. This effect is more easily quantified through analysis of associated values of overturning force (discussed in section 4.3).

Small tiltrotor peak profile velocities and dynamic pressures along the interaction plane are presented in figure 22 (companion to figure 18). The peak profile velocities range from approximately 80 to 30 knots over the DAIP range from 20 to 150 feet. Peak profile dynamic pressures vary from 24 to 4 PSF over the same range.

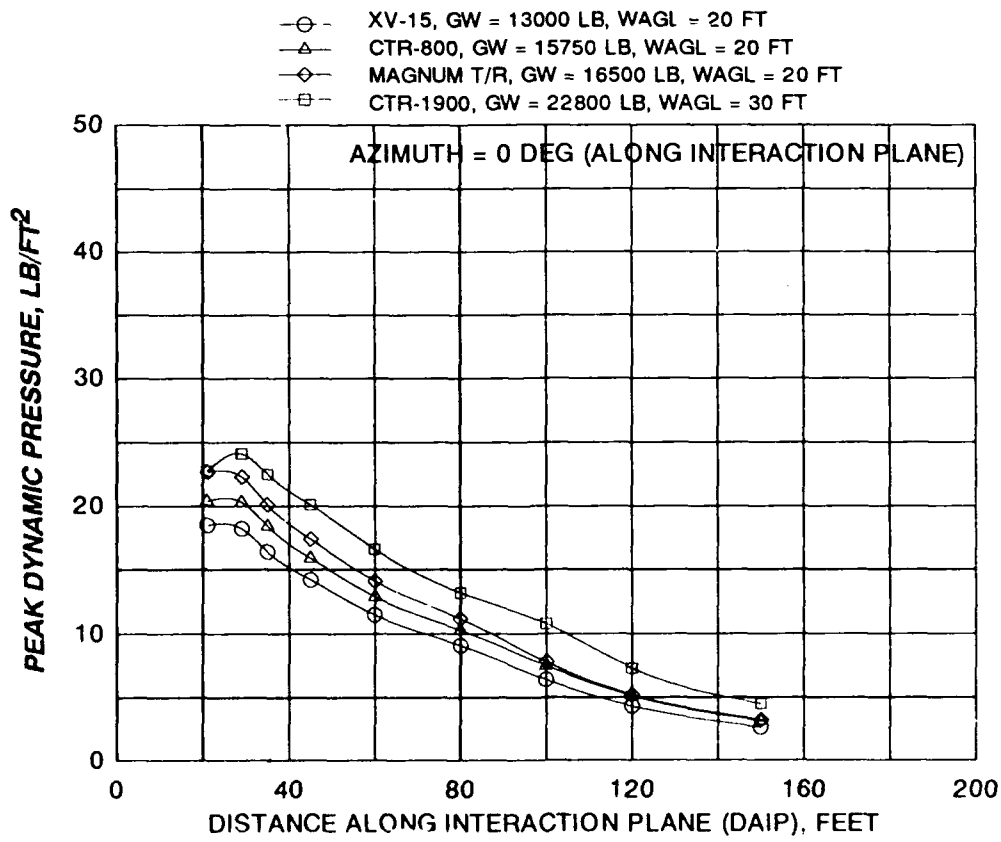
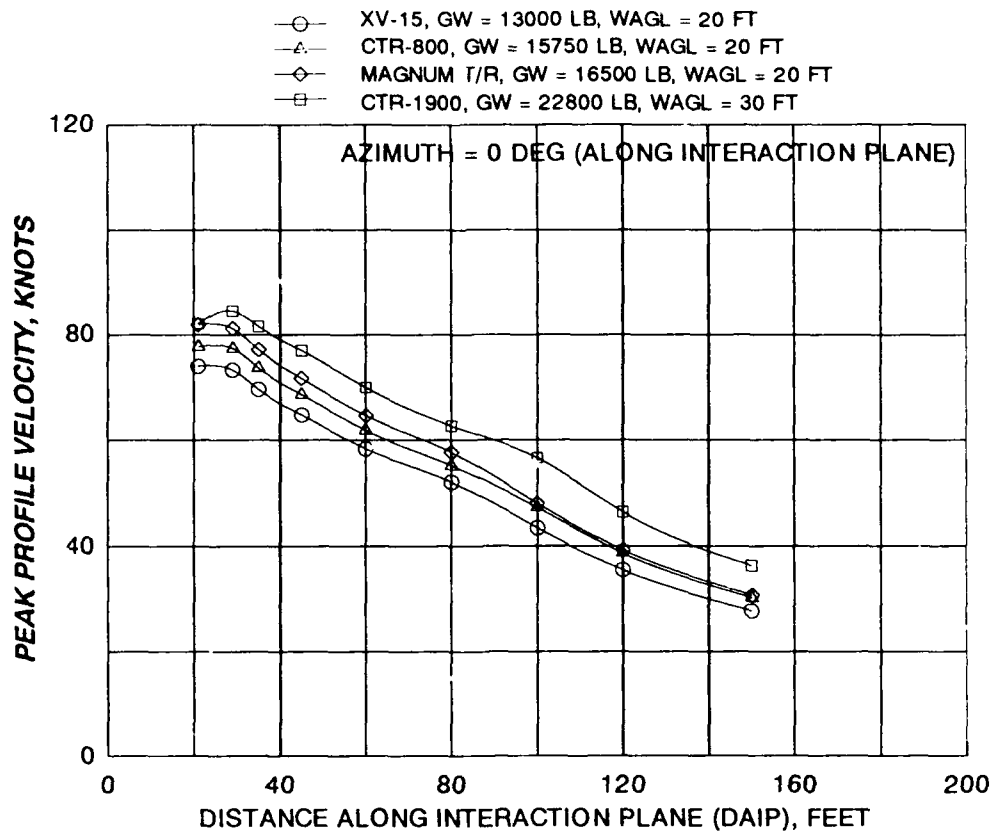

FIGURE 22 PEAK PROFILE VELOCITY AND DYNAMIC PRESSURE COMPARISONS FOR THE SMALL TILTROTOR AIRCRAFT CONFIGURATIONS ALONG THE 0 DEGREE AZIMUTH

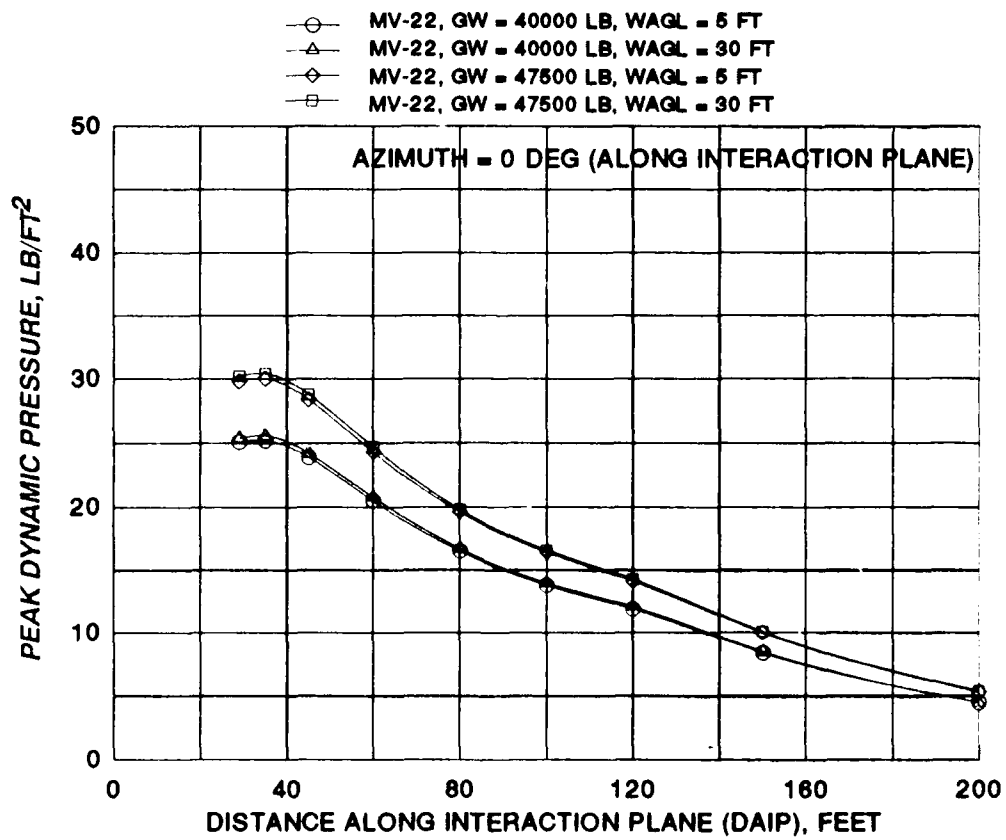
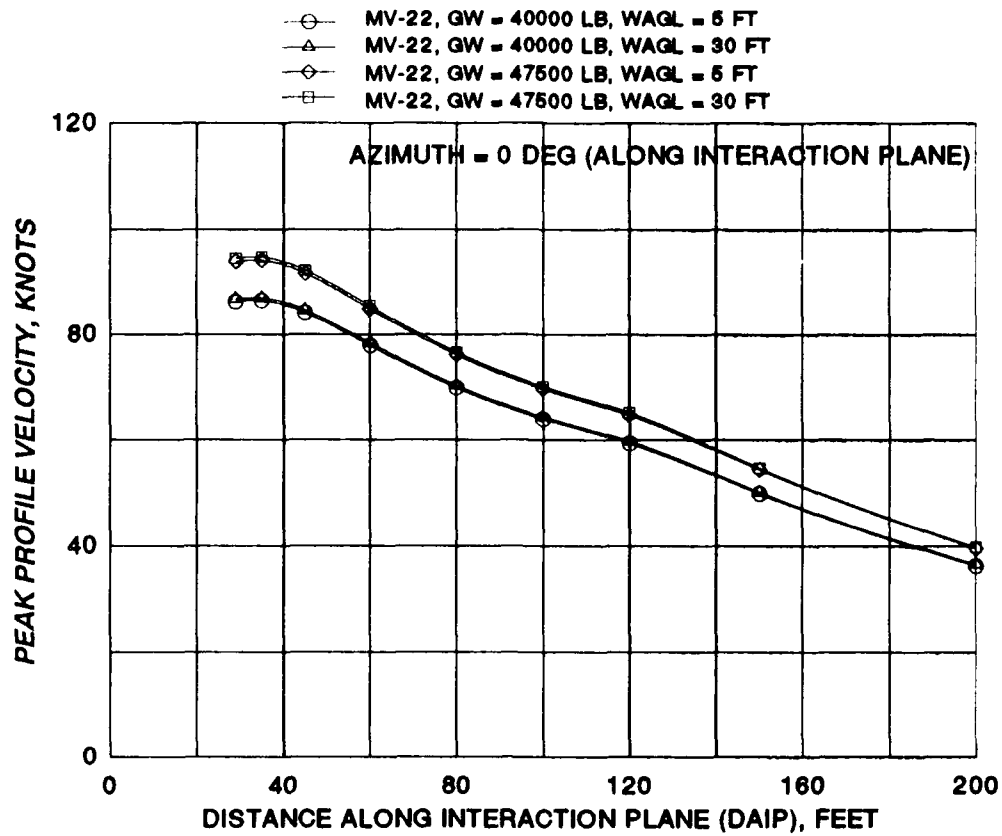

FIGURE 23 PEAK PROFILE VELOCITY AND DYNAMIC PRESSURE COMPARISONS FOR SEVERAL BELL/BOEING MV-22 CONFIGURATIONS ALONG THE 0 DEGREE AZIMUTH

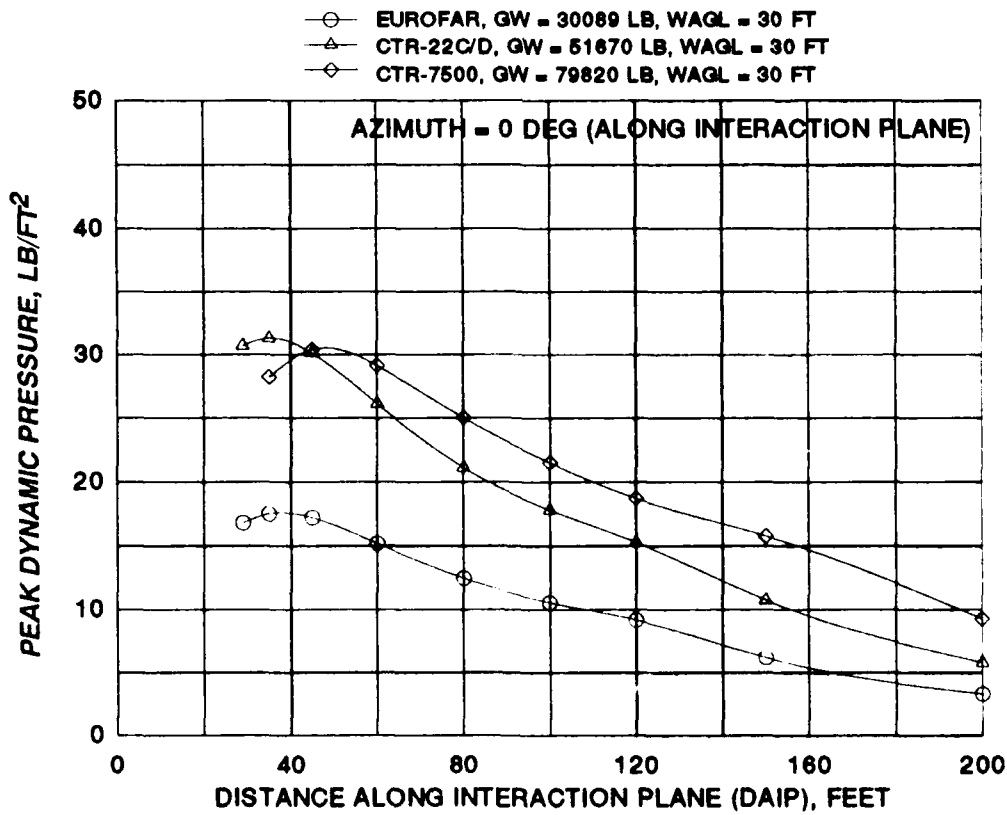
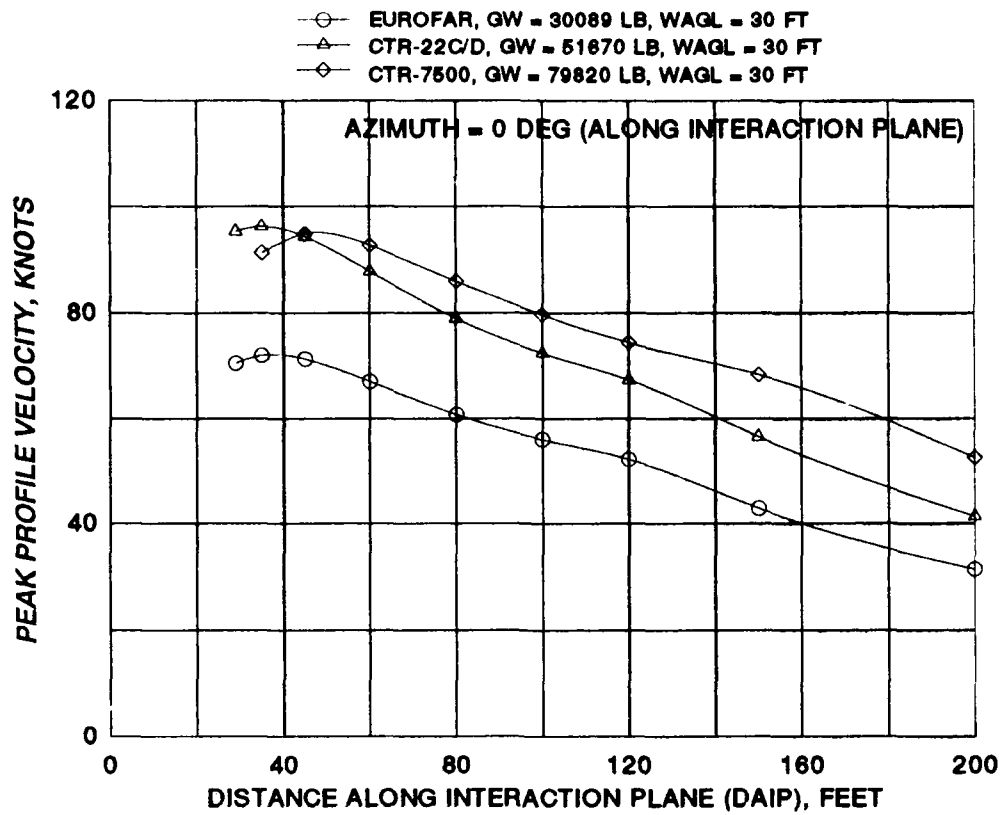

FIGURE 24 PEAK PROFILE VELOCITY AND DYNAMIC PRESSURE COMPARISONS FOR THE LARGE TILTROTOR AIRCRAFT CONFIGURATIONS ALONG THE 0 DEGREE AZIMUTH

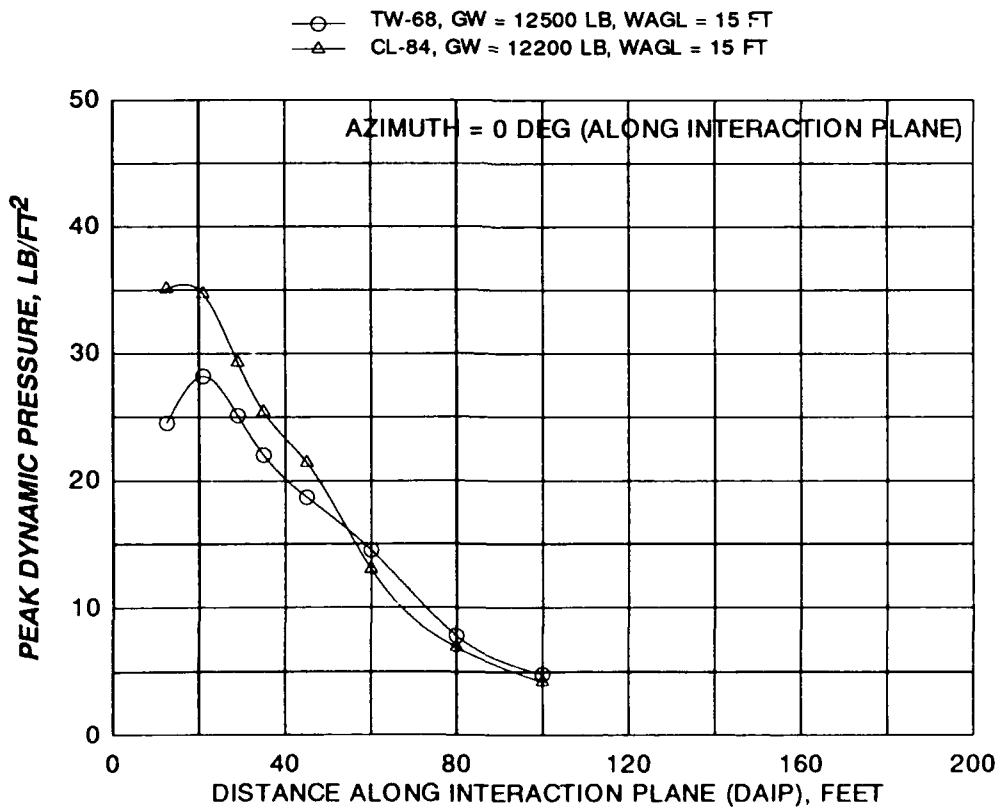
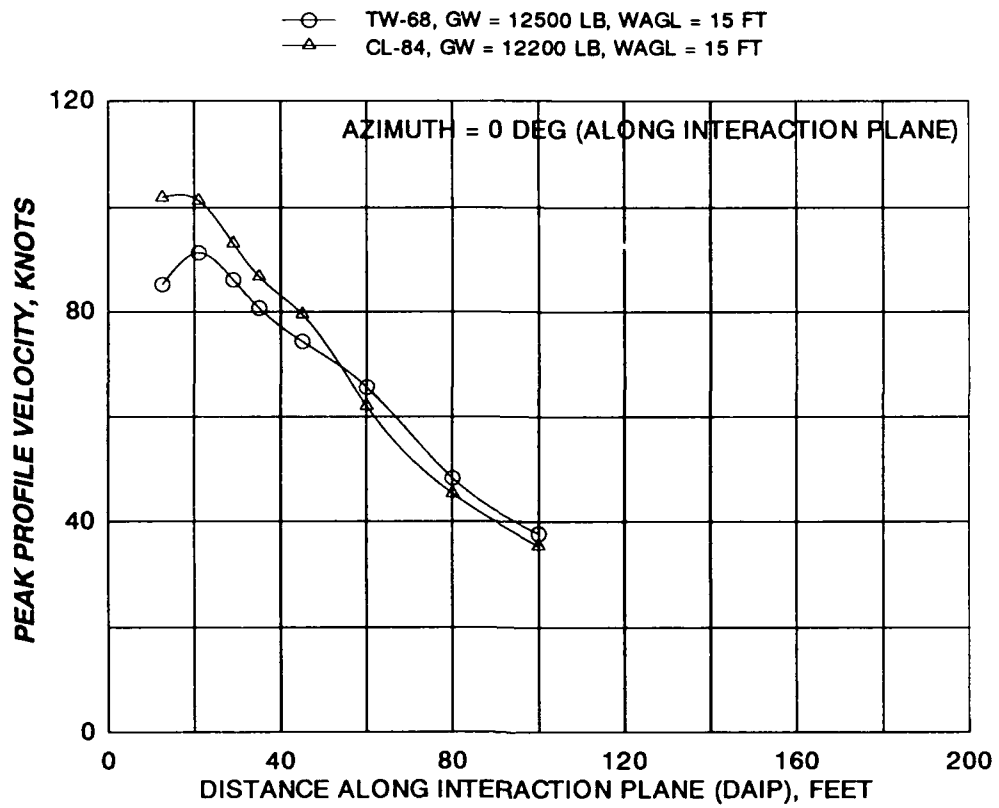

FIGURE 25 PEAK PROFILE VELOCITY AND DYNAMIC PRESSURE COMPARISONS FOR THE SMALL TILTWING AIRCRAFT CONFIGURATIONS ALONG THE 0 DEGREE AZIMUTH

Peak profile velocity and dynamic pressure values for the MV-22 are provided in figure 23 (companion to figure 19). These values are greater than those for the small tiltrotor aircraft by 10 to 20 knots and 2 to 6 PSF over the expanded range from 30 to 200 feet. When these MV-22 velocity and pressure values are compared to the large tiltrotor values presented in figure 24, it can be seen that the Eurofar peak values are significantly lower while CTR-7500 values are slightly higher. Eurofar values are lower because disk loading is lower and wing span is increased for this configuration. At 30,089 pounds, the Eurofar disk loading is 14.1 PSF, whereas, even at 40,000 pounds, the MV-22 disk loading is already up to 17.6 PSF.

Peak profile velocity and dynamic pressure values for the tiltwing aircraft at 20 to 30 feet in front of the nose are almost as large in value as those for the largest tiltrotor configurations, approximately 90 knots and 30 PSF. These data are presented in figure 25 (companion to figure 21). However, as DAIP is increased, these peak velocities and pressures are reduced to being slightly less than those for the smaller tiltrotors at 100 feet.

4.3 PERSONNEL OVERTURNING FORCE COMPARISONS

Personnel overturning force is probably the best documented and least controversial parameter available for use in an evaluation of the acceptability of rotorwash characteristics for a specific rotorcraft. However, this should not lead one to presume that this metric is necessarily the best for preventing accidents. In the context of this analysis, overturning force is used only as a trend indicator in evaluating the "acceptability" of the 11 analyzed rotorcraft, and nothing else. Detailed background information on this parameter can be obtained from references 1 and 3. Based on the guidelines and the complicated evaluation methodology developed in these documents, the critical values of overturning force for people are defined as presented in figure 26. These values vary from 80 to 115 pounds and are specifically based on data for military personnel trained to work in close proximity to rotorcraft. These personnel are assumed to be clothed in flight gear with goggles and helmets. Any application to civilian personnel in street clothing, which is intentionally avoided in this document, would result in much lower limiting values of overturning force in order to address both passenger safety and comfort.

Personnel overturning forces generated by the small tiltrotor aircraft along both the 0 and 270 degree azimuths are presented in figure 27. Along the 270 degree azimuth, maximum force values are always below 60 pounds. This indicates that trained personnel should be able to

HEIGHT AND WEIGHT OF SUBJECTS USED
DURING THE QUALITATIVE DOWNWASH SURVEYS

Subject No.	Height		Weight	
	Inches	Percentile	Pounds	Percentile
1	67	10th	133	2nd
2	73	90th	150	15th
3	74	95th	171	50th
4	74	95th	220	99th

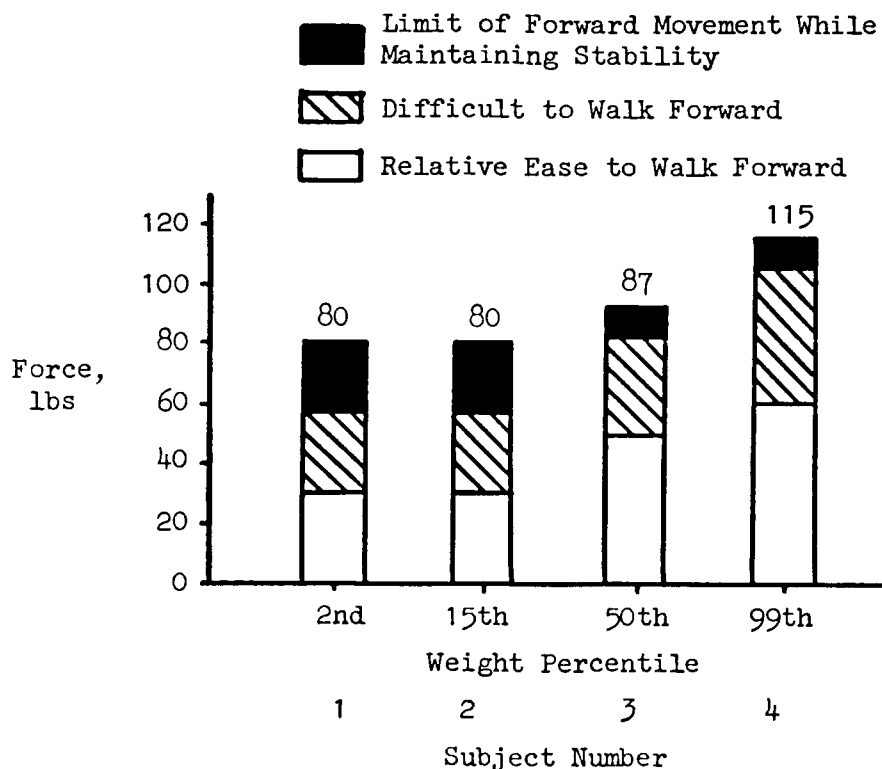

FIGURE 26 CAPABILITIES OF TEST SUBJECTS TO WALK OR MOVE FORWARD UNDER VARIOUS AMOUNTS OF HORIZONTAL RESTRAINT LOADS APPLIED AT A POSITION OF 3 FEET ABOVE GROUND LEVEL (Source: See reference 1.)

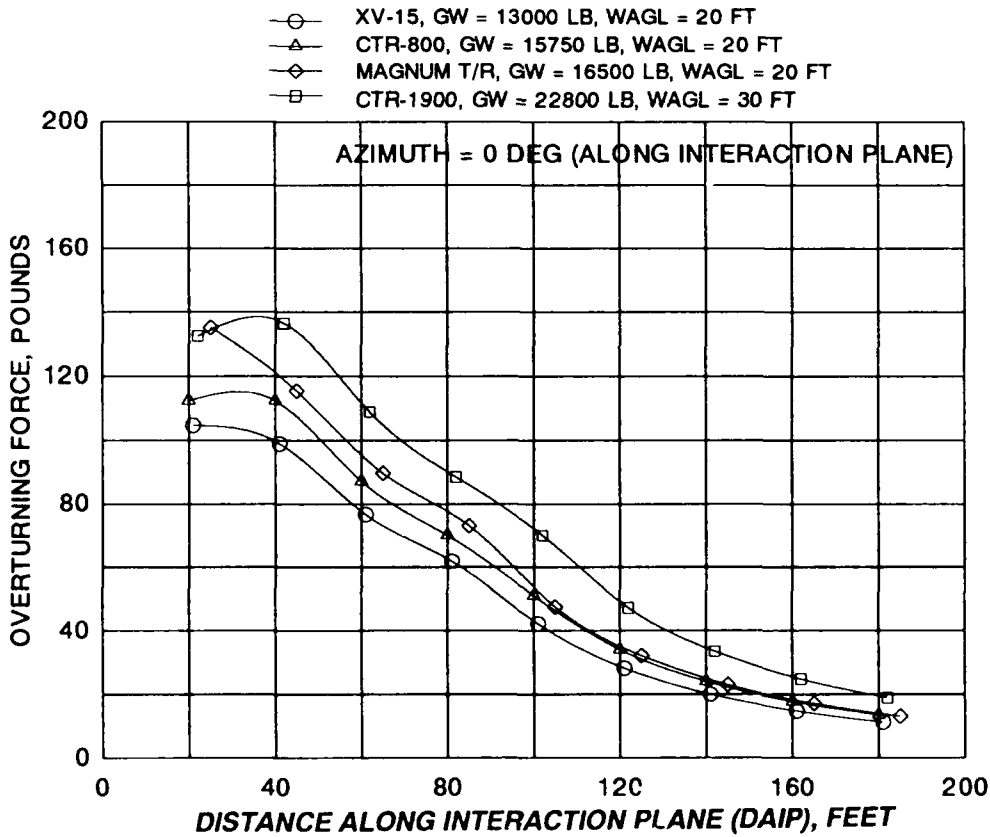
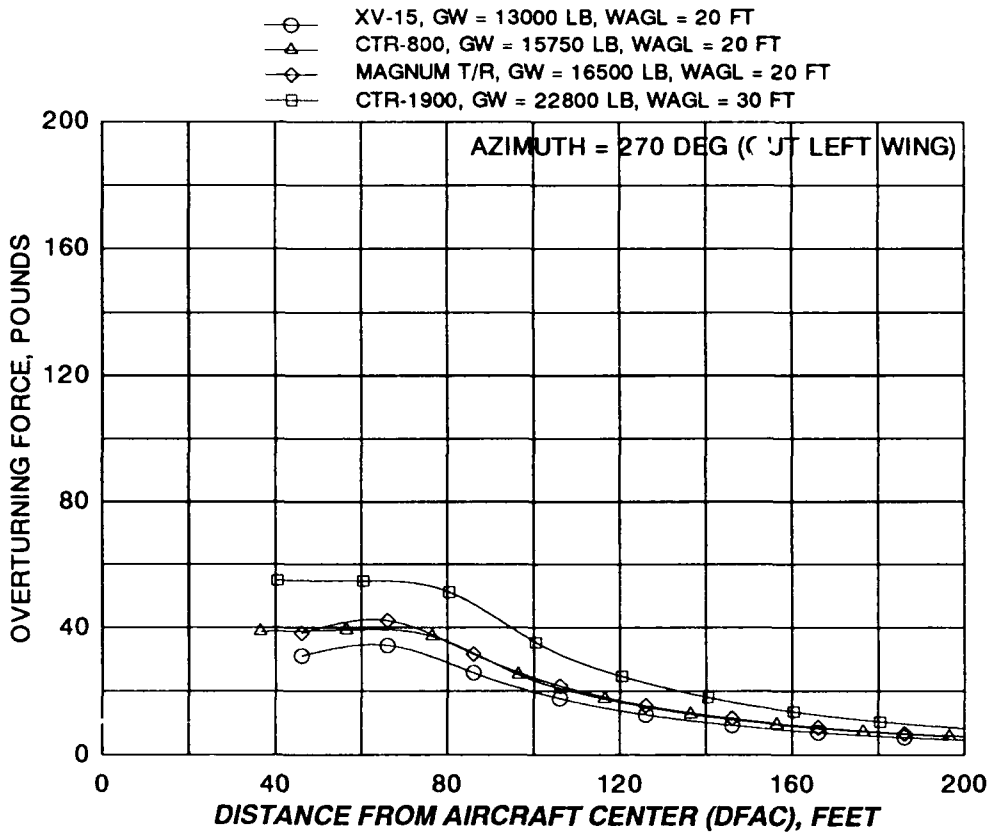

FIGURE 27 PERSONNEL OVERTURNING FORCES FOR SMALL TILTROTOR CONFIGURATIONS

effectively operate in very close proximity to these aircraft. This observation was verified by U.S. Navy personnel for the XV-15 in reference 3. Along the 0 degree azimuth, the situation is considerably different, in that the overturning forces are much larger in magnitude. If 115 pounds is the limiting force for almost all percentiles of personnel, then the MAGNUM Tiltrotor and the CTR-1900 configurations slightly exceed this limit from 20 to 60 feet. The CTR-800 configuration also approaches the limit. At distances greater than 70 to 80 feet, trained personnel should be able to move about safely.

Overturning forces for the larger tiltrotor aircraft are presented in figures 28 and 29. Along the 270 degree azimuth, the Eurofar configuration does not exceed the lower limit of 80 pounds at any time. Values for the MV-22 exceed the lower limit but remain below the upper limit out to 100 feet. Forces for the CTR-22C/D configuration marginally exceed the upper limit very close to the rotor and otherwise are slightly greater than the corresponding MV-22 values. The CTR-7500 configuration is the only configuration which significantly exceeds the upper limit of 115 pounds along the 270 degree azimuth. This value is exceeded from 60 to approximately 120 feet.

Along the 0 degree azimuth, all large tiltrotor configurations except the Eurofar generate forces that significantly exceed the 115 pound overturning force limit. Depending on gross weight, values for the MV-22 and CTR-22C/D configurations do not go below 115 pounds until the DAIP exceeds 80 to 120 feet. This limit is further extended out to 140 feet for the CTR-7500 configuration.

As can be seen in figures 28 and 29, a high probability exists that a requirement will be needed to limit trained personnel movements in close proximity to the larger tiltrotors. The large values of velocity and dynamic pressure generated by these aircraft, based on the analysis conducted in reference 1, are also strong enough to create hazardous conditions for many other types of rotorwash related accidents.

Overturning forces generated by the tiltwing configurations are presented in figure 30. Along the interaction plane very close to the aircraft, these forces are as hazardous as those generated by the large tiltrotor configurations. At DAIP distances beyond 70 feet, overturning forces are reduced to more acceptable levels. Forces along the 270 degree azimuth remain below 40 pounds at all stations and should not significantly affect trained personnel.

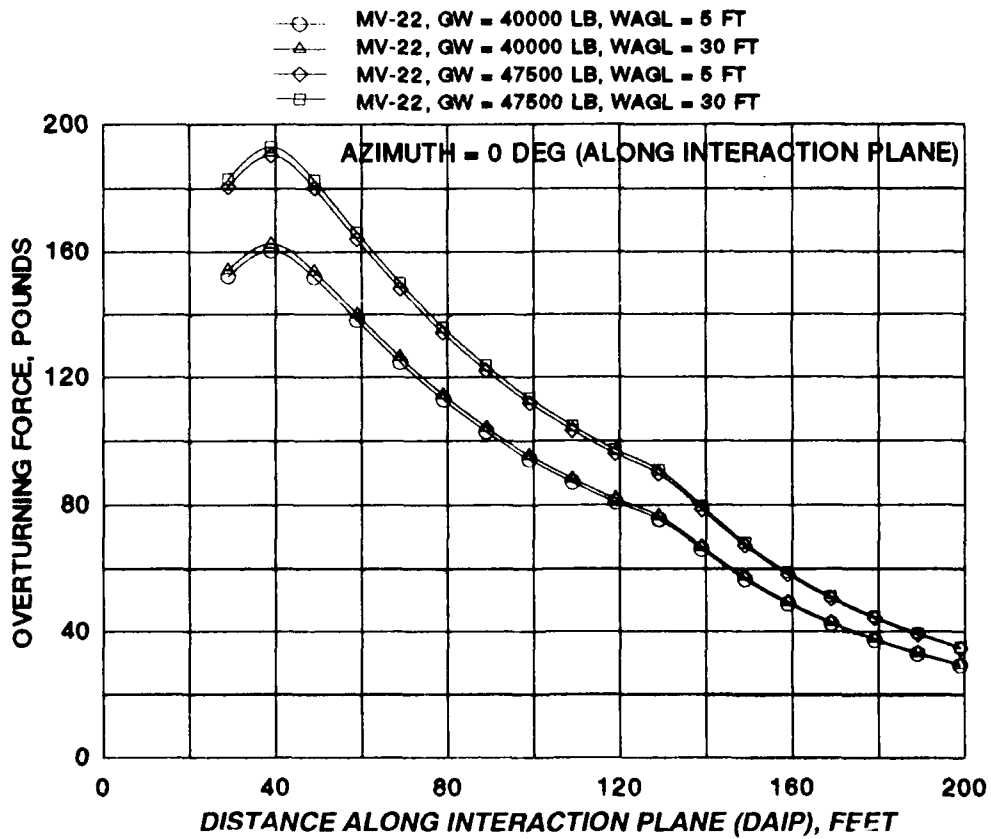
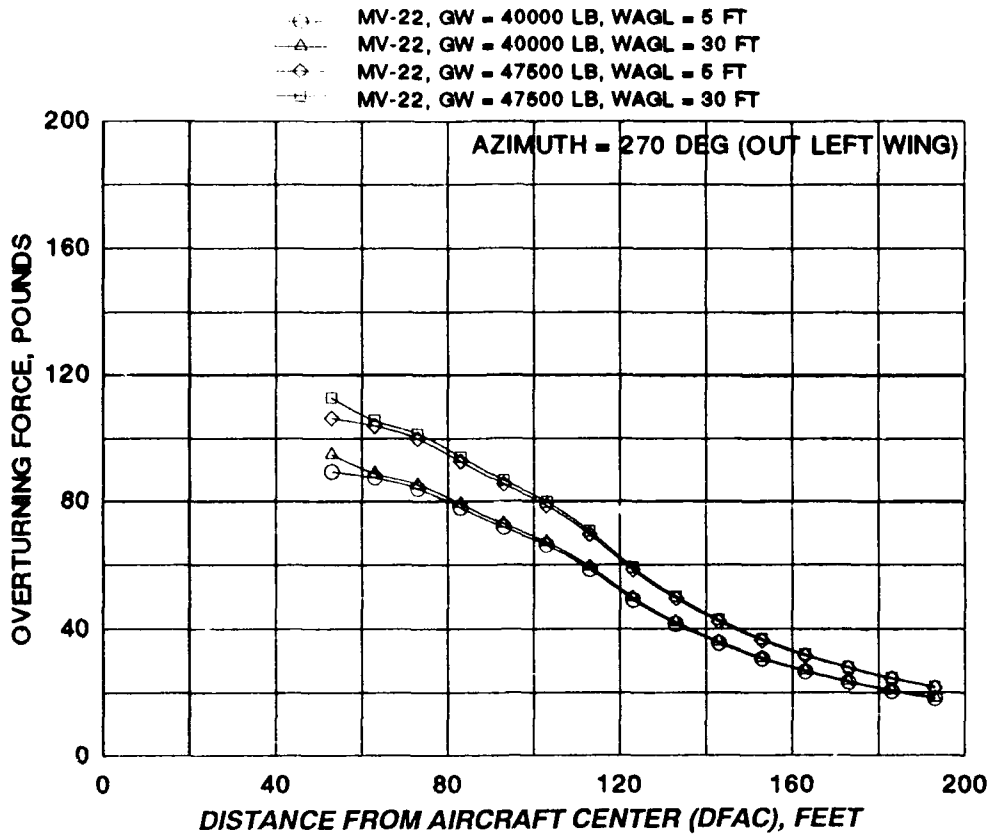

FIGURE 28 PERSONNEL OVERTURNING FORCES FOR VARIOUS MV-22 TILTROTOR CONFIGURATIONS

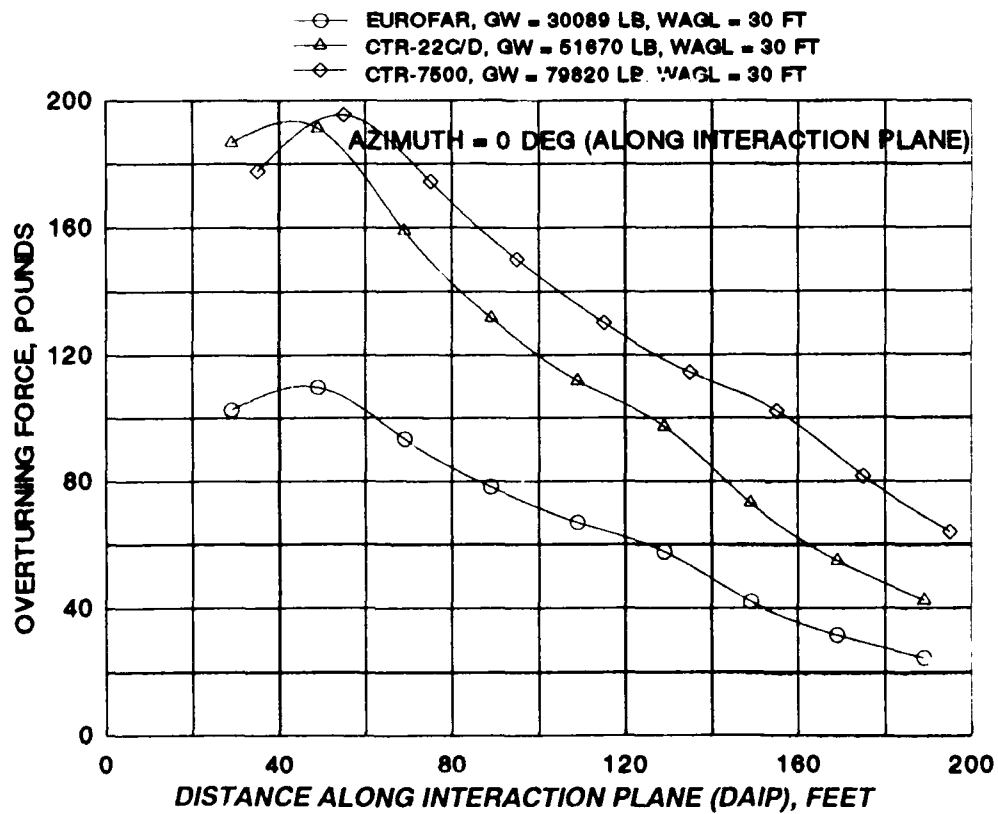
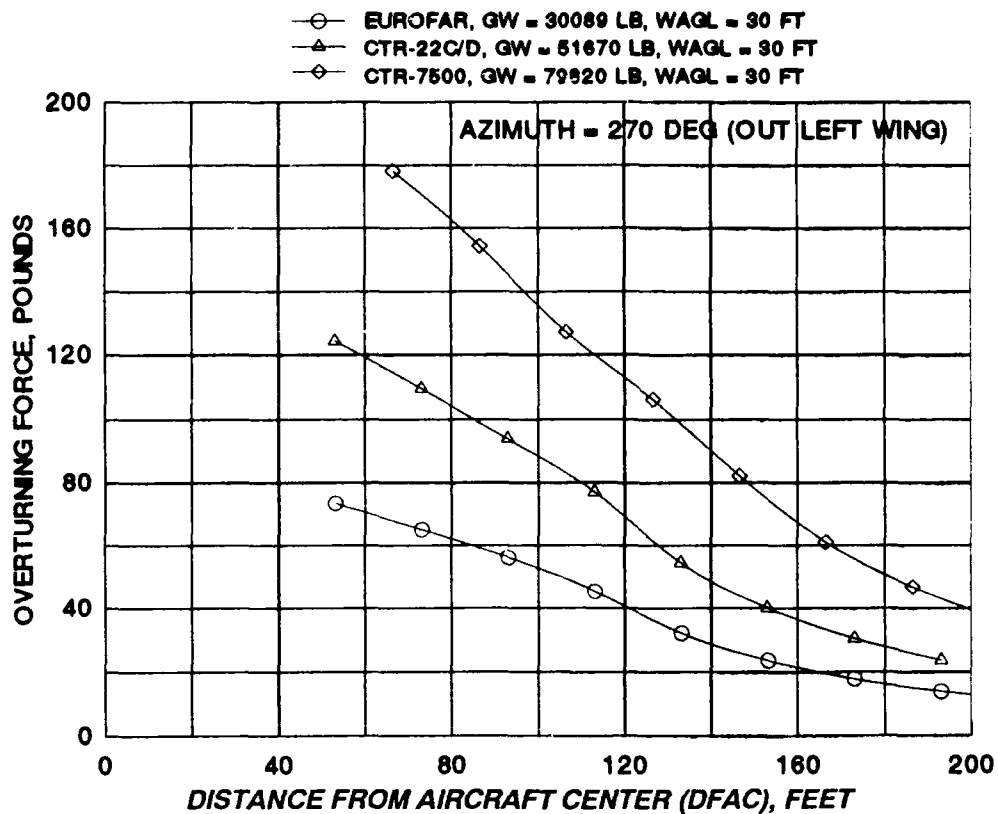

FIGURE 29 PERSONNEL OVERTURNING FORCES FOR LARGE TILTROTOR CONFIGURATIONS

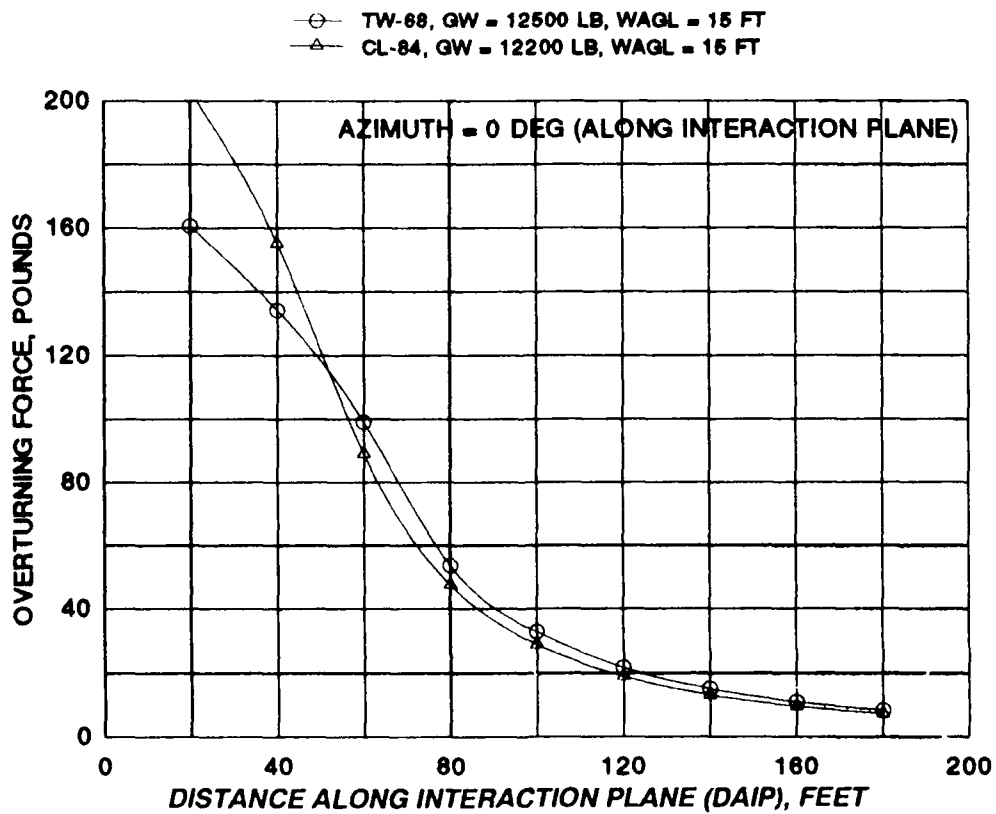
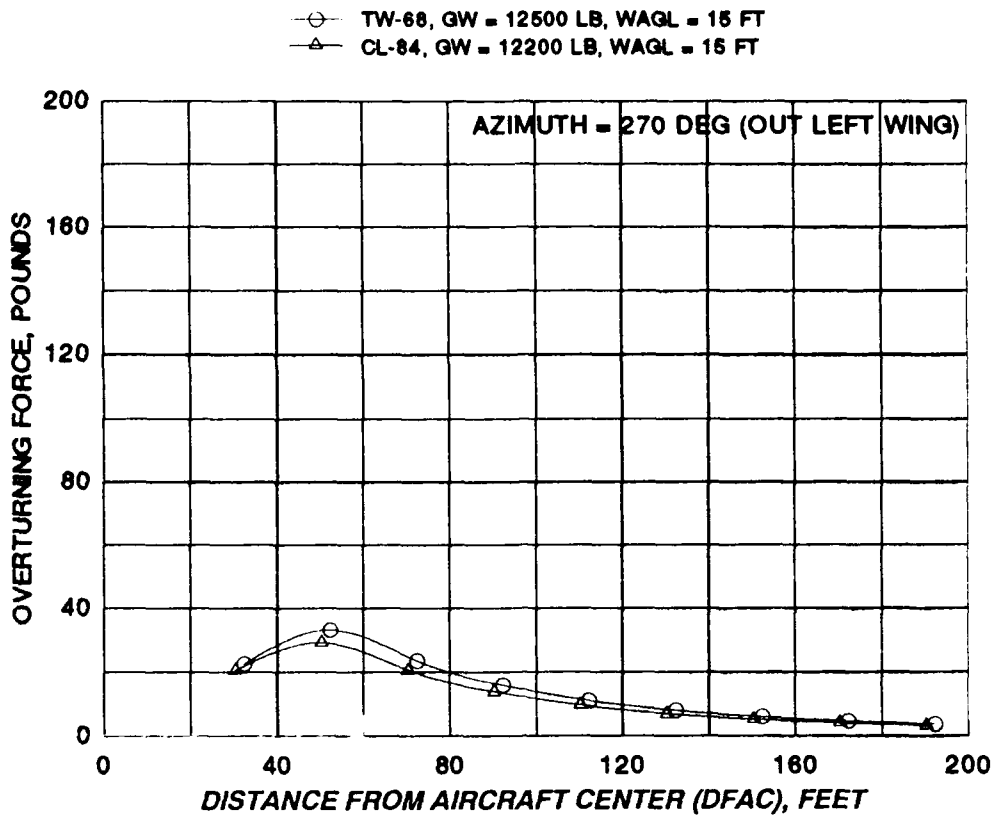

FIGURE 30 PERSONNEL OVERTURNING FORCES FOR SMALL TILTWING CONFIGURATIONS

5.0 CONCLUSIONS AND RECOMMENDATIONS

The steady hover rotorwash characteristics of 11 tiltrotor and tiltwing aircraft have been briefly analyzed and compared with one another in this report. Flight test data have also been correlated with calculated data for two of these aircraft, the Bell XV-15 and Canadair CL-84. Effects due to wind and rotorcraft maneuvering near hover, which would increase the magnitude of the generated rotorwash velocities, are not included in the presented comparisons. Quantification of the effects of these two parameters on rotorwash will require further analytical work and the acquisition of flight test data for correlation purposes. General conclusions which can be drawn from this report, as based on the presented data and guidance obtained from reference 1, are:

- C1. Depending on the various factors involved, ALL evaluated configurations do have the potential to create rotorwash related hazards. These hazards will have to be addressed through vertiport design and vertiport operating procedures.
- C2. The effects on rotorwash of ambient wind and maneuvering near hover clearly have the potential to further increase the values of peak profile velocity, dynamic pressure, and overturning force which are documented in this report.

On a more positive note, it can also be stated that:

- C3. The small tiltrotor configurations (XV-15, Magnum Tiltrotor, CTR-800, and CTR-1900) should not create significant rotorwash related problems when operated at most planned vertiports.
- C4. Operation of the small tiltwing configurations (CL-84 and TW-68) should not create significant rotorwash related problems when operated at most planned vertiports. However, both tiltwings do generate levels of rotorwash in close proximity to the aircraft that may result in significant amounts of entrained particles being ejected out all azimuths for some types of landing surfaces.

Since the analysis effort documented in this report provides a relative comparison of rotorwash characteristics, the data for the 11 tiltrotor and tiltwing configurations are very useful for vertiport design purposes. The use of these data in the evaluation of vertiport design tradeoffs will enhance vertiport safety. No effort has been made to analyze specific types of rotorwash related hazards. This

type of analysis requires information on the design characteristics of the individual vertiport in question. The data provided herein are useful for this type of analysis, however.

Five recommendations result from this analysis effort and the majority of these recommendations are related to flight test data acquisition or correlation. These recommendations are:

- R1. All rotorcraft configurations expected to be operated out of any size of vertiport should be reviewed before operations are initiated to insure that hazardous rotorwash related problems are not encountered. From a safety perspective, the goal should be to determine the maximum size of the tiltrotor and tiltwing configurations that can be operated safely from any specified vertiport configuration (operating procedures should also be factored in this process). Flight operations out of small vertiports with room for the parking of only one or two rotorcraft should be evaluated very carefully before tiltrotors larger than the CTR-1900 are allowed to operate.
- R2. MV-22 Osprey flight test data should be correlated with the ROTWASH analysis program as soon as the data are available. This correlation is critical because the program's tiltrotor prediction methodology is presently based on correlation with only the Bell XV-15. This correlation data base needs to be expanded so that empirically based constants can be better optimized and other improvements to the program can be developed based on sound experimental data. Unfortunately, no opportunities exist at this time for correlation with other tiltwing aircraft.
- R3. Rotorwash flight test data documenting the effects of both wind and maneuvering near hover should be acquired as soon as possible. As noted in reference 1, the effect of a constant ambient wind significantly increases the potential for rotorwash related accidents (up to some as yet undetermined windspeed). The initial acceleration maneuver by a rotorcraft from hover and the final decelerating flare into hover also have the potential to generate higher rotorwash velocities. Flight test data are urgently needed to quantify these effects so that they can be modeled appropriately. Without these data, questions will continue to exist with respect to the definition of worst case scenarios in all safety analyses.

- R4. Further research needs to be conducted to determine if a serious hazard potential exists for the entrainment in the outwash flowfield of small particles from the landing surface (i.e. gravel). The higher disk loading configurations such as the tiltwing may be particularly susceptible to this problem. XC-142 data contained in reference 8 document a serious hazard potential which existed for this configuration during rough field operations.
- R5. Flight tests need to be conducted to define limit values for overturning forces and moments that are appropriate for civilian ramp personnel and passengers. All prior testing to evaluate overturning forces has been limited to military personnel trained to operate in close proximity to rotorcraft. Therefore, these tests resulted in the definition of limit forces not applicable to civilian personnel. Until additional tests are completed, suggested interim values for overturning force are 50 pounds for civilian ramp personnel and 30 pounds for passengers. Also, in an effort to enhance passenger comfort and minimize separation distances between gates, designers should consider use of simple "jet-ways" for boarding and disembarking passengers. Simple "jet-ways" may be particularly desirable in cold weather situations where rotorwash can produce severe wind chill.

REFERENCES

1. Ferguson, S.W., and J.D. Kocurek, "Analysis and Recommendation of Separation Requirements for Rotorcraft Operation at Airports and Heliports," Systems Technology, Inc, Report TR-1224-1, September 1986.
2. Ferguson, S.W., and J.D. Kocurek, "Rotorwash Computer Model - User's Guide," Prepared by EMA and Computational Methodology Associates for the Federal Aviation Administration, Washington D.C., DOT/FAA/RD-90/25, February 1991.
3. Harris, D.J., and R.D. Simpson, "Technical Evaluation of the Rotor Downwash Flow Field of the XV-15 Tilt Rotor Research Aircraft," Naval Air Test Center, Technical Report No. SY-14R-83, July 1983.
4. Harris, D.J., and R.D. Simpson, "CL-84 Tilt-Wing Vertical and Short Takeoff and Landing Downwash Evaluation. Final Report," Naval Air Test Center, Technical Report No. SY-52R-76, April 1976.
5. Anon., "A Comparison of Downwash and Outflow from a Tilt-Wing Aircraft and a Helicopter," Canadair Report RAG-084-107, February 1971.
6. Michaelsen, O.E., "A Comparison of Outflows from a Helicopter, Tilt Wing, and Jet Lift Hovering Aircraft," AIAA 8th Annual Meeting and Technical Display, Washington D.C., AIAA Paper No. 71-992, October 25, 1971.
7. Anon, "State/Regional Tiltrotor/Vertiport Feasibility Studies Data Package," NASA Ames Research Center, June 1, 1989.
8. Lucero, F.N., and G.E. Jones, "XC-142A Operational Suitability Tests", Air Force Flight Test Center, Edward's Air Force Base, CA, FTC-TR-67-28, December 1968.

APPENDIX A

BELL XV-15 AIRCRAFT AND ROTORWASH DATA

Bell XV-15 aircraft characteristics used with the ROTWASH analysis program are listed in table A-1 as obtained from reference A-1. Figure A-1 presents a three-view drawing of the tiltrotor. Table A-2 provides a summary tabulation of parameters defining the conditions for all rotorwash data presented in the appendix. All data are plotted in one of four formats, which include graphs of:

1. mean and peak outwash velocity profiles,
2. peak outwash velocity versus distance,
3. peak outwash dynamic pressure versus distance, and
4. personnel overturning force versus distance.

In each format, data are plotted along both the 0 and 270 degree azimuth. Distance from rotor center (DFRC) is the independent variable along the 270 degree azimuth. Measurements of distance from aircraft center (DFAC) are also noted on the graphs. The DFAC reference point is defined as zero at the location where the aircraft centerline intersects the line connecting the two rotor centers of rotation. Along the 0 degree azimuth, distance along the interaction plane (DAIP) is the independent variable. This point is referenced as zero at the same location as the DFAC point.

REFERENCES

- A-1. Maisel, M., "NASA/Army XV-15 Tilt-Rotor Research Aircraft Familiarization Document," NASA Technical Memorandum TM X-62, 407, January 1975.

TABLE A-1 XV-15 ROTWASH INPUT DATA

<u>Parameter</u>	<u>Value</u>
Rotor radius, feet	12.5
Distance between rotor centers, feet	32.2
Wing download, percent of rotor thrust	13.0
Distance from wheels to rotor plane, feet	12.5
Rotor speed, RPM	589.0
Rotor tip speed, feet/second	771.0
Number of rotor blades per rotor	3
Density ratio	1.0

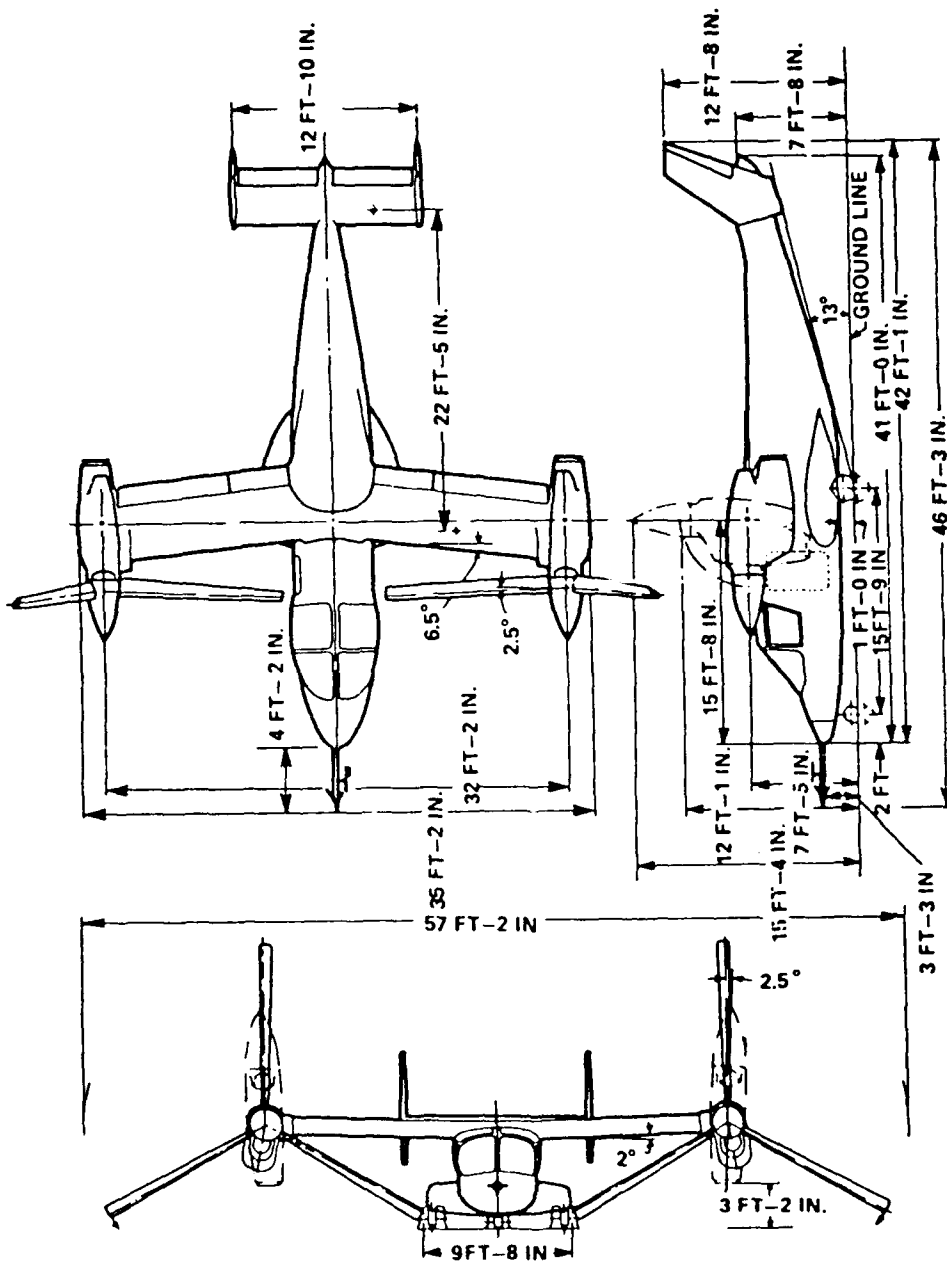

FIGURE A-1 THREE-VIEW DRAWING OF THE BELL XV-15

TABLE A-2 XV-15 ROTORWASH EVALUATION MATRIX

Note: The Figure/Type column provides the figure number and data format type where:

M/P - Mean and peak velocity profile format

PVD - Peak velocity and dynamic pressure format

OTF - Personnel overturning force format

<u>Figure/ Type</u>	<u>Azimuth, Degrees</u>	<u>GW, Pounds</u>	<u>WAGL, Feet</u>	<u>DFRC or DAIP Distance, Feet</u>
A-2 M/P	270.0	13,000	20	18.9,23.9,36.9,49.9, 63.9,83.9,103.9,123.9
A-3 M/P	0.0	13,000	20	21, 29, 35, 45, 60, 80, 100, 120
A-4 PVD	270.0	13,000	20	20 to 150
A-5 PVD	0.0	13,000	20	20 to 150
A-6 OTF	270.0	13,000	20	30 to 190
A-7 OTF	0.0	13,000	20	20 to 180

BELL XV-15
 GW = 13000 LB, WAGL = 20 FT
 AZIMUTH = 270 DEG, DFAC = 35.0 FT (DFRC = 18.9 FT)

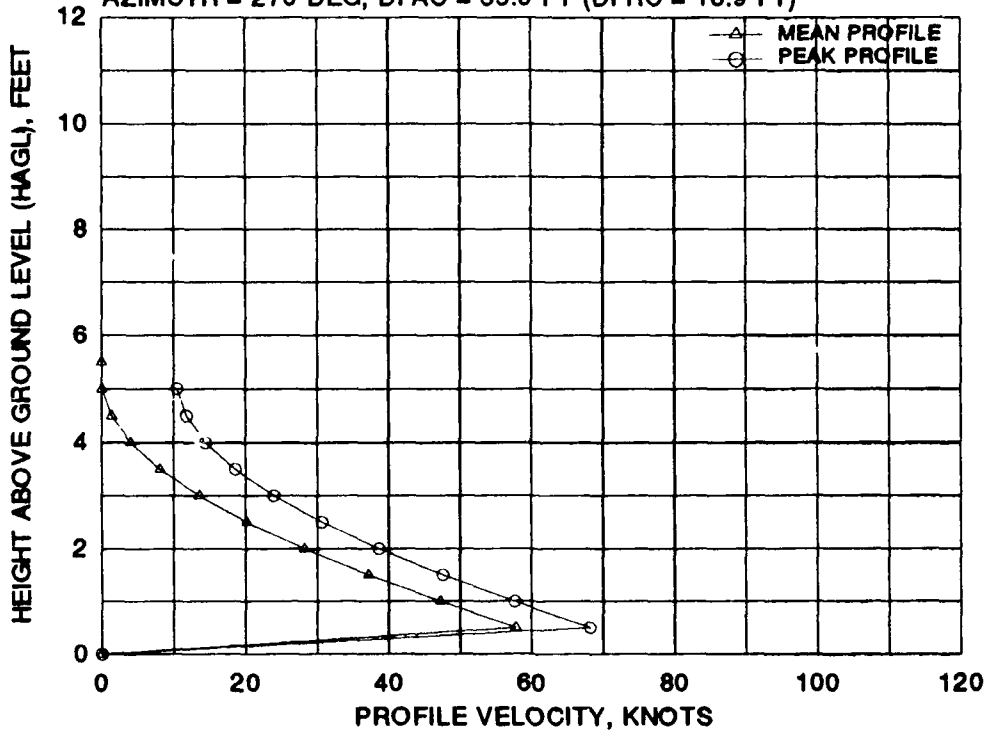

BELL XV-15
 GW = 13000 LB, WAGL = 20 FT
 AZIMUTH = 270 DEG, DFAC = 40.0 FT (DFRC = 23.9 FT)

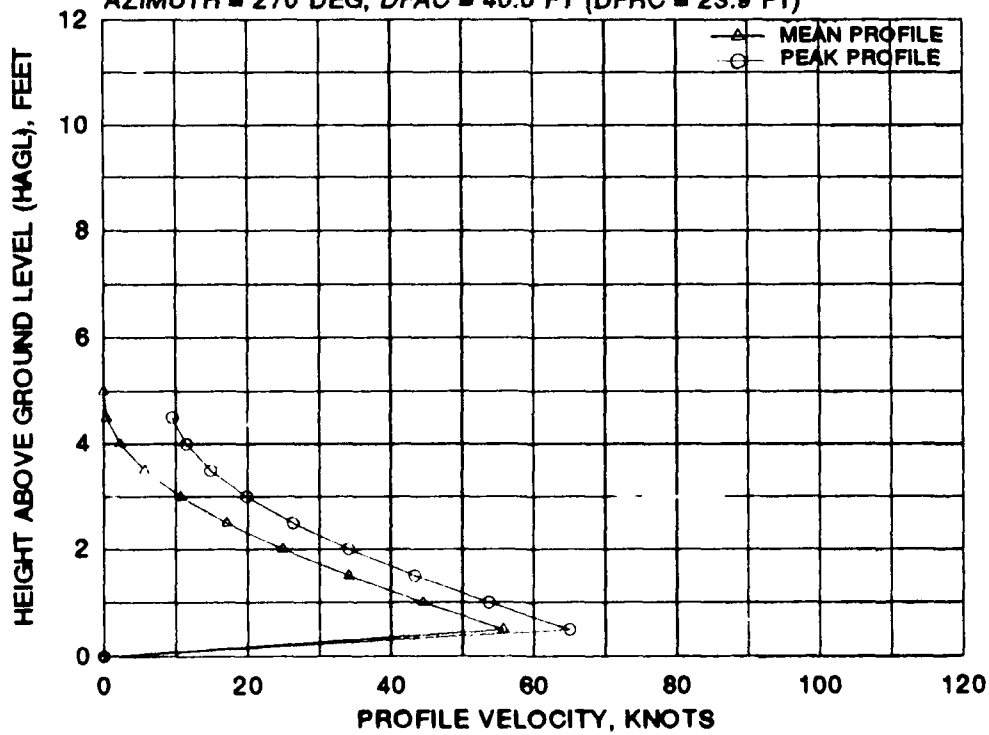
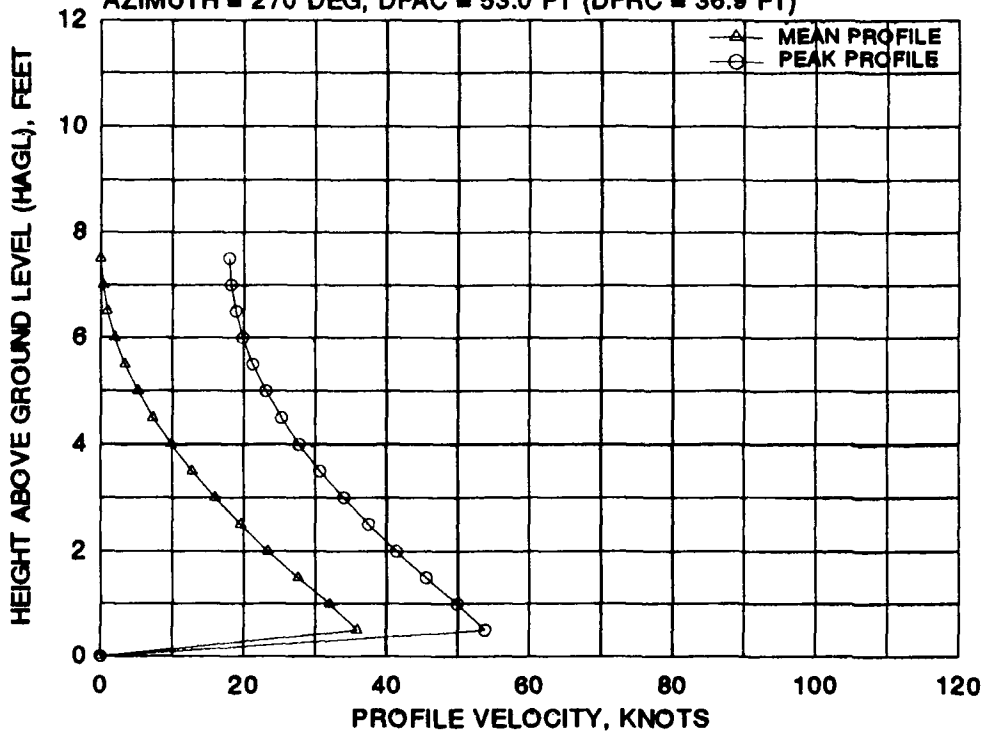

FIGURE A-2 BELL XV-15 MEAN AND PEAK VELOCITY PROFILES FOR EIGHT 270 DEGREE AZIMUTH RADIAL STATIONS AT A WHEEL HEIGHT OF 20 FEET AND A GROSS WEIGHT OF 13,000 POUNDS

BELL XV-15
 GW = 13000 LB, WAGL = 20 FT
 AZIMUTH = 270 DEG, DFAC = 53.0 FT (DFRC = 36.9 FT)



BELL XV-15
 GW = 13000 LB, WAGL = 20 FT
 AZIMUTH = 270 DEG, DFAC = 66.0 FT (DFRC = 49.9 FT)

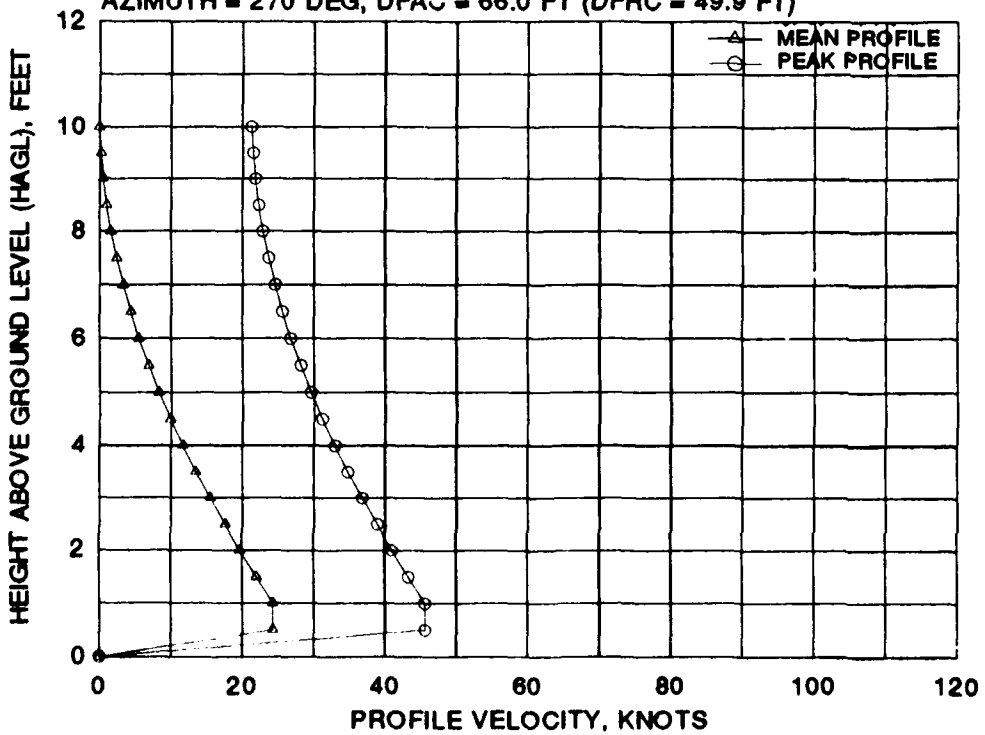
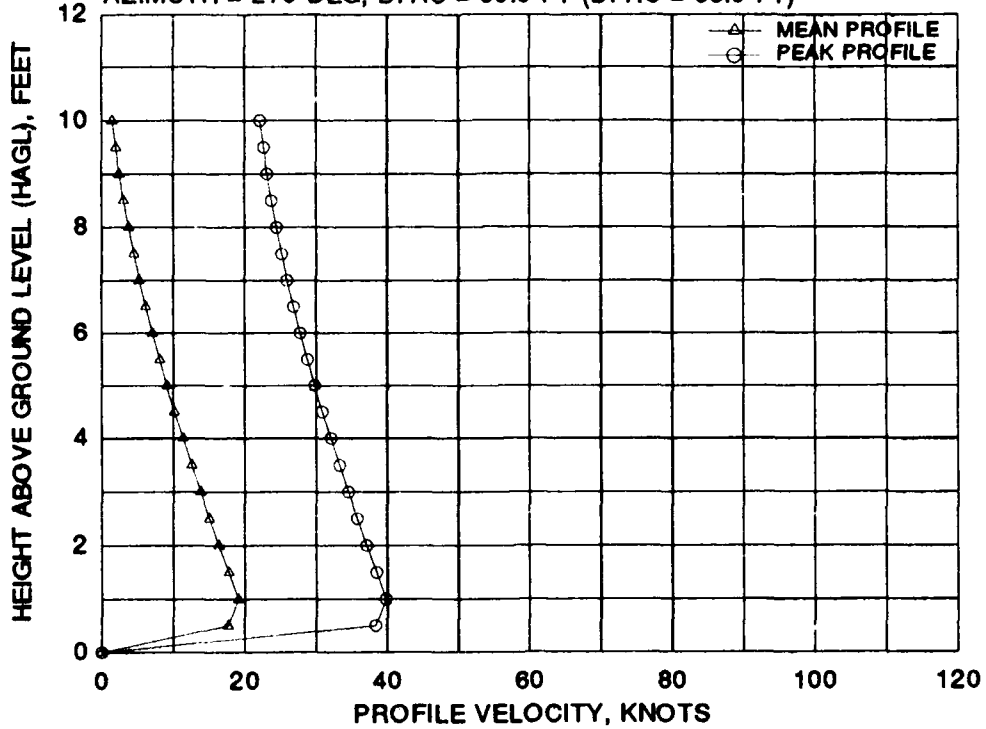

FIGURE A-2 BELL XV-15 MEAN AND PEAK VELOCITY PROFILES FOR EIGHT 270 DEGREE AZIMUTH RADIAL STATIONS AT A WHEEL HEIGHT OF 20 FEET AND A GROSS WEIGHT OF 13,000 POUNDS (Continued)

BELL XV-15
 GW = 13000 LB, WAGL = 20 FT
 AZIMUTH = 270 DEG, DFAC = 80.0 FT (DFRC = 63.9 FT)



BELL XV-15
 GW = 13000 LB, WAGL = 20 FT
 AZIMUTH = 270 DEG, DFAC = 100.0 FT (DFRC = 83.9 FT)

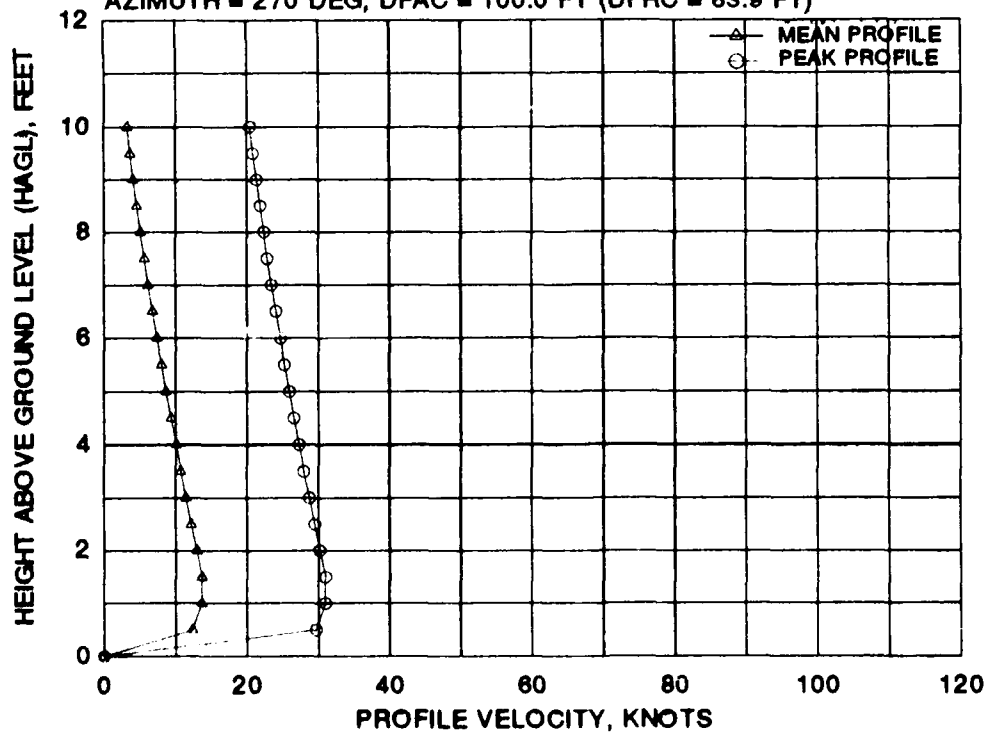
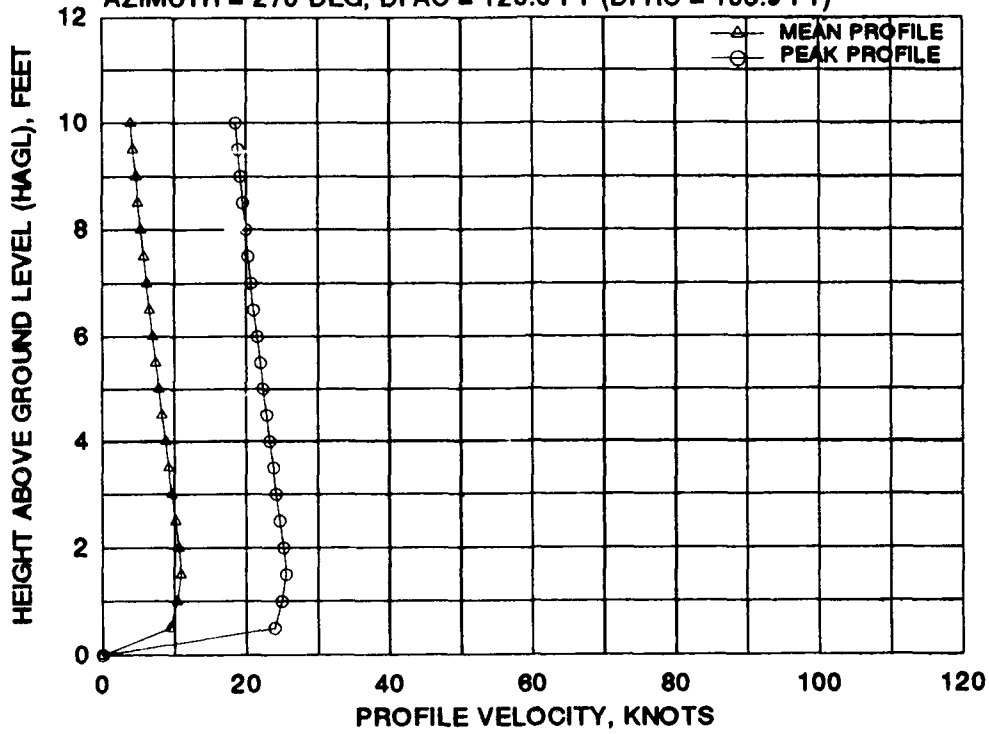

FIGURE A-2 BELL XV-15 MEAN AND PEAK VELOCITY PROFILES FOR EIGHT 270 DEGREE AZIMUTH RADIAL STATIONS AT A WHEEL HEIGHT OF 20 FEET AND A GROSS WEIGHT OF 13,000 POUNDS (Continued)

BELL XV-15
 GW = 13000 LB, WAGL = 20 FT
 AZIMUTH = 270 DEG, DFAC = 120.0 FT (DFRC = 103.9 FT)



BELL XV-15
 GW = 13000 LB, WAGL = 20 FT
 AZIMUTH = 270 DEG, DFAC = 140.0 FT (DFRC = 123.9 FT)

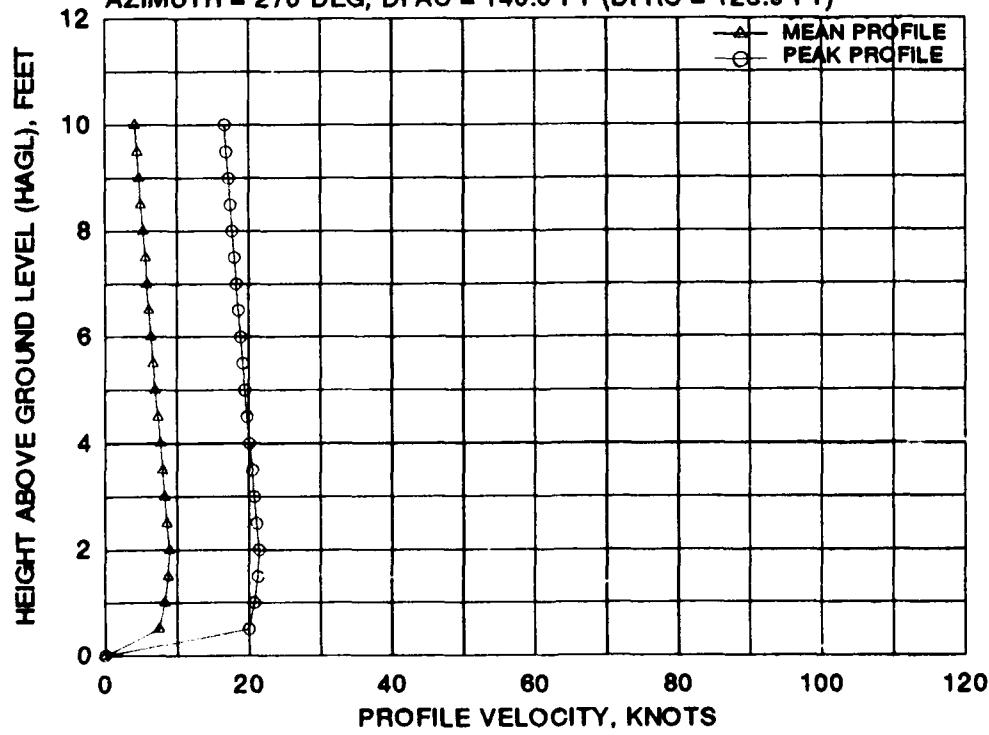
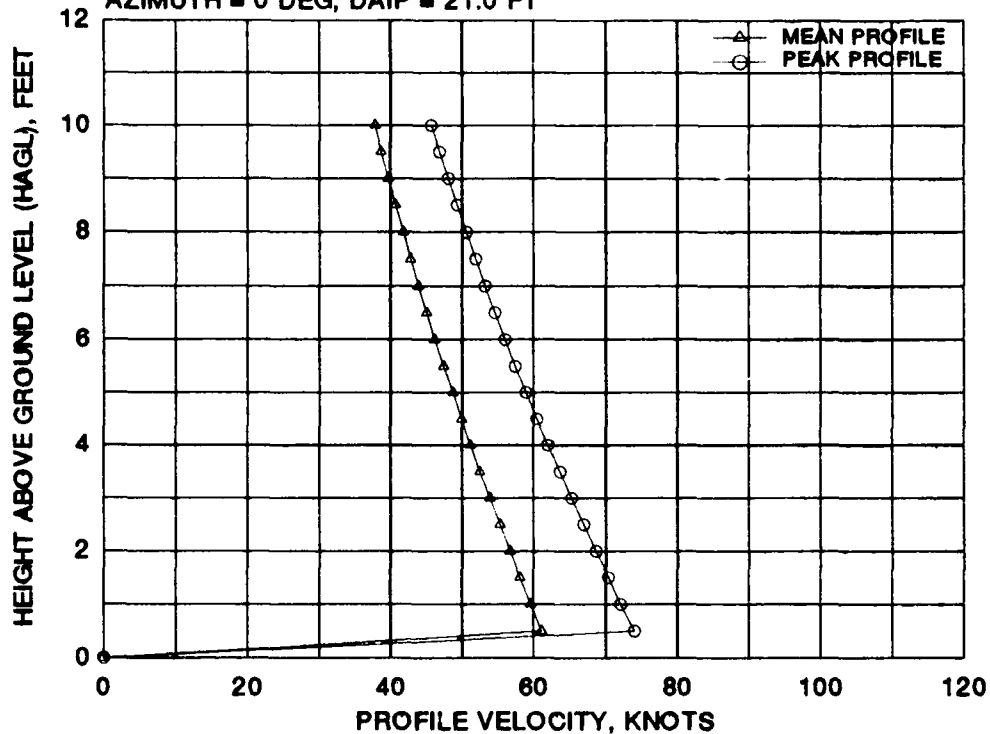

FIGURE A-2 BELL XV-15 MEAN AND PEAK VELOCITY PROFILES FOR EIGHT 270 DEGREE AZIMUTH RADIAL STATIONS AT A WHEEL HEIGHT OF 20 FEET AND A GROSS WEIGHT OF 13,000 POUNDS (Concluded)

BELL XV-15
 GW = 13000 LB, WAGL = 20 FT
 AZIMUTH = 0 DEG, DAIP = 21.0 FT



BELL XV-15
 GW = 13000 LB, WAGL = 20 FT
 AZIMUTH = 0 DEG, DAIP = 29.0 FT

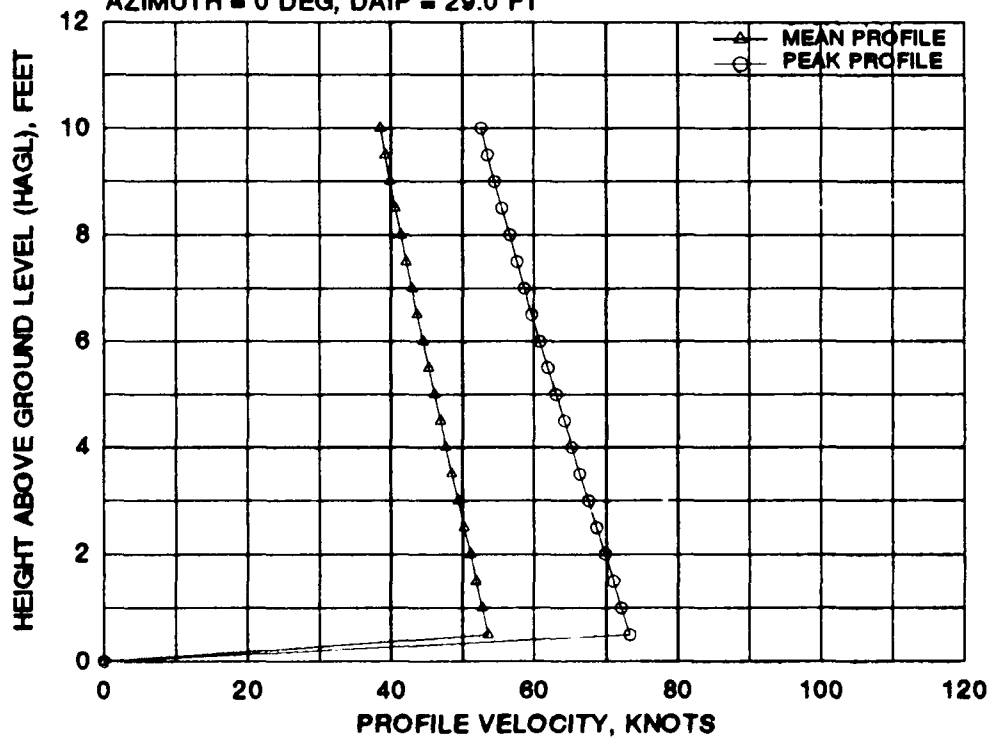
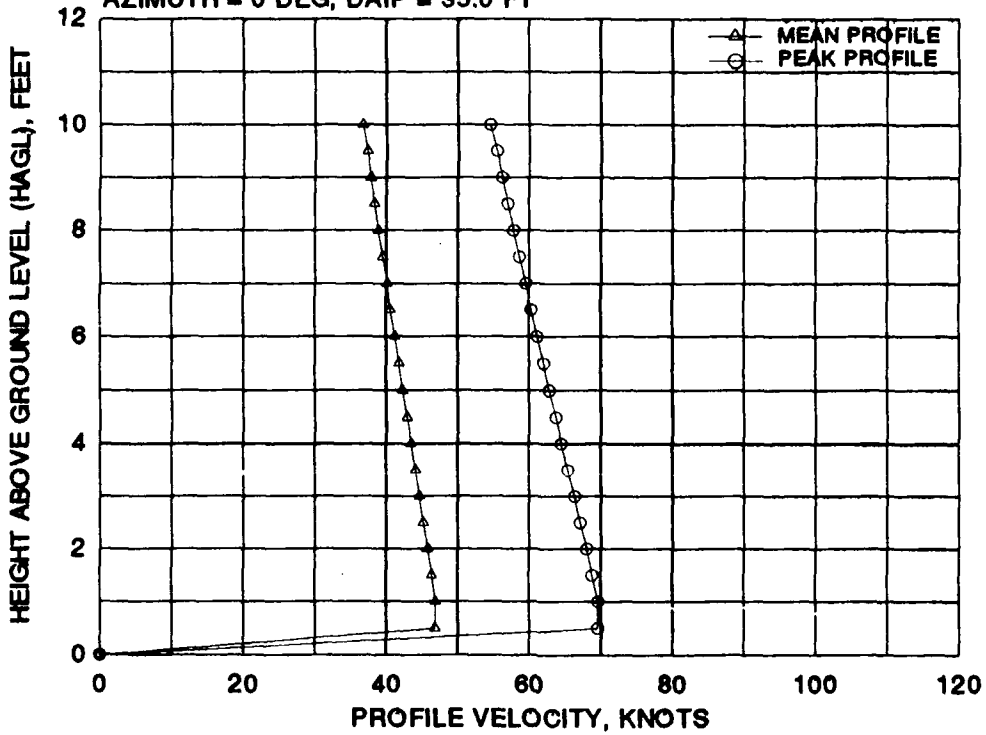

FIGURE A-3 BELL XV-15 MEAN AND PEAK VELOCITY PROFILES FOR EIGHT 0 DEGREE AZIMUTH RADIAL STATIONS AT A WHEEL HEIGHT OF 20 FEET AND A GROSS WEIGHT OF 13,000 POUNDS

BELL XV-15
 GW = 13000 LB, WAGL = 20 FT
 AZIMUTH = 0 DEG, DAIP = 35.0 FT



BELL XV-15
 GW = 13000 LB, WAGL = 20 FT
 AZIMUTH = 0 DEG, DAIP = 45.0 FT

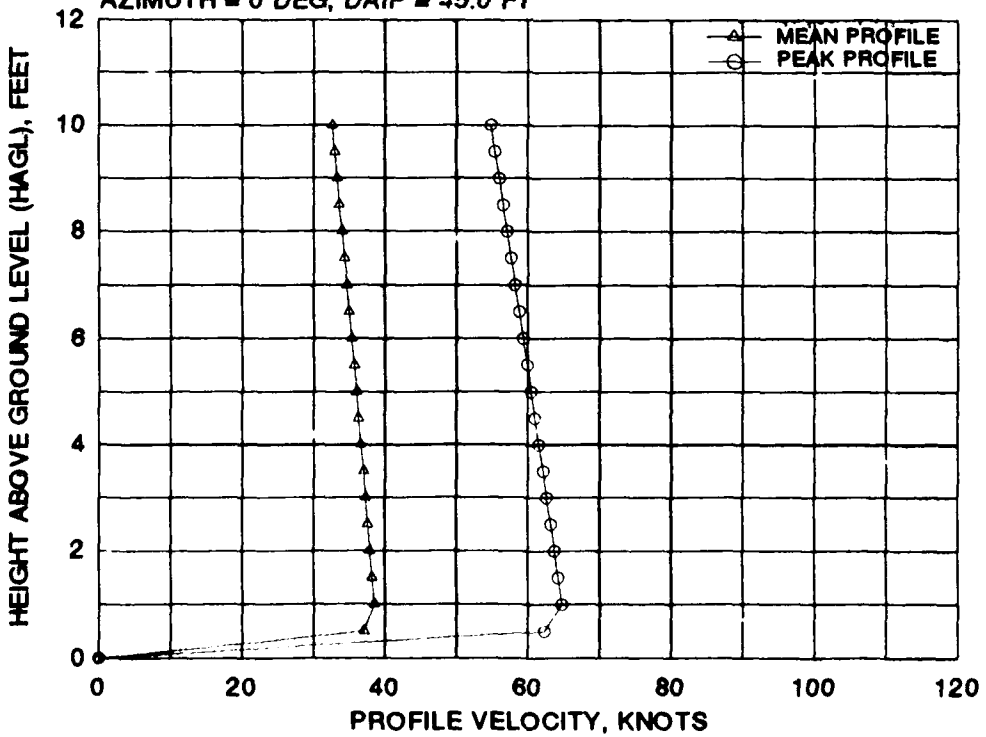
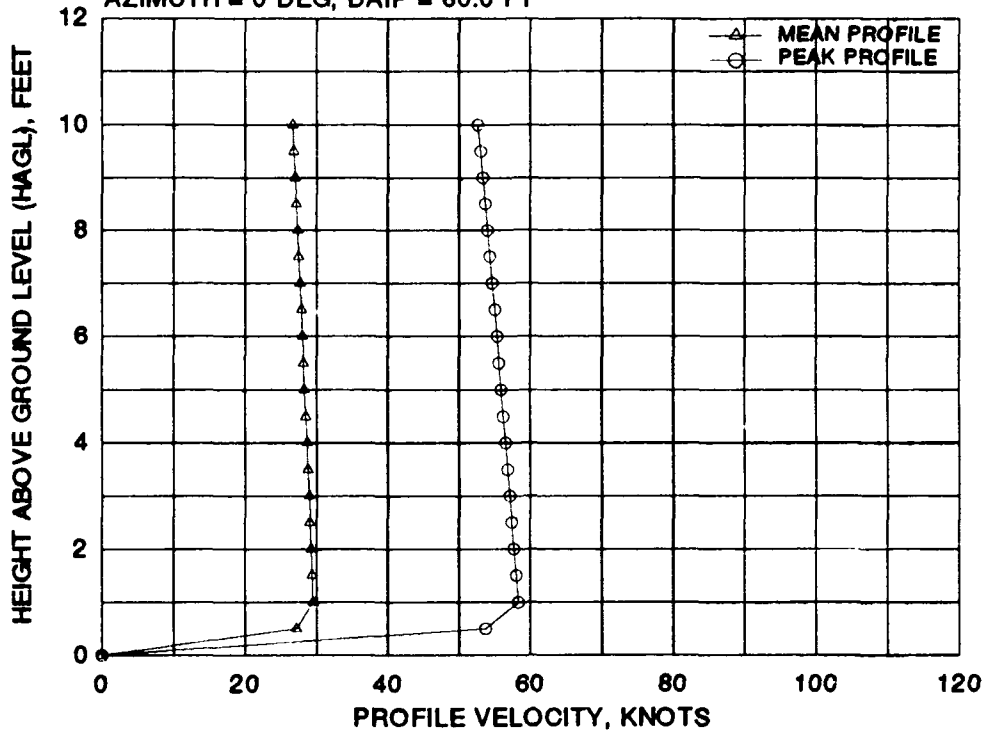

FIGURE A-3 BELL XV-15 MEAN AND PEAK VELOCITY PROFILES FOR EIGHT 0 DEGREE AZIMUTH RADIAL STATIONS AT A WHEEL HEIGHT OF 20 FEET AND A GROSS WEIGHT OF 13,000 POUNDS (Continued)

BELL XV-15
 GW = 13000 LB, WAGL = 20 FT
 AZIMUTH = 0 DEG, DAIP = 60.0 FT



BELL XV-15
 GW = 13000 LB, WAGL = 20 FT
 AZIMUTH = 0 DEG, DAIP = 80.0 FT

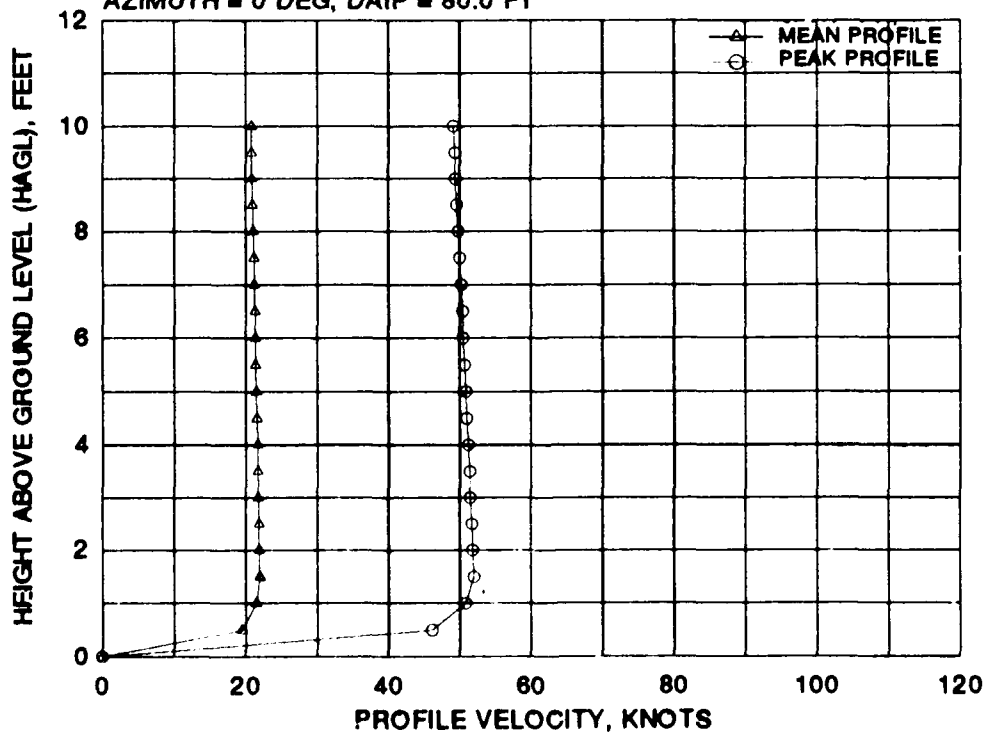
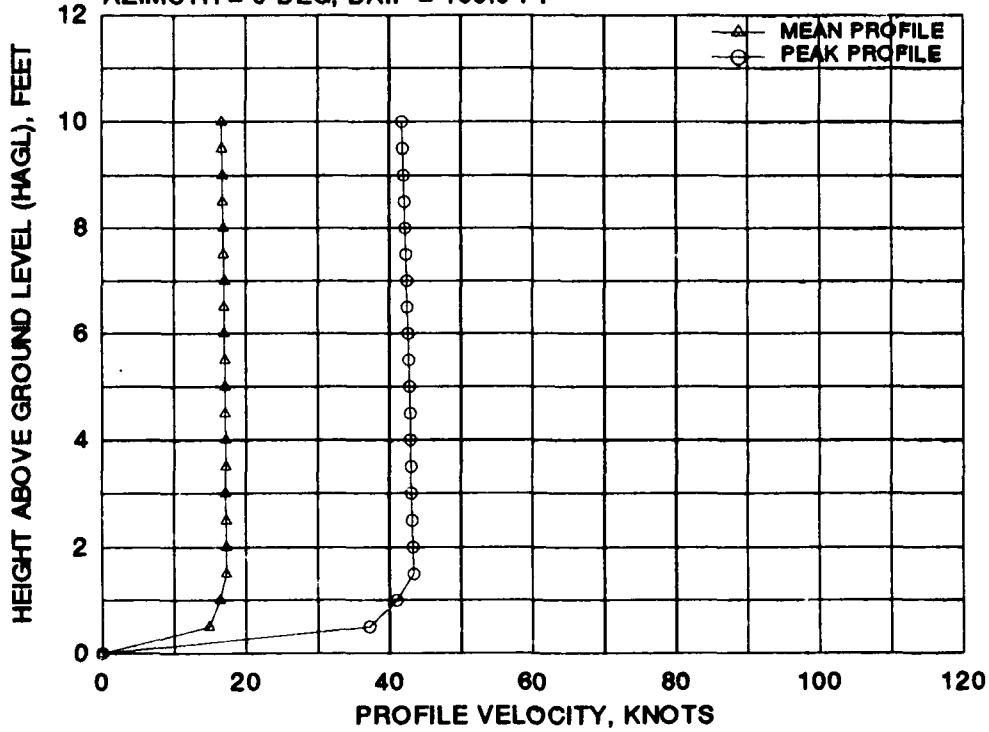

FIGURE A-3 BELL XV-15 MEAN AND PEAK VELOCITY PROFILES FOR EIGHT 0 DEGREE AZIMUTH RADIAL STATIONS AT A WHEEL HEIGHT OF 20 FEET AND A GROSS WEIGHT OF 13,000 POUNDS (Continued)

BELL XV-15
 GW = 13000 LB, WAGL = 20 FT
 AZIMUTH = 0 DEG, DAIP = 100.0 FT



BELL XV-15
 GW = 13000 LB, WAGL = 20 FT
 AZIMUTH = 0 DEG, DAIP = 120.0 FT

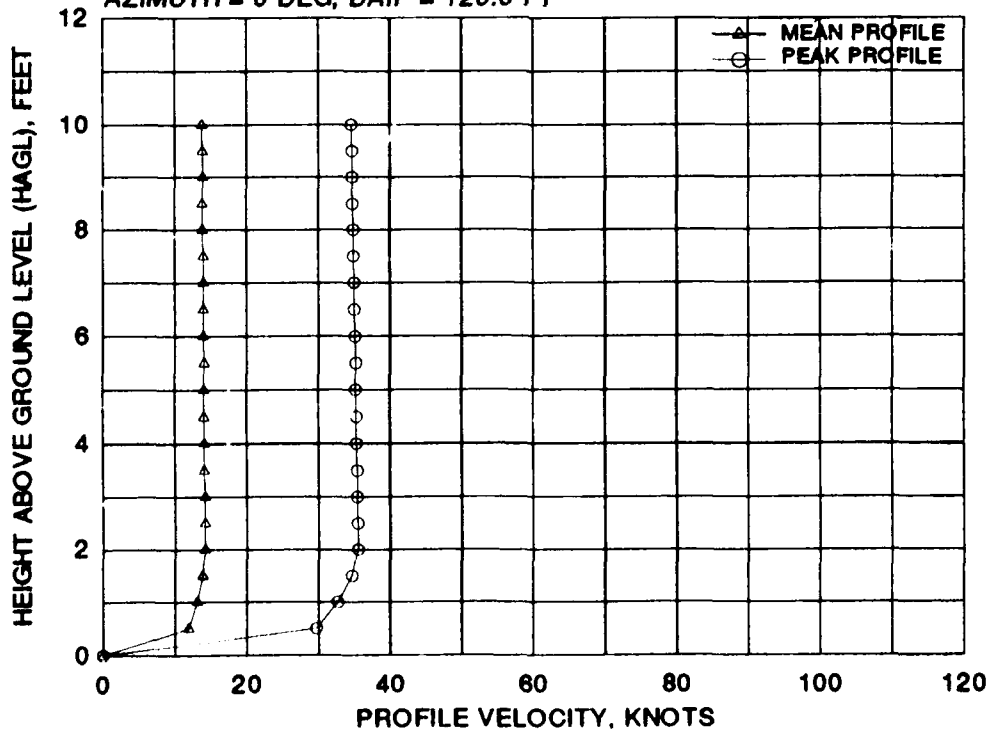

FIGURE A-3 BELL XV-15 MEAN AND PEAK VELOCITY PROFILES FOR EIGHT 0 DEGREE AZIMUTH RADIAL STATIONS AT A WHEEL HEIGHT OF 20 FEET AND A GROSS WEIGHT OF 13,000 POUNDS (Concluded)

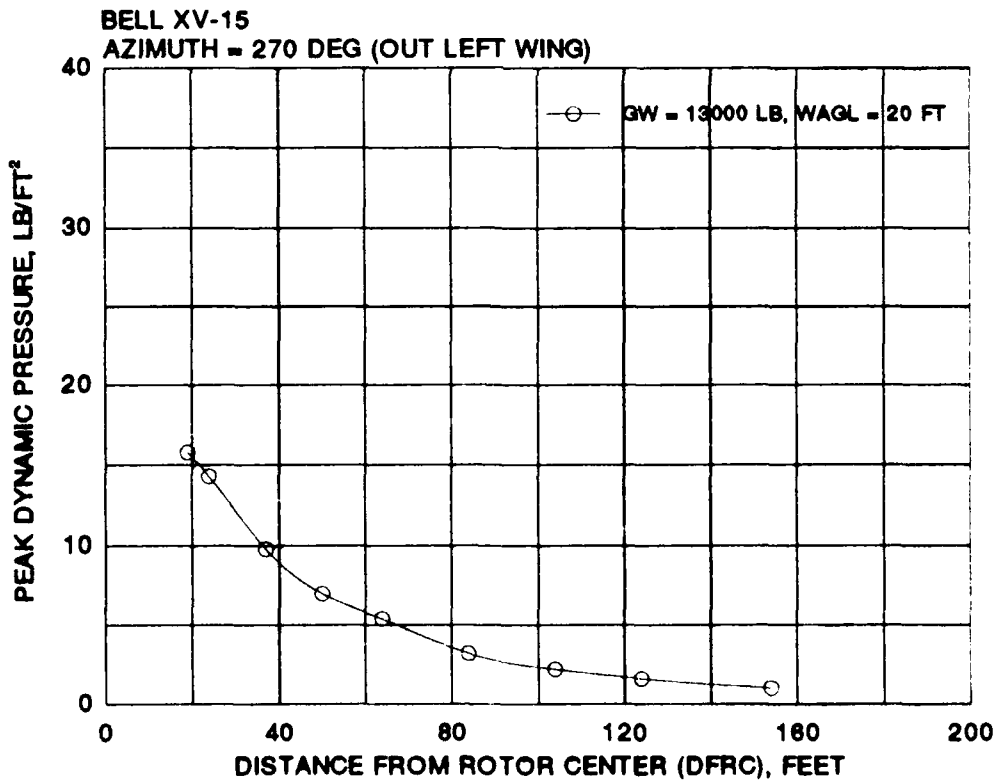
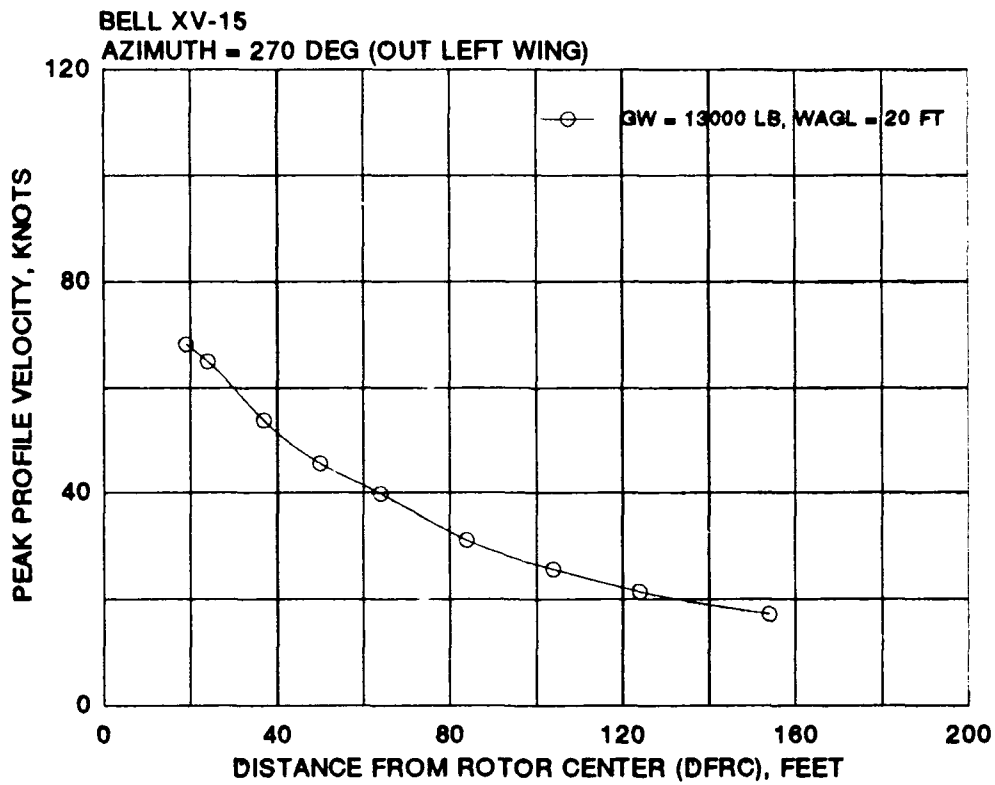

FIGURE A-4 BELL XV-15 PEAK ROTORWASH VELOCITY AND DYNAMIC PRESSURE AS A FUNCTION OF DISTANCE FROM THE ROTOR CENTER (270 DEGREE AZIMUTH)

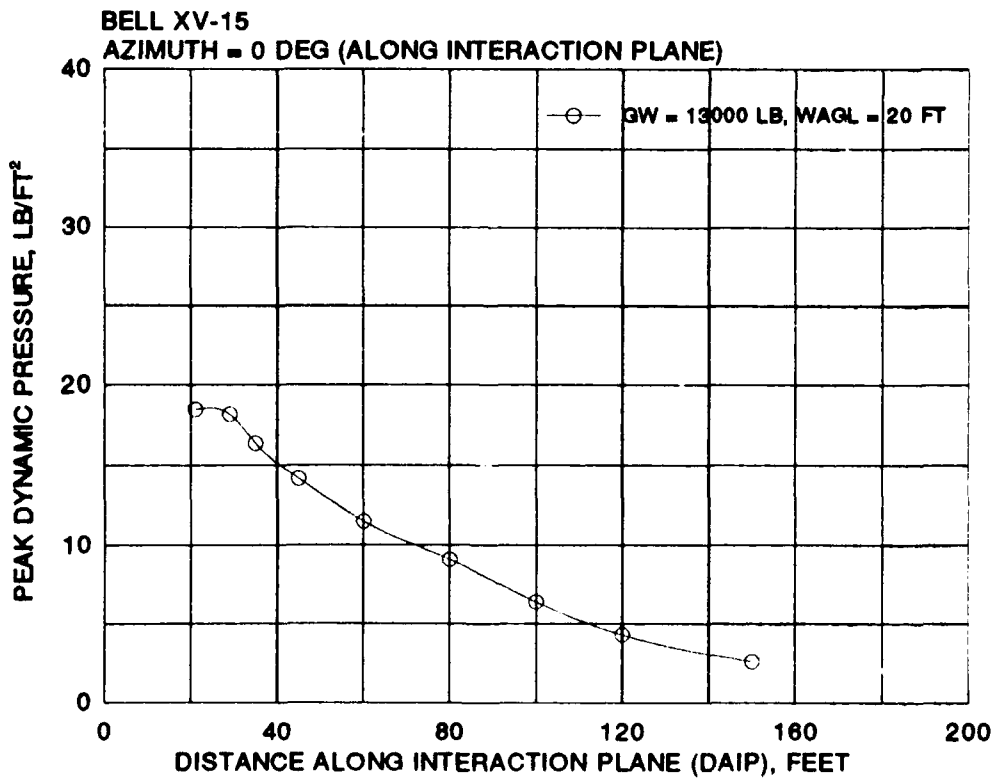
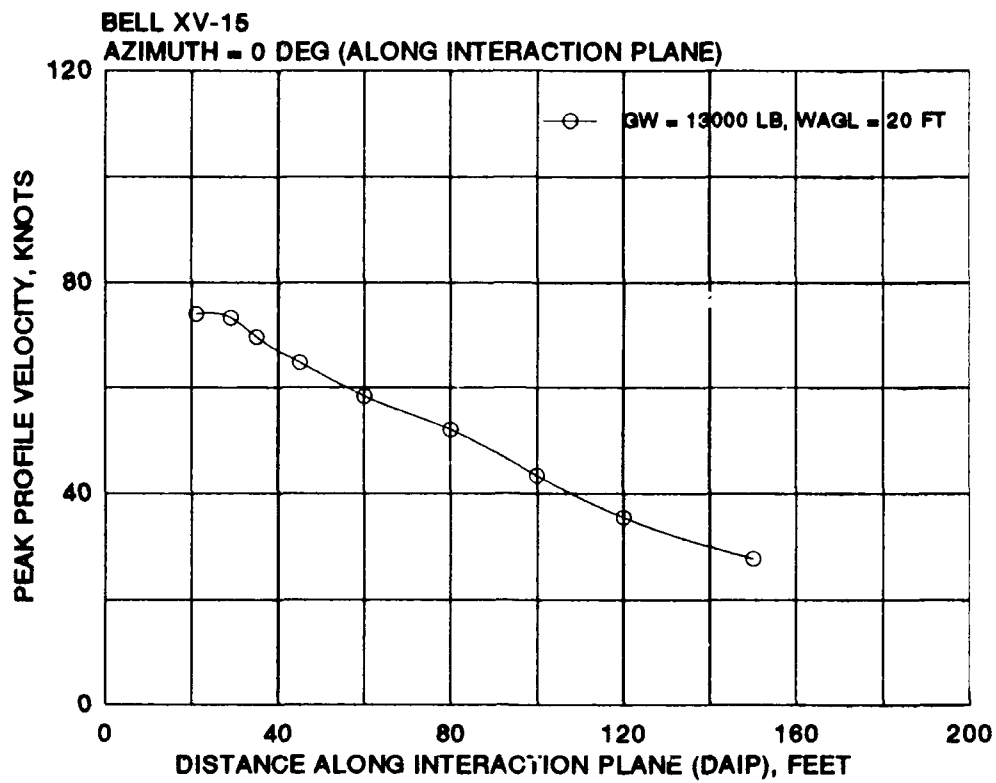

FIGURE A-5 BELL XV-15 PEAK ROTORWASH VELOCITY AND DYNAMIC PRESSURE AS A FUNCTION OF DISTANCE ALONG THE INTERACTION PLANE (0 DEGREE AZIMUTH)

BELL XV-15
AZIMUTH = 270 DEG (OUT LEFT WING)

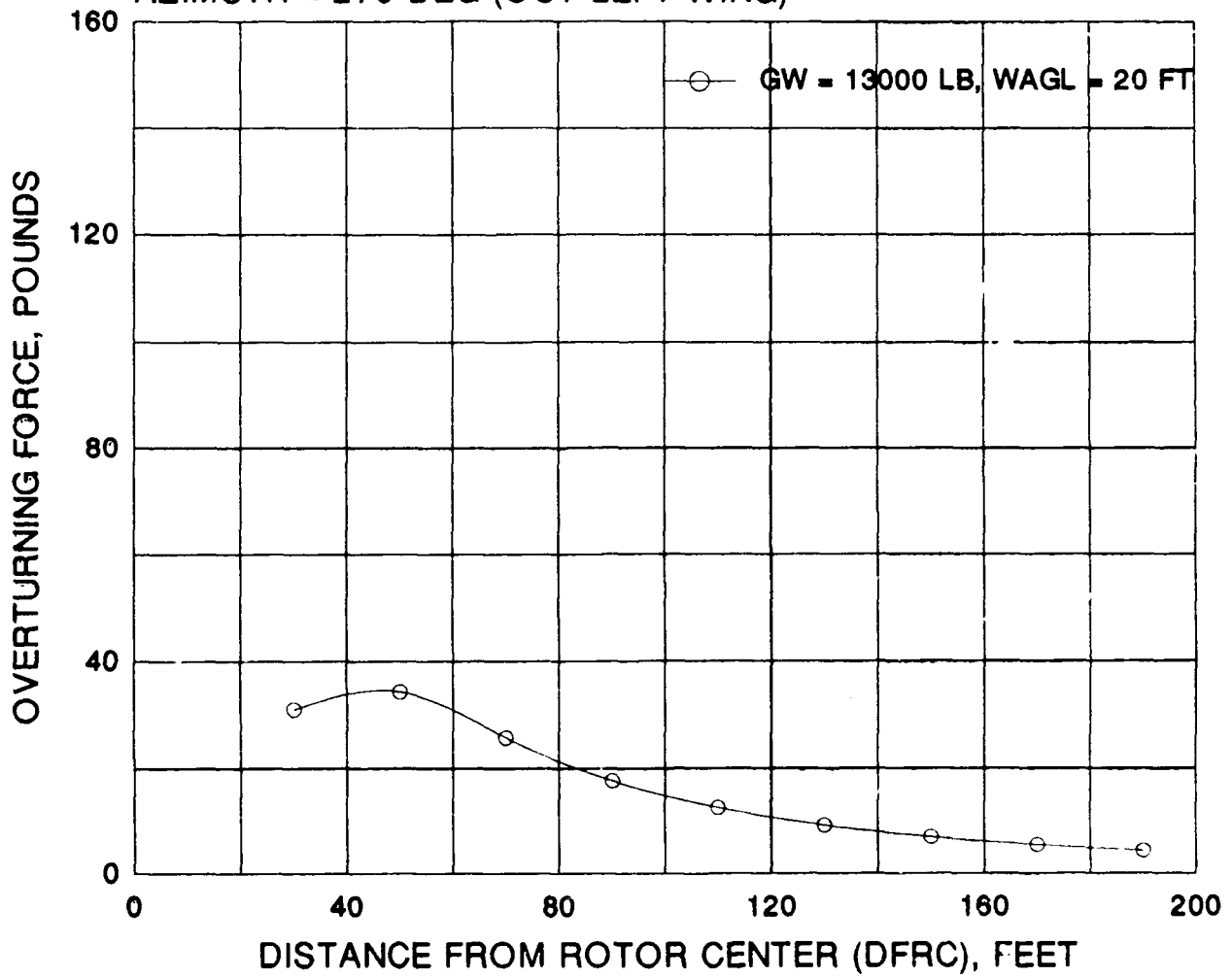

FIGURE A-6 BELL XV-15 OVERTURNING FORCE AS A FUNCTION OF DISTANCE FROM THE ROTOR CENTER (270 DEGREE AZIMUTH)

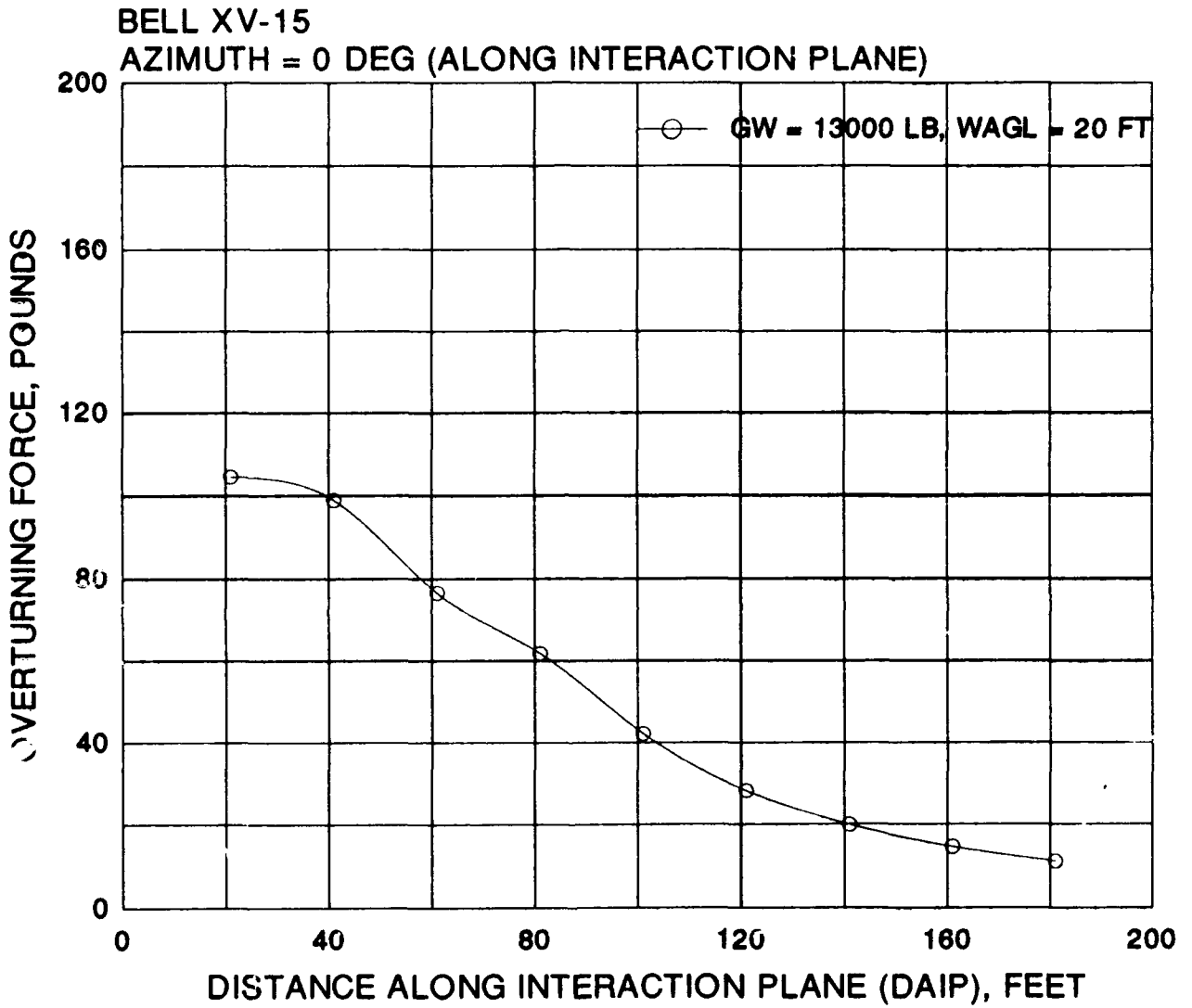

FIGURE A-7 BELL XV-15 OVERTURNING FORCE AS A FUNCTION OF DISTANCE ALONG THE INTERACTION PLANE (0 DEGREE AZIMUTH)

APPENDIX B

BELL/BOEING MV-22 AIRCRAFT AND ROTORWASH DATA

Bell/Boeing MV-22 aircraft characteristics used with the ROTWASH analysis program are listed in table B-1 as obtained from reference B-1. Figure B-1 presents a three-view drawing of the tiltrotor. Table B-2 provides a summary tabulation of parameters defining the conditions for all rotorwash data presented in the appendix. All data are plotted in one of four formats, which include graphs of:

1. mean and peak outwash velocity profiles,
2. peak outwash velocity versus distance,
3. peak outwash dynamic pressure versus distance, and
4. personnel overturning force versus distance.

In each format, data are plotted along both the 0 and 270 degree azimuth. Distance from rotor center (DFRC) is the independent variable along the 270 degree azimuth. Measurements of distance from aircraft center (DFAC) are also noted on the graphs. The DFAC reference point is defined as zero at the location where the aircraft centerline intersects the line connecting the two rotor centers of rotation. Along the 0 degree azimuth, distance along the interaction plane (DAIP) is the independent variable. This point is referenced as zero at the same location as the DFAC point.

REFERENCES

- B-1. Blohm, R., and K. Bartie, "V-22 Aerodynamic Report," Bell/Boeing Report 901-909-632, July 1986.

TABLE B-1 MV-22 ROTWASH INPUT DATA

<u>Parameter</u>	<u>Value</u>
Rotor radius, feet	19.0
Distance between rotor centers, feet	46.6
Wing download, percent of rotor thrust	10.0
Distance from wheels to rotor plane, feet	20.8
Rotor speed, RPM	397.0
Rotor tip speed, feet/second	789.5
Number of rotor blades per rotor	3
Density ratio	1.0

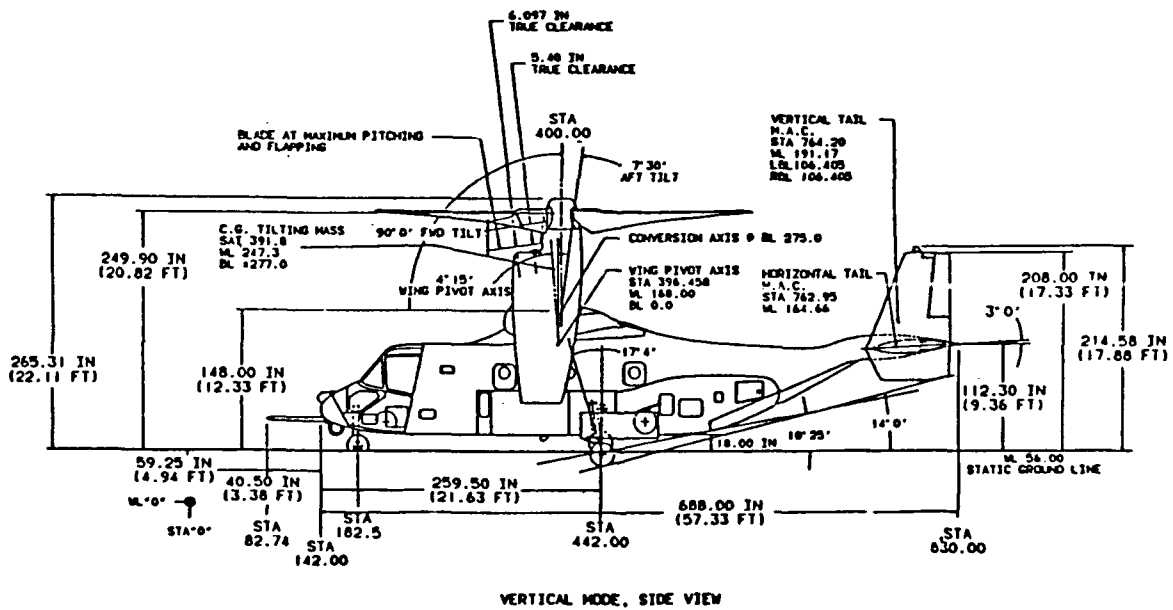
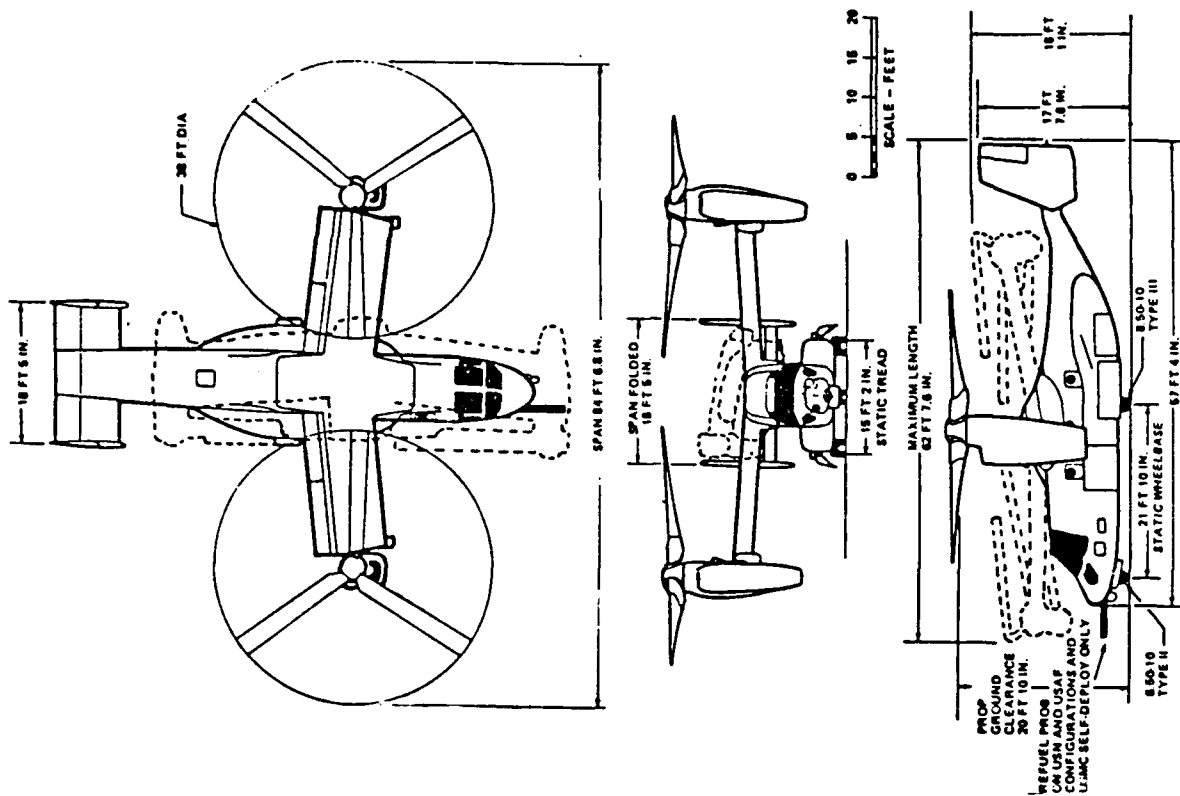

FIGURE B-1 THREE-VIEW DRAWING OF THE BELL MV-22

TABLE B-2 MV-22 ROTORWASH EVALUATION MATRIX

Note: The Figure/Type column provides the figure number and data format type where:

M/P - Mean and peak velocity profile format

PVD - Peak velocity and dynamic pressure format

OTF - Personnel overturning force format

<u>Figure/ Type</u>	<u>Azimuth, Degrees</u>	<u>GW, Pounds</u>	<u>WAGL, Feet</u>	<u>DFRC or DAIP Distance, Feet</u>
B-2 M/P	270.0	40,000	5	29.7, 42.7, 56.7, 76.7, 96.7, 116.7, 146.7, 176.7
B-3 M/P	270.0	40,000	30	29.7, 42.7, 56.7, 76.7, 96.7, 116.7, 146.7, 176.7
B-4 M/P	270.0	47,500	5	29.7, 42.7, 56.7, 76.7, 96.7, 116.7, 146.7, 176.7
B-5 M/P	270.0	47,500	30	29.7, 42.7, 56.7, 76.7, 96.7, 116.7, 146.7, 176.7
B-6 M/P	0.0	40,000	5	29, 35, 45, 60, 80, 100, 120, 150, 200
B-7 M/P	0.0	40,000	30	29, 35, 45, 60, 80, 100, 120, 150, 200
B-8 M/P	0.0	47,500	5	29, 35, 45, 60, 80, 100, 120, 150, 200
B-9 M/P	0.0	47,500	30	29, 35, 45, 60, 80, 100, 120, 150, 200
B-10 PVD	270.0	40,000 47,500	5, 30	30 to 180
B-11 PVD	0.0	40,000 47,500	5, 30	30 to 200
B-12 OTF	270.0	40,000 47,500	5, 30	30 to 170
B-13 OTF	0.0	40,000 47,500	5, 30	30 to 200

BELL-BOEING MV-22 OSPREY
 GW = 40000 LBS, WAGL = 5 FT
 AZIMUTH = 270 DEG, DFAC = 53.0 FT (DFRC = 29.72 FT)

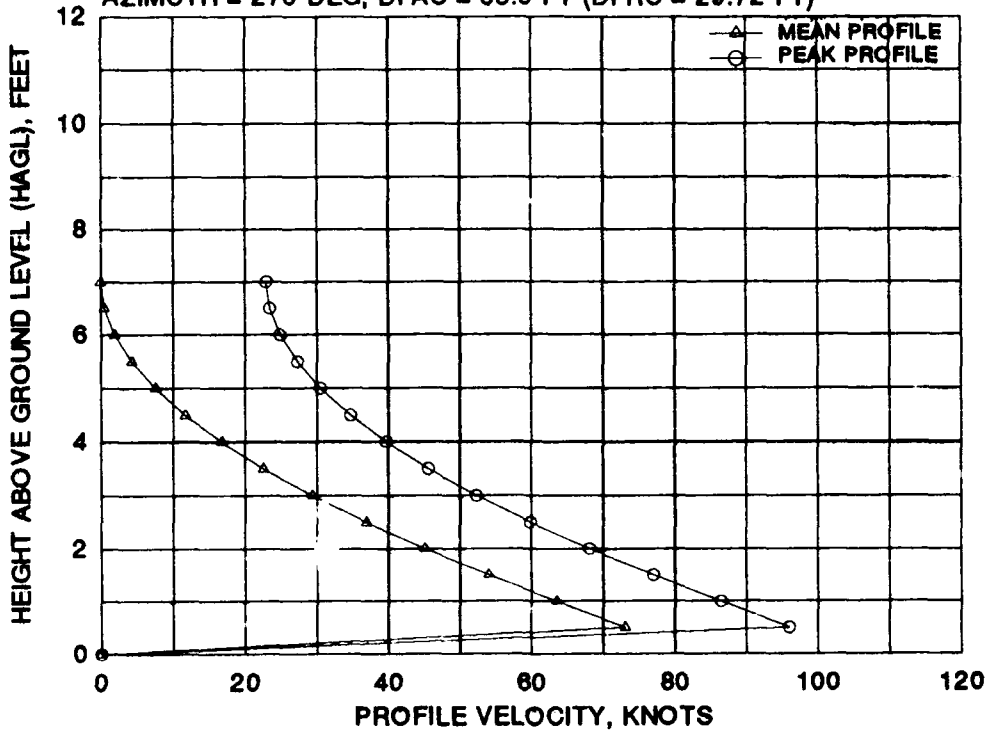

BELL-BOEING MV-22 OSPREY
 GW = 40000 LBS, WAGL = 5 FT
 AZIMUTH = 270 DEG, DFAC = 66.0 FT (DFRC = 42.72 FT)

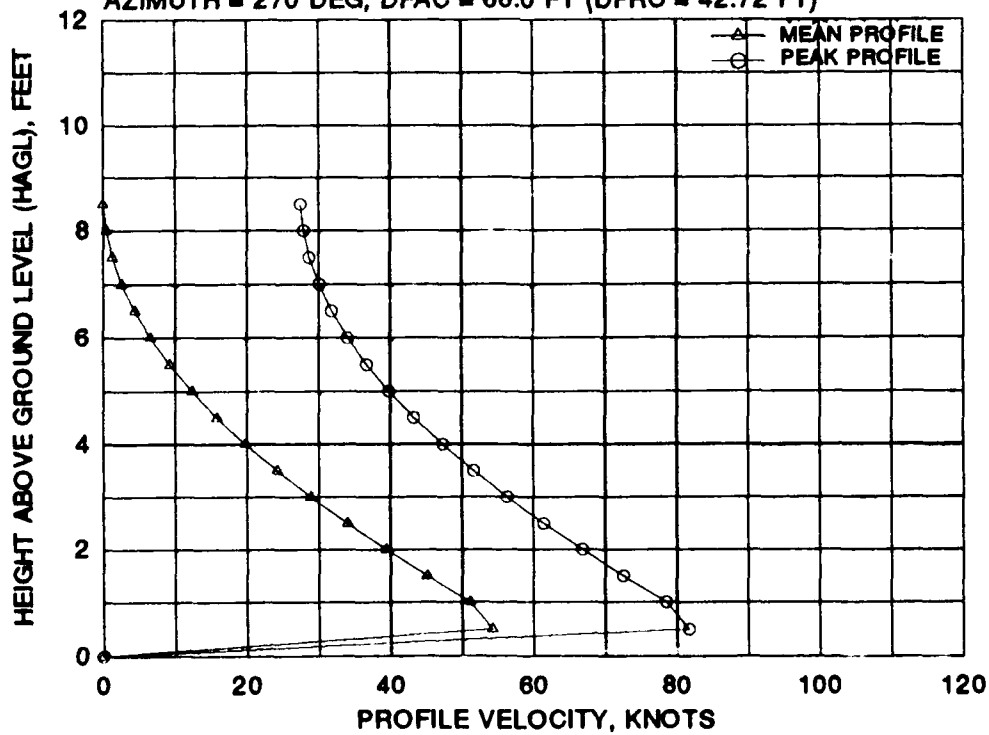
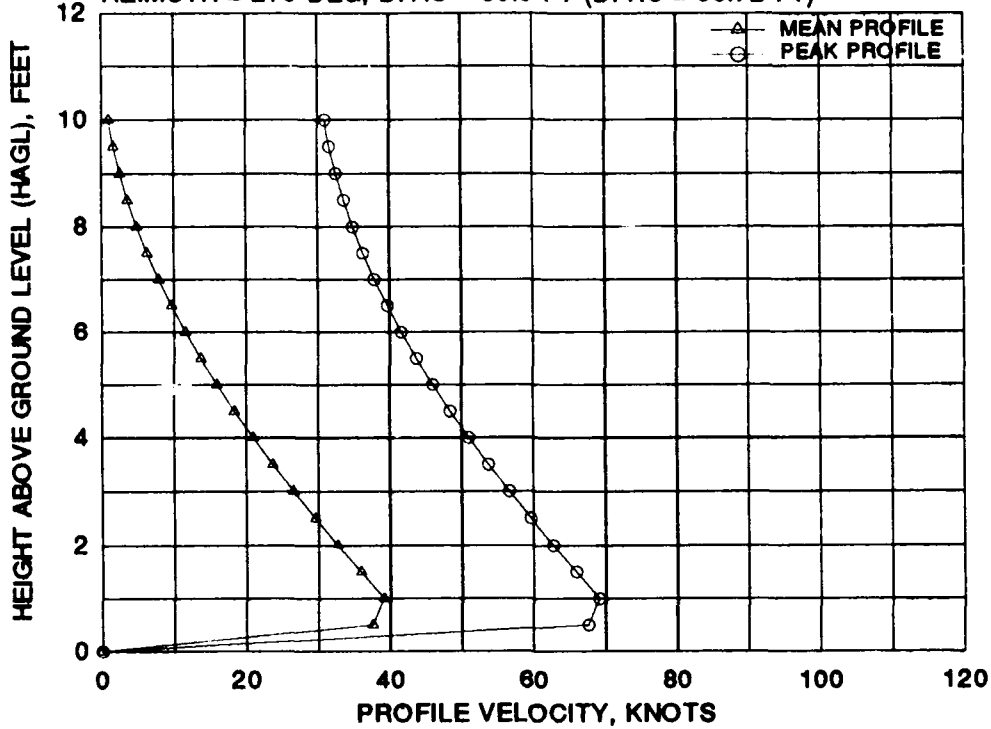

FIGURE B-2 BELL/BOEING MV-22 MEAN AND PEAK VELOCITY PROFILES FOR EIGHT 270 DEGREE AZIMUTH RADIAL STATIONS AT A WHEEL HEIGHT OF 5 FEET AND A GROSS WEIGHT OF 40,000 POUNDS

BELL-BOEING MV-22 OSPREY
 GW = 40000 LBS, WAGL = 5 FT
 AZIMUTH = 270 DEG, DFAC = 80.0 FT (DFRC = 56.72 FT)



BELL-BOEING MV-22 OSPREY
 GW = 40000 LBS, WAGL = 5 FT
 AZIMUTH = 270 DEG, DFAC = 100.0 FT (DFRC = 76.72 FT)

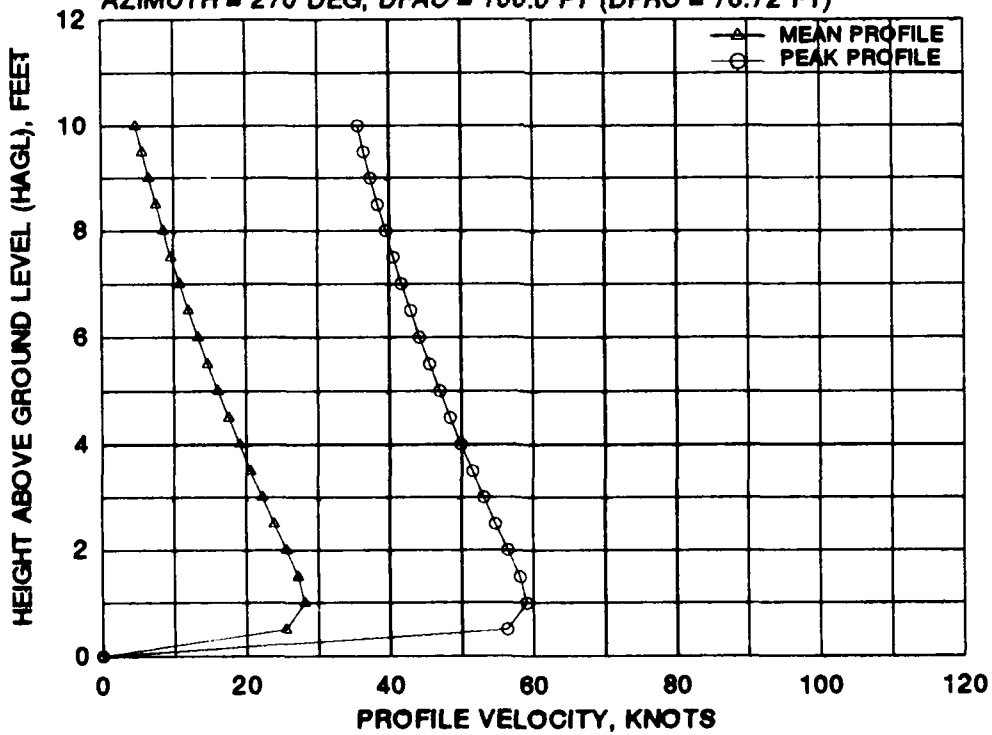
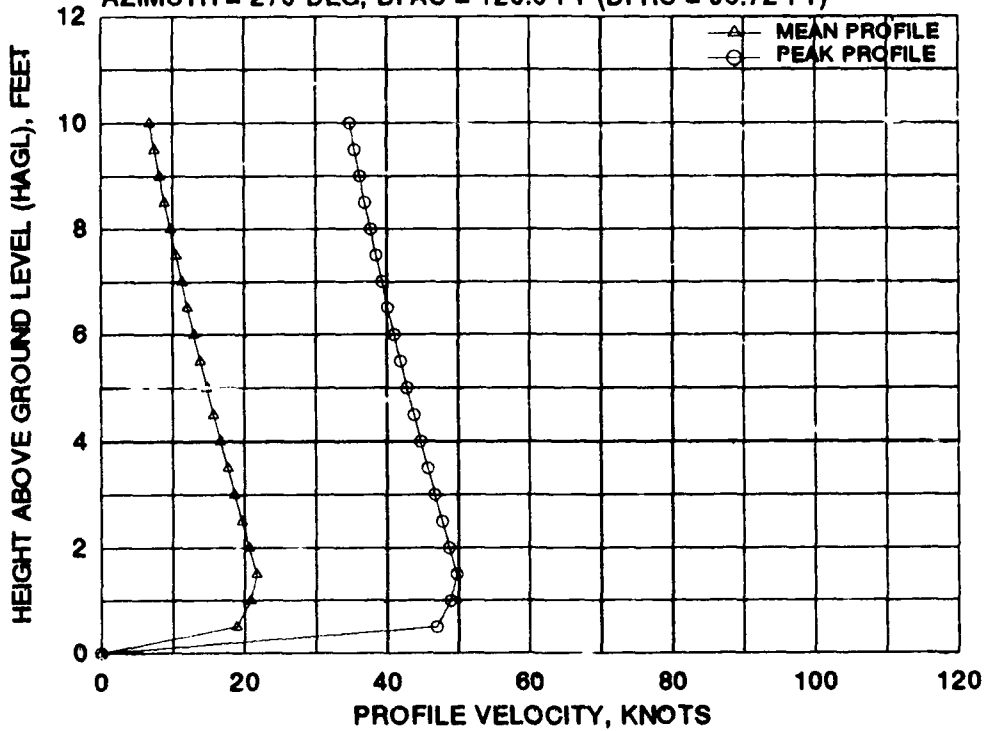

FIGURE B-2 BELL/BOEING MV-22 MEAN AND PEAK VELOCITY PROFILES FOR EIGHT 270 DEGREE AZIMUTH RADIAL STATIONS AT A WHEEL HEIGHT OF 5 FEET AND A GROSS WEIGHT OF 40,000 POUNDS (Continued)

BELL-BOEING MV-22 OSPREY
 GW = 40000 LBS, WAGL = 5 FT
 AZIMUTH = 270 DEG, DFAC = 120.0 FT (DFRC = 96.72 FT)



BELL-BOEING MV-22 OSPREY
 GW = 40000 LBS, WAGL = 5 FT
 AZIMUTH = 270 DEG, DFAC = 140.0 FT (DFRC = 116.72 FT)

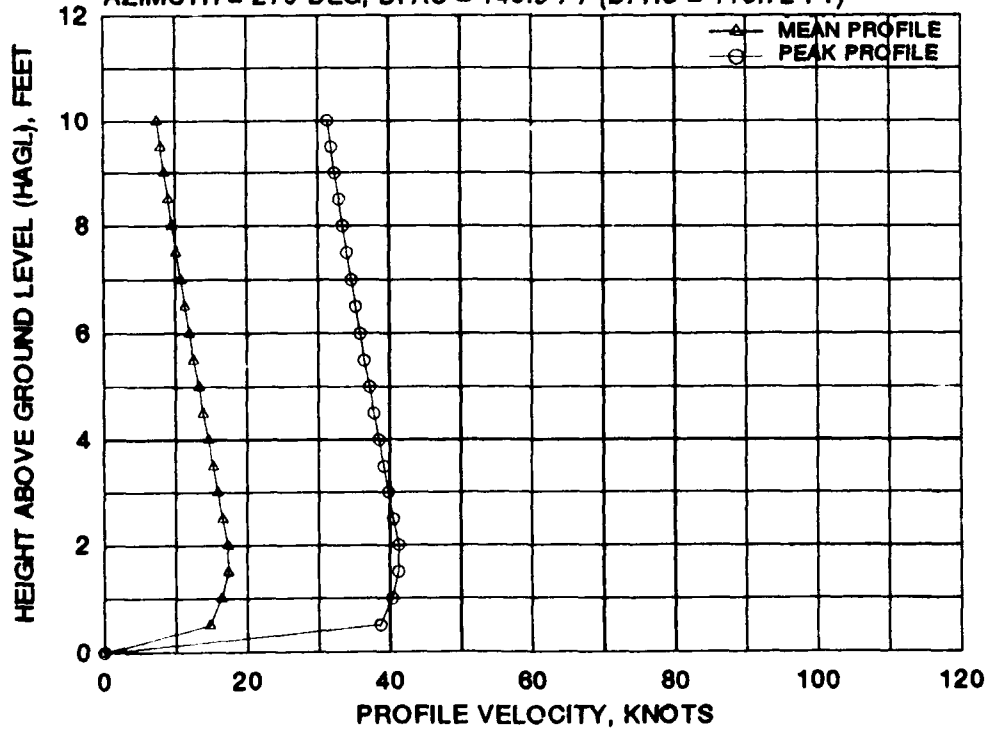
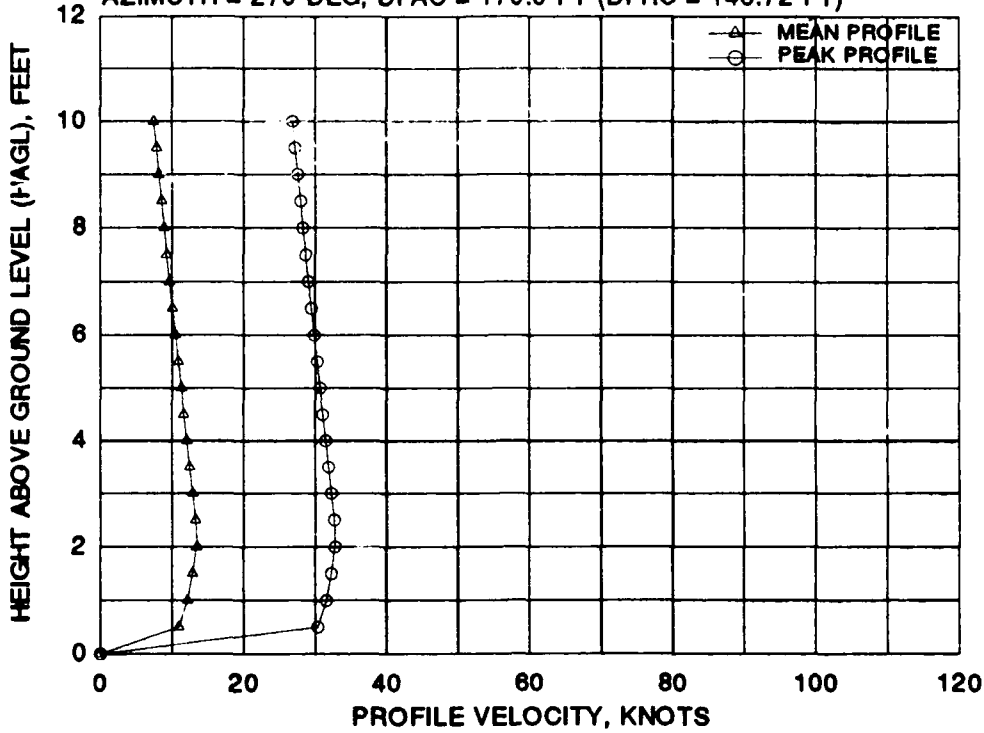

FIGURE B-2 BELL/BOEING MV-22 MEAN AND PEAK VELOCITY PROFILES FOR EIGHT 270 DEGREE AZIMUTH RADIAL STATIONS AT A WHEEL HEIGHT OF 5 FEET AND A GROSS WEIGHT OF 40,000 POUNDS (Continued)

BELL-BOEING MV-22 OSPREY
 GW = 40000 LBS, WAGL = 5 FT
 AZIMUTH = 270 DEG, DFAC = 170.0 FT (DFRC = 146.72 FT)



BELL-BOEING MV-22 OSPREY
 GW = 40000 LBS, WAGL = 5 FT
 AZIMUTH = 270 DEG, DFAC = 200.0 FT (DFRC = 176.72 FT)

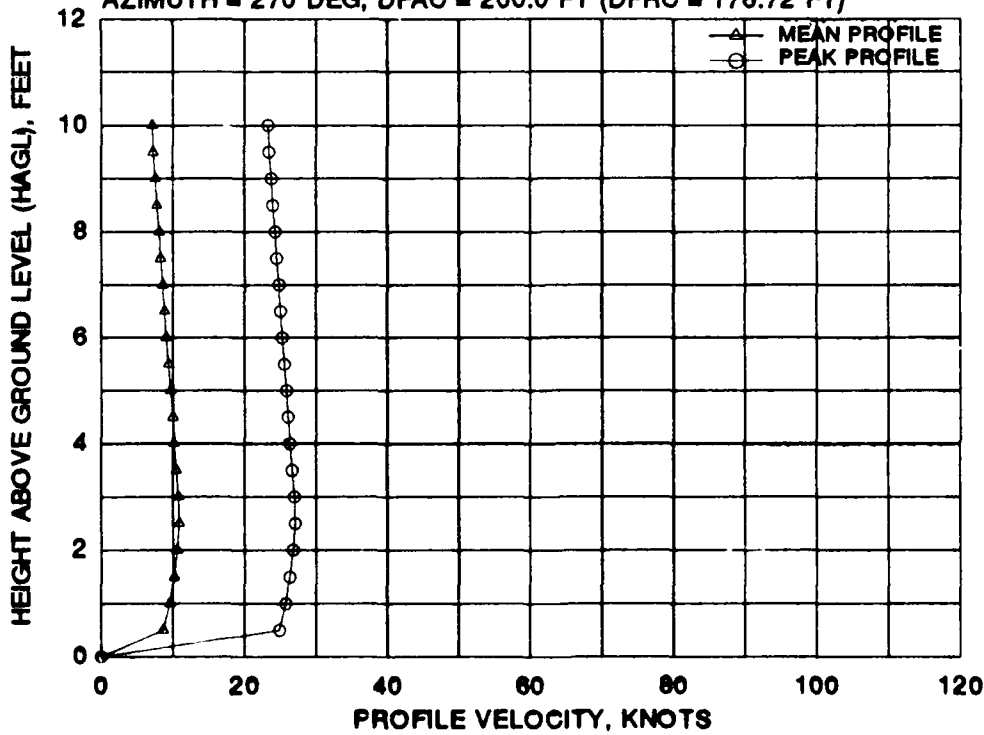
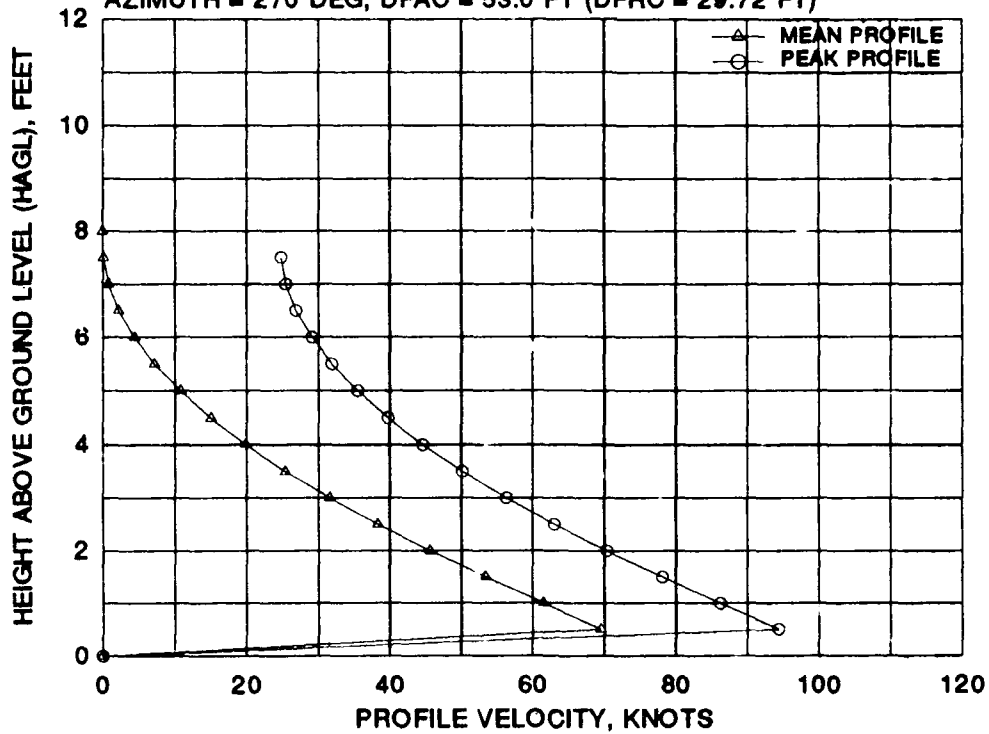

FIGURE B-2 BELL/BOEING MV-22 MEAN AND PEAK VELOCITY PROFILES FOR EIGHT 270 DEGREE AZIMUTH RADIAL STATIONS AT A WHEEL HEIGHT OF 5 FEET AND A GROSS WEIGHT OF 40,000 POUNDS (Concluded)

BELL-BOEING MV-22 OSPREY
 GW = 40000 LBS, WAGL = 30 FT
 AZIMUTH = 270 DEG, DFAC = 53.0 FT (DFRC = 29.72 FT)



BELL-BOEING MV-22 OSPREY
 GW = 40000 LBS, WAGL = 30 FT
 AZIMUTH = 270 DEG, DFAC = 66.0 FT (DFRC = 42.72 FT)

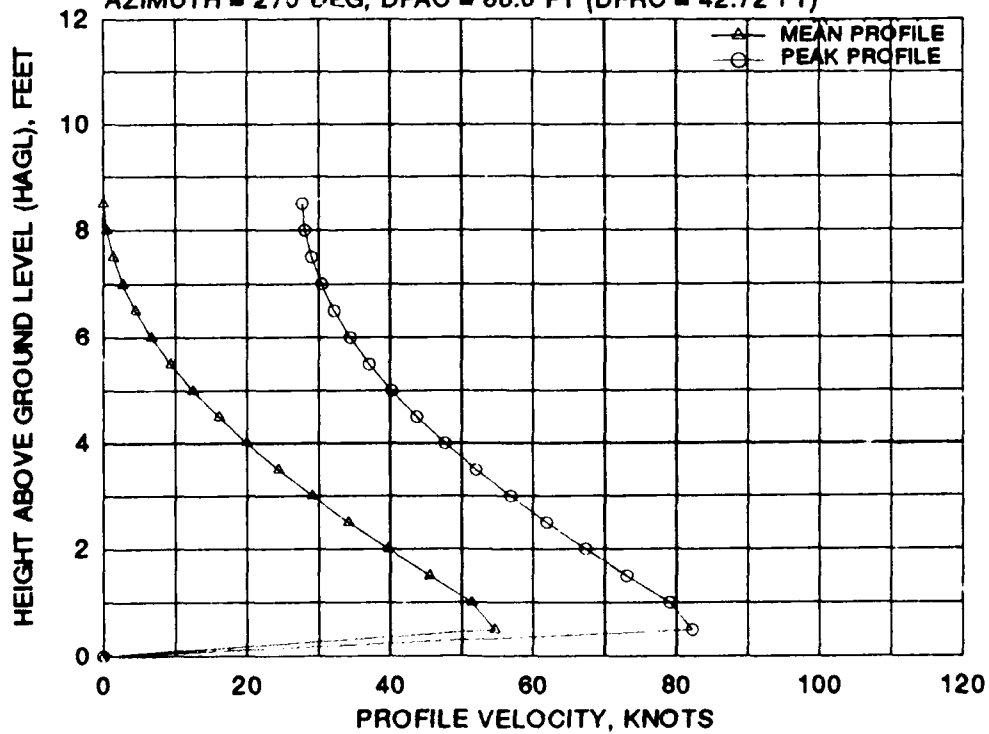
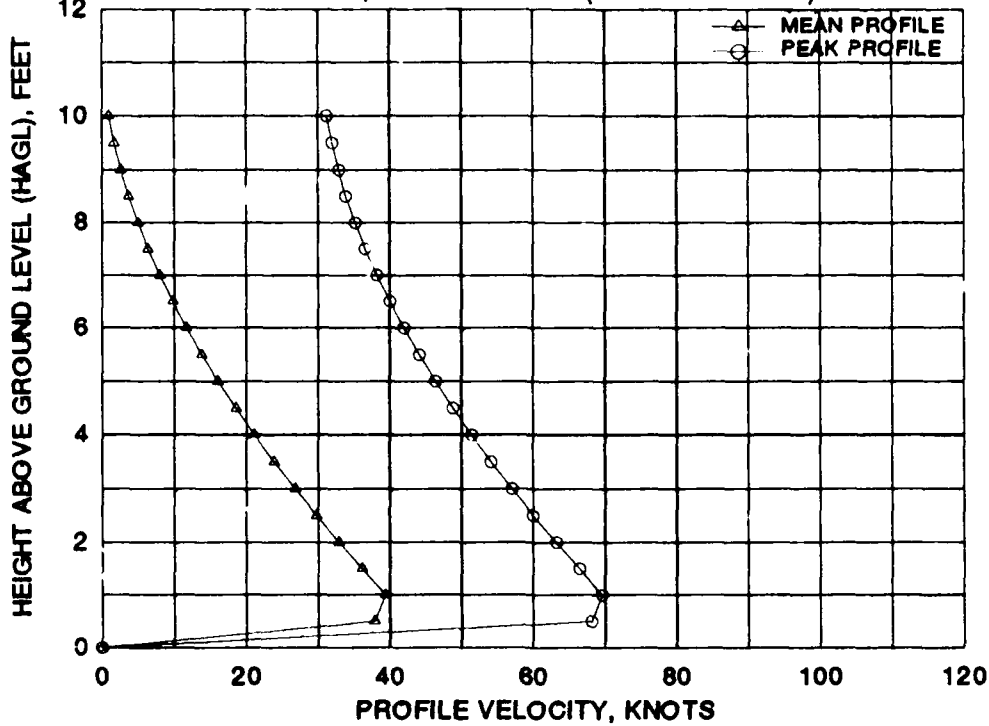

FIGURE B-3 BELL/BOEING MV-22 MEAN AND PEAK VELOCITY PROFILES FOR EIGHT 270 DEGREE AZIMUTH RADIAL STATIONS AT A WHEEL HEIGHT OF 30 FEET AND A GROSS WEIGHT OF 40,000 POUNDS

BELL-BOEING MV-22 OSPREY
 GW = 40000 LBS, WAGL = 30 FT
 AZIMUTH = 270 DEG, DFAC = 80.0 FT (DFRC = 56.72 FT)



BELL-BOEING MV-22 OSPREY
 GW = 40000 LBS, WAGL = 30 FT
 AZIMUTH = 270 DEG, DFAC = 100.0 FT (DFRC = 76.72 FT)

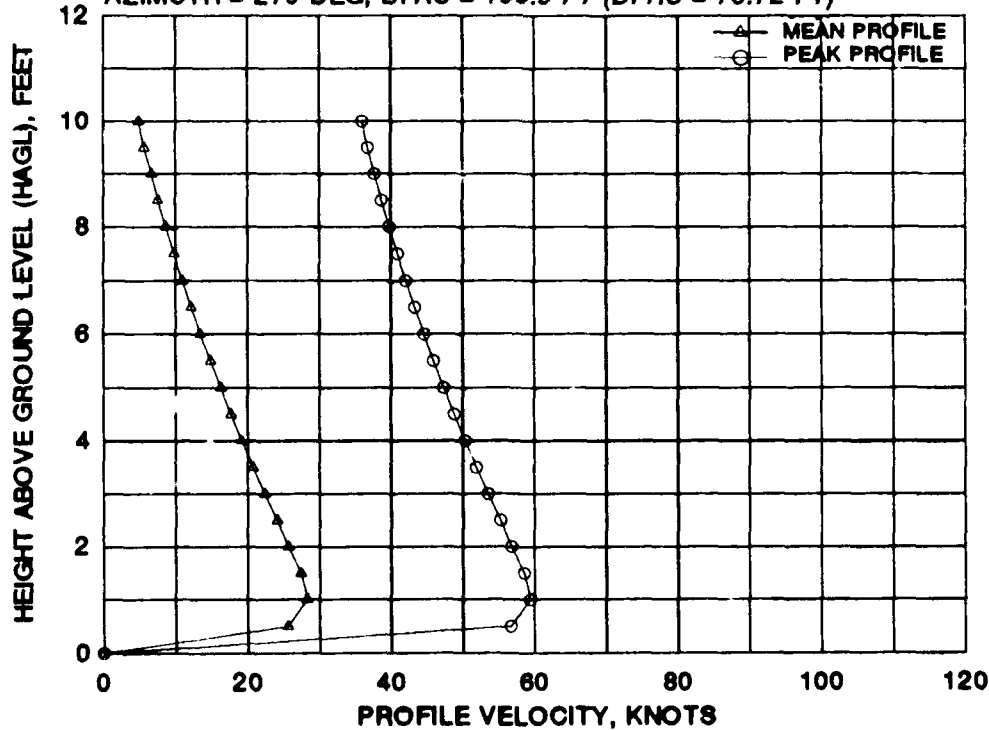
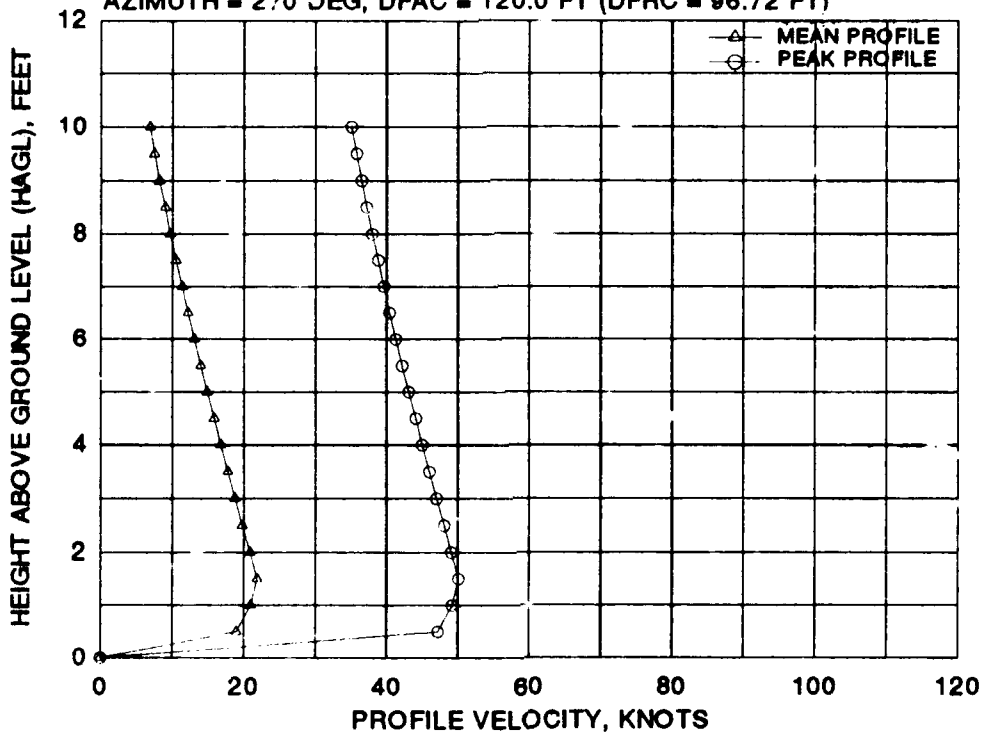

FIGURE B-3 BELL/BOEING MV-22 MEAN AND PEAK VELOCITY PROFILES FOR EIGHT 270 DEGREE AZIMUTH RADIAL STATIONS AT A WHEEL HEIGHT OF 30 FEET AND A GROSS WEIGHT OF 40,000 POUNDS (Continued)

BELL-BOEING MV-22 OSPREY
 GW = 40000 LBS, WAGL = 30 FT
 AZIMUTH = 270 DEG, DFAC = 120.0 FT (DFRC = 96.72 FT)



BELL-BOEING MV-22 OSPREY
 GW = 40000 LBS, WAGL = 30 FT
 AZIMUTH = 270 DEG, DFAC = 140.0 FT (DFRC = 116.72 FT)

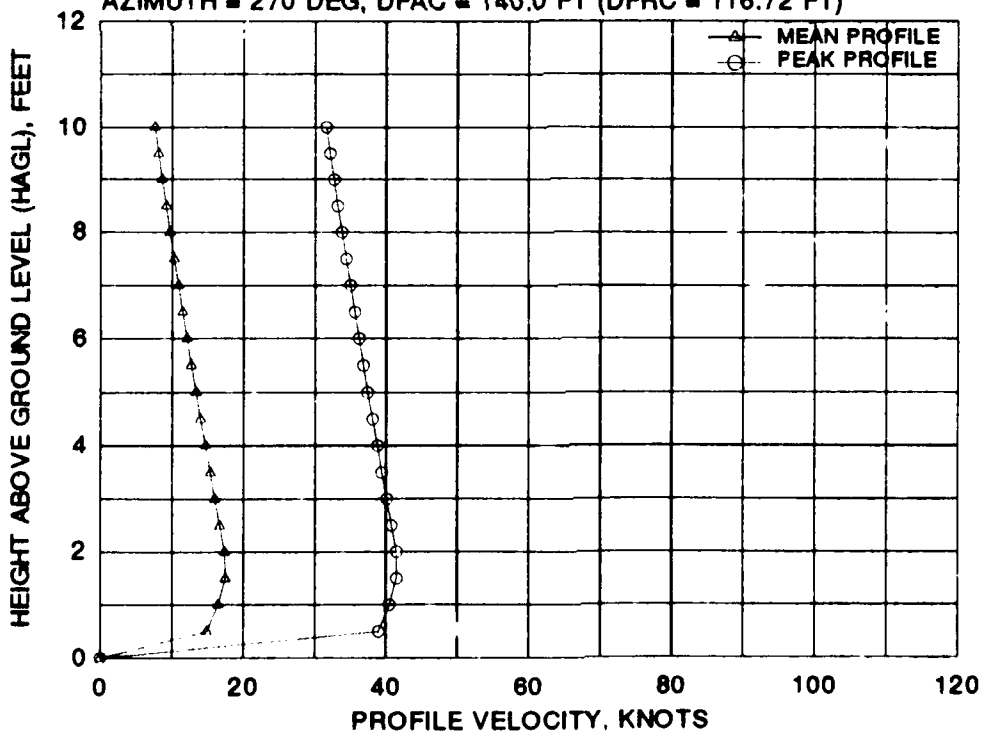
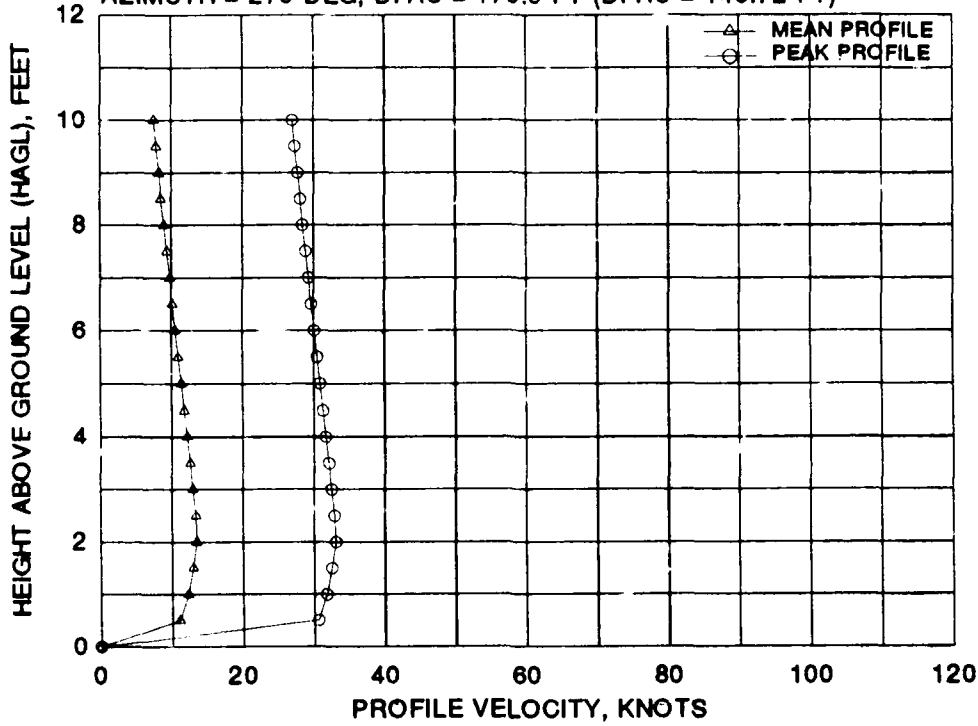

FIGURE B-3 BELL/BOEING MV-22 MEAN AND PEAK VELOCITY PROFILES FOR EIGHT 270 DEGREE AZIMUTH RADIAL STATIONS AT A WHEEL HEIGHT OF 30 FEET AND A GROSS WEIGHT OF 40,000 POUNDS (Continued)

BELL-BOEING MV-22 OSPREY
 GW = 40000 LBS, WAGL = 30 FT
 AZIMUTH = 270 DEG, DFAC = 170.0 FT (DFRC = 146.72 FT)



BELL-BOEING MV-22 OSPREY
 GW = 40000 LBS, WAGL = 30 FT
 AZIMUTH = 270 DEG, DFAC = 200.0 FT (DFRC = 176.72 FT)

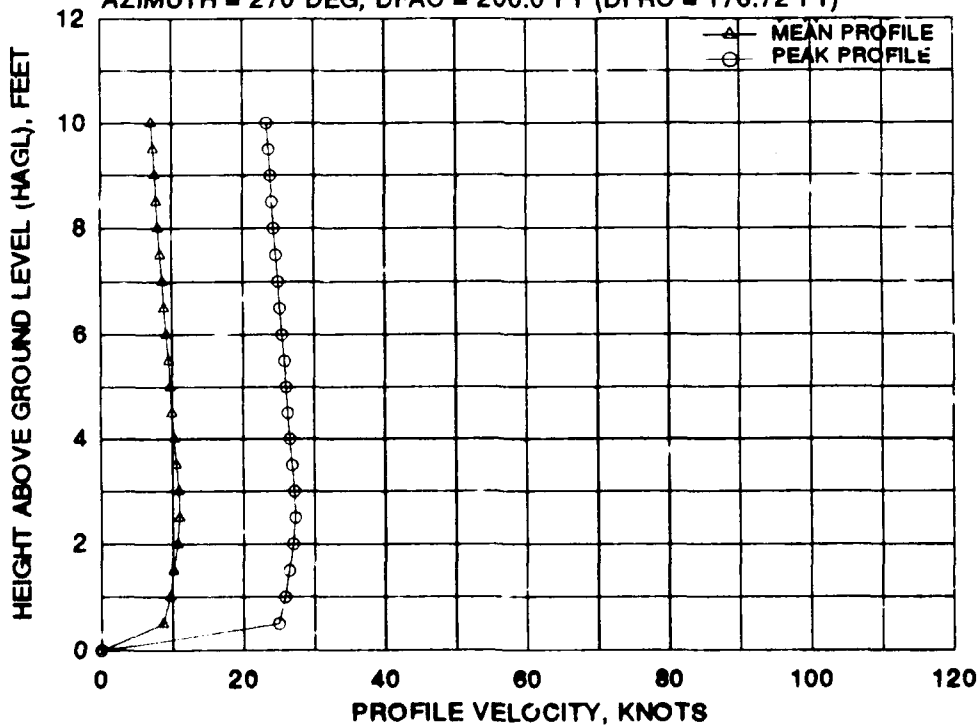
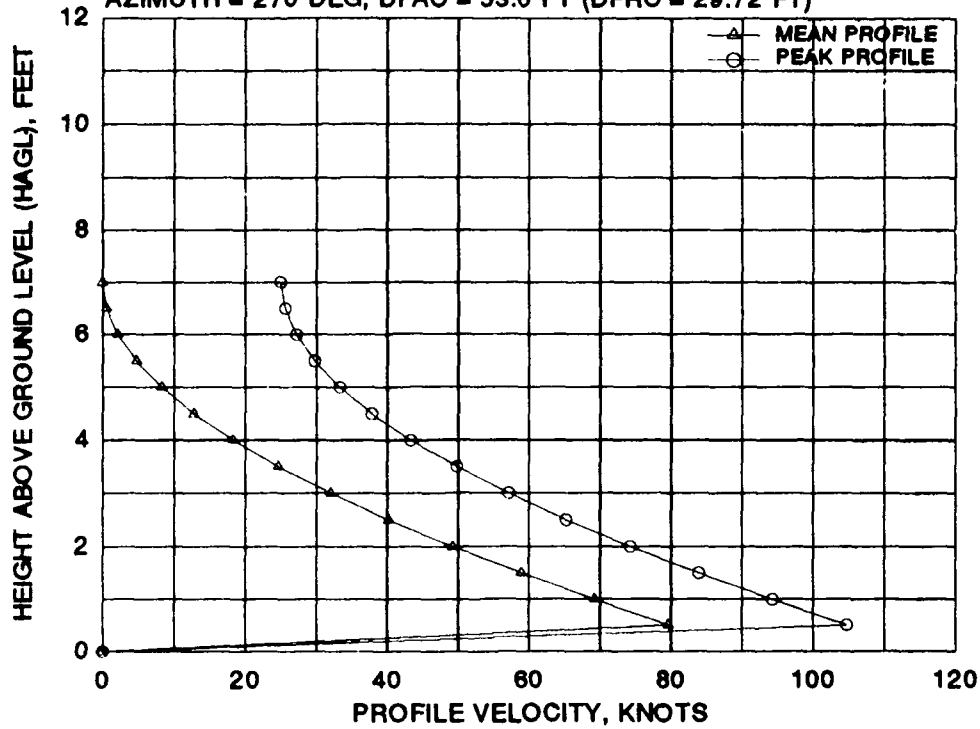

FIGURE B-3 BELL/BOEING MV-22 MEAN AND PEAK VELOCITY PROFILES FOR EIGHT 270 DEGREE AZIMUTH RADIAL STATIONS AT A WHEEL HEIGHT OF 30 FEET AND A GROSS WEIGHT OF 40,000 POUNDS (Concluded)

BELL-BOEING MV-22 OSPREY
 GW = 47500 LBS, WAGL = 5 FT
 AZIMUTH = 270 DEG, DFAC = 53.0 FT (DFRC = 29.72 FT)



BELL-BOEING MV-22 OSPREY
 GW = 47500 LBS, WAGL = 5 FT
 AZIMUTH = 270 DEG, DFAC = 66.0 FT (DFRC = 42.72 FT)

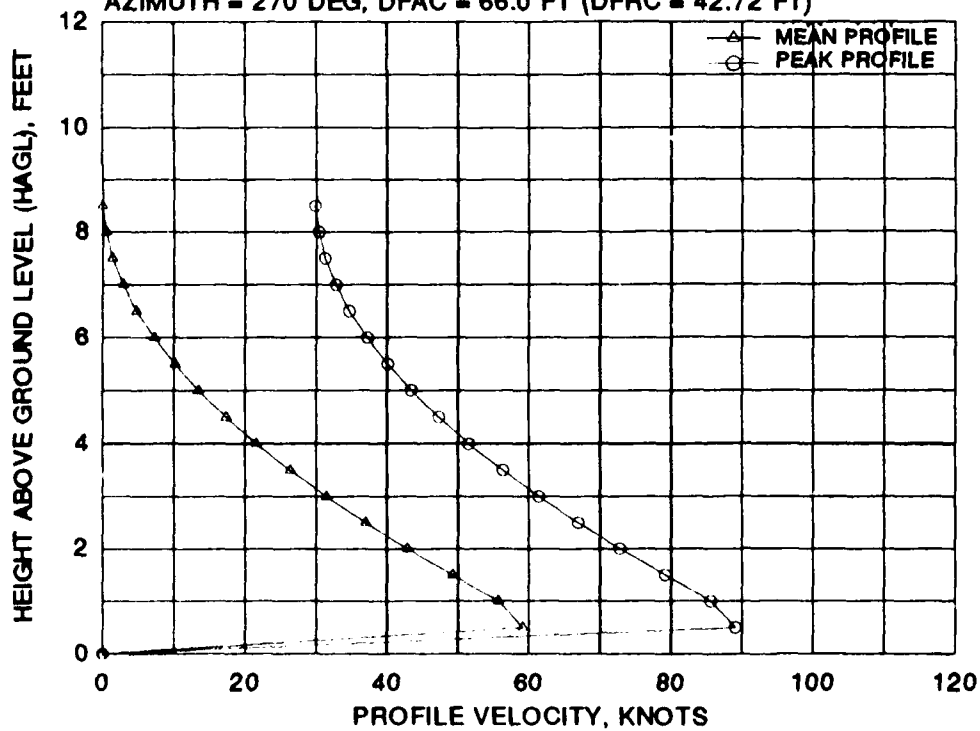
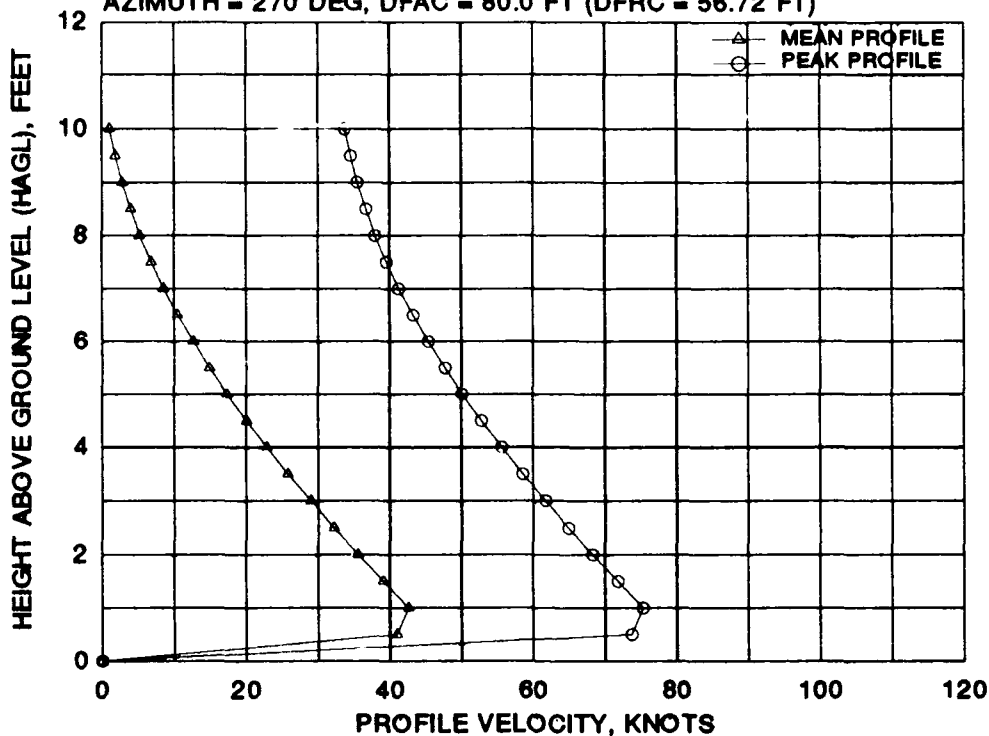

FIGURE B-4 BELL/BOEING MV-22 MEAN AND PEAK VELOCITY PROFILES FOR EIGHT 270 DEGREE AZIMUTH RADIAL STATIONS AT A WHEEL HEIGHT OF 5 FEET AND A GROSS WEIGHT OF 47,500 POUNDS

BELL-BOEING MV-22 OSPREY
 GW = 47500 LBS, WAGL = 5 FT
 AZIMUTH = 270 DEG, DFAC = 80.0 FT (DFRC = 56.72 FT)



BELL-BOEING MV-22 OSPREY
 GW = 47500 LBS, WAGL = 5 FT
 AZIMUTH = 270 DEG, DFAC = 100.0 FT (DFRC = 76.72 FT)

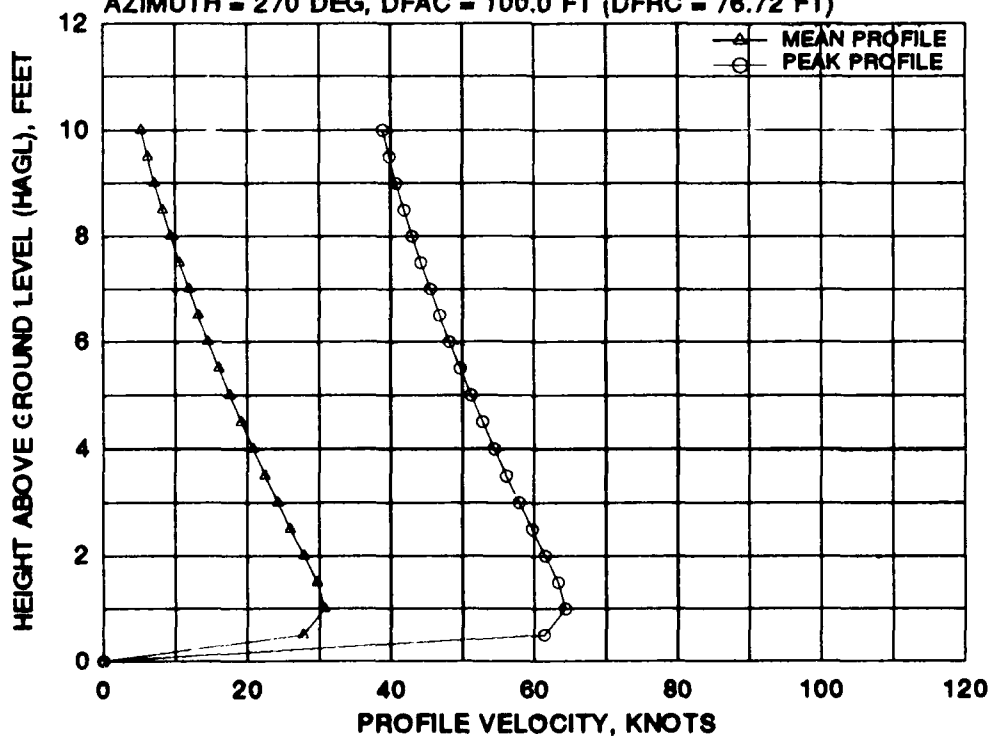
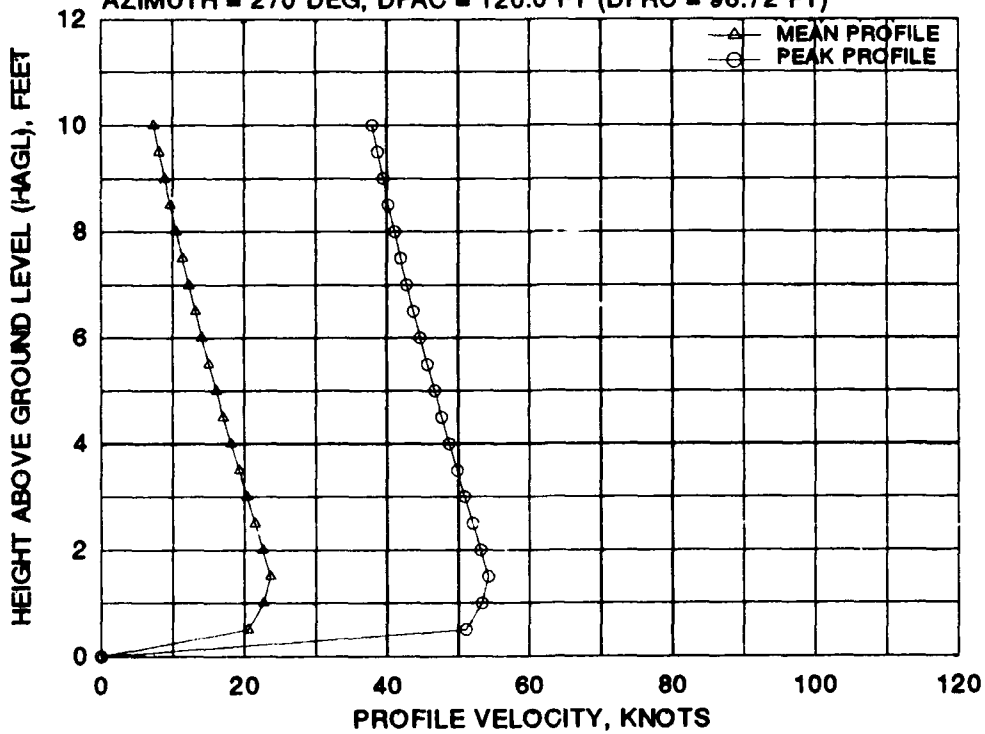

FIGURE B-4 BELL/BOEING MV-22 MEAN AND PEAK VELOCITY PROFILES FOR EIGHT 270 DEGREE AZIMUTH RADIAL STATIONS AT A WHEEL HEIGHT OF 5 FEET AND A GROSS WEIGHT OF 47,500 POUNDS (Continued)

BELL-BOEING MV-22 OSPREY
 GW = 47500 LBS, WAGL = 5 FT
 AZIMUTH = 270 DEG, DFAC = 120.0 FT (DFRC = 96.72 FT)



BELL-BOEING MV-22 OSPREY
 GW = 47500 LBS, WAGL = 5 FT
 AZIMUTH = 270 DEG, DFAC = 140.0 FT (DFRC = 116.72 FT)

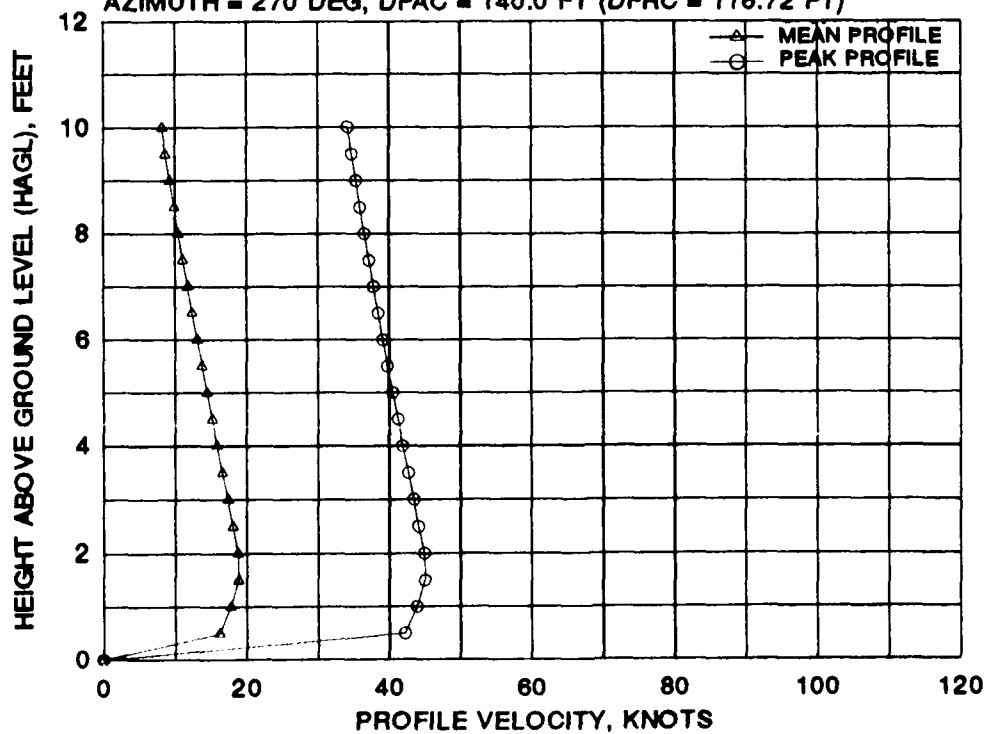
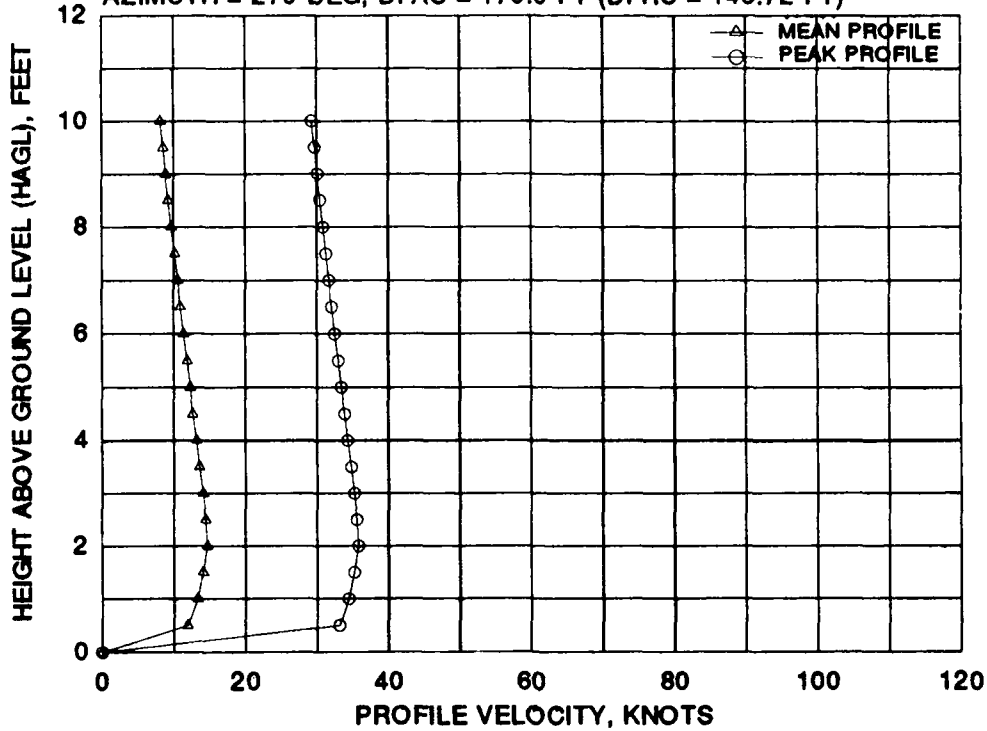

FIGURE B-4 BELL/BOEING MV-22 MEAN AND PEAK VELOCITY PROFILES FOR EIGHT 270 DEGREE AZIMUTH RADIAL STATIONS AT A WHEEL HEIGHT OF 5 FEET AND A GROSS WEIGHT OF 47,500 POUNDS (Continued)

BELL-BOEING MV-22 OSPREY
 GW = 47500 LBS, WAGL = 5 FT
 AZIMUTH = 270 DEG, DFAC = 170.0 FT (DFRC = 146.72 FT)



BELL-BOEING MV-22 OSPREY
 GW = 47500 LBS, WAGL = 5 FT
 AZIMUTH = 270 DEG, DFAC = 200.0 FT (DFRC = 176.72 FT)

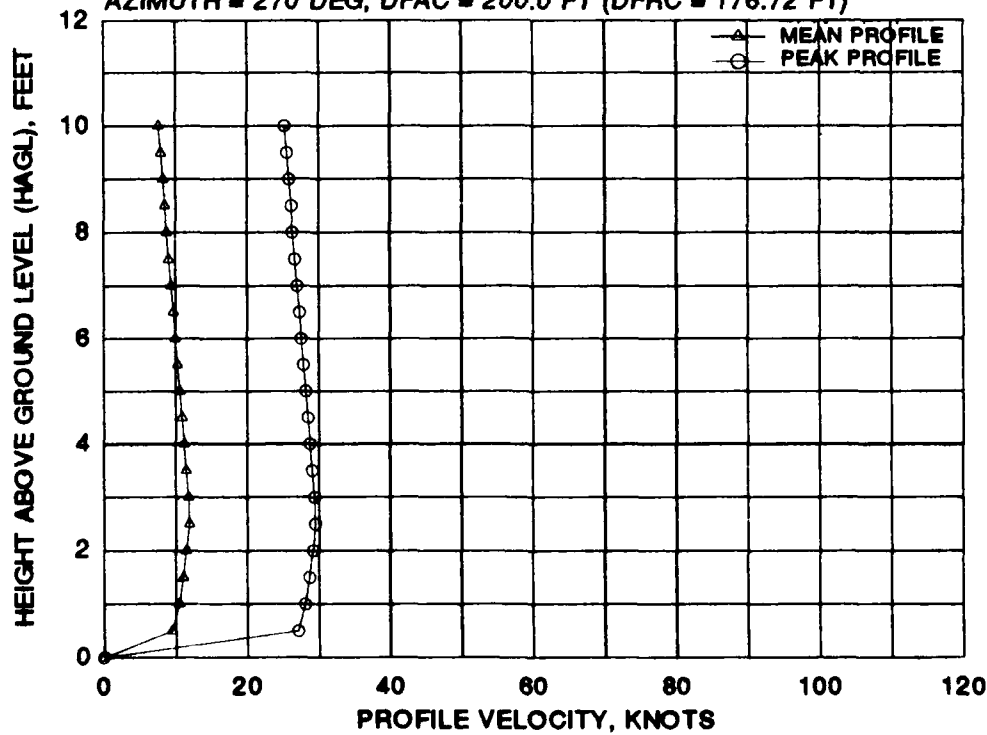
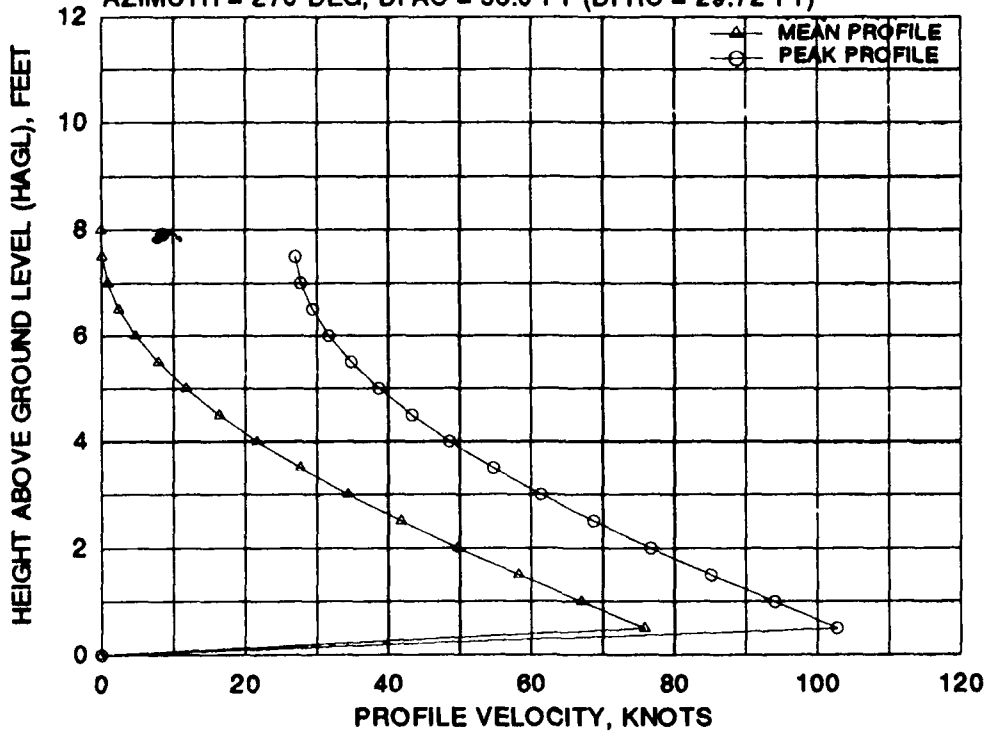

FIGURE B-4 BELL/BOEING MV-22 MEAN AND PEAK VELOCITY PROFILES FOR EIGHT 270 DEGREE AZIMUTH RADIAL STATIONS AT A WHEEL HEIGHT OF 5 FEET AND A GROSS WEIGHT OF 47,500 POUNDS (Concluded)

BELL BOEING MV-22 OSPREY
 GW = 47500 LBS, WAGL = 30 FT
 AZIMUTH = 270 DEG, DFAC = 53.0 FT (DFRC = 29.72 FT)



BELL-BOEING MV-22 OSPREY
 GW = 47500 LBS, WAGL = 30 FT
 AZIMUTH = 270 DEG, DFAC = 66.0 FT (DFRC = 42.72 FT)

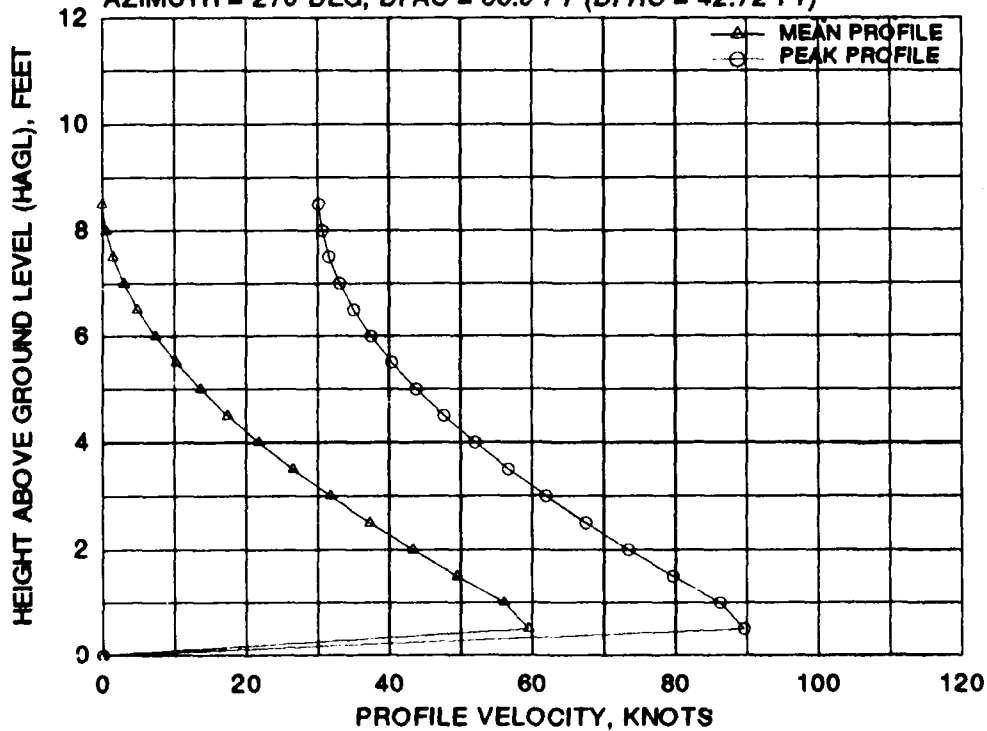
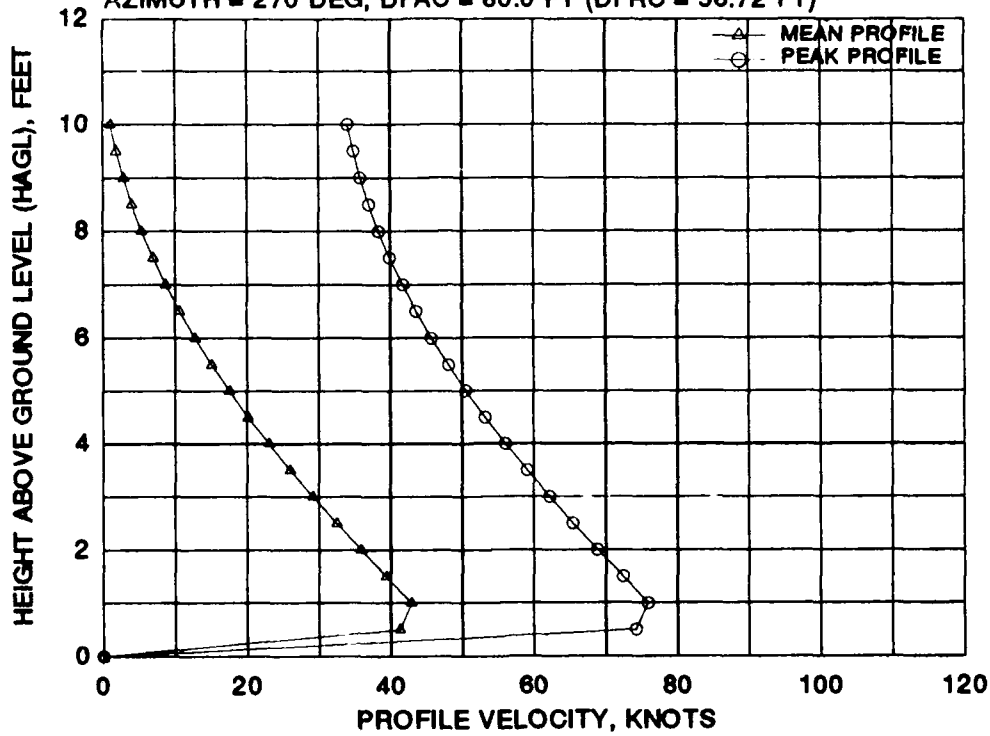

FIGURE B-5 BELL/BOEING MV-22 MEAN AND PEAK VELOCITY PROFILES FOR EIGHT 270 DEGREE AZIMUTH RADIAL STATIONS AT A WHEEL HEIGHT OF 30 FEET AND A GROSS WEIGHT OF 47,500 POUNDS

BELL-BOEING MV-22 OSPREY
 GW = 47500 LBS, WAGL = 30 FT
 AZIMUTH = 270 DEG, DFAC = 80.0 FT (DFRC = 58.72 FT)



BELL-BOEING MV-22 OSPREY
 GW = 47500 LBS, WAGL = 30 FT
 AZIMUTH = 270 DEG, DFAC = 100.0 FT (DFRC = 78.72 FT)

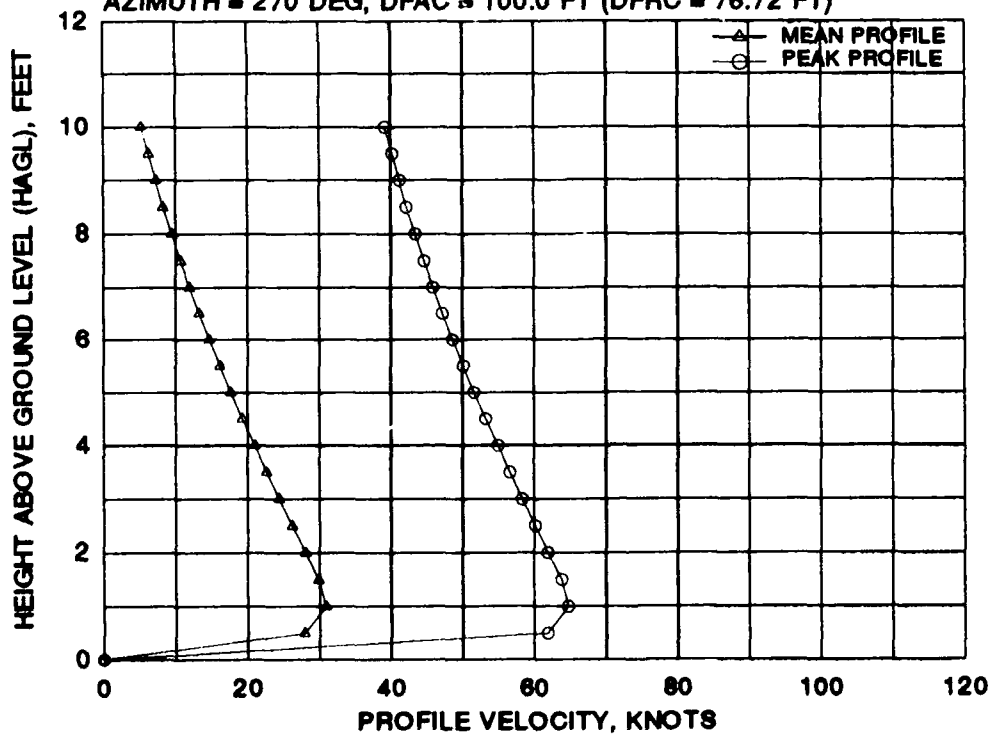
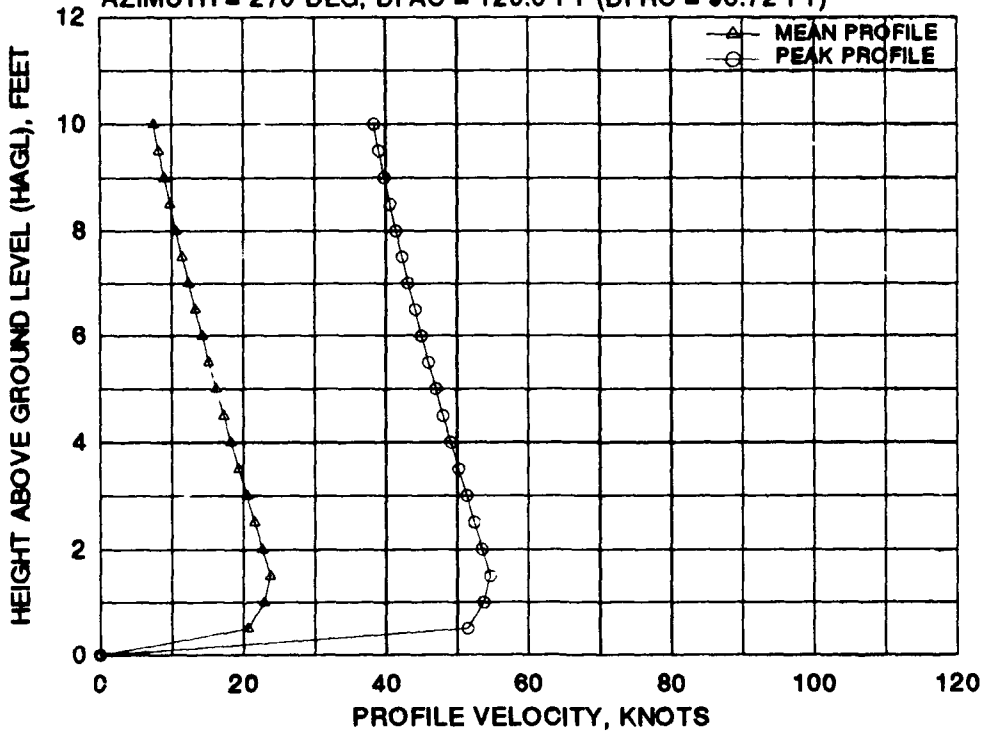

FIGURE B-5 BELL/BOEING MV-22 MEAN AND PEAK VELOCITY PROFILES FOR EIGHT 270 DEGREE AZIMUTH RADIAL STATIONS AT A WHEEL HEIGHT OF 30 FEET AND A GROSS WEIGHT OF 47,500 POUNDS (Continued)

BELL-BOEING MV-22 OSPREY
 GW = 47500 LBS, WAGL = 30 FT
 AZIMUTH = 270 DEG, DFAC = 120.0 FT (DFRC = 96.72 FT)



BELL-BOEING MV-22 OSPREY
 GW = 47500 LBS, WAGL = 30 FT
 AZIMUTH = 270 DEG, DFAC = 140.0 FT (DFRC = 116.72 FT)

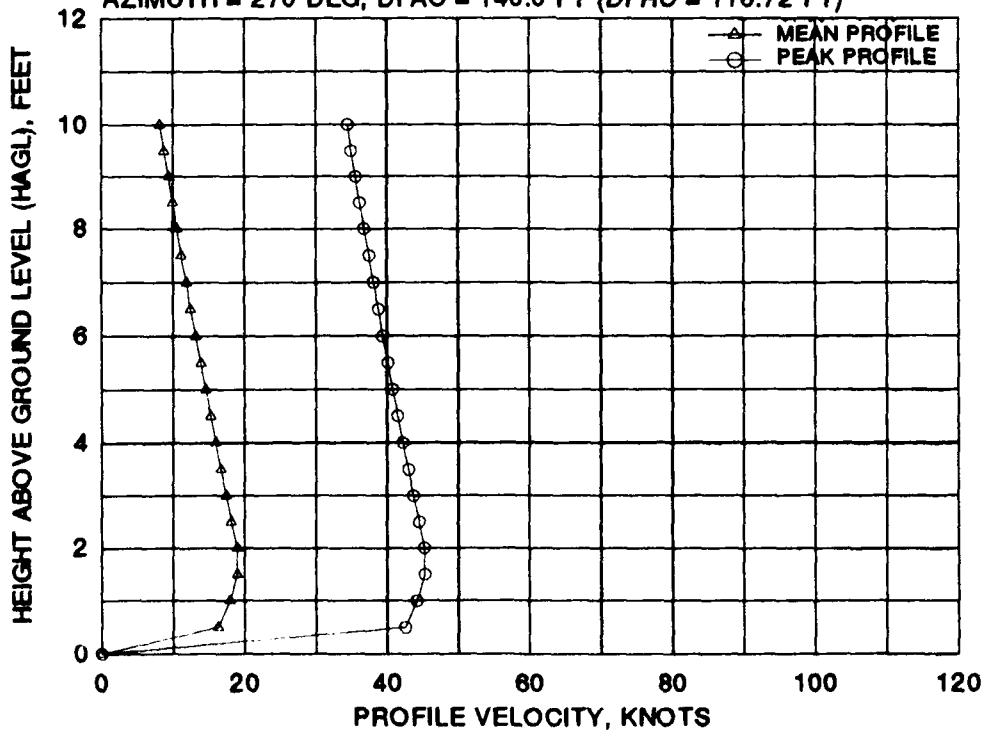
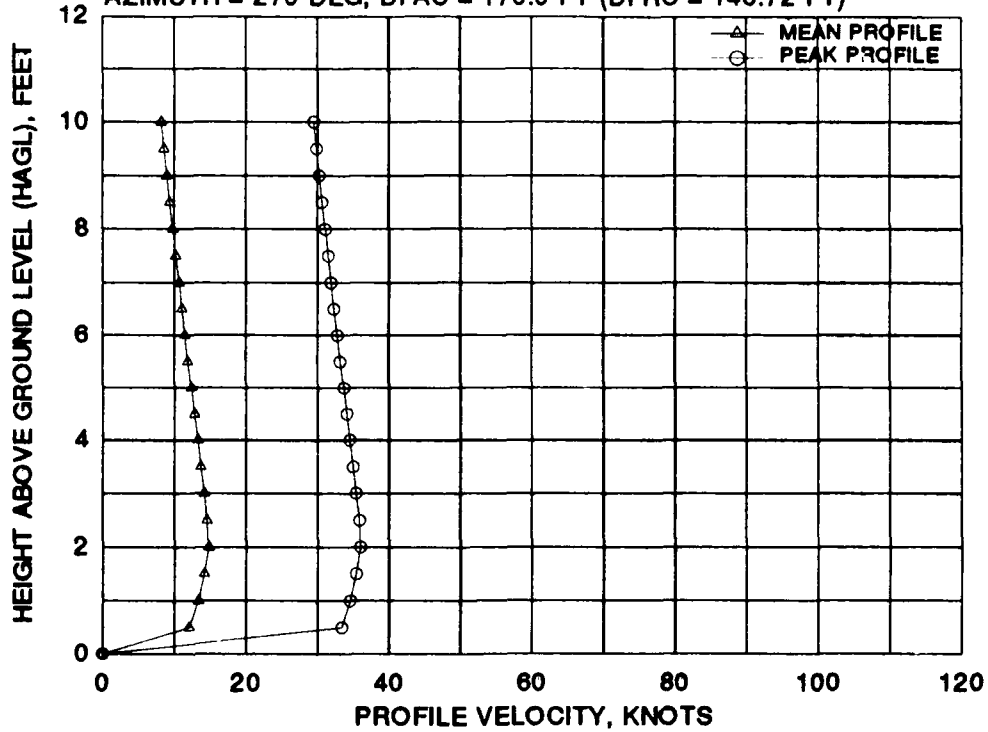

FIGURE B-5 BELL/BOEING MV-22 MEAN AND PEAK VELOCITY PROFILES FOR EIGHT 270 DEGREE AZIMUTH RADIAL STATIONS AT A WHEEL HEIGHT OF 30 FEET AND A GROSS WEIGHT OF 47,500 POUNDS (Continued)

BELL-BOEING MV-22 OSPREY
 GW = 47500 LBS, WAGL = 30 FT
 AZIMUTH = 270 DEG, DFAC = 170.0 FT (DFRC = 146.72 FT)



BELL-BOEING MV-22 OSPREY
 GW = 47500 LBS, WAGL = 30 FT
 AZIMUTH = 270 DEG, DFAC = 200.0 FT (DFRC = 176.72 FT)

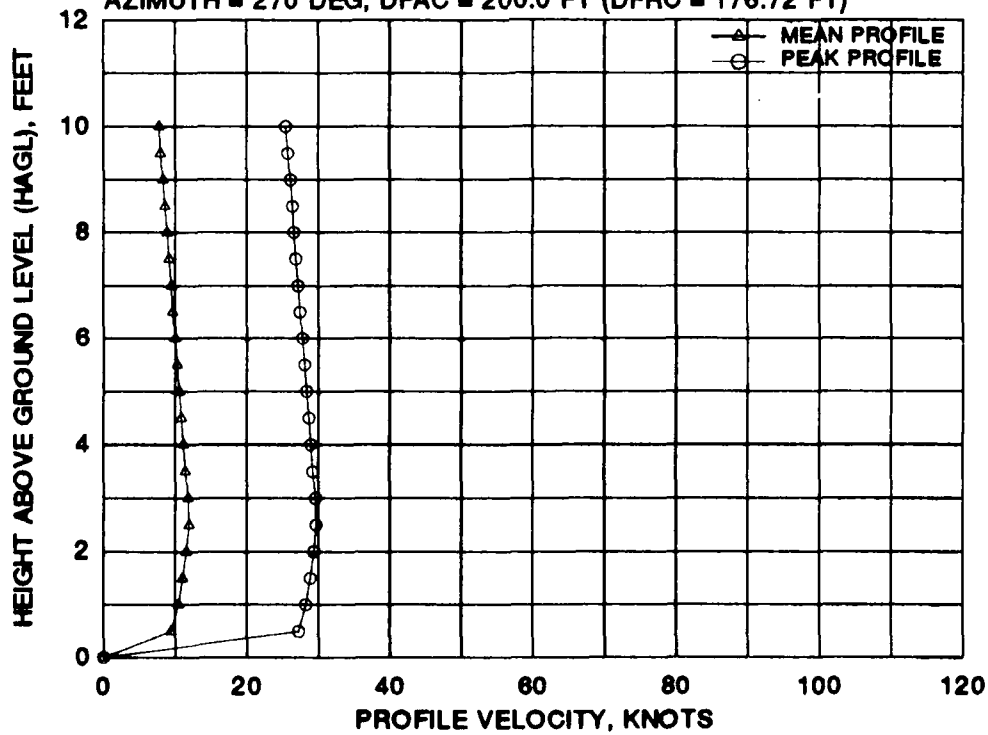
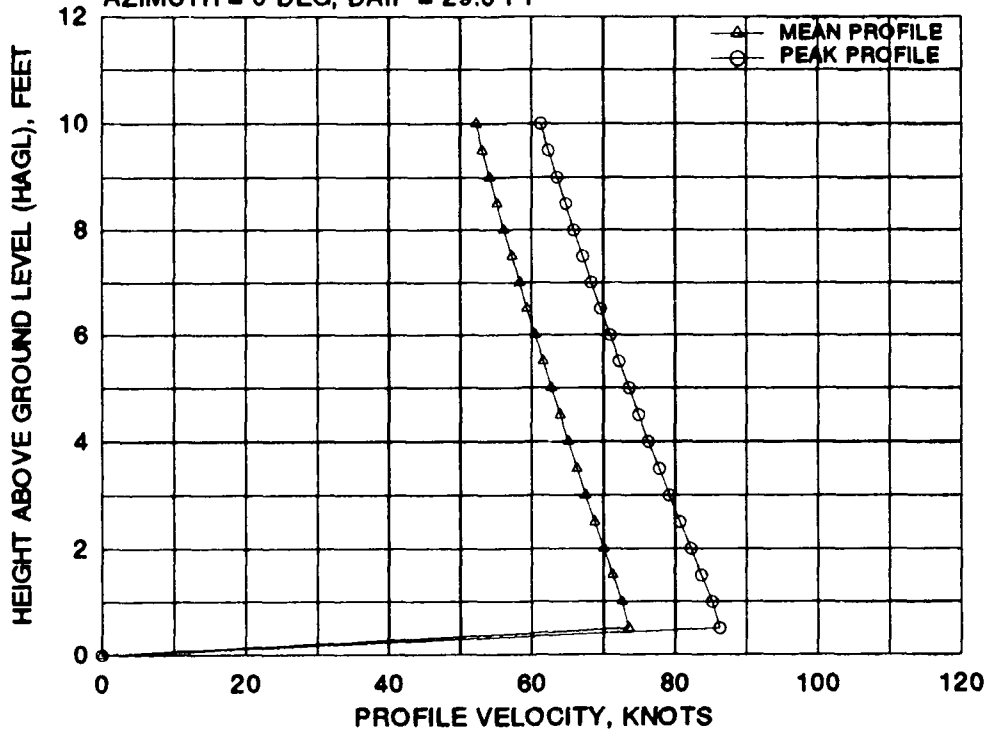

FIGURE B-5 BELL/BOEING MV-22 MEAN AND PEAK VELOCITY PROFILES FOR EIGHT 270 DEGREE AZIMUTH RADIAL STATIONS AT A WHEEL HEIGHT OF 30 FEET AND A GROSS WEIGHT OF 47,500 POUNDS (Concluded)

BELL-BOEING MV-22 OSPREY
 GW = 40000 LBS, WAGL = 5 FT
 AZIMUTH = 0 DEG, DAIP = 29.0 FT



BELL-BOEING MV-22 OSPREY
 GW = 40000 LBS, WAGL = 5 FT
 AZIMUTH = 0 DEG, DAIP = 35.0 FT

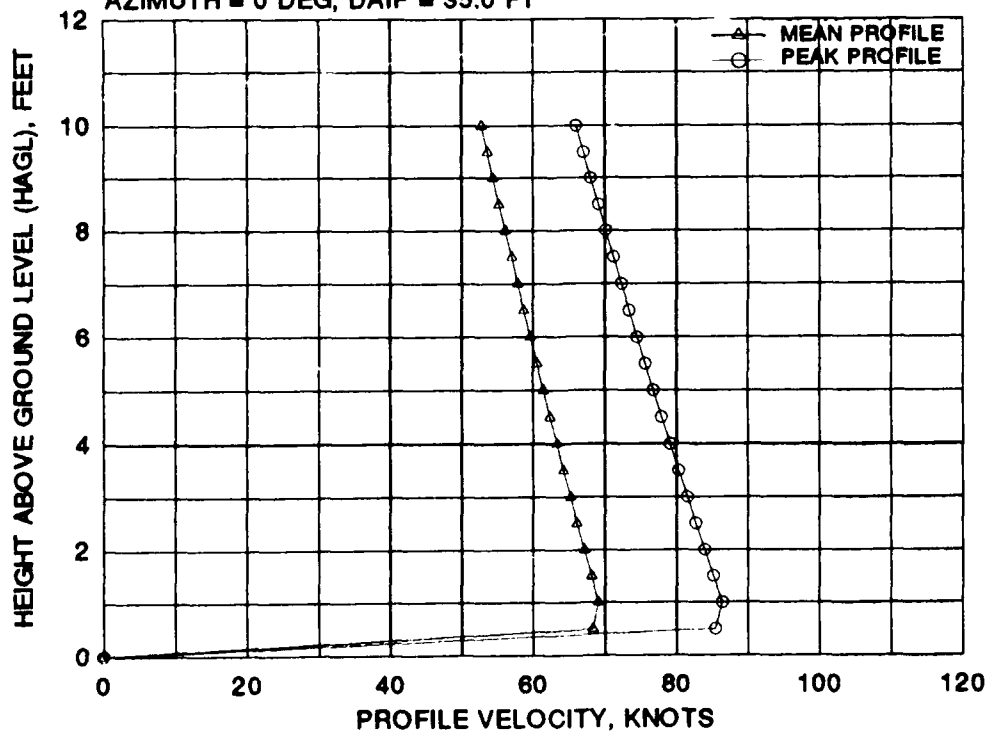
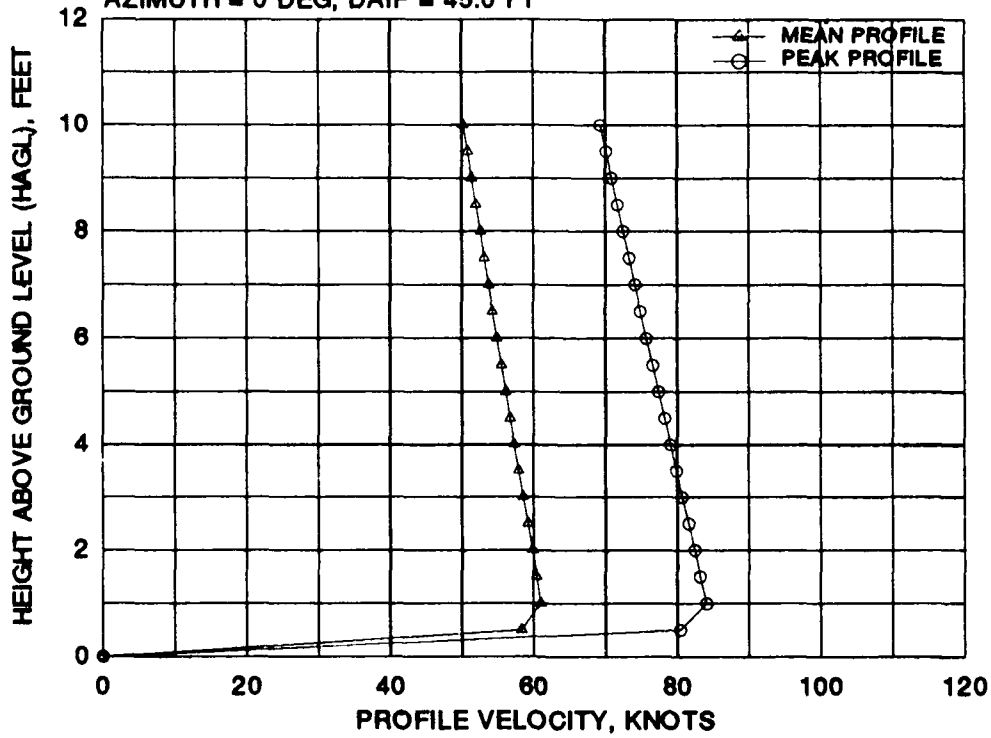

FIGURE B-6 BELL/BOEING MV-22 MEAN AND PEAK VELOCITY PROFILES FOR NINE 0 DEGREE AZIMUTH RADIAL STATIONS AT A WHEEL HEIGHT OF 5 FEET AND A GROSS WEIGHT OF 40,000 POUNDS

BELL-BOEING MV-22 OSPREY
 GW = 40000 LBS, WAGL = 5 FT
 AZIMUTH = 0 DEG, DAIP = 45.0 FT



BELL-BOEING MV-22 OSPREY
 GW = 40000 LBS, WAGL = 5 FT
 AZIMUTH = 0 DEG, DAIP = 60.0 FT

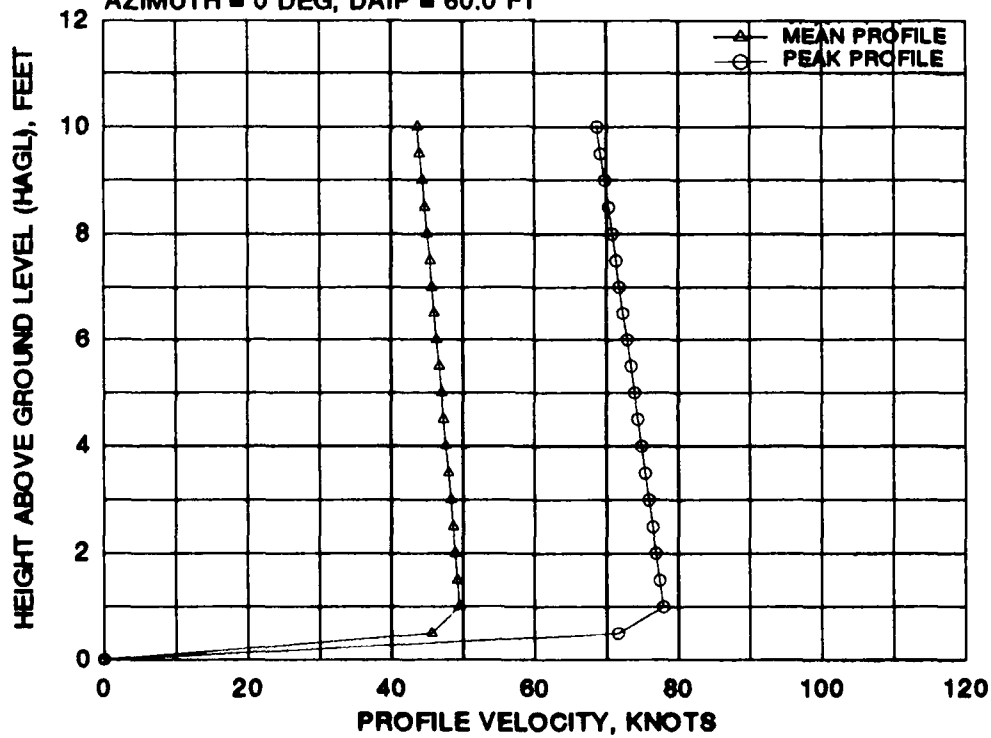
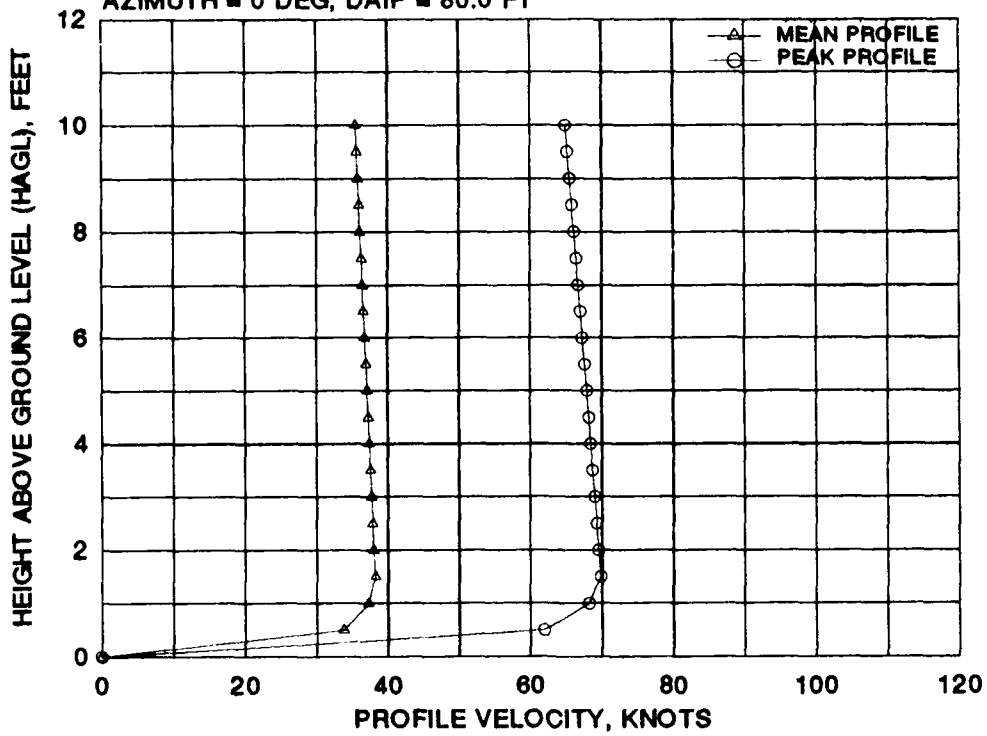

FIGURE B-6 BELL/BOEING MV-22 MEAN AND PEAK VELOCITY PROFILES FOR NINE 0 DEGREE AZIMUTH RADIAL STATIONS AT A WHEEL HEIGHT OF 5 FEET AND A GROSS WEIGHT OF 40,000 POUNDS (Continued)

BELL-BOEING MV-22 OSPREY
 GW = 40000 LBS, WAGL = 5 FT
 AZIMUTH = 0 DEG, DAIP = 80.0 FT



BELL-BOEING MV-22 OSPREY
 GW = 40000 LBS, WAGL = 5 FT
 AZIMUTH = 0 DEG, DAIP = 100.0 FT

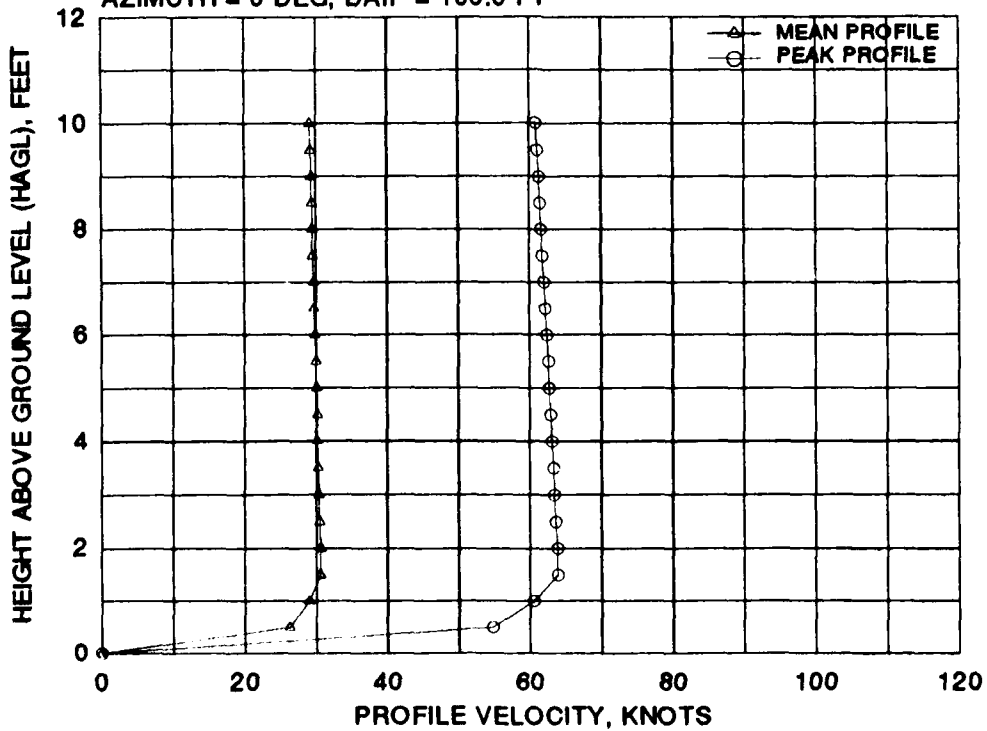

FIGURE B-6 BELL/BOEING MV-22 MEAN AND PEAK VELOCITY PROFILES FOR NINE 0 DEGREE AZIMUTH RADIAL STATIONS AT A WHEEL HEIGHT OF 5 FEET AND A GROSS WEIGHT OF 40,000 POUNDS (Continued)

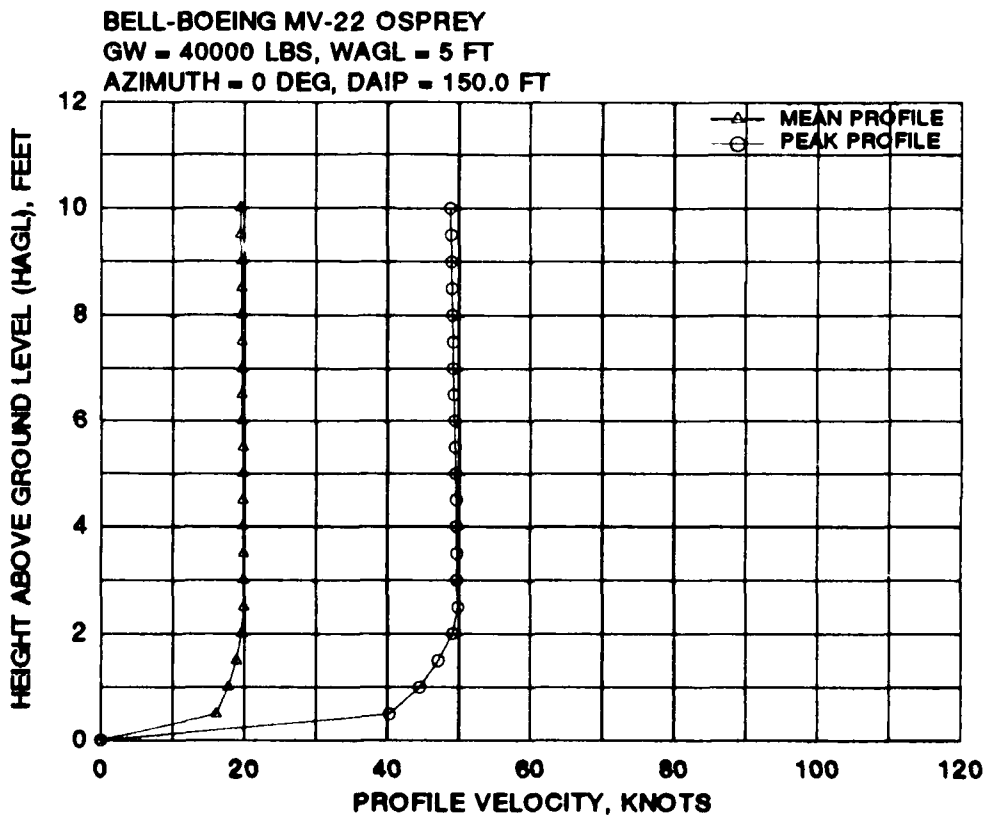
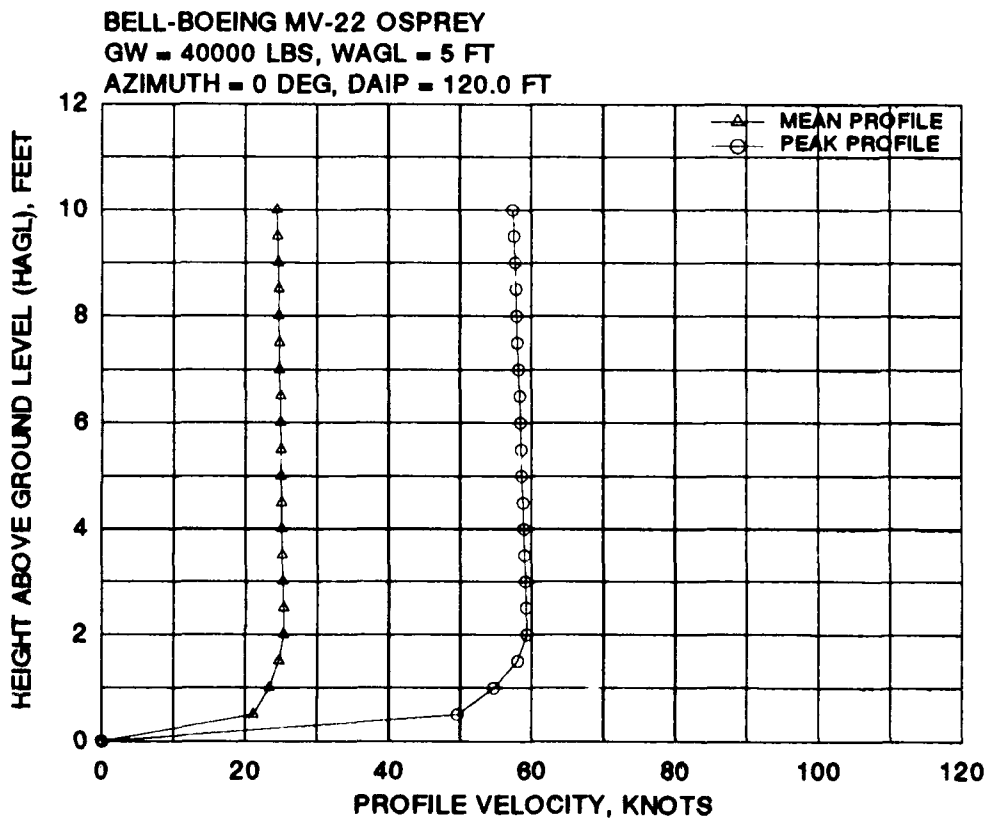

FIGURE B-6 BELL/BOEING MV-22 MEAN AND PEAK VELOCITY PROFILES FOR NINE 0 DEGREE AZIMUTH RADIAL STATIONS AT A WHEEL HEIGHT OF 5 FEET AND A GROSS WEIGHT OF 40,000 POUNDS (Continued)

BELL-BOEING MV-22 OSPREY
GW = 40000 LBS, WAGL = 5 FT
AZIMUTH = 0 DEG, DAIP = 200.0 FT

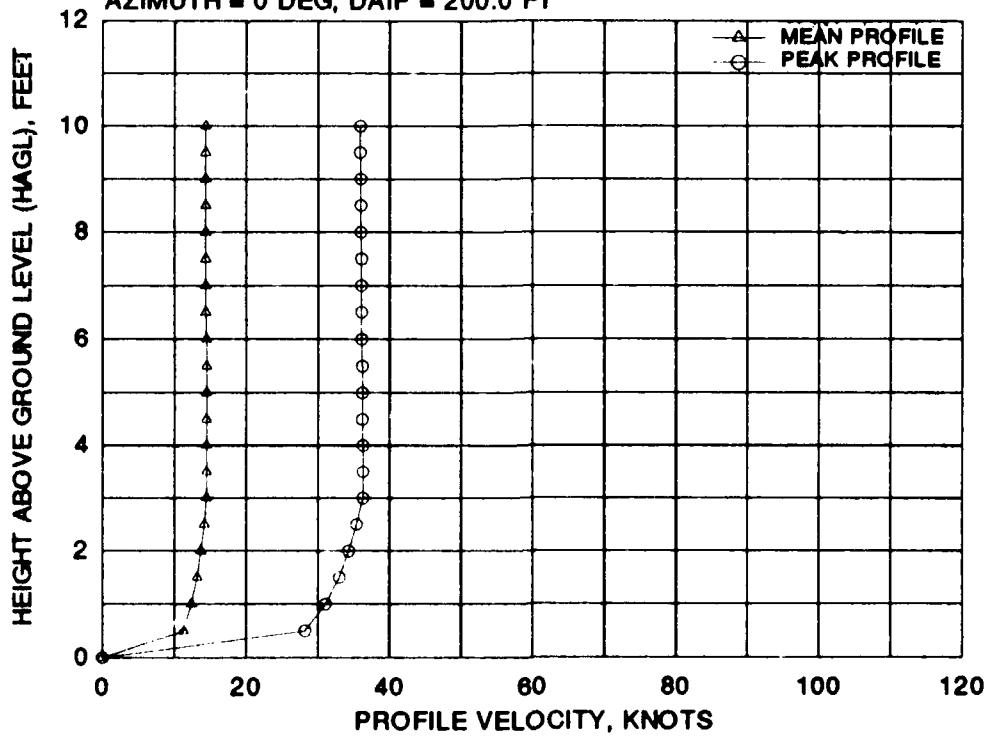
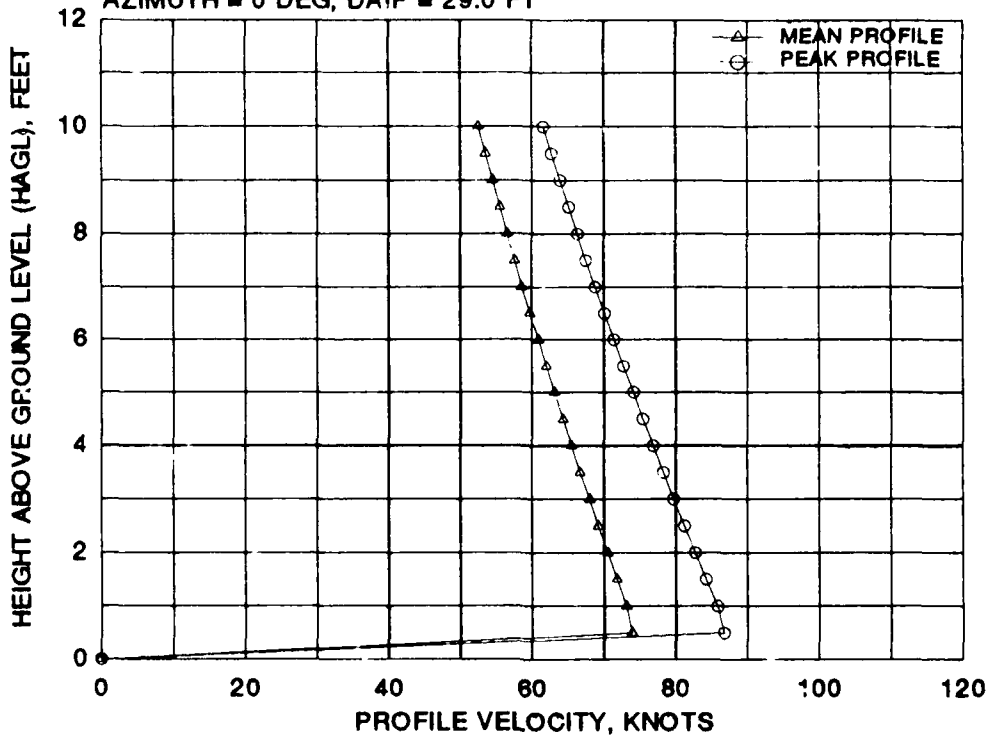

FIGURE B-6 BELL/BOEING MV-22 MEAN AND PEAK VELOCITY PROFILES FOR NINE 0 DEGREE AZIMUTH RADIAL STATIONS AT A WHEEL HEIGHT OF 5 FEET AND A GROSS WEIGHT OF 40,000 POUNDS (Concluded)

BELL-BOEING MV-22 OSPREY
 GW = 40000 LBS, WAGL = 30 FT
 AZIMUTH = 0 DEG, DAIP = 29.0 FT



BELL-BOEING MV-22 OSPREY
 GW = 40000 LBS, WAGL = 30 FT
 AZIMUTH = 0 DEG, DAIP = 35.0 FT

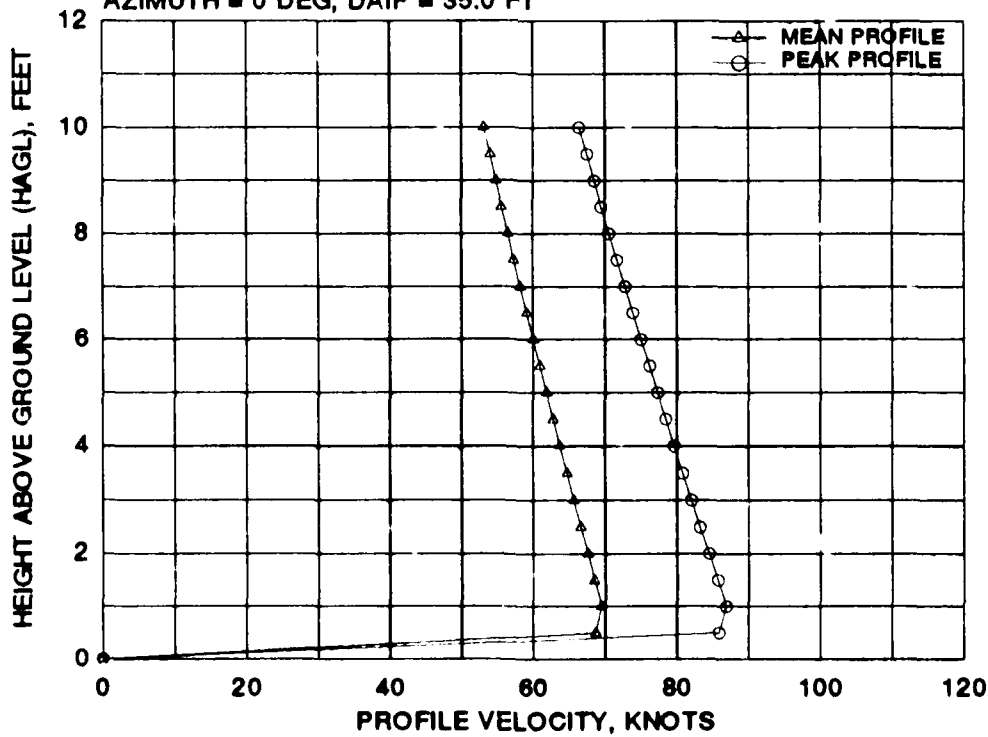

FIGURE B-7 BELL/BOEING MV-22 MEAN AND PEAK VELOCITY PROFILES FOR NINE 0 DEGREE AZIMUTH RADIAL STATIONS AT A WHEEL HEIGHT OF 30 FEET AND A GROSS WEIGHT OF 40,000 POUNDS

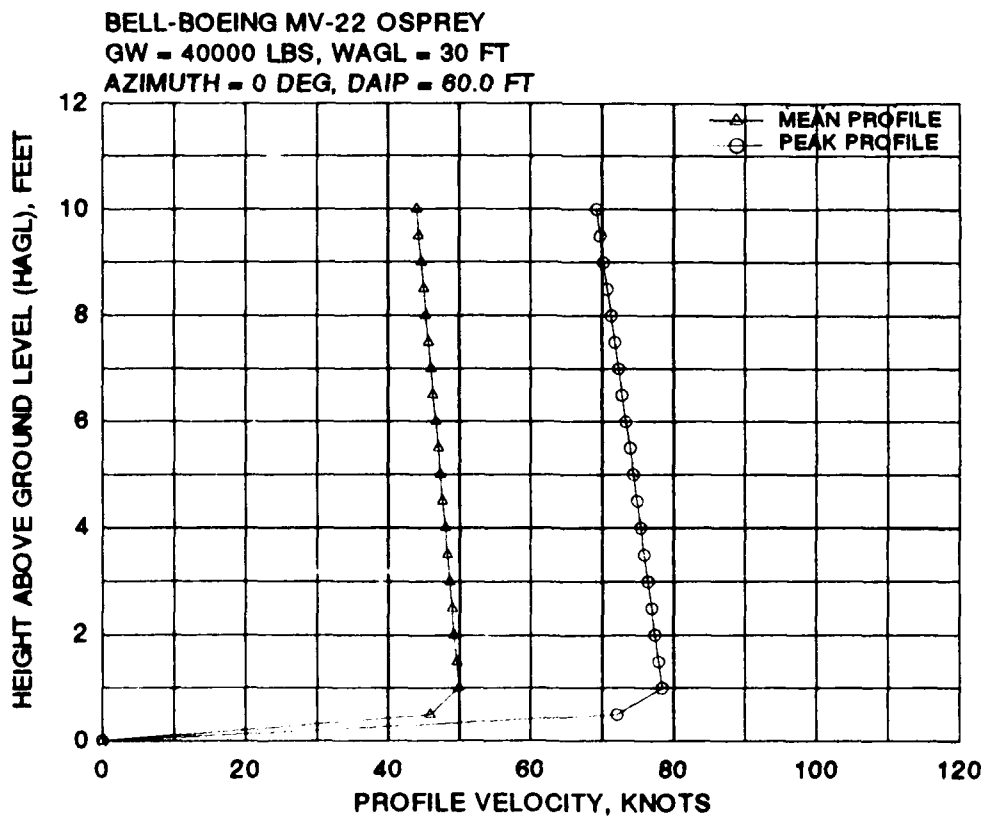
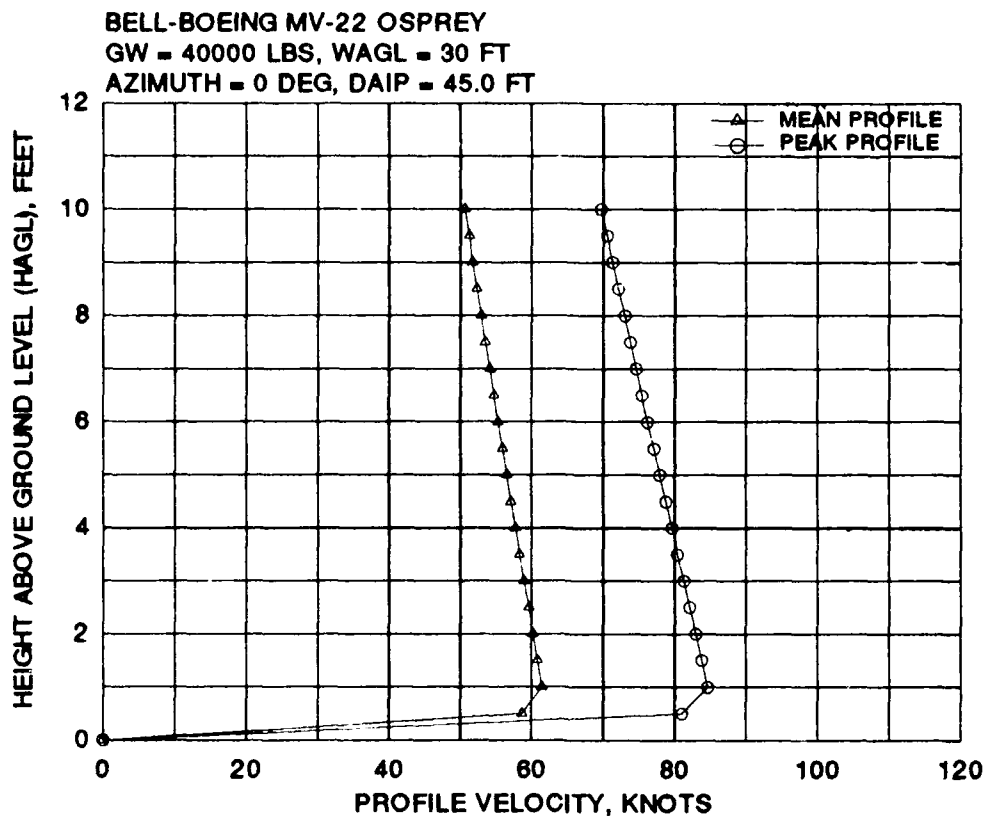
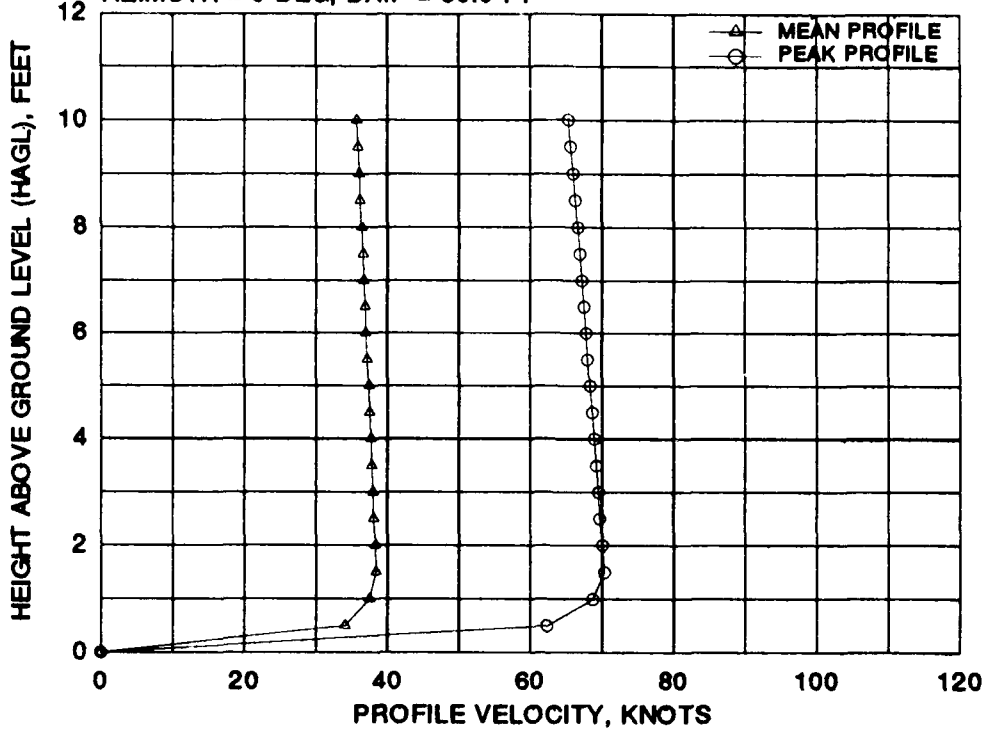

FIGURE B-7 BELL/BOEING MV-22 MEAN AND PEAK VELOCITY PROFILES FOR NINE 0 DEGREE AZIMUTH RADIAL STATIONS AT A WHEEL HEIGHT OF 30 FEET AND A GROSS WEIGHT OF 40,000 POUNDS (Continued)

BELL-BOEING MV-22 OSPREY
 GW = 40000 LBS, WAGL = 30 FT
 AZIMUTH = 0 DEG, DAIP = 80.0 FT



BELL-BOEING MV-22 OSPREY
 GW = 40000 LBS, WAGL = 30 FT
 AZIMUTH = 0 DEG, DAIP = 100.0 FT

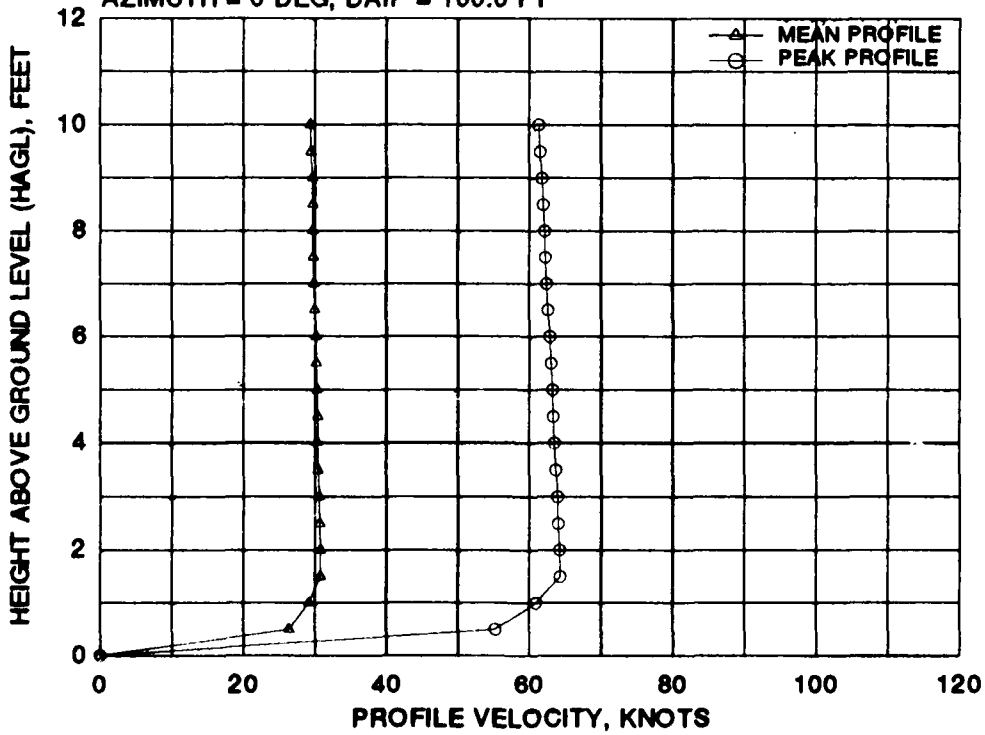
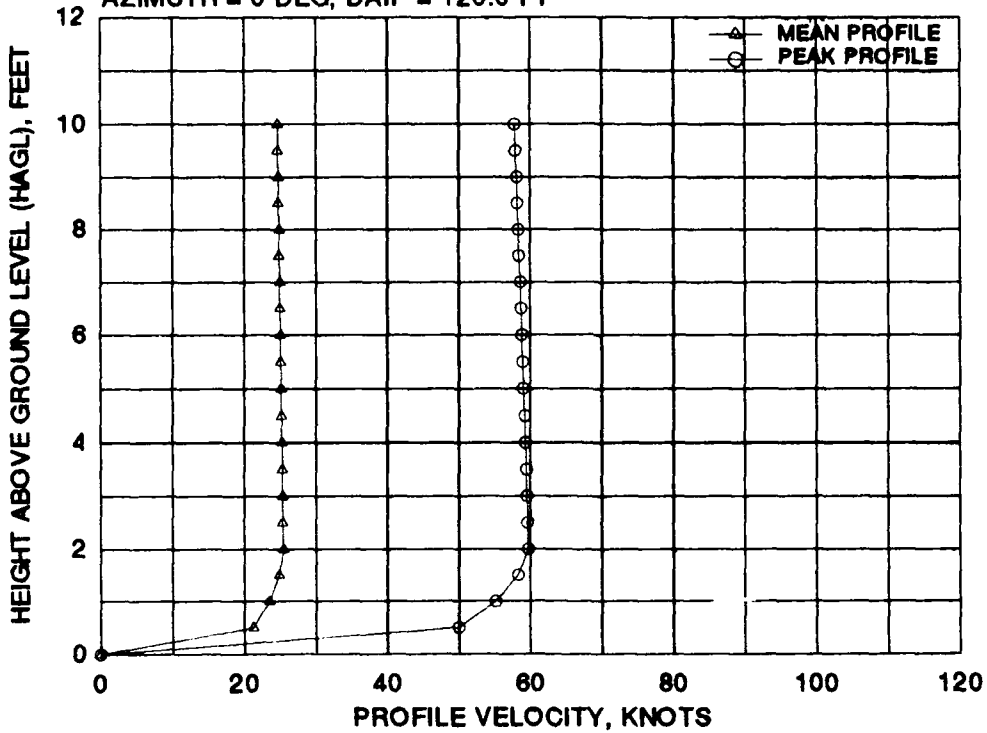

FIGURE B-7 BELL/BOEING MV-22 MEAN AND PEAK VELOCITY PROFILES FOR NINE 0 DEGREE AZIMUTH RADIAL STATIONS AT A WHEEL HEIGHT OF 30 FEET AND A GROSS WEIGHT OF 40,000 POUNDS (Continued)

BELL-BOEING MV-22 OSPREY
 GW = 40000 LBS, WAGL = 30 FT
 AZIMUTH = 0 DEG, DAIP = 120.0 FT



BELL-BOEING MV-22 OSPREY
 GW = 40000 LBS, WAGL = 30 FT
 AZIMUTH = 0 DEG, DAIP = 150.0 FT

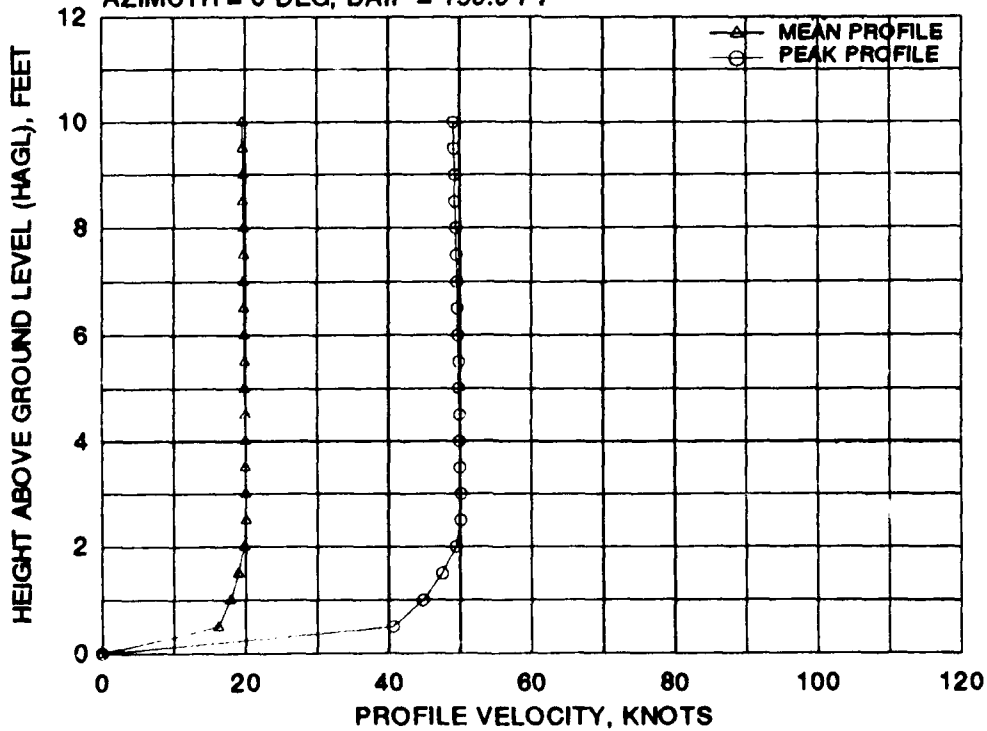

FIGURE B-7 BELL/BOEING MV-22 MEAN AND PEAK VELOCITY PROFILES FOR NINE 0 DEGREE AZIMUTH RADIAL STATIONS AT A WHEEL HEIGHT OF 30 FEET AND A GROSS WEIGHT OF 40,000 POUNDS (Continued)

BELL-BOEING MV-22 OSPREY
GW = 40000 LBS, WAGL = 30 FT
AZIMUTH = 0 DEG, DAIP = 200.0 FT

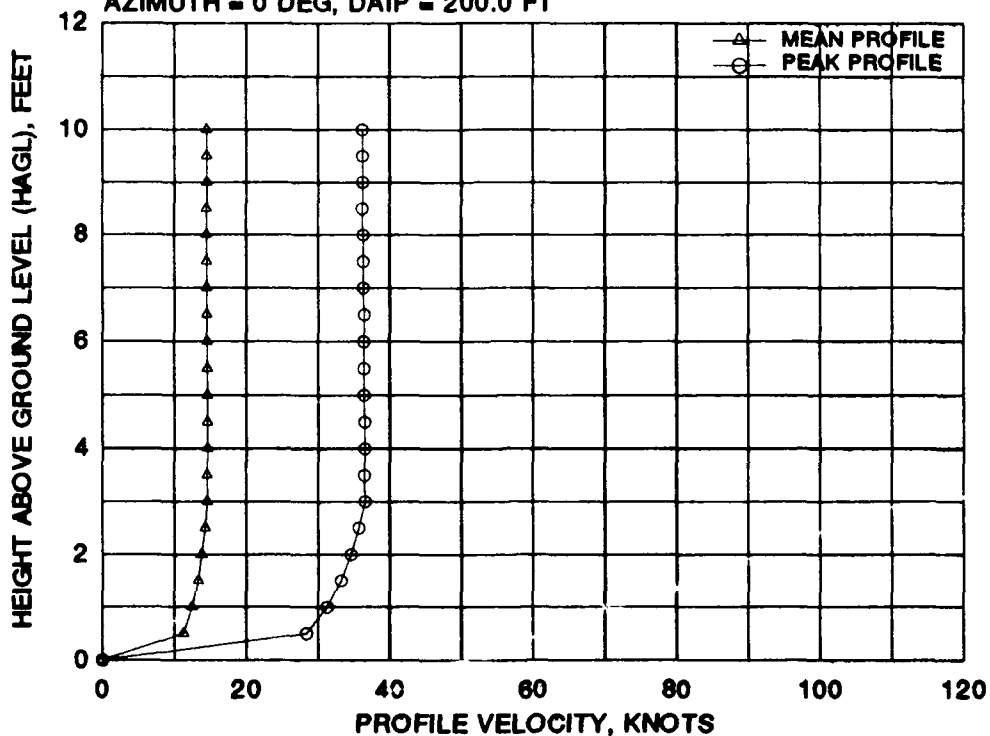
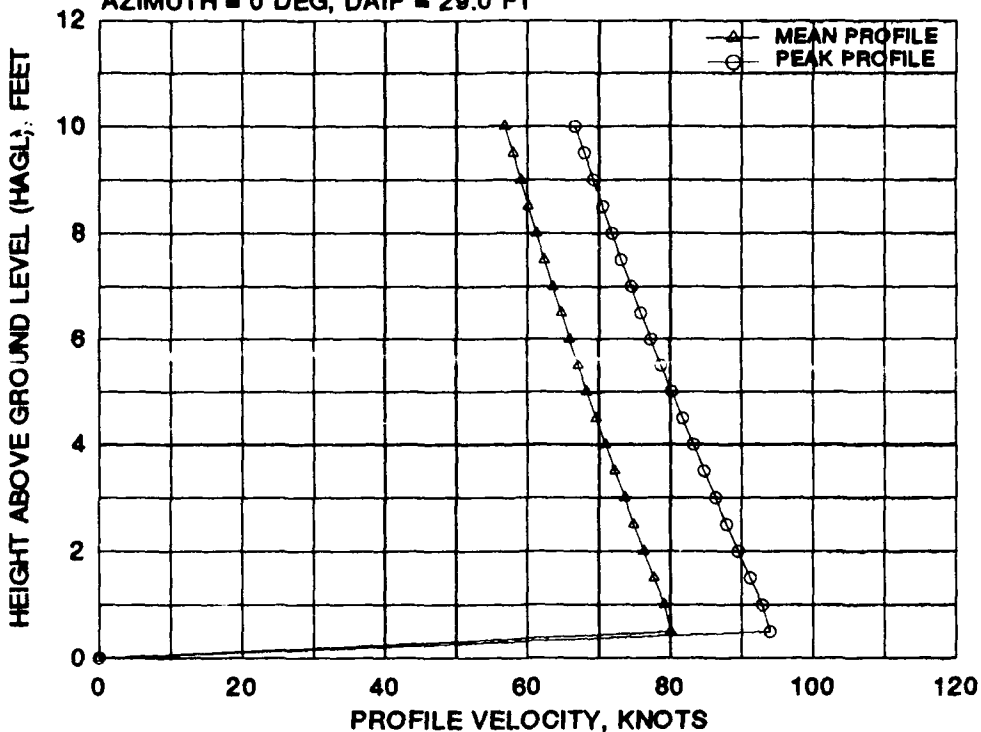

FIGURE B-7 BELL/BOEING MV-22 MEAN AND PEAK VELOCITY PROFILES FOR NINE 0 DEGREE AZIMUTH RADIAL STATIONS AT A WHEEL HEIGHT OF 30 FEET AND A GROSS WEIGHT OF 40,000 POUNDS (Concluded)

BELL-BOEING MV-22 OSPREY
 GW = 47500 LBS, WAGL = 5 FT
 AZIMUTH = 0 DEG, DAIP = 29.0 FT



BELL-BOEING MV-22 OSPREY
 GW = 47500 LBS, WAGL = 5 FT
 AZIMUTH = 0 DEG, DAIP = 35.0 FT

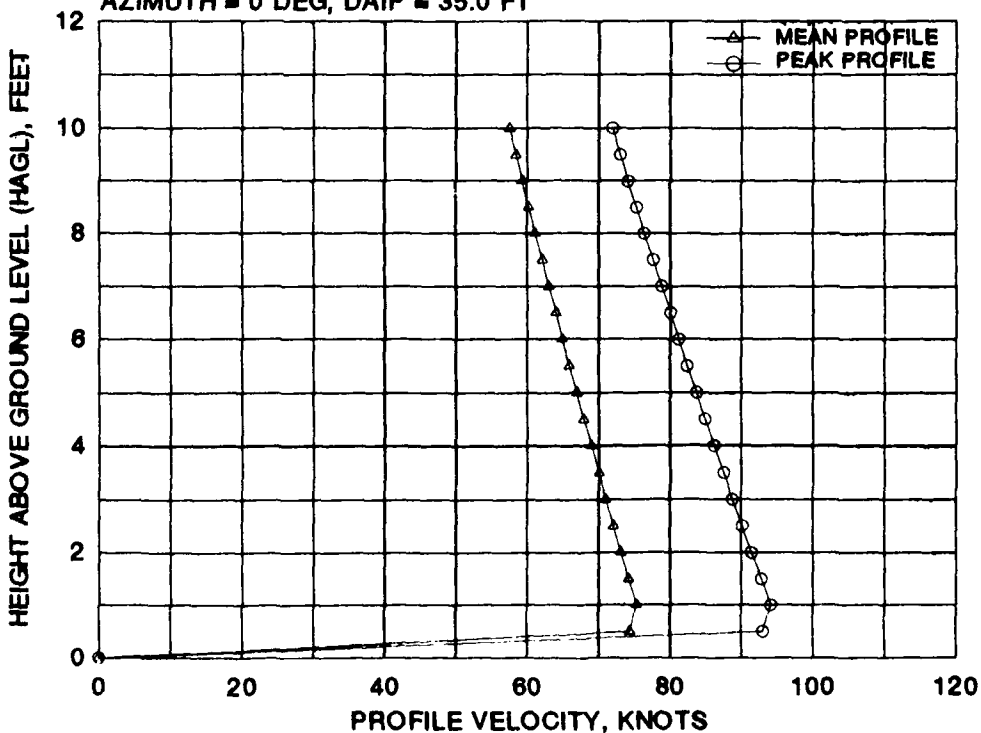
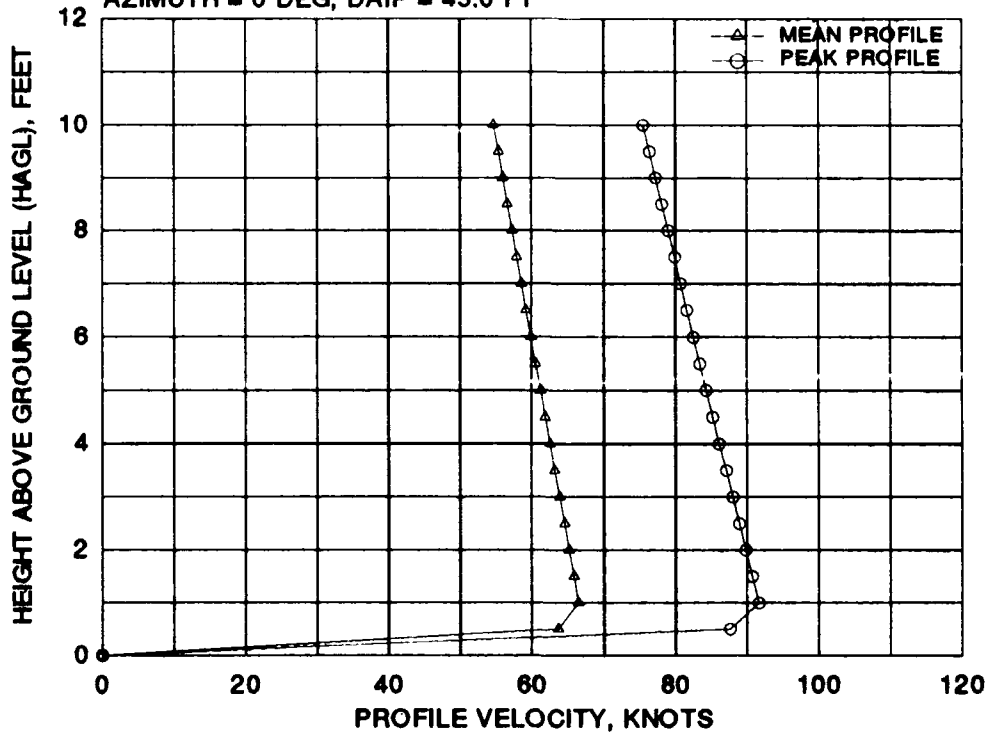

FIGURE B-8 BELL/BOEING MV-22 MEAN AND PEAK VELOCITY PROFILES FOR NINE 0 DEGREE AZIMUTH RADIAL STATIONS AT A WHEEL HEIGHT OF 5 FEET AND A GROSS WEIGHT OF 47,500 POUNDS

BELL-BOEING MV-22 OSPREY
 GW = 47500 LBS, WAGL = 5 FT
 AZIMUTH = 0 DEG, DAIP = 45.0 FT



BELL-BOEING MV-22 OSPREY
 GW = 47500 LBS, WAGL = 5 FT
 AZIMUTH = 0 DEG, DAIP = 60.0 FT

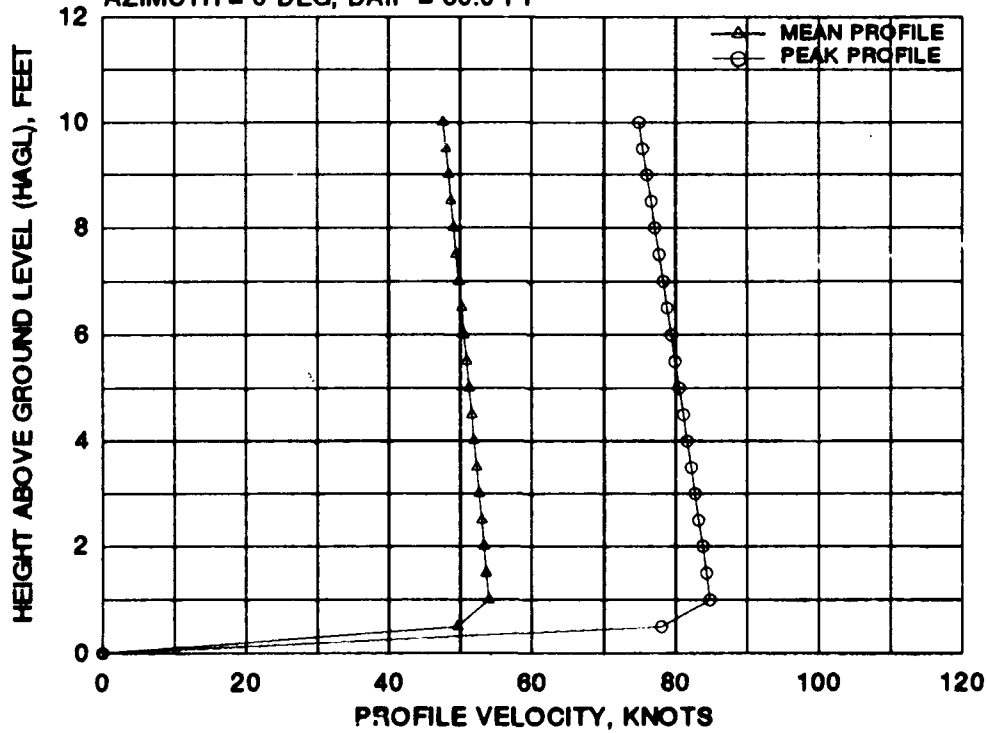

FIGURE B-8 BELL/BOEING MV-22 MEAN AND PEAK VELOCITY PROFILES FOR NINE 0 DEGREE AZIMUTH RADIAL STATIONS AT A WHEEL HEIGHT OF 5 FEET AND A GROSS WEIGHT OF 47,500 POUNDS (Continued)

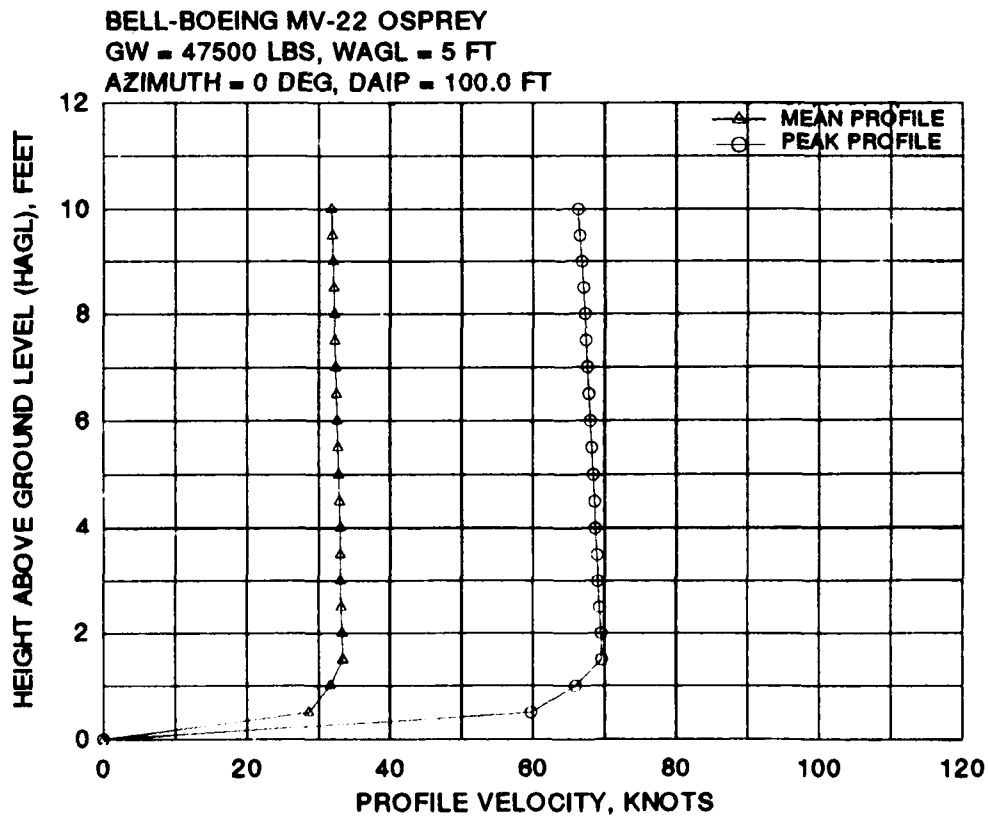
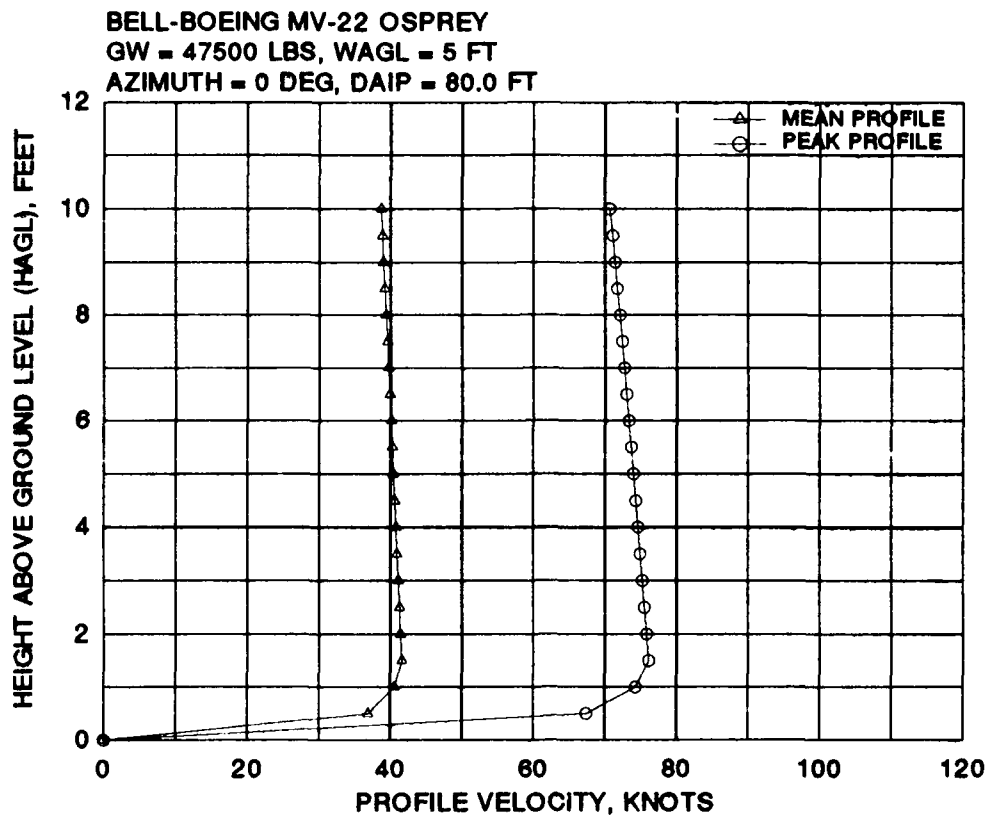
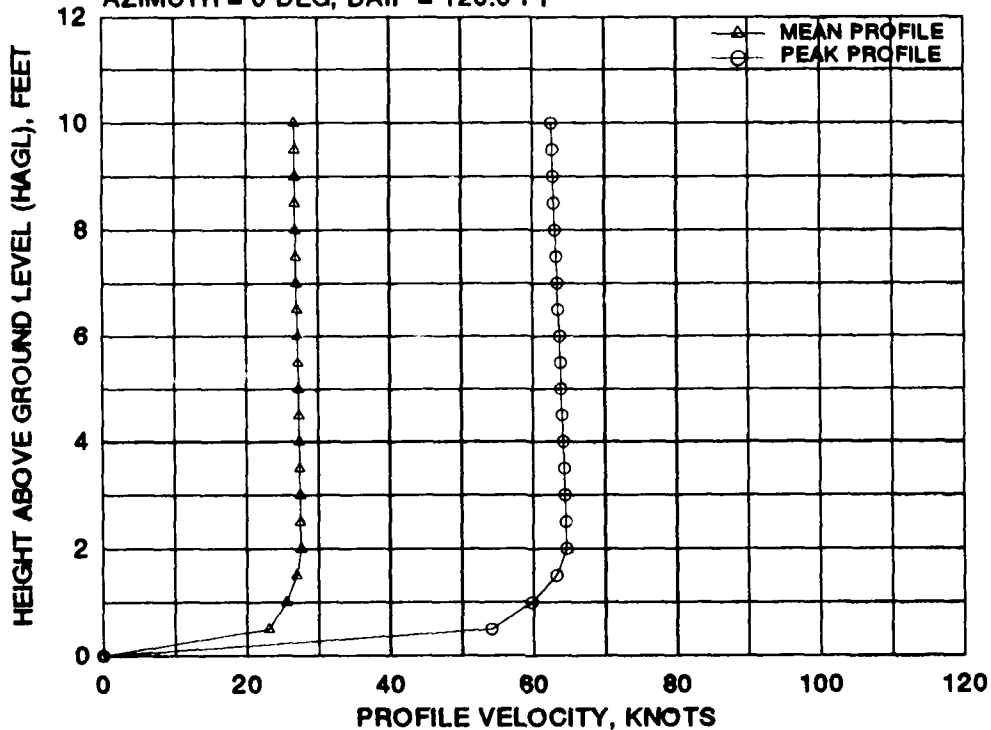

FIGURE B-8 BELL/BOEING MV-22 MEAN AND PEAK VELOCITY PROFILES FOR NINE 0 DEGREE AZIMUTH RADIAL STATIONS AT A WHEEL HEIGHT OF 5 FEET AND A GROSS WEIGHT OF 47,500 POUNDS (Continued)

BELL-BOEING MV-22 OSPREY
 GW = 47500 LBS, WAGL = 5 FT
 AZIMUTH = 0 DEG, DAIP = 120.0 FT



BELL-BOEING MV-22 OSPREY
 GW = 47500 LBS, WAGL = 5 FT
 AZIMUTH = 0 DEG, DAIP = 150.0 FT

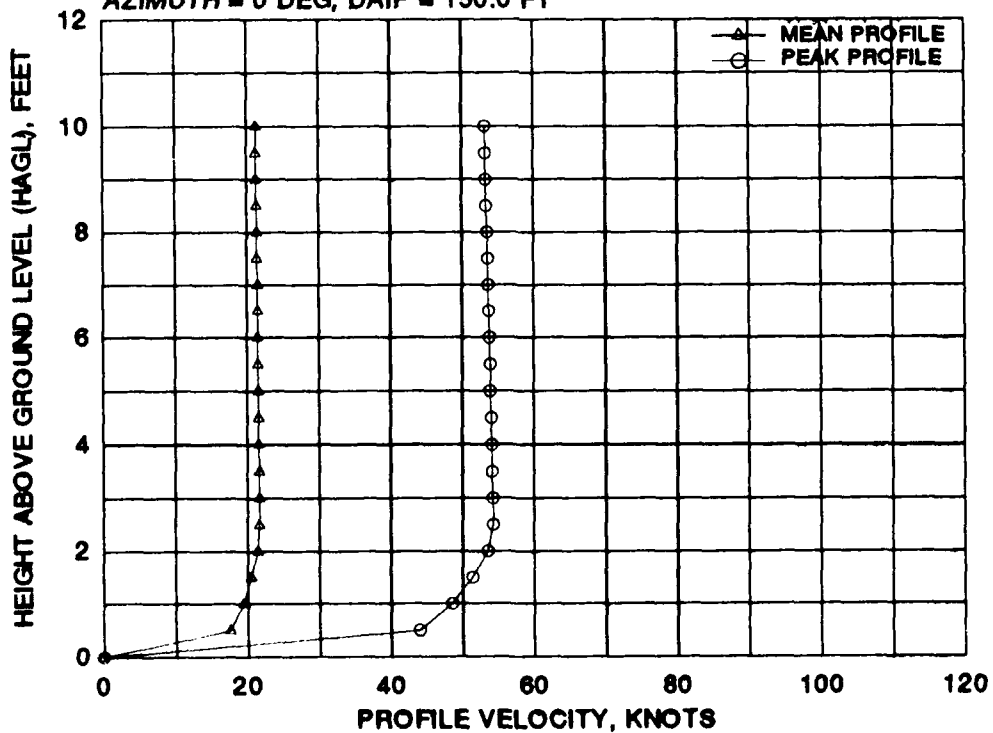

FIGURE B-8 BELL/BOEING MV-22 MEAN AND PEAK VELOCITY PROFILES FOR NINE 0 DEGREE AZIMUTH RADIAL STATIONS AT A WHEEL HEIGHT OF 5 FEET AND A GROSS WEIGHT OF 47,500 POUNDS (Continued)

BELL-BOEING MV-22 OSPREY
GW = 47500 LBS, WAGL = 5 FT
AZIMUTH = 0 DEG, DAIP = 200.0 FT

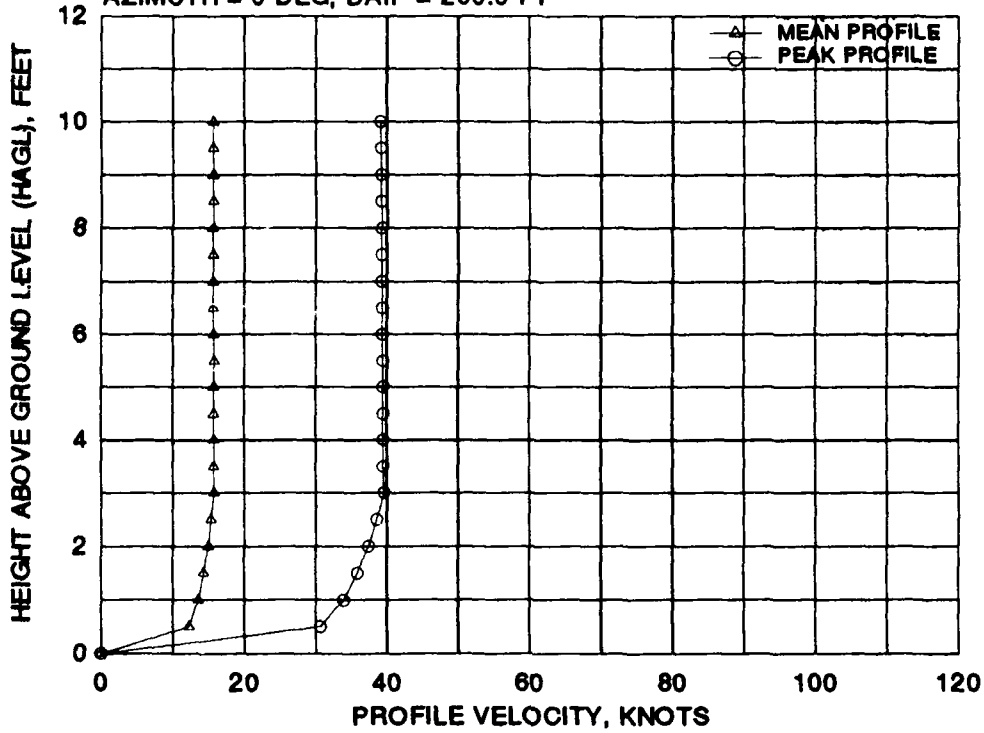
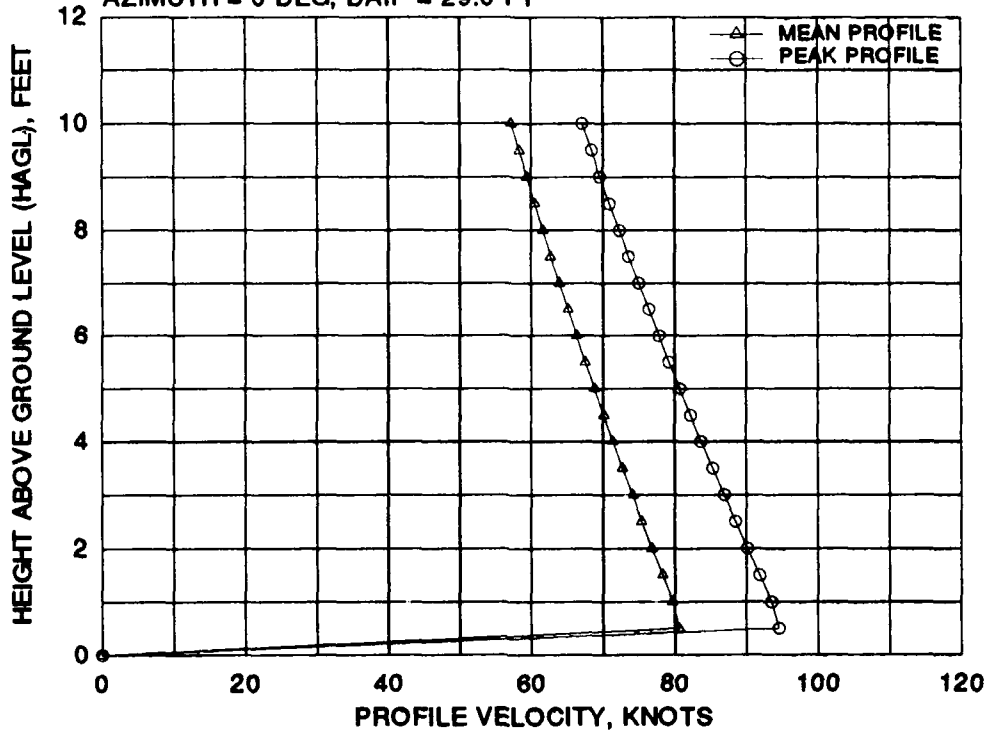

FIGURE B-8 BELL/BOEING MV-22 MEAN AND PEAK VELOCITY PROFILES FOR NINE 0 DEGREE AZIMUTH RADIAL STATIONS AT A WHEEL HEIGHT OF 5 FEET AND A GROSS WEIGHT OF 47,500 POUNDS (Concluded)

BELL-BOEING MV-22 OSPREY
 GW = 47500 LBS, WAGL = 30 FT
 AZIMUTH = 0 DEG, DAIP = 29.0 FT



BELL-BOEING MV-22 OSPREY
 GW = 47500 LBS, WAGL = 30 FT
 AZIMUTH = 0 DEG, DAIP = 35.0 FT

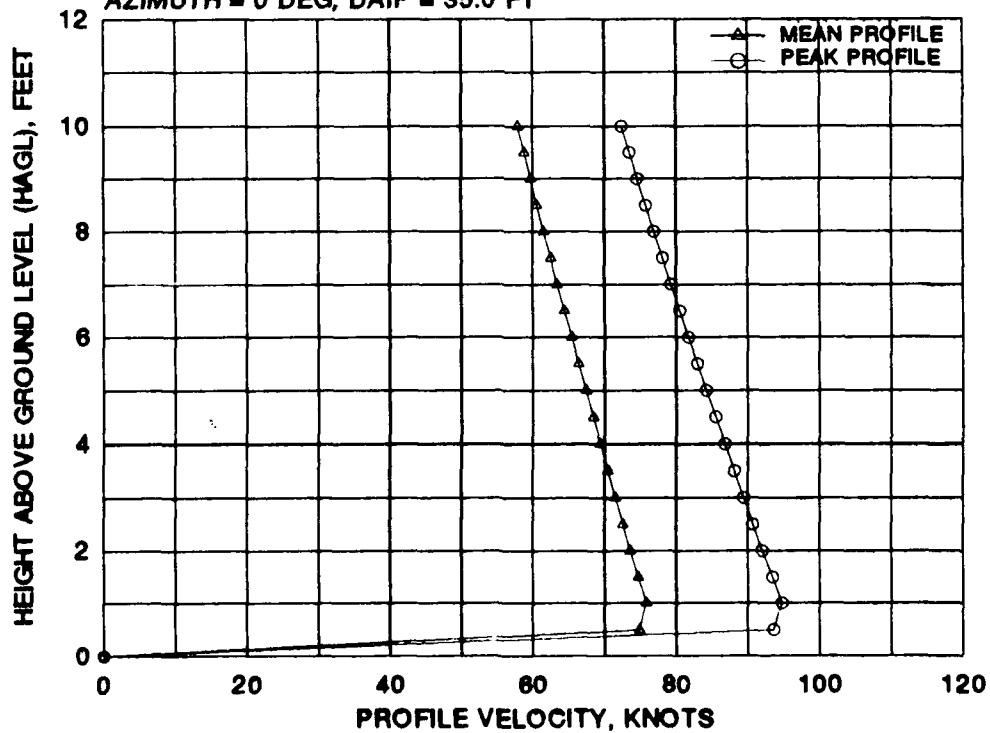
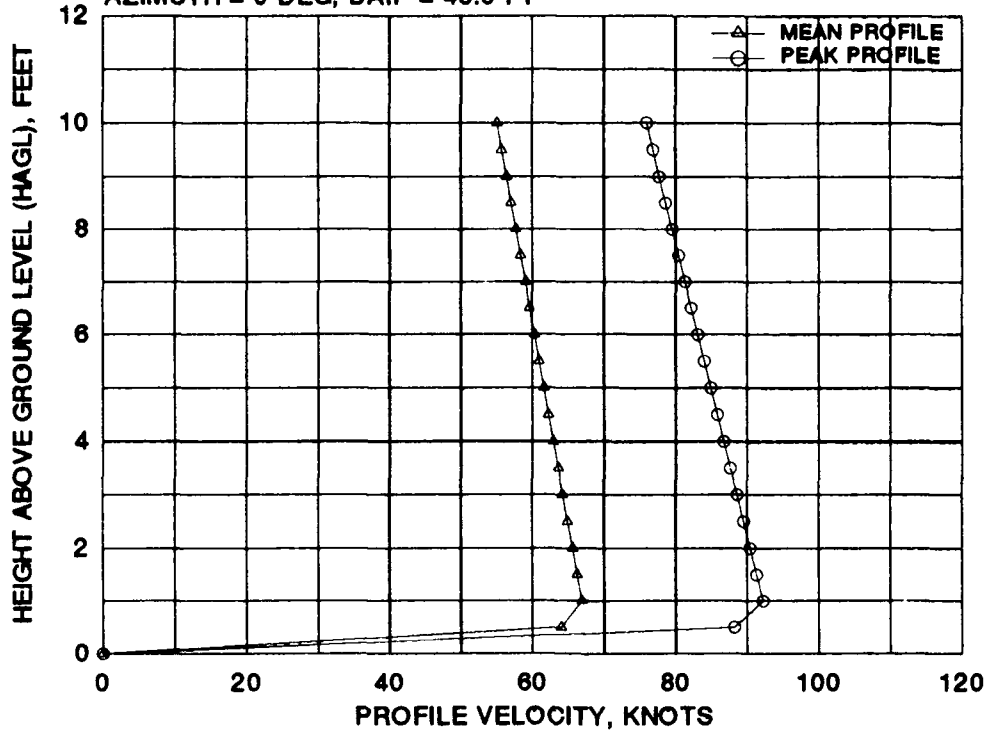

FIGURE B-9 BELL/BOEING MV-22 MEAN AND PEAK VELOCITY PROFILES FOR NINE 0 DEGREE AZIMUTH RADIAL STATIONS AT A WHEEL HEIGHT OF 30 FEET AND A GROSS WEIGHT OF 47,500 POUNDS

BELL-BOEING MV-22 OSPREY
 GW = 47500 LBS, WAGL = 30 FT
 AZIMUTH = 0 DEG, DAIP = 45.0 FT



BELL-BOEING MV-22 OSPREY
 GW = 47500 LBS, WAGL = 30 FT
 AZIMUTH = 0 DEG, DAIP = 60.0 FT

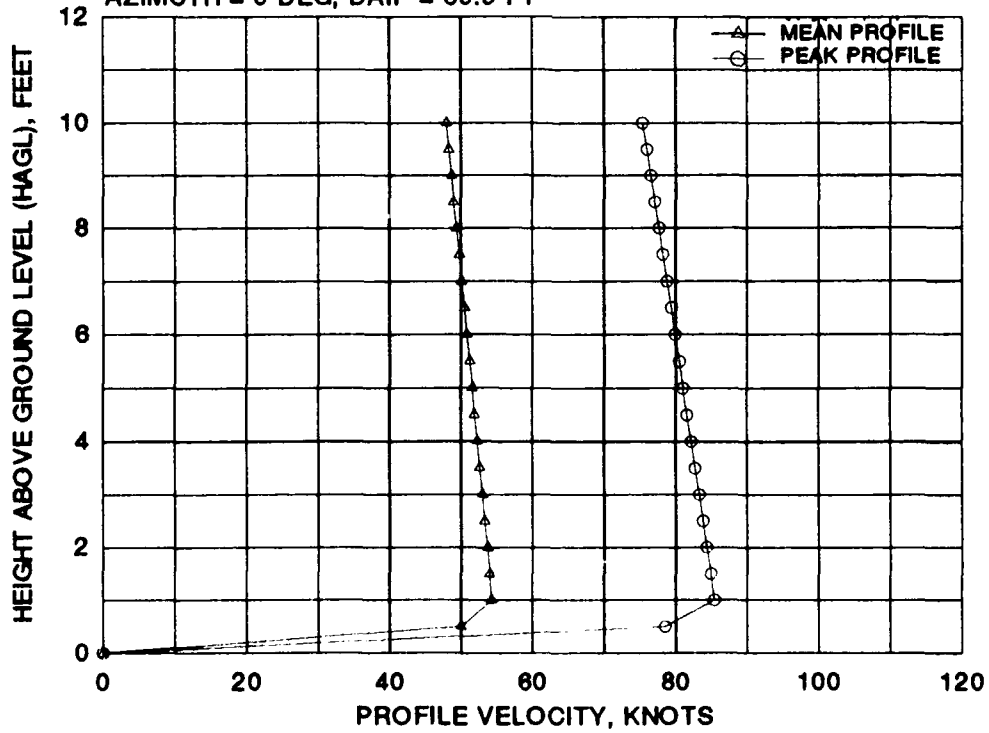
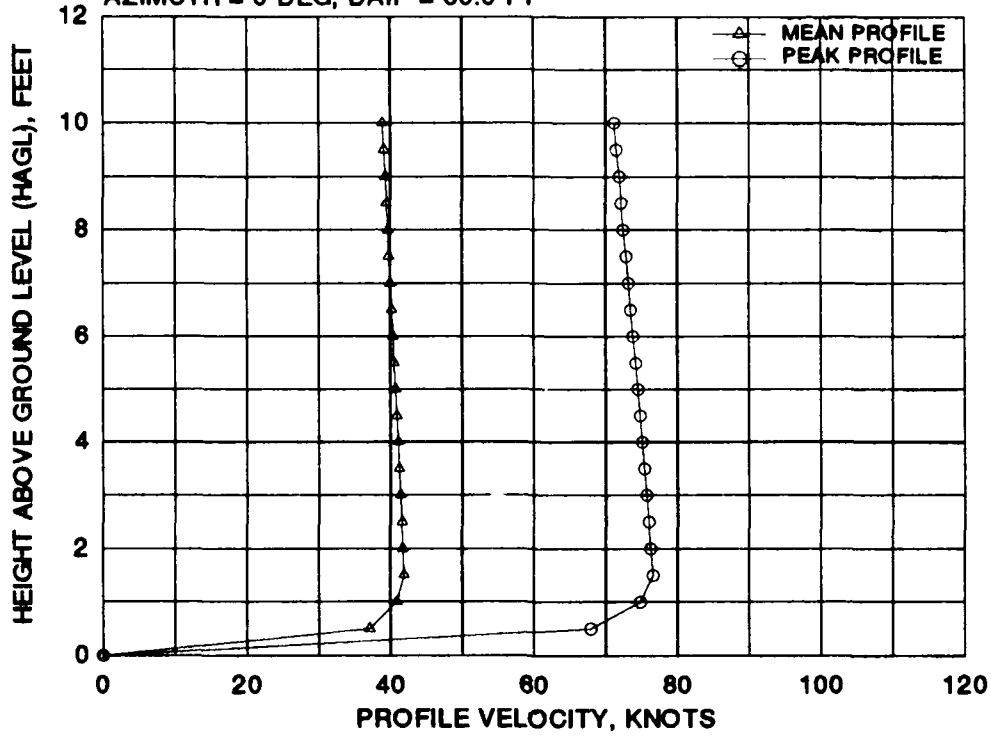

FIGURE B-9 BELL/BOEING MV-22 MEAN AND PEAK VELOCITY PROFILES FOR NINE 0 DEGREE AZIMUTH RADIAL STATIONS AT A WHEEL HEIGHT OF 30 FEET AND A GROSS WEIGHT OF 47,500 POUNDS (Continued)

BELL-BOEING MV-22 OSPREY
 GW = 47500 LBS, WAGL = 30 FT
 AZIMUTH = 0 DEG, DAIP = 80.0 FT



BELL-BOEING MV-22 OSPREY
 GW = 47500 LBS, WAGL = 30 FT
 AZIMUTH = 0 DEG, DAIP = 100.0 FT

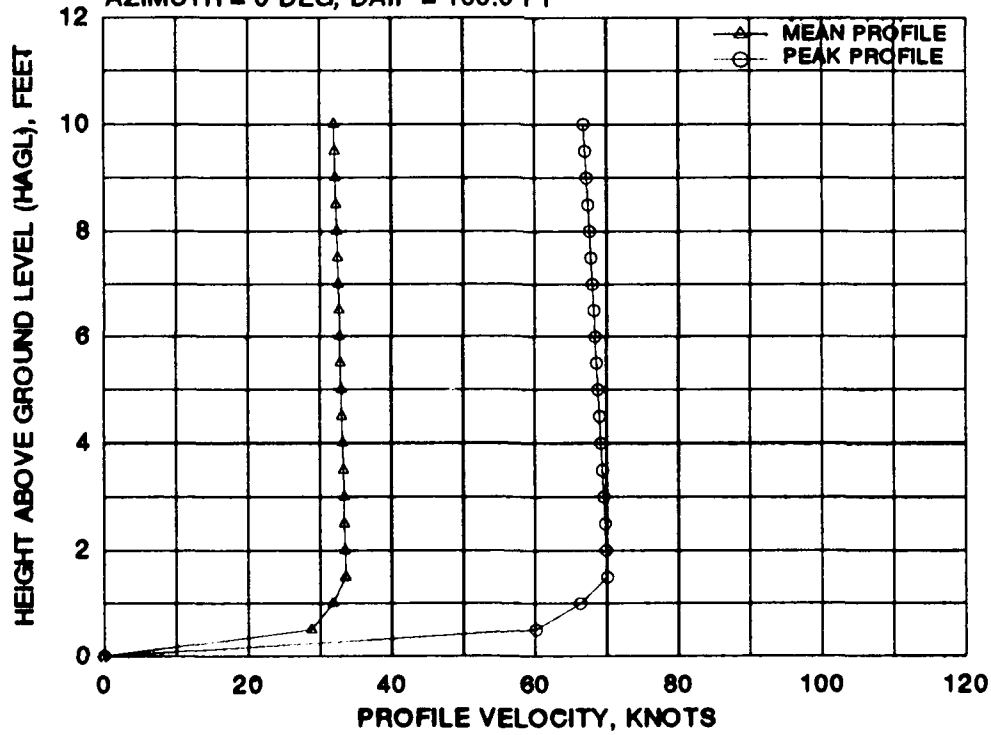
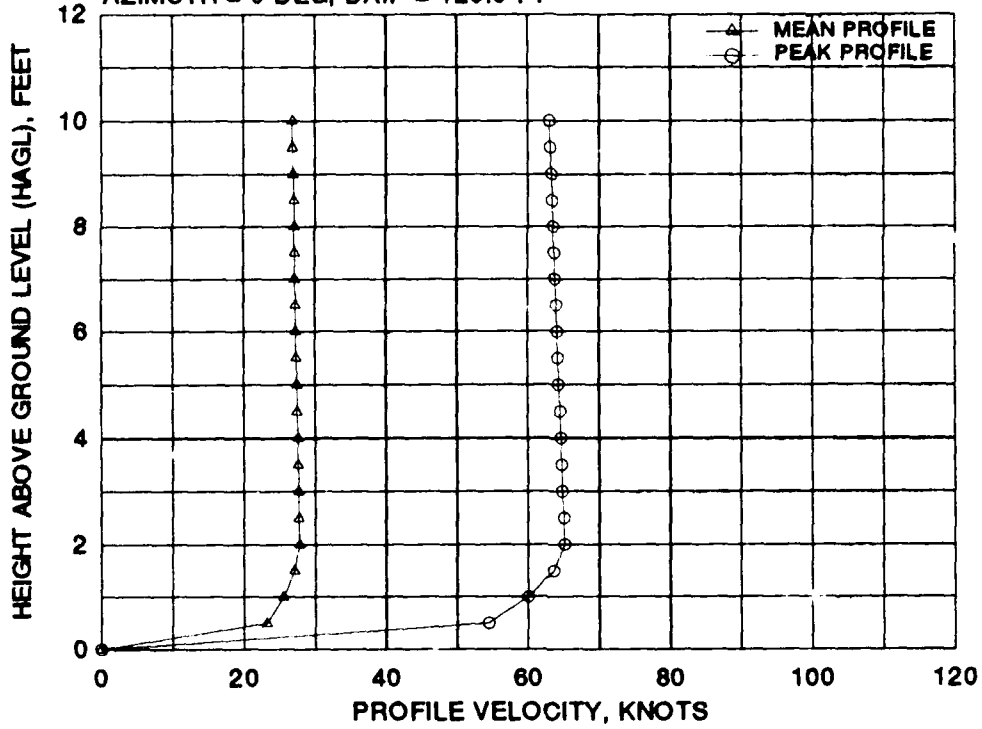

FIGURE B-9 BELL/BOEING MV-22 MEAN AND PEAK VELOCITY PROFILES FOR NINE 0 DEGREE AZIMUTH RADIAL STATIONS AT A WHEEL HEIGHT OF 30 FEET AND A GROSS WEIGHT OF 47,500 POUNDS (Continued)

BELL-BOEING MV-22 OSPREY
 GW = 47500 LBS, WAGL = 30 FT
 AZIMUTH = 0 DEG, DAIP = 120.0 FT



BELL-BOEING MV-22 OSPREY
 GW = 47500 LBS, WAGL = 30 FT
 AZIMUTH = 0 DEG, DAIP = 150.0 FT

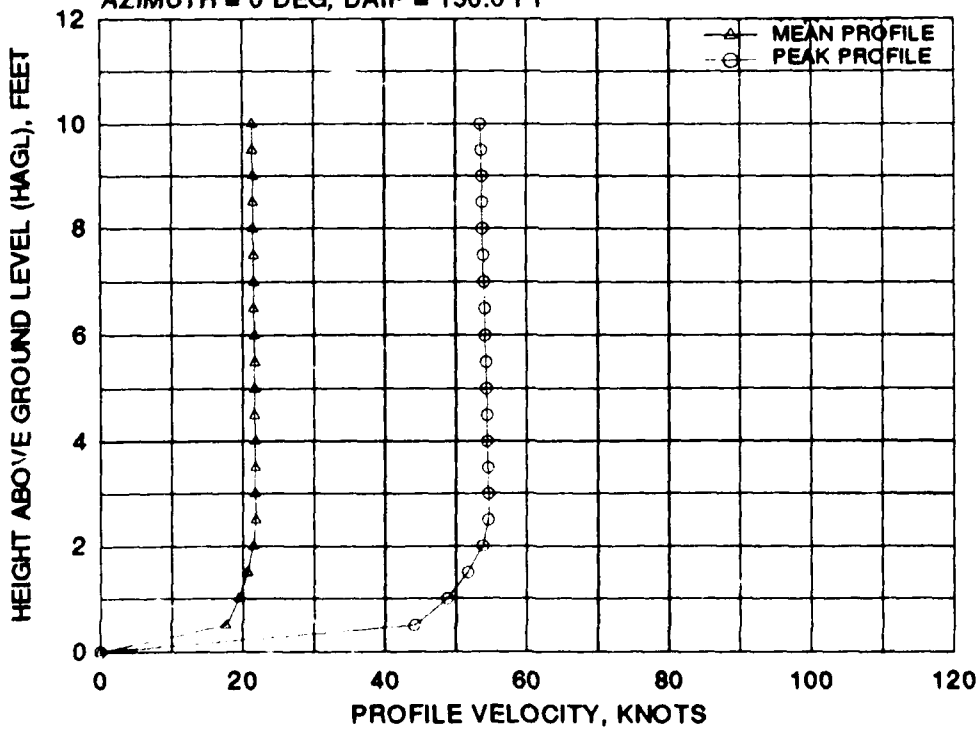

FIGURE B-9 BELL/BOEING MV-22 MEAN AND PEAK VELOCITY PROFILES FOR NINE 0 DEGREE AZIMUTH RADIAL STATIONS AT A WHEEL HEIGHT OF 30 FEET AND A GROSS WEIGHT OF 47,500 POUNDS (Continued)

BELL-BOEING MV-22 OSPREY
GW = 47500 LBS, WAGL = 30 FT
AZIMUTH = 0 DEG, DAIP = 200.0 FT

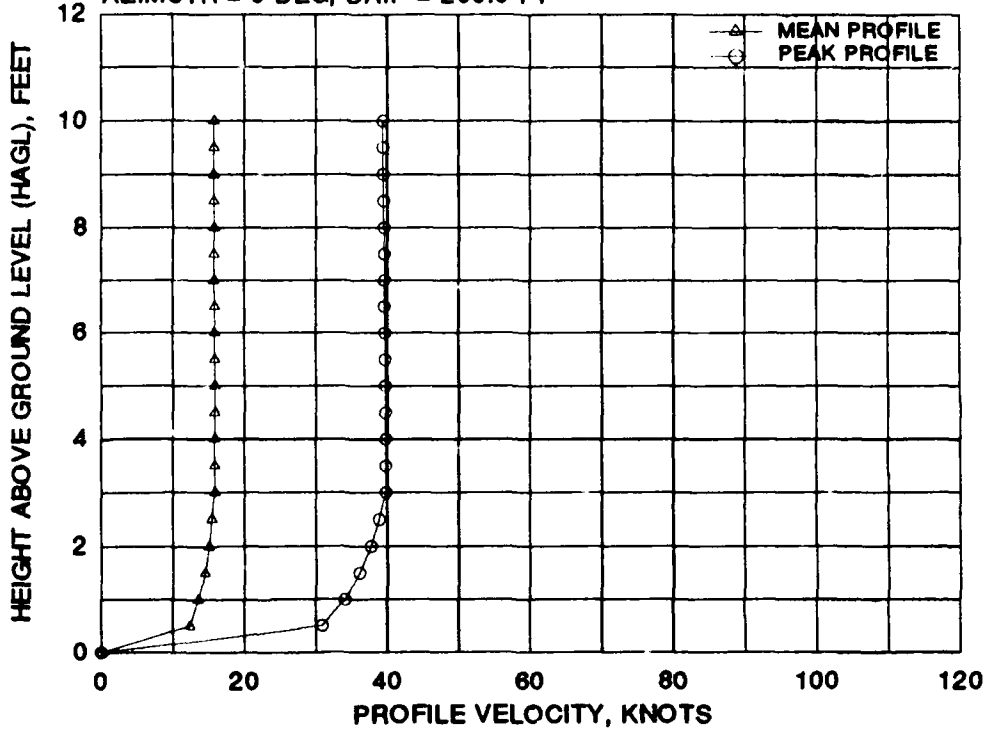

FIGURE B-9 BELL/BOEING MV-22 MEAN AND PEAK VELOCITY PROFILES FOR NINE 0 DEGREE AZIMUTH RADIAL STATIONS AT A WHEEL HEIGHT OF 30 FEET AND A GROSS WEIGHT OF 47,500 POUNDS (Concluded)

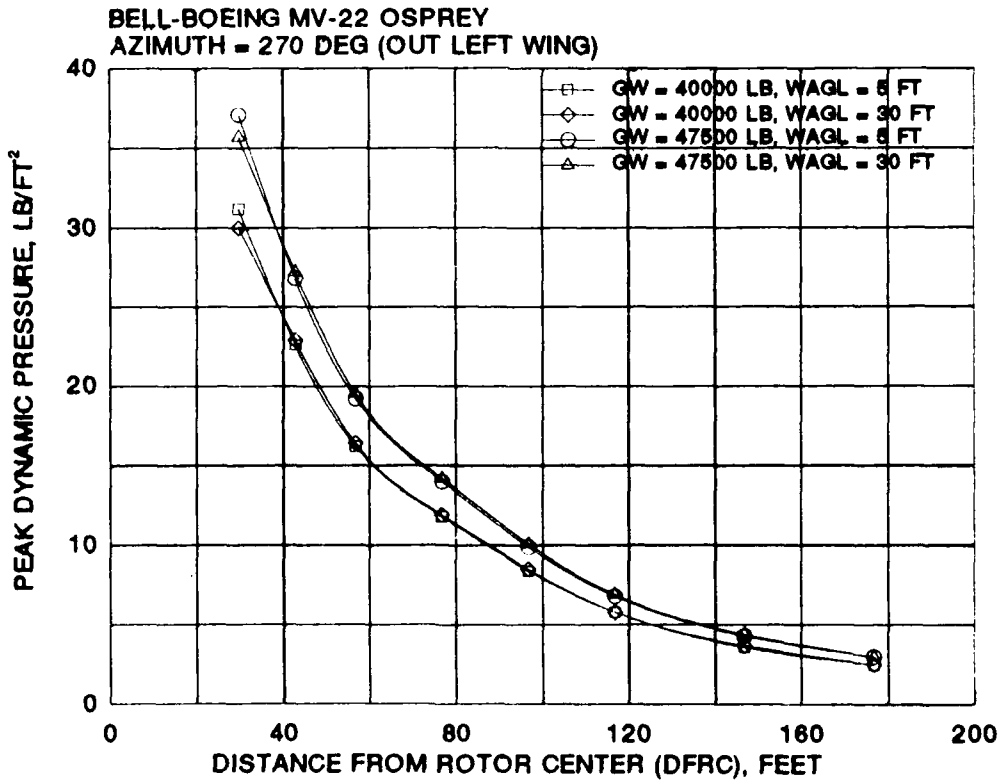
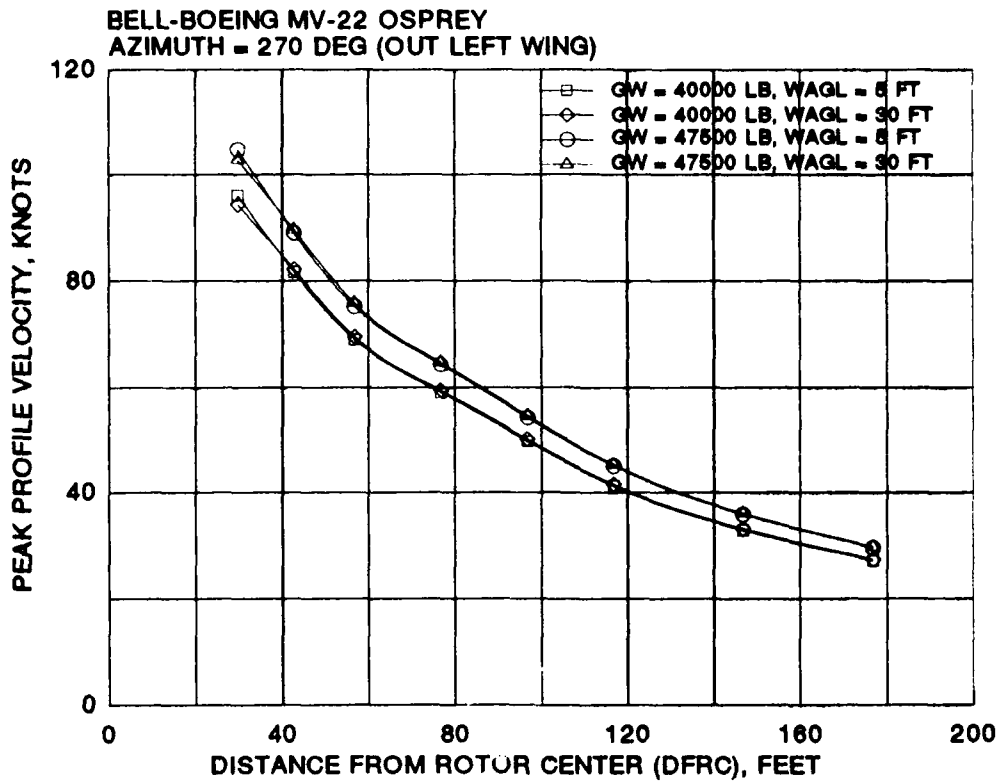
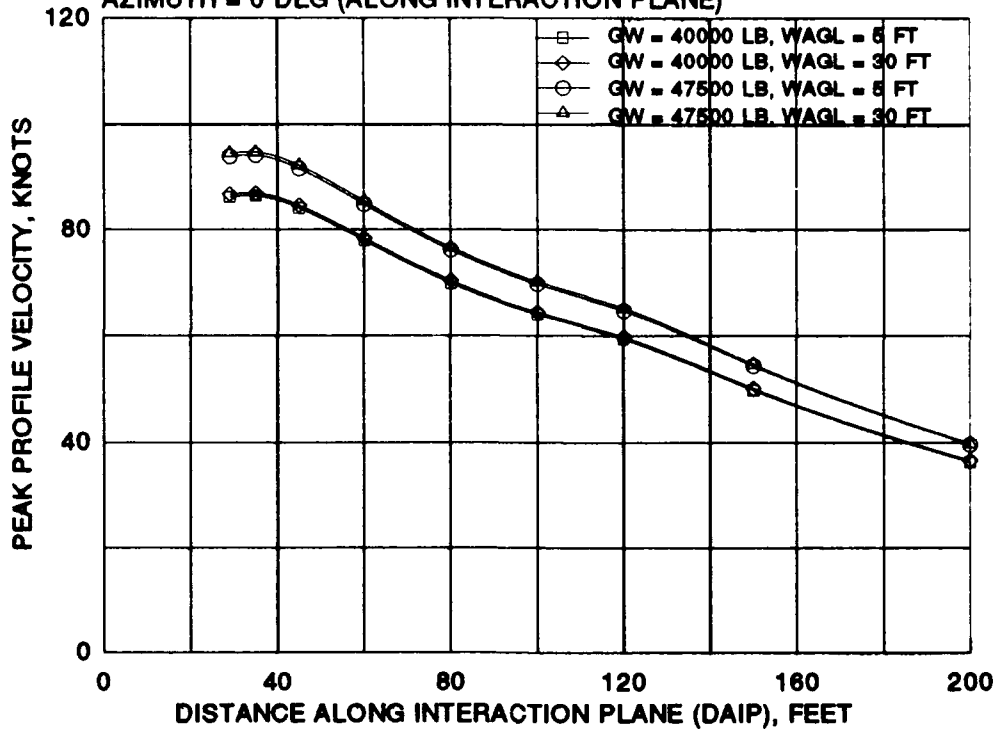

FIGURE B-10 BELL/BOEING MV-22 PEAK ROTORWASH VELOCITY AND DYNAMIC PRESSURE AS A FUNCTION OF DISTANCE FROM THE ROTOR CENTER (270 DEGREE AZIMUTH)

BELL-BOEING MV-22 OSPREY
 AZIMUTH = 0 DEG (ALONG INTERACTION PLANE)



BELL-BOEING MV-22 OSPREY
 AZIMUTH = 0 DEG (ALONG INTERACTION PLANE)

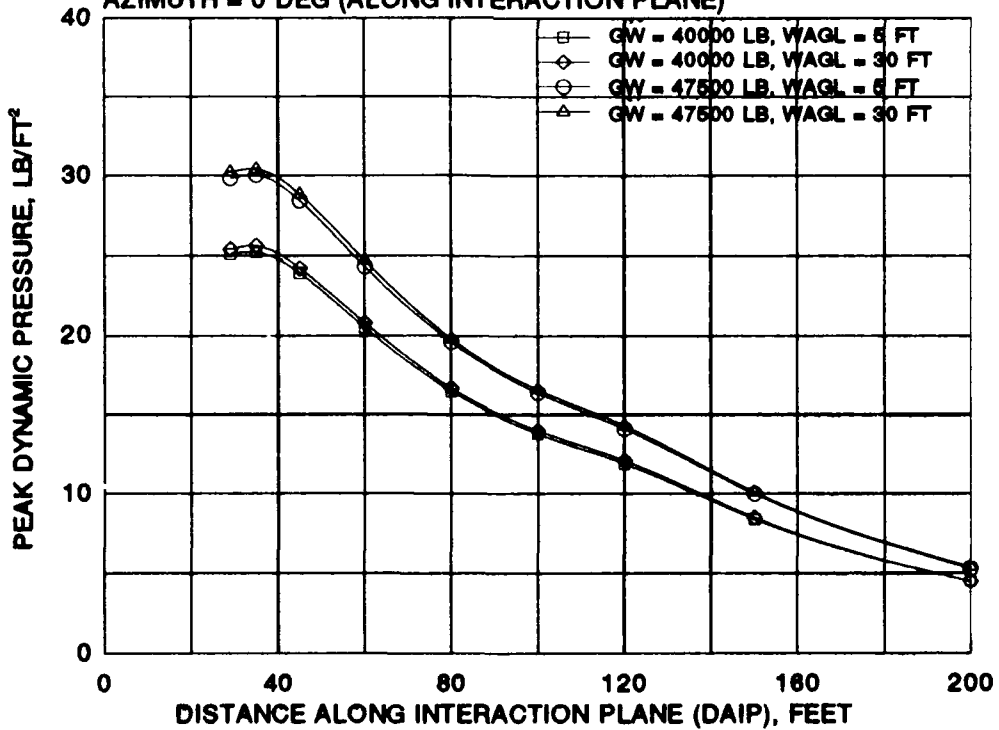

FIGURE B-11 BELL/BOEING MV-22 PEAK ROTORWASH VELOCITY AND DYNAMIC PRESSURE AS A FUNCTION OF DISTANCE ALONG THE INTERACTION PLANE (0 DEGREE AZIMUTH)

BELL-BOEING MV-22 OSPREY
 AZIMUTH = 270 DEG (OUT LEFT WING)

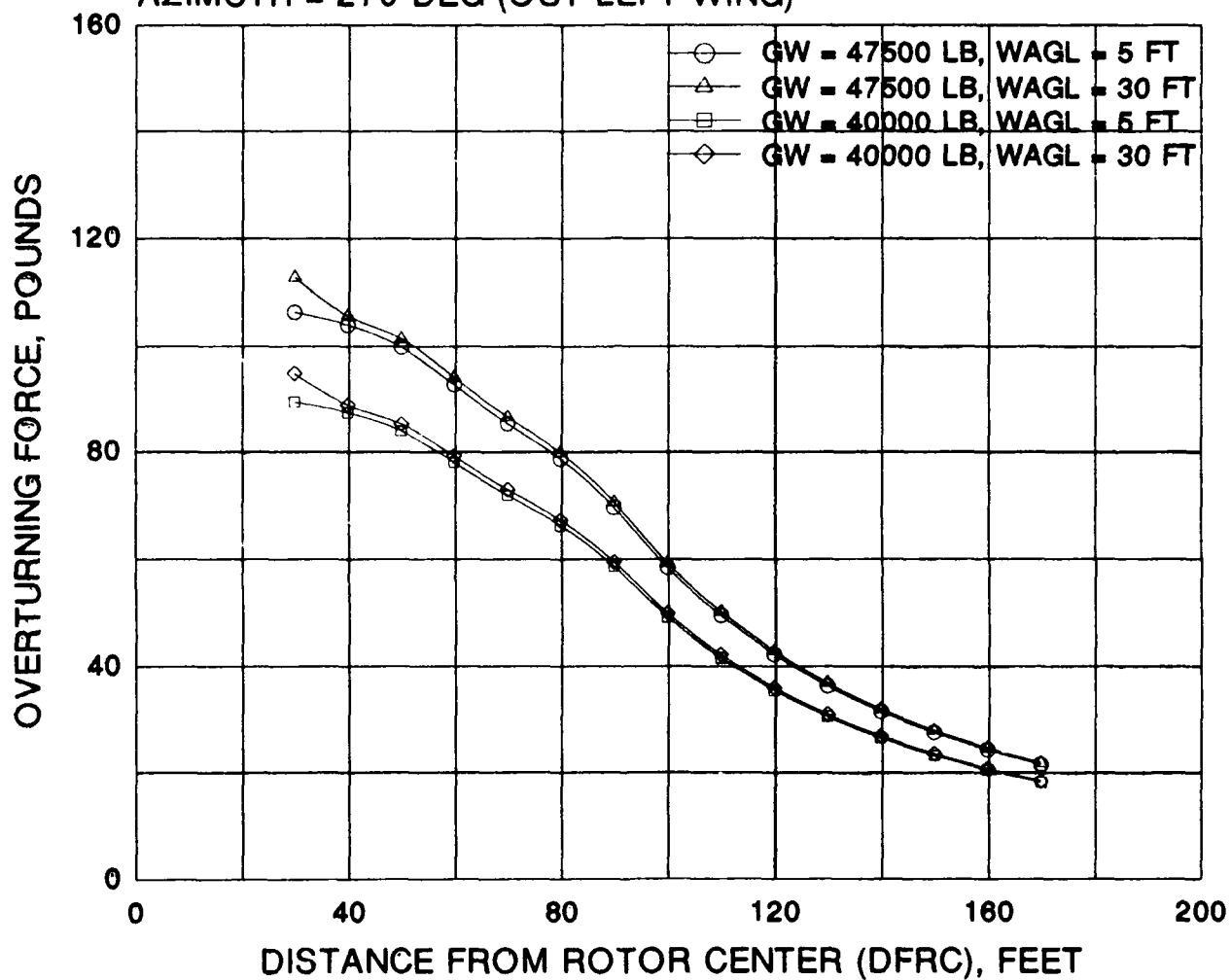

FIGURE B-12 BELL/BOEING MV-22 OVERTURNING FORCE AS A FUNCTION OF DISTANCE FROM THE ROTOR CENTER (270 DEGREE AZIMUTH)

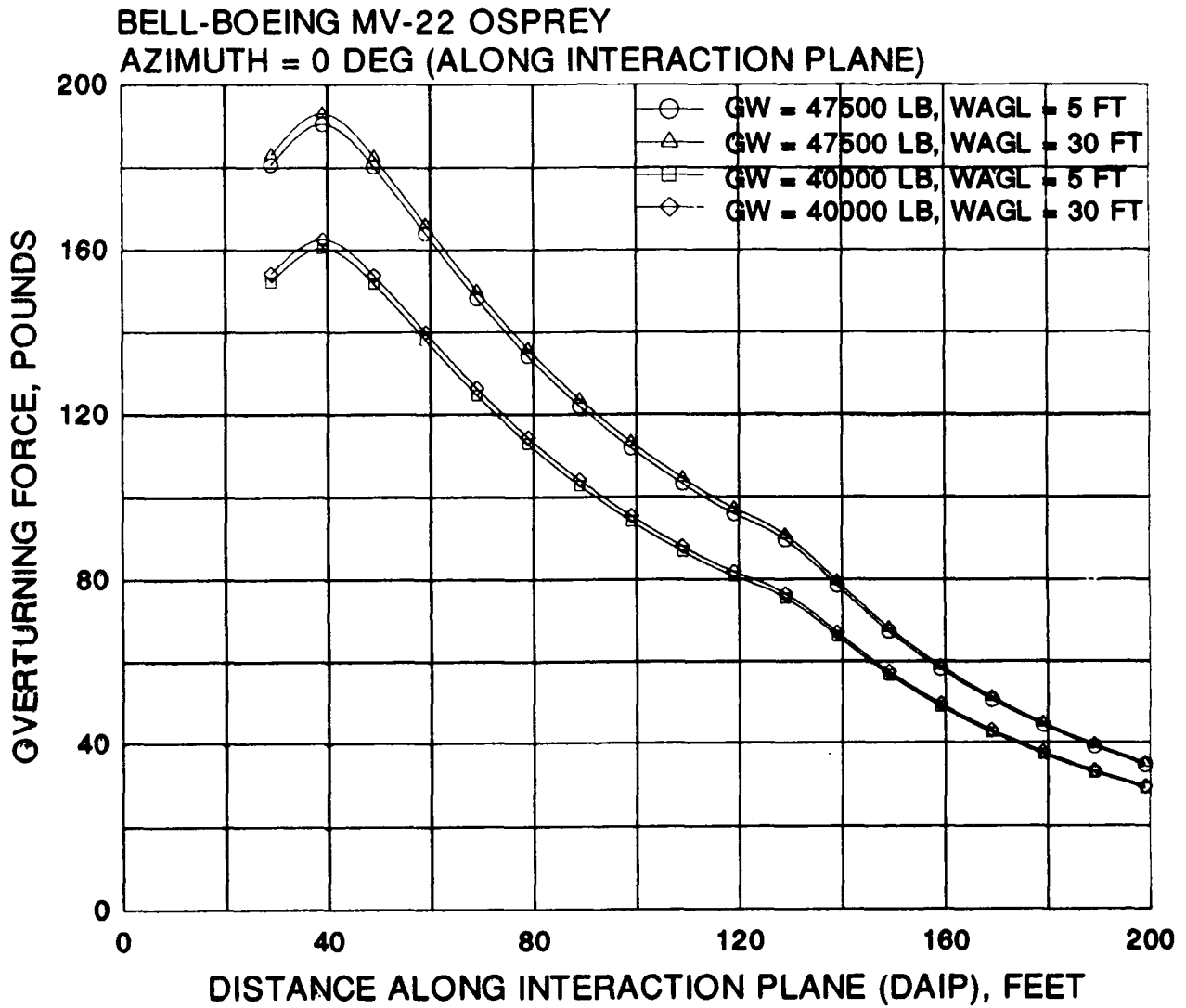

FIGURE B-13 BELL/BOEING MV-22 OVERTURNING FORCE AS A FUNCTION OF DISTANCE ALONG THE INTERACTION PLANE (0 DEGREE AZIMUTH)

APPENDIX C

BELL/BOEING/NASA CTR-22C/D AIRCRAFT AND ROTORWASH DATA

Bell/Boeing/NASA CTR-22C/D aircraft characteristics used with the ROTWASH analysis program are listed in table C-1 as obtained from reference C-1. Figure C-1 presents a three-view drawing of the tiltrotor. Table C-2 provides a summary tabulation of parameters defining the conditions for all rotorwash data presented in the appendix. All data are plotted in one of four formats, which include graphs of:

1. mean and peak outwash velocity profiles,
2. peak outwash velocity versus distance,
3. peak outwash dynamic pressure versus distance, and
4. personnel overturning force versus distance.

In each format, data are plotted along both the 0 and 270 degree azimuth. Distance from rotor center (DFRC) is the independent variable along the 270 degree azimuth. Measurements of distance from aircraft center (DFAC) are also noted on the graphs. The DFAC reference point is defined as zero at the location where the aircraft centerline intersects the line connecting the two rotor centers of rotation. Along the 0 degree azimuth, distance along the interaction plane (DAIP) is the independent variable. This point is referenced as zero at the same location as the DFAC point.

REFERENCES

- C-1. Anon, "State/Regional Tiltrotor/Vertiport Feasibility Studies Data Package," NASA Ames Research Center, June 1, 1989.

TABLE C-1 CTR-22C/D ROTWASH INPUT DATA

<u>Parameter</u>	<u>Value</u>
Rotor radius, feet	19.0
Distance between rotor centers, feet	48.0
Wing download, percent of rotor thrust	9.25
Distance from wheels to rotor plane, feet	23.0
Rotor speed, RPM	397.0
Rotor tip speed, feet/second	789.5
Number of rotor blades per rotor	3
Density ratio	1.0

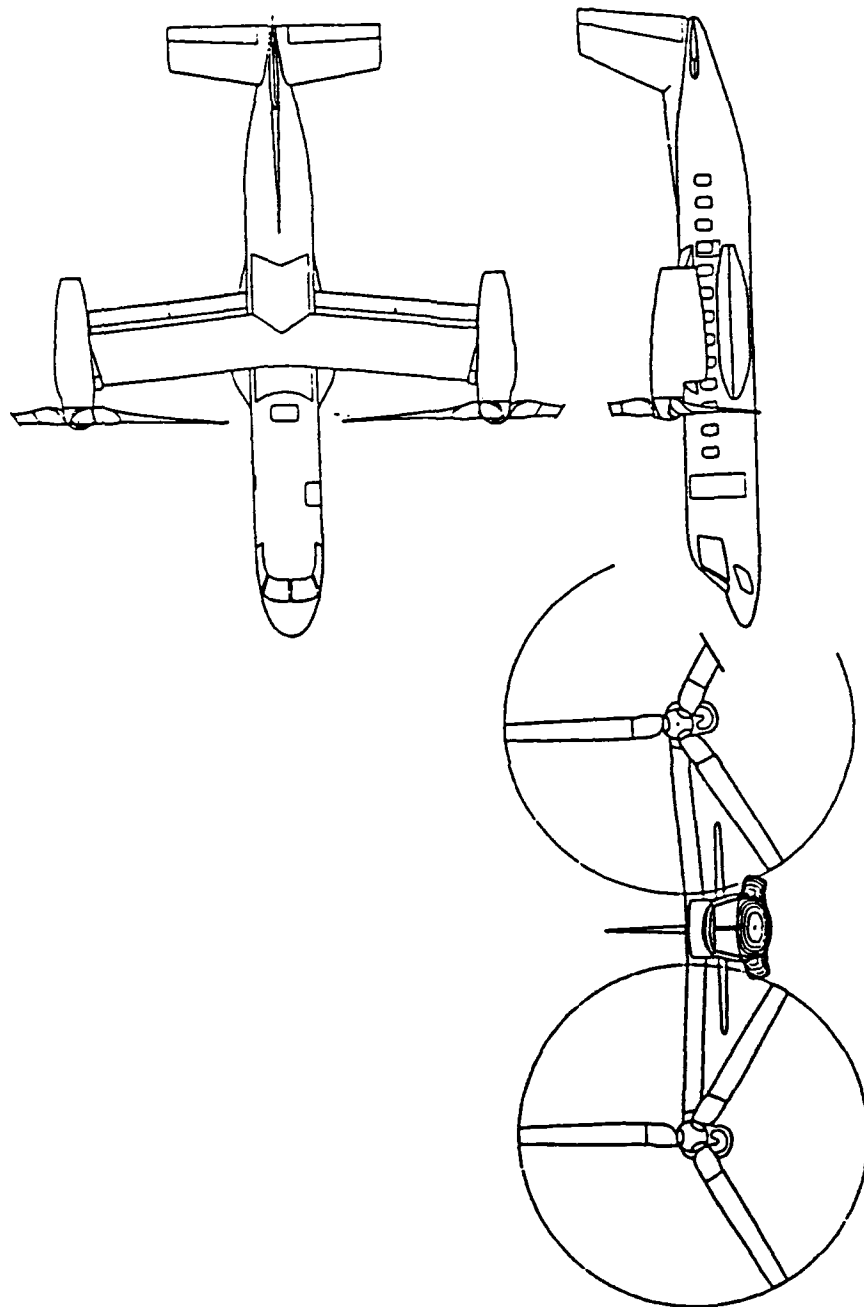

FIGURE C-1 THREE-VIEW DRAWING OF THE CTR-22C/D

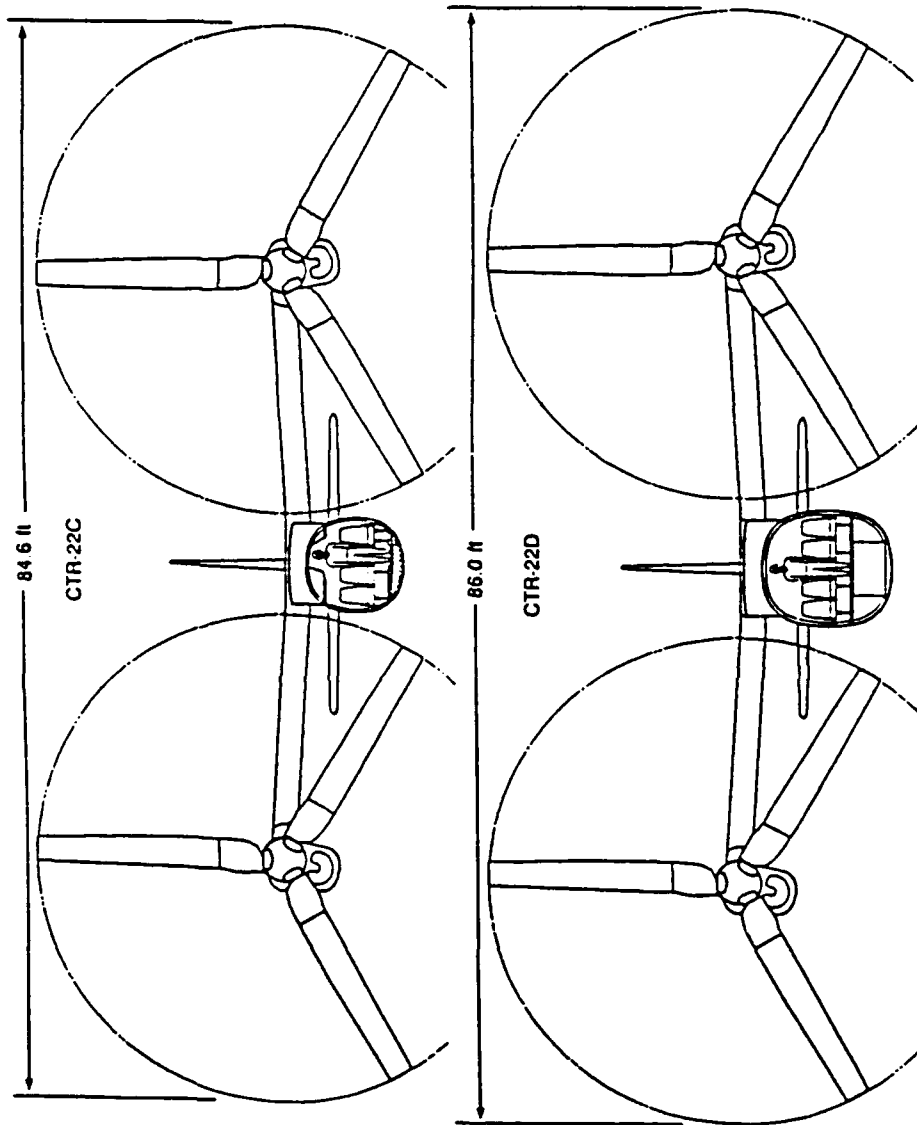

FIGURE C-1 THREE-VIEW DRAWING OF THE CTR-22C/D (Concluded)

TABLE C-2 CTR-22C/D ROTORWASH EVALUATION MATRIX

Note: The Figure/Type column provides the figure number and data format type where:

M/P - Mean and peak velocity profile format

PVD - Peak velocity and dynamic pressure format

OTF - Personnel overturning force format

<u>Figure/ Type</u>	<u>Azimuth, Degrees</u>	<u>GW, Pounds</u>	<u>WAGL, Feet</u>	<u>DFRC or DAIP Distance, Feet</u>
C-2 M/P	270.0	51,670	30	29, 42, 56, 76, 96, 116, 146, 176
C-3 M/P	0.0	51,670	30	29, 35, 45, 60, 80, 100, 120, 150, 200
C-4 PVD	270.0	51,670	30	30 to 180
C-5 PVD	0.0	51,670	30	30 to 200
C-6 OTF	270.0	51,670	30	30 to 170
C-7 OTF	0.0	51,670	30	30 to 190

BELL/BOEING/NASA CTR-22C/D
 GW = 51670 LB, WAGL = 30 FT
 AZIMUTH = 270 DEG, DFAC = 53.0 FT (DFRC = 29.0 FT)

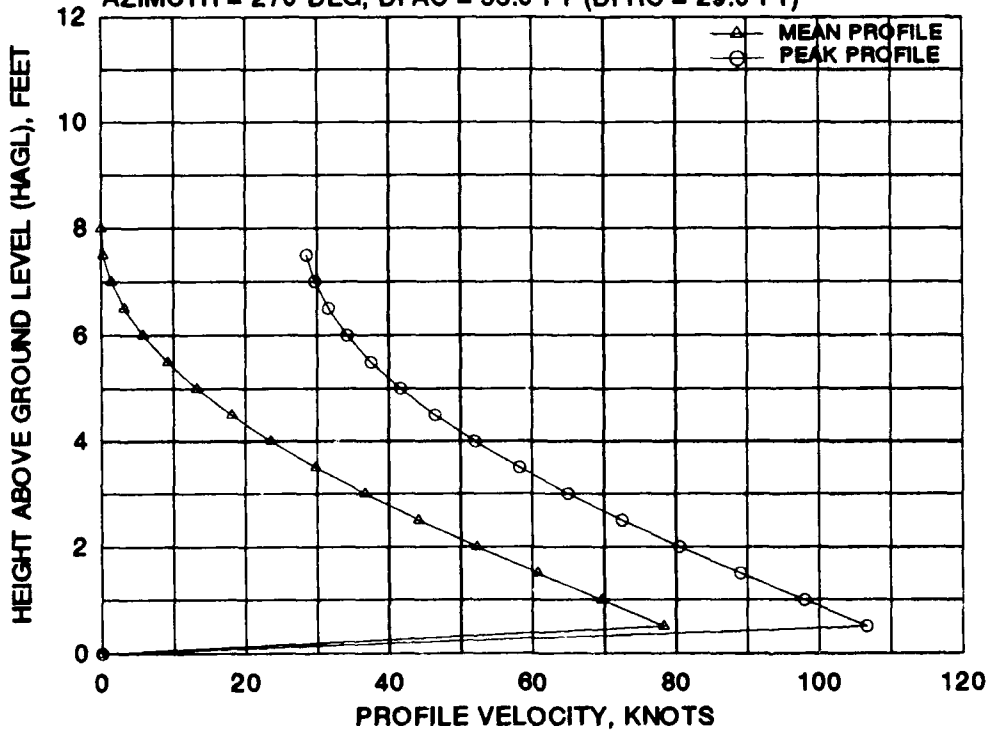

BELL/BOEING/NASA CTR-22C/D
 GW = 51670 LB, WAGL = 30 FT
 AZIMUTH = 270 DEG, DFAC = 66.0 FT (DFRC = 42.0 FT)

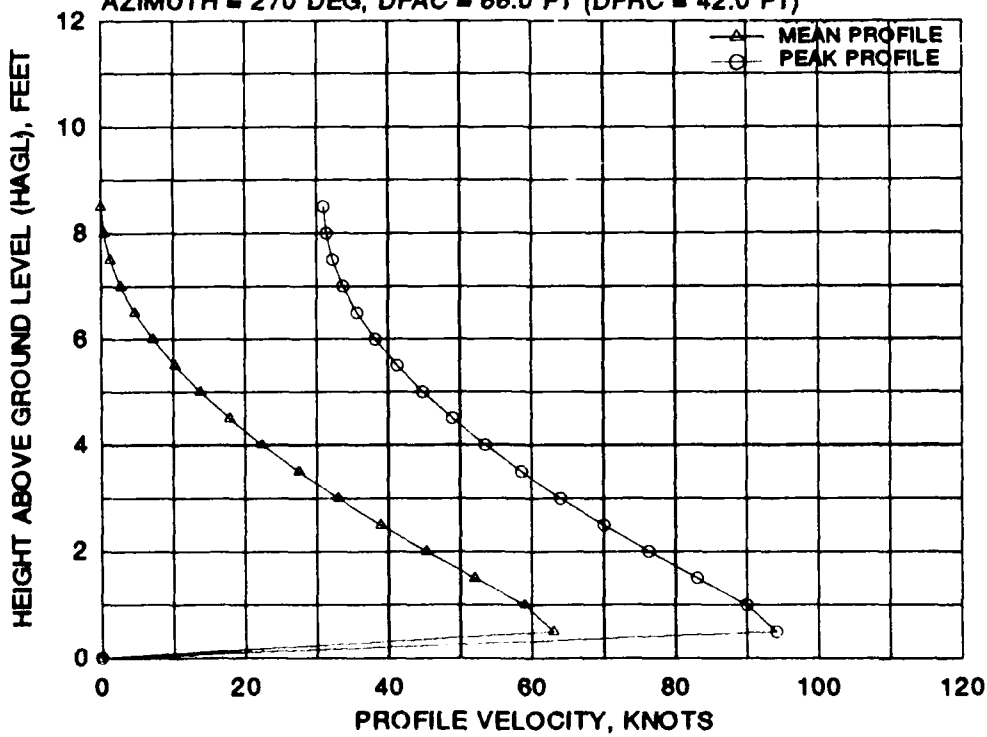
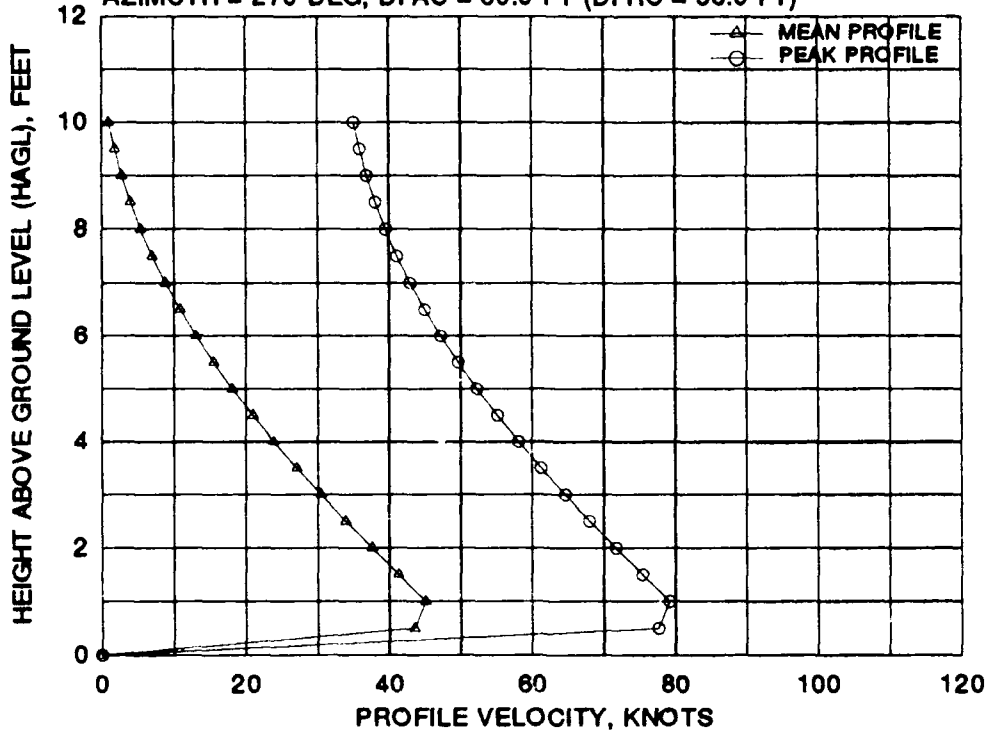

FIGURE C-2 CTR-22C/D MEAN AND PEAK VELOCITY PROFILES FOR EIGHT 270 DEGREE AZIMUTH RADIAL STATIONS AT A WHEEL HEIGHT OF 30 FEET AND A GROSS WEIGHT OF 51,670 POUNDS

BELL/BOEING/NASA CTR-22C/D
 GW = 51670 LB, WAGL = 30 FT
 AZIMUTH = 270 DEG, DFAC = 80.0 FT (DFRC = 56.0 FT)



BELL/BOEING/NASA CTR-22C/D
 GW = 51670 LB, WAGL = 30 FT
 AZIMUTH = 270 DEG, DFAC = 100.0 FT (DFRC = 76.0 FT)

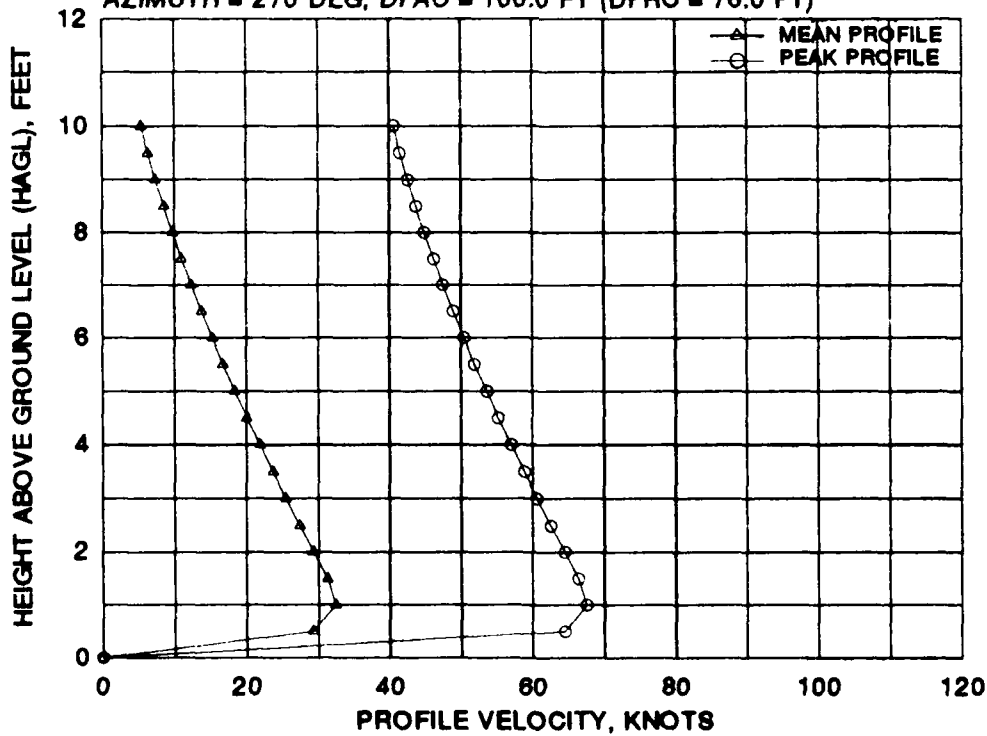
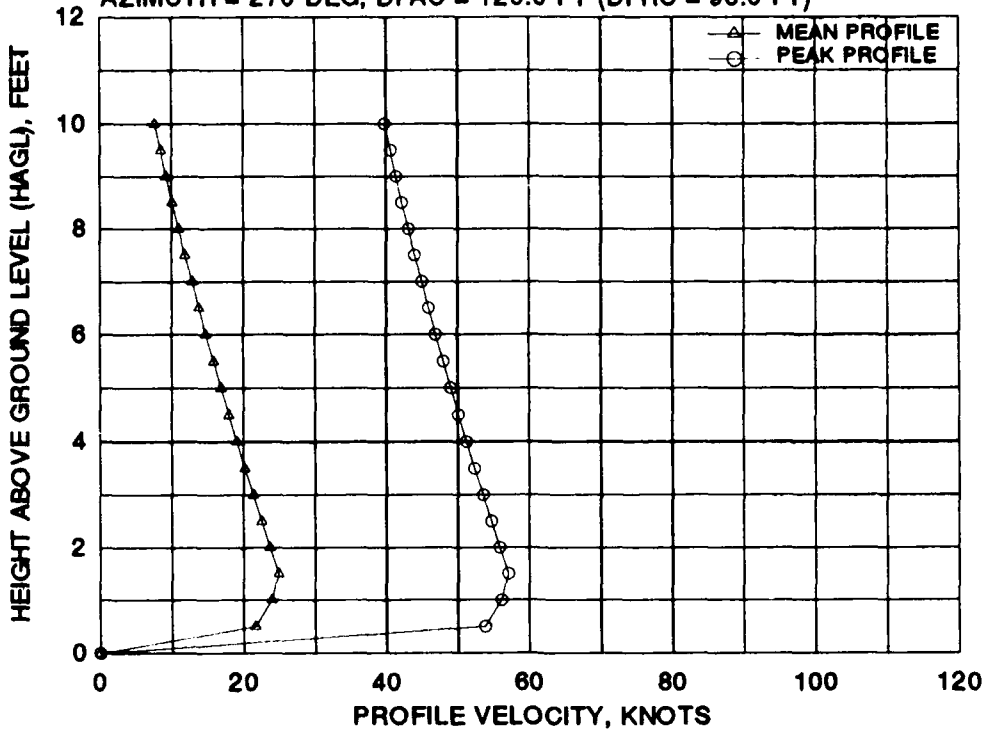

FIGURE C-2 CTR-22C/D MEAN AND PEAK VELOCITY PROFILES FOR EIGHT 270 DEGREE AZIMUTH RADIAL STATIONS AT A WHEEL HEIGHT OF 30 FEET AND A GROSS WEIGHT OF 51,670 POUNDS (Continued)

BELL/BOEING/NASA CTR-22C/D
 GW = 51670 LB, WAGL = 30 FT
 AZIMUTH = 270 DEG, DFAC = 120.0 FT (DFRC = 96.0 FT)



BELL/BOEING/NASA CTR-22C/D
 GW = 51670 LB, WAGL = 30 FT
 AZIMUTH = 270 DEG, DFAC = 140.0 FT (DFRC = 116.0 FT)

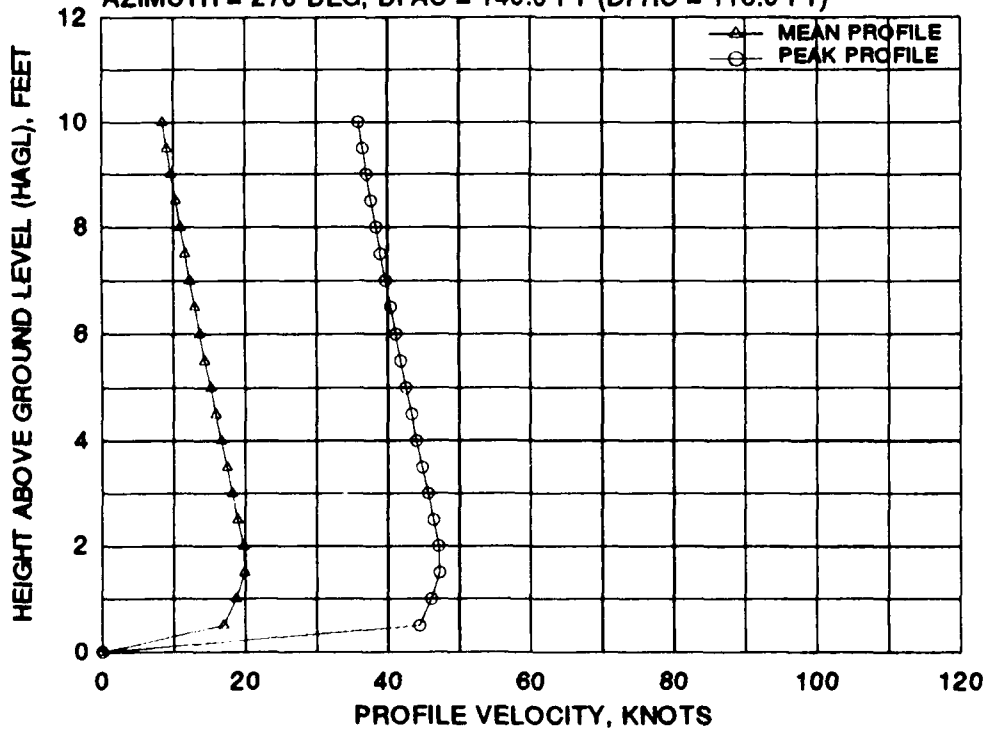
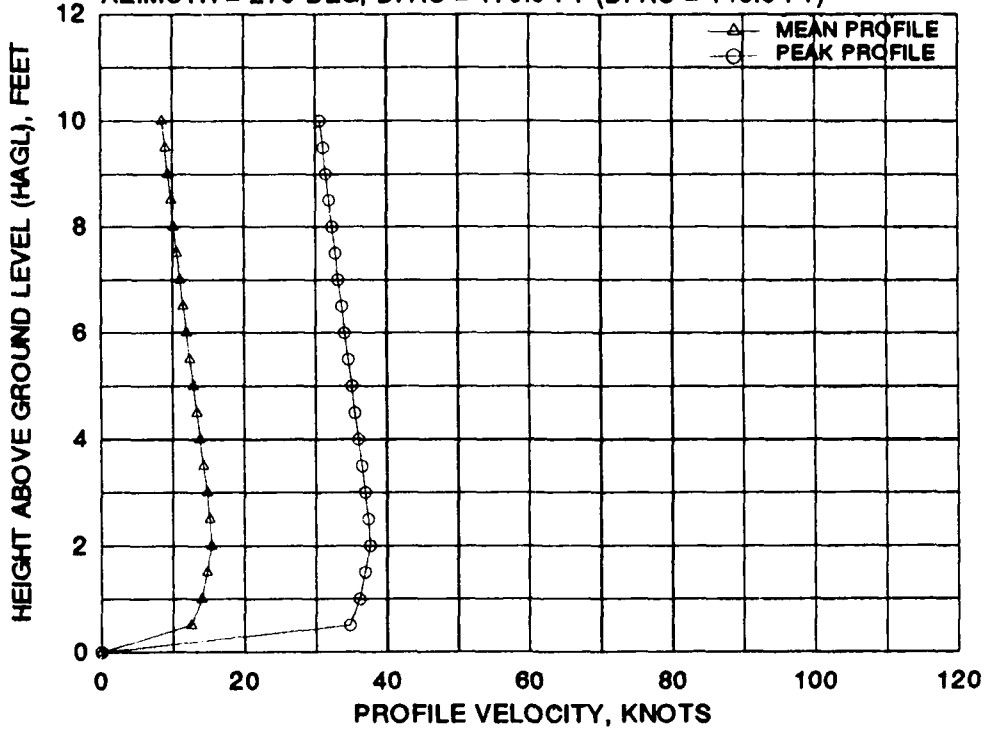

FIGURE C-2 CTR-22C/D MEAN AND PEAK VELOCITY PROFILES FOR EIGHT 270 DEGREE AZIMUTH RADIAL STATIONS AT A WHEEL HEIGHT OF 30 FEET AND A GROSS WEIGHT OF 51,670 POUNDS (Continued)

BELL/BOEING/NASA CTR-22C/D
 GW = 51670 LB, WAGL = 30 FT
 AZIMUTH = 270 DEG, DFAC = 170.0 FT (DFRC = 146.0 FT)



BELL/BOEING/NASA CTR-22C/D
 GW = 51670 LB, WAGL = 30 FT
 AZIMUTH = 270 DEG, DFAC = 200.0 FT (DFRC = 176.0 FT)

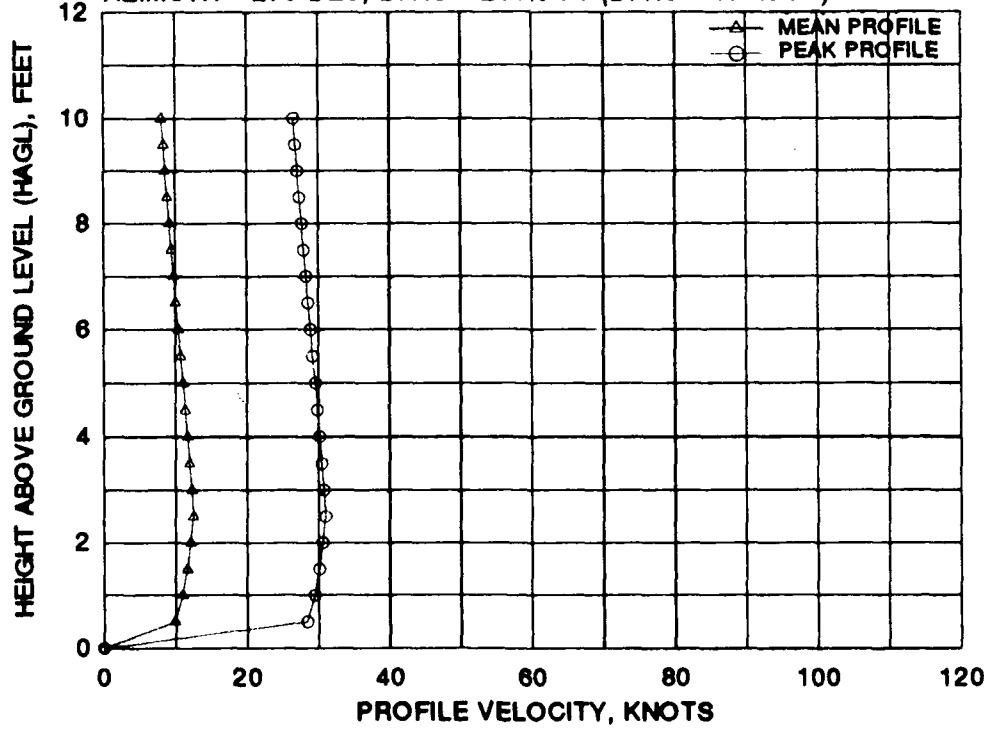
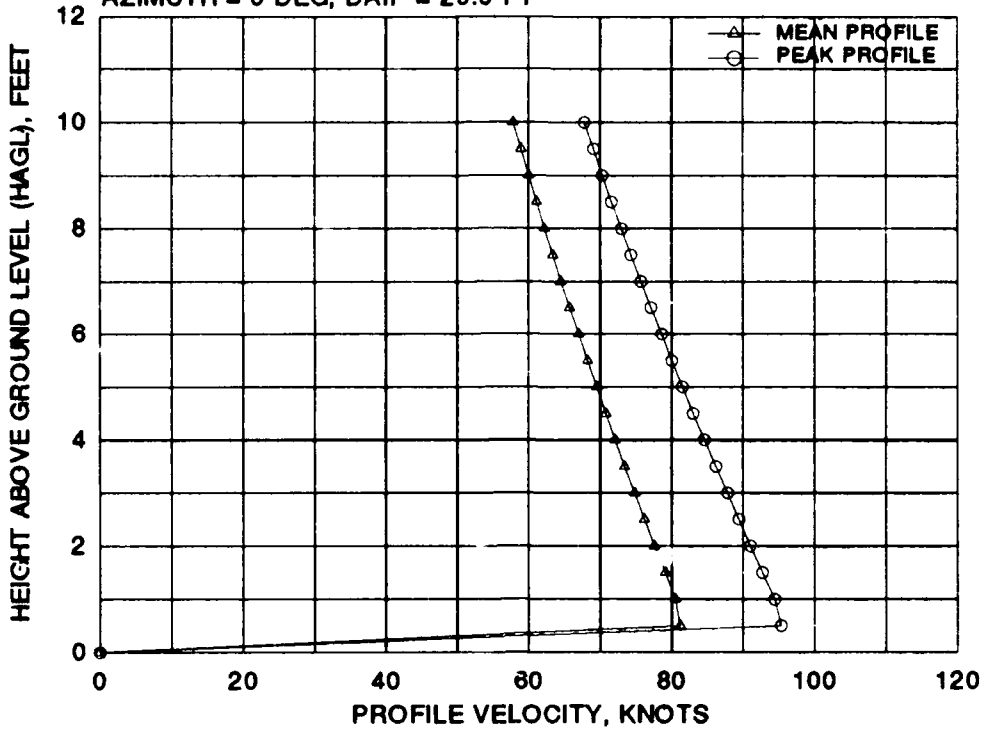

FIGURE C-2 CTR-22C/D MEAN AND PEAK VELOCITY PROFILES FOR EIGHT 270 DEGREE AZIMUTH RADIAL STATIONS AT A WHEEL HEIGHT OF 30 FEET AND A GROSS WEIGHT OF 51,670 POUNDS (Concluded)

BELL/BOEING/NASA CTR-22C/D
 GW = 51670 LB, WAGL = 30 FT
 AZIMUTH = 0 DEG, DAIP = 29.0 FT



BELL/BOEING/NASA CTR-22C/D
 GW = 51670 LB, WAGL = 30 FT
 AZIMUTH = 0 DEG, DAIP = 35.0 FT

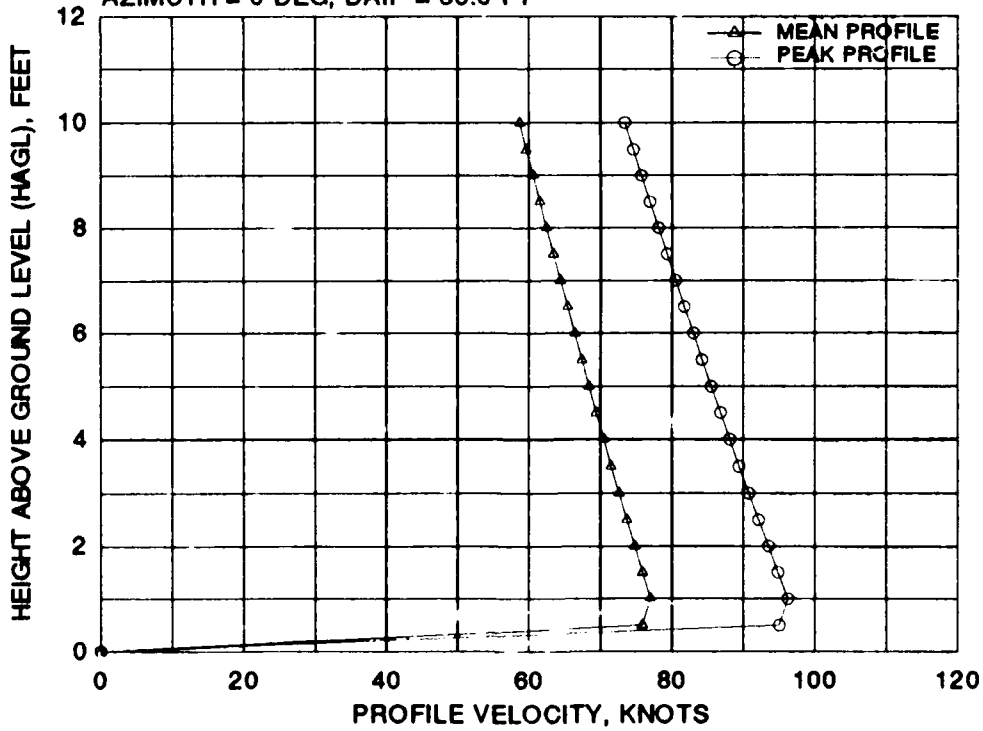
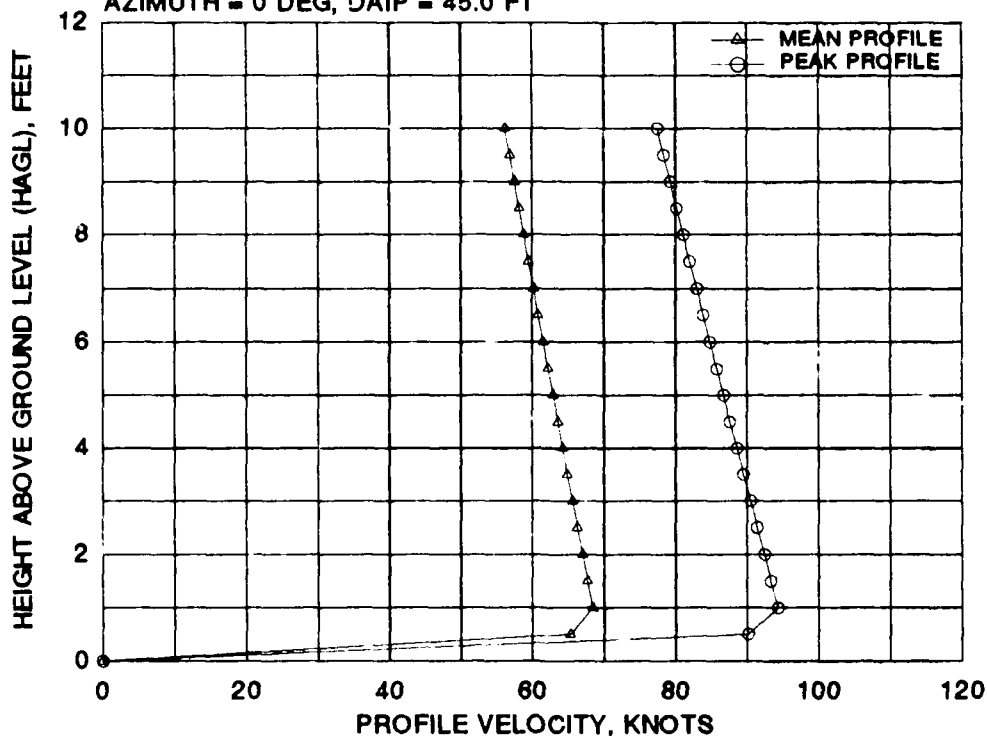

FIGURE C-3 CTR-22C/D MEAN AND PEAK VELOCITY PROFILES FOR NINE 0 DEGREE AZIMUTH RADIAL STATIONS AT A WHEEL HEIGHT OF 30 FEET AND A GROSS WEIGHT OF 51,670 POUNDS

BELL/BOEING/NASA CTR-22C/D
 GW = 51670 LB, WAGL = 30 FT
 AZIMUTH = 0 DEG, DAIP = 45.0 FT



BELL/BOEING/NASA CTR-22C/D
 GW = 51670 LB, WAGL = 30 FT
 AZIMUTH = 0 DEG, DAIP = 60.0 FT

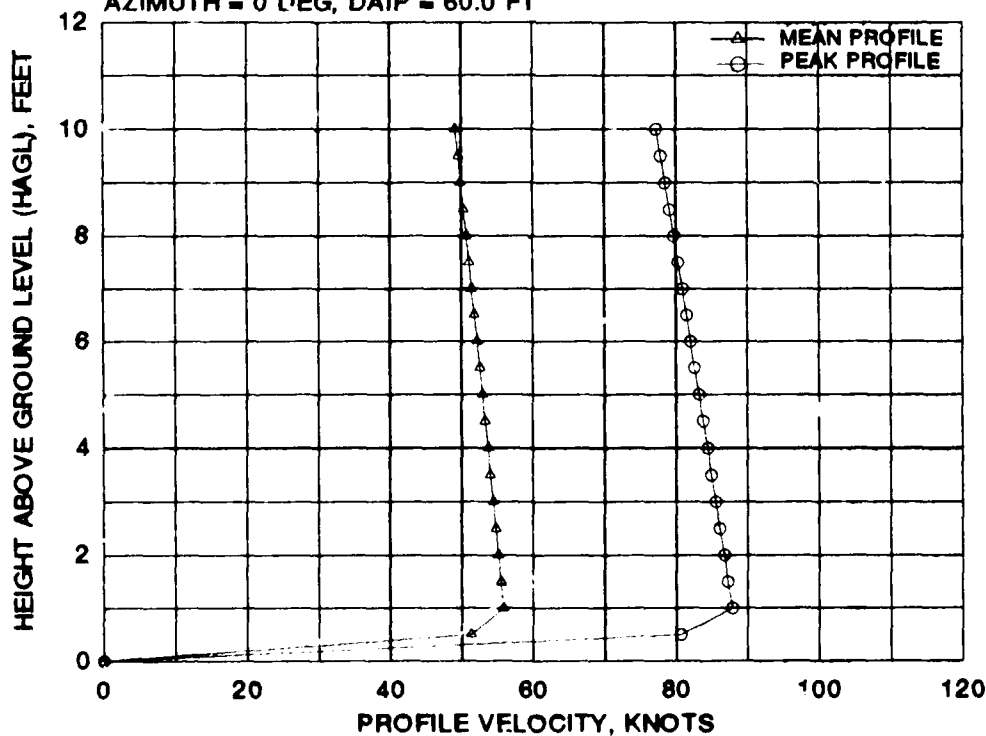
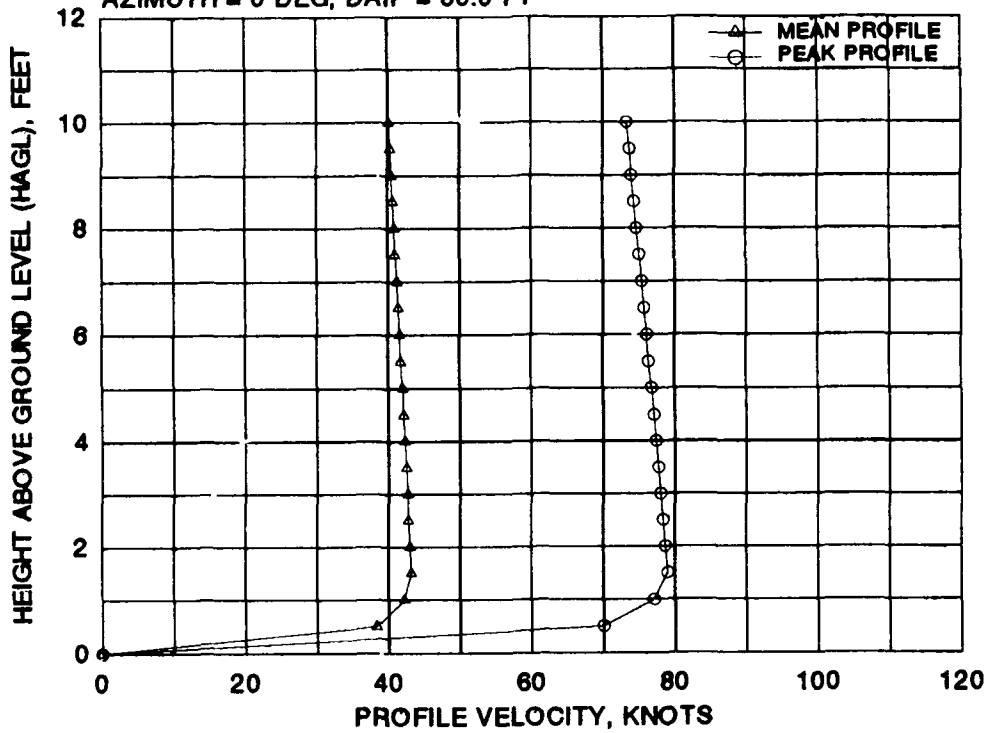

FIGURE C-3 CTR-22C/D MEAN AND PEAK VELOCITY PROFILES FOR NINE 0 DEGREE AZIMUTH RADIAL STATIONS AT A WHEEL HEIGHT OF 30 FEET AND A GROSS WEIGHT OF 51,670 POUNDS (Continued)

BELL/BOEING/NASA CTR-22C/D
 GW = 51670 LB, WAGL = 30 FT
 AZIMUTH = 0 DEG, DAIP = 80.0 FT



BELL/BOEING/NASA CTR-22C/D
 GW = 51670 LB, WAGL = 30 FT
 AZIMUTH = 0 DEG, DAIP = 100.0 FT

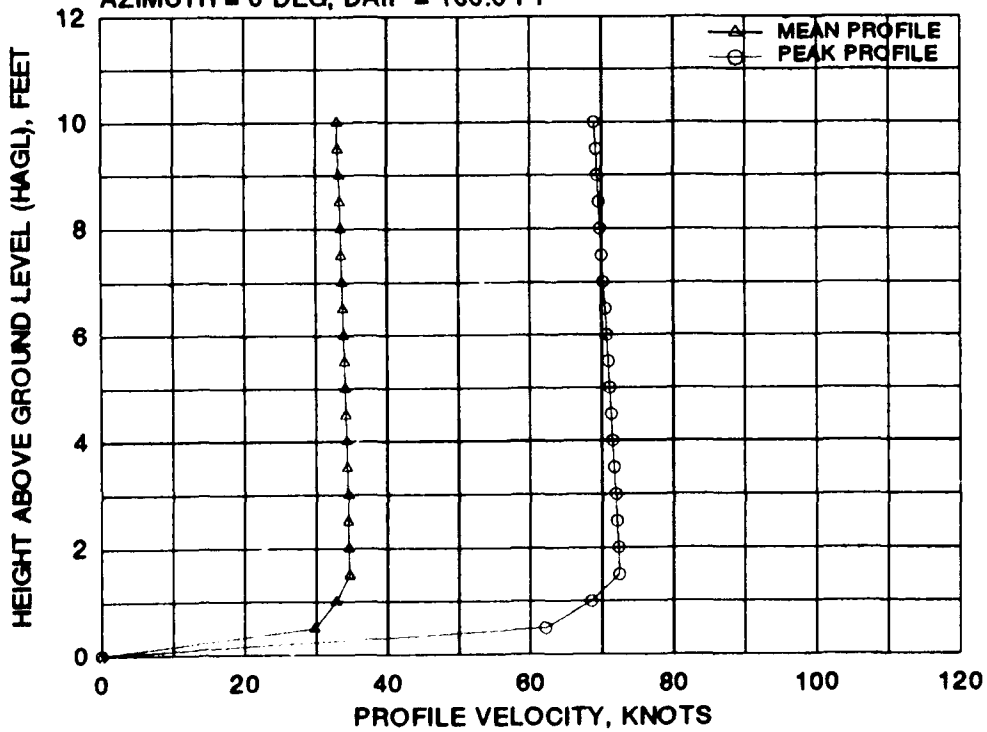
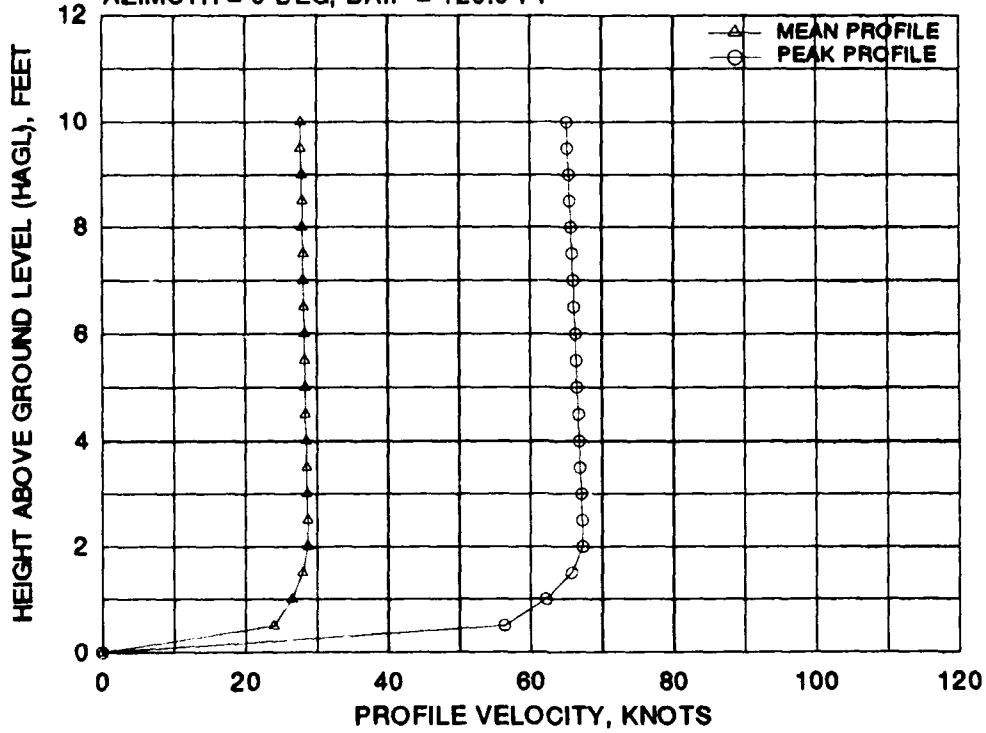

FIGURE C-3 CTR-22C/D MEAN AND PEAK VELOCITY PROFILES FOR NINE 0 DEGREE AZIMUTH RADIAL STATIONS AT A WHEEL HEIGHT OF 30 FEET AND A GROSS WEIGHT OF 51,670 POUNDS (Continued)

BELL/BOEING/NASA CTR-22C/D
 GW = 51670 LB, WAGL = 30 FT
 AZIMUTH = 0 DEG, DAIP = 120.0 FT



BELL/BOEING/NASA CTR-22C/D
 GW = 51670 LB, WAGL = 30 FT
 AZIMUTH = 0 DEG, DAIP = 150.0 FT

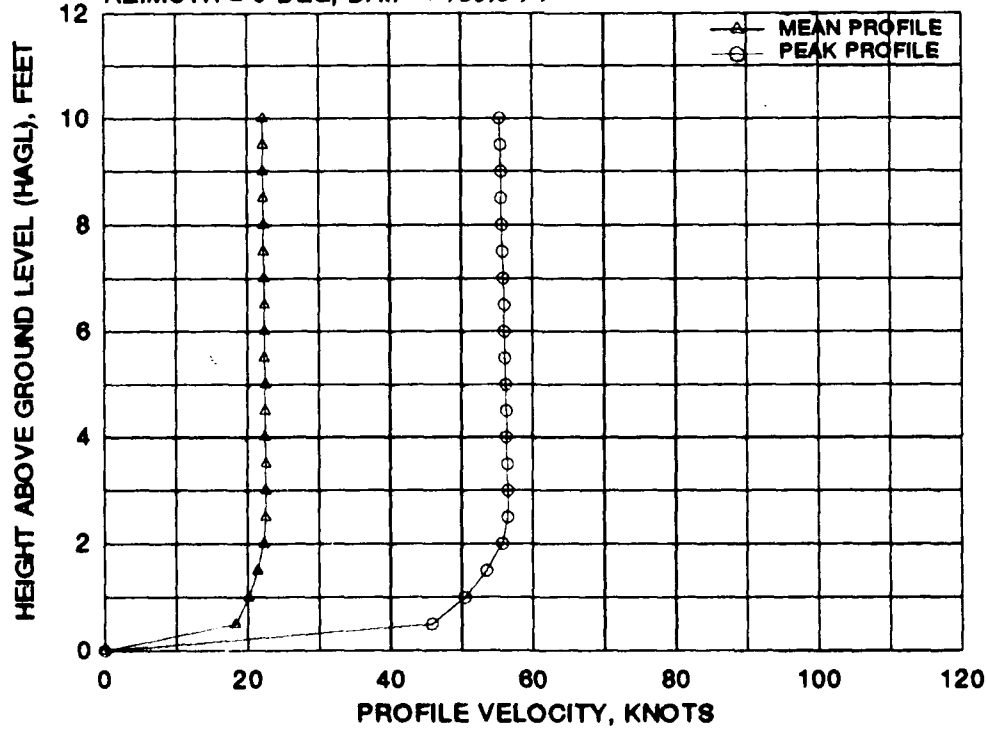

FIGURE C-3 CTR-22C/D MEAN AND PEAK VELOCITY PROFILES FOR NINE 0 DEGREE AZIMUTH RADIAL STATIONS AT A WHEEL HEIGHT OF 30 FEET AND A GROSS WEIGHT OF 51,670 POUNDS (Continued)

BELL/BOEING/NASA CTR-22C/D
GW = 51670 LB, WAGL = 30 FT
AZIMUTH = 0 DEG, DAIP = 200.0 FT

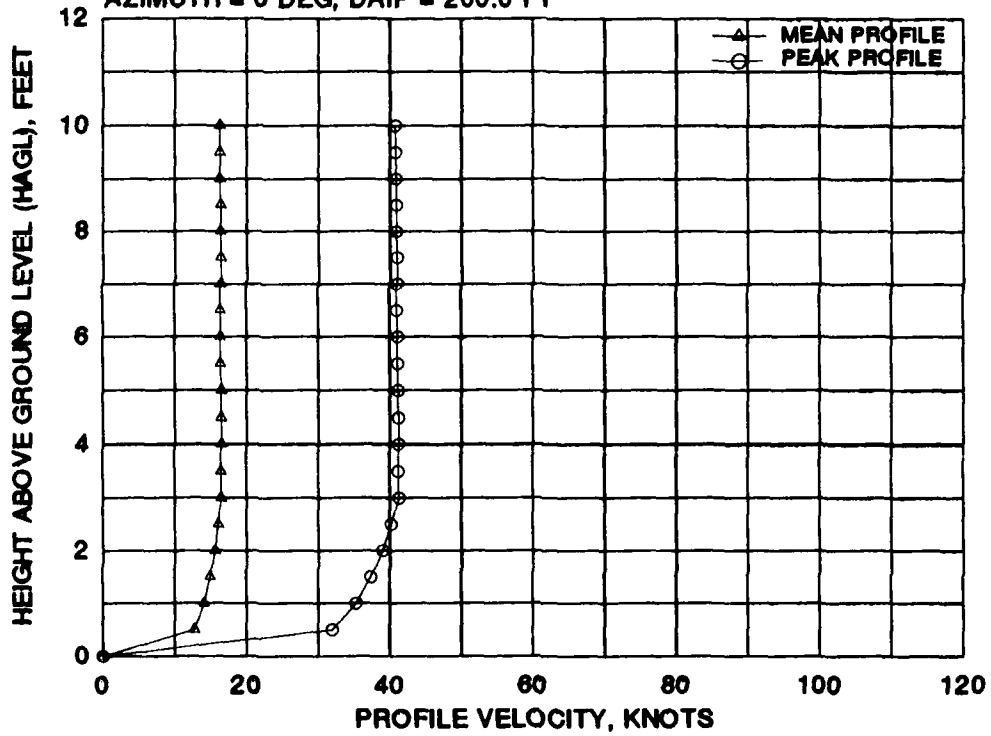

FIGURE C-3 CTR-22C/D MEAN AND PEAK VELOCITY PROFILES FOR NINE 0 DEGREE AZIMUTH RADIAL STATIONS AT A WHEEL HEIGHT OF 30 FEET AND A GROSS WEIGHT OF 51,670 POUNDS (Concluded)

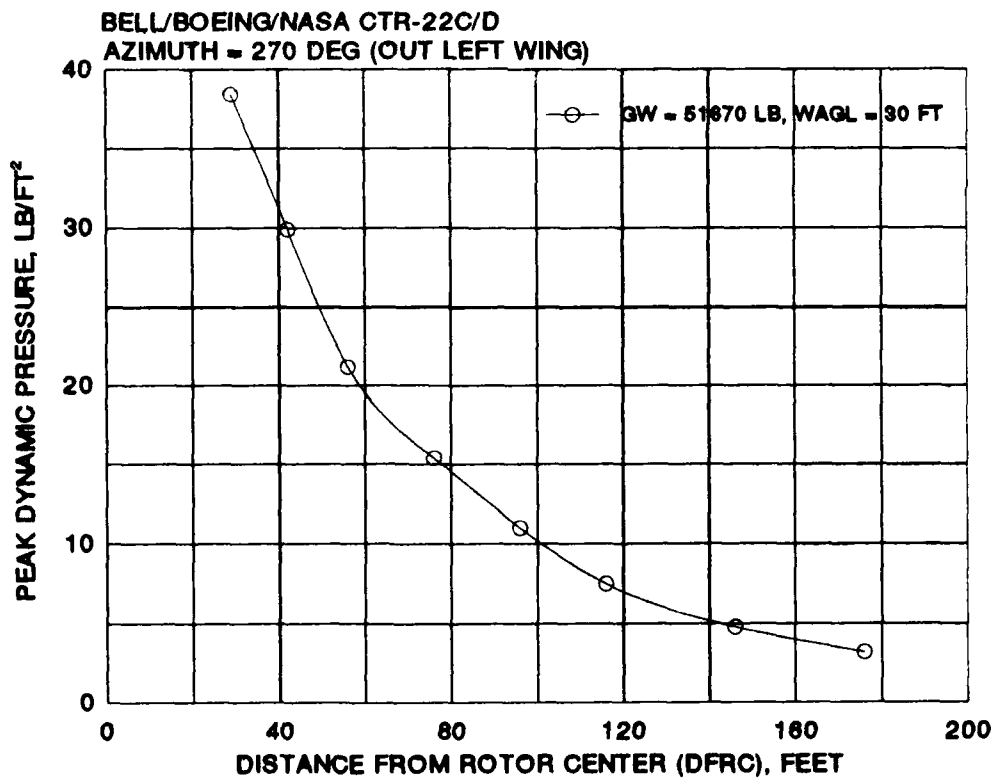
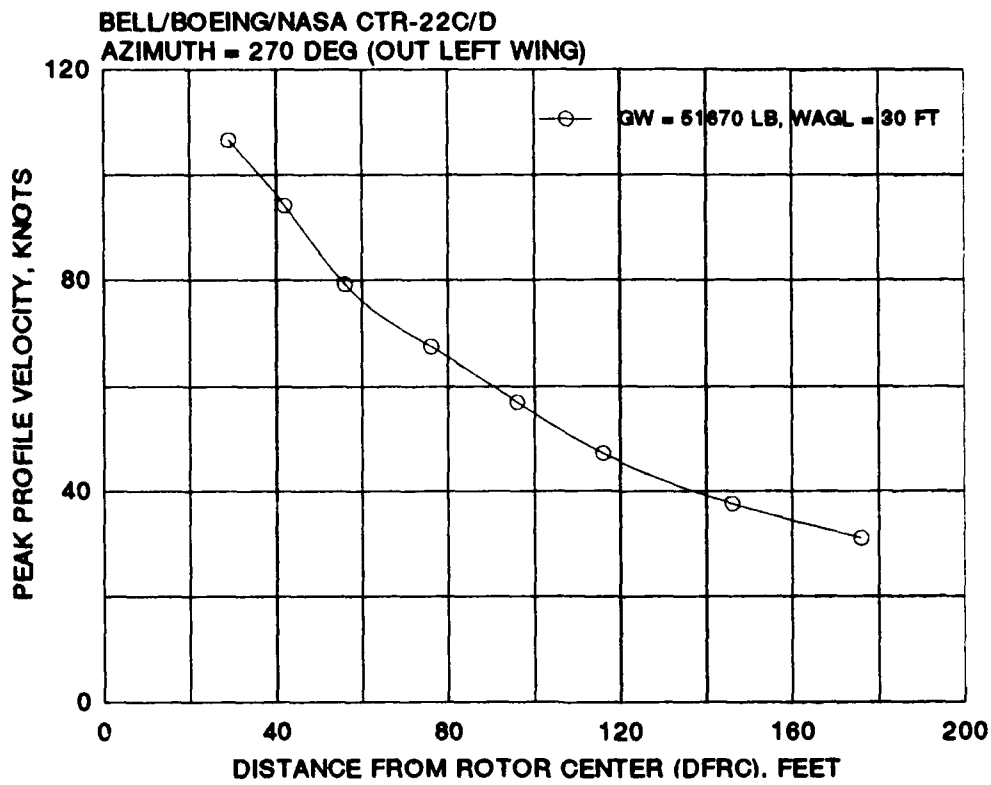

FIGURE C-4 CTR-22C/D PEAK ROTORWASH VELOCITY AND DYNAMIC PRESSURE AS A FUNCTION OF DISTANCE FROM THE ROTOR CENTER (270 DEGREE AZIMUTH)

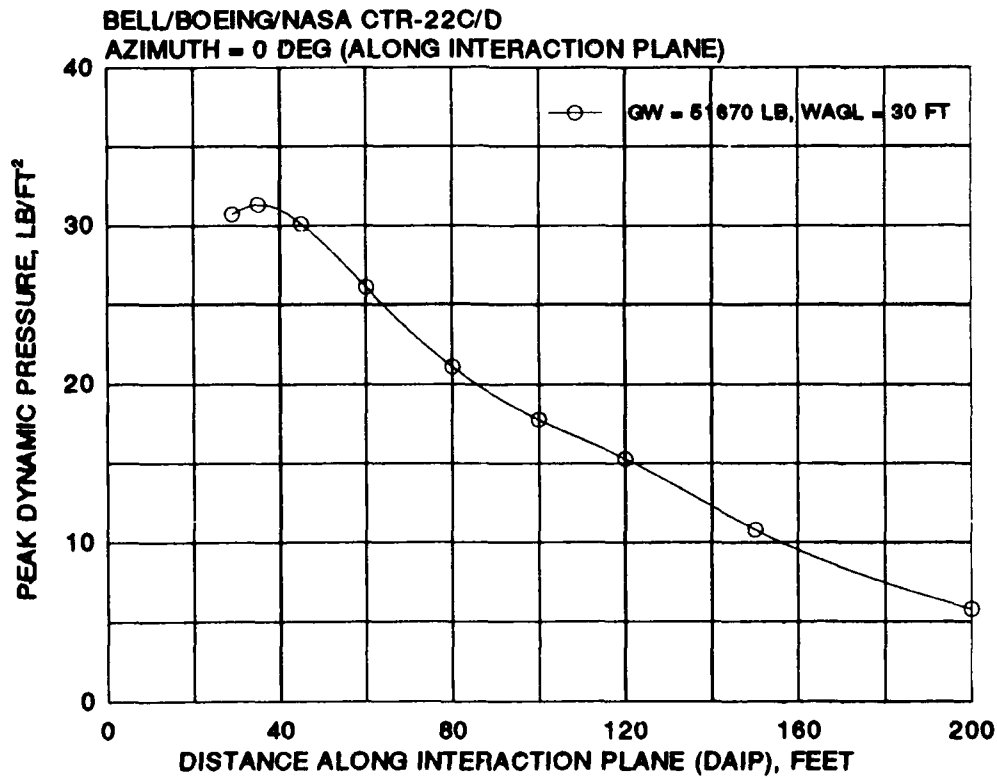
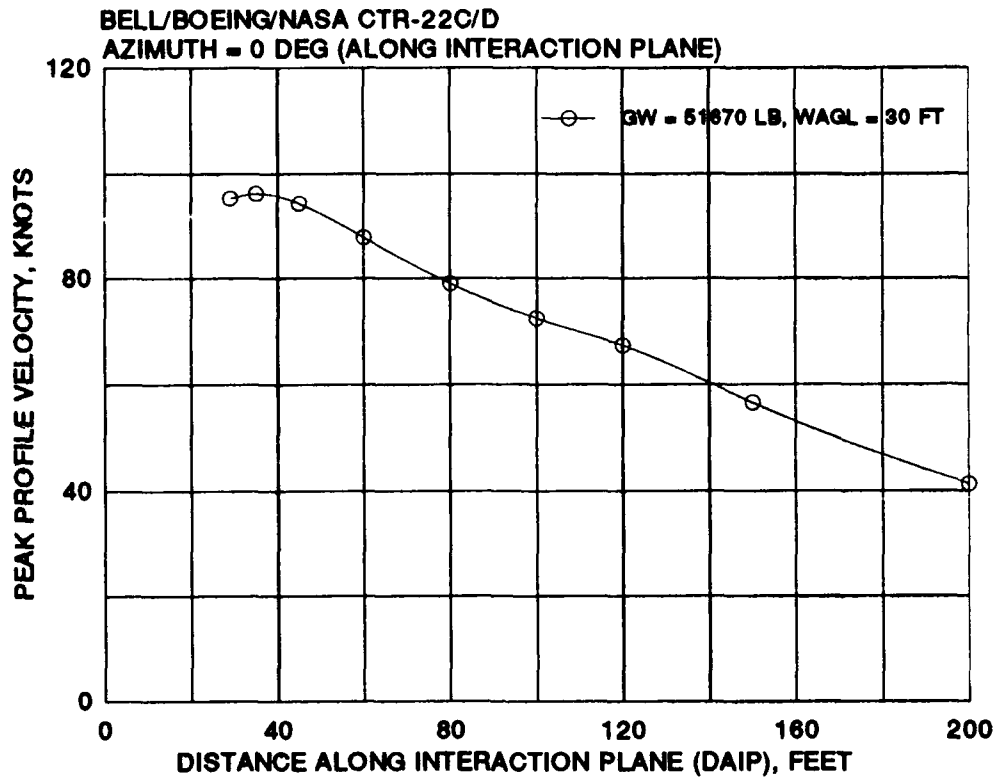

FIGURE C-5 CTR-22C/D PEAK ROTORWASH VELOCITY AND DYNAMIC PRESSURE AS A FUNCTION OF DISTANCE ALONG THE INTERACTION PLANE (0 DEGREE AZIMUTH)

BELL/BOEING/NASA CTR-22C/D
AZIMUTH = 270 DEG (OUT LEFT WING)

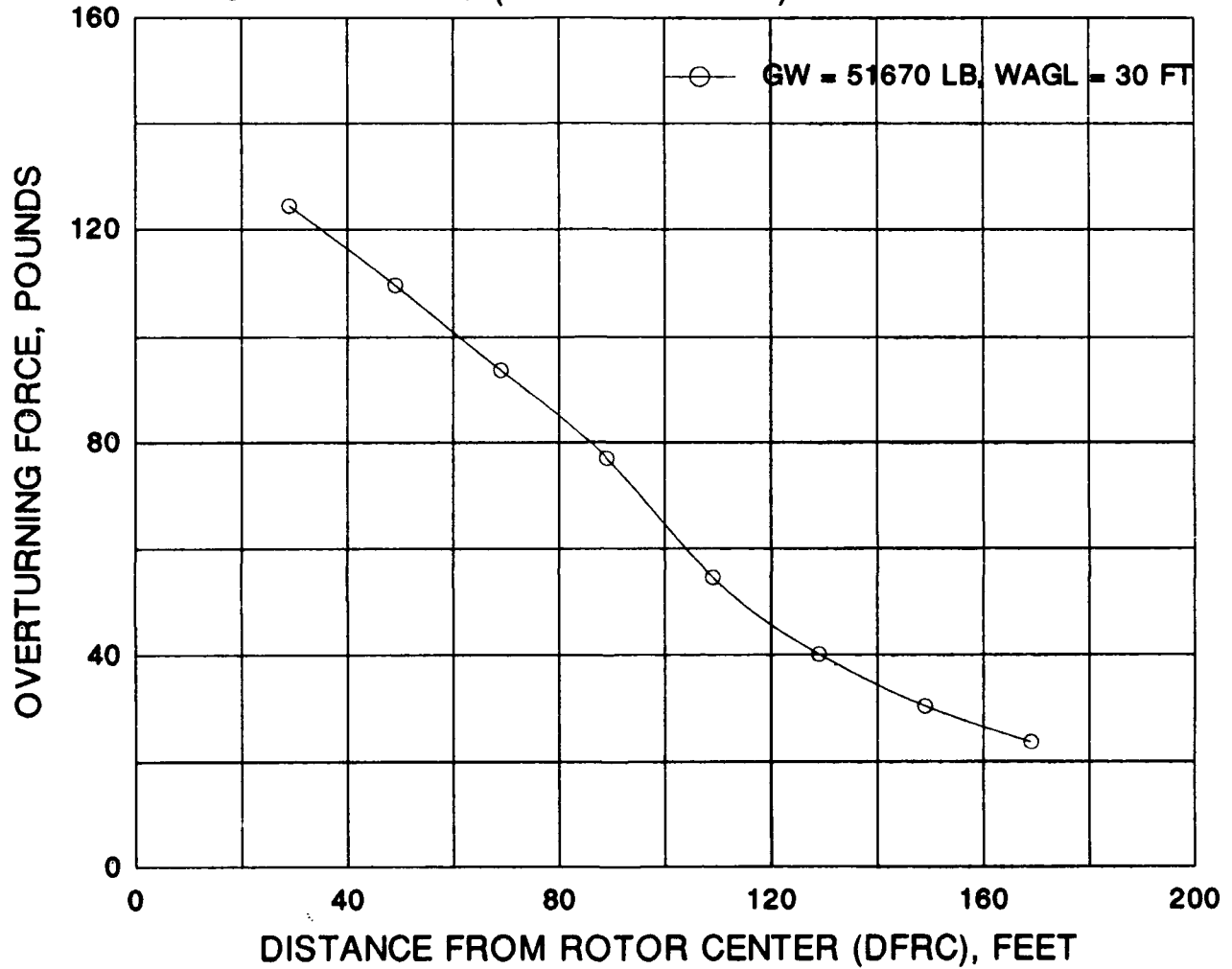

FIGURE C-6 CTR-22C/D OVERTURNING FORCE AS A FUNCTION OF DISTANCE FROM THE ROTOR CENTER (270 DEGREE AZIMUTH)

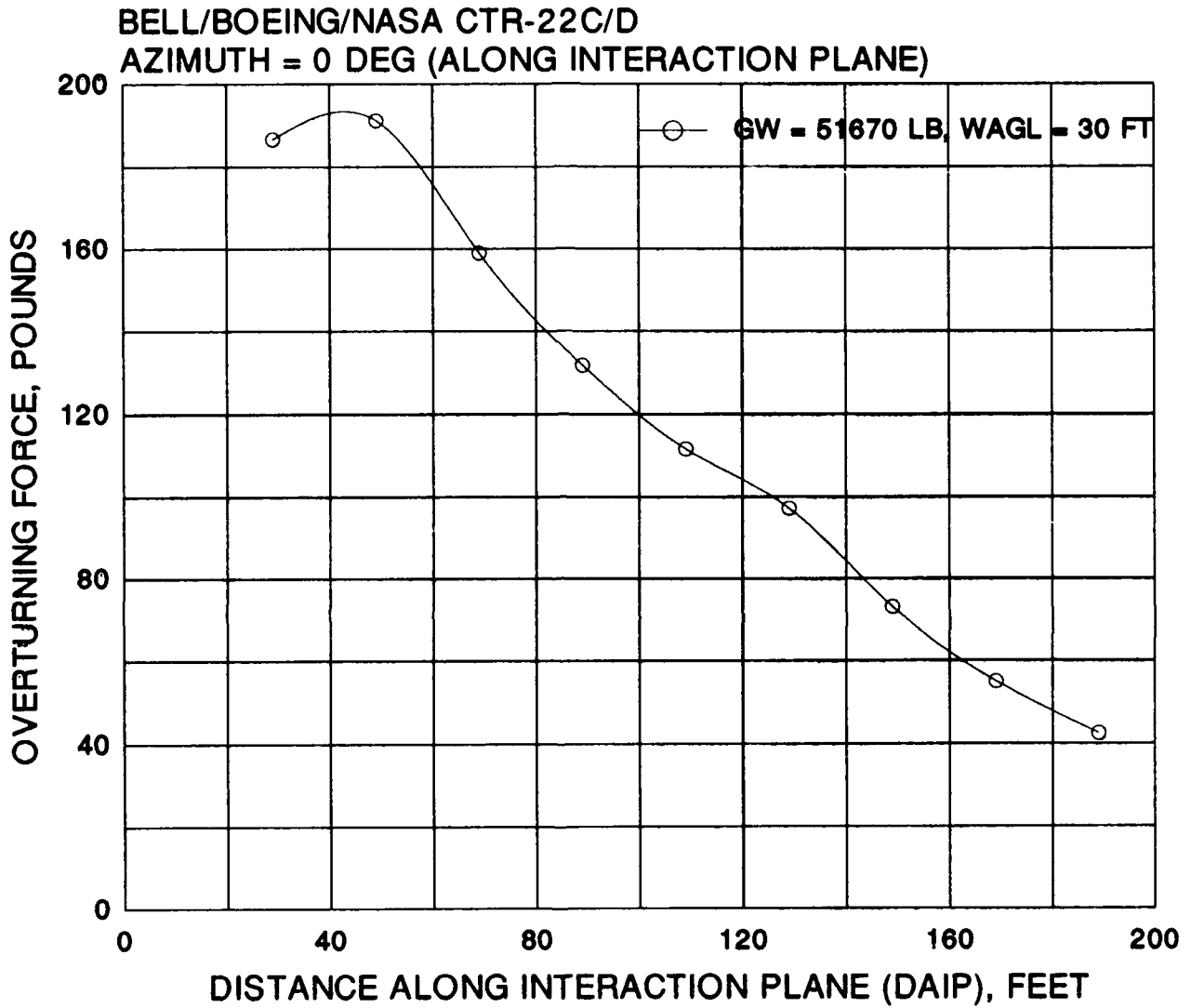

FIGURE C-7 CTR-22C/D OVERTURNING FORCE AS A FUNCTION OF DISTANCE ALONG THE INTERACTION PLANE (0 DEGREE AZIMUTH)

APPENDIX D

BELL/BOEING/NASA CTR-800 AIRCRAFT AND ROTWASH DATA

Bell/Boeing/NASA CTR-800 aircraft characteristics used with the ROTWASH analysis program are listed in table D-1 as obtained from reference D-1. Figure D-1 presents a three-view drawing of the tiltrotor. Table D-2 provides a summary tabulation of parameters defining the conditions for all rotorwash data presented in the appendix. All data are plotted in one of four formats, which include graphs of:

1. mean and peak outwash velocity profiles,
2. peak outwash velocity versus distance,
3. peak outwash dynamic pressure versus distance, and
4. personnel overturning force versus distance.

In each format, data are plotted along both the 0 and 270 degree azimuth. Distance from rotor center (DFRC) is the independent variable along the 270 degree azimuth. Measurements of distance from aircraft center (DFAC) are also noted on the graphs. The DFAC reference point is defined as zero at the location where the aircraft centerline intersects the line connecting the two rotor centers of rotation. Along the 0 degree azimuth, distance along the interaction plane (DAIP) is the independent variable. This point is referenced as zero at the same location as the DFAC point.

REFERENCES

- D-1. Anon, "State/Regional Tiltrotor/Vertiport Feasibility Studies Data Package," NASA Ames Research Center, June 1, 1989.

TABLE D-1 CTR-800 ROTWASH INPUT DATA

<u>Parameter</u>	<u>Value</u>
Rotor radius, feet	13.0
Distance between rotor centers, feet	33.0
Wing download, percent of rotor thrust	9.25
Distance from wheels to rotor plane, feet	13.0
Rotor speed, RPM	551.0
Rotor tip speed, feet/second	750.0
Number of rotor blades per rotor	3
Density ratio	1.0

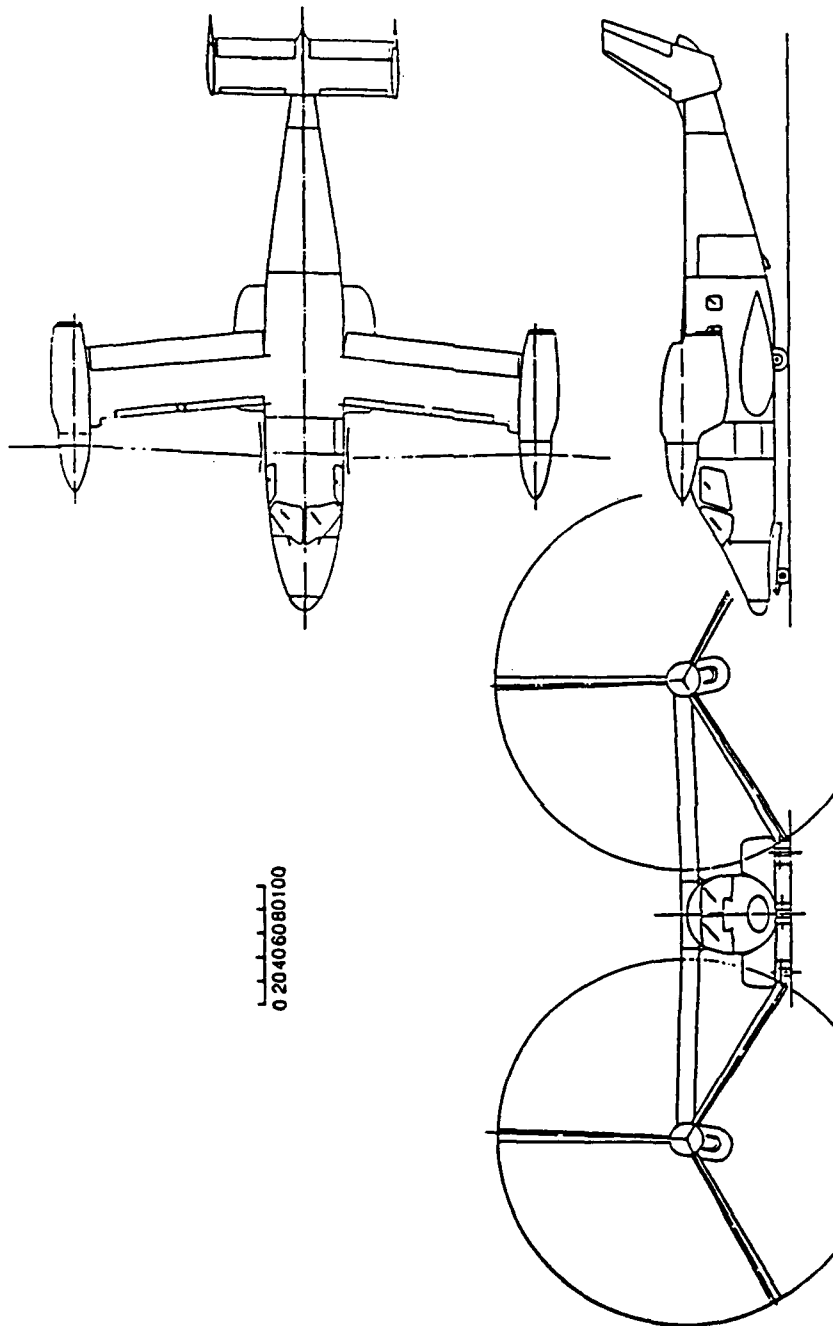

FIGURE D-1 THREE-VIEW DRAWING OF THE CTR-800

TABLE D-2 CTR-800 ROTORWASH EVALUATION MATRIX

Note: The Figure/Type column provides the figure number and data format type where:

M/P - Mean and peak velocity profile format

PVD - Peak velocity and dynamic pressure format

OTF - Personnel overturning force format

<u>Figure/ Type</u>	<u>Azimuth, Degrees</u>	<u>GW, Pounds</u>	<u>WAGL, Feet</u>	<u>DFRC or DAIP Distance, Feet</u>
D-2 M/P	270.0	15,750	20	18.5,23.5,36.5,49.5, 63.5,83.5,103.5,123.5
D-3 M/P	0.0	15,750	20	21, 29, 35, 45, 60, 80, 100, 120
D-4 PVD	270.0	15,750	20	20 to 150
D-5 PVD	0.0	15,750	20	20 to 150
D-6 OTF	270.0	15,750	20	20 to 180
D-7 OTF	0.0	15,750	20	20 to 180

BELL/BOEING/NASA CTR-800
 GW = 15750 LB, WAGL = 20 FT
 AZIMUTH = 270 DEG, DFAC = 35.0 FT (DFRC = 18.5 FT)

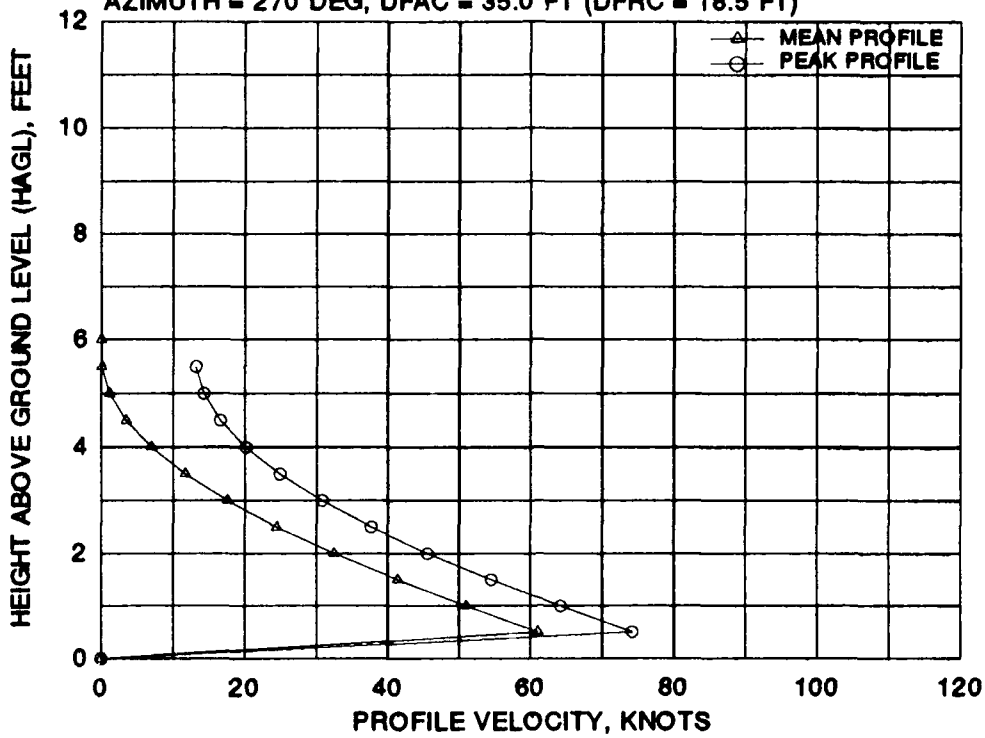

BELL/BOEING/NASA CTR-800
 GW = 15750 LB, WAGL = 20 FT
 AZIMUTH = 270 DEG, DFAC = 40.0 FT (DFRC = 23.5 FT)

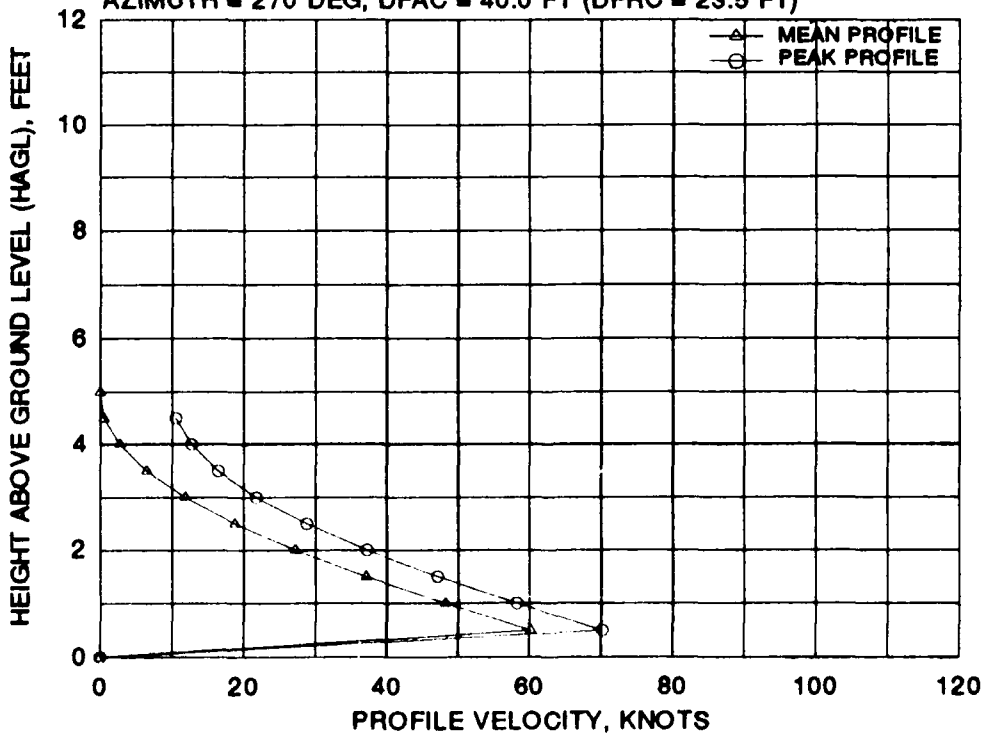
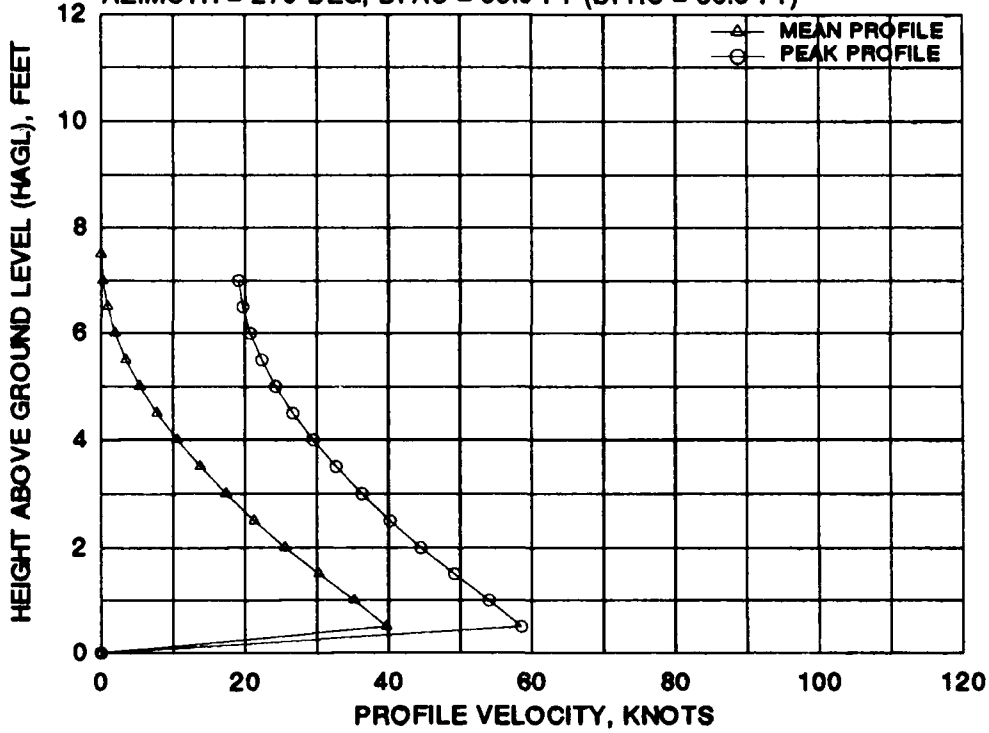

FIGURE D-2 CTR-800 MEAN AND PEAK VELOCITY PROFILES FOR EIGHT 270 DEGREE AZIMUTH RADIAL STATIONS AT A WHEEL HEIGHT OF 20 FEET AND A GROSS WEIGHT OF 15,750 POUNDS

BELL/BOEING/NASA CTR-800
 GW = 15750 LB, WAGL = 20 FT
 AZIMUTH = 270 DEG, DFAC = 53.0 FT (DFRC = 36.5 FT)



BELL/BOEING/NASA CTR-800
 GW = 15750 LB, WAGL = 20 FT
 AZIMUTH = 270 DEG, DFAC = 66.0 FT (DFRC = 49.5 FT)

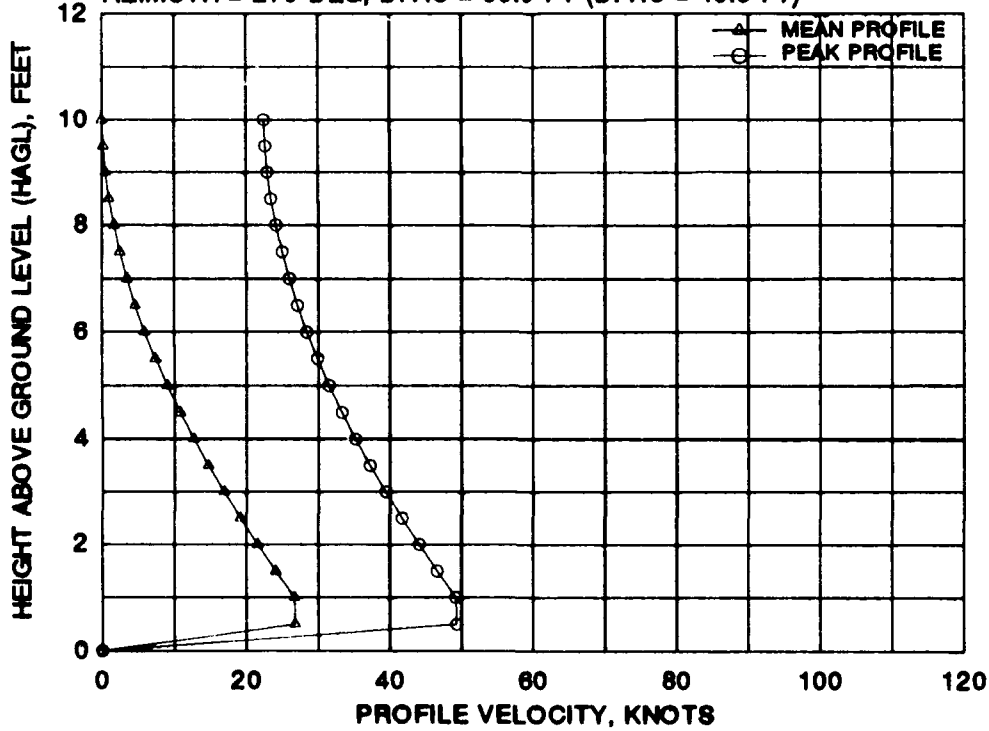
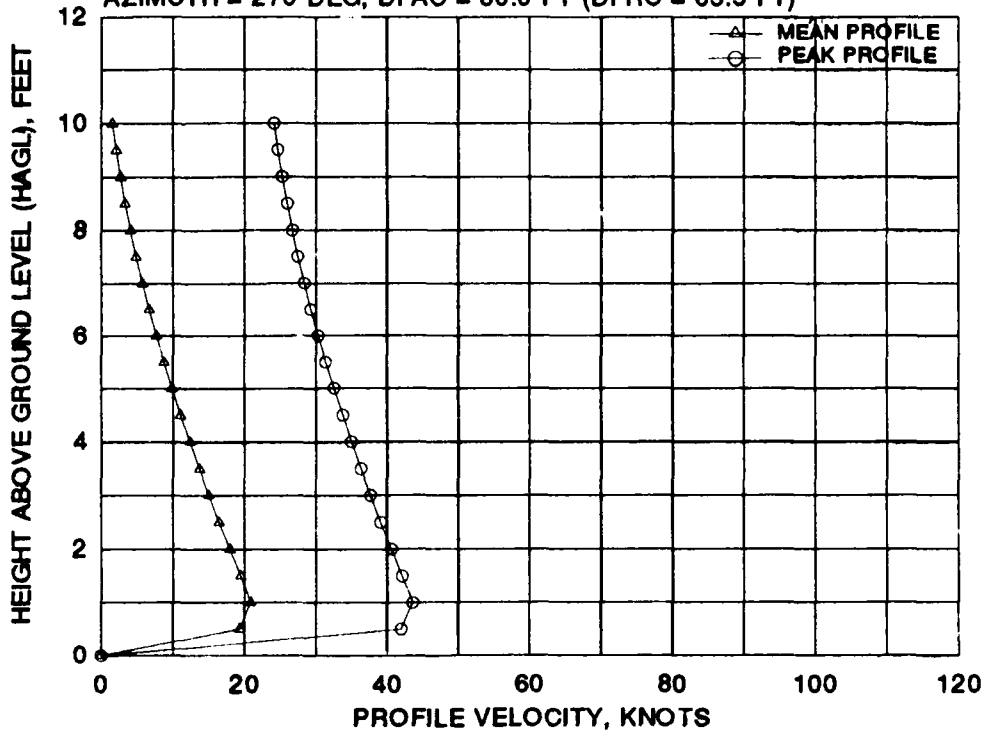

FIGURE D-2 CTR-800 MEAN AND PEAK VELOCITY PROFILES FOR EIGHT 270 DEGREE AZIMUTH RADIAL STATIONS AT A WHEEL HEIGHT OF 20 FEET AND A GROSS WEIGHT OF 15,750 POUNDS (Continued)

BELL/BOEING/NASA CTR-800
 GW = 15750 LB, WAGL = 20 FT
 AZIMUTH = 270 DEG, DFAC = 80.0 FT (DFRC = 63.5 FT)



BELL/BOEING/NASA CTR-800
 GW = 15750 LB, WAGL = 20 FT
 AZIMUTH = 270 DEG, DFAC = 100.0 FT (DFRC = 83.5 FT)

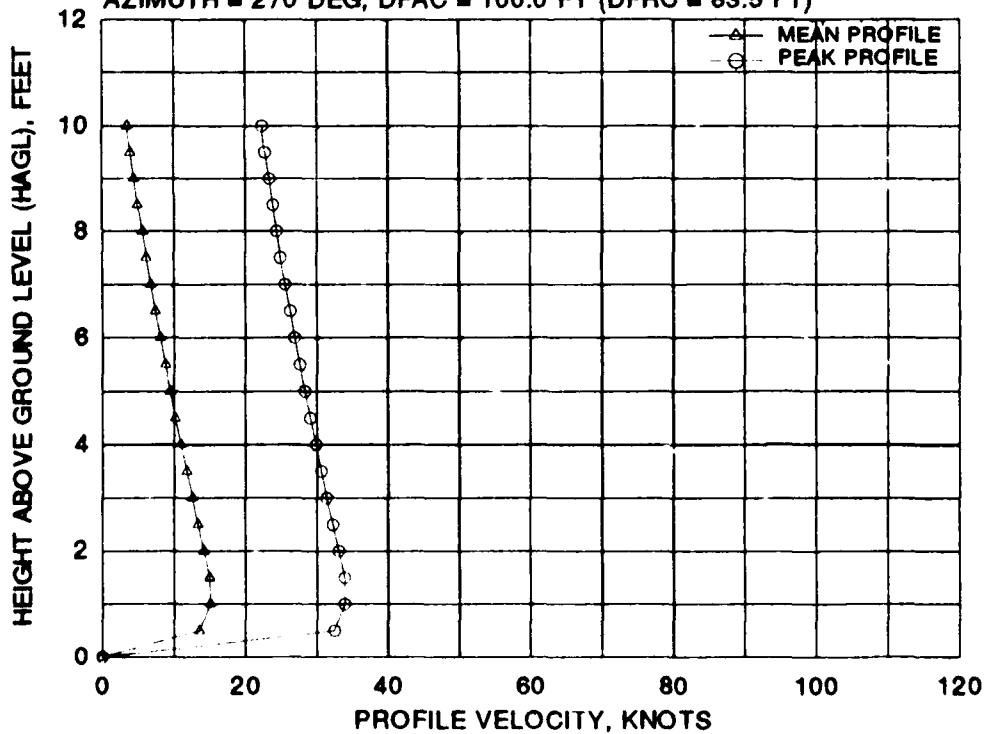
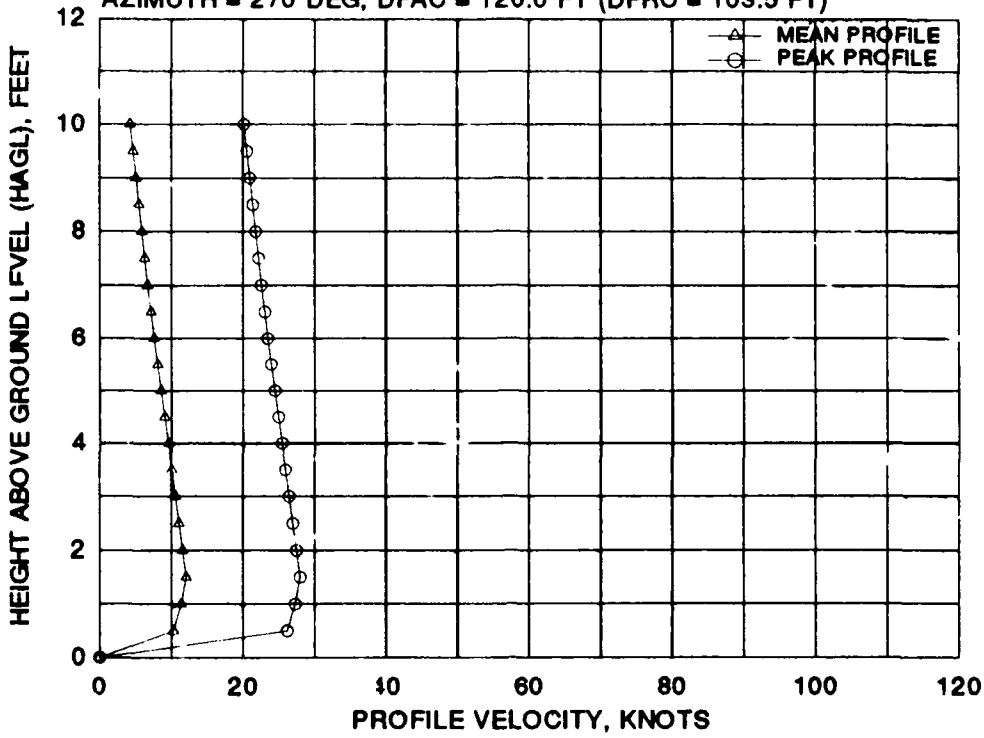

FIGURE D-2 CTR-800 MEAN AND PEAK VELOCITY PROFILES FOR EIGHT 270 DEGREE AZIMUTH RADIAL STATIONS AT A WHEEL HEIGHT OF 20 FEET AND A GROSS WEIGHT OF 15,750 POUNDS (Continued)

BELL/BOEING/NASA CTR-800
 GW = 15750 LB, WAGL = 20 FT
 AZIMUTH = 270 DEG, DFAC = 120.0 FT (DFRC = 103.5 FT)



BELL/BOEING/NASA CTR-800
 GW = 15750 LB, WAGL = 20 FT
 AZIMUTH = 270 DEG, DFAC = 140.0 FT (DFRC = 123.5 FT)

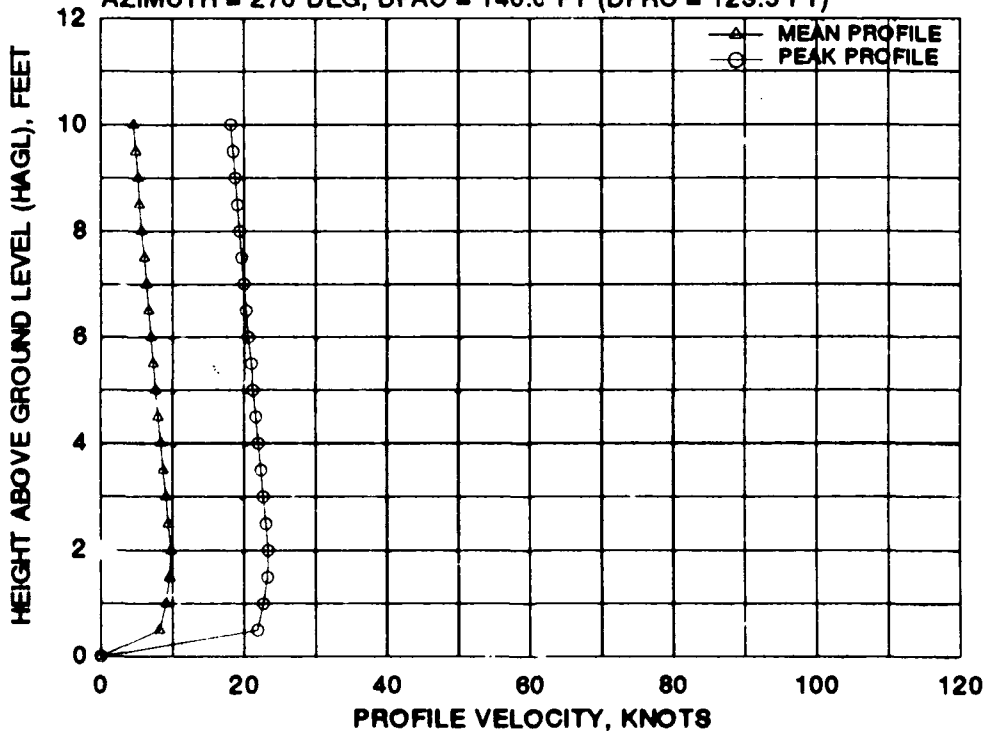
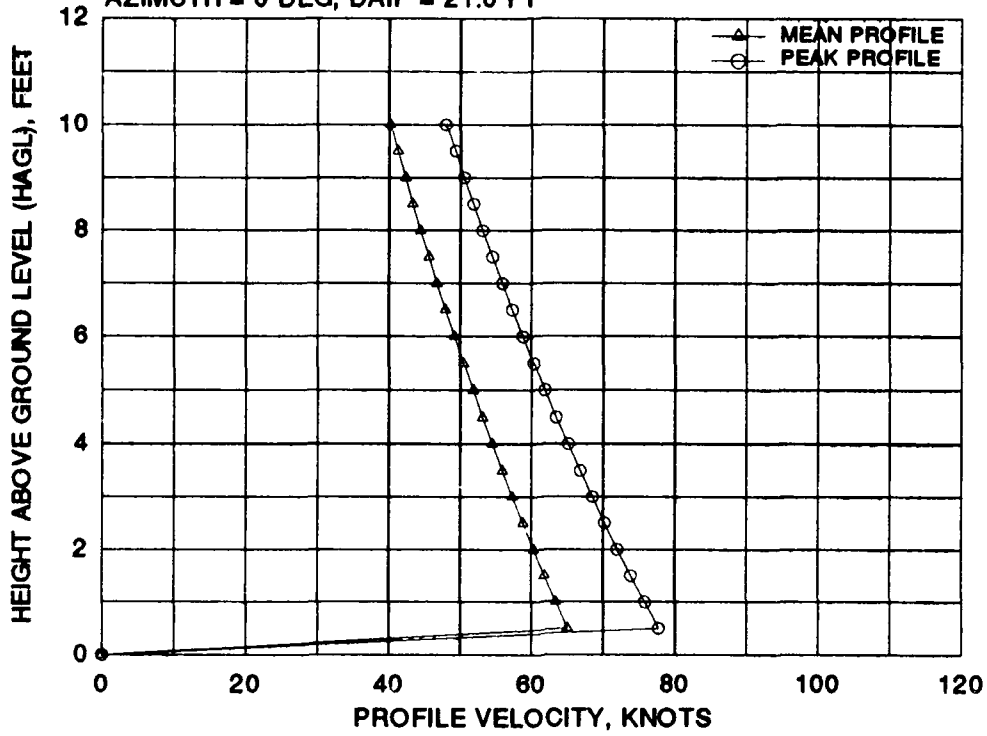

FIGURE D-2 CTR-800 MEAN AND PEAK VELOCITY PROFILES FOR EIGHT 270 DEGREE AZIMUTH RADIAL STATIONS AT A WHEEL HEIGHT OF 20 FEET AND A GROSS WEIGHT OF 15,750 POUNDS (Concluded)

BELL/BOEING/NASA CTR-800
 GW = 15750 LB, WAGL = 20 FT
 AZIMUTH = 0 DEG, DAIP = 21.0 FT



BELL/BOEING/NASA CTR-800
 GW = 15750 LB, WAGL = 20 FT
 AZIMUTH = 0 DEG, DAIP = 29.0 FT

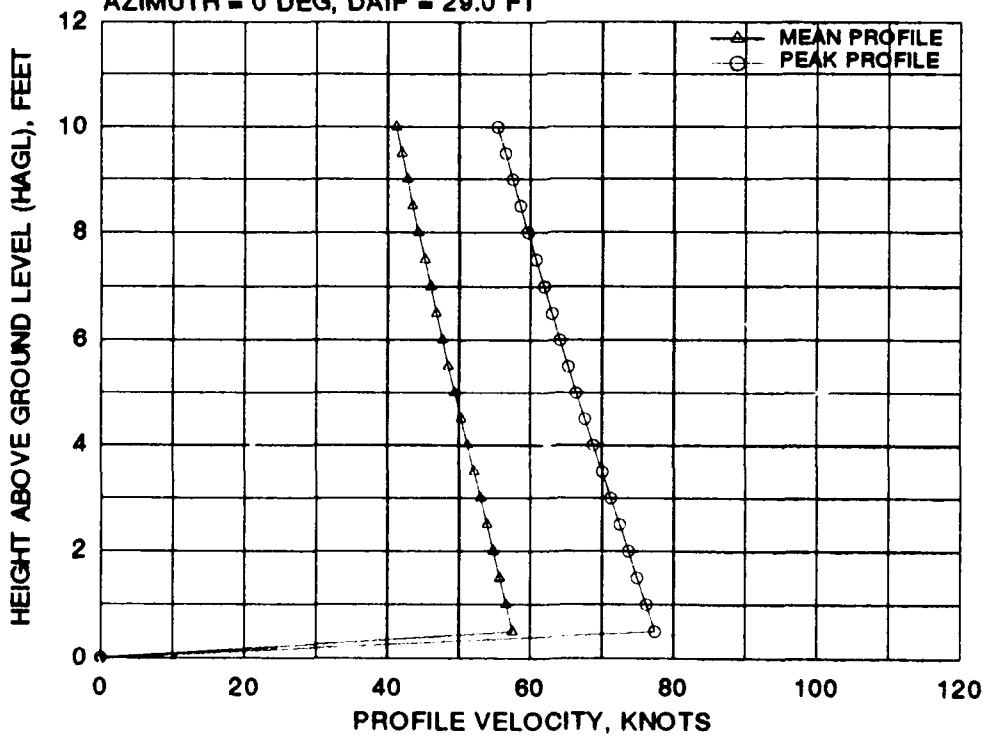
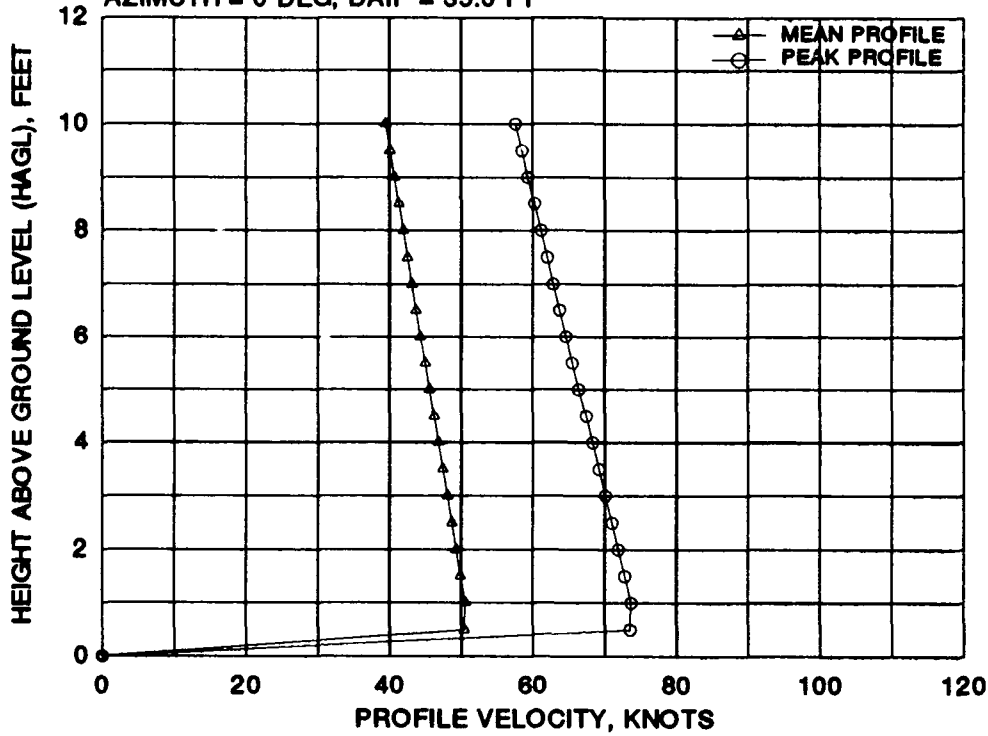

FIGURE D-3 CTR-800 MEAN AND PEAK VELOCITY PROFILES FOR EIGHT 0 DEGREE AZIMUTH RADIAL STATIONS AT A WHEEL HEIGHT OF 20 FEET AND A GROSS WEIGHT OF 15,750 POUNDS

BELL/BOEING/NASA CTR-800
 GW = 15750 LB, WAGL = 20 FT
 AZIMUTH = 0 DEG, DAIP = 35.0 FT



BELL/BOEING/NASA CTR-800
 GW = 15750 LB, WAGL = 20 FT
 AZIMUTH = 0 DEG, DAIP = 45.0 FT

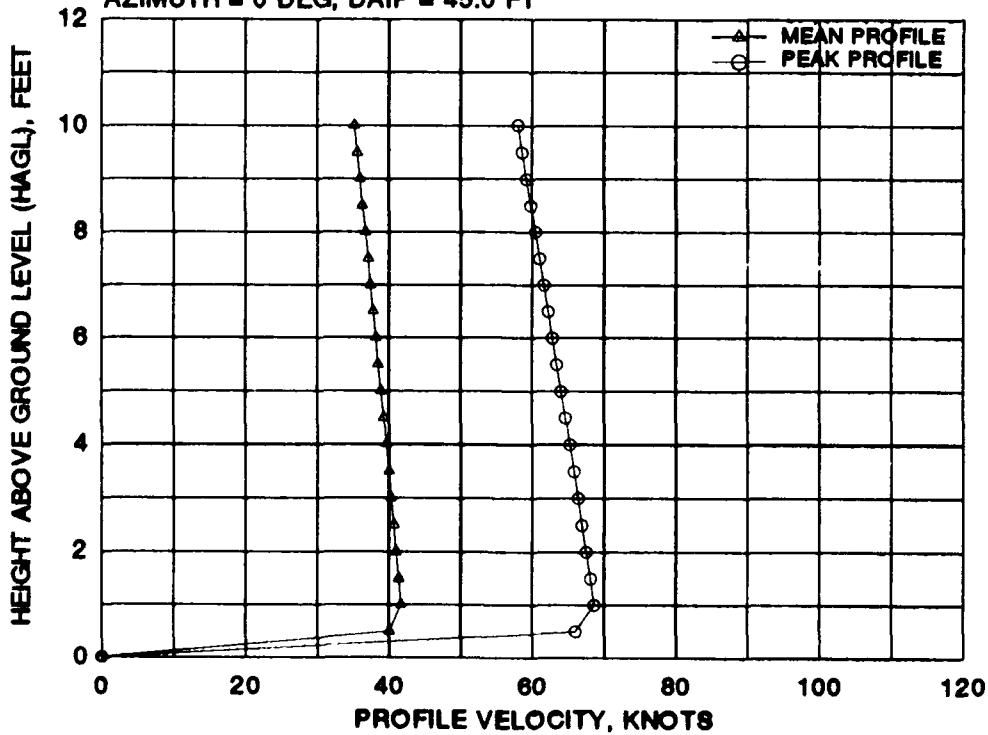

FIGURE D-3 CTR-800 MEAN AND PEAK VELOCITY PROFILES FOR EIGHT 0 DEGREE AZIMUTH RADIAL STATIONS AT A WHEEL HEIGHT OF 20 FEET AND A GROSS WEIGHT OF 15,750 POUNDS (Continued)

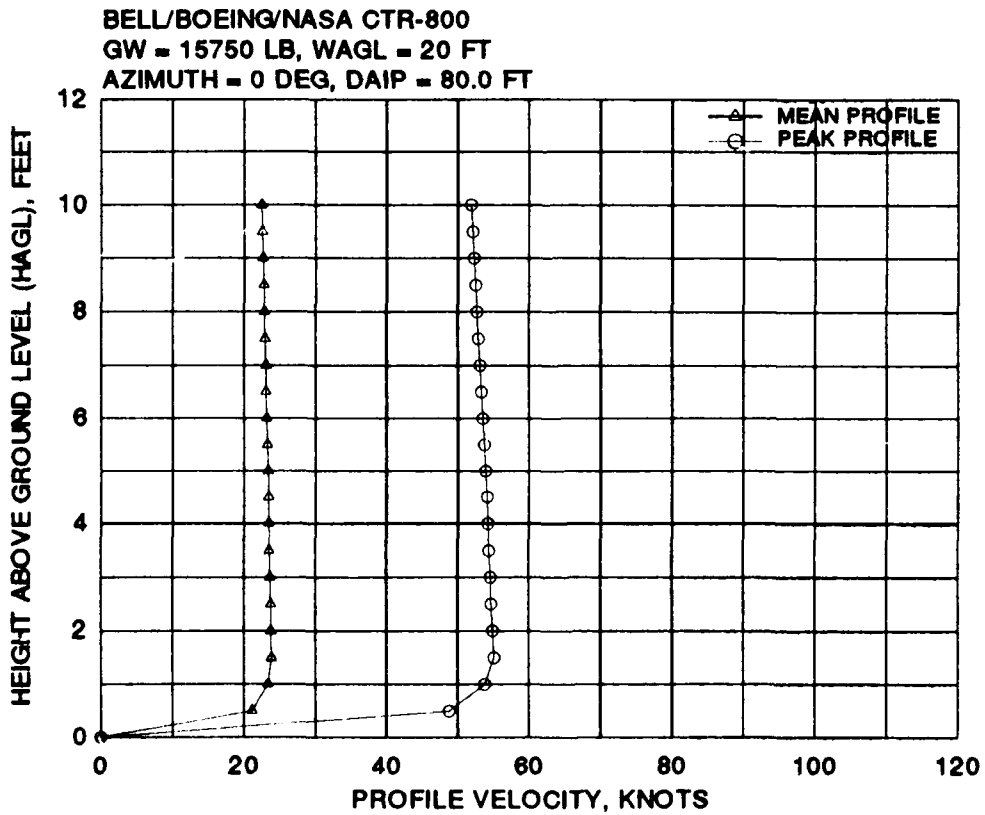
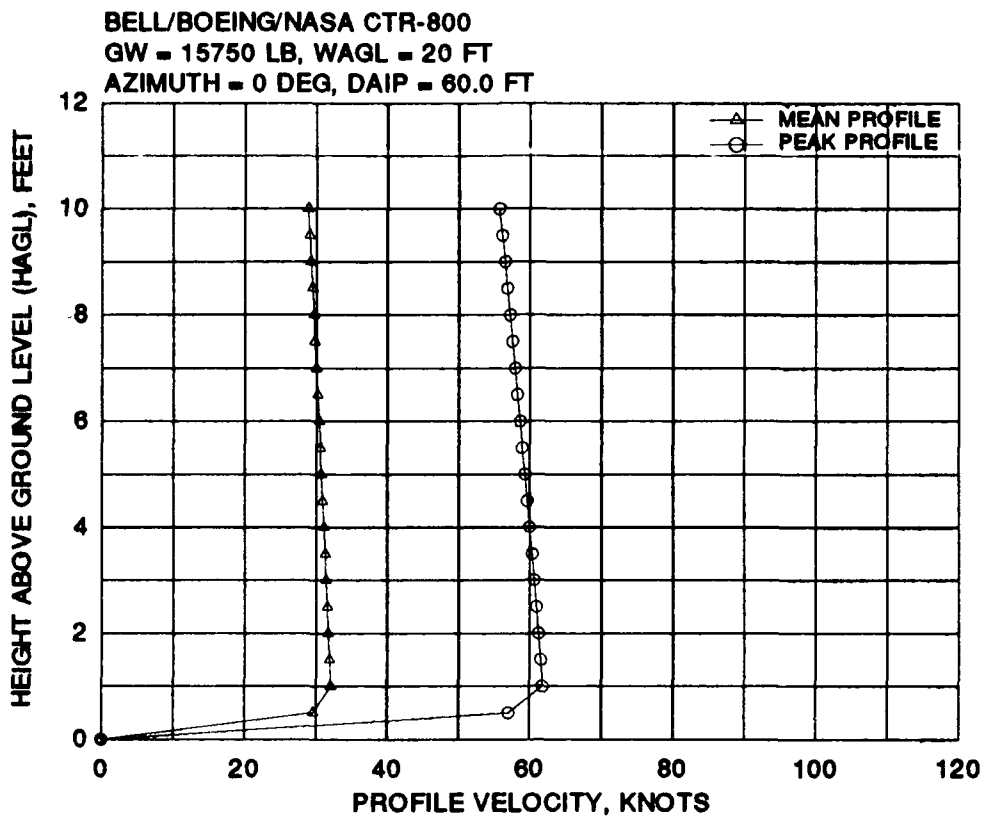

FIGURE D-3 CTR-800 MEAN AND PEAK VELOCITY PROFILES FOR EIGHT 0 DEGREE AZIMUTH RADIAL STATIONS AT A WHEEL HEIGHT OF 20 FEET AND A GROSS WEIGHT OF 15,750 POUNDS (Continued)

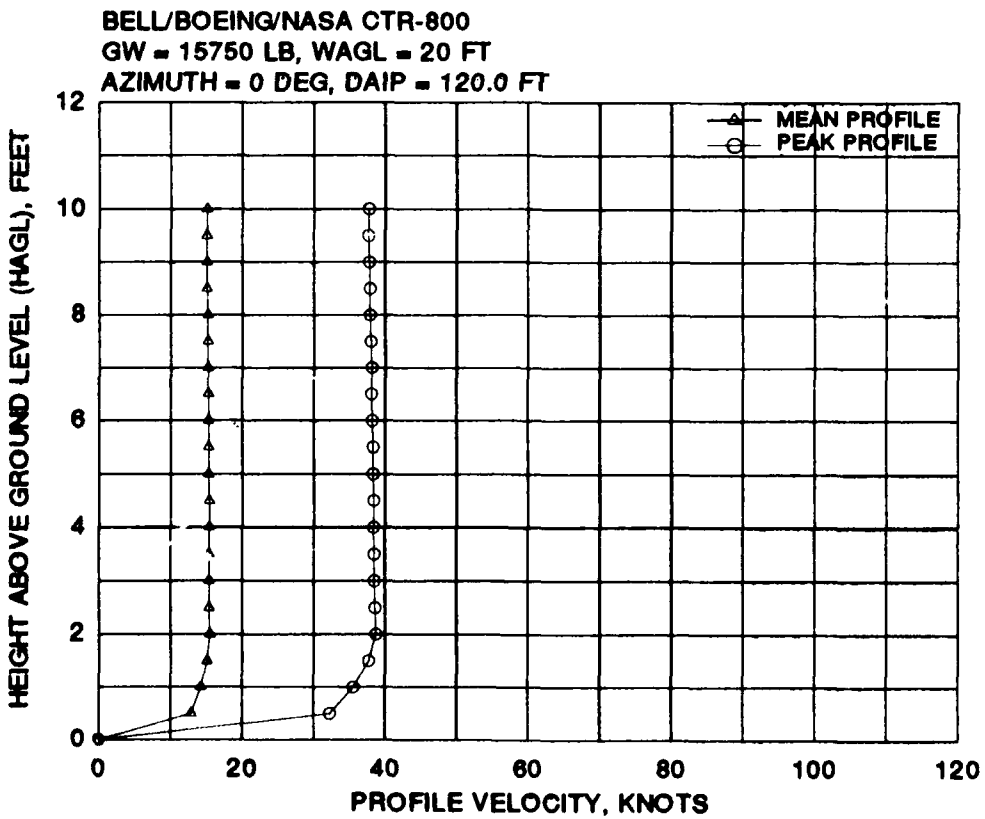
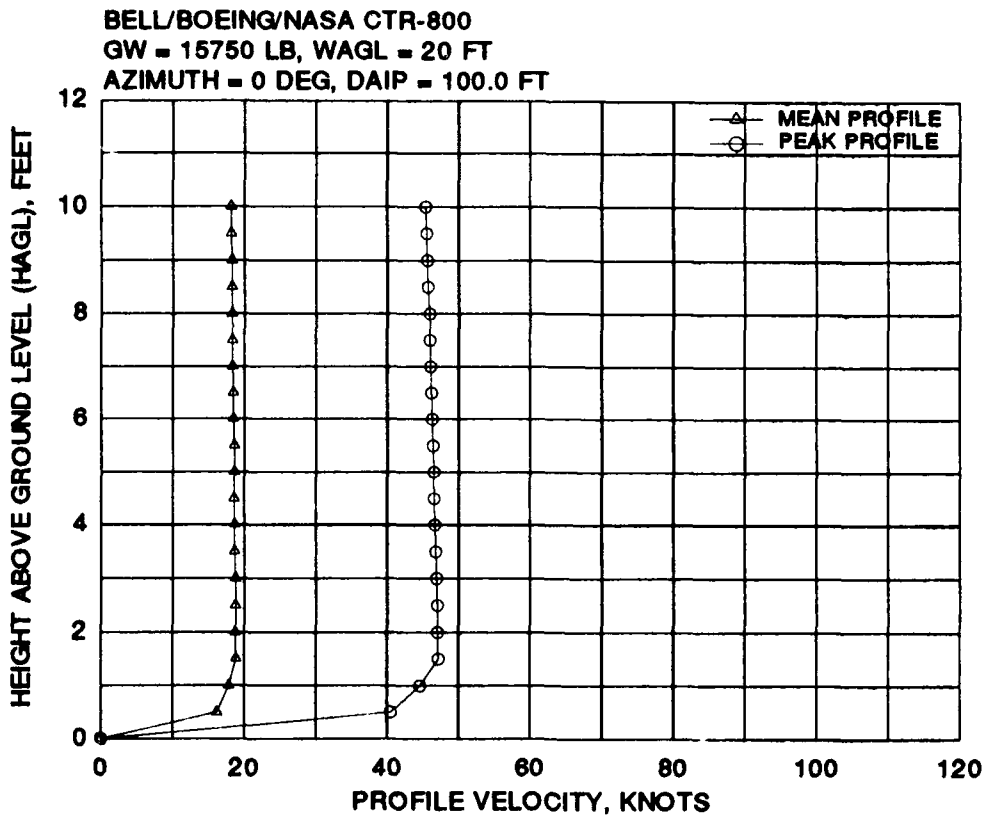

FIGURE D-3 CTR-800 MEAN AND PEAK VELOCITY PROFILES FOR EIGHT 0 DEGREE AZIMUTH RADIAL STATIONS AT A WHEEL HEIGHT OF 20 FEET AND A GROSS WEIGHT OF 15,750 POUNDS (Concluded)

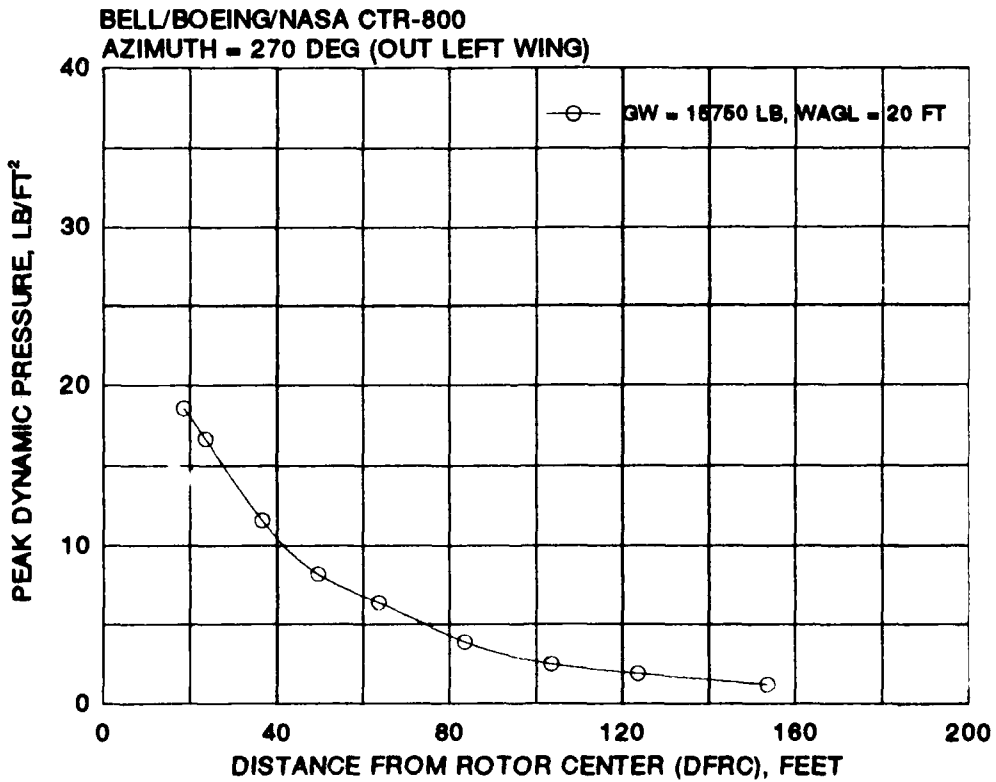
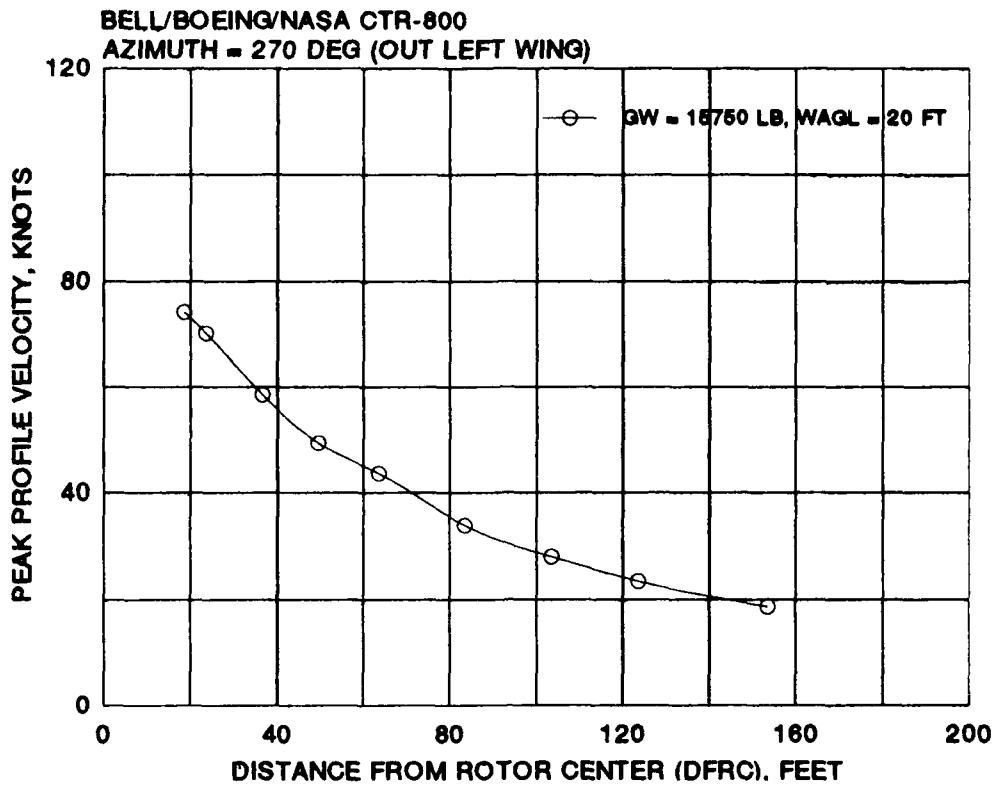

FIGURE D-4 CTR-800 PEAK ROTORWASH VELOCITY AND DYNAMIC PRESSURE AS A FUNCTION OF DISTANCE FROM THE ROTOR CENTER (270 DEGREE AZIMUTH)

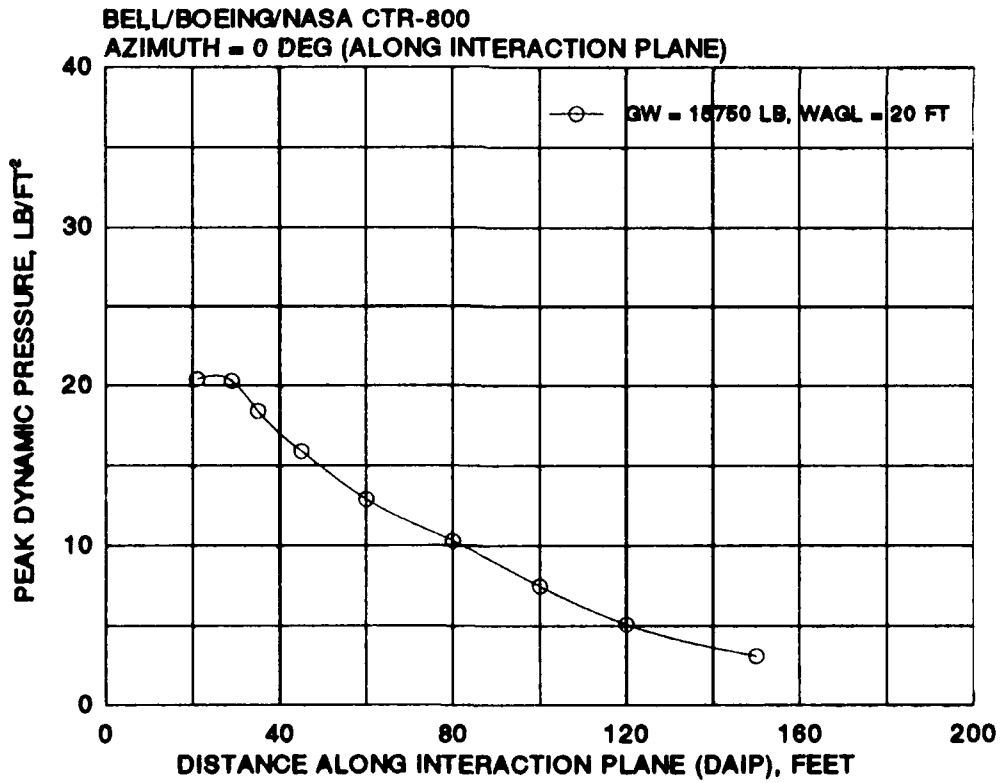
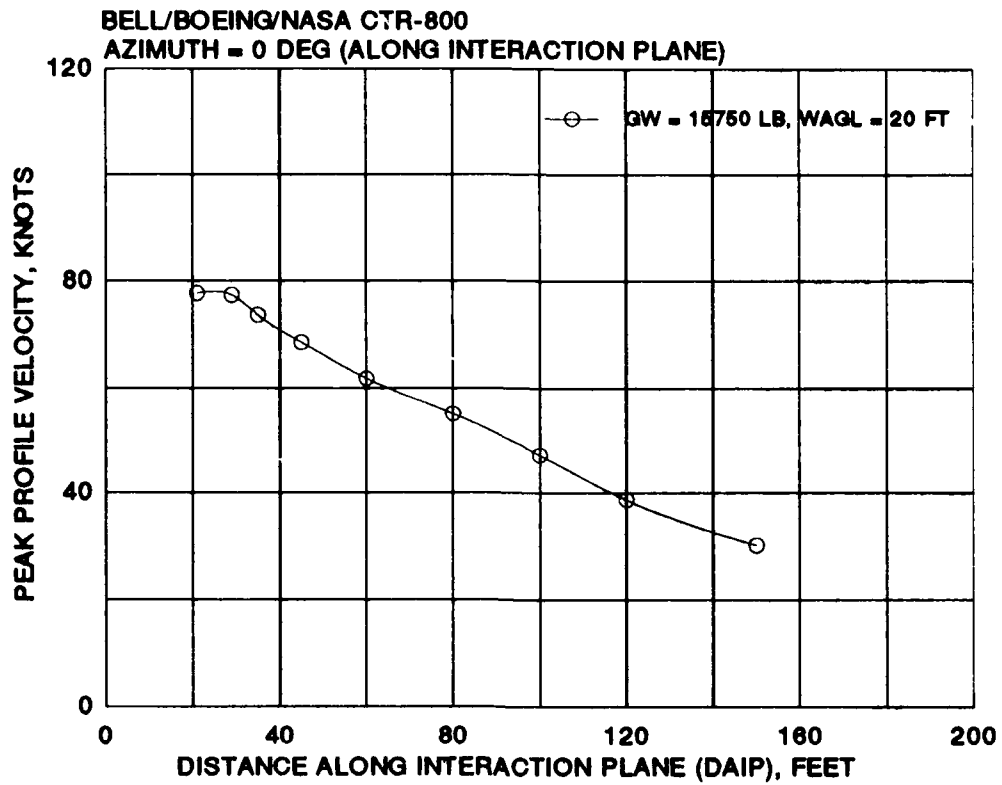

FIGURE D-5 CTR-800 PEAK ROTORWASH VELOCITY AND DYNAMIC PRESSURE AS A FUNCTION OF DISTANCE ALONG THE INTERACTION PLANE (0 DEGREE AZIMUTH)

BELL/BOEING/NASA CTR-800
AZIMUTH = 270 DEG (OUT LEFT WING)

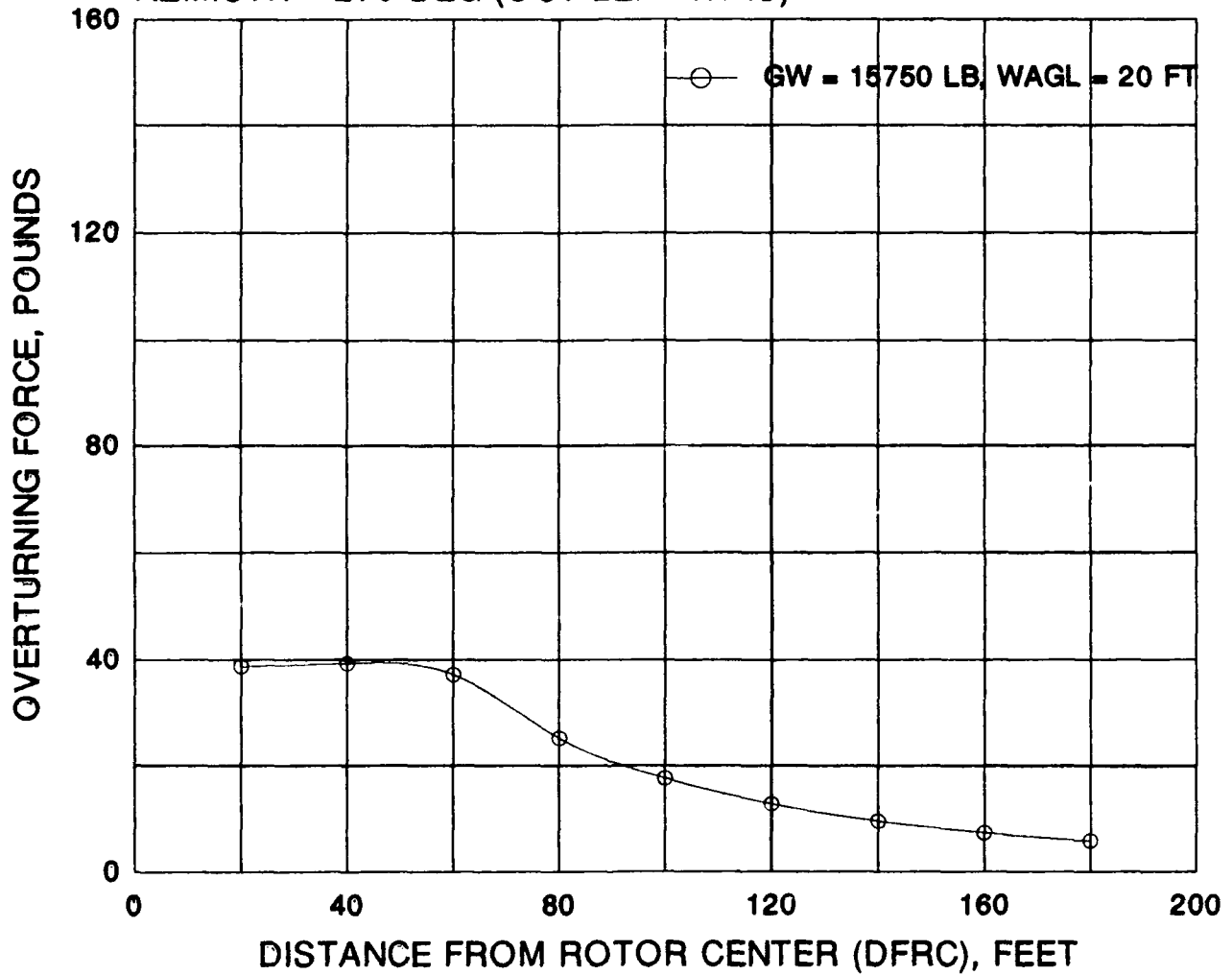

FIGURE D-6 CTR-800 OVERTURNING FORCE AS A FUNCTION OF DISTANCE FROM THE ROTOR CENTER (270 DEGREE AZIMUTH)

BELL/BOEING/NASA CTR-800
AZIMUTH = 0 DEG (ALONG INTERACTION PLANE)

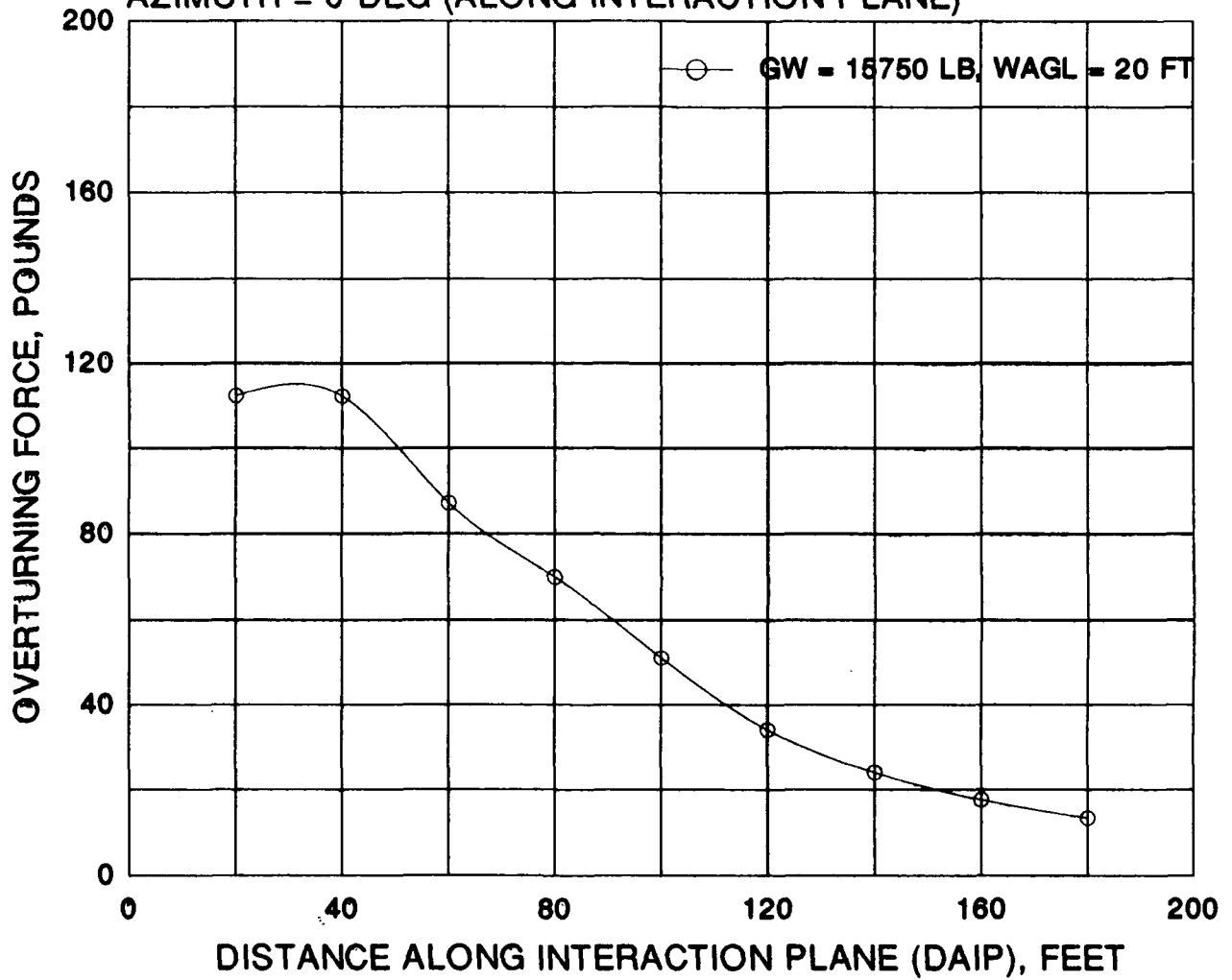

FIGURE D-7 CTR-800 OVERTURNING FORCE AS A FUNCTION OF DISTANCE ALONG THE INTERACTION PLANE (0 DEGREE AZIMUTH)

APPENDIX E

BELL/BOEING/NASA CTR-1900 AIRCRAFT AND ROTORWASH DATA

Bell/Boeing/NASA CTR-1900 aircraft characteristics used with the ROTWASH analysis program are listed in table E-1 as obtained from reference E-1. Figure E-1 presents a three-view drawing of the tiltrotor. Table E-2 provides a summary tabulation of parameters defining the conditions for all rotorwash data presented in the appendix. All data are plotted in one of four formats, which include graphs of:

1. mean and peak outwash velocity profiles,
2. peak outwash velocity versus distance,
3. peak outwash dynamic pressure versus distance, and
4. personnel overturning force versus distance.

In each format, data are plotted along both the 0 and 270 degree azimuth. Distance from rotor center (DFRC) is the independent variable along the 270 degree azimuth. Measurements of distance from aircraft center (DFAC) are also noted on the graphs. The DFAC reference point is defined as zero at the location where the aircraft centerline intersects the line connecting the two rotor centers of rotation. Along the 0 degree azimuth, distance along the interaction plane (DAIP) is the independent variable. This point is referenced as zero at the same location as the DFAC point.

REFERENCES

- E-1. Anon, "State/Regional Tiltrotor/Vertiport Feasibility Studies Data Package," NASA Ames Research Center, June 1, 1989.

TABLE E-1 CTR-1900 ROTWASH INPUT DATA

<u>Parameter</u>	<u>Value</u>
Rotor radius, feet	14.0
Distance between rotor centers, feet	37.0
Wing download, percent of rotor thrust	9.25
Distance from wheels to rotor plane, feet	11.0
Rotor speed, RPM	512.0
Rotor tip speed, feet/second	750.0
Number of rotor blades per rotor	3
Density ratio	1.0

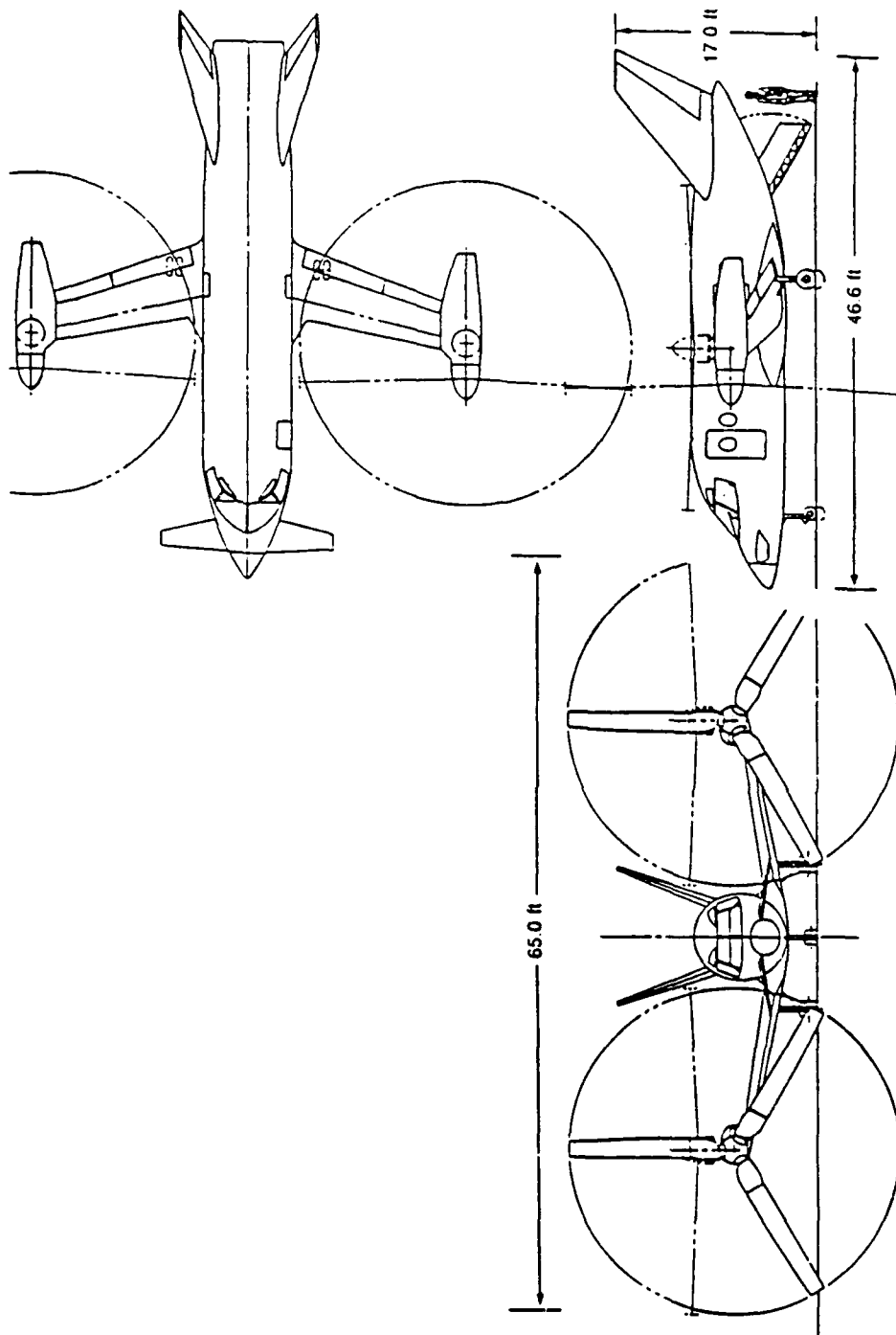

FIGURE E-1 THREE-VIEW DRAWING OF THE CTR-1900

TABLE E-2 CTR-1900 ROTORWASH EVALUATION MATRIX

Note: The Figure/Type column provides the figure number and data format type where:

M/P - Mean and peak velocity profile format

PVD - Peak velocity and dynamic pressure format

OTF - Personnel overturning force format

<u>Figure/ Type</u>	<u>Azimuth, Degrees</u>	<u>GW, Pounds</u>	<u>WAGL, Feet</u>	<u>DFRC or DAIP Distance, Feet</u>
E-2 M/P	270.0	22,800	30	21.5,34.5,47.5,61.5, 81.5,101.5,121.5,151.5
E-3 M/P	0.0	22,800	30	21, 29, 35, 45, 60, 80, 100, 120, 150
E-4 PVD	270.0	22,800	30	20 to 180
E-5 PVD	0.0	22,800	30	20 to 150
E-6 OTF	270.0	22,800	30	20 to 180
E-7 OTF	0.0	22,800	30	20 to 180

BELL/BOEING/NASA CTR-1900
 GW = 22800 LB, WAGL = 30 FT
 AZIMUTH = 270 DEG, DFAC = 40.0 FT (DFRC = 21.5 FT)

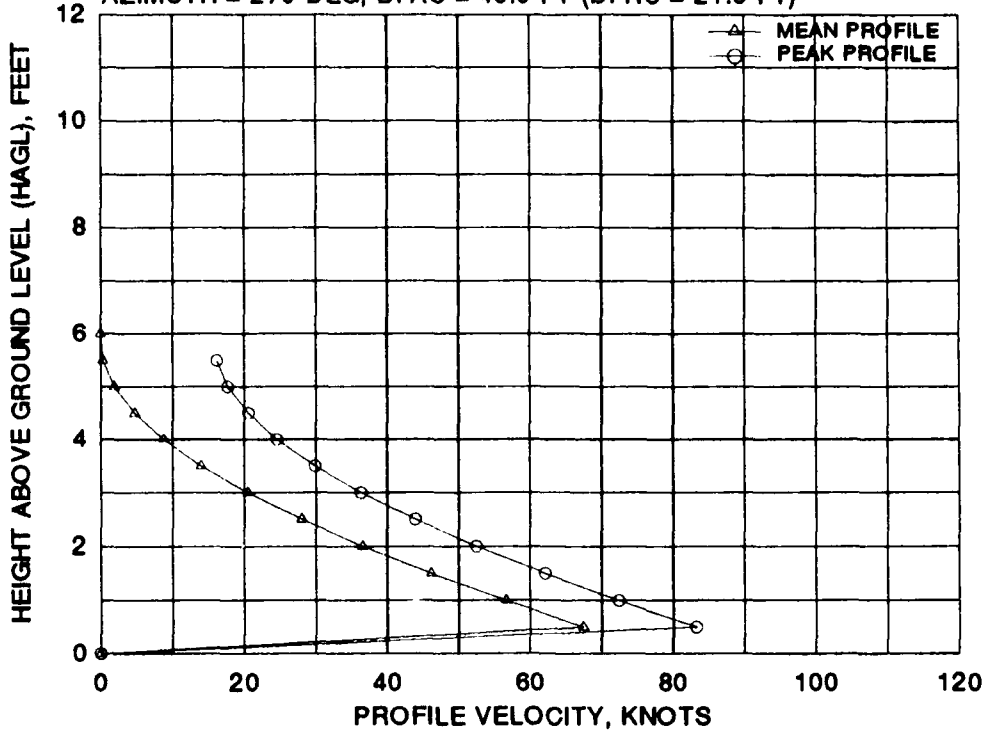

BELL/BOEING/NASA CTR-1900
 GW = 22800 LB, WAGL = 30 FT
 AZIMUTH = 270 DEG, DFAC = 53.0 FT (DFRC = 34.5 FT)

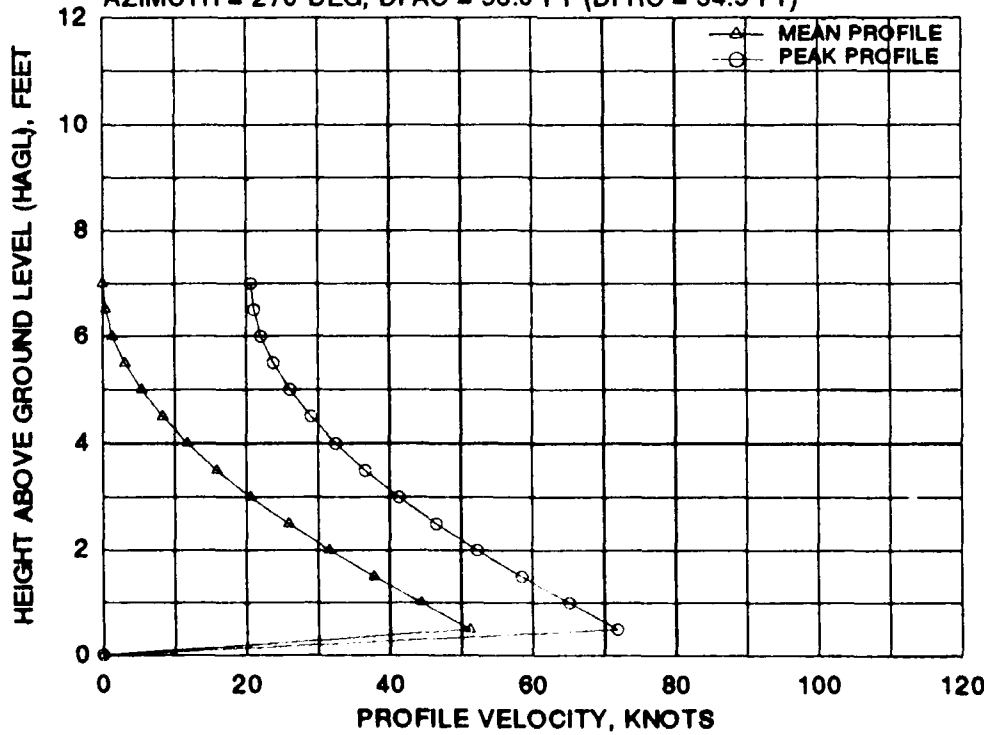
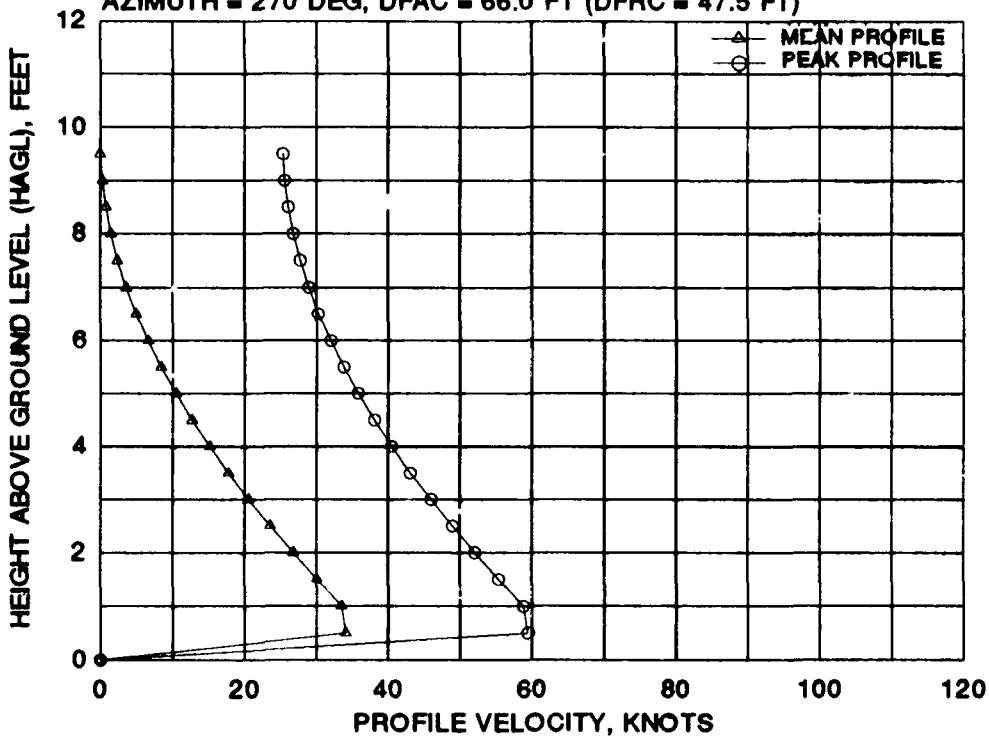

FIGURE E-2 CTR-1900 MEAN AND PEAK VELOCITY PROFILES FOR EIGHT 270 DEGREE AZIMUTH RADIAL STATIONS AT A WHEEL HEIGHT OF 30 FEET AND A GROSS WEIGHT OF 22,800 POUNDS

BELL/BOEING/NASA CTR-1900
 GW = 22800 LB, WAGL = 30 FT
 AZIMUTH = 270 DEG, DFAC = 66.0 FT (DFRC = 47.5 FT)



BELL/BOEING/NASA CTR-1900
 GW = 22800 LB, WAGL = 30 FT
 AZIMUTH = 270 DEG, DFAC = 80.0 FT (DFRC = 61.5 FT)

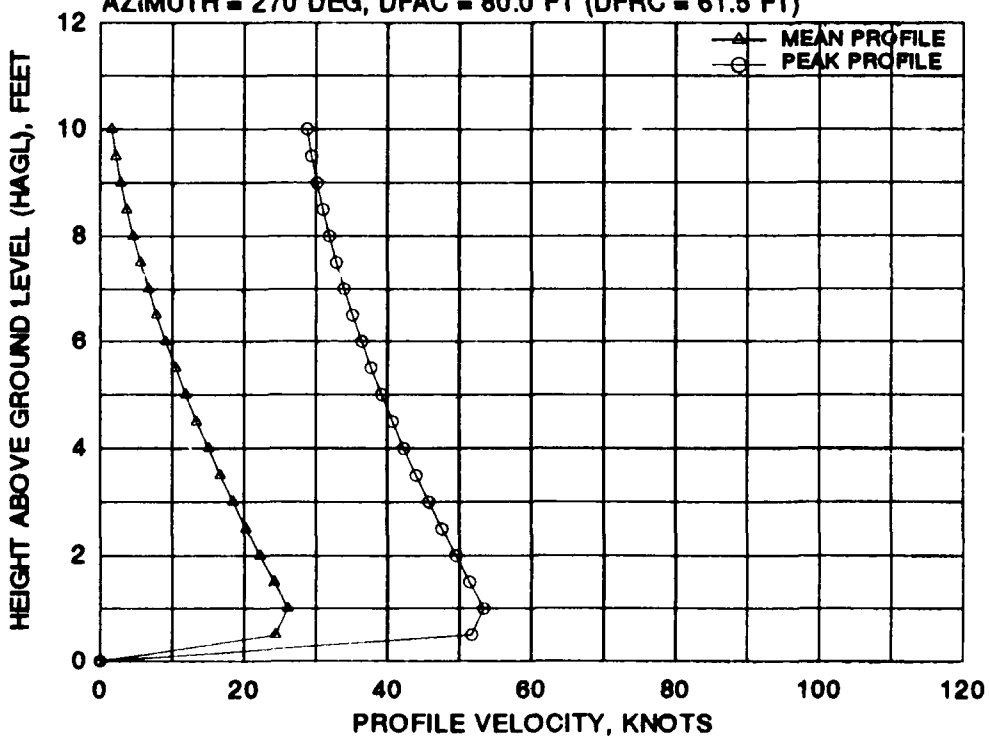
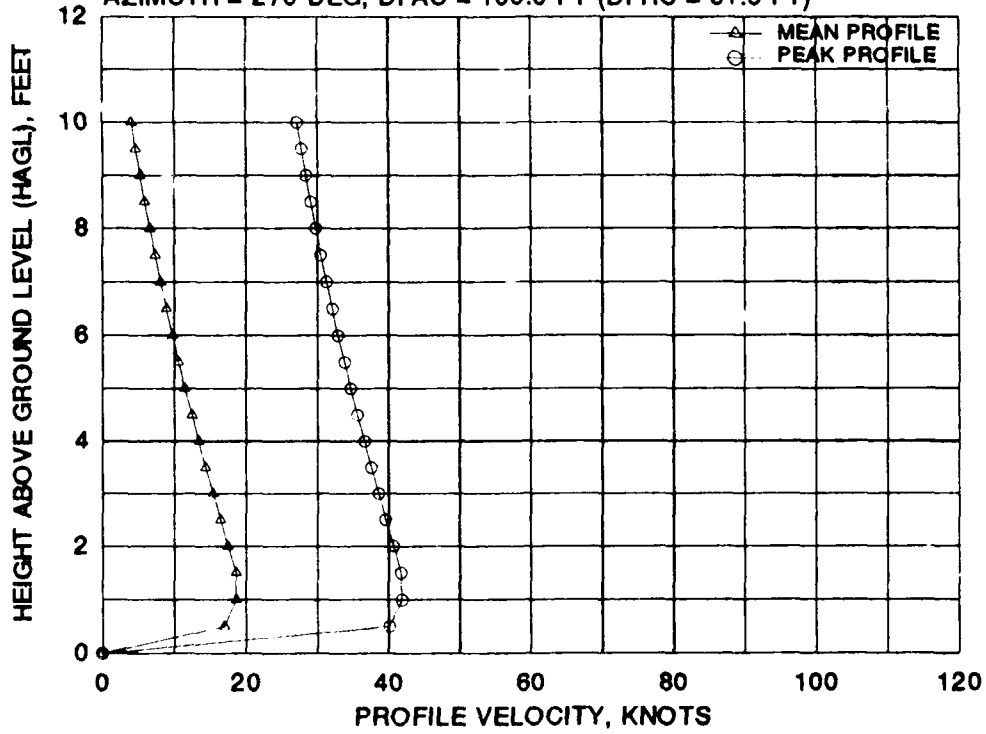

FIGURE E-2 CTR-1900 MEAN AND PEAK VELOCITY PROFILES FOR EIGHT 270 DEGREE AZIMUTH RADIAL STATIONS AT A WHEEL HEIGHT OF 30 FEET AND A GROSS WEIGHT OF 22,800 POUNDS (Continued)

BELL/BOEING/NASA CTR-1900
 GW = 22800 LB, WAGL = 30 FT
 AZIMUTH = 270 DEG, DFAC = 100.0 FT (DFRC = 81.5 FT)



BELL/BOEING/NASA CTR-1900
 GW = 22800 LB, WAGL = 30 FT
 AZIMUTH = 270 DEG, DFAC = 120.0 FT (DFRC = 101.5 FT)

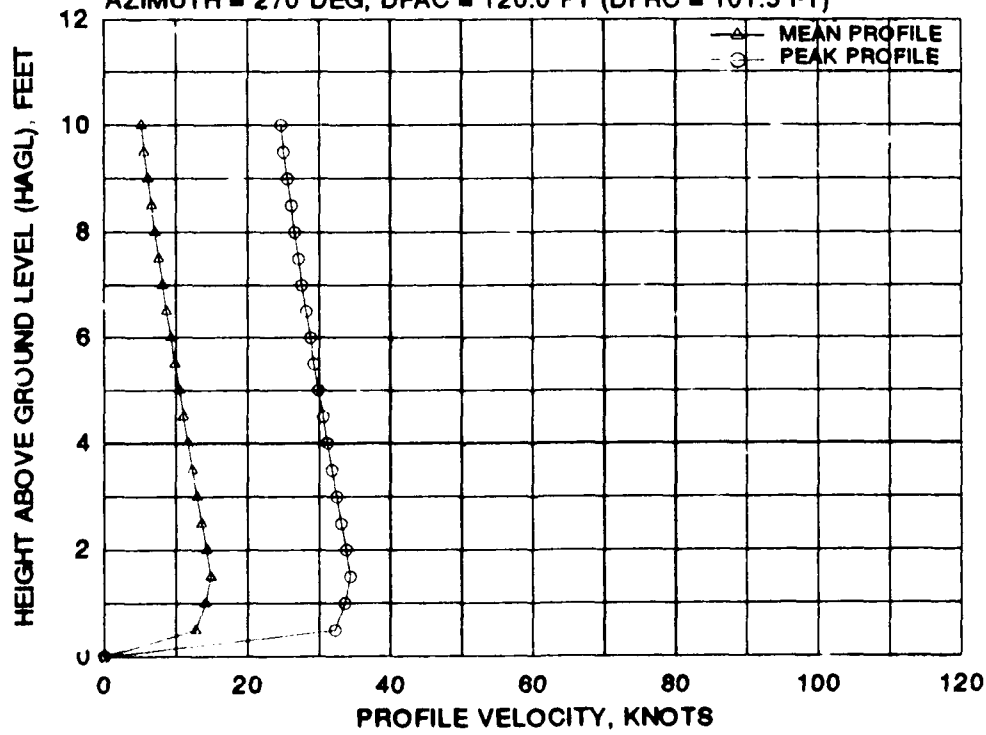
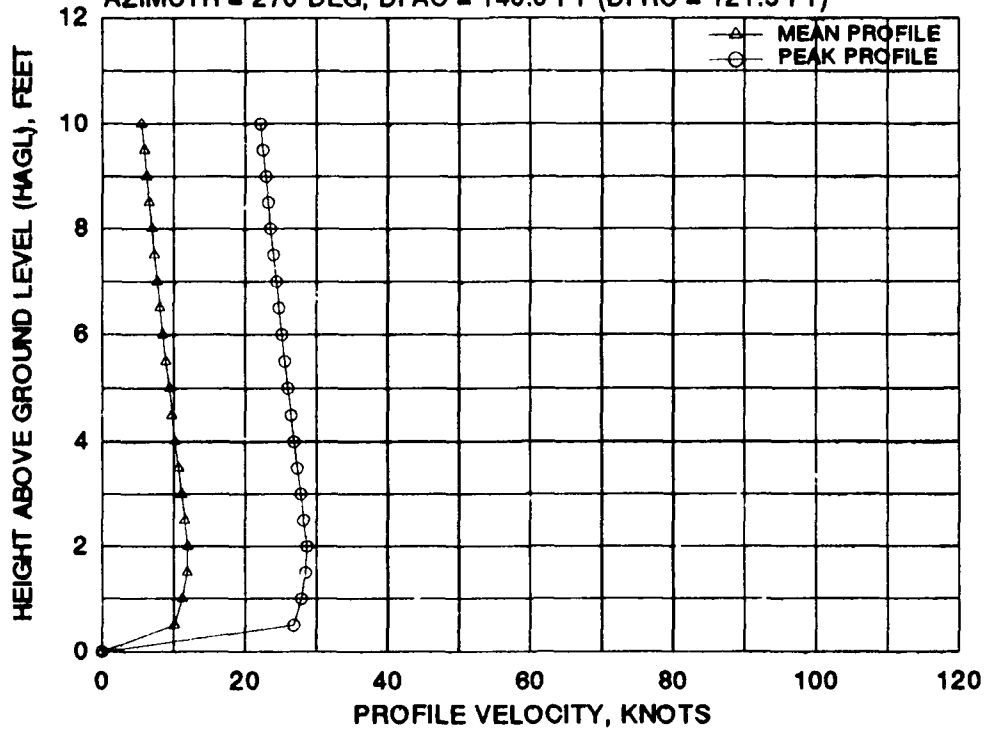

FIGURE E-2 CTR-1900 MEAN AND PEAK VELOCITY PROFILES FOR EIGHT 270 DEGREE AZIMUTH RADIAL STATIONS AT A WHEEL HEIGHT OF 30 FEET AND A GROSS WEIGHT OF 22,800 POUNDS (Continued)

BELL/BOEING/NASA CTR-1900
 GW = 22800 LB, WAGL = 30 FT
 AZIMUTH = 270 DEG, DFAC = 140.0 FT (DFRC = 121.5 FT)



BELL/BOEING/NASA CTR-1900
 GW = 22800 LB, WAGL = 30 FT
 AZIMUTH = 270 DEG, DFAC = 170.0 FT (DFRC = 151.5 FT)

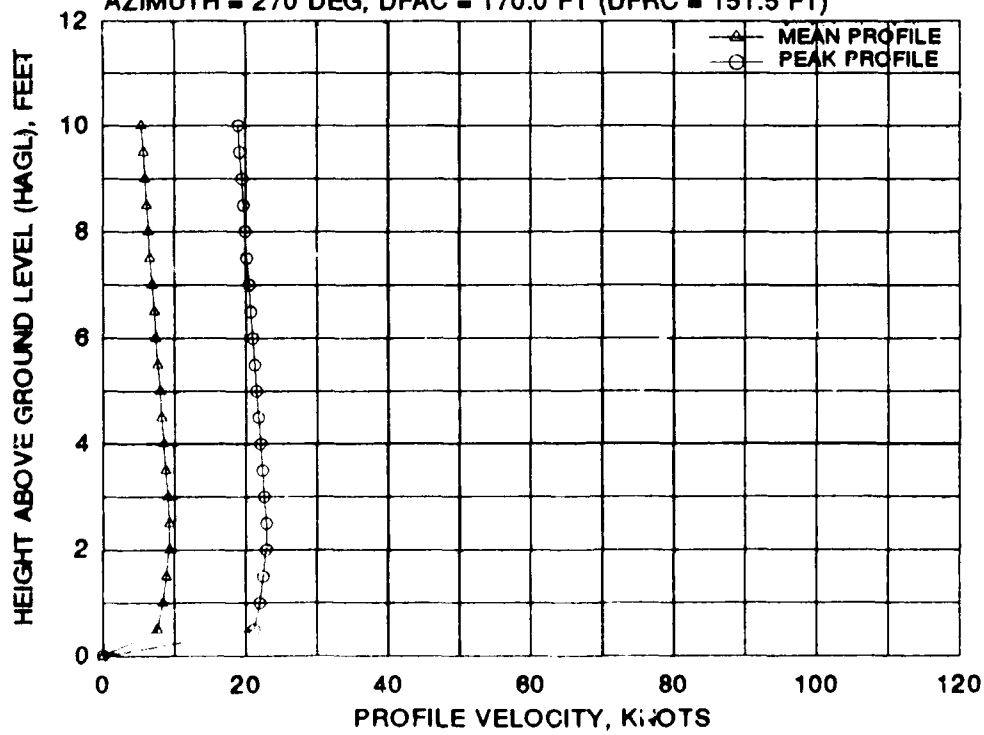
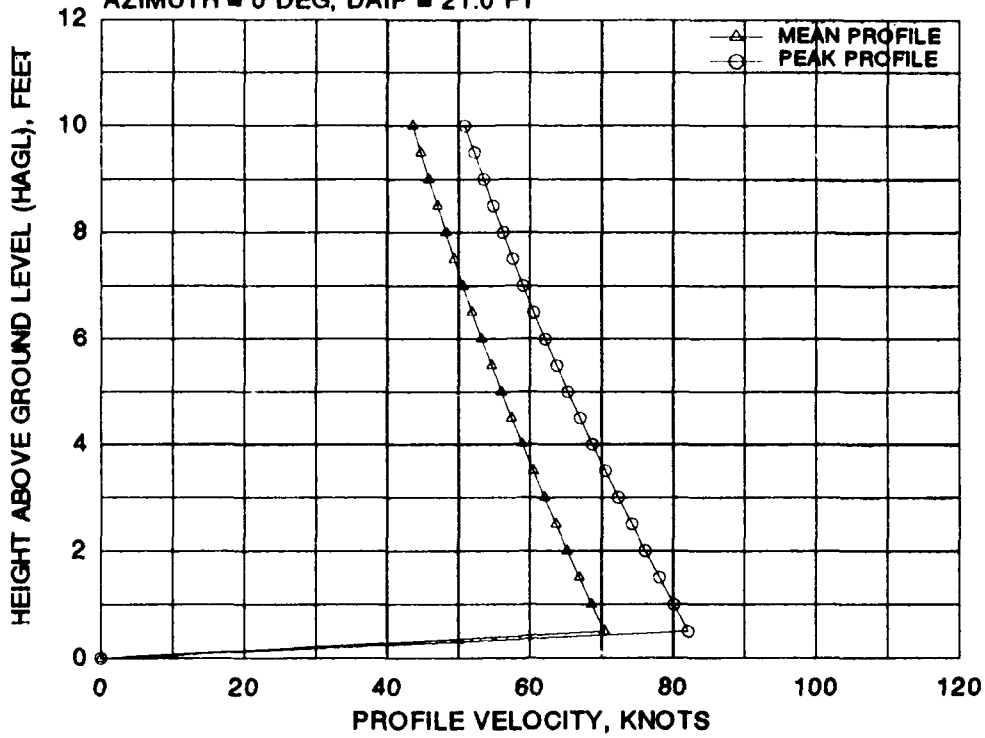

FIGURE E-2 CTR-1900 MEAN AND PEAK VELOCITY PROFILES FOR EIGHT 270 DEGREE AZIMUTH RADIAL STATIONS AT A WHEEL HEIGHT OF 30 FEET AND A GROSS WEIGHT OF 22,800 POUNDS (Concluded)

BELL/BOEING/NASA CTR-1900
 GW = 22800 LB, WAGL = 30 FT
 AZIMUTH = 0 DEG, DAIP = 21.0 FT



BELL/BOEING/NASA CTR-1900
 GW = 22800 LB, WAGL = 30 FT
 AZIMUTH = 0 DEG, DAIP = 29.0 FT

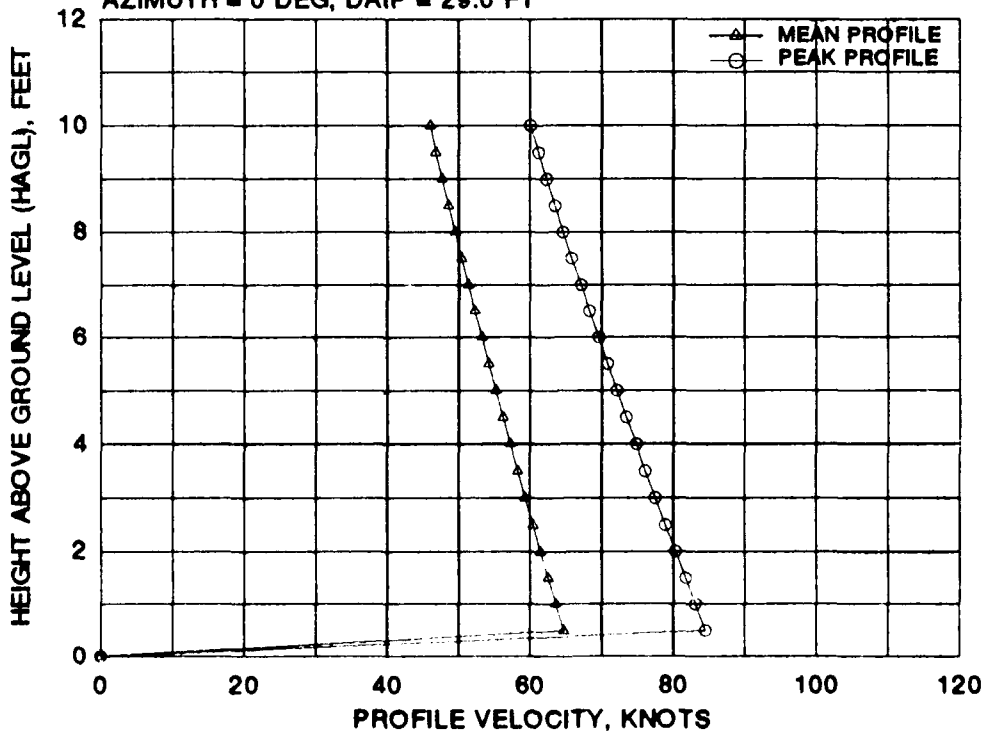
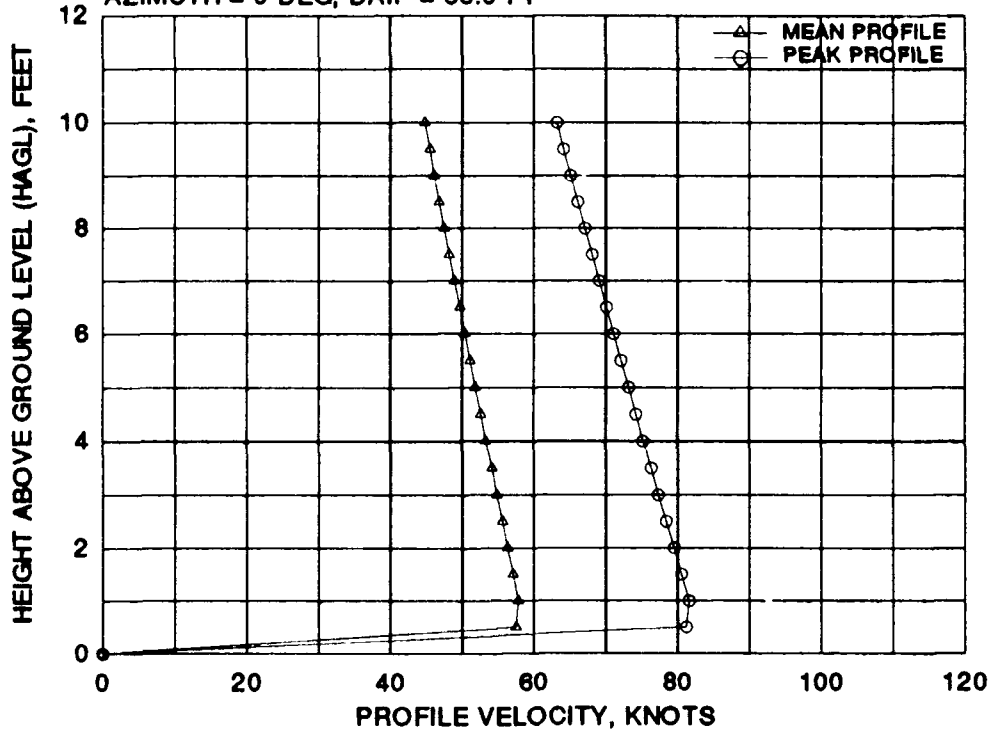

FIGURE E-3 CTR-1900 MEAN AND PEAK VELOCITY PROFILES FOR NINE 0 DEGREE AZIMUTH RADIAL STATIONS AT A WHEEL HEIGHT OF 30 FEET AND A GROSS WEIGHT OF 22,800 POUNDS

BELL/BOEING/NASA CTR-1900
 GW = 22800 LB, WAGL = 30 FT
 AZIMUTH = 0 DEG, DAIP = 35.0 FT



BELL/BOEING/NASA CTR-1900
 GW = 22800 LB, WAGL = 30 FT
 AZIMUTH = 0 DEG, DAIP = 45.0 FT

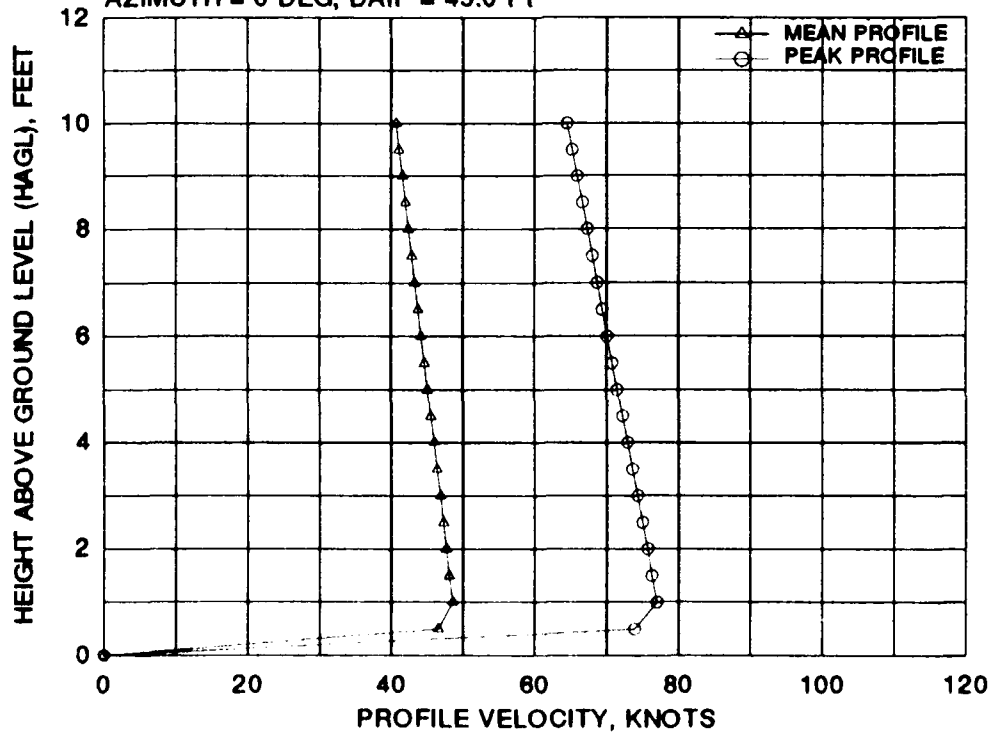
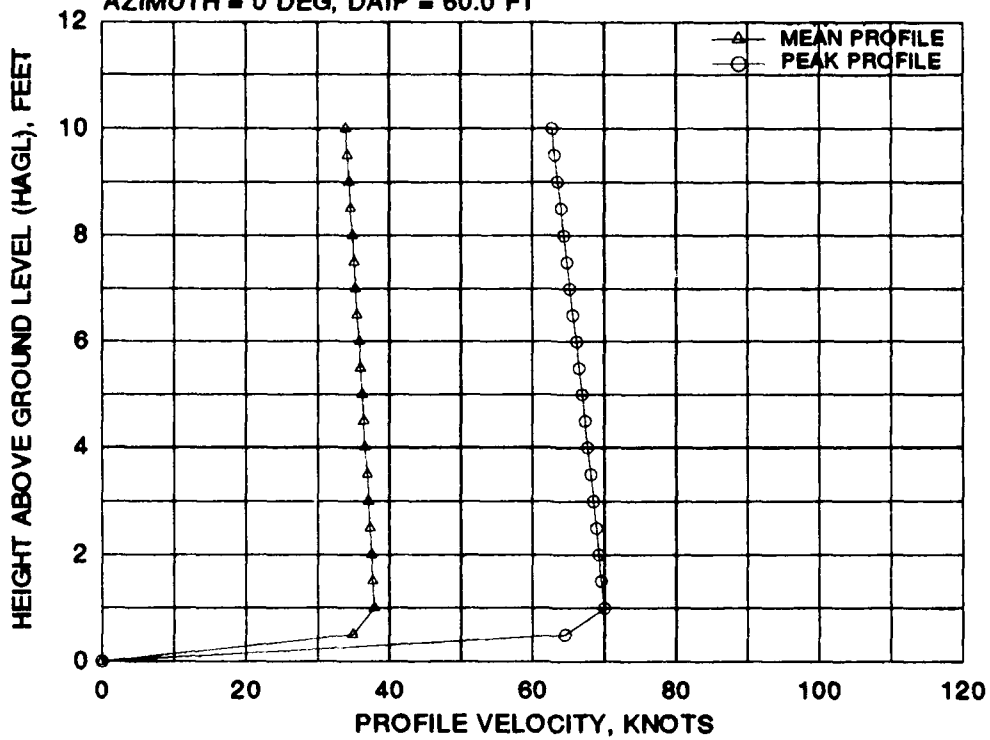

FIGURE E-3 CTR-1900 MEAN AND PEAK VELOCITY PROFILES FOR NINE 0 DEGREE AZIMUTH RADIAL STATIONS AT A WHEEL HEIGHT OF 30 FEET AND A GROSS WEIGHT OF 22,800 POUNDS (Continued)

BELL/BOEING/NASA CTR-1900
 GW = 22800 LB, WAGL = 30 FT
 AZIMUTH = 0 DEG, DAIP = 60.0 FT



BELL/BOEING/NASA CTR-1900
 GW = 22800 LB, WAGL = 30 FT
 AZIMUTH = 0 DEG, DAIP = 80.0 FT

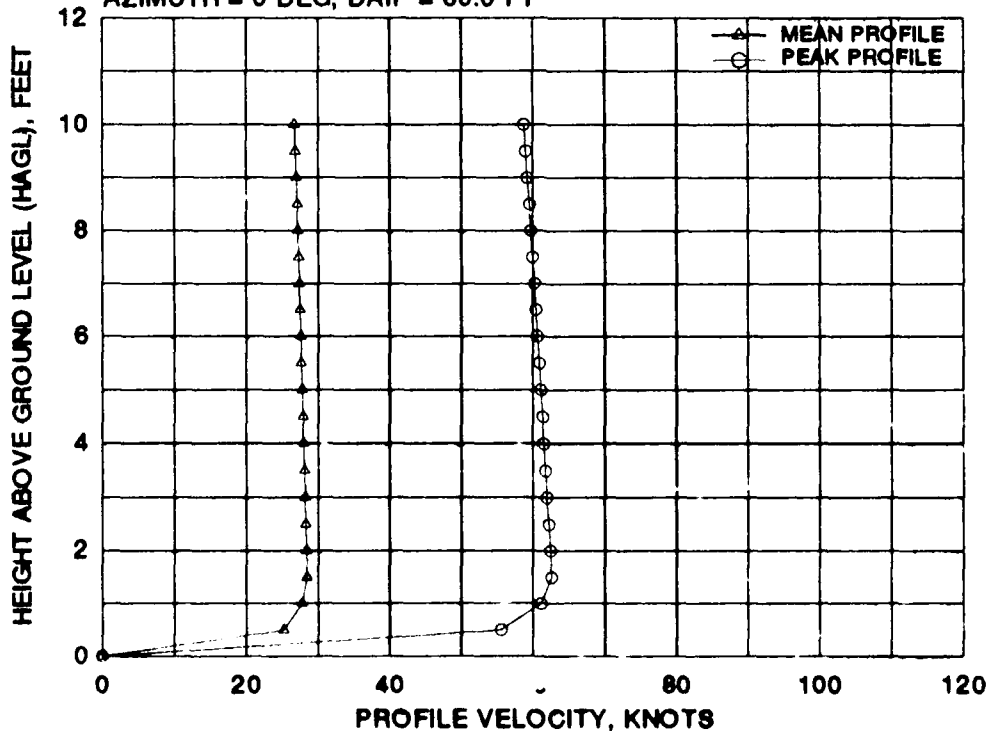
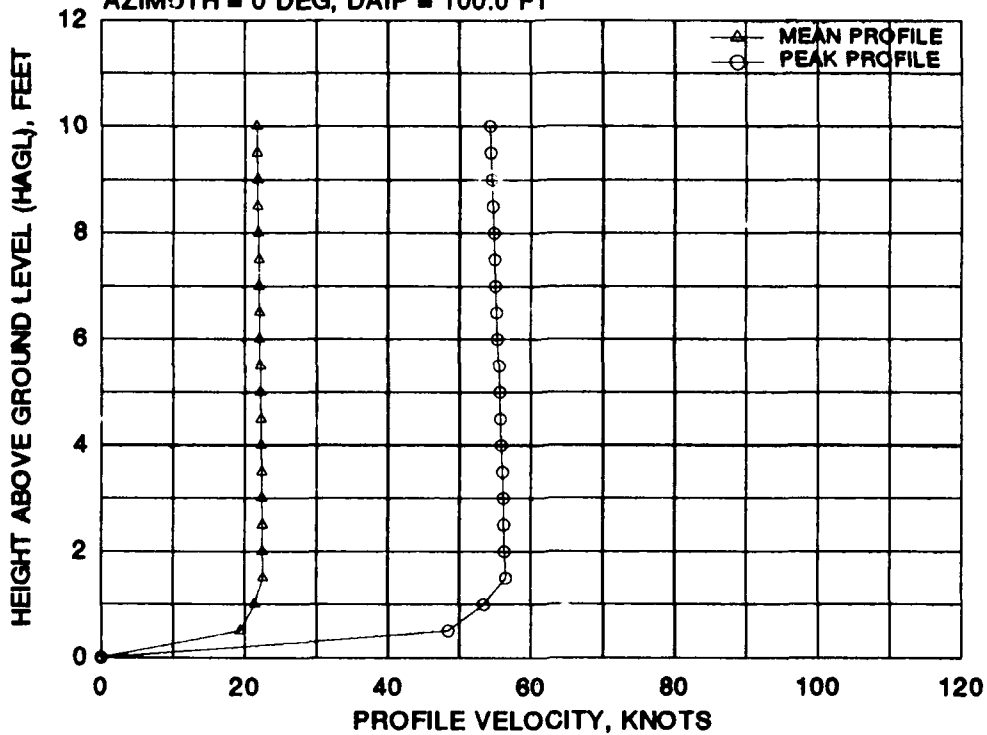

FIGURE E-3 CTR-1900 MEAN AND PEAK VELOCITY PROFILES FOR NINE 0 DEGREE AZIMUTH RADIAL STATIONS AT A WHEEL HEIGHT OF 30 FEET AND GROSS WEIGHT OF 22,800 POUNDS (Continued)

BELL/BOEING/NASA CTR-1900
 GW = 22800 LB, WAGL = 30 FT
 AZIMUTH = 0 DEG, DAIP = 100.0 FT



BELL/BOEING/NASA CTR-1900
 GW = 22800 LB, WAGL = 30 FT
 AZIMUTH = 0 DEG, DAIP = 120.0 FT

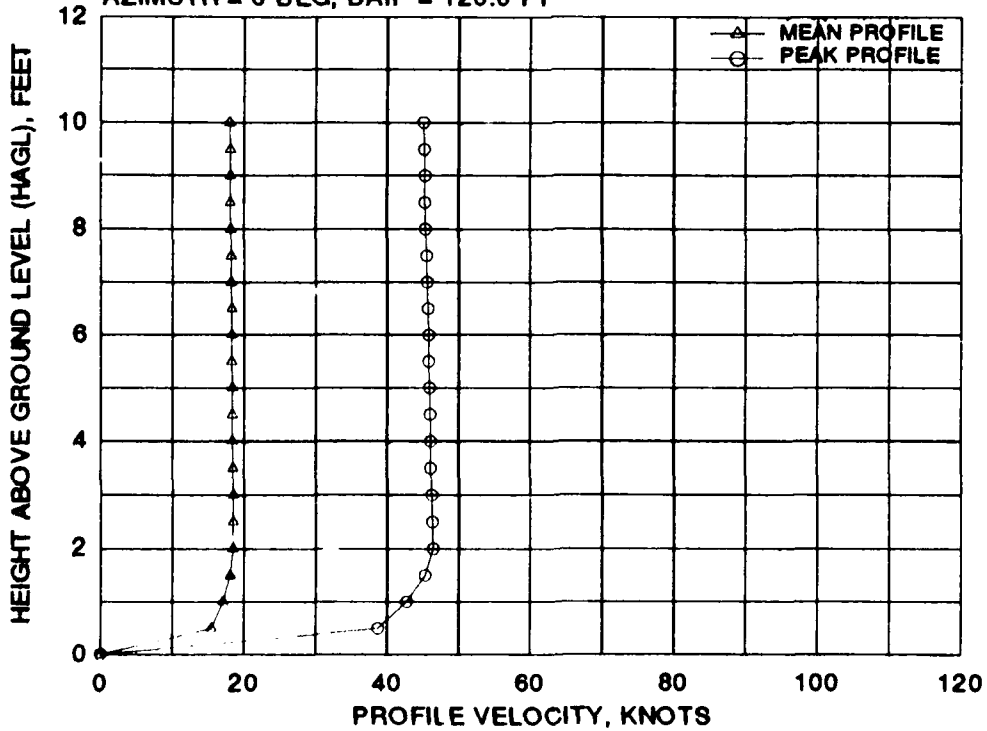

FIGURE E-3 CTR-1900 MEAN AND PEAK VELOCITY PROFILES FOR NINE 0 DEGREE AZIMUTH RADIAL STATIONS AT A WHEEL HEIGHT OF 30 FEET AND A GROSS WEIGHT OF 22,800 POUNDS (Continued)

BELL/BOEING/NASA CTR-1900
GW = 22800 LB, WAGL = 30 FT
AZIMUTH = 0 DEG, DAIP = 150.0 FT

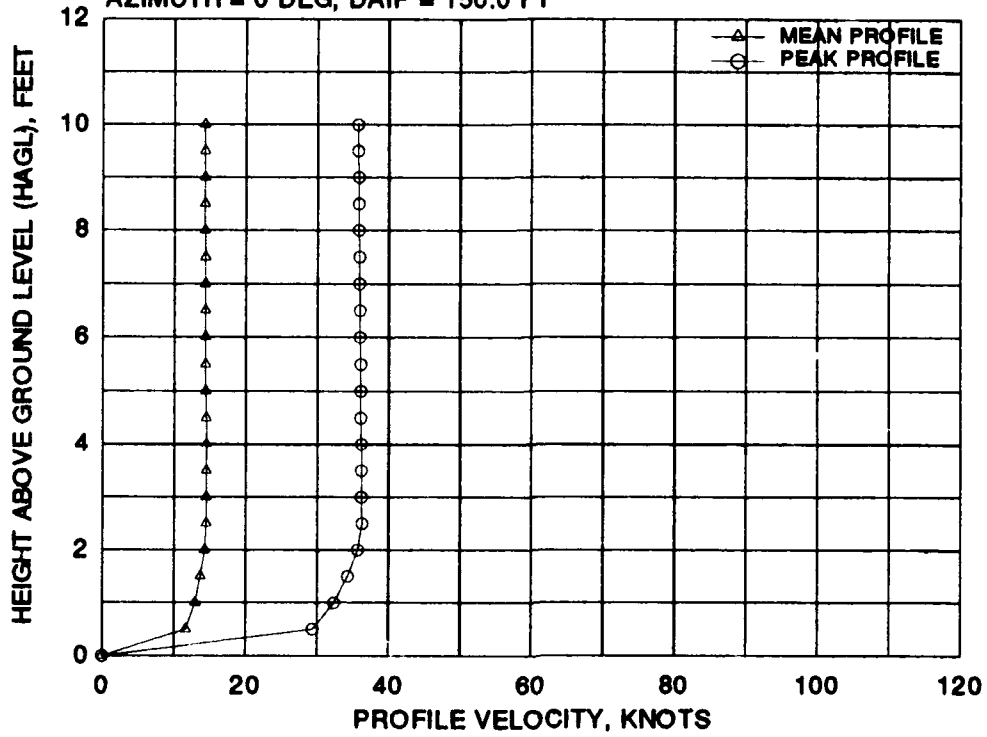

FIGURE E-3 CTR-1900 MEAN AND PEAK VELOCITY PROFILES FOR NINE 0 DEGREE AZIMUTH RADIAL STATIONS AT A WHEEL HEIGHT OF 30 FEET AND A GROSS WEIGHT OF 22,800 POUNDS (Concluded)

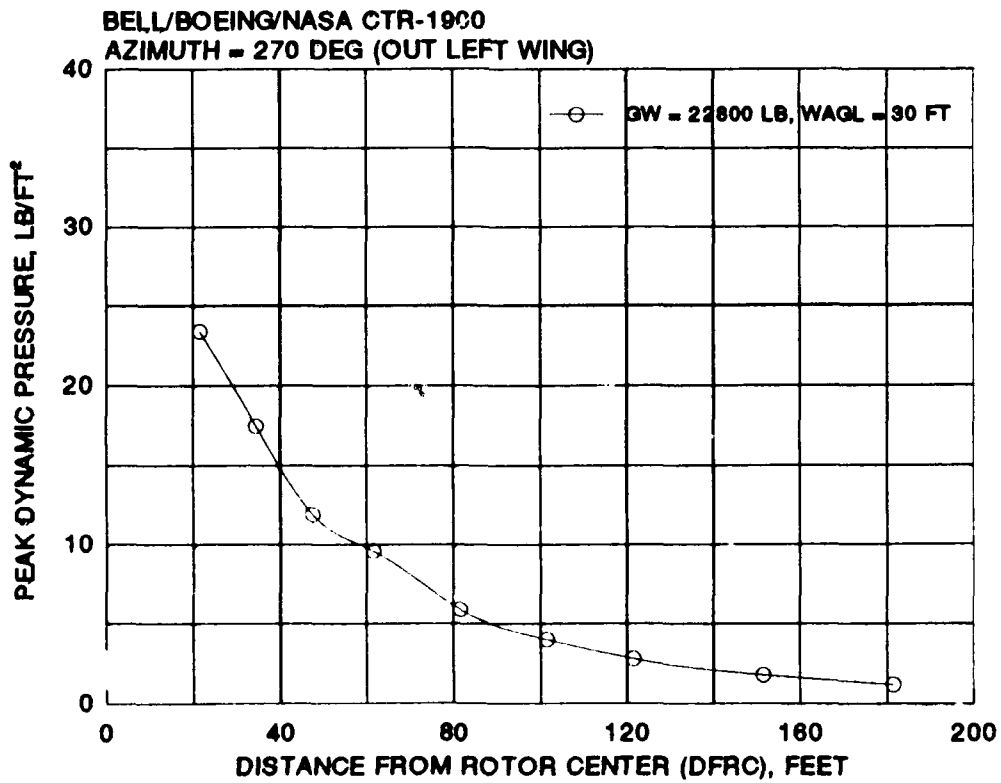
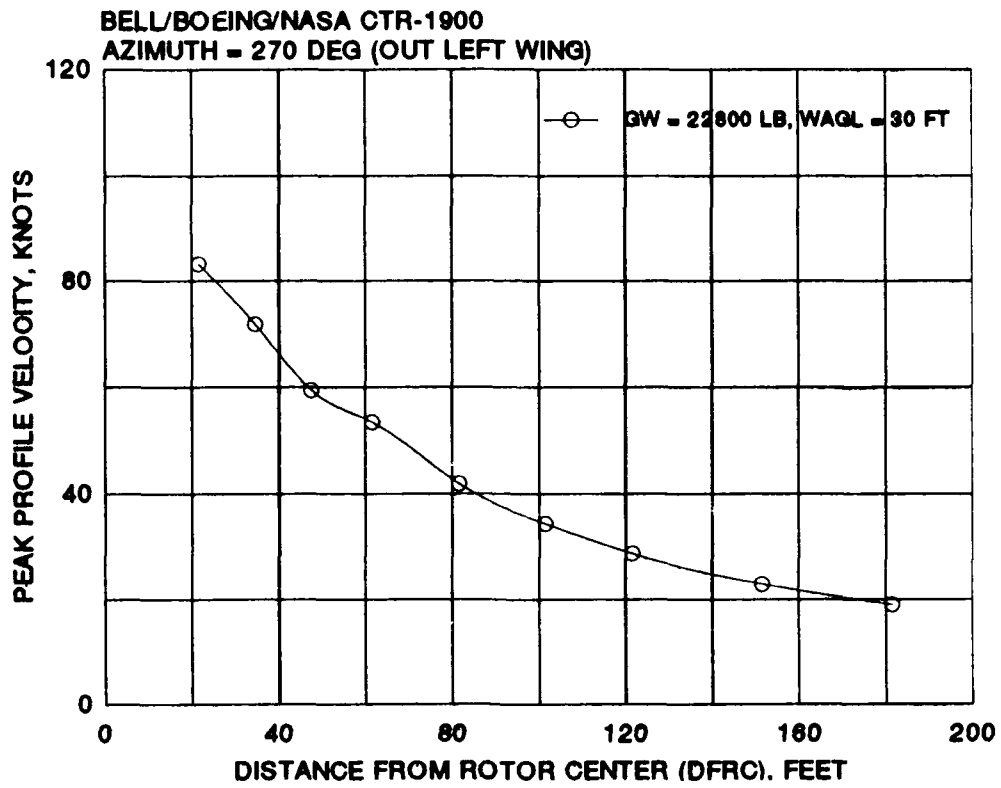

FIGURE E-4 CTR-1900 PEAK ROTORWASH VELOCITY AND DYNAMIC PRESSURE AS A FUNCTION OF DISTANCE FROM THE ROTOR CENTER (270 DEGREE AZIMUTH)

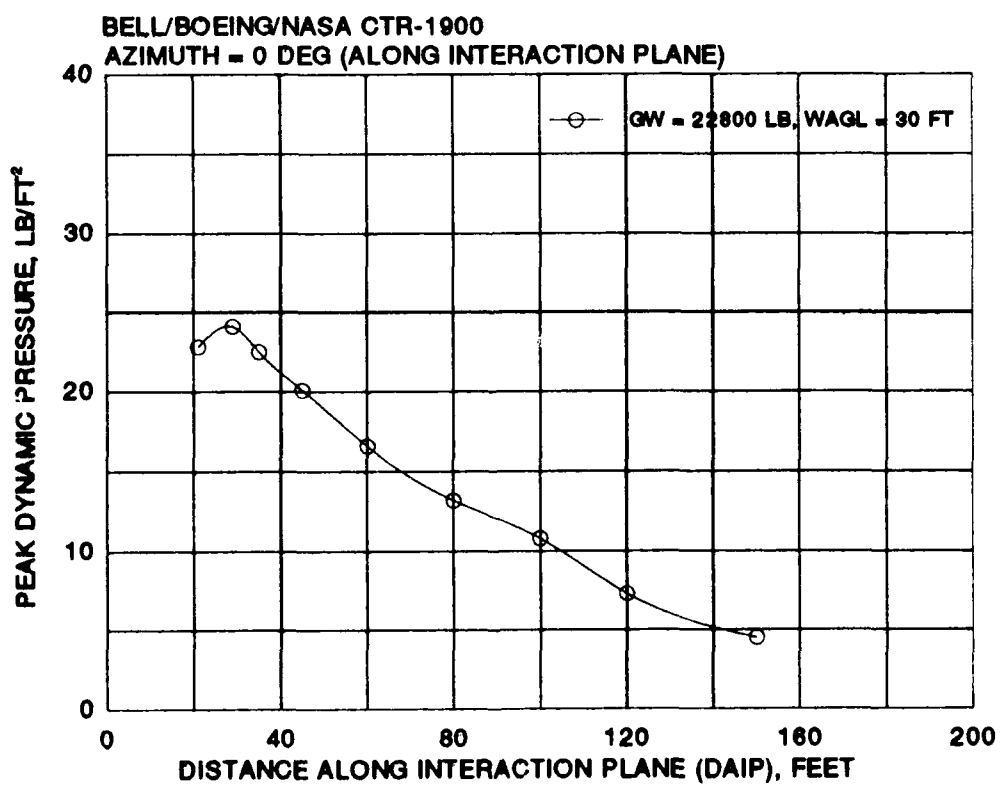
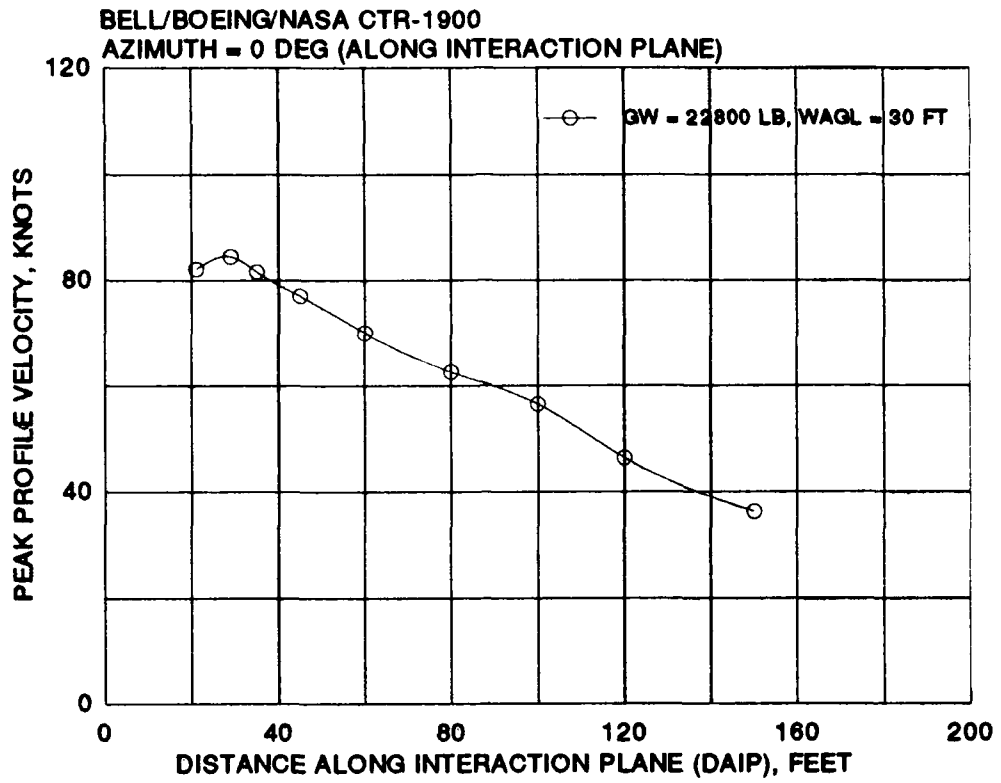

FIGURE E-5 CTR-1900 PEAK ROTORWASH VELOCITY AND DYNAMIC PRESSURE AS A FUNCTION OF DISTANCE ALONG THE INTERACTION PLANE (0 DEGREE AZIMUTH)

BELL/BOEING/NASA CTR-1900
AZIMUTH = 270 DEG (OUT LEFT WING)

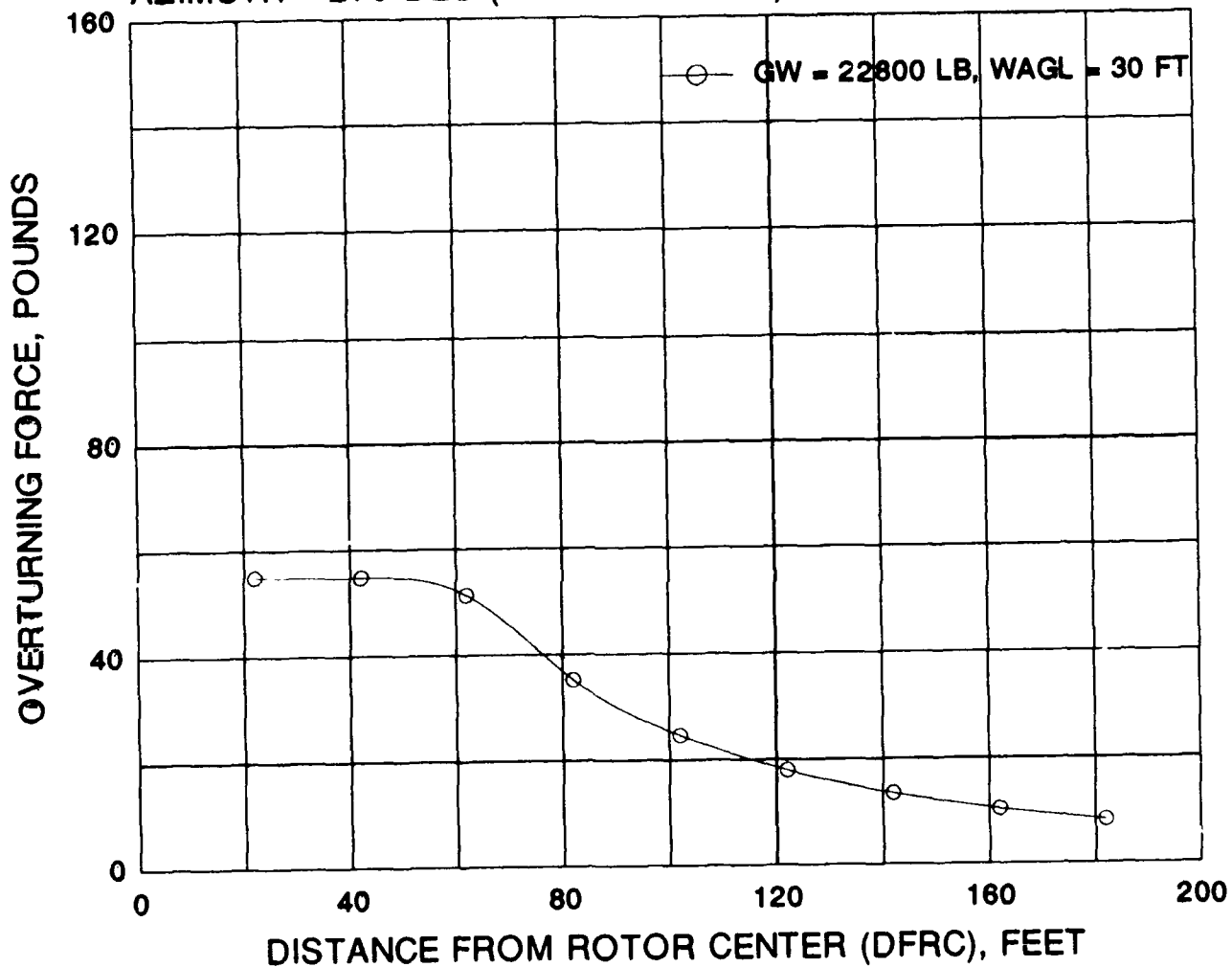

FIGURE E-6 CTR-1900 OVERTURNING FORCE AS A FUNCTION OF DISTANCE FROM THE ROTOR CENTER (270 DEGREE AZIMUTH)

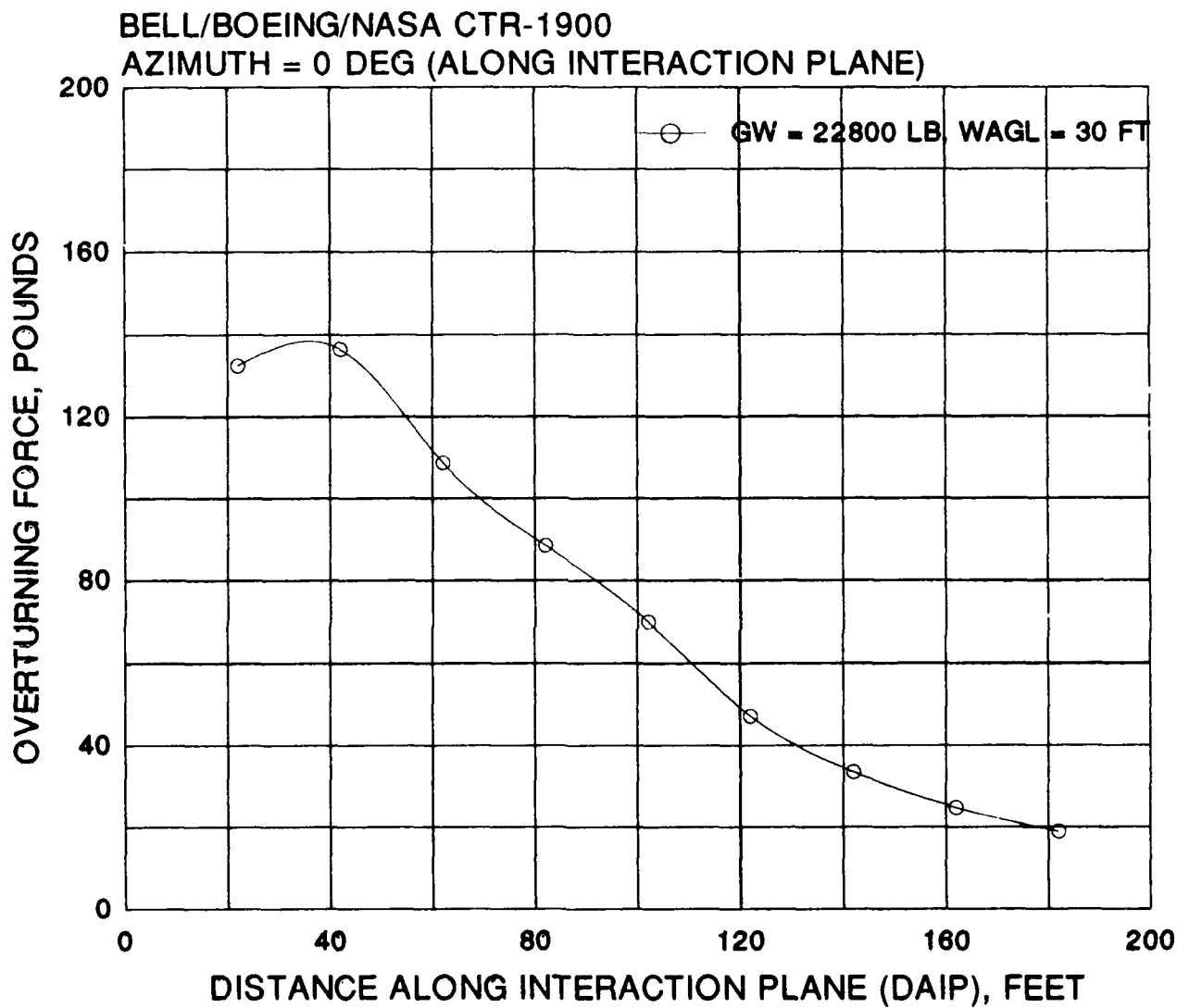

FIGURE E-7 CTR-1900 OVERTURNING FORCE AS A FUNCTION OF DISTANCE ALONG THE INTERACTION PLANE (0 DEGREE AZIMUTH)

APPENDIX F

BELL/BOEING/NASA CTR-7500 AIRCRAFT AND ROTORWASH DATA

Bell/Boeing/NASA CTR-7500 aircraft characteristics used with the ROTWASH analysis program are listed in table F-1 as obtained from reference F-1. Figure F-1 presents a three-view drawing of the tiltrotor. Table F-2 provides a summary tabulation of parameters defining the conditions for all rotorwash data presented in the appendix. All data are plotted in one of four formats, which include graphs of:

1. mean and peak outwash velocity profiles,
2. peak outwash velocity versus distance,
3. peak outwash dynamic pressure versus distance, and
4. personnel overturning force versus distance.

In each format, data are plotted along both the 0 and 270 degree azimuth. Distance from rotor center (DFRC) is the independent variable along the 270 degree azimuth. Measurements of distance from aircraft center (DFAC) are also noted on the graphs. The DFAC reference point is defined as zero at the location where the aircraft centerline intersects the line connecting the two rotor centers of rotation. Along the 0 degree azimuth, distance along the interaction plane (DAIP) is the independent variable. This point is referenced as zero at the same location as the DFAC point.

REFERENCES

- F-1. Anon, "State/Regional Tiltrotor/Vertiport Feasibility Studies Data Package," NASA Ames Research Center, June 1, 1989.

TABLE F-1 CTR-7500 ROTWASH INPUT DATA

<u>Parameter</u>	<u>Value</u>
Rotor radius, feet	23.0
Distance between rotor centers, feet	63.0
Wing download, percent of rotor thrust	9.25
Distance from wheels to rotor plane, feet	21.5
Rotor speed, RPM	328.0
Rotor tip speed, feet/second	790.0
Number of rotor blades per rotor	3
Density ratio	1.0

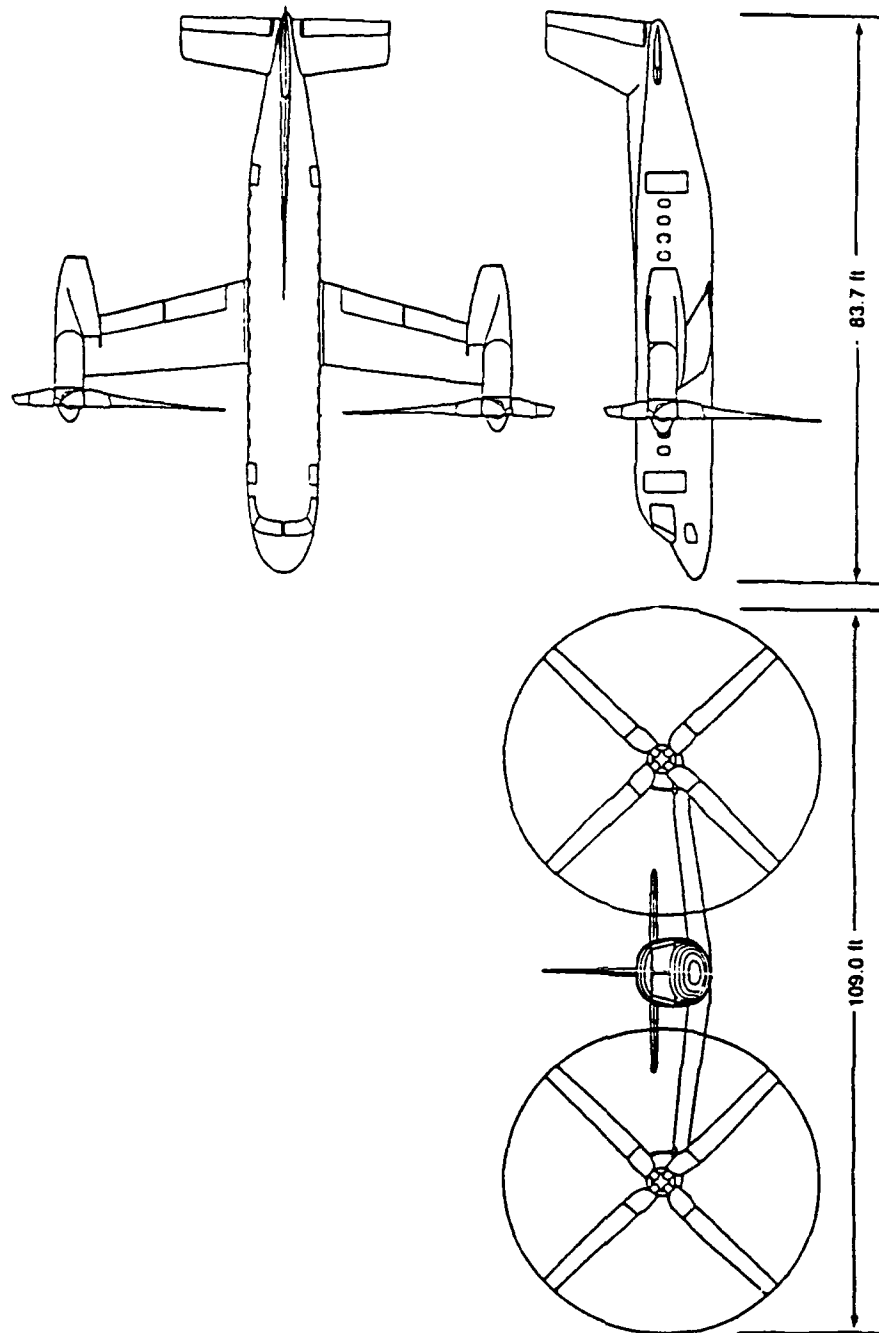

FIGURE F-1 THREE-VIEW DRAWING OF THE CTR-7500

TABLE F-2 CTR-7500 ROTORWASH EVALUATION MATRIX

Note: The Figure/Type column provides the figure number and data format type where:

M/P - Mean and peak velocity profile format

PVD - Peak velocity and dynamic pressure format

OTF - Personnel overturning force format

<u>Figure/ Type</u>	<u>Azimuth, Degrees</u>	<u>GW, Pounds</u>	<u>WAGL, Feet</u>	<u>DFRC or DAIP Distance, Feet</u>
F-2 M/P	270.0	79,820	30	34.5,48.5,68.5,88.5, 108.5,138.5,168.5
F-3 M/P	0.0	79,820	30	35, 45, 60, 80, 100, 120, 150, 200
F-4 PVD	270.0	79,820	30	30 to 170
F-5 PVD	0.0	79,820	30	30 to 200
F-6 OTF	270.0	79,820	30	30 to 200
F-7 OTF	0.0	79,820	30	30 to 200

BELL/BOEING/NASA CTR-7500
 GW = 79820 LB, WAGL = 30 FT
 AZIMUTH = 270 DEG, DFAC = 66.0 FT (DFRC = 24.5 FT)

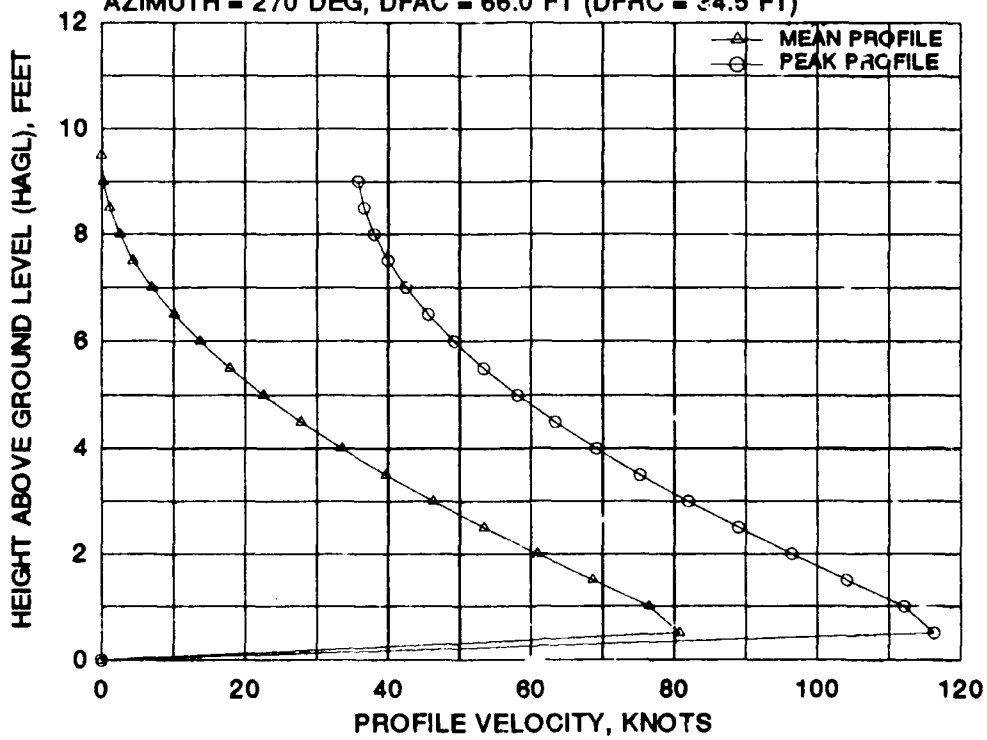

BELL/BOEING/NASA CTR-7500
 GW = 79820 LB, WAGL = 30 FT
 AZIMUTH = 270 DEG, DFAC = 80.0 FT (DFRC = 48.5 FT)

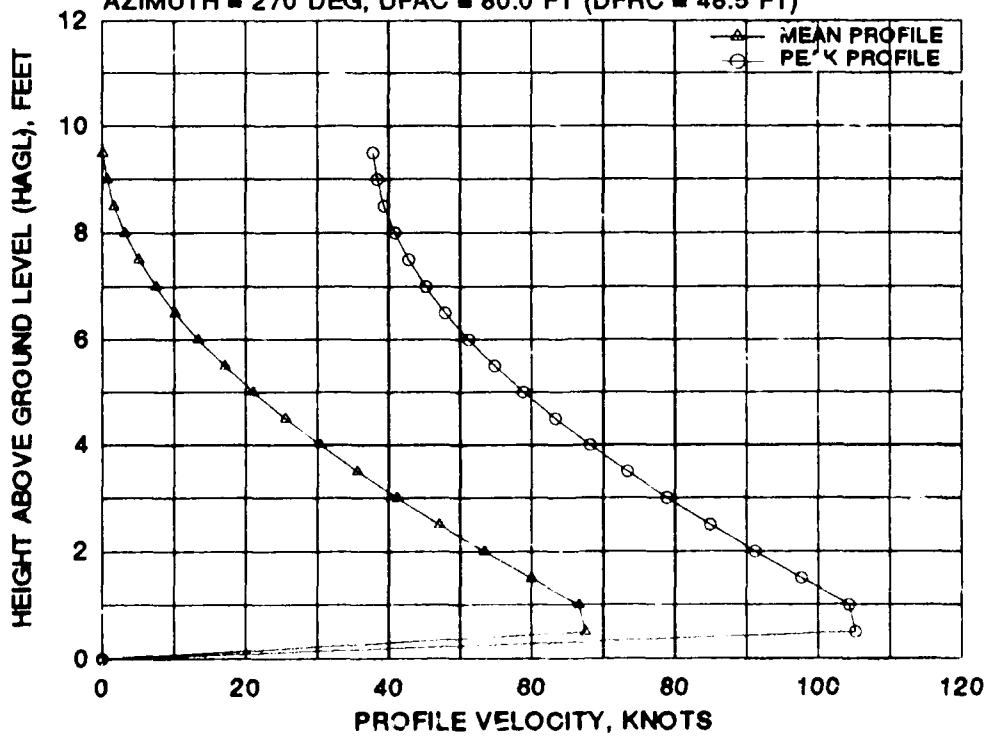
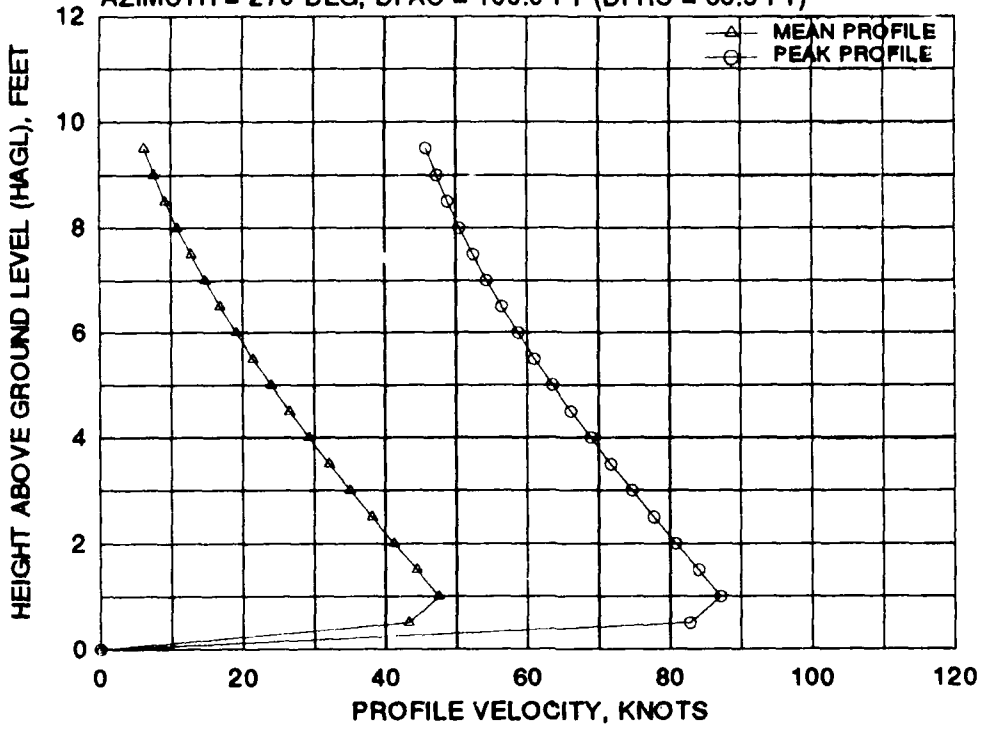

FIGURE F-2 CTR-7500 MEAN AND PEAK VELOCITY PROFILES FOR SEVEN 270 DEGREE AZIMUTH RADIAL STATIONS AT A WHEEL HEIGHT OF 30 FEET AND A GROSS WEIGHT OF 79,820 POUNDS

BELL/BOEING/NASA CTR-7500
 GW = 79820 LB, WAGL = 30 FT
 AZIMUTH = 270 DEG, DFAC = 100.0 FT (DFRC = 88.5 FT)



BELL/BOEING/NASA CTR-7500
 GW = 79820 LB, WAGL = 30 FT
 AZIMUTH = 270 DEG, DFAC = 120.0 FT (DFRC = 88.5 FT)

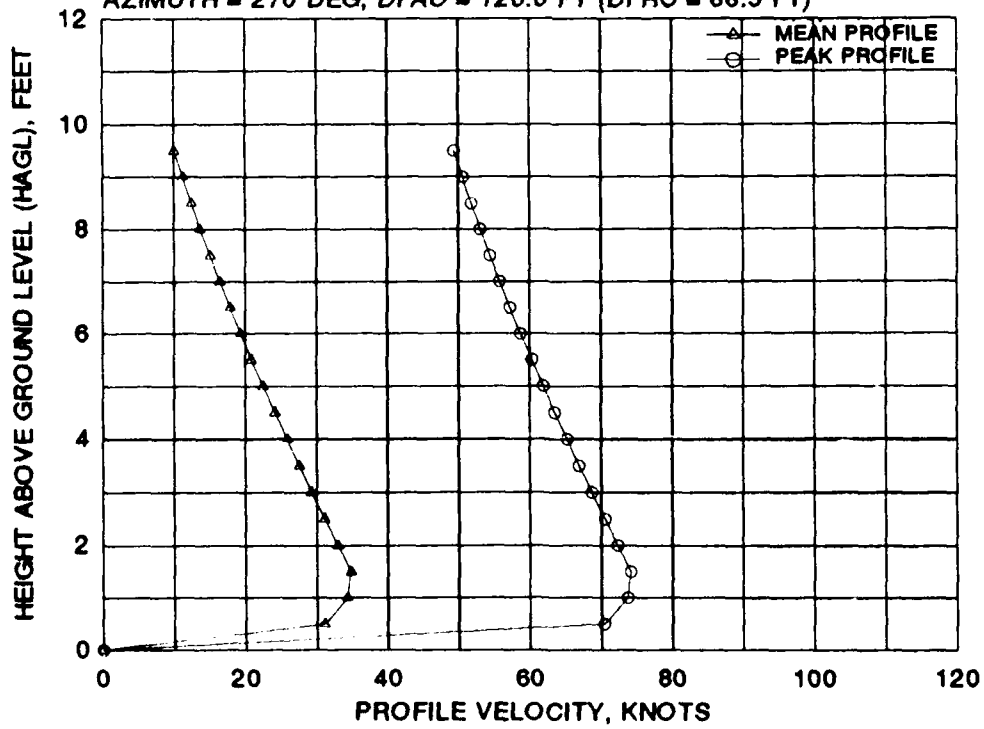
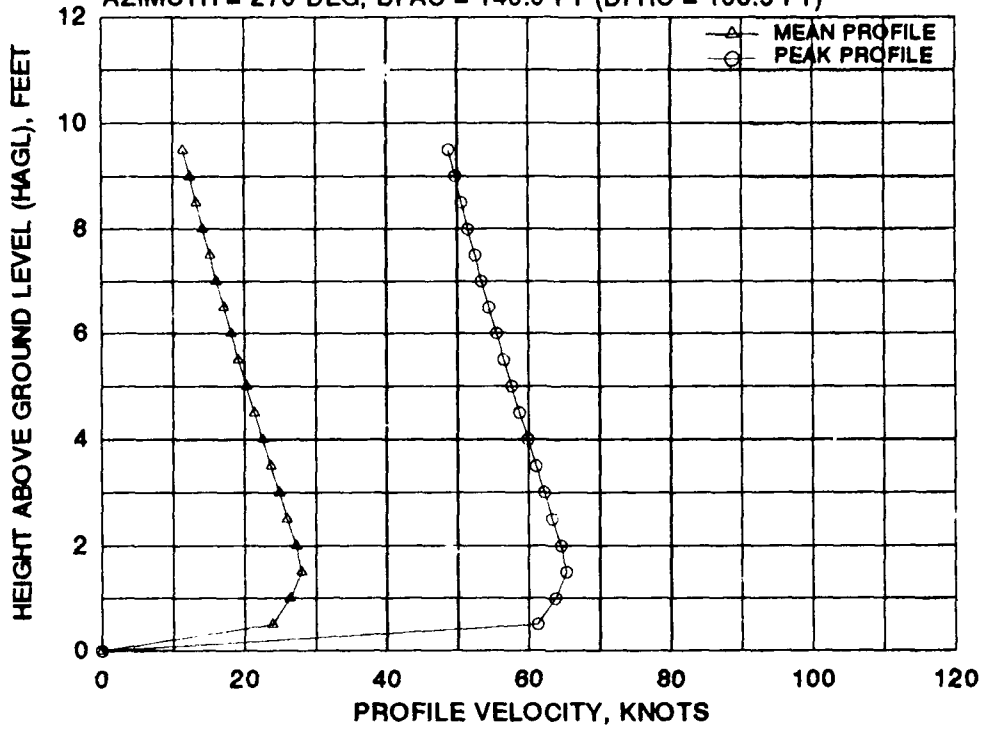

FIGURE F-2 CTR-7500 MEAN AND PEAK VELOCITY PROFILES FOR SEVEN 270 DEGREE AZIMUTH RADIAL STATIONS AT A WHEEL HEIGHT OF 30 FEET AND A GROSS WEIGHT OF 79,820 POUNDS (Continued)

BELL/BOEING/NASA CTR-7500
 GW = 79820 LB, WAGL = 30 FT
 AZIMUTH = 270 DEG, DFAC = 140.0 FT (DFRC = 108.5 FT)



BELL/BOEING/NASA CTR-7500
 GW = 79820 LB, WAGL = 30 FT
 AZIMUTH = 270 DEG, DFAC = 170.0 FT (DFRC = 138.5 FT)

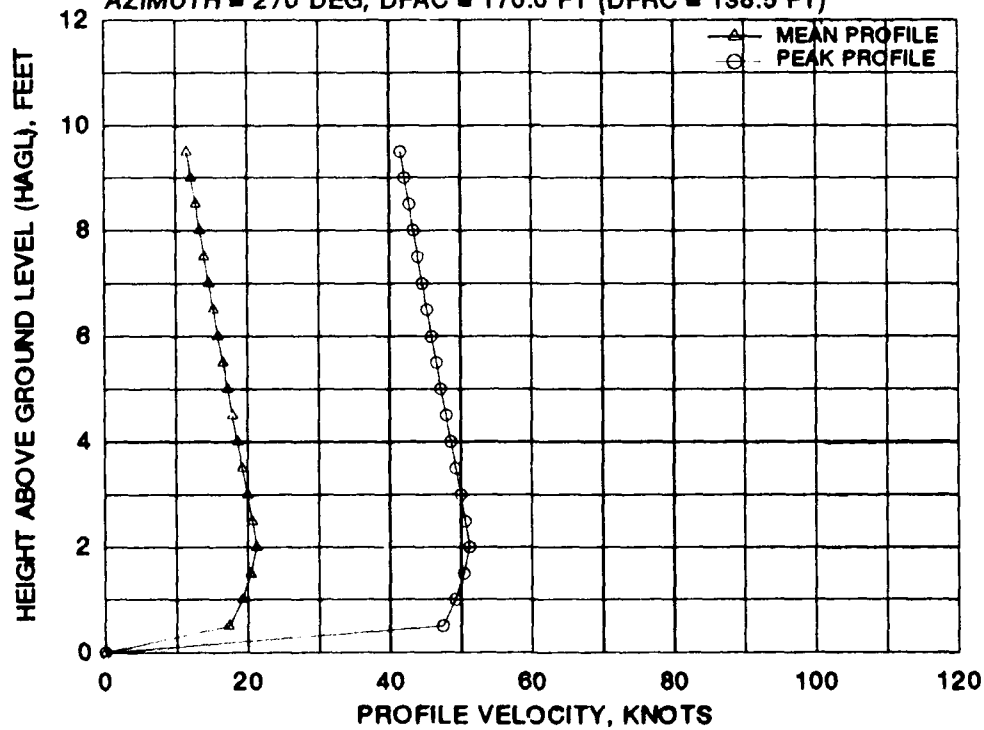

FIGURE F-2 CTR-7500 MEAN AND PEAK VELOCITY PROFILES FOR SEVEN 270 DEGREE AZIMUTH RADIAL STATIONS AT A WHEEL HEIGHT OF 30 FEET AND A GROSS WEIGHT OF 79,820 POUNDS (Continued)

BELL/BOEING/NASA CTR-7500
GW = 79820 LB, WAGL = 30 FT
AZIMUTH = 270 DEG, DFAC = 200.0 FT (DFRC = 188.5 FT)

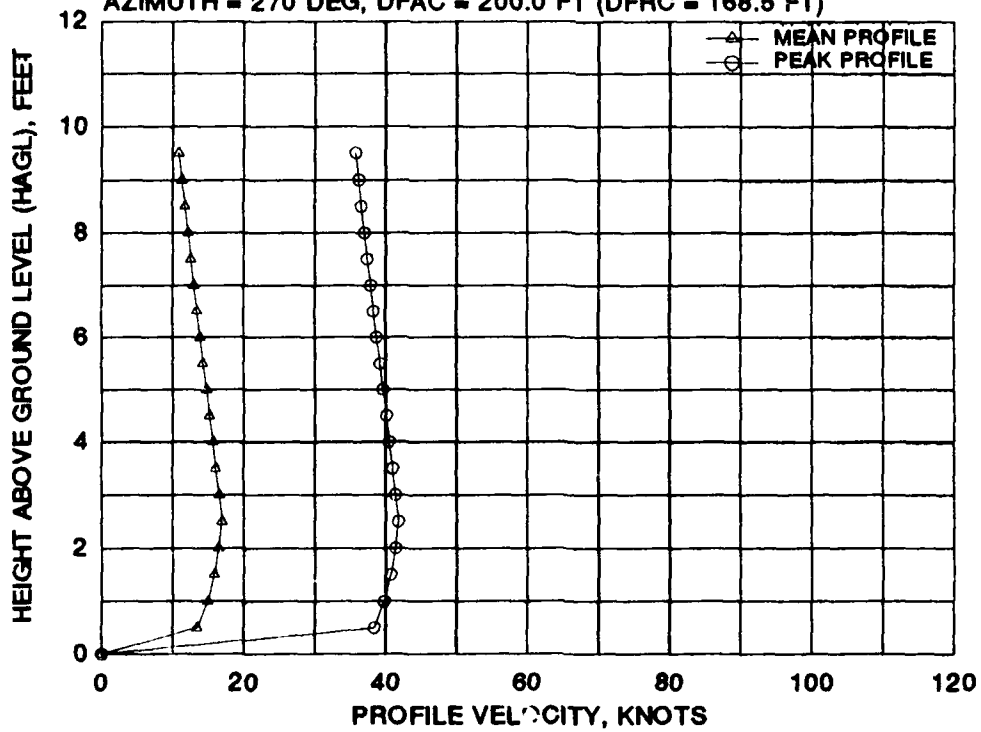
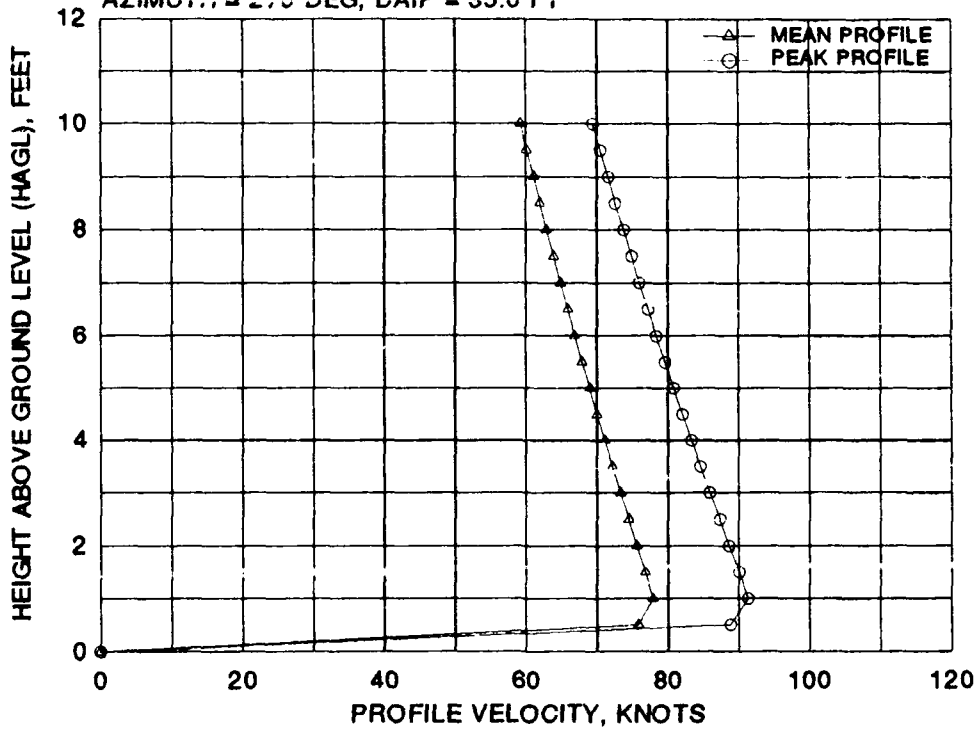

FIGURE F-2 CTR-7500 MEAN AND PEAK VELOCITY PROFILES
FOR SEVEN 270 DEGREE AZIMUTH RADIAL STATIONS
AT A WHEEL HEIGHT OF 30 FEET AND A GROSS
WEIGHT OF 79,820 POUNDS (Concluded)

BELL/BOEING/NASA CTR-7500
 GW = 79820 LB, WAGL = 30 FT
 AZIMUTH = 270 DEG, DAIP = 35.0 FT



BELL/BOEING/NASA CTR-7500
 GW = 79820 LB, WAGL = 30 FT
 AZIMUTH = 270 DEG, DAIP = 45.0 FT

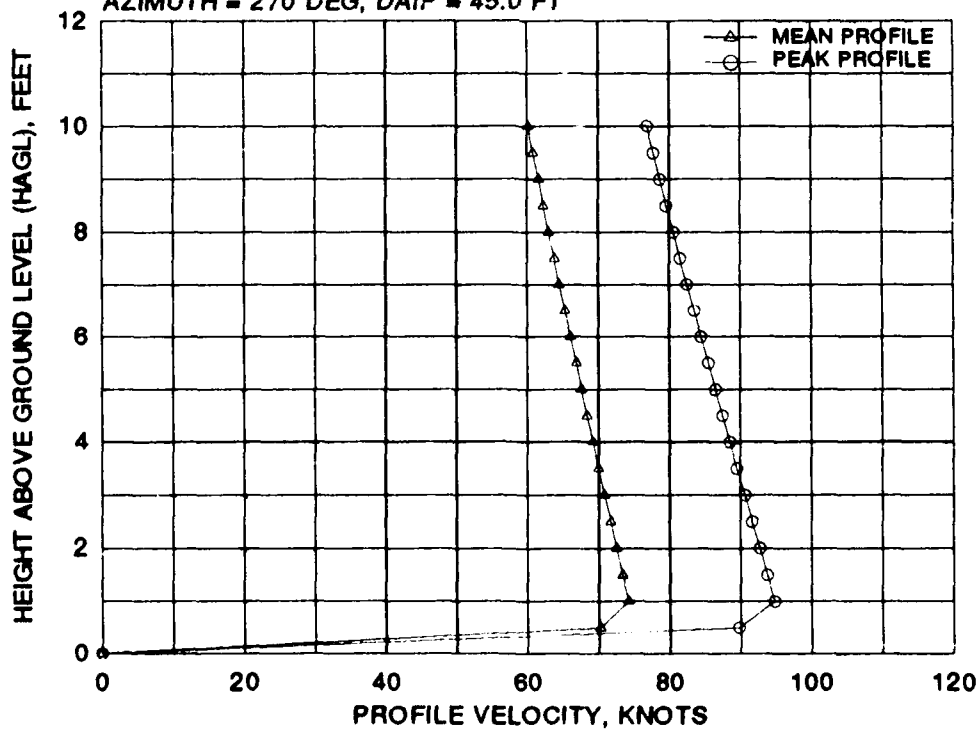
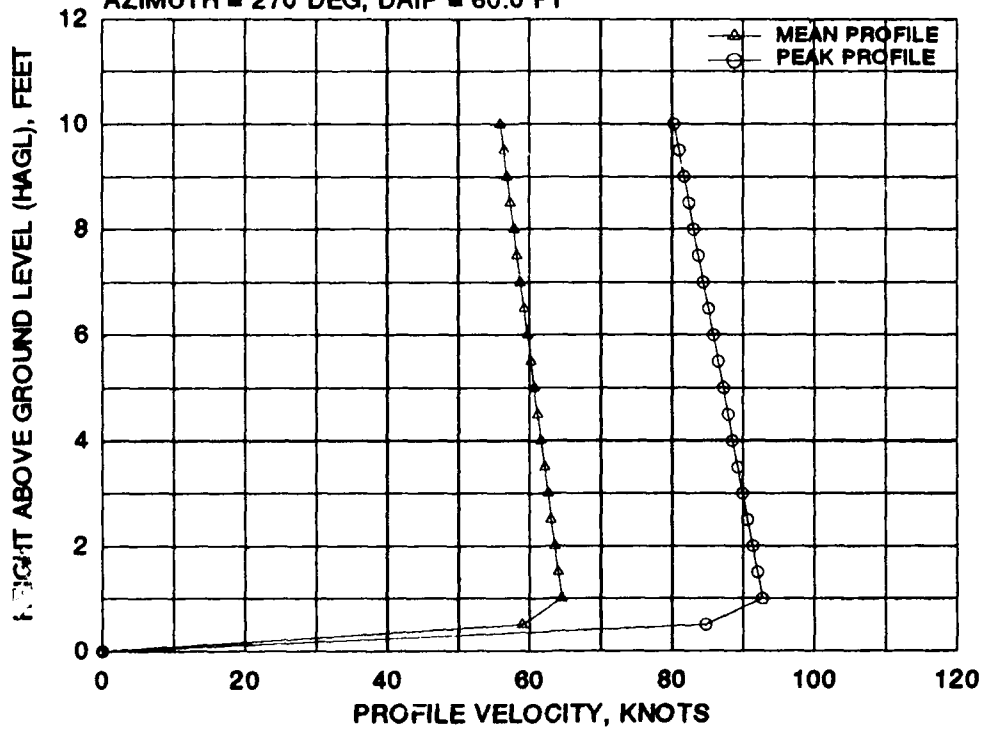

FIGURE F-3 CTR-7500 MEAN AND PEAK VELOCITY PROFILES FOR EIGHT 0 DEGREE AZIMUTH RADIAL STATIONS AT A WHEEL HEIGHT OF 30 FEET AND A GROSS WEIGHT OF 79,820 POUNDS

BELL/BOEING/NASA CTR-7500
 GW = 79820 LB, WAGL = 30 FT
 AZIMUTH = 270 DEG, DAIP = 60.0 FT



BELL/BOEING/NASA CTR-7500
 GW = 79820 LB, WAGL = 30 FT
 AZIMUTH = 270 DEG, DAIP = 60.0 FT

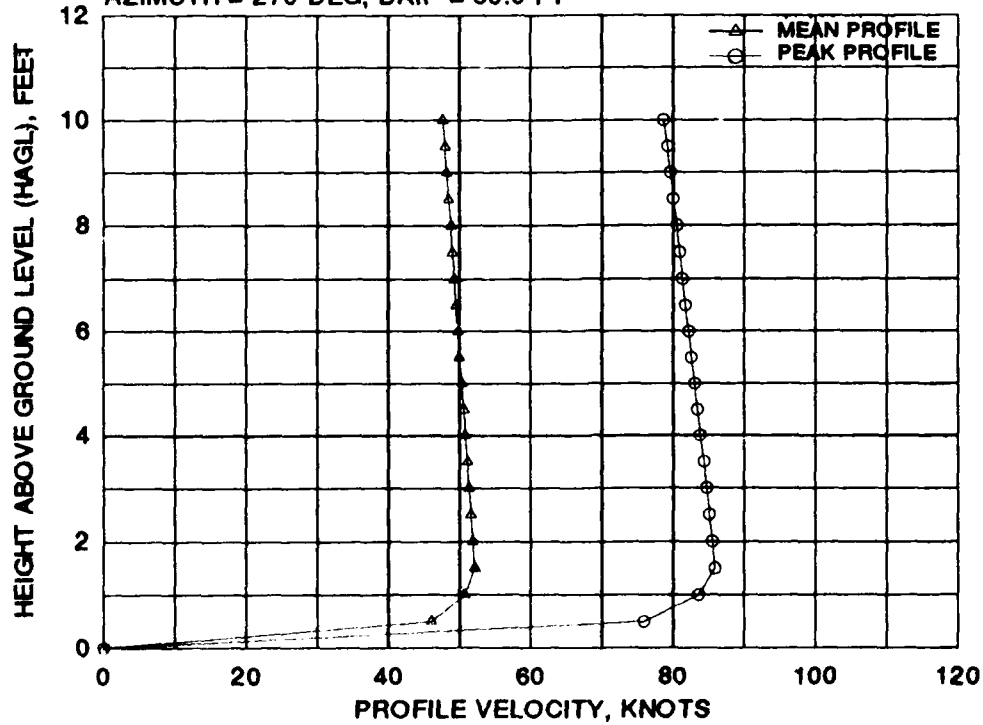
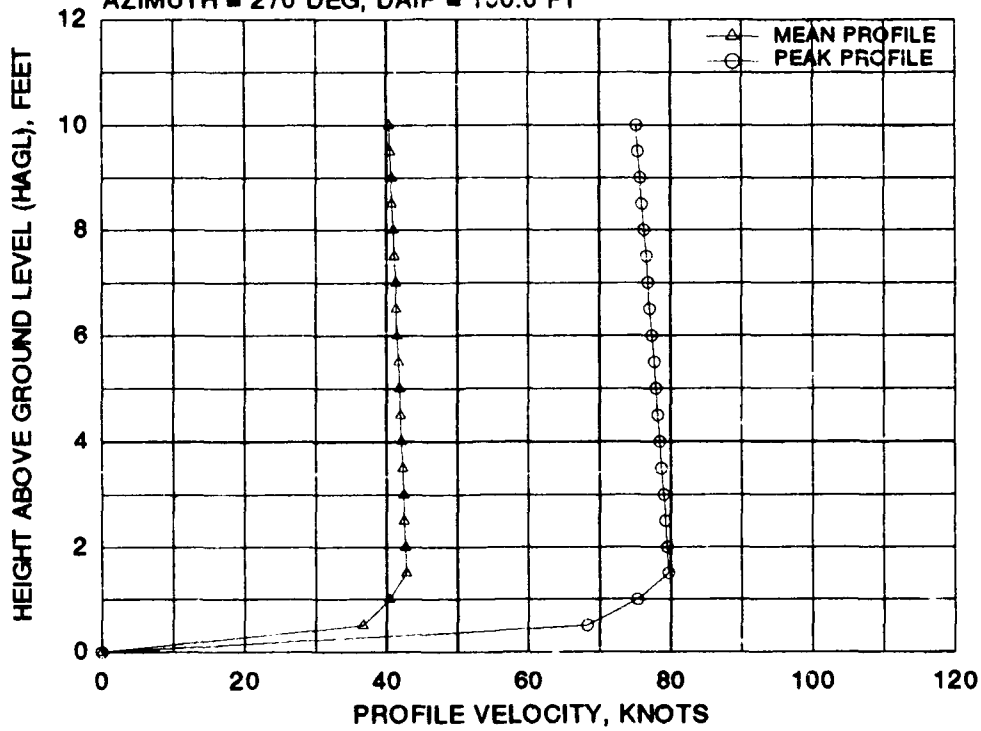

FIGURE F-3 CTR-7500 MEAN AND PEAK VELOCITY PROFILES FOR EIGHT 0 DEGREE AZIMUTH RADIAL STATIONS AT A WHEEL HEIGHT OF 30 FEET AND A GROSS WEIGHT OF 79,820 POUNDS (Continued)

BELL/BOEING/NASA CTR-7500
 GW = 79820 LB, WAGL = 30 FT
 AZIMUTH = 270 DEG, DAIP = 100.0 FT



BELL/BOEING/NASA CTR-7500
 GW = 79820 LB, WAGL = 30 FT
 AZIMUTH = 270 DEG, DAIP = 120.0 FT

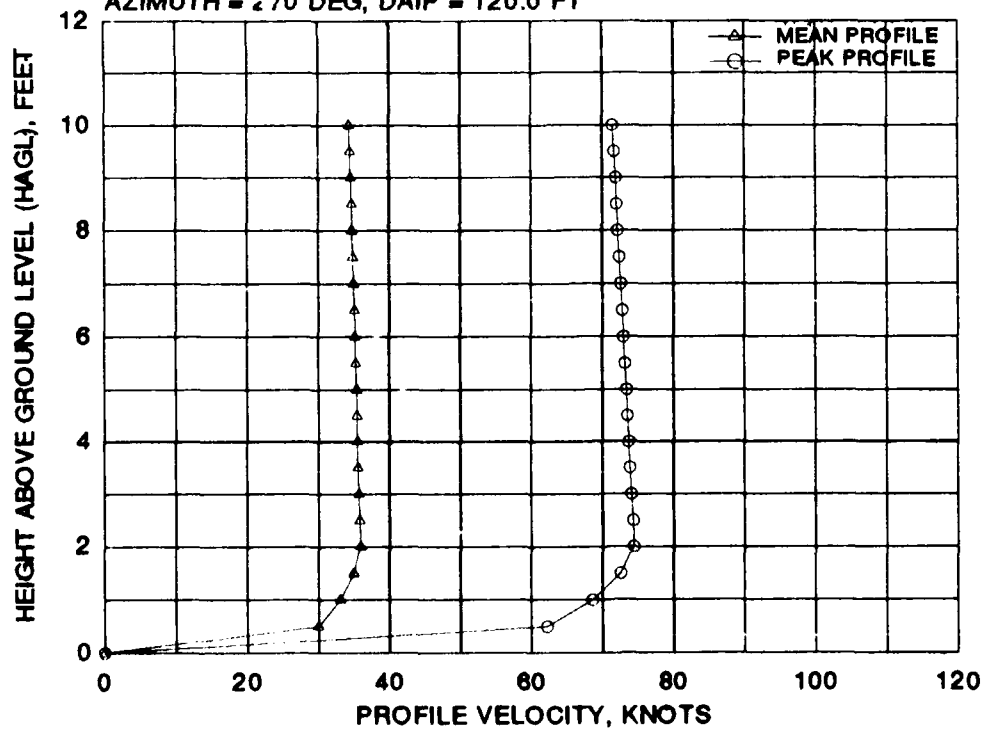
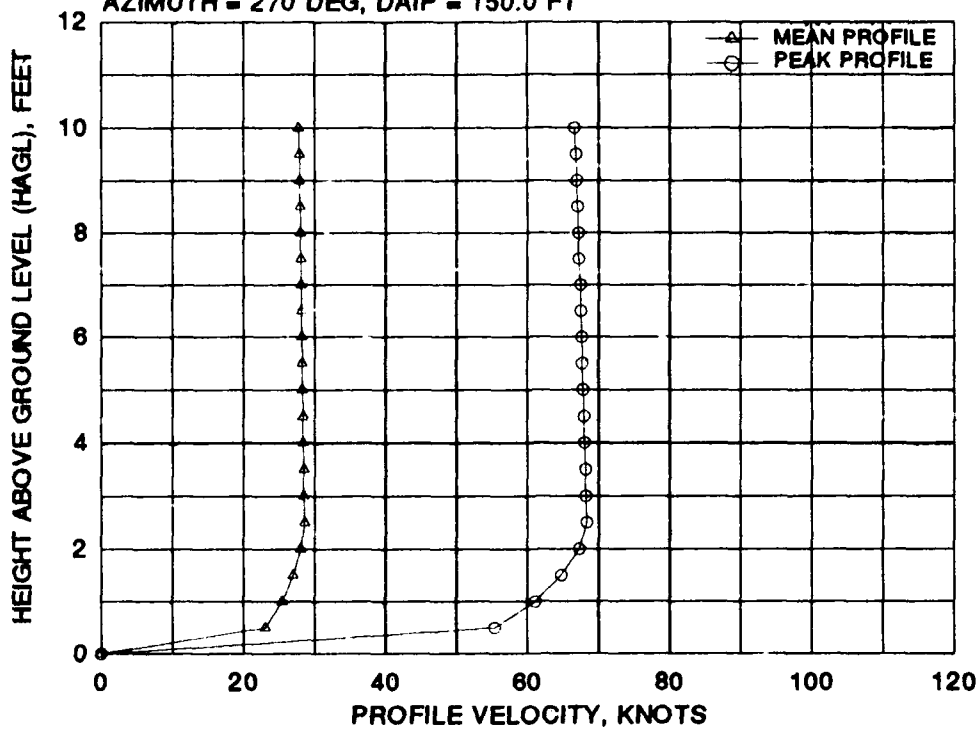

FIGURE F-3 CTR-7500 MEAN AND PEAK VELOCITY PROFILES FOR EIGHT 0 DEGREE AZIMUTH RADIAL STATIONS AT A WHEEL HEIGHT OF 30 FEET AND A GROSS WEIGHT OF 79,820 POUNDS (Continued)

BELL/BOEING/NASA CTR-7500
 GW = 79820 LB, WAGL = 30 FT
 AZIMUTH = 270 DEG, DAIP = 150.0 FT



BELL/BOEING/NASA CTR-7500
 GW = 79820 LB, WAGL = 30 FT
 AZIMUTH = 270 DEG, DAIP = 200.0 FT

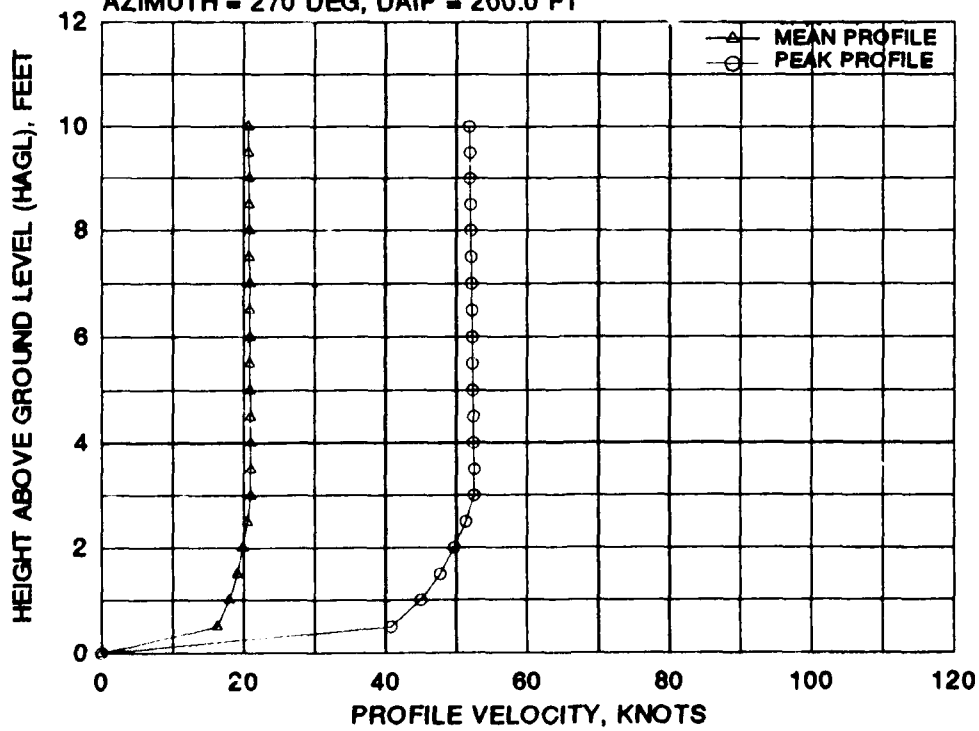

FIGURE F-3 CTR-7500 MEAN AND PEAK VELOCITY PROFILES FOR EIGHT 0 DEGREE AZIMUTH RADIAL STATIONS AT A WHEEL HEIGHT OF 30 FEET AND A GROSS WEIGHT OF 79,820 POUNDS (Concluded)

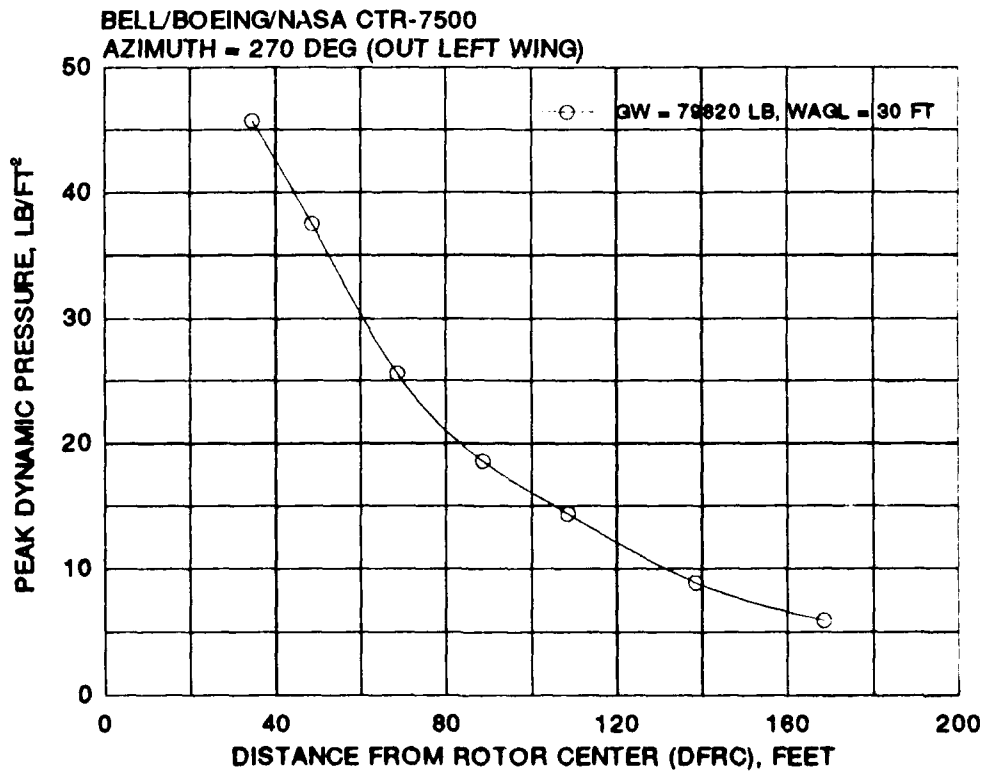
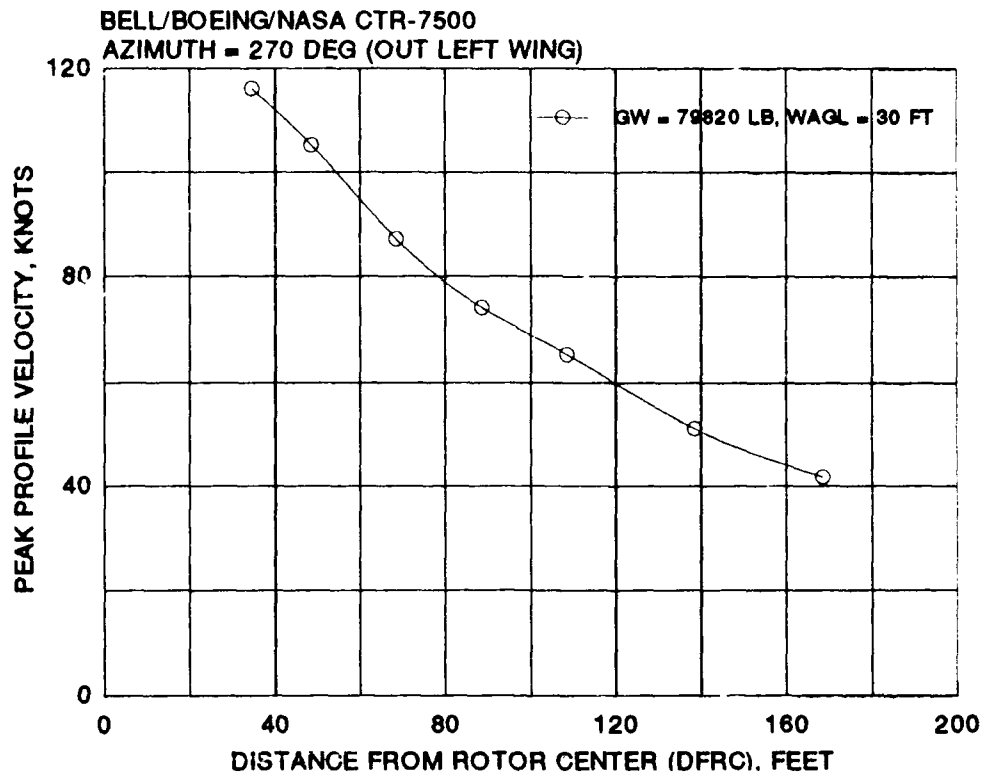

FIGURE F-4 CTR-7500 PEAK ROTORWASH VELOCITY AND DYNAMIC PRESSURE AS A FUNCTION OF DISTANCE FROM THE ROTOR CENTER (270 DEGREE AZIMUTH)

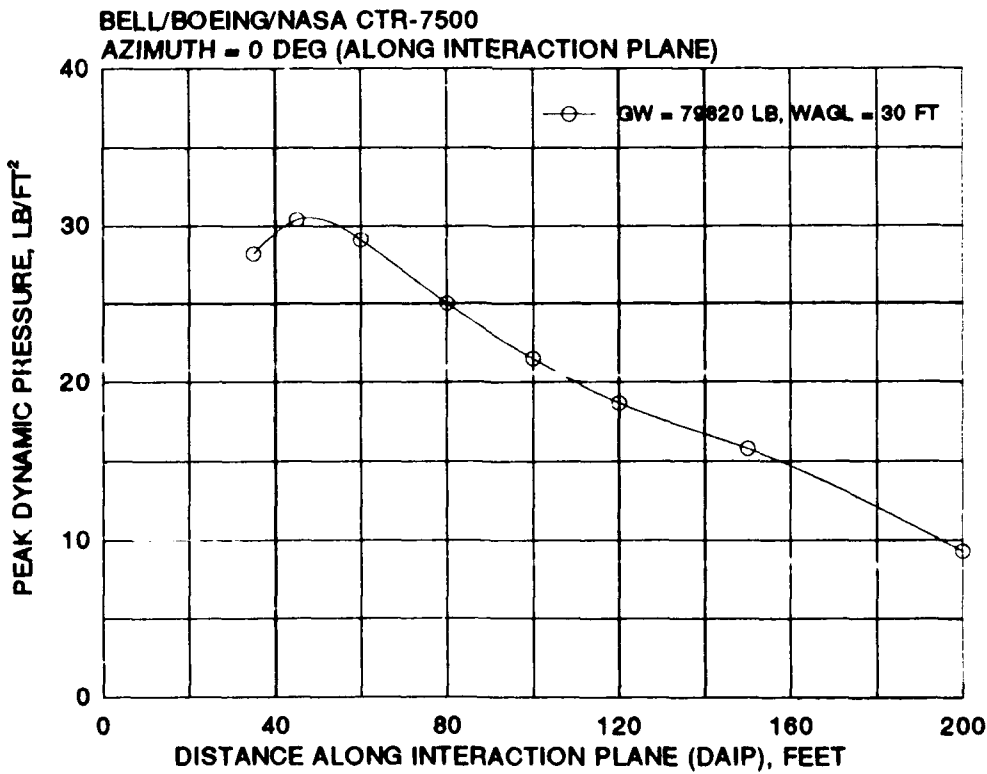
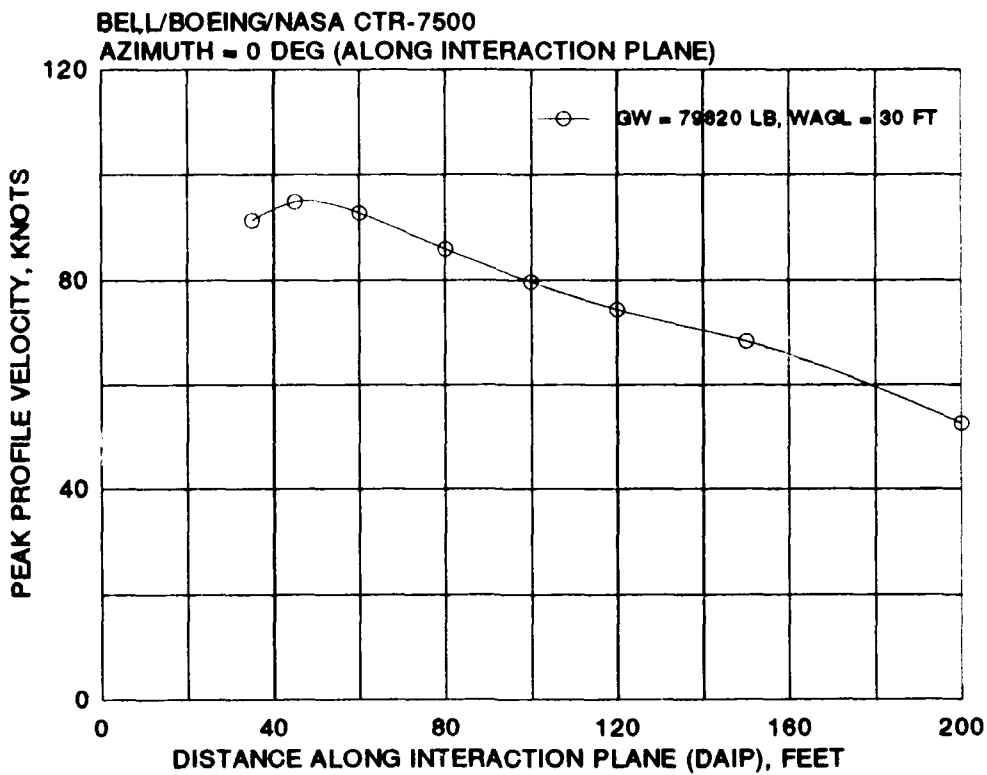

FIGURE F-5 CTR-7500 PEAK ROTORWASH VELOCITY AND DYNAMIC PRESSURE AS A FUNCTION OF DISTANCE ALONG THE INTERACTION PLANE (0 DEGREE AZIMUTH)

BELL/BOEING/NASA CTR-7500
AZIMUTH = 270 DEG (OUT LEFT WING)

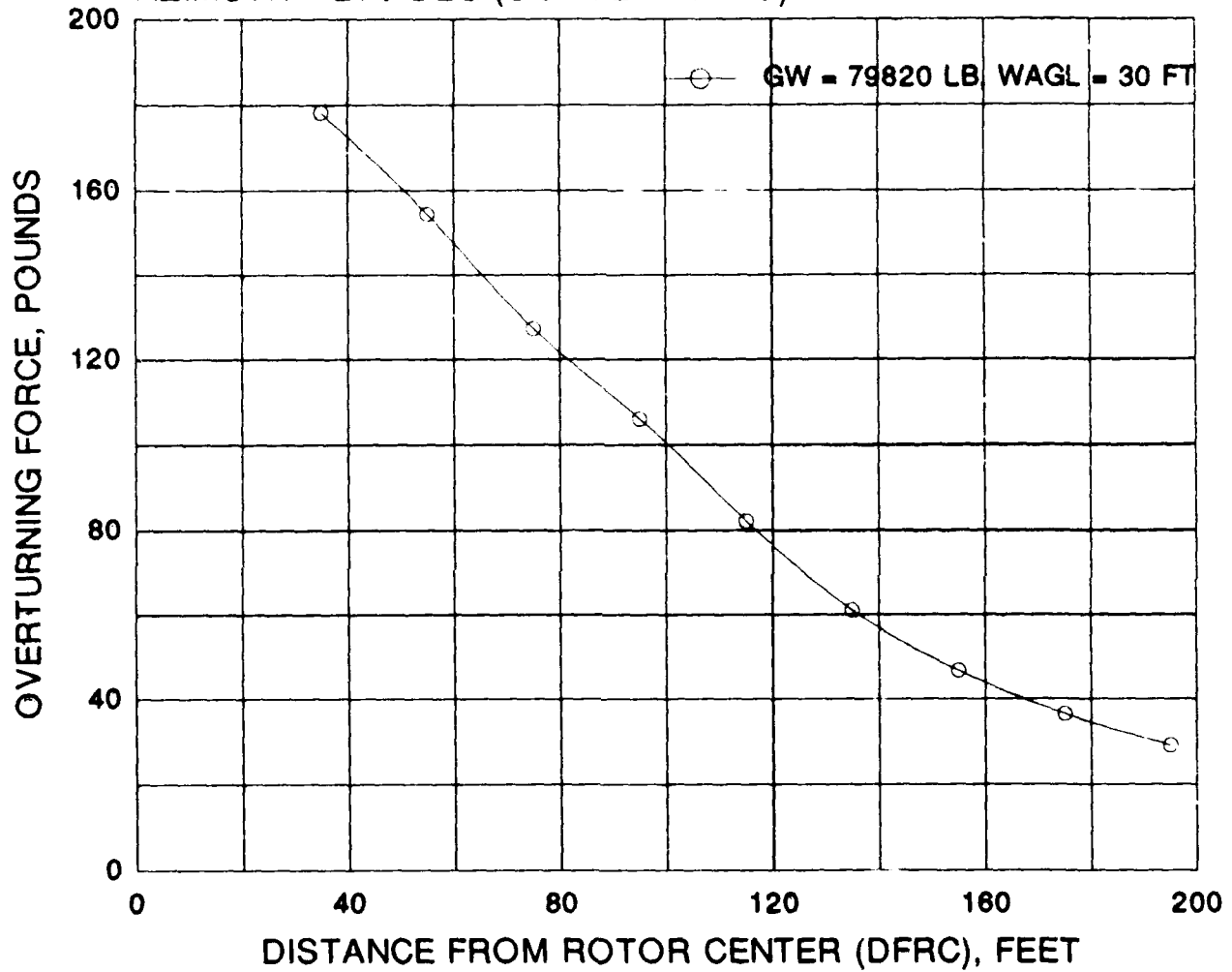

FIGURE F-6 CTR-7500 OVERTURNING FORCE AS A FUNCTION OF DISTANCE FROM THE ROTOR CENTER (270 DEGREE AZIMUTH)

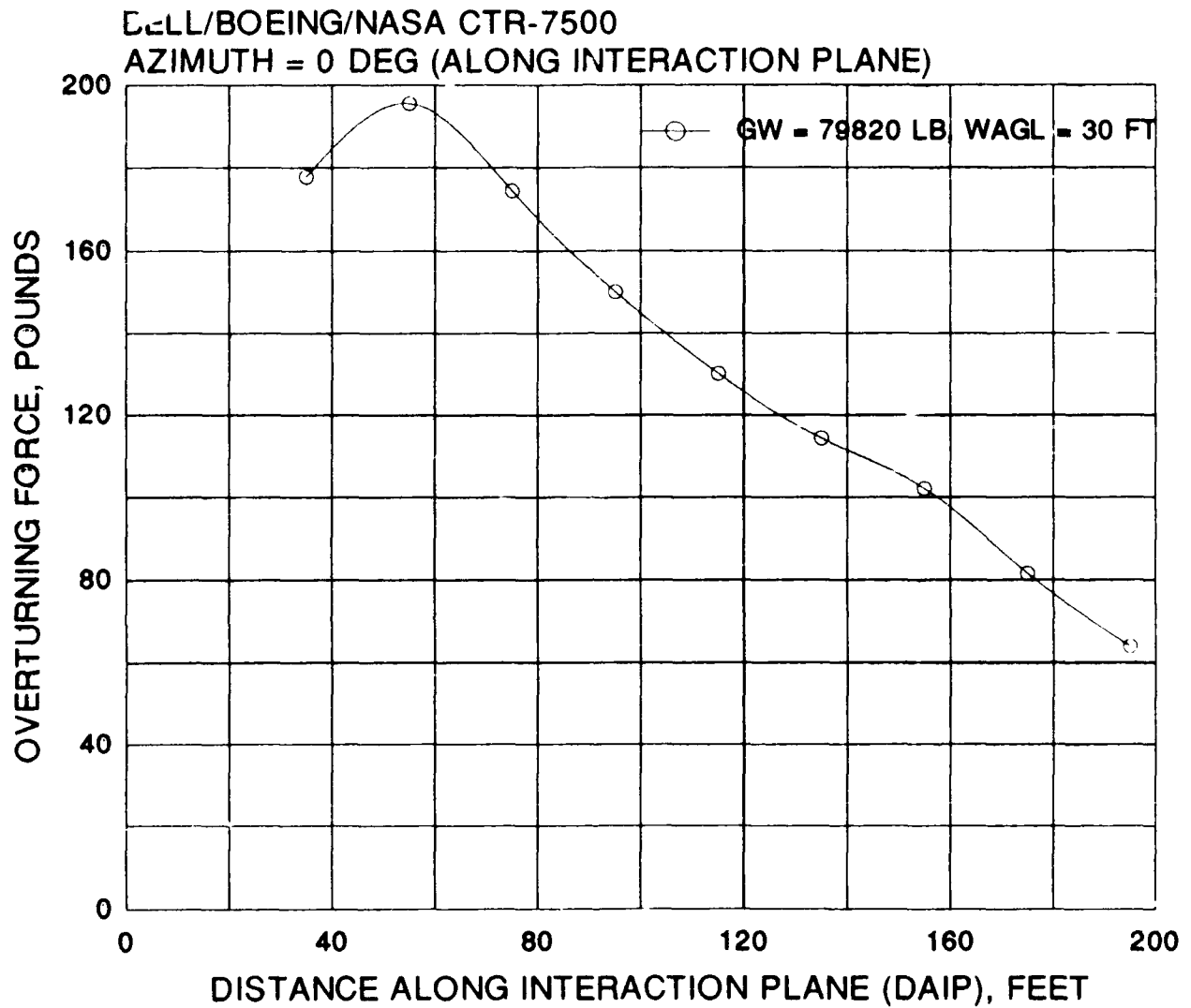

FIGURE F-7 CTR-7500 OVERTURNING FORCE AS A FUNCTION OF DISTANCE ALONG THE INTERACTION PLANE (0 DEGREE AZIMUTH)

APPENDIX G

MAGNUM TILTROTOR AIRCRAFT AND ROTORWASH DATA

Magnum Tiltrotor aircraft characteristics used with the ROTWASH analysis program are listed in table G-1 as obtained from reference G-1. Figure G-1 presents a three-view drawing of the tiltrotor. Table G-2 provides a summary tabulation of parameters defining the conditions for all rotorwash data presented in the appendix. All data are plotted in one of four formats, which include graphs of:

1. mean and peak outwash velocity profiles,
2. peak outwash velocity versus distance,
3. peak outwash dynamic pressure versus distance, and
4. personnel overturning force versus distance.

In each format, data are plotted along both the 0 and 270 degree azimuth. Distance from rotor center (DFRC) is the independent variable along the 270 degree azimuth. Measurements of distance from aircraft center (DFAC) are also noted on the graphs. The DFAC reference point is defined as zero at the location where the aircraft centerline intersects the line connecting the two rotor centers of rotation. Along the 0 degree azimuth, distance along the interaction plane (DAIP) is the independent variable. This point is referenced as zero at the same location as the DFAC point.

REFERENCES

G-1. Configuration statement provided by Magnum T/R, 1989.

TABLE G-1 MAGNUM TILTROTOR ROTWASH INPUT DATA

<u>Parameter</u>	<u>Value</u>
Rotor radius, feet	12.5
Distance between rotor centers, feet	32.2
Wing download, percent of rotor thrust	9.25
Distance from wheels to rotor plane, feet	12.5
Rotor speed, RPM	589.0
Rotor tip speed, feet/second	771.0
Number of rotor blades per rotor	3
Density ratio	1.0

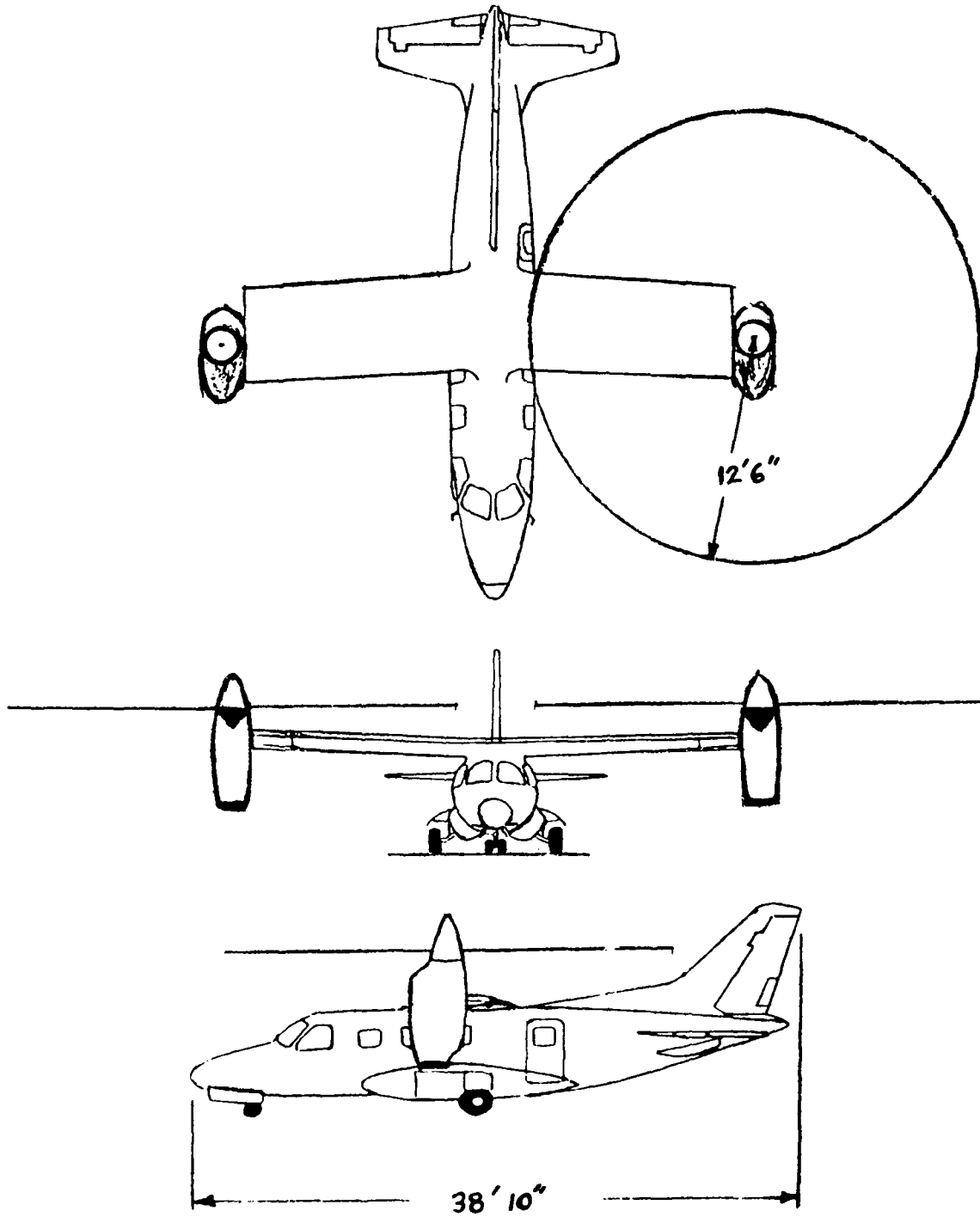

FIGURE G-1 THREE-VIEW DRAWING OF THE MAGNUM TILTROTOR

TABLE G-2 MAGNUM TILTROTOR ROTORWASH EVALUATION MATRIX

Note: The Figure/Type column provides the figure number and data format type where:

M/P - Mean and peak velocity profile format

PVD - Peak velocity and dynamic pressure format

OTF - Personnel overturning force format

<u>Figure/ Type</u>	<u>Azimuth, Degrees</u>	<u>GW, Pounds</u>	<u>WAGL, Feet</u>	<u>DFRC or DAIP Distance, Feet</u>
G-2 M/P	270.0	16,500	20	18.9,23.9,36.9,49.9, 63.9,83.9,103.9,123.9
G-3 M/P	0.0	16,500	20	21, 29, 35, 45, 60, 80, 100, 120
G-4 PVD	270.0	16,500	20	20 to 160
G-5 PVD	0.0	16,500	20	20 to 150
G-6 OTF	270.0	16,500	20	30 to 190
G-7 OTF	0.0	16,500	20	20 to 190

MAGNUM TILT-ROTOR
 GW = 16500 LB, WAGL = 20 FT
 AZIMUTH = 270 DEG, DFAC = 35.0 FT (DFRC = 18.9 FT)

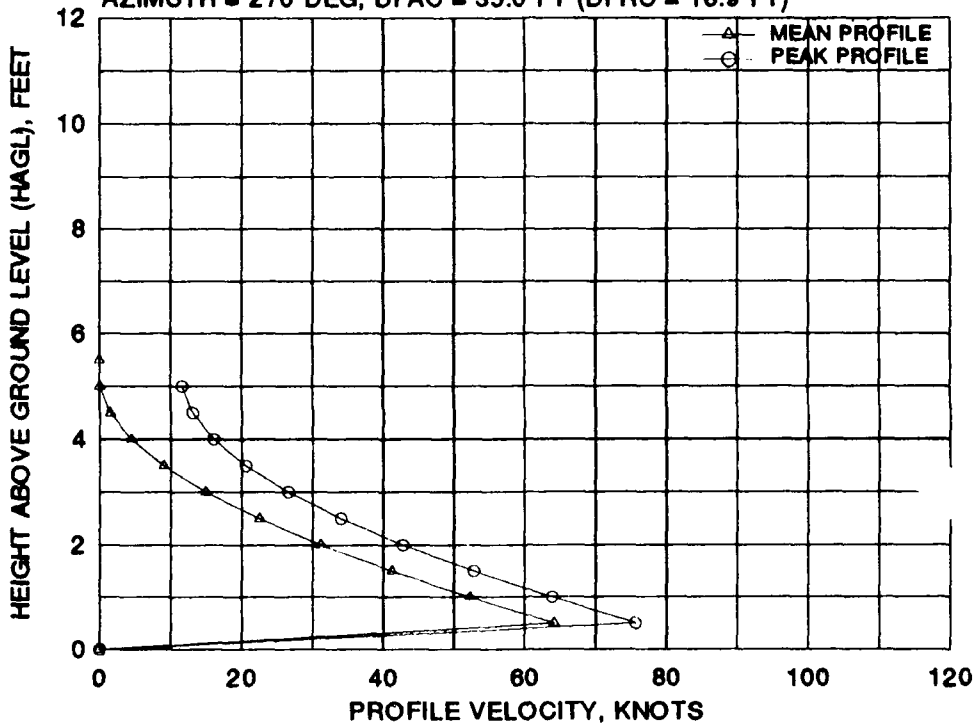

MAGNUM TILT-ROTOR
 GW = 16500 LB, WAGL = 20 FT
 AZIMUTH = 270 DEG, DFAC = 40.0 FT (DFRC = 23.9 FT)

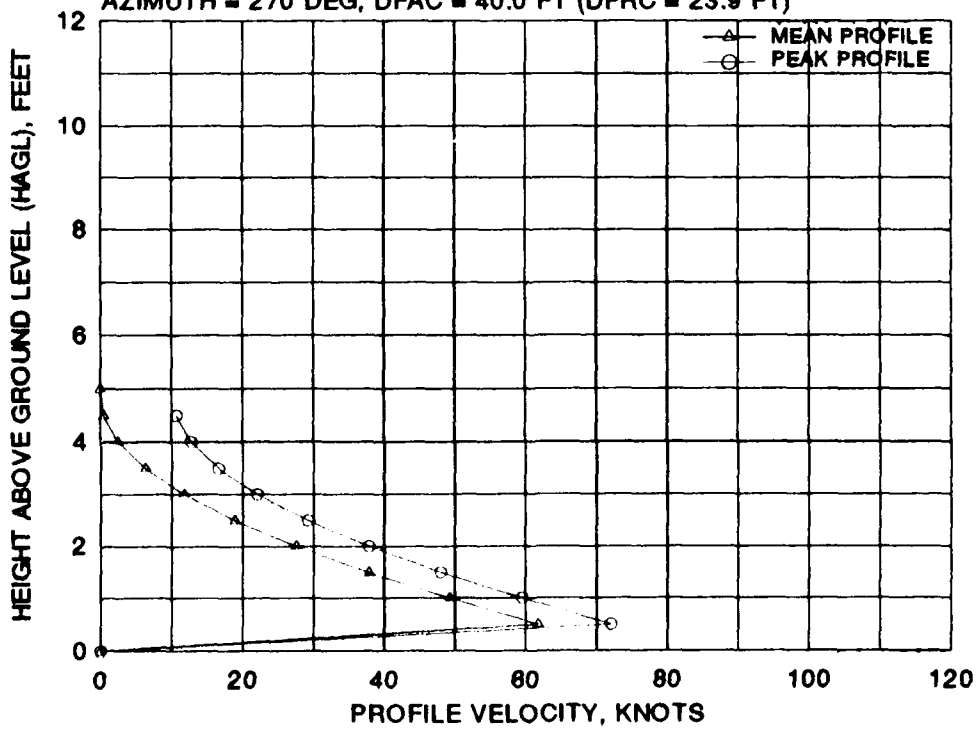

FIGURE G-2 MAGNUM TILTROTOR MEAN AND PEAK VELOCITY PROFILES FOR EIGHT 270 DEGREE AZIMUTH RADIAL STATIONS AT A WHEEL HEIGHT OF 20 FEET AND A GROSS WEIGHT OF 16,500 POUNDS

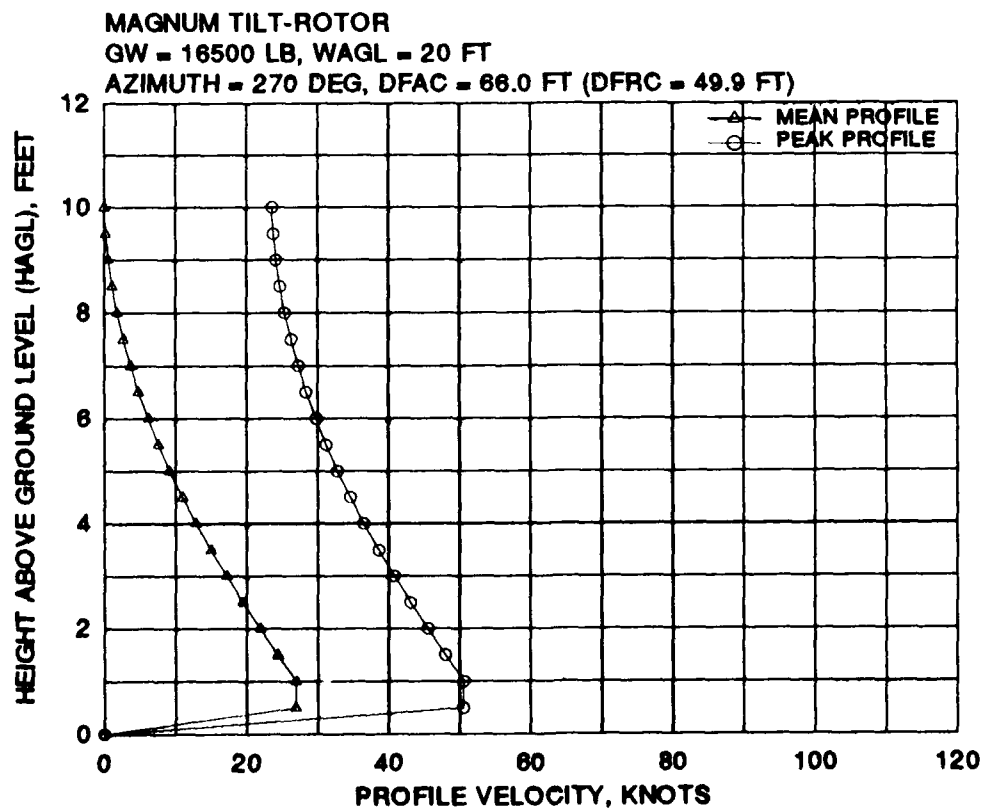
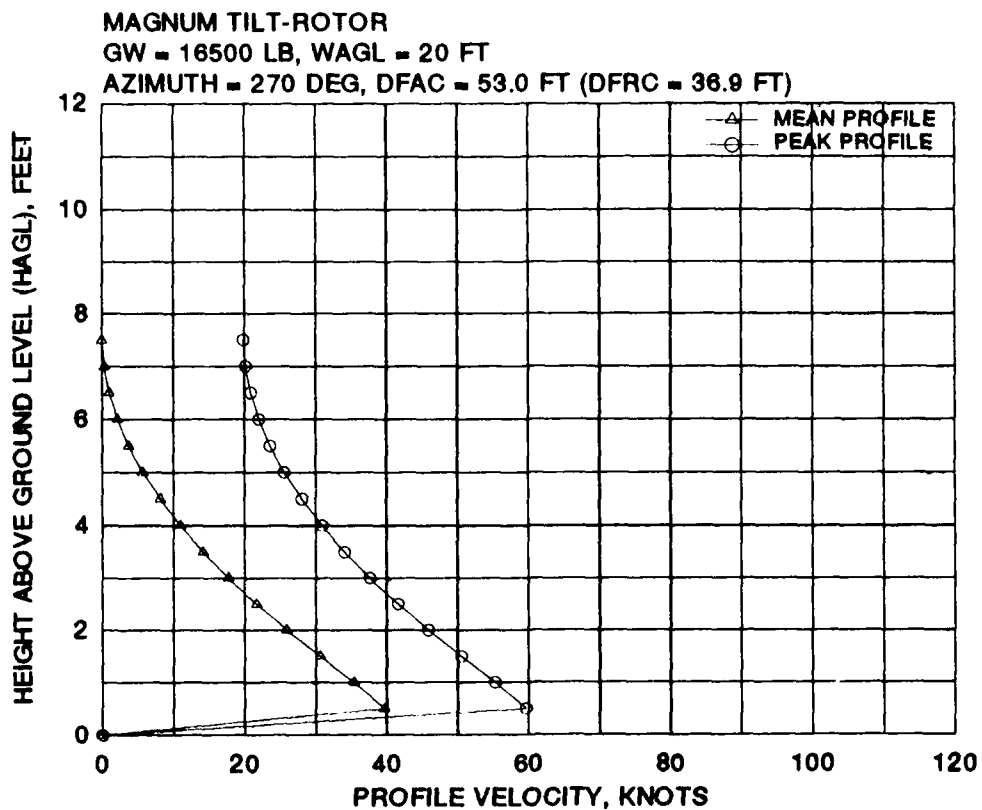

FIGURE G-2 MAGNUM TILTROTOR MEAN AND PEAK VELOCITY PROFILES FOR EIGHT 270 DEGREE AZIMUTH RADIAL STATIONS AT A WHEEL HEIGHT OF 20 FEET AND A GROSS WEIGHT OF 16,500 POUNDS (Continued)

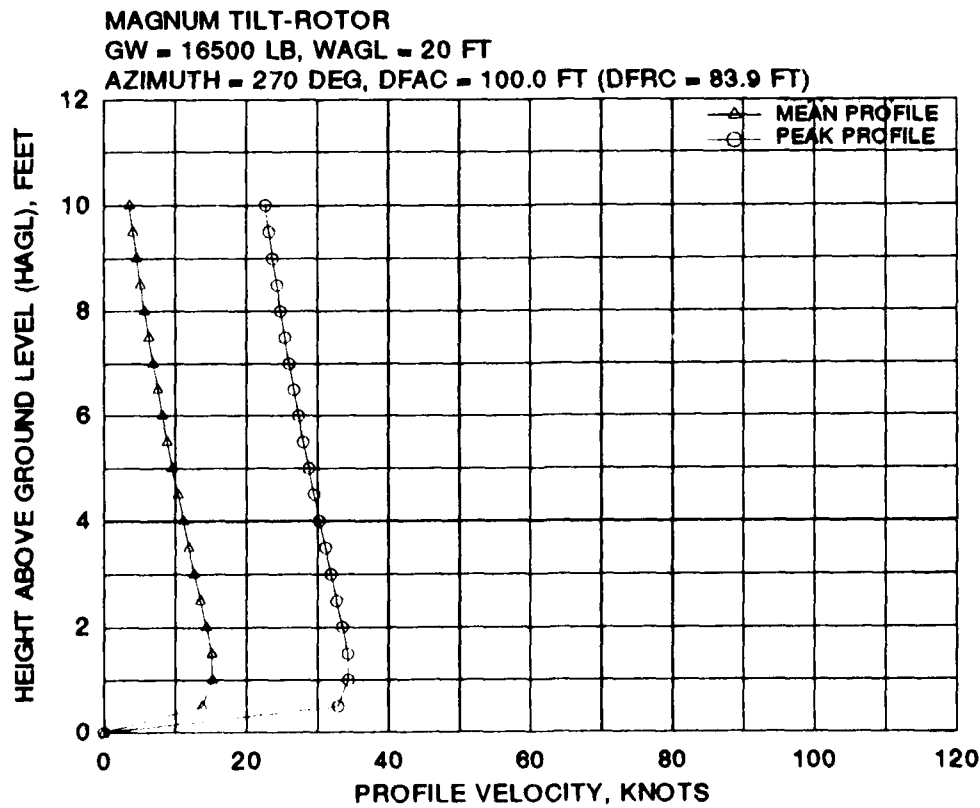
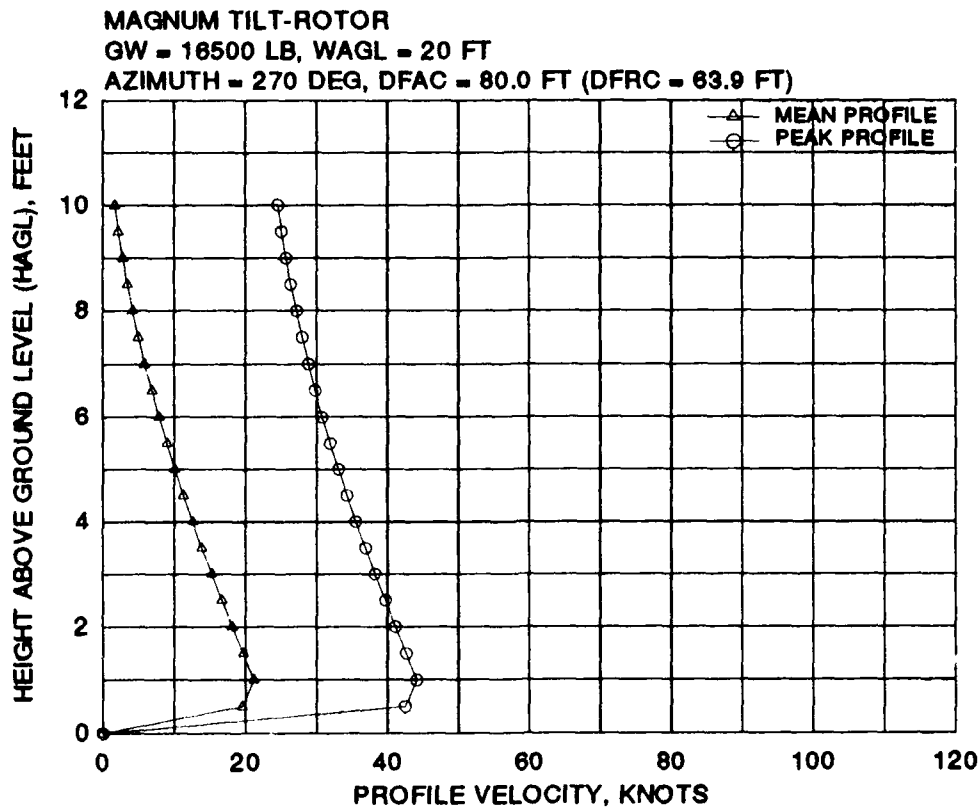

FIGURE G-2 MAGNUM TILTROTOR MEAN AND PEAK VELOCITY PROFILES FOR EIGHT 270 DEGREE AZIMUTH RADIAL STATIONS AT A WHEEL HEIGHT OF 20 FEET AND A GROSS WEIGHT OF 16,500 POUNDS (Continued)

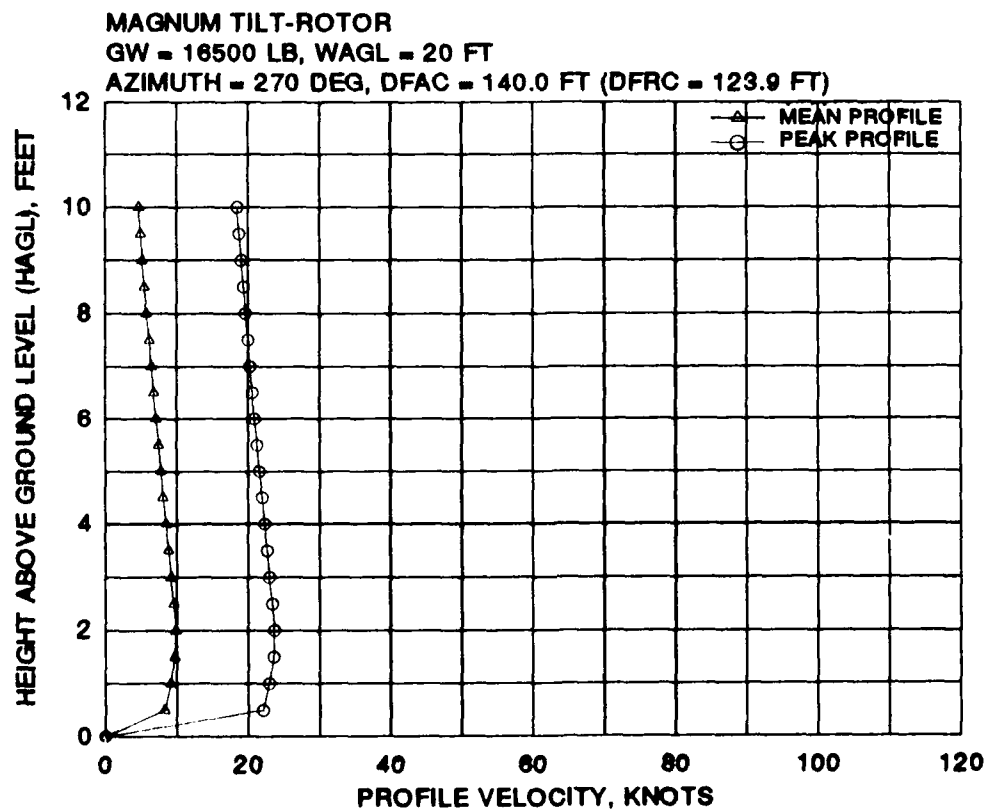
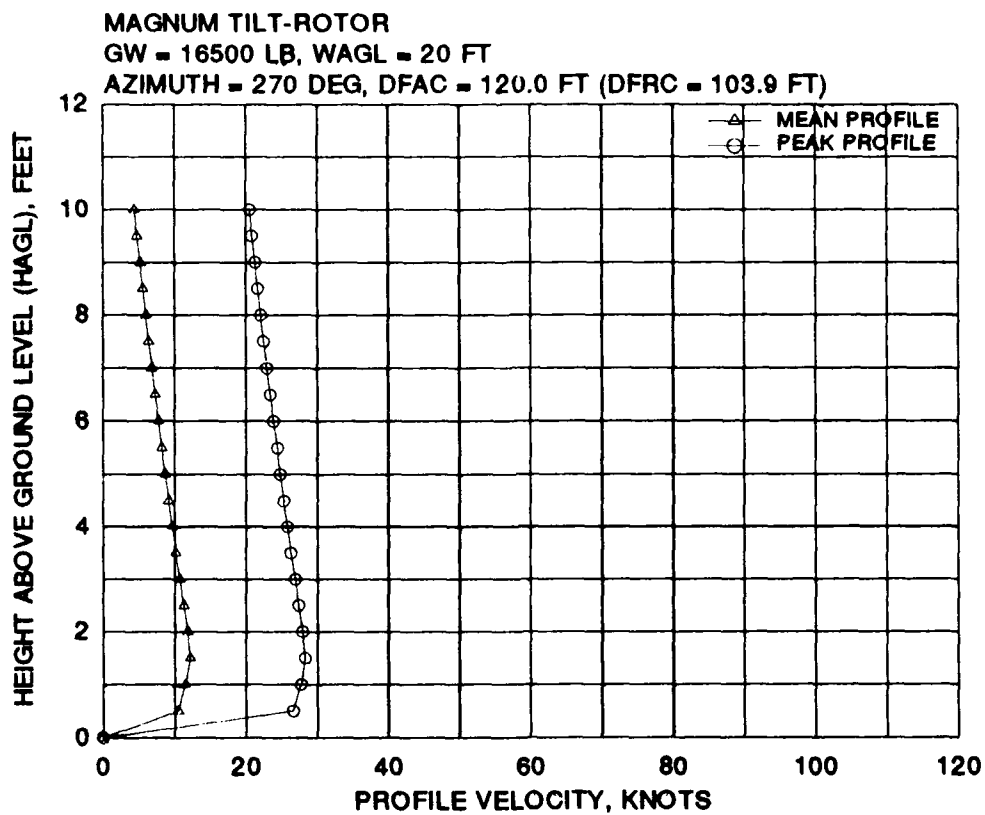

FIGURE G-2 MAGNUM TILTROTOR MEAN AND PEAK VELOCITY PROFILES FOR EIGHT 270 DEGREE AZIMUTH RADIAL STATIONS AT A WHEEL HEIGHT OF 20 FEET AND A GROSS WEIGHT OF 16,500 POUNDS (Concluded)

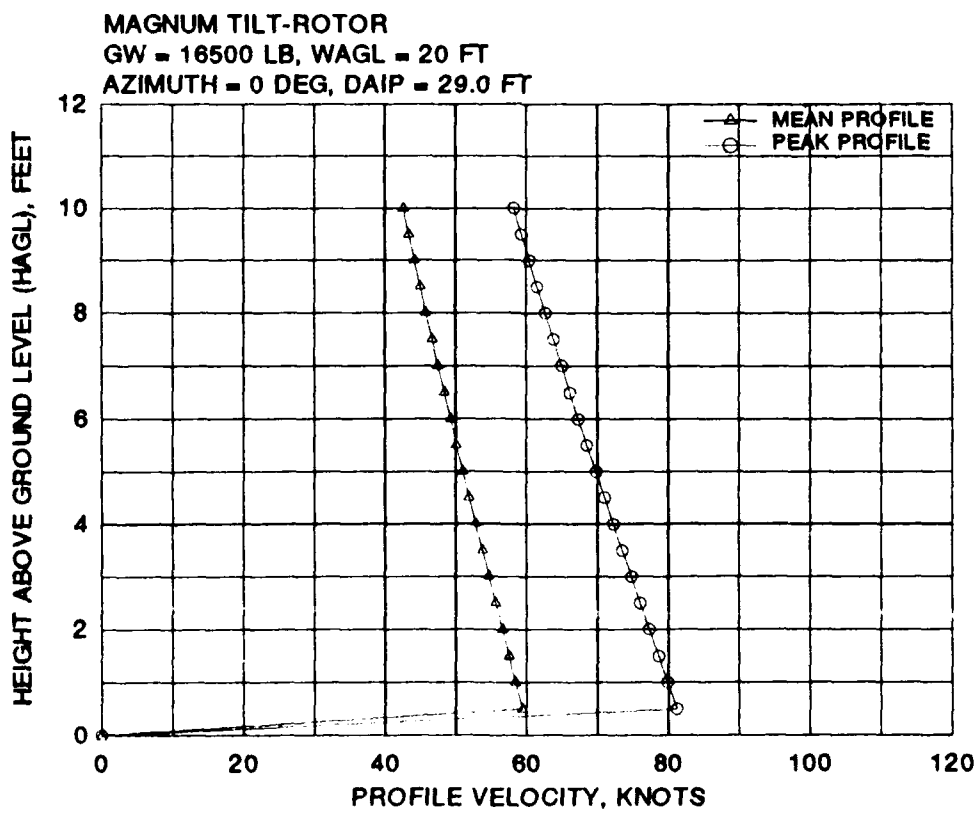
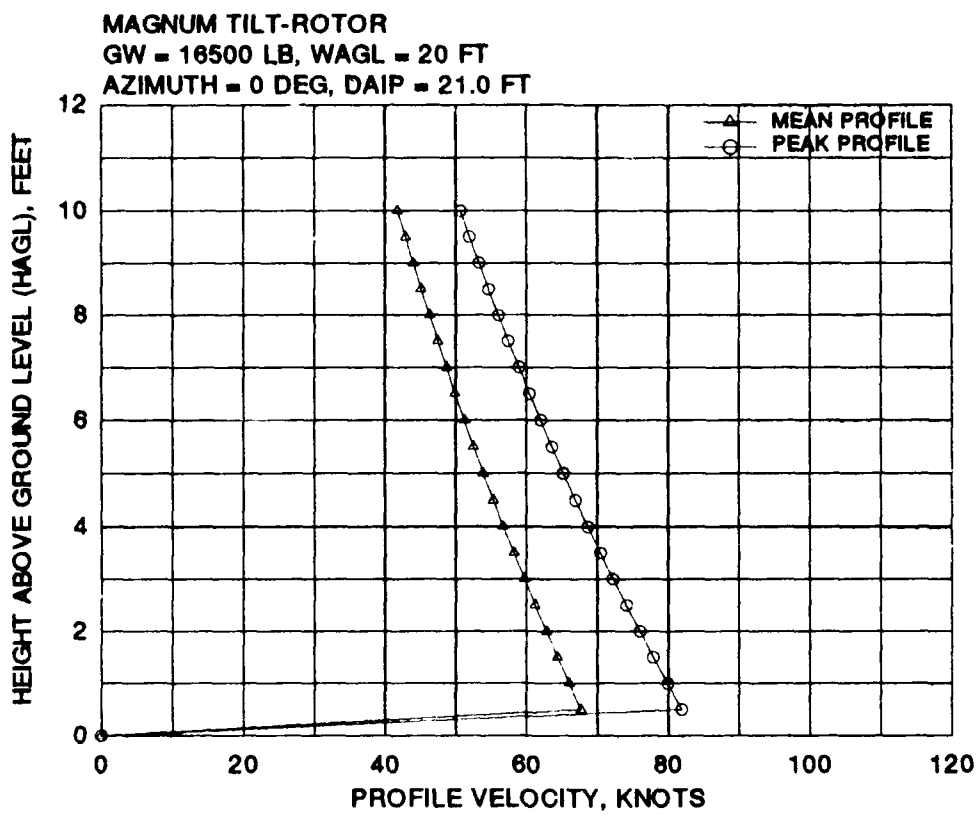

FIGURE G-3 MAGNUM TILTROTOR MEAN AND PEAK VELOCITY PROFILES FOR EIGHT 0 DEGREE AZIMUTH RADIAL STATIONS AT A WHEEL HEIGHT OF 20 FEET AND A GROSS WEIGHT OF 16,500 POUNDS

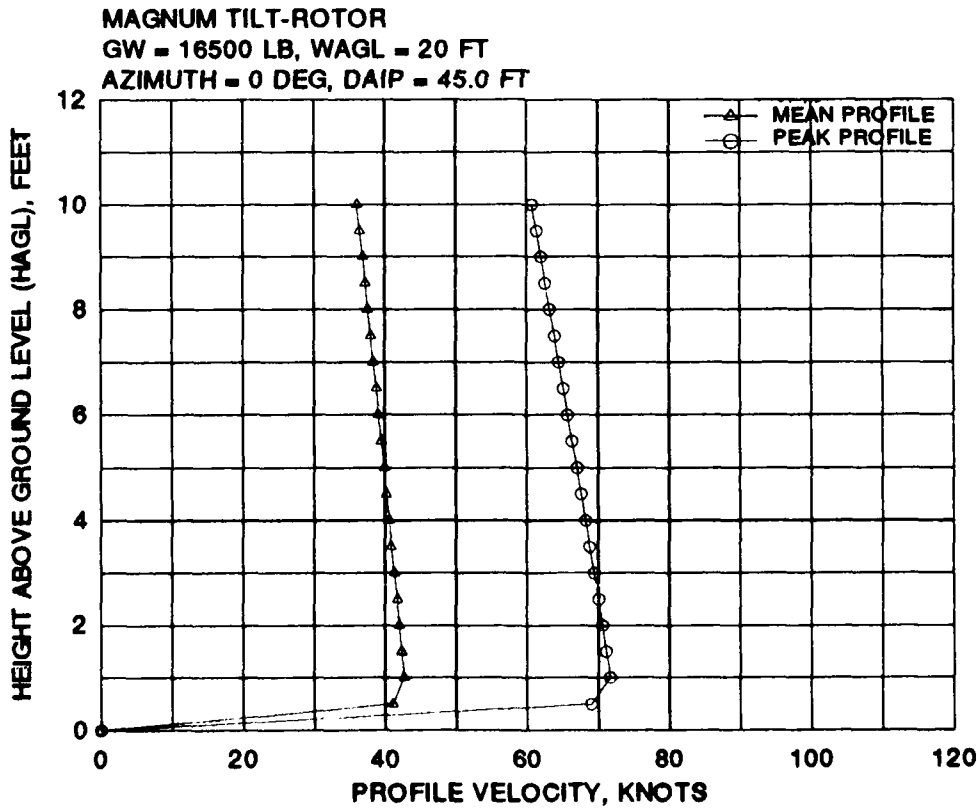
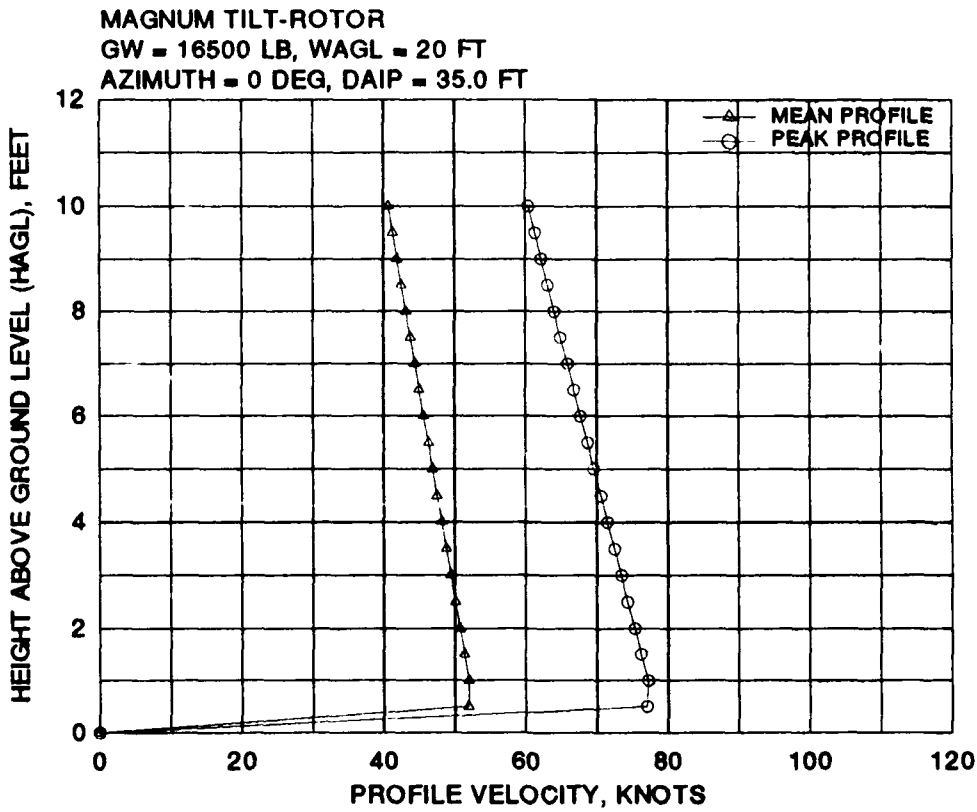

FIGURE G-3 MAGNUM TILTROTOR MEAN AND PEAK VELOCITY PROFILES FOR EIGHT 0 DEGREE AZIMUTH RADIAL STATIONS AT A WHEEL HEIGHT OF 20 FEET AND A GROSS WEIGHT OF 16,500 POUNDS (Continued)

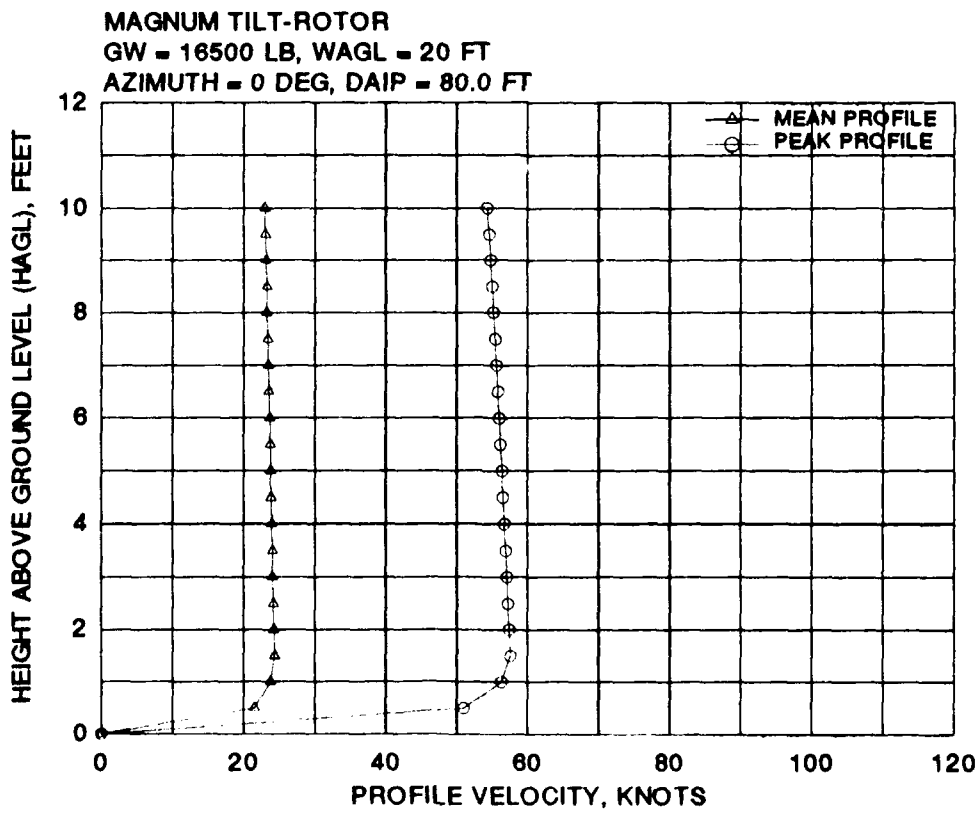
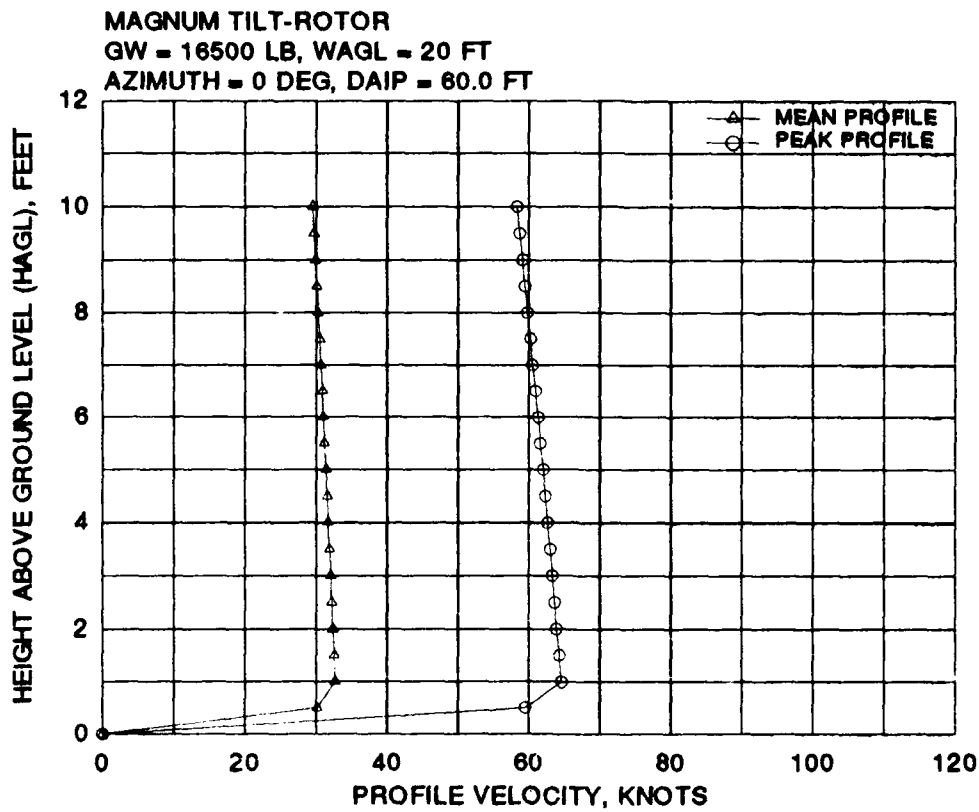

FIGURE G-3 MAGNUM TILTROTOR MEAN AND PEAK VELOCITY PROFILES FOR EIGHT 0 DEGREE AZIMUTH RADIAL STATIONS AT A WHEEL HEIGHT OF 20 FEET AND A GROSS WEIGHT OF 16,500 POUNDS (Continued)

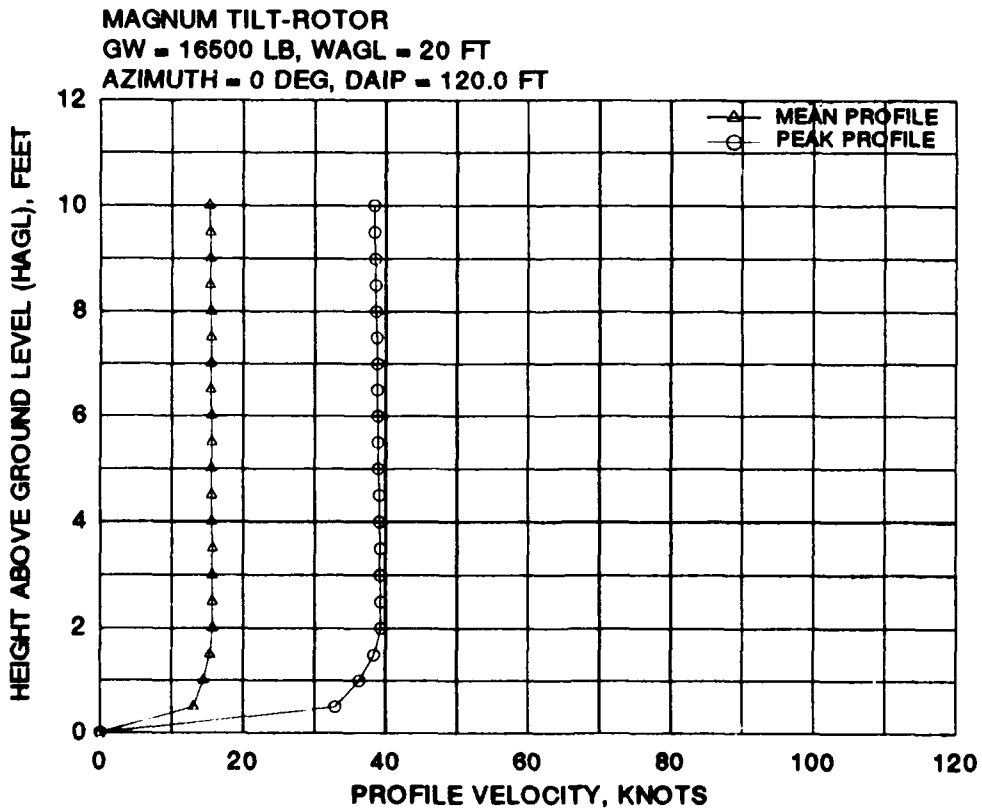
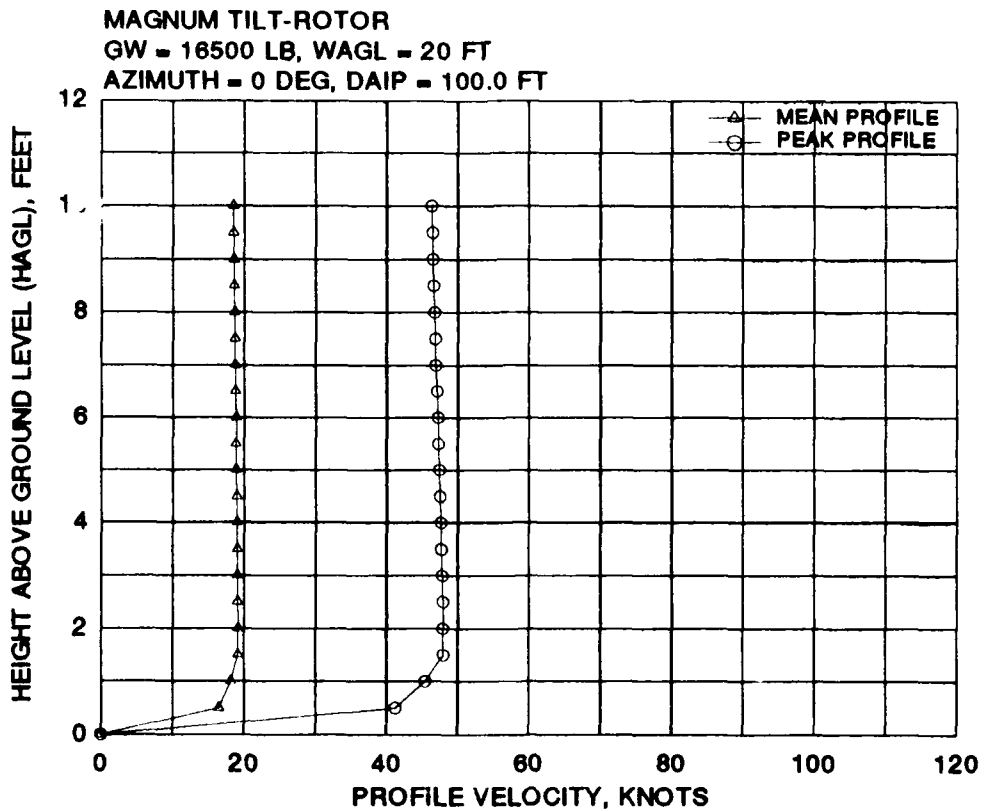

FIGURE G-3 MAGNUM TILTROTOR MEAN AND PEAK VELOCITY PROFILES FOR EIGHT 0 DEGREE AZIMUTH RADIAL STATIONS AT A WHEEL HEIGHT OF 20 FEET AND A GROSS WEIGHT OF 16,500 POUNDS (Concluded)

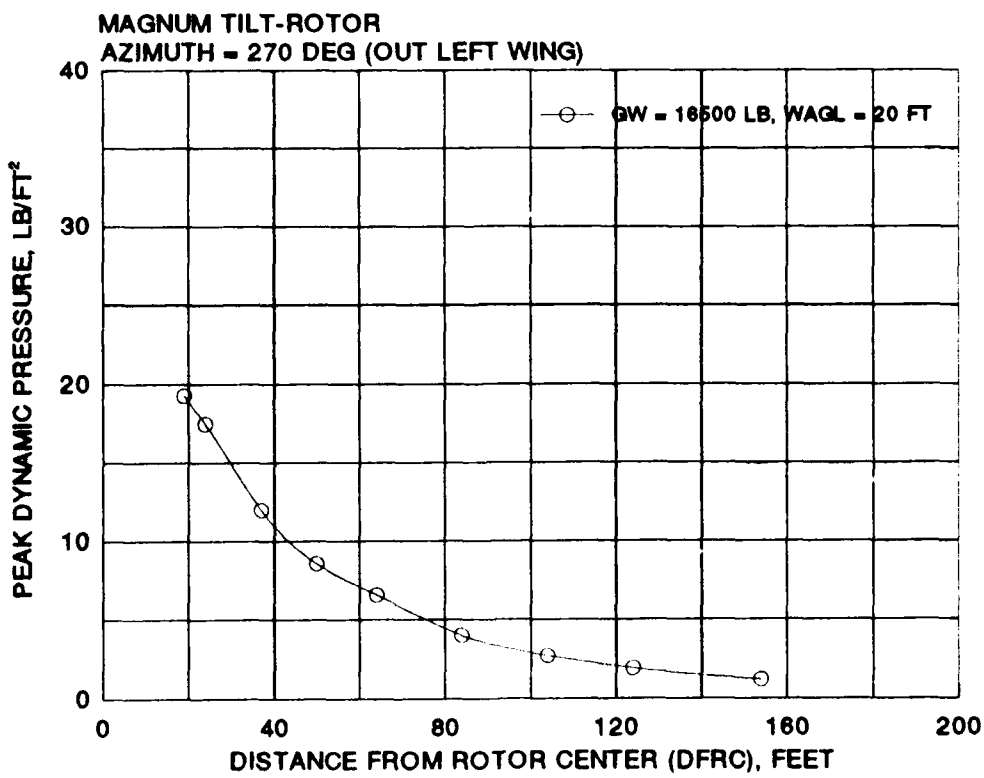
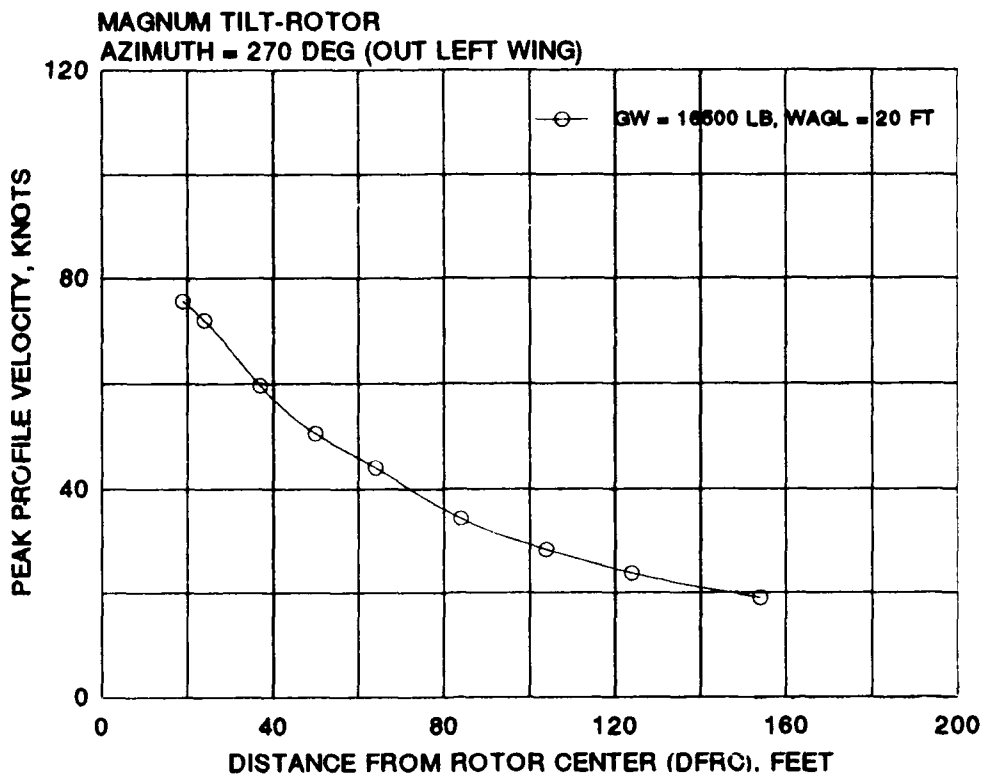

FIGURE G-4 MAGNUM TILTROTOR PEAK ROTORWASH VELOCITY AND DYNAMIC PRESSURE AS A FUNCTION OF DISTANCE FROM THE ROTOR CENTER (270 DEGREE AZIMUTH)

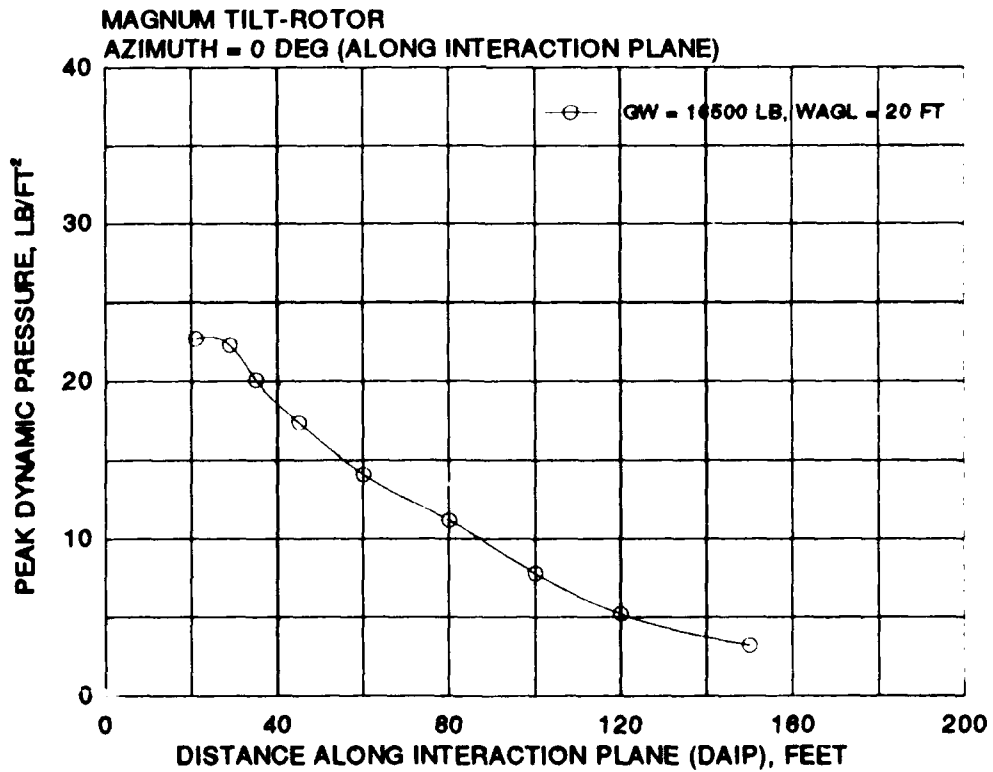
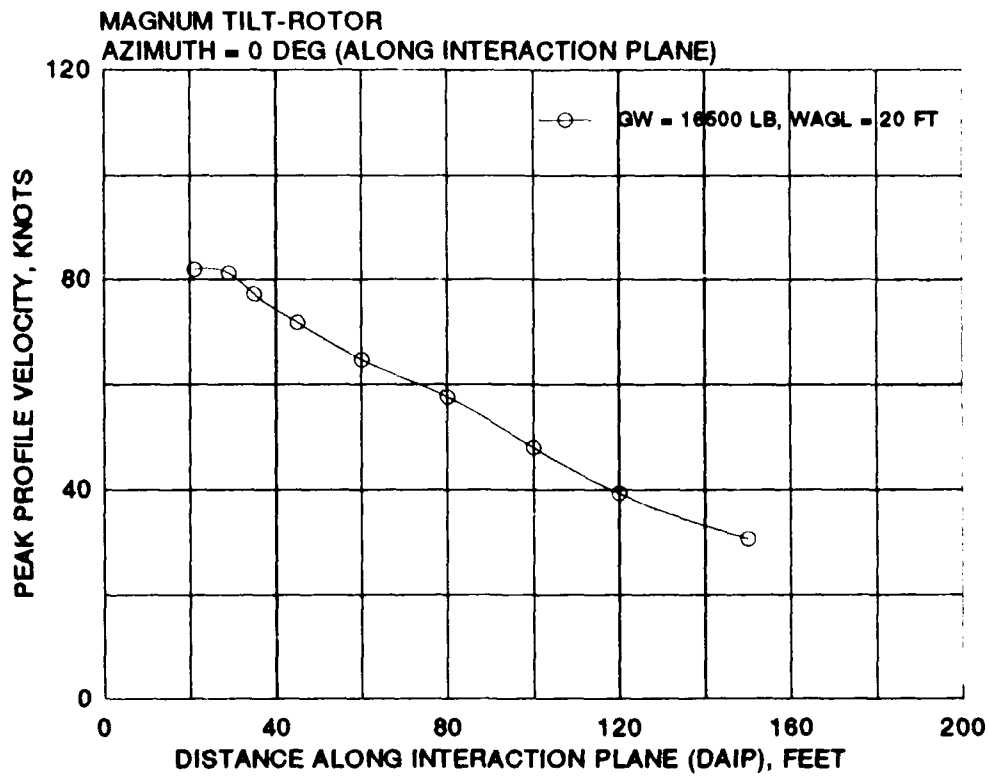

FIGURE G-5 MAGNUM TILTROTOR PEAK ROTORWASH VELOCITY AND DYNAMIC PRESSURE AS A FUNCTION OF DISTANCE ALONG THE INTERACTION PLANE (0 DEGREE AZIMUTH)

MAGNUM TILT-ROTOR
AZIMUTH = 270 DEG (OUT LEFT WING)

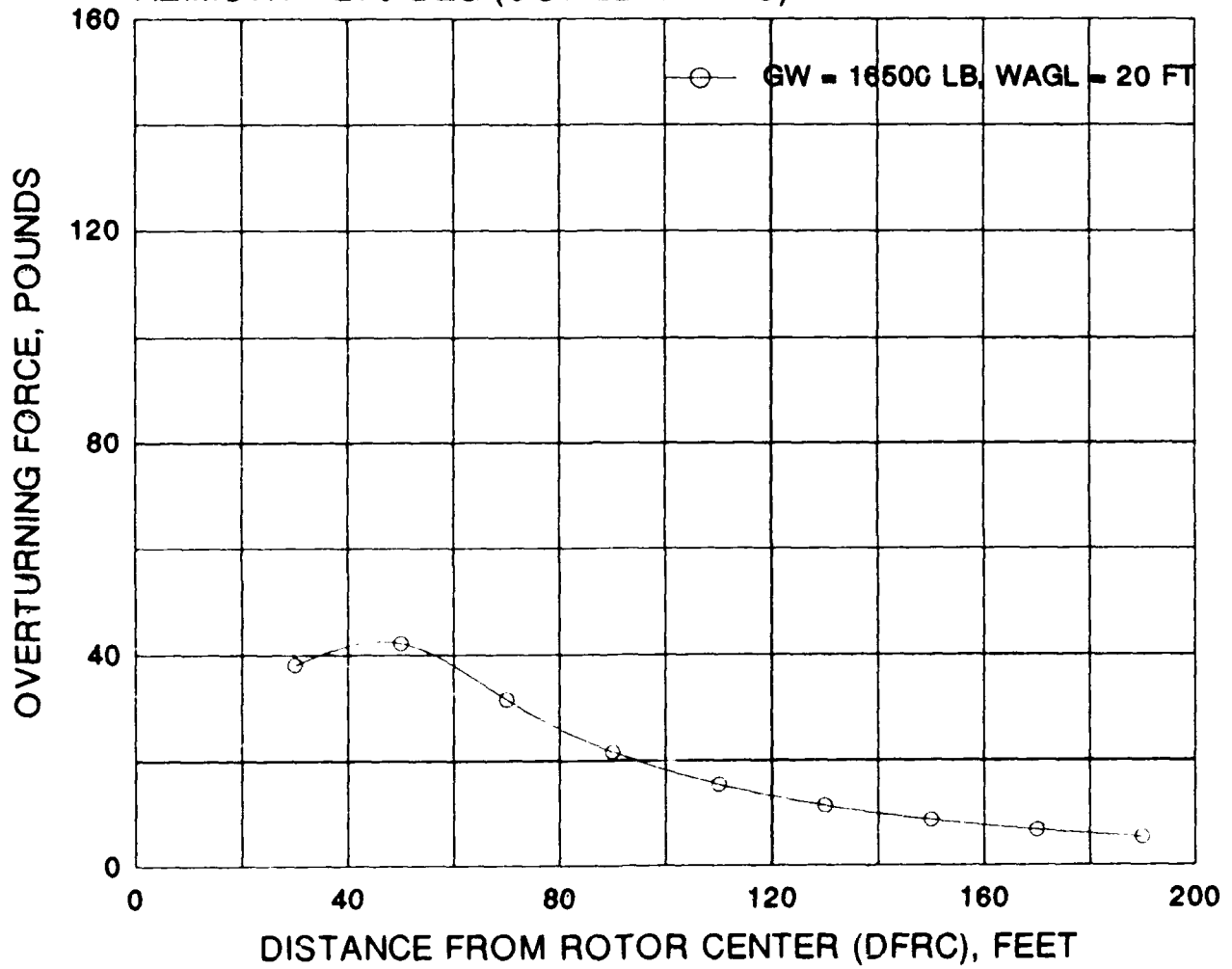

FIGURE G-6 MAGNUM TILTROTOR OVERTURNING FORCE AS A
FUNCTION OF DISTANCE FROM THE ROTOR
CENTER (270 DEGREE AZIMUTH)

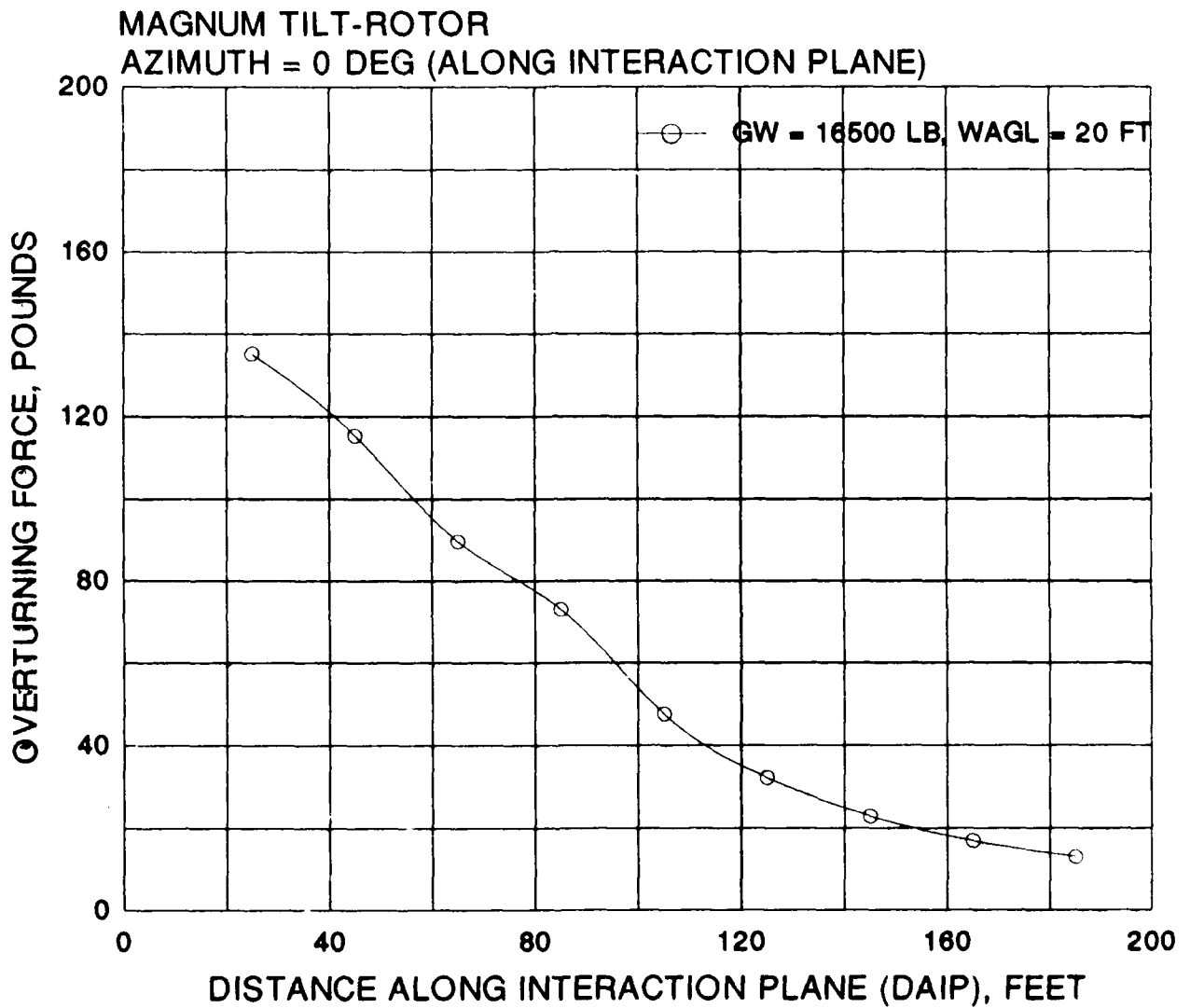

FIGURE G-7 MAGNUM TILTROTOR OVERTURNING FORCE AS A FUNCTION OF DISTANCE ALONG THE INTERACTION PLANE (0 DEGREE AZIMUTH)

APPENDIX H

EUROFAR TILTROTOR AIRCRAFT AND ROTORWASH DATA

Eurofar tiltrotor aircraft characteristics used with the ROTWASH analysis program are listed in table H-1 as obtained from reference H-1. Figure H-1 presents a three-view drawing of the tiltrotor. Table H-2 provides a summary tabulation of parameters defining the conditions for all rotorwash data presented in the appendix. All data are plotted in one of four formats, which include graphs of:

1. mean and peak outwash velocity profiles,
2. peak outwash velocity versus distance,
3. peak outwash dynamic pressure versus distance, and
4. personnel overturning force versus distance.

In each format, data are plotted along both the 0 and 270 degree azimuth. Distance from rotor center (DFRC) is the independent variable along the 270 degree azimuth. Measurements of distance from aircraft center (DFAC) are also noted on the graphs. The DFAC reference point is defined as zero at the location where the aircraft centerline intersects the line connecting the two rotor centers of rotation. Along the 0 degree azimuth, distance along the interaction plane (DAIP) is the independent variable. This point is referenced as zero at the same location as the DFAC point.

REFERENCES

- H-1. Renaud, M.J., et. al., "EUROFAR - The European Future Advanced Rotorcraft," Conference Proceedings of the One Day Royal Aeronautical Society Conference on EUROFAR, Royal Aeronautical Society, April 11, 1989.

TABLE H-1 EUROFAR TILTROTOR ROTWASH INPUT DATA

<u>Parameter</u>	<u>Value</u>
Rotor radius, feet	18.4
Distance between rotor centers, feet	50.2
Wing download, percent of rotor thrust	9.25
Distance from wheels to rotor plane, feet	19.2
Rotor speed, RPM	375.0
Rotor tip speed, feet/second	721.8
Number of rotor blades per rotor	3
Density ratio	1.0

AEROSPATIALE AGUSTA CASA MBB WESTLAND

EUROFAR

PRELIMINARY PHASE

BASELINE
CONFIGURATION

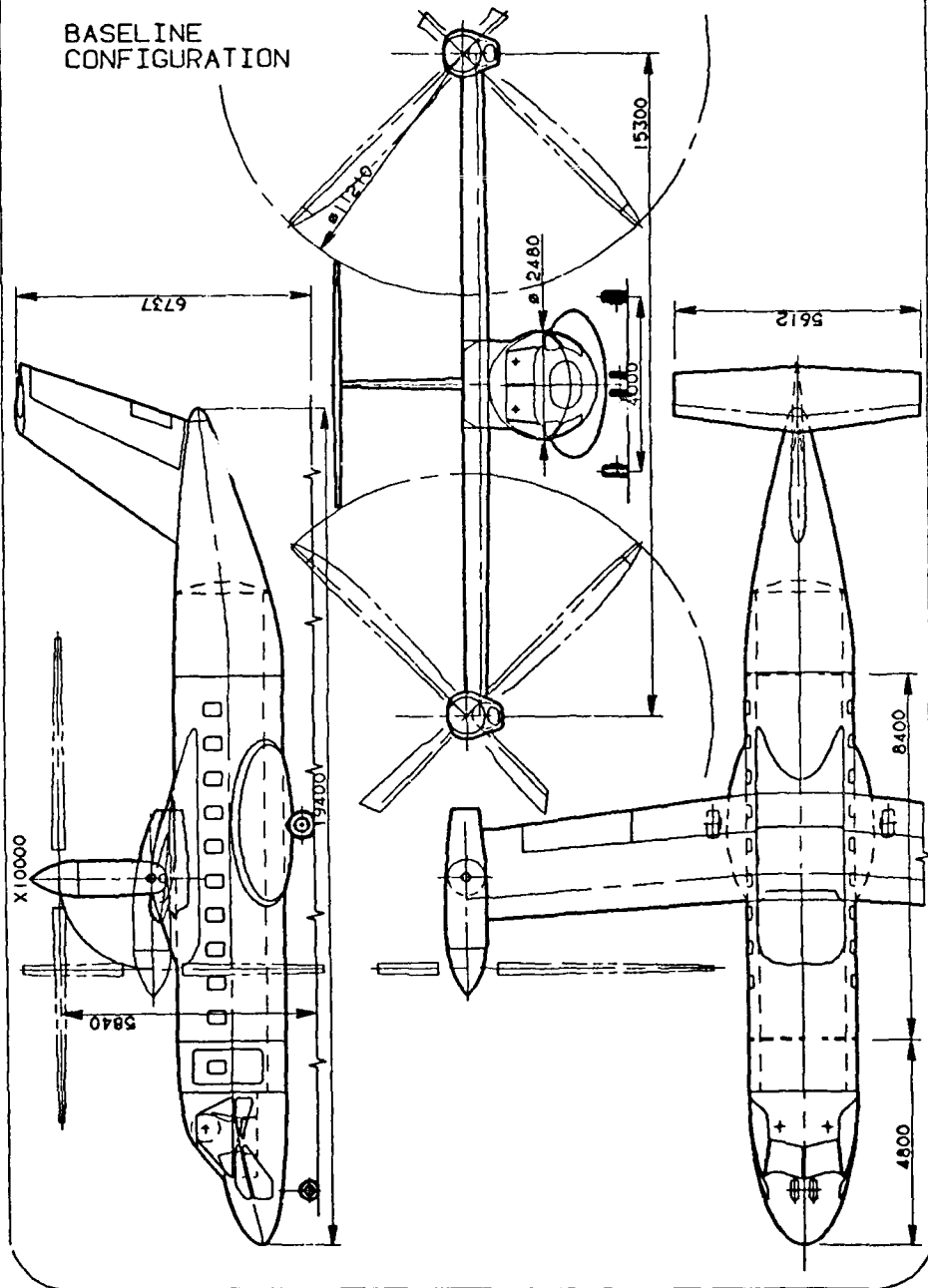

FIGURE H-1 THREE-VIEW DRAWING OF THE EUROFAR TILTROTOR

TABLE H-2 EUROFAR TILTROTOR ROTORWASH EVALUATION MATRIX

Note: The Figure/Type column provides the figure number and data format type where:

M/P - Mean and peak velocity profile format

PVD - Peak velocity and dynamic pressure format

OTF - Personnel overturning force format

<u>Figure/ Type</u>	<u>Azimuth, Degrees</u>	<u>GW, Pounds</u>	<u>WAGL, Feet</u>	<u>DFRC or DAIP Distance, Feet</u>
H-2 M/P	270.0	30,089	30	27.9,40.9,54.9,74.9, 94.9,114.9,144.9,174.9
H-3 M/P	0.0	30,089	30	29, 35, 45, 60, 80, 100, 120, 150, 200
H-4 PVD	270.0	30,089	30	30 to 180
H-5 PVD	0.0	30,089	30	30 to 200
H-6 OTF	270.0	30,089	30	30 to 190
H-7 OTF	0.0	30,089	30	30 to 190

EUROFAR TILT-ROTOR
 GW = 30089 LB, WAGL = 30 FT
 AZIMUTH = 270 DEG, DFAC = 53.0 FT (DFRC = 27.9 FT)

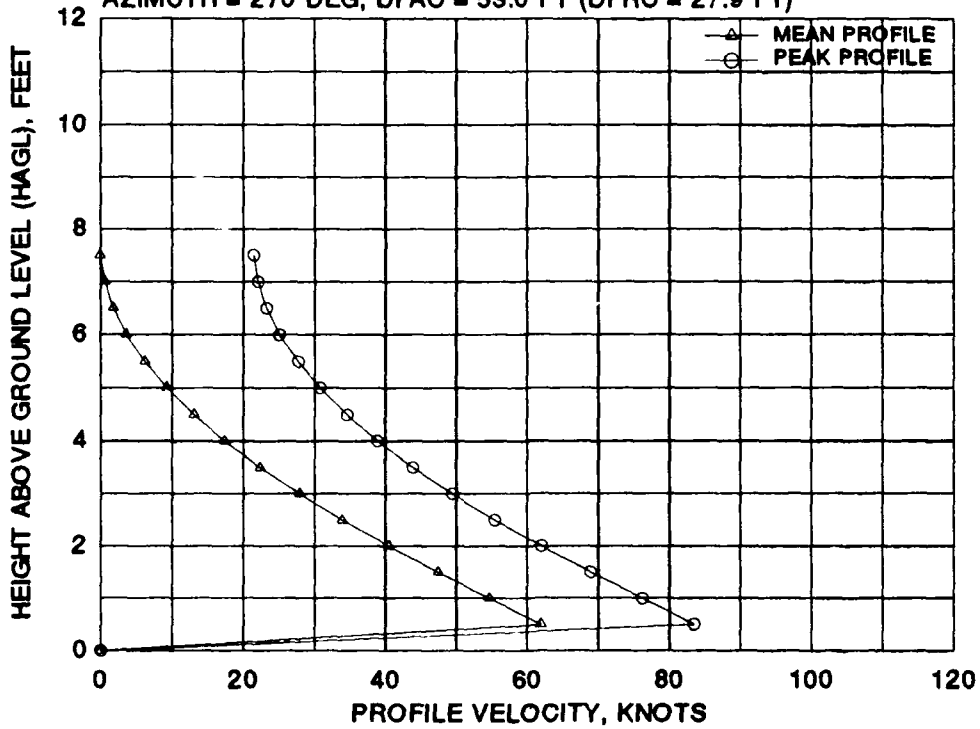

EUROFAR TILT-ROTOR
 GW = 30089 LB, WAGL = 30 FT
 AZIMUTH = 270 DEG, DFAC = 66.0 FT (DFRC = 40.9 FT)

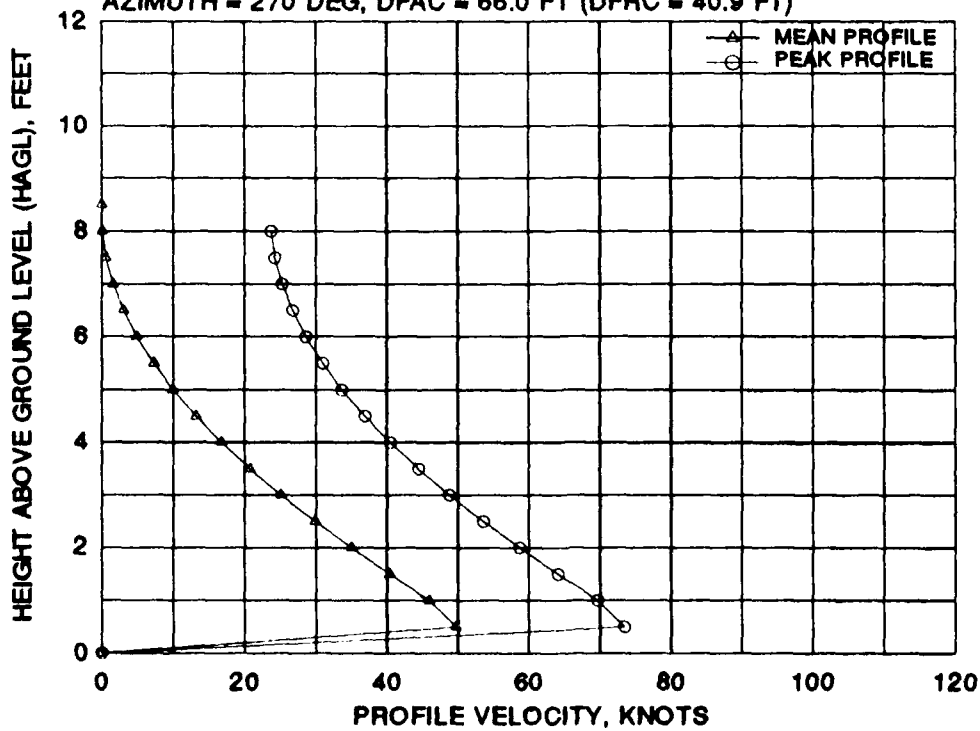
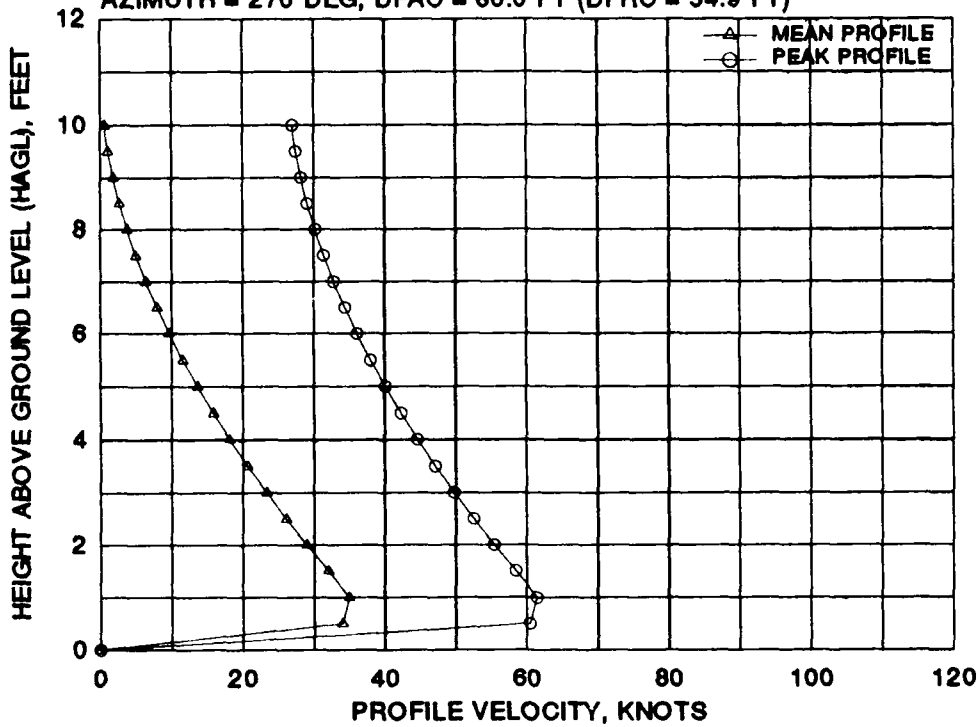

FIGURE H-2 EUROFAR TILTROTOR MEAN AND PEAK VELOCITY PROFILES FOR EIGHT 270 DEGREE AZIMUTH RADIAL STATIONS AT A WHEEL HEIGHT OF 30 FEET AND A GROSS WEIGHT OF 30,089 POUNDS

EUROFAR TILT-ROTOR
 GW = 30089 LB, WAGL = 30 FT
 AZIMUTH = 270 DEG, DFAC = 80.0 FT (DFRC = 54.9 FT)



EUROFAR TILT-ROTOR
 GW = 30089 LB, WAGL = 30 FT
 AZIMUTH = 270 DEG, DFAC = 100.0 FT (DFRC = 74.9 FT)

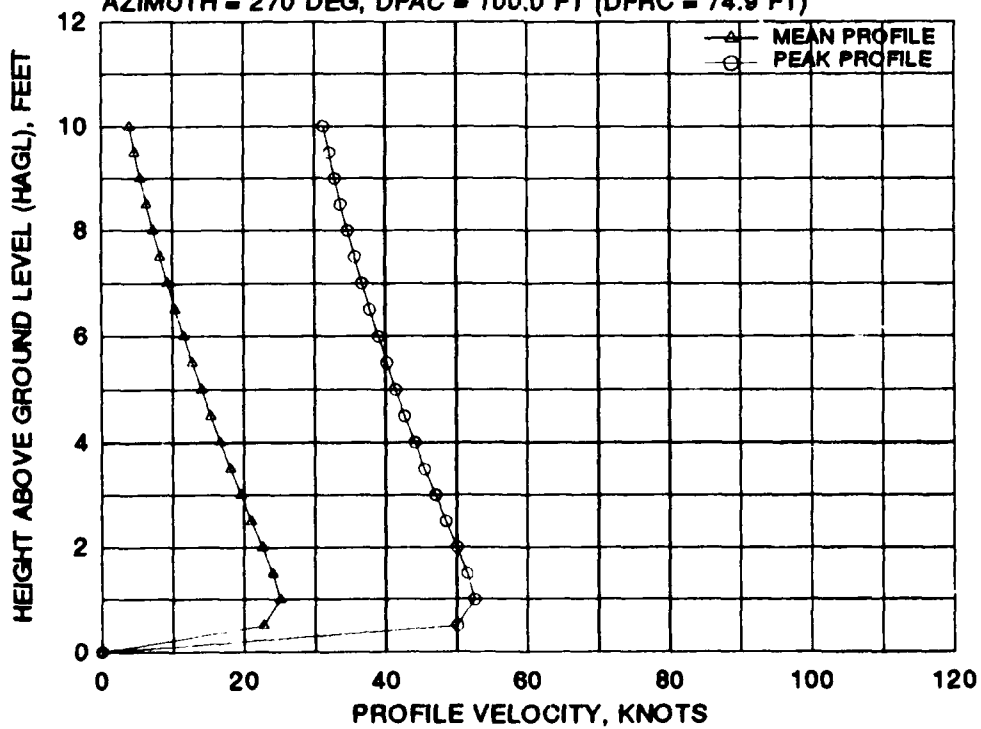
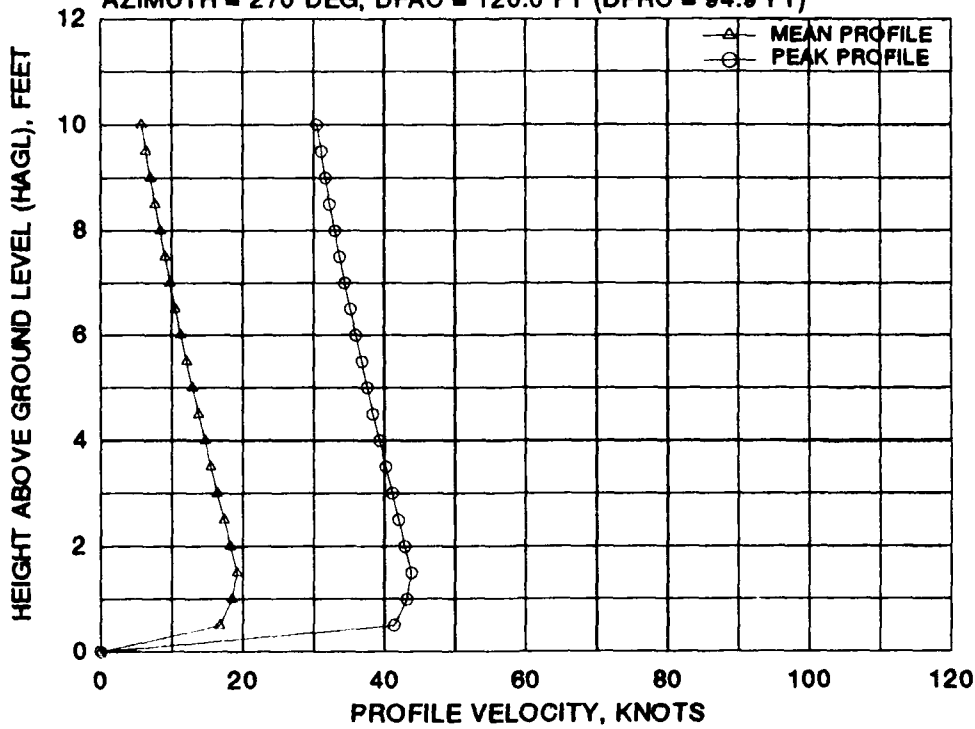

FIGURE H-2 EUROFAR TILTROTOR MEAN AND PEAK VELOCITY PROFILES FOR EIGHT 270 DEGREE AZIMUTH RADIAL STATIONS AT A WHEEL HEIGHT OF 30 FEET AND A GROSS WEIGHT OF 30,089 POUNDS (Continued)

EUROFAR TILT-ROTOR
 GW = 30089 LB, WAGL = 30 FT
 AZIMUTH = 270 DEG, DFAC = 120.0 FT (DFRC = 94.9 FT)



EUROFAR TILT-ROTOR
 GW = 30089 LB, WAGL = 30 FT
 AZIMUTH = 270 DEG, DFAC = 140.0 FT (DFRC = 114.9 FT)

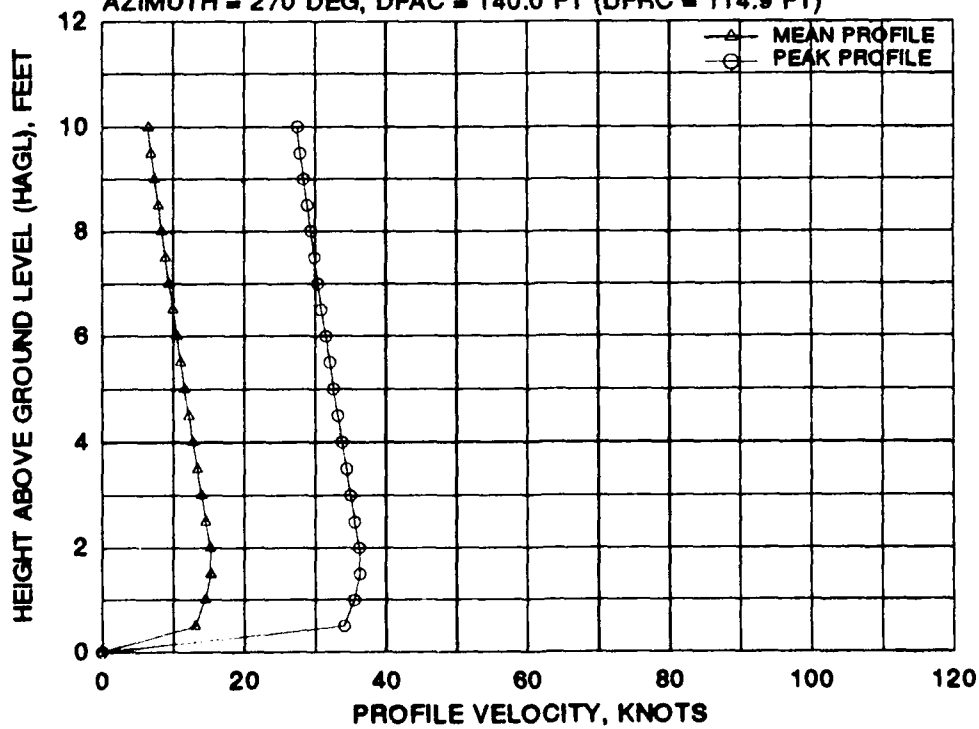
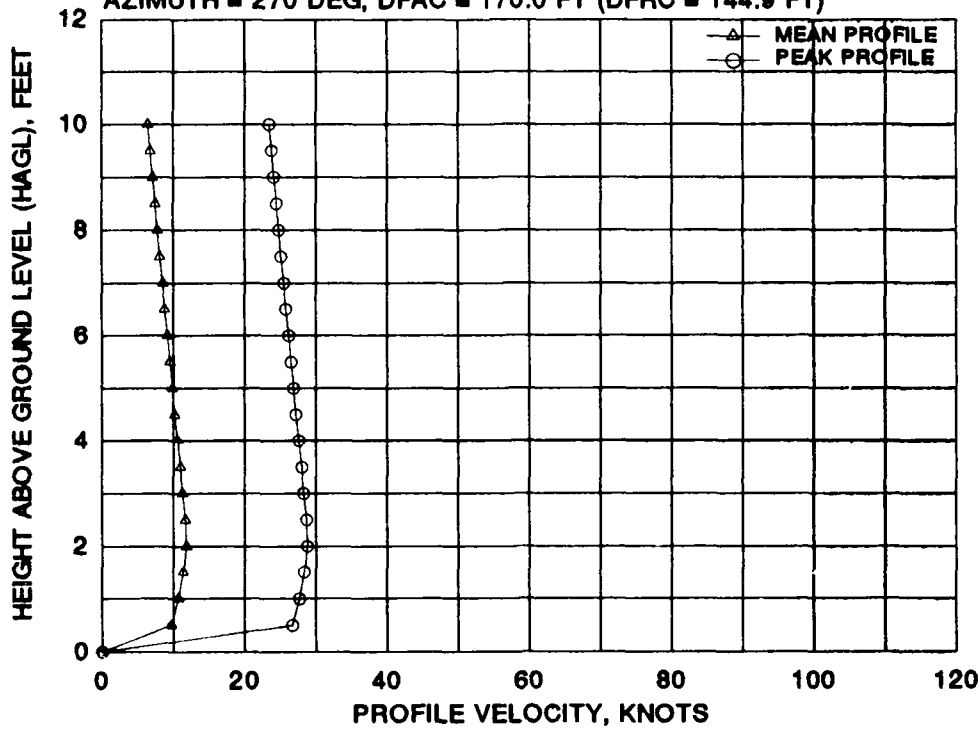

FIGURE H-2 EUROFAR TILTROTOR MEAN AND PEAK VELOCITY PROFILES FOR EIGHT 270 DEGREE AZIMUTH RADIAL STATIONS AT A WHEEL HEIGHT OF 30 FEET AND A GROSS WEIGHT OF 30,089 POUNDS (Continued)

EUROFAR TILT-ROTOR
 GW = 30089 LB, WAGL = 30 FT
 AZIMUTH = 270 DEG, DFAC = 170.0 FT (DFRC = 144.9 FT)



EUROFAR TILT-ROTOR
 GW = 30089 LB, WAGL = 30 FT
 AZIMUTH = 270 DEG, DFAC = 200.0 FT (DFRC = 174.9 FT)

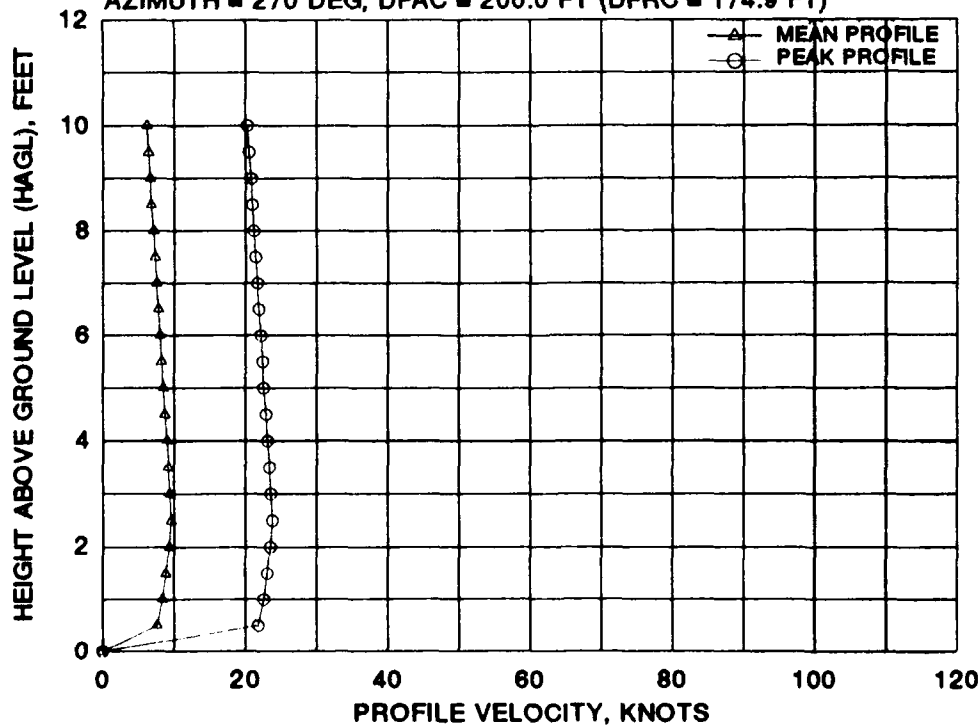

FIGURE H-2 EUROFAR TILTROTOR MEAN AND PEAK VELOCITY PROFILES FOR EIGHT 270 DEGREE AZIMUTH RADIAL STATIONS AT A WHEEL HEIGHT OF 30 FEET AND A GROSS WEIGHT OF 30,089 POUNDS (Concluded)

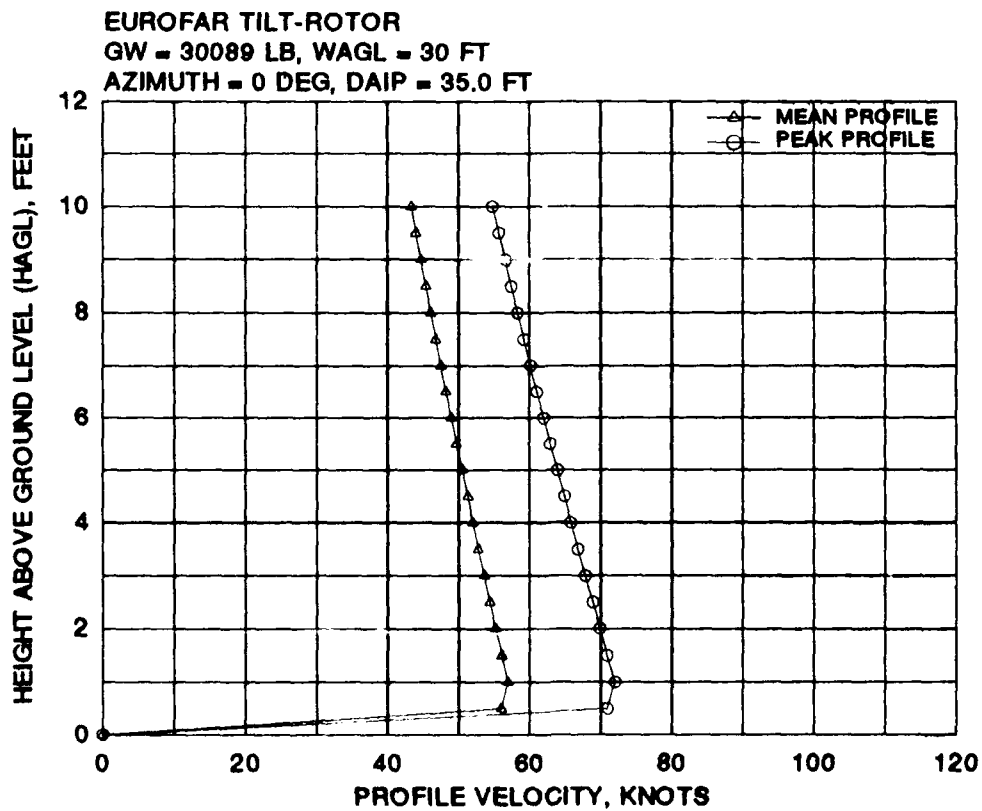
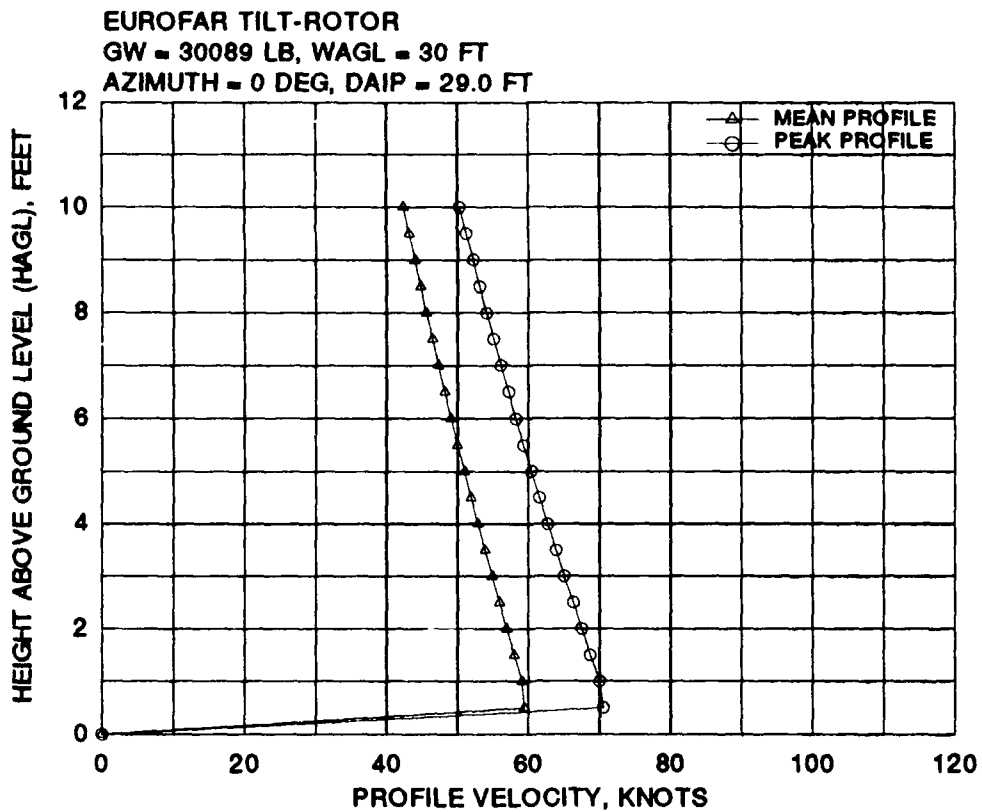
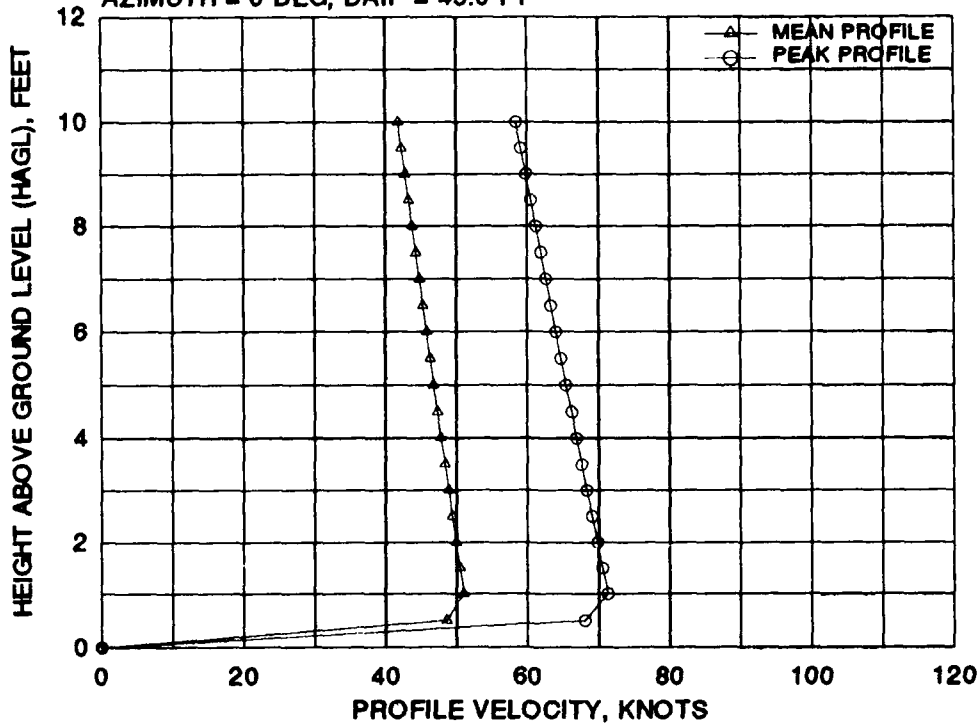

FIGURE H-3 EUROFAR TILTROTOR MEAN AND PEAK VELOCITY PROFILES FOR NINE 0 DEGREE AZIMUTH RADIAL STATIONS AT A WHEEL HEIGHT OF 30 FEET AND A GROSS WEIGHT OF 30,089 POUNDS

EUROFAR TILT-ROTOR
 GW = 30089 LB, WAGL = 30 FT
 AZIMUTH = 0 DEG, DAIP = 45.0 FT



EUROFAR TILT-ROTOR
 GW = 30089 LB, WAGL = 30 FT
 AZIMUTH = 0 DEG, DAIP = 60.0 FT

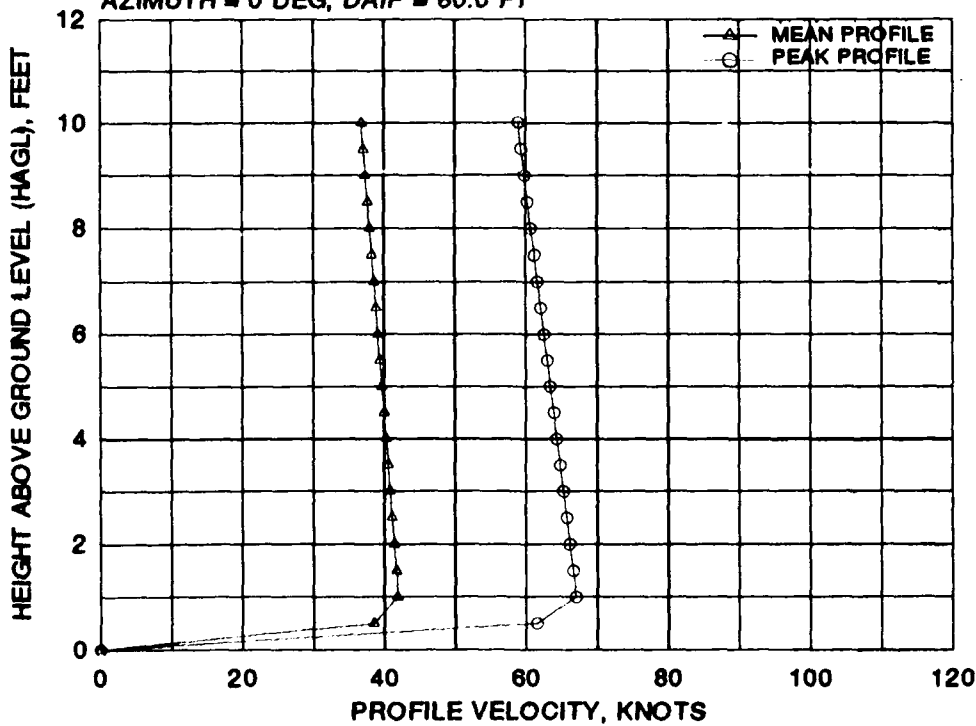

FIGURE H-3 EUROFAR TILTROTOR MEAN AND PEAK VELOCITY PROFILES FOR NINE 0 DEGREE AZIMUTH RADIAL STATIONS AT A WHEEL HEIGHT OF 30 FEET AND A GROSS WEIGHT OF 30,089 POUNDS (Continued)

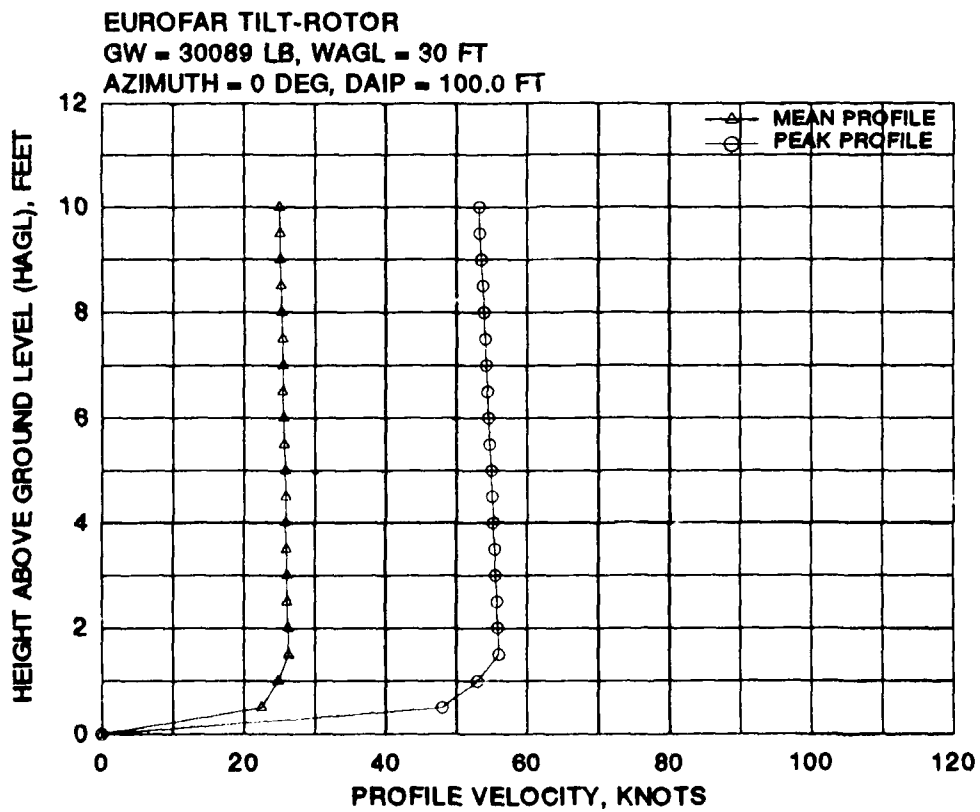
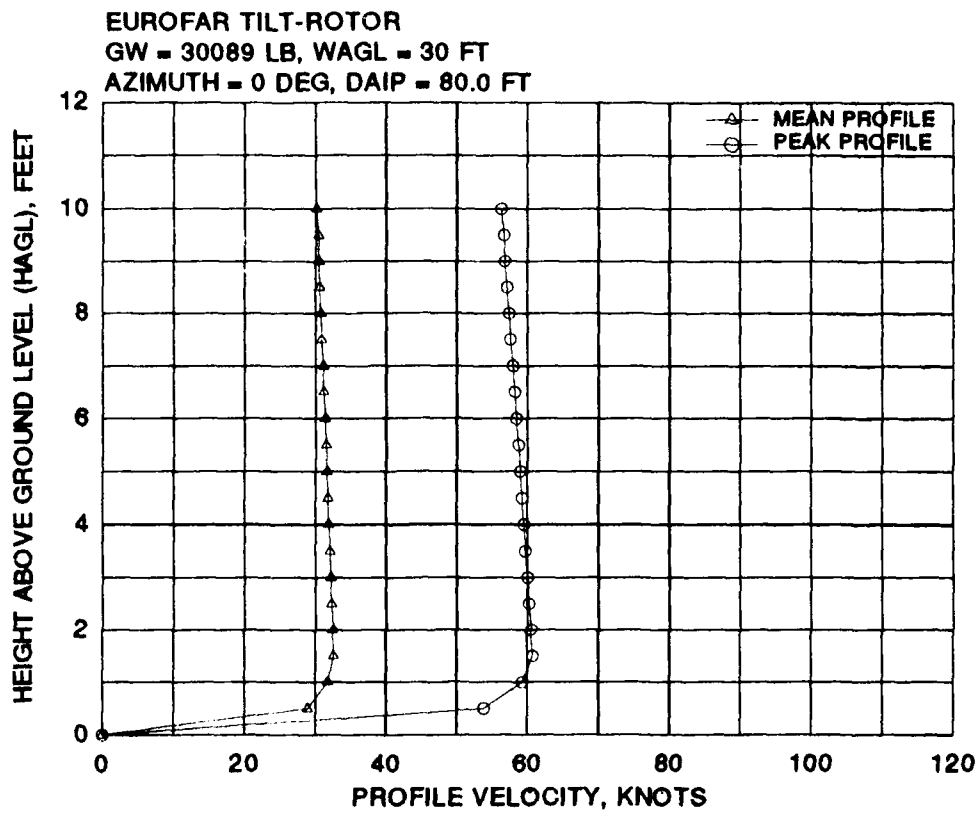
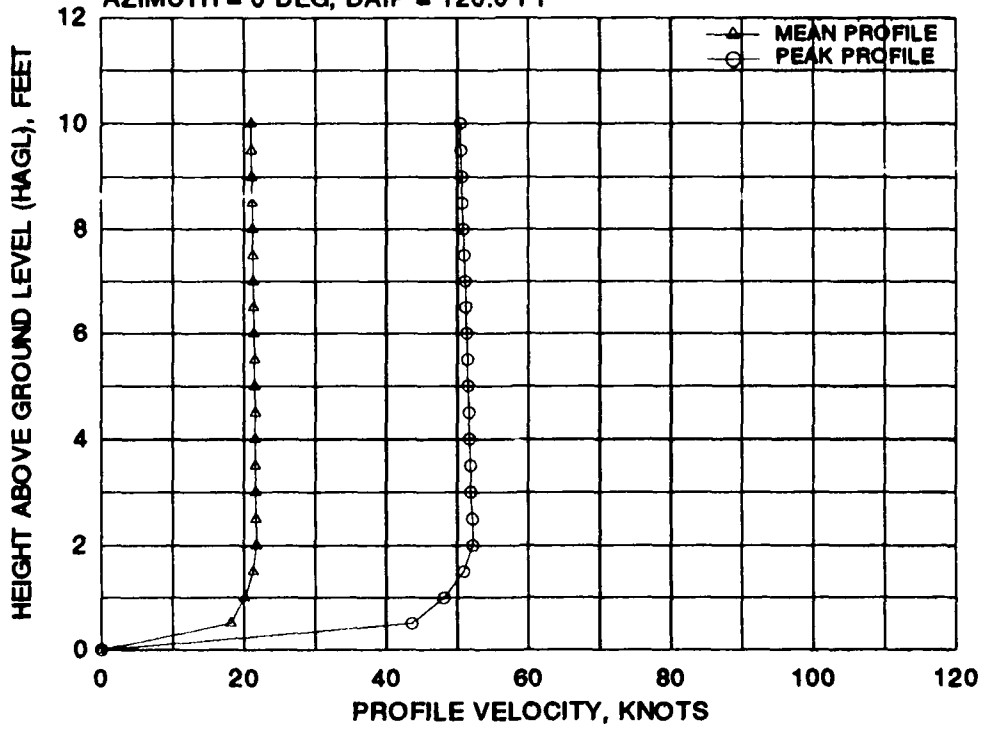

FIGURE H-3 EUROFAR TILTROTOR MEAN AND PEAK VELOCITY PROFILES FOR NINE 0 DEGREE AZIMUTH RADIAL STATIONS AT A WHEEL HEIGHT OF 30 FEET AND A GROSS WEIGHT OF 30,089 POUNDS (Continued)

EUROFAR TILT-ROTOR
 GW = 30089 LB, WAGL = 30 FT
 AZIMUTH = 0 DEG, DAIP = 120.0 FT



EUROFAR TILT-ROTOR
 GW = 30089 LB, WAGL = 30 FT
 AZIMUTH = 0 DEG, DAIP = 150.0 FT

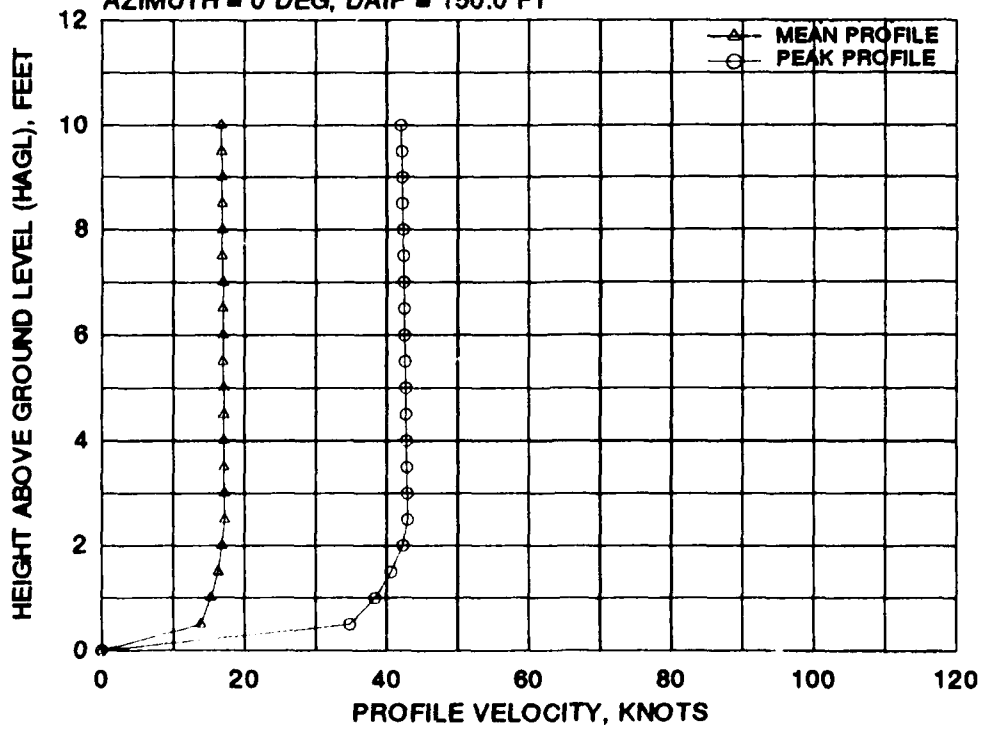

FIGURE H-3 EUROFAR TILTROTOR MEAN AND PEAK VELOCITY PROFILES FOR NINE 0 DEGREE AZIMUTH RADIAL STATIONS AT A WHEEL HEIGHT OF 30 FEET AND A GROSS WEIGHT OF 30,089 POUNDS (Continued)

EUROFAR TILT-ROTOR
GW = 30089 LB, WAGL = 30 FT
AZIMUTH = 0 DEG, DAIP = 200.0 FT

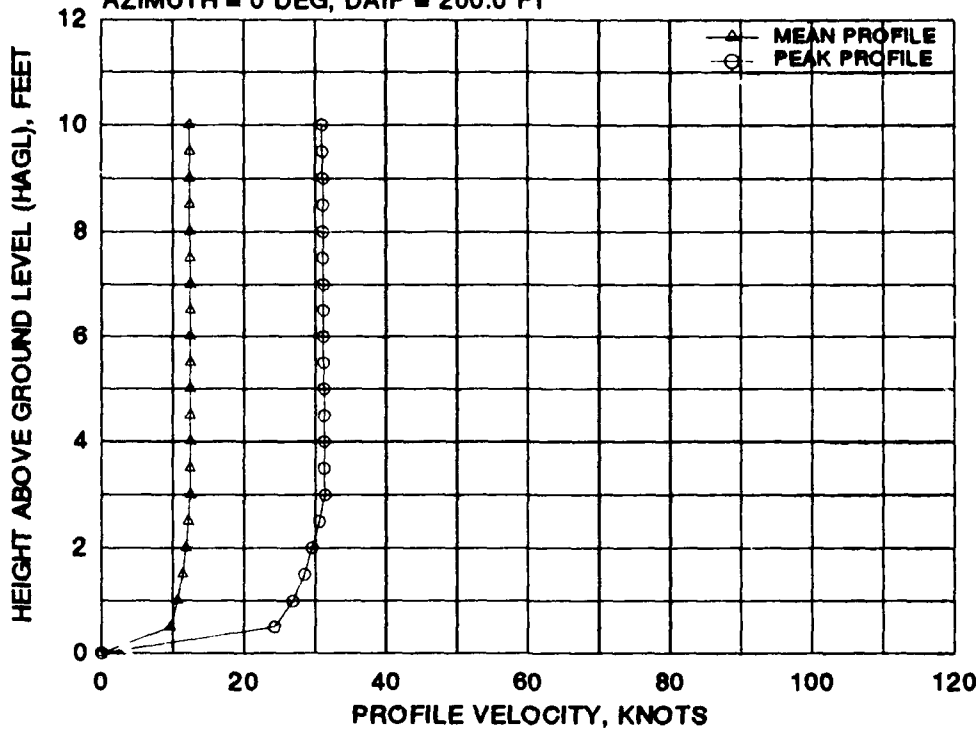

FIGURE H-3 EUROFAR TILTROTOR MEAN AND PEAK VELOCITY PROFILES FOR NINE 0 DEGREE AZIMUTH RADIAL STATIONS AT A WHEEL HEIGHT OF 30 FEET AND A GROSS WEIGHT OF 30,089 POUNDS (Concluded)

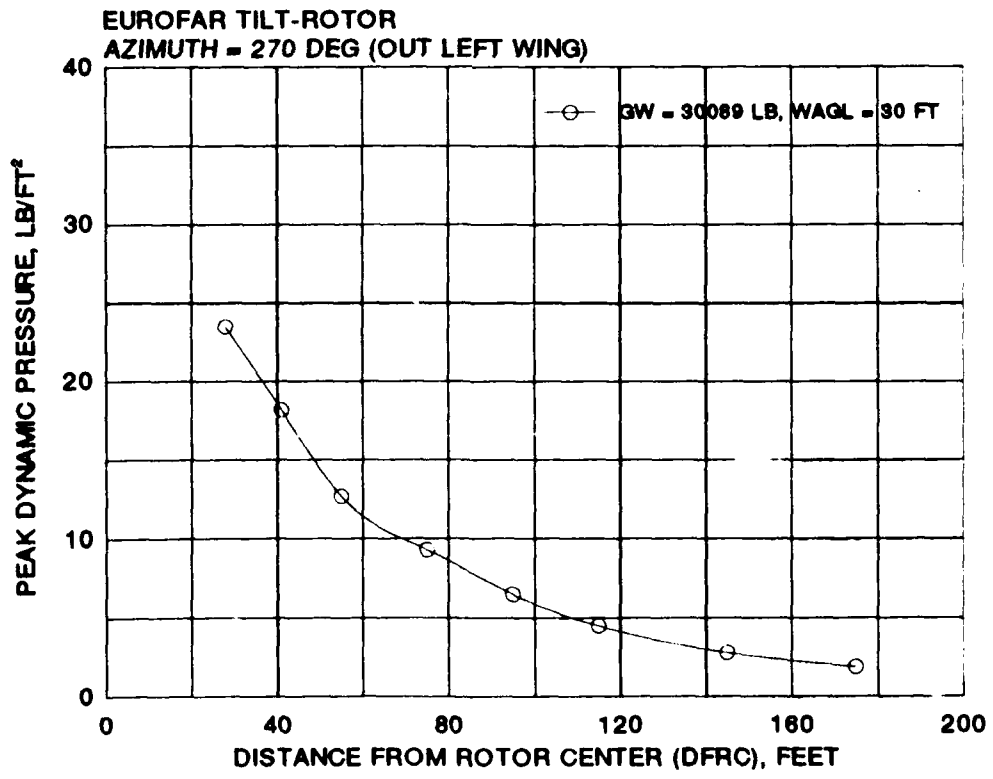
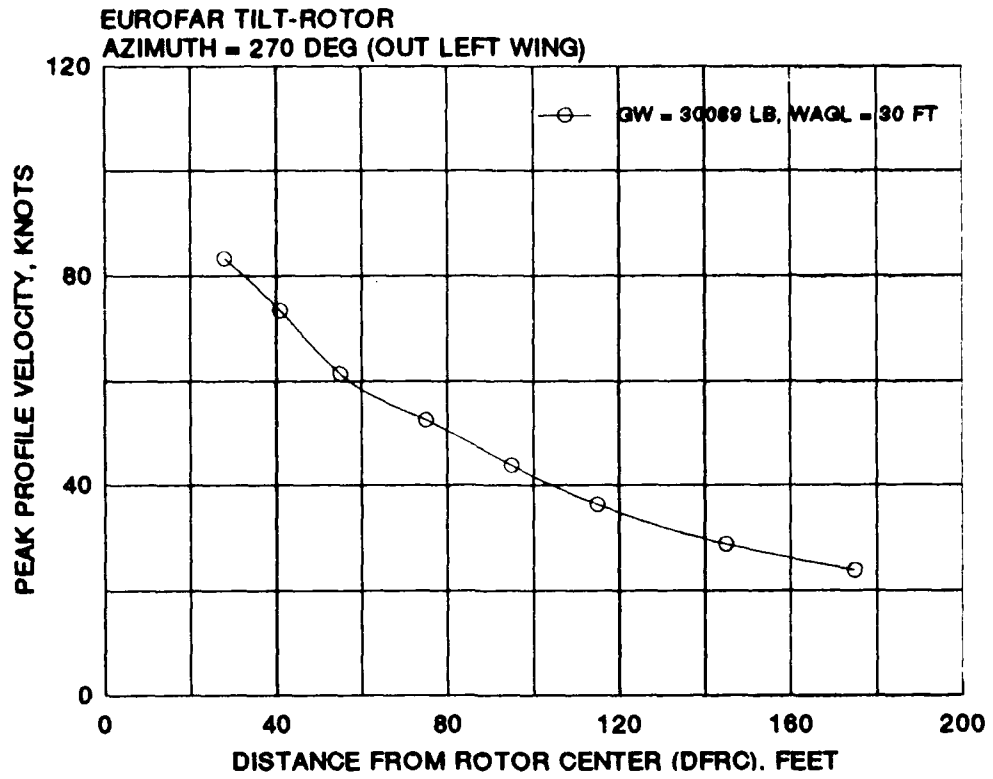

FIGURE H-4 EUROFAR TILTROTOR PEAK ROTORWASH VELOCITY AND DYNAMIC PRESSURE AS A FUNCTION OF DISTANCE FROM THE ROTOR CENTER (270 DEGREE AZIMUTH)

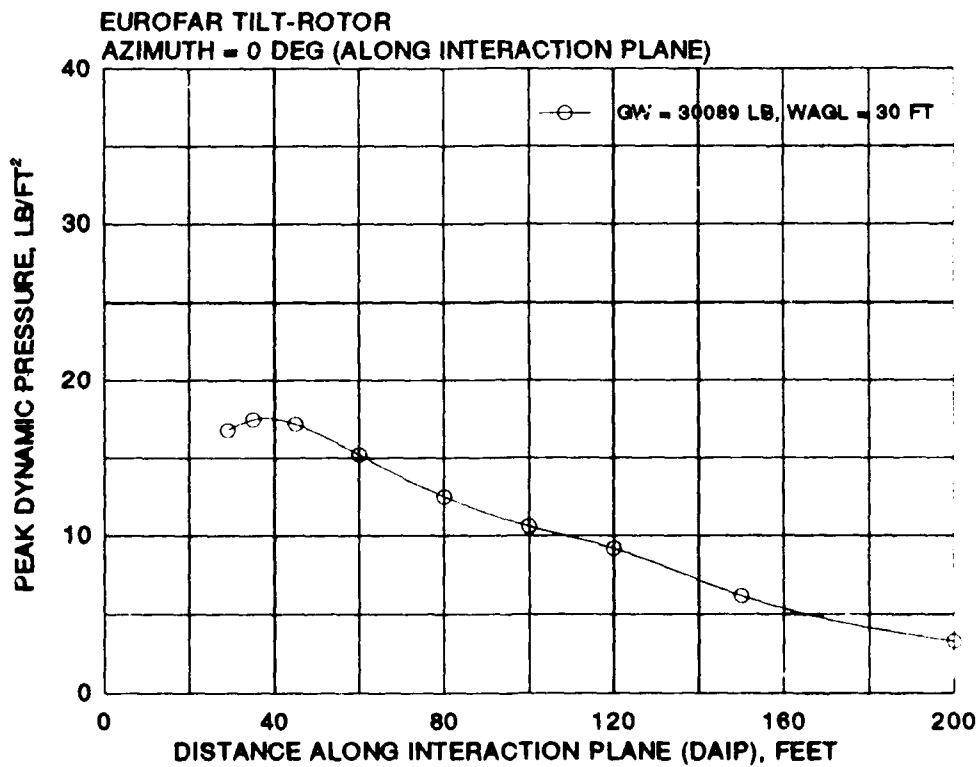
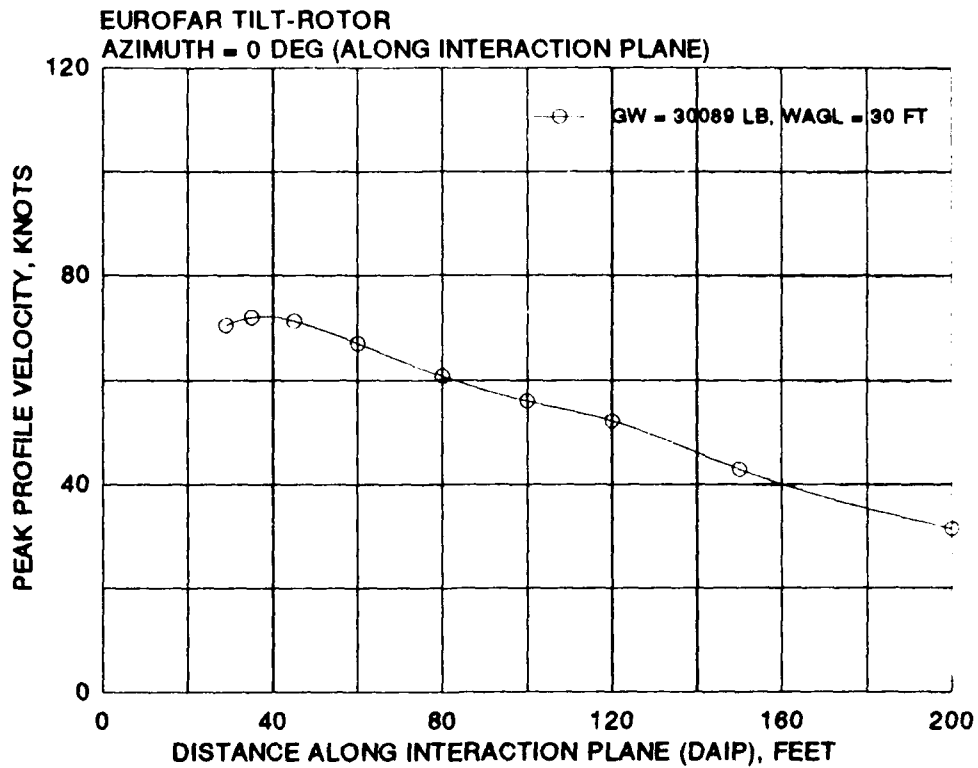

FIGURE H-5 EUROFAR TILTROTOR PEAK ROTORWASH VELOCITY AND DYNAMIC PRESSURE AS A FUNCTION OF DISTANCE ALONG THE INTERACTION PLANE (0 DEGREE AZIMUTH)

EUROFAR TILT-ROTOR
AZIMUTH = 270 DEG (OUT LEFT WING)

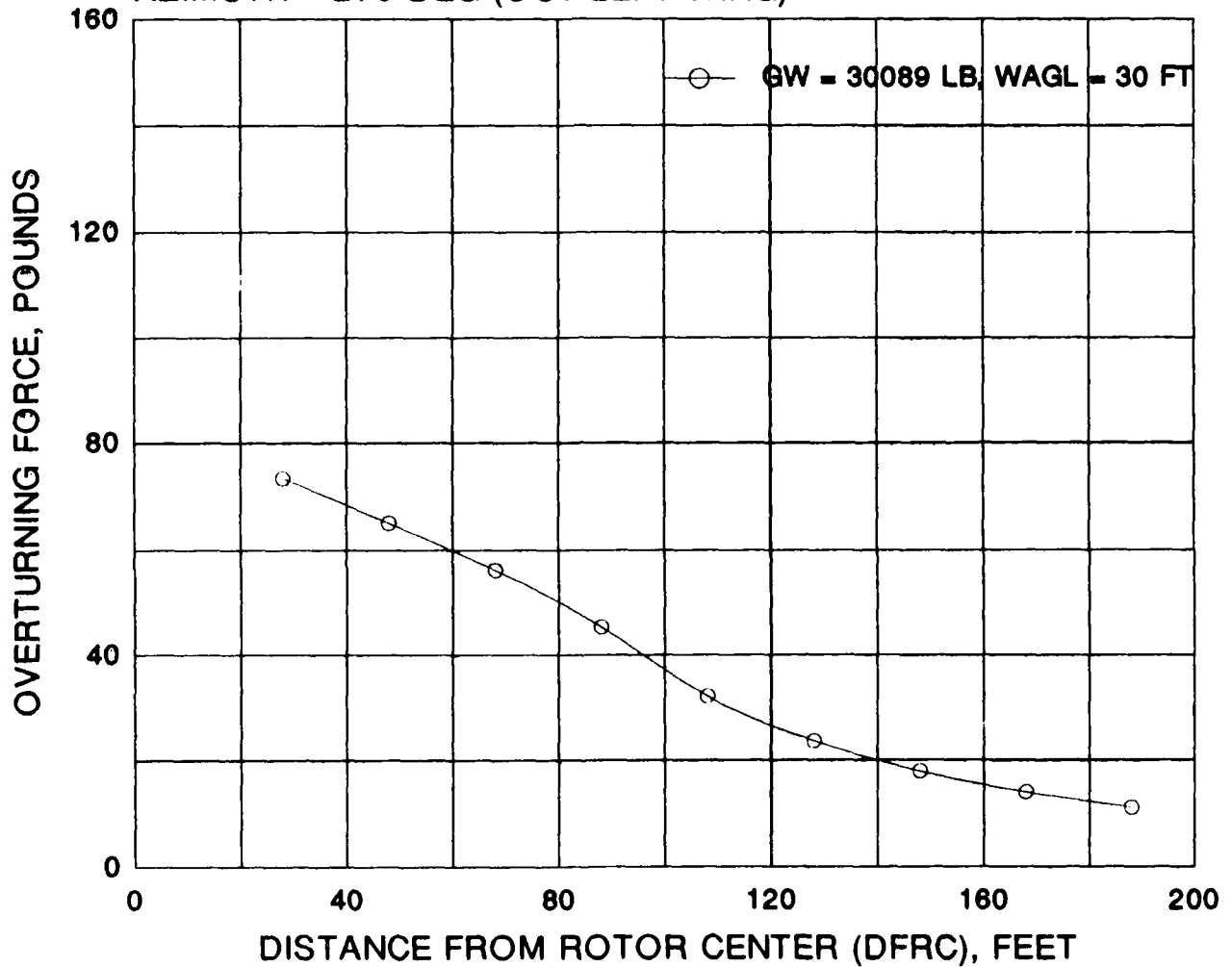

FIGURE H-6 EUROFAR TILTROTOR OVERTURNING FORCE AS A FUNCTION OF DISTANCE FROM THE ROTOR CENTER (270 DEGREE AZIMUTH)

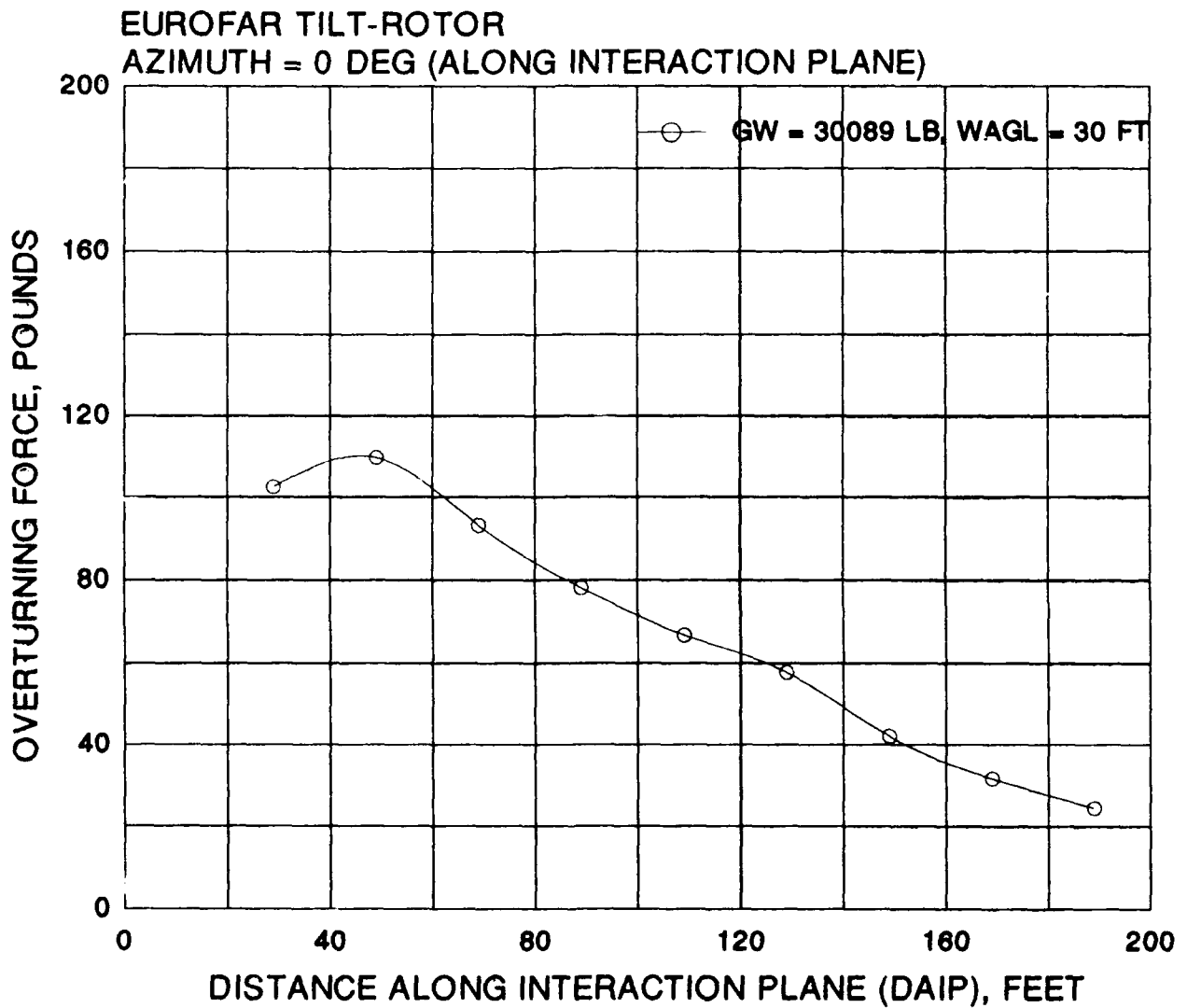

FIGURE H-7 EUROFAR TILTROTOR OVERTURNING FORCE AS A FUNCTION OF DISTANCE ALONG THE INTERACTION PLANE (0 DEGREE AZIMUTH)

APPENDIX I

CANADAIR CL-84 AIRCRAFT AND ROTORWASH DATA

Canadair CL-84 aircraft characteristics used with the ROTWASH analysis program are listed in table I-1 as obtained from reference I-1. Figure I-1 presents a three-view drawing of the tiltwing. Table I-2 provides a summary tabulation of parameters defining the conditions for all rotorwash data presented in the appendix. All data are plotted in one of four formats, which include graphs of:

1. mean and peak outwash velocity profiles,
2. peak outwash velocity versus distance,
3. peak outwash dynamic pressure versus distance, and
4. personnel overturning force versus distance.

In each format, data are plotted along both the 0 and 270 degree azimuth. Distance from rotor center (DFRC) is the independent variable along the 270 degree azimuth. Measurements of distance from aircraft center (DFAC) are also noted on the graphs. The DFAC reference point is defined as zero at the location where the aircraft centerline intersects the line connecting the two rotor centers of rotation. Along the 0 degree azimuth, distance along the interaction plane (DAIP) is the independent variable. This point is referenced as zero at the same location as the DFAC point.

REFERENCES

- I-1. Honaker, Maj. J.S., et. al., "Tri-Service Evaluation of the Canadair CL-84 Tilt-Wing Aircraft," USAAVLABS Technical Report 67-84, November 1967.

TABLE I-1 CL-84 ROTWASH INPUT DATA

<u>Parameter</u>	<u>Value</u>
Rotor radius, feet	7.0
Distance between rotor centers, feet	20.6
Wing download, percent of rotor thrust	2.5
Distance from wheels to rotor plane, feet	15.2
Rotor speed, RPM	1160.5
Rotor tip speed, feet/second	851.0
Number of rotor blades per rotor	4
Density ratio	1.0

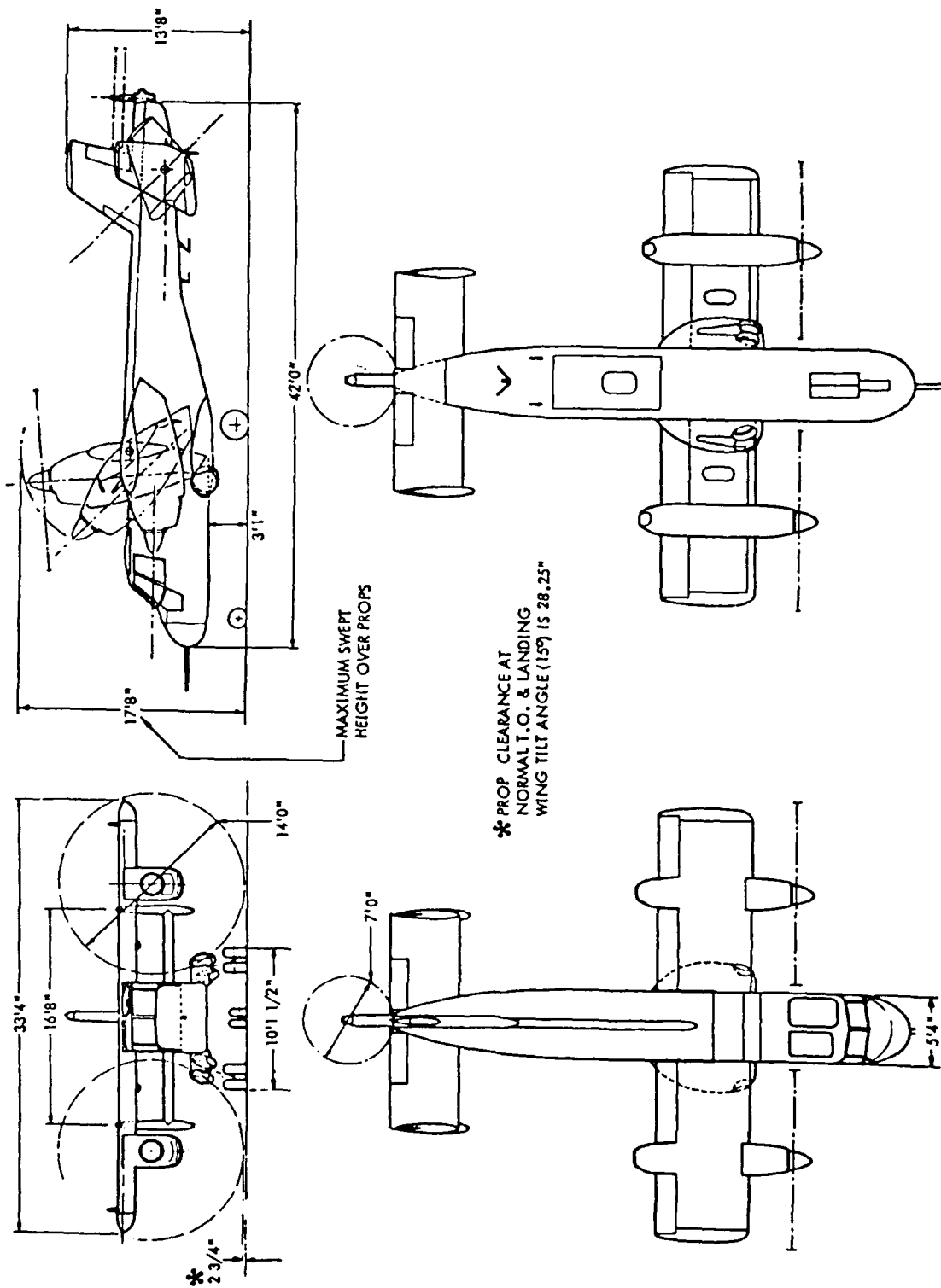

FIGURE I-1 THREE-VIEW DRAWING OF THE CANADAIR CL-84

TABLE I-2 CL-84 ROTORWASH EVALUATION MATRIX

Note: The Figure/Type column provides the figure number and data format type where:

M/P - Mean and peak velocity profile format

PVD - Peak velocity and dynamic pressure format

OTF - Personnel overturning force format

<u>Figure/ Type</u>	<u>Azimuth, Degrees</u>	<u>GW, Pounds</u>	<u>WAGL, Feet</u>	<u>DFRC or DAIP Distance, Feet</u>
I-2 M/P	270.0	12,200	15	14.7, 24.7, 29.7, 42.7, 55.7, 69.7, 89.7, 109.7
I-3 M/P	0.0	12,200	15	12.5, 21, 29, 35, 45, 60, 80, 100
I-4 PVD	270.0	12,200	15	15 to 110
I-5 PVD	0.0	12,200	15	15 to 100
I-6 OTF	270.0	12,200	15	20 to 180
I-7 OTF	0.0	12,200	15	20 to 180

CANADAIR CL-84
 GW = 12200 LB, WAGL = 15 FT
 AZIMUTH = 270 DEG, DFAC = 25.0 FT (DFRC = 14.7 FT)

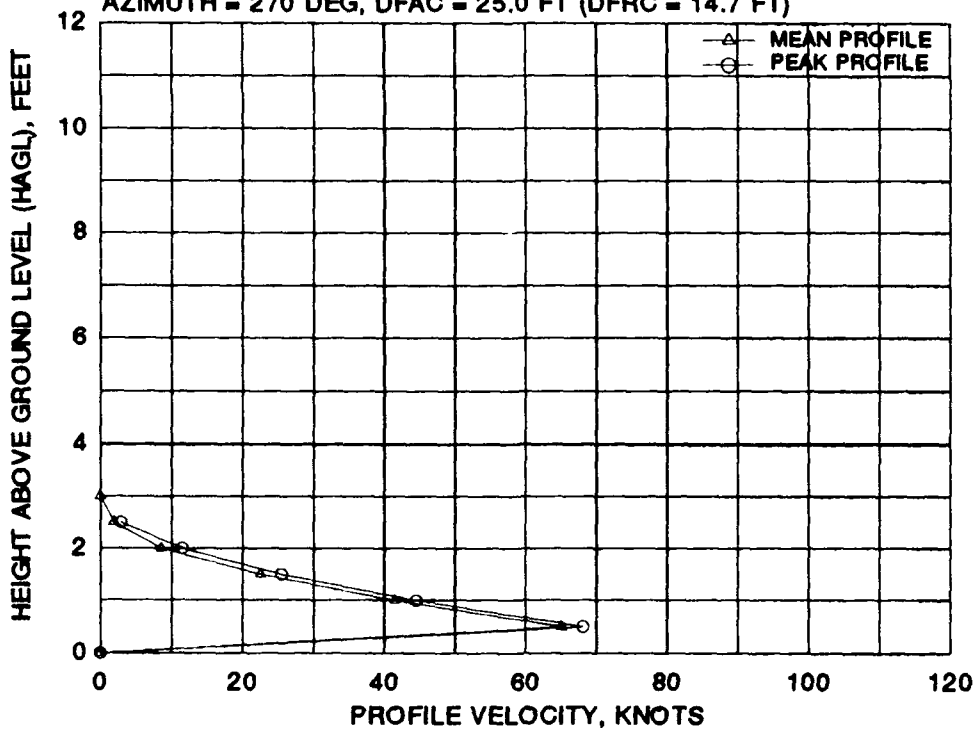

CANADAIR CL-84
 GW = 12200 LB, WAGL = 15 FT
 AZIMUTH = 270 DEG, DFAC = 35.0 FT (DFRC = 24.7 FT)

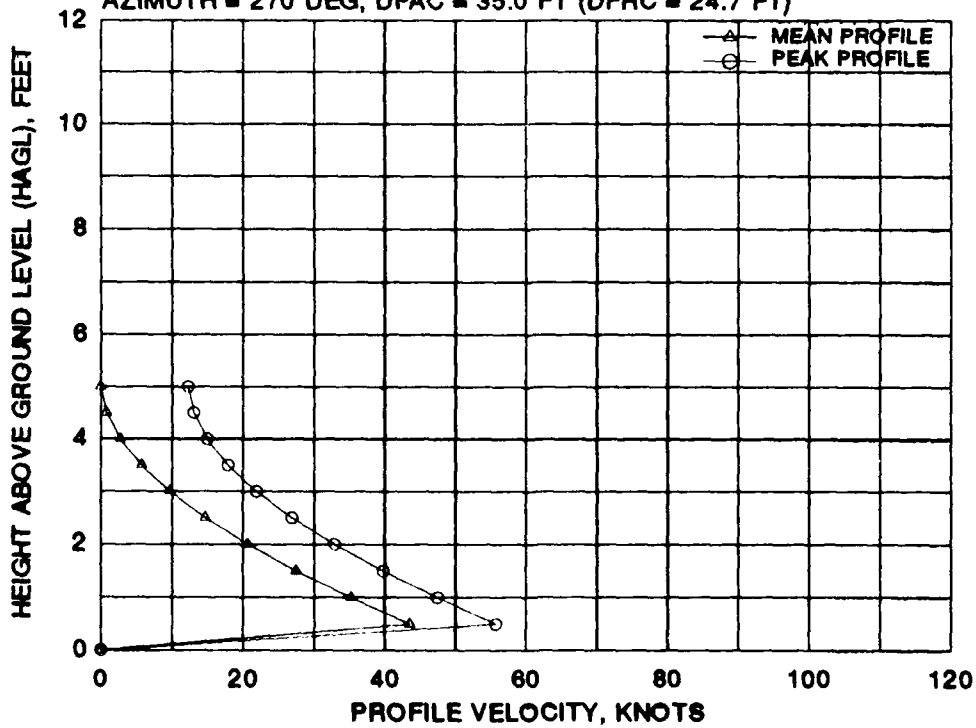

FIGURE I-2 CANADAIR CL-84 MEAN AND PEAK VELOCITY PROFILES FOR EIGHT 270 DEGREE AZIMUTH RADIAL STATIONS AT A WHEEL HEIGHT OF 15 FEET AND A GROSS WEIGHT OF 12,200 POUNDS

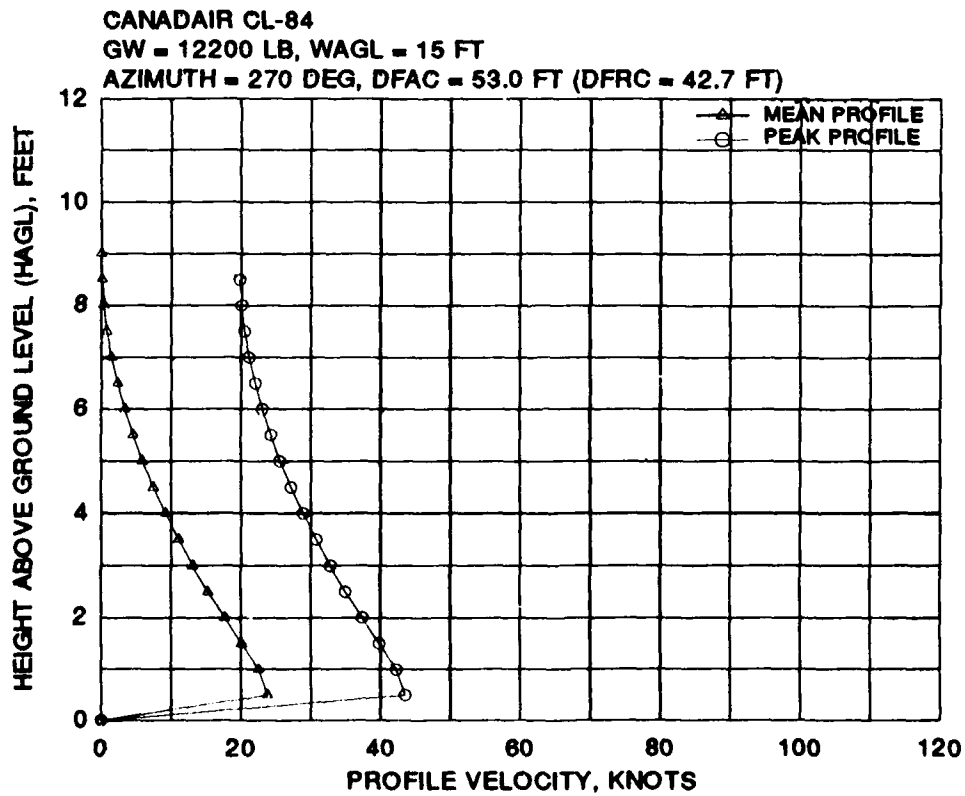
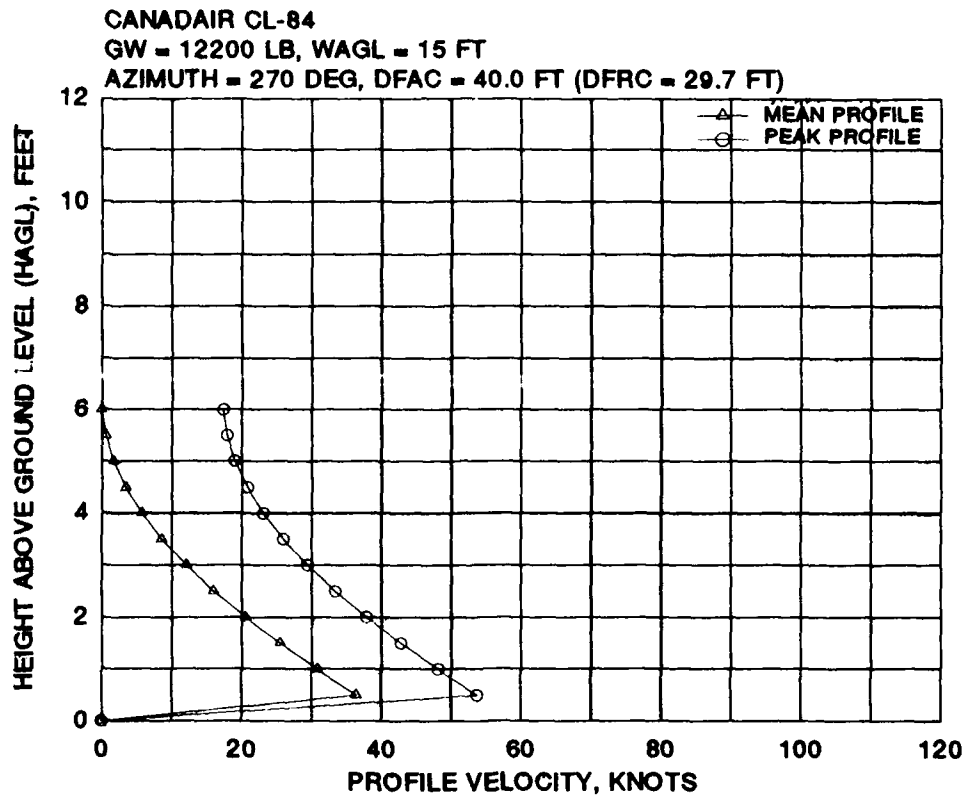
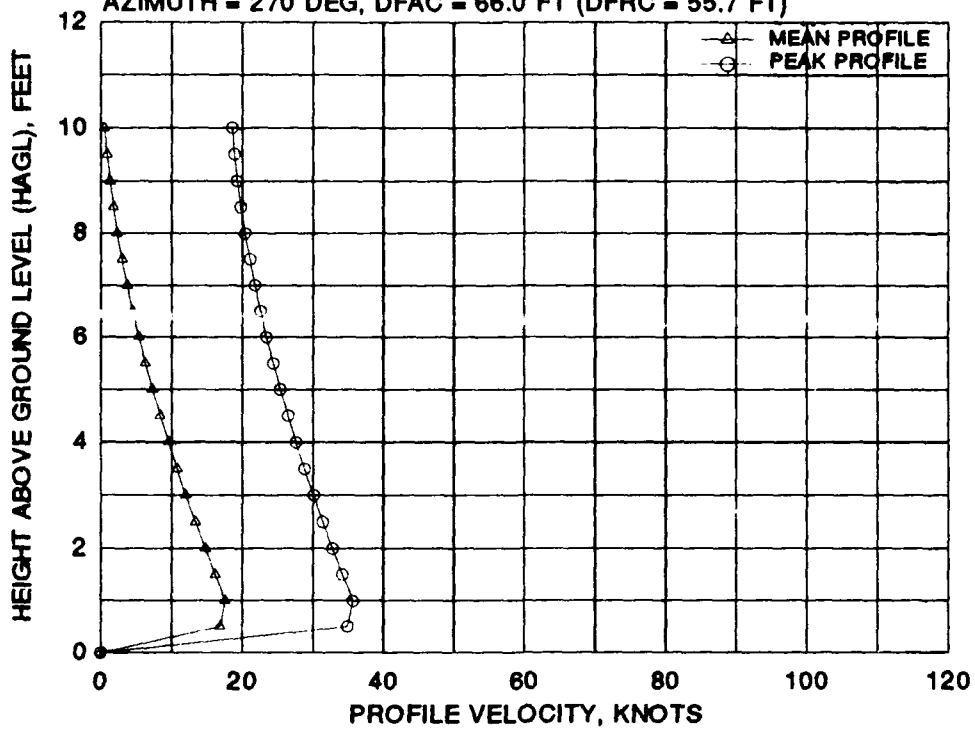

FIGURE I-2 CANADAIR CL-84 MEAN AND PEAK VELOCITY PROFILES FOR EIGHT 270 DEGREE AZIMUTH RADIAL STATIONS AT A WHEEL HEIGHT OF 15 FEET AND A GROSS WEIGHT OF 12,200 POUNDS (Continued)

CANADAIR CL-84
 GW = 12200 LB, WAGL = 15 FT
 AZIMUTH = 270 DEG, DFAC = 66.0 FT (DFRC = 55.7 FT)



CANADAIR CL-84
 GW = 12200 LB, WAGL = 15 FT
 AZIMUTH = 270 DEG, DFAC = 80.0 FT (DFRC = 69.7 FT)

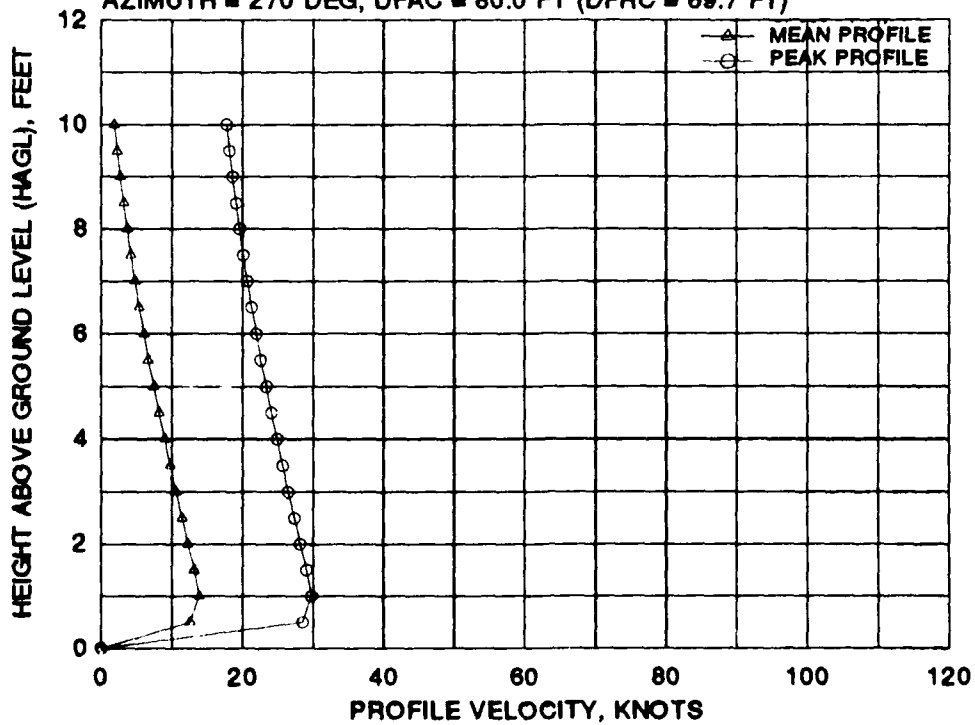
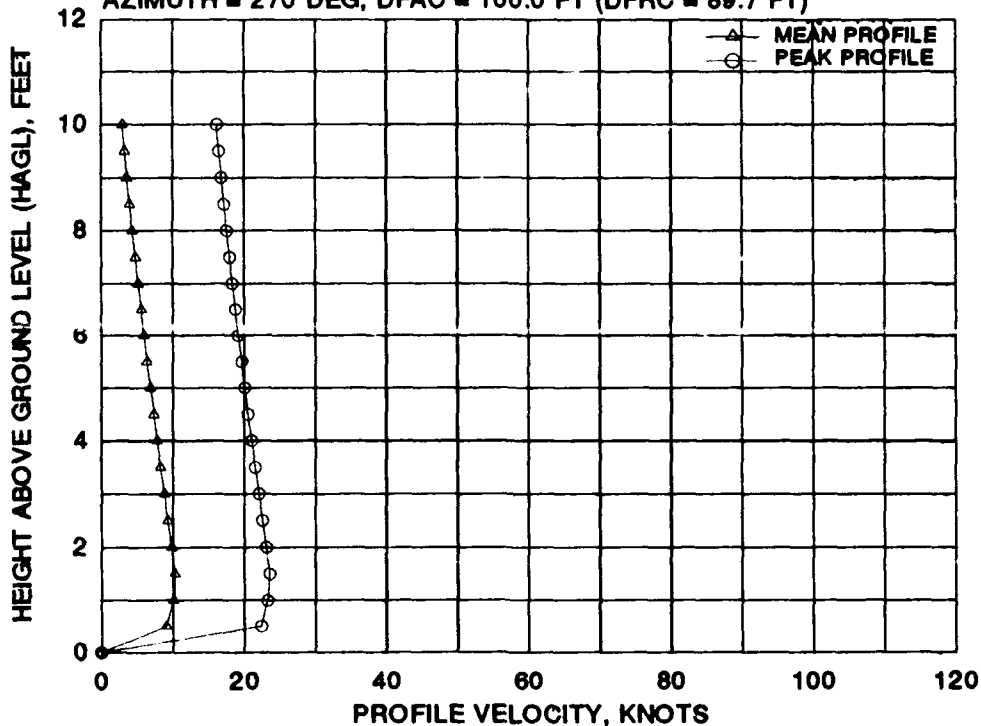

FIGURE I-2 CANADAIR CL-84 MEAN AND PEAK VELOCITY PROFILES FOR EIGHT 270 DEGREE AZIMUTH RADIAL STATIONS AT A WHEEL HEIGHT OF 15 FEET AND A GROSS WEIGHT OF 12,200 POUNDS (Continued)

CANADAIR CL-84
 GW = 12200 LB, WAGL = 15 FT
 AZIMUTH = 270 DEG, DFAC = 100.0 FT (DFRC = 89.7 FT)



CANADAIR CL-84
 GW = 12200 LB, WAGL = 15 FT
 AZIMUTH = 270 DEG, DFAC = 120.0 FT (DFRC = 109.7 FT)

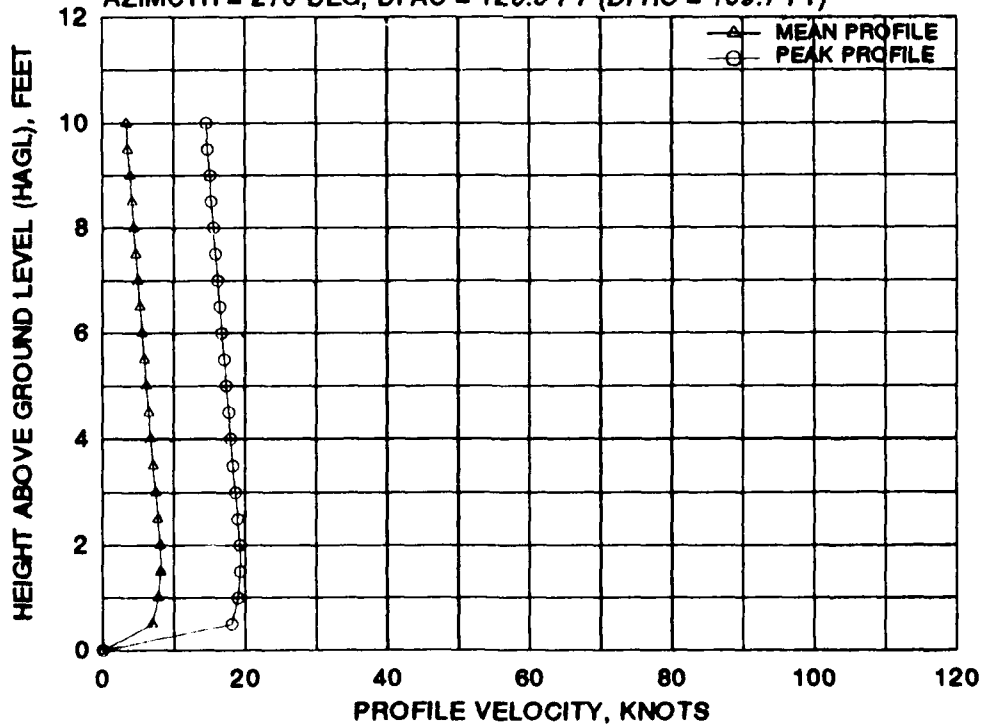
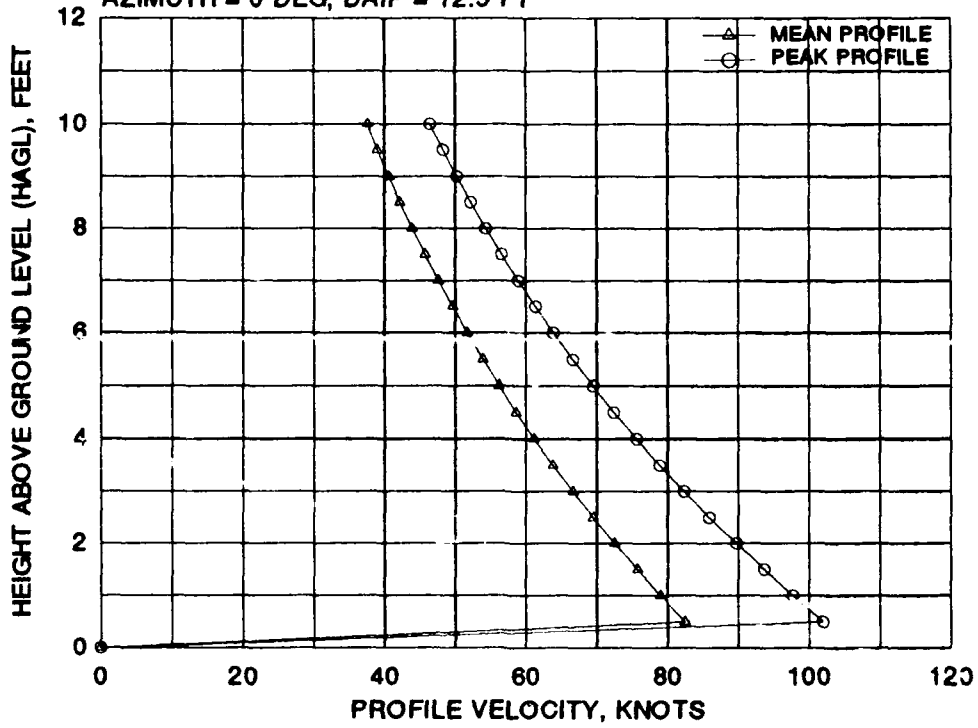

FIGURE I-2 CANADAIR CL-84 MEAN AND PEAK VELOCITY PROFILES FOR EIGHT 270 DEGREE AZIMUTH RADIAL STATIONS AT A WHEEL HEIGHT OF 15 FEET AND A GROSS WEIGHT OF 12,200 POUNDS (Concluded)

CANADAIR CL-84
 GW = 12200 LB, WAGL = 15 FT
 AZIMUTH = 0 DEG, DAIP = 12.5 FT



CANADAIR CL-84
 GW = 12200 LB, WAGL = 15 FT
 AZIMUTH = 0 DEG, DAIP = 21.0 FT

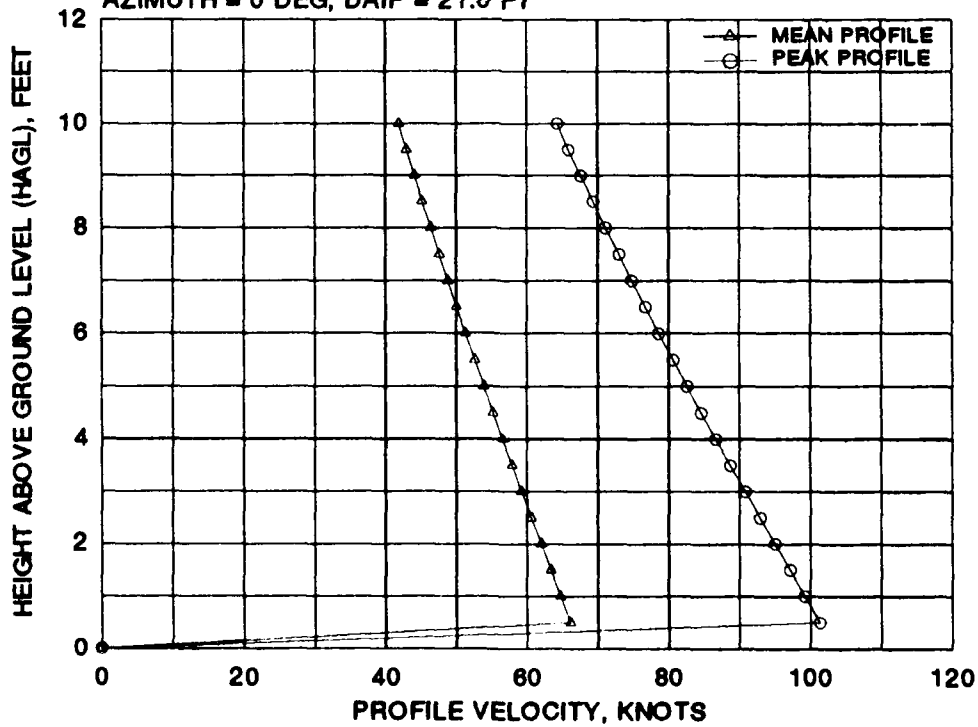
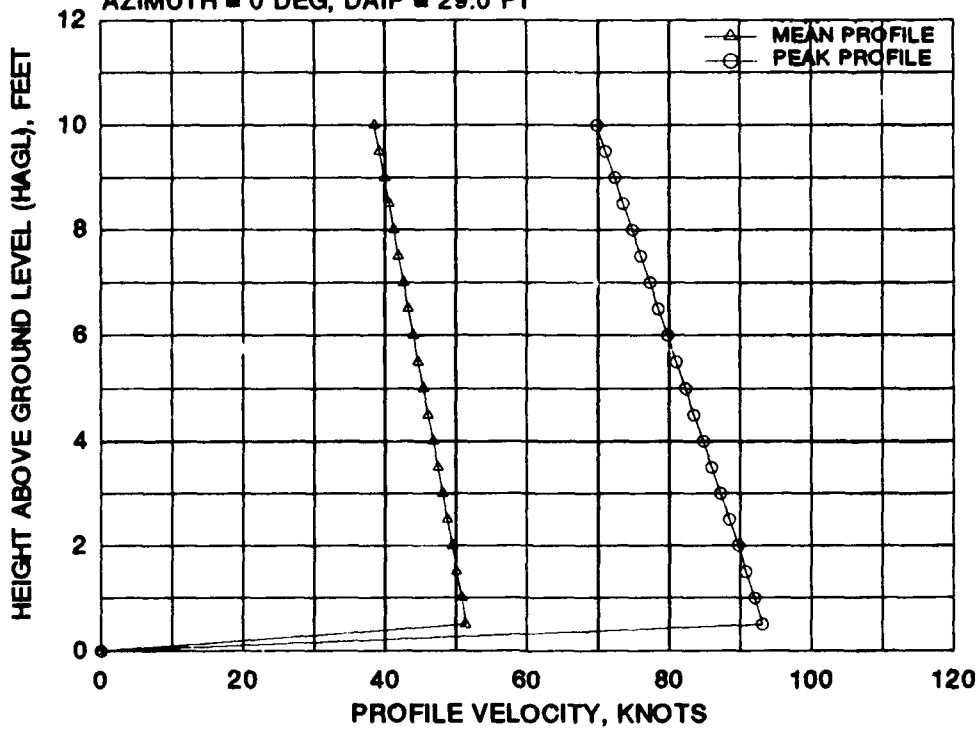

FIGURE I-3 CANADAIR CL-84 MEAN AND PEAK VELOCITY PROFILES FOR EIGHT 0 DEGREE AZIMUTH RADIAL STATIONS AT A WHEEL HEIGHT OF 15 FEET AND A GROSS WEIGHT OF 12,200 POUNDS

CANADAIR CL-84
 GW = 12200 LB, WAGL = 15 FT
 AZIMUTH = 0 DEG, DAIP = 29.0 FT



CANADAIR CL-84
 GW = 12200 LB, WAGL = 15 FT
 AZIMUTH = 0 DEG, DAIP = 35.0 FT

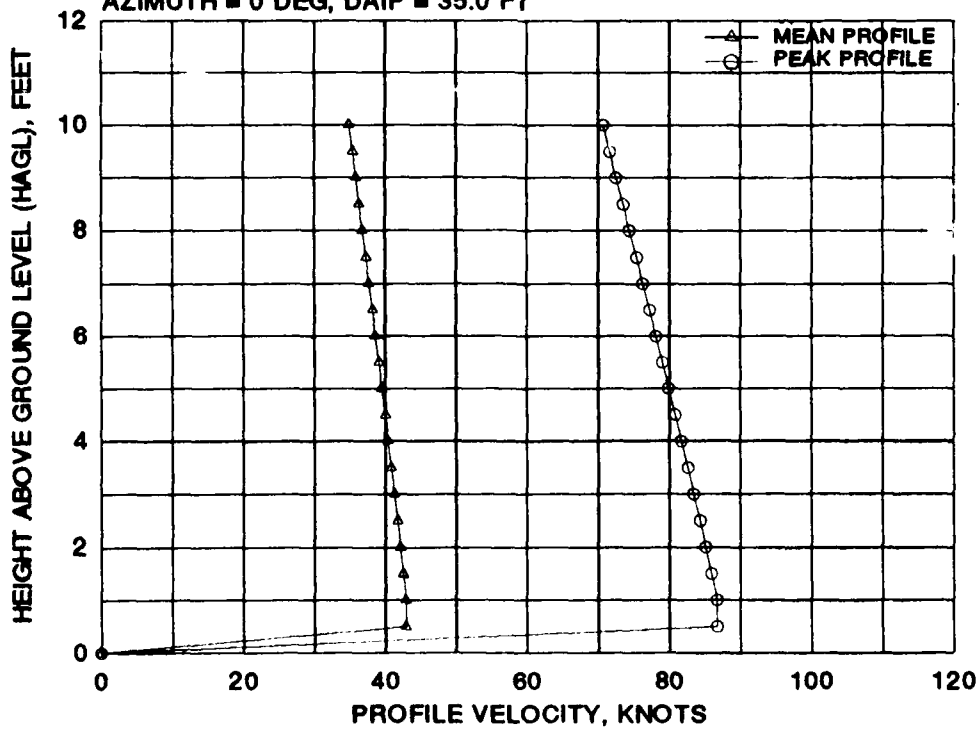

FIGURE I-3 CANADAIR CL-84 MEAN AND PEAK VELOCITY PROFILES FOR EIGHT 0 DEGREE AZIMUTH RADIAL STATIONS AT A WHEEL HEIGHT OF 15 FEET AND A GROSS WEIGHT OF 12,200 POUNDS (Continued)

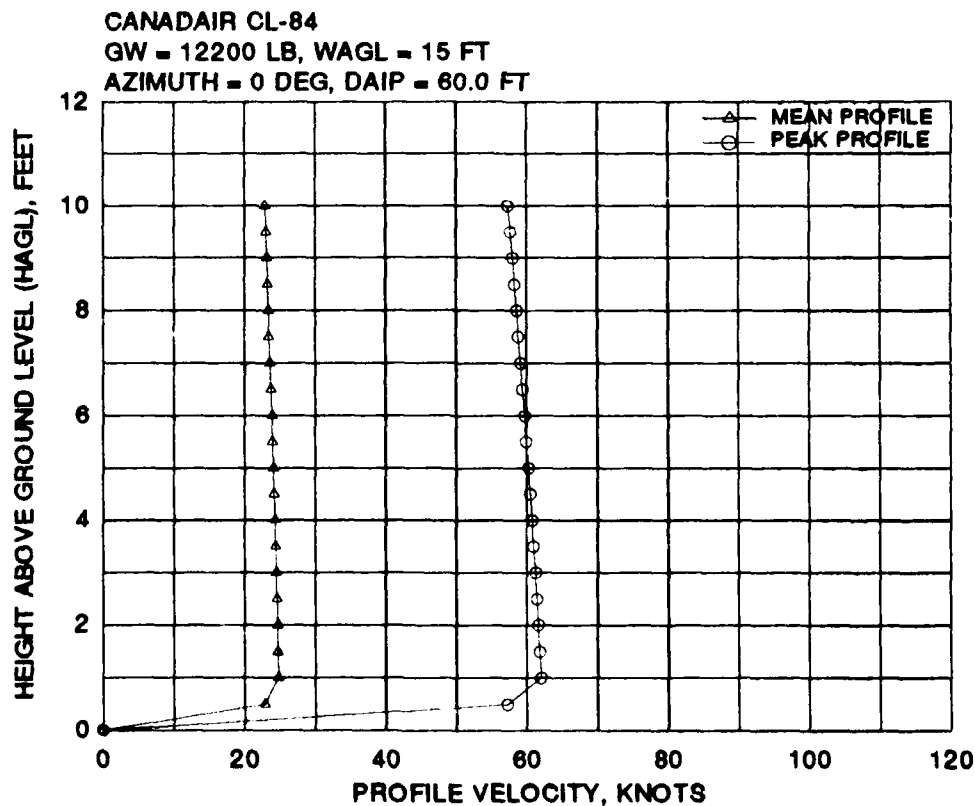
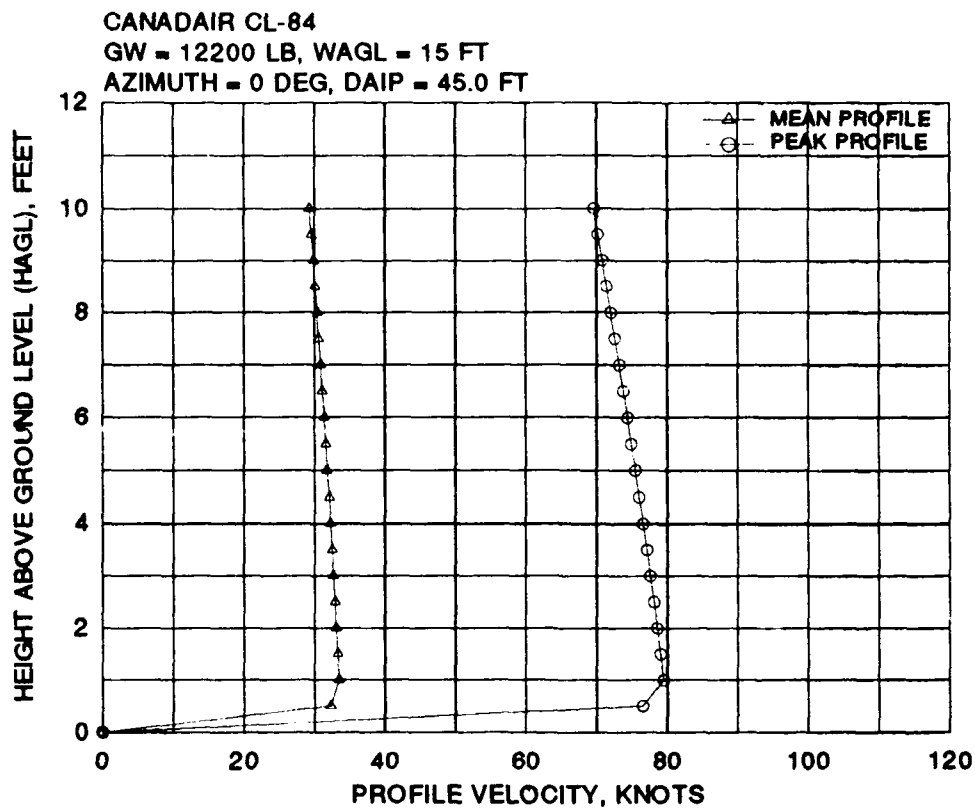
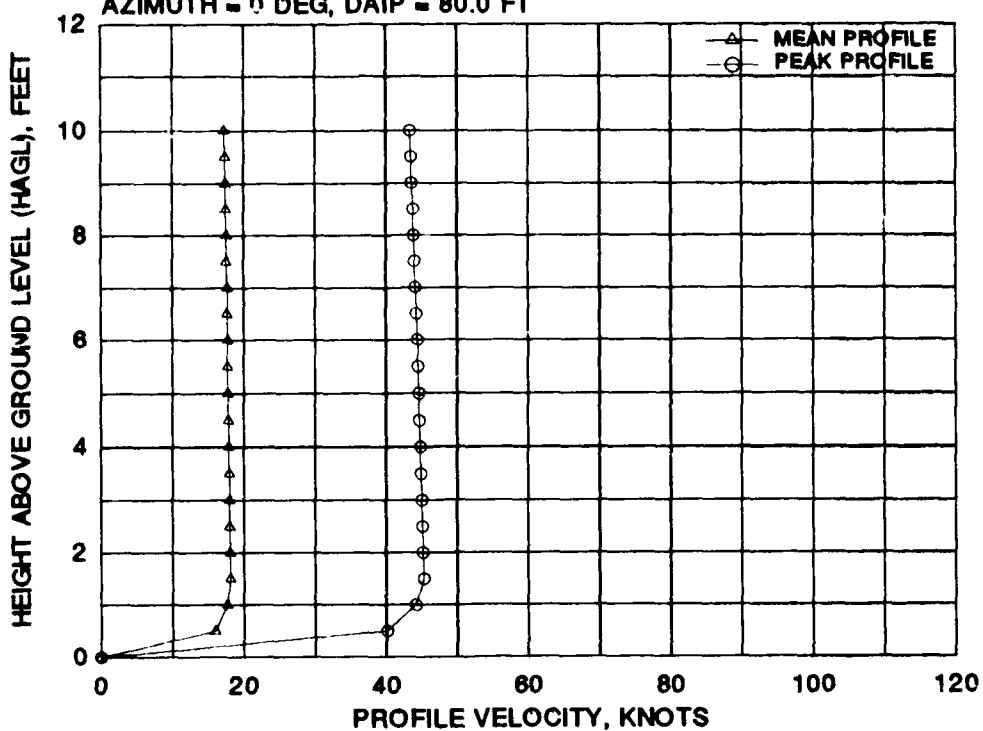

FIGURE I-3 CANADAIR CL-84 MEAN AND PEAK VELOCITY PROFILES FOR EIGHT 0 DEGREE AZIMUTH RADIAL STATIONS AT A WHEEL HEIGHT OF 15 FEET AND A GROSS WEIGHT OF 12,200 POUNDS (Continued)

CANADAIR CL-84
 GW = 12200 LB, WAGL = 15 FT
 AZIMUTH = 0 DEG, DAIP = 80.0 FT



CANADAIR CL-84
 GW = 12200 LB, WAGL = 15 FT
 AZIMUTH = 0 DEG, DAIP = 100.0 FT

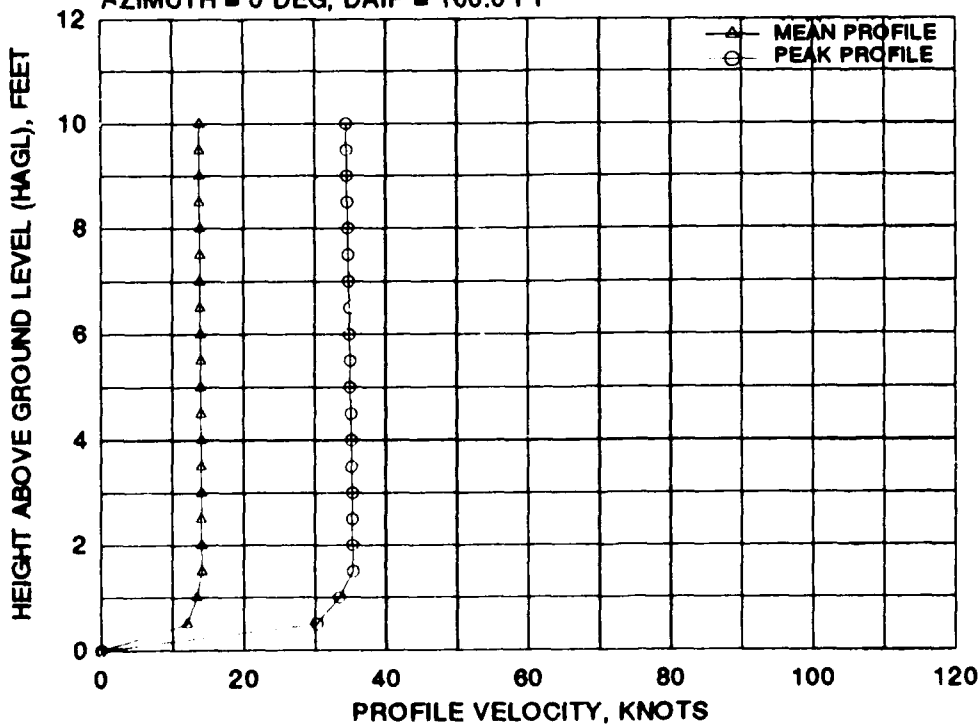

FIGURE I-3 CANADAIR CL-84 MEAN AND PEAK VELOCITY PROFILES FOR EIGHT 0 DEGREE AZIMUTH RADIAL STATIONS AT A WHEEL HEIGHT OF 15 FEET AND A GROSS WEIGHT OF 12,200 POUNDS (Concluded)

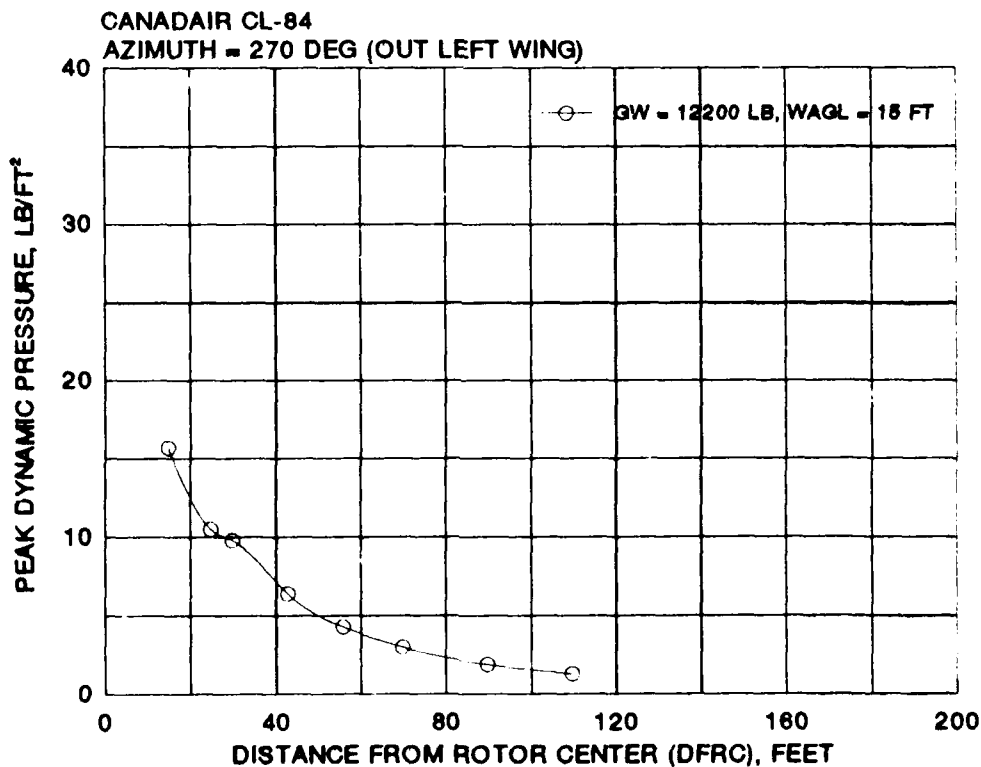
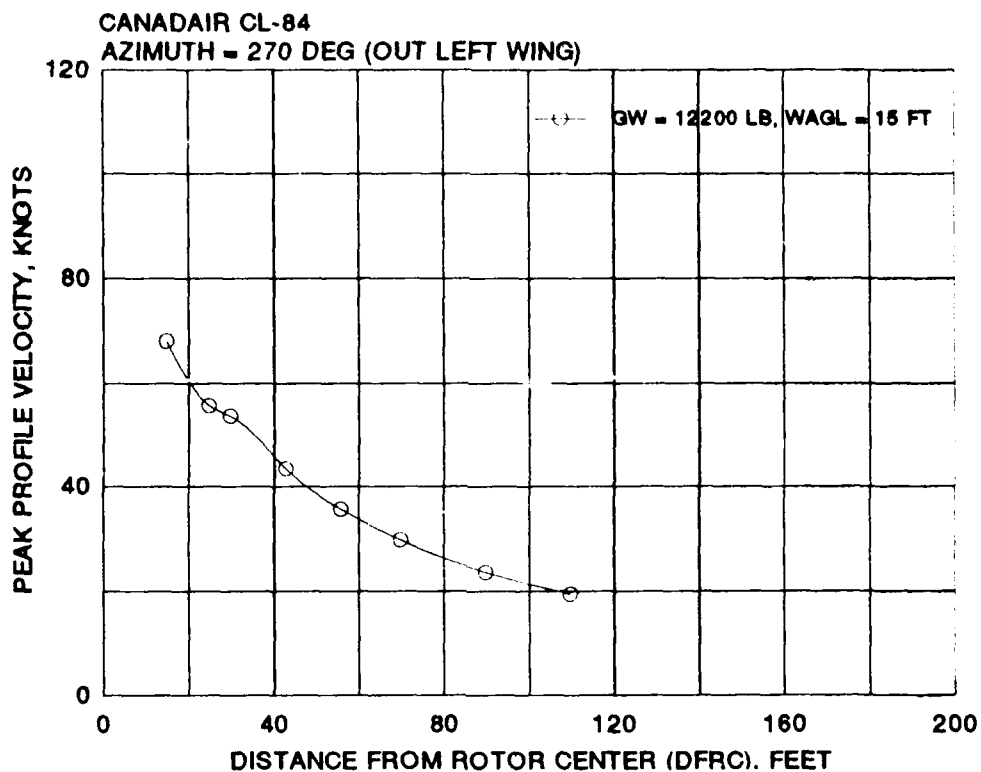

FIGURE I-4 CANADAIR CL-84 PEAK ROTORWASH VELOCITY AND DYNAMIC PRESSURE AS A FUNCTION OF DISTANCE FROM THE ROTOR CENTER (270 DEGREE AZIMUTH)

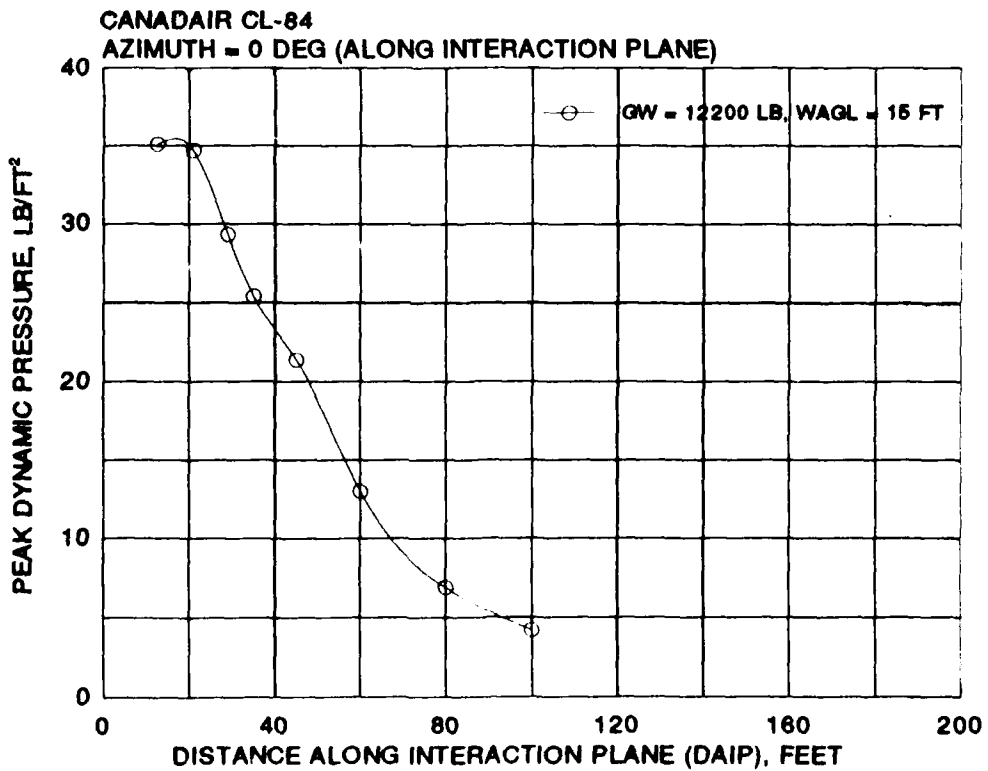
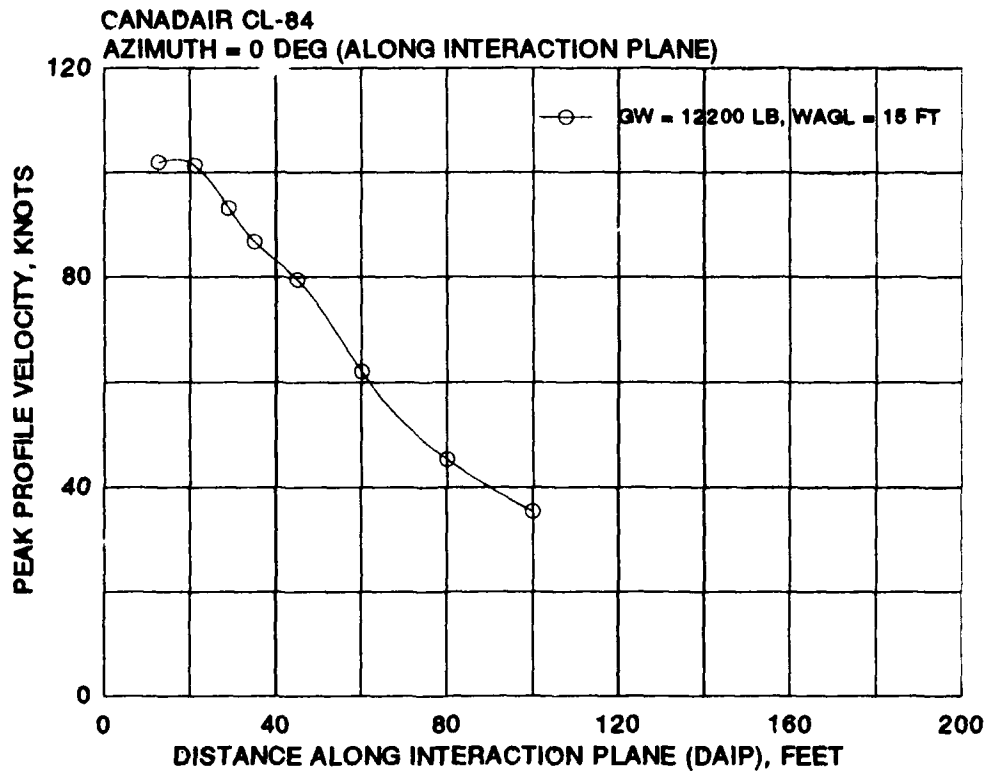

FIGURE I-5 CANADAIR CL-84 PEAK ROTORWASH VELOCITY AND DYNAMIC PRESSURE AS A FUNCTION OF DISTANCE ALONG THE INTERACTION PLANE (0 DEGREE AZIMUTH)

CANADAIR CL-84
AZIMUTH = 270 DEG (OUT LEFT WING)

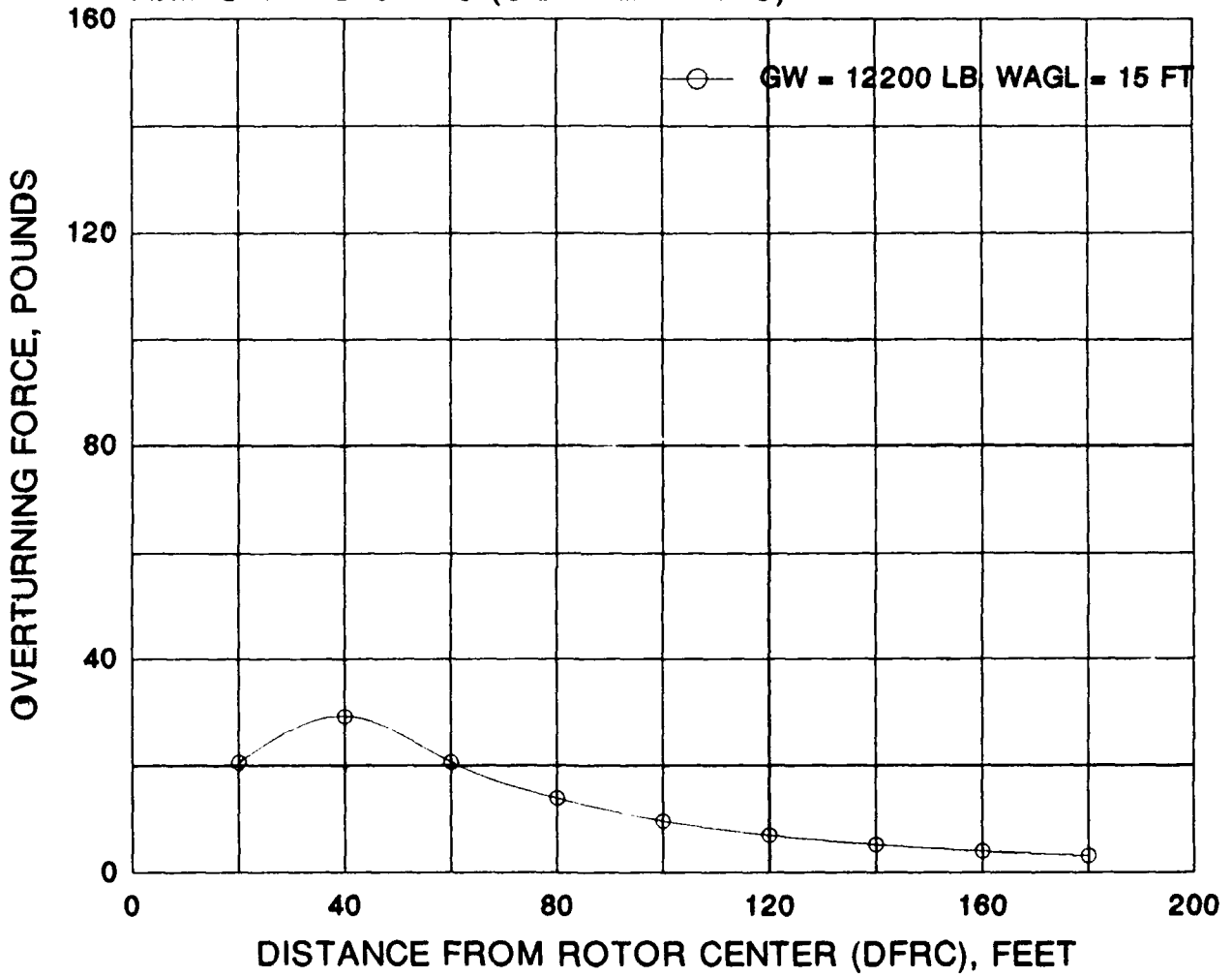

FIGURE I-6 CANADAIR CL-84 OVERTURNING FORCE AS A FUNCTION OF DISTANCE FROM THE ROTOR CENTER (270 DEGREE AZIMUTH)

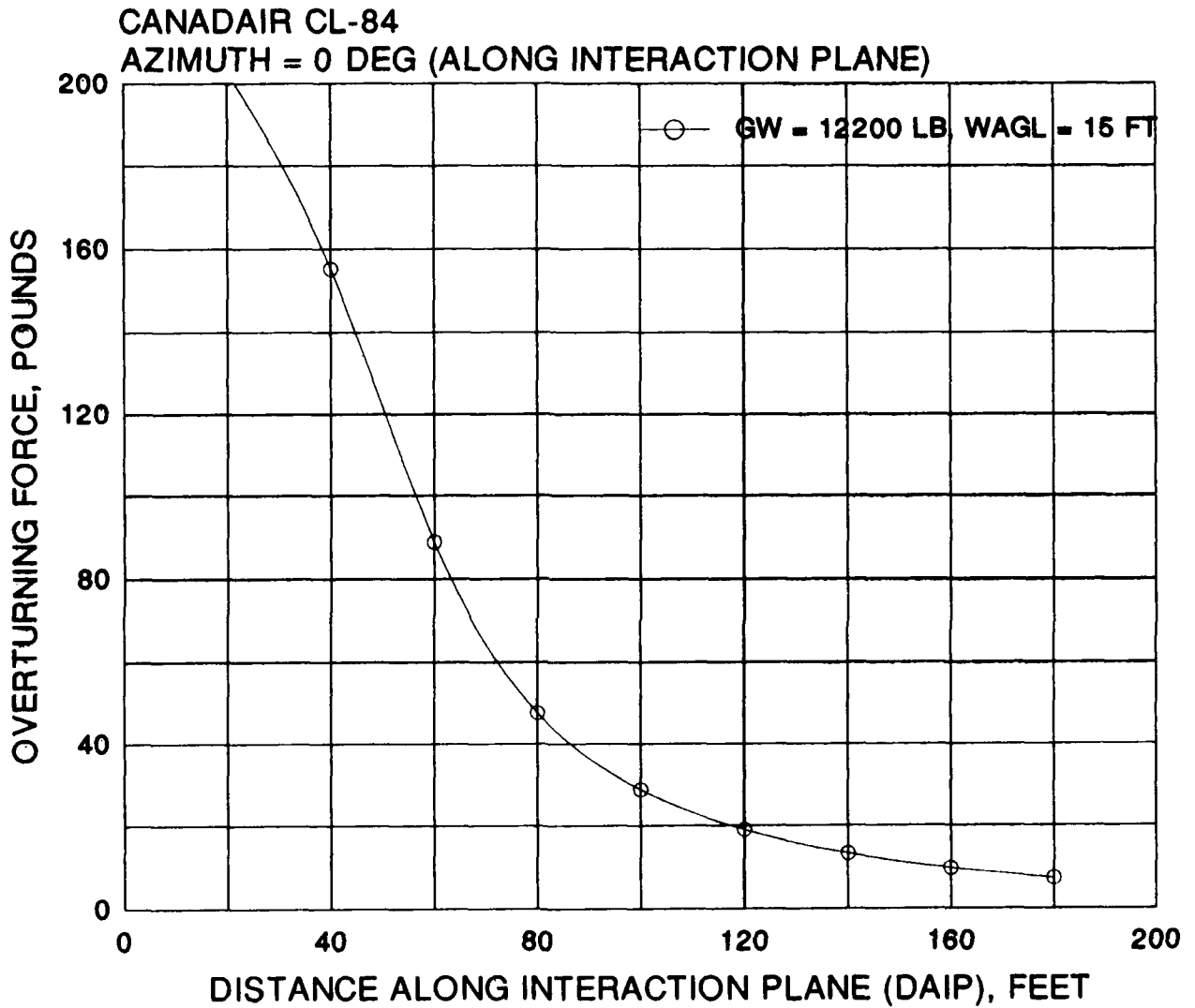

FIGURE I-7 CANADAIR CL-84 OVERTURNING FORCE AS A FUNCTION OF DISTANCE ALONG THE INTERACTION PLANE (0 DEGREE AZIMUTH)

APPENDIX J

ISHIDA TW-68 AIRCRAFT AND ROTORWASH DATA

Ishida TW-68 aircraft characteristics used with the ROTWASH analysis program are listed in table J-1 as obtained from reference J-1. Figure J-1 presents a three-view drawing of the tiltwing. Table J-2 provides a summary tabulation of parameters defining the conditions for all rotorwash data presented in the appendix. All data are plotted in one of four formats, which include graphs of:

1. mean and peak outwash velocity profiles,
2. peak outwash velocity versus distance,
3. peak outwash dynamic pressure versus distance, and
4. personnel overturning force versus distance.

In each format, data are plotted along both the 0 and 270 degree azimuth. Distance from rotor center (DFRC) is the independent variable along the 270 degree azimuth. Measurements of distance from aircraft center (DFAC) are also noted on the graphs. The DFAC reference point is defined as zero at the location where the aircraft centerline intersects the line connecting the two rotor centers of rotation. Along the 0 degree azimuth, distance along the interaction plane (DAIP) is the independent variable. This point is referenced as zero at the same location as the DFAC point.

REFERENCES

J-1. Configuration statement provided by DMAV, Inc.

TABLE J-1 TW-68 ROTWASH INPUT DATA

<u>Parameter</u>	<u>Value</u>
Rotor radius, feet	8.33
Distance between rotor centers, feet	24.7
Wing download, percent of rotor thrust	2.5
Distance from wheels to rotor plane, feet	14.4
Rotor speed, RPM	589.0
Rotor tip speed, feet/second	771.0
Number of rotor blades per rotor	5 (?)
Density ratio	1.0

TW-68 GENERAL ARRANGEMENT

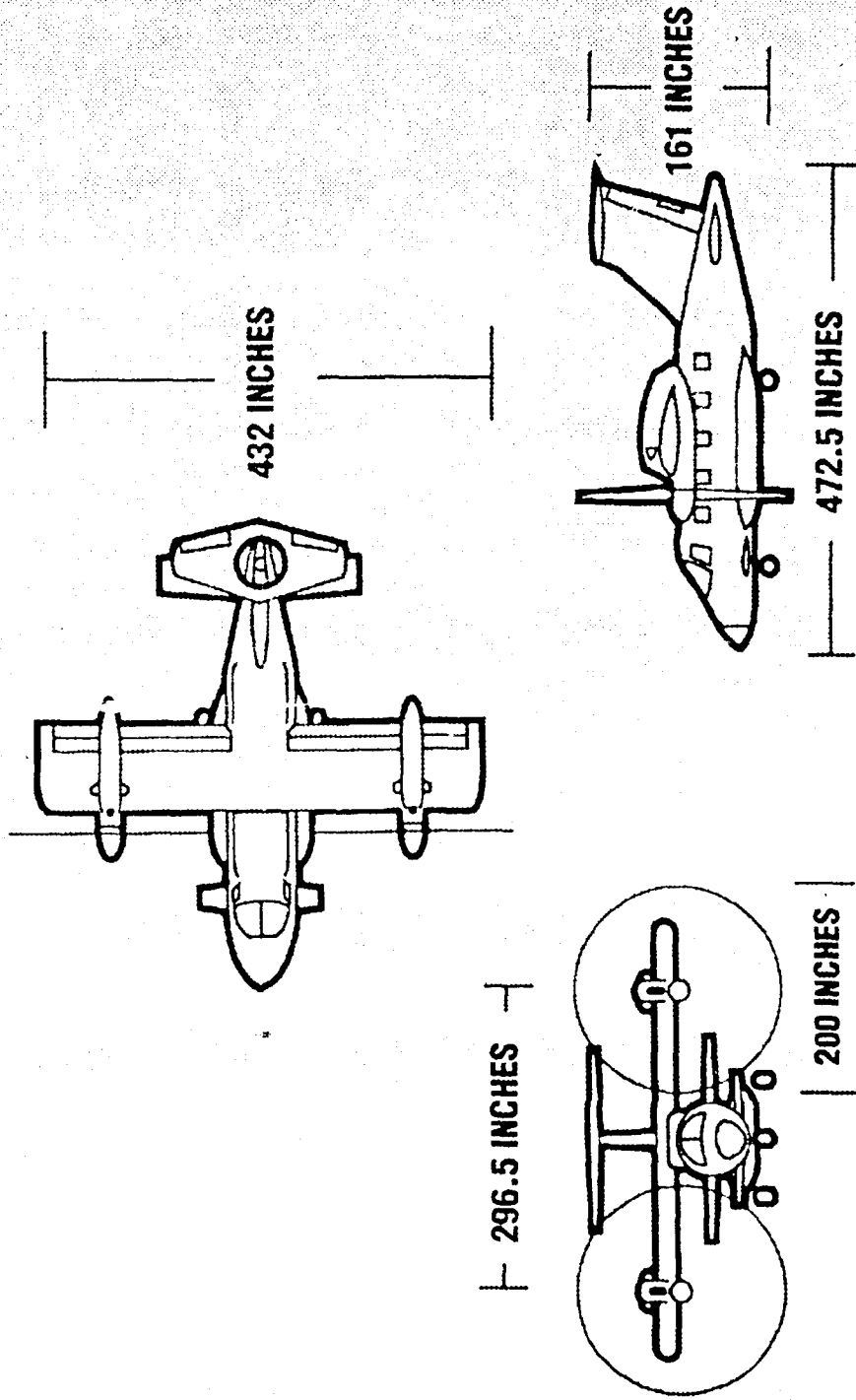

FIGURE J-1 THREE-VIEW DRAWING OF THE ISHIDA TW-68

TABLE J-2 TW-68 ROTORWASH EVALUATION MATRIX

Note: The Figure/Type column provides the figure number and data format type where:

M/P - Mean and peak velocity profile format

PVD - Peak velocity and dynamic pressure format

OTF - Personnel overturning force format

<u>Figure/ Type</u>	<u>Azimuth, Degrees</u>	<u>GW, Pounds</u>	<u>WAGL, Feet</u>	<u>DFRC or DAIP Distance, Feet</u>
J-2 M/P	270.0	12,500	15	12.7, 22.7, 27.7, 40.7, 53.7, 67.7, 87.7, 107.7
J-3 M/P	0.0	12,500	15	12.5, 21, 29, 35, 45, 60, 80, 100
J-4 PVD	270.0	12,500	15	15 to 110
J-5 PVD	0.0	12,500	15	15 to 100
J-6 OTF	270.0	12,500	15	20 to 180
J-7 OTF	0.0	12,500	15	20 to 180

ISHIDA TW-68
 GW = 12500 LB, WAGL = 15 FT
 AZIMUTH = 270 DEG, DFAC = 25.0 FT (DFRC = 12.7 FT)

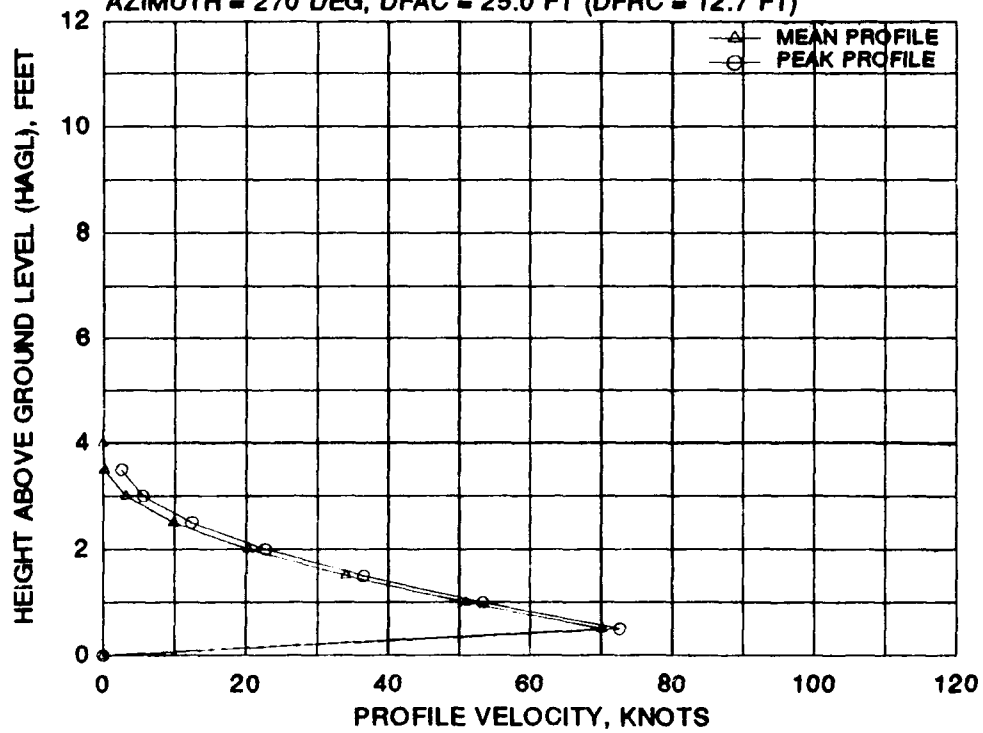

ISHIDA TW-68
 GW = 12500 LB, WAGL = 15 FT
 AZIMUTH = 270 DEG, DFAC = 35.0 FT (DFRC = 22.7 FT)

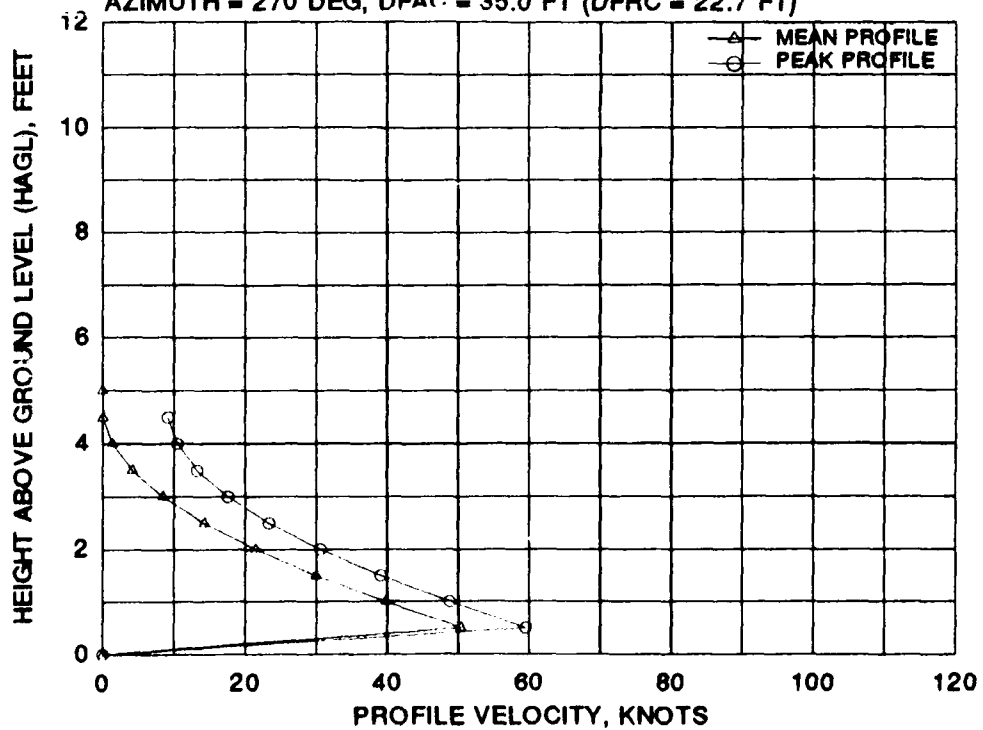
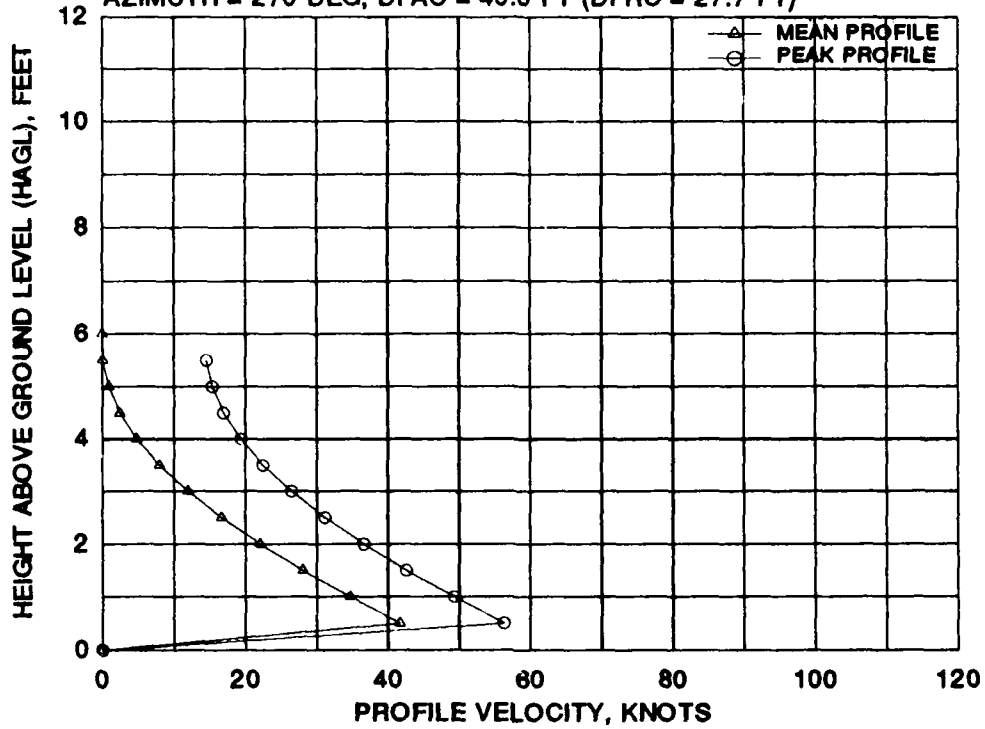

FIGURE J-2 ISHIDA TW-68 MEAN AND PEAK VELOCITY PROFILES FOR EIGHT 270 DEGREE AZIMUTH RADIAL STATIONS AT A WHEEL HEIGHT OF 15 FEET AND A GROSS WEIGHT OF 12,500 POUNDS

ISHIDA TW-68
 GW = 12500 LB, WAGL = 15 FT
 AZIMUTH = 270 DEG, DFAC = 40.0 FT (DFRC = 27.7 FT)



ISHIDA TW-68
 GW = 12500 LB, WAGL = 15 FT
 AZIMUTH = 270 DEG, DFAC = 53.0 FT (DFRC = 40.7 FT)

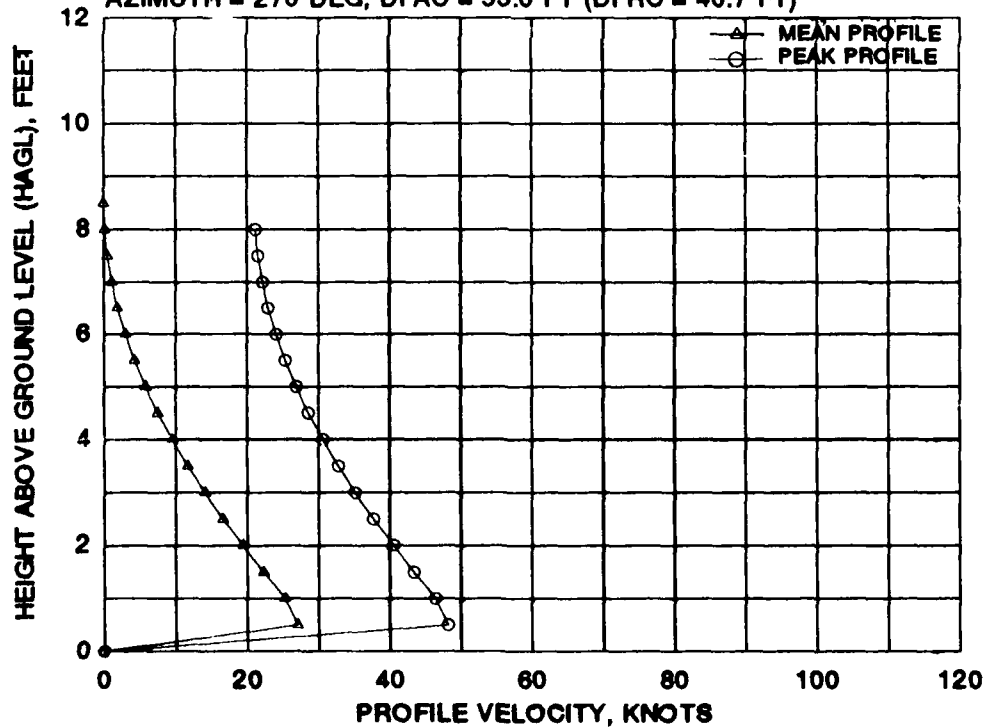

FIGURE J-2 ISHIDA TW-68 MEAN AND PEAK VELOCITY PROFILES FOR EIGHT 270 DEGREE AZIMUTH RADIAL STATIONS AT A WHEEL HEIGHT OF 15 FEET AND A GROSS WEIGHT OF 12,500 POUNDS (Continued)

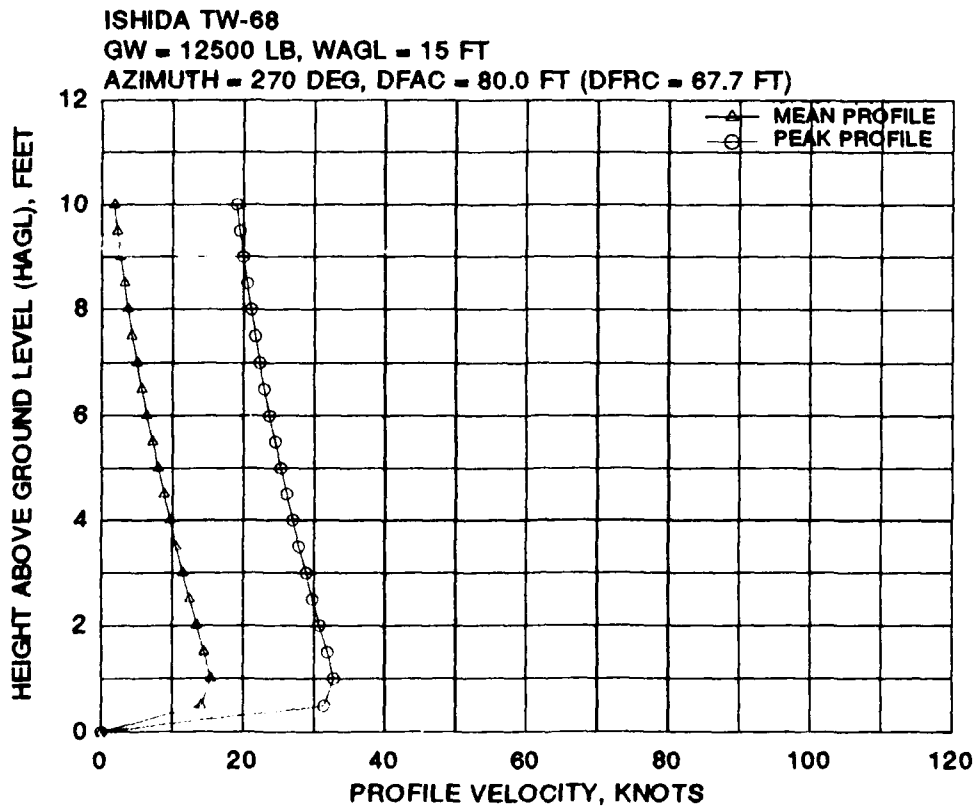
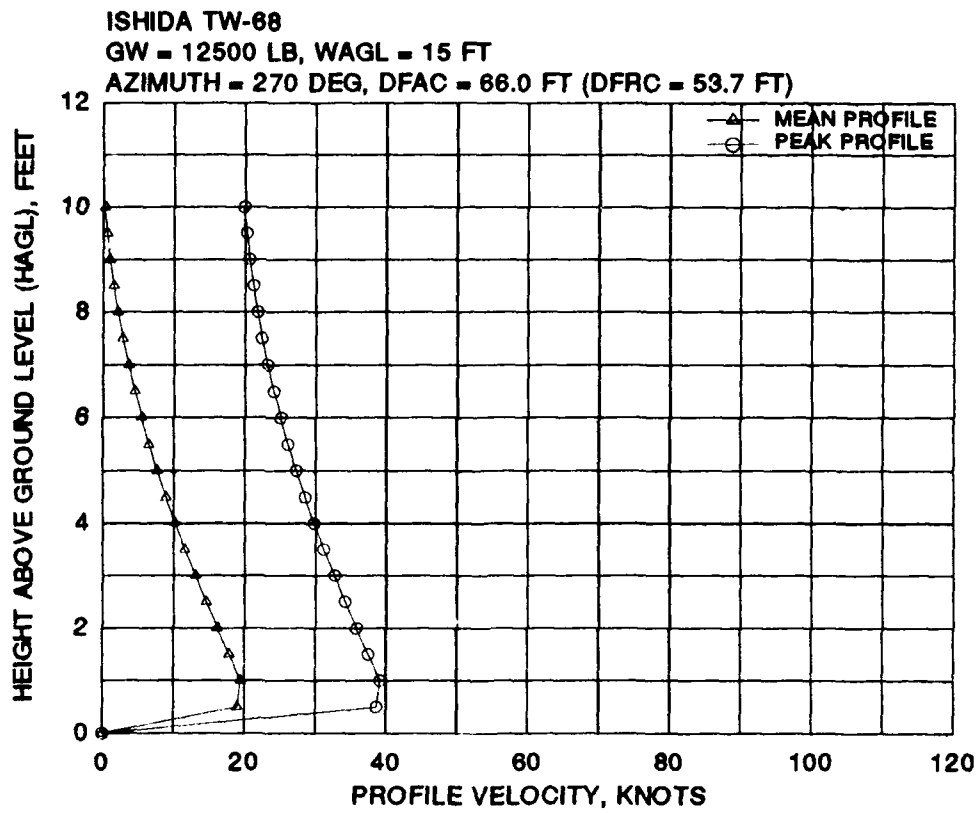
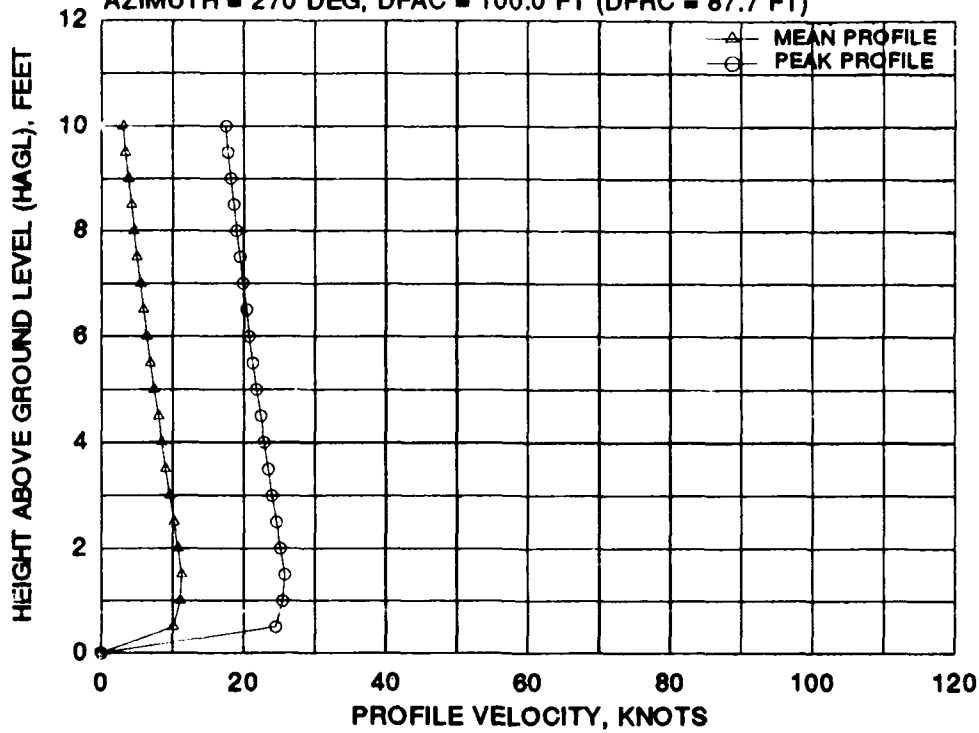

FIGURE J-2 ISHIDA TW-68 MEAN AND PEAK VELOCITY PROFILES FOR EIGHT 270 DEGREE AZIMUTH RADIAL STATIONS AT A WHEEL HEIGHT OF 15 FEET AND A GROSS WEIGHT OF 12,500 POUNDS (Continued)

ISHIDA TW-68
 GW = 12500 LB, WAGL = 15 FT
 AZIMUTH = 270 DEG, DFAC = 100.0 FT (DFRC = 87.7 FT)



ISHIDA TW-68
 GW = 12500 LB, WAGL = 15 FT
 AZIMUTH = 270 DEG, DFAC = 120.0 FT (DFRC = 107.7 FT)

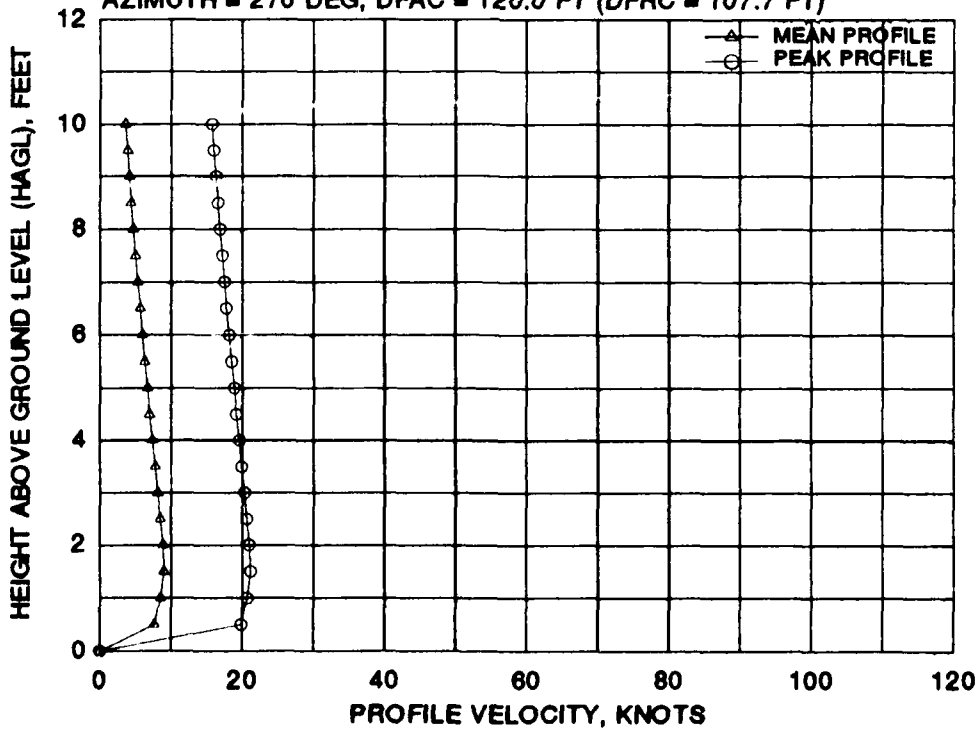
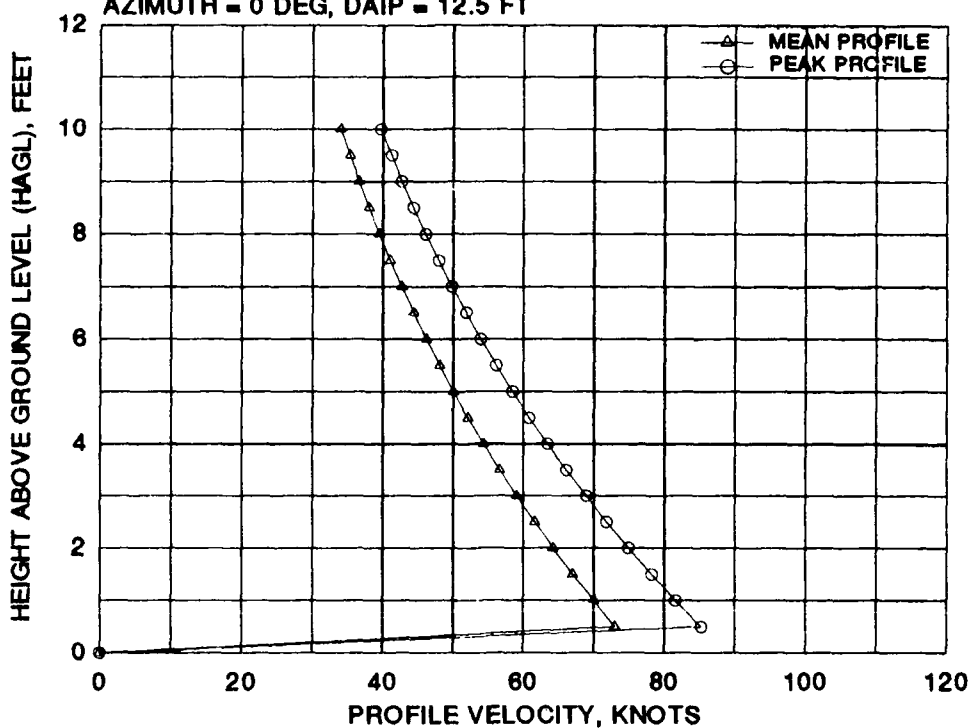

FIGURE J-2 ISHIDA TW-68 MEAN AND PEAK VELOCITY PROFILES FOR EIGHT 270 DEGREE AZIMUTH RADIAL STATIONS AT A WHEEL HEIGHT OF 15 FEET AND A GROSS WEIGHT OF 12,500 POUNDS (Concluded)

ISHIDA TW-68
 GW = 12500 LB, WAGL = 15 FT
 AZIMUTH = 0 DEG, DAIP = 12.5 FT



ISHIDA TW-68
 GW = 12500 LB, WAGL = 15 FT
 AZIMUTH = 0 DEG, DAIP = 21.0 FT

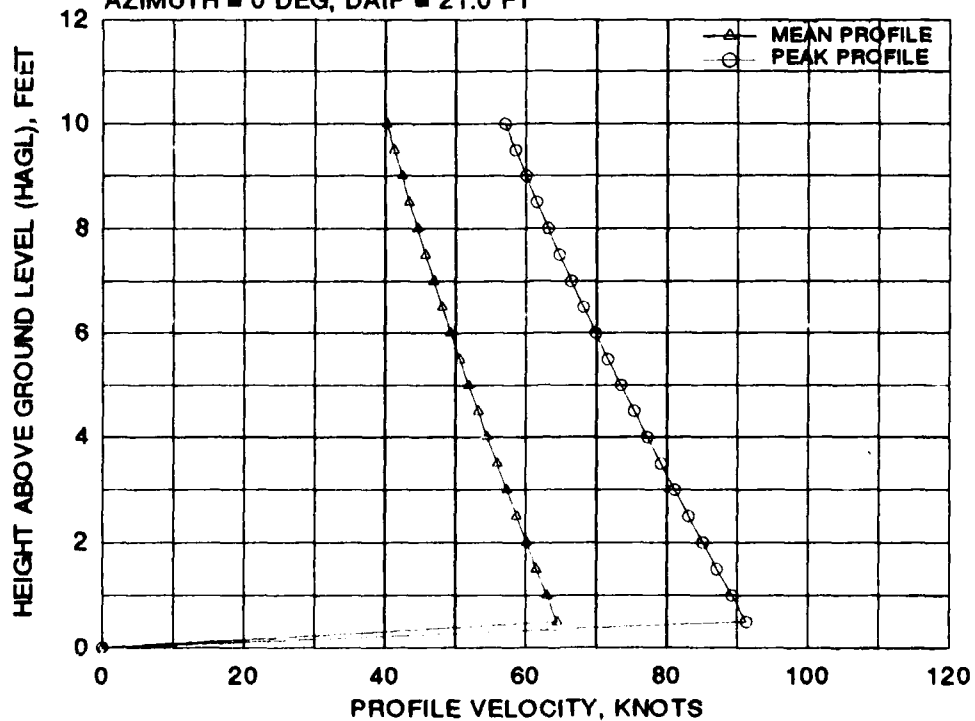
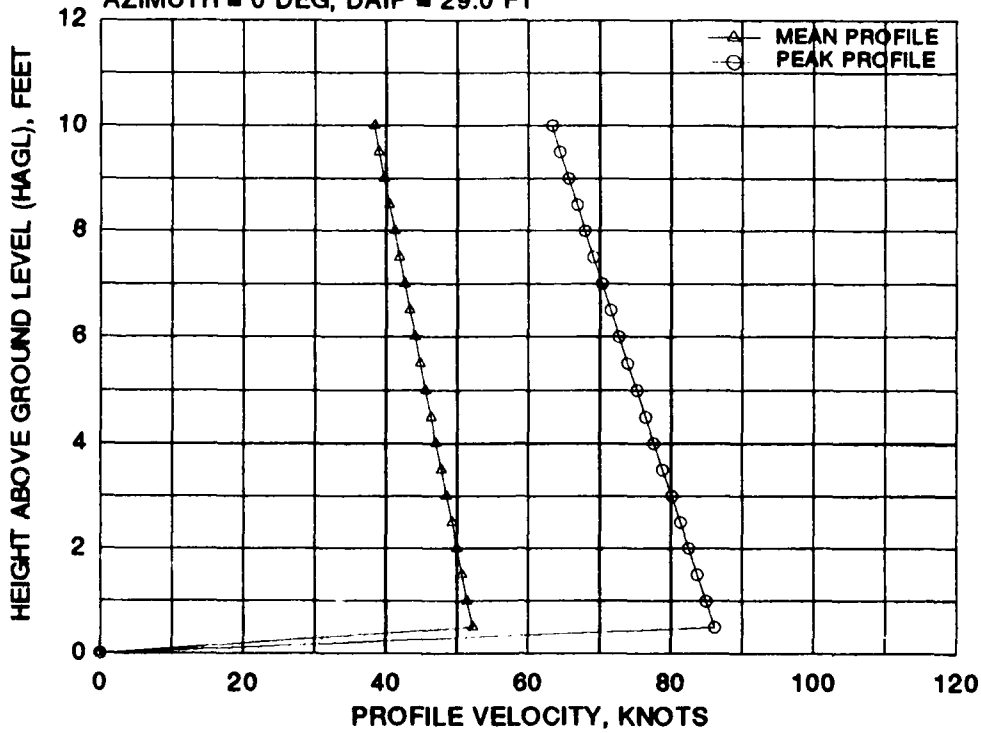

FIGURE J-3 ISHIDA TW-68 MEAN AND PEAK VELOCITY PROFILES FOR EIGHT 0 DEGREE AZIMUTH RADIAL STATIONS AT A WHEEL HEIGHT OF 15 FEET AND A GROSS WEIGHT OF 12,500 POUNDS

ISHIDA TW-68
 GW = 12500 LB, WAGL = 15 FT
 AZIMUTH = 0 DEG, DAIP = 29.0 FT



ISHIDA TW-68
 GW = 12500 LB, WAGL = 15 FT
 AZIMUTH = 0 DEG, DAIP = 35.0 FT

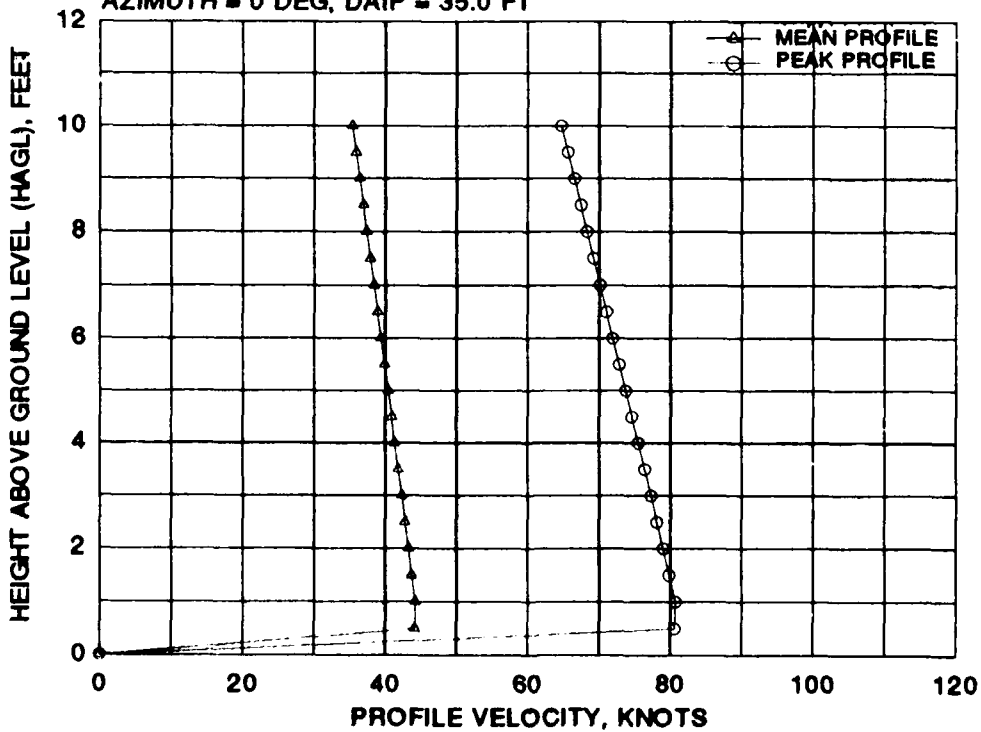
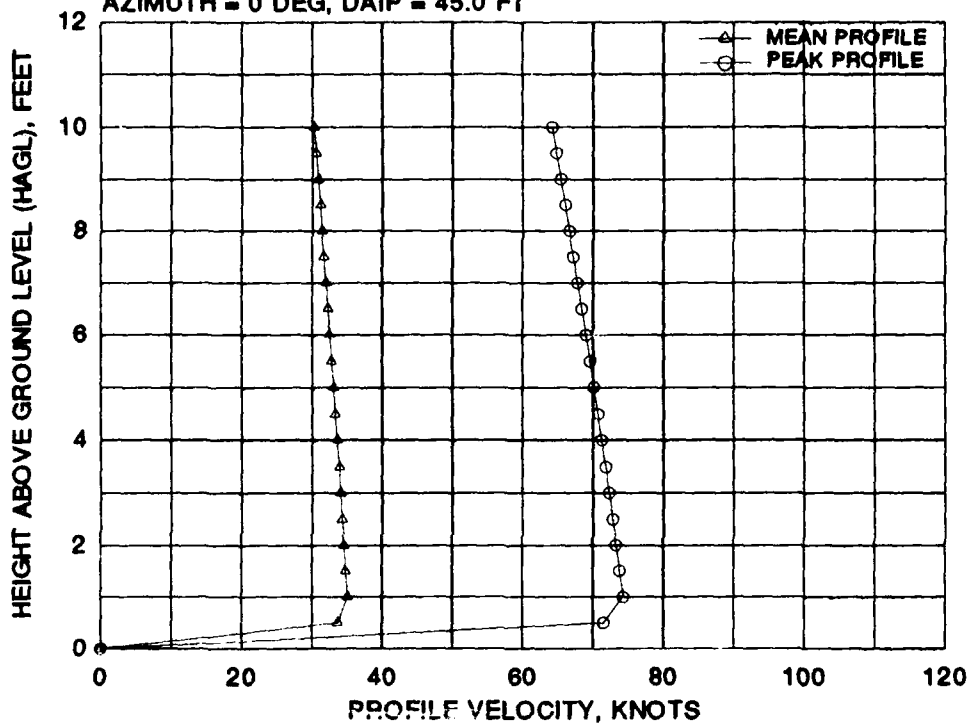

FIGURE J-3 ISHIDA TW-68 MEAN AND PEAK VELOCITY PROFILES FOR EIGHT 0 DEGREE AZIMUTH RADIAL STATIONS AT A WHEEL HEIGHT OF 15 FEET AND A GROSS WEIGHT OF 12,500 POUNDS (Continued)

ISHIDA TW-68
 GW = 12500 LB, WAGL = 15 FT
 AZIMUTH = 0 DEG, DAIP = 45.0 FT



ISHIDA TW-68
 GW = 12500 LB, WAGL = 15 FT
 AZIMUTH = 0 DEG, DAIP = 60.0 FT

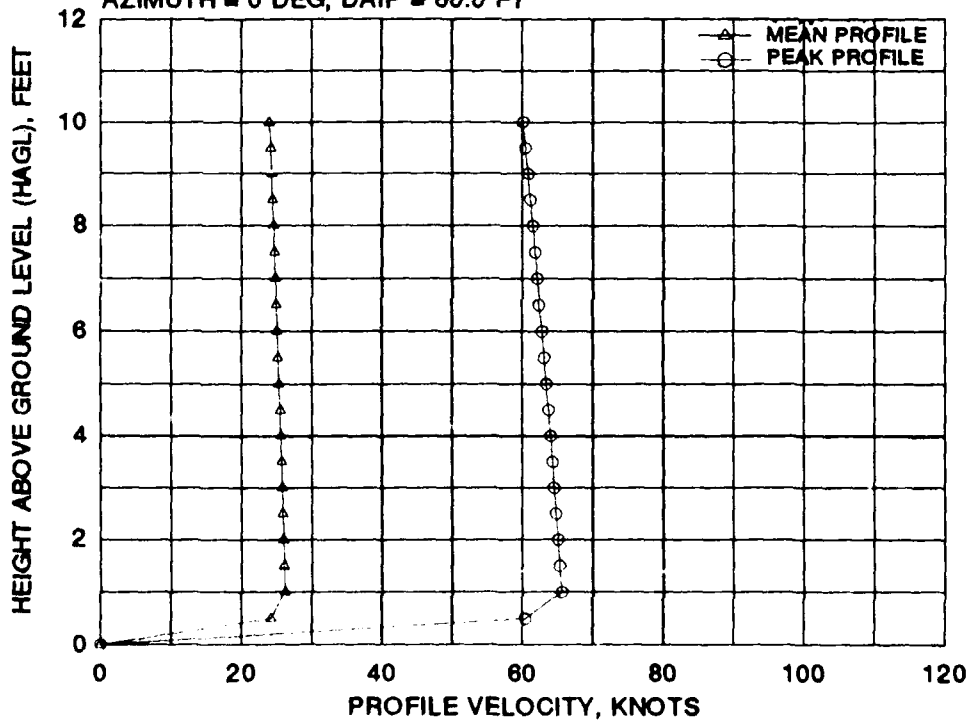
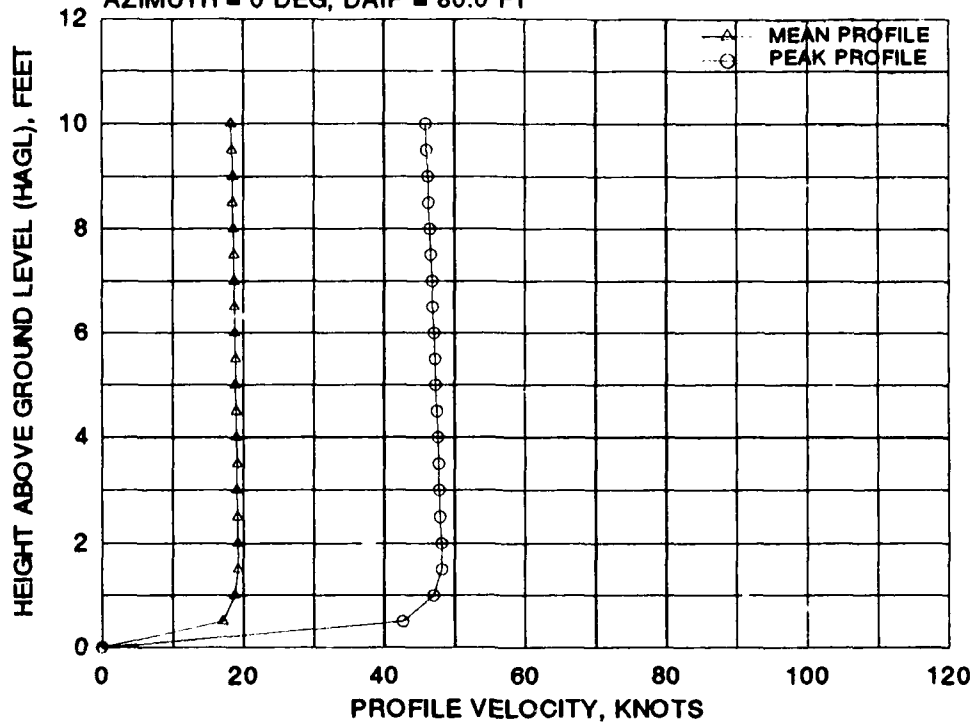

FIGURE J-3 ISHIDA TW-68 MEAN AND PEAK VELOCITY PROFILES FOR EIGHT 0 DEGREE AZIMUTH RADIAL STATIONS AT A WHEEL HEIGHT OF 15 FEET AND A GROSS WEIGHT OF 12,500 POUNDS (Continued)

ISHIDA TW-68
 GW = 12500 LB, WAGL = 15 FT
 AZIMUTH = 0 DEG, DAIP = 80.0 FT



ISHIDA TW-68
 GW = 12500 LB, WAGL = 15 FT
 AZIMUTH = 0 DEG, DAIP = 100.0 FT

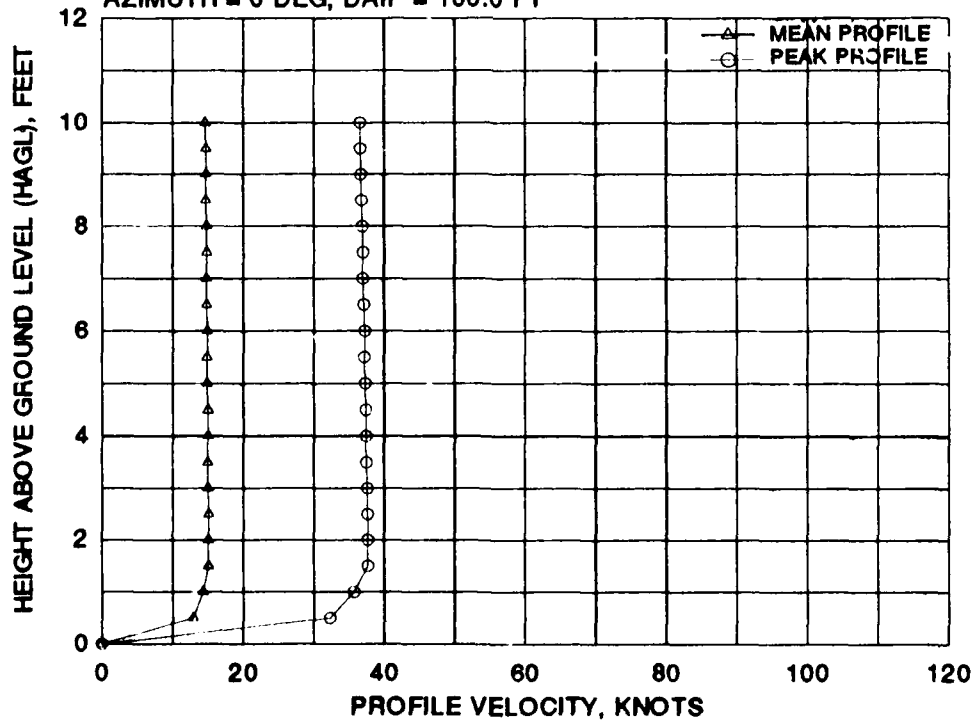

FIGURE J-3 ISHIDA TW-68 MEAN AND PEAK VELOCITY PROFILES FOR EIGHT 0 DEGREE AZIMUTH RADIAL STATIONS AT A WHEEL HEIGHT OF 15 FEET AND A GROSS WEIGHT OF 12,500 POUNDS (Concluded)

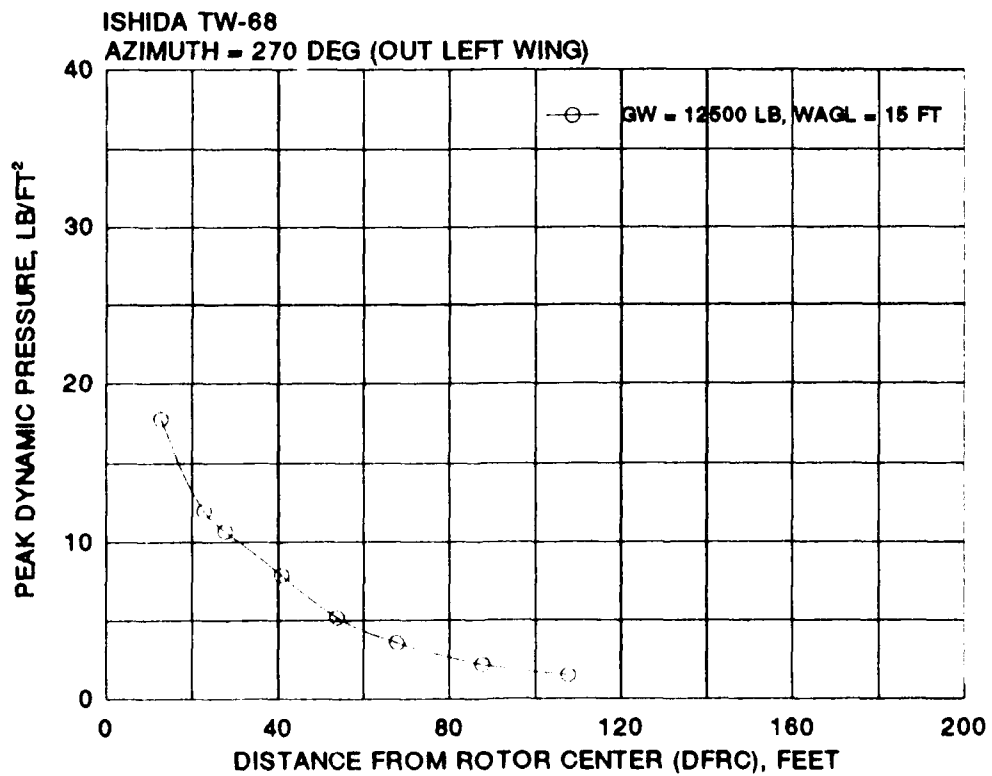
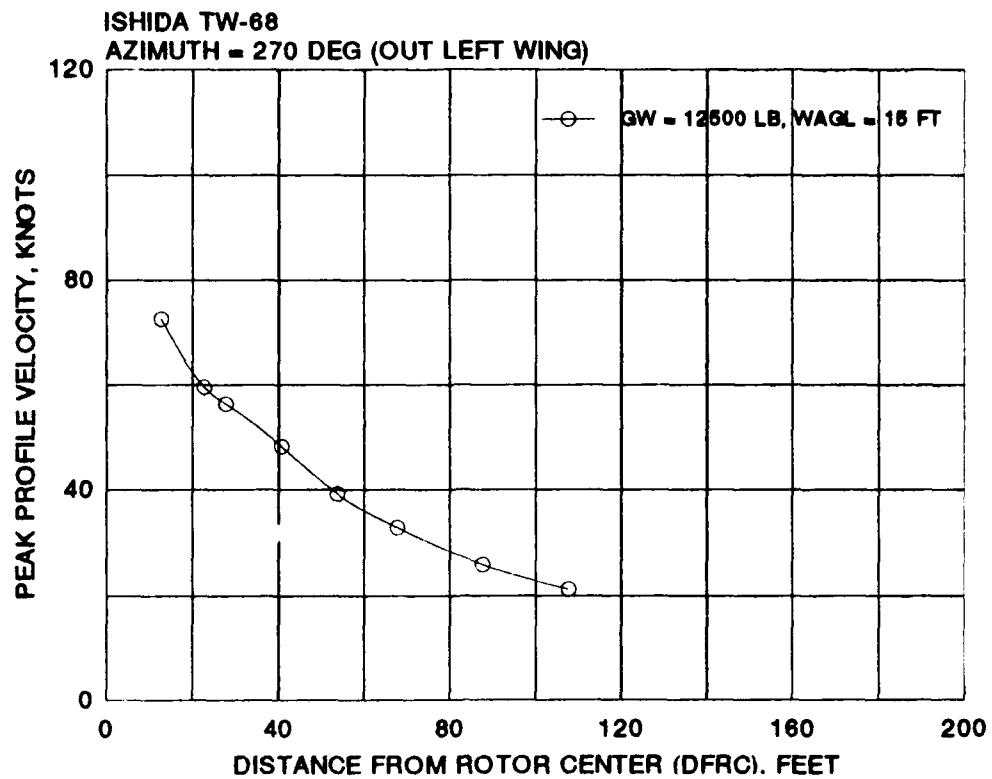

FIGURE J-4 ISHIDA TW-68 PEAK ROTORWASH VELOCITY AND DYNAMIC PRESSURE AS A FUNCTION OF DISTANCE FROM THE ROTOR CENTER (270 DEGREE AZIMUTH)

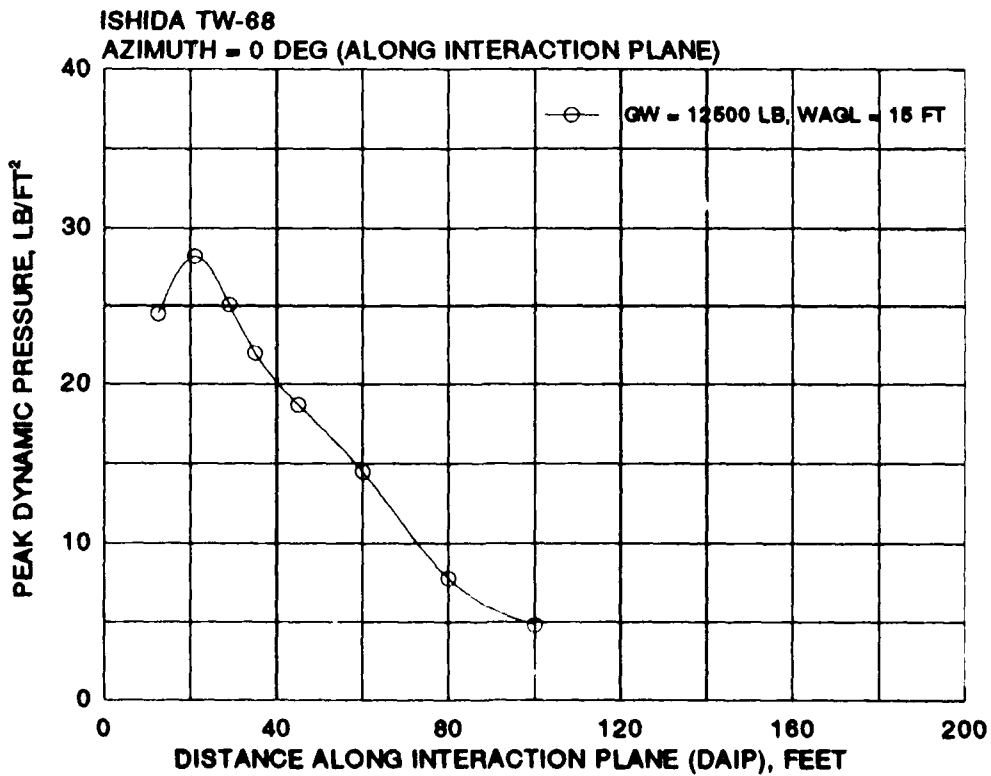
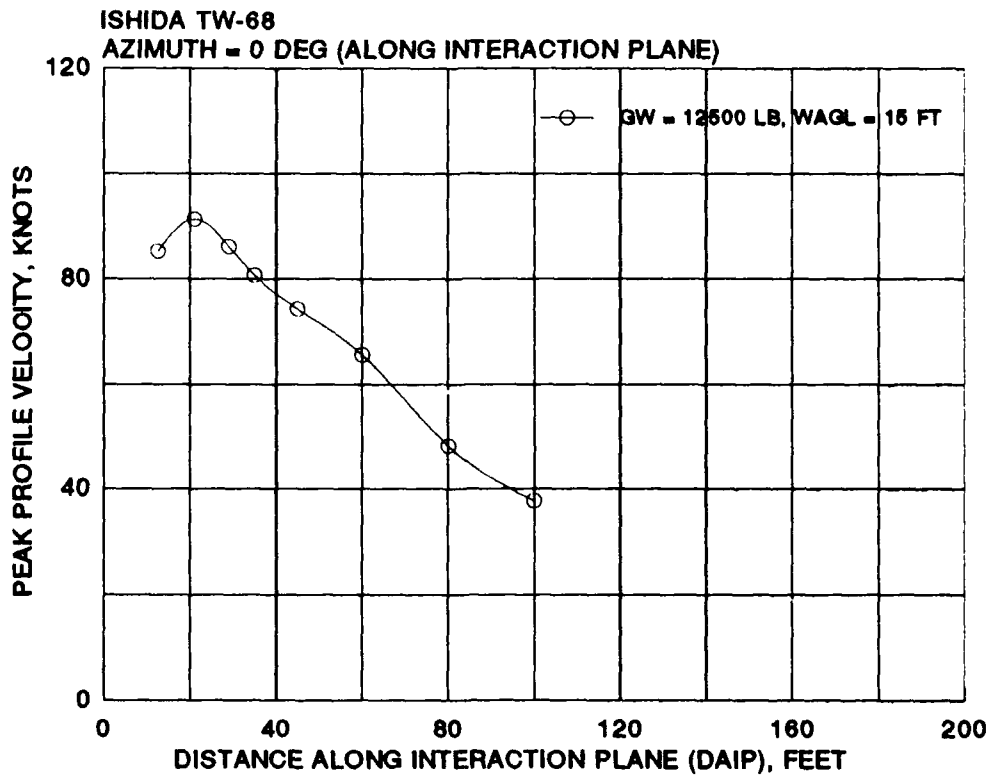

FIGURE J-5 ISHIDA TW-68 PEAK ROTORWASH VELOCITY AND DYNAMIC PRESSURE AS A FUNCTION OF DISTANCE ALONG THE INTERACTION PLANE (0 DEGREE AZIMUTH)

ISHIDA TW-68
AZIMUTH = 270 DEG (OUT LEFT WING)

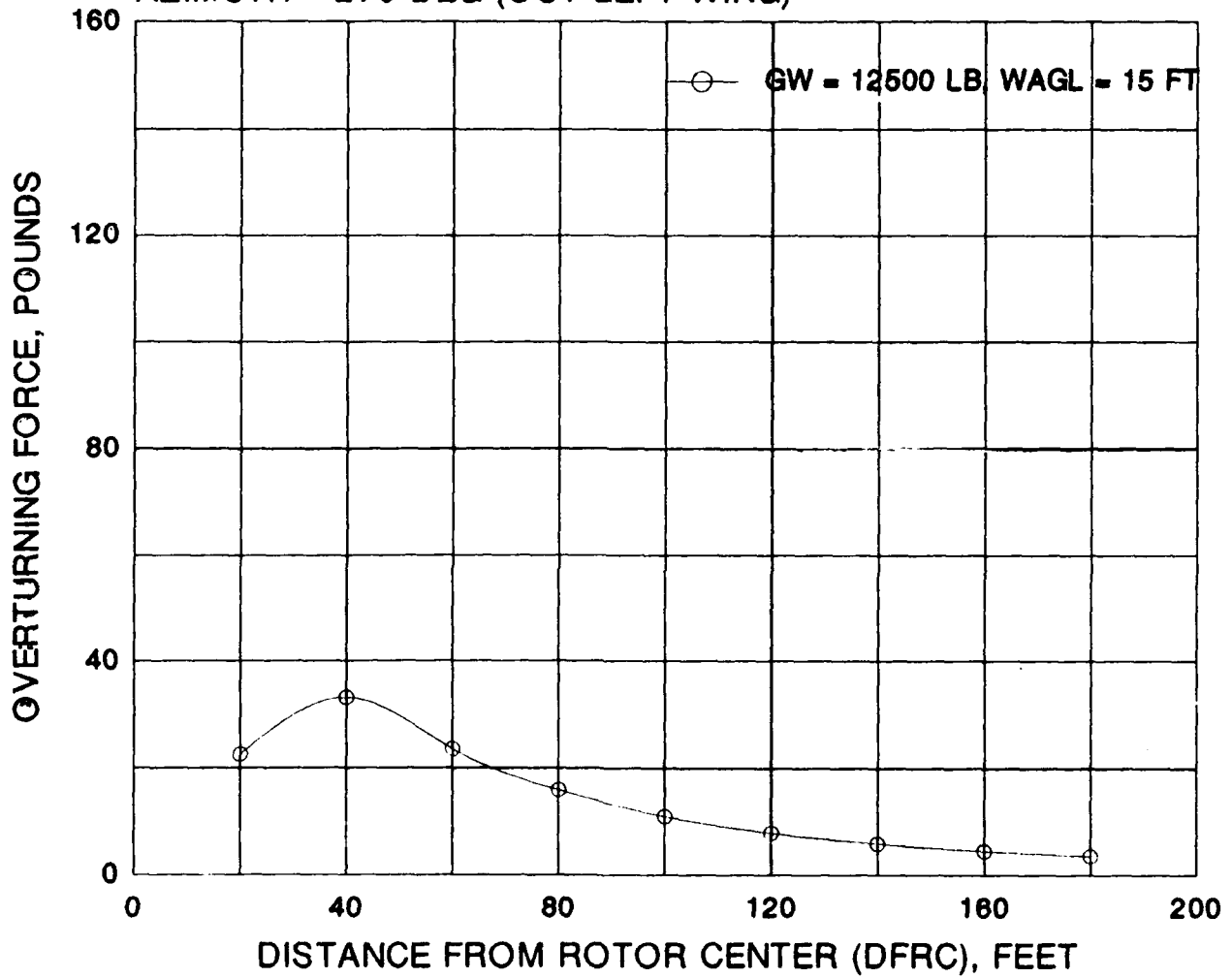

FIGURE J-6 ISHIDA TW-68 OVERTURNING FORCE AS A FUNCTION OF DISTANCE FROM THE ROTOR CENTER (270 DEGREE AZIMUTH)

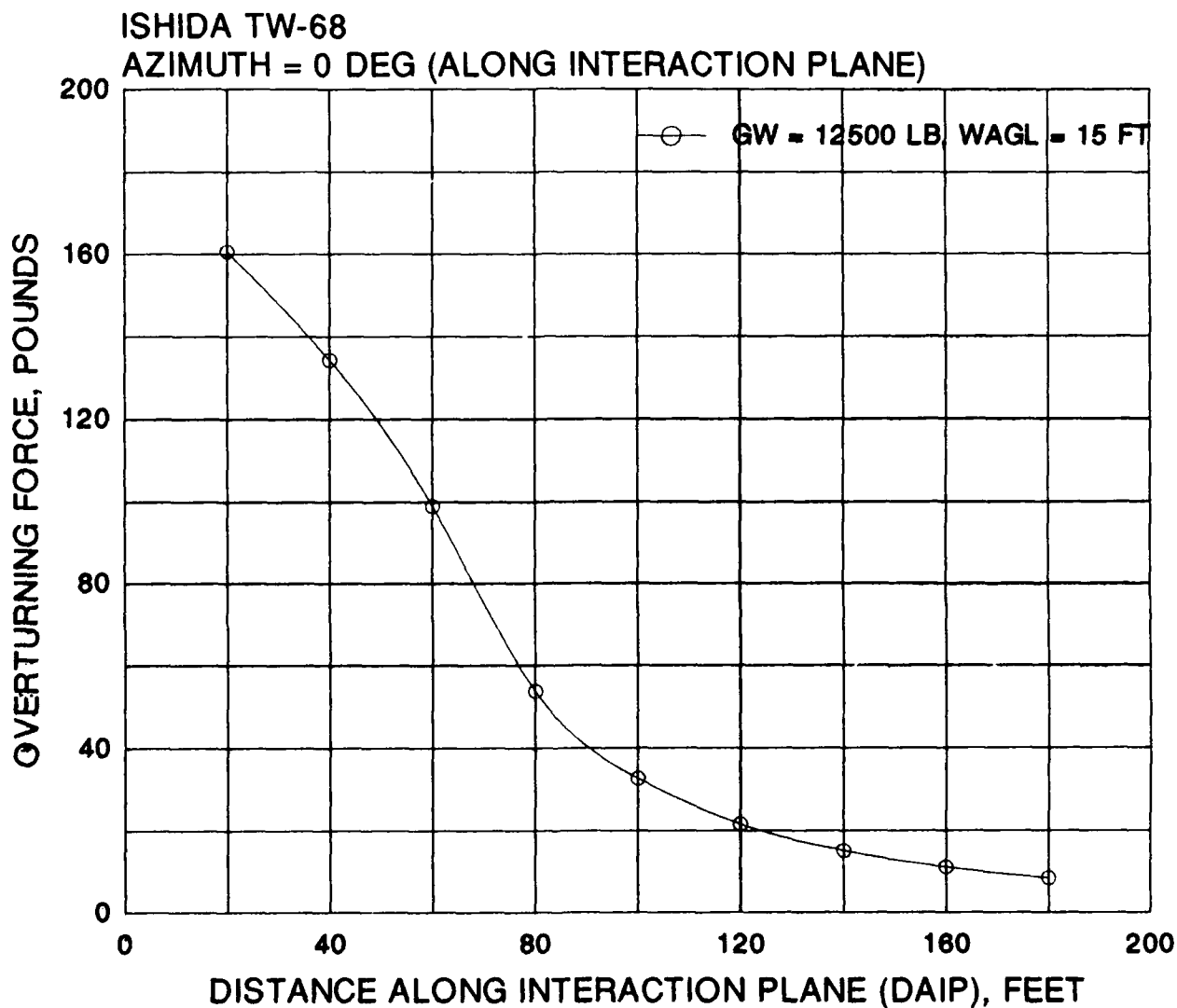

FIGURE J-7 ISHIDA TW-68 OVERTURNING FORCE AS A FUNCTION OF DISTANCE ALONG THE INTERACTION PLANE (0 DEGREE AZIMUTH)