

BEST AVAILABLE COPY

Best Available Copy



Defense Nuclear Agency
Alexandria, VA 22310-3398



DNA-TR-88-173

AD-A222 880

Effects of Ionizing Radiation on the Performance of Selected Tactical Combat Crews

M. A. Dore
G. H. Anno
Pacific-Sierra Research Corporation
12340 Santa Monica Boulevard
Los Angeles, CA 90025-2587

May 1990

Technical Report

DTIC
ELECTE
MAY 29 1990
S B D

CONTRACT No. DNA 001-85-C-0352

Approved for public release.
distribution is unlimited

20030210186

90 05 24 05 5

Destroy this report when it is no longer needed. Do not return to sender.

PLEASE NOTIFY THE DEFENSE NUCLEAR AGENCY,
ATTN: CSTI, 6801 TELEGRAPH ROAD, ALEXANDRIA, VA
22310-3398, IF YOUR ADDRESS IS INCORRECT, IF YOU
WISH IT DELETED FROM THE DISTRIBUTION LIST, OR
IF THE ADDRESSEE IS NO LONGER EMPLOYED BY YOUR
ORGANIZATION.



DISTRIBUTION LIST UPDATE

This mailer is provided to enable DNA to maintain current distribution lists for reports. We would appreciate your providing the requested information.

- Add the individual listed to your distribution list.
- Delete the cited organization/individual.
- Change of address.

NOTE:
Please return the mailing label from the document so that any additions, changes, corrections or deletions can be made more easily.

NAME: _____

ORGANIZATION: _____

OLD ADDRESS

CURRENT ADDRESS

TELEPHONE NUMBER: () _____

SUBJECT AREA(S) OF INTEREST:

DNA OR OTHER GOVERNMENT CONTRACT NUMBER: _____

CERTIFICATION OF NEED-TO-KNOW BY GOVERNMENT SPONSOR (if other than DNA):

SPONSORING ORGANIZATION: _____

CONTRACTING OFFICER OR REPRESENTATIVE: _____

SIGNATURE: _____

CUT HERE AND RETURN



Director
Defense Nuclear Agency
ATTN: TITL
Washington, DC 20305-1000

Director
Defense Nuclear Agency
ATTN: TITL
Washington, DC 20305-1000

REPORT DOCUMENTATION PAGE			Form Approved OMB No. 0704-0188	
Public reporting burden for this collection of information is estimated to average 1 hour per response, including the time for reviewing instructions, searching existing data sources, gathering and maintaining the data needed and completing and reviewing the collection of information. Send comments regarding this burden estimate or any other aspect of this collection of information, including suggestions for reducing this burden, to Washington Headquarters Services, Directorate for Information Operations and Reports, 1215 Jefferson Davis Highway, Suite 1204, Arlington, VA 22202-4302 and to the Office of Management and Budget, Paperwork Reduction Project (0704-0188), Washington, DC 20503				
1. AGENCY USE ONLY (Leave blank)	2. REPORT DATE 900501	3. REPORT TYPE AND DATES COVERED Technical 860312 to 871030		
4. TITLE AND SUBTITLE Effects of Ionizing Radiation on the Performance of Selected Tactical Combat Crews		5. FUNDING NUMBERS C - DNA 001-85-C-0352 PE - 62715H PR - M TA - H WU - DH008905		
6. AUTHOR(S) M. A. Dore; G. H. Anno		8. PERFORMING ORGANIZATION REPORT NUMBER PSR Report 1846		
7. PERFORMING ORGANIZATION NAME(S) AND ADDRESS(ES) Pacific-Sierra Research Corporation 12340 Santa Monica Boulevard Los Angeles, CA 90025-2587		10. SPONSORING/MONITORING AGENCY REPORT NUMBER DNA-TR-88-173		
9. SPONSORING/MONITORING AGENCY NAME(S) AND ADDRESS(ES) Defense Nuclear Agency 6801 Telegraph Road Alexandria, VA 22310-3398 RARP/Young		11. SUPPLEMENTARY NOTES This work was sponsored by the Defense Nuclear Agency under RDT&E RMC Code B350085466 M H 00017 25904D.		
12a. DISTRIBUTION/AVAILABILITY STATEMENT Approved for public release; distribution is unlimited		12b. DISTRIBUTION CODE		
13. ABSTRACT (Maximum 200 words) A general model is developed for characterizing the expected performance of four selected types of tactical army combat crews when the individual crewmembers function at degraded performance levels due to acute exposure to ionizing radiation. The model is also applicable to other situations that degrade individual crewmember performance. The results provide performance data for larger scale U.S. Army models that simulate battlefield conflicts where nuclear weapons might be employed. Performance-level data are generated as a function of dose and time after exposure for each crew type.				
14. SUBJECT TERMS Radiobiological, Effectiveness,		Performance, Tank Crews,		15. NUMBER OF PAGES 136
		Radiation Sickness, (DSE)		16. PRICE CODE
17. SECURITY CLASSIFICATION OF REPORT UNCLASSIFIED	18. SECURITY CLASSIFICATION OF THIS PAGE UNCLASSIFIED	19. SECURITY CLASSIFICATION OF ABSTRACT UNCLASSIFIED	20. LIMITATION OF ABSTRACT SAR	

UNCLASSIFIED

SECURITY CLASSIFICATION OF THIS PAGE

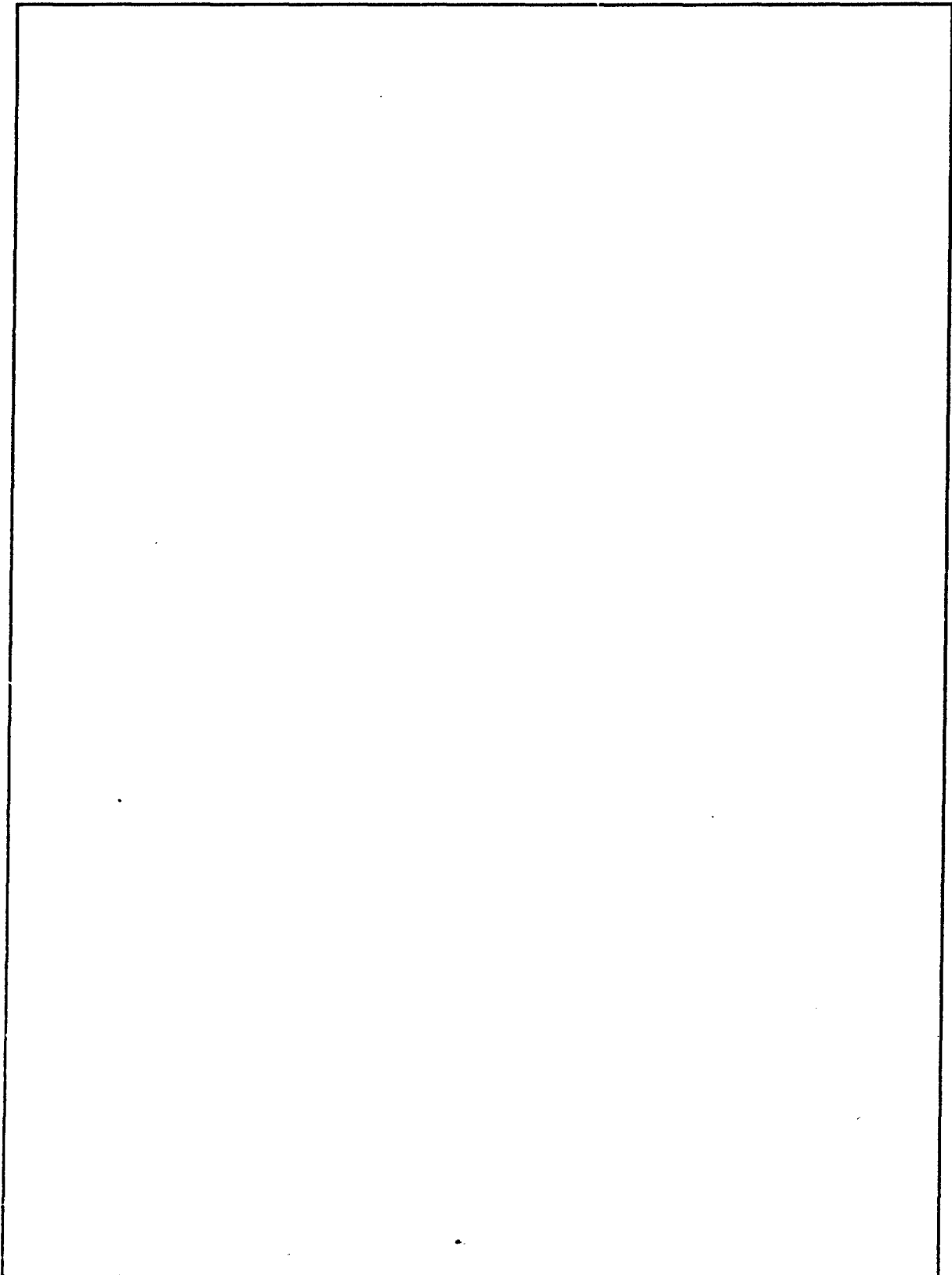

SECURITY CLASSIFICATION OF THIS PAGE

UNCLASSIFIED

PREFACE

This report was prepared by Pacific-Sierra Research Corporation to describe the methodology for developing combat crew performance data based on a series of Intermediate Dose Program (IDP) studies sponsored by the Defense Nuclear Agency (DNA).

Work in this report, sponsored by DNA under contract DNA001-85-C-0352, utilizes the CREW-III model to determine the performance level of combat crew units taking the individual crewmember performance levels into consideration. Short duration tactical combat engagement scenarios are specified and performance levels are determined as a function of dose and time following ionizing radiation exposure.

The authors wish to express their appreciation for the assistance and cooperation of S. Levin; M. J. Moyer of Science Applications International Corporation, La Jolla, California; and for the direction and guidance of R. W. Young of DNA.



Accession For	
NTIS GRA&I	<input checked="" type="checkbox"/>
DTIC TAB	<input type="checkbox"/>
Unannounced	<input type="checkbox"/>
Justification	
By _____	
Distribution/	
Availability Codes	
Dist	Avail and/or Special
A-1	

CONVERSION TABLE

Conversion factors for U.S. Customary to metric (SI) units of measurement

MULTIPLY TO GET	BY	BY	TO GET DIVIDE
angstrom	1.000 000 X E -10		meters (m)
atmosphere (normal)	1.013 25 X E +2		kilo pascal (kPa)
bar	1.000 000 X E +2		kilo pascal (kPa)
barn	1.000 000 X E -28		meter ² (m ²)
British thermal unit (thermochemical)	1.054 350 X E +3		joule (J)
calorie (thermochemical)	4.184 000		joule (J)
cal (thermochemical)/cm ²	4.184 000 X E -2		mega joule/m ² (MJ/m ²)
curie	3.700 000 X E +10		giga becquerel (GBq)
degree (angle)	1.745 329 X E -2		radian (rad)
degree Fahrenheit	$t_c = (t_f - 32) \times 5/9$		degree kelvin (K)
electron volt	1.602 19 X E -19		joule (J)
erk	1.000 000 X E -7		joule (J)
erg/second	1.000 000 X E -7		watt (W)
foot	3.048 000 X E -1		meter (m)
foot-pound-force	1.355 818		joule (J)
gallon (U.S. liquid)	3.785 412 X E -3		meter ³ (m ³)
inch	2.540 000 X E -2		meter (m)
jerk	1.000 000 X E +9		joule (J)
joule/kilogram (J/kg) (radiation dose absorbed)	1.000 000		Gray (Gy)
kilotons	4.183		terajoules
kip (1000 lbf)	4.448 222 X E +3		newton (N)
kip/inch ² (ksi)	6.894 757 X E +3		kilo pascal (kPa)
ktop	1.000 000 X E +2		newton-second/m ² (N-s/m ²)
micron	1.000 000 X E -4		meter (m)
mil	2.540 000 X E -5		meter (m)
mile (international)	1.609 344 X E +3		meter (m)
ounce	2.834 952 X E -2		kilogram (kg)
pound-force (lbs avoirdupois)	4.448 222		newton (N)
pound-force inch	1.129 848 X E -1		newton-meter (N-m)
pound-force/inch	1.751 268 X E +2		newton/meter (N/m)
pound-force/foot ²	4.788 026 X E -2		kilo pascal (kPa)
pound-force/inch ² (psi)	6.894 757		kilo pascal (kPa)
pound-mass (lbm avoirdupois)	4.535 924 X E -1		kilogram (kg)
pound-mass-foot ² (moment of inertia)	4.214 011 X E -2		kilogram-meter ² (kg-m ²)
pound-mass/foot ³	1.601 346 X E +1		kilogram/meter ³ (kg/m ³)
rad (radiation dose absorbed)	1.000 000 X E -2		Gray (Gy)
roentgen	2.579 760 X E -4		coulomb/kilogram (C/kg)
shake	1.000 000 X E -8		second (s)
slug	1.459 390 X E +1		kilogram (kg)
torr (mm Hg, 0°C)	1.333 22 X E -1		kilo pascal (kPa)

*The Becquerel (Bq) is the SI unit of radioactivity; 1 Bq = 1 event/s.
 **The Gray (Gy) is the SI unit of absorbed radiation.

TABLE OF CONTENTS

Section	Page
PREFACE.....	iii
CONVERSION TABLE.....	iv
LIST OF ILLUSTRATIONS.....	vi
LIST OF TABLES.....	vii
1 INTRODUCTION.....	1
2 ANALYSIS OF EMPIRICAL DATA.....	5
3 DEVELOPING TASK DIAGRAMS.....	15
4 MONTE CARLO SIMULATION OF CREW PERFORMANCE.....	17
5 FOUR-DIMENSIONAL FUNCTIONAL FIT.....	19
6 DOSE AND TIME DEPENDENCE.....	24
7 DISCUSSION.....	30
8 LIST OF REFERENCES.....	33
 Appendices	
A TASK DESCRIPTION FOR EMPIRICAL DATA.....	35
B INPUT DATA.....	45
C TASK SCHEMATICS.....	51
D BEST-FIT RESULTS.....	57
E SELECTED PLOTS OF CREW PERFORMANCE VERSUS CREWMEMBER PERFORMANCE.....	67
F CREW PERFORMANCE DATA.....	107
G THREE-DIMENSIONAL PLOTS OF PERFORMANCE OVER DOSE AND... TIME.....	121
H CONTOUR PLOTS OF PERFORMANCE OVER DOSE AND TIME.....	123

LIST OF ILLUSTRATIONS

Figure		Page
1	Combat crew performance--methodology.....	3
2	Scatter plot of σ versus μ for all tasks.....	9
3	Scatter plots of σ versus μ by task group.....	10
4	Final distribution scatter plot.....	13
5	Symptom incidence.....	26
6	Task schematic for gun crew.....	52
7	Task schematic for FDC crew.....	53
8	Task schematic for tank crew.....	54
9	Task schematic for ITV-TOW crew.....	55
10	Final performance plot for gun crew.....	68
11	Final performance plot for FDC crew.....	80
12	Final performance plot for tank crew.....	83
13	Final performance plot for ITV-TOW crew.....	95

LIST OF TABLES

Table		Page
1	Selected Army combat crews.....	2
2	Structure of empirical-task time measurements.....	6
3	Regression results.....	11
4	Reconciliation of overall engagement times.....	18
5	Fit parameters.....	21
6	Symptom incidence.....	27
7	Radiation shielding protection factors.....	27
8	Empirical task descriptions for gun crew.....	36
9	Empirical task descriptions for FDC crew.....	38
10	Empirical task descriptions for tank crew.....	40
11	Empirical task descriptions for ITV-TOW crew.....	42
12	Input data for gun crew.....	46
13	Input data for FDC crew.....	47
14	Input data for tank crew.....	48
15	Input data for ITV-TOW crew.....	50
16	Best-fit results for gun crew.....	58
17	Best-fit results for FDC crew.....	60
18	Best-fit results for tank crew.....	62
19	Best-fit results for ITV-TOW crew.....	64
20	Performance data grids for gun crew.....	108
21	Performance data grids for FDC crew.....	111
22	Performance data grids for tank crew.....	114
23	Performance data grids for ITV-TOW crew.....	117

SECTION 1
INTRODUCTION

This report is one of a series which provides the documentary basis of study efforts to quantify the effects of intermediate level gamma and neutron doses on the combat effectiveness of tactical combat forces. The effort herein builds on the work of the Intermediate Dose Program (IDP), where models were developed to determine the expected performance level of individual soldiers as a function of dose and time after exposure [Anno, Wilson, and Dore, 1983]. While prior IDP work characterized the expected performance of individual soldiers, here that work is extended to small army combat crew units. Four types of crews selected for this study are shown in Table 1, along with a brief description of the specific combat engagement action of each. These crews are all associated with vehicular equipment and represent a significant portion of the tactical force structure.

The methodology followed in developing combat crew performance levels is outlined in Fig. 1. There were two specific objectives of this study. The first was to determine a relationship for the collective performance of a crew as a function of the performance levels of each of the crewmembers. For a typical crew with four crewmembers, the resulting model, as indicated in Fig. 1 under "Four-dimensional functional fits," required eight parameters, two each for the four independent variables (crewmember performances). This relationship can be used in simulation codes such as Ballistic Research Laboratory's (BRL) AURA [Klopac and Roach, 1984] to predict battlefield performance of a crew for an arbitrary mix of degraded crewmembers. It applies regardless of the underlying cause of the degraded performances, whether due to radiation sickness or some other physical or psychological trauma.

Given the above crew performance algorithm, the second objective was to develop a formalism for determining crew performance as a function of acute dose external to the crew vehicle and time after exposure. This formalism, as depicted in the lower portion of Fig. 1,

Table 1. Selected Army combat crews.

Crew Type	No. of Tasks	Crewmembers	No. of Tasks	Brief Description of Engagement Actions	Normal Time (s)
M109 howitzer Gun crew	11 ^a	1 Chief of section 2 Gunner 3 Assistant gunner 4 No. 1 gunnereer	6 3 2 13	Setup, aim, load, and fire 2 rounds	103.2
Fire direction center (FDC)	25	1 Fire direction officer 2 Computer 3 Battle control operator (observer & battery) ^b	1 1 1 (3)	Acquire, calculate, and transmit target sighting data to batteries	33.4
M50A3 tank crew	10 ^c	1 Tank commander 2 Gunner 3 Loader 4 Driver	10 1 6 4	Hit target, emerge from cover, fire, reload 2 rounds and resume cover	28.1
M901 ITV TOW crew	24	1 Tripod leader 2 Gunner 3 Driver ^d 4 Loader	1 4 2 2	Move to site sequentially fire and guide both missiles and reload	157.8

^aIncludes 2 recalls

^bFixed times

^cInferred no data

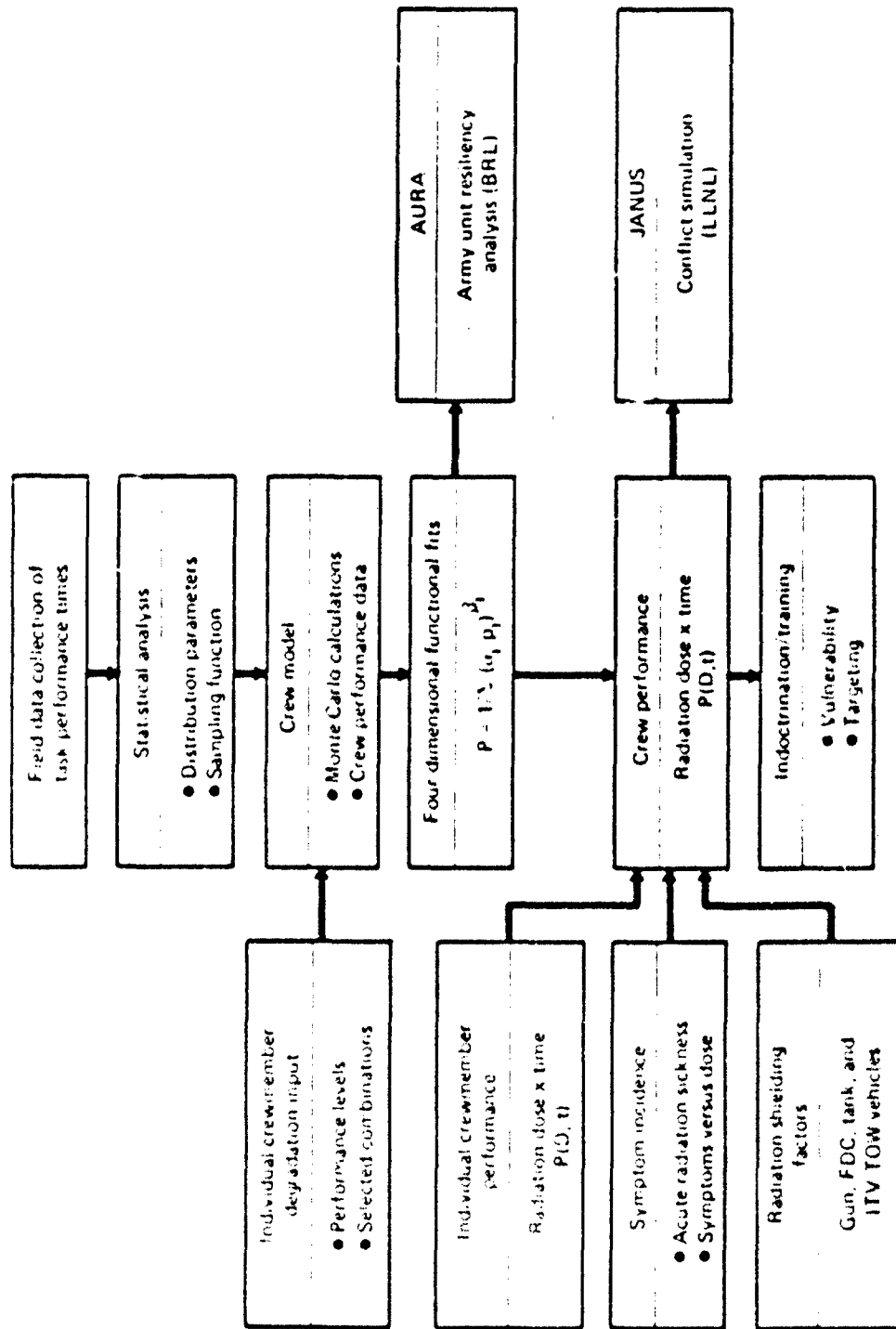

Figure 1. Combat crew performance methodology.

combines a number of factors to yield the desired crew unit performance. Among these factors are: radiation shielding by the vehicle, the variability among individuals in expressing symptoms of radiation sickness, the crew performance algorithm, and results from the IDP studies of dose and time-dependent individual crewmember performance. A complete dose and time-dependent performance surface was then prepared for each crew type by assuming typical vehicle shielding factors and averaging over the distribution of symptom incidence. This set of surfaces is suitable for implementation on higher level combat simulation codes, such as the JANUS code at Lawrence Livermore National Laboratory (LLNL) [Blumenthal et al., 1984].

In this study, performance is expressed as the ratio of the time normally required to complete the specified combat engagement with crewmembers unaffected by radiation (the normal mission time) to the time required when the performance level of one or more crewmembers is degraded (slower) from the effects of radiation. This definition was adopted [Anno, Wilson, and Dore, 1983] in the earlier IDP study of individual crewmembers and has the desirable properties of always yielding a value between zero and one as well as being amenable to empirical field measurements.

A combat engagement consists of a number of tasks shared among the individual crewmembers that must be completed according to a predetermined sequence. The performance of each crewmember is expressed quantitatively in terms of the time taken to complete his assigned tasks. The combat engagements are all very brief, ranging from about 30 s to 1.5 min, and represent critical durations of combat where crewmembers are required to flawlessly execute a large number of often split-second tasks in a coordinated team effort. Accordingly, such intense combat engagements represent critical elements affecting the outcome of tactical battlefield encounters.

In the sections that follow, we discuss the methodology summarized in Fig. 1) developed for determining degraded performance levels for each of the four combat crew units. The appendices contain numerous tables and diagrams referred to in the discussion that provide detailed backup information and data.

SECTION 2
ANALYSIS OF EMPIRICAL DATA

Studies have assembled a large number of field measurements of the time required by trained military personnel to perform the tasks comprising the engagements described in Table 1. The M60A3 tank data [Moyer and Lam, 1987] were combined with data for three other crew types: the M109 howitzer, fire direction center (FDC), and M901 Improved TOW (tube-launched, optically tracked, wire-guided) Vehicle (ITV-TOW) crews [Moyer, O'Donoghue, and Feinberg, 1984]. These data were taken from multiple repetitions of standard operational engagements by trained soldiers. A brief description of each engagement is included in Table 1, and more detailed descriptions of the specific tasks are tabulated in Appendix A.

The goal was to generate an accurate, dynamic model for each crew type. The empirical data gathered were suitable for statistical evaluation to provide the following critical inputs to such a model:

1. Representative mean times for each task
2. Variances about the mean times for crewmembers
3. Detailed chronological sequence and hierarchy of task executions to allow construction of task interaction diagrams

The scope and extent of the measurements for all four crew types is summarized in Table 2. Most tasks for most crew types were performed five or more times by several different crews comprised of different individuals. However, because only a limited number of qualified personnel were available for certain positions, they were required to occupy those positions for all of the trials. For example, for the gun crew a single individual (chief of section) participated in each of the 11 separate crew units. This crewmember performed two of the same tasks five times each for a total of 55 trials. Also, because certain tasks involved the actual firing of

Table 2. Structure of empirical-task time measurements.

Crew Type	No. of Tasks	No. of Separate Crew Units	No. of Separate Individuals	No. of Trials Each	
Gun crew	2	--	1	55 ^a	
	25	11	33	5	
FDC	23	10	30	5	
Tank crew	COFT	18	15	30	7 to 12
	Live	4	10	10	1
		2	4	4	10
ITV-TOW crew	7	--	2	20 ^a & 30 ^a	
	12	5	10	10 ^a	

^aOnly the last 5 trials were used.

expensive, live ordinance, those tasks were not repeated as often. In Table 2, two rows of numbers are used for all crew types but the FDC. The upper numbers represent situations in which the number of qualified personnel was limited.

The entry in Table 2 for the M60A3 tank crew is divided in two because task time measurements of the tank crewmembers were made in two separate environments. The many rapidly occurring tasks for the tank commanders and gunners required that timings be taken in a standard tank simulator, the "conduct of fire trainer" (COFT). This simulator is stationary and does not fire; therefore, the loader and driver tasks were possibly not realistic representations of an actual tank environment in some respects. However, a limited number of loader and driver task timings were taken in real tanks participating in exercise maneuvers. These exercises included live firing of the gun. The two subdivisions given for the tank crews in Table 2

delineate the tasks and number of trials applicable to each set of measurements.

The final mean times and variances for these empirical data are tabulated in Appendix A. Except for the tank crew, these result from five independent trials by each individual. Where more trials were available, only the last five were used. Occasionally, an individual would have only four valid trials; in these cases, the standard statistical practice was employed of introducing an artificial fifth trial equal to the mean of the four valid trials. For the tank crews, however, all available data were used.

Of concern was the possibility of a "learning curve" effect in which a trend towards shorter times would develop with successive trials by an individual. Correlation tests were performed to determine if any systematic trend could be found in going from the first to the fifth trial. Neither a trend toward longer times (due to boredom with repetitions of the same exercise) nor toward shorter times (learning curve) was discernible.

The complete lack of any appropriate data on crewmembers in degraded states was one of the major concerns of this study. In particular, a method was needed for estimating the variance about the mean task times for degraded crewmembers. The solution was to model the variance as a function of the mean, assuming the same functional form to hold for both the degraded and undegraded situations.

Let T_i be the normal (undegraded) mean time for completing task i . Then the performance of a crewmember is defined as $p = T_i/t_i$, where t_i is the longer time required to accomplish the same task when the crewmember is in a degraded state. So for a given performance level p , the mean time for a degraded crewmember to perform task i is just $\mu_i = T_i/p$. A model for the variance about μ_i is desired. If, for healthy crewmembers, a functional relationship of the form $\sigma^2 = f(\mu)$ were found, then we could approximate the degraded variance by assuming:

$$\frac{\sigma_{deg}^2}{\sigma_{norm}^2} = \frac{f(\mu/p)}{f(\mu)} \quad (1)$$

A scatter plot of σ_i versus μ_i was made for each crew type, and a combined plot for all four crew types is shown in Fig. 2. It is immediately obvious that the upward, linear trend is very nebulous.

Grouping tasks according to the type of activity was then considered. The types chosen were:

1. cognitive.
2. physically demanding.
3. normal.

This partitioning of tasks was suggested by the previous IDP study, where trends were observed indicating that certain physically demanding tasks deviated substantially from the norm. A physically demanding task is one that would more effectively fatigue a crewmember compared to other tasks and thus lengthen task performance time. Similar deviations were also observed for certain FDC tasks which require intense mental concentration. These "cognitive" tasks are indicated by a "C" in the column titled "Task Type" in Appendix B. The physically demanding tasks are similarly marked with a "P." The remainder of the tasks are normal and are unmarked.

Examples of scatter plots of σ_i versus μ_i for these activity groupings are shown in Fig. 3. Again, only a very diffuse trend is evident. To assess these results, several statistical tests were applied, including the student-t and standard error. The results are summarized in Table 3, where A and B refer to a straight line best fit of the form $\sigma = A + B\mu$. The results indicate that the activity groupings are not sufficiently distinct from one another to justify distinguishing between them.

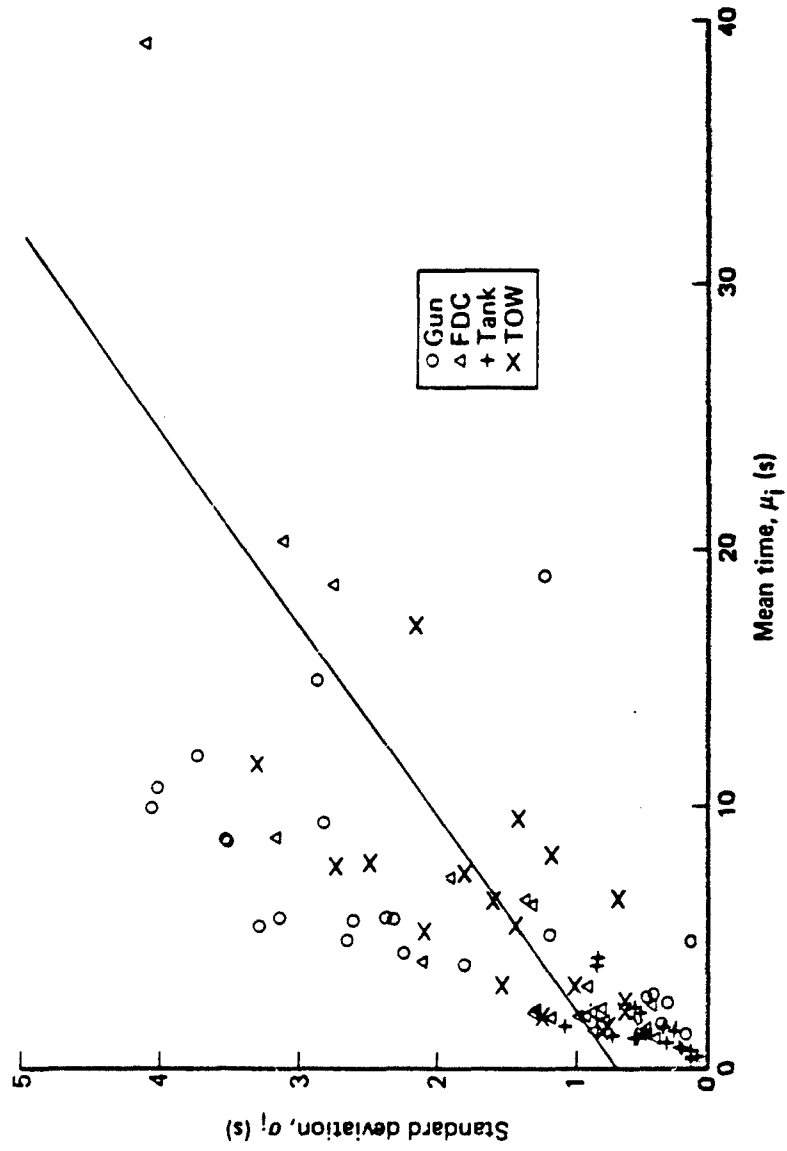
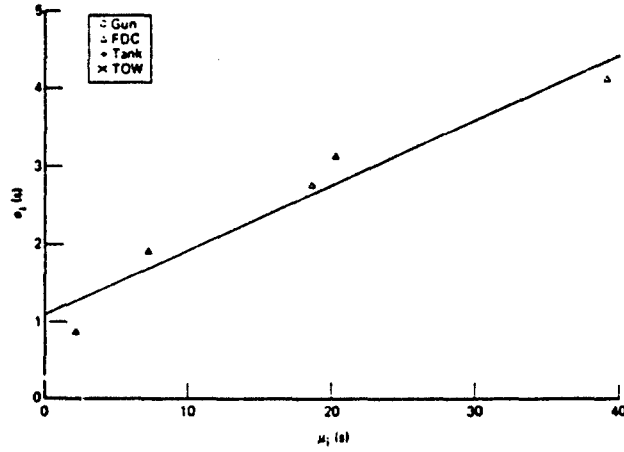
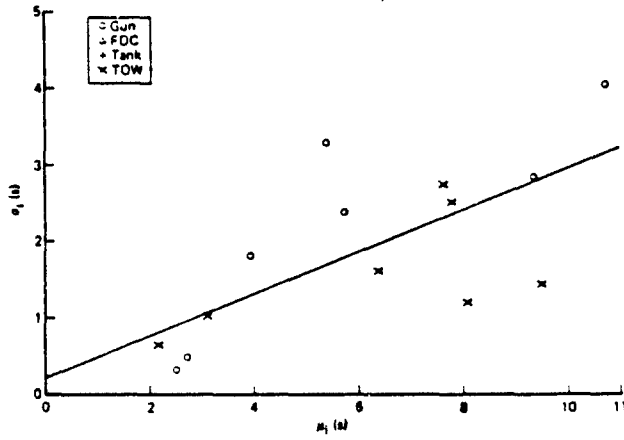

Figure 2. Scatter plot of σ versus μ for all tasks.

a. Cognitive.



b. Demanding.



c. Normal.

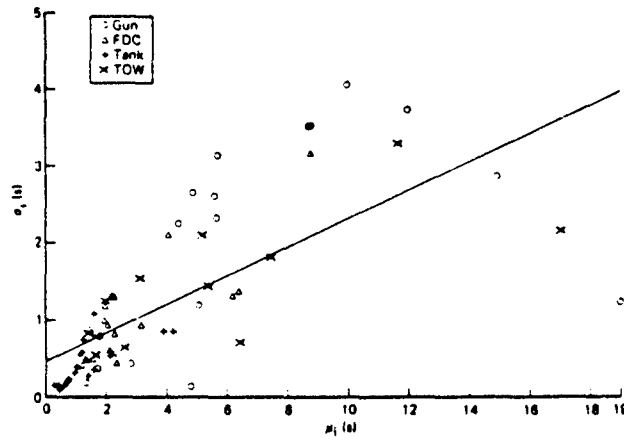

Figure 3. Scatter plot of σ versus μ by task group.

Table 3. Regression results.

	Crew Type	Tasks	SD	A	B	SD(A)	SD(B)	COV(A,B)
1	Gun crew	23	1.1702	1.0741	0.1589	0.4576	0.0572	-0.0222
2	FDC crew	23	0.4979	0.7873	0.0999	0.1271	0.0120	-0.0009
3	Tank crews	20	0.1982	0.1640	0.1943	0.0740	0.0427	-0.0025
4	TOW crew	19	0.5916	0.7269	0.1312	0.2411	0.0344	-0.0068

Standard Error and T-Statistics

Comparisons	Intercept (A)			Slope (B)		
	Standard Error	Student-T	DF	Standard Error	Student-T	DF
Gun crew/FDC crew	0.0990	2.8957	44	0.0122	4.8362	44
Gun crew/Tank crew	0.0968	9.3975	41	0.0153	2.3204	41
Gun crew/TOW crew	0.1103	3.1476	40	0.0143	1.9345	40
FDC crew/Tank crew	0.0312	19.9523	41	0.0099	9.5576	41
FDC crew/TOW crew	0.0613	0.9845	40	0.0083	3.7845	40
Tank crew/TOW crew	0.0577	9.7523	37	0.0124	5.0963	37

Stress Type	Tasks	SD	A	B	SD(A)	SD(B)	COV(A,B)
Cognitive	5	0.3567	1.1004	0.0832	0.2702	0.0125	-0.0027
Demanding	14	0.8310	0.2209	0.2725	0.5364	0.0804	-0.0392
Normal	66	0.7443	0.4671	0.1839	0.1295	0.0231	-0.0021
All tasks	85	0.8077	0.7029	0.1354	0.1170	0.0152	-0.0012

Standard Error and T-Statistics

Comparisons	Intercept (A)			Slope (B)		
	Standard Error	Student-T	DF	Standard Error	Student-T	DF
Cognitive/Demanding	0.1875	4.6909	17	0.0222	8.5278	17
Cognitive/Normal	0.1219	5.1957	69	0.0063	16.4060	69
Cognitive/All tasks	0.1215	3.2715	88	0.0058	8.9665	88
Demanding/Normal	0.1442	1.7071	78	0.0217	3.9950	78
Demanding/All tasks	0.1439	3.3492	97	0.0215	6.3651	97
Normal/All tasks	0.0204	11.5718	149	0.0033	15.3807	149

NOTE: DF = degrees of freedom.

Finally, Fig. 4 is a scatter plot of σ_i^* versus μ_i^* , where

$$\mu_i^* = \frac{1}{N} \sum_{j=1}^N \ln t_{ij} , \quad (2a)$$

$$\sigma_i^* = \sqrt{\frac{1}{N-1} \sum_{j=1}^N (\ln t_{ij} - \mu_i^*)^2} . \quad (2b)$$

and where $j = 1, 2, \dots, N$ ranges over trials for task i , and the t_{ij} are measured times. A best-fit, straight horizontal line was fit to this pattern, and we concluded that such a slope = 0 curve was as good a fit as any other. Thus, the algorithm for sampling for degraded times becomes:

Sample random variables, τ , from a normal distribution with mean, $\mu_i^* - \ln p$, and standard deviation σ_i^* ; then, $t = \exp(\tau)$.

This is equivalent to sampling t from a lognormal distribution with mean,

$$\mu(p) = \mu(p=1)/p = \exp(\mu^* - \ln p + \sigma^{*2}/2) , \quad (3a)$$

and standard deviation (SD),

$$\sigma(p) = \sqrt{e^{2(\mu^* - \ln p) + \sigma^{*2}} (e^{\sigma^{*2}} - 1)} , \quad (3b)$$

i.e.,

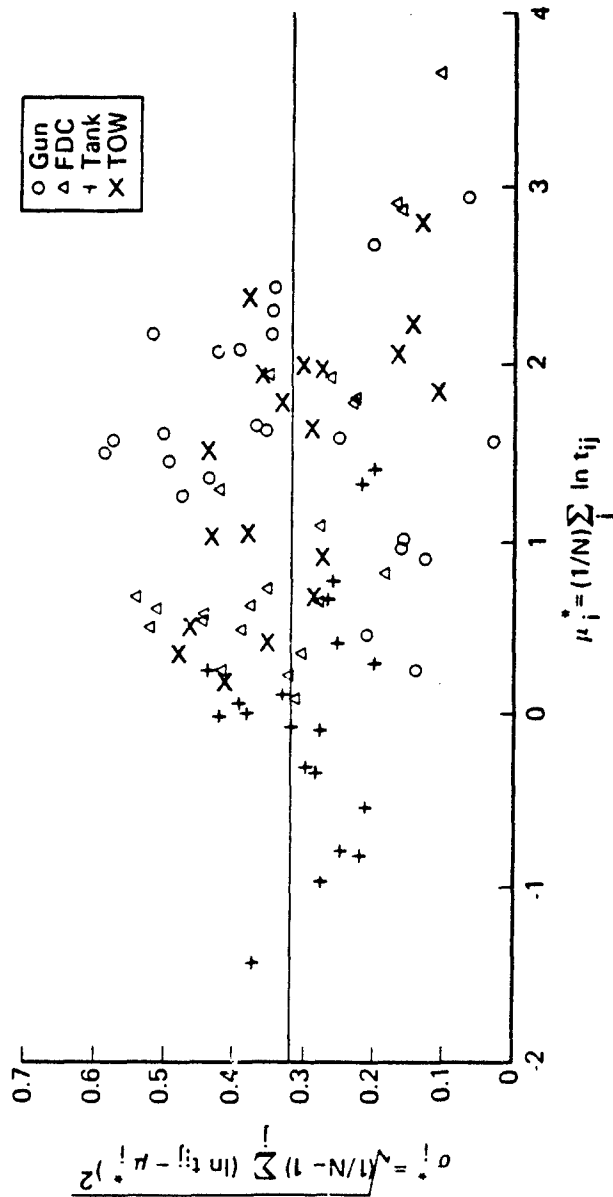

Figure 4. Final distribution scatter plot.

$$\sigma(p) = \sigma(p=1) \sqrt{e^{-2 \ln p}}$$

(3c)

$$= 1/p \cdot \sigma(p=1) .$$

This is the desired relationship for $\sigma(\mu)$. Therefore, an alternative form of sampling for t , which is equivalent, is:

Sample random variables, t , from a lognormal distribution with mean, $\mu(p=1)/p$, and standard deviation, $\sigma(p=1)/p$.

SECTION 3 DEVELOPING TASK DIAGRAMS

The decomposition of an engagement involving several interacting crewmembers into a specific set of modular tasks depends on the level of resolution required. The particular structures chosen for collecting the empirical data were designed to facilitate accurate timings between natural breakpoints in the action. This is illustrated by considering the empirical task lists summarized in Appendix A. Task 24 for the M60A3 tank crew commences immediately after the tank commander (TC) orders "backup." The full description states that this task consists of the driver backing up until the TC orders "stop," whereupon the driver stops and parks the tank. Here two different individuals are involved, and three distinct actions must be performed in sequence, i.e., an action by the driver, then an order from the TC, followed by a final action by the driver. For an accurate simulation in which the TC and driver may be in very different degradation states, the distinction between the three components of this "task" can be significant. A similar situation arises in several of the other empirical tasks.

As a consequence, many of the empirical tasks were subdivided into two or more simulation tasks for incorporation into the final task diagrams. This, in turn, necessitated distributing the mean task time and the associated variance among the subdivided tasks without altering their combined values. Although this could only be done by careful intuitive judgment, the net mean time and variance for the set, which must remain as measured, were preserved. Since for the original measurements these appeared as a single, continuous activity, the addition of detailed internal structure to this set of tasks had negligible effect.

The procedure for redistributing the variances among subdivided tasks results from requiring that three conditions be met. For an empirical task with mean time t , the subtasks are assigned mean times such that

$$t_a + t_b = t . \quad (4)$$

Assuming that the tasks are independent, the standard deviations are then constrained such that

$$\frac{\sigma_a}{\sigma_b} = \frac{t_a}{t_b} \quad \text{and} \quad \sigma_a^2 + \sigma_b^2 = \sigma^2 . \quad (5)$$

The standard deviations for the subtasks are then given by

$$\sigma_b^2 = \frac{\sigma^2}{1 + (t_a/t_b)^2} \quad \text{and} \quad \sigma_a^2 = \sigma^2 - \sigma_b^2 . \quad (6)$$

The resulting input values used for the simulation are tabulated in Appendix B, along with the final task lists for the four crew types. These correspond to the task diagrams in Appendix C. The column marked "data tasks" contains the original empirical task number from the measurement data, and is followed by a letter (a, b, ..., etc.) if the task was subdivided. Empirical tasks 21 through 24 for the M109 gun crew were in fact copies of tasks 8 through 11, i.e., no independent measurements were taken for the repeat of the loading operations.

SECTION 4
MONTE CARLO SIMULATION OF CREW PERFORMANCE

The CREW-III Monte Carlo simulation code [Dore, 1986] was utilized to predict the mean overall engagement time for each crew type. This involved computing 100 independent histories (realizations) of the simulated engagement, resulting in a predicted mean time for each of the types of engagement. The reconciliations of the overall engagement times obtained from this simulation with the measured mean times are shown in Table 4. Since some of the simulated engagements contained additional tasks not included in the original, measured engagements, correction terms were needed to make a meaningful comparison between the predicted and measured times. For example, the initial six tasks for the tank crew, during which the tank commander and gunner are searching for a target, were included to conform to the earlier IDP scenario. These tasks consume an average of about 1.7 s which were not included in the empirical measurements.

Corrections were also required for the measured, empirical overall task times for the tank crew. In discussing the comparison of COFT simulator and field exercise task time measurements, Moyer and Lam [1987] observed: "Comparison of the COFT generated data with the loader shows that the loaders were slower. However, it would appear that the loaders would have added only about a one second delay to the crews ability to fire the second round."

Then, a few sentences later, in reference to timing the drivers, Moyer and Lam [1987] state: "...the time to back up the tank appears to be twice as long as expected based on the IC-6 performance in the COFT. Due to the restricted cues in the COFT, it is possible that these IC's were stopping their simulated tanks sooner than they should have." Based upon these comments, an additional 2.0 s were added to account for the loaders and an additional 1.41872×0.709 s of backup time for the drivers.

Table 4. Reconciliation of overall engagement times.

Crew Type	CREW-III Results			Empirical Data			Percent
	Raw Time	Correction	Net	Raw Time ^a	Correction	Net	
Gun	103.18		103.18	116.43		116.43	-12.8
FDC	93.38		93.38	69.69	+6.86 ^b	76.55	+18.0
Tank	28.06	-1.70 ^c	26.36	22.79	+2.71 ^d	25.50	+3.26
ITV-TOW	157.82	-28.00 ^e	129.82	141.57		141.57	-9.05

^aEmpirical values for total engagement time reflect the less than ideal conditions under which field data measurements were gathered.

^bTasks 11 through 14 were removed.

^cInitial target acquisition.

^dLoader and driver too fast in COFT.

^eDriver tasks.

The right-hand column of Table 4 summarizes the relative accuracy with which the Monte Carlo simulation reproduces the empirical results. Except for the FDC crew, for which the empirical "measurements" are very doubtful, the agreement is satisfactory.

The CREW-III code was then applied to selected combinations of degraded crewmembers. The degradation states chosen and the final mean engagement times found are summarized in Appendix D. For some crew types, additional points were included to ensure that the entire four-space, i.e., four crewmembers, was sufficiently represented.

SECTION 5
FOUR-DIMENSIONAL FUNCTIONAL FIT

A simplified expression for overall crew performance as a function of the performance levels of the individual crewmembers was derived as follows: Consider a crew consisting of four crewmembers, each responsible for a specific subset of the full set of tasks making up the engagement. Assuming that all tasks are performed sequentially, the total time for the engagement would simply be the sum of the time taken by each crewmember. Let T_i be the sum of the normal (undegraded) times for the tasks of crewmember i , $i = 1, 2, \dots, 4$, so that the total mission time is

$$T_{tot} = \sum_{i=1}^4 T_i \quad (7a)$$

The performance of a crewmember is defined as $p_i = T_i/t_i$, where t_i is the longer time required to accomplish the same set of tasks when the crewmember is degraded. Thus, p_i is always between 0 and 1. Similarly, the overall crew performance is given by $P = T_{tot}/t_{tot}$, where $t_{tot} = \sum t_i$. It then follows that

$$P = \frac{1}{\sum \frac{\alpha_i}{p_i}} \quad (7b)$$

where

$$\alpha_i = \frac{T_i}{T_{tot}} \quad (8)$$

Equation (7b) shows that each of the crewmember performances is reciprocally weighted by his fraction of the total mission time when all are undegraded. The assumption of a series of sequential tasks used to derive this expression is true only specifically for the ITV-TOW crew. The other three crew types require the crewmembers to perform tasks in a series-parallel fashion, where at various times during the engagement two or more tasks are performed simultaneously. However, by using Eq. (7b) as a guide, the Monte Carlo results for these other three crew types were found to be remarkably well fit by a generalized form of Eq. (7b).

$$P = \frac{1}{\sum_{i=1}^4 \left(\frac{\alpha_i}{P_i} \right)^{\beta_i}} \quad (9)$$

The β exponents allow four more degrees of freedom to account for interaction effects between crewmembers. Both the α 's and β 's were determined from a simplex algorithm which minimized the standard error over all points. The starting guesses for the α 's were determined from Eq. (8) and the β 's were initialized to 1.0; in all cases, the results converged rapidly to a distinct minimum. The resulting values are tabulated in Table 5, along with the correspondence between the indices and crewmember positions.

The CREW-III simulation for the ITV-TOW crew incorporated only three crewmembers: squad leader, gunner, and loader. The fourth crewmember, the driver, was not included since the empirical data for the ITV-TOW crew was taken without a driver present. As already mentioned, the ITV-TOW tasks are performed sequentially, and therefore the β 's are all 1.0. The accuracy of the CREW-III simulation and subsequent fit to Eq. (9) is evident by noting the near unity values of the β 's for the ITV-TOW crew in Table 5.

The previous IDP study did include a driver, whose total task time was normally 28.0 s for maneuvering and parking at the launch site prior to the other crewmembers beginning their tasks. For both

Table 5. Fit parameters.

Parameter	Gun Crew	FDC Crew	Tank Crew	TOW Crew
α_1	0.073953	0.23466	0.24249	0.13111
α_2	0.074018	0.37234	0.22197	0.47759
α_3	0.24954	0.44990	0.31879	0.17742
α_4	0.59286	--	0.31198	0.21546
β_1	1.2502	1.6017	0.98866	1.0389
β_2	0.67995	0.81154	1.1181	1.0137
β_3	1.0037	0.98212	1.2815	1.0000
β_4	1.1755	--	1.0046	0.96201

Crew Type	Crewmember Index (I)			
	1	2	3	4
M109 howitzer gun crew	Chief of Section	Gunner	Assistant Gunner	No. 1 Cannoneer
Fire Direction center (FDC)	Fire Direction Officer	Computer	Horizontal Control Operator	--
M60A3 tank crew	Tank Commander	Gunner	Loader	Driver
M901 ITV-TOW crew	Squad Leader	Gunner	Driver	Loader

consistency with the previous IDP study and because an actual ITV-TOW crew includes a driver, a modification was made to the results to incorporate the effects of a driver into the results.

This modification consisted of adding an additional 28 s to the engagement time for vehicle motion with an undegraded driver. Then, if $T_{tot} = 129.824$ s is the total engagement time for the three man crew, the new total time will be $T'_{tot} = T_{tot} + 28 = 157.824$ s. Also, the total engagement time with degraded crewmembers becomes

$$T' = T + 28/p_D, \quad \text{where } T = T_{tot} \cdot \sum_{i=1}^3 \left(\frac{\alpha_i}{p_i} \right)^{\beta_i} \quad (10)$$

is the total engagement time for the three-man crew, and p_D is the performance level of the driver. Thus,

$$\begin{aligned} \frac{1}{P'} &= \frac{T'}{T'_{tot}} = \frac{T_{tot}}{T_{tot} + 28} \cdot \sum_{i=1}^3 \left(\frac{\alpha_i}{p_i} \right)^{\beta_i} + \frac{28}{T_{tot} + 28} \left(\frac{1}{p_D} \right) \\ &= \frac{T_{tot}}{T_{tot} + 28} \left[\sum_{i=1}^3 \left(\frac{\alpha_i}{p_i} \right)^{\beta_i} + \left(\frac{28/T_{tot}}{p_D} \right) \right], \end{aligned} \quad (11)$$

so we find that

$$P' = \frac{K}{\sum_{i=1}^4 \left(\frac{\alpha_i}{p_i} \right)^{\beta_i}}, \quad \text{with } \alpha_4 = 28/T_{tot}, \quad \beta_4 = 1, \quad (12)$$

$$p_4 = p_D, \quad \text{and } K = (T_{tot} + 28)/T_{tot}.$$

This is the same form as Eq. (9) except for the constant, K , which is easily removed by incorporating it into the α 's.

Comparisons of the simulation results and the values predicted by Eq. (9) are included in Appendix D. Appendix E contains a representative set of plots of numerous planes in the four-space for each

crew type. Also included on these plots are the points to which they were fit.

SECTION 6
DOSE AND TIME DEPENDENCE

The crew performance formula (Eq. 9) is suitable for many applications involving degraded crewmembers. One such application is the Army Unit Resiliency Analysis (AURA) code at BRL. AURA allows reconstitution of a tactical unit with any mix of degraded personnel, regardless of the underlying cause of the degradation. For instance, the limitations on crew performance caused by wearing mission-oriented protection posture (MOPP) gear in a chemical attack environment can be simulated by applying Eq. (9).

Other battlefield simulation codes are primarily concerned with effects on a tactical unit directly, rather than indirectly through the performance of the crewmembers. One such is the JANUS conflict simulation code at LLNL. One requirement of JANUS is to simulate the time-dependent performance of combat crew units after acute exposure to an intermediate dose of ionizing radiation from a tactical nuclear weapon detonation.

Providing such a model extends naturally from the earlier IDP study [Anno, Wilson, and Dore, 1983] in which the performance of individuals was characterized for acute exposure as a function of dose and time. A given external dose to a unit (e.g., a tank) is reduced by an appropriate shielding factor for each crew position, resulting in a dose to each crewmember. The results of the IDP study were then applied to find the performance level of each crewmember at some later time, and Eq. 9 was then applied to yield the overall unit performance at that time.

A modification of the above procedure is necessary because not all individuals develop any or all of the disabling symptoms of acute radiation sickness which are the cause of degraded performance. The crewmember performance results reported in the IDP study are conditionally dependent upon an individual having expressed these symptoms, and for those individuals who are not affected there is no degradation, i.e., their performance level is 1.0. This individual variability in response to radiation exposure was accounted for by

finding an expected performance for the unit by combining the sixteen possible situations of four crewmembers, each either expressing or not expressing symptoms, weighted by the incidence fractions for developing symptoms.

Estimates of incidence fractions for each of the major symptoms (e.g. nausea, vomiting, fatigability) of acute exposure to ionizing radiation have been determined as a function of dose [Anno, Wilson, and Baum, 1985]. While these incidence fractions are specific to each type of symptom, they are highly correlated, and the actual performance degradation of an individual is usually dominated by the initial and most severe symptom developed. This allows an overall incidence curve to be determined by assuming an individual develops the characteristic degradation with the onset of any one symptom. Curves of incidence fraction versus dose for the major symptoms of radiation sickness are plotted in Fig. 5 based on both lognormal and logistic forms of the distributions with dose. The overall incidence curve consists of the leftmost of these symptom curves at any incidence level. The resulting three-part formula is given in Table 6.

The expected performances were then calculated for the four crew types. First the protection factors from Table 7 were applied to reduce the exposure external to the vehicle by an amount appropriate for inside the type of vehicle. Note that only the M60A3 tank varied in density sufficiently to afford different degrees of radiation protection dependent upon where in the vehicle the crewmember was located. The weights and performances of each crewmember were then calculated for all 16 combinations of symptom incidence and then combined together with Eq. (9), in the manner given as follows: Let D_0 be an acute dose of ionizing radiation external to the vehicle which occurs at time $t = 0$. Then, for the i th crewmember ($i = 1, 2, \dots, 4$), define:

PF_i = protection factor,

$D_i = D_0/PF_i$.

$p_i(D_i, t)$ = conditional performance level of i th crewmember,

$f_i(D_i)$ = probability that symptoms are expressed by i th crewmember.

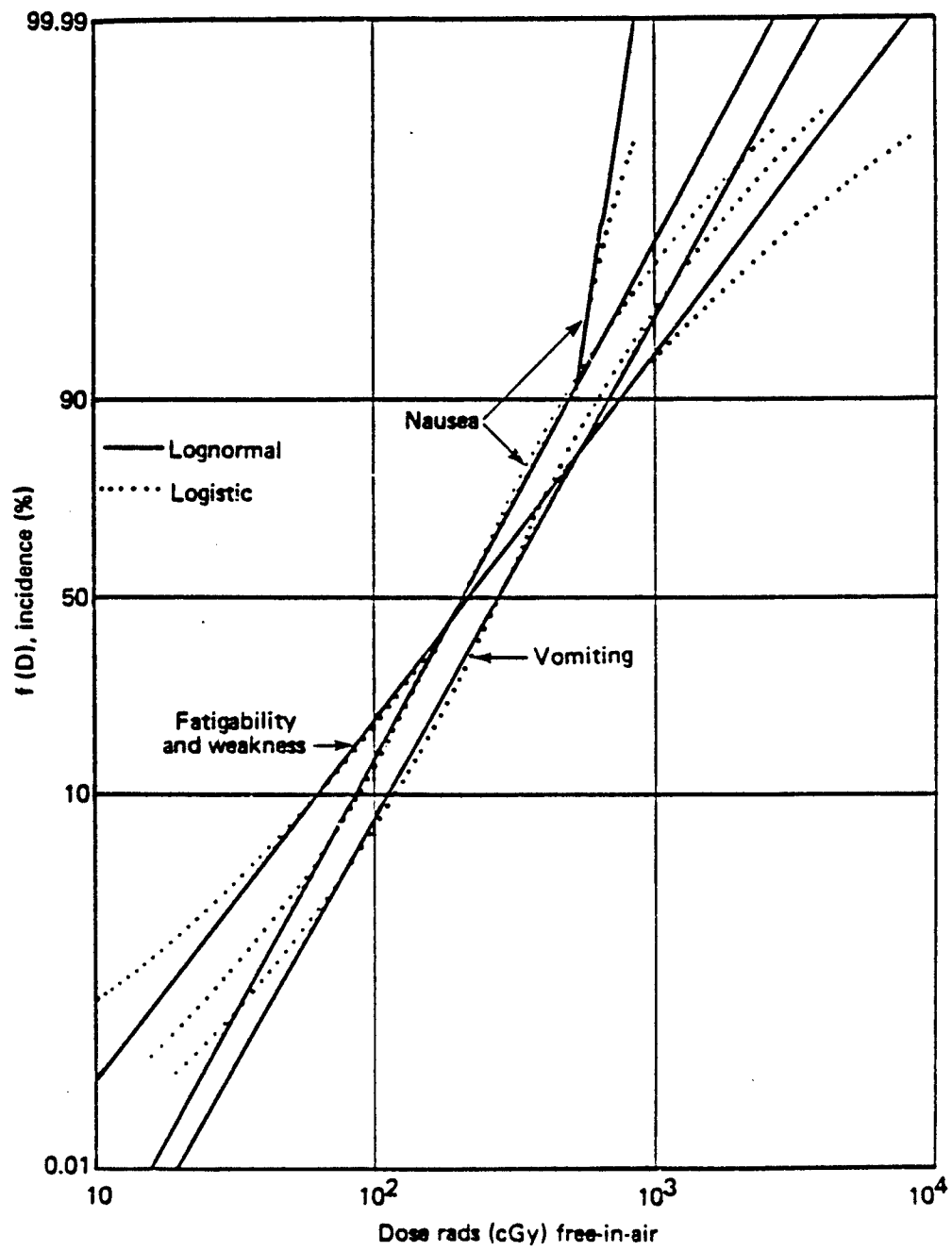

Figure 5. Symptom incidence.

Table 6. Symptom incidence.

Principal Symptom	Dose Range (rads)	a	b
Fatigability and Weakness	0 - 185	8.75	1.63
Nausea	185 - 530	12.2	2.30
Nausea	> 530	49.8	8.27

Symptom incidence:

$$f(D) = \frac{1}{1 - e^{a - b \ln D}}$$

Table 7. Radiation shielding protection factors.

Crew and Position	Factor
M109 howitzer gun crew	
Chief of section	1.3
Gunner	1.3
Assistant gunner	1.3
No. 1 cannoneer	1.3
FDC	
Fire direction officer	1.0
Computer	1.0
Horizontal control operator	1.0
M60A3 tank crew	
Tank commander	1.4
Gunner	2.0
Loader	1.9
Driver	3.8
M901 ITV-TOW crew	
Squad leader	1.4
Gunner	1.4
Driver	1.4
Loader	1.4

The 16 combinations can then be represented by taking:

$$\begin{aligned}
 0 &\Rightarrow \text{Unaffected: } p_i^* = 1.0, & w_i &= 1 - f_i, \\
 1 &\Rightarrow \text{Affected: } p_i^* = p_i, & w_i &= f_i.
 \end{aligned}$$

and arranging all combinations as a binary series, i.e.

Case n:	0	1	2	3	4	5	6	7	8	9	10	11	12	13	14	15	
Crew member	1	0	1	0	1	0	1	0	1	0	1	0	1	0	1	0	1
	2	0	0	1	1	0	0	1	1	0	0	1	1	0	0	1	1
	3	0	0	0	0	1	1	1	1	0	0	0	0	1	1	1	1
	4	0	0	0	0	0	0	0	0	1	1	1	1	1	1	1	1

The weight assigned to the n th case is then given by

$$W_n = \prod_{i=1}^4 w_i, \quad \text{where } \sum_{n=0}^{15} W_n = 1, \quad (13)$$

and the crew performance (given by Eq. 9) for case n is

$$Q_n = \frac{1}{\sum_{i=1}^4 \left(\frac{\alpha_i}{p_i^*} \right) \beta_i}. \quad (14)$$

The combined average crew performance is then given by

$$P(D_o, t) = \sum_{n=0}^{15} W_n Q_n. \quad (15)$$

The unit performances which result from the calculations given above are tabulated in Appendix F as an evenly spaced grid of points in log dose (external to the unit) and log time. The extent of this table is identical to that of the earlier IDP study, and the general

appearance of the surface plots (Appendices G and H), not surprisingly, is very similar to those for individual crewmembers in the IDP study.

SECTION 7

DISCUSSION

The methodology followed in this study to develop crew unit performance demonstrates that a fairly complex procedure, such as that required for modeling the collective actions of individual crewmembers, can often be replaced by a fairly simple yet effective algorithm. This result embodies all the appropriate details and has the obvious advantage of reducing computation, especially for utilization in larger scale battlefield simulations such as AURA, which involve a great amount of other computations. Also, the algorithm developed in this study provides the flexibility that enables crew unit performance estimates to be made for arbitrary levels of degraded states distributed among the various crewmembers, regardless of the cause.

The methodology, as we demonstrate in this study, can also be extended to specifically address crew unit performance where the performance of individual crewmembers may be impaired by the effects of ionizing radiation exposure. Here the conditional crew unit performance algorithm (as developed for AURA) is modified by taking into account both individual variability in response to radiation effects as well as extra- and intravehicular environmental dose levels among the crewmembers.

Crew unit performance data generated in this study pertains to fixed short combat engagement scenarios for the combat crews evaluated along a post-acute-exposure time frame (up to 6 weeks) for extra-vehicular environmental dose levels. These data provide input to other larger-scale battlefield simulation programs such as JANUS, which require prepackaged radiation effects embedded in crew performance values. These performance values are weight-averaged over the sixteen possible combinations of sickness states of four crewmembers.

However, based on the procedure we give to obtain these average crew unit performance values, discrete component crew performance estimates and their associated probabilities can be generated as

desired for arbitrary dose and time, utilizing the shielding factors and symptom incidence data presented in this report and the previously developed dose-time individual crewmember performance data [Anno, Wilson, and Dore, 1983]. This discrete probabilistic crew unit performance data, for example, would be more appropriate for battlefield simulations which treat combat crew unit performance stochastically.

Aside from application to larger-scale battlefield simulation or gaming codes, the graphical presentations of crew unit performance can be useful for training and education purposes in developing tactical guidelines. In this regard, some general observations can be made and caveats noted.

Crew unit performance generally follows the level of performance of the individual crewmembers over dose and time, although not necessarily in a linear fashion. For example, overall crew performance is not greatly affected by any one crewmember who may be significantly degraded compared to the others until that crewmember's performance level approaches around 50 percent. A plot of crew unit performance against decreasing performance values of one of the crewmembers, all others fixed, would initially appear relatively shallow and then rapidly turn down with smaller values of the individual's performance.

Task time variability, derived from field measurements according to a detailed characterization of subtasks that comprise a combat encounter scenario, comes from a population of participants in a normal state of health. Since it is impossible to acquire the corresponding measure of variability from a population of individuals impaired by the effects of ionizing radiation, we must assume that the standard deviation of task-performance time varies monotonically with the increased mean task-performance time expected when an individual is impaired by the effects of radiation. The assumed inverse performance relationship is consistent with the results from the statistical analysis of the field measurement data.

Finally, the crew unit performance values are all based on short but intense actions that take place during the tactical combat engagements modeled. In this regard, we are uncertain how applicable these performance values are to other combat crew scenarios where the action

levels are not as intense or where the duration of performance extends over much longer periods. for example. as in logistic or support operations. road marches. or other activities where protracted fatigue becomes a factor.

SECTION 8
LIST OF REFERENCES

- Anno, G. H., D. B. Wilson, and S. J. Baum. *Severity Levels and Symptom Complexes for Acute Radiation Sickness: Description and Quantification*, Pacific-Sierra Research Corporation, Report 1597, 30 November 1985.
- Anno, G. H., D. B. Wilson, and M. A. Dore. *Acute Radiation Effects on Individual Crewmember Performance*, Pacific-Sierra Research Corporation, Note 572, October 1983.
- Blumenthal, D. K., et al., *An Analysis of a Massed Versus a Dispersed Attacking Ground Force in Close Combat*, Lawrence Livermore National Laboratory, Livermore, California, UCID-20010, 31 January 1984.
- Dore, M. A., *CREW III User's Guide*, Pacific-Sierra Research Corporation, Report 1660, 1 September 1986.
- Klopčic, J. T. and L. K. Roach. *An Introduction to the Use of the Army Unit Resiliency Analysis (AURA) Methodology*, Vol. I, U.S. Ballistics Research Laboratory, Aberdeen Proving Ground, Maryland, Memorandum Report BRL-MR-3384, September 1984.
- Moyer, M. J., and S. Lam. *M60A3 Combat Tank Data*, Science Applications International Corporation, unpublished, forwarded in a letter dated 6 March 1987 to R. W. Young, Defense Nuclear Agency, Washington, DC.
- Moyer, M. J., T. K. O'Donoghue, and M. L. Feinberg. *The Final Report of the Task Timeline Analysis Project*, Science Applications International Corporation, La Jolla, California, Report 1-262-03-509-02, 12 September 1984.

APPENDIX A
TASK DESCRIPTION FOR EMPIRICAL DATA

Tables 8 through 11 detail the empirical tasks performed by the members of the four crews. The mean and standard deviation for each empirical task is included.

Table 8. Empirical task descriptions for gun crew.

Task No.	Description of Actions	Simulator (S) Live Fire (L)	Crewmember	Mean	SD
1	Issues, receives and relays fire mission data	S	Chief of section	18.99	1.247
2	Loads projectile and prepares to ram	L	No. 1 cannoneer	5.74	2.990
3	Laying for deflection	S	Gunner	9.94	4.516
4	Laying for quadrant	S	Assistant gunner	11.96	3.725
5	Laying for deflection and quadrant ^a	S	Gunner and assistant gunner	14.91	3.427
6	Operates and retracts rammer	L	No. 1 cannoneer	5.08	1.223
7	Loading propellant and closing breachblock ^a	L	No. 1 cannoneer	10.72	4.343
8	Stows rammer and tray	S	No. 1 cannoneer	2.72	0.718
9	Loads propellant charge	S	No. 1 cannoneer	2.82	0.509
10	Closes breachblock	S	No. 1 cannoneer	2.51	0.443
11	Checks lay for deflection and quadrant	S	Chief of section	4.81	0.143
12	Primes cannon and attaches lanyard	L	No. 1 cannoneer	4.86	2.580
13	Fires weapon, recovers and detaches lanyard	L	No. 1 cannoneer	5.70	3.128

^aTask 5 is equivalent to tasks 3 and 4 combined; similarly, task 7 is equivalent to tasks 8 through 11, and task 20 is equivalent to tasks 21 through 24.

Table 8. Empirical task descriptions for gun crew (continued).

Task No.	Description of Actions	Simulator (S) Live Fire (L)	Crewmember	Mean	SD
14	Swabs bore and checks clear	L	No. 1 cannoneer	8.75	3.553
15	Positions loading tray and rammer	L	No. 1 cannoneer	3.94	1.811
16	Loads projectile and prepares to ram	L	No. 1 cannoneer	5.39	3.368
17	Lays for quadrant	S	Assistant gunner	1.34	0.345
18	Lays for Deflection	S	Gunner	1.72	0.689
19	Operates & retracts rammer	L	No. 1 cannoneer	5.67	2.329
20	Loads propellant and closes breachblock ^a	L	No. 1 cannoneer	9.36	3.099
21	Stows rammer and tray		No. 1 cannoneer	(2.72	0.718) ^b
22	Loads propellant charge	S	No. 1 cannoneer	(2.82	0.509) ^b
23	Closes breachblock	S	No. 1 cannoneer	(2.51	0.443) ^b
24	Checks lay for deflection and quadrant	S	Chief of section	(4.81	0.143) ^b
25	Primes weapon and attaches lanyard	L	No. 1 cannoneer	4.40	2.302
26	Fires weapon, recovers and detaches lanyard	L	No. 1 cannoneer	5.59	2.661
27	Swabs bore and checks clear	L	No. 1 cannoneer	8.67	3.552

^aTask 5 is equivalent to tasks 3 and 4 combined; similarly, task 7 is equivalent to tasks 8 through 11, and task 20 is equivalent to tasks 21 through 24.

^bTasks 21 through 24 were not measured independently, but are copies of tasks 8 through 11.

Table 9. Empirical task descriptions for FDC crew.

Task No.	Description of Actions	Crewmember	Mean	SD
1	Issues call for fire	(Observer)	2.35	0.547
2	Receives and reads back call for fire	Fire direction officer	2.12	0.915
3	Identifies registration point	(Observer)	3.16	1.080
4	Receives and reads back registration point to be used	Fire direction officer	2.26	1.202
5	Announces target coordinates	(Observer)	6.21	1.509
6	Receives and reads back target coordinates	Fire direction officer	7.22	2.343
7	Describes target	(Observer)	4.06	2.058
8	Receives and reads back target description	Fire direction officer	2.03	1.085
9	Issues fire order	Fire direction officer	2.16	1.292
10	Determines and transmits the message to observer	Fire direction officer	1.98	1.217
11	Transmits "fire mission" to battery	Computer	1.95	1.079
12	Receives and reads back "fire mission"	(Battery)	1.33	0.476
13	Transmits fire order to battery	Computer	1.52	0.548
14	Receives and reads back fire orders to computer	(Battery)	1.81	0.859
15	Plots target and announces chart range	Horizontal control operator	39.14	5.312
16	Receives and reads back target range	Computer	2.28	0.963

Table 9. Empirical task descriptions for FDC crew (continued).

Task No.	Description of Actions	Crewmember	Mean	SD
17	Announces chart deflection	Horizontal control operator	6.39	1.717
18	Receives and reads back target range	Computer	2.18	1.341
19	Computes firing data, converts to fire commands, and transmits deflection to battery	Computer	20.32	9.372
20	Receives and reads back deflection	(Battery)	1.46	0.922
21	Computes site and announces when requested by computer	Fire direction officer	18.64	6.343
22	Computes and transmits quadrant to battery	Computer	8.76	5.806
23	Receives and reads back quadrant	(Battery)	1.17	0.460

Table 10. Empirical task descriptions for tank crew.

Task No.	Description of Actions	Simulator (S) Live Fire (L)	Crewmember	Mean	SD
1	Issues initial fire command, traverse turret	S	Tank commander	0.274	0.141
2	Arm main gun	L	Loader	1.916	--
3	Main gun switch to on, index ammunition, identify target	S	Gunner	1.231	0.738
4	Pull next round	L	Loader	5.745	--
5	Aim main gun, lase range	S	Gunner	1.184	0.575
6	Confirms range	S	Tank commander	1.142	0.549
7	Commands driver forward and gunner to guide driver	S	Tank commander	0.756	0.232
8	Drive tank forward and stop	L	Driver	3.894	0.851
9	Guide driver into firing position	S	Gunner	2.323	0.572
10	Verify hostile target and range; command fire	S	Tank commander	2.127	0.523
11	Final lay, alerts crew	S	Gunner	1.288	0.485
12	Pull trigger	S	Gunner	1.034	0.388
13	Reload, arm main gun, and pull next round	L	Loader	11.027	--
14	Observes round, reports impact	S	Tank commander	1.581	0.354
15	Issues order to reengage	S	Tank commander	0.480	0.140
16	Re-lay main gun, lase range	S	Gunner	0.968	0.320

Table 10. Empirical task descriptions for tank crew (continued).

Task No.	Description of Actions	Simulator (S) Live Fire (L)	Crewmember	Mean	SD
17	Verify range to target, commands fire	S	Tank commander	1.601	1.085
18	Final lay, alerts crew	S	Gunner	0.610	0.145
19	Pulls trigger	S	Gunner	0.747	0.209
20	Reload, select next round	L	Loader	9.544	--
21	Observes round, report impact	S	Tank commander	1.412	0.274
22	Commands cease fire	S	Tank commander	0.401	0.139
23	Commands driver to return to defilade	S	Tank commander	0.453	0.100
24	Return tank to defilade and stop	L	Driver	4.207	0.849

Table 11. Empirical task descriptions for ITV-TOW crew.

Task No.	Description of Actions	Crewmember	Mean	SD
1	Alerts crew, issues elements of initial fire command	Squad Leader	5.32	0.029
2	Erect launcher	Gunner	6.36	0.594
3	Slews turret to track first target	Gunner	11.29	1.845
4	Arming left missile	Squad leader and gunner	2.51	0.011
5	Issues fire order	Squad leader	2.02	0.597
6	Tracks missile to target and announces results	Gunner	19.37 ^a	0.843
7	Terminates 1st firing sequence, issues subsequent fire commands	Squad leader	7.91	0.396
8	Traverses turret to track second target	Gunner	4.80	1.679
9	Arming right missile	Squad leader and gunner	1.46	0.123
10	Issues fire order	Squad leader	1.80	0.763
11	Tracks missile to target, and announces results	Gunner	18.13 ^a	0.961
12	Terminates action, orders reloading	Squad leader	2.17	0.639
13	Preparation for reload	Gunner and loader	16.25	2.484
14	Unloads left launch container	Loader	3.22	0.957

^aIncludes flight time.

Table 11. Empirical task descriptions for ITV-TOW crew (continued).

Task No.	Description of Actions	Crewmember	Mean	SD
15	Loads left launcher	Loader	7.61	1.791
16	Unloads-ejects right launch container	Loader	2.06	0.381
17	Loads right launcher from ready rack	Loader	8.12	1.281
18	Closes cargo hatch	Loader	3.24	0.981
19	Rearranges ready rack	Loader	6.39	0.778

APPENDIX B
INPUT DATA

Data for the gun, FDC, tank, and ITV-TOW crews as input to the CREW 111 code are presented in Tables 12 through 15. The data are input exactly as shown in the tables.

Table 12. Input data for gun crew.

Task No.	Description	Data Task	Task Type	Mean (sec)	SD (sec)	Crewmember	Precursor Task(s)
1	START	--		0.0	0.0	--	--
2	AN:MISSION&DEFL.	1A		15.99	1.226	C.SECT.	1
3	AN: QUADRANT	1B		3.00	0.230	C.SECT.	2
4	LOAD PROJECTILE	2A	P	4.74	2.926	NO. 1 C.	3
5	ROTATE CYLINDER	2B	P	1.00	0.617	NO. 1 C.	3 4
6	LAY FOR DEFL.	3A		8.44	4.446	GUNNER	2
7	RECHECK SIGHT	3B		1.50	0.790	GUNNER	6 8
8	LAY FOR QUAD.	4		11.96	3.725	AST.GNR.	3
9	CYCLE RAMMER	6		5.08	1.223	NO. 1 C.	5
10	STOW RAM & TRAY	8	P	2.72	0.718	NO. 1 C.	9
11	LOAD PROPELLANT	9		2.82	0.509	NO. 1 C.	10
12	CLOSE BREACH	10	P	2.51	0.443	NO. 1 C.	11
13	CHECK AIM	11		4.81	0.143	C.SECT.	7 9
14	PRIME	12		4.86	2.580	NO. 1 C.	12 13
15	FIRE	13		5.70	3.128	NO. 1 C.	14
16	RECOIL	--		1.00	0.0	--	15
17	SWAB BORE	14		8.75	3.553	NO. 1 C.	16
18	AN: NEXT	15A		1.00	0.583	C.SECT.	17
19	POS'N TRAY & RAM	15B	P	3.94	1.811	NO. 1 C.	18
20	AN: QUAD	16A		1.00	0.748	C.SECT.	18
21	LAY FOR QUAD	17		1.34	0.345	AST.GNR.	20
22	LAY FOR DEFL	18		1.72	0.689	GUNNER	21
23	LOAD PROJECTILE	16B	P	5.39	3.368	NO. 1 C.	19 20
24	CYCLE RAMMER	19		5.67	2.329	NO. 1 C.	23
25	STOW RAM & TRAY	(8/21)	P	2.72	0.718	NO. 1 C.	24
26	LOAD PROPELLANT	(9/22)		2.82	0.509	NO. 1 C.	25
27	CLOSE BREACH	(10/23)	P	2.51	0.443	NO. 1 C.	26
28	CHECK AIM	(11/24)		4.81	0.143	C.SECT.	22 24
29	PRIME	25		4.40	2.302	NO. 1 C.	27 28
30	FIRE	26		5.59	2.661	NO. 1 C.	29
31	RECOIL	--		1.00	0.0	--	30
32	SWAB BORE	27		8.67	3.552	NO. 1 C.	31
33	END	--		0.0	0.0	--	32

^dTask numbers in this column refer to empirical data measurements in Appendix A.

Table 13. Input data for FDC crew.

Task No.	Description	Data Task ^a	Task Type	Mean (sec)	SD (sec) ^b	Crewmember	Precursor Task(s)
1	START	--		0.0	0.0	--	--
2	CALL FOR FIRE	1		2.35	(0.547)	--	1
3	RETURN CFF	2		2.12	0.915	FDO	2
4	ID REG'N POINT	3		3.16	(1.080)	--	3
5	RETURN REG'N PT	4		2.26	1.202	FDO	4
6	AN: TARGT COORDS	5		6.21	(1.509)	--	5
7	RETURN TGT CORDS	6	C	7.22	2.343	FDO	6
8	DESCRIBES TARGET	7		4.06	(2.058)	--	7
9	RETURN DESCRIPTN	8		2.03	1.085	FDO	8
10	ISSUE FIRE ORDER	9	C	2.16	1.292	FDO	9
11	MESSAGE TO OBS'R	10		1.98	1.217	FDO	10
12	XMIT FIRE MIS'N	11		1.95	1.079	COMPUTER	2
13	XBAK FIRE MIS'N	12		1.33	(0.476)	--	12
14	XMIT FIRE ORDER	13		1.52	0.548	COMPUTER	10 12
15	XBAK FIRE ORDER	14		1.81	(0.859)	--	13 14
16	BEGIN PLOTTING	15A	C	16.14	3.051	HCO	4
17	FINSH PLOT & AN:	15B	C	23.00	4.348	HCO	7 16
18	RETURN RANGE	16		2.28	0.963	COMPUTER	14 17
19	AN: DEFLECTION	17		6.39	1.717	HCO	18
20	RETURN DEFL.	18		2.18	1.341	COMPUTER	19
21	REQUEST SITE	19A	C	10.16	6.627	COMPUTER	20
22	COMP & XMIT DEFL	19B	C	10.16	6.627	COMPUTER	25
23	RETURN DEFL	20		1.46	(0.922)	--	15 22
24	COMP & AN: SITE	21A	C	17.64	6.315	FDO	11 17
25	REPLY WITH SITE	21B	C	1.00	0.359	FDO	21 24
26	COMP & XMIT QUAD	22		8.76	5.806	COMPUTER	23
27	RETURN QUAD	23		1.17	(0.460)	--	26
28	END	--		0.0	0.0	--	27

^aTask numbers in this column refer to empirical data measurements in Appendix A.

^bStandard deviations indicated in parentheses () were set to 0.0, making these fixed time tasks.

Table 14. Input data for tank crew.

Task No.	Description	Data Task Task ^a	Type	Mean (sec)	SD (sec)	Crewmember	Precursor Task(s)
1	START	--		0.000	0.000	--	--
2	ACQUIRE TARGET	--		0.100	0.050	T.CMDR.	1
3	ACQUIRE TARGET	--		0.200	0.100	GUNNER	-2 1
4	REPORT TARGET	--		1.000	0.400	GUNNER	-2 3
5	SCAN REPORT AREA	--		1.500	1.000	T.CMDR.	-2 4
6	SEE TARGET	--		0.100	0.050	T.CMDR.	-2 5
7	TRAVERSE TURRET	1A		0.274	0.158	T.CMDR.	2 6
8	ISSUE COMMAND	1B		0.274	0.105	T.CMDR.	2 6
9	ARM - "UP"	2		1.916	0.807	LOADER	8
10	SET COMP.	3A		0.500	0.298	GUNNER	8
11	ACQUIRE TARGET	3B		0.731	0.360	GUNNER	7 10
12	SELECT ROUND	4		5.745	2.427	LOADER	9
13	TRACK TARGET	5A		0.592	0.421	GUNNER	11
14	LASER RANGE	5B		0.592	0.421	GUNNER	13
15	CHECK RANGE	6		1.142	0.343	T.CMDR.	14
16	RANGE OK?	--		0.000	0.000	T.CMDR.	15
17	ORDER: RE-LASE	--		3.000	1.000	T.CMDR.	-16 15
18	RE-LASE	--		3.000	1.000	GUNNER	-16 17
19	ORDER: MOVE OUT	7A		0.365	0.086	T.CMDR.	16 18
20	ORDER: TAKE OVER	7B		0.400	0.090	T.CMDR.	19
21	MOVE FORWARD	8A		3.603	0.354	DRIVER	19
22	GUIDE DRIVER	9A		2.023	0.619	GUNNER	20
23	ORDER: STOP	9B		0.300	0.238	GUNNER	21 22
24	STOP	8B		1.000	0.186	DRIVER	23
25	COMMAND FIRE	10		2.127	0.721	T.CMDR.	24
26	FINAL LAY	11		1.288	0.584	GUNNER	25
27	PULL TRIGGER	12		1.034	0.382	GUNNER	26
28	RECOIL TIME	--		0.100	0.000	--	9 27
29	TRACK FLIGHT	14A		0.500	0.289	T.CMDR.	9 27
30	TRACK FLIGHT	--		0.500	0.289	GUNNER	9 27
31	REPORT IMPACT	14B		1.081	0.246	T.CMDR.	-32 29
32	REPORT IMPACT	--		1.500	0.500	GUNNER	-31 30
33	RELOAD	13A	P	5.682	2.712	LOADER	12 28
34	ARM - "UP"	13B		0.500	0.200	LOADER	33

^aTask numbers in this column refer to empirical data measurements in Appendix A.

Table 14. Input data for tank crew (continued).

Task No.	Description	Data Task ^a	Task Type	Mean (sec)	SD (sec)	Crewmember	Precursor Task(s)
35	SELECT NEXT	4		5.745	2.427	LOADER	34
36	ORDER: RE-ENGAGE	15		0.480	0.109	T.CMDR.	31 32
37	RE-LAY & LASE	16		0.968	0.205	GUNNER	36
38	CHECK RANGE	17		1.601	0.873	T.CMDR.	37
39	FINAL LAY	18		0.610	0.105	GUNNER	38
40	PULL TRIGGER	19		0.747	0.158	GUNNER	39
41	RECOIL TIME	--		0.100	0.000	--	19 34
42	TRACK FLIGHT	21A		0.500	0.289	T.CMDR.	19 34
43	TRACK LIGHT	--		0.500	0.289	GUNNER	19 34
44	REPORT IMPACT	21B		0.912	0.242	T.CMDR.	47
45	RELOAD	20	P	5.699	2.262	LOADER	35 41
46	"CEASE FIRE"	22		0.401	0.071	T.CMDR.	44
47	"BACK UP"	23		0.453	0.060	T.CMDR.	46
48	START BACK	24A		3.616	0.116	DRIVER	47
49	"STOP"	24B		0.300	0.032	T.CMDR.	48
50	STOP	24C		1.000	0.061	DRIVER	49
51	END	--		0.000	0.000	--	50

^aTask numbers in this column refer to empirical data measurements in Appendix A.

Table 15. Input data for ITV-TOW crew.

Task No.	Description	Data Task ^a	Task Type	Mean (sec)	SD (sec)	Crewmember	Precursor Task(s)
1	START	--		0.0	0.0	--	--
2	ALERT/GIVE ORDER	1		5.32	0.029	SQD.LDR.	1
3	ERECT LAUNCHER	2		6.36	0.594	GUNNER	2
4	SLEW TURRET	3		11.29	1.845	GUNNER	3
5	AN: SELECT & ARM	4A		0.75	0.006	SQD.LDR.	4
6	ARM 1ST MISSILE	4B		1.76	0.009	GUNNER	5
7	AN: "FIRE"	5		2.02	0.597	SQD.LDR.	6
8	FIRE/TRACK MIS'L	6	P	19.37	0.843	GUNNER	7
9	GIVE 2ND ORDER	7		7.91	0.396	SQD.LDR.	8
10	TRAVERSE TURRET	8		4.80	1.679	GUNNER	9
11	AN: ARM MISSILE	9A		0.44	0.067	SQD.LDR.	10
12	ARM 2ND MISSILE	9B		1.02	0.103	GUNNER	11
13	AN: "FIRE"	10		1.80	0.763	SQD.LDR.	12
14	FIRE/TRACK MIS'L	11	P	18.13	0.961	GUNNER	13
15	AN: CEASE/RELOAD	12		2.17	0.639	SQD.LDR.	14
16	POSITION TURRET	13A		13.20	2.239	GUNNER	15
17	OPEN HATCH	13B		3.05	1.076	LOADER	16
18	UNLOAD LEFT TUBE	14	P	3.22	0.957	LOADER	17
19	LOAD LEFT TUBE	15	P	7.61	1.791	LOADER	18
20	UNLOAD RGHT TUBE	16	P	2.06	0.381	LOADER	19
21	LOAD RIGHT TUBE	17	P	8.12	1.281	LOADER	20
22	CLOSE HATCH/"UP"	18		3.24	0.981	LOADER	21
23	REARRANGE RACK	19	P	6.39	0.778	LOADER	22
24	END	--		0.0	0.0	--	23

^aTask numbers in this column refer to empirical data measurements in Appendix A.

APPENDIX C
TASK SCHEMATICS

Figures 6 through 9 are the schematic representations of the task lists in Appendix B.

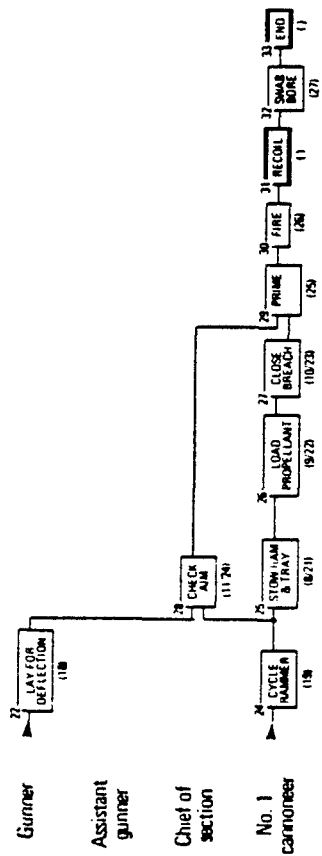
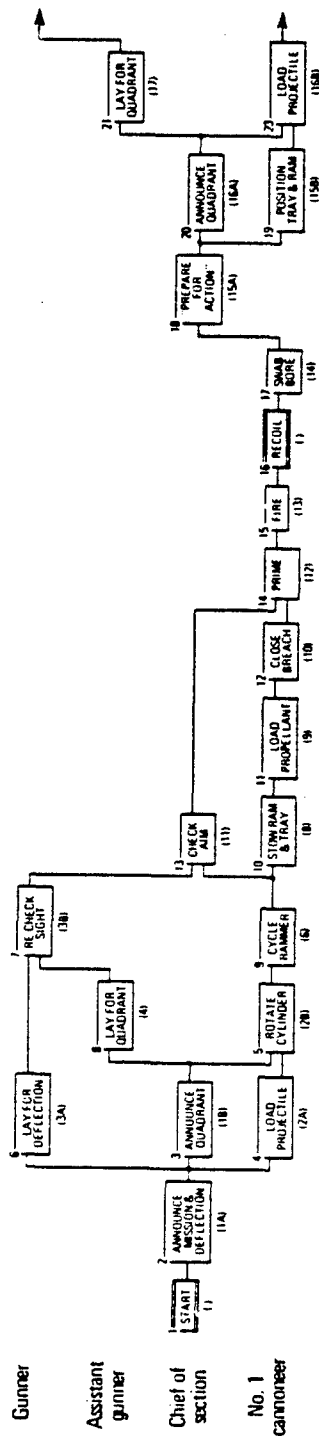

Figure 6. Task schematic for gun crew.

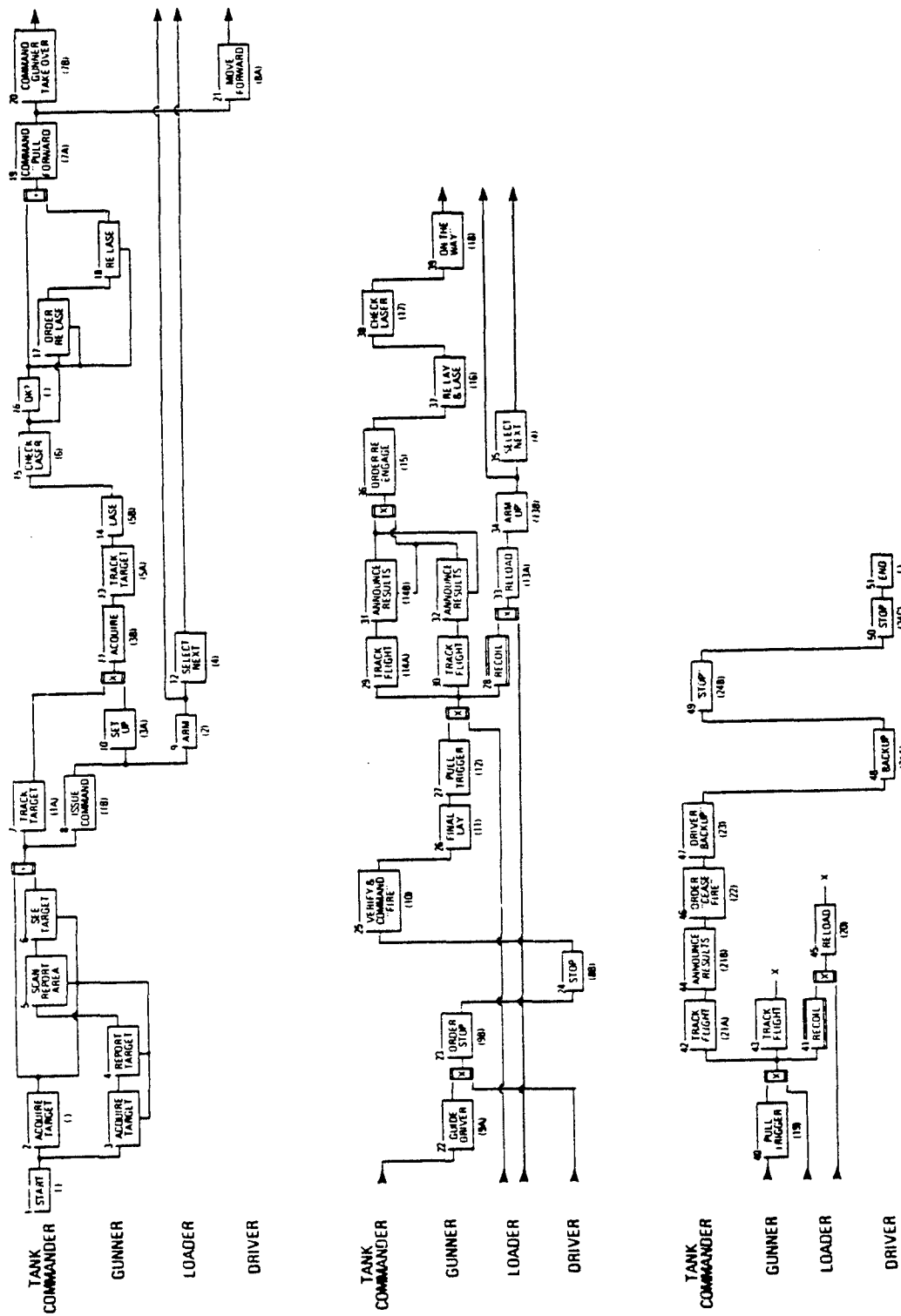

Figure 8. Task schematic for tank crew.

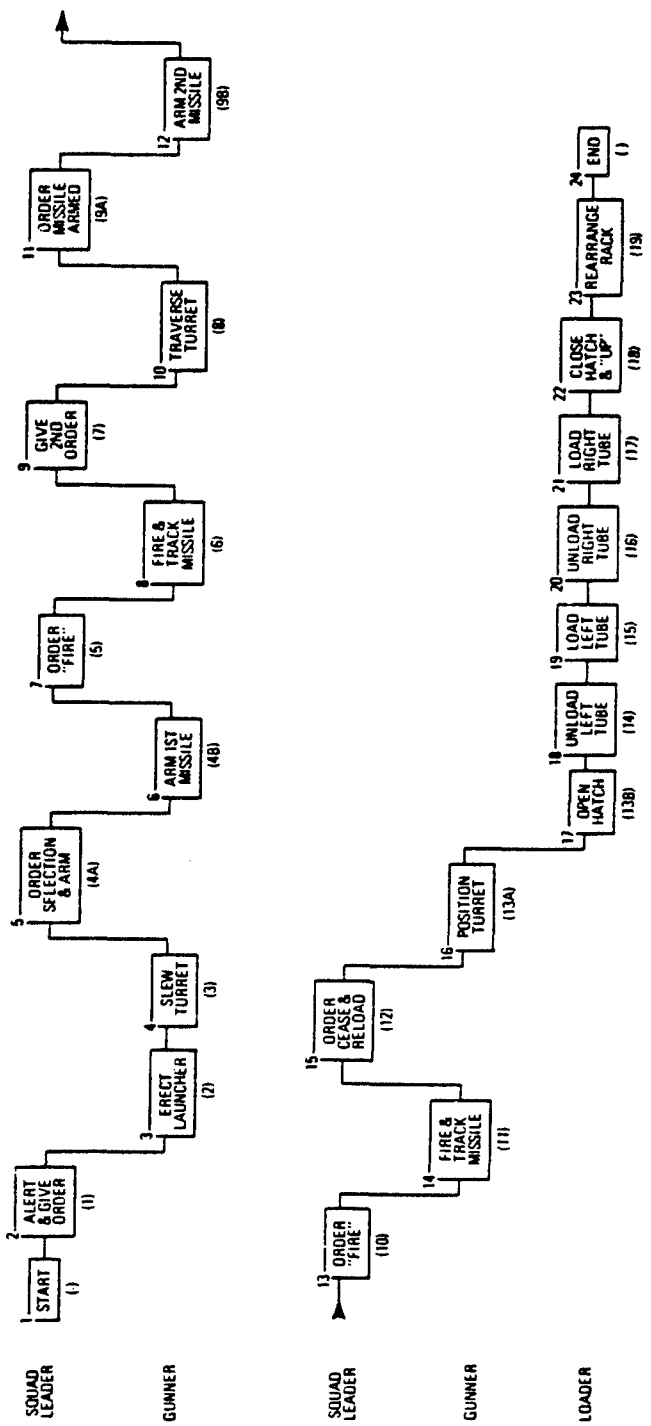

Figure 9. Task schematic for ITV-TOW crew.

APPENDIX D
BEST-FIT RESULTS

In this appendix (Tables 16 through 19), we present the Monte Carlo results from the CREW III code for the four crews by individual crewmember.* The fractional difference is the difference between these results and those predicted by Eq. (9).

*The individual crewmembers are referred to by the following abbreviations:

AG = Assistant gunner
C = Computer
CS = Chief of section
D = Driver
F = Fire direction officer
G = Gunner
H = Horizontal control operator
L = Loader
SL = Squad leader
TC = Tank commander

Table 16. Best-fit results for gun crew
(undegraded mission time:
103.182 s).

Crewmember Performance				Mean (s)	SD (s)	Crew Performance	Predicted by Fit	Fractional Difference
G	AG	CS	L					
0.80	1.00	1.00	1.00	103.654	9.607	0.99545	0.98972	-0.00575
1.00	0.80	1.00	1.00	105.171	9.475	0.98109	0.97477	-0.00644
0.80	0.80	1.00	1.00	105.818	8.913	0.97509	0.96312	-0.01227
0.50	1.00	1.00	1.00	106.426	10.119	0.96952	0.95136	-0.01873
1.00	0.50	1.00	1.00	114.289	11.424	0.90282	0.90867	0.00648
0.80	0.50	1.00	1.00	112.799	11.392	0.91474	0.89854	-0.01771
0.50	0.80	1.00	1.00	110.656	12.026	0.93246	0.92676	-0.00611
0.50	0.50	1.00	1.00	116.808	12.745	0.88335	0.86681	-0.01872
0.30	1.00	1.00	1.00	119.403	17.929	0.86415	0.88254	0.02128
1.00	0.30	1.00	1.00	131.091	17.151	0.78710	0.82385	0.04669
0.80	0.30	1.00	1.00	128.766	14.542	0.80131	0.81552	0.01773
0.20	0.80	1.00	1.00	136.763	29.263	0.75446	0.78392	0.03905
0.50	0.30	1.00	1.00	133.613	15.137	0.77225	0.78929	0.02207
0.30	0.50	1.00	1.00	125.489	17.824	0.82224	0.80931	-0.01573
0.30	0.30	1.00	1.00	133.808	14.324	0.77112	0.74133	-0.03863
0.80	1.00	0.80	1.00	109.192	9.229	0.94496	0.93222	-0.01348
1.00	0.80	1.00	0.80	123.090	12.510	0.83826	0.84168	0.00407
0.80	0.80	0.80	0.80	129.511	11.256	0.79670	0.79187	-0.00607
0.50	1.00	0.50	1.00	133.467	11.907	0.77309	0.76884	-0.00550
1.00	0.50	1.00	0.50	183.749	17.943	0.56154	0.56138	-0.00028
0.80	0.50	0.80	0.50	188.181	15.897	0.54831	0.53278	-0.01739
0.50	0.80	0.50	0.80	150.590	13.356	0.68519	0.67078	-0.02102
0.50	0.50	0.50	0.50	206.819	19.175	0.49890	0.47984	-0.03820
0.30	1.00	0.30	1.00	179.919	16.619	0.57349	0.58273	0.01610
1.00	0.30	1.00	0.30	292.827	31.478	0.35237	0.34482	-0.02141
0.80	0.30	0.80	0.30	297.240	33.308	0.34713	0.33616	-0.03162
0.20	0.80	0.30	0.80	208.957	23.501	0.49380	0.49484	0.00212
0.50	0.30	0.50	0.30	311.130	31.322	0.33164	0.31223	-0.05851
0.30	0.50	0.30	0.50	242.088	18.255	0.42622	0.40009	-0.06129
0.30	0.30	0.30	0.30	349.141	33.313	0.29553	0.27638	-0.06479
1.00	1.00	0.80	1.00	109.788	9.748	0.93983	0.94313	0.00351
1.00	1.00	1.00	0.80	122.170	12.503	0.84458	0.86192	0.02053
1.00	1.00	0.80	0.80	126.276	12.861	0.81711	0.81798	0.00105
1.00	1.00	0.50	1.00	128.549	9.952	0.80267	0.80159	-0.00134
1.00	1.00	1.00	0.50	181.440	19.213	0.56868	0.59566	0.04744
1.00	1.00	0.80	0.50	183.383	19.604	0.56266	0.57434	0.02077
1.00	1.00	0.50	0.80	145.418	12.698	0.70955	0.70935	-0.00029
1.00	1.00	0.50	0.50	201.946	18.327	0.51094	0.51858	0.01496
1.00	1.00	0.30	1.00	168.178	9.884	0.61353	0.63253	0.03097

Table 16. Best-fit results for gun crew
 (undegraded mission time:
 103k.182 s) (continued).

<u>Crewmember Performance</u>				Mean (s)	SD (s)	Crew Performance	Predicted by Fit	Fractional Difference
G	AG	CS	L					
1.00	1.00	1.00	0.30	281.705	28.332	0.36628	0.37254	0.01711
1.00	1.00	0.80	0.30	301.321	32.496	0.34243	0.36409	0.06325
1.00	1.00	0.30	0.80	183.812	11.908	0.56135	0.57366	0.02195
1.00	1.00	0.50	0.30	306.564	32.007	0.33658	0.34086	0.01272
1.00	1.00	0.30	0.50	230.123	20.680	0.44838	0.44213	-0.01393
1.00	1.00	0.30	0.30	333.926	30.359	0.30900	0.30607	-0.00947

Table 17. Best-fit results for FDC crew.
(undegraded mission time:
93.375 s).

Crewmember Performance			Mean (s)	SD (s)	Crew Performance	Predicted by Fit	Fractional Difference
F	C	H					
0.80	1.00	1.00	98.055	13.402	0.95227	0.95680	0.00476
0.50	1.00	1.00	116.395	15.013	0.80223	0.83152	0.03651
0.30	1.00	1.00	156.814	24.770	0.59545	0.63306	0.06316
1.00	0.80	1.00	100.629	13.182	0.92791	0.91571	-0.01315
0.80	0.80	1.00	102.055	14.023	0.91495	0.88168	-0.03636
0.50	0.80	1.00	123.434	18.138	0.75648	0.77419	0.02342
0.30	0.80	1.00	165.834	25.010	0.56306	0.59928	0.06431
1.00	0.50	1.00	124.391	25.575	0.75056	0.74533	-0.00710
0.80	0.50	1.00	125.777	22.691	0.74239	0.72263	-0.02661
0.50	0.50	1.00	141.272	25.788	0.66096	0.64880	-0.01840
0.30	0.50	1.00	180.216	33.306	0.51813	0.52129	0.00610
1.00	0.30	1.00	167.693	31.789	0.55682	0.57271	0.02853
0.80	0.30	1.00	171.653	31.460	0.54398	0.55921	0.02801
0.50	0.30	1.00	184.069	36.961	0.50728	0.51395	0.01315
0.30	0.30	1.00	213.197	38.895	0.43798	0.43053	-0.01700
1.00	1.00	0.80	102.417	11.930	0.91171	0.89700	-0.01614
0.80	1.00	0.80	107.952	12.956	0.86497	0.86433	-0.00074
0.50	1.00	0.80	123.335	17.658	0.75708	0.76078	0.00488
0.30	1.00	0.80	162.743	24.930	0.57376	0.59121	0.03041
1.00	0.80	0.80	115.333	17.410	0.80561	0.83065	0.02599
0.80	0.80	0.80	117.738	16.379	0.79307	0.80256	0.01196
0.50	0.80	0.80	131.961	16.900	0.70760	0.71251	0.00695
0.30	0.80	0.80	168.845	25.147	0.55302	0.56164	0.01558
1.00	0.50	0.80	137.610	21.255	0.67855	0.68799	0.01391
0.80	0.50	0.80	136.008	18.057	0.68654	0.66860	-0.02613
0.50	0.50	0.80	144.619	22.038	0.64566	0.60491	-0.06311
0.30	0.50	0.80	186.496	30.659	0.50068	0.49258	-0.01619
1.00	0.30	0.80	176.535	32.935	0.52893	0.53824	0.01760
0.80	0.30	0.80	184.951	36.285	0.50486	0.52630	0.04246
0.50	0.30	0.80	189.537	36.164	0.49265	0.48602	-0.01345
0.30	0.30	0.80	221.583	42.459	0.42140	0.41076	-0.02526
1.00	1.00	0.50	133.984	15.341	0.69691	0.69054	-0.00914
0.80	1.00	0.50	138.912	14.346	0.67219	0.67102	-0.00174
0.50	1.00	0.50	150.724	15.297	0.61951	0.60689	-0.02038
0.30	1.00	0.50	184.610	25.399	0.50580	0.49388	-0.02355
1.00	0.80	0.50	145.915	16.508	0.63993	0.65054	0.01659
0.80	0.80	0.50	145.589	18.634	0.64136	0.63318	-0.01275
0.50	0.80	0.50	156.978	20.520	0.59483	0.57577	-0.03204
0.30	0.80	0.50	189.092	24.921	0.49381	0.47308	-0.04193

Table 17. Best-fit results for FDC crew
(undegraded mission time:
(93.375 s) (continued).

<u>Crewmember Performance</u>			Mean (s)	SD (s)	Crew Performance	Predicted by Fit	Fractional Difference
F	C	H					
1.00	0.50	0.50	171.036	23.184	0.54594	0.55965	0.02512
0.80	0.50	0.50	167.775	21.257	0.55655	0.54676	-0.01759
0.50	0.50	0.50	177.242	24.738	0.52682	0.50341	-0.04443
0.30	0.50	0.50	202.601	27.660	0.46088	0.42311	-0.08195
1.00	0.30	0.50	212.758	41.553	0.43888	0.45637	0.03985
0.80	0.30	0.50	209.611	33.765	0.44547	0.44776	0.00514
0.50	0.30	0.50	220.650	37.541	0.42318	0.41826	-0.01162
0.30	0.30	0.50	237.129	40.228	0.39377	0.36129	-0.08249
1.00	1.00	0.30	199.124	21.458	0.46893	0.49128	0.04767
0.80	1.00	0.30	202.856	22.735	0.46030	0.48132	0.04566
0.50	1.00	0.30	208.158	23.009	0.44858	0.44741	-0.00261
0.30	1.00	0.30	225.230	26.479	0.41458	0.38283	-0.07657
1.00	0.80	0.30	205.803	22.368	0.45371	0.47069	0.03743
0.80	0.80	0.30	207.053	21.473	0.45097	0.46154	0.02343
0.50	0.80	0.30	214.312	27.083	0.43570	0.43027	-0.01246
0.30	0.80	0.30	239.124	29.276	0.39049	0.37021	-0.05192
1.00	0.50	0.30	227.842	27.096	0.40982	0.42120	0.02776
0.80	0.50	0.30	231.984	31.477	0.40251	0.41385	0.02819
0.50	0.50	0.30	238.886	27.625	0.39088	0.38853	-0.00600
0.30	0.50	0.30	254.987	36.194	0.36620	0.33889	-0.07456
1.00	0.30	0.30	270.894	34.346	0.34469	0.35990	0.04412
0.80	0.30	0.30	281.183	44.969	0.33208	0.35452	0.06758
0.50	0.30	0.30	279.526	45.571	0.33405	0.33578	0.00517
0.30	0.30	0.30	290.646	39.646	0.32127	0.29805	-0.07228

Table 18. Best-fit results for tank crew
(undegraded mission time:
28.062 s).

Crewmember Performance				Mean (s)	SD (s)	Crew Performance	Predicted by Fit	Fractional Difference
TC	G	L	D					
0.80	1.00	1.00	1.00	29.269	3.447	0.95876	0.97058	0.01232
1.00	0.80	1.00	1.00	28.129	3.209	0.99762	0.97807	-0.01960
0.80	0.80	1.00	1.00	30.154	2.902	0.93062	0.92338	-0.00778
0.50	1.00	1.00	1.00	33.957	3.489	0.82640	0.82517	-0.00149
1.00	0.50	1.00	1.00	33.567	3.986	0.83600	0.84226	0.00749
0.80	0.50	1.00	1.00	35.255	3.659	0.79597	0.80139	0.00680
0.50	0.80	1.00	1.00	35.574	3.889	0.78883	0.79080	0.00250
0.50	0.50	1.00	1.00	40.308	4.510	0.69619	0.69960	0.00489
0.30	1.00	1.00	1.00	42.989	4.989	0.65277	0.65170	-0.00164
1.00	0.30	1.00	1.00	41.624	6.690	0.67418	0.66757	-0.00981
0.80	0.30	1.00	1.00	44.522	6.196	0.63030	0.64163	0.01799
0.20	0.80	1.00	1.00	56.800	6.425	0.49405	0.50250	0.01710
0.50	0.30	1.00	1.00	49.791	6.321	0.56360	0.57468	0.01967
0.30	0.50	1.00	1.00	50.158	5.374	0.55947	0.57079	0.02023
0.30	0.30	1.00	1.00	59.920	7.150	0.46832	0.48481	0.03521
0.80	1.00	0.80	1.00	31.113	5.100	0.90194	0.90350	0.00173
1.00	0.80	1.00	0.80	30.269	2.751	0.92709	0.90876	-0.01977
0.80	0.80	0.80	0.80	34.007	4.068	0.82518	0.80812	-0.02068
0.50	1.00	0.50	1.00	43.562	10.171	0.64419	0.64829	0.00637
1.00	0.50	1.00	0.50	41.343	4.524	0.67876	0.66685	-0.01754
0.80	0.50	0.80	0.50	44.862	6.059	0.62552	0.61101	-0.02319
0.50	0.80	0.50	0.80	44.430	8.751	0.63160	0.59767	-0.05372
0.50	0.50	0.50	0.50	53.471	8.504	0.52481	0.48255	-0.08053
0.30	1.00	0.30	1.00	64.747	15.327	0.43341	0.41940	-0.03232
1.00	0.30	1.00	0.30	60.571	6.247	0.46329	0.44888	-0.03112
0.80	0.30	0.80	0.30	64.655	7.502	0.43403	0.42286	-0.02572
0.20	0.80	0.30	0.80	75.645	16.959	0.37097	0.34271	-0.07619
0.50	0.30	0.50	0.30	73.515	8.361	0.38172	0.35707	-0.06456
0.30	0.50	0.30	0.50	74.043	12.731	0.37900	0.34315	-0.09458
0.30	0.30	0.30	0.30	92.668	14.796	0.30282	0.27455	-0.09338
1.00	1.00	0.80	1.00	29.669	3.953	0.94584	0.95579	0.01052
1.00	1.00	1.00	0.80	29.127	2.757	0.96344	0.95443	-0.00935
1.00	1.00	0.80	0.80	31.219	4.046	0.89888	0.88949	-0.01044
1.00	1.00	0.50	1.00	37.789	8.959	0.74260	0.76899	0.03554
1.00	1.00	1.00	0.50	36.257	5.445	0.77397	0.77999	0.00778
1.00	1.00	0.80	0.50	38.315	4.906	0.73240	0.73608	0.00501
1.00	1.00	0.50	0.80	39.167	10.617	0.71647	0.72548	0.01258
1.00	1.00	0.50	0.50	44.562	7.492	0.62973	0.62008	-0.01533
1.00	1.00	0.30	1.00	53.948	16.740	0.52017	0.54955	0.05649
1.00	1.00	1.00	0.30	48.399	4.738	0.57981	0.58838	0.01479
1.00	1.00	0.80	0.30	50.247	5.262	0.55848	0.56304	0.00816

Table 18. Best-fit results for tank crew
(undegraded mission time:
28.062 s) (continued).

Crewmember Performance				Mean (s)	SD (s)	Crew Performance	Predicted by Fit	Fractional Difference
TC	G	L	D					
1.00	1.00	0.30	0.80	52.559	12.942	0.53391	0.52697	-0.01301
1.00	1.00	0.50	0.30	55.807	8.206	0.50284	0.49256	-0.02045
1.00	1.00	0.30	0.50	60.075	16.473	0.46712	0.46905	0.00414
1.00	1.00	0.30	0.30	68.389	15.890	0.41033	0.39224	-0.04409
0.90	1.00	1.00	1.00	27.814	3.002	1.00892	1.00000	-0.00884
0.80	1.00	1.00	1.00	28.817	3.499	0.97380	0.97058	-0.00331
0.70	1.00	1.00	1.00	30.011	3.638	0.93506	0.93148	-0.00382
0.60	1.00	1.00	1.00	32.005	5.784	0.87680	0.88402	0.00823
0.50	1.00	1.00	1.00	34.209	3.629	0.82031	0.82517	0.00592
0.40	1.00	1.00	1.00	37.263	3.822	0.75308	0.75026	-0.00374
0.30	1.00	1.00	1.00	42.925	4.607	0.65374	0.65170	-0.00312
0.20	1.00	1.00	1.00	54.915	6.985	0.51101	0.51615	0.01007
0.10	1.00	1.00	1.00	91.753	14.124	0.30584	0.31793	0.03952
1.00	0.90	1.00	1.00	27.957	3.207	1.00376	1.00000	-0.00374
1.00	0.80	1.00	1.00	28.319	2.977	0.99092	0.97807	-0.01297
1.00	0.70	1.00	1.00	29.723	3.112	0.94412	0.94266	-0.00154
1.00	0.60	1.00	1.00	31.247	3.455	0.89807	0.89855	0.00054
1.00	0.50	1.00	1.00	33.858	4.465	0.82881	0.84226	0.01622
1.00	0.40	1.00	1.00	36.448	4.839	0.76992	0.76830	-0.00211
1.00	0.30	1.00	1.00	43.332	7.335	0.64760	0.66757	0.03083
1.00	0.20	1.00	1.00	52.941	8.038	0.53006	0.52424	-0.01098
1.00	0.10	1.00	1.00	91.170	14.283	0.30780	0.31029	0.00809
1.00	1.00	0.90	1.00	28.505	4.193	0.98446	0.99684	0.01258
1.00	1.00	0.80	1.00	28.947	4.132	0.96943	0.95579	-0.01407
1.00	1.00	0.70	1.00	30.769	4.567	0.91202	0.90607	-0.00652
1.00	1.00	0.60	1.00	33.068	6.157	0.84862	0.84504	-0.00421
1.00	1.00	0.50	1.00	35.749	8.215	0.78497	0.76899	-0.02036
1.00	1.00	0.40	1.00	41.624	9.507	0.67418	0.67278	-0.00207
1.00	1.00	0.30	1.00	55.140	16.834	0.50892	0.54955	0.07983
1.00	1.00	0.20	1.00	76.463	22.704	0.36700	0.39120	0.06595
1.00	1.00	0.10	1.00	132.740	44.313	0.21141	0.19391	-0.08274
1.00	1.00	1.00	0.90	28.310	3.580	0.99124	0.99561	0.00441
1.00	1.00	1.00	0.80	29.879	3.262	0.93919	0.95443	0.01623
1.00	1.00	1.00	0.70	31.282	3.160	0.89707	0.90622	0.01020
1.00	1.00	1.00	0.60	33.192	3.494	0.84544	0.84900	0.00420
1.00	1.00	1.00	0.50	36.114	3.504	0.77704	0.77999	0.00380
1.00	1.00	1.00	0.40	41.305	4.185	0.67939	0.69516	0.02322
1.00	1.00	1.00	0.30	49.094	4.714	0.57160	0.58838	0.02936
1.00	1.00	1.00	0.20	64.482	7.109	0.43519	0.44993	0.03387
1.00	1.00	1.00	0.10	109.445	11.716	0.25640	0.26346	0.02753

Table 19. Best-fit results for ITV-TOW Crew
(undegraded mission time:
157.824 s).

Crewmember Performance				Mean (s)	SD (s)	Crew Performance	Predicted by Fit	Fractional Difference
SL	G	D ^a	L					
0.80	1.00	1.00	1.00	162.926	4.935	0.96869	0.96960	0.00094
0.50	1.00	1.00	1.00	177.587	5.522	0.88871	0.88690	-0.00204
0.30	1.00	1.00	1.00	205.723	5.816	0.76717	0.76817	0.00131
1.00	0.80	1.00	1.00	176.789	5.384	0.89273	0.89306	0.00037
0.80	0.80	1.00	1.00	180.935	5.678	0.87227	0.86854	-0.00428
0.50	0.80	1.00	1.00	196.637	5.682	0.80262	0.80159	-0.00128
0.30	0.80	1.00	1.00	223.738	7.682	0.70540	0.70334	-0.00292
1.00	0.50	1.00	1.00	234.026	8.866	0.67439	0.67497	0.00086
0.80	0.50	1.00	1.00	239.131	8.594	0.65999	0.66087	0.00133
0.50	0.50	1.00	1.00	254.489	9.256	0.62016	0.62138	0.00197
0.30	0.50	1.00	1.00	281.568	10.536	0.56052	0.56067	0.00026
1.00	0.30	1.00	1.00	337.737	14.396	0.46730	0.46968	0.00509
0.80	0.30	1.00	1.00	341.848	14.035	0.46168	0.46281	0.00245
0.50	0.30	1.00	1.00	353.790	15.868	0.44610	0.44309	-0.00674
0.30	0.30	1.00	1.00	384.025	15.719	0.41097	0.41133	0.00086
1.00	1.00	1.00	0.80	166.522	5.424	0.94777	0.94837	0.00064
0.80	1.00	1.00	0.80	171.849	5.230	0.91839	0.92077	0.00260
0.50	1.00	1.00	0.80	186.606	6.219	0.84576	0.84588	0.00014
0.30	1.00	1.00	0.80	213.642	6.392	0.73873	0.73720	-0.00207
1.00	0.80	1.00	0.80	184.608	6.093	0.85491	0.85147	-0.00403
0.80	0.80	1.00	0.80	190.765	5.519	0.82732	0.82915	0.00221
0.50	0.80	1.00	0.80	205.345	6.459	0.76858	0.76792	-0.00085
0.30	0.80	1.00	0.80	234.372	6.348	0.67339	0.67728	0.00578
1.00	0.50	1.00	0.80	242.031	9.018	0.65208	0.65094	-0.00175
0.80	0.50	1.00	0.80	248.679	8.452	0.63465	0.63782	0.00499
0.50	0.50	1.00	0.80	264.326	9.542	0.59708	0.60096	0.00649
0.30	0.50	1.00	0.80	290.175	8.912	0.54389	0.54398	0.00017
1.00	0.30	1.00	0.80	345.089	14.501	0.45734	0.45792	0.00125
0.80	0.30	1.00	0.80	349.241	15.161	0.45191	0.45138	-0.00116
0.50	0.30	1.00	0.80	366.428	16.578	0.43071	0.43261	0.00440
0.30	0.30	1.00	0.80	392.880	15.756	0.40171	0.40228	0.00141
1.00	1.00	1.00	0.50	192.296	7.700	0.82073	0.82218	0.00177
0.80	1.00	1.00	0.50	196.299	6.867	0.80400	0.80136	-0.00328
0.50	1.00	1.00	0.50	212.653	7.363	0.74217	0.74402	0.00250

^aNo variation in driver performance.

Table 19. Best-fit results for ITV-TOW crew
(undegraded mission time:
157.824 s) (continued).

Crewmember Performance				Mean (s)	SD (s)	Crew Performance	Predicted by Fit	Fractional Difference
SL	G	D ^a	L					
0.30	1.00	1.00	0.50	239.250	7.978	0.65966	0.65862	-0.00157
1.00	0.80	1.00	0.50	210.520	7.340	0.74969	0.74835	-0.00179
0.80	0.80	1.00	0.50	215.862	8.208	0.73113	0.73105	-0.00011
0.50	0.80	1.00	0.50	231.317	8.797	0.68228	0.68304	0.00110
0.30	0.80	1.00	0.50	258.199	9.577	0.61125	0.61038	-0.00142
1.00	0.50	1.00	0.50	267.275	9.079	0.59049	0.58890	-0.00270
0.80	0.50	1.00	0.50	273.892	9.744	0.57623	0.57814	0.00332
0.50	0.50	1.00	0.50	288.085	10.372	0.54784	0.54769	-0.00027
0.30	0.50	1.00	0.50	314.944	10.910	0.50112	0.49997	-0.00229
1.00	0.30	1.00	0.50	369.950	14.509	0.42661	0.42632	-0.00067
0.80	0.30	1.00	0.50	370.212	14.026	0.42631	0.42065	-0.01326
0.50	0.30	1.00	0.50	391.071	14.022	0.40357	0.40430	0.00181
0.30	0.30	1.00	0.50	417.531	16.399	0.37799	0.37769	-0.00081
1.00	1.00	1.00	0.30	238.261	10.797	0.66240	0.66727	0.00736
0.80	1.00	1.00	0.30	240.860	11.032	0.65525	0.65349	-0.00269
0.50	1.00	1.00	0.30	256.597	10.614	0.61507	0.61485	-0.00035
0.30	1.00	1.00	0.30	283.046	12.202	0.55759	0.55534	-0.00403
1.00	0.80	1.00	0.30	255.373	9.775	0.61801	0.61780	-0.00034
0.80	0.80	1.00	0.30	259.813	8.873	0.60745	0.60597	-0.00244
0.50	0.80	1.00	0.30	276.243	9.695	0.57132	0.57260	0.00224
0.30	0.80	1.00	0.30	304.458	12.528	0.51838	0.52065	0.00438
1.00	0.50	1.00	0.30	311.031	10.873	0.50742	0.50494	-0.00490
0.80	0.50	1.00	0.30	318.653	11.660	0.49528	0.49701	0.00347
0.50	0.50	1.00	0.30	331.547	11.507	0.47602	0.47433	-0.00355
0.30	0.50	1.00	0.30	360.829	12.542	0.43739	0.43812	0.00166
1.00	0.30	1.00	0.30	413.889	16.507	0.38132	0.38052	-0.00211
0.80	0.30	1.00	0.30	417.046	15.533	0.37843	0.37599	-0.00645
0.50	0.30	1.00	0.30	433.200	17.662	0.36432	0.36287	-0.00397
0.30	0.30	1.00	0.30	465.502	18.800	0.33904	0.34129	0.00664

^aNo variation in driver performance.

APPENDIX E

SELECTED PLOTS OF CREW PERFORMANCE VERSUS CREWMEMBER PERFORMANCE

This appendix contains graphs (Figs. 10 through 13) of crew performance as a function of individual crewmember performance for the four crew types.* Each graph is a "slice" through the four-dimensional performance surface given by Eq. (9). In each case the performance level of two crewmembers is held constant at the values indicated on the graph. The performance level of a third crewmember is the independent variable, ranging from 1 to 0. The four curves correspond to performance levels of 0.3, 0.5, 0.8, and 1.0 for the fourth crewmember whose symbol does not appear in the frame.

*In these plots, the crewmember titles are abbreviated as:

A = Assistant gunner
C' = Computer
C = Chief of section
D = Driver
F = Fire direction officer
G = Gunner
H = Horizontal control operator
L = Loader
S = Squad leader
T = Tank commander

M-109 GUN CREW

FRAME 1 OF 12

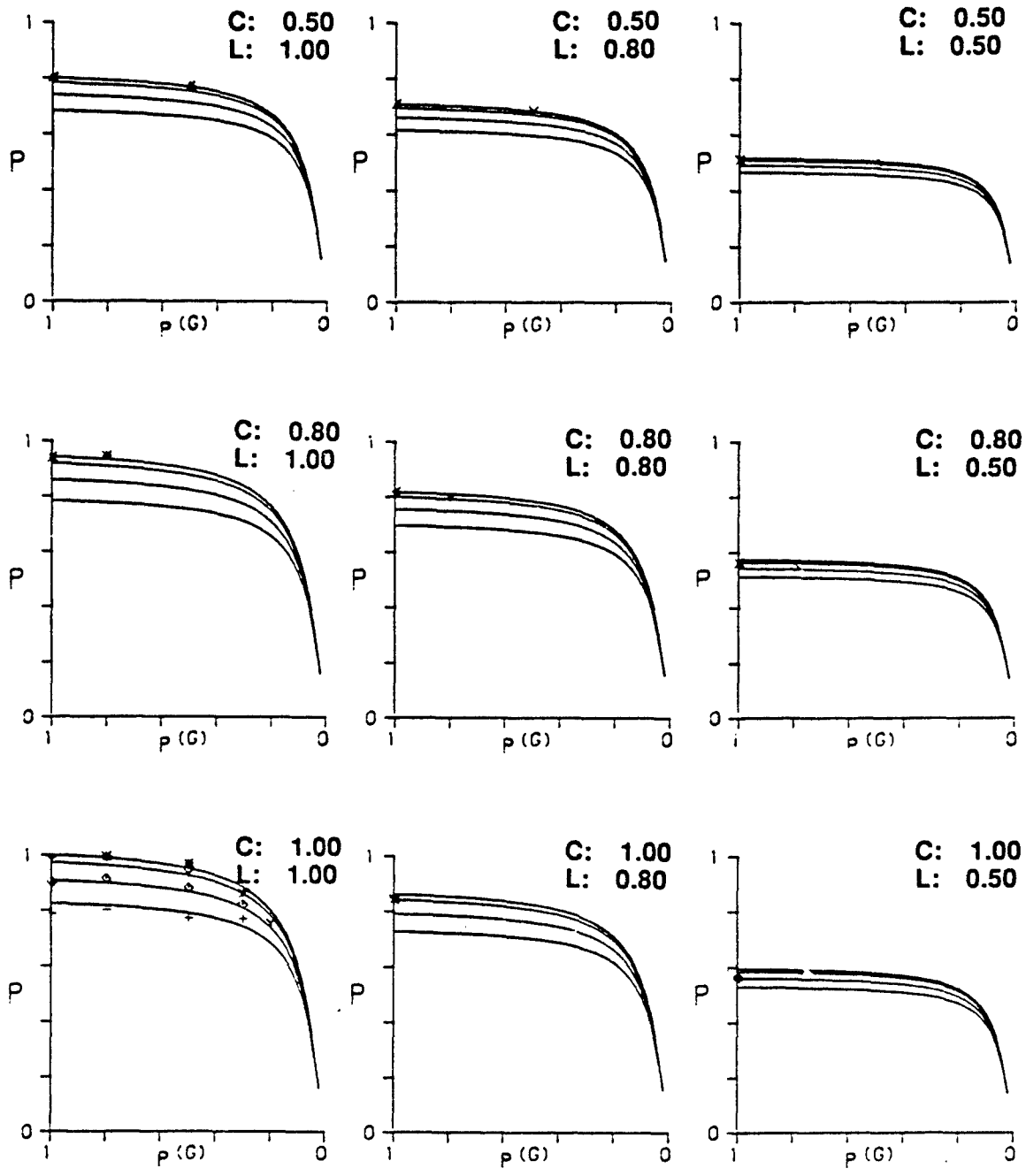

Figure 10. Final performance plot for gun crew.

M-109 GUN CREW

FRAME 2 OF 12

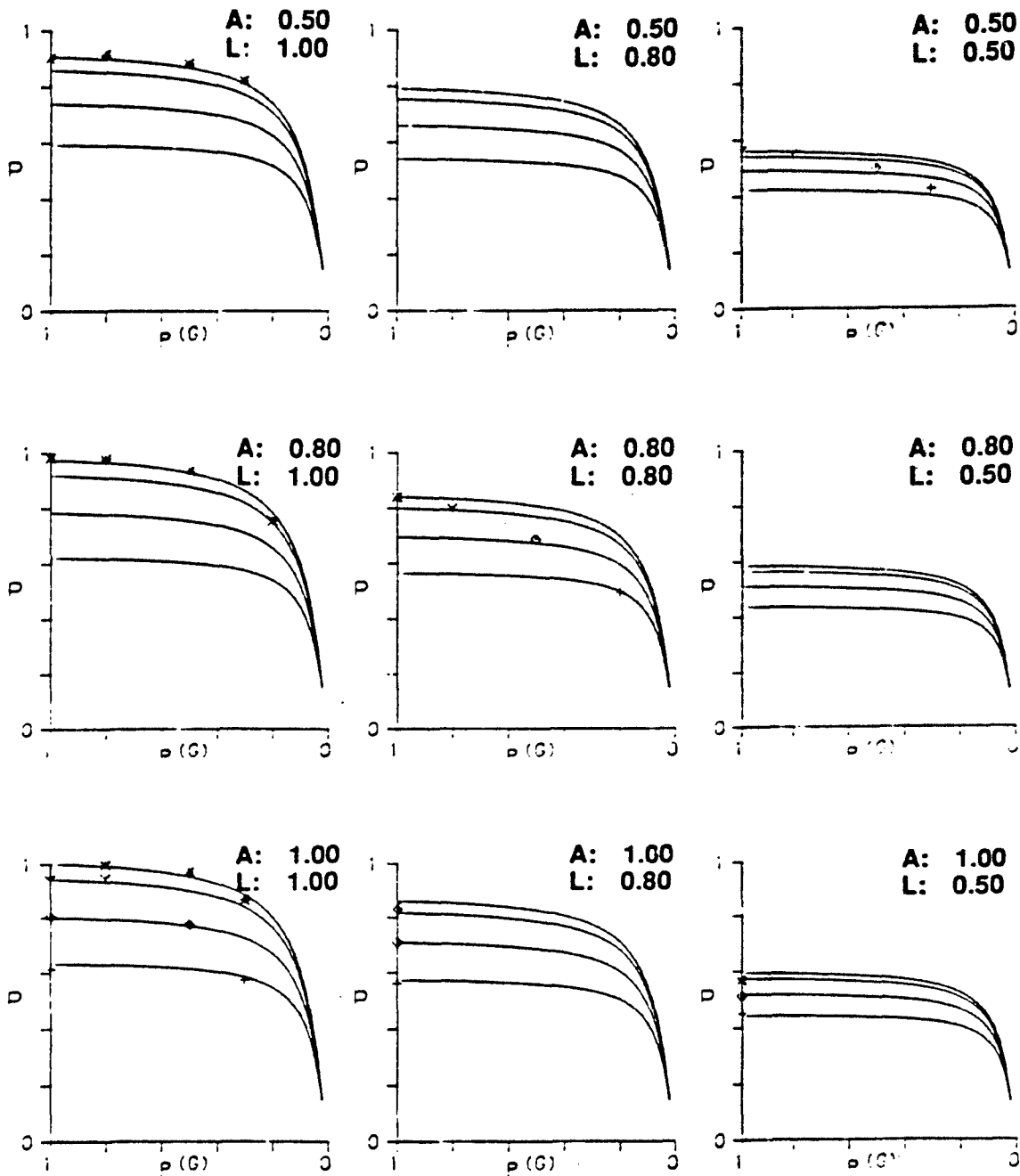

Figure 10. Final performance plot for gun crew (continued).

M-109 GUN CREW

FRAME 3 OF 12

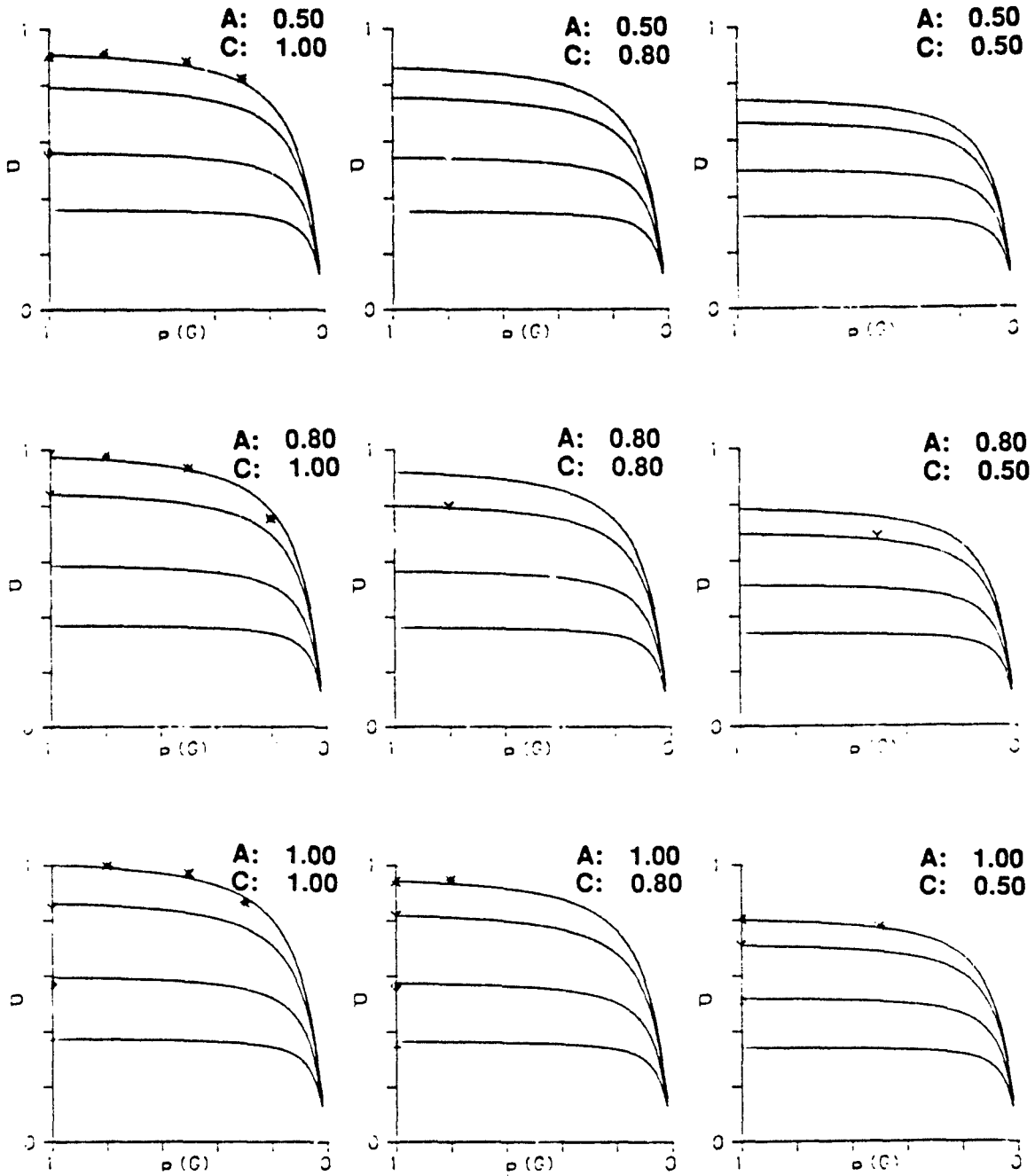

Figure 10. Final performance plot for gun crew (continued).

M-109 GUN CREW

FRAME 4 OF 12

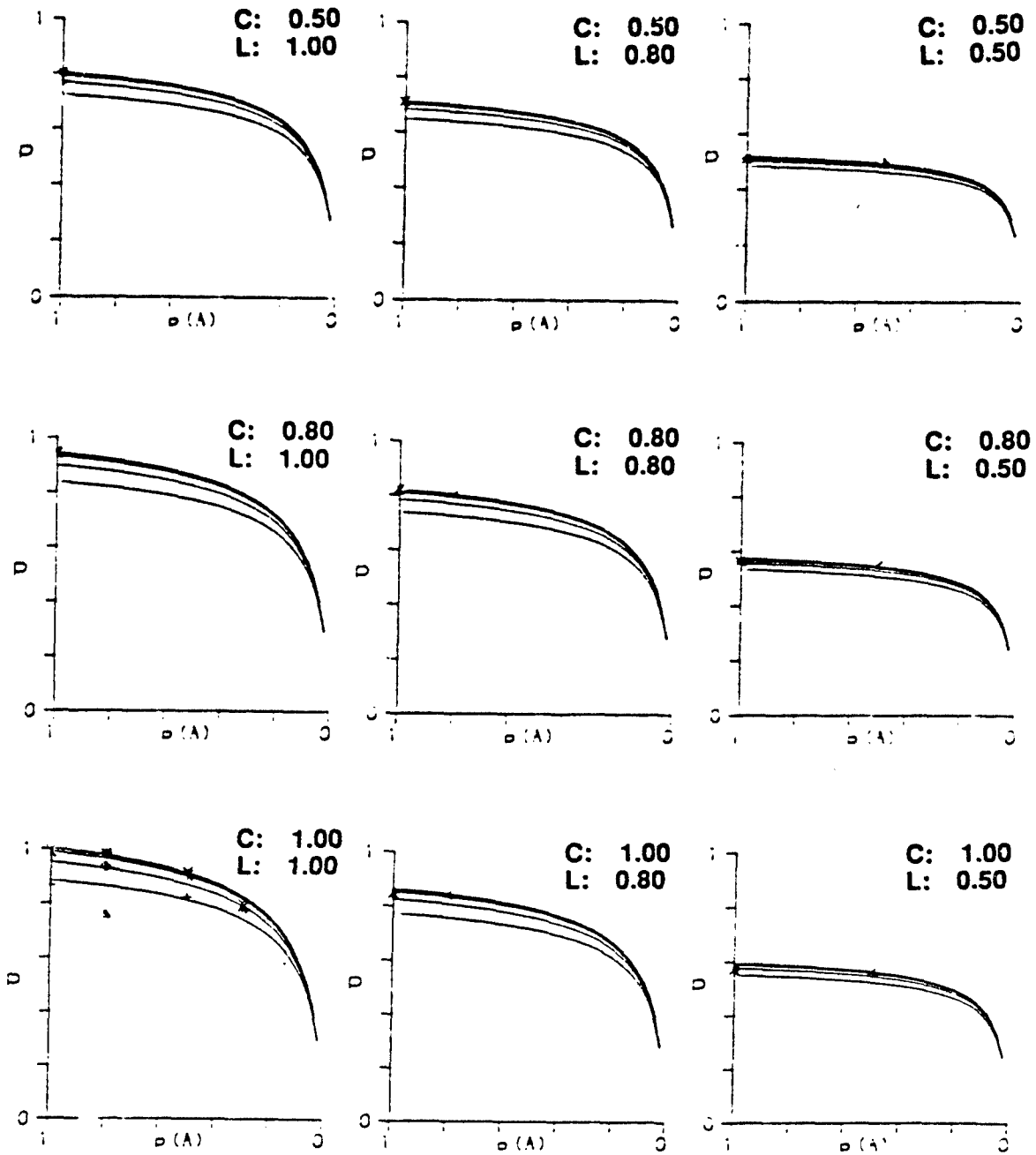

Figure 10. Final performance plot for gun crew (continued).

M-109 GUN CREW

FRAME 5 OF 12

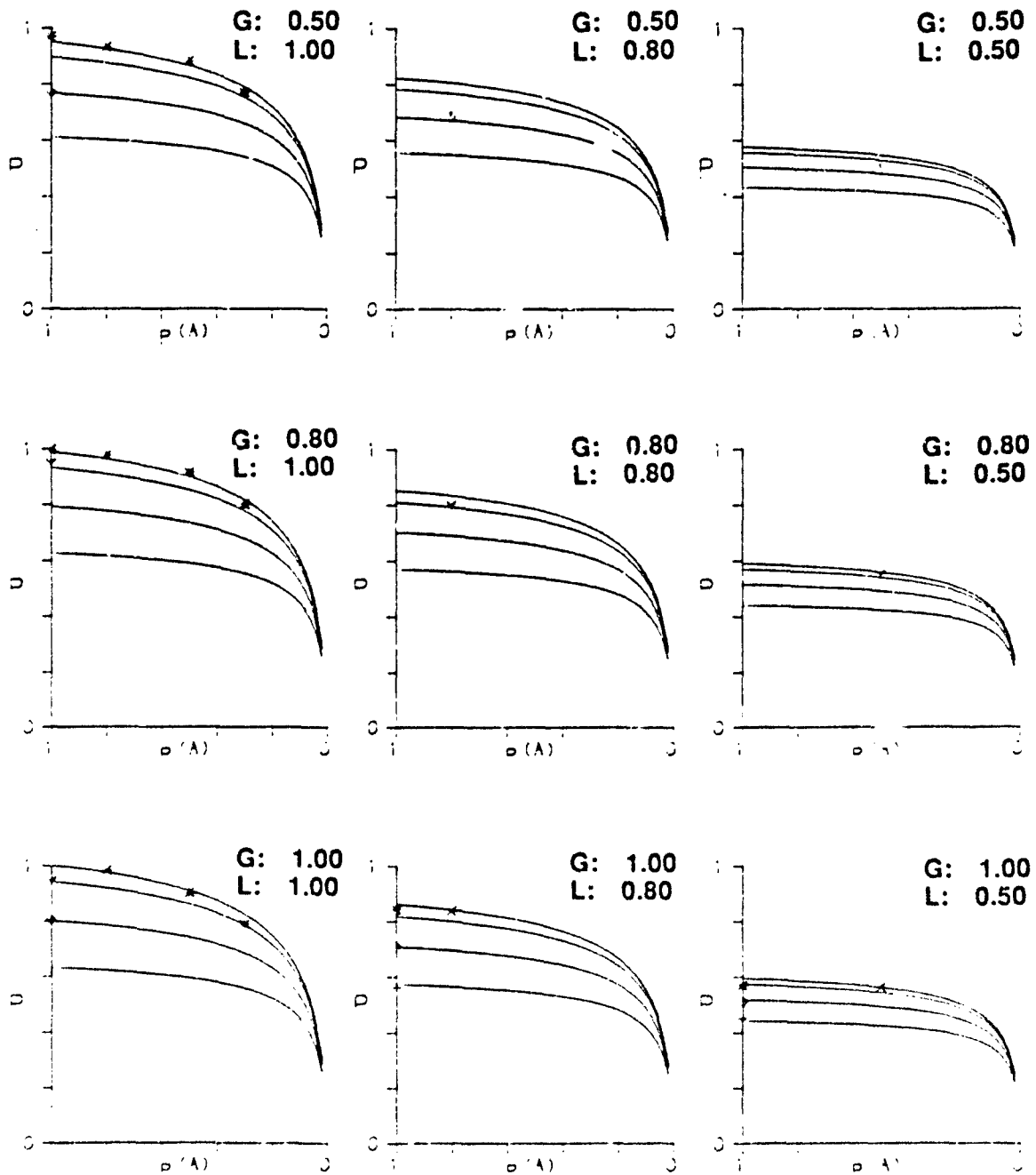

Figure 10. Final performance plot for gun crew (continued).

M-109 GUN CREW

FRAME 6 OF 12

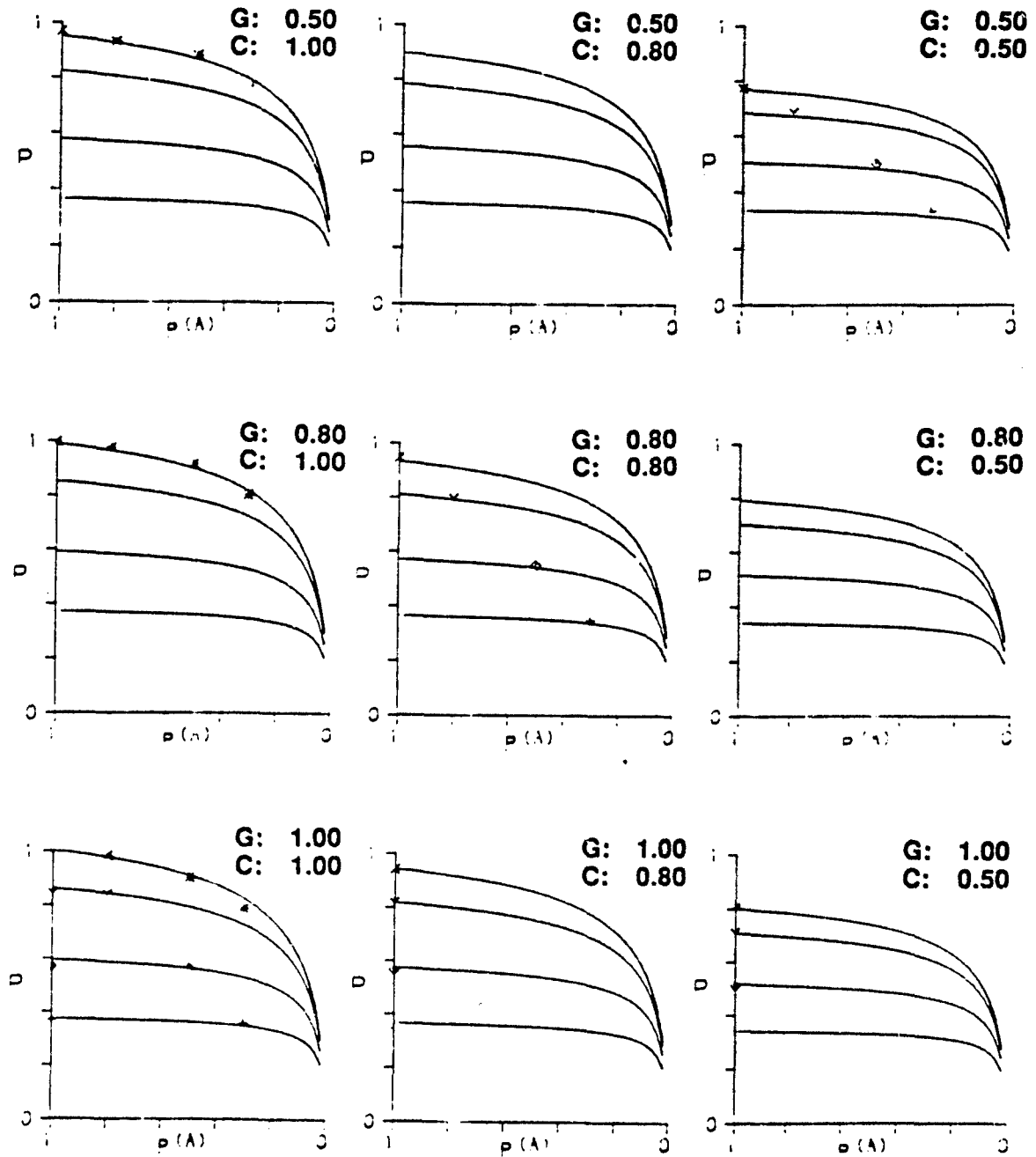

Figure 10. Final performance plot for gun crew (continued).

M-109 GUN CREW

FRAME 7 OF 12

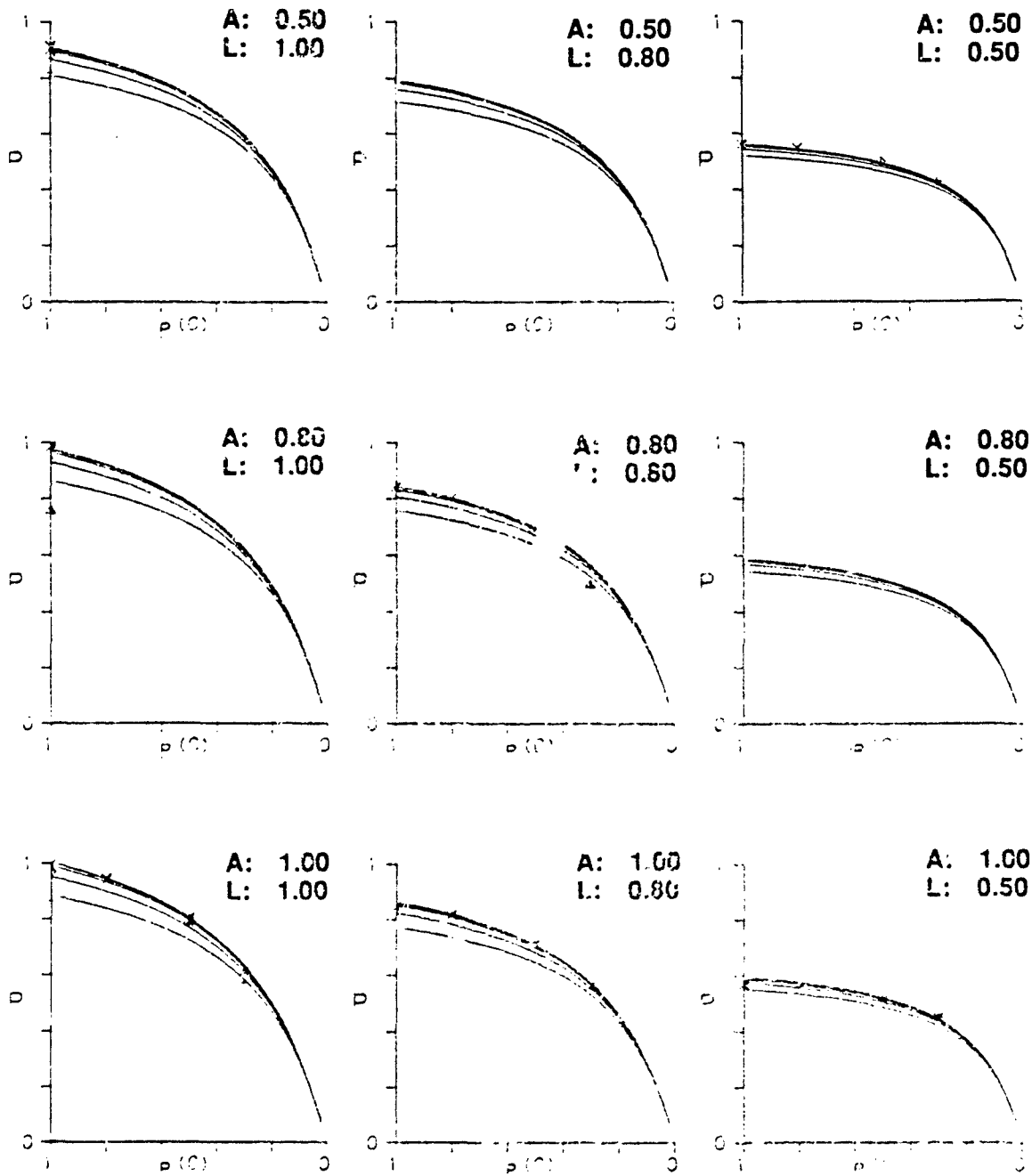

Figure 10. Final performance plot for gun crew (continued).

M-109 GUN CREW

FRAME 8 OF 12

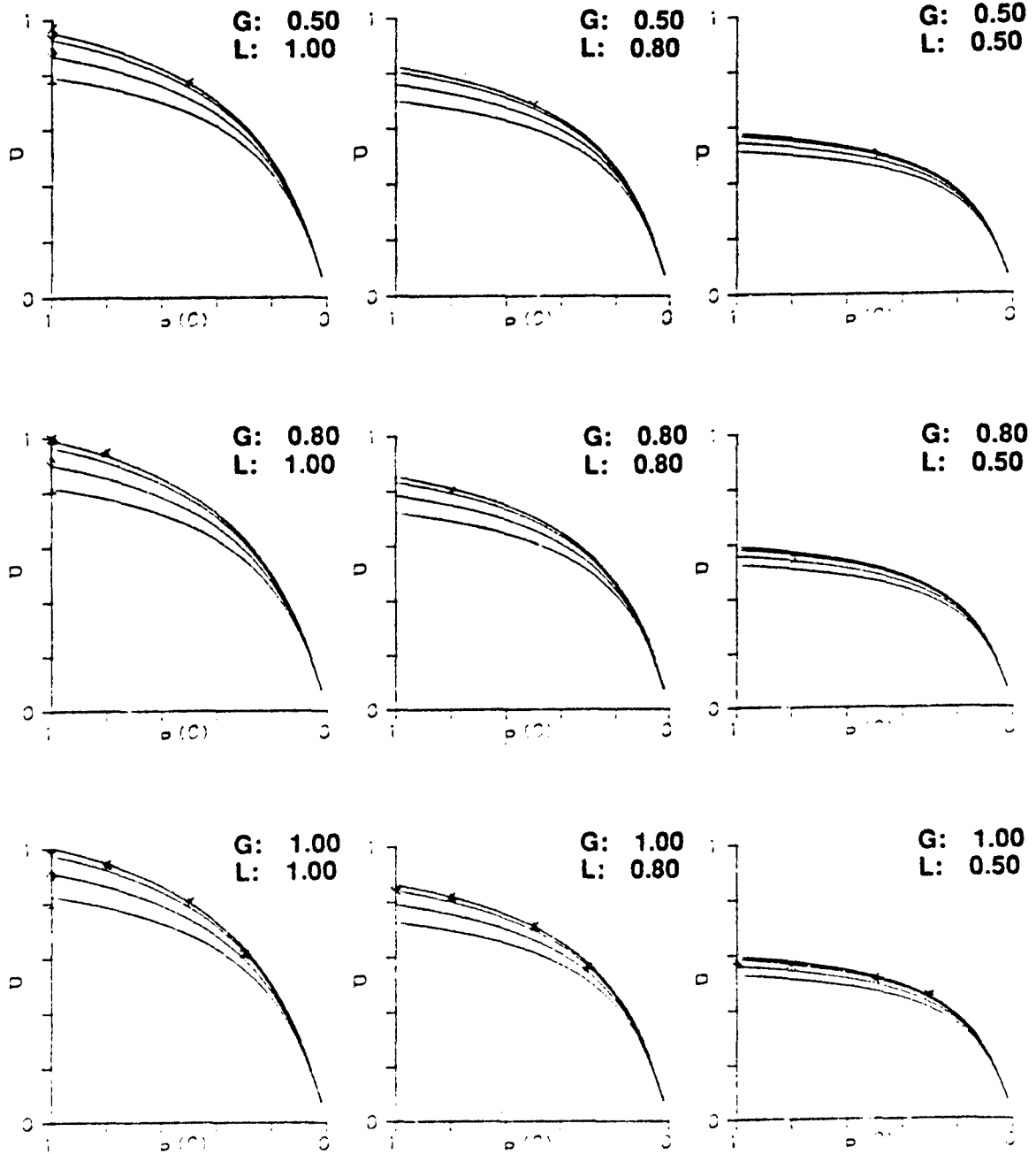

Figure 10. Final performance plot for gun crew (continued).

M-109 GUN CREW

FRAME 9 OF 12

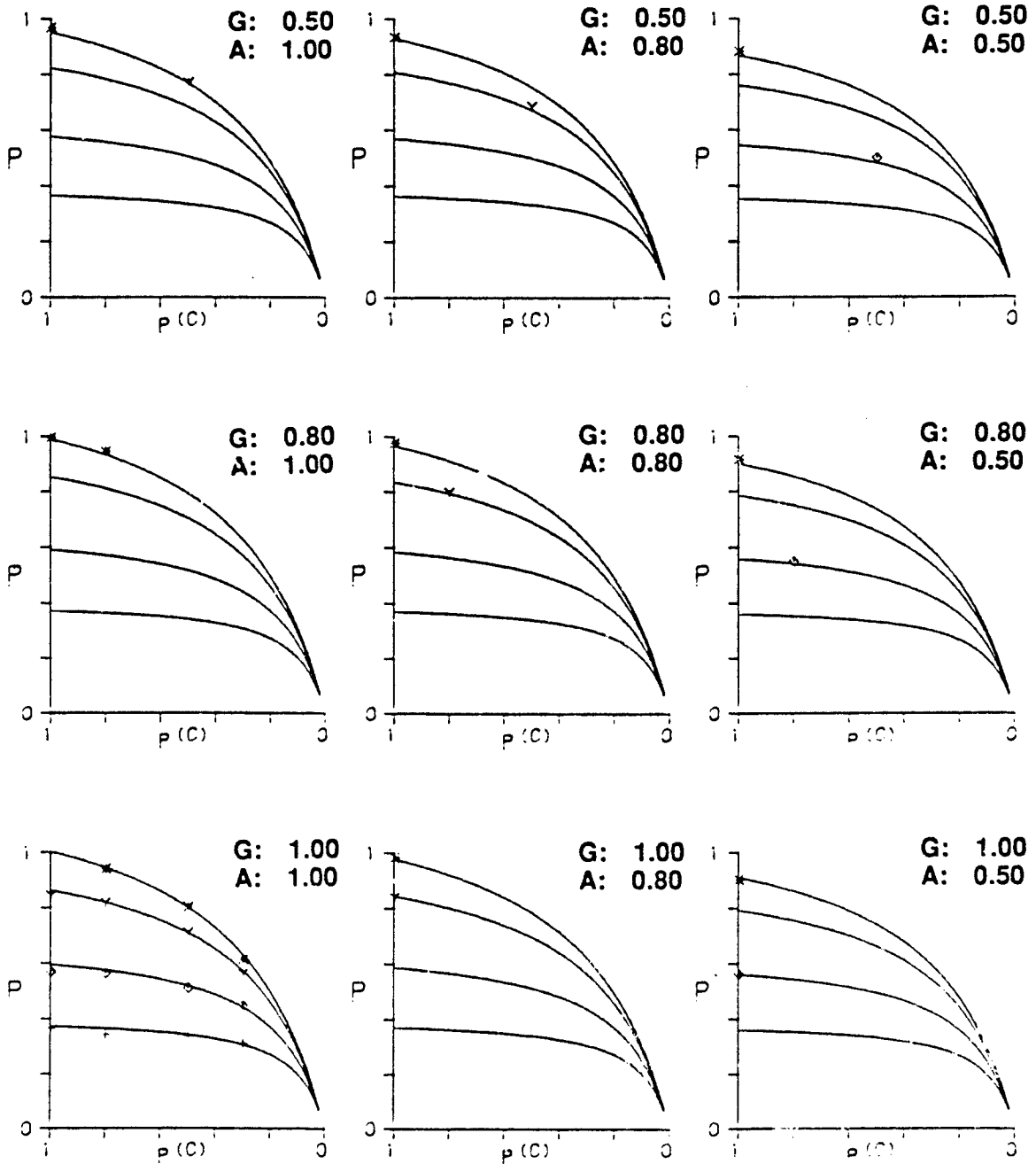

Figure 10. Final performance plot for gun crew (continued).

M-109 GUN CREW

FRAME 10 OF 12

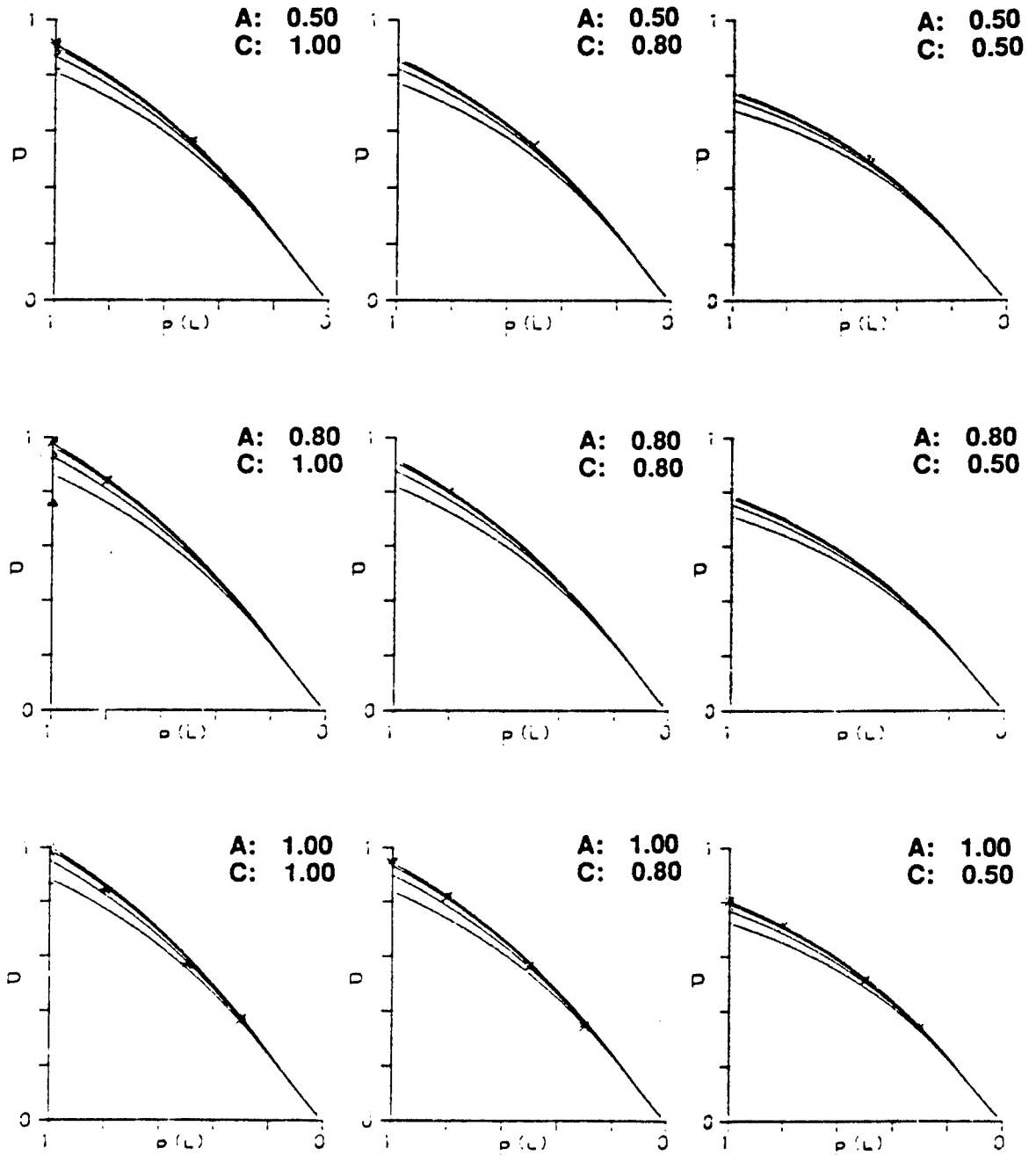

Figure 10. Final performance plot for gun crew (continued).

M-109 GUN CREW

FRAME 11 OF 12

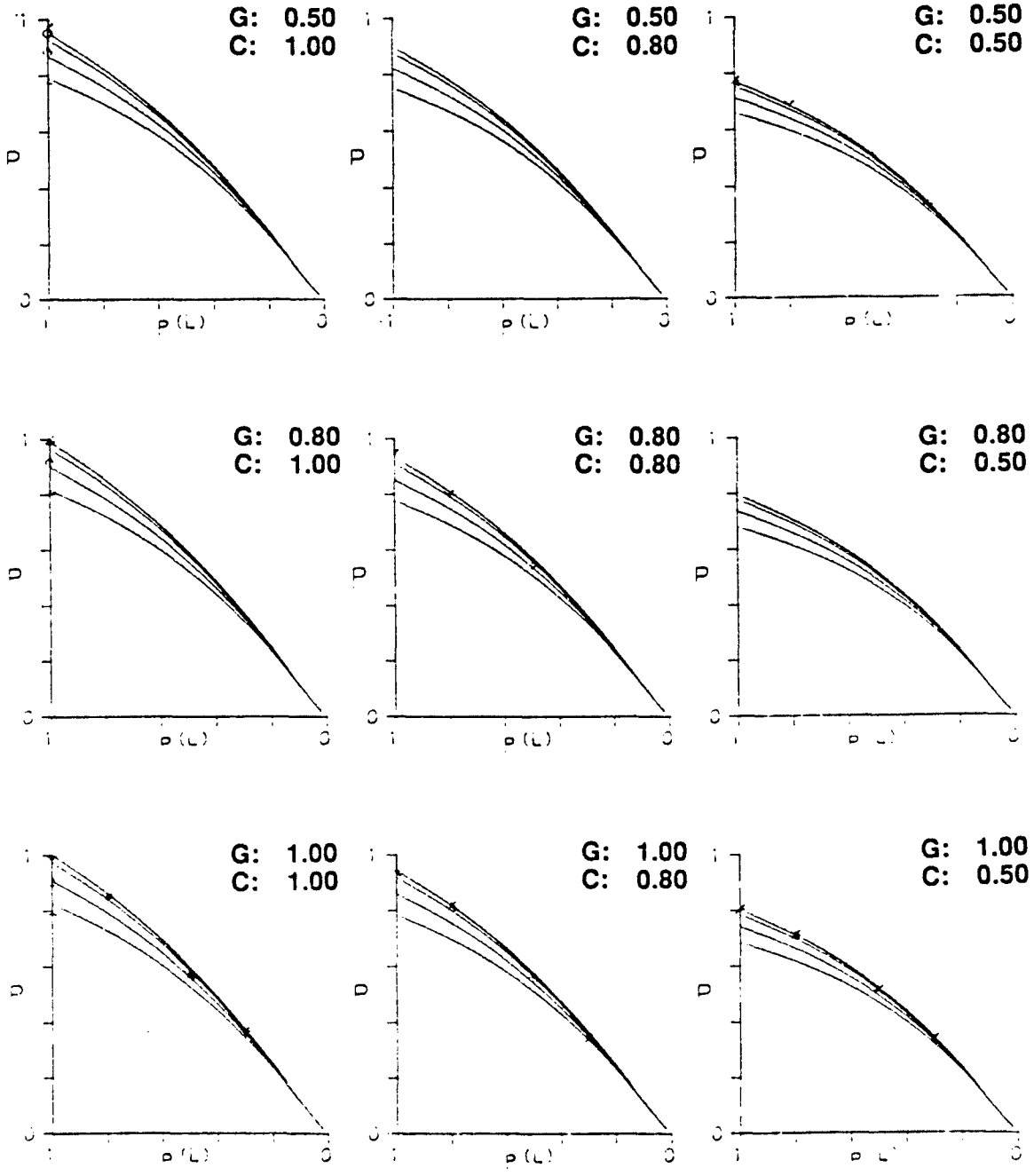

Figure 10. Final performance plot for gun crew (continued).

M-109 GUN CREW

FRAME 12 OF 12

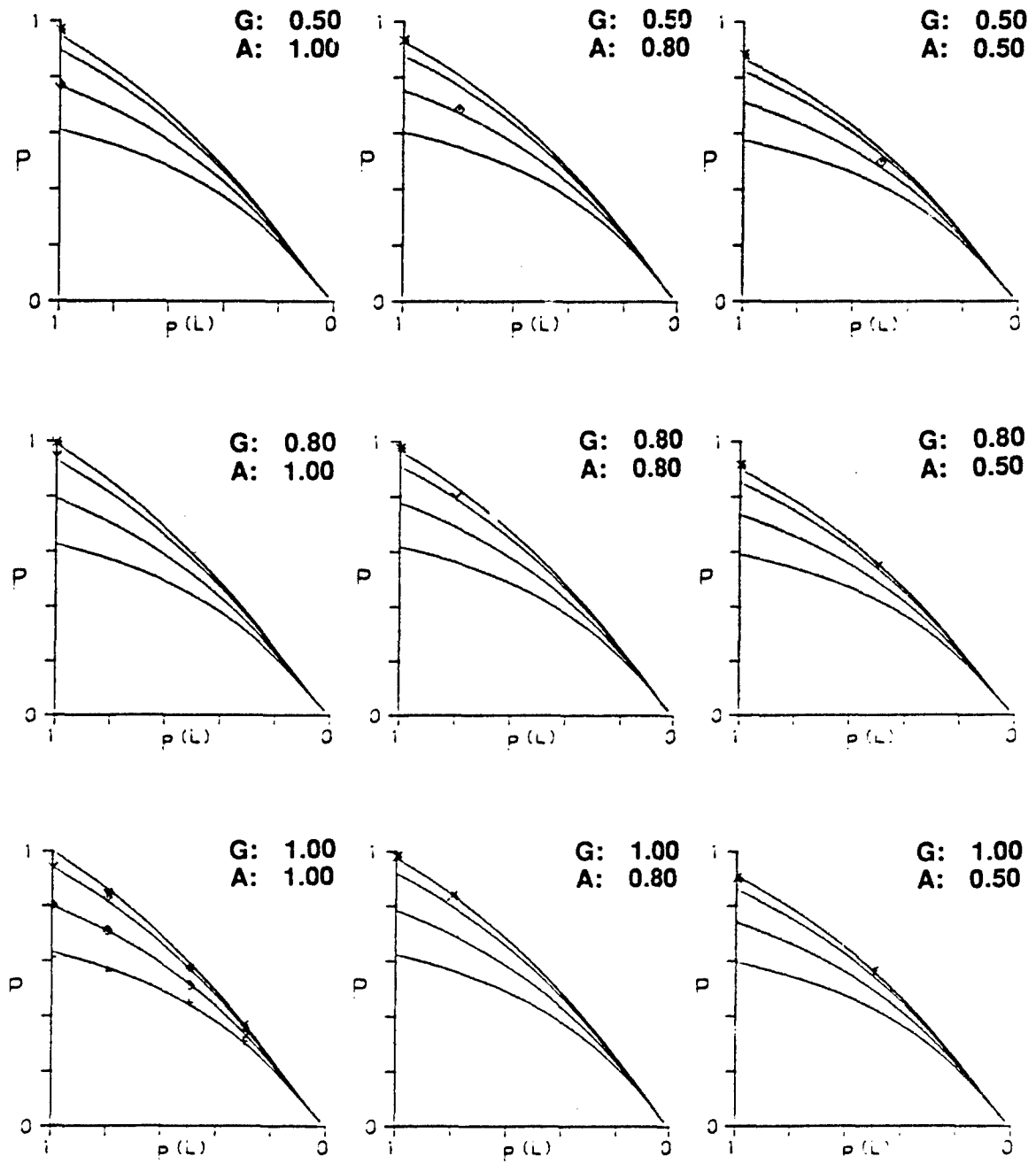

Figure 10. Final performance plot for gun crew (continued).

FDC CREW

FRAME 1 OF 3

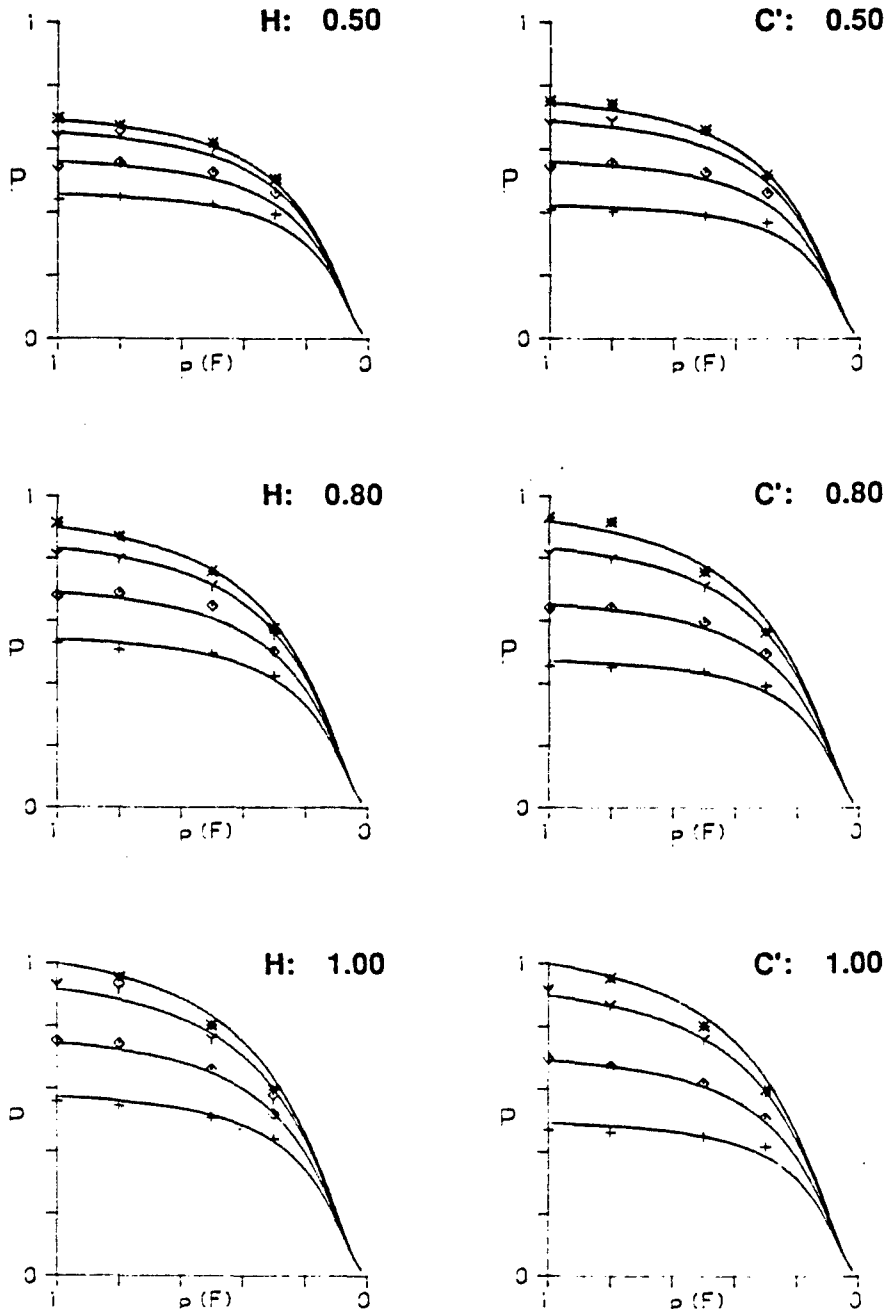

Figure 11. Final performance plot for FDC crew.

FDC CREW

FRAME 2 OF 3

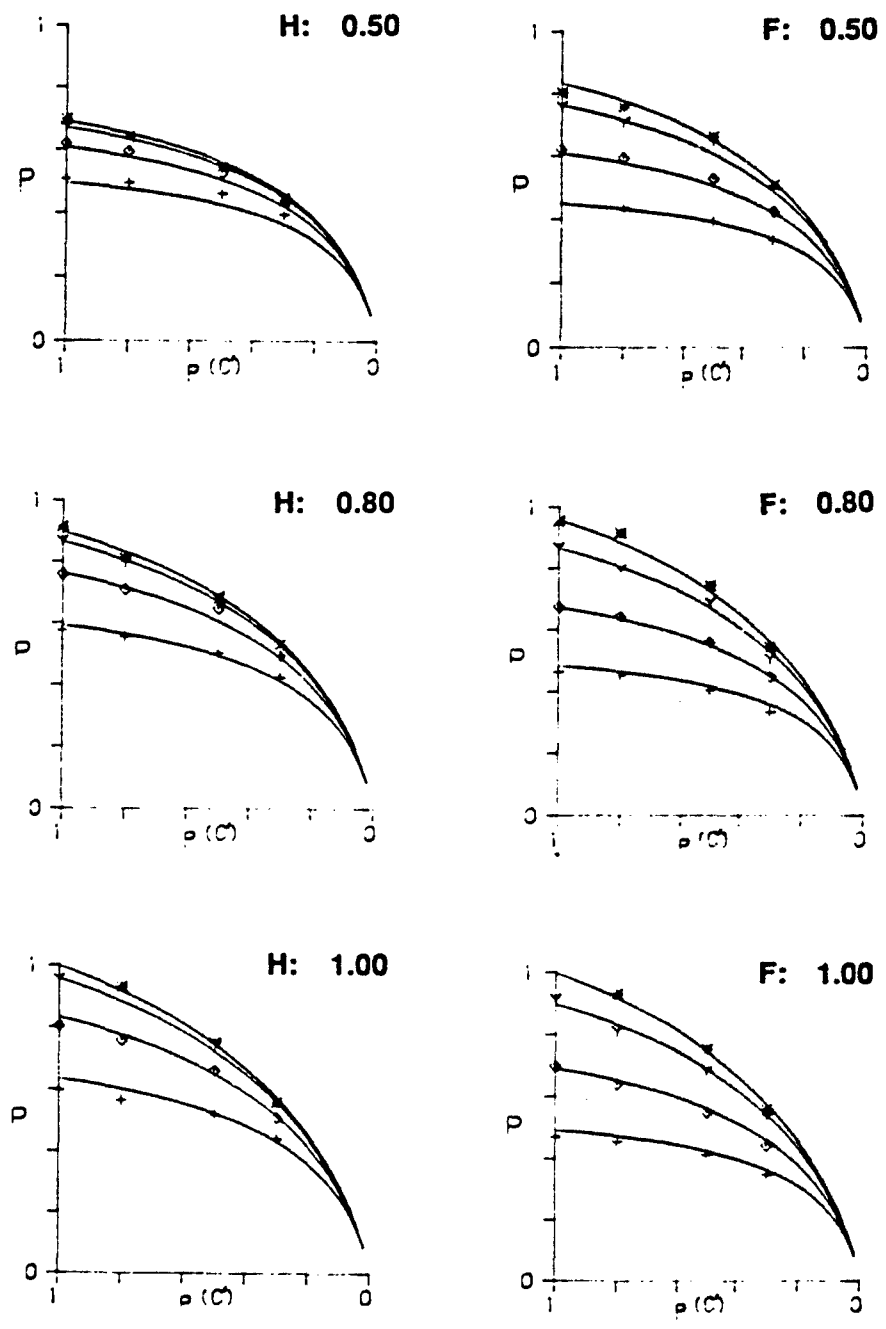

Figure 11. Final performance plot for FDC crew (continued).

FDC CREW

FRAME 3 OF 3

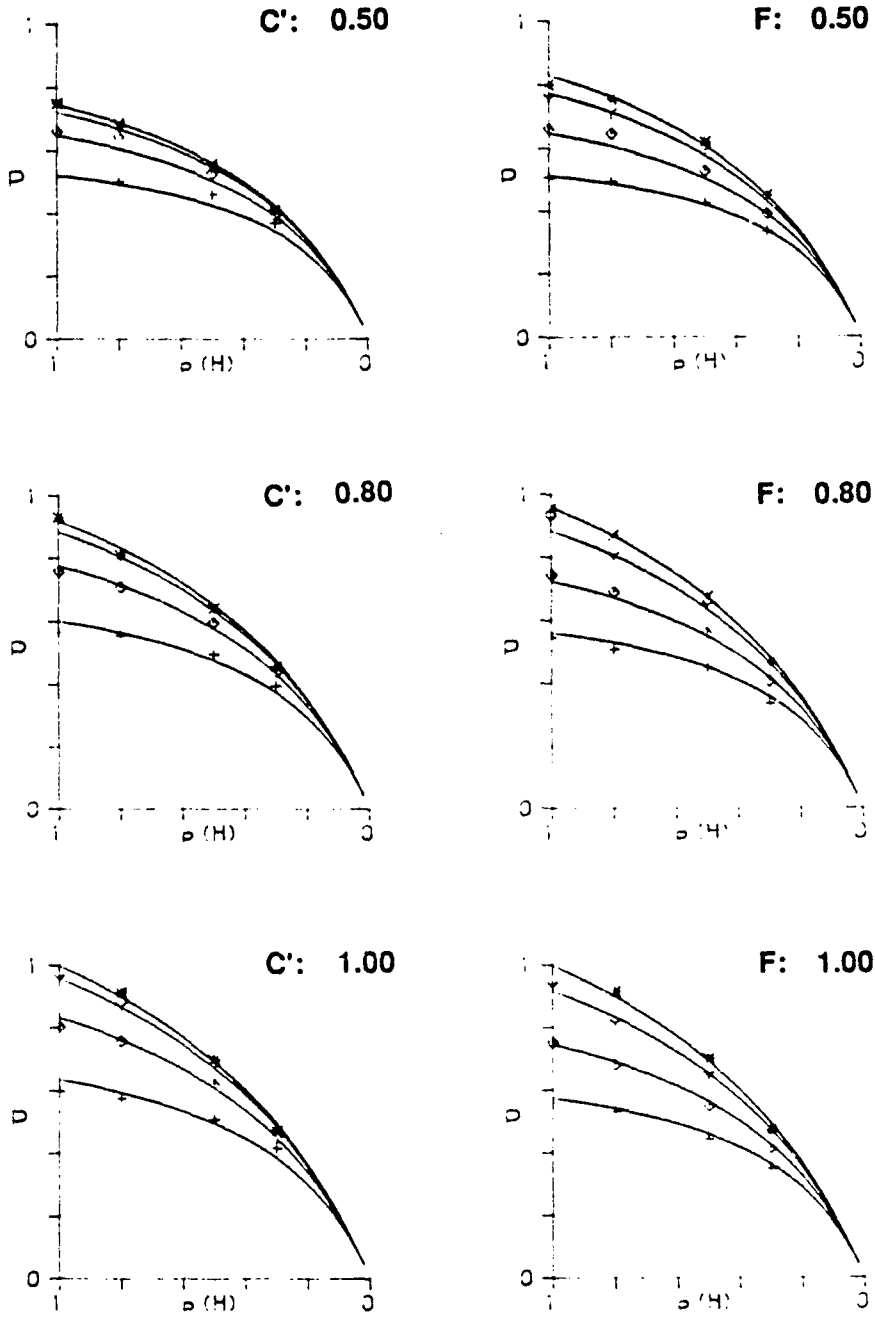

Figure 11. Final performance plot for FDC crew (continued).

M60A3 TANK CREW

FRAME 1 OF 12

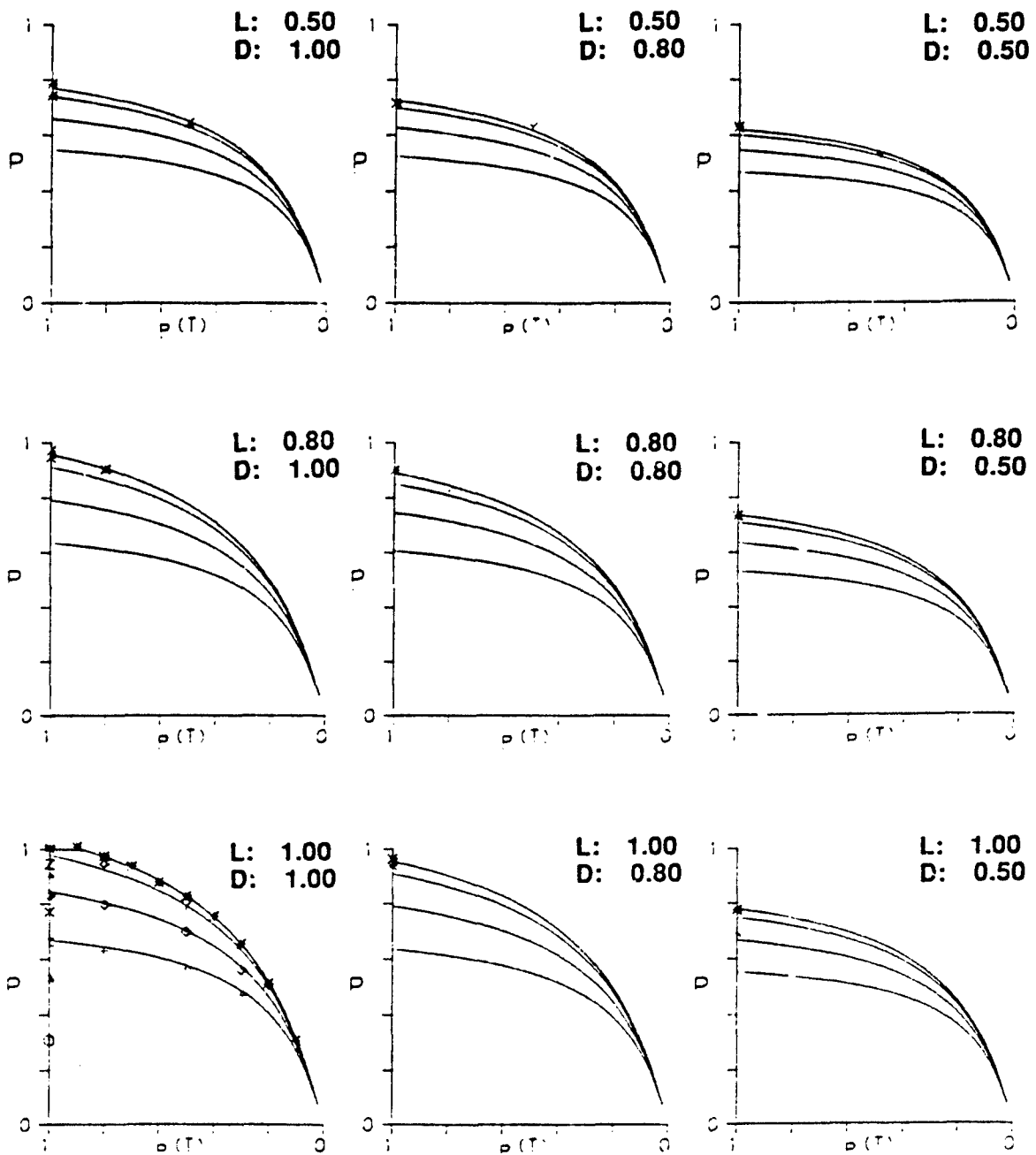

Figure 12. Final performance plot for tank crew.

M60A3 TANK CREW

FRAME 2 OF 12

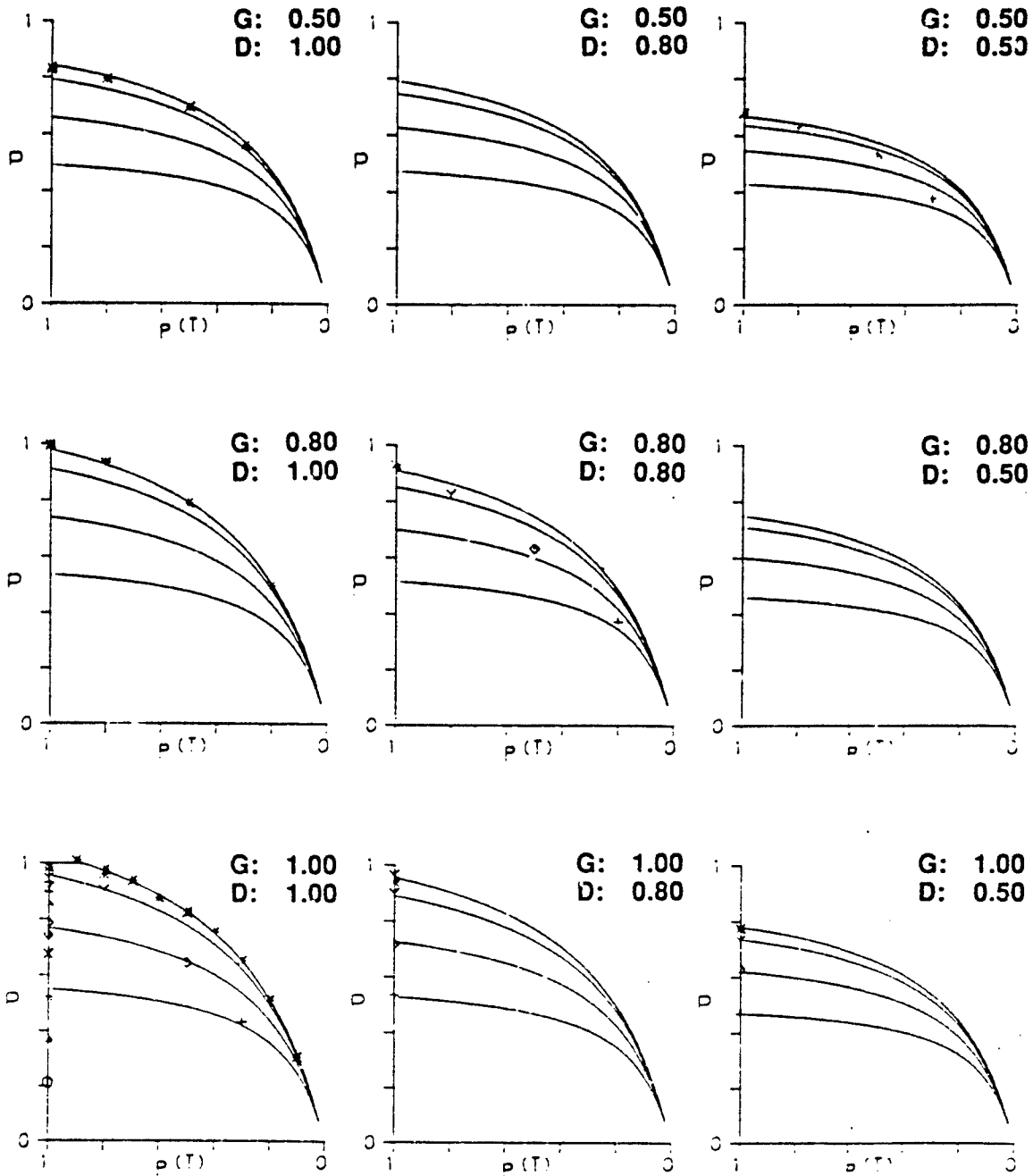

Figure 12. Final performance plot for tank crew (continued).

M60A3 TANK CREW

FRAME 3 OF 12

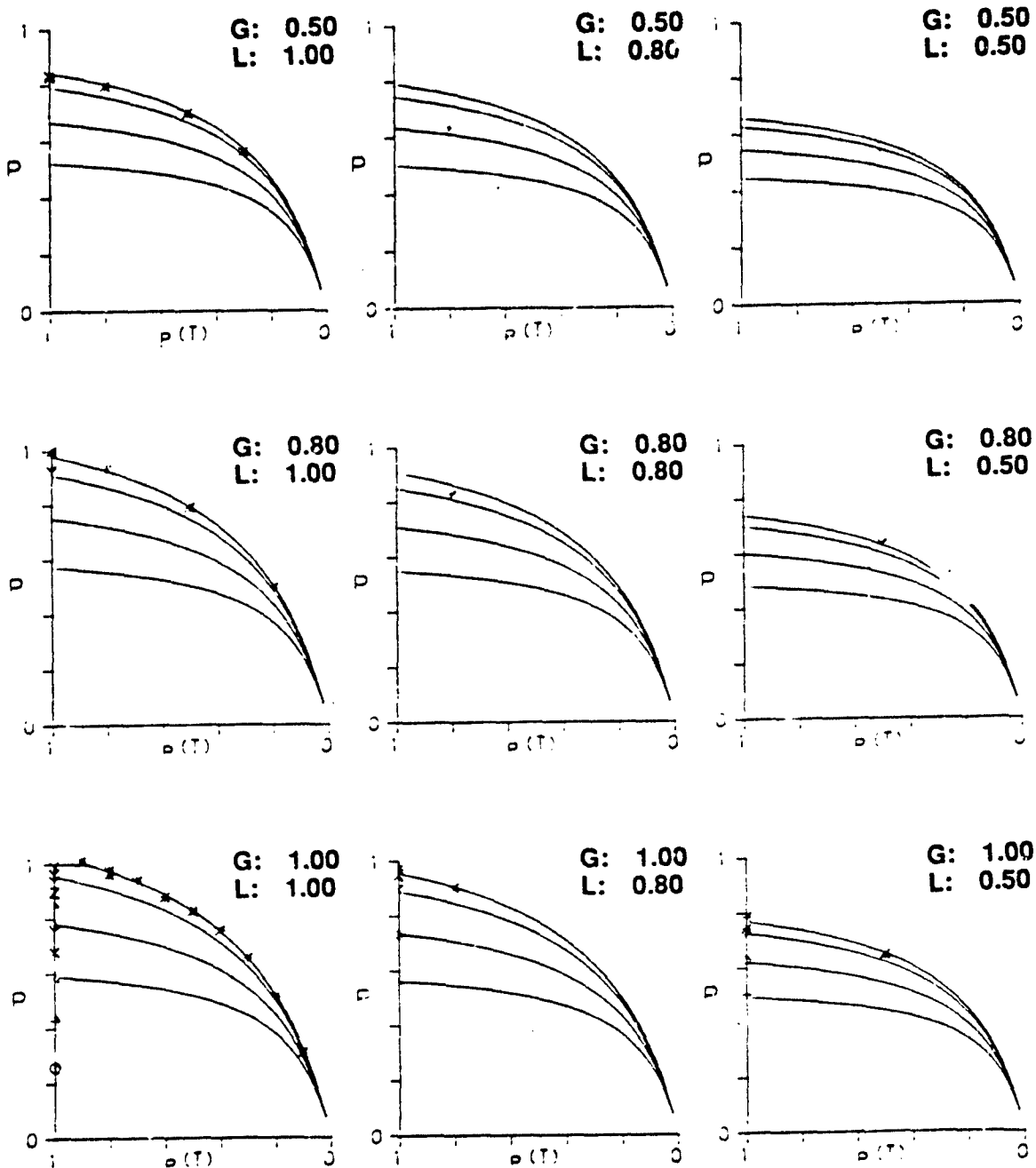

Figure 12. Final performance plot for tank crew (continued).

M60A3 TANK CREW

FRAME 4 OF 12

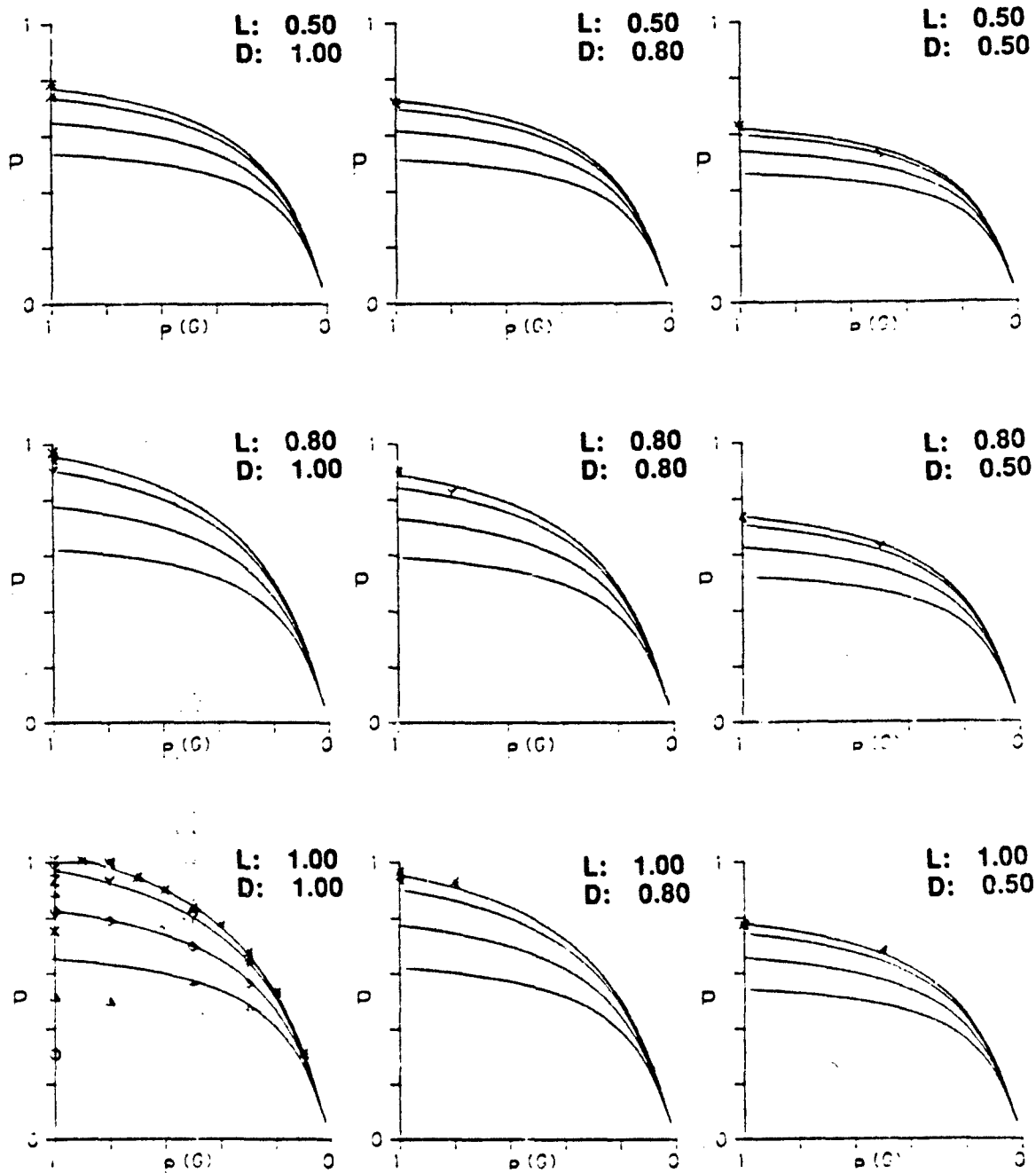

Figure 12. Final performance plot for tank crew (continued).

M60A3 TANK CREW

FRAME 5 OF 12

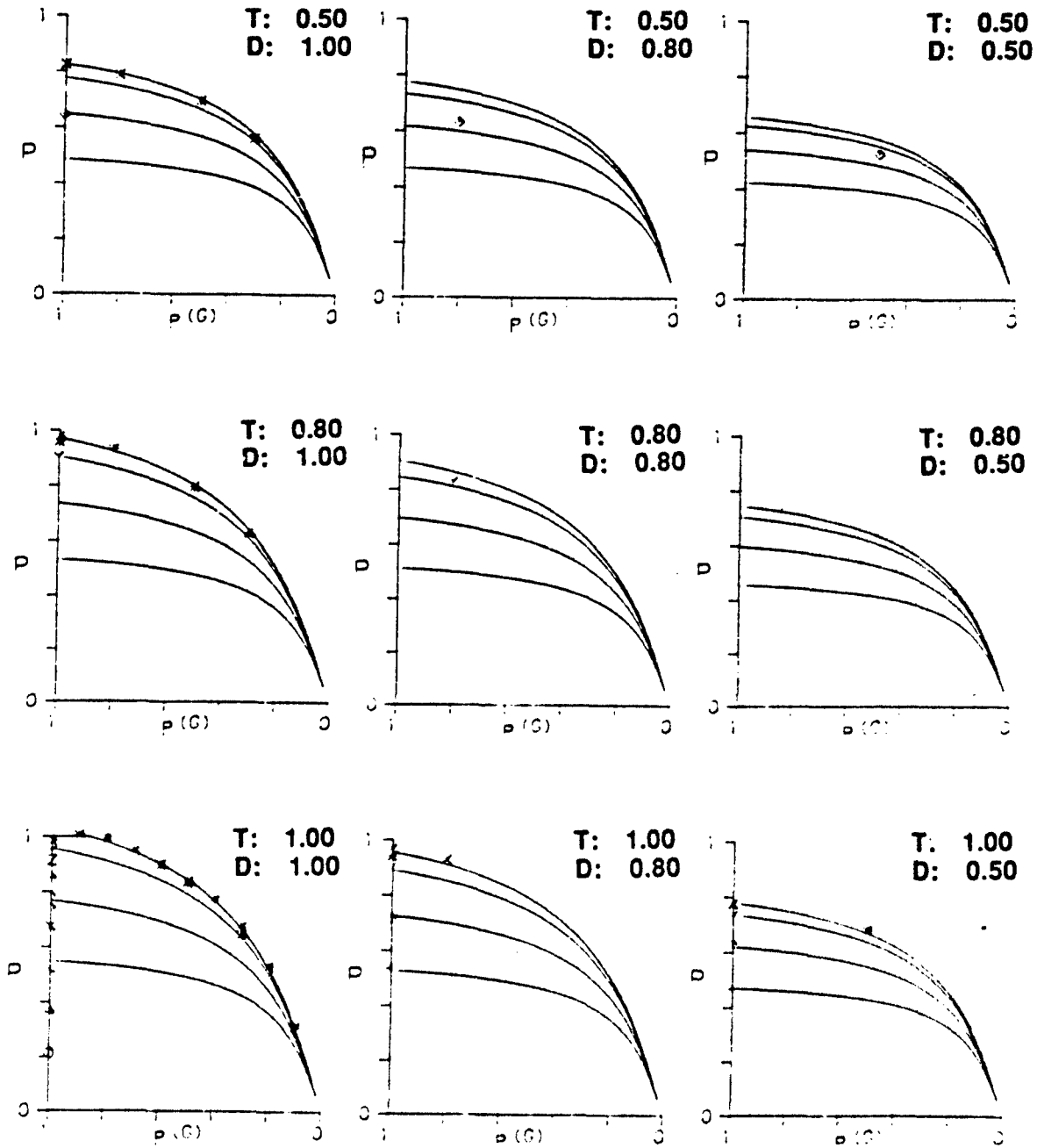

Figure 12. Final performance plot for tank crew (continued).

M60A3 TANK CREW

FRAME 6 OF 12

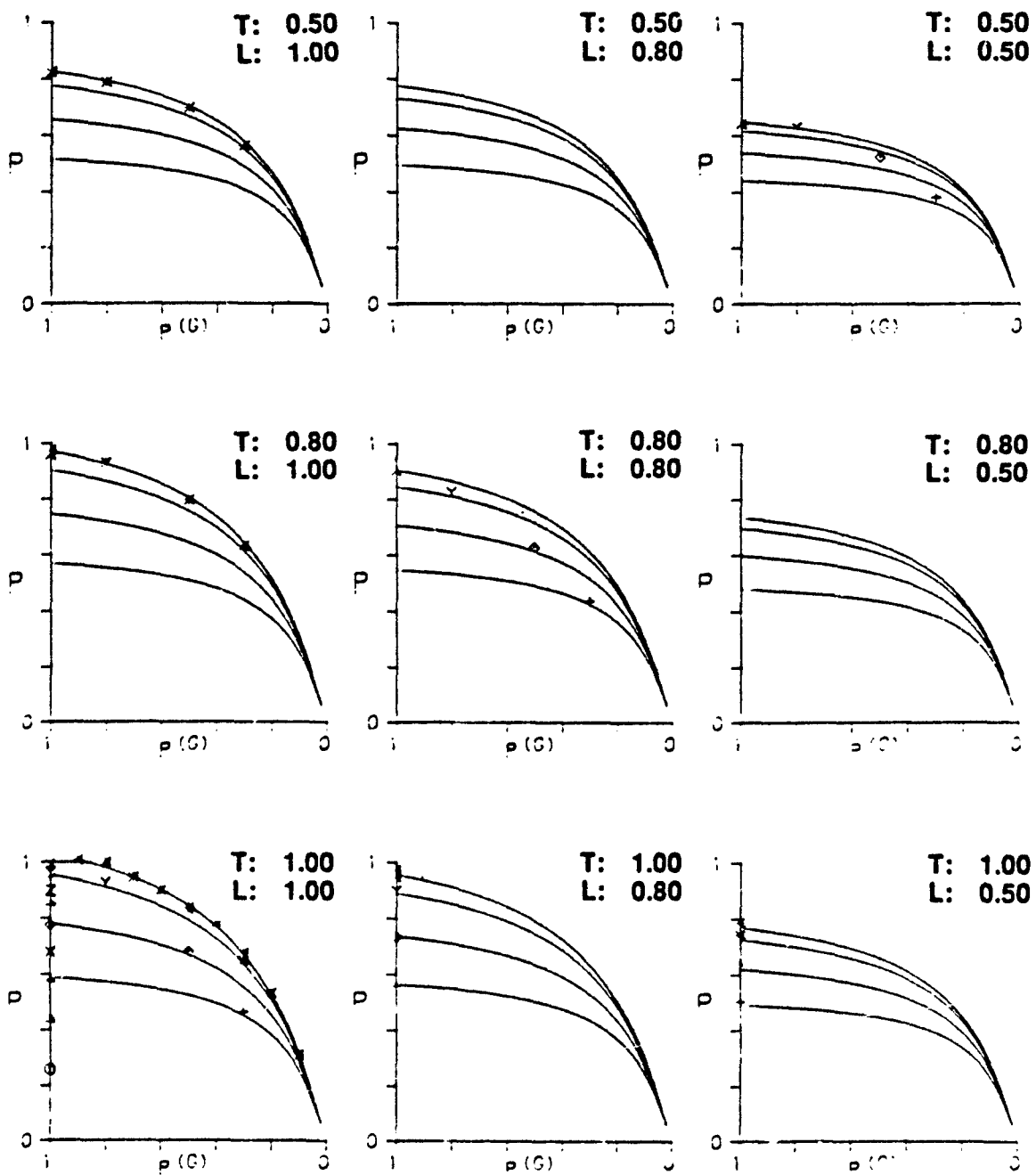

Figure 12. Final performance plot for tank crew (continued).

M60A3 TANK CREW

FRAME 7 OF 12

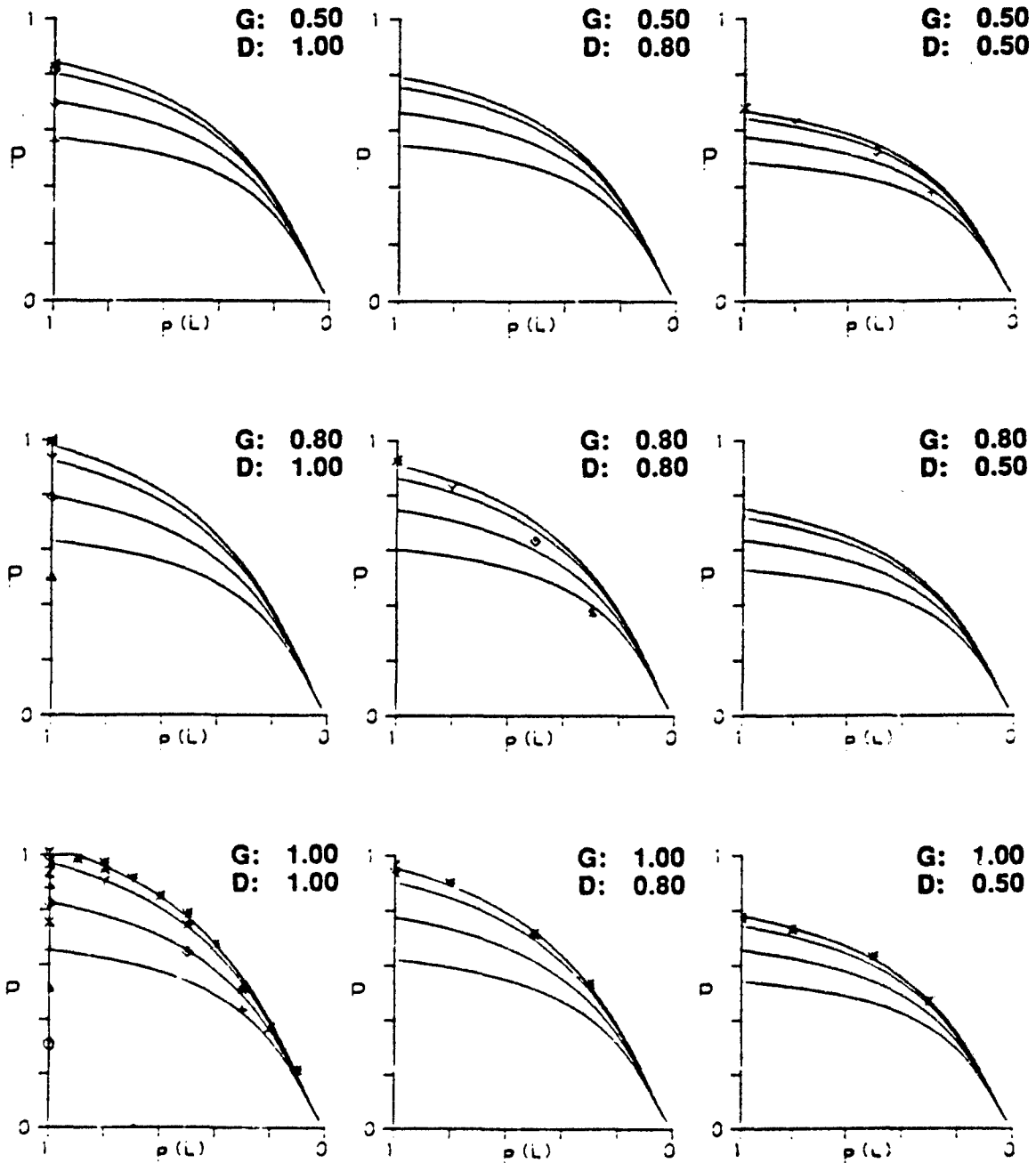

Figure 12. Final performance plot for tank crew (continued).

M60A3 TANK CREW

FRAME 8 OF 12

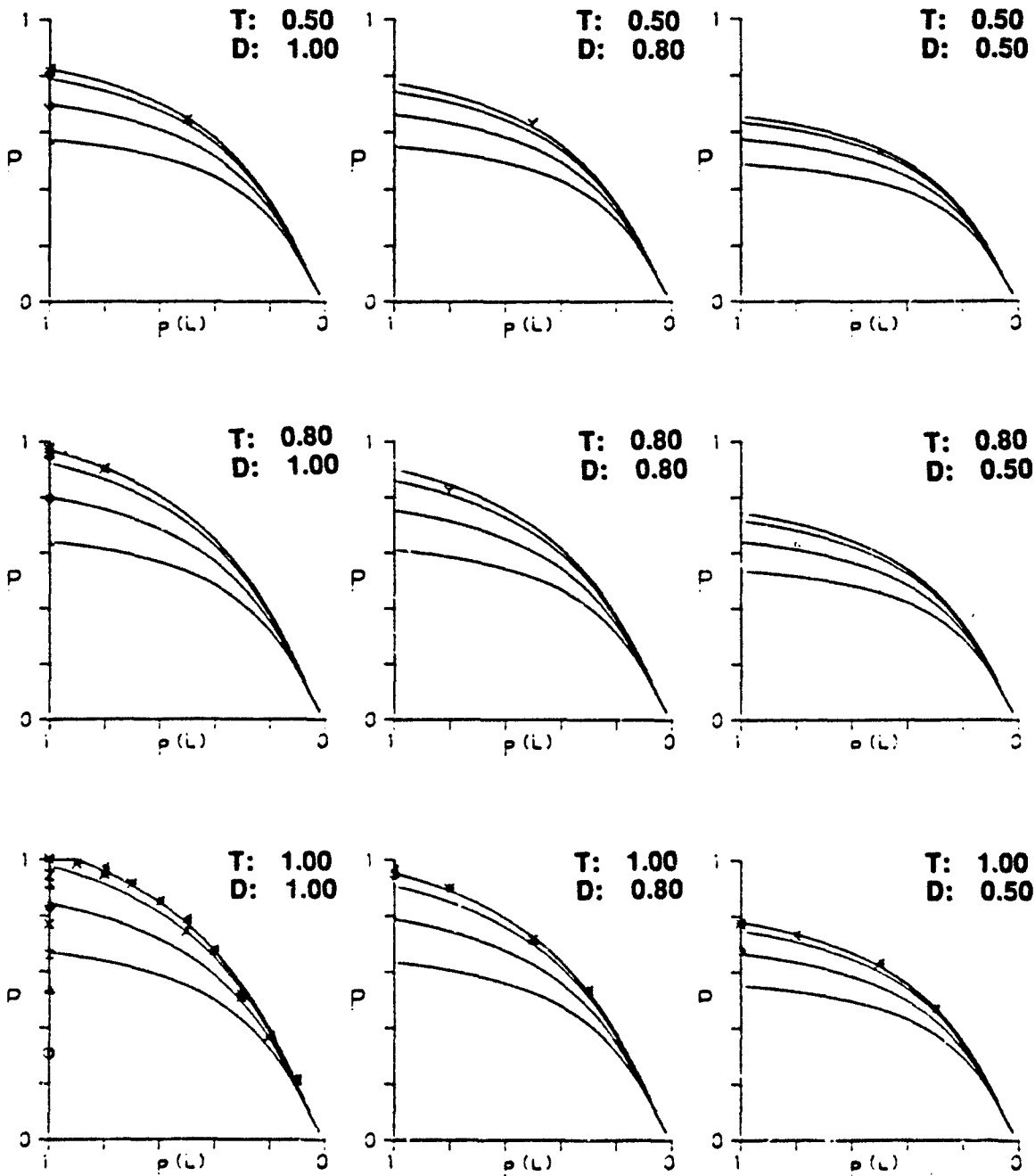

Figure 12. Final performance plot for tank crew (continued).

M60A3 TANK CREW

FRAME 9 OF 12

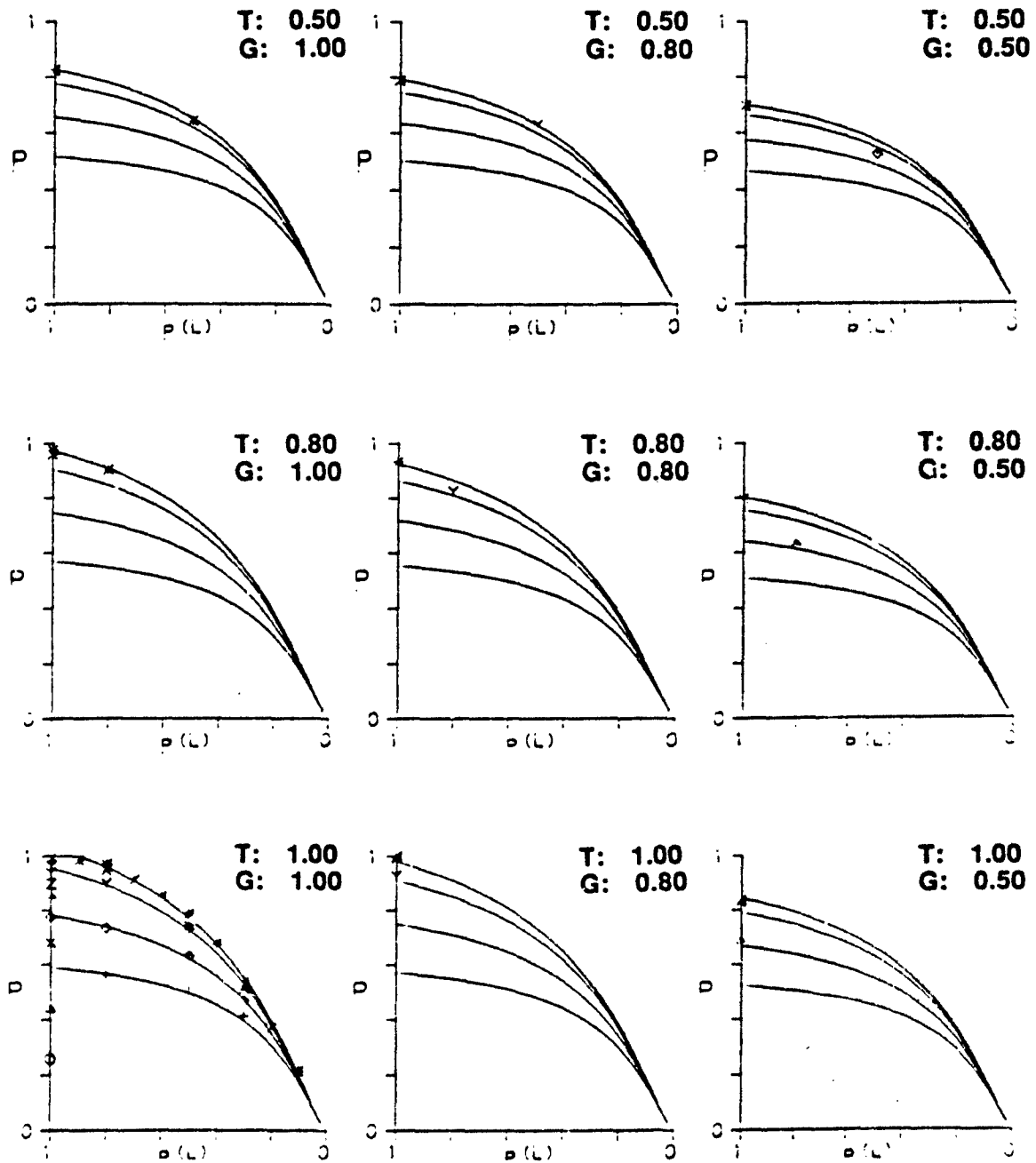

Figure 12. Final performance plot for tank crew (continued).

M60A3 TANK CREW

FRAME 10 OF 12

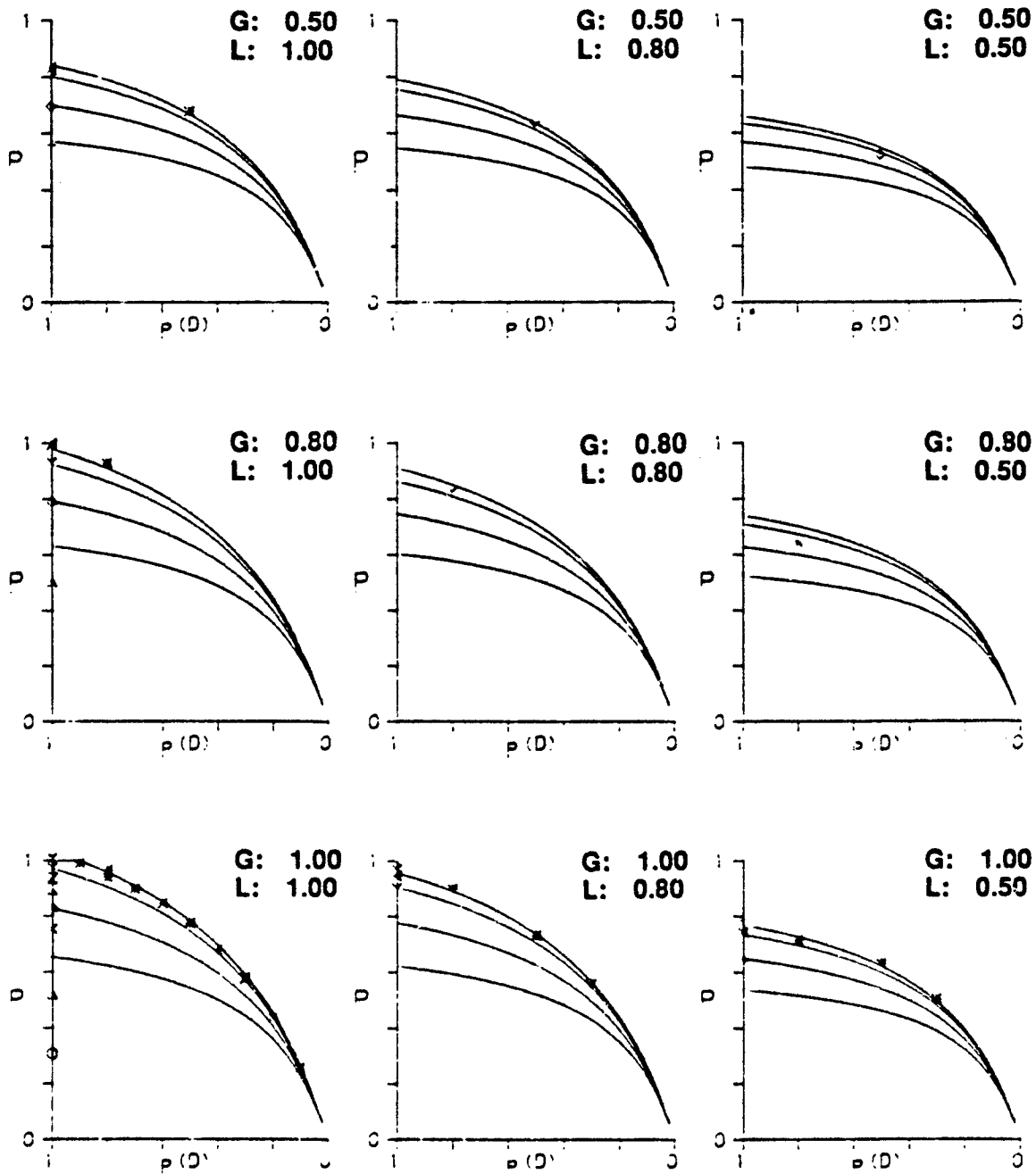

Figure 12. Final performance plot for tank crew (continued).

M60A3 TANK CREW

FRAME 11 OF 12

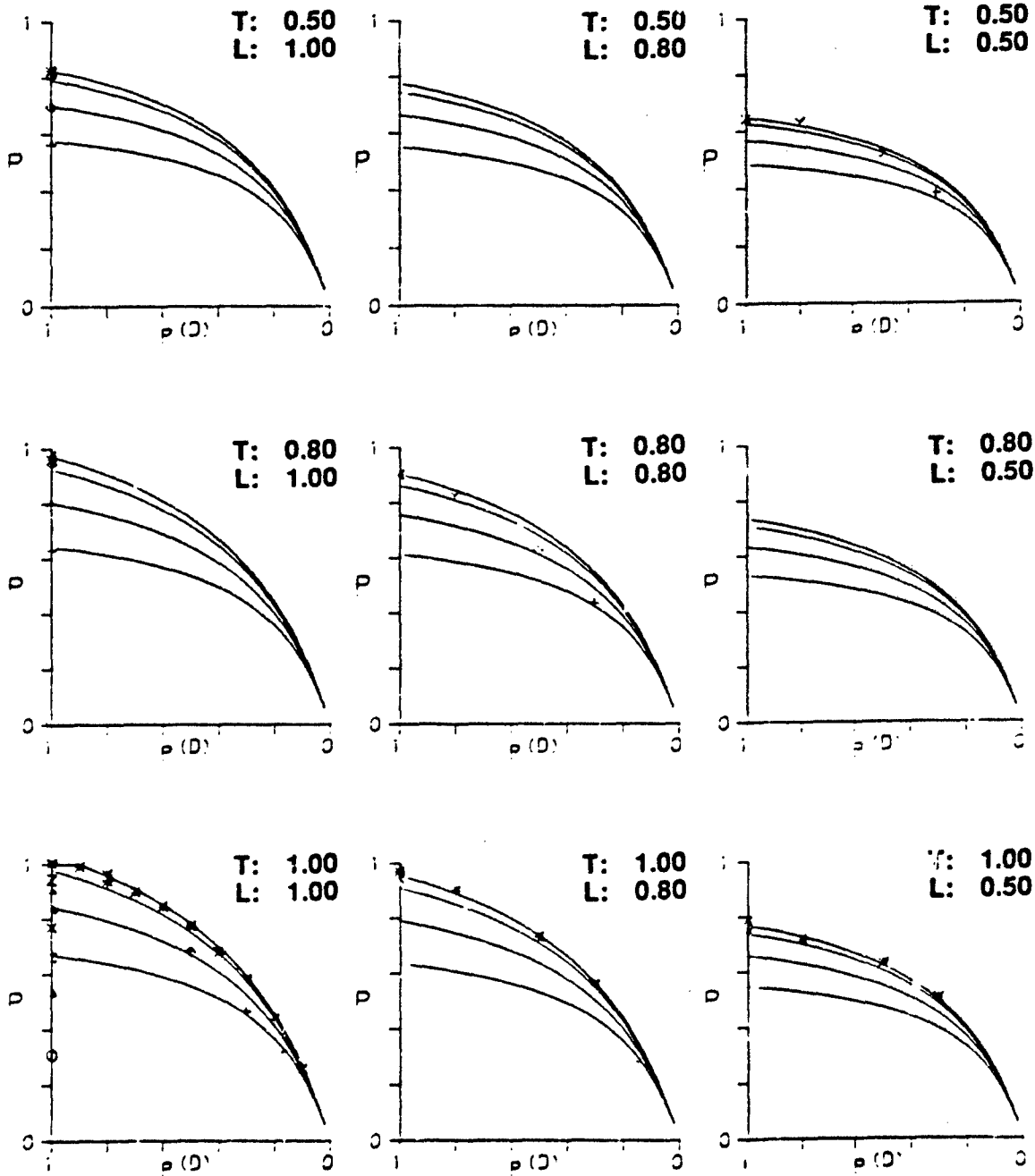

Figure 12. Final performance plot for tank crew (continued).

M60A3 TANK CREW

FRAME 12 OF 12

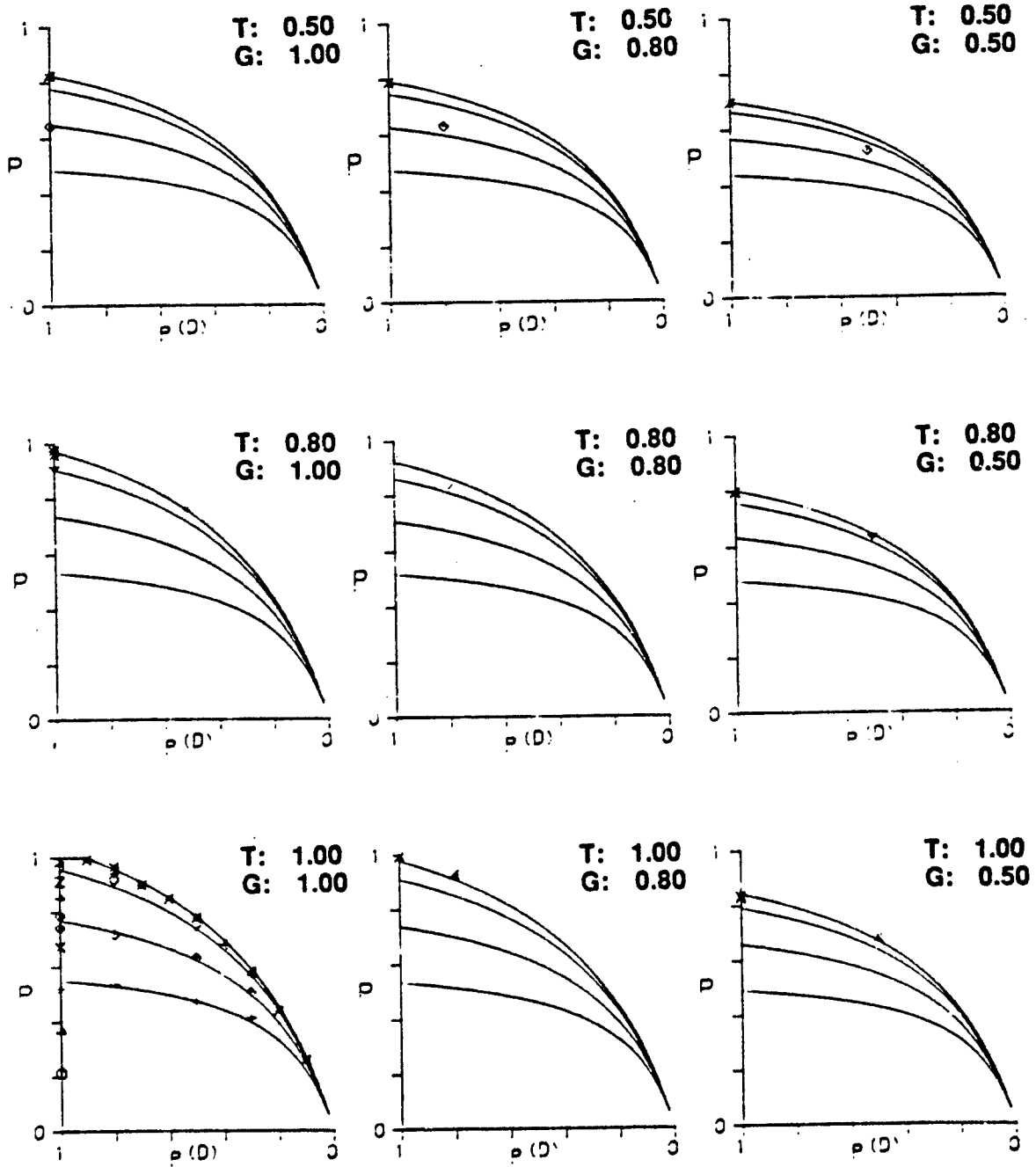

Figure 12. Final performance plot for tank crew (continued).

TOW-ITV CREW

FRAME 1 OF 12

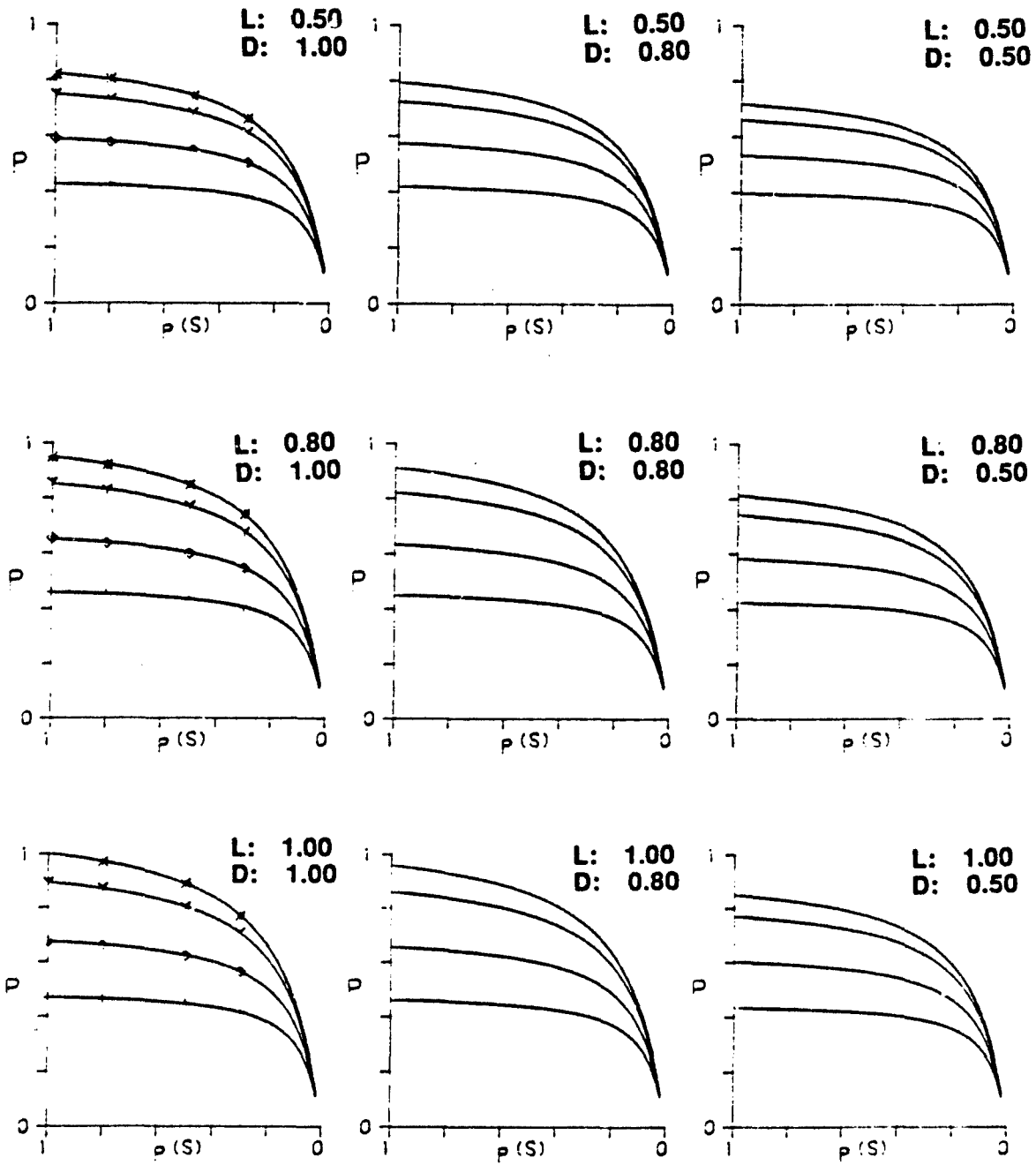

Figure 13. Final performance plot for ITV-TOW crew.

TOW-ITV CREW

FRAME 2 OF 12

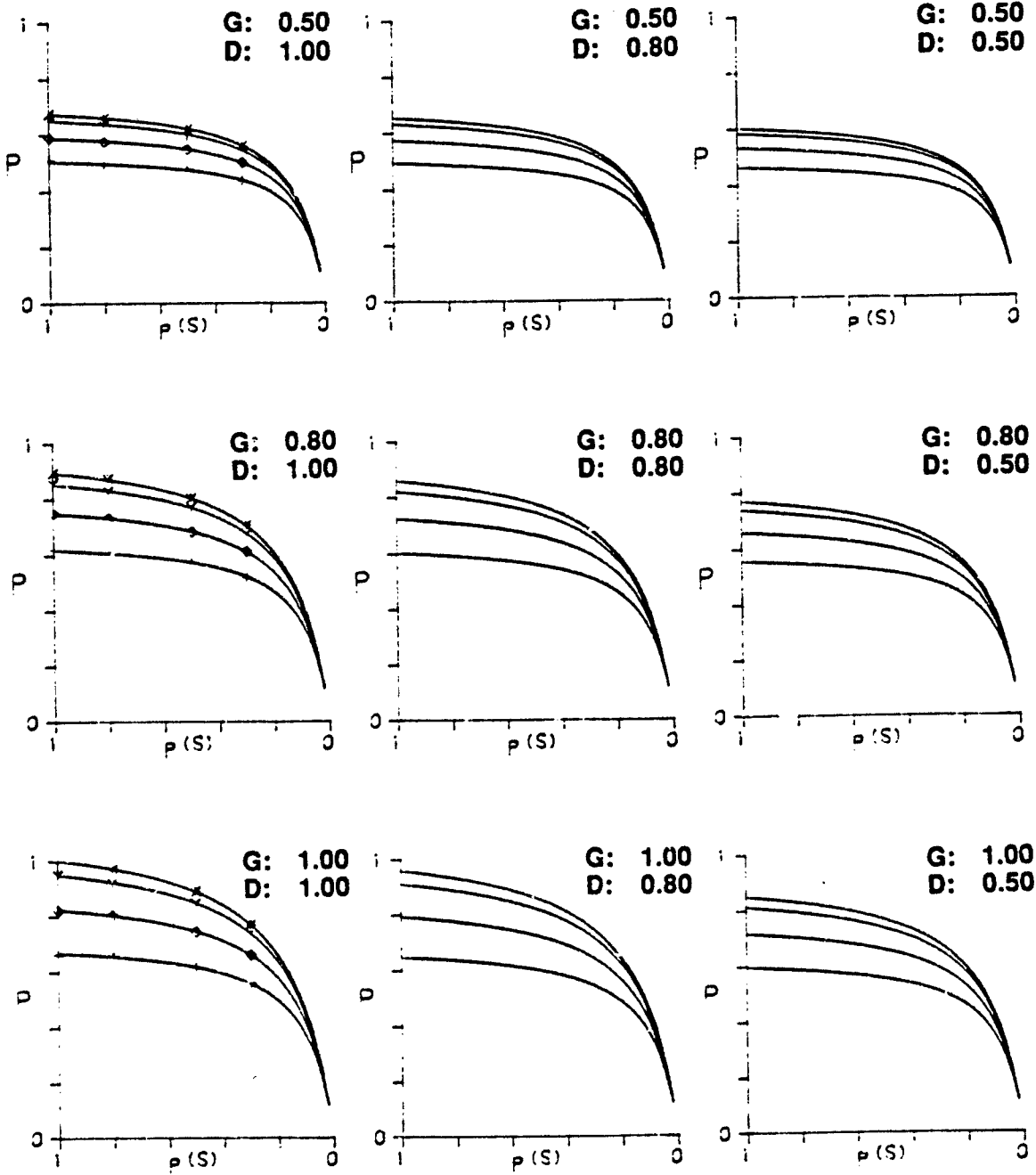

Figure 13. Final performance plot for ITV-TOW crew (continued).

TOW-ITV CREW

FRAME 3 OF 12

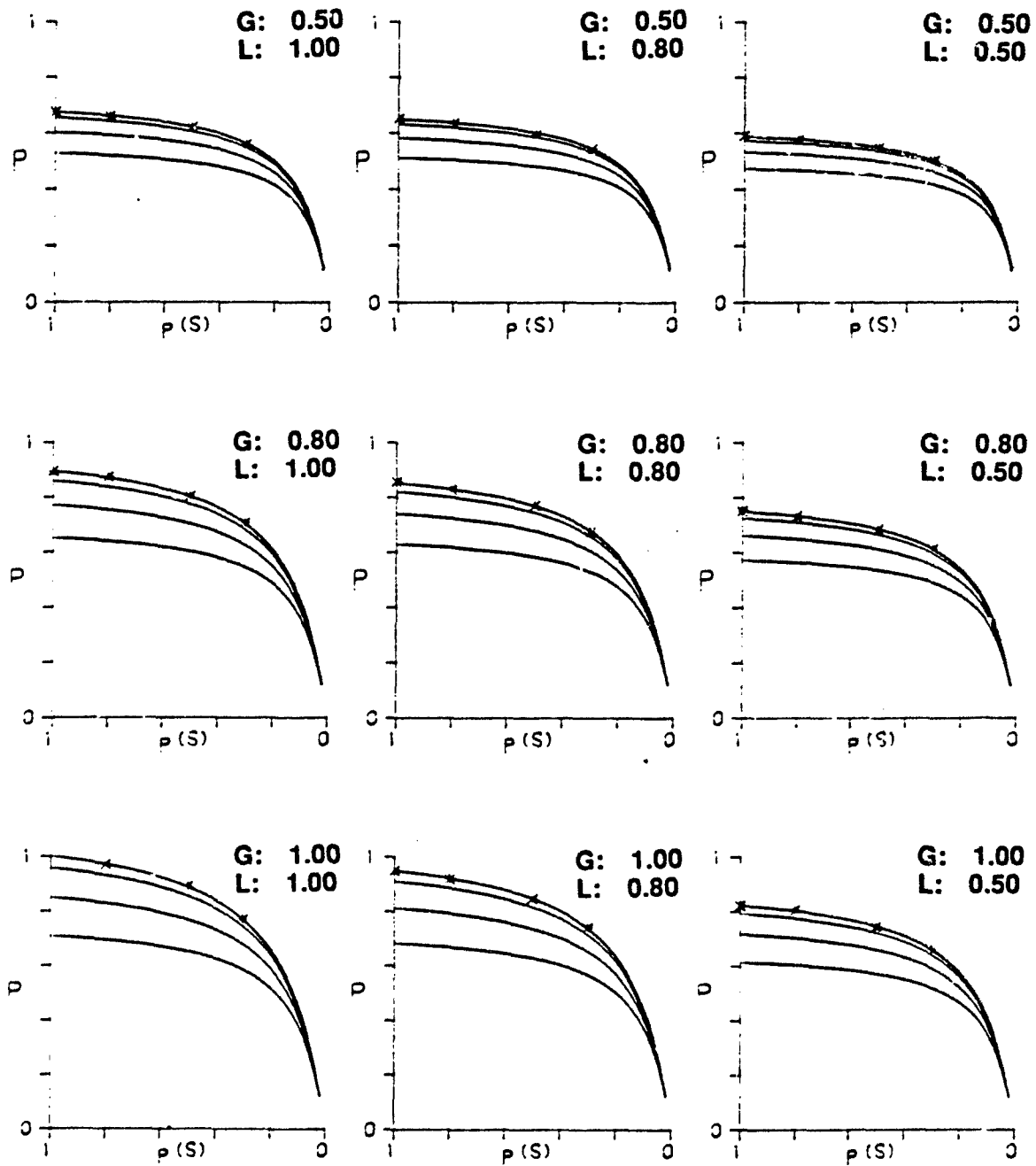

Figure 13. Final performance plot for ITV-TOW crew (continued).

TOW-ITV CREW

FRAME 4 OF 12

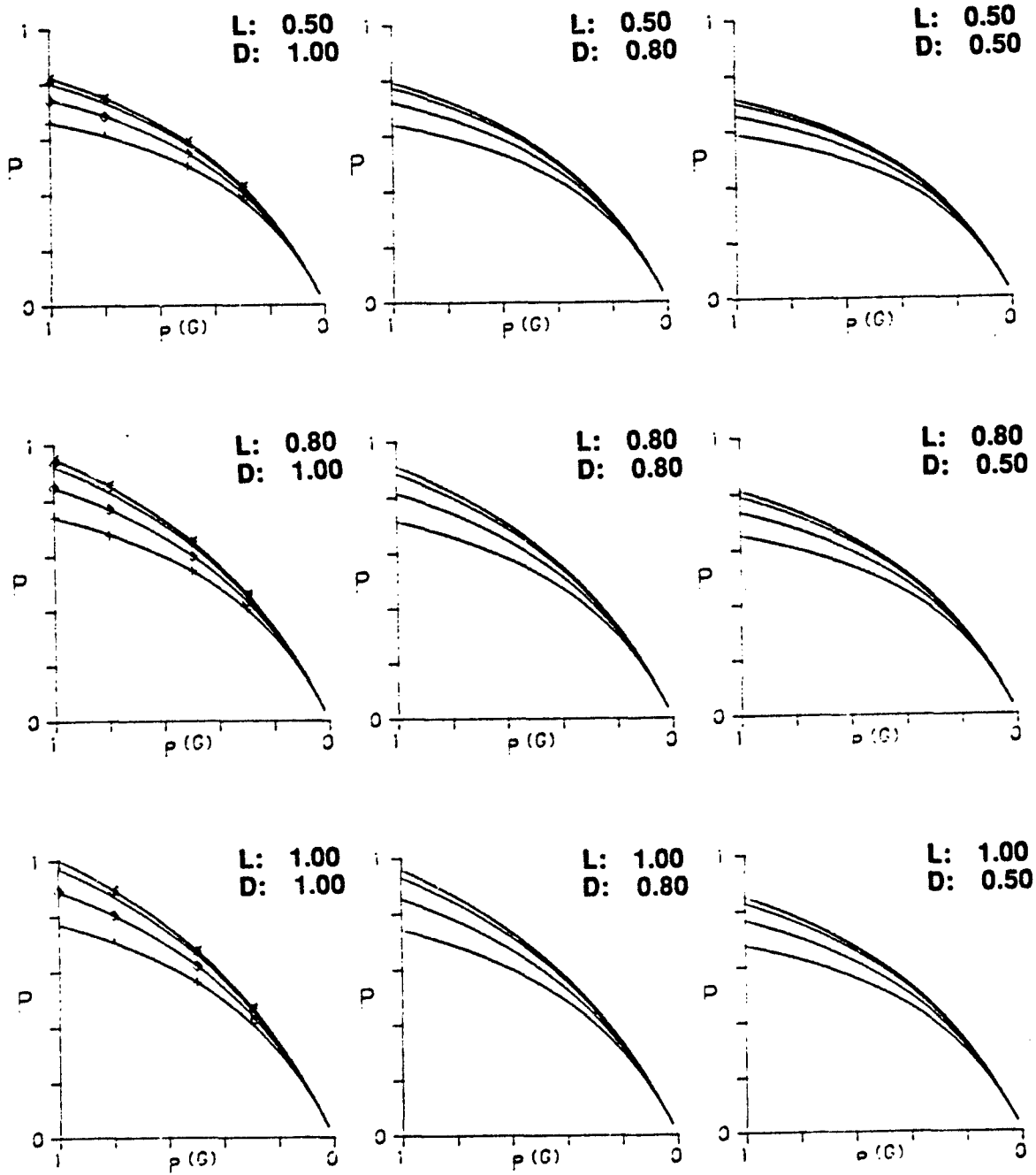

Figure 13. Final performance plot for ITV-TOW crew (continued).

TOW-ITV CREW

FRAME 5 OF 12

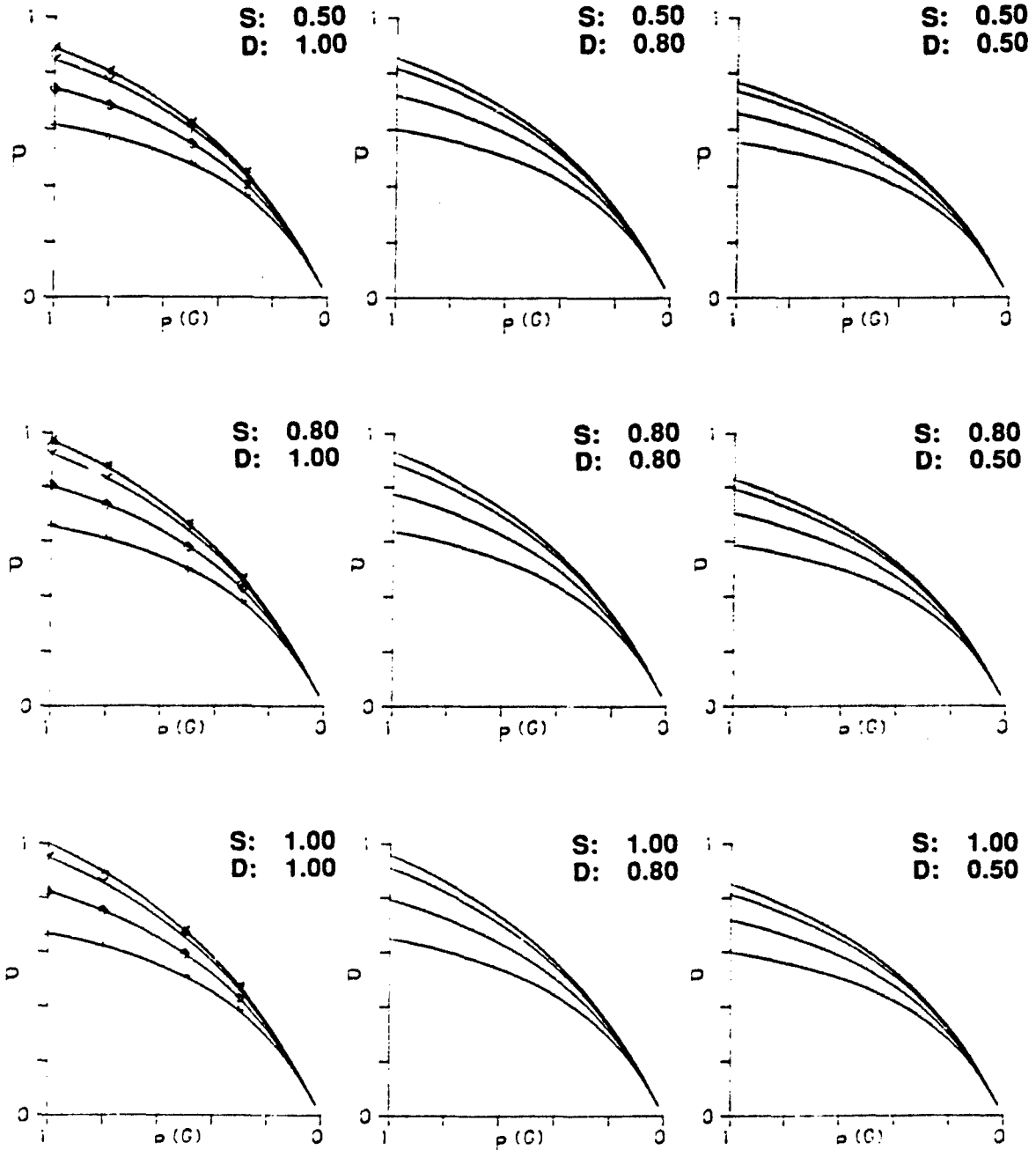

Figure 13. Final performance plot for ITV-TOW crew (continued).

TOW-ITV CREW

FRAME 6 JF 12

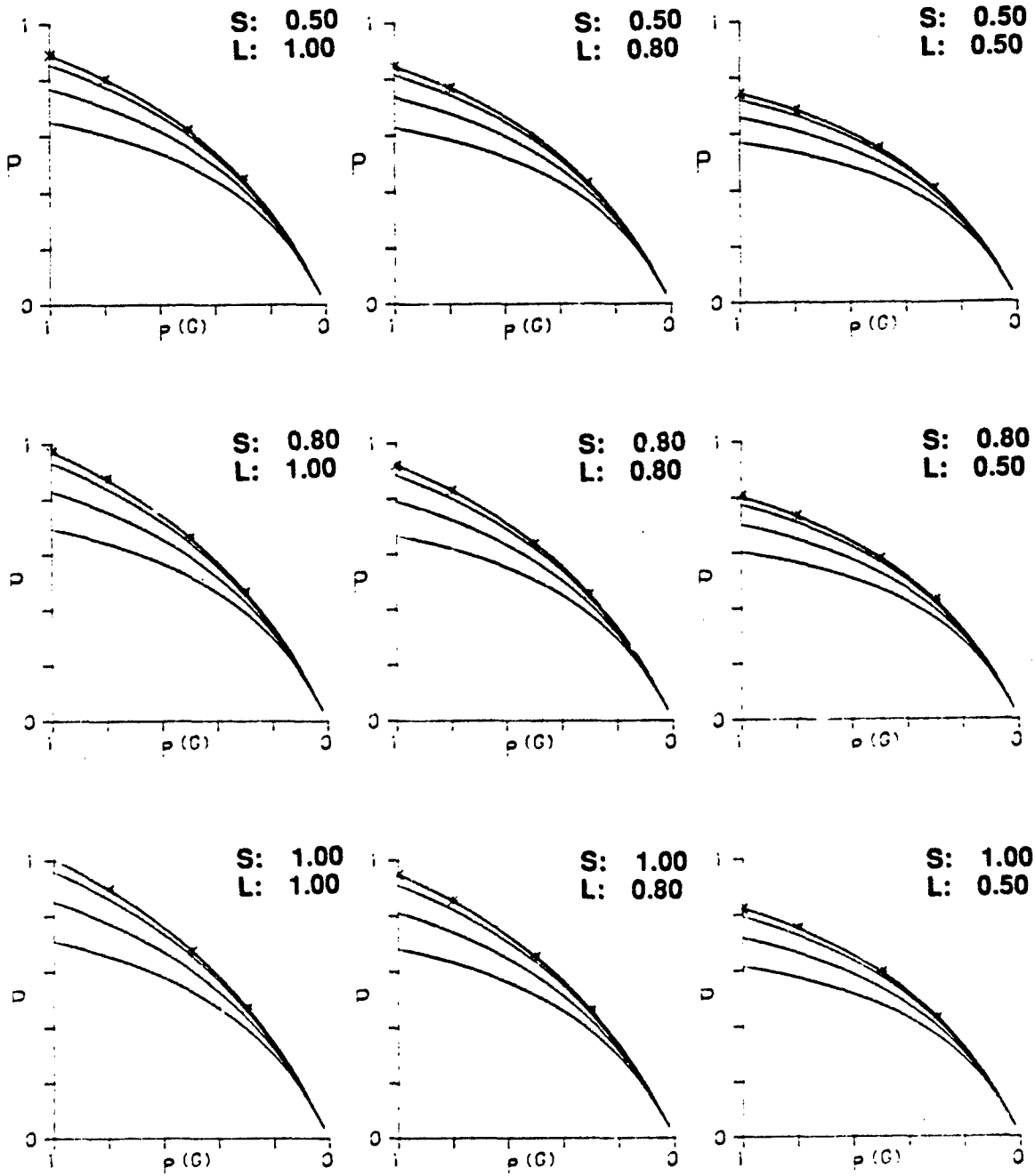

Figure 13. Final performance plot for ITV-TOW crew (continued).

TOW-ITV CREW

FRAME 7 OF 12

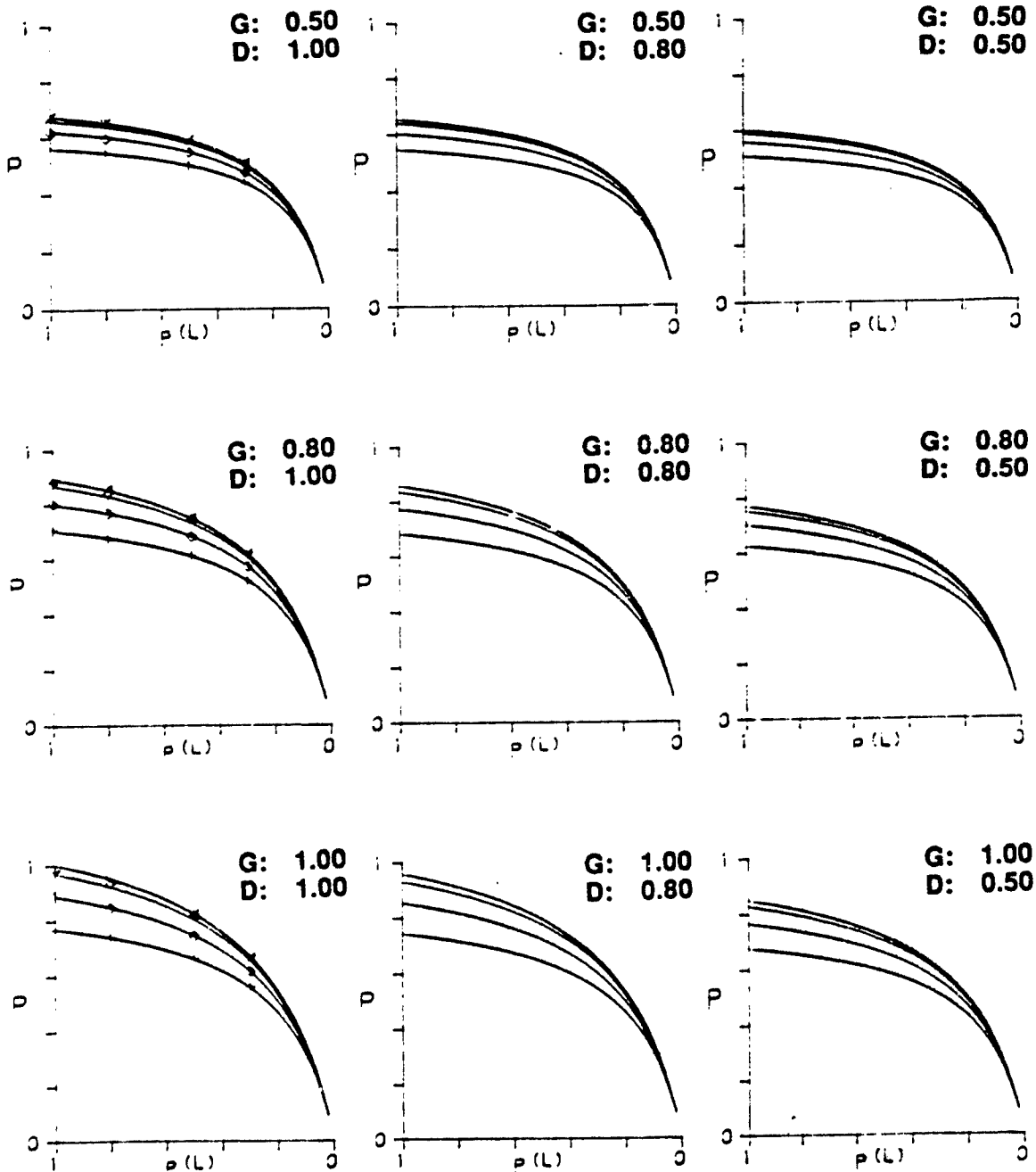

Figure 13. Final performance plot for ITV-TOW crew (continued).

TOW-ITV CREW

FRAME 8 OF 12

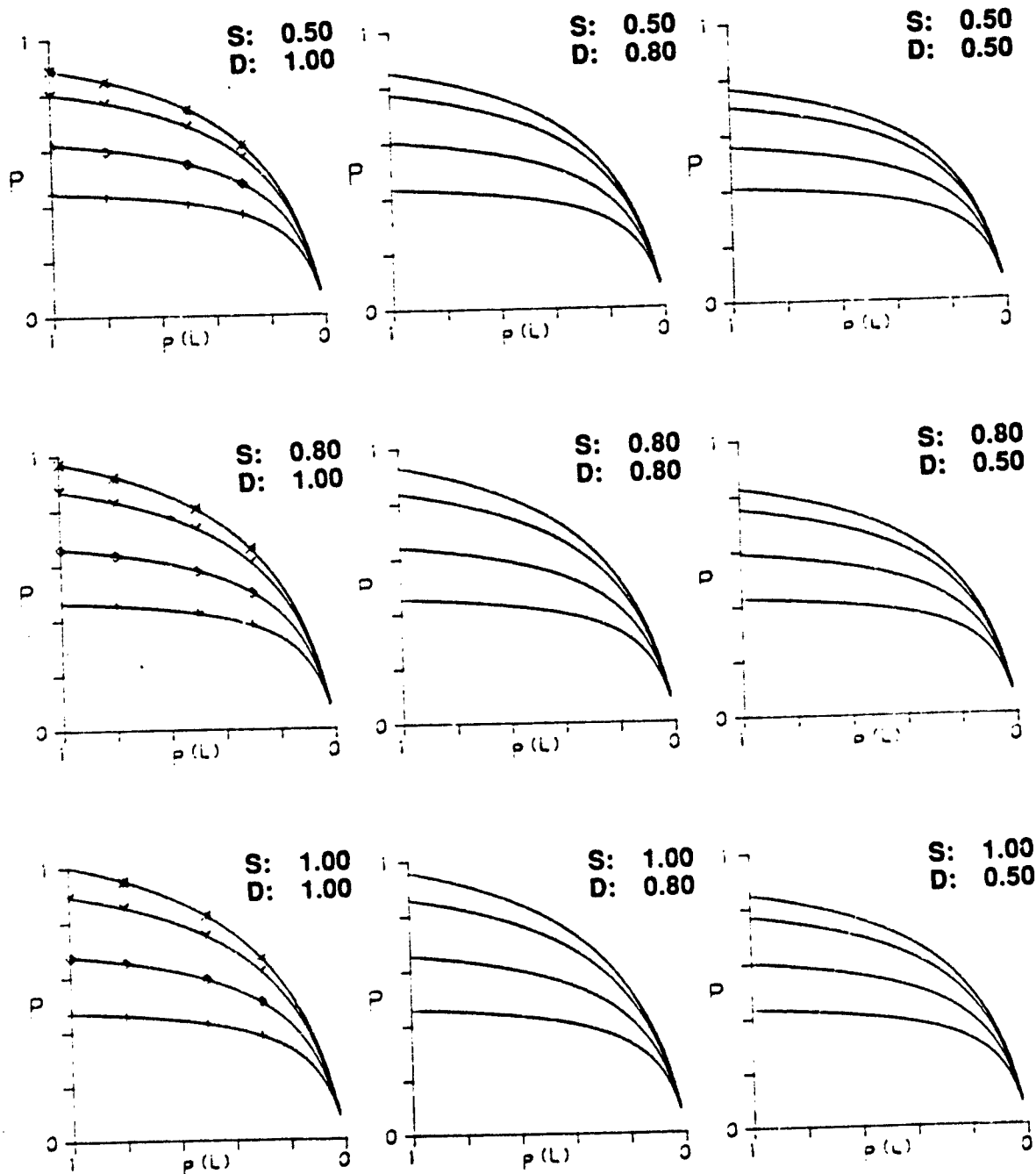

Figure 13. Final performance plot for ITV-TOW crew (continued).

TOW-ITV CREW

FRAME 9 OF 12

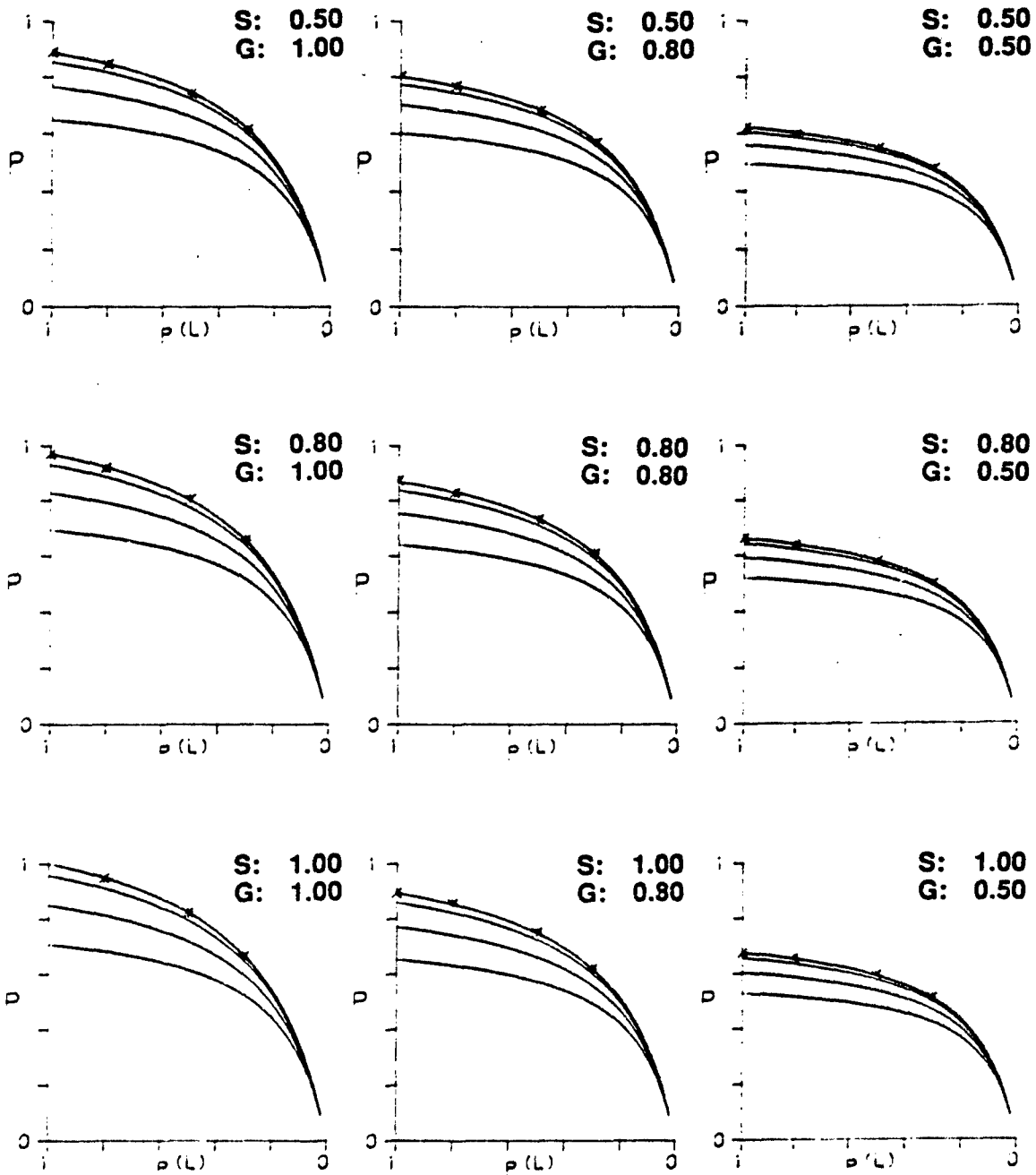

Figure 13. Final performance plot for ITV-TOW crew (continued).

TOW-ITV CREW

FRAME 13 OF 12

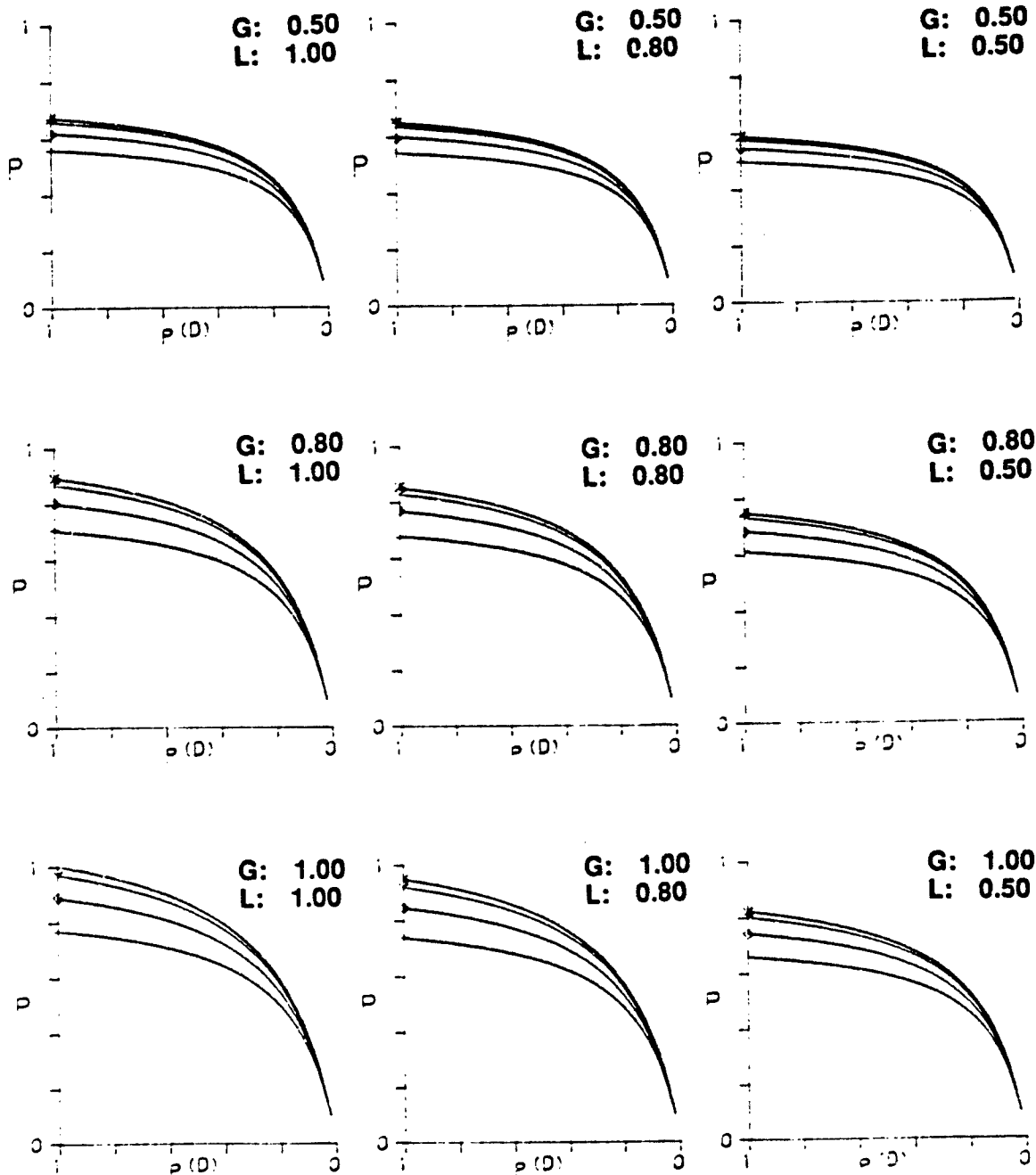

Figure 13. Final performance plot for ITV-TOW crew (continued).

TOW-ITV CREW

FRAME 11 OF 12

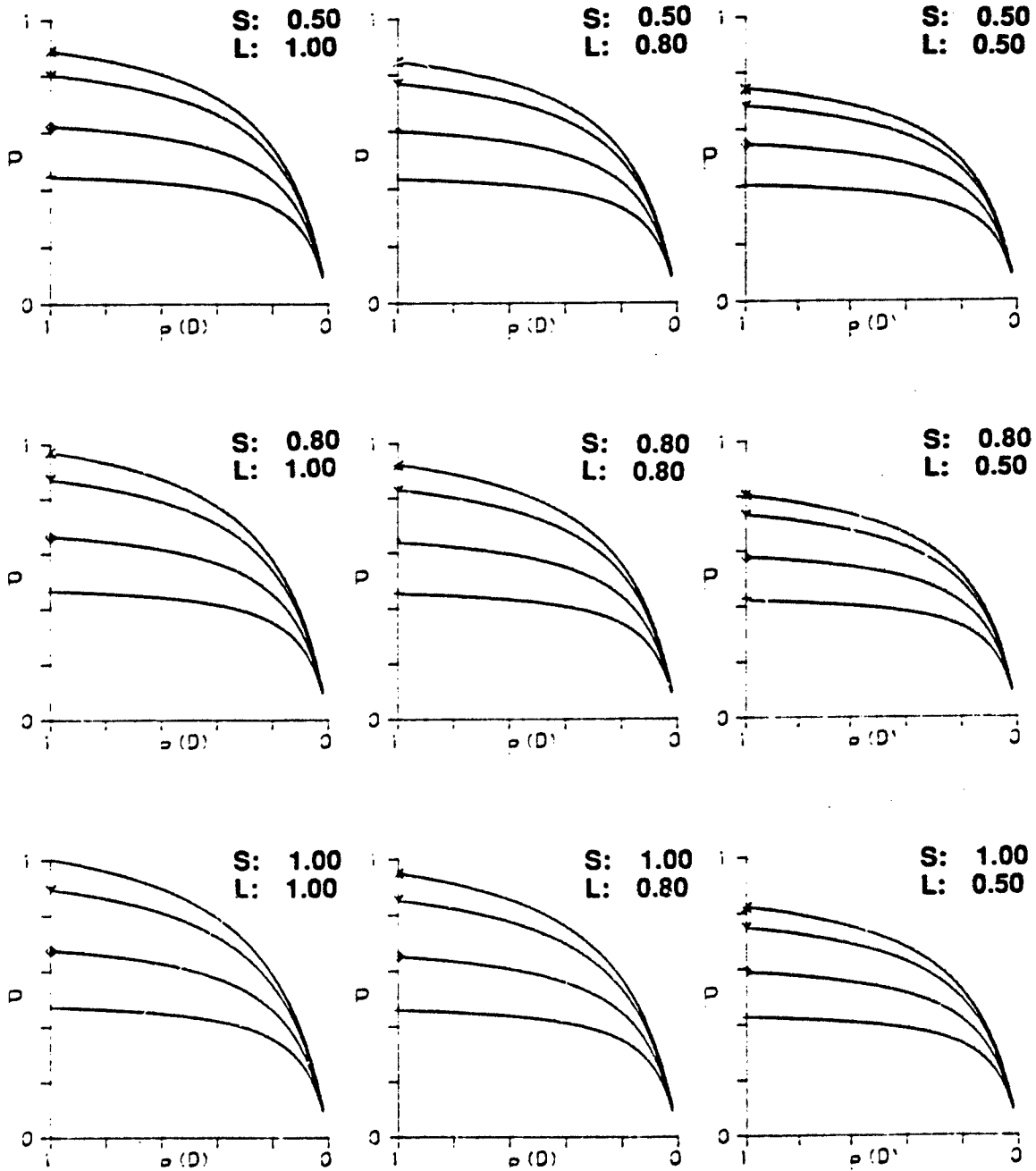

Figure 13. Final performance plot for ITV-TOW crew (continued).

TOW-ITV CREW

FRAME 12 OF 12

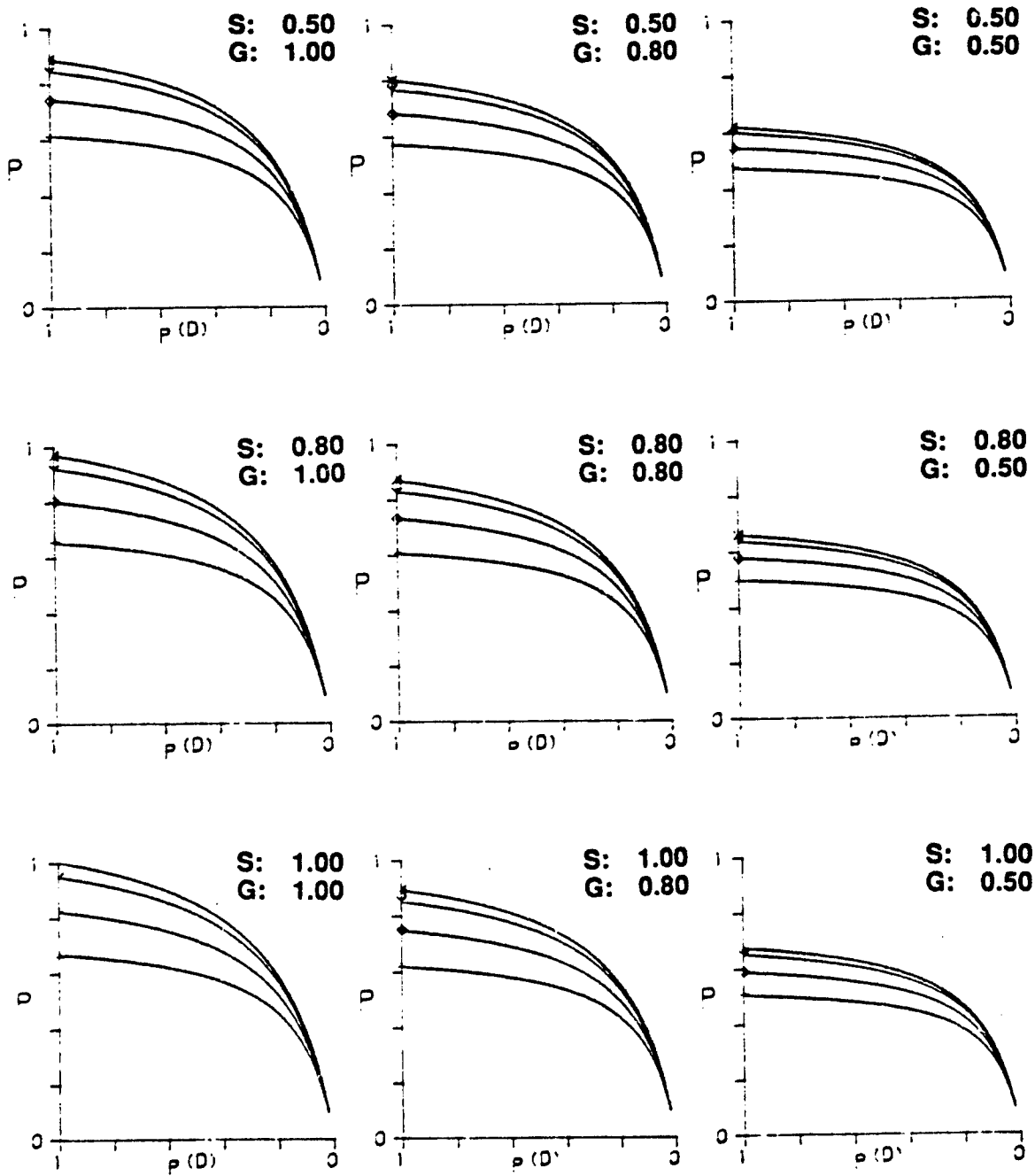

Figure 13. Final performance plot for ITV-TOW crew (continued).

APPENDIX F
CREW PERFORMANCE DATA

Performance as a function of dose and time is tabulated for the four crews in Tables 20 through 23. The times range from 0.2 h to 1258.93 h, and the doses range from 61.1 to 4529.9 rads.

Table 20. Performance data grids for gun crew.

Grid Line	Dose (rads)	Time Grid Lines (h)												
		0.20	0.25	0.32	0.40	0.50	0.63	0.79	1.00	1.26	1.58	2.00	2.51	3.16
18	4529.3	1.0000	1.0000	0.3081	0.6118	0.4645	0.3462	0.2513	0.1772	0.1198	0.0765	0.0435	0.0186	0.0012
17	3516.3	1.0000	1.0000	1.0000	0.7295	0.5583	0.4173	0.2979	0.2056	0.1388	0.1065	0.0845	0.0655	0.0512
16	2729.6	1.0000	1.0000	1.0000	0.9820	0.7536	0.5411	0.4149	0.3363	0.2832	0.2181	0.1492	0.1278	0.1065
15	2118.8	1.0000	1.0000	1.0000	1.0000	0.8425	0.6914	0.5558	0.4556	0.3863	0.2839	0.1930	0.1727	0.1492
14	1644.7	1.0000	1.0000	1.0000	1.0000	1.0000	0.9208	0.6791	0.6102	0.5146	0.4307	0.3353	0.2590	0.2449
13	1276.7	1.0000	1.0000	1.0000	1.0000	1.0000	1.0000	0.7464	0.6564	0.5745	0.4800	0.3909	0.3355	0.3154
12	991.0	1.0000	1.0000	1.0000	1.0000	1.0000	1.0000	1.0000	0.8112	0.6743	0.5983	0.5095	0.4209	0.3663
11	769.3	1.0000	1.0000	1.0000	1.0000	1.0000	1.0000	1.0000	1.0000	0.8098	0.6658	0.6188	0.5616	0.4817
10	597.2	1.0000	1.0000	1.0000	1.0000	1.0000	1.0000	1.0000	1.0000	1.0000	0.8000	0.7261	0.6689	0.5901
9	463.5	1.0000	1.0000	1.0000	1.0000	1.0000	1.0000	1.0000	1.0000	1.0000	1.0000	0.8337	0.7200	0.6753
8	359.3	1.0000	1.0000	1.0000	1.0000	1.0000	1.0000	1.0000	1.0000	1.0000	1.0000	0.9910	0.8203	0.7545
7	273.3	1.0000	1.0000	1.0000	1.0000	1.0000	1.0000	1.0000	1.0000	1.0000	1.0000	1.0000	0.9790	0.8566
6	216.3	1.0000	1.0000	1.0000	1.0000	1.0000	1.0000	1.0000	1.0000	1.0000	1.0000	1.0000	1.0000	0.9655
5	168.3	1.0000	1.0000	1.0000	1.0000	1.0000	1.0000	1.0000	1.0000	1.0000	1.0000	1.0000	1.0000	1.0000
4	130.6	1.0000	1.0000	1.0000	1.0000	1.0000	1.0000	1.0000	1.0000	1.0000	1.0000	1.0000	1.0000	1.0000
3	101.4	1.0000	1.0000	1.0000	1.0000	1.0000	1.0000	1.0000	1.0000	1.0000	1.0000	1.0000	1.0000	1.0000
2	73.7	1.0000	1.0000	1.0000	1.0000	1.0000	1.0000	1.0000	1.0000	1.0000	1.0000	1.0000	1.0000	1.0000
1	61.1	1.0000	1.0000	1.0000	1.0000	1.0000	1.0000	1.0000	1.0000	1.0000	1.0000	1.0000	1.0000	1.0000

Table 20. Performance data grids for gun crew (continued).

Grid Line	Dose (rads)	Time Grid Lines (h)												
		3.98	5.01	6.31	7.94	10.00	12.59	15.85	19.95	25.12	31.62	39.81	50.12	63.10
18	4529.3	0.0008	0.0004	0.0005	0.0004	0.0004	0.0003	0.0003	0.0004	0.0004	0.0003	0.0004	0.0003	0.0001
17	3516.3	0.0638	0.0407	0.0368	0.0306	0.0262	0.0224	0.0232	0.0252	0.0278	0.0233	0.0232	0.0273	0.0177
16	2729.6	0.1063	0.0824	0.0635	0.0429	0.0351	0.0313	0.0313	0.0345	0.0411	0.0481	0.0604	0.0603	0.0474
15	2118.8	0.1521	0.1255	0.0914	0.0557	0.0443	0.0406	0.0396	0.0441	0.0550	0.0723	0.0914	0.1002	0.1024
14	1644.7	0.2270	0.1922	0.1290	0.0912	0.0681	0.0656	0.0671	0.0757	0.0892	0.1307	0.1541	0.1686	0.2239
13	1276.7	0.3003	0.2575	0.1827	0.1238	0.1076	0.1017	0.1075	0.1193	0.1334	0.1891	0.2144	0.2500	0.3457
12	991.0	0.3387	0.3081	0.2665	0.2215	0.1693	0.1490	0.1602	0.1722	0.1846	0.2036	0.2183	0.3389	0.4299
11	769.3	0.4207	0.3833	0.3510	0.3154	0.2742	0.2517	0.2664	0.2814	0.2961	0.3113	0.3513	0.4502	0.5173
10	597.2	0.5129	0.4637	0.4311	0.4042	0.3721	0.3467	0.3548	0.3697	0.3859	0.4035	0.4652	0.5541	0.5932
9	463.5	0.6061	0.5492	0.5092	0.4818	0.4512	0.4230	0.4698	0.4157	0.4343	0.4552	0.5250	0.6265	0.6470
8	359.3	0.6820	0.6265	0.5800	0.5503	0.5240	0.4933	0.4767	0.4789	0.4964	0.5168	0.5839	0.6792	0.6927
7	273.3	0.7531	0.7112	0.6615	0.6301	0.6037	0.6004	0.5996	0.6097	0.6220	0.6366	0.6736	0.7367	0.7469
6	216.3	0.8342	0.7991	0.7515	0.7182	0.7039	0.7174	0.7367	0.7544	0.7652	0.7754	0.7864	0.7993	0.8068
5	168.3	0.9626	0.9090	0.8666	0.8190	0.7975	0.8277	0.8525	0.8712	0.8973	0.9087	0.9186	0.9272	0.9347
4	130.6	1.0000	0.9764	0.9408	0.8989	0.8751	0.9075	0.9326	0.9518	0.9755	0.9864	0.9953	1.0000	1.0000
3	101.4	1.0600	1.0000	0.9854	0.9594	0.9440	0.9639	0.9861	1.0000	1.0000	1.0000	1.0000	1.0000	1.0000
2	73.7	1.0000	1.0000	1.0000	0.9954	0.9950	0.9959	1.0000	1.0000	1.0000	1.0000	1.0000	1.0000	1.0000
1	61.1	1.0000	1.0000	1.0000	1.0000	1.0000	1.0000	1.0000	1.0000	1.0000	1.0000	1.0000	1.0000	1.0000

Table 20. Performance data grids for gun crew (continued).

Grid Line	Dose (rads)	Time Grid Lines (h)												
		79.43	100.00	125.89	158.49	199.53	251.19	316.23	398.11	501.19	630.96	794.33	1000.00	1258.93
18	4529.9	0.0000	0.0000	0.0000	0.0000	0.0000	0.0000	0.0000	0.0000	0.0000	0.0000	0.0000	0.0000	0.0000
17	3516.3	0.0131	0.0000	0.0000	0.0000	0.0000	0.0000	0.0000	0.0000	0.0000	0.0000	0.0000	0.0000	0.0000
16	2729.6	0.0521	0.0138	0.0014	0.0000	0.0000	0.0000	0.0000	0.0000	0.0000	0.0000	0.0000	0.0000	0.0000
15	2118.8	0.0958	0.0643	0.0274	0.0153	0.0000	0.0000	0.0000	0.0000	0.0000	0.0000	0.0000	0.0000	0.0000
14	1644.7	0.2429	0.1603	0.0369	0.0506	0.0142	0.0010	0.0000	0.0000	0.0000	0.0000	0.0000	0.0000	0.0000
13	1276.7	0.3938	0.2905	0.1372	0.1110	0.0703	0.0360	0.0110	0.0000	0.0000	0.0000	0.0000	0.0000	0.0000
12	991.0	0.5245	0.4441	0.3742	0.3157	0.2023	0.1431	0.0782	0.0404	0.0000	0.0000	0.0000	0.0000	0.0000
11	763.3	0.9838	0.5670	0.5424	0.5152	0.4331	0.3610	0.2910	0.2534	0.2245	0.0279	0.0000	0.0000	0.0000
10	537.2	0.6145	0.6276	0.6330	0.6247	0.5973	0.5440	0.4844	0.4318	0.3452	0.2096	0.1383	0.0000	0.0000
9	463.5	0.6539	0.6582	0.6598	0.6560	0.6442	0.6204	0.5809	0.5134	0.4595	0.3888	0.3068	0.1910	0.1013
8	359.3	0.6908	0.6878	0.6366	0.6854	0.6821	0.6788	0.6530	0.5891	0.5640	0.5310	0.4653	0.4019	0.3311
7	273.3	0.7401	0.7352	0.7339	0.7344	0.7362	0.7434	0.7295	0.6798	0.6749	0.6648	0.6254	0.5982	0.5610
6	216.8	0.8090	0.8125	0.8147	0.8142	0.8110	0.8111	0.8068	0.7964	0.7919	0.7885	0.7763	0.7729	0.7652
5	163.3	0.9414	0.9474	0.9527	0.9572	0.9612	0.9634	0.9638	0.9743	0.9791	0.9840	0.9893	0.9952	1.0000
4	130.6	1.0000	1.0000	1.0000	1.0000	1.0000	1.0000	1.0000	1.0000	1.0000	1.0000	1.0000	1.0000	1.0000
3	101.4	1.0000	1.0000	1.0000	1.0000	1.0000	1.0000	1.0000	1.0000	1.0000	1.0000	1.0000	1.0000	1.0000
2	73.7	1.0000	1.0000	1.0000	1.0000	1.0000	1.0000	1.0000	1.0000	1.0000	1.0000	1.0000	1.0000	1.0000
1	61.1	1.0000	1.0000	1.0000	1.0000	1.0000	1.0000	1.0000	1.0000	1.0000	1.0000	1.0000	1.0000	1.0000

Table 21. Performance data grids for FDC crew.

Grid Line	Dose (rads)	Time Grid Lines (h)												
		0.20	0.25	0.32	0.40	0.50	0.63	0.79	1.00	1.26	1.58	2.00	2.51	3.16
13	4523 9	1.0000	1.0000	0.8177	0.6337	0.4901	0.3737	0.2792	0.2023	0.1396	0.0907	0.0521	0.0222	0.0021
17	3516 3	1.0000	1.0000	1.0000	0.7969	0.7402	0.6983	0.6568	0.5955	0.5201	0.4875	0.4378	0.3552	0.2786
16	2729 6	1.0000	1.0000	1.0000	0.9836	0.8107	0.7343	0.7121	0.6577	0.5976	0.5880	0.5360	0.4368	0.3997
15	2113 8	1.0000	1.0000	1.0000	1.0000	0.8926	0.7706	0.7409	0.6967	0.6462	0.6282	0.5734	0.4961	0.4800
14	1644 7	1.0000	1.0000	1.0000	1.0000	1.0000	0.9371	0.7659	0.7261	0.6881	0.6523	0.6008	0.5497	0.5491
13	1276 7	1.0000	1.0000	1.0000	1.0000	1.0000	1.0000	0.8144	0.7571	0.7251	0.6787	0.6307	0.5980	0.5956
12	931 6	1.0000	1.0000	1.0000	1.0000	1.0000	1.0000	1.0000	0.8600	0.7607	0.7362	0.6937	0.6476	0.6214
11	763 3	1.0000	1.0000	1.0000	1.0000	1.0000	1.0000	1.0000	1.0000	0.8476	0.7657	0.7362	0.6976	0.6619
10	597 2	1.0000	1.0000	1.0000	1.0000	1.0000	1.0000	1.0000	1.0000	1.0000	0.8507	0.7844	0.7434	0.7091
9	483 5	1.0000	1.0000	1.0000	1.0000	1.0000	1.0000	1.0000	1.0000	1.0000	1.0000	0.8535	0.7871	0.7642
8	353 3	1.0000	1.0000	1.0000	1.0000	1.0000	1.0000	1.0000	1.0000	1.0000	1.0000	0.9891	0.8635	0.8162
7	273 3	1.0000	1.0000	1.0000	1.0000	1.0000	1.0000	1.0000	1.0000	1.0000	1.0000	1.0000	0.9799	0.8905
6	216 5	1.0000	1.0000	1.0000	1.0000	1.0000	1.0000	1.0000	1.0000	1.0000	1.0000	1.0000	1.0000	0.9706
5	163 3	1.0000	1.0000	1.0000	1.0000	1.0000	1.0000	1.0000	1.0000	1.0000	1.0000	1.0000	1.0000	1.0000
4	130 6	1.0000	1.0000	1.0000	1.0000	1.0000	1.0000	1.0000	1.0000	1.0000	1.0000	1.0000	1.0000	1.0000
3	101 4	1.0000	1.0000	1.0000	1.0000	1.0000	1.0000	1.0000	1.0000	1.0000	1.0000	1.0000	1.0000	1.0000
2	73 7	1.0000	1.0000	1.0000	1.0000	1.0000	1.0000	1.0000	1.0000	1.0000	1.0000	1.0000	1.0000	1.0000
1	51 1	1.0000	1.0000	1.0000	1.0000	1.0000	1.0000	1.0000	1.0000	1.0000	1.0000	1.0000	1.0000	1.0000

Table 21. Performance data grids for FDC crew (continued).

Grid Line	Dose (rads)	Time Grid Lines (h)													
		3.98	5.01	6.31	7.94	10.00	12.59	15.85	19.95	25.12	31.62	39.81	50.12	63.10	
18	4329.4	0.0012	0.0007	0.0010	0.0000	0.0007	0.0006	0.0006	0.0007	0.0007	0.0007	0.0005	0.0007	0.0004	0.0001
17	3516.3	0.2134	0.1437	0.1788	0.1497	0.1297	0.1120	0.1149	0.1231	0.1320	0.1320	0.1195	0.1385	0.1082	0.0526
16	2729.6	0.3596	0.2966	0.2669	0.1958	0.1673	0.1519	0.1563	0.1711	0.1910	0.1910	0.2076	0.2409	0.2227	0.1686
15	2113.3	0.4613	0.4194	0.3431	0.2467	0.2046	0.1916	0.1980	0.2194	0.2491	0.2491	0.2921	0.3385	0.3363	0.3110
14	1644.7	0.5473	0.5109	0.4126	0.3158	0.2785	0.2719	0.2831	0.3144	0.3493	0.3493	0.4070	0.4521	0.4621	0.4841
13	1276.7	0.6020	0.5723	0.4823	0.4039	0.3626	0.3528	0.3694	0.4014	0.4417	0.4417	0.5097	0.5542	0.5814	0.6446
12	991.6	0.6147	0.6045	0.5682	0.5169	0.4302	0.4273	0.4319	0.4774	0.5033	0.5033	0.5311	0.5589	0.6420	0.7146
11	769.3	0.6349	0.6273	0.6130	0.5900	0.5465	0.5272	0.5435	0.5722	0.5932	0.5932	0.6137	0.6434	0.7031	0.7501
10	597.2	0.6739	0.6610	0.6546	0.6453	0.6329	0.6143	0.6240	0.6418	0.6611	0.6611	0.6807	0.7182	0.7602	0.7787
9	463.5	0.7330	0.7111	0.7059	0.6999	0.6900	0.6718	0.6646	0.6736	0.6934	0.6934	0.7152	0.7616	0.8068	0.8113
8	359.3	0.7819	0.7558	0.7437	0.7350	0.7282	0.7199	0.7080	0.7131	0.7312	0.7312	0.7513	0.7999	0.8342	0.8444
7	279.3	0.8257	0.8050	0.7935	0.7715	0.7707	0.7749	0.7758	0.7805	0.7992	0.7992	0.8119	0.8424	0.8596	0.8601
6	216.3	0.8762	0.8562	0.8297	0.8162	0.8199	0.8329	0.8491	0.8644	0.8738	0.8738	0.8806	0.8862	0.8892	0.8898
5	163.3	0.9634	0.9316	0.9043	0.8755	0.8696	0.8901	0.9098	0.9255	0.9418	0.9418	0.9482	0.9528	0.9584	0.9594
4	130.6	1.0000	0.9791	0.9548	0.9260	0.9126	0.9348	0.9529	0.9676	0.9830	0.9830	0.9889	0.9937	1.0000	1.0000
3	101.4	1.0000	1.0000	0.9855	0.9670	0.9561	0.9702	0.9861	1.0000	1.0000	1.0000	1.0000	1.0000	1.0000	1.0000
2	77.7	1.0000	1.0000	1.0000	0.9937	0.9926	0.9941	1.0000	1.0000	1.0000	1.0000	1.0000	1.0000	1.0000	1.0000
1	61.1	1.0000	1.0000	1.0000	1.0000	1.0000	1.0000	1.0000	1.0000	1.0000	1.0000	1.0000	1.0000	1.0000	1.0000

Table 21. Performance data grids for FDC crew (continued).

Grid Line	Dose (rads)	Time Grid Lines (h)													
		79.43	100.00	125.89	158.49	199.53	251.19	316.23	398.11	501.19	630.96	794.33	1000.00	1258.93	
18	4529.3	0.0000	0.0000	0.0000	0.0000	0.0000	0.0000	0.0000	0.0000	0.0000	0.0000	0.0000	0.0000	0.0000	
17	3516.3	0.0272	0.0000	0.0000	0.0000	0.0000	0.0000	0.0000	0.0000	0.0000	0.0000	0.0000	0.0000	0.0000	
16	2723.6	0.1388	0.0298	0.0010	0.0000	0.0000	0.0000	0.0000	0.0000	0.0000	0.0000	0.0000	0.0000	0.0000	
15	2118.8	0.2628	0.1489	0.0525	0.0357	0.0000	0.0000	0.0000	0.0000	0.0000	0.0000	0.0000	0.0000	0.0000	
14	1644.7	0.4778	0.3483	0.2013	0.1483	0.0447	0.0014	0.0000	0.0000	0.0000	0.0000	0.0000	0.0000	0.0000	
13	1276.7	0.6768	0.5152	0.4001	0.3169	0.2244	0.1233	0.0234	0.0000	0.0000	0.0000	0.0000	0.0000	0.0000	
12	931.0	0.7708	0.6389	0.6065	0.5658	0.4845	0.4193	0.3273	0.2123	0.0000	0.0000	0.0000	0.0000	0.0000	
11	759.3	0.7812	0.7711	0.7452	0.7306	0.6903	0.6565	0.6135	0.5306	0.5325	0.0000	0.0000	0.0000	0.0000	
10	537.2	0.7917	0.8034	0.8022	0.7998	0.7926	0.7928	0.7690	0.7458	0.6766	0.4301	0.0001	0.0001	0.0001	
9	463.5	0.8142	0.8172	0.8177	0.8168	0.8141	0.8111	0.8015	0.7813	0.7595	0.7122	0.6269	0.3317	0.1003	
8	359.3	0.8341	0.8323	0.8316	0.8324	0.8318	0.8320	0.8274	0.8112	0.8040	0.7892	0.7240	0.5902	0.3412	
7	273.3	0.8534	0.8549	0.8541	0.8550	0.8558	0.8589	0.8568	0.8456	0.8459	0.8383	0.8011	0.7173	0.5741	
6	216.2	0.8834	0.8891	0.8879	0.8880	0.8883	0.8897	0.8893	0.8871	0.8884	0.8864	0.8719	0.8301	0.7739	
5	163.3	0.9622	0.9649	0.9676	0.9704	0.9731	0.9759	0.9787	0.9816	0.9845	0.9873	0.9897	0.9923	1.0000	
4	130.6	1.0000	1.0000	1.0000	1.0000	1.0000	1.0000	1.0000	1.0000	1.0000	1.0000	1.0000	1.0000	1.0000	
3	101.4	1.0000	1.0000	1.0000	1.0000	1.0000	1.0000	1.0000	1.0000	1.0000	1.0000	1.0000	1.0000	1.0000	
2	78.7	1.0000	1.0000	1.0000	1.0000	1.0000	1.0000	1.0000	1.0000	1.0000	1.0000	1.0000	1.0000	1.0000	
1	61.1	1.0000	1.0000	1.0000	1.0000	1.0000	1.0000	1.0000	1.0000	1.0000	1.0000	1.0000	1.0000	1.0000	

Table 22. Performance data grids for tank crew.

Grid Line	Dose (rads)	Time Grid Lines (h)													
		0.20	0.25	0.32	0.40	0.50	0.63	0.79	1.00	1.26	1.58	2.00	2.51	3.16	
18	4529.3	1.0000	1.0000	0.3224	0.6220	0.4695	0.3489	0.2527	0.1779	0.1219	0.0793	0.0463	0.0205	0.0023	
17	3516.3	1.0000	1.0000	1.0000	0.8637	0.7959	0.7020	0.5676	0.4339	0.3761	0.3515	0.2983	0.2292	0.1730	
16	2729.6	1.0000	1.0000	1.0000	1.0000	0.3647	0.7693	0.7155	0.5963	0.5015	0.4551	0.3552	0.2908	0.2759	
15	2118.8	1.0000	1.0000	1.0000	1.0000	0.9349	0.8368	0.7908	0.7005	0.5895	0.5222	0.4093	0.3503	0.3488	
14	1644.7	1.0000	1.0000	1.0000	1.0000	1.0000	0.9765	0.8267	0.7566	0.6639	0.5762	0.4631	0.4140	0.4091	
13	1276.7	1.0000	1.0000	1.0000	1.0000	1.0000	1.0000	0.8803	0.8134	0.7374	0.6350	0.5283	0.4818	0.4578	
12	991.0	1.0000	1.0000	1.0000	1.0000	1.0000	1.0000	1.0000	0.9157	0.8235	0.7592	0.6682	0.5663	0.5021	
11	769.3	1.0000	1.0000	1.0000	1.0000	1.0000	1.0000	1.0000	1.0000	0.9177	0.8186	0.7736	0.6981	0.6168	
10	597.2	1.0000	1.0000	1.0000	1.0000	1.0000	1.0000	1.0000	1.0000	1.0000	0.9066	0.8538	0.8000	0.7243	
9	463.5	1.0000	1.0000	1.0000	1.0000	1.0000	1.0000	1.0000	1.0000	1.0000	1.0000	0.9252	0.8487	0.8051	
8	359.3	1.0000	1.0000	1.0000	1.0000	1.0000	1.0000	1.0000	1.0000	1.0000	1.0000	1.0000	0.9178	0.8762	
7	273.3	1.0000	1.0000	1.0000	1.0000	1.0000	1.0000	1.0000	1.0000	1.0000	1.0000	1.0000	1.0000	0.9443	
6	216.3	1.0000	1.0000	1.0000	1.0000	1.0000	1.0000	1.0000	1.0000	1.0000	1.0000	1.0000	1.0000	0.9982	
5	168.3	1.0000	1.0000	1.0000	1.0000	1.0000	1.0000	1.0000	1.0000	1.0000	1.0000	1.0000	1.0000	1.0000	
4	130.6	1.0000	1.0000	1.0000	1.0000	1.0000	1.0000	1.0000	1.0000	1.0000	1.0000	1.0000	1.0000	1.0000	
3	101.4	1.0000	1.0000	1.0000	1.0000	1.0000	1.0000	1.0000	1.0000	1.0000	1.0000	1.0000	1.0000	1.0000	
2	73.7	1.0000	1.0000	1.0000	1.0000	1.0000	1.0000	1.0000	1.0000	1.0000	1.0000	1.0000	1.0000	1.0000	
1	61.1	1.0000	1.0000	1.0000	1.0000	1.0000	1.0000	1.0000	1.0000	1.0000	1.0000	1.0000	1.0000	1.0000	

Table 22. Performance data grids for tank crew (continued).

Grid Line	Dose (rads)	Time Grid Lines (h)												
		3 98	5 01	6 31	7 94	10 00	12 59	15 85	19 95	25 12	31 62	39 81	50 12	63 10
18	423 9	0 0014	0 0007	0 0010	0 0009	0 0008	0 0006	0 0006	0 0006	0 0006	0 0004	0 0004	0 0002	0 0000
17	3516 3	0 1253	0 0761	0 0886	0 0699	0 0587	0 0494	0 0488	0 0497	0 0502	0 0433	0 0449	0 0330	0 0163
16	2729 6	0 2465	0 1817	0 1557	0 0994	0 0787	0 0706	0 0754	0 0812	0 0839	0 0861	0 0965	0 0869	0 0663
15	2113 8	0 3430	0 2941	0 2128	0 1298	0 0993	0 0925	0 1032	0 1142	0 1194	0 1318	0 1528	0 1658	0 1662
14	1644 7	0 4010	0 3674	0 2662	0 1713	0 1416	0 1374	0 1464	0 1709	0 1958	0 2243	0 2577	0 2873	0 3533
13	1276 7	0 4414	0 4160	0 3207	0 2306	0 1924	0 1831	0 1969	0 2284	0 2717	0 3148	0 3589	0 4166	0 5427
12	931 0	0 4731	0 4426	0 3875	0 3229	0 2477	0 2226	0 2472	0 2751	0 3044	0 3358	0 3682	0 5280	0 6542
11	763 3	0 5513	0 5157	0 4787	0 4368	0 3869	0 3628	0 3924	0 4226	0 4516	0 4814	0 5358	0 6544	0 7372
10	597 2	0 6435	0 5976	0 5698	0 5442	0 5169	0 4878	0 5075	0 5353	0 5656	0 5967	0 6700	0 7645	0 7976
9	403 5	0 7378	0 6912	0 6491	0 6248	0 5963	0 5655	0 5579	0 5743	0 6064	0 6419	0 7236	0 8226	0 8424
8	359 9	0 8103	0 7739	0 7126	0 6529	0 6605	0 6408	0 6286	0 6432	0 6713	0 7020	0 7748	0 8551	0 8687
7	273 3	0 8721	0 8269	0 7781	0 7432	0 7303	0 7316	0 7456	0 7677	0 7880	0 8054	0 8412	0 8862	0 8943
6	216 3	0 9282	0 8952	0 8453	0 8095	0 8046	0 8261	0 8536	0 8777	0 8926	0 9032	0 9114	0 9192	0 9228
5	163 3	0 9958	0 9631	0 9274	0 8972	0 8818	0 9102	0 9323	0 9520	0 9650	0 9720	0 9776	0 9820	0 9854
4	130 6	1 0000	0 9983	0 9790	0 9570	0 9411	0 9637	0 9797	0 9930	0 9991	1 0000	1 0000	1 0000	1 0000
3	101 4	1 0000	1 0000	0 9999	0 9920	0 9841	0 9939	0 9999	1 0000	1 0000	1 0000	1 0000	1 0000	1 0000
2	72 7	1 0000	1 0000	1 0000	1 0000	1 0000	1 0000	1 0000	1 0000	1 0000	1 0000	1 0000	1 0000	1 0000
1	61 1	1 0000	1 0000	1 0000	1 0000	1 0000	1 0000	1 0000	1 0000	1 0000	1 0000	1 0000	1 0000	1 0000

Table 22. Performance data grids for tank crew (continued).

Grid Line	Dose (rads)	Time Grid Lines (h)													
		79.43	100.00	125.89	158.49	199.53	251.19	316.23	398.11	501.19	630.96	794.33	1000.00	1258.93	
18	4529.9	0.0000	0.0000	0.0000	0.0000	0.0000	0.0000	0.0000	0.0000	0.0000	0.0000	0.0000	0.0000	0.0000	
17	3516.3	0.0098	0.0000	0.0000	0.0000	0.0000	0.0000	0.0000	0.0000	0.0000	0.0000	0.0000	0.0000	0.0000	
16	2729.6	0.0541	0.0116	0.0010	0.0000	0.0000	0.0000	0.0000	0.0000	0.0000	0.0000	0.0000	0.0000	0.0000	
15	2118.8	0.1397	0.0698	0.0300	0.0221	0.0090	0.0000	0.0000	0.0000	0.0000	0.0000	0.0000	0.0000	0.0000	
14	1644.7	0.3642	0.2186	0.1251	0.0951	0.0331	0.0025	0.0003	0.0000	0.0000	0.0000	0.0000	0.0000	0.0000	
13	1276.7	0.5984	0.4140	0.2912	0.2141	0.1407	0.0920	0.0242	0.0000	0.0000	0.0000	0.0000	0.0000	0.0000	
12	991.0	0.7475	0.6312	0.5221	0.4919	0.3547	0.3080	0.2209	0.1344	0.0000	0.0000	0.0000	0.0000	0.0000	
11	763.3	0.7876	0.7704	0.7334	0.7342	0.6480	0.5994	0.5532	0.5107	0.4781	0.0592	0.0000	0.0000	0.0000	
10	537.2	0.9133	0.9245	0.8338	0.8368	0.8253	0.7830	0.7683	0.7589	0.6491	0.4208	0.0000	0.0000	0.0000	
9	463.5	0.9454	0.9445	0.8420	0.8370	0.8265	0.8043	0.7923	0.7962	0.7564	0.6832	0.5883	0.2981	0.0883	
8	353.3	0.9693	0.9627	0.8517	0.8418	0.8329	0.8268	0.8180	0.8146	0.8237	0.8105	0.7226	0.5642	0.3098	
7	279.1	0.9963	0.9935	0.8791	0.8736	0.8702	0.8706	0.8672	0.8663	0.8844	0.8781	0.8272	0.7173	0.5470	
6	216.2	0.9251	0.9254	0.9263	0.9276	0.9290	0.9309	0.9323	0.9340	0.9380	0.9370	0.9169	0.8530	0.7666	
5	163.3	0.9884	0.9910	0.9933	0.9953	0.9970	0.9985	0.9994	0.9999	1.0000	1.0000	1.0000	1.0000	1.0000	
4	130.6	1.0000	1.0000	1.0000	1.0000	1.0000	1.0000	1.0000	1.0000	1.0000	1.0000	1.0000	1.0000	1.0000	
3	101.4	1.0000	1.0000	1.0000	1.0000	1.0000	1.0000	1.0000	1.0000	1.0000	1.0000	1.0000	1.0000	1.0000	
2	79.7	1.0000	1.0000	1.0000	1.0000	1.0000	1.0000	1.0000	1.0000	1.0000	1.0000	1.0000	1.0000	1.0000	
1	61.1	1.0000	1.0000	1.0000	1.0000	1.0000	1.0000	1.0000	1.0000	1.0000	1.0000	1.0000	1.0000	1.0000	

Table 23. Performance data grids for ITV-TOW crew.

Grid Line	Dose (rads)	Time Grid Lines (h)													
		0 20	0 25	0 32	0 40	0 50	0 63	0 79	1 00	1 26	1 58	2 00	2 51	3 16	
13	6229 9	1 0000	1 0000	0 3152	0 6311	0 8887	0 3721	0 2755	0 2035	0 1411	0 0947	0 0579	0 0252	0 0042	
17	3516 3	1 0000	1 0000	1 0000	0 5714	0 3157	0 7017	0 5129	0 4033	0 3054	0 2663	0 2340	0 1920	0 1613	
16	2729 6	1 0000	1 0000	1 0000	0 3552	0 3705	0 7744	0 6853	0 5637	0 4457	0 3827	0 3228	0 2409	0 2039	
15	2113 9	1 0000	1 0000	1 0000	1 0000	0 3260	0 8466	0 8021	0 7034	0 5676	0 4703	0 3814	0 2893	0 2465	
14	1644 7	1 0000	1 0000	1 0000	1 0000	1 0000	0 9599	0 3349	0 7619	0 6474	0 5356	0 4255	0 3467	0 3145	
13	1276 7	1 0000	1 0000	1 0000	1 0000	1 0000	1 0000	0 8817	0 8233	0 7293	0 6062	0 4778	0 4151	0 3828	
12	931 0	1 0000	1 0000	1 0000	1 0000	1 0000	1 0000	1 0000	0 9135	0 8326	0 7536	0 6452	0 5225	0 4419	
11	763 3	1 0000	1 0000	1 0000	1 0000	1 0000	1 0000	1 0000	1 0000	0 9213	0 8217	0 7766	0 6954	0 5979	
10	537 2	1 0000	1 0000	1 0000	1 0000	1 0000	1 0000	1 0000	1 0000	1 0000	0 9034	0 8609	0 8136	0 7345	
9	463 5	1 0000	1 0000	1 0000	1 0000	1 0000	1 0000	1 0000	1 0000	1 0000	1 0000	0 9187	0 8577	0 8135	
9	359 3	1 0000	1 0000	1 0000	1 0000	1 0000	1 0000	1 0000	1 0000	1 0000	1 0000	0 9951	0 9129	0 8782	
7	273 1	1 0000	1 0000	1 0000	1 0000	1 0000	1 0000	1 0000	1 0000	1 0000	1 0000	1 0000	0 9890	0 9363	
6	216 3	1 0000	1 0000	1 0000	1 0000	1 0000	1 0000	1 0000	1 0000	1 0000	1 0000	1 0000	1 0000	0 9839	
5	163 3	1 0000	1 0000	1 0000	1 0000	1 0000	1 0000	1 0000	1 0000	1 0000	1 0000	1 0000	1 0000	1 0000	
4	130 6	1 0000	1 0000	1 0000	1 0000	1 0000	1 0000	1 0000	1 0000	1 0000	1 0000	1 0000	1 0000	1 0000	
3	101 4	1 0000	1 0000	1 0000	1 0000	1 0000	1 0000	1 0000	1 0000	1 0000	1 0000	1 0000	1 0000	1 0000	
2	73 7	1 0000	1 0000	1 0000	1 0000	1 0000	1 0000	1 0000	1 0000	1 0000	1 0000	1 0000	1 0000	1 0000	
1	61 1	1 0000	1 0000	1 0000	1 0000	1 0000	1 0000	1 0000	1 0000	1 0000	1 0000	1 0000	1 0000	1 0000	

Table 23. Performance data grids for ITV-TOW crew (continued).

Grid Line	Dose (rads)	Time Grid Lines (h)												
		3 98	5 01	6 31	7 94	10 00	12 59	15 95	19 95	25 12	31 62	39 81	50 12	63 10
18	4523 3	0 3032	0 6013	0 3014	0 3013	0 3011	0 3009	0 3010	0 3011	0 3012	0 3013	0 3017	0 3014	0 3007
17	3516 3	0 1257	0 0770	0 0583	0 0480	0 0406	0 0344	0 0362	0 0412	0 0477	0 0549	0 0747	0 0725	0 0587
16	2729 6	0 1668	0 1231	0 0911	0 0604	0 0437	0 0432	0 0434	0 0492	0 0543	0 0875	0 1209	0 1421	0 1483
15	2115 8	0 2081	0 1693	0 1237	0 0726	0 0568	0 0520	0 0505	0 0594	0 0810	0 1202	0 1665	0 2031	0 2543
14	1644 7	0 2829	0 2417	0 1676	0 1019	0 0948	0 0822	0 0846	0 1035	0 1236	0 1787	0 2220	0 2691	0 3622
13	1276 7	0 3354	0 3122	0 2234	0 1552	0 1281	0 1212	0 1354	0 1512	0 1789	0 2343	0 2731	0 3318	0 4716
12	991 0	0 4014	0 3583	0 3052	0 2506	0 1987	0 1643	0 1336	0 2044	0 2277	0 2542	0 2733	0 4516	0 5819
11	769 3	0 5162	0 4598	0 4175	0 3742	0 3294	0 3061	0 3330	0 3523	0 3831	0 4086	0 4631	0 6043	0 6935
10	597 2	0 6369	0 5671	0 5231	0 4877	0 4517	0 4284	0 4467	0 4717	0 4998	0 5289	0 6141	0 7261	0 7623
9	463 5	0 7378	0 6644	0 6094	0 5720	0 5340	0 5036	0 4863	0 5114	0 5416	0 5753	0 6644	0 7759	0 7975
8	359 8	0 8087	0 7445	0 6852	0 6431	0 6104	0 5841	0 5735	0 5939	0 6145	0 6454	0 7192	0 8151	0 8290
7	279 3	0 9692	0 8218	0 7645	0 7200	0 6943	0 6822	0 7066	0 7286	0 7476	0 7665	0 8023	0 8563	0 8645
6	216 3	0 9226	0 8912	0 8411	0 7991	0 7826	0 8027	0 8280	0 8504	0 8643	0 8757	0 8864	0 8977	0 9030
5	168 3	0 9819	0 9504	0 9168	0 8877	0 8703	0 8928	0 9138	0 9301	0 9436	0 9512	0 9562	0 9619	0 9667
4	130 6	1 0000	0 9867	0 9651	0 9457	0 9329	0 9494	0 9645	0 9765	0 9875	0 9929	0 9970	1 0000	1 0000
3	101 4	1 0000	1 0000	0 9931	0 9817	0 9747	0 9839	0 9933	1 0000	1 0000	1 0000	1 0000	1 0000	1 0000
2	78 7	1 0000	1 0000	1 0000	0 9986	0 9976	0 9989	1 0000	1 0000	1 0000	1 0000	1 0000	1 0000	1 0000
1	61 1	1 0000	1 0000	1 0000	1 0000	1 0000	1 0000	1 0000	1 0000	1 0000	1 0000	1 0000	1 0000	1 0000

Table 23. Performance data grids for IIV-TOW crew (continued).

Grid Line	Dose (rads)	Time Grid Lines (h)															
		79.43	100.00	125.89	158.49	199.53	251.19	316.23	398.11	501.19	630.96	794.33	1060.00	1258.93			
18	4529.9	0.0000	0.0000	0.5000	0.5000	0.6000	0.0000	0.0000	0.0000	0.0000	0.0000	0.0000	0.0000	0.0000	0.0000	0.0000	0.0000
17	3516.3	0.0508	0.0000	0.0000	0.0000	0.5000	0.0000	0.0000	0.0000	0.0000	0.0000	0.0000	0.0000	0.0000	0.0000	0.0000	0.0000
16	2729.6	0.1790	0.0389	0.0161	0.0000	0.0000	0.0000	0.0000	0.0000	0.0000	0.0000	0.0000	0.0000	0.0000	0.0000	0.0000	0.0000
15	2113.8	0.3026	0.2161	0.1158	0.0534	0.0000	0.0000	0.0000	0.0000	0.0000	0.0000	0.0000	0.0000	0.0000	0.0000	0.0000	0.0000
14	1644.7	0.4290	0.3359	0.2147	0.1032	0.0336	0.0037	0.0000	0.0000	0.0000	0.0000	0.0000	0.0000	0.0000	0.0000	0.0000	0.0000
13	1276.7	0.5557	0.4676	0.3413	0.1711	0.1291	0.0651	0.0231	0.0000	0.0000	0.0000	0.0000	0.0000	0.0000	0.0000	0.0000	0.0000
12	931.0	0.6855	0.5295	0.3725	0.4863	0.2918	0.1901	0.1079	0.0513	0.0000	0.0000	0.0000	0.0000	0.0000	0.0000	0.0000	0.0000
11	769.3	0.7541	0.7426	0.7311	0.6993	0.5602	0.4635	0.3632	0.3103	0.2704	0.0352	0.0000	0.0000	0.0000	0.0000	0.0000	0.0000
10	597.2	0.7821	0.7899	0.7828	0.7828	0.7501	0.6893	0.6010	0.5178	0.4015	0.2231	0.1782	0.0000	0.0000	0.0000	0.0000	0.0000
9	463.5	0.8050	0.9077	0.8086	0.8044	0.7916	0.7712	0.7189	0.6156	0.5361	0.4337	0.3855	0.2520	0.1111	0.0000	0.0000	0.0000
8	359.2	0.8272	0.8250	0.8256	0.8255	0.8286	0.8212	0.7920	0.7032	0.6621	0.6173	0.5611	0.4815	0.3416	0.0000	0.0000	0.0000
7	279.3	0.8630	0.9603	0.8600	0.8612	0.8698	0.8690	0.8552	0.8087	0.7879	0.7661	0.7257	0.6649	0.5685	0.0000	0.0000	0.0000
6	216.3	0.9066	0.9091	0.9105	0.9114	0.9129	0.9137	0.9118	0.9053	0.8936	0.8874	0.8647	0.8238	0.7696	0.0000	0.0000	0.0000
5	163.3	0.9705	0.9737	0.9764	0.9783	0.9811	0.9834	0.9854	0.9875	0.9833	0.9910	0.9926	0.9953	1.0000	0.0000	0.0000	0.0000
4	130.6	1.0000	1.0000	1.0000	1.0000	1.0000	1.0000	1.0000	1.0000	1.0000	1.0000	1.0000	1.0000	1.0000	1.0000	1.0000	1.0000
3	101.4	1.0000	1.0000	1.0000	1.0000	1.0000	1.0000	1.0000	1.0000	1.0000	1.0000	1.0000	1.0000	1.0000	1.0000	1.0000	1.0000
2	79.7	1.0000	1.0000	1.0000	1.0000	1.0000	1.0000	1.0000	1.0000	1.0000	1.0000	1.0000	1.0000	1.0000	1.0000	1.0000	1.0000
1	61.1	1.0000	1.0000	1.0000	1.0000	1.0000	1.0000	1.0000	1.0000	1.0000	1.0000	1.0000	1.0000	1.0000	1.0000	1.0000	1.0000

APPENDIX G

THREE-DIMENSIONAL PLOTS OF PERFORMANCE OVER DOSE AND TIME

a. Gun crew.

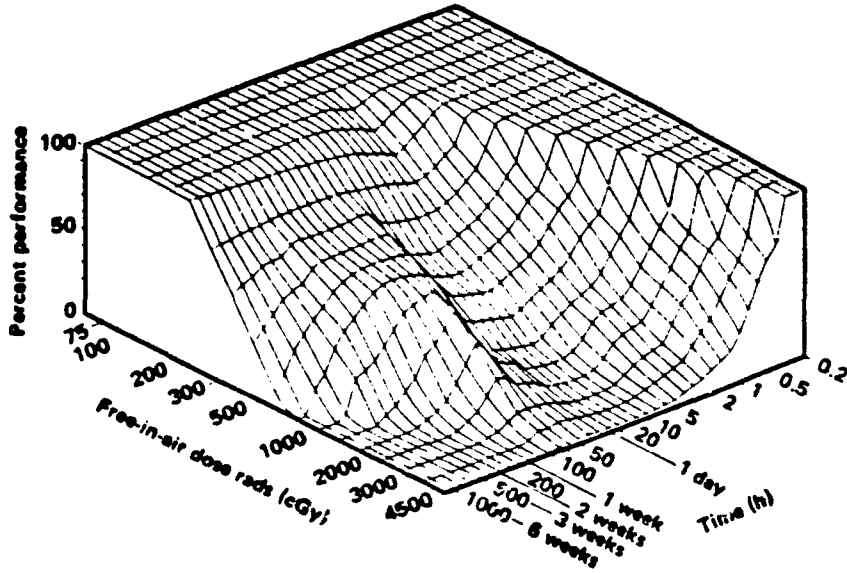

b. FDC crew.

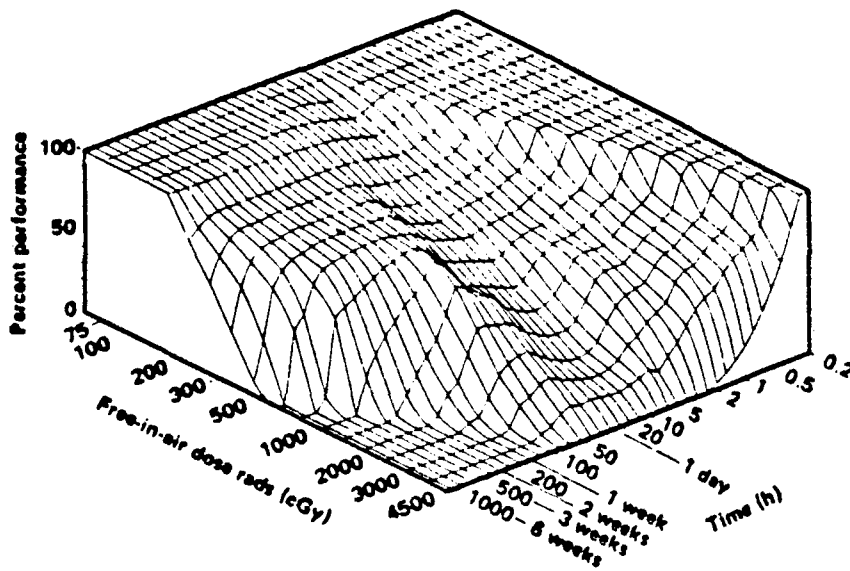

c. Tank crew.

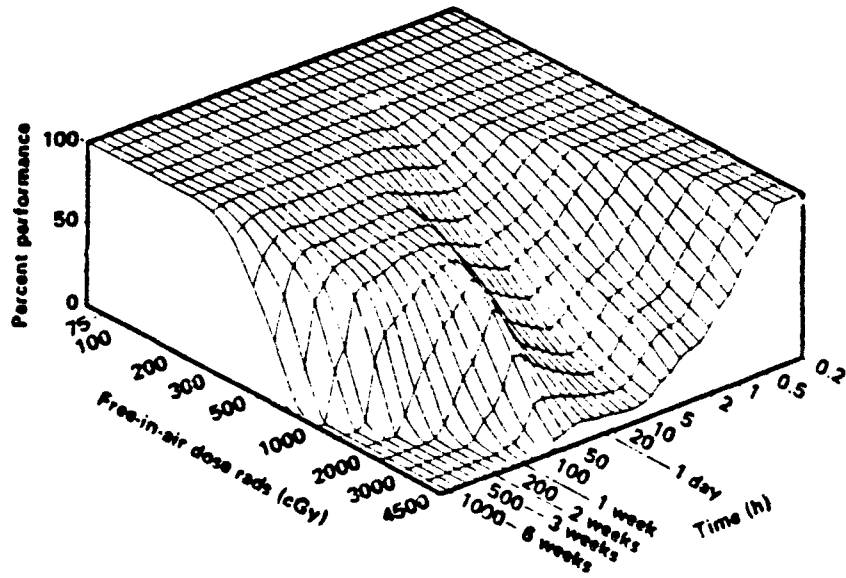

d. ITV-TOW crew.

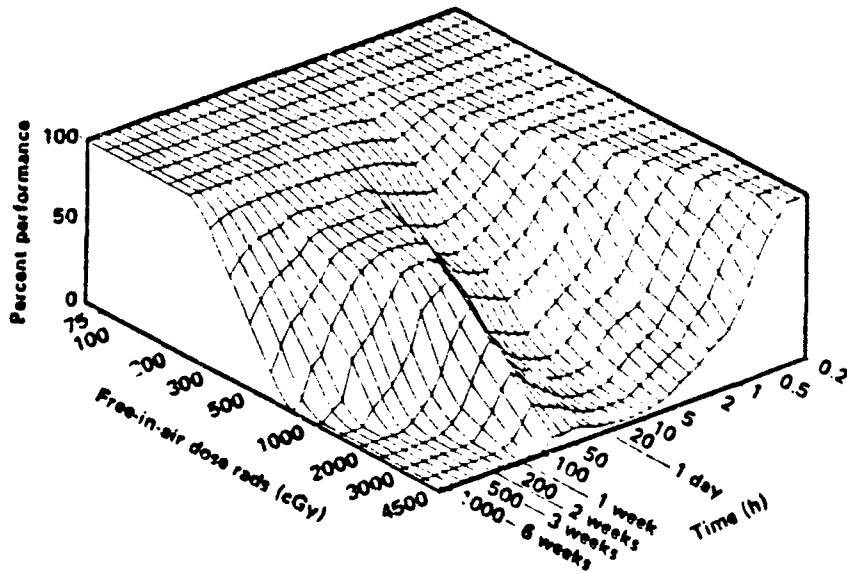

APPENDIX H
CONTOUR PLOTS OF PERFORMANCE OVER DOSE AND TIME
(10 PERCENT PERFORMANCE INTERVALS)

a. Gun crew.

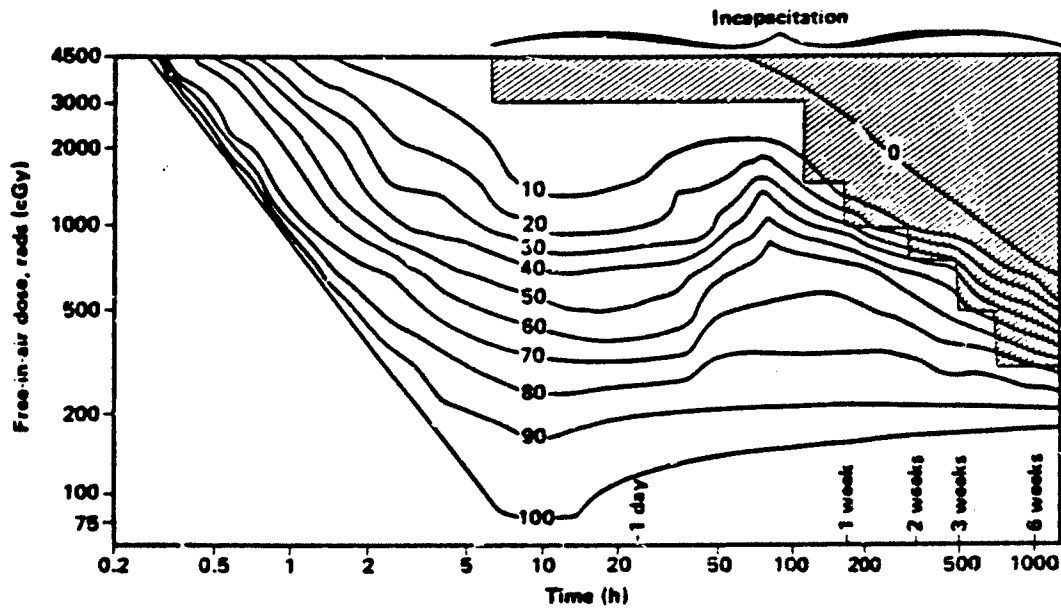

b. FDC crew.

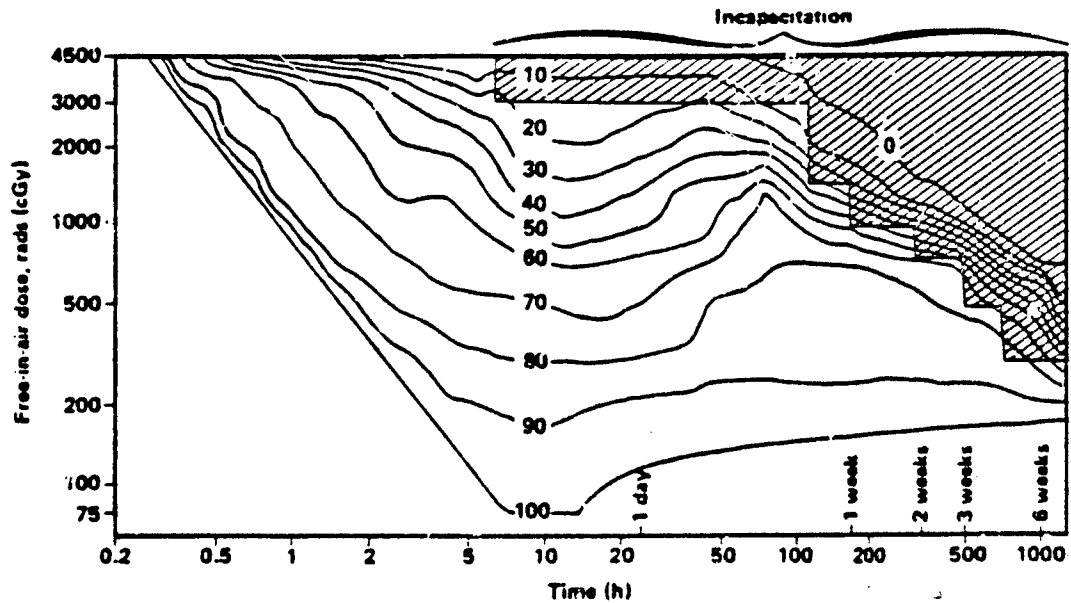

c. Tank crew.

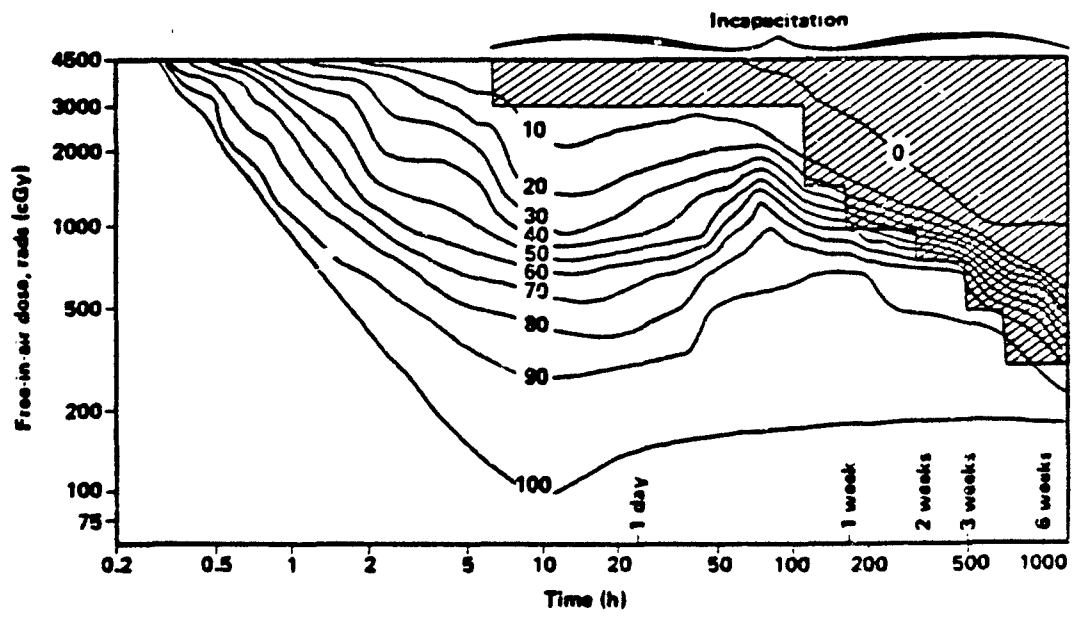

d. ITV-TOW crew.

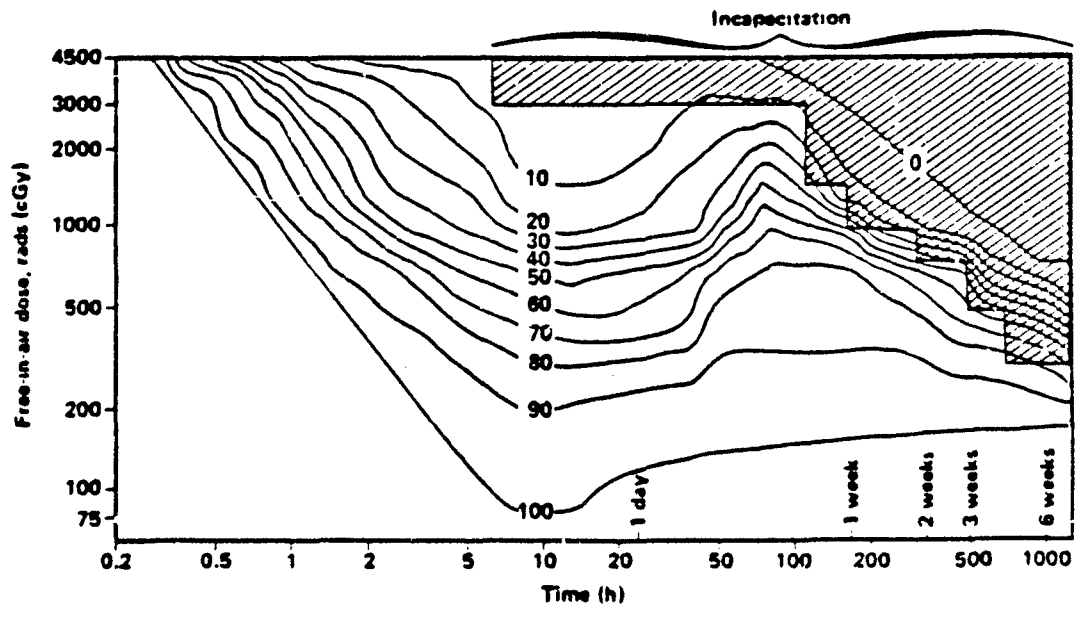

DISTRIBUTION LIST

DNA-TR-88-173

DEPARTMENT OF DEFENSE

ARMED FORCES RADIOBIOLOGY RSCH INST
ATTN: AFFRI-DEPT OF RAD BIOCHEM
ATTN: BHS
ATTN: DIRECTOR
ATTN: EXH
ATTN: MRA
ATTN: PHY
ATTN: RSD
ATTN: SCIENTIFIC DIRECTOR
ATTN: TECHNICAL LIBRARY

ASSISTANT SEC OF DEF (C31)
ATTN: DIR (S&TNFC3)

ASSISTANT SECRETARY OF DEFENSE
INTERNATIONAL SECURITY POLICY
ATTN: NUC FOR & ARMS CNTRL PLCY

ASSISTANT TO THE SECRETARY OF DEFENSE
ATTN: EXECUTIVE ASSISTANT
ATTN: MIL APPL
ATTN: MIL APPL. C FIELD

DEFENSE INTELLIGENCE AGENCY
ATTN: DB
5 CYS ATTN: DB-4, PSCH RESOURCES DIV
ATTN: DB-5C
ATTN: DB-6
ATTN: DIA/VPA-2
ATTN: DN
ATTN: DT
ATTN: OFFICE OF SECURITY
ATTN: OS
ATTN: RTS-2B

DEFENSE INTELLIGENCE COLLEGE
ATTN: DIC/RTS-2
ATTN: DIC/2C

DEFENSE LOGISTICS AGENCY
ATTN: COMMAND SECURITY OFC

DEFENSE NUCLEAR AGENCY
ATTN: CID
ATTN: DFRA
ATTN: DFSP G ULLRICH
ATTN: NANF
ATTN: NASF
ATTN: OPNA
ATTN: OPNS
ATTN: RAEE
20CYS ATTN: RARP
4 CYS ATTN: TITL

DEFENSE NUCLEAR AGENCY
ATTN: TDNM
2 CYS ATTN: TDTT W SUMMA

DEFENSE TECHNICAL INFORMATION CENTER
2 CYS ATTN: DTIC/FDAB

FIELD COMMAND DEFENSE NUCLEAR AGENCY
ATTN: FCPR

3 CYS ATTN: FCPRT
ATTN: NUC SECURITY

INTELLIGENCE CENTER, PACIFIC
ATTN: COMIPAC

INTERSERVICE NUCLEAR WEAPONS SCHOOL
ATTN: TTV
2 CYS ATTN: TTV 3416TH TTSQ

JOINT DATA SYSTEM SUPPORT CTR
ATTN: C-312
ATTN: C-332

NATIONAL DEFENSE UNIVERSITY
ATTN: ICAF, TECH LIB
ATTN: MWCLB-CR
ATTN: LIBRARY
ATTN: STRAT CONCEPTS DIV CTR

NATIONAL SECURITY AGENCY
ATTN: CHIEF A4213

NET ASSESSMENT
ATTN: DOCUMENT CONTROL

OFFICE OF THE SEC OF DEFENSE
ATTN: NAVAL FORCES
ATTN: STRATEGIC PROG & TNF

STRATEGIC AND THEATER NUCLEAR FORCES
ATTN: DR E SEVIN
ATTN: DR SCHNEITER

STRATEGIC TARGET PLANNING
ATTN: JKC (ATTN: DNA REP)
ATTN: JLT
ATTN: JP
ATTN: JPTP

THE JOINT STAFF
ATTN: ED30 J-3 STRAT OPS DIV
ATTN: J-3 SPECIAL OPERATIONS
ATTN: J-3 NUC OPERATIONS BR
ATTN: J-5 NUC & CHEMICAL DIV
ATTN: JAD/SFD
ATTN: JAD/SSD
ATTN: JSOA
ATTN: SAGA

U S EUROPEAN COMMAND/ECJ-3
ATTN: ECJ-3

U S EUROPEAN COMMAND/ECJ-5NPG
ATTN: ECJ-5

U S EUROPEAN COMMAND/ECJ-6 OJ
ATTN: ECJ-6

U S EUROPEAN COMMAND/ECJ2-T
ATTN: ECJ2 T (TGTS DIV)

U S EUROPEAN COMMAND/ECJ4-LW
ATTN: ECJ4 LW

DNA-TR-88-173 (DL CONTINUED)

U S EUROPEAN COMMAND/ECJ5-N
ATTN: ECJ5-N (NUC BRANCH)

U S EUROPEAN COMMAND/ECJ7/LW
ATTN: ECJ-7 LW

UNDER SEC OF DEFENSE FOR POLICY
ATTN: DUSP/P
ATTN: USD/P

UNDER SECRETARY OF DEFENSE
ATTN: CHAIRMAN PSEAG
ATTN: CHAIRMAN DEF SCIENCE BD
2 CYS ATTN: C3I

DEPARTMENT OF THE ARMY

ARMY RESEARCH INSTITUTE
ATTN: COMMANDER

COMBAT MATERIAL EVAL ELEMENT
ATTN: SECURITY ANALYST

DEP CH OF STAFF FOR OPS & PLANS
ATTN: DAMO-FDQ
ATTN: DAMO-NCN
ATTN: DAMO-NCN(NUC CHEM DIR)
ATTN: DAMO-ZXA

DEPARTMENT OF THE ARMY
ATTN: DAMO-NCZ
ATTN: DAMO-OD
ATTN: DAMO-ODSO
ATTN: LAPE-HRE
ATTN: SARD-ZCS (MAJ ADAMS)

HARRY DIAMOND LABORATORIES
ATTN: SLCIS-IM-TL (TECH LIB)

JOINT SPECIAL OPERATIONS COMMAND
ATTN: J-2
ATTN: J-5

U S ARMY AIR DEFENSE SCHOOL
ATTN: COMMANDANT

U S ARMY ARMAMENT RSCH DEV & ENGR CTR
ATTN: DRDAR-LCN-F

U S ARMY ARMOR SCHOOL
ATTN: ATSB-CTD
ATTN: TECH LIBRARY

U S ARMY BALLISTIC RESEARCH LAB
ATTN: AMXBR-VLD-R DR RAINIS
ATTN: AMXBR-VLD DR KLOPCIC
ATTN: DRDAR-BLA-S. TECH LIB
ATTN: DRDAR-BLT
ATTN: SLCBR-D

U S ARMY CHEMICAL SCHOOL
ATTN: ATZN-CM-M

U S ARMY COMD & GENERAL STAFF COLLEGE
ATTN: ATZL-SWJ-CA
ATTN: ATZL-SWT-A

U S ARMY CONCEPTS ANALYSIS AGENCY
ATTN: TECHNICAL LIBRARY

U S ARMY FIELD ARTILLERY SCHOOL
ATTN: ATSF-CD

U S ARMY FORCES COMMAND
ATTN: AF-OPTS

U S ARMY HUMAN ENGINEERING LAB
ATTN: DIRECTOR
ATTN: DR D HODGE

U S ARMY INFANTRY CTR & SCH
ATTN: ATSH-CD-CSO

U S ARMY INTEL THREAT ANALYSIS DET
ATTN: IAX-Z

U S ARMY MATERIEL COMMAND
ATTN: DRCDE-D
ATTN: DRCS

U S ARMY NUCLEAR & CHEMICAL AGENCY
ATTN: MONA-NU
ATTN: MONA-ZB

U S ARMY TRAINING AND DOCTRINE COMD
ATTN: ATCD-AO
ATTN: ATCD-FA
ATTN: ATCD-N, CBT DEV, NUC DIR
ATTN: ATOO-NCO

U S ARMY WAR COLLEGE
ATTN: LIBRARY
ATTN: STRATEGIC STUDIES

US ARMY MATERIEL SYS ANALYSIS ACTVY
ATTN: DRXSJ-DS

USA MILITARY ACADEMY
ATTN: DEPT OF BEHAV SCI & LEADERSHIP
ATTN: DIR NATL SECURITY STUDIES

USA SURVIVABILITY MANAGEMENT OFFICE
ATTN: SLCSM-SE J BRAND

USACACDA
ATTN: ATZL-CAD-N

DEPARTMENT OF THE NAVY

FLEET INTELLIGENCE CENTER
ATTN: FICPAC, CODE 21

MARINE CORPS
ATTN: CODE PPO
ATTN: PSI G/RASP

MARINE CORPS DEV & EDUCATION COMMAND
ATTN: LIBRARY

NAVAL OCEAN SYSTEMS CENTER
ATTN: CODE 9642-B

NAVAL PERSONNEL RES & DEV CENTER
ATTN: CODE P302

NAVAL POSTGRADUATE SCHOOL
ATTN: CODE 1424 LIBRARY

NAVAL RESEARCH LABORATORY
ATTN: CODE 1240
ATTN: CODE 2627 (TECH LIB)

NAVAL SEA SYSTEMS COMMAND
ATTN: PMS-423
ATTN: SEA-09G53 (LIB)
ATTN: SEA-6631

NAVAL SURFACE WARFARE CENTER
ATTN: CODE F-31
ATTN: G GOO

NAVAL TECHNICAL INTELLIGENCE CTR
ATTN: NTIC-DA30

NAVAL WAR COLLEGE
ATTN: CODE E-11 TECH SVC
ATTN: CTR FOR NAV WARFARE STUDIES
ATTN: DOCUMENT CONTROL
ATTN: LIBRARY
ATTN: STRATEGY DEPT

NAVAL WEAPONS EVALUATION FACILITY
ATTN: CLASSIFIED LIBRARY

NUCLEAR WEAPONS TNG GROUP, ATLANTIC
ATTN: CODE 222
ATTN: DOCUMENT CONTROL

NUCLEAR WEAPONS TNG GROUP, PACIFIC
ATTN: CODE 32
ATTN: DOCUMENT CONTROL

OFFICE OF CHIEF OF NAVAL OPERATIONS
ATTN: NIS-22
ATTN: NOP 06D
2 CYS ATTN: NOP 403
ATTN: NOP 50
ATTN: NOP 60
ATTN: NOP 60D
ATTN: NOP 603
ATTN: NOP 91
ATTN: OP 654
ATTN: OP 981

OPERATIONAL TEST & EVALUATION FORCE
ATTN: COMMANDER

PLANS, POLICY & OPERATIONS
ATTN: CODE-P
ATTN: CODE-POC-30

TACTICAL TRAINING GROUP, PACIFIC
ATTN: COMMANDER

DEPARTMENT OF THE AIR FORCE

AFIA/INIS
ATTN: AFIA/INKD

AFIS/INT
ATTN: INT

AIR UNIVERSITY
ATTN: STRATEGIC STUDIES

AIR UNIVERSITY LIBRARY
ATTN: AUL-LSE
ATTN: LIBRARY

ASSISTANT CHIEF OF STAFF
2 CYS ATTN: AF/SAMI

ASSISTANT CHIEF OF THE AIR FORCE
ATTN: SAF/ALR

DEPUTY CHIEF OF STAFF/XOX
ATTN: AFXOOS
ATTN: AFXOXM

FOREIGN TECHNOLOGY DIVISION, AFSC
ATTN: CCN
ATTN: SDA

SPACE DIVISION/YH
ATTN: YH

STRATEGIC AIR COMMAND/ADWN
ATTN: ADWN

STRATEGIC AIR COMMAND/SPD
ATTN: SPD

STRATEGIC AIR COMMAND/STIC
ATTN: 544 SIW/DI (STIC)

STRATEGIC AIR COMMAND/XOXO
ATTN: XOXO

STRATEGIC AIR COMMAND/XPX
ATTN: XPZ

STRATEGIC AIR COMMAND/XRFS
ATTN: XRFS

TACTICAL AIR COMMAND/XPSC
ATTN: TAC/DOA

U S AIR FORCE ACADEMY
ATTN: LIBRARY
ATTN: USAFA/SP

USAF SCHOOL OF AEROSPACE MEDICINE
ATTN: RADIATION SCIENCES DIV

WEAPONS LABORATORY
ATTN: WL/SUL

DEPARTMENT OF ENERGY

LAWRENCE LIVERMORE NATIONAL LAB
ATTN: PAUL T HERMAN
ATTN: Z DIVISION LIBRARY

LOS ALAMOS NATIONAL LABORATORY
ATTN: REPORT LIBRARY
ATTN: T DOWLER

SANDIA NATIONAL LABORATORIES
ATTN: DIV 9013, W LING
ATTN: TECH LIB

OTHER GOVERNMENT

CENTRAL INTELLIGENCE AGENCY

ATTN: COUNTER-TERRORIST GROUP
ATTN: DIRECTOR OF SECURITY
ATTN: MEDICAL SERVICES
ATTN: NIO-T
ATTN: NIO STRATEGIC SYS
ATTN: R & D SUBCOMMITTEE
ATTN: TECH LIBRARY

FEDERAL BUREAU OF INVEST ACADEMY

ATTN: BEHAVIORAL RSCH UNIT
ATTN: LIBRARY

FEDERAL EMERGENCY MANAGEMENT AGENCY

ATTN: ASST ASSOC DIR FOR RSCH
ATTN: CIVIL SECURITY DIVISION
ATTN: G ORRELL NP-CP
ATTN: OFC OF CIVIL DEFENSE

U S DEPARTMENT OF STATE

ATTN: PM/STM

U S NUCLEAR REGULATORY COMMISSION

ATTN: DIR DIV OF SAFEGUARDS
ATTN: S YANIV

DEPARTMENT OF DEFENSE CONTRACTORS

ADVANCED RESEARCH & APPLICATIONS CORP

ATTN: SECURITY OFFICE

AEROSPACE CORP

ATTN: LIBRARY ACQUISITION

BDM INTERNATIONAL INC

ATTN: C SOMERS
ATTN: C WASAFF
ATTN: J BRADDOCK

DATA MEMORY SYSTEMS, INC

ATTN: T DUPUY

KAMAN SCIENCES CORP

ATTN: DASIAC
ATTN: E CONRAD

KAMAN SCIENCES CORPORATION

ATTN: DASIAC

PACIFIC-SIERRA RESEARCH CORP

2 CYS ATTN: G H ANNO

ATTN: H BRODE

2 CYS ATTN: M A DORE

PACIFIC-SIERRA RESEARCH CORP

ATTN: D GORMLEY

2 CYS ATTN: G MCCLELLAN

R & D ASSOCIATES

ATTN: C MCDONALD

2 CYS ATTN: DOCUMENT CONTROL

R & D ASSOCIATES

ATTN: J THOMPSON

SCIENCE APPLICATIONS INTL CORP

ATTN: DOCUMENT CONTROL

ATTN: E SWICK

ATTN: J MARTIN

ATTN: J WARNER

ATTN: M DRAKE

ATTN: R J BEYSTER

SCIENCE APPLICATIONS INTL CORP

ATTN: B BENNETT

ATTN: DOCUMENT CONTROL

ATTN: J FOSTER

ATTN: J PETERS

ATTN: J SHANNON

ATTN: L GOURE

ATTN: M FINEBURG

ATTN: W LAYSON

SCIENCE APPLICATIONS INTL CORP

ATTN: R CRAVER

SYSTEMS RESEARCH & APPLICATION CORP

ATTN: R STEELE

ATTN: S GREENSTEIN