

DTIC FILE COPY

2

WRDC-TR-89-3075

FULL-SCALE BIRDSTRIKE TESTING OF IN-SERVICE
AGED F-111 ADBIRT WINDSHIELD TRANSPARENCIES

Daniel R. Bowman
Gregory J. Stenger
Blaine S. West

University of Dayton Research Institute
300 College Park Avenue
Dayton OH 45469

August 1989

Interim Report for Period May 1985 - November 1987

Approved for public release; distribution is unlimited



DTIC
ELECTE
FEB 14 1990
S D
D

AD-A218 035

FLIGHT DYNAMICS LABORATORY
WRIGHT RESEARCH AND DEVELOPMENT CENTER
AIR FORCE SYSTEMS COMMAND
WRIGHT-PATTERSON AIR FORCE BASE, OHIO 45433-6553

90 02 12 118

NOTICE

When Government drawings, specifications, or other data are used for any purpose other than in connection with a definitely Government-related procurement, the United States Government incurs no responsibility or any obligation whatsoever. The fact that the government may have formulated or in any way supplied the said drawings, specifications, or other data, is not to be regarded by implication, or otherwise in any manner construed, as licensing the holder, or any other person or corporation; or as conveying any rights or permission to manufacture, use, or sell any patented invention that may in any way be related thereto.

This report is releasable to the National Technical Information Service (NTIS). At NTIS, it will be available to the general public, including foreign nations.

This technical report has been reviewed and is approved for publication.

Russell E Urzi

RUSSELL E. URZI
Project Engineer
Aircrew Protection Branch
Vehicle Subsystems Division
Flight Dynamics Laboratory

Ralph J. Speelman

RALPH J. SPEELMAN, Chief
Aircrew Protection Branch
Vehicle Subsystems Division
Flight Dynamics Laboratory

FOR THE COMMANDER

Richard E. Colclough, Jr.

RICHARD E. COLCLOUGH, JR.
Chief
Vehicle Subsystems Division
Flight Dynamics Laboratory

If your address has changed, if you wish to be removed from our mailing list, or if the addressee is no longer employed by your organization please notify WRDC/FIVR, WPAFB OH 45433-6553 to help us maintain a current mailing list.

Copies of this report should not be returned unless return is required by security considerations, contractual obligations, or notice on a specific document.

REPORT DOCUMENTATION PAGE

1a. REPORT SECURITY CLASSIFICATION UNCLASSIFIED		1b. RESTRICTIVE MARKINGS	
2a. SECURITY CLASSIFICATION AUTHORITY		3. DISTRIBUTION/AVAILABILITY OF REPORT Approved for public release; distribution is unlimited	
2b. DECLASSIFICATION/DOWNGRADING SCHEDULE			
4. PERFORMING ORGANIZATION REPORT NUMBER(S) UDR-TR-88-39 ✓		5. MONITORING ORGANIZATION REPORT NUMBER(S) WADC-TR-89-3075	
6a. NAME OF PERFORMING ORGANIZATION University of Dayton Research Institute	6b. OFFICE SYMBOL (if applicable)	7a. NAME OF MONITORING ORGANIZATION Wright Research and Development Center Flight Dynamics Laboratory WRDC/FIVR	
6c. ADDRESS (City, State, and ZIP Code) 300 College Park Avenue Dayton, Ohio 45469		7b. ADDRESS (City, State, and ZIP Code) Wright-Patterson AFB, OH 45433-6553	
8a. NAME OF FUNDING/SPONSORING ORGANIZATION	8b. OFFICE SYMBOL (if applicable)	9. PROCUREMENT INSTRUMENT IDENTIFICATION NUMBER F33615-84-C-3404	
8c. ADDRESS (City, State, and ZIP Code)		10. SOURCE OF FUNDING NUMBERS	
		PROGRAM ELEMENT NO 64212F	PROJECT NO 1926
		TASK NO 01	WORK UNIT ACCESSION NO. 10
11. TITLE (Include Security Classification) FULL SCALE BIRDSTRIKE TESTING OF IN-SERVICE AGED F-111 ADBIRT WINDSHIELD TRANSPARENCIES			
12. PERSONAL AUTHOR(S) Bowman, Daniel R.; Stenger, Gregory J.; West, Blaine S.			
13a. TYPE OF REPORT Interim	13b. TIME COVERED FROM MAY85 TO NOV87	14. DATE OF REPORT (Year, Month, Day) August 1989	15. PAGE COUNT 296
16. SUPPLEMENTARY NOTATION			
17. COSATI CODES		18. SUBJECT TERMS (Continue on reverse if necessary and identify by block number)	
FIELD	GROUP	F-111 aircraft, Simulated Flight Hardware, Strain Data, ADBIRT windshield, Risk Assessment, Birdstrike loads, degradation, Birdstrike Testing.	
19. ABSTRACT (Continue on reverse if necessary and identify by block number) A test program consisting of 22 full-scale birdstrike tests of F-111 ADBIRT windshield transparencies was conducted. Test hardware was developed to simulate flight structure, and four-pound artificial birds were used to impact the transparencies at the most critical location, the upper inboard corner. Testing was completed on windshield panels ranging from unaged baseline windshields to windshields which had been in service for more than five years. The structural integrity of F-111 ADBIRT windshield transparencies was found to be significantly reduced by in-service aging. Capability envelopes were developed for each vendor's windshield, relating bird impact resistance capability to installed age. In addition, to increase understanding of support structure behavior during birdstrike, the aft arch was instrumented with strain gages, and a finite element analysis of the aft arch was performed. Also, a birdstrike risk assessment analysis was made to evaluate the risk of flying the F-111 with degraded windshield panels.			
20. DISTRIBUTION/AVAILABILITY OF ABSTRACT <input checked="" type="checkbox"/> UNCLASSIFIED UNLIMITED <input type="checkbox"/> SAME AS RPT <input type="checkbox"/> DTIC USERS		21. ABSTRACT SECURITY CLASSIFICATION UNCLASSIFIED	
22a. NAME OF RESPONSIBLE INDIVIDUAL Russell E. Urzi		22b. TELEPHONE (Include Area Code) (513) 255-2916	22c. OFFICE SYMBOL WRDC/FIVR

FOREWORD

The effort reported herein was performed by the University of Dayton Research Institute (UDRI), Dayton, Ohio, under Contract No. F33615-84-C-3404, Project 1926, "Birdstrike Resistant Crew Enclosure Program", in support of F-111 transparency systems. The work was administered by the Wright Research and Development Center, Flight Dynamics Laboratory, Wright-Patterson Air Force Base, Ohio, with administrative direction and technical support provided by Lt.

Paul Kolodziejwski and Lt. S. D. Hargis. This investigation was co-sponsored by SM-ALC/MMIEA. Full scale birdstrike testing was performed at the UDRI impact physics test range. The work described herein was conducted during the period May 1985 - December 1987.

Project supervision and technical assistance was provided through the Aerospace Mechanics Division of the University of Dayton Research Institute, Mr. Dale H. Whitford, Supervisor, and the Structures Group, Mr. Blaine S. West, Head. Mr. Gregory J. Stenger was the Project Engineer. Mr. Daniel R. Bowman was responsible for test plan development, full-scale testing, data reduction and analysis, and report generation.

In addition to those listed above, the author wishes to acknowledge the significant contributions to the completion of this work made by Mr. James Higgins of the UDRI Machine Shop, Mr. Ed Strader and Mr. Henry Williams of the UDRI Impact Physics Group, and Mr. Malcolm Kelley of WRDC/FIVR.



Accession For	
NTIS CRA&I	<input checked="" type="checkbox"/>
DTIC TAB	<input type="checkbox"/>
Unannounced	<input type="checkbox"/>
Justification _____	
By _____	
Distribution / _____	
Availability Codes	
Dist	Avail and/or Special
A-1	

TABLE OF CONTENTS

SECTION		PAGE
I	INTRODUCTION AND OBJECTIVE	1
II	TEST ARTICLE	4
III	TEST SETUP	9
	3.1 General Test Considerations	9
	3.2 Hardware Design and Fabrication	11
	3.3 Initial Birdstrike/Arch Performance Testing	18
	3.4 Design Modification	22
IV	TEST PROCEDURE	25
V	TEST RESULTS	27
VI	BIRDSTRIKE RISK ASSESSMENT	37
VII	CONCLUSIONS AND RECOMMENDATIONS	43
	7.1 Conclusions	43
	7.1.1 The Effect of In-Service Aging on Bird Impact Resistance	43
	7.1.2 Birdstrike Risk Assessment	43
	7.1.3 Simulated Flight Hardware Critique	43
	7.2 Recommendations	44
	REFERENCES	45
	APPENDIX A: TEST PLAN INFORMATION	A-1
	APPENDIX B: INDIVIDUAL TEST SUMMARIES AND PHOTOGRAPHS	B-1
	APPENDIX C: STRAIN DATA AND SYSTEM BIRDSTRIKE LOADS ANALYSIS	C-1
	APPENDIX D: TEST HARDWARE DRAWINGS	D-1

LIST OF ILLUSTRATIONS

FIGURE		PAGE
1	F-111 ADBIRT Transparency Normal Cross-Section	5
2	F-111 Crew Module Structure	10
3	Comparison of Cross-Section Properties Between Flight Hardware and Test Hardware	13
4	UDRI Right Hand Aft Arch	14
5	UDRI Center Beam	15
6	UDRI Arch/Center Beam Assembly	16
7	F-111 ADBIRT Transparency Cross-Section at the Aft Arch	17
8	UDRI Impact Physics Test Range 5	19
9	Actual Movie Camera Locations	20
10	Strain Gage Locations	21
11	UDRI F-111 Aft Arch Taper Modification	23
12	Comparison of Cross-Section Properties Between Flight Hardware and Modified Test Hardware	24
13	Bird Impact Point	26
14	Test Data Summary, Velocity vs. Date of Manufacture	31
15	Capability Envelopes for Sierracin and PPG Transparencies	32
16	Effect of Increasing Test Velocity on Windshield Damage for Service-Aged Windshields	35
17	F-111 Windshield Frontal View Predicted Capabilities	38
18	Bird Weight Probability Curve	39
19	F-111 Velocity Profile Data in the Bird Environment	40
20	A Comparison of Birdstrike Risk for Sierracin and PPG	42

LIST OF TABLES

TABLE		PAGE
1	Original Bird Impact Test Matrix	6
2	Revised Test Matrix	8
3	Brief F-111 Test Summary	28
4	Comparison of Baseline and In-Service Aged Windshield Birdstrike Resistance Capabilities	33
5	Probability of Damage P(D) (Penetration) Given a Birdstrike for PPG and Sierracin Service Aged Windshields	41

LIST OF SYMBOLS AND SUBSCRIPTS

Symbols

- A = Area (in.²)
C = Distance from neutral axis to outermost fiber (in.)
E = Modulus of elasticity (psi)
I = Moment of inertia (in.⁴)
k = Fraction of energy transmitted to the aft arch
L = Length (ft. or in.)
m = Mass of the bird (lb.-sec²/ft.)
M = Maximum bending moment (in.-lb.)
P = Peak load (lb.)
R = Reaction at the sill (lb.)
V = Velocity (fps or kts)
 Δt = Time of impact - squash up time of the bird (sec.)
 ϵ = Strain (in./in.)
 θ = Angle of incidence (degrees)
 ϕ = Inclination of aft arch from vertical (degrees)
 σ = Stress (psi)
 τ = Shear stress (psi)

Subscripts

- b = Bird
fps = Feet per second
h = Horizontal
kts = Knots
n = Normal to the windshield surface
o = Out of plane of arch
r = Radial, in-plane of arch
v = Vertical

SECTION I

INTRODUCTION AND OBJECTIVE

Mission profiles requiring high speed flights at low altitudes have significantly increased the number of birdstrike incidents on USAF aircraft. Operational history has shown the F-111 to be particularly vulnerable to birdstrike damage.

To reduce this vulnerability, the Wright Research and Development Center, Flight Dynamics Laboratory (WRDC/FIVR) initiated a program with PPG Industries, Inc. to develop, test, and evaluate laminated transparency configurations for the F-111¹. As a result of this program, Bird Impact Resistant Transparencies (BIRT) were developed for the windshield and the canopy. Subsequent birdstrike testing in late 1972 revealed that the aft windshield arch was of insufficient strength to withstand a birdstrike along the aft edge of the windshield.

In June 1973, the Air Force awarded a contract to McDonnell Aircraft Company (MCAIR) for the design, development, and fabrication of a structural modification which, with the new BIRT windshield, would improve the F-111 windshield system bird impact resistance². Subsequent birdstrike qualification testing of the MCAIR full-length arch reinforcement resulted in shear failure of the transparency along the aft arch when impacted at the upper inboard corner of the windshield.

From mid-1975 to mid-1976, UDRI conducted a program under Contract F33615-75-C-3134 with WRDC/FIVR to further improve the bird impact resistance of the F-111 windshield system. Analysis indicated that the aft arch support structure was too stiff relative to the BIRT transparency, and that a more detailed analysis would be required to optimize the bird impact resistance within the F-111 system design constraints. This program resulted in the development of a tapered aft arch reinforcement that was optimized within the design constraints. This system

had a birdstrike resistance capability of 425 knots at the critical impact point³.

In an effort to reduce weight, increase edge strength, and ultimate bird impact resistance capability, the Alternate Design Bird Impact Resistant Transparency (ADBIRT) was developed by Sierracin/Sylmar in 1976 under contract with WRDC/FIVR. In 1979, the ADBIRT transparency system became operational with a bird impact resistance capability of 490 knots at the critical impact point. Sierracin/Sylmar Corp. qualified on the existing aft arch with the UDRI reinforcement. PPG Industries qualified on the existing aft arch with the UDRI reinforcement and an additional PPG developed reinforcement. This additional PPG developed reinforcement was then added with the ADBIRT retrofit.

Since 1979, service life of ADBIRT transparencies has been dictated by qualitative visual inspection. Parts have been removed from service when optical defects developed, such as scratches, acrylic crazing, rainbowing, and interlayer discoloration; and when structural defects developed, such as birdstrike damage, surface cracks, and delamination.

The first indication of possible ADBIRT in-service birdstrike resistance degradation was discovered in a program entitled Flightline Thermal Environment Testing of F-111 Transparencies⁴, completed in 1981, in which several thermally cycled and in-service aged transparencies were birdstrike tested. The testing undertaken indicated significant degradation; however, only a limited number of transparencies were tested. In 1985, the UDRI conducted a general transparency testing methodology⁵ program in which coupons from various transparencies including the F-111 ADBIRT windshield were laboratory aged using ultra-violet light combined with heat and humidity and subjected to a series of laboratory tests to ascertain structural and optical durability. This program was part of a larger and more complete effort by Mr. Malcolm Kelley of WRDC/FIVR to develop a transparency durability/life cycle database from both laboratory coupon testing and field tracking of failed windshields. In

instrumented impact beam tests, F-111 coupons which had been subjected to three "equivalent" years of laboratory aging showed a 40% reduction in energy absorption (a direct indication of bird impact resistance capability). It was suspected that some combination of age, service loading, thermal cycling, UV radiation, and moisture contributed to eventually degrade the impact strength of transparencies. However, at the time it was also hypothesized that the laboratory aging might be too severe.

On 13 June 1986, an F-111A Sierracin BIRT canopy transparency installed in May 1979, broke out of its frame while the aircraft was in flight at Mach 1.9 and 45,000 feet altitude. On 15 February 1987, an F-111D had a birdstrike on the right windshield while flying at 500 feet AGL and 480 knots. The bird punched through near the center beam, leaving a hole larger than a softball, and damaging or destroying several circuit breaker panels and other small items on the aft bulkhead. Bird weight was estimated at 4.8 pounds. The transparency was a Sierracin ADBIRT windshield installed in May 1980. It was speculated that the effects of in-service aging may have contributed to these failures since both failures were not characteristic of new transparencies.

This report documents the results of a program conducted by the University of Dayton Research Institute to birdstrike test in-service aged F-111 windshields. The main objective of this program was to determine the effect of in-service aging on the bird impact resistance capability of the F-111 windshield. Secondary objectives included a birdstrike penetration risk assessment of new and aged windshields, and determination of the validity of using simulated flight hardware for testing aircraft transparencies.

SECTION II
TEST ARTICLE

The basic test articles were new and in-service aged right-hand F-111 ADBIRT windshield transparencies. The cross-section is illustrated in Figure 1. The original bird impact test matrix, Table 1, included 19 total transparencies. Of the in-service aged transparencies, there were to be an equal number of PPG and Sierracin parts for each age group for comparison purposes.

It was desirable to test transparencies with known in-service lives (actual time on the airplane) because time on the airplane was suspected to affect degradation. At the time of the development of the test plan, and when the initial test matrix transparencies were acquired from McClellan AFB*, it was thought that there was little probability of determining dates of installation for the windshields. Consequently, the "in-service age" was defined as the date of manufacture subtracted from the date of removal. Prior to the initiation of actual testing, however, it was discovered that dates of installation were available as part of the windshield service life database being compiled by Mr. Malcolm Kelley, WRDC/FIVR from the aircraft weight and balance records and from the base shop log books. Also, to eliminate geographical location as a variable, it was decided that testing should be limited to windshields from Cannon AFB (where the in-service failures occurred) and to Mountain Home AFB, which has a similar type of climate.** These two bases were chosen as a worst using the logic that the UK bases hangar their airplanes which protects them from the climate, and the Plattsburgh and Pease

*These transparencies were removed from service and stored at McClellan AFB to be used for failure analysis and for possible repair and reinstallation.

**The F-111 bases are located in three geographical areas. Group 1: Western U.S. - Cannon and Mt. Home, Group 2: Northeastern U.S.-Plattsburgh and Pease, and Group 3: United Kingdom-Lakenheath and Upper Heyford.

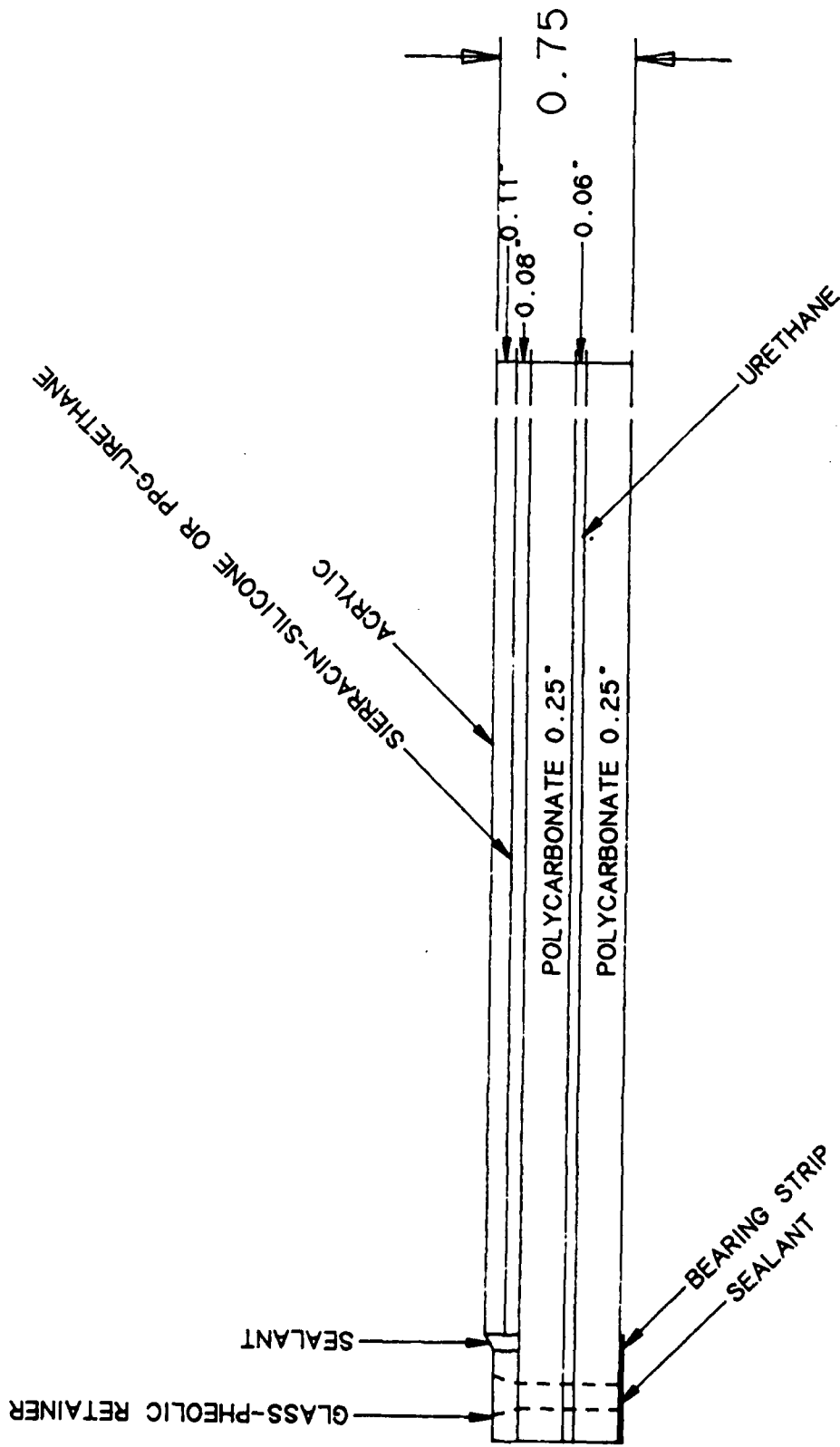

Figure 1. F-111 ADBIRT Transparency Nominal Cross-Section.

TABLE 1
ORIGINAL BIRD IMPACT TEST MATRIX

<u>QUANTITY</u>	<u>AGE</u>	<u>MANUFACTURER</u>
3	5 years old (in-service)	PPG
3	5 years old	Sierracin
2	3 years old	PPG
2	3 years old	Sierracin
2	2 years old	PPG
2	2 years old	Sierracin
1	1 year old	PPG
1	1 year old	Sierracin
3	Baseline (Structurally Sound Optical Rejects)	PPG
<hr/>		
19		

bases do not receive as much sun as the Cannon and Mountain Home bases. These two requirements, that actual time on the airplane be known and that the windshields be from Cannon or Mountain Home, limited the number of windshields which could be chosen for this test program. Consequently, transparencies did not exist for all the categories shown in the original test matrix of Table 1. The same general philosophy of the original test plan was pursued using available transparencies obtained from McClellan AFB. In addition, late in the test program, the test matrix was expanded to include two UK base transparencies to determine if degradation differed by geographical location. The revised test matrix is shown in Table 2.

TABLE 2
REVISED TEST MATRIX

Quantity	Installed Age	Manufacturer
0	4-6 years	PPG
4	4-6 years	Sierracin
1	3-4 years	PPG
2	3-4 years	Sierracin
1	2-3 years	PPG
2	2-3 years	Sierracin
4	1-2 years	PPG
2	1-2 years	Sierracin
0	0-1 years	PPG
3	0-1 years	Sierracin
2	0 years	PPG
1	0 years	Sierracin
Total	22	

SECTION III
TEST SETUP

3.1 GENERAL TEST CONSIDERATIONS

An initial step in the program was to reevaluate the proposed testing methodology and to develop a rational testing approach to best accomplish the program objectives. Originally, testing was proposed to be hardstand-rigid frame testing, whereby relative performance of the transparencies on the rigid frame would be used as a measure of system performance.

While examining an F-111 crew module being utilized in a thermal testing program at WPAFB, an additional used and stored F-111E crew escape module was discovered. The possibility of acquiring this crew module (Air Force Serial Number 68-024) for testing was pursued favorably. The use of an actual crew enclosure reduced the cost of frame development and allowed for more realistic testing. The aft arch and forward center beam were expected to sustain damage during transparency testing. Consequently, it was desirable to design a replaceable center beam and aft arch to preclude the sacrifice of large amounts of expensive and unavailable flight structure. The F-111 crew module and support structure are shown in Figure 2.

Historically, full scale birdstrike testing of aircraft transparencies has been accomplished either on a hardstand (rigid fixturing), or on actual flight hardware. This program is one of the first to bridge the gap between hardstand birdstrike testing and flight hardware birdstrike testing. Hardstand testing is reasonably economical; however, the validity of test results achieved on a rigid hardstand are questionable because most aircraft support systems are not rigid, but are flexible, and birdstrike resistance capability for a transparency system can be very dependent on support structure stiffness. For instance, if the aft windshield arch is too stiff, peak loads will increase, and the windshield will tear at the aft arch behind the impact point; if the aft arch is too flexible, the windshield may fail due to excessive

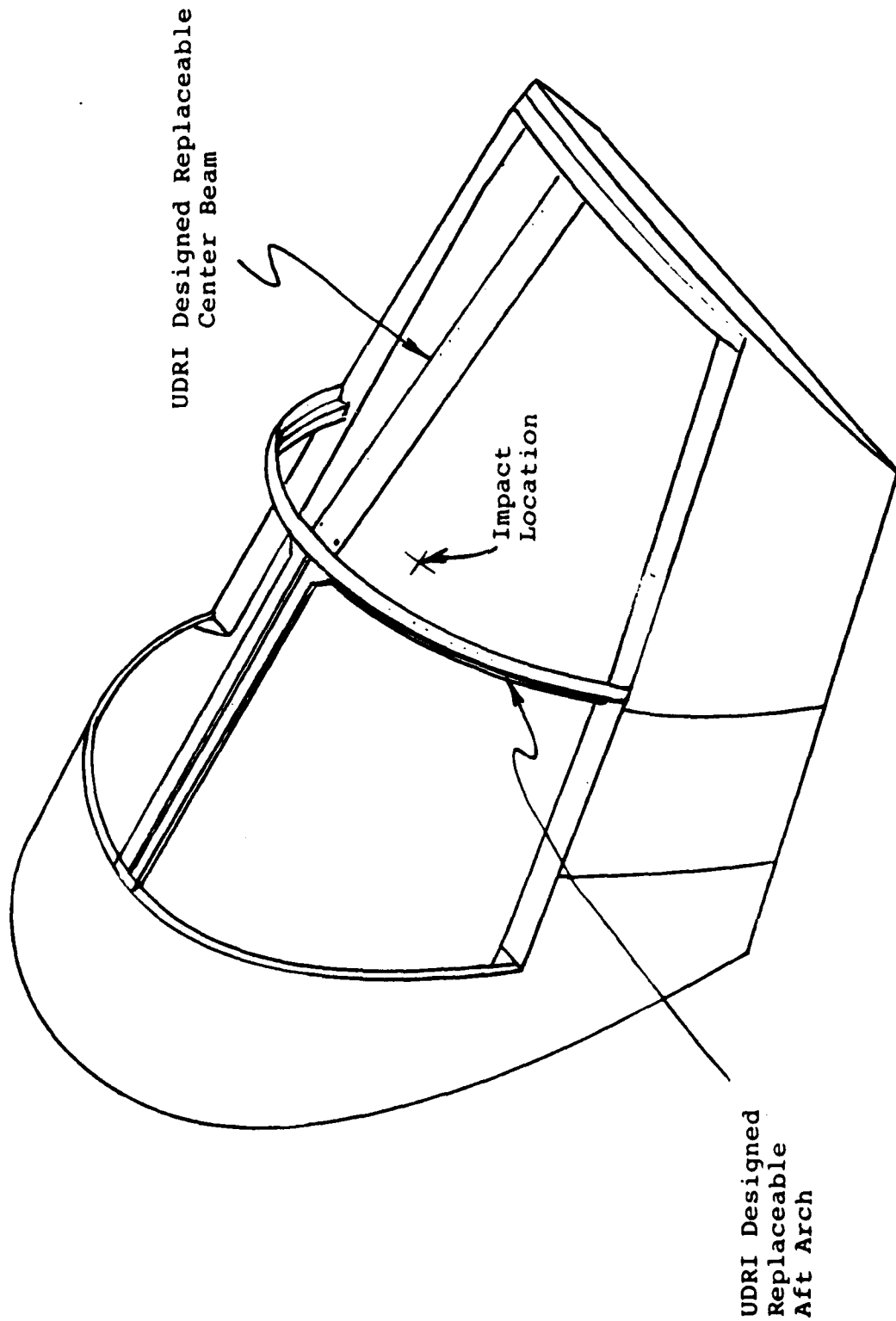

Figure 2. F-111 Crew Module Structure.

deflection. The stiffness and strength of the aft arch need to be closely tailored to the windshield stiffness and strength to optimize system bird impact resistance. Flight hardware testing provides optimal test results; however, flight hardware is expensive and often in short supply. Therefore, a suitable alternative is desirable. The best alternative is simulated flight hardware, which can be designed and fabricated at a reasonable cost with stiffness and strength values close to actual flight hardware values for realistic system structural response.

3.2 HARDWARE DESIGN AND FABRICATION

Test hardware was developed in accordance with the following material and geometric constraints. The material used should be readily available, reasonably priced, machinable, weldable, and tough. The cross-sectional engineering properties should match the properties of the flight hardware as closely as practical under the constraints of material and fabrication methods; the F-111 windshield being extremely sensitive to small changes in aft arch stiffness as evidenced by the work accomplished by UDRI to develop an aft arch reinforcement for the BIRT.³ In addition, the cross-sectional shape must be similar to the existing shape to allow the canopy to fit against the aft arch without interference.

A 4130 chrome-moly steel was chosen to satisfy the material constraints. It was decided that it would be advantageous to build the aft arch in two pieces (the production arch is one piece) to allow change-out of damaged right-hand arches without requiring changeout of the left hand windshield which was not being tested. Only right hand windshields were tested to eliminate the need to move and remount the crew module test fixture and all associated instrumentation.

The stiffness about the x-axis (reference Figure 3) was considered to be the most important parameter. The arch was constructed of 0.25-inch nominal plate to take advantage of the

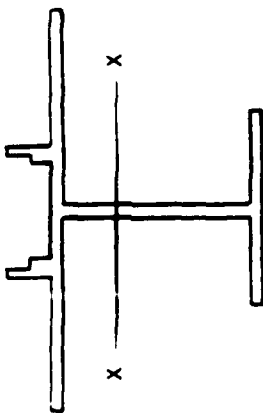

Existing Center Beam Properties

$$I_{xx} = 0.294 \text{ in.}^4 \quad I_{yy} = 0.267 \text{ in.}^4$$

$$EI_{xx} = 4.70 \times 10^6 \text{ lb.in.}^2 \quad EI_{yy} = 4.27 \times 10^6 \text{ lb.in.}^2$$

FLIGHT HARDWARE

Material: Ti: 6Al-4V

$$\sigma_u \approx 157 \text{ ksi}$$

$$\sigma_y \approx 143 \text{ ksi}$$

$$E = 16 \times 10^6 \text{ psi}$$

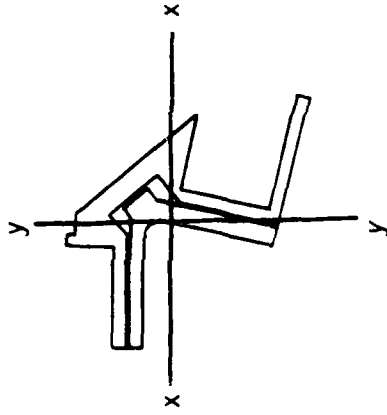

Existing Aft Arch Properties
Behind the Impact Point

$$I_{xx} = 0.280 \text{ in.}^4 \quad I_{yy} = 0.298 \text{ in.}^4$$

$$EI_{xx} = 4.48 \times 10^6 \text{ lb.in.}^2 \quad EI_{yy} = 4.77 \times 10^6 \text{ lb.in.}^2$$

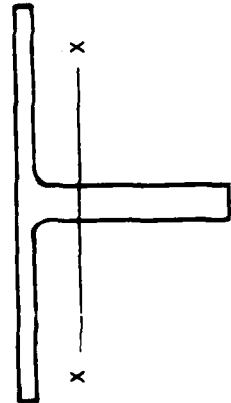

UDRI Center Beam Properties

$$I_{xx} = 0.204 \text{ in.}^4 \quad I_{yy} = 0.30 \text{ in.}^4$$

$$EI_{xx} = 5.92 \times 10^6 \text{ lb.in.}^2 \quad EI_{yy} = 8.72 \times 10^6 \text{ lb.in.}^2$$

TEST HARDWARE

Material: AISI-4130

$$\sigma_u \approx 163 \text{ ksi}$$

$$\sigma_y \approx 145 \text{ ksi}$$

$$E = 29 \times 10^6 \text{ psi}$$

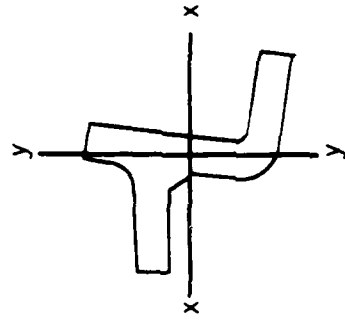

UDRI Aft Arch Properties
Constant Cross Section

$$I_{xx} = 0.154 \text{ in.}^4 \quad I_{yy} = 0.105 \text{ in.}^4$$

$$EI_{xx} = 4.46 \times 10^6 \text{ lb.in.}^2 \quad EI_{yy} = 3.05 \times 10^6 \text{ lb.in.}^2$$

Figure 3. Comparison of Cross-Section Properties Between Flight Hardware and Test Hardware.

plastic region* of the stress strain curve without developing an unstable section, because the section was expected to plastically deform during the birdstrike event. The use of 0.25-inch plate caused the forward flange for the test arch to be stiffer than the forward flange of the production arch. However, the forward flange was expected to yield prior to shear failure of the transparency. The production arch has a non-constant cross-section. The stiffness is a minimum just above the sill, and reaches a maximum at the point where the center beam attaches to the arch. The initial test arch design** was of constant cross-section to simplify fabrication and minimize cost. It was realized that because the test arch did not exactly match the production arch, some minor deviation from actual capability for the system was possible.

Three centerbeams, one left-hand arch, and six right-hand arches were constructed. Figure 3 presents a comparison of cross-section properties for the flight hardware and test hardware. The UDRI aft arch is shown in Figure 4. The UDRI center beam is shown in Figure 5. The arch center beam assembly is illustrated in Figure 6. Grade 8 alloy capscrews were used for all arch to sill and arch to centerbeam connections. Engineering drawings of the test hardware are illustrated in Appendix D. Flight hardware fasteners for the windshield were located, but the price per fastener was prohibitive and delivery could not be achieved to accommodate the desired test schedule. Equivalent strength and ductility fasteners (NAS 1203 and NAS 1204) were substituted. Figure 7 is a cross-section of the transparency at the aft arch.

*At the hardness used for this program, Rockwell C35.5-C37.0, 4130 steel has an elongation of approximately 11 percent).

** After the initial evaluation test shot, this arch design was modified as described in Paragraph 3.4.

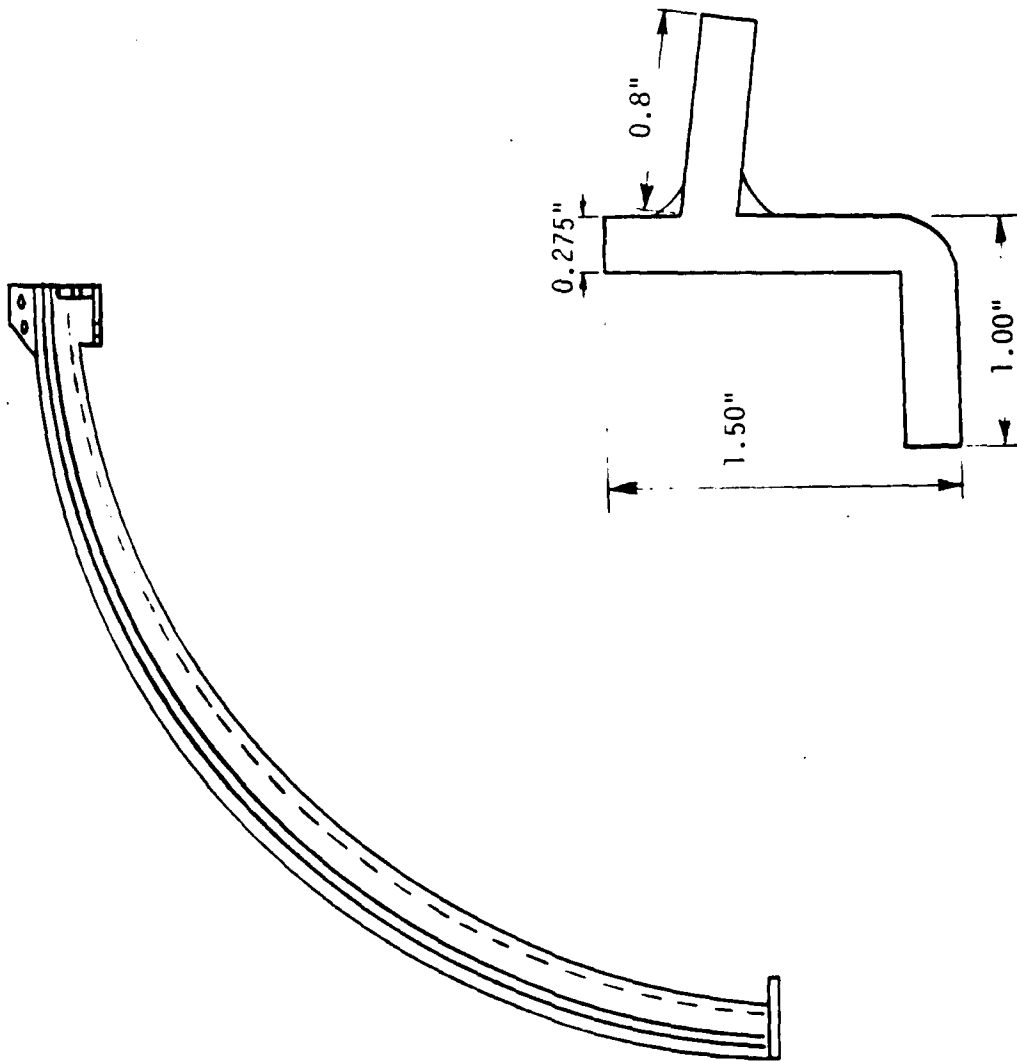
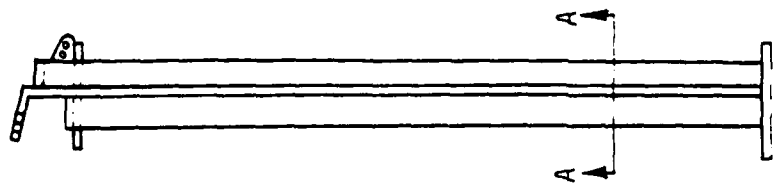

SEC A-A

Figure 4. UDRI Right Hand Aft Arch.

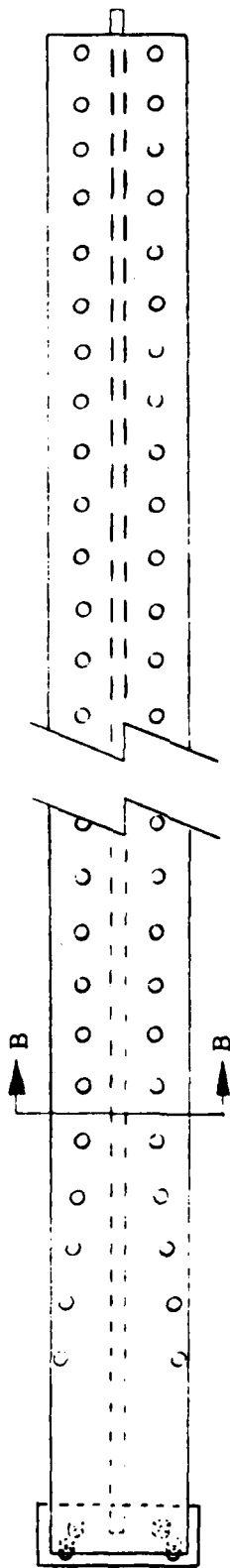
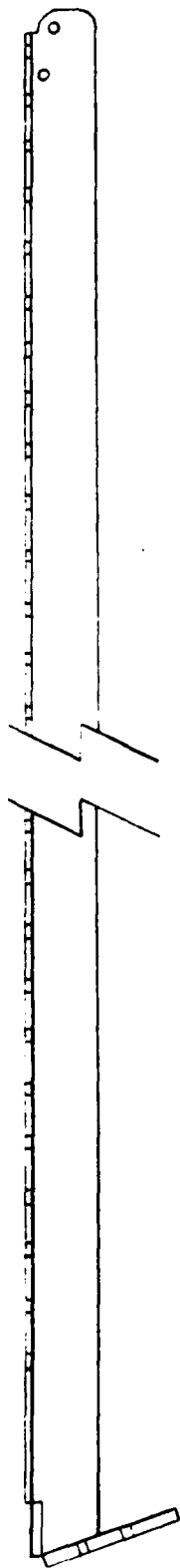

SEC B-B

Figure 5. UDRI Center Beam.

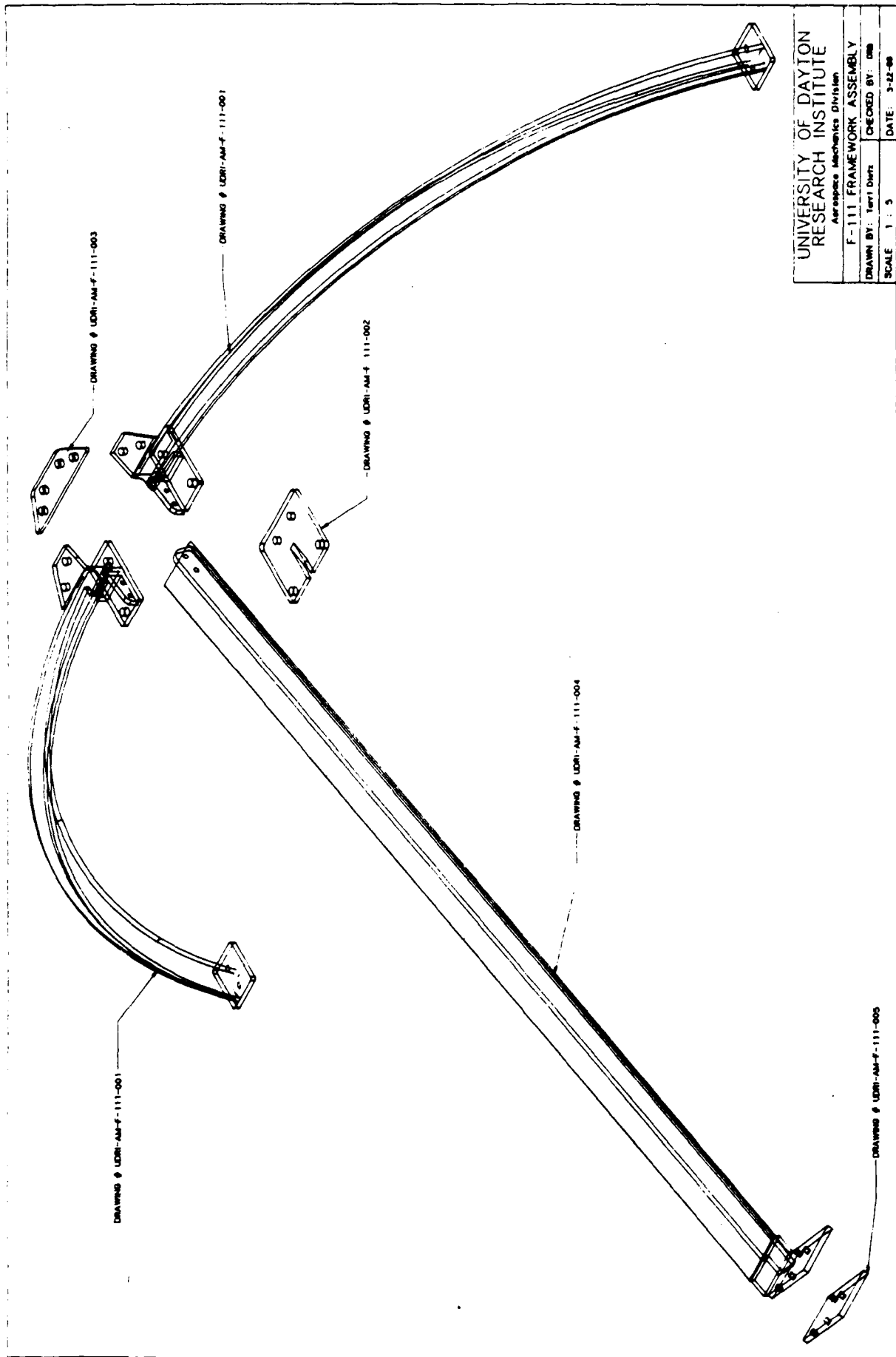

UNIVERSITY OF DAYTON RESEARCH INSTITUTE Aerospace Mechanics Division		
F-111 FRAMEWORK ASSEMBLY		
DRAWN BY: Terri Dietz	CHECKED BY: DMB	
SCALE: 1:5	DATE: 3-22-68	

Figure 6. UDRI Arch/Center Beam Assembly.

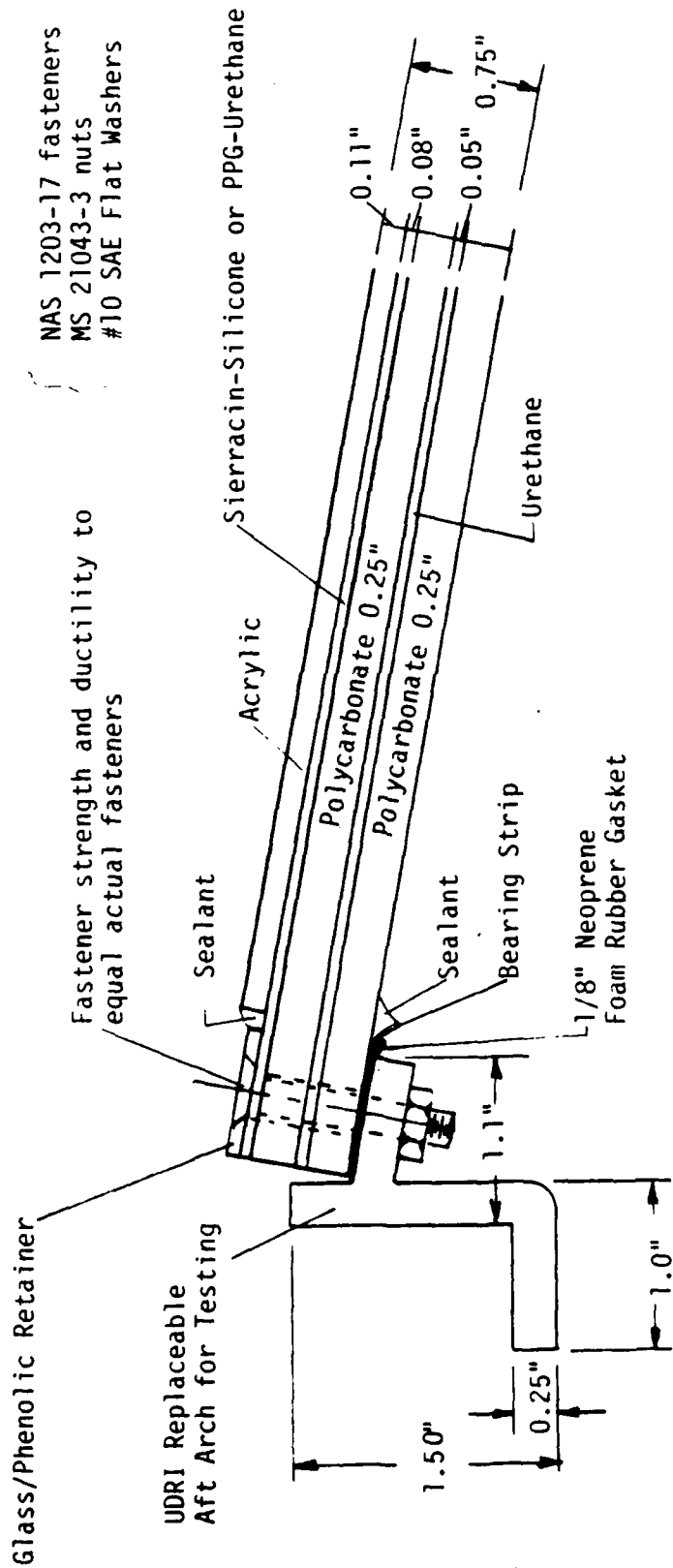

Figure 7. F-111 ADBIRT Transparency Cross-Section at the Aft Arch.

3.3 INITIAL BIRDSTRIKE/ARCH PERFORMANCE TESTING

Birdstrike testing was conducted at the University of Dayton Impact Physics Range 5, see Figure 8. The F-111 crew module was rigidly mounted to the laboratory floor. Both internal and external lighting was used. Movie camera locations are shown in Figure 9. The velocity detection system consisted of a pair of laser/photocell detectors, separated by a known distance, coupled to a 2-track Nicolet 204 oscilloscope. Right-hand windshield panels were tested with the left-hand windshield panels installed. Birdstrike films of the F-111 show that the canopy panels do provide out-of-plane support for the aft arch. For this reason, and to determine the percentage of bird entering the cockpit, the canopy panels and framework were in place during testing. The aft arch was instrumented with strain gages in test numbers 1, 3, 7-9, 11-13, 15, and 17-22. Strain gage locations are shown in Figure 10. Additional test setup information is included in the Test Plan, Appendix A.

Setup for full scale birdstrike testing was completed on 12 May 1987. As an initial birdstrike/arch performance test, a baseline PPG right hand windshield was installed and birdstrike tested with a 4.048 lb. artificial gelatin bird at 464 knots. The transparency successfully defeated the bird, and the shot was considered a pass. However, both 1/4 inch grade 8 bolts which connect the arch to the sill sheared 4 milliseconds into the birdstrike event. In addition, an arch-to-centerbeam 1/4 inch grade 8 connection bolt sheared. These bolt failures were considered unusual. The UDRI test arch was comparable in stiffness to the production aft arch at the point of impact; however, the production arch tapers down to a smaller cross-section at the sill. The UDRI arch had a constant cross-section, consequently it was stiffer than the production arch at the sill. The increased stiffness of the test arch at the sill resulted in a larger bending moment and shear force at the sill during the birdstrike event, which accounted for the failure of the arch-to-sill fasteners. The test arch (UDRI #1) was permanently deformed

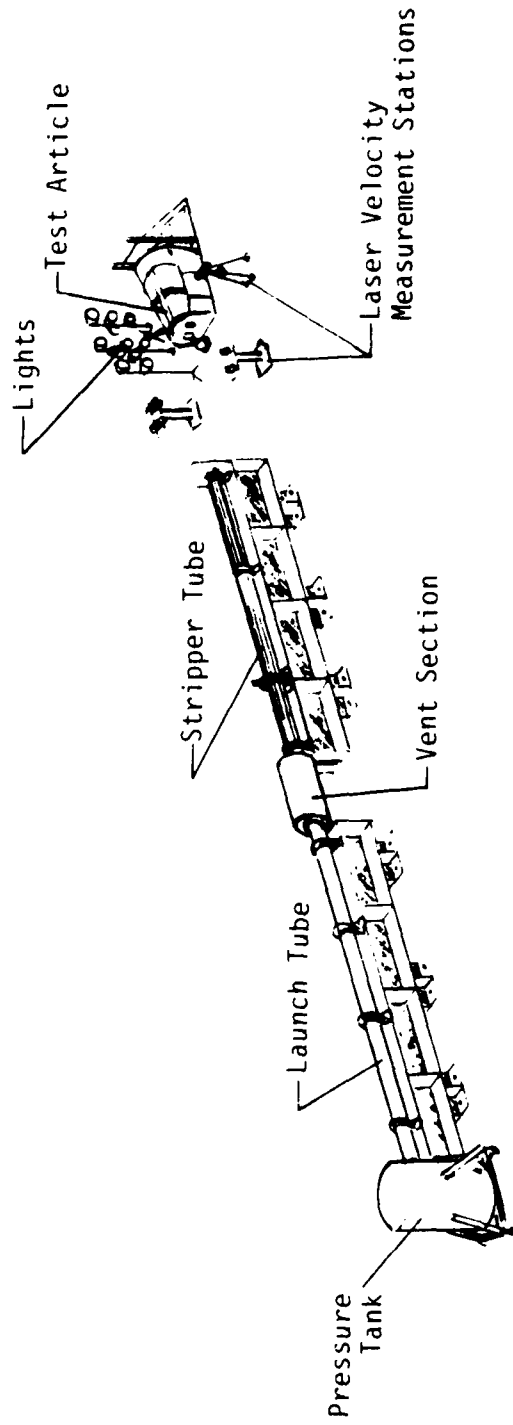

Figure 8. UDRI Impact Physics Test Range 5.

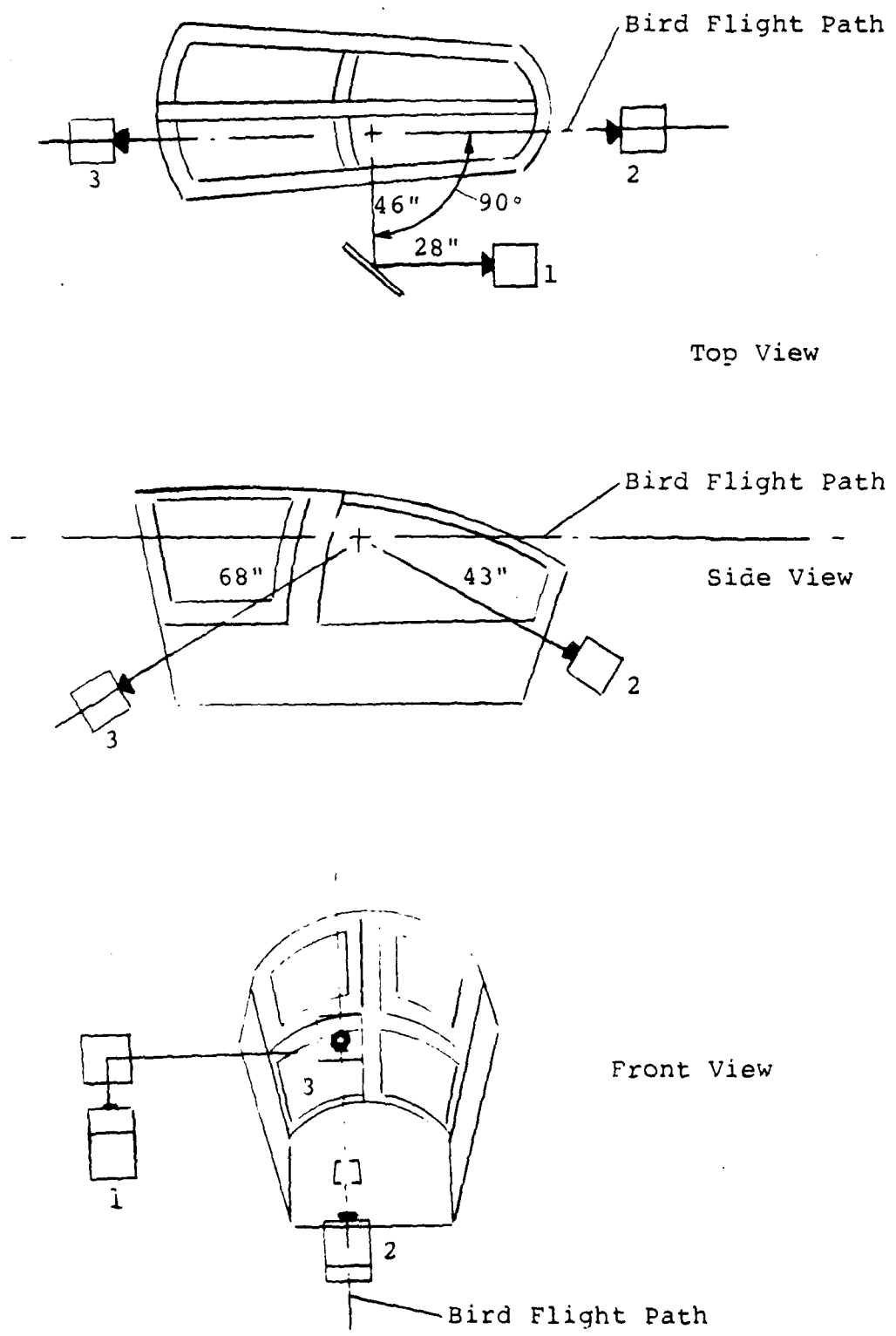
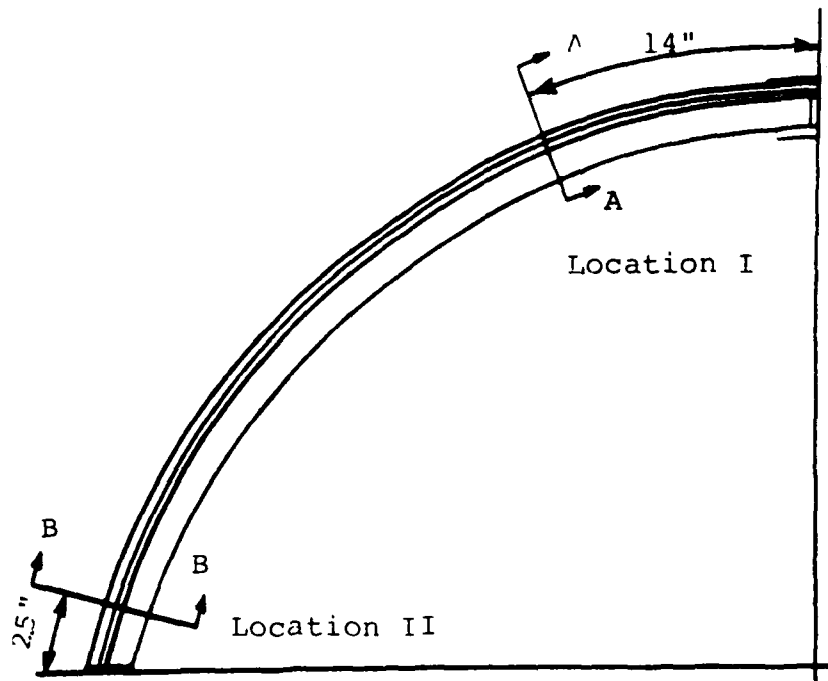
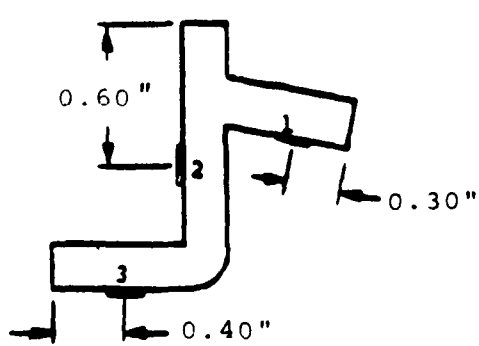

Figure 9. Actual Movie Camera Locations.



NOTE: Distances measured along top of forward flange.



Sec A-A

Location I

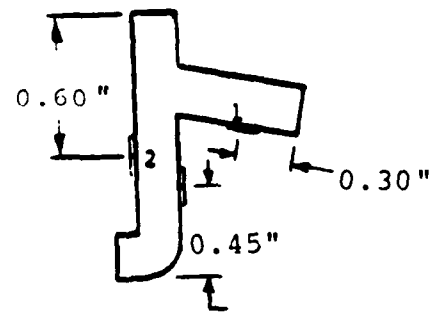

Sec. B-B

Location II

Figure 10. Strain Gage Locations.

in plane and out of plane, with no fractures, indicating that the weldment performed satisfactorily, maintaining high strength, ductility, and cross-section integrity.

3.4 DESIGN MODIFICATION

The UDRI test arch was analyzed to determine alternate methods to more closely match the overall section properties of the test arch to those of the production titanium arch. The modification selected is shown in Figure 11, and was made to all subsequent test arches. In addition, the arch to sill connection bolts and the arch to center beam connection bolt, which sheared in shot #1, were increased from 1/4 inch grade 8 bolts to 5/16 inch grade 8 bolts. Figure 12 presents a comparison of cross-section properties for the flight hardware and the modified test hardware.

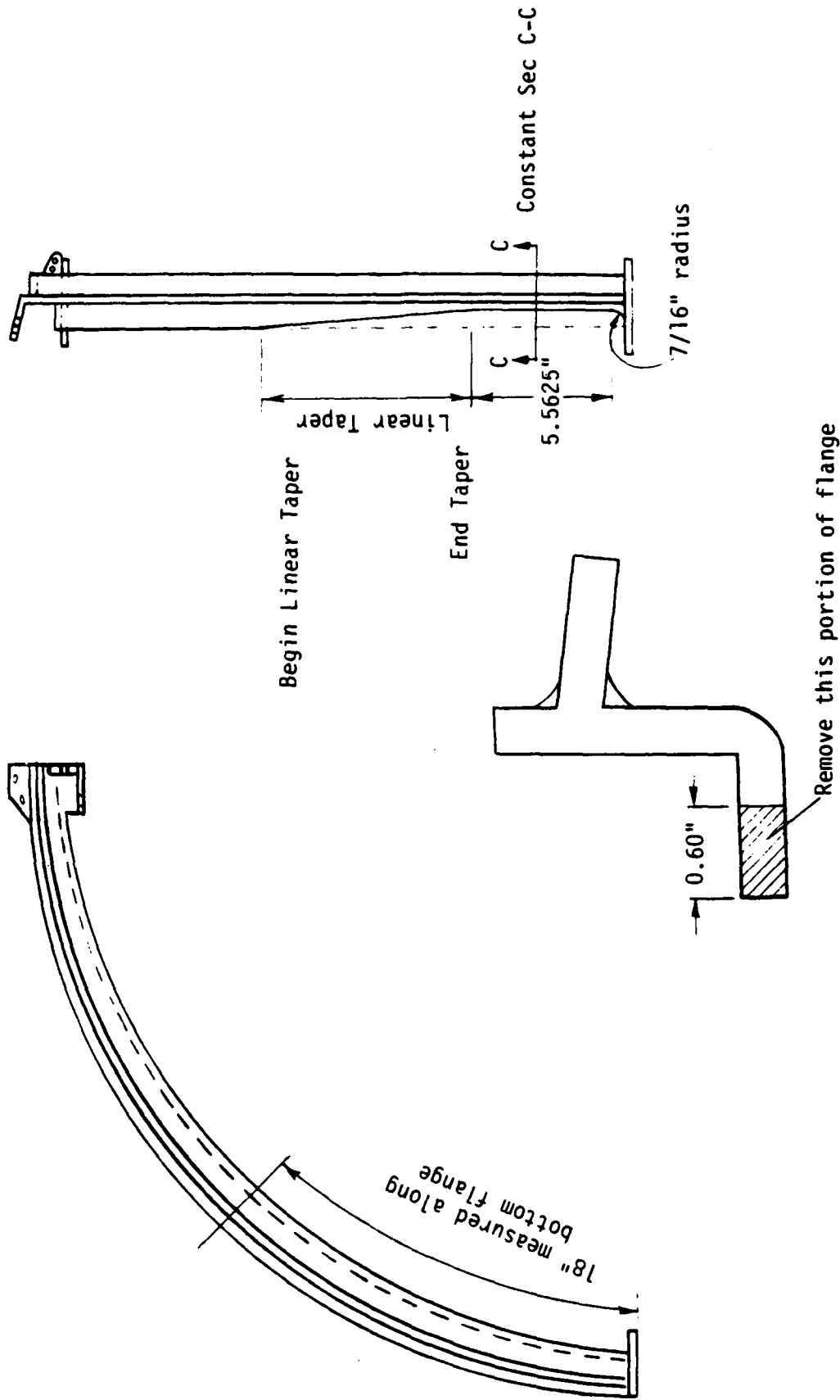

SEC C-C

Figure 11. UDRI F-111 Aft Arch Taper Modification.

FLIGHT HARDWARE

Material: Ti: 6Al-4v
 $\sigma_u \approx 157$ ksi
 $\sigma_y \approx 143$ ksi
 $E = 16 \times 10^6$ psi

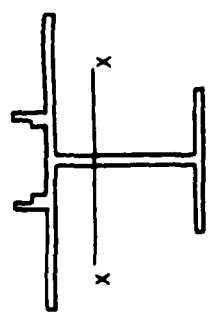
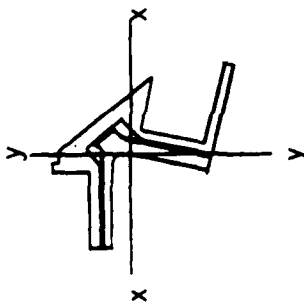
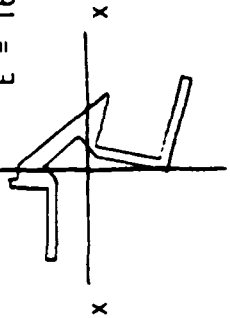

Existing Center Beam Properties
 $I_{xx} = 0.294 \text{ in.}^4$ $I_{yy} = 0.267 \text{ in.}^4$
 $EI_{xx} = 4.70 \times 10^6 \text{ lb.in.}^2$ $EI_{yy} = 4.27 \times 10^6 \text{ lb.in.}^2$

Existing Aft Arch Properties Behind the Impact Point
 $I_{xx} = 0.280 \text{ in.}^4$ $I_{yy} = 0.298 \text{ in.}^4$
 $EI_{xx} = 4.48 \times 10^6 \text{ lb.in.}^2$ $EI_{yy} = 4.77 \times 10^6 \text{ lb.in.}^2$

Existing Aft Arch Properties 6" Above the Sill
 $I_{xx} = 0.158 \text{ in.}^4$ $I_{yy} = 0.091 \text{ in.}^4$
 $EI_{xx} = 2.53 \times 10^6 \text{ lb.in.}^2$ $EI_{yy} = 1.45 \times 10^6 \text{ lb.in.}^2$

TEST HARDWARE

Material: AISI-4130
 $\sigma_u \approx 163$ ksi
 $\sigma_y \approx 145$ ksi
 $E = 29 \times 10^6$ psi

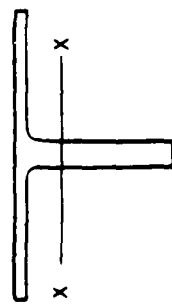
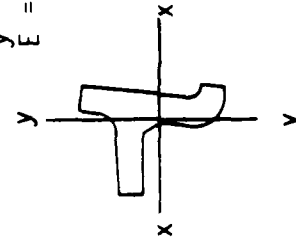
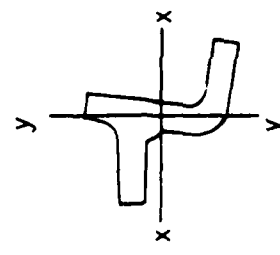

UDRI Center Beam Properties
 $I_{xx} = 0.204 \text{ in.}^4$ $I_{yy} = 0.30 \text{ in.}^4$
 $EI_{xx} = 5.92 \times 10^6 \text{ lb.in.}^2$ $EI_{yy} = 8.72 \times 10^6 \text{ lb.in.}^2$

UDRI Aft Arch Properties Behind the Impact Point
 $I_{xx} = 0.154 \text{ in.}^4$ $I_{yy} = 0.105 \text{ in.}^4$
 $EI_{xx} = 4.46 \times 10^6 \text{ lb.in.}^2$ $EI_{yy} = 3.05 \times 10^6 \text{ lb.in.}^2$

UDRI Aft Arch Properties from Sill to 6" Above the Sill
 $I_{xx} = 0.078 \text{ in.}^4$ $I_{yy} = 0.049 \text{ in.}^4$
 $EI_{xx} = 2.26 \times 10^6 \text{ lb.in.}^2$ $EI_{yy} = 1.43 \times 10^6 \text{ lb.in.}^2$

Figure 12. Comparison of Cross-Section Properties Between Flight Hardware and Modified Test Hardware.

SECTION IV
TEST PROCEDURE

A brief summary of the test plan follows (the complete test plan is presented in Appendix A). The windshields were installed in the crew module per the applicable Technical Order (T.O. 1F-111(B) A-2-2-1) except for the following: a neoprene 1/8 inch sponge gasket was used in place of sealant, and fasteners of equivalent strength and ductility were substituted for the flight hardware fasteners.

Artificial four-pound gelatin birds were used to impact the transparencies at the most critical location, the upper inboard corner (reference Figure 13).

A baseline capability, which because the UDRI arch and centerbeam was expected to be different than baseline capabilities determined in actual flight structure tests, was established with the new baseline optical reject transparencies purchased from PPG. The in-service aged transparencies were then tested after the baseline capability was established.

Velocities were calculated immediately following each test from the velocity detection system. The reported velocities are an average of the bird head and tail velocities (which are different because the bird tends to oscillate during flight). Still photographs were taken after each test to document damage. The birdstrike films were processed overnight and viewed the following morning.

After each test throughout the program, the windshield test article was removed and the aft arch was inspected for damage. Damaged arches were removed and replaced. The damaged arches were annealed, reformed to correct shape, rewelded where required, re-heat-treated to a Rockwell hardness of C35.5-C37.0, and then reused. Also, after each birdstrike test, the results were analyzed in-house at UDRI before a windshield and test velocity were chosen for the next test.

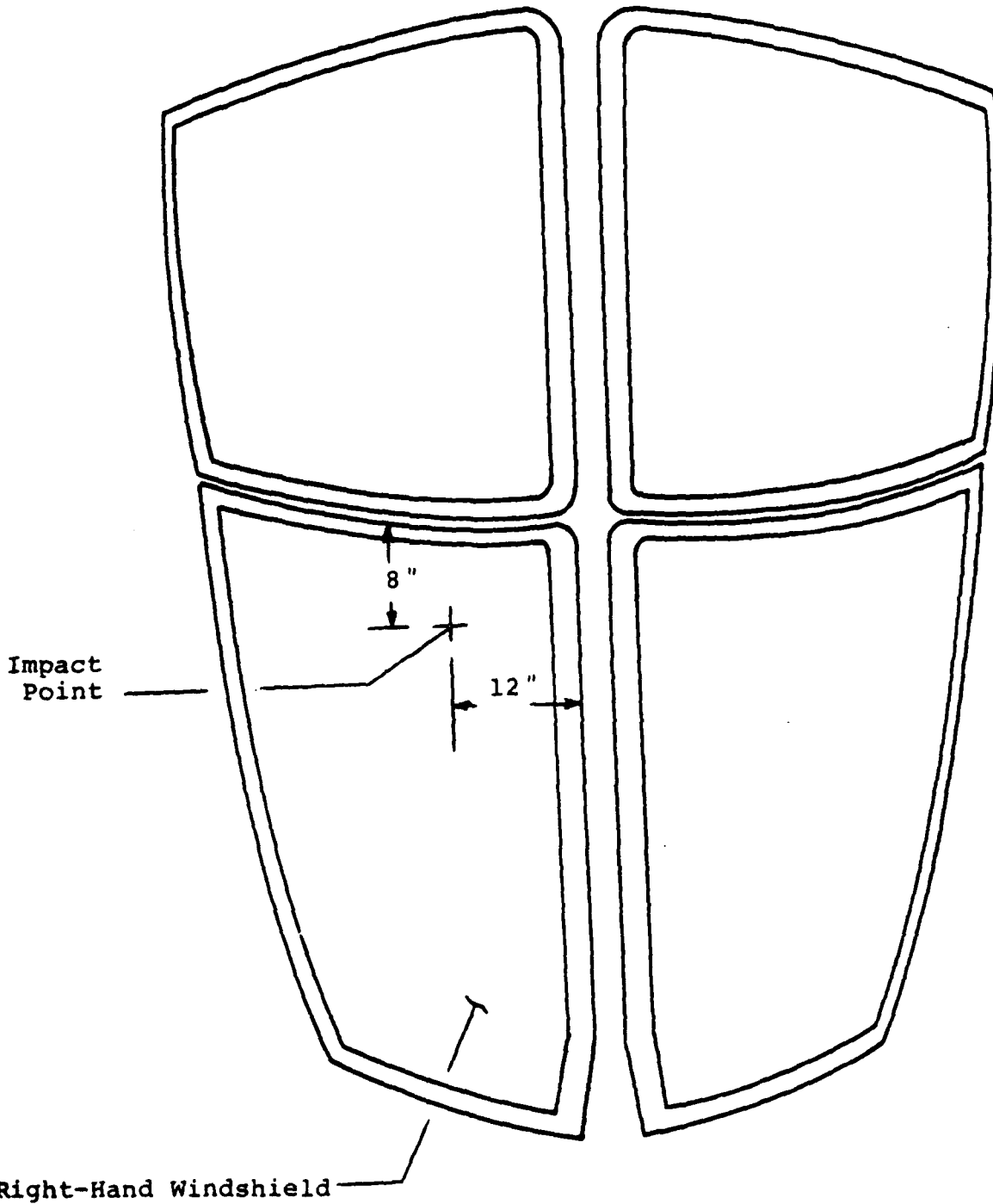

TOP VIEW

All dimensions in inches as measured from the edge of the transparency along the transparency surface.

Figure 13. Bird Impact Point.

SECTION V
TEST RESULTS

Mr. Steve Wortman of SM-ALC/MAQCC observed the results of the initial birdstrike/arch performance test (which, as noted earlier, was a pass with unusual support behavior), and indicated a desire to witness a second test at the same velocity of the oldest Sierracin window available. On 14 May, a Sierracin windshield, manufactured in August 1979 with an installed service life (actual time on the airplane) of between five years, six months and six years at Cannon AFB, was birdstrike tested at 466 knots with a 4.043 lb. artificial bird. The windshield failed catastrophically. The bird punched a 7 inch x 17 inch hole through the windshield on line with the impact point along the aft arch. Examination of the failed transparency revealed no evidence of ductility (elongation). The portion of the bird which penetrated (approximately one-third) continued onward and punched a 5 inch x 6 inch hole through the aft bulkhead in line with and slightly below the impact point. The aft arch was not damaged. Subsequently, the modified UDRI aft arches (right and left) were installed, and on 1 June a baseline PPG windshield was birdstrike tested with a 4.03 lb. artificial bird at 470 knots. The shot was a pass with no bolt failures or unusual arch behavior. The 470 knot velocity was considered to be at or very near the system baseline capability.

Table 3 presents a summary of 22 birdstrike tests on 21 windshields (the same windshield was used for tests 5 and 6). Detailed bird impact test data and photographs for each shot are included in Appendix B. Strain data was obtained to analyze system structural response. Strain data plots and an analysis of system loads during birdstrike are included in Appendix C.

In an effort to develop a relationship between time in-service and degradation, several theories were postulated. One theory which was hypothesized was a "total age" theory in which

TABLE 3

BRIEF F-111 TEST SUMMARY

Test Date	Test No.	Seq. No.	Mfgr. S/N	DOM	DOI	DOR	Service Life DOR- DOM	Installed Life DOR- DOI	Base	Test Velocity	Comments/Brief Summary of Results
5-12-87	1	Baseline	PPG 151901-104	6-85-11-85						464 kts	Pass-sheared arch/sill connection bolts and a centerbeam connection bolt. Arch permanently deformed and requires modification.
5-14-87	2	89	Sier 192	8-79	9-26-79	After 6/85	5y 10m-6y 4m	5y 6m-6y	Cannon	466 kts	Catastrophic failure-punched large hole. No arch damage.
6-1-87	3	Baseline	PPG	6-85-11-85						470 kts	Pass-with modified arch-UDRI. System capability. Arch permanently deformed.
6-4-87	4	135	Sier 102	6-79	5-6-80	10-83	4y 5m	3y 5m	Cannon	402 kts	Failure-large flap opened up and then closed. No arch damage
6-8-87	5	632	Sier 200	9-79	1-21-81	7-24-86	5y 11m	5y 6m	Cannon	297 kts	Pass - minimal acrylic cracking - W/S still in elastic range. No arch damage.
6-9-87	6	632	Sier 200	9-79	1-21-81	7-24-86	5y 11m	5y 6m	Cannon	354 kts	Failure - large flap opened up and then closed. Extensive cracking of all plies. No arch damage.
6-11-87	7	22	Sier 132	5-79	5-18-82	8-85	6y 3m	3y 3m	Cannon	358 kts	Failure - large flap opened up and then closed. Poly plies spalled off in places. No arch damage.
6-15-87	8	528	PPG 16-087	8-8-80	4-24-82	7-25-85	5y	3y 2m	Mt. Home	355 kts	Failure - W/S tore through bolt holes for 12" at aft arch. No arch damage.
6-17-87	9	144	PPG 16-660	7-22-83	12-15-83	9-17-85	2y 11m	1y 9m	Cannon	398 kts	Failure - W/S tore all along along aft arch. No arch damage
6-18-87	10	143	Sier 514	4-82	8-30-82	3-15-84	2y	1y 6m	Cannon	350 kts	Pass - minimal acrylic cracking. Minor permanent arch deformation
6-24-87	11	558	Sier 92	7-84	8-7-85	2-7-86	1y 7m	6m	Mt. Home	433 kts	Marginal pass-some acrylic cracking. No polycarbonate failure. 13 bolts sheared behind impact point. Negligible bird penetration. Permanent arch deformation.
6-25-87	12	151	Sier 692	11-82	3-29-85	10-11-85	2y 11m	6.5m	Mt. Home	391 kts	Pass-small pocket behind the impact point. Permanent arch deformation.

TABLE 3 (continued)

Test Date	Test No.	Seq. No.	Mfgr. S/N	DOM	DOI	DOR	Service Life DOR-DOM	Installed Life DOR-DOI	Base	Test Velocity	Comments/Brief Summary of Results
6-29-87	13	UD #12	Sier 522	7-82	8-2-82	11-8-83	1y 4m	1y	Mt. Home	433 kts	Marginal pass - same as #11. Minor bird penetration. Permanent arch deformation.
7-6-87	14	UD #11	PPG 16-245	11-18-80	4-2-82	8-30-83	2y 9m	1y 5m	Mt. Home	389 kts	Failure- W/S tore along aft arch for 18". Flap opened up. Extensive cracking. Permanent arch deformation.
7-13-87	15	551	Sier 248	2-85	-	-	-	0		455 kts	Pass - small pocket behind impact point, 10 bolts sheared behind impact point. No polycarbonate cracking. Permanent arch deformation.
7-15-87	16	582	Sier 052	6-84	8-13-84	10-17-86	2y 4m	2y 2.5m	Mt. Home	436 kts	Failure - w/s tore along aft arch for 8". 16 bolts sheared behind impact point. Extensive cracking. Permanent arch deformation.
8-5-87	17	140	PPG 16-432	8-26-81	8-30-82	1-23-84	2y 5m	1y 5m	Cannon	355 kts	Pass - no permanent deformation. NO damage except unusual acrylic cracking near front sill, and one 3" middle ply polycarbonate crack.
8-7-87	18	623	PPG 030	1-28-85	6-20-85	3-26-86	1y 2m	9m	Cannon	435 kts	Failure - w/s tore along aft arch for 8". Flap opened up. Permanent arch deformation.
8-11-87	19	148	PPG 002	1-3-85	1-85/6-85	1-9-86	1y	6m-12m	Cannon	390 kts	Pass - small pocket at impact point. Extensive acrylic cracking away from impact point. Permanent arch deformation.
8-17-87	20	88	Sier 264	10-81	4-10-83	4-11-85	3y 6m	2y	Cannon	388 kts	Failure - w/s tore along aft arch for 8". Flap opened up. Permanent arch deformation.
8-20-87	21	615	PPG 16-292	2-11-81	5-11-84	1-5-87	5y 11m	2y 8m	Lakenheath	424 kts	Failure - w/s tore along aft arch for 10". Flap opened up. Permanent arch deformation.
8-26-87	22	548	PPG 16-580	8-18-83	1-26-84	12-6-85	2y 4m	1y 10m	Lakenheath	383 kts	Failure - w/s tore along aft arch for 6". Permanent arch deformation.

degradation is related only to the date of manufacture. Figure 14 is a plot of birdstrike resistance capability versus date of manufacture. No trend is evident from this plot, although at least one source in the literature indicates a reduction in bare polycarbonate impact strength with absolute age.⁷ A plot of birdstrike resistance capability versus installed age (date of installation subtracted from date of removal) is presented for each vendor in Figure 15. (Note that a predicted capability curve for 0.725 inch stretched acrylic is included.*) This plot indicates a definite relationship between installed age and degradation. The actual cause of degradation may be a complex combination of extrinsic factors including absolute age, installed age, geographic location, and more specific intrinsic factors such as total UV exposure, thermal history, fatigue, hydrolysis, and molecular attack. Table 4 presents a comparison of baseline and in-service aged windshield birdstrike resistance.

The full scale tests on the two transparencies which were from the UK indicated no significant difference in capability compared to the Cannon and Mountain Home windshields. The UK windshields were expected to perform better (show less degradation with age) if UV or flightline thermal history are causing the degradation, because the aircraft at the UK are kept in hangars out of the sun.

A difference in edge performance between the PPG and Sierracin parts was observed for windshields with less

*This curve was estimated from historical birdstrike data including edge attachment effects from Reference 8, flexure beam test data of laboratory aged acrylic from Reference 5, and laboratory testing of coupon specimens from in-service aged T-38 acrylic windshields from Reference 9.

- SIERRACIN PASS
- SIERRACIN FAILURE
- △ PPG PASS
- ▲ PPG FAILURE

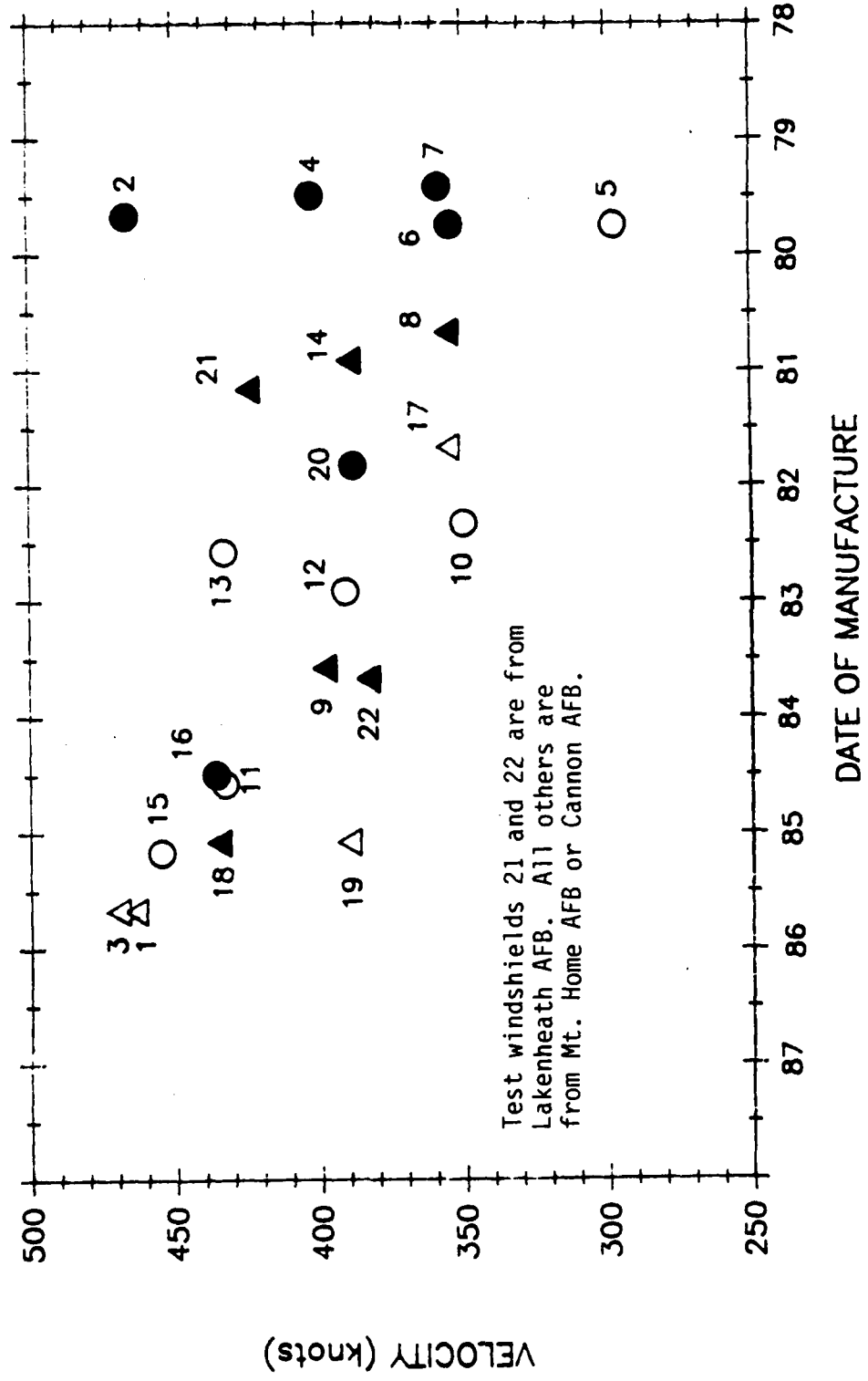

Figure 14. Test Data Summary, Velocity vs. Date of Manufacture.

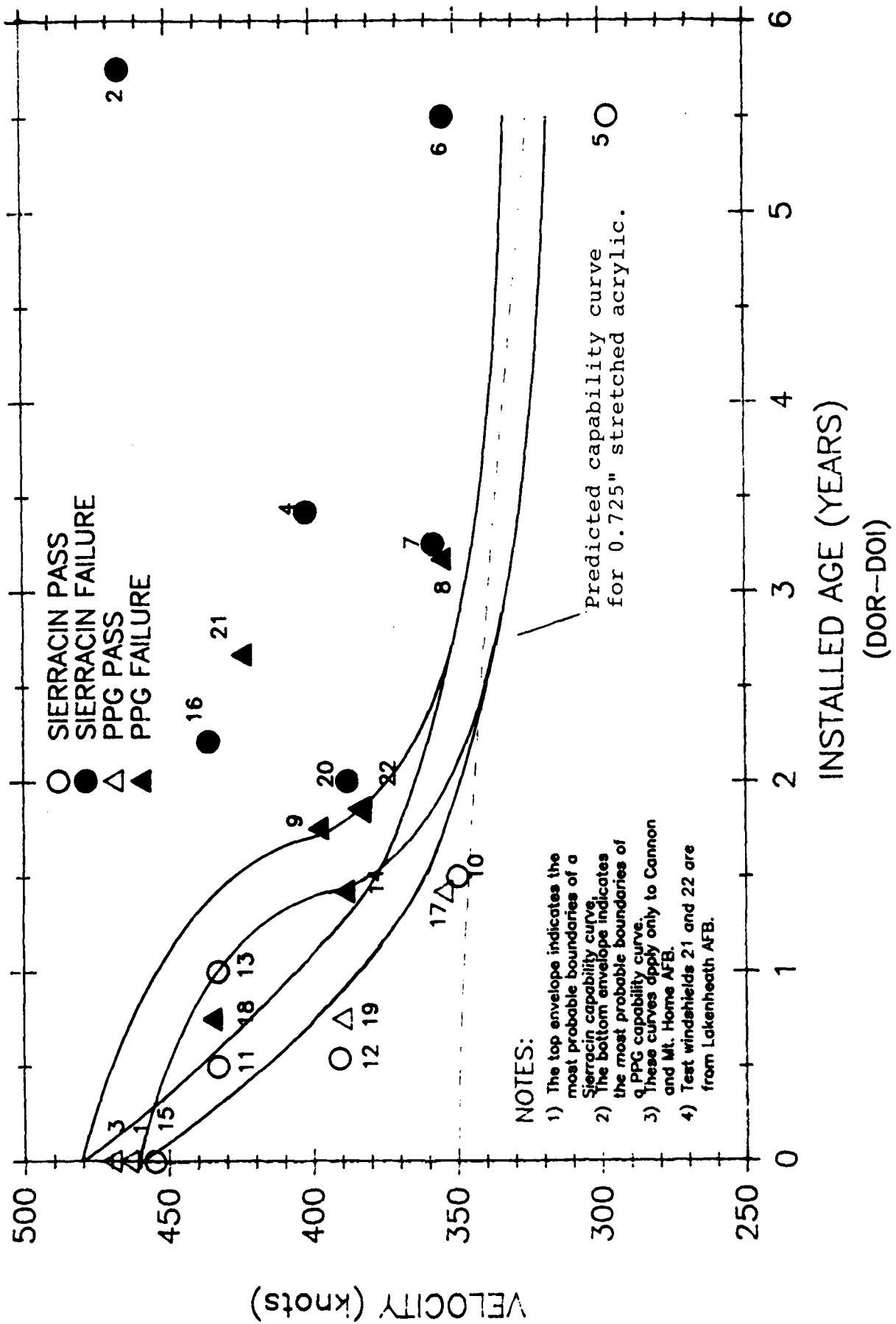

Figure 15. Capability Envelopes for Sierracin and PPG Transparencies.

TABLE 4
COMPARISON OF BASELINE AND IN-SERVICE AGED WINDSHIELD
BIRDSTRIKE RESISTANCE CAPABILITIES

<u>Transparency</u>	<u>Installed Age (years)</u>	<u>Capability (knots)</u>	<u>% Reduction* in Velocity</u>	<u>% Reduction** in Energy</u>
Baseline	0	470		
PPG	1	395	16.0	29.4
	2	355	24.5	42.9
	3	333	29.1	49.8
	4	325	30.9	52.2
Sierracin	1	440	6.4	12.4
	2	365	22.3	39.7
	3	337	28.3	48.6
	4	325	30.9	52.2

* Reduction = $\frac{\text{Baseline} - \text{Reduced Capability}}{\text{Baseline}} \times 100\%$

** Reduction = $\frac{\text{Baseline}^2 - \text{Reduced Capability}^2}{\text{Baseline}^2} \times 100\%$

These capabilities were determined from the test program. Actual baseline capability on flight structure is 490 knots. Because of the nature of the failures, it is not appropriate to scale up the capability for all age groups 20 knots.

than 1.5-2 years of installed age. For Sierracin shots 11, 13, 15, and 16, the edge attachment sheared 10-16 bolts behind the impact point without failing the edge attachment. For PPG shots 1, 3, and 18 the bolts yielded behind the impact point but did not fail, and the transparency started to tear through the bolt hole line. This difference in edge attachment performance may be partially attributed to a difference in transparency stiffness for the two vendors. The PPG transparencies appear to be more stiff than the Sierracin transparencies, accounting for lower loads transmitted to the arch; the stiffer window being a more efficient shell structure, thereby distributing the load more evenly. The less stiff Sierracin windshield allows more localized deformation and load concentration immediately behind the impact point, causing bolt failure. This bolt failure is unique to the UDRI test hardware and is attributable to flange and overall arch stiffness differences between the UDRI test hardware and the flight hardware. In addition, the canopy frame was not in intimate contact with the UDRI test aft arch, allowing more out-of-plane deformation in the UDRI aft arch than exists in the actual flight system.

There is a change in failure mode between the degraded and baseline windshields. When shot at velocities exceeding their capability, new windshields are ductile and crack resistant, absorb energy, and maintain coherency (no spalling). The degraded windshields, however, have decreased crack tolerance, absorb little energy (minimum plastic deformation), and have a tendency to spall. The effect of increasing velocity and strain rate on transparency damage is depicted in Figure 16.

Analysis of the birdstrike films and the failed transparencies indicated that cracking and subsequent failure paths were initiated at the bolt holes behind the impact point. This was expected, because the bolt holes are sites of stress concentration. The F-111 ADBIRT windshield is especially sensitive to edge attachment failure at the aft arch because of the limited distance between the fasteners and the edge of the

INCREASING TEST VELOCITY & STRAIN RATE



PASS

FAIL

Elastic Behavior
No Permanent Deformation
Minor Acrylic Cracking Possible
Permanent Deformation
Acrylic Cracking
Minor Poly Cracking Possible
Fastener Shear Failure Behind Impact Point
Fine Bird Spray Entering Cockpit
Tearing of Windshield Behind Impact Point
Measurable Bird Penetration
Danger to the Pilot
Significant Poly Cracking
Mushroom Shaped Flap Opening Up, Then Closing
Extensive Poly Cracking
Punch Through
Minimal Reduction in Bird Kinetic Energy

Figure 16. Effect of Increasing Test Velocity on Windshield Damage for Service-Aged Windshields.

windshield. The edge distance is dictated by the aft arch forward flange geometry and is approximately half an optimal edge distance. One good indication of polycarbonate ductility is the amount of bolt hole deformation behind the impact point. As the transparencies age, bolt hole deformation decreases and the chance of developing cracks at the bolt holes increases. This is an indication of decreased fracture toughness and possible embrittlement. The amount of crack branching into the polycarbonate plies from the edge attachment and the punch-through failures indicate that the polycarbonate properties may be changing throughout the windshield, not just at the edge attachment. Fracture toughness describes a material's ability to resist crack propagation. A decrease in fracture toughness means that the material is more notch sensitive and has less resistance to crack growth. Polycarbonate embrittlement is characterized by a decrease in plastic deformation and ultimate stress.¹⁰ In addition, it is hypothesized that as the polycarbonate becomes degraded, the strain rate sensitivity increases. At low impact velocities, the critical fracture toughness or embrittlement strain and/or strain rate are not exceeded, resulting in normal elastic-plastic behavior; but at high velocities the critical strain and/or strain rate are exceeded, resulting in elastic response followed by brittle failure (unstable crack growth) with little or no plastic deformation evident.

SECTION VI
BIRDSTRIKE RISK ASSESSMENT

To evaluate the risk of flying the F-111 with degraded windshield panels as compared to new windshield panels, a birdstrike risk assessment analysis was made using a computer program which was developed by UDRI under contract with WPAFB¹¹. This program utilizes a windshield function which is developed from a frontal view of the transparency with predicted bird impact resistance capabilities, see Figure 17; a birdweight probability curve, see Figure 18; and velocity profile data, see Figure 19. The program uses this data to calculate the probability of damage (penetration) given a birdstrike. Table 5 presents probability of damage given a birdstrike for velocity profiles from United Kingdom and western United States bases. The numbers presented give relative comparisons between baseline and aged transparencies; for instance, a four year installed age transparency is approximately 5.5 times more likely to be penetrated by a given birdstrike than the baseline transparency. A plot of normalized probability versus installed age is presented in Figure 20. This plot shows that the PPG windshields are at greater risk, in the first 2.5 years, of being penetrated by a birdstrike than the Sierracin windshields.

NOTES: 1. Total frontal area 835
in² (includes both
windshield panels).
2. Zones not to scale.

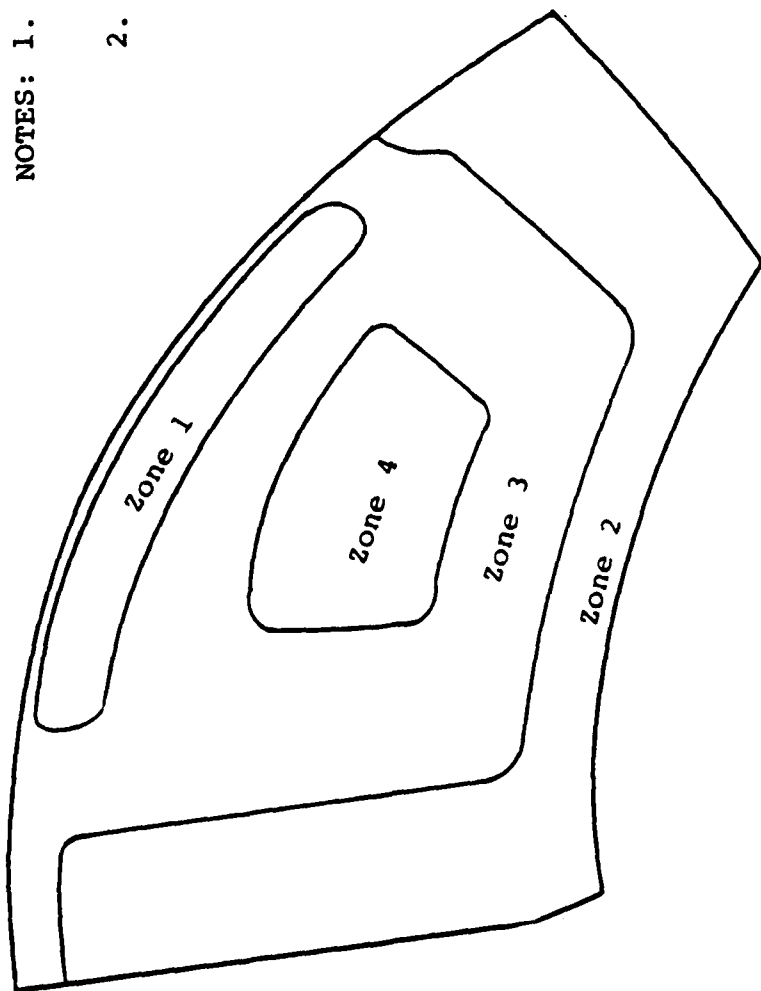

Zone	Percent of Total Area	Sierracin				PPG				
		Baseline*	1 YR	2 YR	3 YR	4 YR	1 YR	2 YR	3 YR	4 YR
1	10	490	440	365	333	325	395	355	333	325
2	40	500	450	375	343	335	405	365	343	335
3	41			Transition	Transition			Transition	Transition	
4	9	780	700	580	530	515	625	560	530	515

*Reference 10.

Figure 17. F-111 Windshield Frontal View Predicted Capabilities.

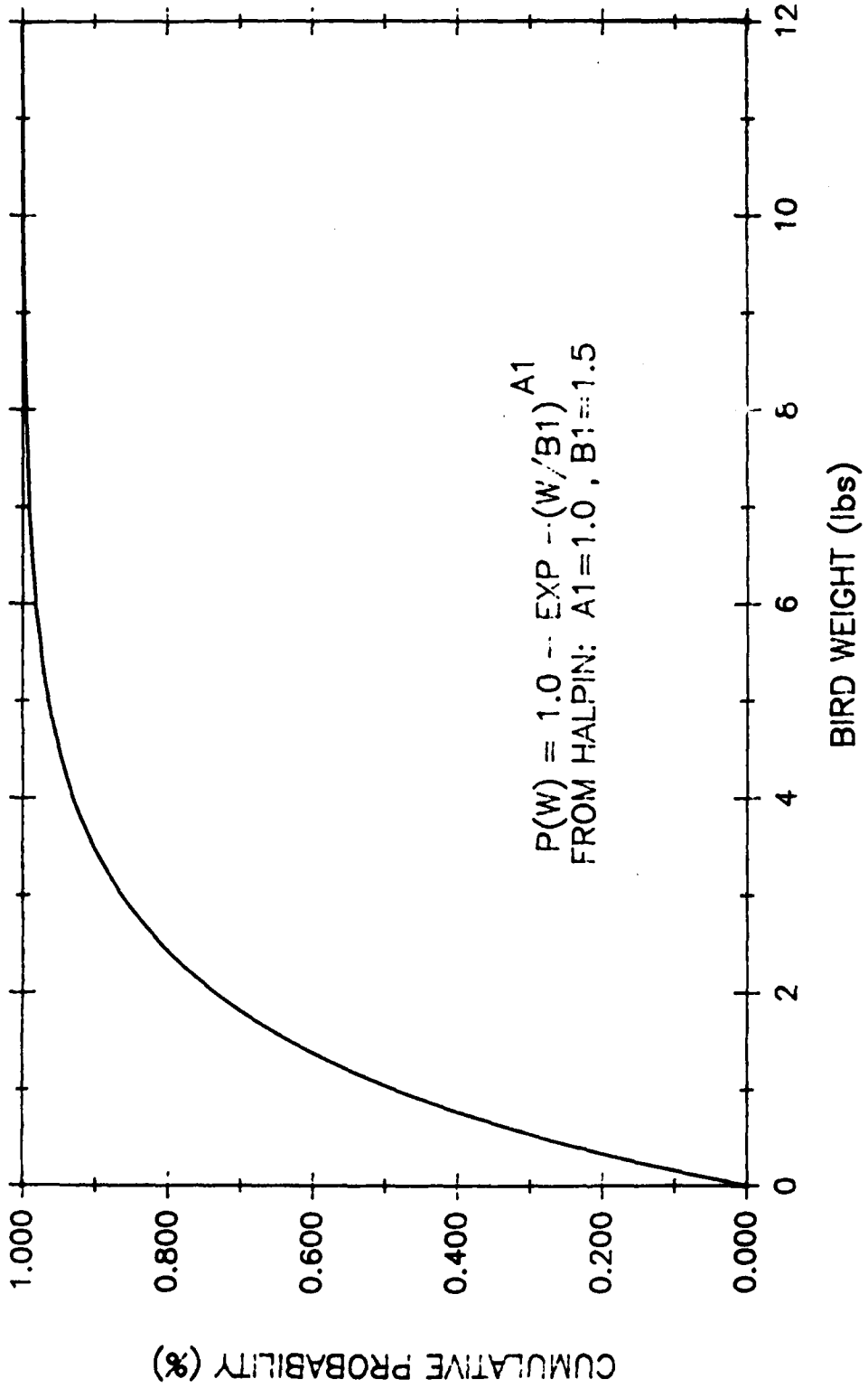

Figure 18. Bird Weight Probability Curve.

O --- O F-111A MT. HOME 1 Oct 76 -- 30 Nov 83 , 4140.2 hrs
 ● --- ● F-111D CANNON 1 Oct 76 -- 31 Mar 82 , 252.8 hrs
 △ --- △ F-111E UPPER HEYFORD 1 Oct 76 -- 31 Dec 85 , 4657 hrs
 ▲ --- ▲ F-111F LAKENHEATH 1 Oct 82 -- 31 Oct 86 , 1251.5 hrs

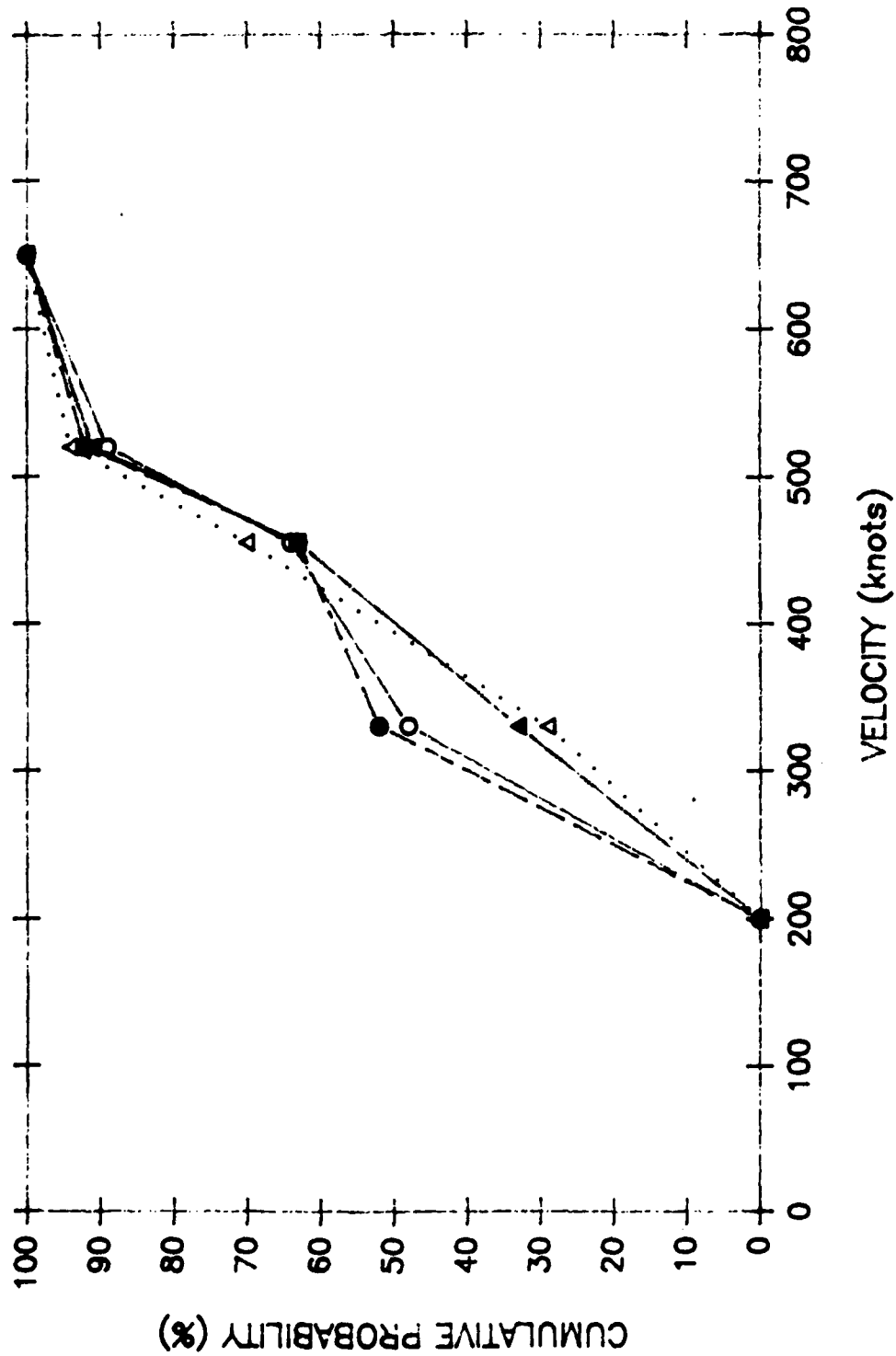

Figure 19. F-111 Velocity Profile Data in the Bird Environment.

TABLE 5

PROBABILITY OF DAMAGE P(D) (PENETRATION) GIVEN A BIRDSTRIKE
FOR PPG AND SIERRACIN SERVICE AGED WINDSHIELDS

Transparency	Installed Age	F-111A ^a P(D)	F-111D ^b P(D)	F-111E ^c P(D)	F-111F ^d P(D)
Baseline	0	0.0218	0.0200	0.0191	0.0224
PPG	1	0.0571	0.0535	0.0556	0.0616
	2	0.0838	0.0790	0.0849	0.0919
	3	0.1021	0.0966	0.1055	0.1129
	4	0.1139	0.1079	0.1187	0.1263
Sierracin	1	0.0365	0.0339	0.0339	0.0385
	2	0.0758	0.0714	0.0762	0.0824
	3	0.1021	0.0966	0.1055	0.1129
	4	0.1139	0.1079	0.1187	0.1263

NOTES: Bird weight distribution from Halpin, $\alpha=1$ $\beta=1.5$

Assumes same birdweight distribution for western USA
and United Kingdom.

(a) Mt. Home AFB, 1 Oct. 1976-30 Nov. 1983, 4140.2 hrs.

(b) Cannon AFB, 1 Oct. 1976-31 Mar. 1982, 252.8 hrs.

(c) Upper Heyford RAFB, 1 Oct. 1976-31 Dec. 1985,
4567 hrs.

(d) Lakenheath RAFB, 1 Oct. 1982-31 Oct. 1986,
1251.5 hrs.

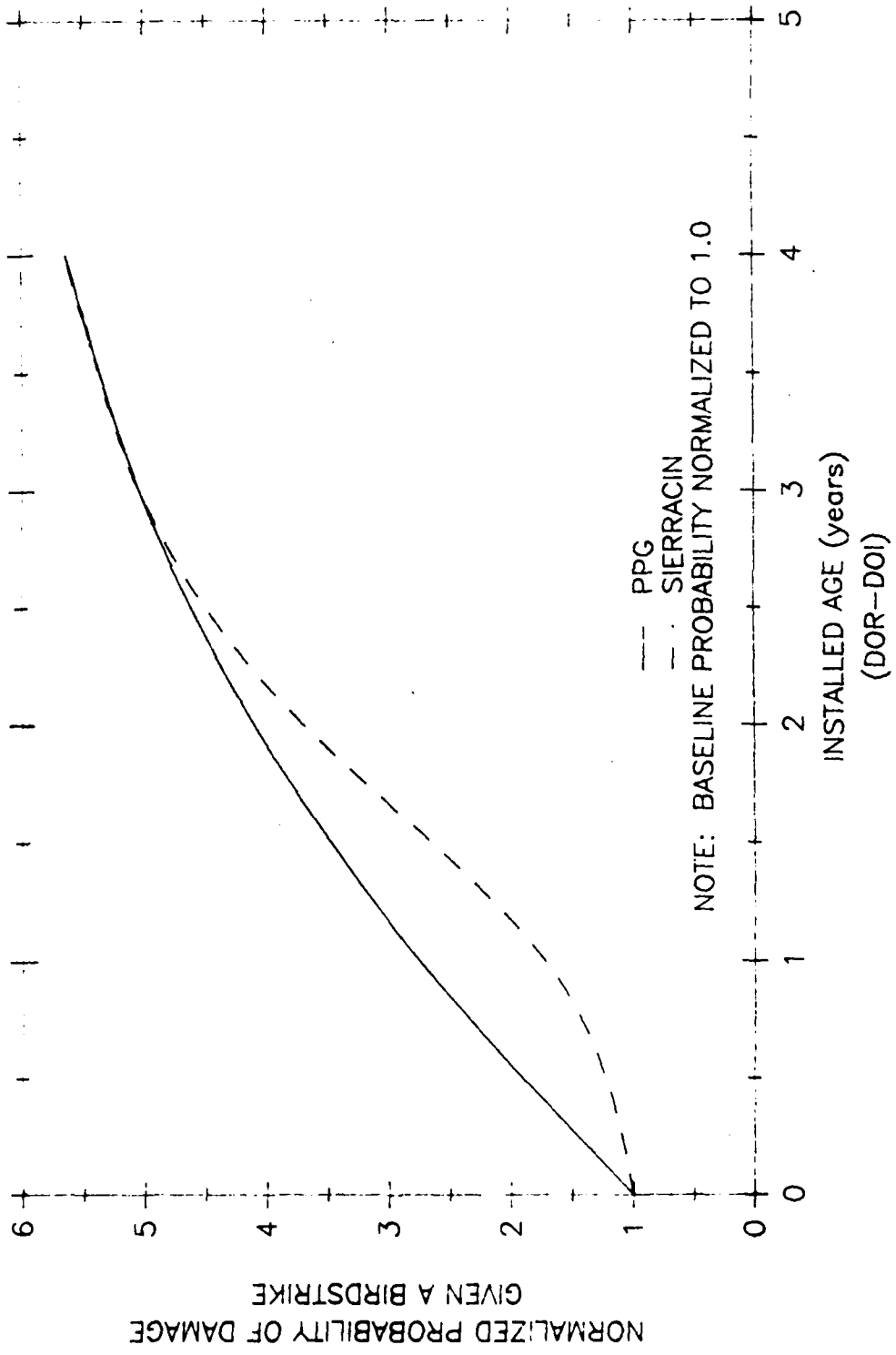

Figure 20. A Comparison of Birdstrike Risk for Sierracin and PPG.

SECTION VII
CONCLUSIONS AND RECOMMENDATIONS

7.1 CONCLUSIONS

7.1.1 Effect of In-Service Aging on Bird Impact Resistance

The structural integrity of the F-111 ADBIRT windshields is significantly reduced by in-service aging. Results of the bird impact tests indicate that the windshield capability is reduced to 360 knots after two years (40% in terms of impact energy) and reaches an asymptotic minimum value of 325 knots at an installed age of five years. The cause of degradation is unknown.

7.1.2 Effect of In-Service Aging on Bird Impact Risk

Birdstrike risk assessment of the windshields indicates that, given a birdstrike, degradation causes the likelihood of penetration to increase significantly. A two-year installed age F-111 ADBIRT windshield is 3.5-4 times more likely to be penetrated by a given birdstrike than a newly installed windshield. A five year installed age windshield is six times more likely to be penetrated by a given birdstrike than a newly installed windshield.

7.1.3 Simulated Flight Hardware Critique

Overall, the UDRI simulated flight structure performed very well.* The windshield baseline capability with the UDRI designed simulated flight hardware was above 470 knots, whereas the actual flight hardware system capability is between 490 and 500 knots.

* Although the arches did develop some cracking in the weld affected zones, it was minor and did not affect the tests, and was caused mostly by the thermal cycling experienced by the arches when they were heat-treated. This minor cracking could be eliminated by removal of all mill-scale, and by careful preheating of the arches when they are welded.

Test results demonstrate that simulated flight hardware can be used as an economical tool to study windshield performance.

7.2 RECOMMENDATIONS

A two-phase coupon testing program to study the F-111 degradation problem is recommended. The proposed program would include a series of laboratory tests of in-service aged and new baseline F-111 ADBIRT windshield transparency coupon specimens. The objective of Phase I would be to develop a laboratory test database. This data would be used to evaluate the physical property changes in the windshield materials, and degradation trends could be correlated with full-scale birdstrike test results. The objective of Phase II would be to determine the cause of F-111 ADBIRT windshield full-scale birdstrike degradation.

Additional recommended future work includes: full-scale testing of ADBIRT windshields from different bases to determine the effect of geographic location on degradation; full-scale testing of the F-111 at other impact points such as a center shot on the windshield and a canopy shot to define the effect of degradation on the entire transparency system capability; full-scale testing of an F-111 transparency which has been subjected to pressure thermal cycling at the windshield system life cycle durability facility in Building 65, Wright-Patterson Air Force Base, to evaluate in-flight pressure-thermal effects independent of other environmental factors; the development of a non-destructive test method to evaluate transparency degradation in-situ; and investigation of methods to control or eliminate degradation in future transparency systems.

REFERENCES

1. Littell, H. Edward, Improved Windshield and Canopy Protection Development Program, AFFDL-TR-74-75, June 1974.
2. Lewis, A. L. and Cooke, K. W., F-111 Bird-Resistant Windshield Support Structure, AFFDL-TR-74-40, 10 May 1974.
3. West, Blaine S., Design and Testing of F-111 Bird Resistant Windshield/Support Structure, Volume 1 - Design and Verification Testing, AFFDL-TR-76-01, October 1976.
4. Simmons, Robert J., Flightline Thermal Environment Testing of F-111 Transparencies, AFWAL-TR-83-3062, July 1983.
5. Clayton, K. I., West, B. S., and Bowman, D. R., Aircraft Transparency Test Methodology, AFWAL-TR-85-3125, March 1986.
6. Heath, J. B. R. and Gould, R. W., "Degradation of the Bird Impact Resistance of Polycarbonate," Conference on Aerospace Transparent Materials and Enclosures, Scottsdale, AZ, July 1983.
7. Lawrence, J. H., Guidelines for the Design of Aircraft Windshield/Canopy Systems, AFWAL-TR-80-3003, February 1980.
8. Ursell, C. R., Investigation of the Effect of Age on the Structural Integrity of F-5 Canopies, Southwest Research Institute Project No. 03-6116-001, June 1981.
9. Yamasaki, R. S. and Blaga, A., "Degradation of Polycarbonate Sheeting on Outdoor Exposure, Relationship Between Changes in Molecular Weight and Tensile Properties," International Union of Testing and Research Laboratories for Materials and Structures, Vol. 10, No. 58, July-August 1977.
10. Berens, A. P., West, B. S. and Turella, M. A., On a Probabilistic Model for Evaluating the Birdstrike Threat to Aircraft Crew Enclosures, UDR-TR-78-124, November 1978.
11. Brockman, R. A., A Finite Element Program for the Materially and Geometrically Nonlinear Analysis of Three-Dimensional Structures Subjected to Static and Transient Loading, AFWAL-TR-80-3152, January 1981.

APPENDIX A

TEST PLAN INFORMATION

1.0 INTRODUCTION

This document is intended to provide the basic information for conducting bird impact tests on F-111 transparencies. These tests are to be conducted in the UDRI Impact Physics Facility by UDRI personnel. The objective of these tests is to compare the bird impact capability of F-111 transparencies removed from service (in-service aged) to the bird impact capability of baseline (unaged) transparencies.

A brief description of the test article, test set-up, test facility and conditions, test article instrumentation, data acquisition, and success criteria is presented in the subsequent sections of this document.

2.0 TEST ARTICLE

The basic test articles are right-hand windshield transparencies. The basic windshield support structure will be an actual F-111 crew escape module, Air Force Serial Number 68-024, manufacturers Serial Number 227, manufacturers Part Number 12K2005-815. The center beams and windshield aft arch will be high strength steel designed by UDRI to simulate the dynamic structural behavior of the actual system (see Figures A1 and A2). Multiple sets of this critical structure will be manufactured to allow for expected structural damage.

Artificial four-pound gelatin birds will be impacted at the most critical location, the upper inboard corner (see Figure A3). Right-hand windshield panels will be tested with the left-hand windshield panels installed. Birdstrike films of the F-111 show that the canopy panels do provide out-of-plane support for the aft arch. For this reason, and to determine the percentage of bird entering the cockpit, the canopy panels and framework will be in place during testing.

Fastener strength and ductility to equal actual fasteners

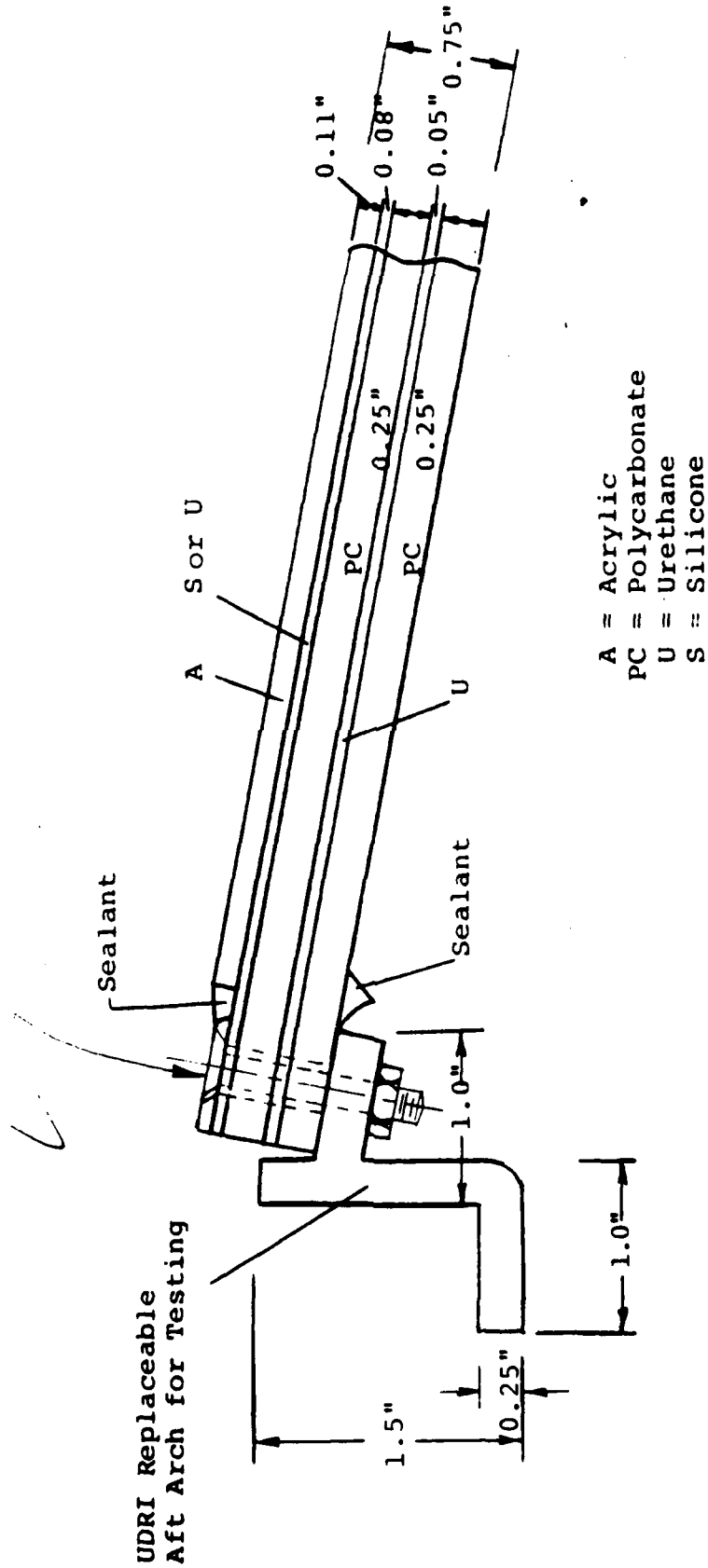

A = Acrylic
 PC = Polycarbonate
 U = Urethane
 S = Silicone

Figure A1. F-111 ADBIRT Transparency Cross-Section.

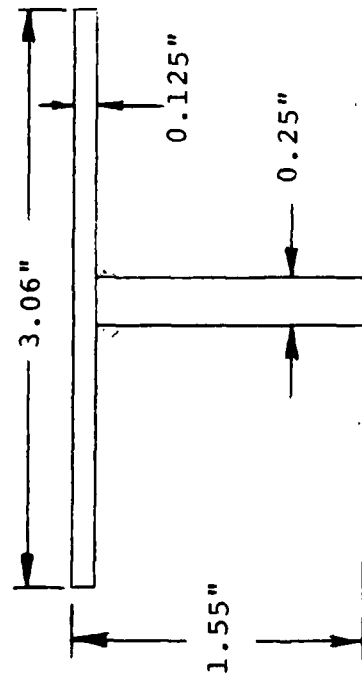
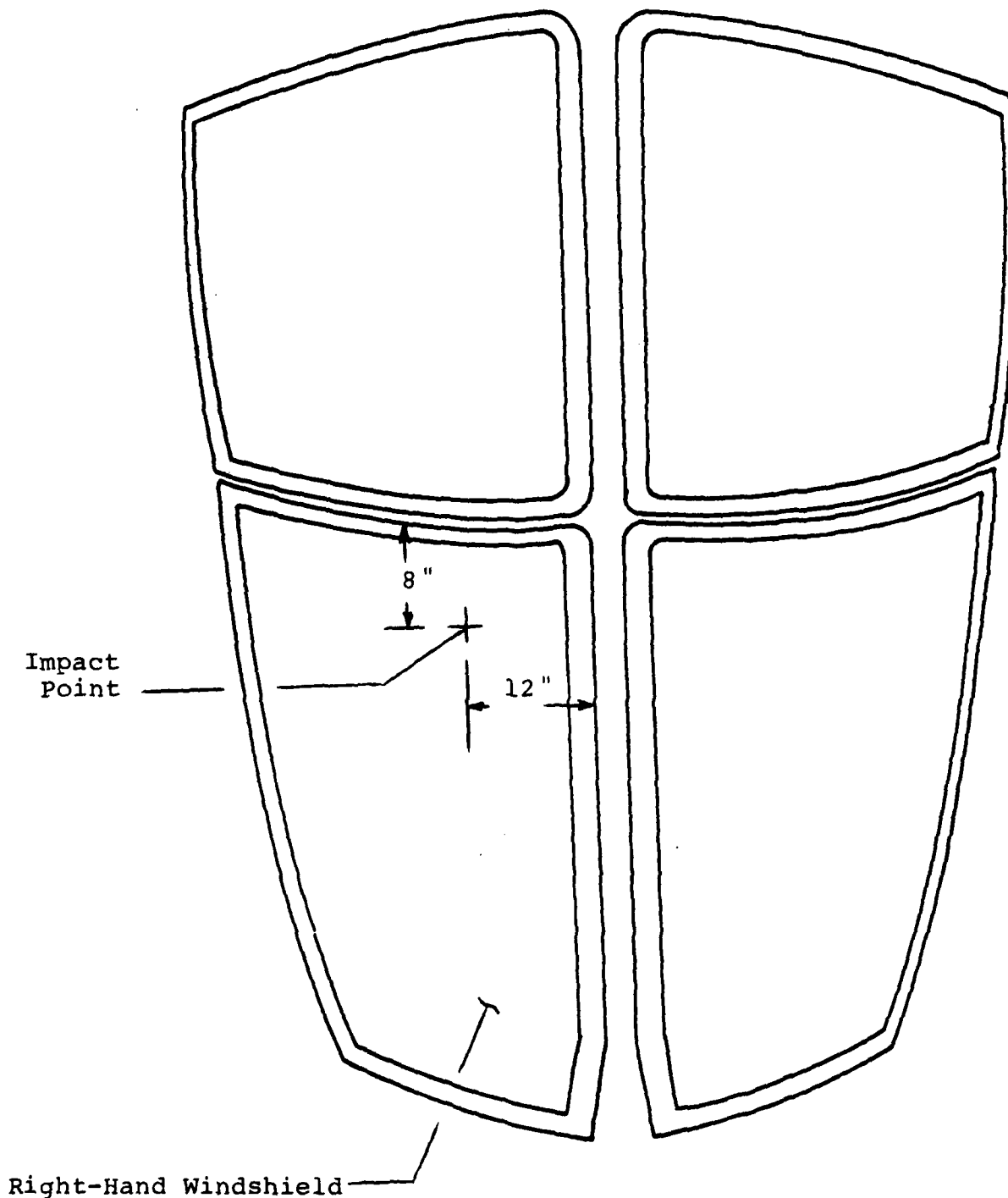

Figure A2. UDRI Designed Replaceable Center Beam.



TOP VIEW

All dimensions in inches as measured from the edge of the transparency along the transparency surface.

Figure A3. Bird Impact Point.

There are 19 right-hand F-111 windshield transparencies available for use on this test program. These are the current F-111 ADBIRT transparencies.

the bird impact test matrix, Table A1, includes 19 total transparencies. Of the in-service aged transparencies, there will be an equal number of PPG and Sierracin parts for each age group for comparison purposes.

TABLE A1
BIRD IMPACT TEST MATRIX

6	5 years old (in-service)
4	3 years old
4	2 years old
2	1 year old
3	Baseline (structurally sound optical rejects from PPG)
—	
19	Total

A baseline capability, which because the UDRI arch and center beam may be different from baseline capabilities determined in actual flight structure tests, will be determined with the three optical reject transparencies purchased from PPG. The five-year-old transparencies will be tested after the baseline capability is established, followed by the 3, 2, and 1 year old transparencies.

3.0 TEST SETUP

Test setup procedures will be similar to those previously employed at UDRI and AEDC for bird impact testing. The crew escape module will be rigidly fixed to the laboratory floor. The test assembly shall be positioned such that the centerline of the bird gun is parallel with respect to the theoretical roll axis of the aircraft.

Prior to the initiation of any work by UDRI personnel on or near the F-111 laminated transparency, all personnel will be briefed on the potential problems associated with handling or working near the F-111 transparencies. Since the materials used in the construction of the transparencies are sensitive to damage by specific foreign substances such as oils, fluids, liquids, adhesives, etc., every precaution must be taken to protect test articles during their installation in the UDRI range. Before any treatment of the transparency is accomplished, the UDRI personnel will check with the WRDC/FIVR project manager for approval to use that particular substance or procedure on the transparency. In addition, all personnel will be encouraged to report any unusual event (dropped a tool on the canopy, etc.) which could have a detrimental effect on the performance of the canopy during the birdstrike test.

The transparency to be tested shall be installed in the F-111 crew escape module by UDRI personnel per the applicable Technical Order, except that sealants may be omitted (neoprene gasket material will be used in place of sealant for the test article), and fastener use will depend on availability. Installation of windshield fairings is not required.

Modification to the crew module shall be made as required for testing. All remaining instrumentation installation, checkout, and operation will be accomplished by UDRI. This would normally include photography, gun operation, etc.

4.0 TEST FACILITY

Birdstrike testing will be accomplished at the UDRI Impact Physics Laboratory. The UDRI will furnish test engineers, technicians, cameramen, and support personnel capable of installing and removing the test article, and will have the

capability of meeting all test requirements contained in this test plan. Proposed capabilities of the UDRI Bird Impact Facility will include the following parameters and tolerances.

Hardware Related Items

1. Bird and Bird Weight
 - a. Tolerance ± 0.1 lb.
 - b. Measurement uncertainty ± 0.002 lb.
 - c. The test program will use gelatin test birds
2. Bird Velocity
 - a. Tolerance $\pm 2.5\%$
 - b. Measurement uncertainty:
 - (1) Primary system $\pm 0.5\%$
 - (2) Backup system 1%
3. Bird Shape/Orientation
 - a. Bird Shape
 - (1) During acceleration - use slip fit sabot
 - (2) During free flight - L/D remains approximately constant. (Should stay in a compact cylindrical package approximate dimensions 4.25 inch x 8.5 inch)
 - b. Bird Orientation During Free Flight Mode
 - (1) Pitch 0° to 15°
 - (2) Yaw 0° to 15°
4. Impact Location
 - a. Tolerance ± 1.0 inch in all directions perpendicular to the axis of the gun
5. Sabot
 - a. Non-deforming material for velocities less than 600 knots .
 - b. Sabot completely stripped (no contact with target). The sabot stripper shall not alter bird orientation beyond the tolerance limits during the free flight mode to the target.

6. Test Article Temperature Conditioning
 - a. Test temperature 70°F (ambient conditions)
 - b. Tolerance $\pm 15^\circ\text{F}$
 - c. Measurement uncertainty $\pm 1.8^\circ\text{F}$
7. Target Lighting System
 - a. Adequate to cover operation of three 5000 fps color movie cameras
 - b. Recommended systems:
 - (1) 1000 watts exterior floodlights - 28
 - (2) 1000 watts interior floodlights - 16
8. Target Protection System
 - a. 100% up to 15 seconds before firing

5.0 TEST ARTICLE INSTRUMENTATION

Instrumentation Requirements

a. Calibration Requirements - Calibrated velocity measurement system and back-up X-ray system.

b. Strain Data Acquisition

The purpose of the strain gage instrumentation on these tests is to evaluate dynamic response characteristics of the arch. Strain data for a range of velocities is desired to correlate actual and theoretical arch behavior. A real time correlation between impact and strain response must be made. The UDRI Impact Physics personnel will install strain gages per the instructions given in Figures A4 and A5. The strain gages to be monitored during each test will be specified by the on-site test engineer. The magnitude of the strain expected on each gage for a given test will be supplied by the test engineer. The UDRI maximum data storage capability is 2,000 data points per channel. At a sampling rate of one data point per 0.02 millisecond, each channel will hold 40 milliseconds of data. This should be sufficient to document the birdstrike event and evaluate permanent deformation.

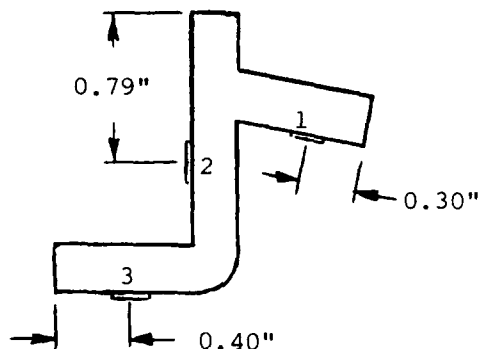

NOTES:

1. Gages should be located to accuracy of ± 0.03 inches.
2. Actual location of gages should be determined and recorded after installation.
3. Gages to be installed with gage element perpendicular to the plane of the paper.
4. Alignment of gages should be ± 2 degrees of specified orientation.
5. Gages to be Micro Measurement type CEA-06-250UN-120 or equivalent.
6. It is recommended that gage installations be made with a high quality adhesive such as Micro Measurement M-Bond AE-10.
7. A protective coating of M-Bond B and an overcoat of RTV is suggested for protection from mechanical injury and impingement of test debris.
8. Gage wiring should be neatly secured to the arch flange such that chance of damage will be minimized.

Figure A4. Strain Gage Location on Cross-Section.

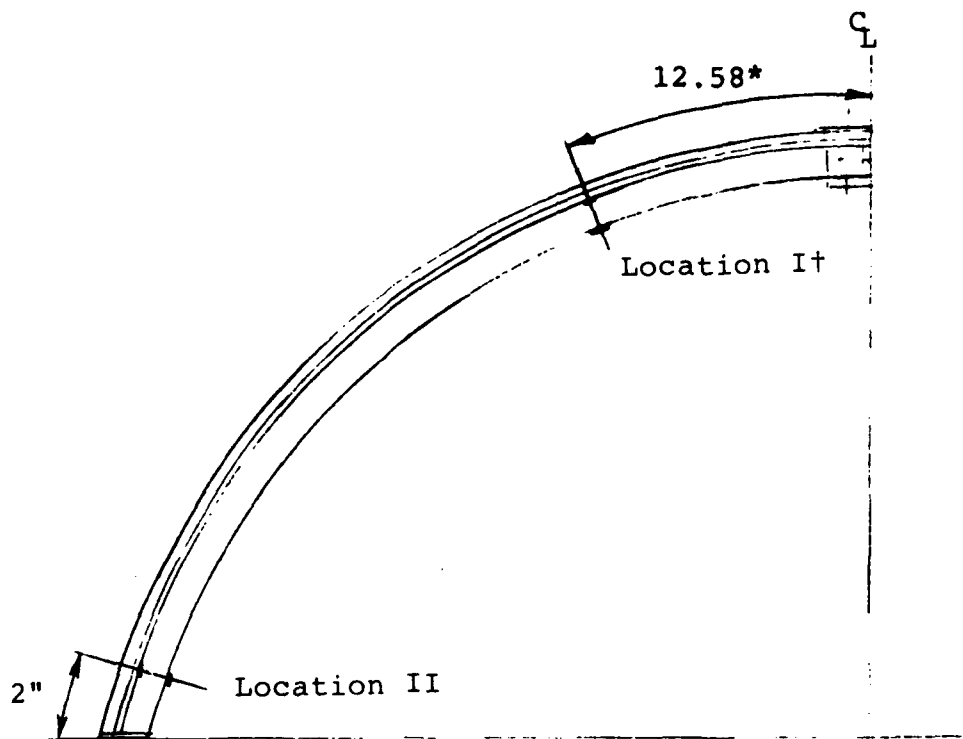

View Looking Aft at Windshield Arch Datum Plane, R/H Side

*Measured in inches along the surface of the transparency, which corresponds to 0.75 inch above the top flange.

†This gage location is directly behind the bird impact point.

NOTES:

The location of the gages along the aft arch should be within $\pm 1/16$ inch.

Figure A5. Strain Gage Location Along Arch.

c. Photography Requirements

(1) Movies - Three 5000 fps color movie cameras are required for each bird test. Suitable artificial lighting shall be required to allow the simultaneous use of these three cameras. Synchronized timing marks on all movie camera film will be required to properly reduce the data. Camera locations will be as shown in Figure A6, with cameras aimed to show the maximum amount of detail possible. Particular care should be taken to ensure good coverage of the aft arch, and the aft arch will be painted for contrast. Targets will be used on the structure to aid in interpreting the film data. The x, y, and z coordinates of each camera will be determined relative to the gun centerline (and thus the crew module).

(2) Stills - Still documentary 3 inch x 5 inch photographs will be necessary to document pre- and post-test setup and specimen conditions. Color photos will be taken and selected color and black and white prints will be made. Approximately three pre-test photographs are anticipated for each test. The number of post-test photographs per test is a function of the extent of damage. In addition, post-test photographs with the transparency out of its frame will be taken.

6.0 DATA ACQUISITION

Analysis of test results is dependent on an accurate and thorough job of recording all details of test preparation and execution that could affect the test. This record keeping may at times be a tedious and seemingly unnecessary tasks; however, it should be emphasized that complete and accurate records are perhaps the most important aspect of conducting a successful test program.

For this test program, a test file will be made for each bird shot. A sample data sheet is shown in Figure A7. It is impossible to foresee every event that might accompany a test

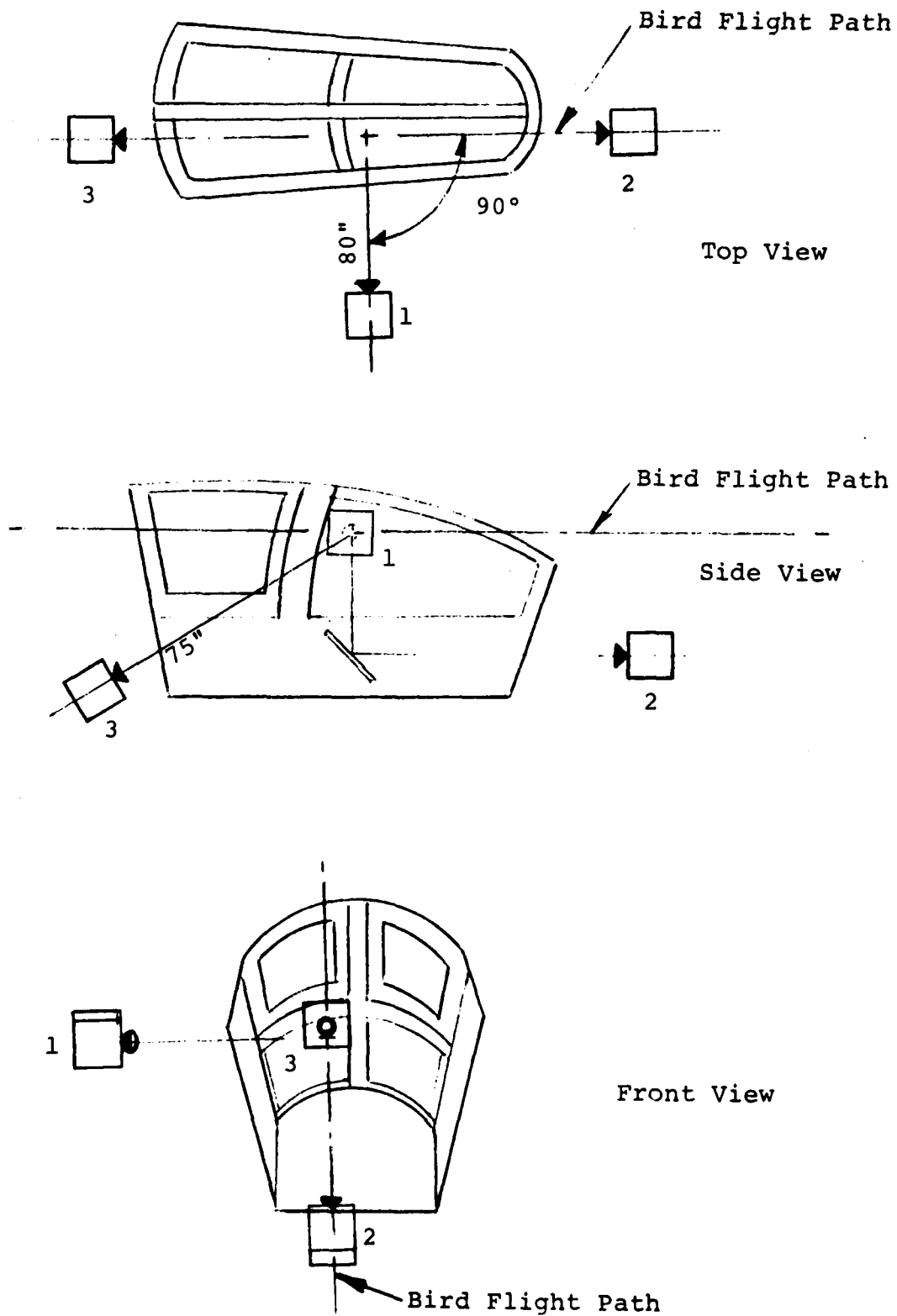

Figure A6. Movie Camera Locations.

UDRI
F-111 RIGHT-HAND TRANSPARENCY
BIRD IMPACT TEST

TEST SUMMARY

I. BASIC TEST DATA

Date of Test _____ Test No. _____
Impact Pt. _____
Planned Impact Vel. _____ Actual Impact Vel. _____
Bird Wt. _____ Kinetic Energy _____
Ambient Temperature _____ Transparency Temp. _____

II. TEST HARDWARE

Crew Module Ident. _____
R/H Windshield:
Manufacturer _____
Serial Number _____
Date of Manufacture _____
Date of Removal _____
Weight _____
L/H Windshield _____
R/H Canopy _____
L/H Canopy _____
Aft Arch Configuration _____
Fasteners:
Aft Arch _____
Center Beam _____
Sill _____
Forward Arch _____

III. HARDWARE TEST HISTORY

Crew Module _____
L/H Windshield _____ R/H Windshield _____
L/H Canopy _____ L/H Canopy _____
Aft Arch _____
Arch Reinforcement _____
Structural Damage and/or Modifications _____

Pertinent Fastener Substitutes _____

IV. PRE-TEST OBSERVATIONS

Figure A7. Sample Data Sheet (page 1 of 2).

V. POST-TEST OBSERVATIONS

VI. SIGNIFICANCE OF TEST

Figure A7. Sample Data Sheet (page 2 of 2).

program. However, a number of items felt to be necessary for inclusion in the test file are enumerated below. Any additional data judged to be pertinent by UDRI personnel will be made a part of the test file.

Test File Information

1. A complete identification of the specimen and configuration tested including source, manufacturer's code or serial number, transparency weight, position of impact and method of mounting.
2. results of all visual inspections, including photographs before and after testing. Careful inspection of transparency before and after testing with sketches and documentation of scratches, defects, and edge conditions.
3. The ambient conditions of temperature and relative humidity at the time of testing.
4. The evidence supported by the high speed records.
5. The location(s) of the high speed camera(s) and size of background grids if used.
6. The planned and actual impact velocity.
7. Descriptions of the test instrumentation and their accuracies.
8. Record of previous shots on transparencies and support structure. Also note any structural repairs that have been made to support structure.
9. Sketches, still photographs, and comments showing damage or unique features of a given test.
10. Any interpretation of the results.

7.0 SUCCESS CRITERIA

A. Transparency

A transparency is considered to have demonstrated adequate structural capability at a given velocity if there is

minimal bird penetration or no excessive deflection after impact with a four pound bird at ambient temperature. Failure of the outer acrylic ply is acceptable. Cracks in the polycarbonate structural ply, plastic deformation in the support structure, and fastener failure are acceptable provided that bird penetration does not occur. The on-site test engineer will evaluate the results from each test to determine if the shot is a pass or a failure.

B. Test Program

The test plan objectives shall be considered satisfied when sufficient data has been acquired for analysis and evaluation, and a final report including movies and still photographs has been delivered.

APPENDIX B

INDIVIDUAL TEST SUMMARIES AND PHOTOGRAPHS

UDRI
F-111 RIGHT-HAND TRANSPARENCY
BIRD IMPACT TEST

TEST SUMMARY

I. BASIC TEST DATA

Date of Test 5/12/87 Test No. 1 Shot No. 5-0427
 Impact Pt. see report
 Planned Impact Vel. 450 kts/761 fps Actual Impact Vel. 464 kts/785 fps
 Bird Wt. 4.048 lb Kinetic Energy 38,734 ft-lbs
 Ambient Temperature 75°

II. TEST HARDWARE

Crew Module Ident. AFSN 68-024 Mfgr. SN 227

R/H Windshield:

Manufacturer PPG 151901-104 Optical Reject
 Serial Number 1560-01-080-937985
 Date of Manufacture Baseline
 Date of Removal Baseline
 Weight 46.9 lb

L/H Windshield PPG 015-157 DOM 9-23-80
 R/H Canopy PPG 504973FSPP DOM 3-26-75 (same for all tests)
 L/H Canopy Sierracin SN 013 DOM 9-77
 Aft Arch Configuration UDRI Aft Arch #1 Center Beam #1

Fasteners:	Screws	Nuts	Washers	Torque
Aft Arch	NAS 1203-17	MS21043-3	#10 SAE	40 in-lbs
Center Beam	NAS 1204-17	1/4" grade 8	1/4" SAE	25 in-lbs
Sill	NAS 1204-17	1/4" grade 8	1/4" SAE	25 in-lbs
Forward Arch	NAS 1203-17	10-32 machine	#10 SAE	25 in-lbs

III. HARDWARE TEST HISTORY

screws
(same for all tests)

Crew Module Unknown
 L/H Windshield None R/H Windshield None
 L/H Canopy None R/H Canopy None
 Aft Arch None
 Arch Reinforcement None
 Structural Damage and/or Modifications None

Pertinent Fastener Substitutes Use grade 8 1/2-28 fasteners at sill connections

IV. PRE-TEST OBSERVATIONS

Impact angle at centerline beam ≈21.5°
 First fastener in aft arch (from center beam) not used, and first fastener in center beam (from aft arch) not used.

V. POST-TEST OBSERVATIONS

Cracked canopy - sheared both bolts at sill on arch
First 4 bolts at aft edge of sill pulled through transparency
Transparency pocketed at impact point. Permanent deformation in arch
at impact point. Canopy retainer plate bent up. Sheared off 1/2" bolt
at lower rear arch to center beam connection plate on right side
(test side).
Cracked canopy skin at base where aft arch pushed out

VI. SIGNIFICANCE OF TEST

Forward arch flange appears to be too stiff--only very local rotation,
and not much rotation aft.
Stiffness of arch at sill appears to be too high causing excessive
side load and moment at sill
Pass - at 464 knots.

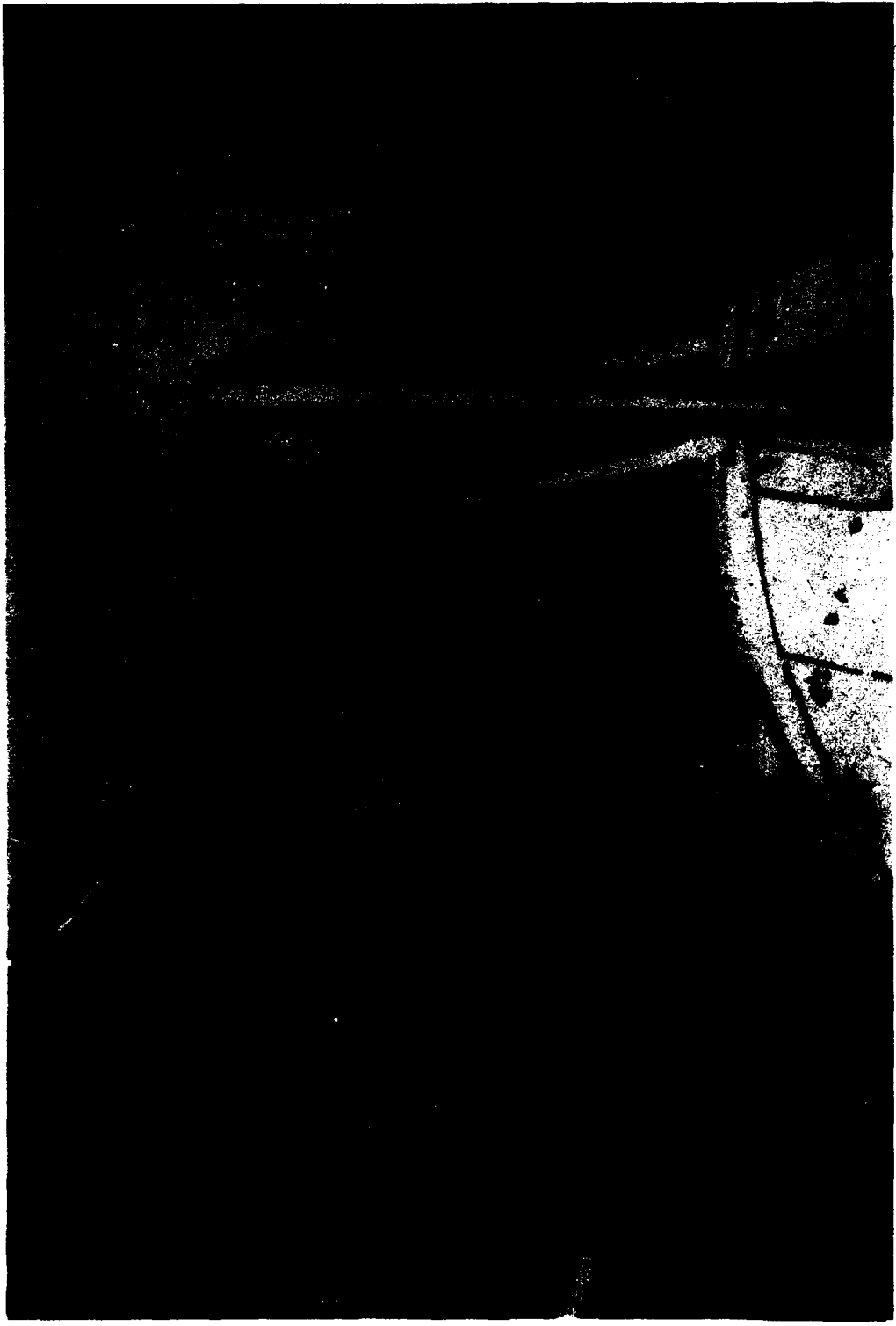

TEST NO. 1 SHOT NO. 5-0427



TEST NO. 1 SHOT NO. 5-0427



TEST NO. 1 SHOT NO. 5-0427

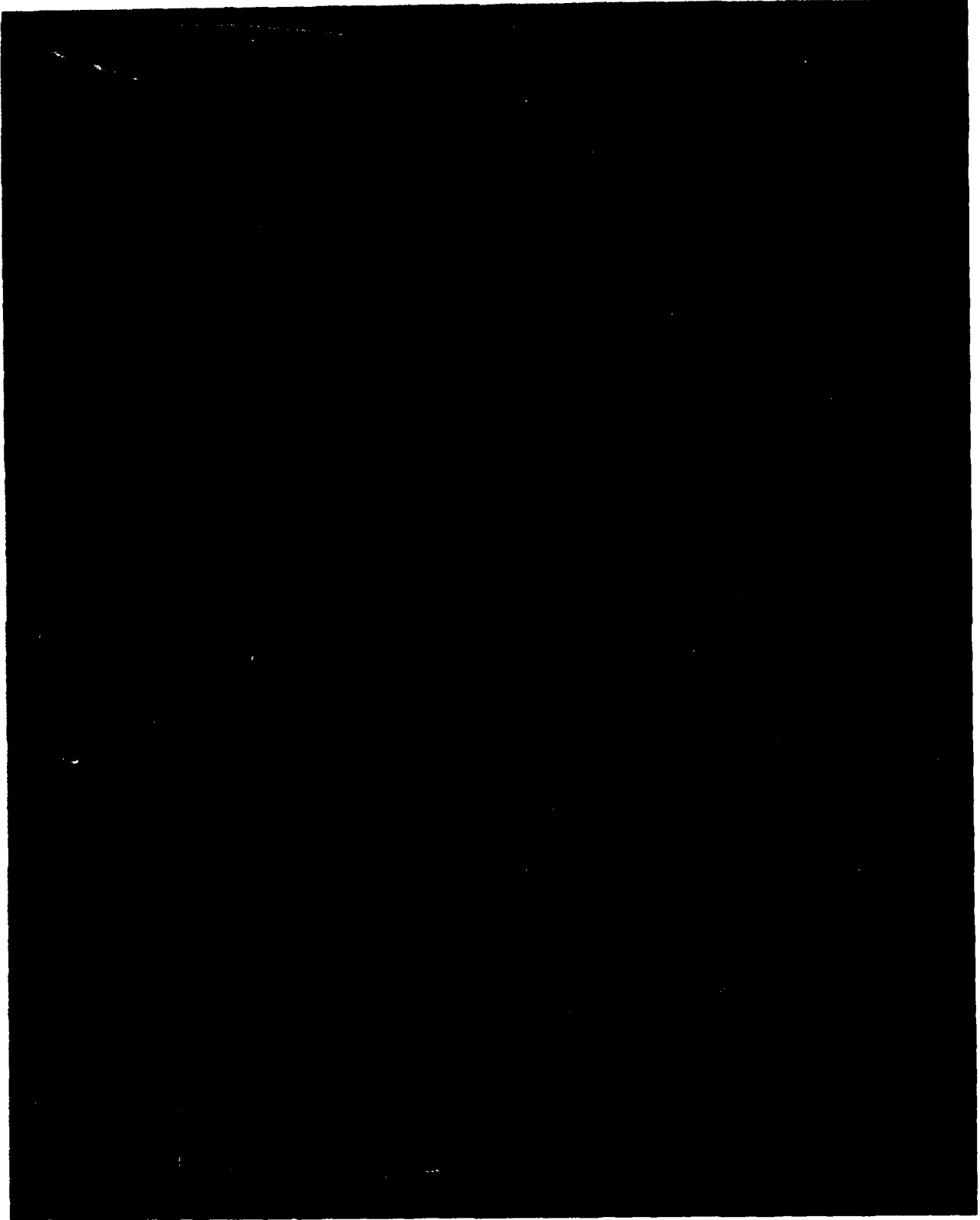

TEST NO. 1 SHOT NO. 5-0427

UDRI
F-111 RIGHT-HAND TRANSPARENCY
BIRD IMPACT TEST

TEST SUMMARY

I. BASIC TEST DATA

Date of Test 5/14/87 Test No. 2 Shot No. 5-0428
Impact Pt. _____
Planned Impact Vel. 465 kts/786 fps Actual Impact Vel. 466 kts/788 fps
Bird Wt. 4.043 lb Kinetic Energy 38,983 ft-lbs
Ambient Temperature 77°

II. TEST HARDWARE

Crew Module Ident. _____

R/H Windshield:

Manufacturer Sierracin Sequence No. 89
Serial Number 192
Date of Manufacture 8-79 Date of Installation: 9-26-79
Date of Removal 6-85 Installed age 5y 6m to 6y
Weight 50.4 lbs Weighed 49.0 at UDRI
L/H Windshield Same as Shot #1
R/H Canopy "
L/H Canopy "
Aft Arch Configuration UDRI Arch #3 Center beam #1

Fasteners:	Screws	Nuts	Washers	Torque
Aft Arch	<u>NAS 1203-17</u>			
Center Beam	<u>NAS 1204-17</u>			
Sill	<u>NAS 1204-17</u>			
Forward Arch	<u>NAS 1203-17</u>			

III. HARDWARE TEST HISTORY

Crew Module Previous Test
L/H Windshield Previous Test R/H Windshield None
L/H Canopy Previous Test R/H Canopy Previous Test
Aft Arch None
Arch Reinforcement None
Structural Damage and/or Modifications None to arch

Pertinent Fastener Substitutes None

IV. PRE-TEST OBSERVATIONS

Minor scratches on both surfaces of transparency.
Interlayer discoloration at both front corners of transparency.

V. POST-TEST OBSERVATIONS

Brittle failure - Punched hole 7" x 17"

Back of hole cracked through bolt line

Concentric polycarbonate cracks out from impact point

Large piece broke mirror and 3 lights

Bird punched hole in back of crew module directly behind the impact point

Aft arch did not get loaded - no damage.

VI. SIGNIFICANCE OF TEST

No polycarbonate ductility detectable

Failure at 466 knots.

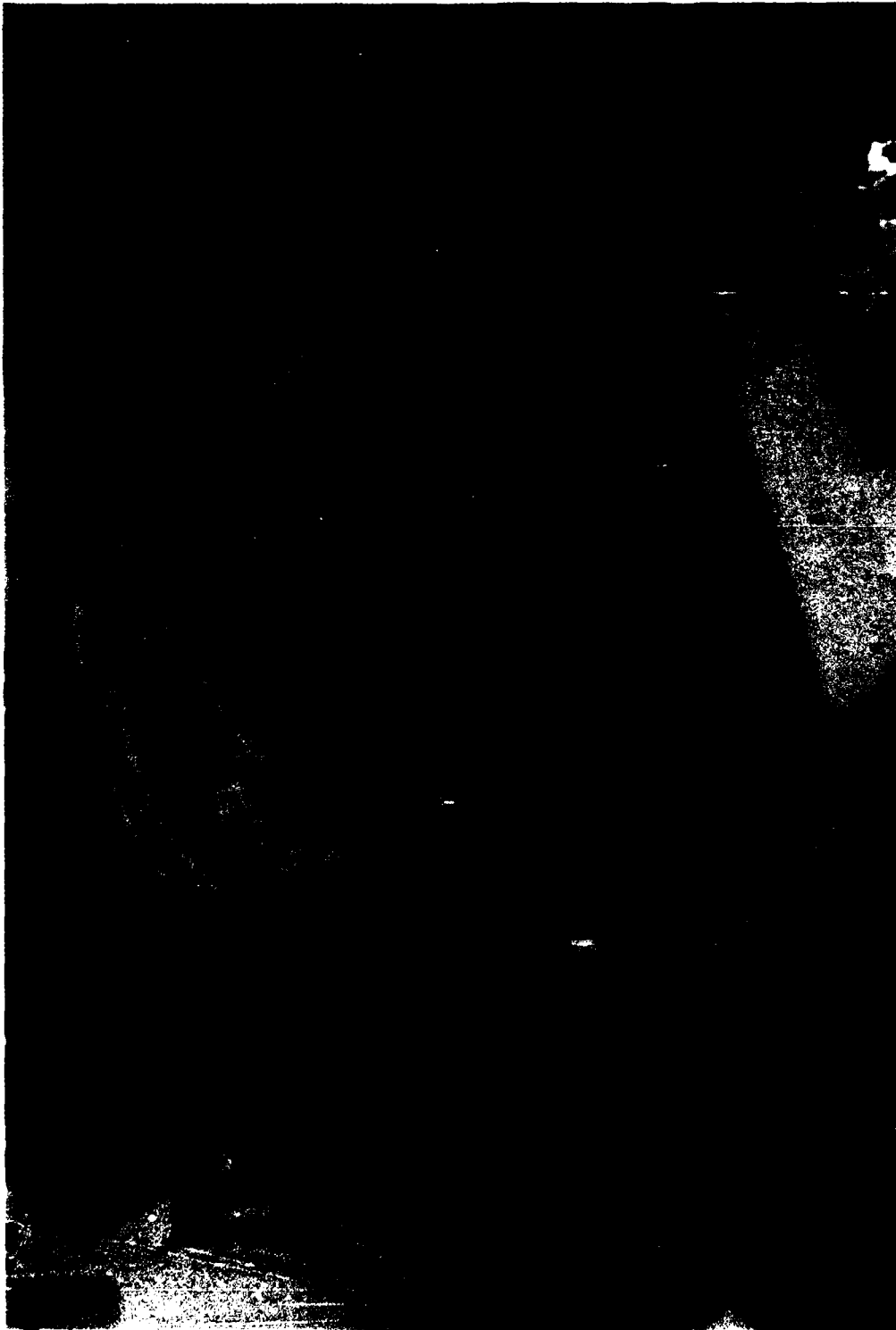

TEST NO. 2 SHOT NO. 5-0428



TEST NO. 2 SHOT NO. 5-0428

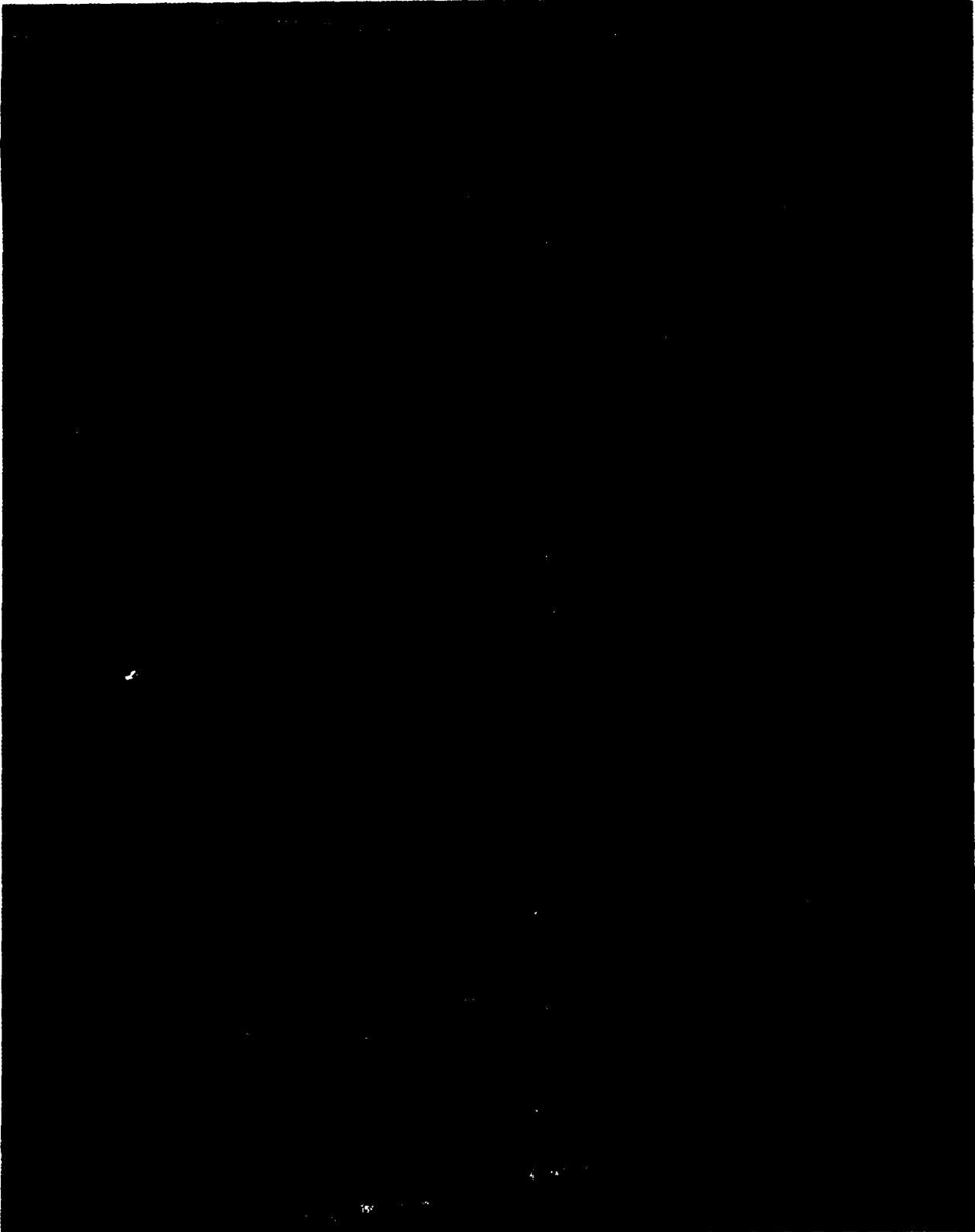

TEST NO. 2 SHOT NO. 5-0428

UDRI
F-111 RIGHT-HAND TRANSPARENCY
BIRD IMPACT TEST

TEST SUMMARY

I. BASIC TEST DATA

Date of Test 6/1/87 Test No. 3 Shot No. 5-0429
Impact Pt. _____
Planned Impact Vel. 470 kts/794 fps Actual Impact Vel. 470 kts/794 fps
Bird Wt. 4.030 lb Kinetic Energy 39,451 ft-lbs
Ambient Temperature 73°

II. TEST HARDWARE

Crew Module Ident. _____

R/H Windshield:

Manufacturer PPG Baseline #2 (new)

Serial Number _____

Date of Manufacture _____

Date of Removal _____

Weight _____

L/H Windshield _____

R/H Canopy _____

L/H Canopy _____

Aft Arch Configuration UDRI #2 (new) tapered flange design, Center Beam #1

<u>Fasteners:</u>	<u>Screws</u>	<u>Nuts</u>	<u>Washers</u>	<u>Torque</u>
-------------------	---------------	-------------	----------------	---------------

Aft Arch	<u>NAS 1203-17</u>	_____	_____	_____
----------	--------------------	-------	-------	-------

Center Beam	<u>NAS 1204-17</u>	_____	_____	_____
-------------	--------------------	-------	-------	-------

Sill	<u>NAS 1204-17</u>	_____	_____	_____
------	--------------------	-------	-------	-------

Forward Arch	<u>NAS 1203-17</u>	_____	_____	_____
--------------	--------------------	-------	-------	-------

III. HARDWARE TEST HISTORY

Crew Module Previous tests

L/H Windshield Previous tests R/H Windshield none

L/H Canopy Previous tests R/H Canopy Previous tests

Aft Arch UDRI Aft Arch #2

Arch Reinforcement _____

Structural Damage and/or Modifications Tapered design

Lower flange removed from sill to up 18". Used 5/16" grade 8 bolts at sill

and center beam connection at location where failure occurred in test #1.

Pertinent Fastener Substitutes None

IV. PRE-TEST OBSERVATIONS

Bird was six days old - slightly tougher than new one

Note forward canopy retainer strip removed from arch from bolts 7 through 16
along aft arch counting from the center beam.

V. POST-TEST OBSERVATIONS

Approximately 1" of permanent arch deformation at impact point with
crack in poly ply (inboard) between 18th and 19th bolt hole locations;
runs about 4-5" toward impact point.
Concentric acrylic ply cracks extending almost to forward arch.
Polycarbonate plies tore through bolts 10-11-12 for 3" behind
impact point.
Films indicate that the bird may have been slightly yawed toward the
centerline of the module and slightly tail high.

VI. SIGNIFICANCE OF TEST

Torsional stiffness and forward flange stiffness larger than production
and causing increased edge attachment loading.
Pass at 470 knots.
Unless windshield was degraded, this is the system capability.
Arch modifications satisfactory.



TEST NO. 3 SHOT NO. 5-0429

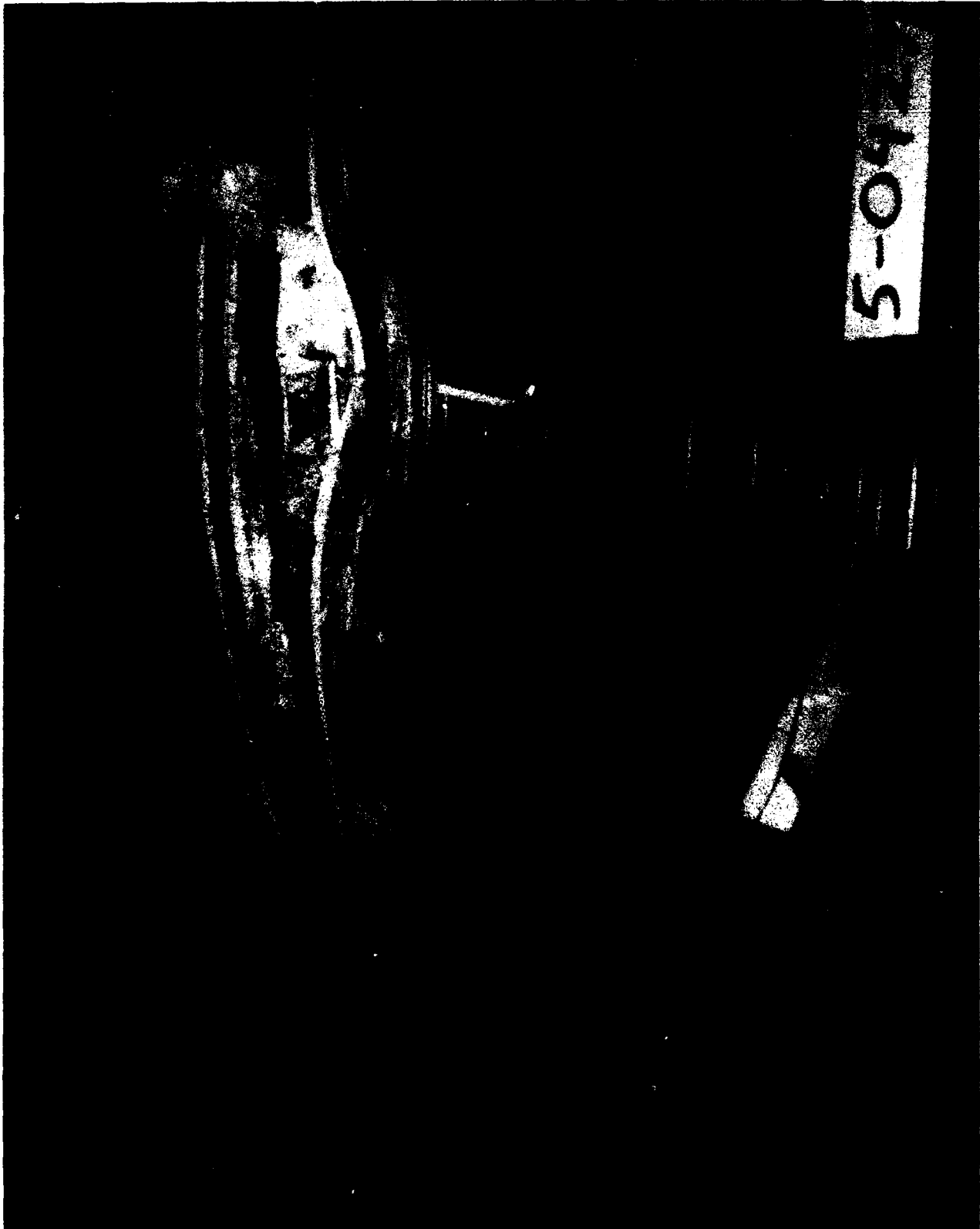

TEST NO. 3 SHOT NO. 5-0429



TEST NO. 3 SHOT NO. 5-0429

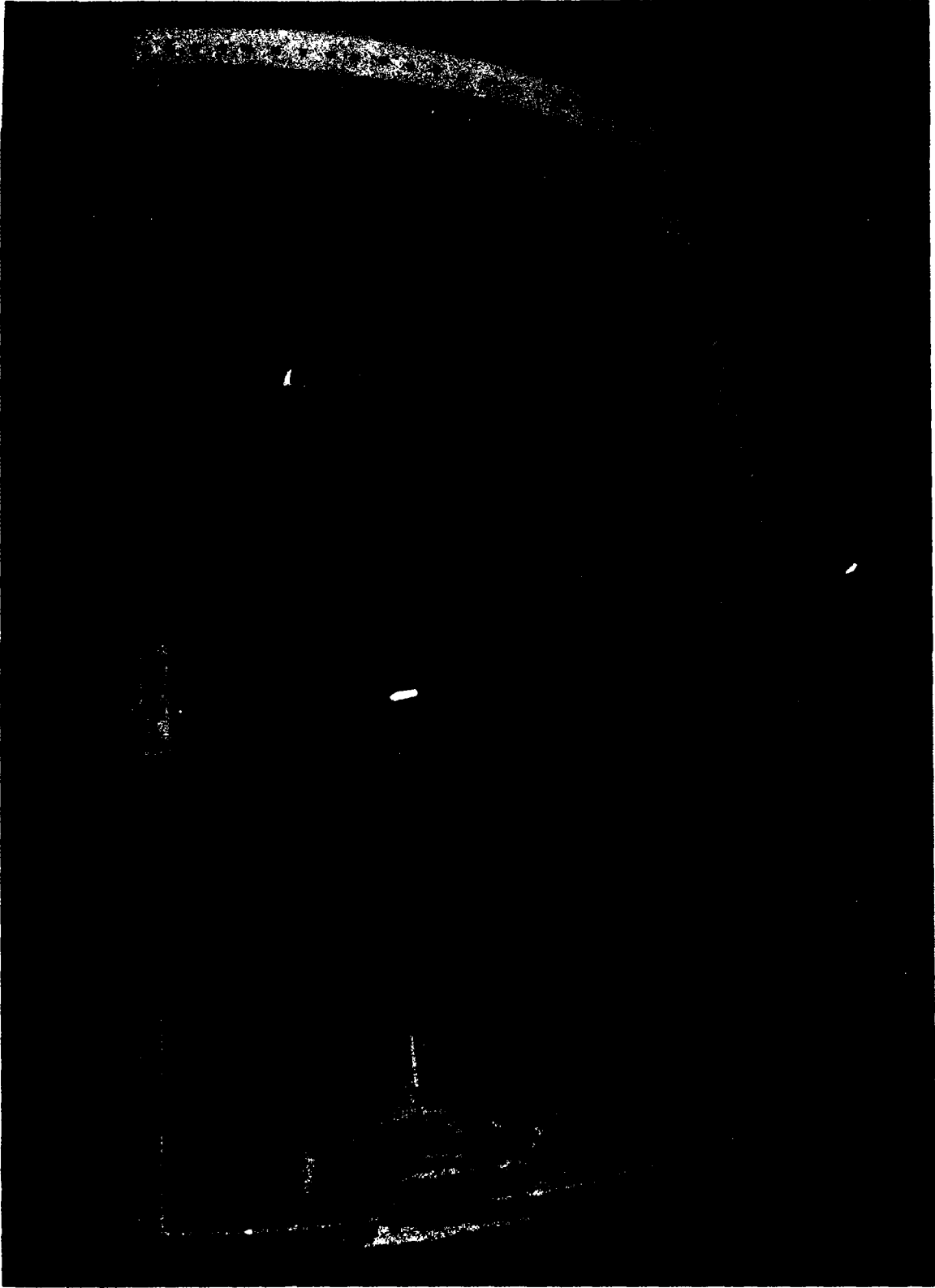

TEST NO. 3, SHOT NO. 5-0429

UDRI
F-111 RIGHT-HAND TRANSPARENCY
BIRD IMPACT TEST

TEST SUMMARY

I. BASIC TEST DATA

Date of Test 6-4-87 Test No. 4 Shot No. 5-0430
Impact Pt. _____
Planned Impact Vel. 390 kts/659 fps Actual Impact Vel. 402 kts/679 fps
Bird Wt. 4.045 lb. Kinetic Energy 28,958 ft-lbs
Ambient Temperature 72°

II. TEST HARDWARE

Crew Module Ident. _____

R/H Windshield:

Manufacturer Sierracin Sequence No. 135

Serial Number 102

Date of Manufacture 6/79 Date of Installation: 5-6-80

Date of Removal 10/25/83 Installed Age: 3y 5m

Weight 49.5 lbs. Weighed at 47 lb 10 oz at UDRI

L/H Windshield _____

R/H Canopy _____

L/H Canopy _____

Aft Arch Configuration UDRI #3 Modified - Center Beam #1

Fasteners:	Screws	Nuts	Washers	Torque
Aft Arch	<u>NAS 1203-17</u>			
Center Beam	<u>NAS 1204-17</u>			
Sill	<u>NAS 1204-17</u>			
Forward Arch	<u>NAS 1203-17</u>			

III. HARDWARE TEST HISTORY

Crew Module Previous testing

L/H Windshield Previous testing R/H Windshield none

L/H Canopy Previous Testing R/H Canopy Previous Testing

Aft Arch Used in 2nd shot - undamaged, then modified

Arch Reinforcement _____

Structural Damage and/or Modifications _____

Pertinent Fastener Substitutes None

IV. PRE-TEST OBSERVATIONS

Note difference in weight

Some interior and exterior scratches

Interlayer discolored at forward starboard corner

Small delamination poly-poly ply at aft arch from bolts 5-7 2 1/2" x 1/4"

No nut on first fastener (from center beam) in aft arch. First fastener

in center beam (from aft arch) not in place.

V. POST-TEST OBSERVATIONS

Brittle failure - large flap folded over and sprung back, interior
poly ply spalled off $\approx 5" \times 14"$
Remaining hole 3" square at bolts 8-10.
No damage to bolts at impact location.
No damage to arch.
Minor acrylic cracking
Several long poly cracks in both plies

VI. SIGNIFICANCE OF TEST

Failure at 402 knots
Threshold below 400 knots



TEST NO. 4 SHOT NO. 5-0430



TEST NO. 4 SHOT NO. 5-0430

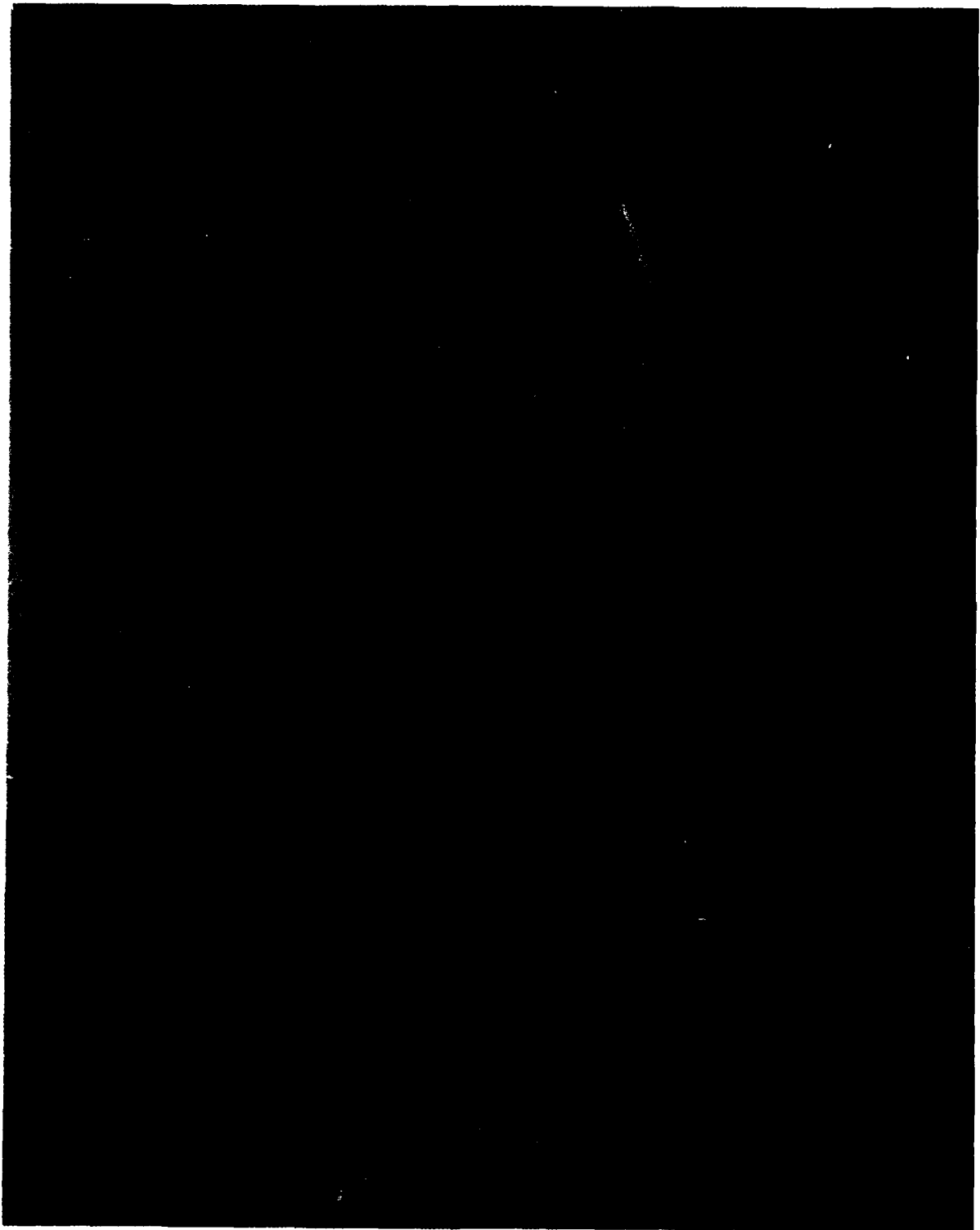

TEST NO. 4 SHOT NO. 5-0430

UDRI
F-111 RIGHT-HAND TRANSPARENCY
BIRD IMPACT TEST

TEST SUMMARY

I. BASIC TEST DATA

Date of Test 6/8/87 Test No. 5 Shot No. 5-0431
Impact Pt. _____
Planned Impact Vel. 310 kts/524 fps Actual Impact Vel. 297 kts/502 fps
Bird Wt. 4.022 lb Kinetic Energy 15,739 ft-lbs
Ambient Temperature 70°

II. TEST HARDWARE

Crew Module Ident. _____

R/H Windshield:

Manufacturer Sierracin Seq. No. 632
Serial Number 200
Date of Manufacture 9-79 Date of Installation: 1-21-81
Date of Removal 7-24-86 Installed Age 5y 6m
Weight 50 lb Weighed 49 lb. 11 oz at UDRI
L/H Windshield _____
R/H Canopy _____
L/H Canopy _____
Aft Arch Configuration UDRI #3 Modified Center Beam #1

<u>Fasteners:</u>	<u>Screws</u>	<u>Nuts</u>	<u>Washers</u>	<u>Torque</u>
Aft Arch	<u>NAS 1203-17</u>			
Center Beam	<u>NAS 1204-17</u>			
Sill	<u>NAS 1204-17</u>			
Forward Arch	<u>NAS 1203-19</u>			

III. HARDWARE TEST HISTORY

Crew Module Previous Testing
L/H Windshield Previous Testing R/H Windshield None
L/H Canopy Previous Testing R/H Canopy Previous Testing
Aft Arch Shots 2 and 4
Arch Reinforcement None
Structural Damage and/or Modifications None

Pertinent Fastener Substitutes Switched to NAS 1203-19 at front sill
(because of NAS 1203-17 shortage)

IV. PRE-TEST OBSERVATIONS

RTV stop missing at forward edge of windshield. Acrylic chipped up and
missing in places on front sill. Minor scratches. Overall, excepting
the front sill, window does not look too bad.
No nut on first fastener forward of aft arch in center beam.

V. POST-TEST OBSERVATIONS

Minor surface acrylic cracks.

Bird 90% intact after test.

No permanent deformation of the windshield.

Bolts 8-14 on the aft arch elongated; windshield returned to original shape.

Film indicates bird attitude was tail down - windshield deflected a fair amount in the film - arch possibly 1/2".

VI. SIGNIFICANCE OF TEST

Pass at 297 knots - windshield still in elastic range.



TEST NO. 5 SHOT NO. 5-0431

B-26



TEST NO. 5 SHOT NO. 5-0431

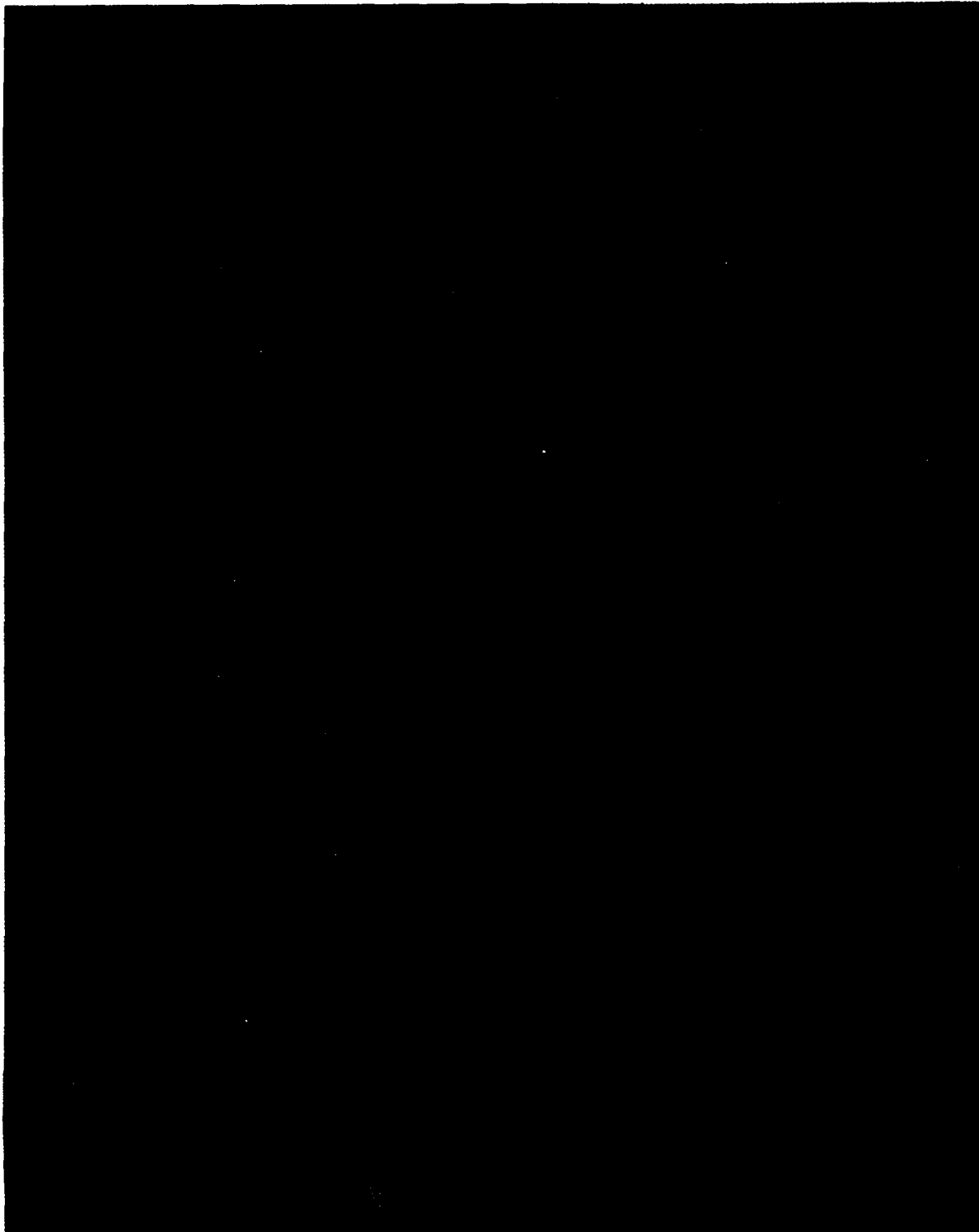

TEST NO. 7 SHOT NO. 5-0433

UDRI
F-111 RIGHT-HAND TRANSPARENCY
BIRD IMPACT TEST

TEST SUMMARY

I. BASIC TEST DATA

Date of Test 6/9/87 Test No. 6 Shot No. 5-0432
Impact Pt. _____
Planned Impact Vel. 350 kts/592 fps Actual Impact Vel. 354 kts/598 fps
Bird Wt. 3.992 lb Kinetic Energy 22,167 ft-lbs
Ambient Temperature 68°

II. TEST HARDWARE

Crew Module Ident. _____

R/H Windshield:

Manufacturer Sierracin Seq. No. 632 Same as Test No. 5
Serial Number 200
Date of Manufacture _____
Date of Removal _____
Weight _____
L/H Windshield _____
R/H Canopy _____
L/H Canopy _____
Aft Arch Configuration UDRI #3 Center Beam #1

<u>Fasteners:</u>	<u>Screws</u>	<u>Nuts</u>	<u>Washers</u>	<u>Torque</u>
Aft Arch	<u>NAS 1203-17</u>			
Center Beam	<u>NAS 1204-17</u>			
Sill	<u>NAS 1204-17</u>			
Forward Arch	<u>NAS 1203-19</u>			

III. HARDWARE TEST HISTORY

Crew Module Previous Testing
L/H Windshield Previous Teting R/H Windshield Test No. 5
L/H Canopy Previous Teting R/H Canopy Previous Testing
Aft Arch Shots 2, 4 and 5
Arch Reinforcement _____
Structural Damage and/or Modifications Screws 8-14 on aft arch
elongated by Shot #5
Pertinent Fastener Substitutes None

IV. PRE-TEST OBSERVATIONS

Note post-test observations, Test #5

V. POST-TEST OBSERVATIONS

Extensive poly and acrylic cracking

One large chunk of bird in cockpit (10-20%)

Film showed that large flap opened up, then closed.

No visible damage to the arch

VI. SIGNIFICANCE OF TEST

Windshield failure at 354 kts

Capability between 300 and 354 kts

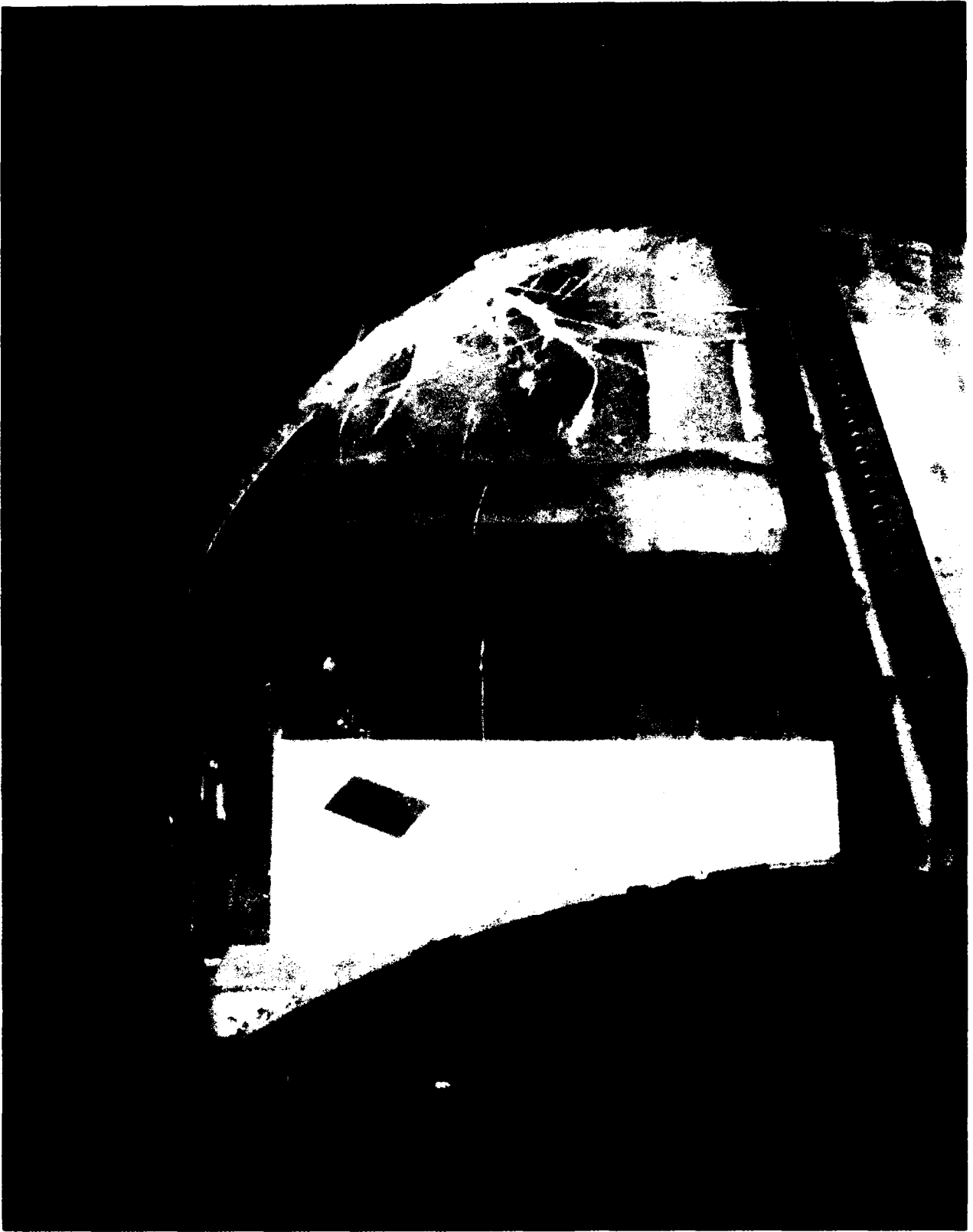

TEST NO. 6, SHOT NO. 5-0432

B-31

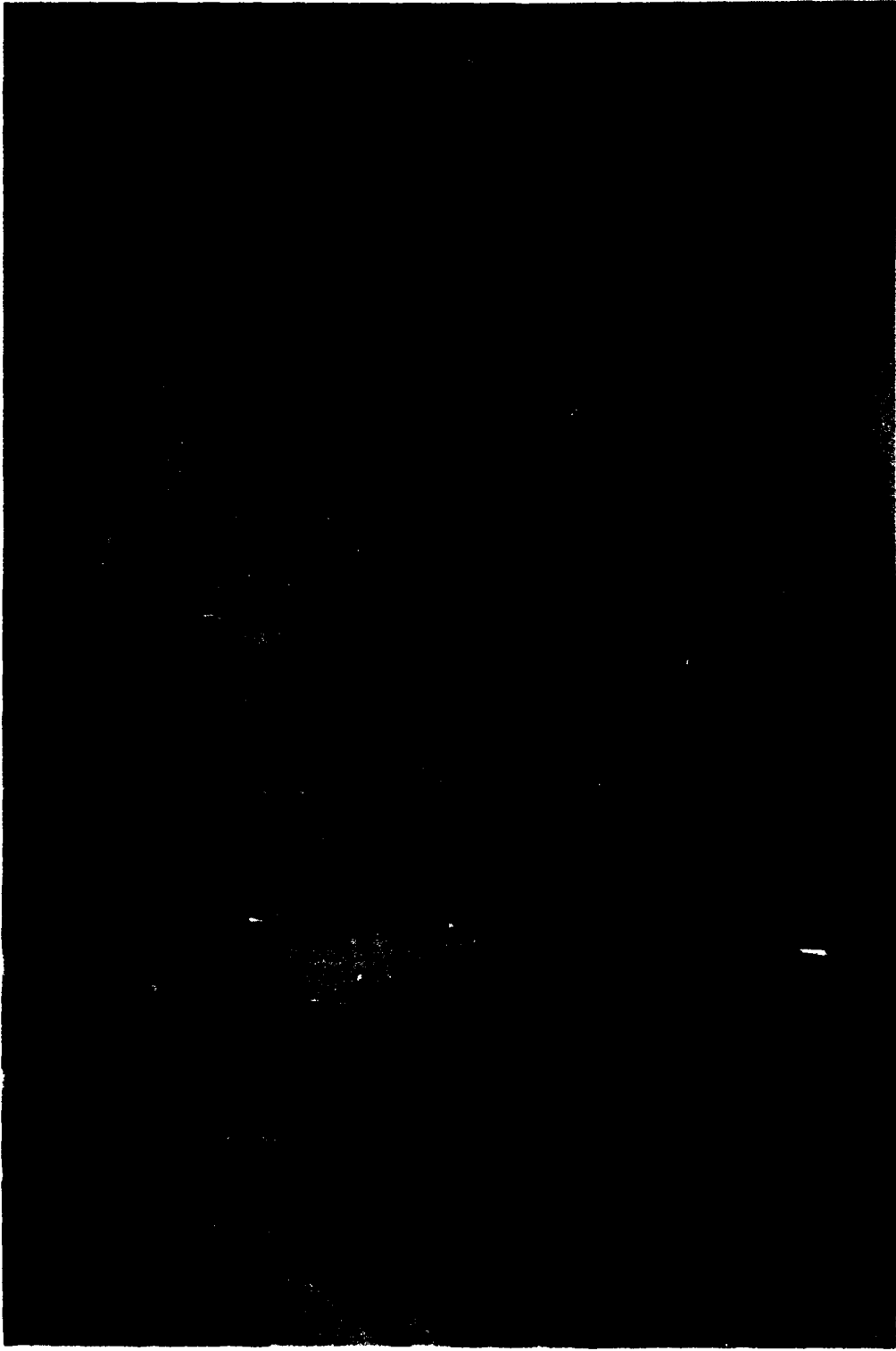

TEST NO. 6 SHOT NO. 5-0432

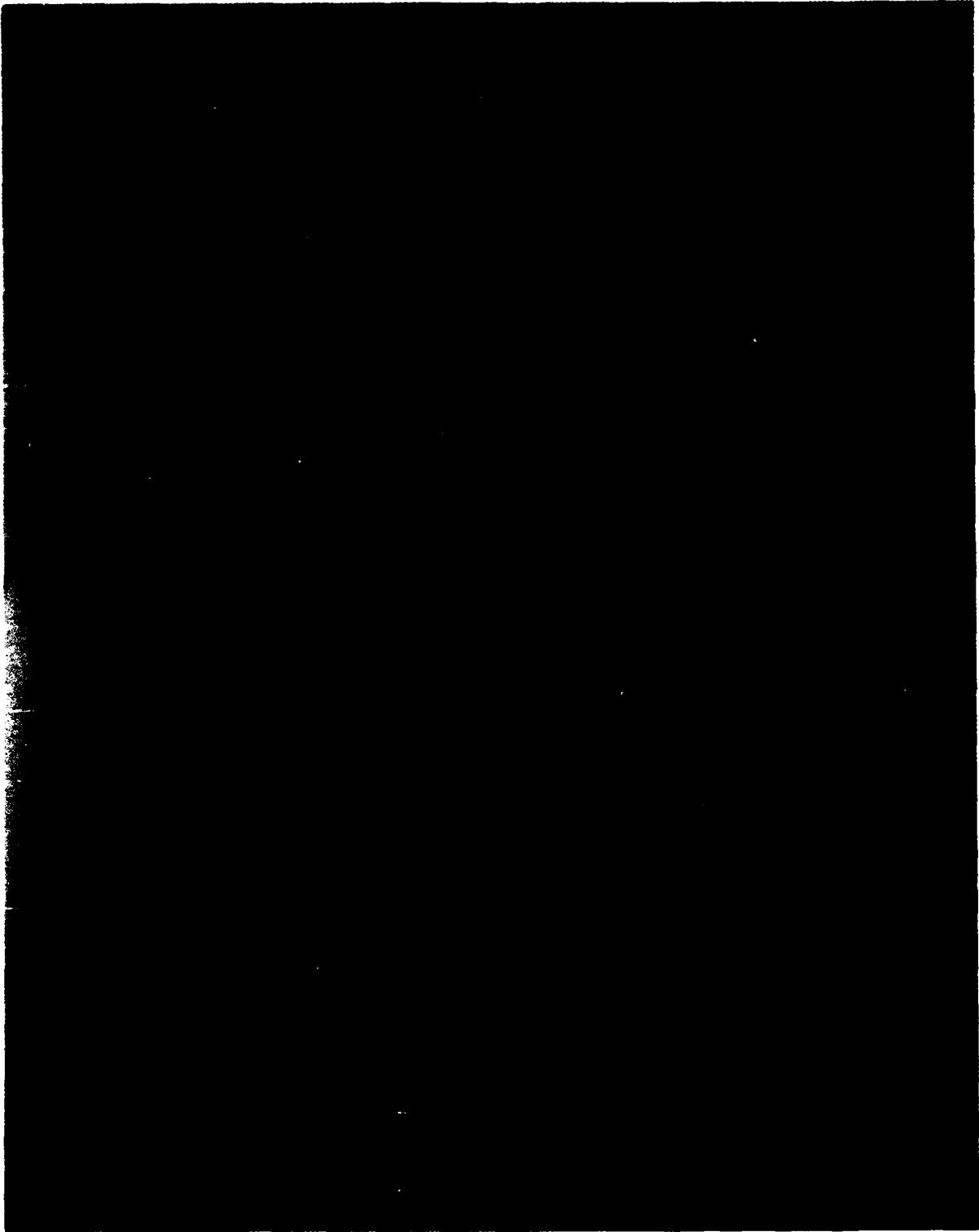

TEST NOS. 5 & 6 SHOT NOS. 5-0431 AND 5-0432

UDRI
F-111 RIGHT-HAND TRANSPARENCY
BIRD IMPACT TEST

TEST SUMMARY

I. BASIC TEST DATA

Date of Test 6/11/87 Test No. 7 Shot No. 5-0433
Impact Pt. _____
Planned Impact Vel. 350 kts/592 fps Actual Impact Vel. 358 kts/604 fps
Bird Wt. 3.986 lb Kinetic Energy 22,500 ft-lbs
Ambient Temperature 68°

II. TEST HARDWARE

Crew Module Ident. _____

R/H Windshield:

Manufacturer Sierracin Seq. #22
Serial Number 132
Date of Manufacture 5-79 Date of Installation: 5-18-82
Date of Removal 8-85 Installed Age 3y 3m
Weight 50.7 lb Weighed 49 lb. at UDRI
L/H Windshield _____
R/H Canopy _____
L/H Canopy _____
Aft Arch Configuration UDRI #5 Center Beam #3

<u>Fasteners:</u>	<u>Screws</u>	<u>Nuts</u>	<u>Washers</u>	<u>Torque</u>
<u>Aft Arch</u>	<u>NAS 1203-17</u>			
<u>Center Beam</u>	<u>NAS 1204-15</u>			
<u>Sill</u>	<u>NAS 1204-15</u>			
<u>Forward Arch</u>	<u>NAS 1203-15</u>			

III. HARDWARE TEST HISTORY

Crew Module Previous Testing
L/H Windshield Previous Testing R/H Windshield None
L/H Canopy Previous Testing R/H Canopy Previous Testing
Aft Arch None - center beam also has no test history
Arch Reinforcement _____
Structural Damage and/or Modifications -

Pertinent Fastener Substitutes Note change of fasteners at center beam, sill, and forward arch to reduce number of washers required

IV. PRE-TEST OBSERVATIONS

Minor interior and exterior scratches. Interlayer discolored at forward starboard corner.
Dot crazing evident in post-test lighting on most of windshield surface.

V. POST-TEST OBSERVATIONS

Note sketch - extensive cracking and large flap (from bolts 5-19 along aft arch) opened up allowing bird penetration along aft arch.

Some polycarbonate spalled off both plies.

Minimal bolt damage behind impact.

Film indicates 10% of bird penetrated.

VI. SIGNIFICANCE OF TEST

Failure at 358 knots.



TEST NO. 7, SHOT NO. 5-0433

B-36



TEST NO. 7 SHOT NO. 5-0433



TEST NO. 7, SHOT NO. 5-0433

UDRI
F-111 RIGHT-HAND TRANSPARENCY
BIRD IMPACT TEST

TEST SUMMARY

I. BASIC TEST DATA

Date of Test 6/15/87 Test No. 8 Shot No. 5-0434
Impact Pt. _____
Planned Impact Vel. 350 kts/592 fps Actual Impact Vel. 355 kts/600 fps
Bird Wt. 3.970 lb. Kinetic Energy 22,193 ft-lbs
Ambient Temperature 68°

II. TEST HARDWARE

Crew Module Ident. _____

R/H Windshield:

Manufacturer PPG 16-087 Seq. #528
Serial Number 16-087
Date of Manufacture 8/8/80 Date of Installation: 4/24/82
Date of Removal 7/25/85 Installed Age 3y 2m
Weight 48.0 lb Weighed 48 lb 4 oz at UD (extra wt. possibly sealant)
L/H Windshield _____
R/H Canopy _____
L/H Canopy _____
Aft Arch Configuration UDRI #5 Center Beam #3

Fasteners:	Screws	Nuts	Washers	Torque
Aft Arch	<u>NAS 1203-17</u>	<u>1 washer-locknut</u>		
Center Beam	<u>NAS 1204-15</u>	<u>2 washers</u>		
Sill	<u>NAS 1204-15</u>	<u>1 washer</u>		
Forward Arch	<u>NAS 1203-15</u>	<u>3 washers</u>		

III. HARDWARE TEST HISTORY

Crew Module Previous Testing
L/H Windshield Previous Testing R/H Windshield None
L/H Canopy Previous Testing R/H Canopy Previous Testing
Aft Arch Shot #7
Arch Reinforcement _____
Structural Damage and/or Modifications None

Pertinent Fastener Substitutes First 1/4" fastener at the sill by aft arch would not fit - replaced with #10 fastener.

IV. PRE-TEST OBSERVATIONS

Windshield extremely bowed at aft arch, much more curvature than others; had to use a lot of torque on aft arch to get window in place, then torque reduced to correct values.
Windshield has surface crazes or scratches and interior scratches.
First fastener on aft arch not used.

V. POST-TEST OBSERVATIONS

Windshield failed along aft arch through bolts 7-17

Bird entered through open hole ~5% bird penetration.

Extensive acrylic cracks, some poly cracking -- starting from bolt holes

VI. SIGNIFICANCE OF TEST

Failure at 355 knots.



TEST NO. 8 SHOT NO. 5-0434

B-41



TEST NO. 8 SHOT NO. 5-0434

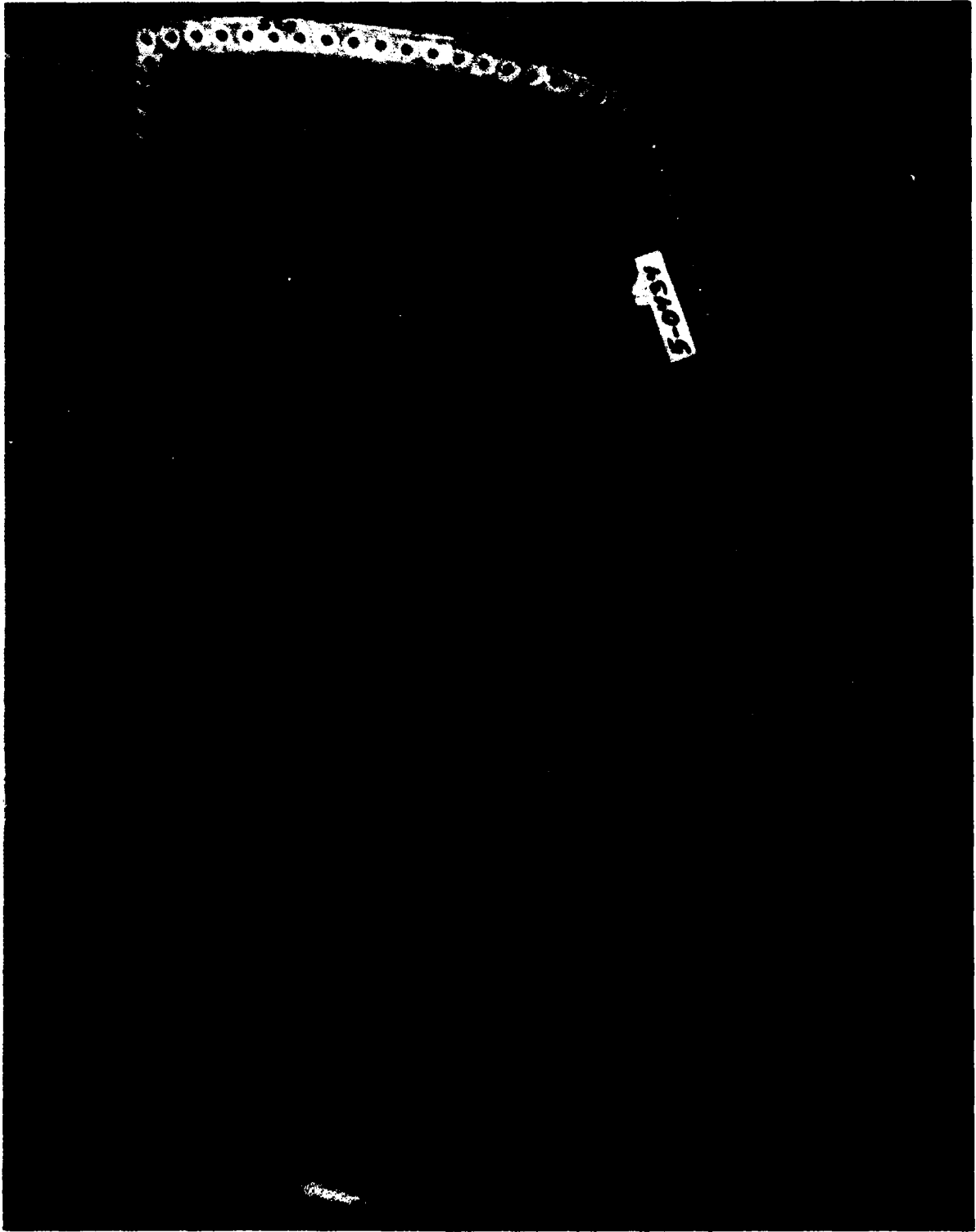

TEST NO. 8 SHOT NO. 5-0434

UDRI
F-111 RIGHT-HAND TRANSPARENCY
BIRD IMPACT TEST

TEST SUMMARY

I. BASIC TEST DATA

Date of Test 6/17/87 Test No. 9 Shot No. 5-0435
Impact Pt. _____
Planned Impact Vel. 390 kts/650 fps Actual Impact Vel. 398 kts/672 fps
Bird Wt. 4.020 lb Kinetic Energy 28,189
Ambient Temperature 68°

II. TEST HARDWARE

Crew Module Ident. _____

R/H Windshield:

Manufacturer PPG Seq. #144
Serial Number 16-660
Date of Manufacture 7-22-83 Date of Installation: 12-15-83
Date of Removal 9-17-85 Installed Age ly 9m
Weight 47.6 lb Weighed 48.0 lb at UDRI
L/H Windshield _____
R/H Canopy _____
L/H Canopy _____
Aft Arch Configuration UDRI #5 Center Beam #3

Fasteners:	Screws	Nuts	Washers	Torque
Aft Arch	<u>NAS 1203-17</u>			
Center Beam	<u>NAS 1204-15</u>			
Sill	<u>NAS 1204-15</u>			
Forward Arch	<u>NAS 1203-15</u>			

III. HARDWARE TEST HISTORY

Crew Module Previous Testing
L/H Windshield Previous Testing R/H Windshield None
L/H Canopy Previous Testing R/H Canopy Previous Testing
Aft Arch Shots #7 and #8
Arch Reinforcement _____
Structural Damage and/or Modifications _____

Pertinent Fastener Substitutes None

IV. PRE-TEST OBSERVATIONS

Interior of windshield looks like someone tried to scrape off coating.
Interior coating is verly cloudy and white-looking.
Some interior and exterior scratches. Delamination at aft arch for
bolts 17-22 (counting from center beam) between inner ply and retainer.
Several small delaminations along forward arch between acrylic and
poly ply.

V. POST-TEST OBSERVATIONS

Windshield tore through bolt holes from the second bolt hole, all the way down to just short of the sill.

Extensive acrylic cracking, several poly cracks

One pound of bird was removed from cockpit \approx 25%

Aft arch was slightly bent out of plane.

Center arch to cover beam connection bolt 1/4" failed (possibly stripped by technician).

VI. SIGNIFICANCE OF TEST

Failure at 398 knots.

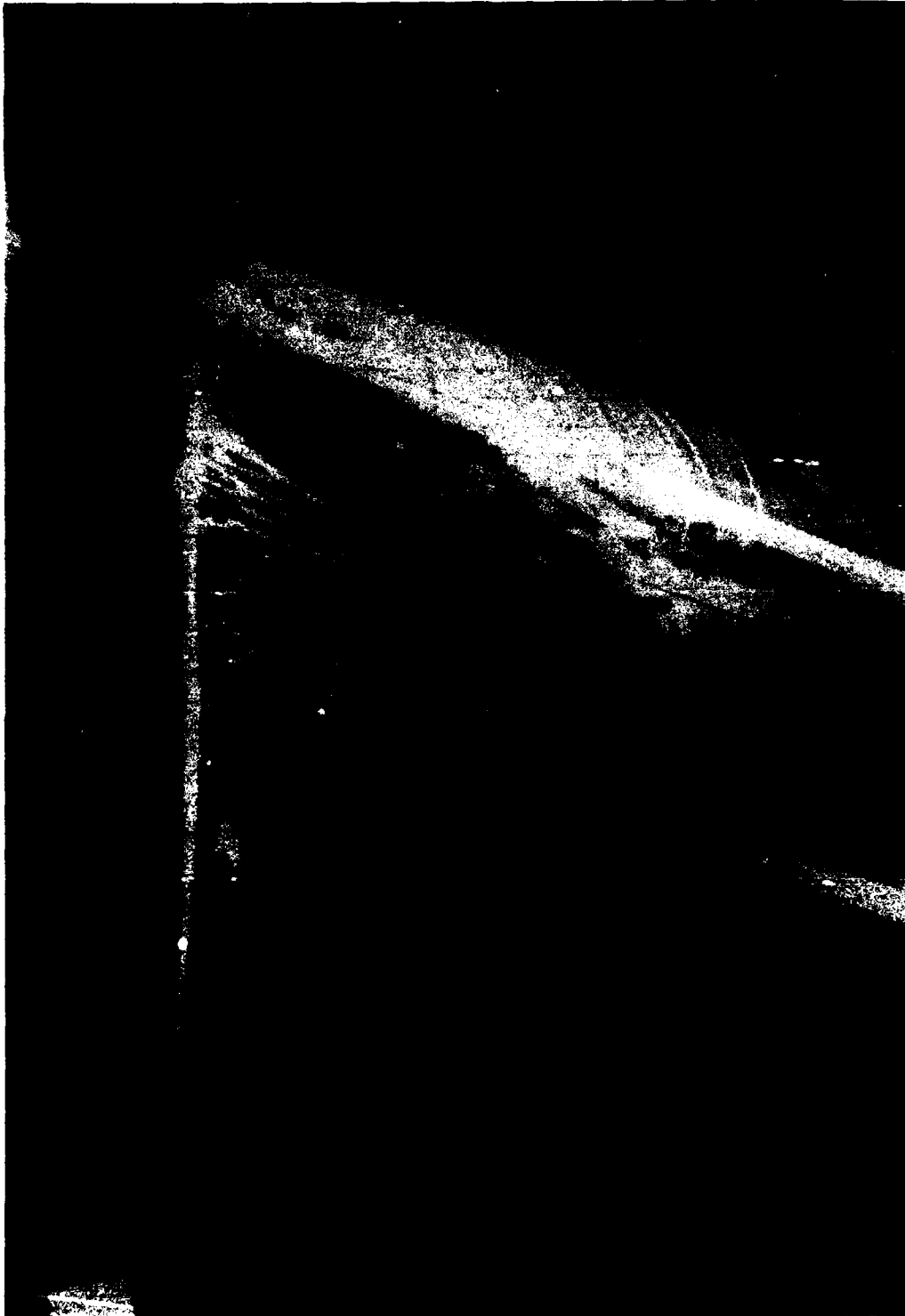

TEST NO. 9 SHOT NO. 5-0435

B-46



TEST NO. 9, SHOT NO. 5-0435

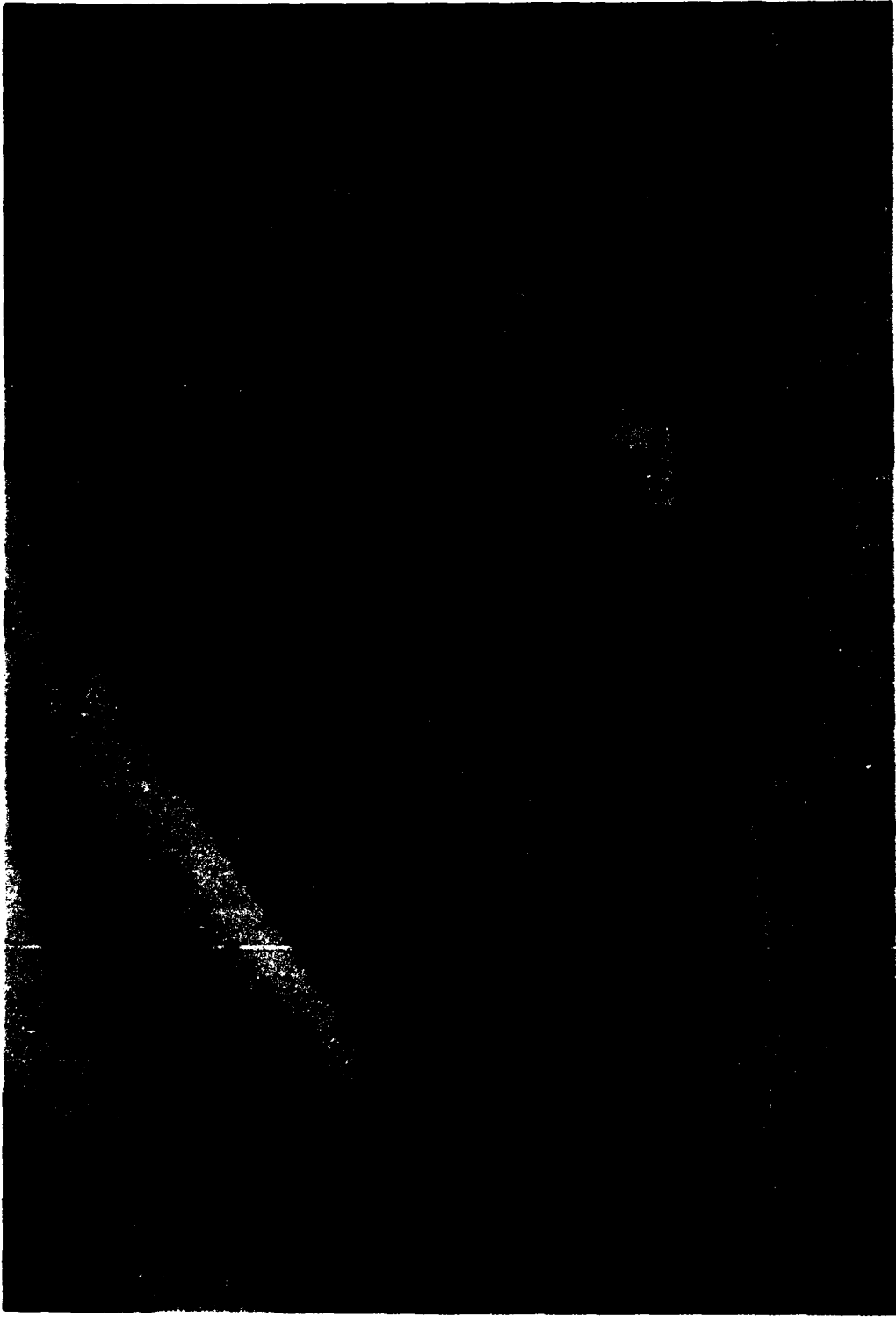

TEST NO. 9 SHOT NO. 5-0435

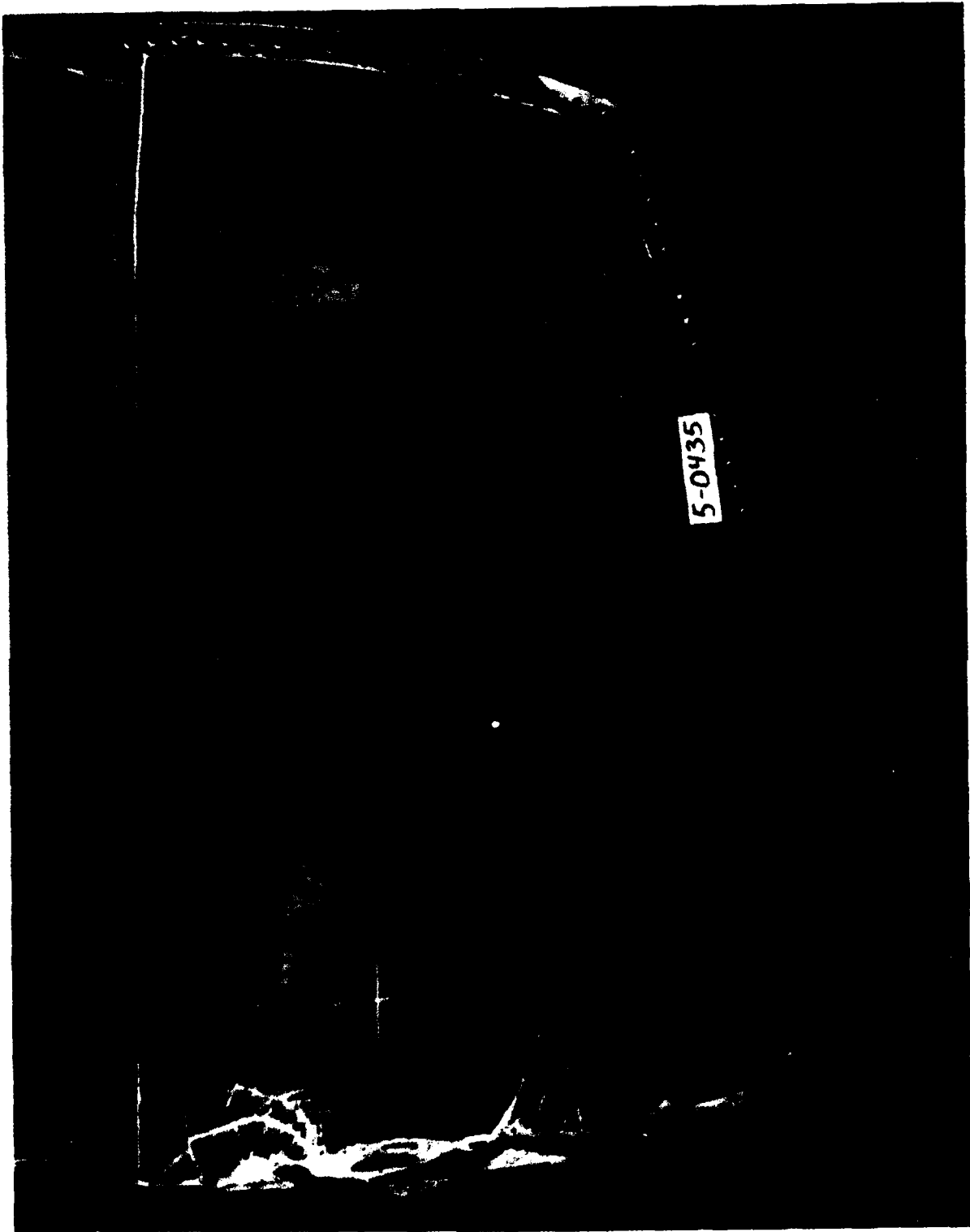

TEST NO. 9 SHOT NO. 5-0435

UDRI
F-111 RIGHT-HAND TRANSPARENCY
BIRD IMPACT TEST

TEST SUMMARY

I. BASIC TEST DATA

Date of Test 6/18/87 Test No. 10 Shot No. 5-0436
Impact Pt. _____
Planned Impact Vel. 350 kts/591 fps Actual Impact Vel. 350 kts/591 fps
Bird Wt. 4.006 lb Kinetic Energy 21,727 ft-lbs
Ambient Temperature 68°

II. TEST HARDWARE

Crew Module Ident. _____

R/H Windshield:

Manufacturer Sierracin Seq. #143
Serial Number 514
Date of Manufacture 4-82 Date of Installation: 8-30-82
Date of Removal 3-15-84 Installed Age ly 6m
Weight 48.4 lb Weighed 48 lb 4 oz at UDRI
L/H Windshield _____
R/H Canopy _____
L/H Canopy _____
Aft Arch Configuration UDRI #6 Center beam #3

<u>Fasteners:</u>	<u>Screws</u>	<u>Nuts</u>	<u>Washers</u>	<u>Torque</u>
Aft Arch	<u>NAS 1203-17</u>			
Center Beam	<u>NAS 1204-15</u>			
Sill	<u>NAS 1204-15</u>			
Forward Arch	<u>NAS 1203-15</u>			

III. HARDWARE TEST HISTORY

Crew Module Previous Testing
L/H Windshield Previous Testing R/H Windshield None
L/H Canopy Previous Testing R/H Canopy Previous Testing
Aft Arch None
Arch Reinforcement _____
Structural Damage and/or Modifications -

Pertinent Fastener Substitutes Two NAS 1203-15 used on aft arch

IV. PRE-TEST OBSERVATIONS

Many interior poly scratches. Minor exterior scratches plus crazing.
One small acrylic crack at front sill.

V. POST-TEST OBSERVATIONS

Minor acrylic cracking.

Aft arch slightly bowed down and forward flange slightly bent over.

Bolts 7-14 elongated.

Forward arch flange tore along root from 5-1/2" to 16"

From films--bird yawed toward center beam 15°

One small handful of bird squeezed between arch and center beam.

VI. SIGNIFICANCE OF TEST

Pass at 350 kts.

Windshield still in elastic range.

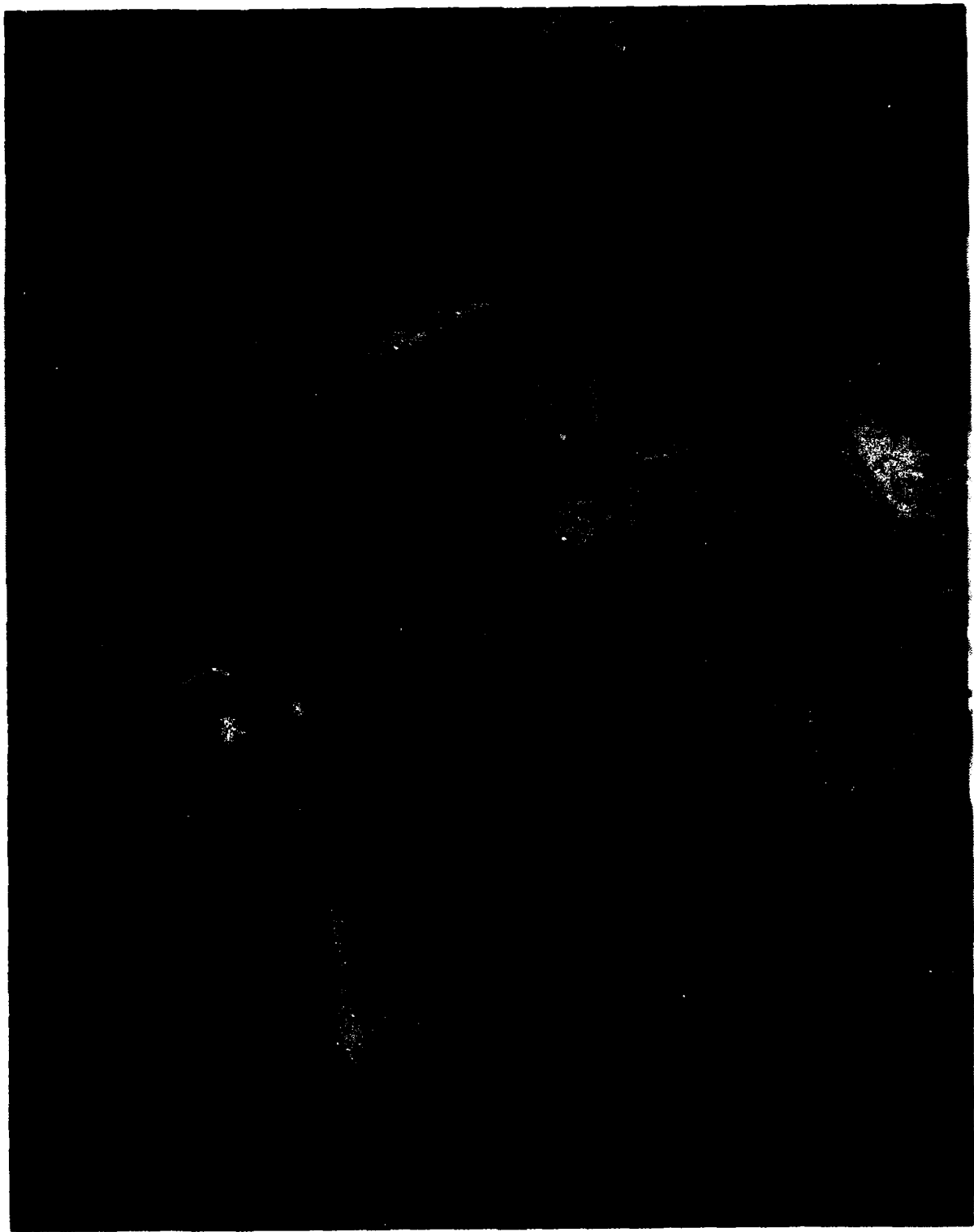

TEST NO. 10 SHOT NO. 5-0436

B-52



TEST NO. 10, SHOT NO. 5-0436



TEST NO. 10, SHOT NO. 5-0436

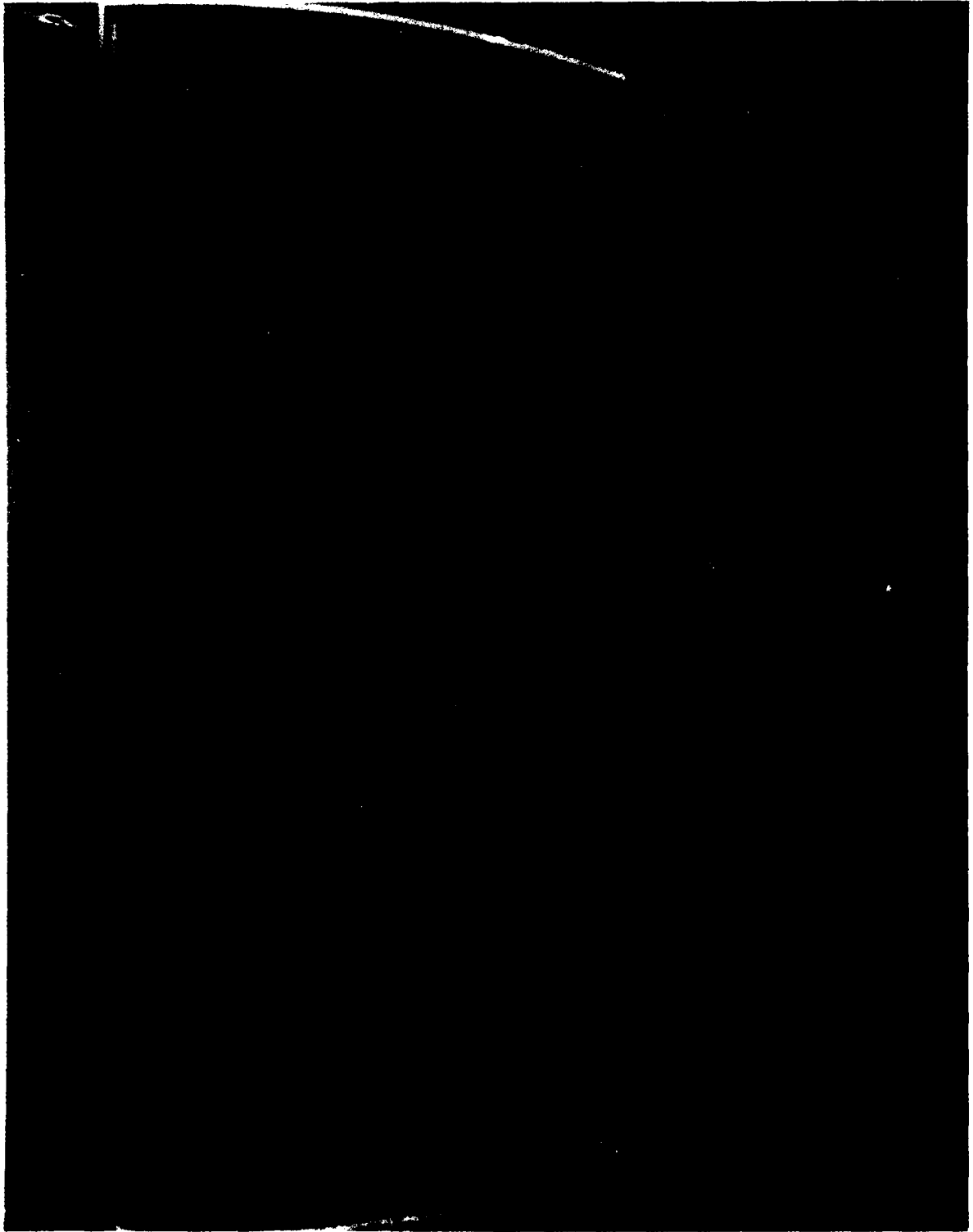

TEST NO. 10 SHOT NO. 5-0436

UDRI
F-111 RIGHT-HAND TRANSPARENCY
BIRD IMPACT TEST

TEST SUMMARY

I. BASIC TEST DATA

Date of Test 6/24/87 Test No. 11 Shot No. 5-0437
Impact Pt. _____
Planned Impact Vel. 430 kts/727 fps Actual Impact Vel. 433 kts/732 fps
Bird Wt. 4.008 lb Kinetic Energy 33,348 ft-lbs
Ambient Temperature 68°

II. TEST HARDWARE

Crew Module Ident. _____

R/H Windshield:

Manufacturer Sierracin Seq. #558
Serial Number 092
Date of Manufacture 7/84 Date of Installation: 8-7-85
Date of Removal 2/7/86 Installed Age 6m
Weight 50.5 lb Weighed 50 lb 8.5 oz at UDRI
L/H Windshield _____
R/H Canopy _____
L/H Canopy _____
Aft Arch Configuration UDRI #5 Center Beam #3

<u>Fasteners:</u>	<u>Screws</u>	<u>Nuts</u>	<u>Washers</u>	<u>Torque</u>
Aft Arch	<u>NAS 1203-17</u>			
Center Beam	<u>NAS 1204-15</u>			
Sill	<u>NAS 1204-15</u>			
Forward Arch	<u>NAS 1203-17</u>			

III. HARDWARE TEST HISTORY

Crew Module Previous Testing
L/H Windshield Previous Testing R/H Windshield None
L/H Canopy Previous Testing R/H Canopy Previous Testing
Aft Arch Shots 7, 8 and 9
Arch Reinforcement _____
Structural Damage and/or Modifications Forward sill damage;
16 clip angles installed with one continuous strip for reinforcement.
Pertinent Fastener Substitutes _____

IV. PRE-TEST OBSERVATIONS

Windshield looks to be in good condition.
Some minor scratches.

V. POST-TEST OBSERVATIONS

Bolts 5-18 sheared at the aft arch.

Fastax camera did not run.

8" of windshield stuck under aft arch flange at impact point.

Minor acrylic cracking. Some middle poly ply cracking.

No bird penetration visible in film, except possibly very small spray
apparent in side camera shot.

Aft arch deformed out of plane.

VI. SIGNIFICANCE OF TEST

Edge attachment much stronger on the Sierracin part - caused bolt shear
failure behind impact point.

Polycarbonate appears to be fairly good.

Bolt shear failure caused by the stiffer UDRI aft arch.

Pass at 433 knots.



TEST NO. 11 SHOT NO. 5-0437



TEST NO. 11 SHOT NO. 5-0437

B-59

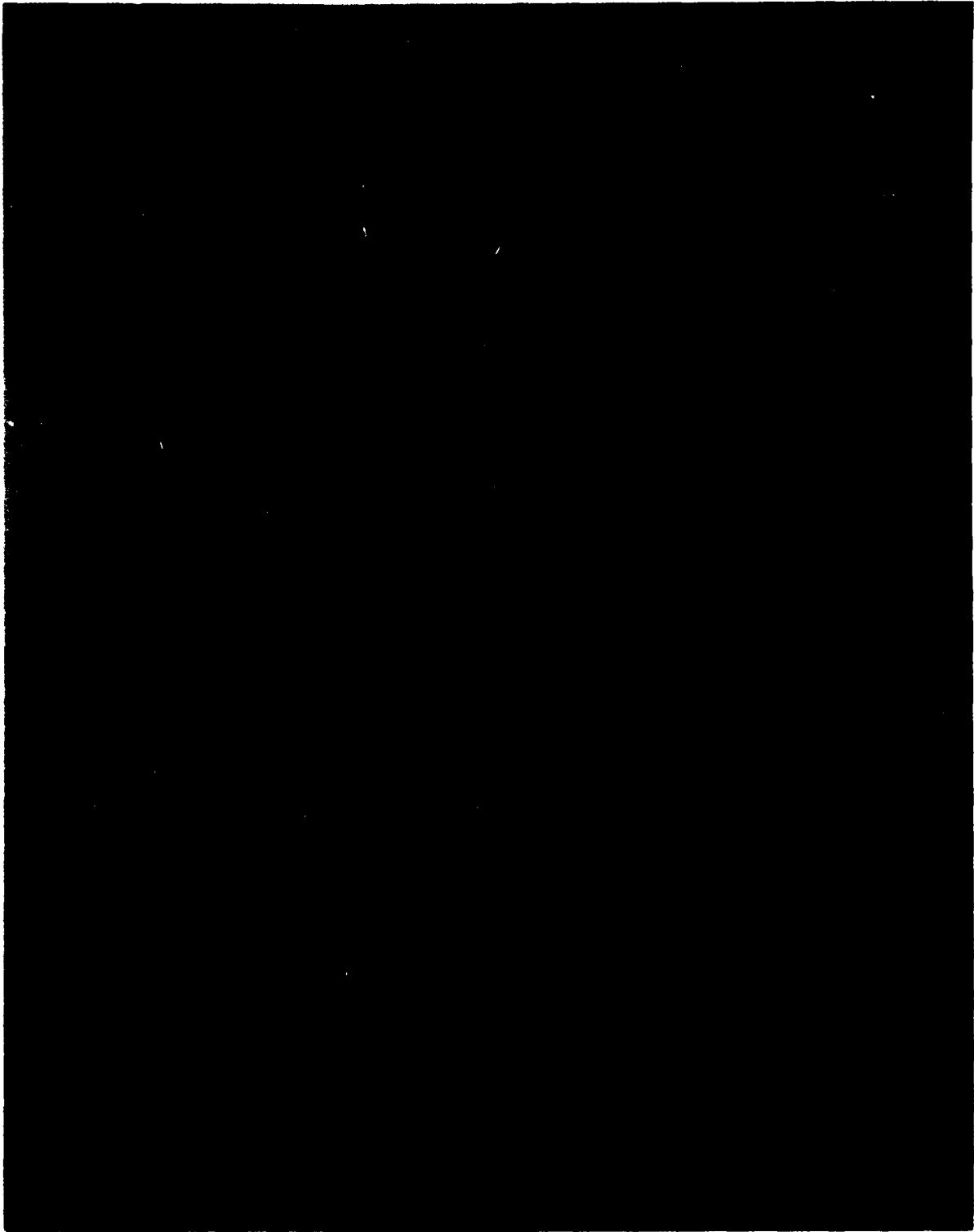

TEST NO. 11 SHOT NO. 5-0437

UDRI
F-111 RIGHT-HAND TRANSPARENCY
BIRD IMPACT TEST

TEST SUMMARY

I. BASIC TEST DATA

Date of Test 6/25/87 Test No. 12 Shot No. 5-0438
Impact Pt. _____
Planned Impact Vel. 390 kts/659 fps Actual Impact Vel. 391 kts/661 fps
Bird Wt. 4.00 lb Kinetic Energy 27,138 ft-lbs
Ambient Temperature 68°

II. TEST HARDWARE

Crew Module Ident. _____

R/H Windshield:

Manufacturer Sierracin Seq. #151
Serial Number 692
Date of Manufacture 11/82 Date of Installation: 3-29-85
Date of Removal 9/85 Installed Age 6.5m
Weight 49.6 lb Weighed 49.0 lb at UDRI
L/H Windshield _____
R/H Canopy _____
L/H Canopy _____
Aft Arch Configuration UDRI #4 Center beam #2

<u>Fasteners:</u>	<u>Screws</u>	<u>Nuts</u>	<u>Washers</u>	<u>Torque</u>
Aft Arch	<u>NAS 1203-17</u>			
Center Beam	<u>NAS 1204-15</u>			
Sill	<u>NAS 1204-15</u>			
Forward Arch	<u>NAS 1203-17</u>			

III. HARDWARE TEST HISTORY

Crew Module Previous Testing
L/H Windshield Previous Testing R/H Windshield None
L/H Canopy Previous Testing R/H Canopy Previous Testing
Aft Arch None
Arch Reinforcement -
Structural Damage and/or Modifications Front sill as noted for Shot #11.
Pertinent Fastener Substitutes None

IV. PRE-TEST OBSERVATIONS

Minor scratches, interior and exterior.
Arch and windshield were fairly difficult to install.

V. POST-TEST OBSERVATIONS

Minimal damage - minor cracking.
Permanent deformation behind impact point.
No bolt failure.
Arch permanently deformed.
5/16" bolt sheared through the threads at center beam connection.
Bird was tail high (5°)
Bird head yawed toward center beam; head of bird 10" from center beam.
Tail on target. No bird penetration.

VI. SIGNIFICANCE OF TEST

Pass at 391 knots.

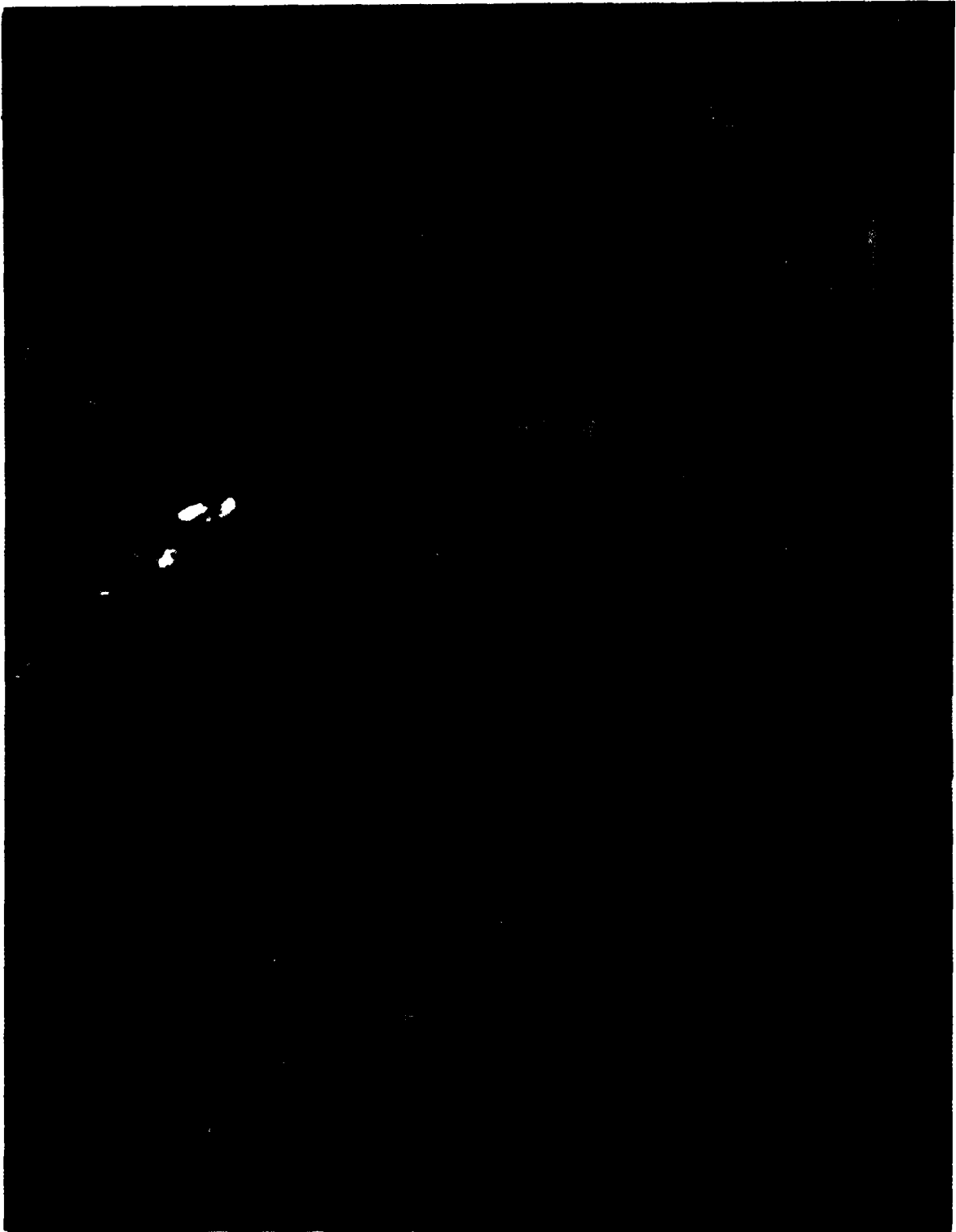

TEST NO. 12 SHOT NO. 5-0438

B-63

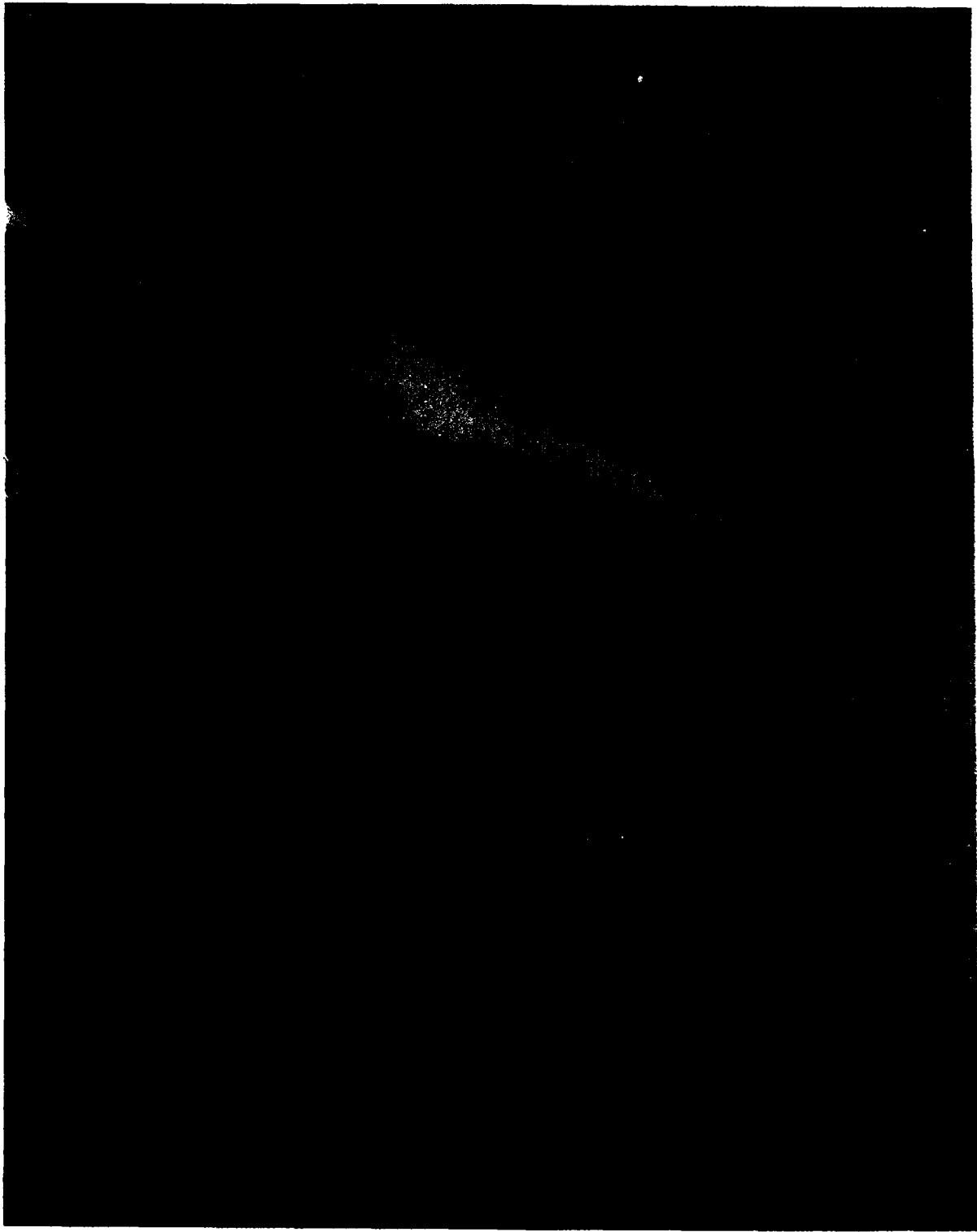

TEST NO. 12 SHOT NO. 5-0438

B-64



TEST NO. 12 SHOT NO. 5-0438

B-65

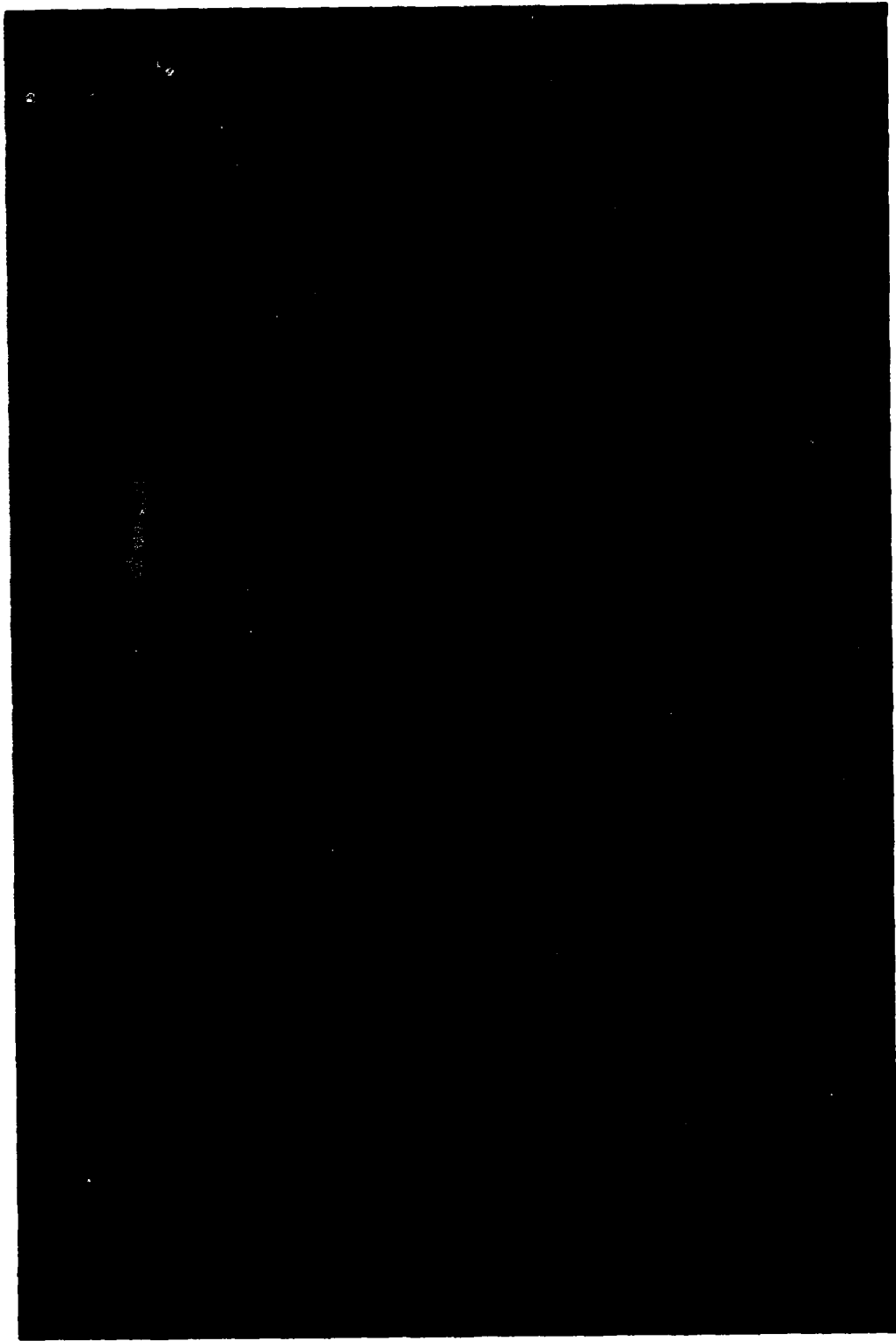

TEST NO. 12 SHOT NO. 5-0438

UDRI
F-111 RIGHT-HAND TRANSPARENCY
BIRD IMPACT TEST

TEST SUMMARY

I. BASIC TEST DATA

Date of Test 6/29/87 Test No. 13 Shot No. 5-0439
Impact Pt. _____
Planned Impact Vel. 430 kts/727 fps Actual Impact Vel. 433 kts/732 fps
Bird Wt. 4.001 lb. Kinetic Energy 33,289 ft-lbs
Ambient Temperature 68°

II. TEST HARDWARE

Crew Module Ident. _____

R/H Windshield:

Manufacturer Sierracin Seq. No. UD#12

Serial Number 522

Date of Manufacture 7/82 Date of Installation: 8-2-82

Date of Removal 11/8/83 Installed Age 1 y

Weight 50.0 lb. Weighed 49.5 lb at UDRI

L/H Windshield _____

R/H Canopy _____

L/H Canopy _____

Aft Arch Configuration UDRI #3 Center beam #2

Fasteners:	Screws	Nuts	Washers	Torque
------------	--------	------	---------	--------

Aft Arch	<u>NAS 1203-17</u>			
----------	--------------------	--	--	--

Center Beam	<u>NAS 1204-15</u>			
-------------	--------------------	--	--	--

Sill	<u>NAS 1204-15</u>			
------	--------------------	--	--	--

Forward Arch	<u>NAS 1203-17</u>			
--------------	--------------------	--	--	--

III. HARDWARE TEST HISTORY

Crew Module Previous Testing

L/H Windshield Previous Testing R/H Windshield None

L/H Canopy Previous Testing R/H Canopy Previous Testing

Aft Arch Shots 2, 4, 5 and 6

Arch Reinforcement _____

Structural Damage and/or Modifications Forward sill reinforcement as noted for Shot #11.

Pertinent Fastener Substitutes _____

IV. PRE-TEST OBSERVATIONS

Windshield looks excellent except for one small crack at front sill.

First fastener in aft arch not installed.

V. POST-TEST OBSERVATIONS

Nose of bird hit 11" over from center beam.

Sheared bolts 5-18 along aft arch.

4" x 8" permanent pocket

Some acrylic cracking, one middle poly ply crack.

VI. SIGNIFICANCE OF TEST

Pass at 433 knots.

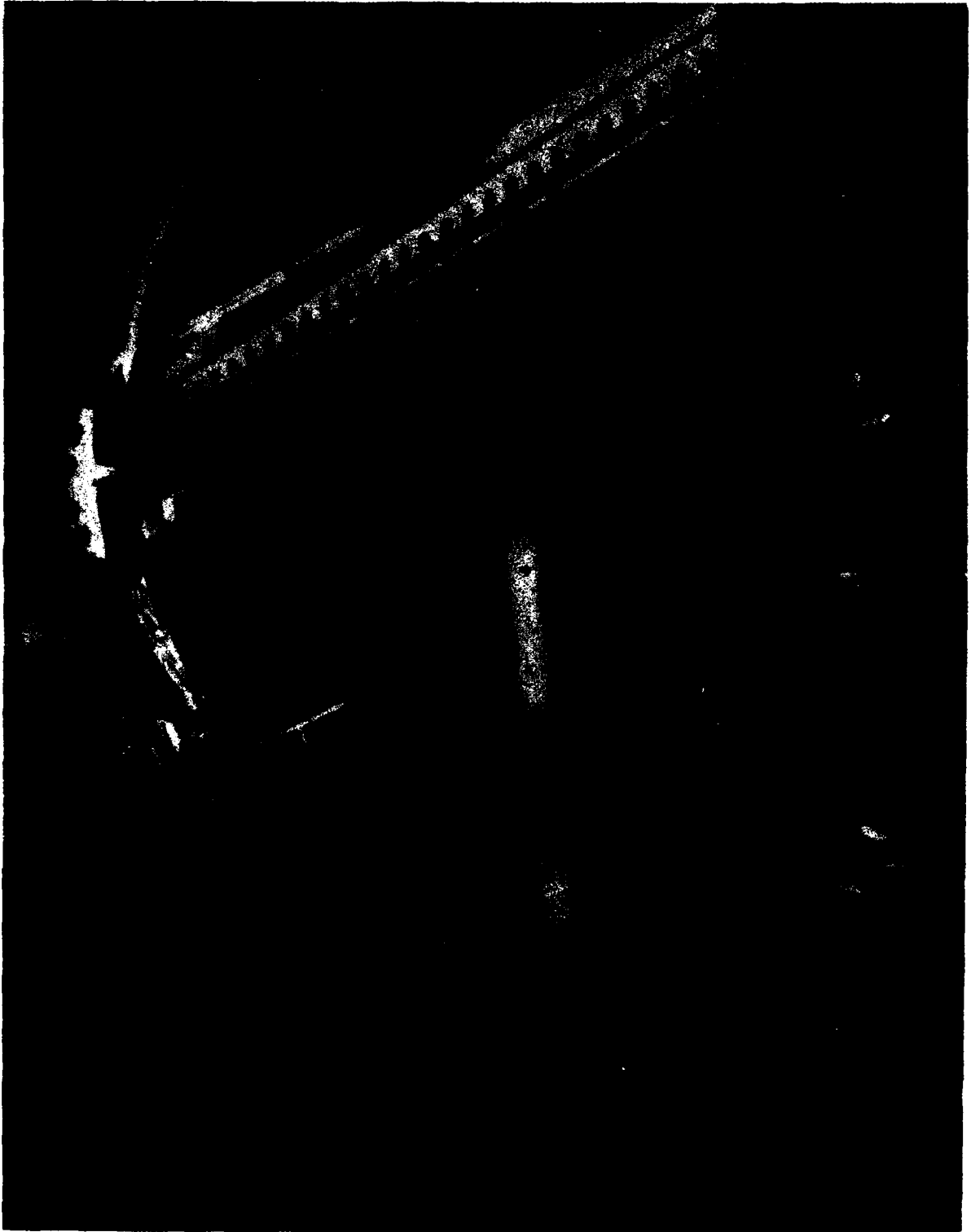

TEST NO. 13, SHOT NO. 5-0439

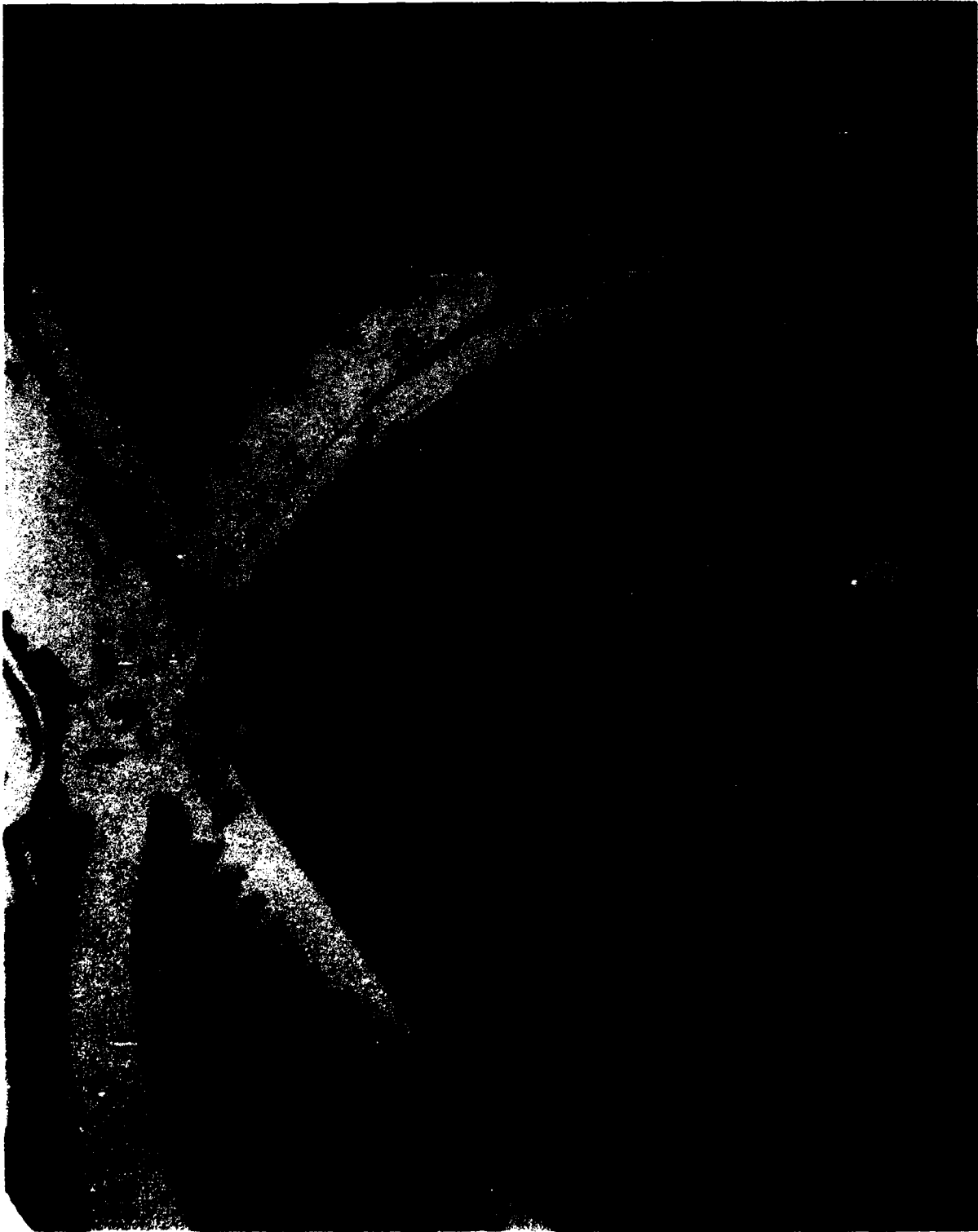

TEST NO. 13 SHOT NO. 5-0439

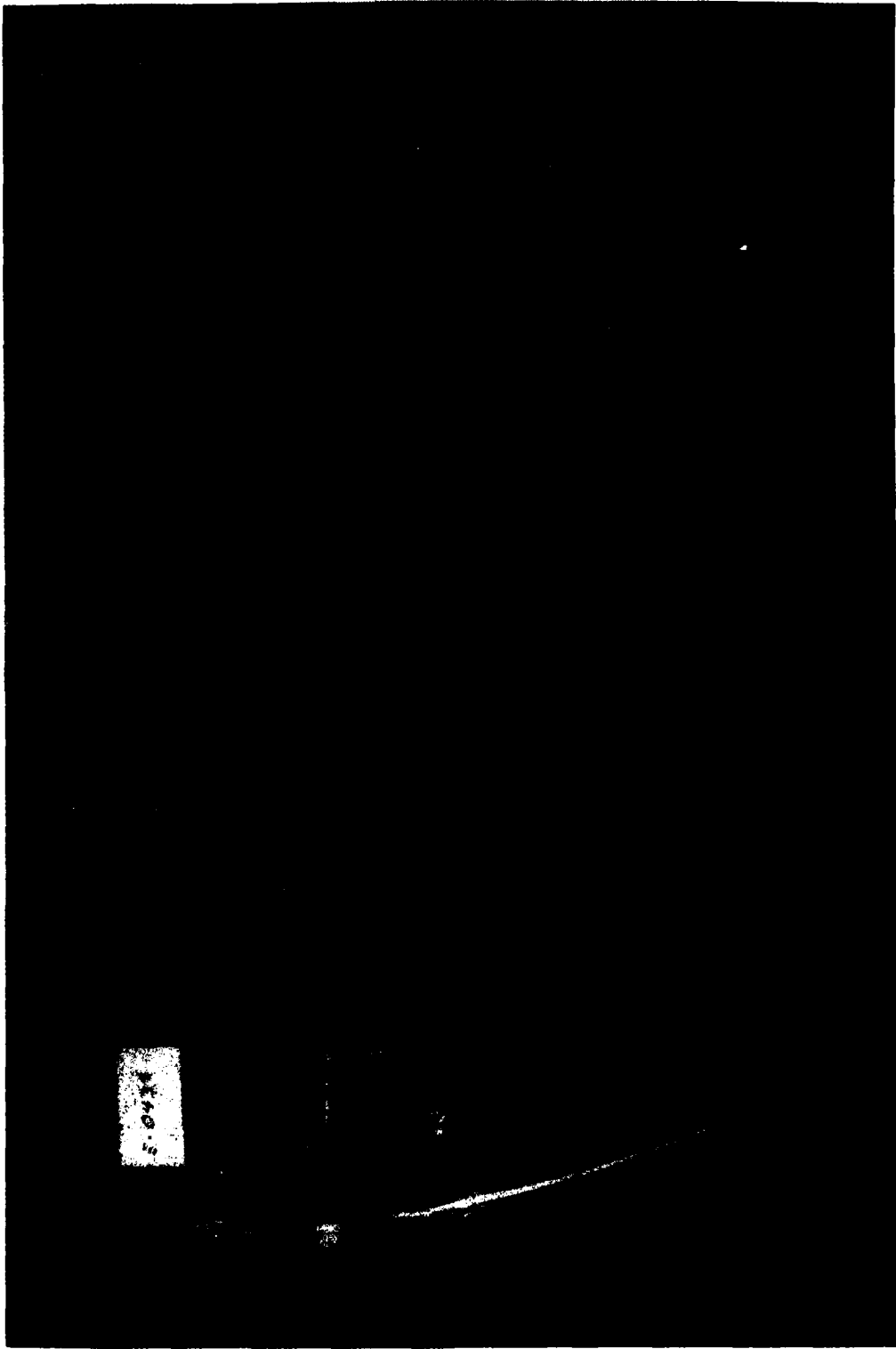

TEST NO. 13 SHOT NO. 5-0439

UDRI
F-111 RIGHT-HAND TRANSPARENCY
BIRD IMPACT TEST

TEST SUMMARY

I. BASIC TEST DATA

Date of Test 7/6/87 Test No. 14 Shot No. 5-0440
Impact Pt. _____
Planned Impact Vel. 390 kts/659 fps Actual Impact Vel. 389 kts/657 fps
Bird Wt. 4.026 lb Kinetic Energy 27,026 ft-lbs
Ambient Temperature 70°

II. TEST HARDWARE

Crew Module Ident. _____

R/H Windshield:

Manufacturer PPG Sequence No. UD#11
Serial Number 16-245
Date of Manufacture 11/18/80 Date of Installation: 4-2-82
Date of Removal 8/30/83 Installed Age 1y 5m
Weight 475 lb Weighed 47 lb, 10 oz at UDRI
L/H Windshield _____
R/H Canopy _____
L/H Canopy _____
Aft Arch Configuration UDRI #6 Center Beam #3

Fasteners:	Screws	Nuts	Washers	Torque
Aft Arch	<u>NAS 1203-17</u>			
Center Beam	<u>NAS 1204-15</u>			
Sill	<u>NAS 1204-15</u>			
Forward Arch	<u>NAS 1203-17</u>			

III. HARDWARE TEST HISTORY

Crew Module Previous testing
L/H Windshield Previous Testing R/H Windshield None
L/H Canopy Previous Testing R/H Canopy Previous Testing
Aft Arch Used for Shot #10, slightly deformed; bent back to shape on press
Arch Reinforcement none
Structural Damage and/or Modifications Aft arch as noted,
forward sill as noted for Shot #11.

Pertinent Fastener Substitutes _____

IV. PRE-TEST OBSERVATIONS

Windshield has small spots (scrapes) all over exterior acrylic--looks
like it went through hailstorm or something.
Minor delamination along forward sill right at edge of viewing area.

V. POST-TEST OBSERVATIONS

Extensive cracking, all plies.

Large flap opened up.

Windshield tore along aft arch, fasteners 7-22.

Fair amount of bird penetrated.

Out-of-plane arch deformation.

VI. SIGNIFICANCE OF TEST

Failure at 389 knots.

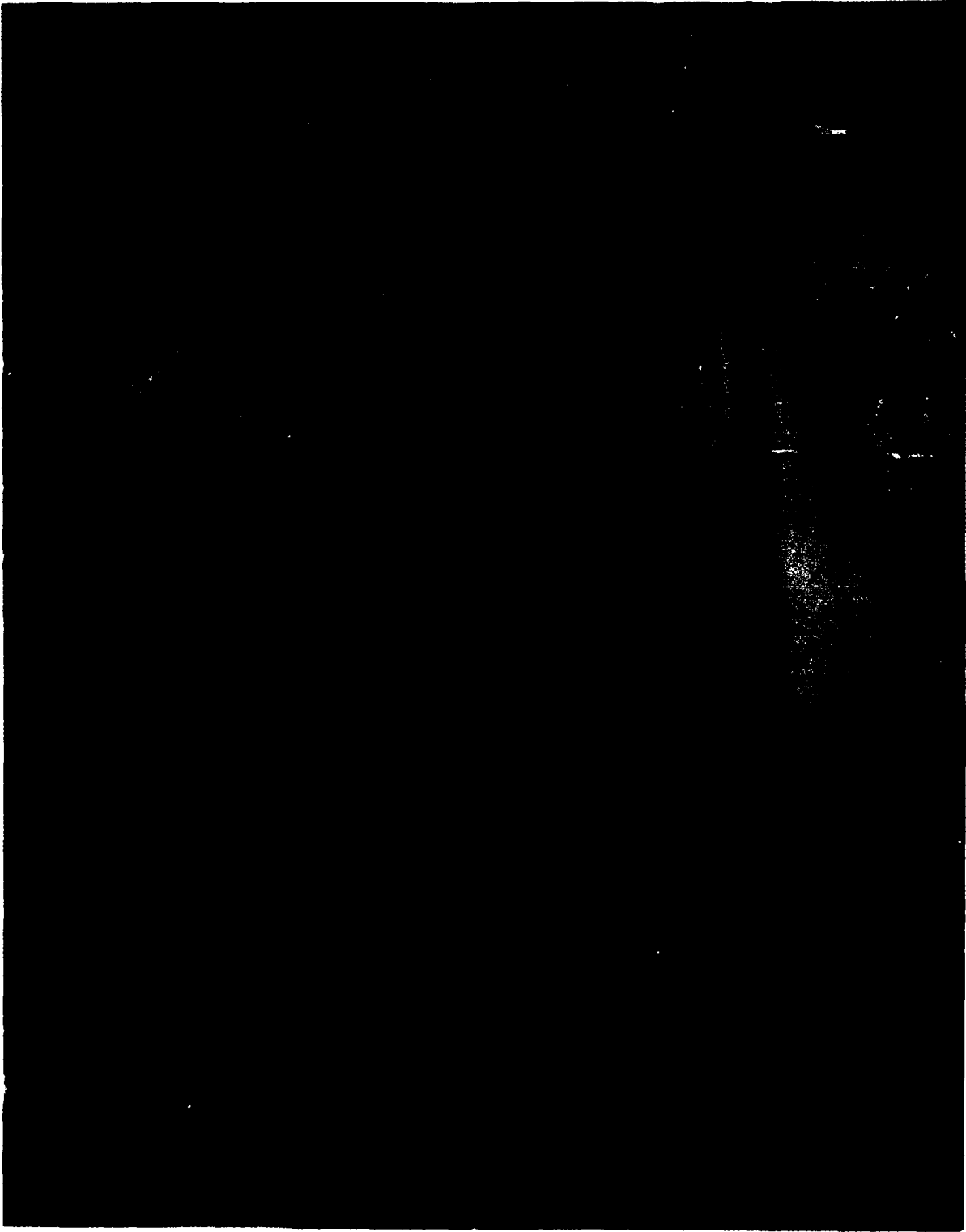

TEST NO. 14 SHOT NO. 5-0440

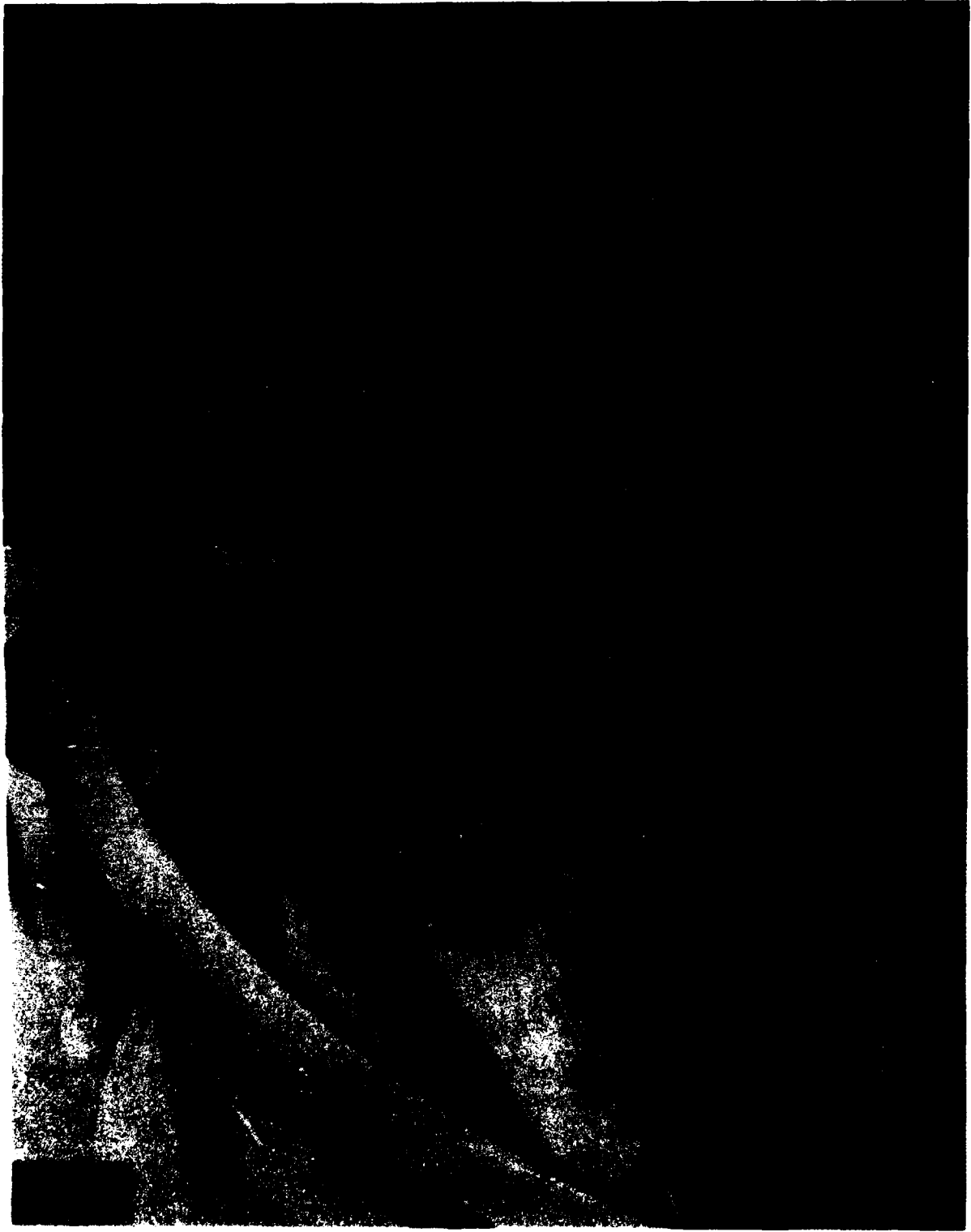

TEST NO. 14 SHOT NO. 5-0440

B-75



TEST NO. 14 SHOT NO. 5-0440

UDRI
F-111 RIGHT-HAND TRANSPARENCY
BIRD IMPACT TEST

TEST SUMMARY

I. BASIC TEST DATA

Date of Test 7/13/87 Test No. 15 Shot No. 5-0441
Impact Pt. _____
Planned Impact Vel. 470 kts/794 fps Actual Impact Vel. 455 kts/769 fps
Bird Wt. 4.010 lb Kinetic Energy 36,345 ft-lbs
Ambient Temperature 70°

II. TEST HARDWARE

Crew Module Ident. _____

R/H Windshield:

Manufacturer Sierracin Seq. #551

Serial Number 248

Date of Manufacture 2/85

Date of Removal Brand new; never used

Weight 48.6 lb Weighed 48 lb. 1 oz at UDRI

L/H Windshield _____

R/H Canopy _____

L/H Canopy _____

Aft Arch Configuration UDRI #1 Center beam #1

Fasteners:	Screws	Nuts	Washers	Torque
Aft Arch	<u>NAS 1203-17</u>			
Center Beam	<u>NAS 1204-15</u>			
Sill	<u>NAS 1204-15</u>			
Forward Arch	<u>NAS 1203-17</u>			

III. HARDWARE TEST HISTORY

Crew Module Previous Testing

L/H Windshield Previous testing R/H Windshield none

L/H Canopy Previous Testing R/H Canopy Previous Testing

Aft Arch _____

Arch Reinforcement _____

Structural Damage and/or Modifications Aft arch annealed, straightened, reheat treated, several cracks in the vicinity of the re-weld are obvious.

Pertinent Fastener Substitutes _____

IV. PRE-TEST OBSERVATIONS

Windshield looks excellent, several interior and exterior scratches mostly caused by installation.

V. POST-TEST OBSERVATIONS

- No poly cracking - some acrylic cracking
- Sheared bolts 5-15 on aft arch.
- Significant edge attachment deformation
- Small ductile pocket behind impact point
- Some of the arch cracks opened up
- Possibly a minute amount of bird penetration

VI. SIGNIFICANCE OF TEST

- Pass at 455 knots.
-
-
-
-
-

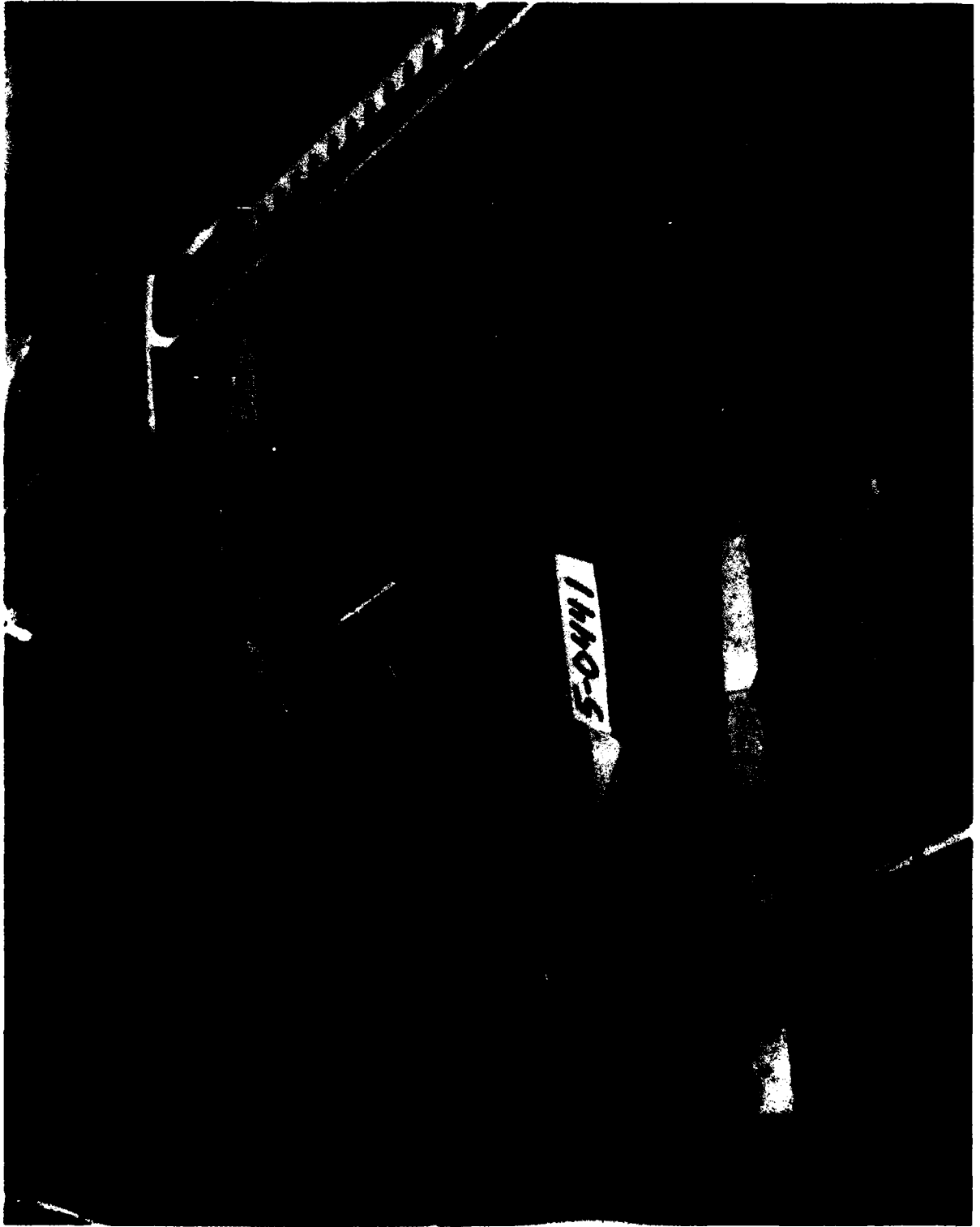

TEST NO. 15 SHOT NO. 5-0441

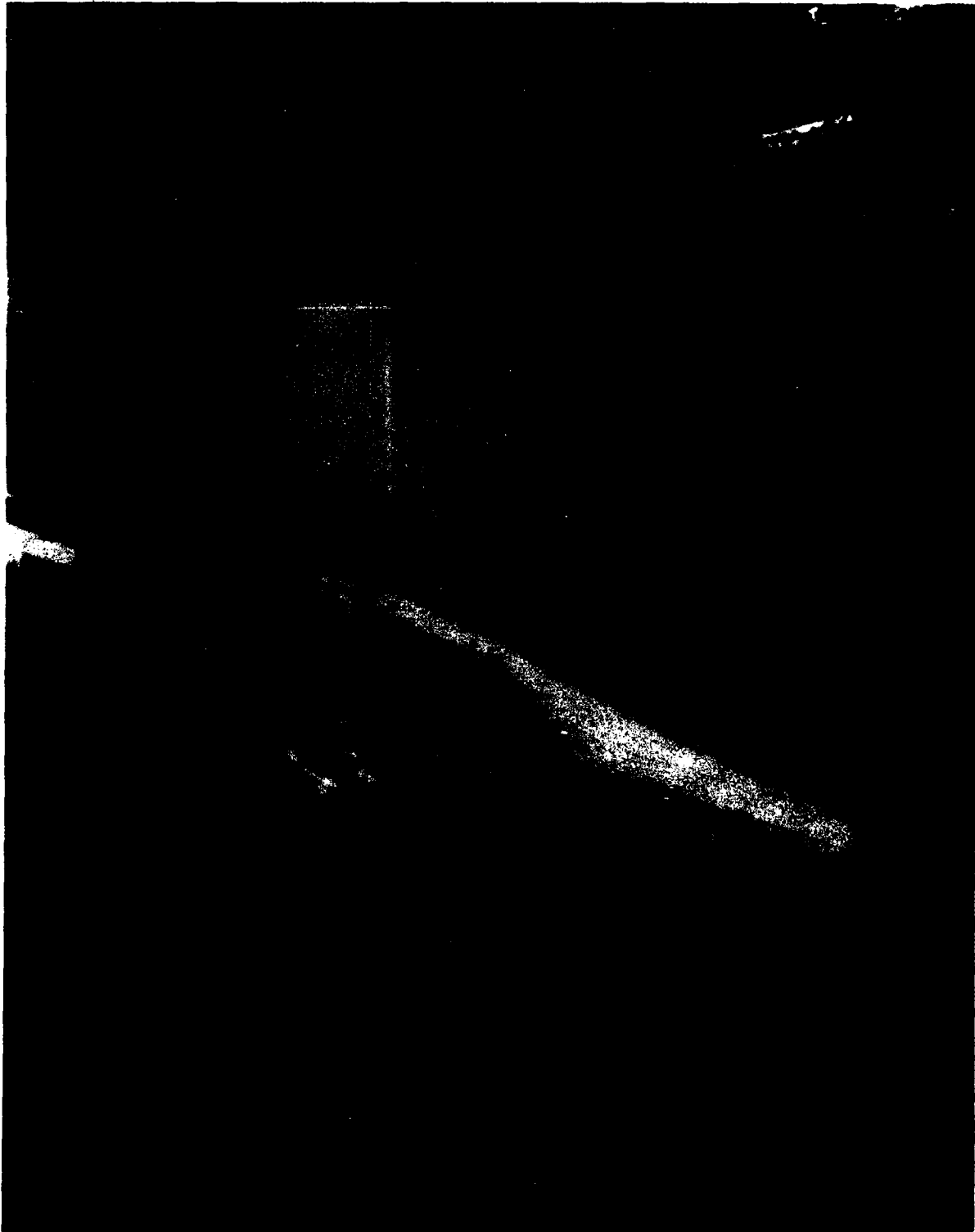

TEST NO. 15 SHOT NO. 5-0441

B-80



TEST NO. 15 SHOT NO. 5-0441

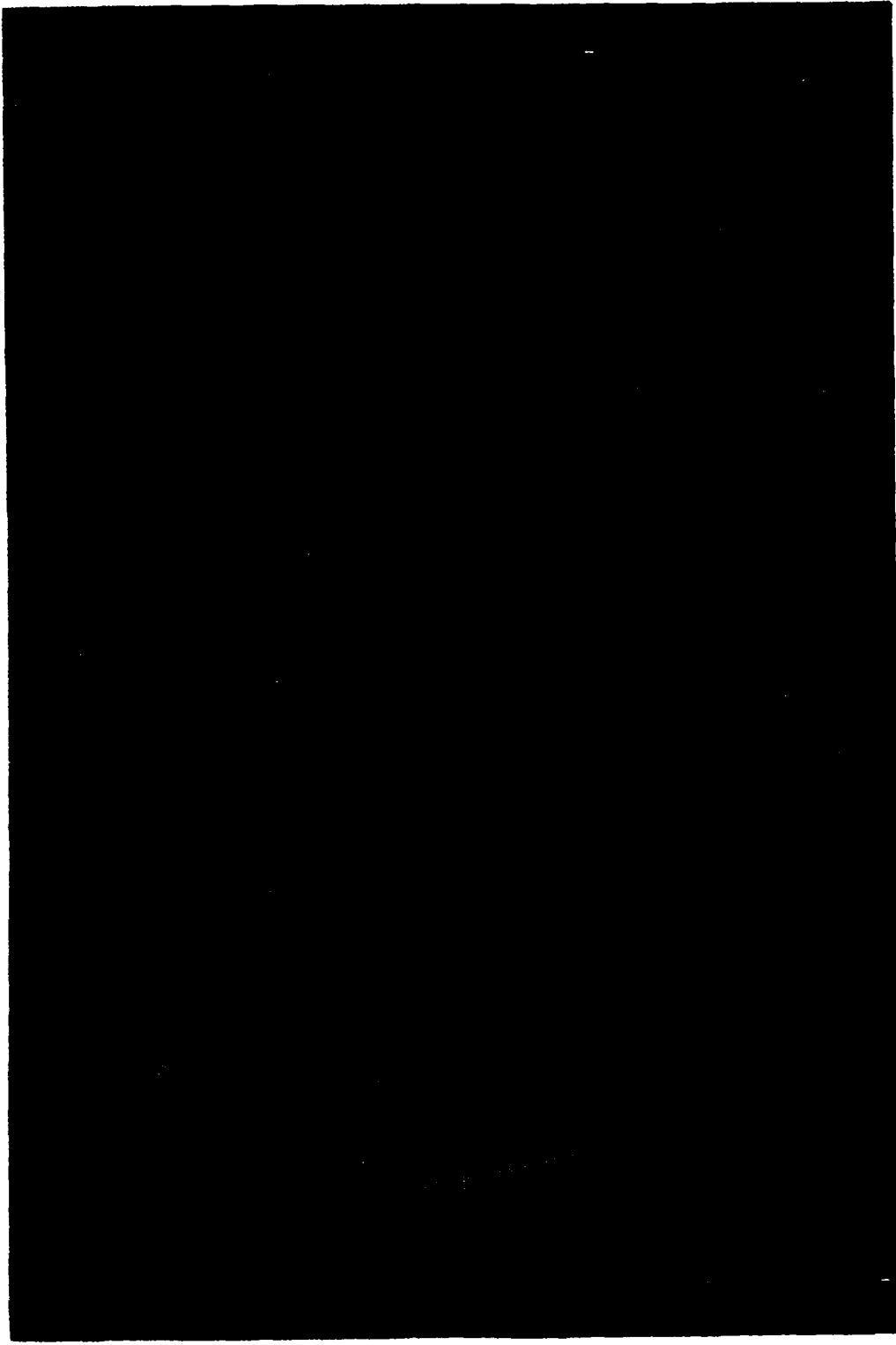

TEST NO. 15 SHOT NO. 5-0441

UDRI
F-111 RIGHT-HAND TRANSPARENCY
BIRD IMPACT TEST

TEST SUMMARY

I. BASIC TEST DATA

Date of Test 7/15/87 Test No. 16 Shot No. 5-0442
Impact Pt. _____
Planned Impact Vel. 430 kts/727 fps Actual Impact Vel. 436 kts/736 fps
Bird Wt. 4.022 lb. Kinetic Energy 33,831 ft-lbs
Ambient Temperature 70°

II. TEST HARDWARE

Crew Module Ident. _____

R/H Windshield:

Manufacturer Sierracin Seq. #582

Serial Number 052

Date of Manufacture 6/84 Date of Installation: 8-13-84

Date of Removal 10/17/86 Installed Age 2y 2.5m

Weight 47.3 lb Weighed 47 lb. 3.5 oz at UDRI

L/H Windshield _____

R/H Canopy _____

L/H Canopy _____

Aft Arch Configuration UDRI #4 Center Beam #2

<u>Fasteners:</u>	<u>Screws</u>	<u>Nuts</u>	<u>Washers</u>	<u>Torque</u>
Aft Arch	<u>NAS 1203-17</u>			
Center Beam	<u>NAS 1204-15</u>			
Sill	<u>NAS 1204-15</u>			
Forward Arch	<u>NAS 1203-17</u>			

III. HARDWARE TEST HISTORY

Crew Module Previous Testing

L/H Windshield Previous Testing R/H Windshield None

L/H Canopy Previous Testing R/H Canopy Previous Testing

Aft Arch _____

Arch Reinforcement _____

Structural Damage and/or Modifications Arch annealed, straightened, heat treated. Cracking evident along weld under support flange. One tiny crack on top of flange. Also some small cracks evident in holes directly behind impact point.

Pertinent Fastener Substitutes _____

IV. PRE-TEST OBSERVATIONS

Windshield looks good, no scratches.

V. POST-TEST OBSERVATIONS

Moderate acrylic cracking.

Inboard poly ply cracking.

Large tear (8") along aft arch.

Bolts 3-19 sheared along the aft arch.

Significant bird penetration.

Arch permanently deformed.

VI. SIGNIFICANCE OF TEST

Failure at 436 knots.



TEST NO. 16 SHOT NO. 5-0442

B-85

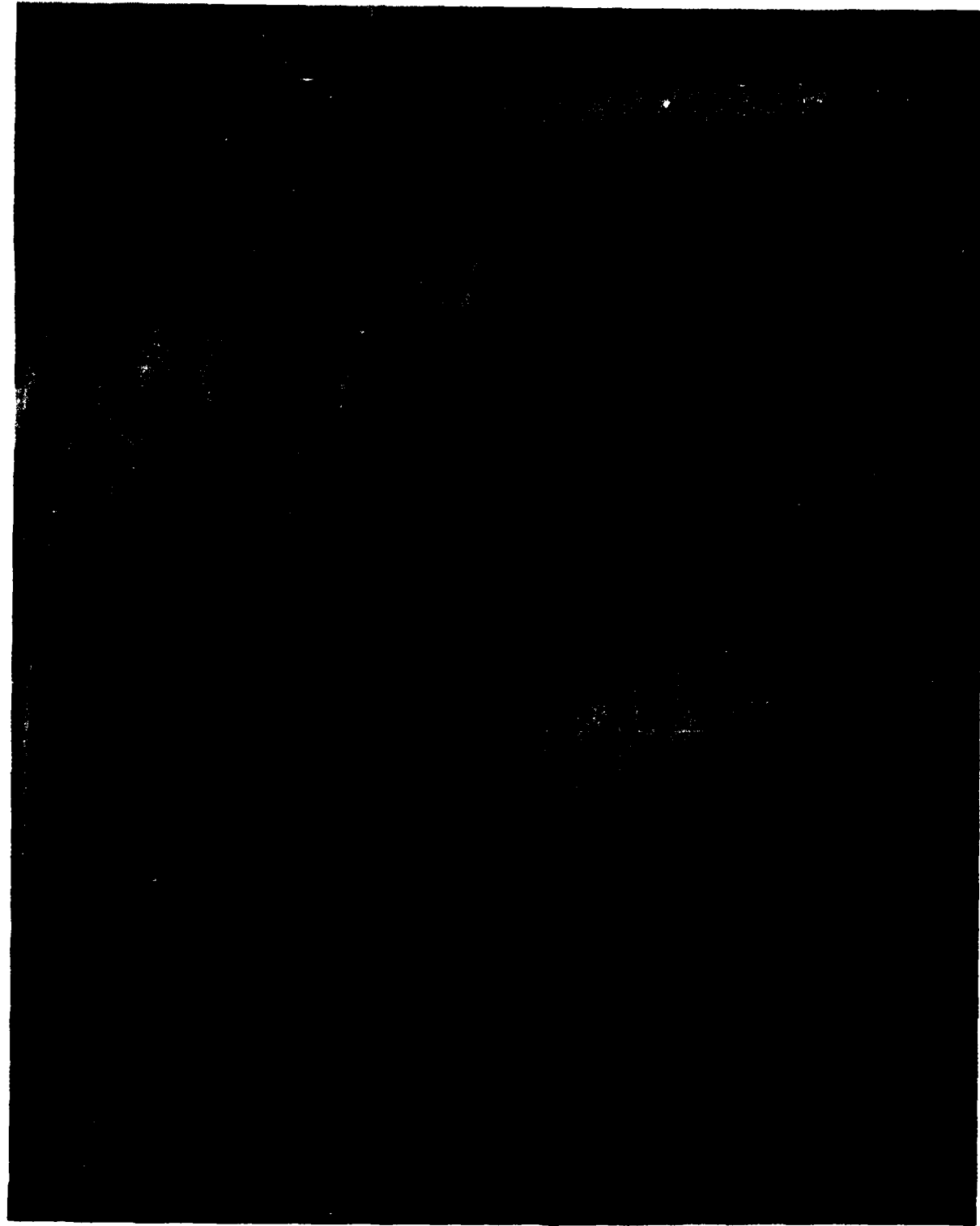

TEST NO. 16 SHOT NO. 5-0442



TEST NO. 16 SHOT NO. 5-0442

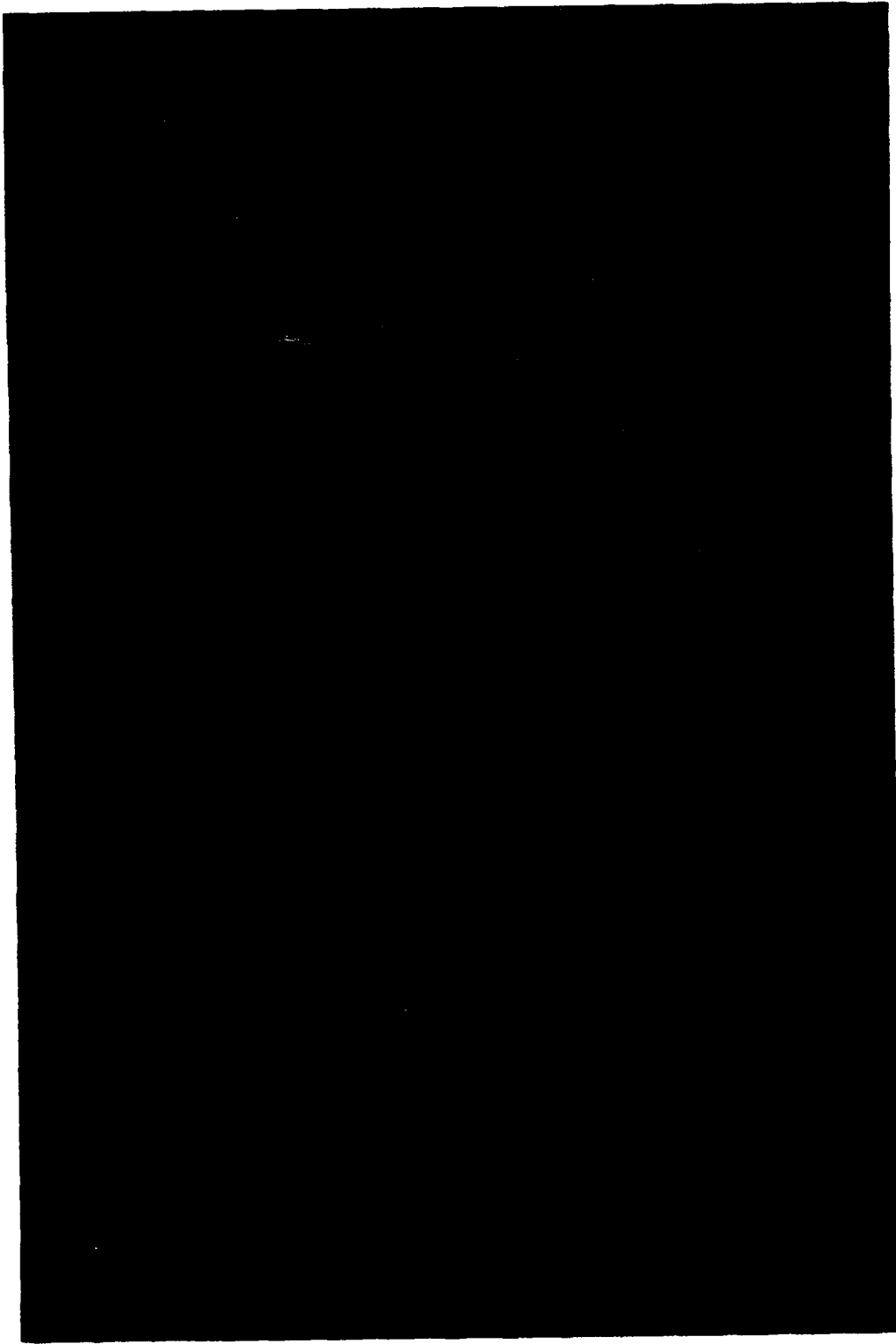

TEST NO. 16 SHOT NO. 5-0442

UDRI
F-111 RIGHT-HAND TRANSPARENCY
BIRD IMPACT TEST

TEST SUMMARY

I. BASIC TEST DATA

Date of Test 8/5/87 Test No. 17 Shot No. 5-0443
Impact Pt. _____
Planned Impact Vel. 350 kts/592 fps Actual Impact Vel. 354 kts/598 fps
Bird Wt. 4.013 lb Kinetic Energy 22,284 ft-lbs
Ambient Temperature 70°

II. TEST HARDWARE

Crew Module Ident. _____

R/H Windshield:

Manufacturer PPG Seq. #140
Serial Number 016-432
Date of Manufacture 8-26-81 Date of Installation: 8-30-82
Date of Removal 1-23-84 Installed Age ly 5m
Weight 47.9 lb Weighed 48 lb. 1 oz at UDRI
L/H Windshield _____
R/H Canopy _____
L/H Canopy _____
Aft Arch Configuration UDRI #3 Center Beam #2

Fasteners:	Screws	Nuts	Washers	Torque
Aft Arch	<u>NAS 1203-17</u>			
Center Beam	<u>NAS 1204-15</u>			
Sill	<u>NAS 1204-15</u>			
Forward Arch	<u>NAS 1203-17</u>			

III. HARDWARE TEST HISTORY

Crew Module Previous Testing
L/H Windshield Previous Testing R/H Windshield None
L/H Canopy Previous Testing R/H Canopy Previous Testing
Aft Arch _____
Arch Reinforcement _____
Structural Damage and/or Modifications Aft arch annealed, old weld ground out, straightened, rewelded, annealed, then heat treated.

Pertinent Fastener Substitutes _____

IV. PRE-TEST OBSERVATIONS

Minor scratches.

V. POST-TEST OBSERVATIONS

No permanent deformation. Windshield looks very good.
Extensive acrylic cracking at the front sill, caused by residual stress.
3" middle poly ply crack radiating from 9th bolt hole.

VI. SIGNIFICANCE OF TEST

Pass at 355 knots - looks like it should be able to stand another
15-20 knots.

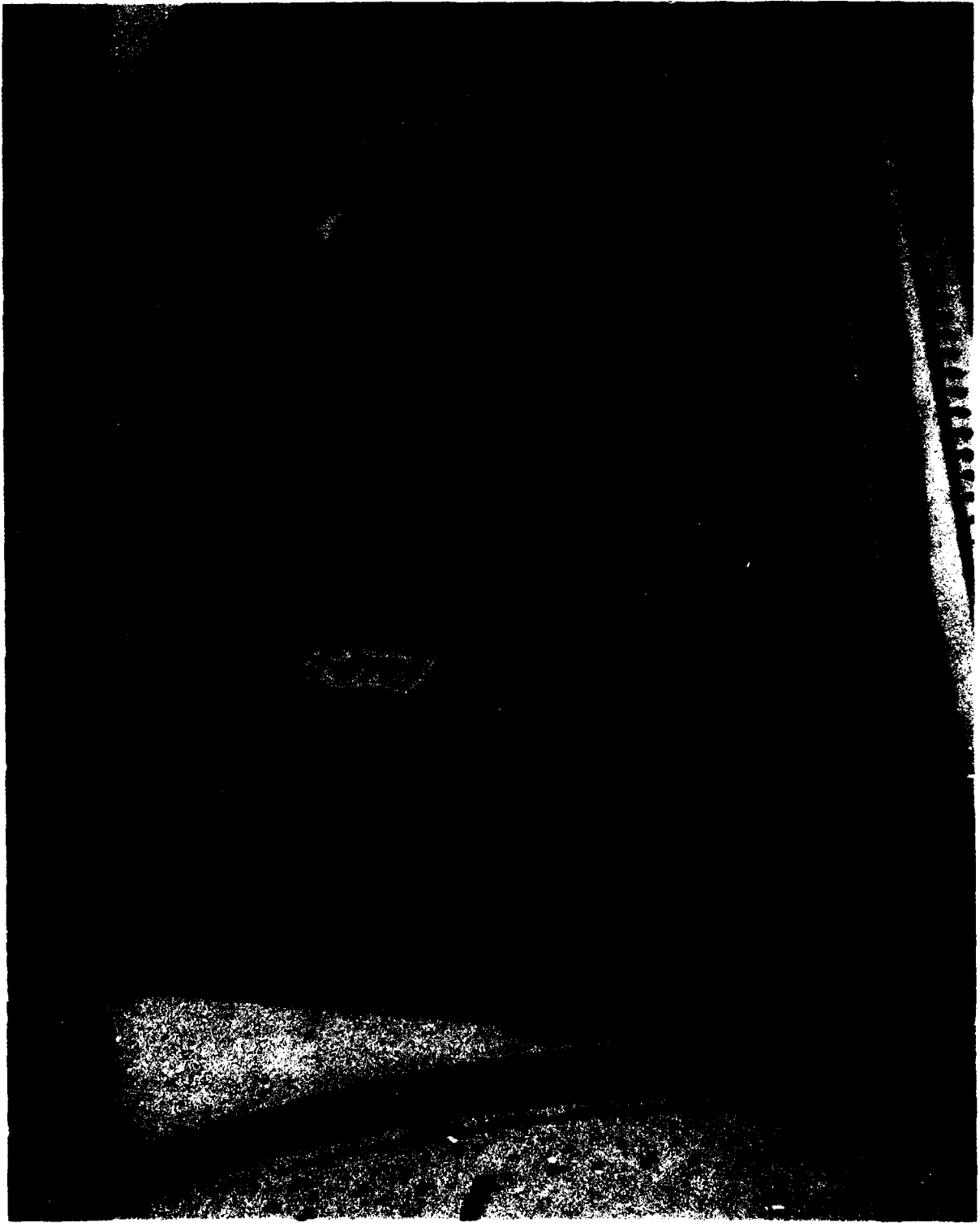

TEST NO. 17 SHOT NO. 5-0443

B-91

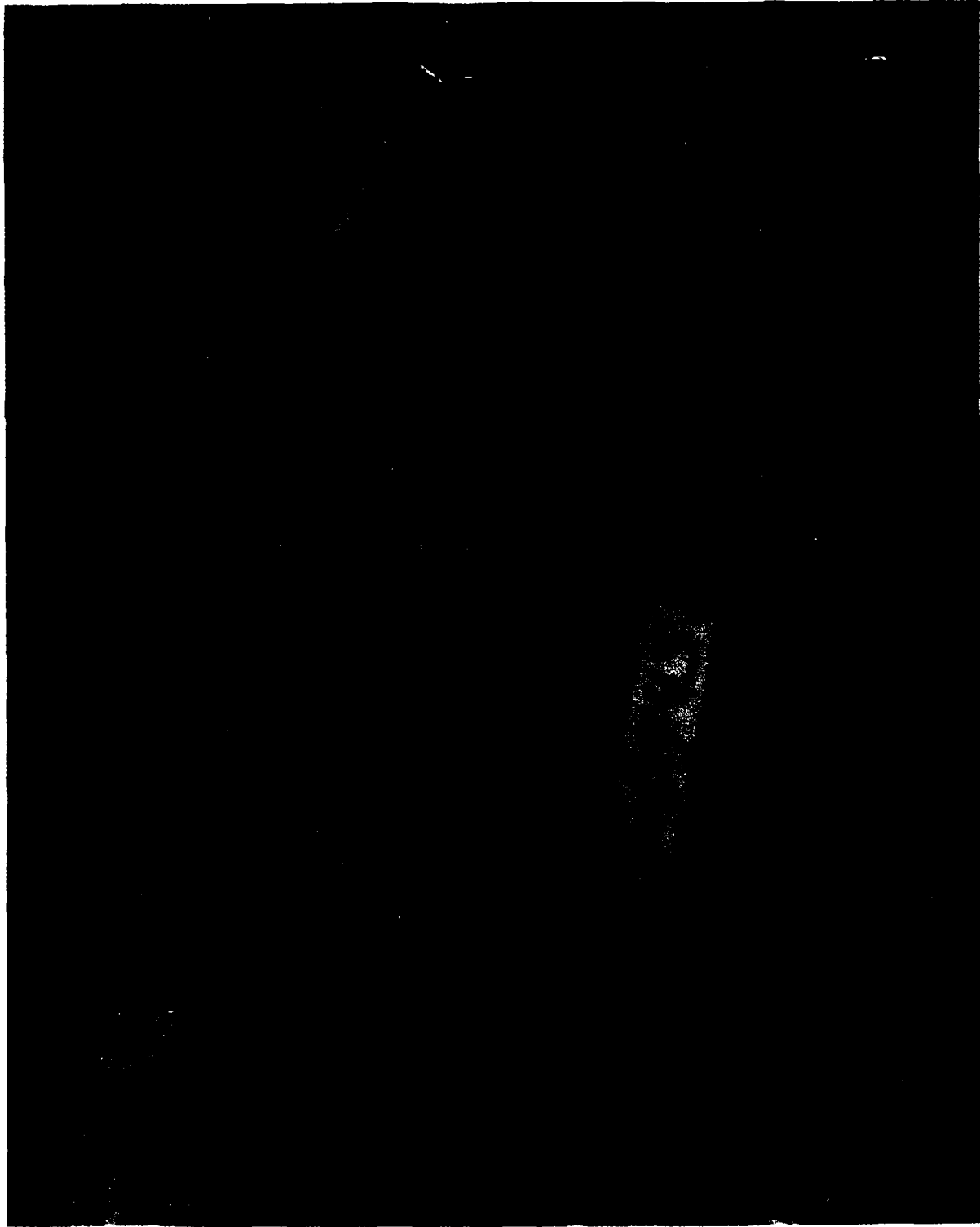

TEST NO. 17 SHOT NO. 5-0443

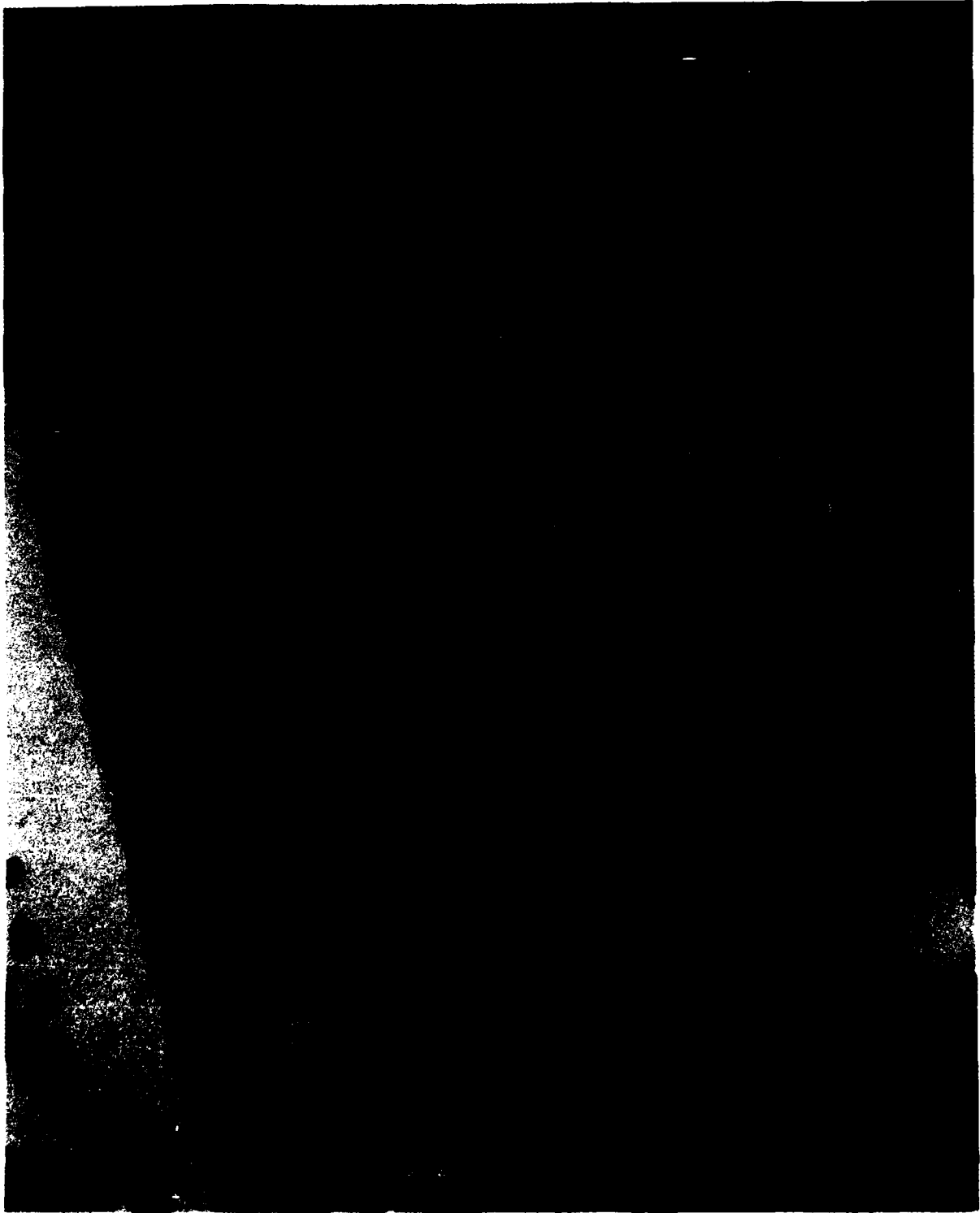

TEST NO. 17 SHOT NO. 5-0443

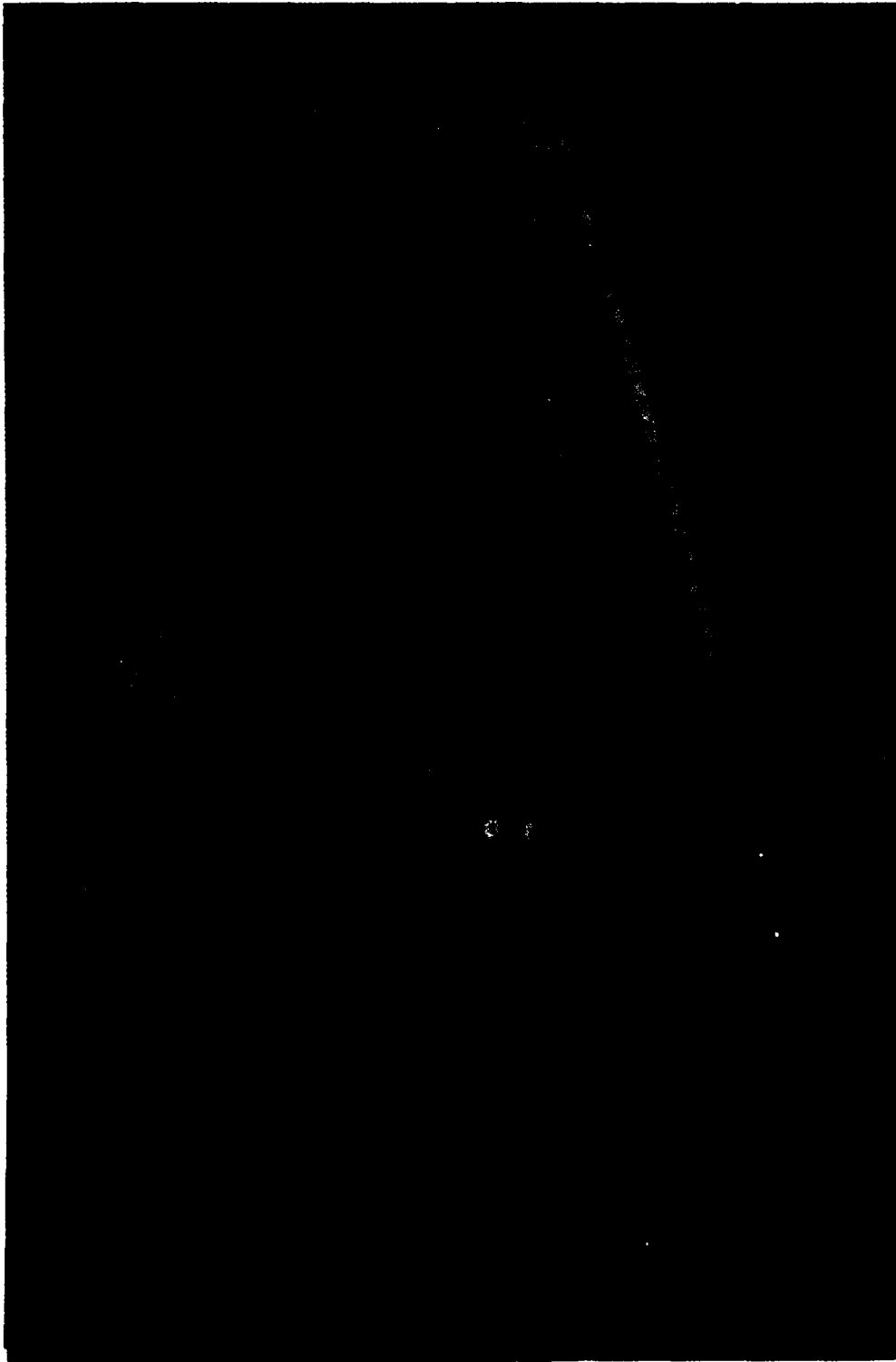

TEST NO. 17 SHOT NO. 5-0443

UDRI
F-111 RIGHT-HAND TRANSPARENCY
BIRD IMPACT TEST

TEST SUMMARY

I. BASIC TEST DATA

Date of Test 8-7-87 Test No. 18 Shot No. 5-0444
Impact Pt. _____
Planned Impact Vel. 430 kts/727 fps Actual Impact Vel. 435 kts/735 fps
Bird Wt. 4.012 lb Kinetic Energy 33,655 ft-lbs
Ambient Temperature 70°

II. TEST HARDWARE

Crew Module Ident. _____

R/H Windshield:

Manufacturer PPG Seq. No. 623
Serial Number 030
Date of Manufacture 1-28-85 Date of Installation: 6-20-85
Date of Removal 3-26-86 Installed age 9 months
Weight 50 lb Weighed 47 lb. 13 oz at UDRI
L/H Windshield _____
R/H Canopy _____
L/H Canopy _____
Aft Arch Configuration UDRI #3 Center Beam #2

<u>Fasteners:</u>	<u>Screws</u>	<u>Nuts</u>	<u>Washers</u>	<u>Torque</u>
Aft Arch	<u>NAS 1203-17</u>			
Center Beam	<u>NAS 1204-15</u>			
Sill	<u>NAS 1204-15</u>			
Forward Arch	<u>NAS 1203-17</u>			

III. HARDWARE TEST HISTORY

Crew Module Previous Testing
L/H Windshield Previous Testing R/H Windshield None
L/H Canopy Previous Testing R/H Canopy Previous Testing
Aft Arch _____
Arch Reinforcement _____
Structural Damage and/or Modifications Aft arch used for previous shot; notice modifications for Test #17.
Pertinent Fastener Substitutes _____

IV. PRE-TEST OBSERVATIONS

Several minor acrylic scratches.

V. POST-TEST OBSERVATIONS

Large mushroom-shaped flap broken out at impact point (did not disconnect)
Major amount of bird penetration.
Extensive acrylic cracking, 24"x18" area in vicinity of impact
Multiple poly cracks.
≈ 25% of the bird penetrated.

VI. SIGNIFICANCE OF TEST

Failure at 435 knots.



TEST NO. 18 SHOT NO. 5-0444

B-97

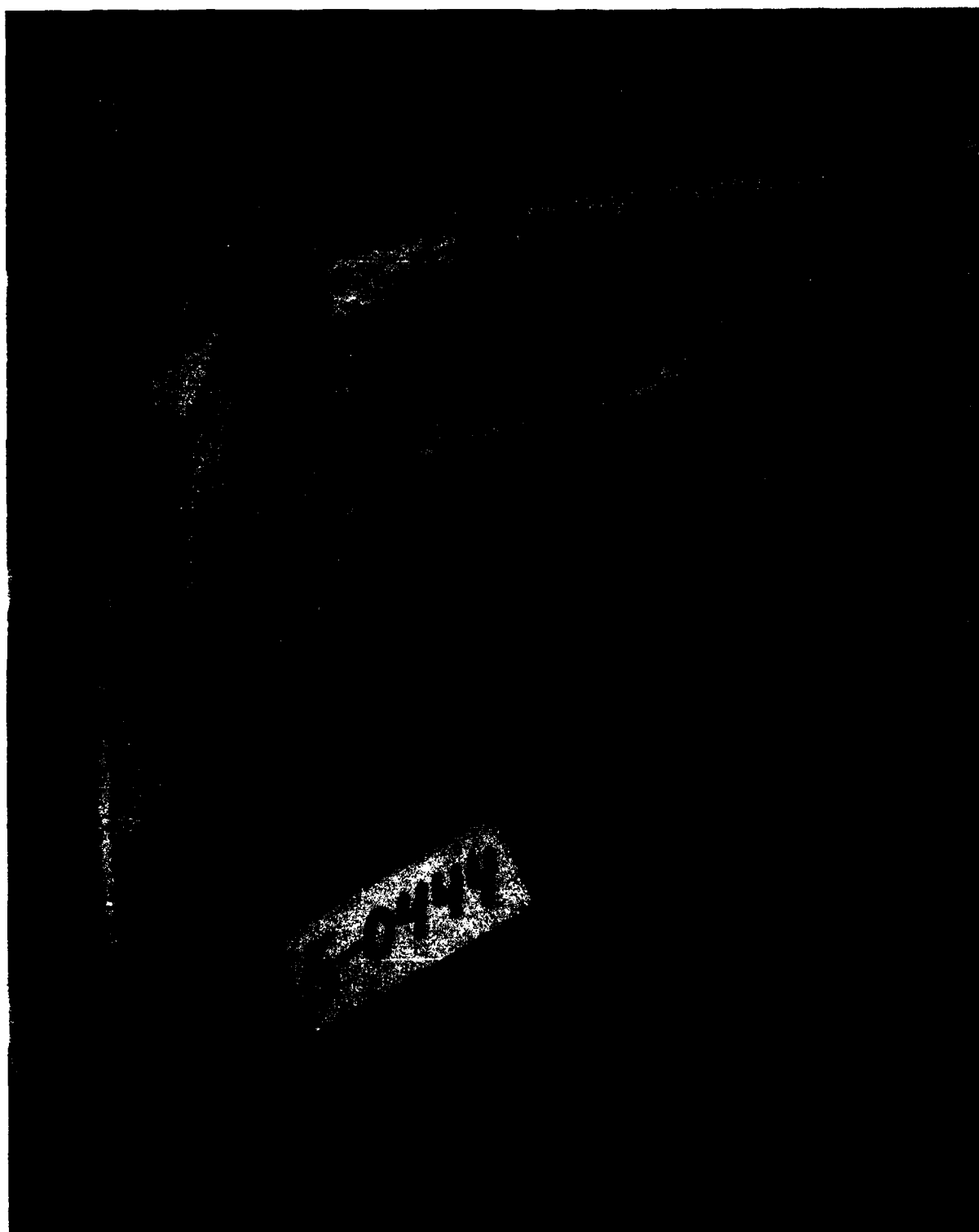

TEST NO. 18 SHOT NO. 5-0444

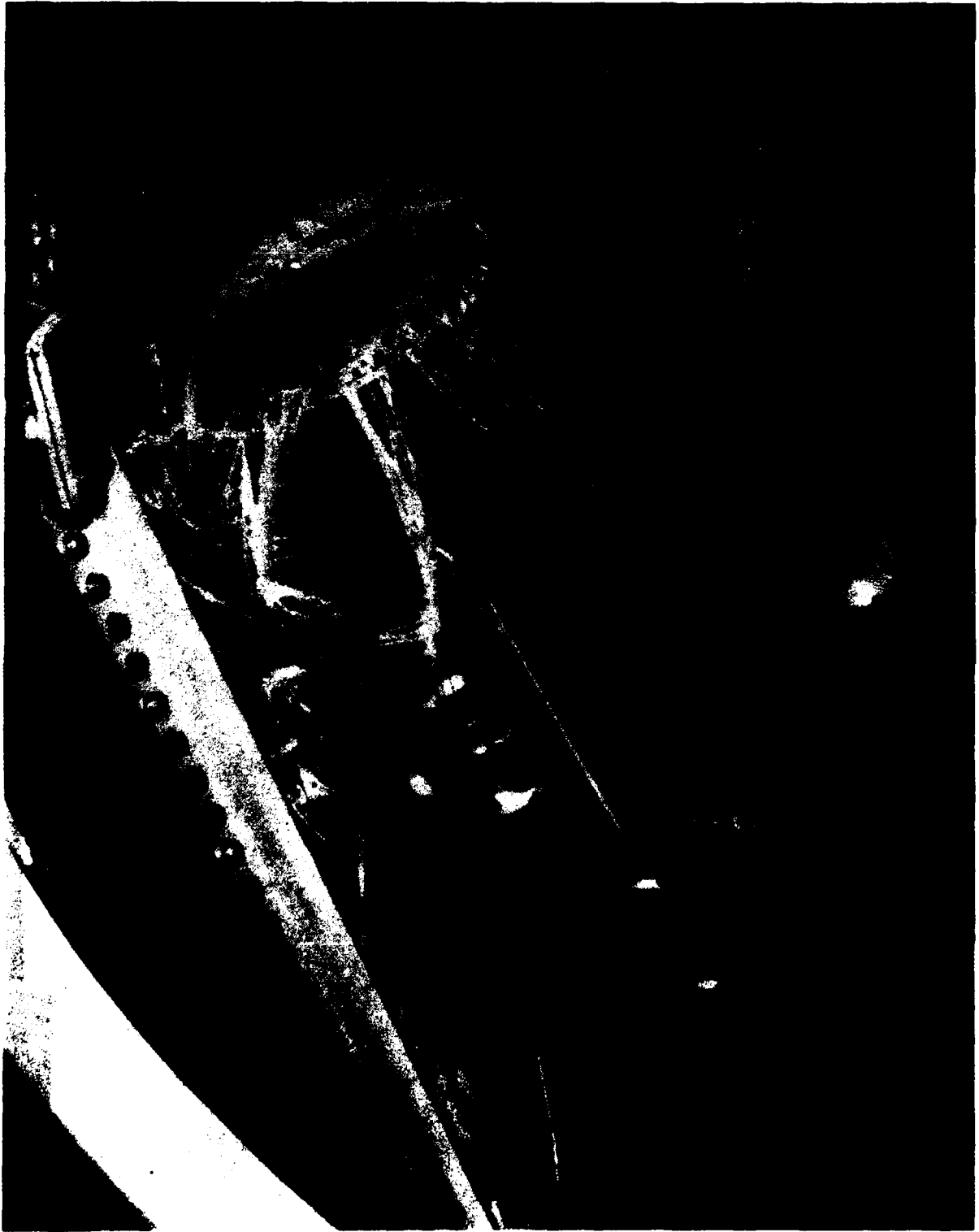

TEST NO. 18, SHOT NO. 5-0444

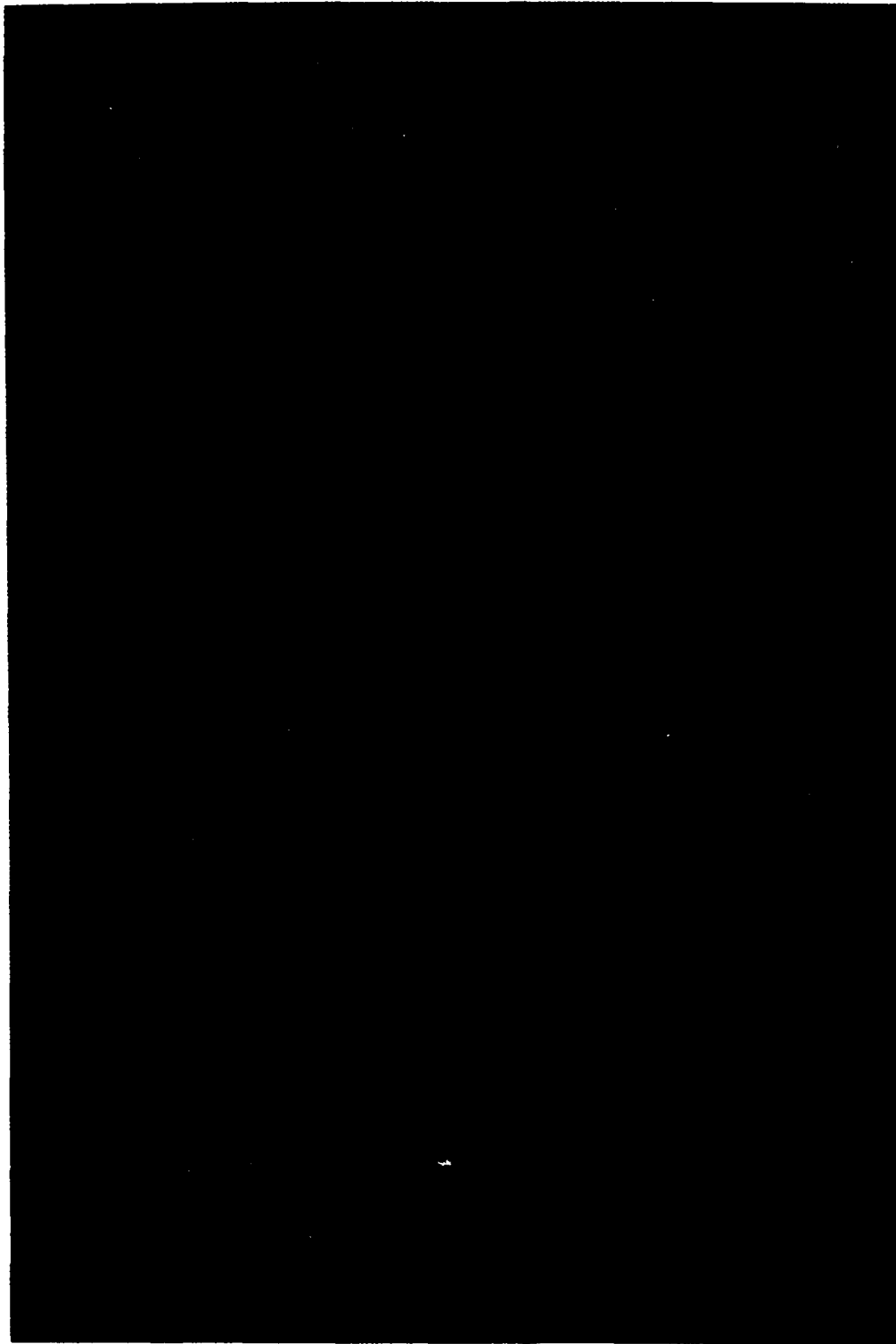

TEST NO. 18 SHOT NO. 5-0444

UDRI
F-111 RIGHT-HAND TRANSPARENCY
BIRD IMPACT TEST

TEST SUMMARY

I. BASIC TEST DATA

Date of Test 8/11/87 Test No. 19 Shot No. 5-0445
Impact Pt. _____
Planned Impact Vel. 390 kts/658 fps Actual Impact Vel. 390 kts/658 fps
Bird Wt. 4.001 lb Kinetic Energy 26,899 ft-lbs
Ambient Temperature 67°

II. TEST HARDWARE

Crew Module Ident. _____

R/H Windshield:

Manufacturer PPG Seq. #148
Serial Number 002
Date of Manufacture 1-3-85 Date of Installation: 1-85 to 6-85
Date of Removal 1-9-86 Installed Age 6m to 1y
Weight 49 lb Weighed 47 lb. 14 oz at UDRI
L/H Windshield _____
R/H Canopy _____
L/H Canopy _____
Aft Arch Configuration Aft Arch #2, Center Beam #1

<u>Fasteners:</u>	<u>Screws</u>	<u>Nuts</u>	<u>Washers</u>	<u>Torque</u>
<u>Aft Arch</u>	<u>NAS 1203-17 and NAS 1203-19</u>			
<u>Center Beam</u>	<u>NAS 1204-15</u>			
<u>Sill</u>	<u>NAS 1204-15</u>			
<u>Forward Arch</u>	<u>NAS 1203-17</u>			

III. HARDWARE TEST HISTORY

Crew Module Previous Testing
L/H Windshield Previous Testing R/H Windshield None
L/H Canopy Previous Testing R/H Canopy Previous Testing
Aft Arch _____

Arch Reinforcement

Structural Damage and/or Modifications Aft arch annealed, ground, welded, annealed, heat-treated to C35.5 to C37.0. Arch needed some persuasion to get into place.

Pertinent Fastener Substitutes No. 6,9,11,12,13,14,15,17,18,21,22,23,24,25, 26,27,31 on aft arch all replaced with NAS 1203-19 w/washer on head to retain strap.

IV. PRE-TEST OBSERVATIONS

Fastener #1 on arch and #1 and 2 on center beam not in. Fasteners 3 and 4 on center beam replaced with #10 NAS 1203-15 screws. Windshield extremely oversized, very difficult to install--probable cause of premature in-service failure (crazing extensive), was stress on window during service. Windshield in compression at aft arch. Interior coating discolored white with scratches.

V. POST-TEST OBSERVATIONS

Small pocket at impact point.

Extensive cracking of acrylic away from impact point.

Very unusual acrylic chipping at impact point caused by prestress compressive load.

Permanent arch deformation.

No polycarbonate cracking.

VI. SIGNIFICANCE OF TEST

Pass at 390 knots.

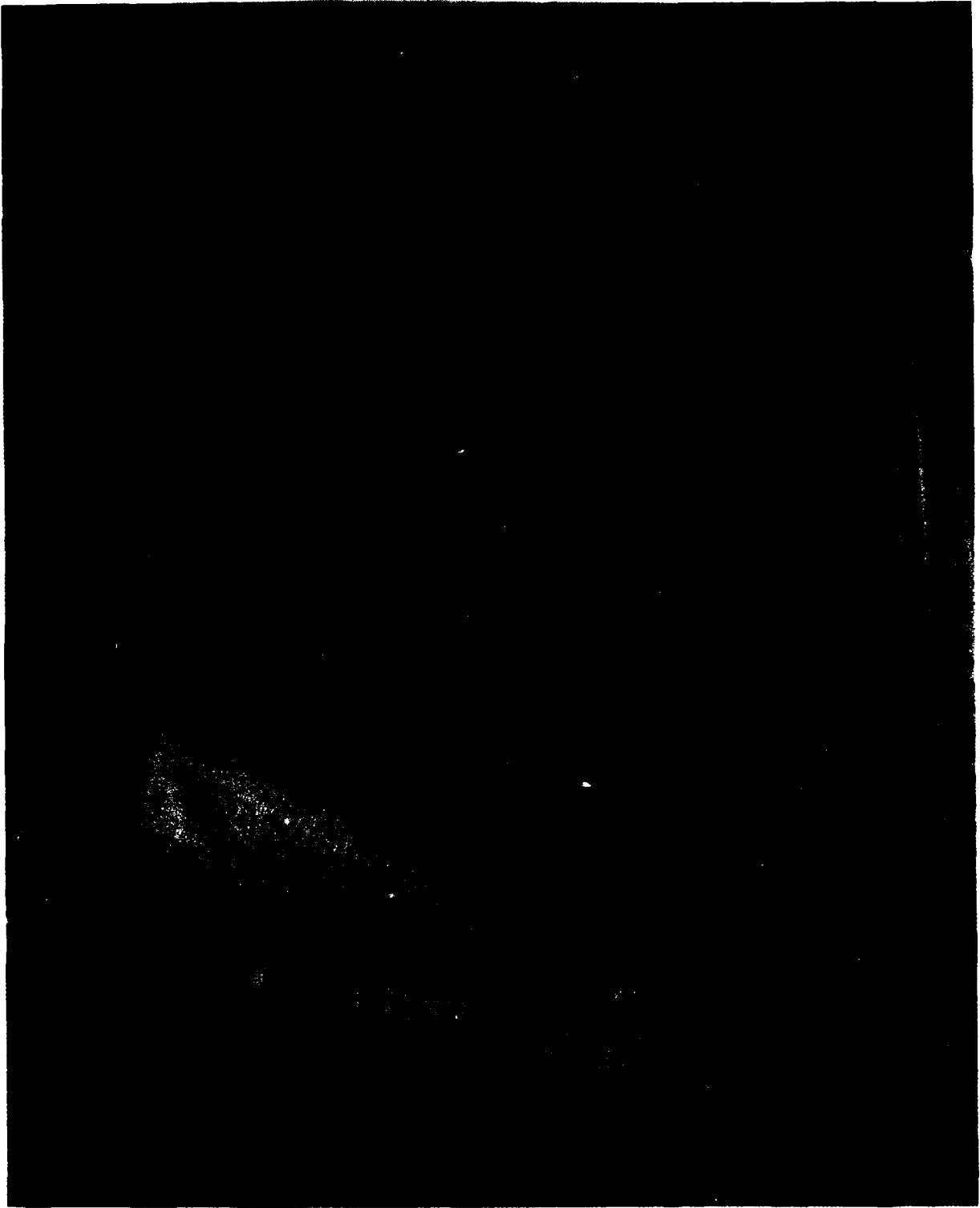

TEST NO. 19 SHOT NO. 5-0445

B-103

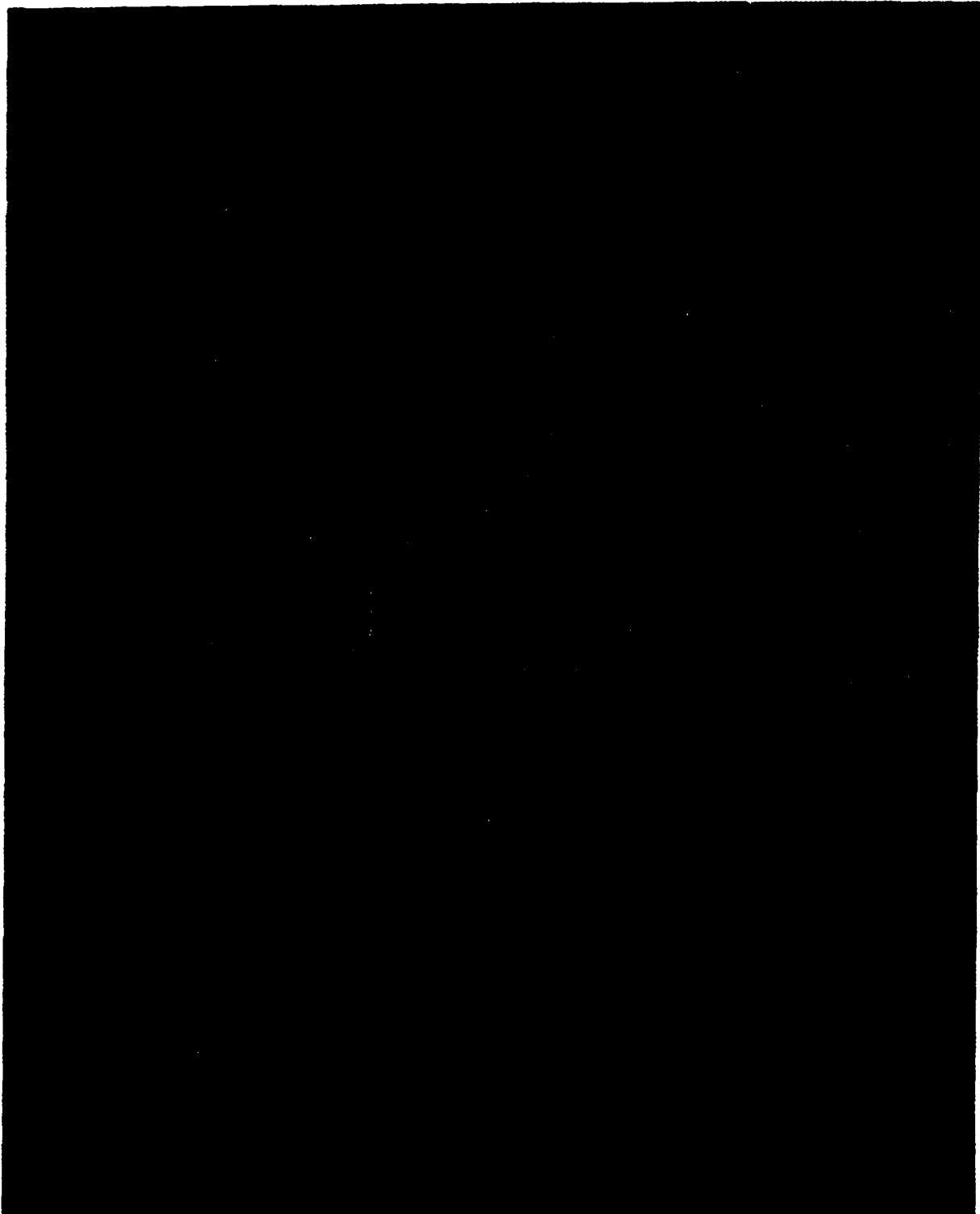

TEST NO. 19 SHOT NO. 5-0445

B-104



TEST NO. 19, SHOT NO. 5-0445



TEST NO. 19 SHOT NO. 5-0445

UDRI
F-111 RIGHT-HAND TRANSPARENCY
BIRD IMPACT TEST

TEST SUMMARY

I. BASIC TEST DATA

Date of Test 8/17/87 Test No. 20 Shot No. 5-0446
Impact Pt. _____
Planned Impact Vel. 390 kts/659 fps Actual Impact Vel. 388 kts/655 fps
Bird Wt. 3.970 lb Kinetic Energy 26,448 ft-lbs
Ambient Temperature 66°

II. TEST HARDWARE

Crew Module Ident. _____

R/H Windshield:

Manufacturer Sierracin Seq. #88
Serial Number 264
Date of Manufacture 10/81 Date of Installation: 4-10-83
Date of Removal 4/11/85 Installed Age 2y
Weight 47.2 lb Weighed 46 lb. 7 oz at UDRI
L/H Windshield _____
R/H Canopy _____
L/H Canopy _____
Aft Arch Configuration UDRI #6 Center Beam #3

Fasteners:	Screws	Nuts	Washers	Torque
Aft Arch	<u>NAS 1203-17</u>			
Center Beam	<u>NAS 1204-15</u>			
Sill	<u>NAS 1204-15</u>			
Forward Arch	<u>NAS 1203-17</u>			

III. HARDWARE TEST HISTORY

Crew Module Previous Testing
L/H Windshield Previous Testing R/H Windshield None
L/H Canopy Previous Testing R/H Canopy Previous Testing
Aft Arch _____
Arch Reinforcement _____
Structural Damage and/or Modifications Aft arch annealed, ground,
straightened, welded, annealed, heat treated to C35.5 to C37.0
Pertinent Fastener Substitutes _____

IV. PRE-TEST OBSERVATIONS

Windshield has several scratches and minor delamination along center beam
between poly plies.
Interior coating spotted in vicinity of aft arch.

V. POST-TEST OBSERVATIONS

Windshield tore along aft arch bolts 8-17.

Significant poly cracking -- flap opened up.

25% of bird penetrated.

Permanent arch deformation, out of plane.

VI. SIGNIFICANCE OF TEST

Failure at 388 knots.



TEST NO. 20 SHOT NO. 5-0446

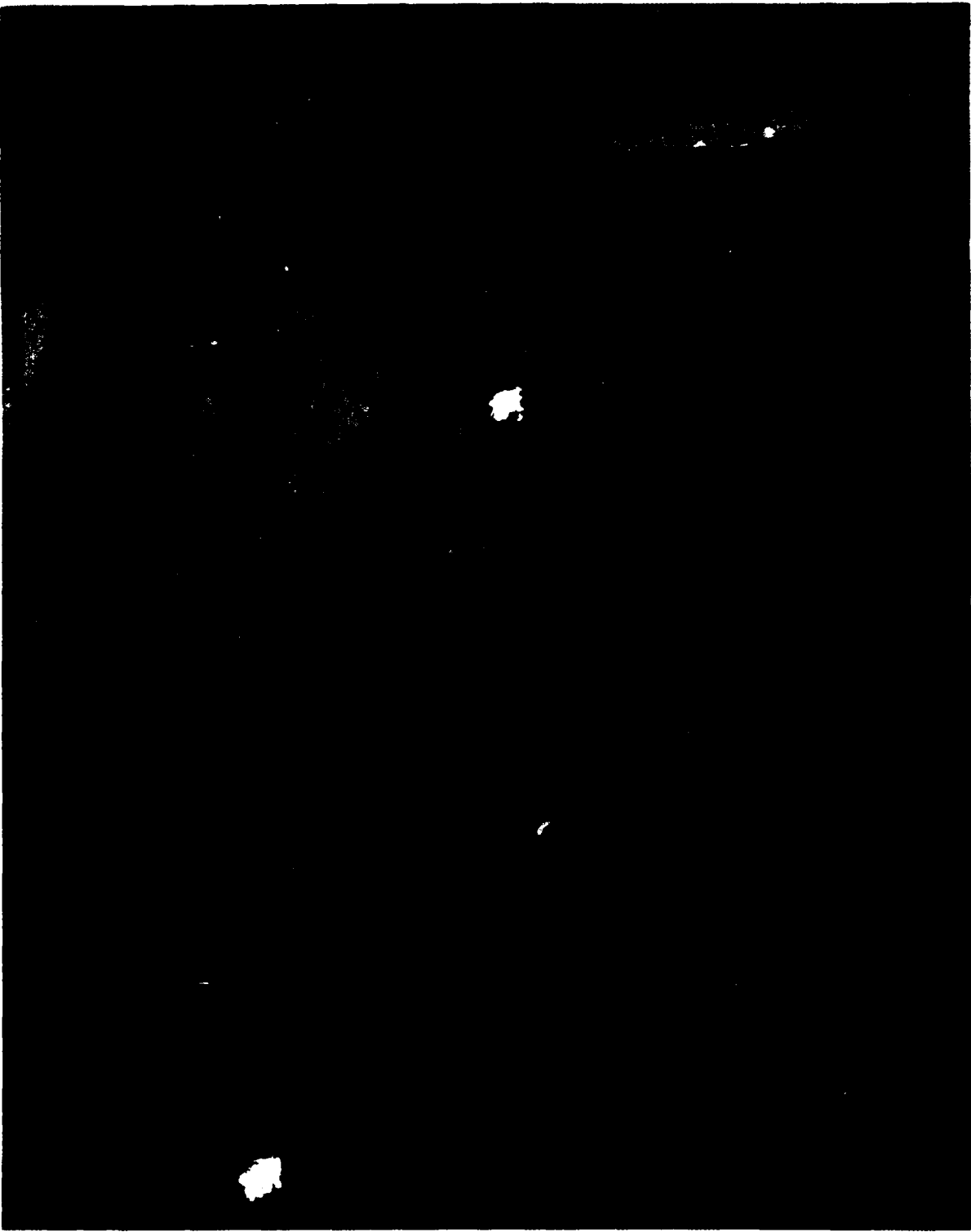

TEST NO. 20, SHOT NO. 5-0446



TEST NO. 20 SHOT NO. 5-0446

B-111



TEST NO. 20 SHOT NO. 5-0446

B-112

UDRI
F-111 RIGHT-HAND TRANSPARENCY
BIRD IMPACT TEST

TEST SUMMARY

I. BASIC TEST DATA

Date of Test 8/20/87 Test No. 21 Shot No. 5-0447
Impact Pt. _____
Planned Impact Vel. 430 kts/727 fps Actual Impact Vel. 424 kts/716 fps
Bird Wt. 4.016 lb Kinetic Energy 31,969 ft-lbs
Ambient Temperature 66°

II. TEST HARDWARE

Crew Module Ident. _____

R/H Windshield:

Manufacturer PPG Seq. #615
Serial Number 16-292
Date of Manufacture 2-11-81 Date of Installation: 5-11-84
Date of Removal 1-5-87 Installed Age 2y 8m
Weight 47.1 lb Weighed 47 lb. 6 oz at UDRI
L/H Windshield _____
R/H Canopy _____
L/H Canopy _____
Aft Arch Configuration UDRI #5 Center Beam #3

<u>Fasteners:</u>	<u>Screws</u>	<u>Nuts</u>	<u>Washers</u>	<u>Torque</u>
Aft Arch	<u>NAS 1203-17</u>			
Center Beam	<u>NAS 1204-17</u>			
Sill	<u>NAS 1204-17</u>			
Forward Arch	<u>NAS 1203-17</u>			

III. HARDWARE TEST HISTORY

Crew Module Previous Testing
L/H Windshield Previous Testing R/H Windshield None
L/H Canopy Previous Testing R/H Canopy Previous Testing
Aft Arch _____
Arch Reinforcement _____
Structural Damage and/or Modifications Arch annealed, straightened,
ground, welded, annealed, heat-treated to C35.5 to C37.0
Pertinent Fastener Substitutes _____

IV. PRE-TEST OBSERVATIONS

Severe crazing and minute scratches over entire outer ply. Some inner
surface scratching.
Windshield too long at aft edge.
Windshield extremely difficult to get into place.

V. POST-TEST OBSERVATIONS

Large, mushroom-shaped flap opened up at impact point.

Acrylic cracked.

Poly cracks in both plies.

Many poly cracks radiating from bolt hole at upper inboard corner.

<25% of bird penetrated.

Permanent arch deformation.

VI. SIGNIFICANCE OF TEST

Failure at 424 knots.



TEST NO. 21 SHOT NO. 5-0447

B-115

TEST NO. 21, SHOT NO. 5-0447



TEST NO. 21 SHOT NO. 5-0447

B-117



TEST NO. 21 SHOT NO. 5-0447

UDRI
F-111 RIGHT-HAND TRANSPARENCY
BIRD IMPACT TEST

TEST SUMMARY

I. BASIC TEST DATA

Date of Test 8/26/87 Test No. 22 Shot No. 5-0448
Impact Pt. _____
Planned Impact Vel. 390 kts/659 fps Actual Impact Vel. 383 kts/647 fps
Bird Wt. 4.000 lb Kinetic Energy 26,001 ft-lbs
Ambient Temperature 65°

II. TEST HARDWARE

Crew Module Ident. _____

R/H Windshield:

Manufacturer PPG Seq. #548
Serial Number 680
Date of Manufacture 8-18-83 Date of Installation: 1-26-84
Date of Removal 12-6-85 Installed Age 1y 10m
Weight 46.6 lb Weighed 47 lb. at UDRI
L/H Windshield _____
R/H Canopy _____
L/H Canopy _____
Aft Arch Configuration UDRI #4 Center beam #2

<u>Fasteners:</u>	<u>Screws</u>	<u>Nuts</u>	<u>Washers</u>	<u>Torque</u>
Aft Arch	<u>NAS 1203-17</u>			
Center Beam	<u>NAS 1204-15</u>			
Sill	<u>NAS 1204-15</u>			
Forward Arch	<u>NAS 1203-17</u>			

III. HARDWARE TEST HISTORY

Crew Module Previous Testing
L/H Windshield Previous Testing R/H Windshield None
L/H Canopy Previous Testing R/H Canopy Previous Testing
Aft Arch _____
Arch Reinforcement _____
Structural Damage and/or Modifications _____

Pertinent Fastener Substitutes _____

IV. PRE-TEST OBSERVATIONS

Interior coating extremely cloudy (milky-white)
Some interior scratches; hard to detect because of coating
Some exterior scratches.

V. POST-TEST OBSERVATIONS

Windshield tore along aft arch from bolts 8-13 (5-6")

Moderate acrylic cracking.

Significant polycarbonate cracking, interior ply mostly.

Bird penetration < 10%

Permanent arch deformation.

VI. SIGNIFICANCE OF TEST

Failure at 383 knots.

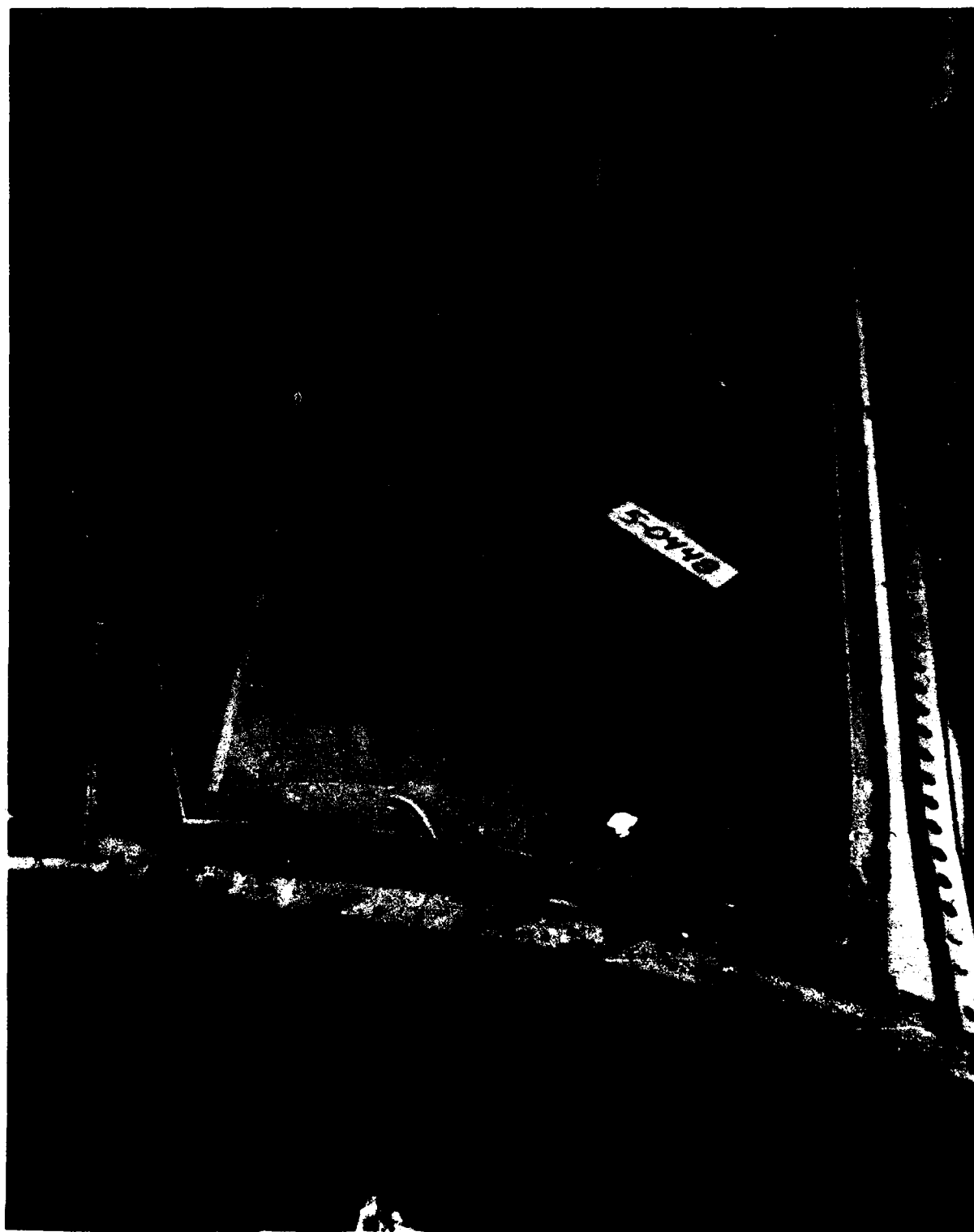

TEST NO. 22 SHOT NO. 5-0448

B--121

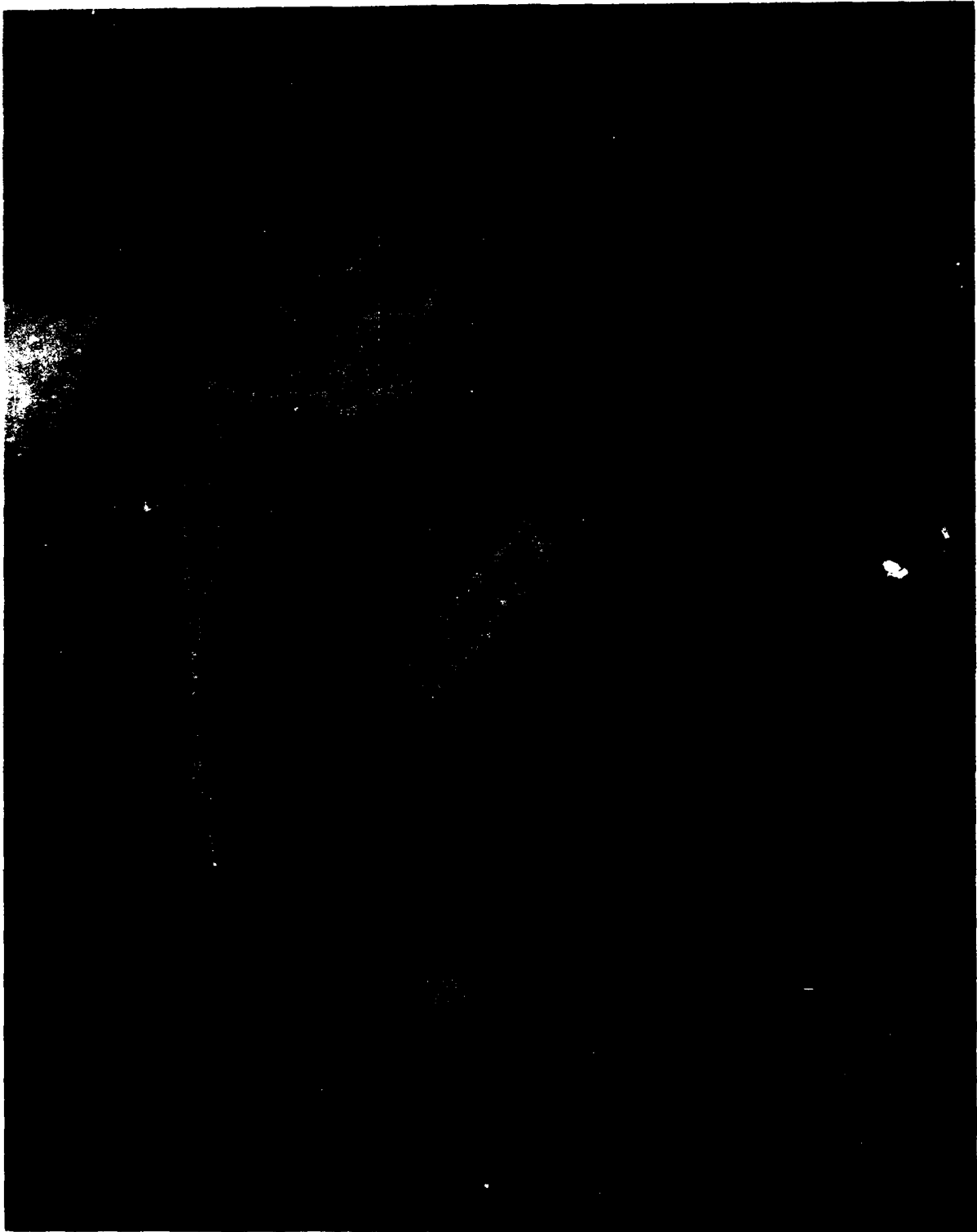

TEST NO. 22 SHOT NO. 5-0448

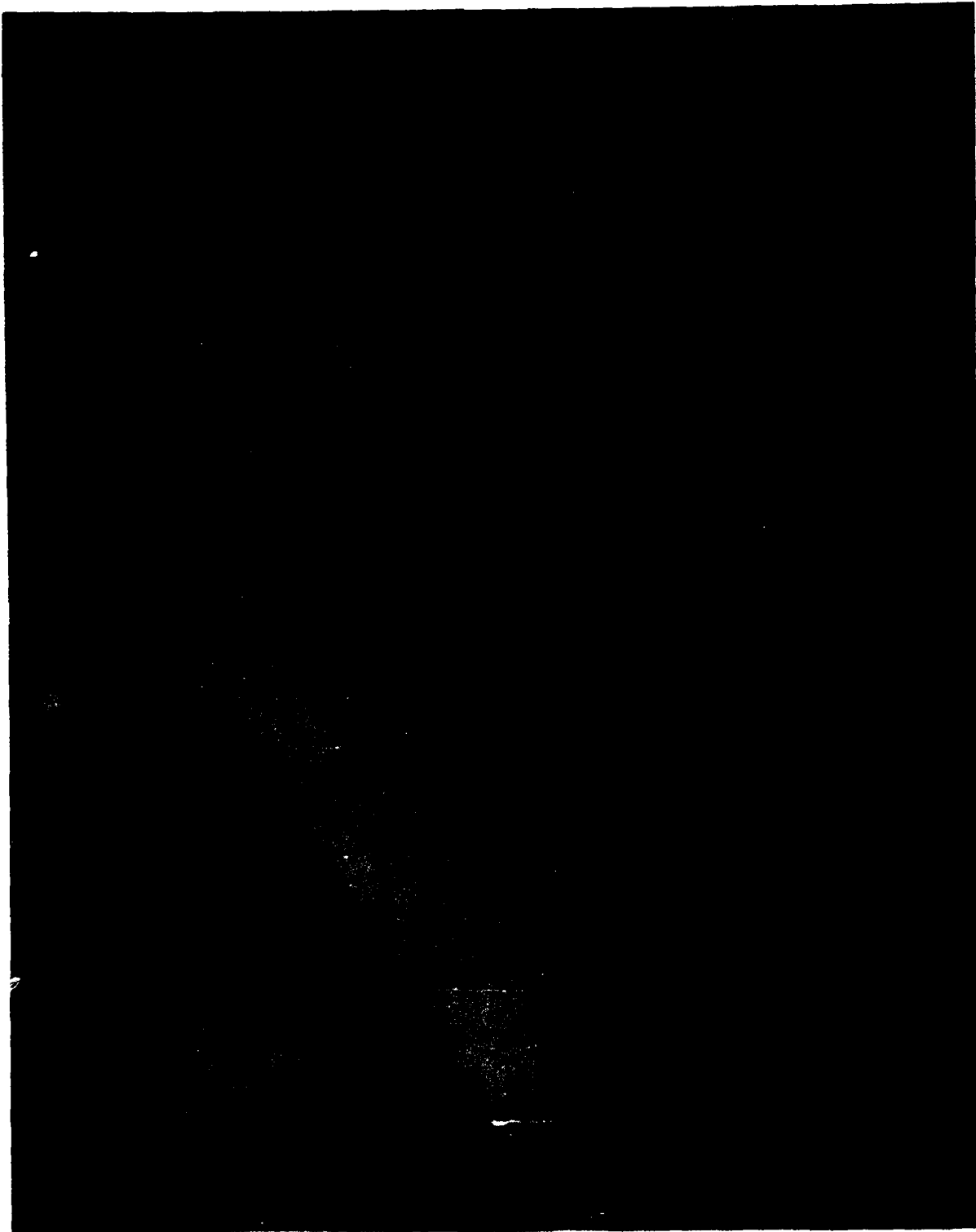

TEST NO. 22, SHOT NO. 5-0448

B-123



TEST NO. 22 SHOT NO. 5-0448

APPENDIX C

STRAIN DATA PLOTS
AND SYSTEM BIRDSTRIKE LOADS ANALYSIS

1.0 STRAIN DATA AND LOADS ANALYSIS

Strain data was obtained as part of the system structural response analysis. Strain data plots follow this analysis. The strain data was very inconsistent. In addition, under the dynamic birdstrike loadings, many gages failed adhesively. M-Bond AE-10 strain gage adhesive was used throughout most of the testing; being replaced late in the program with M-Bond 610 adhesive. The 610 adhesive adhered better to the arch, but debonding was still common.

Strain data from tests which were failures would not be expected to be consistent with shots which were passes, because after windshield failure the bird impacts the arch normal to the plane of the arch, causing out-of-plane deformation. There are a number of possible explanations for the erratic strain data from the shots which were passes:

- (1) at the high strain rate, the strain gage adhesive may behave viscoelastically;
- (2) there was test-to-test variation in bird orientation (pitch and yaw) and impact location;
- (3) due to manufacturing procedures, minor variations existed in the test arches; and
- (4) the windshields transmit loads differently, depending on manufacturer and overall stiffness.

The state of strain at the same instant was determined for each of the strain gage locations at Location II for each test. Location II gages were used because the strain at these gages was below the yield strain, allowing linear analysis. This strain was converted to stress assuming that the arch is experiencing stress only normal to the plane of a cross-section of the arch ($\sigma_y = \sigma_z = 0$), which allows use of Hooke's law in the form $\sigma_x = E\epsilon_x$.

Simultaneous equations were written to determine the axial load in the arch and the bending moments at Station II (reference Figure 10). The vertical sill reaction was determined from the axial load, and the average values at each velocity are listed in Table C1. Note that these values are averages using windshields from both manufacturers. The axial loads were reasonably consistent; however, the moments at the sill varied somewhat and are intentionally omitted to avoid confusion.

TABLE C1
VERTICAL SILL LOADS - FROM STRAIN DATA

<u>Velocity</u>	<u>Vertical Sill Load</u>
knots	pounds
350	8600
390	12000
430	14600

In addition to the strain data, there are several boundary conditions which were used to estimate the peak load on the aft arch during birdstrike.

1. In Test Number 1 at 464 knots, two 1/4 inch grade 8 sill bolts sheared, thus the horizontal reaction was greater than the shear strength of those two bolts, which is

$$\begin{aligned}
 P_{\text{ultimate}} &= [\tau_{\text{ultimate}}] [A_{\text{bolts}}] \\
 &= (0.62) (150,000\text{psi}) (2) (\pi) \frac{(0.25 \text{ in})^2}{4} = 9130\#
 \end{aligned}$$

2. The use of two 5/16 inch grade 8 sill bolts stopped the shear problem; however, these bolts did begin to yield on a few of the higher velocity shots. Consequently, the horizontal reaction for a 430-470 knot shot was between P_{yield} and P_{ultimate} .

$$\begin{aligned}
 P_{\text{yield}} &= [\tau_{\text{yield}}] [A_{\text{bolts}}] = (70,500 \text{ psi}) (2) (\pi) \frac{(0.3125 \text{ in})^2}{4} \\
 &= 10,800\#
 \end{aligned}$$

$$\begin{aligned}
 P_{\text{ultimate}} &= [\tau_{\text{ultimate}}] [A_{\text{bolts}}] \\
 &= (0.62) (150,000 \text{ psi}) (2) (\pi) \left(\frac{0.3125 \text{ in}^2}{4} \right) = 14,300\#
 \end{aligned}$$

3. In-plane yielding of the aft arch began at a velocity of approximately 350 knots.

The maximum stress in the aft arch may be expressed by the classic bending stress equation $\sigma = \frac{Mc}{I}$.

For boundary Condition 3, the maximum in-plane bending moment was determined by static analysis of the F-111 support structure using the Material and Geometric Nonlinear Analysis (MAGNA) finite element code.¹¹ Curved beam elements were used for the aft arch and for the forward and aft center beam. The load P_r was applied in the plane of the aft arch and was distributed over 8 inches which is approximately equal to the width of the footprint of the bird. The end fixity for the aft arch is assumed to be represented by a fixed end condition, since analysis of the strain data indicates that significant sill moments exist. The modeling conditions and results are shown in Figures C1 and C2. The maximum in-plane bending moment (which occurs directly behind the impact point) is given by

$$M_r = 2.2 P_r$$

The peak normal load on the windshield is determined from the momentum equation

$$P_n \Delta t = mV_n$$

The normal component of the velocity, $V_n = V \sin \theta$, see Figure C3. The time of impact is assumed to equal the "squash up time" of the bird, $\Delta t = \frac{L_b}{v}$, and finally, a constant k is introduced to

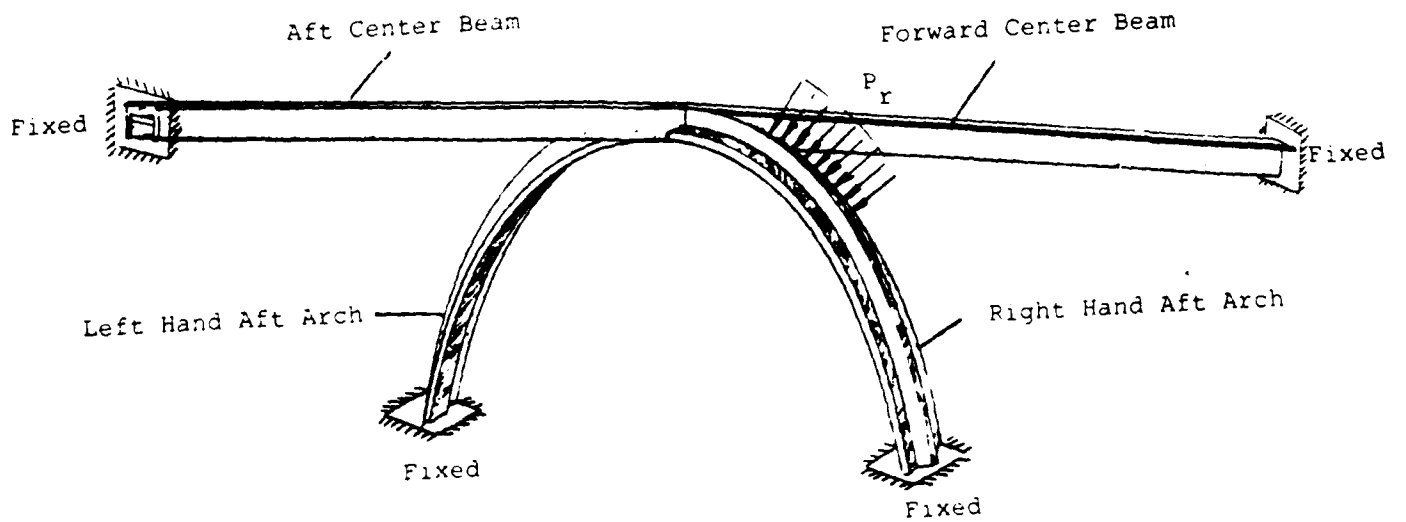
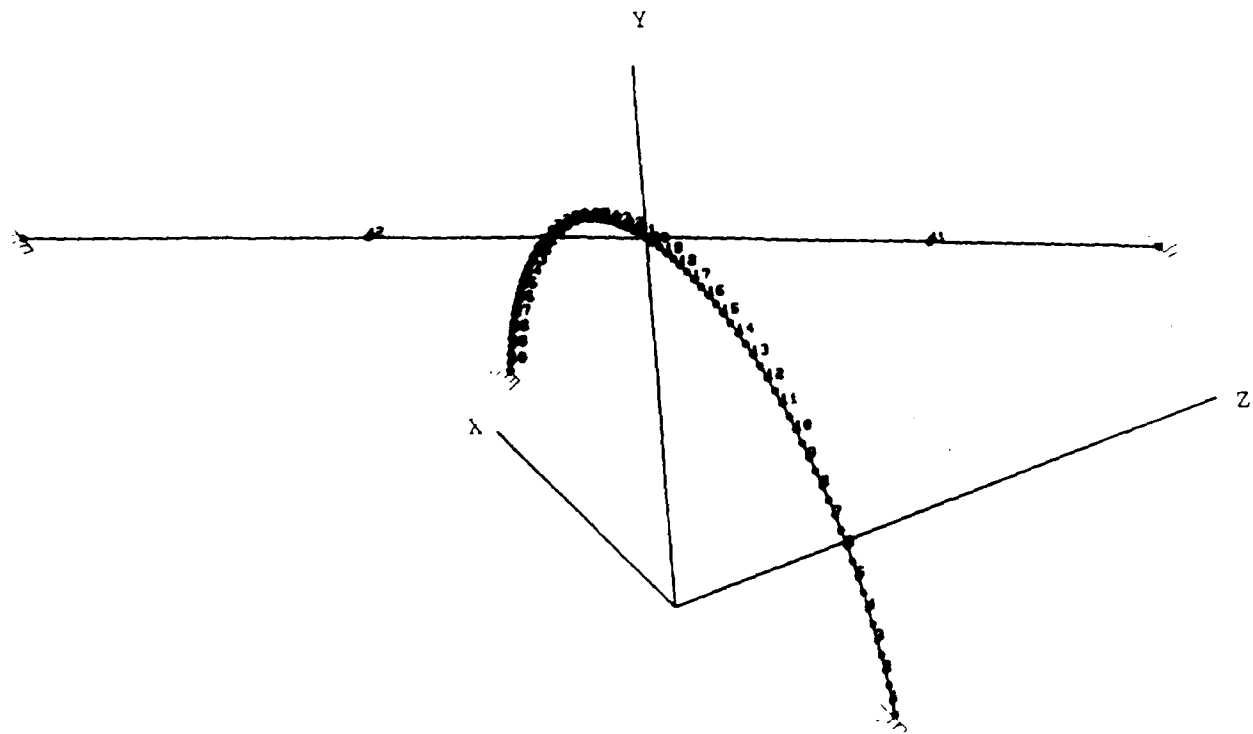

Figure C1. F-111 Support Structure Finite Element Model.

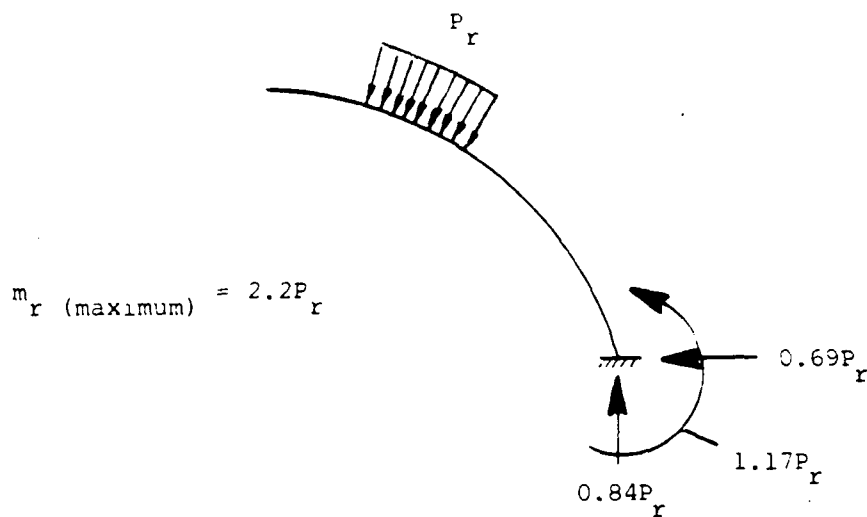
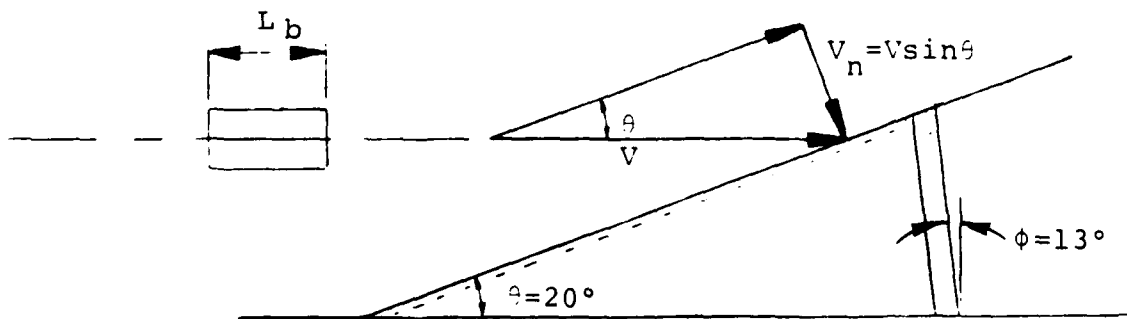

Figure C2. Finite Element Results.



NOTE: L_b , the effective length of the bird, is assumed to be equal to 12 inches.

L , the bird length, does not equal L_b .

Figure C3. Bird Impact Angle of Incidence and Velocity Vectors.

adjust for the fact that only a percentage of the energy (and thus the peak load) introduced into the windshield is transmitted to the aft arch. The remainder of the energy is absorbed by the windshield and other support structure. Thus,

$$P_n = \frac{kmV_{fps}^2 \sin\theta}{L_b}$$

or, for V in knots, $V_{fps} = 1.69 V_{kts}$, so

$$P_n = \frac{km(1.69)^2 V_{kts}^2 \sin\theta}{L_b}$$

This peak normal load can be resolved into two components, an in-plane component (radial to the arch), P_r , and an out-of-plane component (normal to the arch), P_o .

$$P_r = P_n \cos(\theta - \phi)$$

$$P_o = P_n \sin(\theta - \phi)$$

Thus, substituting the peak in-plane load into the bending stress equation, the in-plane bending stress is given by

$$\sigma_r = \left[\frac{km(1.69)^2 V_{kts}^2 \sin\theta \cos(\theta - \phi)}{L_b} \right] (2.2) \left(\frac{C}{I} \right)$$

For yielding at 350 knots,

$$145,000 = k \left[\frac{4}{32.2} \right] \frac{(1.69)^2 (350)^2 \sin 20^\circ \cos 7^\circ (2.2)}{1} \frac{(0.8069)}{(0.1357)}$$

solving for k,

$$k = 0.75$$

The resulting peak in-plane load on the arch at 470 knots is

$$P_r = km \frac{(1.69)^2 v_{kts}^2 \sin\theta \cos(\theta - \phi)}{L_b}$$
$$P_r = (0.75) \frac{\left[\frac{4}{32.2}\right] (1.69)^2 (470)^2 \sin 20^\circ \cos 7^\circ}{1}$$
$$P_r = 19,900\#$$

From Figure 15, the horizontal and vertical sill reactions are

$$R_v = 0.84 P_r = 16,800\#$$
$$R_h = 0.69 P_r = 13,800\#$$

Note that the horizontal reaction is smaller than the shear strength of the 5/16 inch bolts at the sill, satisfying boundary condition Number 2.

The final estimated loads are shown in Table C2. These loads approximate the boundary conditions, and are presented as averages for PPG and Sierracin windshields. The loads are derived assuming linear system response; being a simplification of the complex real-world problem which involves high strain rates, large displacements, and plasticity. These nonlinear effects may reduce the peak loads reported in Table C2 for the higher velocity shots (470 knots and above) due to the fact that once the arch begins to yield, its ability to carry additional load is reduced. However, the arch still has the capability to absorb additional energy by additional displacement.

1.0.1 Strain Data and Loads Analysis Summary

Dynamic strain gage data is often inconsistent and difficult to interpret; however, it is valuable for estimating strain and stress levels and is extremely valuable for determining if the material is yielding. Theoretical/empirical analysis can be used to describe system behavior. Loads

TABLE C2

FINAL LOAD ESTIMATIONS

Velocity (knots)	Horizontal Sill Reaction, R_H (pounds)	Vertical Sill Reaction, R_V (pounds)	Peak Radial Load on the Arch P_r	Peak Load on the Arch, normal to the windshield, P_n (pounds)
350	7,150	9,000	11,000	11,100
390	8,900	11,200	13,700	13,800
430	10,300	13,700	16,600	16,700
470	13,800	16,800	19,900	20,000
500	15,500	18,900	22,600	22,800

corresponding to given velocities can be estimated and used in the design of new systems providing increased birdstrike protection, or loads can be estimated to apply to existing windshield structure which is being retrofitted with bird impact resistant transparencies.

2.0 STRAIN DATA PLOTS

GAUGE I-1

)

Test No. 1 Shot 5-0427

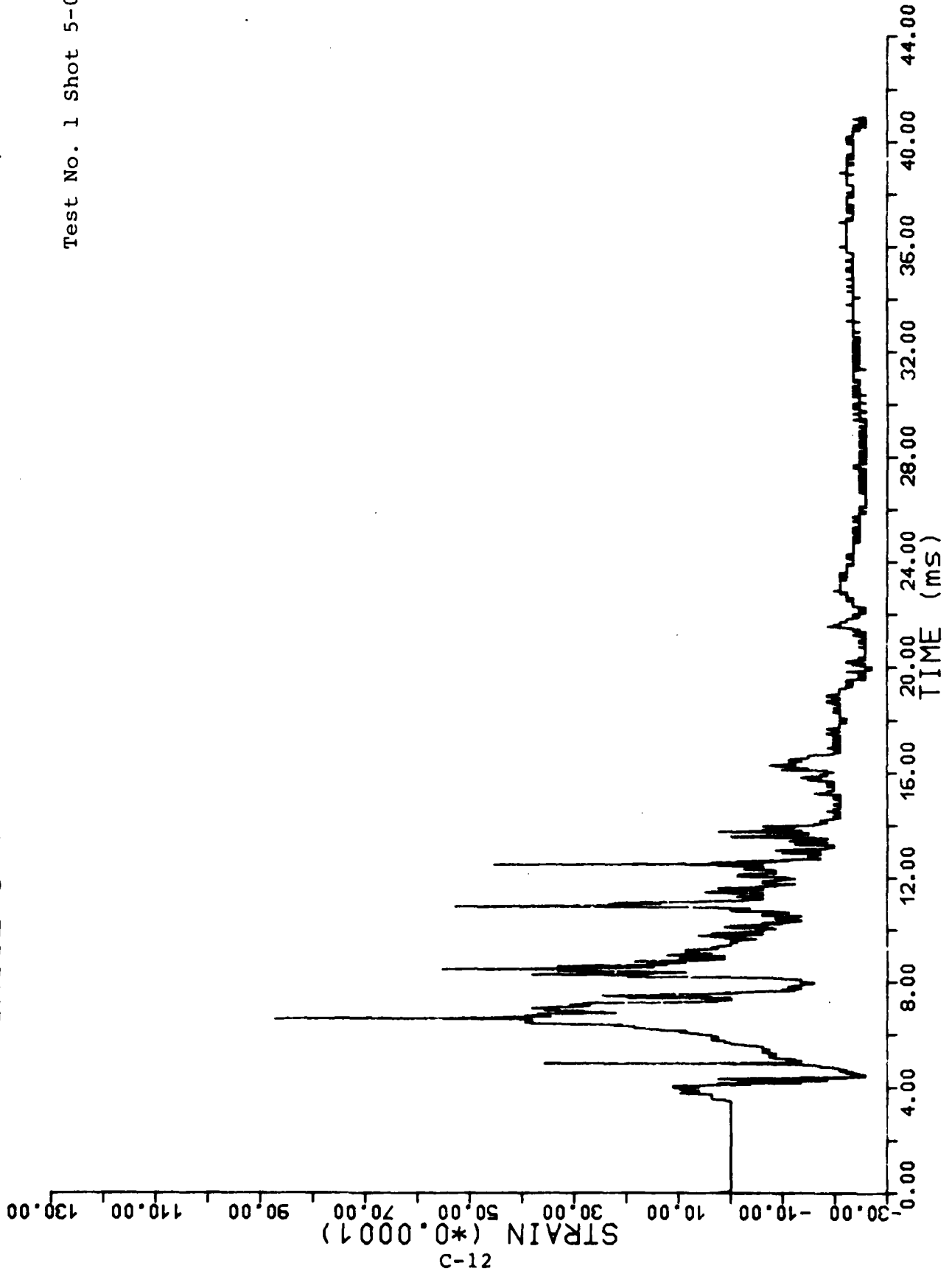

GAUGEI-2

Test No. 1 Shot 5-0427

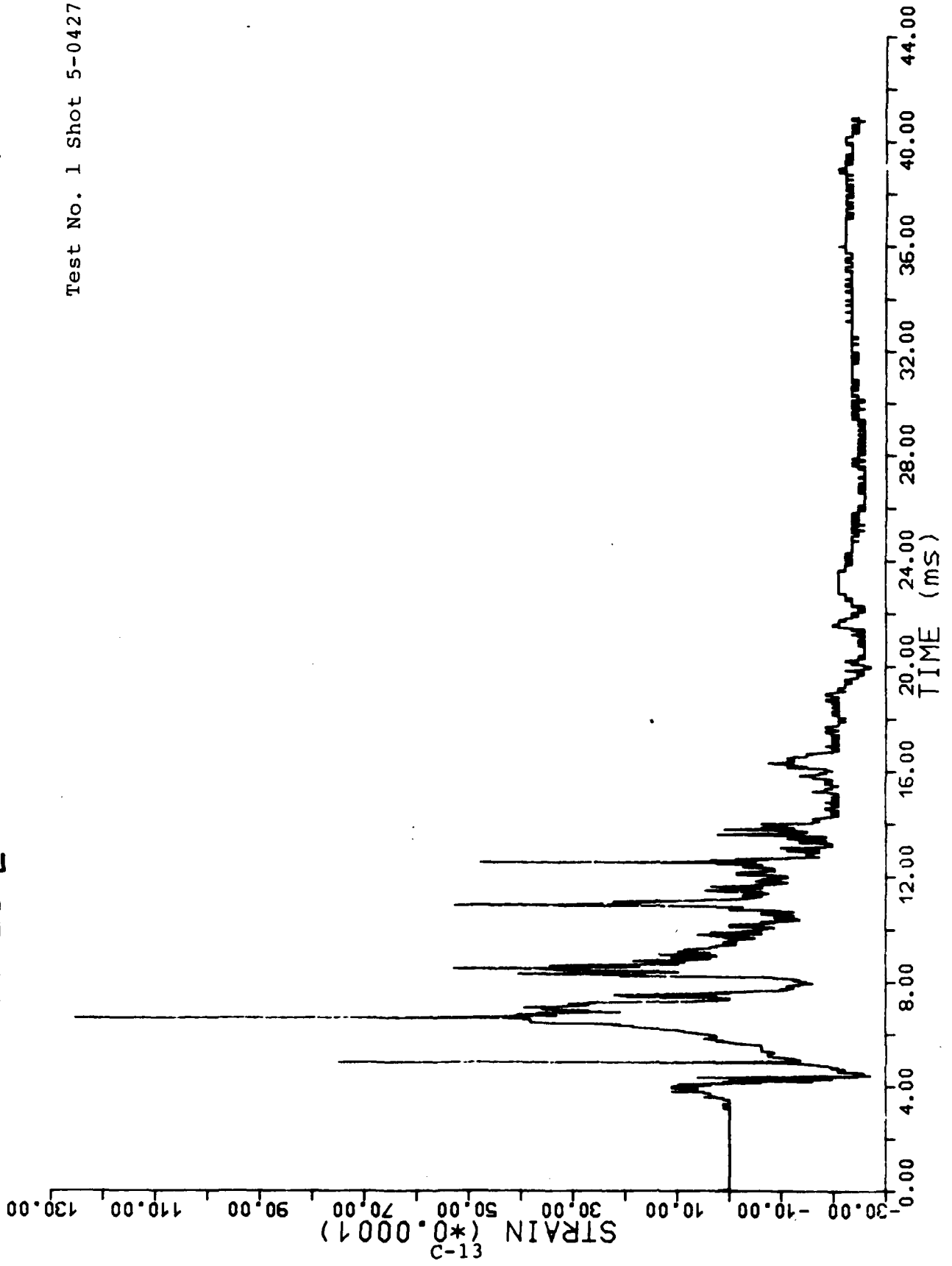

GAUGE I-3

Test No. 1 Shot 5-0427

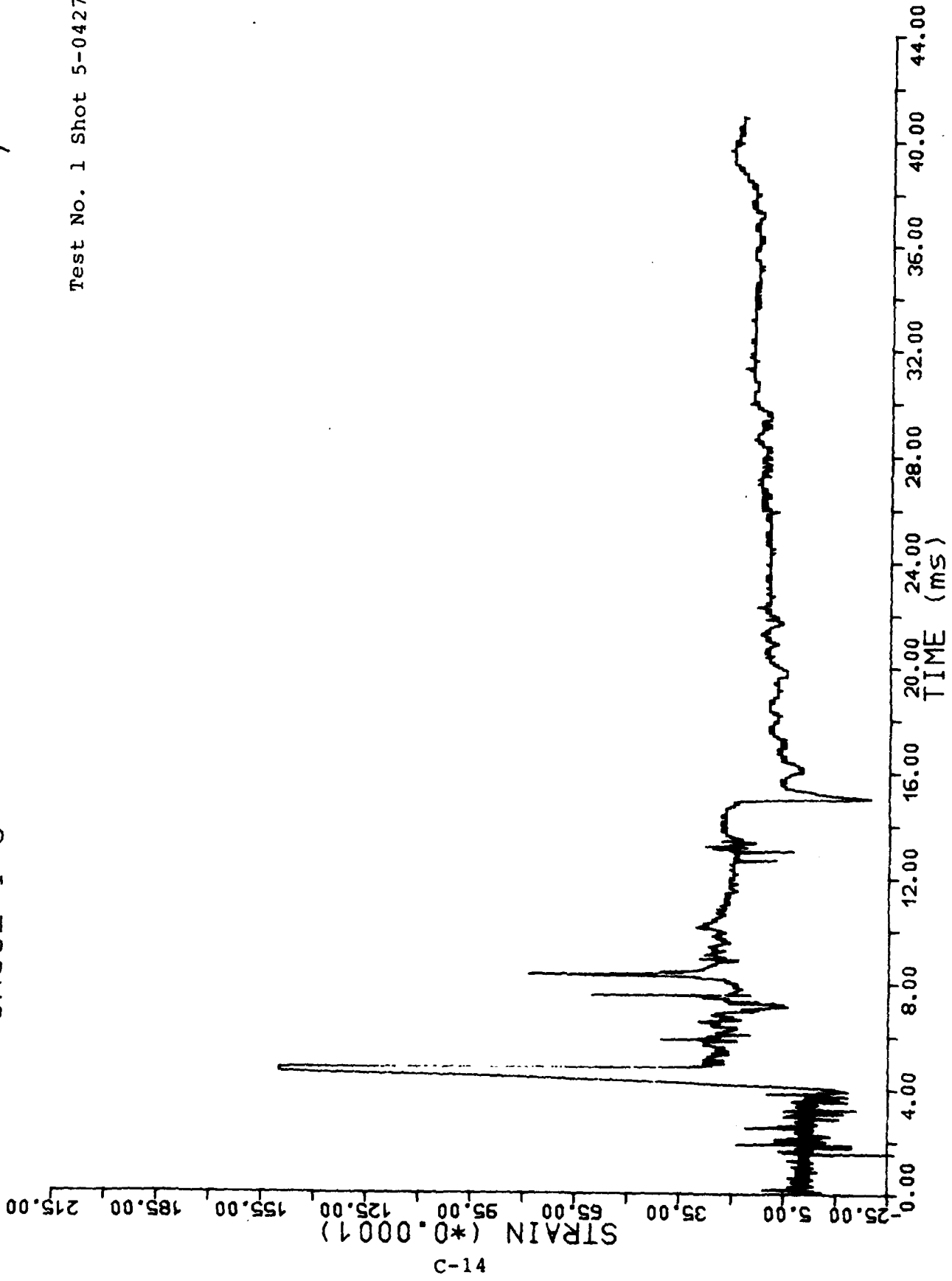

C-14

GAUGE II-1

Test No. 1 Shot 5-0427

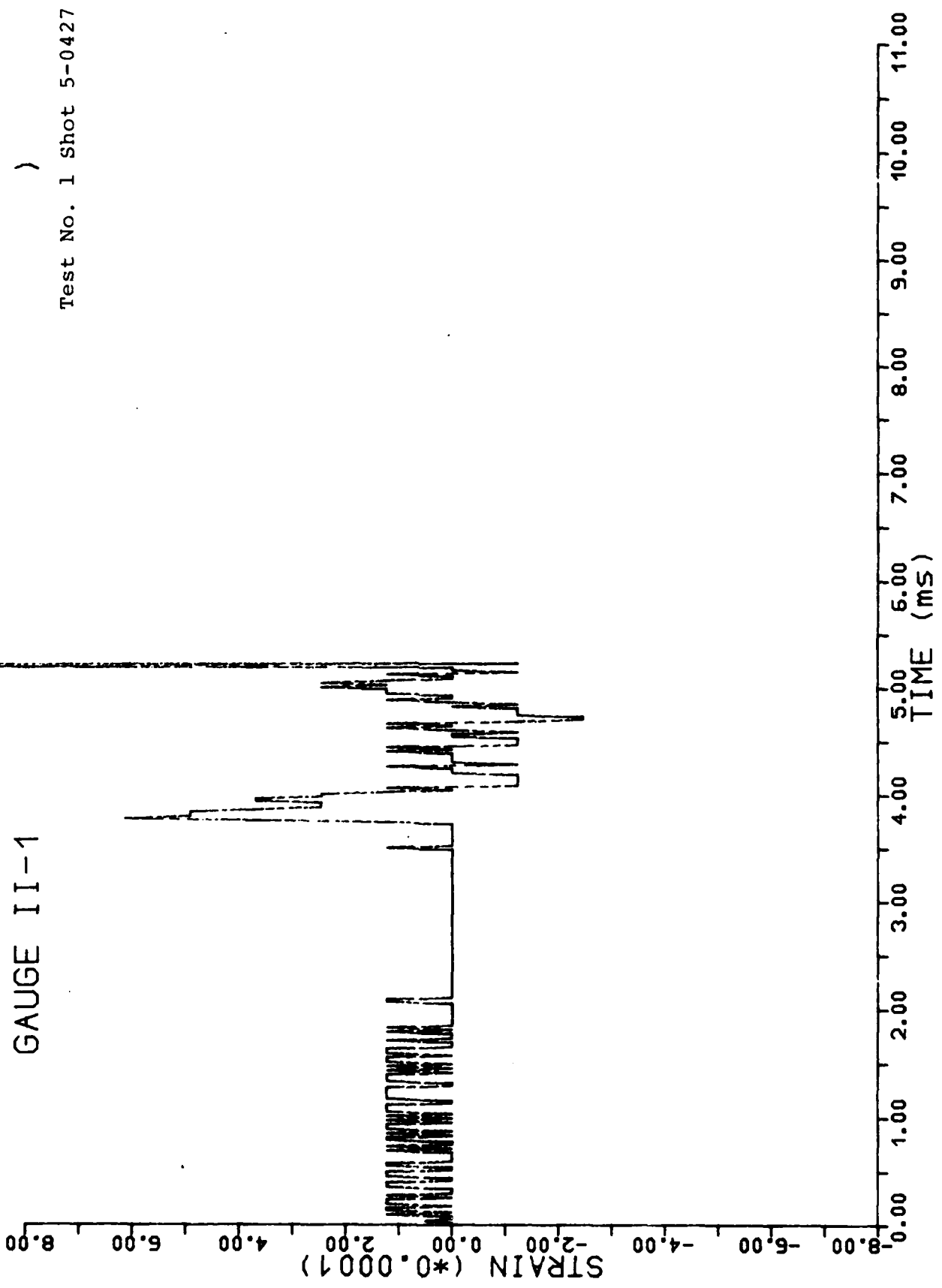

GAUGE II-2

Test No. 1 Shot 5-0427

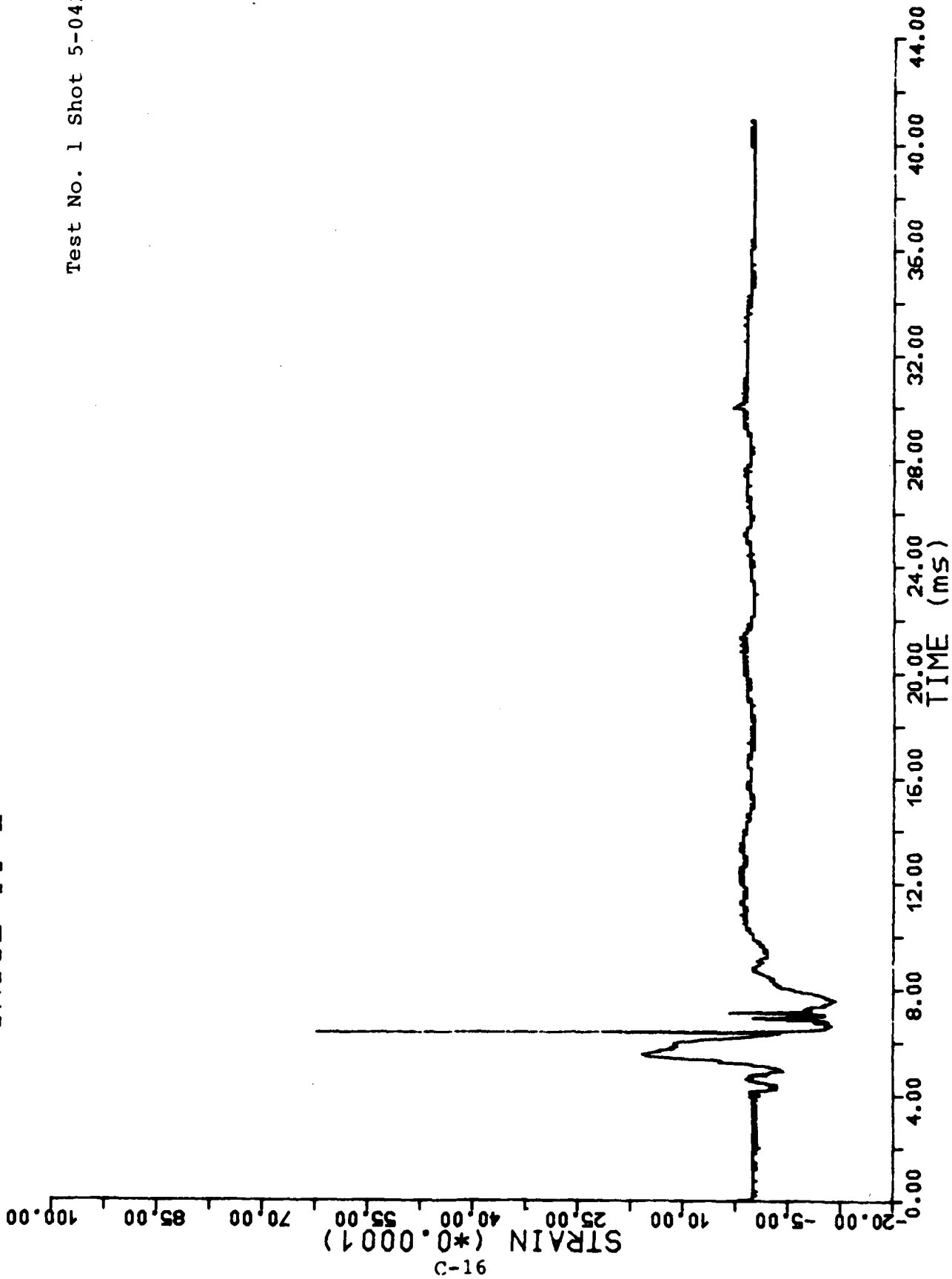

GAUGE II-3

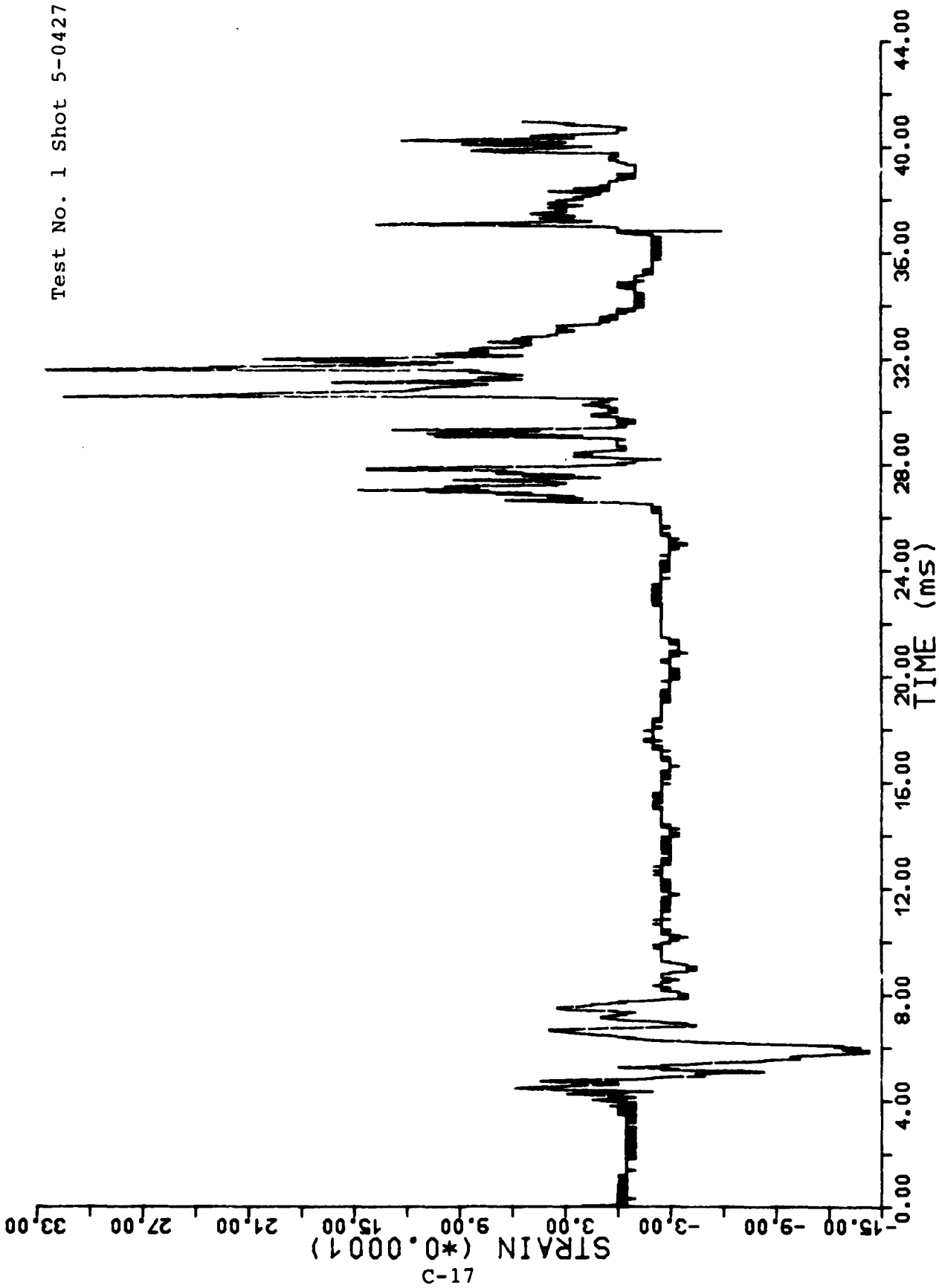

GAUGE I-1

Test No. 3 Shot 5-0429

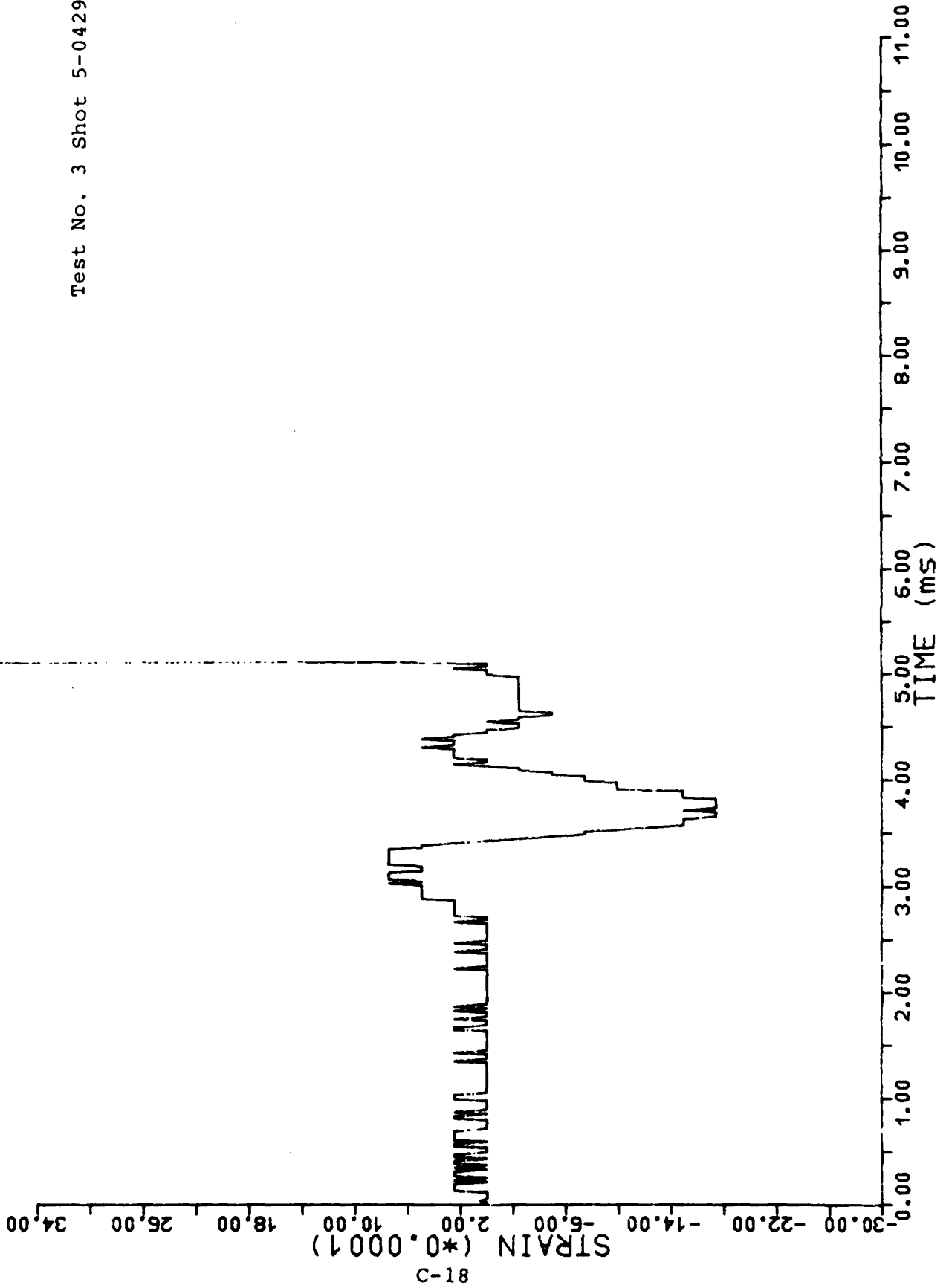

GAUGE I-2

Test No. 3 Shot 5-0429

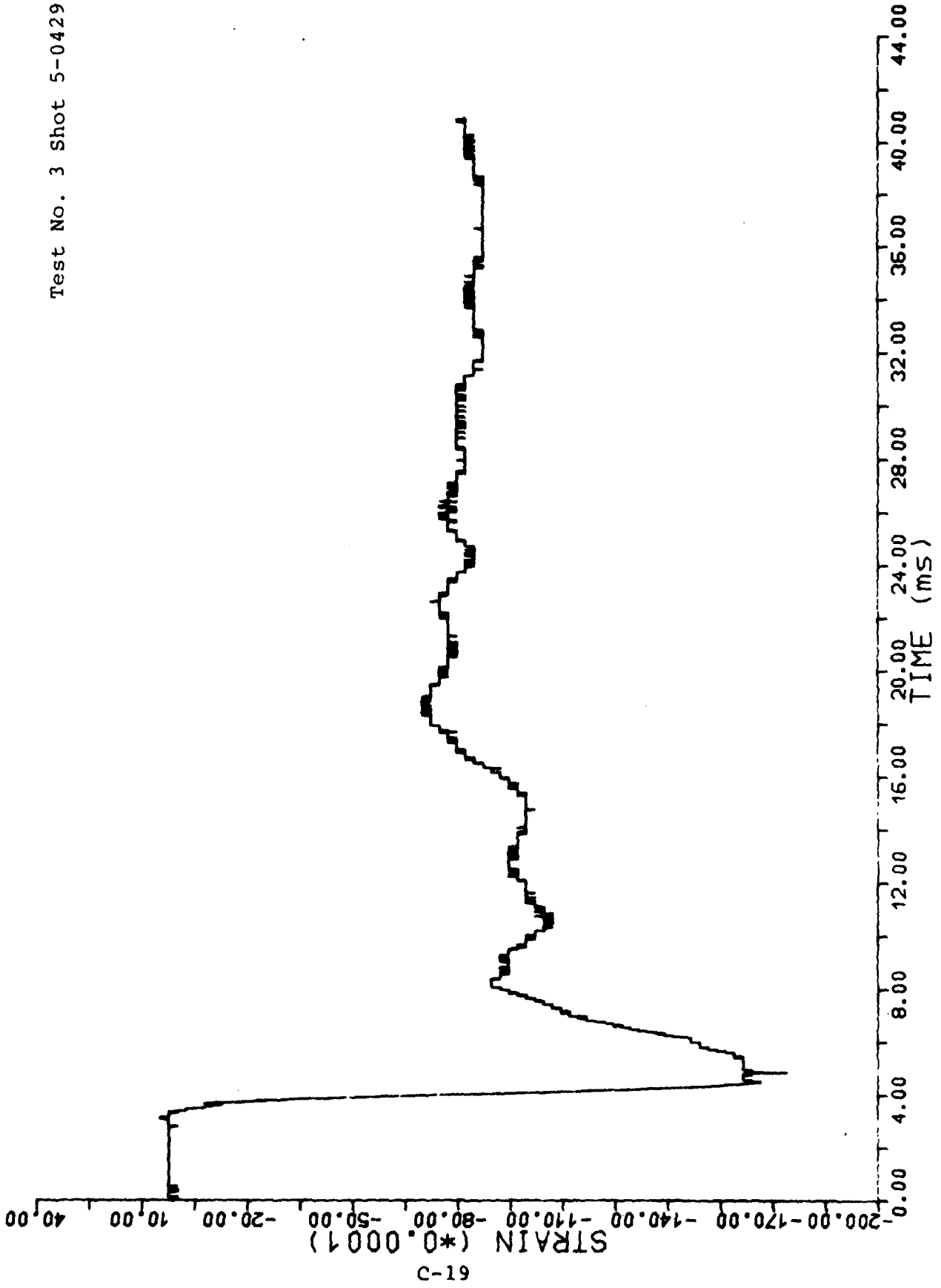

GAUGE II-1

Test No. 3 Shot 5-0429

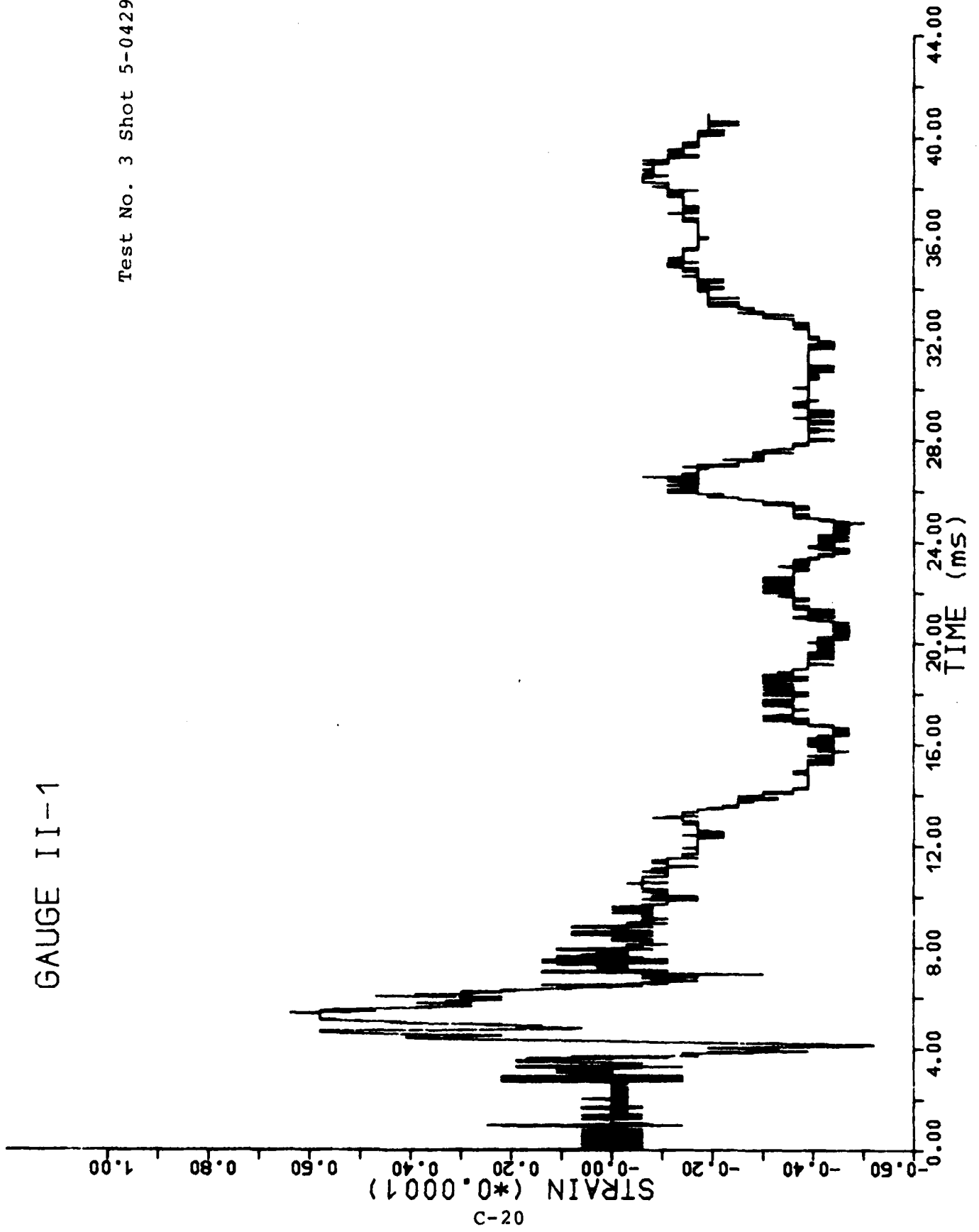

C-20

GAUGE II-2

Test No. 3 Shot 5-0429

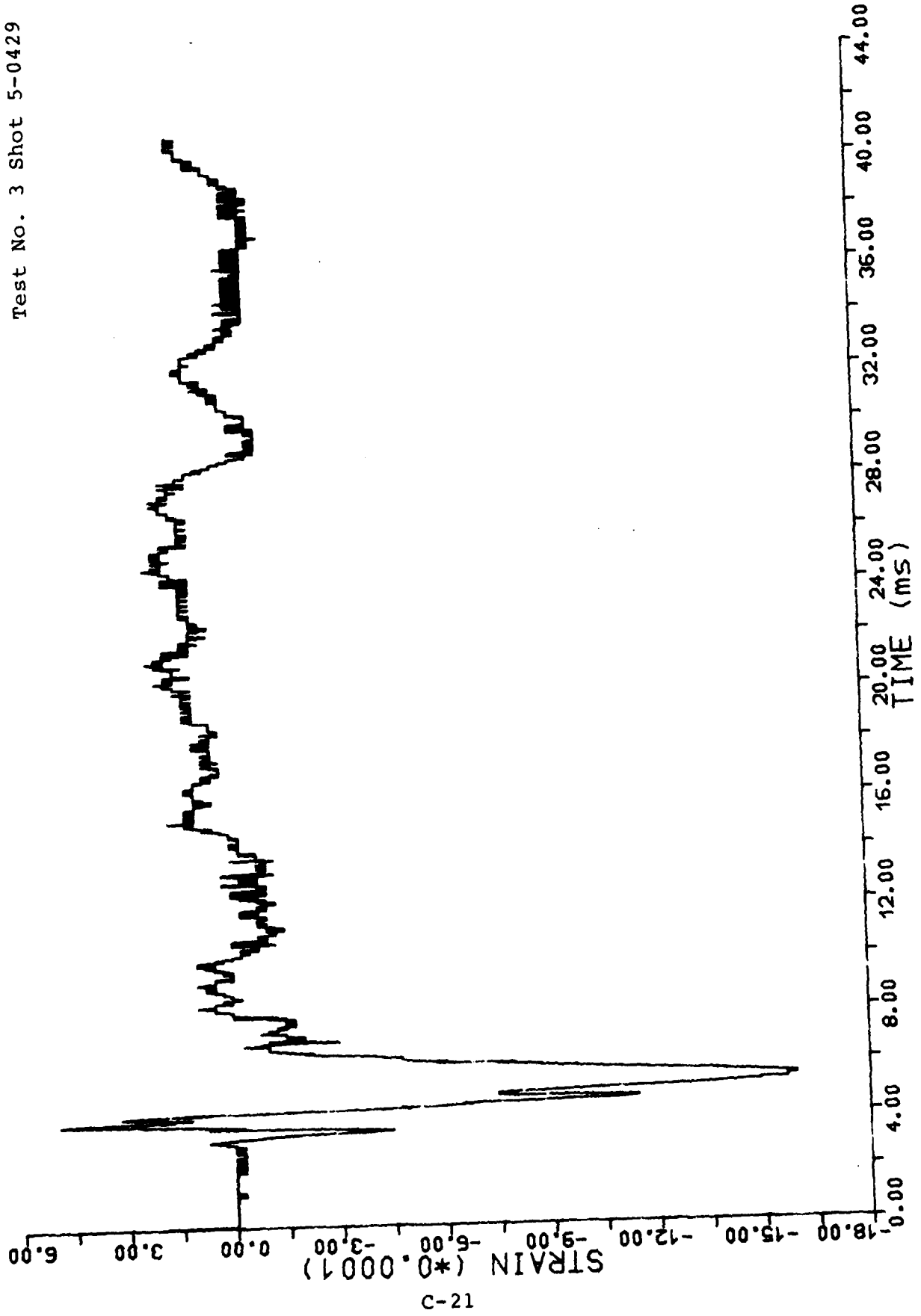

12-C

gauge I-1)

Test No. 7 Shot 5-0433

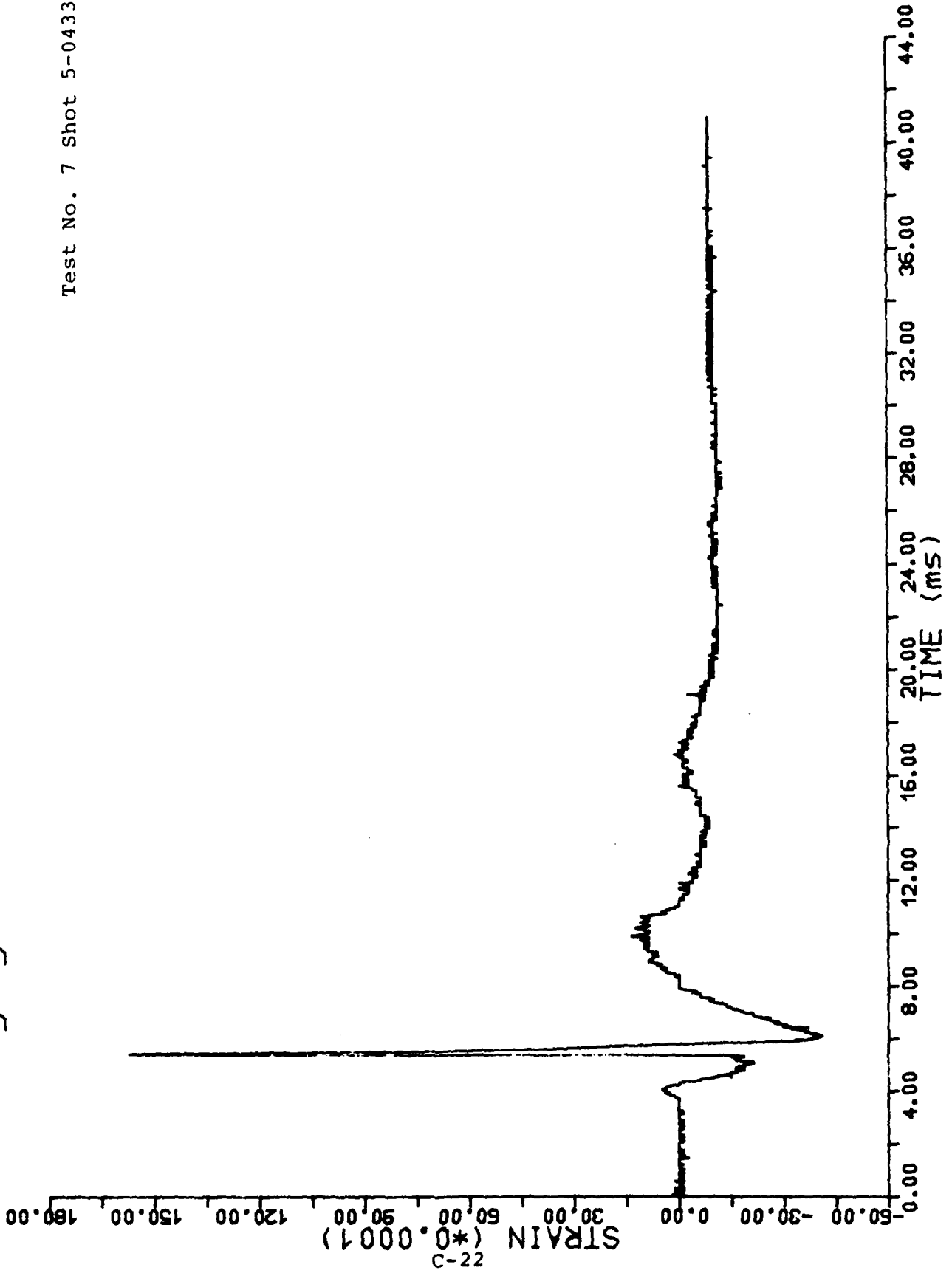

22-C
STRAIN (*0.0001)

gauge I-2

Test No. 7 Shot 5-0433

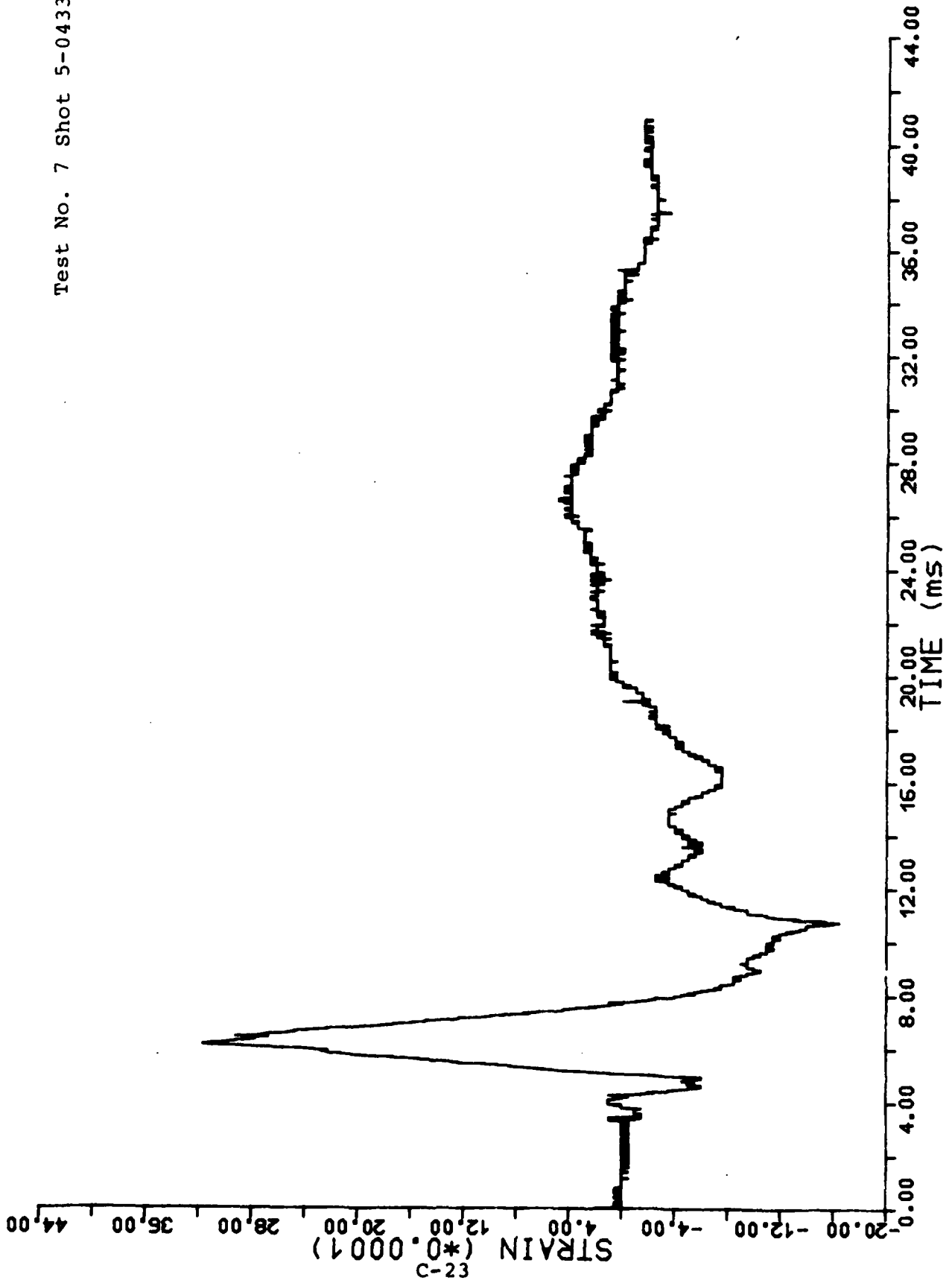

gauge I-3

Test No. 7 Shot 5-0433

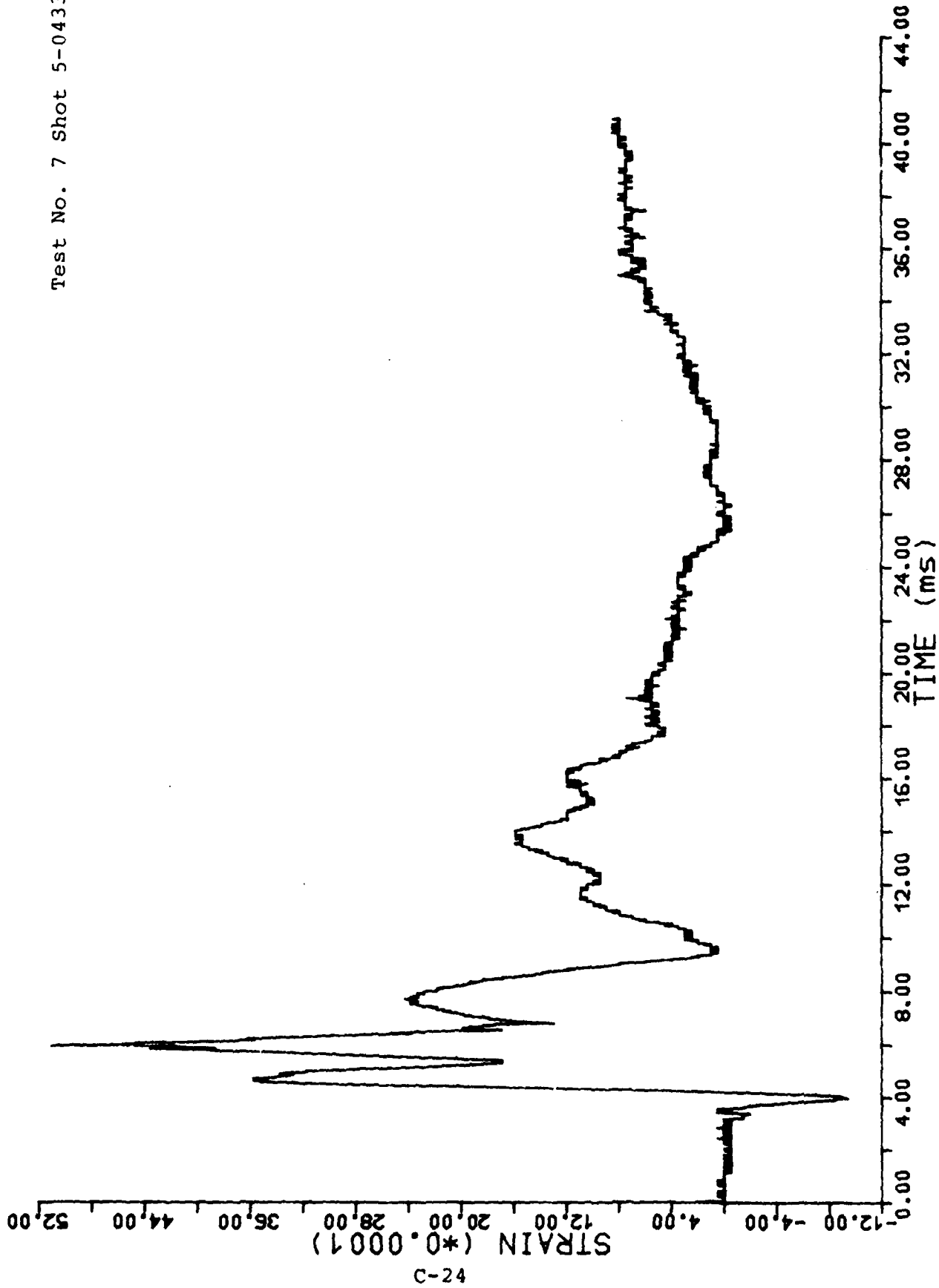

C-24

gauge II-3

Test No. 7 Shot 5-0433

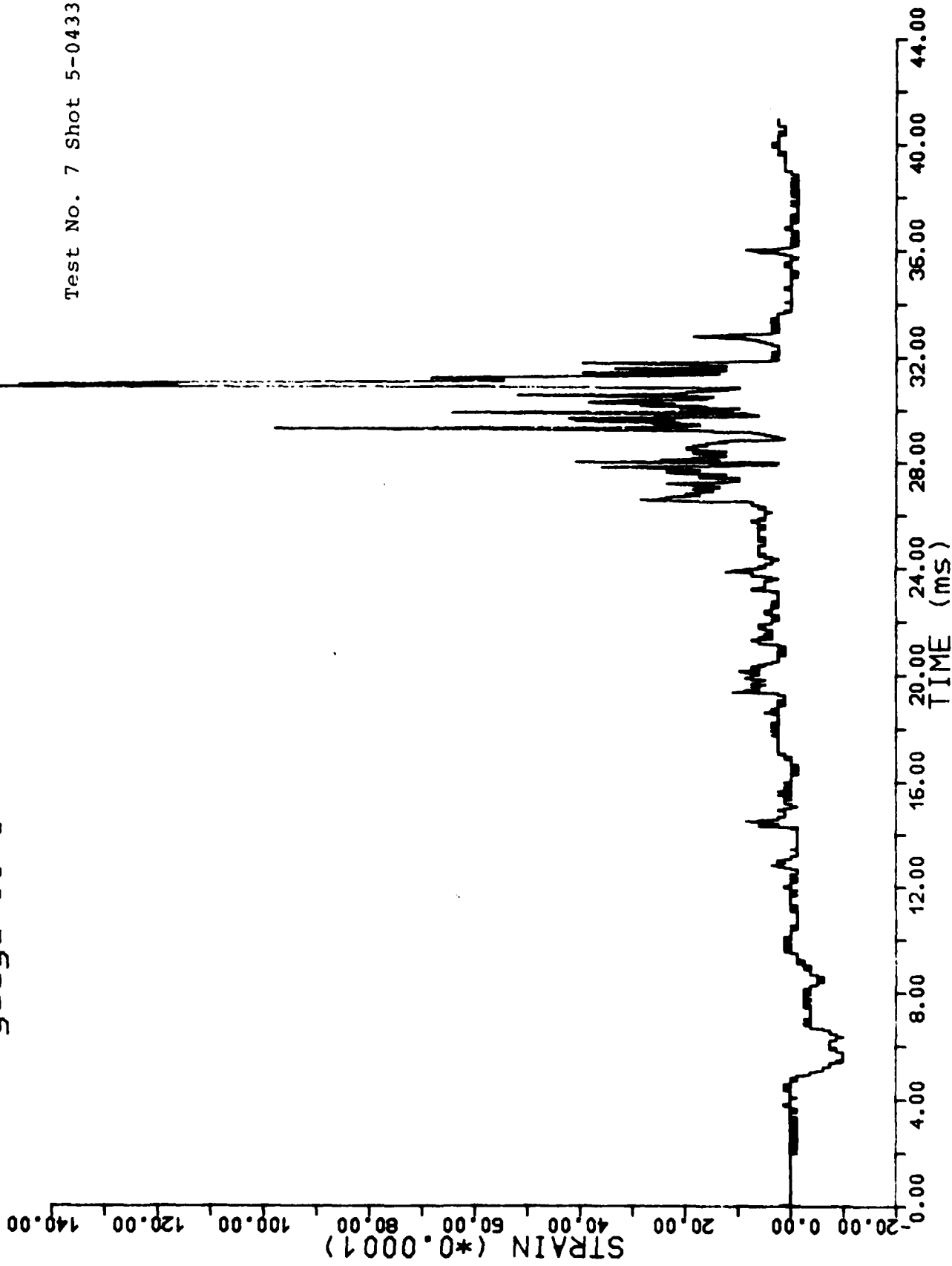

gauge I-1

Test No. 8 Shot 5-0434

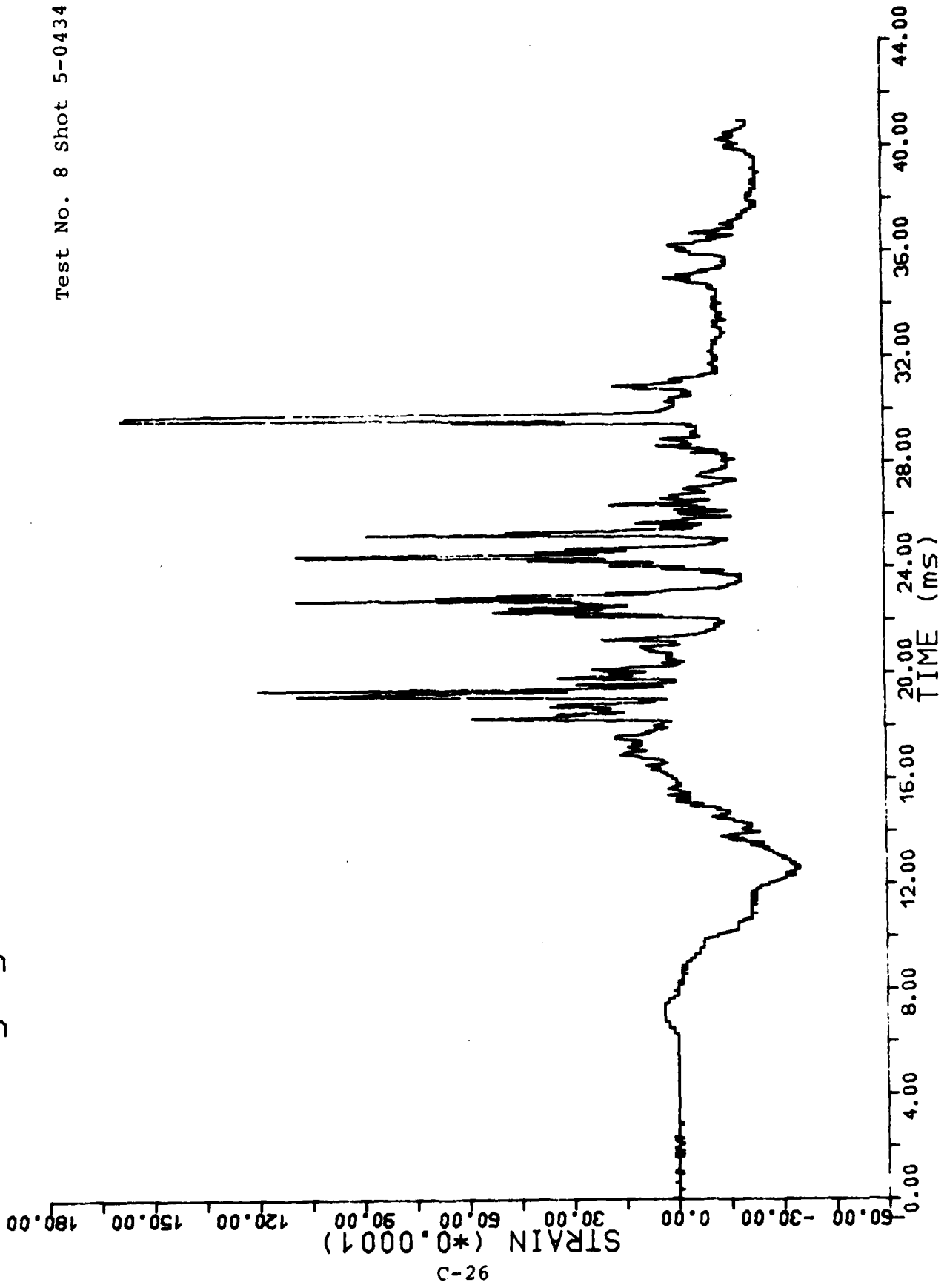

gauge I-2

Test No. 8 Shot 5-0434

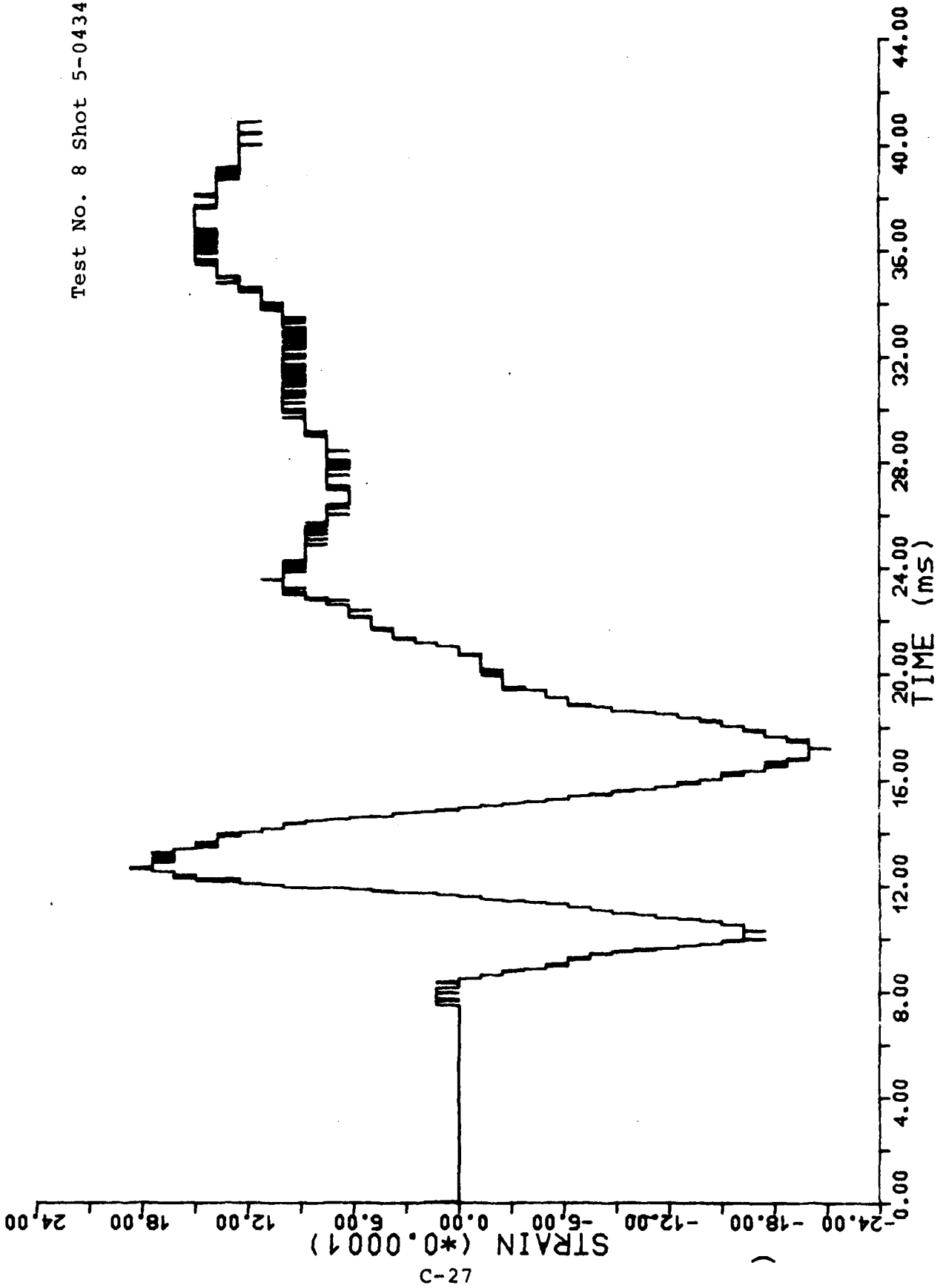

C-27

gauge I-3

Test No. 8 Shot 5-0434

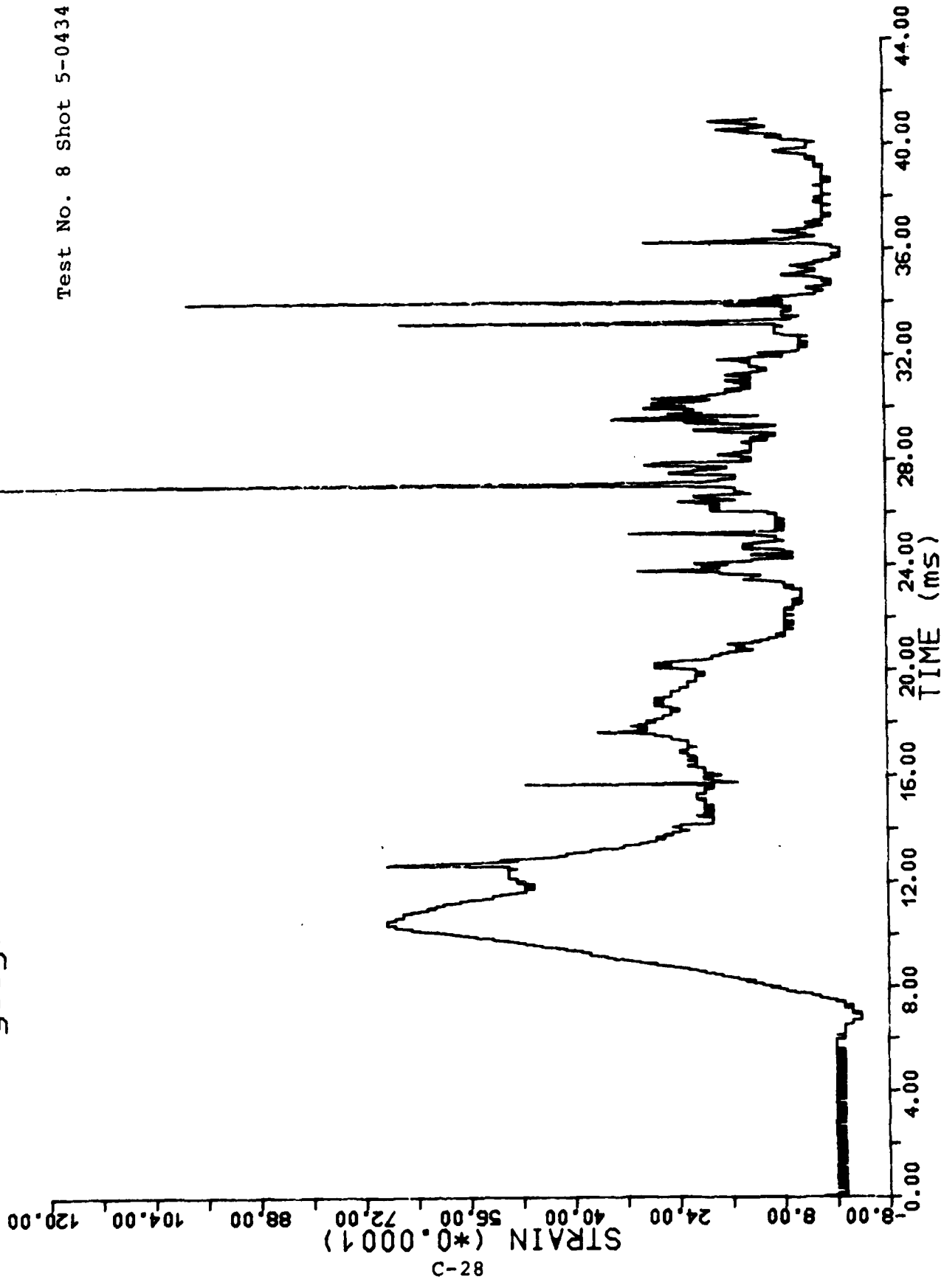

gauge II-1

Test No. 8 Shot 5-0434

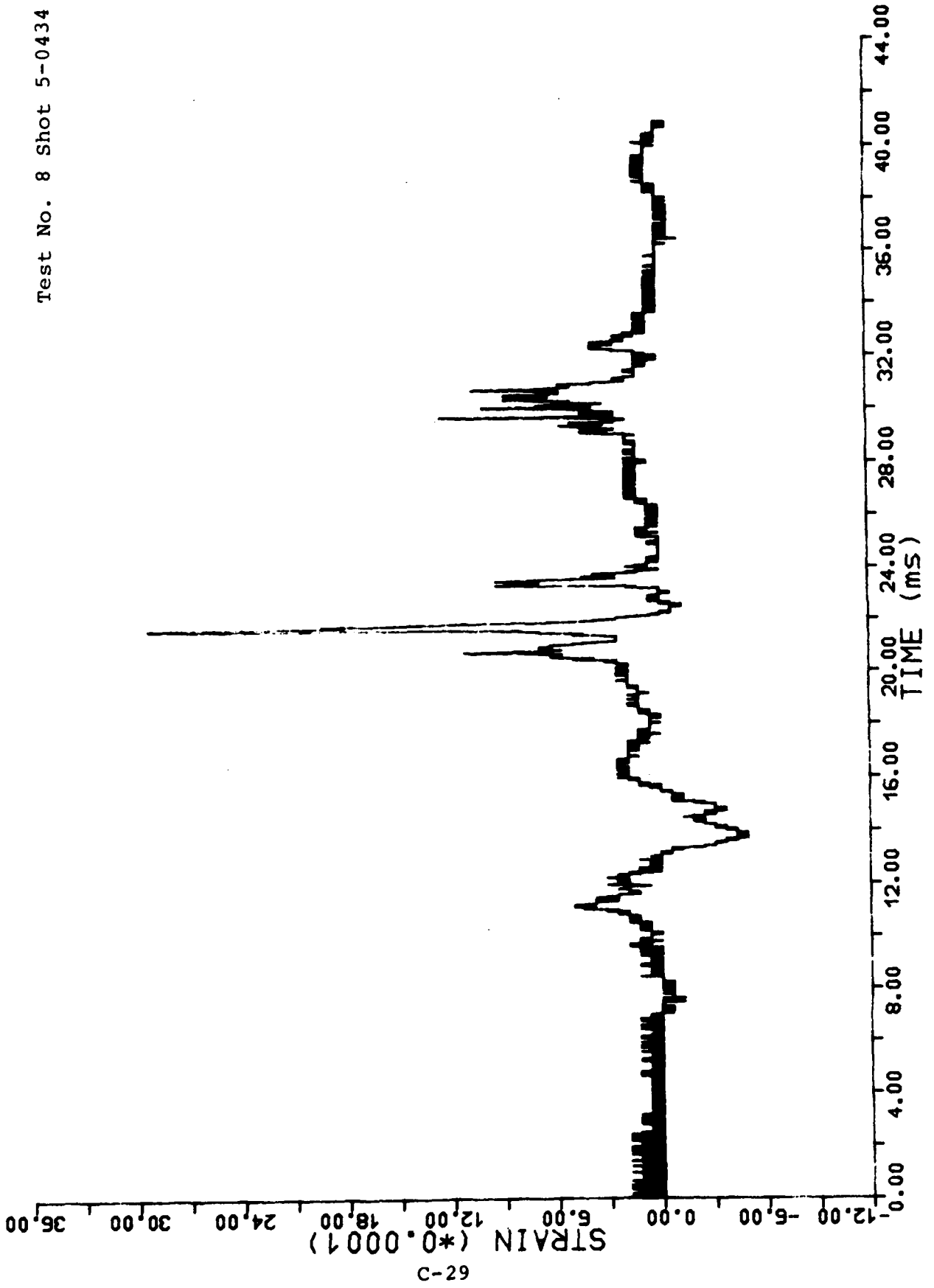

gauge II-2

Test No. 8 Shot 5-0434

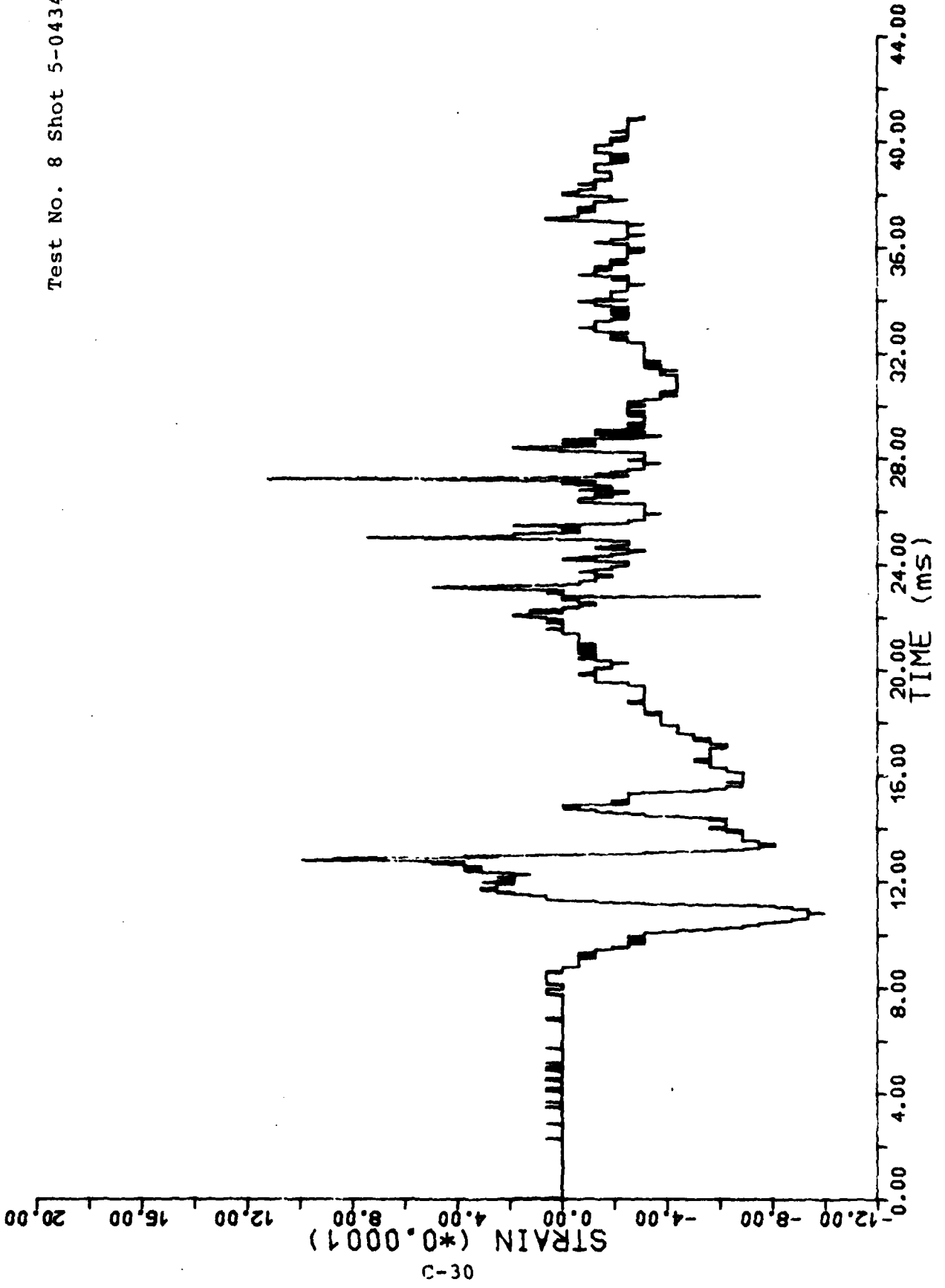

C-30

gauge II-3

Test No. 8 Shot 5-0434

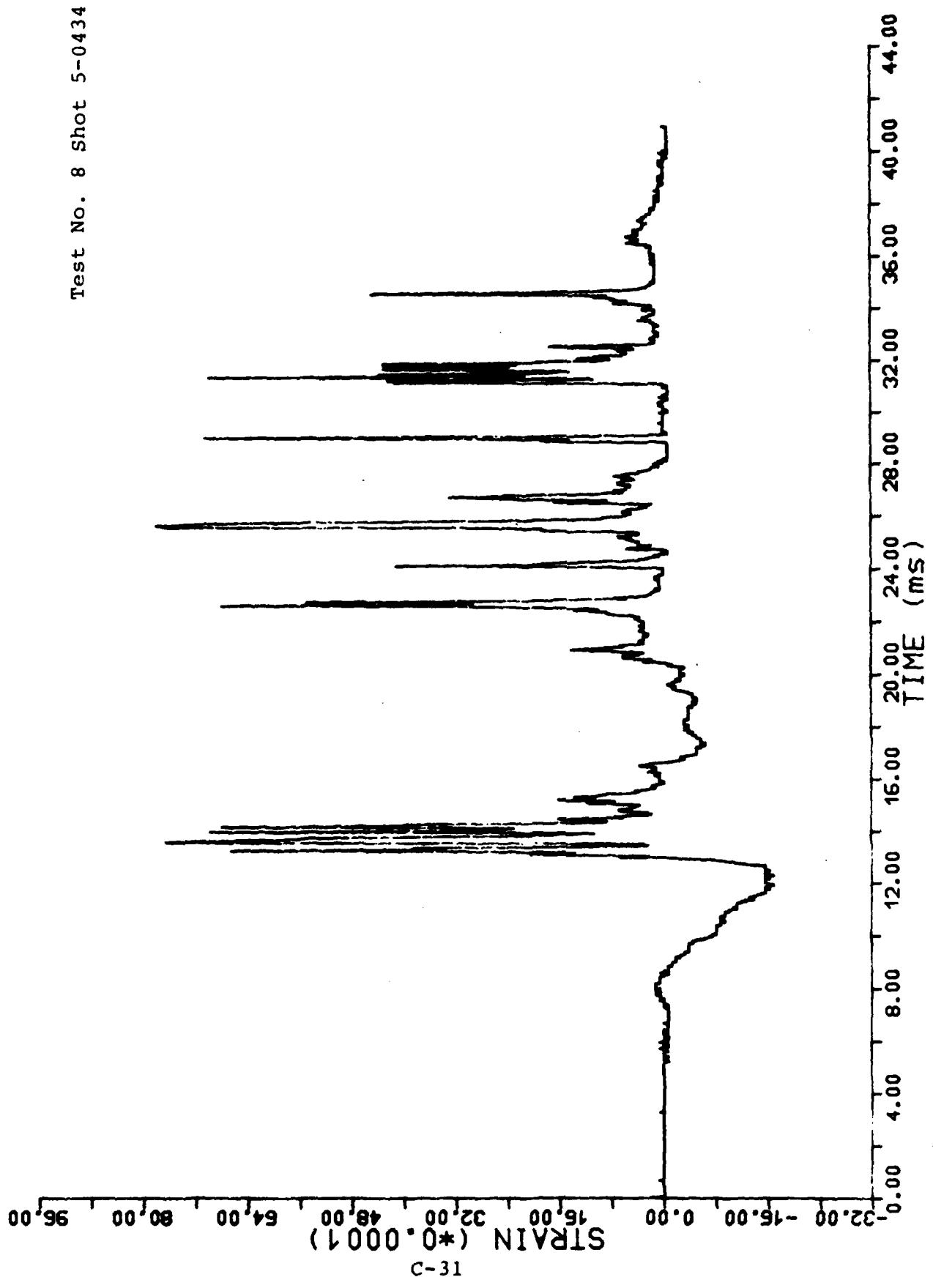

C-31

gage I-1

Test No. 9 Shot 5-0435

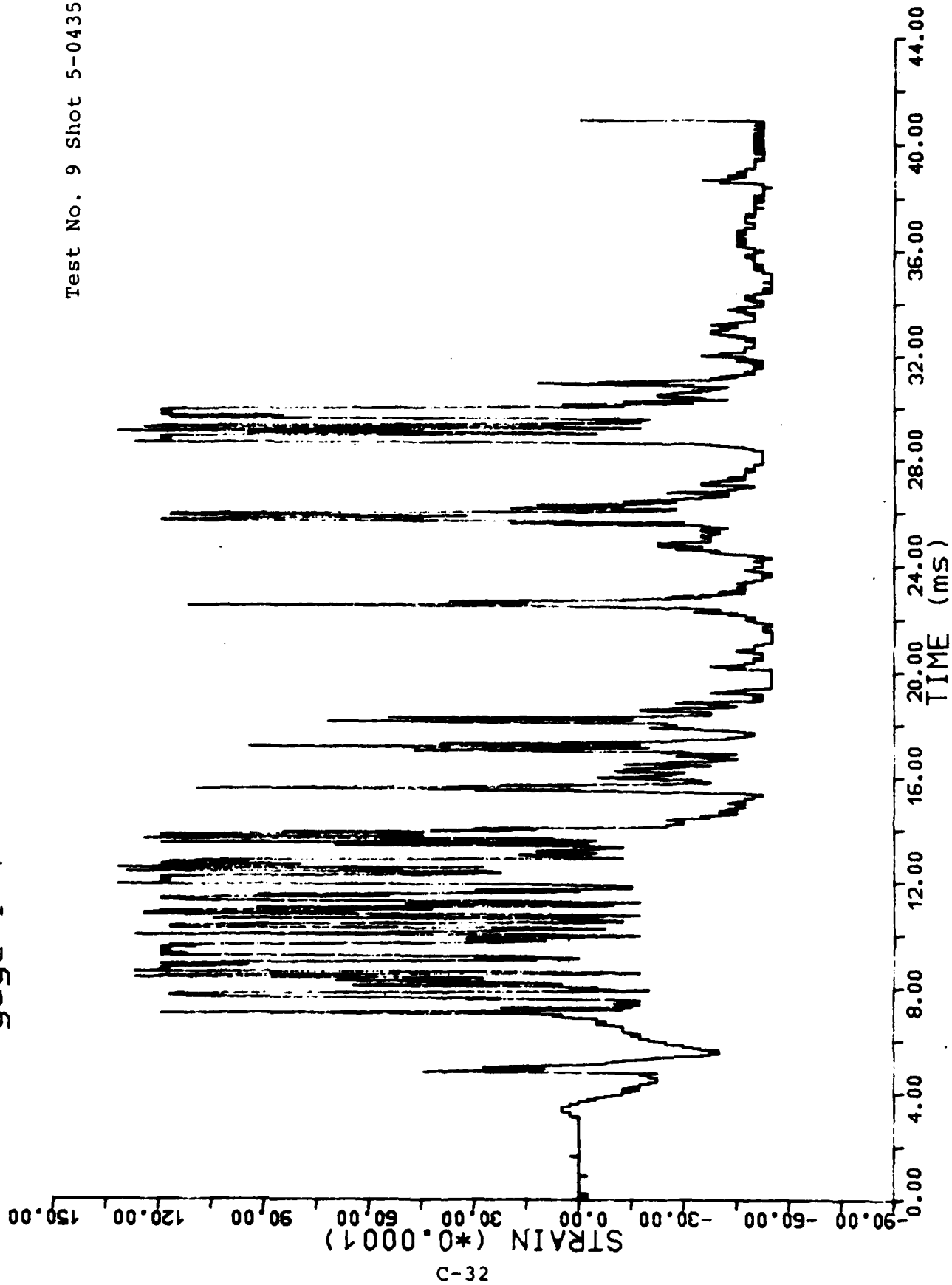

C-32

gauge I-2

Test No. 9 Shot 5-0435

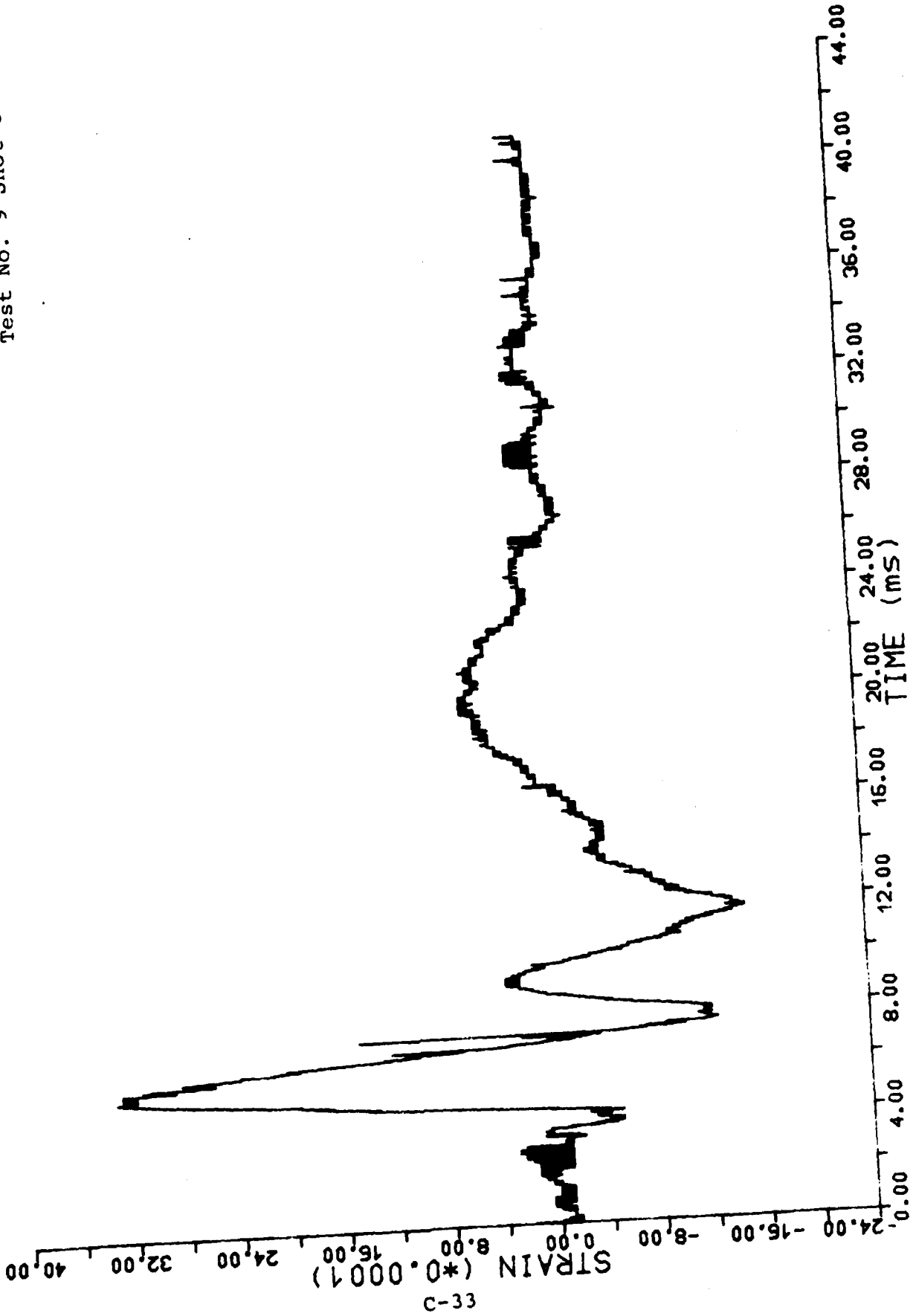

33-C

gauge I-3

Test No. 9 Shot 5-0435

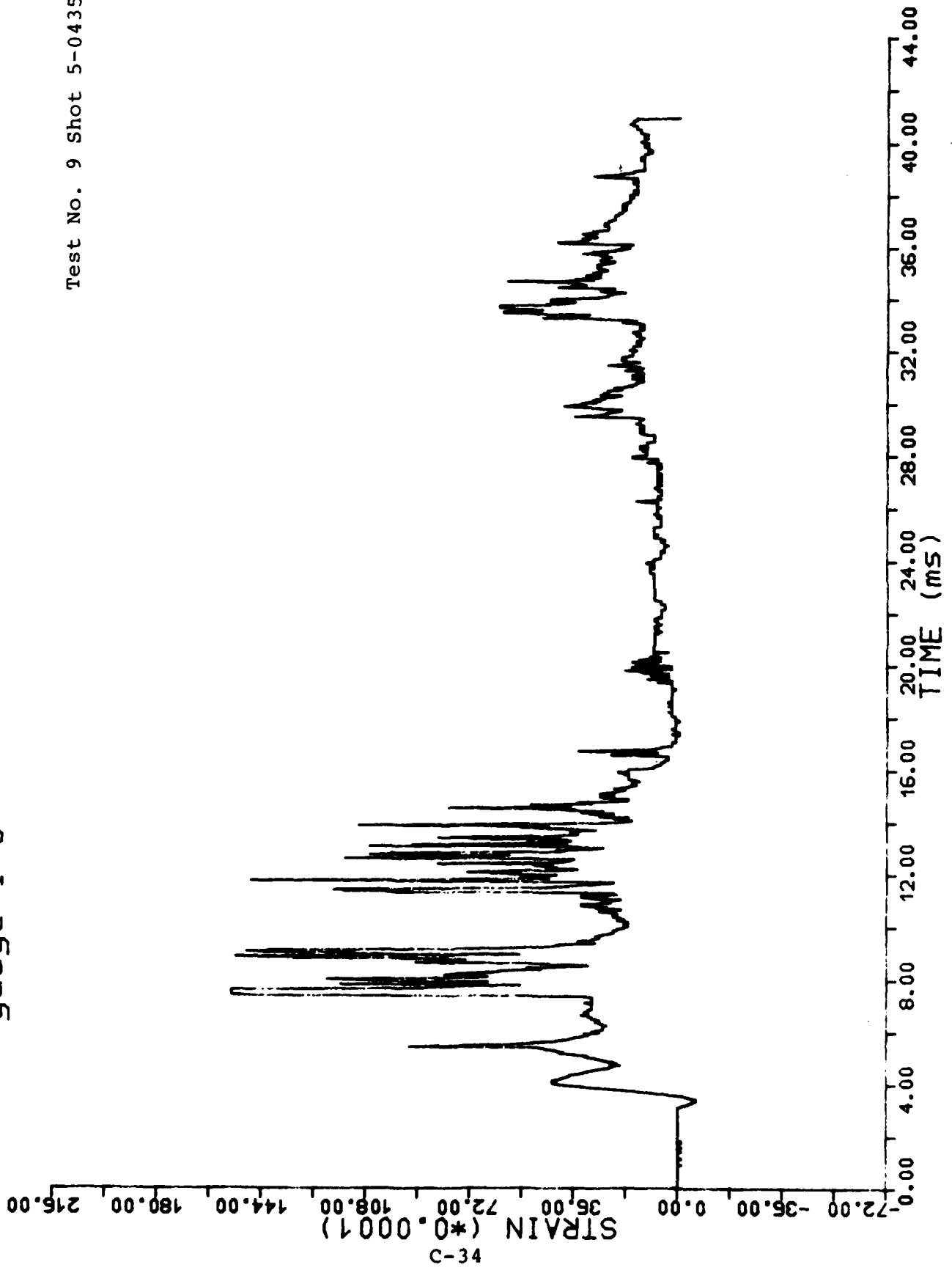

C-34

gauge II-1)

Test No. 9 Shot 5-0435

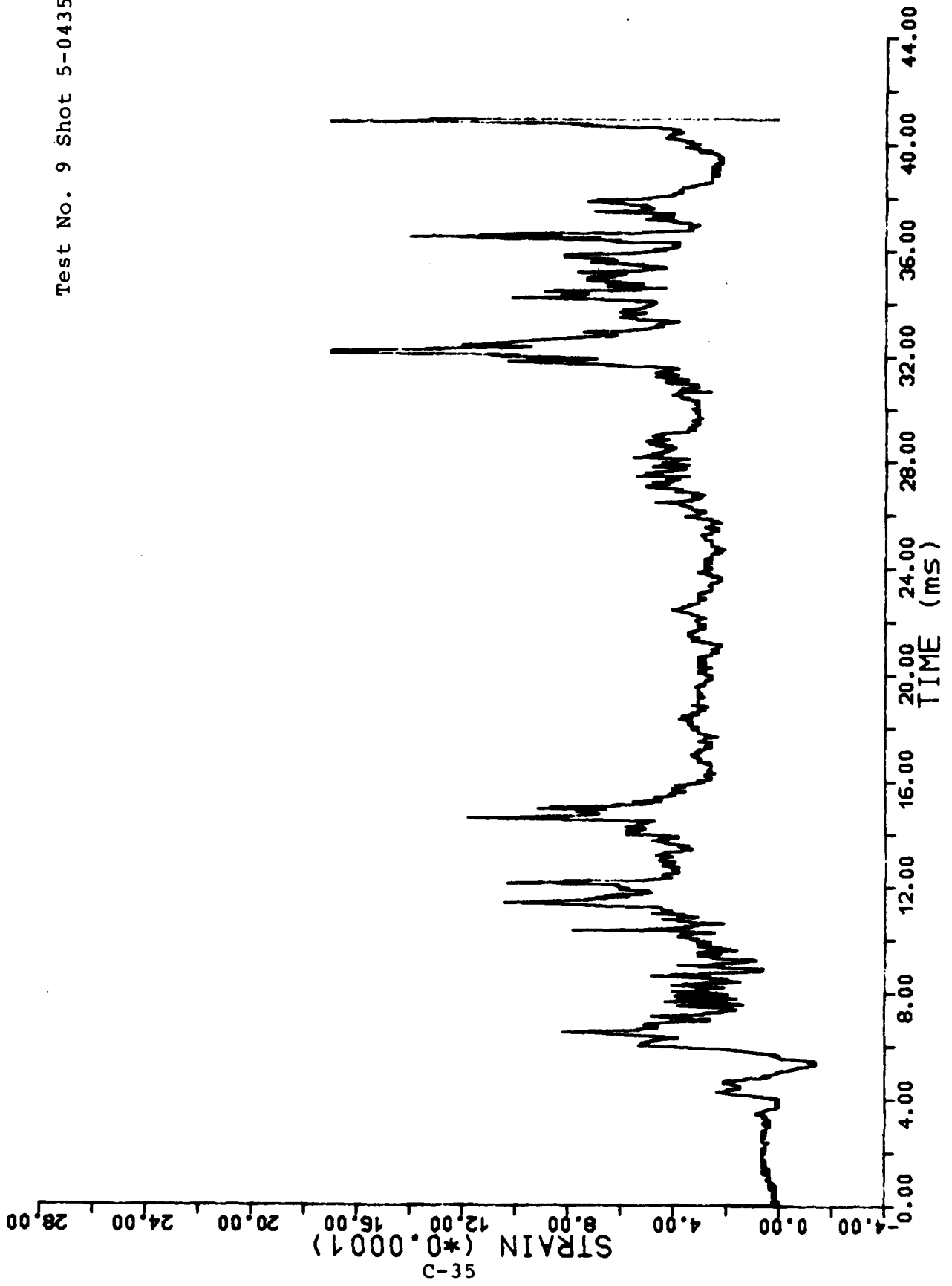

55-C

gauge II-2)

Test No. 9 Shot 5-0435

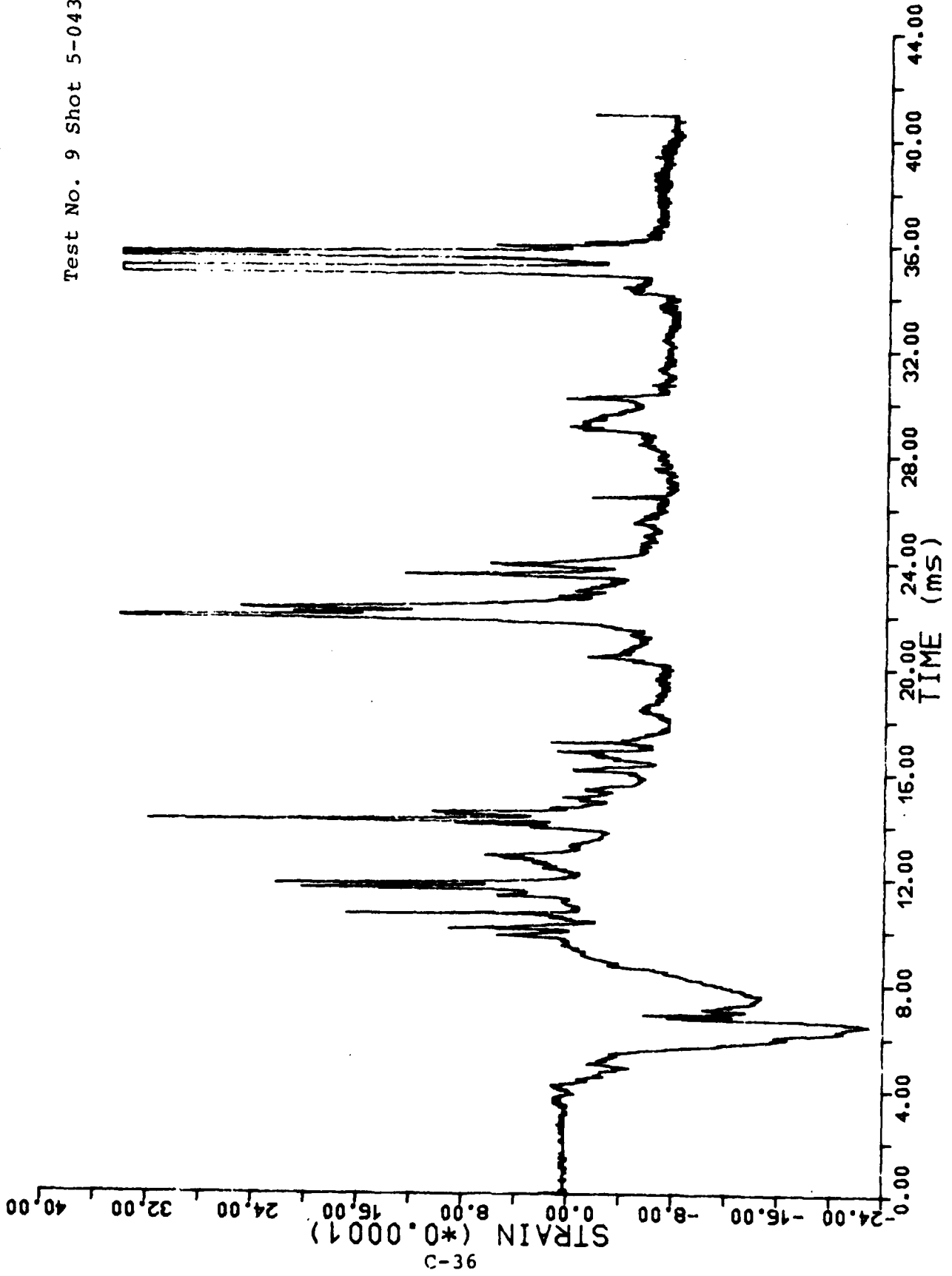

9C-3

gauge II-3

Test No. 9 Shot 5-0435

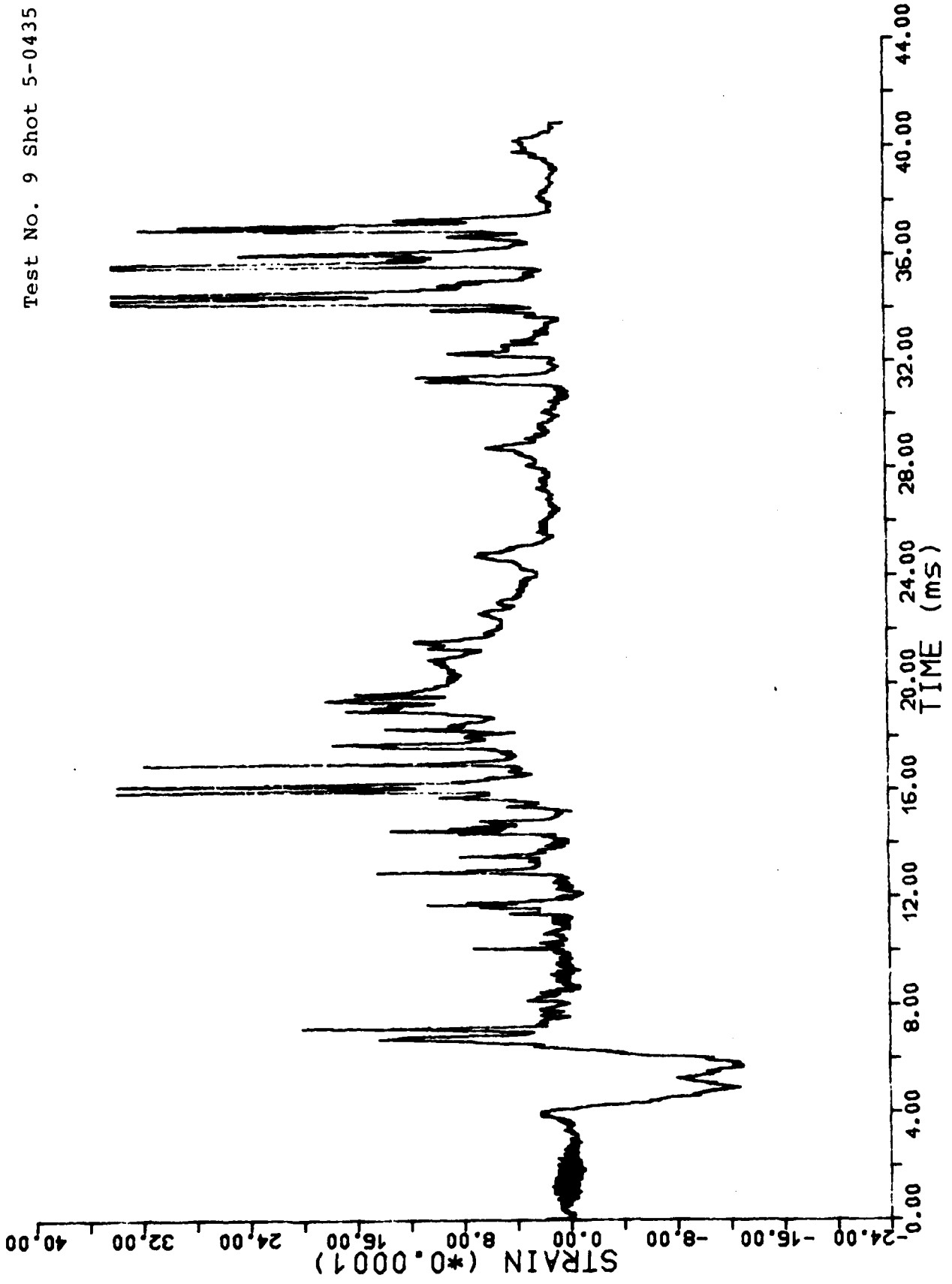

gauge I-1

Test No. 11 Shot 5-0437

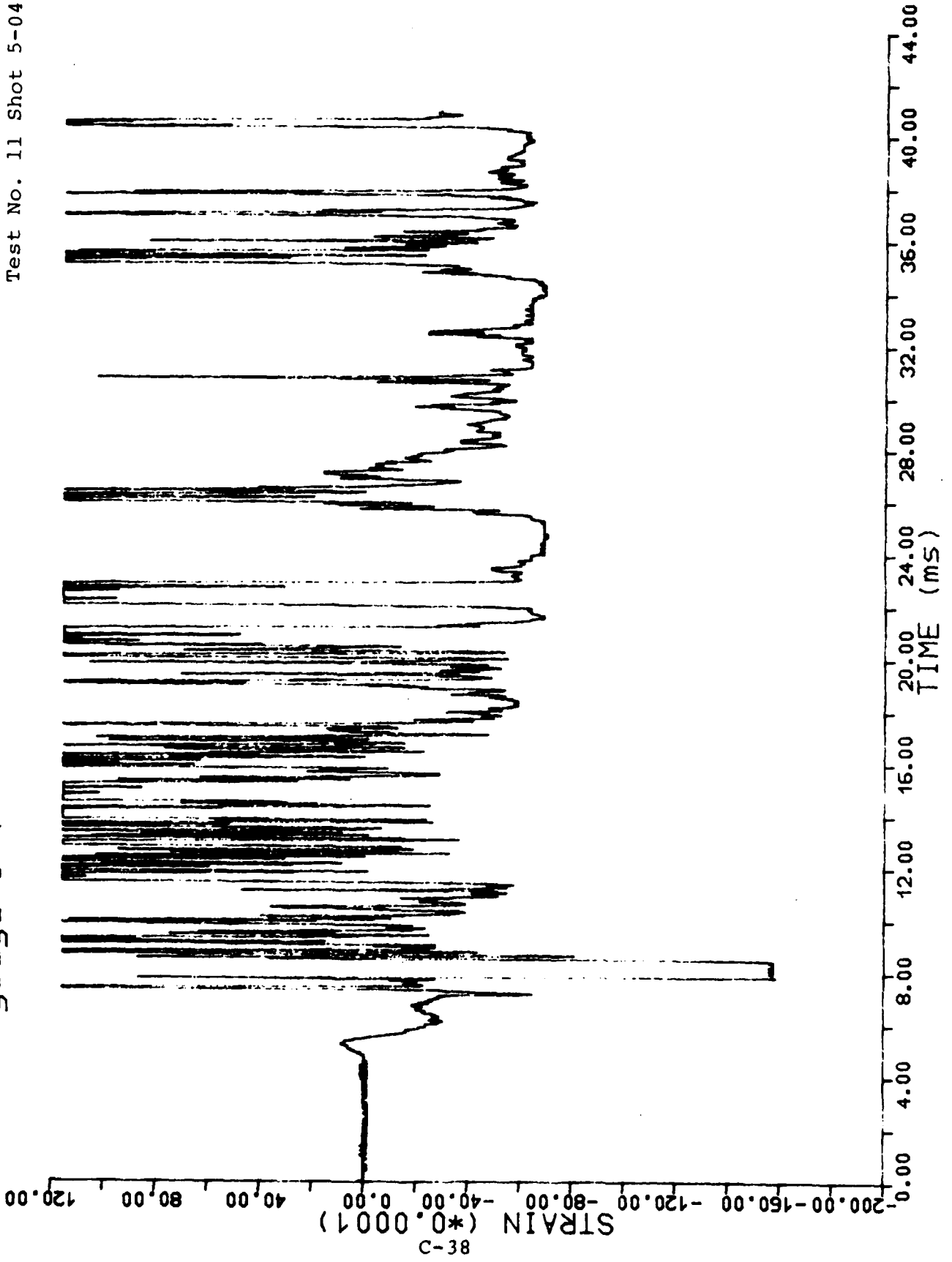

88-C

gauge I-2

Test No. 11 Shot 5-0437

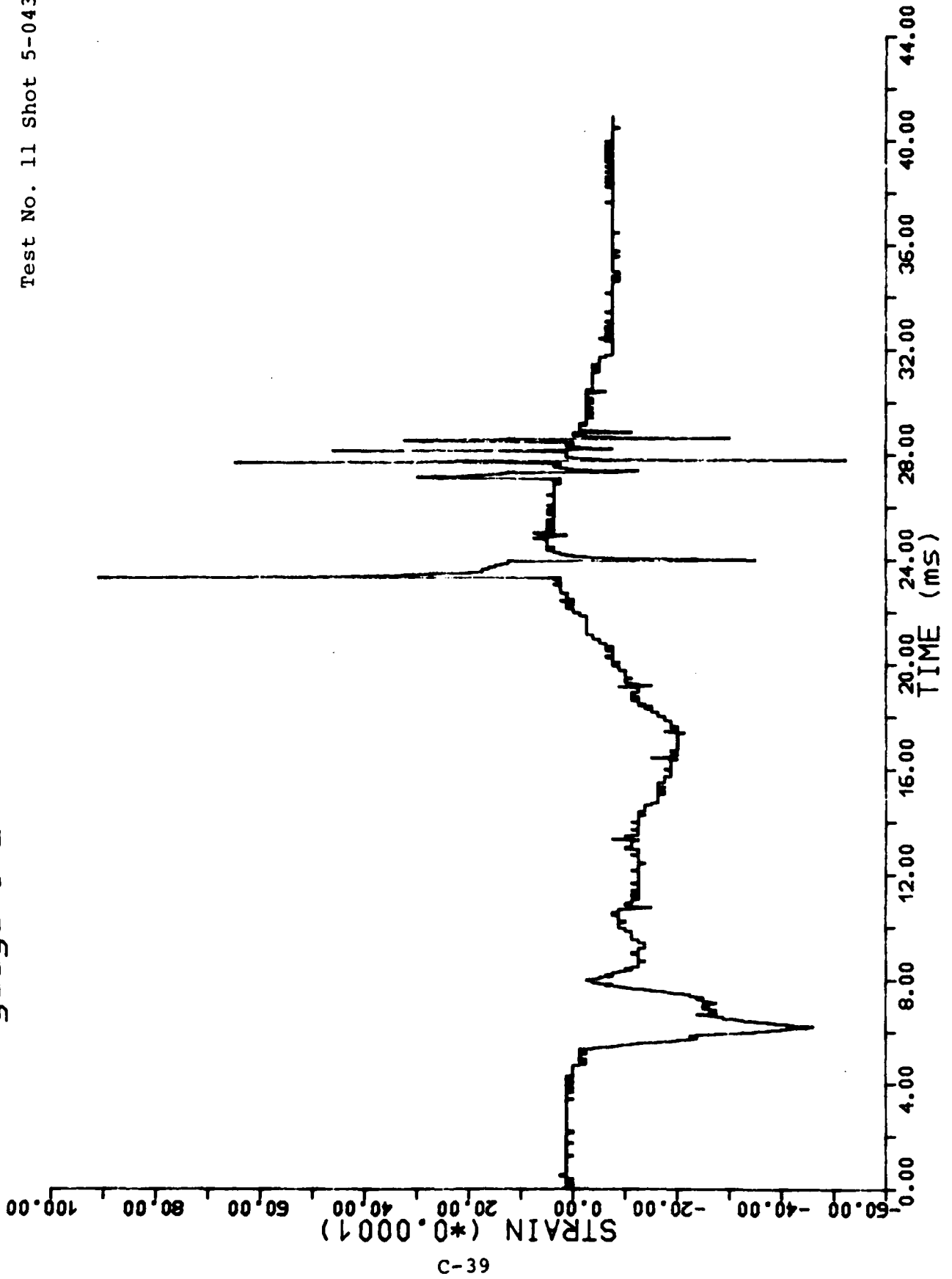

gauge I-3

Test No. 11 Shot 5-0437

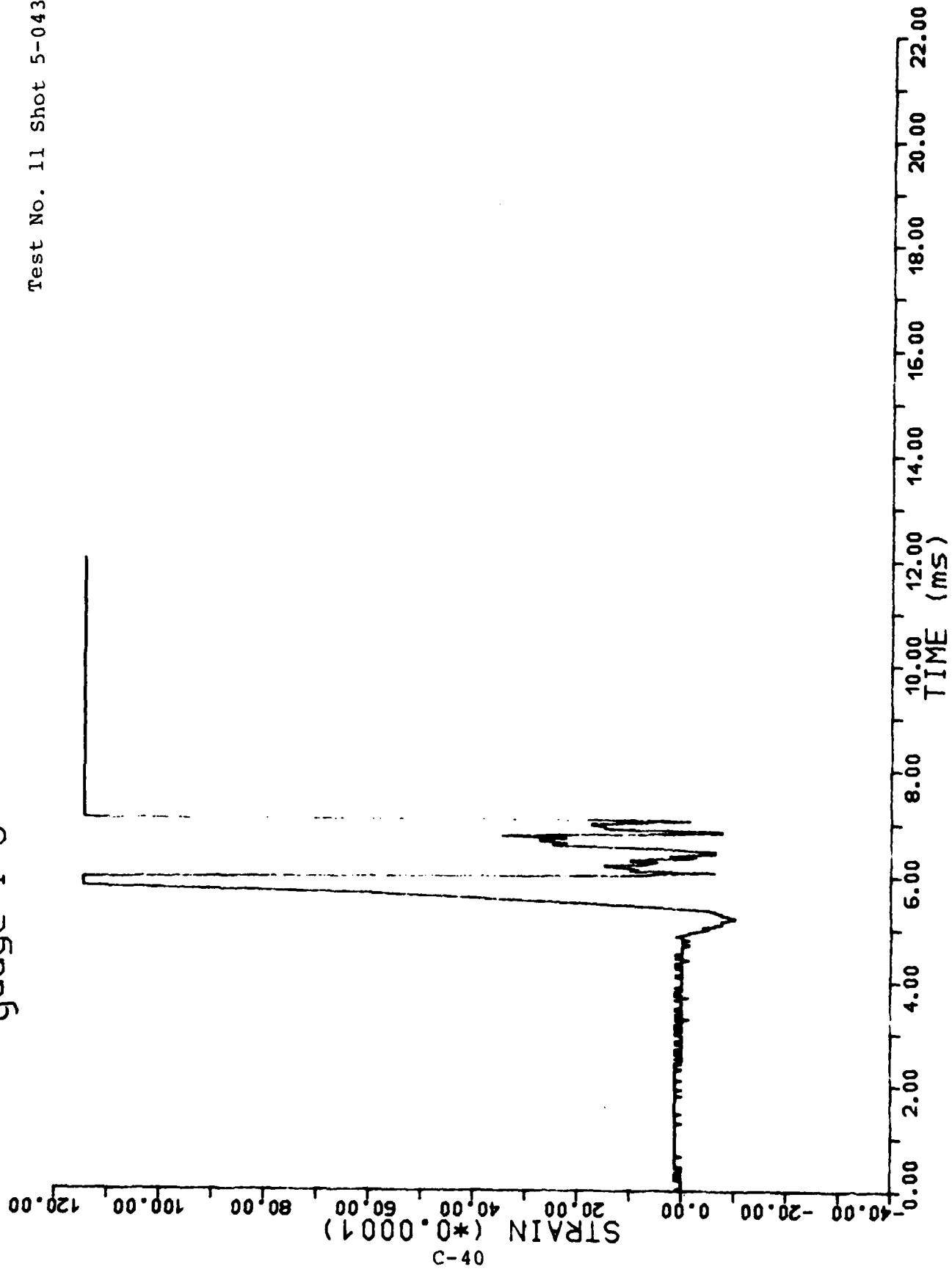

C-40

GAUGE II-1

Test No. 11 Shot 5-0437

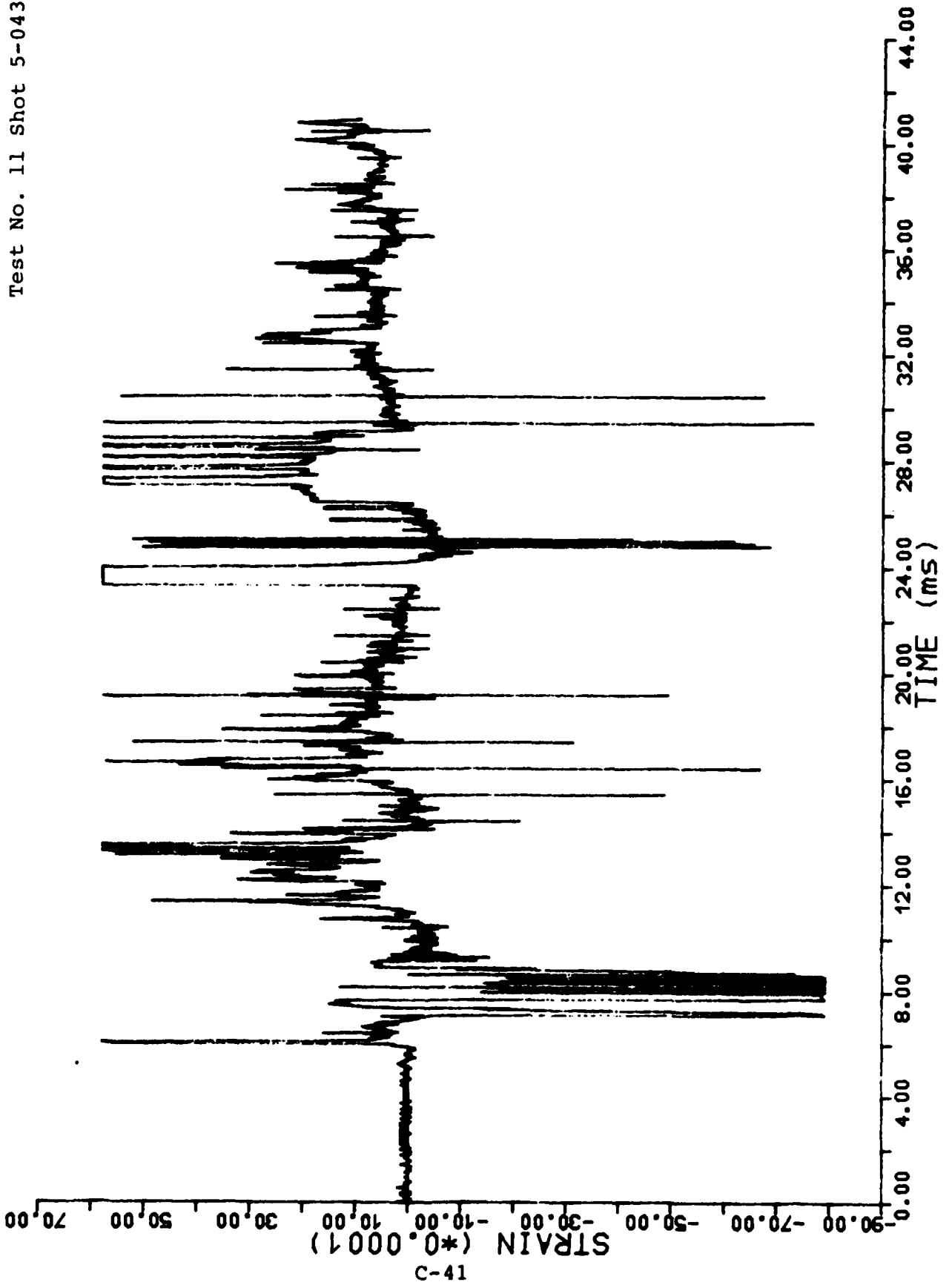

C-41

GAUGE II-2

Test No. 11 Shot 5-0437

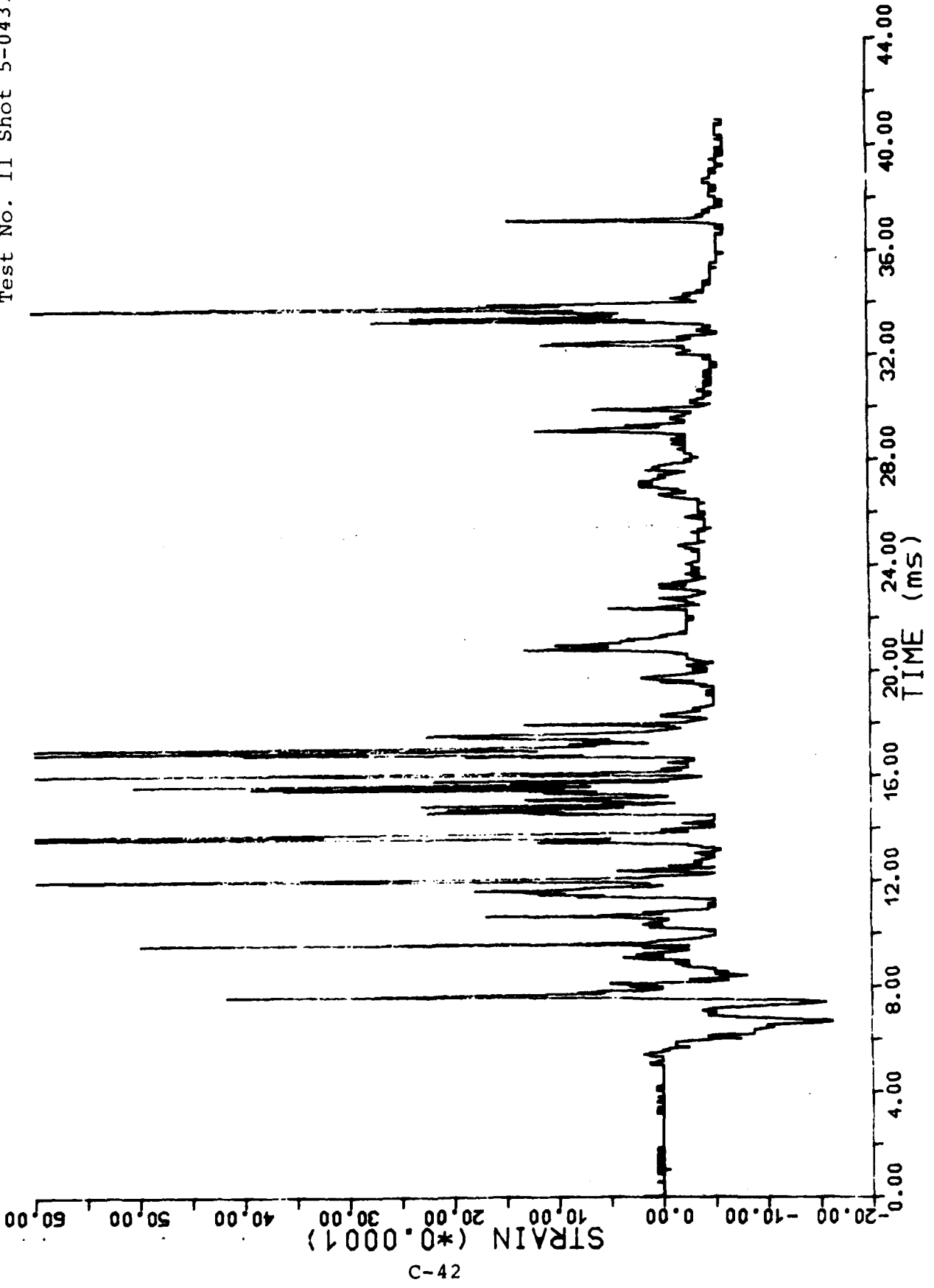

C-42

GAUGE II-3

Test No. 11 Shot 5-0437

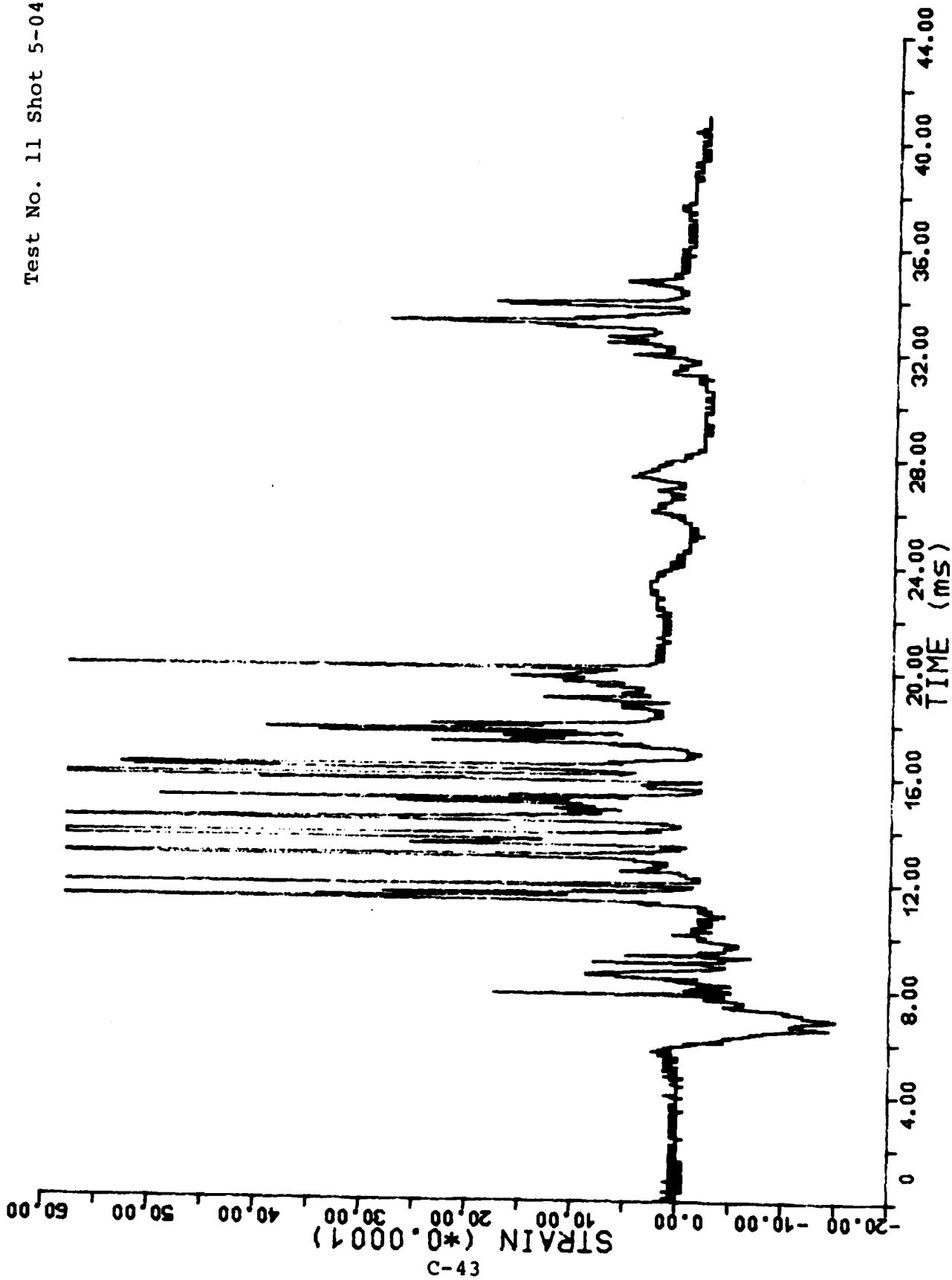

C-43

gauge (-1)

Test No. 12 Shot 5-0436

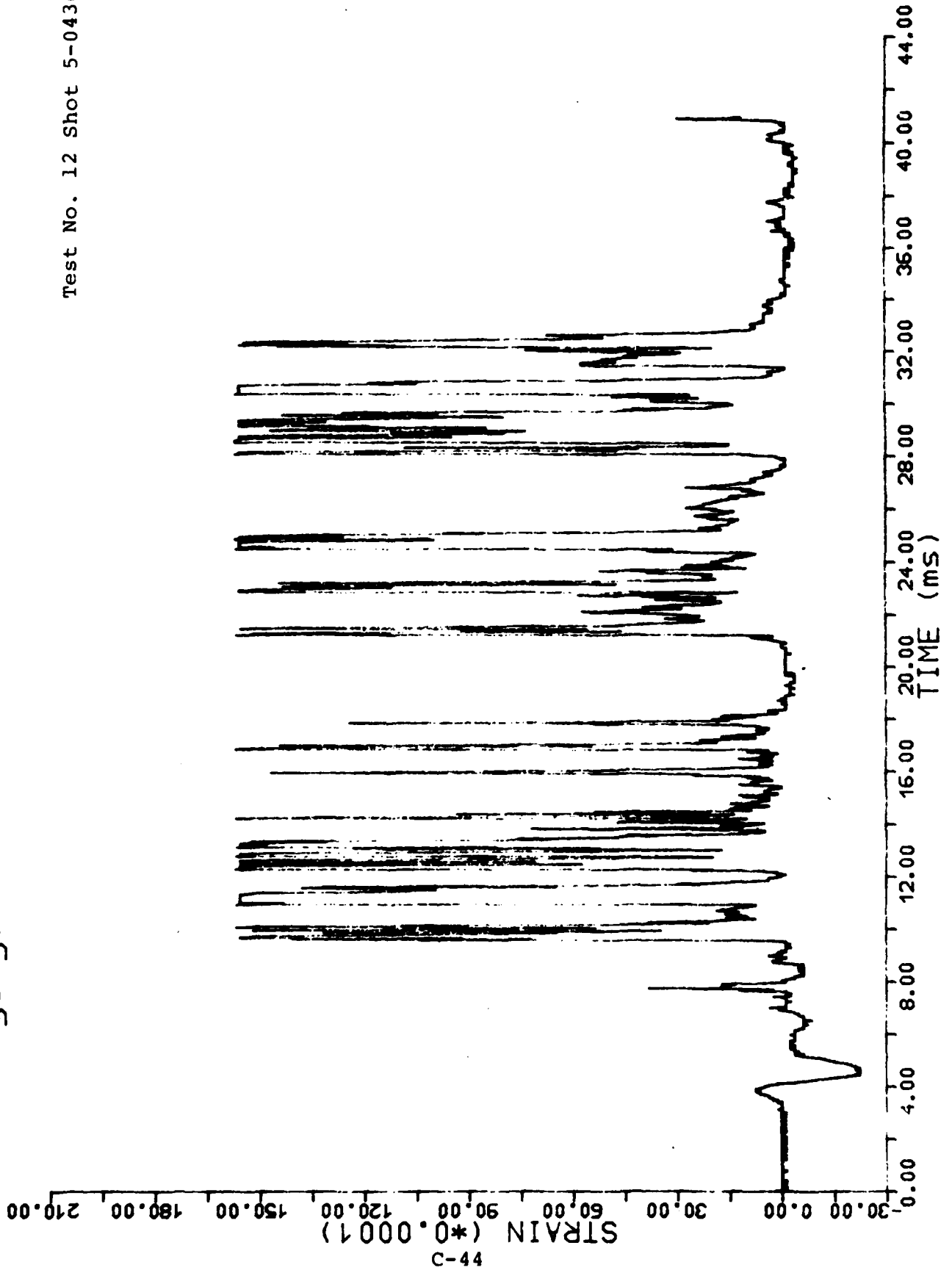

GAUGE I-2

Test No. 12 Shot 5-0436

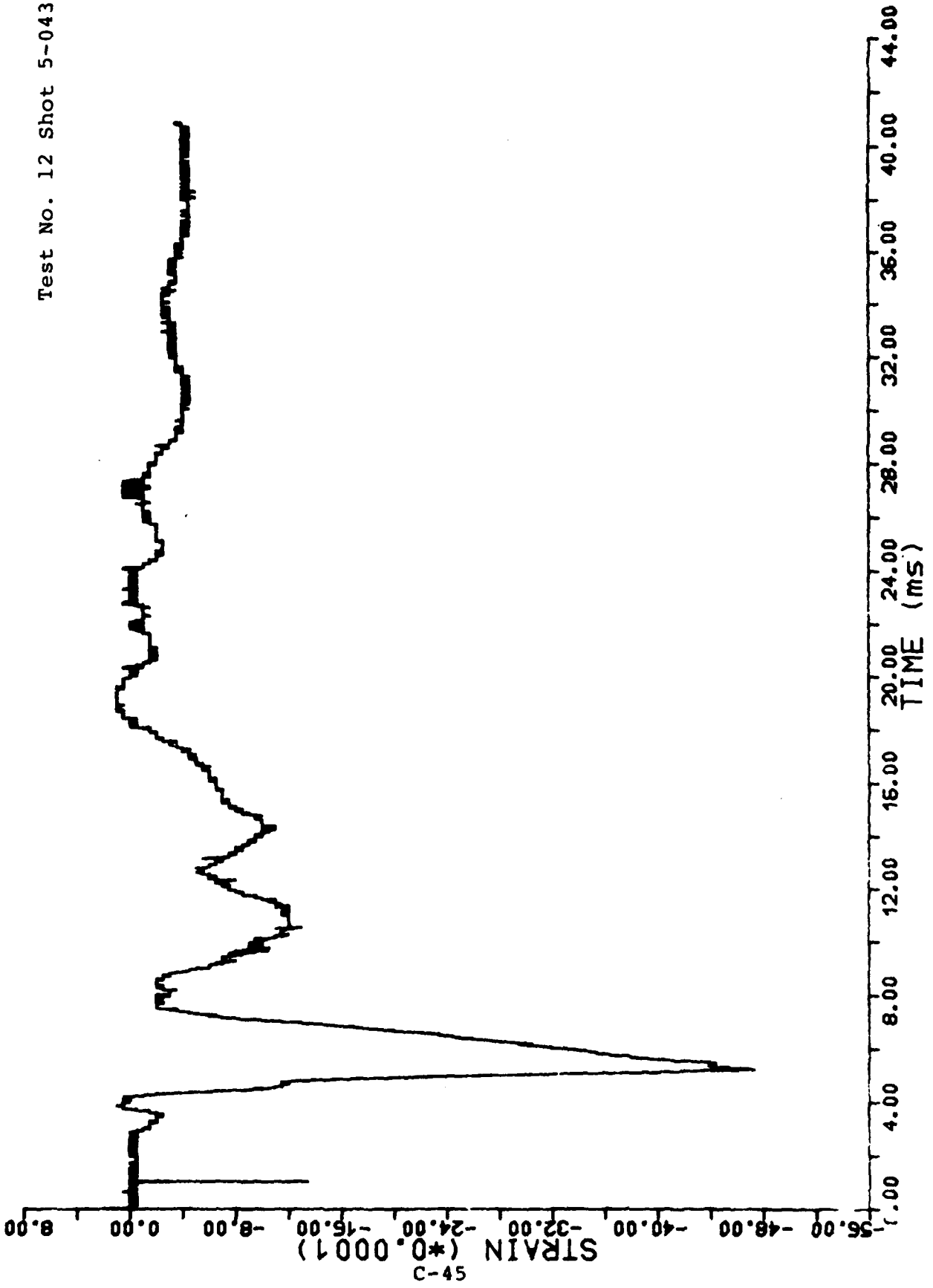

54-C

GAUGE I-3

Test No. 12 Shot 5-0436

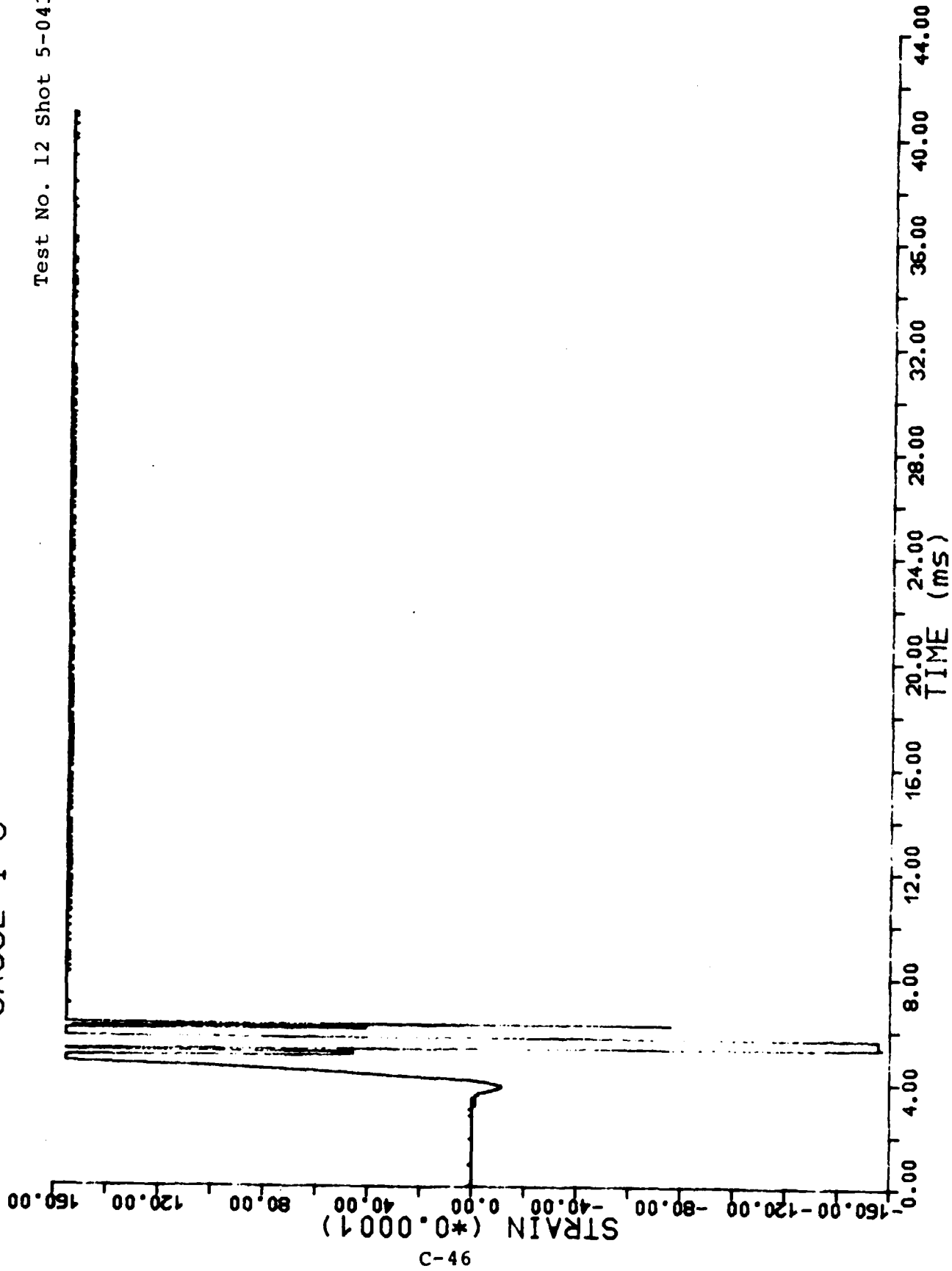

GAUGE II-1

Test No. 12 Shot 5-0436

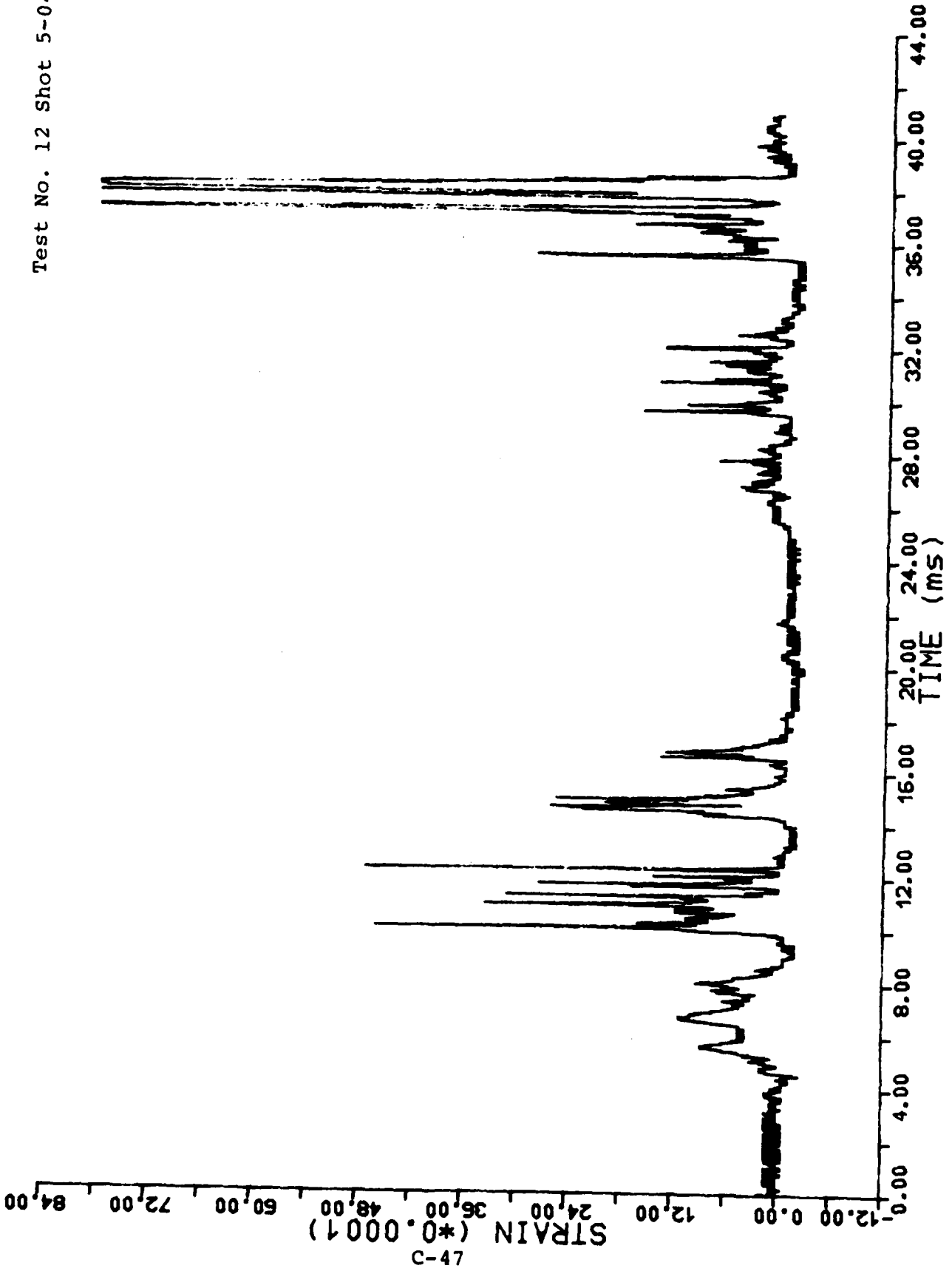

C-47

GAUGE II-2

Test No. 12 Shot 5-0436

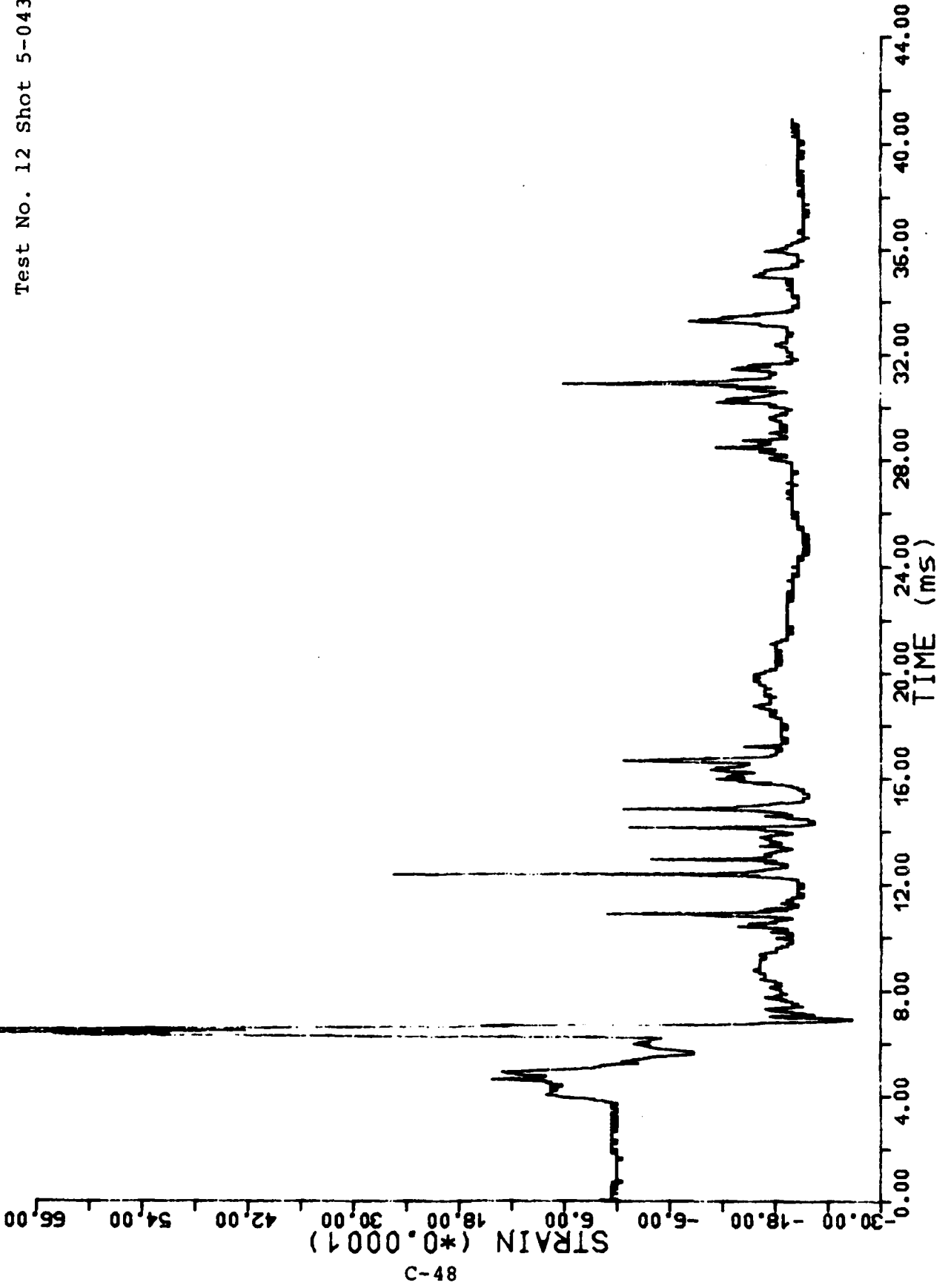

8-48

GAUGE II-3

Test No. 12 Shot 5-0436

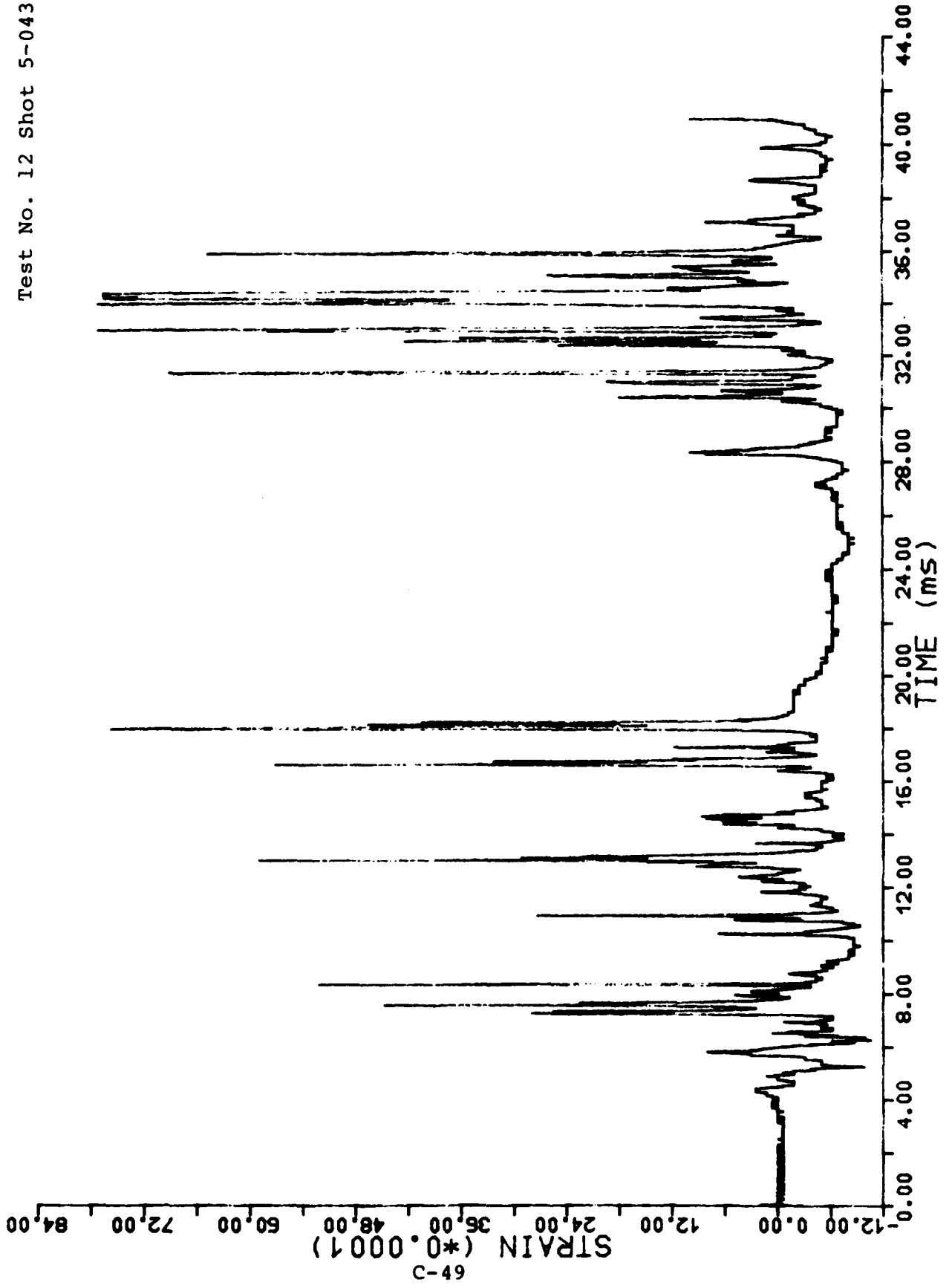

GAUGE I-1

Test No. 13 Shot 5-0439

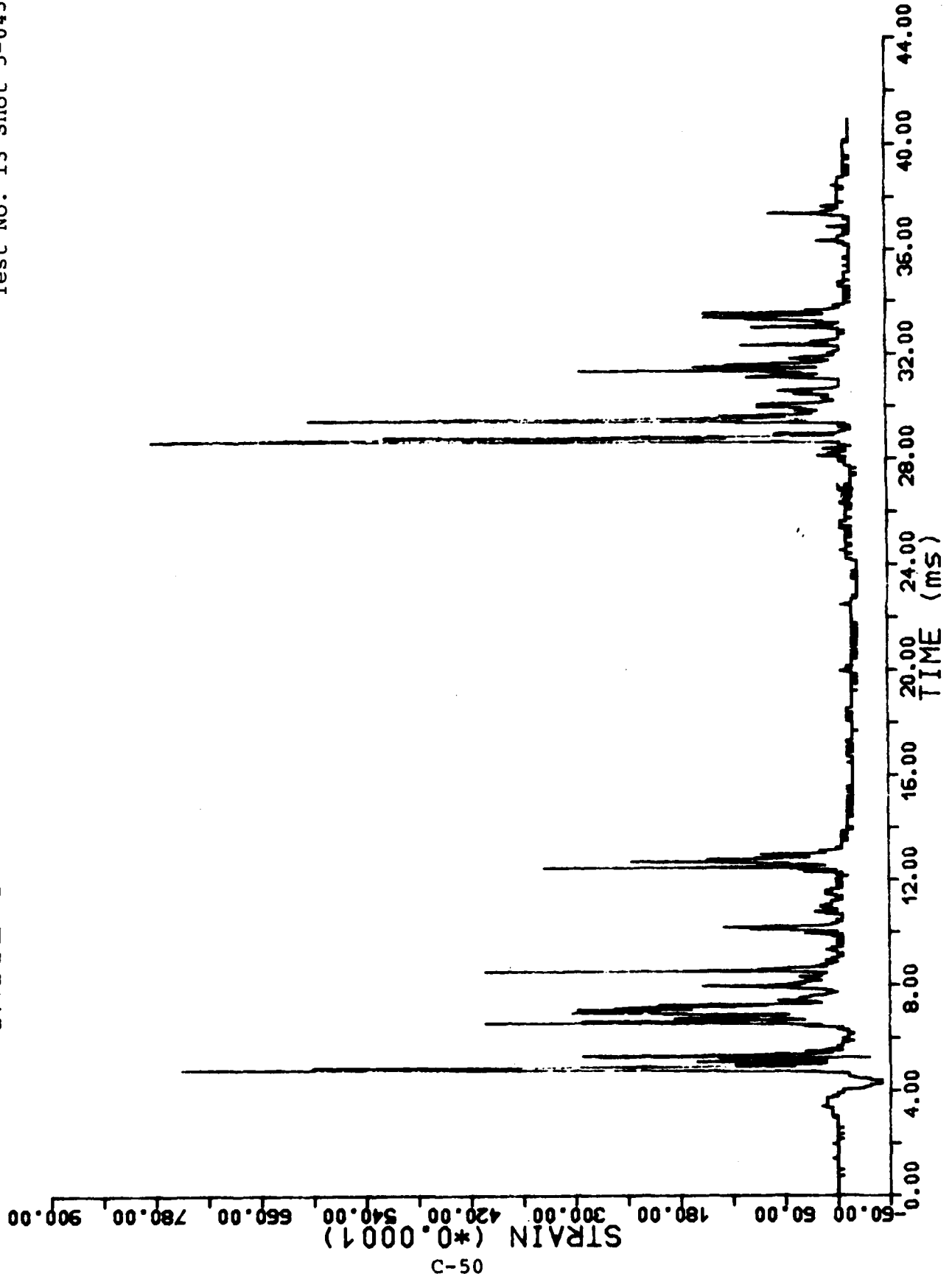

C-50

GAUGE I-2

Test No. 13 Shot 5-0439

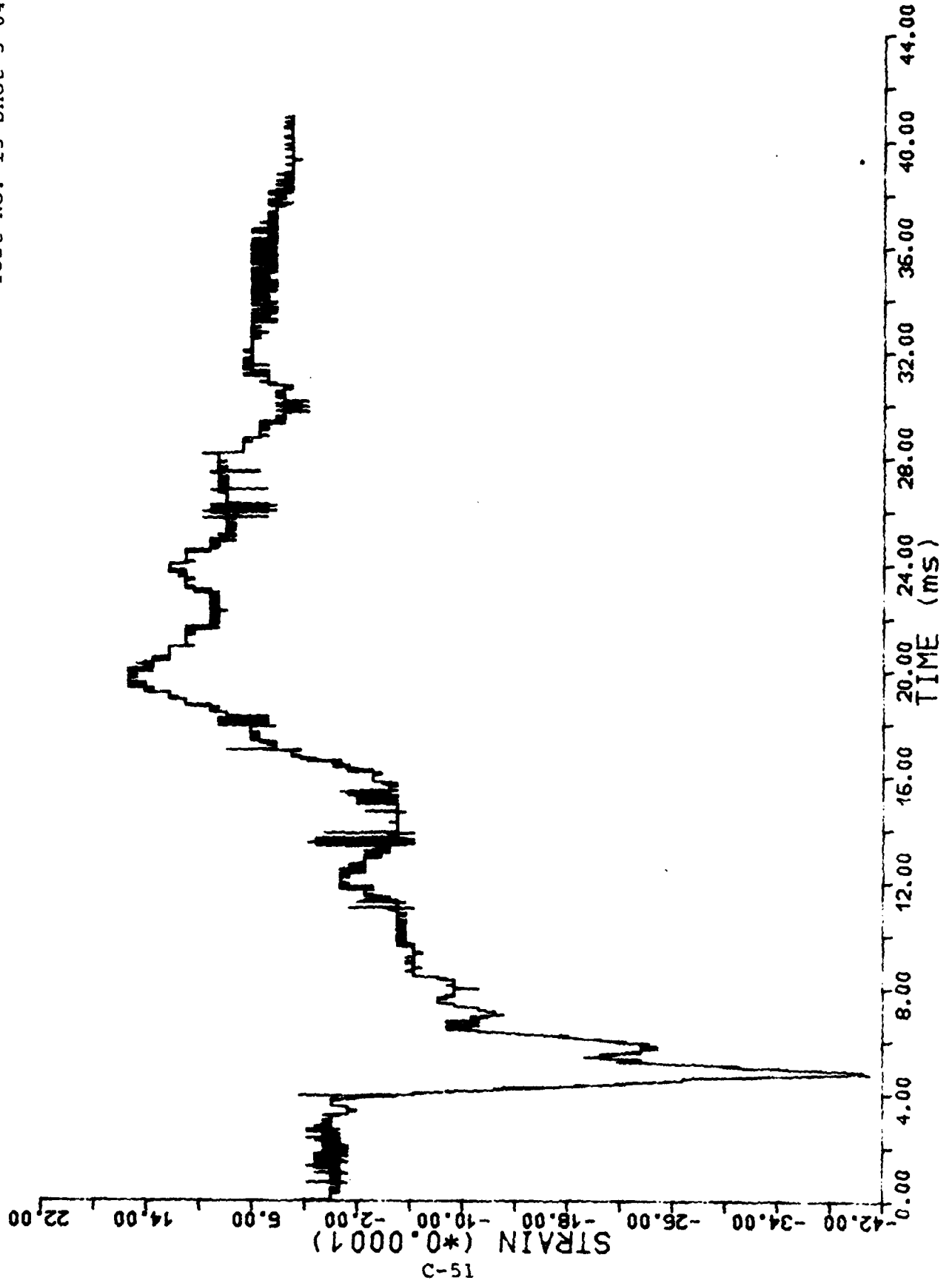

GAUGE I-3

Test No. 13 Shot 5-0439

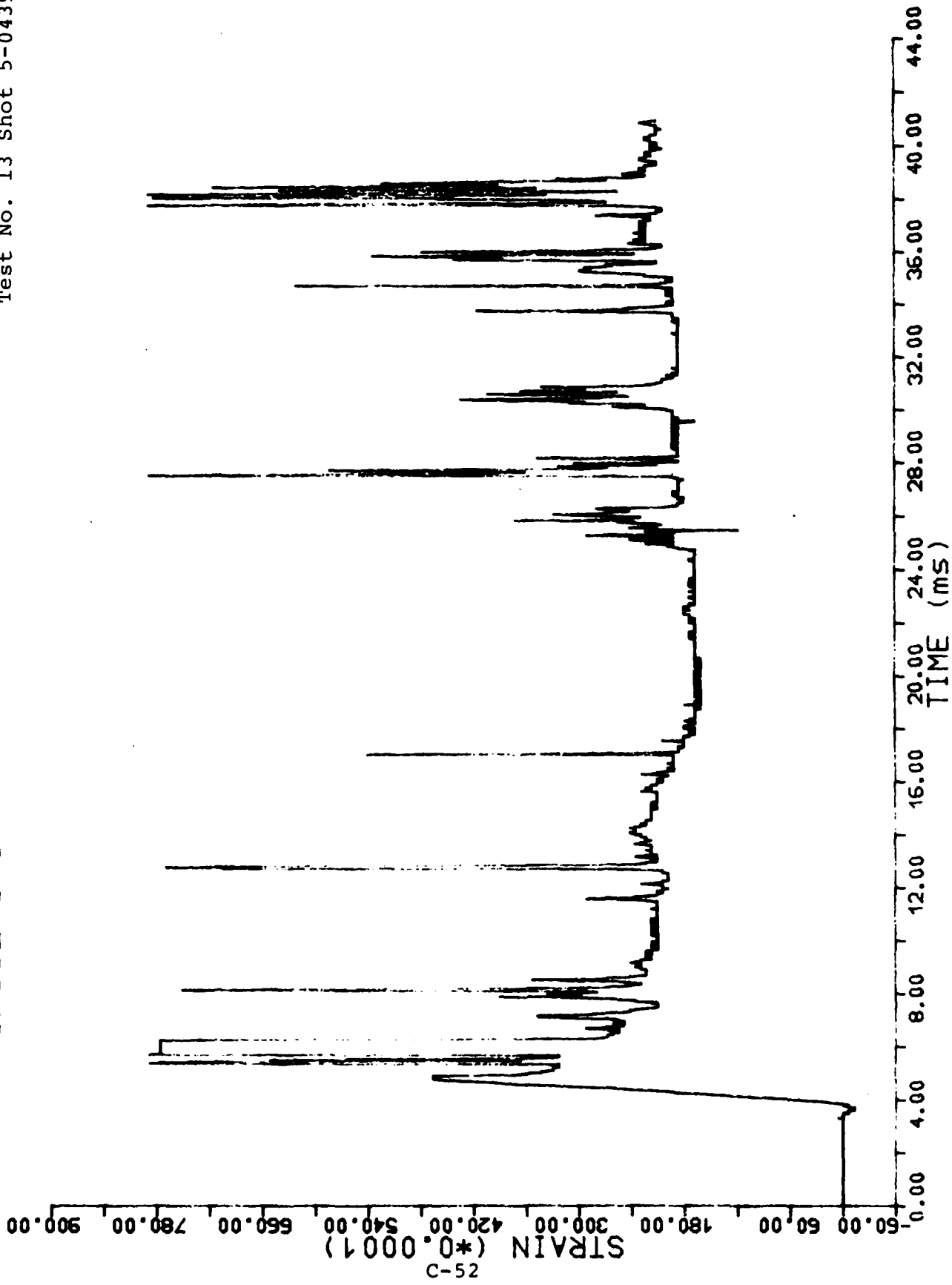

C-52

GAUGE II-1

Test No. 13 Shot 5-0439

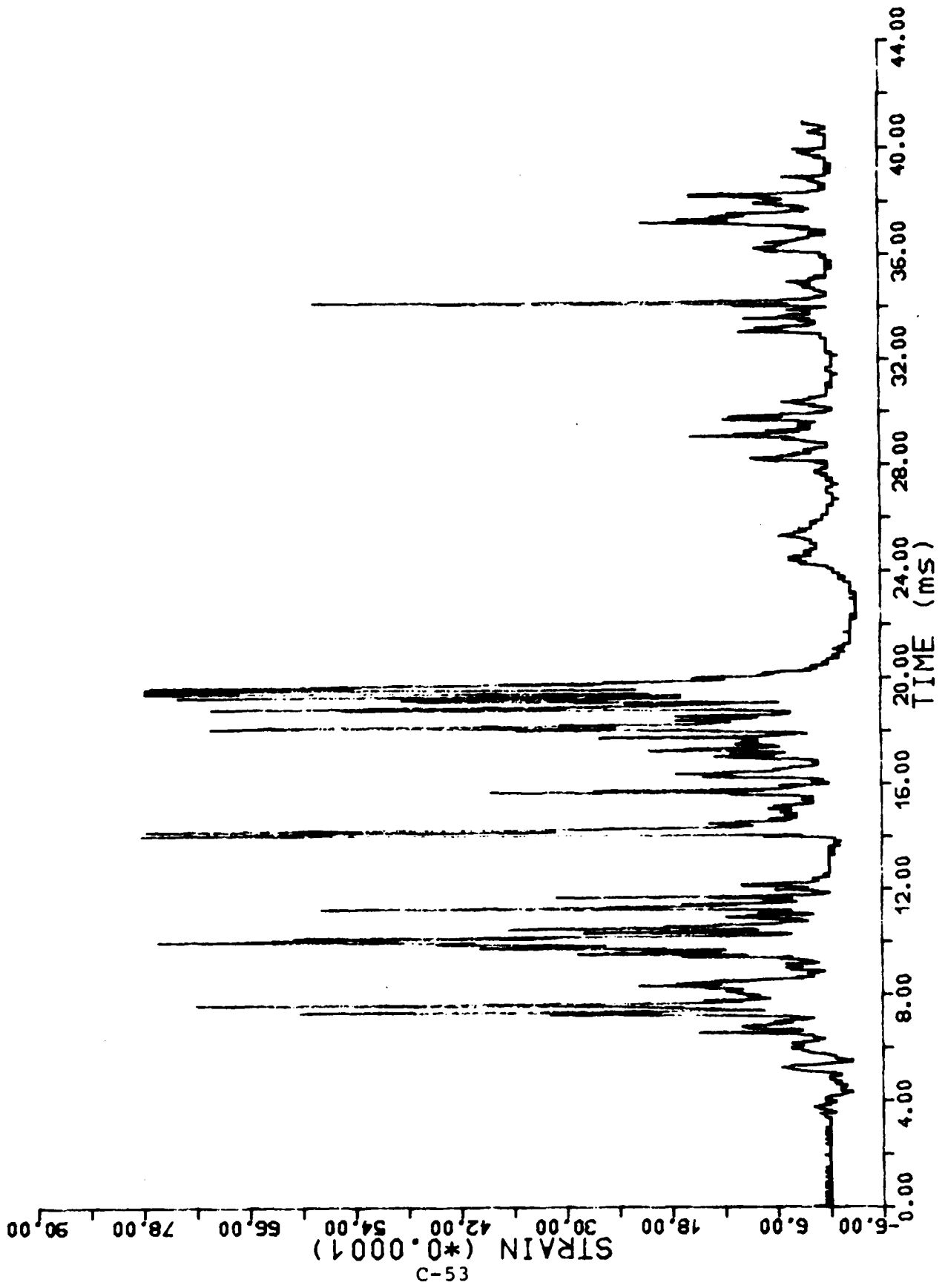

C-53

GAUGE II-2

Test No. 13 Shot 5-0439

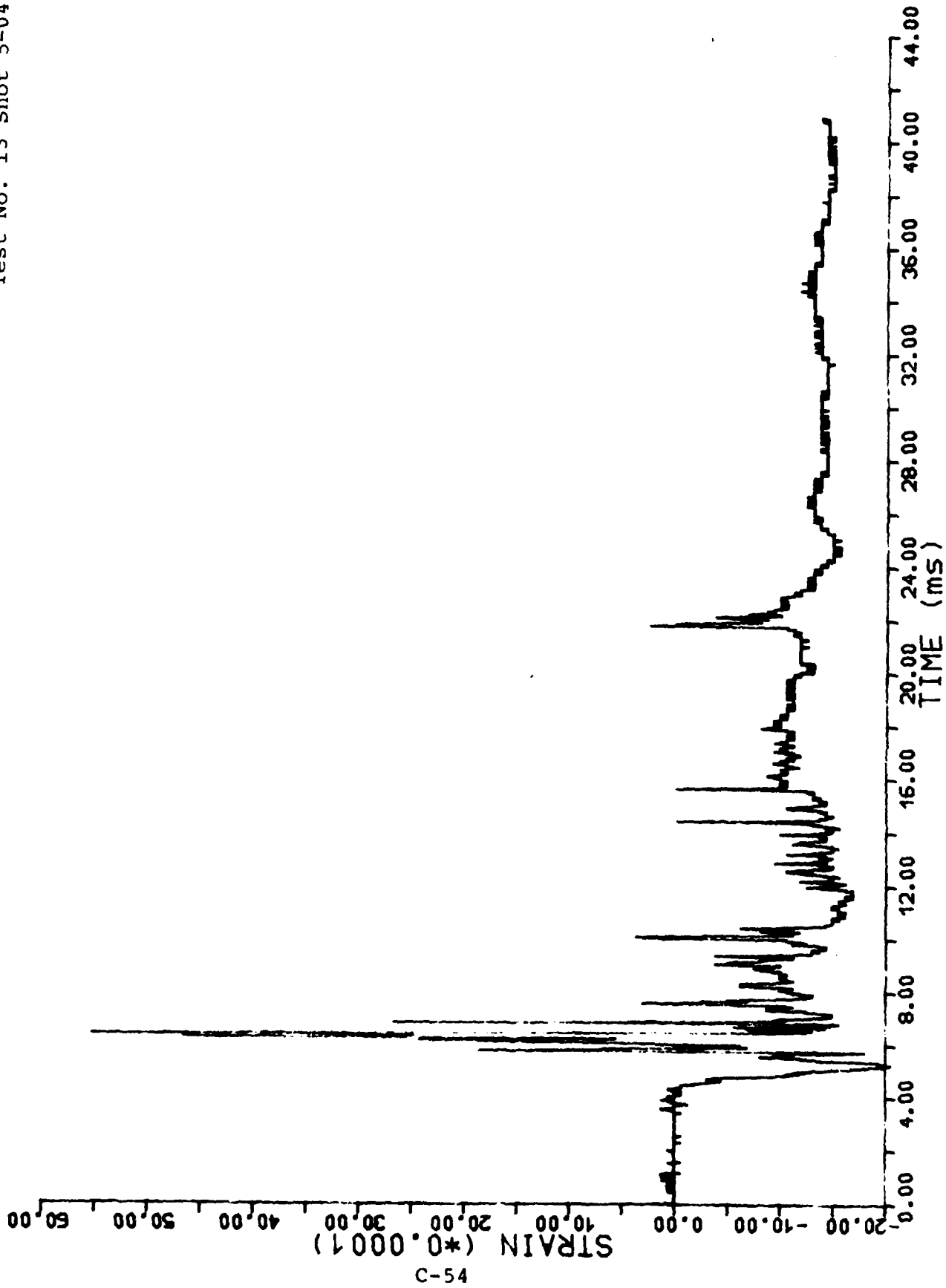

C-54

GAUGE I-1

)

Test No. 15 Shot 5-0441

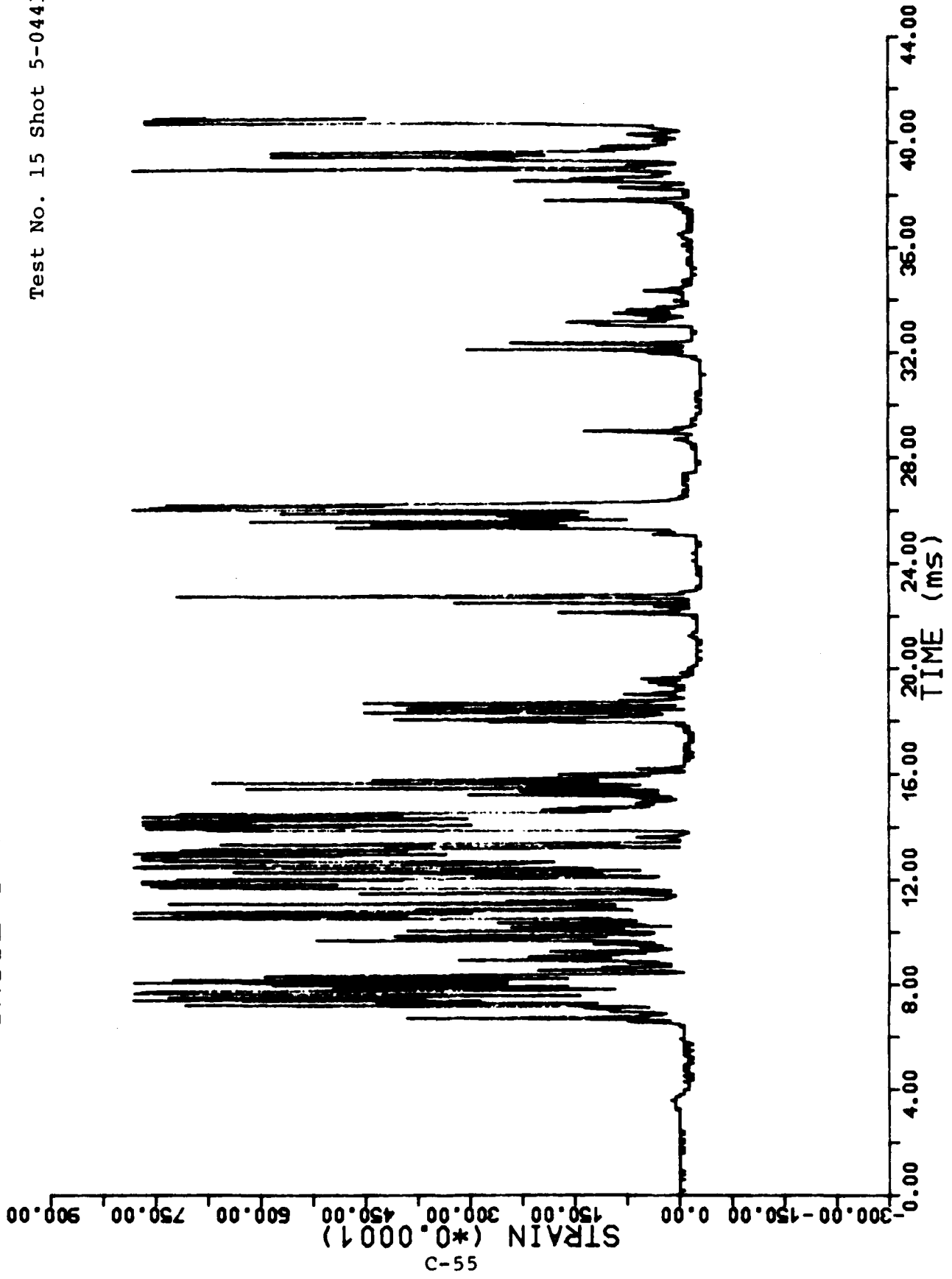

C-55

GAUGE I-2

Test No. 15 Shot 5-0441

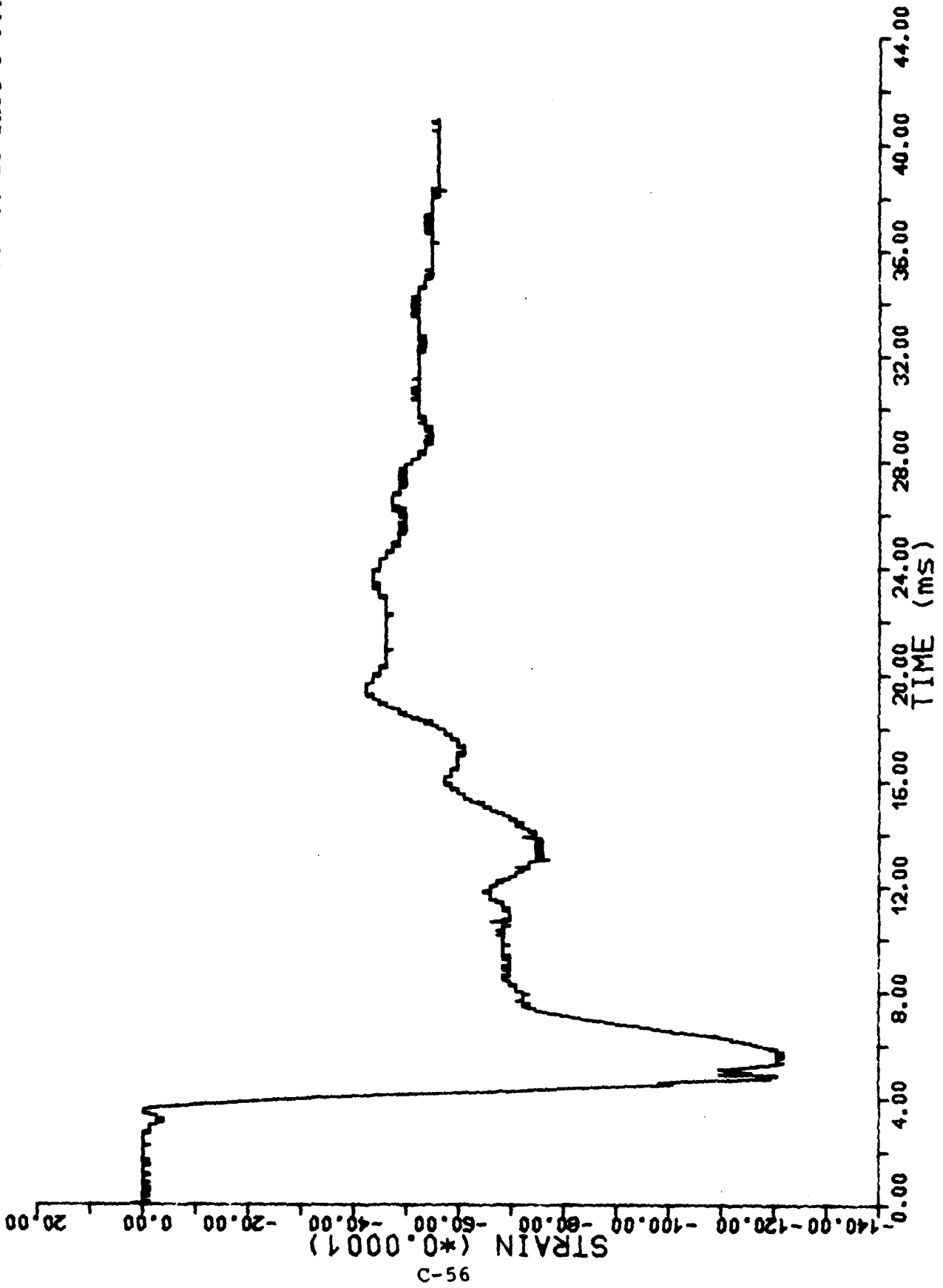

GAUGE I-3

Test No. 15 Shot 5-0441

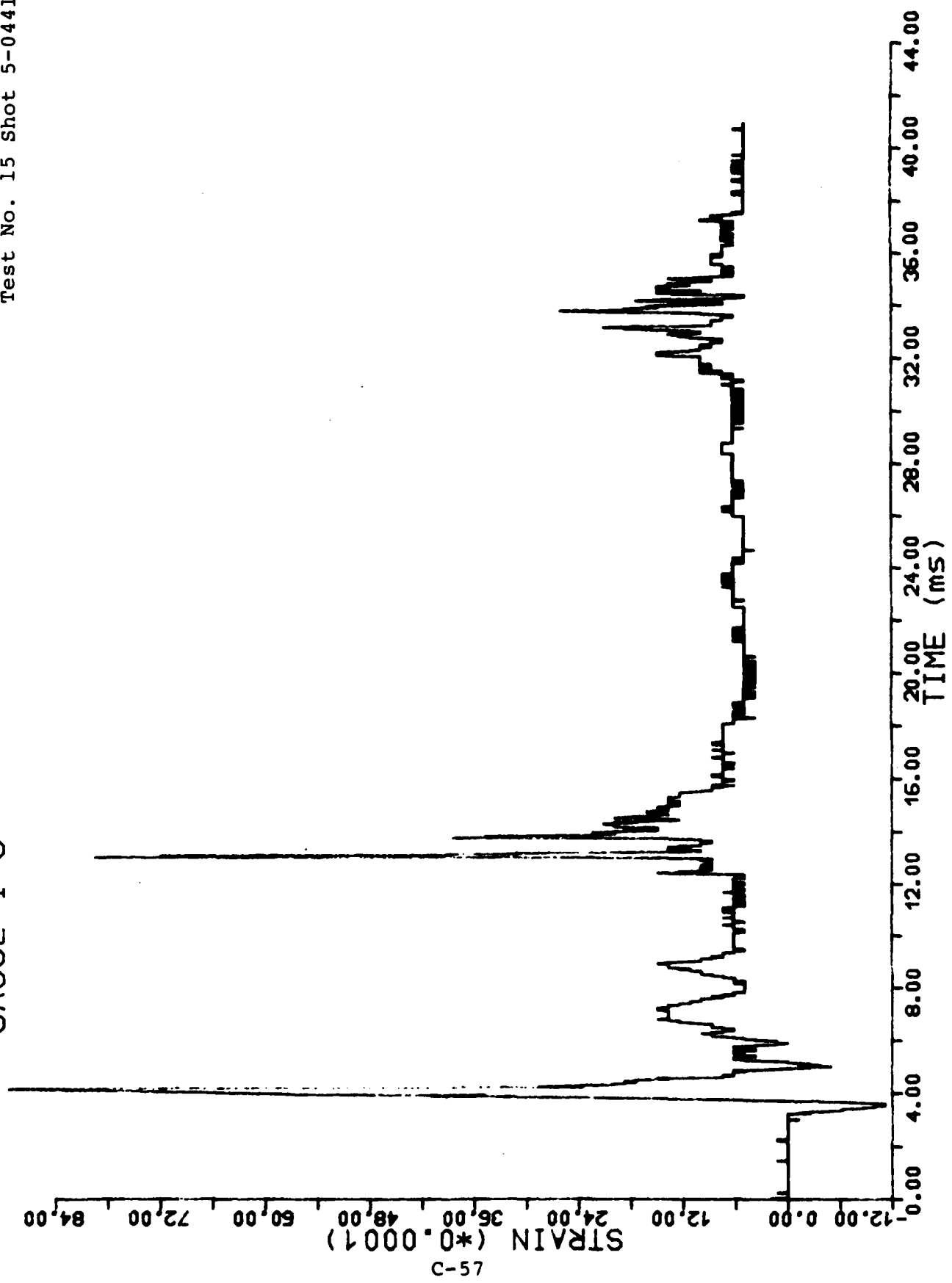

C-57

GAUGE II-1

Test No. 15 Shot 5-0441

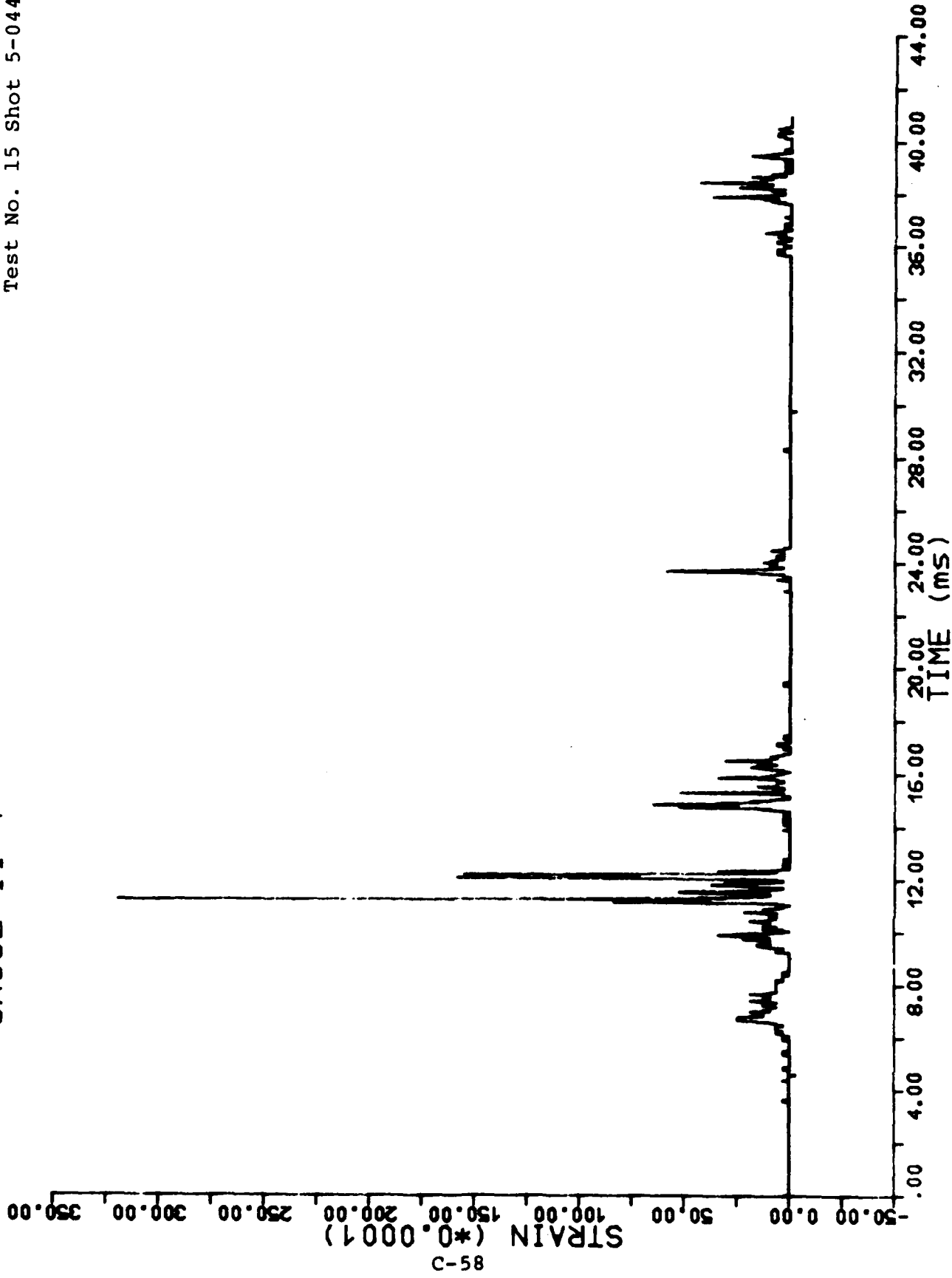

85-C

GAUGE II-2

Test No. 15 Shot 5-0441

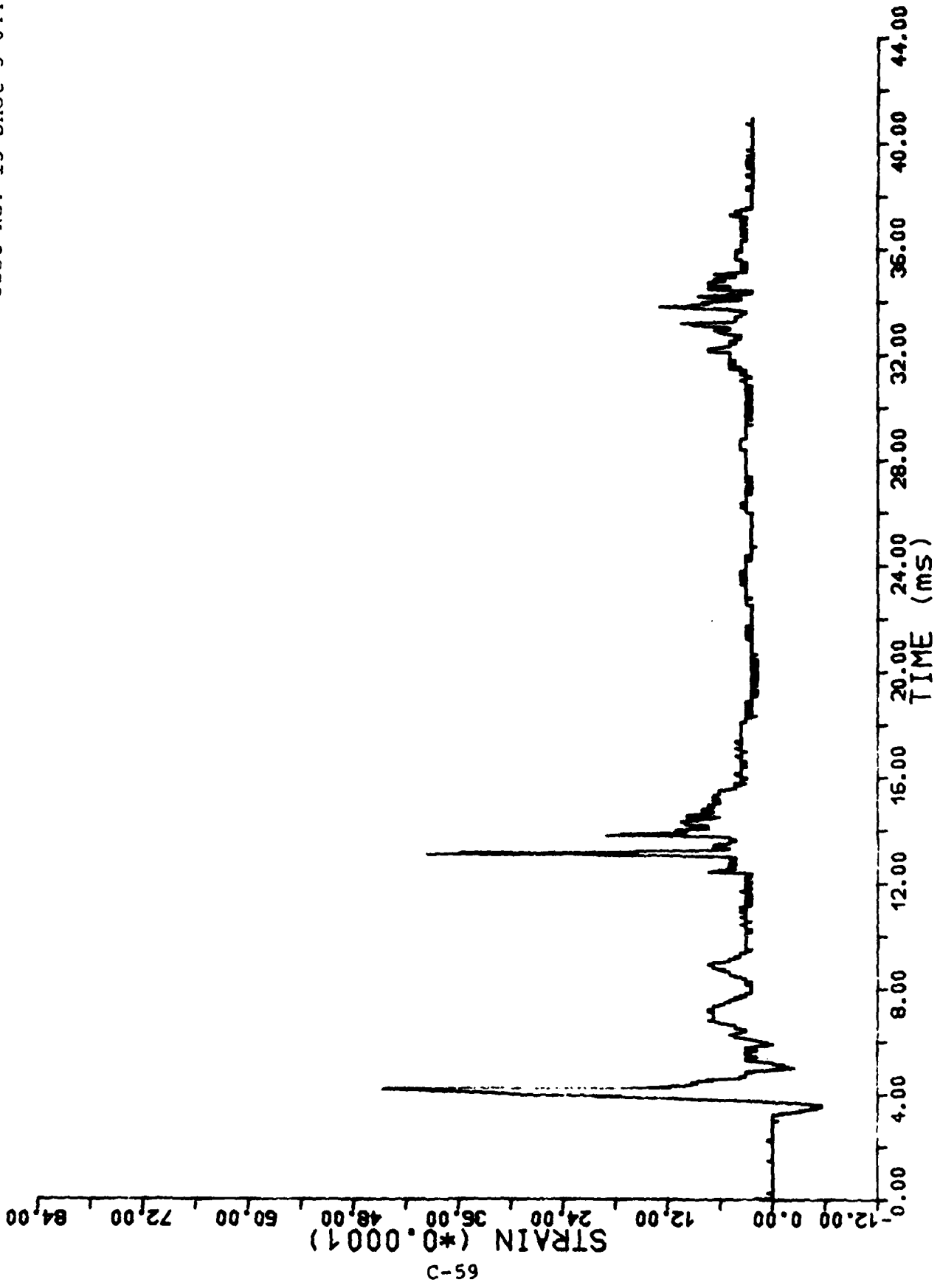

GAUGE II-3

Test No. 15 Shot 5-0441

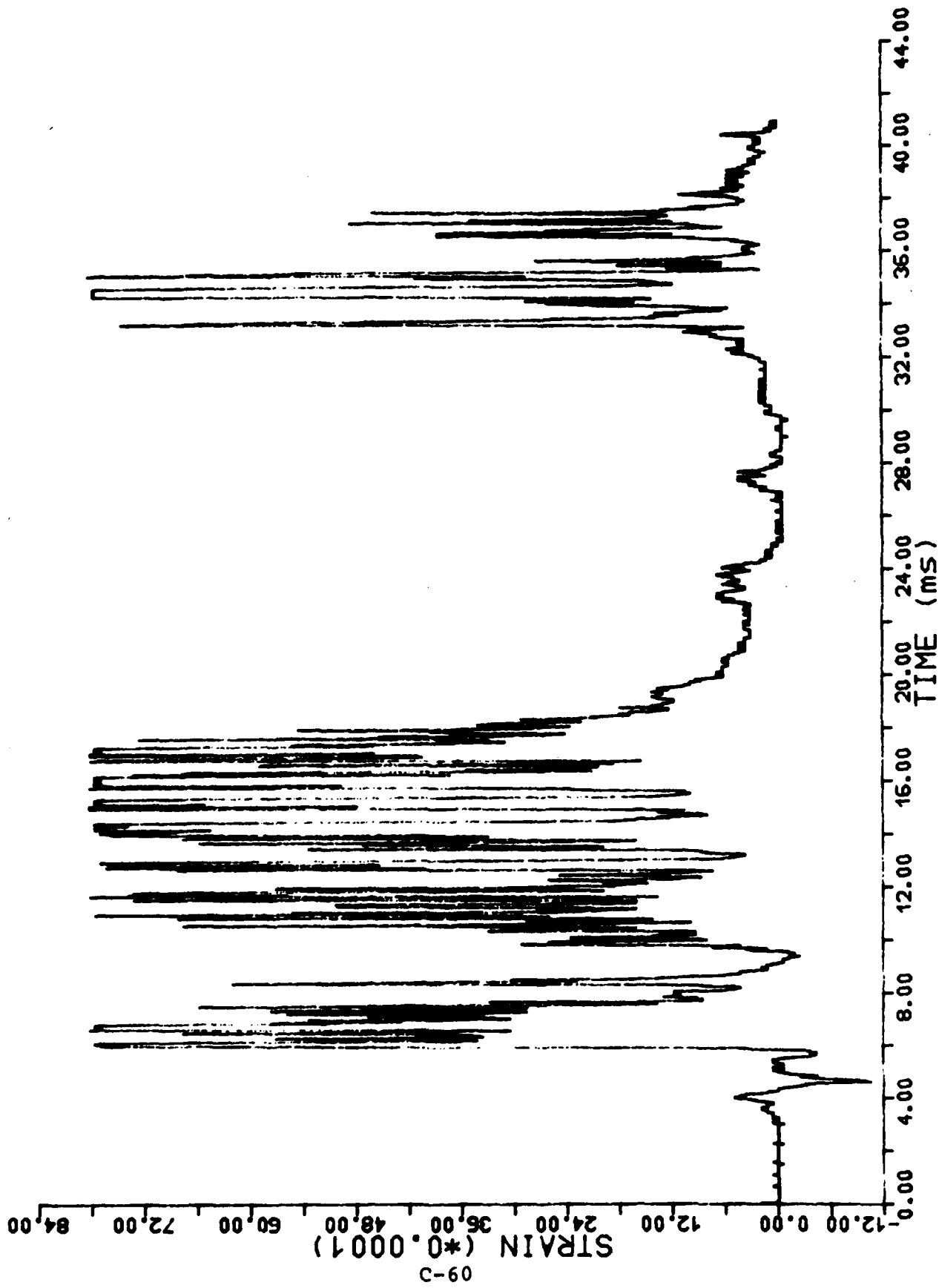

Gauge I-1

Test No. 17 Shot 5-0443

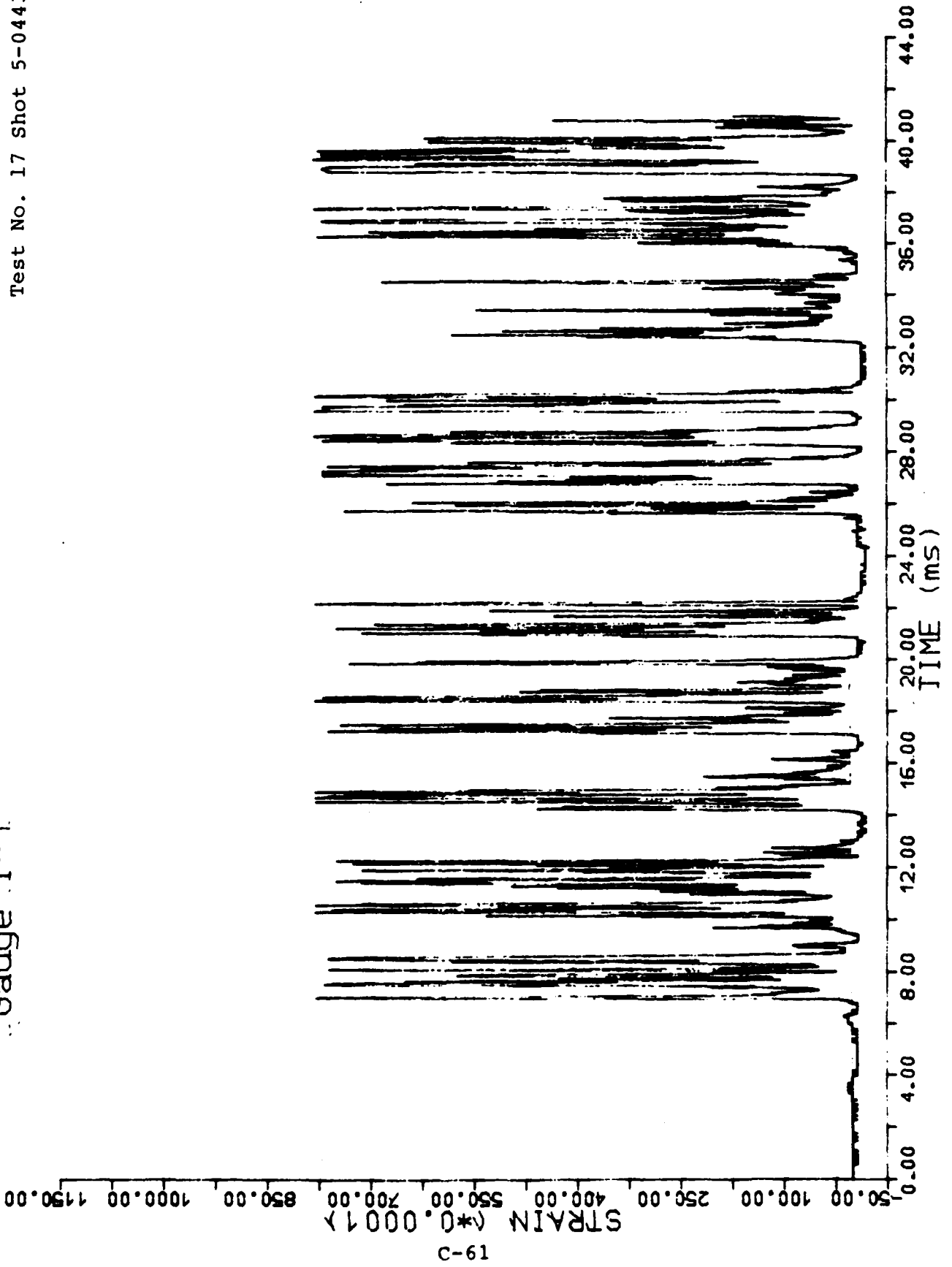

GAUGE I-2

Test No. 17 Shot 5-0443

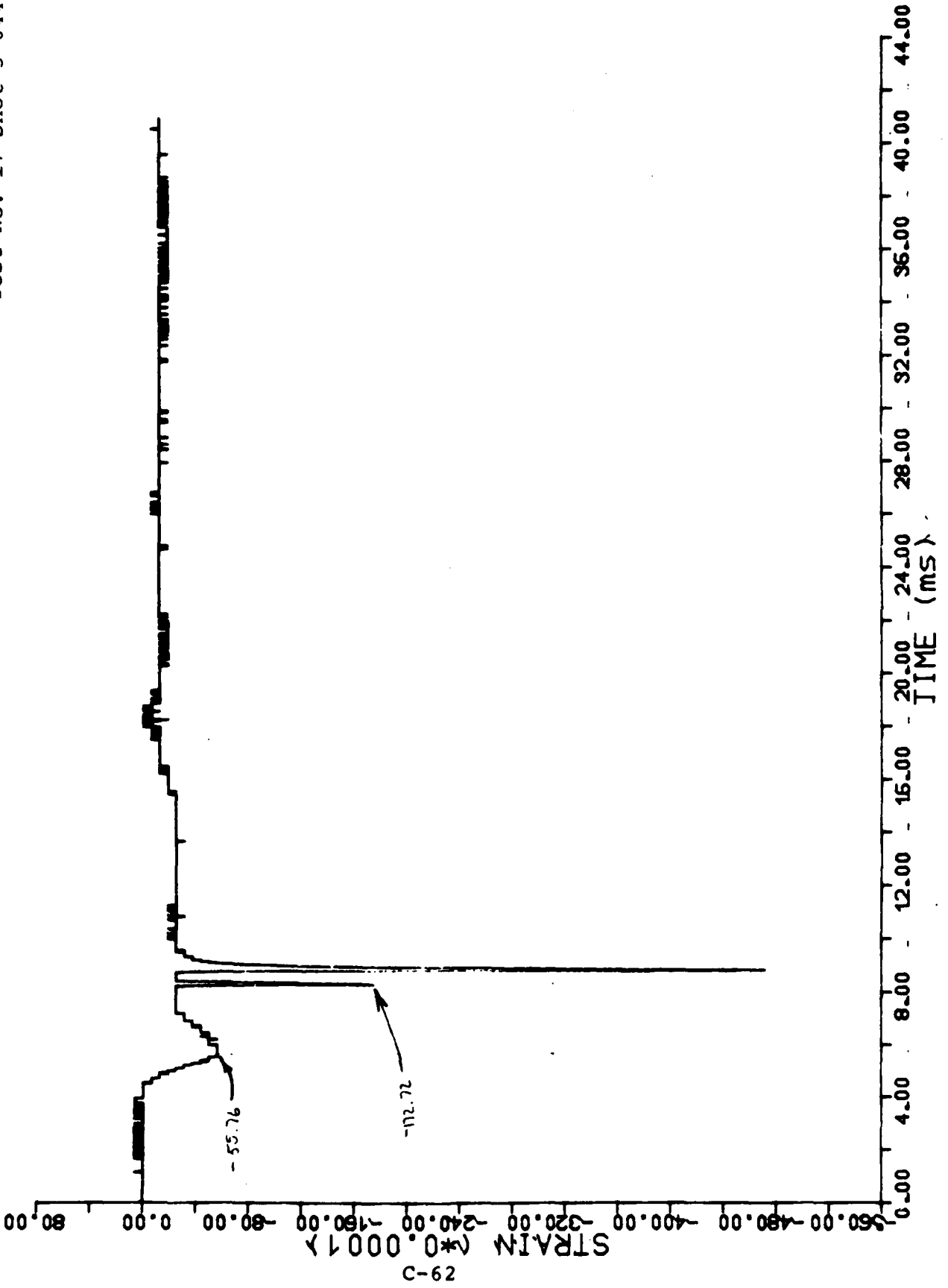

GAUGE I-3

Test No. 17 Shot 5-0443

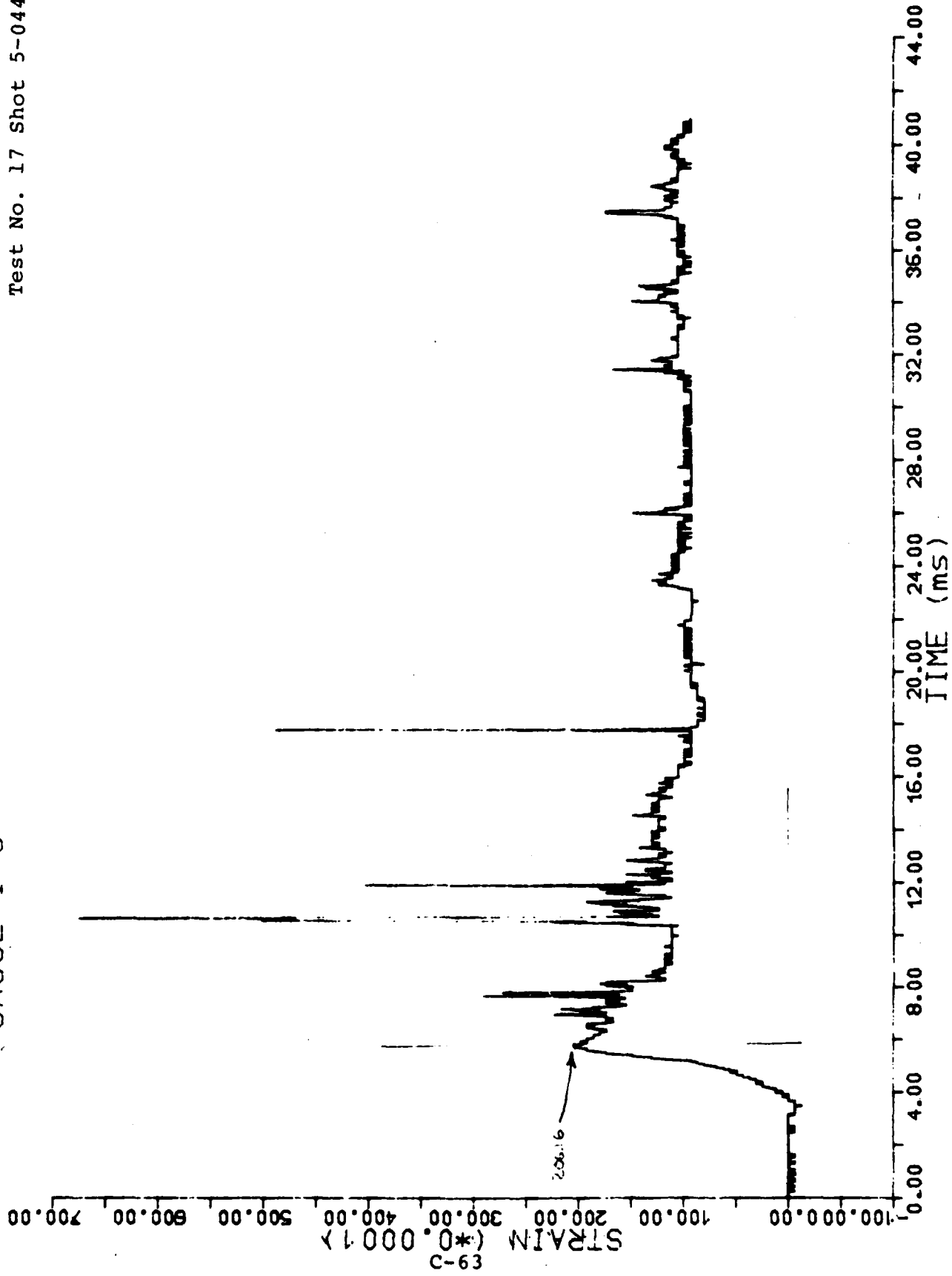

GAUGE II-1

Test No. 17 Shot 5-0443

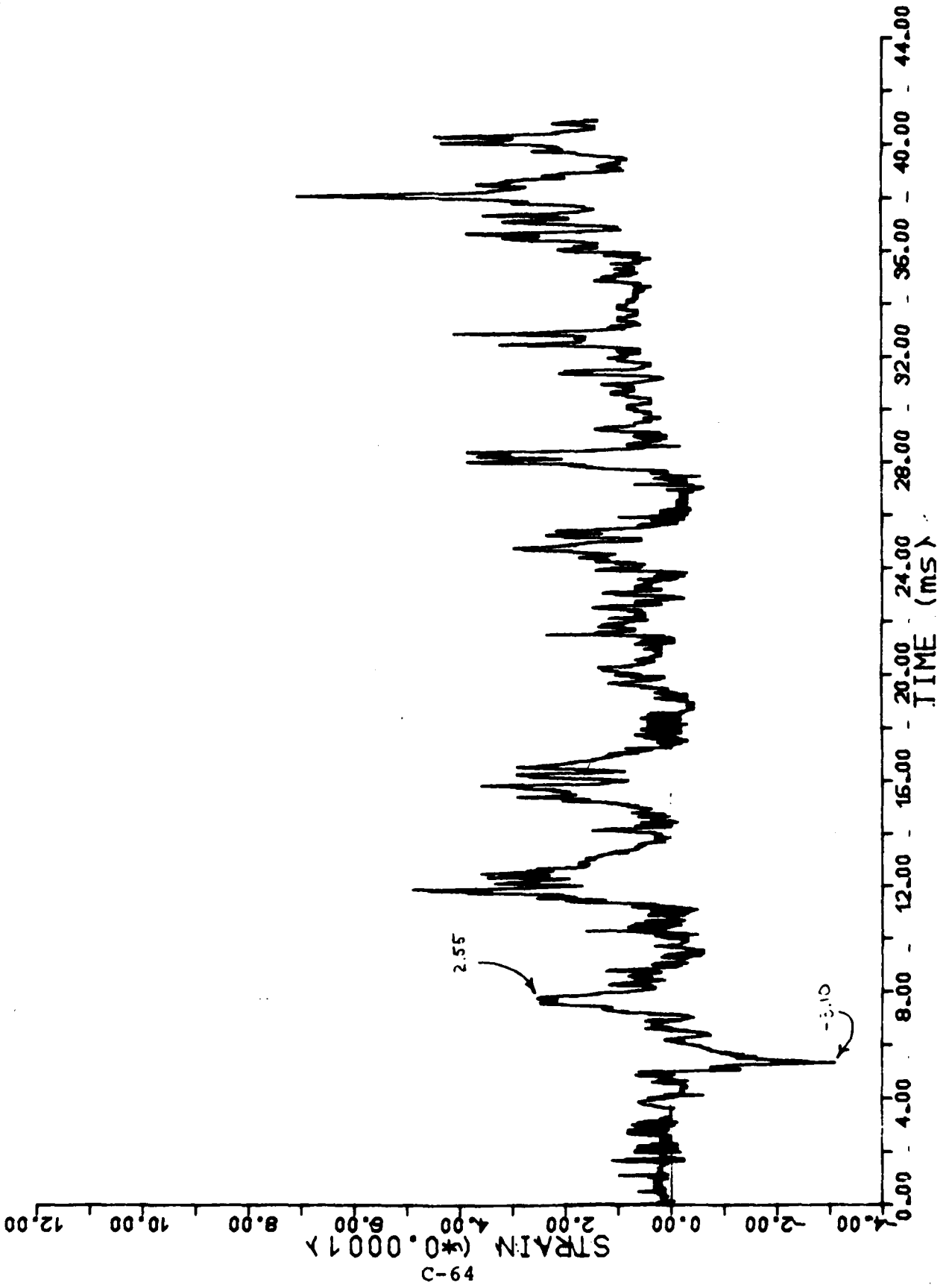

GAUGE II-2

Test No. 17 Shot 5-0443

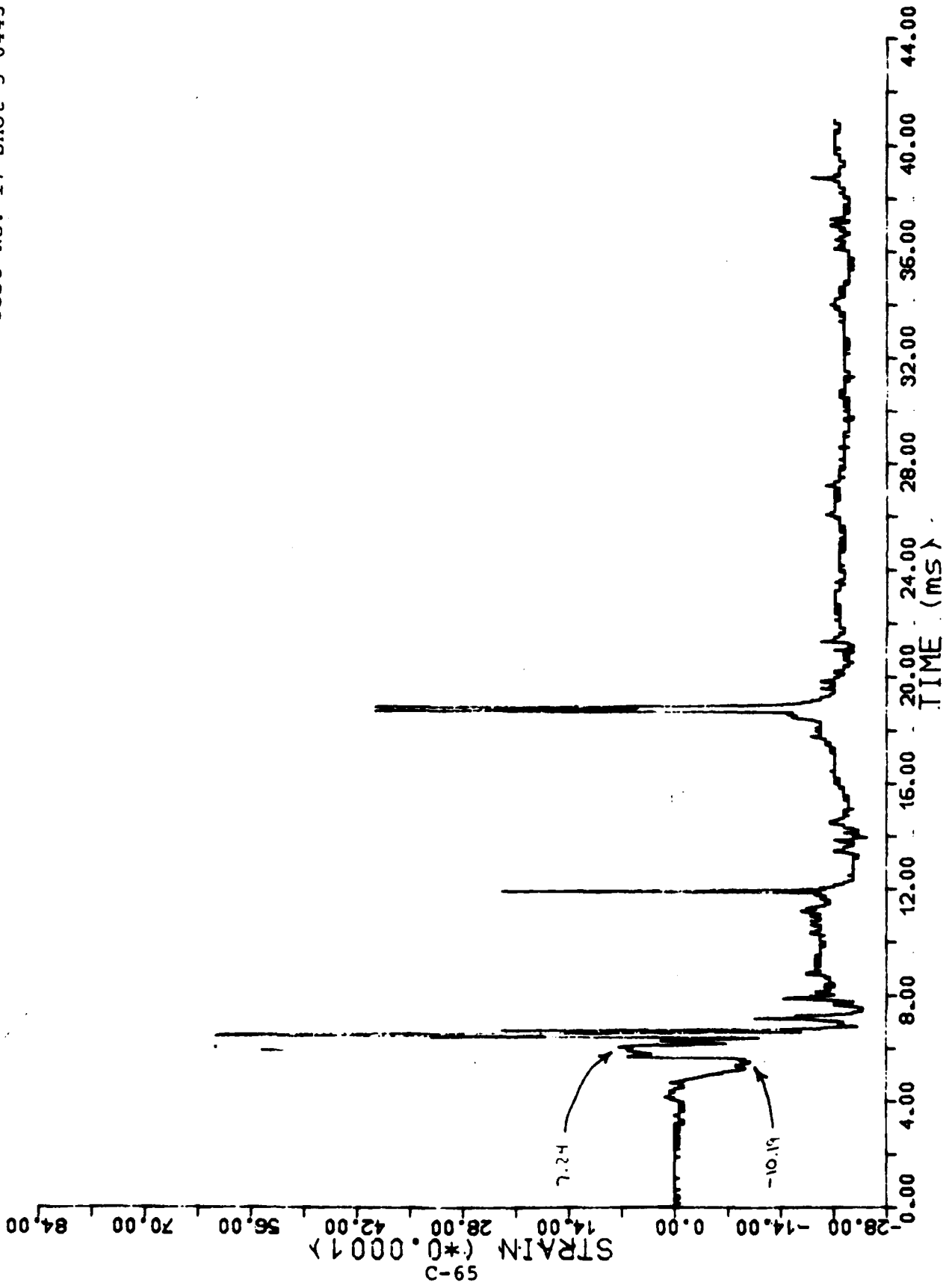

GAUGE I-1

Test No. 18 Shot 5-0444

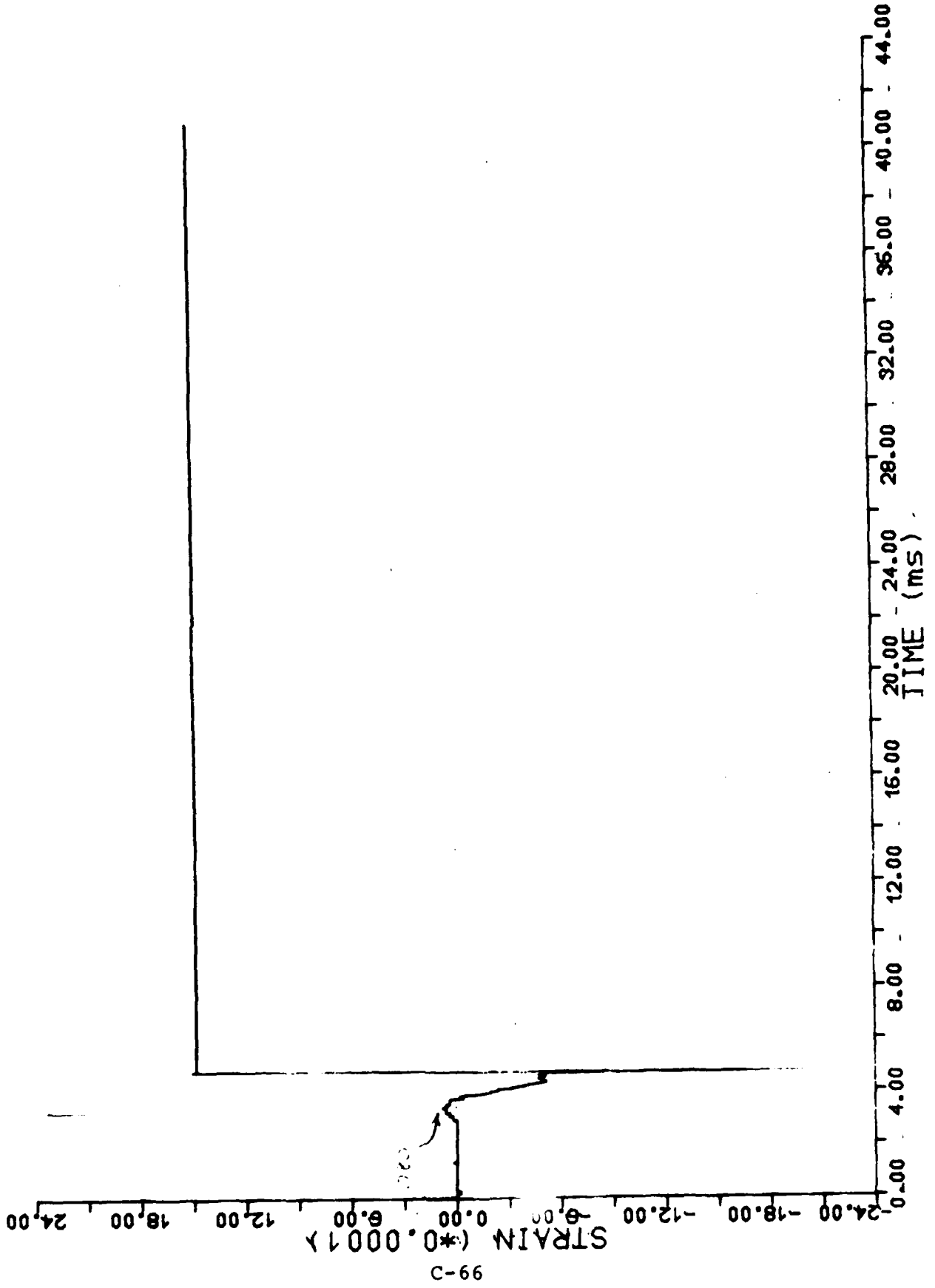

GAUGE I-2

Test No. I8 Shot 5-0444

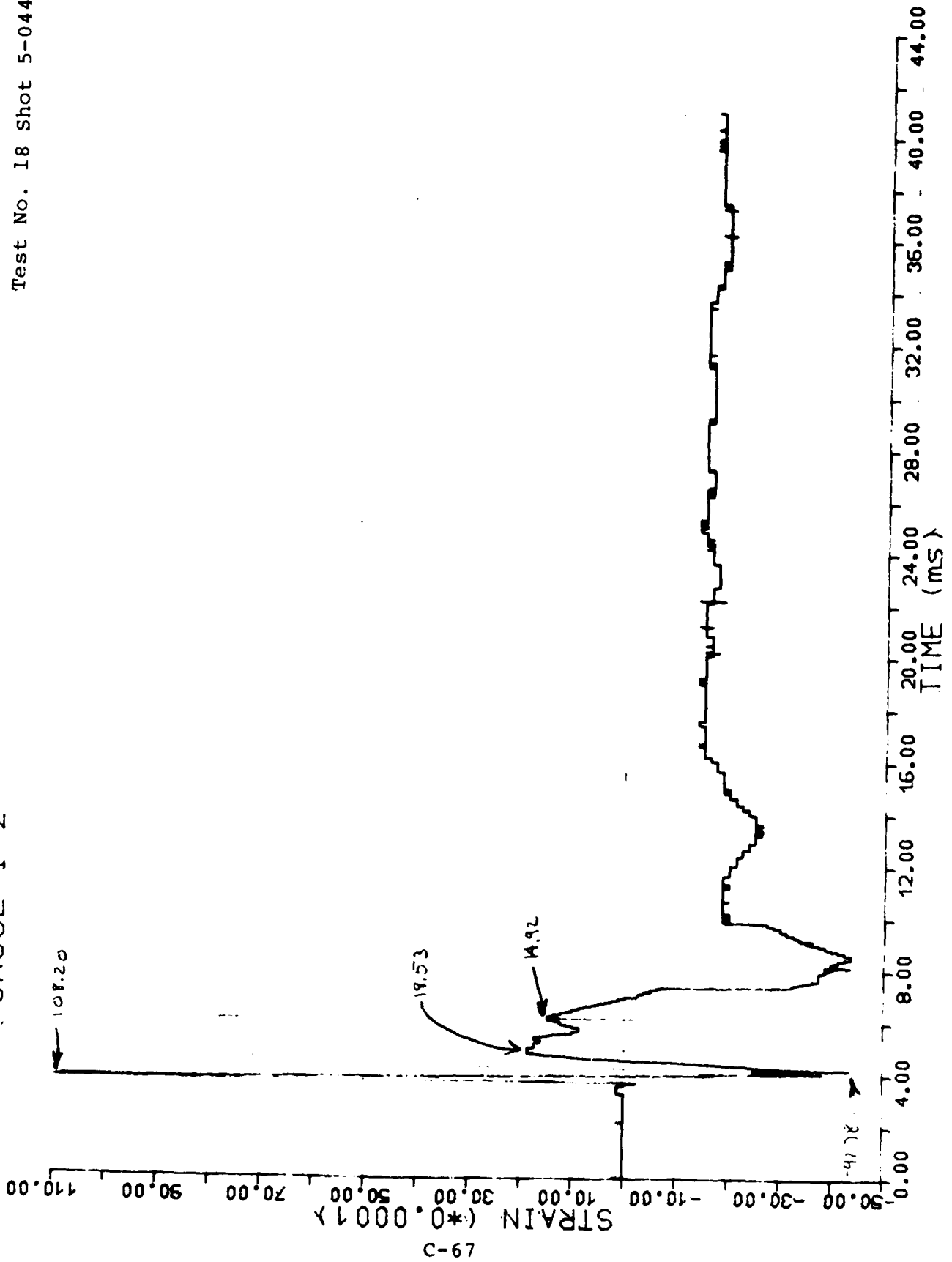

69-C

GAUGE I-3

Test No. 18 Shot 5-0444

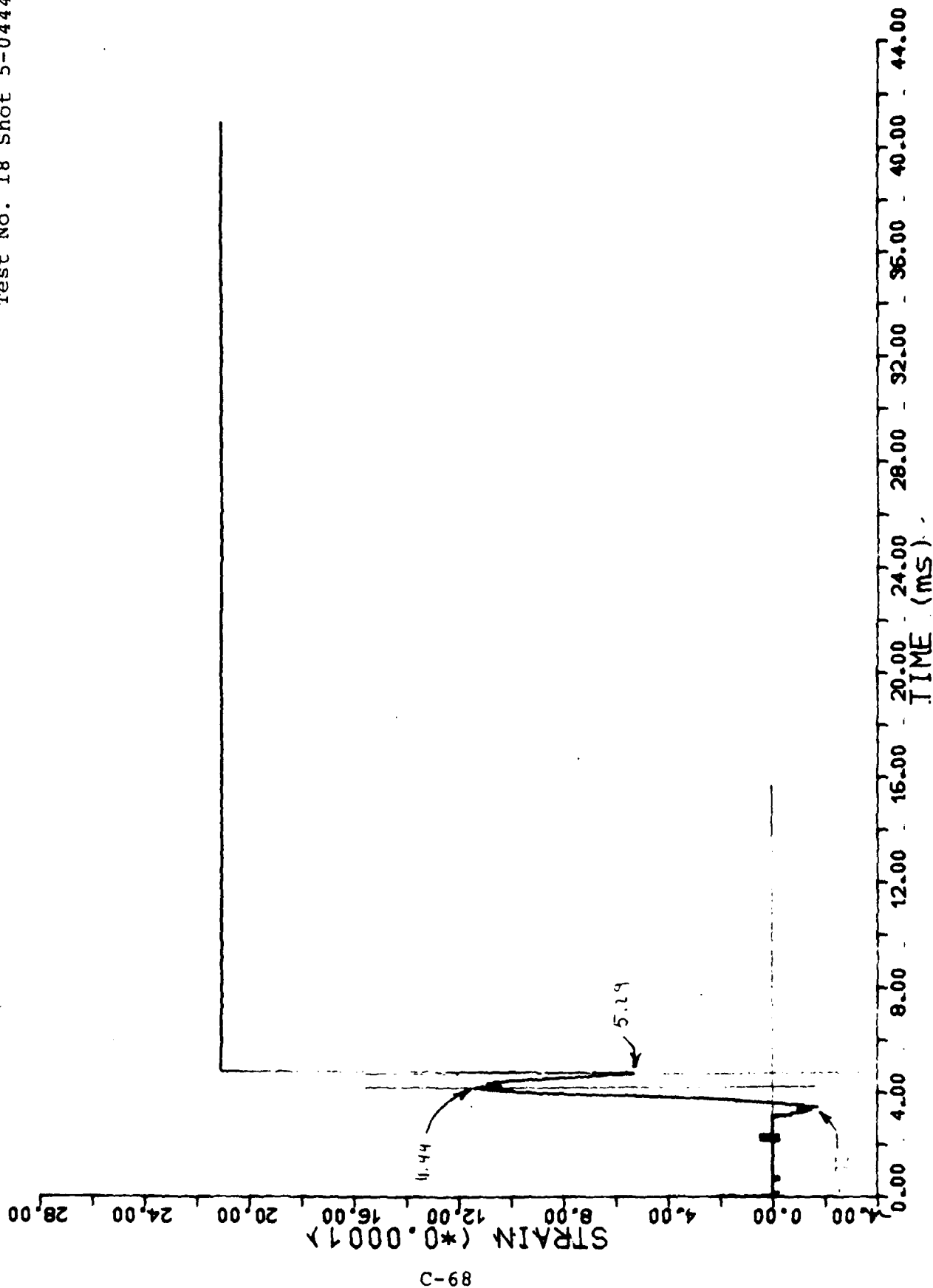

89-C

GAUGE II--1

Test No. 18 Shot 5-0444

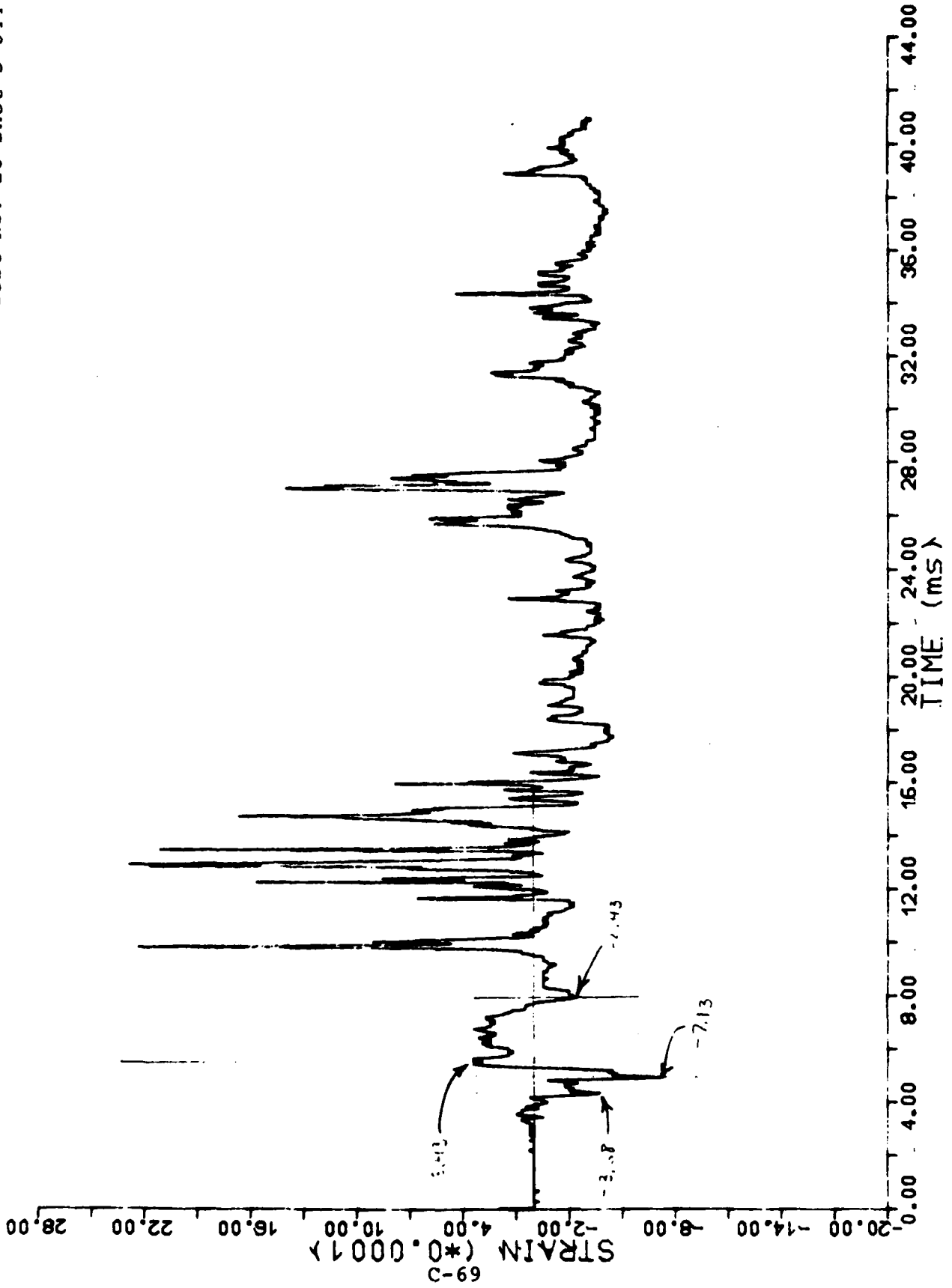

GAUGE II-2

Test No. 18 Shot 5-0444

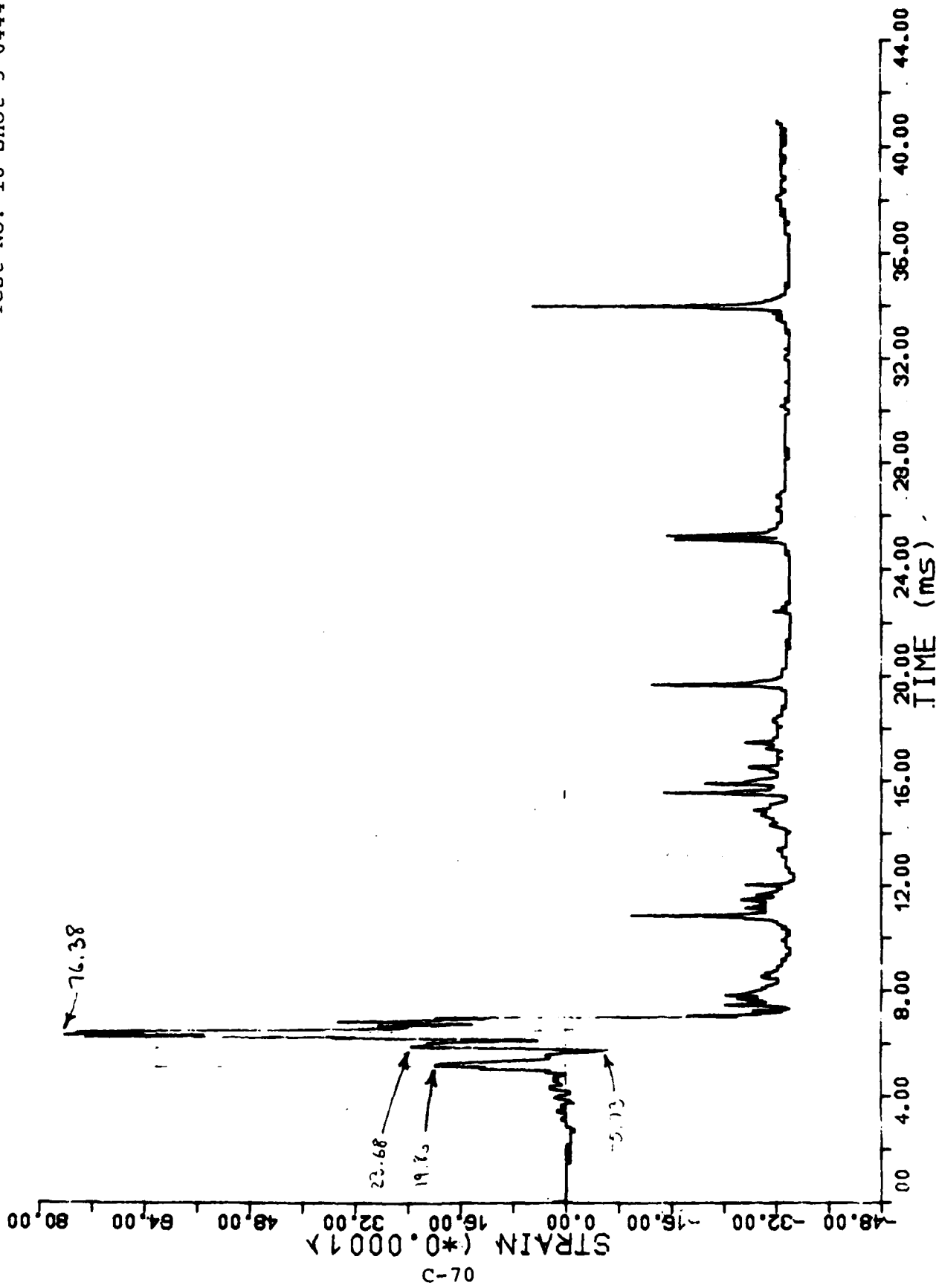

07-C

GAUGE I-1

Test No. 19 Shot 5-0445

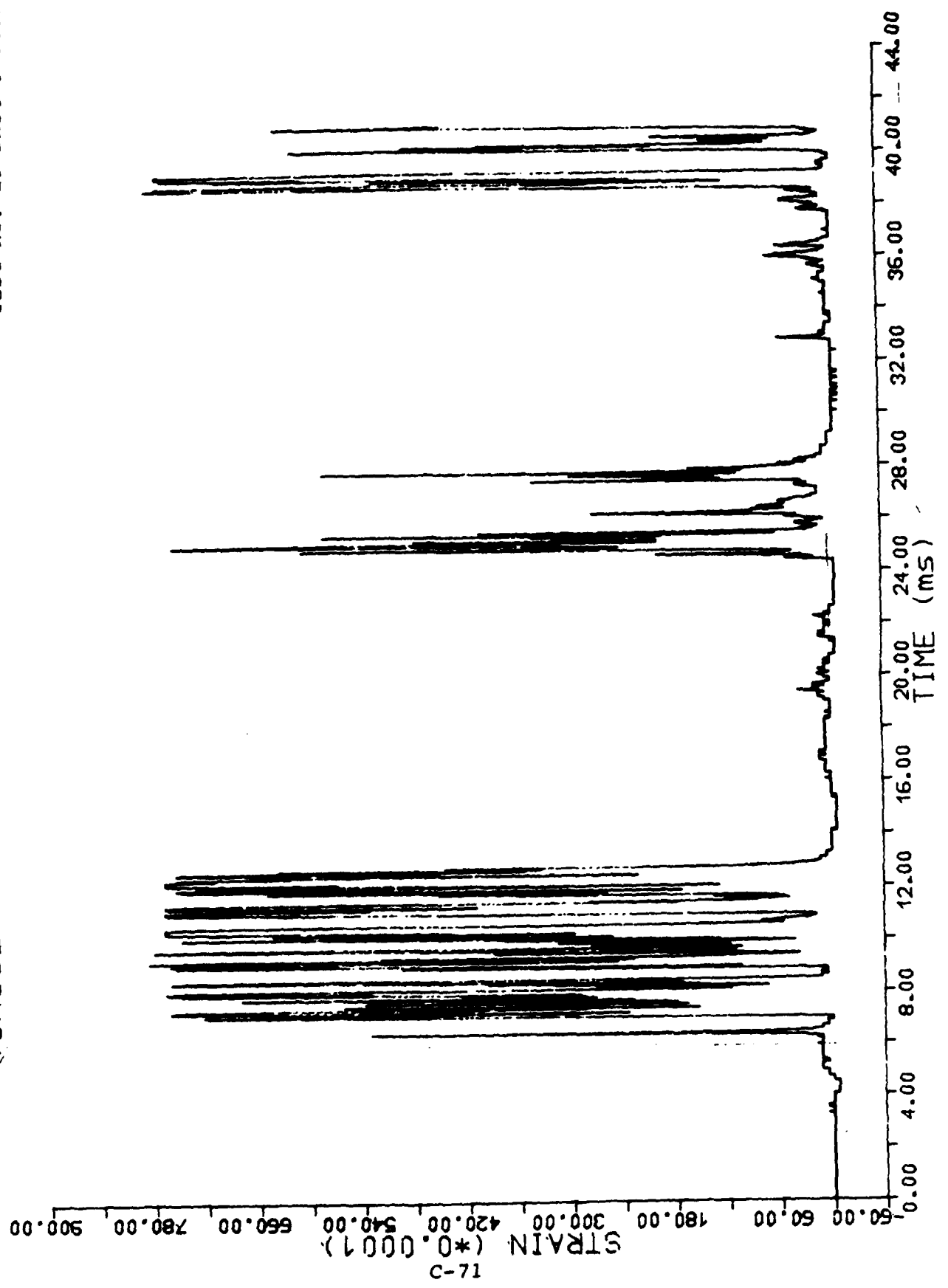

17-C

GAUGE I-2

Test No. 19 Shot 5-0445

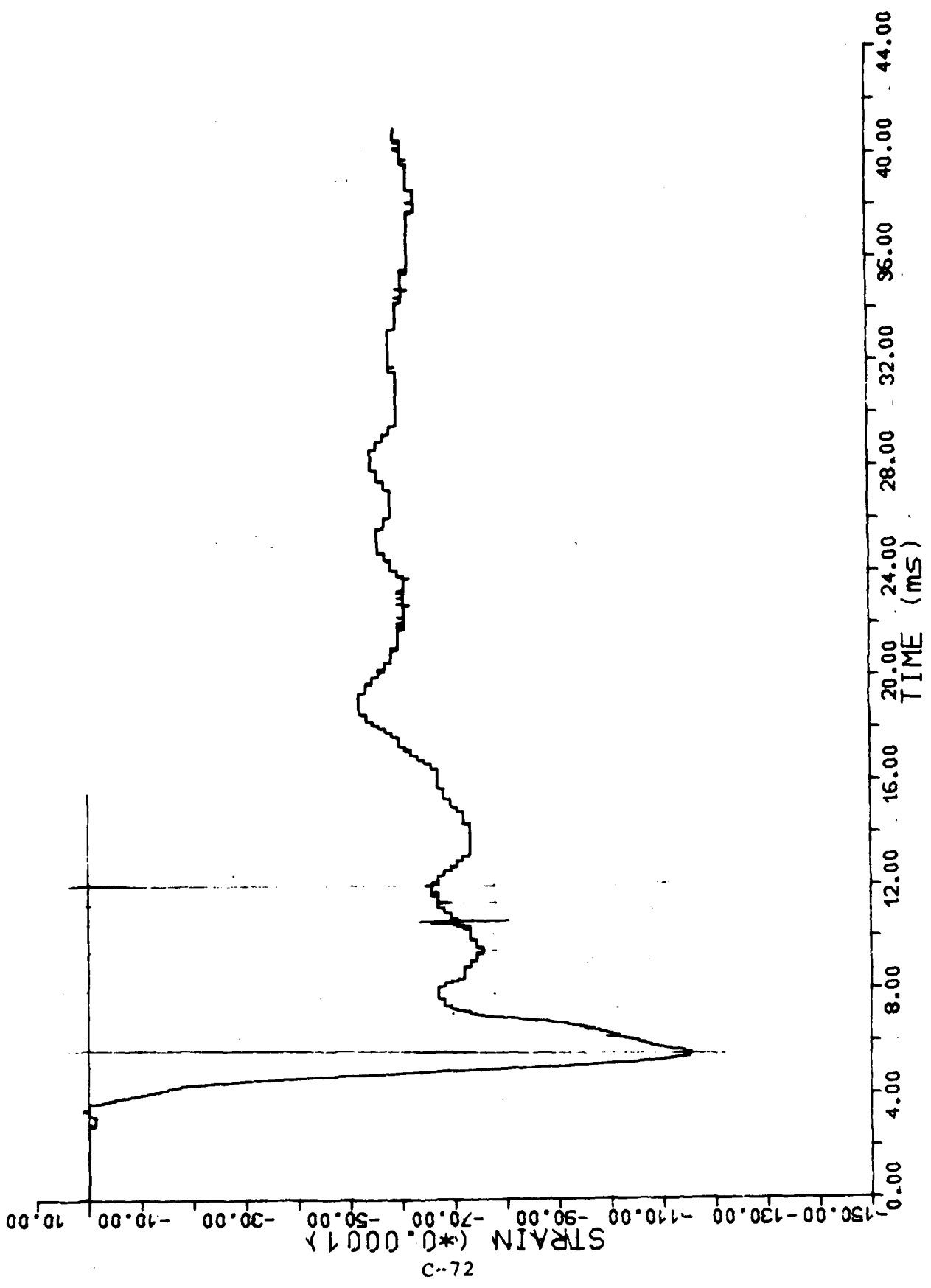

27-C

GAUGE I-3

Test No. 19 Shot 5-0445

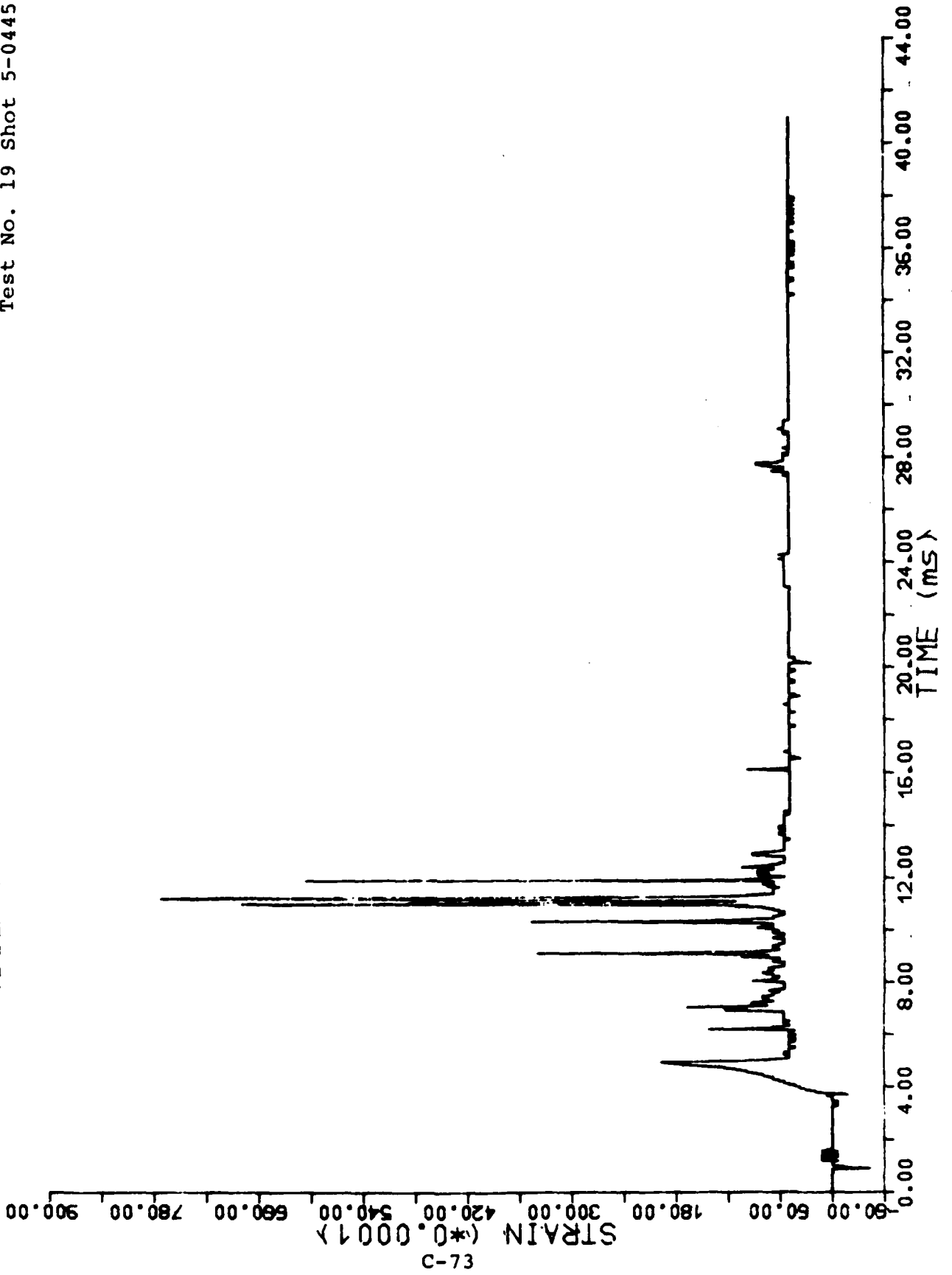

C-73

GAUGE . II - 1

Test No. 19 Shot 5-0445

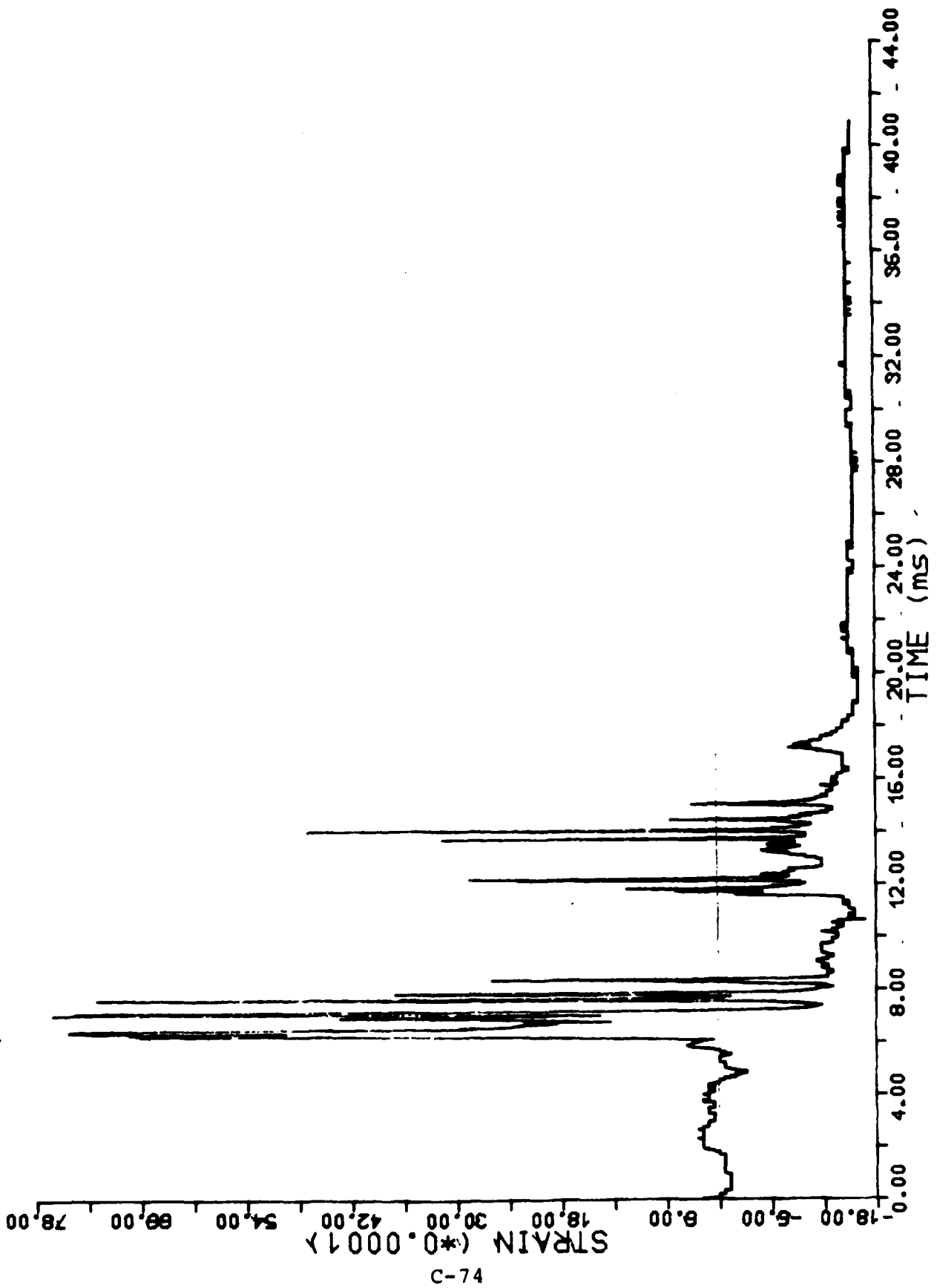

C-74

GAUGE II-2

Test No. 19 Shot 5-0445

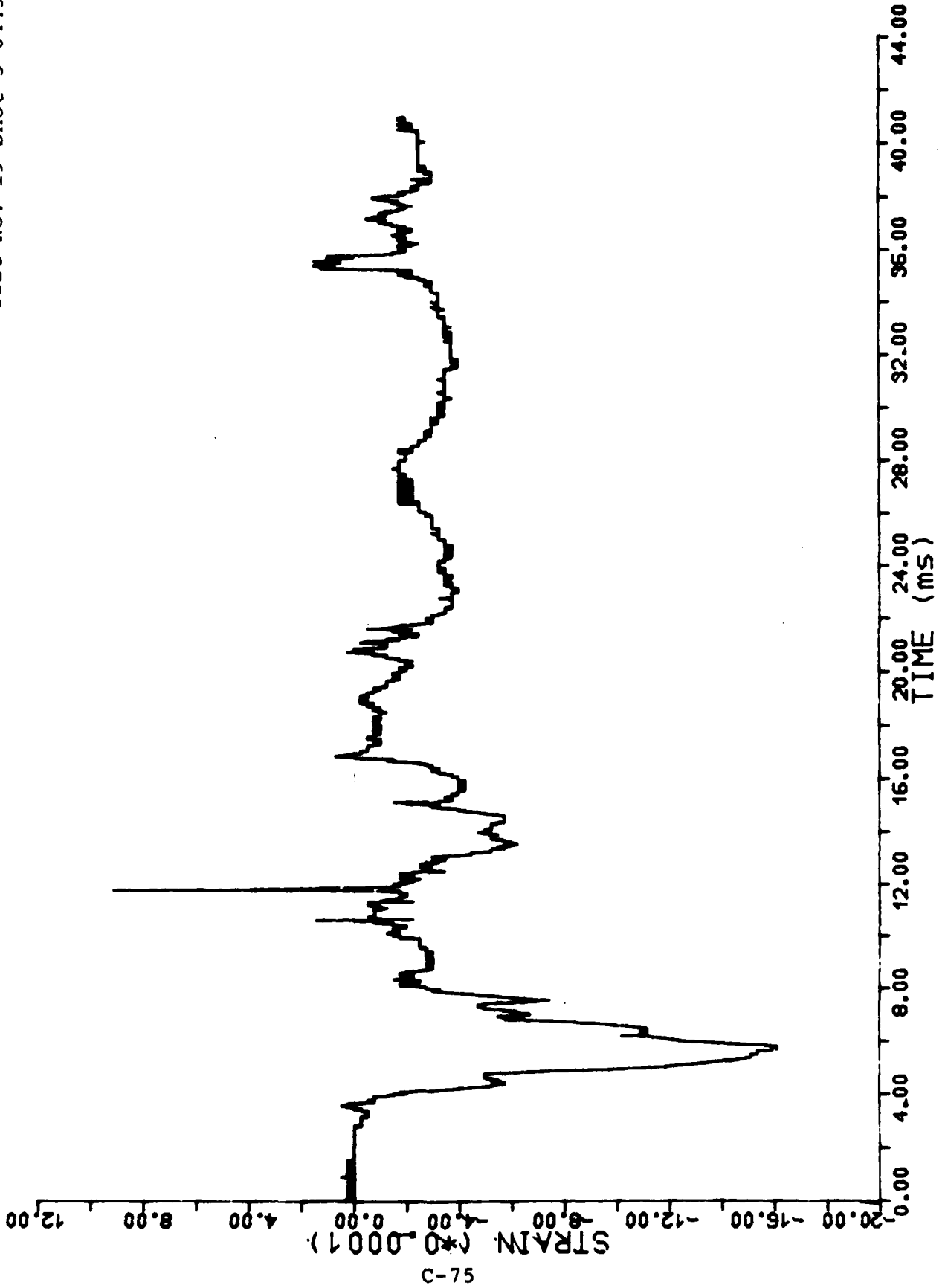

5-C-75

GAUGE II-S

Test No. 19 Shot 5-0445

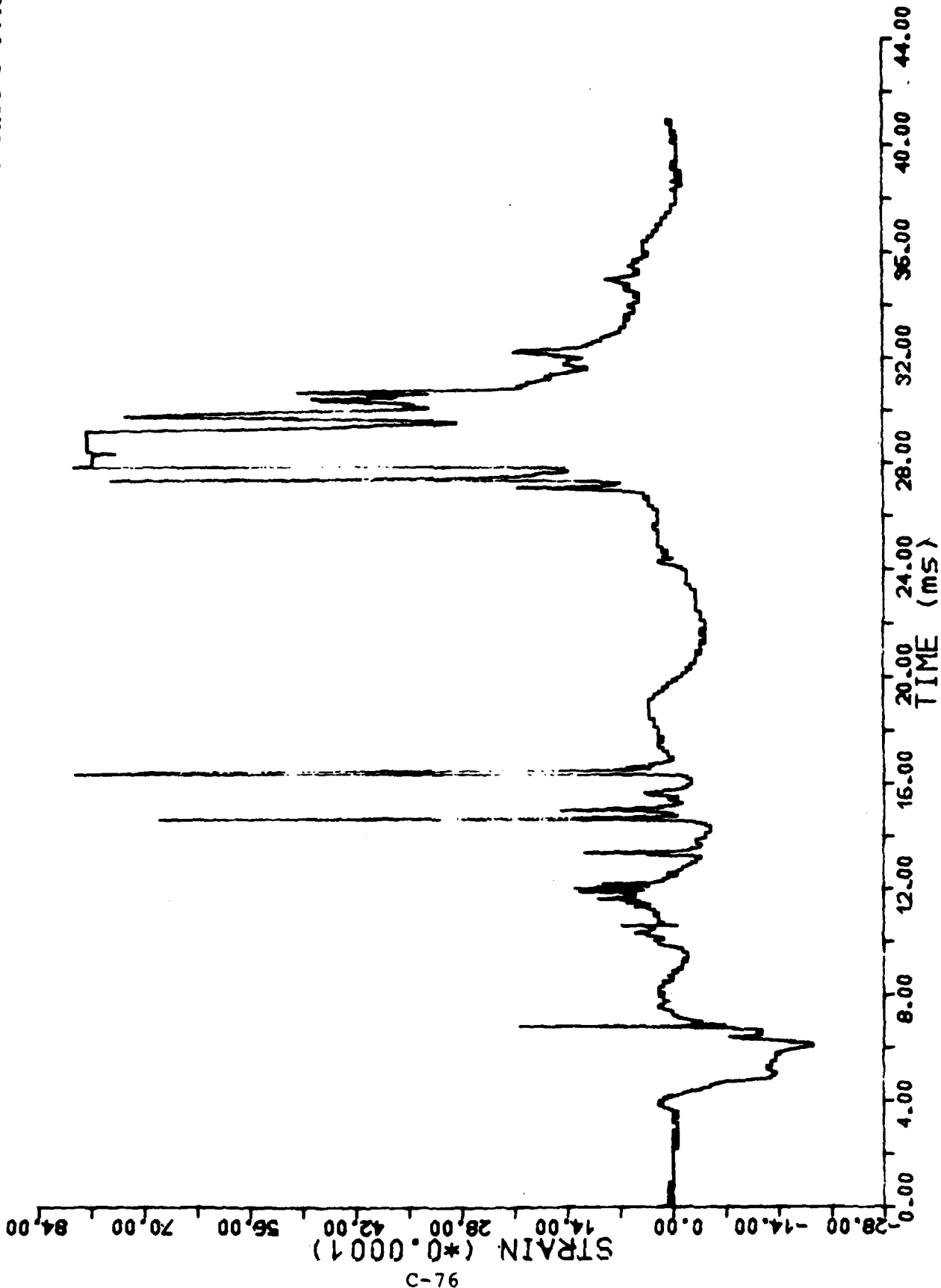

C-76

GAUGE I-1

Test No. 20 Shot 5-0446

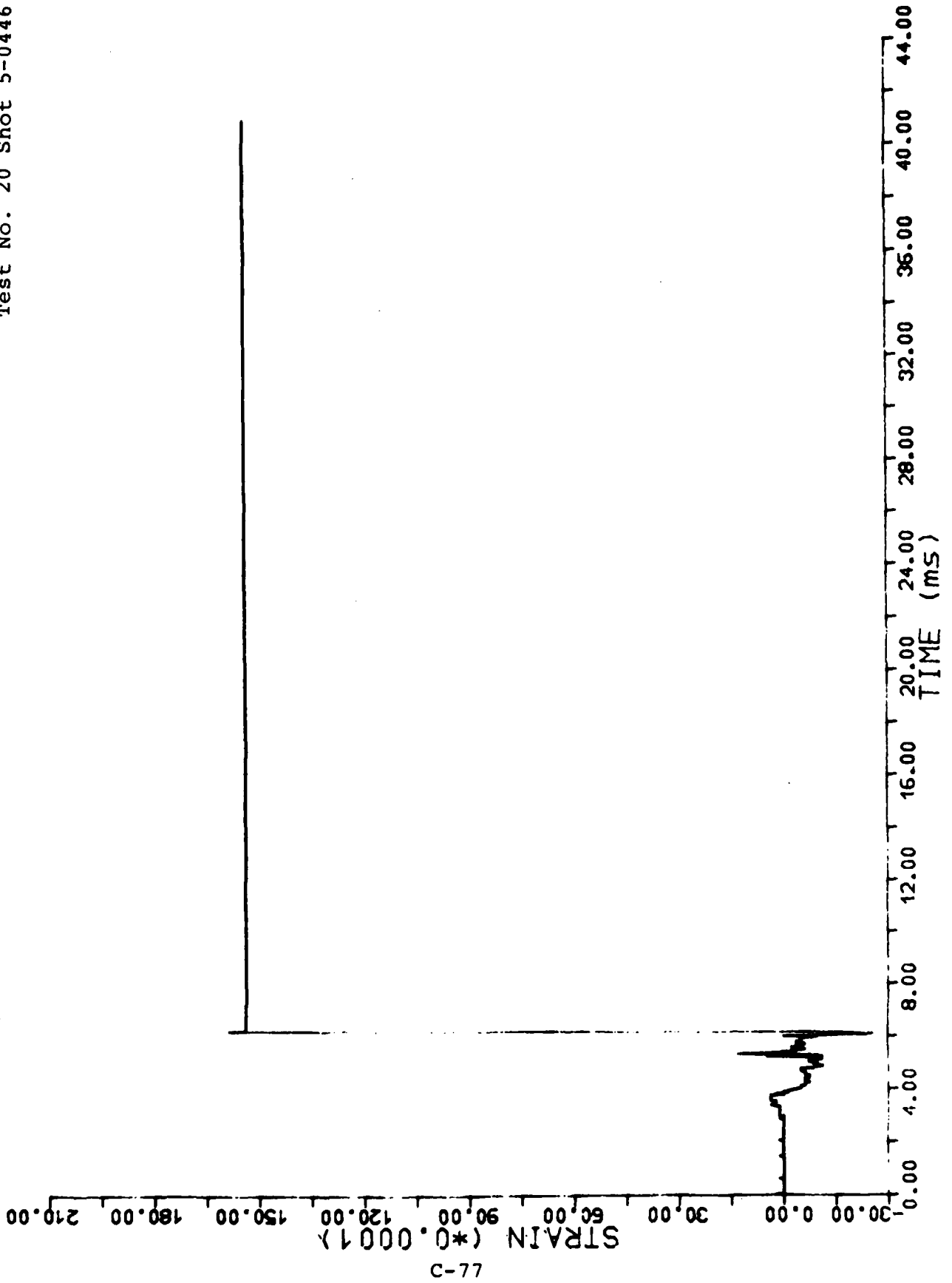

C-77

GAUGE I-2

Test No. 20 Shot 5-0446

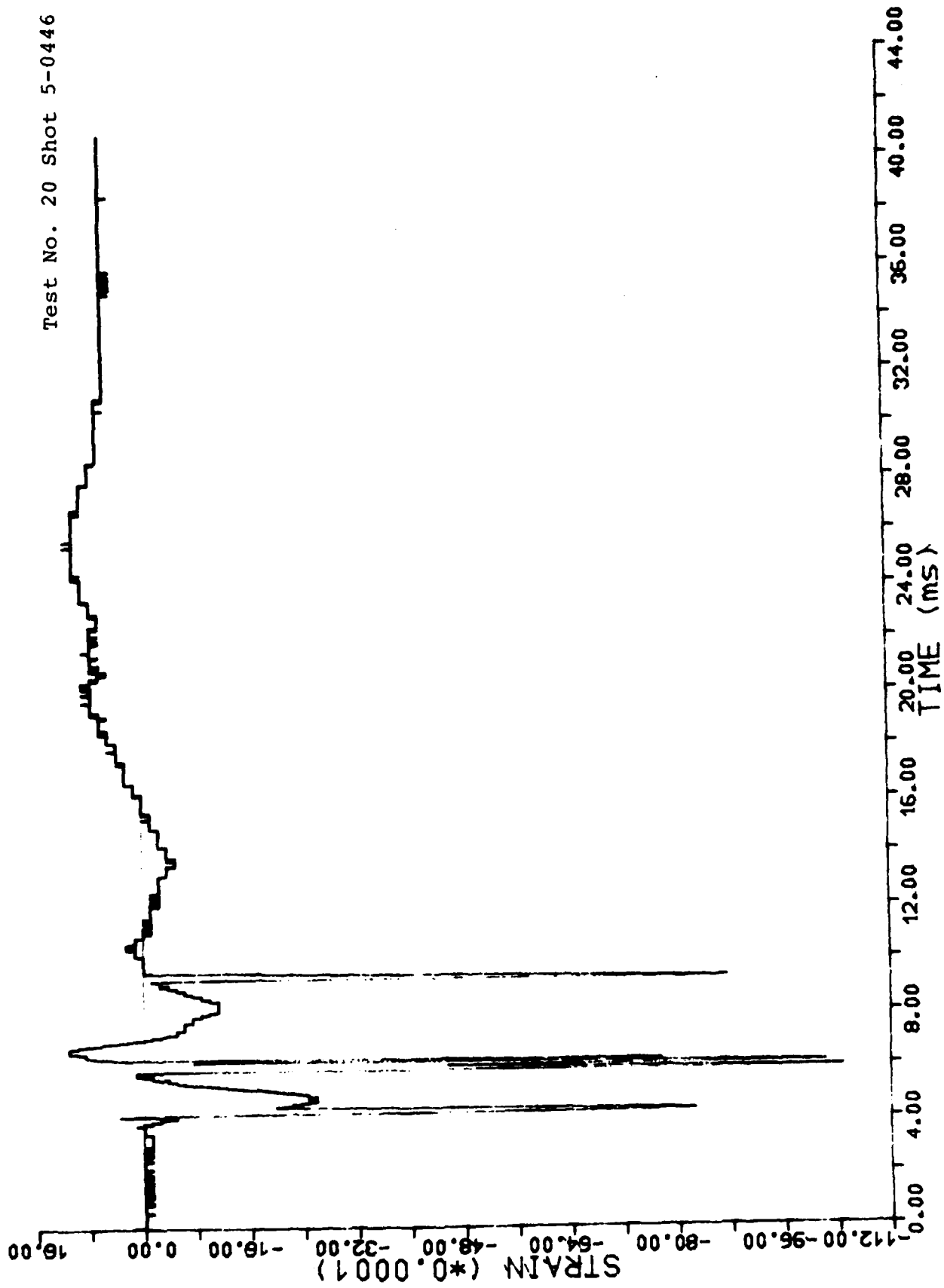

GAUGE I-3

Test No. 20 Shot 5-0446

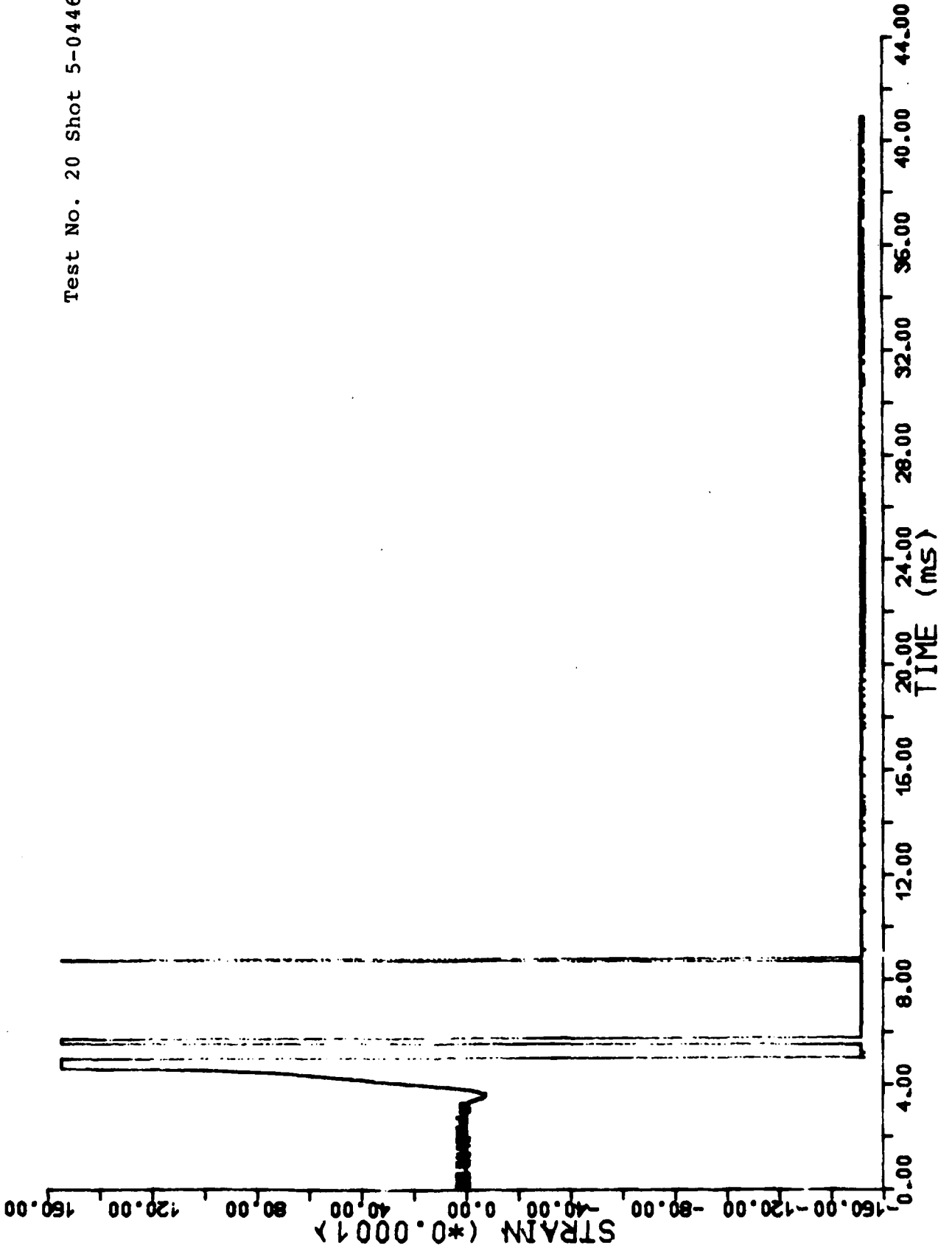

C-79

GAUGE II-1

Test No. 20 Shot 5-0446

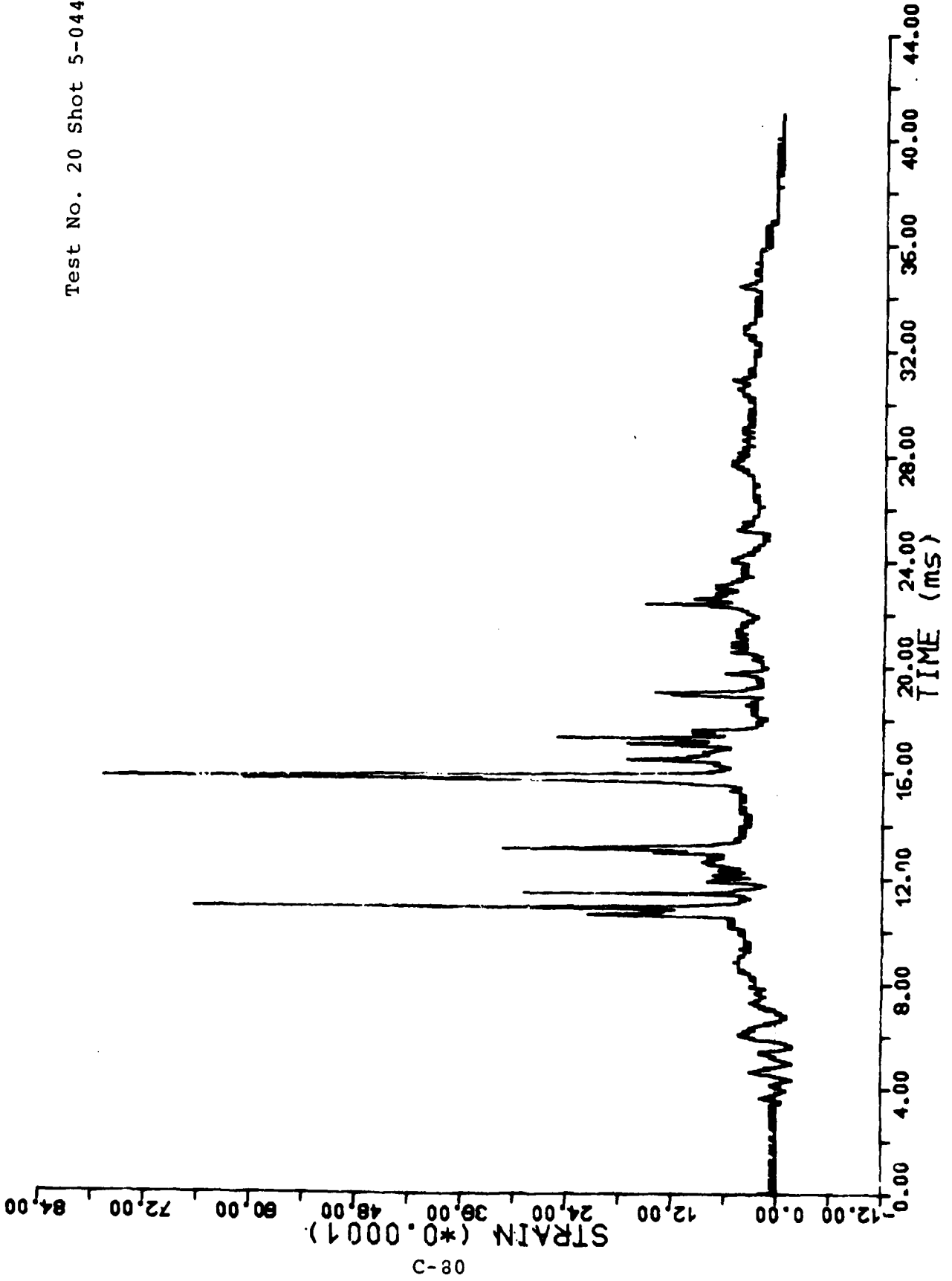

08-C

GAUGE II-2

Test No. 20 Shot 5-0446

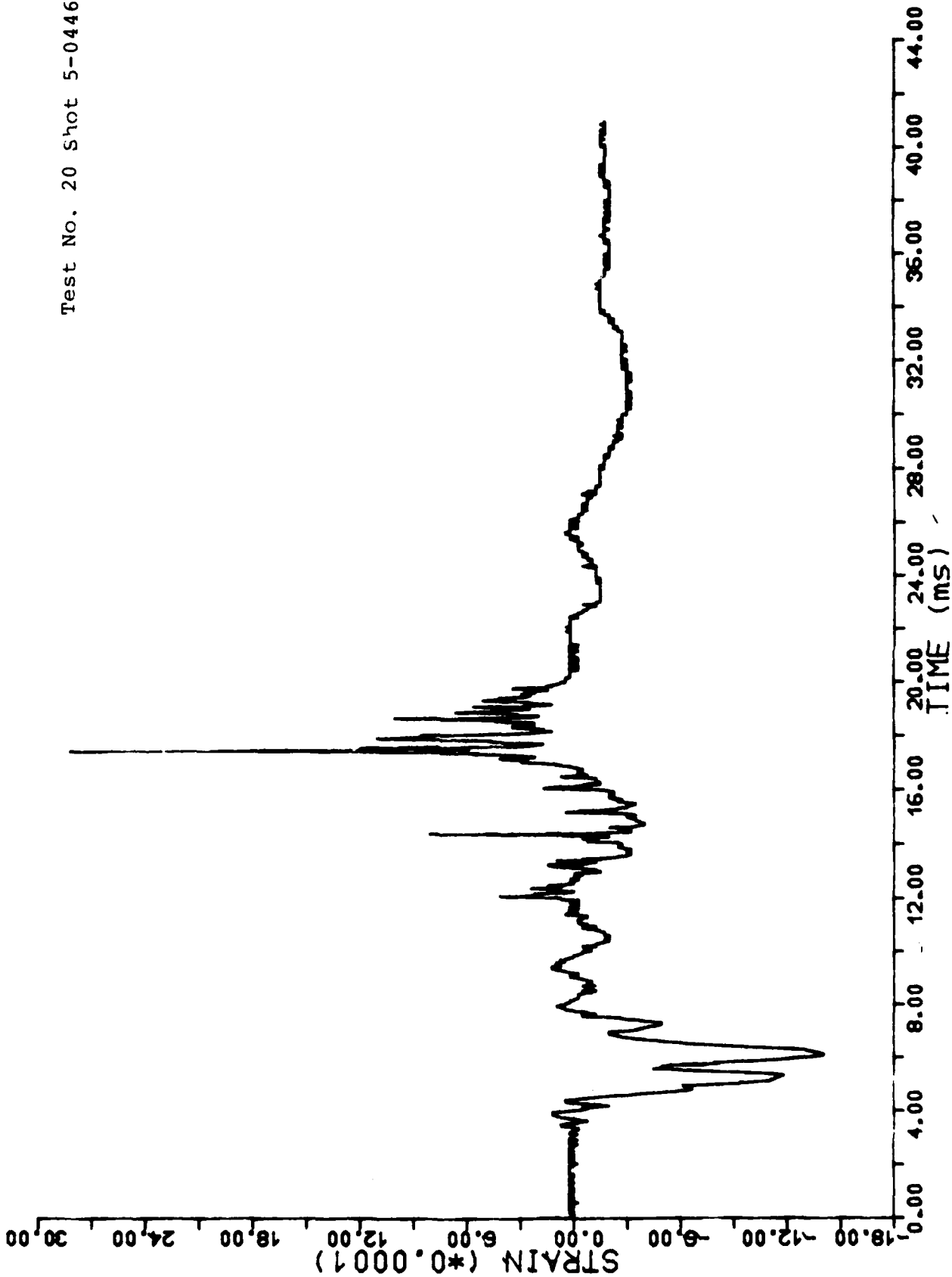

GAUGE II-3

Test No. 20 Shot 5-0446

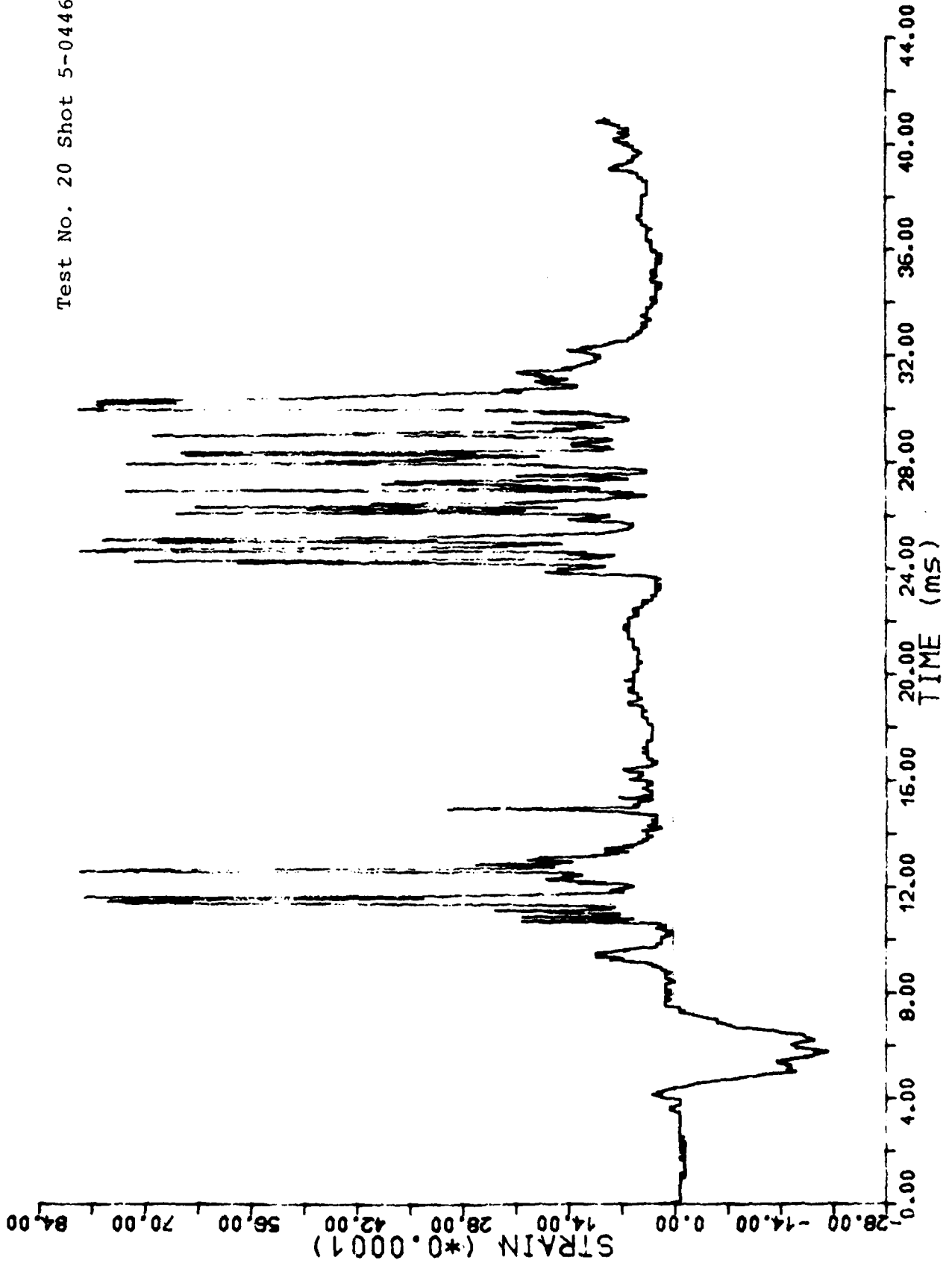

GAUGE I-1

Test No. 21 Shot 5-0447

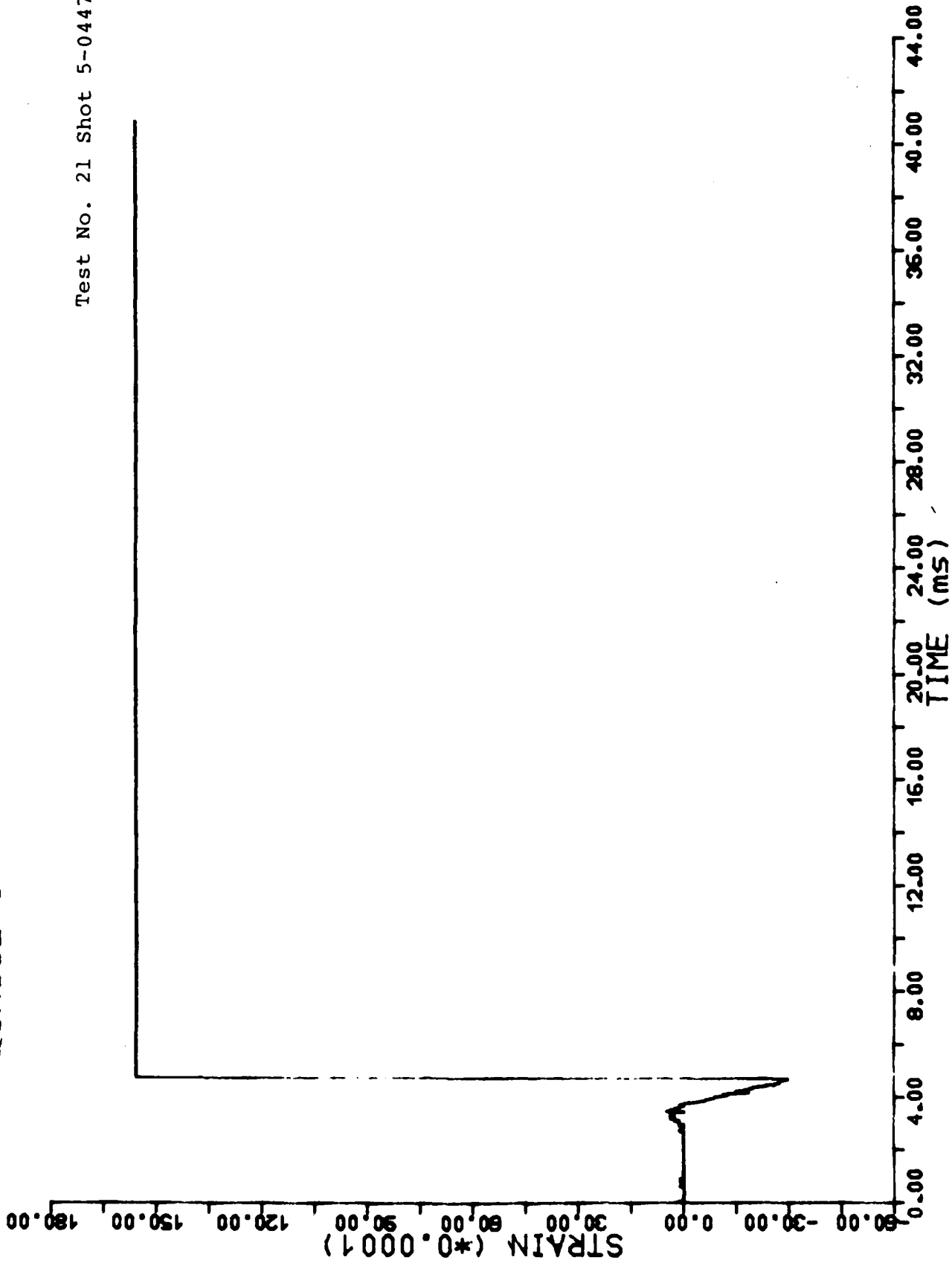

GAUGE I-2

γ

Test No. 20 Shot 5-0447

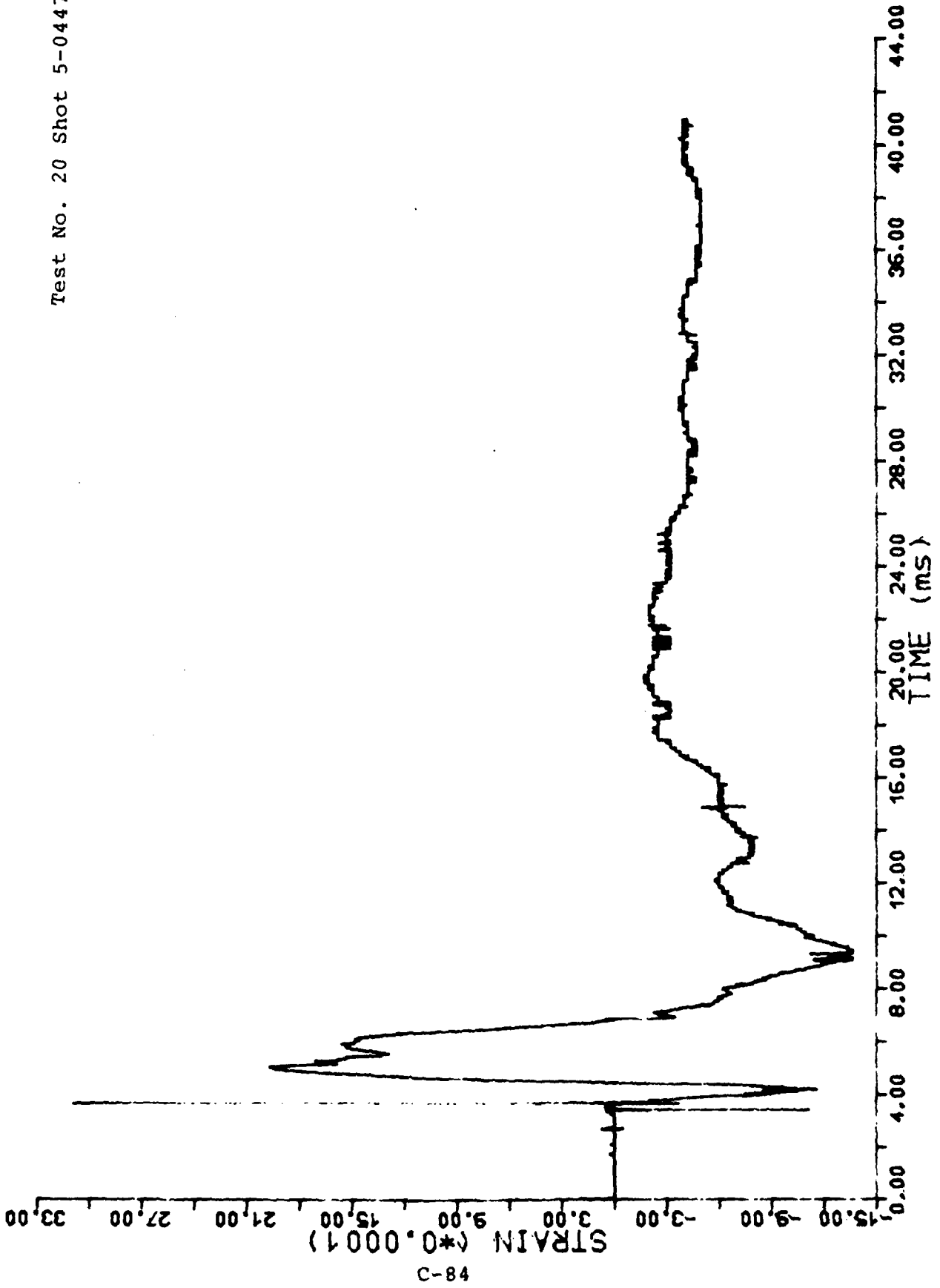

C-84

GAUGE I-S

Test No. 21 Shot 5-0447

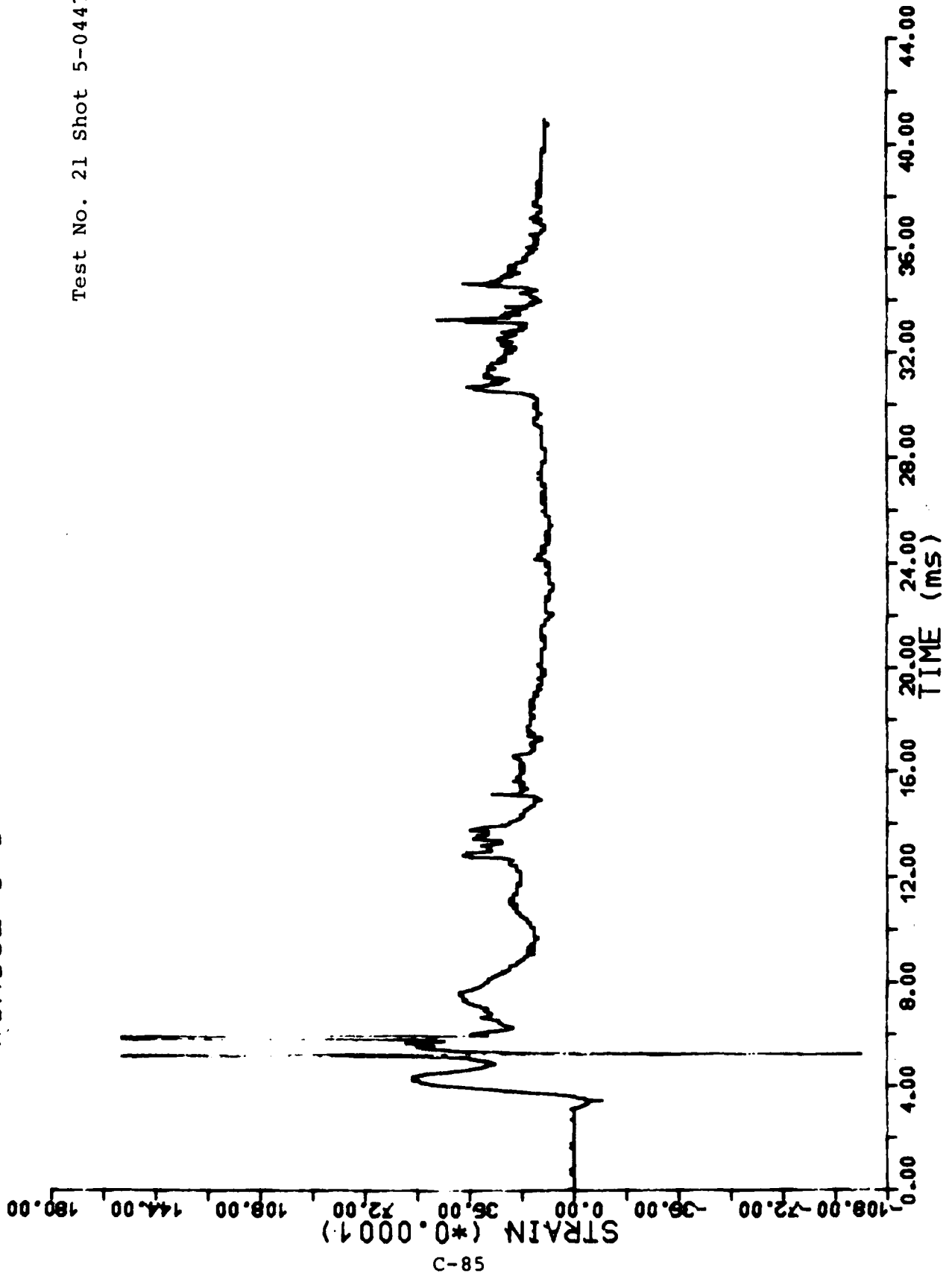

C-85

GAUGE I-3

Test No. 21 Shot 5-0447

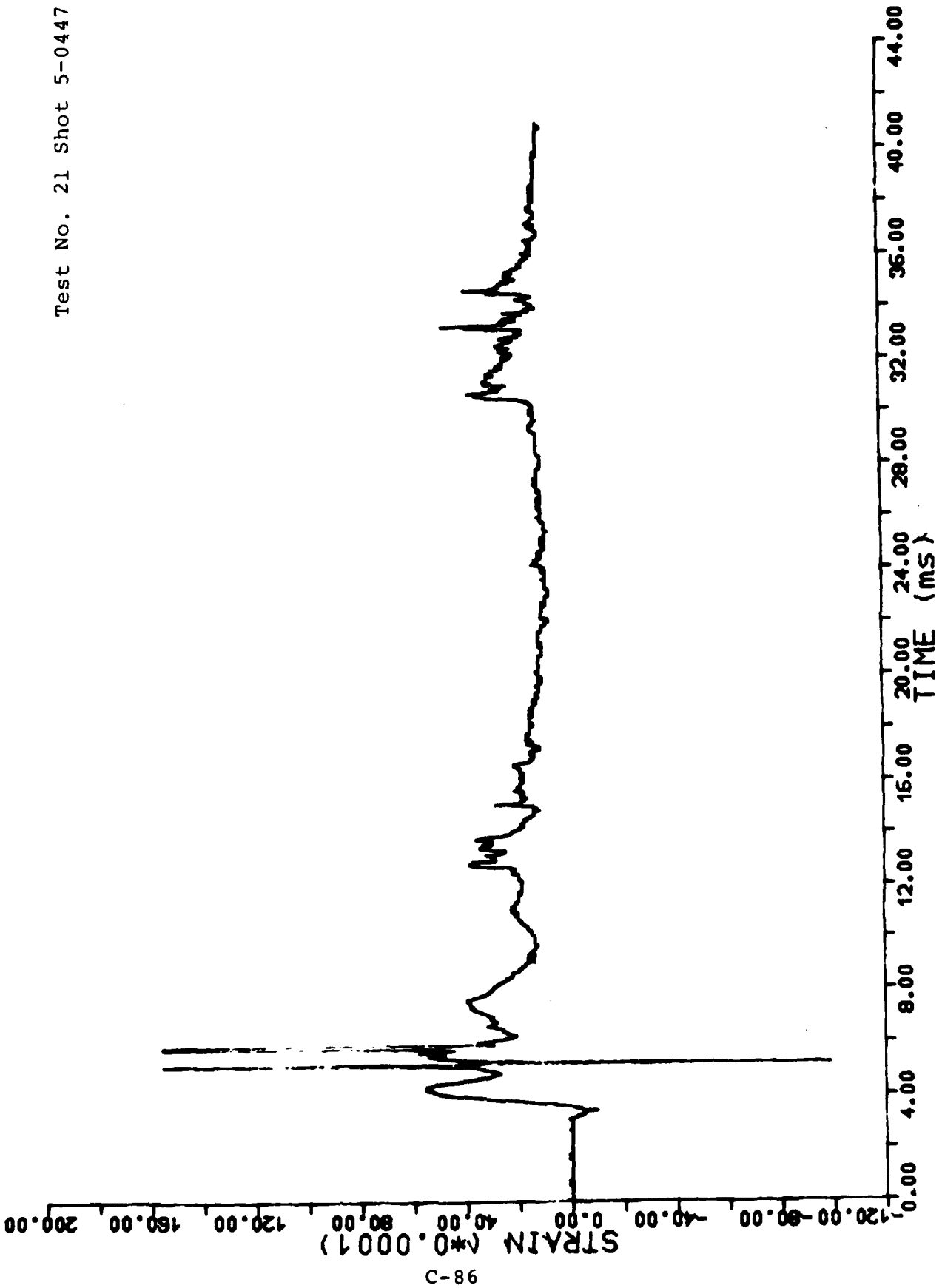

GAUGE II-1

Test No. 21 Shot 5-0447

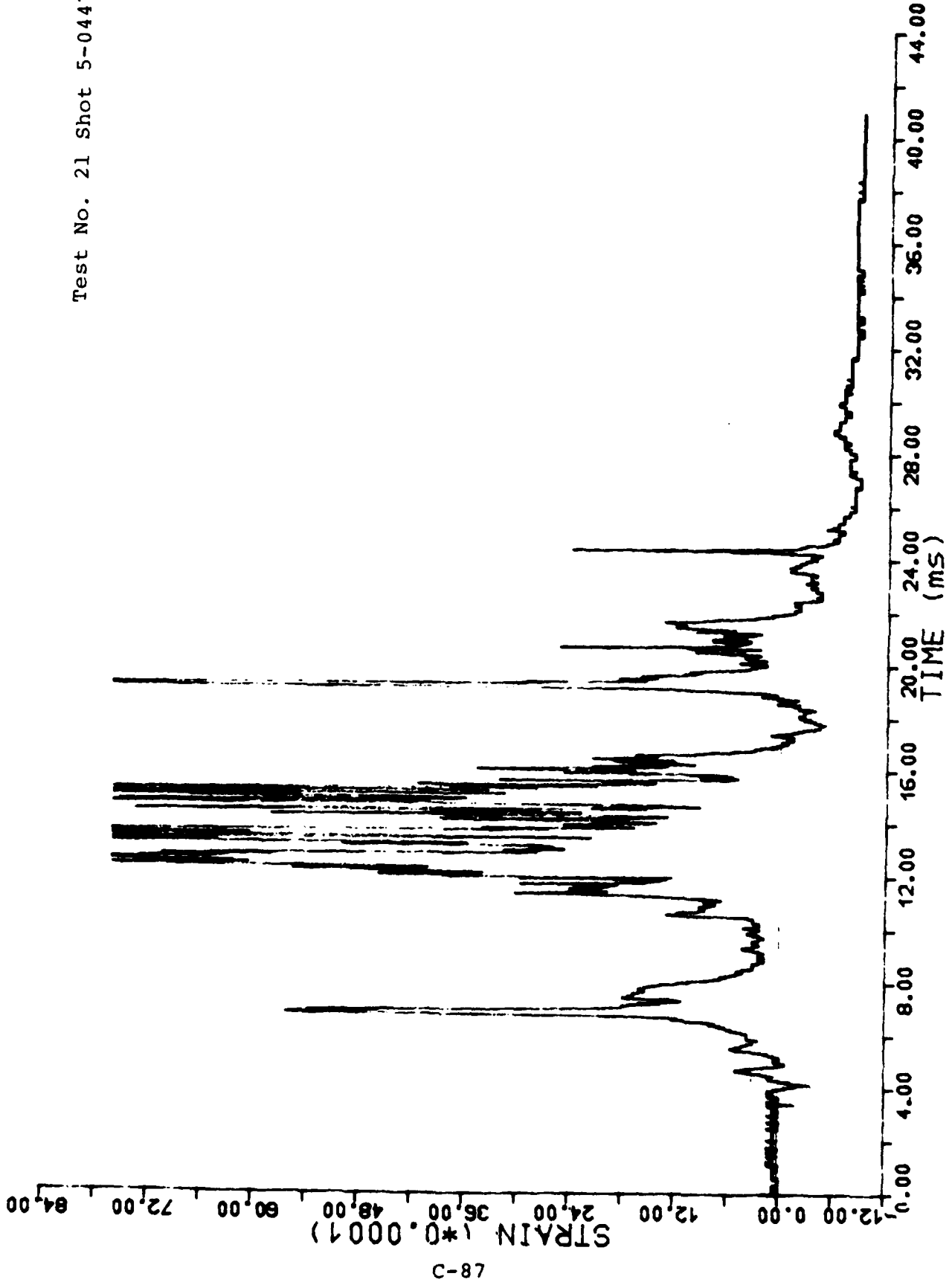

78-C

GAUGE II-1

Test No. 21 Shot 5-0447

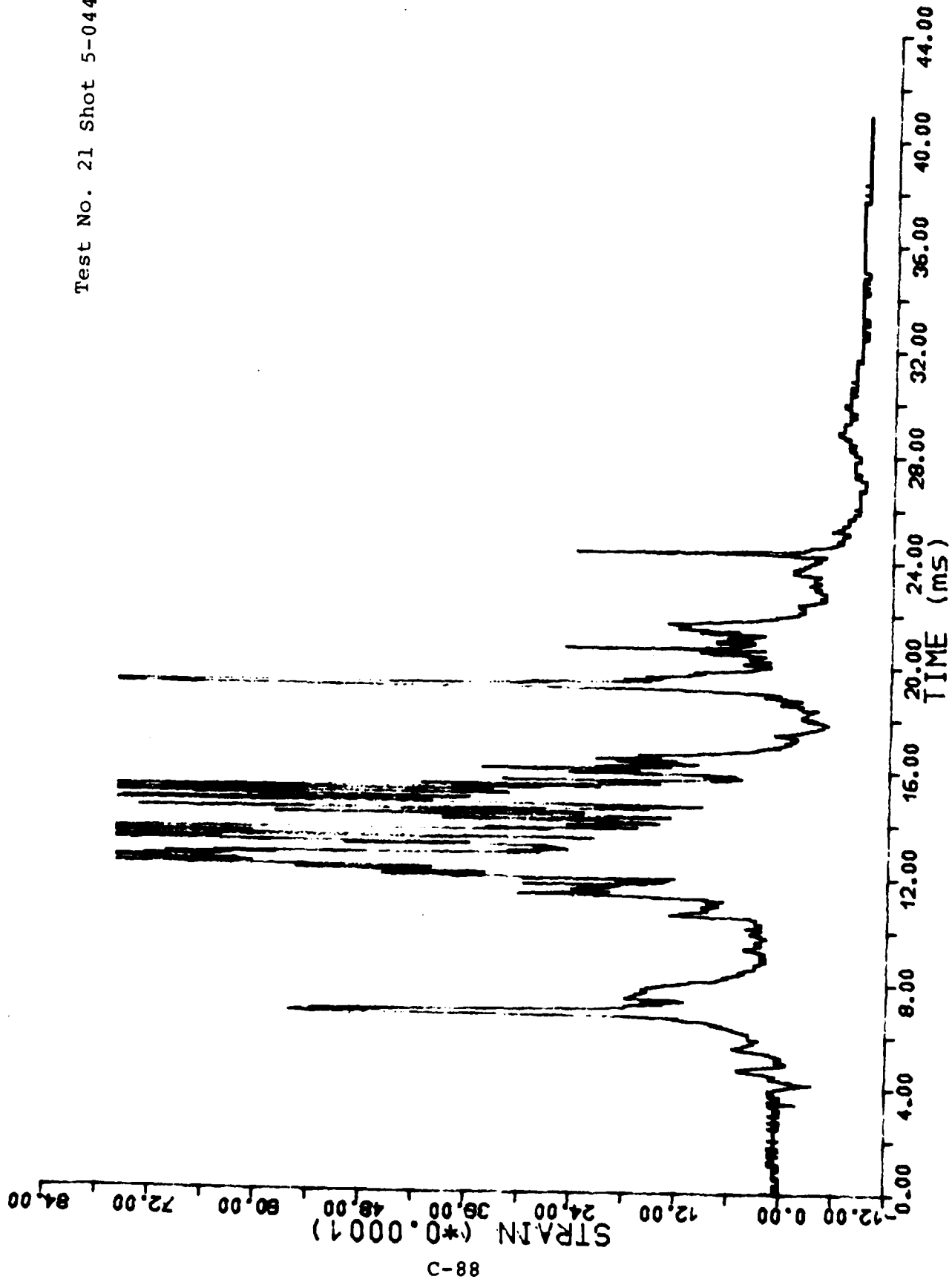

GAUGE II-2

Test No. 21 Shot 5-0447

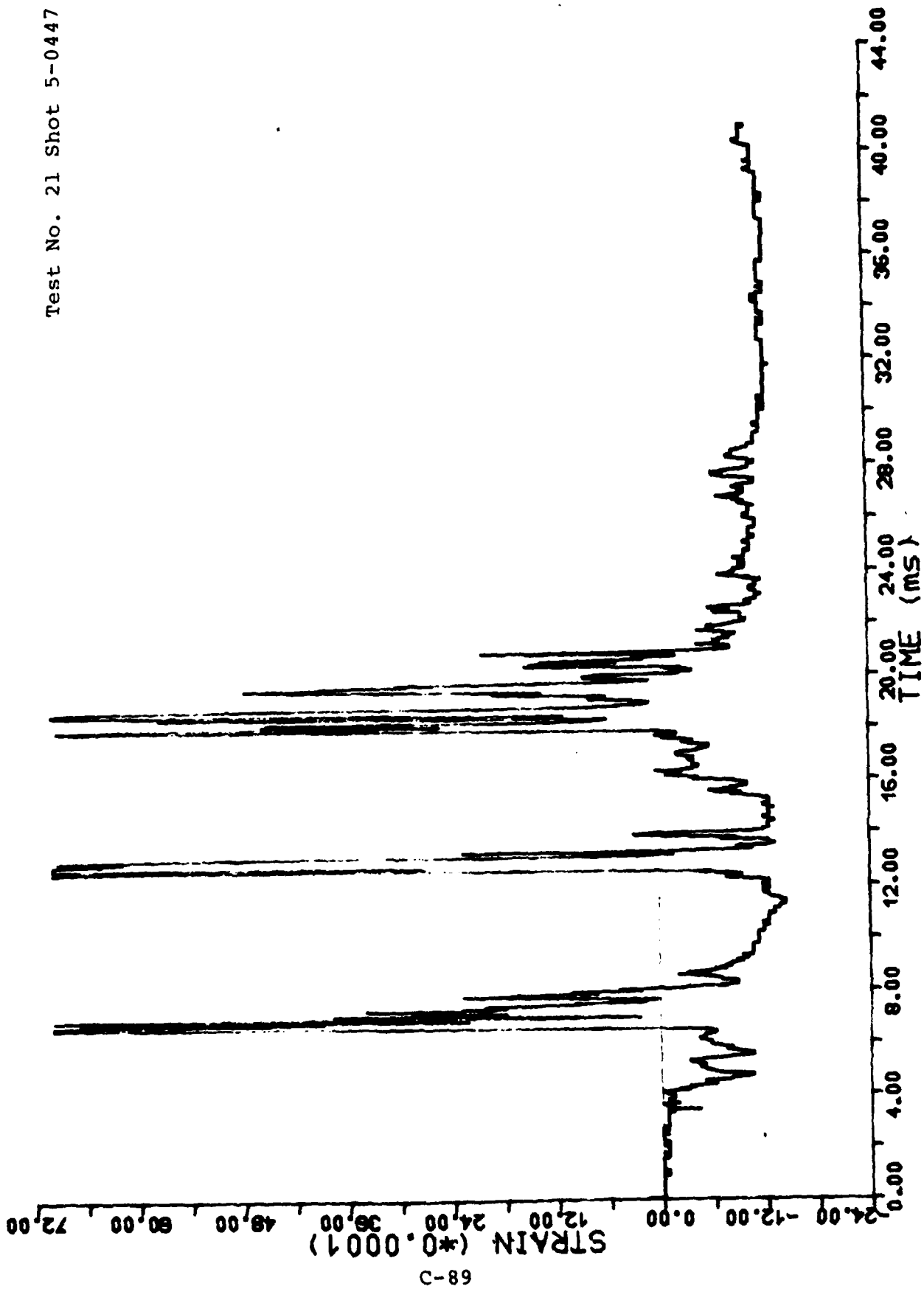

68-C

GAUGE II-3

Test No. 21 Shot 5-0447

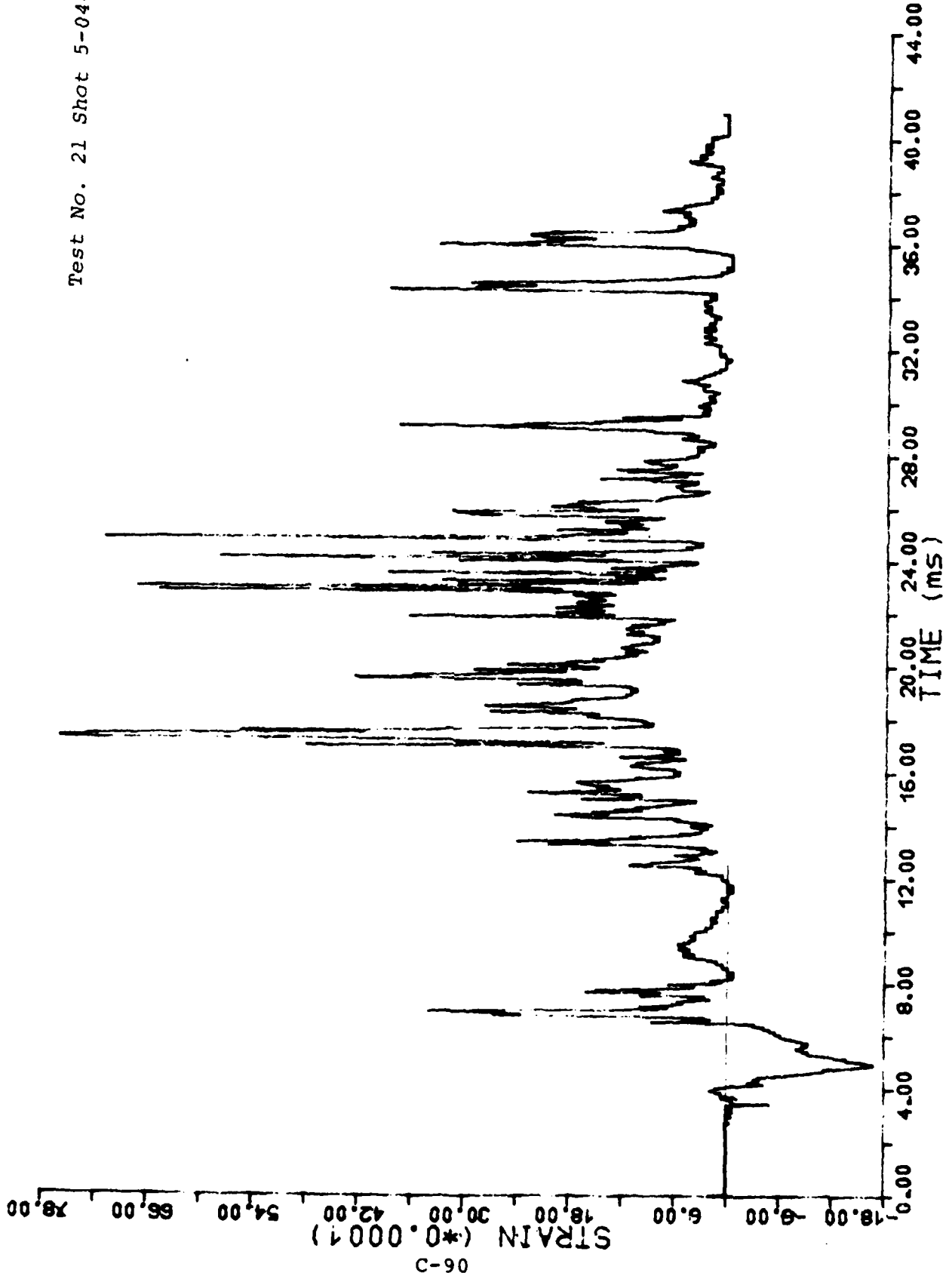

C-90

GAUGE I-1

Test No. 22 Shot 5-0448

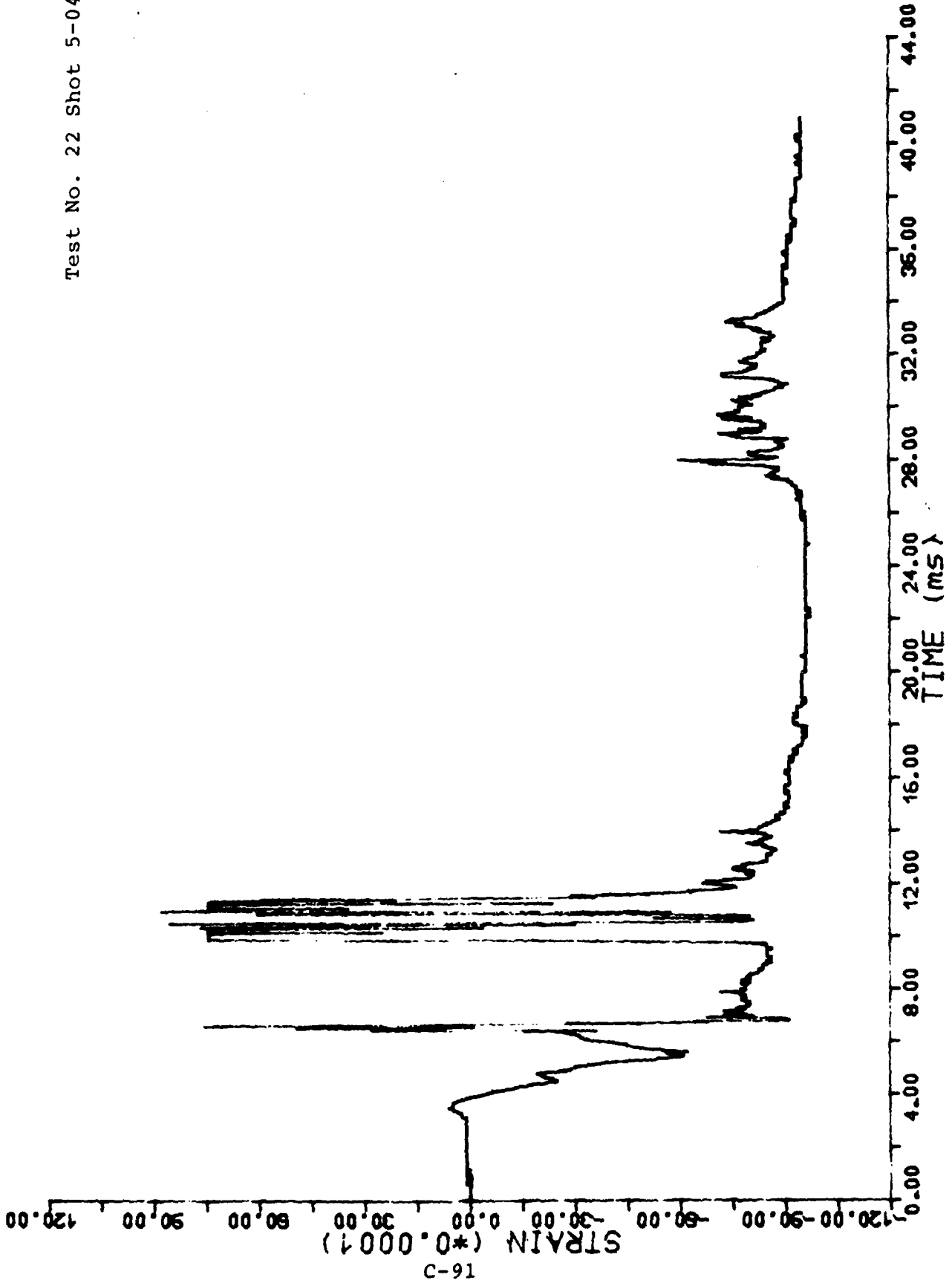

16-C

STRAIN ($\times 0.0001$)

TIME (MS)

GAUGE I-2

Test No. 22 Shot 5-0448

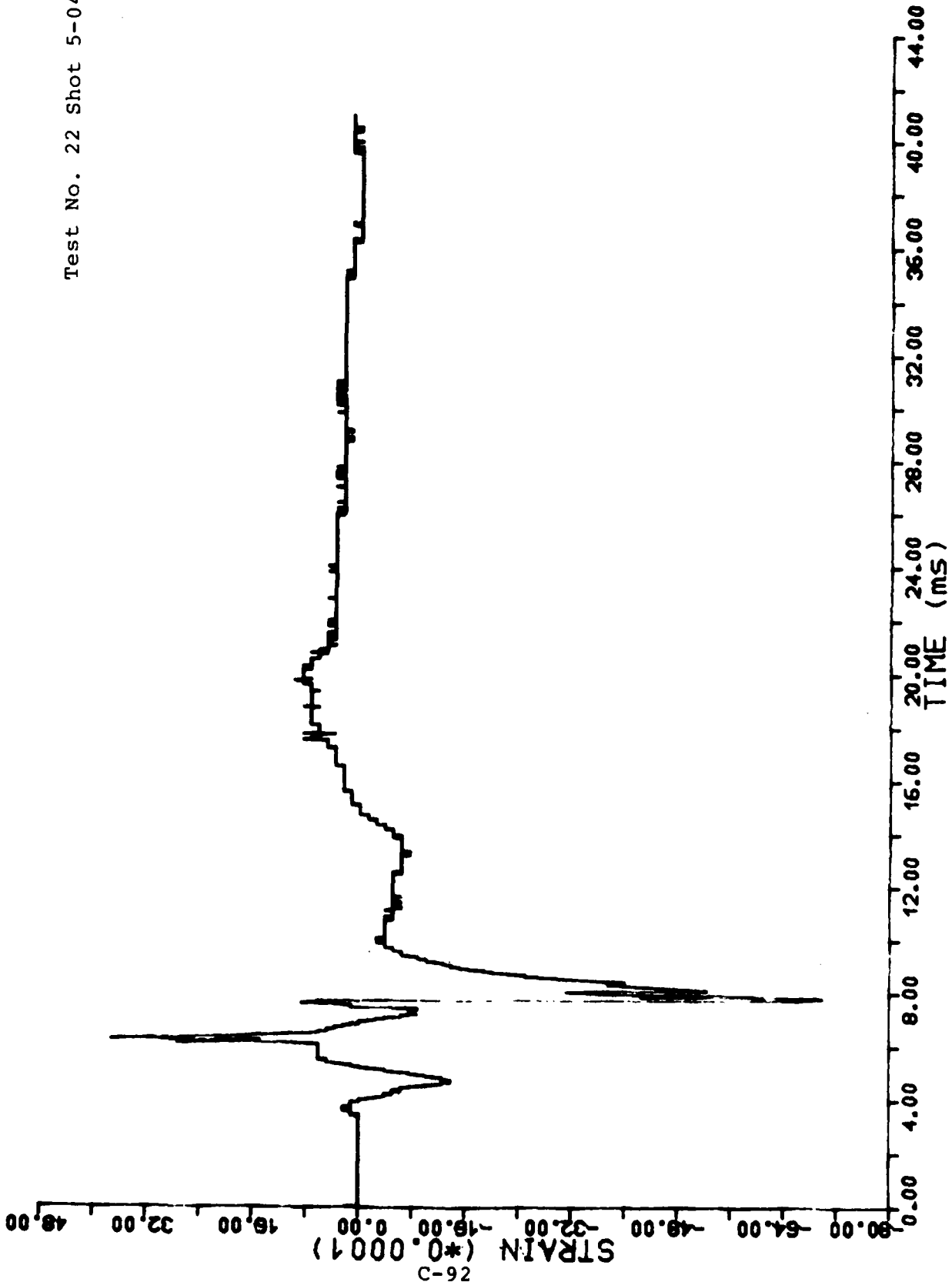

C-92

GAUGE I-3

Test No. 22 Shot 5-0448

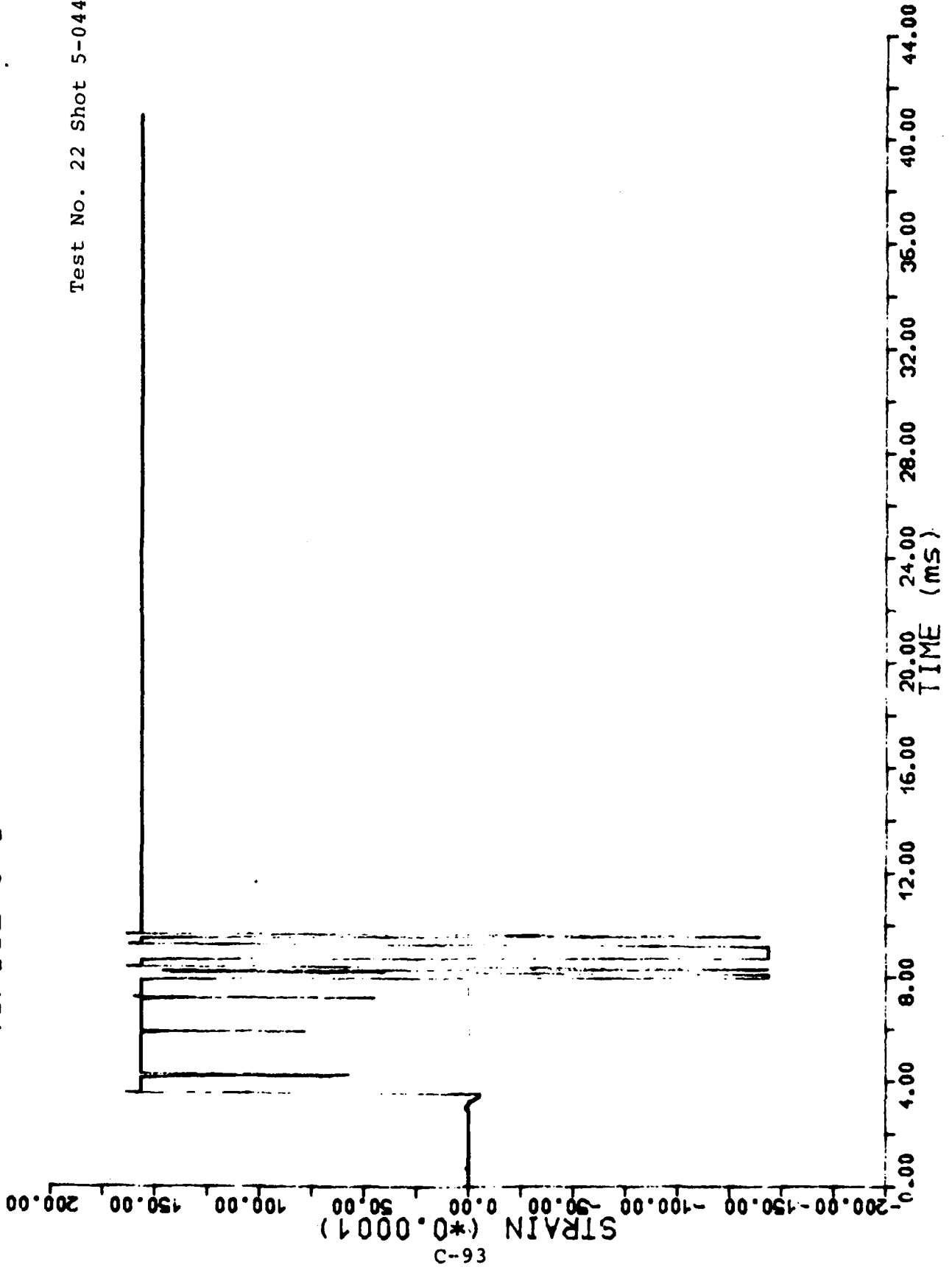

36-C

GAUGE II-1

Test No. 22 Shot 5-0448

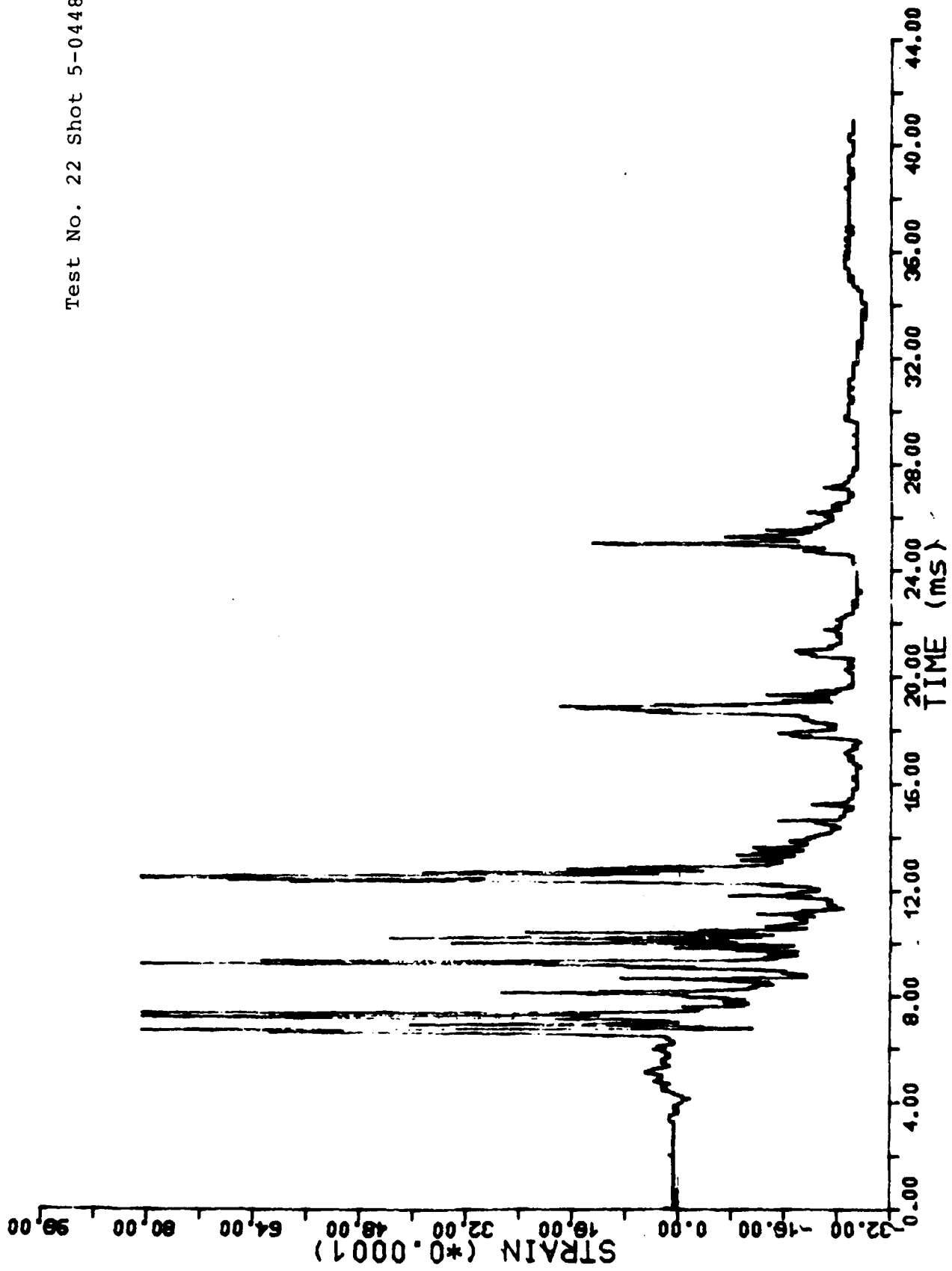

GAUGE II-2

Test No. 22 Shot 5-0448

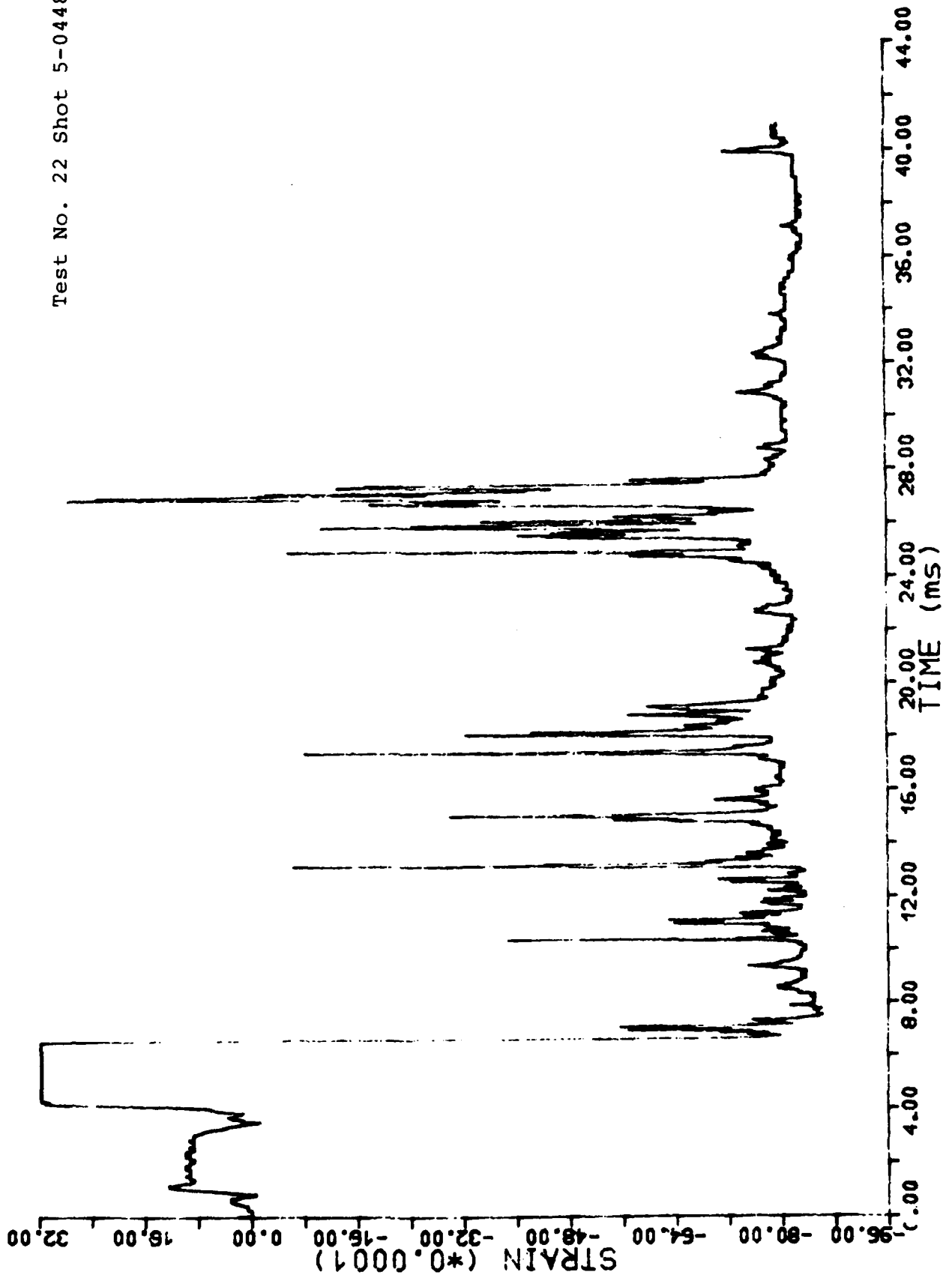

C-95

GAUGE II-S

Test No. 22 Shot 5-0448

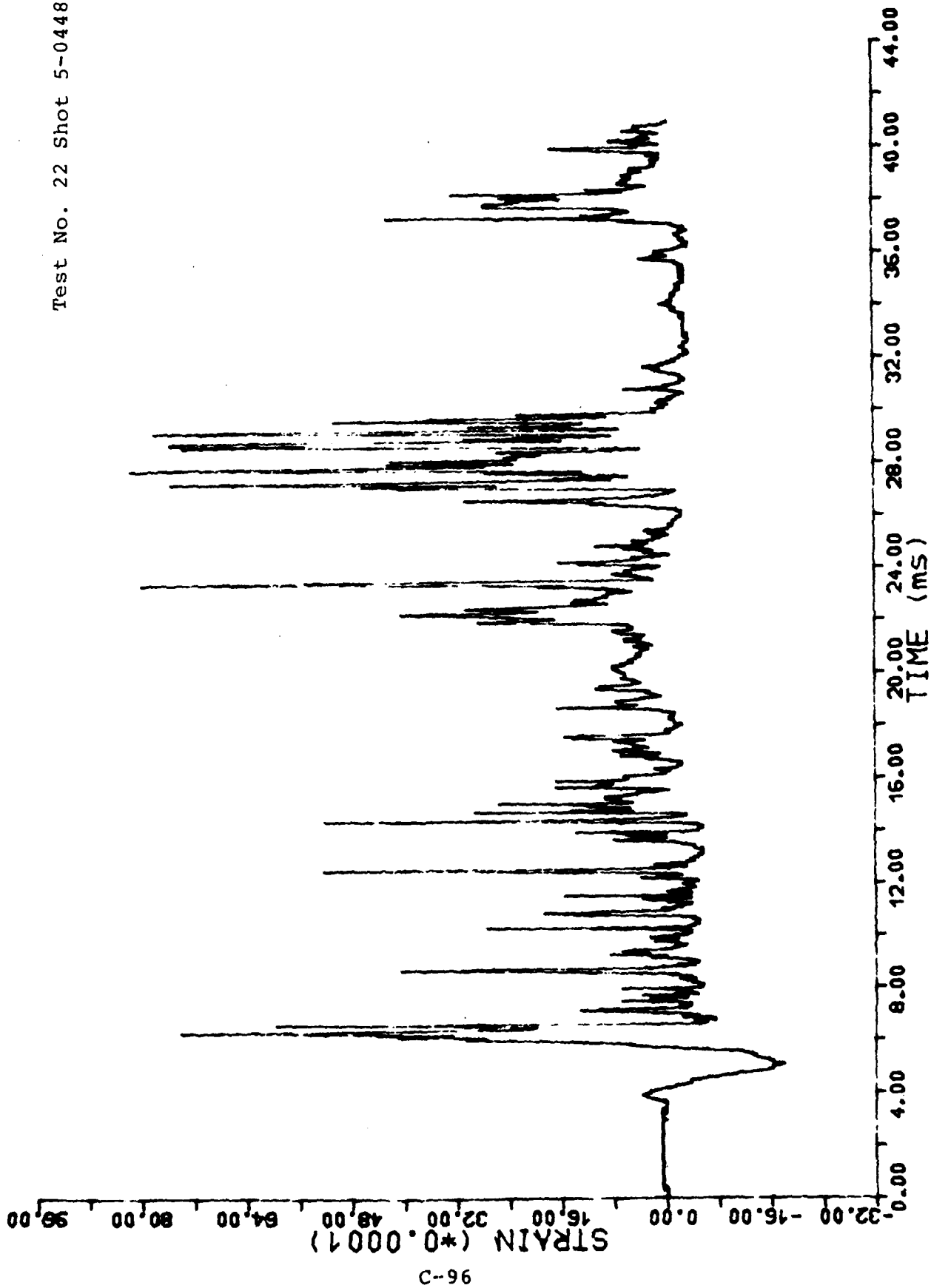

96-C

APPENDIX D

TEST HARDWARE DRAWINGS

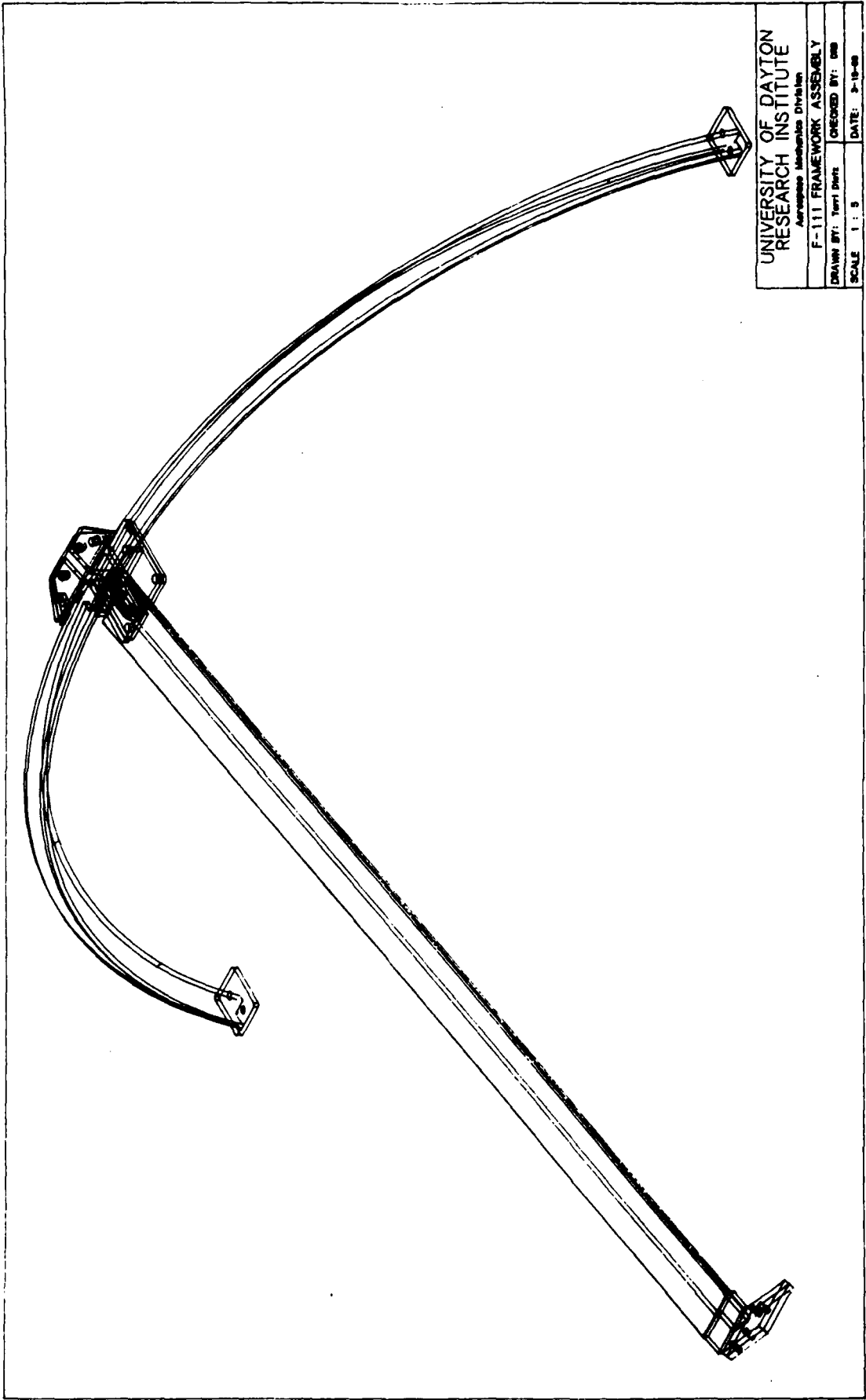

UNIVERSITY OF DAYTON
RESEARCH INSTITUTE
Aerospace Mechanics Division
F-111 FRAMEWORK ASSEMBLY
DRAWN BY: TURT DERTS CHECKED BY: DBB
SCALE: 1 : 5 DATE: 2-10-68

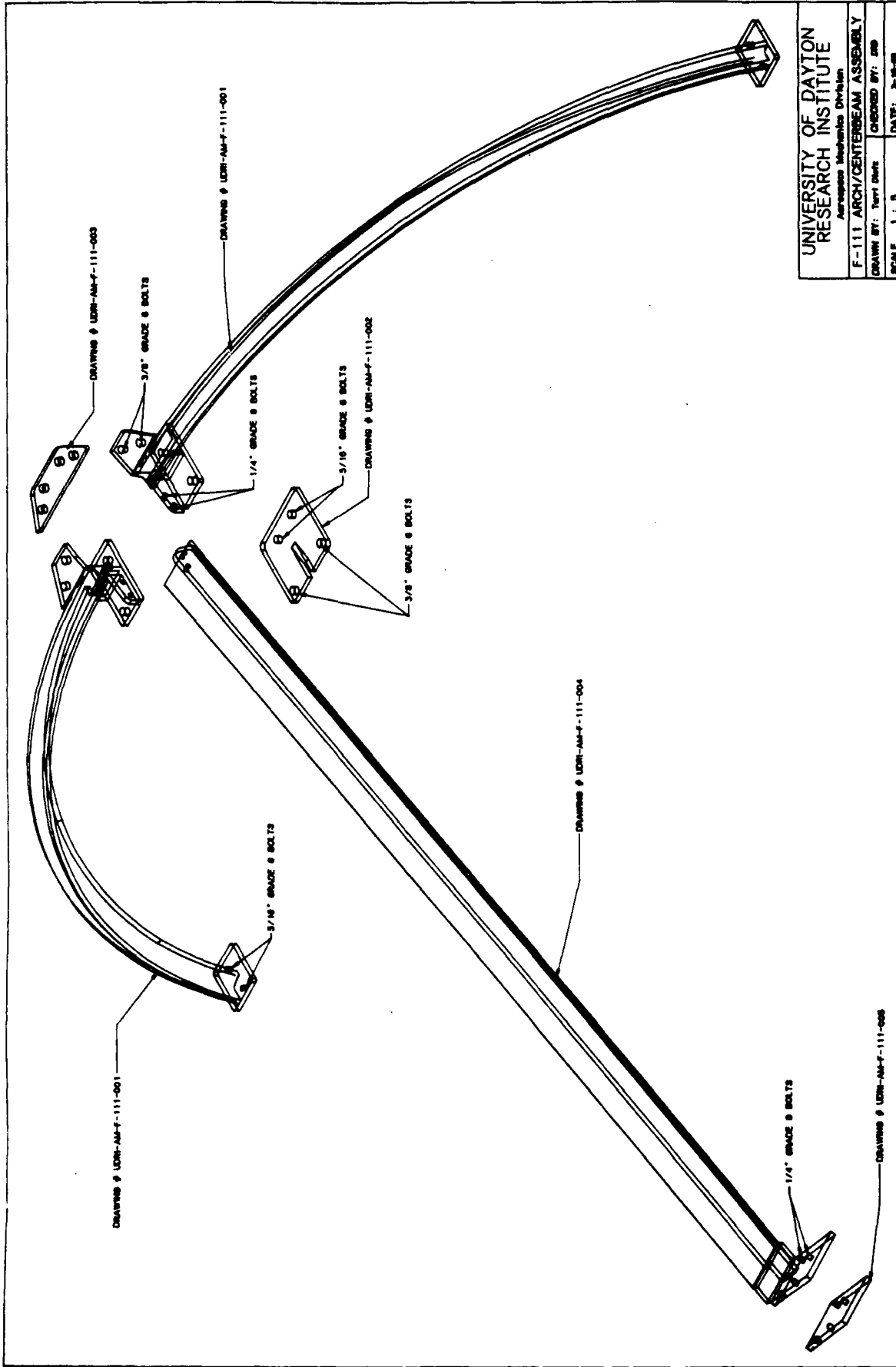

UNIVERSITY OF DAYTON RESEARCH INSTITUTE Aerospace Mechanics Division	
F-111 ARCH/CENTERBEAM ASSEMBLY	
DRAWN BY: Terry Dault	CHECKED BY: JWB
SCALE 1 : 5	DATE: 3-10-68

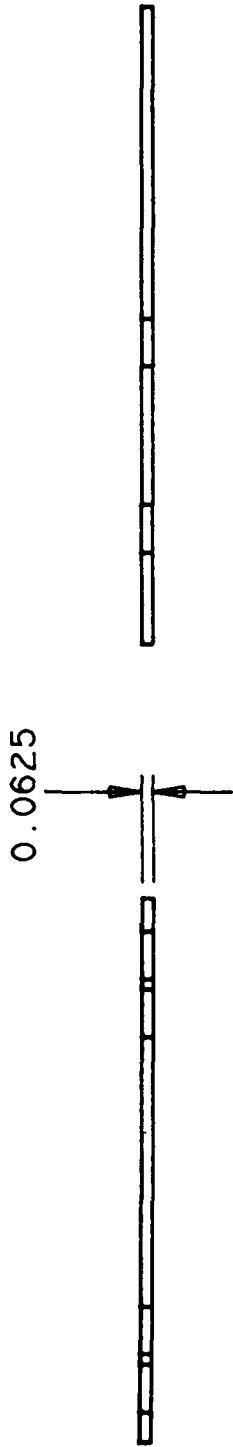

NOTES:

- 1) Material - aluminum
- 2) Match drill holes to forward bulkhead

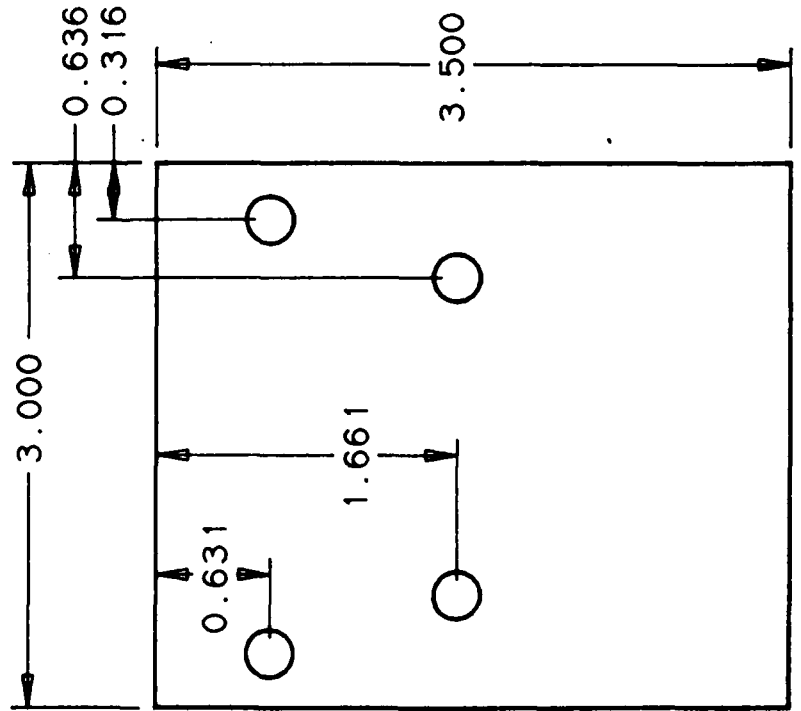

UNIVERSITY OF DAYTON RESEARCH INSTITUTE Aerospace Mechanics Division	
F-111 ALUMINUM SHIM	
DRAWN BY: TERRI DIETZ	CHECKED BY: DRB
SCALE: FULL	DATE: 2-25-88
DRAWING NUMBER: UDRI-AM-F-111-005	

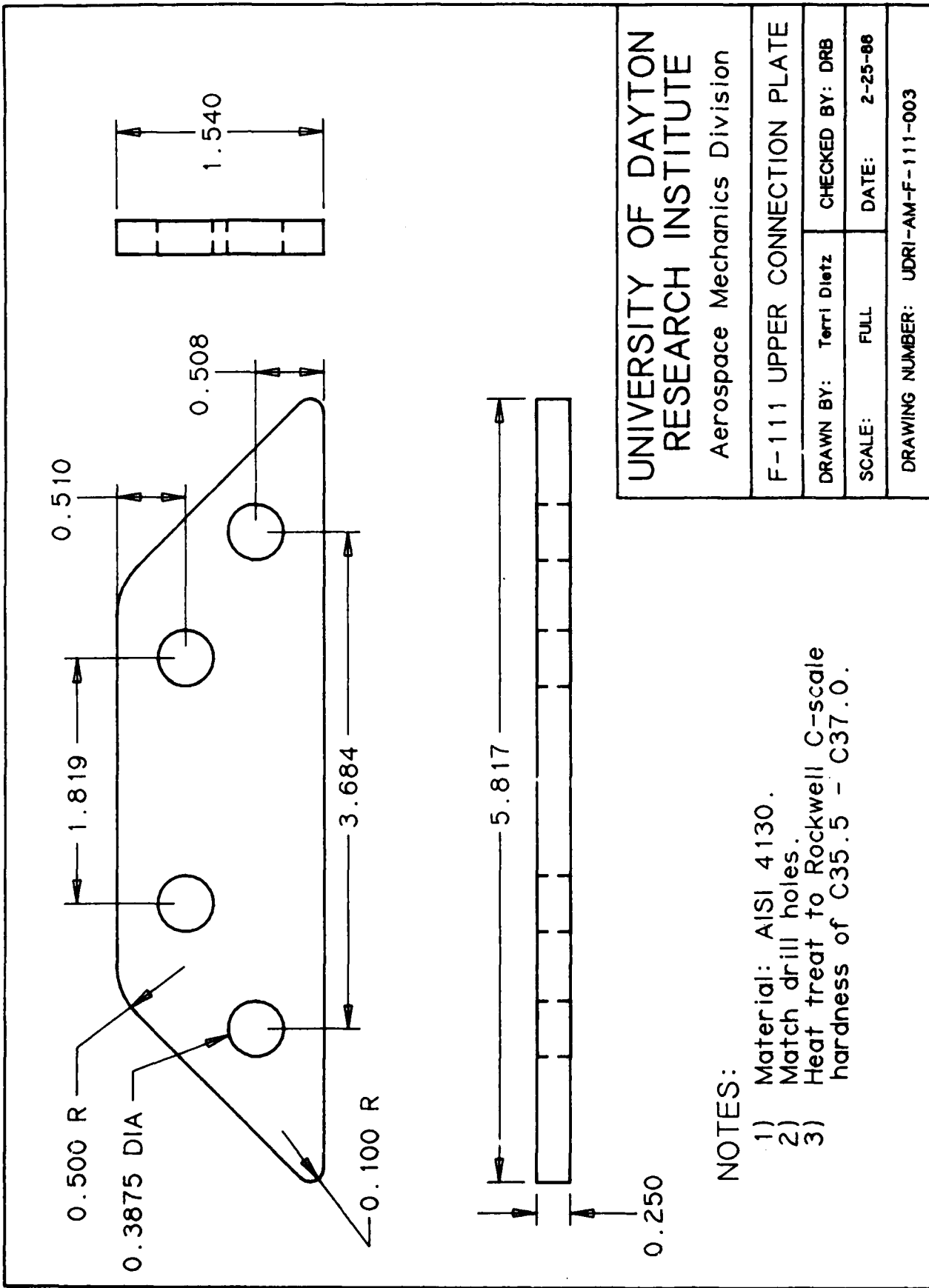

NOTES:

- 1) Material: AISI 4130.
- 2) Match drill holes.
- 3) Heat treat to Rockwell C-scale hardness of C35.5 - C37.0.

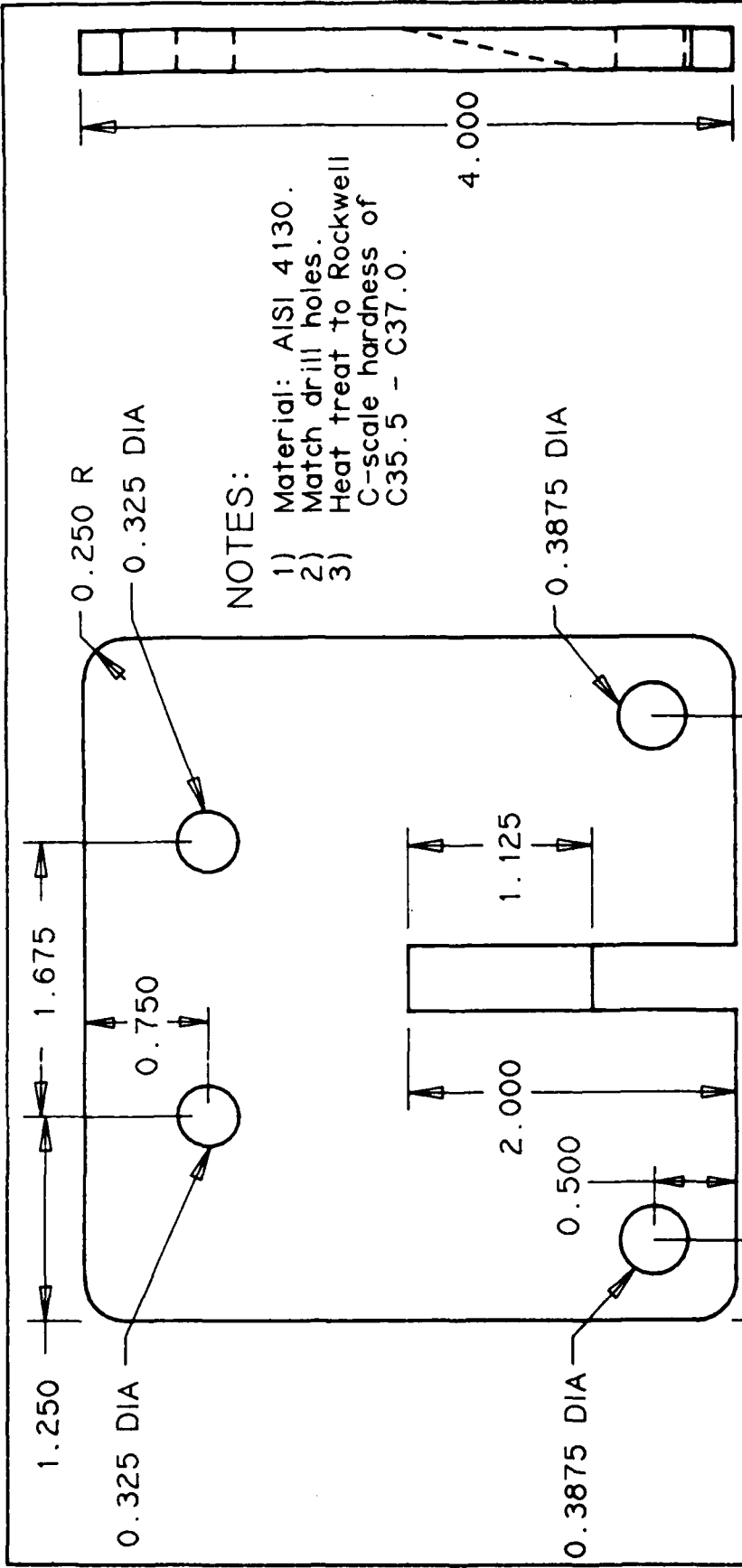

NOTES:

- 1) Material: AISI 4130.
- 2) Match drill holes.
- 3) Heat treat to Rockwell C-scale hardness of C35.5 - C37.0.

**UNIVERSITY OF DAYTON
RESEARCH INSTITUTE**
Aerospace Mechanics Division

F-111 LOWER CONNECTION PLATE	
DRAWN BY: Terrl Dietz	CHECKED BY: DRB
SCALE: FULL	DATE: 2-25-68
DRAWING NUMBER: UDRI-AM-F-111-002	

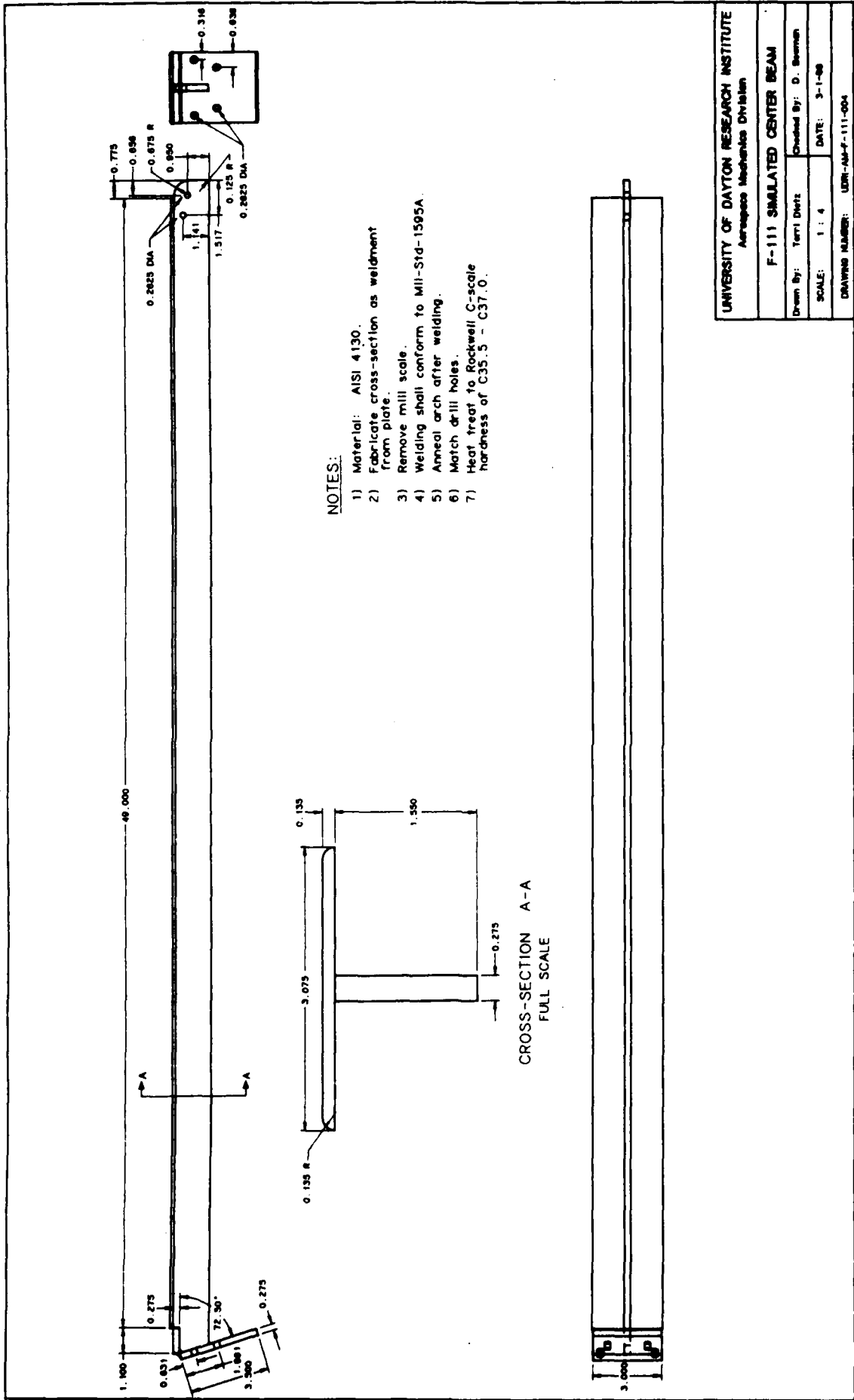

NOTES:

- 1) Material: AISI 4130.
- 2) Fabricate cross-section as weldment from plate.
- 3) Remove mill scale.
- 4) Welding shall conform to Mil-Std-1595A.
- 5) Anneal arch after welding.
- 6) Match drill holes.
- 7) Heat treat to Rockwell C-scale hardness of C35.5 - C37.0.

CROSS-SECTION A-A
FULL SCALE

UNIVERSITY OF DAYTON RESEARCH INSTITUTE Aerospace Mechanics Division	
F-111 SIMULATED CENTER BEAM	
Drawn By: Terry Dietz	Checked By: D. Swinnen
SCALE: 1 : 4	DATE: 3-1-68
DRAWING NUMBER: UDR-AM-P-111-004	

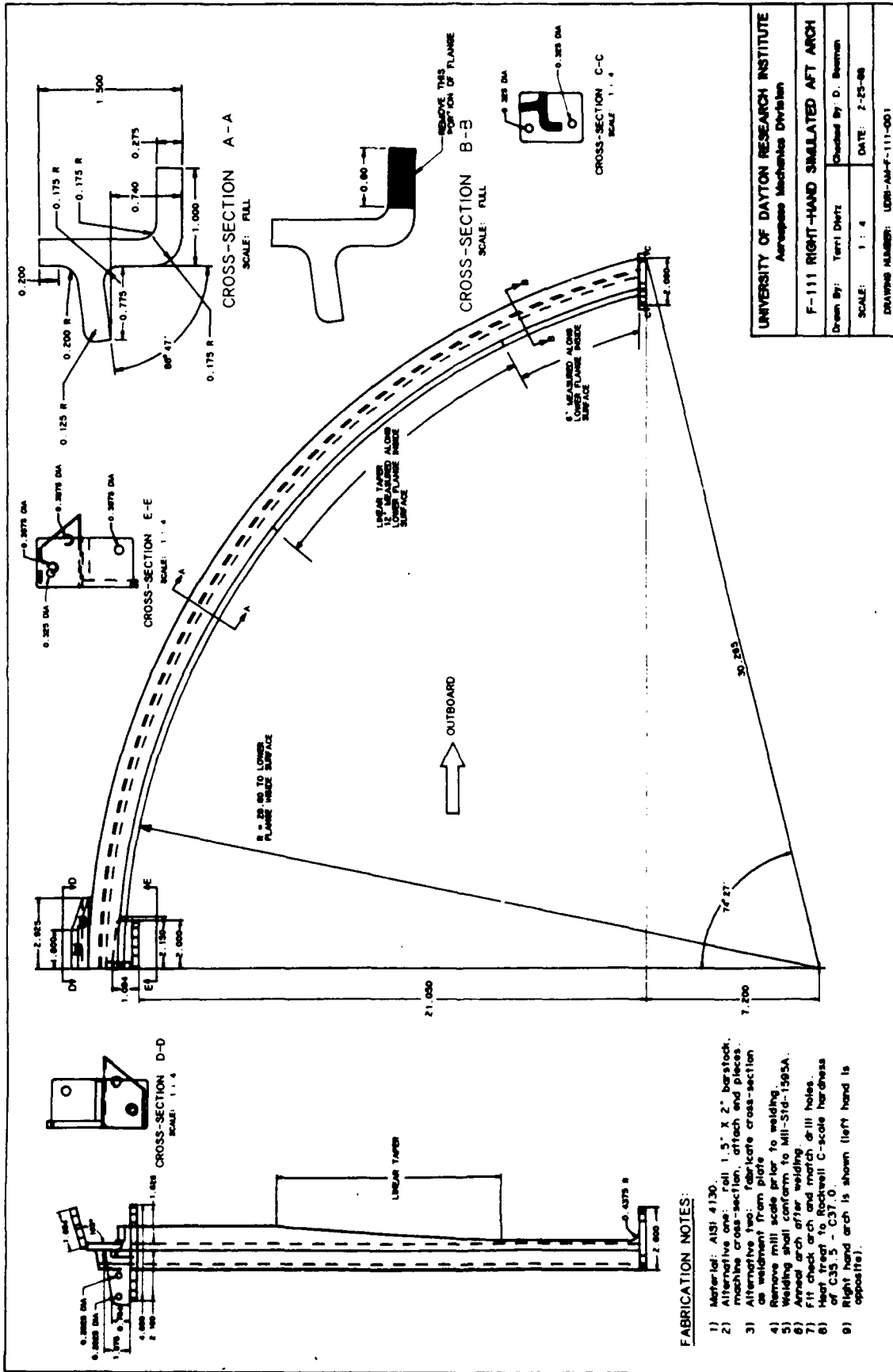

UNIVERSITY OF DAYTON RESEARCH INSTITUTE Aerospace Mechanics Division	
F-111 RIGHT-HAND SIMULATED AFT ARCH	
Drawn By: Terry Dierz	Checked By: D. Beaman
SCALE: 1:1	DATE: 2-23-88
DRAWING NUMBER: LDRB-AM-F-111-001	

FABRICATION NOTES:

- 1) Material: AISI 4130.
- 2) Alternative use: Mill 1.5" x 2" barstock, machine cross-section, attach end pieces.
- 3) Alternative use: fabricate cross-section as weldment from plate.
- 4) Remove mill scale prior to welding.
- 5) Welding shall conform to Mil-Std-1585A.
- 6) Anneal arch after welding.
- 7) Fit check arch and match drill holes.
- 8) Heat treat to Rockwell C-scale hardness of C35.5 - C37.0.
- 9) Right hand arch is shown (left hand is opposite).