

AD-A210 901

MEMORANDUM REPORT BRL-MR-3772

# BRL

EXPENDABLE DEARMER EVALUATION

LAWRENCE J. VANDE KIEFT  
ALFRED L. BINES

JULY 1989

APPROVED FOR PUBLIC RELEASE; DISTRIBUTION UNLIMITED.

U.S. ARMY LABORATORY COMMAND

BALLISTIC RESEARCH LABORATORY  
ABERDEEN PROVING GROUND, MARYLAND

DESTRUCTION NOTICE

Destroy this report when it is no longer needed. DO NOT return it to the originator.

Additional copies of this report may be obtained from the National Technical Information Service, U.S. Department of Commerce, Springfield, VA 22161.

The findings of this report are not to be construed as an official Department of the Army position, unless so designated by other authorized documents.

The use of trade names or manufacturers' names in this report does not constitute indorsement of any commercial product.

SECURITY CLASSIFICATION OF THIS PAGE

## REPORT DOCUMENTATION PAGE

Form Approved  
OMB No. 0704-0188

1a. REPORT SECURITY CLASSIFICATION UNCLASSIFIED		1b. RESTRICTIVE MARKINGS	
2a. SECURITY CLASSIFICATION AUTHORITY		3. DISTRIBUTION / AVAILABILITY OF REPORT APPROVED FOR PUBLIC RELEASE: DISTRIBUTION UNLIMITED.	
2b. DECLASSIFICATION / DOWNGRADING SCHEDULE			
4. PERFORMING ORGANIZATION REPORT NUMBER(S) BRL-MR-3772		5. MONITORING ORGANIZATION REPORT NUMBER(S)	
6a. NAME OF PERFORMING ORGANIZATION Ballistic Research Laboratory	6b. OFFICE SYMBOL (if applicable) SLCBR-TB-EE	7a. NAME OF MONITORING ORGANIZATION	
6c. ADDRESS (City, State, and ZIP Code) Aberdeen Proving Ground, MD 21005-5066		7b. ADDRESS (City, State, and ZIP Code)	
8a. NAME OF FUNDING / SPONSORING ORGANIZATION Ballistic Research Laboratory	8b. OFFICE SYMBOL (if applicable)	9. PROCUREMENT INSTRUMENT IDENTIFICATION NUMBER	
8c. ADDRESS (City, State, and ZIP Code) Aberdeen Proving Ground, MD 21005-5066		10. SOURCE OF FUNDING NUMBERS	
		PROGRAM ELEMENT NO.	PROJECT NO.
		TASK NO.	WORK UNIT ACCESSION NO.
11. TITLE (Include Security Classification) EXPENDABLE DEARMER EVALUATION			
12. PERSONAL AUTHOR(S) LAWRENCE J. VANDE KIEFT AND ALFRED L. BINES			
13a. TYPE OF REPORT	13b. TIME COVERED FROM 88-10-01 TO 89-03-01	14. DATE OF REPORT (Year, Month, Day)	15. PAGE COUNT
16. SUPPLEMENTARY NOTATION			
17. COSATI CODES		18. SUBJECT TERMS (Continue on reverse if necessary and identify by block number) Dearmers, Expendable Dearmers, MK 2 Dearmers Evaluation	
FIELD	GROUP	SUB-GROUP	
19	01		
19	06		
19. ABSTRACT (Continue on reverse if necessary and identify by block number) The Ordnance, Missile, Munitions Center and School (OMMC&S) at Huntsville, AL, asked the Ballistic Research Laboratory (BRL) to study the problem of developing an expendable dearmers. Included in this study was the evaluation of a device that had been developed by a contractor, the AMETEK Company, in cooperation with the OMMC&S. This device purported to be an expendable dearmers, having all the required characteristics. This report details the experiments that were run to compare the performance of this device with that of the US Army MK 2 Mod O Dearmers. The performance of the AMETEK device was inferior to that of the MK 2 Dearmers, but the AMETEK Device is operationally more flexible in that it can use bullet rounds as well as blank rounds. Only blank rounds were used in this evaluation.			
20. DISTRIBUTION / AVAILABILITY OF ABSTRACT <input checked="" type="checkbox"/> UNCLASSIFIED/UNLIMITED <input type="checkbox"/> SAME AS RPT. <input type="checkbox"/> DTIC USERS		21. ABSTRACT SECURITY CLASSIFICATION UNCLASSIFIED	
22a. NAME OF RESPONSIBLE INDIVIDUAL Lawrence J. Vande Kieft		22b. TELEPHONE (Include Area Code) (301) 278-6212	22c. OFFICE SYMBOL SLCBR-TB-EE

## CONTENTS

	<u>Page</u>
LIST OF FIGURES . . . . .	v
ACKNOWLEDGEMENTS . . . . .	vii
1 INTRODUCTION . . . . .	1
2 EXPERIMENTAL PROCEDURE . . . . .	1
3 RESULTS . . . . .	11
4 CONCLUSIONS . . . . .	14
DISTRIBUTION . . . . .	15

## FIGURES

	<u>Page</u>
1. AMETEK expendable dearmmer . . . . .	2
1a. Photograph of exploded view of AMETEK expendable dearmmer . . . . .	3
2. Experimental setup for evaluating dearmmers . . . . .	4
3a. MK 2 Mod O dearmmer in position for firing . . . . .	5
3b. Close-up photo of MK 2 Mod O dearmmer . . . . .	5
4. Front face and slug from the MK 2 Mod O dearmmer after impact, following ricochet . . . . .	6
5. Cineradiography system for rapid sequence x-ray imaging . . . . .	7
6. Schematic diagram of the firing circuit . . . . .	9
7. Sequences of x-ray images of AMETEK device number 1 test. These are representative sequences, typical of most of the tests that were run . . . . .	10
8. Dearmer slugs showing deformation resulting from impact . . . . .	11

## ACKNOWLEDGEMENTS

The authors are grateful to the following people for their help in the accomplishment of this task: Mr. Steven Herman, OMMC&S, for technical discussions and suggestions; Mr. James Petrousky, Naval Explosive Ordnance Disposal Technology Center, Indian Head, MD, for helpful suggestions; Mr. Ned McCubbin, USATECHDET, NOS Indian Head, MD, for the loan of a MK 2 Mod O Dearmer; MSGT Sampson, Picatinny Arsenal, for providing the .50-Cal Impulse Cartridges for use in the MK 2 and AMETEK Dearmers; Messrs. George Melani and Steven Stegall for assistance in running the experiments; Mr. James Lawrence, an AMETEK consultant, for his assistance in coordinating procurement of the various materials required for these tests and for his participation in and validation of the tests; and especially to MSGT Ronald Deermar, Human Engineering Laboratory, APG, MD, for raising the problem in the first place and providing much helpful insight into its solution.

## 1. INTRODUCTION

MSGT Ronald Deermer, currently attached to the US Army Human Engineering Laboratory (HEL) at the Aberdeen Proving Ground, approached personnel at the Ballistic Research Laboratory (BRL) with the problem of developing an expendable dearmer. Some efforts had been made in this direction, but nothing had been accepted by the military. The BRL proposed several potential solutions to this problem and was funded to pursue one of them, a shaped charge device. Included in this study was the evaluation of a device that had been developed by a contractor, the AMETEK Company, in cooperation with the Ordnance, Missile, Munitions Center and School at Huntsville, AL. This device purported to be an expendable dearmer, having all the required characteristics. It will be referred to in this report as the AMETEK device.

The AMETEK device is illustrated in Figures 1 and 1a. It is essentially a right circular cylinder made from mild steel, bored to accept a cylindrical slug in the front and a .50-caliber cartridge in the rear, having a shoulder separating the two chambers. A plastic insert is used to match the shape of the cartridge to the hole bored to accept it; it fills the void space between the cartridge and the chamber. A steel cap is screwed onto the back end of this device to hold the cartridge in place.

There exist several different methods of de-arming explosive devices, one of which involves the use of shaped charges to punch holes through the items, either causing them to initiate or damaging them to the point where they would no longer pose a threat. The devices discussed in this report operate differently; they rely upon momentum transfer to the fuze of the ordnance being de-armed in such a way that the fuze is torn off or rendered inoperable without causing initiation. For this reason, larger slugs traveling at high speeds are used. The speeds must be high enough to disable the fuzes, but not high enough to cause initiation.

## 2. EXPERIMENTAL PROCEDURE

The basis for evaluation of the AMETEK devices was chosen to be a comparison between the muzzle velocities of their slugs and dent depths, produced in aluminum armor witness blocks, with velocities and dent depths produced by the MK 2 dearmer fired under identical conditions.

A schematic diagram of the experimental setup for evaluating the AMETEK devices is shown in Figure 2; the associated photos are shown in Figures 3a and 3b.

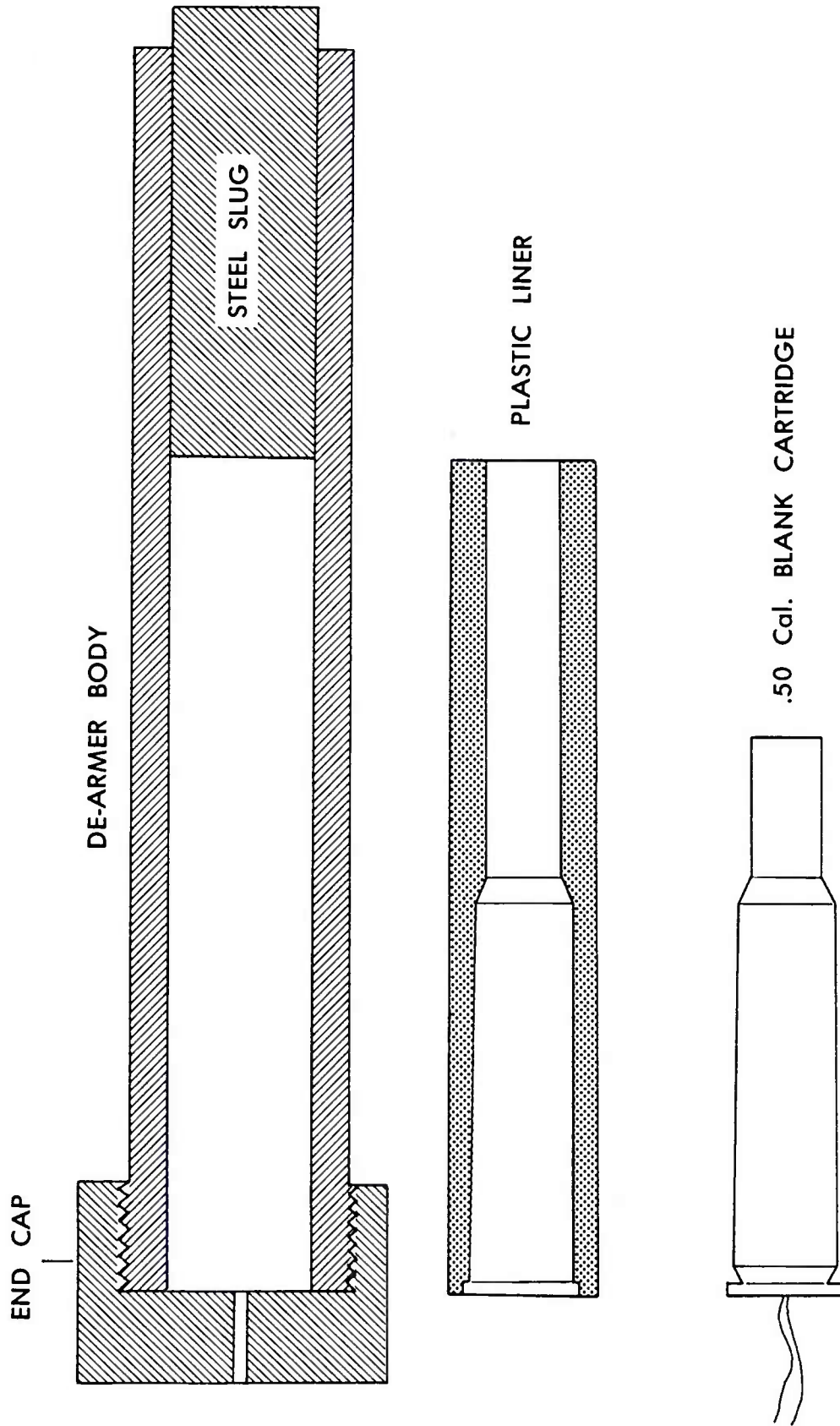

Figure 1. AMETEK expendable dearmor.



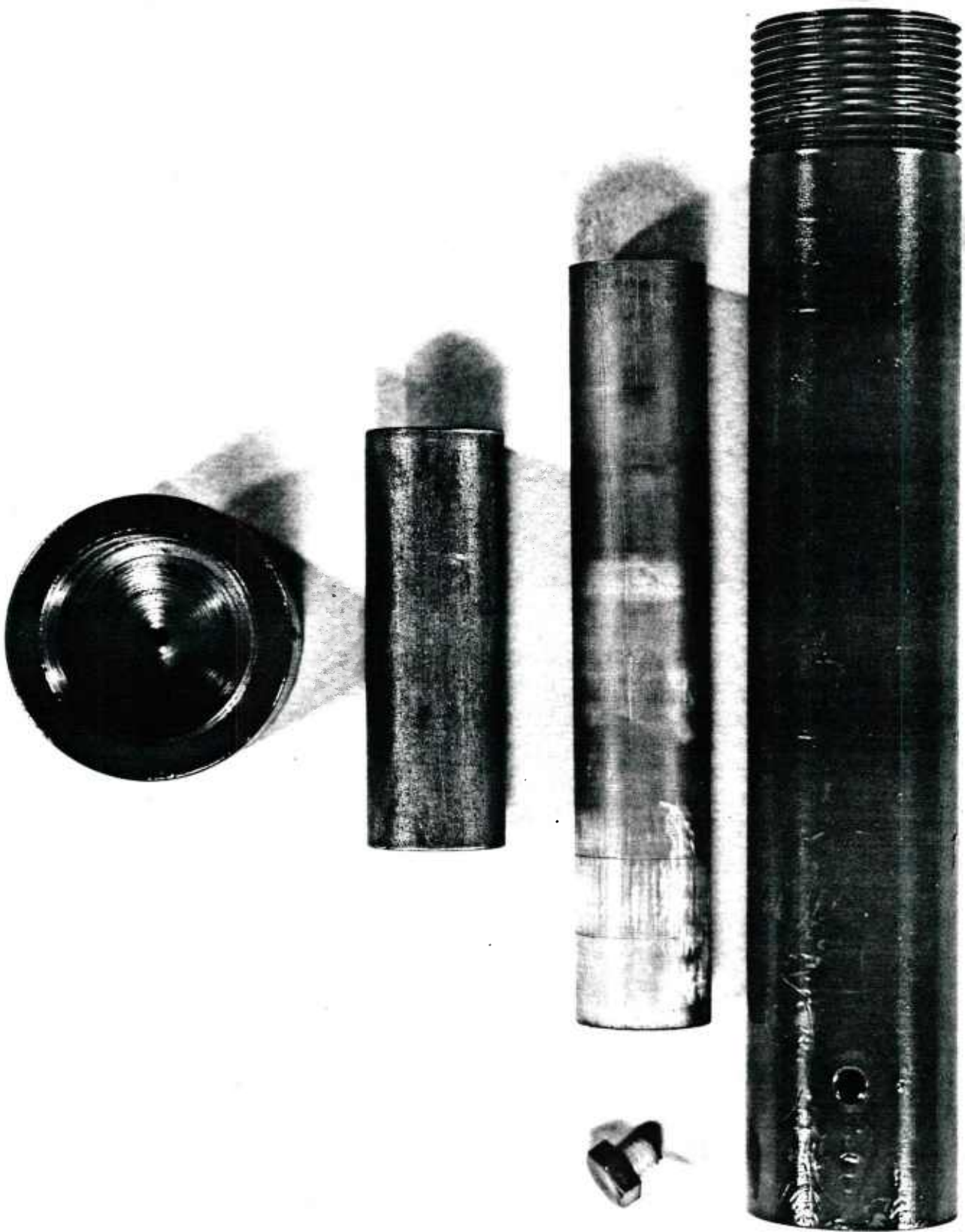

Figure 1a. Photograph of exploded view of AMETEK expendable deamer.

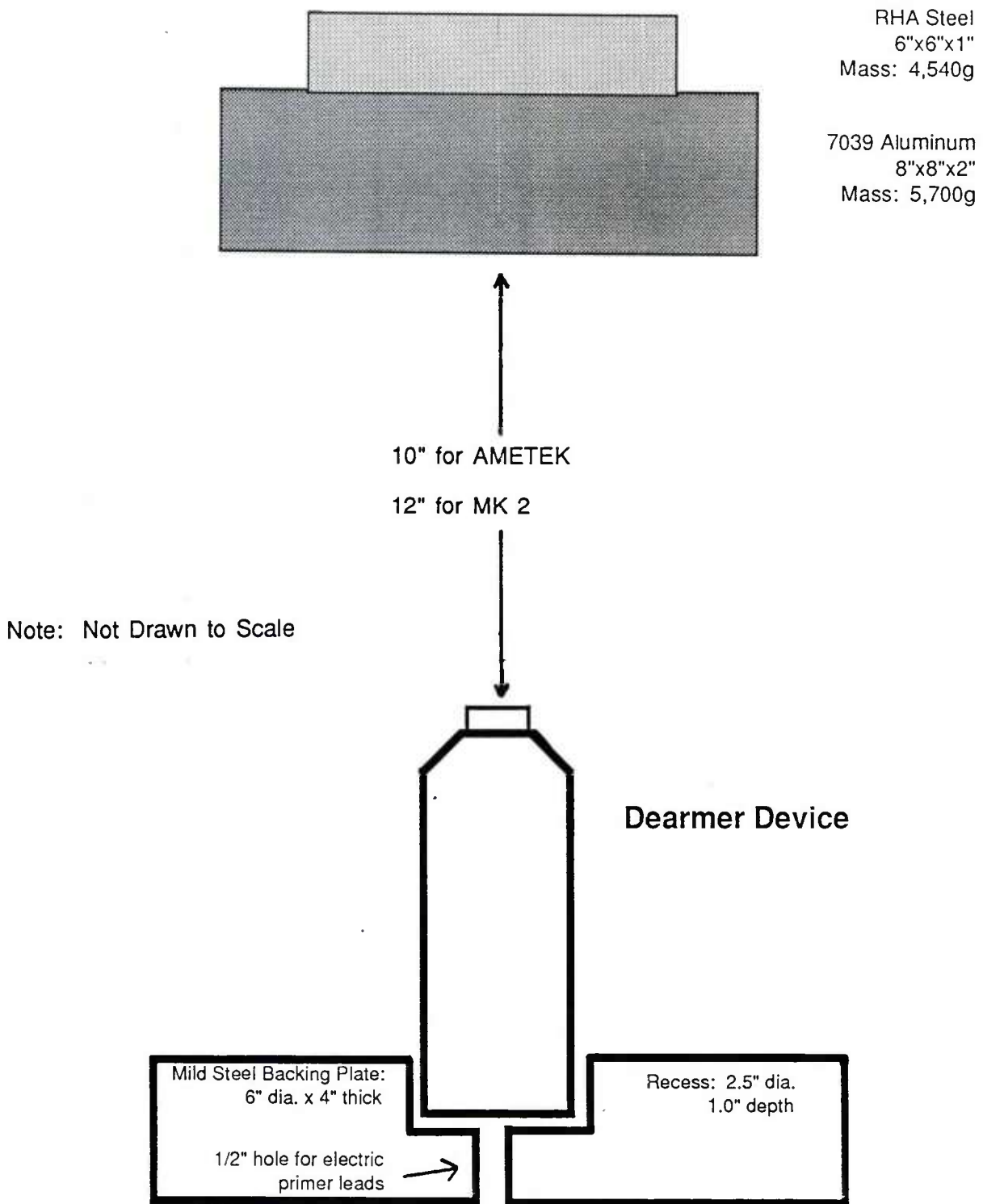

Figure 2. Experimental setup for evaluating dearmers.



Figure 3a. MK 2 Mod O dearmers in position for firing.

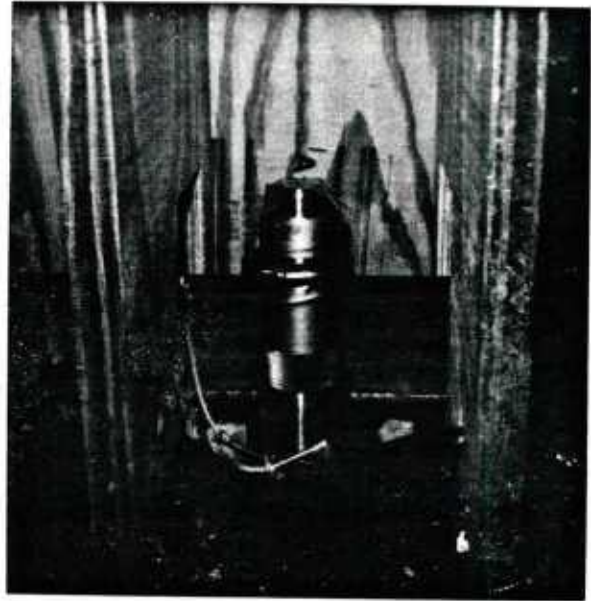

Figure 3b. Close-up photo of MK 2 Mod O dearmers.

Shots were fired vertically, to provide a more rigid recoil backstop and to provide a higher degree of symmetry than would have existed in a horizontal configuration. One complication that resulted from this was the damage that was caused by the steel slug ricocheting from the aluminum witness plate onto the MK 2 dearmers and damaging its front face. It required repair twice during this series of tests. Figure 4 is a photo of the front face of the MK 2 and the top of the slug that impacted it; the impact marks are clearly visible.

A massive steel block was machined to accept the back of the dearmers and was rigidly supported from beneath. In this way, recoil was minimized and was the same for all shots. The dearmers were mounted in this backing block with their symmetry axis vertical and were aimed at the middle of a witness plate configuration. This target configuration consisted of two plates, an aluminum witness plate for dent depth recording and a steel plate to provide additional inertial mass. Dimensions are shown in the figure.

Because of the different dimensions of the AMETEK devices and the MK 2 dearmers, different stand-off distances were required between the rest position of the slug and the bottom of the witness plate. This created no problem because velocity measurements were made before impact to the witness plate, and there would be essentially no velocity change in the last increment



Figure 4. Front face and slug from the MK 2 Mod O Dearmer after impact, following ricochet.

of travel. Also, dent depths from the AMETEK devices were meaningless because they used unhardened steel slugs that mushroomed greatly upon impact. The impact, thus, produced very shallow, wide dents not suitable for comparison with dents made by the MK 2 dearmers slugs. Thus, most of the useful data came from the Cineradiography photos.

Figures 3a and 3b show some of the details of the mounting. Vertical alignment was achieved by clamping the dearmers to a vertical piece of angle iron welded to the base plate. A standard hose clamp, shown in the photos, was used for this purpose. The plywood shown is the protective cover for the image intensifier screen. (The markings on the plywood have no meaning in this experiment.)

Projectile speeds were measured by a Cineradiography system. A schematic diagram of this system is shown in Figure 5.

This system consists of four x-ray tubes grouped together and directed across the target region, through a protective sheet of plywood, onto an image intensifier screen. X-rays striking this screen produce photons in the visible region of the spectrum, which are then focused onto four micro-channel amplifiers, one for each x-ray tube. These amplifiers consist of two phosphor screens separated by a bundle of capillary tubes internally coated with a phosphor. Photons from the image intensifier screen strike the initial phosphor screen which emits electrons; the number depends upon the intensity of the image at that point. These electrons are accelerated down the capillary tubes by

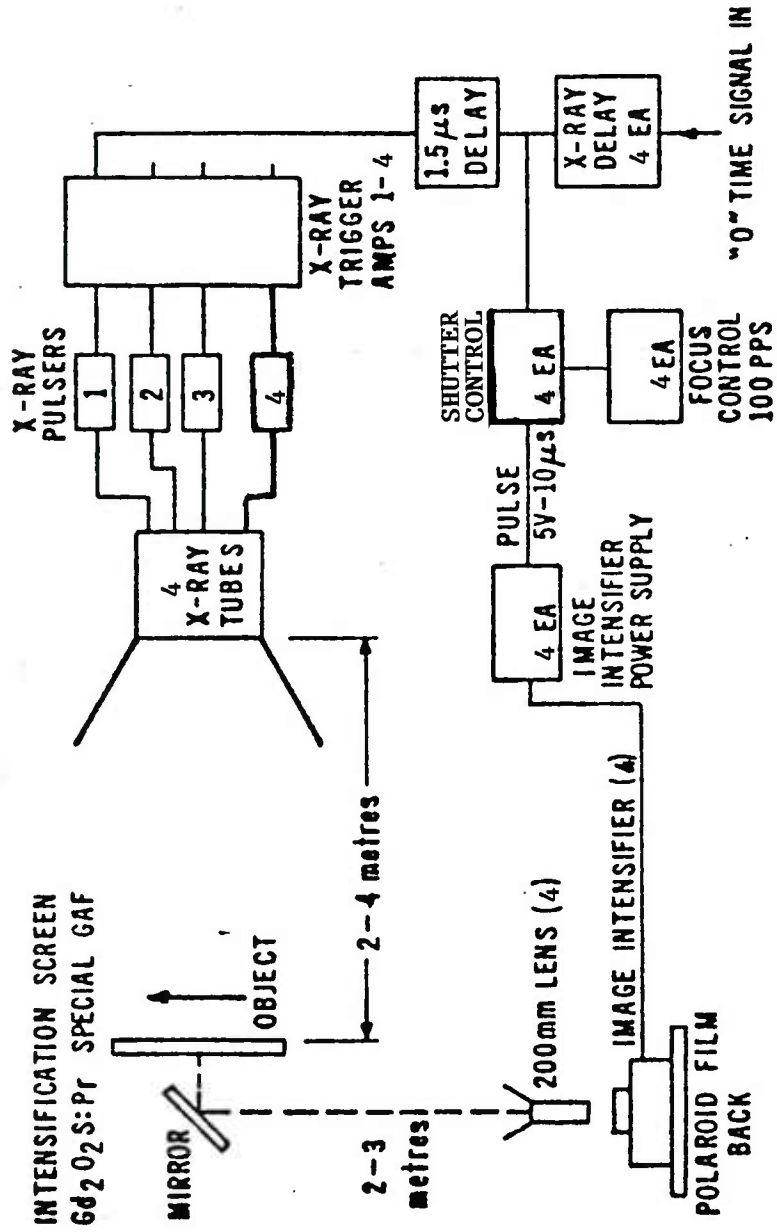

Figure 5. Cineradiography system for rapid sequence x-ray imaging.



a potential difference established between the two phosphor end screens. During their travel they strike the phosphor coating on the capillary walls, causing more electrons to be emitted. These electrons strike the final phosphor end screen and create an amplified optical image. In operation, this screen is pressed directly onto a Polaroid film, thus exposing it to the shadow image of whatever is in the target region at the moment of exposure.

The time resolution of this system is limited only by the relaxation time of the image intensifier screen, which is somewhat less than 10  $\mu$ sec. In these experiments, a fine conductive wire was bound over the slug of the dearmmer and attached to the firing circuit to act as a trigger. Figure 6.

When this trigger wire broke, it initiated the timing sequence for taking the x-rays. In all of the AMETEK dearmmer shots, the following sequence was used: The firing button was pushed; the trigger wire broke; 10  $\mu$ sec later the first x-ray was taken, and the next three x-rays followed at 500- $\mu$ sec intervals. In summary, x-rays were taken at the intervals of 10, 500, 1,000, and 1,500  $\mu$ sec after the trigger wire broke. This sequence yielded a nicely spaced set of images, almost filling the available image space. The first image always showed the slug just after it began to move; the second showed the slug almost out of the barrel or having just emerged; the third, the slug travelling toward the witness plate; and the fourth, moments before impact. Figure 7 shows a typical sequence of these images.

The x-ray sequence was almost identical for the MK 2 dearmmer shots. The only difference was that the last x-ray was taken with a 1,400- $\mu$ sec delay instead of the 1,500- $\mu$ sec delay used for the AMETEK shots. This was necessary because the slugs from the MK 2 dearmmer had a slightly higher speed, and they would have impacted the witness plate at the 1,500- $\mu$ sec delay time, making it impossible to calculate the impact speed. In fact, one shot was spoiled because of this.

The left-hand sequence shows the static photos, one for each camera, from which comparisons are made with the dynamic photos shown on the right. Use of this procedure avoids problems with parallax and is necessary since the cameras are not coaxially emplaced.

The x-rays were read by using a Leitz Optical Comparator. Notice in Figure 7 the horizontal and vertical reference lines in the background of each photo. The vertical lines are 100 mm apart, and the horizontal lines are separated by 127 mm. In this set of experiments, only the horizontal reference lines were used since these orthogonally intersect the direction of projectile flight. Using these, the operator can directly read the position of the projectile for each x-ray, in other words, for

Power Designs

Model 6050A DC Source

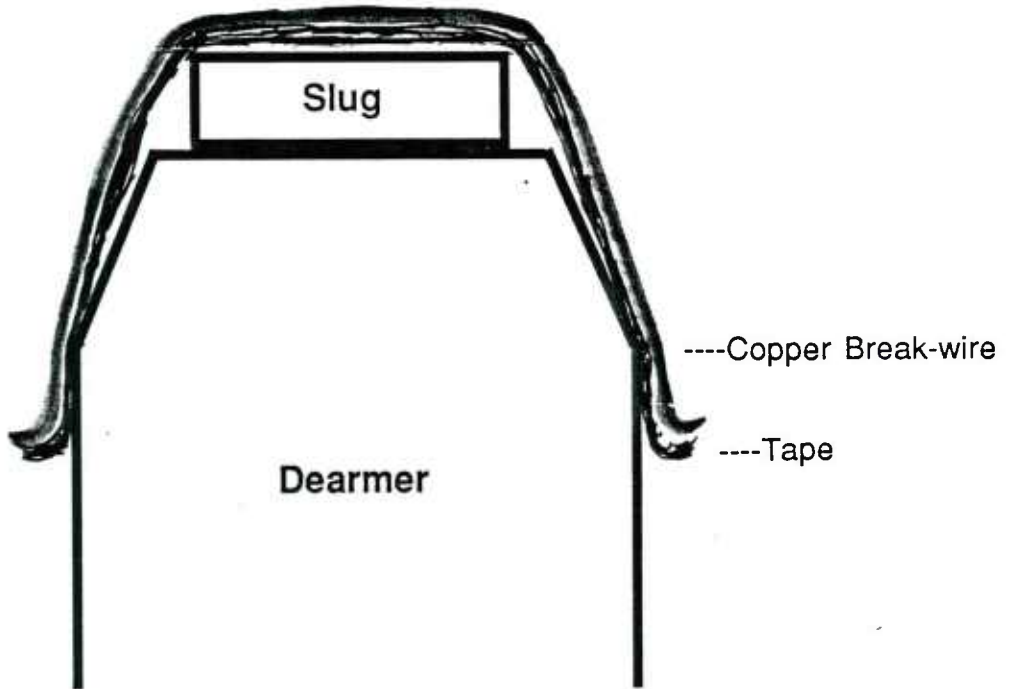
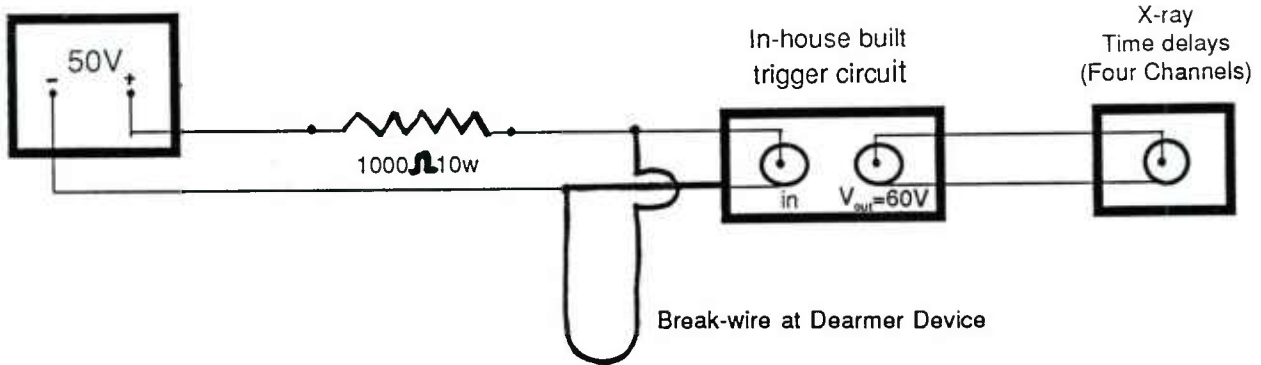

Note: When slug moves, wire breaks which starts time delays on x-ray system. Tape is needed to insulate break-wire from slug as it ejects.

Figure 6. Schematic diagram of the firing circuit.

AMETEK Shot 1

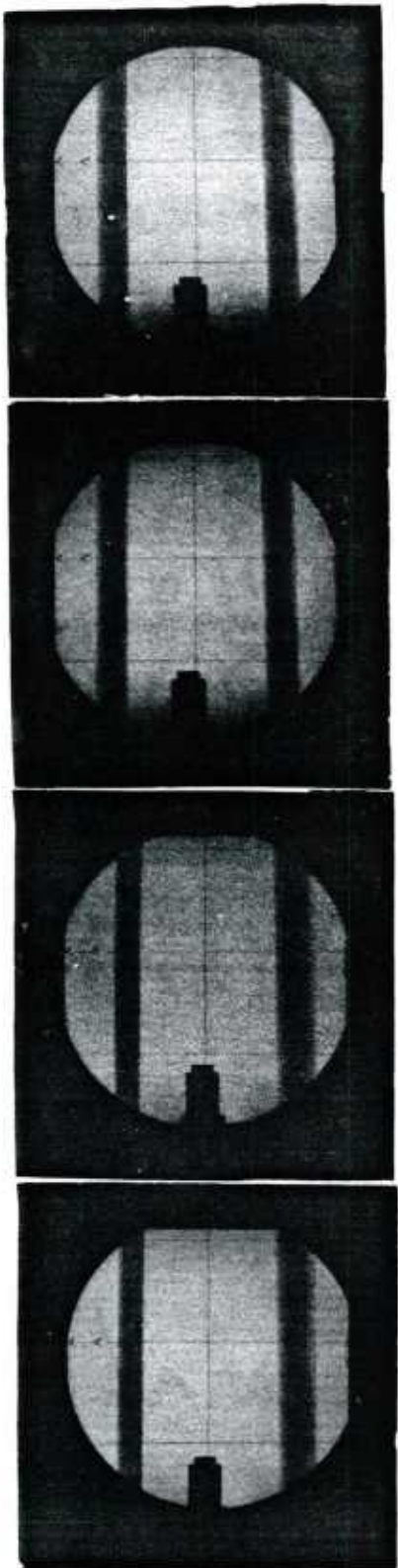

STATIC IMAGES

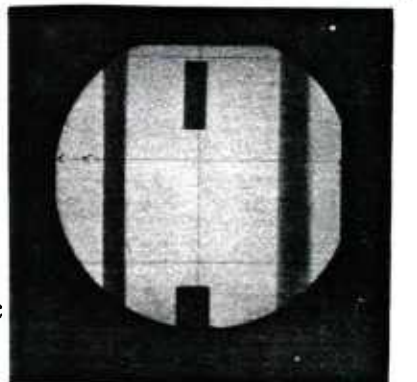
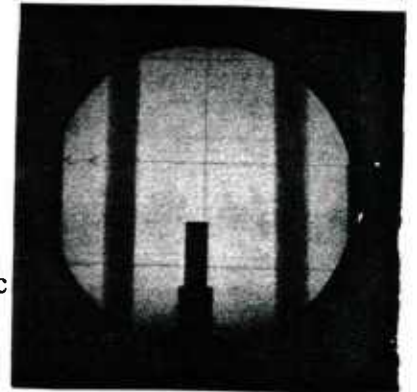

DYNAMIC IMAGES

Figure 7. Sequences of x-ray images of AMETEK device number 1 test. These are representative sequences, typical of most of the tests that were run.



TABLE 1. Projectile Data.

	Slug mass, g	Slug length, in		Slug diameter, in		
		before	after	before	after	
AMETEK						
device no.						
1	301.3	2.998	2.759	1.000	1.215	
2	301.5	2.900	2.700	1.000	1.270	
3	300.9	2.999	2.707	0.999	1.237	
4	301.4	3.000	2.718	1.000	1.243	
5	301.0	3.001	2.728	0.999	1.225	
MK 2 dearmers						
1	299.2	2.992		1.000	1.003*	
2	299.8	2.979		1.000	--	

\* After three shots

NOTE: The mass of the steel inertial backing plate was 4,540 g. The aluminum witness plates were made from 7039 aluminum, having the approximate dimensions 8-in square by 2-in thick.

The cartridges that were used in all of these tests were identified as follows:

U.S. Navy NAVSEA

Cartridge, 50-Cal. Blank

(Electrically initiated)

1377-00-896-3694-M174

Lot No. CRA79D002-002

Five shots were fired with the AMETEK devices in the configuration in which they were received. They were apparently designed to be used with either blank or bulletted cartridges. Since these tests were performed with blank cartridges, there was a void space where the bullet would normally be found. Each AMETEK device was supplied with a plastic insert to fill the space between the cartridge case and the inside of the dearmers cylinder. In approximately half of the shots, these plastic liners bonded tightly to the inside of the dearmers. In the remaining shots, they could be removed and the dearmers immediately reused. In all cases after firing, the dearmers were able to accept a new slug, so if a new cartridge could be inserted, they could be reused.

each time. Since four position-time coordinates are known, three independent speeds can be calculated. The speed of the slug at which it exits the dearmmer is likely the most operationally important speed because the slug length is the usual stand-off distance for this device; however, the speed of impact is a better measure of performance.

### 3. RESULTS

As mentioned before, the criteria for performance were chosen to be projectile speed and depth of dent in an aluminum armor witness block. The only usable dents were those made by the hardened steel projectiles, those that came with the MK 2 dearmmer, although they were also fired from the AMETEK devices. The other slugs, those provided with the AMETEK devices, mushroomed upon impact to the point that no useful dent resulted. Figure 8 shows a photo of the five AMETEK slugs after they had been fired and of the two hardened steel slugs, one before and the other after having been fired.

Table 1 lists the parameters pertinent to the projectiles that were fired. As can be seen, the slug masses are very consistent within and between the two groups. This is also true of their lengths and diameters. There is a greater variation in the mass of the witness plates (Table 2), but even that is a very small percentage and turns out to be irrelevant since dent depths formed no basis for comparison of performance.

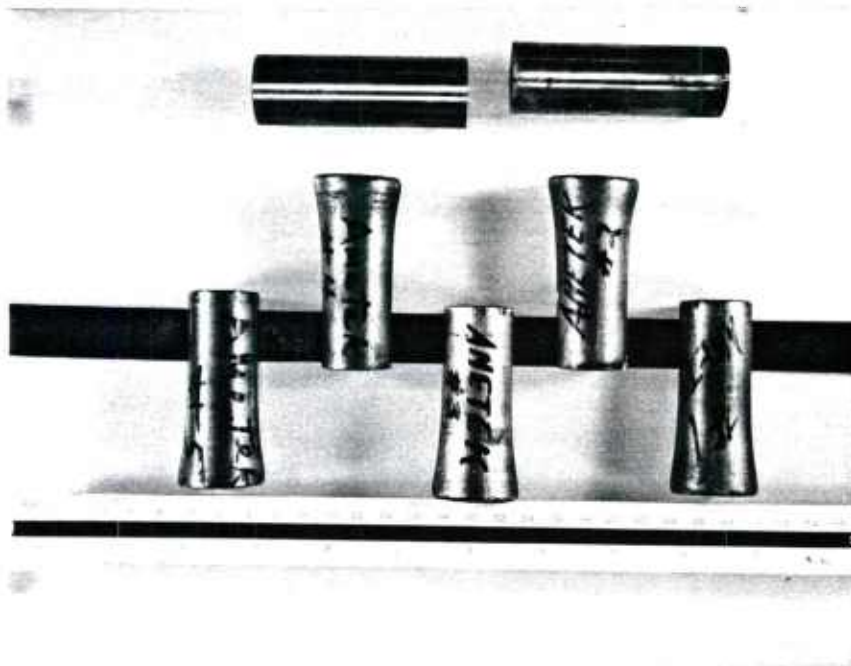

Figure 8. Dearmmer slugs showing deformation resulting from impact.

Two additional AMETEK shots were fired, one with all conditions the same as before except that a hardened slug was used, and the other with hardened slug and a cylindrical polyethylene plug used to fill the void space normally occupied by the bullet.

Three data shots were fired with the MK 2 dearmmer. Data from these shots and those described above are in Table 2.

TABLE 2. Data from Dearmer Evaluation Tests.

Shot ID	Final velocity, ft/sec	Dent depth/Vol, in/ml	Witness plate mass, g	Comments
AMETEK				
1	603.17		5,738	
2	590.3		5,733	
3	629.85		5,633	
4	604.07		5,637	
5	601.09		5,717	
9	693.59	0.266/3.4		Reused no. 5 w/no. 2 hard slug and Polyethylene plug
10	612.43	0.217/3.0		W/no. 2 hard slug and air space vice bullet or plug
MK 2				
1	760.3	0.325/3.9		
2	761.5	0.322/4.2		
3	766.7	0.324/4.0		

Note: No dent depth/volume data were obtained in shots 1-5 because mild steel slugs were used. See text for details.

#### 4. CONCLUSIONS

The MK 2 dearmers yielded very uniform and consistent data for all three categories of information, viz., projectile speed, dent depth and dent volume. The AMETEK devices yielded data that were somewhat more scattered and that indicated lower performance in terms of slug speed and kinetic energy: Average projectile speed for the normal shots of the AMETEK devices was 605.69 ft/sec. This compares with 762.83 ft/sec, approximately 25% greater, for the MK 2. The energies corresponding to these speeds, for the projectile masses used, are 5,129.45 J and 8,136.31 J, respectively.

These differences in performance were likely caused by the void volume ahead of the cartridge in the AMETEK devices. When this was partially filled as in shot 9, the final slug speed, as indicated in Table 2, was significantly greater than for those fired without the polyethylene spacer, however, not as great as those achieved by the MK 2s with the same slug masses. This void space does give the AMETEK device greater flexibility in that it can use bulletted rounds as well as blank cartridges. Performance of the AMETEK dearmers was not evaluated with bulletted rounds in this series of experiments.

In operation, these devices will not be as well supported in the rear as they were for these tests. Consequently, because of lower chamber pressure and reduced time for the propellant to operate, there may be further degradation in performance, particularly for the less massive dearmers. This will be true for any dearmers design that relies upon momentum transfer for its effectiveness, and so is not a deficiency specific to the AMETEK design.

DISTRIBUTION LIST

<u>No of Copies</u>	<u>Organization</u>	<u>No of Copies</u>	<u>Organization</u>
12	Administrator Defense Technical Info Center ATTN: DTIC-DDA Cameron Station Alexandria, VA 22304-6145		
1	HQDA (SARD-TR) Washington, DC 20310-0001	1	Commander US Army Tank Automotive Command ATTN: AMSTA-DDL (Technical Library) Warren, MI 48397-5000
1	Commander US Army Materiel Command ATTN: AMCDRA-ST 5001 Eisenhower Avenue Alexandria, VA 22333-0001	1	Director US Army TRADOC Analysis Command ATTN: ATAA-SL White Sands Missile Range, NM 88002-5502
1	Commander US Army Laboratory Command ATTN: AMSLC-DL Adelphi, MD 20783-1145	1	Commandant US Army Infantry School ATTN: ATSH-CD-CSO-OR Fort Benning, GA 31905-5660
2	Commander Armament RD&E Center US Army AMCCOM ATTN: SMCAR-MSI Picatinny Arsenal, NJ 07806-5000	1	AFWL/SUL Kirtland AFB, NM 87117-5800
2	Commander Armament RD&E Center US Army AMCCOM ATTN: SMCAR-TDC Picatinny Arsenal, NJ 07806-5000	1	Air Force Armament Laboratory ATTN: AFATL/DLODL Eglin AFB, FL 32542-5000
1	Director Benet Weapons Laboratory Armament RD&E Center US Army AMCCOM ATTN: SMCAR-LCB-TL Watervliet, NY 12189-4050		<u>Aberdeen Proving Ground</u> Dir, USAMSAA ATTN: AMXSY-D AMXSY-MP, H. Cohen Cdr, USATECOM ATTN: AMSTE-TO-F Cdr, CRDEC, AMCCOM ATTN: SMCCR-RSP-A SMCCR-MU SMCCR-MSI Cdr, USATEU ATTN: SMCTE-OP, LT. Spencer Edgewood Area, Bldg. 5137
1	Commander US Army Armament, Munitions and Chemical Command ATTN: SMCAR-ESP-L Rock Island, IL 61299-5000		
1	Commander US Army Aviation Systems Command ATTN: AMSAV-DACL 4300 Goodfellow Blvd. St. Louis, MO 63120-1798		
1	Director US Army Aviation Research and Technology Activity Ames Research Center Moffett Field, CA 94035-1099		

<u>No of Copies</u>	<u>Organization</u>	<u>No of Copies</u>	<u>Organization</u>
1	HQDA DAMA-ART-M Washington, DC 20310	1	Commander US Army Research Office ATTN: Chemistry Division P.O. Box 12211 Research Triangle Park, NC 27709-2211
1	C.I.A. OIR/DB/Standard GE47 HQ Washington, D.C. 20505	2	Office of Naval Research ATTN: Dr. A. Faulstick, Code 23 800 N. Quincy Street Arlington, VA 22217
1	Chairman DoD Explosives Safety Board ATTN: COL Powell Room 856-C Hoffman Bldg 1 2461 Eisenhower Avenue Alexandria, VA 22331	1	Commander Naval Sea Systems Command ATTN: Dr. R. Bowen SEA 06I Washington, DC 20362
3	Commander Armament RD&E Center US Army AMCCOM ATTN: SMCAR-LCE, Dr. N. Slagg, Mike Joyce, Charles Capuccino Picatinny Arsenal, NJ 07806-5000	1	Commander Naval Explosive Ordnance Disposal Technology Center ATTN: Technical Library, Code 604 Indian Head, MD 20640
1	Commander US Army Armament Munitions and Chemical Command ATTN: AMSMC-IMP-L Rock Island, IL 61299-7300	1	Commander Naval Research Lab ATTN: Code 6100 Washington, DC 20375
1	Commander US AMCCOM ARDEC CCAC Benet Weapons Laboratory ATTN: SMCAR-CCB-TL Watervliet, NY 12189-4050	1	Commander Naval Surface Weapons Center ATTN: Code G13 Dahlgren, VA 22448-5000
1	Commander CECOM R&D Technical Library ATTN: AMSEL-IM-L (Reports Section) Bldg 2700 Fort Monmouth, NJ 07703-5000	1	Commander Naval Surface Weapons Center ATTN: Mr. L. Roslund, R10C Silver Spring, MD 20902-5000
1	Commander MICOM Research, Development and Engineering Center ATTN: AMSMI-RD-CS-R (DOC) Redstone Arsenal, AL 35898	1	Commander Naval Surface Weapons Center ATTN: Code X211, Lib Silver Spring, MD 20902-5000
1	Commander US Army Development & Employment Agency ATTN: MODE-ORO Fort Lewis, WA 98433-5000	1	Commander Naval Surface Weapons Center ATTN: Carl Gotzmer Silver Spring, MD 20902-5000
1	Commandant USAFAS ATTN: ATSF-TSM-CN Fort Sill, OK 73503-5600	1	Commander Naval Weapons Center ATTN: Dr. L. Smith, Code 326 China Lake, CA 93555



<u>No of Copies</u>	<u>Organization</u>	<u>No of Copies</u>	<u>Organization</u>
1	Commander Naval Weapons Center ATTN: Dr. R. Atkins, Code 385 China Lake, CA 93555	1	Director Lawrence Livermore National Laboratories University of California ATTN: Lee Frahm P.O. Box 808 Livermore, CA 94550
1	Commander Naval Weapons Center ATTN: Dr. R. Reed, Jr., Code 388 China Lake, CA 93555	1	Director Los Alamos National Lab ATTN: Mr. J. Ramsey P.O. Box 1663 Los Alamos, NM 87545
1	Commander Naval Weapons Station NEDED ATTN: Dr. Louis Rothstein, Code 50 Yorktown, VA 23691	1	Director Los Alamos National Lab ATTN: Mary Stinecipher P.O. Box 1663 Los Alamos, NM 87545
1	Commander Fleet Marine Force, Atlantic ATTN: G-4 (NSAP) Norfolk, VA 23511	1	Irving B. Akst IDOS Corporation P.O. Box 285 Pampa, TX 79065
1	Commander Air Force Rocket Propulsion Laboratory ATTN: Mr. R. Geisler, Code AFRPL MKPA Edwards AFB, CA 93523	1	Director Sandia National Lab ATTN: Dr. Robert Carling Livermore, CA 94557-0096
1	AFWL/SUL Kirtland AFB, NM 87117	3	Commandant USAOMMCS ATTN: ATSK-CME Mr. Steven J. Herman, Mr. Eugene J. Squires, SGT Michael Caswell Redstone Arsenal, AL 35897-6500
1	Air Force Armament Laboratory ATTN: AFATL/Gary Parsons Eglin AFB, FL 32542-5000	1	Commander Naval Surface Weapons Center ATTN: Dr. Kurt Mueller, Code R-10 Silver Spring, MD 20902-5000
1	Air Force Armament Laboratory ATTN: AFATL/Thomas Floyd Eglin AFB, FL 32542-5000	1	Air Force Armament Laboratory ATTN: Dr. Michael Patrick Eglin AFB, FL 32542-5000
1	Commander Ballistic Missile Defense Advanced Technology Center ATTN: Dr. David C. Sayles P.O. Box 1500 Huntsville, AL 35807	1	Director Los Alamos National Lab ATTN: Dr. Howard Cady P.O. Box 1663 Los Alamos, NM 87545
1	Director Lawrence Livermore National Laboratories University of California ATTN: Dr. M. Finger P.O. Box 808 Livermore, CA 94550	6	Commander Belvoir RD&E Center ATTN: STRBE-N, (Dr. David Heberlein) STRBE-NA (Dr. Herman Spitzer) STRBE-NAN (Ms. Pamela Jacobs) (Mr. Rick Martinez) (Mr. Josh Williams) (Mr. Steve Bishop) Fort Belvoir, VA 22060-5606
1	Director Lawrence Livermore National Laboratories University of California ATTN: Kenneth Scribner P.O. Box 808 Livermore, CA 94550		

<u>No of Copies</u>	<u>Organization</u>
2	Commander Naval Explosive Ordnance Disposal Technology Center ATTN: Mr. James Petrousky, Code 601 Indian Head, MD 20640
2	Commander USATECHDET Naval Explosive Ordnance Disposal Technology Center Indian Head, MD 20640-5096
1	James Lawrence AMETEK Company 5944 51st Ave. North St. Petersburg, FL 33709