

DTIC FILE CARD

4

AFGL-TR-88-0299

CRRES SPACERAD PLASMA WAVE EXPERIMENT

R. R. Anderson  
D. A. Gurnett

The University of Iowa  
Department of Physics and Astronomy  
Iowa City, Iowa 52242

October 1988

Final Report  
20 April 1982 - 30 June 1988

**AD-A210 791**

APPROVED FOR PUBLIC RELEASE; DISTRIBUTION UNLIMITED

AIR FORCE GEOPHYSICS LABORATORY  
AIR FORCE SYSTEMS COMMAND  
UNITED STATES AIR FORCE  
HANSCOM AFB  
MASSACHUSETTS 01731-5000

DTIC  
ELECTE  
AUG 4 1989  
S A D

103

This technical report has been reviewed and is approved for publication.

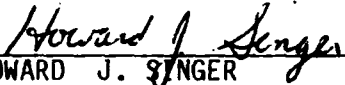
  
\_\_\_\_\_  
HOWARD J. SINGER  
Contract Manager

  
\_\_\_\_\_  
NELSON C. MAYNARD  
Branch Chief

FOR THE COMMANDER

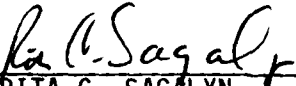
  
\_\_\_\_\_  
RITA C. SAGALYN  
Division Director

This report has been reviewed by the ESD Public Affairs Office (PA) and is releasable to the National Technical Information Service (NTIS).

Qualified requestors may obtain additional copies from the Defense Technical Information Center. All others should apply to the National Technical Information Service.

If your address has changed, or if you wish to be removed from the mailing list, or if the addressee is no longer employed by your organization, please notify AFGL/DAA, Hanscom AFB, MA 01731. This will assist us in maintaining a current mailing list.

Do not return copies of this report unless contractual obligations or notices on a specific document requires that it be returned.

REPORT DOCUMENTATION PAGE

1a REPORT SECURITY CLASSIFICATION Unclassified		1b RESTRICTIVE MARKINGS	
2a SECURITY CLASSIFICATION AUTHORITY		3 DISTRIBUTION/AVAILABILITY OF REPORT Approved for public release; Distribution unlimited	
2b DECLASSIFICATION/DOWNGRADING SCHEDULE			
4 PERFORMING ORGANIZATION REPORT NUMBER(S)		5 MONITORING ORGANIZATION REPORT NUMBER(S) AFGL-TR-88-0299	
6a. NAME OF PERFORMING ORGANIZATION The University of Iowa Dept. Physics & Astronomy	6b. OFFICE SYMBOL (if applicable) 02542	7a. NAME OF MONITORING ORGANIZATION Office of Naval Research (N62880)	
6c ADDRESS (City, State, and ZIP Code) The University of Iowa Dept. of Physics & Astronomy Iowa City, IA 52242		7b. ADDRESS (City, State, and ZIP Code) Room 286 536 South Clark Street Chicago, IL 60605	
8a. NAME OF FUNDING SPONSORING ORGANIZATION Air Force Geophysics Laboratory	8b. OFFICE SYMBOL (if applicable) PHG	9 PROCUREMENT INSTRUMENT IDENTIFICATION NUMBER F19628-82-K-0028	
8c. ADDRESS (City, State, and ZIP Code) Hanscom AFB, MA 01731-5320		10 SOURCE OF FUNDING NUMBERS	
		PROGRAM ELEMENT NO 61102F	PROJECT NO 7601
		TASK NO 12	WORK UNIT ACCESSION NO AL
11 TITLE (Include Security Classification) CRRES SPACERAD PLASMA WAVE EXPERIMENT			
12 PERSONAL AUTHOR(S) Anderson, Roger R., and Gurnett, Donald A.			
13a. TYPE OF REPORT Final	13b. TIME COVERED FROM 82APR20 TO 88JUN30	14. DATE OF REPORT (Year, Month, Day) October 1988	15. PAGE COUNT 42
16 SUPPLEMENTARY NOTATION			
17 COSATI CODES		18. SUBJECT TERMS (Continue on reverse if necessary and identify by block number)	
FIELD	GROUP	Plasma Wave Experiment; Search Coil Magnetometer, Passive Plasma Sounder, Spectrum Analyzer, Sweep Frequency Receiver, Electric Fields, Magnetic Fields.	
19 ABSTRACT (Continue on reverse if necessary and identify by block number) This document is the Final Report for Contract F19628-82-K-0028 from the Air Force Geophysics Laboratory under which the University of Iowa Department of Physics and Astronomy designed, constructed, tested, and delivered a Main Electronics Package (AFGL 701-15A), two Electric Field Preamps (AFGL 701-15B and AFGL 701-15C) and Search Coil Magnetometer (AFGL 701-13-2) (collectively known now as either the Passive Plasma Sounder (PPS) or the Plasma Wave Experiment) as a part of the AFGL 701 SPACERAD instrumentation on the CRRES (Combined Release and Radiation Effects Satellite) project. The report is divided into nine sections. Section 1 contains the introduction. Section 2 discusses the scientific objectives and the importance of the Plasma Wave Experiment in the CRRES SPACERAD mission. Section 3 describes the instrument design rationale and the instrument development philosophy. The instrument description is contained in Section 4. Section 5 describes the instrument commands and their verifications. Section 6 discusses the testing and operations of the experiment. Section 7 contains a schematic drawing of the instrumentation electronics and lists (cont. on back)			
20 DISTRIBUTION AVAILABILITY OF ABSTRACT <input checked="" type="checkbox"/> UNCLASSIFIED <input type="checkbox"/> LIMITED <input type="checkbox"/> SAME AS RPT <input type="checkbox"/> DTIC USERS		21 ABSTRACT SECURITY CLASSIFICATION Unclassified	
22a. NAME OF RESPONSIBLE INDIVIDUAL Howard Singer		22b. TELEPHONE (Include Area Code)	22c. OFFICE SYMBOL AFGL/PHG

Block #19 (cont. from front page)

of the schematics, drawings, and wiring diagrams that describe the as-built configuration of the Plasma Wave Experiment instrumentation. Problems encountered during the construction and testing of the instrument and their resolutions are discussed in Section 8. Conclusions and recommendations are included in Section 9. Test results from already completed environmental and EMC/RFI tests have already been submitted to AFGL and to the Air Force Headquarters Space Division Space Test Program. The recertification of the calibration of the instrument is recommended in the near future under a new contract covering the re-delivery (necessitated due to the removal during the launch-delay storage period), pre-launch, and launch operations.

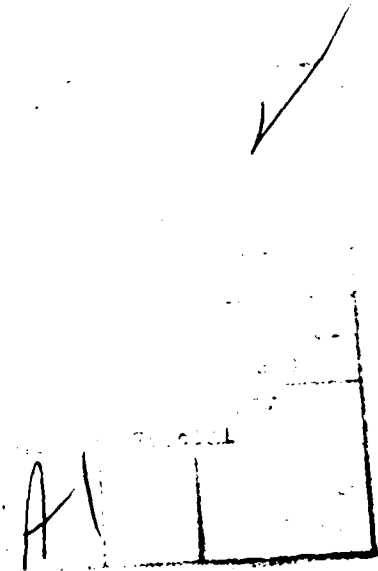

## Preface

This document is the Final Report for Contract F19628-82-K-0028 from the Air Force Geophysics Laboratory under which the University of Iowa Department of Physics and Astronomy designed, constructed, tested, and delivered a Main Electronics Package (AFGL 701-15A), two Electric Field Preamps (AFGL 701-15B and AFGL 701-15C) and Search Coil Magnetometer (AFGL 701-13-2) (collectively known now as either the Passive Plasma Sounder (PPS) or the Plasma Wave Experiment) as a part of the AFGL 701 SPACERAD instrumentation on the CRRES (Combined Release and Radiation Effects Satellite) project. The report is divided into nine sections. Section 1 contains the introduction. Section 2 discusses the scientific objectives and the importance of the Plasma Wave Experiment in the CRRES SPACERAD mission. Section 3 describes the instrument design rational and the instrument development philosophy. The instrument description is contained in Section 4. Section 5 describes the instrument commands and their verifications. Section 6 discusses the testing and operations of the experiment. Section 7 contains a schematic drawing of the instrumentation electronics and lists of the schematics, drawings, and wiring diagrams that describe the as-built configuration of the Plasma Wave Experiment instrumentation. Problems encountered during the construction and testing of the instrument and their resolutions are discussed in Section 8. Conclusions and recommendations are included in Section 9. Test results from already completed environmental and EMC/RFI tests have already been submitted to AFGL and to the Air Force Headquarters Space Division Space Test Program. Recertification of the calibration of the instrument is recommended in the near future under a new contract covering the re-delivery (necessitated due to the removal during the launch-delay storage period), pre-launch, and launch operations.

### Acknowledgments

The following University of Iowa scientific and engineering personnel have contributed to the research reported in this document:

Dr. Roger R. Anderson, Research Scientist,  
PPS Principal Investigator  
Professor Donald A. Gurnett, PPS Co-Investigator  
Daniel L. Odem, Electrical Engineer, PPS Project Manager  
Dr. Robert R. Shaw, Research Scientist,  
Plasma Wave Engineering Group Manager  
Donald L. Kirchner, Electrical Engineer  
Miles H. Bailey, Electrical Engineer (now retired)  
Steven L. Remington, Electrical Engineer  
Mike A. Mitchell, Electrical Engineer  
William J. Schintler, Electrical Engineer  
David R. Tomash, Electrical Engineer  
Pete Sheyko, Electrical Engineer  
Marc M. DeBower, Mechanical Engineer  
Elwood A. Kruse, R&QA Engineer  
Robert J. Barrie, Supervisor of Technical Services  
Robert G. Beall, Design Draftsman  
Howard L. Zimmon, Design Draftsman  
Terry F. Averkamp, Staff Programmer  
Robert W. Lane, Staff Programmer  
Jean E. Hospodarsky, Secretary  
Kathy R. Kurth, Secretary  
Thomas D. Robertson, Contracts Administrator

#### Address:

The University of Iowa  
Department of Physics and Astronomy  
Iowa City, Iowa 52242

#### Telephone:

319-335-1686 (Main Office)  
319-335-1924 (Principal Investigator)  
319-335-1693 (Contracts Administrator)

### Publications

The following paper was a result of effort supported by this contract:

"The Passive Plasma Sounder (AFGL-701-15) and Search Coil Magnetometer (AFGL-701-13-2)" by Roger R. Anderson and Donald A. Gurnett, CRRES/SPACERAD Experiment Descriptions, AFGL-TR-85-0017, Environmental Research Papers, No. 906, M. S. Gussenhoven, E. G. Mullen, and R. C. Sagalyn, editors, Air Force Geophysics Laboratory, Hanscom AFB, MA 01731, pp. 45-53, 1985, ADA160504.

TABLE OF CONTENTS

<u>Section</u>	<u>Contents</u>	<u>Page</u>
1	INTRODUCTION . . . . .	1
2	SCIENTIFIC OBJECTIVES . . . . .	3
3	INSTRUMENT DESIGN RATIONAL AND DESIGN PHILOSOPHY . . . . .	5
4	INSTRUMENT DESCRIPTION . . . . .	9
5	INSTRUMENT COMMANDS . . . . .	19
6	EXPERIMENT TESTING AND OPERATIONS . . . . .	23
7	SCHEMATICS, DRAWINGS, AND WIRING DIAGRAMS . . . . .	24
8	PROBLEMS AND THEIR RESOLUTIONS . . . . .	33
9	CONCLUSIONS AND RECOMMENDATIONS . . . . .	35

LIST OF TABLES

	<u>Page</u>
Table 1 Sweep Frequency Receiver Noise Levels and Minimum Detectable Sine Wave Amplitude . . . . .	14
Table 2 Discrete Frequencies for the CRRES Plasma Wave Experiment Sweep Frequency Receiver in kHz . . . . .	15
Table 3 Multichannel Spectrum Analyzer Characteristics . . . . .	16
Table 4 High-Level Relay Commands and their Verification . . . . .	19
Table 5 Serial-Digital Command Format . . . . .	20
Table 6 PPS Serial-Digital Command Verification Table . . . . .	21
Table 7 Serial/Digital Status Word Interpretation . . . . .	22
Table 8 Passive Plasma Sounder Thermal Requirements . . . . .	23



## SECTION 1

### INTRODUCTION

This document is the Final Report for Contract F19628-82-K-0028 from the Air Force Geophysics Laboratory under which the University of Iowa Department of Physics and Astronomy designed, constructed, tested, and delivered a Main Electronics Package (AFGL 701-15A), two Electric Field Preamps (AFGL 701-15B and AFGL 701-15C) and Search Coil Magnetometer (AFGL 701-13-2) (collectively known now as either the Passive Plasma Sounder (PPS) or the Plasma Wave Experiment) as a part of the AFGL 701 SPACERAD instrumentation on the CRRES (Combined Release and Radiation Effects Satellite) project. The primary purpose of the AFGL 701 SPACERAD instrumentation on CRRES is to determine the effects of the radiation belt environment on micro-electronics used or proposed to be used in space flight packages. The supporting instrumentation, of which the Plasma Wave Experiment is a part, has been included to characterize the in situ radiation belt environment and to analyze the processes including wave-particle interactions that affect the radiation belt particles that can damage the micro-electronics that are being tested. In addition to providing this information, the wave, field, plasma, and particle measurements from CRRES will provide valuable data for long term studies of the radiation belt environment as well as for event studies such as those associated with geomagnetic storms and substorms.

In this Final Report we will first discuss the scientific objectives and the importance of the Plasma Wave Experiment in the CRRES SPACERAD mission. Then we will describe the instrument design rationale and the instrument development philosophy. Next we will describe the instrument and then its

commands and their verifications. After that we will discuss the testing and operations of the experiment. Section 7 contains a schematic drawing of the instrumentation electronics and lists of the schematics, drawings, and wiring diagrams that describe the as-built configuration of the Plasma Wave Experiment instrumentation. Problems encountered during the construction and testing of the instrument and their resolutions are discussed in Section 8. Conclusions and recommendations are included in Section 9. Test results from already completed environmental and EMC/RFI tests have already been submitted to AFGL and to the Air Force Headquarters Space Division Space Test Program and will not be repeated here. Recertification of the calibration of the instrument is recommended in the near future under a new contract covering the re-delivery (necessitated due to the removal during the launch-delay storage period), pre-launch, and launch operations.

## SECTION 2

### SCIENTIFIC OBJECTIVES

Wave-particle interactions are one of the major factors causing changes in the energetic particle populations in the earth's radiation belts. Since plasma waves can play a major role in changing the energetic particle population through pitch angle scattering, ion heating, and other wave particle interaction processes which exchange energy and/or momentum between the waves and the particles, the measurement of the plasma wave environment is essential to the SPACERAD mission. Both electrostatic and electromagnetic waves can pitch-angle scatter energetic particles into the atmospheric loss-cone such that they are subsequently lost within a bounce period. Plasma waves can also add energy to or take energy away from the particles. Direct measurements of the plasma wave modes and intensities are essential for calculating pitch-angle diffusion coefficients and for assessing the effects of the plasma waves on the energetic particles and the background thermal plasma. A crucial parameter required for understanding and evaluating wave-particle interactions is the electron number density.

The purposes of the University of Iowa Passive Plasma Sounder (also known as the Plasma Wave Experiment) on the SPACERAD GTO portion of CRRES are to measure and characterize the plasma wave environment, to determine the electron number density, and to help identify the region of space the satellite is in. The characterization of the plasma waves is important for identifying the wave modes taking part in the wave-particle interaction processes and for evaluating the effect of the waves on the particles. The electron number density is a necessary parameter for evaluating wave dispersion relations and determining the resonant energy in the various

wave-particle interactions. The Passive Plasma Sounder is able to obtain the characteristics of the thermal plasma near the spacecraft at low densities and without regard to spacecraft charging. The CRRES Plasma Wave Experiment will provide electron number density measurements continuously over the range from  $10^{-2}$  to  $2 \times 10^3 \text{ cm}^{-3}$  using passive sounding techniques. A comparison of the plasma wave measurements with the energetic particle measurements will be used to study the various wave-particle interaction processes.

Identification of the region of space the spacecraft is in will significantly aid in the interpretation of the wave-particle interaction processes taking place. The location of boundaries in the magnetosphere such as the plasmopause or magnetopause can be identified by changes in the plasma density and by changes in the type of plasma waves, both detected by the Plasma Wave Experiment, as well as by other field, particle, and plasma changes detected by other experiments on the spacecraft.

## SECTION 3

### INSTRUMENT DESIGN RATIONAL AND DESIGN PHILOSOPHY

The CRRES SPACERAD GTO Plasma Wave Experiment instrumentation has been designed to adequately measure the plasma wave environment in the earth's radiation belts with emphasis on high frequency and time resolution, a large dynamic range, and sufficient frequency response to cover all the characteristic frequencies of the plasma that are of interest. In order to distinguish electromagnetic waves from electrostatic waves, our instrument includes a search coil magnetometer as well as having inputs from the two electric field antenna systems. The dynamic range for all of the receivers are about 100 dB (a factor of  $10^5$  in amplitude) or more beginning at the respective receiver's noise level. Past plasma wave measurements in the radiation belts show that this range should adequately cover the expected range of plasma wave amplitudes detected. With a 100 meter tip-to-tip antenna, this range will allow one to measure from the weak levels expected for the continuum radiation and  $(n+1/2) f_g^-$  emissions ( $f_g^-$  is the electron cyclotron frequency) outside the plasmasphere to the intense levels produced by terrestrial kilometric radiation, upper hybrid resonance noise, and ground transmitters observed inside the plasmasphere. It is important to have sufficient sensitivity to measure the weak continuum radiation because the lower cutoff of this radiation is at  $f_p^-$ , the electron plasma frequency. The electron number density,  $N_e$ , is determined from the relation  $f_p^- = 8.98 \times 10^4 N_e^{1/2}$  where  $N_e$  is in units of electrons per  $\text{cm}^3$  and  $f_p^-$  is in kHz. Figure 1 is a plot of the expected variation in the characteristic frequencies of the plasma for a typical CRRES GTO dayside pass. In addition to  $f_g^-$  and  $f_p^-$ , the proton cyclotron frequency and proton plasma frequency,

CHARACTERISTIC FREQUENCIES FOR CRRES GTO ORBIT

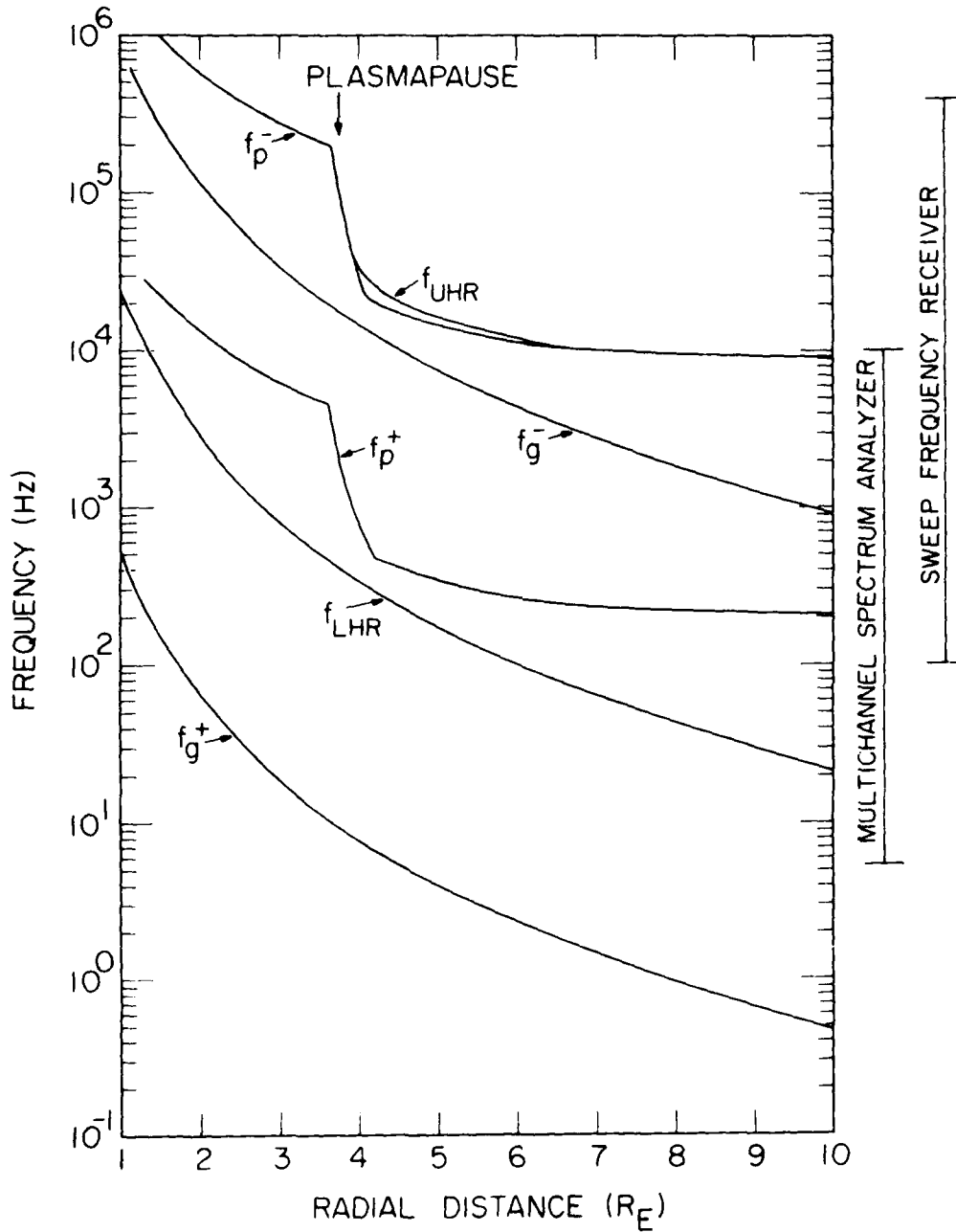

UNIVERSITY OF IOWA CRRES GTO PASSIVE PLASMA SOUNDER  
RECEIVER FREQUENCY COVERAGE

Figure 1

$f_g^+$  and  $f_p^+$ ; the upper hybrid resonance frequency,  $f_{UHR} = ((f_g^-)^2 + (f_p^-)^2)^{1/2}$ ; and the lower hybrid resonance frequency,  $f_{LHR} \sim (f_g^- \times f_g^+)^{1/2}$ , are also shown. The 5.6 Hz to 400 kHz frequency range of the CRRES Plasma Wave Experiment covers most of the important characteristic frequencies expected to be encountered by CRRES in the region above about  $2 R_E$  (Earth radii). Below about  $2 R_E$  when the plasma frequency exceeds 400 kHz, the Langmuir Probe Experiment will provide the electron number density measurements. Electromagnetic plasma waves below 5.6 Hz will be in the frequency range covered by the Fluxgate Magnetometer Experiment. Electric field fluctuations below 5.6 Hz will be measured by the Langmuir Probe Experiment.

Based on the above design considerations, the Plasma Wave Experiment on the SPACERAD GTO portion of CRRES will provide detailed information on factors which cause changes in the energetic particle population by measuring the characteristics of plasma waves in the Earth's radiation belts over the frequency range from 5.6 Hz to 400 kHz. In order to keep design and development costs low, we used designs inherited from our previous very successful space flight projects as much as possible. The search coil magnetometer is a spare unit from our University of Iowa Plasma Wave Experiment on the Dynamics Explorer project. The spectrum analyzer design was copied from our ISEE 1 Plasma Wave Experiment. The Sweep Frequency Receiver was designed similar to the one we flew on ISEE 1.

The Sweep Frequency Receiver and the Multichannel Spectrum Analyzer can each be independently commanded to either have their inputs locked to a single sensor or to cycle through all three sensors. The Sweep Frequency Receiver when commanded to the cycle mode (CYCLE1), cycles E-B-E-LANG at a 32 second per sensor rate (E is the Fairchild long wire antenna, B is the Search

Coil Magnetometer, and LANG is the input from the Langmuir Probe Experiment sensor). The Multichannel Spectrum Analyzer when commanded to the cycle mode (CYCLE2), cycles B-E-B-LANG at a 4 second per sensor rate.

The cycling mode for the Sweep Frequency Receiver (SFR) emphasizes sampling from the Fairchild long wire electric antenna because it is more sensitive at the high frequencies covered by the SFR. The cycling mode for the Multichannel Spectrum Analyzer (MSA) emphasizes sampling for the Search Coil magnetometer because it is most sensitive at the lower frequencies covered by the MSA.



## SECTION 4

### INSTRUMENT DESCRIPTION

The Passive Plasma Sounder (PPS) or Plasma Wave Experiment on CRRES consists of the Main Electronics Package (AFGL 701-15A), two Electric Field Preamps (AFGL 701-15B and AFGL 701-15C), and the Search Coil Magnetometer (AFGL 701-13-2). The CRRES Plasma Wave Experiment will provide measurements of electric fields from 5.6 Hz to 400 kHz and magnetic fields from 5.6 Hz to 10 kHz with a dynamic range of at least 100 dB. Magnetic field measurements from 10 kHz to 400 kHz will also be possible but the dynamic range will be reduced due to the roll off of the search coil magnetometer above 10 kHz. Electrostatic  $dN/N$  measurements from 5.6 Hz up to 400 kHz will also be possible via signals from the Langmuir Probe experiment. The Plasma Wave Instrument sensors consist of an extendable 100 m tip-to-tip fine wire long electric dipole antenna (procured from Fairchild by AFGL) and a boom-mounted search coil magnetometer. The primary sensors for the Langmuir Probe Experiment, double spherical probes separated by 100 meters, can also be used for either electric field or electrostatic  $dN/N$  measurements by the Plasma Wave Experiment. The basic CRRES Plasma Wave Experiment instrumentation includes two receivers: (1) a 128-channel sweep frequency receiver for high-frequency-resolution spectrum measurements from 100 Hz to 400 kHz and (2) a 14-channel spectrum analyzer to provide high-time-resolution spectra from 5.6 Hz to 10 kHz.

A block diagram of the CRRES GTO SPACERAD Plasma Wave Experiment is shown in Figure 2. The Plasma Wave Experiment will measure the electromagnetic and/or electrostatic fields detected by three sensors:

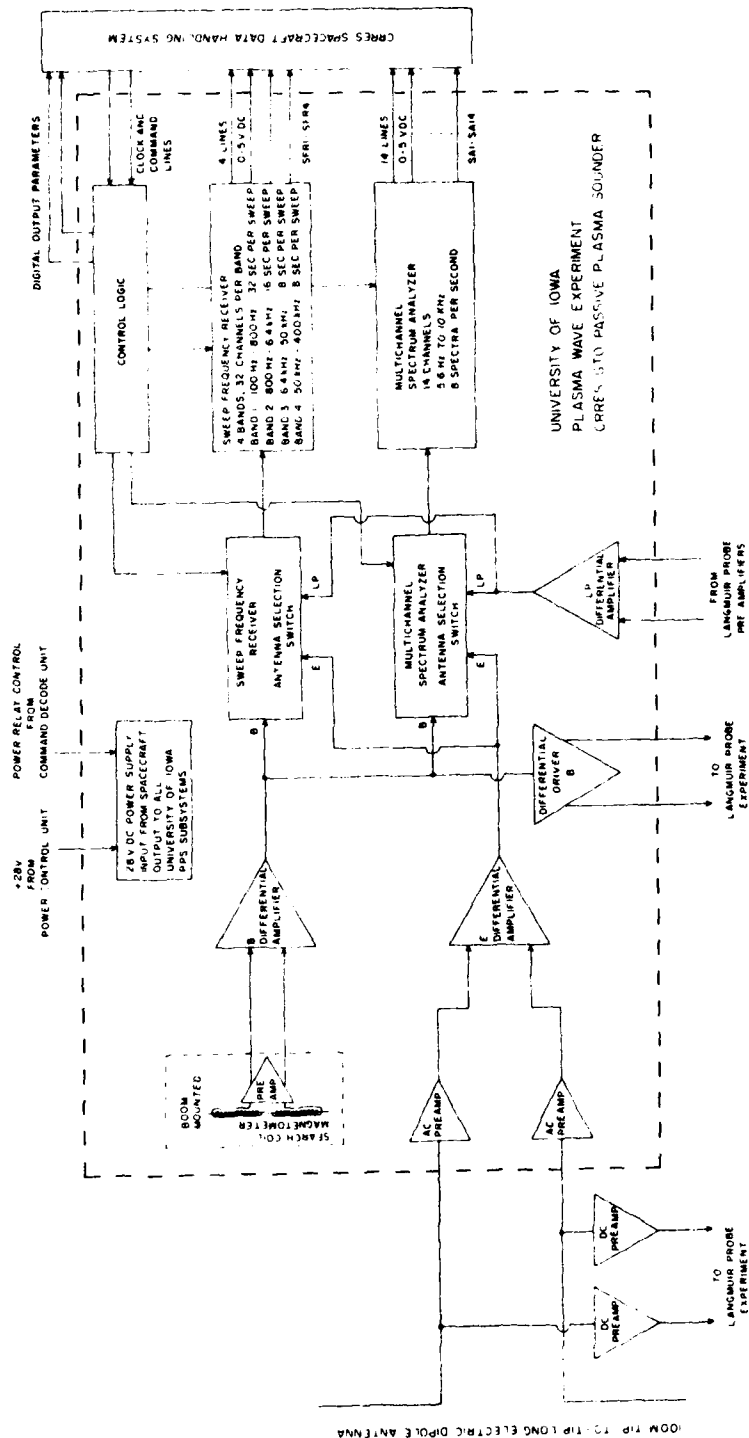

ROOM TIP TO-TIP LONG ELECTRIC DIPOLE ANTENNA

Figure 2

(1) a 100-meter tip-to-tip extendable fine wire long electric dipole antenna (procured from Fairchild by AFGL), (2) a search coil magnetometer (a spare unit from the University of Iowa Plasma Wave Experiment on the Dynamics Explorer project) mounted at the end of a 6-meter boom (supplied by the CRRES spacecraft contractor BASD, and (3) a 100-meter tip-to-tip spherical double probe electric antenna (a part of the UCB/AFGL Langmuir Probe Experiment). The first two sensors are the primary sensors for our Plasma Wave Experiment while the third sensor is the primary sensor for the Langmuir Probe Experiment. A drawing of the CRRES spacecraft showing the location of the sensors is shown in Figure 3. Two high-input-impedance electric field preamplifiers (AFGL 701-15B and AFGL 701-15C) are located on the spacecraft near the base of each half of the extendable fine wire long electric dipole. The search coil magnetometer (AFGL 701-13-2) contains a high permeability  $\mu$ -metal core 0.41 meter long, wound with 10,000 turns of #42 wire, and a preamplifier. Signals from the sensors, after buffering by appropriate preamplifiers and differential amplifiers, are routed via two sets of antenna selection switches to the Sweep Frequency Receiver and the Multichannel Spectrum Analyzer in the Plasma Wave Experiment and to the Langmuir Probe Experiment.

The Sweep Frequency Receiver covers the frequency range from 100 Hz to 400 kHz in four bands with 32 steps per band. The fractional step separation of the Sweep Frequency Receiver,  $df/f$ , is about 6.7% across the entire frequency range. Band 1 (100 Hz to 800 Hz) is sampled one step per second or 32 seconds per sweep; Band 2 (800 Hz to 6.4 kHz) is sampled two steps per second or 16 seconds per sweep; and Band 3 (6.4 kHz to 50 kHz) and Band 4 (50 kHz to 400 kHz) are each sampled four steps per second or 8 seconds per sweep. The sweep frequency receiver on ISEE 1, from which the CRRES one has

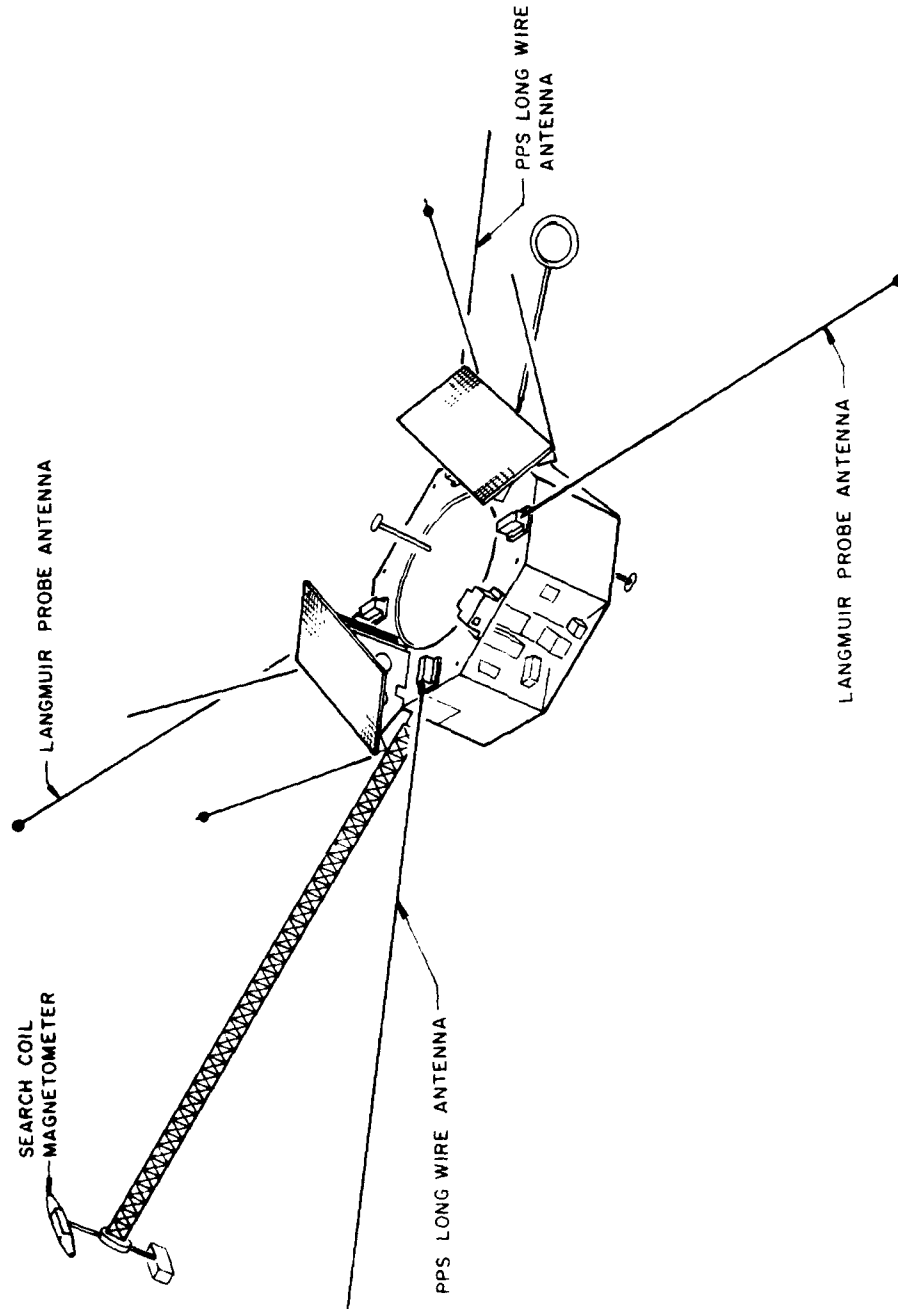

— CRRES PLASMA WAVE EXPERIMENT SENSORS —

Figure 3

been patterned after, had each of the four bands sampled one step per second or 32 seconds per sweep. To accomplish the faster sampling rates on the three upper bands on CRRES, two additional frequency synthesizer circuits had to be added. The nominal bandwidths of the four bands are 7 Hz, 56 Hz, 448 Hz, and 3.6 kHz, respectively. The four bands each have a logarithmic compressor which measures the signal amplitude over about a 100 dB dynamic range beginning at the noise level of the receiver and produces a 0.0 to 5.10 Volt DC analog output approximately proportional to the logarithm of the input amplitude. The sampling of the four Sweep Frequency Receiver analog outputs (one for each band) will be done by the Spacecraft Data Handling System and will allow us to produce high frequency resolution spectra. Table 1 lists the noise levels and the minimum detectable sine wave amplitudes for the four CRRES PPS Sweep Frequency Receiver bands. The sensitivity of the Search Coil Magnetometer is  $35 \mu\text{V}/\text{nT}\cdot\text{Hz}$  up to 10 kHz and then falls off at a 12 dB per octave rate thereafter. Table 2 lists the 128 discrete frequencies for the Sweep Frequency Receiver.

Table 1

Sweep Frequency Receiver Noise Levels and  
Minimum Detectable Sine Wave Amplitudes.

	Noise Level (Volt <sup>2</sup> /Hz)	Minimum Detectable Sine Wave Amplitude (Volts)
Band 1 (100 Hz to 800 Hz) (Bandwidth = 7 Hz)	$2.5 \times 10^{-12}$	$4.2 \times 10^{-6}$
Band 2 (800 Hz to 6.4 kHz) (Bandwidth = 56 Hz)	$4.5 \times 10^{-13}$	$5.0 \times 10^{-6}$
Band 3 (6.4 kHz to 50 kHz) (Bandwidth = 448 Hz)	$3.9 \times 10^{-14}$	$4.2 \times 10^{-6}$
Band 4 (50 kHz to 400 kHz) (Bandwidth = 3.6 kHz)	$1.3 \times 10^{-14}$	$6.9 \times 10^{-6}$

Table 2

Discrete Frequencies for the CRRES Plasma Wave Experiment  
Sweep Frequency Receiver in kHz.

<u>Step No.</u>	<u>Band 1</u>	<u>Band 2</u>	<u>Band 3</u>	<u>Band 4</u>
01	0.104	0.836	6.69	53.5
02	0.113	0.904	7.23	57.9
03	0.122	0.973	7.78	62.2
04	0.130	1.04	8.33	66.7
05	0.139	1.11	8.89	71.1
06	0.148	1.18	9.45	75.6
07	0.157	1.25	10.0	80.2
08	0.166	1.32	10.6	84.7
09	0.175	1.40	11.2	89.4
10	0.184	1.47	11.8	94.0
11	0.202	1.61	12.9	103.
12	0.211	1.69	13.5	108.
13	0.230	1.84	14.7	118.
14	0.250	2.00	16.0	128.
15	0.259	2.07	16.6	133.
16	0.279	2.23	17.9	143.
17	0.289	2.31	18.5	148.
18	0.309	2.47	20.0	158.
19	0.330	2.64	21.1	169.
20	0.351	2.81	22.5	180.
21	0.372	2.98	23.8	191.
22	0.394	3.15	25.2	202.
23	0.428	3.42	27.4	219.
24	0.451	3.61	28.8	231.
25	0.486	3.89	31.1	249.
26	0.510	4.08	32.6	261.
27	0.547	4.38	35.0	280.
28	0.585	4.68	37.4	299.
29	0.624	4.99	39.9	320.
30	0.678	5.43	43.4	347.
31	0.721	5.77	46.1	369.
32	0.799	6.23	49.9	399.

The CRRES PPS Multichannel Spectrum Analyzer consists of 14 narrow-band filters logarithmically spaced in frequency (4 filters per decade in frequency) from 5.6 Hz to 10 kHz followed by 14 logarithmic compressors each having a dynamic range of about 110 dB. The nominal 3 dB sine wave bandwidth

of each narrow-band filter is  $\pm 15\%$  of the center frequency except for the two highest frequency channels (5.62 kHz and 10.0 kHz) whose bandwidths are  $\pm 7.5\%$  of the center frequency. Frequency response curves for the 14 channels of the Multichannel Spectrum Analyzer are shown in Figure 4. The channel center frequencies, effective noise bandwidths, noise levels, and minimum detectable sine wave amplitudes are listed in Table 3. The 14 0.0 to 5.10 Volt DC analog outputs are sampled simultaneously 8 times per second by the Spacecraft Data Handling System which will allow us to produce high time resolution spectra.

Table 3  
Multichannel Spectrum Analyzer Characteristics

Channel Number	Center Frequency	Effective Noise Bandwidth	Noise Level ( $V^2/Hz$ )	Minimum Detectable Sine Wave Amplitude (Volts)
01	5.6 Hz	1.12 Hz	$3.5 \times 10^{-10}$	$2.0 \times 10^{-5}$
02	10.0 Hz	2.00 Hz	$9.4 \times 10^{-11}$	$1.4 \times 10^{-5}$
03	17.8 Hz	3.56 Hz	$4.3 \times 10^{-11}$	$1.2 \times 10^{-5}$
04	31.1 Hz	6.22 Hz	$1.6 \times 10^{-11}$	$1.0 \times 10^{-5}$
05	56.2 Hz	11.2 Hz	$8.4 \times 10^{-12}$	$9.7 \times 10^{-6}$
06	100. Hz	20.0 Hz	$4.4 \times 10^{-12}$	$9.4 \times 10^{-6}$
07	178. Hz	35.6 Hz	$1.8 \times 10^{-12}$	$7.9 \times 10^{-6}$
08	311. Hz	62.2 Hz	$5.0 \times 10^{-13}$	$5.6 \times 10^{-6}$
09	562. Hz	112. Hz	$1.8 \times 10^{-13}$	$4.4 \times 10^{-6}$
10	1.00 kHz	200. Hz	$8.5 \times 10^{-14}$	$4.1 \times 10^{-6}$
11	1.78 kHz	356. Hz	$2.6 \times 10^{-14}$	$3.1 \times 10^{-6}$
12	3.11 kHz	622. Hz	$1.6 \times 10^{-14}$	$3.2 \times 10^{-6}$
13	5.62 kHz	560. Hz	$2.3 \times 10^{-14}$	$3.6 \times 10^{-6}$
14	10.0 kHz	1.00 kHz	$3.5 \times 10^{-15}$	$1.9 \times 10^{-6}$

The mass of the Main Electronics Box is 5.06 kg. The mass of each of the two Electric Field Preamplifiers is 0.303 kg. The mass of the Search Coil Magnetometer is 0.290 kg. The entire PPS complement draws 0.175 Amps



A-684-1039

CRRES PSS SPECTRUM ANALYZER FILTER RESPONSE

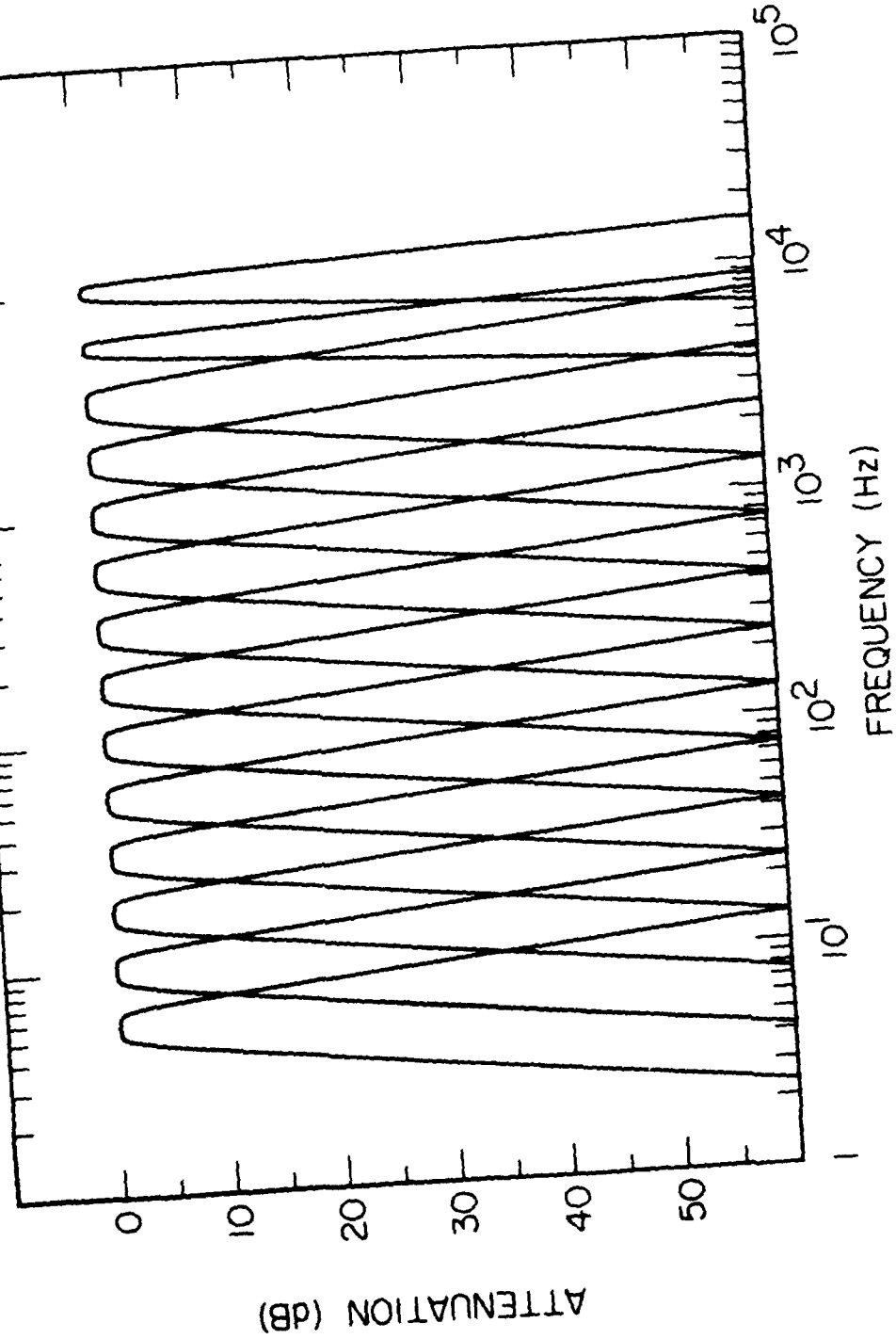

Figure 4

at 28 Volts at room temperature for a total power consumption of 4.9 watts. This includes slightly less than 50 mW each ( $3 \times 50 \text{ mW} = 150 \text{ mW}$  total) for the two Electric Field Preamplifiers and the Search Coil Magnetometer. The remaining 4.75 Watts are dissipated in the Main Electronics Box.

## SECTION 5

### INSTRUMENT COMMANDS

The Spacecraft Data Handling System will provide the clock and command lines for controlling the receivers and the sampling and the analog to digital conversions of the receivers' 0.0 to 5.10 Volt DC analog outputs. The CRRES SPACERAD Passive Plasma Sounder has two high-level relay commands and one 16-bit serial-digital command. The high-level relay commands turn the experiment power on and off. Table 4 identifies the high-level relay commands and their verification. The serial-digital command determines which sensor is connected to which receiver and whether or not the receivers are locked onto a single sensor or cycle through all of the sensors. Table 5 identifies the serial-digital command bit format for the different states and Table 6 contains the command verification status for the serial-digital command.

Table 4

High-Level Relay Commands and their Verification.

---

<u>HIGH-LEVEL RELAY COMMANDS</u>	<u>VERIFICATION</u>
HLR COMMAND 1: PPS POWER ON	PPS ON/OFF STATUS = 1
HLR COMMAND 2: PPS POWER OFF	PPS ON/OFF STATUS = 0

---

Table 5

## Serial-Digital Command Format

Command Name	Command Bits (Bit 0 is first bit into interface)															SFR Sensor	SA Sensor	
	0	1	2	3	4	5	6	7	8	9	10	11	12	13	14			15
Serial 1	1	0	0	0	1	0	0	0	1	0	0	0	0	0	0	0	E	B
Serial 2	1	0	0	0	1	0	0	0	1	0	0	0	1	0	0	0	B	B
Serial 3	1	0	0	0	1	0	0	0	1	0	0	0	0	1	0	0	LANG	B
Serial 4	1	0	0	0	1	0	0	0	1	0	0	0	1	1	0	0	CYCLE1	B
Serial 5	1	0	0	0	1	0	0	0	1	0	0	0	0	0	1	0	E	LANG
Serial 6	1	0	0	0	1	0	0	0	1	0	0	0	1	0	1	0	B	LANG
Serial 7	1	0	0	0	1	0	0	0	1	0	0	0	0	1	1	0	LANG	LANG
Serial 8	1	0	0	0	1	0	0	0	1	0	0	0	1	1	1	0	CYCLE1	LANG
Serial 9	1	0	0	0	1	0	0	0	1	0	0	0	0	0	0	1	E	E
Serial 10	1	0	0	0	1	0	0	0	1	0	0	0	1	0	0	1	B	E
Serial 11	1	0	0	0	1	0	0	0	1	0	0	0	0	1	0	1	LANG	E
Serial 12	1	0	0	0	1	0	0	0	1	0	0	0	1	1	0	1	CYCLE1	E
Serial 13	1	0	0	0	1	0	0	0	1	0	0	0	0	0	1	1	E	CYCLE2
Serial 14	1	0	0	0	1	0	0	0	1	0	0	0	1	0	1	1	B	CYCLE2
Serial 15	1	0	0	0	1	0	0	0	1	0	0	0	0	1	1	1	LANG	CYCLE2
Serial 16	1	0	0	0	1	0	0	0	1	0	0	0	1	1	1	1	CYCLE1	CYCLE2

NOTES: 0 is Active Low.

1 is Active High.

SA is the Multichannel Spectrum Analyzer.

SFR is the Sweep Frequency Receiver.

E is the Fairchild long wire electric dipole antenna.

B is the search coil magnetometer.

LANG is the input from the Langmuir Probe Experiment.

CYCLE1 cycles E-B-E-LANG at a 32 second per sensor rate.

CYCLE2 cycles B-E-B-LANG at a 4 second per sensor rate.

Serial 1 is the Power On Reset state - the state after the experiment is turned on and before any serial commands are received.

Table 6

PPS Serial-Digital Command Verification Table

---

Serial Command Name	PPS S/D Status Word Bits (Bit 0 is first bit into interface)							
	0	1	2	3	4	5	6	7
Serial 1	0	0	0	0	0	0	x	x
Serial 2	0	0	0	1	0	0	x	x
Serial 3	0	0	0	0	1	0	x	x
Serial 4	0	0	0	x	x	1	x	x
Serial 5	0	1	0	0	0	0	x	x
Serial 6	0	1	0	1	0	0	x	x
Serial 7	0	1	0	0	1	0	x	x
Serial 8	0	1	0	x	x	1	x	x
Serial 9	1	0	0	0	0	0	x	x
Serial 10	1	0	0	1	0	0	x	x
Serial 11	1	0	0	0	1	0	x	x
Serial 12	1	0	0	x	x	1	x	x
Serial 13	x	x	1	0	0	0	x	x
Serial 14	x	x	1	1	0	0	x	x
Serial 15	x	x	1	0	1	0	x	x
Serial 16	x	x	1	x	x	1	x	x

NOTES: 0 is Active Low.  
 1 is Active High.  
 x indicates the bit can be ignored for command verification.

---

The CRRES SPACERAD GTO PPS experiment has three status words: two analog words, the Low Voltage Power Supply Monitor (LVPS) located in Frame 1 of Subcom 18 and the Search Coil Magnetometer temperature (TEMP) located in Frame 3 of Subcom 18, and the PPS Serial/Digital (S/D) Status word located in Frame 1 of Subcom 19. Calibration tables or algorithms for determining the LVPS and TEMP values have been delivered to AFGL. The interpretation of the S/D status word is shown below in Table 7.

Table 7

## Serial/Digital Status Word Interpretation

Status word bits (Bit 0 is the first bit into interface)								Interpretation
0	1	2	3	4	5	6	7	
0	0	0	x	x	x	x	x	SA Sensor=B,LOCK
0	1	0	x	x	x	x	x	SA Sensor=LANG,LOCK
1	0	0	x	x	x	x	x	SA Sensor=E,LOCK
1	1	0	x	x	x	x	x	Not Valid
0	0	1	x	x	x	x	x	SA CYCLE2,Sensor=B
0	1	1	x	x	x	x	x	SA CYCLE2,Sensor=B
1	0	1	x	x	x	x	x	SA CYCLE2,Sensor=E
1	1	1	x	x	x	x	x	SA CYCLE2,Sensor=LANG
x	x	x	0	0	0	x	x	SFR Sensor=E,LOCK
x	x	x	0	1	0	x	x	SFR Sensor=LANG,LOCK
x	x	x	1	0	0	x	x	SFR Sensor=B,LOCK
x	x	x	1	1	0	x	x	Not Valid
x	x	x	0	0	1	x	x	SFR CYCLE1,Sensor=E
x	x	x	0	1	1	x	x	SFR CYCLE1,Sensor=E
x	x	x	1	0	1	x	x	SFR CYCLE1,Sensor=B
x	x	x	1	1	1	x	x	SFR CYCLE1,Sensor=LANG
x	x	x	x	x	x	0/1	x	SYN 3 Lowest Frequency Logic line
x	x	x	x	x	x	x	0/1	"OR" of Top 4 Bits of SYN 1

NOTES: 0 is Active Low  
 1 is Active High  
 SA is the Multichannel Spectrum Analyzer.  
 SFR is the Sweep Frequency Receiver.  
 E is the Fairchild long wire electric dipole antenna.  
 B is the search coil magnetometer.  
 LANG is the input from the Langmuir Probe Experiment.  
 CYCLE1 cycles E-B-E-LANG at a 32 second per sensor rate.  
 CYCLE2 cycles B-E-B-LANG at a 4 second per sensor rate.  
 LOCK indicates the receiver stays on a given sensor.  
 SYN 3 is the synthesizer for the lowest frequency SFR Band.  
 SYN 1 is the synthesizer for the two highest frequency SFR Bands.  
 x indicates the bit can be ignored.

## SECTION 6

### EXPERIMENT TESTING AND OPERATIONS

The CRRES SPACERAD Plasma Wave Experiment has successfully completed all system and spacecraft environmental, mechanical, and electrical tests. Test results from already completed environmental, electrical, mechanical, and EMC/RFI tests have already been submitted to AFGL and to the Air Force Headquarters Space Division Space Test Program or to BASD as required. Data from the calibration of the instrument have been delivered to AFGL. Re-certification of the calibration data is recommended in the near future under a new contract covering the re-delivery (necessitated due to the removal during the launch-delay storage period), pre-launch, and launch operations.

The thermal requirements for the PPS instruments are shown below in Table 8.

Table 8

#### PASSIVE PLASMA SOUNDER THERMAL REQUIREMENTS

AFGL-701-13-2 (Search Coil Magnetometer)		Degrees C (Sensor)	
Preferred operating limits:		0 to +40	
Acceptable operating limits:		0 to +40	
Survival limits:		-40 to +80	
AFGL-701-15(PPS)		Degrees C	
	Pre-amps	Electronics	Boom Mech.
Preferred operating limits:	0 to +40	0 to +40	0 to +40
Acceptable operating limits:	0 to +40	0 to +40	0 to +40
Survival limits:	-40 to +60	-40 to +60	-40 to +60
<p>Note: The differential temperature between Pre-amps shall be less than 10° C.</p>			

## SECTION 7

### SCHEMATICS, DRAWINGS, AND WIRING DIAGRAMS

#### 7.0 Schematic Drawing of CRRES PPS Electronics

The following page contains a drawing of the CRRES PPS electronics. Subsequent pages contain lists of the drawings, schematics, and wiring diagrams from which the instrumentation described in this report was constructed. These drawings, schematics, and wiring diagrams are on file at the University of Iowa and copies of them have also been delivered to AFGL.



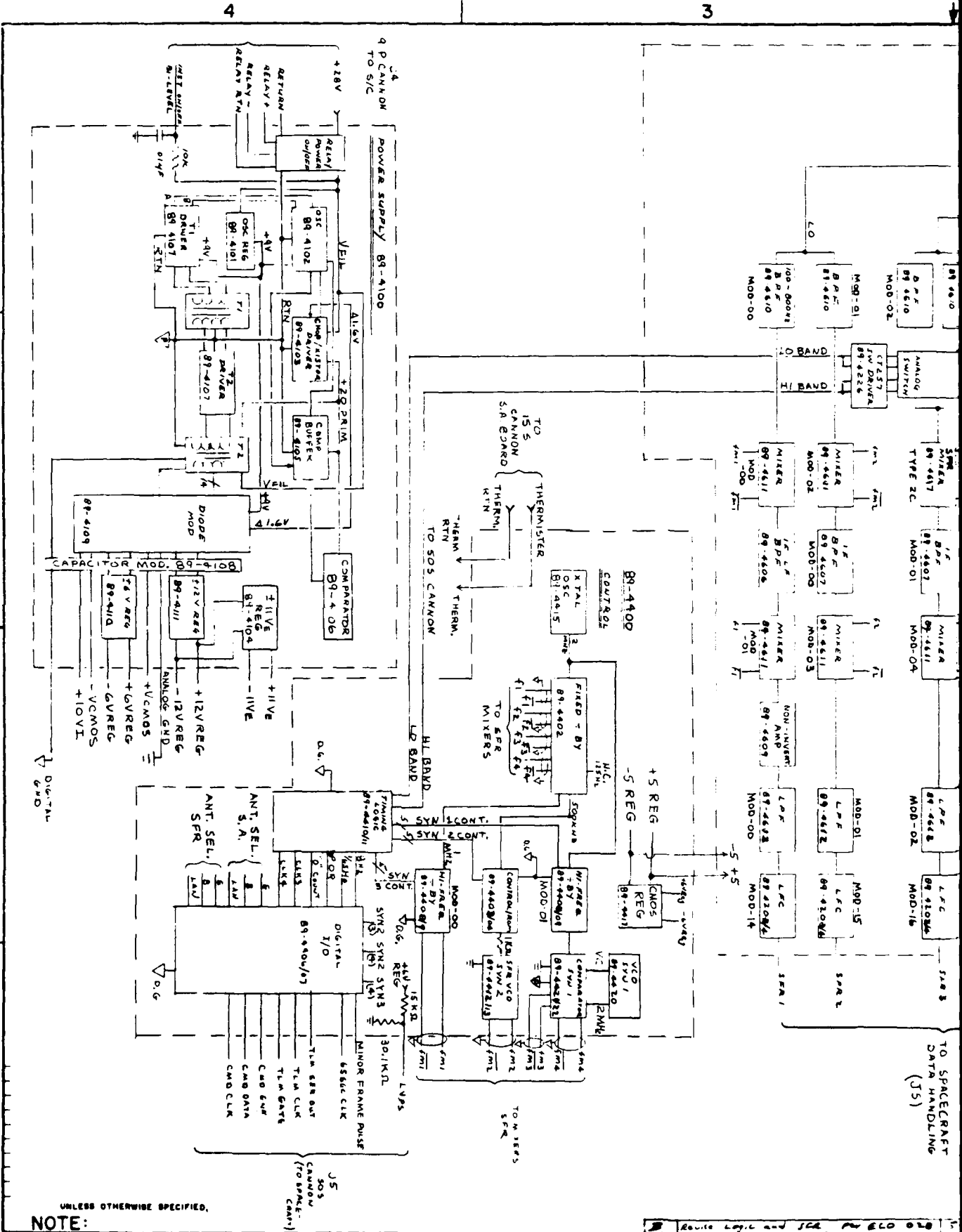

UNLESS OTHERWISE SPECIFIED, NOTE:

A

Route Logic and SFR to ELO 060

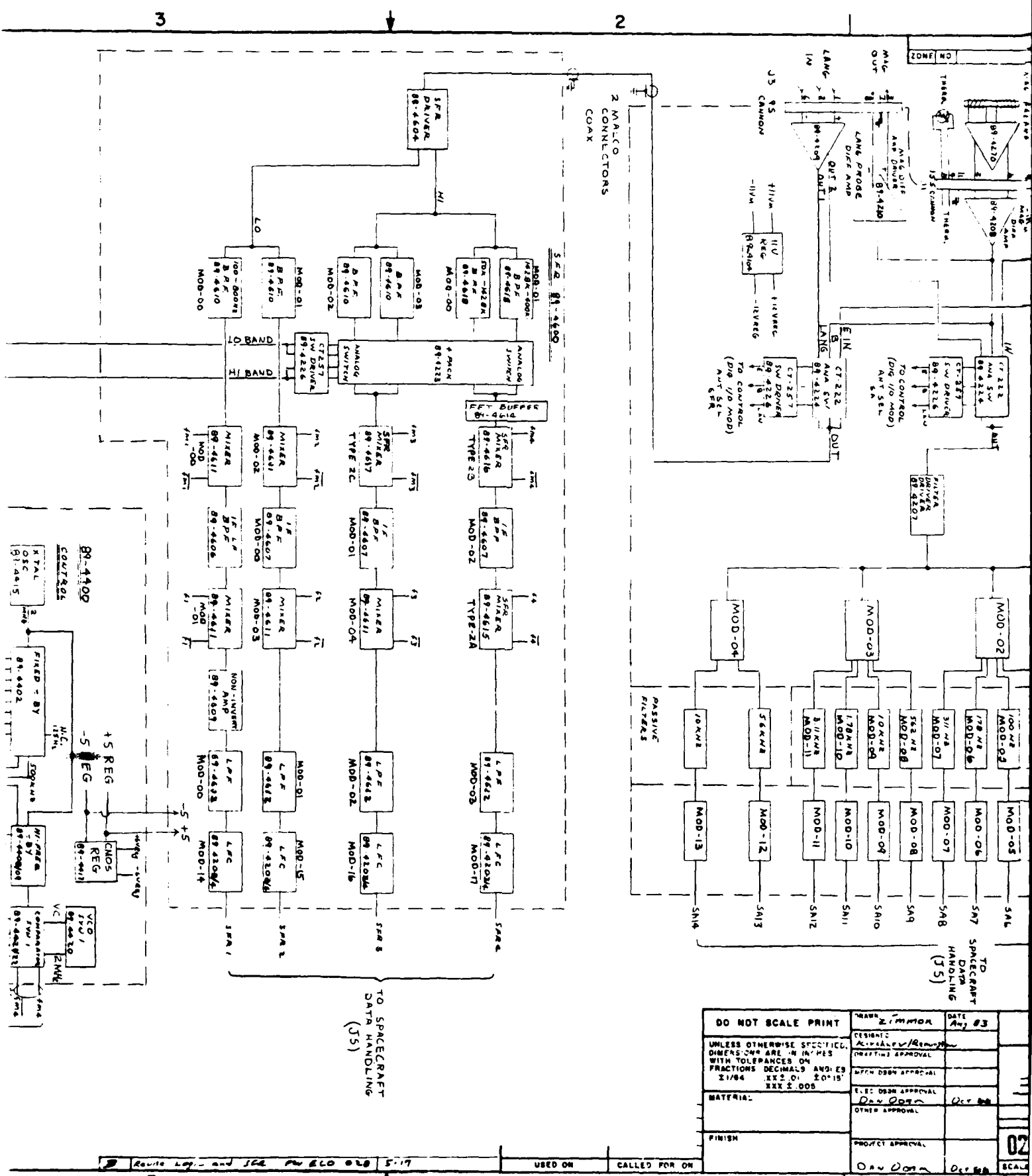

DO NOT SCALE PRINT	NAME: Zimmor	DATE: Aug 83
UNLESS OTHERWISE SPECIFIED, DIMENSIONS ARE IN INCHES WITH TOLERANCES ON FRACTIONS DECIMALS AND DEGREES 2/100 1/2 0.1 20'15" MAX 2.000	DESIGNER: [Signature]	DATE: [Signature]
MATERIAL:	ATCH DSBM APPROVAL:	ELEC DSBM APPROVAL:
FINISH:	OTHER APPROVAL:	PROJECT APPROVAL:
	DATE: [Signature]	DATE: [Signature]

3 Review Log - and See No ELO 020 5-17

2 USED ON CALLED FOR ON

02 SCALE

REVISIONS: SEE A-2,3

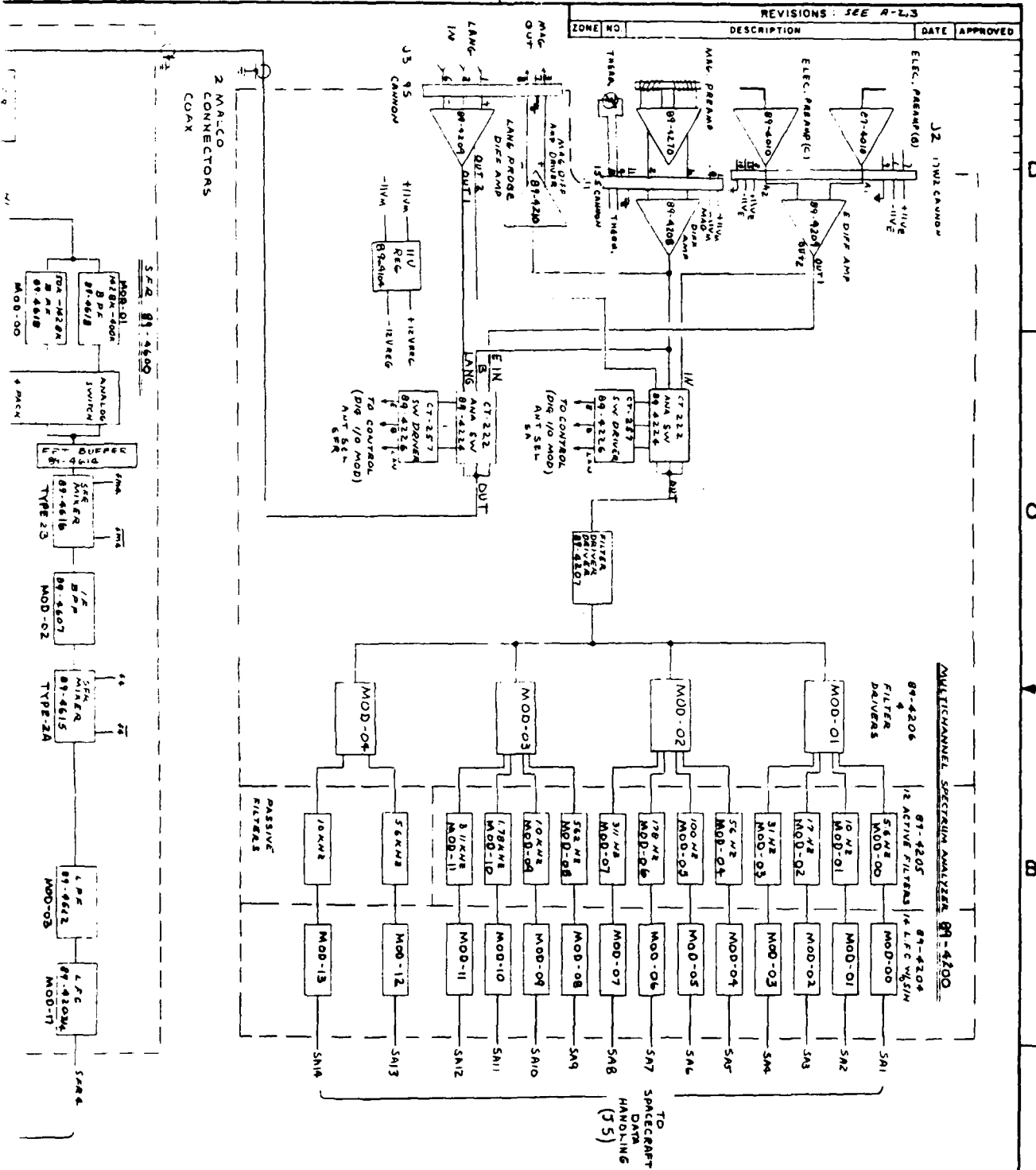

MULTICHANNEL SPECTRUM ANALYZER 89-4200

TO DATA HANDLING (75)

<p><b>DO NOT SCALE PRINT</b></p> <p>UNLESS OTHERWISE SPECIFIED, DIMENSIONS ARE IN INCHES WITH TOLERANCES ON FRACTIONS DECIMALS AND DEGREES</p> <p>1/16" ± .01 1/32" ± .01 XXX ± .005</p>	<p>DESIGNED: <i>Z. J. J. J.</i></p> <p>DRAWING APPROVAL: <i>[Signature]</i></p> <p>ELECT. DESIGN APPROVAL: <i>[Signature]</i></p> <p>OTHER APPROVAL: <i>[Signature]</i></p> <p>PROJECT APPROVAL: <i>[Signature]</i></p>	<p>DATE: <i>Aug 83</i></p>	<p>UNIVERSITY OF IOWA DEPT. OF PHYSICS &amp; ASTRONOMY IOWA CITY, IOWA</p>												
	<p><b>CRRES BLOCK DIAGRAM</b></p>			<p>DRAWING IDENTIFICATION</p> <table border="1"> <tr> <th>CON.</th> <th>REV.</th> <th>SIZE</th> <th>DESIGNATION</th> <th>TRV</th> </tr> <tr> <td>02542</td> <td>89</td> <td>D</td> <td>1000</td> <td>A</td> </tr> </table>		CON.	REV.	SIZE	DESIGNATION	TRV	02542	89	D	1000	A
	CON.	REV.	SIZE	DESIGNATION	TRV										
	02542	89	D	1000	A										
<p>SCALE: 1/1</p>			<p>WEIGHT: 2.9 g</p>												
<p>SHEET: 1 OF 1</p>															

USED ON \_\_\_\_\_ CALLED FOR ON \_\_\_\_\_

B.

C.

### 7.1 CRRES PPS Mechanical Drawings List

University of Iowa <u>Drawing Number</u>	<u>Title</u>
89-001-0	Housing, Electronics, Sh. 1
89-001-0	Housing, Electronics, Sh. 1
89-002-0	Heat Sink Mounting Plates Power Supply
89-003-0	Filter Conn. Location
89-004-0	Motherboard Templates
89-005-0	Connector Support Bracket - Logic
89-006-0	Housing, Electronics, Detail, Power Supply
89-007-0	Support Bracket, Connector
89-008-0	Grommet, Coax
89-009-0	Grommet, Wiring
89-010-3	Housing, Preamp
89-012-0	T1 Mounting Assembly
89-013-0	T2 Mounting Assembly
89-014-0	L3 Mounting Assembly
89-015-0	L4 Mounting Assembly
89-016-1	Filter Feedthru Connections
89-019-0	Post Standoff
89-0415-0	Radiation Shield, XTAL Osc

### 7.2 CRRES PPS Preamp Drawings List

University of Iowa <u>Drawing Number</u>	<u>Title</u>
89-4000-0	Preamp & Motherboard Assembly
89-4010-0	Long Electric Antenna

### 7.3 CRRES PPS Power Supply Drawings List

<u>University of Iowa</u> <u>Drawing Number</u>	<u>Title</u>
89-3100-2	Power Supply Block Diagram
89-4100-4	Power Supply Assembly
89-4100-1	Power Supply Wiring
89-4101-0	Input Filter & Osc. Reg.
89-4102-0	Oscillator
89-4103-0	Chopper Trans. Driver
89-4104-0	+11V Regulator
89-4105-0	Comparator Buffer
89-4106-0	Comparator
89-4107-1	T1 and T2 Driver
89-4108-1	Capacitor Module
89-4109-0	Diode Module
89-4110-0	$\pm 6V$ Regulator
89-4111-0	$\pm 12 V$ Power Filter
89-4112-0	Oscillator (Alternate)

#### 7.4 CRRES PPS Spectrum Analyzer Drawings List

University of Iowa <u>Drawing Number</u>	<u>Title</u>
89-3200-0	Spectrum Analyzer Block Diagram
89-4200-6	Spectrum Analyzer Motherboard Assembly
89-4200-5	Spectrum Analyzer Motherboard Wiring
89-4202-0	Sample & Hold
89-4204-0	Low Frequency Compressor
89-4205-0	Active Filter
89-4206-2	Filter Driver
89-4207-0	Filter Driver Driver
89-4208-2	Magnetic Diff. Amp
89-4209-2	Electric Diff. Amp
89-4210-3	Magnetic Diff. Amp Driver
89-4223-0	Analog Switches (4 pack)
89-4224-0	Analog Switches (3 pack)
89-4226	Analog Switch Driver

## 7.5 CRRES PPS Control Logic Drawings List

University of Iowa

Drawing Number

Title

89-3400-0	Control Logic Block Diagram
89-4400-2	Control Logic Motherboard Assembly
89-4400-2	Control Logic Motherboard Wiring
89-4402-0	Fixed Divide By
89-4404-0	Control Logic & ROM
89-3407-1	Digital I/O Schematic
89-4407-0	Digital I/O Assembly
89-4409-1	High Frequency Divide by Logic
89-3411-0	Timing Logic Schematic
89-4411-0	Timing Logic Assembly
89-4413-1	VCO SYN 2
89-4415-1	XTAL Osc. & Radiation Shield
89-4416-0	Sample & Hold Interface
89-4417-1	C-MOS Reg.
89-4420-2	VCO SYN 1
89-4422-0	Comparator SYN 1

## 7.6 CRRES PPS Sweep Frequency Receiver Drawings List

University of Iowa

Drawing Number

Title

89-3600-0	SFR Block Diagram
89-4600-2	SFR Motherboard Assembly
89-4600-2	SFR Motherboard Wiring
89-4604-1	SFR Driver
89-4606-0	IF Low Freq. BPF
89-4607-2	High Freq. IF BPF
89-4609-0	Non-Inverting Amp
89-4610-0	5 Pole Active BPF
89-4611-0	Low Frequency Mixer
89-4612-1	7 Pole Active LPF
89-4614-1	FET Buffer
89-4615-0	Mixer Type 2A 50 Hz to 200 Hz
89-4616-0	Mixer Type 2B 400 Hz to 2 MHz
89-4617-0	Mixer Type 2C
89-4618-0	High-Low BPF



7.7 CRRES PPS Project Documents Drawings List

University of Iowa

Drawing Number

Title

89-1000-0	CRRES Block Diagram
89-6002-1	Main Housing Outline
89-6003-0	Search Coil Outline
89-6007-0	DPU Timing Diagram
89-6008-0	Search Coil Housing Configuration
89-6010-0	Subcom Format
89-6011-0	Misc. Interface Circuits
89-6012-1	Preamp Housing Outline
89-6014-0	Reverse Voltage Protection
89-6015-0	Power Input Filter
89-6016-1	Pin Connections (Sheets 1 thru 8)
89-6017-0	Main Box Wiring & Assembly
89-6023-0	Assembly & Fabrication Notes

## SECTION 8

### PROBLEMS AND THEIR RESOLUTIONS

During system level thermal vacuum testing at AFGL high noise levels were observed on the high frequency SFR channels. Broken solder joints were found when the instrument was returned to Iowa for examination. The primary cause was determined to be excessive conformal coating under some of the modules. AFGL personnel participated in a meeting at Iowa where the problems and solutions were discussed in detail. All of the boards were examined and the excess conformal coating was removed wherever possible. All of the solder joints were examined and those showing signs of stress were resoldered.

During the next system level thermal vacuum test at AFGL the high noise levels in the SFR<sup>4</sup> channels reappeared at high temperature. Trouble shooting at Iowa identified the problem as an oscillation of the IF filter caused by the mutual coupling of two inductors. This coupling was a function of both the closeness of the inductors and temperature. The problem was solved by interchanging the position within the IF filter module of one of the inductors and a resistor. This repositioning increased the physical separation of the two inductors and thus decreased the mutual coupling. After this change was made, no oscillation of the IF filter was observed even at high temperatures.

During the trouble shooting for the SFR<sup>4</sup> noise problem, the -11 Volt supply for the Search Coil Magnetometer was accidentally shorted to ground. This stressed or damaged components in three modules. To repair the problem

we replaced two capacitors in the Langmuir Probe Diff amp module, rebuilt the 11 Volt filter module, and replaced the -11 Volt regulator pass transistor.

A memo from Dave Berrier at the Aerospace Corporation alerted us to potential problems with 1N5804 diodes. Our power supply electronics contained 21 diodes from the suspect lot. We removed all of the suspect diodes and replaced them with new ones from acceptable lots.

Small cracks were observed in the Search Coil Magnetometer structure near two of the mounting holes. After much analysis and discussion with AFGL, BASD, the Aerospace Corporation, and the Air Force Space Division it was finally decided that threaded brass rods were to be epoxied into the two mounting holes.

During a vibration test at AFGL, mounting hardware on one connector vibrated loose. New mounting hardware with locking washers was installed and the correct locking torque on all of the screws and bolts in the instrument was applied and verified. All of the mounting hardware was also spot bonded with Stycast 1095.

During EMC testing at BASD, significant conducted interference related to the Fairchild WADA antennas was observed. The source appeared to be the +28 V return line to the antennas. We proposed possible solutions but none were found acceptable because of large costs to implement the required changes or the added risk to the successful operation of the antennas they might pose.

## SECTION 9

### CONCLUSIONS AND RECOMMENDATIONS

We have designed, developed, constructed, tested, and delivered a Plasma Wave Experiment for CRRES that will adequately satisfy its intended objectives of characterizing the plasma wave environment in the radiation belts and determining the electron number density continuously over the range from  $10^{-2}$  to  $2 \times 10^3 \text{ cm}^{-3}$  using passive sounding techniques. If more funds, telemetry, and time had been available, two additions to the experiment would have made the experiment even better. One would be to add a second spectrum analyzer such that both the electric and magnetic fields could be sampled simultaneously. The other would be to have added an analog or digital wideband system such that significant amounts of waveform data could be collected in order to better identify the frequency-time characteristics of the plasma waves being observed.

During the EMC-RFI testing, a number of spacecraft and experiment boxes were shown to produce interference. Much more attention to reducing such interference needs to be paid from the very beginning of spacecraft projects. Another concern regarding the spacecraft is the inflexible telemetry format. It is unfortunate that provisions could not have been made to allow all of the experiments (both LEO and GTO) to obtain useful data simultaneously. A more flexible telemetry format would also allow reassigning telemetry space if one or more instruments lost the capability to provide useful data during the mission.