

DTIC FILE COPY

2

AD-A209 488

# NAVAL POSTGRADUATE SCHOOL

Monterey, California



**S** DTIC  
ELECTE  
JUN 29 1989  
**D** <sub>CS</sub> **D**

## THESIS

A SIMULATION OF SHIP SURVIVABILTY VERSUS  
RADAR DETECTION RANGES AGAINST  
LOW FLYING TARGET

by

WANG, Kuei-Min

March 1989

Thesis Advisor: Edward Rockower

Approved for public release; distribution is unlimited

89 6 28 042

REPORT DOCUMENTATION PAGE				Form Approved OMB No 0704-0188		
1a REPORT SECURITY CLASSIFICATION <b>Unclassified</b>			1b RESTRICTIVE MARKINGS			
2a SECURITY CLASSIFICATION AUTHORITY			3 DISTRIBUTION/AVAILABILITY OF REPORT <b>Approved for public release; Distribution is unlimited</b>			
2b DECLASSIFICATION/DOWNGRADING SCHEDULE						
4. PERFORMING ORGANIZATION REPORT NUMBER(S)			5 MONITORING ORGANIZATION REPORT NUMBER(S)			
6a. NAME OF PERFORMING ORGANIZATION <b>Naval Postgraduate School</b>		6b OFFICE SYMBOL (If applicable) <b>55</b>	7a NAME OF MONITORING ORGANIZATION <b>Naval Postgraduate School</b>			
6c. ADDRESS (City, State, and ZIP Code) <b>Monterey, California 93943-5000</b>			7b ADDRESS (City, State, and ZIP Code) <b>Monterey, California 93943-5000</b>			
8a. NAME OF FUNDING / SPONSORING ORGANIZATION		8b. OFFICE SYMBOL (If applicable)	9 PROCUREMENT INSTRUMENT IDENTIFICATION NUMBER			
8c. ADDRESS (City, State, and ZIP Code)			10 SOURCE OF FUNDING NUMBERS			
			PROGRAM ELEMENT NO	PROJECT NO	TASK NO	WORK UNIT ACCESSION NO
11. TITLE (Include Security Classification) <b>A SIMULATION OF SHIP SURVIVABILITY VERSUS RADAR DETECTION RANGES AGAINST LOW FLYING TARGET</b>						
12 PERSONAL AUTHOR(S) <b>WANG, Kuei-Min</b>						
13a TYPE OF REPORT <b>Master's thesis</b>		13b TIME COVERED FROM _____ TO _____		14 DATE OF REPORT (Year, Month, Day) <b>1989 March</b>	15 PAGE COUNT <b>94</b>	
16 SUPPLEMENTARY NOTATION <b>The views expressed in this thesis are those of the author and do not reflect the official policy or position of the Department of Defense or the U.S. Government</b>						
17 COSATI CODES			18 SUBJECT TERMS (Continue on reverse if necessary and identify by block number) <b>Survivability</b>			
FIELD	GROUP	SUB-GROUP				
19 ABSTRACT (Continue on reverse if necessary and identify by block number) <p>A simualtion is developed (System Performance Simulation or SPS) which models ship survivability under Surface-to-surface missiles' (SSM) saturation attack. Using this simulation, a plan of improving the weapon systems is developed for current naval ships. The plan is used in a stochastic model which predicts the results of the inner air battle, and is responsive to the attack and defense characteristics and variables.</p>						
20 DISTRIBUTION/AVAILABILITY OF ABSTRACT <input checked="" type="checkbox"/> UNCLASSIFIED/UNLIMITED <input type="checkbox"/> SAME AS RPT <input type="checkbox"/> DTIC USERS			21 ABSTRACT SECURITY CLASSIFICATION <b>Unclassified</b>			
22a NAME OF RESPONSIBLE INDIVIDUAL <b>Edward Rockower</b>			22b TELEPHONE (Include Area Code) <b>408-655-0116</b>		22c OFFICE SYMBOL <b>55Rf</b>	

Approved for public release; distribution unlimited.

A Simulation of Ship Survivability Versus Radar  
Detection Ranges Against Low Flying Target

by

Kuei Min Wang  
Lieutenant, Navy of Republic of China  
B.S., Naval Academy of Republic of China, 1981

Submitted in partial fulfillment of the  
requirements for the degree of

MASTER OF SCIENCE IN OPERATIONS RESEARCH

from the

NAVAL POSTGRADUATE SCHOOL  
March, 1989

Author:



Kuei Min Wang

Approved By:



Edward Rockower, Thesis Advisor

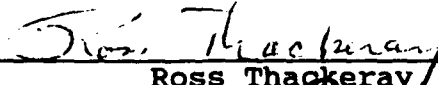

Ross Thackeray, Second Reader



Peter Purdue, Chairman, Department  
of Operations Research

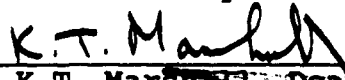

K.T. Marshall, Dean of Information  
and Policy Sciences

ABSTRACT

A simulation is developed (System Performance Simulation, or SPS) which models ship survivability under Surface-to-surface missiles' (SSM) saturation attack. Using this simulation, a plan of improving the weapon systems is developed for current naval ships. The plan is used in a stochastic model which predicts the results of the inner air battle, and is responsive to the attack and defense characteristics and variables.



Accession For	
NTIS CRA&I	<input checked="" type="checkbox"/>
DTIC TAB	<input type="checkbox"/>
Unannounced	<input type="checkbox"/>
Justification	
By	
Distribution/	
Availability Codes	
Dist	Avail and/or Special
A-1	

## TABLE OF CONTENTS

I.	INTRODUCTION.....	1
	A. BACKGROUND.....	1
	B. EQUIPPING THE WARSHIP.....	3
	C. ANTI-SHIP MISSILE DEFENSE COMPUTER SIMULATION.....	4
II.	SPS STRUCTURE.....	6
	A. THE MISSILE ENGAGEMENT IN THE REAL WORLD.....	6
	B. PURPOSE OF THE SIMULATION.....	7
	C. THE INTERACTION AREA.....	8
	D. BASIC NETWORK OF THE INTERACTION OF SSMS AND SAMS.....	11
	E. EVENTS AND ROUTINES.....	13
	1. Reload event.....	13
	2. intercept event.....	14
	3. Assessment event.....	15
	4. Statistics routine.....	15
	F. AAW DEFENSE SAM FIRING DOCTRINE.....	15
III.	SPS AND AAW DEFENSE PERFORMANCE.....	18
	A. ACCURACY OF SPS.....	18
	B. DEFENSE FIREPOWER.....	20
	1. Maximum firepower (MFP).....	20
	2. Analysis of the current AAW performance...	29
IV.	SPS WITH THE MODIFICATION PLAN.....	31
	A. THE PLAN OF IMPROVING THE AAW WEAPON SYSTEM...	31

B.	IMPROVING SYSTEM REACTION TIME.....	34
C.	IMPROVING SAM'S PK VALUE FROM 0.3 TO 0.5.....	34
D.	IMPROVING PK VALUE FROM 0.5 TO 0.7.....	43
V.	CLOSE-IN RANGE DEFENSE.....	45
A.	THE CLOSE-IN WEAPON SYSTEM.....	45
1.	Operation of CIWS.....	45
2.	Pk of the CIWS.....	46
B.	INTERGRATED PERFORMANCE OF THE SAM SYSTEM AND CIWS.....	46
C.	FINAL ANALYSIS OF THE AAW WEAPON SYSTEM'S PERFORMANCE.....	52
D.	SEQUENTIAL ATTACKING SSM'S SCENARIO.....	58
VI.	CONCLUSIONS.....	60
	APPENDIX A.....	62
	APPENDIX B.....	63
	APPENDIX C.....	77
	APPENDIX D.....	81
	LIST OF REFERENCES.....	82
	INITIAL DISTRIBUTION LIST.....	83

LIST OF TABLES

TABLE I. SAMPLE SIZE IN TERMS OF THE ESTIMATED SHIP SURVIVABILITY.....20

TABLE II. THE MAXIMUM FIREPOWER AND FIREPOWER.....30

TABLE III. THE DEFINITION OF EACH STATE.....34

TABLE IV. THE EQUATION OF PREDICTING THE PK OF THE CIWS.....48

## LIST OF FIGURES

Figure 1.	Four inbound SSMS attacking a frigate.....	10
Figure 2.	The network of SSMS and SAMs interaction ....	12
Figure 3.	Maximum firepower of the original AAW weapon system.....	23
Figure 4.	The AAW operation and maximum firepower at 30 NMs detection range.....	24
Figure 5.	The AAW operation and maximum firepower at 25 NMs detection range.....	25
Figure 6.	The AAW operation and maximum firepower at 20 NMs detection range.....	26
Figure 7.	The AAW operation and maximum firepower at 15 NMs detection range.....	27
Figure 8.	The AAW operation and maximum firepower at 10 NMs detection range.....	28
Figure 9.	Interaction of SAMs and SSMS.....	30
Figure 10.	The plan for improving the AAW performance...	33
Figure 11.	The comparison of the maximum firepowers.....	35
Figure 12.	The firepower after the second state.....	36
Figure 13.	Ship survivability at the first two states...	37
Figure 14.	Interaction of SAMs and SSMS.....	39
Figure 15.	The leakers in the first three states.....	40
Figure 16.	The firepower of the first three states.....	41
Figure 17.	The ship survivability.....	42
Figure 18.	The interaction in the first three states....	44
Figure 19.	The pk value of the CIWS.....	47
Figure 20.	The expected leakers in the fourth and the fifth states.....	49



Figure 21.	The survivability of the last two states.....	50
Figure 22.	The upgraded degree of the survivability in the last state.....	51
Figure 23.	The AAW performance in state five.....	53
Figure 24.	The AAW performance in state one.....	54
Figure 25.	The ratio of leaker in each state.....	55
Figure 26.	Ship survivability of the five states for five detection ranges.....	56
Figure 27.	Expected number of SSMS killed by the CIWS at each detection range.....	57
Figure 28.	The improved weapon system vs. four sequential attacking SSMS.....	59

## I. INTRODUCTION

### A. BACKGROUND

Isolated and exposed on the open seas, surface fleets in the 20th century have proved increasingly vulnerable to a succession of ever more sophisticated attacks from the air.<sup>1</sup>

However, the dream of turning the medium size ship into the master of the modern war is now approaching reality. By means of advanced technologies and improved ship building industries, increasingly sophisticated weapon systems are installed on board the warships.

Unlike the battleships in World War II, the armor of the current destroyers and frigates is less than one inch thick and is not able to sustain several, or even one successful air or surface attack. Any type of munitions, such as bombs from an airplane or surface-to-surface missiles could cause a disaster to the ship.

During the Falklands War in 1982, the British Frigate Sheffield was sunk by an Exocet missile which was fired from 40 miles away. It is obvious that the missile technology is now sophisticated enough to make ships more vulnerable, and

---

<sup>1</sup>Time, June 1, 1988, p.23.

the Sheffield incident confirms that it is difficult to harden smaller surface ships to survive missile attacks.

The surface-to-surface missiles(SSM) could be fired from the surface, the air and under water. The SSM platform could be a ten thousand ton warship, a 50 ton fast attack missile-craft(FAC), a specific aircraft, or submarines. Since the new missiles are so accurate and powerful that they can cause great damage, a FAC challenge to a big warship is becoming possible. Unless the warship has a capable defense system, the swarming SSMS from the FACs over the horizon will eliminate their target completely.

For the navies of the third world nations, a modern fleet is too expensive to maintain, but they still need a sea power strong enough to protect themselves from their enemies. The cheapest way to achieve this is to build a modern FAC force, which could displace from 50 tons to 500 tons and be armed with four or more SSMS and other weapons. If the effective fire range of the SSMS is over 50 NMs and the enemy has no air force superiority, these small forces would be hard to detect by the enemy's warship. This means the SSM attack from the FACs may well come as a surprise and the warship is at greater risk than ever.

The USS Stark incident, which happened on May 17, 1987, is another case of air-to-surface missiles (ASM) engagement.

The Stark did not activate its missile defenses and was seriously damaged as a result of the attack of two Aerospatiale AM39 Exocet ASMs launched by the Iraqi Dassault-Breguet Mirage F1 fighters. Under normal circumstances, the Stark weapon systems could have had an excellent chance of defeating the ASM attack.

One scenario is drawn from the Stark incident. The airplane, or the surface ship, launches SSMS and then maneuvers away, so the target ship does not have a chance to shoot down the airplane before the SSMS are fired. At this time, the only thing the warship can do is to defend itself from the inbound SSMS. The situation has then become what is often called an inner air battle.

#### B. EQUIPPING THE WARSHIP

There are many countries that have ex-US Destroyers (DD), Patrol Frigates (PF), and other old ships, most of which are undergoing renovations to prolong their lives and to improve their sensors and weapon systems for future use. Some of these countries are trying to replace their ex-US warships with more capable medium size warships.

Whatever these countries are doing, the trend that seems to lead all the navies is to build some type of ships which have sophisticated sensors, modernized weapon systems and advanced ship design. This type of warship is expected to

not only carry out multiple missions to save government expense, but also to have increased survivability in combat.

Because the final attack is delivered by missiles, in the Anti Air Warfare (AAW) area, the potential threat could come from the air, the surface or subsurface platforms. With the Stark incident in mind, the naval authorities would like to know what survivability their current warships have when faced with a sudden missile attack, and what would happen to the survivability if the enemy launches a saturation attack? If the ship's performance cannot satisfy the survivability requirement, what enhancement of the AAW weapon systems is needed? In other words, in order to improve the survivability, which part of the weapon system can be improved or what new weapon can be added to the original SAM (Surface to Air Missile) system with the given budget?

#### C. ANTI-SHIP MISSILE DEFENSE COMPUTER SIMULATION.

As an aid in answering the questions raised above, a System Performance Simulation (SPS<sup>2</sup>) has been created. SPS is able to estimate ship survivability based on the weapon systems on board, and indicate the way to improve the ship survivability. It can also help to develop the tactics for

---

<sup>2</sup>Please see Appendix B for the computer program of SPS and Appendix C for the output table.

the employment of defensive systems which have various characteristics.

The anti-air-warfare oriented SPS is a probabilistic event store computer simulation of the interactions between a SAM system and multiple surface to surface missiles. It was developed as a Monte Carlo computer simulation which requires a relatively large number of computer runs, and a certain number of external calculations, but it uses only a relatively modest amount of running time on an IBM AT type computer. The basic operational modeling of the SSM/SAM(surface-to-air missile) duel, the data required to characterize both offensive and defensive systems performance and tactics, and the computer implementation of the model as a simulation are described in the next chapters.

## II. SPS STRUCTURE

### A. THE MISSILE ENGAGEMENT IN THE REAL WORLD

When the attacking platforms are approaching the target ship, two conditions may appear: one is that the attacking platforms are detected by the electronic warfare(EW) and the radar systems of the target ship and are themselves attacked, the other one is that the platforms fire at the target and maneuver away without any problem. In the time the attacking platforms are detected by the ship prior to firing their SSMS, the target ship may be able to fire at them with long range SAMs or SSMS. If the ship does not have the long range SAMs to engage the attacking platforms, then the ship can activate the EW system to interfere with the initial firing. The EW system may have the chance to create a false ship image on the attacking platforms' radar. This image could mislead the SSMS. In such a situation, the target ship may have a higher survivability. If the SSMS are fired from the attacking platform without being jammed, in other words, if the attacking platforms are not detected by the target ship before the SSMS are fired, and provided that the sea condition is so good that these SSMS could be detected by the ship's sensors at some range, the ship must then engage them directly. The engagement includes the AAW weapon system reaction event and ship's maneuvering right after the SSMS are detected. The

number of defense layers depends on the weapon systems on the ship. Generally speaking, the medium range defense relies on SAMs. The medium caliber guns such as 76 mm or 5" gun, and close in weapon system such as phalanx can take the close range defense. The two layer defense systems mentioned above is the "hardkill". As for the "softkill" systems such as chaff launchers, they could also help to mislead the attacking SSMs. A number of factors can influence the ship's effective defense in the real battle scenario, such as weather, sea condition, sensors, EW system, effective intercept range of the weapon on ship, degree of the air cover by the fighters, alert status of the ship (e.g. general quarters), personnel's physical condition and level of the personnel training. These factors may bring different consequences.

#### B. PURPOSE OF THE SIMULATION

As mentioned earlier, the real SSM engagement is extremely complicated because many factors are involved. Computer simulation is able to simulate the operations of the real SSM engagements with a detailed and extensive computer model.

The main objective of this simulation is more limited than in the reality. It is to estimate the ship survivability in a small saturation SSM attack. The deterministic assumptions of the radar detection range, the effectiveness of sensors and weapon system, the single shot kill probability (pk) value of



SAM and SSM, the sea condition, the personnel training level etc. can therefore be used to simplify the computer simulation model. With these simulation output data, the basic analysis of the 12ship survivability can be obtained. The operation of this model will be discussed in the following sections.

### C. THE INTERACTION AREA

The geometry of the first scenario used in the SPS is illustrated in Figure 1. The simulation is initiated by the detection of four SSMS approaching the target ship simultaneously. The defending SAM system includes a search radar, two fire control radars(FCR) and one SAM launcher.

The inbound SSMS are assumed be detected at the ranges 30, 20, 15 or 10 NMs. As soon as the SSMS are detected, the SAM system starts reacting. The reaction time from detection to launch (given a load launcher) is assumed to be either 30 or 20 seconds. During the initial reaction time, the first SAM is loaded, the system is relaying the detection signal to the FCRs for lock-on of two of the intruders and the computer system is computing the data which is needed to fire the SAM. Then, the first SAM is launched at the first target which is locked on by FCR1. Five seconds later the second SAM is loaded and fired at the second target that is locked on by FCR2. The third SAM is loaded right after the second SAM has been fired. After these two targets are intercepted by two SAMs, the SAM

system needs another eight seconds to assess the result of the interception. If the kill has been confirmed, the SAM system then starts the same steps on the remaining SSMS. Otherwise, it will immediately reattacks the survivor(s) of the first two intercepts. This constitutes a shoot-look-shoot doctrine.

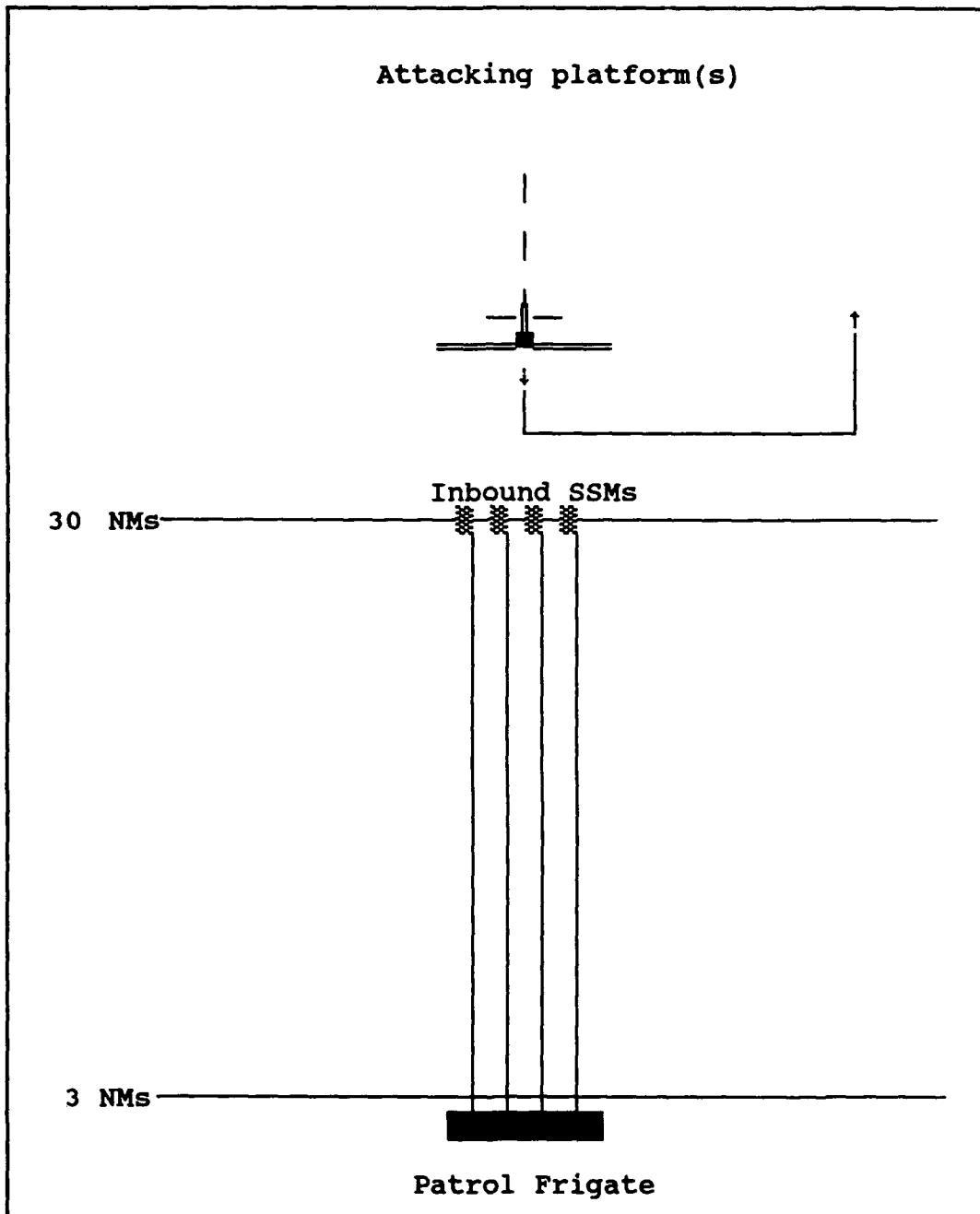

**Figure 1.** Four inbound SSMs attacking a Frigate.

#### D. BASIC NETWORK OF THE INTERACTION OF SSMs AND SAMs

The basic concept of simulating the interactions of SSM and SAM is contained in a network, as shown in Figure 2. The network is built of nodes which show the possible sequences of events as the SAMs shoot down the SSMs in a series of firings. If the first set of two firings shoots down two SSMs, the second series will have only two targets. If the first series fails, there will be four, and so on.

Since there are four incoming SSMs initially, the first node is represented by "1234". The meanings of the other nodes are as followed:

"34": The first and second SSM are shot down; the two FCRs are shifted to the third and the fourth SSMs. The engagement is continuous.

"234": The first SSM is deleted; then FCR 1 is shifted to the third SSM that is locked right away. The second SSM survives the first SAM. Hence FCR 2 keeps tracking the second SSM while second SAM is fired at it.

"134": The SAM does not shoot down the first SSM. So FCR 1 has to keep tracking it and another SAM is fired after the assessment. (The assessment event will be explained in the next section.)

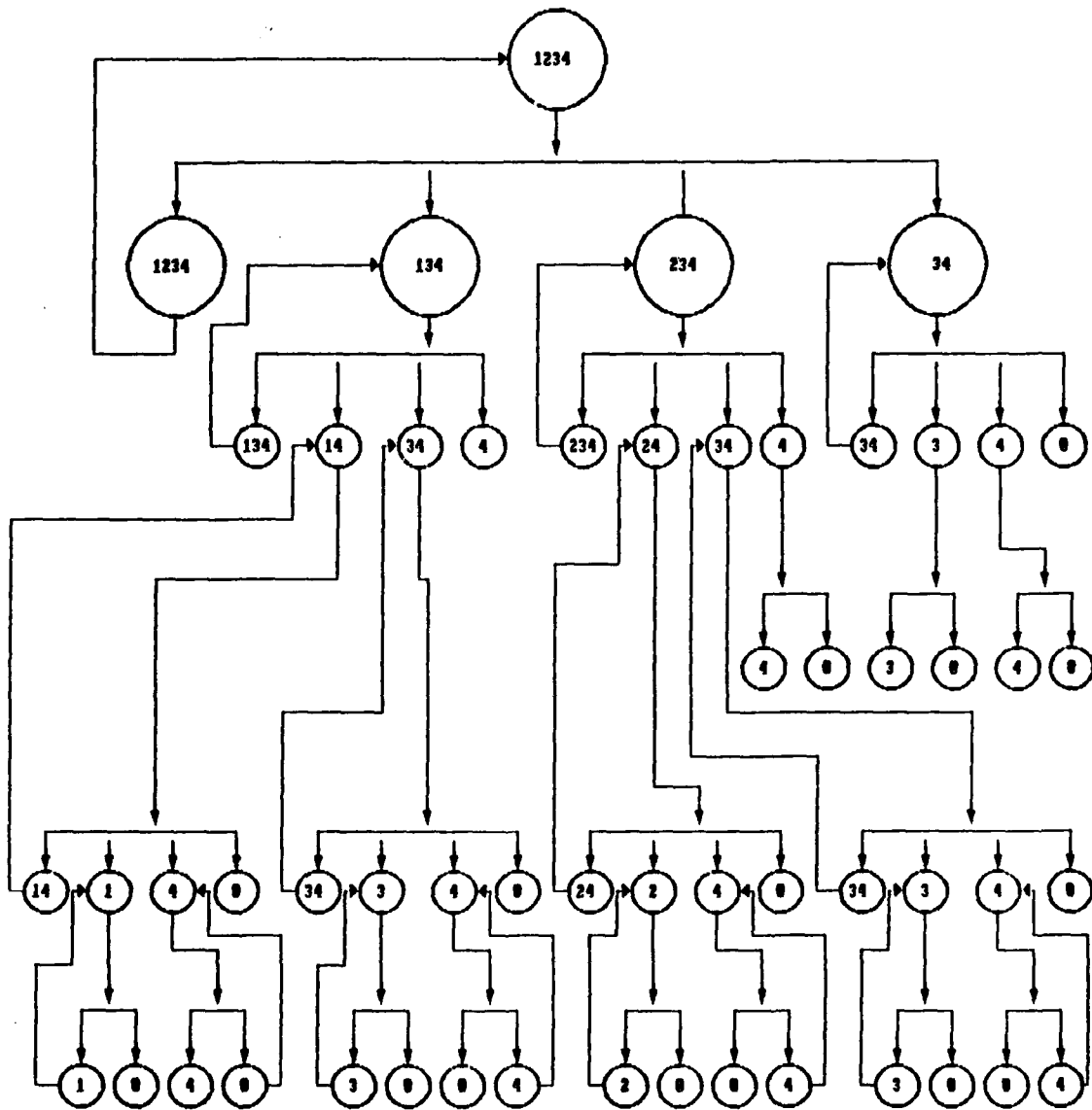

**Figure 2.** The network of SSMs and SAMs interaction.

"14": The first SSM survives SAM defense, but FCR 1 still keeps tracking it, and another SAM is fired at it.

FCR 2 tracks the fourth SSM after the third one is shot down.

"24": The second SSM leaks through SAM defense. So another SAM is fired at it after the assessment. FCR 1 is shifted to the fourth SSM from the two deleted SSMS which are the first and the third SSMS.

"1": The first SSM is the only one that survives. FCR 1 still tracks this SSM and a SAM is fired at it.

"2": It is the same situation as "1" except for the SSM and the tracking FCR.

"3 and 4": The third SSM survives, but which FCR is tracking it depends on which SSM is shot down first in the earlier engagements.

#### E. EVENTS AND ROUTINES

##### 1. Reload event:

Since the single missile launcher needs 5 seconds reloading time to load the next SAM, the whole system is not able to fire the next SAM unless the launcher is ready. So whenever the target is locked on by the FCR, the SAM system

must check the missile launcher to see if the standby SAM is ready on the launcher, and the time of firing of the SAM is the time the SAM system and launcher system are both ready.

2. Intercept event:

Impact time and intercept distance will be calculated in this event. When the SAMs are fired toward the inbound SSMS, the equation of finding the impact time and intercept distance is the following:

$D_{TGT}$ : the current distance from the SSM at detection.

T: the current clocktime at detection.

$S_1$ : speed of SAM.

$S_2$ : speed of SSM.

Equation of the impact time (IT):

$$IT = [D_{TGT} / (S_1 + S_2)] + T$$

Equation of the impact distance (ID):

$$ID = (IT) \times S_2.$$

In this event, it is necessary to check if the intercept range is within the minimum intercept range, which is 3 NMs. If the intercept range is within three NMs, none of the SAMs can be fired from the ship, because the gyro of the

SAM would not stabilize to function well until the SAM has flown a certain minimum distance.

3. Assessment event:

The assumed assessment time is eight seconds.

In this event, the SSMS' position and time after the assessment would be updated, and the uniformly distributed random number is generated for deciding if the intercepted SSM is eliminated or not, based on the pk assumed for the run.

4. Statistics routine:

After each iteration is completed, the SPS arrives at the statistics routine, which will calculate and update the expected number of SAMs fired, the expected number of SSMS that have been shot down, the expected number of SSMS leaking through the SAMs' defense and the ship survivability. These calculations and updating procedures will repeat until the last loop and last iteration is finished.

F. AAW DEFENSE SAM FIRING DOCTRINE

"In sea battle, defense is usually weaker."<sup>3</sup>

In a hostile situation, more than one wave of attack from the enemy is expected. Therefore, in terms of endurance, it is not rational for a single ship to exhaust its missiles

---

<sup>3</sup>Wayne P. Hughes, fleet tactics, p. 143.



simply for countering the first wave of attack, and not considering the ensuing attacks. For example, in the October War of 1973, the Egyptian SSMs had approximately two times the range of that of Israel's SSMs. The Israelis FACs were still able to approach the Egyptians craft, inducing the Egyptians to exhaust their missiles ineffectively. On the other hand, it is too expensive to have a large number of missiles on board. For these reasons, the optimal firing doctrine with effective firepower is desired to apply , not only to decrease the ship vulnerability, but also to save the number of SAM missiles for the next expected engagement. That is one of the important considerations during the AAW defense, hence the different firing doctrines need to be considered in different circumstances. "Shoot-look-shoot-shoot" and "shoot-look-salvo" have higher probability to shoot down incoming targets than the doctrine of "shoot-look-shoot". These doctrines are worth using for the battle group or the task group to secure the HVU (high value unit). Albeit that some SAMs could be wasted, it is possible for the ship to replenish SAMs from a supply ship or other ships.

With the limited amount of SAMs and the other ammunition on board, although "the defense is usually weaker", the sole patrol frigate is still expected to survive of the first several waves of air attack. In this case, due to the battle

life of a single ship, the mentioned doctrines are not able to conserve SAMs for the ship. Instead of using the first two firing doctrines, the "shoot-look-shoot" could be the optimal firing doctrine in single ship defense. "Shoot-look-shoot" is the firing doctrine that is able to continue firing the SAM and assessing the result of the intercept until the target is eliminated.

In SPS, the simplifying assumptions limit the number of missiles fired to, perhaps, a maximum of seven . Therefore it is not important to test, at each firing, for missile availability. However, because of the need to conserve missiles in larger engagements, the average number of missiles fired in each run of the SPS is recorded.

### III. SPS AND AAW DEFENSE PERFORMANCE

#### A. Accuracy of SPS

In the planning stage of this research the sample size must be decided. While time and cost have to be taken into account, the decision is based on how large an error we are willing to tolerate in the estimate of a target ship survivability. Since SPS is not a large model, it does not take a long computer run time in an AT type computer. Therefore, a maximum error of the ship survivability of 0.01 is able to be chosen in SPS. According to the maximum error of 0.01, the sample size of SPS is determined by the following:

$N$  = number of iterations.

$e$  = error, which is 0.01.

$\sigma^2$  = population variance.

$\alpha$  = 0.05, which is significance level =  $p(\text{type 1 error}) = p(\text{reject null hypothesis} \mid \text{null hypothesis is true})$ .

$Z_{\alpha/2}$  = critical value.

$p$  = population proportion, which is the estimate ship survivability in the model.

The sample size with accuracy 0.01 is drawn from the following formula<sup>4</sup>:

$$N = ( Z_{\alpha/2} \times \sigma^2 / e )^2$$

Since the standard deviation of the parent binary population is  $\sigma = [p(1-p)]^{0.5}$ , the expression for the needed sample size becomes

$$N = (Z_{\alpha/2} \times \sigma^2 / e)^2 = (Z_{\alpha/2} / e)^2 \times p \times (1-p)$$

Let the estimated ship survivability(SS) be 0.01, then the sample is (when rounded up)

$$N = (1.96 / 0.01)^2 \times 0.01 \times (1 - 0.01) = 380.32$$

So that the estimated SS at different range are illustrated in table I. The largest sample size is selected from the table I, which can create the output data within 0.01 accuracy.

#### B. Defense firepower

The original AAW weapon system on board has two fire

---

<sup>4</sup>Jerry Banks and John S. Carson, II. "Discrete-event system simulation", p.427.

**Table I. SAMPLE SIZE IN TERMS OF THE ESTIMATED SHIP SURVIVABILITY.**

Est. SS	0.01	0.02	0.08	0.17	0.18
Sample size	381	753	2828	5421	5671
Est. SS	0.25	0.48	0.64	0.74	
Sample size	7203	9589	8852	7392	

control radars, one single rail launcher, 30 seconds reaction time and 0.3 pk value of SAM. The assumptions of the ship's AAW weapon systems and the engagement scenario in Appendix A.

1. Maximum firepower (MFP)

During the engagement, an utmost performance of the weapon system must be achieved to defend itself or defend the task force from the attackers. The firepower is a basic way to evaluate the weapon system's performance.

To make effective use of SAM-equipped ships in screening a convoy or task force from air attack (either aircraft or missiles), a method of determining the effect of various ship dispositions on the overall AAW-ASMD screen effectiveness is necessary. One model that can be used in determining effectiveness is called a firepower analyzer. This model simply determines the number of shots (or salvos) a SAM ship can get off at a given air target as a function of the target's closest point of approach (CPA) to the SAM ship. The number of shots that the SAM ship can fire during the time the target is within range is a function of maximum SAM range, target speed, SAM speed, SAM refire rate and

the SAM ship firing doctrine.<sup>5</sup>

One thing in SPS that is different from the above description is that inbound targets are "home-all-the-way" toward the ship instead of passing by the ship. There is no CPA that relates to the ship. In this case, the maximum firepower is the effective measurement to evaluate the system's utmost performance. In other words, the maximum firepower is the maximum number of SAMs that can be fired from the ship at the given target detection range during the engaging time, i.e., once the incoming targets are detected by the ship's search radar, the defense system starts reacting, the launcher starts loading a SAM, the system computer begins to compute the targets' future position that allows the FCRs to track and to lock on the targets. When the first two targets are locked on, two SAMs are fired in sequence. Due to the "shoot-look-shoot" firing doctrine, two FCRs have to keep tracking the targets until the kill assessment is made by the system.

To analyze the maximum firepower, the SAM's pk value is always assumed to be 1, with which the analysis is able to point out the number of SAMs that can be launched at the four targets. For this reason, the FCR is automatically shifted

---

<sup>5</sup> NAVAL OPERATIONS ANALYSIS, p. 228.

to the next flying target after the assessment event, and the engaging procedure is the same as before until the last target is wiped out from the air, or the intercept range is equal or less than the minimum intercept range. Note that "maximum" in MFP is a reference to the fact that MFP is the maximum number of SSMS that could ideally be destroyed if  $p_k$  were one. Later, firepower (FP) refers to the number of SAMs that could be launched, hence FP can exceed MFP.

The maximum firepower of the current AAW weapon system in operational scenario is shown in Figure 3.

The number of SAMs that can be fired at the SSMS is directly proportional to the detection range. Hence when the radar detection range decreases, the maximum firepower decreases as well. Observe Figures 4, 5, 6, 7 and 8, each coordinate represents "(time, range)". "M.I.R" represents the minimum intercept range of the SAM. The line which is marked as "FOUR ATTACKING SSMS" is the flight route of the inbound SSMS. The start point of this line is the time and range, when and where the target ship detects the four attacking missiles. The end of this line is the time the ship is hit. The line of "SAM1" represents the first SAM fired at one of the SSMS from the coordinate of the X-axis. The coordinate where the two lines meet is the impact point of the SAM and SSMS. As long as this coordinate is under the line of

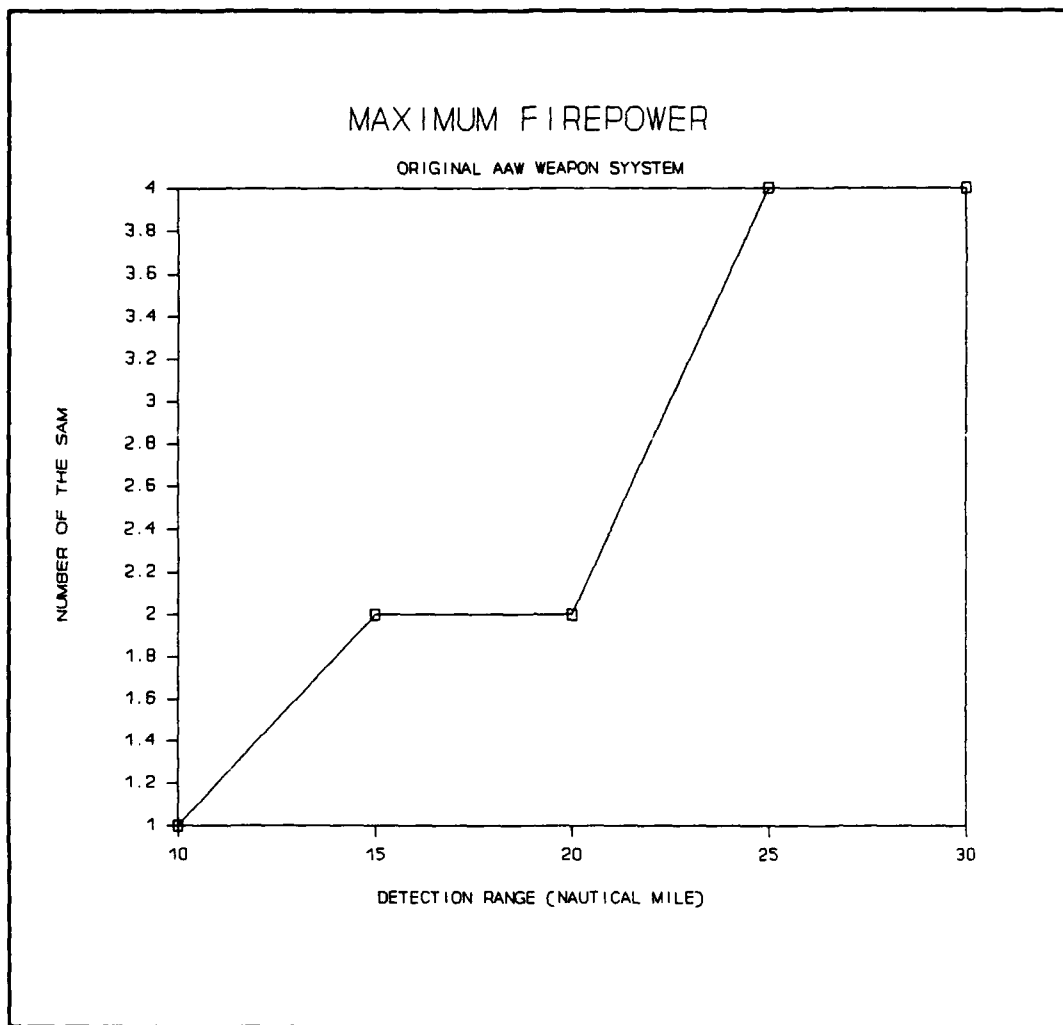
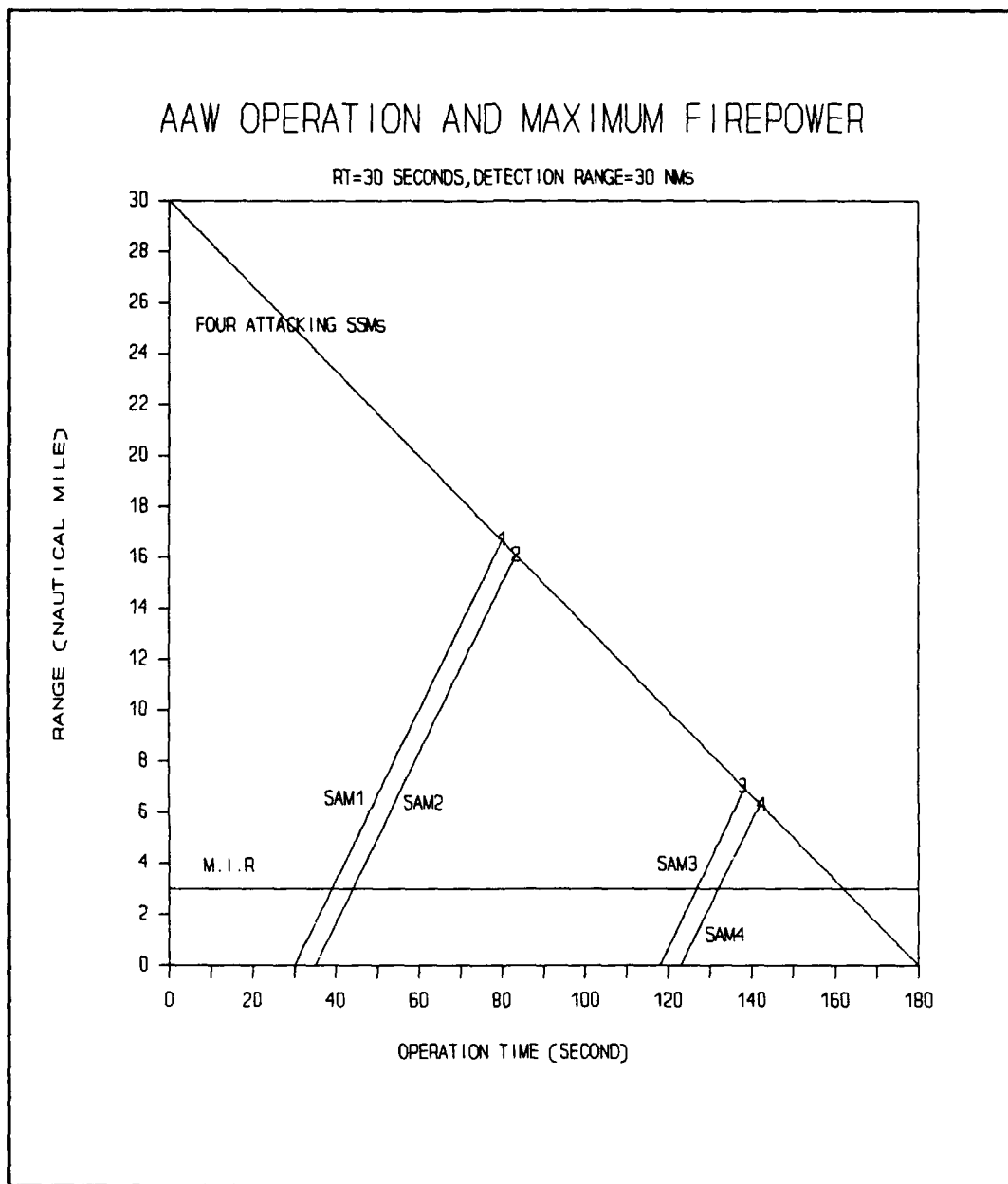

Figure 3. Maximum firepower of the original AAW weapon system.

"M.I.R", the SAM cannot be fired effectively and would not be counted into the maximum firepower.





**Figure 4.** The AAW operation and maximum firepower at 30 NMs detection range.

Impact point: "1"=(80, 16.67), "2"=(83.33, 16.11),

"3"=(138.1, 6.9), "4"=(142, 6.33).

The maximum firepower is four.

## AAW OPERATION AND MAXIMUM FIREPOWER

RT=30 SECONDS, DETECTION RANGE=25 NMS

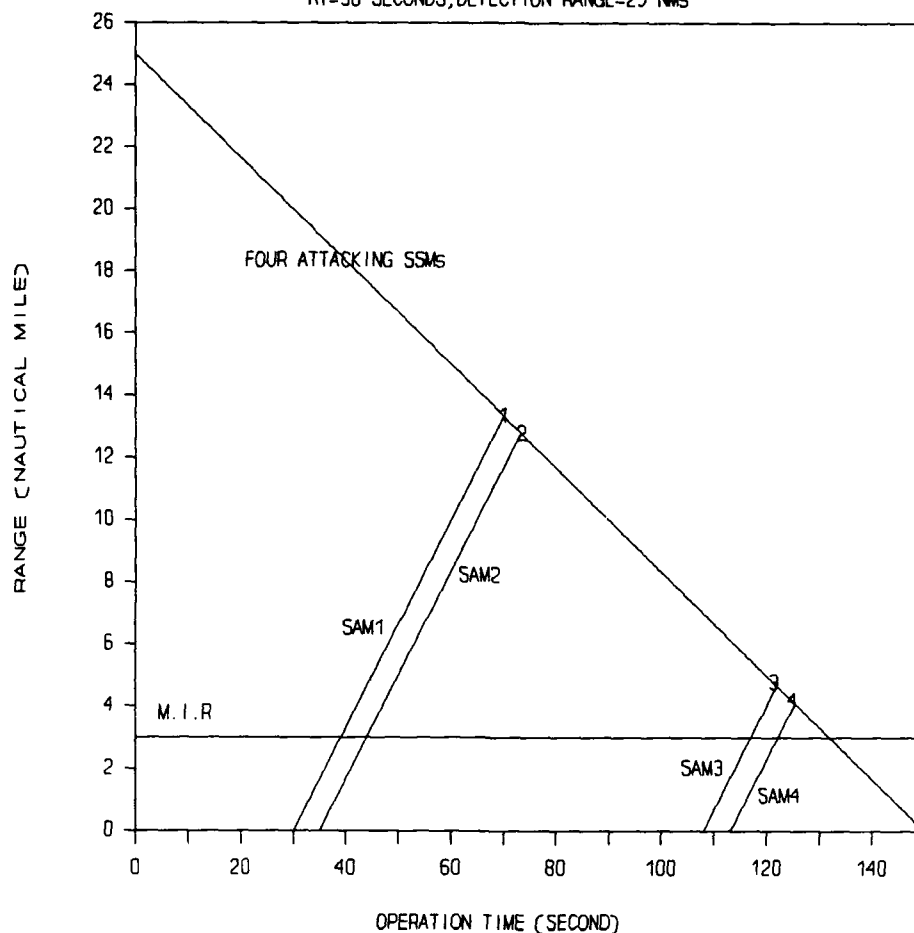

**Figure 5.** The AAW operation and maximum firepower at 25 NMs detection range.

Impact point: "1"=(70, 13.33), "2"=(73.33, 12.78),  
 "3"=(122, 4.67), "4"=(125.33, 4.11).

Maximum firepower is four.

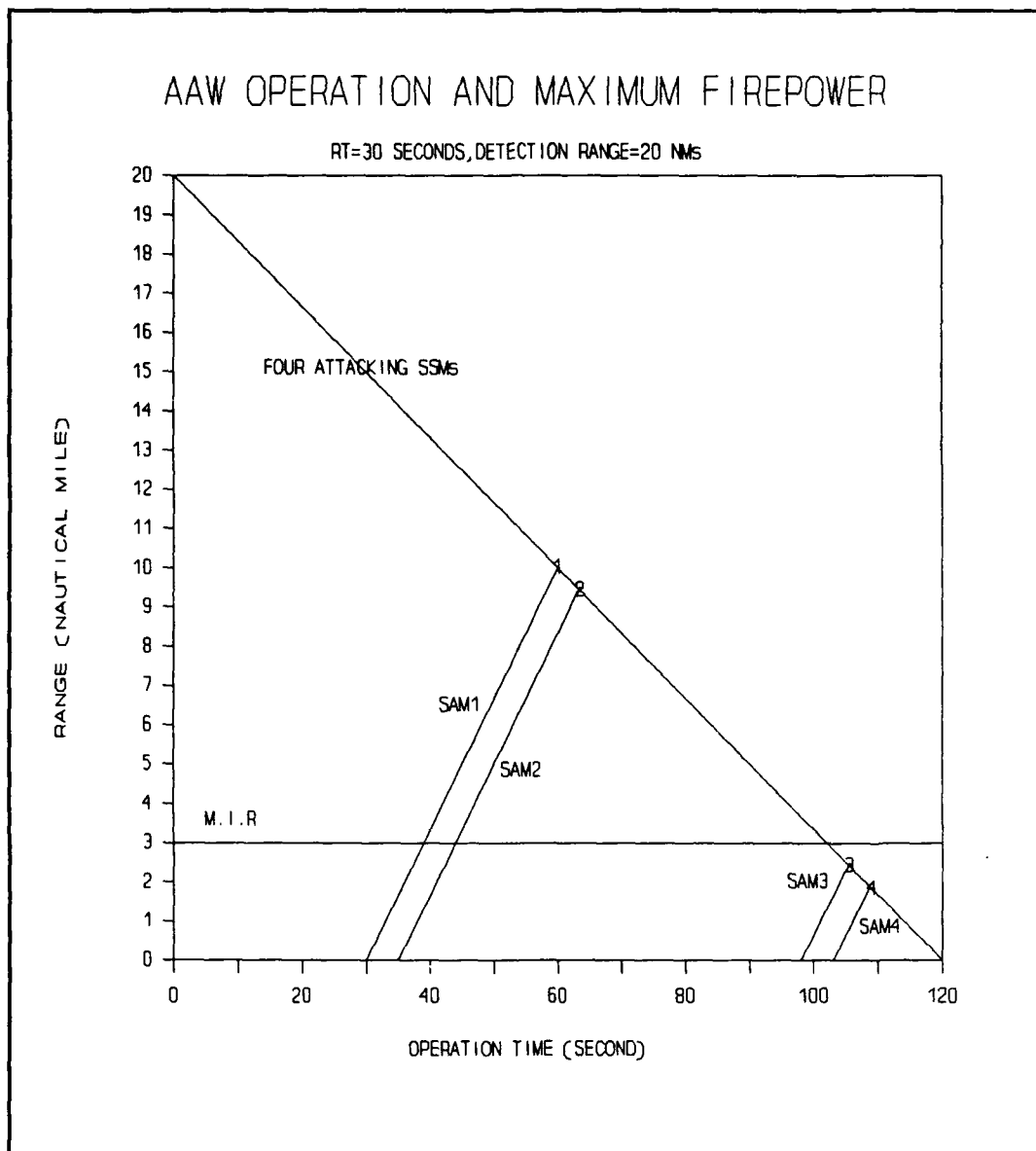

**Figure 6.** The AAW operation and maximum firepower at 20 NMs detection range.  
 Impact point: "1"=(60, 10), "2"=(63.33, 9.44),  
                   "3"=(105.33, 2.44), "4"=(108.67, 1.89).  
 "3" and "4" are not effective, thus the maximum firepower is two.

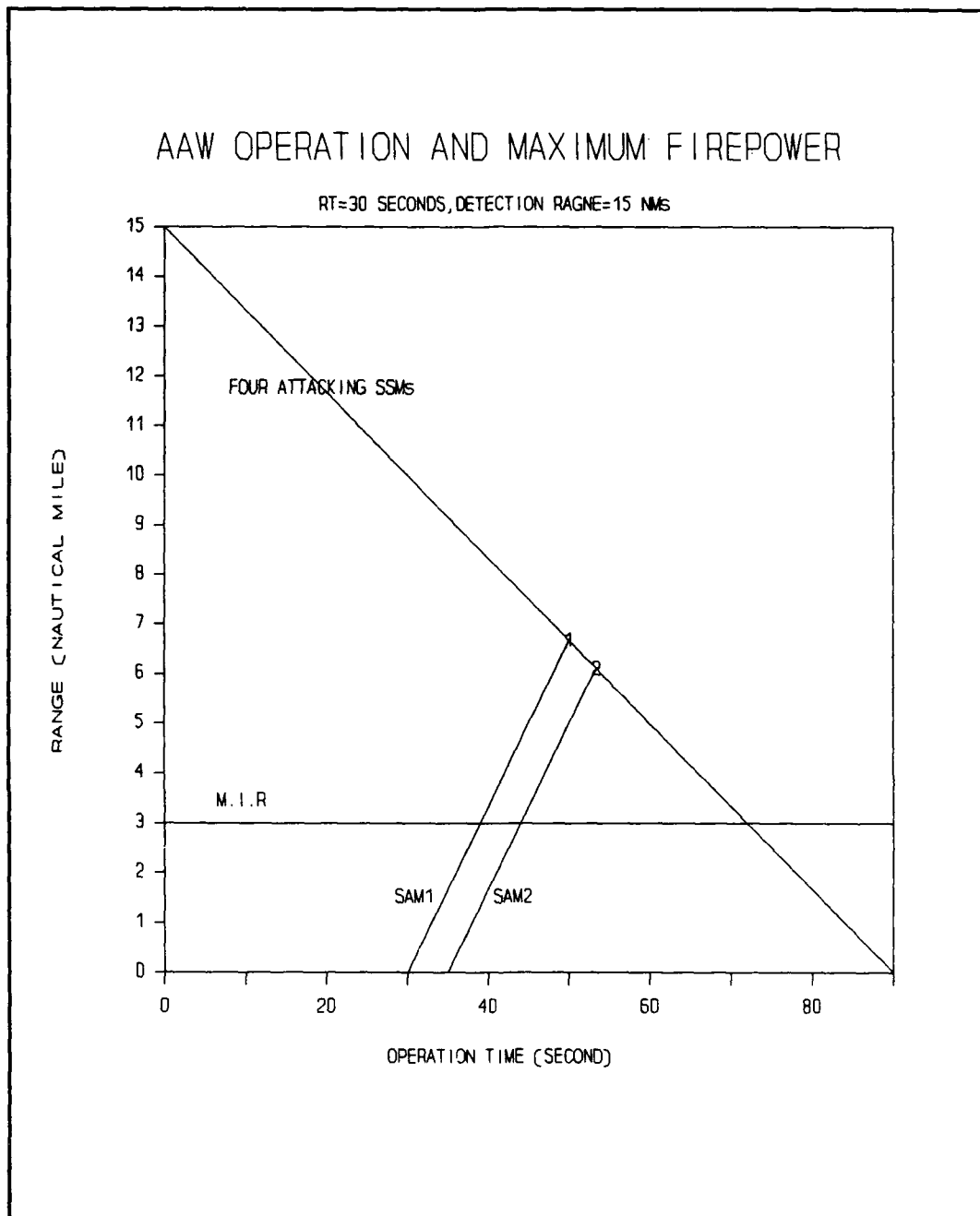

**Figure 7.** The AAW operation and maximum firepower at 15 NMs detection range.  
 Impact point: "1"=(50, 6.67), "2"=(53.33, 6.11).  
 Maximum firepower is two.

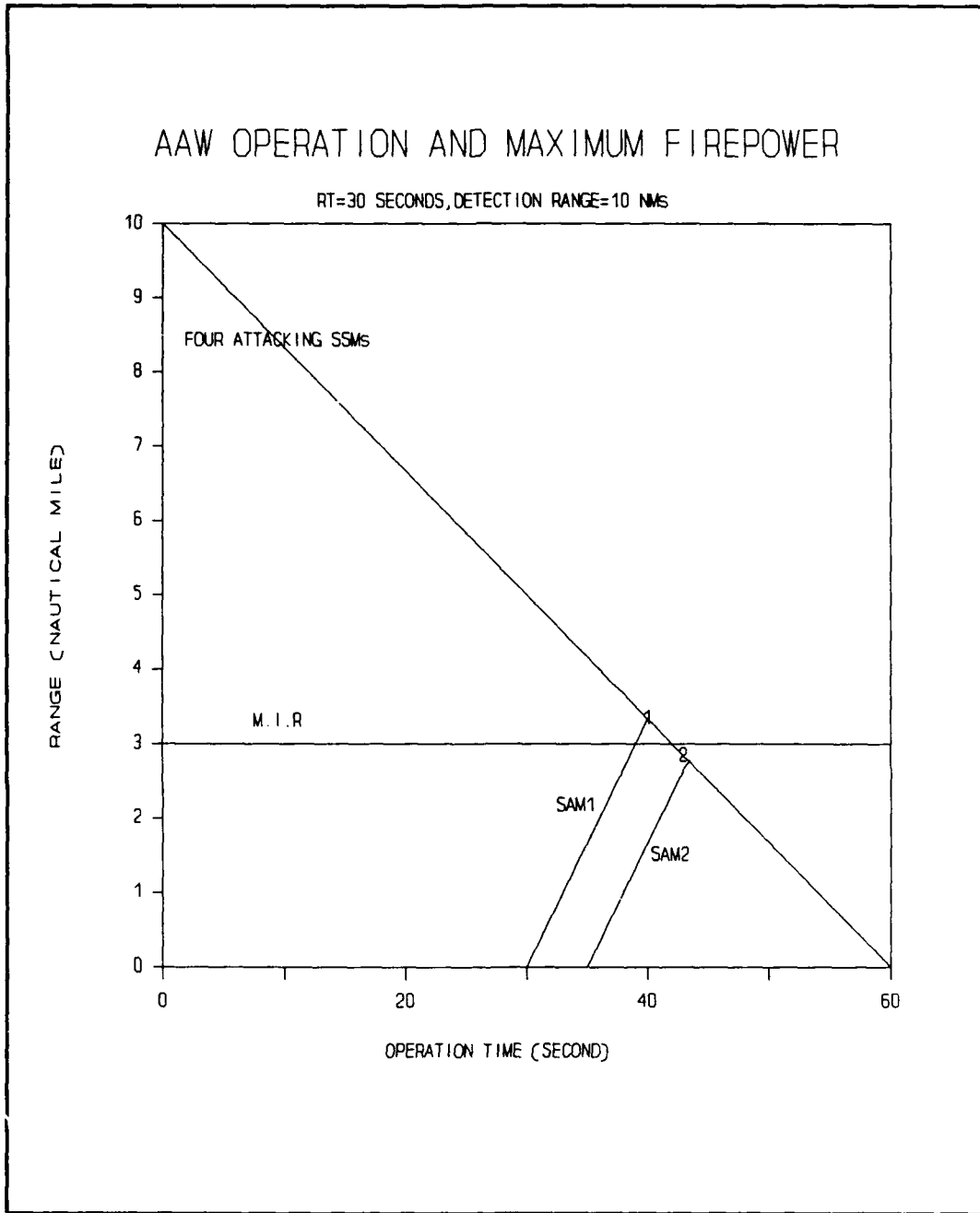

**Figure 8.** The AAW operation and maximum firepower at 10 NMs detection range.  
 Impact point: "1"=(40, 3.33), "2"=(43.33, 2.78).  
 Maximum firepower is one.

## 2. Analysis of the current AAW performance

Firepower is different from maximum firepower because in the original system the pk value is less than 1.0 and hence different from the one in maximum firepower. Therefore, the engaging scenario is no longer one SAM to each SSM. It could be several SAMs vs. one SSM. The miss probability of the SAM does not allow the system to shift its FCRs away from the still surviving target, locked on by an FCR to another target, which would take extra time to reengage the surviving target. Thus the right way to do this is to keep shooting the same target until it is shot down or the targets are within the minimum intercept range. If there is only one attacking target, the firepower would be high enough to give a relatively high ship survivability. The survivability is nearly zero as the adversary launches a four SSM saturation attack. The reasons for that would include the pk of the SAM and the system and the detection range. A discussion of the relative importance of these factors will be found in the next chapter.

The maximum firepower and the firepower of the current system at each detection range is demonstrated in table II. The interaction of the ship firepower and the attacking SSMs is presented in Figure 9 in which the expected leakers decrease as the firepower goes up.

**Table II. THE MAXIMUM FIREPOWER AND FIREPOWER.**

	Detection range (NMs)				
	10	15	20	25	27
M.F.P*	1	2	2	4	4
F.P*	1	2.91	3.81	5.57	6.14

\* M.F.P: Maximum firepower.

F.P: Firepower.

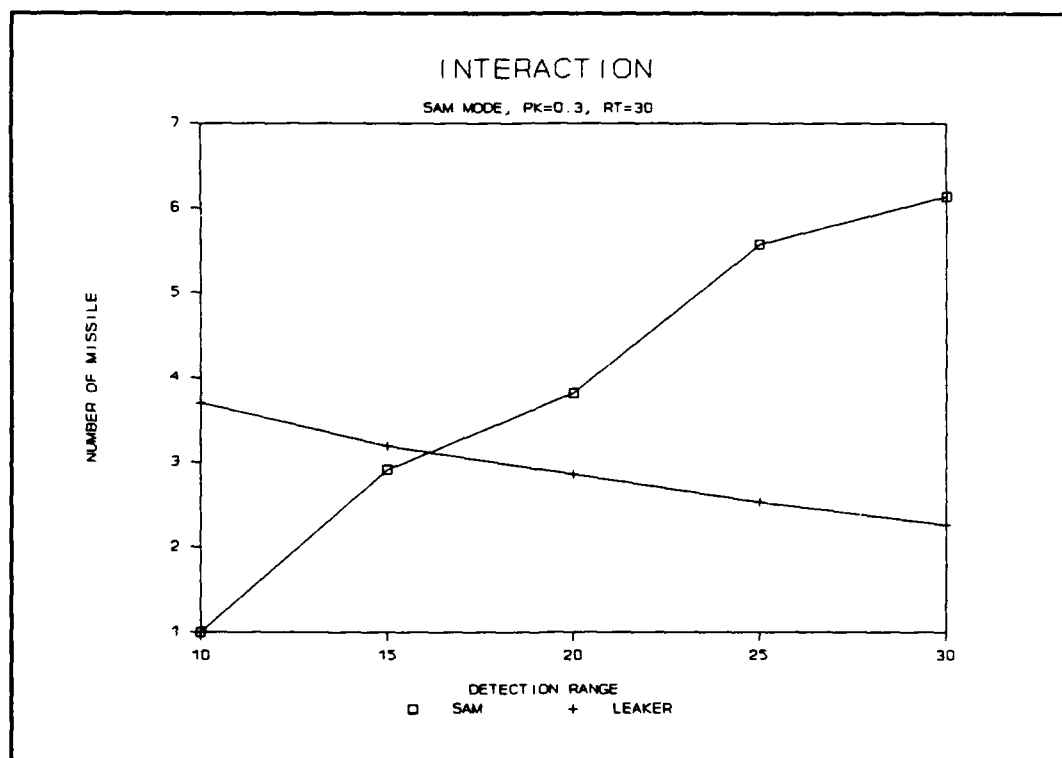

**Figure 9. Interaction of SAMs and SSMs**

#### IV. SPS WITH THE MODIFICATION PLAN

##### A. THE PLAN OF IMPROVING THE AAW WEAPON SYSTEM

Many nations that own ex-US warships cannot afford to replace their current warships with more advanced ones because of the limited budget. Thus the optimal plan will be improving the current AAW weapon system in the most inexpensive way possible to have ship survivability upgraded at least to 0.15, 0.60 and 0.70 at the detection range of 20, 25 and 30 NMs. The improvement plan includes the software and the mechanics of the weapon system. The former consists of computer processing speed which is related to the system reaction time, and the assessing speed. The latter comprises launcher's loading speed, the speed and pk value of the SAM, as well as the effective intercept range.

Since the performance of the mechanical part has been designed to its fullest capacity, a simple small upgrading change will be both costly and mechanically difficult. Take the reloading time of the missile launcher for instance, it is difficult to reduce it from the current five seconds to three or two seconds. The job would entail extensive mechanical overhaul and great expense without gaining much advancement on the performance. As for increasing the speed of the SAM, both the dynamic system and the material strength of the SAM would have to be modified. The price tag for such



modification could be very high. Finally, in order to expand the intercept range of SAM, extra fuel capacity and an updated gyrocompass would be added to prolong the maximum intercept range and to lessen the minimum intercept range. This is also expensive. Therefore the improvement plan shown in Figure 10 is preferred.

As Figure 10 shows, the inexpensive way in the plan is to work on the software part. The first step is the modification of the reaction time that can increase the maximum firepower and firepower. The next step is the improvement of SAM's pk value. Two states are involved in this step : upgrading the pk value from 0.3 to 0.5, and from 0.5 to 0.7. As the pk value hits 0.7, the cost of additional upgrading would become unbearable. If the final performance of the system is still unsatisfactory, then the third step should integrate the SAM system with pk value 0.7 with close in weapon system (CIWS). The CIWS is an independent system which has its own tracking radar, data processing component and the ability of assessing the intercept result. Details on CIWS will be discussed later. The following sections will discuss the medium range AAW defense performance which is the first line of defense for the ship and introduction of the close in defense will be in the next chapter.

"w" in the flow represents the ship survivability at ranges of 20, 25 and 30 NMs to achieve 0.15, 0.63 and 0.73.

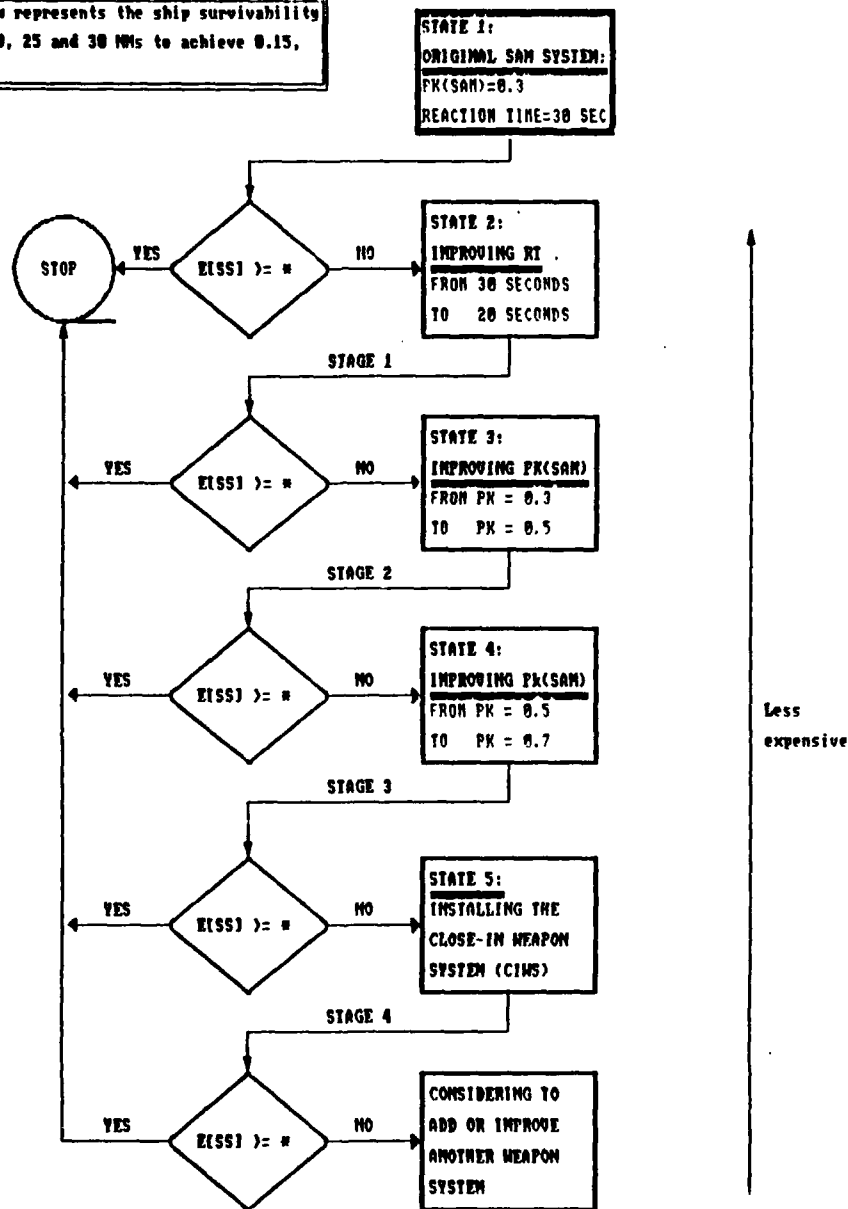

Figure 10. The plan for improving the AAW performance

In the improvement plan, there are five states defined in the following table:

**Table III THE DEFINITION OF EACH STATE.**

state	pk	reaction time	CIWS
1	0.3	30	NO
2	0.3	20	NO
3	0.5	20	NO
4	0.7	20	NO
5	0.7	20	YES

**B. IMPROVING SYSTEM REACTION TIME**

The alternative to increasing the survivability by improving the pk is to expand the system's maximum firepower which increases the number of shots that can be fired at an attacking missile, and hence increases the probability of hitting the targets. The limit of reaction time can be extended to 20 seconds from 30 seconds. Figure 11 shows the maximum firepower is doubled at the detection range 10 NMs and 20 NMs when the reaction time reaches 20 seconds. The firepower with 20 and 30 seconds reaction time at the pk equals to 0.3, is demonstrated in Figure 12.

In Figure 12, the third curve representing "difference" points out the tendencies of firepower differences between

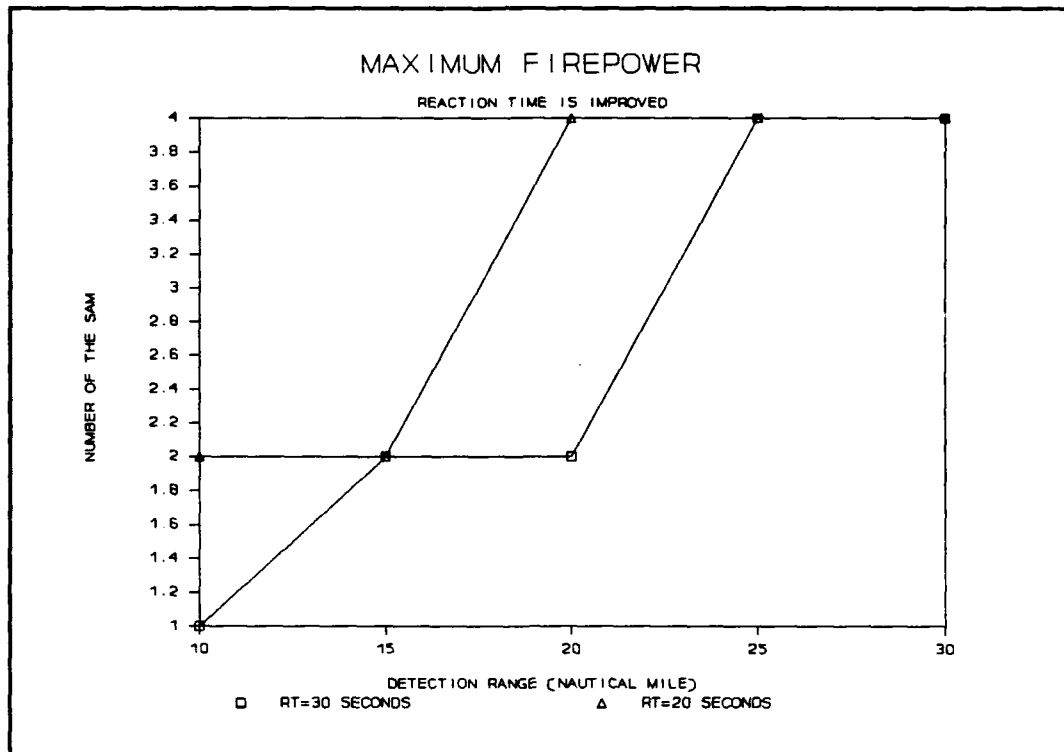

**Figure 11.** The comparison of the maximum firepowers.

the two reaction times. Between 10 NMs and 25 NMs of the detection range, "difference" declines but goes up after 25 NMs. Evidently, the firepower is improved after the system reaction time is reduced. Moreover, the "difference" curve shows, as expected, that the smaller the detection range is, the bigger the gap between 20 seconds and 30 seconds is and the more the firepower will be.

However, such improvement will not change the ship survivability too much because SAM's pk value is still too small. Higher firepower has a higher probability to shoot down one SSM, but in four SSMs situation, higher firepower with

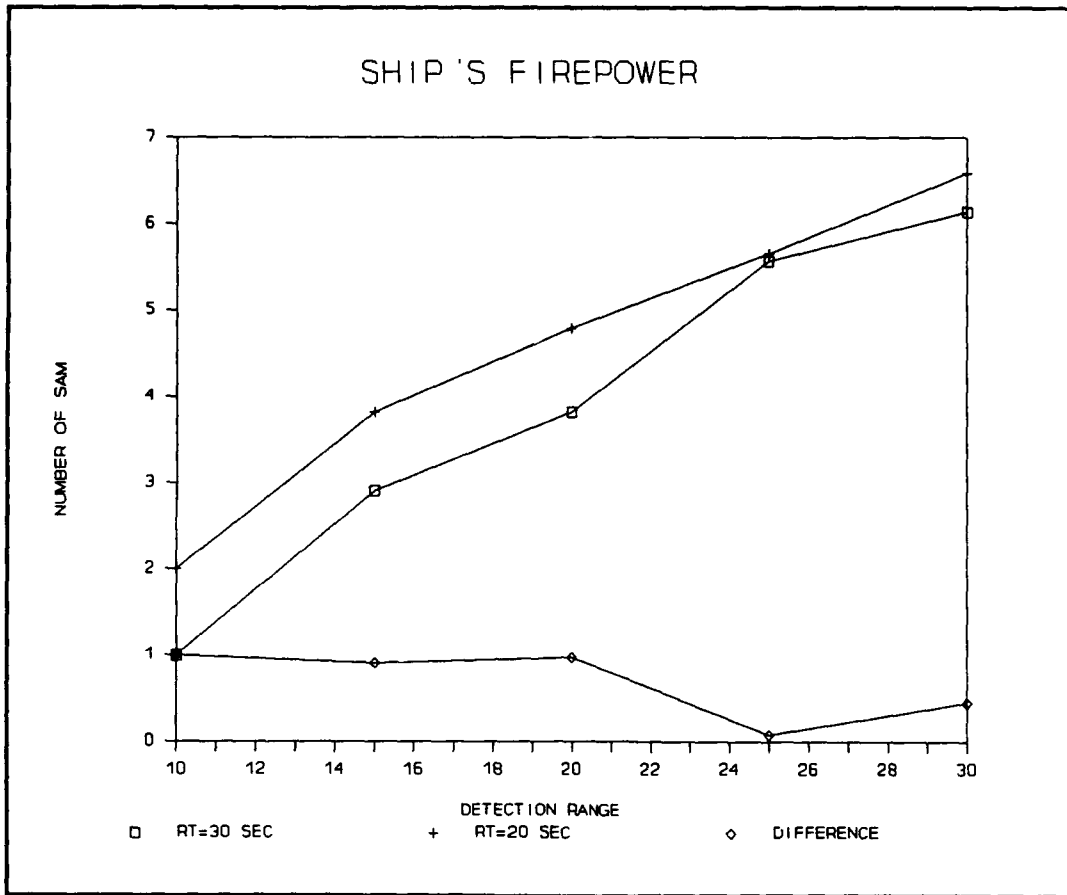

**Figure 12.** The firepower after the second state.

lower SAM's pk value gives almost no chance of the target ship surviving. This is shown in Figure 13. For example, at detection range 20 NMs, the firepower is increased from 3.82 to 4.79 (Figure 12), but the survivability is not changed (Figure 13).

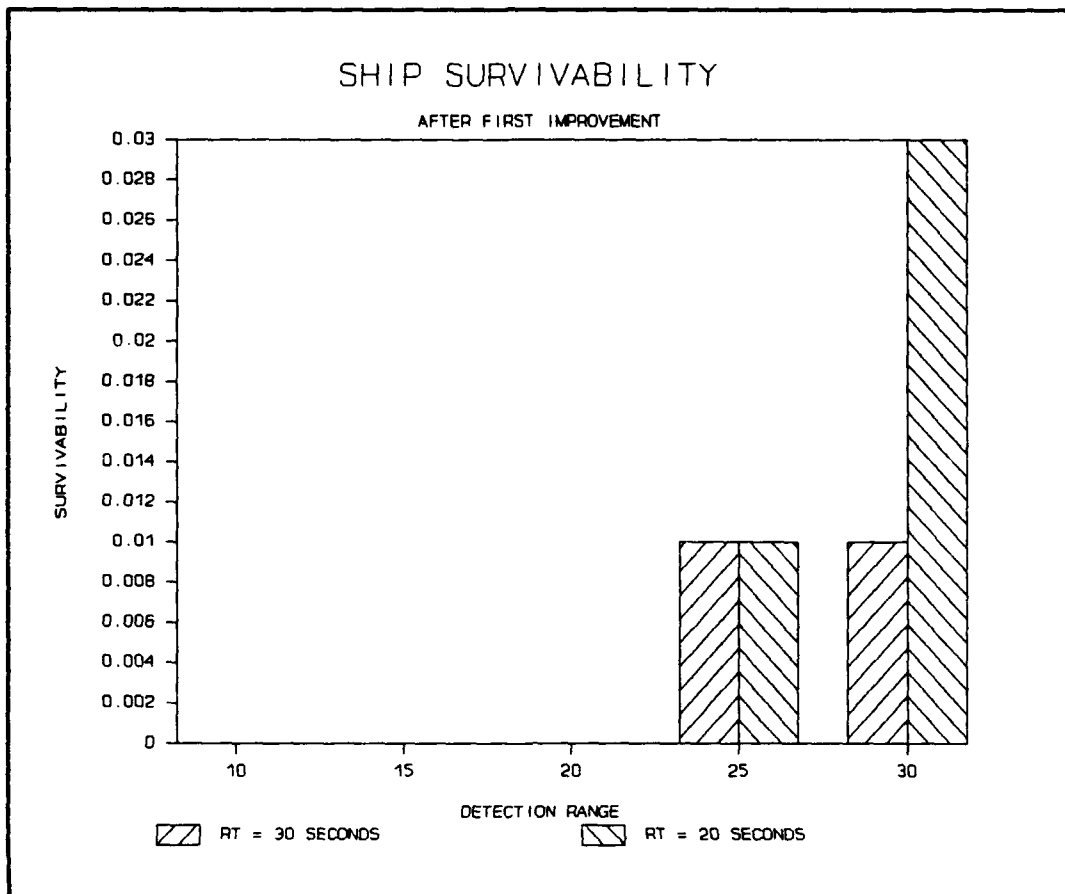

**Figure 13.** Ship survivability at the first two states.

#### C. IMPROVING SAM's PK VALUE FROM 0.3 TO 0.5

The SAMs in current use will have been in ready mode on the launcher or stored in the magazine for a period of time. Some parts of these missiles would have degenerated due to the life distribution, which is the main determinant that leads to the decline of the SAMs' pk value. Thus, a missile that, when new had an effective pk of .5, may well have a current pk of 0.3. But, since the pk includes such factors as propulsion and guidance reliability, as well as warhead

lethality it is possible that the pk of the SAM is constituted by the following factors: the pk of the SAMs can be stored after renovation.

When the pk of SAM is upgraded to 0.5, the weapon system's performance has improved significantly. Figure 14 illustrates the interaction of the ship firepower and the attacking SSMS in this state. The degree of this leaker's decrease in the first three states is demonstrated in Figure 15. The mean value over the detection ranges of leaker ( $E[\text{leaker}]$ ) at the fourth state is 2.19 which is improved 22% from the second state and which is 3% better than of the second improvement state.

The mean value of the expected firepower is 4.236, a 7% saving from the second state, and has the 22% improvement in decreasing the leaking targets as mentioned earlier. The expected firepower of the first three states are exhibited in Figure 16 and Figure 17 shows the ship survivability. The mean value of the ship survivability is 0.054 which is 13.5 times the second, a big improvement from the last state, but it still needs to be upgraded. The state of improving the ship survivability will be introduced in the next section.

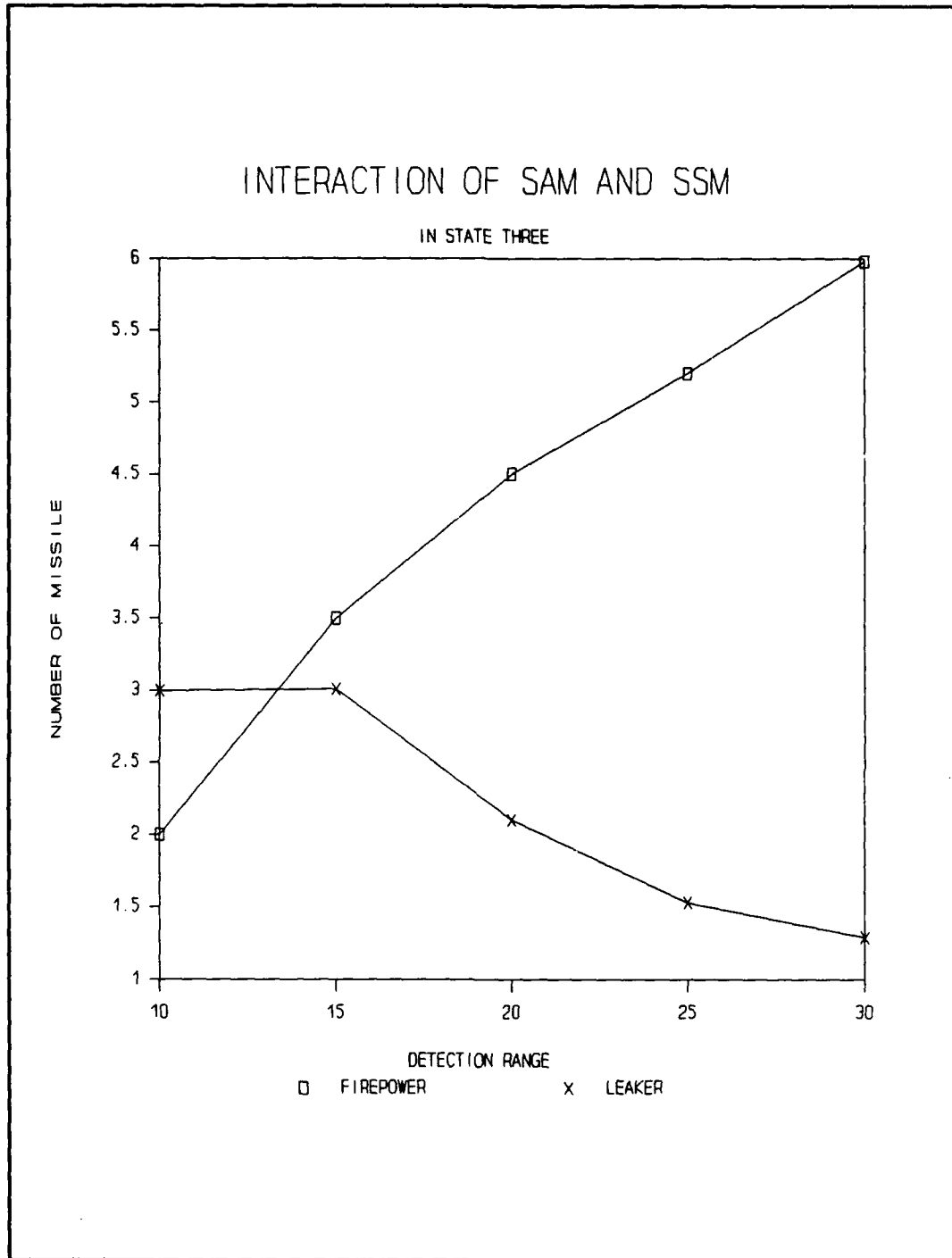

**Figure 14.** Interaction of SAMs and SSMs.



# FIREPOWER

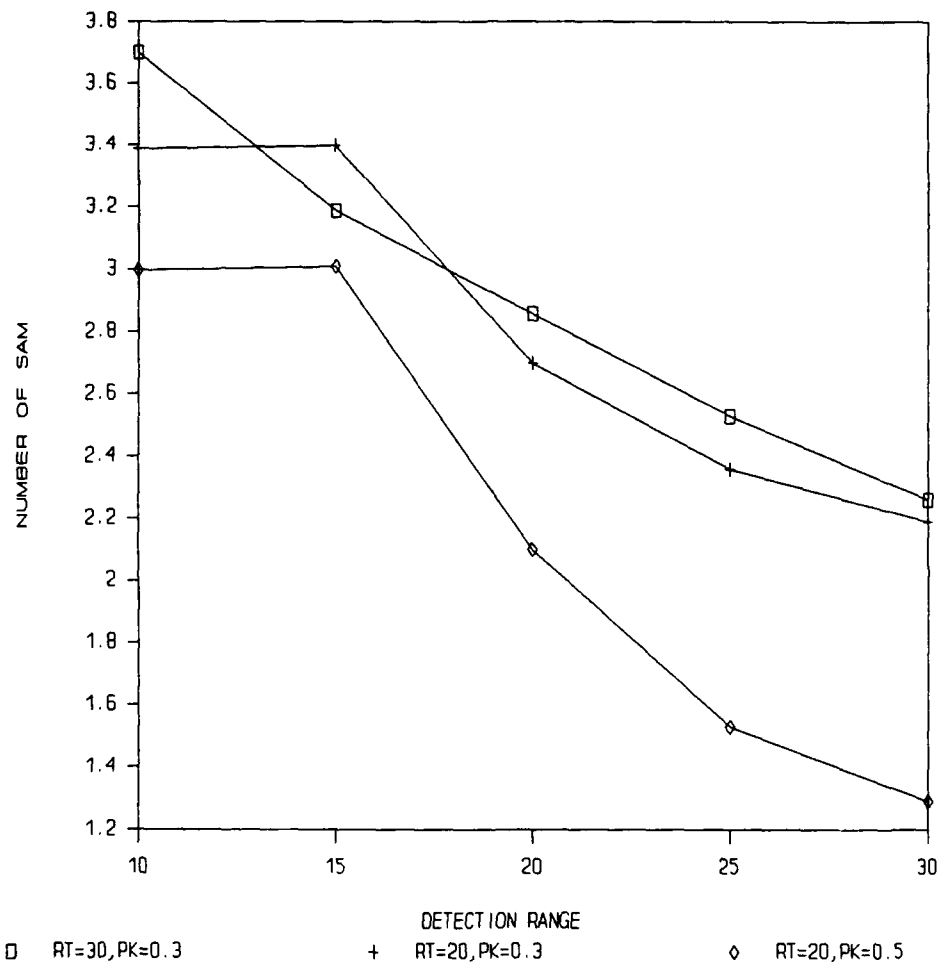

Figure 15. The leakers in the first three states.

# EXPECTED NUMBER OF SAMs TO BE FIRED

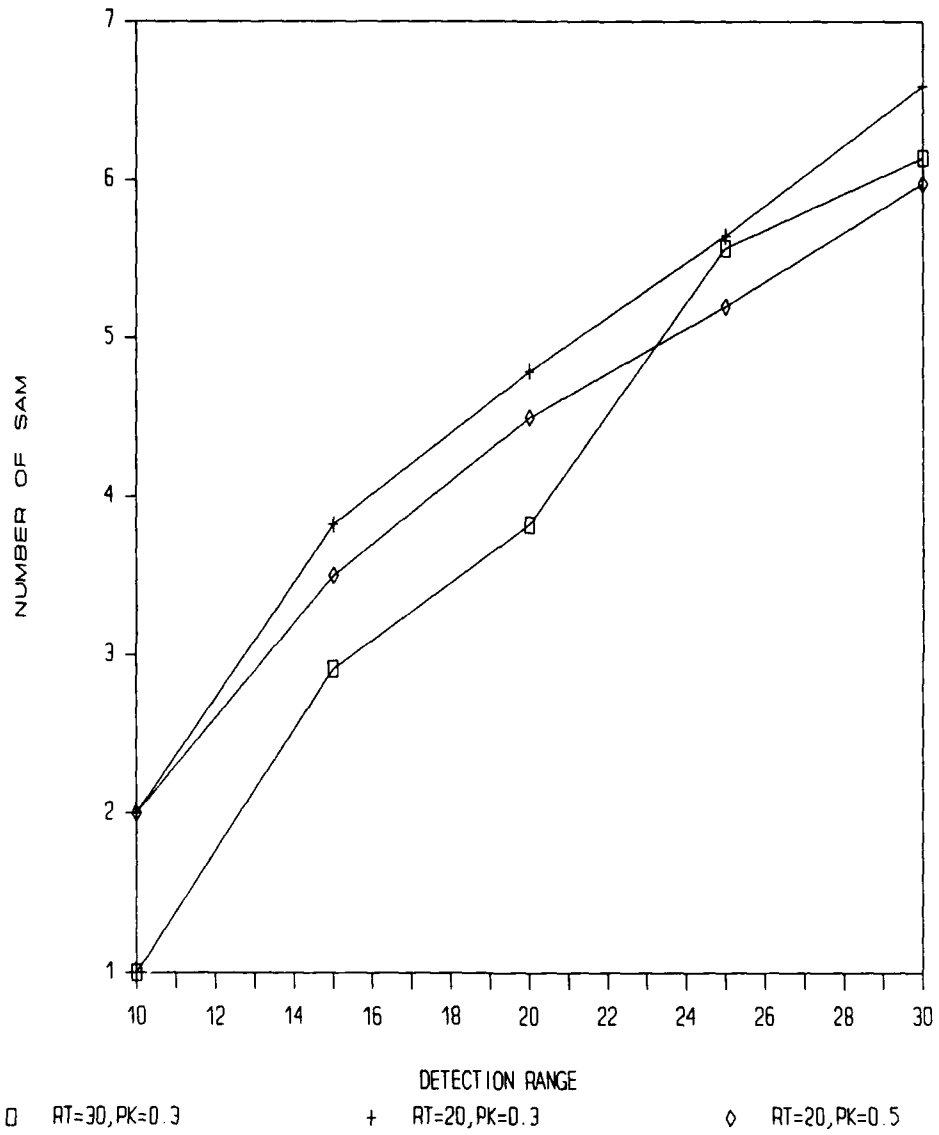

Figure 16. The firepower of the first three states.

# SHIP SURVIVABILITY

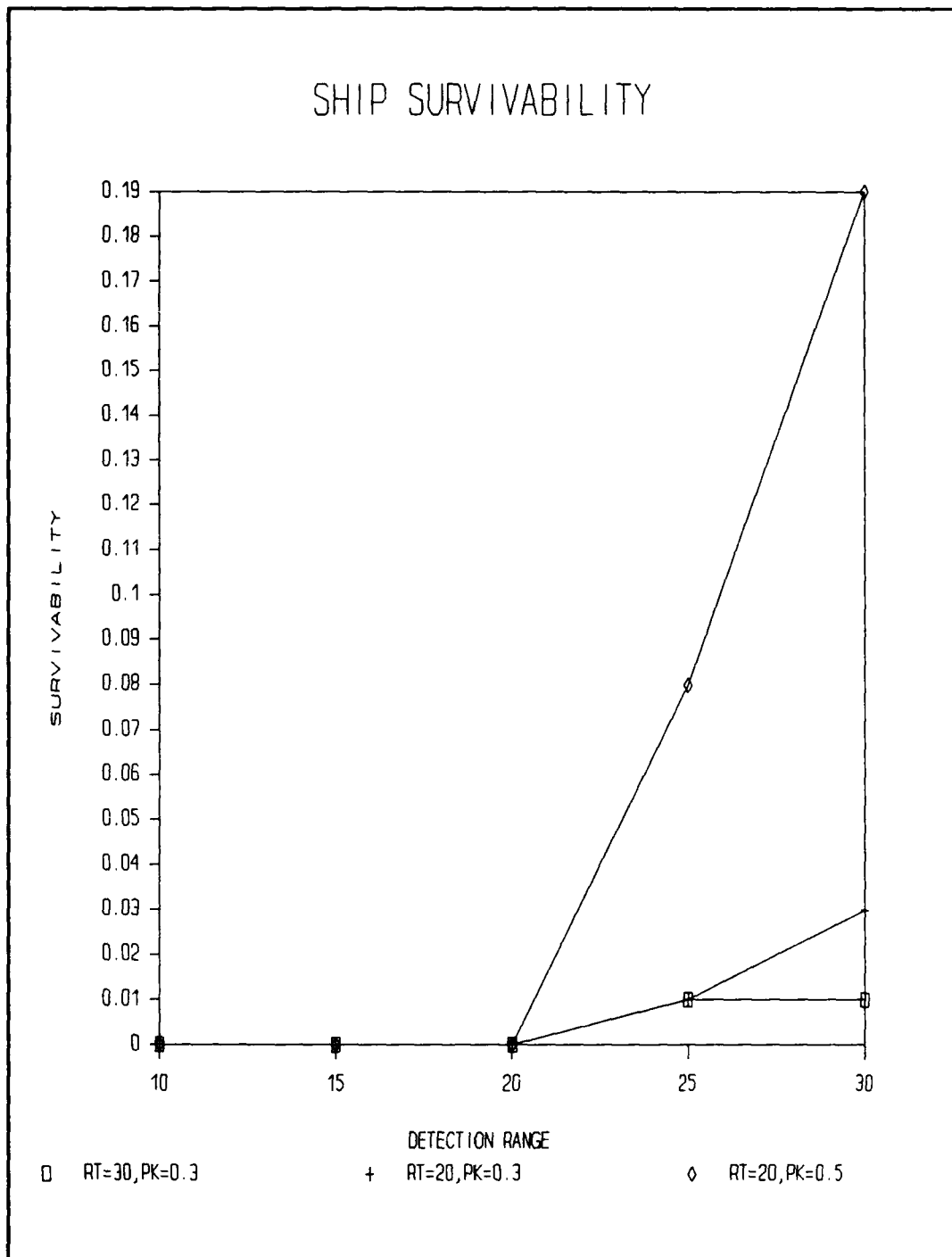

Figure 17. The ship survivability.

D. Improving pk value from 0.5 to 0.7

After two states of improvement, the performance of AAW is upgraded to a level that still falls short of the expected goal. So the upgrading process of the SAM's pk value has to be continued in this state.

With SAM's pk value improved to 0.7, the interaction of the SAMs and SSMS is more remarkable than ever. Demonstrated in Figure 18, the mean value number of SAM fired is reduced from 4.24 to 3.83 and the leakers are decreased from 2.19 to 1.71. The degree of the improvement in firepower is 9.5% and of the leaker is 21.9%.

The improving rate of leakage in the fourth and the fifth states is almost the same, but the firepower of the fourth state is less than the third one. In a sense, the performance of this state is more effective than before. As shown in Figure 17 the ship survivability has a notable advancement in this state because of the smaller leakage. The mean value of the expected number of SSM killed by one SAM in this state is 0.597, compared to 0.428 in the third state and 0.26 in the second state. Thus the survivability in this state has a bigger bound than before. The increased mean value of survivability is 2.7 times that of the third state. From the previous survivability analysis, there is an increase in the predicted survivability for a detection range greater than 25

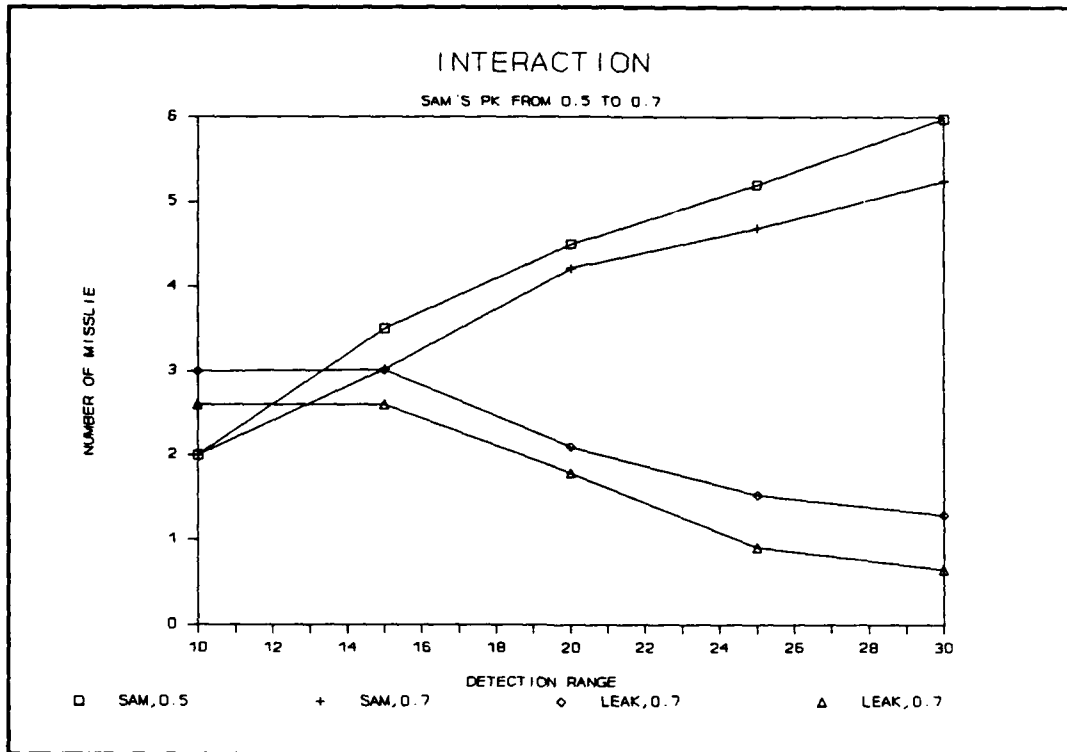

**Figure 18.** The interaction in the first three states.

NMs when the pk and reaction time are improved. However, the survivability remains zero within 25 NMs detection range. This fact reveals that the improvements of the system reaction time and the SAM's pk value do not affect the survivability for short detection ranges.

In order to increase the survivability in the close detection range, a close in weapon system has to be introduced and installed on the ship.

## V. CLOSE-IN RANGE DEFENSE

### A. THE CLOSE-IN WEAPON SYSTEM

Afer the CIWS is purchased and integrated with the present improved AAW weapon system, the attacking SSMS would then have to encounter double defense nets which provide a better survivability. The characteristics of the CIWS<sup>6</sup> could enhance AAW's performance. So the major consideration in deciding which type of CIWS ought to be installed on the ship will depend on its effective intercept range, system reaction time and firing rate.

#### 1. Operation of CIWS

Since the SAM's minimum effective intercept range is three NMs, the CIWS must have a maximum intercept range close to three NMs so that the second defensive action can be executed immediately if the first defense fails. The assumed CIWS's maximum and minimum intercept ranges are two NMs and 0.1 NMs. There will be a small gap of six seconds between the two systems' operations.

When a leaker leaves the SAM's minimum effective intercept range, which is three NMs, the CIWS mode is on and

---

<sup>6</sup>Please see Appendix D for the characteristics of the CIWS.

takes over the defense responsibility. As long as the mode is on, CIWS needs five seconds reaction time to process the data and to lock-on. Next step after the reaction event is to start its continuous firing at the leaker. The maximum continuous firing time is eight seconds. After each continuous firing event, CIWS must assess the intercepting result which takes one second. If the engaged leaker is not shot down, then the CIWS would reengage it for the rest of the time that the intercept range still exceeds 0.1 NM.

In case SAM's assessment event is not finished until the range of the leaker is within two NMs, the CIWS mode cannot start its firing until SAM's system clarifies the assessment. In such case, the CIWS cannot engage the leaker with its full firepower. In other words, the time the leaker can be engaged is not enough to create a good pk value.

The most significant factor to affect the CIWS's defense is the pk value. This will be discussed in the following paragraph.

## 2. pk of the CIWS

Unlike SAM, the pk value of CIWS is determined by the number of the bullets that are fired at the target. The longer the firing lasts, the higher pk is obtained. The equation to produce the pk value in Figure 19 is demonstrated in Table III. For instance, the maximum firing time of CIWS

is eight seconds, which would generate 0.6 maximum pk value according to the equation in Table III.

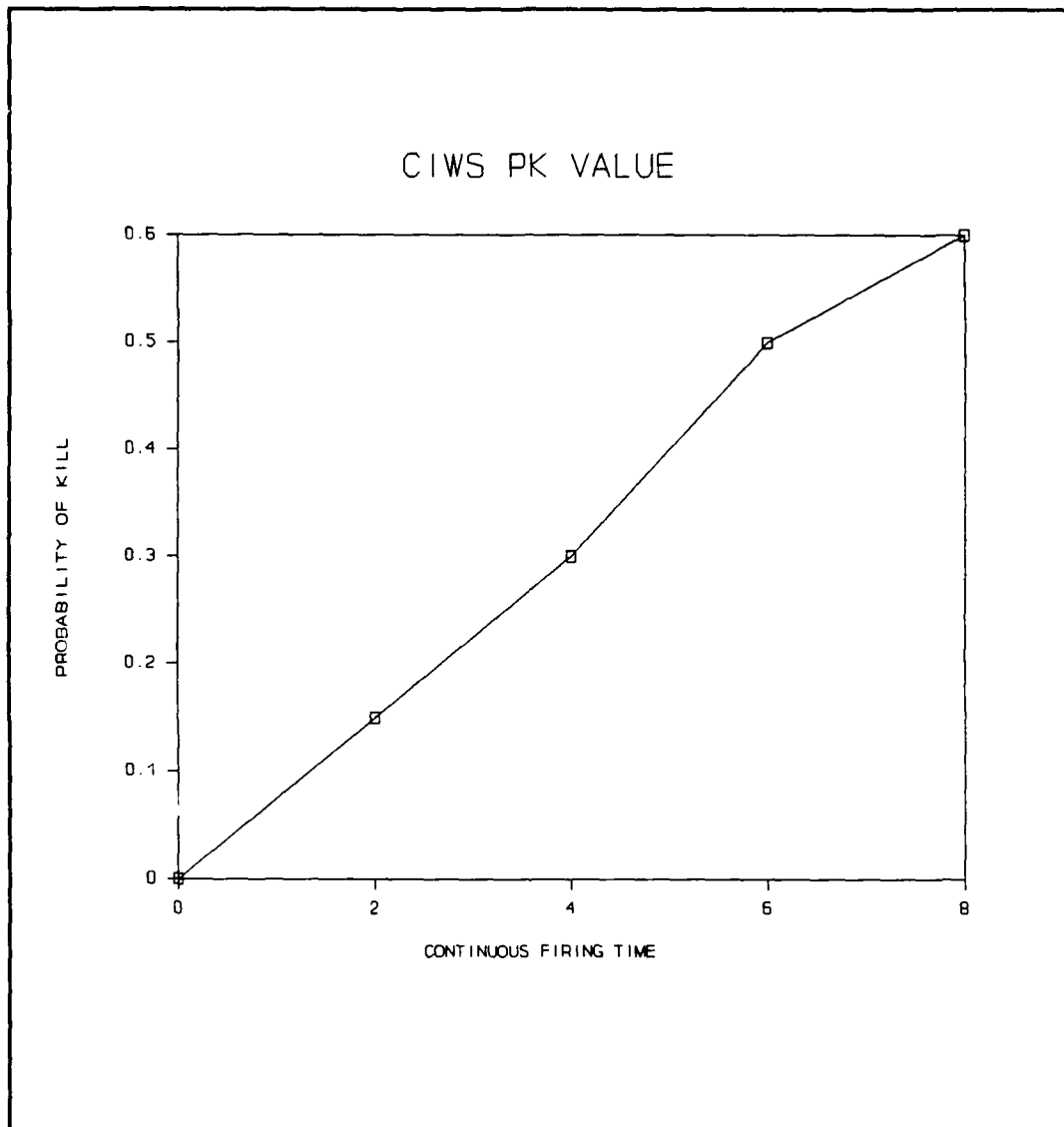

Figure 19. The pk value of the CIWS.



**Table IV. THE EQUATION OF PREDICTING THE PK OF THE CIWS.**

CONTINUOUS FIRING TIME (CFT)	EQUATION TO FIND THE PK VALUE
(0,4]	$PK = 0.075 \times CFT$
(4,6]	$PK = 0.1 \times CFT - 0.1$
(6,8]	$PK = 0.05 \times CFT + 0.2$

\*\* Unit of time: second.

**B. INTEGRATED PERFORMANCE OF THE SAM SYSTEM AND CIWS**

After the improved SAM system is linked up with CIWS, the AAW performance of the ship is strengthened in the closer range and the AAW defense capability is upgraded as a whole. Figure 20 shows the expected number of leakers, and the difference of the leakers in the latter two improvement states, which are state four and state five. Represented by the third curve, which displays the number of the deleted leaker increases when the detection range is close to 10 NMs. Within twenty NMs, the mean value of the expected reduction in the number of leakers after the fourth improvement state is 0.373, compared to 0.653 in this state. The improvement is almost doubled. Figure 21 displays a significant improvement in the survivability in this state.

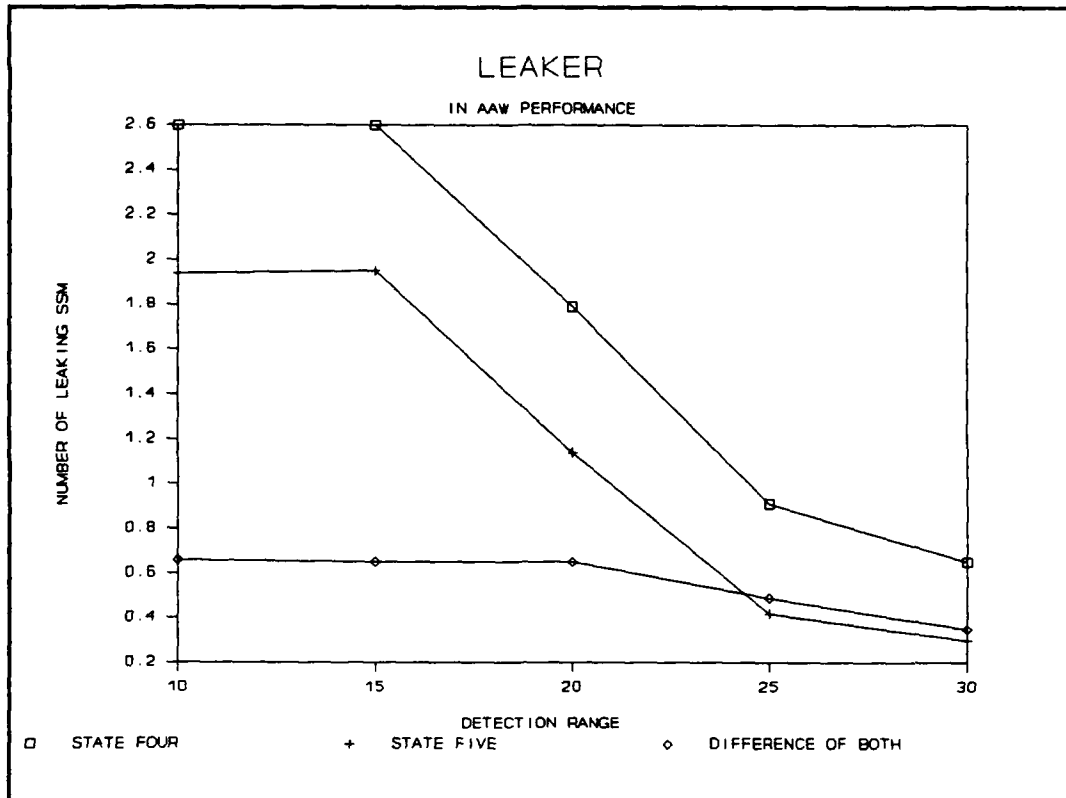

**Figure 20.** The expected leakers in the fourth and the fifth states.

Furthermore, Figure 22 indicates the increased value of the survivability from the fourth state.

In Figure 22, the curve which represents the increased value of the survivability from the fourth state to the fifth state is upgraded while the range is between 15 NMs and 25 NMs, but the curve is downgraded afterwards. A longer detection range allows more time for firing more SAMs to defend the targets in the medium defense line. This condition will reduce the number of leakers. So CIWS in the longer detection range will defend less incoming SSMS than the one

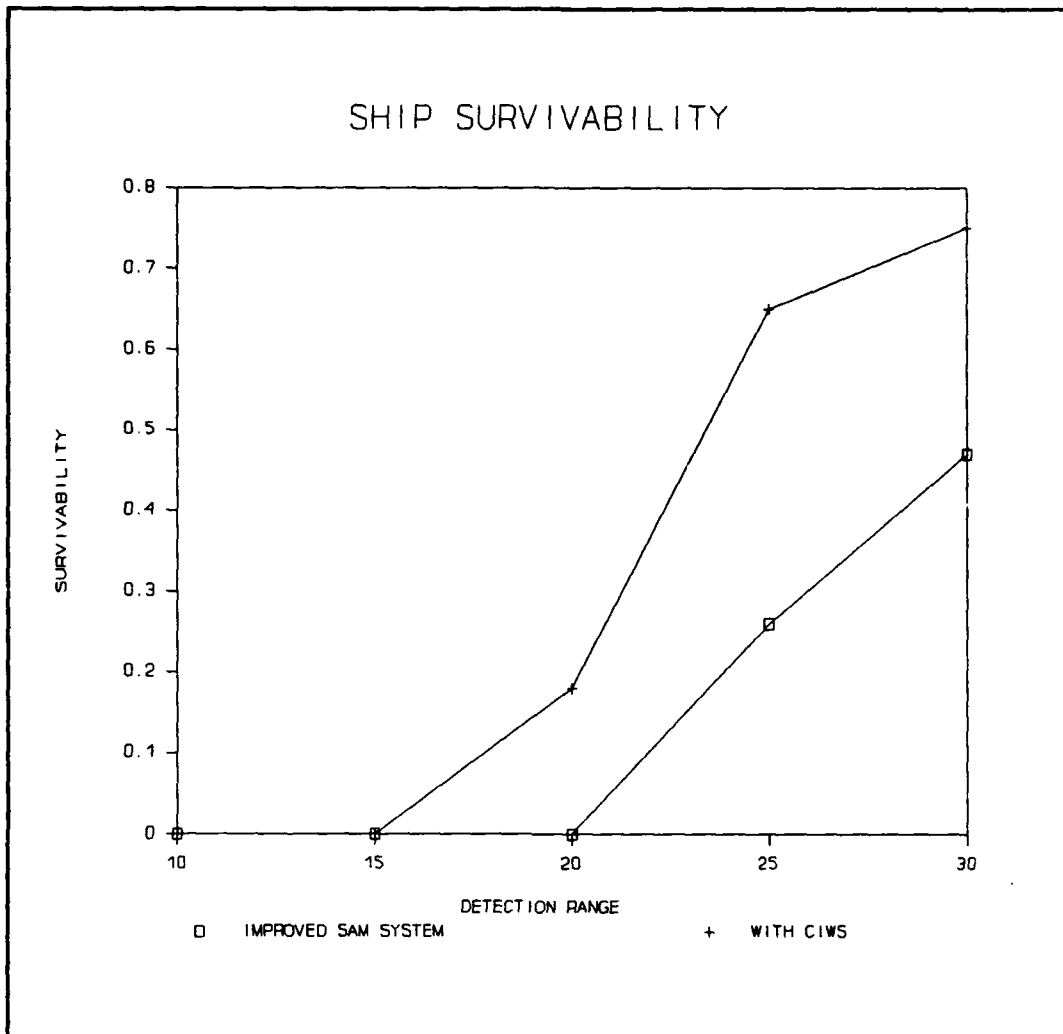

**Figure 21.** The survivability of the last two states.

in the closer detection range. The fact exhibits the defense capability in close range are improved.

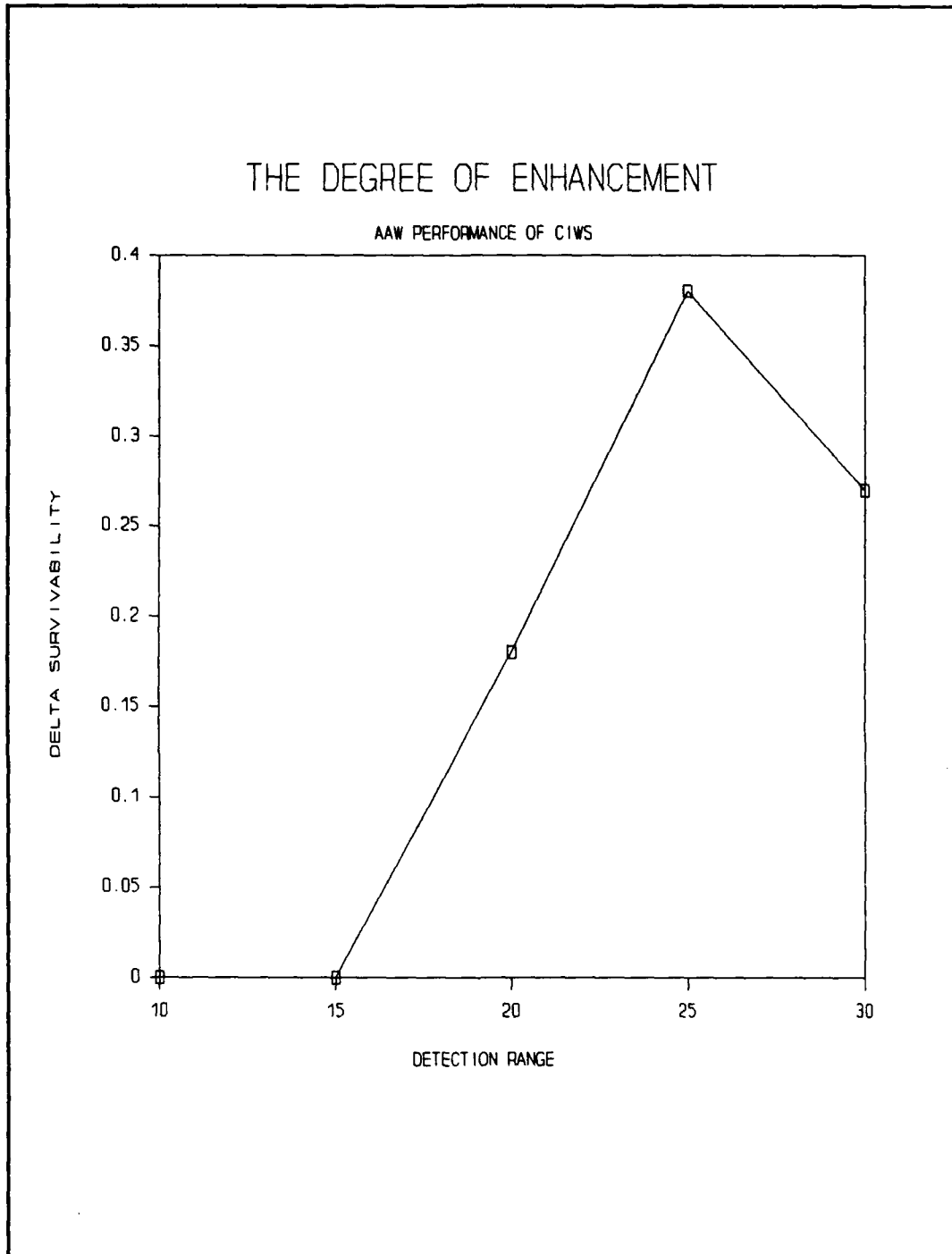

**Figure 22.** The upgraded degree of the survivability in the last state.

The most important thing in this improvement state is that the result of the expected survivability values, 0.18, 0.65, and 0.75 at the 20 NMs, 25 NMs and 30 NMs of the detection range meets the original expectation.

#### C. FINAL ANALYSIS OF THE AAW WEAPON SYSTEM'S PERFORMANCE

Four attacking SSMS were assumed to be fired from the attacking platforms at the target ship simultaneously. This means that there was no spacing time among these SSMS either at detection or arrival at the target. The target ship's defense capability before and after the improvement plan of the AAW weapon system is illustrated in Figure 23 and 24. These two figures demonstrate the expected number of leakers and the expected number of SSM which are destroyed by SAM or by the combination of SAM and CIWS. In system state five the leakers are obviously far less than those in state one. The ratio of the expected leakers to the total SSMS in the state one is 0.727, and in the state five is 0.288. The ratio of the expected leakers from state one to state five is shown in Figure 25, from which it is apparent that fraction of attacking missiles that penetrate the defenses decreases significantly.

The ship survivability at each range is shown in Figure 26. Five legends in the bottom of this Figure represent the increased survivability in each state, and the total stacked

bar is the final survivability at that range. A tendency can be seen from this figure: at the longer detection ranges,

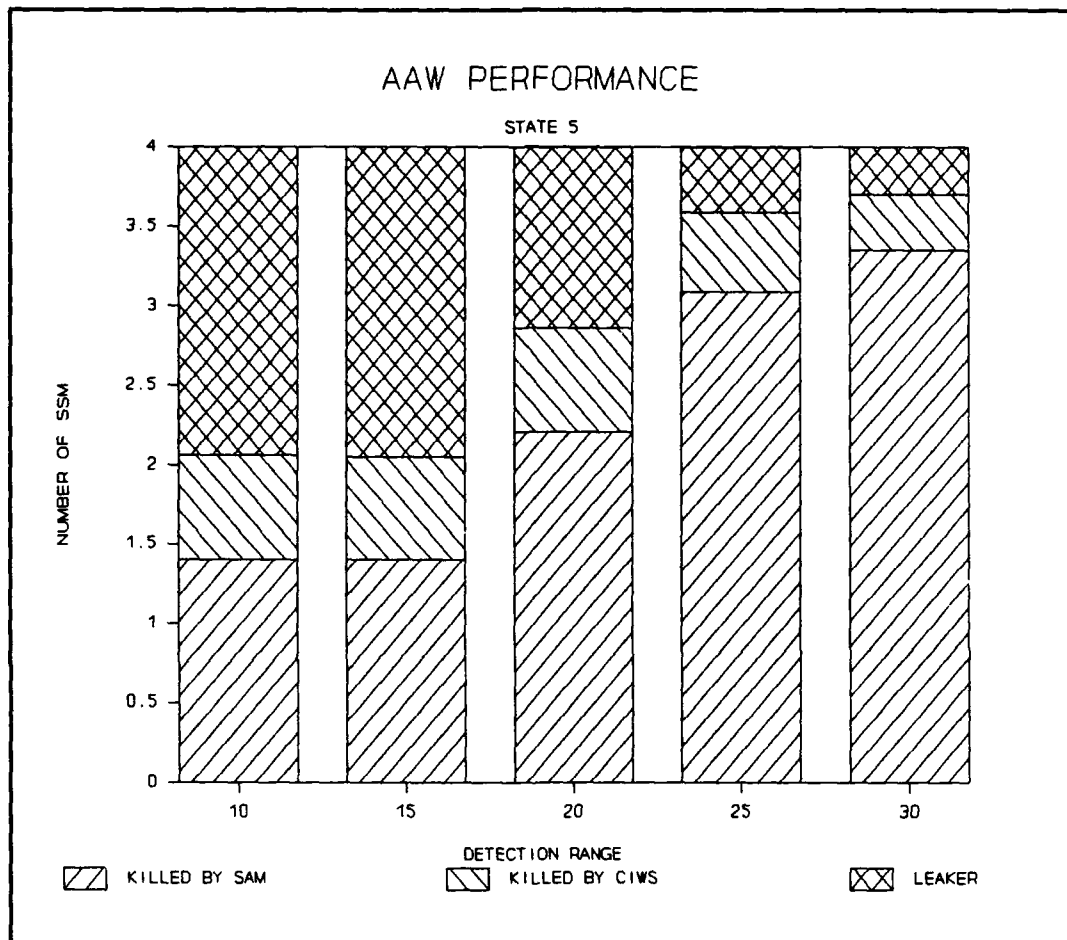
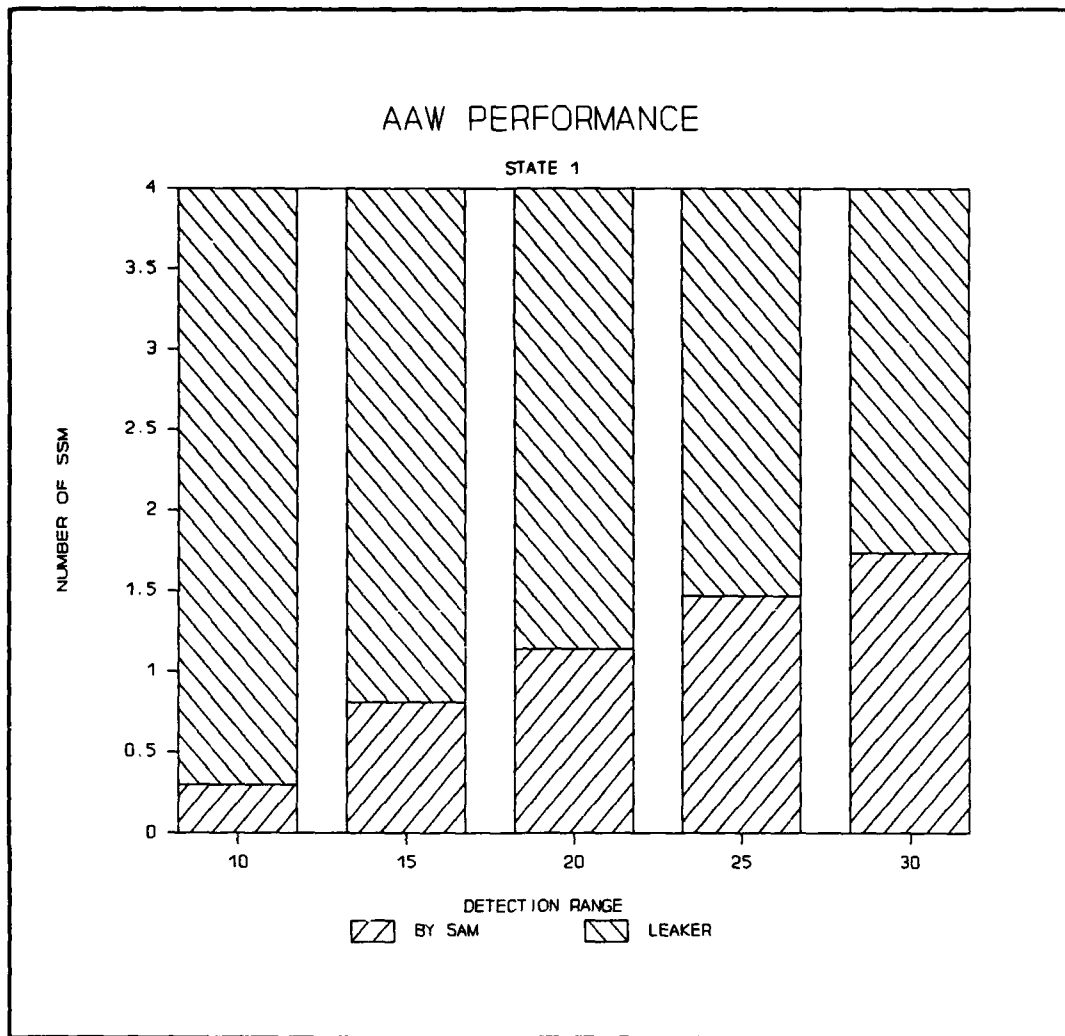

Figure 23. AAW performance in state five.

the survivability ratio created by the SAM's defense increases and that due to the CIWS decreases. And this tendency is induced by the detection range, i.e., the expected firepower is larger at a longer detection range than a closer detection range. This condition would allow more shots at the attacking



**Figure 24. AAW performance in state one.**

SSMs at the longer detection range. The chance to destroy the SSMS in this condition should then be greater, which is able to generate a higher ship survivability. The expected number of leakers would then be less which would lessen the burden on the close-in defense. This is the main factor which reduces the ship survivability ratio created by CIWS at the

longer range. The CIWS's performance in terms of the detection range is shown in Figure 27. The ship survivability at the detection range of 20 NMs is 0.18, which makes it seem that the achievement is completed by the CIWS alone as shown in Figure 26. Actually, the expected number of killed SSMS before they enter the close-in line defense is 2.21, i.e., the expected number of leakers is 1.79, which will meet the CIWS and the expected leakers will then be reduced to 1.14. That is what gives the ship 0.18 survivability.

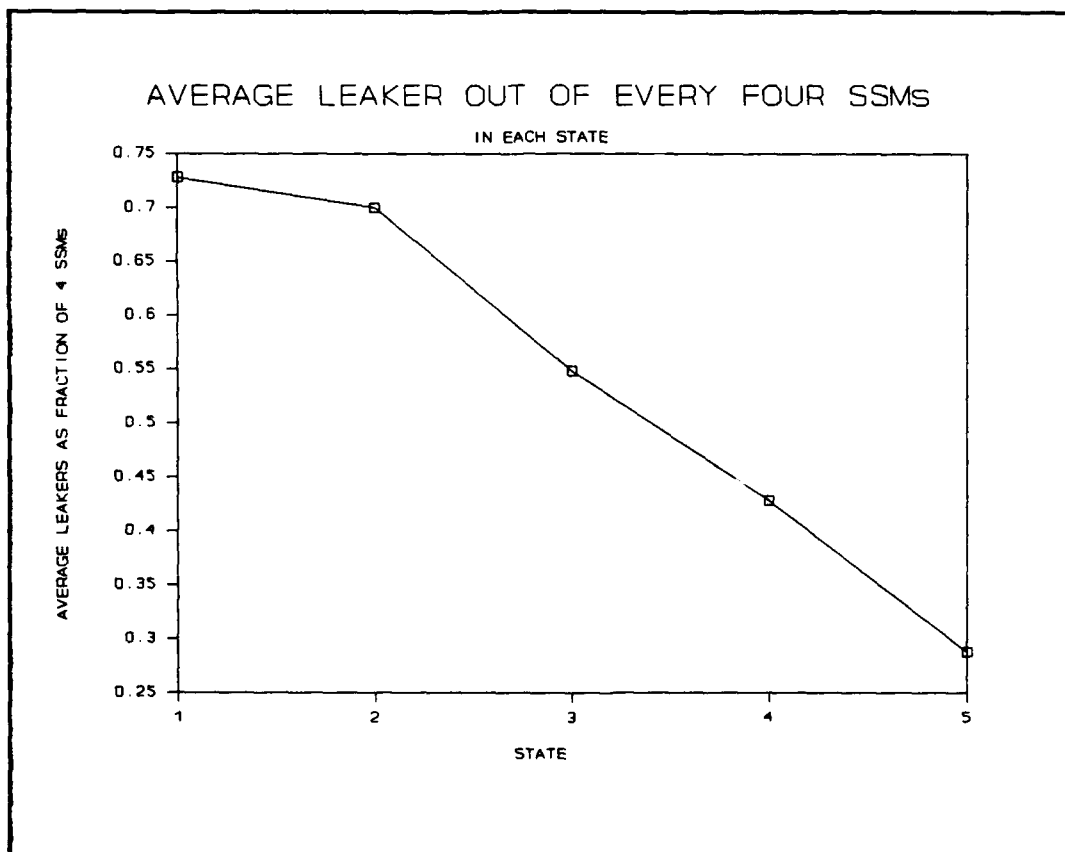
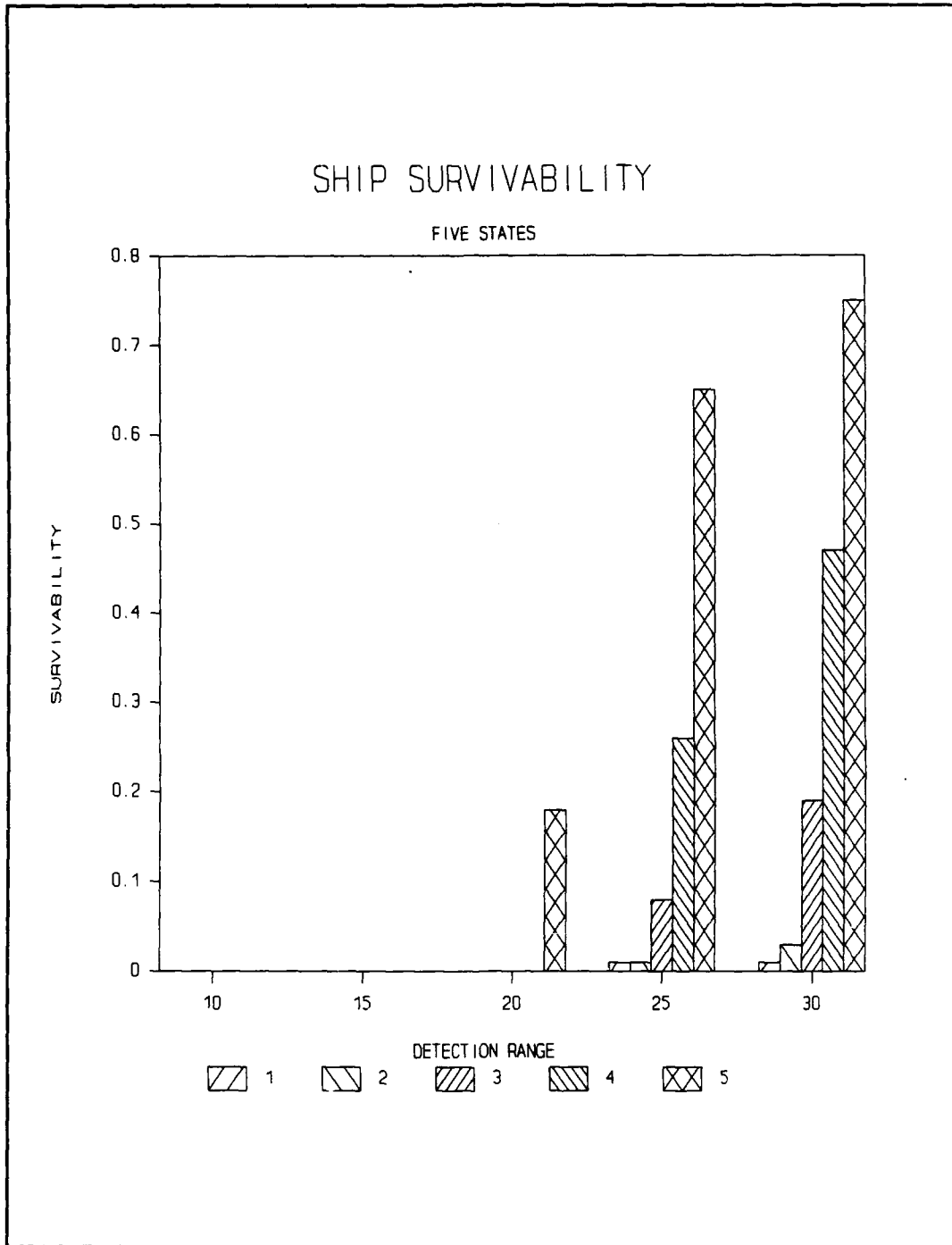
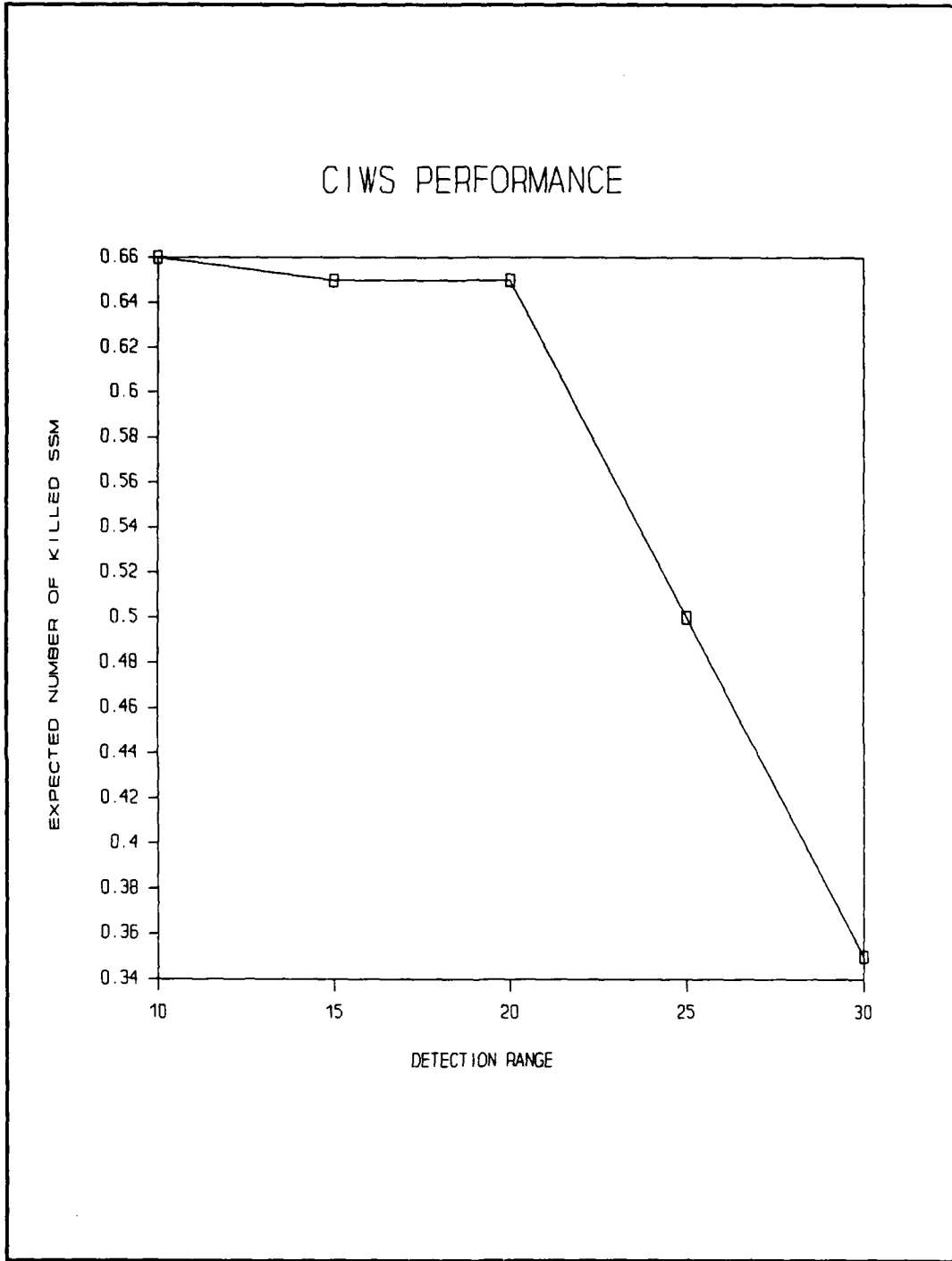

Figure 25. The ratio of leakers in each state.





**Figure 26. Ship survivability of the five states for five detection ranges.**

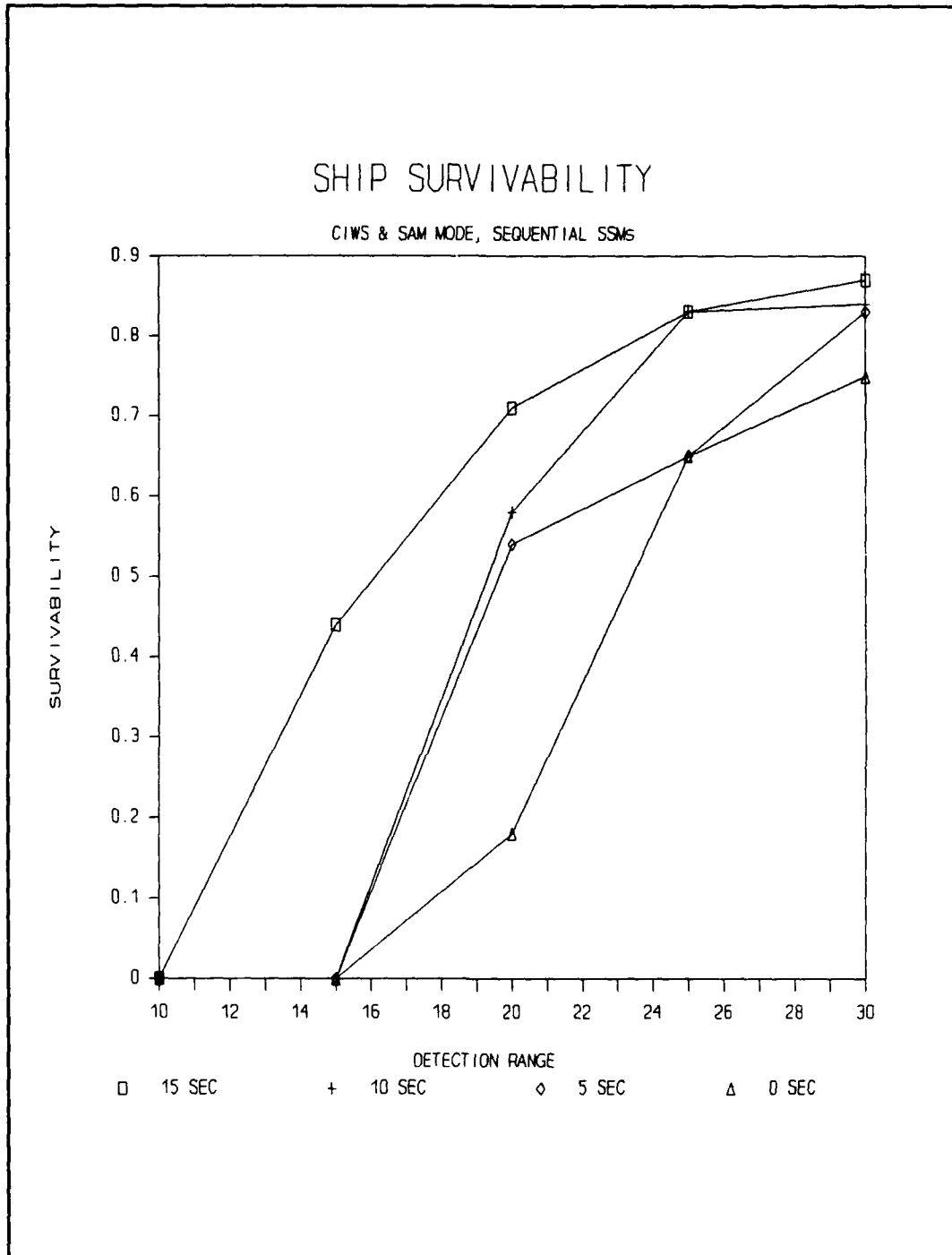

**Figure 27.** Expected number of SSMS killed by the CIWS at each detection range.

#### D. SEQUENTIAL ATTACKING SSMS SCENARIO

Up to this point the four SSMS are assumed to attack the target ship simultaneously. In this section, ship survival when the SSM attack sequentially will be discussed.

To the target ship, the sequential attacking SSMS scenario will give the AAW weapon systems extra time to fire more SAMs at the SSM. The increased firepower is able to create a better survivability than when the attack is simultaneous. The greater the spacing time between two of the SSMS, the higher survivability should be. Figure 28 presents the survivability of the sequential attacking SSMS in which the average spacing of the four curves are assumed to be zero, five, ten and fifteen seconds respectively. The spacing time has a greater influence on survivability when the detection range is shorter than at the longer detection ranges.



**Figure 28.** The improved weapon system vs. four sequential attacking SSMS.

## VI. CONCLUSIONS

The objectives of this research were to investigate an AAW weapon systems improvement plan designed to enhance ship survivability. The modeling assumptions and data base are integrated into a stochastic computer code which predicts the ship survivability. The goal of this model is to predict ship survivability at each successive stage ("state") of the AAW weapon systems improvement plan, and to order the states of improvement by increasing cost.

In this plan, the improvements are focused on increasing the maximum firepower, improving the SAM's pk value and adding CIWS. The ship survivability was upgraded to the specified value after these improvements were completed. Based on the ship survivability in a saturation attack by four SSMs, the current AAW weapon systems would be useful in defending against only one or two inbound SSMS.

For future use, all the weapon systems on board should be taken into account in the model, such as five inch, 76 mm and 40 mm gun(s), EW and the chaff system. In addition to the weapon systems, weather and sea condition, sensor reliability and personnel's condition ought to be considered as well. In this situation, so many variables would have to be added into the simulation model that the model would be greatly expanded and more complicated. The increased model

costs in model development and application generate a need to consider the trade-off between the study costs and the expected improvement in the quality of decision making that might result. However, the present study addresses the major factors needed for a reasonable initial assessment.

This research has not provided the "final answer" to the questions involved in naval programs for "modernizing the aging warship." In fact, it has simply proposed a methodology, a method with which to attack the problem.

## Appendix A

### Assumptions of the SPS

- There are four low altitude incoming targets.
- The target spacing is zero (arrives almost simultaneously).
- The radar detection ranges are 30, 25, 20, 15, 10 NMs.
- The reaction time from target detection to missile launched is assumed to be 20 and 30 seconds.
- The minimum intercept range of SAM is three NMs, the maximum intercept range is 30 NMs.
- The single missile kill probabilities are assumed to be 0.3, 0.5 and 0.7.
- The engagement doctrine is shoot-look-shoot and the missile is home-all-the-way.
- The missile launch cycle time is 5 seconds and the target kill assessment time is 8 seconds.
- the missile's average speed is 20 NMs/Min and the target's speed is 10 NMs/Min.

## Appendix B

### The program of SPS

```
CLS
OPTION BASE 1
DIM SS(5,10,30),EK(5,10,30),NS(5,10,30),RA(1000)
DIM SA(5,10,30),TM(5,10,30)
DIM LEAKTHRU(5,10,30),ESI(5,10,30),ESA(5,10,30),RM(10,50)
DIM BG(5,10,30)
INPUT "SEED =";SEED
PRINT"SEED=";SEED
IF SEED > 0 THEN SEED=-SEED
X=RND(SEED)
TIMES="00:00:00"
S1=1/3 ' S2: speed of SAM
S2=1/6 ' S1: speed of TGT
SZ=9589
INPUT "SPACING=";SPACING ' THE SPACING TIME BETWEEN THE
                          ' TGTs
SEQ=SPACING ' SAME AS SPACING FOR SUBSTITUTION.
CIWSRT=5 ' CIWS REACTION TIME IS 5 SEC.
MI=2 ' MI IS THE MAXIMUM INTERCEPT RANGE OF THE
      ' CIWS
      CIWSPK=.5
      I=0:PK=.70

610 IF PK<.30 THEN GOTO 1280
    I=I+1:J=0
    QQ(I)=PK:
    RT=30

640 IF RT<20 THEN GOTO 1220
    J=J+1:K=0:RM(I,J)=RT
    RT1=RT:RANGE=30

680 IF RANGE<10 THEN GOTO 1180
    K=K+1:TOTALT=RANGE*6
    RA(K)=RANGE
    HIT=0:SUCCESS=0:LEAKING=0:TLEAK=0:NOLEAK=0
    SAMPTGT1=0
    SAMPTGT2=0
    SAMPTGT3=0
    SAMPTGT4=0
    TGTKILLED=0
    GOODCIWS=0
```



```

      'GOODCIWS: COUNT THE DESTROYED TGT BY CIWS.
      N=1
      SAVEOK=0
800:      IF N>SZ THEN GOTO 1070          'N IS SAMPLE SIZE

T=0:TP=0:TGTK=0:M=0:L=0:MARK=0:OK=4:TGT1SUC=0:TGT2SUC=0:AR=0
      RL=1          'RL IS RELOAD NUMBER
      TT=6*RANGE   'TT IS TOTAL TIME
      TC=6*(RANGE-3) 'TC IS CRITICAL TIME
      TGT1SAM=0: TGT2SAM=0: TGT3SAM=0: TGT4SAM=0
      TGT1=1:TGT2=1:TGT3=1:TGT4=1
      GOSUB 2210
      SAMPTGT1=SAMPTGT1+TGT1SAM
      SAMPTGT2=SAMPTGT2+TGT2SAM
      SAMPTGT3=SAMPTGT3+TGT3SAM
      SAMPTGT4=SAMPTGT4+TGT4SAM
      NNSAM=TGT1SAM+TGT2SAM+TGT3SAM+TGT4SAM
      IF TGT1=0 THEN TGTK=TGTK+1: OK=OK-1
      IF TGT2=0 THEN TGTK=TGTK+1: OK=OK-1
      IF TGT3=0 THEN TGTK=TGTK+1: OK=OK-1
      IF TGT4=0 THEN TGTK=TGTK+1: OK=OK-1
      TLEAK=TLEAK+OK
      IF OK=0 THEN SUCCESS=SUCCESS+1:NOLEAK=NOLEAK+1
      'NOLEAK: THE SUCCESSFUL DEFENSE BY SAM
      IF FLAG=1 THEN GOSUB CIWS
      TGTKILLED=TGTKILLED+TGTK
      IF CIWSFLAG=1 THEN
          OK=OK-AR
          IF OK > 0 THEN HIT =HIT+1
          IF OK = 0 THEN SUCCESS=SUCCESS+1
          TGTKBYMAC =4-OK
      'TGTKBYMAC: THE TGTs ARE KILLED BY SAM AND CIWS
      END IF
      N=N+1: RT=RT1
      GOTO 800
1070      N=SZ
          SA(I,J,K)=NOLEAK
          GOSUB 4780
1170      RANGE=RANGE-5:GOTO 680
1180:
1210      RT=RT-10:GOTO 640
1220:
1270      PK=PK-.2:GOTO 610

1280:
      LPRINT"RT:REACTION TIME."
      LPRINT"RANGE: DETECTION RANGE."
      LPRINT"NSAM:THE # OF THE SAM FIRED."
      LPRINT"E(NS):EXPECTED # OF THE SAM FIRED."

```

```

LPRINT"V: THE # OF SUCCESSFUL DEFENSE OF THE SHIP."
LPRINT"E(V): EXPECTED VALUE OF V, WHICH IS THE SURVIVALBILITY
OF THE SHIP"
LPRINT"      IN SAM MODE."
LPRINT"BINGO: THE # OF THE TGTS ARE DISTROYED BY SAM."
LPRINT"EK(SAM): EXPECTED # OF THE TGTS ARE DESTROYED BY SAM."
LPRINT"HIT: THE EXPECTED # OF THE SHIP IS HIT BY AT LEAST 1
INBOUND TGTS"
LPRINT"LEAK: THE # OF THE TGTS LEAKING THROUGHT THE SAM
DEFENSE."
LPRINT"E(L): EXPECPTED VALUE OF THE LEAKING TGTS."
LPRINT"CIWS: # OF TGTS KILLED BY CIWS"
LPRINT"EK(S&C): EXSPECTED # OF THE TGTs DESTROYED BY SAM AND
CIWS."
LPRINT"PENETRATOR: THE EXPECTED # OF TGTS HIT THE SHIP
SUCCESSFULLY"
LPRINT"SS: SHIP SURVIVALBILITY.": LPRINT" "

```

```

LPRINT"RT RANGE NSAM E(NS)  V   E(V) BINGO  EK    HIT   LEAK
      E(L) EK    EK  PENET- SS"
LPRINT"                                SAM    SAM      (L)
      CIWS S&C  RATOR  "
LPRINT"_____ "

```

```

A$= "## ## ##### #.## ##### #.## ##### #.## #.## #####
      #.## #.## #.## #.## #.##"
B$= "\ \#.#"
C$="PK="
FOR I=1 TO 3
  LPRINT USING B$;C$,QQ(I)
  FOR J=1 TO 2
    FOR K=1 TO 5
      AA=RM(I,J)      'REACTION TIME
      BB=RA(K)        'RANGE
      CC=TM(I,J,K)    'TOTAL SAM THE SHIP HAS FIRED
      DD=NS(I,J,K)    'EXPECTED # OF THE SAM HAVE BEEN FIRED
      EE=SA(I,J,K)    'THE # OF SUCCESSFUL DEFENSE OF THE
                      'SHIP
      FF=ESA(I,J,K)   'THE EXPECTED # OF SUCCESSFUL DEFENSE
                      'OF THE SHIP
      GG=BG(I,J,K)    'THE # OF THE DESTROYED TGTs BY SAM
      HH=EK(I,J,K)    'THE EXPECTED # OF THE DESTROYED TGTs
                      'BY SAM
      LL=DEFFAIL(I,J,K)/N 'EXPECTED # OF AT LEAST ONE TGTs
                      'IMPACT THE SHIP
                      'IF THERE IS NO CIWS
      MM=LEAKTHRU(I,J,K) 'THE # OF THE TGTs GET THRU THE
                      'SAM'S DEFENSE
    
```

```

NN=ESI(I,J,K)          'THE EXPECTED # OF THE TGTs GET
                        'THRU THE SAM's
                        'DEFENSE
OO=CIWSKILL(I,J,K)    'THE # OF THE TGTs ARE KILLED BY
                        'THE CIWS
PP=TOTALEK(I,J,K)     'THE FINAL EK (TGTs ARE DEFENDED
                        'BY SAM AND CIWS)
QQ=(MM-BYCIWS(I,J,K))/N 'THE TGTs IMPACT THE SHIP
                        'SUCCESSFULLY
RR=SS(I,J,K)          'THE SHIP's SURVIVALBILITY
'SA(I,J,K): SUCCESS. ESI(I,J,K):EXPECT # TGT GETTING
'THRU.
LPRINT USING A$;AA, BB, CC, DD, EE, FF, GG, HH, LL, MM, NN, OO, PP, QQ, RR

      NEXT K
    NEXT J
  NEXT I
  LPRINT "RUNNING TIME=";TIME$
  STOP

```

```

1400 REM RELOAD:

```

```

      IF NFROM=1234 AND WHERE=1234 THEN
        IF TP-T<1 THEN TP=T+1
        GOTO 1460
      END IF

```

```

      IF NFROM=1234 AND WHERE=34 THEN

```

```

        'TP=T-4 THE EXACT TIME FOLLOWING TGT3 FOR SPACING
        '4 SEC WHEN FCR1
        'FIRES SAM AT TGT3. SAM START RELOADING RIGHT
        'AFTER THIS INCIDENT AT TP.
        IF TP-T<1 THEN TP=T+1 ELSE TP=TP+0
        GOTO 1460
      END IF

```

```

      IF NFROM=234 AND WHERE=34 THEN
        IF TP-T>1 THEN TP=TP+0:T=T+0
        GOTO 1460
      END IF

```

```

      IF NFROM=134 AND WHERE=34 THEN
        IF TP-T<1 THEN T=TP+1
        GOTO 1460
      END IF

```

```

1460      IF NFROM=234 AND (WHERE=24 OR WHERE=4) THEN GOTO
      IF NFROM=34 AND (WHERE=3 OR WHERE=4) THEN GOTO 1460
      IF NFROM=34 AND NFROM=34 THEN

```

```

        IF TP-T<1 THEN TP=T+1
        GOTO 1460
    END IF
    IF NFROM=134 AND (WHERE=14 OR WHERE=4) THEN GOTO
1460
        IF NFROM=234 AND WHERE=234 THEN GOTO 1460
        IF NFROM=134 AND WHERE=134 THEN GOTO 1460
    1460 RETURN

1470 REM MEET2:
    'FIRST BLOCK IS ENGAGING THE 1ST TGT
    'SECOND " " " " 2ND "
    'PRINT"MEET2-START"
    'PRINT"MEET2-START"
    DTGT=RANGE-(T/6)
    T=T+(DTGT/(S1+S2))
    DTGT=RANGE-(T/6)
    DTGTP=RANGE-(TP/6)
    TP=TP+(DTGTP/(S1+S2))
    DTGTP=RANGE-(TP/6)
    IF DTGT <= 3 AND DTGTP <= 3 THEN
        FLAG=1:NSAM1=NSAM1-1:NSAM2=NSAM2-1:RETURN
    END IF
    IF DTGT <= 3 AND DTGTP > 3 THEN NSAM1=NSAM1-1:TGT1SUC=1
    IF DTGT > 3 AND DTGTP <= 3 THEN NSAM2=NSAM2-1:TGT2SUC=1
    1600 RETURN

1610 ' MEET1:
        DTGT=RANGE-(T/6)
        T=T+DTGT/(S1+S2)
        DTGT=RANGE-(T/6)
        IF DTGT <= 3 THEN FLAG=1:
NSAM1=NSAM1-1:LEAKING=LEAKING+1
    1680 RETURN

1690 'ASSESSMENT2:
    R1=RND
    R2=RND
    TGTA=1
    TGTB=1
    T=T+8:DTGT=RANGE-(T/6)
    TP=TP+8:DTGTP=RANGE-(TP/6)
    CIWSDTGT=DTGT:CIWSDTGTP=DTGTP
    CIWST=T:CIWSTP=TP 'CIWST AND CIWSTP ARE THE CIWS
    'MODE
    IF DTGT <= 3 AND DTGTP <= 3 THEN FLAG=1:GOTO 1810
    IF TGT1SUC=1 AND DTGTP <= 3 THEN FLAG=1:GOTO 1810
    IF TGT2SUC=1 AND DTGT <= 3 THEN FLAG=1:GOTO 1810
    IF R1 =< PK THEN TGTA=0

```

```

                IF R2 =< PK THEN TGTB=0
1810  RETURN

1840  'ASSESSMENT1:
        R=RND
        TGT=1
        T=T+8:DTGT=RANGE-(T/6):CIWST=T:CIWSDTGT=DTGT
        IF R =< PK THEN TGT=0
        IF DTGT <= 3 THEN FLAG=1
2010  RETURN

2210  'S1234: (FCR1 LOCK-ON TGT1, FCR2 LOCK-ON TGT2. NEED
        ' REACTION TIME.)
        FLAG=0      'IF FLAG=1 THEN SAM'S DEFENSE IS ENDED
        CIWSFLAG=0  'IF CIWSFLAG=1 THEN CIWS MODE IS ON,
                    ' WHICH IMPLY THERE
                    'ARE TGT's LEAKING THRU THE SAM's DEFENSE
        MARK=0
        NFROM=1234:KUM=0 'KUM IS THE CODE FOR 1234-134-34-3
                    'USE ONLY
        WHERE=1234 'WHERE IS USED IN RELOAD FOR THIS PLACE
        T= T+RT
        TP=TP-SPACING+RT
        CONST1=0
        CONST2=SPACING
        CIWST=T:CIWSTP=TP
2270  GOSUB 1400
        TGT1SAM=TGT1SAM+1
        TGT2SAM=TGT2SAM+1
        NSAM1=TGT1SAM:NSAM2=TGT2SAM
        GOSUB 1470:TGT1SAM=NSAM1:TGT2SAM=NSAM2:IF FLAG=1
THEN RETURN
        IF TGT2SUC=1 THEN
            MARK=1:GOSUB 1840:TGT1=TGT: GOSUB 4380:RETURN
        END IF
        GOSUB 1690: IF FLAG=1 THEN RETURN
        TGT1=TGTA:TGT2=TGTA
        IF TGT1=1 AND TGT2=1 THEN GOTO 2270
        IF TGT1=0 AND TGT2=0 THEN GOSUB 2400
        IF TGT1=0 AND TGT2=1 THEN GOSUB 2745
        IF TGT1=1 AND TGT2=0 THEN GOSUB 3075
2390  RETURN

2400  'S34:(SUBROUTINE FOR TGT1 AND TGT2 HAVE BEEN KILLED BUT
        NOT TGT3 AND TGT4)
        FLAG=0: WHERE=34
        'THREE COMBINATIONS FLOW INTO NODE 34:
        '1234-34
        '1234-234-34

```

```

      '1234-134-34
      IF NFROM=1234 THEN
        T=T-2*SPACING
        TP=TP-2*SPACING
        CONST1=2*SPACING
        CONST2=2*SPACING
      ELSEIF NFROM=234 THEN
        TP= TP-2*SPACING
      ELSEIF NFROM=134 THEN
        T=T-3*SPACING
        CONST1=3*SPACING
        CONST2=0
      END IF
      IF NFROM=1234 THEN T=T+RT:TP=TP+RT:GOSUB 1400
      IF NFROM=234 THEN TP=TP+RT:GOSUB 1400
      IF NFROM=134 THEN T=T+RT: GOSUB 1400
2540   TGT3SAM=TGT3SAM+1
        TGT4SAM=TGT4SAM+1
        NSAM1=TGT3SAM:NSAM2=TGT4SAM
        NFROM=34
        GOSUB 1470:TGT3SAM=NSAM1:TGT4SAM=NSAM2: IF FLAG=1 THEN
RETURN
      IF TGT2SUC=1 THEN
        MARK=1:GOSUB 1840:TGT3=TGT: GOSUB 3860:RETURN
      END IF
      GOSUB 1690: IF FLAG=1 THEN RETURN
      IF TGT2SUC=1 AND TGT1SUC=0 THEN TGT3=TGTA:GOSUB
3860:RETURN
      IF TGT1SUC=1 AND TGT2SUC=0 THEN TGT4=TGTB:GOSUB
3580:RETURN
      TGT3=TGTA:TGT4=TGTB
      IF TGT3=1 AND TGT4=1 THEN GOSUB 1400:GOTO 2540
      IF TGT3=0 AND TGT4=0 THEN RETURN
      IF TGT3=0 AND TGT4=0 THEN RETURN
      IF TGT3=0 AND TGT4=1 THEN GOSUB 3580
      IF TGT3=1 AND TGT4=0 THEN GOSUB 3860
RETURN
2745 'S234: (SUBROUTINE FOR TGT1 HAS BEEN KILLED BUT NOT
      ' TGT2,TGT3 AND TGT4)
      ' NOTE:
      '     1. FCR1 MOVE TO TGT3, AND FCR2 IS STILL ON TGT2
      '     2. IN THIS CASE, FCR1 NEED REACTION BECAUSE OF
      '        ENGAGING NEW TGT
      FLAG=0:WHERE=234
      TP=TP+0
      T=T-(2*SPACING)+RT
      CONST1=2*SPACING
      CONST2=0

```

```

2850   GOSUB 1400
      TGT2SAM=TGT2SAM+1
      TGT3SAM=TGT3SAM+1
      NSAM1=TGT2SAM:NSAM2=TGT3SAM
      GOSUB 1470:TGT2SAM=NSAM1:TGT3SAM=NSAM2: IF FLAG=1
THEN RETURN
      NFROM=234
      IF TGT2SUC=1 THEN
          MARK=1:GOSUB 1840:TGT2=TGT: GOSUB 4200:RETURN
      END IF
      GOSUB 1690: IF FLAG=1 THEN RETURN
      TGT2=TGTA:TGT3=TGTB
      IF TGT2=1 AND TGT3=1 THEN GOTO 2850
      IF TGT2=0 AND TGT3=0 THEN GOSUB 3580
      IF TGT2=0 AND TGT3=1 THEN GOSUB 2400
      IF TGT2=1 AND TGT3=0 THEN GOSUB 3340
3070 RETURN

3075 'S134:(SUBROUTINE FOR TGT2 HAS BEEN KILLED BUT NOT TGT1,
      ' AND TGT3,TGT4 STILL EXIST)
      'NOTE:
      ' 1. BECAUSE TGT1 HAS NOT BEEN KILLED, SO IT NEEDS
      ' TO FIRE SAM TOWARD
      ' TGT1 AND NO REACTION TIME NECESSARY.
      ' 2. FCR2 KILLED TGT2 AND SHIFT TO NEXT TGT WHICH IS
      ' TGT3, SO IT NEED
      ' TO ADD REACTION TIME FOR LOCKING ON THE TGT.

      FLAG=0: WHERE=134:KUM=1: 'PRINT "134"
      T=T+0
      TP=TP-SPACING+RT
      CONST1=0
      CONST2=SPACING
3200   GOSUB 1400
      TGT1SAM=TGT1SAM+1
      TGT3SAM=TGT3SAM+1
      NSAM1=TGT1SAM:NSAM2=TGT3SAM:NFROM=134
3240   GOSUB 1470:TGT1SAM=NSAM1:TGT3SAM=NSAM2:IF FLAG=1 THEN
RETURN
      IF TGT2SUC=1 THEN
          MARK=1:GOSUB 1840:TGT1=TGT:GOSUB 3580:RETURN
      END IF
      NFROM=134:GOSUB 1690: IF FLAG=1 THEN RETURN
      TGT1=TGTA:TGT3=TGTB
      IF TGT1=1 AND TGT3=1 THEN GOTO 3200
      IF TGT1=0 AND TGT3=0 THEN GOSUB 3580
      IF TGT1=0 AND TGT3=1 THEN GOSUB 2400
      IF TGT1=1 AND TGT3=0 THEN GOSUB 4550
3330 RETURN

```

```

3335 'S24:(TGT2 AND TGT4 LEFT, BUT FCRI SHIFTS FROM TGT3 TO
      'TGT4 SO FCRI NEEDS THE REACTION TIME TO LOCK ON TGT4.)
      FLAG=0:WHERE=24: 'PRINT "IN 24"
      IF MARK=1 THEN TP=TP+0:GOTO 3400
      T=T-SPACING+RT:TP=TP+0
      CONST1=SPACING
      CONST2=0
3400  GOSUB 1400
      TGT2SAM=TGT2SAM+1
      TGT4SAM=TGT4SAM+1
      NSAM1=TGT2SAM:NSAM2=TGT4SAM
      NFROM=24
      GOSUB 1470:TGT2SAM=NSAM1:TGT4SAM=NSAM2:IF FLAG=1 THEN
RETURN
      IF TGT2SUC=1 THEN
          MARK=1:GOSUB 1840:TGT1=TGT:GOSUB 4200:RETURN
      END IF
      GOSUB 1690: IF FLAG=1 THEN RETURN
      TGT2=TGTA:TGT4=TGTB
      IF TGT2=1 AND TGT4=1 THEN GOTO 3400
      IF TGT2=1 AND TGT4=0 THEN GOSUB 4200
      IF TGT2=0 AND TGT4=1 THEN GOSUB 3580
      IF TGT2=0 AND TGT4=0 THEN RETURN
      IF TGT2=0 AND TGT4=0 THEN RETURN
3570 RETURN

3580 'S4: WHEN TGT1,TGT2 AND TGT3 HAVE BEEN KILLED, THERE IS
      'ONLY TGT4 LEFT
      'NOTE:
      ' 1. CASE 1: WHICH FROM NODE 234 IS TO KILL TGT2 AND
      ' TGT3, THEN SHIFT THE FCR, WHICH WE SHOULD CHOOSE
      ' MIN(T,TP) OF THE FCR TO TGT4.
      ' 2. CASE 2: WHICH FROM NODE 134 IS TO KILL TGT1 AND
      ' TGT3, THEN SHIFT THE FCR, WHICH WE SHOULD CHOOSE
      ' MIN(T,TP) OF THE FCR, TO TGT4.
      ' 3. IN THESE TWO CASES, IT NEEDS TO ADD THE REACTION
      ' TIME TO LOCK ON TGT4.
      FLAG=0: WHERE=4
      '1234-34-4.
      '1234-234-4.
      '1234-234-34-4.
      '1234-234-24-4.
      '1234-134-4.
      '1234-134-34-4.
      '1234-134-14-4.
      IF NFROM=34 THEN T=TP: GOTO 3730
      IF T >= TP THEN T=TP
      IF NFROM=234 THEN T=T-2*SPACING+RT

```



```

3740     IF NFROM=134 THEN T=T-3*SPACING+RT
        TGT4SAM=TGT4SAM+1
        NSAM1=TGT4SAM
        GOSUB 1610:TGT4SAM=NSAM1:IF FLAG=1 THEN RETURN
        NFROM=4:GOSUB 1840:IF FLAG=1 THEN RETURN
        TGT4=TGT: IF MARK = 1 THEN RETURN
        IF TGT4=0 THEN RETURN
        IF TGT4=1 THEN GOTO 3740

3850 RETURN

3860 ' S3: (WHEN ALL THE OTHER THREE TGTS WERE KILLED, TGT3
      ' LEFT)
      'NOTE:
      '   THERE ARE THREE CASES FOR NODE 3:
      '       1. NODE 1234 --> NODE 34 --> NODE 3.
      '       2. NODE 1234 --> NODE 234 --> NODE 34
      '           --> NODE 3.
      '       3. NODE 1234 --> NODE 134 --> NODE 34
      '           --> NODE 3.
      '   BECAUSE TGT3 HAS ALREADY BEEN TRACKED BY FCR,
      '   SO THERE IS NO REACTION TIME FOR TGT3.
      FLAG=0:WHERE=3
      '1234-34-3
      '1234-234-34-3 (NEED TO BE CAREFUL IN DECIDING THE VALUE OF
      'T. SEE NEXT LINE
      IF KUM=1 AND NFROM=34 THEN:T=TP:GOTO 4090
      IF T >= TP THEN T=TP
4090     TGT3SAM=TGT3SAM+1
        NSAM1=TGT3SAM
        GOSUB 1610:TGT3SAM=NSAM1: IF FLAG=1 THEN RETURN
        NFROM=3:GOSUB 1840:IF FLAG=1 THEN RETURN
        TGT3=TGT:IF MARK=1 THEN RETURN
        IF TGT3=0 THEN RETURN
        IF TGT3=1 THEN GOTO 4090

4190 RETURN

4200 'S2: TGT2 LEFT ONLY.
      ' THIS CASE WOULD HAPPEN ONLY FROM NODE 24. NO
      ' REACTION TIME NECESSARY.

      FLAG=0: WHERE=2
      IF NFROM=234 AND MARK=1 THEN
          IF TGT2=1 THEN T=TP:GOTO 4270
          IF TGT2=0 THEN GOSUB 3580:RETURN
      END IF
      IF NFROM=24 AND MARK=1 THEN T=TP
      IF T >= TP THEN T=TP
4270     TGT2SAM=TGT2SAM+1

```

```

NSAM1=TGT2SAM
GOSUB 1610:TGT2SAM=NSAM1:IF FLAG=1 THEN RETURN
NFROM=2:GOSUB 1840:IF FLAG=1 THEN RETURN
TGT2=TGT:IF MARK=1 THEN RETURN
IF TGT2= 0 THEN RETURN
IF TGT2=1 THEN GOTO 4270
4270 RETURN

4380 'S1: TGT1 LEFT ONLY
      'NO REACTION TIME NECESSARY
      FLAG=0: WHERE=1
      IF T >= TP THEN T=TP
4440 TGT1SAM=TGT1SAM+1
      NSAM1=TGT1SAM
      GOSUB 1610:TGT1SAM=NSAM1:IF FLAG=1 THEN RETURN
      NFROM=1:GOSUB 1840:IF FLAG=1 THEN RETURN
      TGT1=TGT:IF MARK=1 THEN RETURN
      IF TGT1=0 THEN RETURN
      IF TGT1=1 THEN GOTO 4440
4540 RETURN

4550 'S14:(FCR2 KILLED TGT2 AND TGT3 ,AND NOW SHIFTS TO TGT4,
      'WHICH NEED REACTION TIME.)
      FLAG=0: WHERE=14:
      T=T+O
      TP=TP-SPACING+RT
      CONST1=0
      CONST2=SPACING
4615 GOSUB 1400
      TGT1SAM=TGT1SAM+1
      TGT4SAM=TGT4SAM+1
      NSAM1=TGT1SAM:NSAM2=TGT4SAM
      GOSUB 1470:TGT1SAM=NSAM1:TGT4SAM=NSAM2:IF FLAG=1 THEN
RETURN
      IF TGT2SUC=1 THEN
          MARK=1:GOSUB 1840:TGT1=TGT:GOSUB 4380:RETURN
      END IF
      NFROM=14:GOSUB 1690: IF FLAG=1 THEN RETURN
      TGT1=TGTA
      TGT2=TGTB
      IF TGT1=1 AND TGT4=1 THEN GOTO 4615
      IF TGT1=1 AND TGT4=0 THEN GOSUB 4380
      IF TGT1=0 AND TGT4=1 THEN GOSUB 3580
      IF TGT1=0 AND TGT4=0 THEN RETURN
      IF TGT1=0 AND TGT4=0 THEN RETURN
4770 RETURN

4780 'STATISTIC:

```

```

'TOTALSAM: TOTAL SAMs HAVE BEEN FIRED FROM THE N SAMPLE SIZE
'NSAM # OF MISSILES THAT CAN BE LAUNCHED AGAINST THE INCOMING
'TARGETS
'EK: EXPECTED NUMBER OF TARGETS BEING KILLED.
'SS: SHIP SURVIVABILITY AGAINST 4 TARGETS.
'ESA: EXPECTED # OF DEFENSE SUCCESSFULLY.
'SA: THE # OF SUCCESSFUL DEFENSE.
  BG(I,J,K)=TGTKILLED 'TGTs ARE KILLED BY SAM
  LEAKTHRU(I,J,K)=TLEAK 'TGTs GET THRU THE SAM DEFENSE
  DEFFAIL(I,J,K)=HIT 'AT LEAST ONE TGT IMPACTS SHIP
  BYCIWS(I,J,K)=GOODCIWS
  TOTALSAM=SAMPTGT1+SAMPTGT2+SAMPTGT3+SAMPTGT4
  TM(I,J,K)=TOTALSAM
'TOTALSAM: TOTAL SAM THE SHIP HAS FIRED AT THE INBOUND TGTs
  LEAKTHRU(I,J,K)=TLEAK
  ESI(I,J,K)=LEAKTHRU(I,J,K)/N
  NS(I,J,K)=TOTALSAM/N
  EK(I,J,K)=TGTKILLED/N
  SS(I,J,K)=1-(HIT/N)
  ESA(I,J,K)=SA(I,J,K)/N
  CIWSKILL(I,J,K)=BYCIWS(I,J,K)/N
  TOTALEK(I,J,K)=(TGTKILLED+GOODCIWS)/N
5000 RETURN

```

CIWS:

```

'IN ORDER FOR THE MAX INTERCEPT RANGE IS 2NM WHICH TAKES TGTs
'12 SECONDS TO FLY
'OVER THE SHIP, WHICH IMPLIES THAT THERE IS NO CHANCE, NO
'ENOUGH TIME, TO
'REENGAGE 2ND TGT.
  CIWSFLAG=1
  TOTALMAG=1200 ' TOTAL MAGAZINES
  FIRERATE=30
  OUCH=0
  TGT=1
IF CIWSDTGT < CIWSDTGTP THEN CIWSDTGT=CIWSDTGTP: CIWST=CIWSTP
CIWSSTARTT=(CIWSDTGT-MI)*6+CIWST 'CIWSSTARTT: THE TIME THE
'CIWS MODE STARTED
IF CIWSDTGT >= 3 THEN '3 NM=(5 SEC)*(1/6)(NM/SEC)+2NM
  CIWST=(CIWSDTGT-3)*6+CIWST '5 SEC IS THE CIWS REACTION
  'TIME
END IF
'REACTION AND START FIRING THE CIWS:
CIWST=CIWST+CIWSRT 'THE TIME CIWS FIRE BY ADDING THE REACTION
'TIME
CIWSDTGT=RANGE-CIWST/6 'THE TGT RANGE WHEN THE CIWS START
' FIRING
5010 DIFF=TOTALT-CIWST

```

```

IF CIWSDTGT <= 0.1 OR DIFF <= .6 THEN OUCH=1: GOTO 5020

' FIRING:
  GOSUB SEEKPK
  CIWST=CIWST+CONTFIRET           'THE CIWST HERE IS THE
                                   'TIME TO CHECK PK

  CIWSDTGT=RANGE-CIWST/6
  GOSUB CIWSSUB1
  IF CIWSDTGT <= 0.1 THEN OUCH=1: GOTO 5020
  IF TGT=1 THEN GOTO 5010
5020 IF NFROM=1234 OR NFROM=134 OR NFROM=234 THEN OUCH=1
RETURN

```

```

CIWSSUB1:
' THE CIWS WILL BE ON AT THE ONE WHO HAS BEEN PROCESSED BY THE
' SAM FIRST ALREADY
IF RANGE <= 10 AND NFROM=1234 THEN
  TGTT$="TGT2"
  TGT=TGT2
END IF :GOTO 6000

```

```

IF NFROM=1234 THEN TGT=TGT1: TGTT$="TGT1"
IF NFROM=134 THEN TGT=TGT1: TGTT$="TGT1"
IF NFROM=234 THEN TGT=TGT2: TGTT$="TGT2"
IF NFROM=34 THEN TGT=TGT3: TGTT$="TGT3"
IF NFROM=14 THEN TGT=TGT1: TGTT$="TGT1"
IF NFROM=24 THEN TGT=TGT2: TGTT$="TGT2"
IF NFROM=1 THEN TGT=TGT1: TGTT$="TGT1"
IF NFROM=2 THEN TGT=TGT2: TGTT$="TGT2"
IF NFROM=3 THEN TGT=TGT3: TGTT$="TGT3"
IF NFROM=4 THEN TGT=TGT4: TGTT$="TGT4"

```

```

6000:
  R=RND
  IF R <= CIWSPK THEN TGT=0:GOODCIWS=GOODCIWS+1:AR=AR+1
  IF RANGE <= 10 AND NFROM=1234 THEN TGT2=TGT: GOTO 6610
  IF NFROM=1234 THEN TGT1=TGT: GOTO 6610
  IF NFROM=134 THEN TGT1=TGT: GOTO 6610
  IF NFROM=234 THEN TGT2=TGT: GOTO 6610
  IF NFROM=34 THEN TGT3=TGT: GOTO 6610
  IF NFROM=14 THEN TGT1=TGT: GOTO 6610
  IF NFROM=24 THEN TGT2=TGT: GOTO 6610
  IF NFROM=1 THEN TGT1=TGT: GOTO 6610
  IF NFROM=2 THEN TGT2=TGT: GOTO 6610
  IF NFROM=3 THEN TGT3=TGT: GOTO 6610
  IF NFROM=4 THEN TGT4=TGT: GOTO 6610

```

```

6610 'ASSESSMENT:
      CIWST=CIWST+2

```

RETURN

SEEKPK:

CONTFIRET=DIFF-.6

IF DIFF > 8.6 THEN CIWSPK=0.6 :CONTFIRET=8

'8.6 SEC BECAUSE OF INCLUDING THE 0.1 NM OF THE MIN INTERCEPT  
'RANGE

IF DIFF > 6.6 AND DIFF <= 8.6 THEN CIWSPK=.05\*CONTFIRET+.2

IF DIFF > 4.6 AND DIFF <= 6.6 THEN CIWSPK=.1\*CONTFIRET-.1

IF DIFF > 0.6 AND DIFF <= 4.6 THEN CIWSPK=.075\*CONTFIRET

RETURN

5250 END

Appendix C

Output data

Simultaneous SSMs attack (spacing = 0)

pk=0.3, state 1:

<u>SAM DEFENSE</u>				<u>RESULT</u>		
<u>RT</u>	<u>RANGE</u>	<u>E[#SAM]</u>	<u>SS</u>	<u>EK[SSM]</u>	<u>E[LEAK]</u>	<u>SS</u>
30	30	6.14	0.01	1.74	2.26	0.01
30	25	5.57	0.01	1.47	2.53	0.01
30	20	3.82	0.00	1.14	2.86	0.00
30	15	2.91	0.00	0.81	3.19	0.00
30	10	1.00	0.00	0.30	3.70	0.00

pk=0.3, state 2:

<u>SAM DEFENSE</u>				<u>RESULT</u>		
<u>RT</u>	<u>RANGE</u>	<u>E[#SAM]</u>	<u>SS</u>	<u>EK[SSM]</u>	<u>E[LEAK]</u>	<u>SS</u>
20	30	6.59	0.03	1.81	2.19	0.03
20	25	5.65	0.01	1.64	2.36	0.01
20	20	4.79	0.00	1.30	2.70	0.00
20	15	3.82	0.00	0.60	3.40	0.00
20	10	2.00	0.00	0.61	3.39	0.00

pk=0.5, state 3:

<u>SAM DEFENSE</u>					<u>RESULT</u>	
<u>RT</u>	<u>RANGE</u>	<u>E[#SAM]</u>	<u>SS</u>	<u>EK[SSM]</u>	<u>E[LEAK]</u>	<u>SS</u>
20	30	5.98	0.19	2.71	1.29	0.19
20	25	5.20	0.08	2.47	1.53	0.08
20	20	4.50	0.00	1.90	2.10	0.00
20	15	3.50	0.00	0.99	3.01	0.00
20	10	2.00	0.00	1.00	3.00	0.00

pk=0.7, state 4 and state 5:

<u>SAM DEFENSE</u>					<u>CIWS DEFENSE</u>		<u>RESULT</u>	
<u>RT</u>	<u>RANGE</u>	<u>E[#SAM]</u>	<u>SS</u>	<u>EK[SSM]</u>	<u>E[LEAK]</u>	<u>EK[SSM]</u>	<u>E[LEAK]</u>	<u>SS</u>
20	30	5.24	0.47	3.35	0.65	0.35	0.3	0.75
20	25	4.69	0.26	3.09	0.91	0.50	0.42	0.65
20	20	4.21	0.00	2.21	1.79	0.65	1.14	0.18
20	15	3.02	0.00	1.40	2.60	0.65	1.95	0.00
20	10	2.00	0.00	1.40	2.60	0.66	1.94	0.00

Sequential SSMs attack (spacing = 5 seconds)

<u>SAM DEFENSE</u>						<u>CIWS DEFENSE</u>	<u>RESULT</u>	
<u>RT</u>	<u>RANGE</u>	<u>E[#SAM]</u>	<u>SS</u>	<u>EK[SSM]</u>	<u>E[LEAK]</u>	<u>EK[SSM]</u>	<u>E[LEAK]</u>	<u>SS</u>
20	30	5.24	0.63	3.55	0.45	0.24	0.21	0.83
20	25	5.02	0.36	3.15	0.85	0.43	0.43	0.65
20	20	4.18	0.24	2.85	1.15	0.50	0.65	0.54
20	15	3.79	0.00	1.54	2.46	0.56	1.90	0.00
20	10	2.00	0.00	1.40	2.60	0.67	1.92	0.00

Sequential SSMs attack (spacing = 10 seconds)

<u>SAM DEFENSE</u>						<u>CIWS DEFENSE</u>	<u>RESULT</u>	
<u>RT</u>	<u>RANGE</u>	<u>E[#SAM]</u>	<u>SS</u>	<u>EK[SSM]</u>	<u>E[LEAK]</u>	<u>EK[SSM]</u>	<u>E[LEAK]</u>	<u>SS</u>
20	30	5.49	0.65	3.57	0.43	0.23	0.20	0.84
20	25	5.17	0.64	3.54	0.46	0.24	0.21	0.83
20	20	4.94	0.31	2.96	1.04	0.44	0.60	0.58
20	15	4.00	0.00	1.40	2.60	0.67	1.93	0.00
20	10	2.00	0.00	1.40	2.60	0.67	1.93	0.00



Sequential SSMs attack (spacing = 15 seconds)

<u>SAM DEFENSE</u>					<u>CIWS DEFENSE</u>		<u>RESULT</u>	
<u>RT</u>	<u>RANGE</u>	<u>E[#SAM]</u>	<u>SS</u>	<u>EK[SSM]</u>	<u>E[LEAK]</u>	<u>EK[SSM]</u>	<u>E[LEAK]</u>	<u>SS</u>
20	30	5.53	0.71	3.65	0.35	0.19	0.16	0.87
20	25	5.29	0.65	3.55	0.45	0.24	0.21	0.83
20	20	5.11	0.45	3.21	0.79	0.35	0.44	0.71
20	15	4.15	0.24	2.37	1.63	0.49	1.13	0.44
20	10	3.19	0.00	1.55	2.45	0.56	1.89	0.00

## Appendix D

### Assumptions of CIWS

- The maximum intercept range is two NMs.
- The minimum intercept range is 0.1 NMs.
- The reaction time of CIWS is five seconds.
- The fire rate is 30 rounds per second.
- The assessment time is two seconds.
- The total ammunition is 1200 rounds.

## LIST OF REFERENCES

1. Banks, Jerry and John S. Carson, II, *Discrete-event system Simulation*, Prentice-Hall Inc., 1984.
2. Hughes, Wayne P., Jr., *Fleet Tactics*, Naval Institute Press, 1986.
3. Kachigan, Sam Kash, *Statistical Analysis*, Radius Press, 1986.
4. Hamburg, Morris, *Statistical Analysis for Decision Making*, Harcourt Brace Jovanovich, 1987.
5. Operation's Analysis Study Group, *Naval Operations Analysis*, Naval Institute Press, 1986.
6. DeGroot, Morris H., *Probability and Statistics*, Addison-Wesley Publishing Company, 1986.

INITIAL DISTRIBUTION LIST

1. Professor Edward Rockower Code 55 Rf 4  
Department of Operations Research  
Naval Postgraduate School  
Monterey, CA 93943
2. Professor Ross Thackeray Code 74 2  
Department of Operations Research  
Naval Postgraduate School  
Monterey, CA 93943
3. Dr. Jen Wang 1  
6-216  
THE JOHNS HOPKINS UNIVERSITY  
APPLIED PHYSICS LABORATORY  
Johns Hopkins Road  
Laurel, Maryland 20707-6099
4. Library, Code 0142 2  
Naval Postgraduate School  
Monterey, CA 93943-5002
5. Defense Technical Information Center 1  
Cameron Stations  
Alexandria, Virginia 22304-6145
6. Naval Ocean Systems Center (NOSC) 1  
ATTN: Library  
San Diego, California 92152
7. Naval Operational Intelligence Center (NOIC) 1  
ATTN: Operations Officer  
4301 Suitland Road  
Washington, D.C. 20390
8. Naval War College 1  
ATTN: Library  
Newport, Rhode Island 02841
9. War college 1  
Ta Chih  
Taipei, Taiwan  
Republic Of China

- |     |  |   |
|-----|--|---|
| 10. | NTDS<br>P.O. Box 8555<br>Tsoying, Kachsiung, Taiwan<br>Republic Of China   | 1 |
| 11. | Chung San Institute of Science and Technology<br>P.O Box 1, Lung Tan<br>Tao Yuan, Taiwan<br>Republic Of China    | 1 |
| 12. | Naval Academy<br>ATTN: Library<br>Tsoying, Kaohsiung, Taiwan<br>Republic Of China                                | 1 |
| 13. | Lt. H.C. Lu<br>SMC 1610<br>Naval Postgraduate School<br>Monterey, CA 93943                                       | 1 |
| 14. | Lt. H.K. Chia<br>SMC 1919<br>Naval Postgraduate School<br>Monterey, CA 93943                                     | 1 |
| 15. | Lt. Carlos Vallejo<br>SMC 2820<br>Naval Postgraduate School<br>Monterey, CA 93943                                | 1 |
| 16. | Lt. Col. Y.C. Feng<br>SMC 1506<br>Naval Postgraduate School<br>Monterey, CA 93943                                | 1 |
| 17. | Chung Cheng Institute of Technology<br>Ta Hsi 33509 Yuan Shu Lin<br>Tao Yuan Hsian<br>Taiwan, Republic Of China. | 1 |
| 18. | Lt. Kuei-Min Wang<br>3-2 Lane 338<br>Chung Shan West Road<br>Fong Shan City 83026<br>Taiwan, Republic Of China.  | 2 |