

FILE COPY

ESL-TR-87-28  
VOL III

**THERMAL DESORPTION/ULTRAVIOLET  
PHOTOLYSIS PROCESS TECHNOLOGY  
RESEARCH, TEST, AND EVALUATION  
PERFORMED AT THE NAVAL  
CONSTRUCTION BATTALION CENTER,  
GULFPORT, MS, FOR THE USAF  
INSTALLATION RESTORATION  
PROGRAM, VOLUME III**

**R.W. HELSEL, R.W. THOMAS**

**EG&G IDAHO, INC.  
P.O. BOX 1625  
IDAHO FALLS ID 83415**

**DECEMBER 1987**

**FINAL REPORT**

**MAY 1985 - JULY 1985**

DTIC  
ELECTE  
DEC 1 6 1988  
S E

AD-A202 266

APPROVED FOR PUBLIC RELEASE: DISTRIBUTION UNLIMITED



**ENGINEERING & SERVICES LABORATORY  
AIR FORCE ENGINEERING & SERVICES CENTER  
TYNDALL AIR FORCE BASE, FLORIDA 32403**

NOTICE

PLEASE DO NOT REQUEST COPIES OF THIS REPORT FROM  
HQ AFESC/RD (ENGINEERING AND SERVICES LABORATORY).  
ADDITIONAL COPIES MAY BE PURCHASED FROM:

NATIONAL TECHNICAL INFORMATION SERVICE  
5285 PORT ROYAL ROAD  
SPRINGFIELD, VIRGINIA 22161

FEDERAL GOVERNMENT AGENCIES AND THEIR CONTRACTORS  
REGISTERED WITH DEFENSE TECHNICAL INFORMATION CENTER  
SHOULD DIRECT REQUESTS FOR COPIES OF THIS REPORT TO:

DEFENSE TECHNICAL INFORMATION CENTER  
CAMERON STATION  
ALEXANDRIA, VIRGINIA 22314

## **DISCLAIMER NOTICE**

**THIS DOCUMENT IS BEST QUALITY PRACTICABLE. THE COPY FURNISHED TO DTIC CONTAINED A SIGNIFICANT NUMBER OF PAGES WHICH DO NOT REPRODUCE LEGIBLY.**

REPORT DOCUMENTATION PAGE				Form Approved OMB No. 0704-0188	
1a. REPORT SECURITY CLASSIFICATION			1b. RESTRICTIVE MARKINGS		
2a. SECURITY CLASSIFICATION AUTHORITY			3. DISTRIBUTION/AVAILABILITY OF REPORT Approved for public release Distribution Unlimited		
2b. DECLASSIFICATION/DOWNGRADING SCHEDULE					
4. PERFORMING ORGANIZATION REPORT NUMBER(S)			5. MONITORING ORGANIZATION REPORT NUMBER(S) ESL-TR-87-28		
6a. NAME OF PERFORMING ORGANIZATION EG&G Idaho		6b. OFFICE SYMBOL (if applicable)	7a. NAME OF MONITORING ORGANIZATION		
6c. ADDRESS (City, State, and ZIP Code) P.O. Box 1625 Idaho Falls, ID 83415			7b. ADDRESS (City, State, and ZIP Code)		
8a. NAME OF FUNDING/SPONSORING ORGANIZATION Air Force Engineering & Services Center		8b. OFFICE SYMBOL (if applicable) RDVW	9. PROCUREMENT INSTRUMENT IDENTIFICATION NUMBER		
8c. ADDRESS (City, State, and ZIP Code) HQ AFESC/RDVW  Tyndall AFB, FL 32403-6001			10. SOURCE OF FUNDING NUMBERS		
			PROGRAM ELEMENT NO.	PROJECT NO.	TASK NO.
			WORK UNIT ACCESSION NO.		
11. TITLE (Include Security Classification) Thermal Desorption/Ultraviolet Photolysis Process Technology Research, Test, and Evaluation performed at the NCBC, Gulfport, MS, for the USAF Installation Restoration Program					
12. PERSONAL AUTHOR(S) R.W. Helsel and R.W. Thomas					
13a. TYPE OF REPORT FINAL		13b. TIME COVERED FROM May 85 TO July 85	14. DATE OF REPORT (Year, Month, Day) December 1987		15. PAGE COUNT 920
16. SUPPLEMENTARY NOTATION Availability of this report is specified on reverse of front cover.					
17. COSATI CODES			18. SUBJECT TERMS (Continue on reverse if necessary and identify by block number)		
FIELD	GROUP	SUB-GROUP	Herbicide Orange	Thermal Treatment	2,4-D
07	01		Dioxin	Incineration	2,4,5, T
14	01		Analytical Methods		2,3,7,8-TCDD
19. ABSTRACT (Continue on reverse if necessary and identify by block number) The objective of this effort was to examine the feasibility of using a thermal desorption/ultraviolet (TD/UV) destruction technology to treat Herbicide Orange (HO)-contaminated soil at the Naval Construction Battalion Center (NCBC), Gulfport, Mississippi. The IT Corporation pilot scale TD/UV apparatus was used to successfully treat 1700 pounds of sandy-loam, cement stabilized, soil that had been contaminated with HO and 2,3,7,8 tetrachlorobenzo-p-dioxin (TCDD). The TD/UV process volatilizes organic compounds from the soil matrix; collects the desorbed organics in a solvent; and, destroys the contaminants with high-intensity ultraviolet light. The desorption process occurs between 850 to 1150 degrees F. in a nitrogen atmosphere to prevent combustion of the organics. Analysis of feedstock showed TCDD levels ranged from 233-272 parts per billion (ppb). Concentration in the treated soil, measured as the sum of all dioxin/furan congeners, was less than 1ppb, the USAF criterion. The TD/UV process demonstrated the capability to treat dioxin-contaminated soil (cont'd. on reverse side)					
20. DISTRIBUTION/AVAILABILITY OF ABSTRACT <input checked="" type="checkbox"/> UNCLASSIFIED/UNLIMITED <input type="checkbox"/> SAME AS RPT <input type="checkbox"/> DTIC USERS			21. ABSTRACT SECURITY CLASSIFICATION Unclassified		
22a. NAME OF RESPONSIBLE INDIVIDUAL Terry L. Stoddart, Maj. USAF, RSC			22b. TELEPHONE (include Area Code) (904) 283-2942		22c. OFFICE SYMBOL RDVW

and a scaled up version could be considered as a bulk reduction process for restoration of sites contaminated with chlorinated organic compounds including other DOD Herbicide Orange contaminated sites. Sensitivity analyses of six variables (geographic location, soil quantity, electrical power prices, labor, capital equipment use charge, and transportation) were performed to estimate the cost for conditions other than those found at NCBC. The cost to treat one ton of contaminated soil using a scaled up system, based on treatment of 20,000 tons at NCBC, is \$402/ton. The process may have application for treatment of other chlorinated organic compounds. The process may have unique application in geographical areas where incineration would not be accepted.

One negative aspect is that the photolysed solvent remains a hazardous waste and must be handled appropriately. Additional R&D is required to establish an alternate photolysis unit to overcome the problem.

*See +*  
This report is organized into four volumes: Volume I presents the final report on the performance of the Thermal Desorption/Ultraviolet Photolysis process for use in decontaminating soil containing Herbicide Orange/Dioxin. Volume II contains appendices A through O. Volume III contains appendix P. Volume IV contains appendices Q through V.

*See Pg. V*

NTIS GRA&I	<input checked="" type="checkbox"/>
DTIC TAB	<input type="checkbox"/>
Unannounced	<input type="checkbox"/>
Justification	
By _____	
Distribution/	
Availability Codes	
Dist	Avail and/or Special
A-1	DM 23



PREFACE

This report was prepared for the Air Force Engineering and Services Center, Engineering and Services Laboratory, Tyndall AFB, Florida, under Job Order Number (JON) 2103 9027. The principal contractor, EG&G Idaho, Inc., is the prime contractor for the Department of Energy, Idaho National Engineering Laboratory. The major subcontractor for the project is the International Technologies Corporation, Knoxville, Tennessee.

This report is organized into four volumes: Volume I presents the final report on the performance of the Thermal Desorption/Ultraviolet Photolysis process for use in decontaminating soil containing Herbicide Orange/dioxin. Volume II contains appendices A through O. Volume III contains appendix P. Volume IV contains appendices Q through V.

Other contributors to this report include: E. Alperin, W.A. Prop, A.E. Grey, D.L. Miller, H.J. Welland, D.J. Harvego, H.D. Williams, and G. Peterson.

This report has been reviewed by the Public Affairs Office (PAO) and is releasable to the National Technical Information Services (NTIS). At NTIS, it will be available to the general public, including foreign nationals.

This report has been reviewed and approved for publication.

*Terry L. Stoddart*  
 TERRY L. STODDART, Maj, USAF, BSC  
 Chief, Environmental Restoration R&D

*Thomas J. Walker*  
 THOMAS J. WALKER, Lt Col, USAF, BSC  
 Chief, Environics Division

*F. Thomas Lubozynski*  
 F. THOMAS LUBOZYNSKI, Maj, USAF, BSC  
 Chief, Environmental Engineering Branch

*Lawrence D. Hokanson*  
 LAWRENCE D. HOKANSON, Colonel, USAF  
 Director, Engineering and Services Laboratory

TABLE OF CONTENTS

Section	Title	Page
P	INVESTIGATION OF THE APPLICABILITY OF THE EPA MOBILE INCINERATOR SYSTEM FOR TREATING SOILS CONTAMINATED WITH HERBICIDE ORANGE.....	1

*Cont'd*

→ Contents of this appendix include; *See Appendix*

APPENDIX P

INVESTIGATION OF THE APPLICABILITY  
OF THE  
EPA MOBILE INCINERATOR SYSTEM  
FOR TREATING SOILS  
CONTAMINATED WITH HERBICIDE ORANGE

The documents contained in this appendix were published according to their own internal style, which deviates from ESL format. They have, therefore, been published without editing.



INVESTIGATION OF THE APPLICABILITY OF  
THE EPA MOBILE INCINERATOR SYSTEM FOR TREATING SOILS  
CONTAMINATED WITH HERBICIDE ORANGE

By

R. Helsel, J. Fleming, E. Alperin, A. Groen,

For

Air Force Engineering and Services Center  
Tyndall AFB, Florida

July 3, 1985

# TABLE OF CONTENTS

Section	Title	Page
I	INTRODUCTION.....	11
	A. OBJECTIVE.....	11
	B. BACKGROUND.....	11
	C. SCOPE.....	12
II	SOIL CHARACTERIZATION.....	13
	A. SOIL PREPARATION PROCEDURES.....	13
	B. ANALYSIS OF PHYSICAL-CHEMICAL PROPERTIES.....	14
	C. ANALYSIS OF HERBICIDE CONTAMINATION.....	18
III	LABORATORY TREATABILITY TESTS.....	26
	A. EXPERIMENTAL PLAN.....	26
	B. THERMAL TREATMENT TEST EQUIPMENT.....	27
	C. STANDARD TEST PROCEDURE.....	27
	D. TREATABILITY TEST RESULTS AND DISCUSSION.....	29
	1. Treatability Data.....	30
	2. Physical Effects of Treatment.....	38
IV	BATCH PILOT KILN TESTS.....	43
	A. EXPERIMENTAL PROCEDURES AND EQUIPMENT.....	43
	B. TEST RESULTS AND DISCUSSION.....	47
	1. Visual Observations.....	47
	2. Test Data.....	48
V	HEAT TRANSFER EVALUATION.....	61
	A. OBJECTIVES.....	61
	B. PREVIOUS HEAT TRANSFER STUDY RESULTS.....	62
	C. HEAT TRANSFER COMPUTER SIMULATION RESULTS.....	63
VI	EVALUATION OF (MIS) TREATMENT CAPABILITIES.....	68
VII	CONCLUSIONS.....	77
VIII	RECOMMENDATIONS.....	79
IX	REFERENCES.....	80

## LIST OF ANNEXES

	Page
1. Battelle Methods Employed in the Physical-Chemical Analyses of JI, Eglin, and NCBC Soils.....	82
2. Battelle Final Report on Physical-Chemical Characterization of Uncontaminated Soils from JI, Eglin, and NCBC.....	115
3. Battelle Data Table for Physical-Chemical Characterization of Contaminated Soils from JI, Eglin, and NCBC.....	123
4. Allis-Chalmers Report on Small batch kiln Test Sieve Analysis and Bulk Density Measurements for JI, Eglin, and NCBC Soils.....	124
5. Analytical Methods for 2,3,7,8-TCDD .....	199
6. Summary of QA/QC Results for 2,3,7,8-TCDD Analyses.....	223
7. Analytical Data Sheets .....	227
8. Experimental Data Laboratory Test Data .....	244
9. Particle Entrapment Theory.....	261
10. Sample Computer Heat Transfer and Heat and Material Balance Calculations.....	266
11. Statistical Data .....	276

## LIST OF FIGURES

Figure	Title	Page
1	Schematic of Oven Interior.....	28
2	Typical Time-Temperature Profiles for Laboratory Desorption Tests.....	31
3	Effect of Time and Temperature on Removal of 2,3,7,8-TCDD from JI Soil.....	33
4	Effect of Time and Temperature on Removal of 2,3,7,8-TCDD from Eglin Soil.....	34
5	Effect of Time and Temperature on Removal of 2,3,7,8-TCDD from NCBC Soil.....	35
6	Effect of Treatment Time at 481°C on Removal of 2,3,7,8-TCDD.	36
7	Schematic Diagram of the Pilot Batch Kiln.....	44
8	Photograph of the Allis-Chalmers Pilot Kiln System.....	45
9	Comparison of Entrainment With Superficial Gas Velocity in Batch Pilot Kiln.....	53
10	Particle Size Distribution of JI Soil Before and After Batch Kiln Test 4.....	55
11	Particle Size Distribution of Eglin Soil Before and After Batch Kiln Test 6.....	56
12	Particle Size Distribution of NCBC Soil Before and After Batch Kiln Test 10.....	57
13	Time-Temperature History for Three Batch Pilot Kiln Tests Using Approximately Equal Heat Inputs.....	58
14	Projected Vapor Pressure of 2,3,7,8-TCDD at High Temperatures.....	70
15	Plot of LNPD vs. IVP.....	71
16	Predicted Time-Temperature Required to Achieve 1 ppb 2,3,7,8-TCDD for Soils Initially Containing 100 ppb and 500 ppb.....	72
17	Temperature vs. Time for Heat Transfer Run Number 2.....	74
18	Vapor Pressure vs. Time for Heat Transfer Run Number 2.....	75

LIST OF TABLES

Table	Title	Page
1	Soil Characterization Methods.....	15
2	Physical-Chemical Analysis of Uncontaminated Soil Samples....	16
3	Physical-Chemical Analysis of Contaminated Soil Samples.....	17
4	Summary of Thermal Analysis Results.....	19
5	Analytical Methods Used for Determination of Herbicides.....	21
6	Analysis of Baseline Soil Samples for Compounds of Interest..	22
7	Analysis of Contaminated Soil Samples for Compounds of Interest.....	23
8	Evaluation of Relative Concentrations of Herbicide Constituents for Contaminated Test Soils.....	25
9	Summary of Treatability Results - Effect of Time and Temperature on Final Concentration of 2,3,7,8-TCDD.....	32
10	Calculated Removal Efficiencies For 2,3,7,8-TCDD.....	37
11	Analysis of Test Soil Samples Treated at 558°C for Compounds of Interest.....	39
12	Calculated Removal Efficiencies for 2,4-DBE and 2,4,5-TBE After Treatment at 558°C.....	40
13	Summary of Weight Loss Data From Laboratory Treatability Tests.....	41
14	Test Conditions - Batch Kiln Testing.....	46
15	Weight Loss During Pilot Kiln Tests.....	49
16	Soil Bulk Densities Before and After Pilot Kiln Tests.....	50
17	Summary of Soil Entrainment Results During Batch Kiln Tests..	52
18	Summary of Dynamic Angle-of-Repouse Measurements.....	60
19	Parameters for Heat Transfer Runs.....	64

## LIST OF TABLES

Table	Title	Page
20	Predicted Temperatures from Computer Models.....	65
21	Secondary Combustion Chamber Burner Fuel Requirements for Heat Transfer Runs.....	67
22	Predicted Treatment Efficiency for Heat Transfer Runs..	76

## LIST OF ABBREVIATIONS, ACRONYMS, AND SYMBOLS

NCBC	Naval Construction Battalion Center, Gulfport, Mississippi
JI	Johnston Island
CDD	Chlorodibenzodioxin
CDF	Chlorodibenzofuran
TCDD	Tetrachlorodibenzo-p-dioxin
PCDD	Total pentachlorodibenzo dioxin isomers
H <sub>x</sub> CDD	Total hexachlorodibenzo dioxin isomers
H <sub>p</sub> CDD	Total pentachlorodibenzo dioxin isomers
OCDD	Total octachlorodibenzodioxin isomers
2,4-DBE	Butyl ester of 2,4-dichlorophenoxyacetic acid (C <sub>12</sub> H <sub>14</sub> Cl <sub>2</sub> O <sub>3</sub> )
2,4,5-TBE	Butyl ester of 2,4,5-trichlorophenoxyacetic acid (C <sub>12</sub> H <sub>13</sub> O <sub>3</sub> Cl <sub>3</sub> )
2,4-D	2,4-dichlorophenoxyacetic acid (C <sub>8</sub> H <sub>6</sub> Cl <sub>2</sub> O <sub>3</sub> )
2,4,5-T	2,4,5-trichlorophenoxyacetic acid (C <sub>8</sub> H <sub>5</sub> Cl <sub>3</sub> O <sub>3</sub> )
HO	Herbicide Orange, 50:50 (by volume) mixture of n-butyl esters of 2,4-D and 2,4,5-T
MIS	EPA Mobile Incinerator System
TGA	Thermal Gravimetric Analysis
DSC	Differential scanning calorimeter
SCC	Secondary combustion chamber

## SECTION I

### INTRODUCTION

#### A. OBJECTIVE

This study was done to determine the applicability of the EPA's mobile incineration system (MIS) for treating soil contaminated with Herbicide Orange at three Department of Defense sites - Eglin Air Force Base, the Naval Construction Battalion Center (NCBC), Gulfport, Mississippi, and Johnston Island. Beyond demonstrating the technical feasibility of thermal decontamination, the study was to evaluate the treatment characteristics of the soils to identify potential processing problems and to estimate operating rates and corresponding operating conditions which would achieve treatment ("clean-up") criteria. The results of this study would provide some technical basis for supporting and planning a possible demonstration by the Air Force of the MIS at Johnston Island.

#### B. BACKGROUND

The U.S. Air Force is engaged in a multitask program to investigate three Department of Defense sites known to be contaminated with residual Herbicide Orange (Reference 1), and to identify, evaluate, and demonstrate selected technologies that could be used to decontaminate and restore these sites. Herbicide Orange is an equal mixture of the butyl esters of 2,4-dichlorophenoxyacetic acid (2,4-DBE) and 2,4,5-trichlorophenoxyacetic acid (2,4,5-TBE), containing low or trace concentrations of various related chemical compounds originating from raw materials or byproduct reactions (Reference 2). One of these compounds has been determined to be 2,3,7,8-tetrachlorodibenzo-p-dioxin (2,3,7,8-TCDD), a highly toxic and stable compound which is the subject of much scientific and regulatory attention today. Previous field investigations at all three sites have ascertained the approximate location and concentration of the herbicide constituents and have enabled preliminary estimates to be made of the quantities of soil that could require decontamination. Additional, more extensive site surveys are currently being completed.

New federal regulations enacted under RCRA, which will be effective after July 15, 1985, stipulate stringent requirements for treating or disposing of dioxin waste materials, including contaminated soil. Incineration has been demonstrated to be effective in destroying Herbicide Orange (References 3 and 4). Each incineration system and dioxin waste matrix must be tested to establish adequate treatment efficiency before being permitted to operate on a "production basis." Decontamination of soil containing dioxin by using incineration had not been demonstrated.

A mobile incineration system (MIS) has been constructed by EPA for use in treating hazardous waste materials at various sites, and in evaluating



the technology for specific wastes. This process unit has recently completed a trial burn involving dioxin contaminated waste liquids, sludges, and soil in Missouri. A longer demonstration run is planned by EPA which will involve processing quantities of various dioxin contaminated soils from Missouri sites.

In support of EPA's mobilization of the MIS for that trial burn and demonstration, IT Corporation conducted a study to investigate the capability of the MIS to treat soil contaminated with 2,3,7,8-TCDD. The study consisted of two parts:

- A series of laboratory thermal desorption experiments to determine the effect of key process variables and soil (feed) characteristics on removal of 2,3,7,8-TCDD
- A series of pilot-scale batch kiln tests and computer simulations to define the material processing and heat transfer characteristics of the kiln

This research was completed in late 1984. A final report describing the results has been submitted to EPA for review.

### C. SCOPE

This study, as an extension of the previous EPA study, consisted of four activities - soil characterization, laboratory treatability tests, pilot-scale kiln processing tests, and engineering assessment of projected MIS performance. Soil characterization measured chemical properties, including Herbicide Orange concentration, and physical properties which could affect processing. Bench-scale treatability tests determined the relationship between residence time, temperature, and treatment efficiency. Samples of contaminated soil were exposed to different conditions, and the final concentration of 2,3,7,8-TCDD was analyzed. The pilot kiln tests utilized uncontaminated soil to simulate the approximate MIS conditions of gas flow, temperature, and agitation to investigate particulate entrainment, heat transfer and changes in physical form (agglomeration/slagging or attrition). Engineering assessment included performing heat and material balance calculations and heat transfer calculations using computer simulations and determining the various limitations of the MIS which would establish processing rate capabilities.

## SECTION II

### SOIL CHARACTERIZATION

The chemical and physical properties of soils subjected to incineration temperatures are expected to influence the treatability and processing performance. Volatilization of organic pollutants from soil at ambient conditions has been shown to be affected by the exposed surface area (corresponding to particle size) and composition of the soil (References 5, 6 and 7). Interaction (adsorption/ absorption) between organic compounds and a soil matrix can reduce the apparent vapor pressure. Thermochemical transitions of natural organic matter and minerals contained in soils can occur at temperatures as low as 400°C (References 8 through 12). Both oxidation and pyrolysis of organic materials can occur, depending particularly on the availability of oxygen. The thermal stability of specific organic compounds which might be present in contaminated soils varies greatly within the operating range of the MIS (References 13 and 14). Physical alteration of the soil, such as attrition from thermal stresses and agitation/abrasion, and slagging or agglomeration caused by mineralogical transformations, will affect solids flow characteristics, heat transfer, and particulate generation (entrainment).

Previous studies of thermal treatment of contaminated soils included analysis of the untreated soil for primary chemical and physical parameters. These same analyses were performed for this study on samples from each of the three sites. The soil samples were collected from designated locations and shipped to ITC's Environmental Research Laboratory in Knoxville, Tennessee. Samples of both uncontaminated and contaminated soils were packaged in sealed metal paint cans. Each sample weighed approximately 4 kilograms. Both the contaminated and uncontaminated samples used for laboratory treatability tests were prepared for analysis and testing according to procedures described below. Samples of uncontaminated soil were shipped to Allis-Chalmers' test facility and were used for batch kiln tests without any preparation.

The initial contaminated NCBC soil sample had a very low concentration of 2,3,7,8-TCDD. Three additional samples were taken at the site, shipped to ITC, prepared, and analyzed. Based on the results, one of the three was selected as the test sample. It was intended that all three contaminated test soils would have greater than 400 ppb 2,3,7,8-TCDD.

#### A. SOIL PREPARATION PROCEDURES

The samples of soil received from the Air Force were pretreated for use before analysis and thermal treatment tests. This was necessary to achieve a uniform test soil of known 2,3,7,8-TCDD concentration, from which representative aliquots could be taken for each test. Previous ITC research activities with soil containing trace levels of contamination had established the importance of such soil preparation, particularly for small-scale tests.

1. A portion of soil was transferred within the hood from the container to a metal foil tray, separating larger organic matter (e.g., roots, grass) and breaking up large soil agglomerates.
2. The soil was spread out uniformly on a metal tray and allowed to air dry within the hood for 2-3 days with occasional stirring and gentle breaking of larger soil agglomerates using a spatula.
3. The dried soil was screened in several batches, using a standard wire mesh screen with 2 mm openings. Oversize soil was returned to the drying tray and manually broken up using a spatula. Final oversize soil was weighed and transferred to the original soil container. Grinding or milling of the soil was not done.
4. The soil fractions less than 2 mm from each batch were combined in a widemouth, 1-gallon glass jar, blended for 1 hour, using a jar roller, and weighed.
5. Three separate aliquots of soil from random locations within the 1-gallon jar were transferred to individual 250 cc, amber, wide-mouth jars with Teflon®-lined caps. These sample jars were coded, labeled, and submitted for analysis of 2,3,7,8-TCDD to verify uniformity.

#### B. ANALYSIS OF PHYSICAL-CHEMICAL PROPERTIES

Battelle-Columbus Laboratories was contracted by ITC to perform selected analyses, including pH, conductivity, organic matter, cation exchange capacity (CEC), moisture content, specific surface area, oil and grease, and particle size. Table 1 lists the parameters and corresponding methods used by Battelle. These procedures are described in Annex 1. Samples of uncontaminated soil from each site were initially analyzed by Battelle; samples of contaminated soil from each site were analyzed later for selected parameters to investigate the potential effect of the contamination on the measurements.

Table 2, as reproduced from Battelle's final test report Annex 2, summarizes the characterization data for the uncontaminated samples, and Table 3 summarizes the data from the contaminated samples. A comparison between the data from each site and between uncontaminated and contaminated samples can be summarized by the following major points:

- The pH of the Eglin soil is acidic whereas the JI and NCBC soils are slightly alkaline.
- The conductivity of the JI soil is more than one order of magnitude higher than the other two soils.
- The organic matter measured for all the contaminated soil samples was much higher than for the uncontaminated samples. This difference was most noticeable for the JI soil samples; the difference in NCBC samples was relatively small.

TABLE 1. SOIL CHARACTERIZATION METHODS

Parameter	Method references <sup>a</sup>	Method
Organic matter	Schultz, 1980 Watson, 1978	Potassium dichromate oxidation using colorimetric determination of Cr <sup>3+</sup>
pH	McLean, 1980	Measurement of 1:1 (weight: volume mixture of soil water)
Electrical conductivity	Watson, 1978	Measurement of 1:2 (soil:water) slurry using conductivity meter
Surface area	Carter, et al., 1965 Heilman, et al., 1965 Cihacek and Bremner, 1979	Adsorption of monolayer of ethylene glycol monoethyl ether
Particle size	ASTM, 1972 ASTM, 1978	Combined sieving (particles >75 $\mu$ m and sedimentation particles less than 75 $\mu$ m) measured by hydrometer
Cation exchange capacity (CEC)	Allen, et al., 1974	Saturation of exchange sites with NH <sub>4</sub> <sup>+</sup> followed by washing of excess NH <sub>4</sub> <sup>+</sup> reagent and displacement of adsorbed NH <sub>4</sub> <sup>+</sup> with KCl; NH <sub>4</sub> <sup>+</sup> measured by ion specific electrode
Oil and grease	ASTM D4281-83	Extraction with methyl tert-butyl ether after soil is conditioned with aqueous sodium chloride and potassium hydrogen phosphate; gravimetric determination of filtered and evaporated extract
Moisture	ASTM Part II-82216	Oven drying at 110°C to constant weight

<sup>a</sup>Complete references given in Battelle-Columbus procedures, Annex 1.

TABLE 2. PHYSICAL-CHEMICAL ANALYSIS OF UNCONTAMINATED SOIL

Physical-chemical parameters <sup>a</sup>	Jl	Eglin	NCBC
pH	8.24	5.21	8.29
Conductivity (millimhos/cm)	4.99	0.0418	0.279
Organic matter (percent)	<0.50	<0.50	1.5
Cation exchange capacity (milliequivalents/100)	0.12	0.15	3.9
Moisture content (percent)	1.86	0.12	0.48
Surface area (m <sup>2</sup> /g)	6.74	2.46	12.3
Oil and grease content (micrograms/g)	664.9	116.0	1759
Particle size distribution (percent)			
Medium sand (between 425 microns and 2.00 mm)	41.3	41.3	25.7
Fine sand (between 75 and 425 microns)	36.2	51.9	59.4
Silt (between 5 and 75 microns)	19.2	4.77	12.3
Clay (smaller than 5 microns, including colloids) <sup>b</sup>	3.31	2.03	2.70
Colloids (less than 1 micron)	2.94	1.67	2.25

<sup>a</sup>All analyses were done in duplicate with the exception of surface area, which was done in replicates of five. Values reported represent averages. Annex 2 gives deviation values.

<sup>b</sup>Note that the clay fraction includes the colloid fraction, so that the percentages total greater than 100 percent.

TABLE 3. PHYSICAL-CHEMICAL ANALYSIS OF CONTAMINATED SOIL

Physical-chemical parameters <sup>a</sup>	J1	Eglin	NCBC
pH	8.45	3.83	8.55
Conductivity (millimhos/cm)	5.02	0.146	0.205
Organic matter (percent)	4.22	1.22	2.34
Cation exchange capacity (milliequivalents/100 g)	0.73	0.77	2.45
Moisture content (percent)	0.34	0.55	0.38
Oil and grease content (micrograms/g)	1884	4069	3386

<sup>a</sup>All analyses were done in duplicate. Values given are averages. Annex 3 gives deviation values.

- The oil and grease content of the contaminated soil samples was higher than the uncontaminated samples. This difference was most noticeable (factor of 40) for Eglin soil.
- The cation exchange capacity of all contaminated soils was higher than the corresponding uncontaminated samples. NCBC soil had much higher values than the other two soils.
- The surface area did not vary greatly between soils. Likewise, the particle size distributions of the three soils were not greatly different. The clay fraction varied only between 3.5 and 7 percent.

Visual inspection of each sample received resulted in the following observations:

- JI - White/gray; sandstone-like, uniform; contaminated sample slightly darker, probably higher moisture; large stones and chunks (agglomerates) present in both.
- Eglin - Tan; sandy with some agglomerates which easily broke up, twigs and grass noticeable; uncontaminated sample appeared drier and dustier.
- NCBC - Light to dark brown; sandy loam with pebbles and broken shells; some grass and twigs evident; variation in relative amounts of moisture and shell/pebble fraction between the five samples received.

Thermogravimetric analysis (TGA) and differential scanning calorimetry (DSC) analysis of the three samples of uncontaminated soil were performed by Allis-Chalmers as part of the pilot batch kiln tests. Table 4 summarizes the results of these analyses; the actual test data are given in Annex 2. It is obvious that the JI soil, which is principally calcium carbonate, exhibits substantial weight loss as a result of calcination (decarboxylation). The theoretical weight loss attributed to conversion of  $\text{CaCO}_3$  to  $\text{CaO}$  (with the release of  $\text{CO}_2$ ) is 44 percent. Calcination occurs at temperatures above about  $625^\circ\text{C}$ , with a corresponding large endotherm. The Eglin soil showed a moderate and extended exotherm between about  $270$  and  $550^\circ\text{C}$ , where a sharp endotherm occurred; only a small weight loss occurred. The NCBC soil showed a major and extended endotherm between about  $225$  and  $550^\circ\text{C}$ , where a sharp endotherm occurred. A marked weight loss occurred above that temperature, starting at  $630^\circ\text{C}$ .

Allis-Chalmers also performed sieve analyses and bulk density measurements on soil before and after pilot batch kiln processing. These results are discussed in Section IV and the data are presented in Annex 4.

### C. ANALYSIS OF HERBICIDE CONTAMINATION

The prepared uncontaminated and contaminated soils were sampled and analyzed by ITC for the primary chemical constituents of Herbicide Orange and

TABLE 4. SUMMARY OF THERMAL ANALYSIS RESULTS<sup>a</sup>

Soil identification	Weight loss (%) <sup>b</sup>	Corresponding temperature range (°C)	Initiation of exotherm or endotherm (°C) <sup>c</sup>
JI	1.4	25 - 350	130 (-)
	42.5	350 - 1050	310 (-)
	<u>43.9</u>		
Eglin	2.4	25 - 1050	270 (+) 550 (-)
NCBC	0.3	25 - 200	225 (+)
	1.4	200 - 520	550 (-)
	3.8	520 - 1090	
	<u>5.5</u>		

<sup>a</sup>Refer to Annex 4 for DSC and TGA data.

<sup>b</sup>Percent of initial gross weight.

<sup>c</sup>Exotherm = (+), Endotherm = (-)



for CDD and CDF compounds, including 2,3,7,8-TCDD. Arsenic was also analyzed to establish if any Herbicide Blue contamination was present. Herbicide Blue is composed principally of sodium dimethyl arsenate. The "uncontaminated" samples were analyzed to establish a baseline concentration of all constituents. Standard published EPA methods listed in Table 5 were used for quantitative determination of each parameter, except for the sample preparation and analysis of 2,3,7,8-TCDD and other CDDs and CDFs, which are described in Annex 5.

Two pretreatment/extraction procedures were used for the untreated soil samples to evaluate potential differences in the accuracy of analytical results. Previous studies with thermally treated Missouri soil samples demonstrated significantly lower 2,3,7,8-TCDD results using the standard jar extraction procedure with hexane/methanol (specified by EPA - CLP) than the more rigorous procedure involving Soxhlet extraction with benzene after acid treatment of the sample. Therefore, the Soxhlet procedure was used for all thermally treated samples. Both procedures were used for untreated soil samples for comparative purposes, and a comparison of results is given in Annex 6.

The method used for determining 2,4-DBE and 2,4,5-TBE actually measures the free acids, 2,4-D and 2,4,5-T, after chemically converting any esters present to the respective acid. Therefore, the reported values represent the combined ester and acid concentration present in the soil.

Three aliquots of soil were taken from each prepared soil sample and submitted for 2,3,7,8-TCDD analysis. Other parameters were determined on single aliquots. The results of the triplicate analyses, using both sample preparation procedures, are given in Annex 6. Tables 6 and 7 summarize the analytical results for the baseline ("uncontaminated") and contaminated soil samples. Annex 7 gives the specific analytical data. The baseline soils showed the presence of very low (<1 ppm) levels of herbicide constituents. No 2,3,7,8-TCDD was detected at analytical detection limits of 0.2 to 0.8 ppb, although total tetra isomers were detected in the Eglin and NCBC samples. Hepta CDD was detected in both JI and NCBC samples at less than 1 ppb and octa CDD was found at 1 to 3 ppb in all three baseline soil samples. The only CDF detected was for the total octa isomers in the NCBC sample. Arsenic was not detected in any sample at the normal detection limit of 1 ppm for the analytical method used.

The contaminated test soils contained approximately 0.1 to 0.2 weight percent Herbicide Orange based on the combined values for 2,4-D (including 2,4-DBE) and 2,4,5-T (including 2,4,5-TBE). Three phenols were detected, with 2,4,5-trichlorophenol the most significant at concentrations of about 50 ppm. The concentrations of 2,3,7,8-TCDD were approximately 100 ppb for JI and Eglin and 500 ppb for NCBC. These values were considered appropriate for conducting treatability tests since they represented the higher range of values determined in site surveys. No other CDDs were detected except hepta and octa isomers in the JI soil and octa isomers in Eglin. TCDF was detected above 1 ppb in all samples, and OCDF was detected in JI soil.

TABLE 5. ANALYTICAL METHODS USED FOR DETERMINATION OF HERBICIDES

Parameter	Sample preparation	Analytical method
2,4-DBE/2,4-D and 2,4,5-TBE/2,4,5-T	8150 <sup>a</sup>	8150 <sup>a</sup>
Chlorophenols	3540 <sup>a</sup>	8040 <sup>a</sup>
2,3,7,8-TCDD	EPA-CLP <sup>b</sup> and Acid/Soxhlet <sup>c</sup>	EPA-CLP <sup>b</sup>
Arsenic	3020 <sup>a</sup>	7060 <sup>a</sup>

<sup>a</sup>Test Methods for Evaluating Solid Wastes, SW-846, 2nd Edition, U.S. EPA, July 1982.

<sup>b</sup>Described in EPA-EMSL IFB Solicitation WA-84-A002. Detailed procedure given in Annex 5.

<sup>c</sup>Detailed procedure given in Annex 5.

TABLE 6. ANALYSIS OF BASELINE SOIL SAMPLES  
FOR COMPOUNDS OF INTEREST<sup>a</sup>

Compound	Concentration <sup>b</sup> (ppb)		
	JI	Eglin	NCBC
2,4-D	160	160	470
2,4,5-T	210	240	150
2,4-dichlorophenol	ND(1000)	ND(1000)	ND(1000)
2,4,6-trichlorophenol	ND(1000)	ND(1000)	ND(1000)
2,4,5-trichlorophenol	ND(1000)	ND(1000)	ND(1000)
Arsenic	ND(10,000)	ND(10,000)	ND(10,000)
2,3,7,8-TCDD	ND(0.5)	ND(0.8)	ND(0.2)
TCDD	ND(0.52)	0.31	0.13
TCDF	ND(0.17)	ND(0.52)	ND(0.11)
PCDD	ND(0.41)	ND(0.81)	ND(0.42)
PCDF	ND(0.33)	ND(0.96)	ND(0.76)
H <sub>x</sub> CDD	ND(0.84)	ND(0.37)	ND(0.60)
H <sub>x</sub> CDF	ND(0.21)	ND(0.27)	ND(0.18)
H <sub>p</sub> CDD	0.63	ND(0.17)	0.73
H <sub>p</sub> CDF	ND(1.0)	ND(1.0)	ND(1.0)
OCDD	1.73	2.6	2.0
OCDF	ND(0.11)	ND(0.06)	0.26

<sup>a</sup>Soils were analyzed after preparation according to protocol described in Section III (e.g., <2 mm, air dried).

<sup>b</sup>ND = not detected using the analytical procedure identified in Table 5. Detection levels given in parentheses.

TABLE 7. ANALYSIS OF CONTAMINATED SOIL SAMPLES FOR COMPOUNDS OF INTEREST<sup>a</sup>

Compound	Concentration <sup>b</sup> (ppb)		
	JI	Eglin	NCBC
2,4-D	900,000	1,200,000	370,000
2,4,5-T	890,000	1,700,000	710,000
2,4-dichlorophenol	1,900	2,400	1,100
2,4,6-trichlorophenol	1,100	ND	ND
2,4,5-trichlorophenol	38,000	20,000	53,000
Arsenic	ND(10,000)	ND(10,000)	ND(10,000)
2,3,7,8-TCDD	106 <sup>c</sup>	101 <sup>c</sup>	494 <sup>c</sup>
TCDD	126	127	604
TCDF	6.6	2.1	2.3
PCDD	ND(1.09)	ND(1.5)	ND(0.48)
PCDF	ND(1.7)	ND(1.6)	ND(1.9)
H <sub>x</sub> CDD	ND(3.7)	ND(1.2)	ND(0.59)
H <sub>x</sub> CDF	ND(0.67)	ND(0.73)	ND(3.6)
H <sub>p</sub> CDD	29.0	ND(0.72)	ND(1.5)
H <sub>p</sub> CDF	ND(3.5)	ND(2.1)	ND(1.7)
OCDD	32.0	2.6	ND(2.4)
OCDF	1.3	ND(0.33)	ND(0.98)

<sup>a</sup>Soils were analyzed after preparation according to protocol (e.g., <2 mm, air dried).

<sup>b</sup>ND = not detected. Detection levels given in parentheses.

<sup>c</sup>Average of analyses of triplicate aliquots of prepared test soil. Values for other compounds are for a single aliquot.

Arsenic was not detected in any sample at the 1 ppm detection limit. No additional arsenic analyses were performed for any test samples.

Table 8 compares the relative concentrations of 2,3,7,8-TCDD, the three chlorophenols, and 2,4-DBE to the principal Herbicide Orange constituent, 2,4,5-TBE. These ratios can be evaluated relative to the original composition of Herbicide Orange reported in previous studies by the Air Force (Reference 2). The chlorophenols are present at approximately the same relative concentrations as the original material, whereas the 2,3,7,8-TCDD levels are approximately three orders of magnitude higher than levels determined in the original material. This could be a result of differences in volatilization rates and chemical decomposition occurring in the environment during the past decade.

TABLE 8. EVALUATION OF RELATIVE CONCENTRATIONS OF HERBICIDE  
CONSTITUENTS FOR CONTAMINATED TEST SOILS

Compound	Weight ratio of compound to 2,4,5-TBE		
	Jl	Eglin	NCBC
2,4-DBE <sup>a</sup>	1.04	0.723	0.534
2,4,5-TBE <sup>a</sup>	1.00	1.00	1.00
2,4-dichlorophenol	$1.75 \times 10^{-3}$	$1.16 \times 10^{-3}$	$1.27 \times 10^{-3}$
2,4,6-trichlorophenol	$1.01 \times 10^{-3}$	b	b
2,4,5-trichlorophenol	$3.5 \times 10^{-2}$	$9.6 \times 10^{-3}$	$6.12 \times 10^{-2}$
2,3,7,8-TCDD	$9.76 \times 10^{-5}$	$4.87 \times 10^{-5}$	$5.70 \times 10^{-4}$

<sup>a</sup>2,4-DBE = butyl ester of 2,4-D; 2,4,5-TBE = butyl ester of 2,4,5-T.

<sup>b</sup>2,4,6-trichlorophenol was not detected for these samples.

## SECTION III

### LABORATORY TREATABILITY TESTS

A series of bench scale tests was performed to establish the effect of the key process variables, residence time and temperature, on the treatability (dioxin-removal efficiency) of the three test soils. After the soils were prepared by drying and screening as described in Section II, separate aliquots were placed in a small furnace for different time periods. The treated samples were analyzed for 2,3,7,8-TCDD and the results were evaluated to determine the relationship between treatment conditions and final concentration of 2,3,7,8-TCDD. These results were also compared to previous results in which Missouri soils were used. This section describes the experimental activities and test results.

#### A. EXPERIMENTAL PLAN

Experimental activities for this project were conducted at ITC's Environmental Research Laboratory in Knoxville, Tennessee. A specially designed "high-hazard" section of the laboratory permitted the dioxin-contaminated soils to be prepared, tested, and analyzed safely and efficiently. This entire section of the laboratory is designed for the safe handling and analysis of chemicals and samples having toxic or unknown properties. This laboratory has four isolated, negative-pressure cubicles that contain hoods and laboratory benches constructed of materials selected for easy decontamination. Total containment is assured, since all used water is collected and all air leaving the facility is filtered through HEPA and activated carbon filters on the high-velocity hoods. All dioxin-containing materials generated from test activities were packaged and stored for disposal.

The results developed from this study were obtained using a simple and consistent experimental method and apparatus designed to expose the study soils to a specified temperature for a specified time. Treatability was measured by comparing the analyses of 2,3,7,8-TCDD in the untreated and treated soil. The test equipment and procedures are described in this section. The features incorporated into the test system and procedures included (1) sufficient soil quantity to enable analytical sensitivity below 1 ppb and duplicate analysis as necessary, (2) a static but very thin layer of soil to minimize the potential effects of temperature gradients and gas-phase diffusion (in terms of both release of volatilized materials and exposure to the purge gas), and (3) quickly achieving and maintaining steady-state conditions. The experimental apparatus and procedures were the same as those used on previous treatability testing of Missouri soils. A QA/QC plan was prepared and followed during the testing.

## B. THERMAL TREATMENT TEST EQUIPMENT

The principal test equipment was a Lindberg furnace, Model 51848, with an electronic temperature controller and 1600-watt heater system. The oven is double-shell construction with interior surfaces made of Moldatherm<sup>®</sup>, a molded aluminum-silicate insulation material. This oven is capable of operating up to 1100°C and has a relatively fast heat-up rate due to low mass. The interior space is approximately 10 cm wide by 11 cm high by 21 cm deep. A loose block (1.2 cm thick) of Moldatherm is placed on the bottom of the oven to provide additional separation between an object placed in the oven and the hot interior surface of the oven. A built-in thermocouple was used to control the interior oven temperature to the set point. The oven was placed inside a bench-top hood for all tests. Several modifications were made to the oven. Incoloy<sup>®</sup> (3/8 inch) tubing was inserted through the back wall and connected to an air cylinder to provide continuous purging of the interior space during each test. The purge gas was directed against the back wall to promote preheating and distribution. The purge gas flow rate, measured with a standard rotometer, was maintained at approximately 100 cc/minute, equivalent to about 5 percent turnover per minute. A separate thermocouple was used to measure the test temperature. This NBS traceable, Type K, sheathed thermocouple was placed approximately 3 centimeters above the soil surface at the center of the oven. The thermocouple, the temperature indicator, and the purge gas rotometer were calibrated before testing. A Keithley Model 871 Digital Temperature Indicator was used with both thermocouples.

A specially made tray was used to contain the soil within the oven. The tray, which weighed approximately 430 grams, was 9 cm wide by 3.2 cm high by 19.3 cm long and made of Incoloy to resist oxidation at the expected maximum test temperatures. A separate Incoloy lid was used to cover the tray when necessary. The soil was leveled within the tray to a fixed uniform thickness of approximately 2.5 mm. Figure 1 is a scale schematic drawing of the interior of the oven, with tray inserted.

## C. STANDARD TEST PROCEDURE

The standard thermal desorption test consisted of the following steps:

1. Initiate a data log sheet (see Annex 8).
2. Weigh the empty, clean tray.
3. Transfer a representative aliquot (~30 grams) of prepared soil from the jar to the tray using a stainless steel scoop.
4. Weigh the soil and tray and adjust the soil quantity to achieve approximately 30 grams, which results in the approximate desired soil depth.
5. Distribute and level the soil within the tray to ~2.5 mm. Return excess to the sample jar.



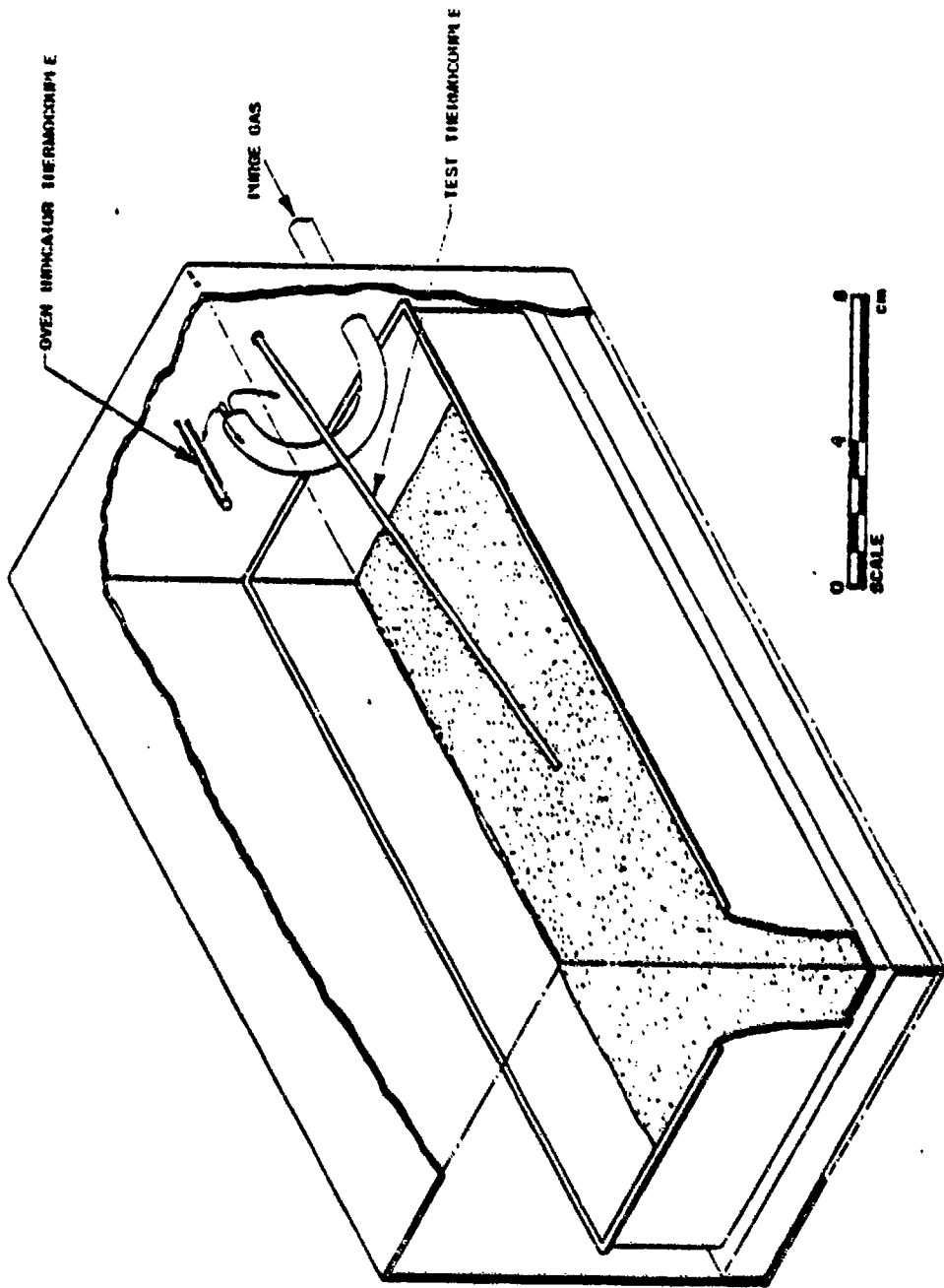

Figure 1. Schematic of Oven Interior

6. Turn the purge gas flow on to the proper setting on the rotometer.
7. Place the tray with soil in the oven at ambient temperature and close the oven door.
8. Set the oven temperature controller set-point to the target test temperature and start the timer.
9. Monitor and record the times and temperatures, periodically, throughout the test period.
10. When the prescribed residence time at the target temperature is reached, shut off the oven heater and purge gas flow and open the oven door.
11. Cautiously withdraw the hot tray and soil using special tongs, place a cover on the tray, and place the covered tray in a separate hood for cooling for approximately 1 hour.
12. Close the oven door and set the temperature at 600°C for approximately 10 minutes. This step is to ensure that no residual materials from the sample remain in the oven.
13. Weigh the tray (without cover) plus treated soil.
14. Transfer an aliquot (typically about 10 grams) of treated soil from the tray to a tared, 250 cc, widemouth, amber bottle with Teflon-lined cap. Code, label, and submit this aliquot for 2,3,7,8-TCDD analysis. Transfer the remainder of the treated soil to an identical type bottle, label and store as a retainer.
15. Clean the tray, cover, and nondisposable implements using the following procedure:
  - Rinse with acetone and wipe clean
  - Scrub with detergent (Alconox®) solution and rinse with hot tap water followed by distilled water
  - Rinse with acetone and allow to dry
  - Rinse three times with methylene chloride (e.g., ~15-25 ml each rinse for the tray)
  - Air dry and store.

#### D. TREATABILITY TEST RESULTS AND DISCUSSION

A total of 16 separate thermal desorption tests were performed using three different test temperatures, ranging from about 430°C to 560°C, for times between 8 and 30 minutes. Two sets of duplicate tests were included for QA/QC purposes. All tests were performed using soil prepared as described previously, except for two tests which used oversize (>2 mm) pieces of JI and NCBC soil to investigate any differences in treatability due to gross differences in particle size. The test results are presented

according to: (1) treatability or removal efficiency for the herbicide constituents and (2) effects of treatment on soil characteristics. Experimental data are summarized in Annex 8. Annex 7 presents all the analytical data while Annex 6 gives QA/QC results.

## 1. Treatability Data

Analysis and interpretation of the test results must consider the typical temperature profile (temperature vs residence time) for the small oven system used in testing. The soil samples were placed in the oven at ambient temperature, and the initial test period involved heating the oven and soil to the target test temperature. This unsteady state heat-up period lasted from about 5 to 9 minutes, with longer time corresponding to higher ultimate temperature. Figure 2 illustrates typical temperature profiles for the three target test temperatures. The target test time was initiated (at time zero) when the test temperature reached approximately the target test temperature.

Treatability or removal efficiency was determined by measuring the final concentration of 2,3,7,8-TCDD and comparing it to the initial concentration and the criteria or goal of 1 ppb. Test conditions (time and temperature combinations) were based on previous treatability tests to demonstrate the influence of these two parameters on treatment. Longer times were selected for certain tests using the NCBC soil which had considerably higher initial concentration than the other two test soil samples (i.e., ~500 ppb vs ~100 ppb). The residence times were considered representative of the normal operational capabilities of the MIS.

Table 9 summarizes the treatability test results, arranged by test temperature, soil type, and treatment time. The test number is listed for reference to data given in Appendix F. The results for each soil were plotted in Figures 3, 4, and 5 to show the effects of time and temperature. Data for all three soils at 481°C were plotted in Figure 6 to show the effect of soil type. The shape of the treatability curves in these figures was developed, in part, based on previous testing with Missouri soil which yielded more data points (times) for each particular target test temperature.

The data show that treatment of all three soils to less than 1 ppb 2,3,7,8-TCDD is feasible if temperatures of 500°C or more are achieved. The results are very similar to those obtained in previous tests with Missouri soils. Table 10 lists the calculated removal efficiencies for 2,3,7,8-TCDD. Nearly all tests above the minimum temperature resulted in at least 99 percent removal. The significant effect of temperature appears to be more pronounced for JI soil, which showed very low removal efficiency at the lowest temperature of 429°C. The coarse (>2 mm) particle size material had lower final 2,3,7,8-TCDD concentration than the prepared (<2 mm) soil used for most tests, despite the fact that analysis of an aliquot of coarse material from NCBC indicated a higher initial 2,3,7,8-TCDD concentration. Since there is considerable variation in the type of soil particles within

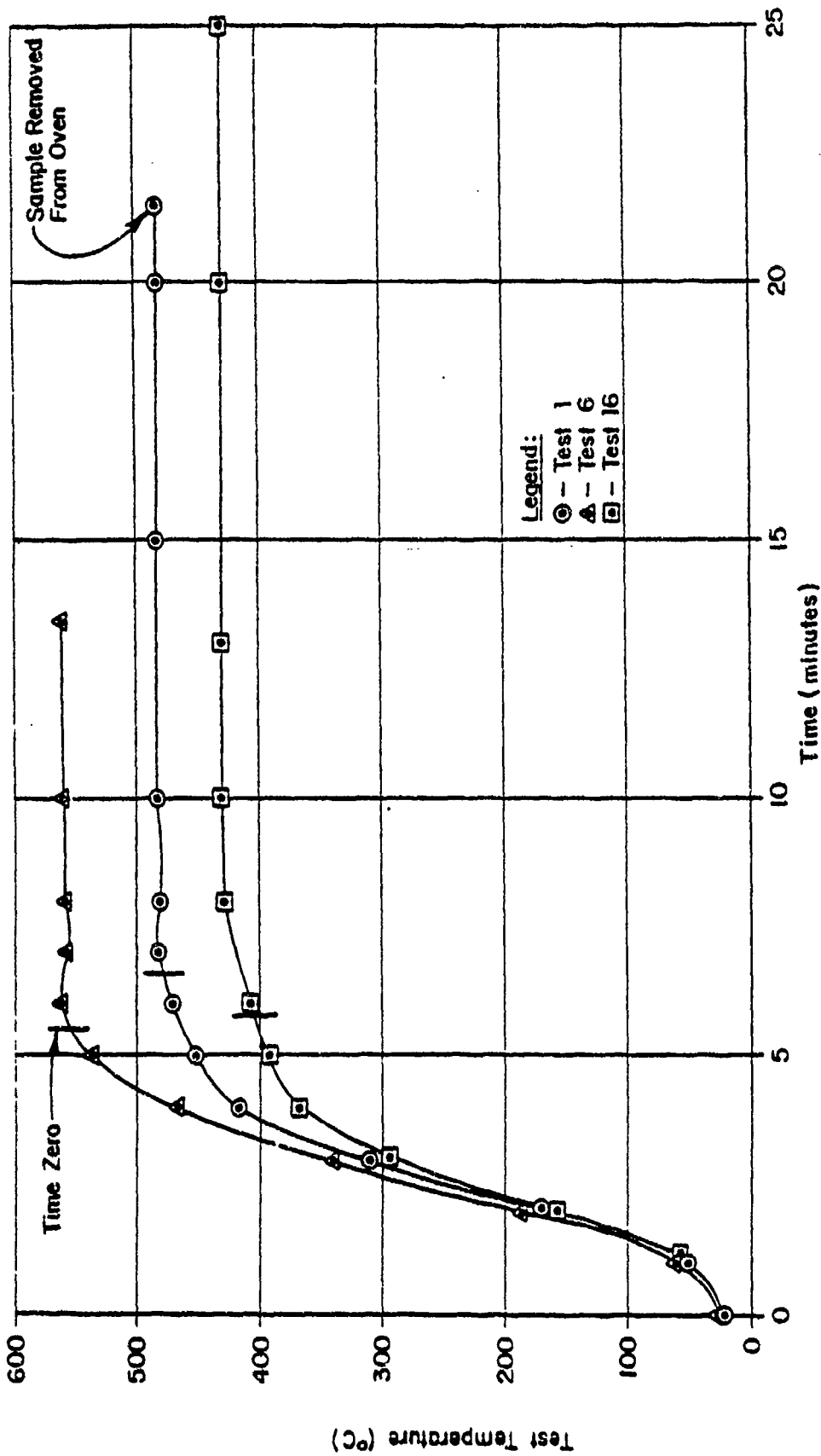

Legend:  
 ○ - Test 1  
 △ - Test 6  
 □ - Test 16

Figure 2. Typical Time-Temperature Profiles for Laboratory Desorption Tests

TABLE 9. SUMMARY OF TREATABILITY RESULTS - EFFECT OF TIME AND TEMPERATURE ON FINAL CONCENTRATION OF 2,3,7,8-TCDD

Nominal test temperature <sup>a</sup> (°C)	Soil identification	Time at test temperature <sup>b</sup> (min)	Final 2,3,7,8-TCDD concentration (ppb)	Test number
430	JI	20	38.5	15
	Eglin	20	4.4	16
	NCBC	30	27.4 <sup>c</sup> 25.7 <sup>c</sup>	14
481	JI	15	4.5	1
	JI	30	1.6	5
	JI (>2 mm)	30	0.44	12
	Eglin	15 <sup>d</sup>	1.3	2 <sup>d</sup>
	Eglin	15 <sup>d</sup>	0.8	4 <sup>d</sup>
	Eglin	30	0.45	3
	NCBC	15	10.1	9
	NCBC	30	4.6	10
	NCBC (>2 mm)	30	0.74	11
558	JI	8	0.81 <sup>c</sup>	6
	JI	c	0.31 <sup>c</sup>	c
	Eglin	8	0.71	7
	NCBC	15 <sup>d</sup>	0.99	8 <sup>d</sup>
	NCBC	15 <sup>d</sup>	0.53	13 <sup>d</sup>

<sup>a</sup>Refer to time-temperature data (Annex 8) for exact temperatures during entire test.

<sup>b</sup>This period begins at "zero time" when the target test temperature is reached; zero time is actually 5 to 9 minutes after start of heat-up.

<sup>c</sup>Analytical duplicate; separate aliquots of treated soil were analyzed.

<sup>d</sup>Experimental duplicates.

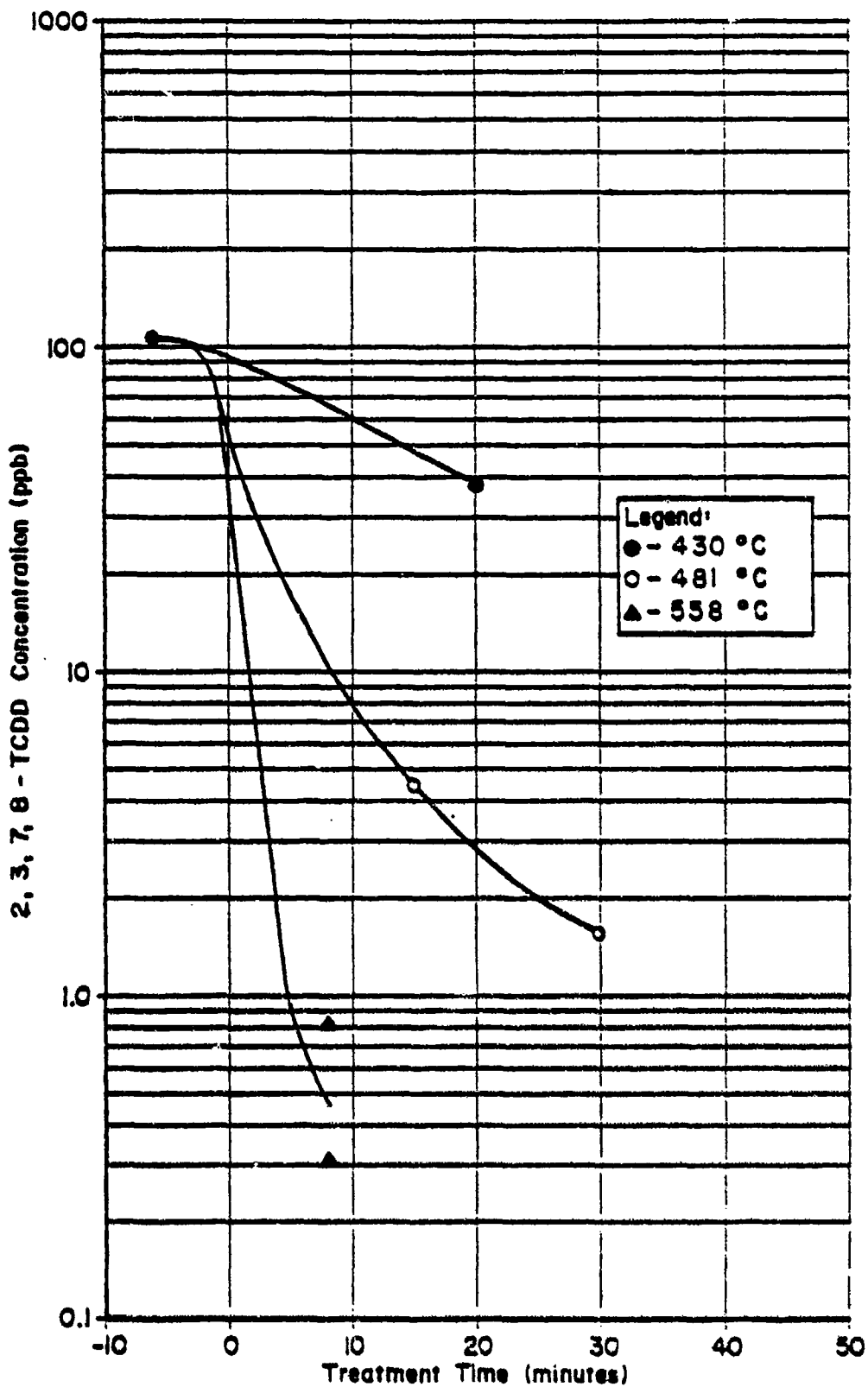

Figure 3. Effect of Time and Temperature on Removal of 2,3,7,8,-TCDD from JI Soil

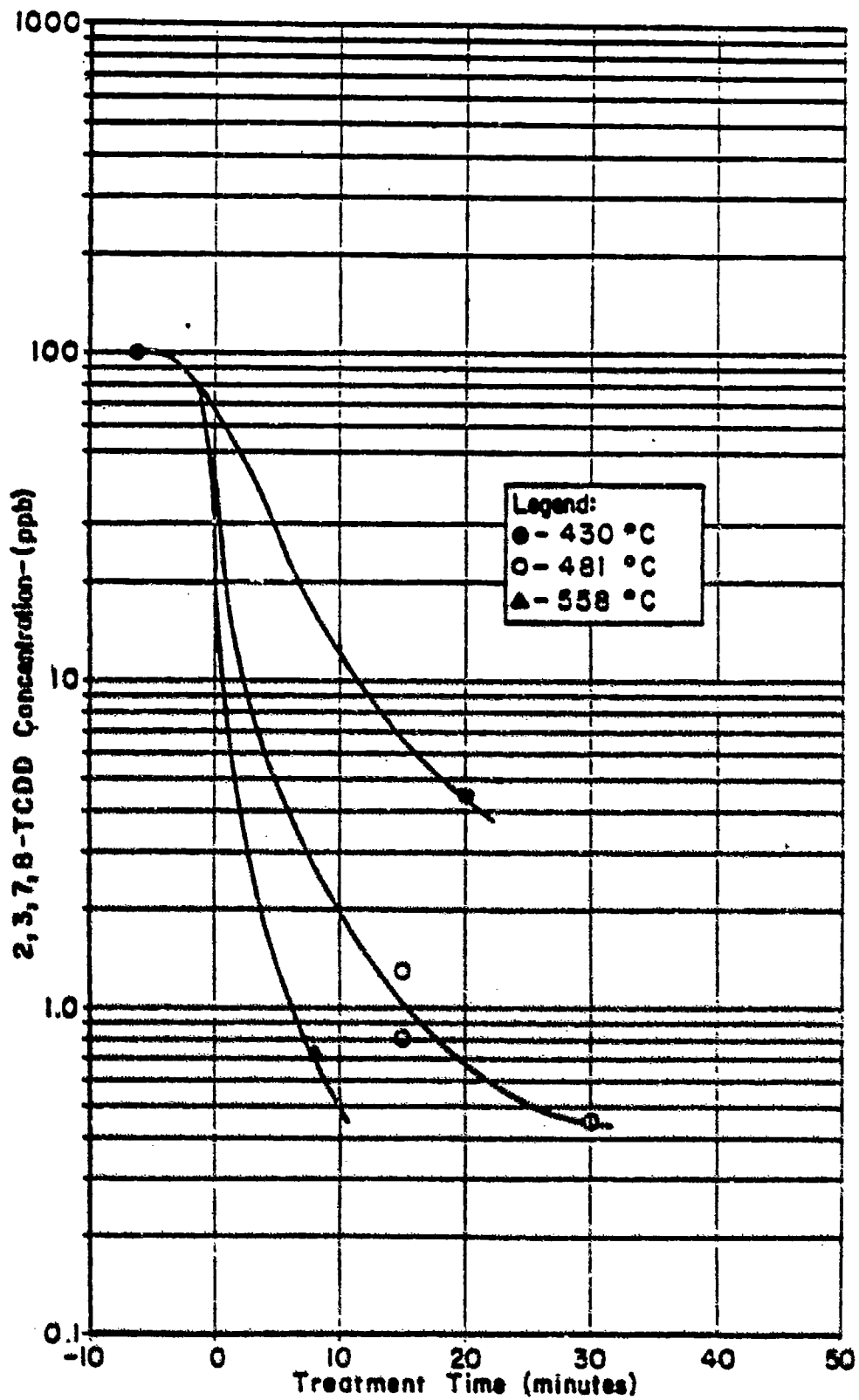

Figure 4. Effect of Time and Temperature on Removal of 2,3,7,8-TCDD from Eglin Soil

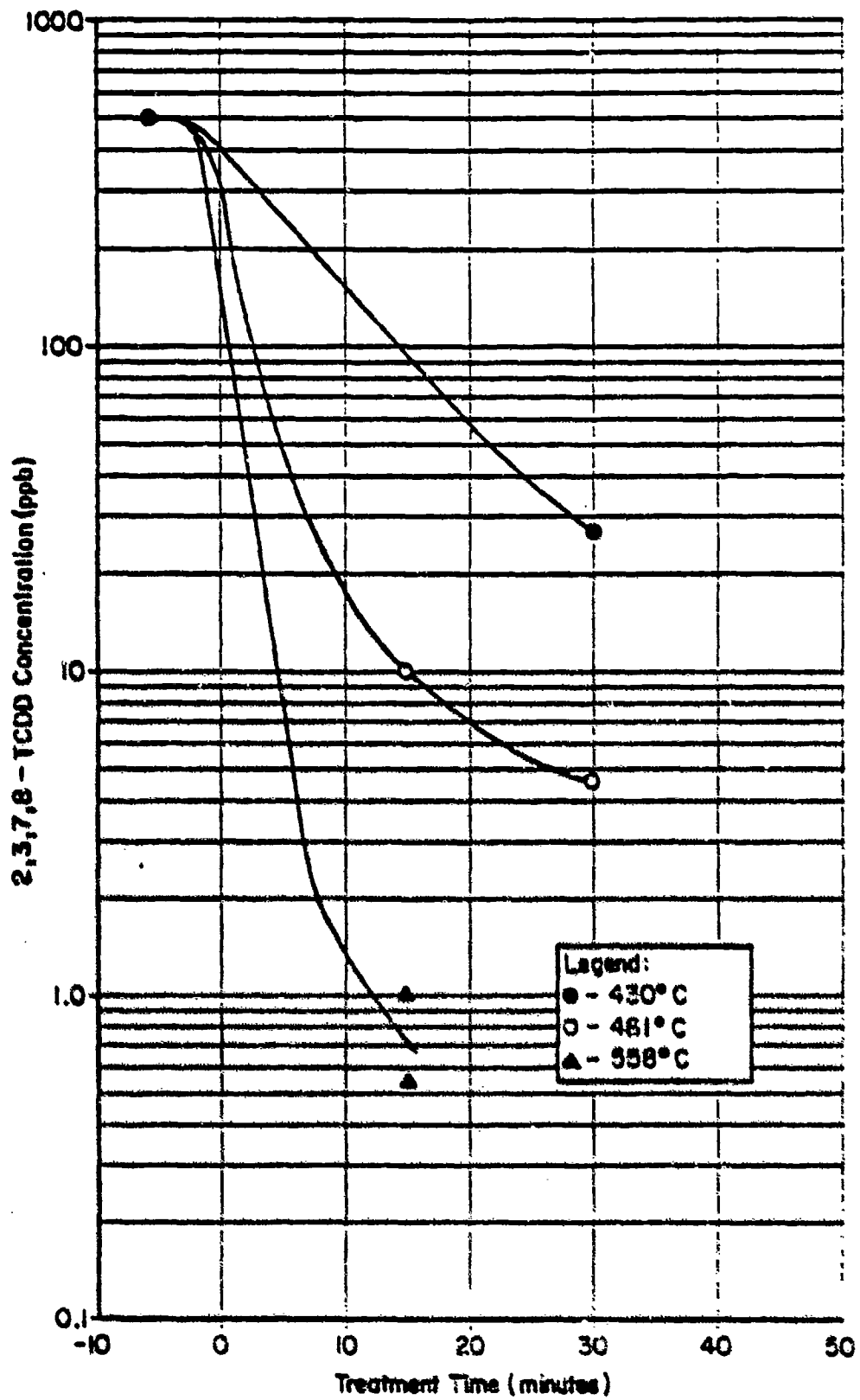

Figure 5. Effect of Time and Temperature on Removal of 2,3,7,8-TCDD from HCBC Soil



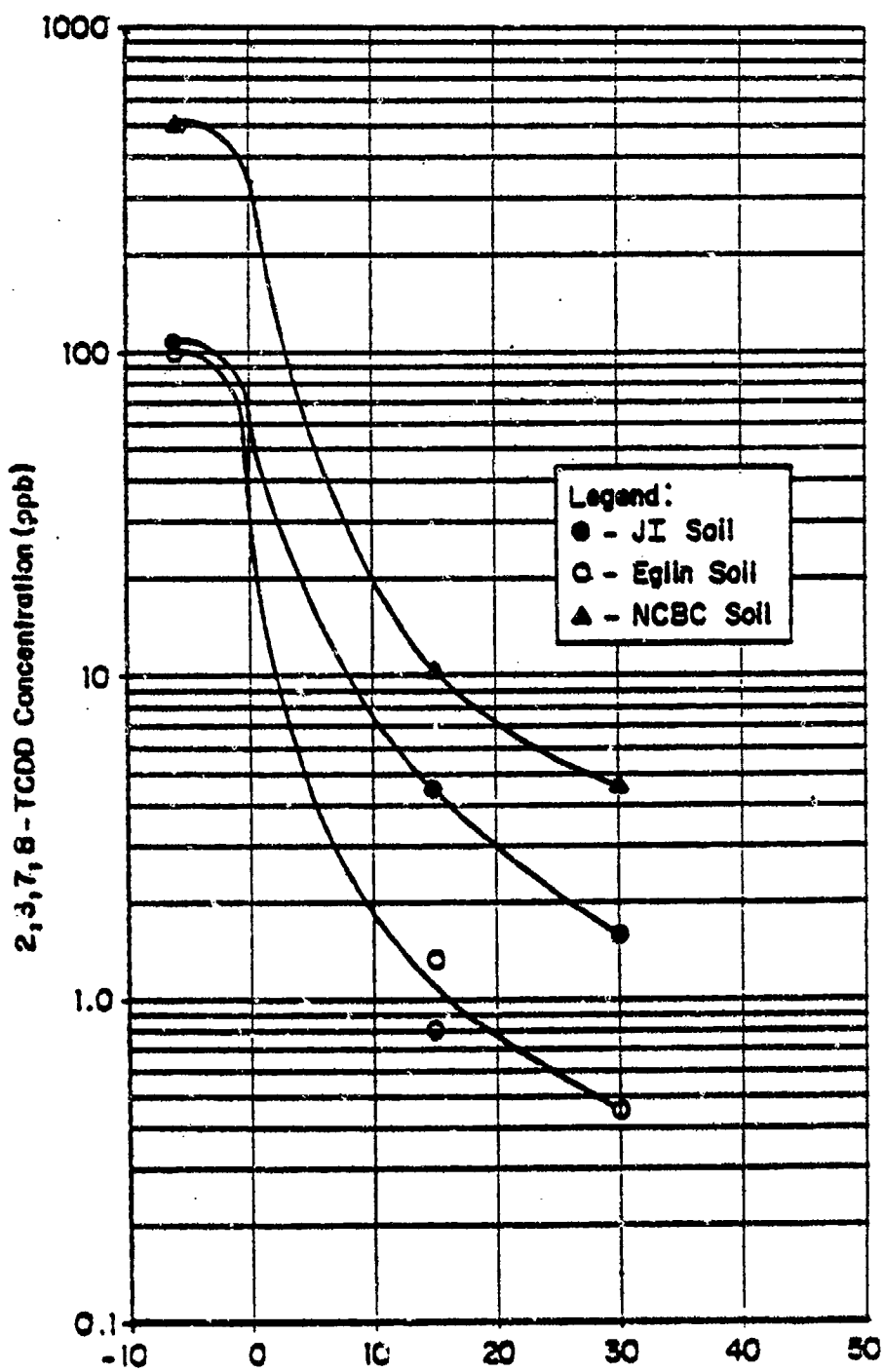

Figure 6. Effect of Treatment Time at 481°C on Removal of 2,3,7,8-TCDD

TABLE 10. CALCULATED REMOVAL EFFICIENCIES FOR 2,3,7,8-TCDD

Test number	Initial 2,3,7,8-TCDD concentration (ppb)	Final 2,3,7,8-TCDD concentration (ppb)	Removal efficiency <sup>a</sup> (%)
15	106	38.5	65.51
16	101	4.4	95.72
14	494	26.6 <sup>b</sup>	94.75
1	106	4.5	96.00
5	106	1.6	98.58
12 <sup>c</sup>	106	0.44	99.61
2 <sup>d</sup>	101	1.3	98.74
4 <sup>d</sup>	101	0.8	99.22
3	101	0.45	99.56
9	494	10.1	98.01
10	494	4.6	99.09
11 <sup>d</sup>	148	0.74	99.51
6	106	0.56 <sup>b</sup>	99.29
7	101	0.71	99.31
8 <sup>d</sup>	494	0.99	99.81
13 <sup>d</sup>	494	0.53	99.90

<sup>a</sup>Removal Efficiency =

$$100 \left[ 1 - \frac{(\text{Final conc.} \times \text{treated sample weight})}{(\text{Initial conc.} \times \text{untreated sample weight})} \right]$$

<sup>b</sup>Average of analytical duplicates.

<sup>c</sup>Test soil was >2 mm fraction.

<sup>d</sup>Experimental duplicates.

the NCBC test soil sample, it is possible that the actual aliquot of over-size material used in the test had a much lower initial concentration. On the other hand, these results may be due to the distribution or location of herbicide on/within the soil matrix. Coarse material, being comprised more of impervious gravel and shells, may contain predominantly surficial deposits of herbicide, which vaporize more readily; heat and mass transfer are not expected to significantly affect desorption rates for surficial deposits.

For the tests performed at 558°C which gave final 2,3,7,8-TCDD values less than 1 ppb, analysis of the treated soil was also done for the herbicide constituents identified in the untreated test soil (see Section II). Table 11 lists these results. For all soils, the residual concentration of 2,4-D was nondetectable at less than 50 ppb detection level and 2,4,5-T was detected at less than 20 ppb. This represents a removal efficiency of greater than 99.99 percent as given in Table 12. The residual concentrations of the three chlorophenols could not be determined below the normal detection level (1 ppm) by the standard analytical protocol used.

Residual concentrations of all CDD and CDF congeners above tetra were non-detectable at levels typically less than 0.5 ppb except for the JI samples. The hepta and octa CDD contained in the untreated JI soil were effectively removed, although a residual concentration of octa CDF represented 25 percent of the starting concentration. The detection levels of the thermally treated samples were lower by a factor of 2 to 8 times, apparently because of the absence of other chemical compounds and the reduced interaction of the CDDs and CDFs with the soil matrix (Section II). The residual concentration of TCDF compared to the untreated soil indicates a removal efficiency of only about 90 percent for JI soil and 80 percent for NCBC, although final concentrations were less than 0.7 ppb for all soils. This is contrasted to the removal efficiencies for 2,3,7,8-TCDD of greater than 99 percent.

## 2. Physical Effects of Treatment

Visual inspection and weight loss measurements were conducted to understand the changes in the soil matrix caused by the exposure to high temperatures. DTA analysis of each soil was discussed in Section II. The test temperatures used in the treatability study were lower than the DTA range and lower than the temperatures achieved in the batch pilot kiln tests. Therefore, transformations observed during the treatability tests are not fully indicative of expected behavior in the MIS.

Table 13 presents the data on the total weight loss which occurred as a result of thermal treatment, and compares this loss with the theoretical loss attributed to initial "free moisture." The final column of values represents the weight loss unaccounted for by initial moisture and is assumed to be a result of combined thermochemical transitions of the mineral and organic matter in each soil matrix. The data are arranged by soil type and in order of increasing temperature and time. All three soils show some increase in unaccounted-for weight loss as the temperature increases. This

TABLE 11. ANALYSIS OF TEST SOIL SAMPLES TREATED AT 558°C  
FOR COMPOUNDS OF INTEREST

Compound	Concentration <sup>a</sup> (ppb)		
	J1 <sup>b</sup>	Eglin <sup>b</sup>	NCBC <sup>c</sup>
2,4-D	ND(47)	ND(12)	ND(31)
2,4,5-T	16	0.8	3
2,4-dichlorophenol	ND(1000)	ND(1000)	ND(1000)
2,4,6-trichlorophenol	ND(1000)	ND(1000)	ND(1000)
2,4,5-trichlorophenol	ND(1000)	ND(1000)	ND(1000)
Arsenic	NA <sup>d</sup>	NA <sup>d</sup>	NA <sup>d</sup>
2,3,7,8-TCDD	0.81/0.31 <sup>e</sup>	0.71	0.99/0.55 <sup>f</sup>
TCDD	0.27	0.42	1.6
TCDF	0.63	0.40	ND(0.26)
PCDD	ND(0.35)	ND(0.29)	ND(0.30)
PCDF	ND(0.44)	ND(0.39)	ND(0.79)
H <sub>x</sub> CDD	ND(0.40)	ND(0.44)	ND(0.41)
H <sub>x</sub> CDF	ND(0.82)	ND(0.31)	ND(0.41)
H <sub>p</sub> CDD	ND(0.20)	ND(0.34)	ND(0.30)
H <sub>p</sub> CDF	ND(0.52)	ND(0.78)	ND(0.49)
OCDD	ND(0.34)	ND(0.68)	ND(0.49)
OCDF	0.30	ND(0.40)	ND(0.38)

<sup>a</sup>ND = not detected using the analytical procedure identified in Section II.  
Detection levels are given in parentheses.

<sup>b</sup>Time at 550°C = 8 minutes.

<sup>c</sup>Time at 550°C = 15 minutes.

<sup>d</sup>Arsenic not analyzed on treated soils since it was not detected in initial test soils.

<sup>e</sup>Analytical duplicates.

<sup>f</sup>Experimental duplicates.

TABLE 12. CALCULATED REMOVAL EFFICIENCIES FOR 2,4-DBE AND 2,4,5-TBE AFTER TREATMENT AT 558°C

Test number	Site identification	Removal efficiency <sup>a</sup> (%)	
		2,4-DBE	2,4,5-TBE
6	JTB	>99.995 <sup>c</sup>	99.9982
7	Eglin <sup>b</sup>	>99.999 <sup>c</sup>	99.9999
8	NCBC <sup>d</sup>	>99.991 <sup>c</sup>	99.9996

$$^a \text{Removal Efficiency} = 100 \left[ 1 - \frac{(\text{Final conc.} \times \text{treated sample weight})}{(\text{Initial conc.} \times \text{untreated sample weight})} \right]$$

<sup>b</sup>Time of treatment = 8 minutes.

<sup>c</sup>Efficiency calculated based on detection level for the specific analysis.

<sup>d</sup>Time of treatment = 15 minutes.

TABLE 13. SUMMARY OF WEIGHT LOSS DATA FROM LABORATORY TREATABILITY TESTS

Test number	Soil identification	Nominal test temperature (°C)	Test time (min.)	Initial sample weight (grams)	Final sample weight (grams)	Weight loss (grams)	Total weight loss (%)	Initial moisture (%)	Total weight loss less moisture loss (%)
15	J1	431	15	29.93	20.42	1.51	5.05	2.31	2.74
1	J1	481	15	30.80	29.00	1.80	5.84	2.31	3.53
5	J1	480	30	34.21	32.22	1.99	5.82	2.31	3.51
12	J1 (>2 mm)	482	30	36.90	34.83	2.07	5.61	(2.31) <sup>b</sup>	3.30
6	J1	558	8	36.13	33.72	2.41	6.67	2.31	4.36
16	Eglin	431	15	30.71	30.16	0.55	1.79	0.79	1.00
2 <sup>b</sup>	Eglin	481	15	31.89	31.32	0.57	1.79	0.79	1.00 <sup>c</sup>
4 <sup>b</sup>	Eglin	481	15	32.83	32.25	0.58	1.77	0.79	0.98 <sup>c</sup>
3	Eglin	483	30	36.62	35.98	0.74	2.02	0.79	1.23
7	Eglin	559	8	31.04	30.37	0.67	2.16	0.79	1.37
14	MCDC	433	20	29.49	28.75	0.74	2.51	1.07	1.44
9	MCDC	483	15	31.38	30.54	0.84	2.68	1.07	1.61
10	MCDC	482	30	31.56	30.76	0.80	2.53	1.07	1.46
11	MCDC (>2 mm)	481	30	41.19	40.29	0.90	2.19	(1.07) <sup>b</sup>	1.12
8	MCDC	556	15	30.63	29.65	0.98	3.20	1.07	2.13
13	MCDC	560	8	30.19	29.26	0.93	3.08	1.07	2.01

<sup>a</sup>Initial moisture of air dried, screened test soil. Moisture of soil as received was higher.  
<sup>b</sup>Moisture was not determined specifically for the coarse (>2 mm) fraction.  
<sup>c</sup>Experimental duplicates.

weight loss, which is highest for JI soil, was expected, based on the DTA results. The weight loss for JI soil would be significantly higher at temperatures above those used for the treatability tests (see Section IV).

The visual changes which occur to constituents of soil exposed to high temperatures can indicate irreversible physical and chemical transitions which may influence processing characteristics in the MIS. For example, upon drying a moist clay can fragment, producing many very fine clay particles which show greatly different behavior in the kiln. Attrition and fusion or slagging are important changes that can be demonstrated in bench- and pilot-scale devices. Combustion or pyrolysis (charring) of organic matter can usually be detected through color changes. Color change may also indicate a mineralogical transition.

Inspection of the three test soils before and after the thermal desorption tests resulted in several observations. The JI soil became darker (gray) in color and had evidence of small black particles. The NCBC and Eglin soils changed from brown to reddish brown. No significant difference in particle size was noticed. Color photographs were taken of the soil samples before and after treatment and are on file at IT Corporation.

## SECTION IV

### BATCH KILN PILOT TESTS

#### A. EXPERIMENTAL PROCEDURES AND EQUIPMENT

Pilot-scale batch kiln tests were performed on uncontaminated samples from the three sites. Testing was conducted by Allis-Chalmers during the period of January 9-11, 1985 at its test center in Oak Creek, Wisconsin. The test unit and procedures have been used by Allis-Chalmers for studying the processing of many different materials other than soil. The test conditions were specified by ITC and the tests were witnessed by an ITC technical representative.

Tests were conducted in a 14-inch diameter batch kiln which is shown schematically in Figure 7. A photograph of the pilot kiln system (being used for a different project) is shown in Figure 8. A total of 11 tests were conducted, using the three soils. The test conditions are summarized in Table 14. Sample numbers used by Allis-Chalmers to identify the three soils are given for references. The soil samples used in the tests were not sieved; the particle size range was representative of the composite drum of soil as received.

All tests were performed so that the final kiln temperature was approximately 1038°C (1900°F) and the initial kiln loadings were 7 percent by volume. All tests were made with a kiln rotational speed of 2.8 rpm. These values were selected to be representative of the MIS; the temperature and loading are approximate upper limits of the operating range. Likewise, the ranges of total gas flow rates were chosen to reflect the ranges of superficial gas velocities that are used in operation of the MIS at 50 percent excess air (10 percent excess oxygen) in the kiln. Three gas flow rates were selected for each soil. In addition, one test using Egin soil was performed at a lower gas flow rate to allow comparison with previous test data from Missouri soils. Another test using JI soil was made using an intermediate gas flow rate to further define the relationship between entrainment and gas flow rate. Higher rates of gas flow were not possible due to limitations of the batch kiln.

Each test was run for 60 minutes. The kiln was brought up to temperature and the initial gas flow rates were set before charging the kiln with a preweighed quantity of soil. The soil charges were placed into the kiln through the exit gas port, using a shovel made for this purpose. The kiln is heated using natural gas and air and/or oxygen to satisfy combustion parameters. The relative feed rates of these three gases were varied during each run to reach and maintain the desired operating temperature while keeping the total gas flow rate constant throughout the run. The gas feed rates given in Table 14 represent the equilibrium rates achieved after reaching steady-state.



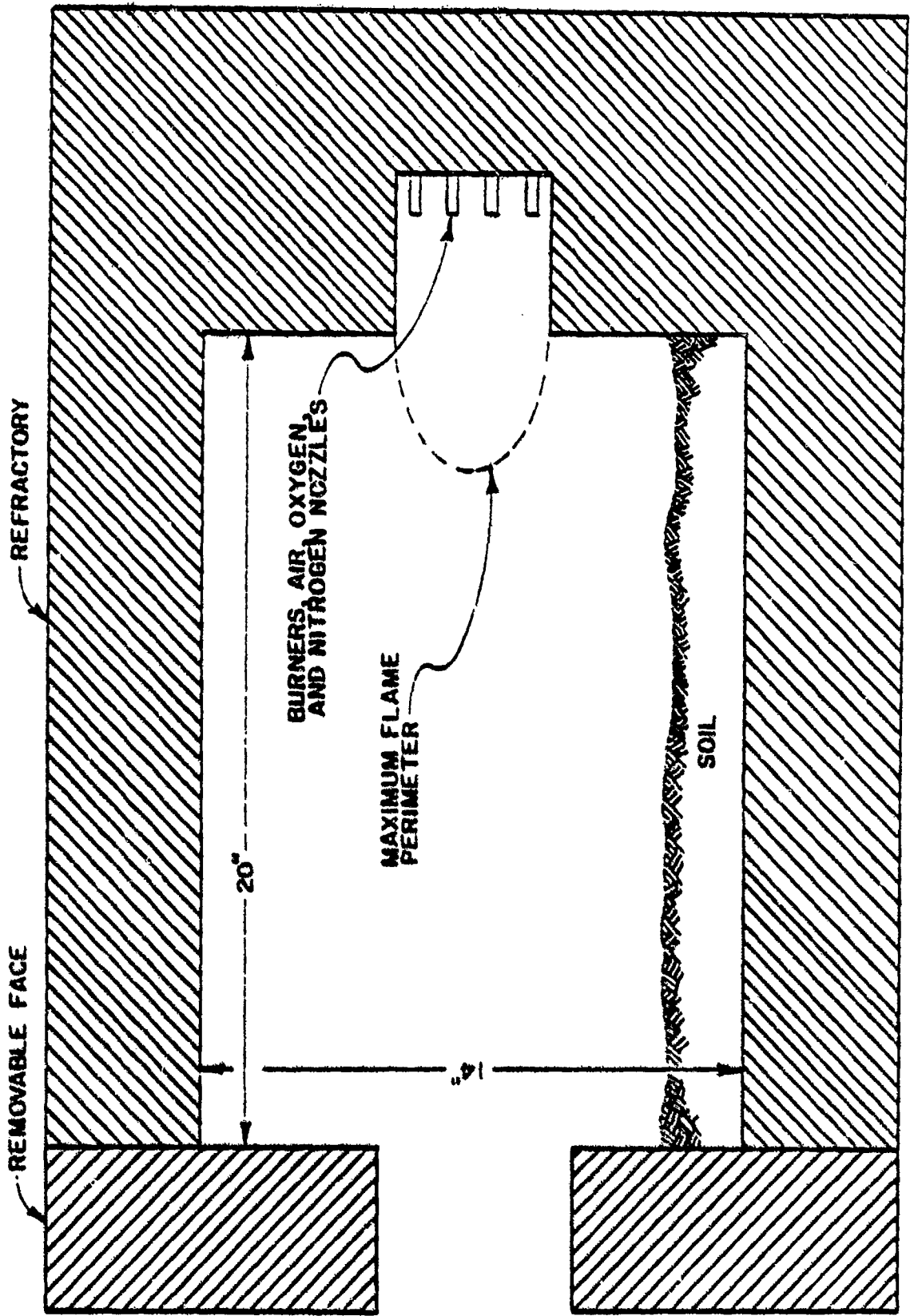

Figure 7. Schematic Diagram of Pilot Batch Kiln

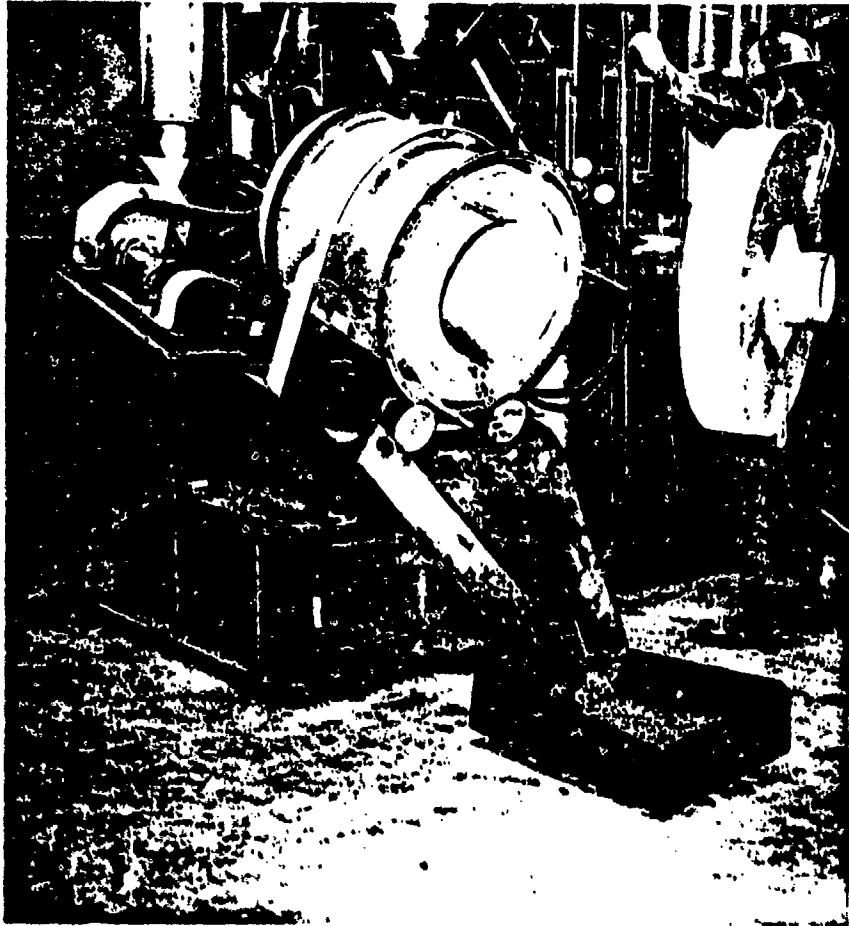

Figure 8. Photograph of the Allis-Chalmers  
Pilot Kiln System

TABLE 14. TEST CONDITIONS - BATCH KILN TESTING

Test number	Soil identification	Soil code number	AFC	Feed rates (SCFM)		Exit gas flow rate (ACFM)	Charge weight (kg)	Final temperatures (°C)	
				Natural	Oxygen			Gas	Soil
1	Ji	4761	28.1	1.7	2.2	150	5.44	1041	1020
2 <sup>a</sup>	Ji	4761	29.1	2.0	1.6	200	5.44	1040	1039
3	Eglin	4760	27.3	2.4	2.3	150	4.75	1038	1028
4	Ji	4761	91.0	6.0	2.9	450	5.44	1041	1029
5	Eglin	4760	58.5	4.4	3.1	300	4.75	1040	1021
6	Eglin	4760	91.0	6.0	2.9	450	4.75	1040	1021
7	Ji	4761	59.0	4.4	3.1	300	5.44	1039	1035
8	MCBC	4768	29.0	1.8	2.0	150 <sup>b</sup>	4.68	1038	1014
9	MCBC	4768	59.2	4.2	2.6	300	4.68	1038	1024
10	MCBC	4768	92.8	5.8	2.3	450	4.68	1040	1037
11	Eglin	4760	20.9	2.0	2.1	110	4.75	1038	1033

<sup>a</sup>Test 2 is labeled as 4761-2 in Annex 4.

<sup>b</sup>Power failure; total gas flow varied from 32 to 24 scfm.

The gas and soil temperatures were taken by means of two stationary thermocouples inserted through the exit gas port of the kiln. Temperatures were recorded on a continuous chart recorder.

Particles escaping from the gas exit port were collected on three metal trays placed on the floor and weighed after each test. Particle size determinations were also performed on the collected material. For tests with the highest gas velocity, some entrained solids fell outside the area covered by the trays. When this occurred, the floor was swept after the test and the sweepings kept separate from the contents of the trays. Some entrained particles may have escaped through the ventilation hood above the gas exit port. This loss is considered to be negligible, based on observations made during the tests.

During Tests 3 and 5, the kiln was observed to leak at the beginning of each test. This leakage was stopped after several minutes. The spilled material from Test 5 was collected at 8 minutes into the test and found to weigh 0.66 kg. The material was allowed to remain in the tray during Test 3.

During Test 8, a power outage interfered with operation of the compressor that supplied combustion air to the kiln. The reduced air pressure did not provide the desired air flow. Therefore, this test was performed at a total gas feed rate of 32 scfm for 40 minutes and then at 24 scfm for the final 20 minutes of the test.

## B. TEST RESULTS AND DISCUSSION

### 1. Visual Observations

During batch kiln testing, visual observations were made to assess the characteristics of the soils during processing. JI soil was observed to break apart during the run. The greatest apparent attrition occurred after 15 to 30 minutes. Bed temperatures during the maximum attrition period were about 850°C (1562°F). This behavior is considered to be a result of physical changes occurring during calcination. The color changed from light gray to white.

Eglin soil showed little visual change during the tests other than a slight color change. Small pieces of organic matter were observed to burn, but these particles amounted to only a very small percentage of the soil.

The NCBC soil was observed to have significant organic "burnout" during the tests. Burning was observed both from fine organic matter distributed evenly within the soil as well as a number of larger pieces such as small sticks. After heating in the kiln, this soil had a distinctly different appearance, changing from what appeared to be a relatively homogeneous mass of fine material with some shells intermixed to a mixture of shell, sand, and small gravel. Treated soil appeared to have a much higher percentage of shell than was apparent from inspecting the untreated sample, possibly as a result of attrition of nonshell material or burn-off of superficial material.

In contrast to previous testing on Missouri soil, these three test soils were observed to have significantly greater entrainment. This was apparent from the visible presence of particles in the air-stream exiting the kiln. Although most of the material was collected, some was observed as being in the air that entered the fume hood positioned over the exit gas port. Higher superficial gas velocities were used for these tests than for previous tests. Entrainment is discussed more fully below.

## 2. Test Data

The 11 test runs were performed at constant total gas feed rates. The relative rates of air, oxygen, and natural gas supplied to the kiln were adjusted throughout the tests to maintain the desired test conditions of 1038°C (1900°F) and 10 percent excess oxygen (~50 percent excess air). Data sheets given in Appendix B show the actual gas feed rates for each test, along with recorded temperatures of the gas and soil bed.

Feed moisture contents given in the data sheets represent the soil moisture content of the samples as received. Previous tests with Missouri soil demonstrated the influence of moisture content on heat-up rates, attrition and entrainment; the influence of moisture content was not studied during this test work.

### a. Weight Loss Data

The data sheets in Annex 4 give the specific weights of product remaining in the kiln, exhaust dust collected in trays positioned under the exit air port of the kiln, and floor sweepings taken from around the trays. The floor sweepings were taken since entrained particles were observed to fall outside the area covered by the trays. The weight of entrained dust for each test was taken to be a combination of collected exhaust dust and floor sweepings. Charge weights were determined based on the bulk density of the soil and were calculated to be equivalent to a volume of soil equal to 7 percent of the volume of the batch kiln. Table 15 compares the total product-plus-entrainment weight with the charge weight and demonstrates the effect of differences in the thermal stability and composition of the three soils. All tests with the JI soil were observed to have a significant loss between the charge weight and the total product weight. Some of this loss is attributable to loss of moisture, but the greatest loss is attributed to calcination. In comparison, the Egin soil had only a small weight loss that can be accounted for by loss of moisture and organic burnout. The Gulfport soil experienced a weight loss intermediate between the other two soils which was attributed to a combination of moisture loss, organic burnout, and calcination of the many shells observed in the soil sample. These results are in agreement with the DSC/TGA results reported in Section II.

Bulk densities for the three soils as received are given in Table 16, along with the densities of the kiln products after the tests. It is apparent that the JI soil underwent a significant decrease in density during the tests. This is attributed in part to the weight loss caused by calcination (conversion of calcium carbonate to calcium oxide). The density of

TABLE 15. WEIGHT LOSS DURING PILOT KILN TESTS

Soil Identification	Initial charge	Weight (kg)			Total collected	Unaccounted for	Weight loss (%)	Test No.
		Product	Entrainment	Loss				
J1	5.44	2.63	0.23	2.66	2.78	51.1	1	
J1	5.44	2.13	0.40	2.53	2.91	53.5	2	
J1	5.44	2.00	0.51	2.51	2.93	53.9	7	
J1	5.44	1.77	0.69	2.46	2.98	64.8	4	
Eglin	4.75	3.73	0.89	4.62	0.13	2.7	11	
Eglin	4.75	3.03	1.30	4.43	0.32	6.7	3	
Fellin	4.75	3.23	1.09	4.31	0.44	9.3	5	
Eglin	4.75	2.84	1.45	4.29	0.46	9.7	6	
MCRC	4.68	3.36	0.14	3.50	1.18	25.2	8	
MCRC	4.68	3.00	0.57	3.57	1.11	23.7	9	
MCRC	4.68	2.60	0.94	3.54	1.14	24.4	10	

Includes floor sweepings, does not include any fine particulates which may have been drawn into exhaust hood above gas exit port

Weight loss is assumed to be equivalent to unaccounted for material.

TABLE 16. SOIL BULK DENSITIES BEFORE AND AFTER KILN TESTS

Sample or test Number	Soil description	Density (lb/ft <sup>3</sup> )
Sample 4760	Eglin As Received	80.04
Sample 4761	JI As Received	85.98
Sample 4768	NCBC As Received	78.92
Test 1	JI/After Test	55.56
Test 2	JI/After Test	54.31
Test 3	Eglin/After Test	94.28
Test 4	JI/After Test	51.19
Test 5	Eglin/After Test	92.40
Test 6	Eglin/After Test	92.40
Test 7	JI/After Test	47.45
Test 8	NCBC/After Test	84.29
Test 9	NCBC/After Test	87.41
Test 10	NCBC/After Test	118.63
Test 11	Elgin/After Test	93.03

Eglin soil appeared to increase slightly during the test. The density of NCBC soil increased slightly in two tests and increased a moderate amount in the third test.

#### b. Particle Entrainment Data

Based on the total combustion gas flow through the pilot kiln given in Table 14, the average superficial velocity within the kiln was calculated. These values are given in Table 17 and compared to the relative weight of entrained soil. Figure 9 shows the relationship between entrainment and kiln gas superficial velocity for the three soils. Data were taken at gas superficial velocities representative of MIS operation at 50 percent excess air. One test for Eglin soil at 2.3 feet per second superficial velocity was observed to have some leakage of soil from the front of the batch kiln. This accounts for the high value for that data point.

Entrainment of NCBC soil appears to have the greatest dependence on velocity while Eglin soil has the least. Eglin soil had high entrainment for the entire range of superficial velocities, while the other soils had lower (less than 10 percent of total charge after 60 minutes) entrainment, particularly at low gas velocities.

During the batch kiln tests, the soil bed was watched through the 5-inch diameter exit gas port. The nature of the air currents in the kiln was noted in all of the tests and could be observed particularly well during periods when flames were present in the kiln as the result of organic burn-out. The air currents appeared to be turbulent in all of the tests, although tests at lower gas velocities (1.8 and 2.3 feet per second) had significantly slower "swirling" of flames.

The entrainment process appeared to be influenced by kiln rotation and flow characteristics of the particular soil. As particles were rolled over and subjected to the gas flow, they were caught by swirling currents (eddies) near the soil surface. The eddies appeared to lift soil particles into the exit airstream.

A direct relationship between entrainment in the pilot kiln and the MIS cannot be made, so the values given in Figure 9 are not representative of the MIS, nor can simple correlations be used to predict entrainment rate. A limited study of entrainment theory was carried out as part of this project to understand the implications of the batch kiln results. Although the literature reports empirical relationships which are useful for evaluating simple flow situations, the accurate modeling of a direct-fired rotary kiln processing a diverse range of solids requires considerable additional technical study and testing. A brief summary of literature findings is presented in Annex 9.

#### c. Particle Size

Screen analyses were run on the soil samples as received, and for each test on kiln products and entrained dust collected on the trays. These data



TABLE 17. SUMMARY OF SOIL ENTRAINMENT RESULTS DURING BATCH KILN TESTS

Soil identification	Superficial gas velocity in kiln (ft./sec.)	Entrainment		Test No.
		Weight (kg)	% of charge	
JI	2.34	0.23	4.2	1
JI	3.12	0.40	7.4	2
JI	4.67	0.51	9.4	7
JI	7.01	0.69	12.7	4
Eglin	1.71	0.89	18.7	11
Eglin	2.34	1.40	29.5	3
Eglin	4.67	1.08	22.7	5
Eglin	7.01	1.45	30.5	6
NCBC	2.34	0.14	3.0	8
NCBC	4.67	0.57	12.2	9
NCBC	7.01	0.94	20.1	10

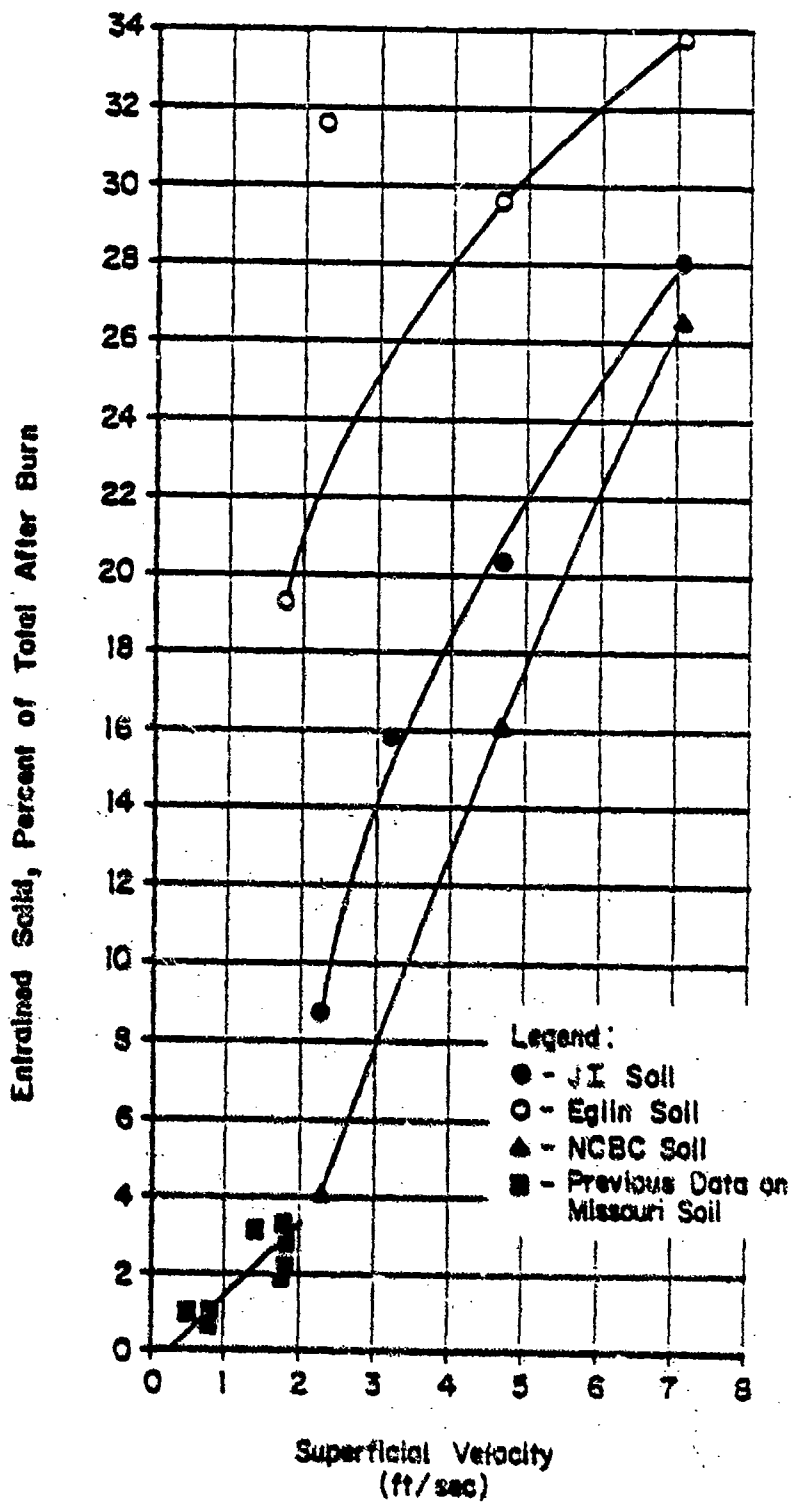

Figure 9. Comparison of Entrainment with Superficial Gas Velocity in Batch Pilot Kiln

are presented in Annex 4. All screen fractions are given as a percentage of the initial sample weight. Both Tyler and ASTM micron sieve sizes are given.

The results of selected screen analyses are summarized in Figures 10, 11, and 12. Each figure gives the particle size distribution of the soil fractions that apply to the test conducted on each soil with a gas superficial velocity of 7.1 feet per second. This superficial velocity was selected since it produced the maximum entrainment during the tests, giving a larger sample of exhaust dust for screen analyses. The figures plot the screen size versus the weight percent of the total sample retained on that sieve. The total of the kiln product and exhaust dust equals 100 percent of the total soil recovered after the test.

Figure 10 gives the results from Test 4 with JI soil, showing a shift in the particle size representing attrition during the test. It is also apparent that the smaller particles were selectively entrained.

Figure 11 gives the results from Test 6 with Eglin soil. The screen analysis of the sample as received reveals that the soil has a fairly uniform size of about 28 mesh. No separation of finer particles from coarser particles was observed in the exhaust dust and kiln product. The size distribution after batch testing closely matched that of the sample as received.

Figure 12 gives the results from Test 10 with NCBC soil. The screen analyses of the kiln product and exhaust dust show the selective entrainment of the smaller particles, starting at about 28 mesh. The combination of the kiln product and exhaust dust closely matches the screen sizes found in the sample as received, indicating little or no attrition or agglomeration. The reduction of particles in the 0.75-inch range is attributed to the burning of sticks that were observed in the sample.

#### d. Temperature Data

During batch kiln tests, temperature data for the soil and exhaust gas were continuously recorded; these data are given in Annex 4. Final temperatures (at steady-state) are listed in Table 14. Since all the tests were conducted to achieve the same final temperatures, the only differences between tests were during the heat-up period, which lasted from about 6 to 30 minutes depending on heat input, charge weight, moisture content, and soil type. Figure 13 compares temperature profiles for the three soils at the same heat input. For JI soil, a plateau at about 850°C was obvious, corresponding to calcination. The heat-up rates for JI and NCBC soil were influenced by the higher initial moisture content. Also, the charge weight for JI soil was greater than the other two.

#### e. Dynamic Angle of Repose

The dynamic angle of repose for the three soils was measured using a 38-inch diameter drum, rotating at 0.82 rpm. This property is important in

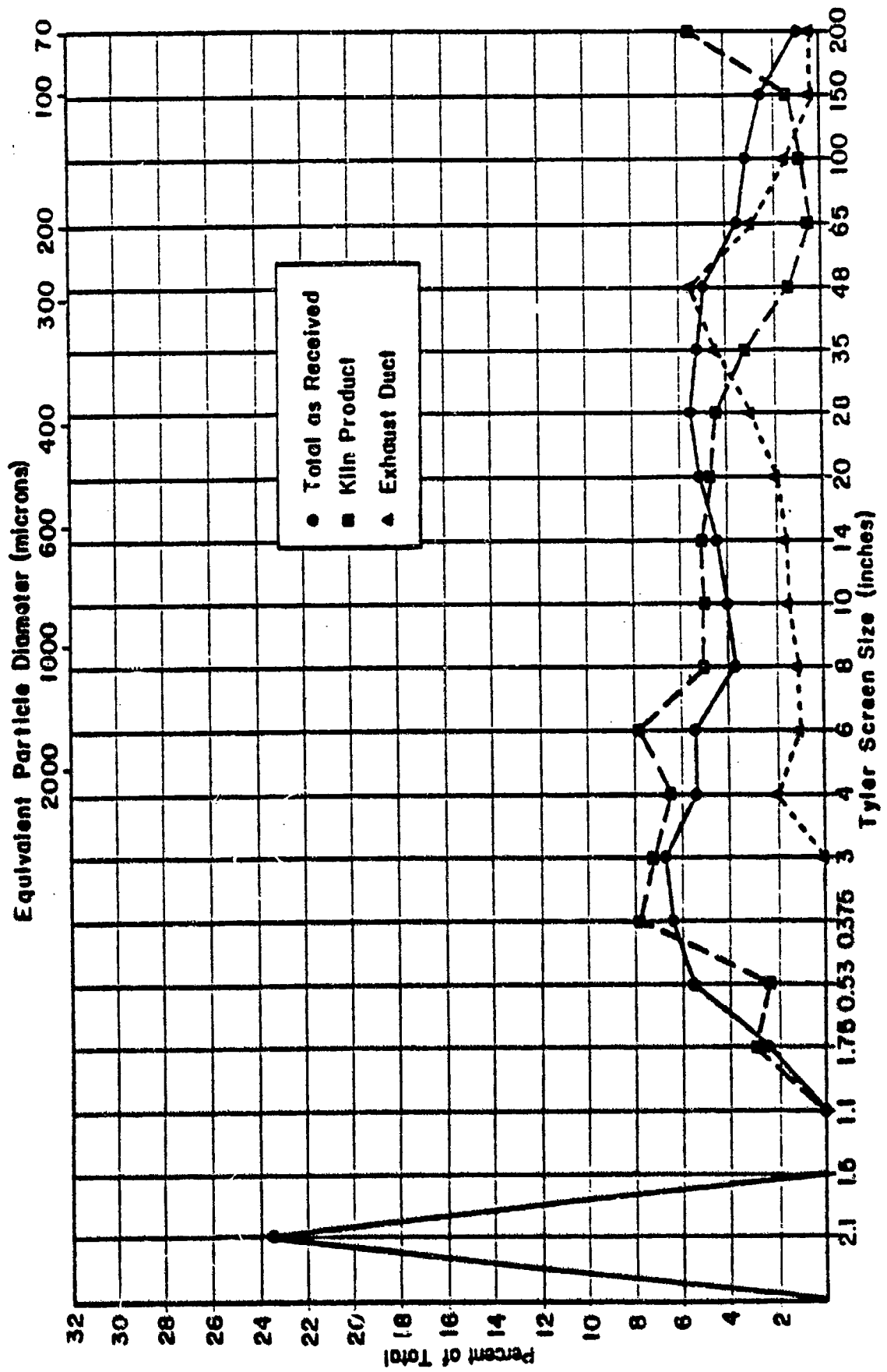
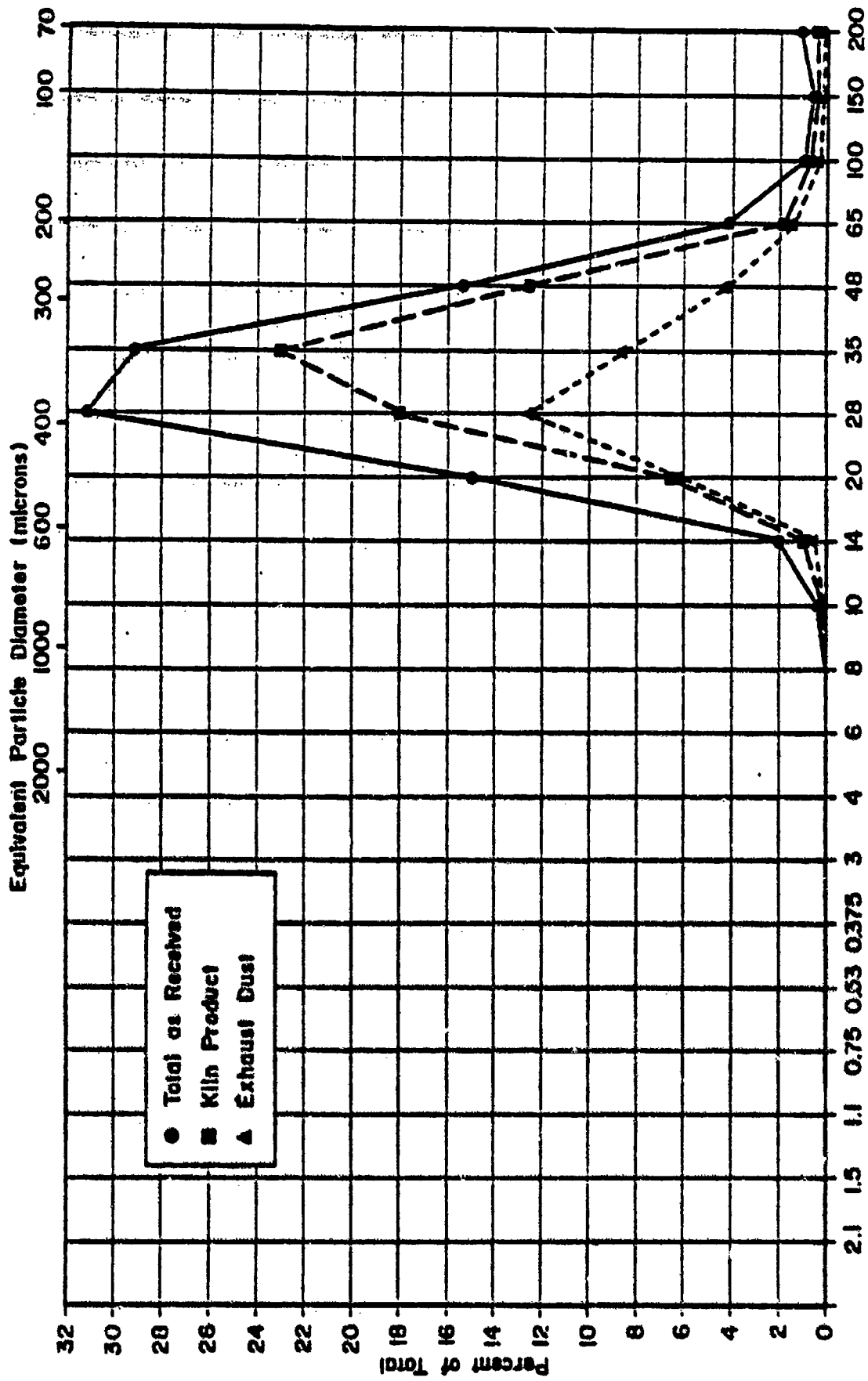

Figure 10. Particle Size Distribution of JI Soil Before and After Batch Kiln Test 4



Tyler Screen Size (inches)  
 Figure 11. Particle Size Distribution of Elgin Sofl  
 Before and After Batch Kiln Test 6

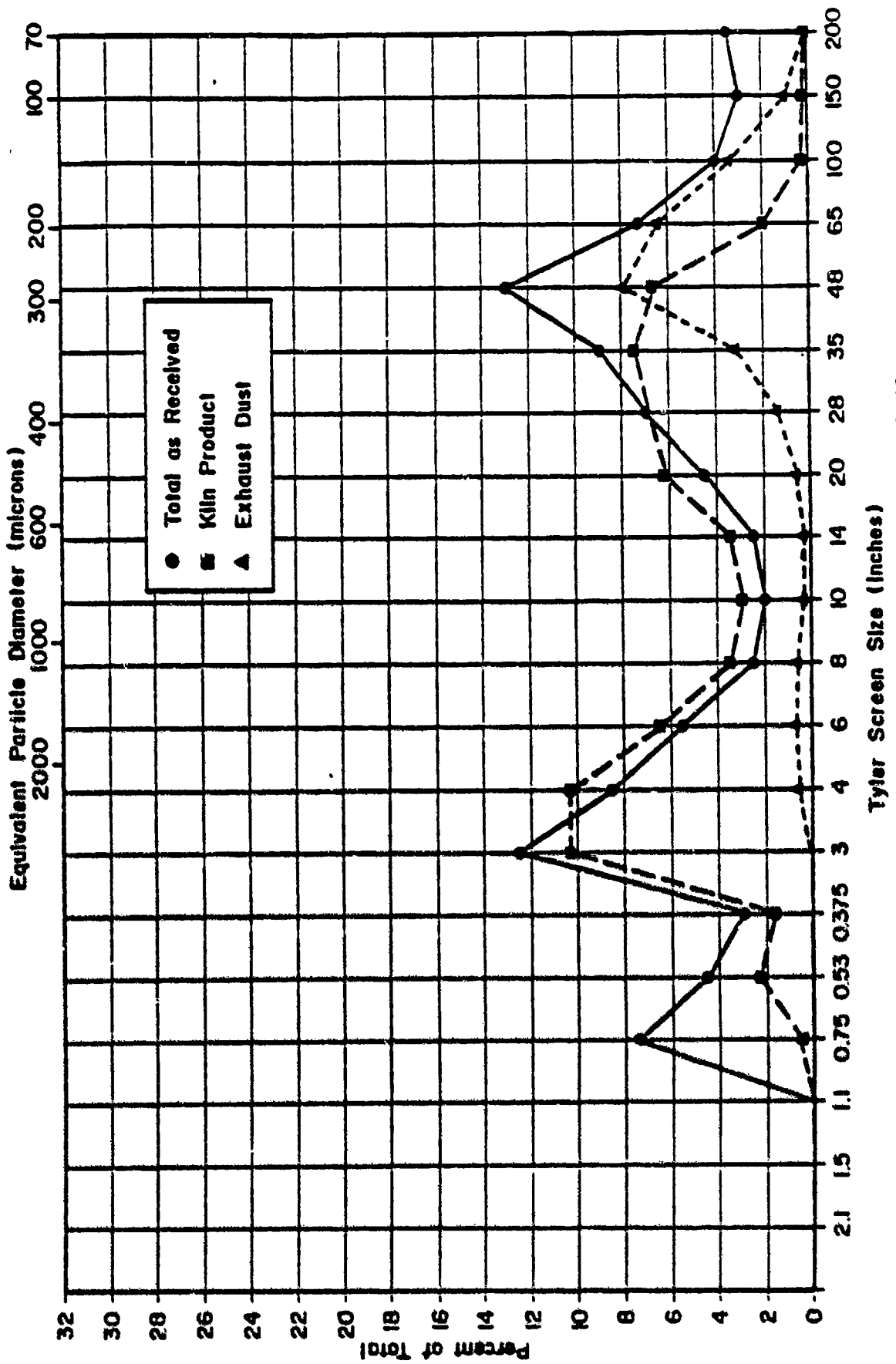

Figure 12. Particle Size Distribution of NCBC Soil Before and After Batch Kiln Test 10

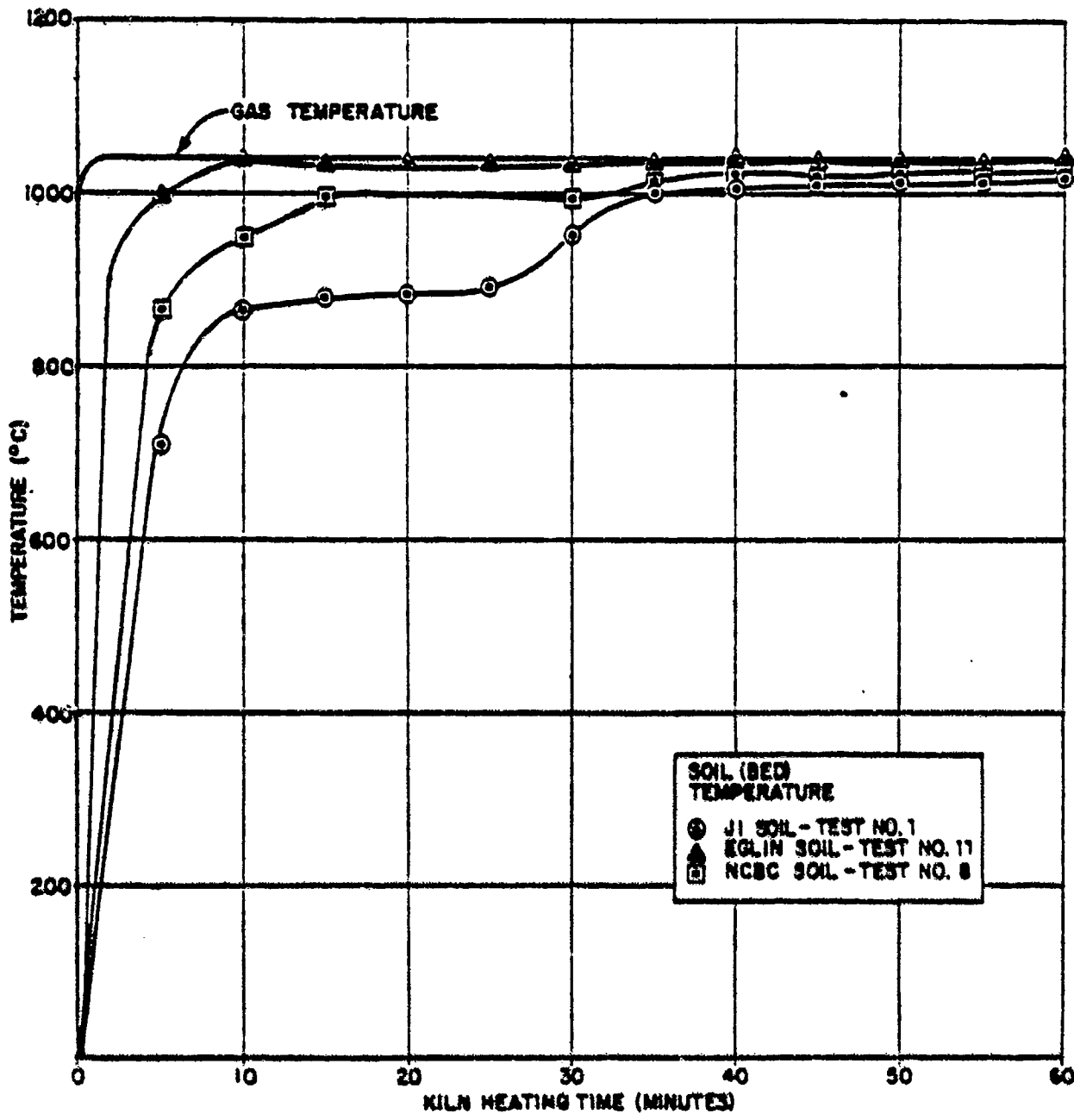

Figure 13. Time-Temperature History for Three Batch Pilot Kiln Tests Using Approximately Equal Heat Inputs

assessing the soil flow characteristics and resulting effect of kiln inclination on residence time. Tests were conducted on all three soils as received and on NCBC and Eglin samples after firing in the kiln. Data from these tests are given in Annex 4 and summarized in Table 18.

During this testing, JI soil was observed to roll over in a continuous fashion, with the larger particles generally staying on the outside of the sample, covering smaller particles underneath. The observed angle of repose was slightly greater than that for Missouri soil (clay-loam) studied previously, but close enough to allow data measurements of flow of Missouri soil through the MIS kiln to be applied to predictions for JI soil. A kiln loading of approximately 6 percent will be used in calculations related to heat transfer.

Eglin soil was observed to have a relatively low angle of repose, as would be expected from sand. After firing, the observed angle decreased significantly and the sand was observed to flow in a smooth motion. It is expected that this soil will flow quickly through the MIS. The Allis-Chalmers computerized mass flow model has not been verified with soils and, therefore, it is not possible to accurately predict soil flow rates through the MIS. An assumption of a kiln loading of 4 percent will be used in heat transfer analyses, based on previous MIS trials using sand.

NCBC soil was observed not to have the rolling motion characteristic of the other two soils. Instead, this soil stayed in a mostly stable mass which slid down the side of the test apparatus without much blending. After firing, the soil was observed to exhibit some rolling motion, although the sliding was still apparent. The sliding motion is thought to result from the presence of a large number of shells in the soil. This soil will have a high loading in the MIS, even though the measured angle of repose is low. No previous specific MIS test data or validated flow models are available to confirm this. The loading of this soil will be taken to be 7 percent for the purpose of heat transfer calculations.



TABLE 18. SUMMARY OF DYNAMIC ANGLE-OF-REPOSE MEASUREMENTS

Soil identification	Initial moisture (%)	Bed loading (%)	Angle of repose	
			Upper section (%)	Lower section (%)
JI	6.5	7	49	39
Elgin	1.2	7	44	35
Eglin <sup>b</sup>	~0	4.4 <sup>a</sup>	32	32
NCBC	6.4	7	40	40
NCBC <sup>b</sup>	~0	2.5 <sup>a</sup>	35	33

<sup>a</sup>Insufficient sample remaining to have desired soil charge.

<sup>b</sup>After firing in kiln.

## SECTION V

### HEAT TRANSFER EVALUATION

A special computer program was used to model heat transfer in the MIS kiln for the three test soils. The program had been developed and was applied to this study by Allis-Chalmers personnel. Previous results ITC obtained from a similar study of Missouri soil were used as a basis to select the input conditions for computer runs. The program models the overall heat transfer in a kiln by dividing the kiln into three or four regions and modeling each region separately. In the first region, the wet solid is heated from ambient temperature to the boiling point of water. In the second region, water is evaporated at a constant solid temperature. In the third region, the dry solid achieves its final temperature. If calcination is known to occur, a fourth region is modeled for its heat duty at constant temperature. This region is important for studying lime kiln performance.

The heat transfer constants used in the computer calculations were derived from a proprietary Allis-Chalmers data base developed from studies using other feed materials typically processed in rotary kilns, such as limestone. The constants are adjusted according to the characteristics and configuration of the kiln which is to be modeled. A difficulty in accurately modeling the heat transfer characteristics of the MIS kiln is presented by the flights within the kiln toward the feed end. The heat transfer constants used in this study were the same as those used for the study of the treatment of Missouri soil in the MIS. The program does not account for differences in the heat transfer characteristics (other than heat capacity) of various soil types or particle sizes. The constants are listed with the sample computer printouts in Annex 10.

The runs were selected to demonstrate the differences in the predicted soil time-temperature profiles due to differences in overall heat duty and soil heat capacities, as obtained from TGA and DSC analyses described in Section II.

#### A. OBJECTIVES

Definition of heat transfer in the MIS kiln enables prediction of the operating limits for maximum soil processing rates. The maximum feed rate varies dramatically with the composition of the soil being treated. Differences in soil that affect the treatment rate include the moisture content, organic content, quantity of material subject to thermochemical transitions (e.g., calcination), heat capacity, and requirement for excess air (to meet RCRA/DRE requirements) during kiln operation.

Prediction of the maximum treatment rate is important in assessing the cost effectiveness of using the MIS or some larger rotary kiln incinerator. The projected maximum processing rate will also be useful in planning and conducting effective field demonstrations. Operating the MIS near its maximum capacity will provide valuable data with which to evaluate/design larger

systems. This will allow accurate cost analyses to be done on larger units to aid in comparison with other treatment alternatives.

An additional objective of the heat transfer work was to help define possible improvements in the MIS, identify important data collection needs for field demonstrations, and reveal major design changes that could be incorporated in a larger-scale unit.

## B. PREVIOUS HEAT TRANSFER STUDY RESULTS

The heat transfer characteristics of the MIS in treating soil from Missouri were studied extensively during previous work for the EPA. In that study, the effects of soil moisture content, heat capacity, and kiln excess air on the time-temperature profile of soil in the kiln were investigated. Also, a series of heat and material balances was performed using ITC's computer model. The results of that work, which are important to understanding of the results reported herein, will be documented in an EPA report in 1985. A synopsis of the conclusions and observations of the previous work is given here.

Previous work demonstrated that the kiln would not normally be limited by heat transfer within the range of operating conditions selected for the Missouri trial burn. Overall MIS capacity limitations include the rate of the solids feed system and the requirement for a 2-second residence time for gas in the secondary combustion chamber (SCC). The limit on the SCC results from the high percentage of kiln excess air used. It was determined that kiln excess air needed to be less than 100 percent and preferably less than 50 percent before the kiln could be operated at its heat transfer limit. The primary effect of soil moisture content was the increase in enthalpy due to vaporization, which reduces the heat available for quickly increasing the soil temperature. The reduction in available heat caused by soil moisture becomes very important above 10 percent. Soil moisture content had a greater effect on soil discharge temperature than the dry soil feed rate within the range studied. This limit is a result of the total fuel that can be fired, rather than of heat transfer. The heat transfer rate will affect capacity only when these other limitations are removed. Heat transfer is limiting when the feed rate increases to the point where the soil residence time in the kiln is low, and therefore the soil does not reach the time-temperature condition required for sufficient decontamination.

Several recommendations were presented to EPA based on this previous work. The first and foremost was to operate the incinerator at low excess air concentrations. Normal operation of hazardous waste incinerators calls for excess air concentrations of 100 to 150 percent. This gives a "cushion" to allow the system to handle sudden surges in the waste feed heating value, and prevents conditions where complete combustion is not obtained. When treating soil, which has a negligible heating value, this mode of operation is not necessary, eliminating the need for high excess air. This allows operation at lower (25 to 50 percent) excess air, reducing entrainment and enabling higher heat input and corresponding higher soil feed rates to achieve a given time-temperature condition.

Physical modifications recommended for the MIS included the addition of dams at the discharge end of the kiln and modifications in the exit air discharge ducting to permit greater adjustment in kiln slope. These modifications would increase the maximum kiln loading and therefore enable higher feed rates while maintaining the required soil residence times. These modifications would be particularly important in treating a free-flowing soil, such as sand.

### C. HEAT TRANSFER COMPUTER SIMULATION RESULTS

Computer runs were selected to give a number of data points in the region of maximum kiln capacity for each of the three soils. The conditions were selected based on knowledge gained through the previous work and specific data gathered on the soils during the batch pilot kiln tests and laboratory treatability tests.

Table 19 outlines the 15 heat transfer runs performed; five runs were performed for each soil. Example printouts of the computer runs are given in Annex 10, along with heat and material balance program runs performed at the same conditions. Three of the runs for each soil were performed at conditions of 12 percent moisture and 50 percent excess air, with varied feed rates, to allow definition of the heat transfer limit. Two additional runs were performed on each soil at 25 and 100 percent excess air to demonstrate the effect of excess air concentration on treatment. A constant fuel feed rate to the kiln equivalent to 5.5 million Btu/hour was used for all runs. Higher kiln heat duties would make it difficult to maintain the mandatory 2-second residence time in the SCC.

The results of the 15 heat transfer runs are summarized in Table 20. Comparison of the runs demonstrates the effects of soil feed rate and kiln excess air on soil discharge temperatures. The results of the heat and material balance program runs are also summarized in Table 20. This program assumes temperature equilibrium between the gas and solids. This temperature represents an average between the two temperatures given by the heat transfer program, weighted for the heat capacity of the total gas and solids leaving the kiln. Inspection of Table 20 reveals that the heat and material balance program gives a somewhat higher temperature than does the Allis-Chalmers heat transfer model. The magnitude of this difference is not considered significant since the lower temperature calculated by the heat transfer program will result in conservative estimates of the kiln capacity.

The soil temperature predicted by the heat transfer program assumes a uniform bed temperature. In an operating kiln, temperature gradients will be present in both individual (large) soil particles and in the bulk soil bed. To account for this, an allowance of approximately 50°C (90°F) should be made in the soil discharge temperatures. For soils that may have a higher temperature gradient, such as those with relatively large chunks or those that do not mix well in a moving bed, the allowance may need to be slightly greater.

TABLE 19. PARAMETERS FOR HEAT TRANSFER RUNS

Run No.	Soil identification	Soil dry weight (lb/hr)	H <sub>2</sub> O (lb/hr)	H <sub>2</sub> O (%)	loading (x)	Kiln air (lb/hr)	Excess air (x)	Fuel (10 <sup>6</sup> Btu/hr)	Specific heat of dry soil (Btu/lb.°F)	ΔH Calc.	Soil heat value (Btu/lb)
1	Eglin	3400	464	12	4	6270	50	5.5	0.23	14	9
2	Eglin	4000	545	12	4	6270	50	5.5	0.23	14	9
3	Eglin	3000	409	12	4	6270	50	5.5	0.23	14	9
4	Eglin	3400	464	12	4	8354	100	5.5	0.23	14	9
5	Eglin	3400	464	12	4	5220	25	5.5	0.23	14	9
6	J1	3400	464	12	6	6270	50	5.5	0.19	520	25
7	J1	4000	545	12	6	6270	50	5.5	0.19	520	25
8	J1	3000	409	12	6	6270	50	5.5	0.19	520	25
9	J1	3400	464	12	6	8354	100	5.5	0.19	520	25
10	J1	3400	464	12	6	5220	25	5.5	0.19	520	25
11	MCBC	3400	464	12	7	6270	50	5.5	0.20	65	90
12	MCBC	4000	545	12	7	6270	50	5.5	0.20	65	90
13	MCBC	3000	409	12	7	6270	50	5.5	0.20	65	90
14	MCBC	3400	464	12	7	8354	100	5.5	0.20	65	90
15	MCBC	3400	464	12	7	5220	25	5.5	0.20	65	90

TABLE 20. PREDICTED TEMPERATURES FROM COMPUTER MODELS

Run No.	Soil Identification	Excess air (%)	Soil		Soil dry feed rate (lb/hr)	Predicted temperature (°C)		IIR program
			residence time (min.)			Heat Transfer Program	Flue gas	
1	Eglin	50	15.5		3400	821	953	937
2	Eglin	50	13.1		4000	733	921	876
3	Eglin	50	17.5		3000	680	979	981
4	Eglin	100	15.5		3400	634	825	801
5	Eglin	25	15.5		3400	951	1030	1025
6	J1	50	20.0		3400	793	955	947
7	J1	50	17.0		4000	781	934	898
8	J1	50	22.6		3000	802	966	971
9	J1	100	20.0		3400	640	809	811
10	J1	25	20.0		3400	811b	998b	1038
11	MCBC	50	21.7		3400	628	949	990
12	MCBC	50	18.5		4000	792	920	936
13	MCBC	50	24.6		3000	884	982	1029
14	MCBC	100	21.7		3400	708	825	846
15	MCBC	25	21.7		3400	960	1020	1083

\*From heat and material balance program; soil discharge and flue gas temperatures are considered equal.  
 †Data for soil heat value was input as negative; actual temperatures should be somewhat higher (~35°C).

Past comparisons of the heat transfer model with actual MIS operational data have indicated that the heat transfer coefficients used in the model may be slightly high, causing the model to predict higher soil discharge temperatures and lower exit gas temperatures than those experienced in the kiln. The magnitude of this effect is undefined and will require evaluation of additional operating data. However, preliminary indications are that the effect is less than 55°C (100°F) for soil discharge temperature when the kiln is operating at low mass flow (~1000 pounds/hour), low firing rate (~3.0 mm Btu/hour), and high excess air (~100 percent). The results presented in Table 20 should only be employed for approximate estimates of kiln capacity.

The data presented in Table 20 indicate the thermal and heat transfer limitations of the MIS kiln for treating the three soils of interest. At 50 percent excess air and 12 percent moisture, all three soils apparently can be treated at a rate of 4000 pounds per hour dry weight as determined by soil exit temperatures above 700°C (see Section VI). The Eglin soil may have a slightly lower maximum rate, due primarily to the free-flowing nature of the soil which reduces the kiln loading and associated soil residence time. At 100 percent excess air, the heat transfer limit appears to be approximately 3400 pounds/hour for the JI and NCBC soils and somewhat lower for the Eglin soil.

The heat and material balance program was used to check the results from the heat transfer program and to examine limits in the secondary combustion chamber (SCC). The heat and material balance evaluation results revealed an additional system limitation at 100 percent excess air. Table 21 gives the secondary burner fuel requirements for the 15 example runs. Examination of Runs 4, 9, and 14 in Table 21 shows that the burner requirements in the SCC exceed the burner limitations of  $5.5 \times 10^6$  Btu/hour. This limit relates to both the actual burner feed rate limitations and the limit on combustion gas flow rate that may be tolerated in the SCC to meet the 2-second gas residence time requirement. Analysis of the runs performed at 3400 pounds/hour and 12 percent moisture yielded maximum excess air percentages of 61, 66, and 74 percent for treating Eglin, JI, and NCBC, respectively. However, the above analysis assumes that the solids discharge and exit gas temperatures in the kiln are equal. In the operating system, the gas temperature entering the secondary is significantly higher than that predicted by the heat and material balance program. Therefore, the heat load on the secondary burners would be expected to be less than calculated, allowing higher soil feed rates at the same excess air and moisture indicated by the values in Table 21. In summary, operation at 100 percent excess air, 3400 pounds/hour dry solids feed, and 12 percent moisture represents a point close to the operational limit of both the kiln and SCC.

The effect of soil moisture content was not included as part of this heat transfer study. For estimates of system performance at higher moisture contents, the total water feed rate as given in Table 19 should be used for comparison, rather than the dry soil feed rate. This should yield reasonably accurate results for soil having moisture contents up to 20 percent. Reports describing previous heat transfer studies should be referenced.

TABLE 21. SECONDARY COMBUSTION CHAMBER BURNER FUEL REQUIREMENTS FOR HEAT TRANSFER RUNS

Run No.	Soil identification	Excess air (%)	Soil dry feed rate (lb/hr)	SCC burner requirement ( $10^6$ Btu/hr)
1	Eglin	50	3400	4.756
2	Eglin	50	4000	5.562
3	Eglin	50	3000	4.186
4	Eglin	100	3400	7.651
5	Eglin	25	3400	3.402
6	JI	50	3400	4.630
7	JI	50	4000	5.424
8	JI	50	3000	4.063
9	JI	100	3400	7.501
10	JI	25	3400	3.262
11	NCBC	50	3400	4.119
12	NCBC	50	4000	4.842
13	NCBC	50	3000	3.606
14	NCBC	100	3400	6.988
15	NCBC	25	3400	2.781



## SECTION VI

### EVALUATION OF MIS TREATMENT CAPABILITIES

In order to translate the laboratory treatability data and the calculated heat transfer rates of the MIS kiln to a projected overall soil treatment capacity, a statistical evaluation was performed and the results were combined with the predicted soil temperature profile in the kiln. Multiple linear regression analysis was performed using all the treatability data, considering a variety of different mathematical models relating time, temperature, and 2,3,7,8-TCDD concentration. This data analysis was done using the computer software package SAS (Statistical Analysis System) developed and maintained by the SAS Institute, Box 8000, Cary, North Carolina. Dr. Robert McLean, Professor of Statistics at the University of Tennessee, Knoxville, Tennessee carried out the statistical evaluation as a consultant to ITC. A similar statistical evaluation was previously performed on treatability studies of a single Missouri soil contaminated with 2,3,7,8-TCDD. Therefore, some of the models which were evaluated had already been identified and were simply confirmed using the new data. In addition, several new models were considered which utilized the initial 2,3,7,8-TCDD concentration as a variable, since each of the three soils had different initial concentrations.

Statistical evaluation of previous laboratory thermal desorption test data had shown that soil moisture content and purge gas type and flow rate had no significant effect on treatability, except the indirect effect of initial soil moisture on the temperature profile (heat-up time) during a specified treatment period. Particle size was shown to have an effect only for gross differences (e.g., 5 cm cubes vs 2 mm material), and this was considered to be primarily due to heat transfer within the large particles.

The data base used for the statistical analysis is presented in Appendix I. For each test, different parameters such as time, temperature, vapor pressure, etc. were calculated for use in the regression analysis. Mathematical models were developed relating the concentration of 2,3,7,8-TCDD after treatment with one or more of the parameters.

The effect of soil type on treatability was determined to be minor if the variation in starting concentration was accounted for. There was no statistical method to ascertain the effect of soil type because only one starting concentration for each soil was available.

The three models which were found to best fit the 16 laboratory desorption test results from this study, and their R-square values are as follows:

$$\begin{aligned} \text{LNPD} &= 1.170 - 4.164 \times 10^{-5} (\text{IVP}) & (1) \\ \text{R - square} &= 0.80 \end{aligned}$$

$$\text{LNPD} = -0.213 - 8.63 \times 10^{-5} (\text{IVP}) + 3.02 \times 10^{-10} (\text{IVP})^2 \quad (2)$$

$$\text{R-square} = 0.91$$

$$\text{LD} = 0.204 + 0.908 (\text{LINC}) + 0.226 (\text{TIME}) + 1.91 \times 10^{-4} (\text{TEMP}) - 5.97 \times 10^{-6} (\text{TEMP})^2 - 5.24 \times 10^{-4} (\text{TITP}) \quad (3)$$

$$\text{R-square} = 0.93$$

where:

LNPD =  $\log_e$  of weight fraction of initial 2,3,7,8-TCDD remaining after treatment,

IVP = integral of vapor pressure over the treatment period (mmHg·minutes),

LD =  $\log_{10}$  of final concentration (in ppb) of 2,3,7,8-TCDD,

LINC =  $\log_{10}$  of initial concentration (in ppb) of 2,3,7,8-TCDD,

TIME = time at constant nominal treatment temperature (minutes),

TEMP = nominal treatment temperature ( $^{\circ}\text{C}$ ), and

TITP = TIME · TEMP.

The integral of vapor pressure is determined by calculating the vapor pressure of 2,3,7,8-TCDD for the average temperature during each 1-minute interval (including during the heat up period) and summing these values, which is essentially equivalent to the area under a plot of vapor pressure versus time. The predicted vapor pressure of 2,3,7,8-TCDD is shown in Figure 14 with the corresponding Antoine equation (Reference 15).

These models are, to some extent, a function of the characteristic time-temperature profile for the experimental apparatus and procedures used to generate the data. This must be considered when attempting to predict treatment performance in the MIS, which will have a somewhat different time-temperature profile depending on a number of factors, such as initial soil moisture content, solids feed rate, and heat input.

Figure 15 is a plot of LNPN versus IVP, showing reasonably linear dependence. By using Equation (2), the approximate conditions of time and temperature to achieve certain treatment efficiencies can be calculated. Figure 16 shows the significance of temperature on reducing the concentration of 2,3,7,8-TCDD from 100 ppb and 500 ppb to 1 ppb. Assuming a constant solids temperature within the MIS kiln, the required residence time for the 100 ppb contamination level varies from less than 1 minute at  $800^{\circ}\text{C}$  to about 16 minutes at  $500^{\circ}\text{C}$ . Less residence time would be required for soils with lower contamination levels. However, the solids temperature in the kiln varies and complicates the prediction of residence time requirements.

The relationship found in this study between treatment efficiency and time-temperature, as represented by Equations (1) through (3), is comparable to the results developed previously for Missouri soil.

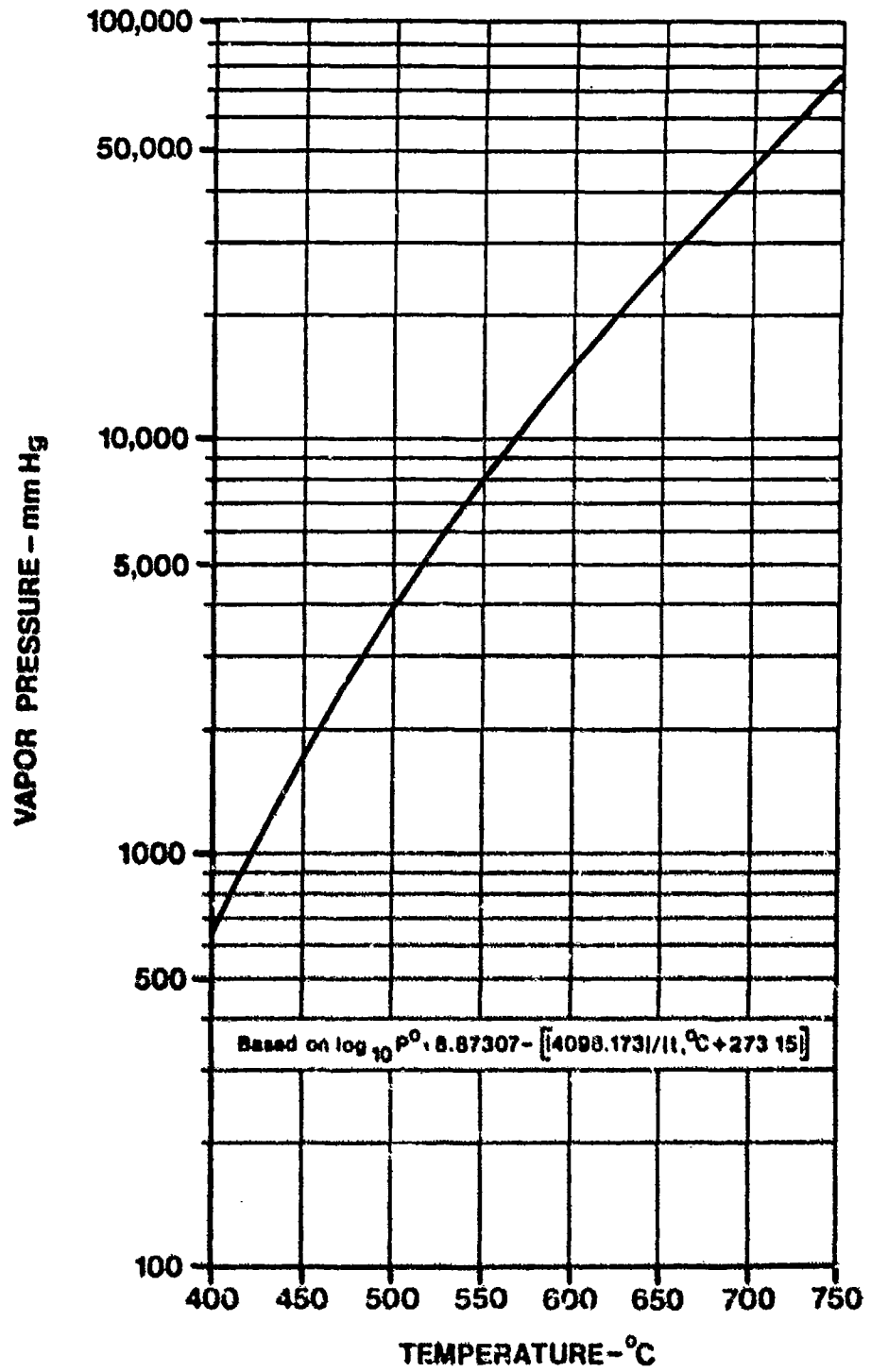

Figure 14. Projected Vapor Pressure of 2,3,7,8-TCDD at High Temperatures

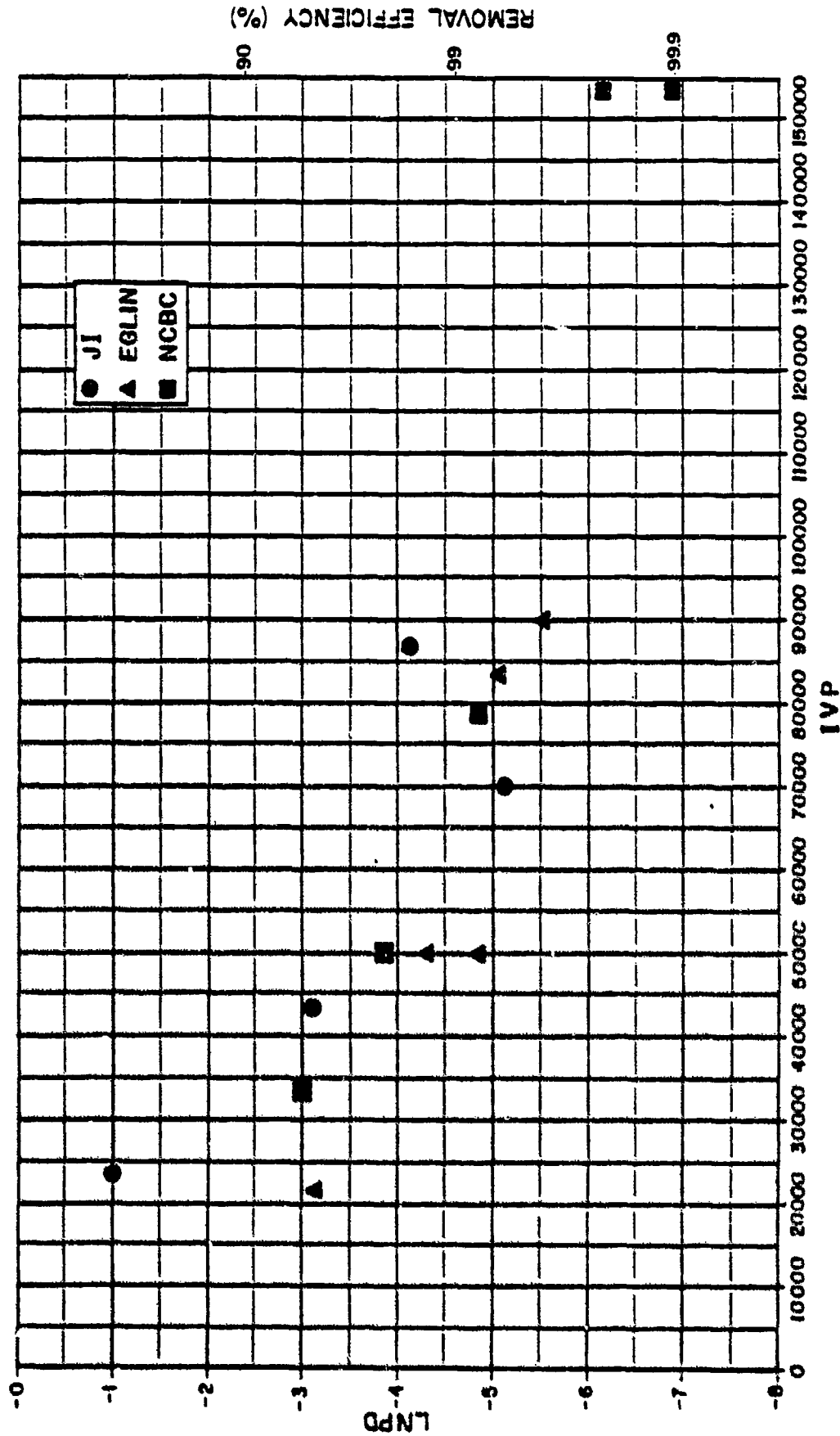

Figure 15. Plot of LNP vs. IVP

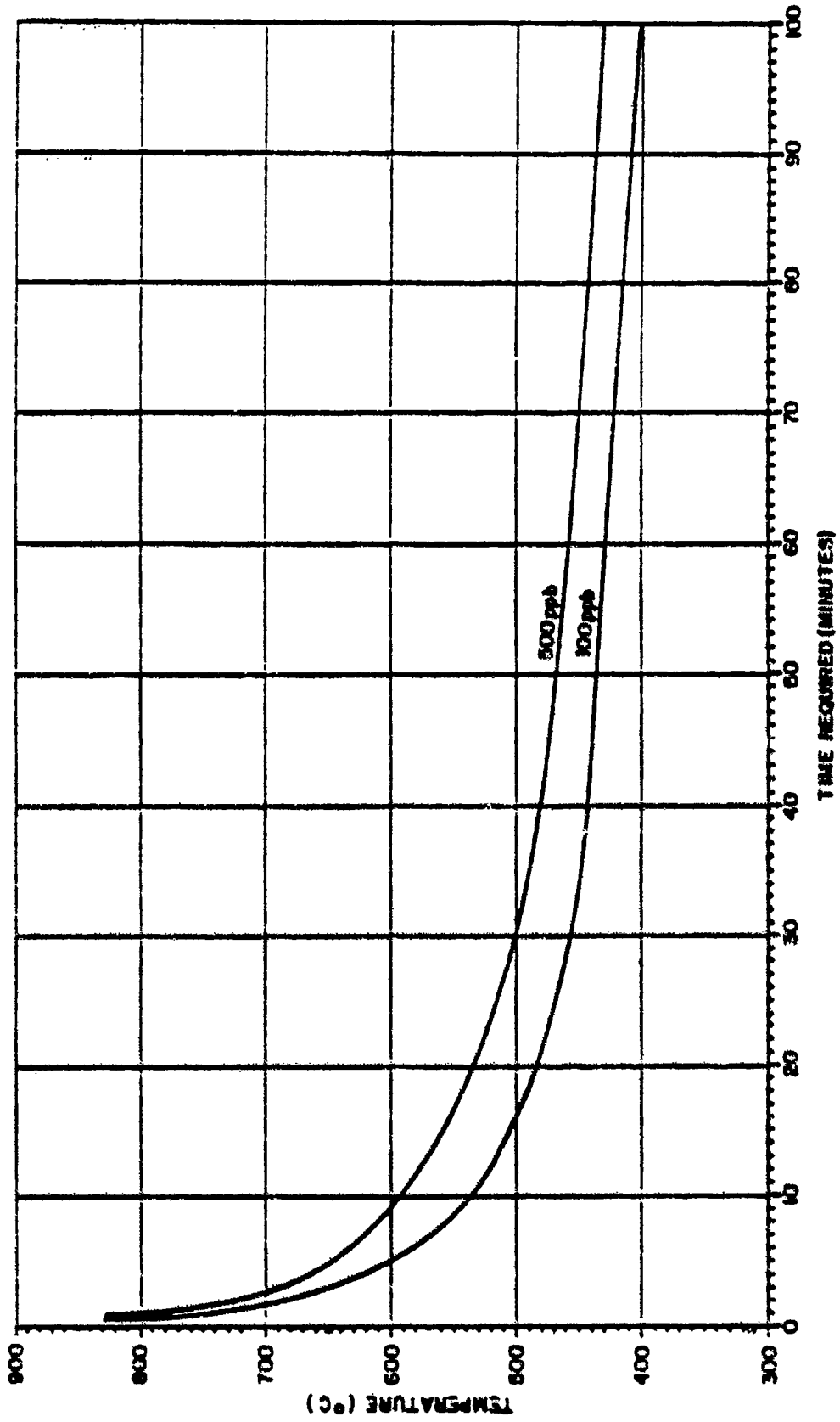

Figure 16. Predicted Time-Temperature Required to Achieve 100ppb 2,3,7,8-TCDF for Soils Initially Containing 100ppb and 500ppb

By employing the heat transfer program discussed in Section V, the soil time-temperature profile for any set of conditions can be estimated. Figure 17 shows the calculated soil residence time for each linear foot (indicated by a dot) of the kiln, considering the measured soil density, estimated loading, and selected soil feed rate of 4000 pounds per hour dry weight. The corresponding vapor pressure-versus-time profile shown in Figure 18 was developed from Figure 17, assuming that the soil temperature increases stepwise at 1-foot intervals. The average of the calculated vapor pressures at the front and rear of each 1-foot interval was used to develop the values for each point on the curve. The area under this time-vapor pressure curve was approximated by summing the area of the steps in the figure. By using the resulting IVP value of 141,000 mmHg·min in Equation (1), and assuming a soil feed containing 500 ppb, the estimated final 2,3,7,8-TCDD concentration was calculated to be 0.4 ppb. This value is near the lower limit of the treatability data used to generate Equation (1). Predicting values below 0.1 ppb would not be justified without further data taken at low dioxin concentrations (<0.1 ppb).

This same procedure was used to calculate the final 2,3,7,8-TCDD concentration for each of the heat transfer cases described in Section V. Table 22 reveals that the model predicts that 2,3,7,8-TCDD concentrations of less than 1 ppb will be met for all but two cases. Both of these cases assumed high excess air concentrations (100 percent). However, upon examination of the computer sheets for Run 9, it was discovered that the heat value was input as a negative number, reducing the discharge temperature by about 50°C (90°F). If this had been input correctly, the predicted concentration would fall below 1 ppb. Run 2, which had a high soil feed rate (4000 pounds/hour), and low kiln residence time, was the only other run that gave a final concentration above 0.1 ppb.

The predictive model is strongly a function of temperature. Using Run 2 as an example, predicted temperatures were reduced by 55°C (100°F) and the final 2,3,7,8-TCDD concentration recalculated. This method yielded a revised concentration of 7 ppb. The other runs were evaluated using the same reduced temperature. This did not significantly affect the results, for Run 14, which yielded a predicted dioxin concentration of 2 ppb.

The predictive model is also affected by the assumptions made on kiln loading given in Section IV and summarized in Table 19. As an example, the predicted 2,3,7,8-TCDD concentrations were recalculated for Run 4 assuming a kiln loading of 7 percent as opposed to 4 percent as used for Table 22. The resulting dioxin concentration for this case was 5 ppb, which represents close to the maximum effect possible for variations in kiln loadings.

To select a set of MIS operating conditions (time-temperature combinations) that will meet the required treatment efficiency (1 ppb), all parameters affecting heat transfer, heat duty, soil residence time, and starting 2,3,7,8-TCDD concentration must be specified, and the other limitations of the MIS discussed in Section V must be considered. Excessive moisture and soil feed rate will pose difficulty in achieving decontamination criteria if highly contaminated soil is processed.

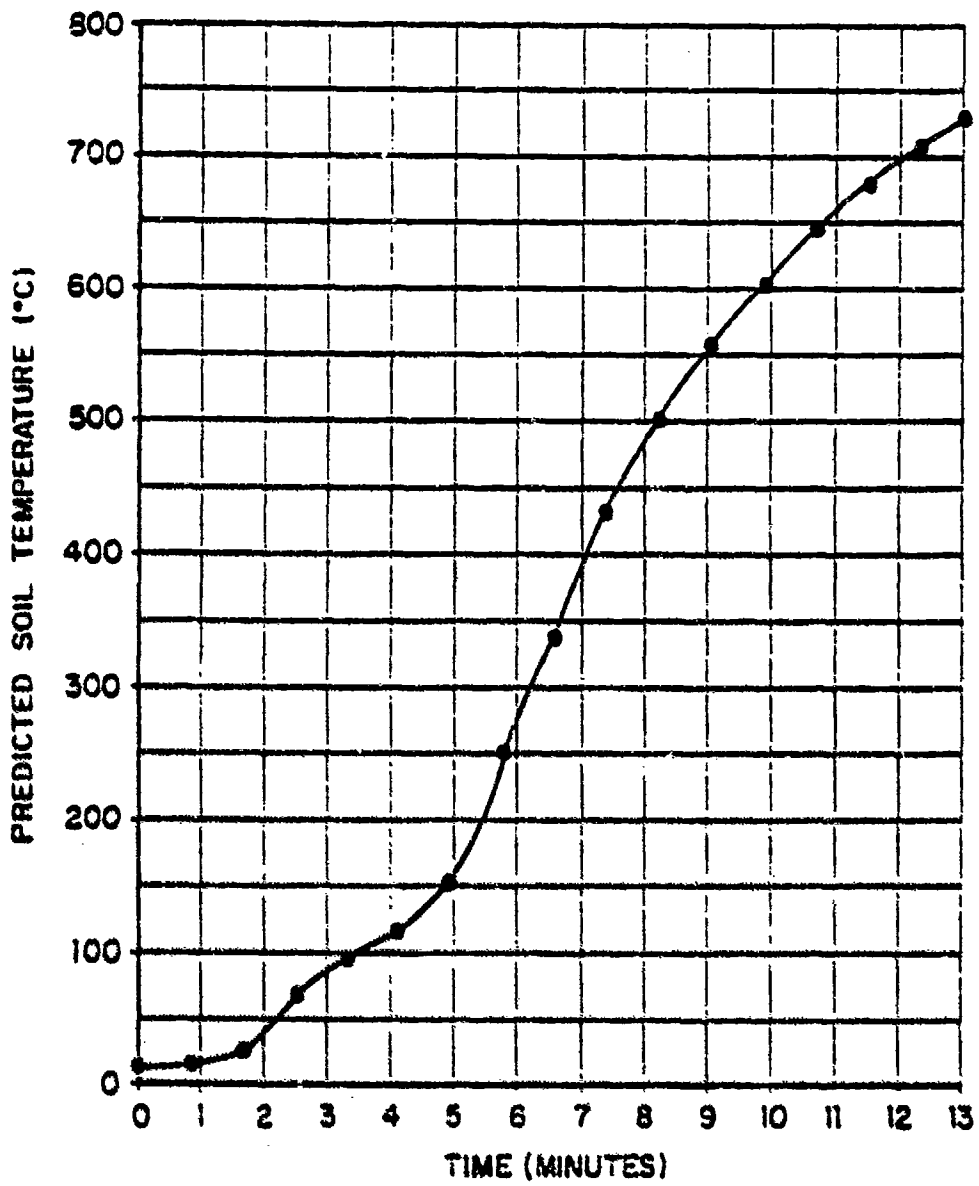

Figure 17. Temperature Vs. Time for Heat Transfer Run Number 2

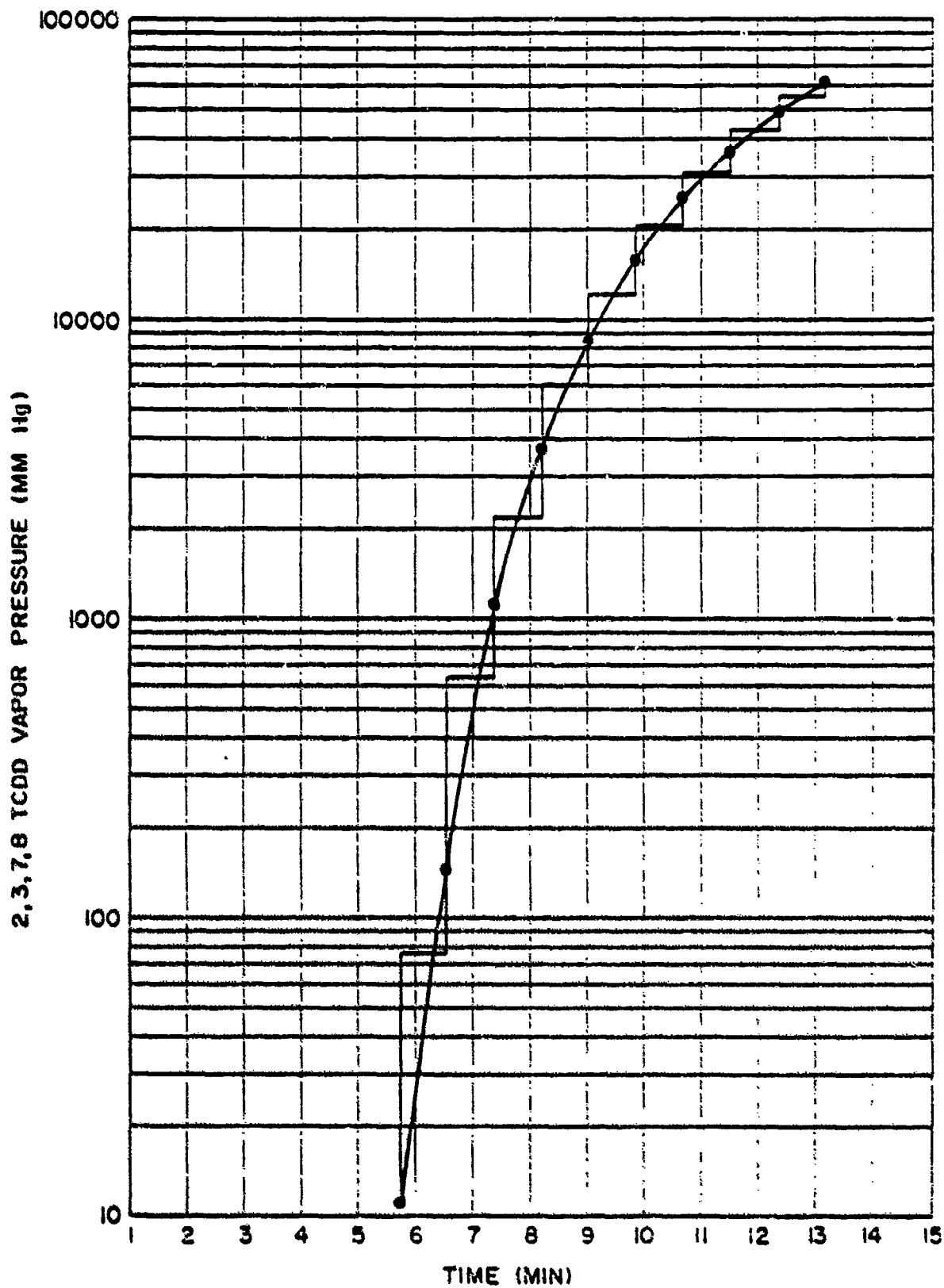

Figure 18. Vapor Pressure Vs. Time for Heat Transfer Run Number 2



TABLE 22. PREDICTED TREATMENT EFFICIENCY FOR HEAT TRANSFER RUNS

Run No.	Soil identification	Excess air (%)	Soil dry feed rate (lb/hr)	Calculated 2,3,7,8-TCDD concentration (ppb) <sup>a</sup>
1	Eglin	50	3400	<0.1
2	Eglin	50	4000	0.4
3	Eglin	50	3000	<0.1
4	Eglin	100	3400	20
5	Eglin	25	3400	<0.1
6	JI	50	3400	<0.1
7	JI	50	4000	<0.1
8	JI	50	3000	<0.1
9	JI	100	3400	15 <sup>b</sup>
10	JI	25	3400	<0.1
11	NCBC	50	3400	<0.1
12	NCBC	50	4000	<0.1
13	NCBC	50	3000	<0.1
14	NCBC	100	3400	<0.1
15	NCBC	25	3400	<0.1

<sup>a</sup>Assumes initial concentration of 500 ppb 2,3,7,8-TCDD and 12% moisture.

<sup>b</sup>Data for soil heating value was input as negative due to calcination endotherm; actual concentration is expected to be somewhat lower (<1 ppb).

## SECTION VII

### CONCLUSIONS

The following conclusions, based on the results of the project, are supported by previous results of related studies.

1. Thermal treatment studies of Herbicide Orange-contaminated soils from Johnston Island, Eglin Air Force Base, and the Naval Construction Battalion Center at conditions representative of the MIS capabilities were successful in achieving less than 1 ppb residual concentrations of 2,3,7,8-TCDD and related isomers in the treated soils. Concentrations of 2,3-DBE and 2,4,5-TBE were reduced to less than 50 ppb under the same condition, equivalent to greater than 99.99 percent removal efficiency from the soils. This removal efficiency is not the same as the DRE determined by stack gas sampling on incinerators.
2. Treatment is greatly influenced by temperature and residence time. Statistical evaluation of the treatability data from all three test soils showed the 2,3,7,8-TCDD concentration after treatment to be directly proportional to the starting concentration and logarithmically proportional to the time and temperature.
3. The soil type had a minor influence on treatability. Eglin soil gave the highest removal efficiencies and Johnston Island soil gave the lowest. The differences in treatability appeared greater at lower temperatures.
4. The treatability of the three soils studied was comparable to that of a Missouri soil sample studied previously in the first trial/demonstration burn of the EPA MIS. The influence of treatment time and temperature on removal efficiency was very similar.
5. Chemical and physical changes occurred in each of the three soils studied, depending on their composition. None of these changes were determined to pose a serious operational difficulty, such as slagging. However, the JI soil showed substantial weight loss, presumably accompanied by the generation of carbon dioxide, and consumption of heat as a result of calcination.
6. Entrainment of soil particles was determined to represent a potential operating difficulty if high soil feed rates and high excess air are used. The amount of entrainment is dependent on soil type and corresponding particle size distribution.
7. Based on computer simulation, heat transfer rates in the kiln should not limit the MIS capacity to treat contaminated soil for any of the three soils if moisture content is below about 20 percent. Other physical

attributes of the MIS, including SCC burner feed rates, soil feed system, kiln loading, and operating protocol, such as using high excess air, represent kiln capacity limitations. Soil processing rates of 3500 to 4000 pounds per hour should be realized, even with highly contaminated soil at these sites.

SECTION VIII  
RECOMMENDATIONS

To validate the heat transfer and heat and material balance computer simulations used in this study, a thorough review and interpretation of all available operating data from the recent MIS trial/demonstration burns should be performed. In addition, appropriate additions in data collection/instrumentation, particularly accurate measurement of solids temperature in the kiln, would provide a sounder data base for this validation. This would enable better predictions of operating capabilities when considering the variety of applications and operating conditions which could be involved in soil decontamination efforts.

Additional studies should be carried out to better define particulate entrainment from soils processed by the MIS (or other kiln systems). Preliminary review of pertinent theory and available data provides justification and a basis for comprehensive evaluation of this important process aspect.

## SECTION IX

### REFERENCES

1. Channell, R. E. and Stoddart, T. L., Herbicide Orange Monitoring Program, ESL-TR-83-56, Engineering and Services Laboratory, Air Force Engineering and Services Center, Tyndall AFB, FL, April 1984.
2. Hughes, B. M., et al., Analytical Methodology for Herbicide Orange. Volume I: Determination of Chemical Composition, NTIS ADA01579, Aerospace Research Laboratories, Wright-Patterson AFB, OH, May 1975.
3. Wong, T. S., "Dioxin Formation and Destruction in Combustion Processes," presented at 77th Annual Meeting of the Air Pollution Control Association, San Francisco, CA, 24-29 June 1984.
4. Ackerman, D. G., Fisher, H. J., Johnson, R. J., Maddalone, R. F., Matthews, B. J., Moon, E. L., Schever, K. H., Shih, C. C., Tobias R. F. (TRW, Inc.), Venezia, R. A., (EPA), At Sea Incineration of Herbicide Orange Onboard the M/T Vulcanus, EPA-600/2-78-086, U. S. Environmental Protection Agency, April 1978.
5. Spencer, W. F., Farmer, W. J., and Cliath, M. M., Pesticide Volatilization, Agricultural Reserach Service, U.S. Department of Agriculture, 1973.
6. Thibodeaux, L. J., Chemodynamics-Environmental Movement of Chemicals in Air, Water, and Soil, John Wiley & Sons, NY, 1979.
7. Khan, S. U., Pesticides in the Soil Environment, Elsevier Scientific Publishing Company, NY, 1980.
8. Schnitzer, M. and Khan, S. U., eds., Soil Organic Matter, Elsevier Scientific Publishing Company, NY, 1978.
9. Schnitzer, M. and Hoffman, I., "Pyrolysis of Soil Organic Matter," in Division 5-3--Soil Microbiology, Soil Science Proceedings, 1964.
10. Flaig, W., Beutelspacher, H., and Reitz, E., in Soil Components - Organic Components, Vol. 1, Gieseking, J. E., ed., Springer-Verla, New York, NY, 1975.
11. Earnest, C. M., "Thermal Analysis of Minerals in Coal and Coal Ash," presented at the Pittsburgh Conference on Analytical Chemistry and Applied Spectroscopy, Atlantic City, NJ, 1981.
12. Earnest, C. M., The Application of Differential Thermal Analysis and Thermogravimetry to the Study of Kaolinite Clay Minerals, Perkin-Elmer Thermal Analysis Application Study 30, 1980.

13. Cudahy, J. J., et al., IT Corporation, Incineration Characteristics of RCRA Listed Hazardous Wastes, Contract No. 68-03-2568, USEPA Industrial Research Laboratory, Cincinnati, OH, July 1981.
14. Dellinger, B., et al., Determination of the Thermal Stability of Selected Hazardous Organic Compounds, USEPA, Combustion Research Facility, Jefferson, AR, 1984.
15. Freeman, R. A. and Schroy, J. M., "Environmental Mobility of Dioxins," presented at 8th ASTM Aquatic Symposium for Toxic Substances, Soil Science, 137:6, pp. 457-463, June 1984.

BATTELLE METHODS EMPLOYED IN THE  
PHYSICAL-CHEMICAL ANALYSES OF JI,  
EGLIN, AND NCBC SOILS

- 1A STANDARD OPERATING PROCEDURE FOR DETERMINATION OF SOIL ORGANIC MATTER
- 1B STANDARD OPERATING PROCEDURE FOR DETERMINATION OF SOIL PH
- 1C STANDARD OPERATING PROCEDURE FOR DETERMINATION OF ELECTRICAL CONDUCTIVITY IN SOILS
- 1D STANDARD OPERATING PROCEDURE FOR DETERMINATION OF SOIL SURFACE AREA
- 1E STANDARD OPERATING PROCEDURE FOR PARTICLE SIZE ANALYSIS OF SOILS
- 1F STANDARD OPERATING PROCEDURE FOR DETERMINATION OF SOIL CATION EXCHANGE CAPABILITY
- 1G METHOD FOR DETERMINATION OF TOTAL SOLVENT-EXTRACTABLE CONTENT OF SOILS AND SEDIMENTS

EEF 0-08-1  
July 17, 1984STANDARD OPERATING PROCEDURE FOR  
DETERMINATION OF SOIL ORGANIC MATTER1.0 Scope

This method detects the organic matter content of soils based on the oxidation of organic carbon by potassium dichromate. A colorimetric determination of the  $Cr^{3+}$  ion produced is used to determine the organic matter present based on the comparisons with standard soils of known organic matter. By adjusting the ratios of reagents and soil, the organic matter content of a wide variety of soils can be determined by this method (Schulze, 1960; Watson, 1978).

2.0 Summary of Method

Soils of known organic matter content and test soils are treated with potassium dichromate and sulfuric acid to oxidize organic carbon. After treatment with barium chloride, all solutions are allowed to stand overnight. The absorbance for each solution is read at 611 nm on a spectrophotometer and organic matter is determined from the standard curve.

3.0 Interferences

Chlorides in soils can reduce  $Cr_2O_7^{2-}$ , leading to  $Cr^{3+}$  and thus unrealistically high results. Ferrous iron can also lead to unrealistically high results. During air drying of soils, however,  $Fe^{2+}$  is oxidized to  $Fe^{3+}$ , minimizing the interference caused by  $Fe^{2+}$ . Oxides of Mn can oxidize soil organic matter, giving unrealistically low results. These interferences are not usually serious (Schulze, 1980).

4.0 Apparatus

4.1 Colorimeter. A high quality spectrophotometer capable of measuring absorbance at 611 nm, for detecting the presence of  $Cr^{3+}$ .



4.2 Flasks. 125 ml Erlenmeyer flasks acid washed, for mixing soil and reagents.

4.3 Balance. A top-loading balance for weighing soil to the nearest 0.01g.

4.4 Stir Rods. Glass stirring rod, for mixing the soil and reagents.

4.5 Pipettes. Glass volumetric pipettes of 10.0 and 20.0 ml capacity.

4.6 Graduated cylinder. 100 ml capacity graduated cylinder, for adding  $\text{BaCl}_2$  solution to soils.

#### 5.0 Reagents

5.1 2N potassium dichromate. Dissolve 98.07g  $\text{K}_2\text{Cr}_2\text{O}_7$  per 1.0 l Barnstead water.

5.2 Concentrated sulfuric acid (98%  $\text{H}_2\text{SO}_4$ )

5.3 0.5% (w/v) barium chloride. Dissolve 5 g  $\text{BaCl}_2$  in 1.0 l Barnstead water.

5.4 Organic matter standard. A soil of known organic matter content, from which various weights are taken to prepare the standard curve.

#### 6.0 Calibration

Calibration for this procedure, aside from routine calibration of balances, involves careful preparation of the standard curve. Using the standard soil, weigh out 0, 0.5, 1.0, 1.5, 2.0, and 2.5 g portions into

4.2 Flasks. 125 ml Erlenmeyer flasks acid washed, for mixing soil and reagents.

4.3 Balance. A top-loading balance for weighing soil to the nearest 0.01g.

4.4 Stir Rods. Glass stirring rod, for mixing the soil and reagents.

4.5 Pipettes. Glass volumetric pipettes of 10.0 and 20.0 ml capacity.

4.6 Graduated cylinder. 100 ml capacity graduated cylinder, for adding  $\text{BaCl}_2$  solution to soils.

#### 5.0 Reagents

5.1 .2N potassium dichromate. Dissolve 98.07g  $\text{K}_2\text{Cr}_2\text{O}_7$  per 1.0 l Barnstead water.

5.2 Concentrated sulfuric acid (98%  $\text{H}_2\text{SO}_4$ )

5.3 0.5% (w/v) barium chloride. Dissolve 5 g  $\text{BaCl}_2$  in 1.0 l Barnstead water.

5.4 Organic matter standard. A soil of known organic matter content, from which various weights are taken to prepare the standard curve.

#### 6.0 Calibration

Calibration for this procedure, aside from routine calibration of balances, involves careful preparation of the standard curve. Using the standard soil, weigh out 0, 0.5, 1.0, 1.5, 2.0, and 2.5 g portions into

separate 125 ml Erlenmeyer flasks that have been acid washed. Handle the standards exactly as described below in Section 7.0, Procedures.

### 7.0 Procedures

Weigh 1.0g of air-dry, 2 mm mesh sieved soil into a 125 ml Erlenmeyer flask. Depending on the organic matter content, the amount of soil may have to be reduced. For soils expected to contain greater than 10% organic matter, but which are not truly organic soils, use a 0.5 g sample. For an organic soil, use a 0.1 g portion. To each flask (standards and samples), add 10 ml of 2N  $K_2Cr_2O_7$  and swirl to mix. Then add 20 ml concentrated  $H_2SO_4$  and swirl to mix well. Leave each flask undisturbed for 60 minutes. Next, in the same sequence as the acid was added, add to each flask 100 ml of 0.5%  $BaCl_2$  solution. Leave the flasks undisturbed overnight. Set the spectrophotometer to 611 nm, the slit width to 2.0 nm, the lamp switches to visible, and the mode to absorbance. Turn on the spectrophotometer, allow sufficient time for warm-up (approximately 2 hours), and determine the absorbance of each solution at 611 nm, including all standards, blanks, and samples.

### 8.0 Calculations

Plot the standard curve on graph paper or via linear regression as percent organic matter versus absorbance at 611 nm. From the absorbance of the samples, the corresponding percent organic matter can be determined from the standard curve.

### 9.0 References

Schulte, E.E., 1980. Recommended soil organic matter test, pp 28-31. In: Recommended Chemical Soil Test Procedures for the North Central Region, North Central Regional Publication No. 221 (Revised). North Dakota Central Agricultural Experiment Station, North Dakota State University, Fargo, North Dakota.

Watson, M.E. 1978. Soil testing procedures, Research Extension Analytical Laboratory. Ohio Agricultural Research and Development Center, Wooster, Ohio 20 pp.

Approved by:

Mich. F. Aeth 7/25/84  
Section 320 SUP Representative

\_\_\_\_\_  
A. Barker

Ramma Mayer 7/25/84  
R. Mayer

EFP 0-08-1  
July 17, 1984STANDARD OPERATING PROCEDURE FOR  
DETERMINATION OF SOIL pH1.0 Scope

Soil pH is a measure of the hydrogen ion concentration in the soil solution. This method determines soil solution pH when soils are mixed in a 1:1 ratio (weight:volume) with water. It has been recommended as a standard method for the determination of soil pH by the North Central Region Soil Testing Committee, which includes representatives from Alaska, Illinois, Indiana, Iowa, Kansas, Michigan, Minnesota, Missouri, Nebraska, North Dakota, Ohio, Pennsylvania, South Dakota, and Wisconsin (McLean, 1980).

2.0 Summary of Method

A soil solution is made by mixing equal parts of soil and distilled water. The hydrogen ion concentration is determined by using a glass indicating electrode paired with a calomel reference electrode. The combination electrode is attached to a pH meter and the unit is calibrated with standardized buffer solutions prior to use. pH of the soil solution is measured to the nearest 0.1 pH unit.

3.0 Interferences

Soil pH measurements can be influenced by a number of factors, depending upon soil type and individual characteristics. The use of a standard protocol that has been used on many different soil types, such as the standard method described here, minimizes interferences.

4.0 Apparatus

4.1 pH meter. A high quality pH meter, such as a digital display ion analyzer/pH meter.

4.2 Electrodes. A combination glass indicating and calomel reference electrode for sensing hydrogen ion activity.

4.3 Balance. A top-loading digital display balance accurate to 0.01 g for weighing soil.

4.4 Beaker. A beaker of approximately 30 ml capacity.

4.5 Stirring apparatus. A magnetic stir plate with stir bar for the constant mixing of soil and water while determining pH.

4.6 Pipette. A pipette of 10.0 ml capacity.

#### 5.0 Reagents

5.1 Distilled or Barnstead water. Required to form a soil/water slurry.

5.2 Standard buffers. Commercially standardized buffer of pH 4.0 and 7.0, for standardizing the pH meter and electrode.

#### 6.0 Calibration

Prior to determining soil pH, the pH meter must be standardized. Using the pH 7.0 standard buffer in a small beaker, adjust the digital display to read 7.0 by turning the calibration knob and while constantly stirring the beaker. Return the function knob to standby, remove the electrode from the pH 7.0 buffer, wash the electrode with distilled water, and submerge the electrode in constantly stirred pH 4.0 standard buffer. If the meter does not read pH 4.0, use the temperature compensator knob to achieve a reading of pH 4.0, wash the electrode as before, and standardize again with pH 7.0 buffer. Repeat the standardization procedure until the two readings are consistent.

7.0 Procedure

Weigh 10.0 g of air-dry sieved soil (passing a 2.00 mm screen) into a small beaker. Add 10.0 ml of distilled water, mix thoroughly with a glass rod, and allow the slurry to stand undisturbed for 10 minutes. Stir the soil suspension again and immediately submerge the pH electrode while continuing to swirl the beaker. Turn the function knob from standby to pH and read the pH to the nearest 0.1 pH unit. Return the switch to standby, remove the electrode, and rinse it thoroughly with distilled water.

9.0 Calculations

No calculations are required.

9.0 References

McLean, E.O. 1980. Recommended pH and lime requirement tests, pp. 5-8. In: Recommended Chemical Soil Test Procedures for the North Central Region, North Central Regional Publication No. 221 (Revised). North Dakota Agricultural Experiment Station, North Dakota State University, Fargo, North Dakota.

Approved by:

Mich. J. Potts 7/25/84  
SECTION 323 SUP REPRESENTATIVE

\_\_\_\_\_  
A. GERTER

Ronald M. Meyer 7/25/84  
A. Meyer

REF 0-08-1  
July 17, 1984**STANDARD OPERATING PROCEDURE FOR  
DETERMINATION OF ELECTRICAL CONDUCTIVITY IN SOILS****1.0 Scope**

This method is designed to determine the electrical conductivity in a soil-water slurry, an indication of the soluble salts content of the soil. The method described below is applicable to most soils, including those in the North Central Region (Alaska, Illinois, Indiana, Iowa, Kansas, Michigan, Minnesota, Missouri, Nebraska, North Dakota, Ohio, Pennsylvania, South Dakota, and Wisconsin.) Procedures are adapted from the soil testing procedures used at the Research Extension Analytical Laboratory at the Ohio Agricultural Research and Development Center (Meason, 1978).

**2.0 Summary of Method**

A soil-water slurry (1:2 soil:water ratio) is prepared, allowed to equilibrate, filtered, and pipetted into a calibrated conductivity cell connected to a conductivity meter. The meter display is in conductance and is multiplied by the cell constant to give conductivity in micro- or millimhos/cm.

**3.0 Interferences**

Accurate conductance readings require a very clean conductivity cell. This can be accomplished between readings by thorough washing with distilled or Barnstead water. Periodically, the cell should be washed with a solution containing 100 ml isopropyl alcohol, 100 ml ethyl ether, 50 ml concentrated HCl, and 50 ml distilled water. For storage between uses, the conductivity cell should be soaked in Barnstead water.

**4.0 Apparatus**

**4.1 Conductance meter.** A high quality digital display conductance meter, e.g., a YSI Model 32.



4.2 Conductivity cell. A conductivity cell compatible with the conductivity meter and having a known cell constant, such as a YSI 3401 platinized platinum - iridium electrode with a cell constant of  $K = 1.0/\text{cm}$ .

4.3 Balance. A top-loading digital display balance accurate to 0.01 g. for weighing soil.

4.4 Beaker. A 150 ml beaker for preparing the soil-water slurry.

4.5 Funnel and Filter Paper. A glass or plastic funnel and filter paper for filtering the soil-water solution.

4.6 Pipette. Pipette or small graduated cylinder, for adding 40 ml water to 20g soil.

4.7 Stir rods. Glass stir rod, for mixing the soil-water slurry.

#### 5.0 Reagents

5.1 Distilled or Barnstead water. Required to form a soil-water slurry.

#### 5.3 Calibration

The YSI 3401 conductivity cell has a cell constant of  $1.0/\text{cm}$ . If the cell is placed in a solution in an upright manner, no correction of the cell constant is required. If, however, the cell is inverted and the testing solution is pipetted into the cell, a correction factor needs to be calculated. To determine the corrected cell constant, immerse the cell in room temperature tap water, record the conductance, and multiply by the cell constant ( $1.0/\text{cm}$ ). Remove the cell from the tap water, rinse with distilled water, invert the cell, and seal the vent hole in the cell by wrapping it in paraffin. Fill the cell with the same tap water used previously, record the conductance, and multiply by  $1.0/\text{cm}$  to get conductivity. Subtract the two

conductivity determinations, and divide the answer by the second conductivity determination. This final answer is the percent variation of the cell constant and when added to 1.0/cm is the corrected cell constant. All subsequent conductance measurements are to be multiplied by the corrected cell constant to determine the conductivity.

#### 7.0 Procedure

Weigh 20.0 grams of air-dry, 2mm mesh sieved soil into a 150 ml beaker. Add 40.0 ml distilled or Barnstead water, stir thoroughly with a glass rod, and allow the contents to stand undisturbed for 30 minutes. Prepare a funnel and filter paper (e.g., Whatman 1). Pour the supernatant through the filter funnel, being careful not to disturb the settled soil in the bottom of the beaker. After the filter has drained, fill a calibrated conductivity cell with the filtrate (or immerse the upright cell in the filtrate if the volume of filtrate is great enough to submerge the cell), turn the knob on the conductivity meter to the conductance mode, adjust the range switch until a digital display is obtained, and record the conductance.

#### 8.0 Calculations

Multiply the conductance by the appropriate cell constant to obtain conductivity in milli- or micromhos.

#### 9.0 References

Watson, M.E. 1978. Soil Testing Procedures, Research Extension Analytical Laboratory. Ohio Agricultural Research and Development Center, Wooster, Ohio 20 pp.

EEF D-08-1  
July 17, 1984

Approved by:

*Philip J. ... 7/22/84*  
SECTION 725 SUP REPRESENTATIVE

\_\_\_\_\_  
A. Barker

*James M. ... 7/22/84*  
A. Mayer

EEF 0-08-1  
July 17, 1984STANDARD OPERATING PROCEDURE FOR  
DETERMINATION OF SOIL SURFACE AREA1.0 Scope

This method determines the specific surface area of soils based on the adsorption by soil particles of a monolayer of ethylene glycol monoethyl ether (EGME). Adsorption is based on an equilibration of EGME and soil particles followed by vacuum desiccation of unadsorbed EGME. Previous studies in the soil science community have shown that the method is applicable to widely different soil types (Carter et. al., 1965; Hailman, et. al., 1965; Cihacek and Bremner, 1979).

2.0 Summary of Method

Air-dried sieved soil is mixed with reagent grade EGME and equilibrated for 1 hour. The sample is then vacuum desiccated to constant weight over desiccant. Surface area is calculated by dividing the grams of adsorbate retained per gram of soil by  $0.000236 \text{ g/m}^2$ , which is the weight of EGME required to form a monolayer over  $1\text{m}^2$  surface area.

3.0 Interferences

There are no interferences described in the literature using this procedure.

4.0 Apparatus

4.1 Balance. An electronic (digital read out) balance accurate to 0.01 g for weighing soil samples prior to the addition of EGME, and a balance accurate to 0.001 g for weighing desiccated soils.

4.2 Weighing pans. Shallow aluminum weighing pans for equilibrating soil and EGME.

4.3 Desiccator. A vacuum desiccator plus desiccant and vacuum pump for drying soils.

4.4 Pipettes. Glass or plastic pipettes capable of delivering 3 ml of EGME.

4.5 Soil sieve. A soil sieve with a mesh opening of 2.00 mm for sieving air-dry soil.

#### 5.0 Reagents

5.1 Ethylene glycol monoethyl ether (2-ethoxyethanol). Reagent grade EGME for sorbing to soil surfaces; approximately 3.0 ml per soil sample.

5.2 Calcium sulfate. Several hundred grams of  $\text{CaSO}_4$  (dried) as a desiccant for drying EGME-equilibrated soil samples.

#### 6.0 Calibration

The calibration procedures involved in this method include those associated with balances. These are performed on a periodic basis by the SCL instrument laboratory.

#### 7.0 Procedure

Air-dry the soil. Sieve the air-dried soil to pass a 2.00 mm mesh screen. Obtain tare weights of triplicate labelled aluminum weighing pans that were placed overnight in a desiccator containing  $\text{CaSO}_4$  desiccant. Weights should be obtained to the nearest 0.001 g. To each of the tared triplicate weighing pans add 1.1 g of air-dry sieved soil, using the top-loading electronic balance (accurate to 0.01g). Place the pans of soil into a desiccator containing  $\text{CaSO}_4$ , evacuate the desiccator for 45 minutes with a vacuum pump and shut off the vacuum lines to maintain the vacuum in the desiccator. After at least 1 hour, weigh the pans of soil, evacuate the

desiccator again for 45 minutes, and weigh again at least 1 hour later. Continue this procedure until a constant weight is obtained (to nearest 0.001 g).

After constant weight has been obtained, add 3.0 ml of reagent grade EGME to each pan of soil to form a slurry. After 1 hour of equilibration of the slurry, place the pans of soil in the desiccator and evacuate for 45 minutes. After maintaining the vacuum for an additional hour, obtain weights (to the nearest 0.001 g) for each pan, place the pans back into the desiccator, evacuate for 45 minutes, and allow the pans to sit overnight under vacuum desiccation. Weigh the pans again, evacuate the desiccator for 45 minutes, and reweigh one hour later. Continue this procedure until a constant weight is obtained. Record all weights in ink in the laboratory record book.

#### 8.0 Calculations

For each pan, calculate the total surface area (TSA) by dividing the grams of EGME adsorbed per gram of soil by 0.000296g/m<sup>2</sup>, the Dyal-Hendricks value for the weight of EGME required to form a monolayer on a surface area of 1m<sup>2</sup>. That is,

$$TSA = \frac{a - b}{(0.000296 \text{ g/m}^2)(b - c)}$$

where: a = weight of desiccated soil, EGME, and pan;  
b = weight of desiccated soil and pan;  
c = tare weight of pan.

#### 9.0 References

Carter, D.L., M.D. Heilman, and C.L. Gonzalez. 1965. Ethylene glycol monoethyl ether for determining surface area of silicate minerals. *Soil Sci.* 100:356-360.

Heilman, M.D., D.L. Carter, and C.L. Gonzalez. 1965. The ethylene glycol monoethyl ether (EGME) technique for determining soil-surface area. *Soil Sci.* 100:409-413.

ESF D-08-1  
July 17, 1984

Cihacek, L.J., and J.M. Bremner. 1979. A simplified ethylene glycol monoethyl ether procedure for assessment of soil surface area. Soil Sci. Soc. Am. J. 43:821-822.

Approved by:

Mick J. Roth 7/15/84  
SECTION 525 SUP REPRESENTATIVE

\_\_\_\_\_  
A. Jarker

Francis Meyer 7/12/84  
F. Meyer

SEP 0-12-1  
July 17, 1984STANDARD OPERATING PROCEDURE FOR  
PARTICLE SIZE ANALYSIS OF SOILS1.0 Scope

This method describes a standard way to determine the particle size distribution in soils. It is adapted from an ASTM procedure (ASTM, 1972; ASTM, 1978) and is widely applicable to soils.

2.0 Summary of Method

Air-dry soil is analyzed for particle size distribution based on sieving (for those particles larger than 75  $\mu\text{m}$ ) or by a sedimentation process (those particles passing the 75  $\mu\text{m}$  sieve). A hydrometer is used in the sedimentation procedure.

3.0 Interferences

Not applicable.

4.0 Apparatus

4.1 Balance. A balance sensitive to 0.01 g for weighing the material passing a 75  $\mu\text{m}$  sieve and for weighing the material retained on larger sieves.

4.2 Mortar and Pestle. A ceramic mortar and pestle for breaking up larger soil clumps.

4.3 Hydrometer. An ASTM hydrometer, graduated to read in either specific gravity of the suspension or grams per liter of suspension.

4.4 Sedimentation Cylinder. A glass 1000 ml graduated cylinder, for performing sedimentation analyses.



4.5 Thermometer. A thermometer accurate to 1°F (0.5°C).

4.6 Soil Sieves. A series of sieves, of square-mesh woven-wire cloth, as follows:

No. 4	4.75 mm
No. 10	2.00 mm
No. 20	850 $\mu$ m
No. 40	425 $\mu$ m
No. 60	250 $\mu$ m
No. 140	106 $\mu$ m
No. 200	75 $\mu$ m

4.7 Beaker. A beaker of 250 ml capacity.

4.8 Timing Device. A watch or clock with a second hand.

4.9 Electric Stirring Apparatus. A high-speed electric stirring device, such as a "milk shake stirrer."

## 5.0 Reagents

5.1 Dispersing Agent. A solution of sodium hexametaphosphate, freshly prepared by dissolving 40 g of sodium hexametaphosphate per 1.0 liter of Barnstead water.

## 6.0 Calibration

The hydrometer should be calibrated in distilled water and in a solution containing sodium hexametaphosphate. Bring a 1000 ml glass graduated cylinder to volume with Barnstead water. To another 1000 ml glass graduated cylinder add 125 ml of a solution of sodium hexametaphosphate (40 g/l) and bring to volume with Barnstead water, with constant mixing. After assuring that the cylinders of liquid are at room temperature (e.g. 22°C), add the

hydrometer to the cylinder containing water and record the value as read at the top of the meniscus. Ideally this should be 0. Next, put the hydrometer in the cylinder containing the sodium hexametaphosphate solution and record the reading at the top of the meniscus. The difference between the readings is called the composite correction factor and is to be used in the calculations (Section 8.0).

#### 7.0 Procedure

Spread the soil sample in an exhaust hood so that it will air-dry. When the soil is air-dry and can be ground in a mortar and pestle, mix the sample thoroughly to assure uniformity, gently grind the soil in the mortar and pestle until soil particles are broken up (do not grind soil and gravel particles to a fine powder), and mix the sample again. Weigh triplicate portions (about 5.0 g), oven-dry them (105°C for 24 hours) and re-weigh them to determine moisture content. Using sieves No. 4 and 10, separate the soil sample into three fractions: greater than 4.75 mm diameter, less than 4.75 mm but greater than 2.00 mm diameter, and less than 2.00 mm diameter. Record the weights of all size fractions. The results constitute the portion greater than 2.00 mm diameter.

The portion passing the 2.00 mm sieve is to be fractionated further. Add 50 g of the less than 2.00 mm air-dry soil (or more accurately, soil of known moisture content), to a 250 ml beaker. Cover the soil with 125 ml of sodium hexametaphosphate solution (40 g/l) and stir until the soil is thoroughly wet. Allow the mixture to sit at room temperature for at least 16 hours.

At the end of the soaking period, disperse the soil further by stirring for one minute with a high speed electric "milk shake stirrer." Immediately transfer the soil-water slurry to a glass 1000 ml graduate cylinder and bring to volume with Barnstead water. Cover the cylinder with paraffin (2 layers) and repeatedly invert and upright the cylinder for 1 minute. During this mixing, make sure all soil is being dispersed and that none settles in the cylinder. After the 1 minute period, place the cylinder on a level, sturdy surface at room temperature. Record the time of day and

after 2, 5, 15, 30, 60, 250, and 1440 minutes, use an ASTM-approved hydrometer to obtain a sedimentation reading. Approximately 20 to 25 seconds before a reading is done, carefully insert the hydrometer into the cylinder. Read the hydrometer at the top of the meniscus formed by the suspension around the stem of the hydrometer and immediately remove the hydrometer from the cylinder.

After the final hydrometer reading is taken, i.e. at 1440 minutes, pour the suspension onto a 75  $\mu$ m sieve (No. 200), wash the sieve with water until the wash water is clear, transfer the material to a suitable container such as a beaker, and dry in an oven at 105°C overnight. After the oven-drying is complete, fractionate the dried material on the following sieves: No. 20, 40, 60, 140, and the bottom pan, weighing the portion retained by each.

### 8.0 Calculations

The moisture content of the original soil sample is calculated as follows:

$$\frac{(\text{air-dry weight of soil} + \text{pan}) - (\text{oven-dry weight of soil} + \text{pan})}{(\text{oven-dry weight of soil} + \text{pan}) - (\text{weight of empty pan})}$$

Results can be expressed as percentage moisture by multiplying by 100.

Calculate the portion greater than 4.75 mm (A), between 4.75 mm and 2.00 mm (B), and less than 2.00 mm (C), as follows:

$$\frac{\text{fraction in question (in grams)}}{\text{total grams of soil (A + B + C)}} \times 100$$

The percentage (P) of soil remaining in suspension at the level at which the hydrometer measures the density of the suspension is calculated as follows:

$$P = \left[ 1 - \left( \frac{R_s}{R} \right) \right] \times 100$$

where:

$R$  = hydrometer reading minus the composite correction,

$a$  = a correction factor for the model of hydrometer used, and in most cases equals 1.00 for a specific gravity of 2.65 for soil,

$M$  = oven-dry mass of soil dispersed in the hydrometer test

The diameter ( $D$ ) of the particles corresponding to the percentage indicated by a given hydrometer reading is calculated as follows:

$$D = K (L/T)^{1/2}$$

where:

$K$  = a constant that is dependent on temperature and specific gravity. At 22°C and 2.65 specific gravity, the value of  $K$  is 0.01332. Other values can be obtained from Table 3 of ASTM, 1972.

$L$  = distance from the surface of the suspension to the level at which the density of the suspension is measured. In cm; this value is known as the effective depth and requires the use of Table 2 of ASTM, 1972.

$T$  = interval of time from beginning of sedimentation to the taking of the reading; in min.

#### 9.0 References

ASTM, 1972. Standard method for particle-size analysis of soils. ASTM D422-63, Washington, D.C.

ASTM, 1978. Standard method for dry preparation of soil samples for particle-size analysis and determination of soil constants. ASTM D421-58, Washington, D.C.

EEF D-12-1  
July 17, 1984

Approved by:

*Mich. J. Huth 7/25/84*  
Section 520 SUP Representative

\_\_\_\_\_

A. Barker

*Rosemary M. Meyer 7/25/84*  
R. Meyer

REF 0-13-1  
July 17, 1984STANDARD OPERATING PROCEDURE FOR  
DETERMINATION OF SOIL CATION  
EXCHANGE CAPACITY1.0 Scope

This method is designed to determine the cation exchange capacity in soils, which indicates the capacity of soils to bind important plant nutrients. It is based on the displacement from exchange sites of nutrient cations such as Ca, K, and Mg, with an extracting cation. The extracting cation is then displaced and analyzed in the leachate. Although several different cations can be employed to displace the soil cations, the cation of choice should be low in the soil to prevent low CEC determinations. Therefore, ammonium is used most widely and is employed in this procedure.

2.0 Summary of Method

Ammonium acetate is added to a known quantity of soil to both displace the bound cations and to saturate the exchange sites. An ethanol solution is used to wash the soil, followed by the displacement of  $\text{NH}_4^+$  ions by KCl. The displaced  $\text{NH}_4^+$  ions are analyzed using an ammonium ion-specific electrode, and the concentration of ammonium ions in the leachate is proportional to the  $\text{K}^+$  ions bound to the soil and thus to the CEC.

3.0 Interferences

To provide accurate CEC determination the displacing ion should not be present in high concentrations in the soil. In addition, monovalent ions have proven to give less variable results than divalent displacing cations, such as calcium or magnesium.

4.0 Apparatus

4.1 Balance. A top-loading digital display electronic balance, or similar balance of equal accuracy, for weighing soils to the nearest 0.01 g.

4.2 Shaker. A shaker capable of holding a 125 ml Erlenmeyer flask, to provide constant shaking for 1 hour.

4.3 Filter Flask and Funnel. A 250 ml filter flask with a Buchner funnel, for washing the soil sample.

4.4 Filter Paper. Whatman number 44 filter paper (or similar paper) that fits the Buchner funnel, for washing the soil.

4.5 Volumetric Flasks. A 100 ml volumetric flask, for adjusting to volume the displaced  $\text{NH}_4^+$  solution, and 1.0 l and 500 ml volumetric flasks for preparing reagents.

4.6 Ammonium ion-specific electrode. An Orion ammonium ion-specific electrode and digital display pH/millivolt meter such as an Orion 501A.

#### 5.0 Reagents

5.1 Ammonium acetate. One molar solution, made by dissolving 77.1 g ammonium acetate in a total of 1.0 liter of Barnstead water in a volumetric flask. Adjust to pH 7.0, using glacial acetic acid and a standardized pH meter.

5.2 Industrial Alcohol. Mix 60 ml denatured ethanol with 40 ml Barnstead water.

5.3 Potassium Chloride. A 3% solution, prepared by dissolving 30.0 g KCl in a total of 1.0 l Barnstead water.

#### 6.0 Calibration

Calibration for this procedure includes the preparation of a standard curve for the ammonium ion-specific electrode. To prepare the

standard curve, first prepare standard solutions containing 1, 10, 100, and 1000 ppm  $\text{NH}_4\text{Cl}$  from the 0.1 M  $\text{NH}_4\text{Cl}$  Orion standard. Add 93.5 ml of the Orion standard to a 500 ml volumetric flask and bring to volume with Barnstead water, to give a 1000 ppm  $\text{NH}_4^+$  standard. Add 50.0 ml of the 1000 ppm standard to a 500 ml volumetric flask and bring to volume with Barnstead water, to give a 100 ppm standard solution. Add 50.0 ml of the 100 ppm standard to a 500 ml volumetric flask and bring to volume, giving a 10 ppm standard. Prepare the 1.0 ppm standard by adding 50.0 ml of the 10 ppm standard to a 500 ml volumetric flask and bringing to volume.

Before determining the standard curve, check the electrode slope as follows. Mix 100 ml Barnstead water and 1.0 ml of 10 M NaOH solution (Orion standard) in a 150 ml beaker. Turn the function switch on the model 501A pH/mV meter to relative millivolt, place the electrode in the beaker, and stir the beaker constantly with a magnetic stir bar. Now pipet 1.0 ml of 1000 ppm standard into the beaker and adjust the reading to 000.0 with the calibration knob. Next, add 10.0 ml of 1000 ppm standard into the beaker. Correct electrode operation is indicated by a reading of  $-57 (\pm 3)$  mV.

To prepare the standard curve, add approximately 7 ml of 1 ppm standard to a 10 ml beaker, add a small magnetic stirring bar, and stir the solution constantly. Place the electrode in the solution, being careful not to trap bubbles under the electrode. Add 0.1 ml (100  $\mu$ ) of 10 M NaOH to the beaker, set the function switch to rel mv, and record the display. Return the function switch to stand-by, remove the electrode, rinse thoroughly with Barnstead water, and repeat the above procedures for the remaining standard solutions. Plot the millivolt reading on the ordinate (linear axis) against concentration on the abscissa (log axis) on semilogarithmic paper.

The standard curve should be recalibrated every two hours during the analysis.

#### 7.0 Procedure

Add 5.0 g air-dried, sieved (<2.00 mm) soil to a 125 ml Erlenmeyer flask. Add 125 ml of 1M ammonium acetate and shake the mixture for 1 hour at room temperature. Using Whatman 44 filter paper, repeatedly wash the soil



under vacuum filtration in a Buchner funnel with portions of industrial ethanol solution. Use at least 100 ml of the ethanol solution and reject all washings. Leach the soil with small (20-30 ml) portions of 5% KCl until a total of 100 ml (in a volumetric flask) has been collected. Determine the  $\text{NH}_4^+\text{-N}$  concentration in the leachate using the ammonium ion-specific electrode as described earlier for the preparation of the standard curve.

### 8.0 Calculations

CEC should be expressed as milliequivalents per 100 g of dry soil. The conversion from ppm (g/ml)  $\text{NH}_4^+\text{-N}$  as determined with the ammonium electrode to CEC is as follows:

$$\text{CEC (meq/100 g)} = \frac{(0.111)A}{(1 - B)}$$

where:

A = ppm  $\text{NH}_4^+\text{-N}$  from the standard curve, and

B = moisture content of the soil, expressed as a decimal fraction rather than percent.

The derivation for this formula is as follows:

CEC (expressed in meq/g dry soil) =

$$\frac{(\mu\text{g/ml NH}_4^+\text{-N})(100 \text{ ml leachate})(1 \text{ mg}/1000 \mu\text{g})}{(5 \text{ g air-dry soil})(1 - \text{moisture content})(18 \text{ mg/meq})}$$

### 9.0 References

Allen, S. E., M. N. Grimshaw, J. A. Parkinson, and C. Quarmby. 1974. Chemical Analysis of Ecological Materials. Wiley and Son, New York. 565 pp.

EEF D-13-1  
July 17, 1984

Approved by:

*Philip F. Smith 7/25/84*  
Secretary and SUP Representative

\_\_\_\_\_  
A. SARKER

*Russell M. Majors 7/27/84*  
A. HAYES

JUL 20 1994

METHOD FOR DETERMINATION OF TOTAL SOLVENT-EXTRACTABLE  
CONTENT OF SOILS AND SEDIMENTS1. Scope

- 1.1 This method covers the extraction and quantification of the total solvent-extractable content of soils and sediments at concentrations above 10 ug/g.
- 1.2 The method is suitable for the extraction of most phenols, anilines, and neutral semivolatile organic compounds.
- 1.3 Low boiling organic components are lost by evaporation and are not included in the total solvent-extractable content.

2. Summary of Method

- 2.1 The wet or dry soil or sediment sample is mixed with aqueous sodium chloride/potassium dihydrogen phosphate and equilibrated with methyl tert-butyl ether (MTBE). The MTBE extract is dried and concentrated. The concentrated extract is filtered to remove any particulate material. The solvent is evaporated from a portion of the concentrated extract and the residue weight is determined.

3. Interferences

- 3.1 Relatively large amounts of extractable components boiling below 200°C will make it difficult to obtain reproducible residue weights. Relatively large amounts of extractable high molecular weight polymeric material may interfere with the filtration of the concentrated extract.

4. APPARATUS

- 4.1 Separator Funnel — 100-ml with Teflon stopcock.
- 4.2 Kuderna-Danish Apparatus — 25-ml concentrator tube fitted with a micro-Snyder column.
- 4.3 Weighing Dish — approximately 2-cm diameter aluminum foil.
- 4.4 Syringe — 2-ml gas-tight with Teflon Luer Lock.

- 4.5 Filter Assembly -- 25-mm disposable, with Millipore Millex-SR, 0.5  $\mu$ m PTFE membrane filter.
  - 4.6 Boiling Chips -- approximately 10-40 mesh carborundum.
  - 4.7 Water Bath -- heated, capable of temperature control of  $\pm 2^\circ\text{C}$ . The bath should be used in a hood.
  - 4.8 Microbalance -- capable of accurately weighing to  $\pm 0.001$  mg.
  - 4.9 Rotary Mixer -- capable of rotating a 6-oz sample bottle end-over-end at approximately 30 rpm.
5. Reagents
- 5.1 Salt Solution -- Dissolve 300 g of NaCl and 20 g of  $\text{KH}_2\text{PO}_4$  in 800 mL of water and dilute to one liter with water.
  - 5.2 Methyl tert-Butyl Ether (MTBE) -- Distilled-in-glass grade.
  - 5.3 Magnesium Sulfate -- Anhydrous powder.
  - 5.4 Corn Oil Standard, high level -- Dissolve 500 mg of corn oil in 80 mL of MTBE and dilute to 100 mL with MTBE.
  - 5.5 Corn Oil Standard, low level -- Dilute 10 mL of the high level corn oil standard to 100 mL with MTBE.
6. Quality Assurance
- 6.1 Blank -- Determine the residue weights (7.6) of triplicate 100  $\mu$ L aliquots of MTBE. An average value of  $0.0 \pm 10$   $\mu$ g should be obtained.
  - 6.2 Corn Oil Standards -- Determine the residue weights (7.6) of triplicate 100- $\mu$ L aliquots of the low level corn oil standard and the high level corn oil standard. Average values of  $50 \pm 10$   $\mu$ g and  $500 \pm 25$   $\mu$ g should be obtained for the low level and high level standards, respectively.
7. Procedure
- 7.1 Extraction -- Add 30 mL of 30% NaCl/2%  $\text{KH}_2\text{PO}_4$  and 30 mL of MTBE to 30 g of soil in a 6-oz wide-mouth bottle having a Teflon-lined screw cap. Tumble the bottle end over end

for 16 hours. Weigh the bottle before and after the tumbling period to determine any decrease in gross weight from loss of solvent. If the gross weight has decreased by more than 0.5 g, the sample must be discarded.

- 7.2 Phase Separation -- Let the sample stand to allow the phases to separate. Decant the MTBE and water layers into a 100-ml separatory funnel and allow the phases to separate for 10 minutes. Withdraw the aqueous layer and discard.
- 7.3 Drying -- Transfer the MTBE extract to a 2-oz narrow-mouth bottle having a Teflon-lined screw cap. Add 2 g of anhydrous magnesium sulfate, shake the sample vigorously for one minute, and allow the sample to stand for at least 5 minutes.
- 7.4 Concentration -- Transfer 25 mL of the clear extract to a Kuderna-Danish apparatus, add two boiling chips, and concentrate the extract to 0.5-0.8 mL in a water bath at 80-90°C.
- 7.5 Filtration -- Transfer the concentrated extract to the barrel of a 2-ml syringe fitted with a Millipore Millex-SR 0.5  $\mu$ m PTFE membrane filter. Insert the plunger of the syringe and express the filtrate into a 1-ml volumetric flask. Rinse the K-0 tube with 0.2 mL of MTBE, transfer the rinse to the syringe and filter the rinse into the volumetric flask. Dilute to volume by the addition of MTBE and mix thoroughly.
- 7.6 Determination of Residue Weight -- Transfer 100  $\mu$ L of the extract to an aluminum weighing dish that has been tared on a microbalance; place the dish under a heat lamp at a distance of 8 cm from the lamp for one minute to allow the solvent to evaporate; transfer the dish to the microbalance; allow the dish to equilibrate for one minute; and, weigh to determine the residue weight.

separate 125 ml Erlenmeyer flasks that have been acid washed. Handle the standards exactly as described below in Section 7.0, Procedures.

### 7.0 Procedures

Weigh 1.0g of air-dry, 2 mm mesh sieved soil into a 125 ml Erlenmeyer flask. Depending on the organic matter content, the amount of soil may have to be reduced. For soils expected to contain greater than 10% organic matter, but which are not truly organic soils, use a 0.5 g sample. For an organic soil, use a 0.1 g portion. To each flask (standards and samples), add 10 ml of 2N  $K_2Cr_2O_7$  and swirl to mix. Then add 20 ml concentrated  $H_2SO_4$  and swirl to mix well. Leave each flask undisturbed for 60 minutes. Next, in the same sequence as the acid was added, add to each flask 100 ml of 0.5%  $BaCl_2$  solution. Leave the flasks undisturbed overnight. Set the spectrophotometer to 611 nm, the slit width to 2.0 nm, the lamp switches to visible, and the mode to absorbance. Turn on the spectrophotometer, allow sufficient time for warm-up (approximately 2 hours), and determine the absorbance of each solution at 611 nm, including all standards, blanks, and samples.

### 8.0 Calculations

Plot the standard curve on graph paper or via linear regression as percent organic matter versus absorbance at 611 nm. From the absorbance of the samples, the corresponding percent organic matter can be determined from the standard curve.

### 9.0 References

- Schulte, E.E., 1980. Recommended soil organic matter test, pp 29-31. In: Recommended Chemical Soil Test Procedures for the North Central Region, North Central Regional Publication No. 221 (Revised). North Dakota Central Agricultural Experiment Station, North Dakota State University, Fargo, North Dakota.
- Watson, M.E. 1978. Soil testing procedures. Research Extension Analytical Laboratory. Ohio Agricultural Research and Development Center, Wooster, Ohio 20 pp.

Approved by:

Willy F. Adh 7/25/84  
SECTION 525 SUP REPRESENTATIVE

\_\_\_\_\_  
A. BARKER

Ronna Mayer 7/25/84  
R. Mayer

BATTELLE FINAL REPORT ON  
PHYSICAL-CHEMICAL CHARACTERIZATION  
OF UNCONTAMINATED SOILS FROM  
JI, EGLIN, AND NCBC



FINAL REPORT

on

PHYSICAL-CHEMICAL CHARACTERIZATION  
OF SOILS

to

IT ENVIROSCIENCE

December 12, 1984

by

R.F. Arthur and T. C. Zrick

BATTELLE  
Columbus Laboratories  
505 King Avenue  
Columbus, Ohio 43201

Final Report  
on  
Physical-Chemical Characterization  
of Soils

to  
IT Enviroscience

INTRODUCTION

IT Enviroscience (IT) submitted three soil samples to Battelle's Columbus Laboratories for selected physical and chemical characterization. The analyses to be completed included pH, electrical conductivity, organic matter content, cation exchange capacity, moisture content, surface area, oil and grease (solvent extractable) content, and particle size distribution. This report presents the results of this project in tabular and brief descriptive form.

Materials and Methods

The methods employed were the same as those included in the appendix of the previous Final Report to IT on project 525-J-8687. All analyses were performed in duplicate with the exception of surface area, in which five replicates were used.

## Results and Discussion

Table 1 presents a comparison of the three IT soils and is largely self-explanatory. Each characteristic is discussed briefly below.

### pH

Sample IT 4543 was considerably more acidic than the other two samples. Samples IT 4540 and IT 4569 exhibited similar pH readings, even though their physical appearances were considerably different from one another. That is, while IT 4540 resembled a normal soil, sample IT 4569 resembled ground limestone, which would be expected to exhibit a high pH. The three pH values, however, are not atypical for widely dispersed soils.

### Electrical Conductivity

Electrical conductivity (EC) is an indication of soluble salts content. Samples IT 4540 and IT 4543 showed very low EC readings compared to sample IT 4569. Nevertheless, all three soils are low in soluble salts compared to truly saline soils (e.g., an EC greater than 10 millimhos/cm).

### Organic Matter

All three soils were very low in organic matter content. Samples IT 4543 and IT 4569 were among the lowest we have measured. A typical midwestern agricultural soils may have an organic matter content of 4 to 7 percent, while truly organic soils, such as a Histosol in southern Florida, may have organic matter contents of 50 percent or more.

### Cation Exchange Capacity

Cation exchange capacity (CEC) is a measure of the ability of a soil to bind important nutrient cations, such as calcium, magnesium, and

potassium. A soil with a high CEC, e.g., 10 to 15 milliequivalents/100 g or more, generally is more fertile than soils exhibiting low CECs. The IT soils all showed low CECs, with samples IT 4543 and IT 4569 showing comparably low values. These results compare well with the organic matter contents and illustrate the influence of organic matter on CEC.

#### Moisture Content

The values for moisture content in Table I reflect the air-dry nature of the samples as received. The main reason for determining the moisture content of the air-dry samples is to correct the results of various analyses to reflect oven-dry weights of soil.

#### Surface Area

The surface areas of the three soils samples are considerably less than the soil sample previously analyzed for IT. This is the result of the relatively low proportion of clay in the three samples most recently analyzed (see Particle Size Distribution).

#### Oil and Grease (Solvent-extractable) Content

Sample IT 4540, with an average solvent-extractable content of 1759 micrograms/g, was considerably higher in total solvent-extractable content than the other two samples. The origin of the solvent extractable content, whether anthropogenic or natural, is not indicated by the analysis performed. Nevertheless, it is likely that sample IT 4540 has been subjected to a level of anthropogenic input of oil and grease. Some other analysis, such as gas chromatography-mass spectroscopy, would be required to identify the materials making up the solvent extractable content.

#### Particle Size Distribution

The results of the particle size analysis are for the less-than-2.00-mm fraction since the samples as received were air-dry and sieved

TABLE 5. PHYSICAL-CHEMICAL ANALYSIS OF SAMPLE 17 SOIL SAMPLES

Physical-Chemical Parameters (a)	EURLIN		JL
	17 4503	17 4569	
1. pH (± standard deviation)	8.2 ± 0.021	5.21 ± 0.049	0.20 ± 0.036
2. Conductivity (millimhos/cm ± standard deviation)	0.279 ± 0.004	0.0418 ± 0.001	4.99 ± 0.148
3. Organic Matter (percent ± standard deviation)	1.5 ± 0.07	< 0.50	< 0.50
4. Cation Exchange Capacity (milliequivalents/100 g ± standard deviation)	3.0 ± 0.05	0.15 ± 0.008	0.12 ± 0.02
5. Moisture Content (percent ± standard deviation)	0.40 ± 0	0.12 ± 0.01	1.06 ± 0.13
6. Surface Area (m <sup>2</sup> /g ± standard deviation)	12.3 ± 1.95	2.05 ± 0.765(b)	6.74 ± 1.47
7. Oil and Grease Content (micrograms/g)	1759 ± 49.5	118.0 ± 4.2	664.9 ± 20.5
8. Particle Size Distribution (percent ± standard deviation)			
a. Medium Sand (between 425 microns and 7.00 mm)	25.7 ± 2.15	41.3 ± 3.48	41.3 ± 3.04
b. Fine Sand (between 75 and 425 microns)	59.4 ± 1.13	51.9 ± 3.26	36.2 ± 1.56
c. Silt (between 5 and 75 microns)	12.3 ± 1.03	4.77 ± 0.23	19.2 ± 1.91
d. Clay (smaller than 5 microns, including colloids) (c)	2.70 ± 0.42	2.03 ± 0.52	3.31 ± 0.42
Colloids (less than 1 micron)	2.25 ± 0.36	1.67 ± 0.47	2.94 ± 0.30

(a) All analyses were done in duplicate with the exception of surface area, which was done in triplicate of five.

(b) This mean and standard deviation represent four replicates. A fifth replicate yielded unacceptably high results compared to the other four replicates. If the fifth value is included, the surface area for sample 17 4569 is calculated as 3.52 ± 3.32 m<sup>2</sup>/g.

(c) Note that the clay fraction includes the colloid fraction, so that the percentage total greater than 200 percent.

to 2.00-mm or less. All three soils had fairly high contents of medium and fine sands, and fairly low clay contents. Based on these results, the less-than-2.00-mm fraction of IT 4540, IT 4543, and IT 4569 are classified as loamy sand, sand, and loamy sand to sandy loam, respectively. These results also explain the relatively low values for CEC, organic matter, and surface areas, which are those parameters influenced considerably by the extent of the clay-size fraction in a soil.

#### CONCLUSION

Although the three soils included in this study represent non-contaminated background soils, the results of the physical-chemical characterization should prove useful to IT for understanding the fate of 2,3,7, 8-tetrachlorodibenzodioxin in similar soils.

BATTELLE DATA TABLE FOR  
PHYSICAL-CHEMICAL CHARACTERIZATION  
OF CONTAMINATED SOILS FROM  
JI, EGLIN, AND NCBC

TABLE 1. PHYSICAL-CHEMICAL ANALYSIS OF THREE 1/2 GALLON SAMPLES (contaminated soil)

Physical-Chemical Parameters(a)(b)	037-3-ENR8	037-4-11	037-13-MC8C-1
1. pH (± standard deviation)	3.83 ± 0.035	0.45 ± 0.071	0.55 ± 0.071
2. Conductivity (millimhos/cm ± standard deviation)	0.106 ± 0.003	5.02 ± 0.404	0.205 ± 0.71
3. Organic Matter (percent ± standard deviation)	1.22 ± 0.042	4.22 ± 0.141	2.34 ± 0.177
4. Cation Exchange Capacity (millimoles/liters/100 g ± standard deviation)	0.77 ± 0.078	0.73 ± 0.16	2.45 ± 0.95
5. Moisture Content (percent ± standard deviation)	0.55 ± 0.78	0.34 ± 0.48	0.38 ± 0.53
6. Oil and Grease Content (micrograms/g)	6050.0 ± 945.1	1884.5 ± 863.9	3786.5 ± 529.6

(a) All analyses were done in duplicate.

(b) All methods used are the same as those described in detail in Battelle's Final Report to II Environmental on Project 526-J-6687, dated July 25, 1964.



ALLIS-CHALMERS REPORT ON SMALL BATCH  
KILN TEST SIEVE ANALYSIS AND BULK DENSITY  
MEASUREMENTS OF JI, EGLIN, AND NCBC SOILS

ALLIS-CHALMERS  
PROCESS RESEARCH & TEST CENTER  
9180 FIFTH AVENUE

SMALL BATCH KILN TEST AND COMPUTER STUDY

For

IT CORPORATION

Test Center Project No. 85-003

Charge No. 01-6712-52357

Date Performed: January 9-11, 1985

Date Reported: January 30, 1985

Reported By: K. K. Mak

## TABLE OF CONTENTS

	Page No.
INTRODUCTION. . . . .	1
CONCLUSION. . . . .	1
TESTWORK AND COMPUTER STUDY SUMMARY . . . . .	1

### APPENDICES:

Appendix A - Small Batch Kiln Test Results

B - Small Batch Kiln Test Time-Temperature Curves

C - Bulk Densities of Soil and Product

D - Screen Analysis of Soil and Product

E - Dynamic Angle of Repose

F - TGA and DSC Test Results

## INTRODUCTION

In accordance with Subcontracting Agreement and Purchase Order No. 4-12-27-01 from IT Corporation, Allis-Chalmers Energy and Minerals Systems Company performed a rotary kiln study for IT Corporation.

The objective of the study is to determine the behavior of contaminated soil on pyrolysis, and the degree of exhaust dust carry over.

The study included small batch kiln tests using three uncontaminated soils supplied by IT Corporation, and kiln heat transfer computer study.

The small batch kiln tests were performed at Allis-Chalmers Process Research & Test Center during the period of January 9-11, 1985. These tests were witnessed by Mr. J. L. Fleming of IT Corporation.

## CONCLUSION

Based on the small batch kiln test result, the following conclusions have been obtained:

1. All three(3) soils (4761, 4760, 4768) did not show any signs of sticking, slagging or balling when kiln gas temperature of 1038 °C was used.
2. Kiln exhaust gas dust increased with higher gas velocity through kiln.
3. Material 4768 tend to slide in kiln instead of turning over bed motion.

## TESTWORK AND COMPUTER STUDY SUMMARY

### Material Description

Three 5 gallon pails of uncontaminated soil were received at the Allis-Chalmers Process Research & Test Center. They were opened at the presence of Mr. J. L. Fleming.

Soil 4761 looked like a clay structure with a few occasional 2 or 3 inches lumps. Soil 4760 looked like a sandy soil. Soil 4768 looked like a sandy soil with large amounts of embedded sea shells.

### Moisture Content

The moisture content of the as received soils are shown below:

Soil 4761	6.5% Moisture
Soil 4760	1.2% Moisture
Soil 4768	6.4% Moisture
Soil 4768	5.0% Moisture (oven dried at 100 °C overnight)

### Small Batch Kiln Test

Eleven small batch kiln tests were performed and witnessed by Mr. J. L. Fleming of IT Corporation. Total retention time for each heat was set at 60 minutes. Kiln speed was 2.8 rpm and bed loading was around 7 percent. A summary of the test conditions used in the batch kiln tests is tabulated below.

<u>Heat No.</u>	<u>Soil</u>	<u>Feed Moisture</u> %	<u>Kiln Gas Temp</u> °C	<u>Total Gas Input</u> SCFM	<u>Excess O<sub>2</sub></u> %
1	4761	6.5	1038	32	10
2	4761	6.5	1038	45	10
3	4760	1.2	1038	32	10
4	4761	6.5	1038	100	10
5	4760	1.2	1038	66	10
6	4760	1.2	1038	100	10
7	4761	6.5	1038	66	10
8	4768	6.4	1038	32	10
9	4768	6.4	1038	66	10
10	4768	6.4	1038	100	10
11	4760	1.2	1038	25	10

Test results and observations are shown in Appendix A. Time-temperature curves for each heat are shown in Appendix B.

### Bulk Densities and Screen Analysis

The loose bulk densities of the as received material and batch kiln products are shown in Appendix C. The screen size structures of the as received soil and product from the small batch kiln tests are summarized and shown in Appendix D.

### Dynamic Angle of Repose Inside Kiln

Dynamic angle of repose tests on as received soil, 4760 and 4768 test product were performed using a glass-faced 38 inch diameter drum. The drum was rotated at 0.82 rpm equivalent to 0.6 rpm in the EERU unit. Test results are shown in Appendix E.

### Loss On Ignition

A loss-on-ignition test was performed on the as received soil sample. The sample was held at 1000 °C (1832 °F) for 30 minutes. Test result showed that the loss in weight was 46.62% in soil 4761, 2.07% in soil 4760 and 12.46% in soil 4768.

TGA AND DSC TESTS

Thermogravimetric Analysis (TGA) and Differential Scanning Calorimeter (DSC) tests were performed on each of the three as received soils. The results are shown in Appendix F.

Heat Transfer Computer Program Study

This will be provided in a separate addendum report.

*K. K. Mak*

K. K. Mak  
Senior Engineer, Process Development  
Process Research & Test Center  
A-C Energy & Minerals Systems Company

KKM/sjk

APPENDIX A

**Small Batch Kiln Test**

Project Name IT Corporation

Date January 9, 1985

Heat No. 1 (4761-1)

Kiln Ret. Time 60 mins

Excess O<sub>2</sub> 10 %

Kiln Speed 2.8 rpm

Kiln Temp at Time of Feed 1038 °C

Kiln Loading 7 %

Feed Moisture 6.5 %

Total Gas Input Rate 32 SCFM

Charge Weight 5.44 Kg

Time Min	Bed Temp °C #2	Off Gas Temp °C #1	Process Gas Input Comp SCFM			Remarks
			Air	O <sub>2</sub>	Nat. Gas	
0		1038	30		2.0	Fine dust blown out at start.
5	708	919	29.5	1	2.5	
10	865	1040	28.0	1	3.3	
15	879	1041	28.0	1	3.0	
20	884	1039	28.5	1	2.9	
25	892	1037	28.5	1	2.8	
30	954	1051	27.3	2.4	2.4	Between 25 and 32 min - the 3 large pieces broke up. Bed temp incurred 140 °C in 8 minutes.
35	1000	1044	28.1	2.2	1.7	
40	1006	1034	28.1	2.2	1.7	
45	1013	1037	28.1	2.2	1.7	
50	1014	1037	28.1	2.2	1.7	
55	1018	1040	28.1	2.2	1.7	
60	1020	1041	28.1	2.2	1.7	

Product Weight 2.43 Kg

Exhaust Dust Weight 0.25 Kg

Floor Sweepings \_\_\_\_\_ Kg

Total Product Weight 2.66 Kg

Observations: \_\_\_\_\_

\_\_\_\_\_

\_\_\_\_\_



**Small Batch Kiln Test**

Project Name IT Corporation

Date January 9, 1985

Heat No. 2 (4761-2)

Kiln Ret. Time 60 mins      Excess O<sub>2</sub> 10 %

Kiln Speed 2.8 rpm      Kiln Temp at Time of Feed 1038 °C

Kiln Loading 7 %      Feed Moisture 6.5 %

Total Gas Input Rate 45 SCFM      Charge Weight 5.44 Kg

Time Min	Bed Temp °C	Off Gas Temp °C	Process			Remarks
			Gas Input Comp SCFM			
			Air	O <sub>2</sub>	Nat. Gas	
0		1040	39.1	2.7	3.2	Irregular bed action.  -10 Min regular bed action - No large pieces (broken).
5	693	894	37.6	3.8	3.6	
10	882	1038	36.8	4.4	3.8	
			35.3	4.5	4.2	
15	920	1042	36.4	4.9	4.0	
			36.8	4.4	3.8	
20	942	1039	37.6	3.8	3.6	
			38.4	3.2	3.4	
25	985	1045	39.1	2.7	3.2	
30	1019	1040	39.1	2.1	3.0	
35	1028	1043	39.1	2.1	3.0	
			39.1	1.8	2.9	
40	1034	1039	39.1	1.6	2.8	
			39.1	1.6	2.8	
45	1036	1043	39.1	1.6	2.8	
50	1034	1037	39.1	1.6	2.8	
55	1035	1038	39.1	1.6	2.8	
60	1039	1040	39.1	1.6	2.8	

Product Weight 2.13 Kg      Exhaust Dust Weight .34 Kg

Floor Sweepings .06 Kg      Total Product Weight 2.53 Kg

Observations: \_\_\_\_\_  
 \_\_\_\_\_  
 \_\_\_\_\_

Small Batch Kiln Test

Project Name IT Corporation

Date January 9, 1985

Heat No. 3 (4760-1)

Kiln Ret. Time 6.0 mins      Excess O<sub>2</sub> 10 %  
 Kiln Speed 2.8 rpm      Kiln Temp at Time of Feed 1038 °C  
 Kiln Loading 7 %      Feed Moisture 1.2 %  
 Total Gas Input Rate 32 SCFM      Charge Weight 4.75 Kg

Time Min	Bed Temp °C	Off Gas Temp °C	Process Gas Input Comp SCFM			Remarks
			Air	O <sub>2</sub>	Nat. Gas	
0		1038	25.1	3.9	3.0	Roots burned immediately.
			25.8	3.4	2.8	
5	906	1046	27.3	2.3	2.4	
10	1010	1044	27.3	2.3	2.4	
15	1025	1040	27.3	2.3	2.4	
20	1027	1040	27.3	2.3	2.4	
25	1025	1037	27.3	2.3	2.4	
30	1026	1038	27.3	2.3	2.4	
35	1028	1038	27.3	2.3	2.4	
40	1028	1040	27.3	2.3	2.4	
45	1029	1040	27.3	2.3	2.4	
50	1030	1038	27.3	2.3	2.4	
55	1029	1039	27.3	2.3	2.4	
60	1028	1038	27.3	2.3	2.4	

Product Weight 3.03 Kg      Exhaust Dust Weight 1.4 Kg

Floor Sweepings \_\_\_\_\_ Kg      Total Product Weight 4.43 Kg

Observations: \_\_\_\_\_  
 \_\_\_\_\_  
 \_\_\_\_\_

**Small Batch Kiln Test**

Project Name IT Corporation

Date January 10, 1985

Heat No. 4 (4761-3)

Kiln Ret. Time 60 mins

Excess O<sub>2</sub> 10 %

Kiln Speed 2.8 rpm

Kiln Temp at Time of Feed 1038 °C

Kiln Loading 7 %

Feed Moisture 6.5 %

Total Gas Input Rate 100 SCFM

Charge Weight 5.44 Kg

Time Min	Bed Temp °C	Off Gas Temp °C	Process			Remarks
			Gas Input Comp SCFM			
			Air	O <sub>2</sub>	Nat. Gas	
0		1038	85	7.4	7.6	Considerable dust blown out.
5	864	1043	86	6.3	7.2	At 13 Min Bed Temp approaching Off Gas.
			87	5.7	7	
10	874	1040	89	4.5	6.6	
15	931	1041	89.6	3.9	6.4	
			91	2.9	6	
20	1010	1034	91	2.9	6	
25	1022	1040	91	2.9	6	
30	1015	1040	91	2.9	6	
35	1020	1038	91	2.9	6	
40	1019	1040	91	2.9	6	
45	1021	1039	91	2.9	6	
50	1024	1039	91	2.9	6	
55	1028	1043	91	2.9	6	
60	1029	1041	91	2.9	6	

Product Weight 1.77 Kg

Exhaust Dust Weight 0.44 Kg

Floor Sweepings 0.25 Kg

Total Product Weight 2.46 Kg

Observations: \_\_\_\_\_  
 \_\_\_\_\_  
 \_\_\_\_\_

**Small Batch Kiln Test**

Project Name IT Corporation

Date January 10, 1985

Heat No. 5 (4760-2) Sand

Kiln Ret. Time 60 mins

Excess O<sub>2</sub> 10 %

Kiln Speed 2.8 rpm

Kiln Temp at Time of Feed 1038 °C

Kiln Loading 7 %

Feed Moisture 1.2 %

Total Gas Input Rate 66 SCFM

Charge Weight 4.75 Kg

Time Min	Bed Temp °C	Off Gas Temp °C	Process Gas Input Comp SCFM			Remarks
			Air	O <sub>2</sub>	Nat. Gas	
0			56	4.8	5	
5	932	1012	57.7	3.7	4.6	
10	992	1034	58.5	3.1	4.4	At 10 Min 0.66 Kg leakage a Kiln Cover.
15	1009	1030	58.5	3.1	4.4	
20	1013	1040	58.5	3.1	4.4	
25	1016	1038	58.5	3.1	4.4	
30	1017	1040	58.5	3.1	4.4	
35	1018	1040	58.5	3.1	4.4	
40	1020	1041	58.5	3.1	4.4	
45	1018	1036	58.5	3.1	4.4	
50	1019	1039	58.5	3.1	4.4	
55	1022	1041	58.5	3.1	4.4	
60	1021	1040	58.5	3.1	4.4	

Kiln Leakage 0.66 Kg

Product Weight 2.57 Kg

Exhaust Dust Weight 0.90 Kg

Floor Sweepings 0.18 Kg

Total Product Weight 4.31 Kg

Observations: \_\_\_\_\_

\_\_\_\_\_

\_\_\_\_\_

**Small Batch Kiln Test**

Project Name IT Corporation

Date January 10 , 1985

Heat No. 6 (4760-3) Sand

Kiln Ret. Time 60 mins      Excess O<sub>2</sub> 10 %  
 Kiln Speed 2.8 rpm      Kiln Temp at Time of Feed 1038 °C  
 Kiln Loading 7 %      Feed Moisture 1.2 %  
 Total Gas Input Rate 100 SCFM      Charge Weight 4.75 Kg

Time Min	Bed Temp °C	Off Gas Temp °C	Process Gas Input Comp SCFM			Remarks
			Air	O <sub>2</sub>	Nat. Gas	
0		1038	91	2.9	6	Organics burned out.
			87	5.7	7	
5	993	1043	89	4.5	6.6	At 8 Min Bed Off Gas approaching line out conditions.
10	1009	1038	90.4	3.4	6.2	
15	1017	1040	91	2.9	6	
20	1018	1040	91	2.9	6	
25	1020	1039	91	2.9	6	
30	1019	1039	91	2.9	6	
35	1021	1037	91	2.9	6	
40	1023	1040	91	2.9	6	
45	1021	1038	91	2.9	6	
50	1018	1038	91	2.9	6	
55	1020	1038	91	2.9	6	
60	1021	1040	91	2.9	6	

Product Weight 2.84 Kg      Exhaust Dust Weight 1.01 Kg  
 Floor Sweepings 0.44 Kg      Total Product Weight 4.29 Kg

Observations: \_\_\_\_\_  
 \_\_\_\_\_  
 \_\_\_\_\_

Small Batch Kiln Test

Project Name IT Corporation

Date January 10, 1985

Heat No. 7 (4761-4)

Kiln Ret. Time 60 mins

Excess O<sub>2</sub> 10 %

Kiln Speed 2.8 rpm

Kiln Temp at Time of Feed 1038 °C

Kiln Loading 7 %

Feed Moisture 6.5 %

Total Gas Input Rate 66 SCFM

Charge Weight 5.44 Kg

Time Min	Bed Temp °C	Off Gas Temp °C	Process Gas Input Comp SCFM			Remarks
			Air	O <sub>2</sub>	Nat. Gas	
0		1038	56.2	4.8	5	
5	840	1018	55.4	5.4	6	
10	921	1038	56.2	4.8	5	
15	944	1039	58.0	3.7	4.6	
20	1009	1041	59.0	2.6	4.2	
25	1028	1035	59.0	3.1	4.4	
30	1036	1039	59.0	3.1	4.4	
35	1032	1038	59.0	3.1	4.4	
40	1037	1040	59.0	3.1	4.4	
45	1035	1039	59.0	3.1	4.4	
50	1033	1036	59.0	3.1	4.4	
55	1038	1040	59.0	3.1	4.4	
60	1035	1039	59.0	3.1	4.4	

Product Weight 2.00 Kg

Exhaust Dust Weight 0.42 Kg

Floor Sweepings 0.09 Kg

Total Product Weight 2.51 Kg

Observations: \_\_\_\_\_

\_\_\_\_\_

\_\_\_\_\_

**Small Batch Kiln Test**

Project Name IT Corporation

Date January 11, 1985

Heat No. 8 (4768-1)

Kiln Ret. Time 60 mins      Excess O<sub>2</sub> 10 %  
 Kiln Speed 2.8 rpm      Kiln Temp at Time of Feed 1038 °C  
 Kiln Loading 7 %      Feed Moisture 6.4 %  
 Total Gas Input Rate 32 SCFM      Charge Weight 4.68 Kg

Time Min	Bed Temp °C	Off Gas Temp °C	Process Gas Input Comp SCFM			Remarks
			Air	O <sub>2</sub>	Nat. Gas	
0			25.1	3.9	3.0	Organics burning out. 3 Min to complete. Bed more free flowing at 3 Min rather than sliding.
5	865	996	23.5	5.1	3.4	
10	947	1042	24.3	4.5	3.2	Air Compressor off low pressure - change to high pressure system (8 Min Bed Temp below expected).
15	996	1041	25.1	3.0	3.0	
20						
25	800	870	25.1	3.9	3.0	
30	985	1043	25.1	3.9	3.0	
35	1009	1040	26.6	2.8	2.6	
40	1021	1038	26.6	2.8	2.6	
45	1010	1033	20.0	2.0	1.8	
50	1012	1038	20.0	2.0	1.8	
55	1014	1038	20.0	2.0	1.8	
60	1014	1038	20.0	2.0	1.8	

Product Weight 3.36 Kg      Exhaust Dust Weight 0.12 Kg

Floor Sweepings 0.02 Kg      Total Product Weight 3.50 Kg

Observations: \_\_\_\_\_  
 \_\_\_\_\_  
 \_\_\_\_\_

Small Batch Kiln Test

Project Name IT Corporation

Date January 11, 1985

Heat No. 9 (4768-2)

Kiln Ret. Time 60 mins

Excess O<sub>2</sub> 10 %

Kiln Speed 2.8 rpm

Kiln Temp at Time of Feed 1038 °C

Kiln Loading 7 %

Feed Moisture 6.4 %

Total Gas Input Rate 66 SCFM

Charge Weight 4.68 Kg

Time Min	Bed Temp °C	Off Gas Temp °C	Process Gas Input Comp SCFM			Remarks
			Air	O <sub>2</sub>	Nat. Gas	
0		1038	60	2.0	4	
5	929	1037	56	4.8	5	
10	1013	1037				
15	1023	1040	59.2	2.6	4.2	
20	1021	1037	59.2	2.6	4.2	
25	1023	1038	59.2	2.6	4.2	
30	1023	1039	59.2	2.6	4.2	
35	1024	1038	59.2	2.6	4.2	
40	1023	1037	59.2	2.6	4.2	
45	1021	1036	59.2	2.6	4.2	
50	1026	1040	59.2	2.6	4.2	
55	1025	1039	59.2	2.6	4.2	
60	1024	1038	59.2	2.6	4.2	

Product Weight 3.00 Kg

Exhaust Dust Weight 0.52 Kg

Floor Sweepings 0.05 Kg

Total Product Weight 3.57 Kg

Observations: \_\_\_\_\_  
 \_\_\_\_\_  
 \_\_\_\_\_



### Small Batch Kiln Test

Project Name IT Corporation

Date January 11, 1985

Heat No. 10 (4768-3)

Kiln Ret. Time 60 mins      Excess O<sub>2</sub> 10 %  
 Kiln Speed 2.8 rpm      Kiln Temp at Time of Feed 1038 °C  
 Kiln Loading 7 %      Feed Moisture 6.4 %  
 Total Gas Input Rate 100 SCFM      Charge Weight 4.68 Kg

Time Min	Bed Temp °C	Off Gas Temp °C	Process Gas Input Comp SCFM			Remarks
			Air	O <sub>2</sub>	Nat. Gas	
0		1038	91	2.9	6	Organics burned out within 2 Min from start.
5	926	1020				
10	1020	1047				
15	1029	1042	92	2.3	5.8	
20	1026	1034	92	2.3	5.8	
25	1026	1034	92	2.3	5.8	
30	1028	1036	92	2.3	5.8	
35	1029	1036	92	2.3	5.8	
40	1036	1040	92	2.3	5.8	
45	1034	1039	92	2.3	5.8	
50	1033	1035	92	2.3	5.8	
55	1033	1038	92	2.3	5.8	
60	1037	1040	92	2.3	5.8	

Product Weight 2.60 Kg      Exhaust Dust Weight 0.81 Kg  
 Floor Sweepings 0.13 Kg      Total Product Weight 3.54 Kg

Observations: \_\_\_\_\_  
 \_\_\_\_\_  
 \_\_\_\_\_

Small Batch Kiln Test

Project Name IT Corporation

Date January 11, 1985

Heat No. 11 (4760-4)

Kiln Ret. Time 60 mins

Excess O<sub>2</sub> 10 %

Kiln Speed 2.8 rpm

Kiln Temp at Time of Feed 1038 °C

Kiln Loading 7 %

Feed Moisture 1.2 %

Total Gas Input Rate 25 SCFM

Charge Weight 4.75 Kg

Time Min	Bed Temp °C	Off Gas Temp °C	Process Gas Input Comp SCFM			Remarks
			Air	O <sub>2</sub>	Nat. Gas	
0						
5	996	1043	17.1	4.9	3	
10	1040	1043	19.4	3.2	2.4	
15	1034	1038	20.9	2.1	2.0	
20	1035	1038	20.9	2.1	2.0	
25	1035	1037	20.9	2.1	2.0	
30	1035	1038	20.9	2.1	2.0	
35	1035	1040	20.9	2.1	2.0	
40	1035	1038	20.9	2.1	2.0	
45	1036	1040	20.9	2.1	2.0	
50	1037	1038	20.9	2.1	2.0	
55	1032	1032	20.9	2.1	2.0	
60	1033	1038	20.9	2.1	2.0	

Product Weight 3.73 Kg

Exhaust Dust Weight 0.86 Kg

Floor Sweepings 0.03 Kg

Total Product Weight 4.62 Kg

Observations: \_\_\_\_\_  
 \_\_\_\_\_  
 \_\_\_\_\_

APPENDIX B

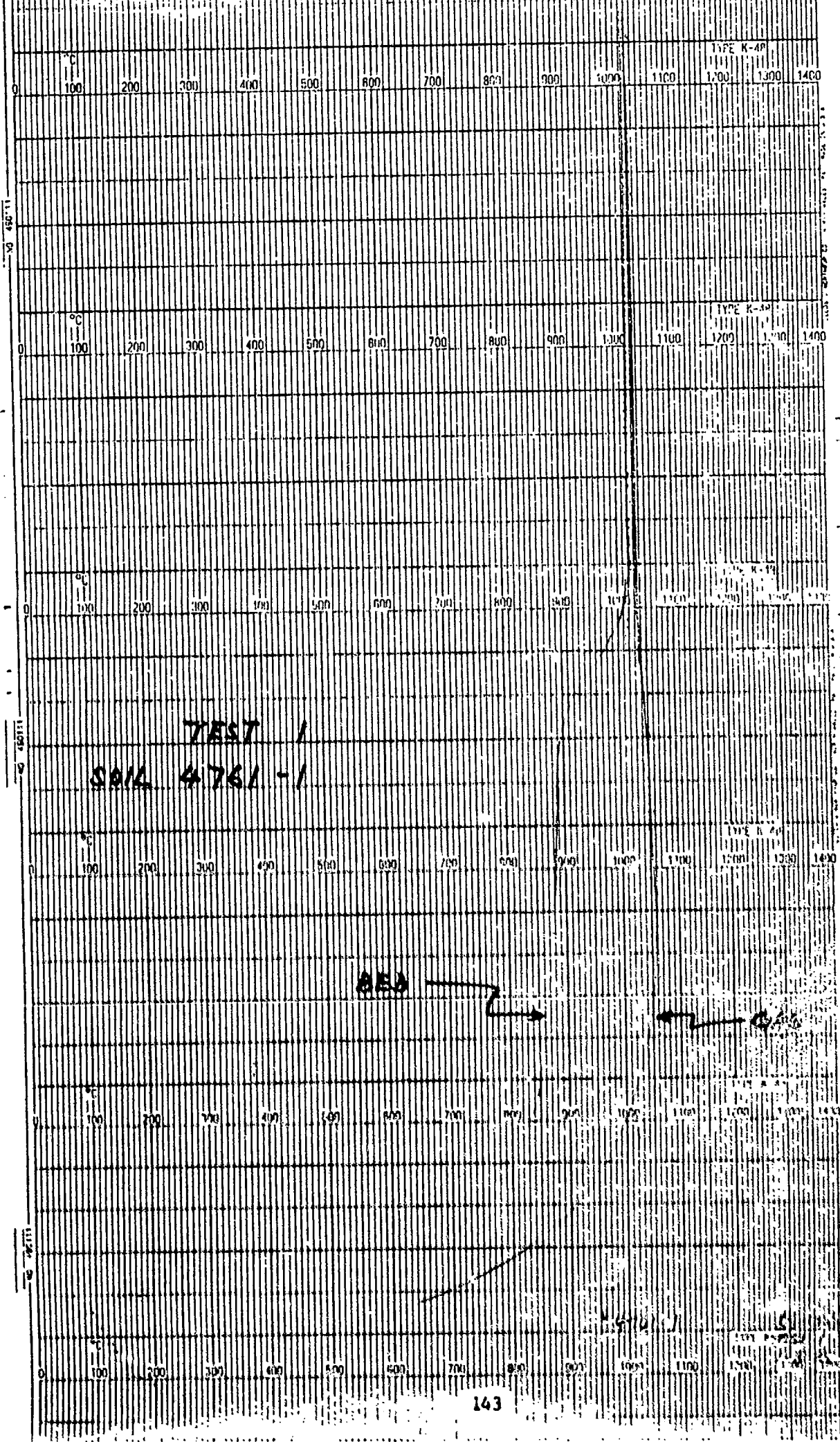

TEST 1  
SAIL 4761-1

BED

GAS

100 200 300 400 500 600 700 800 900 1000 1100 1200 1300 1400

100 200 300 400 500 600 700 800 900 1000 1100 1200 1300 1400

100 200 300 400 500 600 700 800 900 1000 1100 1200 1300 1400

100 200 300 400 500 600 700 800 900 1000 1100 1200 1300 1400

TEST 2  
SOIL 4761

100 200 300 400 500 600 700 800 900 1000 1100 1200 1300 1400

DEE

← GAS

100 200 300 400 500 600 700 800 900 1000 1100 1200 1300 1400

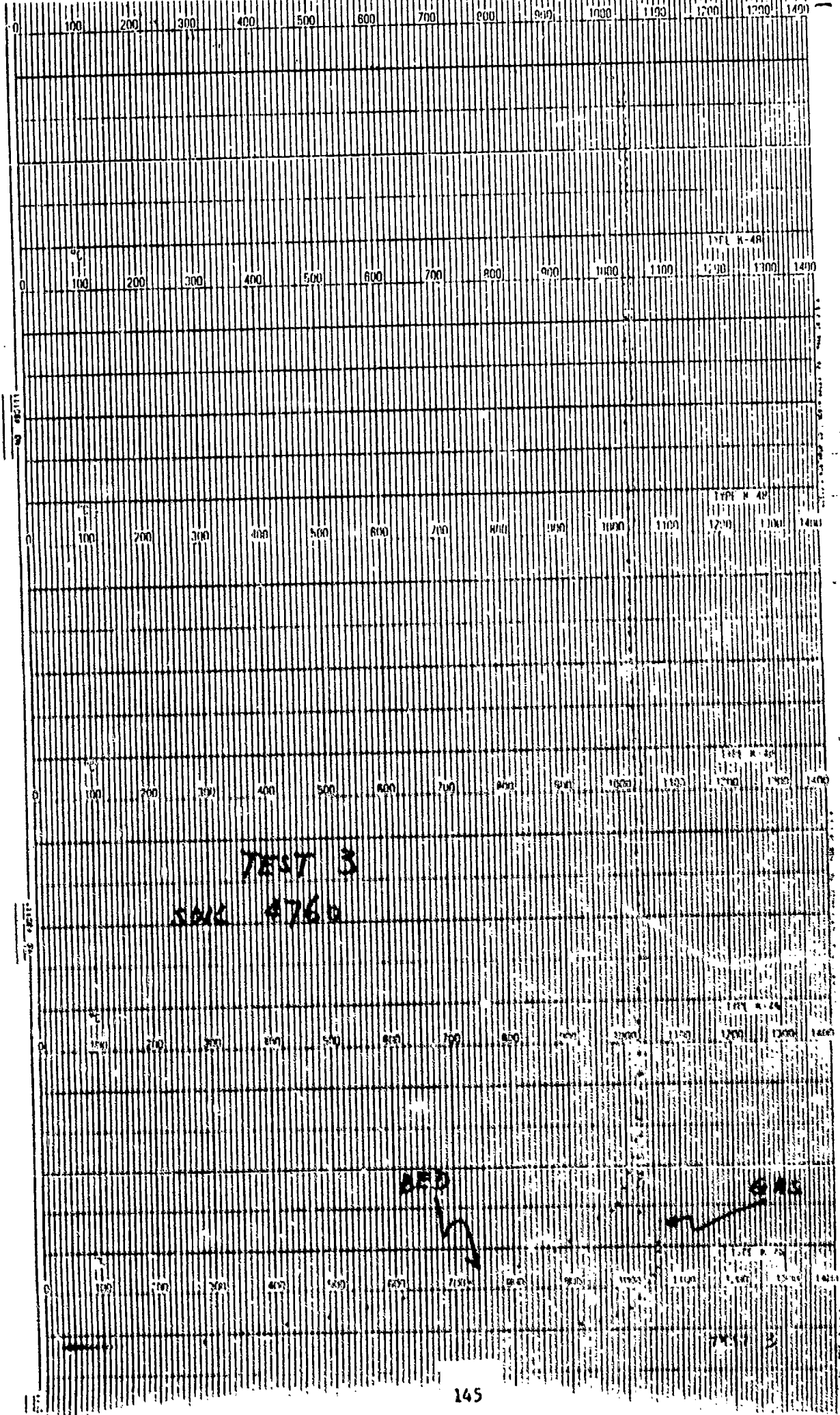

TEST 3

SAC 4760

SAC

SAC

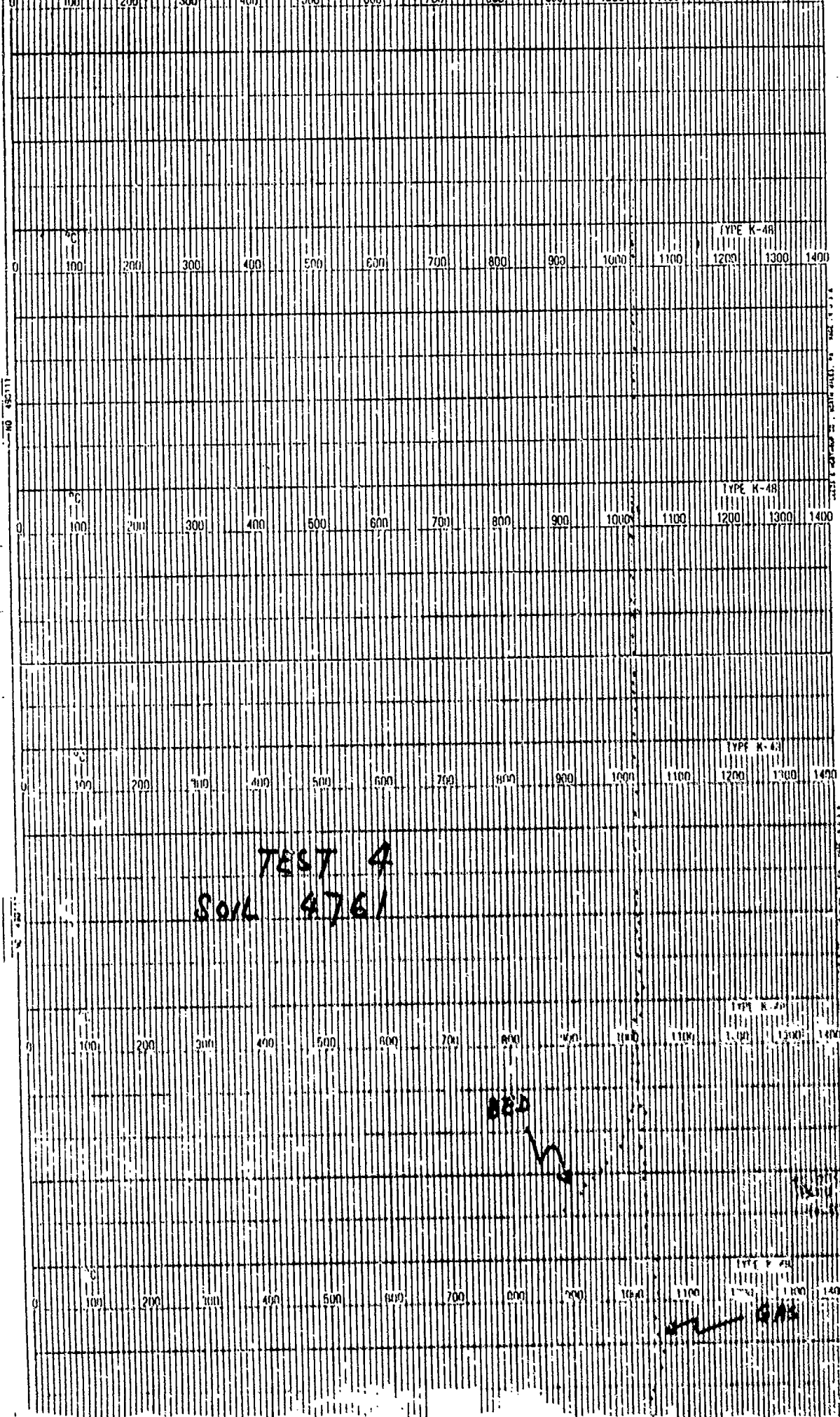

NO 450111

TYPE K-48

TYPE K-48

TYPE K-48

TYPE K-48

TEST 4  
SOIL 4761

W

GAS

0 100 200 300 400 500 600 700 800 900 1000 1100 1200 1300 1400

0 100 200 300 400 500 600 700 800 900 1000 1100 1200 1300 1400  
°C TYPE K-48

0 100 200 300 400 500 600 700 800 900 1000 1100 1200 1300 1400  
°C TYPE K-48

0 100 200 300 400 500 600 700 800 900 1000 1100 1200 1300 1400  
°C TYPE K-48

TEST 5  
SOIL 4760

BED

← GAS

0 100 200 300 400 500 600 700 800 900 1000 1100 1200 1300 1400  
°C TYPE K-48



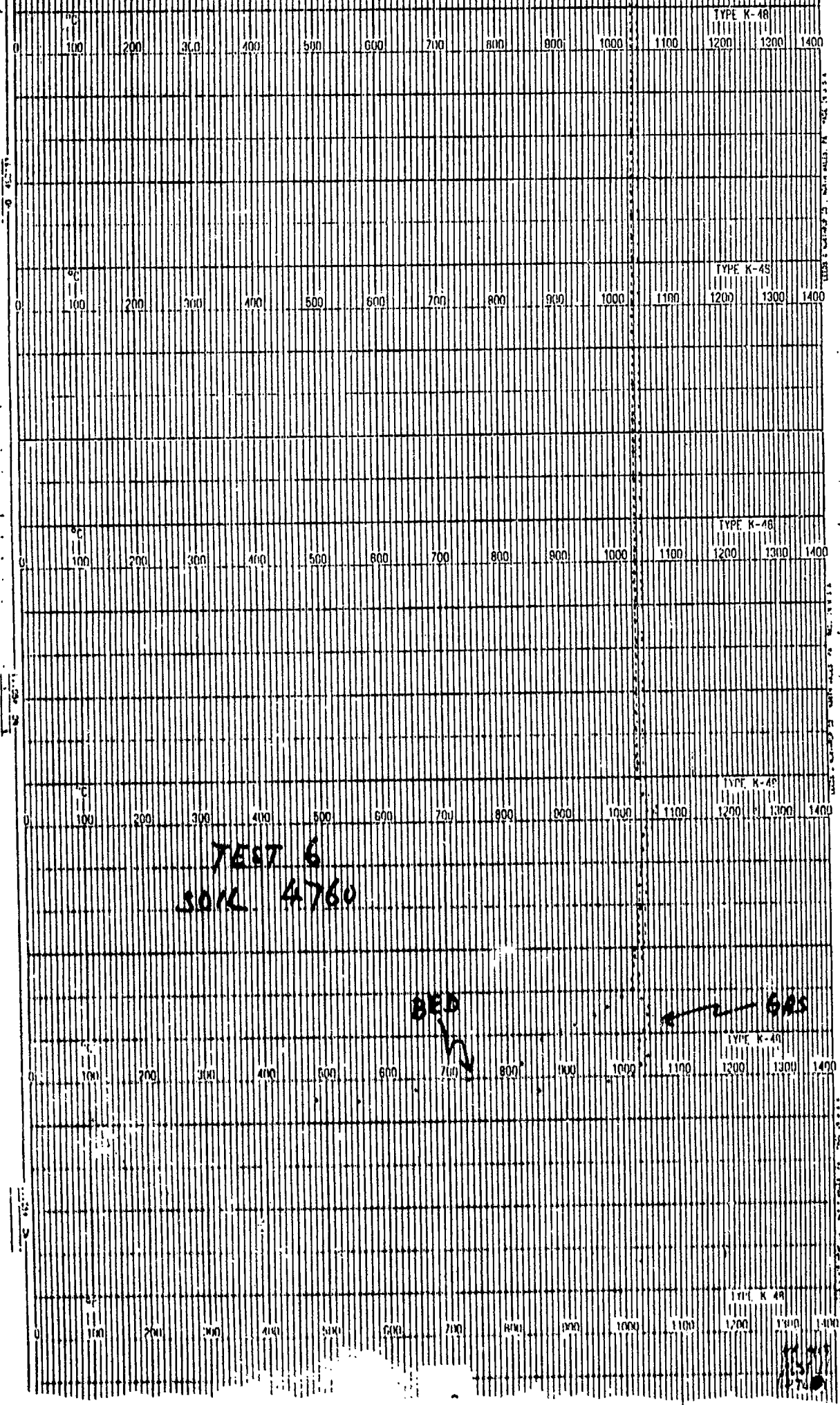

TEST 6  
SOIL 4760

BED  
↘

← GAS

TEST 6

NO 48011

TYPE K-48  
0 100 200 300 400 500 600 700 800 900 1000 1100 1200 1300 1400

TYPE K-48  
0 100 200 300 400 500 600 700 800 900 1000 1100 1200 1300 1400

TYPE K-48  
0 100 200 300 400 500 600 700 800 900 1000 1100 1200 1300 1400

TEST 7  
SOIL 4761

TYPE K-48  
0 100 200 300 400 500 600 700 800 900 1000 1100 1200 1300 1400

TYPE K-48  
0 100 200 300 400 500 600 700 800 900 1000 1100 1200 1300 1400

BED  
N

GAS

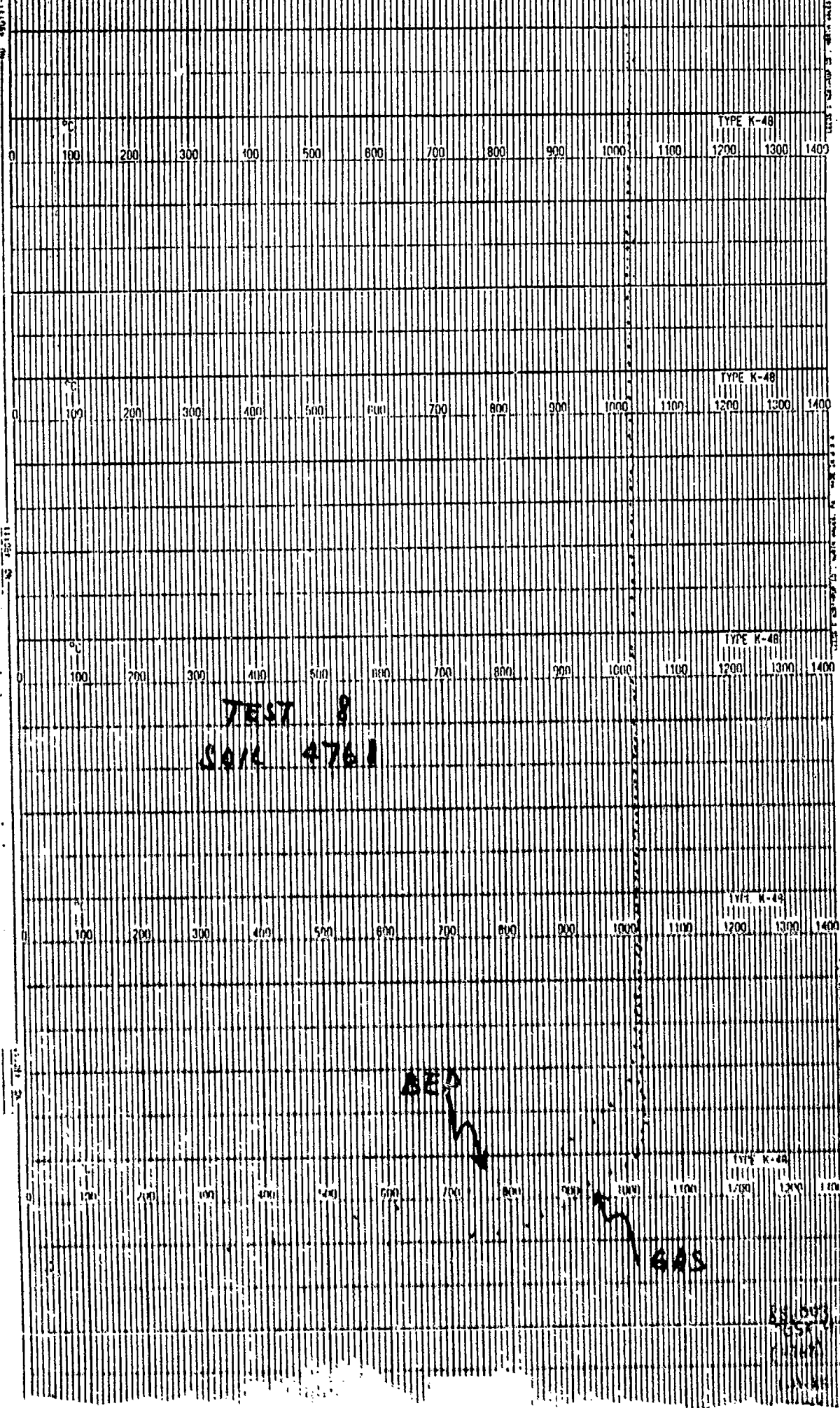

TYPE K-48

0 100 200 300 400 500 600 700 800 900 1000 1100 1200 1300 1400

TYPE K-48

0 100 200 300 400 500 600 700 800 900 1000 1100 1200 1300 1400

TYPE K-48

0 100 200 300 400 500 600 700 800 900 1000 1100 1200 1300 1400

TEST 8  
SAIL 4761

TYPE K-48

0 100 200 300 400 500 600 700 800 900 1000 1100 1200 1300 1400

BED

TYPE K-48

0 100 200 300 400 500 600 700 800 900 1000 1100 1200 1300 1400

GAS

ASL 500  
ASL 500

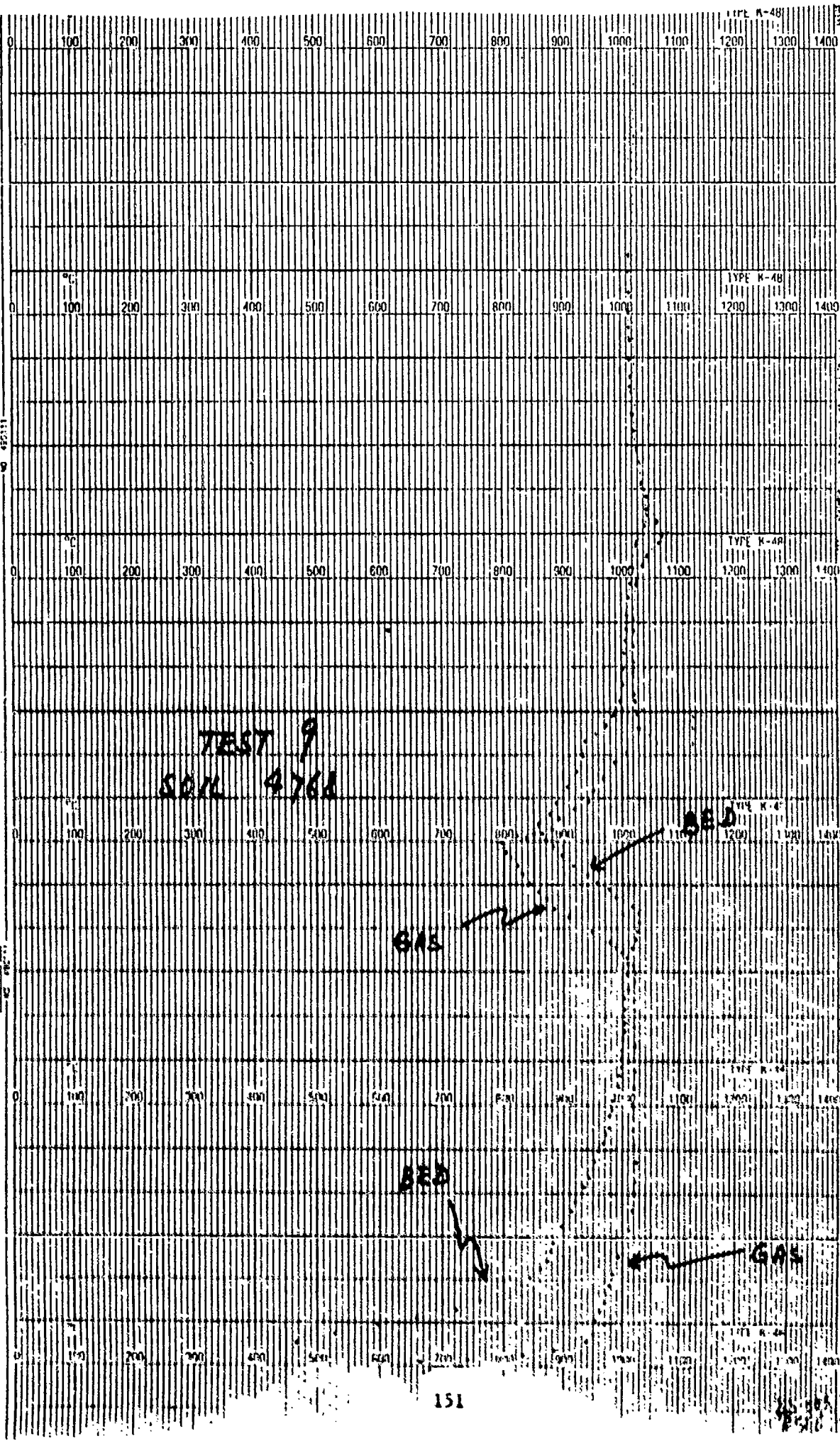

TEST 9  
SOIL 476A

GAS

BED

BED

GAS

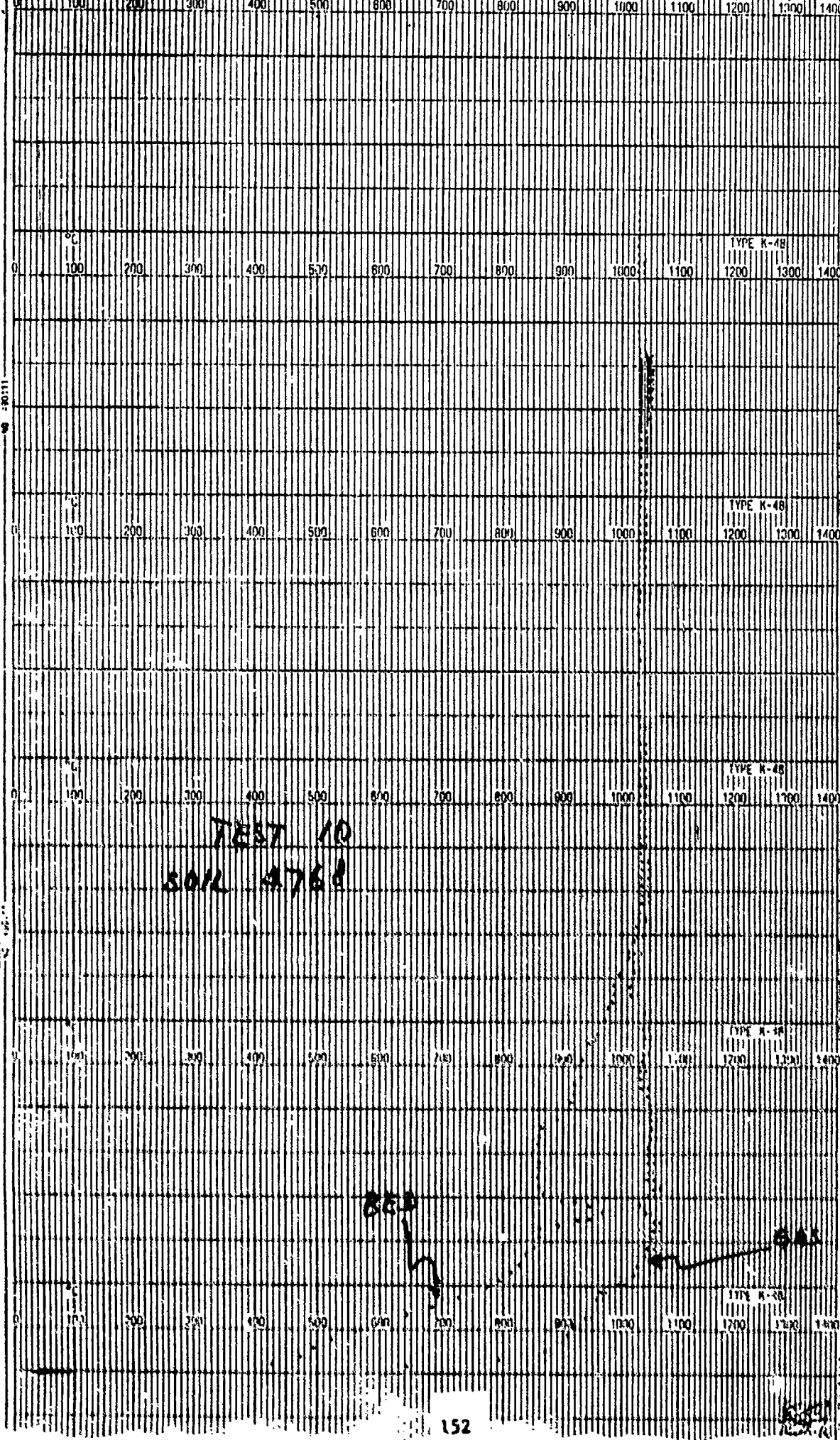

TEST 10  
SOIL 4768

BED

GAS

TYPE K-48  
0 100 200 300 400 500 600 700 800 900 1000 1100 1200 1300 1400

1158 1159

TYPE K-48  
0 100 200 300 400 500 600 700 800 900 1000 1100 1200 1300 1400

TYPE K-48  
0 100 200 300 400 500 600 700 800 900 1000 1100 1200 1300 1400

TEST II  
Soil 4760

1158 1159

TYPE K-48  
0 100 200 300 400 500 600 700 800 900 1000 1100 1200 1300 1400

820

TYPE K-48  
0 100 200 300 400 500 600 700 800 900 1000 1100 1200 1300 1400

845

APPENDIX C

LOOSE BULK DENSITY OF MATERIALS, lb/ft<sup>3</sup>

As Received 4761	85.98
As Received 4760	80.04
As Received 4768	78.92
Test 1 Product	55.56
Test 2 Product	54.31
Test 3 Product	94.28
Test 4 Product	51.19
Test 5 Product	92.40
Test 6 Product	92.40
Test 7 Product	47.45
Test 8 Product	84.29
Test 9 Product	87.41
Test 10 Product	118.63
Test 11 Product	93.03



APPENDIX D

AS RECEIVED SOIL SCREEN ANALYSIS

PERCENTAGE PASSING

<u>Screen Size</u>	<u>Soil 4761</u>	<u>Soil 4760</u>	<u>Soil 4768</u>
2.1 Inch	100.00		
1.5 Inch	76.59		
1.1 Inch	-		
.75 Inch	-		100.00
.53 Inch	74.06		92.49
.375 Inch	68.31		88.08
3 Mesh	61.69		85.04
4 Mesh	54.77	100.00	72.68
6 Mesh	49.17	99.96	64.22
8 Mesh	43.52	99.90	58.66
10 Mesh	39.77	99.84	56.14
14 Mesh	35.71	99.60	54.02
20 Mesh	31.54	97.57	51.52
28 Mesh	26.36	82.92	47.01
35 Mesh	20.90	51.71	40.06
48 Mesh	15.67	22.43	30.95
65 Mesh	10.71	6.97	17.94
100 Mesh	6.94	2.77	10.58
150 Mesh	3.62	1.77	6.74
200 Mesh	1.24	1.15	3.67
Pan	0	0	0

SIEVE#MAIN

SIEVE#KATH

62

00000250 00002450

SIEVE ANALYSIS

ALLIS-CHALMERS

MATERIAL SOIL 4761  
SUBMITTED BY IT CORP.  
BATCH KILN TEST /

TEST NO.85-003

DATE 1-10-85

A= AS REC. FEED SAMPLE  
B= 4761-1 MILN PROD. TEST /  
C= 4761-1 EXHAUST DUST, TEST /  
D=

SIEVE SIZE		A		B		C		D	
EQUIV	ASTM	PERCENTAGE	PERCENTAGE	PERCENTAGE	PERCENTAGE	PERCENTAGE	PERCENTAGE	PERCENTAGE	PERCENTAGE
1. MESH	MM-M	ON	PASSING	ON	PASSING	ON	PASSING	ON	PASSING
2.1	53000	0.00	100.00	0.00	100.00	0.00	100.00	0.00	100.00
1.5	32500	23.41	76.59	0.00	100.00	0.00	100.00	0.00	100.00
1.1	26500	0.00	0.00	0.00	100.00	0.00	100.00	0.00	100.00
.75	19000	0.00	0.00	0.00	100.00	0.00	100.00	0.00	100.00
.53	13200	2.57	74.06	12.61	87.39	0.00	100.00	0.00	100.00
.375	9500	5.75	68.31	9.04	78.37	0.00	100.00	0.00	100.00
M=3	6700	6.62	61.69	10.98	67.37	0.00	100.00	0.00	100.00
"	4750	6.92	54.77	10.98	57.29	0.00	100.00	0.00	100.00
6	3350	7.60	49.17	7.56	49.73	2.35	97.65		
9	2360	5.65	43.52	7.61	42.12	0.81	96.83		
10	1700	3.74	39.77	6.26	35.86	0.77	96.06		
14	1180	4.97	35.71	7.29	28.57	1.54	74.52		
20	850	4.17	31.04	4.65	23.92	5.35	89.17		
28	600	5.18	26.74	5.80	17.12	13.14	76.04		
35	425	3.43	20.96	0.00	0.00	16.69	59.35		
48	300	3.25	15.67	0.00	0.00	16.56	42.79		
65	210	4.94	10.71	0.00	0.00	16.77	25.03		
100	150	3.02	5.84	0.00	0.00	14.63	11.38		
150	104	3.37	3.67	0.00	0.00	7.36	4.02		
200	75	2.35	1.24	0.00	0.00	2.77	1.45		
270	55	0.00	0.00	0.00	0.00	0.00	0.00		
325	45	0.00	0.00	0.00	0.00	0.00	0.00		
400	38	0.00	0.00	0.00	0.00	0.00	0.00		
500	28	0.00	0.00	0.00	0.00	0.00	0.00		
FAN	"	1.04	0.00	17.12	0.00	1.45	0.00		

NO. PCT. SIZE (LOG-LOG)	A	B	C	D
30675	10116	570		
0.654	0.044	1.820		
*****	*****	*****		
0.00	0.00	0.00		
*****	*****	*****		
*****	*****	*****		

SIEVE ANALYSIS

ALLIS-CHALMERS

MATERIAL SOIL 4761 - /  
 SUBMITTED BY IT CORP.  
 BATCH KILN TEST /

TEST NO. 85-003

DATE 1-10-65

		100						10						1						.2					
MESH MU-M		198	6	5	4	3	2	198	6	5	4	3	2	198	6	5	4	3	2	198	6	5	4	3	2
4.2	107MM	7																							
A = AS REC. FEED SAMPLE																									
3.0	75000	7																							
B = 4761-1 KILN PROD.																									
2.1	53000	7																							
C = 4761-1 EXHAUST DUST																									
1.5	37500	4	A																						
1.1	26500	4																							
.75	19000	4																							
.53	13200	C	BA																						
.375	9500	C	BA																						
N=3	6700	C	BA																						
4	4750	C		1																					
6	3750	C		1																					
8	2360	C			AB																				
10	1790	C			AB																				
14	1180	C			A	B																			
20	850	C			A	B																			
28	600	C			A	B																			
35	425	C			A																				
48	300	C			A																				
65	212	C			A																				
100	150	C			A																				
150	106																								
200	75																								
270	53																								
325	45																								
400	38																								

		100						10						1						.2					
MESH MU-M		198	6	5	4	3	2	198	6	5	4	3	2	198	6	5	4	3	2	198	6	5	4	3	2
1=A+B		2=A+C		3=A+D		4=B+C		5=B+D		6=C+D															
7=A+B+C		8=A+B+D		9=A+C+D		10=A+C+D		11=A+B+C+D																	

SIEVE#GAIN

SIEVE#GAIN

62

00000250 00002450

SIEVE ANALYSIS

ALLIS-CHALMERS

MATERIAL SOIL 4761  
SUBMITTED BY IT CORP.  
BATCH KILN TEST 2  
TEST NO.85-003

DATE 1-10-85

A= AS REC. FEED SAMPLE  
R= 4761-2 KILN PROD. TEST 2  
C= 4761-2 EXHAUST DUST TEST 2  
D=

SIEVE SIZE		A		R		C		D	
EQUIV.	ASTM	PERCENTAGE		PERCENTAGE		PERCENTAGE		PERCENTAGE	
T. MESH	MU-M	ON	PASSING	ON	PASSING	ON	PASSING	ON	PASSING
2.1	53000	0.00	100.00	0.00	100.00	0.00	100.00		
1.5	37500	23.41	76.59	0.00	100.00	0.00	100.00		
1.1	26500	0.00	0.00	0.00	100.00	0.00	100.00		
.75	19000	0.00	0.00	0.00	100.00	0.00	100.00		
.53	13200	2.53	74.06	7.25	92.75	0.00	100.00		
.375	9500	5.75	68.31	7.84	84.91	0.00	100.00		
M=3	6700	6.62	61.69	10.09	74.82	0.00	100.00		
4	4750	6.92	54.77	10.27	64.54	0.00	100.00		
6	3350	5.60	49.17	8.13	56.40	1.60	98.40		
8	2360	5.65	43.52	8.64	47.76	1.08	97.32		
10	1700	3.74	39.77	6.81	40.95	1.22	96.10		
14	1180	4.07	35.71	6.42	34.53	3.20	92.89		
20	850	4.17	31.54	7.55	26.99	7.60	85.29		
28	600	5.18	26.36	7.54	19.45	12.18	73.11		
35	425	5.45	20.90	0.00	0.00	14.51	58.61		
48	300	5.23	15.67	0.00	0.00	16.60	42.00		
65	212	4.96	10.71	0.00	0.00	16.95	25.05		
100	150	3.77	6.94	0.00	0.00	12.76	12.29		
150	106	3.32	3.62	0.00	0.00	6.93	5.36		
200	75	2.38	1.24	0.00	0.00	3.03	2.33		
270	53	0.00	0.00	0.00	0.00	0.00	0.00		
325	45	0.00	0.00	0.00	0.00	0.00	0.00		
400	38	0.00	0.00	0.00	0.00	0.00	0.00		
500	28	0.00	0.00	0.00	0.00	0.00	0.00		
PAN	0	1.24	0.00	19.45	0.00	2.33	0.00		

80 PCT. SIZE (LOG-LOG) =  
SLOPE:80% SIZE TO SMALLEST DATUM  
SPECIFIC GRAVITY  
ESTIMATED SP.GR. FOR 40% VOIDS  
VOIDS FRACTION  
BULK WEIGHT (LBS/FT\*\*3)

A	B	C	D
39678.	8060.	735.	
0.664	0.544	1.549	
*****	*****	*****	
0.00	0.00	0.00	
*****	*****	*****	
*****	*****	*****	

SIEVE ANALYSIS

MATERIAL SOIL 4761  
 SUBMITTED BY IT CORP.  
 BATCH KILN TEST 2

TEST NO. 85-003

DATE 1-10-85

MESH	MU-M	100					10					1					.2			
		198	6	5	4	3	2	198	6	5	4	3	2	198	6	5		4	3	2
4.2	107HH	7																		
A= AS REC. FEED SAMPLE																				
3.0	75000	7																		
B= 4761-2 KILN PROD.																				
2.1	53000	7																		
C= 4761-2 EXHAUST DUST																				
1.5	37500	4	A																	
1.1	26500	4																		
.75	19000	4																		
.53	13200	CB	A																	
.375	9500	C	B	A																
M=3	6700	C	B	A																
4	4750	C		BA																
6	3350	C		BA																
8	2360	C			1															
10	1700	C			1															
14	1180	C				AB														
20	850	C				AB														
28	600	C					A	B												
35	425		C					A												
48	300			C					A											
65	212				C					A										
100	150					C					A									
150	106							C				A								
200	75									C				A						
270	53																			
325	45																			
400	38																			

MESH	MU-M	198	6	5	4	3	2	198	6	5	4	3	2	198	6	5	4	3	2
1=A+B	2=A+C	3=A+D	4=B+C	5=B+D	6=C+D														
7=A+B+C	8=A+B+D	9=A+C+D	0=P+C+D	1=A+B+C+D															

STIEVE ANALYSIS

ALLIS-CHALMERS

MATERIAL SOIL 4760  
 SUBMITTED BY IT CORP.  
 BATCH KILN TEST 3

TEST NO.85-003.

DATE 1-10-85

A= AS REC. FEED SAMPLE DRIED AT 100 C  
 B= TEST 3 KILN PROD. 4760-1  
 C= TEST 2 EXHAUST DUST 4760-1  
 D=

SIEVE SIZE		A		B		C		D	
EQUIV.	ASTM	PERCENTAGE		PERCENTAGE		PERCENTAGE		PERCENTAGE	
T.MESH	NU-M	ON	PASSING	ON	PASSING	ON	PASSING	ON	PASSING
4	4750	0.00	100.00	0.00	100.00	0.00	100.00		
6	3350	0.04	99.96	0.06	99.94	0.00	100.00		
8	2360	0.06	99.94	0.02	99.98	0.00	100.00		
10	1700	0.06	99.94	0.04	99.96	0.00	100.00		
14	1180	0.24	99.76	0.26	99.74	0.03	99.97		
20	850	2.03	97.97	2.32	97.68	0.49	99.51		
28	600	14.65	85.35	14.94	85.06	9.96	90.04		
35	425	31.21	68.79	30.29	69.71	38.52	61.48		
48	300	29.28	70.72	28.85	71.15	34.97	65.03		
65	212	15.47	84.53	16.15	83.85	12.73	87.27		
100	150	4.20	95.80	4.93	95.07	2.64	97.36		
150	106	1.00	99.00	1.12	98.88	0.44	99.56		
200	75	0.62	99.38	0.54	99.46	0.14	99.86		
270	53	0.00	100.00	0.00	100.00	0.00	100.00		
325	45	0.00	100.00	0.00	100.00	0.00	100.00		
400	38	0.00	100.00	0.00	100.00	0.00	100.00		
500	26	0.00	100.00	0.00	100.00	0.00	100.00		
PAN	0	1.15	98.85	0.48	99.52	0.09	99.91		

	A	B	C	D
80 PCT. SIZE (LOG-LOG)	584.	787.	560.	
SLOPE, 60% SIZE TO SMALLEST DATUM	2.064	2.127	2.901	
SPECIFIC GRAVITY	*****	*****	*****	
ESTIMATED SF. GR. FOR 40% VOIDS	0.00	0.00	0.00	
VOIDS FRACTION	*****	*****	*****	
BULK WEIGHT (LBS/FT**3)	*****	*****	*****	

SIEVE ANALYSIS  
 MATERIAL SOIL 4760  
 SUBMITTED BY IT CORP.  
 BATCH KILN TEST 3  
 TEST NO. 85-003

ALLIS-CHALMERS

DATE 1-10-85

A= AS REC. FEED SAMPLE DRIED AT 100 C  
 B= TEST 1 KILN PROD. 4760-1  
 C= TEST 1 EXHAUST DUST 4760-1

MESH	MU-M	100					10					1					.2			
		198	6	5	4	3	2	198	6	5	4	3	2	198	6	5		4	3	2
.53	13200	7																		*
.375	9500	7																		
M=3	6700	7																		
	4	4750	7																	
	6	3350	C1																	
	8	2360	C1																	
	10	1700	C1																	
	14	1180	7																	
	20	850	7																	
	28	600	7																	
	35	425	7																	
	48	300					BA	C												
	65	212																		
	100	150																		
	150	106																		
	200	75																		
	270	53																		
	325	45																		
	400	38																		
	500	26	*																	
MESH	MU-M	198	6	5	4	3	2	198	6	5	4	3	2	198	6	5	4	3	2	*
1=A+B	2=A+C	3=A+D	4=B+C	5=B+D	6=C+D															
7=A+B+C	8=A+B+D	9=A+C+D	0=B+C+D	1=A+B+C+D																



SIEVE ANALYSIS

ALLIS-CHALMERS

MATERIAL SOIL 4761  
 SUBMITTED BY IT CORP.  
 BATCH KILN TEST 4

TEST NO.85-003

DATE 1-10-85

A= AS REC. FEED SAMPLE  
 B= 4761-3 KILN PROD. TEST 4  
 C= 4761-3 EXHAUST DUST TEST 4  
 D=

SIEVE SIZE		A		B		C		D	
EQUIV.	ASTM	PERCENTAGE		PERCENTAGE		PERCENTAGE		PERCENTAGE	
T. MESH	MU-M	ON PASSING		ON PASSING		ON PASSING		ON PASSING	
2.1	53000	0.00	100.00	0.00	100.00	0.00	100.00	0.00	100.00
1.5	37500	23.41	76.59	0.00	100.00	0.00	100.00	0.00	100.00
1.1	26500	0.00	0.00	0.00	100.00	0.00	100.00	0.00	100.00
.75	19000	0.00	0.00	0.00	100.00	0.00	100.00	0.00	100.00
.53	13200	2.53	74.06	4.76	95.24	0.00	100.00	0.00	100.00
.375	9500	5.75	68.31	9.24	86.00	0.00	100.00	0.00	100.00
N#3	6700	6.62	61.69	14.39	71.60	0.00	100.00	0.00	100.00
4	4750	6.92	54.77	14.45	57.15	0.00	100.00	0.00	100.00
6	3350	5.60	49.17	9.07	48.08	7.81	92.19	0.00	100.00
8	2360	5.65	43.52	10.08	38.00	4.02	88.18	0.00	100.00
10	1700	3.74	39.77	7.37	30.63	3.93	84.25	0.00	100.00
14	1180	4.07	35.71	6.78	23.85	5.04	79.21	0.00	100.00
20	850	4.17	31.54	7.12	16.73	5.39	73.82	0.00	100.00
28	600	5.18	26.36	7.42	9.31	7.37	66.45	0.00	100.00
35	425	5.45	20.90	0.00	0.00	11.18	55.26	0.00	100.00
48	300	5.23	15.67	0.00	0.00	15.80	39.47	0.00	100.00
65	212	4.96	10.71	0.00	0.00	18.56	20.91	0.00	100.00
100	150	3.77	6.94	0.00	0.00	11.69	9.22	0.00	100.00
150	106	3.32	3.62	0.00	0.00	3.32	3.90	0.00	100.00
200	75	2.38	1.24	0.00	0.00	2.31	1.60	0.00	100.00
270	53	0.00	0.00	0.00	0.00	0.00	0.00	0.00	100.00
325	45	0.00	0.00	0.00	0.00	0.00	0.00	0.00	100.00
400	38	0.00	0.00	0.00	0.00	0.00	0.00	0.00	100.00
500	26	0.00	0.00	0.00	0.00	0.00	0.00	0.00	100.00
PAN	0	1.24	0.00	9.31	0.00	1.60	0.00	0.00	100.00

	A	B	C	D
80 PCT. SIZE (LOG-LOG) =	39678.	8277.	1252.	
SLOPE, 80% SIZE TO SMALLEST DATUM	0.664	0.820	1.390	
SPECIFIC GRAVITY	*****	*****	*****	
ESTIMATED SP. GR. FOR 40% VOIDS	0.00	0.00	0.00	
VOIDS FRACTION	*****	*****	*****	
BULK WEIGHT (LBS/FT**3)	*****	*****	*****	

SIEVE ANALYSIS

MATERIAL SOIL 4761  
 SUBMITTED BY IT CORP.  
 BATCH KILN TEST 4

TEST NO.85-003

DATE 1-10-85

MESH	MU-M	198	6	5	4	3	2	10	WEIGHT % PASSING	1	198	6	5	4	3	2	1	
4.2	107MM	7																.2
	A=	AS REC.																
3.0	75000	7																
	B=	4761-3																
2.1	53000	7																
	C=	4761-3																
1.5	37500	4	A															
1.1	26500	4																
.75	19000	4																
.53	13200	CB	A															
.375	9500	C	B	A														
N=3	6700	C	BA															
4	4750	C	1															
6	3350	C	1															
8	2360	C	A	B														
10	1700	C	A	B														
14	1180	C	A	B														
20	850	C	A	B														
28	600	C	A	B														
35	425	C	A															
48	300	C	A															
65	212	C	A															
100	150	C	A															
150	106	CA																
200	75	CA																
270	53																	
325	45																	
400	38																	

MESH	MU-M	198	6	5	4	3	2	198	6	5	4	3	2	198	6	5	4	3	2
1=A+B	2=A+C	3=A+D	4=B+C	5=B+D	6=C+D														
7=A+B+C	8=A+B+D	9=A+C+D	10=B+C+D	11=A+B+C+D															

SIEVE ANALYSIS

ALLIS-CHALMERS

MATERIAL SOIL 4760  
 SUBMITTED BY IT CORP.  
 BATCH KILN TEST 5

TEST NO. 85-003

DATE 1-10-85

A= AS REC. FEED SAMPLE DRIED AT 100 C

R= TEST 5 KILN PROD. 4760-2

C= TEST 5 EXHAUST DUST, 4760-2

D=

SIEVE SIZE EQUIV. ASTM T. MESH	ASTM MU-M	A		B		C		D	
		PERCENTAGE ON PASSING	PERCENTAGE ON PASSING	PERCENTAGE ON PASSING	PERCENTAGE ON PASSING	PERCENTAGE ON PASSING	PERCENTAGE ON PASSING		
4	4750	0.00	100.00	0.00	100.00	0.00	100.00		
6	3350	0.04	99.96	0.00	100.00	0.00	100.00		
8	2360	0.06	99.94	0.06	99.94	0.00	100.00		
10	1700	0.06	99.94	0.06	99.94	0.04	99.96		
14	1180	0.24	99.76	0.17	99.83	0.09	99.91		
20	850	2.03	97.97	1.50	98.50	1.82	98.18		
28	600	14.65	85.35	9.80	90.20	18.33	81.67		
35	425	31.21	68.79	27.17	72.83	37.16	62.84		
48	300	29.28	70.72	34.97	65.03	24.53	75.47		
65	212	15.47	84.53	19.15	80.85	12.27	87.73		
100	150	4.20	95.80	5.35	94.65	4.34	95.66		
150	106	1.00	99.00	1.00	99.00	0.93	99.07		
200	75	0.62	99.38	0.45	99.55	0.22	99.78		
270	53	0.00	100.00	0.00	100.00	0.00	100.00		
325	45	0.00	100.00	0.00	100.00	0.00	100.00		
400	38	0.00	100.00	0.00	100.00	0.00	100.00		
500	26	0.00	100.00	0.00	100.00	0.00	100.00		
PAN	0	1.15	0.00	0.33	0.00	0.27	0.00		

	A	B	C	D
90 PCT. SIZE (LOG-LOG) =	584.	546.	604.	
SLOPE, 80% SIZE TO SMALLEST DATUM	2.044	2.759	2.737	
SPECIFIC GRAVITY	*****	*****	*****	
ESTIMATED SP. GR. FOR 40% VOIDS	0.00	0.00	0.00	
VOIDS FRACTION	*****	*****	*****	
BULK WEIGHT (LBS/FT <sup>3</sup> )	*****	*****	*****	

STEVE ANALYSIS

ALLIS-CHALMERS

MATERIAL SOIL 4760  
 SUBMITTED BY IT CORP.  
 BATCH KILN TEST 5

TEST NO. 85-003

DATE 1-10-85

A= AS REC. FEED SAMPLE DRIED AT 100 C

B= TEST 5 KILN PROD. 4760-2

C= TEST 5 EXHAUST DUST. 4760-2

MESH	MU-M	198	6	5	4	3	2	100	198	6	5	4	3	2	1	198	6	5	4	3	2	1	.2	
.53	13200	7																					*	
.375	9500	7																						
N=3	6700	7																						
4	4750	7																						
6	3350	4A																						
8	2360	C1																						
10	1700	7																						
14	1180	7																						
20	850	7																						
28	600	1C																						
35	425		B	A	C																			
48	300						B	A	C															
65	212														C									
100	150																							
150	106																							
200	75																							
270	53																							
325	45																							
400	38																							
500	26	*																						
MESH MU-M	198	6	5	4	3	2	198	A	G	4	3	2	198	A	G	4	3	2					*	
1=A+B	2=A+C						3=A+D	4=B+C					5=B+D	6=C+D										
7=A+B+C	8=A+B+D						9=A+C+D	0=B+C+D																

SIEVE ANALYSIS

ALLIS-CHALMERS

MATERIAL SOIL 4760  
 SUBMITTED BY IT CORP.  
 BATCH KILN TEST 6

TEST NO. 85-003

DATE 1-10-85

A= AS REC. FEED SAMPLE DRIED AT 100 C  
 B= TEST 6 KILN PROD. 4760-3  
 C= TEST 6 EXHAUST DUST, 4760-3  
 D=

SIEVE SIZE		A		B		C		D	
EQUIV.	ASTM	PERCENTAGE		PERCENTAGE		PERCENTAGE		PERCENTAGE	
T. MESH	MM-M	ON	PASSING	ON	PASSING	ON	PASSING	ON	PASSING
4	4750	0.00	100.00	0.00	100.00	0.00	100.00		
6	3350	0.04	99.96	0.03	99.97	0.00	100.00		
8	2360	0.06	99.94	0.03	99.97	0.00	100.00		
10	1700	0.06	99.94	0.03	99.97	0.00	100.00		
14	1180	0.24	99.76	0.16	99.84	0.06	99.94		
20	850	2.03	97.97	1.79	98.21	1.55	98.45		
28	600	14.65	85.35	15.07	84.93	8.61	91.39		
35	425	31.21	68.79	34.18	65.82	21.91	78.09		
48	300	29.28	70.72	30.91	69.09	31.33	68.67		
55	212	15.47	84.53	13.60	86.40	24.89	75.11		
100	150	4.20	95.80	3.26	96.74	8.60	91.40		
150	106	1.00	99.00	0.58	99.42	2.00	98.00		
200	75	0.62	99.38	0.21	99.79	0.45	99.55		
270	53	0.00	100.00	0.00	100.00	0.00	100.00		
325	45	0.00	100.00	0.00	100.00	0.00	100.00		
400	38	0.00	100.00	0.00	100.00	0.00	100.00		
500	28	0.00	100.00	0.00	100.00	0.00	100.00		
FAN	0	1.15	98.85	0.16	99.84	0.12	99.88		

	A	B	C	D
80 PCT. SIZE (LOG-LOG) -	584.	786.	522.	
SLOPE, 60% SIZE TO SMALLEST DATUM	2.064	3.029	3.341	
SPECIFIC GRAVITY	*****	*****	*****	
ESTIMATED SP. GR. FOR 40% VOIDS	0.00	0.00	0.00	
VOIDS FRACTION	*****	*****	*****	
BULK WEIGHT (LBS/FT <sup>3</sup> )	*****	*****	*****	

SIEVE ANALYSIS

ALLIS-CHALMERS

MATERIAL SOIL 4760  
 SUBMITTED BY IT CORP.  
 BATCH KILN TEST 6

TEST NO. 85-003

DATE 1-10-85

A = AS REC. FEED SAMPLE DRIED AT 100 C  
 B = TEST & KILN PROD. 4760-3  
 C = TEST & EXHAUST DUST, 4760-3

MESH	MU-M	100					10					WEIGHT % PASSING					1	2		
		198	6	5	4	3	2	198	6	5	4	3	2	198	6	5			4	3
.53	13200	7																		*
.375	9500	7																		
M=3	6700	7																		
4	4750	7																		
6	3350	C1																		
8	2360	C1																		
10	1700	7																		
14	1180	7																		
20	850	7																		
28	600	7																		
35	425	C	1																	
48	300			C		A	B													
65	212							C	A	B										
100	150										2									
150	106											4					C	B		
200	75												4							
270	53																			
325	45																			
400	36																			
500	26	*																		
MESH MU-M	198	6	5	4	3	2		198	6	5	4	3	2		198	6	5	4	3	2
1-A+B	2-A+C				3-A+D			4-B+C							5-B+D					6-C+D
7-A+B+C	8-A+B+D				9-A+C+D			0-B+C+D							1-A+B+C+D					

SIEVE ANALYSIS

ALLIS-CHALMERS

MATERIAL SOIL 4761  
 SUBMITTED BY IT CORP.  
 BATCH KILN TEST 7

TEST NO. 85-003

DATE 1-10-85

A= AS REC. FEED SAMPLE  
 B= 4761-4 KILN PROD. TEST 7  
 C= 4761-4 EXHAUST DUST TEST 7  
 D=

SIEVE SIZE		A		B		C		D	
EQUIV.	ASTM	PERCENTAGE		PERCENTAGE		PERCENTAGE		PERCENTAGE	
T. MESH	MU-M	ON	PASSING	ON	PASSING	ON	PASSING	ON	PASSING
2.1	53000	0.00	100.00	0.00	100.00	0.00	100.00	0.00	100.00
1.5	37500	23.41	76.59	0.00	100.00	0.00	100.00	0.00	100.00
1.1	26500	0.00	0.00	0.00	100.00	0.00	100.00	0.00	100.00
.75	19000	0.00	0.00	0.00	100.00	0.00	100.00	0.00	100.00
.53	13200	2.53	74.04	6.13	93.87	0.00	100.00	0.00	100.00
.375	9500	5.75	68.31	10.14	83.73	0.00	100.00	0.00	100.00
M=3	6700	6.62	61.69	13.37	70.36	0.00	100.00	0.00	100.00
4	4750	6.92	54.77	13.46	56.90	0.00	100.00	0.00	100.00
6	3350	5.60	49.17	8.82	48.08	1.77	98.23	0.00	100.00
8	2360	5.65	43.52	8.48	39.61	3.43	94.81	0.00	100.00
10	1700	3.74	39.77	6.47	33.13	5.30	89.50	0.00	100.00
14	1180	4.07	35.71	5.54	27.60	6.63	82.87	0.00	100.00
20	850	4.17	31.54	6.01	21.59	6.08	76.80	0.00	100.00
28	600	5.18	26.36	6.77	14.82	8.18	68.62	0.00	100.00
35	425	5.45	20.96	0.00	0.00	12.27	56.35	0.00	100.00
48	300	5.23	15.67	0.00	0.00	16.46	39.89	0.00	100.00
65	217	4.96	10.71	0.00	0.00	18.90	20.99	0.00	100.00
100	150	3.77	6.94	0.00	0.00	13.70	7.29	0.00	100.00
150	106	3.32	3.62	0.00	0.00	5.19	2.10	0.00	100.00
200	75	2.38	1.24	0.00	0.00	1.44	0.66	0.00	100.00
270	53	0.00	0.00	0.00	0.00	0.00	0.00	0.00	100.00
325	45	0.00	0.00	0.00	0.00	0.00	0.00	0.00	100.00
400	38	0.00	0.00	0.00	0.00	0.00	0.00	0.00	100.00
500	26	0.00	0.00	0.00	0.00	0.00	0.00	0.00	100.00
FAN	0	1.24	0.00	14.82	0.00	0.66	0.00	0.00	100.00

	A	B	C	D
20 PCT. SIZE (LOG-LOG) =	39678.	9670.	1014.	
SLOPE BOX SIZE TO SMALLEST DATUM	0.664	0.431	1.841	
SPECIFIC GRAVITY	2.65	2.65	2.65	
ESTIMATED SP. GR. FOR 40% VOIDS	0.00	0.00	0.00	
VOIDS FRACTION	0.00	0.00	0.00	
AIR WEIGHT (LBS-FT <sup>3</sup> )	119.0	119.0	119.0	

STEVE ANALYSIS

HALLIS-CHALMERS

MATERIAL

SOIL 4761

SUBMITTED BY

IT CORP.

BATCH KILN TEST 7

TEST NO. 85-003

DATE 1-10-85

	100	10	WEIGHT % PASSING					1	12
MESH MU-M	198 6 5 4 3 2	198 6 5 4 3 2	198	6	5	4	3	2	
4.2 107MH	7								
A= AS REC. FEED SAMPLE									
3.0 75000	7								
B= 4761-4 KILN PROD. TFST	7								
2.1 53000	7								
C= 4761-4 EXHAUST DUST TEST	7								
1.5 37500	4 A								
1.1 26500	4								
.75 19000	4								
.53 13200	CB A								
.375 9300	C B A								
M=3 6700	C BA								
4 4750	C 1								
6 3350	C 1								
8 2360	C AB								
10 1700	C A B								
14 1180	C A B								
20 850	C A B								
28 600	C A B								
35 425	C A								
48 300	C A								
65 212	C A								
100 150									
150 106									
200 75									
270 53									
325 45									
400 38									

MESH MU-M	198 6 5 4 3 2	100	10	1	12
1=A+B	2=A+C	3=A+B	4	5	6
7=A+B+C	8=A+B+D	9	10	11	12
			171		



SIEVE ANALYSIS  
 MATERIAL  
 SUBMITTED BY

SOIL 4758  
 IT CORP.  
 BATCH KILN TEST 8

ALLIS-CHALMERS

TEST NO. 85-003

DATE 1-11-85

A# AS REC. FEED SAMPLE DRIED AT 100 C  
 R# 4768-1 TEST 8 KILN PROD.  
 C# 4768-1 TEST 8 EXHAUST DUST  
 D#

SIEVE SIZE		A		B		C		D	
EQUIV.	ASTM	PERCENTAGE	PERCENTAGE	PERCENTAGE	PERCENTAGE	PERCENTAGE	PERCENTAGE	PERCENTAGE	PERCENTAGE
T. WASH	MU-M	ON	PASSING	ON	PASSING	ON	PASSING	ON	PASSING
20	19000	0.00	100.00	0.00	100.00	0.00	100.00	0.00	100.00
30	13200	7.51	92.49	1.89	98.11	0.00	100.00	0.00	100.00
40	9500	4.41	95.59	2.48	97.52	0.00	100.00	0.00	100.00
45	6700	3.04	96.96	3.61	96.39	0.00	100.00	0.00	100.00
50	4750	17.38	82.62	11.62	88.38	0.00	100.00	0.00	100.00
60	3350	8.46	91.54	10.63	89.37	2.83	97.17	0.00	100.00
70	2500	5.52	94.48	6.19	93.81	1.70	98.30	0.00	100.00
80	1900	2.52	97.48	3.96	96.04	1.21	98.79	0.00	100.00
100	1500	2.12	97.88	3.38	96.62	1.02	98.98	0.00	100.00
125	1180	2.50	97.50	3.31	96.69	2.34	97.66	0.00	100.00
150	850	4.21	95.79	5.73	94.27	5.82	94.18	0.00	100.00
200	600	6.95	93.05	8.01	91.99	11.63	88.37	0.00	100.00
250	425	7.11	92.89	10.43	89.57	15.27	84.73	0.00	100.00
300	312	12.01	87.99	13.56	86.44	22.54	77.46	0.00	100.00
350	190	7.32	92.68	7.79	92.21	12.53	87.47	0.00	100.00
400	150	3.84	96.16	3.23	96.77	10.50	89.50	0.00	100.00
450	100	2.04	97.96	1.44	98.56	6.54	93.46	0.00	100.00
500	75	0.00	100.00	0.00	100.00	0.00	100.00	0.00	100.00
550	50	0.00	100.00	0.00	100.00	0.00	100.00	0.00	100.00
600	38	0.00	100.00	0.00	100.00	0.00	100.00	0.00	100.00
650	28	0.00	100.00	0.00	100.00	0.00	100.00	0.00	100.00
700	20	0.00	100.00	0.00	100.00	0.00	100.00	0.00	100.00
750	15	0.00	100.00	0.00	100.00	0.00	100.00	0.00	100.00
800	12	0.00	100.00	0.00	100.00	0.00	100.00	0.00	100.00
850	10	0.00	100.00	0.00	100.00	0.00	100.00	0.00	100.00
900	8	0.00	100.00	0.00	100.00	0.00	100.00	0.00	100.00
950	6	0.00	100.00	0.00	100.00	0.00	100.00	0.00	100.00
1000	0	0.00	100.00	0.00	100.00	0.00	100.00	0.00	100.00

	A	B	C
NO. OF 1. SIZE (LOG-LOG)	5862	4719	528
SLOPE, 80% SIZE TO SMALLEST DATUM	0.797	1.296	2.616
SPECIFIC GRAVITY	#####	#####	#####
ESTIMATED SF. GR. FOR 400 MESH	0.00	0.00	0.00
VOIDS FRACTION	#####	#####	#####
BULK WEIGHT (LBS/FT <sup>3</sup> )	#####	#####	#####

SIEVE ANALYSIS

ALLIÉ-CHALMERS

MATERIAL SOIL 4768  
 SUBMITTED BY IT CORP.  
 BATCH KILN TEST 8

TEST NO. 85-003

DATE 1-11-85

A= AS REC. FEED SAMPLE DRIED AT 100 C  
 B= 4768-1 TEST 8 KILN PROD  
 C= 4768-1 TEST 8 EXHAUST DUST

MESH	MU-M	100					10					1								
		198	6	5	4	3	2	198	6	5	4	3	2	198	6	5	4	3	2	
.75	19000	7																		
.53	13200	C1																		
.375	9500	CBA																		
N=3	6700	CBA																		
4	4750	C	BA																	
6	3350	C	BA																	
8	2360	C	BA																	
10	1700	C	1																	
14	1180	C	1																	
20	850	C	1																	
28	600	C	1																	
35	425	C	AB																	
48	300	C	AB																	
65	212		C																	
100	150		C																	
150	106																			
200	75																			
270	53																			
325	45																			
400	38																			
500	30																			
MESH	MU-M	198	6	5	4	3	2	198	6	5	4	3	2	198	6	5	4	3	2	1
1-A+B	2-A+C	3-A+D	4-B+C	5-B+D	6-C+D	7-D+E	8-E+F	9-F+G	10-G+H	11-H+I	12-I+J	13-J+K	14-K+L	15-L+M	16-M+N	17-N+O	18-O+P	19-P+Q	20-Q+R	21-R+S
7-A+B+C	8-A+B+D	9-A+C+D	10-B+C+D	11-B+C+E	12-C+D+E	13-D+E+F	14-E+F+G	15-F+G+H	16-G+H+I	17-H+I+J	18-I+J+K	19-J+K+L	20-K+L+M	21-L+M+N	22-M+N+O	23-N+O+P	24-O+P+Q	25-P+Q+R	26-Q+R+S	27-R+S+T

SIEVE ANALYSIS

ALLIS-CHALMERS

MATERIAL SOIL 4768  
 SUBMITTED BY IT CORP.  
 BATCH MILN TEST 9

TEST NO. 85-003

DATE 1-11-85

A= AS REC. FEED SAMPLE DRIED AT 100 C

B= 4768-2 TEST 9 KILN PROD.

C= 4768-2 TEST 9 EXHAUST DUST

SIEVE SIZE		A		B		C		D	
EQUIV.	ASTM	PERCENTAGE	PERCENTAGE	PERCENTAGE	PERCENTAGE	PERCENTAGE	PERCENTAGE	PERCENTAGE	PERCENTAGE
T. MESH	NO-N	ON PASSING	ON PASSING	ON PASSING	ON PASSING	ON PASSING	ON PASSING	ON PASSING	ON PASSING
		0.00	100.00	0.00	100.00	0.00	100.00		
		7.51	92.49	0.94	99.06	0.00	100.00		
		4.41	88.08	0.66	98.40	0.00	100.00		
N=3		3.04	95.04	2.59	95.81	0.00	100.00		
4		12.36	72.68	12.28	83.53	0.00	100.00		
6		8.46	64.22	13.62	69.91	2.16	97.84		
8		5.56	58.46	8.72	61.20	1.28	96.56		
10		2.52	56.14	4.36	56.84	1.28	95.28		
14		2.12	54.02	3.36	53.48	2.08	93.19		
20		2.50	51.52	3.76	49.72	2.68	90.52		
28		4.51	47.01	6.95	42.76	4.11	86.41		
35		6.95	40.06	10.11	32.65	5.37	81.04		
48		9.11	30.95	11.62	21.03	10.71	70.33		
65		13.01	17.94	12.74	8.29	29.38	40.95		
100		7.37	10.58	5.98	2.31	20.99	19.96		
150		3.84	6.74	1.68	0.63	12.69	7.26		
200		3.06	3.67	0.37	0.26	5.85	1.41		
270		0.00	0.00	0.00	0.00	0.00	0.00		
325		0.00	0.00	0.00	0.00	0.00	0.00		
400		0.00	0.00	0.00	0.00	0.00	0.00		
500		0.00	0.00	0.00	0.00	0.00	0.00		
PAN		3.67	0.00	0.26	0.00	1.41	0.00		

	A	B	C	D
80 PCT. SIZE (LOG-LOG) -	5862.	4364.	412.	
SLOPE, 80% SIZE TO SMALLEST DATUM	0.707	1.413	2.369	
SPECIFIC GRAVITY	*****	*****	*****	
ESTIMATED SP. GR. FOR 40% VOIDS	0.00	0.00	0.00	
VOIDS FRACTION	*****	*****	*****	
BULK WEIGHT (LBS/FT**3)	*****	*****	*****	

SIEVE ANALYSIS

ALLIS-CHALMERS

MATERIAL SOIL 4768

SUBMITTED BY IT CORP.

BATCH KILN TEST 9

TEST NO. 85-003

DATE 1-11-85

A= AS REC. FEED SAMPLE DRIED AT 100 C

B= 4768-2 TEST 9 KILN PROD.

C= 4768-2 TEST 9 EXHAUST DUST

MESH	MU-M	100					10					1					.2			
		198	6	5	4	3	2	198	6	5	4	3	2	198	6	5		4	3	2
.75	19000	7																		
.53	13200																			*
.375	9500																			
M=3	6700																			
4	4750																			
6	3350																			
8	2360																			
10	1700																			
14	1180																			
20	850																			
28	600																			
35	425																			
48	300																			
65	212																			
100	150																			
150	106																			
200	75																			
270	53																			
325	45																			
400	38																			
500	26	*																		*
MESH MU-M	198	6	5	4	3	2	198	6	5	4	3	2	198	6	5	4	3	2		
1-A+B	2-A+C						4-B+C						6-C+D							
3-A+B+C	8-A+B+D						0-B+C+D						+-A+B+C+D							

SIEVE#MAIN

SIEVE#MAIN

62

00000250 00002450

SIEVE ANALYSIS

ALLIS-CHALMERS

MATERIAL SOIL 4766  
SUBMITTED BY IT CORP.  
BATCH KILN TEST 10

TEST NO. 85-003

DATE 1-11-85

A = AS REC. FEED SAMPLE DRIED AT 100 C  
B = 4766-3 TEST 10 KILN PROD.  
C = 4766-3 TEST 10 EXHAUST DUST  
D =

SIEVE SIZE		A		B		C		D	
EQUIV.	ASTM	PERCENTAGE		PERCENTAGE		PERCENTAGE		PERCENTAGE	
T. MESH	MU-M	ON	PASSING	ON	PASSING	ON	PASSING	ON	PASSING
.75	19000	0.00	100.00	0.00	100.00	0.00	100.00		
.53	13200	7.51	92.49	0.87	99.13	0.00	100.00		
.375	9500	4.41	95.59	3.26	96.74	0.00	100.00		
#3	6700	3.04	96.96	2.48	97.52	0.00	100.00		
4	4750	12.36	87.64	13.92	86.08	0.00	100.00		
5	3350	8.46	91.54	13.92	86.08	2.39	97.61		
8	2360	3.54	96.46	7.17	92.83	2.39	97.61		
10	1760	2.52	97.48	4.66	95.34	2.02	97.98		
14	1180	2.12	97.88	4.15	95.85	1.17	98.83		
20	850	2.50	97.50	4.90	95.10	1.03	98.97		
28	600	4.51	95.49	8.60	91.40	2.30	97.70		
35	425	6.95	93.05	10.90	89.10	5.11	94.89		
48	300	9.11	90.89	10.51	89.49	11.73	88.27		
65	212	13.01	86.99	9.23	90.77	29.78	70.22		
100	150	7.37	92.63	2.75	97.25	24.34	75.66		
150	106	3.84	96.16	0.36	99.64	12.62	87.38		
200	75	3.05	96.95	0.18	99.82	4.27	95.73		
250	60	0.00	100.00	0.00	100.00	0.00	100.00		
325	45	0.00	100.00	0.00	100.00	0.00	100.00		
400	38	0.00	100.00	0.00	100.00	0.00	100.00		
500	28	0.00	100.00	0.00	100.00	0.00	100.00		
500	0	3.67	96.33	0.15	99.85	0.84	99.16		

60 PCT. SIZE (LOG-LOG) =	A	B	C	D
SLOPE, 80% SIZE TO SMALLEST DATUM	5862.	4816.	384.	
SPECIFIC GRAVITY	0.707	1.510	2.786	
ESTIMATED SP. GR. FOR 40% VOIDS	*****	*****	*****	
VOIDS FRACTION	0.00	0.00	0.00	
BULK WEIGHT (LBS/FT**3)	*****	*****	*****	

MATERIAL SOIL 4768  
 SUBMITTED BY IT CORP.  
 BATCH KILN TEST 10

TEST NO. 85-003

DATE 1-11-85

A= AS REC. FEED SAMPLE DRIED AT 100 C  
 B= 4768-3 TEST 10 KILN PROD.  
 C= 4768-3 TEST 10 EXHAUST DUST

MESH	MU-M	100	198	6	5	4	3	2	10	198	6	5	4	3	2	1	198	6	5	4	3	2	1	2
.75	19000	7																						
.53	13200	C1																						*
.375	9500	CBA																						
N=3	6700	CBA																						
4	4750	C BA																						
6	3350	C 1																						
8	2360	C 1																						
10	1700	C AB																						
14	1180	C A B																						
20	850	C A B																						
28	600	C A B																						
35	425	C A B																						
48	300	C A B																						
65	212	C A B																						
100	150	C A B																						
150	106	A C B																						
200	75	A C																						
270	53																							
325	45																							
400	38																							
500	26	*																						
MESH	MU-M	198	6	5	4	3	2		198	6	5	4	3	2		198	6	5	4	3	2		1	2
1=A+B	2=A+C	3=A+D	4=B+C	5=B+D	6=C+D																			
7=A+B+C	8=A+B+D	9=A+C+D	0=B+C+D	1=A+B+C+D																				

SIEVE ANALYSIS

ALLIS-CHALMERS

MATERIAL SOIL 4760  
 SUBMITTED BY IT CORP.  
 BATCH KILN TEST //

TEST NO. 85-003

DATE 1-11-85

A= AS REC. FEED SAMPLE DRIED AT 100 C

B= TEST 11 KILN PROD. 4760-4

C= TEST 11 EXHAUST DUST, 4760-4

SIEVE SIZE		A		B		C		D	
EQUIV.	ASTM	PERCENTAGE		PERCENTAGE		PERCENTAGE		PERCENTAGE	
T. MESH	MU-M	ON	PASSING	ON	PASSING	ON	PASSING	ON	PASSING
4	4750	0.00	100.00	0.00	100.00	0.00	100.00		
6	3750	0.04	99.96	0.08	99.92	0.09	99.91		
8	2360	0.06	99.94	0.08	99.92	0.14	99.86		
10	1700	0.06	99.94	0.04	99.96	0.09	99.91		
14	1180	0.24	99.76	0.20	99.80	0.09	99.91		
20	850	2.03	97.97	2.29	97.71	0.54	99.46		
28	600	14.65	85.35	14.94	85.06	10.76	89.24		
35	425	31.31	68.69	27.08	72.92	38.08	61.92		
48	300	29.28	70.72	28.99	71.01	33.41	66.59		
45	312	15.47	84.53	17.90	82.10	12.26	87.74		
100	150	4.26	95.74	5.59	94.41	2.95	97.05		
150	106	1.00	99.00	1.27	98.73	0.91	99.09		
200	75	0.62	99.38	0.80	99.20	0.41	99.59		
270	53	0.00	100.00	0.00	100.00	0.00	100.00		
325	45	0.00	100.00	0.00	100.00	0.00	100.00		
400	38	0.00	100.00	0.00	100.00	0.00	100.00		
500	30	0.00	100.00	0.00	100.00	0.00	100.00		
PAN	0	1.15	0.00	0.68	0.00	0.27	0.00		

	A	B	C
90 PCT. SIZE (LOG-LOG) -	584.	585.	565.
SLOPE, PCT SIZE TO SMALLEST DATUM	2.064	2.322	2.814
SPECIFIC GRAVITY	*****	*****	*****
ESTIMATED SF. GR. FOR 40% MOIDS	0.00	0.00	0.00
MOIDS FRACTION	*****	*****	*****
BULK WEIGHT (LBS/FT**3)	*****	*****	*****

SIEVE ANALYSIS

MATERIAL SOIL 4760  
 SUBMITTED BY IT CORP.  
 BATCH KILN TEST //

DATE 1-11-85

TEST NO. 85-003

A= AS REC. FEED SAMPLE DRIED AT 100 C  
 B= TEST 11 KILN PROD. 4760-4  
 C= TEST 11 EXHAUST DUST. 4760-4

MESH	MU-M	100					10					1					.2			
		198	6	5	4	3	2	198	6	5	4	3	2	198	6	5		4	3	2
.53	13200	7																		
.375	9500	7																		
M=3	6700	7																		
4	4750	7																		
6	3350	7																		
8	2360	7																		
10	1700	7																		
14	1180	7																		
20	850	7																		
28	600	7																		
35	425					B2														
48	300						B	A	C											
65	212							B	A	C										
100	150																			
150	106																			
200	75																			
270	53																			
325	45																			
400	38																			
500	26	*																		
MESH MU-M	198	6	5	4	3	2	198	6	5	4	3	2	198	6	5	4	3	2		
1=A+B	2=A+C				3=A+D		4=B+C						5=B+D						6=C+D	
7=A+B+C	8=A+B+D				9=A+C+D		0=B+C+D						1=A+B+C+D							



APPENDIX E

Dynamic Angle of Repose Test

Company Name IT Corporation  
Test No. 1  
Test Date January 9, 1985  
Test Apparatus Size 38" ID x 10" Wide  
Feed Material 4761 As Received  
Feed Moisture (%) 6.5  
Test Apparatus Speed (rpm) 0.82  
52" Mobile Kiln Equivalent Speed (rpm) 0.6  
Bed Loading (%) 7

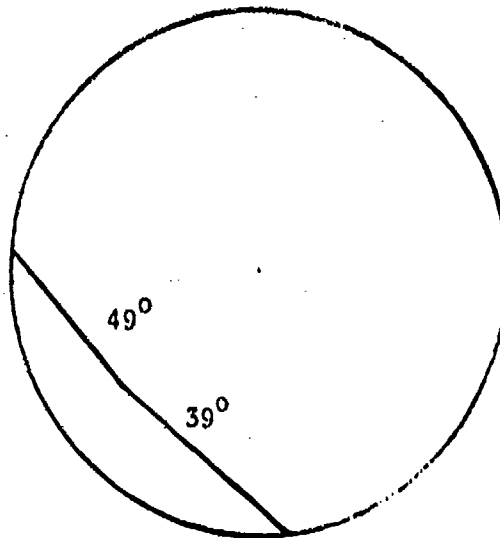

# Dynamic Angle of Repose Test

Company Name IT Corporation

Test No. 2

Test Date January 9, 1985

Test Apparatus Size 38" ID x 10" Wide

Feed Material 4760 As Received

Feed Moisture (%) 1.2

Test Apparatus Speed (rpm) 0.82

52" Mobile Kiln Equivalent Speed (rpm) 0.60

Bed Loading (%) 7

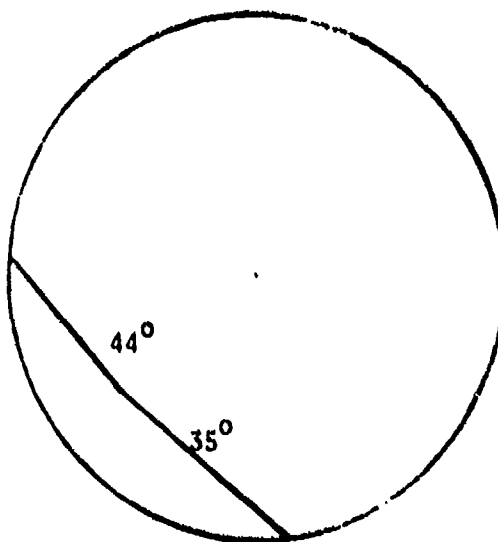

# Dynamic Angle of Repose Test

Company Name IT Corporation  
Test No. 3  
Test Date January 10, 1985  
Test Apparatus Size 10" Wide x 38" ID  
Feed Material 4768 As Received  
Feed Moisture (%) 6.4  
Test Apparatus Speed (rpm) 0.82  
52" Mobile Kiln Equivalent Speed (rpm) 0.6  
Bed Loading (%) 7

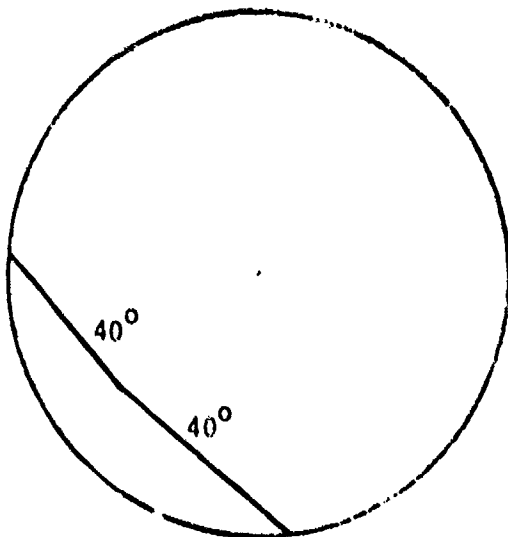

NOTE: Material did not turn over in kiln. Bed slides on kiln wall.

# Dynamic Angle of Repose Test

Company Name IT Corporation

Test No. 4

Test Date January 14, 1985

Test Apparatus Size 38" ID x 10" Wide

Feed Material 4760 (Tests 3, 5, 6 and 11 Batch Kiln)

Feed Moisture (%) 0

Test Apparatus Speed (rpm) 0.82

52" Mobile Kiln Equivalent Speed (rpm) 0.6

Bed Loading (%) 4.42%

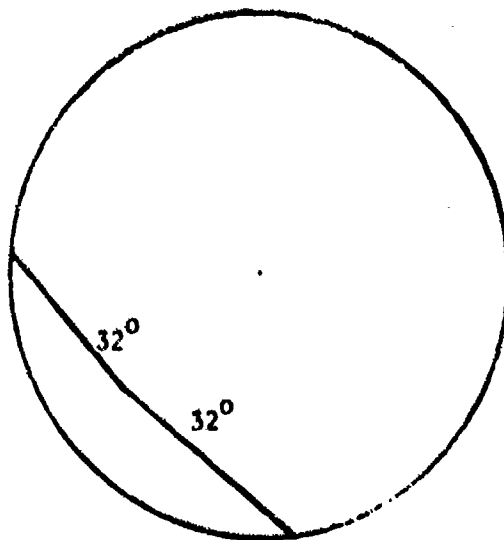

NOTE: Only 12.25 Kg available for test (16.66 desired).

# Dynamic Angle of Repose Test

Company Name IT Corporation  
Test No. 5  
Test Date January 14, 1985  
Test Apparatus Size 10" Wide x 38" ID  
Feed Material 4768 Test Product  
Feed Moisture (%) 0  
Test Apparatus Speed (rpm) 0.82  
52" Mobile Kiln Equivalent Speed (rpm) 0.6  
Bed Loading (%) 2.54%

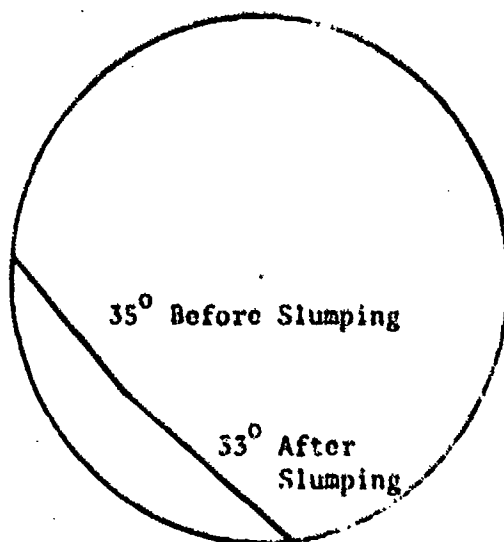

NOTE: 9 Kg available for test (16.43 Kg desired).

APPENDIX F

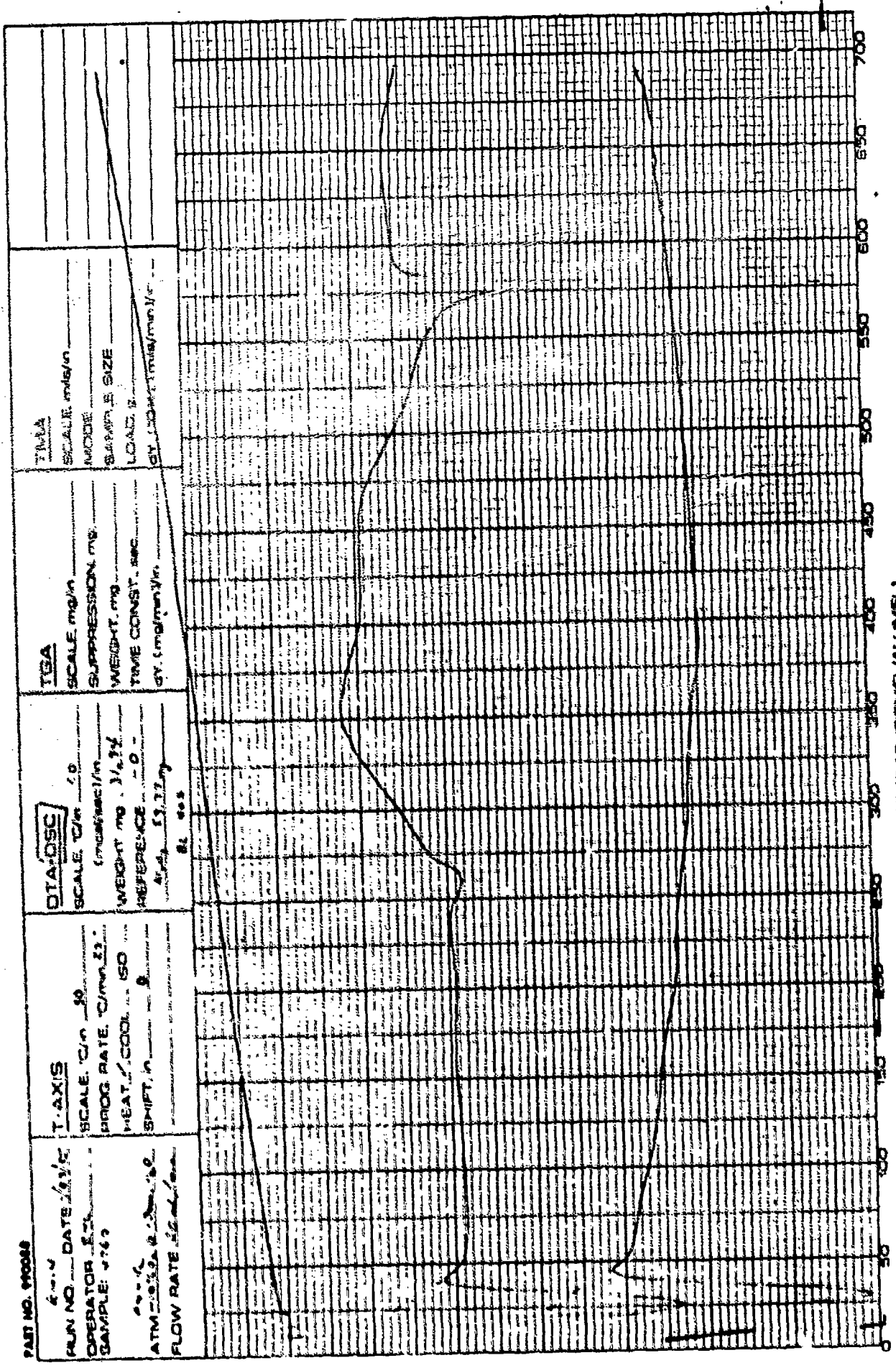

PART NO. 90088

RUN NO. 4-11 DATE 1/1/58  
 OPERATOR J.S.  
 SAMPLE: 769  
 ATM 10<sup>-2</sup> 10<sup>-2</sup> 10<sup>-2</sup>  
 FLOW RATE 50 ml/min

T-AXIS  
 SCALE °C/in 50  
 PROG RATE °C/min 50  
 HEAT COOL 50  
 SHIFT 0

DTA-OSC  
 SCALE °C/in 10  
 (magnification)  
 WEIGHT NO. 1/2  
 REFERENCE 0  
 AREA 53.22  
 SL. nos

TGA  
 SCALE mg/in  
 SUPPRESSION mg  
 WEIGHT mg  
 TIME CONST. sec  
 dy. (mg/min)/yr

TMA  
 SCALE mm/in  
 MODE  
 SAMPLE SIZE  
 LOAD g  
 dy. (mm/min)/yr

TEMPERATURE, °C (CHROMEL/ALUMEL)



INPUT DATA

WTAL203 59.77 MG./WT.SAMPLE 31.94 MG./HR 20.DEG.C/MIN. DELTAW 1.00

N=NUMBER OF DATA POINTS = 27

CALCULATED DATA

TEMP DEG.C	DELTA Y AO IN.	DELTA Y SAMP IN.	E INST.CONST	CP KCAL/KG-C	H KCAL/KG	TOT. HEAT KCAL/KG
25.0	3.15	1.35	1.1652	0.1478	0.0000	0.00
50.0	4.13	2.25	0.9522	0.2012	4.3624	4.36
75.0	4.42	2.37	0.9357	0.2101	5.1417	9.50
100.0	4.62	2.45	0.9349	0.2151	5.3154	14.82
125.0	4.80	2.50	0.9335	0.2193	5.4301	20.25
150.0	4.93	2.53	0.9337	0.2231	5.5291	25.78
175.0	5.07	2.59	0.9342	0.2282	5.6412	31.42
200.0	5.24	2.67	0.9297	0.2332	5.7675	37.19
225.0	5.32	2.67	0.9349	0.2345	5.8453	43.03
250.0	5.42	2.80	0.9344	0.2457	6.0024	49.04
275.0	5.56	2.55	0.9253	0.2216	5.8420	54.88
300.0	5.64	2.24	0.9244	0.1946	5.2027	60.08
325.0	5.72	1.71	0.9231	0.1656	4.5024	64.58
350.0	5.82	1.71	0.9171	0.1473	3.9113	68.49
375.0	5.96	1.63	0.9042	0.1554	3.7840	72.28
400.0	6.05	2.07	0.8985	0.1747	4.1264	76.40
425.0	6.07	2.14	0.9026	0.1814	4.4515	80.86
450.0	6.08	2.20	0.9076	0.1876	4.6122	85.47
475.0	6.13	2.37	0.9063	0.2017	4.8662	90.33
500.0	6.16	2.73	0.9075	0.2327	5.4300	95.76
525.0	6.23	3.05	0.9027	0.2586	6.1413	101.91
550.0	6.27	3.32	0.9070	0.2813	6.7484	108.65
575.0	6.30	4.37	0.9026	0.3705	8.1471	116.80
600.0	6.32	3.10	0.9045	0.2634	7.9233	124.72
625.0	6.35	3.13	0.9049	0.2660	6.8174	131.34
650.0	6.38	3.17	0.9051	0.2712	6.7149	138.06
675.0	6.40	3.33	0.9065	0.2835	6.9339	144.99

PROGRAM EQUATIONS

$$E = WT.AL203 * HR * CPAL / (60 * DELTAY) , KCAL/SEC-DEG.C$$

$$CPSAMP = 60 * E * DELTYS / (WTSAMP * HR) , KCAL/KG.DEG.C$$

$$H/KG = CPSAMP * DELTAT , KCAL/KG.DEG.C$$

$$CPAL203 = 1.72398141E-1 + 5.54395190E-4T - 1.0735742E-6(T**2) + 1.17693296E-9(T**3) - 4.6222700E-13(T**4)$$

12  
11  
10  
9  
8  
7  
6  
5  
4  
3

PART NO. 99-088

RUN NO. 44-2 DATE 12/12  
 OPERATOR 571  
 SAMPLE 4761  
 ATM 200  
 FLOW RATE 62 ml/min

**T-AXIS**  
 SCALE °C/in 30  
 PROG. RATE °C/min 2.0  
 HEAT/COOL ISO  
 SHIFT, n 0

**DTA-DSC**  
 SCALE °C/in 1.0  
 (mcal/sec)/in  
 WEIGHT, mg 2.9.5.3  
 REFERENCE 0  
A 5 L 400

**TGA**  
 SCALE, mg/in  
 SUPPRESSION, mg  
 WEIGHT, mg  
 TIME CONST., sec  
 dY, (mg/min)/in

**TMA**  
 SCALE, mils/in  
 MODE  
 SAMPLE SIZE  
 LOAD, g  
 dY, (10 X) (mils/min)/in

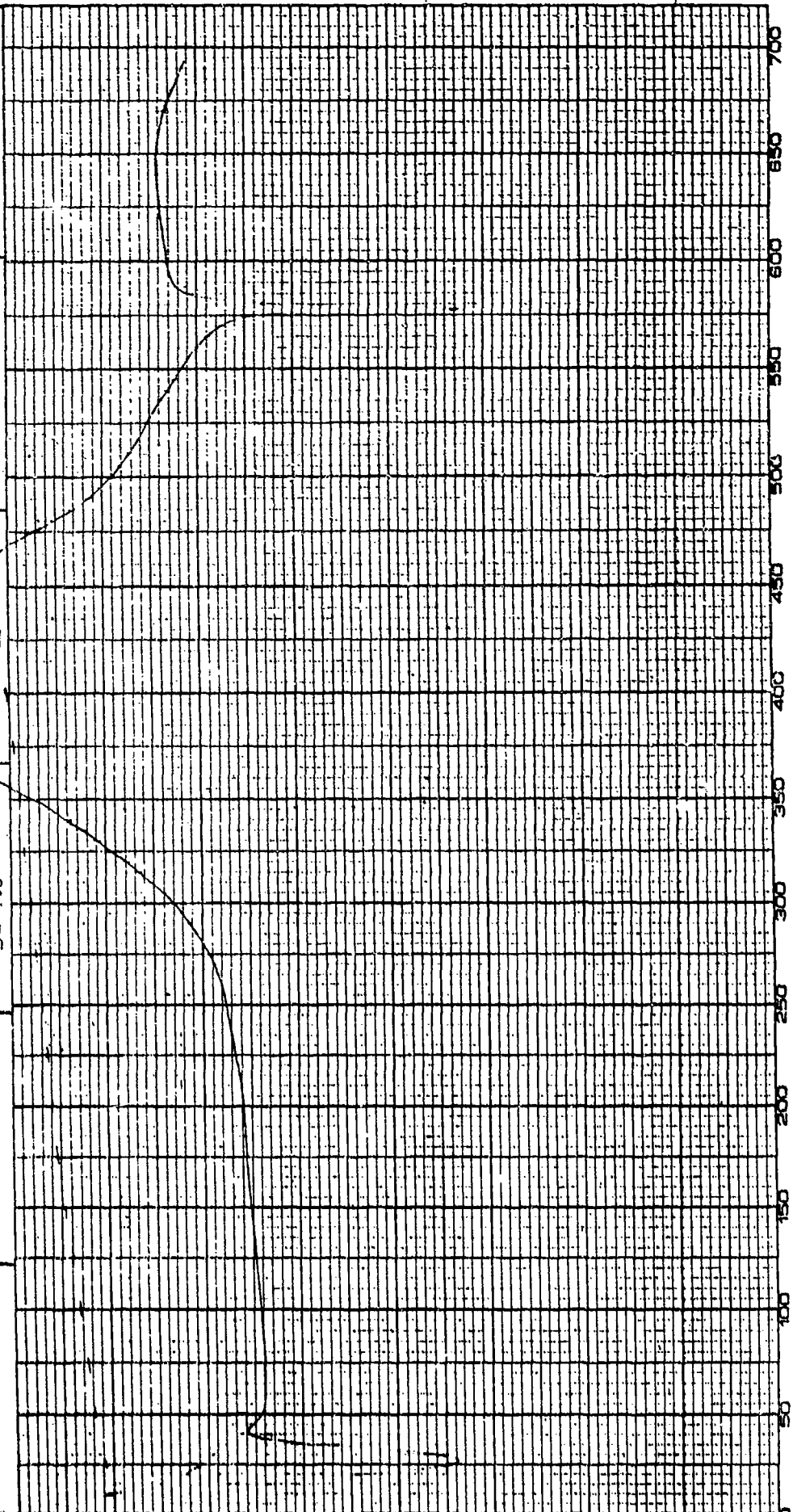

TEMPERATURE, °C (CHROMEL/ALUMEL)

INPUT DATA

WTAL203 59.77 MG./WT.SAMPLE 29.53 MG./HR 20.DEG.C/MIN./ DELTAQ 1.00

N=NUMBER OF DATA POINTS = 27

CALCULATED DATA

TEMP - DEG.C	DELTA Y AD I'	DELTA Y SAMP IN.	E INST.CONST	CP KCAL/KG-C	H KCAL/KG	TOT. HEAT KCAL/KG
25.0	3.18	1.00	1.1652	0.1154	0.0000	0.00
50.0	4.13	1.74	0.9572	0.1683	3.5838	3.58
75.0	4.42	1.85	0.9359	0.1759	4.3028	7.89
100.0	4.62	1.89	0.9349	0.1795	4.4426	12.33
125.0	4.80	1.93	0.9338	0.1831	4.5325	16.86
150.0	4.95	1.93	0.9387	0.1840	4.5892	21.45
175.0	5.07	1.96	0.9382	0.1868	4.6358	26.09
200.0	5.24	2.00	0.9297	0.1869	4.6966	30.78
225.0	5.32	1.99	0.9349	0.1890	4.7239	35.51
250.0	5.42	1.93	0.9344	0.1832	4.6527	40.16
275.0	5.56	1.91	0.9253	0.1701	4.4169	44.58
300.0	5.64	1.89	0.9249	0.1400	3.8769	48.45
325.0	5.72	0.92	0.9231	0.0803	2.8285	51.28
350.0	5.82	0.13	0.9171	0.0121	1.2299	52.51
375.0	5.96	-0.94	0.9042	-0.0863	-0.9280	51.58
400.0	6.05	-1.71	0.8995	-0.1561	-3.0305	48.55
425.0	6.07	-1.47	0.9026	-0.1348	-3.6160	44.92
450.0	6.06	-0.56	0.9076	-0.0516	-2.3304	42.59
475.0	6.13	0.49	0.9063	0.0451	-0.0815	42.51
500.0	6.16	1.37	0.9075	0.1263	2.1428	44.65
525.0	6.23	1.81	0.9027	0.1660	3.6537	48.30
550.0	6.27	2.25	0.9020	0.2062	4.6521	52.95
575.0	6.30	3.20	0.9026	0.2934	6.2453	59.20
600.0	6.32	2.27	0.9045	0.2086	6.2754	65.47
625.0	6.35	2.29	0.9049	0.2105	5.2388	70.71
650.0	6.38	2.35	0.9051	0.2161	5.3323	76.05
675.0	6.40	2.55	0.9065	0.2348	5.6365	81.68

PROGRAM EQNS

$$E = WT.AL203 * HR * CPAL / (60 * DELTYA), \text{KCAL/SEC-DEG.C}$$

$$CPSAMP = 60 * E * DELTYS / (WTSAMP * HR), \text{KCAL/KG.DEG.C}$$

$$H/KG = CPSAMP * DELTAT, \text{KCAL/KG.DEG.C}$$

$$CPAL203 = 1.72398141E-1 + 5.34395190E-4T - 1.0735742E-6(T**2) + 1.17693296E-9(T**3) - 4.8282706E-13(T**4)$$

12  
11  
10  
9  
8  
7  
6  
5  
4

PART NO. 990088

RUN NO. 404-5 DATE 1/23/65  
OPERATOR E.T.L.  
SAMPLE 4761  
ATM 20.7630 - 2 cm H<sub>2</sub>O  
FLOW RATE 60 ml/min

T-AXIS  
SCALE °C/in 50  
PROG. RATE °C/min 20  
HEAT COOL 150  
SHIFT. in 0

DTA/DSC  
SCALE °C/in 1.0  
(mcal/sec)/in  
WEIGHT. mg 21.73  
REFERENCE -0-  
AL<sub>2</sub>O<sub>3</sub> 53.77g  
0.2 400

TGA  
SCALE, mg/in  
SUPPRESSION, mg  
WEIGHT, mg  
TIME CONST., sec  
dY. (mg/min)/in

TMA  
SCALE, mils/in  
MODE  
SAMPLE SIZE  
LOAD, g  
dY. (10X), (mils/min)/in

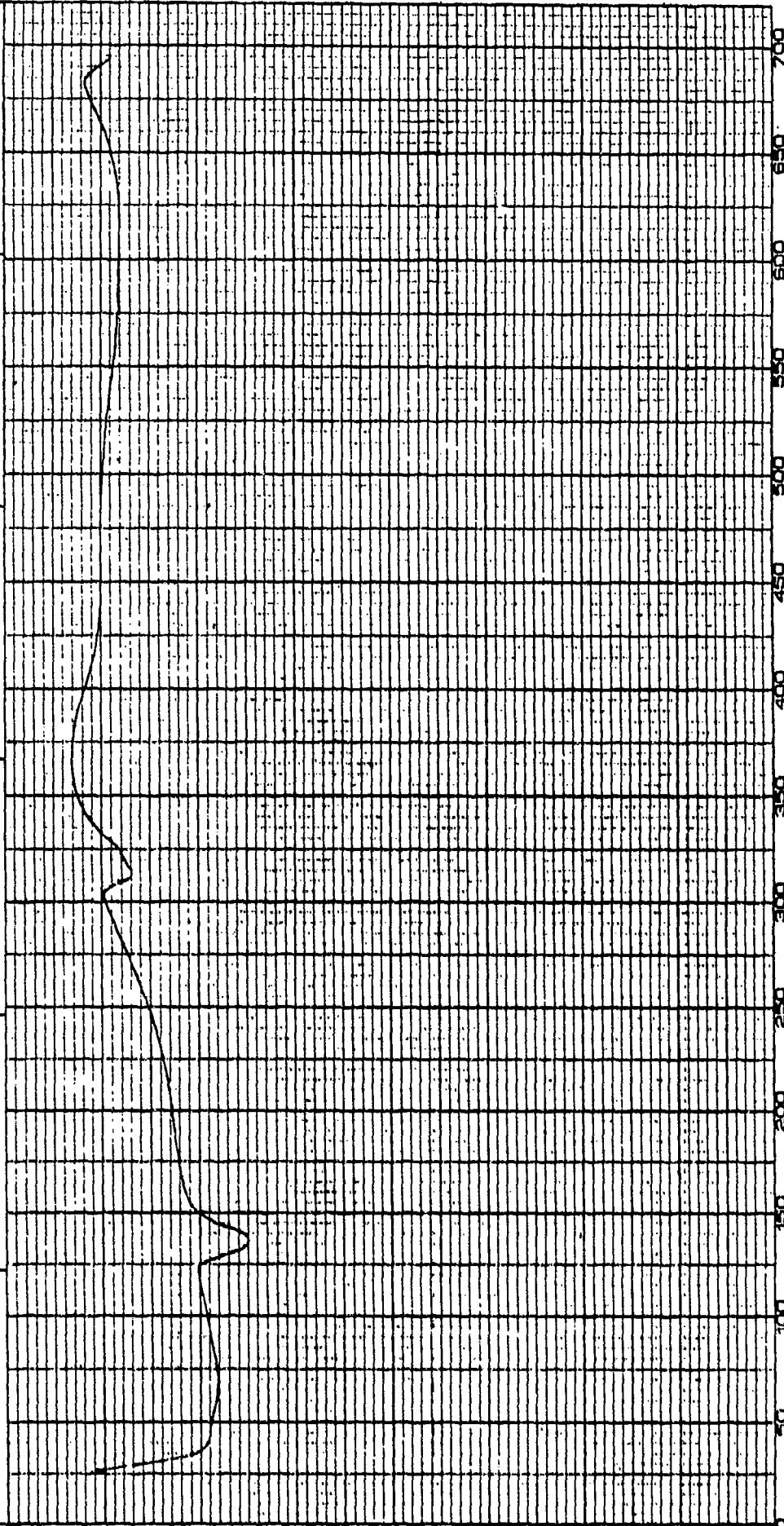

TEMPERATURE °C (CHROMEL/ALUMEL)

INPUT DATA

WTAL203 59.77 MG./WT.SAMPLE 21.73 MG./HR 20.DEG.C/MIN./ DELTAQ 1.00

N=NUMBER OF DATA POINTS = 27

CALCULATED DATA

TEMP DEG.C	DELTA Y AQ IN.	DELTA Y SAMP IN.	E INST.CONST	CP KCAL/KG-C	H KCAL/KG	TOT. HEAT KCAL/KG
25.0	3.18	0.00	1.1652	0.0000	0.0000	0.00
50.0	4.13	1.30	0.9522	0.1709	2.1363	2.14
75.0	4.42	1.42	0.9359	0.1635	4.4297	6.57
100.0	4.62	1.33	0.9349	0.1731	4.5199	11.09
125.0	4.80	1.40	0.9338	0.1805	4.4825	15.57
150.0	4.93	1.45	0.9367	0.1879	4.6049	20.17
175.0	5.07	1.31	0.9382	0.1697	4.4599	24.64
200.0	5.24	1.31	0.9297	0.1681	4.2229	28.87
225.0	5.32	1.25	0.9349	0.1613	4.1186	32.98
250.0	5.42	1.19	0.9344	0.1535	3.9356	36.92
275.0	5.56	1.00	0.9253	0.1277	3.5157	40.44
300.0	5.64	0.83	0.9249	0.1060	2.9216	43.36
325.0	5.72	1.04	0.9231	0.1325	2.9815	46.34
350.0	5.62	0.63	0.9171	0.0798	2.6538	48.99
375.0	5.96	0.63	0.9042	0.0786	1.9801	50.97
400.0	6.05	0.34	0.8995	0.1042	2.2855	53.26
425.0	6.47	1.03	0.9026	0.1284	2.9069	56.17
450.0	6.06	1.12	0.9076	0.1403	3.3587	59.52
475.0	6.13	1.20	0.9063	0.1501	3.6311	63.16
500.0	6.16	1.31	0.9075	0.1641	3.9234	67.08
525.0	6.23	1.42	0.9027	0.1770	4.2637	71.35
550.0	6.27	1.36	0.9020	0.1943	4.6404	75.99
575.0	6.30	1.69	0.9026	0.2106	5.0608	81.05
600.0	6.32	1.78	0.9045	0.2223	5.4110	86.46
625.0	6.35	1.83	0.9049	0.2349	5.7142	92.17
650.0	6.38	1.88	0.9051	0.2349	5.8720	98.05
675.0	6.40	1.74	0.9065	0.2178	5.6584	103.70

PROGRAM EQUATIONS

$$E = WT.AL203 * HR * CPAL / (60 * DELTYA), \text{MCAL/SEC-DEG.C}$$

$$CPSAMP = 60 * E * DELTYS / (WTSAMP * HR), \text{KCAL/KG.DEG.C}$$

$$H/KG = CPSAMP * DELTAT, \text{KCAL/KG.DEG.C}$$

$$CPAL203 = 1.72398141E-1 + 5.34395190E-4T - 1.0735742E-6(T**2) + 1.17693296E-9(T**3) - 4.82827060E-13(T**4)$$

12  
11  
10  
9  
8  
7  
6  
5  
4  
3

PART NO. 990449

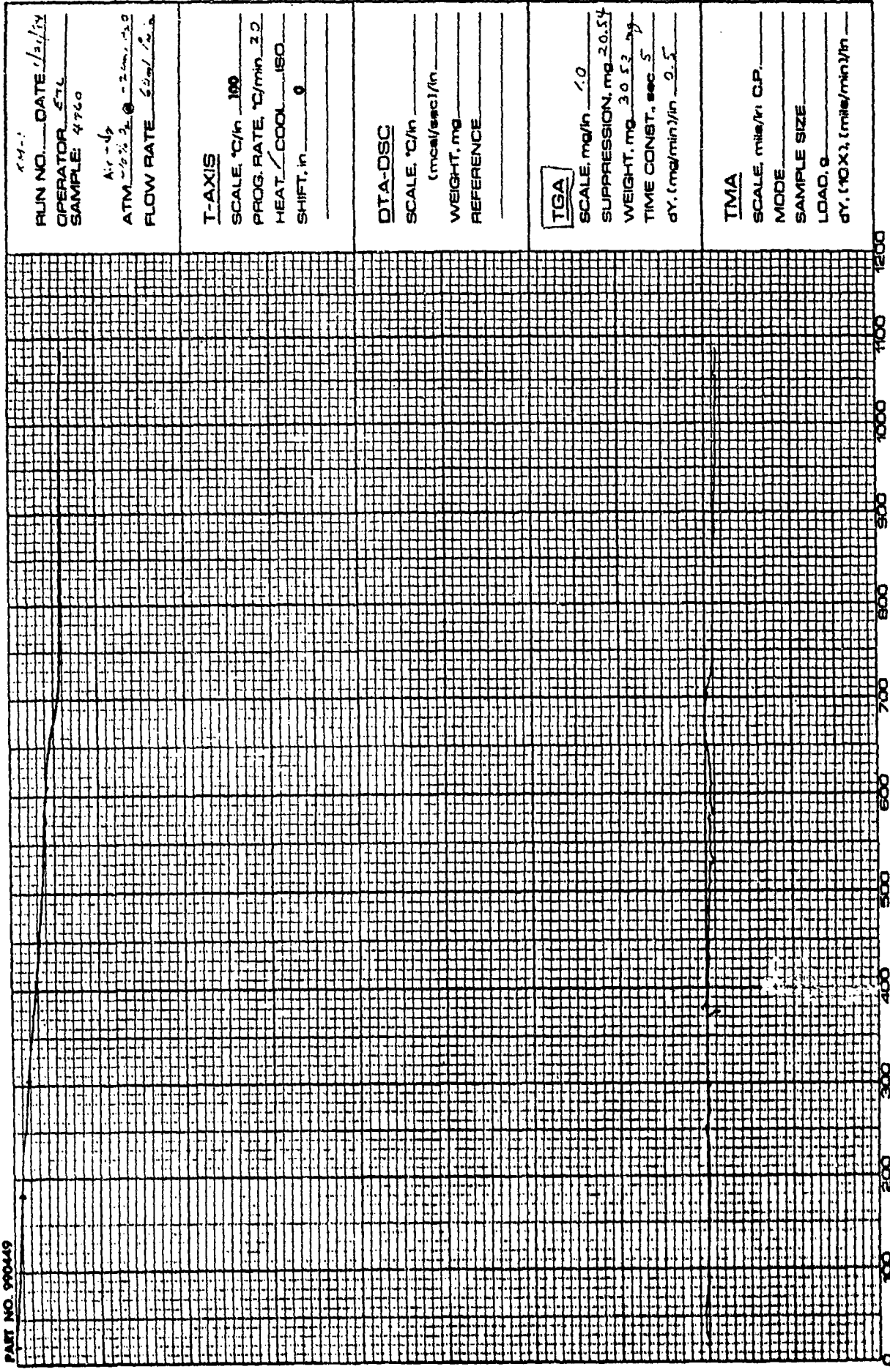

RUN NO. 14-1 DATE 1/21/54  
 OPERATOR STL  
 SAMPLE 4760  
 Air - 4g  
 ATM 10% 2.0 -2.0  
 FLOW RATE 50 ml/min

T-AXIS

SCALE, °C/in 100  
 PROG. RATE, °C/min 2.0  
 HEAT/COOL ISO  
 SHIFT, in 0

DTA-DSC

SCALE, °C/in \_\_\_\_\_  
 (mcal/sec)/in \_\_\_\_\_  
 WEIGHT, mg \_\_\_\_\_  
 REFERENCE \_\_\_\_\_

TGA

SCALE, mg/in 1.0  
 SUPPRESSION, mg 20.54  
 WEIGHT, mg 30.53  
 TIME CONST., sec 5  
 dY, (mg/min)/in 0.5

TMA

SCALE, mils/in C.P. \_\_\_\_\_  
 MODE \_\_\_\_\_  
 SAMPLE SIZE \_\_\_\_\_  
 LOAD, g \_\_\_\_\_  
 dY, (10X), (mils/min)/in \_\_\_\_\_

TEMPERATURE, °C (CHROMEL/ALUMEL)

MEASURED VARIABLE

SOIL 4760 As Received TGA

0.72 mg. total wt loss @ 1050°C

$$\text{or } \frac{0.72}{30.53} \times 100 = 2.36 \%$$

PART NO. 89049

RUN NO. <u>141</u> DATE <u>2-8-52</u> OPERATOR <u>E-L</u> SAMPLE <u>791</u> ATM <u>Air</u> FLOW RATE <u>20 ml/min</u>	T-AXIS SCALE, °C/in <u>100</u> PROG. RATE, °C/min <u>2.0</u> HEAT/Cool <u>ISO</u> SHIFT, in <u>0</u>	DTA-DSC SCALE, °C/in _____ (mcal/sec)/in _____ WEIGHT, mg _____ REFERENCE _____	TGA SCALE, mg/in <u>1.0</u> SUPPRESSION, mg/0.26 _____ WEIGHT, mg <u>20.32</u> TIME CONST., sec <u>5</u> dY, (mg/min)/in <u>2.5</u>	TMA SCALE, mils/in C.R. _____ MODE _____ SAMPLE SIZE _____ LOAD, g _____ dY, (10 X), (mils/min)/in _____
---	--	---	--	---

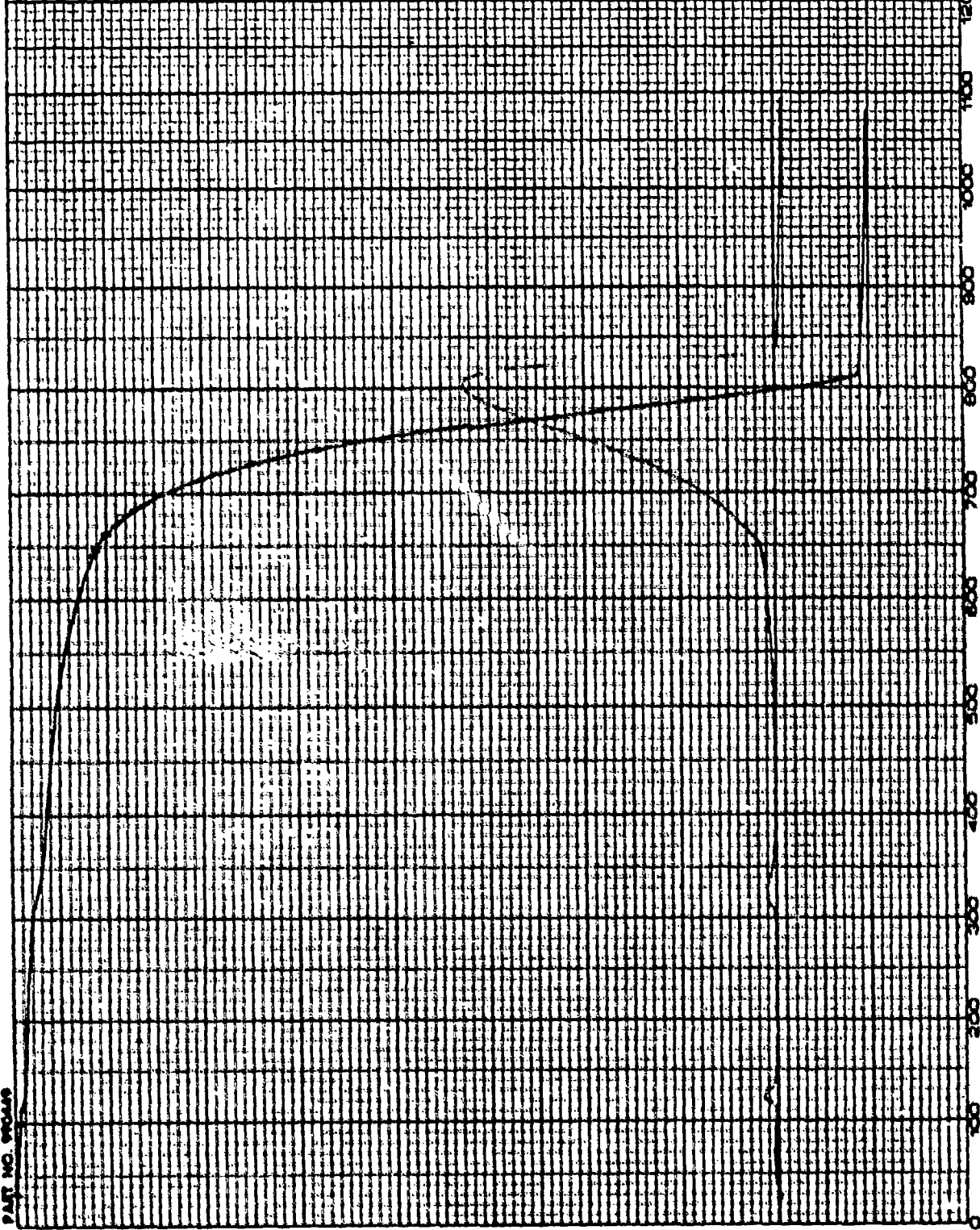



Soil 4761 As Received TGH

8.90 mg. total loss @ 105°C

2.80 mg loss @ 350°C

$$\text{total wt loss} = \frac{8.90}{20.26} \times 100 = 43.93\%$$

---

Calcination wt. loss

$$\frac{8.90 - 2.80}{20.26} \times 100 = 30.11\%$$

PART NO. 99069

RUN NO. <u>1003</u> DATE <u>11/11/58</u> OPERATOR <u>STL</u> SAMPLE <u>4753</u> ATM <u>13.5</u> FLOW RATE <u>50 ml/min</u>	<b>AXIS</b> SCALE, °C/in <u>100</u> PROG RATE, °C/min <u>20</u> HEAT/COOL <u>ISO</u> SHIFT, in <u>0</u>	<b>DTA-DSC</b> SCALE, °C/in _____ (mcal/sec)/in _____ WEIGHT, mg _____ REFERENCE _____	<b>TGA</b> SCALE, mg/in <u>1.0</u> SUPPRESSION, mg <u>21.34</u> WEIGHT, mg <u>31.34</u> TIME CONST., sec <u>5</u> dY, (mg/min)/in <u>0.5</u>	<b>TMA</b> SCALE, mils/in C.P. _____ MODE _____ SAMPLE SIZE _____ LOAD, g _____ dY, (10X), (mils/min)/in _____
--	---	--	---	---

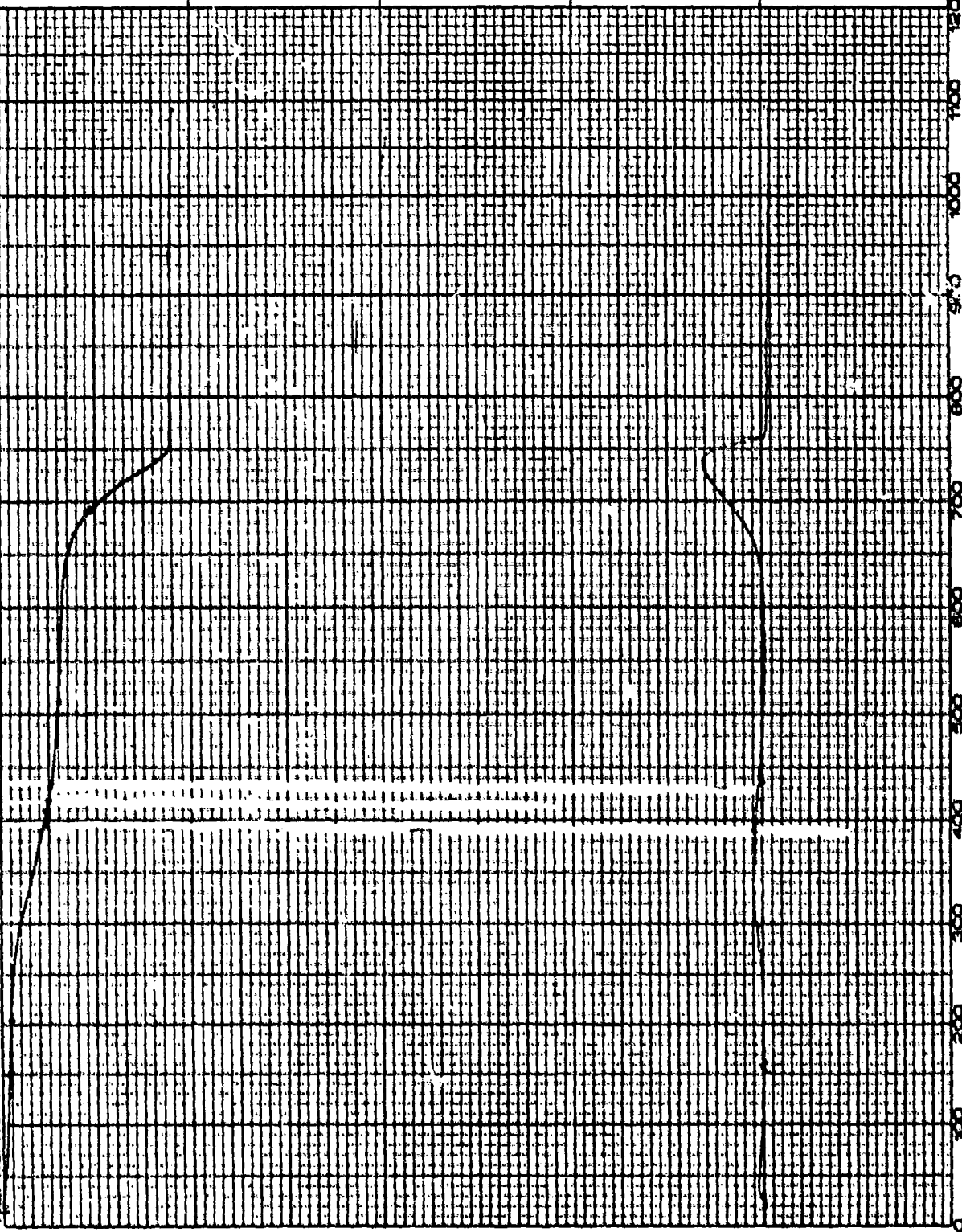

Soil 4768 As Received TGH

1.73 mg. loss @ 1090°C

$$\frac{1.73}{31.34} \times 100 = 5.52\% \text{ wt loss}$$

---

0.55 mg. loss @ 520°C

$$\frac{0.55}{31.34} \times 100 = 1.75\% \text{ wt loss}$$

---

0.10 mg. loss @ 200°C

$$\frac{0.10}{31.34} \times 100 = 0.32\% \text{ wt loss}$$

---

ANALYTICAL METHODS FOR 2,3,7,8-TCDD

SA SAMPLE PREPARATION PROCEDURES - JAR METHOD

SB SAMPLE PREPARATION PROCEDURES - SOXHLET METHOD

SC ANALYSES PROCEDURES

SD STANDARD VERIFICATION

NOTE: THESE ARE REPRINTED AS USED

## APPENDIX A

## SAMPLE PREPARATION PROCEDURES FOR DIOXIN IN SOILS - JAR METHOD

## 1.0 SUMMARY OF METHOD

- 1.1 Soil and sediment samples are extracted with a methanol/hexane mixture using a jar extraction technique after spiking the sample with  $^{37}\text{Cl}_4$ -2,3,7,8-TCDD and  $^{13}\text{C}_{12}$ -2,3,7,8-TCDD. After filtering, sample cleanup procedures are followed before analysis by GC/MS is performed.

## 2.0 REAGENTS

- 2.1 Spiking standard solution (contains both internal and surrogate standards).  $^{13}\text{C}_{12}$ -2,3,7,8-TCDD internal standard at a concentration of 500 ng/ml and  $^{37}\text{Cl}_4$ -2,3,7,8-TCDD surrogate standard at a concentration of 100 ng/ml, both in the same hexane solution. The standard ID number is 358:32-IPB SOIL. GC/MS IS mixture is prepared at a concentration of 200 ng/ml in isooctane.
- 2.2 Sulfuric acid (concentrated); ACS grade; specific gravity 1.84.
- 2.3 Potassium hydroxide; 20% aqueous. Prepare by cautiously adding, with stirring, 200 g of potassium hydroxide pellets to 800 ml of distilled/deionized water contained in a beaker in a cold water bath. After the potassium hydroxide has dissolved and the solution is at room temperature, transfer to a plastic bottle.
- 2.4 Methylene chloride; pesticide quality or equivalent.
- 2.5 Hexane; pesticide quality or equivalent.
- 2.6 Methanol; pesticide quality or equivalent.
- 2.7 Toluene; pesticide quality or equivalent.
- 2.8 Sodium sulfate; ACS, granular, anhydrous. Prepare by a 24 hour methylene chloride extraction. After preparation, store in an oven maintained at 110°C.
- 2.9 Silica gel; type 60, EM reagent, 70-230 mesh, or equivalent. Prepare by soxhlet extraction with methylene chloride overnight, drying, and then activating in an aluminum foil covered glass container for 24 hours at 130°C.
- 2.10 Alumina-neutral; Fisher brand, 80-200 mesh. Prepare by soxhlet extraction with methylene chloride, followed by drying and then activating, in an aluminum foil-covered glass container for 24 hours at 190°C.
- 2.11 Sulfuric acid; impregnated silica gel, 40% w/w. To prepare, add two parts (200 g) concentrated sulfuric acid to three parts silica gel (300 g) contained in a one-glass liter bottle equipped with a Teflon-lined screw cap. Mix thoroughly with a glass rod until no lumps are visible. Label the bottle with "Sulfuric Acid - impregnated silica gel" and "Caution - contains concentrated sulfuric acid."

- 2.12 Sodium hydroxide modified silica gel, 33% w/w. To prepare, add 1 part 1M NaOH to two parts activated silica gel contained in a glass jar equipped with a teflon lined screw cap. Mix thoroughly with a glass rod until no lumps are visible. Label bottle with "NaOH - impregnated silica gel".
- 2.13 Carboapak C (activated carbon) on Celite; prepare by thoroughly mixing 3.6 grams of Carboapak C (80/100 mesh) and 16.4 grams of Celite 545 in a 40-ml vial. Activate at 130°C for six hours. Store in a desiccator. CAUTION: Check each new batch of mixed Carboapak/Celite to ensure TCDD recovery of > 50%. Subject the low level concentration calibration solution to the procedure in section 6.3.0-6.3.12 and measure the quantity of labeled and unlabeled TCDD.

### 3.0 CAUTIONS

- 3.1 Samples received for this preparation procedure are of unknown composition but may be potentially carcinogenic, mutagenic, toxic or in other ways hazardous.
- 3.2 It is mandatory that the initial weighing of the samples, addition of isotopically labelled 2,3,7,8-TCDD, and mixing of the sample, be performed inside of the designated dioxin hood, in the high hazard laboratory.
- 3.3 Personnel involved in this sample preparation procedure should be thoroughly familiar with laboratory SOP's on the processing of high hazard samples.

### 4.0 EQUIPMENT AND MATERIALS

- 4.1 Electrical platform shakers.
- 4.2 500 ml glass jars (amber) with teflon-lined screw caps to be used on the platform shakers.
- 4.3 Kuderna-Danish concentration apparatuses, consisting of a three-ball macro Snyder column, a 500 ml evaporative flask and a 10 ml graduated concentrator tube.
- 4.4 Mini vials (reactivials); 1.0 ml. capacity with conical interiors and graduated at 0.1 ml; equipped with teflon-faced rubber septa and screw caps.
- 4.5 Concentration vials; 20 ml screw top, septum sealed, scintillation vials.
- 4.6 Concentration device; nitrogen blowdown apparatus, Organomation and Pierce concentration devices, or equivalent.
- 4.7 Glass filtering funnels, short stem.
- 4.8 Filter paper, Whatman #4 or equivalent.

- 5.0 SAMPLE EXTRACTION: Jar extraction. NOTE: Extremely wet samples may require centrifuging to remove water before addition of sodium sulfate. The liquid will be run as a water sample (see water method).
- 5.1 Prepare designated dioxin hood as instructed in laboratory SOP for processing high hazard samples. This includes obtaining, preparing and labelling the requisite number of 500 ml jars before placing in the hood.
  - 5.2 Transfer 10 g of the soil or sediment (wet weight) to a tared 500 ml jar ( $\pm$  0.5 g weighed to 3 significant figures).
  - 5.3 Spike the sample with 100  $\mu$ l of spiking solution, containing both internal and surrogate standards, adding the solution at several sites over the surface of the sample.
  - 5.4 Add 20 g anhydrous sodium sulfate. Stir the mixture thoroughly with a stainless steel spatula.
  - 5.5 Allow the mixture to stand for two hours, mix thoroughly with the spatula and allow the mixture to stand for an additional six hours. Mix the sample again, insuring that no lumps are present. During the period that the samples set, turn off the light in the hood and close the hood sash.
  - 5.6 Add 20 ml of methanol, stir, and add 150 ml of hexane. Remove the spatula while rinsing it with hexane.
  - 5.7 Place the extraction jar containing the soil, sodium sulfate, and solvents in the shaker and shake for at least 3 hours.
  - 5.8 After the three hour shaking period, turn off the shaker and allow the solids to settle before proceeding.
  - 5.9 Into the top of a 500 ml KD flask, insert a glass filter funnel containing Whatman #4 filter paper (or equivalent) rinsed with hexane.
  - 5.10 Carefully decant the extract through the filter funnel, using a stainless steel spatula to facilitate the transfer process.
  - 5.11 Rinse the inside of the jar and contents with hexane, using the spatula to mix the hexane with the solid material remaining in the beaker.
  - 5.12 Decant the washing into the filter funnel, using the spatula to facilitate the transfer.
  - 5.13 Concentrate the extract volume to approximately 3 ml with a Kuderna-Danish apparatus.
  - 5.14 Transfer the concentrated extract to a 20 ml scintillation vial. Rinse the evaporator flask with three 5 ml portions of hexane; transfer each rinse into the scintillation vial. During these transfers, evaporate the solvent using a gentle stream of dry nitrogen.

5.15 After the final rinse has been added, reduce the extract volume to approximately 1 ml.

#### 5.0 DUAL COLUMN CLEAN-UP

- 6.1 Either the necessary columns have been prepared and are in a drying oven, or the silica gel and alumina columns need preparation. If columns need to be prepared, obtain enough 1 x 20 cm columns (for the silica gel columns) and 1 x 30 cm columns, for the alumina columns.
- 6.2 Place a small wad of glass wool in the bottom of the 1 x 20 cm columns and add 1.0 g of silica gel, 2.0 g of the NaOH impregnated silica gel, 1 g silica gel, 4 g of the 40% w/w sulfuric acid treated silica gel and 2.0 g of silica gel. Gently tap the columns to allow the contents to settle, after each addition.
- 6.3 Place a small wad of glass wool in the bottom of the 1 x 30 cm columns and add 6 g of alumina and a 1 cm layer of sodium sulfate. Gently tap the columns to allow the contents to settle.
- 6.4 Attach the silica gel and alumina columns to lab supports so that the silica gel column is above the alumina column and the lower tip of the silica gel column is inserted into the top of the alumina column.
- 6.5 Rinse both columns with hexane to remove any air bubbles and discard the hexane.
- 6.6 When the silica gel and alumina columns have stopped dripping hexane, place a clean Erlenmeyer flask under the alumina column and transfer the hexane concentrate obtained from step 5.15 to the top of the silica gel column. Rinse the scintillation vial with 2 x 0.5 ml portions of hexane and add the washings to the top of the silica gel column.
- 6.7 Wash the silica gel column with 120 ml of hexane, added in aliquots by means of a transfer pipet. Remove the silica gel column.
- 6.8 Wash the alumina column by placing 20 ml of hexane on the column and elute until the hexane has dropped below the sodium sulfate layer. Remove the Erlenmeyer flask and retain (with aluminum foil cap) until directions are given to discard.
- 6.9 Place a clean, labelled 125 ml Erlenmeyer flask under the alumina column and place 20 ml of 20% v/v methylene chloride in hexane on the alumina column, catching the eluent in the Erlenmeyer flask.
- 6.10 Place the 125 Erlenmeyer flask on the Organomation or Pierce concentration apparatus and reduce the volume of the solvent until less than 10 ml of solvent is remaining, but do not evaporate to dryness.
- 6.11 Quantitatively transfer the hexane extracts to labelled 10 ml K-D concentrator tubes. Rinse the Erlenmeyer flask with several small (1-2 ml) portions of hexane, adding the washes to the K-D concentrator tube.



- 6.12 Transfer the K-0 concentrator tubes to the concentration device and concentrate the hexane extract to approximately 1.0 ml, using a gentle stream of nitrogen and heat if necessary.
- 6.13 After the 1.0 ml volume has been obtained, remove the K-0 concentrator tube and quantitatively transfer the contents of the K-0 concentrator tube to designated conical mini-vials. Rinse the concentrator tube with 2 X 0.5 ml portions of hexane and transfer the washes to the concentrate vial. Complete necessary paperwork (See QA section.)
- 6.14 Store the hexane concentrate in a freezer until just prior to GC/MS analysis.
- 6.15 Concentrate the hexane to near dryness and add 50  $\mu$ l of 200 ppb standard of  $^{13}\text{C}$ -TCDF. Return sample to the reach-in refrigerator.

#### 7.0 ACTIVATED CARBON CLEAN-UP

- 7.1 After GC/MS analysis of samples processed through the dual column methodology in Section 6.0, the possibility exists that certain matrices may produce indeterminate results. In such cases an activated carbon column clean-up technique will be employed.
- 7.2 Obtain from the desiccator the activated Celite/Carbopak (from Section 2.13).
- 7.3 Insert a small wad of glass wool into a small (7 mm O.D. x 15 cm) disposable pipet and, using vacuum aspiration at the pointed tip of the pipet, add the Celite/Carbopak mixture until a 2 cm column is obtained.
- 7.4 Prepare the column by adding the following solvents/solvent mixtures in the designated aliquot sizes: (place a clean 125 ml Erlenmeyer flask under the column)
  - 2 ml toluene.
  - 1 ml 75/20/5 (v/v/v) methylene chloride/methanol/benzene.
  - 1 ml 50/50 (v/v) cyclohexane/methylene chloride.
  - 2 ml hexane.
- 7.5 When the bottom of the hexane meniscus just touches the top of the Celite/Carbopak material, quantitatively transfer the 50  $\mu$ l of sample onto the column.
- 7.6 Rinse the sample container with 2 1 ml portions of hexane, adding the rinses onto the column.
- 7.7 Sequentially wash the column with the following solvents/solvent mixtures in the designated aliquot sizes:
  - 1 ml 50/50 (v/v) cyclohexane/methylene chloride
  - 1 ml 75/20/5 (v/v/v) methylene chloride/methanol/benzene.

- 7.8 Remove the 125 ml Erlenmeyer flask and replace with a concentrator tube or Reacti-vial.
- 7.9 Elute the TCDD from the column with 2 ml of toluene into the concentrator tube or Reacti-vial.
- 7.10 Store the toluene eluent in a freezer until the GC/MS analysis is to be performed.
- 7.11 Shortly before the analysis, concentrate the extract to near dryness and add 50  $\mu$ l of isooctane for GC/MS analysis.
- 7.12 Complete any paperwork requirements and store the concentrate in the reach-in refrigerator (See QA section for examples of paperwork.)

#### 8.0 CAUSTIC AND ACID CLEANUP (OPTIONAL)

- 8.1 Certain samples may require additional cleanup before column chromatography in order to achieve acceptable detection limits. The following is a procedure which involves acid and caustic wash of the sample.
- 8.2 After step 5.15 is completed, quantitatively transfer the extract to a 125-ml separatory funnel.
- 8.3 Wash the extract with 30 ml 20% aqueous potassium hydroxide by shaking for 10 minutes. Let stand for 10 minutes and discard the aqueous layer.
- 8.4 Wash the extract with 25 ml of distilled deionized water by shaking for 2 minutes. Let stand for 10 minutes and discard the aqueous layer.
- 8.5 Slowly add 50 ml concentrated sulfuric acid to the extract and shake for 10 minutes. Let stand for 10 minutes and discard the acid layer. Repeat until acid layer remains colorless after extraction.
- 8.6 Wash extract with 20 ml distilled/deionized water by shaking for 2 minutes. Let stand for 10 minutes and discard the aqueous layer.
- 8.7 Quantitatively transfer the organic layer to a 20-ml scintillation vial and dry over 10 g anhydrous sodium sulfate.
- 8.8 Reduce the extract volume to approximately 1 ml.
- 8.9 Proceed to dual column cleanup if required.

#### 9.0 GLASSWARE PREPARATION PROCEDURES

- 9.1 Rinse glassware with the last solvent used in it. Wash with hot water containing detergent. Rinse with copious amounts of tap water and several portions of distilled water; drain dry. Rinse with high purity acetone and hexane and allow to air dry. When dry, heat in a muffle furnace to 400°C for 1 hour. (Volumetric glassware should not be heated in a muffle furnace.) Remove from the oven when cool; store inverted in a clean environment.

0150-SS

## APPENDIX B

## SAMPLE PREPARATION PROCEDURES FOR DIOXIN IN SOILS - SOXHLET METHOD

## 1.0 SUMMARY OF METHOD

- 1.1 Soil samples are spiked with isotopically labeled TCDD, pretreated with 1 N-HCl for 1 hour and air dried. The dry soil is transferred to a glass soxhlet thimble and subsequently soxhlet extracted with benzene for 16 hours. The extract is concentrated and cleaned up using liquid column chromatography steps. The extract is analyzed by HRGC/LRMS for 2,3,7,8-TCDD.

## 2.0 REAGENTS

- 2.1 Soaking standard solution (contains both internal and surrogate standards).  $^{13}C_{12}$ -2,3,7,8-TCDD internal standard at a concentration of 500 ng/ml and  $^{37}Cl_4$ -2,3,7,8-TCDD surrogate standard at a concentration of 100 ng/ml, both in the same hexane solution. The standard ID number is 358:32-IFB. GC/MS IS mixture is prepared at a concentration of 200 ng/ml in isooctane.
- 2.2 Sulfuric acid (concentrated); ACS grade; specific gravity 1.84.
- 2.3 Methylene chloride; pesticide quality or equivalent.
- 2.4 Hexane; pesticide quality or equivalent.
- 2.5 1-N HCl
- 2.6 Benzene; pesticide quality or equivalent.
- 2.7 Sodium sulfate: ACS, granular, anhydrous. Prepare by a 24-hour methylene chloride extraction. Store in an oven maintained at 110°C.
- 2.8 Silica gel; type 60, EM reagent, 70-230 mesh, or equivalent. Prepare by soxhlet extraction with methylene chloride overnight, drying, and then activating in an aluminum foil covered glass container for 24 hours at 130°C.
- 2.9 Alumina-neutral; Fisher brand, 80-200 mesh. Prepare by soxhlet extraction with methylene chloride, followed by drying and then activating in an aluminum foil-covered glass container for 24 hours at 190°C.
- 2.10 Sulfuric acid; impregnated silica gel, 40% v/v. To prepare, add two parts (200 g) concentrated sulfuric acid to three parts silica gel (300 g) contained in a glass liter bottle equipped with a Teflon-lined screw cap. Mix thoroughly with a glass rod until no lumps are visible. Label the bottle with "Sulfuric Acid - impregnated silica gel" and "Caution - contains concentrated sulfuric acid," date prepared and person preparing the reagent. All information will be recorded in the laboratory standard notebook.

- 2.11 Sodium hydroxide modified silica gel, 33% v/v. To prepare, add 1 part 1M NaOH to two parts activated silica gel contained in a glass jar equipped with a Teflon-lined screw cap. Mix thoroughly with a glass rod until no lumps are visible. Label bottle with "NaOH - impregnated silica gel," date prepared and person preparing the reagent. All information will be recorded in the laboratory standard notebook.
- 2.12 Carbopak C (activated carbon) on Celite; prepare by thoroughly mixing 3.5 g of Carbopak C (80/100 mesh) and 16.4 g of Celite 545 in a 40-ml vial. Activate at 130°C for six hours. Store in a desiccator. CAUTION: Check each new batch of mixed Carbopak/Celite to ensure TCDD recovery of > 50%. Subject the low level concentration calibration solution to the procedure in section 6.3.0-6.3.12 and measure the quantity of labeled and unlabeled TCDD. Label bottle with "Activated Carbopak/Celite," date prepared and person preparing the reagent. All information will be recorded in the laboratory standard notebook.
- 2.13 Potassium hydroxide; 20% aqueous. Prepare by cautiously adding, with stirring, 200 g of potassium hydroxide pellets to 800 ml of distilled/deionized water contained in a beaker in a cold water bath. After the potassium hydroxide has dissolved and the solution is at room temperature, transfer to a plastic bottle.

### 3.0 CAUTIONS

- 3.1 Samples received for this preparation procedure are of unknown composition but may be potentially carcinogenic, mutagenic, toxic or in other ways hazardous.
- 3.2 It is mandatory that all handling of the samples be performed inside of the designated dioxin hood in the high hazard laboratory.
- 3.3 Personnel involved in this sample preparation procedure should be thoroughly familiar with laboratory SOPs on the processing of high hazard samples.

### 4.0 EQUIPMENT AND MATERIALS

- 4.1 Glass soxhlet system with glass thimbles.
- 4.2 Heating mantles with temperature control.
- 4.3 Kuderna-Danish concentration apparatuses, consisting of a three-ball macro Snyder column, a 500-ml evaporative flask, and a 10-ml graduated concentrator tube.
- 4.4 Mini vials (reactivials); 1.0 ml. capacity with conical interiors and graduated at 0.1 ml; equipped with Teflon-faced rubber septa and screw caps.
- 4.5 Concentration vials; 20-ml screw top, septum sealed, scintillation vials.

- 4.6 Concentration device; nitrogen blowdown apparatus, Organomation and Pierce concentration devices, or equivalent.
- 4.7 Glass filtering funnels, short stem.
- 4.8 Filter paper, Whatman No. 4 or equivalent.
- 4.9 Filter paper, Whatman No. 2 or equivalent.
- 4.10 Buchner funnel set up.

#### 5.0 SAMPLE PREPARATION AND EXTRACTION

- 5.1 Prepare designated dioxin hood as instructed in laboratory SOP for processing high hazard samples. This includes obtaining, preparing and labeling the requisite number of soxhlet systems.
- 5.2 Weigh out 10g of soil into a 250 ml amber jar and spike with 100  $\mu$ l of the internal/surrogate mixture.
- 5.3 Add 100 ml of 1-N HCl to the jar and shake on a platform shaker for 1 hour.
- 5.4 Pour the soil/acid mixture through a Buchner Funnel and neutralize the soil by pouring 300 ml Distilled water through the Funnel. Allow the soil to air dry for 16 hours.
- 5.5 Place a small amount of silica gel in a glass extraction thimble.
- 5.6 Carefully transfer the dry sample into the extraction thimble. Charge the soxhlet extractor with fresh benzene and soxhlet extract for 16 hours.
- 5.7 Concentrate the extract volume to approximately 3 ml with a K-D apparatus.
- 5.8 Transfer the concentrated extract to a 20-ml scintillation vial. Rinse the evaporator flask with three 5-ml portions of hexane; transfer each rinse into the scintillation vial. During these transfers, evaporate the solvent using a gentle stream of dry nitrogen.
- 5.9 After the final rinse has been added, reduce the extract volume to approximately 1 ml.

#### 6.0 DUAL COLUMN CLEAN-UP

- 6.1 Either the necessary columns have been prepared and are in a drying oven, or the silica gel and alumina columns need preparation. If columns need to be prepared, obtain enough 1 x 20 cm columns (for the silica gel columns) and 1 x 30 cm columns, for the alumina columns.
- 6.2 Place a small wed of glass wool in the bottom of the 1 x 20 cm columns and add 1.0 g of silica gel, 2.0 g of the NaOH impregnated silica gel, 1 g

silica gel, 4 g of the 40% w/w sulfuric acid treated silica gel and 2.0 g of silica gel. Gently tap the columns to allow the contents to settle after each addition.

- 6.3 Place a small wad of glass wool in the bottom of the 1 X 30 cm columns and add 6 g of alumina and a 1-cm layer of sodium sulfate. Gently tap the columns to allow the contents to settle.
- 6.4 Attach the silica gel and alumina columns to lab supports so that the silica gel column is above the alumina column and the lower tip of the silica gel column is inserted into the top of the alumina column.
- 6.5 Rinse both columns with hexane to remove any air bubbles and discard the hexane.
- 6.6 When the silica gel and alumina columns have stopped dripping hexane, place a clean Erlenmeyer flask under the alumina column and transfer the hexane concentrate obtained from step 5.8 to the top of the silica gel column. Rinse the scintillation vial with two 0.5-ml portions of hexane and add the washings to the top of the silica gel column.
- 6.7 Wash the silica gel column with 90 ml of hexane, added in aliquots by means of a transfer pipet. Remove the silica gel column.
- 6.8 Wash the alumina column by placing 20 ml of hexane on the column and eluting until the hexane has dropped below the sodium sulfate layer. Remove the Erlenmeyer flask and retain (with aluminum foil cap) until directions are given to discard.
- 6.9 Place a clean, labeled 125-ml Erlenmeyer flask under the alumina column and place 20 ml of 20% v/v methylene chloride in hexane on the alumina column, catching the eluent in the Erlenmeyer flask.
- 6.10 Place the 125-Erlenmeyer flask on the Organomation or Pierce concentration apparatus and reduce the volume of the solvent until less than 10 ml of solvent remains, but do not evaporate to dryness.
- 6.11 Quantitatively transfer the hexane extract to labeled 10-ml K-0 concentrator tubes. Rinse the Erlenmeyer flask with several small (1 to 2 ml) portions of hexane, adding the washes to the K-0 concentrator tube.
- 6.12 Transfer the K-0 concentrator tubes to the concentration device and concentrate the hexane extract to approximately 1.0 ml, using a gentle stream of nitrogen and heat if necessary.
- 6.13 After the 1.0 ml volume has been obtained, remove the K-0 concentrator tube and quantitatively transfer the contents of the K-0 concentrator tube to designated conical vials. Rinse the concentrator tube with two 0.5-ml portions of hexane and transfer the washes to the concentrate vial. Complete necessary paperwork (see QA section).
- 6.14 Store the hexane concentrate in a freezer until just prior to GC/MS analysis.

6.15 Concentrate the hexane to near dryness and add 50  $\mu$ l of 200 ppb standard of an appropriate Is. Return sample to the reach-in refrigerator.

#### 7.0 ACTIVATED CARBON CLEAN-UP

- 7.1 After GC/MS analysis of samples processed through the dual column method in Section 6.0, the possibility exists that certain matrices may produce indeterminate results. In such cases an activated carbon column clean-up technique will be employed.
- 7.2 Obtain from the desiccator the activated Celite/Carbopak (from Section 2.13).
- 7.3 Insert a small wad of glass wool into a small (7 mm O.D. X 15 cm) disposable pipet and, using vacuum aspiration at the pointed tip of the pipet, add the Celite/Carbopak mixture until a 2-cm column is obtained.
- 7.4 Prepare the column by adding the following solvents/solvent mixtures in the designated aliquot sizes: (place a clean 125-ml Erlenmeyer flask under the column)
  - 2 ml toluene,
  - 1 ml 75/20/5 (v/v/v) methylene chloride/methanol/benzene,
  - 1 ml 50/50 (v/v) cyclohexane/methylene chloride,
  - 2 ml hexane.
- 7.5 When the bottom of the hexane meniscus just touches the top of the Celite/Carbopak material, quantitatively transfer the 50  $\mu$ l of sample onto the column.
- 7.6 Rinse the sample container with two 1-ml portions of hexane, adding the rinses onto the column.
- 7.7 Sequentially wash the column with the following solvents/solvent mixtures in the designated aliquot sizes:
  - 1 ml 50/50 (v/v) cyclohexane/methylene chloride
  - 1 ml 75/20/5 (v/v/v) methylene chloride/methanol/benzene.
- 7.8 Remove the 125-ml Erlenmeyer flask and replace with a concentrator tube or Reacti-vial.
- 7.9 Elute the TCDD from the column with 2 ml of toluene into the concentrator tube or Reacti-vial.
- 7.10 Store the toluene eluent in a freezer until the GC/MS analysis is to be performed.
- 7.11 Shortly before the analysis, concentrate the extract to near dryness and add 50  $\mu$ l of isooctane for GC/MS analysis.
- 7.12 Complete any paperwork requirements and store the concentrate in the reach-in refrigerator (see QA section for examples of paperwork).

## 8.0 CAUSTIC AND ACID CLEANUP (OPTIONAL)

- 8.1 Certain samples may require additional cleanup before column chromatography in order to achieve acceptable detection limits. The following is a procedure which involves acid and caustic wash of the sample.
- 8.2 After step 5.12 is completed, quantitatively transfer the extract to a 125-ml separatory funnel.
- 8.3 Wash the extract with 30 ml 20% aqueous potassium hydroxide by shaking for 10 minutes. Let stand for 10 minutes and discard the aqueous layer.
- 8.4 Wash the extract with 25 ml of distilled deionized water by shaking for 2 minutes. Let stand for 10 minutes and discard the aqueous layer.
- 8.5 Slowly add 50 ml of concentrated sulfuric acid to the extract and shake for 10 minutes. Let stand for 10 minutes and discard the acid layer. Repeat until acid layer remains colorless after extraction.
- 8.6 Wash extract with 20 ml of distilled/deionized water by shaking for 2 minutes. Let stand for 10 minutes and discard the aqueous layer.
- 8.7 Quantitatively transfer the organic layer to a 20-ml scintillation vial and dry over 10 g anhydrous sodium sulfate.
- 8.8 Reduce the extract volume to approximately 1 ml.
- 8.9 Proceed to dual column cleanup if required.

## 9.0 GLASSWARE PREPARATION PROCEDURES

- 9.1 Rinse glassware with the last solvent used in it. Wash with hot water containing detergent. Rinse with copious amounts of tap water and several portions of distilled water; drain dry. Rinse with high purity acetone and hexane and allow to air dry. When dry, heat in a muffle furnace to 400°C for 1 hour. (Volumetric glassware should not be heated in a muffle furnace.) Remove from the oven when cool; store inverted in a clean environment.

D224-AP-8



## APPENDIX - C

## DIOXIN ANALYSES - ANALYSIS PROCEDURES

## 1.0 INTRODUCTION

- 1.1 This is a qualitative and quantitative (high resolution) GC/(low resolution) MS analysis specific for the 2,3,7,8 isomer of tetrachloro-dibenzo-p-dioxin using selected ion monitoring. A sample is spiked with isotopically labeled  $^{13}\text{C}_{12}$ -2,3,7,8-TCDD as internal standard and with  $^{37}\text{Cl}_4$ -2,3,7,8-TCDD as surrogate. Quantitation is based on the response of native TCDD relative to the internal standard. Performance is based on surrogate standard results. Percent recovery of the IS/SURR mixture is based on the GC/MS internal standard  $^{13}\text{C}$ -2,3,7,8-TCDF.

## 2.0 SAFETY

- 2.1 Samples are sent to IT Corporation from suspected or known hazardous waste sites. Samples are to be handled from receipt to storage by qualified personnel only. Analysts must have a working knowledge of safety protocols and be adept at safety procedures. GC/MS instruments must be equipped with vapor contamination traps on the capillary split and sweep vents and on the rough pump effluent lines prior to use (see Safety SOP).

## 3.0 SET-UP AND INSTALLATION

- 3.1 Install a 60 meter, 0.25 mm i.d., fused silica SP2130, 0.20 micron film thickness capillary column. Set the head pressure to approximately 20-25 psi and the split and sweep flows to 30 ml/min and 3 ml/min respectively.
- 3.2 Create a reasonable unit resolution tune for PFTBA. Adjust the zero according to the instrument manufacturers suggested settings. Set the preamp sensitivity to  $10^{-4}$  amps/volts. The electron multiplier must be set to achieve 800,000 area units for 2 ng of  $^{13}\text{C}_{12}$ -TCDD as injected for N/E 334. Calibrate the instrument.
- 3.3 Establish the following MID descriptors:

3.3.1 NAME "TC" for running column performance mixture

MID                   DESC: TC  
INST: PINN           CALI: CAL19

MASS DEFECT AT 100 AMU	20 MHU
MASTER RATE	1024
TOTAL ACQU TIME	0.318 SECS
TOTAL SCAN TIME	0.450 SECS
CENT SAMP INT	0.200 MS
CALI MASS RANGE	44 TO 614 AMU

INT NO.	BEGIN MASS	END MASS	TIME REQUEST	(SECS) ACTUAL	MPW	MPW	MA	TH	BL	ION
1	319.849	320.150	0.050	0.054	1	100	1	1	0	POS
2	321.849	322.150	0.050	0.052	1	100	1	1	0	POS
3	322.849	323.109	0.050	0.052	1	100	1	1	0	POS
4	327.849	328.150	0.050	0.054	1	100	1	1	0	POS
5	331.849	332.150	0.050	0.052	1	100	1	1	0	POS
6	332.849	334.150	0.050	0.052	1	100	1	1	0	POS

3.3.2 NAME "TD" for running standards and samples

MID                   DESC: TD  
INST: FINN           CALI CAL39

MASS DEFECT AT 100 AMU   30 MPU  
MASTER RATE               1024  
TOTAL ACQU TIME           0.430 SECS  
TOTAL SCAN TIME           0.450 SECS  
CENT SAMP INT             0.200 MS  
CALI MASS RANGE           44 TO 614 AMU

INT NO.	BEGIN MASS	END MASS	TIME REQUEST	(SECS) ACTUAL	MPW	MPW	MA	TH	BL	ION
1	296.849	297.150	0.050	0.052	1	100	1	1	0	POS
2	319.849	320.150	0.050	0.054	1	100	1	1	0	POS
3	321.849	322.150	0.050	0.052	1	100	1	1	0	POS
4	327.849	328.150	0.050	0.054	1	100	1	1	0	POS
5	331.849	332.150	0.050	0.052	1	100	1	1	0	POS
6	333.849	334.150	0.050	0.052	1	100	1	1	0	POS
7	315.849	316.150	0.050	0.052	1	100	1	1	0	POS
8	317.849	318.150	0.050	0.054	1	100	1	1	0	POS

3.4 Set the GC conditions as follows:

Injection Port Temp       250°C  
Separator Temp            250°C  
Initial Temp               70°C  
Initial Time               4 min  
Ramp Rate 1               20°C/min  
Temp 2                     250°C  
Hold Time 2               0 min  
Ramp Rate 2               4°C/min  
Temp 3                     250°C  
Hold Time 3               5 min\*  
Split/Sweep               85 sec  
Filament/Heater turn on time   10 min

\* Held for at least 2 min beyond the retention time of the last isomer of TCOO in the performance mixture.

3.5 Analyze the 7 isomer EPA test mixture. If no isomers are co-eluting with 2,3,7,8-TCDD, conditions stated above are acceptable to proceed. If co-elution does occur with 2,3,7,8-TCDD, the column must be changed or conditions modified in order to stop co-elution.

3.6 Create a library with the following entries:

Entry 1 -  $^{13}C$  - 2,3,7,8-TCDD (Internal standard)

- delete all masses except 322/334
- amount = 1000
- units = pg/ul
- quant mass = 322

Entry 2 -  $^{13}C$  - 2,3,7,8-TCDD (Secondary ion)

- delete all masses except 322/334
- amount = 1000
- units = pg/ul
- quant mass = 334

Entry 3 - 2,3,7,8-TCDD

- delete all masses except 320, 322, 332, 257
- amount = 1000
- units = pg/ul
- quant mass = 320

Entry 4 - 2,3,7,8-TCDD (Secondary ion)

- delete all masses except 320, 322, 332, 257
- amount = 1000
- units = pg/ul
- quant mass = 322

Entry 5 - 2,3,7,8-TCDD (Tertiary ion)

- delete all masses except 320, 322, 332, 328
- amount = 1000
- units = pg/ul
- quant mass = 257

Entry 6 -  $^{37}Cl$  - 2,3,7,8-TCDD (Recovery int. std.)

- delete all masses except 328
- amount = 200
- units = pg/ul
- quant mass = 328

#### 4.0 ANALYSIS

##### 4.1 General Description

- 4.1.1 A five point calibration consisting of a 200 pg/ul (1 ppb equivalent), a 1000 pg/ul (5 ppb equivalent), a 5000 pg/ul (25 ppb equivalent), a 20,000 pg/ul (100 ppb equivalent), and a 20,000 pg/ul (200 ppb equivalent) standard must be run in triplicate and a linear response curve generated before samples are

analyzed. The 200 ng/ul standard is analyzed at the beginning of each eight hour shift to verify system performance and conformity to the multipoint calibration (see QA section on standard paperwork). Samples are received in 50 ul volumes and require no further preparation by the GC/MS laboratory.

#### 4.1.2 COMPOSITION OF CONCENTRATION CALIBRATION SOLUTIONS

Solution #	Concentration of 2,3,7,8-TCDD			Unlabeled
	Isotopically Labeled		13C-TCDF	
	13C12	37Cl4		
1	1 ng/ul	0.06 ng/ul	0.2 ng/ul	0.2 ng/ul
2	1 ng/ul	0.12 ng/ul	0.2 ng/ul	1 ng/ul
3	1 ng/ul	0.2 ng/ul	0.2 ng/ul	5 ng/ul
4	1 ng/ul	0	0.2 ng/ul	20 ng/ul
5	1 ng/ul	0	0.2 ng/ul	40 ng/ul

#### 4.2 Procedures for GC/MS Analysis Initial Calibration

4.2.1 The GC conditions for all standards, samples, and the column performance mixture are as stated in Section 3.4.

4.2.2 Tune and calibrate the instrument as in step 3.2 or verify that the instrument has been tuned and calibrated within the past week and has performed satisfactorily when last used. If the method has not been performed successfully within the last seven days, check the tune and recalibrate.

4.2.3 Acquire the seven isomer EPA test mix. If no isomers are co-eluting with 2,3,7,8-TCDD, proceed with 4.2.4. If co-elution does occur, the conditions must be modified or the column must be changed. The MID descriptor TC must be used for this analysis (section 3.3).

4.2.3.1 Determine and document acceptable system performance with the following criteria:

- A. Five data points for each GC peak are acquired.
- B. GC column performance -- The valley between 2,3,7,8-TCDD and the peaks representing all other TCDD isomers must be resolved with a valley <25%. Valley % =  $x/y \times 100$  when y is peak height of 2,3,7,8-TCDD and x is baseline to valley height (Fig. 1).
- C. Ratio of integrated ion current for m/z 320 to m/z 322 for 2,3,7,8-TCDD must be  $\geq 0.67$  and  $\leq 0.87$ .

mean RFs for each compound do not differ by more than  $\pm 10\%$ , the RF can be considered to be independent of analyte quantity for the calibration concentration range, and the mean of the five mean RFs shall be used for concentration calculations.

- 4.2.7 Fill out all necessary paperwork for the standard calibration QA/QC (see QA/QC section for paperwork).
  - 4.2.8 Plot the response factor vs concentration for the five point calibration curve for QA/QC reporting.
- 4.3 Calibration before the start of each eight hour shift
- 4.3.1 Inject 2  $\mu$ l of the performance check solution as in 4.2.3 - 4.2.3.i.f.
  - 4.3.2 Inject 2  $\mu$ l of the concentration calibration solution #1 (200 pg/ $\mu$ l) determine and document acceptable performance for
    - 4.3.2.1 MS sensitivity - signal-to-noise (S/N) ratio of  $> 2.5$  for  $m/z$  257 and  $> 10$  for  $m/z$  322 for unlabeled 2,3,7,8-TCDD. The ratio of integrated ion current for  $m/z$  257 to  $m/z$  322 must be  $\geq 0.20$  and  $\leq 0.45$ .
    - 4.3.2.2 Measured response factor for unlabeled 2,3,7,8-TCDD relative to  $^{14}C_{12}$ -2,3,7,8-TCDD is within  $\pm 10\%$  of the mean values established (Section 4.2) by triplicate analyses of the concentration calibration solutions.
    - 4.3.2.3 If both these criteria are met, fill out the bottom portion of form 248A (QA/QC section). If the RF ratios are within 10% of the calibration average samples may then be analyzed. DO NOT UPDATE the shift standard to the response list. Use  $K:S:I$  only. If the 10% criteria are not met, reanalyze the shift standard. If still out of bounds, a new multipoint must be run. Multipoints may continue to be used for as long as the shift standards conform to this criteria. Xerox a copy of Form 248A for inclusion with the shift standard packages and an extra copy to be placed in the instrument log book so that subsequent shift standard entries may be made on the same form.
    - 4.3.2.4 Acquire sample analyses. Samples may be analyzed following a successful shift standard analysis. Performance standards must be rerun within every eight hours. The injection procedure must be carefully adhered to to avoid cross contamination. If the background of a sample analysis remains high towards the end of an acquisition, the column should be baked out for an extra period of time to avoid possible chromatographic carryover into the next sample injection.

Septa should be changed after approximately 40 injections. Capillary injection port liners should be cleaned or exchanged with every other septum change. Good sense and experience prevail.

4.3.3 After eight hours from the injection of the column performance check solution (4.3.1), the tune is over and the performance check solution must be analyzed again. If all criteria (4.2.3.1 a-f) are met, the samples analyzed during that eight hour period are acceptable. If the criteria are not met, the samples must be reanalyzed.

4.4 For all injections, a hot needle injection technique is used.

4.4.1 Injection Technique (Hot Needle) - The syringe must be thoroughly cleaned between injections to avoid cross contamination. Remove the plunger between injections and wipe it thoroughly with a kimwipe. Rinse the syringe with ten to fifteen full syringe volumes of hexane solvent wash. Replace the solvent wash with pesticide quality hexane daily. If a hamilton syringe cleaner is available that is equipped with a vacuum source, use this also. Do not use the hamilton syringe cleaner if there is no vacuum pump attached. Insert the needle into the septum port, wait approximately ten seconds for the needle to heat, then pump the plunger back and forth a few times. Rinse with the solvent wash hexane again. Work the plunger up and down in the syringe barrel to reduce excess hexane wash. There should be approximately 0.5 ul of solvent left in the syringe barrel following this final rinse.

Draw back the plunger so that there are about 2 ul of air in the barrel. Draw 2.1 ul of sample into the needle. Usually to get a total of 2 ul of sample, it is necessary to pull the plunger back approximately 1.2 ul. The sample should be drawn up into the barrel and the amount confirmed to be 2 ul. If it is not, the sample should be expelled and process repeated.

After getting 2.0 ul of sample into the barrel, insert the needle into the injector port and wait 6 seconds. Rapidly make the injection.

After making the injection, remove the needle as quickly as possible. As soon as the injection is made, start the GC.

4.5 Identification criteria for native 2,3,7,8-TCDD

4.5.1 Retention time (at maximum peak height) of the sample component must be within 3 seconds of the retention time of the  $^{13}C_{12}$ -2,3,7,8-TCDD. Retention times are required for all chromatograms, but scan numbers are optional. These parameters should be printed next to the appropriate peak.

4.5.2 The integrated ion currents detected for m/z 257, 320, and 322 must maximize simultaneously. If there are peaks that will

affect the maximization or quantitation of peaks of interest, attempts should be made to narrow the scan window to eliminate the interfering peaks. This should be reported on a separate chromatogram.

- 4.5.3 The integrated ion current for each analyte and surrogate compound ion (m/z 257, 320, 322 and 329) must be at least 2.5 times background noise and must not have saturated the detector; internal standard ions (m/z 332 and 334) must be at least 10 times background and must not have saturated the detector.
- 4.5.4 Relative abundance of m/z 257 to m/z 322 should be  $\geq 20\%$  and  $\leq 45\%$ .
- 4.5.5 Abundance of integrated ion counts detected for m/z 320 must be  $\geq 67\%$  and  $\leq 97\%$  of integrated ion counts detected for m/z 322.

### 5.0 DELIVERABLES

5.1 Each sample "package" must include the following:

- a) RIC (1000 - end of run)
- b) Complete quantitation report. (input area and scan # manually if missed)
- c) (EICP of m/e 332; m/e 334; m/e 316, and m/e 318)
- d) (EICP of 320; 322; 332; and 257)
- e) (EICP of 320; 322; 332; and 329)
- f) Quan (320; 322; 257; 5 scans) The center of the 5 scan window is the retention time of <sup>13</sup>C<sub>12</sub>-2,3,7,8-TCDD
- g) A standard package including all of (a) through (e) plus an attached copy of the TCDD calibration summary (Form 243A)

5.1.1 See QA/QC section for batch report deliverables

### 6.0 TOTAL ION CONFORMATION

6.1 Inject 2  $\mu$ l of a DFTPP solution into the GC/MS system using the same GC conditions as stated in section 3.4 with the MS scanning from 35-450 at 1 sec/scan. Required calibration criteria for DFTPP shall be:

m/z	Relative Intensity
51	30 - 60 percent of base peak
68	< 2 percent of m/z = 69
70	< 2 percent of m/z = 69
127	40 - 60 percent of base peak
197	< 1 percent of base peak
198	100 percent (base peak)
199	5 - 9 percent of base peak
275	10 - 30 percent of base peak
385	> 1 percent of base peak
441	less than m/z = 443
442	> 40 percent of base peak
443	17 - 23 percent of m/z = 442

6.2 Inject 4.1 of the positive TCDD sample using the same GC conditions in section 3.4. MS data acquisition requirements shall be:

6.2.1 Cycle time  $\leq$  1.5 seconds.

6.2.2 Acquisition of  $\geq$  5 spectra during elution of 2,3,7,8-TCDD from the GC.

6.2.3 MS scanning from 150-350 at 1 sec/scan.

6.3 Subtract an appropriate background spectrum, and plot a spectrum of 2,3,7,8-TCDD after background subtraction. (The person responsible for MS data interpretation is responsible for demonstrating that the background spectrum selected for subtraction was an appropriate spectrum.) Provide a hard copy of the background spectrum, the TCDD spectrum before subtraction, and the TCDD spectrum after subtraction. The quality of the plotted spectrum will be affected by other sample components that have approximately the same GC retention time and will be highly variable. Desired spectral features are:

Base peak = m/z 322  
Ratio of m/z 320 to 322 = 0.77  
Ratio of m/z 320 to 324 = 1.58  
Ratio of m/z 257 to 322 = 0.32  
Ratio of m/z 257 to 259 = 1.03  
Ratio of m/z 194 to 196 = 1.54  
m/z 160 and 161 =  $\geq$  10% of m/z 322

Because  $^{13}\text{C}_{12}$ -2,3,7,8-TCDD, the internal standard, is present in every sample and has essentially the same retention time as unlabeled 2,3,7,8-TCDD, the spectrum after background subtraction will represent a mixture. When  $^{13}\text{C}_{12}$ -2,3,7,8-TCDD is present at a higher concentration than unlabeled 2,3,7,8-TCDD, the resultant spectrum must be normalized to m/z 322 to demonstrate desired spectral features.

7.0 SEE QA/QC SECTION FOR EXAMPLES OF ALL PAPERWORK NECESSARY FOR COMPLETE REPORTING OF GC/MS DATA

0150-AP



## APPENDIX D

## DIOXIN ANALYSIS - STANDARD VERIFICATION

## 1.0 Summary

- 1.1 All standards bought commercially must be checked for both purity and accuracy of concentration. The benchmark standard for verification of accuracy is a 7.37 ug/ml standard of native 2,3,7,8-TCDD supplied by the USEPA.

## 2.0 Receipt of Standards and Standard Checks of Stock Solutions

- 2.1 Standards received from commercial suppliers of dioxin are checked into the building and logged into a standard notebook. The standards are transferred to volumetric flasks and brought up to volume in toluene. A known dilution of the stock is analyzed on GC/MS to check for both purity and accuracy of concentration vs. an already approved standard of the USEPA benchmark standard. If the response factor agrees  $\pm 10\%$  from the check standard, the new lot is approved for use. The hardcopies of the standard check will contain EICP's for all compounds of interest from both the new standard and the benchmark standard and will be filed for future reference.

## 3.0 Storage of Approved Standards

- 3.1 The approved stock will be transferred to tared numbered and labeled vials (2 ml size). The weights of the standards will be recorded (Form 1). When a new standard bottle is used, it is weighed first to insure no volume loss during storage. The standards are kept at  $-4^{\circ}\text{C}$  for no longer than six months.

## 4.0 Working Standard Solutions

- 4.1 Dilutions of the stock solutions are made for all working standards to be used in the extraction laboratory and the GC/MS laboratory.
- 4.2 Before use of the working level standards on sample analysis, the solutions must be approved for concentration and purity as in the stock solutions. The extraction lab standard is analyzed by GC/MS and compared to the shift calibration solution. If the calculated amounts are  $\pm 10\%$  of expected amount, the standard is approved for use in the extraction laboratory. When new GC/MS shift standards are made and approved as above, a new five point calibration in triplicate must be run.
- 4.3 Working standard solutions are stored as per Section 3.0

5.0 Standard Notebook

5.1 All standards made are logged into a standard notebook that includes volumes used; solvents; any problems encountered; date made; date expired; weights of each standard container; concentration; approval date.

Standard or Stock Solution # \_\_\_\_\_ Ref. # \_\_\_\_\_ Lot # \_\_\_\_\_

Compound(s): \_\_\_\_\_

Original Conc. \_\_\_\_\_ Solvent \_\_\_\_\_ Total Volume \_\_\_\_\_

Sol'n Prepared By \_\_\_\_\_ at Date/Time \_\_\_\_\_

Container Tare (grams) \_\_\_\_\_ Container + Solvent (grams) \_\_\_\_\_

Container Gross (grams) \_\_\_\_\_

Special Notes : \_\_\_\_\_

\_\_\_\_\_

\_\_\_\_\_

\_\_\_\_\_

Date Used	User Initials	Weight Before Use (grams)	Weight After Use (grams)	Volume Removed (ml/g)	Weight After Section (grams) Replacement

**SUMMARY OF QA/QC RESULTS FOR 2,3,7,8-TCDD ANALYSES**

**6A COMPARISON OF SOIL PREPARATION PROCEDURES AND TRIPLICATE ANALYSES OF CONTAMINATED SOILS**

**6B ACCURACY AND PRECISION RESULTS FOR 2,3,7,8-TCDD ANALYSES**

**6C RESULTS OF DUPLICATE LABORATORY THERMAL DESORPTION EXPERIMENTS**

COMPARISON OF SAMPLE PREPARATION TECHNIQUES FOR ANALYSIS  
OF 2,3,7,8-TCDD IN UNTREATED SOILS

Soil Identification	CONCENTRATION OF 2,3,7,8-TCDD (ppb)	
	Acid extraction and sonic w/benzene	Jar Method w/hexane-methanol
J1	110	99.1
J1	111	98
J1	97.2	104
	$\bar{x} = 106$ RSD = 7.2%	$\bar{x} = 100.4$ RSD = 3.2%
Eglin	93.9	71
Eglin	98	79
Eglin	112	88
	$\bar{x} = 101.3$ RSD = 9.3%	$\bar{x} = 72.7$ RSD = 7.2%
NCBC	470	497
NCBC	501	420
NCBC	510	450
	$\bar{x} = 493.7$ RSD = 4.3%	$\bar{x} = 455.7$ RSD = 8.5%
NCBC >2 mm	148	
	148	
	$\bar{x} = 148.5$	

2301 7A-T-9

## SUMMARY OF 2,3,7,8-TCDD QA/QC RESULTS

Mean percent accuracy = 97.4  
 Standard deviation = 24.6  
 Percent RSD = 25.2  
 Number of data points = 55

PrecisionTriplicate analyses of starting soil

	<u>Soil/Method</u>	<u>Mean (ppb)</u>	<u>SD(ppb)</u>	<u>% RSD</u>
1)	J1/soxhlet	101	9.4	9.4
2)	Eglin/soxhlet	106	7.7	7.3
3)	NCBC/soxhlet	493	20.9	4.3
4)	J1/jar	72.8	5.6	7.7
5)	Eglin/jar	100	3.2	3.2
6)	NCRC/jar	455	38.8	8.5

Duplicate Analyses

- 1) Samples ID = J2155/J2156  
 Variation<sup>a</sup> = 0.57%  
 Mean Concentration = 148.5 ppb
- 2) Samples ID = J1942/J1945  
 Variation<sup>a</sup> = 39%  
 Mean Concentration = 0.36 ppb
- 3) Samples ID = J2204/J2265  
 Variation<sup>a</sup> = 6.4%  
 Mean Concentration = 25.5 ppb

10 blanks out of 45 samples = 22%

$$^a \frac{S_1 - S_2}{S} \times 100 = \text{RPD (relative percent difference).}$$

0301 TA-SUMMARY

## RESULTS OF DUPLICATE TREATMENT TESTS

Test number	Soil type	Test temp. (°C)	Time at test temp. (min)	Total time in oven (min)	Initial soil weight (gm)	Purge gas (atmo-sphere)	Purge <sup>b</sup> gas flow (cc/min)	Weight loss (g)	Final COB conc. (ppb)
2	GLIM	481	15	23.0	31.89	Air	100 10	1.79	1.3
4	GLIM	481	15	23.0	32.87	Air	100 10	1.79	0.8
8	MCBC	556	15	23.0	30.63	Air	100 10	3.20	0.99
13	MCBC	548	5	23.0	30.19	Air	100 10	3.08	0.53

<sup>a</sup>See time-temperature logs, Appendix F.

<sup>b</sup>Precision based on calibration data for rotameter.

0277EPA-F-11

**ANALYTICAL DATA SHEETS**

- 7A 2,3,7,8-TCDD RESULTS FOR UNCONTAMINATED AND CONTAMINATED  
SOIL SAMPLES USED FOR LABORATORY THERMAL DESORPTION TESTS**
  
- 7B 2,3,7,8-TCDD RESULTS FOR SOIL SAMPLES AFTER LABORATORY THERMAL  
DESORPTION TESTS**
  
- 7C ANALYTICAL REPORTS FOR HERBICIDE COMPOUNDS IN SAMPLES BEFORE  
AND AFTER LABORATORY THERMAL DESORPTION TESTS**



ANALYTICAL DATA FOR 2,3,7,8-TCDF CONCENTRATION AND COMPOSITIONAL ISOTOPES

Report Date: 4/1/95  
Customer: GRI, V&I, F&L

Sample Number	Enteris Cleanup Met. (g)	P/P Total Mass. (g)	TCDF Conc. (ppb)	Date	Time	Rel. Vol. Almond. (μl)	P/P Conc. (ppb)	Mass. % C12	P/P Conc. (ppb)	Rel. Vol. Almond. (μl)	P/P Conc. (ppb)	Mass. % C13	Total Conc. (ppb)	Rel. Vol. Almond. (μl)	P/P Conc. (ppb)	Mass. % C13	Final Conc. (ppb)	Sample No.	P/P Conc. (ppb)	Mass. % C13	Final Conc. (ppb)
J 1877	Yes	18.47	ND	0.28	10/31/94	14:17		0.79	696	99			115520	70000	90000	110000	70000	115520	90000	110000	70000
J 1878	Yes	18.34	ND	0.44	10/31/94	14:50		0.77	213	106			201278	19000	19000	201278	19000	201278	19000	201278	19000
J 1879	Yes	9.91	ND	0.58	10/31/94	15:23		0.84	218	106			91100	20000	20000	91100	20000	91100	20000	91100	20000
J 1880	Yes	1.3	93.9		10/31/94	15:57	0.79	0.98	700	100			172717	40000	40000	172717	40000	172717	40000	172717	40000
J 1881	Yes	1.96	98.0		12/04/94	13:22	0.84	0.84	258	124			170762	211531	211531	170762	211531	170762	211531	170762	211531
J 1882	Yes	1.12	112		12/04/94	12:41	0.94	0.81	259	122			206552	313175	313175	206552	313175	206552	313175	206552	313175
J 1883	Yes	1.27	118		12/04/94	13:34	0.94	0.81	252	126			410644	515017	515017	410644	515017	410644	515017	410644	515017
J 1884	Yes	1.29	111		12/04/94	13:12	0.81	0.81	243	122			432170	902712	902712	432170	902712	432170	902712	432170	902712
J 1885	Yes	1.43	97.2		11/01/94	0:29	0.74	0.95	198	93			549852	730274	730274	549852	730274	549852	730274	549852	730274
J 2014	Yes	0.56	470		17/19/94	16:18	0.70	0.70	149	70			2511590	2165100	2165100	2511590	2165100	2511590	2165100	2511590	2165100
J 2015	Yes	1.02	548		01/29/95	22:15	0.80	0.86	190	94			1501790	2154090	2154090	1501790	2154090	1501790	2154090	1501790	2154090
J 2016	Yes	1.29	510		01/28/95	23:33	0.84	0.75	209	102			477212	605739	605739	477212	605739	477212	605739	477212	605739
J 2155	Yes	3.51	149		01/19/95	0:13	0.90	0.81	208	100			3928668	3435810	3435810	3928668	3435810	3928668	3435810	3928668	3435810
J 2156	Yes	3.71	140		01/19/95	32:42	0.79	0.80	202	101			4276830	3435320	3435320	4276830	3435320	4276830	3435320	4276830	3435320
J 1866	Yes	1.12	11.0		11/01/94	10:36	0.80	0.81	253	126			510104	654414	654414	510104	654414	510104	654414	510104	654414
J 1867	Yes	1.27	70.9		11/01/94	11:11	0.70	0.80	203	102			670290	917972	917972	670290	917972	670290	917972	670290	917972
J 1868	Yes	1.27	68.0		11/01/94	11:56	0.80	0.80	208	100			213624	410000	410000	213624	410000	213624	410000	213624	410000
J 1869	Yes	1.44	99.1		10/31/94	11:23	0.82	0.79	279	114			681948	588592	588592	681948	588592	681948	588592	681948	588592
J 1870	Yes	1.29	98.5		11/01/94	13:23	0.80	0.82	201	101			591952	755987	755987	591952	755987	591952	755987	591952	755987
J 1871	Yes	1.07	104		10/31/94	11:56	0.70	0.79	210	103			810201	1046190	1046190	810201	1046190	810201	1046190	810201	1046190

Lab: GRS Research

Project: 10101  
 Column: 10101

APPENDIX E-1. (Cont from)

Lab: IAS Knoxville

Sample Number	Extra Cleanup	Aligned Met. (s)	PFB SCOD Mass. (s)	62/75 Met. (s)	Instr. ID	Date	Time	Rel. Ion Abund.		PFB Surrogate		222	252	286	10101	10101		
								320/322	337/334	62/75	62/75							
J 1920	Yes	1.20	477	0.00	4000	12/03/04	20:52	0.79	0.01	143	72	19464400	23091000	11050220	53939	1943170	746140	J01
J 2012	Yes	1.57	428	0.00	4000	01/19/05	15:01	0.79	0.70	133	67	12195700	15375400	6950000	453790	1709440	2727920	J01
J 2013	Yes	1.37	450	0.00	4000	01/19/05	15:45	0.80	0.02	137	69	5126900	7190870	3295470	274633	1062700	1791640	J01
J 1939	Yes	1.91	873	0.00	4000	12/03/04	11:41	0.79	0.02	146	73	18227000	20730700	9436130	241636	956830	1170170	J01
J 1900	Yes	2.11	465	0.00	4000	12/03/04	13:09	0.79	0.79	148	73	13516400	17563400	8037630	179555	1173710	1691760	J01
10100135(00)	Yes	10.0	40	0.02	4500	11/15/04	0:51	0.00	0.00	253	126				100720	216900	255760	J01
10100137A(00)	Yes	10.0	40	0.40	4000	11/09/04	11:00	0.00	0.00	226	113				162940	419775	539513	2006104
10100137B(00)	Yes	10.0	40	0.70	4000	11/09/04	14:14	0.79	0.79	226	113				57760	1760700	1206177	2006104
10100105(00)	Yes	10.0	40	0.40	4500	11/29/04	4:50	0.04	0.04	151	76				195104	711604	1006496	J01
10100107(00)	Yes	10.0	40	0.21	4000	01/19/05	0:59	0.00	0.00	133	67				405090	1011740	2270010	J01
10100108(00)	Yes	10.0	40	0.55	4500	01/19/05	9:04	0.79	0.79	214	137				112305	190320	2006104	2006104
10100120(00)	Yes	10.0	40	0.69	4500	01/19/05	7:06	0.00	0.00	215	127				157345	275605	400720	2006104

© 2011 IAS - Knoxville

ANNUAL DATA FOR 2,3,7,8 TCDF AND RELATED TOXIC SUBSTITUTES

Report Date: 8/2005  
 Customer: EPA/OPDS/ES/C

Line: 1035 Hexachloro

Sample Number	Catch Cleanup	Alignm. Met. (g)	Net Wt. (g)	Wt. %	Factor	Date	Time	Net. Wt. (g)	Wt. %	Wt. %	Wt. %	Wt. %	Wt. %	Relatives to Hexachloro		Wt. %	Wt. %	Wt. %
														322	320			
J 1940	Yes	9.97	4.5	0.53	0.00	11/12/04	12:15	0.03	0.04	233	116	10902.1	125120	0.00720	117177	24100	769110	Suspected
J 1941	Yes	9.75	1.6	0.03	0.00	12/04/04	11:13	0.70	0.03	144	72	251400	340432	158977	472508	17790100	2112100	Suspected
J 1942	Yes	9.93	0.81	0.00	0.00	12/04/04	11:46	0.00	0.05	140	72	166784	117416	921306	2099100	10626700	17902400	Suspected
J 1945	Yes	9.41	0.31	0.00	0.00	12/04/04	10:34	0.77	0.03	139	70	21644	202740	109912	1969240	7400000	9700000	Suspected
J 2158	Yes	10.39	10	0.44	0.00	01/19/05	9:33	0.00	0.00	134	97	11049	17066	3720	172440	544712	647152	Suspected
J 1943	Yes	10.2	1.26	0.03	0.00	11/12/04	12:51	0.06	0.06	240	270	81344	131119	46112	322940	1101200	1540000	Suspected
J 1944	Yes	10.0	0.83	0.00	0.00	01/09/05	22:20	0.04	0.04	227	64	35670	40104	10750	206667	177740	918416	Suspected
J 1946	Yes	10.87	0.45	0.00	0.00	12/04/04	13:35	0.02	0.00	140	70	39640	49232	20512	126207	493463	1417716	Suspected
J 1946	Yes	9.91	0.71	0.00	0.00	12/04/04	15:06	0.00	0.01	136	68	1213050	1570500	701641	472950	1745030	1540000	Suspected
J 2153	Yes	9.46	10.3	0.74	0.00	01/19/05	12:09	0.79	0.01	200	100	200104	300939	107040	252475	654010	817736	Suspected
J 2154	Yes	10.60	6.6	0.70	0.00	01/19/05	11:31	0.70	0.02	181	92	66240	64792	70512	110501	475100	507512	Suspected
J 2019	Yes	10.13	0.99	0.00	0.00	01/19/05	10:12	0.79	0.02	132	68	47796	60112	20012	240075	652752	747074	Suspected
J 2157	Yes	10.29	0.74	0.00	0.00	01/19/05	10:57	0.77	0.01	202	101	0.00	0.00	206	0.00	100775	135004	Suspected
Blank 100(m)	Yes	10.0	10	0.56	0.00	11/21/04	10:29	0.00	0.00	206	103	0.00	0.00	0.00	0.00	0.00	0.00	Suspected
Blank 150(m)	Yes	10.0	10	0.48	0.00	12/04/04	15:31	0.00	0.03	175	87	0.00	0.00	0.00	0.00	0.00	0.00	Suspected
Blank 170(m)	Yes	10.0	10	0.69	0.00	01/19/05	9:06	0.00	0.00	215	107	0.00	0.00	0.00	0.00	0.00	0.00	Suspected
Blank 160(m)	Yes	10.0	10	0.56	0.00	01/19/05	9:44	0.00	0.00	218	117	0.00	0.00	0.00	0.00	0.00	0.00	Suspected
J 2203	Yes	10.00	0.53	0.00	0.00	02/21/05	10:21	0.79	0.02	215	100	16709	29212	12504	112274	392445	650670	Suspected
J 2204	Yes	10.36	21.0	0.03	0.00	02/21/05	16:10	0.03	0.03	216	100	396600	993005	421515	109041	741120	117000	Suspected
J 2205	Yes	10.71	25.7	0.02	0.00	02/21/05	22:36	0.02	0.01	244	122	1049670	1317140	805005	169515	300515	400010	Suspected
J 2206	Yes	9.94	30.5	0.00	0.00	02/21/05	21:20	0.00	0.01	197	99	237090	2970000	1761900	209251	601629	700070	Suspected
J 2207	Yes	9.97	4.4	0.00	0.00	02/21/05	21:59	0.78	0.03	200	100	11000	101000	300100	110000	110000	227000	Suspected
Blank 210(m)	Yes	10.0	10	0.25	0.00	02/21/05	14:40	0.00	0.00	211	107	0.00	0.00	0.00	0.00	0.00	0.00	Suspected

Corrected for contribution by active WDM; 0.9% of wt 322 subtracted.  
 00 - Suspected Blank  
 10 - Field Blank  
 P - Particle Size/Concentration Analysis  
 00 - Not Detected  
 B - Active WDM Spike  
 0 - Duplicate/Fertilized Field Blank  
 00 - Detection Limited  
 Wt. % based on 257 mg.



IT CORPORATION

## IT ANALYTICAL SERVICES

8815 Middlebrook Pike • Knoxville, Tennessee 37921 • 615-586-6401



## CERTIFICATE OF ANALYSIS

TO IT Technology Development  
ATTN: Dick Kelsel  
312 Directors Drive  
Knoxville, TN 37923

DATE REPORTED November 29, 1984  
PROJECT CODE ITTK 19028  
ORDER NUMBER ITTD 9736.04

Sample Description: Six (6) solid samples received November 20, 1984

Concentration units are ug/gram (ppm)

	<u>2,4-D</u>	<u>2,4,5-T</u>
437-14-3	0.47	0.15
437-14-4	0.16	0.21
437-14-5	0.16	0.24
437-3-EAFB	1200.	1700.
437-4-JI	900.	990.
437-13-1	370.	710.
Blank	0.039	0.032

Sworn to and subscribed before me this 29th  
day of November, 1984  
My commission expires January 16, 1988

[Signature]  
Notary Public

[Signature]  
Approved by

Laboratory Manager

Date



Accredited by the American Association for Laboratory Accreditation in the chemical field as being so listed in the current AALA Directory of Accredited Laboratories



**IT ANALYTICAL SERVICES**  
 2315 Middlebrook Pike • Knoxville, Tennessee 37921 • 615-588-6411



**CERTIFICATE OF ANALYSIS**

TO: IT Technology Development  
 ATTN: Dick Hiesel  
 312 Directors Drive  
 Knoxville, TN 37922

DATE REPORTED: November 30, 1984  
 PROJECT CODE: ITDK 19028  
 ORDER NUMBER: ITTD 9736.04

Sample Description: 437-14-3

**ACID EXTRACTABLE ORGANICS - PRIORITY POLLUTANT ANALYSIS**

<u>Compound</u>	<u>Concentration ppm</u>	<u>Compound</u>	<u>Concentration ppm</u>
2-chlorophenol	ND	4-nitrophenol	ND
2,4-dichlorophenol	ND	p-chloro-m-cresol	ND
2,4-dimethylphenol (m-xylene)	ND	pentachlorophenol	ND
4,6-dinitro-O-cresol	ND	phenol	ND
2,4-dinitrophenol	ND	2,4,6-trichlorophenol	ND
2-nitrophenol	ND	2,4,5-Cl <sub>3</sub> phenol	<del>1.9</del>

Reanalyzed

Remarks: ND = Not detected  
 <1.0 = Detected but at a level less than the lower quantitation limit of 1.0 ppm (parts per million).

Sworn to and subscribed before me this 30th  
 day of November, 1984  
 My commission expires January 16, 1988  
 \_\_\_\_\_  
 Notary Public

Dick Hiesel  
 Approved by \_\_\_\_\_  
 Laboratory Manager  
 Title

**AAA** Accredited by the American Association for Laboratory Accreditation in the chemical field as being in good standing in the current AAA Directory of Accredited Laboratories



**IT ANALYTICAL SERVICES**  
 5515 Middlebrook Pike • Knoxville, Tennessee 37921 • 423-528-6111



**CERTIFICATE OF ANALYSIS**

TO IT Corporation  
 ATTN: A. Groen  
 312 Directors Drive  
 Knoxville, TN 37923

DATE REPORTED June 25, 1985  
 PROJECT CODE ITDK 20085  
 ORDER NUMBER Project #9736.04

Sample Description: #4540, Clean soil, 5-2-85  
 Concentration units are ug/gram (ppm)

	<u>437-14-3</u>
2,4,5-Trichlorophenol	ND

Remarks: ND = Not detected.

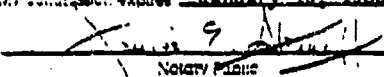
Sworn to and subscribed before me this 25th  
 day of June, 1985  
 My commission expires January 16, 1988  
  
 Notary Public

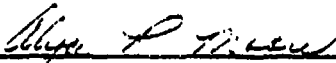
  
 Approved by \_\_\_\_\_  
 Laboratory Manager

 Accredited by the American Association for Laboratory Accreditation. The chemist  
 listed herein is listed in the current AALA Directory of Accredited Laboratories.



IT CORPORATION

# IT ANALYTICAL SERVICES

5515 Wadleybrook Pkwy • Knoxville, Tennessee 37921 • 615-533-6401



## CERTIFICATE OF ANALYSIS

TO IT Technology Development  
ATTN: Dick Heisel  
312 Directors Drive  
Knoxville, TN 37923

DATE REPORTED: November 30, 1984  
PROJECT CODE: ITDK 19028  
ORDER NUMBER: ITTD 9736.04

Sample Description: 437-14-d

### ACID EXTRACTABLE ORGANICS - PRIORITY POLLUTANT ANALYSIS

<u>Compound</u>	<u>Concentration ppm</u>	<u>Compound</u>	<u>Concentration ppm</u>
2-chlorophenol	ND	4-nitrophenol	ND
2,4-dichlorophenol	ND	p-chloro-m-cresol	ND
2,4-dimethylphenol (m-xylene)	ND	pentachlorophenol	ND
4,6-dinitro-0-cresol	ND	phenol	ND
2,4-dinitrophenol	ND	2,4,6-trichlorophenol	ND
2-nitrophenol	ND		

Remarks: ND = Not detected  
<1.0 = Detected but at a level less than the lower quantitation limit of 1.0 ppm (parts per million).

Sworn to and subscribed before me this 30th  
day of November, 1984  
My commission expires January 16, 1988  
*[Signature]*  
Notary Public

*[Signature]*  
Approved by Laboratory Manager  
Title



Accredited by the American Association for Laboratory Accreditation in the chemical  
field of testing as listed in the current AALA Directory of Accredited Laboratories



IT CORPORATION

# IT ANALYTICAL SERVICES

3315 Middlebrook Pike • Knoxville, Tennessee 37921 • 615-538-6611



## CERTIFICATE OF ANALYSIS

TO IT Technology Development  
ATTN: Dick Hiesel  
312 Directors Drive  
Knoxville, TN 37923

DATE REPORTED November 30, 1984  
PROJECT CODE ITDK 19029  
ORDER NUMBER ITTD 9736.04

Sample Description: 437-14-5  
*5 g/lr. - 1.0m.*

### ACID EXTRACTABLE ORGANICS - PRIORITY POLLUTANT ANALYSIS

<u>Compound</u>	<u>Concentration</u> ppm	<u>Compound</u>	<u>Concentration</u> ppm
2-chlorophenol	ND	4-nitrophenol	ND
2,4-dichlorophenol	ND	p-chloro-m-cresol	ND
2,4-dimethylphenol (m-xylene)	ND	pentachlorophenol	ND
4,6-dinitro-O-cresol	ND	phenol	ND
2,4-dinitrophenol	ND	2,4,6-trichlorophenol	ND
2-nitrophenol	ND		

Remarks: ND = Not detected  
<1.0 = Detected but at a level less than the lower quantitation limit of 1.0 ppm (parts per million).

Sworn to and subscribed before me this 30th  
day of November, 1984  
My commission expires January 16, 1988  
  
Notary Public

Approved by \_\_\_\_\_  
Laboratory Manager  
The \_\_\_\_\_



Accredited by the American Association for Laboratory Accreditation in the chemical field of testing as listed in the current AALA Directory of Accredited Laboratories





# IT ANALYTICAL SERVICES

3315 Alcoa Road, P.O. Box 1000, Knoxville, Tennessee 37921 • 615-555-0011



## CERTIFICATE OF ANALYSIS

TO IT Technology Development  
ATTN: Dick Haisel  
312 Directors Drive  
Knoxville, TN 37923

DATE REPORTED January 16, 1985  
PROJECT CODE ITDK 19206  
ORDER NUMBER 9736.03

Sample Description: Three (3) soil samples received December 18, 1984  
Concentration units are ug/gram (ppm)

	<u>2,4-D</u>	<u>2,4,5-T</u>
437-25-1	<0.047	0.016
437-25-2	<0.012	0.0008
437-25-3	<0.031	0.003

Sworn to and subscribed before me this 16th  
day of January, 1985  
My commission expires January 16, 1988  
  
Notary Public

Approved by \_\_\_\_\_  
The Laboratory Manager



Accredited by the American Association for Laboratory Accreditation in the chemical field of testing as listed in the current AALA Directory of Accredited Laboratories



# IT ANALYTICAL SERVICES

5516 Middlebrook Pike • Knoxville, Tennessee 37921 • 615 555-6401



## CERTIFICATE OF ANALYSIS

TO IT Technology Development  
ATTN: Dick Heisel  
312 Directors Drive  
Knoxville, TN 37923

DATE REPORTED November 30, 1984  
PROJECT CODE ITDK 19028  
ORDER NUMBER ITTD 9736.04

Sample Description: 437-13-1  
NCBG cont.

### ACID EXTRACTABLE ORGANICS - PRIORITY POLLUTANT ANALYSIS

<u>Compound</u>	<u>Concentration ppm</u>	<u>Compound</u>	<u>Concentration ppm</u>
2-chlorophenol	ND	4-nitrophenol	ND
2,4-dichlorophenol	1.1	p-chloro-m-cresol	ND
2,4-dimethylphenol (m-xylene)	ND	pentachlorophenol	ND
4,6-dinitro-O-cresol	ND	phenol	ND
2,4-dinitrophenol	ND	2,3,6-trichlorophenol	ND
2-nitrophenol	ND	2,4,5-Tris phenol	53.

Remarks: ND = Not detected  
<1.0 = Detected but at a level less than the lower quantitation limit of 1.0 ppm (parts per million).

System and suspended before the 30th  
of November, 1984  
My commission expires January 16, 1988  
  
Notary Public

Approved by  
Laboratory Manager



Accredited by the American Association for Laboratory Accreditation in the chemical and testing as listed in the current AAAL Directory of Accredited Laboratories



IT CORPORATION

# IT ANALYTICAL SERVICES

1815 Westwood Drive • Knoxville, Tennessee 37921 • 615 522-4211



## CERTIFICATE OF ANALYSIS

TO IT Technology Development  
ATTN: Dick Haisel  
312 Directors Drive  
Knoxville, TN 37923

DATE REPORTED November 30, 1984  
PROJECT CODE ITDK 19028  
ORDER NUMBER ITTD 9736.04

Sample Description: 437-4-JI

### ACID EXTRACTABLE ORGANICS - PRIORITY POLLUTANT ANALYSIS

<u>Compound</u>	<u>Concentration</u> ppm	<u>Compound</u>	<u>Concentration</u> ppm
2-chlorophenol	ND	4-nitrophenol	ND
2,4-dichlorophenol	1.9	p-chloro-m-cresol	ND
2,4-dimethylphenol (m-xylene)	ND	pentachlorophenol	ND
4,6-dinitro-o-cresol	ND	phenol	ND
2,4-dinitrophenol	ND	2,4,6-trichlorophenol	1.1
2-nitrophenol	ND	2,4,5-Cl <sub>3</sub> phenol	38.

Remarks: ND = Not detected  
<1.0 = Detected but at a level less than the lower quantitation limit of 1.0 ppm (parts per million).

Checked and described before me this 30th  
day of November, 1984  
My commission expires January 16, 1988  
  
Notary Public

Approved by \_\_\_\_\_  
Laboratory Manager



Accredited by the American Association for Laboratory Accreditation. The criteria used in this listing is used in the current AALA Directory of Accredited Laboratories.



# IT ANALYTICAL SERVICES

2215 Middlebrook Pike • Knoxville, Tennessee 37921 • 615-533-6401



## CERTIFICATE OF ANALYSIS

TO IT Technology Development  
ATTN: Dick Heisel  
312 Directors Drive  
Knoxville, TN 37923

DATE REPORTED November 30, 1984  
PROJECT CODE ITDK 19028  
ORDER NUMBER ITTD 9736.04

Sample Description: 437-3-EAFB

### ACID EXTRACTABLE ORGANICS - PRIORITY POLLUTANT ANALYSIS

<u>Compound</u>	<u>Concentration ppm</u>	<u>Compound</u>	<u>Concentration ppm</u>
2-chlorophenol	ND	4-nitrophenol	ND
2,4-dichlorophenol	2.4	p-chloro-m-cresol	ND
2,4-dimethylphenol (m-xylene)	ND	pentachlorophenol	ND
4,6-dinitro-o-cresol	ND	phenol	ND
2,4-dinitrophenol	ND	2,4,6-trichlorophenol	ND
2-nitrophenol	ND	2,4,5-Cl <sub>3</sub> phenol	20.

Remarks: ND = Not detected  
<1.0 = Detected but at a level less than the lower quantitation limit of 1.0 ppm (parts per million).

Examined and analyzed before me this 30th  
day of November, 1984  
My commission expires January 16, 1988

[Signature]  
Notary Public

[Signature]  
Accepted by LABORATORY MANAGER  
Date



Accredited by the American Association for Laboratory Accreditation in the Chemical  
field of testing for AQA in the current AALA Directory of Accredited Laboratories



# IT ANALYTICAL SERVICES

5515 Macomber Pike • Knoxville, Tennessee 37921 • 415-588-4011



## CERTIFICATE OF ANALYSIS

TO: IT Technology Development  
ATTN: Dick Heisel  
312 Directors Drive  
Knoxville, TN 37923

DATE REPORTED: January 16, 1985  
PROJECT CODE: ITDK 19206  
ORDER NUMBER: 9736.03

Sample Description: 437-25-3

### ACID EXTRACTABLE ORGANICS - PRIORITY POLLUTANT ANALYSIS

Compound	Concentration ppm	Compound	Concentration ppm
2-chlorophenol	ND	4-nitrophenol	ND
2,4-dichlorophenol	ND	p-chloro-m-cresol	ND
2,4-dimethylphenol (m-xylene)	ND	pentachlorophenol	ND
4,5-dinitro-0-cresol	ND	phenol	ND
2,4-dinitrophenol	ND	2,3,5-trichlorophenol	ND
2-nitrophenol	ND		

Remarks: ND = Not detected  
<1.0 = Detected but at a level less than the lower quantitation limit of 1.0 ppm (parts per million)

Report prepared before the date 16th  
of January, 1985  
the expiration of service January 16, 1988

\_\_\_\_\_  
ANALYST

\_\_\_\_\_  
Laboratory Manager



Approved by the American Association for Laboratory Accreditation in the chemical  
and allied fields by the current ANLA Society of Accredited Laboratories



# IT ANALYTICAL SERVICES

5215 W. Glendale Pike • Knoxville, Tennessee 37921 • 412-433-1411



## CERTIFICATE OF ANALYSIS

TO: IT Technology Development  
ATTN: Dick Heisel  
312 Directors Drive  
Knoxville, TN 37923

DATE REPORTED: January 16, 1985  
PROJECT CODE: ITOK 19206  
ORDER NUMBER: 9736.03

Sample Description: 437-25-2 -

### ACID EXTRACTABLE ORGANICS - PRIORITY POLLUTANT ANALYSIS

Compound	Concentration ppm	Compound	Concentration ppm
2-chlorophenol	ND	4-nitrophenol	ND
2,4-dichlorophenol	ND	p-chloro-m-cresol	ND
2,4-dimethylphenol (m-xylene)	ND	pentachlorophenol	ND
4,6-dinitro-0-cresol	ND	phenol	ND
2,4-dinitrophenol	ND	2,4,6-trichlorophenol	ND
2-nitrophenol	ND		

Remarks: ND = Not detected  
<1.0 = Detected but at a level less than the lower quantitation limit of 1.0 ppm (parts per million)

Sample received by the Lab. 16th  
Date: January, 1985  
My responsibility expires January 16, 1988

*[Signature]*  
Henry P. [unclear]

*[Signature]*  
LABORATORY MANAGER



Approved by the American Association for Laboratory Accreditation in the month of [unclear] 1985 as a member of the current AAAL Directory of Accredited Laboratories



# IT ANALYTICAL SERVICES

5815 Middlebrook Pike • Knoxville, Tennessee 37921 • 615-628-3471



## CERTIFICATE OF ANALYSIS

TO IT Technology Development  
ATTN: Dick Helsei  
312 Directors Drive  
Knoxville, TN 37923

DATE REPORTED January 16, 1985  
PROJECT CODE ITDK 19206  
ORDER NUMBER 9736.03

Sample Description: 437-25-1

### ACID EXTRACTABLE ORGANICS - PRIORITY POLLUTANT ANALYSIS

Compound	Concentration ppm	Compound	Concentration ppm
2-chlorophenol	ND	4-nitrophenol	ND
2,4-dichlorophenol	ND	p-chloro-m-cresol	ND
2,4-dimethylphenol (m-xylene)	ND	pentachlorophenol	ND
4,5-dinitro-o-cresol	ND	phenol	ND
2,4-dinitrophenol	ND	2,4,6-trichlorophenol	ND
2-nitrophenol	ND		

Remarks: ND = Not detected  
<1.0 = Detected but at a level less than the lower quantitation limit of 1.0 ppm (parts per million)

Sworn to and subscribed before me this 16th  
day of January, 1985  
My commission expires January 16, 1988

[Signature]  
Notary Public

[Signature]  
Approved by  
Laboratory Manager



Approved by the American Association of Laboratory Accreditation, Inc. Member  
# 211767-01, listed in the current AALA Directory of Accredited Laboratories



IT CORPORATION

# IT ANALYTICAL SERVICES

5815 Middlebrook Pike • Knoxville, Tennessee 37921 • 615-555-6401



## CERTIFICATE OF ANALYSIS

TO: IT Technology Development  
ATTN: Dick Heisel  
312 Directors Drive  
Knoxville, TN 37923

DATE REPORTED: November 29, 1984  
PROJECT CODE: ITDK 19029  
ORDER NUMBER: ITTD 9736.04

Sample Description: Eight (8) solid samples received November 20, 1984

Concentration units are ug/gram (ppm)

	<u>Arsenic</u>
437-14-1	<10.
437-14-2	<10.
437-14-3	<10.
437-14-4	<10.
437-14-5	<10.
437-3-EAFB	<10.
437-4-J1	<10.
437-13-1	<10.

Sample and submitted before the 20th  
day of November, 1984  
My commission expires January 16, 1988

\_\_\_\_\_  
Notary Public

\_\_\_\_\_  
LABORATORY MANAGER



Approved by the American Association of Laboratory Accreditation in the chemical  
and metallurgical fields. The current ASLA Laboratory Accredited List is on file.



EXPERIMENTAL DATA - LABORATORY TREATABILITY TESTS

8A SUMMARY OF TEST DATA

8B TEST DATA LOGS

SUMMARY OF MEASUREMENT DATA

Chromatological test number	Soil bed sample number	Analytical sample numbers	Soil temperature (°C)	Soil temperature at test (°C)	Time to soil (min)	Soil depth (cm)	Soil identification	2,3,7,8-TCDF concentration (ppb) ± 1σ	Final 2,3,7,8-TCDF concentration (ppb) ± 1σ
1	037-0-1	1900	481	15	21.5	20.00	J1	106	4.5
2	037-10-1	1901	481	15	23.0	21.00	0g11a	101	1.3
3	037-11-1	1910	483	20	26.7	26.62	0g11a	102	0.45
4	037-12-1 <sup>a</sup>	1911	481	15	23.0	22.01	0g11a	101	0.8
5	037-15-1	1901	480	20	27.2	26.21	J1	106	1.5
6	037-16-1	1912	558	8	13.6	26.13	J1	106	0.81
7	037-17-1 <sup>b</sup>	1905							0.31
8	037-18-1	1906	558	6	16.5	21.00	0g11a	101	0.71
9	037-21-0	2019	556	15	23.0	20.63	MCBC	495	0.99
10	037-26-1	2153	483	15	22.5	21.20	MCBC	494	10.1
11	037-27-1	2154	482	20	20.0	21.56	MCBC	494	4.6
12	037-29-1	2157	481	20	19.0	41.19	MCBC (>2mm)	1018	0.74
13 <sup>c</sup>	037-32-1	2158	482	20	20.0	26.90	J1 (>2mm)	1053	0.94
14	037-33-1	2203	560	15	23.0	20.19	MCBC	494	0.51
15	037-34-1	2204	433	20	25.0	29.09	MCBC	494	27.4
16	037-35-1	2205							25.7
17	037-36-1	2206	411	15	25.6	29.93	J1	106	16.5
18	037-37-1	2207	411	15	25.6	20.71	0g11a	101	4.4

<sup>a</sup>So: 110; Temperature data on test logs; Temperature given above is appropriate average after 15 min zero.  
<sup>b</sup>Average of analyses of triplicate aliquots of soil except as noted.  
<sup>c</sup>All 2,3,7,8-TCDF analyses were obtained using acid pretreatment and subbit extraction scheme.  
<sup>d</sup>Experimental duplicate of test 2.  
<sup>e</sup>Qualitative duplicate.  
<sup>f</sup>Average of analyses for duplicate aliquots of coarse fraction.  
<sup>g</sup>Soil concentration of coarse (>2 mm) assumed to be equal to <2 mm material.  
<sup>h</sup>Experimental duplicate of test 8.

Expt # AF1  
Treatment Test Data Log

Section No.: 10A  
Revision No.: 2  
Date: Oct. 15, 1984  
Page: 2 of 2

Untreated soil identification # 437-4-JL Date of Test 11/5/84  
Treated soil identification 437-9-AFIT By A. Green

A. Treatment Test Conditions

Target temperature 476 °C (test) Purge Gas & Flow Rate 0.1 l/min  
Target residence time 15 minutes Soil depth 2-3 mm  
Special conditions \_\_\_\_\_

B. Actual Test Data

1. Test tray, utensils cleaned 10/29/84
2. Soil quantity
  - Check soil depth/uniformity - ✓
  - Weight of tray A - 433.67 grams
  - Weight of tray plus soil-start - 464.47 grams
  - Weight of untreated soil- - 30.80 grams
  - Weight of tray plus soil- end - 462.67 grams
  - Weight loss during treatment - 1.80 grams

3. Data Record

Time (min.)	Oven Indicator	Temp. (°C)	Test (NBS)	Time (min.)	Oven Indicator	Temp. (°C)	Test (NBS)
0	54		21	21:30	454		481
1	139		52				
2	283		169				
3	376		309				
4	452		418				
5	451		451				
6	452		469				
6:30	452		477				
7:00	454		481				
8:00	454		479				
10:00	455		481				
15:00	453		482				
20:00	453		481				

Purge gas flow - initial 0.1 l/min  
- final 0.1 l/min.

D. Comments/Observations

\* Start t = 0  
\* Stop t = 15 min  
- reduce set point 2°C @ 13:00 min 435 @ 464g  
- some black carbon like particles visible in treated sample when removed from oven.  
Figure 10-1A

Expt \*AF2

Section No.: 10A  
Revision No.: 2  
Date: Oct. 15, 1984  
Page: 2 of 2

Treatment Test Data Log

Untreated soil identification 437-3-EAFB

Date of Test: 11/5/84

Treated soil identification 437-10-AF2T

By H. [Signature]

A. Treatment Test Conditions

Target temperature 478 °C (test) Purge Gas & Flow Rate 0.1 L/min

Target residence time 15 minutes Soil depth 2-3 cm

Special conditions \_\_\_\_\_

B. Actual Test Data

1. Test tray, utensils cleaned 11/5/84

2. Soil quantity

Check soil depth/uniformity	-	<u>                    </u>
Weight of tray	<u>A</u>	- <u>433.77</u> grams
Weight of tray plus soil-start		- <u>465.66</u> grams
Weight of untreated soil-		- <u>31.89</u> grams
Weight of tray plus soil- end		- <u>465.09</u> grams
Weight loss during treatment		- <u>0.57</u> grams

3. Data Record

Time (min.)	Oven Indicator	Temp. (°C)	Test (NBS)	Time (min.)	Oven Indicator	Temp. (°C)	Test (NBS)
<u>0</u>	<u>54</u>		<u>24</u>	<u>18</u>	<u>454</u>		<u>481</u>
<u>1</u>	<u>139</u>		<u>55</u>	<u>20</u>	<u>454</u>		<u>481</u>
<u>2</u>	<u>288</u>		<u>173</u>	<u>23</u>	<u>454</u>		<u>480</u> *R
<u>3</u>	<u>401</u>		<u>318</u>				
<u>4</u>	<u>449</u>		<u>421</u>				
<u>5</u>	<u>451</u>		<u>449</u>				
<u>6</u>	<u>453</u>		<u>462</u>				
<u>7</u>	<u>454</u>		<u>470</u>				
<u>8</u>	<u>459</u>		<u>474</u> *				
<u>10</u>	<u>455</u>		<u>479</u>				
<u>12</u>	<u>455</u>		<u>482</u>				
<u>14</u>	<u>454</u>		<u>481</u>				
<u>16</u>	<u>454</u>		<u>481</u>				

Purge gas flow - initial 0.1 L/min  
- final 0.1 L/min.

D. Comments/Observations

4 start 5 min.  
at stop t=15 min  
redness soil pt 22 @ 12.30

Figure 10-1A

Experiment # AF3  
Treatment Test Data Log

Section No.: 10A  
Revision No.: 2  
Date: Oct. 15, 1984  
Page: 2 of 2

Untreated soil identification 437-3-CAF3 Date of Test 11/15/84  
Treated soil identification 437-11-AF3T By A. [Signature]

A. Treatment Test Conditions

Target temperature 478 °C (test) Purge Gas & Flow Rate 0.1 l/min  
Target residence time 30 minutes Soil depth 2.3 mm  
Special conditions None

B. Actual Test Data

1. Test tray, utensils cleaned 11/5/84  
2. Soil quantity  
Check soil depth/uniformity - -  
Weight of tray - 431.58 grams  
Weight of tray plus soil-start - 468.20 grams  
Weight of untreated soil - 36.62 grams  
Weight of tray plus soil-end - 467.46 grams  
Weight loss during treatment - 0.74 grams

3. Data Record

Time (min.)	Oven Indicator	Temp. (°C)	Test (NBS)	Time (min.)	Oven Indicator	Temp. (°C)	Test (NBS)
0	51		22	20	452		482
1	146		57	25	453		482
2:30	355		253	30	452		481
3	407		320	35	452		480
4	449		426	36:30	453		480
5	452		456				
6	455		470				
6:50	454 *		475				
8:00	455		480				
10:00	453		484				
12	453		485				
14	454		485				
15	454		485				

Purge gas flow - initial 0.1 l/min  
- final 0.1 l/min.

C. Comments/Observations

→ residence soil 2.4 - final 491 °C  
→ residence soil 2.4  
upper layer of soil appear more whole than submerge soil  
Figure 10-1A

Supplement # AF4  
Treatment Test Data Log

Section No.: 10A  
Revision No.: 2  
Date: Oct. 15, 1984  
Page: 2 of 2

Untreated soil identification 437-3-EAFB Date of Test 11/15/84  
Treated soil identification 437-12-AFAT By [Signature]

A. Treatment Test Conditions

Target temperature 478 °C (test) Purge Gas & Flow Rate 0.1 L/min  
Target residence time 1.5 minutes Soil depth 2-3 mm  
Special conditions none

B. Actual Test Data

1. Test tray, utensils cleaned 11/15/84
2. Soil quantity
 

Check soil depth/uniformity	-	<input checked="" type="checkbox"/>
Weight of tray	<u>A</u>	- <u>437.76</u> grams
Weight of tray plus soil-start		- <u>466.59</u> grams
Weight of untreated soil-		- <u>32.83</u> grams
Weight of tray plus soil- end		- <u>466.01</u> grams
Weight loss during treatment		- <u>0.58</u> grams

3. Data Record

Time (min.)	Oven Indicator	Temp. (°C)	Test (NBS)	Time (min.)	Oven Indicator	Temp. (°C)	Test (NBS)
0	54		23	18	452		282
1	141		59	20	451		281
2	291		179	27			
3	400		322				
4	445		426				
5:30	449		456				
6	450		463				
7	450		470				
8	451		474				
10	451		479				
12	451		482				
14	451		482				
16	452		482				

Purge gas flow - Initial 0.1 L/min  
- final 0.1 L/min.

C. Comments/Observations

Start too slow to measure

Figure 10-LA

Experiment # AF5  
Treatment Test Data Log

Section No.: 10A  
Revision No.: 2  
Date: Oct. 15, 1984  
Page: 2 of 2

Untreated soil identification 437-4-32 Date of Test 11/21/84  
Treated soil identification 437-15-AF5T By A. [Signature]

A. Treatment Test Conditions

Target temperature 475 °C (test) Purge Gas & Flow Rate 0.1 l/min air  
Target residence time 30 minutes Soil depth 2-3 mm  
Special conditions \_\_\_\_\_

B. Actual Test Data

1. Test tray, utensils cleaned 11/20/84
2. Soil quantity
 

Check soil depth/uniformity	-	<input checked="" type="checkbox"/>
Weight of tray	<u>A</u>	<u>433.77</u> grams
Weight of tray plus soil-start		<u>467.98</u> grams
Weight of untreated soil-		<u>34.21</u> grams
Weight of tray plus soil- end		<u>465.99</u> grams
Weight loss during treatment		<u>1.99</u> grams

3. Data Record

Time (min.)	Oven Indicator	Temp. (°C)	Test (NBS)	Time (min.)	Oven Indicator	Temp. (°C)	Test (NBS)
0	SA		23	20	453		481
1	149		55	25	453		460
2	302		172	30	453		480
3	416		317	35	453		479
4	445		412	37:10	453		479 <sup>xxx</sup>
5	448		441				
6	448		466				
7	450		474				
7:10			485 <sup>x</sup>				
8	450		473 <sup>+</sup>				
10	453		477				
12:15	453		480				
15	453		481				

Purge gas flow - initial 0.1 l/min  
- final 0.1 l/min.

D. Comments-Observations

*to start time shown as 30 min - black carbon like specks visible in treated soil*  
*to correct value 20 = 447*

Figure 10-1A

Experiment # AF6  
Treatment Test Data Log

Section No.: 10A  
Revision No.: 2  
Date: Oct. 15, 1964  
Page: 2 of 2

Untreated soil identification 437-4-JI Date of Test 11/2/64  
Treated soil identification 437-16-NF6T By A. Blum

A. Treatment Test Conditions

Target temperature 550 °C (test) Purge Gas & Flow Rate 0.1 air l/min  
Target residence time 8 minutes Soil depth 2-3 cm  
Special conditions \_\_\_\_\_

B. Actual Test Data

1. Test tray, utensils cleaned \_\_\_\_\_
2. Soil quantity
 

Check soil depth/uniformity	-	✓
Weight of tray <u>B</u>	-	<u>431.50</u> grams
Weight of tray plus soil-start	-	<u>467.71</u> grams
Weight of untreated soil-	-	<u>36.13</u> grams
Weight of tray plus soil- end	-	<u>465.30</u> grams
Weight loss during treatment	-	<u>2.41</u> grams

*not used  
= 534  
reference to 530.2*

3. Data Record

Time (min.)	Temp. (°C)		Time (min.)	Temp. (°C)	
	Oven Indicator	Test (NBS)		Oven Indicator	Test (NBS)
0	53	20			
1	161	59			
2	318	185			
3	435	330			
4	520	465			
5	535	535			
5:25	536	550 *			
6	538	560 *			
7	536	556			
8	537	557			
10	535	559			
12	535	559			
13:25	535	559, start to 0			

Purge gas flow - initial 0.1 l/min  
- final 0.1 l/min.

D. Comments/Observations

*\* record to 0  
A - reference not found to 530.2*

Figure 10-1A



Experimental # A77  
Treatment Test Data Log

Section No.: 10A  
Revision No.: 2  
Date: Oct. 15, 1984  
Page: 2 of 2

Untreated soil identification 437-3-EAFB Date of Test 11/21/84  
Treated soil identification 437-18-AFTT By [Signature]

A. Treatment Test Conditions

Target temperature 550 °C (test) Purge Gas & Flow Rate 0.1 air 2/min  
Target residence time 5 minutes Soil depth 2-3 mm  
Special conditions -

B. Actual Test Data

1. Test tray, utensils cleaned 11/21/84
2. Soil quantity
  - Check soil depth/uniformity - ✓
  - Weight of tray A - 433.77 grams
  - Weight of tray plus soil-start - 464.61 grams
  - Weight of untreated soil- - 31.04 grams
  - Weight of tray plus soil- end - 464.14 grams
  - Weight loss during treatment - 0.67 grams

2. Data Record

Time (min.)	Temp. (°C)		Time (min.)	Temp. (°C)	
	Oven Indicator	Test (NBS)		Oven Indicator	Test (NBS)
<u>0</u>	<u>54</u>	<u>20</u>			
<u>1</u>	<u>189</u>	<u>71</u>			
<u>2</u>	<u>332</u>	<u>202</u>			
<u>3</u>	<u>442</u>	<u>353</u>			
<u>4</u>	<u>525</u>	<u>475</u>			
<u>5</u>	<u>534</u>	<u>526</u>			
<u>6</u>	<u>534</u>	<u>542</u>			
<u>6:30</u>		<u>547</u>			
<u>7:00</u>	<u>535</u>	<u>550</u>			
<u>8:00</u>	<u>536</u>	<u>555</u>			
<u>10</u>	<u>537</u>	<u>559</u>			
<u>12</u>	<u>537</u>	<u>559</u>			
<u>14:30</u>	<u>537</u>	<u>559</u> <u>dry to 8mm</u>			

Purge gas flow - initial 0.1 2/min  
- final 0.1 2/min.

D. Comments/Observations  
\* AFTT test

Figure 10-3A

Experiment # AF8  
Treatment Test Data Log

Section No.: 10A  
Revision No.: 2  
Date: Oct. 15, 1984  
Page: 2 of 2

Untreated soil identification 437-13-N2B-C-1 Date of Test 12-13-84  
Treated soil identification 437-20-AFBT by H. Loden

A. Treatment Test Conditions

Target temperature 550 °C (test) Purge Gas & Flow Rate 0.1 air 2/min  
Target residence time 15 minutes Soil depth 2-3 mm  
Special conditions -

B. Actual Test Data

1. Test tray, utensils cleaned 12/13/84
2. Soil quantity
 

Check soil depth/uniformity	-	<u>                    </u>
Weight of tray	-	<u>431.62 grams</u>
Weight of tray plus soil-start	-	<u>462.25 grams</u>
Weight of untreated soil-	-	<u>30.63 grams</u>
Weight of tray plus soil- end	-	<u>411.27 grams</u>
Weight loss during treatment	-	<u>0.98 grams</u>

3. Data Record

Time (min.)	Temp. (°C)		Time (min.)	Temp. (°C)	
	Oven Indicator	Test (NBS)		Oven Indicator	Test (NBS)
<u>0</u>	<u>54</u>	<u>21</u>	<u>                    </u>	<u>                    </u>	<u>                    </u>
<u>1</u>	<u>144</u>	<u>43</u>	<u>                    </u>	<u>                    </u>	<u>                    </u>
<u>2</u>	<u>295</u>	<u>140</u>	<u>                    </u>	<u>                    </u>	<u>                    </u>
<u>3</u>	<u>410</u>	<u>276</u>	<u>                    </u>	<u>                    </u>	<u>                    </u>
<u>4</u>	<u>503</u>	<u>409</u>	<u>                    </u>	<u>                    </u>	<u>                    </u>
<u>5</u>	<u>530</u>	<u>496</u>	<u>                    </u>	<u>                    </u>	<u>                    </u>
<u>6</u>	<u>535</u>	<u>522</u>	<u>                    </u>	<u>                    </u>	<u>                    </u>
<u>8</u>	<u>537</u>	<u>545</u>	<u>                    </u>	<u>                    </u>	<u>                    </u>
<u>9:50</u>	<u>537</u>	<u>550</u>	<u>                    </u>	<u>                    </u>	<u>                    </u>
<u>10</u>	<u>537</u>	<u>552</u>	<u>                    </u>	<u>                    </u>	<u>                    </u>
<u>15</u>	<u>539</u>	<u>557</u>	<u>                    </u>	<u>                    </u>	<u>                    </u>
<u>20</u>	<u>546</u>	<u>557</u>	<u>                    </u>	<u>                    </u>	<u>                    </u>
<u>22:50</u>	<u>539</u>	<u>556</u>	<u>                    </u>	<u>                    </u>	<u>                    </u>

Purge gas flow - initial 0.1 l/min  
- final 0.1 l/min.

D. Comments/Observations

*\* added to so*  
*- sample appeared unchanged when put in the oven - more reddish coloration after cooling - lower layer appears slightly darker*  
*Figure 40-12*

E. P. HAF 9  
Treatment Test Data Log

Section No.: 10A  
Revision No.: 2  
Date: Oct. 15, 1984  
Page: 2 of 2

Untreated soil identification 437-13-NC66-1

Date of Test 1/12/85

Treated soil identification 437-26-AFCT

By H. H. H.

A. Treatment Test Conditions

Target temperature 478 °C (test) Purge Gas & Flow Rate 20.1 l/min

Target residence time 15 minutes Soil depth 2-3 mm

Special conditions \_\_\_\_\_

B. Actual Test Data

1. Test tray, utensils cleaned 12/10/84

2. Soil quantity

Check soil depth/uniformity	-	_____
Weight of tray	-	<u>471.95</u> grams
Weight of tray plus soil-start	-	<u>462.96</u> grams
Weight of untreated soil-	-	<u>21.35</u> grams
Weight of tray plus soil- end	-	<u>462.12</u> grams
Weight loss during treatment	-	<u>0.84</u> grams

3. Data Record

Time (min.)	Oven Indicator	Temp. (°C)	Test (NBS)	Time (min.)	Oven Indicator	Temp. (°C)	Test (NBS)
0	52		20	20	452		403
1	210		97	22:30	452		482
2	320		220				
3	452		362				
4	450		424				
5	451		448				
6	452		463				
7	452		472				
7:20			475				
8	453		477				
9	454		481				
10	452		483				
15:40	452		488				

Purge gas flow - initial \_\_\_\_\_ l/min  
- final \_\_\_\_\_ l/min.

C. Comments/Observations

Exp. 1 - AFI 10  
 Treatment Test Data Log

Untreated soil identification 437-13-NCS-1 Date of Test 11/2/65  
 Treated soil identification 437-27-AFIOT By H. C. Coe

A. Treatment Test Conditions

Target temperature 475 °C (test) Purge Gas & Flow Rate                          l/min  
 Target residence time 30 minutes Soil depth 2-3 cm  
 Special conditions   

B. Actual Test Data

1. Test tray, utensils cleaned 11/2/65  
 2. Soil quantity   

Check soil depth/uniformity	-	<u>                        </u> ✓
Weight of tray	-	<u>433.79</u> grams
Weight of tray plus soil-start	-	<u>485.29</u> grams
Weight of untreated soil-	-	<u>31.56</u> grams
Weight of tray plus soil- end	-	<u>464.49</u> grams
Weight loss during treatment	-	<u>0.80</u> grams

3. Data Record

Time (min.)	Temp. (°C)		Time (min.)	Temp. (°C)	
	Oven Indicator	Test (NBS)		Oven Indicator	Test (NBS)
<u>0</u>	<u>54</u>	<u>23</u>	<u>30</u>	<u>453</u>	<u>461</u>
<u>1</u>	<u>178</u>	<u>68</u>	<u>35</u>	<u>453</u>	<u>460</u>
<u>2</u>	<u>337</u>	<u>167</u>	<u>38</u>	<u>453</u>	<u>466</u>
<u>3</u>	<u>450</u>	<u>347</u>			
<u>4</u>	<u>450</u>	<u>416</u>			
<u>5</u>	<u>452</u>	<u>441</u>			
<u>6</u>	<u>452</u>	<u>456</u>			
<u>7</u>	<u>453</u>	<u>466</u>			
<u>8</u>	<u>457</u>	<u>473</u> <small>steady</small>			
<u>10</u>	<u>453</u>	<u>480</u>			
<u>15</u>	<u>453</u>	<u>483</u>			
<u>20</u>	<u>457</u>	<u>482</u>			
<u>25</u>	<u>453</u>	<u>482</u>			

Purge gas flow - Initial 0.1 l/min  
 - Final 0.1 l/min.

C. Comments/Observations

Figure 10-1A

Exp 4A #11  
 Treatment Test Data Log

Untreated soil identification 4684 + 10 mesh Date of Test 1/12/85  
 Treated soil identification 137-29-4=11T By A. H.

A. Treatment Test Conditions

Target temperature 476 °C (test) Purge Gas & Flow Rate 0 l/min  
 Target residence time 30 minutes Soil depth \_\_\_\_\_ mm  
 Special conditions - soil is oversize of 10 mesh in test run

B. Actual Test Data

1. Test tray, utensils cleaned 1/12/85
2. Soil quantity
- |                                |          |                     |
|--------------------------------|----------|---------------------|
| Check soil depth/uniformity    | -        | _____               |
| Weight of tray                 | <u>A</u> | <u>433.71</u> grams |
| Weight of tray plus soil-start | -        | <u>474.90</u> grams |
| Weight of untreated soil-      | -        | <u>41.19</u> grams  |
| Weight of tray plus soil- end  | -        | <u>474.00</u> grams |
| Weight loss during treatment   | -        | <u>0.90</u> grams   |

3. Data Record

Time (min.)	Oven Indicator	Temp. (°C)	Test (NBS)	Time (min.)	Oven Indicator	Temp. (°C)	Test (NBS)
0	50		25	39	654		481 <u>at 1.2</u>
1	194		65				
2	315		165				
3	425		312				
4	440		405				
5	469		430				
7	452		460				
8	453		468				
9	453		473 <u>stabilize</u>				
10	454		476				
15	454		483				
20	454		482				
30	454		461				

Purge gas flow - initial \_\_\_\_\_ l/min  
 - final \_\_\_\_\_ l/min.

D. Comments/Observations

@ ~ 450°C popping & cracking heard while run - some weight loss may be due to loss of sample moisture  
 - still occasional pop @ 470°C  
 Figure 10-1A  
 moisture

Equipment # AF12  
 Treatment Test Data Log

Untreated soil identification #456 E - T10 mesh <sup>Inclusion info</sup> Date of Test 1/12/85  
 Treated soil identification 457-30 - AF12T By A. J. [Signature]

A. Treatment Test Conditions

Target temperature 275 °C (test) Purge Gas & Flow Rate 0.1 L/min  
 Target residence time 30 minutes Soil depth \_\_\_\_\_ mm  
 Special conditions T10 mesh soil (oven from previous)

B. Actual Test Data

1. Test tray, utensils cleaned 1/12/85
2. Soil quantity
 

Check soil depth/uniformity	-	_____
Weight of tray	-	<u>431.55</u> grams
Weight of tray plus soil-start	-	<u>465.45</u> grams
Weight of untreated soil-	-	<u>36.90</u> grams
Weight of tray plus soil- end	-	<u>465.38</u> grams
Weight loss during treatment	-	_____ grams

3. Data Record

Time (min.)	Oven Indicator	Temp. (°C)	Test (NBS)	Time (min.)	Oven Indicator	Temp. (°C)	Test (NBS)
0	54		22				
1	164		52				
2	305		160				
3	425		310				
4	447		400				
5	441		438				
7	453		471				
8	453		474 <sup>start</sup>				
10	453		479				
15	453		483				
25	453		482				
30	454		481				
38	454		461 <sup>stop</sup>				

Purge gas flow - initial 0.1 L/min  
 - final 0.1 L/min.

C. Comments/Observations

Figure 10-1A

Exp 14 AF 14  
 Treatment Test Data Log

Untreated soil identification #437-13-UCBC-1  
 Treated soil identification 437-33-AF14T

Date of Test 2/7/85  
 by A G

A. Treatment Test Conditions

Target temperature 430 °C (cast) Purge Gas & Flow Rate 0-1 l/min  
 Target residence time 30 minutes Soil depth 2-3 mm  
 Special conditions \_\_\_\_\_

B. Actual Test Data

1. Test tray, utensils cleaned 2/7/85
2. Soil quantity
 

Check soil depth/uniformity	-	<input checked="" type="checkbox"/>
Weight of tray B	-	<u>431.56</u> grams
Weight of tray plus soil-start	-	<u>961.05</u> grams
Weight of untreated soil-	-	<u>29.99</u> grams
Weight of tray plus soil- end	-	<u>460.39</u> grams
Weight loss during treatment	-	<u>0.74</u> grams

3. Data Record

Time (min.)	Oven Indicator	Temp. (°C)	Test (NBS)	Time (min.)	Oven Indicator	Temp. (°C)	Test (NBS)
0	50		21	30	404		431
1	153		49	35	404		431
2	301		170				
3	405		300				
4	406		376				
5	408		400				
9:30	408		428				
10	408		430				
17:30	407		424				
18	406		425				
19	405		431				
20	404		432				
24	403		431				

Purge gas flow - Initial 0-1 l/min  
 - final 0-1 l/min.

C. Comments/Observations

analytical duplicate sample prepared & submitted

Figure 10-1A

Exp. # AF 15  
Treatment Test Data Log

Section No.: 10A  
Revision No.: 2  
Date: Oct. 16, 1984  
Page: 2 of 2

Untreated soil identification 437-4-5L Date of Test 2/7/85  
Treated soil identification 437-3A-AFIST By A. Khan

A. Treatment Test Conditions

Target temperature 430 °C (test) Purge Gas & Flow Rate 0.1 l/min  
Target residence time 20 minutes Soil depth 2-3 mm  
Special conditions \_\_\_\_\_

B. Actual Test Data

1. Test tray, utensils cleaned 2/7/85
2. Soil quantity
 

Check soil depth/uniformity	-	
Weight of tray	-	<u>433.76</u> grams
Weight of tray plus soil-start	-	<u>467.69</u> grams
Weight of untreated soil-	-	<u>29.93</u> grams
Weight of tray plus soil- end	-	<u>462.18</u> grams
Weight loss during treatment	-	<u>1.51</u> grams

3. Data Record

Time (min.)	Temp. (°C)		Time (min.)	Temp. (°C)	
	Oven Indicator	Test (NBS)		Oven Indicator	Test (NBS)
<u>0</u>	<u>52</u>	<u>21</u>	<u>25:40</u>	<u>403</u>	<u>432 stop</u>
<u>1</u>	<u>127</u>	<u>45</u>			<u>+20 min</u>
<u>2</u>	<u>300</u>	<u>153</u>			
<u>3</u>	<u>407</u>	<u>293</u>			
<u>4</u>	<u>402</u>	<u>365</u>			
<u>5</u>	<u>402</u>	<u>390</u>			
<u>5:40</u>	<u>404</u>	<u>400</u>			
<u>6:00</u>	<u>404</u>	<u>405</u>			
<u>8:00</u>	<u>406</u>	<u>426</u>			
<u>10:00</u>	<u>406</u>	<u>430</u>			
<u>13</u>	<u>402</u>	<u>432</u>			
<u>15</u>	<u>463</u>	<u>432</u>			
<u>20</u>	<u>463</u>	<u>432</u>			

Purge gas flow - initial 0.1 l/min  
- final 0.1 l/min.

D. Comments/Observations

Figure 10-1A



Expt # AF 16  
Treatment Test Data Log

Section No.: 10A  
Revision No.: 2  
Date: Oct. 15, 1984  
Page: 2 of 2

Untreated soil identification 437-3- EAFB  
Treated soil identification 437-35-AF16T

Date of Test 2/7/85  
By A. Allen

A. Treatment Test Conditions

Target temperature 430 °C (test) Purge Gas & Flow Rate G-1 l/min cm  
Target residence time 20 minutes Soil depth 2-3 mm  
Special conditions \_\_\_\_\_

B. Actual Test Data

1. Test tray, utensils cleaned 2/7/85
2. Soil quantity
 

Check soil depth/uniformity	-	<input checked="" type="checkbox"/>
Weight of tray	<u>D</u>	<u>431.55</u> grams
Weight of tray plus soil-start		<u>462.29</u> grams
Weight of untreated soil-		<u>30.78</u> grams
Weight of tray plus soil- end		<u>461.74</u> grams
Weight loss during treatment		<u>6.55</u> grams

3. Data Record

Time (min.)	Temp. (°C)	Test (NBS)	Time (min.)	Temp. (°C)	Test (NBS)
0	52	23	21	403	432
1	156	52	24	403	432
2	306	53	25:40		
3	407	303			
4	403	366			
5	403	391			
5:40	407	400 <sup>initial</sup>			
6:00	407	403 <sup>new</sup>			
7:00	406	420 <sup>initial</sup>			
10:00	406	428			
12	405	432			
15	407	432			
18	403	432			

Purge gas flow - initial G-1 l/min  
- final G-1 l/min.

D. Comments/Observations

Figure 10-1A

PARTICLE ENTRAINMENT THEORY

## PARTICLE ENTRAINMENT THEORY

There are three equations of interest to estimate entrainment velocities of particles in air. These correlations do not determine the rate of entrainment.

1. The horizontal fluid velocity required to cause a spherical particle at rest on a bed of solids (soil) to lift off the bed is depicted in Figure G-1, assuming a particle density of 2.6 g/cc and air temperature of 2000°F.

$$U = \sqrt{\frac{4g D_p (\rho_p - \rho_f)}{3 \rho_f}} \quad (\text{Reference A})$$

where:  $U$  = fluid velocity (ft/sec),  
 $g$  = gravitational constant (32.3 ft/sec<sup>2</sup>),  
 $D_p$  = particle diameter (ft),  
 $\rho_p$  = particle density (lb/ft<sup>3</sup>),  
 $\rho_f$  = fluid density (lb/ft<sup>3</sup>)

This equation does not account for viscosity of the air or the static friction of the particle against the bed surface. Similar correlations are reported for non-spherical particles, multiple particles, and inclined ducts.

2. The terminal settling velocity of a particle falling through a fluid is expressed by:

$$U_T = \sqrt{\frac{4g D_p (\rho_p - \rho_f)}{3 \rho_f C_d}} \quad (\text{Reference B})$$

This equation is not for horizontal air velocities. The  $C_d$  term or coefficient of drag accounts for the characteristics of the fluid and particle.

3. The last correlation developed by Zenz (Reference C) shown in Figure G-2 estimates the horizontal velocity in pipes required to pick up a particle at rest and entrain it in the air and also the saltation velocity required to keep the particle suspended based on the particle Reynolds number and drag coefficient. This last correlation accounts for both the density and viscosity of the fluid.

The difficulty in using the Zenz correlation is determining the velocity profile within the kiln and accounting for the kiln rotation and particle size distribution. The turbulence profile due to the burner nozzles should be considered as well. The effect of large particles in soil samples with the same mean particle distribution has been observed to reduce the entrainment rate significantly.

In summary, the following factors are thought to effect any theoretical based estimate of entrainment.

- Velocity profile in kiln
  - Entrance and end effects
  - Burner nozzles
- Kiln diameter and length
- Kiln rotation effects
- Particle size distribution effects

#### REFERENCES

- A. Zenz, F. A. and Othmer, D. F., "Fluidization and Fluid-Particle Systems," Reinhold Chemical Engineering Series, C. W. Wilke, ed., Reinhold Publishing Corp., NY.
- B. Boucher, D. F., "Fluid and Particle Dynamics," Chemical Engineers' Handbook, 5th ed., H. B. Crawford and R. J. Keeler, eds., McGraw-Hill Book Company, NY, 1973, 68 pp.
- C. Zenz, F. A., "Conveyability of Materials of Mixed Particle Size," I & EC Fundamentals, 3:1, February 1964.

0318 JI-AP-6

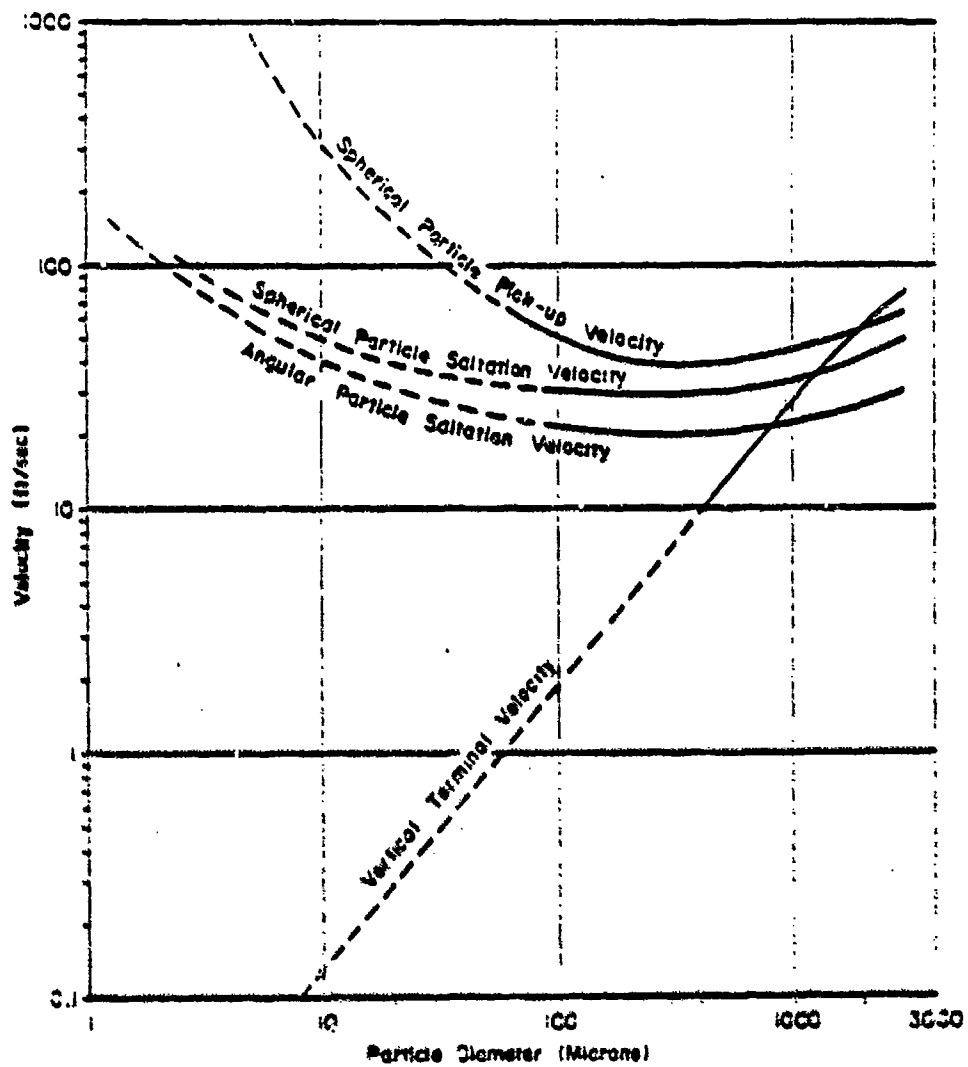

Figure G-2 Correlation of Single Particle Entrainment Saltation Velocities

SPS-09/00/5-3-83

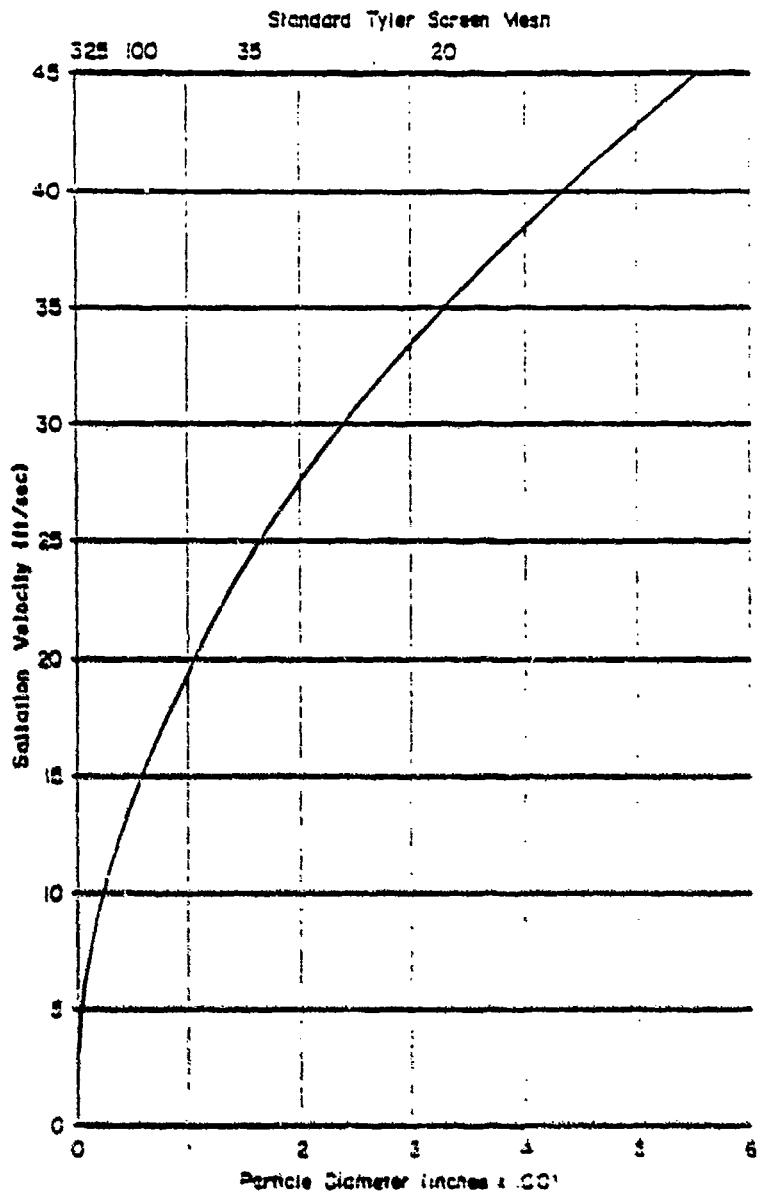

Figure 3-1  
Theoretical Saltation Velocity Versus Particle Diameter

9738.06 / JWH/S-3-85

SAMPLE COMPUTER HEAT TRANSFER AND HEAT MATERIAL BALANCE CALCULATIONS

10A ALLIS-CHALMERS HEAT TRANSFER COMPUTER PRINTOUT - RUN 2

10B ITC HEAT AND MATERIAL BALANCE COMPUTER PRINTOUT - RUN 2

2/13/85

NAME 0.89999974 \*LS= 0.89999974 \*EGAS= 520.000000 \*D1= 4.20000007 \*D2= 5.42000007 \*FA= 0.39099991E-01 \*FC= 6.54.000000 \*FS= 7400.000000 \*XEL= 0.5100000022 \*TS1= 60.00000000 \*TT2= 1450.000000 \*TJ= 0.000000000E+00 \*MFC= 0.00000000E+00 \*TCL= 100.000000 \*CS= 0.2500000019 \*COM9= 91567.0000 \*PEF= 0.8000000311 \*FLENGTH= 6.00000000 \*AM01ST= 0.117999922E-01 \*RLENGTH= 16.90000000

SOIL 4760 RUN 2

INPUT DATA:  
 INTERNAL KILN DIAMETER (FT) 4.42  
 EXTERNAL KILN DIAMETER (FT) 5.42  
 AREA LOAD FRACTION 0.040  
 GAS FLOW RATE (LB/HR) 5354.  
 2430.  
 AVERAGE GAS CONDUCTIVITY (BTU/FT-MR-F) 0.0445  
 WILM WALL CONDUCTIVITY (BTU/FT-MR-F) 0.410  
 AVERAGE GAS VISCOSITY (LB/HR-FT) 0.116  
 AVERAGE GAS DENSITY (LB/CUFT) 0.0169  
 AVERAGE PRANDTL NUMBER OF GAS 0.71  
 AVERAGE GAS EMISSIVITY 920.00  
 AVERAGE SOLID EMISSIVITY 0.90  
 INCREMENT OF KILN WALL EMISSIVITY 0.90  
 INCREMENT OF KILN LENGTH (FT) 0.10  
 INITIAL HEAT TRANSFER COEF FROM WALL TO FLUID (BTU/MR-F-FT2) 2.38  
 CONVERGENCE CRITERION FOR INNER WALL TEMPERATURE 0.0050  
 CONVERGENCE CRITERION FOR OUTER WALL TEMPERATURE 0.0100  
 CONVERGENCE CRITERION FOR SOLIDS TEMPERATURE 5.  
 AMBIENT FLUID CONDUCTIVITY (LB/KUZYR) 0.0174  
 PRANDTL NUMBER OF THE AMBIENT FLUID 0.0700  
 AMBIENT FLUID VISCOSITY (LB/HR-FT) 0.71  
 AMBIENT AIR TEMPERATURE (F) 0.045  
 63.

HEAT INPUT BY FUEL COMBUSTION (BTU/MIN) 91827.0  
 FLAME LENGTH ESTIMATED (FT) 6.00  
 EMISSIVITY OF FLAME 0.90  
 FLAME HEAT RELEASE DISTRIBUTION, GAMMA 6  
 FLAME HEAT RELEASE DISTRIBUTION, DELTA 0.0  
 FLAME HEAD LENGTH FROM SOLID EXIT (FT) 0.0  
 HEAT OF CLINKER FORMATION (BTU/MIN) 0.0  
 CLINKERING HEAT RELEASE LENGTH (FT) 0.0  
 CLINKERING HEAT RELEASE, GAMMA 0  
 CLINKERING HEAT RELEASE, DELTA 0.0  
 CLINKERING HEAD LENGTH (FT) 0.0  
 CALCINATION HEAT REQUIRED (BTU/PIN) 0.0  
 MOISTURE FRACTION IN ASSED SOLIDS 0.012  
 WATERPUN SOLID TEMPERATURE (F) 1999.0

THE CALCULATED TOTAL BED ANGLE (DEGREES) 87.22  
 THE CALCULATED BED DEPTH FT. 0.384

DATA SUMMARY

INLET GAS TEMPERATURE (F)	100.0	GAS TO SOLIDS (CONVECTION)	3.54	50. FT/FT
INLET SOLID TEMPERATURE (F)	1405.3	GAS TO SOLIDS (RADIATION)	2.65	50. FT/FT
GAS EXIT TEMPERATURE (F)	1465.9	GAS TO SOLIDS (FREE CONVECTION)	55.23	50. FT/FT
SOLID EXIT TEMPERATURE (F)	60.0	GAS TO WALL (CONVECTION)	11.23	50. FT
WATERPUN SOLID TEMPERATURE (F)	1405.4	GAS TO WALL (RADIATION)	11.27	50. FT/FT
KILN LENGTH (FT)	16.1	SOLIDS TO WALL (CONVECTION)	2.59	50. FT/FT
FUEL CONSUMPTION (BTU/MIN)	11697.0	SOLIDS TO WALL (RADIATION)	30.81	50. FT/FT
		WALL TO AMBIENT (CONVECTION)	17.03	55. FT/FT



SUMMARY OF TEMPERATURES AND FLOWS  
DECREES F. AND LBS/HR

AXIAL DISTANCE (FEET)	SOLIDS		GASES		TM	KILN WALL		M/R
	FS	FS	FG	FG		T/D	M/W	
0.0	40.0	2400.00	100.0	8356.00	79.1	65.5	0.950	0.940
1.0	82.0	2400.00	145.5	8356.00	102.8	71.4	1.139	0.902
2.0	86.5	2400.00	822.4	2356.00	586.0	161.1	1.926	1.174
3.0	218.1	2400.00	1499.2	8356.00	1452.7	251.9	2.215	1.622
4.0	375.8	2400.00	2086.2	8356.00	1783.7	322.0	2.394	1.770
5.0	445.3	2400.00	2117.1	8356.00	1780.1	322.2	2.364	1.760
6.0	1133.2	2400.00	2033.1	8356.00	1710.4	313.1	2.367	1.746
7.0	1206.9	2400.00	2041.3	8356.00	1736.1	316.1	2.353	1.752
8.0	1268.3	2400.00	2006.0	8356.00	1753.1	318.3	2.357	1.765
9.0	1268.3	2400.00	1972.4	8356.00	1760.3	319.1	2.354	1.741
10.0	1827.4	2400.00	1848.6	2356.00	1773.6	320.6	2.361	1.775
11.0	1892.3	2400.00	1925.8	8356.00	1766.2	322.0	2.364	1.772
12.0	1238.3	2400.00	1909.5	8356.00	1794.5	322.9	2.366	1.786
13.0	1291.4	2400.00	1895.8	8356.00	1799.0	323.4	2.366	1.780
14.0	1287.7	2400.00	1836.7	8356.00	1800.5	323.6	2.367	1.790
15.0	1289.2	2400.00	1873.1	8356.00	1799.9	323.5	2.367	1.789
16.0	1405.4	2400.00	1848.7	8356.00	1797.7	323.3	2.366	1.764
16.1	1405.4	2400.00	1895.9	8356.00	1797.4	323.2	2.366	1.746

SUMMARY OF HEAT TRANSFER PATHS  
ATU-52/MOURE/AFVAL FOOT

DISTANCE (FEET)	GAS -TO- SOLIDS CONVECTION RADIATION		GAS -TO- WALL CONVECTION RADIATION		WALL -TO- SOLIDS CONVECTION RADIATION		WALL -TO- AMBIENT CONV. AND RAD.	
	Q <sub>CS</sub>	Q <sub>CR</sub>	Q <sub>CS</sub>	Q <sub>CR</sub>	Q <sub>CS</sub>	Q <sub>CR</sub>	Q <sub>CA</sub>	Q <sub>RA</sub>
0.0	523.	83.	0.	0.	403.	216.	0.	171.
1.0	1081.	206.	0.	0.	1442.	358.	0.	397.
2.0	9605.	7384.	0.	0.	6097.	1459.	0.	5366.
3.0	12379.	6753.	0.	0.	6477.	6425.	0.	14789.
4.0	20285.	6797.	0.	0.	10861.	11252.	0.	15462.
5.0	18368.	2202.	0.	0.	12639.	10933.	0.	18529.
6.0	12420.	3602.	0.	0.	16130.	78615.	0.	17649.
7.0	9167.	2655.	0.	0.	11813.	64732.	0.	17910.
8.0	7329.	20601.	0.	0.	8668.	53202.	0.	14123.
9.0	5278.	17012.	0.	0.	21442.	34701.	0.	14203.
10.0	6176.	11303.	0.	0.	6851.	16669.	0.	16352.
11.0	3346.	10022.	0.	0.	3317.	29527.	0.	14494.
12.0	2237.	7574.	0.	0.	4414.	24321.	0.	13586.
13.0	1637.	5735.	0.	0.	3775.	29521.	0.	18037.
14.0	1269.	4408.	0.	0.	1235.	17789.	0.	16655.
15.0	822.	3484.	0.	0.	292.	13722.	0.	16648.
16.0	601.	2806.	0.	0.	256.	11517.	0.	16023.
16.1	786.	2750.	0.	0.	235.	14405.	0.	16019.
<b>SUM OF HEAT</b>								
<b>AVERAGE HEAT LOSS, Btu/(ft<sup>2</sup>·hr)</b>								
							0.	278214.
								906.

## \*\*\*\*\* INPUT DATA SUMMARY \*\*\*\*\*

```

1,EERU KILN CAPACITY ESTIMATION
2,AF SOIU-#1
2,2/18/85
3,9735.05
4,JLF
5,60,406.8,3,6,0,0/
6,6/
06,C      H2      O2      N2      WAT  ASH
07,SOIL          1.0/
07,0,0,0,0,0,0,0,0,0,0,0,0,0,0,0,100,0/
08,2400,0,0/
09,.001,60,0/
07,WATER          1.0/
07,0,0,0,0,0,100,0,0,0,0,0,0,0,0,0,0,0/
08,29,0,0/
09,.001,60,0/
07,AUX1          3.0/
07,91,9,0,0,0,0,0,0,0,0,0,0,0,0,0,0/
08,0,0,0/
09,18000,60,0/
07,AUX2          3.0/
07,91,9,0,0,0,0,0,0,0,0,0,0,0,0,0,0/
08,0,0,0/
09,18000,60,0/
07,FUEL1          1.0/
07,91,9,0,0,0,0,0,0,0,0,0,0,0,0,0,0/
08,306,0,0/
09,18000,60,0/
07,FUEL2          2.0/
07,91,9,0,0,0,0,0,0,0,0,0,0,0,0,0,0/
08,0,0,0/
09,18000,60,0/
10,0,406.3,3,.29689,1,100,60,.01,0,45,100/
10,
15,2200,405.8,3,.5,1,50,60,.01,0,50,50/
15,AUX2

```

I. FUEL TO PRIMARY BURNER

FUEL NAME	***** COMPONENT FLOW TO FURNACE *****					
	CARBON	HYDROGEN	OXYGEN	NITROGEN	WATER	ASH
SOIL						
PERCENT	0.000	0.000	0.000	0.000	0.000	100.000
POUNDS	0.000	0.000	0.000	0.000	0.000	2400.000
LB-MOLE	0.000	0.000	0.000	0.000	0.000	0.000
WATER						
PERCENT	0.000	0.000	0.000	0.000	100.000	0.000
POUNDS	0.000	0.000	0.000	0.000	29.000	0.000
LB-MOLE	0.000	0.000	0.000	0.000	1.610	0.000
FUEL1						
PERCENT	91.000	9.000	0.000	0.000	0.000	0.000
POUNDS	278.460	27.540	0.000	0.000	0.000	0.000
LB-MOLE	23.184	13.661	0.000	0.000	0.000	0.000
TOT FUEL						
POUNDS	278.460	27.540	0.000	0.000	29.000	2400.000
LB-MOLE	23.184	13.661	0.000	0.000	1.610	0.000

## 1. PRIMARY BURNER HEAT AND MATERIAL BALANCE

***** HEAT IN *****	TEMP DEG F	LBS / HR	BTU / LB	MM BTU/HR
FUEL SOIL	60.000	2400.000	0.001	0.000
FUEL WATER	60.000	29.000	0.001	0.000
FUEL FUEL1	60.000	306.000	18000.000	5.508
DRY AIR	60.000	8284.038	0.000	0.000
AIR HUM.	60.000	82.840	1059.900	0.088
OVERALL TOTAL	0.000	11101.879		5.596

***** HEAT OUT *****	LB-MOLES	LBS / HR	BTU/LB	MM BTU/HR
FLU GAS OUT: 1777.83 DEG F				
CO2	23.184	1020.340	461.733	0.471
H2O	19.869	357.952	1935.832	0.693
N2	113.563	3181.568	457.803	1.457
AIR (XS)	143.125	4142.019	447.551	1.854
TOTAL FLU GAS	299.740	8701.879		4.474
SOLIDS OUT BOTTOM:				
ASH	0.000	2400.000	343.567	0.825
INERT	0.000	0.000	343.567	0.000
RAD LOSS				0.297
OVERALL TOTAL	299.740	11101.879		5.596

## III. FUEL TO SECONDARY BURNER

FUEL NAME	***** COMPONENT FLOW TO FURNACE *****					
	CARBON	HYDROGEN	OXYGEN	NITROGEN	WATER	ASH
FUEL2						
PERCENT	91.000	9.000	0.000	0.000	0.000	0.000
POUNDS	0.000	0.000	0.000	0.000	0.000	0.000
LB-MOLE	0.000	0.000	0.000	0.000	0.000	0.000
AUX2						
PERCENT	91.000	9.000	0.000	0.000	0.000	0.000
POUNDS	356.929	35.301	0.000	0.000	0.000	0.000
LB-MOLE	29.717	17.510	0.000	0.000	0.000	0.000
TOT FUEL						
POUNDS	356.929	35.301	0.000	0.000	0.000	0.000
LB-MOLE	29.717	17.510	0.000	0.000	0.000	0.000

## IV. SECONDARY BURNER HEAT AND MATERIAL BALANCE

***** HEAT IN *****	TEMP DEG F	LBS / HR	BTU / LB	KWH BTU/HR
FUEL FUEL2	60.000	0.000	18000.000	0.000
FUEL AUX2	60.000	392.230	18000.000	7.060
PRIM. FLU GAS	1777.833	8701.879		4.474
DRY AIR	60.000	7963.846	0.000	0.000
AIR HUM.	60.000	79.638	1059.900	0.084
OVERALL TOTAL	0.000	17137.593		11.619

***** HEAT OUT *****	LB-MOLES	LBS / HR	BTU/LB	KWH BTU/HR
FLU GAS OUT: 2200.00 DEG F				
CO2	52.901	2328.209	593.726	1.382
H2O	41.799	753.035	2189.468	1.649
N2	259.127	7259.694	581.862	4.224
AIR (XS)	234.854	6796.634	568.466	3.864
TOTAL FLU GAS	588.681	17137.593		11.119
SOLIDS OUT BOTTOM:				
ASH	0.000	0.000	428.000	0.000
INERT	0.000	0.000	428.000	0.000
RAD LOSS				0.500
OVERALL TOTAL	588.681	17137.593		11.619

## V. PRIMARY BURNER AIR SUMMARY

	LBS AIR	***** OXYGEN ***** POUNDS	***** LB-MOLE	***** NITROGEN ***** POUNDS	***** LB-MOLE
TOTAL	8284.038	1920.903	60.028	6363.136	227.125
THEORETICAL	4142.019	960.451	30.014	3181.568	113.563
TOT - THEO.	4142.019	960.451	30.014	3181.568	113.563

PERCENT XS AIR FOR PRIMARY BURNER = 100.00

## VI. SECONDARY BURNER AIR SUMMARY

	LBS AIR	***** OXYGEN ***** POUNDS	***** LB-MOLE	***** NITROGEN ***** POUNDS	***** LB-MOLE
TOTAL	7963.846	1846.657	57.708	6117.189	218.346
THEORETICAL	5309.231	1231.104	38.472	4078.126	145.564
TOT - THEO.	2654.615	615.552	19.236	2039.063	72.782

PERCENT XS AIR FOR SECONDARY BURNER = 50.00

## VII. TOTAL AIR TO PRIM. AND SEC. BURNERS

	LBS AIR	***** OXYGEN ***** POUNDS	***** LB-MOLE	***** NITROGEN ***** POUNDS	***** LB-MOLE
TOTAL	16247.884	3767.559	117.736	12480.325	445.471
THEORETICAL	9451.250	2191.556	68.486	7259.694	259.127
TOT - THEO.	6796.634	1576.004	49.250	5220.631	186.345

TOTAL PERCENT XS AIR = 71.91

## VIII. GAS FLOW RATES

STREAM	TEMPERATURE (DEG F)	PRESSURE (PSI)	ACFM
1 PRIM OUT	1777.833	14.678	8172.188
2 SEC OUT	2200.000	14.660	19101.663
PRIM AIR	60.000	14.696	1810.575
SEC AIR	60.000	14.696	1682.457



STATISTICAL DATA

11A PARAMETERS USED IN REGRESSION ANALYSIS LISTED BY SOIL TYPE

11B PARAMETERS USED IN REGRESSION ANALYSIS LISTED IN ORDER OF  
INCREASING IVP

PARAMETERS USED IN REGRESSION ANALYSES LISTED IN ORDER OF SIZE, TYPE

Self-identification	IRMSD	Meanair temperature (°C)	Time at minimal temperature (min)	IRMSD	D	IRP	LIHC	FR	LPR	LPRN	LD	LOUPP	TP	IRMSD	IRMSD
J1	106	482	15	8315	0.50	42047	2.02531	0.04235	-1.3221	-3.1594	0.65321	3.4461	2793.2	1767256204	212329
J1	106	481	18	16514	0.50	40165	2.02531	0.01509	-1.0212	-4.1934	0.70412	3.4461	2747.3	7024407225	231361
J1	106	559	8	5514	0.50	40165	2.02531	0.00528	-2.2771	-5.2433	-0.25385	3.4461	0667.8	4885273668	312401
J1	106	432	20	9757	38.50	23728	2.02531	0.26371	-0.4398	-1.0128	1.80546	3.0613	1151.6	562733284	186626
J1	106	23	0	0	106.00	0	2.02531	0.00000	0.0000	0.0000	2.02531	1.9653	0.0	0	0
Eglin	101	462	15	9802	1.30	40039	2.00432	0.10494	-2.2820	-2.2820	0.11394	3.4361	2793.2	2705247921	212329
Eglin	101	465	30	16554	0.65	40039	2.00432	0.04464	-3.3511	-4.3130	-0.34279	3.4361	2734.0	8103700041	235325
Eglin	101	462	15	9616	0.80	40284	2.00432	0.00732	-2.1812	-4.4329	-0.79091	3.4461	2793.2	2428912656	232324
Eglin	101	559	9	6525	0.71	82805	2.00432	0.00703	-2.1531	-4.9576	-0.43314	3.4461	0477.1	6956660925	312401
Eglin	101	432	20	9426	4.40	22641	2.00432	0.04356	-1.3609	-1.1105	0.43314	3.4461	1151.6	514427761	186629
Eglin	101	23	0	0	101.00	0	2.00432	0.00000	0.0000	0.0000	2.00432	3.4361	0.0	0	0
WDC	494	557	15	1516	0.79	152409	2.03373	0.00200	-2.4501	-6.2126	-0.06438	3.4361	0637.0	23252070171	310259
WDC	494	484	15	9609	10.10	49654	2.03373	0.00945	-1.6804	-3.0900	1.06132	3.4604	0401.0	2465517110	312324
WDC	494	483	30	10774	4.60	79309	2.03373	0.00931	-2.0310	-4.1765	0.66276	3.4531	2035.0	6200417400	312324
WDC	494	559	15	10923	0.53	153070	2.03373	0.00107	-2.9535	-6.0374	-0.27572	3.4423	0356.0	23430424000	144700
WDC	494	23	0	17974	25.00	33631	2.03373	0.05305	-1.2600	-2.9216	-1.42600	3.4530	1178.0	1110401161	186761
WDC	494	23	0	0	494.00	0	2.03373	1.00000	0.0000	0.0000	2.03373	-0.9651	0.0	0	0

IRMSD - Initial 2,3,7,8-TCDF concentration (ppb)  
 IRTP - Integral of temperature over treatment period (°C · min)  
 J1 - Initial 2,3,7,8-TCDF concentration (ppb)  
 LIHC - Integral of vapor pressure over treatment period (mmHg · min)  
 FR - Initial fraction of 2,3,7,8-TCDF concentration  
 LPR - Integral of 2,3,7,8-TCDF remaining after treatment  
 LPRN - Log of LPR  
 LD - Log of final D  
 LOUPP - (Log of 2,3,7,8-TCDF vapor pressure in mmHg)  
 TP - IRP Squared  
 IRMSD - (Time) · (Temp)

PARAMETERS WITH 28 DISCRESSIONS AND 1755 IN COMP. 64. INCREASING UP

Soil Identification	DATE	Temp (°C)	Temp (°F)	SS (ppm)	0	10P	10MC	70	170	10P	10	10WY	VP	10P-10	10P-20	111P
Ep1a	806	23	73	0	0	2.02531	1.00000	0.00000	0.00000	0.00000	2.02531	-4.3651	0.0	0.0	0.0	529
Ep1c	801	23	73	0	0	2.02531	1.00000	0.00000	0.00000	0.00000	2.02531	-4.3651	0.0	0.0	0.0	529
Ep1b	802	23	73	0	0	2.02531	1.00000	0.00000	0.00000	0.00000	2.02531	-4.3651	0.0	0.0	0.0	529
Ep1d	803	23	73	0	0	2.02531	1.00000	0.00000	0.00000	0.00000	2.02531	-4.3651	0.0	0.0	0.0	529
Ep1e	804	23	73	0	0	2.02531	1.00000	0.00000	0.00000	0.00000	2.02531	-4.3651	0.0	0.0	0.0	529
Ep1f	805	23	73	0	0	2.02531	1.00000	0.00000	0.00000	0.00000	2.02531	-4.3651	0.0	0.0	0.0	529
Ep1g	807	23	73	0	0	2.02531	1.00000	0.00000	0.00000	0.00000	2.02531	-4.3651	0.0	0.0	0.0	529
Ep1h	808	23	73	0	0	2.02531	1.00000	0.00000	0.00000	0.00000	2.02531	-4.3651	0.0	0.0	0.0	529
Ep1i	809	23	73	0	0	2.02531	1.00000	0.00000	0.00000	0.00000	2.02531	-4.3651	0.0	0.0	0.0	529
Ep1j	810	23	73	0	0	2.02531	1.00000	0.00000	0.00000	0.00000	2.02531	-4.3651	0.0	0.0	0.0	529
Ep1k	811	23	73	0	0	2.02531	1.00000	0.00000	0.00000	0.00000	2.02531	-4.3651	0.0	0.0	0.0	529
Ep1l	812	23	73	0	0	2.02531	1.00000	0.00000	0.00000	0.00000	2.02531	-4.3651	0.0	0.0	0.0	529
Ep1m	813	23	73	0	0	2.02531	1.00000	0.00000	0.00000	0.00000	2.02531	-4.3651	0.0	0.0	0.0	529
Ep1n	814	23	73	0	0	2.02531	1.00000	0.00000	0.00000	0.00000	2.02531	-4.3651	0.0	0.0	0.0	529
Ep1o	815	23	73	0	0	2.02531	1.00000	0.00000	0.00000	0.00000	2.02531	-4.3651	0.0	0.0	0.0	529
Ep1p	816	23	73	0	0	2.02531	1.00000	0.00000	0.00000	0.00000	2.02531	-4.3651	0.0	0.0	0.0	529
Ep1q	817	23	73	0	0	2.02531	1.00000	0.00000	0.00000	0.00000	2.02531	-4.3651	0.0	0.0	0.0	529
Ep1r	818	23	73	0	0	2.02531	1.00000	0.00000	0.00000	0.00000	2.02531	-4.3651	0.0	0.0	0.0	529
Ep1s	819	23	73	0	0	2.02531	1.00000	0.00000	0.00000	0.00000	2.02531	-4.3651	0.0	0.0	0.0	529
Ep1t	820	23	73	0	0	2.02531	1.00000	0.00000	0.00000	0.00000	2.02531	-4.3651	0.0	0.0	0.0	529
Ep1u	821	23	73	0	0	2.02531	1.00000	0.00000	0.00000	0.00000	2.02531	-4.3651	0.0	0.0	0.0	529
Ep1v	822	23	73	0	0	2.02531	1.00000	0.00000	0.00000	0.00000	2.02531	-4.3651	0.0	0.0	0.0	529
Ep1w	823	23	73	0	0	2.02531	1.00000	0.00000	0.00000	0.00000	2.02531	-4.3651	0.0	0.0	0.0	529
Ep1x	824	23	73	0	0	2.02531	1.00000	0.00000	0.00000	0.00000	2.02531	-4.3651	0.0	0.0	0.0	529
Ep1y	825	23	73	0	0	2.02531	1.00000	0.00000	0.00000	0.00000	2.02531	-4.3651	0.0	0.0	0.0	529
Ep1z	826	23	73	0	0	2.02531	1.00000	0.00000	0.00000	0.00000	2.02531	-4.3651	0.0	0.0	0.0	529

10P - Initial 2,3,7,8-TCDF concentration (ppb)  
 10WY - Initial 2,3,7,8-TCDF concentration (ppb)  
 10 - Initial 2,3,7,8-TCDF concentration (ppb)  
 10P-10 - Change of 2,3,7,8-TCDF concentration (ppb)  
 10P-20 - Change of 2,3,7,8-TCDF concentration (ppb)  
 10 - Initial 2,3,7,8-TCDF concentration (ppb)  
 10P-10 - Change of 2,3,7,8-TCDF concentration (ppb)  
 10P-20 - Change of 2,3,7,8-TCDF concentration (ppb)  
 10 - Initial 2,3,7,8-TCDF concentration (ppb)  
 10P-10 - Change of 2,3,7,8-TCDF concentration (ppb)  
 10P-20 - Change of 2,3,7,8-TCDF concentration (ppb)