

Best Available Copy



AD-A200 830

IC FILE COPY

RD & E

C E N T E R

# Technical Report

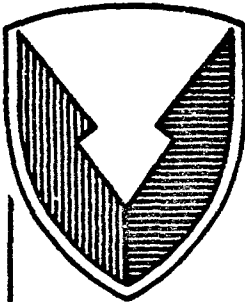

No. 13358

EVALUATION OF THE TURBODYNE™ II  
SELF-CLEANING AIR FILTRATION SYSTEM ON  
A KNOWN MILITARY ENGINE

DTIC  
ELECTE  
S OCT 07 1988 D  
aD

By Alfred Lemmo  
U.S. Army Tank-Automotive Command  
ATTN: AMSTA-RGE  
Warren, MI 48397-5000

APPROVED FOR PUBLIC RELEASE:  
DISTRIBUTION IS UNLIMITED

U.S. ARMY TANK-AUTOMOTIVE COMMAND  
RESEARCH, DEVELOPMENT & ENGINEERING CENTER  
Warren, Michigan 48397-5000

88 10 6 107

~~88 8 15 142~~

Best Available Copy

Y990 sidellowA tac

**NOTICES**

This report is not to be construed as an official Department of the Army position.

Mention of any trade names or manufacturers in this report shall not be construed as an official endorsement or approval of such products or companies by the U.S. Government.

Destroy this report when it is no longer needed. Do not return it to the originator.

Best Available Copy

UNCLASSIFIED

SECURITY CLASSIFICATION OF THIS PAGE

Form Approved  
OMB No 0704-0188  
Exp. Date Jun 30, 1986

REPORT DOCUMENTATION PAGE

1a. REPORT SECURITY CLASSIFICATION Unclassified				1b. RESTRICTIVE MARKINGS			
2a. SECURITY CLASSIFICATION AUTHORITY				3. DISTRIBUTION / AVAILABILITY OF REPORT Approved for public release: distribution is unlimited			
2b. DECLASSIFICATION / DOWNGRADING SCHEDULE				4. PERFORMING ORGANIZATION REPORT NUMBER(S)			
5. MONITORING ORGANIZATION REPORT NUMBER(S) 13358				6a. NAME OF PERFORMING ORGANIZATION U.S. Army Tank-Automotive Command			
6b. OFFICE SYMBOL (if applicable) AMSTA-RGE		7a. NAME OF MONITORING ORGANIZATION U.S. Army Tank-Automotive Command				7b. ADDRESS (City, State, and ZIP Code) Warren, MI 48397-5000	
6c. ADDRESS (City, State, and ZIP Code) Warren, MI 48397-5000				8a. NAME OF FUNDING / SPONSORING ORGANIZATION			
8b. OFFICE SYMBOL (if applicable)		9. PROCUREMENT INSTRUMENT IDENTIFICATION NUMBER				8c. ADDRESS (City, State, and ZIP Code)	
10. SOURCE OF FUNDING NUMBERS				11. TITLE (Include Security Classification) Evaluation of the Turbodyne™ II Self-Cleaning Air Filtration System on a Known Military Engine (U)			
PROGRAM ELEMENT NO.		PROJECT NO.		TASK NO.		WORK UNIT ACCESSION NO.	
12. PERSONAL AUTHOR(S) Lemmo, Alfred C.							
13a. TYPE OF REPORT Final		13b. TIME COVERED FROM 3/87 TO 6/87		14. DATE OF REPORT (Year, Month, Day) May 88		15. PAGE COUNT 120	
16. SUPPLEMENTARY NOTATION Test conducted in cooperation with the Pall Land and Marine Corporation							
17. COSATI CODES			18. SUBJECT TERMS (Continue on reverse if necessary and identify by block number)				
FIELD	GROUP	SUB-GROUP	Self-cleaning air filter, dust, turbocharger erosion, inertial precleaner, Centrisep <sup>®</sup> , Turbodyne™ II, Stainless steel mesh, blowback, scavenge, SAE J726, separation (con't)				
19. ABSTRACT (Continue on reverse if necessary and identify by block number)							
<p>The concept of a new type of self-cleaning air filtration system was demonstrated and evaluated. The system acquired significant advantages in volume, performance and logistics considerations by placement of the self-cleaning stainless steel barrier filter downstream of the turbocharger. The pressurized air within the barrier filter was used to blow back and clean the filter medium. Adequate protection of the turbocharger compressor wheel from dust erosion was accomplished by the highly efficient inertial precleaner alone. The precleaner was shown to be effective even at low airflow rates and high dust loads; the overall system completed 200 hours of operation on a Cummins VTA-903 using a modified SAE J726 test cycle at zero visibility without developing excessive restriction.</p>							
20. DISTRIBUTION / AVAILABILITY OF ABSTRACT <input checked="" type="checkbox"/> UNCLASSIFIED/UNLIMITED <input type="checkbox"/> SAME AS RPT. <input type="checkbox"/> DTIC USERS				21. ABSTRACT SECURITY CLASSIFICATION Unclassified			
22a. NAME OF RESPONSIBLE INDIVIDUAL Alfred C. Lemmo				22b. TELEPHONE (Include Area Code) (313) 574-5566		22c. OFFICE SYMBOL AMSTA-RGE	

DD FORM 1473, 84 MAR

83 APR edition may be used until exhausted.  
All other editions are obsolete.

SECURITY CLASSIFICATION OF THIS PAGE

Item 18. continued

efficiency, A.C. Coarse

PREFACE

The author wishes to acknowledge the contributions of those individuals most directly responsible on-site for the successful completion of this test program. From Pall Land and Marine Corporation (PLM), a subsidiary of Pall Corporation, these include Mr. Robert Gianni, who operated the PLM-supplied equipment throughout the test; Mr. Robert Russell and Mr. Joseph Peri, who assisted in setup and calibration; and most especially Mr. Charles Roach, vice president of PLM, who has provided extensive support and consultation from start to finish. From the U.S. Army Tank-Automotive Command, the expertise and professionalism of the personnel from the Design and Manufacturing Technology Directorate is also gratefully acknowledged. From the Power Train Branch responsible individuals include Mr. Robert Medwith, test cell operator; Mr. Lawrence Niemchak, Mr. Martin Agnetti and Mr. Kenneth Ratcliff, instrumentation specialists; and Mr. Wendal McCann, electrician. Mr. Michael Richard, air flow technician, also made extensive contributions.



Accession For		
NTIS	CRA&I	<input checked="" type="checkbox"/>
DTIC	TAB	<input type="checkbox"/>
Unannounced		<input type="checkbox"/>
Justification		
By		
Contributor		
Availability Codes		
1	2	3
A-1		

TABLE OF CONTENTS

Section	Page
1.0. INTRODUCTION . . . . .	13
2.0. OBJECTIVES . . . . .	13
3.0. CONCLUSIONS . . . . .	13
4.0. RECOMMENDATIONS . . . . .	13
5.0. DISCUSSION . . . . .	13
5.1. <u>Background</u> . . . . .	13
5.2. <u>Equipment Calibration</u> . . . . .	14
5.3. <u>Test Configuration</u> . . . . .	22
5.4. <u>Results</u> . . . . .	37
5.5. <u>Additional Testing</u> . . . . .	69
APPENDIX A. TEST PLAN . . . . .	A-1
APPENDIX B. ORIGINAL DATA . . . . .	B-1
APPENDIX C. SAMPLE DATA SHEETS FOR CALIBRATION SETUP AND TEST SETUP . . . . .	C-1
DISTRIBUTION LIST . . . . .	Dist-1

Preceding Page Blank

## LIST OF ILLUSTRATIONS

Figure	Title	Page
5-1.	Turbodyne System . . . . .	15
5-2.	Centrisep® Air Cleaner . . . . .	16
5-3.	Two-Stage Centrisep® Inertial Separators . . . . .	17
5-4.	Cylinder Charge Pressures, Turbodyne vs. Conventional Filter Systems. . . . .	18
5-5.	Turbodyne™ II (Self-Cleaning Air Filter). . . . .	19
5-6.	Self-Cleaning Barrier Filter . . . . .	20
5-7.	Section A-A. . . . .	21
5-8.	Right Front View of Calibration Setup. . . . .	23
5-9.	Right Front Closeup View of Intake Air and Exhaust Connections to Turbocharger. . . . .	24
5-10.	Left Front View of Turbodyne™ II System in Calibration Setup. . . . .	25
5-11.	Overall Left Front View of Calibration Setup . . . . .	26
5-12.	Dust Feeder . . . . .	28
5-13.	View into Air Inlet Hood. . . . .	30
5-14.	Right Rear View of Test Setup . . . . .	31
5-15.	Right Front View of Test Setup. . . . .	32
5-16.	Left Front View of Turbodyne™ II System in Test Configuration . . . . .	33
5-17.	Left Front View of Primary and Blowback Scavenge Systems. . . . .	34
5-18.	Left Front View of Test Setup . . . . .	35
5-19.	Overall Left Front View of Test Setup . . . . .	36
5-20.	Control Room Equipment Including Efficiency Measurement Controls, Dust Feeder Controls and Manometers . . . . .	38
5-21.	Data Monitoring and Acquisition System Controls with Engine and Dynamometer Controls . . . . .	39

LIST OF ILLUSTRATIONS (Continued)

Figure	Title	Page
5-22.	Left Rear View of Test Setup. . . . .	40
5-23.	Horsepower Degradation. . . . .	41
5-24.	BFSC Changes--100% Flow . . . . .	42
5-25.	BFSC Changes--80% Flow. . . . .	43
5-26.	BSFC Changes--60% Flow. . . . .	44
5-27.	BSFC Changes--40% Flow. . . . .	45
5-28.	BSFC Changes--20% Flow. . . . .	46
5-29.	Engine Performance Curves . . . . .	48
5-30.	Filtration Efficiency . . . . .	50
5-31.	Membrane Filters Before and After Development of Barrier Filter Leakage. . . . .	51
5-32.	Turbocharger Turbine and Compressor Wheels after 200 Hours. . . . .	52
5-33.	Turbocharger Turbine Housing After 200 Hours. . . . .	54
5-34.	Turbocharger Compressor Housing After 200 Hours . . . . .	55
5-35.	Turbocharger Bearing Housing from Turbine Side After 200 Hours . . . . .	56
5-36.	Turbocharger Bearing Housing from Compressor Side after 200 Hours . . . . .	57
5-37.	Barrier Filter Pressure Drop. . . . .	58
5-38.	100% Airflow Parameters . . . . .	59
5-39.	Intake Manifold Pressure. . . . .	60
5-40.	Turbocharger Discharge Pressure . . . . .	61
5-41.	Turbocharger Pressure Ratio . . . . .	62
5-42.	Turbocharger Discharge Temperature. . . . .	63



LIST OF ILLUSTRATIONS (Continued)

Figure	Title	Page
5-43.	Barrier Filter Element Mounted Eccentrically in Housing . . .	64
5-44.	Labyrinth Seals Internal to Barrier Filter Housing. . . . .	65
5-45.	Lower Bearing Assembly Internal to Barrier Filter Housing . .	66
5-46.	Barrier Filter Element with End Cap . . . . .	67
5-47.	Barrier Filter Element Shown in Relation to Housing . . . . .	68

LIST OF TABLES

Table	Title	Page
5-1.	Engine Operating Conditions . . . . .	27
5-2.	200-Hour Air Cleaner Test--Spectrographic Oil Analysis . . . . .	49
5-3.	Additional Testing--Precleaner Efficiency . . . . .	70
5-4.	Various Centrisep® Air Cleaner Systems Effluent Particle Size Analysis --By Count . . . . .	71
5-5.	Turbodyne™ II Self-Cleaning Air Filter--TACOM Dust Particle Size Data . . . . .	72



## 1.0. INTRODUCTION

This test program was conducted by the U.S. Army Tank-Automotive Command (TACOM) at TACOM in cooperation with the Pall Land and Marine Corporation (PLM), a supplier of filtration equipment, to demonstrate and evaluate the concept of a new type of self-cleaning air filtration system having significant advantages in volume, performance and logistics considerations. The prototype equipment had not been previously tested on an engine. A modified SAE J726 variable flow 100-minute cycle was tested with A.C. Coarse Test Dust at zero visibility for 200 hours. Restriction and efficiency measurements were the primary evaluation tools, along with equipment protection from dust ingestion damage.

## 2.0. OBJECTIVES

The basic objective was to evaluate the capability of the overall Turbodyne™ II Self-Cleaning Air Filtration System to operate for 200 hours at zero visibility with acceptable pressure rise on a known military engine, the Cummins VTA-903. Additionally, the provision of only inertial precleaning of the air before the turbocharger made protection of the compressor wheel an important evaluation criterion. Limited additional testing sought to evaluate the precleaner capability at lower airflow rates and higher dust loads.

## 3.0. CONCLUSIONS

The overall system passed the 200-hour test and protected the turbocharger compressor wheel from significant damage. The system was shown to be effective even at low airflows and high dust loads.

## 4.0. RECOMMENDATIONS

The subject self-cleaning air filtration system can be considered a viable candidate for future vehicle propulsion systems and should undergo further engineering development for on-vehicle applications. If planned precleaner efficiency improvements are realized, the precleaner and barrier filter without the self-cleaning feature, which the supplier terms Turbodyne I Air Filtration System, may be a candidate for retrofitting vehicles to reduce life cycle costs, provided that removal for cleaning at shorter intervals, more currently typical of filter replacement, is acceptable.

## 5.0. DISCUSSION

### 5.1. Background

In a conventional military vehicle air filtration system an inertial precleaner and barrier filter are placed in series upstream of the turbocharger and engine. In the Turbodyne™ II system only the precleaner is upstream of the turbocharger with the barrier filter

placed in the pressurized air stream after the turbocharger. Figure 5-1 is a schematic of this arrangement. The system relies on a highly efficient precleaner to protect the turbocharger compressor wheel from damage by dust particle ingestion. The precleaner consists of an array of vortex-generating tubes (trade name Centriseq<sup>®</sup>) in which the dust particles are removed at the periphery of each tube (see Figure 5-2) and carried away in a scavenge flow. The system tested used a two-stage configuration as illustrated in Figure 5-3. This figure also shows the supplier's figures for dimensions, relative pressure drop and separation efficiency.

The claimed advantages of the Turbodyne<sup>™</sup> II configuration are several. Figure 5-4 shows that higher cylinder charge pressures are obtained by compressing the air after it has experienced the pressure drop across the precleaner only, rather than both precleaner and barrier filter. Figure 5-1 shows that only positive pressure lines are found after the final filtration step (barrier filter) such that any leaks would not result in contaminated air entering the engine. In a conventional system the presence of negative pressure lines after the barrier filter allows for possible ingestion of contaminants into the engine should leaks occur. The most important advantage of the Turbodyne<sup>™</sup> II system is the reduced surface area of filter medium required for equivalent filtration and pressure drop compared to a conventional system. This is possible due to the placement of the filter medium in the high-pressure air stream after the turbocharger. The barrier filter package is thereby reduced in volume.

Figures 5-5 through 5-7 illustrate the self-cleaning mechanism of the barrier filter. Figure 5-5 is a detailed diagram of the overall system. The barrier filter element consists of a stainless steel mesh folded in pleats and wrapped around a cylinder which rotates eccentrically to the housing axis. The rotation is accomplished by a solenoid actuator (see Figure 5-6) and is variable in speed. A small section of the pleated cylinder surface is exposed at any time to a chamber running the length of the cylinder which can be exposed to atmospheric pressure by opening a solenoid valve. This allows the high-pressure air within the housing to blow the dust particles on the exposed section of the pleats out through the chamber, thereby cleaning the barrier filter one lengthwise strip of surface pleats at a time.

Figure 5-7 is an enlarged view of Section A-A from Figure 5-6 which provides an end view of the chamber and barrier filter. Labyrinth seals running lengthwise down the barrier filter surface separate the majority of the pleats from those exposed to the chamber volume. The frequency of the solenoid valve actuation can vary the degree of surface cleaning.

## 5.2. Equipment Calibration

The test equipment was set up in two stages. First, a calibration configuration was assembled to determine the engine speed and load settings that would yield the airflows required by the modified SAE

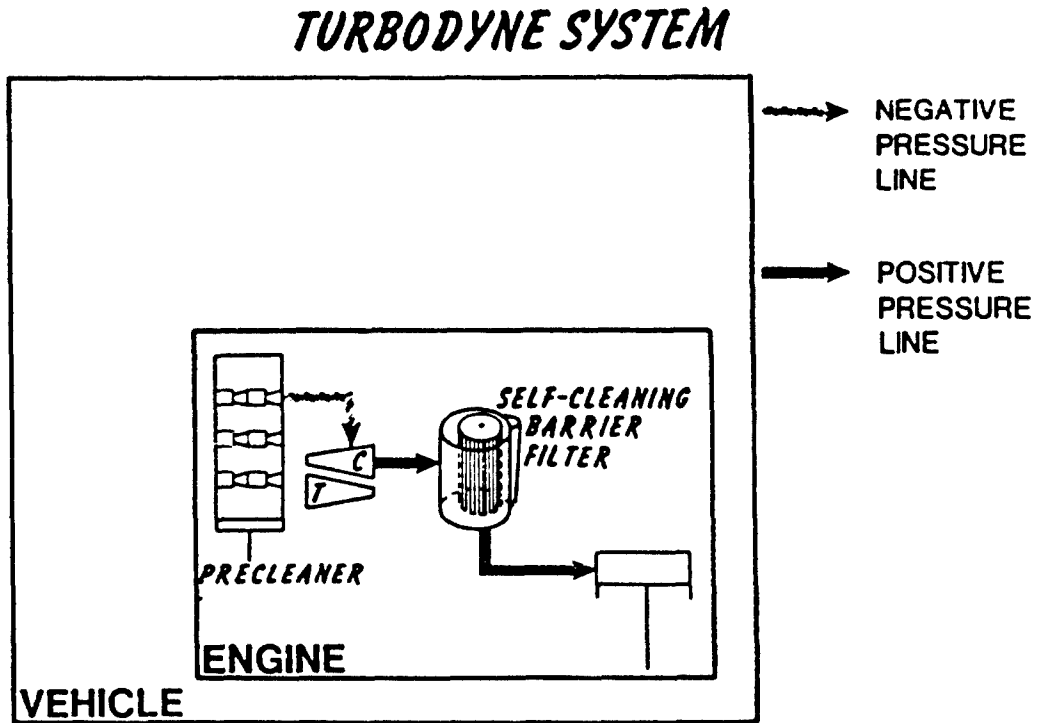

Figure 5-1. Turbodyne System

# CENTRISEP® AIR CLEANER

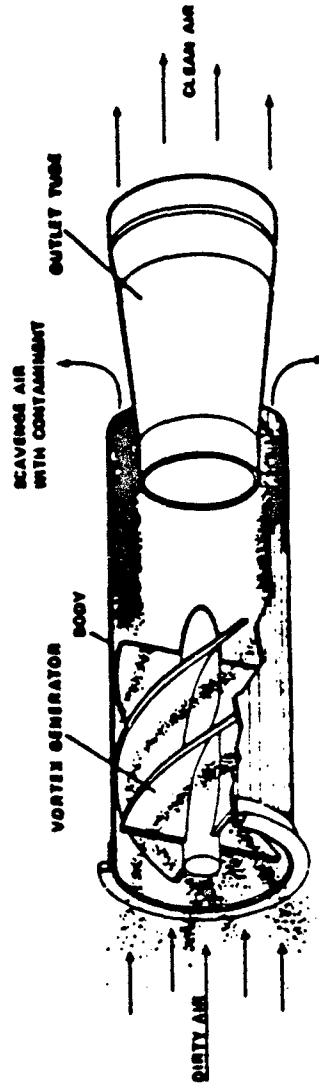
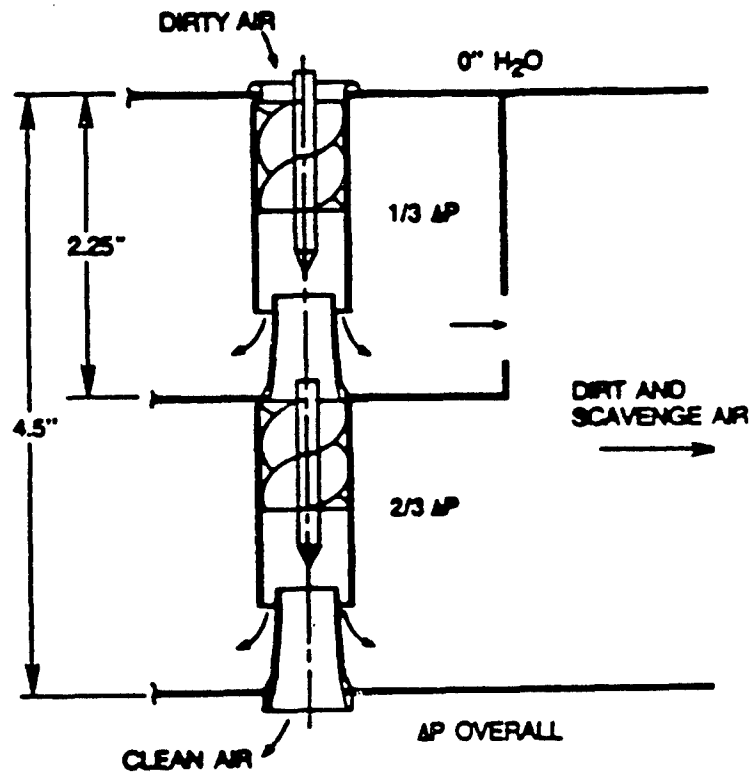

Figure 5-2. Centrisep<sup>®</sup> Air Cleaner

Best Available Copy

### TWO STAGE CENTRISEP® INERTIAL SEPARATORS



#### SEPARATION EFFICIENCY — 20% SCAVENGE

TEST DUST	PRESENT	FUTURE
A.C. COARSE	96/97%	98/99%
A.C. FINE	90/91%	92/93.5%

Figure 5-3. Two-Stage Centrisep<sup>®</sup> Inertial Separators



### CYLINDER CHARGE PRESSURES TURBODYNE VS. CONVENTIONAL FILTER SYSTEMS

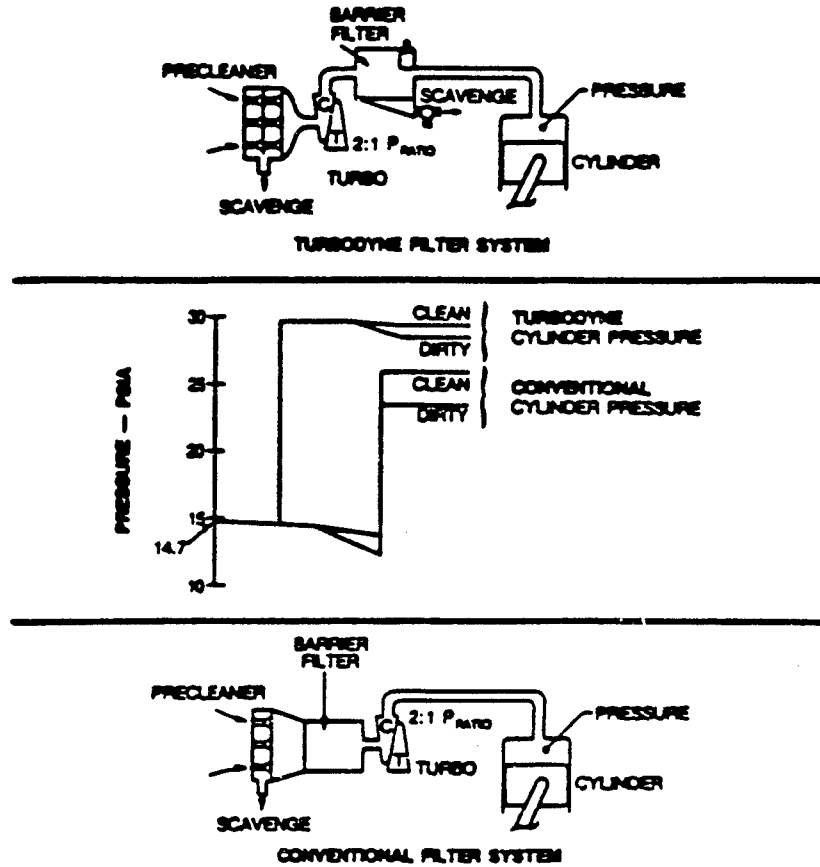

Figure 5-4. Cylinder Charge Pressures, Turbodyne vs. Conventional Filter Systems

### TURBODYNE™ II (SELF CLEANING AIR FILTER)

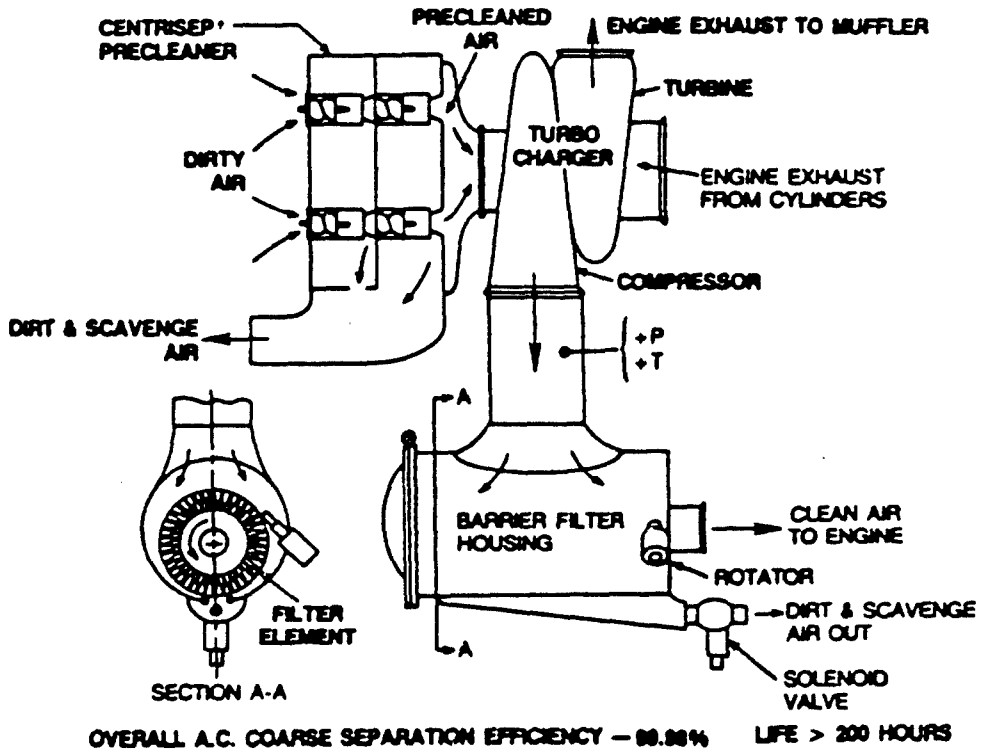

Figure 5-5. Turbodyne™ II (Self-Cleaning Air Filter)

### SELF-CLEANING BARRIER FILTER

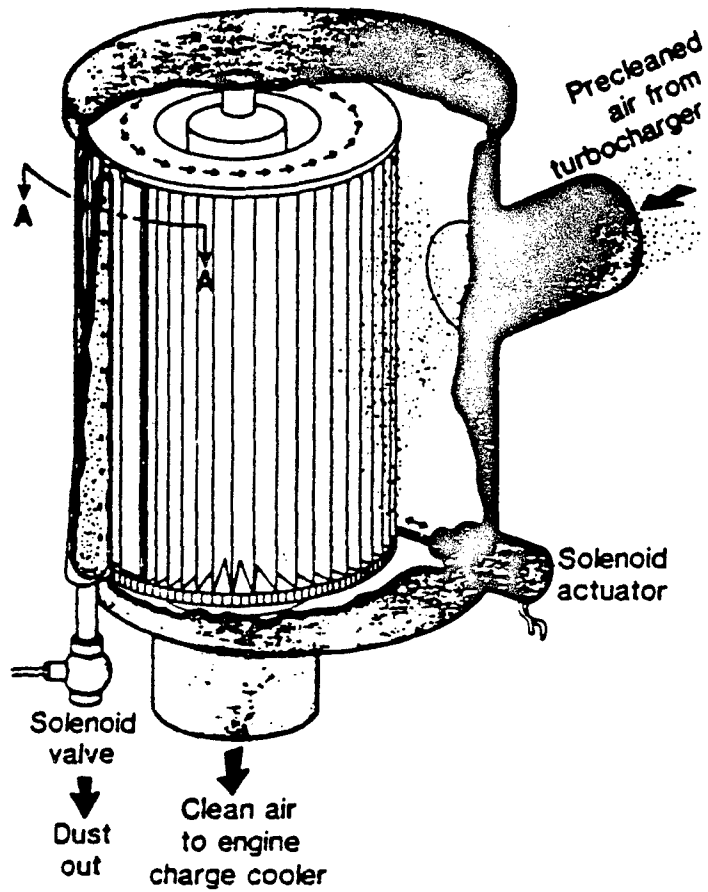

Figure 5-6. Self-Cleaning Barrier Filter

Best Available Copy

SECTION A-A

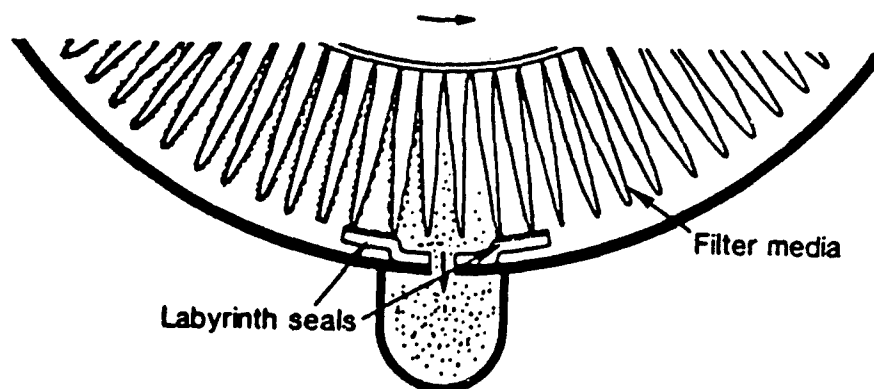

Figure 5-7. Section A-A

test cycle shown in Attachment 4 of the test plan (Appendix A of this report). Airflows of 100%, 80%, 60%, 50%, 40%, 30%, and 20% of the engine maximum were required. The average cycle airflow was 60%. A right front view of the calibration setup is shown in Figure 5-8. This represents one of several minor deviations from the test plan (see Attachment 2 of Appendix A).

Air entered the system through a conventional air filter element without a housing (to minimize pressure losses) located at the rear of the test cell (left background in Figure 5-8). The filter was used to protect the laminar flow element-type airflow meter which is seen mounted with the manufacturer's recommended lengths of straight pipe both upstream and downstream of the meter. The air made a right angle turn before entering the turbocharger. The barrier filter housing is the metallic cylinder suspended above the turbocharger in Figure 5-8. The filter housing axis should have been level but was not during the calibration phase because the stainless steel connector between the engine exhaust manifold and the turbocharger (see Figure 5-9) was originally installed backwards. This did not affect the airflow calibration results but became a problem later when the system was reconfigured to perform testing with dust.

Instead of the solenoid valve shown in Figures 5-5 and 5-6 to purge or "blow back" the barrier filter surface, this prototype equipment used a motorized mechanism to lift a hammer, which was then released to strike a plunger, that opened a mechanical blowback valve. This mechanism appears at the upper left in Figure 5-10. The mechanism would not operate properly with the barrier filter in the slightly inclined position shown. Figure 5-11 shows an overall left front view of the calibration setup including the cooling tower in the left foreground.

Target pressure differentials across the airflow meter were calculated for each required percent flow based on the maximum measured airflow using the meter manufacturer's calibration curve with correction factors for pressure, temperature and air viscosity. These targets were refined and verified by running the engine in an iterative process to arrive at the engine speed and load settings shown in Table 5-1 which were used throughout the test. All the testing was at full load except at 20% airflow.

### 5.3. Test Configuration

After completion of the airflow calibration, the airflow meter, filter and associated piping were removed and replaced by the precleaner which was considered to produce nearly equivalent restriction at all flows. The dust feeder and scavenge systems for the dust removed from the precleaner and barrier filter were installed. A system to measure the overall dust separation efficiency was also installed.

Figure 5-12 shows the dust feeder which consisted of a hopper for the dust, a turntable onto which the dust was metered by a rotating screw and a vacuum system to transfer the dust from the turntable into the intake air stream of the engine. The screw feed rate was calibrated daily.

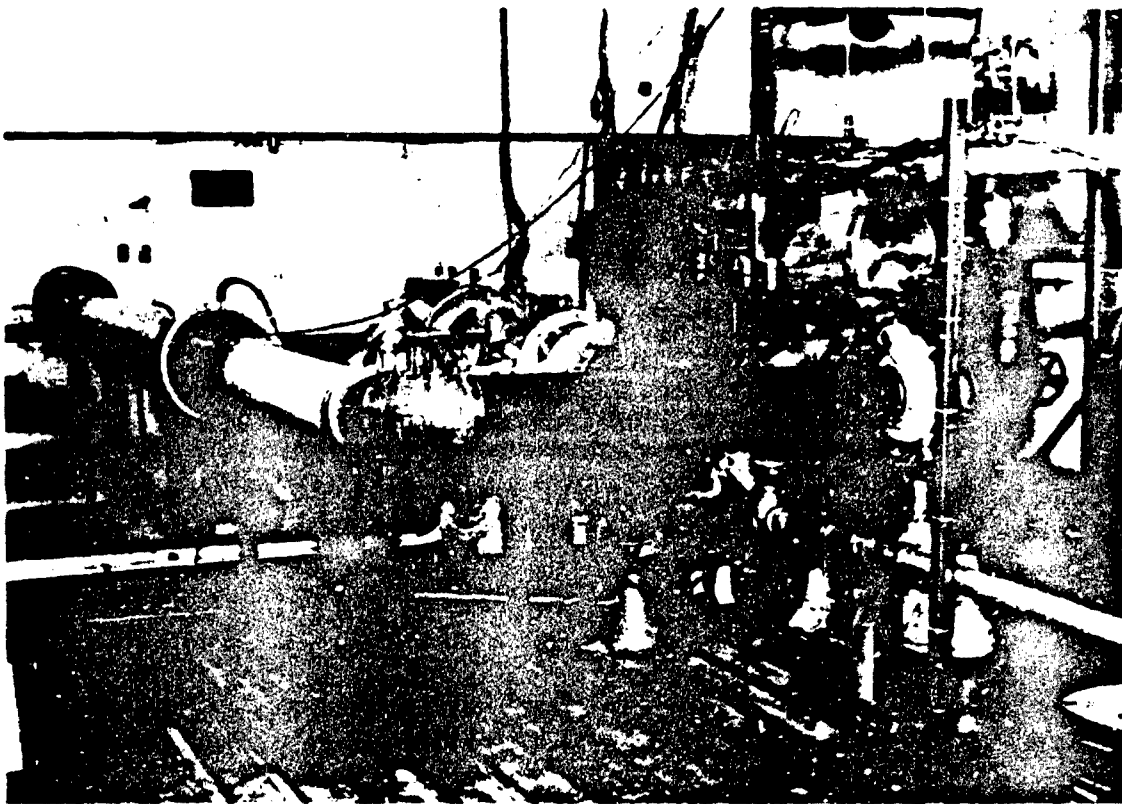

Figure 5-8. Right Front View of Calibration Setup

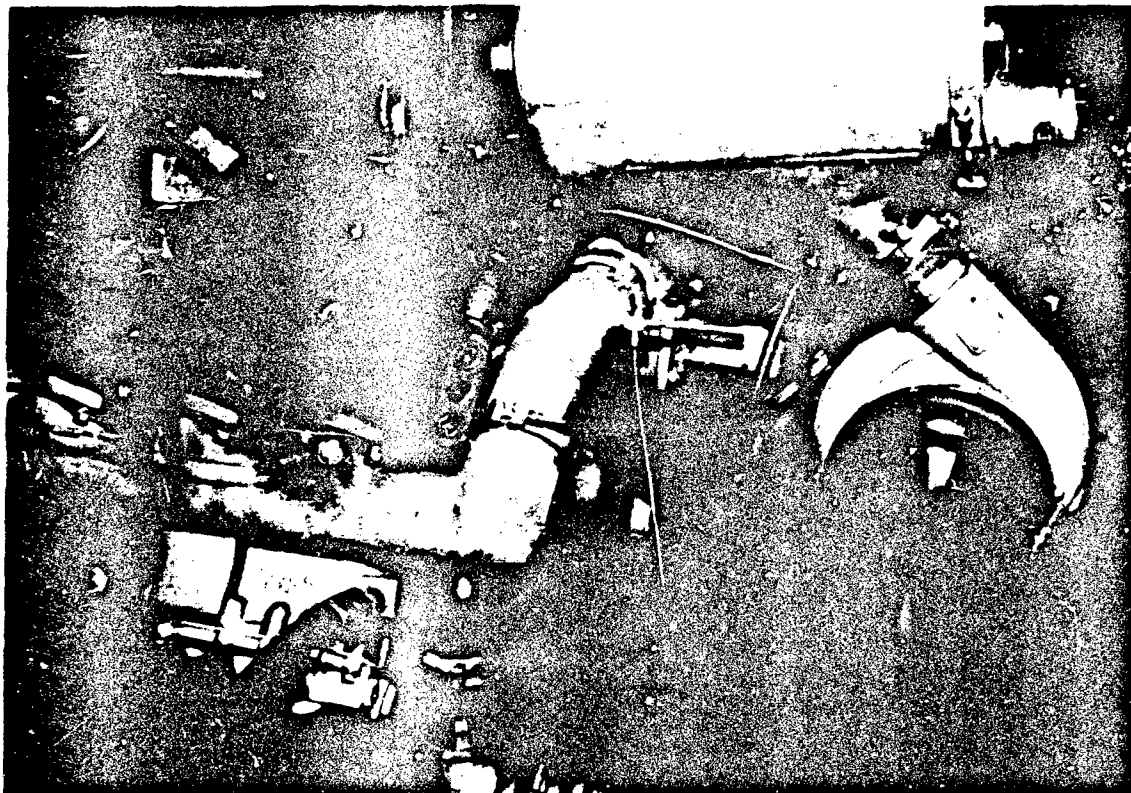

Figure 5-9. Right Front Closeup View of Intake Air and Exhaust Connections to Turbocharger

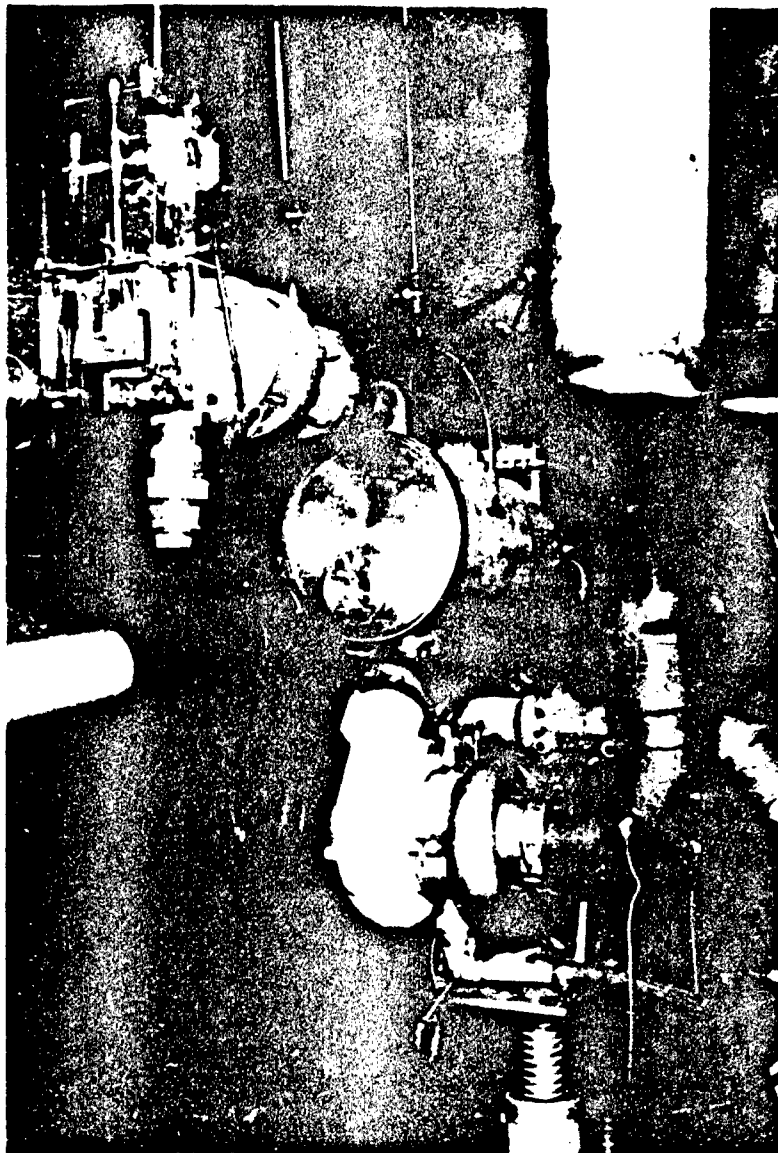

Figure 5-10. Left Front View of Turbodyne<sup>TM</sup> II System in Calibration Setup



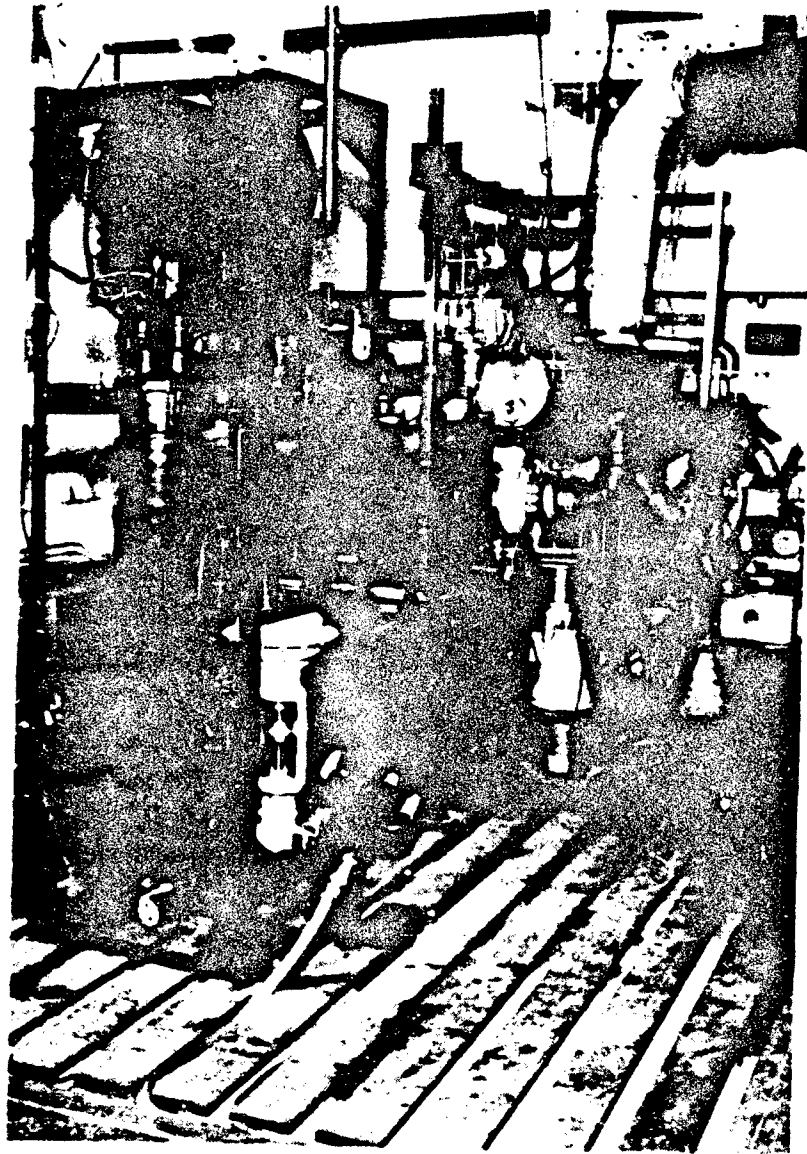

Figure 5-11. Overall Left Front View of Calibration Setup

Table 5-1. Engine Operating Conditions

<u>Percent Airflow</u>	<u>Engine RPM</u>	<u>Load</u>
100	2,600	Full
80	2,200	Full
60	1,873	Full
50	1,705	Full
40	1,540	Full
30	1,335	Full
20	980	333 lb-ft

Best Available Copy

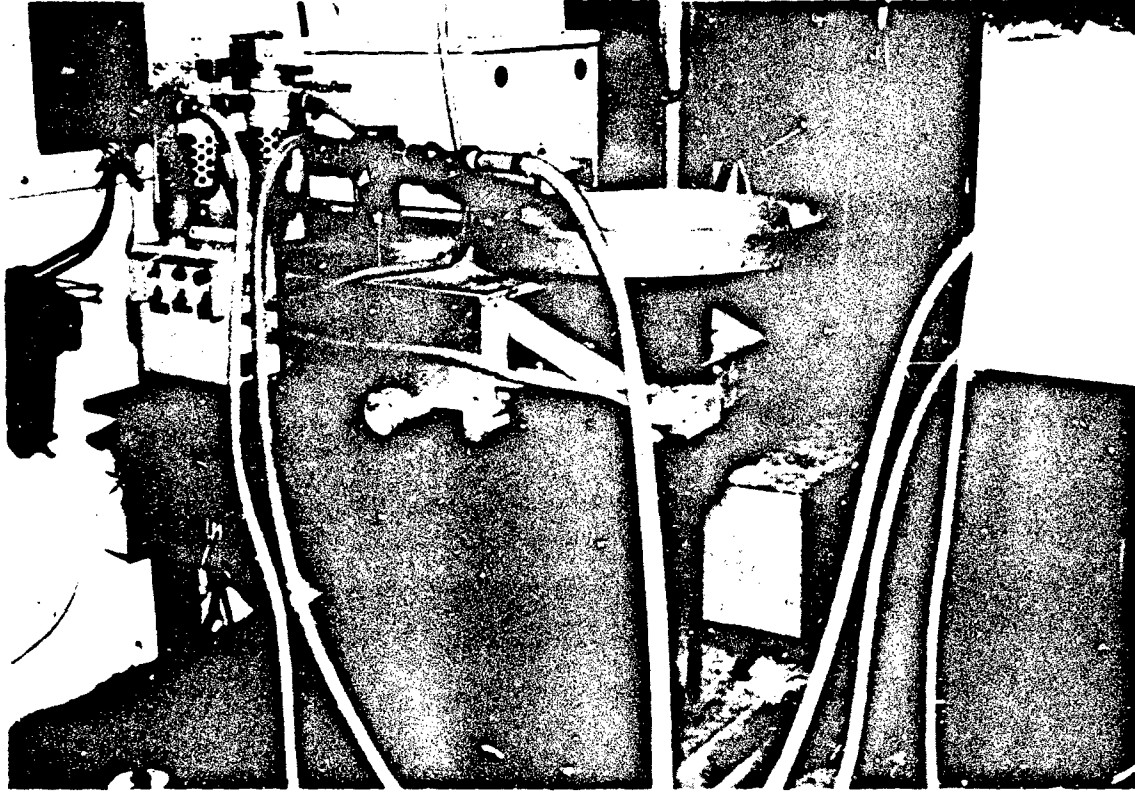

Figure 5-12. Dust Feeder

Figure 5-13 shows the inlet to the precleaner. The piping mounted in the opening of the hood was designed to disperse the dust uniformly over the cross-sectional area of the hood. A portion of the array of vortex generating tubes in the precleaner is visible.

Figure 5-14, a right rear view of the setup, shows the positions of the dust feeder, precleaner and portions of the scavenge systems for the precleaner and barrier filter (blowback flow). The dust feeder is just beyond the test cell control room window (not visible). The primary scavenge flow exits the precleaner from below. The flow is drawn by the primary scavenge blower seen more clearly in the right foreground of Figure 5-15. A conventional air filter element housed in the cylindrical canister at the center right in Figure 5-15 (a right front view) served as the blowback filter, trapping the dust purged from the barrier filter by operation of the blowback valve located above it.

Figure 5-16 is a closeup left front view of the turbo-charger, barrier filter, blowback valve and mechanism and blowback filter. Note that the barrier filter was leveled and braced above the sight glass on the front cover. The vertical pipe from the blowback valve to the blowback filter was open to the test cell air at the top. This prevented dust from being drawn from the blowback filter back into the barrier filter when internal barrier filter pressure dropped below test cell air pressure at low engine speed. The main functions were to allow excess air to carry the expelled dust into the blowback filter and reduce restriction for the blower. The air was drawn through the filter by the blowback scavenge blower located on the lower level of the table at right in Figure 5-17 and partially hidden from view. The blower is identical to the auxiliary primary scavenge blower seen in the center foreground in Figure 5-17. This blower was used to draw the primary scavenge air through the primary scavenge collector seen in the left foreground in Figure 5-17. The single blower quickly proved insufficient and a second identical blower was added, replacing the flow control flap between the first blower and collector. The entrance to the primary scavenge collector was also open to the test cell air to reduce restriction for the blowers.

The primary scavenge collector (see Figure 5-18) consisted of a cut-off 55-gallon drum with an air cleaner mounted above it. The lower section of the air cleaner contained an inertial precleaner that separated the heavier dust particles into the drum below. The lighter dust particles were trapped by a conventional air filter element (primary scavenge filter) in the upper half of the air cleaner.

Figure 5-19 is an overall left front view of the test setup. The only later significant change was the addition of the second auxiliary primary scavenge blower. The control room window is visible behind the dust feeder. Thermocouple connections were made through the overhead boom. Pressure transducers were located in a rack visible in the right

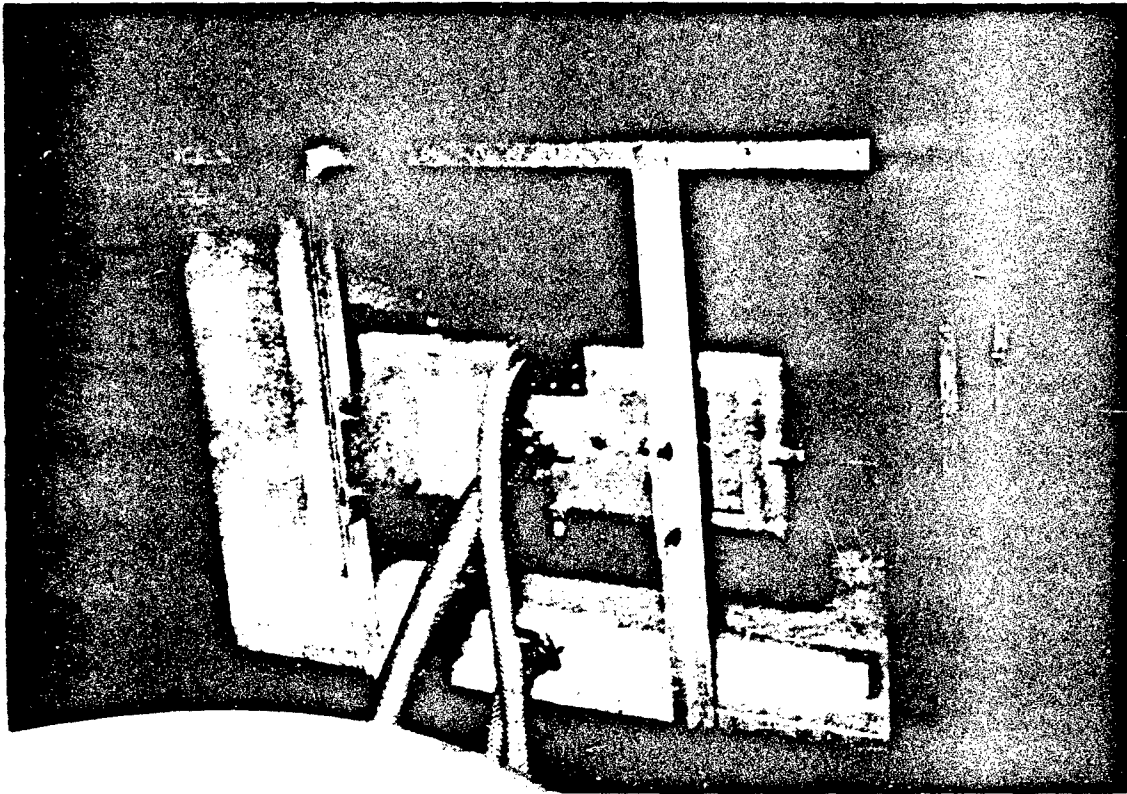

Figure 5-13. View into Air Inlet Hood

Best Available Copy

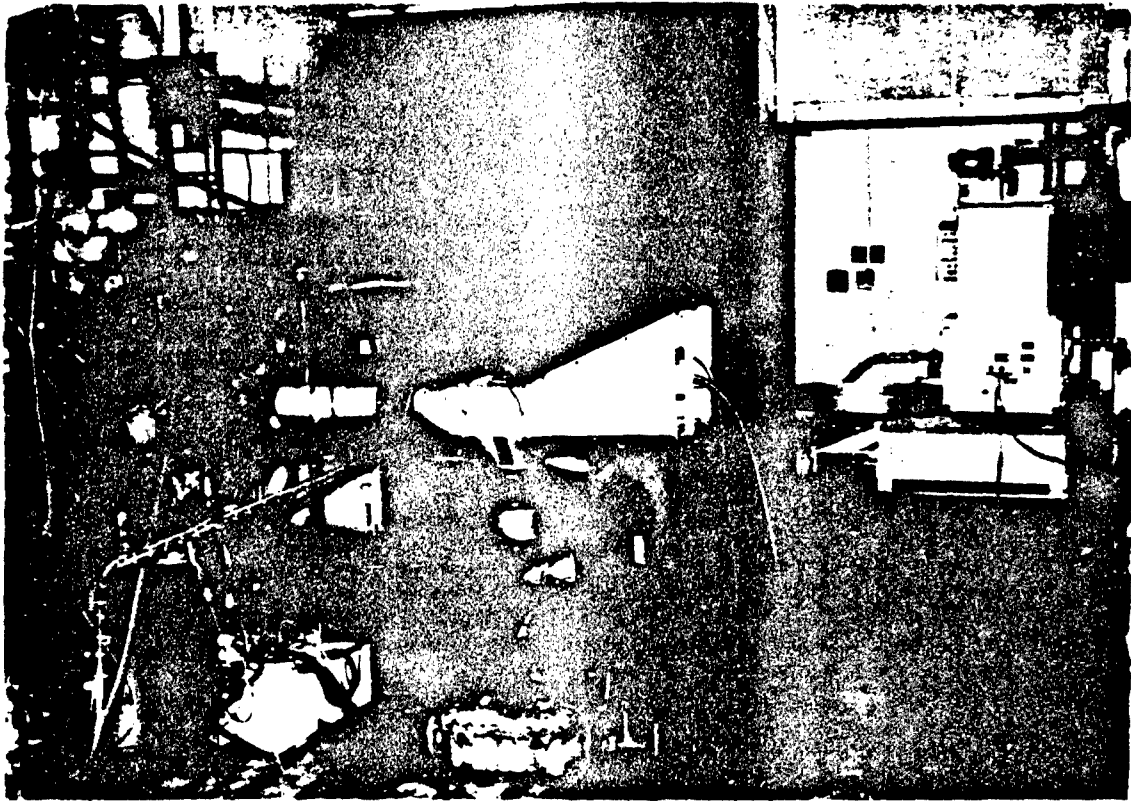

Figure 5-14. Right Rear View of Test Setup

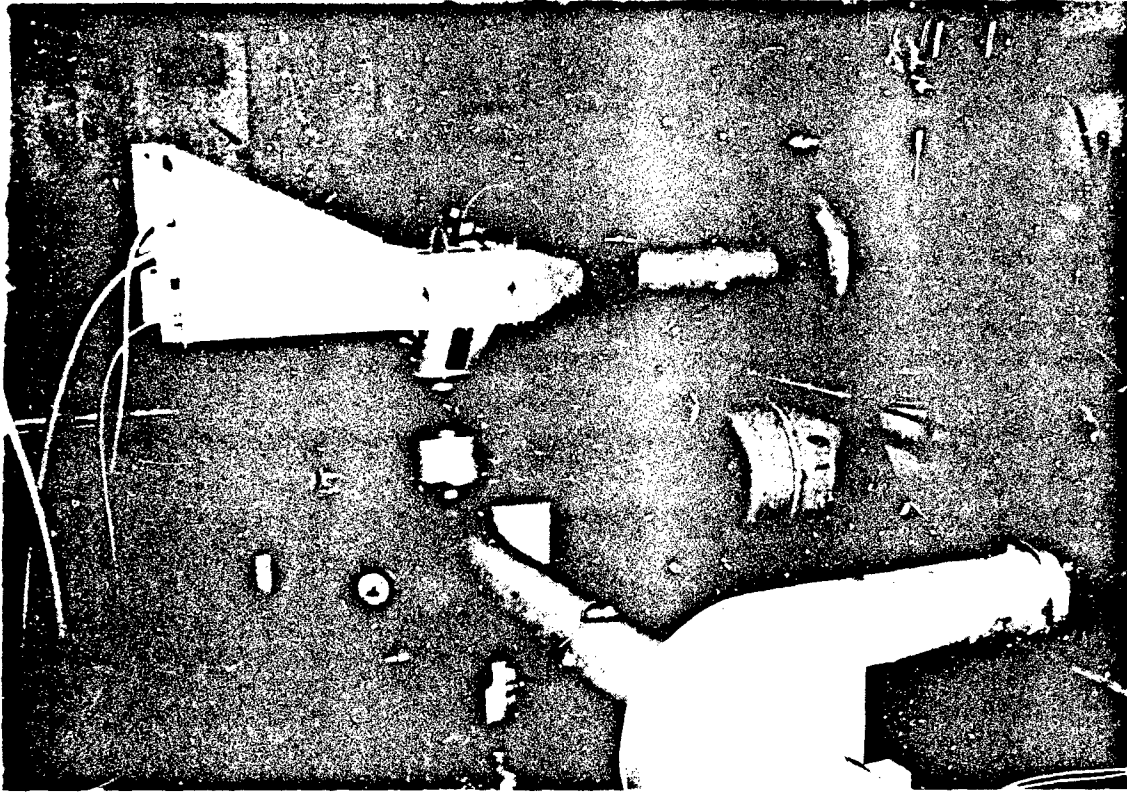

Figure 5-15. Right Front View of Test Setup

Best Available Copy

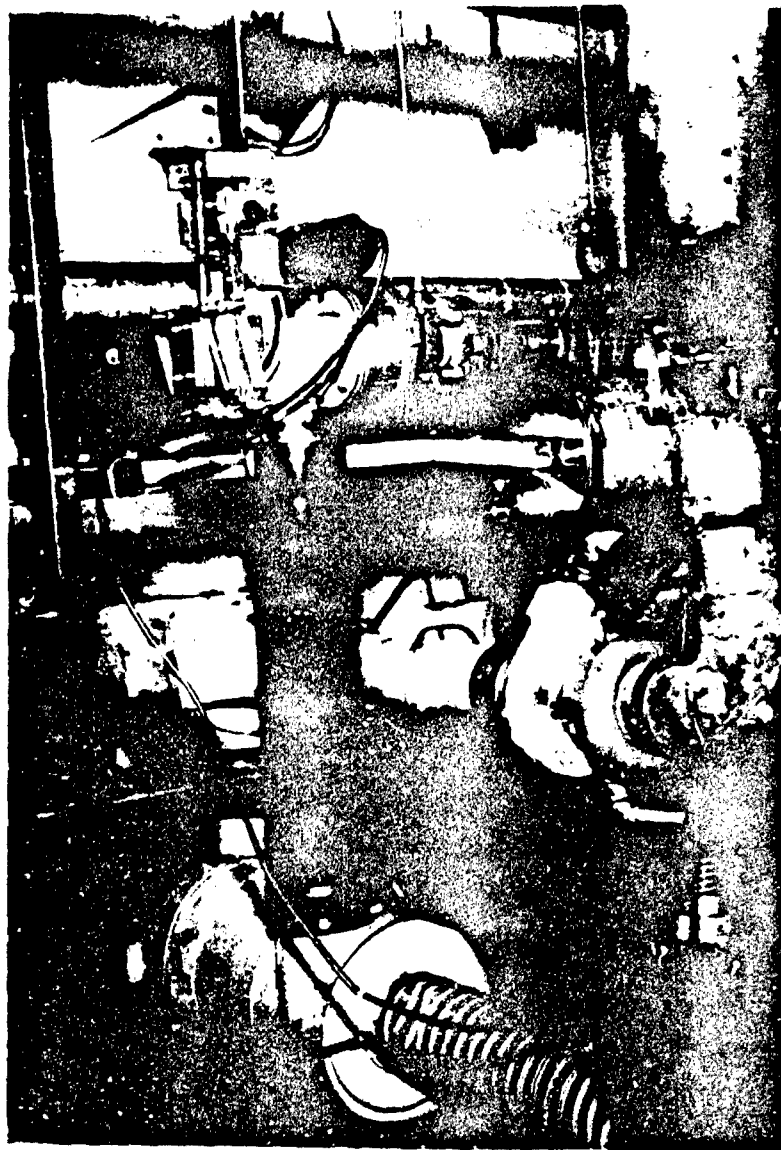

Figure 5-16. Left Front View of Turbodyne<sup>TM</sup> II System in Test Configuration



Best Available Copy

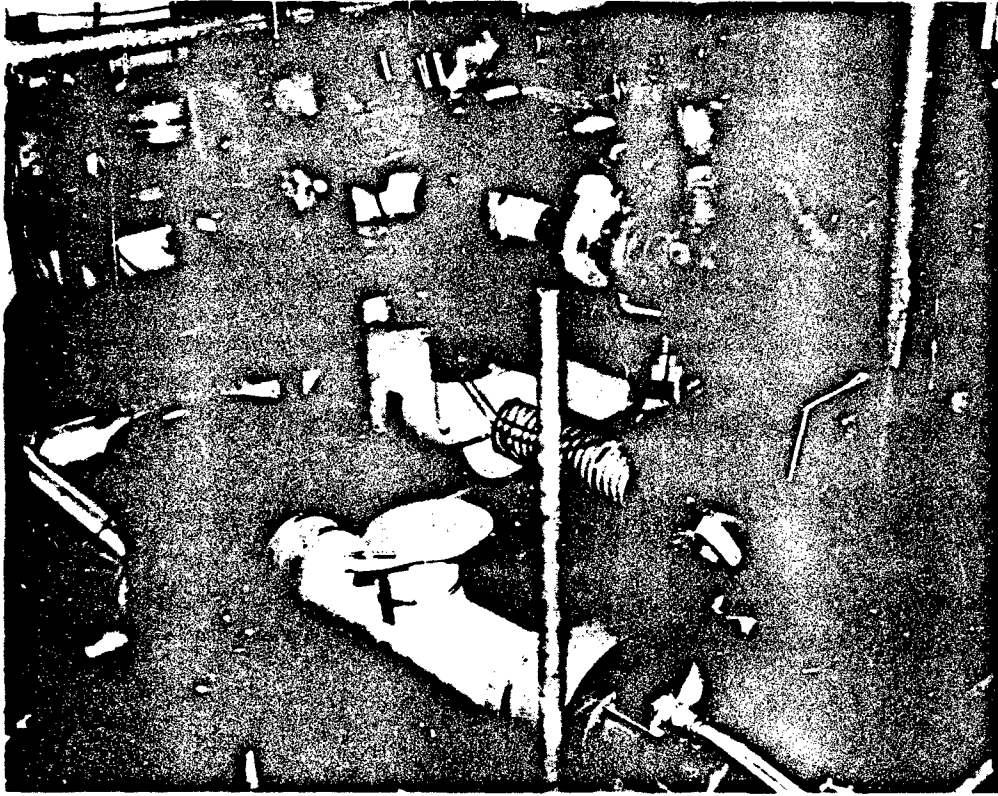

Figure 5-17. Left Front View of Primary and Blowback Scavenge Systems

Best Available Copy

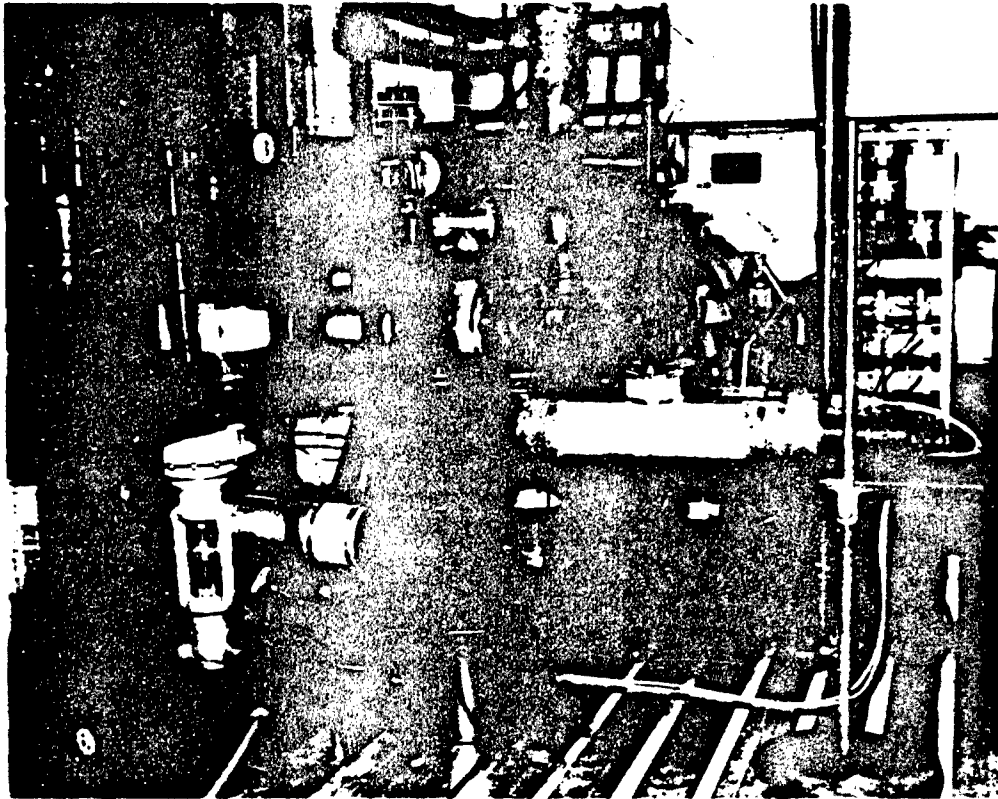

Figure 5-18. Left Front View of Test Setup

Best Available Copy

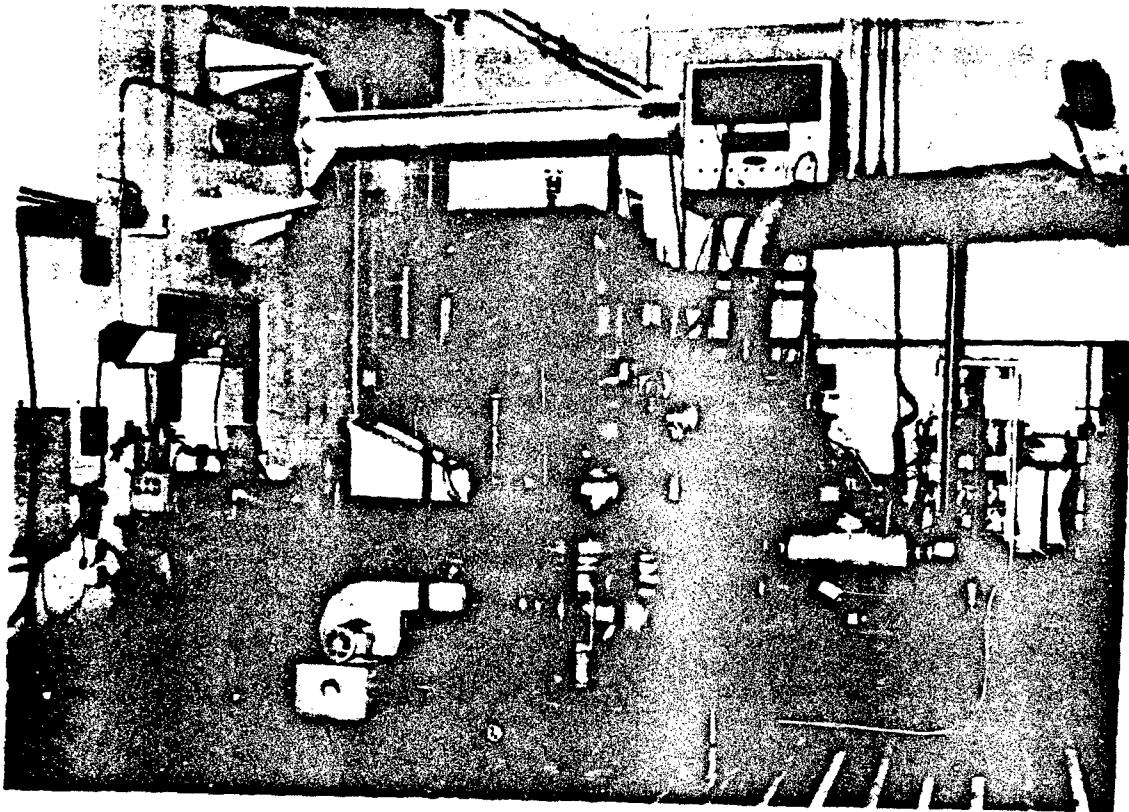

Figure 5-19. Overall Left Front View of Test Setup

background. Additional pressure taps and some backups were routed directly to a bank of manometers in the control room seen at right in Figure 5-20. At left on the countertop in Figure 5-20 were controls for the dust feeder and efficiency measurement system. These were operated by PLM. The window to the test cell is at the extreme left.

Figure 5-21 shows the control room engine and dynamometer controls and data monitoring and acquisition system. The test cell window is not visible to the right.

Figure 5-22 shows additional controls for the dust feeder and blowback valve on the upper level of the table. The blowback scavenge blower is located on the lower level. The tripod at lower right in Figure 5-22 houses the membrane or absolute filter used to measure the overall system filtration efficiency. An isokinetic sample of the engine intake air was drawn from just after the barrier filter (upper right in Figure 5-17) through this filter. The sample flow is maintained proportional to the engine airflow by adjustment of the valve above the flowmeter at left in Figure 5-20.

Before beginning the 200-hour test, a terminating condition was determined by simulating a dirty filter in the intake air stream. The pressure in the engine intake manifold, resulting from a restriction of 25 inches of water column after the precleaner, was selected. This pressure was approximately 13.4 psig.

Details of test procedures may be found in the test plan, Appendix A. Substantive deviations from the test plan are discussed in this section. In practice, the engine was brought to each operating point before starting the dust feed. The dust feed was stopped before proceeding to the next operating point.

#### 5.4. Results

The figures discussed in this section present the data for the 100%, 80%, 60%, 40% and 20% flow conditions. Due to limitations of the plotting software it was necessary for clarity to substitute an average of a prior and subsequent reading for some points that were missed or obviously in error. The original data are shown in Appendix B.

The engine had been run for over 200 hours since its last rebuild before starting this test. Some erroneously high horsepower readings early in the test were traced to brush drag in the dynamometer. Figure 5-23 shows the horsepower degradation experienced at the various airflows over the 120 cycles of the test. This is not an unusual degree of loss. The brake specific fuel consumption (BSFC) at each flow correspondingly increased as shown in Figures 5-24 through 5-28. Consistent readings were difficult to obtain at low speed as seen in Figure 5-28. The jump in BSFC just past the midpoint of the test

Best Available Copy

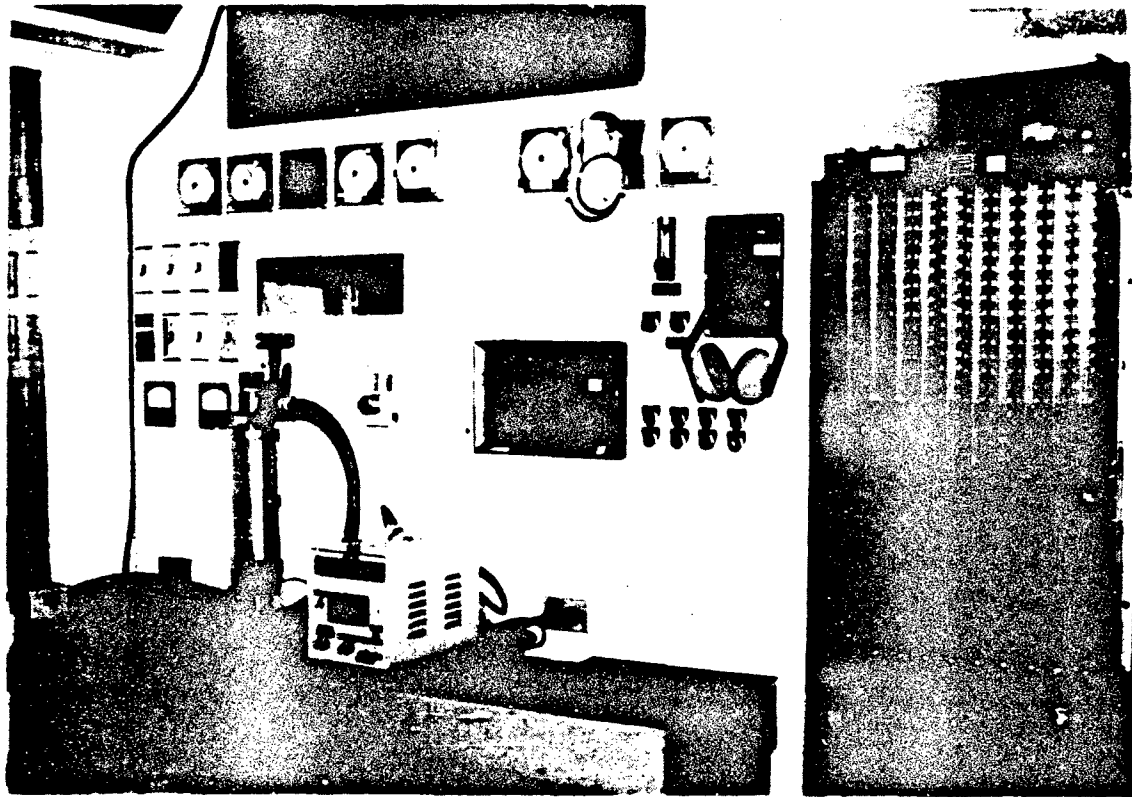

Figure 5-20. Control Room Equipment Including Efficiency Measurement Controls, Dust Feeder Controls and Manometers

Best Available Copy

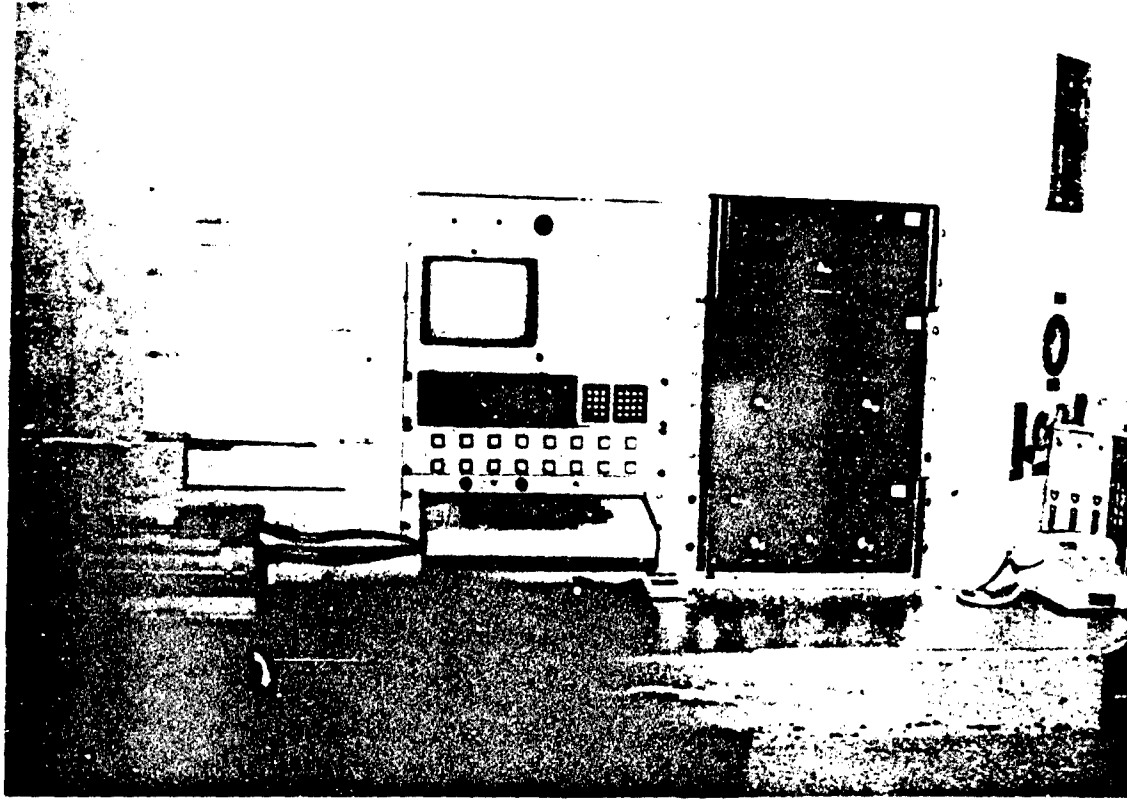

Figure 5-21. Data Monitoring and Acquisition System Controls with Engine and Dynamometer Controls

Best Available Copy

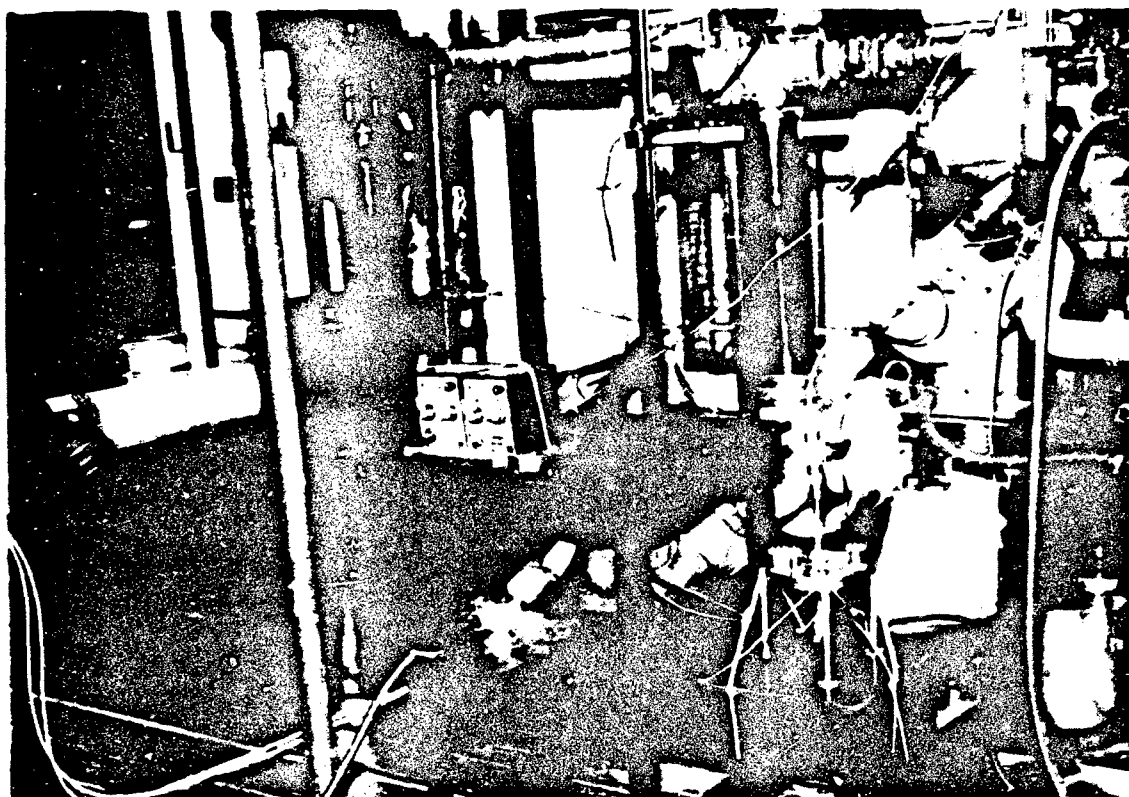

Figure 5-22. Left Rear View of Test Setup

# HORSEPOWER DEGRADATION

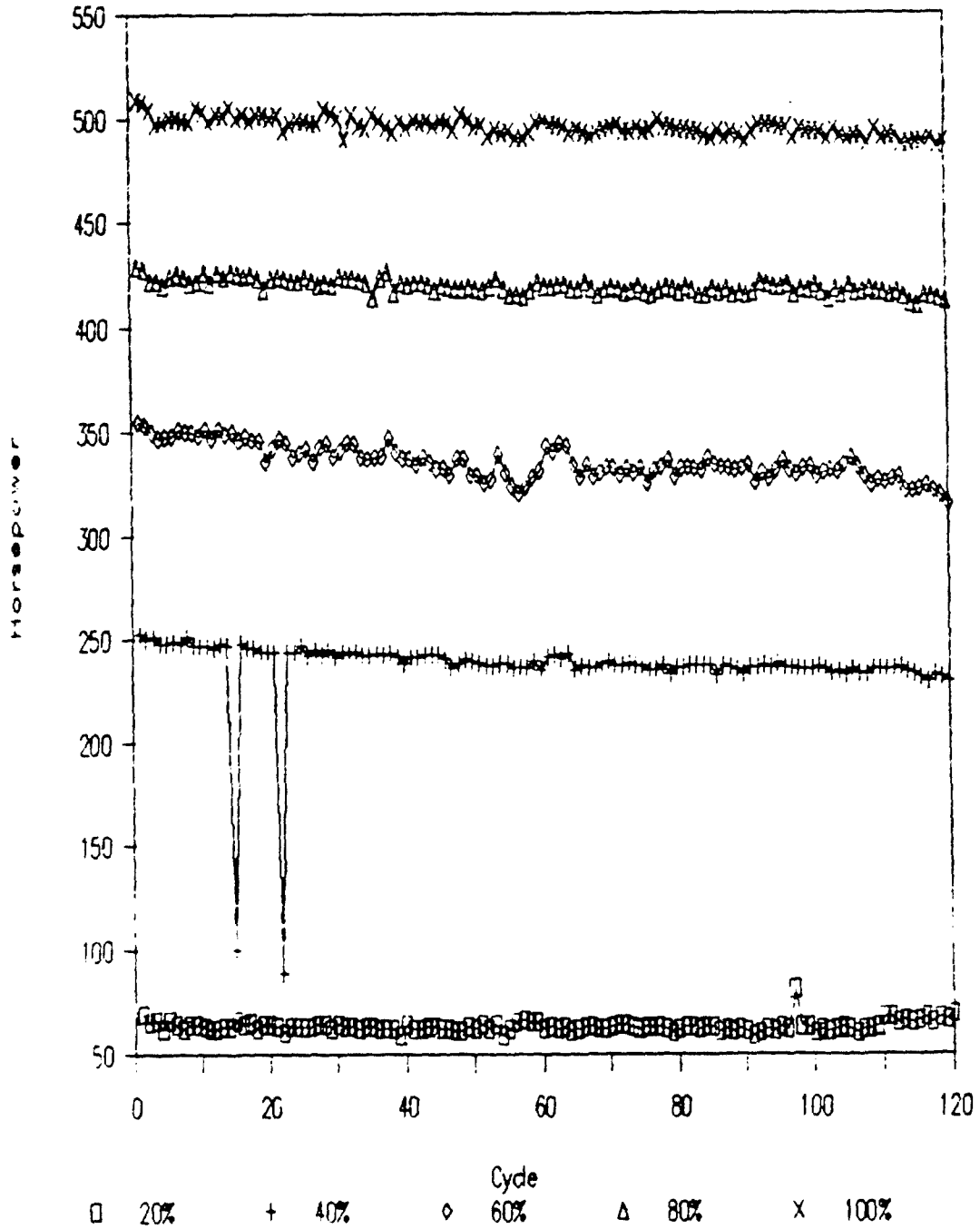

Figure 5-23. Horsepower Degradation



Best Available Copy

### BSFC CHANGES - 100% FLOW:

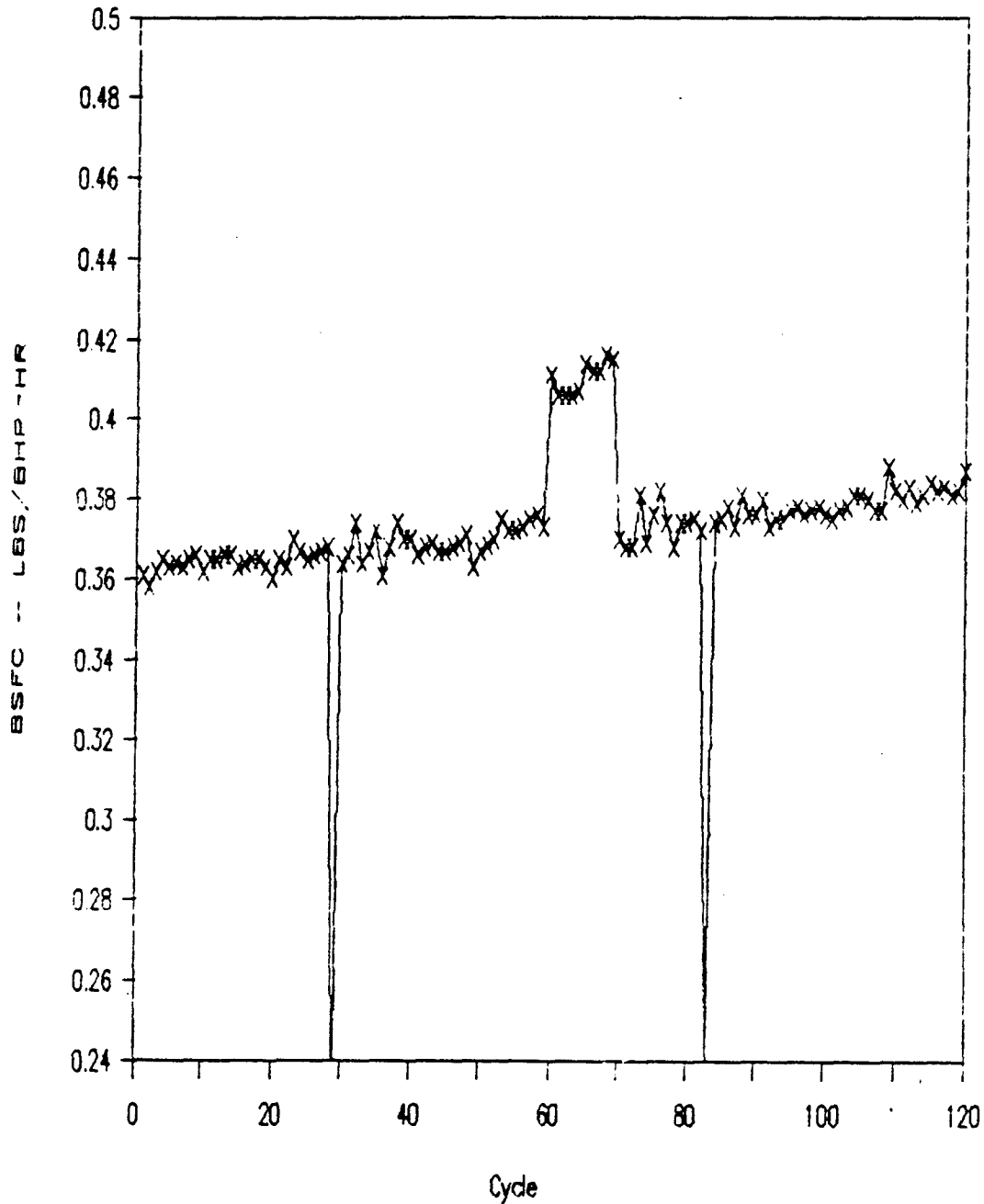

Figure 5-24. BSFC Changes--100% Flow

BSFC CHANGES - 80% FLOW

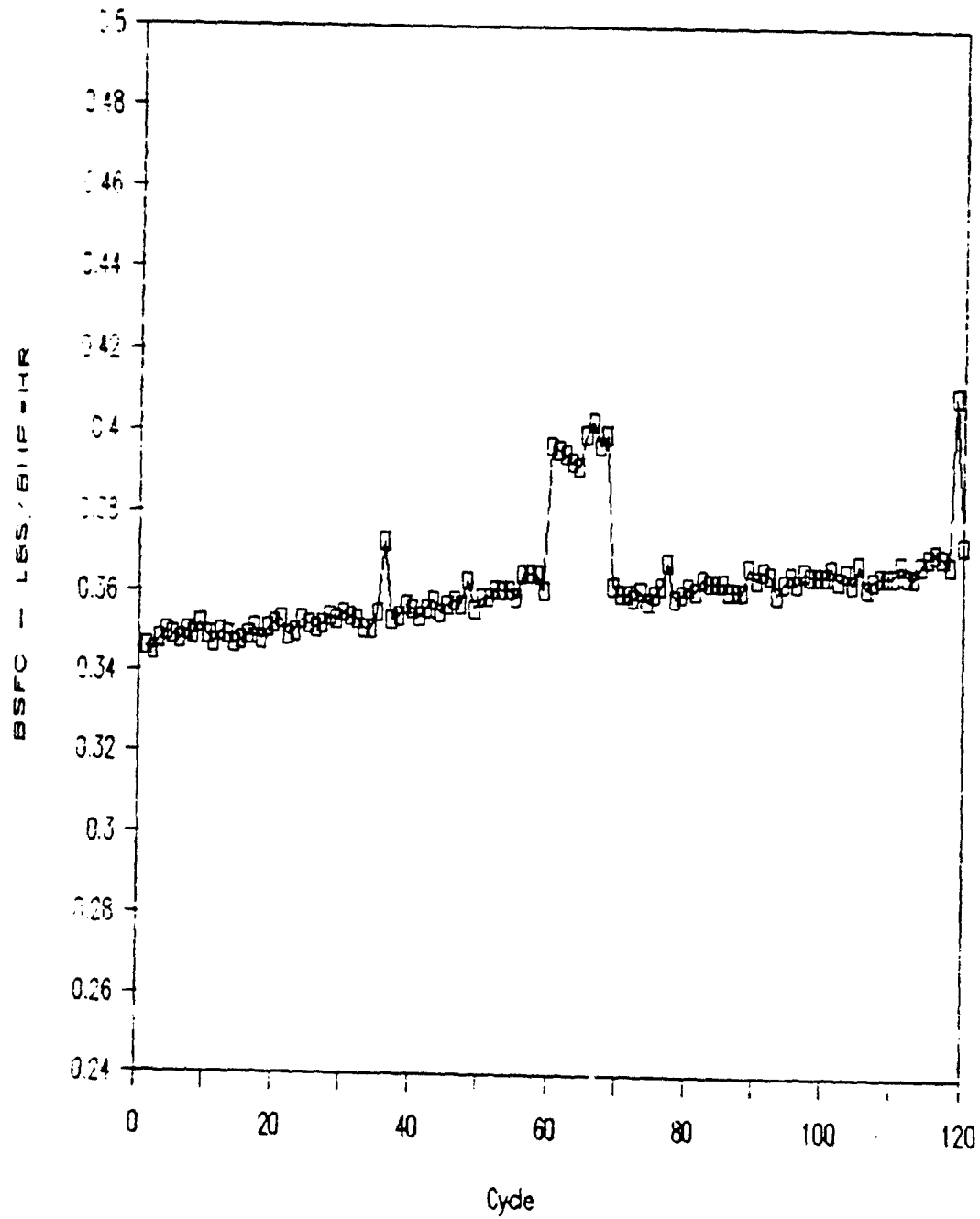

Figure 5-25. BSFC Changes--80% Flow

### BSFC CHANGES - 60% FLOW

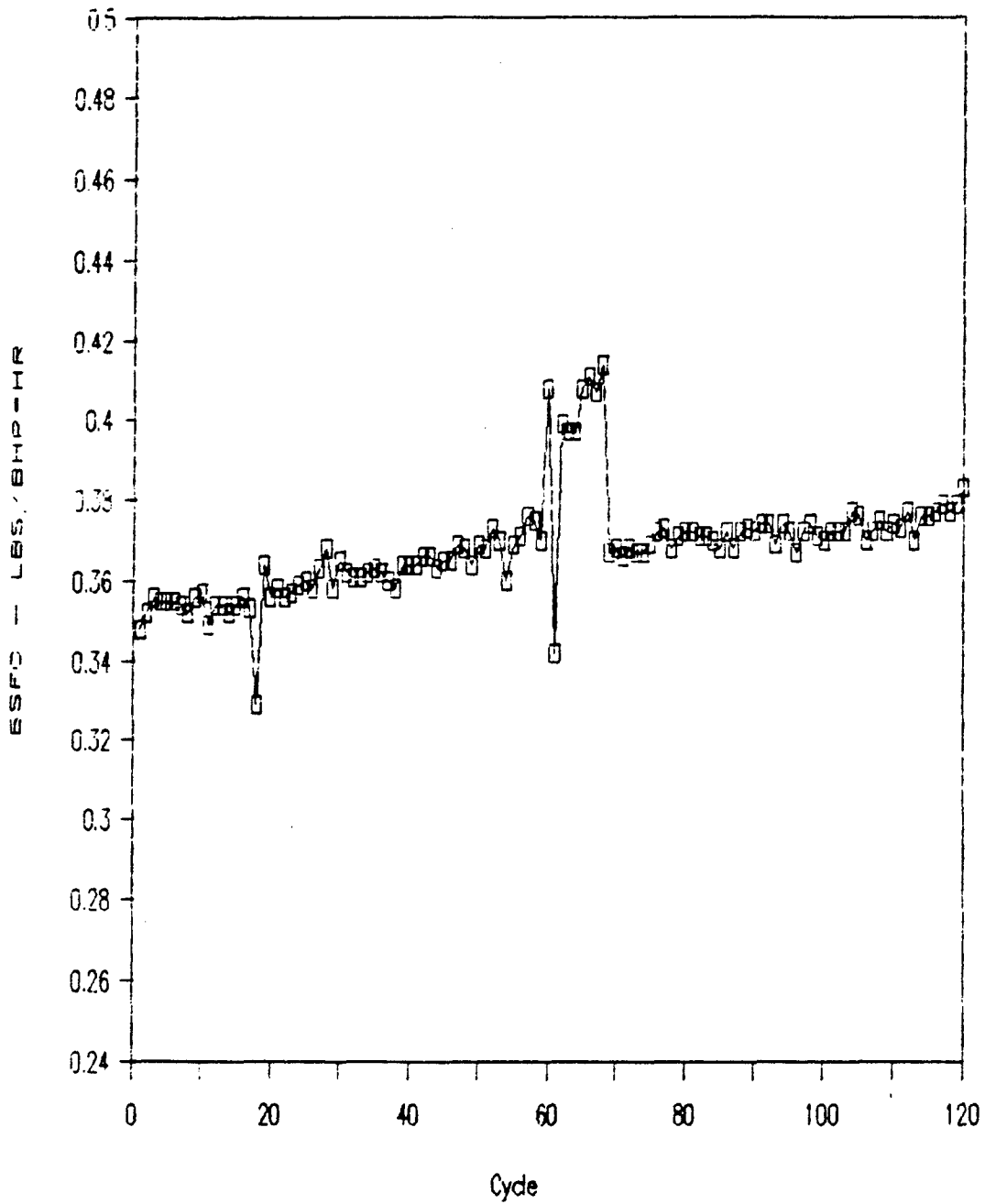

Figure 5-26. BSFC Changes--60% Flow

BSFC CHANGES - 40% FLOW

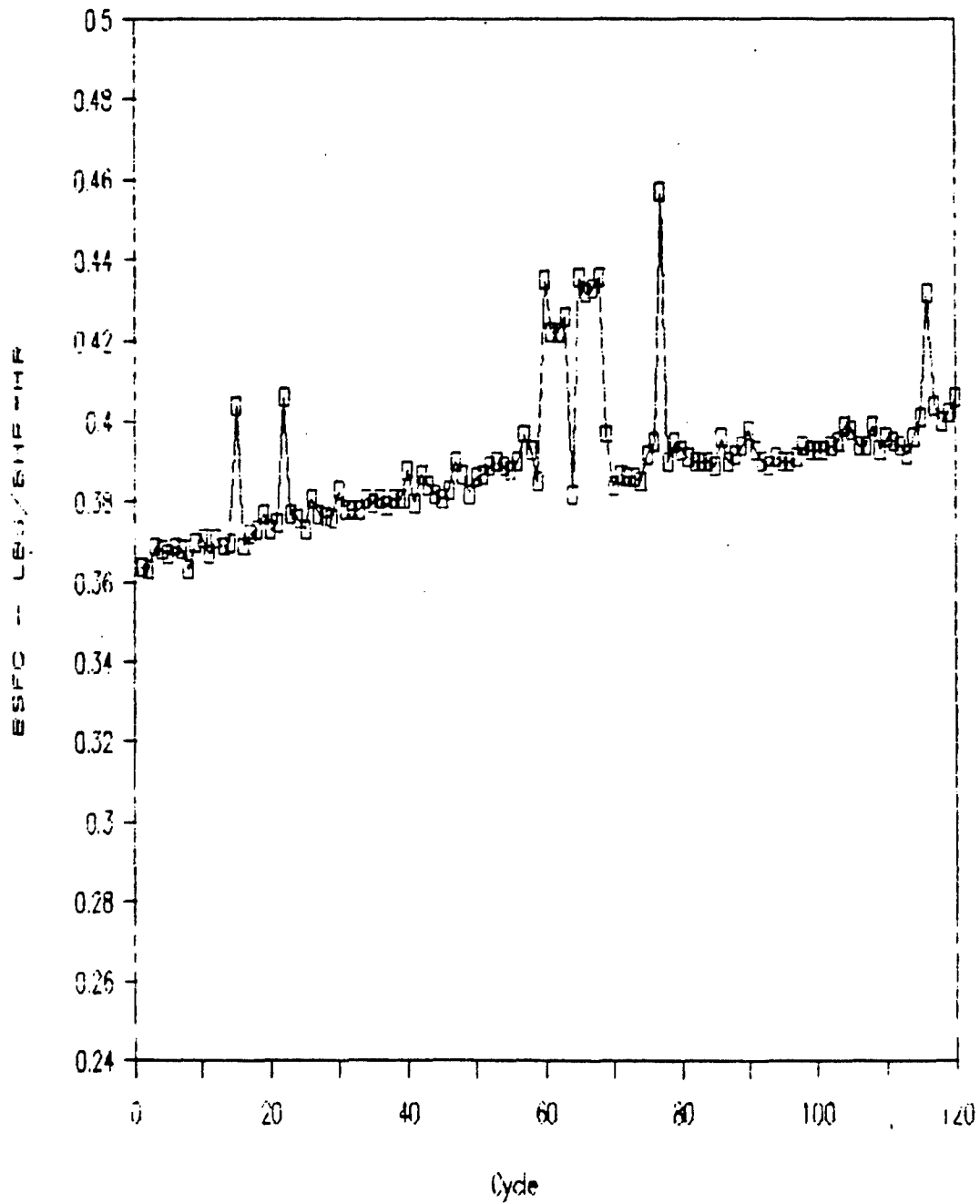

Figure 5-27. BSFC Changes--40% Flow

BSFC CHANGES - 20% FLOW

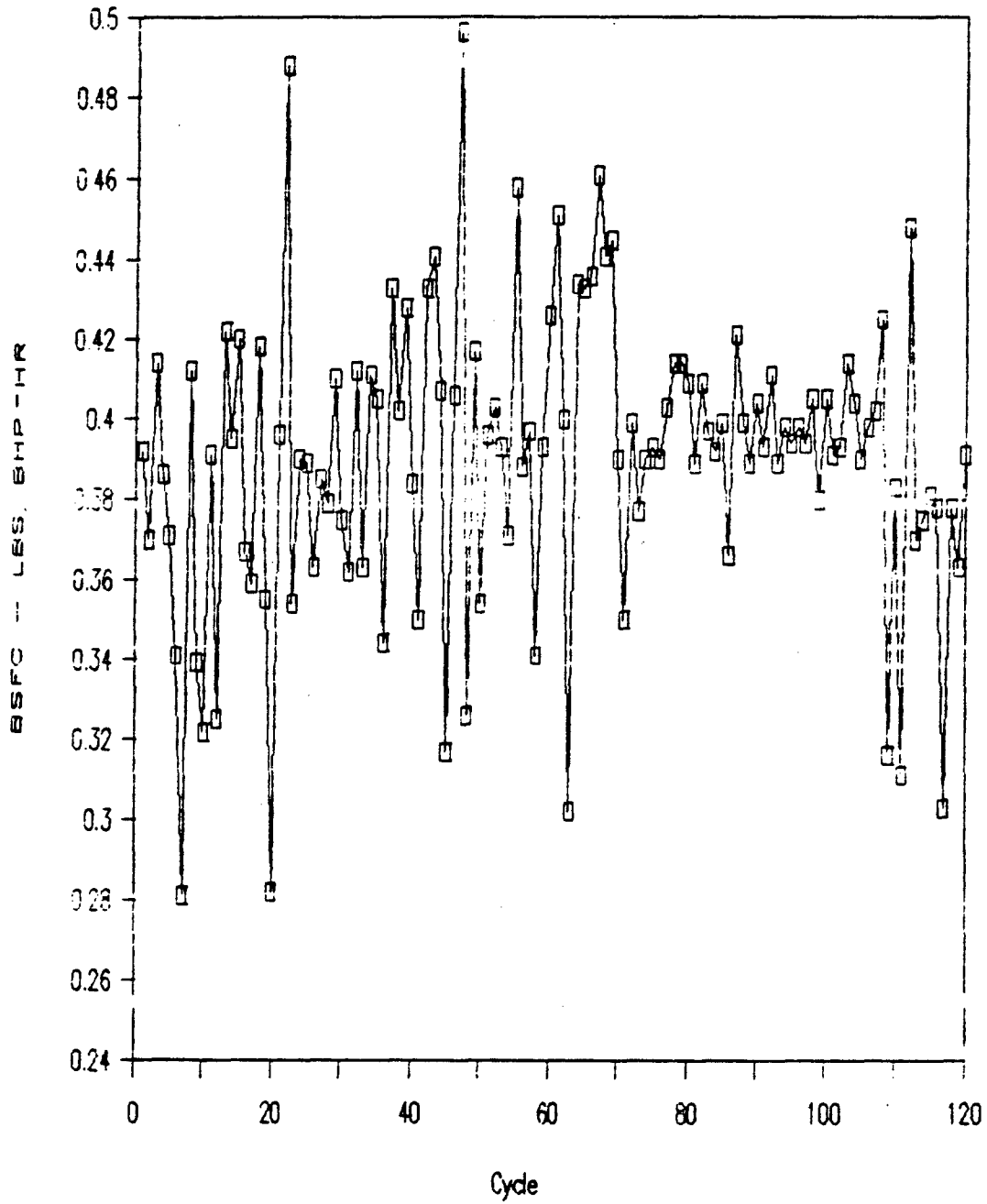

Figure 5-28. BSFC Changes--20% Flow

occurred during a period of low ambient air temperature which was produced by opening the outer test cell doors and running the test at night. However, problems with the fuel scale calibration were also encountered during this period. Basic engine curves comparing performance before and after the 200 hours of zero visibility dust ingestion are shown in Figure 5-29. Performance with the dirty barrier filter element and performance after its replacement following the 200-hour test with a new element is also compared in Figure 5-29.

A summary of spectrographic oil analysis is shown in Table 5-2. The substantial increase in silicon content indicates dust entering the oil. However, the dust particles that got through to the engine were probably too small to produce excessive wear. Engine crankcase pressure did not increase appreciably during the test (approximately 1 inch of water column at 100% airflow). A compression balance test using Simplified Test Equipment-Internal Combustion Engine-Reprogrammable (STE-ICE-R) equipment was within 5% after the 200 hours. Because the engine was well worn at the start of the test a teardown was not done at completion.

Figure 5-30 depicts the changes in overall system filtration efficiency as measured by PLM during some of the 100% airflow periods. The efficiency increased initially as might be expected due to plugging of the barrier filter pores. However, the efficiency soon dropped from approximately 99.3% to approximately 99.4% and remained there. After the 200-hour test was completed, PLM removed and studied the barrier filter element and concluded that this phenomenon was due to a manufacturing problem. The sintering operation used to repair cracks in the pleat crown was believed to have failed, allowing a small leakage of dust. PLM did not regard this as a fatigue failure because it did not propagate and suggested that the problem could be solved by adding additional annealing steps in the manufacturing cycle to eliminate cracking during the pleating operation.

Figure 5-31 shows the difference in membrane filter deposition from test cycle number 2 (99.7% efficiency) and test cycle number 57 (99.4% efficiency). The efficiencies were calculated from:

$$1 - \frac{(\text{membrane filter weight increase in grams})}{(26.5 \text{ g/min}) (100 \text{ min}) (.6) (.0055)}$$

where the zero visibility dust feed rate was 26.5 g/min over the 100-minute cycle at an average airflow rate of 60%. The ratio of flow areas of the sampling tube and engine air inlet duct was .0055.

Because the turbocharger's high-speed compressor wheel was exposed to air that was only precleaned, its condition was of primary concern in this test. It became convenient to halt the test after 97 hours for midpoint inspection. The turbocharger was disassembled and no measurable changes were found in its critical dimensions at that time. Figure 5-32 shows the turbine and compressor wheels after 200 hours. Even the rubber-stamped part number was still clearly visible on the compressor wheel and there was still no change in dimensions. The compressor wheel lost less than .01 g in weight out of 470 g.

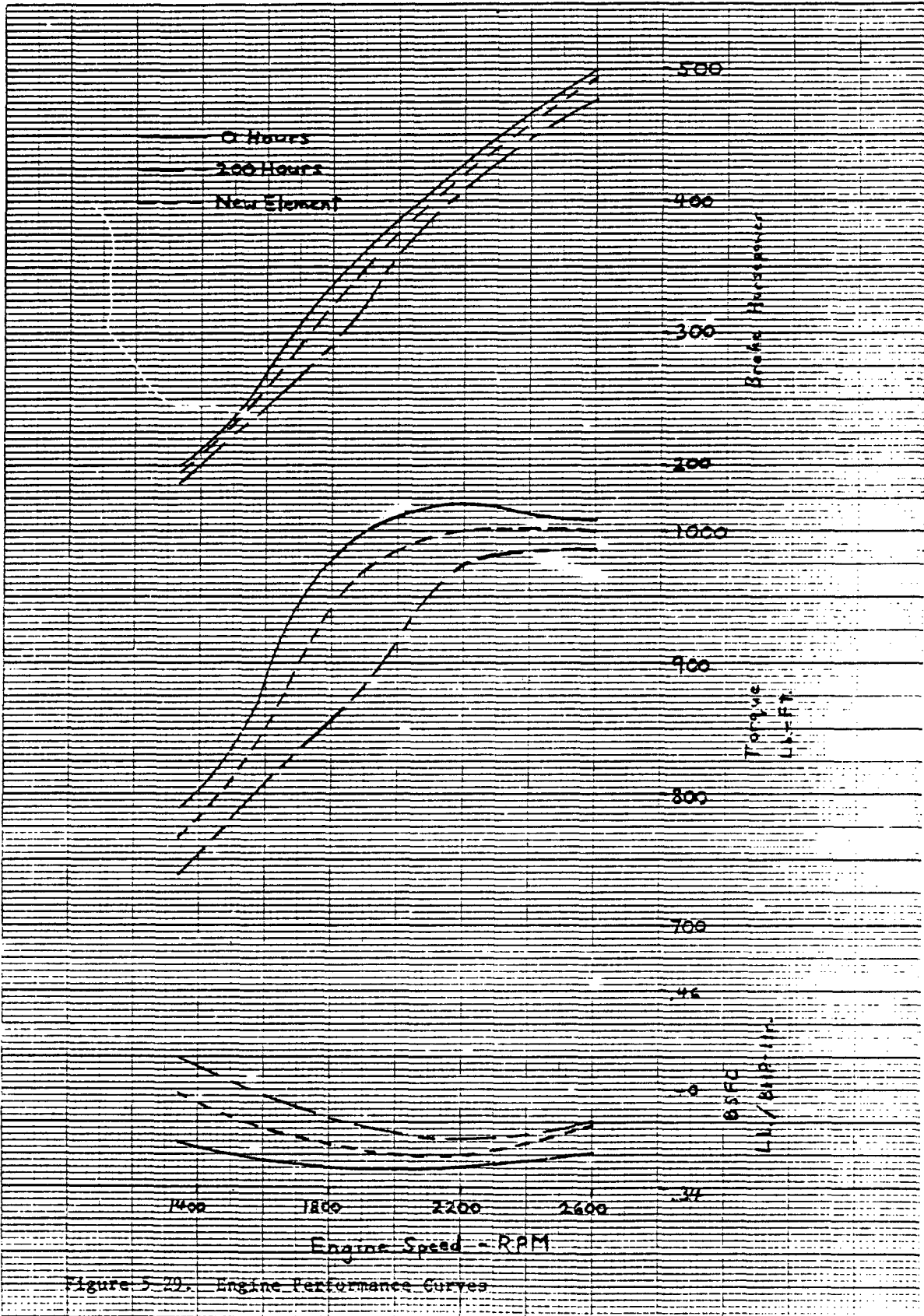

Figure 5-29. Engine Performance Curves.

Table 5-2. 200-Hour Air Cleaner Test--Spectrographic Oil Analysis

Date	Metals ppm	Fe	Al	Cr	Cu	Mg	Na	Ni	Pb	Si	Ti	B	Mo	Zn
4/2	0 hours	23	0	5	2	473	6	0	11	10	0	91	0	998
4/10	31 1/6 hours	66	18	21	4	495	9	0	13	50	0	90	0	998
4/16	61 2/3 hours	161	68	45	8	563	22	5	25	227	3	92	2	998
4/18	79 hours	135	60	38	8	539	19	4	23	184	0	95	3	998
4/24	97 hours	193	85	47	9	554	27	5	28	291	4	85	4	998
-----oil change-----														
4/28	122 hours	91	50	25	3	516	18	0	9	179	0	111	0	998
4/30	134 hours	125	68	35	4	536	23	3	11	264	4	108	3	998
5/4	150 hours	233	90	47	6	516	30	5	12	350	5	109	0	998
5/9	186 2/3 hours	358	143	73	12	495	53	8	23	552	8	101	4	998
5/11	200 hours	356	167	69	13	557	51	6	25	657	9	99	5	998



# FILTRATION EFFICIENCY

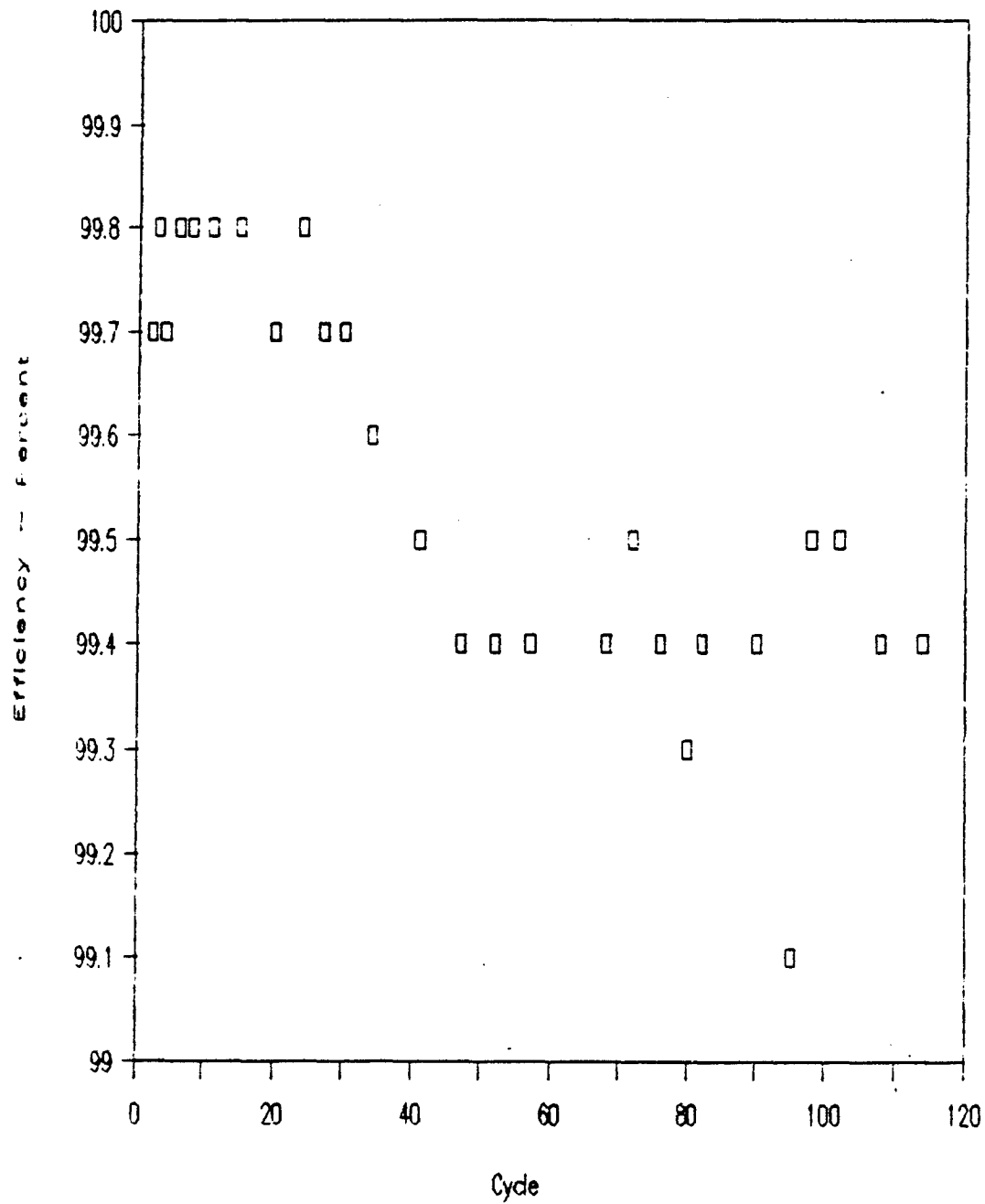

Figure 5-30. Filtration Efficiency

Best Available Copy

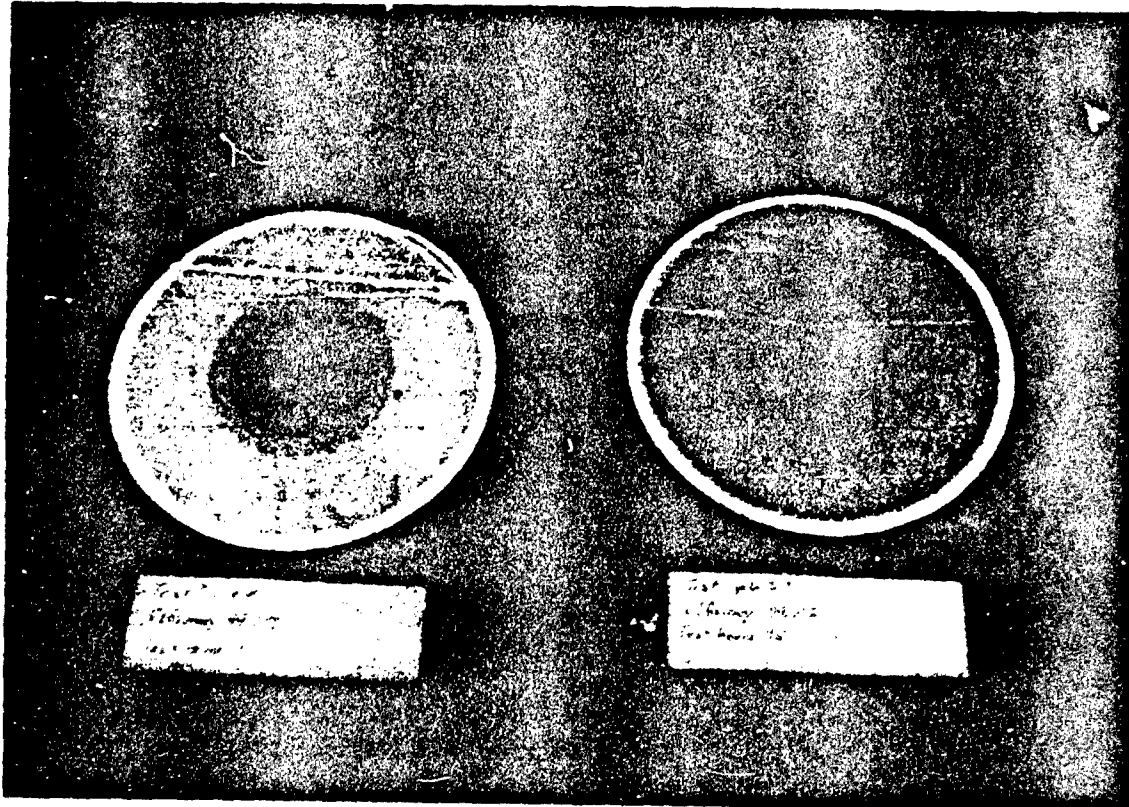

Figure 5-31. Membrane Filters Before and After Development of Barrier Filter Leakage

Best Available Copy

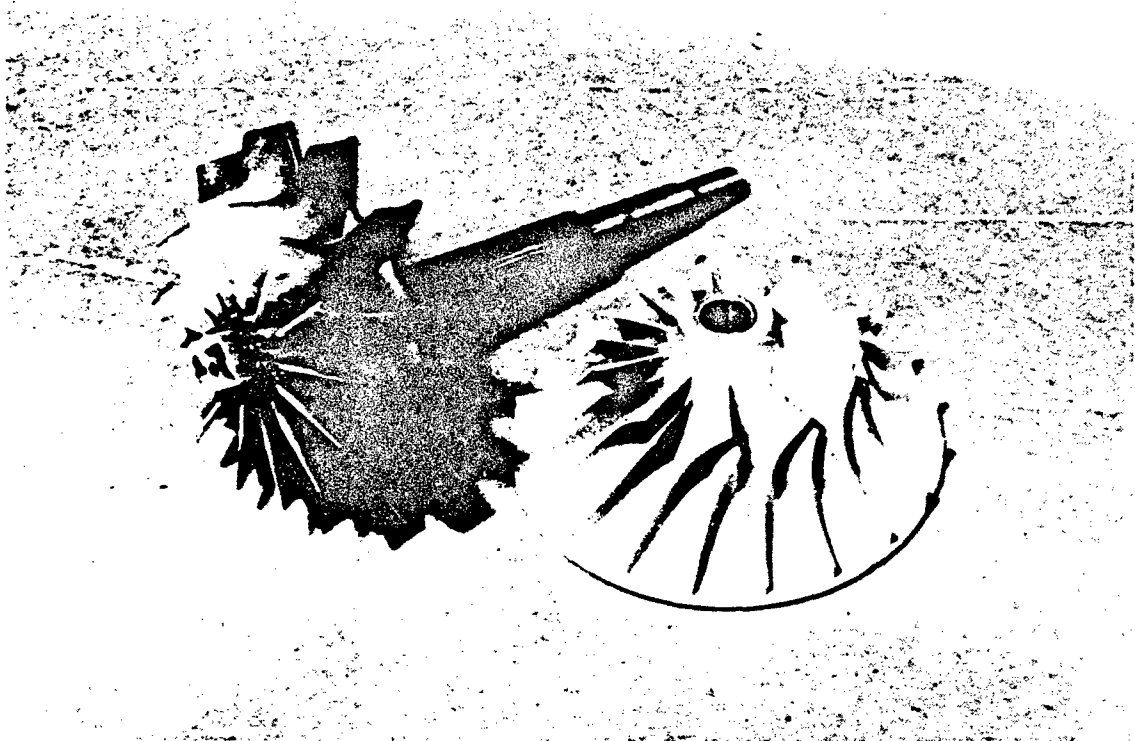

Figure 5-32. Turbocharger Turbine and Compressor Wheels after 200 Hours

The surface finish of the compressor wheel was measured as 50-60 microinches at the start of testing. After 200 hours a slight polishing effect was noticeable at the periphery of the blades and base. Surface finish measurements decreased gradually, moving radially from the hub where they remained 50-60 microinches to the periphery where the surface finish was approximately 30 microinches.

Figures 5-33 through 5-36 show the remaining major turbocharger parts including the turbine wheel housing, the compressor wheel housing and the bearing housing (with heat shield) from the turbine and compressor sides, respectively.

All the turbocharger parts including the turbine and compressor wheels (Figure 5-32) were lightly coated with dust as well as normal carbon deposits on the exhaust side. The dust was somewhat heavier on the compressor side of the bearing housing behind the wheel (Figure 5-36). An annular brown stain was visible inside the compressor housing (Figure 5-34). It did not rub off.

Figure 5-37 shows the changes in pressure drop across the barrier filter at several airflow rates over the course of the test. Some of the variations are attributable to experiments run by PLM to study the self-cleaning capability of the system. Both the barrier rotational speed and the frequency of the blowback pulses were doubled in test cycles 61-69, 92-96 and 112-120. The results indicated a limited ability to reduce the pressure drop before it began to rise again. The lower ambient temperatures in test cycles 61-64 were not believed to appreciably affect the barrier pressure drop.

Figure 5-38 shows the engine intake manifold pressure, turbocharger air discharge pressure, turbocharger pressure ratio, turbocharger air discharge temperature, barrier filter pressure drop and engine BSFC at the 100% airflow condition for all test cycles. Figures 5-39 through 5-42 show the same manifold and turbocharger data with the results at four other airflow conditions. No rise in turbocharger air discharge temperature occurred during the test, although this parameter was sensitive to ambient air temperature. A noticeable improvement in turbocharger performance occurred after exhaust leaks at the turbocharger were repaired at midpoint teardown. Evidence of exhaust leaks had not been noticed earlier. The drop in turbocharger performance during the last few test cycles was also believed due to exhaust leaks at that time. Although the engine intake manifold pressure began to drop consistently below the previously determined terminating value of 13.4 psig, the test was not terminated early because the problem was not believed due to deterioration of the air filtration system performance. The barrier filter pressure drop was decreasing at the time (Figure 5-37) due to increased cleaning rate.

Figures 5-43 through 5-47 show the barrier filter after completion of the 200-hour test. A light coating of dust is evident. Figure 5-43 shows the filter element mounted eccentrically in the housing. It is held against the upper labyrinth seals (Figure 5-44) by the spring-loaded lower bearing assembly (Figure 5-45). The element is shown with the end cap in Figure 5-46 and in relation to the housing in Figure 5-47.

Best Available Cop.

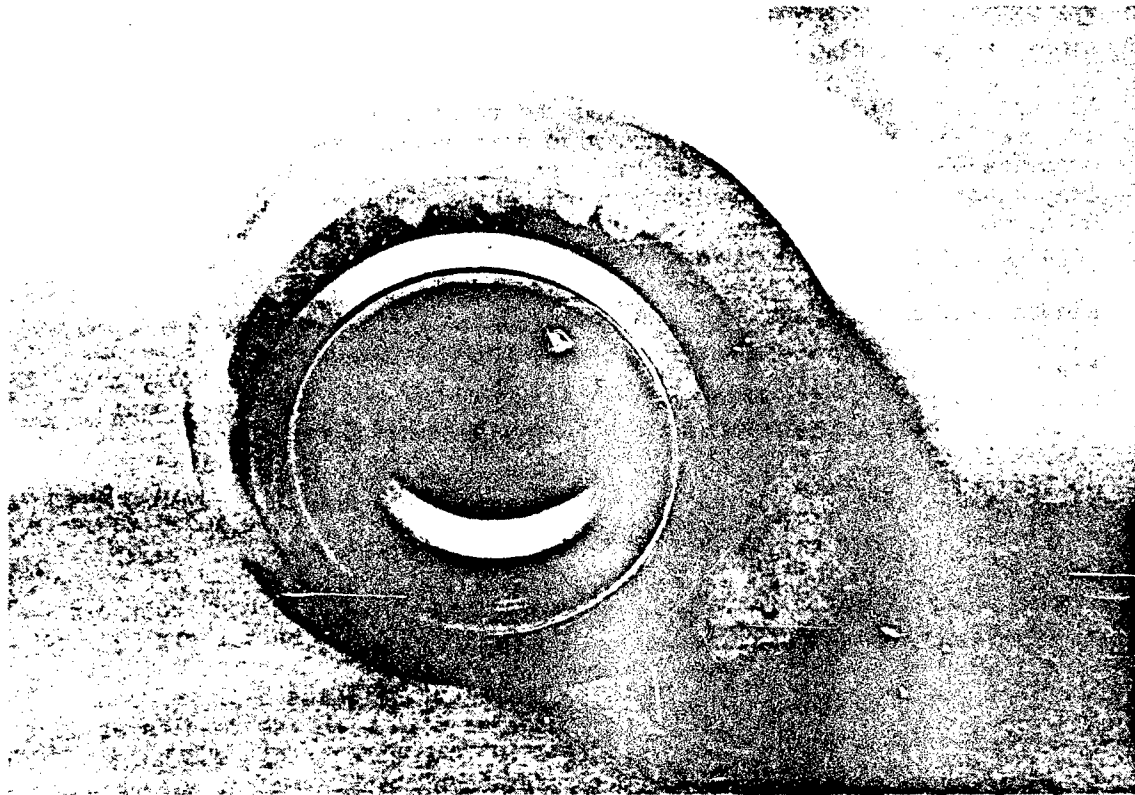

Figure 5-33. Turbocharger Turbine Housing After 200 Hours

Best Available Copy

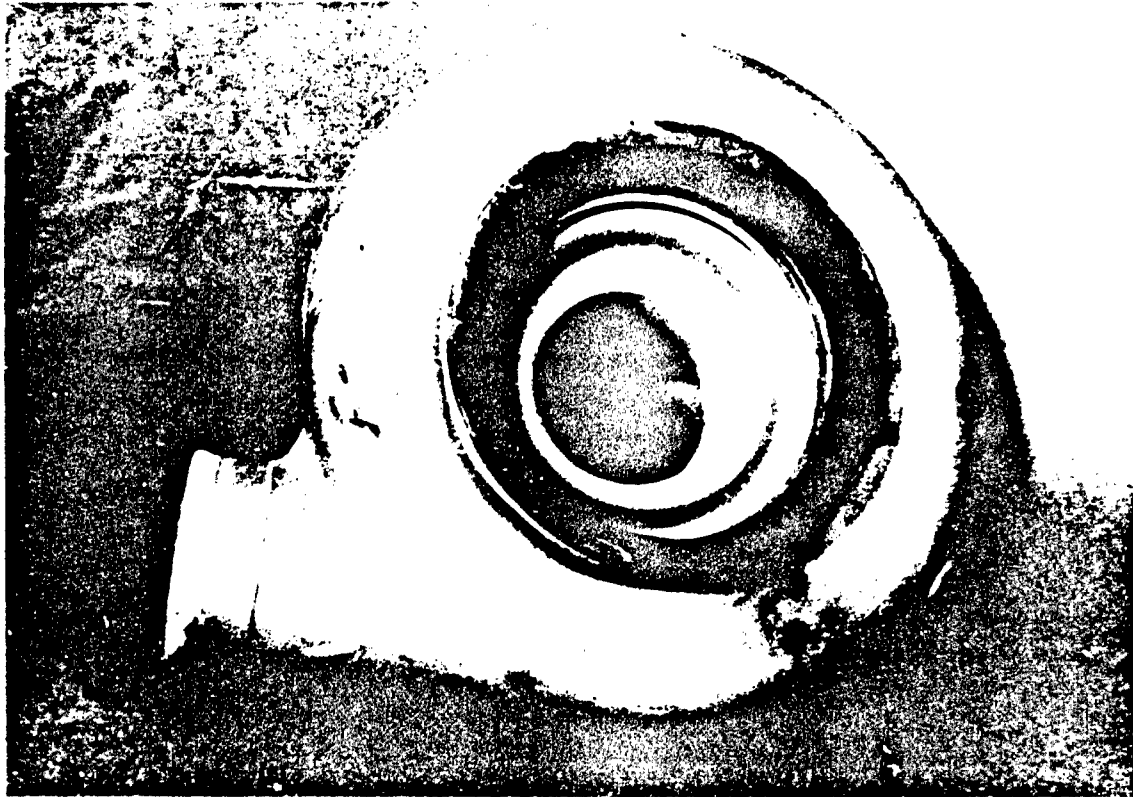

Figure 5-34. Turbocharger Compressor Housing After 200 Hours

Best Available Copy



Figure 5-35. Turbocharger Bearing Housing from Turbine Side After 200 Hours

Best Available Copy

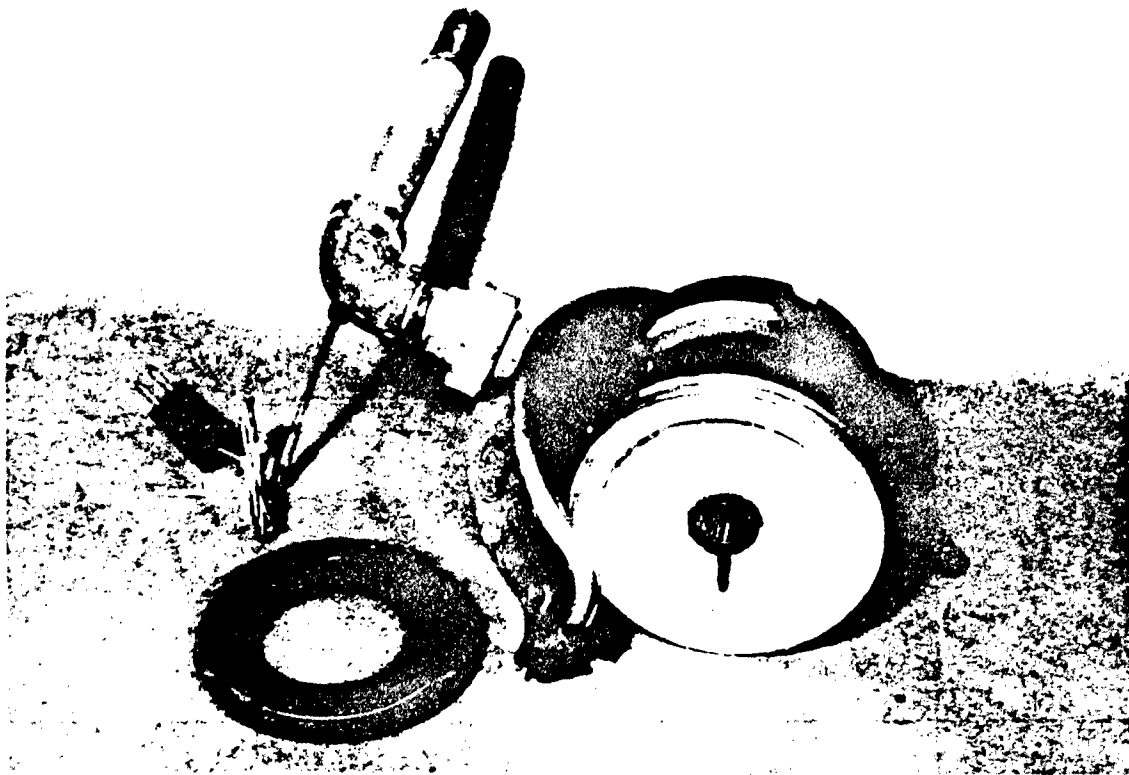

Figure 5-36. Turbocharger Bearing Housing from Compressor Side after 200 Hours



# BARRIER FILTER PRESSURE DROP

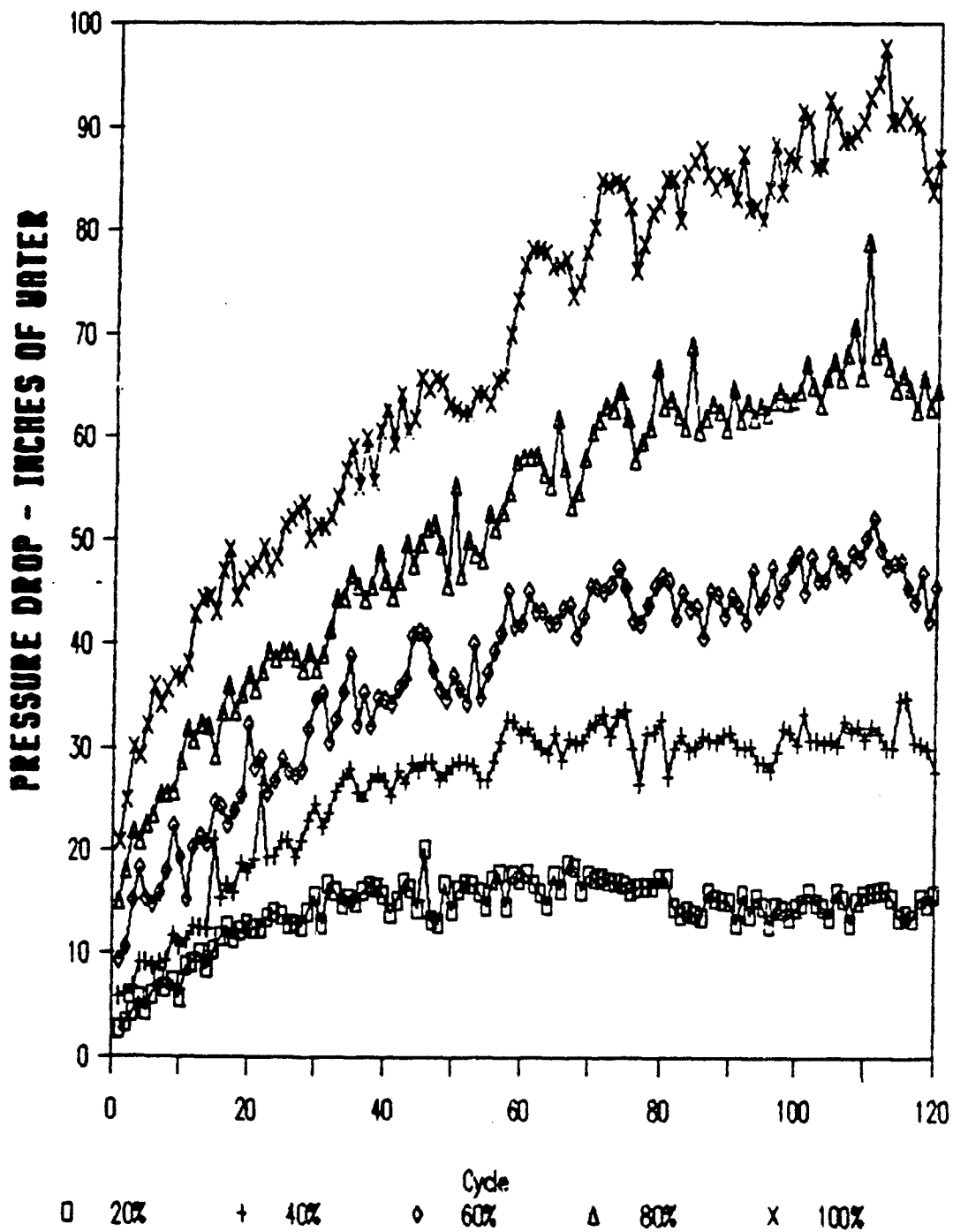

Figure 5-37. Barrier Filter Pressure Drop

# 100% AIRFLOW PARAMETERS

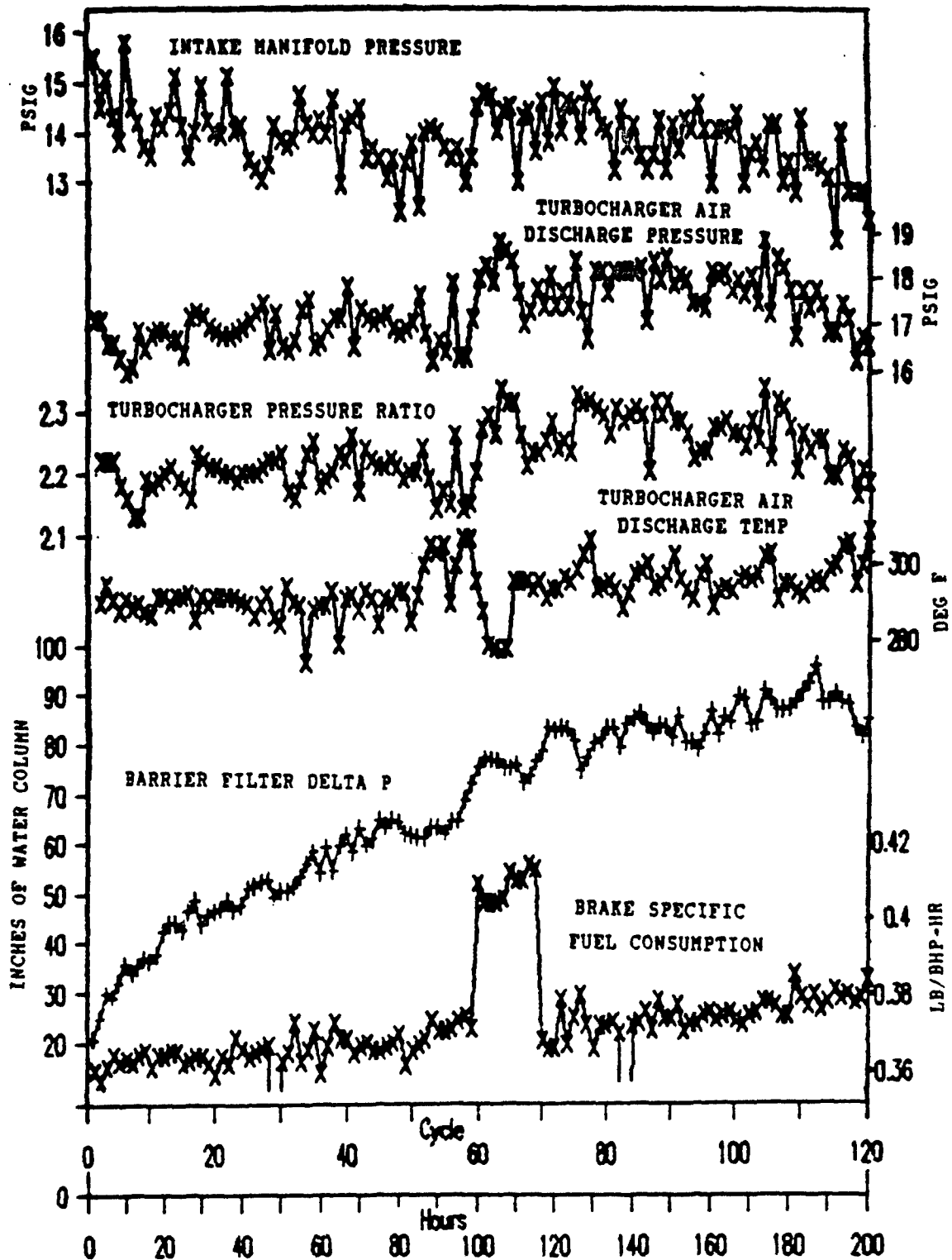

Figure 5-38. 100% Airflow Parameters

# INTAKE MANIFOLD PRESSURE

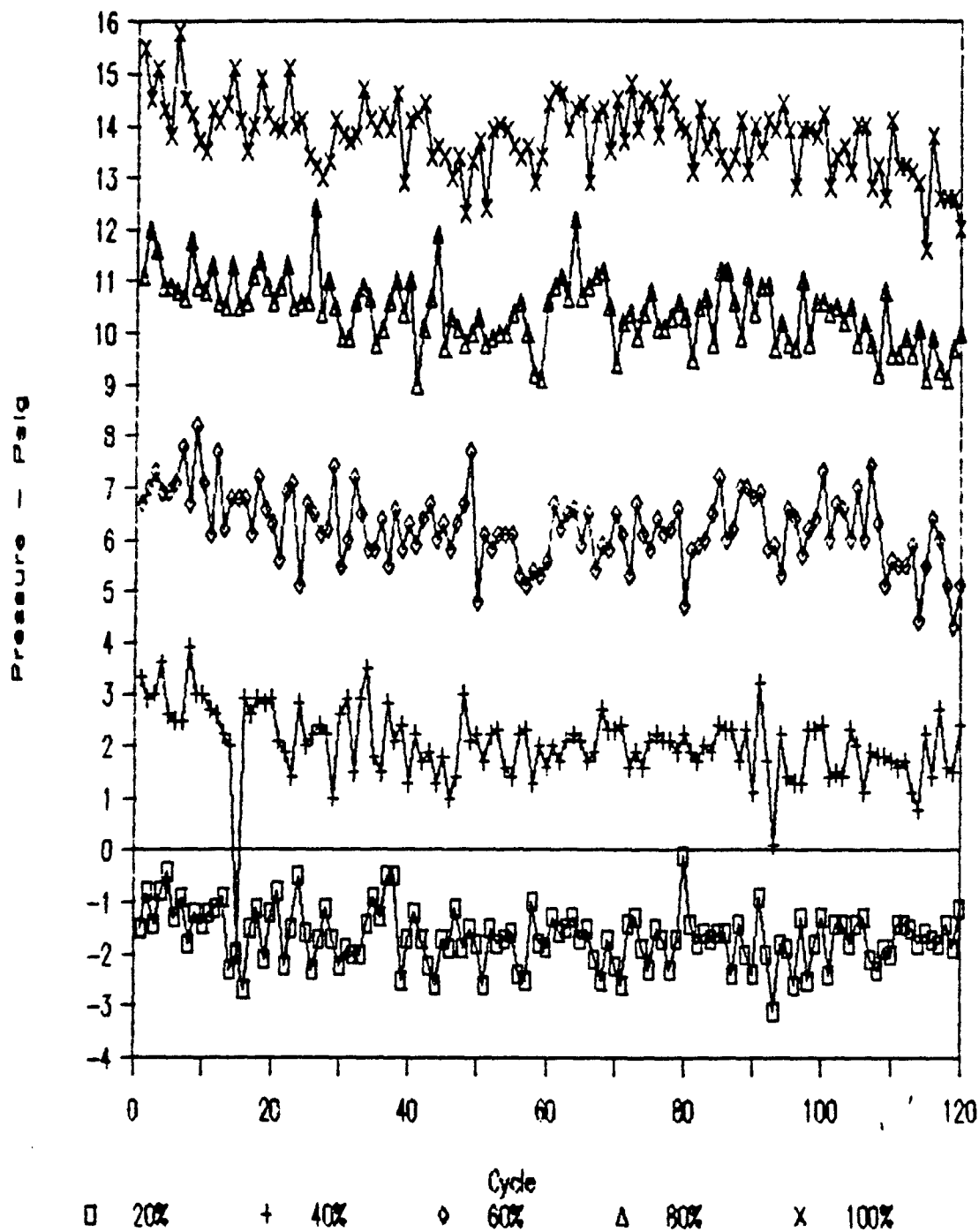

Figure 5-39. Intake Manifold Pressure

# TURBOCHARGER DISCHARGE PRESSURE

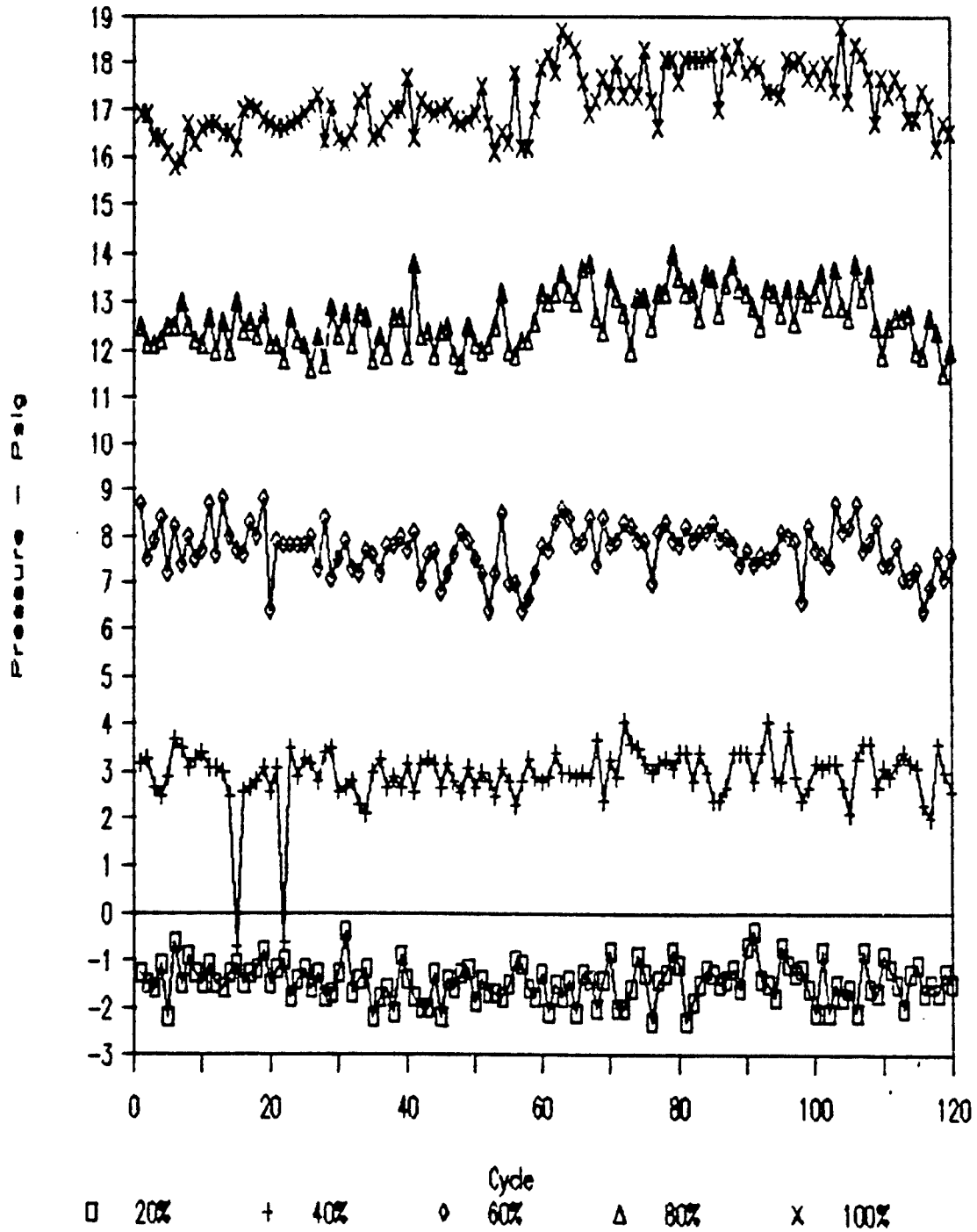

Figure 5-40. Turbocharger Discharge Pressure

# TURBOCHARGER PRESSURE RATIO

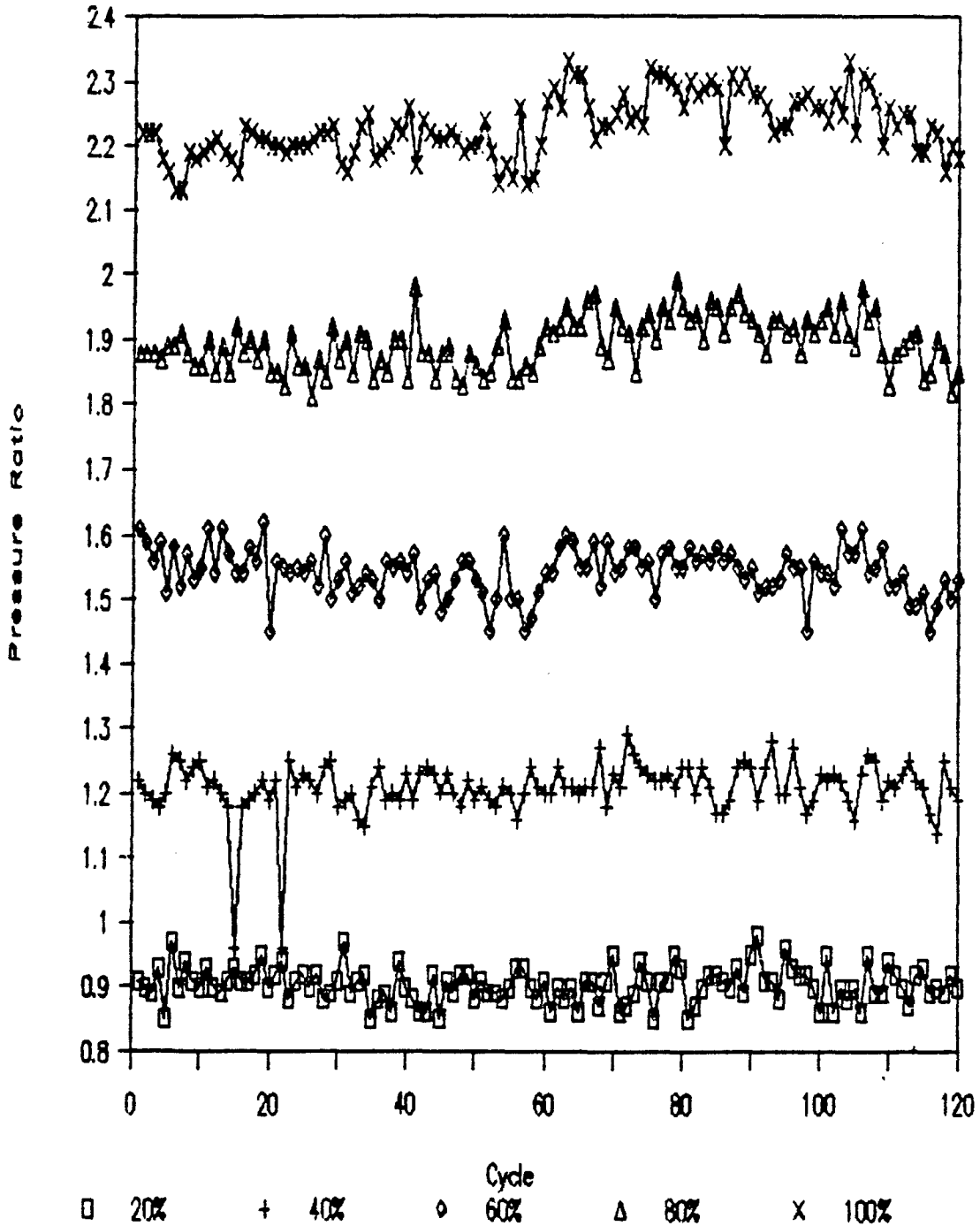

Figure 5-41. Turbocharger Pressure Ratio

# TURBOCHARGER DISCHARGE TEMPERATURE

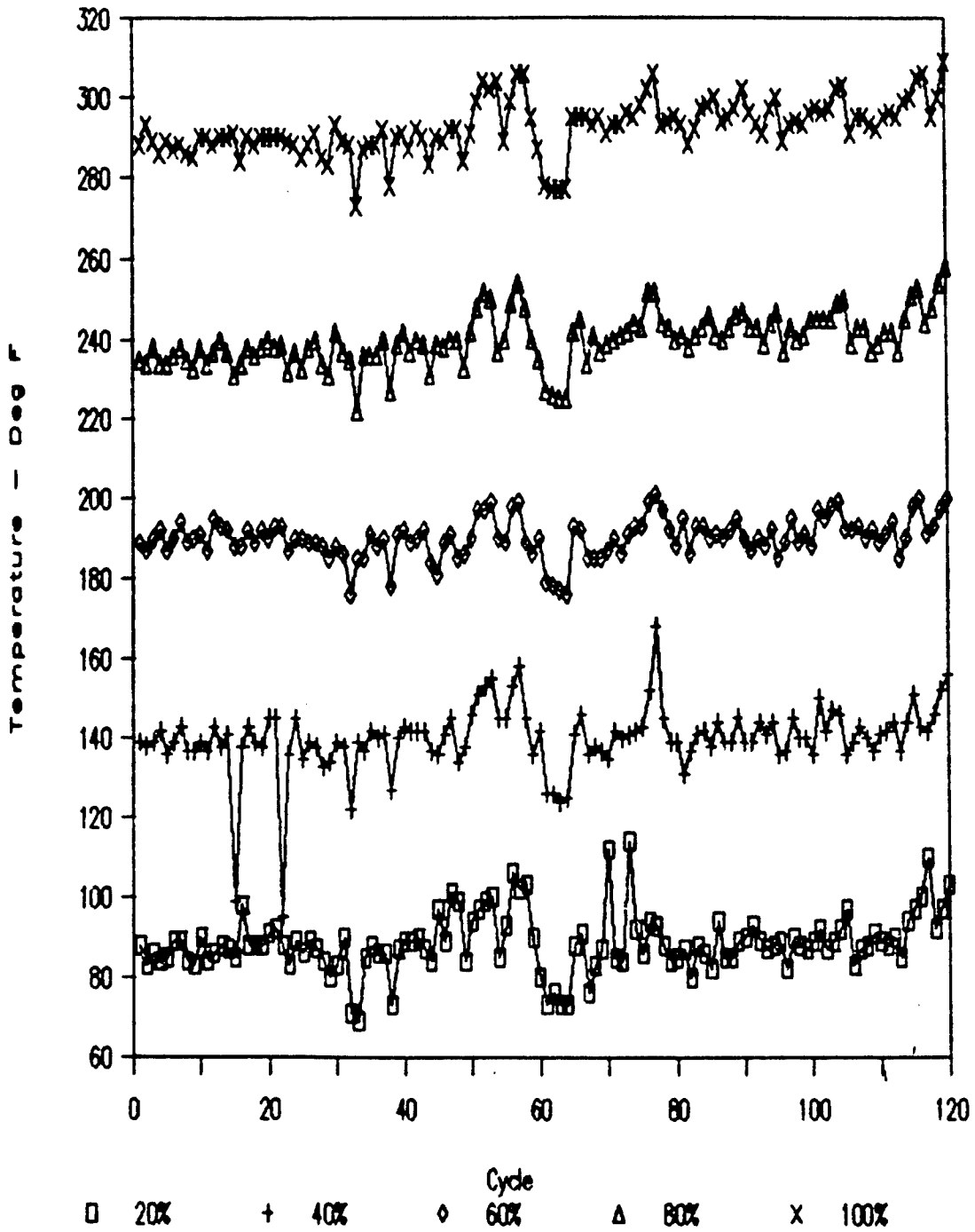

Figure 5-42. Turbocharger Discharge Temperature

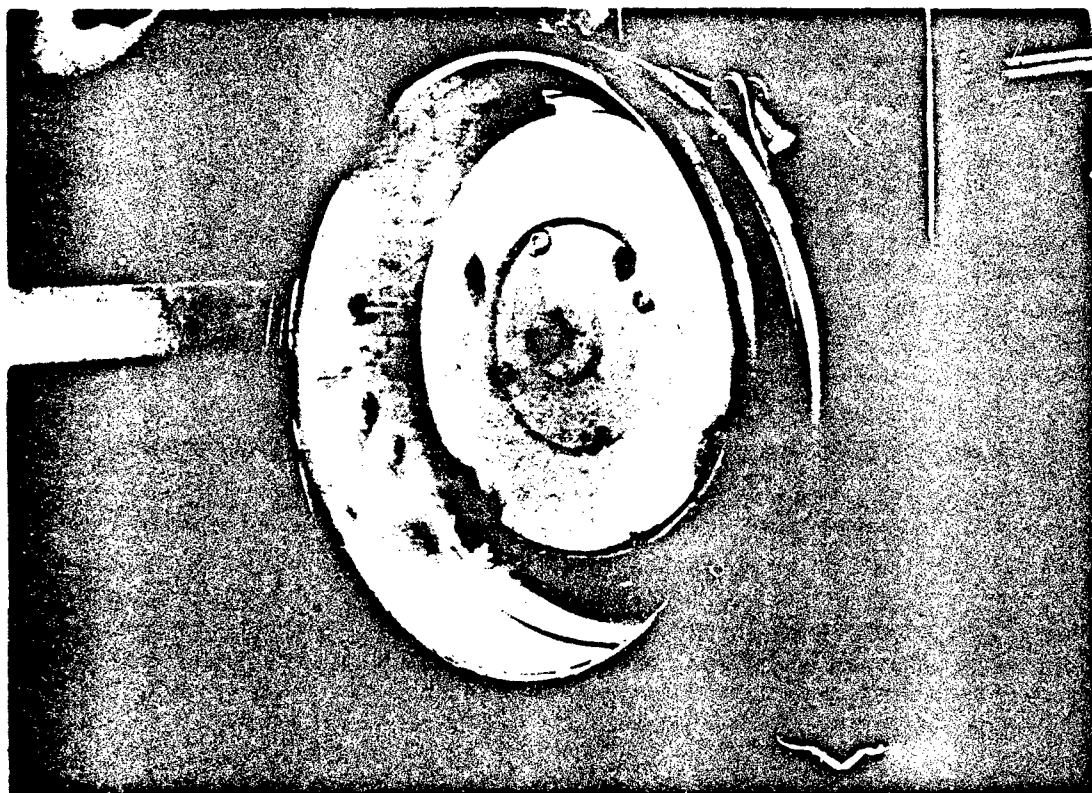

Figure 5-43. Barrier Filter Element Mounted Eccentrically in Housing

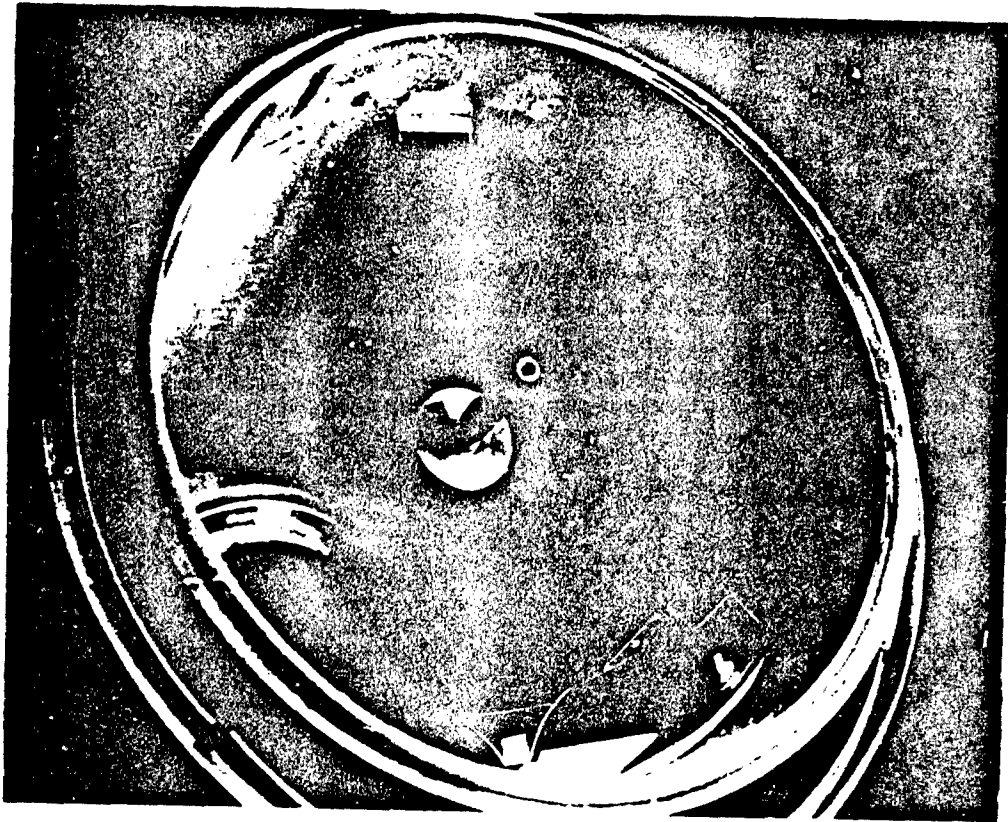

Figure 5-44. Labyrinth Seals Internal to Barrier Filter Housing



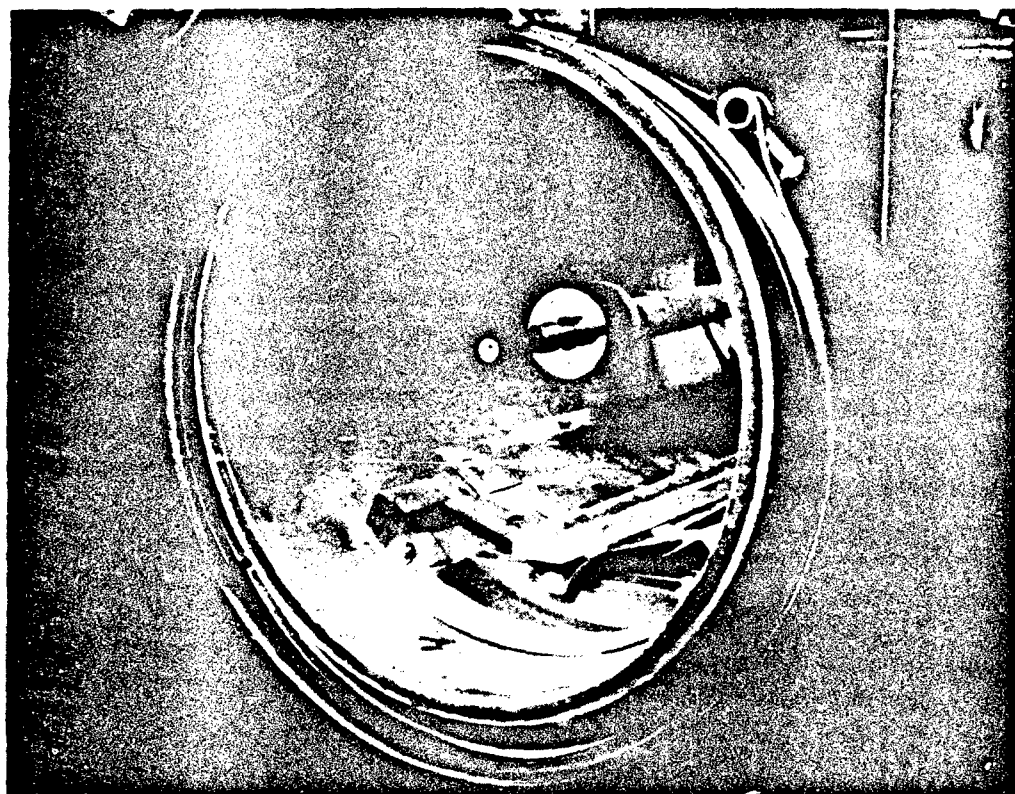

Figure 5-45. Lower Bearing Assembly Internal to Barrier Filter Housing

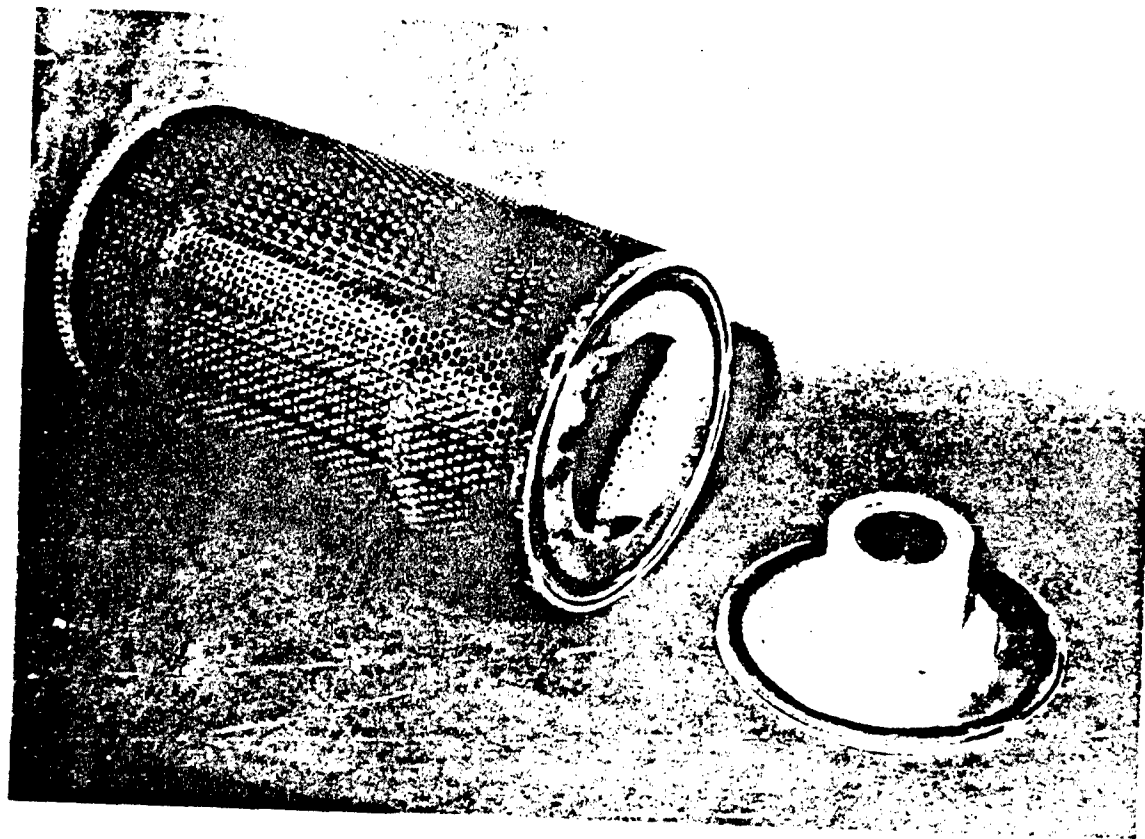

Figure 5-46. Barrier Filter Element with End Cap

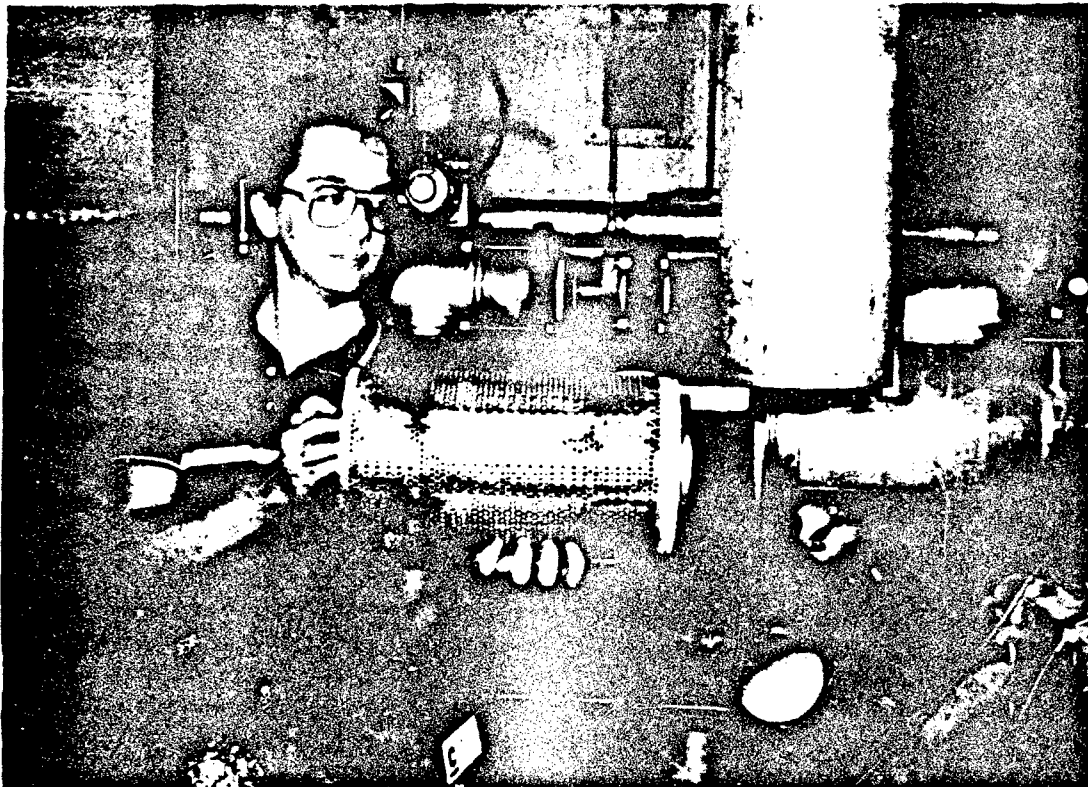

Figure 5-47. Barrier Filter Element Shown in Relation to Housing

Upon dismantling the test setup at the conclusion of the additional testing discussed in the next section, a cake of dust was found at the entrance to the aftercooler where air leaving the barrier filter impinged on the duct wall as the air made a sharp turn into the aftercooler. Calculations of the heat transfer effectiveness of the aftercooler showed no deterioration in performance during the 200-hour test. The uncorrected hot-side-only temperature gradients actually showed a slight increase. The aftercooler was not inspected internally.

### 5.5. Additional Testing

After completion of the 200-hour test and a performance check (Figure 5-29), a new barrier filter element was installed. Four regular 100-minute test cycles were run to coat the new barrier with dust. Three special test conditions were then run (see first column of Table 5-3) for 100 minutes each to evaluate the precleaner performance at low airflow (20%) and high dust loading (20 times zero visibility). The results are summarized in Table 5-3. The precleaner continued to perform well under these difficult conditions although a surprising difference was found between the two low-flow conditions. This may have been due to error (see below). The turbocharger compressor wheel was visually unchanged and no additional precise measurements were taken.

Upon dismantling all the test equipment, over 1.8 kg of dust was found in joints of the primary scavenge system. This was believed to have accumulated in stagnation areas primarily during the 200-hour test but may have affected the results shown in Table 5-3, especially the zero visibility 20% airflow case which had by far the lowest total dust ingestion. Even a minor gain or loss of accumulated dust in the joints would have significantly affected these results. A total of 196,901 grams of dust had been fed to the system during the 200 hours, an average of 1.03 times zero visibility. Assuming an average overall separation efficiency of 99.5%, approximately 985 grams reached the engine. A total of approximately 1,200 grams of dust was ingested into the engine during all the testing out of a total of nearly 265,000 grams fed to the system.

PLM data acquired elsewhere on dust particle size distribution by count for effluents from the precleaner and overall system are shown in Table 5-4 (columns 2 and 4). Table 5-5 presents summary results of an analysis of dust particle size distribution conducted at Yuma Proving Ground on samples taken at the conclusion of the TACOM testing. These results are given as cumulative volume percent for samples taken from the primary scavenge collector, primary scavenge filter, blowback scavenge filter and several of the membrane filters. If it is assumed that dust particle volume and weight are well correlated, the primary scavenge collector dust (Table 5-5, column 1) correlates well with the specified weight percent particle size distribution of AC Coarse Test Dust (12 ± 2% each for the 0- to 5-micron and 5- to 10-micron ranges) neglecting the precleaner effluent content. Column 1 is skewed

Table 5-3. Additional Testing--Precleaner Efficiency

Condition	1 Dust Ingested (grams)	2 Precleaner Scavenge Collection (grams)	3 Barrier Weight Increase (grams)	4 Barrier Scavenge Collection (grams)	5 Dust to Engine (grams)	6 Cumula- tive Ingested (2+3+4+5) (grams)	7 Ingested Error (6-1)/(1) %	Precleaner Separation Efficiency (2/1) %	(2/6) %
1 X zero visibility 20% airflow 63 hp	520	412.7	25.9	46.2	.5	485.3	-6.67	79.4	85.0
20 X zero visibility 20% airflow 63 hp	10,612	10,582	33.2	45.2	.4	10,660.8	.46	99.7	99.3
20 X zero visibility 100% airflow 500 hp	52,890.0	52,733.3	27.5	302.7	194.1	53,297.6	.77	99.8	99.0

Table 5-4. Various Centrisep<sup>®</sup> Air Cleaner Systems Effluent Particle Size Analysis--By Count

**VARIOUS CENTRISEP AIR CLEANER SYSTEMS  
EFFLUENT PARTICLE SIZE ANALYSIS -- BY COUNT  
CENTRISEP INGESTION: A.C. COARSE TEST DUST**

PARTICLE SIZE RANGE (MICROMETERS)	PERCENT (BY COUNT)							
	CENTRISEP SINGLE STAGE		CENTRISEP TWO STAGE		CENTRISEP PLUS 8" THICK DEPTH BARRIER (PERMAKLEEN)		CENTRISEP PLUS CORRUGATED BARRIER	
	%	CUM.	%	CUM.	%	CUM.	%	CUM.
Up To 5	78.1	78.1	90.4	90.4	98.7	98.7	98.5	98.5
5 - 15	20.3	98.4	9.3	99.7	3.0	99.7	1.5	100
15 - 25	3.2	99.6	<.3	100	<.3	100		
25 & >	.4	100						

Table 5-5. Turbodyne™ II Self-Cleaning Air Filter--TACOM  
Dust Particle Size Data

TURBODYNE II SELF-CLEANING AIR FILTER-TACOM  
DUST PARTICLE SIZE DATA

TACOM#	1 PRIMARY SCAVENGE DUST RED BASSEL		2 SCAVENGE ELEMENT DIER SEPARATOR		3 BLOWBACK FILTER (YELLOW A/C) ANG		4 MODERN FILTER CLEAN AIR TO ENGINE		4A BASELINE FIBER GLASS FILTER		4B MODERN FILTER CLEAN AIR TO ENGINE		3889 BASELINE FIBER GLASS FILTER		2782A MODERN FILTER ADJUST ED W/ BASELINE		2783 MODERN FILTER CLEAN AIR TO ENGINE		3889 BASELINE FIBER GLASS FILTER		2783A MODERN FILTER ADJUST ED W/ BASELINE	
	MICRONS	VRG	MICRONS	VRG	MICRONS	VRG	MICRONS	VRG	MICRONS	VRG	MICRONS	VRG	MICRONS	VRG	MICRONS	VRG	MICRONS	VRG	MICRONS	VRG	MICRONS	VRG
203	100		100		100		100		100		100		100		100		100		100		100	
161	99.8		99		99.9		99.9		99.9		99.9		99.9		99.9		99.9		99.9		99.9	
128	98.4		99.7		99.7		98.4		99.7		99.7		99.7		99.7		99.7		99.7		99.7	
102	96.3		99.1		99.5		96.3		99.5		99.5		99.5		99.5		99.5		99.5		99.5	
81	92.9		99.4		99.3		96.9		99.3		99.3		99.3		99.3		99.3		99.3		99.3	
64	89.6		97.3		99.4		96.1		99.4		99.4		99.4		99.4		99.4		99.4		99.4	
51	83.5		93.9		99.1		96.2		99.1		99.1		99.1		99.1		99.1		99.1		99.1	
40	75.1		89.1		98.7		95.7		98.7		98.7		98.7		98.7		98.7		98.7		98.7	
32	66		83.4		98.3		95.4		98.3		98.3		98.3		98.3		98.3		98.3		98.3	
25	56.2		77.6		97.7		95.1		97.7		97.7		97.7		97.7		97.7		97.7		97.7	
20	46.6		71.1		97		94.6		97		97		97		97		97		97		97	
16	38.0		66.6		96		93.7		96		96		96		96		96		96		96	
13	31.5		62.6		95.5		92.5		95.5		95.5		95.5		95.5		95.5		95.5		95.5	
10	26.1		59.3		94.6		91.2		94.6		94.6		94.6		94.6		94.6		94.6		94.6	
8	21.1		56.2		93.7		89.5		93.7		93.7		93.7		93.7		93.7		93.7		93.7	
6	17.3		53.4		92.7		87.6		92.7		92.7		92.7		92.7		92.7		92.7		92.7	
5	13.7		50.8		91.8		85		91.8		91.8		91.8		91.8		91.8		91.8		91.8	
4	10.5		47.7		90.9		81.2		90.9		90.9		90.9		90.9		90.9		90.9		90.9	
3	7.6		43.4		89.1		76.5		89.1		89.1		89.1		89.1		89.1		89.1		89.1	
2.5	5.5		38.2		87.1		71.3		87.1		87.1		87.1		87.1		87.1		87.1		87.1	
2	4		32.9		84.8		66.1		84.8		84.8		84.8		84.8		84.8		84.8		84.8	
1.6	2.7		26.6		79.6		59.7		79.6		79.6		79.6		79.6		79.6		79.6		79.6	
1.3	1.8		20.4		71.3		52.8		71.3		71.3		71.3		71.3		71.3		71.3		71.3	
1	1.2		14.8		58.2		44.6		58.2		58.2		58.2		58.2		58.2		58.2		58.2	
0.8	0.7		8.5		36.3		30.9		36.3		36.3		36.3		36.3		36.3		36.3		36.3	
0.6	0.3		3.6		15.2		14.9		15.2		15.2		15.2		15.2		15.2		15.2		15.2	
							0.1															

slightly more toward lighter particle content in the larger size ranges than the specified AC Coarse distribution. The opposite would have been expected. Column 2 is appropriately skewed toward lighter particles.

Given the preponderance of light particles in the precleaner effluent reaching the barrier filter (Table 5-4, column 2), the distribution by count (Table 5-4) approximates the distribution by volume (Table 5-5, column 3) for the blowback scavenge filter. This does not account for any preferential retention of particles in the barrier filter based on particle size. Such preferential retention may provide an explanation for the unexpected skewing of the membrane filter distributions in Table 5-5 (third column of sets 4, 4A, 4B and 4C) toward heavier particles than the results for the blowback scavenge filter. This would suggest that the barrier preferentially retained the larger particles. The leakage of the barrier filter discussed earlier which resulted in decreased overall separation efficiencies and increased deposition on the membrane filters would not explain the reversed distributions of the blowback scavenge filter and membrane filters. However, it could explain the heavier-than-expected distribution of particles on the membrane filters. The membrane filters sampled were all from the latter part of the 200-hour test, well after the leakage developed.





APPENDIX A

TEST PLAN



PROPULSION SYSTEMS DIVISION

Test Program No. \_\_\_\_\_

I. TITLE: Evaluation of the Turbodyne<sup>TM</sup> II Self-Cleaning Air Filtration System on a Known Military Engine

II. PURPOSE: Determine the capability of the Turbodyne<sup>TM</sup> System precleaner to protect the turbocharger compressor wheel from erosion and demonstrate the capability of the overall system to operate for 200 hours with minimum pressure rise.

III. OUTLINE OF TEST:

1. Prepare engine and test cell equipment.
2. Perform initial measurements on new turbocharger and install on engine.
3. Configure system to calibrate engine air flow.
4. Install and calibrate instrumentation.
5. Calibrate engine air flow.
6. Configure system to run test.
7. Checkout instrumentation and dust feed system.
8. Begin 200 hour test.
9. Disassemble turbocharger and perform measurements at least once during test.
10. Recalibrate engine air flow, if required.
11. Complete 200 hour test.
12. Evaluate precleaner efficiency at low air flow.
13. Evaluate precleaner efficiency at low air flow and high dust concentration.
14. Evaluate precleaner efficiency and system capacity at high air flow and high dust concentration.
15. Final evaluations and test report.

IV. TEST MATERIAL: Turbodyne<sup>TM</sup> self-cleaning air cleaner system including 2-stage Centrisep inertial precleaner. The supplier will also provide test dust sufficient to complete Section VI.11.

V. TEST EQUIPMENT: Test Cell No. 6, VTA-903 engine, dynamometer, controls, associated instrumentation and equipment, Bldg. 212. The air cleaner supplier will also provide a dust feeding system and efficiency measuring system for the test. Standard military diesel fuel and lubricating oil will be used in the engine.

VI. TEST PROCEDURES:

1. Prepare engine and test cell equipment.

- a. Run standard exhaust system from engine to cell fan inlet.
- b. Move water tower to position at least 30" forward of front face of engine block or sufficient to allow ready access for removal of turbocharger. Route plumbing accordingly.

2. Turbocharger Measurements and Installation

a. Perform the following measurements on a new turbocharger compressor wheel and blades, noting which blades and which locations on blades are measured (the leading edge of the blade is of primary interest):

(1) Weigh entire wheel after removing all lubricants, etc., on most accurate available balance.

(2) Record several blade contours by shadowgraph.

(3) Evaluate surface finish of several blades.

(4) Measure thickness of several blades at several locations on each using point micrometer.

b. Install the turbocharger and Turbodyne<sup>TM</sup> System barrier filter assembly on the engine per Pall drawing No. CJ-00127-1, Rev. A (Attachment 1). The turbocharger centerline is located 18.55" from the engine face and 4.62" above the crankshaft centerline. The turbocharger/filter assembly requires a 100 lb. capable support in the form of a table with suitable insulating material beneath the turbocharger and a 100 lb. capable support of the filter from above per Pall drawing CJ-00127-1, Rev. A (Attachment 1).

### 3. System Configuration for Engine Air Flow Calibration.

Install the remaining equipment of the air intake system with the scavenge blower per Attachment 1 with the following deviations:

a. Install the 8" diameter Meriam laminar flow element with a 9' length of 8" diameter pipe upstream and a 4' length downstream of the element located between the precleaner and turbocharger. Use 5-1/2" to 8" round transitions between the Pall supplied equipment and the lengths of pipe. Layout the equipment toward the southeast corner of the test cell to allow sufficient room (See Attachment 2). Provide and plug pressure taps in the lengths of 8" diameter pipe in the locations shown in Attachment 2

b. The scavenge duct (item 15 in parts list on Attachment 1) will extend from the opposite side of the precleaner from that shown in the drawing.

c. Do not install the dust feeder or efficiency measurement system at this time. The dust collection system may be installed (See VI.6.b).

d. A floor support for the scavenge duct and a 20 lb. capable support of the precleaner from above will be required per Attachment 1.

### 4. Instrumentation and Utilities Supplied to Pall Equipment.

Due to the unusual air intake system for this test, the air intake instrumentation will be listed separately below from the engine instrumentation. Most of the air intake instrumentation is also summarized on the instrumentation schematic, Pall drawing No. SKCB00127-151, Rev. A (Attachment 3) which includes 2 pressures (P10 and P11) and 2 temperatures (T4 and T5) that are required for the efficiency measurement system and not needed for the engine air flow calibration. The required temperature ranges may be slightly higher as shown below. Attachment 3 does not show the pressure readouts required for the Meriam air flow element during engine air flow calibration.

Intake Air System			
a.	Temperatures, $\frac{0}{F}$	Range	Accuracy
(1)	Air, downstream of precleaner	80-120	<u>+2</u>
(2)	Air, downstream of turbocharger	100-370	<u>+2</u>
(3)	Air, downstream of barrier filter	100-370	<u>+2</u>
(4)	Air, after efficiency measurement system flowmeter (not required for engine air flow calibration)	100-180	<u>+2</u>
(5)	Air, after efficiency measurement system heat exchanger (not required for engine air flow calibration)	100-370	<u>+2</u>
(6)	Air, intake manifold	100-370	<u>+2</u>

<u>b. Intake Air System Pressures</u>		<u>Units</u>	<u>Range</u>
(1) Air, upstream of precleaner, gauge, static	in. Water	0,-1	
(2) Air, downstream of precleaner, gauge, total	in. Water	0,-7	
(3) Air, upstream of turbocharger, gauge, total	in. Water	0,-15	
(4) Air, downstream of turbocharger, total	psia	15,34	
(5) Air, inside barrier filter, upstream of medium, total	psia	15,34	
(6) Air, downstream of barrier filter, total	psia	15,34	
(7) Air, downstream of barrier filter, total	psia	15,34	
(8) Scavenge air, upstream of fan	in. Water	0,-6	
(9) Scavenge air, downstream of fan	in. Water	0,2	
(10) Air, before absolute filter, gauge, total (not required for engine air flow calibration)	psig	+20	
(11) Air, after efficiency measurement system flow meter, gauge, total (not required for engine airflow calibration)	psig	+20	
(12) Air, delta Meriam	in. Water		
(13) Barometer	in. Mercury	28,32	
(14) Air, cell depression	in. Water		
(15) Air, intake manifold, total	psig		
<u>c. Engine Parameters</u>		<u>Range</u>	<u>Accuracy</u>
(1) Engine Speed, RPM	0-3000	.5%	
(2) Dynamometer load, lb.-ft.	0-1200	.5% of max	
(3) Brake horsepower, bhp	0-550		
(4) Fuel Flow, lb/hr			
(5) BSFC, lb/bhp-hr			
<u>d. Engine Temperatures, <math>\frac{^{\circ}F}{^{\circ}C}</math></u>		<u>Range</u>	<u>Accuracy</u>
(7) Fuel, before final filter	60-120	+2	
(8) Fuel, spillback		+2	
(9) Oil, Engine Sump	120-300	+2	
(10) Oil, engine gallery	120-300	+2	
(11) Oil, turbo outlet		+2	
(12) Coolant, engine inlet	120-250	+1	
(13) Coolant, engine outlet	120-250	+1	
(14) Water tower inlet	35-100	+2	
(15) Water tower outlet	35-200	+2	
(16) Dynamometer water inlet		+2	
(17) Dynamometer water outlet	max 150		
(18) Ref. bath	200	+10	
(19) Ref. bath (key in)	200	+10	
(20-27) Exhaust ports 1-8	200-1500	+2	
(28) Exhaust, before turbocharger, left	200-1500	+2	
(29) Exhaust, before turbocharger, right	200-1500	+2	
(30) Exhaust, after turbocharger	200-1500	+2	

e. <u>Engine Pressures</u>	<u>Range</u>	<u>Accuracy</u>
(16) Blowby, crankcase-in. water	-10,+10	1
(17) Exhaust, before turbocharger, static-in. mercury	0-60	1
(18) Exhaust, after turbocharger, static-in. water	0-30	1
(19) Fuel, spillback, psi	0-10	
(20) Coolant, engine inlet, psi	0-25	2
(21) Coolant, engine outlet, psi	0-25	2
(22) Water tower inlet, psi	20-100	
(23) Water tower outlet, psi	20-100	
(24) Water dynamometer inlet, psi	12-50	
(25) Oil, engine gallery, psi	15-80	

f. Utilities Required to Support Pall-Supplied Equipment

- (1) 115 VAC, 60 cycle, single phase, 5 amps.
- (2) 230 VAC, 60 cycle, single phase, 3 amps.
- (3) 230/440 VAC, 60 cycle, 3 phase.
- (4) 80-100 psi shop air.
- (5) 10 volts d.c. source.
- (6) 24 volts d.c. source, 4 amps.
- (7) city water, 1-1/4 GPM.

g. Observe the following engine operating limits and test conditions for the air flow calibration and 200 hour test

(1) Oil pan temperature 250°F warning, 260°F manual return to idle.  
Contact test engineer.

(2) Oil pressure at idle: 15 PSI warning, 10 PSI shutdown. Oil pressure at normal operation: 40 to 85 PSI above 1000 RPM, 30 PSI warning, 28 PSI shutdown.

(3) Air cell ambient as close as possible to 70°F.

(4) Coolant outlet temperature 205 ± 5°F, warning 212°F, manual return to idle at or above 215°F. Cooling system will be pressurized to 15-16 PSI.

(5) Fuel temperature near fuel pump inlet: 86°F ± 5°F.

(6) Crankcase pressure maximum 8 in. H<sub>2</sub>O. Blow-by maximum 20 CFM.

(7) Nominal fuel flow 800 lb/hr at 2600 RPM.

(8) Exhaust port outlet temperatures 1300°F maximum.

(9) Exhaust outlet static pressure at rated conditions: 16 in water +2 (within 4" after turbocharger).



h. All instrumentation including Pall-supplied equipment shall be checked out and calibrated before continuing further. Run the engine to check for leaks and other problems.

#### 5. Calibration Procedure for Engine Air Flow

a. Warm-up the engine and bring it to stable, full-power operation. Note the pressure drop across the Meriam flow element. The test engineer will calculate the 100 percent flow SCFM and the required Meriam pressure drop for air flows of 80%, 60%, 50%, 40%, 30% and 20% of the flow at full power under the given ambient conditions. Run the engine until stable at each calculated pressure drop and determine suitable operating speed and load points in consultation with the test engineer. The scavenge blower should be operating during the calibration procedures with its 0-10 volt control voltage proportional to the desired percent flow rate.

b. Conduct a full-load performance test followed by a half-load performance test, each from 1000 rpm to 2600 rpm in 200 rpm increments and decrements (2 readings at each speed and load condition, one at increasing speed, one at decreasing speed). Record all data after the engine has stabilized at each point. Consult with the test engineer for the scavenge blower speed setting at each point.

c. Obtain photographs of the system air flow calibration configuration before dismantling it to conduct the test.

d. Replace the Meriam flow element with a butterfly valve or other variable restrictor. Connect the pressure lines formerly connected to the Meriam to the pressure taps in the 8" diameter pipe lengths (See Section VI.3.a). Start the engine and stabilize it at rated conditions. Adjust the restrictor to produce 25" water column restriction. The pressure in the intake manifold at these conditions will be the terminating condition for the 200 hour test if 200 hours of self-cleaning operation cannot be achieved.

#### 6. Test Configuration.

a. Remove the restriction and lengths of 8" diameter pipe and configure the system per Attachment 1.

b. Install the dust feeder and efficiency measurement system per Attachment 1.

c. Install the dust collection system, connecting the trap to the scavenge blower and the barrier filter discharge. Avoid low points in the line from the barrier filter discharge to prevent dust settling.

d. Obtain photographs of the system in the test configuration.

## 7. System Checkout.

Checkout all instrumentation and the functioning of the dust feeder and efficiency measurement systems before proceeding with the test. Pull personnel will operate the dust feeder and efficiency measurement equipment during the test. The dust feeder is calibrated to provide constant zero visibility dust concentration (.025 g./ft<sup>3</sup>) in the air stream if provided with a 0-10 volt d.c. signal proportional to the percent air flow rate (e.g., 10 volts at 100% flow, 2 volts at 20% flow).

## 8. 200 Hour Test.

a. Bring the engine to stable operation at rated conditions before introducing dust into the intake air stream. Follow the 100 minute variable flow cycle shown in Attachment 4, which consists of ten 10-minute periods of operation at the conditions determined in section VI.5.a. If restarting in the middle of a cycle, always bring the engine to stable operation before commencing dust feed.

b. The engine is controlled in standard fashion independently of the dust feed system which is controlled manually by a 0-10 volt d.c. signal that is proportional to the percent air flow rate. When increasing air flow during a cycle, have the increase of engine speed slightly lead the dust feed increase. When decreasing air flow during a cycle, have the decrease of engine speed slightly lag the dust feed decrease. This is to assure that the desired dust concentration is not exceeded during the transition periods.

c. Take all system data just before the end of each ten minute period in the first cycle and just before the end of each ten minute period in the third cycle and every third cycle thereafter (every 5 hours). This requirement may be reduced for later cycles.

d. Inspect thermocouples and pressure fittings, especially those exposed to high dust concentration, during shutdown periods or at least every six cycles (ten hours). Blow out the pressure fittings daily.

e. Weigh dust fed to the system and scavenged from the system during every cycle used for efficiency measurements. Conduct efficiency measurements for one cycle each day using the industrial air cleaner calculation from SAE J726, May 81, para. 1.4.16.2.

f. Empty the dust collector and clean the filter daily. Do not reuse the collected dust.

g. Take an eight ounce oil sample before starting the 200 hour test and every 100 hours thereafter. Take two ounce oil samples at 20 hour intervals. (Purge oil sample line and take sample from oil gallery with engine idling. Replace the removed sample oil with the same amount and type of new oil). Check the engine oil level and appearance at the completion of every shift or before the engine is started for a new day of tests.

h. The following maintenance to the engine will be conducted before starting the 200 hour test and after completing 100 and 200 test hours:

- (1) Change oil
- (2) Replace oil and fuel filters
- (3) Record oil added (less sample) to bring to required level.

9. Turbocharger Evaluation.

After 20 hours of test operation, or at the discretion of the test engineer, remove and disassemble the turbocharger and repeat the procedures of Section VI.2.a. to evaluate the effects of the precleaned air intake stream on the compressor wheel blades. This procedure may be performed several times during the 200 hour test.

10. Recalibration of Engine Air Flow.

If it is determined that the turbocharger condition has significantly deteriorated or that system parameters have changed for other reasons, the test engineer may request a recalibration of the engine air flow by repeat of the procedures given in Sections VI.3 and VI.5.

11. Termination of 200 Hour Test.

The 200 hour test will be terminated prior to 200 test hours if the intake manifold pressure drops to the level determined in Section VI.5.d.

12. Evaluation of Precleaner Efficiency at Low Air Flow.

Clean the barrier filter canister and weigh the filter element and the absolute filter from the efficiency measurement system. Also, clean out the scavenge lines. Re-install the filters and run the system at 20% air flow rate with the self-cleaning mechanism turned off for 100 minutes, weighing the dust fed to and scavenged from the system by the precleaner blower. Take all system data every 20 minutes after starting. When finished, weigh the filters and any dust accumulated in the filter canisters for calculation of precleaner efficiency.

13. Evaluation of Precleaner Efficiency at Low Air Flow and High Dust Concentration.

Repeat the procedures of Section VI.12 above with the dust feed concentration increased to twenty times zero visibility and the self-cleaning mechanism turned on. Weigh any dust accumulated in the scavenge lines.

14. Evaluation of Precleaner Efficiency and System Capacity at High Air Flow and High Dust Concentration.

Repeat the procedures of Section VI.12 above with a dust feed concentration of twenty times zero visibility and 100% engine air flow rate. Run the engine with the air cleaner self-cleaning mechanism turned on maximum. Weigh any dust accumulated in the scavenge lines.

15. Final Evaluations and Test Report.

- a. Consolidate and evaluate data.
- b. Inspect, measure and photograph engine parts (e.g., turbocharger blades) as instructed by the test engineer.
- c. Prepare report.

VII. COMMENTS:

Since this test plan cannot give detailed instructions or anticipate every situation or problem, further instructions can be expected from the project engineer as necessary.

- (1) Torque values should be maintained as specified by test engineer or as provided by engine Test Manual.
- (2) Do not use lower quality bolts than SAE #5 or Metric 8.8.
- (3) Daily or before every start-up of test, check coolant and oil levels and check for loose bolts, nuts, brackets, harnesses, cracks. Correct the problem and report it to the project engineer. Record the above in the log book in detail.
- (4) Before start of the 200 hour test, remove and check the coolant thermostat for proper functioning.
- (5) Air operated torque wrench should never be used on any bolts or nuts, in connection with the engine or any rotating mechanism.
- (6) Do not use the first five pages of the Shop log book. This is for engineering instructions only!.
- (7) Please provide: (a) Emergency air shut-off valve (b) high visibility transparent fuel line at control room window.
- (8) Shop Manual instructions should be closely followed for the engine, turbocharger, and other equipment.

VIII. JOB ASSIGNMENTS:

1. AMSTA-TB will be responsible for gathering data, maintaining a daily detailed, well-readable log book and test data log, directing personnel and general execution of test.

2. AMSTA-RGE will be responsible for decisions at preparation of test, for day-to-day technical decisions, monitoring the test, evaluation of data and preparing a report.

Best Available Copy

Attachment 1  
1 of 4

approx.  
100 lb.

TURBODYNE  
OVERALL LIFE MEASUREMENT  
SYSTEM

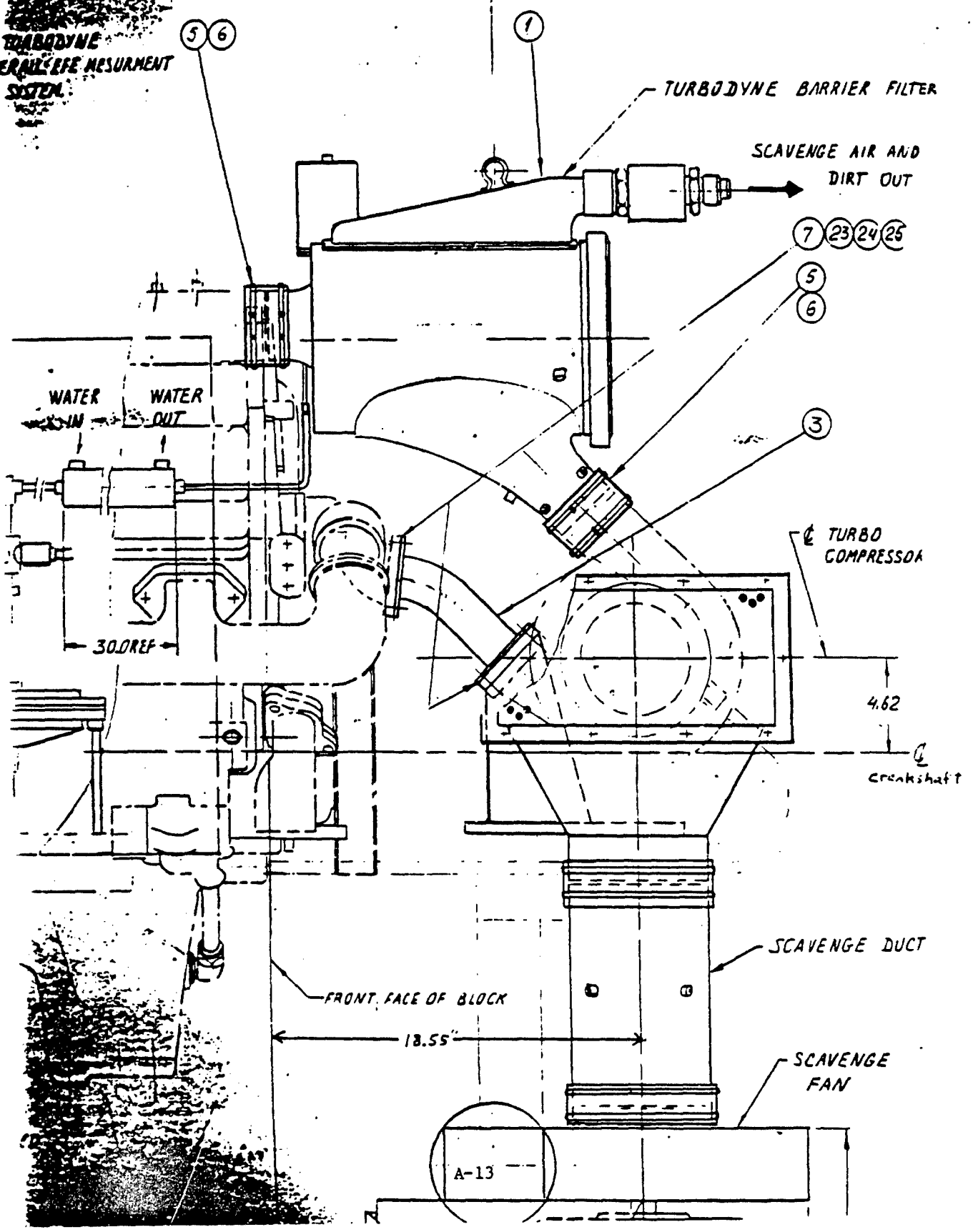

SCAVENGE AIR AND  
DIRT OUT

7 23 24 25

5  
6

3

TURBO  
COMPRESSOR

4.62

CRANKSHAFT

SCAVENGE DUCT

SCAVENGE  
FAN

FRONT FACE OF BLOCK

18.55"

A-13

30.0 REF

Attachment 1  
2 of 4

APPROX 20 LB

Best Available Copy

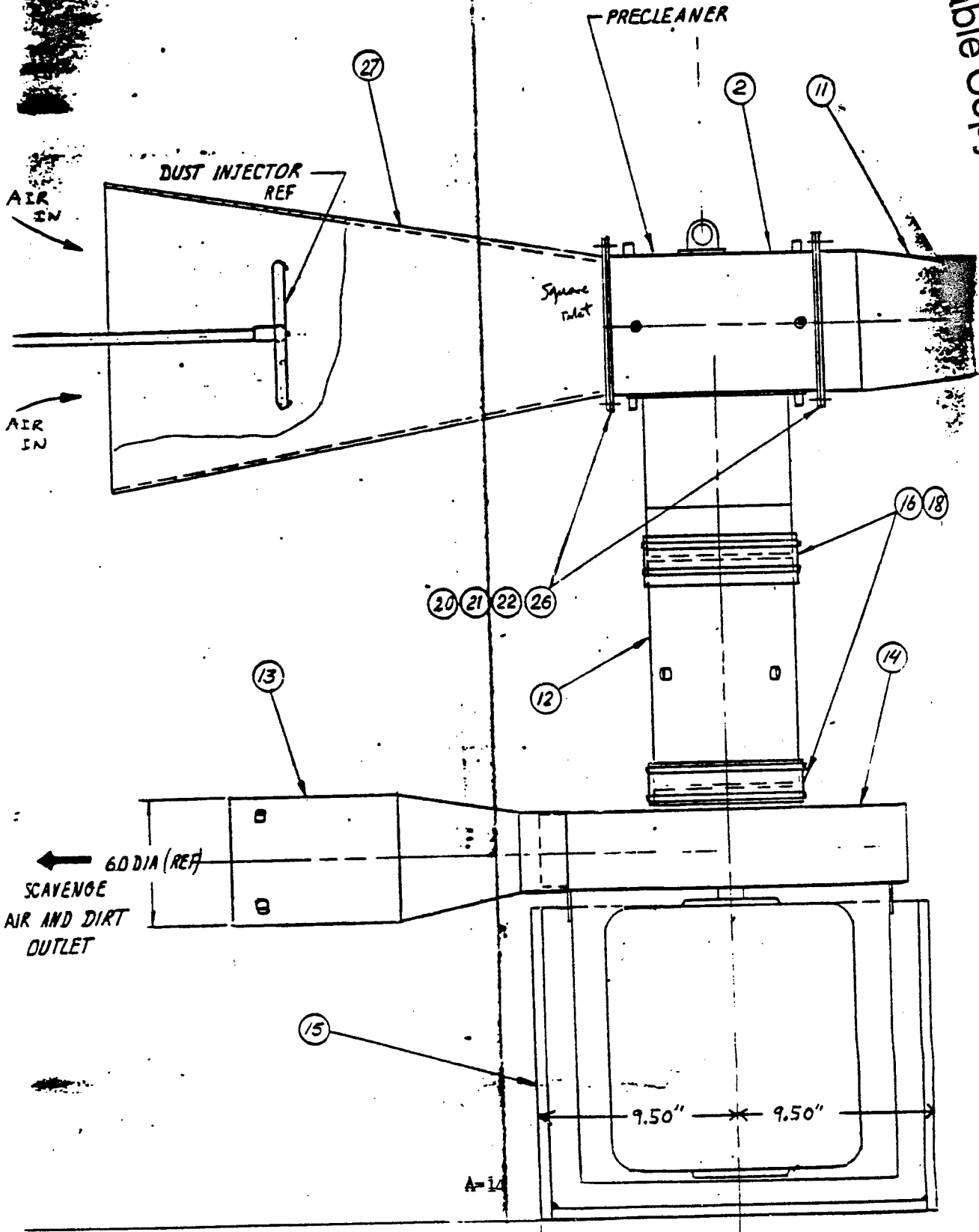

A-14

Best Available Copy

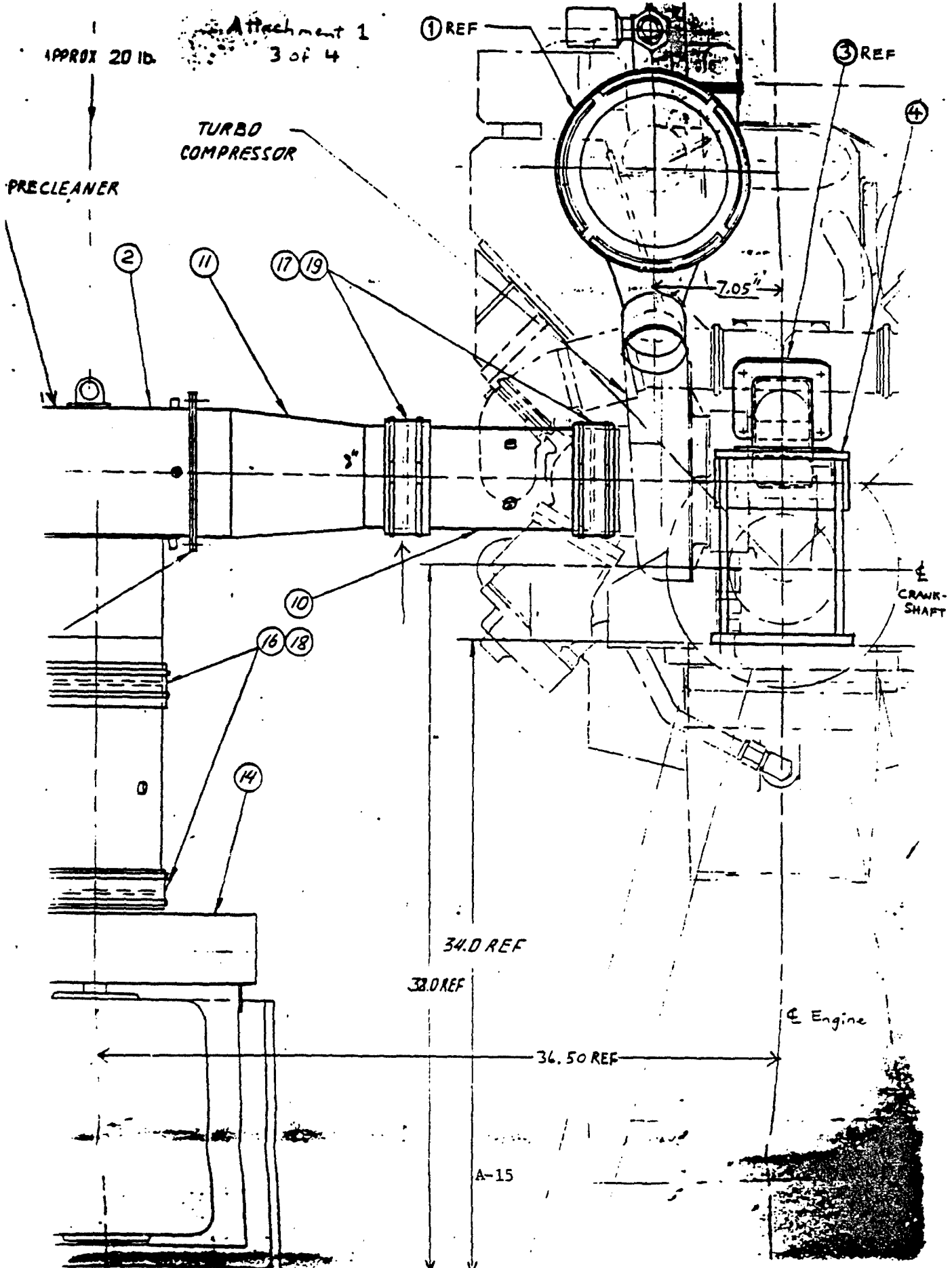



Best Available Copy

28	1	AA-9500D1629	ELBOW	
27	1	CB-00127-1L25	INLET HOD	
26	A/R	CB-00127-1L24	GASKET	
25	8	127362	3/8 WASHER	CUMMINS
24	8	3016182	3/8-24 LOCK NUT	CUMMINS
23	8	MS35308-365	3/8-24x1 3/4 HEX BOLT	
22	34	AN3451-15	10-32 NUT	
21	68	AN 960-10	No 10 WASHER	
20	34	AN173-4	10-32x 1/2 HEX BOLT	
19	4	CB-00127-1L222	CLAMP 5 1/2"	
18	4	CB-00127-1L221	CLAMP 7"	
17	2	CB-00127-1L21	HUMP HOSE 5 1/2"	
16	2	CB-00127-1L20	HUMP HOSE 7"	
15	1	CA-00126-1L26A	SCAVENGE DUCT	
14	1	CC-00127-1L17	SCAVENGE BLOWER	
13	1	CC-00127-1L16	BLOWER EXHAUST TRANSITION	
12	1	CB-00127-1L15	SCAVENGE (TRANSITION) EXTENSION	
11	1	CB-00127-1L14	ENGINE (TRANSITION) EXTENSION	
10	1	CD-00127-1L13	ENGINE TRANSITION	
9	1	CD-D029-1	TURBODYNE OVERALL EFF. MESURM SYST.	
8	1	CE-D024-1	CENTRISEP DUST FEEDER SYSTEM	
7	2	190849	GASKET	CUMMINS
6	4	3012971	CLAMP	CUMMINS
5	2	211280	HOSE	CUMMINS
4	1	CD-00127-1L12	SUPPORT	
3	1	CD-00127-1L11	CONNECTOR	
2	1	CE-00127-1D21	PRECLEANER ASSY	
1	1	CE-00127-1D1	BARRIER FILTER ASSY	
ITEM	REQD	PART NO	DESCRIPTION	MATL

Test Cell No. 6

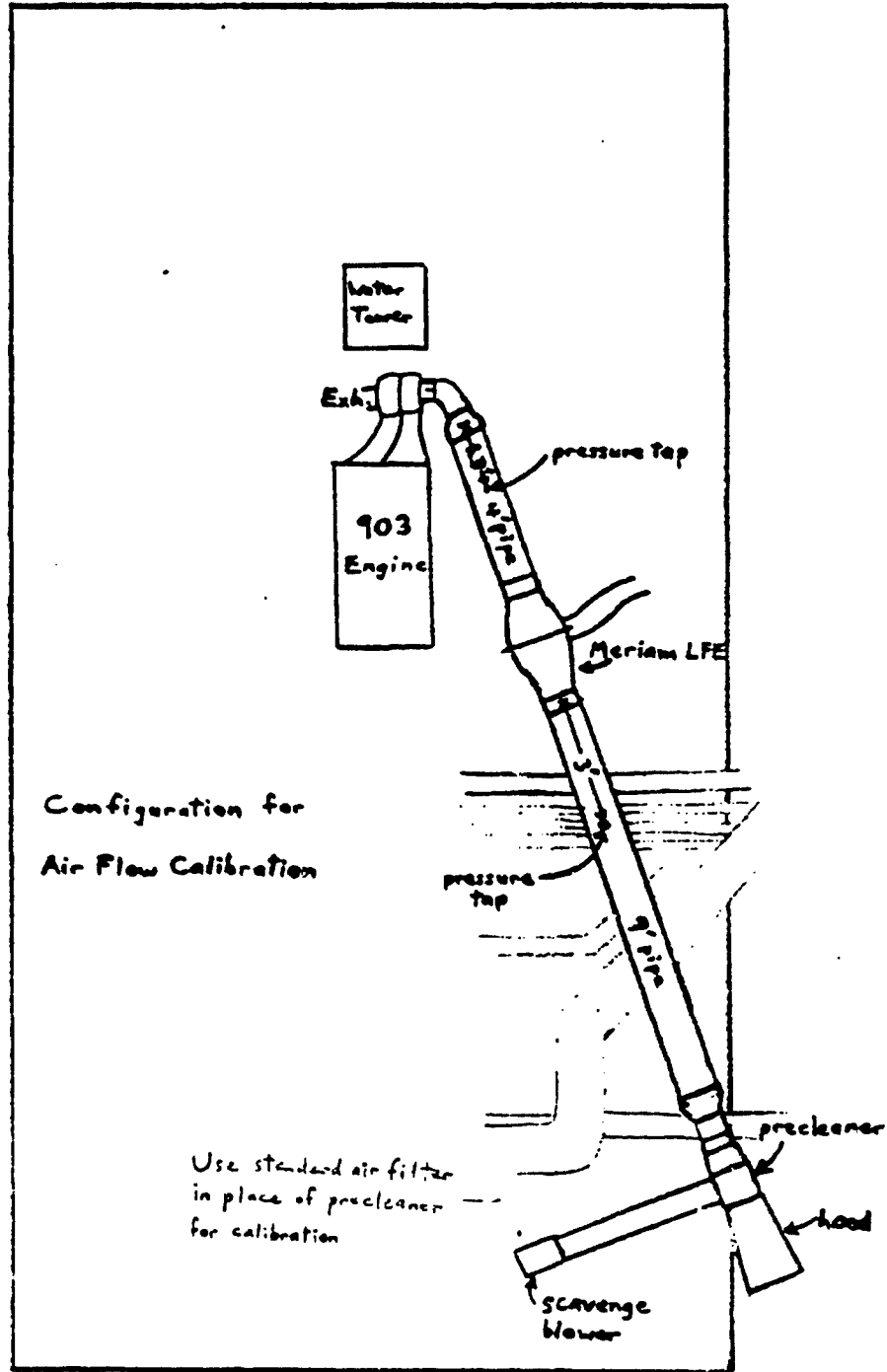

Configuration for  
Air Flow Calibration

Use standard air filter  
in place of precleaner  
for calibration

← to Bed

Not to Scale

A-17

TURBODYNE II INSTRUM

47 1512

K-E PLUG IN TO THE CENTER TAP

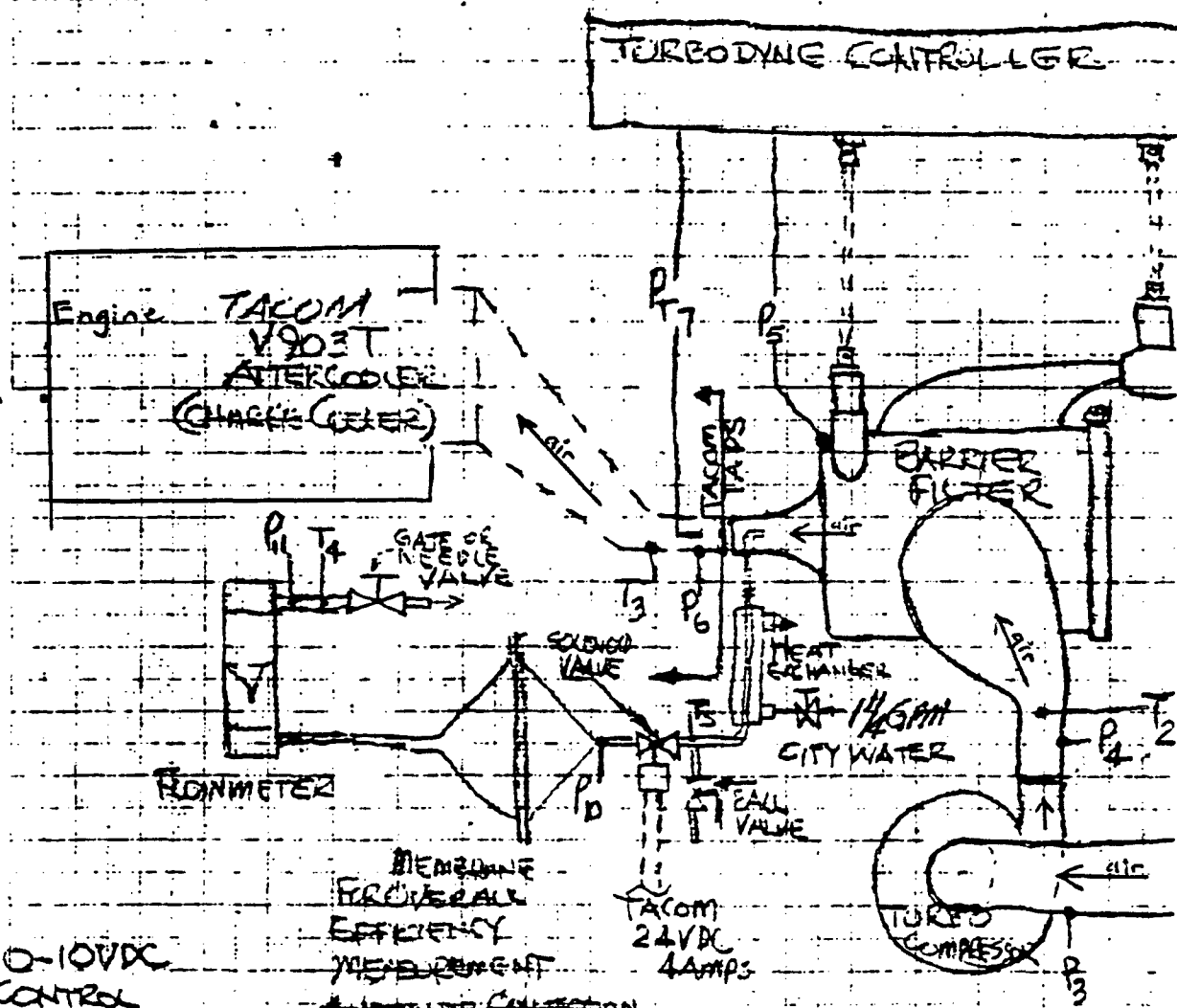

0-10VDC CONTROL VOLTAGE PROPORTIONAL TO RELATIVE FLOW

MEMBRANE PRO OVERALL EFFICIENCY MEASUREMENT

A-10 MINUTE COLLECTION

B-100 MINUTE COLLECTION (60% AVERAGE FLOW)

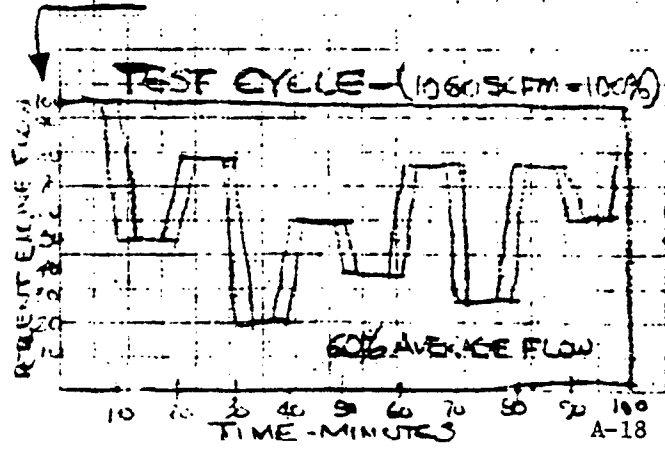

TACOM AIR 42 TO 212.5 SLPM  
DIRT 2.1 MG/HR

# INSTALLATION SCHEMATIC

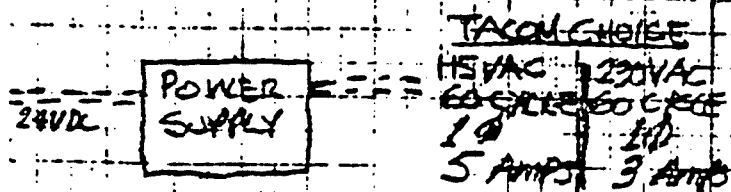

REQUIRED INSTRUMENTATION		
READOUT	UNITS	RANGE MIN/MAX
P <sub>1</sub>	in H <sub>2</sub> O	0 -1
P <sub>2</sub>	in H <sub>2</sub> O	0 -7
P <sub>3</sub>	in H <sub>2</sub> O	0 -10
P <sub>4</sub>	PSIG	15 34
P <sub>5</sub>	PSIG	15 34
P <sub>6</sub>	PSIG	15 34
P <sub>7</sub>	PSIG	15 34
P <sub>8</sub>	in H <sub>2</sub> O	0 -6
P <sub>9</sub>	in H <sub>2</sub> O	0 +2
P <sub>10</sub>	PSIG	15 20
P <sub>11</sub>	PSIG	15 20
T <sub>1</sub>	°F	80 100
T <sub>2</sub>	°F	100 320
T <sub>3</sub>	°F	100 330
T <sub>4</sub>	°F	100 150
T <sub>5</sub>	°F	100 330

TACOM  
 AIR 1445 #185 STAIR 1/4 SEC PULSE  
 DIET 3694/HR

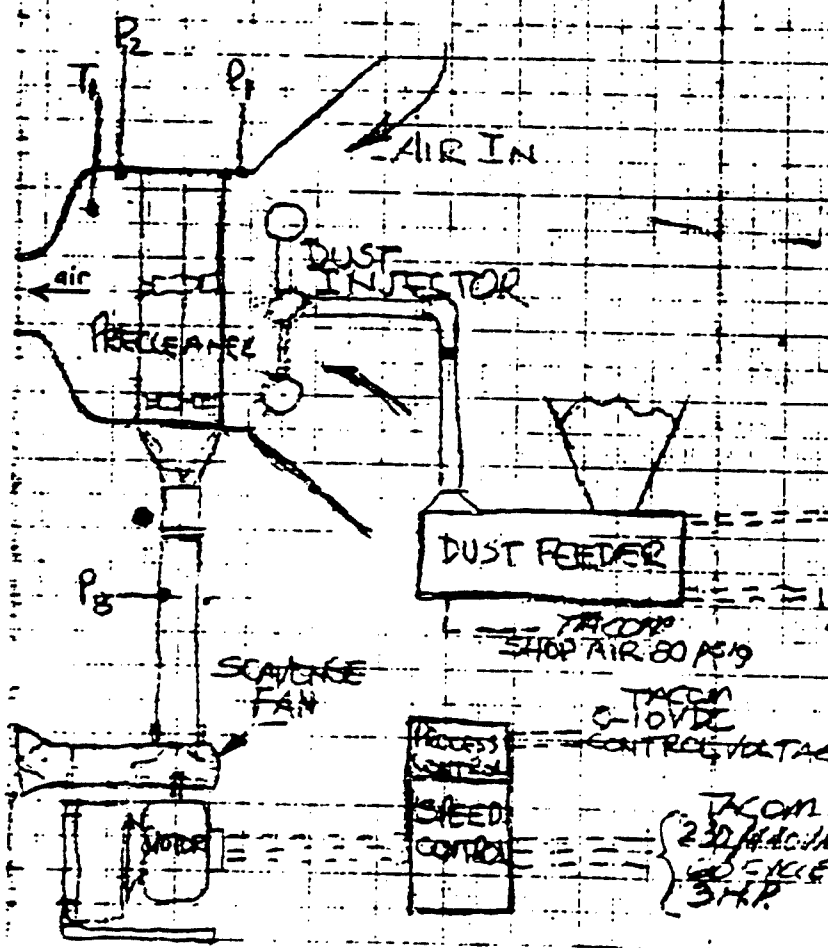

ALL PRESSURE & TEMPERATURE TAPS ARE 1/8 FEMALE IPT

TACOM 0-10VDC CONTROL VOLTAGE

TACOM 115VAC 60 CYCLE 1 Ø 5 AMPS

TACOM 0-10VDC CONTROL VOLTAGE

TACOM 220VAC 60 CYCLE 3 Ø 3 AMP

FIGURE 1

REV A  
 19/1/87  
 Attachment 3  
 2 of 2

VARIABLE FLOW CYCLE

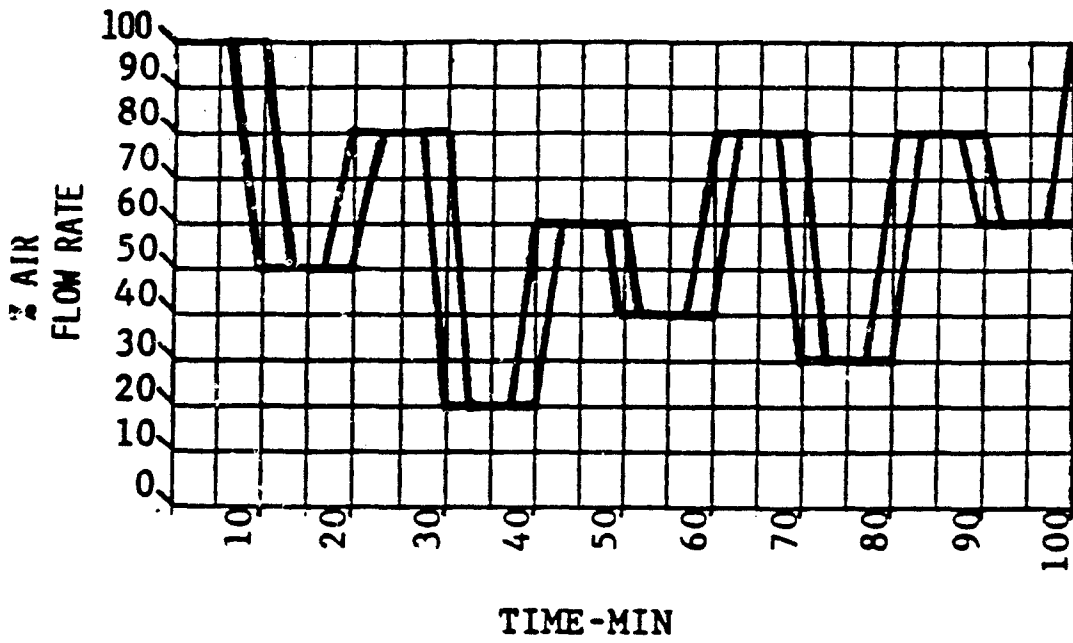

APPENDIX B  
ORIGINAL DATA

B-2

Best Available Copy

### 100% AIRFLOW

CYCLE	HP	BSFC	BAROM PRES	P AIR IN	P TC OUT	PR	DEL P BARR	P IN MAN	AMB T	T TC OUT	T IN MAN	DEL T AFTC	EFFIC
1.	509.	0.361	29.83	-11.91	16.9	2.22	20.82	15.5	68.	298.	225.	63.	0.0
2.	508.	0.358	29.83	-11.88	16.9	2.22	24.91	14.5	73.	293.	237.	56.	99.7
3.	504.	0.362	29.25	-13.48	16.4	2.22	30.09	15.1	70.	289.	228.	61.	99.8
4.	497.	0.365	29.97	-11.79	16.4	2.18	29.19	14.3	69.	286.	234.	52.	99.7
5.	498.	0.363	29.97	-11.91	16.1	2.16	32.22	13.8	72.	289.	237.	52.	0.0
6.	500.	0.364	29.98	-10.17	15.8	2.13	36.08	15.8	67.	287.	230.	57.	99.8
7.	500.	0.363	29.98	-9.94	15.9	2.13	34.26	14.5	71.	288.	230.	58.	0.0
8.	499.	0.365	29.98	-10.74	16.7	2.19	35.66	14.2	67.	286.	228.	58.	99.8
9.	498.	0.366	29.98	-12.82	16.3	2.18	37.04	13.7	69.	285.	227.	58.	0.0
10.	505.	0.362	29.95	-12.16	16.6	2.19	36.66	13.5	70.	290.	231.	59.	0.0
11.	503.	0.365	29.95	-11.27	16.7	2.20	38.17	14.3	70.	290.	228.	62.	99.8
12.	498.	0.365	29.95	-13.38	16.7	2.21	42.73	14.1	70.	288.	227.	61.	0.0
13.	502.	0.366	29.95	-13.38	16.5	2.19	44.25	14.4	70.	290.	228.	62.	0.0
14.	501.	0.366	29.95	-10.97	16.5	2.18	44.49	15.1	70.	290.	228.	62.	0.0
15.	505.	0.363	29.97	-11.98	16.2	2.16	43.08	14.1	72.	291.	227.	64.	99.8
16.	500.	0.364	29.97	-13.11	17.0	2.23	46.98	13.5	69.	284.	222.	62.	0.0
17.	501.	0.365	29.97	-11.33	17.1	2.22	49.14	14.0	72.	290.	224.	66.	0.0
18.	499.	0.365	29.97	-9.79	17.0	2.21	44.33	14.9	70.	288.	228.	60.	0.0
19.	501.	0.363	29.97	-12.91	16.8	2.21	45.97	14.2	70.	290.	229.	61.	0.0
20.	501.	0.360	29.92	-11.80	16.7	2.20	47.02	14.0	72.	290.	224.	66.	99.7
21.	500.	0.365	29.92	-12.67	16.6	2.20	47.58	13.9	73.	290.	229.	61.	0.0
22.	501.	0.363	29.92	-11.99	16.6	2.19	49.20	15.1	70.	290.	232.	58.	0.0
23.	494.	0.370	29.95	-11.95	16.7	2.20	47.14	14.0	71.	289.	232.	57.	0.0
24.	497.	0.367	29.95	-10.98	16.8	2.20	48.32	14.1	71.	288.	226.	62.	99.8
25.	499.	0.365	29.95	-10.41	16.9	2.20	51.43	13.4	69.	285.	228.	57.	0.0
26.	0.	0.000	30.00	0.00	0.0	1.00	0.00	0.0	0.	0.	0.	0.	0.0
27.	497.	0.367	0.00	-11.18	17.3	0.00	52.97	13.0	72.	291.	231.	60.	99.7
28.	497.	0.368	0.00	-12.43	16.3	0.00	53.45	13.3	68.	285.	227.	58.	0.0
29.	504.	0.223	29.92	-11.43	17.1	2.23	50.14	14.1	64.	283.	224.	59.	0.0
30.	502.	0.364	29.92	-9.50	16.4	2.17	51.28	13.8	74.	293.	230.	63.	99.7
31.	500.	0.366	29.92	-9.49	16.3	2.16	51.31	13.7	73.	289.	225.	64.	0.0
32.	489.	0.374	29.92	-11.81	16.5	2.19	52.24	13.8	69.	286.	229.	59.	0.0
33.	501.	0.364	29.86	-10.66	17.2	2.23	54.12	14.7	55.	273.	223.	50.	0.0
34.	496.	0.367	29.86	-11.03	17.4	2.25	56.78	14.1	68.	287.	227.	60.	99.8
35.	495.	0.372	29.86	-12.10	16.4	2.18	59.05	13.9	71.	288.	229.	60.	0.0
36.	501.	0.361	29.86	-11.84	16.5	2.19	55.10	14.2	70.	288.	226.	62.	0.0
37.	498.	0.368	29.86	-9.63	16.8	2.20	59.94	13.9	72.	292.	231.	61.	0.0
38.	495.	0.374	29.85	-12.98	17.0	2.23	55.32	14.6	58.	276.	224.	54.	0.0
39.	493.	0.370	29.85	-10.43	17.0	2.22	60.53	12.9	70.	290.	232.	58.	0.0
40.	498.	0.370	29.85	-9.33	17.7	2.26	62.64	14.1	71.	291.	233.	58.	0.0



### 100% AIRFLOW

CYCLE	HP	BSFC	BAROM PRES	P AIR IN	P TC OUT	PR	DEL P BARR	P IN MAN	AMB T	T TC OUT	T IN MAN	DEL T AFT:
41.	495.	0.366	29.85	-10.45	16.4	2.17	59.17	14.2	70.	287.	239.	57. 99.5
42.	498.	0.368	29.85	-11.95	17.2	2.24	64.09	14.4	72.	292.	231.	61. 0.0
43.	497.	0.369	29.85	-11.26	17.0	2.22	60.51	13.4	73.	290.	221.	59. 0.0
44.	498.	0.367	29.85	-10.77	16.9	2.21	61.72	13.6	67.	283.	219.	64. 0.0
45.	496.	0.367	29.85	-9.71	17.0	2.21	65.75	13.4	73.	290.	225.	65. 0.0
46.	498.	0.368	29.85	-9.17	17.1	2.22	64.55	13.0	72.	289.	224.	65. 0.0
47.	497.	0.369	29.85	-12.53	16.8	2.21	65.60	13.4	75.	292.	226.	66. 99.4
48.	494.	0.371	30.03	-11.26	16.7	2.19	65.17	12.3	76.	292.	225.	67. 0.0
49.	501.	0.363	30.21	-12.13	16.8	2.20	63.05	13.3	67.	284.	226.	58. 0.0
50.	498.	0.367	30.21	-11.91	16.9	2.20	62.64	13.7	74.	291.	233.	58. 0.0
51.	495.	1.588	30.21	-11.10	17.5	2.24	62.20	12.4	81.	299.	235.	64. 0.0
52.	496.	0.370	30.21	-12.02	16.7	2.19	62.26	13.9	85.	304.	237.	67. 99.4
53.	491.	0.375	30.21	-11.43	16.1	2.14	64.13	14.0	86.	302.	237.	65. 0.0
54.	494.	0.372	30.21	-10.37	16.5	2.17	64.18	13.9	84.	304.	237.	67. 0.0
55.	492.	0.372	30.13	-10.03	16.3	2.15	63.23	13.6	73.	289.	229.	60. 0.0
56.	493.	0.373	30.13	-9.75	17.8	2.26	65.39	13.4	82.	299.	231.	68. 0.0
57.	490.	0.375	30.13	-9.45	16.2	2.14	65.77	13.6	88.	306.	235.	71. 99.4
58.	490.	0.376	30.13	-9.78	16.2	2.15	69.84	12.9	89.	306.	234.	72. 0.0
59.	493.	0.373	30.13	-9.70	17.0	2.20	73.07	13.4	79.	295.	227.	68. 0.0
60.	497.	0.411	30.29	-13.02	17.9	2.27	76.57	14.4	64.	287.	229.	58. 0.0
61.	498.	0.406	30.29	-11.86	18.2	2.29	78.14	14.7	56.	278.	227.	51. 0.0
62.	496.	0.406	30.29	-12.31	17.8	2.26	78.03	14.6	55.	277.	227.	50. 0.0
63.	496.	0.406	30.29	-12.81	18.7	2.33	77.83	13.9	55.	277.	227.	50. 0.0
64.	495.	0.407	30.29	-11.40	18.5	2.31	76.39	14.3	55.	277.	228.	49. 0.0
65.	492.	0.414	30.08	-12.25	18.3	2.31	76.55	14.4	70.	295.	231.	64. 0.0
66.	494.	0.412	30.08	-13.12	17.6	2.26	77.04	12.9	71.	295.	236.	59. 0.0
67.	492.	0.412	30.08	-11.47	16.9	2.21	73.61	14.2	71.	295.	231.	64. 0.0
68.	491.	0.416	0.00	-10.65	17.2	0.00	74.85	14.3	69.	293.	230.	63. 99.4
69.	493.	0.415	0.00	-11.74	17.7	0.00	77.78	13.5	71.	295.	231.	64. 0.0
70.	494.	0.370	29.96	-12.66	17.3	2.25	80.15	14.5	68.	291.	225.	66. 0.0
71.	495.	0.368	29.96	-10.10	18.0	2.28	84.72	13.7	68.	293.	229.	64. 0.0
72.	496.	0.368	29.96	-11.47	17.3	2.24	84.21	14.8	69.	293.	231.	62. 99.5
73.	493.	0.381	29.96	-10.63	17.6	2.25	84.71	13.9	73.	296.	233.	63. 0.0
74.	493.	0.369	29.96	-9.54	17.3	2.23	84.39	14.5	70.	295.	232.	63. 0.0
75.	495.	0.376	29.71	-11.37	18.3	2.32	82.20	14.4	72.	298.	232.	66. 0.0
76.	493.	0.382	0.00	-10.61	17.2	0.00	75.96	13.8	77.	302.	219.	83. 99.4
77.	494.	0.374	0.00	-10.79	16.6	0.00	78.51	14.7	79.	306.	236.	70. 0.0
78.	498.	0.368	29.98	-11.88	18.1	2.30	81.59	14.4	67.	293.	231.	62. 0.0
79.	495.	0.374	29.98	-11.33	18.1	2.29	82.47	14.0	69.	294.	231.	63. 0.0
80.	495.	0.374	29.98	-11.21	17.6	2.26	84.87	13.9	70.	295.	227.	68. 99.3

100% AIRFLOW

CYCLE	HP	BSFC	BAROM PRES	P AIR IN	P TC OUT	PR	DEL P BARR	P IN MAN	AMB T	T TC OUT	T IN MAN	DEL T AFTC
81.	494.	0.375	29.98	-11.77	18.1	2.30	64.87	13.1	70.	293.	229.	64. 0.0
82.	494.	0.372	30.02	-8.98	18.1	2.28	80.92	14.3	63.	288.	227.	61. 99.4
83.	493.	0.237	30.02	-10.47	18.1	2.29	85.44	13.6	68.	292.	230.	62. 0.0
84.	493.	0.374	30.02	-12.75	18.1	2.30	86.59	14.0	70.	297.	233.	64. 0.0
85.	491.	0.375	30.02	-10.11	18.2	2.29	87.77	13.4	71.	298.	233.	65. 0.0
86.	490.	0.378	30.02	-8.94	17.0	2.20	85.35	13.1	74.	300.	233.	67. 0.0
87.	493.	0.373	29.95	-12.40	18.3	2.31	83.98	13.4	68.	294.	227.	67. 0.0
88.	490.	0.381	29.95	-12.37	17.9	2.29	85.24	14.1	70.	295.	229.	66. 0.0
89.	492.	0.376	29.95	-10.67	18.4	2.31	84.96	13.1	70.	297.	231.	66. 0.0
90.	491.	0.376	29.95	-12.46	17.8	2.28	82.92	14.0	74.	302.	235.	67. 99.4
91.	488.	0.380	29.95	-9.99	18.0	2.28	87.33	13.5	69.	296.	233.	65. 0.0
92.	493.	0.373	30.32	-11.29	17.9	2.26	81.99	14.1	71.	293.	227.	66. 0.0
93.	496.	0.375	30.32	-9.74	17.4	2.22	82.26	13.9	69.	291.	227.	64. 0.0
94.	496.	0.375	30.32	-10.62	17.4	2.23	80.83	14.4	75.	297.	229.	68. 0.0
95.	496.	0.377	30.32	-12.36	17.3	2.23	83.90	13.9	77.	300.	229.	71. 99.1
96.	495.	0.378	30.32	-10.83	18.1	2.27	88.33	12.8	68.	289.	229.	60. 0.0
97.	495.	0.376	30.32	-12.06	18.0	2.27	83.67	13.9	70.	293.	227.	66. 0.0
98.	490.	0.377	30.32	-11.60	18.1	2.28	87.26	13.9	72.	294.	230.	64. 99.5
99.	494.	0.378	30.32	-12.76	17.7	2.26	86.46	13.8	71.	293.	229.	64. 0.0
100.	493.	0.376	30.15	-9.52	17.9	2.26	91.48	14.2	71.	296.	232.	64. 0.0
101.	493.	0.375	30.15	-10.17	17.6	2.24	90.83	12.8	73.	297.	227.	70. 0.0
102.	492.	0.377	30.15	-11.05	18.0	2.28	85.99	13.4	73.	296.	231.	65. 99.5
103.	490.	0.378	30.15	-13.29	17.4	2.25	86.22	13.6	74.	297.	232.	65. 0.0
104.	494.	0.381	30.15	-11.43	18.8	2.33	92.60	13.1	77.	302.	237.	65. 0.0
105.	491.	0.381	30.15	-10.10	17.2	2.22	91.17	14.0	78.	303.	237.	66. 0.0
106.	490.	0.380	30.05	-11.94	18.4	2.31	88.63	14.0	67.	291.	228.	63. 0.0
107.	491.	0.377	30.05	-12.33	18.2	2.30	88.84	12.8	71.	295.	230.	65. 0.0
108.	491.	0.377	30.05	-12.64	17.7	2.27	89.46	13.2	72.	295.	233.	62. 99.4
109.	487.	0.388	30.19	-13.49	16.7	2.20	90.61	12.6	74.	293.	229.	65. 0.0
110.	494.	0.382	30.19	-12.30	17.7	2.26	92.83	14.1	71.	292.	229.	63. 0.0
111.	490.	0.380	30.19	-10.83	17.3	2.23	94.13	13.2	74.	295.	232.	65. 0.0
112.	491.	0.383	30.19	-10.59	17.7	2.25	97.71	13.2	75.	296.	232.	64. 0.0
113.	491.	0.379	30.04	-12.48	17.4	2.25	90.44	13.1	74.	295.	233.	62. 0.0
114.	487.	0.381	30.04	-9.76	16.8	2.19	90.62	12.9	77.	299.	236.	63. 99.4
115.	487.	0.384	30.04	-10.29	16.8	2.19	92.15	11.6	82.	300.	231.	69. 0.0
116.	488.	0.382	30.04	-10.21	17.4	2.23	90.54	13.8	84.	305.	234.	71. 0.0
117.	488.	0.383	30.01	-11.75	17.1	2.22	90.22	12.6	85.	306.	236.	70. 0.0
118.	490.	0.381	29.98	-11.79	16.2	2.16	85.42	12.6	76.	295.	229.	66. 0.0
119.	486.	0.382	29.98	-12.68	16.7	2.20	83.71	12.6	82.	300.	232.	68. 0.0
120.	488.	0.387	29.98	-11.65	16.5	2.18	87.13	12.0	87.	309.	236.	73. 0.0

### 80% AIRFLOW

CYCLE	HP	BSFC	BAROM PRES	P AIR IN	P TC OUT	PR	DEL P BARR	P IN #MAH	AMB T	T TC OUT	T IN MAN	DEL T AFTC
1.	429.	0.346	29.83	-6.87	12.5	1.88	14.97	11.1	67.	235.	201.	34.
2.	428.	0.345	0.00	-10.52	12.1	0.00	18.10	12.0	67.	234.	204.	30.
3.	422.	0.348	29.25	-8.55	12.1	1.88	21.91	11.6	71.	238.	206.	32.
4.	422.	0.350	29.97	-9.04	12.2	1.87	20.90	10.9	69.	234.	210.	24.
5.	420.	0.349	29.97	-9.06	12.5	1.89	22.59	10.9	70.	234.	213.	21.
6.	424.	0.348	29.98	-8.94	12.5	1.89	23.55	10.8	70.	236.	206.	30.
7.	425.	0.350	29.98	-6.77	13.0	1.91	25.49	10.7	71.	233.	207.	31.
8.	424.	0.349	29.98	-7.15	12.5	1.88	25.55	11.8	67.	235.	204.	31.
9.	421.	0.352	29.98	-7.77	12.2	1.86	25.78	10.9	69.	233.	203.	30.
10.	422.	0.349	29.95	-8.26	12.1	1.86	28.78	10.8	72.	238.	206.	32.
11.	426.	0.347	29.95	-7.91	12.7	1.90	31.84	11.3	67.	234.	202.	32.
12.	421.	0.350	29.95	-7.41	12.0	1.85	30.72	10.6	73.	237.	203.	34.
13.	426.	0.349	29.95	-8.12	12.6	1.89	32.38	10.5	71.	240.	204.	36.
14.	424.	0.347	29.95	-7.03	12.0	1.85	32.08	11.3	70.	237.	203.	34.
15.	426.	0.348	29.97	-7.31	13.0	1.92	29.28	10.5	66.	231.	201.	30.
16.	425.	0.349	29.97	-7.38	12.4	1.88	33.41	10.6	70.	234.	198.	36.
17.	424.	0.351	29.97	-8.89	12.6	1.90	36.00	11.1	71.	238.	199.	39.
18.	425.	0.348	29.97	-6.99	12.3	1.87	33.44	11.4	69.	236.	204.	32.
19.	423.	0.351	29.97	-7.56	12.8	1.90	35.16	10.9	71.	238.	204.	34.
20.	418.	0.352	29.92	-6.08	12.1	1.85	37.00	10.6	76.	240.	204.	36.
21.	423.	0.353	29.92	-5.90	12.1	1.85	35.55	10.9	73.	238.	206.	32.
22.	424.	0.349	29.92	-5.29	11.8	1.83	37.40	11.3	71.	239.	208.	31.
23.	423.	0.350	29.95	-10.31	12.7	1.91	39.30	10.5	67.	232.	203.	29.
24.	422.	0.353	29.95	-6.58	12.2	1.86	38.52	10.6	72.	237.	202.	35.
25.	422.	0.352	29.95	-7.44	12.1	1.86	39.27	10.6	70.	233.	204.	29.
26.	424.	0.351	29.93	-4.08	11.6	1.81	39.35	12.4	70.	238.	203.	35.
27.	422.	0.352	29.93	-7.89	12.3	1.87	38.57	10.4	72.	240.	206.	32.
28.	420.	0.354	29.93	-10.12	11.7	1.84	37.55	11.0	69.	234.	203.	31.
29.	421.	0.353	29.92	-8.39	12.9	1.92	39.24	10.5	64.	231.	200.	31.
30.	420.	0.355	29.92	-7.46	12.3	1.87	37.56	9.9	76.	242.	202.	40.
31.	424.	0.354	29.92	-6.73	12.8	1.90	39.00	9.9	72.	237.	202.	35.
32.	423.	0.353	29.92	-6.78	12.1	1.85	41.39	10.6	67.	235.	204.	31.
33.	423.	0.351	29.86	-7.51	12.8	1.91	44.41	10.9	55.	222.	199.	23.
34.	422.	0.351	29.86	-6.84	12.7	1.90	44.41	10.7	68.	236.	203.	33.
35.	421.	0.355	29.86	-8.91	11.8	1.84	46.72	9.8	71.	236.	204.	32.
36.	414.	0.373	29.86	-7.01	12.3	1.87	45.57	10.1	70.	236.	206.	30.
37.	423.	0.353	29.86	-7.77	11.9	1.85	44.29	10.6	73.	240.	207.	33.
38.	426.	0.354	29.85	-7.61	12.7	1.90	45.56	11.0	58.	227.	197.	30.
39.	416.	0.357	29.85	-7.50	12.7	1.90	48.77	10.4	72.	239.	208.	31.
40.	421.	0.356	29.85	-7.04	11.9	1.84	46.04	11.0	74.	242.	209.	33.

## 80% AIRFLOW

CYCLE	HP	BSFC	BAROM PRES	P AIR IN	P TC OUT	PR	DEL P BARR	P IN MAN	AMB T	T TC OUT	T IN MAN	DEL T AFTC
41.	420.	0.354	29.85	-8.01	13.8	1.98	44.44	9.0	70.	237.	206.	31.
42.	421.	0.356	29.85	-9.06	12.3	1.88	45.99	10.1	72.	240.	206.	37.
43.	421.	0.358	29.85	-7.08	12.4	1.88	49.65	10.7	73.	239.	207.	32.
44.	420.	0.355	29.85	-6.39	11.9	1.84	47.60	11.9	66.	231.	154.	37.
45.	417.	0.357	29.85	-7.11	12.4	1.88	49.66	9.7	74.	239.	201.	38.
46.	420.	0.358	29.85	-8.68	12.5	1.89	51.10	10.3	73.	238.	200.	38.
47.	419.	0.357	30.03	-7.02	11.9	1.84	51.59	10.1	74.	240.	202.	38.
48.	418.	0.363	30.03	-9.07	11.7	1.83	49.50	9.8	76.	240.	201.	39.
49.	418.	0.356	30.21	-8.17	12.5	1.88	45.49	10.0	68.	233.	201.	32.
50.	419.	0.359	30.21	-9.41	12.1	1.86	55.29	10.3	75.	242.	209.	33.
51.	418.	0.359	30.21	-7.86	12.0	1.84	46.61	9.8	82.	248.	211.	37.
52.	417.	0.361	30.21	-7.37	12.1	1.85	50.02	9.9	84.	252.	213.	39.
53.	419.	0.361	30.21	-9.33	12.5	1.89	48.59	10.0	86.	250.	213.	37.
54.	423.	0.361	30.13	-7.60	13.2	1.93	48.05	10.0	69.	237.	210.	27.
55.	418.	0.359	30.13	-6.99	12.0	1.84	52.49	10.4	74.	240.	204.	36.
56.	415.	0.365	30.13	-7.25	11.9	1.84	51.01	10.6	83.	249.	206.	43.
57.	415.	0.365	30.13	-8.05	12.2	1.86	52.68	10.0	88.	254.	207.	47.
58.	414.	0.365	30.13	-6.32	12.2	1.85	54.61	9.2	83.	248.	207.	41.
59.	417.	0.361	30.13	-8.49	12.6	1.89	57.65	9.1	76.	240.	201.	39.
60.	421.	0.397	30.29	-6.94	13.2	1.92	58.02	10.6	64.	235.	208.	27.
61.	419.	0.396	30.29	-7.95	13.0	1.91	58.02	10.9	56.	227.	207.	20.
62.	419.	0.395	30.29	-6.31	13.2	1.92	53.22	11.1	55.	226.	202.	24.
63.	420.	0.393	30.29	-8.12	13.6	1.95	56.31	10.7	55.	225.	205.	20.
64.	420.	0.392	30.29	-6.99	13.2	1.92	55.25	12.2	54.	225.	203.	22.
65.	418.	0.400	30.08	-8.97	13.0	1.92	61.72	10.7	70.	242.	206.	36.
66.	418.	0.403	30.08	-7.16	13.7	1.96	56.99	10.9	73.	245.	207.	38.
67.	421.	0.397	30.08	-6.77	13.8	1.97	53.23	11.1	62.	234.	205.	29.
68.	418.	0.400	30.08	-6.06	12.7	1.89	54.63	11.2	70.	241.	205.	36.
69.	415.	0.362	29.96	-6.48	12.4	1.87	57.86	10.5	68.	237.	206.	31.
70.	418.	0.360	29.96	-7.29	13.5	1.95	60.39	9.4	68.	230.	205.	36.
71.	419.	0.360	29.96	-6.36	13.1	1.92	61.62	10.2	68.	240.	205.	35.
72.	418.	0.359	29.96	-7.72	12.8	1.91	62.96	10.4	68.	241.	206.	35.
73.	416.	0.361	29.96	-6.73	12.0	1.85	62.60	9.9	71.	242.	207.	35.
74.	417.	0.358	29.96	-6.17	13.1	1.92	64.51	10.4	72.	244.	208.	36.
75.	420.	0.360	29.71	-7.87	13.1	1.94	61.82	10.8	69.	243.	204.	39.
76.	416.	0.362	29.71	-8.39	12.5	1.90	57.68	10.1	79.	251.	211.	41.
77.	415.	0.368	29.71	-8.52	13.2	1.95	59.50	10.1	79.	252.	210.	42.
78.	417.	0.359	29.98	-6.59	13.2	1.93	60.85	10.3	73.	244.	206.	38.
79.	419.	0.360	29.98	-7.99	14.0	1.99	66.66	10.6	70.	243.	206.	37.
80.	418.	0.362	29.98	-7.04	13.5	1.95	62.84	10.3	69.	240.	207.	34.

## 80% AIRFLOW

CYCLE	HP	BSFC	BAROM PRES	P AIR IN	P TC OUT	PR	DEL P BAPP	P IN #MAN	AMS T	T TC OUT	T IN MAP	DEL T AFTC
81.	416.	0.361	29.98	-6.65	13.2	1.93	63.61	9.5	71.	241.	205.	36.
82.	419.	0.364	30.02	-8.01	13.3	1.94	62.02	10.5	65.	238.	203.	35.
83.	417.	0.363	30.02	-9.09	12.7	1.90	60.86	10.7	70.	241.	205.	36.
84.	415.	0.363	30.02	-7.38	13.6	1.96	68.77	9.8	70.	243.	206.	37.
85.	415.	0.363	30.02	-8.03	13.5	1.95	60.49	11.2	72.	246.	207.	39.
86.	418.	0.361	29.95	-7.74	12.8	1.91	61.78	11.2	68.	241.	203.	38.
87.	416.	0.361	29.95	-7.64	13.4	1.95	63.22	10.6	69.	240.	201.	39.
88.	418.	0.361	29.95	-6.13	13.8	1.97	62.40	9.9	69.	243.	204.	39.
89.	415.	0.367	29.95	-7.05	13.3	1.94	60.80	11.1	72.	246.	207.	39.
90.	416.	0.364	29.95	-7.26	13.2	1.93	64.73	10.4	74.	247.	209.	38.
91.	415.	0.366	29.95	-7.73	12.9	1.91	61.65	10.9	70.	243.	209.	34.
92.	416.	0.365	30.32	-8.18	12.5	1.88	63.37	10.9	74.	243.	201.	42.
93.	421.	0.360	30.32	-7.93	13.3	1.93	61.77	9.7	70.	239.	201.	38.
94.	420.	0.363	30.32	-9.27	13.2	1.93	63.07	10.2	74.	244.	202.	42.
95.	419.	0.365	30.02	-8.70	12.8	1.91	62.23	9.8	76.	247.	203.	44.
96.	419.	0.363	30.32	-6.49	13.3	1.92	63.53	9.7	68.	237.	205.	32.
97.	420.	0.366	30.32	-8.10	12.6	1.88	64.61	11.0	73.	243.	204.	39.
98.	415.	0.365	30.32	-6.98	13.3	1.93	63.37	9.8	70.	240.	203.	37.
99.	418.	0.365	30.32	-8.62	13.0	1.91	63.64	10.6	70.	241.	206.	35.
100.	417.	0.365	30.15	-9.04	13.2	1.93	64.53	10.6	73.	245.	204.	41.
101.	420.	0.367	30.15	-7.19	13.6	1.95	67.20	10.4	71.	245.	204.	41.
102.	416.	0.364	30.15	-8.60	12.9	1.91	65.02	10.5	73.	245.	204.	41.
103.	413.	0.366	30.15	-7.41	13.7	1.96	63.12	10.2	76.	245.	209.	36.
104.	418.	0.363	30.15	-9.43	12.9	1.91	65.87	10.5	76.	249.	211.	38.
105.	415.	0.368	30.15	-7.87	12.7	1.89	67.41	9.8	78.	250.	211.	39.
106.	420.	0.362	30.05	-8.78	13.8	1.98	65.73	10.2	67.	239.	204.	35.
107.	416.	0.364	30.05	-9.04	13.1	1.93	68.22	9.8	72.	243.	205.	38.
108.	416.	0.365	30.05	-6.06	13.6	1.95	70.79	9.2	71.	243.	206.	37.
109.	418.	0.365	30.19	-7.40	12.5	1.88	65.95	10.8	69.	237.	204.	33.
110.	416.	0.365	30.19	-5.52	11.9	1.83	78.94	9.6	72.	239.	204.	35.
111.	416.	0.368	30.19	-8.04	12.5	1.88	68.04	9.6	74.	242.	206.	36.
112.	415.	0.365	30.19	-7.63	12.7	1.89	68.36	9.9	75.	242.	206.	36.
113.	416.	0.365	30.04	-8.42	12.7	1.90	66.83	9.6	68.	237.	202.	35.
114.	414.	0.368	30.04	-8.33	12.8	1.91	64.72	10.1	78.	245.	206.	39.
115.	411.	0.370	30.04	-5.82	12.0	1.84	66.18	9.1	84.	251.	209.	42.
116.	410.	0.371	30.04	-9.09	11.9	1.85	64.79	9.9	85.	253.	208.	45.
117.	415.	0.370	29.98	-7.57	12.7	1.90	62.64	9.3	75.	244.	205.	39.
118.	414.	0.368	29.98	-7.93	12.4	1.88	65.87	9.1	79.	248.	208.	40.
119.	413.	0.410	29.98	-8.76	11.5	1.82	62.91	9.7	86.	254.	209.	45.
120.	412.	0.373	29.98	-7.70	12.0	1.85	64.69	10.0	88.	258.	210.	48.

B-8

Best Available Copy

60% AIRFLOW

CYCLE	HP	BSFC	BAROM PRES	P AIR IN	P TC OUT	PR	DEL P BARR	P IN MAN	AMB T	T TC OUT	T IN MAN	DEL T AFTC
1.	355.	0.348	29.85	-4.47	8.7	1.61	9.19	6.7	68.	199.	197.	2.
2.	353.	0.352	0.00	-4.44	7.5	0.00	10.51	7.0	68.	187.	190.	-3.
3.	350.	0.356	29.97	-5.57	7.9	1.56	15.12	7.3	70.	190.	187.	3.
4.	347.	0.355	29.97	-4.25	8.4	1.59	18.28	6.9	71.	192.	195.	-3.
5.	348.	0.355	29.98	-5.28	7.2	1.51	15.23	6.9	69.	187.	181.	6.
6.	348.	0.355	29.98	-4.73	8.2	1.58	14.59	7.1	70.	190.	188.	2.
7.	351.	0.354	29.98	-4.73	7.4	1.52	15.78	7.6	72.	174.	190.	4.
8.	350.	0.352	29.98	-6.15	8.0	1.57	17.99	6.7	70.	189.	186.	3.
9.	350.	0.356	29.98	-5.80	7.5	1.53	22.42	8.2	67.	190.	188.	2.
10.	348.	0.357	29.95	-6.66	7.7	1.55	19.33	7.1	69.	191.	187.	4.
11.	352.	0.349	29.95	-4.91	8.7	1.61	15.15	6.1	69.	187.	184.	3.
12.	347.	0.354	29.95	-6.24	7.6	1.54	20.23	7.7	73.	195.	187.	6.
13.	352.	0.354	29.95	-3.89	8.8	1.61	21.41	6.2	70.	193.	187.	6.
14.	349.	0.352	29.95	-6.63	8.0	1.57	20.75	6.8	70.	192.	186.	6.
15.	350.	0.354	29.97	-4.94	7.7	1.54	24.65	6.8	68.	188.	180.	8.
16.	346.	0.356	29.97	-6.38	7.6	1.54	24.27	6.8	69.	188.	182.	6.
17.	348.	0.353	29.97	-4.11	8.3	1.58	22.49	6.1	76.	192.	181.	11.
18.	346.	0.329	29.97	-4.68	8.0	1.56	23.88	7.2	69.	189.	187.	2.
19.	346.	0.364	29.92	-4.53	8.8	1.62	25.35	6.6	70.	192.	189.	3.
20.	336.	0.356	29.92	-5.02	6.4	1.45	32.18	6.3	76.	190.	188.	2.
21.	342.	0.358	29.92	-6.27	7.9	1.56	27.96	5.6	75.	193.	190.	3.
22.	347.	0.356	29.92	-4.23	7.8	1.55	29.03	6.9	73.	193.	189.	4.
23.	345.	0.357	29.95	-2.39	7.8	1.54	25.55	7.1	68.	187.	185.	2.
24.	338.	0.359	29.95	-5.33	7.8	1.55	26.82	5.1	76.	190.	185.	5.
25.	340.	0.360	29.95	-2.72	7.8	1.54	28.92	6.7	72.	190.	186.	4.
26.	342.	0.358	29.93	-4.64	8.0	1.56	27.65	6.5	70.	189.	185.	4.
27.	336.	0.363	29.93	-6.76	7.3	1.52	27.20	6.1	72.	189.	191.	-2.
28.	343.	0.368	29.93	-6.87	8.4	1.60	27.91	6.2	65.	188.	186.	0.
29.	344.	0.358	29.92	-4.14	7.1	1.50	31.76	7.4	65.	185.	184.	1.
30.	338.	0.365	29.92	-5.20	7.5	1.53	34.65	5.5	70.	188.	184.	4.
31.	341.	0.362	29.92	-4.64	7.9	1.56	35.30	6.0	70.	186.	182.	4.
32.	345.	0.361	29.86	-4.40	7.3	1.51	30.48	7.2	56.	176.	167.	9.
33.	344.	0.361	29.86	-6.60	7.2	1.52	32.67	6.5	64.	185.	185.	-1.
34.	338.	0.362	29.86	-4.94	7.7	1.54	35.41	5.8	69.	185.	186.	-1.
35.	337.	0.363	29.86	-2.89	7.6	1.53	38.90	5.8	73.	191.	187.	4.
36.	338.	0.362	29.86	-3.42	7.2	1.50	32.23	6.4	70.	188.	127.	1.
37.	338.	0.360	29.86	-6.32	7.8	1.56	35.38	5.5	72.	190.	192.	-2.
38.	347.	0.358	29.85	-4.13	7.8	1.55	32.08	6.6	58.	178.	180.	-2.
39.	340.	0.364	29.85	-4.92	8.0	1.56	34.87	5.8	72.	191.	188.	3.
40.	337.	0.364	29.85	-4.69	7.7	1.54	34.59	6.3	74.	192.	199.	3.

60% AIRFLOW

CYCLE	HP	BSFC	BAROM PRES	P AIR IN	P TC OUT	PR	DEL P BARR	P IN MAN	AMB T	T TC OUT	T IN MAN	DEL T AFTC
41.	337.	0.364	29.85	-4.73	8.1	1.57	34.25	5.9	72.	189.	188.	1.
42.	334.	0.366	29.85	-3.83	7.0	1.49	35.65	6.4	73.	190.	189.	1.
43.	338.	0.366	29.85	-2.99	7.6	1.53	36.64	6.7	73.	192.	190.	2.
44.	335.	0.363	29.85	-4.76	7.7	1.54	40.71	6.0	69.	184.	130.	4.
45.	332.	0.365	29.85	-4.26	6.8	1.48	41.13	6.3	69.	181.	178.	3.
46.	333.	0.365	29.85	-2.54	7.2	1.50	40.65	5.8	73.	189.	181.	3.
47.	329.	0.369	30.03	-4.82	7.6	1.53	37.45	6.3	77.	191.	190.	1.
48.	337.	0.368	30.21	-4.78	8.1	1.56	35.61	6.7	66.	185.	190.	-5.
49.	337.	0.364	30.21	-7.00	7.9	1.56	34.62	7.7	70.	186.	188.	-2.
50.	329.	0.369	30.21	-6.64	7.5	1.53	36.99	4.8	76.	190.	190.	0.
51.	329.	0.368	30.21	-5.49	7.2	1.51	35.74	6.1	82.	197.	192.	5.
52.	325.	0.373	30.21	-6.41	6.4	1.45	34.34	5.8	85.	197.	192.	5.
53.	327.	0.370	30.21	-4.07	7.2	1.50	40.08	6.1	85.	199.	193.	6.
54.	339.	0.360	30.13	-5.40	8.5	1.60	34.87	6.1	69.	190.	189.	1.
55.	330.	0.369	30.13	-6.77	7.0	1.50	37.29	6.1	76.	189.	184.	5.
56.	324.	0.371	30.13	-6.51	7.0	1.50	39.35	5.3	84.	198.	190.	8.
57.	320.	0.376	30.13	-5.55	6.4	1.45	41.00	5.1	88.	199.	190.	9.
58.	324.	0.375	30.13	-6.05	6.7	1.47	45.06	5.4	76.	189.	188.	1.
59.	328.	0.370	30.13	-5.47	7.2	1.51	41.55	5.3	73.	186.	181.	5.
60.	331.	0.408	30.29	-5.10	7.8	1.54	41.90	5.6	70.	190.	188.	2.
61.	343.	0.342	30.29	-5.22	7.7	1.54	45.03	6.7	56.	179.	134.	-5.
62.	340.	0.399	30.29	-5.95	8.3	1.58	43.03	6.2	56.	178.	185.	-7.
63.	344.	0.397	30.29	-6.02	8.6	1.60	43.11	6.5	54.	177.	186.	-9.
64.	343.	0.397	30.29	-5.42	8.4	1.59	41.92	6.6	54.	176.	185.	-4.
65.	334.	0.408	30.08	-4.77	7.8	1.55	41.89	5.9	72.	193.	188.	5.
66.	328.	0.411	30.08	-4.46	7.9	1.55	43.34	6.5	75.	192.	188.	4.
67.	334.	0.407	30.08	-4.77	8.4	1.59	43.63	5.4	65.	185.	184.	1.
68.	328.	0.414	30.08	-5.47	7.4	1.52	40.66	5.9	69.	185.	185.	0.
69.	330.	0.367	29.96	-5.87	8.4	1.59	42.52	5.8	68.	185.	183.	2.
70.	333.	0.368	29.96	-3.08	7.8	1.54	45.43	6.5	66.	187.	184.	3.
71.	333.	0.366	29.96	-3.93	7.9	1.55	45.33	6.1	69.	190.	187.	3.
72.	329.	0.368	29.96	-4.08	8.3	1.58	44.89	5.3	69.	186.	186.	0.
73.	332.	0.367	29.96	-6.03	8.2	1.58	45.59	6.7	70.	191.	188.	3.
74.	330.	0.367	29.96	-4.60	7.9	1.55	47.19	6.1	73.	193.	188.	5.
75.	333.	0.369	29.71	-6.07	7.9	1.56	45.27	5.8	71.	193.	184.	9.
76.	325.	0.372	29.71	-4.86	7.0	1.50	42.14	6.4	81.	199.	190.	9.
77.	331.	0.373	29.71	-5.07	8.1	1.57	41.83	6.1	78.	201.	190.	11.
78.	333.	0.368	29.98	-3.75	8.3	1.58	43.58	6.2	76.	197.	198.	9.
79.	336.	0.371	29.98	-4.10	7.9	1.55	45.49	6.6	70.	192.	181.	11.
80.	328.	0.372	29.98	-6.21	7.8	1.55	46.47	4.7	71.	188.	181.	7.

## 60% AIRFLOW

CYCLE	HP	BSFC	BAROM PRES	P AIR IN	P TC OUT	PR	DEL P BARR	P IN MAN	AMB T	T TC OUT	T IN MAN	DEL T AFTC
81.	332.	0.372	29.98	-6.98	8.2	1.58	45.93	5.8	73.	195.	189.	7.
82.	333.	0.371	30.02	-5.34	7.9	1.56	42.42	5.9	65.	186.	183.	3.
83.	332.	0.371	30.02	-5.85	8.1	1.57	44.94	6.0	73.	193.	188.	5.
84.	331.	0.370	30.02	-3.18	8.1	1.56	43.25	6.5	71.	192.	182.	5.
85.	337.	0.368	30.02	-4.03	8.3	1.58	43.55	7.2	66.	190.	189.	2.
86.	334.	0.372	29.95	-4.81	7.9	1.56	40.60	6.0	68.	191.	181.	10.
87.	333.	0.368	29.95	-6.06	8.0	1.57	44.98	6.2	69.	190.	181.	9.
88.	332.	0.372	29.95	-4.97	7.8	1.55	44.65	7.0	69.	192.	184.	8.
89.	331.	0.373	29.95	-5.99	7.4	1.53	42.58	7.0	73.	195.	187.	8.
90.	332.	0.372	29.95	-6.07	7.7	1.55	44.63	6.8	69.	190.	183.	2.
91.	334.	0.374	30.32	-4.52	7.4	1.51	43.59	6.9	67.	187.	185.	2.
92.	325.	0.374	30.32	-3.28	7.6	1.52	42.09	5.8	75.	190.	181.	9.
93.	330.	0.369	30.32	-5.42	7.5	1.52	46.98	5.9	73.	188.	181.	7.
94.	327.	0.374	30.32	-4.37	7.6	1.53	43.62	5.3	76.	192.	182.	10.
95.	331.	0.372	30.32	-5.96	8.1	1.57	44.63	6.6	68.	185.	183.	2.
96.	336.	0.367	30.32	-3.96	8.0	1.55	47.37	6.4	67.	189.	186.	3.
97.	331.	0.372	30.32	-5.58	7.9	1.55	44.28	5.7	74.	195.	185.	10.
98.	329.	0.374	30.32	-0.68	6.6	1.45	45.98	6.2	71.	199.	183.	6.
99.	332.	0.371	30.32	-2.37	8.2	1.56	47.66	6.4	72.	191.	187.	4.
100.	333.	0.370	30.15	-6.17	7.7	1.54	48.69	7.3	67.	188.	181.	7.
101.	328.	0.372	30.15	-6.11	7.6	1.54	44.95	6.0	79.	197.	184.	13.
102.	330.	0.372	30.15	-4.37	7.4	1.52	48.36	6.7	75.	195.	182.	7.
103.	331.	0.372	30.15	-6.07	8.7	1.61	46.07	6.6	76.	198.	191.	7.
104.	330.	0.377	30.15	-5.58	8.1	1.57	46.13	6.0	77.	199.	191.	8.
105.	334.	0.376	30.05	-4.83	8.2	1.57	48.59	7.0	67.	192.	190.	2.
106.	337.	0.370	30.05	-5.65	8.7	1.61	47.21	6.0	69.	192.	185.	7.
107.	333.	0.372	30.05	-5.15	7.7	1.54	46.88	7.4	70.	193.	185.	8.
108.	328.	0.375	30.05	-2.76	7.9	1.55	48.81	6.3	70.	190.	185.	4.
109.	324.	0.372	30.19	-5.60	8.3	1.58	48.18	5.1	78.	192.	183.	9.
110.	326.	0.374	30.19	-4.89	7.4	1.52	50.17	5.6	73.	189.	185.	4.
111.	325.	0.373	30.19	-6.48	7.4	1.52	52.15	5.5	74.	191.	187.	4.
112.	327.	0.377	30.19	-3.95	7.8	1.54	49.08	5.5	76.	194.	186.	6.
113.	328.	0.370	30.04	-3.73	7.1	1.49	47.34	5.9	70.	185.	181.	4.
114.	321.	0.376	30.04	-2.52	7.1	1.49	47.80	4.4	76.	190.	133.	7.
115.	321.	0.376	30.04	-3.75	7.3	1.51	47.92	5.5	83.	198.	187.	11.
116.	322.	0.377	30.04	-5.34	6.4	1.45	45.47	6.4	95.	200.	188.	12.
117.	324.	0.379	29.98	-5.93	6.9	1.49	44.11	6.0	76.	191.	180.	11.
118.	321.	0.377	29.98	-3.01	7.6	1.53	46.79	5.1	79.	193.	186.	7.
119.	319.	0.379	29.98	-3.99	7.1	1.50	42.31	4.3	83.	197.	188.	9.
120.	315.	0.383	29.98	-4.14	7.6	1.53	45.38	5.1	88.	200.	188.	12.



40% AIRFLOW

CYCLE	HP	BSFC	BAROM PRES	P AIR IN	P TC OUT	PR	DEL P BARR	P IN MAN	AMB T	T TC OUT	T IN MAN	DEL T AFTC
1.	253.	0.364	29.83	-1.85	3.2	1.22	5.74	3.3	70.	139.	173.	-34.
2.	250.	0.363	0.00	-1.24	3.3	0.00	5.97	2.9	68.	138.	172.	-34.
3.	251.	0.369	29.97	-2.84	2.7	1.19	6.75	3.0	69.	139.	170.	-31.
4.	248.	0.368	29.97	-2.45	2.5	1.18	9.05	3.6	71.	142.	179.	-37.
5.	248.	0.367	29.98	-2.18	2.9	1.20	9.07	2.6	69.	136.	163.	-27.
6.	249.	0.369	29.98	-3.09	3.7	1.26	8.71	2.5	70.	139.	172.	-33.
7.	248.	0.368	29.98	-3.41	3.5	1.25	9.07	2.5	73.	143.	173.	-30.
8.	251.	0.363	29.98	-2.08	3.1	1.22	9.29	3.9	69.	137.	170.	-33.
9.	247.	0.370	29.98	-3.88	3.3	1.24	11.66	3.0	68.	137.	173.	-36.
10.	247.	0.371	29.95	-5.28	3.4	1.25	10.62	3.0	69.	139.	172.	-33.
11.	247.	0.367	29.95	-1.38	3.1	1.21	11.21	2.7	69.	137.	171.	-34.
12.	246.	0.371	29.95	-2.72	3.1	1.22	12.59	2.6	73.	143.	171.	-28.
13.	248.	0.369	29.95	-0.17	3.0	1.20	12.44	2.2	70.	138.	170.	-32.
14.	247.	0.370	29.95	-4.08	2.5	1.18	12.38	2.0	71.	141.	170.	-29.
15.	100.	0.404	29.97	-4.15	-0.7	0.96	21.05	-1.8	74.	99.	160.	-61.
16.	248.	0.369	29.97	-2.73	2.6	1.18	15.26	2.9	69.	138.	166.	-28.
17.	246.	0.372	29.97	-3.37	2.7	1.19	16.53	2.6	75.	143.	168.	-25.
18.	246.	0.373	29.97	-2.49	2.8	1.20	15.80	2.9	70.	139.	172.	-33.
19.	244.	0.377	29.92	-3.54	3.1	1.22	18.68	2.8	70.	138.	169.	-31.
20.	244.	0.373	29.92	-2.91	2.6	1.19	17.82	2.9	77.	145.	174.	-29.
21.	244.	0.375	29.92	-4.35	3.1	1.22	19.10	2.1	76.	145.	175.	-30.
22.	89.	0.406	29.92	-2.44	-0.6	0.96	26.37	1.9	71.	95.	172.	-77.
23.	244.	0.377	29.95	-3.90	3.5	1.25	19.31	1.4	68.	136.	169.	-33.
24.	244.	0.376	29.95	-3.29	2.9	1.21	19.37	2.8	76.	145.	170.	-25.
25.	247.	0.373	29.95	-2.81	3.3	1.23	20.89	2.0	67.	135.	171.	-36.
26.	242.	0.381	29.93	-2.23	3.2	1.22	20.97	2.2	70.	139.	174.	-35.
27.	245.	0.377	29.93	-2.25	2.8	1.20	19.32	2.4	70.	138.	174.	-36.
28.	242.	0.722	29.93	-2.05	3.4	1.24	20.91	2.2	65.	133.	169.	-36.
29.	245.	0.376	29.92	-3.70	3.5	1.25	22.84	1.0	66.	134.	169.	-35.
30.	241.	0.383	29.92	-2.44	2.6	1.18	24.49	2.6	70.	139.	167.	-29.
31.	244.	0.378	29.92	-2.77	2.7	1.19	22.28	2.9	69.	138.	168.	-30.
32.	243.	0.378	29.86	-3.93	2.8	1.20	23.64	1.5	56.	122.	146.	-24.
33.	244.	0.378	29.86	-2.83	2.3	1.16	25.81	2.9	69.	139.	172.	-33.
34.	242.	0.381	29.86	-2.99	2.1	1.15	27.03	3.5	68.	137.	172.	-35.
35.	242.	0.380	29.86	-2.63	3.0	1.21	28.02	1.8	73.	142.	172.	-30.
36.	243.	0.381	29.86	-3.31	3.3	1.24	25.59	1.5	71.	140.	174.	-34.
37.	242.	0.379	29.86	-2.32	2.7	1.19	24.92	2.8	71.	141.	174.	-33.
38.	243.	0.381	29.85	-1.38	2.9	1.20	26.82	2.1	56.	127.	168.	-41.
39.	241.	0.381	29.85	-3.46	2.7	1.19	27.41	2.4	71.	140.	176.	-36.
40.	238.	0.388	29.85	-3.81	3.2	1.23	26.84	1.3	74.	143.	175.	-32.

### 40% AIRFLOW

CYCLE	HP	BSFC	BAROM PRES	P AIR IN	P TC OUT	PR	DEL P BARR	P IN MAN	AMB T	T TC OUT	T IN MAN	DEL T AFTC
41.	241.	0.380	29.85	-2.74	2.6	1.19	25.36	2.2	72.	142.	176.	-34.
42.	241.	0.387	29.85	-4.17	3.2	1.23	27.79	1.7	74.	142.	175.	-33.
43.	242.	0.384	29.85	-4.28	3.3	1.24	26.53	1.9	72.	142.	176.	-34.
44.	242.	0.382	29.85	-3.07	3.2	1.23	28.55	1.3	69.	137.	166.	-29.
45.	242.	0.381	29.85	-3.88	2.7	1.20	27.84	1.8	69.	136.	167.	-31.
46.	240.	0.383	29.85	-2.64	3.2	1.23	28.66	1.0	73.	141.	168.	-27.
47.	236.	0.390	30.03	-3.10	2.8	1.20	28.63	1.4	78.	145.	173.	-23.
48.	238.	0.387	30.21	-2.09	2.6	1.18	26.90	3.0	66.	134.	170.	-36.
49.	240.	0.382	30.21	-2.51	3.1	1.22	27.60	2.1	70.	138.	173.	-35.
50.	239.	0.386	30.21	-4.21	2.7	1.19	28.26	2.2	78.	146.	177.	-31.
51.	238.	0.387	30.21	-2.62	3.0	1.21	28.62	1.7	83.	151.	178.	-27.
52.	237.	0.389	30.21	-1.82	2.8	1.19	28.54	2.2	85.	153.	179.	-26.
53.	237.	0.390	30.21	-2.85	2.5	1.18	28.30	2.3	85.	155.	179.	-24.
54.	238.	0.389	30.13	-1.81	3.1	1.21	26.96	1.6	76.	145.	174.	-29.
55.	238.	0.388	30.13	-4.19	2.8	1.20	25.97	1.4	77.	145.	172.	-27.
56.	236.	0.390	30.13	-2.94	2.3	1.16	28.79	2.2	85.	153.	175.	-22.
57.	236.	0.397	30.13	-2.78	2.8	1.20	30.66	2.3	89.	158.	176.	-18.
58.	236.	0.393	30.13	-4.09	3.3	1.24	32.71	1.3	76.	145.	173.	-29.
59.	239.	0.385	30.13	-3.70	2.9	1.21	32.55	2.0	70.	136.	166.	-30.
60.	235.	0.435	30.29	-4.37	2.8	1.20	31.39	1.6	72.	142.	183.	-41.
61.	241.	0.422	30.29	-1.79	2.9	1.20	31.85	2.0	56.	126.	170.	-44.
62.	242.	0.422	30.29	-3.41	3.4	1.24	30.74	1.7	50.	126.	171.	-45.
63.	240.	0.426	30.29	-2.67	3.0	1.21	29.96	2.1	55.	124.	170.	-46.
64.	243.	0.382	30.29	-3.68	3.0	1.21	29.51	2.2	54.	125.	170.	-45.
65.	235.	0.436	30.08	-2.89	2.9	1.20	31.36	2.1	70.	141.	172.	-31.
66.	237.	0.432	30.08	-1.91	3.0	1.21	28.80	1.7	76.	146.	174.	-28.
67.	236.	0.433	30.08	-4.57	2.9	1.21	30.82	1.9	66.	136.	171.	-35.
68.	236.	0.436	30.08	-4.89	3.7	1.27	30.40	2.7	69.	138.	170.	-32.
69.	238.	0.397	29.96	-4.60	2.4	1.18	30.62	2.3	68.	137.	166.	-28.
70.	239.	0.384	29.96	-2.97	3.3	1.23	31.85	2.3	66.	135.	169.	-34.
71.	237.	0.387	29.96	-4.25	2.9	1.21	32.42	2.4	71.	142.	172.	-30.
72.	237.	0.386	29.96	-2.43	4.1	1.29	33.24	1.6	70.	140.	172.	-32.
73.	238.	0.386	29.96	-3.76	3.6	1.26	31.14	1.9	70.	141.	172.	-31.
74.	237.	0.385	29.96	-2.31	3.5	1.24	33.02	1.6	71.	142.	173.	-31.
75.	237.	0.392	29.71	-2.07	3.2	1.23	33.71	2.1	71.	143.	168.	-25.
76.	235.	0.395	29.71	-4.75	3.0	1.22	30.01	2.2	80.	152.	174.	-22.
77.	235.	0.457	29.71	-1.28	3.2	1.22	26.47	2.1	79.	168.	187.	-19.
78.	237.	0.390	29.98	-2.03	3.3	1.23	31.39	2.1	75.	145.	171.	-26.
79.	233.	0.395	29.98	-1.12	3.1	1.21	31.60	1.9	69.	139.	170.	-31.
80.	236.	0.393	29.98	-3.73	3.4	1.24	32.72	2.2	70.	139.	165.	-26.

40% AIRFLOW

CYCLE	HP	BSFC	BAROM PRES	P AIR IN	P TC OUT	PR	DEL P BARR	P IN MAN	AMB T	T TC OUT	T IN MAN	DEL T AFTC
81.	236.	0.391	30.02	-3.04	3.4	1.24	27.25	1.9	61.	131.	172.	-41.
82.	237.	0.390	30.02	-3.04	2.8	1.20	29.93	1.7	68.	137.	166.	-31.
83.	237.	0.390	30.02	-3.29	3.4	1.24	31.26	2.0	72.	141.	171.	-30.
84.	237.	0.390	30.02	-3.11	3.0	1.21	29.78	1.9	72.	142.	172.	-30.
85.	237.	0.389	30.02	-4.25	2.4	1.17	30.04	2.4	66.	138.	171.	-33.
86.	232.	0.396	29.95	-0.77	2.4	1.17	31.10	2.3	73.	144.	171.	-27.
87.	237.	0.390	29.95	-1.98	2.7	1.19	30.78	2.3	70.	139.	166.	-27.
88.	236.	0.392	29.95	-4.29	3.4	1.24	30.63	1.7	70.	139.	167.	-28.
89.	235.	0.394	29.95	-4.59	3.4	1.25	31.21	2.3	73.	145.	172.	-27.
90.	233.	0.398	29.95	-4.29	3.4	1.24	31.51	1.1	70.	139.	172.	-33.
91.	236.	0.393	30.32	-2.39	2.8	1.19	30.10	3.2	70.	139.	169.	-30.
92.	236.	0.390	30.32	-3.69	3.4	1.24	29.97	1.7	76.	144.	166.	-22.
93.	237.	0.389	30.32	-2.78	4.1	1.28	30.23	0.1	73.	141.	166.	-25.
94.	236.	0.391	30.32	-1.84	2.9	1.20	28.65	2.2	76.	144.	166.	-22.
95.	238.	0.390	30.32	-4.42	2.8	1.20	28.66	1.4	67.	136.	166.	-30.
96.	236.	0.390	30.32	-3.25	3.9	1.27	27.94	1.3	67.	137.	172.	-35.
97.	236.	0.391	30.32	-4.29	2.9	1.21	29.70	1.3	76.	145.	170.	-25.
98.	235.	0.394	30.32	-2.57	2.4	1.17	31.91	2.3	72.	140.	169.	-29.
99.	235.	0.393	30.32	-3.46	2.7	1.19	31.55	2.3	73.	140.	170.	-30.
100.	235.	0.393	30.15	-3.16	3.2	1.23	30.37	2.4	68.	136.	164.	-28.
101.	236.	0.393	30.15	-2.03	3.1	1.22	33.42	1.4	79.	150.	169.	-19.
102.	235.	0.394	30.15	-3.58	3.2	1.23	30.77	1.5	73.	142.	169.	-27.
103.	233.	0.395	30.15	-1.16	3.2	1.22	30.84	1.4	77.	147.	175.	-28.
104.	234.	0.399	30.15	-3.61	2.7	1.19	30.50	2.3	77.	146.	175.	-29.
105.	232.	0.398	30.05	-4.93	2.1	1.16	30.97	2.0	66.	136.	169.	-33.
106.	235.	0.394	30.05	-3.64	3.3	1.23	30.27	1.1	68.	139.	168.	-25.
107.	233.	0.394	30.05	-4.31	3.6	1.26	32.61	1.9	74.	143.	172.	-29.
108.	232.	0.399	30.05	-2.74	3.6	1.25	31.69	1.8	71.	140.	171.	-31.
109.	235.	0.393	30.19	-2.40	2.7	1.19	32.09	1.8	69.	137.	165.	-28.
110.	235.	0.396	30.19	-2.64	3.1	1.22	30.94	1.7	73.	141.	172.	-31.
111.	235.	0.395	30.19	-4.76	2.9	1.21	32.06	1.6	73.	142.	171.	-29.
112.	235.	0.394	30.19	-4.67	3.2	1.23	31.46	1.7	76.	144.	172.	-29.
113.	236.	0.392	30.04	-4.87	3.4	1.25	30.09	1.1	70.	137.	166.	-29.
114.	234.	0.396	30.04	-2.29	3.2	1.22	30.10	0.8	78.	144.	167.	-23.
115.	233.	0.401	30.04	-1.17	3.1	1.21	34.65	2.2	84.	151.	172.	-21.
116.	231.	0.432	30.04	-3.96	2.3	1.17	34.86	1.4	86.	143.	168.	-25.
117.	229.	0.404	29.98	-1.71	2.0	1.14	30.63	2.7	75.	142.	170.	-28.
118.	232.	0.400	29.98	-2.60	3.6	1.25	30.47	1.6	79.	146.	171.	-25.
119.	231.	0.402	29.98	-1.92	3.0	1.21	29.95	1.5	83.	152.	172.	-20.
120.	229.	0.406	29.98	-3.56	2.6	1.19	27.81	2.4	88.	156.	174.	-18.

20% AIRFLOW

CYCLE	HP	BSFC	BAROM PRES	P AIR IN	P TC OUT	FR	DEL P BAR	P IN MAN	AMB T	T TC OUT	T IN MAN	DEL T AFTC
1.	69.	0.392	29.83	-1.28	-1.3	0.91	2.57	-1.5	67.	88.	168.	-80.
2.	65.	0.370	0.00	-1.17	-1.5	0.00	3.19	-0.8	67.	83.	163.	-80.
3.	66.	0.414	29.25	-1.57	-1.6	0.89	4.51	-1.4	71.	85.	162.	-76.
4.	62.	0.386	29.97	-0.46	-1.1	0.93	5.66	-0.8	70.	84.	169.	-85.
5.	66.	0.371	29.98	-0.46	-2.2	0.85	4.45	-0.4	69.	85.	159.	-74.
6.	64.	0.341	29.98	-2.64	-0.6	0.97	5.94	-1.3	73.	87.	166.	-77.
7.	62.	0.281	29.98	-1.88	-1.5	0.90	7.54	-0.9	74.	89.	164.	-75.
8.	64.	0.412	29.98	-0.41	-0.9	0.94	6.55	-1.6	69.	84.	157.	-75.
9.	64.	0.339	29.98	-0.19	-1.3	0.91	7.22	-1.2	68.	83.	164.	-81.
10.	63.	0.322	29.95	-1.13	-1.5	0.90	5.62	-1.4	72.	90.	167.	-77.
11.	62.	0.391	29.95	-0.09	-1.1	0.93	8.76	-1.2	68.	84.	160.	-76.
12.	62.	0.325	29.95	-1.82	-1.5	0.90	9.10	-1.1	73.	86.	161.	-75.
13.	63.	0.422	29.95	-0.49	-1.6	0.89	9.98	-0.9	75.	88.	160.	-72.
14.	63.	0.395	29.95	-0.41	-1.3	0.91	8.52	-2.3	70.	87.	163.	-76.
15.	66.	0.420	29.97	-0.06	-1.1	0.93	10.36	-2.0	71.	85.	156.	-71.
16.	64.	0.367	29.97	-4.49	-1.5	0.91	11.59	-2.7	87.	98.	158.	-60.
17.	65.	0.359	29.97	-0.26	-1.3	0.91	12.56	-1.5	75.	88.	154.	-66.
18.	62.	0.418	29.97	-2.18	-1.2	0.92	11.42	-1.1	70.	88.	165.	-77.
19.	64.	0.355	29.97	-0.15	-0.8	0.95	12.07	-2.1	71.	88.	162.	-74.
20.	64.	0.282	29.92	-0.19	-1.5	0.90	12.75	-1.2	75.	91.	164.	-73.
21.	63.	0.396	29.92	-1.70	-1.2	0.92	12.30	-0.6	77.	92.	165.	-73.
22.	60.	0.488	29.92	-1.65	-1.0	0.94	12.28	-2.2	71.	88.	169.	-61.
23.	63.	0.354	29.95	-0.26	-1.8	0.88	13.35	-1.5	67.	83.	161.	-78.
24.	63.	0.390	29.95	-0.41	-1.4	0.91	13.91	-0.5	76.	89.	160.	-71.
25.	63.	0.389	29.95	-1.99	-1.2	0.92	13.61	-1.0	72.	86.	166.	-80.
26.	63.	0.363	29.93	-2.85	-1.6	0.90	12.74	-2.3	70.	89.	163.	-74.
27.	64.	0.385	29.93	-2.05	-1.3	0.92	12.63	-1.7	73.	87.	166.	-75.
28.	64.	0.379	29.93	-0.92	-1.8	0.88	12.54	-1.1	68.	84.	161.	-77.
29.	62.	0.410	29.92	-1.40	-1.7	0.89	13.96	-1.7	64.	80.	159.	-79.
30.	64.	0.375	29.92	-1.19	-1.3	0.91	15.53	-2.2	69.	83.	155.	-72.
31.	63.	0.362	29.92	0.19	-0.4	0.97	12.76	-1.9	74.	90.	161.	-71.
32.	63.	0.412	29.86	-1.24	-1.7	0.89	16.65	-2.0	57.	71.	138.	-57.
33.	62.	0.363	29.86	-0.30	-1.4	0.91	15.89	-2.0	55.	69.	158.	-69.
34.	63.	0.411	29.86	0.28	-1.2	0.92	14.68	-1.4	70.	65.	162.	-77.
35.	63.	0.405	29.86	-1.64	-2.2	0.85	15.29	-0.9	75.	88.	165.	-77.
36.	62.	0.344	29.86	-1.14	-1.8	0.88	14.82	-1.3	70.	86.	164.	-78.
37.	62.	0.433	29.86	1.34	-1.6	0.89	15.99	-0.5	72.	86.	165.	-79.
38.	62.	0.402	29.85	-0.06	-2.1	0.86	16.51	-0.5	58.	73.	153.	-69.
39.	59.	0.428	29.85	-0.38	-0.9	0.94	16.37	-2.5	72.	97.	169.	-82.
40.	64.	0.384	29.85	1.45	-1.4	0.90	15.54	-1.7	73.	89.	166.	-77.

20% AIRFLOW

CYCLE	HP	BSFC	BAROM PRES	P AIR IN	P TC OUT	PR	DEL P BARR	P IN MAN	AMB T	T TC OUT	T IN MAN	DEL T AFTC
41.	62.	0.350	29.85	-1.82	-1.8	0.88	13.78	-1.2	70.	89.	146.	-79.
42.	62.	0.433	29.85	0.93	-2.0	0.86	15.03	-1.7	73.	90.	166.	-76.
43.	63.	0.441	29.85	0.37	-2.0	0.86	16.83	-2.2	72.	87.	164.	-77.
44.	63.	0.407	29.85	-1.78	-1.3	0.92	16.30	-2.6	67.	84.	150.	-66.
45.	62.	0.317	29.85	-0.96	-2.2	0.85	14.24	-1.7	75.	97.	162.	-65.
46.	62.	0.406	29.85	-1.83	-1.4	0.91	20.18	-1.9	72.	89.	157.	-68.
47.	61.	0.496	30.03	0.27	-1.6	0.89	13.14	-1.1	75.	101.	166.	-65.
48.	61.	0.326	30.03	-3.27	-1.3	0.92	12.85	-1.9	76.	99.	162.	-63.
49.	63.	0.417	30.21	-0.19	-1.2	0.92	16.71	-1.5	70.	84.	164.	-80.
50.	62.	0.354	30.21	-1.48	-1.9	0.88	14.08	-1.8	76.	94.	169.	-75.
51.	64.	0.396	30.21	-1.92	-1.4	0.91	16.12	-2.6	83.	97.	168.	-71.
52.	62.	0.403	30.21	-1.22	-1.7	0.89	16.82	-1.5	85.	99.	167.	-68.
53.	64.	0.393	30.21	-2.09	-1.7	0.89	16.65	-1.8	86.	100.	168.	-68.
54.	59.	0.371	30.13	-0.02	-1.8	0.88	15.98	-1.7	68.	85.	166.	-81.
55.	62.	0.458	30.13	-2.26	-1.5	0.90	14.56	-1.6	75.	93.	161.	-68.
56.	65.	0.388	30.13	-0.28	-1.0	0.93	17.06	-2.4	91.	106.	164.	-58.
57.	66.	0.397	30.13	-2.16	-1.1	0.93	17.74	-2.5	88.	102.	162.	-60.
58.	65.	0.341	30.13	-1.51	-1.6	0.90	14.50	-1.0	84.	103.	166.	-63.
59.	65.	0.393	30.13	-1.51	-1.8	0.88	17.56	-1.8	74.	90.	154.	-64.
60.	62.	0.426	30.29	-0.24	-1.3	0.91	17.09	-1.9	63.	80.	167.	-87.
61.	63.	0.451	30.29	-1.90	-2.1	0.86	17.67	-1.3	56.	73.	163.	-90.
62.	62.	0.705	30.29	-0.20	-1.5	0.90	16.64	-1.6	60.	76.	163.	-87.
63.	63.	0.302	30.29	-1.44	-1.8	0.88	15.79	-1.5	55.	73.	163.	-90.
64.	61.	0.434	30.29	0.88	-1.4	0.90	14.62	-1.3	54.	73.	163.	-90.
65.	62.	0.433	30.08	-0.53	-2.1	0.86	17.61	-1.7	71.	88.	162.	-74.
66.	63.	0.436	30.08	-0.92	-1.3	0.91	16.14	-1.5	73.	91.	163.	-72.
67.	63.	0.461	30.08	-1.44	-1.4	0.91	18.73	-2.1	59.	76.	159.	-83.
68.	62.	0.441	30.08	-0.89	-2.0	0.87	18.38	-2.5	67.	83.	160.	-77.
69.	62.	0.445	29.96	-0.31	-1.4	0.91	16.03	-1.7	70.	87.	160.	-73.
70.	63.	0.390	29.96	-0.06	-0.8	0.95	17.65	-2.2	97.	112.	163.	-51.
71.	64.	0.350	29.96	-0.28	-2.0	0.86	17.18	-2.6	68.	85.	160.	-75.
72.	64.	0.399	29.96	-2.78	-2.0	0.87	17.43	-1.4	68.	84.	163.	-79.
73.	63.	0.377	29.96	-0.85	-1.6	0.89	17.04	-1.3	96.	114.	167.	-53.
74.	62.	0.390	29.96	-1.58	-0.9	0.94	16.93	-1.9	76.	92.	165.	-70.
75.	63.	0.393	29.71	0.93	-1.3	0.91	16.65	-2.3	70.	86.	154.	-68.
76.	63.	0.390	29.71	-2.12	-2.3	0.85	16.02	-1.5	79.	94.	163.	-69.
77.	63.	0.403	29.71	-3.82	-1.4	0.91	16.34	-1.7	78.	93.	162.	-69.
78.	62.	0.414	29.98	-0.99	-1.3	0.91	16.48	-2.3	73.	88.	158.	-70.
79.	60.	0.414	29.98	-3.74	-0.8	0.95	16.45	-1.7	69.	84.	162.	-78.
80.	62.	0.409	29.98	-3.12	-1.1	0.93	17.32	-0.1	71.	85.	153.	-68.

20% AIRFLOW

CYCLE	HP	BSFC	BAROM PRES	P AIR IN	P TC OUT	PR	DEL P BARR	P IN MMHG	AMB T	T TC OUT	T IN MAN	DEL T AFTC
81.	63.	0.389	29.98	-0.80	-2.3	0.85	17.29	-1.4	73.	87.	160.	-73.
82.	63.	0.409	30.02	-0.80	-1.9	0.87	14.52	-1.8	64.	80.	157.	-77.
83.	62.	0.397	30.02	-2.49	-1.5	0.90	13.72	-1.6	72.	88.	159.	-71.
84.	62.	0.392	30.02	-1.11	-1.2	0.92	14.18	-1.7	69.	86.	160.	-74.
85.	63.	0.399	30.02	-1.69	-1.3	0.92	13.79	-1.6	66.	82.	162.	-80.
86.	61.	0.366	30.02	-3.13	-1.5	0.91	13.48	-1.6	74.	94.	165.	-71.
87.	62.	0.421	29.95	1.19	-1.4	0.90	15.91	-2.4	69.	85.	154.	-69.
88.	61.	0.399	29.95	-2.98	-1.2	0.93	15.36	-1.4	69.	85.	157.	-72.
89.	62.	0.389	29.95	-1.18	-1.6	0.89	15.07	-2.0	74.	89.	160.	-71.
90.	61.	0.404	29.95	0.26	-0.7	0.95	14.97	-2.4	73.	90.	163.	-73.
91.	59.	0.393	29.95	-4.95	-0.4	0.98	12.88	-0.9	70.	93.	169.	-76.
92.	60.	0.411	30.32	-1.65	-1.4	0.91	15.74	-2.0	74.	89.	154.	-65.
93.	62.	0.389	30.32	-2.71	-1.5	0.91	13.69	-3.1	71.	87.	153.	-66.
94.	61.	0.398	30.32	-0.19	-1.8	0.88	15.38	-1.8	73.	89.	154.	-66.
95.	63.	0.394	30.32	-2.66	-0.7	0.96	14.54	-1.9	74.	89.	153.	-64.
96.	62.	0.398	30.32	-1.24	-1.1	0.93	12.77	-2.6	67.	82.	161.	-79.
97.	81.	0.394	30.32	-2.33	-1.3	0.92	14.62	-1.3	73.	90.	157.	-67.
98.	63.	0.405	30.32	0.24	-1.2	0.92	14.22	-2.5	72.	88.	155.	-67.
99.	63.	0.380	30.32	-1.61	-1.6	0.90	13.56	-1.8	71.	87.	158.	-71.
100.	60.	0.405	30.15	-1.23	-2.1	0.86	14.44	-1.3	75.	89.	155.	-66.
101.	62.	0.391	30.15	-2.48	-0.8	0.95	14.85	-2.4	78.	92.	153.	-63.
102.	61.	0.393	30.15	-0.88	-2.1	0.86	15.89	-1.4	73.	87.	157.	-70.
103.	62.	0.414	30.15	0.04	-1.5	0.90	14.87	-1.4	75.	89.	162.	-73.
104.	63.	0.404	30.15	-2.11	-1.8	0.88	14.46	-1.8	76.	92.	165.	-73.
105.	62.	0.390	30.15	-2.35	-1.6	0.90	13.54	-1.4	78.	97.	166.	-69.
106.	60.	0.398	30.05	-1.55	-2.1	0.86	15.90	-1.3	67.	83.	157.	-74.
107.	62.	0.402	30.05	-0.73	-0.8	0.95	15.29	-2.1	71.	87.	156.	-69.
108.	62.	0.425	30.05	-1.32	-1.6	0.89	12.93	-2.3	72.	88.	162.	-74.
109.	63.	0.316	30.19	-3.26	-1.7	0.89	15.14	-1.9	78.	91.	155.	-64.
110.	68.	0.383	30.19	-1.57	-0.9	0.94	15.71	-2.0	73.	89.	158.	-69.
111.	68.	0.311	30.19	-1.34	-1.2	0.92	15.98	-1.4	73.	89.	160.	-72.
112.	65.	0.448	30.19	-0.80	-1.5	0.90	16.04	-1.4	75.	90.	161.	-71.
113.	66.	0.370	30.04	-0.43	-2.0	0.87	16.16	-1.5	68.	85.	155.	-70.
114.	65.	0.762	30.04	-2.32	-1.3	0.92	15.40	-1.8	79.	94.	157.	-63.
115.	66.	0.381	30.04	-1.70	-1.1	0.93	13.53	-1.6	82.	97.	160.	-63.
116.	68.	0.378	30.04	-0.50	-1.7	0.89	13.81	-1.7	85.	100.	161.	-61.
117.	65.	0.303	30.04	-1.68	-1.5	0.90	13.41	-1.8	85.	110.	170.	-60.
118.	67.	0.378	29.98	-1.51	-1.7	0.89	15.39	-1.4	78.	92.	158.	-66.
119.	66.	0.363	29.98	-2.17	-1.3	0.92	14.74	-1.9	82.	97.	160.	-63.
120.	69.	0.391	29.98	-1.86	-1.5	0.90	15.68	-1.1	87.	103.	160.	-57.

APPENDIX C  
SAMPLE DATA SHEETS FOR  
CALIBRATION SETUP AND TEST SETUP

C-1

Best Available Copy

NEW ENGINE SERIAL NUMBER 11053470-03  
 MODEL V7A-903T  
 SPECIAL PROGRAM CODE  
 SELF CLEANING AIR FILTER  
 INITIAL CELL ASSIGNMENT 6  
 COMPRESSION RATIO 15.5 TO 1  
 CUSTOMER NAME  
 TURBOCHARGER / ANSTA-RG  
 SPECIAL INSTRUCTIONS  
 NEW DATA DISK INSTALLED 03/19/87  
 BEGIN RECORDS WITH 1. L.A.N.

THIS PURPOSE OF THIS TEST IS TO  
 DETERMINE THE CAPABILITY OF THE  
 FUEL SYSTEM PRECLEANER TO  
 PROTECT THE TURBOCHARGER  
 COMPRESSOR WHEEL FROM EROSION  
 AND DEPOSITION OF SLAG TO OPERATE  
 FOR 200 HOURS WITH MINIMUM  
 PRESSURE RISE.  
 POC FOR THIS PROGRAM IS  
 HARRY NIENHACK  
 574-5711  
 DON CLIFF  
 574-5711 / HOME 792-1227  
 POC FOR TECHNICAL INFO. IS  
 AL LEMO  
 574-5566 / HOME 561-0251  
 OPERATOR(S): ROBERT MEDWICH

Calibration Sample Data Sheet

TEST	13	14	15	16	17	18	19	20	21	22	UNIT
131 DATE	3/23	3/23	3/23	3/24	3/24	3/24	3/24	3/24	3/24	3/24	MM/DD
132 TIME	15:04	15:04	15:04	15:04	15:04	15:04	15:04	15:04	15:04	15:04	MM
133 TORQUE	1508	1501	1011	1020	1019	1014	1011	1011	1011	1011	HP
142 FUEL CONSUMPTION	50.9	50.1	50.0	50.4	50.4	50.4	46.1	46.1	47.8	47.8	LB/HR
143 BSFC	184.2	178.6	178.3	183.8	183.6	183.6	133.9	133.9	133.9	133.9	BSFC
145 INLET AIR SYSTEM PRESS. H2O	0.00	0.00	0.00	0.00	0.00	0.00	0.00	0.00	0.00	0.00	PSI
136 BAROMETRIC PRESSURE H2O	-0.57	-0.58	-0.40	-0.59	-0.58	-0.56	-0.55	-0.55	-0.55	-0.55	PSI
139 RELATIVE HUMIDITY	0	0	0	0	0	0	0	0	0	0	%
062 AIR AFTER FILTER STAT H2O	-2.23	-2.44	-2.47	-2.37	-2.23	-2.17	-2.15	-1.87	-1.93	-1.93	H2O
103 AIR AFTER TURBO PA PSI	16.4	15.9	16.6	16.4	16.5	14.8	14.5	13.6	12.3	12.3	PSI
104 AIR B4 FULT. MED. PSI	15.6	15.5	15.6	15.4	15.4	13.8	13.8	11.6	11.6	11.6	PSI
105 AIR APT FULT. MED. PSI	15.0	14.8	14.7	14.7	14.4	13.3	13.4	12.5	10.6	10.6	PSI
092 AIR. B4 ABS. FULT. P10	-3.94	-3.87	-3.81	-3.93	-3.93	-3.58	-3.60	-3.12	-3.17	-3.17	H2O
100 AIR. APT EMS	-6.85	-6.93	-4.53	-3.93	-3.74	-5.61	-5.69	-5.01	-5.01	-5.01	H2O
087 AIR. DELTA MERIAN	70	70	70	81	81	81	81	82	81	81	DEG F
106 AIR. INTAKE MANIFOLD	82	82	82	90	90	90	91	91	91	91	DEG F
099 INTAKE AIR SYS TEMPS. H2O	224	224	229	248	250	230	242	231	227	227	DEG F
023 AIR. AFTER TURBO T2	78	78	82	82	83	82	82	82	81	81	DEG F
024 AIR. APT EMS ELW T3	224	224	229	248	250	230	242	231	227	227	DEG F
025 AIR. APT EMS EXH T3	78	78	82	82	83	82	82	82	81	81	DEG F
028 FUEL B4 FINAL FULT. DEO F	224	224	229	248	250	230	242	231	227	227	DEG F









DISTRIBUTION LIST

	Copies
Commander Defense Technical Information Center Bldg. 5, Cameron Station ATTN: DDAC Alexandria, VA 22304-9990	12
Manager Defense Logistics Studies Information Exchange ATTN: AMXMC-D Fort Lee, VA 23801-6044	2
Commander U.S. Army Tank-Automotive Command ATTN: AMSTA-CF (Mr. Orlicki)	1
AMSTA-DDL	2
AMSTA-RGT (Mr. Manning)	1
AMSTA-RGE (Dr. Munt)	20
AMSTA-RGR (Dr. Brysik)	1
AMSTA-RG	1
Warren, MI 48397-5000	
Director U.S. Army Materiel Systems Analysis Activity (AMSAA) ATTN: AMXSY-MP (Mr. Cohen) Aberdeen Proving Ground, MD 21005-5071	1
Pall Land and Marine Corporation 30 Seacliff Avenue Glen Cove, NY 11542 ATTN: Mr. Charles Roach	3

Dist-1

Best Available Copy