

2

DTIC FILE COPY

USAFOEHL REPORT

88-080EH0118FVB



AD-A196 106

VIBRATION IN THE PMEL AND FIRE STATION BUILDINGS DURING ENGINE TESTS IN THE T-9 NOISE SUPPRESSOR SYSTEM, McCONNELL AFB KS

JEFFERY C. JENKINS, Captain, USAF, BSC

June 1988

Final Report

DTIC ELECTE  
AUG 01 1988  
S D  
QH

Distribution is unlimited; approved for public release

USAF Occupational and Environmental Health Laboratory  
Human Systems Division (AFSC)  
Brooks Air Force Base, Texas 78235-5501

## NOTICES

When Government drawings, specifications, or other data are used for any purpose other than a definitely related Government procurement operation, the Government thereby incurs no responsibility nor any obligation whatsoever. The fact that the Government may have formulated, or in any way supplied the said drawing, specifications, or other data, is not to be regarded by implication, or otherwise, as in any manner licensing the holder or any other person or corporation; or conveying any rights or permission to manufacture, use, or sell any patented invention that may in any way be related thereto.

The mention of trade names or commercial products in this publication is for illustration purposes and does not constitute endorsement or recommendation for use by the United States Air Force.

Do not return this copy. Retain or destroy.

Air Force installations may direct requests for copies of this report to: USAF Occupational and Environmental Health Laboratory (USAFOEHL) Library, Brooks AFB TX 78235-5501.

Other Government agencies and their contractors registered with the DTIC should direct requests for copies of this report to: Defense Technical Information Center (DTIC), Cameron Station, Alexandria VA 22314.

Non-Government agencies may purchase copies of this report from: National Technical Information Service (NTIS), 5285 Port Royal Road, Springfield VA 22161

The Public Affairs Office has reviewed this report, and it is releasable to the National Technical Information Service, where it will be available to the general public, including foreign nations.

This report has been reviewed and is approved for publication.

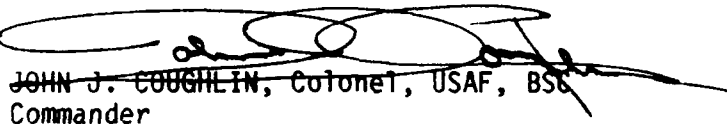
  
~~JOHN J. COUGHLIN, Colonel, USAF, BSC~~  
Commander

Prepared By:

  
JEFFERY C. JENKINS, Capt, USAF, BSC  
Consultant, Industrial Hygiene Engineer

Reviewed By:

  
WILEY TAYLOR, Lt Col, USAF, BSC  
Chief, Industrial Hygiene Branch

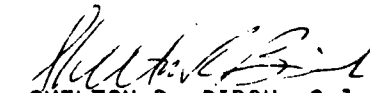
  
SHELTON R. BIRCH, Col, USAF, BSC  
Chief, Consultant Services Division

REPORT DOCUMENTATION PAGE

1a. REPORT SECURITY CLASSIFICATION <b>UNCLASSIFIED</b>		1b. RESTRICTIVE MARKINGS <b>NA</b>	
2a. SECURITY CLASSIFICATION AUTHORITY <b>NA</b>		3. DISTRIBUTION / AVAILABILITY OF REPORT <b>Approved for public release; distribution is unlimited.</b>	
2b. DECLASSIFICATION / DOWNGRADING SCHEDULE <b>NA</b>			
4. PERFORMING ORGANIZATION REPORT NUMBER(S)  <b>88-080EH0118FVB</b>		5. MONITORING ORGANIZATION REPORT NUMBER(S)	
6a. NAME OF PERFORMING ORGANIZATION <b>USAF Occupational and Environ- mental Health Laboratory</b>	6b. OFFICE SYMBOL (if applicable) <b>ECH</b>	7a. NAME OF MONITORING ORGANIZATION	
6c. ADDRESS (City, State, and ZIP Code)  <b>Brooks AFB TX 78235-5501</b>		7b. ADDRESS (City, State, and ZIP Code)	
8a. NAME OF FUNDING / SPONSORING ORGANIZATION <b>Same as 6a</b>	8b. OFFICE SYMBOL (if applicable)	9. PROCUREMENT INSTRUMENT IDENTIFICATION NUMBER	
8c. ADDRESS (City, State, and ZIP Code)		10. SOURCE OF FUNDING NUMBERS	
		PROGRAM ELEMENT NO	PROJECT NO
		TASK NO	WORK UNIT ACCESSION N
11. TITLE (Include Security Classification) <b>Vibration in the PMEL and Fire Station Buildings During Engine Tests in the T-9 Noise Suppressor System, McConnell AFB KS</b>			
12. PERSONAL AUTHCR(S) <b>Captain Jeffery C. Jenkins</b>			
13a. TYPE OF REPORT <b>Final</b>	13b. TIME COVERED FROM _____ TO _____	14. DATE OF REPORT (Year, Month, Day) <b>June 1988</b>	15. PAGE COUNT <b>37</b>
16. SUPPLEMENTARY NOTATION			
17. COSATI CODES		18. SUBJECT TERMS (Continue on reverse if necessary and identify by block number)	
FIELD	GROUP	Acceleration	
		A/F32T-9	
		Engine Test Cell	
		Noise Suppressor, Environmental Eng	
		T-9 NSS	
		Vibration, noise, health, SES	
19. ABSTRACT (Continue on reverse if necessary and identify by block number)			
<p>Vibration measurements were collected at the Precision Measurement Equipment Laboratory (PMEL) and Fire Station buildings during operations of the A/F32T-9 Large Turbo Fan Engine, Enclosed Noise Suppressor System (T-9 NSS) at McConnell AFB KS. Vibration levels were measured with the following engines operating in the T-9 NSS: J57-59W, TF33-P3, TF30-P7, F100, TF41-A1, J85-5, F101-GE-102, and the F108-CF-100. The highest vibration levels were measured with an F101 engine operating at afterburner power in the T-9 NSS. The measured floor vibration levels are well below both the limits recommended to prevent adverse health effects and those limits recommended to prevent a decrease in proficiency at performing work tasks. The measured floor vibration levels do not even exceed the threshold of perception of the most sensitive individuals to whole body vibration. Measurements did not rule out the possibility of exceeding recommended levels for interference with vibration sensitive calibrations at the PMEL building.</p>			
20. DISTRIBUTION / AVAILABILITY OF ABSTRACT <input checked="" type="checkbox"/> UNCLASSIFIED/UNLIMITED <input type="checkbox"/> SAME AS RPT <input type="checkbox"/> DTIC USERS		21. ABSTRACT SECURITY CLASSIFICATION <b>Unclassified</b>	
22a. NAME OF RESPONSIBLE INDIVIDUAL <b>Jeffery C. Jenkins, Captain, USAF, BSC</b>		22b. TELEPHONE (Include Area Code) <b>(512) 536-3214</b>	22c. OFFICE SYMBOL <b>USAF0EHL/ECH</b>

## ACKNOWLEDGMENTS

The author gratefully acknowledges the technical assistance provided by the staff of the Biodynamic Environment Branch, Armstrong Aerospace Medical Research Laboratory (AAMRL/BBE), Wright-Patterson AFB OH. Particular thanks are extended to Mr John Cole for approving a joint effort with his staff, loaning their data acquisition systems, and providing access to their data analysis system. Special thanks are extended to Mr Harald Hille for his efforts in providing on-site technical assistance, Mr Robert Powell and Mr Robert Lee for their help in establishing a survey protocol, and Mr Keith Kettler of the University of Dayton for his help in calibrating the recording systems, as well as his assistance in the mechanics of data processing. Special thanks are also conveyed to Mr Henry Mohlman and Mr Fred Lampley also of the University of Dayton who ran the computer programs to provide low frequency vibration results.

The author would also like to acknowledge the professional work of Capt Terry Fairman who was USAFOEHL's technical expert in establishing the protocol for collecting the vibration data and analyzing the resulting tape recorded data. Finally, sincere thanks are extended to Lt Col Glenn Gaudet, Capt Frank Liebhaber, Capt Isaac Atkins, and MSgt John Randall for their efforts in collecting the data.

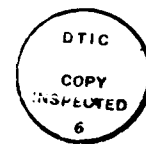

<b>Accession For</b>	
NTIS GRA&I	<input checked="" type="checkbox"/>
DTIC TAB	<input type="checkbox"/>
Unannounced	<input type="checkbox"/>
Justification	
By _____	
Distribution/	
<b>Availability Codes</b>	
Dist	Avail and/or Special
A-1	

## CONTENTS

	Page
DD Form 1473	i
Acknowledgments	iii
I. INTRODUCTION	
A. Purpose	1
B. Problem	1
C. Scope	1
II. DISCUSSION	
A. Measurement Methodology	1
B. Results	3
C. Observations	4
III. CONCLUSIONS	7
IV. RECOMMENDATIONS	7
References	8
Appendix	
A Sampling Locations and Measurement System	9
B Data Summary	17
Distribution List	33

## I. INTRODUCTION

A. Purpose: This report provides one-third octave band vibration data on the A/F32T-9 Large Turbo Fan Engine Enclosed Noise Suppressor System (T-9 NSS) at McConnell AFB KS. Data were obtained in support of a request from the T-9 Program Management Office, SA-ALC/MMIMH, Kelly AFB TX, for noise and vibration data to support their First Article Tests (FAT) on the new facility. Sites for vibration measurements were selected based on input provided during the T-9 Task Group meetings at McConnell AFB and consultation with the Program Management office at Kelly AFB.

B. Problem: The Williams Steel Inc./Cullum-Detuners Ltd. T-9 NSS is a prefabricated, air cooled, demountable, acoustically treated, jet engine noise suppressor system designed to totally enclose a single engine during ground run-up operations. This facility is designed to permit testing of bare engines under controlled environmental conditions, and to reduce the noise emitted to the neighboring area through the use of a muffled, air cooled exhaust system. This one facility can serve many different engine types and is designed to provide an efficient enclosed work area for maintenance personnel. T-9 noise suppressors are programmed to be sited at over 20 SAC bases and Air National Guard units in the next several years. The vibration survey was requested to evaluate the potential impact of any increased vibration levels on the occupants of surrounding buildings and the operations performed in those buildings.

C. Scope: This report provides measured data defining vibration levels produced by the following aircraft engines operating in the T-9 NSS during ground run-up operations: J57-59W, TF33-P3, TF30-P7, F100, TF41-A1, J85-5, F101-GE-102, and F108-CF-100. Vibration data are reported for measurement locations at the Precision Measurement Equipment Laboratory (PMEL), Bldg 1099, and the Fire Station, Bldg 1201. The vibration environments produced by T-9 NSS operations were evaluated at all measurement locations in both buildings using recommended occupational vibration exposure limits as guidelines. Because workers at the fire station also have sleeping and messing quarters in Bldg 1201, measurement locations there were also evaluated using recommended nonoccupational vibration exposure limits as guidelines. The vibration environment at PMEL was also compared to standards in the Instrument Society of America (ISA) publication ISA RP52.1 1975.<sup>8</sup> Conclusions are presented as to the effect of vibration on occupants of the fire station and to the effects of vibration on measurements carried out in PMEL.

## II. DISCUSSION

### A. Measurement Methodology

1. USAFOEHL collected both the vibration and noise data for each engine during approximately two hour test periods; therefore, the background vibration levels should have been similar for background measurements and measurements taken during ground run-up operations of aircraft engines in the T-9 NSS. The T-9 NSS and the 100 meter far-field noise measurement

sites are shown in Figure 1, Appendix A. The locations of the Precision Measurement Equipment Laboratory (PMEL) building and the fire station relative to the T-9 NSS are shown in a copy of a segment of the McConnell AFB base map, Figure 2, Appendix A. The noise measurement sites outside the PMEL and the fire station buildings are also shown in Figure 2. The locations inside the PMEL building and the Fire Station building where the vibration measurements were obtained are shown in Figures 3 and 4 of Appendix A, respectively. At each measurement position, the accelerometer was attached to a metal surface with a magnetic stud. At measurement positions 1, 2, and 6 inside the PMEL building and both of the two measurement positions inside the fire station building a two inch steel cube was glued to the floor or wall. The steel cube provided a mounting surface for the accelerometer and an accurate resolution of the total vibration into three orthogonal components. At position 3 inside the PMEL building, a metal washer was glued to the top of a table to provide a mounting surface for the accelerometer and a means to measure the vertical component of the vibration. Positions 4 and 5 inside the PMEL building were located on the auto collimator transmitter and receiver units. The accelerometer was attached directly to the metal surface of the stand supporting each of these units to measure the vertical component of the vibration. The orthogonal axes for the vibration measurements were defined as follows: the z-axis was the vertical component, the x-axis was the horizontal component perpendicular to the wall facing the T-9 NSS, and the y-axis was the horizontal component parallel to the same wall. A portable tape recording system was used to record the vibration for one axis at a time. A diagram of the vibration sampling system is shown in Figure 5, Appendix A, with a list of the equipment used.

2. Approximately 20 seconds of data were recorded on audio tape at each sampling position for later analysis using a one-third octave band digital frequency analyzer. To extend the frequency response of the tape recorder below 20 Hz, a voltage controlled oscillator (VCO), constructed by the staff of the Biodynamic Environment Branch, Armstrong Aerospace Medical Research Laboratory (AAMRL/BBE), Wright-Patterson AFB OH, was used in the mixed mode to produce an unmodulated and a frequency modulated (FM) signal. The frequency response of the system excluding the accelerometer was 0 to 63 Hz for the FM signal and 20 to 20,000 Hz for the unmodulated signal. For vibration measurements with the accelerometer attached, the two signals provided an overall frequency response from 2.5 to 6300 Hz. The mixed signals were recorded on one channel of the Nagra IV-D tape recorder and analyzed separately with electronic discrimination of the FM signal. The signal condition gain of the FM signal was controlled by the setting of the range on the General Radio 1982 Sound Level Meter and the gain on the VCO. The signal condition gain of the unmodulated signal was controlled by the range setting on the General Radio 1982 Sound Level Meter and the Tape Deck Gain of the Nagra IV-D tape recorder. The system, as configured, provided for live monitoring of the recorded unmodulated signal level only.

3. Before and after the survey, calibration signals were generated by recording a 100 Hz calibration signal generated by use of a mechanical shaker with an output of 1 g (9.81 meters/sec<sup>2</sup>) at 100 Hz, and a 20 Hz calibration signal generated by use of an electronic oscillator. As part of the presurvey master calibration, the output of a sine wave sweep generator was used to generate frequency response recordings for the entire system excluding the accelerometer. The same 100 Hz and 20 Hz calibration signals were recorded in the field at the

beginning and end of each data tape. The low frequency (FM) recordings were analyzed at Wright-Patterson AFB OH since USAFOEHL did not have the discriminator needed to analyze the recorded FM signals. The high frequency (unmodulated) signals were analyzed at USAFOEHL. The data from the two separate signals were then combined using the values from the FM signal for the one-third octave bands from 2.5 to 50 Hz and the values from the AM signal for the one-third octave bands from 63 Hz to 6300 Hz. A computer program written within USAFOEHL/ECH was used to calculate frequency response and background corrected vibration spectra.

## B. Results

1. Table 1, Appendix B, presents a summary of the vibration limits specified in the standards used to evaluate the vibration levels measured at the PMEL and fire station buildings and a summary of the measured vibration levels at several positions in both buildings during ground run-up operations of the F101 engine at afterburner power in the T-9 NSS. The first limits presented are the one-third octave band vibration limits specified in the Instrument Society of America (ISA) Recommended Practice (RP)52.1 1975.<sup>8</sup> This document specifies the acceptable vibration limits from 0.1 to 200 Hz to avoid adverse impact of measurements and equipment calibrations. The second limits summarized are from ANSI S3.29-1983 "Guide to the Evaluation of Human Exposure to Vibration in Buildings."<sup>5</sup> These limits are referred to as the "Base Response Curve" and are approximately equal to the threshold of perception of the most sensitive individuals to whole-body vibration. These limits are specified for the one-third octave bands from 1 Hz to 80 Hz for vibration of the torso along the anatomical axes. The anatomical axes can be described as head-to-foot vibration (z-axis) and front-to-back (x-axis) and side-to-side (y-axis) vibration. Head-to-foot vibration is also referred to as longitudinal vibration. Side-to-side and front-to-back vibration are also referred to as transverse vibration. The acceptable vibration limits are specified separately for longitudinal vibration (z-axis) and transverse vibration (x-/y-axes). The last limits summarized are from ISO 2631-1978 "Guide for the Evaluation of Human Exposure to Whole-body Vibration."<sup>4</sup> These limits are for the fatigue-decreased proficiency boundary. Exposures above this boundary can be regarded as posing a significant risk of adversely effecting the working efficiency in many tasks, particularly tasks known to be effected by fatigue. The fatigue-decreased proficiency boundary limits are specified over the same frequency range and for the same defined axes as the "Base Response Curve" from ANSI S3.29 1983. Also summarized are the one-third octave band vibration levels measured on the walls of the fire station and PMEL (location 1, x-axis--perpendicular to the wall) and on the floors of both buildings near the respective wall sites (location 2, z-axis--vertical) for the F101 engine at afterburner power.

2. The reported vibration levels are for the fixed set of axes for each position referenced to the PMEL and fire station buildings. The orientation of the axes used to evaluate the measured vibration versus the recommended limits in ANSI S3.29 1983 and ISO 2631-1978 depends on the orientation of the torso of anyone exposed to whole body vibration. For example, the orientation of the anatomical axes would be the same as the measurement axes for one of the positions on the floor for someone standing on the floor or sitting in a chair facing the wall. On the other hand, the anatomical axes would be oriented differently for someone lying on the floor.



Data are presented for the F101 engine at afterburner power because it produced the largest measured noise levels and vibration levels of the eight engines measured during the McConnell AFB survey of the T-9 NSS.

3. Figure 6, Appendix B, displays the measured wall vibration at PMEL (position 1, x-axis) with the F101 engine operating at afterburner power in the T-9 NSS and the corresponding background vibration data along with the ISA RP52.1 limits and the z-axis base response curve from ANSI S3.29-1983 (the approximate threshold of perception of the most sensitive humans). Figure 7, Appendix B, contains plots of the vibration data and limits for the F101 engine at PMEL for the floor vibration at position 2 along the z-axis (head-to-foot or vertical vibration). Figures 8 and 9, Appendix B, display similar data for the F101 engine at position 1 along the x-axis and position 2 along the z-axis at the fire station. Figures 10 and 11 present the same data for the F108 engine at take-off power at position 1 along the x-axis and position 2 along the z-axis at PMEL. Figures 12 and 13 present the same data at position 1 along the x-axis and position 2 along the z-axis at the fire station for the F108 engine. Figures 14 and 15 present the same data at position 3 along the z-axis at PMEL for the F101 and F108 engines, respectively. Position 3 was located on the top of a table in the pressure room.

4. Far field noise levels for the T-9 NSS measured at a distance of 100 meters have been previously reported in United States Air Force Occupational and Environmental Health Laboratory (USAFOEHL) reports 87-068EH0118ENA, "First Article Noise Survey of the A/F32T-9 Large Turbo Fan Engine Enclosed Noise Suppressor System, Far-Field Noise, McConnell AFB KS;"<sup>2</sup> 87-082EH0186FNA, "First Article Test Noise Survey of the A/F32T-9 Large Turbo Fan Engine Enclosed Noise Suppressor System, Sky Harbor IAP, Phoenix AZ;"<sup>3</sup> and 88-018EH0060ANA, "First Article Test Noise Survey of the A/F32T-9 Large Turbo Fan Engine Enclosed Noise Suppressor System, Ellsworth AFB SD."<sup>1</sup>

5. Flat-weighted overall and one-third octave band acoustical noise data are presented for the measurement locations outside the PMEL and fire station buildings in Table 2, Appendix B, of this report. Also, flat-weighted overall and one-third octave band acoustical noise data are presented for the 50 degree and 180 degree positions at 100 meters in Table 3, Appendix B. This noise data is presented to support the assertion that vibration levels measured during T-9 NSS operations above the normal background vibration levels are due mostly to acoustic noise impinging on the buildings, not to the ground-borne transmission of mechanical vibration.

### C. Observations

1. The vibration levels measured for the two floor sites at PMEL and the one floor site at the Fire Station indicate, as expected, there is no potential for a hazardous vibration exposure even for the worst case condition of the F101 engine operating at afterburner power.<sup>4</sup> In fact, the vibration levels measured for the floor sites were below the base response curve from ANSI standard S3.29-1983 (approximately the threshold of perception of the most sensitive individuals).<sup>5</sup> Acoustic noise induced vibrations of the walls along the axis perpendicular to the plane of the walls were larger in magnitude than the floor vibrations. Measured wall vibrations were large enough to exceed the threshold of perception during operations at afterburner power for

several of the engines, but still below the fatigue-decreased proficiency boundary specified in ISO 2631-1978. However, it must be stressed the standards contained in both ANSI S3.29-1983 and ISO 2631-1978 were developed for human exposure to whole-body vibration and not for the threshold of tactile perception. An individual would have to stand or lean against the wall to be exposed to whole-body vibration through the wall.

2. The wall vibrations were large enough during engine operations at afterburner power to possibly produce rattling of windows or objects attached to the walls. This is the most typical effect of building vibrations and can lead to some concern on the part of building occupants. Occupant concerns can normally be reduced with assurances that no hazard exists and an explanation of the cause of the vibrations.<sup>6</sup> Window rattling can normally be reduced or eliminated by the use of a flexible caulking material such as silicone or butyl rubber. Rattling of objects attached or hung from the walls can likewise be reduced or eliminated by the placement of silicone or other vibration isolating material between the object and the wall. Obviously, non-essential items can be removed from the walls.

3. Our measurements from the floor sites at PMEL indicate even the more stringent vibration level limits of ISA RP52.1 were not exceeded at frequencies above 5 Hz for ground run-up operations of the F101 and F108 engines. The limits recommended in ISA RP52.1 are listed in Table 1, Appendix B and plotted in addition to the vibration levels measured at the PMEL and fire station buildings in Figures 6 through 15, Appendix B. ISA RP52.1 specifies vibration limits separately for two frequency ranges: from 0.1 to 30 Hz, the limit is specified as a maximum displacement amplitude of 0.25 microns and from 30 to 200 Hz, the limit is specified as a maximum acceleration of  $10^{-3}$  g ( $g = \text{gravitation acceleration constant} = 9.81 \text{ m/s}^2$ ).<sup>8</sup> By assuming harmonic motion, the maximum displacement amplitude limit for 0.1 to 30 Hz was converted to the acceleration limits listed in Table 1, Appendix B. For frequencies at or below 5 Hz, the limit of detection of our measurement system appears to be greater than both the limits specified in ISA RP52.1 and the vibration levels actually present during measurements of background and engine run-up conditions. Data for the first six engines in the frequency region 5-50 Hz is believed to represent the electronic noise floor of the recording system with the VCO in line, not actual measured vibration levels. For the last two engines, the F101 and F108, the VCO gain was increased, significantly reducing the electronic noise floor problem. A subsequent seismic survey by the Aerospace Guidance and Metrology Center indicates no background vibration levels in excess of the ISA RP52.1 recommended limits.<sup>7</sup> They did not collect data during engine run-up operations in the T-9 NSS. However, they did conclude it would be relatively easy for PMEL personnel to schedule sensitive calibrations around T-9 NSS operations.

4. The vibration levels measured on top of the table in the pressure room of the PMEL building are above ISA RP52.1 recommended limits for both background and engine run-up conditions. These limits are exceeded from 2.5 to 31.5 Hz and at 125 Hz where the vibration reaches a peak around 70 dB (see Figures 14 and 15, Appendix B). These elevated vibration levels are due to the compressor motor attached to the base of the table. There is no significant difference between the acceleration levels measured during background and ground run-up conditions.

5. The vibration data indicate resonances in the frequency range from 12.5 to 50 Hz for the walls at both PMEL and the Fire Station. (See Figures 6, 8, 10, and 12 in Appendix B for plots of wall vibration levels for the F101 engine and the F108 engine.) There are no clear resonance frequencies for the vertical vibration of the floors of either building. This corresponds well with the vibration patterns of buildings reported in ANSI S3.29-1983:

"Buildings tend to vibrate at well defined frequencies with the largest motions usually at structural resonances. Whole-structure-motion frequencies range from approximately 10 Hz for low-rise structures to below 1 Hz for tall structures (e.g., ten stories). Mid-floor vibrations are typically between 8 Hz and 16 Hz, although some massive spans could have resonance frequencies as low as 4 Hz. Mid-wall frequencies are between 10 and 25 Hz for light walls (e.g., wood framed residential structures), and possibly up to 50 Hz for masonry."<sup>5</sup>

This ANSI standard also states vibratory motions at the resonance frequencies of the wall or floor will dominate over vibratory motions generated at specific frequencies by machinery in regards to the effects of vibration on the occupants. Table 2, Appendix B, shows the maximum SPL measured at the sites outside of PMEL and the fire station occurred in the same one-third octave band as the maximum wall acceleration (x-axis) for both PMEL and the Fire Station with the F101 engine at afterburner power.

6. The peak sound pressure level (SPL) measured in the 50 degree and the 180 degree direction at a distance of 100 m occurred in the one-third octave band centered at 16 Hz for all four engines with afterburners (TF30, F100, J85, and F101) and the F108 turbofan engine (See Table 3, Appendix B). Sound Pressure Levels within 6 dB of this 16 Hz peak were generally produced in the one-third octave bands from 8 Hz to 50 Hz. Thus, the T-9 NSS was emitting the greatest sound energy in the frequencies which one would expect to observe the greatest vibration of the walls of buildings. As noted above, the observed resonances for wall vibrations were in this frequency range also. This observation is further supported by the results of a study of the infrasound and vibration levels in Building 999, a building near the Hush House at Luke AFB AZ. In this study, the infrasound and vibration levels during F-16 aircraft and F-100 engine run-up in the Hush House were measured at the Hush House and in Building 999. Foundation, wall, and roof truss vibration levels of Building 999 were also measured during mechanical excitation of the building with a vibratory compactor. The contractors concluded the low frequency noise (approximately 13 Hz peak) and wall vibration in Building 999 were due to low frequency airborne sound, with ground vibration only a secondary source of building vibration.<sup>9</sup> They based this conclusion on two observations: (1) the low frequency noise measured in Building 999 during Hush House operations was greater than would be expected based on the measured foundation vibration, and (2) the measured difference between the vibration levels of the roof trusses and the foundation was much greater during ground run-ups in the Hush House than during operation of the vibratory compactor.

### III. CONCLUSIONS

A. There is no potential for hazardous exposure to whole-body vibration through the floor of either the PMEL or Fire Station buildings due to run-up operations in the T-9 NSS of any of the eight engines surveyed.

B. Floor vibrations were below the threshold of perception of the most sensitive individuals.

C. Wall vibrations were greater in magnitude but still well under recommended limits for 8-hour exposures based on both health effects and the lower limits for decreased performance--fatigue. Wall vibrations could produce some rattling of windows and objects attached to the wall.

D. Floor vibrations were under the recommended limits of ISA RP52.1 for the frequency range from 5 Hz to 200 Hz. The detection limits of our measurements were above the limits recommended for 0.1 Hz to 5 Hz. However, it is doubtful these limits were exceeded.

E. Vibration levels measured on top of the table in the pressure room of the PMEL building were above the limits of ISA RP52.1 for both background and engine run-up conditions. This vibration was caused by a pump operating in the pressure room.

F. Measured floor and wall vibration levels were induced by transfer of acoustical energy to the PMEL and fire station buildings and not the transmission of ground-borne vibration from the T-9 Noise Suppressor System.

### IV. RECOMMENDATIONS

A. Precision Measurement Equipment Laboratory personnel should schedule sensitive calibrations around T-9 Noise Suppressor System ground run-up operations.

B. Precision Measurement Equipment Laboratory personnel should move the pump outside the pressure room, use vibration dampening materials to reduce the transmission of vibration to the floor and table, or not perform sensitive calibrations while the pump is operating.

C. Vibration isolating materials should be used to reduce any observed rattling of windows or objects attached to the walls of nearby buildings. Any concerned occupants should be assured the vibration levels resulting from ground run-up operations of aircraft engines in the T-9 Noise Suppressor System are not large enough to damage the structure or present a health hazard.

## REFERENCES

1. Ali, Ali Y., 1Lt, USAF, BSC, First Article Test Noise Survey of the A/F32T-9 Large Turbo Fan Engine Enclosed Noise Suppressor System, Ellsworth AFB SD, USAFOEHL Report 88-018EH0060ANA, USAF Occupational and Environmental Health Laboratory, Brooks AFB TX (Feb 1988)
2. Fairman, Terry M., Capt, USAF, BSC, First Article Noise Survey of the A/F32T-9 Large Turbo Fan Engine Enclosed Noise Suppressor System, Far-Field Noise, McConnell AFB KS, USAFOEHL Report 87-068EH0118ENA, USAF Occupational and Environmental Health Laboratory, Brooks AFB TX (May 1987)
3. Jenkins, Jeffery C., Capt, USAF, BSC and Terry M. Fairman, Capt, USAF, BSC, First Article Test Noise Survey of the A/F32T-9 Large Turbo Fan Engine Enclosed Noise Suppressor System, Sky Harbor IAP, Phoenix AZ, USAFOEHL Report 87-082EH0186FNA, USAF Occupational and Environmental Health Laboratory, Brooks AFB TX (Jun 1987)
4. Guide for the Evaluation of Human Exposure to Whole-Body Vibration, ISO Standard 2631-1978(E), International Organization for Standardization, (1978)
5. Guide to the Evaluation of Human Exposure to Vibration in Buildings, ANSI Standard S3.29-1983, American National Standards Institute, New York NY (1983) (Also, ASA Standard 48-1983, Acoustical Society of America, New York NY 1983)
6. Hubbard, Harvey H., "Noise Induced House Vibrations and Human Perception." Noise Control Engineering Journal, Volume 19/Number 2, 49-55, (1982)
7. Parcel, Lynn G., and David P. Schick, A Seismic Survey of the PMEL at McConnell AFB, Kansas, USAF Measurement Standards Laboratory Report 87DB-GBO, USAF Measurements Standards Laboratory, Newark Air Force Station, Newark OH (05 Oct 1987)
8. Telecon, Topic: Discussion of Seismic Survey of PMEL Facility at McConnell AFB KS and Applicable Vibration Standards from the Instrument Society of America Recommended Practice 52.1. Capt Jeffery C. Jenkins, USAF, with Mr Lynn G. Parcel, Aerospace Guidance and Metrology Center, Newark Air Force Station, Newark OH, 19 Jan 88
9. Ver. Istvan L. and Douglas W. Andersen, Report on the Infrasound and Vibration Study at Luke Air Force Base, Phoenix, Arizona, Bolt Beranek and Newman Inc., Cambridge MA (28 Apr 1984)

APPENDIX A  
Sampling Locations and  
Measurement System

(This page left blank)

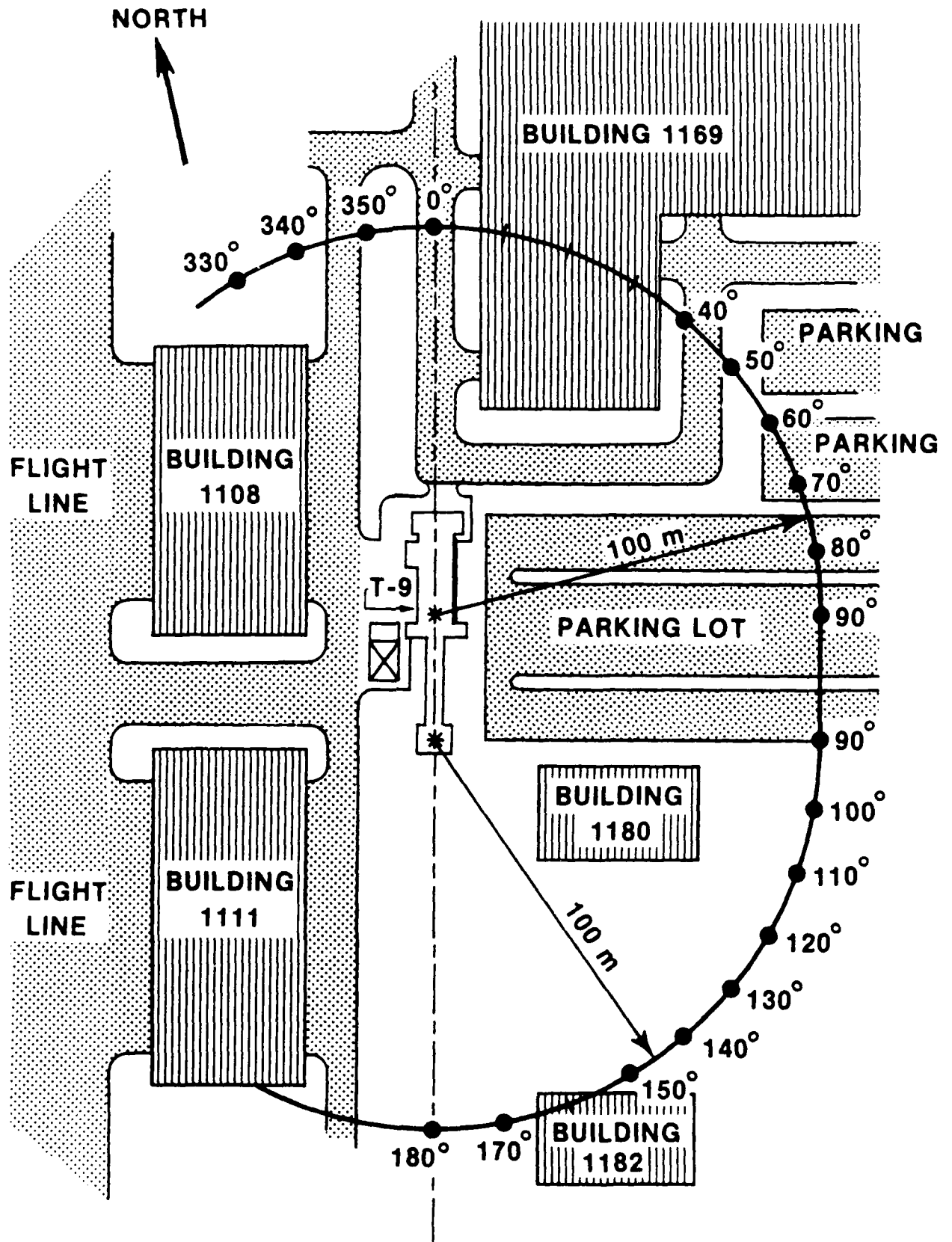

Figure 1: A/F32T-9 Noise Suppressor System Far-Field Measurement Locations



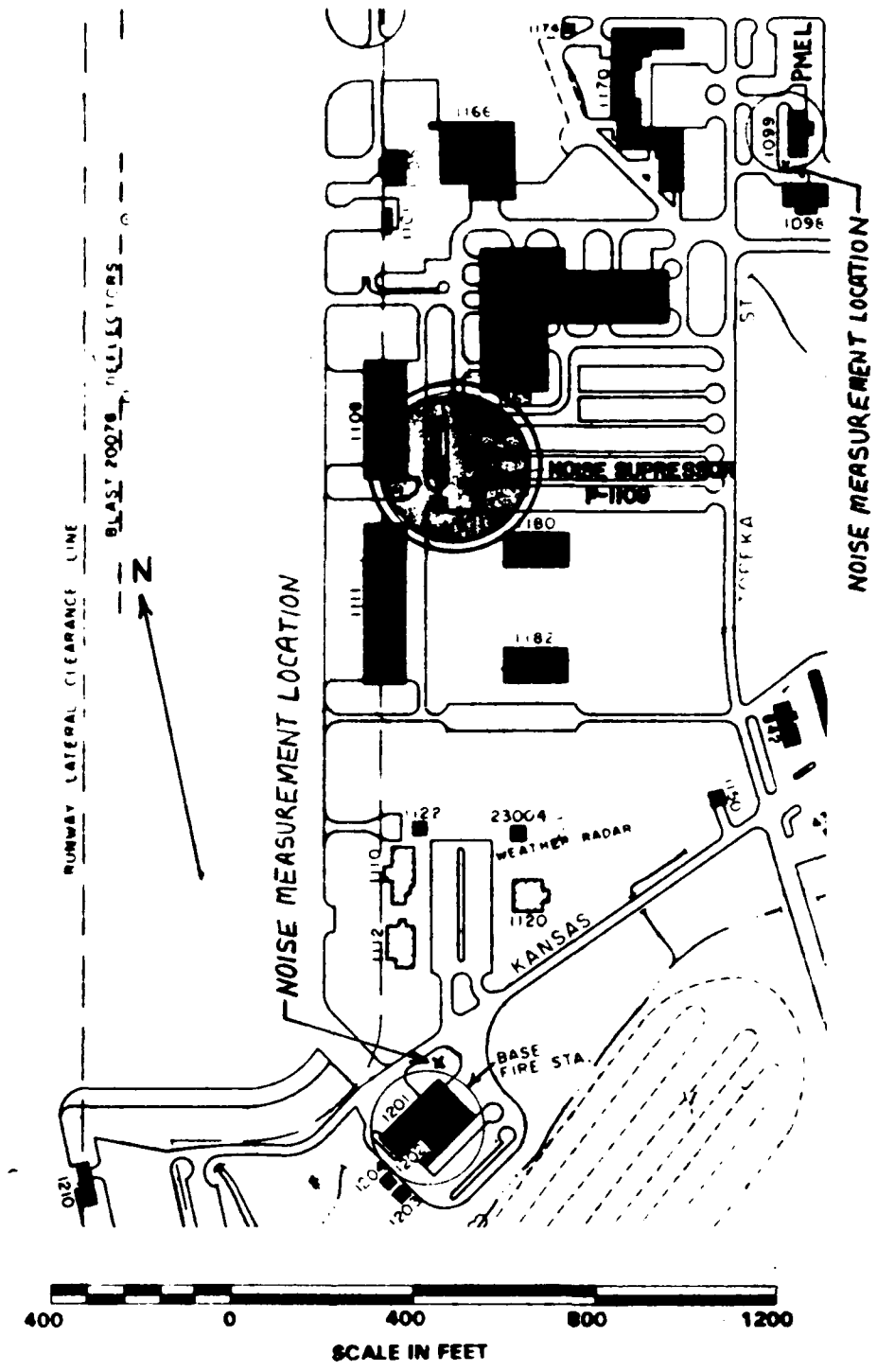
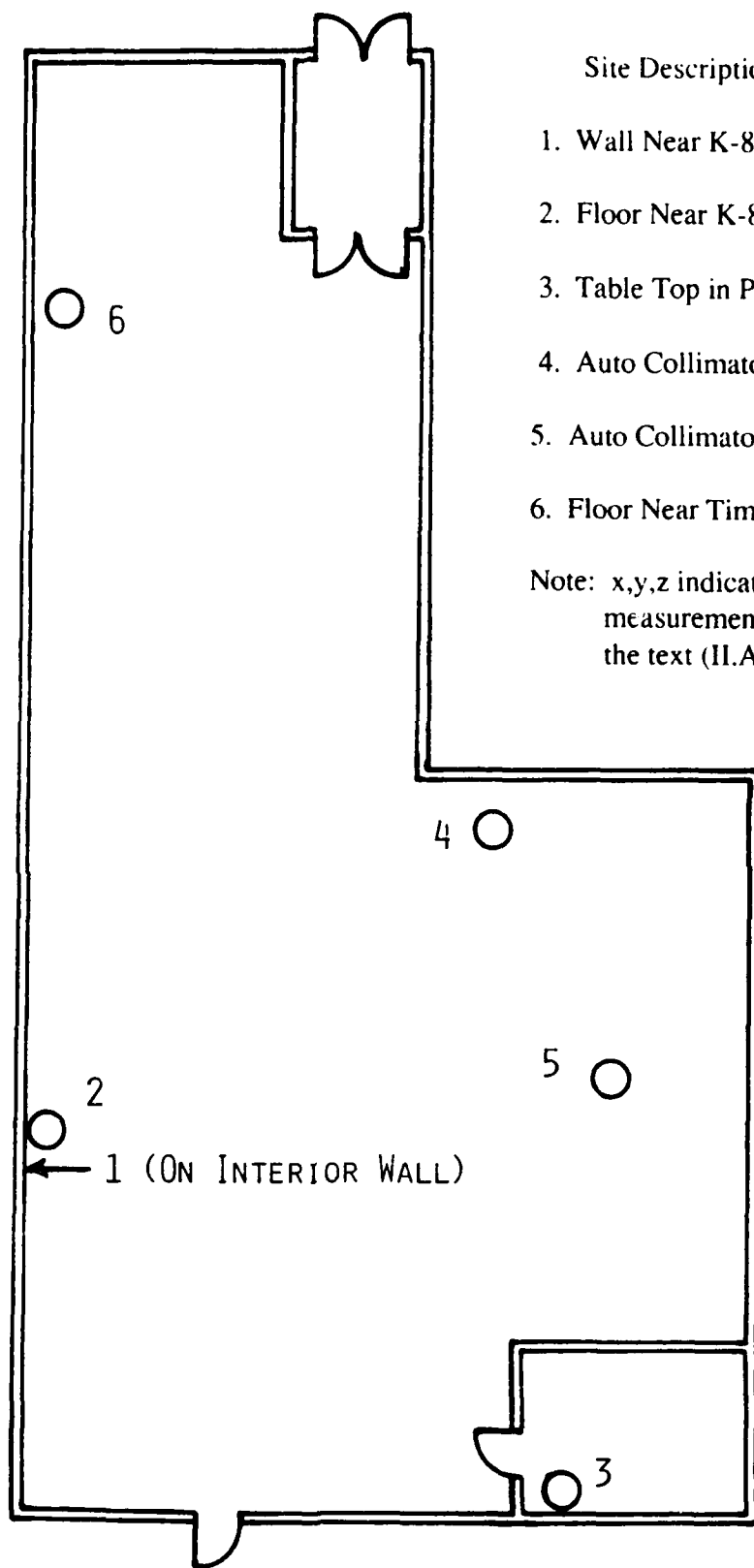

Figure 2: A/F32T-9 Noise Suppressor System, PMEL Building (1099) and Base Fire Station (Bldg 1201)



Site Descriptions:

1. Wall Near K-8 Console (x,y,z)
2. Floor Near K-8 Console (x,y,z)
3. Table Top in Pressure Room (z)
4. Auto Collimator Sender (z)
5. Auto Collimator Receiver (z)
6. Floor Near Time Clock (x,y,z).

Note: x,y,z indicates axis of measurement as described in the text (II.A.2., pp. 3).

Figure 3: Vibration Measurement Sites Inside the PMEL Building (1099)

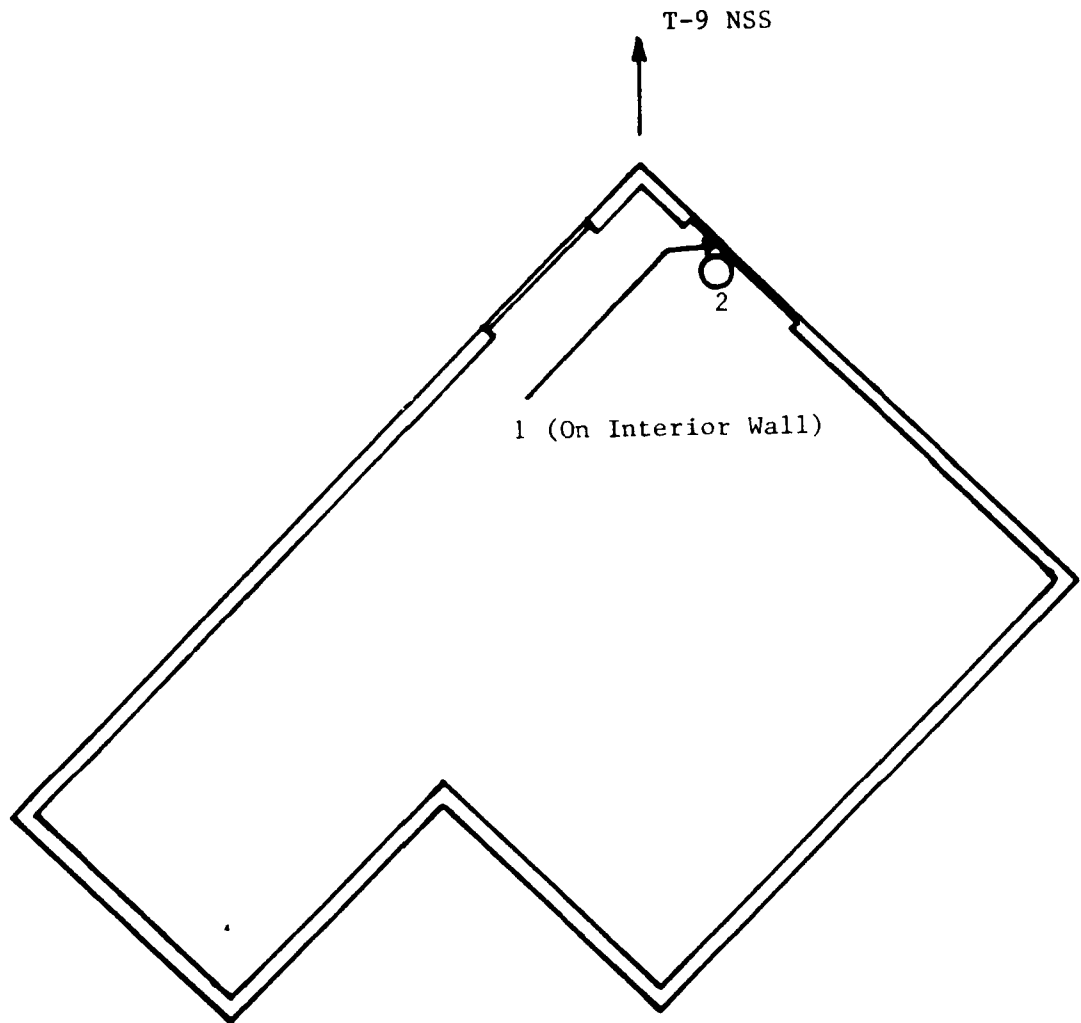

Site Descriptions:

1. Wall Below the Window (x,y,z)
2. Floor (x,y,z)

Note: x,y,z indicates axis of measurement as described in the text (II.A.2., pp. 3)

**Figure 4: Vibration Measurement Sites Inside the Fire Station (Bldg 1201).**

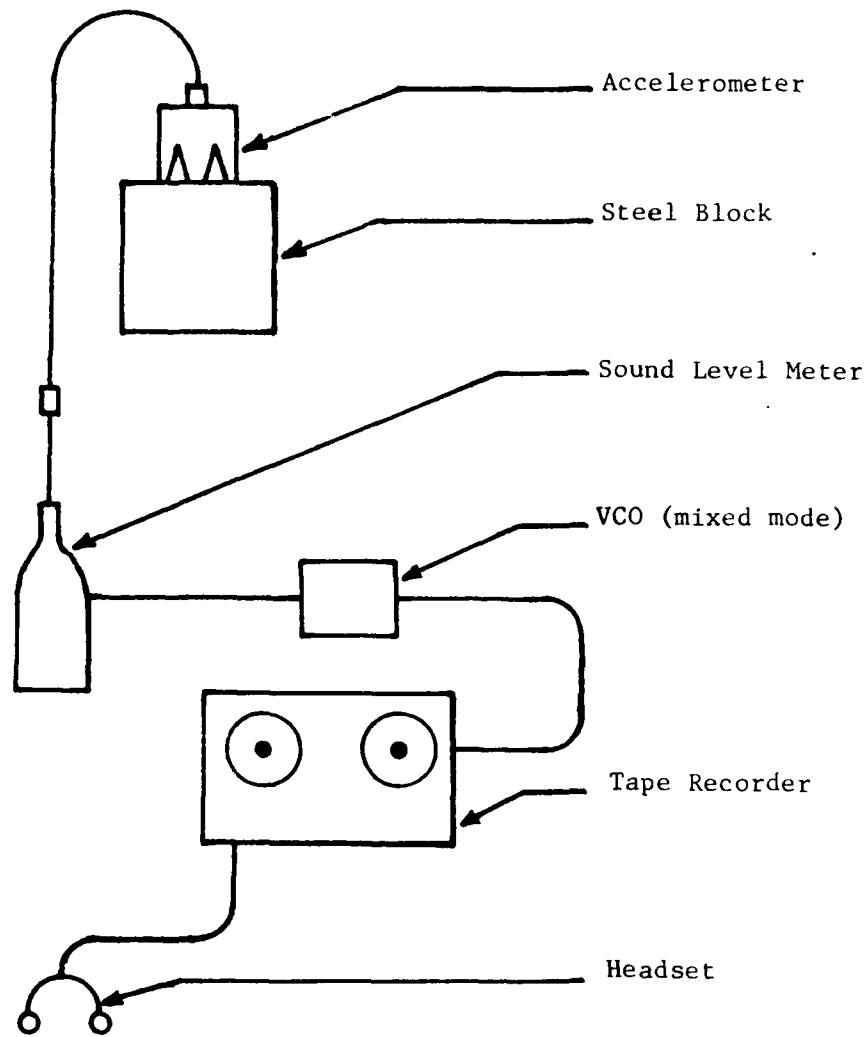

**Equipment List:**

- Approx. 2"x2" steel block used as accelerometer mount
- Endevco Model 2217E Accelerometer
- Gen Rad 1982 Sound Level Meter used as a signal conditioner
- Voltage Controlled Oscillator (VCO) for low frequency recording
- Nagra IV-D Tape Recorder
- Headset with announce microphone
- Gen Rad 1557-A Vibration Calibrator (1g @ 1000 Hz)
- Hewlett-Packard 204D Oscillator (20 Hz)

**Figure 5: Diagram of Vibration Sampling System and Equipment List**

(This page left blank)

APPENDIX B  
Data Summary

(This page left blank)

**Table 1: Summary of Vibration Limits and Measured Vibration Levels (Worst Cases)**

Freq (Hz)	Vibration Limits (m/s <sup>2</sup> )					Measured Vibration Levels (m/s <sup>2</sup> )*			
	ISA RP52.1 1975	ANSI S3.29 1983 Perception Threshold		ISO 2631.1978 8h Fatigue Boundary		F101 Engine			
						Fire Station		PMEL	
		z	x,y	z	x,y	1x	2z	1x	2z
2.5	6.16E-5	.0063	.0045	.400	.280	9.44E-3	#1.41E-3	1.76E-3	6.17E-3
3.15	9.80E-5	.0057	.0057	.355	.355	3.05E-3	5.07E-4	5.62E-4	2.16E-3
4	1.58E-4	.0050	.0072	.315	.450	2.21E-3	6.61E-4	4.62E-4	#4.47E-4
5	2.46E-4	.0050	.0090	.315	.560	3.47E-3	#7.94E-4	#5.01E-4	#5.62E-4
6.3	3.92E-4	.0050	.0110	.315	.710	4.47E-3	3.16E-4	3.43E-4	#3.55E-4
8	6.25E-4	.0050	.0140	.315	.900	3.51E-3	.62E-4	5.19E-4	#2.82E-4
10	9.86E-4	.0063	.0180	.400	1.12	8.91E-3	5.50E-4	9.44E-4	#4.47E-4
12.5	1.54E-3	.0078	.0230	.500	1.40	1.78E-2	5.82E-4	2.79E-3	1.80E-4
16	2.53E-3	.0100	.0290	.630	1.80	5.01E-2	7.33E-4	7.94E-3	5.50E-4
20	3.95E-3	.0130	.0360	.800	2.24	3.98E-2	6.84E-4	1.00E-2	3.85E-4
25	6.17E-3	.0160	.0450	1.00	2.80	7.94E-2	5.01E-4	5.62E-3	#5.62E-4
31.5	9.81E-3	.0200	.0570	1.25	3.55	1.26E-1	7.33E-4	1.12E-2	#7.08E-4
40	9.81E-3	.0250	.0720	1.60	4.50	8.91E-2	4.47E-4	3.51E-3	#5.01E-4
50	9.81E-3	.0310	.0900	2.00	5.60	1.78E-1	3.85E-4	2.45E-3	#5.01E-4
63	9.81E-3	.0390	.1100	2.50	7.10	3.63E-2	2.14E-4	1.12E-3	1.78E-4
80	9.81E-3	.0500	.1400	3.15	9.00	1.17E-2	8.61E-5	7.08E-4	3.35E-5
100	9.81E-3					6.31E-3	6.38E-5	5.62E-4	2.92E-5
125	9.81E-3					4.62E-3	2.48E-4	7.24E-4	#9.77E-5
160	9.81E-3					3.02E-3	1.46E-4	4.62E-4	5.31E-5
200	9.81E-3					4.32E-3	1.00E-4	1.51E-4	#1.95E-4

\* Background corrected acceleration levels

# Not background corrected because Background Vibration Level > Vibration Level measured during engine operations

Note: ISO 2631.1978 also recommends limits for a "reduced comfort" boundary and an "exposure limit" boundary. The "reduced comfort" boundary is approximately 1/3 (10 dB lower) of the "fatigue-decreased proficiency" boundary. The recommended "exposure limit" boundary is a factor of 2 higher (6 dB higher) than the "fatigue-decreased proficiency" boundary.



**Table 2: Measured Sound Pressure Level Outside PMEL and the Fire Station with Engines Operating at Maximum Power**

MEASURED SOUND PRESSURE LEVEL (DB)

1/3 OCTAVE BAND

DISTANCE = 328 METERS (PMEL)    DISTANCE = 404 METERS (FS)

FREQ (HZ)	*F101 Engine		*TF30 Engine		*F100 Engine		*J85-5 Engine		#F108 Engine	
	PMEL	FS	PMEL	FS	PMEL	FS	PMEL	FS	PMEL	FS
3.15	75	76	78		79	79	@	79	@	74
4	86	76	87		88	89		78		75
5	83	76	80		82	82		79		69
6.3	79	79	78		79	80		80		72
8	81	84	78		79	82		79		74
10	82	84	79		78	82		78		73
12.5	86	88	83		83	85		77		73
16	88	91	84		85	88		76		75
20	88	93	84		85	89		74		74
25	87	92	85	89	85	88		74		71
31.5	85	91	80	89	80	88		73		71
40	83	90	77	86	79	87		70		68
50	81	94	76	89	77	89		71		70
63	79	89	72	85	74	83		71		67
80	75	83	69	78	69	73		70		62
100	69	78	65	75	64	65		66		61
125	65	74	62	70	60	64		68		58
160	60	70	57	67	58	63		62		55
200	58	69	54	67	57	64		59		52
250	55	71	52	67	55	64		57		49
315	53	71	48	66	53	63		58		47
400	50	73	46	66	51	63		61		47
500	49	74	43	71	49	67		60		45
630	47	71	41	68	49	64		60		45
800	45	71	40	64	49	60		58		45
1000	44	71	39	64	49	60		55		46
1250	43	68	38	64	47	59		56		46
1600	42	65		60	45	57		54		43
2000	40	60		56	44	54		52		40
2500	38	55		52	42	50		51		40
3150		50						49		36

Table 2 (Cont'd)

	*F101 Engine		*TF30 Engine		*F100 Engine		*J85-5 Engine		#F108 Engine	
	PMEL	FS	PMEL	FS	PMEL	FS	PMEL	FS	PMEL	FS
FREQ (HZ)										
4000								46		38
5000	39	48						43		36
6300	40	49						40		33
8000	42	51						38		33
10000	43	52						39		33
OVERALL	96	101	93	95	93	93		88		84

\* Maximum power is afterburner power.

# Maximum power is take-off power.

@ Data unavailable at this location.

**Table 3: Measured Sound Pressure Levels at Maximum Power at  
the 50 and 180 Degree 100 m Positions**

Engine	TF30	F100	J85	F101	F108
Overall SPL:					
0 Degrees	98	101	96	105	96
50 Degrees	99	99	88	104	92
180 Degrees	106	106	89	110	95
1/3 Octave Band SPL at 180 Degrees					
Frequency(Hz):					
3.15	88	83	72	79	75
4	87	89	73	82	76
5	89	83	72	87	77
6.3	88	88	76	90	81
8	90	89	80	94	84
10	92	91	77	95	83
12.5	96	94	79	98	86
16	101	101	82	104	89
20	96	97	79	100	87
25	98	96	80	101	83
31.5	96	97	77	100	82
40	96	96	72	100	83
50	95	95	77	101	81
63	93	93	74	98	80
80	87	88	69	93	78
100	81	82	66	88	75
1/3 Octave Band SPL at 50 Degrees					
Frequency(Hz):					
3.15	76	76	67	71	71
4	88	87	72	75	76
5	82	82	72	84	76
6.3	83	81	72	84	75
8	84	83	72	88	78
10	88	86	79	91	80
12.5	88	92	76	94	82
16	92	90	79	98	84
20	89	90	79	95	83
25	89	89	79	97	82
31.5	86	86	77	95	84
40	85	85	73	92	80
50	84	85	74	92	78
63	80	83	76	90	79
80	78	81	66	87	74
100	77	79	64	85	75

FIGURE 6: MEASURED VIBRATION LEVELS FOR GROUND RUNUP OF THE F101 ENGINE AT AFTERBURNER, PMEL BLDG, SITE 1 (WALL), X-AXIS

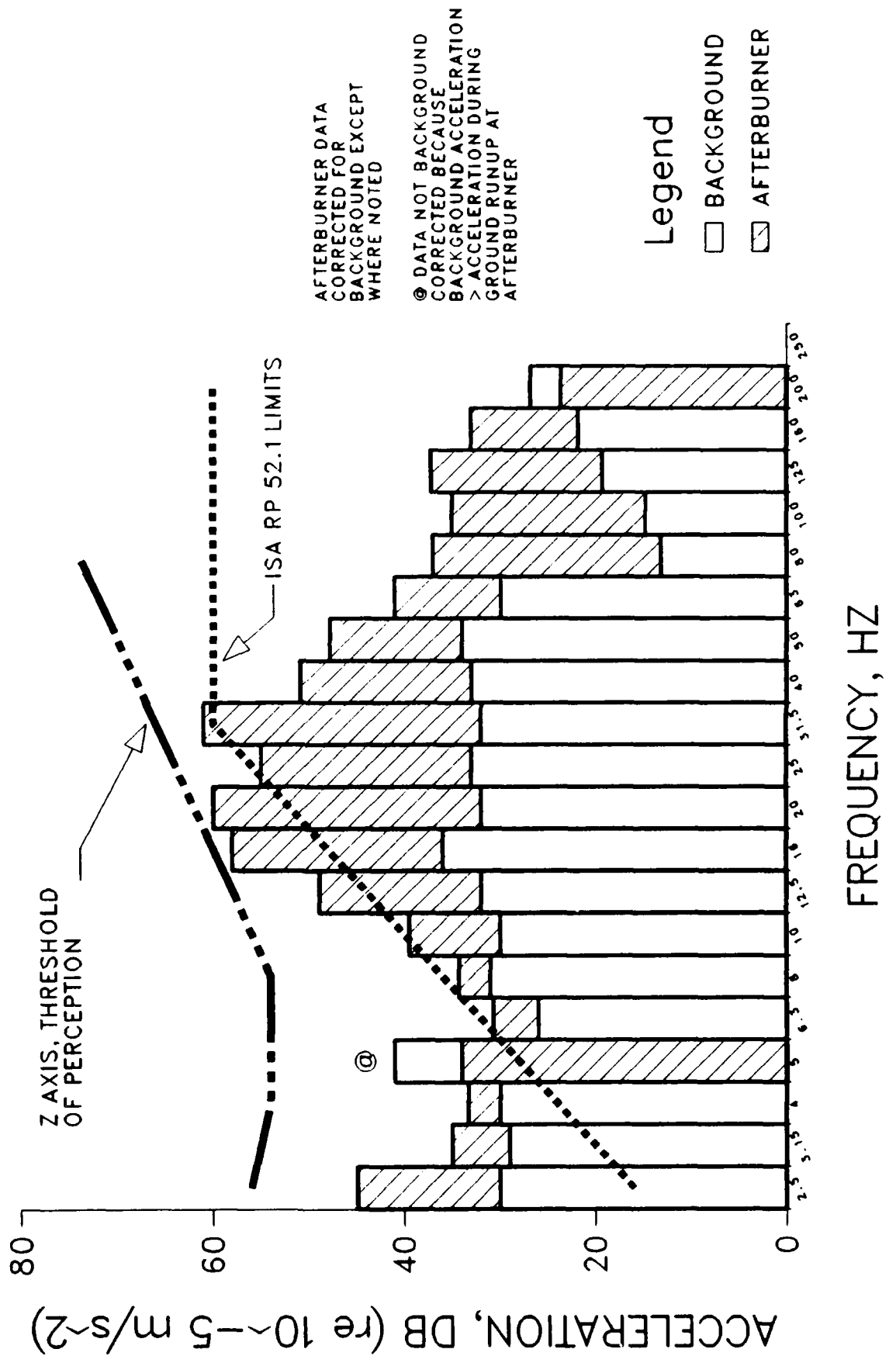

FIGURE 7: MEASURED VIBRATION LEVELS FOR GROUND RUNUP OF THE F101 ENGINE AT AFTERBURNER, PMEL BLDG, SITE 2 (FLOOR), Z-AXIS

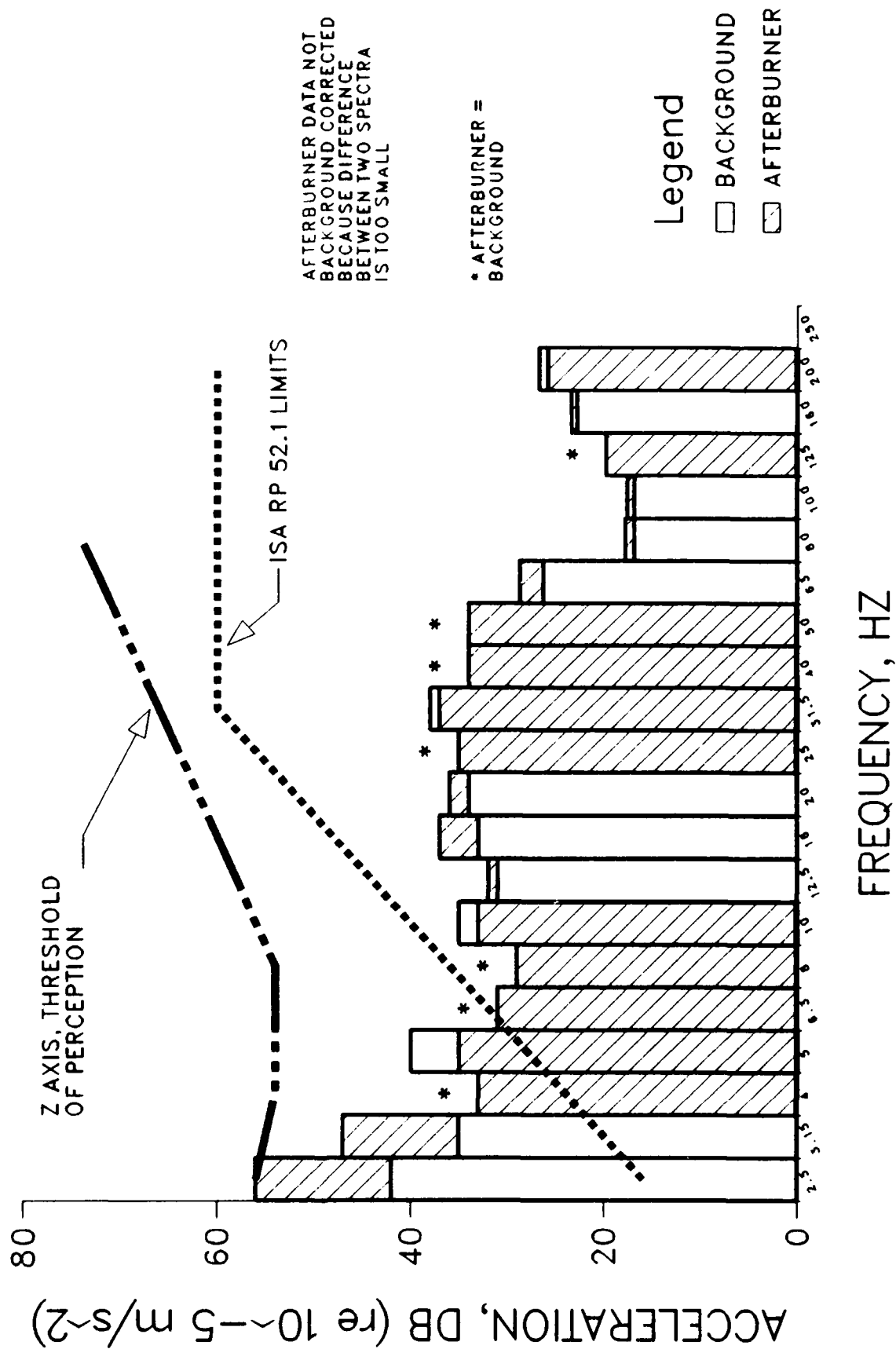

FIGURE 8: MEASURED VIBRATION LEVELS FOR GROUND RUNUP OF THE F101 ENGINE AT AFTERBURNER, FIRE STATION, SITE 1 (WALL), X--AXIS

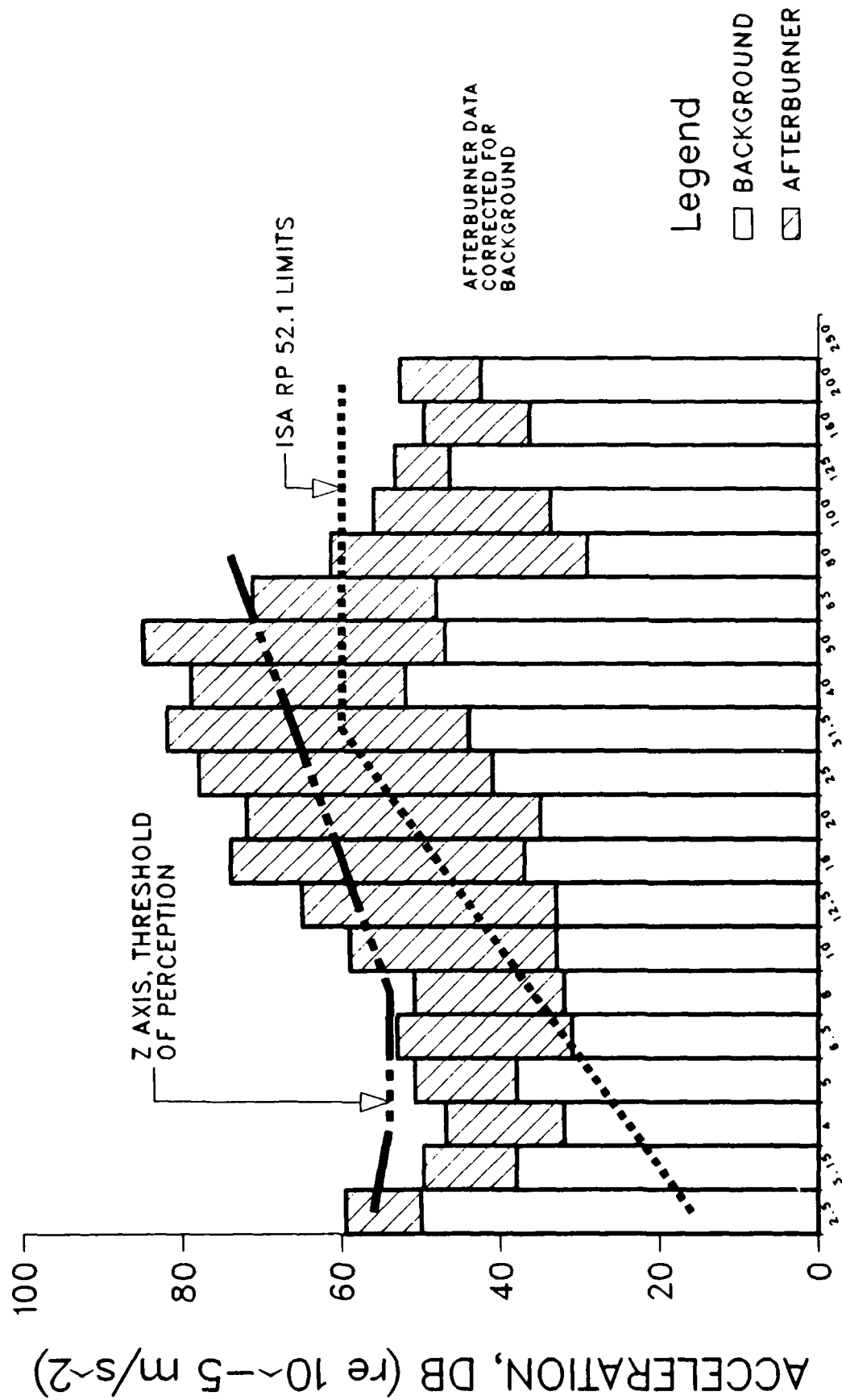

FIGURE 9: MEASURED VIBRATION LEVELS FOR GROUND RUNUP OF THE F101 ENGINE AT AFTERBURNER, FIRE STATION, SITE 2 (FLOOR), Z--AXIS

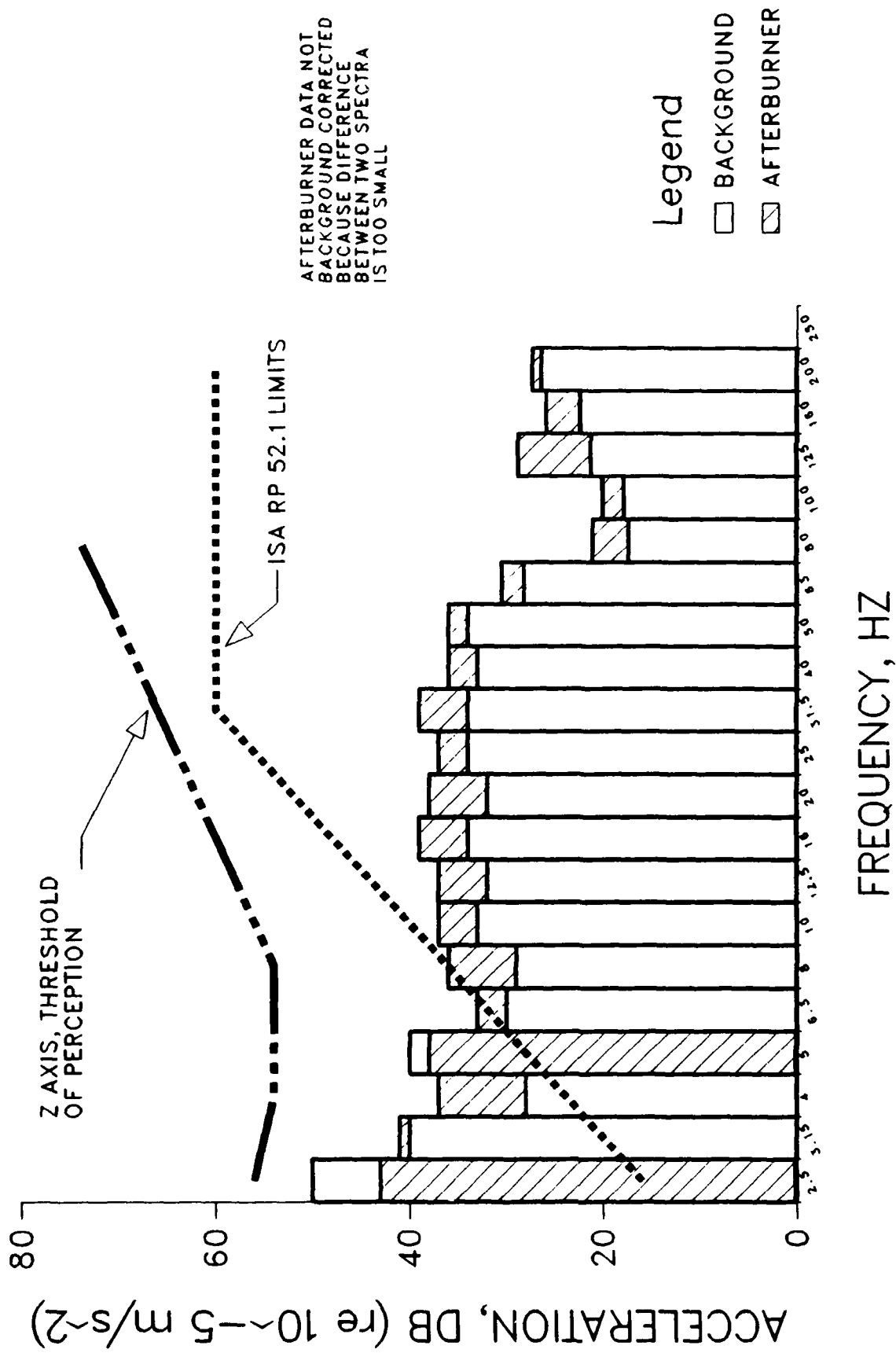

FIGURE 10: MEASURED VIBRATION LEVELS FOR GROUND RUNUP OF THE F108 ENGINE AT TAKE OFF, PMEL BLDG, SITE 1 (WALL), X-AXIS

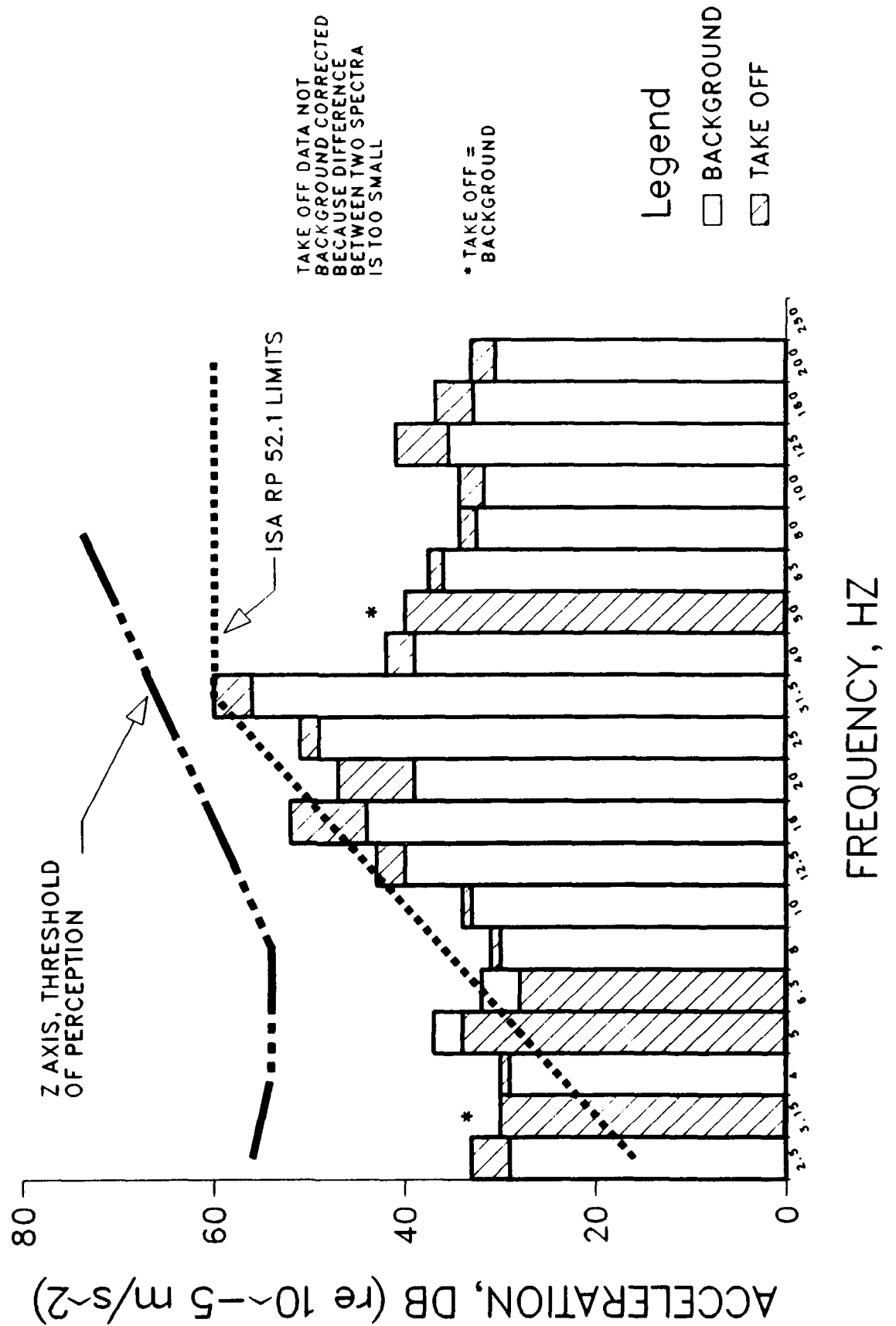



FIGURE 11: MEASURED VIBRATION LEVELS FOR GROUND RUNUP OF THE F108 ENGINE AT TAKE OFF PMEL BLDG, SITE 2 (FLOOR), Z--AXIS

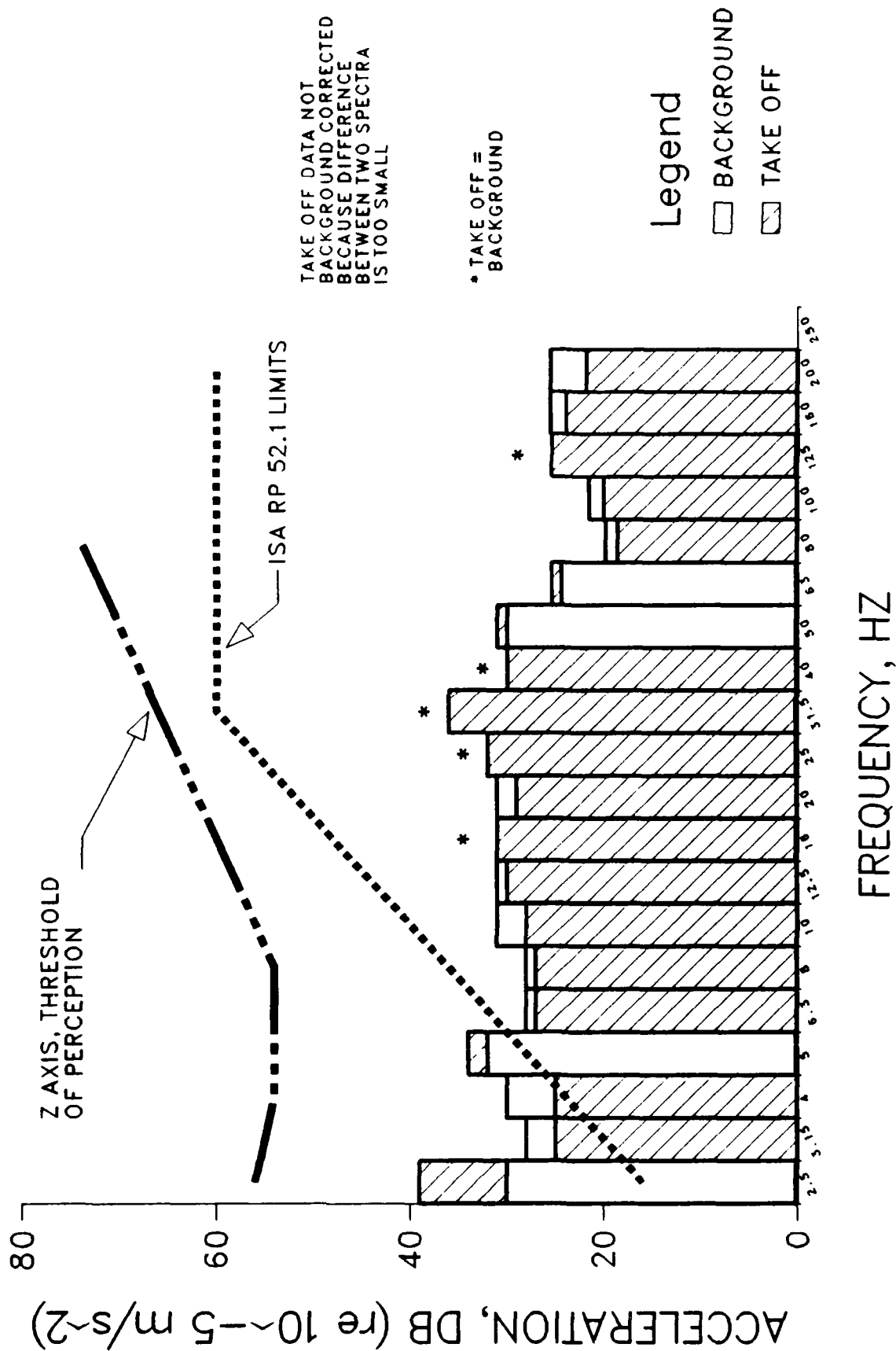

FIGURE 12: MEASURED VIBRATION LEVELS FOR GROUND RUNUP OF THE F108 ENGINE AT TAKE OFF, FIRE STATION, SITE 1 (WALL), X-AXIS

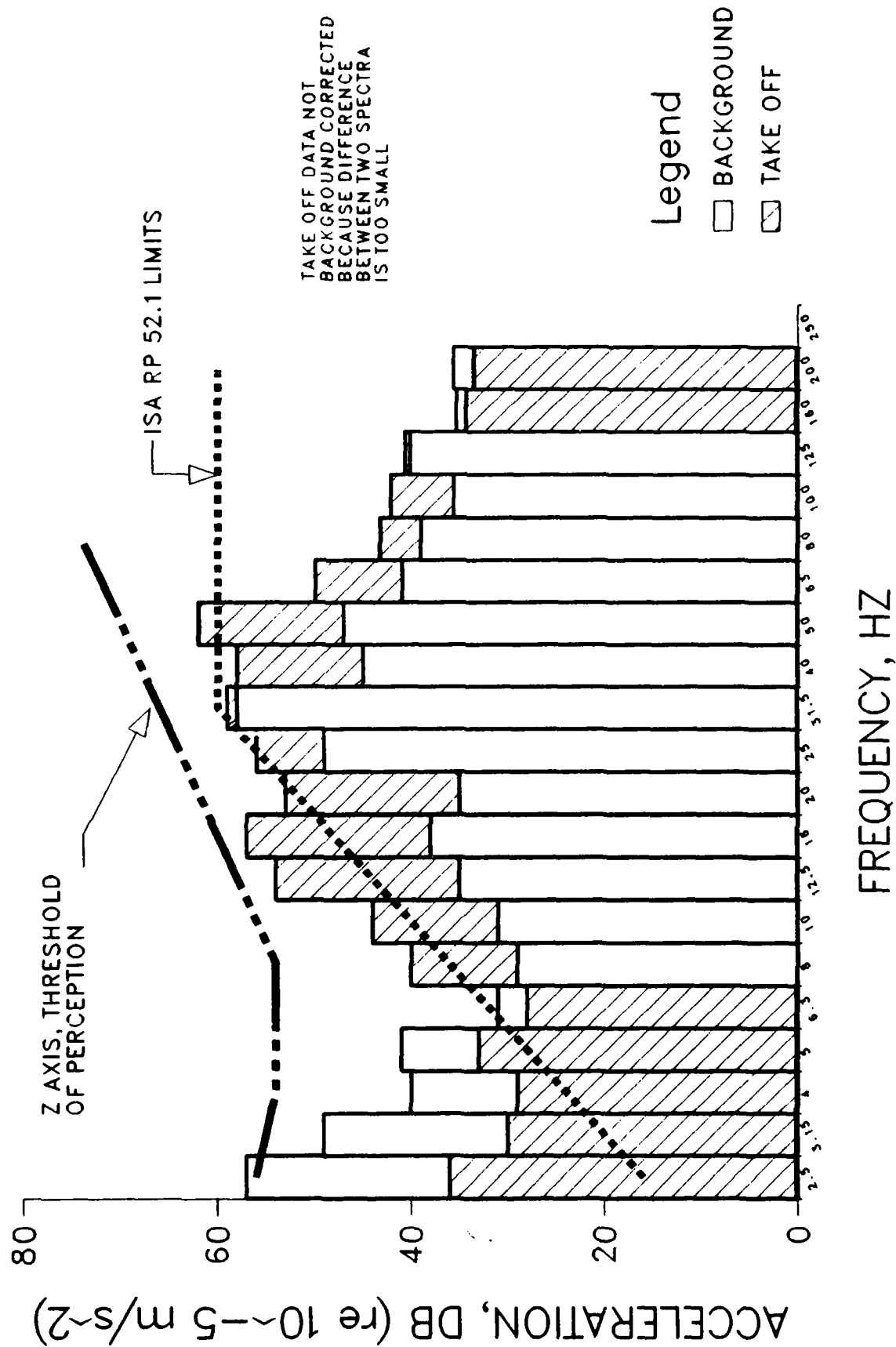

FIGURE 13: MEASURED VIBRATION LEVELS FOR GROUND RUNUP OF THE F108 ENGINE AT TAKE OFF, FIRE STATION, SITE 2 (FLOOR), Z--AXIS

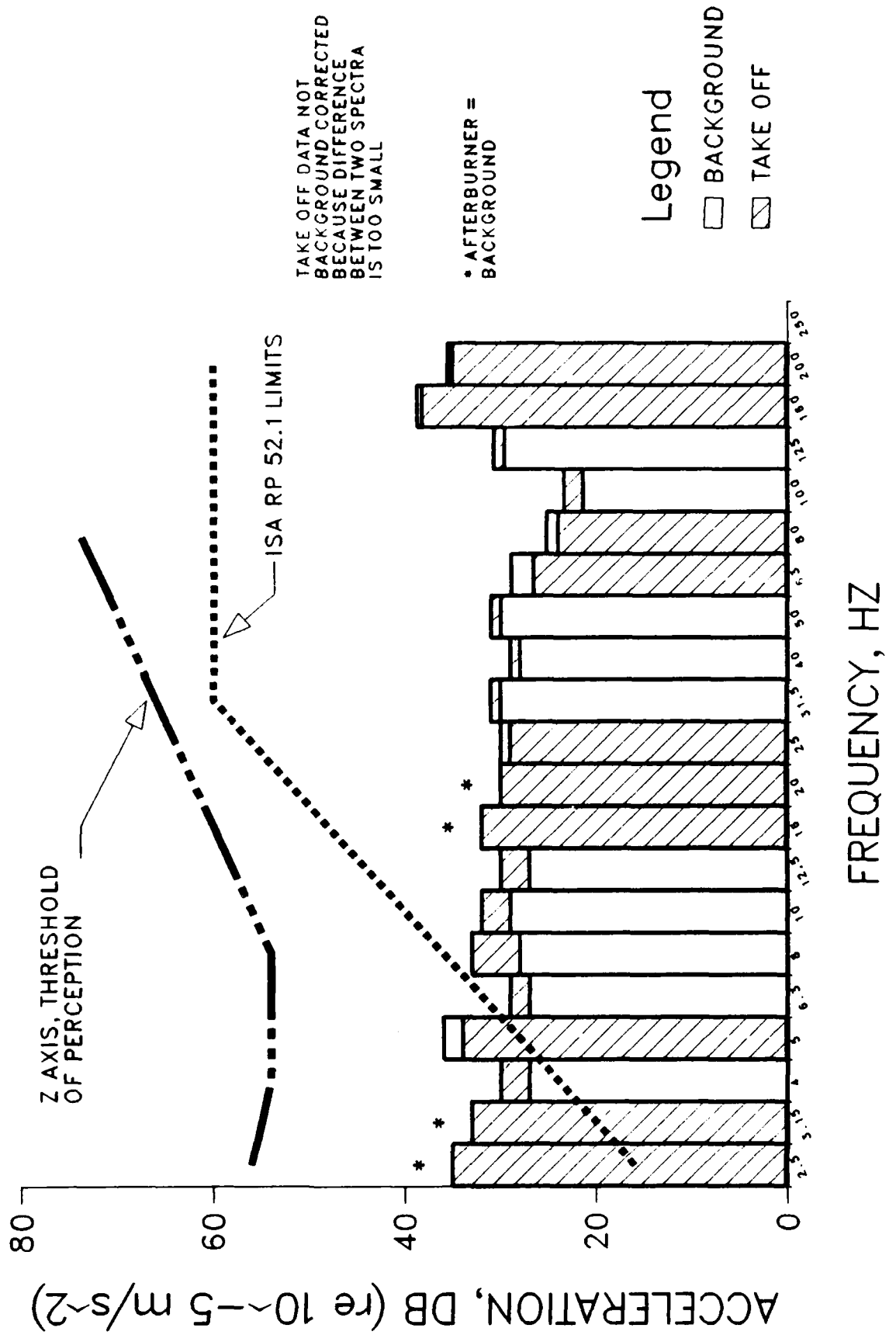

FIGURE 14: MEASURED VIBRATION LEVELS FOR GROUND RUNUP OF THE F101 ENGINE AT AFTERBURNER, PMEL BLDG, SITE 3 (TABLE), Z-AXIS

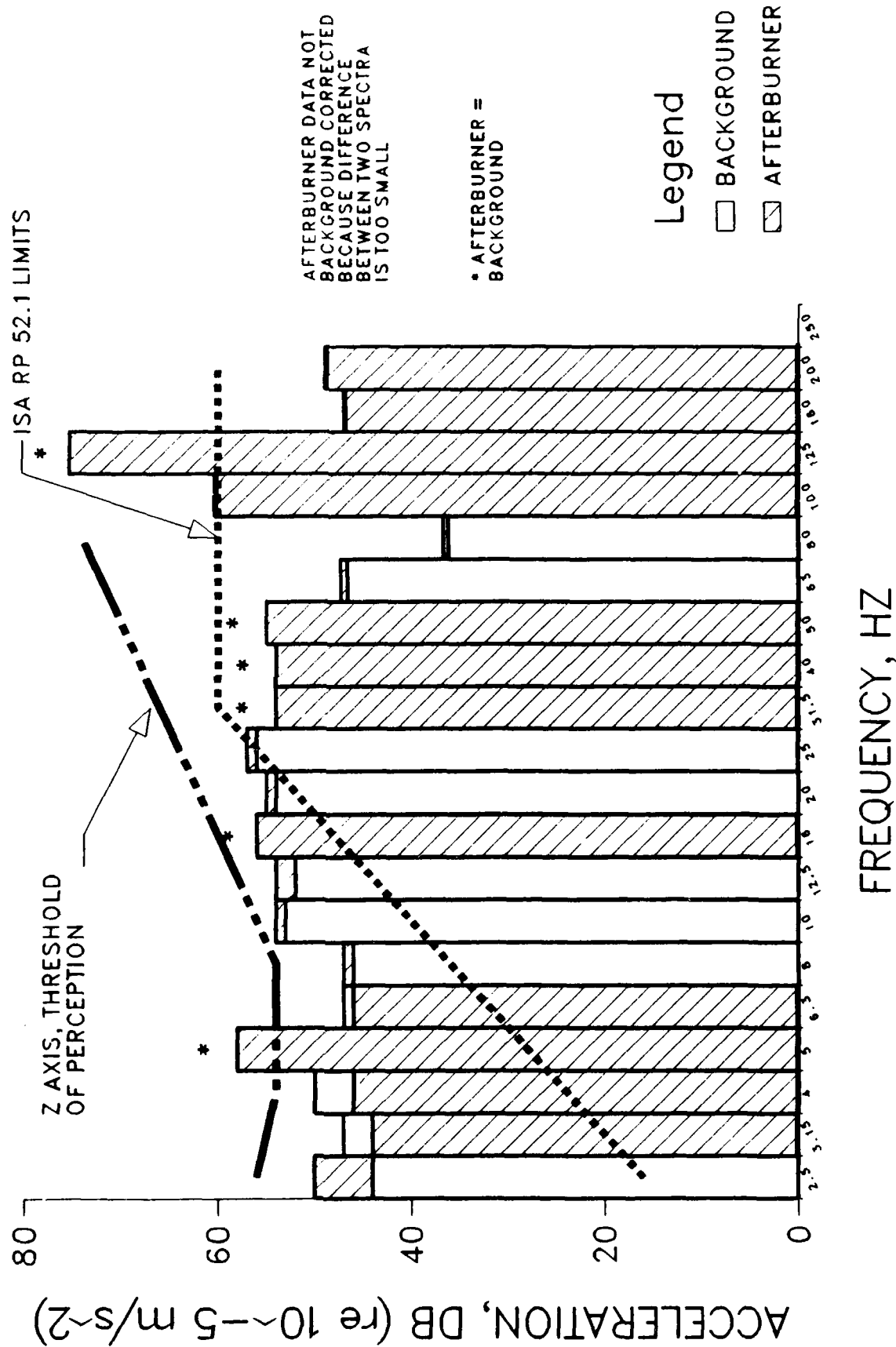
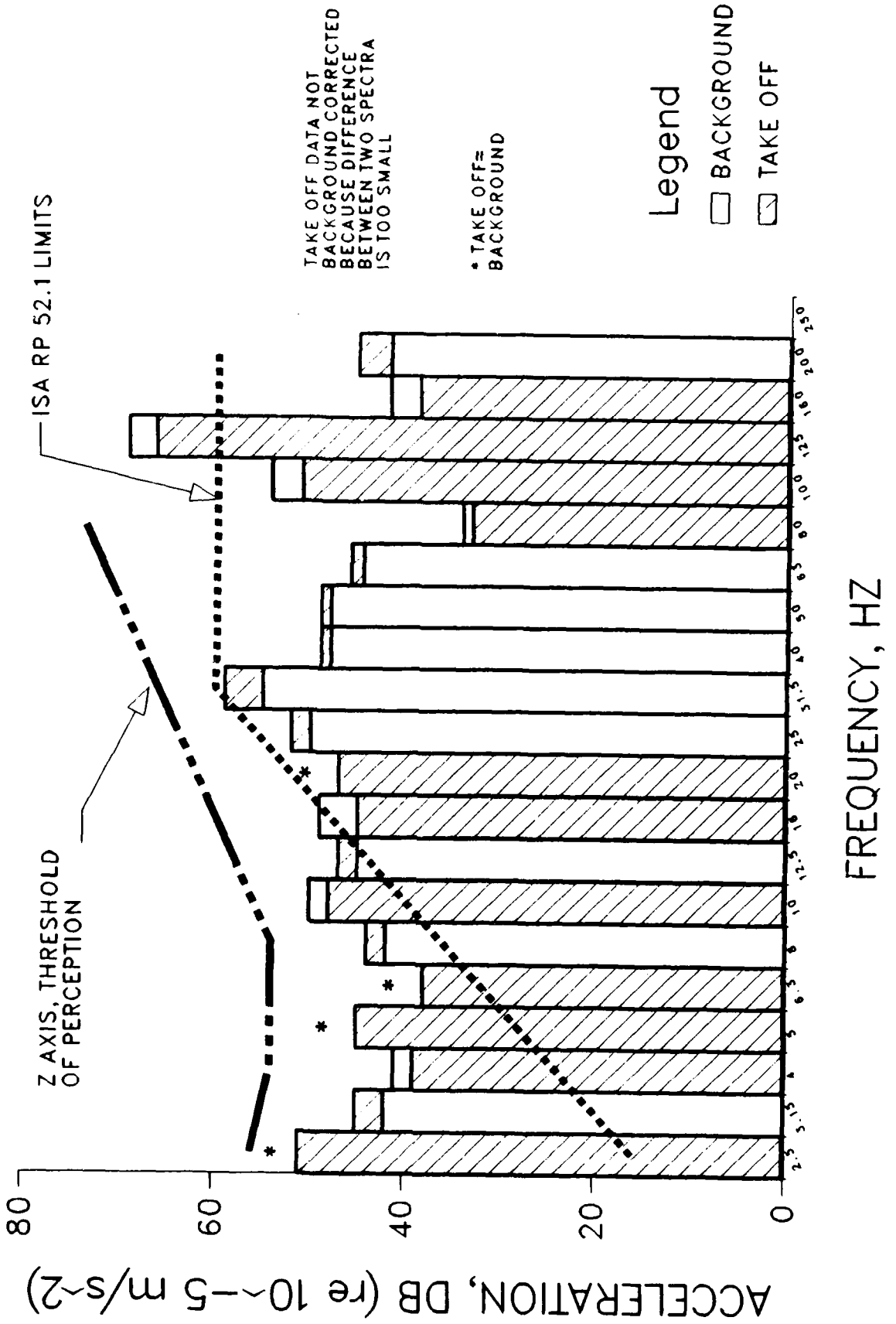

FIGURE 15: MEASURED VIBRATION LEVELS FOR GROUND RUNUP OF THE F108 ENGINE AT TAKE OFF, PMEL BLDG, SITE 3 (TABLE), Z--AXIS



Distribution List

	Copies
SA-ALC/MMIMH Kelly AFB TX 78241-5000	10
AAMRL/BBE Wright-Patterson AFB OH 45433-6573	5
HQ AFLC/SGB Wright-Patterson AFB OH 45433-5001	1
HQ AFLC/DE Wright-Patterson AFB OH 45433-5001	1
HQ AFLC/DEPV Wright-Patterson AFB OH 45433-5001	1
HQ AFSC/SGPB Andrews AFB DC 20332-5000	1
HQ ANGSC/SG Andrews AFB DC 20331-6008	5
HQ ANGSC/DE Andrews AFB DC 20331-6008	1
HQ USAF/SGPA Bolling AFB DC 20332-6188	1
HQ USAF/LEEV Bolling AFB DC 20330-5000	1
HQ USAF/LEYY Bolling AFB DC 20330-5000	1
HQ SAC/SGPB Offutt AFB NE 68113-5001	5
HQ SAC/DE Offutt AFB NE 68113-5001	1
HQ SAC/LGM Offutt AFB NE 68113-5001	1

Distribution List (Cont'd)	Copies
USAF Regional Medical Center Wiesbaden/SCiB APO New York 09220-5300	1
OL AD, USAFOEHL APO San Francisco 96274-5000	1
USAFSAM/TSK Brooks AFB TX 78235-5301	1
USAFSAM/EDH Brooks AFB TX 78235-5301	1
HQ HSD/EV Brooks AFB TX 78235-5000	1
Defense Technical Information Center (DTIC) Cameron Station Alexandria VA 22319	2
HQ AFESC/RDV Tyndall AFB FL 32403-6001	1
NGB/LGM Washington DC 20310-5000	5
HQ 8 AF/LGMS Barksdale AFB LA 71110-5000	1