

UNCLASSIFIED

SECURITY CLASSIFICATION OF THIS PAGE (When Data Entered)

REPORT DOCUMENTATION PAGE		READ INSTRUCTIONS BEFORE COMPLETING FORM
1. REPORT NUMBER BRL-TR-2872	2. GOVT ACCESSION NO.	3. RECIPIENT'S CATALOG NUMBER
4. TITLE (and Subtitle) ANALYSIS PROCEDURE FOR MUZZLE MOTION DATA COLLECTED WITH THE SCHMIDT DISPLACEMENT TRANSDUCER INSTRUMENTATION		5. TYPE OF REPORT & PERIOD COVERED FINAL REPORT
		6. PERFORMING ORG. REPORT NUMBER
7. AUTHOR(s) RURIK K. LODER EMMA M. WINEHOLT		8. CONTRACT OR GRANT NUMBER(s)
9. PERFORMING ORGANIZATION NAME AND ADDRESS		10. PROGRAM ELEMENT, PROJECT, TASK AREA & WORK UNIT NUMBERS
11. CONTROLLING OFFICE NAME AND ADDRESS		12. REPORT DATE
		13. NUMBER OF PAGES 119
14. MONITORING AGENCY NAME & ADDRESS (if different from Controlling Office)		15. SECURITY CLASS. (of this report) UNCLASSIFIED
		15a. DECLASSIFICATION/DOWNGRADING SCHEDULE
16. DISTRIBUTION STATEMENT (of this Report)		
17. DISTRIBUTION STATEMENT (of the abstract entered in Block 20, if different from Report)		
18. SUPPLEMENTARY NOTES		
19. KEY WORDS (Continue on reverse side if necessary and identify by block number) Gun Accuracy Projectile-Gun Dynamics Cannon Motion SDT Measurement Technique		
20. ABSTRACT (Continue on reverse side if necessary and identify by block number) jmk In many gun accuracy investigations the projectile as well as the muzzle dynamics during shot exit must be determined. Not every instrumentation used for gun barrel motion measurements is suitable for the obtainment of the muzzle motion due to temporal resolution and spatial accuracy requirements. An instrumentation referred to as the Schmidt Displacement Transducer (SDT) has recently been developed at the Ballistic Research Laboratory which is well suited for these type of measurements. This report contains a brief review (continued on next page)		

DD FORM 1473

1 JAN 73

EDITION OF 1 NOV 65 IS OBSOLETE

UNCLASSIFIED

SECURITY CLASSIFICATION OF THIS PAGE (When Data Entered)

20. (continued)

of instrumentation applicable to the measurement of barrel and muzzle motion, a description of the SDT instrumentation and its application for monitoring muzzle motion, an analysis procedure for SDT type of data for extracting the muzzle motion with respect to the ground, and the developed computer data analysis program with appropriate examples.

TECHNICAL REPORT BRL-TR-2872

ANALYSIS PROCEDURE FOR MUZZLE  
MOTION DATA COLLECTED WITH THE  
SCHMIDT DISPLACEMENT  
TRANSDUCER INSTRUMENTATION

✓ RURIK K. LODER  
EMMA M. WINEHOLT

┌ NOVEMBER 1987

APPROVED FOR PUBLIC RELEASE; DISTRIBUTION UNLIMITED.

US ARMY BALLISTIC RESEARCH LABORATORY  
ABERDEEN PROVING GROUND, MARYLAND

DESTRUCTION NOTICE

Destroy this report when it is no longer needed. DO NOT return it to the originator.

Additional copies of this report may be obtained from the National Technical Information Service, U.S. Department of Commerce, Springfield, VA 22161.

The findings of this report are not to be construed as an official Department of the Army position, unless so designated by other authorized documents.

The use of trade names or manufacturers' names in this report does not constitute indorsement of any commercial product.

## TABLE OF CONTENTS

	Page
LIST OF FIGURES.....	iii
1. INTRODUCTION.....	1
2. SIGHT INSTRUMENTATION AND MEASUREMENT TECHNIQUE.....	2
3. DATA ANALYSIS CONCEPT AND PROCEDURE.....	5
3.1. Experimental Arrangement.....	5
3.2. Analysis Procedure.....	6
3.2.1. Data Conversion.....	6
3.2.2. Modeling Of Muzzle Flexure.....	8
3.2.3. Translation And Rotation Parameters.....	13
4. OUTLINE AND DESCRIPTION OF COMPUTER PROGRAMS.....	15
4.1. General Description.....	15
4.2. Computer Program MUZMO40.....	16
4.2.1. Subroutine COEF1.....	16
4.2.2. Subroutine COEF2.....	16
4.2.3. Subroutine CONVOL.....	16
4.2.4. Subroutine CONVT.....	16
4.2.5. Subroutine DATAIN.....	16
4.2.6. Subroutine DIFFER.....	16
4.2.7. Subroutine DISS4.....	17
4.2.8. Subroutine FILT.....	17
4.2.9. Subroutine ORIENT.....	17
4.2.10. Subroutine PLOT4.....	17
4.2.11. Subroutine WRDAT.....	17
4.3. Computer Program MUZPRED.....	17
4.3.1. Subroutine CALCZ.....	18
4.3.2. Subroutine COEF1.....	20
4.3.3. Subroutine COEF2.....	20
4.3.4. Subroutine CONVOL.....	20
4.3.5. Subroutine DATAIN.....	20
4.3.6. Subroutine DATA4.....	20
4.3.7. Subroutine DIFFER.....	21
4.3.8. Subroutine DISS4.....	21
4.3.9. Subroutine FILT.....	21
4.3.10. Subroutine PREDCT.....	21
4.3.11. Subroutine UNITV.....	22
4.3.12. Subroutine WRFILE.....	22
5. CONCLUSIONS.....	23
REFERENCES.....	25
APPENDIX A - BRIEF REVIEW OF CANNON MOTION MEASUREMENT TECHNIQUES.....	29
A.1. Introduction.....	30
A.2. Streak Photography.....	30
A.3. Electrooptical Displacement Transducers.....	30

**TABLE OF CONTENTS (continued)**

	Page
A.4. Optical Lever Instrumentation.....	31
A.5. Electromagnetic Proximity Transducers.....	31
A.6. Interferometric Measurement Techniques.....	31
A.7. Electromechanical Devices.....	32
A.8. Strain Gauge Instrumentation.....	32
A.9. Accelerometer Instrumentation.....	33
 APPENDIX B - ESTABLISHMENT OF CANNON FLEXURE WITH RESPECT TO BORESIGHT REFERENCE LINE PRIOR TO SHOT START.....	 35
B.1. Gun Aiming Point/System Frame Of Reference.....	36
B.2. Bore Straightness/Axis.....	37
 APPENDIX C - COMPUTER PROGRAMS.....	 39
C.1. Program MUZMO40.....	40
C.1.1. Listing Of Job Control Language Of MFA File MUZMO40/ UN=BOOTS.....	40
C.1.2. Listing Of FORTRAN Program.....	41
C.1.3. Card Image Formats That Are Required For The Input Data Section Of MFA File MUZMO40/UN=BOOTS.....	57
C.1.4. Output.....	59
C.2. Program MUZPRED.....	60
C.2.1. Listing Of Job Control Language Of MFA File MUZPRED/ UN=BOOTS.....	60
C.2.2. Listing Of FORTRAN Program.....	61
C.2.3. Listing Of Auxiliary FORTRAN Subroutines (MFA File DIFFATR).....	78
C.2.4. Card Image Formats That Are Required For The Input Data Section of MFA File MUZPRED/UN=BOOTS.....	83
 APPENDIX D - SAMPLE PROBLEM.....	 87
D.1. Program MUZMO40.....	89
D.1.1. Sample Input Card Images.....	89
D.1.2. Sample Printed Output (Program MUZMO40).....	90
D.2. Program MUZPRED.....	94
D.2.1. Sample Input Card Images From Tape Unit 5 (Normal Input).....	94
D.2.2. Sample Input Card Images From Tape Unit 3 (MFA File DISPL40).....	95
D.2.3. Sample Input Card Images From Tape Unit 7 (MFA File...)	96
D.2.4. Sample Input Card Images From Tape Unit 10 (MFA File UVECT40).....	97
D.2.5. Sample Printed Output (Program MUZPRED).....	98
D.2.6. Sample Plotted Output.....	106

## LIST OF FIGURES

Figure		Page
2.1	Sensor Arrangement And Block Diagram Of Electronic Circuit Of The SDT.....	3
2.2	Sensor Arrangement And Signal-Displacement Correlation For The SDT <sub>z</sub> .....	4
3.1	Sensor Locations For Monitoring Muzzle Motion.....	6
3.2	Muzzle Recoil Velocity.....	9
3.3	Determination Of Well Boundaries.....	10
3.4	Rotation Of Tube Axis With Respect To Ground Reference System.....	14
4.1	Flowchart For Program MUZMO40.....	15
4.2	Flowchart For Program MUZPRED.....	18
B.1	Accurate Measurement Of Bore Curvature Prior To Shot Start.....	38
D.1	Horizontal Displacement, cm.....	107
D.2	Vertical Displacement, cm.....	107
D.3	Magnitude, cm.....	107
D.4	Phase Angle, deg.....	107
D.5	X-Y Plot Of Displacement, cm.....	108
D.6	X-Y Plot Of Sensor 1 Displacement, cm.....	108
D.7	X-Y Plot Of Sensor 1 Displacement, Amplitude Zeroed At Time Of Shot Ejection.....	108
D.8	$e'_{31}$ At ZREF = .0.....	109
D.9	$e'_{32}$ At ZREF = .0.....	109
D.10	X-Y Plot Of $e'_{32}$ At ZREF = 0.....	109
D.11	Horizontal Displacement At ZREF = .0, cm.....	110
D.12	Vertical Displacement At ZREF = .0, cm.....	110
D.13	X-Y Plot Of Displacement At ZREF = .0, cm.....	110
D.14	Horizontal Velocity At ZREF = .0, cm/ms.....	111

## LIST OF FIGURES (continued)

Figure		Page
D.15	Vertical Velocity At ZREF = .0, cm/ms.....	111
D.16	X-Y Plot Of Velocity At ZREF = .0; cm/ms.....	111
D.17	$e'_{31}$ At ZREF = - 7.524 cm.....	112
D.18	$e'_{32}$ At ZREF = - 7.524 cm.....	112
D.19	X-Y Plot Of $e'_{31}$ And $e'_{32}$ At ZREF = - 7.524 cm.....	112
D.20	Horizontal Displacement At ZREF = - 7.524 cm.....	113
D.21	Vertical Displacement At ZREF = - 7.524 cm.....	113
D.22	X-Y Plot Of Displacement At ZREF = - 7.524 cm.....	113
D.23	$e'_{31}$ At ZREF = - 7.524 cm.....	114
D.24	$e'_{32}$ At ZREF = - 7.524 cm.....	114
D.25	X-Y Plot Of $e'_{31}$ And $e'_{32}$ At ZREF = - 7.524 cm.....	114



## 1. INTRODUCTION

Gun accuracy essentially encompasses the complete delivery mechanism of one or many projectiles fired from a gun to a target intercept space-time volume so that the warhead will be able to defeat the target. The main thrust of the ongoing US work is directed toward tank gun accuracy and projectile launch integrity in order to increase the hit probability of our tank fleets. Much of this involves product improvement of fielded weapons and development support for new systems. Hence, most of the work involves system engineering and analysis and is hardware related and, as such, is classified. The Ballistic Research Laboratory (BRL) is in the process of actively exploiting innovative ideas and concepts to assure that projectiles will leave the muzzle in the proper aim direction by reducing the gun related variation of projectile launch parameters to that obtained when firing from precision mounts. To support these tasks and develop the appropriate technology base, BRL is pursuing a basic research program which addresses, among other technology areas, the projectile launch from the gun.

In particular, we are concerned with the sources and mechanisms which cause the bias of the impact point relative to the target as well as with the errors and impact distribution due to parameter variations. For all practical purposes, the effect of exterior ballistic related sources as well as the propagation of variations in the launch parameters on the projectile flight trajectory are well understood and predictable with sufficient accuracy. Contrarily, the sources and processes which determine the variation of the projectile launch parameters are least understood. Though a reasonable qualitative understanding exists, quantitative relationships remain a problem. Unfortunately, a methodology correlating projectile and gun parameters with the projectile dynamics immediately after projectile release from the muzzle and satisfying the needs of quantitative analysis has not been developed yet. To remove this obstacle and to develop the required methodology for a quantitative simulation of projectile launch, BRL is pursuing a multi-pronged approach including both theory and experiment. The experimental program addresses both the validation of gun system accuracy models under development and the improvement of our diagnostic capability. One part focuses on the investigation of the disengagement mechanism of the projectile from the cannon. This includes the adaptation of available instrumentation and measurement techniques along with the development of new ones suitable for the measurement of the muzzle motion with the appropriate temporal and spatial resolution and without any interference to the projectile and gun dynamics. The muzzle dynamics is intrinsically connected to the projectile motion, i.e., muzzle aim, transverse velocity and angular rotation during shot exit are manifested in and reflect the projectile launch parameters.

Most of the instrumentation and measurement techniques for monitoring gun barrel motion are directly applicable to the measurement of the six degrees-of-freedom motion of the muzzle section of the gun barrel. A brief review of barrel motion measurement techniques is provided in Appendix A. Unfortunately, there are certain difficulties involved in selecting the appropriate measurement techniques and combining them into an instrumentation setup which allows the extraction of the six degrees-of-freedom motion of the muzzle with the required accuracy from the observables. For instance, the effect of longitudinal and radial stress waves produced in the tube by the

traveling projectile and combustion gas pressure as well as the abrupt decorking of the tube is largest at the muzzle end and manifests itself in the recoil motion of the muzzle as the projectile moves through it. We have observed short time reductions of the muzzle recoil velocity by more than one fourth from its value prior to shot exit. Therefore, the recoil motion must be measured directly at the muzzle and cannot be inferred from measurements at other locations. Also, because of the high frequency content of these stress waves, the use of piezoelectric accelerometers mounted on the outer surface of the cannon may not be expedient for the measurement of the axial and the transverse muzzle motion. Other instrumentation, such as the electrooptical or electromagnetic displacement sensors, must be employed which do not interfere with the projectile or the tube motion and are not affected by the radial vibrations of the tube and the precursor-blast environment. In addition, a time resolution on the order of microseconds or less and a spatial resolution on the order of microns are desirable to adequately describe projectile exit phenomenology.

The Schmidt displacement transducer (SDT) instrumentation and measurement technique recently developed at BRL for the determination of the projectile motion during shot exit [1][2][3][4] can also be applied to the measurement of the muzzle motion. This displacement transducer can provide data which, after the appropriate data analysis, allow the determination of five parameters of the six degrees-of-freedom motion of the muzzle. Only the rotation about the bore axis cannot be determined. The technique has been applied and checked in a recent experiment [5][6] and, subsequently, has been employed in a tank gun accuracy firing test to obtain the muzzle aim at shot exit.

This report contains a brief description of the SDT (Section 2.) and discusses the data analysis concept and procedure (Section 3.) which form the basis of the computer program (Section 4.). The data used for illustrating the analysis program are from the cited experiments.

## **2. SDT INSTRUMENTATION AND MEASUREMENT TECHNIQUE**

The Schmidt displacement transducer for monitoring transverse displacements (Figure 2.1) as well as its function are described in Reference [4]. As shown, the SDT consists of two pairs of semicircular inductors peripherally connected to an oscillator and concentrically arranged in a ring configuration, ninety degrees apart. This ring is placed concentric with and perpendicular to the tube axis at the desired measurement location, thus establishing an electromagnetic coupling between the active sensor and the conducting tube surface. The currents from each sensor pair are fed to a low-gain differential amplifier and its output is then amplified to a suitable level for recording. The polarity and magnitude of these currents are a direct measure of the direction and the magnitude of the closeness of the outer barrel surface to the two semicircular inductors and, when calibrated, yield the appropriate transverse displacement of the tube relative to the electromagnetic center of the SDT ring. Employing two or more SDT systems at the muzzle allows the pointing vector of the muzzle to be extracted from the displacements. The functional relationship between the measured voltages and the corresponding transverse displacements has been found to be:

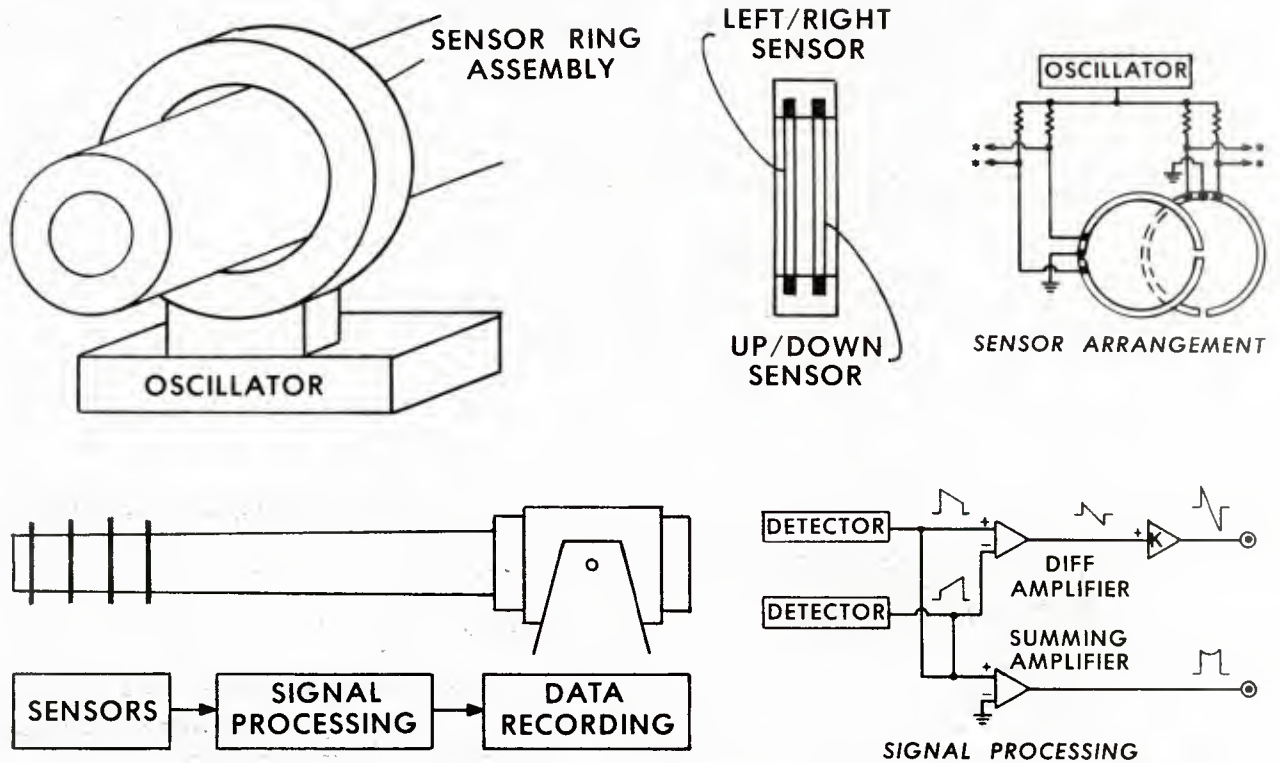

Figure 2.1. Sensor Arrangement And Block Diagram Of Electronic Circuit Of The SDT

$$x = \frac{V_x}{a_o \sqrt{1 + a_x V_x^2 + a_y V_y^2}}, \quad y = \frac{V_y}{b_o \sqrt{1 + b_x V_x^2 + b_y V_y^2}}, \quad (2.1)$$

where  $V_x$  and  $V_y$  denote voltage and  $x$  and  $y$  the corresponding displacements. The coefficients occurring in these relations will vary from setup to setup and must be determined prior to each firing experiment. Since the sensor rings are considerably lighter than the cannon, the calibration is best done by mounting the sensor ring on positioning devices and displacing the sensor with respect to the resting cannon.

The axial or  $z$ -component of the tube motion can also be obtained by employing the SDT technique. This, however, requires that the exterior cannon surface be modified. This is achieved by alternating spatially either the radius or the electric conductivity of the outer surface of the cannon. Though, in principle, the sum signal from the SDT system can be used directly for monitoring the translation in the  $z$ -direction, it is advisable to separate the measurement of the  $z$ -displacement from that of  $x$  and  $y$ . Two sensor designs in which unwanted contributions from the transverse and rotational

tube motion are sufficiently suppressed are practicable: one consisting of four individual sensor loops ninety degrees apart, aligned parallel with the tube axis with the four signals summed (Figure 2.2 (a)) and the other consisting of a single loop arranged concentrically around the tube (Figure 2.2 (b)). The relationship between the recorded voltage and the corresponding displacement is given by

$$z = z_{i+1} + \Delta z_i \left[ \frac{1}{2} + \frac{1}{\pi} \arcsin P_i(\zeta) \right],$$

$$\zeta = 2 \frac{V(t) - E_i}{E_{i+1} - E_i}, \quad V(t) \in (E_{i+1}, E_i], \quad (2.2)$$

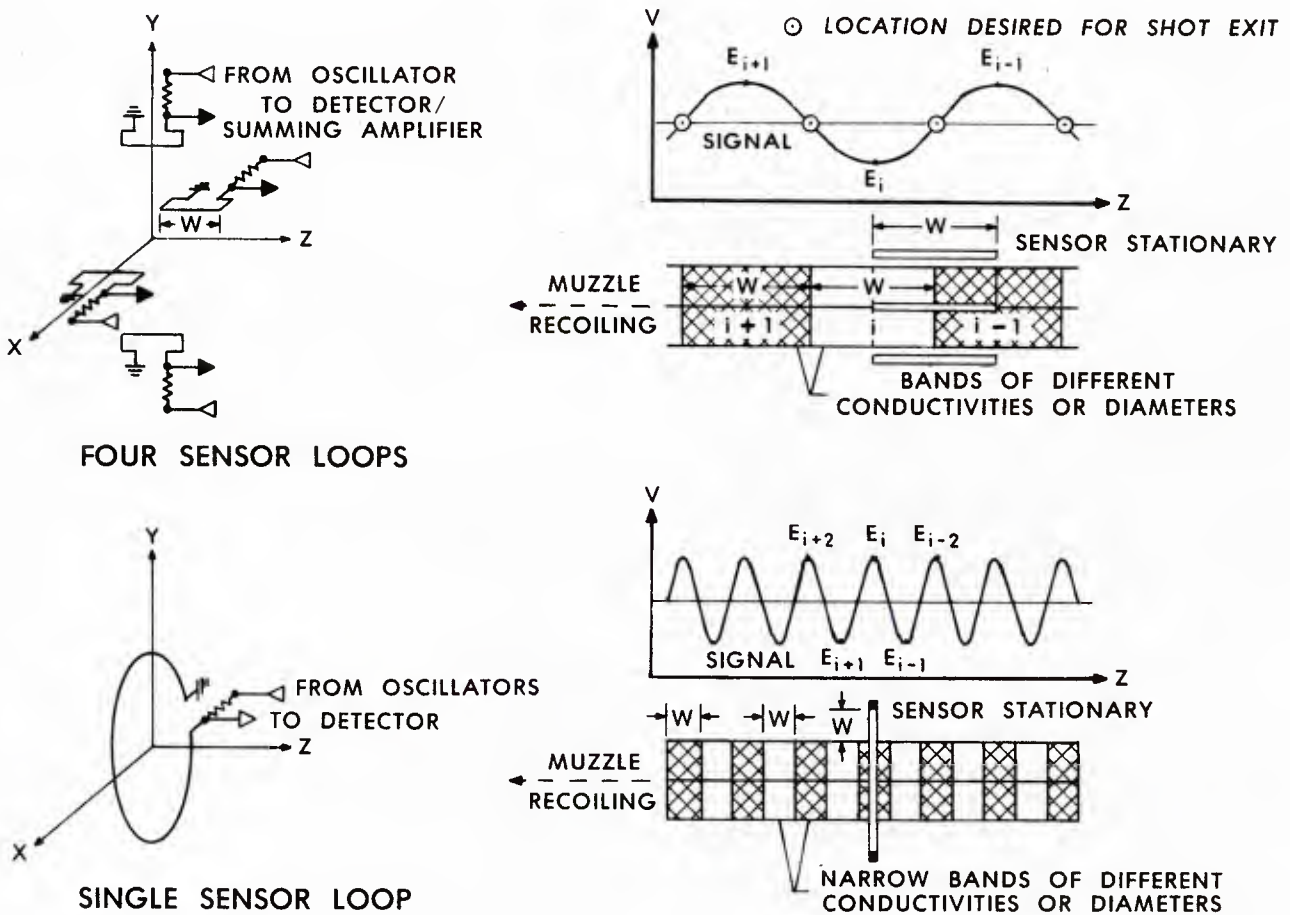

Figure 2.2. Sensor Arrangement And Signal-Displacement Correlation For The  $SDT_z$

where  $Z_{i+1}$  is the accumulated recoil displacement up to the extremum  $E_{i+1}$  and  $\Delta Z_i$  the distance between the extrema  $E_{i+1}$  and  $E_i$ . The coefficient of the polynomial  $P_i(\zeta)$  may vary from interval to interval and must be determined prior to the firing experiment. The width of the periodic bands,  $w$ , depends on the design and the accuracy requirement. For the four sensor loop design  $w$  should be a full or one-third sensor length and for the single sensor loop design  $w$  should be about the mean distance from the sensor ring to the cannon surface. From the analysis point of view, the highest accuracy and linearity should occur during shot exit. This requires that the initial location of the sensor at shot start be selected such that its location at shot exit is in the vicinity of  $\sin P(\zeta) = 0$  or, equivalently, the band edge should be close to the center plane of the sensor. Since radial tube expansion and contraction may slightly shift the signal level,  $w$  should be short enough to include the recording of the extrema enclosing the measurement interval of interest, thus allowing self-adjusting conversion of the signal.

Special care has to be taken in the mounting arrangement for the SDT rings in order that neither the muzzle blast nor the counterrecoiling muzzle will damage the instrumentation. In firing tests with tank guns it has been found that it is best to physically disconnect the sensor rings from the mounts after the projectile has left the muzzle and let them freely move with the recoiling gun<sup>\*)</sup>. For small caliber guns, this provision is not necessary.

### 3. DATA ANALYSIS CONCEPT AND PROCEDURE

As pointed out earlier, the desire for gun accuracy is the driving force behind most of our cannon motion measurements. These measurements must provide data which allow the correlation of target location, aiming point of muzzle after laying the gun (shot start), aiming point and transverse as well as angular velocity of muzzle at shot exit, initial free flight motion of projectile, and target impact location. The obtaining of appropriate muzzle motion-related parameters for direct fire weapons mounted on resting platforms is addressed here.

#### 3.1. Experimental Arrangement

It is presumed that the transverse displacements of the muzzle section of the cannon is monitored at  $m$  locations, where  $m$  is at least two, and the muzzle recoil at  $m'$  locations, where  $m'$  is at least one, with sensors which measure these displacements with respect to the ground (Figure 3.1). An  $m=3$  and  $m' = 2$  system is currently being developed at BRL, consisting of three transverse SDT units about three bore diameters apart and two axial single loop SDT units located in between to measure five of the six degrees-of-freedom. Only the rotation of the tube about its main axis is not obtainable. Though the data analysis is general, it has been developed with this particular case in mind.

---

\*) An upcoming BRL-MR by J.Q. Schmidt and T.L. Brosseau will describe a mounting arrangement for the SDT rings which was successfully employed in a recent tank gun accuracy experiment.

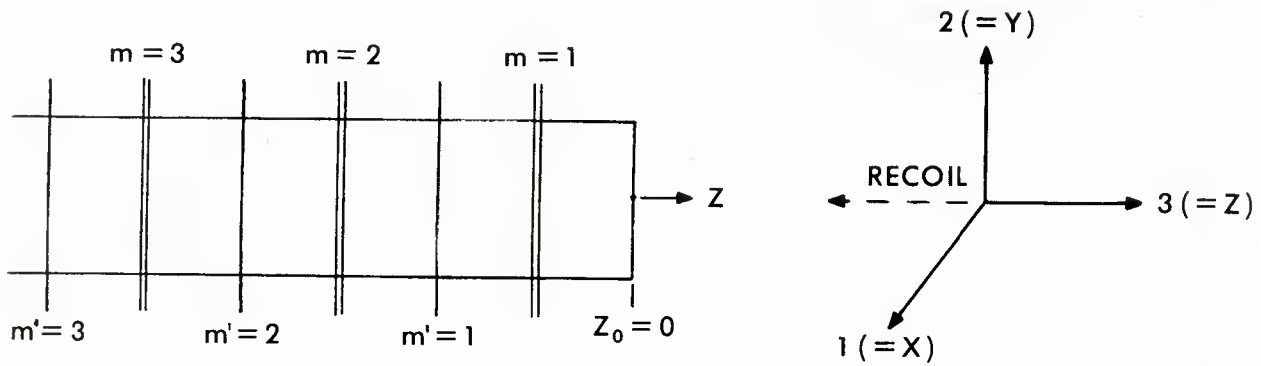

**Figure 3.1. Sensor Locations For Monitoring Muzzle Motion**

It is further assumed that the instrumentation is completely decoupled from the gun and its platform; i.e., work on the gun can be done without any disturbance of the sensors. The frame of reference provided by the array of sensors must stay the same from the time the gun is laid until the shot has left the muzzle. This requirement allows one to relate the position of the tube axis at the individual measurement locations to a reference line established prior to the actual firing and to calibrate the muzzle-pointing vector as obtained from the sensors to the aiming point established by bore sighting (Appendix B).

### 3.2. Analysis Procedure

It is presumed that the recorded signals have been converted into voltages by accounting for the appropriate calibration for the total instrumentation and recording chain and are arranged into time series with a common time basis,

$$\begin{aligned}
 V(v, \mu, \lambda), \quad v = 1,2, \quad \mu = 1,2, \dots, m, \quad \lambda = 1,2, \dots, \ell, \\
 V(3, \mu', \lambda), \quad \mu' = 1,2, \dots, m', \quad \lambda = 1,2, \dots, \ell,
 \end{aligned}
 \tag{3.1}$$

where  $\lambda$  is the index for the discrete time  $t = \lambda \Delta t$ ,  $\Delta t$  is the time increment, and  $\ell$  is the length of the available data window.

#### 3.2.1. Data Conversion

These voltages are then converted into displacements using the appropriate mapping correlation. For the transverse SDT signals we have, according to Eq. (2.1),

$$S(v, \mu, \lambda) = V(v, \mu, \lambda) / [C_{v0} \sqrt{1 + C_{v1} V(1, \mu, \lambda)^2 + C_{v2} Y(2, \mu, \lambda)^2} ] ,$$

$$S(v, \mu, \lambda) = S(v, \mu, \lambda) - S_0(v, \mu), \quad *)$$

(3.2)

$$v = 1, 2, \mu = 1, 2, \dots m, \lambda = 1, 2, \dots \ell ,$$

where  $S_0(v, \mu)$  is an alignment function as defined in Appendix B. The locations  $Z_0$  along the tube,  $Z(\mu) = Z(\mu, \lambda)$ , where these transverse displacements are recorded, move with the tube axially and are computable from the axial SDT signals. Their conversion into displacement, though more complex, is also straightforward if one follows the procedure sketched below.

$\forall \mu', \mu' \in [1, 2, \dots m]: \quad **)$

0 find the extrema of the time series  $V(3, \mu', \lambda)$ ,  $\lambda = 1, 2, \dots \ell$ , and their corresponding times

$$\hat{E}(\mu', j), \hat{\ell}(j) = \lambda_j, \quad j = 1, 2, \dots J_{\mu'}$$

0  $\forall j, j \in [1, 2, \dots J_{\mu'}]$ :

0 for  $j = 1$ :

identify the z-interval to which  $\hat{E}(\mu', 1)$  belongs  $\rightarrow i = i_{\mu'}$ ,

let  $\Delta E = E_i - E_{i+1}$ , where  $E_i - E_{i+1}$  is taken from calibration, and

set  $A = E(\mu', 1) - \Delta E$ ,  $Z_0 = 0$ ,  $\Lambda = 0$

0 let  $\Delta Z = Z_i - Z_{i+1}$ , where  $Z_i - Z_{i+1}$  is given by the calibration, and

set  $B = A$ ,  $A = E(\mu', j)$ ,  $\Lambda_0 = \Lambda + 1$ ,  $\Lambda = \hat{\ell}(j)$

0  $\forall \lambda, \lambda \in [\Lambda_0, \Lambda]$  :

let  $\zeta = 2[V(3, \mu', \lambda) - B] / [A - B] - 1$

and compute

$$S(3, \mu', \lambda) = Z_0 + \Delta Z [ 1/2 + \frac{1}{\pi} \arcsin P(\zeta) ]$$

-----  
\*) FORTRAN type substitution statements are used throughout.

\*\*\*) Special notation is being used where the symbols have the following meaning:  $\forall \dots$  for all and  $\epsilon \dots$  from the interval

- 0 if  $j=1$ : subtract  $S(3, \mu', 1)$  from the calculated displacements to equate the  $z$ -displacement at shot start to zero

$$\forall \lambda, \lambda \in [1, \hat{\lambda}(1)]: S(3, \mu', \lambda) = S(3, \mu', \lambda) - S(3, \mu', 1)$$

- 0 set  $Z_0 = S(3, \mu', \hat{\lambda}(j))$  and  $i=i-1$  to provide the initial displacement and identification for the next  $z$ -interval (3.3)

### 3.2.2. Modeling Of Muzzle Flexure

To develop the above mentioned data analysis algorithm which allows the extraction of five of the six degrees-of-freedom motion parameters from the time series, we have to make certain model assumptions.

The tube flexure near the muzzle end ( $z=0$ ) may be modelled as a polynomial of  $k$ -th order in  $z$ :

$$S(v, z, \lambda) = \sum_0^{\infty} C(\kappa, v, \lambda) z^{\kappa}, \quad v=1,2, \lambda=1,2,\dots,\ell . \quad (3.4)$$

For the end conditions for a free beam at  $z=0$  we may assume zero bending moment as well as zero shearing force. Thus,

$$[EIS''] \Big|_{z=0} = 0 \rightarrow S''(v, 0, \lambda) = 0, \text{ and} \quad (3.5)$$

$$[EIS'''] \Big|_{z=0} = 0 \rightarrow S'''(v, 0, \lambda) = 0, \quad (3.6)$$

where Eq. (3.5) is the expression for bending moment, Eq. (3.6) the expression for shearing force,  $E$  Young's modulus of elasticity and  $I = I(z)$  the moment of inertia. From that we have the requirement that

$$C(2, v, \lambda) = C(3, v, \lambda) = 0 \quad \text{and} \quad k \leq \mu+1 . \quad (3.7)$$

As the gun barrel recoils, the sensor locations with respect to the muzzle face will vary with the recoil as

$$z(\mu, \lambda) = z_0(\mu) + \int d\lambda \dot{z}(z, \lambda), \quad \mu = 1, 2, \dots, m, \quad (3.8)$$

where  $\dot{z}(z, \lambda)$  is the recoil velocity of the muzzle which is obtainable from the  $S(3, \mu', \lambda)$ ,  $\mu'=1, 2, \dots, m'$ . Because these recoil displacements are not



recorded at the locations  $z(\mu)$ ,  $\mu=1,2,\dots,m$ , and because the tube response to the travelling projectile and combustion gas pressure is large and transient at the muzzle, straightforward linear inter- or extrapolation may not be expedient, especially if the muzzle motion is to be determined with very high accuracy.

The recoil velocity at the locations  $z(\mu')$  may be computed by convoluting the time series  $S(3, \mu', \lambda)$  with an appropriate FIR (finite impulse response) differentiator  $D(\lambda')$  [7],

$$\dot{S}(\mu', \lambda) = \sum_{\lambda'} D(\lambda') S(3, \mu', \lambda - \lambda'), \quad \mu'=1,2,\dots,m', \quad \lambda=1,2,\dots,\ell. \quad (3.9)$$

This velocity history (Figure 3.2) consists of a trend describing the gross

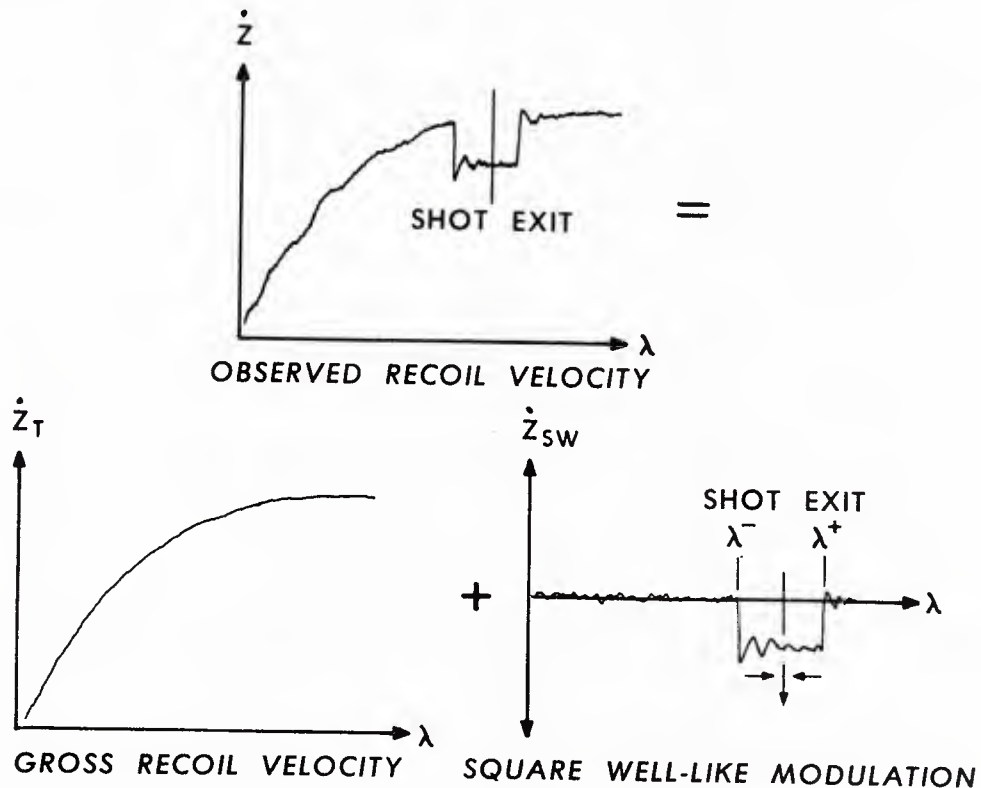

**Figure 3.2. Muzzle Recoil Velocity**

recoil motion of the tube at that particular location and a square well-like modulation derived from the transient in-bore loads. The arrows show the behavior of the well as the measurement location is moved towards the muzzle face: the width enveloping the shot exit time narrows and the depth increases. The left wall correlates to the passage of the rotating/driving band of the projectile travelling towards the muzzle and the right wall to a tube stress relaxation wave produced by the decorking of the pressurized tube and travelling from the muzzle back to the breech. To separate the gross

recoil velocity and the well-like modulation in the presence of noise, we may proceed in the following way:

$$0 \quad \forall \mu', \mu' \in [1, 2, \dots, m']:$$

- 0 Compute an upper and lower envelope of the data, their difference, and their maximal and mean values:

$$\Delta \dot{S}_{\max} = \overline{\Delta \dot{S}} = 0$$

$\forall \lambda, \lambda \in [\Delta\lambda+1, \dots, \ell-\Delta\lambda]$ , where  $2 \Delta\lambda+1$  is the arc length,

$$\dot{S}^+(\mu', \lambda) = \max\{\dot{S}(\mu', \lambda-\Delta\lambda), \dots, \dot{S}(\mu', \lambda+\Delta\lambda)\} \dots \text{upper bound ,}$$

$$\dot{S}^-(\mu', \lambda) = \min\{\dot{S}(\mu', \lambda-\Delta\lambda), \dots, \dot{S}(\mu', \lambda+\Delta\lambda)\} \dots \text{lower bound ,}$$

$$\Delta \dot{S}(\mu', \lambda) = \dot{S}^+(\mu', \lambda) - \dot{S}^-(\mu', \lambda) \dots \text{difference ,}$$

$$\Delta \dot{S}_{\max} = \max\{\Delta \dot{S}_{\max}, \Delta \dot{S}(\mu', \lambda)\} \dots \text{maximum , and}$$

$$\overline{\Delta \dot{S}} = \overline{\Delta \dot{S}} + \Delta \dot{S}(\mu', \lambda) ,$$

$$\overline{\Delta \dot{S}} = \overline{\Delta \dot{S}} / (\ell - 2\Delta\lambda) \dots \text{mean .}$$

The behavior of the resulting function is illustrated in Figure 3.3.

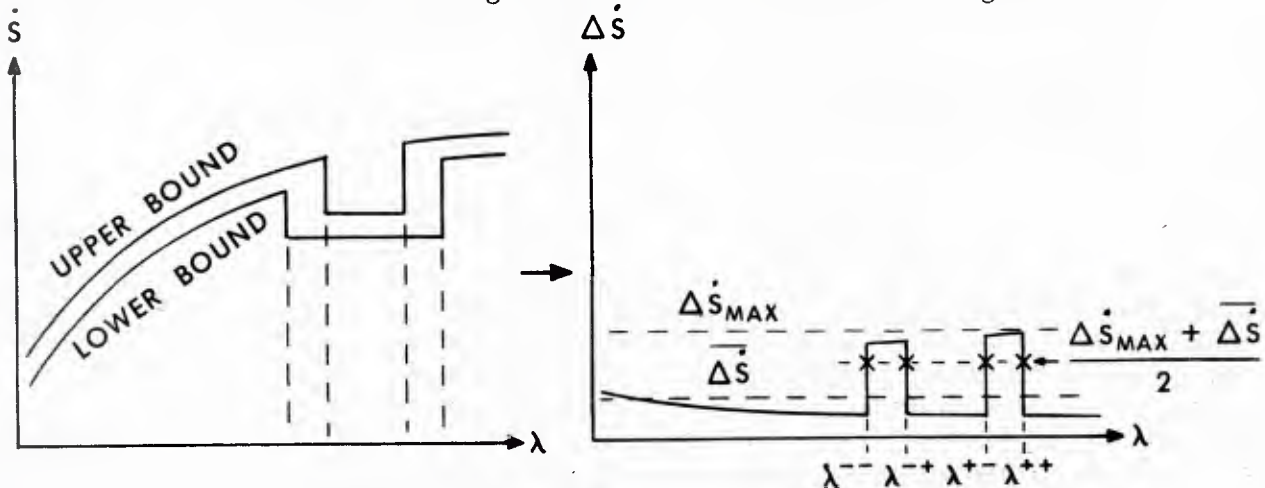

Figure 3.3. Determination Of Well Boundaries

- 0 Determine the times  $\lambda^{--}, \lambda^{-+}, \lambda^{+-},$  and  $\lambda^{++}$  at which the difference curve intersects the line  $\Delta\dot{S} = (\Delta\dot{S}_{\max} + \Delta\dot{S})/2$  and compute from them the time locations of the left and right well boundaries,  $\ell^-(\mu') = 1/2(\lambda^{--} + \lambda^{-+})$  and  $\ell^+(\mu') = 1/2(\lambda^{+-} + \lambda^{++})$ .
- 0 Using spline fitting or least squares (LSQ) technique, set forth a function (e.g., a sequence of cubic splines or a higher order polynomial) such that

$$f(\mu', \lambda) \stackrel{\text{LSQ}}{=} \{\dot{S}(\mu', \lambda)\} \text{ for } \lambda \leq \ell^-(\mu') \text{ and } \lambda \geq \ell^+(\mu'),$$

where  $f(\mu', \lambda)$  now describes the gross recoil velocity. Subtraction of this function from the data yields a time series which contains the leftover noise and the well-like modulation:

$$\Delta\dot{S}(\mu', \lambda) = \dot{S}(\mu', \lambda) - f(\mu', \lambda), \quad \lambda = 1, 2, \dots, \ell.$$

- 0 Using a LSQ procedure, the depth of the well can be obtained

$$g(\mu', \lambda) \stackrel{\text{LSQ}}{=}_{\text{def}} g_0 + g_1 \lambda \quad \{\Delta\dot{S}(\mu', \lambda)\}, \quad \lambda \in [\ell^-(\mu') + \delta\ell, \ell^+(\mu') - \delta\ell].$$

- 0 With that, the decomposition of the individual velocity signal into a gross recoil velocity and a time dependent well-like modulation is completed,

$$\dot{S}(\mu', \lambda) = f(\mu', \lambda) + e(\lambda - \ell^-(\mu'))e(\ell^+(\mu') - \lambda)g(\mu', \lambda) + n(\mu', \lambda),$$

where  $e(x) = 0$  for  $x < 0$  and  $e(x) = 1$  for  $x > 0$  and  $n(\mu', \lambda)$  is the remainder after subtracting the gross recoil velocity and the well from the data.

- 0 From these individual functions a new function describing the recoil motion of the muzzle relative to the instantaneous measurement location  $z(\mu'=1, \lambda)$  can be derived:

$$\dot{z}(\zeta, \lambda) = F(\zeta, \lambda) + e(\lambda - L^-(\zeta))e(L^+(\zeta) - \lambda)G(\zeta, \lambda), \text{ where}$$

$$F(\zeta, \lambda) = \text{def } \sum_0^{k'} f_{\kappa}(\lambda) \zeta^{\kappa} \stackrel{\text{LSQ}}{=} \{f(\mu', \lambda)\},$$

$$G(\zeta, \lambda) = \text{def} \sum_0^{k'} g_{\kappa}(\lambda) \zeta^{\kappa} \stackrel{\text{LSQ}}{=} \{g(\mu', \lambda)\},$$

$$L^{-}(\zeta) = \text{def} \sum_0^{k'} \ell_{\kappa}^{-} \zeta^{\kappa} \stackrel{\text{LSQ}}{=} \{\ell^{-}(\mu')\},$$

$$L^{+}(\zeta) = \text{def} \sum_0^{k'} \ell_{\kappa}^{+} \zeta^{\kappa} \stackrel{\text{LSQ}}{=} \{\ell^{+}(\mu')\},$$

$$\text{for } k' \leq (m'-1), \zeta = z - z(\mu'=1, \lambda) \text{ and } \zeta(\mu') = z_{\text{o}}(\mu') - z_{\text{o}}(1). \quad (3.10)$$

By continuously updating the location of the muzzle we can obtain the translation of this location relative to the resting frame of reference:

$$\zeta = z - z_{\text{o}}(1), \dot{\zeta} = \dot{z}(\zeta, 1) \dots \text{initial location and velocity with respect to } z_{\text{o}}(\mu'=1)$$

$\forall \lambda, \lambda \in [2, \dots, \ell]$ :

$$\begin{aligned} \zeta &= \zeta + \Delta \lambda \dot{\zeta} && \dots \text{updated location of } \zeta \\ \dot{\zeta} &= \dot{z}(\zeta, \lambda) && \dots \text{updated velocity of muzzle at } \zeta \\ z(\lambda) &= z_{\text{o}}(1) + \zeta && \dots \text{updated displacement of location } z \\ \dot{z}(\lambda) &= \dot{\zeta} && \dots \text{updated velocity of location } z \end{aligned} \quad (3.11)$$

Setting  $z = z_{\text{o}}(\mu)$ ,  $\mu=1, 2, \dots, m$ , provides the cannon recoil motion at the sensor locations which monitor the transverse muzzle displacements. Insertion of the appropriate quantities into Eq. (3.4) yields a set of algebraic equations,

$\forall v$  and  $\lambda$ ,  $v=1, 2$  and  $\lambda \in [1, 2, \dots, \ell]$ :

$$\begin{vmatrix} 1 & z(1, \lambda) & z^4(1, \lambda) \dots z^k(1, \lambda) \\ 1 & z(2, \lambda) & z^4(2, \lambda) \dots z^k(2, \lambda) \\ \dots & & \\ 1 & z(m, \lambda) & z^4(m, \lambda) \dots z^k(m, \lambda) \end{vmatrix} \cdot \begin{vmatrix} C(0, v, \lambda) \\ C(1, v, \lambda) \\ C(4, v, \lambda) \\ \dots \\ C(k, v, \lambda) \end{vmatrix} = \begin{vmatrix} S(v, 1, \lambda) \\ S(v, 2, \lambda) \\ \dots \\ S(v, m, \lambda) \end{vmatrix}, \quad (3.12)$$

from which the coefficients  $C(\kappa, v, \lambda)$ ,  $\kappa=0, 1, 4, \dots, k(\leq \mu+1)$ , can be computed either directly, if  $k=\mu+1$ , or via LSQ, if  $k < \mu+1$ .

### 3.2.3. Translation And Rotation Parameters

The translation of a point lying on the muzzle axis with respect to the ground frame of reference is

$$S(v, z, \lambda) = \sum_0^k C(\kappa, v, \lambda) z(\lambda)^\kappa, \quad v=1,2, \\ S(3, z, \lambda) = z(\lambda), \quad \lambda = 1, 2, \dots, \ell. \quad (3.13)$$

One can now obtain its linear transverse velocity by convoluting the time series with an appropriate FIR differentiator:

$$S(v, z, \lambda) = \frac{d}{d\lambda} S(v, z, \lambda) = \sum_{\lambda'} D(\lambda') S(v, z, \lambda - \lambda'), \quad v=1,2, \quad \lambda=1,2,\dots,\ell. \quad (3.14)$$

The linear axial velocity  $S(3, z, \lambda) = z(z, \lambda)$  is given by Eq. (3.11).

The slope of the muzzle at position  $z$  is given by

$$S'(v, z, \lambda) = \frac{d}{dz} S(v, z, \lambda) = \sum_0^k \kappa C(\kappa, v, \lambda) z(\lambda)^{\kappa-1}, \quad v=1,2, \quad \lambda=1,2,\dots,\ell. \quad (3.15)$$

From Eq. (3.15) and neglecting any rotation of the tube axis we can determine the axes of the moving coordinate system which is located at the axial location  $z$  (Figure 3.4) relative to the ground frame of reference

$$\begin{aligned} \vec{e}'_1(\lambda) &= \frac{1}{u} (1, 0, -s'_1), \\ \vec{e}'_2(\lambda) &= \frac{1}{uv} (-s'_1 s'_2, 1 + s'^2_1, -s'_2), \\ \vec{e}'_3(\lambda) &= \frac{1}{v} (s'_1, s'_2, 1), \quad \text{where} \\ u &= \sqrt{1 + s'^2_1}, \quad v = \sqrt{1 + s'^2_1 + s'^2_2}, \\ s'_1 &= S'(1, z, \lambda), \quad s'_2 = S'(2, z, \lambda), \quad \text{and} \\ \lambda &= 1, 2, \dots, \ell. \end{aligned} \quad (3.16)$$

The axis given by  $\vec{e}'_3$  may also be described by two successive rotations  $\theta$  and  $\phi$  relative to the reference axis. The expression for  $\theta$  and  $\phi$  in terms

of the instantaneous tube axes are

$$\theta(\lambda) = \arcsin \left[ \sqrt{e'_{31}{}^2 + e'_{32}{}^2} \sqrt{1 + e'_{31}{}^2 + e'_{32}{}^2} \right],$$

$$\phi(\lambda) = \arccos \left[ e'_{32} \sqrt{e'_{31}{}^2 + e'_{32}{}^2} \right],$$

where  $e'_{31} = e'_{31}(\lambda)$ ,  $e'_{32} = e'_{32}(\lambda)$ ,  $\lambda=1,2,\dots,l$ . (3.17)

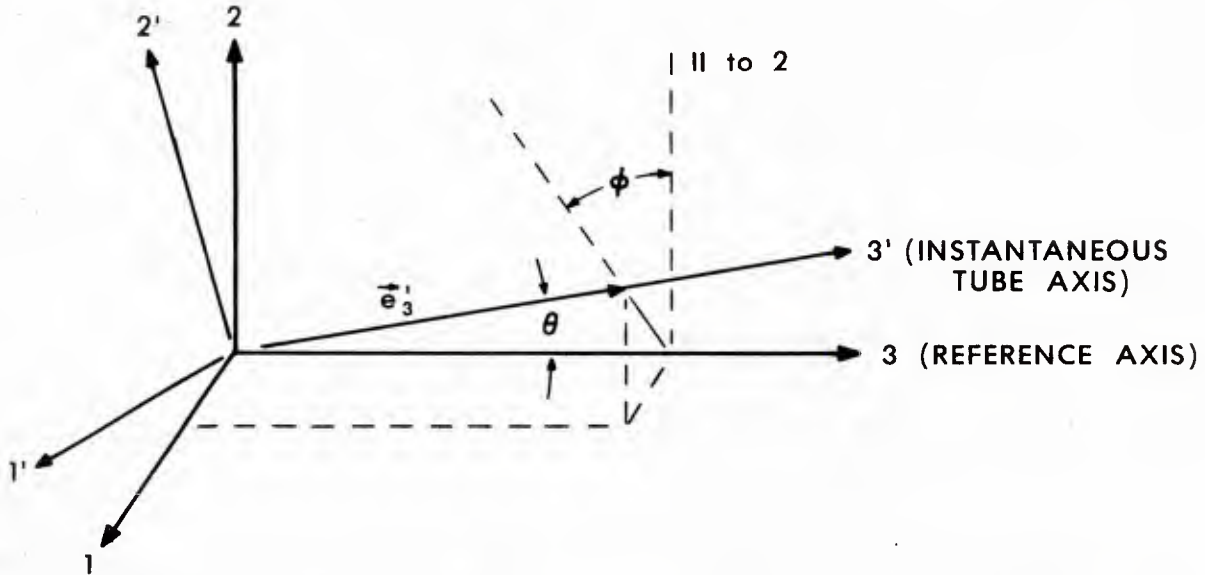

Figure 3.4. Rotation Of Tube Axis With Respect To Ground Reference System

The rate of change of  $\theta$  and  $\phi$  may be determined by numerical differentiation:

$$\dot{\theta}(\lambda) = \sum_{\lambda'} D(\lambda') \theta(\lambda - \lambda') \text{ and } \dot{\phi}(\lambda) = \sum_{\lambda'} D(\lambda') \phi(\lambda - \lambda'). \quad (3.18)$$

Having determined the translation and rotation of a coordinate frame centered on the muzzle axis we can express any vector given with respect to a moving coordinate system as a vector with respect to the ground frame of reference as

$$V(v, \lambda) = S(v, z, \lambda) + \sum_{\nu=1}^3 V^*(z; \nu', \lambda) e'_{\nu'} \quad , \quad \nu=1,2,3, \lambda=1,2,\dots,l. \quad (3.19)$$

It should be noted that the derived quantities depend on the initial gun curvature which is very seldom obtained experimentally. Equating  $S(v, \mu)$ ,  $\nu=1,2$  and  $\mu=1,2,\dots,m$ , in Eq. (3.2) to the mean value of the displacement time series before any motion occurs, the above equations describe the temporal change in the displacements with respect to the unknown initial tube flexure. Because of the free end conditions of the tube at the muzzle face the

equations will yield the correct motion at the muzzle end regardless of the downtube curvature before shot start.

#### 4. OUTLINE AND DESCRIPTION OF COMPUTER PROGRAMS

##### 4.1. General Description

The BRL CYBER computer system consists of three mainframes: mainframe A(MFA), which is a CYBER 750, mainly used for input/output, mainframe R(MFB), a CYBER 825, for computer graphics, and mainframe Z(MFZ), a CYBER 7600, for floating point computations. In addition, MFA and MFB share a common file space and both use the NOS operating system. MFZ, though, uses the SCOPE operating system. The commercial package DISSPLA [8] was chosen to generate the plots. Version 8.2 of DISSPLA is resident on all mainframes, while Version 9.0 is available only on MFA and MFB. Plots are available on a CALCOMP plotter or a printer attached to an interactive terminal (in this case, a TEKTRONIX 4695 printer interfaced to a Tektronix 4107 terminal). One computer program uses the International Mathematical and Statistical Library (IMSL) [9], which is also available on all mainframes.

The data analysis computer package consists of two programs, MUZMO40 and MUZPRED, both written in FORTRAN IV. The first program is a preprocessor and the second one does the actual computations. Program MUZMO40 inputs the raw data (in counts), converts the data into engineering units and then filters and/or differentiates the data. The input data are assumed to be on a data file. In our case, a Nicolet oscilloscope is interfaced with a Hewlett-Packard 9845C microcomputer which, in turn, communicates with the BRL CYBER computer system. The data are retrieved from the Nicolet disk, stored on the HP9845C disk, and then transferred to a file on MFA. This transfer is described in Reference [10]. The output data file from the first program is then used as an input to the second program.

Listings of the programs, the job control language (JCL) to run the programs, descriptions and formats for the input data and a sample case along with sample input and output are given in Appendices C and D.

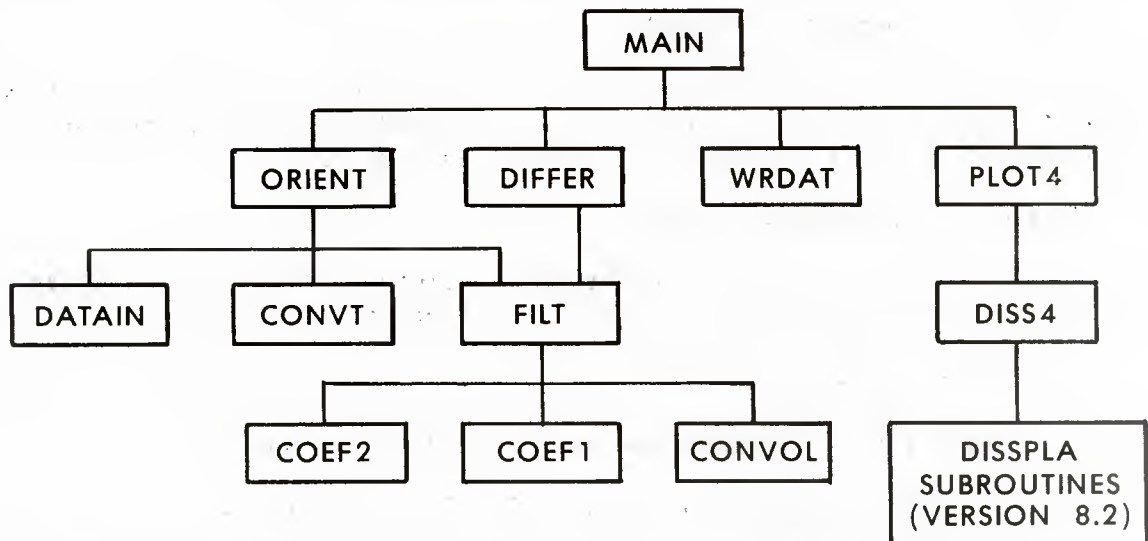

Figure 4.1. Flowchart For Program MUZMO40

## 4.2. Computer Program MUZMO40

The flowchart for MUZMO40 is shown in Figure 4.1. The main program calls the subroutines in proper sequence as determined by the input control variables: IPLT1, IPLT2, IPLT3, and IPRT. If the control variable equals 1, the operation is done; otherwise, not. IPLT1 controls the plotting of the displacements; IPLT2 controls the plotting of the velocities; IPLT3 controls the plotting of the accelerations; and IPRT controls the saving of the processed data for future use.

### 4.2.1. Subroutine COEF1

This subroutine inputs the coefficient array and other necessary parameters of a previously generated FIR lowpass or highpass filter.

### 4.2.2. Subroutine COEF2

This subroutine inputs the coefficient array and other necessary parameters of a previously generated FIR differentiator.

### 4.2.3. Subroutine CONVOL

This subroutine does a linear convolution of the NFILT coefficients with a data array of length NFILT. This process then proceeds in moving arc fashion along the entire data array. The convolutions at the endpoints are accounted for by reflection of the data at the endpoints. See the listing in Appendix C for more details.

### 4.2.4. Subroutine CONVT

This subroutine converts the displacement data from counts to voltages and then to engineering units (microns, in this case). The conversion is nonlinear as discussed previously in Section 2 and as expressed in Eq. (2.1). The data are also converted from microns to centimeters to conform with other test data.

### 4.2.5. Subroutine DATAIN

This subroutine inputs the data from a previously generated file into a dummy array. Under the control of subroutine ORIENT, the data are then transferred into the appropriate 3-dimensional array.

### 4.2.6. Subroutine DIFFER

This subroutine provides the control for the calculation of the first and second derivatives. The order of processing is:

- Displacement is inputted,
- Velocity is generated using an FIR differentiator,
- Velocity is smoothed using an FIR lowpass filter,
- Acceleration is generated using an FIR differentiator, and



- o Acceleration is smoothed using an FIR lowpass filter.

#### 4.2.7. Subroutine DISS4

This subroutine generates the plot, using DISSPLA (Version 8.2), and stores it on a file named PLFILE. This plot file can then be viewed and printed at the computer terminal and/or sent to the CALCOMP plotter.

#### 4.2.8. Subroutine FILT

This subroutine inputs the FIR coefficients and convolutes the data under the control of the variable ITYPE. If ITYPE=1, the data are lowpass or highpass filtered; if ITYPE=2, the data are differentiated. Note that the processed data are returned in the same array in which they were inputted.

#### 4.2.9. Subroutine ORIENT

This subroutine inputs the data related control parameters, reads NCH sets of data into the appropriate part of the 3-dimensional array DAT, converts the data into engineering units if ICVT  $\neq$  0, and lowpass filters the data if IFILT  $\neq$  0. If IDERIV = 1, displacement data are inputted and the velocities and accelerations are calculated; if IDERIV = 0, all three are inputted. For each data set, the parameters MIN, NIN, and IU are read in. MIN and NIN are indices which control the placement of the data set into the three-dimensional array, as in DAT(MIN,NIN,L), and IU indicates on which tape unit the data file resides.

#### 4.2.10. Subroutine PLOT4

This subroutine provides the control over what is plotted by subroutine DISS4. Also, the data must be put into 1-dimensional arrays to be plotted.

#### 4.2.11. Subroutine WRDAT

This subroutine writes all the data that have been processed onto a file on tape unit 18. This file is then saved and used as an input to the second program.

### 4.3. Computer Program MUZPRED

The flowchart for MUZPRED is shown in Figure 4.2. The main program inputs the control variables and then calls the subroutines. The control variables are: NCH which is the number of channels to be inputted (usually 6), NPLOTP, NPLOTTC and NPLOTU which contain the number of plots to be generated in subroutines PREDCT, CALCZ, and UNITV, respectively, and IPRINT which controls the writing of an output data file. A few other data related variables are inputted: LKEY, in particular, which is defined as the index in the input data array that corresponds to the time when the midpoint of the rotating band of the projectile passes sensor 1. When plots are generated, time is zeroed at the time of LKEY.

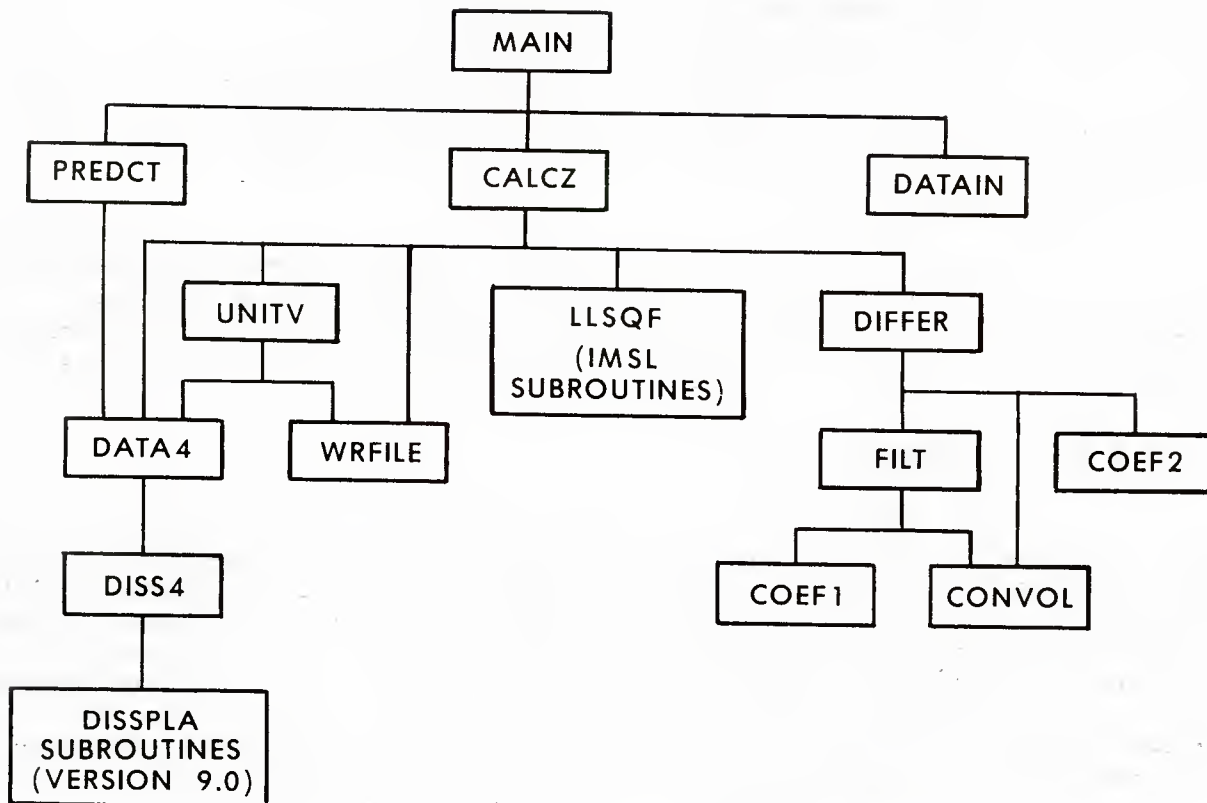

Figure 4.2. Flowchart For Program MUZPRED

#### 4.3.1. Subroutine CALCZ

The data base [5][6] on which the development of this analysis program relied did not contain muzzle recoil motion. Hence, the axial muzzle motion analysis based on the procedure outlined in Eqs. (3.10) to (3.12) was not incorporated into the computer programs. However, since this motion was obtained by an earlier experiment<sup>\*)</sup> using the same gun fixture, projectile type and propellant charge, a provision has been added to this subroutine to scale an externally supplied function for the muzzle recoil velocity to the projectile in-bore travel and gas pressure history. This function, a 5-th order polynomial, was generated by least squares model fitting of the average of three data sets. Its coefficients are read into array C. The times of beginning of recoil motion, LZM, maximum pressure, LPM, and shot exit, LEM, of this model function are inputted as well as the corresponding last two of the data set, LPD and LED. After proportionally scaling LZD, the scaled time

<sup>\*)</sup> Axial muzzle displacement data recorded about four calibers back of muzzle face with a two-dimensional displacement transducer (ZIMMER) were graciously supplied to BRL by Mr. T.O. Andrews, Royal Armament Research and Development Establishment, Fort Halstead, Kent, UK, March 1985.

series for the muzzle recoil velocity is computed by assigning the value zero to all time points when  $l < LZD$  and the value of LED to all time points when  $l > LED$ . The displacement array is then obtained by numerical integration of the velocity over time.

The distances of the sensors from the muzzle are read into a 3x2 array Z along with the reference distance ZREF. At each point in time a least squares fourth-degree polynomial, with the second- and third-degree coefficients set equal to zero, was fit to the data of all three sensors according to Eqs. (3.4) through (3.9). The horizontal and vertical fits are done separately and the results of each fit are evaluated at ZREF and saved in array DAT.

At this point the information in array DAT is:

DAT(1,1,L)	COEF(3) - horizontal,
DAT(1,2,L)	COEF(3) - vertical,
DAT(2,1,L)	displacement at ZREF - horizontal,
DAT(2,2,L)	displacement at ZREF - vertical,
DAT(3,1,L)	slope at ZREF - horizontal,
DAT(3,2,L)	slope at ZREF - vertical,
DAT(4,1,L)	COEF(1) - horizontal,
DAT(4,2,L)	COEF(1) - vertical,
DAT(5,1,L)	COEF(2) - horizontal,
DAT(5,2,L)	COEF(2) - vertical,
DAT(6,1,L)	recoil velocity, and
DAT(6,2,L)	recoil displacement.

Next, subroutine UNITV is called to calculate the unit vector at each discrete time, using the slopes. That procedure is described in Section 4.3.11. During this procedure, the arrays DAT(6,1,L) and DAT(6,2,L) are overwritten.

The displacement at ZREF is then differentiated to form the velocity, lowpass filtered and saved also in array DAT, overwriting DAT(3,1,L) and DAT(3,2,L). At this point the information in array DAT is:

DAT(1,1,L)	COEF(3) - horizontal,
DAT(1,2,L)	COEF(3) - vertical,
DAT(2,1,L)	displacement at ZREF - horizontal,
DAT(2,2,L)	displacement at ZREF - vertical,

DAT(3,1,L)	velocity at ZREF - horizontal,
DAT(3,2,L)	velocity at ZREF - vertical,
DAT(4,1,L)	COEF(1) - horizontal,
DAT(4,2,L)	COEF(1) - vertical,
DAT(5,1,L)	COEF(2) - horizontal,
DAT(5,2,L)	COEF(2) - vertical,
DAT(6,1,L)	$e'_{31}$ , and
DAT(6,2,L)	$e'_{32}$ .

The plots are then generated as specified by NPLOT and the arrays MDAT and NDAT. Any inputs required for plotting reside on a file on tape unit 7.

#### 4.3.2. Subroutine COEF1

This subroutine inputs the coefficient array and other necessary parameters of a previously generated FIR lowpass or highpass filter.

#### 4.3.3. Subroutine COEF2

This subroutine inputs the coefficient array and other necessary parameters of a previously generated FIR differentiator.

#### 4.3.4. Subroutine CONVOL

This subroutine does a linear convolution of the NFILT coefficients with a data array of length NFILT. This process then proceeds in moving arc fashion along the entire data array. The convolution at the endpoints are accounted for by reflection of the data at the endpoints. See the listing in Appendix C for more details.

#### 4.3.5. Subroutine DATAIN

This subroutine inputs the data from program MUZMO40 into a three-dimensional array as specified by variables M and N. The input data array dimension is 4100, but, because of central memory size limitations, the data-processing array DAT is restricted to 2500 points.

#### 4.3.6. Subroutine DATA4

This subroutine prepares the data arrays for plotting. Special provision is made to zero the data at the time LKEY mentioned in the main program; the abscissa is zeroed on the time plots and both abscissa and ordinate on the x-y plots.

#### 4.3.7. Subroutine DIFFER

This subroutine calls the subroutines required for differentiating if IUD  $\neq$  0 and then calls the ones required for lowpass or highpass filtering if IUF  $\neq$  0.

#### 4.3.8. Subroutine DISS4

This subroutine generates the plot, using DISSPLA (Version 9.0), and stores it on a local file named META. Up to three curves can be plotted and options are available for color, scales and labels. For more details see the subroutine listing.

#### 4.3.9. Subroutine FILT

This subroutine reads in the FIR lowpass or highpass filter coefficients and calls the subroutine CONVOL to convolute the data. Note that the processed data are returned in the same array in which they were inputted.

#### 4.3.10. Subroutine PREDCT

This subroutine does a straight line extrapolation from the data of sensors 2 and 3 to the position of sensor 1, the variables DZ31 and DZ32 being the distances from sensor 3 to sensor 1 and 2, respectively. The values of the prediction can then be compared with the ones of sensor 1; the magnitudes and phase angles of both data sets are calculated to aid in this comparison.

In the vicinity of LKEY the displacements are averaged over short time spans and their magnitudes and phase angles are calculated, stored, and printed.

At this point the information in array DAT is:

DAT(1,1,L)	sensor 1 displacement - horizontal,
DAT(1,2,L)	sensor 1 displacement - vertical,
DAT(2,1,L)	sensor 2 displacement - horizontal,
DAT(2,2,L)	sensor 2 displacement - vertical,
DAT(3,1,L)	sensor 3 displacement - horizontal,
DAT(3,2,L)	sensor 3 displacement - vertical,
DAT(4,1,L)	prediction displacement - horizontal,
DAT(4,2,L)	prediction displacement - vertical,
DAT(5,1,L)	prediction magnitude,
DAT(5,2,L)	prediction phase angle, degrees,

DAT(6,1,L)            sensor 1 magnitude, and  
 DAT(6,2,L)            sensor 1 phase angle, degrees.

NPLOTU plots are then generated with the input arrays MDAT and NDAT controlling what is plotted. Any inputs required for plotting reside on a file on tape unit 3.

#### 4.3.11. Subroutine UNITV

This subroutine calculates the translation and rotation parameters as described in Section 3.2.3, Eq. (3.16) in particular. The three-dimensional array DAT, at entry to the subroutine, contains the information as shown in subroutine CALCZ. The array is overwritten again in this subroutine as follows:

DAT(1,1,L)             $e'_{j3}$  , j = 1,2, or 3,  
 DAT(1,2,L)            (irrelevant),  
 DAT(2,1,L)            (irrelevant),  
 DAT(2,2,L)            (irrelevant),  
 DAT(3,1,L)            slope at ZREF-horizontal,  
 DAT(3,2,L)            slope at ZREF-vertical,  
 DAT(4,1,L)            (irrelevant),  
 DAT(4,2,L)            (irrelevant),  
 DAT(5,1,L)            (irrelevant),  
 DAT(5,2,L)            (irrelevant),  
 DAT(6,1,L)             $e'_{j1}$  , j = 1,2, or 3, and  
 DAT(6,2,L)             $e'_{j2}$  , j = 1,2, or 3.

NPLOTU plots are then generated as specified by the input arrays MDAT and NDAT. Any inputs required for plotting reside on a file on tape unit 10.

#### 4.3.12. Subroutine WRFILE

This subroutine takes data from a three-dimensional array and transfers all or part of one column into a one-dimensional array which is then written on an output file located on tape unit 9. This procedure is done NARR times and the columns to be written are chosen according to the input arrays MDAT and NDAT. LST and LSP are the starting and stopping indices, respectively, of the data to be written.

## 5. CONCLUSIONS

The methodology described in the report allows the exploitation of the SDT technology for the determination of the muzzle motion during the in-bore and launch motion of the projectile with a very high accuracy. The theoretical foundation is general. It contains all the equations and procedures necessary for the analysis of three-dimensional time series presenting the tube displacement in the longitudinal as well as in the horizontal and vertical directions from SDT type instrumentation at  $k$ -locations. This allows the determination of five of the six degrees-of-freedom parameters as a function of time for all points lying on the tube axis in the spatial measurement domain. Only the rotation about the longitudinal tube axis is not obtainable. For most gun accuracy related investigations however, the knowledge of this parameter is not required, since one is mainly interested in the transverse velocity and the aiming direction of the muzzle and in their temporal derivatives during shot exit.

Currently the computer program is explicitly set up for the analysis of transverse data collected at three locations at the muzzle end of the tube while allowing for the muzzle recoil. It can easily be extended, if necessary, to  $n > 3$  locations and to include determination of the axial muzzle motion from respective SDT data, employing the outlined theoretical formulation.

## REFERENCES

1. Schmidt, J.Q., "A Radio Frequency Oscillator Technique for Measuring Projectile Velocity," ARBRL-TR-02158, US Army Ballistic Research Laboratory, Aberdeen Proving Ground, MD., April 1979.
  2. Loder, R.K. and Schmidt, J.Q., "Radio Frequency Oscillator Technique for Monitoring Velocity and Structural Integrity of Projectiles During Their Exit from the Muzzle," ARBRL-MR-03100, US Army Ballistic Research Laboratory, Aberdeen Proving Ground, MD., April 1981.
  3. Loder, R.K., Schmidt, J.Q., and Wineholt, E.M., "Radio Frequency Oscillator Measurement for Monitoring Projectile Launch," Proceedings of the Sixth International Symposium on Ballistics, pp. 136-145, Orlando, FL., October 1981.
  4. Schmidt, J.Q., "A Radio Frequency Oscillator Technique for Measuring Projectile Transverse Displacement at Muzzle Exit," ARBRL-TR-02448, US Army Ballistic Research Laboratory, Aberdeen Proving Ground, MD., November 1982.
  5. Schmidt, J.Q. and Andrews, T.O., "Joint BRL-RARDE 40-mm Firing Experiment to Assess Projectile Launch Parameters Measurement Techniques," BRL-TR-2679, US Army Ballistic Research Laboratory, Aberdeen Proving Ground, MD., September 1985.
  6. Loder, R.K., Wineholt, E.M., Fancett, R.K., Dickens, J.D., Brown, P.J., and Vance, K.A., Results of the Joint BRL-RARDE 40-mm Firing Experiment to Define Projectile Launch, Paper presented at the Fourth US Army Symposium on Gun Dynamics, Riviera Beach, FL., May 1985.
  7. Rabiner, L.R. and Gold, B., Theory and Application of Digital Signal Processing, Prentice-Hall, Inc., Englewood Cliffs, N.J., 1975.
  8. Display Integrated Software System and Plotting Language (DISSPLA), Version 8.2, 1975, and Version 9.0, October, 1981, Integrated Software Systems Corporation, 10505 Sorrento Valley Rd, San Diego, CA 92121.
  9. IMSL Library Reference Manual, IMSL LIB-0008, June 1980, International and Statistical Libraries, Inc., GNB Building, 7500 Bellaire Boulevard, Houston, TX 77036.
  10. Henry, C.L., "Procedures for the Transfer of Data Files between the BRL CYBER Computer System and the IBD Hewlett-Packard Minicomputer Network," ARBRL-MR-03298, US Army Ballistic Research Laboratory, Aberdeen Proving Ground, MD., August 1983.
- A-1 Gay, H.P., "Displacement-Time Recorder," BRL-R-610, USA Ballistic Research Laboratory, Aberdeen Proving Ground, MD, 1946.
- A-2 Stearns, B.K. and Walker, R.C., "Measurement of Gun Barrel Motion with Optical Trackers", Proceedings of the Second U.S. Army Symposium on Gun Dynamics, pp. 11-117, Rensselaerville, NY, September 1978.



## REFERENCES (continued)

- A-3 Baran, A.F. and Haug, B.T., "Muzzle Motion Measurement of the 30mm, L21E1 RARDEN Gun Mounted in a Sheridan Vehicle as Compared with Rigid Mount Tests," ARBRL-MR-03182, USA Ballistic Research Laboratory, Aberdeen Proving Ground, MD, 1982.
- A-4 Haug, B.T., "Measuring Displacement of Gun System Components by the Use of OPTRON Optical Trackers," ARBRL-MR-03331, USA Ballistic Research Laboratory, Aberdeen Proving Ground, MD, 1984.
- A-5 Warken, D., Preparatory Gun Barrel Vibration Measurements for Comparison of Theory and Experiment, Workshop on Projectile-Gun Dynamics under the Auspices of DEA-G-1060, USA Ballistic Research Laboratory, Aberdeen Proving Ground, MD., April 1979.
- A-6 Biele, J.K., Lateral Motion of a 105mm Smoothbore Tank Cannon, Workshop on Projectile Gun Dynamics under the Auspices of DEA-G-1060, USA Ballistic Research Laboratory, Aberdeen Proving Ground, MD, April 1979.
- A-7 Andrew, T.O., private communication, Royal Armament Research and Development Establishment, Fort Halstead, Sevenoaks, Kent, UK, October 1984.
- A-8 Brown, P.J., "Trial On 40mm Gun At RARDE," HEL Document TP25193, HE/SHOCK/36, Hunting Engineering Ltd., Reddings Wood, Ampthill, Bedford, UK, 1980.
- A-9 Schmidt, J.Q. and Andrews, T.O., "Description of the Joint BRL-RARDE 40mm Firing Experiment To Define Projectile Launch," Proceedings of the Fourth US Army Symposium on Gun Dynamics, pp IIII-III31, Riviera Beach, FL, May 1985.
- A-10 Gay, H.P. and Elder, A.S., "The Lateral Motion of a Tank Gun and its Effect on the Accuracy of Fire," BRL-R-1070, USA Ballistic Research Laboratory, Aberdeen Proving Ground, MD, March 1959.
- A-11 Haug, B.T., "Optical Device For Determining Small Angular Motion," BRL-MR-2601, USA Ballistic Research Laboratory, Aberdeen Proving Ground, MD, March 1976.
- A-12 Blakney, R.H., "Muzzle Deflection Measurement System," ARBRL-CR-00376, USA Ballistic Research Laboratory, Aberdeen Proving Ground, MD, 1978.
- A-13 Blakney, R.H., "Measurement of Angular Muzzle Motion on a 105mm Tank Gun during Firing," Proceedings of the Second US Army Symposium on Gun Dynamics, pp II8-I33, Rensselaerville, NY, September 1978.
- A-14 Nordstroem, S. and Eglund, C.E., An Electrooptical Device for Measuring the Motions of the Muzzle of Artillery Weapons, 29-th Meeting of the Aeroballistic Range Association, Kyoto, Japan, April 1978.

## REFERENCES (continued)

- A-15 Bulman, D.N. and Foley, P., A Device for Measuring the Transverse Motion of a Gun Barrel, Technical Note AM 91, Royal Military College of Science, Shrivenham, UK, 1980.
- A-16 Cox, P.A. and Hokanson, J.C., "The Influence of Tube Support Conditions on Muzzle Motions," Proceedings of the Third US Army Symposium on Gun Dynamics, pp IV41-IV64, Rensselaerville, NY, May 1982.
- A-17 Simkins, T.E., Scanlon, R.D. and Benedict, R., "Transverse Motion of an Elastically Supported 30mm Gun Tube during Firing," Proceedings of the Third US Army Symposium on Gun Dynamics, pp I72-I95, Rensselaerville, NY, May 1982.
- A-18 Loder, R.K., "On In-Bore Microwave Interferometry," Proceedings of the Sixth International Symposium on Ballistics, pp 439-450, Orlando, FL, October 1981.
- A-19 Warken, D., Holographische Untersuchungen zur Aufweitung eines Woffenrohres waerend des Schusses, Report 8/75, Ernst Mach Institut-Abteilung fuer Ballistik, Weil/Rhein, FRG.
- A-20 Warken, D., "Application of Coherent Optical Techniques for the Analysis of Gun Tube Vibrations and Deformation," Proceedings of the Third International Symposium on Ballistics, Karlsruhe, FRG, March 1977.
- A-21 Isbell, W.M., et. al., Behavior of Porous Beryllium under Thermodynamical Loading, Report UCRL51682 Pt. 1, Lawrence Livermore Laboratory, December 1977.
- A-22 Barker, L.M. and Hollenbach, R.E., "Laser Interferometer for Measuring High Velocities of Any Reflecting Surface," J. Appl. Physics 43, pp 4669-4675, 1972.
- A-23 Isbell, W.M., TRANSAR, a New Laser Interferometer for Measurement of Transverse Motion in Dynamic Experiments, ATA Assoc. Report 78-23, Applied Technology Associates, Santa Barbara, CA., 1978.
- A-24 Isbell, W.M., Advances in Laser Interferometry for Measurement of Dynamic Material Properties and Gun Dynamics, Interior Ballistics Division Seminar, USA Ballistic Research Laboratory, Aberdeen Proving Ground, MD., July 1982.
- A-25 Soifer, M.T. and Becker, R.S., "Dynamics Simulation Model of the 75mm ADMAG Gun System," Proceedings of the Third US Army Symposium on Gun Dynamics, pp I48-I71, Rensselaerville, NY, May 1982.
- A-26 Loder, R.K., On The M392A2 Projectile-M68 Tank Cannon Interface, Presentation at the Second US Army Symposium on Gun Dynamics, Rensselaerville, NY, September 1978.

### REFERENCES (continued)

- A-27 Pilcher, J.O., Henry, C.L. and Murray, R.B., "Application of Accelerometers for the Measurement of Gun Tube Motion," Proceedings of the First Conference on Gun Dynamics (Dynamics of Precision Gun Weapons), pp 497-513, Rock Island, IL, January 1977.
- A-28 Bulman, D.N., The Use of Accelerometers for the Measurement of Gun Barrel Transverse Motion, Preliminary Report, The Royal Military College of Science, Applied Mechanics Branch, Shrivenham, UK, October 1980.
- B-1 "US Army Test and Evaluation Command Test Operation Procedure "Measurements of Cannon," DRSTE-RP-702-102, TOP 3-2-802 (AD #A031780), US Army Aberdeen Proving Ground (STEAP-MT-M), Aberdeen Proving Ground, MD, August 1976.

**APPENDIX A**

**BRIEF REVIEW OF CANNON MOTION MEASUREMENT TECHNIQUES**

## APPENDIX A

### BRIEF REVIEW OF CANNON MOTION MEASUREMENT TECHNIQUES

#### A.1 Introduction

Various instrumentation and measurement techniques are available to monitor the gun tube motion during the in-bore travel and launch of a projectile. Most methods are based on the utilization of streak photography, electrooptical displacement transducers, optical levers, electromagnetic proximity transducers, interferometry, electromechanical devices, strain gauges, accelerometers, etc. The authors, not being aware of any publication containing a review of experimental methods for measuring tube motion, felt compelled for reasons of completeness to provide a very brief description of the above mentioned methods with some references to applications.

#### A.2. Streak Photography

Streak photography [A-1] is probably one of the best photographic techniques for recording the motion history of a vibrating tube. In this instrumentation, the image formed by a small reflector bonded to the surface is recorded on film by a moving-film, shutterless camera in the form of a continuous, wavy line against a contrasting background. This time-displacement record can be evaluated with an accuracy of the order of  $10^{-3}$  cm and a time resolution of about 1 msec. Due to the extra labor and time involved in processing the optical data this technique is relatively costly over techniques which utilize electronic recording.

#### A.3. Electrooptical Displacement Transducers

Electrooptical displacement transducer instrumentation combines the advantage of optics and electronic recording by incorporating an optical system in an electronic circuit. Two different arrangements are described here.

The first one employs a light-dark discontinuity on the cannon surface which is imaged by a lens system onto a photocathode which converts the optical image into an electron beam. This beam, in turn, is imaged via an electromagnetic field onto the center of a small aperture and thereafter amplified by an electron multiplier. The resulting current is used as a servo loop control for the electromagnetic field generator. The correcting current, necessary to keep the electron image centered on the aperture, is recorded as a measure of target deflection. Displacement range and resolution are a function of the focal length of the lens system and its distance from the target. In the US, one-dimensional electrooptical transducers manufactured by Optron, a Division of Universal Technology Inc., of Woodbridge, Connecticut have been successfully employed for measuring gun dynamics [A-2][A-3][A-4]. In Western Europe two-dimensional electrooptical transducers manufactured by Zimmer OHG, Darmstadt, FRG, are employed for the same purpose [A-5][A-6][A-7] and as a standard for calibrating other less expensive instrumentation for measuring tube motion.

In the second arrangement, a collimated light beam passes over a knife edge and partially illuminates a large area light-sensitive photodiode through

a narrow slit. The knife edge, e.g., a razor blade, is mounted to the gun tube, parallel to the tube axis and perpendicular to the light beam, and is positioned such that it partially blocks the light beam passing through the slit. For instance, if the knife edge is arranged horizontally in the vertical plane of the tube axis, any vertical tube motion will move the edge up or down and regulate the light striking the sensor. The detected signal is then amplified and recorded. The signal change is directly proportional to the gun tube displacement in the vertical direction. By using two light sources and corresponding sensors positioned orthogonally, both the horizontal and vertical components of the tube motion can be measured [A-8][A-9].

#### **A.4. Optical Lever Instrumentation**

Optical lever instrumentation is ideally suited for monitoring local angular deflection of gun tubes [A-10]. It has recently been integrated with electronic recording [A-11] and applied to the measurement of the muzzle-pointing direction [A-12][A-13][A-14]. In this measurement technique a collimated light beam is incident on and reflected by a mirror rigidly attached to the gun tube and imaged via a lens system onto a two-dimensional, position-sensing photodetector. As the gun tube changes its curvature, the mirror rotates with it, thereby changing the direction of the reflected light beam and, thus, the location of the light spot on the photodetector. The x and y components of the induced photocurrent are recorded as a function of time and converted into a displacement history with respect to the electric center of the sensor. Superposition of the geometry of the optical lever setup yields the local angular deflection history. This type of instrumentation is employed in muzzle reference systems for tank guns.

#### **A.5. Electromagnetic Proximity Transducers**

Electromagnetic proximity transducers are increasingly being used for measuring tube displacements [A-15][A-16][A-17]. Most operate on the eddy current principle: a varying electromagnetic field, usually in the radio frequency range, is generated by an oscillator and radiated from its active inductance coil/antenna to a proximate surface location or protrusion of the tube. Eddy currents are induced in the metallic surface and generate an electromagnetic field which then couples back into the active inductance coil. As the surface vibrates, the recoupling to the inductance coil changes, which, in turn, causes a change in the oscillator impedance and, thus, a modulation in the oscillator current frequency and/or current amplitude. This modulation is recorded as a function of time and transferred into a displacement history. Inductive proximity probes which can readily be adapted to the measurement of gun dynamics are commercially available.

The Schmidt displacement transducer (SDT) described in this report is a proximity transducer, which integrates over the tube perimeter, thus suppressing contributions from local vibrations and yielding a large signal-to-noise ratio.

#### **A.6. Interferometric Measurement Techniques**

Interferometric measurement using laser as well as microwave techniques can also be used to record certain dynamic parameters of tube motion. In this technique a monochromatic coherent electromagnetic wave is divided by a beam

splitter into two parts which travel different paths and recombine to form interference fringes. If one of the beams is reflected by a moving object, which in our case is the tube surface, well-defined maxima and minima in the fringe intensity are produced and recorded either photographically or electrically. MW interferometry represents a convenient tool to monitor the axial recoil motion history of guns at the breech as well as at the muzzle. Using an appropriate experimental setup, the latter event can even be obtained together with projectile travel from in-bore MW interferometry [A-18]. In the visible spectrum, D. Warken [A-19][A-20] pioneered the application of holographic interferometry and laser speckle photography for the investigation of the spatial displacement field of local tube surfaces in clearly defined time intervals. Though the experimental arrangement for providing a time sequence of holograms or speckle photographs may be quite cumbersome to set up and the recorded information difficult to analyze, these optical methods are well suited for the detailed investigation of the displacement field of those locations on the gun surface which have inhomogeneities in geometry or in material properties. For typical gun tube vibration measurements however, they are too complex and too detailed. On the contrary, laser interferometry with electronic recording is very attractive for the temporal measurement of local tube motion. A multitude of interferometer configurations have been developed to meet numerous experimental requirements. Three of them, generally identified by the acronyms DISAR [A-21], VISAR [A-22] and TRANSAR [A-23], should easily be adaptable for the measurement of gun motion [A-24]. The first is basically a Michelson interferometer in which the light source is a high-powered laser and the target a diffuse scatterer. The backscattered light is collected by a telescope and brought to interference with the unscattered reference beam. In the second configuration, essentially a laser Doppler velocimeter, the backscattered light is again collected and collimated by a lens system and is divided into two beams. After sending one beam around an optical delay leg it is recombined with the undelayed beam. The interference fringe history thus formed is proportional to the velocity change of the reflecting surface. In the third configuration, the TRANSAR, the backscattered light is collected at two different directions, usually in a diagonally opposite setup, via telescopes and optically heterodyned to yield the temporal displacement/velocity of the scattering surface location orthogonal to the direction of the incident beam and in the plane formed by the direction in which the scattering is observed.

#### **A.7. Electromechanical Devices**

A recent innovation of an electromechanical device is the "tuning fork" transducer developed by S&D Dynamics [A-25]. In this measurement technique, a cylindrical section of the cannon is sandwiched between two prongs of a tuning fork-like mechanical device with its stem rigidly attached to a nonmovable mass. As the tube moves towards one of the prongs, it forces the prongs to move with it, which, in turn, causes a bending of the stem. This deformation is then picked up by strain gauges mounted on the stem and recorded.

#### **A.8. Strain Gauge Instrumentation**

Strain gauge instrumentation usually employs a matrix of temperature-compensating strain transducers appropriately aligned and mounted on the outer surface of the cannon to measure local tube strains [A-6][A-26]. Each strain gauge forms an active leg in a Wheatstone bridge. The strain contribution to

tube bending, however, must be separated analytically from that produced by the gas pressure, the gun recoil, and the dynamic contact of the projectile with the bore surface during projectile in-bore travel and launch, before it can be translated into tube curvature.

#### **A.9. Accelerometer Instrumentation**

The accelerometer instrumentation as customarily employed [A-17][A-26][A-27][A-28] uses piezoelectric accelerometers which are bonded to the outer surface of the cannon in a matrix arrangement to record local tube accelerations. Because of the unfortunate susceptibility of piezoelectric transducers to high frequency shocks which can produce temporary step function like zero shifts in the signals, their application for monitoring cannon vibration is limited.



**APPENDIX B**

**ESTABLISHMENT OF CANNON FLEXURE WITH RESPECT TO BORE SIGHT REFERENCE LINE  
PRIOR TO SHOT START**

## APPENDIX B

### ESTABLISHMENT OF CANNON FLEXURE WITH RESPECT TO BORE SIGHT REFERENCE LINE PRIOR TO SHOT START

There are a few gun-related observables which should or must be determined just prior to the commencement of fire. They represent the initial values of gun flexure and aiming point. If their determination is simultaneously done with the measurement of the tube displacements, we can establish a frame of reference where these three sets of observables are correlated. Hence, it is presumed that a muzzle/tube displacement measurement arrangement as described in Section 3.1 is an integral part of the overall measurement setup and is used to monitor the tube flexure during the establishment of the aiming point and the initial tube curvature.

#### B.1. Gun Aiming Point/System Frame Of Reference

In many gun accuracy-related investigations, we are interested in the relationship between the projectile impact and the initial aiming point of the gun. Restricting the discussion to direct fire weapons, we can employ a boresight or an alignment telescope for the establishment of the aiming point or points on the target. Because of the simplicity of the measurement, the intersection of the line of sight given by a boresight placed into the muzzle or breech section of the cannon with the target witness board is habitually used as the reference point. However, any other section of the bore may be used for establishing the line of aim. For example, the line of sight which passes through the center of the breech and the center of the muzzle is also employed as a line of aim as reference.

In the following we assume that the line of aim is established by a boresight placed into the muzzle and presents the mean of many measurements in which the boresight has systematically been rotated and, if necessary, reseat. By statistically averaging the observations, we can practically eliminate gun locality and human related bias. At the same time the aiming points are recorded, we may also record the muzzle displacements and calculate from their averages the location and the slope of the muzzle. These expressions are respectively,

$$S_A(v) = S(v, z=0, \bar{\lambda}), \quad v=1,2 \quad \text{and} \quad \vec{e}'_{Ai} = \vec{e}'_i(\bar{\lambda}), \quad i=1,2,3, \quad (\text{B.1})$$

using the algorithm described in Section 3.2. Because of the free beam condition at the muzzle face, the muzzle end is basically a rigid hollow cylinder. This allows us to postulate a frame of reference which has its origin at  $(S_A(1), S_A(2), 0)$  and its third axis pointed to the aim point. It has to be noted that this line of aim is not the actual one at shot start, since it has been established with the additional weight of the boresight in the muzzle. If the boresight is removed, the tube flexure will readjust itself to a new slightly different stress equilibrium, thereby changing its muzzle shape. However, with the system frame of reference defined, any change in the muzzle motion can be expressed relative to it.

## B.2. Bore Straightness/Axis

Generally, gun tubes are not straight. Reasons for this include residual stresses, variation in wall thickness, machining accuracy and tolerances, eccentricity of rifling, storage position, environment, etc. Also large thermal distortion can be induced by solar irradiation. The sun-exposed side of the cannon will warm up and expand with respect to the shadowed part. This produces, in addition to the natural crookedness and the gravitational droop, a curvature in the cannon with its center of curvature lying in the shadowed plane, thus bending the muzzle away from the sun. Hence, it is important to measure the initial conditions of the tube bending immediately prior to the commencement of fire for gun accuracy, diagnostic, and model simulation purposes.

Up till now tube straightness or bend has been measured with an alignment telescope and an illuminated bull's-eye target which is moved through the tube [B-1]. The telescope is placed on an adjustable mount near the muzzle or breech of the tube and adjusted so that the line of sight passes through the center of the bore at the commencement of the rifling or forcing cone and the muzzle. The deviations from the line of sight are measured at various positions along the tube axis in both horizontal and vertical directions with an accuracy of about .025mm by means of micrometer attachments on the telescope. This cumbersome optical measurement technique is amenable to automatization by introducing a laser beam as line of reference, replacing the bull's eye target by a two-dimensional electrooptical position sensor, mechanizing the push or pull of the target carriage through the bore, and digitally recording the beam location as a function of the axial displacement of the target. Such a device has recently been introduced by Watervliet Arsenal to measure the tube curvature during and after manufacturing. The target carriage is centered in the bore by mechanical springs which limits the accuracy of the measurement. Because gun dynamics model simulations strongly indicate that muzzle motion at shot exit is very sensitive to the tube bend at shot start, the inaccuracy introduced by the mechanical alignment mechanism of the target carriage with the bore center must be reduced as much as possible.

For smoothbore guns, this can be done with relative ease by mounting a SDT system into the outer surface of the probe concentric and coplanar with the photodiode and recording the respective signals concurrently as a function of the axial displacement. The SDT instrumentation provides the location of the geometric center of the bore relative to the probe center and the position sensor gives the location of the reference laser beams with respect to the probe center. By introducing a parallel plate which is mounted on a motor-driven, computer-controlled goniometric cradle or rotational displacement device into the light path, we can displace the light beam in the plane of rotation in a controlled way. By letting the parallel plate oscillate about its zero position normal to the beam and recording the beam location at the zero transition and the extreme displacements, we even can account for any rotational movement of the probe about the axis and uniquely correlate the bore axis relative to the reference coordinate system given by the laser beam arrangement (Figure B.1). This measurement will yield the geometric center of the bore,  $\sigma$ , with regard to the reference beam and as a function of the axial position  $\zeta$ :

$$\vec{\sigma}(\zeta) = (\xi, \eta, \zeta) . \quad (B.2)$$

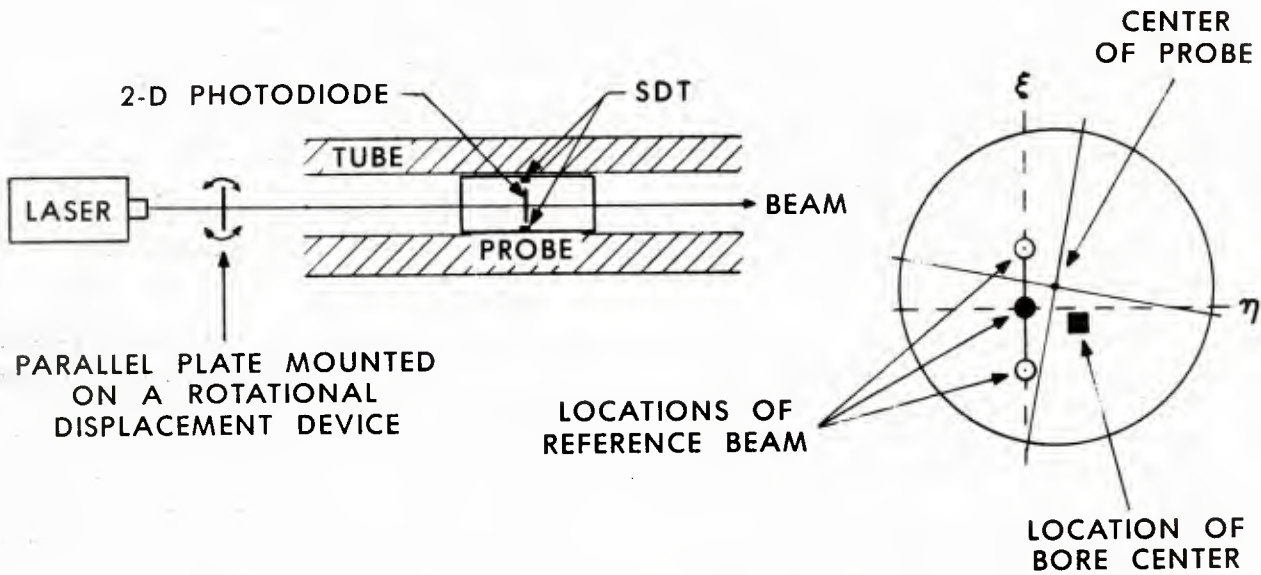

Figure B.1. Accurate Measurement Of Bore Curvature Prior To Shot Start

Measuring the tube flexure at the same time yields

$$S^*(v, z, \zeta) , \quad v=1,2, \quad (B.3)$$

where  $z$  and  $\zeta$  are the locations of the SDT instrumentation and the probe, respectively. We can calibrate the tube axis as defined by the individual SDT measurements to the bore axis as

$$S^*(v, z, \zeta) = S^*(v, z, z) - [S^*(v, z, z) - \sigma_v(z)], \quad v=1,2. \quad (B.4)$$

If we align the laser reference beam collinear with the line of aim we can avoid minute translation and rotation in correlating the two reference systems and can define the alignment function  $S_o(v, \mu)$  appearing in Eq. (3.2) as

$$S_o(v, \mu) = S^*(v, z_\mu, z_\mu) - \sigma_v(z_\mu) , \quad v=1,2, \quad \mu=1,2,\dots,m . \quad (B.5)$$

**APPENDIX C**  
**COMPUTER PROGRAMS**

APPENDIX C

COMPUTER PROGRAMS

C.1. Program MUZMO40

C.1.1. Listing Of Job Control Language Of MFA File MUZMO40/UN=BOOTS

BOOTS,STMFZ,P5,T50,MS300000.  
ACCOUNT,PDXXX.  
REQUEST,PLFILE,\*PF.  
REQUEST,TAPE7,\*PF.  
REQUEST,TAPE18,\*PF.  
ATTACH,DISSPLA,ID=DISSPLA.  
ATTACH,COMPRS,ID=DISSPLA.  
LIBRARY,\*,DISSPLA,COMPRS.  
FTN,LCM=I,L=0.  
BEGIN,GETMFAU,FILE,LF=TAPE1,PF=BR0512A,UN=BOOTS.  
BEGIN,GETMFAU,FILE,LF=TAPE2,PF=BR0511A,UN=BOOTS.  
BEGIN,GETMFAU,FILE,LF=TAPE8,PF=BR0509A,UN=BOOTS.  
BEGIN,GETMFAU,FILE,LF=TAPE9,PF=BR0508A,UN=BOOTS.  
BEGIN,GETMFAU,FILE,LF=TAPE10,PF=BR0510A,UN=BOOTS.  
BEGIN,GETMFAU,FILE,LF=TAPE11,PF=BR0507A,UN=BOOTS.  
BEGIN,GETMFAU,FILE,LF=TAPE4,PF=DIFF1,UN=BOOTS.  
BEGIN,GETMFAU,FILE,LF=TAPE17,PF=LPF62,UN=BOOTS.  
MAP,OFF.  
LGO.  
BEGIN,SAVMFAU,FILE,LF=TAPE18,PF=DVA05U,UN=BOOTS.

APPENDIX C

C.1.2. Listing Of FORTRAN Program

```

1          PROGRAM MUZZLE(INPUT,OUTPUT,TAPE5=INPUT,TAPE6=OUTPUT,TAPE1,TAPE17
*          ,PLFILE,TAPE2,TAPE3,TAPE4,TAPE7,TAPE8,TAPE9,TAPE10,TAPE11,TAPE18)
C
C          ANALYSIS OF MUZZLE MOTION DATA - PROGRAM 1
5          C
          COMMON/I/MIN(6),NIN(6),NTS(24),NCH,IDERIV,IFILT,NPT,LDEL
*          ,NLSQ,LABEL(10),LABL(3,2,24),LCNT(2,7)
          REAL LDEL
          COMMON DUM(1),
10         * X(5000),Y1(5000),Y2(5000),Y3(5000),Y4(5000),Y5(5000),Y6(5000)
          COMMON/LEV1/DTIME,CT(3,2),CT1(3,2),CT2(3,2),CT3(3,2),CVT(3,6)
*          ,TSTART,ZZ(3,2)
          COMMON/LEV2C/DAT(3,2,5000),DATD(3,2,5000),DATDD(3,2,5000)
          LEVEL 2,DAT,DATD,DATDD
15         LABEL(1)=10H BOOTS
          LABEL(2)=10HBLDG.390
          LABEL(3)=10HX 6121
          LABEL(4)=10HMUZZLE
          CALL COMPRS
20         CALL SETDEV(0,6)
          READ(5,2)IPLT1,IPLT2,IPLT3,IPRT
          WRITE(6,1)IPLT1,IPLT2,IPLT3,IPRT
          CALL ORIENT
          IF(IPLT1.EQ.1)CALL PLOT4(DAT)
25         IF(IDERIV.EQ.0)GO TO 100
          CALL DIFFER
          IF(IPLT2.EQ.1)CALL PLOT4(DATD)
          IF(IPLT3.EQ.1)CALL PLOT4(DATDD)
100        IF(IPRT.EQ.1)CALL WRDAT
30         CALL DONEPL
          STOP
          1 FORMAT(1H1,' IPLT1 =',I3,' IPLT2 =',I3,' IPLT3 =',I3,' IPRT =',I3)
          2 FORMAT(10I3)
          END

```

```

1          SUBROUTINE COEF1(NFILT,H,IU)
C
C          READS IN COEFFICIENTS OF AN FIR LOWPASS OR HIGHPASS FILTER
C
5          DIMENSION H(512)
          READ(IU)NFILT,FP,TBWID,DP,DS
          IF(ISW.NE.1)WRITE(6,1)
          IF(ISW.NE.1)WRITE(6,2)NFILT,FP,TBWID,DP,DS
          N=(NFILT+1)/2
10         READ(IU)(H(I),I=1,N)
          IF(ISW.NE.1)WRITE(6,3)
          IF(ISW.EQ.1)GO TO 200
          DO 100 I=1,N,5
          IST=I+4
15         IF(IST.GT.N)IST=N
          WRITE(6,4)I,(H(II),II=I,IST)
100        CONTINUE
          WRITE(6,5)
200       ISW=1
20         RETURN
          1  FORMAT(//,' FILTER PARAMETERS,')
          2  FORMAT(5X,' NFILT = ',I5,' FP = ',F10.5,' TBWID = ',F10.5,
* ' DP = ',F10.5,' DS = ',F10.5)
          3  FORMAT(5X,' FILTER COEFFICIENTS')
25         4  FORMAT(5X,I5,5E15.8)
          5  FORMAT(//)
          END

```



```
1          SUBROUTINE COEF2(NFILT,H,IU,JTYPE)
C
C          READ IN COEFFICIENTS OF AN FIR DIFFERENTIATOR
C
5          DIMENSION H(64),EDGE(20),FX(10),WTX(10)
          IF(ISW.NE.1)WRITE(6,1)
          READ(IU)NFILT,JTYPE,NBANDS
          IF(ISW.NE.1)WRITE(6,2)NFILT,JTYPE,NBANDS
          JB=2*NBANDS
10         READ(IU)(EDGE(J),J=1,JB)
          IF(ISW.NE.1)WRITE(6,5)(EDGE(J),J=1,JB)
          READ(IU)(FX(J),J=1,NBANDS)
          IF(ISW.NE.1)WRITE(6,6)(FX(J),J=1,NBANDS)
          READ(IU)(WTX(J),J=1,NBANDS)
15         IF(ISW.NE.1)WRITE(6,7)(WTX(J),J=1,NBANDS)
          READ(IU)(H(J),J=1,64)
          IF(ISW.NE.1)WRITE(6,3)
          IF(ISW.EQ.1)GO TO 200
          N=NFILT/2+1
20         DO 100 I=1,N,5
          IST=I+4
          IF(IST.GT.N)IST=N
          WRITE(6,4)I,(H(II),II=I,IST)
100        CONTINUE
25         WRITE(6,8)
200        ISW=1
          RETURN
          1  FORMAT(//,' FILTER PARAMETERS')
          2  FORMAT(5X,' NFILT = ',I5,' JTYPE = ',I5,' NBANDS = ',I5)
30         3  FORMAT(5X,' FILTER COEFFICIENTS')
          4  FORMAT(5X,I5,5E15.8)
          5  FORMAT(5X,' EDGE ',20F6.4)
          6  FORMAT(5X,' FX ',10F6.2)
          7  FORMAT(5X,' WTX ',10F7.1)
35         8  FORMAT(//)
          END
```

```

1          SUBROUTINE CONVOL(H,X,NDIM,NFILT,JTYPE)
C
C          THIS CONVOLUTION IS VALID ONLY FOR NFILT = ODD INTEGER
C          NFILT MAX. SET TO 1023 - CAN BE RESET BE REDIMENSIONING ARRAYS
5          C          IF JTYPE = 1, EVEN SYMMETRY ASSUMED FOR REFLECTION AT ENDPOINTS
C          C          IF JTYPE = 2, ODD SYMMETRY ASSUMED FOR REFLECTION AT ENDPOINTS
C
C          DIMENSION H(512),X(NDIM),S(1030),T(1030)
C          IF(JTYPE.EQ.1)SGN=1.
10         IF(JTYPE.EQ.2)SGN=-1.
C          IF(JTYPE.EQ.1)A=0.
C          IF(JTYPE.EQ.2)A=2.
C          IF(JTYPE.LT.1.OR.JTYPE.GT.2)WRITE(6,1)
C          IF(JTYPE.LT.1.OR.JTYPE.GT.2)STOP
15         L=NFILT-1
C          NCOEF=NFILT/2+1
C          J=NCOEF
C          K=J-1
C          DO 10 I=1,NCOEF
20         S(I)=SGN*X(NCOEF-I+1)+A*X(1)
C          S(NFILT-I+1)=X(J)
C          T(NCOEF+I-1)=SGN*X(NDIM-I+1)+A*X(NDIM)
C          J=J-1
10        CONTINUE
25         DO 40 I=1,NDIM
C          X(I)=.0
C          DO 20 J=1,K
C          X(I)=X(I)+H(J)*(SGN*S(J)+S(NFILT-J+1))
20        CONTINUE
30         X(I)=X(I)+H(NCOEF)*S(NCOEF)
C          IF(I.EQ.NDIM)GO TO 50
C          DO 30 J=1,L
C          S(J)=S(J+1)
30        CONTINUE
35         IF(I.LE.NDIM-NCOEF)S(NFILT)=X(I+NCOEF)
C          IF(I.GT.NDIM-NCOEF)S(NFILT)=T(I+NFILT-NDIM+1)
40        CONTINUE
50        RETURN
1         FORMAT(' ERROR IN SUB CONVOL - JTYPE NOT EQUAL TO 1 OR 2')
40        END

```

```

1          SUBROUTINE CONV(T,M,N,ISW)
      C
      C          CONVERSION OF DATA (IN COUNTS) TO DISPLACEMENTS
      C
5          COMMON/I/MIN(6),NIN(6),NTS(24),NCH,IDERIV,IFILT,NPT,LDEL
      *      ,NLSQ,LABEL(10),LABL(3,2,24),LCNT(2,7)
      REAL LDEL
      COMMON/LEV1/DTIME,CT(3,2),CT1(3,2),CT2(3,2),CT3(3,2),CVT(3,6)
      *      ,TSTART,ZZ(3,2)
10         COMMON/LEV2C/DAT(3,2,5000),DATD(3,2,5000),DATDD(3,2,5000)
      LEVEL 2,DAT,DATD,DATDD
      ISW=ISW+1
      J=N
      IF(M.EQ.1.AND.N.EQ.2)J=4
15         WRITE(6,1)M,N,CT(M,N),CVT(M,J)
      DO 100 L=1,NPT
      DAT(M,N,L)=DAT(M,N,L)*CT(M,N)
      IF(M.EQ.1)GO TO 100
      DAT(M,N,L)=DAT(M,N,L)*CVT(M,N)
20         100 CONTINUE
      C
      C          CHANGE MICRONS TO CENTIMETERS
      C
25         DO 150 L=1,NPT
      DAT(M,N,L)=DAT(M,N,L)*1.E-4
150        CONTINUE
      C
30         IF(M.GT.1)GO TO 300
      IF(MOD(ISW,2).NE.0)GO TO 300
      DO 200 L=1,NPT
      SQ1=SQRT(1.+CVT(1,2)*DAT(M,1,L)**2+CVT(1,3)*DAT(M,2,L)**2)
      SQ2=SQRT(1.+CVT(1,5)*DAT(M,1,L)**2+CVT(1,6)*DAT(M,2,L)**2)
      DAT(M,1,L)=CVT(1,1)*DAT(M,1,L)/SQ1
      DAT(M,2,L)=CVT(1,4)*DAT(M,2,L)/SQ2
35         200 CONTINUE
      300 RETURN
      1  FORMAT(2I3,2F10.5)
      END

```

1  
5  
10  
15  
20

C  
C  
C

```
SUBROUTINE DATAIN(M,N,Z,IU)
INPUT EXPERIMENTAL DATA
COMMON/I/MIN(6),NIN(6),NTS(24),NCH,IDERIV,IFILT,NPT,LDEL
* ,NLSQ,LABEL(10),LABL(3,2,24),LCNT(2,7)
REAL LDEL
COMMON/LEV1/DTIME,CT(3,2),CT1(3,2),CT2(3,2),CT3(3,2),CVT(3,6)
* ,TSTART,ZZ(3,2)
DIMENSION Z(5000)
LEVEL 2,Z
READ(IU)NTS
DO 50 I=1,24
LABL(M,N,I)=NTS(I)
50 CONTINUE
WRITE(6,3)M,N,(LABL(M,N,I),I=1,24)
READ(IU)NPT
READ(IU)TSTART,DTIME
WRITE(6,2)NPT,TSTART,DTIME
READ(IU)(Z(I),I=1,NPT)
RETURN
2 FORMAT(I10,2F10.5)
3 FORMAT(1X,2I2,1X,24A2)
END
```

```

1          SUBROUTINE DIFFER
          C
          C          CALC FIRST AND SECOND DERIVATIVES
          C
5          COMMON/I/MIN(6),NIN(6),NTS(24),NCH,IDERIV,IFILT,NPT,LDEL
          * ,NLSQ,LABEL(10),LABL(3,2,24),LCNT(2,7)
          REAL LDEL
          COMMON/LEV1/DTIME,CT(3,2),CT1(3,2),CT2(3,2),CT3(3,2),CVT(3,6)
          * ,TSTART,ZZ(3,2)
10         COMMON/LEV2C/DAT(3,2,5000),DATD(3,2,5000),DATDD(3,2,5000)
          LEVEL 2,DAT,DATD,DATDD
          DO 500 I=1,NCH
          M=MIN(I)
          N=NIN(I)
15         DO 100 J=1,NPT
          DATD(M,N,J)=DAT(M,N,J)
100        CONTINUE
          ITYPE=2
          CALL FILT(DATD,M,N,NPT,ITYPE)
20         DO 150 J=1,NPT
          DATD(M,N,J)=DATD(M,N,J)/DTIME
150        CONTINUE
          WRITE(6,1)(LABL(M,N,J),J=1,24)
          ITYPE=1
25         CALL FILT(DATD,M,N,NPT,ITYPE)
          WRITE(6,2)(LABL(M,N,J),J=1,24)
          DO 200 J=1,NPT
          DATDD(M,N,J)=DATD(M,N,J)
200        CONTINUE
          ITYPE=2
30         CALL FILT(DATDD,M,N,NPT,ITYPE)
          DO 250 J=1,NPT
          DATDD(M,N,J)=DATDD(M,N,J)/DTIME
250        CONTINUE
          WRITE(6,1)(LABL(M,N,J),J=1,24)
35         ITYPE=1
          CALL FILT(DATDD,M,N,NPT,ITYPE)
          WRITE(6,2)(LABL(M,N,J),J=1,24)
          500 CONTINUE

```

40

```
RETURN  
1  FORMAT(' CHANNEL ',24A2,' HAS BEEN DIFFERENTIATED')  
2  FORMAT(' CHANNEL ',24A2,' HAS BEEN FILTERED')  
END
```

48

```

1      SUBROUTINE DISS4(X,Y1,Y2,Y3,NPT,LABEL,X4,Y4,N4)
      C
      C
      C
5      DIMENSION LABEL(10),X(NPT),Y1(NPT),Y2(NPT),Y3(NPT),X4(N4),Y4(N4)
      XORIG=X(1)
      XSTP='SCALE'
      XMAX=X(NPT)
      YORIG=1.E100
10     YSTP='SCALE'
      YMAX=-1.E100
      DO 200 I=1,NPT
      IF(Y1(I).LT.YMAX)GO TO 100
      YMAX=Y1(I)
15     100 IF(Y1(I).GT.YORIG)GO TO 200
      YORIG=Y1(I)
200    CONTINUE
      IF(YORIG.EQ.YMAX)YMAX=YMAX+.01
      WRITE(6,1)NPT,XORIG,XMAX,YORIG,YMAX
20     1  FORMAT(I5,4E15.5)
      CALL HEIGHT(.28)
      J=J+1
      CALL BGNPL(J)
      CALL PHYSOR(1.,1.)
25     CALL XINTAX
      CALL SETCLR('BLACK')
      CALL TITLE(LABEL(7),-11,'L',1,'',5,9.,6.5)
      CALL GRAF(XORIG,XSTP,XMAX,YORIG,YSTP,YMAX)
      IMARK=0
30     CALL SETCLR('BLUE')
      CALL CURVE(X,Y1,NPT,IMARK)
      CALL SETCLR('RED')
      CALL DASH
      IF(Y2(1).NE.1.E100)CALL CURVE(X,Y2,NPT,IMARK)
35     CALL RESET('DASH')
      CALL SETCLR('GREEN')
      CALL DOT
      IF(Y3(1).NE.1.E100)CALL CURVE(X,Y3,NPT,IMARK)
      CALL RESET('DOT')

```

49

40

```
IMARK=-1  
CALL SETCLR('RED')  
IF(N4.GT.0)CALL CURVE(X4,Y4,N4,IMARK)  
CALL ENDPL(J)  
RETURN  
END
```

45

50



```

1          SUBROUTINE FILT(Z,M,N,NPT,ITYPE)
C
C          INPUTS FIR COEFFICIENTS AND CONVOLVES THE DATA
C          ITYPE = 1 - COEFFICIENTS ARE FOR A LOWPASS OR A HIGHPASS FILTER
5          2 - COEFFICIENTS ARE FOR A DIFFERENTIATOR
C
          DIMENSION Z(3,2,5000),X(5000),H(512)
          LEVEL 2,Z
          PI2=6.283185307179865
10         DO 100 I=1,NPT
           X(I)=Z(M,N,I)
100        CONTINUE
           IF(ITYPE.EQ.1)GO TO 150
           JTYP=2
15         IU=4
           CALL COEF2(NFILT,H,IU,JTYP)
           DO 120 I=1,NFILT
           H(I)=H(I)*PI2
120        CONTINUE
           REWIND IU
           GO TO 200
150        JTYP=1
           IU=17
           CALL COEF1(NFILT,H,IU)
25         REWIND IU
200        CALL CONVOL(H,X,NPT,NFILT,JTYP)
           DO 300 I=1,NPT
           Z(M,N,I)=X(I)
300        CONTINUE
30         RETURN
          END

```

1

SUBROUTINE ORIENT

C  
C  
C  
C  
C  
C

READ CONTROL PARAMETERS  
READ DATA INTO APPROPRIATE ARRAYS  
CONVERT DATA, IF DESIRED  
FILTER DATA, IF DESIRED

5

COMMON/I/MIN(6),NIN(6),NTS(24),NCH,IDERIV,IFILT,NPT,LDEL  
\* ,NLSQ,LABEL(10),LABL(3,2,24),LCNT(2,7)  
REAL LDEL  
COMMON/LEV1/DTIME,CT(3,2),CT1(3,2),CT2(3,2),CT3(3,2),CVT(3,6)  
\* ,TSTART,ZZ(3,2)  
COMMON/LEV2C/DAT(3,2,5000),DATD(3,2,5000),DATDD(3,2,5000)  
LEVEL 2,DAT,DATD,DATDD  
COMMON/LEV2D/Z(5000)  
LEVEL 2,Z  
READ(5,1)NCH,ICVT,IFILT,IDERIV  
WRITE(6,6)NCH,ICVT,IFILT,IDERIV  
IF(IDERIV.EQ.0)JL=3  
IF(IDERIV.EQ.1)JL=1  
WRITE(6,5)  
DO 150 J=1,JL  
DO 100 I=1,NCH  
READ(5,1)MIN(I),NIN(I),IU  
WRITE(6,1)MIN(I),NIN(I),IU  
M=MIN(I)  
N=NIN(I)  
CALL DATAIN(M,N,Z,IU)  
IF(J.EQ.2)GO TO 70  
IF(J.EQ.3)GO TO 90  
DO 60 K=1,NPT  
DAT(M,N,K)=Z(K)  
60 CONTINUE  
GO TO 100  
35 70 DO 80 K=1,NPT  
DATD(M,N,K)=Z(K)  
80 CONTINUE  
GO TO 100  
90 DO 95 K=1,NPT

10

15

52

20

25

30

35

```
40      DATDD(M,N,K)=Z(K)
95      CONTINUE
100     CONTINUE
150     CONTINUE
      IF(ICVT.EQ.0)GO TO 325
45     WRITE(6,7)
      READ(5,3)(CVT(1,J),J=1,6)
      WRITE(6,3)(CVT(1,J),J=1,6)
      READ(5,3)(CVT(2,J),J=1,2)
      WRITE(6,3)(CVT(2,J),J=1,2)
50     READ(5,3)(CVT(3,J),J=1,2)
      WRITE(6,3)(CVT(3,J),J=1,2)
      DO 300 I=1,3
      DO 300 J=1,2
      READ(5,2)M,N,CT1(M,N),CT2(M,N),CT3(M,N)
55     CT(M,N)=CT1(M,N)/CT2(M,N)/CT3(M,N)
      WRITE(6,2)M,N,CT1(M,N),CT2(M,N),CT3(M,N),CT(M,N)
300     CONTINUE
325     ISW=0
      DO 400 I=1,NCH
60     M=MIN(I)
      N=NIN(I)
      IF(ICVT.EQ.0)GO TO 350
      CALL CONV(T,M,N,ISW)
350     IF(IFILT.EQ.0)GO TO 400
65     ITYPE=1
      CALL FILT(DAT,M,N,NPT,ITYPE)
      WRITE(6,4)(LABL(M,N,J),J=1,3)
400     CONTINUE
      RETURN
70     1  FORMAT(4I3)
      2  FORMAT(2I3,4F10.5)
      3  FORMAT(8F10.5)
      4  FORMAT(' CHANNEL ',3A2,' HAS BEEN FILTERED')
      5  FORMAT('//,' INPUT DATA CHANNELS')
75     6  FORMAT(' NCH = ',I3,' ICVT = ',I3,' IFILT = ',I3,' IDERIV = ',I3)
      7  FORMAT('//,' CALIBRATION CONSTANTS')
      END
```

1  
5  
10  
15  
20  
25  
30  
35

C  
C  
C

```
SUBROUTINE PLOT4(DAT)
:
PUTS 3-DIMENSIONAL ARRAY INTO 1-DIMENSIONAL ARRAYS FOR PLOTTING

DIMENSION DAT(3,2,5000)
LEVEL 2,DAT
COMMON/I/MIN(6),NIN(6),NTS(24),NCH,IDERIV,IFILT,NPT,LDEL
* ,NLSQ,LABEL(10),LABL(3,2,24),LCNT(2,7)
REAL LDEL
COMMON DUM(1),
* X(5000),Y1(5000),Y2(5000),Y3(5000),Y4(5000),Y5(5000),Y6(5000)
DUM(1)=1.E100
NPLT=2500
N4=0
ENCODE(11,1,LABEL(7))(LABL(1,1,J),J=1,3)
DO 100 J=1,NPLT
X(J)=J
Y1(J)=DAT(MIN(1),NIN(1),J)
IF(MIN(3).NE.0)Y2(J)=DAT(MIN(3),NIN(3),J)
IF(MIN(5).NE.0)Y3(J)=DAT(MIN(5),NIN(5),J)
Y4(J)=DAT(MIN(2),NIN(2),J)
IF(MIN(4).NE.0)Y5(J)=DAT(MIN(4),NIN(4),J)
IF(MIN(6).NE.0)Y6(J)=DAT(MIN(6),NIN(6),J)
100 CONTINUE
IF(MIN(3).EQ.0)Y2(1)=DUM(1)
IF(MIN(4).EQ.0)Y5(1)=DUM(1)
IF(MIN(5).EQ.0)Y3(1)=DUM(1)
IF(MIN(6).EQ.0)Y6(1)=DUM(1)
ENCODE(11,1,LABEL(7))(LABL(1,1,J),J=1,3)
CALL DISS4(X,Y1,Y2,Y3,NPLT,LABEL,X4,Y4,N4)
ENCODE(11,1,LABEL(7))(LABL(1,2,J),J=1,3)
CALL DISS4(X,Y4,Y5,Y6,NPLT,LABEL,X4,Y4,N4)
RETURN
1 FORMAT(3A2,5X)
END
```

54

```

1          SUBROUTINE WRDAT
C
C          WRITES ALL PROCESSED DATA ONTO OUTPUT FILE TO BE SAVED FOR LATER USE
C
5          COMMON/LEV2C/DAT(3,2,5000),DATD(3,2,5000),DATDD(3,2,5000)
          LEVEL 2,DAT,DATD,DATDD
          COMMON/I/MIN(6),NIN(6),NTS(24),NCH,IDERIV,IFILT,NPT,LDEL
*          ,NLSQ,LABEL(10),LABL(3,2,24),LCNT(2,7)
          REAL LDEL
10         COMMON/LEV1/DTIME,CT(3,2),CT1(3,2),CT2(3,2),CT3(3,2),CVT(3,6)
*         ,TSTART,ZZ(3,2)
          IF(IFILT.EQ.0)WRITE(6,2)
          IF(IFILT.NE.0)WRITE(6,5)
          DO 200 I=1,NCH
15         DO 100 J=1,24
          NTS(J)=LABL(MIN(I),NIN(I),J)
100        CONTINUE
          WRITE(18)NTS
          WRITE(6,1)NTS
          WRITE(18)NPT
          WRITE(18)TSTART,DTIME
          WRITE(18)(DAT(MIN(I),NIN(I),J),J=1,NPT)
200        CONTINUE
          IF(IDERIV.EQ.0)GO TO 700
25         WRITE(6,3)
          DO 400 I=1,NCH
          DO 300 J=1,24
          NTS(J)=LABL(MIN(I),NIN(I),J)
300        CONTINUE
          WRITE(18)NTS
30         WRITE(6,1)NTS
          WRITE(18)NPT
          WRITE(18)TSTART,DTIME
          WRITE(18)(DATD(MIN(I),NIN(I),J),J=1,NPT)
          WRITE(18)(DAT(MIN(I),NIN(I),J),J=1,NPT)
35         CONTINUE
          WRITE(6,4)

```

```
DO 600 I=1,NCH
DO 500 J=1,24
NTS(J)=LABL(MIN(I),NIN(I),J)
40      500 CONTINUE
        WRITE(18)NTS
        WRITE(6,1)NTS
        WRITE(18)NPT
        WRITE(18)TSTART,DTIME
45      WRITE(18)(DATDD(MIN(I),NIN(I),J),J=1,NPT)
        600 CONTINUE
        700 RETURN
        1  FORMAT(5X,' WRITING ON FILE - ',24A2)
        2  FORMAT('//,' INPUT DATA - UNFILTERED')
50      3  FORMAT(' FIRST DERIVATIVE - FILTERED')
        4  FORMAT(' SECOND DERIVATIVE - FILTERED')
        5  FORMAT('//,' INPUT DATA - FILTERED')
        END
```

APPENDIX C

C.1.3. Card Image Formats That Are Required For The Input Data Section Of MFA File MUZMO40/UN=BOOTS

TABLE C.1. INPUT DATA FORMATS FOR TAPE UNIT 5

<u>Card</u>	<u>Condition*</u>	<u>Column</u>	<u>Format</u>	<u>Variable</u>	<u>Calling Subroutine</u>	<u>Description</u>
1		1-3	I3	IPLT1	MAIN	If IPLT1=1, displacements are plotted
		4-6	I3	IPLT2		If IPLT2=1, velocities are plotted
		7-9	I3	IPLT3		If IPLT3=1, accelerations are plotted
		10-12	I3	IPRT		If IPRT=1, displacements, velocities and accelerations are written on a file on tape unit 18.
2		1-3	I3	NCH	ORIENT	Number of data sets to be inputted
		4-6	I3	ICVT		If ICVT ≠ 0, data conversion is done
		7-9	I3	IFILT		If IFILT ≠ 0, displacements are filtered
		10-12	I3	IDERIV		If IDERIV ≠ 0, differentiation is done
3		1-3	I3	MIN(I)	ORIENT	First index for placement of data into array DAT
		4-6	I3	MIN(I)		Second index for placement of data into array DAT
		7-9	I3	IU		Tape unit number on which data file resides

4 Repeat card 3 until NCH cards are inputted.

5. Repeat sets of cards 3 and 4 for JL sets: JL=3 if IFILT = 0 or JL=1 if IFILT = 1.

\*Omit the card if condition is not met.

TABLE C.1. INPUT DATA FORMATS FOR TAPE UNIT 5 (continued)

<u>Card</u>	<u>Condition</u>	<u>Column</u>	<u>Format</u>	<u>Variable</u>	<u>Calling Subroutine</u>	<u>Description</u>
6	ICVT $\neq$ 0	1-10	F10.5	CVT(1,1)	ORIENT	Coefficients for conversion of data of sensor 1 [conversion is nonlinear, as in Eq. (3.2)]
	11-10	F10.5	CVT(1,2)			
	21-20	F10.5	CVT(1,3)			
	31-40	F10.5	CVT(1,4)			
	41-50	F10.5	CVT(1,5)			
	51-60	F10.5	CVT(1,6)			
7	ICVT $\neq$ 0	1-10	F10.5	CVT(2,1)	ORIENT	Coefficients for conversion of data of sensor 2 [conversion is linear]
	11-20	F10.5	CVT(2,2)			
8	ICVT $\neq$ 0	1-10	F10.5	CVT(3,1)	ORIENT	Coefficients for conversion of data of sensor 3 [conversion is linear]
	11-20	F10.5	CVT(3,2)			
9**	ICVT $\neq$ 0	1-3	I3	M	ORIENT	First index of arrays CT1,CT2,CT3
	4-6	I3	N			Second index of arrays CT1,CT2,CT3
	7-16	F10.5	CT1(M,N)			Transducer calibration factors
	17-26	F10.5	CT2(M,N)			
	27-36	F10.5	CT3(M,N)			
10	ICVT $\neq$ 0	Repeat card 9 until 6 cards are inputted.				

\*\*Since these data sets had not been previously converted into voltages so this input card was incorporated into the calculations such that  $CT(M,N)=CT1(M,N)/CT2(M,N)/CT3(M,N)$ . The data are then multiplied by the appropriate CT before the other conversion is done.



#### C.1.4. Output

The normal printed output of this program is mainly informative and diagnostic. The output consists of:

1. Input variables;
2. Identification of input data channels;
3. Calibration constants;
4. Lowpass filter coefficients (when used first time);
5. Differentiator coefficients (when used first time); and
6. Path each channel follows as it is differentiated, filtered, and/or written on an output file.

The plotted output consists of sets of two plots: one for horizontal data and one for vertical. The number of curves on each plot is determined by the array MIN. The number of sets plotted is determined by the variables IPLT1, IPLT2, and IPLT3.

## C.2. Program MUZPRED

### C.2.1. Listing Of Job Control Language Of MFA File MUZPRED/UN=BOOTS

```
BOOTS,T200.  
USER,BOOTS,XXXXXXX.  
CHARGE,PDXXX,PD.  
ATTACH,DISSPL9/UN=DISSPLA.  
ATTACH,IMSL/UN=LIBRARY.  
LIBRARY,DISSPL9,IMSL.  
FTN,L=0.  
GET,A=DIFFATR.  
FTN,I=A,L=0.  
ATTACH,TAPE1=DVA05.  
GET,TAPE2=DIFF1.  
GET,TAPE3=DISPL40.  
ATTACH,TAPE4=DVA05U.  
GET,TAPE7=RECL40.  
GET,TAPE8=LPF62.  
GET,TAPE10=UVECT40.  
LGO.  
REPLACE,TAPE9=MUZPT05.  
REPLACE,META=DISS05R.  
EXIT.  
REPLACE,META=DISSERR.
```

### C.2.2. Listing Of FORTRAN Program

```
1          PROGRAM DISS9(INPUT,OUTPUT,TAPE5=INPUT,TAPE6=OUTPUT,TAPE1,TAPE2,
* TAPE3,TAPE4,TAPE7,TAPE8,TAPE9,TAPE10,META,TAPE13)
      C
      C          ANALYSIS OF MUZZLE MOTION DATA - PROGRAM 2
5      C
      C          PLOTTING IN COLOR USING DISSPLA 9.0 ON A TEKTRONIX 4107 TERMINAL
      C
      COMMON/LEV1/DAT(6,2,2500),LABL(3,2,24),MIN(9),NIN(9),TSTART,DTIME,
* NPT,NPLT,LKEY
10     DIMENSION LABEL(10)
      LABEL(1)=10H BOOTS
      LABEL(2)=10HBLDG.390
      LABEL(3)=10HX 6121
      LABEL(4)=10HDISSPLA9.0
15     CALL COMPRS
      CALL SETDEV(13,13)
      WRITE(6,1)
      READ(5,2)NCH,NPLOT, NPLOTP, NPLOT, NPLOTU, IPRINT
      IF(EOF(5).NE..0)GO TO 200
20     WRITE(6,7)NCH,NPLOT, NPLOTP, NPLOT, NPLOTU, IPRINT
      DO 110 I=1,NCH
      READ(5,2)MIN(I),NIN(I),IU
      WRITE(6,6)MIN(I),NIN(I),IU
      IF(IU.EQ.0)IU=1
25     CALL DATAIN(MIN(I),NIN(I),IU)
110    CONTINUE
      READ(5,3)LKEY
      WRITE(6,4)LKEY
      CALL PREDCT(NPLOT)
30     CALL CALCZ(NPLOT, NPLOTP, NPLOT, NPLOTU, IPRINT)
200    CALL DONEPL
      STOP
      1  FORMAT(1H1)
      2  FORMAT(20I3)
35     3  FORMAT(16I5)
      4  FORMAT(//,' LKEY = ',I5)
      6  FORMAT(' MIN, NIN, IU -',20I3)
      7  FORMAT(' NCH, NPLOT, NPLOTP, NPLOT, NPLOTU, IPRINT -',20I3)
      END
```

```
      END
      SUBROUTINE CALCZ(NPLOTG,NPLOTU,IPRINT)
C
C
C      THIS SUBROUTINE SCALES A SET OF RECOIL MOTION DATA FROM A SIMILAR
C      FIRING TO THE TIME OF THIS FIRING, CALCULATES THE DISPLACEMENT IN
5      C      THE Z-DIRECTION OF EACH COMPONENT (HORIZONTAL AND VERTICAL) AT EACH
C      DISCRETE TIME, DIFFERENTIATES THIS RESULTING DISPLACEMENT, AND
C      PLOTS THE RESULTS IF NPLOTG .NE. 0.
C
      DIMENSION C(10),MDAT(9),NDAT(9),AA(3,3),BB(3),COEF(3),IWK(50),
10      * WRK(50),Z(3,2),ZZ(2500)
      COMMON/LEV1/DAT(6,2,2500),LABL(3,2,24),MIN(9),NIN(9),TSTART,DTIME,
      * NPT,NPLT,LKEY
C
C      LZM = MODEL L(START OF MOTION)
15      C      LPM = MODEL L(PEAK PRESSURE)
C      LEM = MODEL L(SHOT EJECTION)
C
C      LPD = DATA L(PEAK PRESSURE)
C      LED = DATA L(SHOT EJECTION)
20      C      LZD IS THEN DETERMINED BY SCALING THE TWO SETS OF PARAMETERS
C
      READ(5,1)LZM,LPM,LEM
      READ(5,1)LPD,LED
      RAT=FLOAT(LEM-LZM)/FLOAT(LEM-LPM)
25      LZD=FLOAT(LED)-RAT*FLOAT(LED-LPD)
      RLSPAN=LED-LZD
      WRITE(6,6)
      WRITE(6,1)LZM,LPM,LEM
      WRITE(6,1)LZD,LPD,LED
30      READ(5,1)MPOLY
      MPP=MPOLY+1
      WRITE(6,7)
      READ(5,2)(C(M),M=1,MPP)
      WRITE(6,2)(C(M),M=1,MPP)
35      RVMAX=.0
      DO 200 L=1,NPT
      DAT(6,1,L)=.0
      DAT(6,2,L)=.0
      FL=FLOAT(L-LZD)/RLSPAN
```

```

40          IF(L.LE.LZD)GO TO 200
           DO 100 M=1,MPP
           DAT(6,1,L)=DAT(6,1,L)+C(M)*FL**(M-1)
           DAT(6,2,L)=DAT(6,2,L)+C(M)*FL**M/FLOAT(M)
100        CONTINUE
45          DAT(6,2,L)=DAT(6,2,L)*RLSPAN*DTIME
           IF(DAT(6,1,L).LT.RVMAX)GO TO 260
           RVMAX=DAT(6,1,L)
200        CONTINUE
260        DO 270 LL=L,NPT
           DAT(6,1,LL)=RVMAX
           DAT(6,2,LL)=DAT(6,2,LL-1)+RVMAX*DTIME
270        CONTINUE
           READ(5,2)Z(1,1),Z(1,2),Z(2,1),Z(3,1)
           Z(2,2)=Z(2,1)
55          Z(3,2)=Z(3,1)
           WRITE(6,8)
           WRITE(6,2)Z
           C
           C
60          TEMPORARY - THE VARIABLE CONV IS NECESSARY TO CHANGE THE RECOIL
           C
           C
           CONV=.1
           C
           DO 450 L=1,NPT
65          DO 350 K=1,3
           AA(K,1)=1.
           AA(K,2)=Z(K,1)+CONV*D(6,2,L)
           AA(K,3)=AA(K,2)**4
           BB(K)=DAT(K,1,L)
70          350 CONTINUE
           TOL=.0
           KBASIS=0
           CALL LLSQF(AA,3,3,3, BB, TOL, KBASIS, COEF, WRK, IWK, IER)
75          DAT(4,1,L)=COEF(1)
           DAT(5,1,L)=COEF(2)
           DAT(1,1,L)=COEF(3)
           DO 400 K=1,3
           AA(K,1)=1.

```

```
      AA(K,2)=Z(K,2)+CONV*DAT(6,2,L)
80      AA(K,3)=AA(K,2)**4
      BR(K)=DAT(K,2,L)
400     CONTINUE
      TOL=.0
      KBASIS=0
85     CALL LLSOF(AA,3,3,3,BR,TOL,KBASIS,COEF,WRK,IWK,IFR)
      DAT(4,2,L)=COEF(1)
      DAT(5,2,L)=COEF(2)
      DAT(1,2,L)=COEF(3)
450     CONTINUE
90     READ(5,4)NZREF
      WRITE(6,10)NZREF
      DO 480 I=1,NZREF
      READ(5,2)ZREF
      WRITE(6,11)ZREF
95     DO 454 L=1,NPT
      DAT(2,1,L)=DAT(4,1,L)+DAT(5,1,L)*ZREF+DAT(1,1,L)*ZREF**4
      DAT(2,2,L)=DAT(4,2,L)+DAT(5,2,L)*ZREF+DAT(1,2,L)*ZREF**4
      DAT(3,1,L)=DAT(5,1,L)+4.*DAT(1,1,L)*ZREF**3
      DAT(3,2,L)=DAT(5,2,L)+4.*DAT(1,2,L)*ZREF**3
100    454 CONTINUE
      TKEY=DTIME*FLOAT(LKEY)
      TST=-1.+TKEY
      TSP= 2.+TKEY
      LST=(TST-TSTART)/DTIME+1.E-10+1.
105    LSP=(TSP-TSTART)/DTIME+1.E-10
      IU=9
      IF(IPRINT.EQ.0)GO TO 455
      NARR=3
      READ(5,4)(MDAT(II),NDAT(II),II=1,NARR)
110    WRITE(6,9)(MDAT(II),NDAT(II),II=1,NARR)
      CALL WRFILE(DAT,MDAT,NDAT,NARR,TST,LST,LSP,LARL,DTIME,IU)
455    DO 456 L=1,NPT
      ZZ(L)=DAT(1,1,L)
456    CONTINUE
115    CALL UNITV(NPLOTU,IPRINT,TST,LST,LSP,IU)
      DO 457 L=1,NPT
      DAT(1,1,L)=ZZ(L)
```

```

120      C
      C      IUD = INPUT TAPE UNIT FOR DIFFERENTIATOR
      C      IUF = INPUT TAPE UNIT FOR FIR FILTER
      C      IF IUD OR IUF = 0, THAT OPERATION IS NOT DONE.
      C

125      IUD=2
      IUF=8
      DO 460 L=1,NPT
      ZZ(L)=DAT(2,1,L)
460     CONTINUE
130     CALL DIFFER(ZZ,NPT,DTIME,IUD,IUF)
      DO 462 L=1,NPT
      DAT(3,1,L)=ZZ(L)
      ZZ(L)=DAT(2,2,L)
462     CONTINUE
      CALL DIFFER(ZZ,NPT,DTIME,IUD,IUF)
135     DO 464 L=1,NPT
      DAT(3,2,L)=ZZ(L)
464     CONTINUE
      IF(NPLOT.C.EQ.0)GO TO 480
      WRITE(6,3)
140     NCURV=1
      IUPLT=7
      REWIND IUPLT
      READ(IUPLT,5)TIMEL,TIMER
      READ(IUPLT,4)LAXIS,ICOLOR
145     DO 470 II=1,NPLOT.C
      ITYPE=0
      IF(II.EQ.3.OR.II.EQ.6.OR.II.EQ.13)ITYPE=1
      N4=1
      IF(ITYPE.EQ.1)N4=2
150     NCRV=NCURV*(ITYPE+1)
      READ(IUPLT,4)(MDAT(K),NDAT(K),K=1,NCRV)
      WRITE(6,9)(MDAT(K),NDAT(K),K=1,NCRV)
      ISC=0
      IF(II.EQ.4)ISC=1
155     IF(ITYPE.EQ.1)ISC=1
      IF(II.EQ.6)TIMEL=-1.
      IF(II.EQ.6)TIMER= 1.

```

```
CALL DATA4(NCURV,MDAT,NDAT,ISC,ITYPE,LAXIS,ICOLOR,N4,TIMEL,TIMER,  
* IUPLT)  
160 470 CONTINUE  
480 CONTINUE  
500 RETURN  
1  FORMAT(16I5)  
2  FORMAT(8E10.3)  
165 3  FORMAT(//,' PLOTTING IN SUBROUTINE CALCZ')  
4  FORMAT(20I3)  
5  FORMAT(2F5.0)  
6  FORMAT(//,' SUBROUTINE CALCZ - SCALING PARAMETERS')  
7  FORMAT(' COEFFICIENTS OF RECOIL MOTION CURVE')  
170 8  FORMAT(' Z-ARRAY')  
9  FORMAT(/,' "MDAT, NDAT" PAIRS -',20I3)  
10  FORMAT(' NZREF =',I3)  
11  FORMAT(/' ZREF = ',F10.5)  
END
```



```

1          SUBROUTINE DATAIN(M,N,IU)
      C
      C          INPUT EXPERIMENTAL DATA
      C
5         COMMON/LEV1/DAT(6,2,2500),LABL(3,2,24),MIN(9),NIN(9),TSTART,DTIME,
*        NPT,NPLT,LKEY
          DIMENSION NTS(24),Z(4100)
          READ(IU)NTS
          DO 50 I=1,24
10        LABL(M,N,I)=NTS(I)
50       CONTINUE
          WRITE(6,3)M,N,(LABL(M,N,I),I=1,24)
          READ(IU)NDATA
          READ(IU)TSTART,DTIME
15       WRITE(6,1)NDATA,TSTART,DTIME
          READ(IU)(Z(I),I=1,NDATA)
          NPT=NDATA
      C
      C          NECESSARY BECAUSE OF CENTRAL MEMORY SIZE RESTRICTIONS
      C
20       IF(NPT.GT.2500)NPT=2500
      C
          NPLT=NPT
          DO 100 I=1,NPT
25       DAT(M,N,I)=Z(I)
100      CONTINUE
          RETURN
          1  FORMAT(' NDATA, TSTART, DTIME -',I10,2F10.5)
          2  FORMAT(I10,2F10.5)
          3  FORMAT(1X,2I2,1X,24A2)
30      END

```

67

1                   SUBROUTINE DATA4(NCURV,MDAT,NDAT,ISC,ITYPE,LAXIS,ICOLOR,N4,TIMEL,  
\* TIMER,IUPLT)

C  
C  
C  
C  
C

5                   THIS SUBROUTINE PREPARES THE DATA ARRAYS IN PROPER FASHION SO  
                  THAT A WIDE VARIETY OF PLOTS CAN BE GENERATED USING THE SAME  
                  PLOTTING SUBROUTINE.

10                  DIMENSION MDAT(9),NDAT(9),X(2500),Y1(2500),Y2(2500),Y3(2500),  
                  \* DUM(1),X4(8),Y4(8),LXNAME(2),LYNAME(2)  
                  COMMON/LEVI/DAT(6,2,2500),LABL(3,2,24),MIN(9),NIN(9),TSTART,DTIME,  
                  \* NPT,NPLT,LKEY

                  X4(1)=.0  
                  IF(N4.EQ.0)GO TO 40  
                  READ(IUPLT,3)((X4(I),Y4(I)),I=1,N4)  
15                  DO 30 I=1,N4  
                  X4(I)=X4(I)\*DTIME

30                  CONTINUE  
                  WRITE(6,6)((X4(I),Y4(I)),I=1,N4)

68  
20                  40   DUM(1)=1.E100  
                  TST=X4(1)+TIMEL  
                  TSP=X4(1)+TIMER  
                  LST=(TST-TSTART)/DTIME+1.E-10+1.  
                  LSP=(TSP-TSTART)/DTIME+1.E-10  
                  NPLT=LSP-LST+1  
25                  TSTRT=-X4(1)  
                  X4(1)=.0

C  
C  
C  
C  
C

30                  SPECIAL CONDITION - IF N4 = 2, THE PLOT ORIGIN IS MADE AT THESE  
                  COORDINATES

                  IF(N4.EQ.2)N4=0

35                  J=0  
                  DO 100 L=LST,LSP  
                  J=J+1  
                  IF(ITYPE.EQ.1)GO TO 50  
                  X(J)=TSTRT+DTIME\*FLOAT(L-1)  
                  Y1(J)=DAT(MDAT(1),NDAT(1),L)

```

40      IF(NCURV.GE.2)Y2(J)=DAT(MDAT(2),NDAT(2),L)
      IF(NCURV.GE.3)Y3(J)=DAT(MDAT(3),NDAT(3),L)
      GO TO 100
50     X(J)=DAT(MDAT(1),NDAT(1),L)
      Y1(J)=DAT(MDAT(2),NDAT(2),L)
      IF(NCURV.GE.2)Y2(J)=DAT(MDAT(3),NDAT(3),L)
45     IF(NCURV.GE.2)Y3(J)=DAT(MDAT(4),NDAT(4),L)
      IF(N4.EQ.0)X(J)=X(J)-DAT(MDAT(1),NDAT(1),LKEY)
      IF(N4.EQ.0)Y1(J)=Y1(J)-DAT(MDAT(2),NDAT(2),LKEY)
100    CONTINUE
      IF(N4.EQ.0)WRITE(6,5)DAT(MDAT(1),NDAT(1),LKEY),DAT(MDAT(2),NDAT(2)
50     *,LKEY)
      IF(NCURV.LT.2)Y2(1)=DUM(1)
      IF(NCURV.LT.3.AND.ITYPE.EQ.0)Y3(1)=DUM(1)
      ENCODE(10,1,TITLE)(LABL(MDAT(1),NDAT(1),J),J=1,3)
      WRITE(6,2)LST,LSP,X(1),X(NPLOT)
55     LXNAME(1)=' '
      LYNAME(1)=' '
      LXNAME(2)=' '
      LYNAME(2)=' '
      IF(LAXIS.EQ.1)READ(IUPLT,4)LXNAME,LYNAME
60     IF(LAXIS.EQ.1)WRITE(6,4)LXNAME,LYNAME
      CALL DISS4(X,Y1,Y2,Y3,NPLOT,TITLE,X4,Y4,N4,ISC,ITYPE,LXNAME,LYNAME
      *,ICOLOR,IUPLT)
      RETURN
65     1 FORMAT(3A2,4X)
      2 FORMAT(' PLOT LIMITS - ',2I5,2F10.4)
      3 FORMAT(8F10.0)
      4 FORMAT(8A10)
      5 FORMAT(' COORDINATES AT SHOT EJECTION - ',2(E12.5,3X))
70     6 FORMAT(' SPECIAL COORDINATES',8F10.3)
      END

```

```

1      SUBROUTINE DISS4(X,Y1,Y2,Y3,NPT,TITLE,X4,Y4,N4,ISC,ITYPE,LXNAME,
      * LYNAME,ICOLOR,IUPLT)
      C
      C      ISC=0 SELF-SCALE
5      C      =1 READ IN XORIG, XMAX, YORIG, YMAX
      C
      C      ITYPE=0 NORMAL PLOT
      C      =1 POLAR PLOT
      C
10     C      ICOLOR=0 BLACK/WHITE
      C      =1 COLOR
      C
      C      DIMENSION X(NPT),Y1(NPT),Y2(NPT),Y3(NPT),X4(N4),Y4(N4)
      * ,RAT(10),LXNAME(2),LYNAME(2)
15     C      IF(ISC.NE.0)GO TO 300
      C      XORIG=X(1)
      C      XSTP='SCALE'
      C      XMAX=X(NPT)
      C      YORIG=1.E100
70     C      YSTP='SCALE'
20     C      YMAX=-1.E100
      C      DO 200 I=1,NPT
      C      IF(Y1(I).LT.YMAX)GO TO 100
      C      YMAX=Y1(I)
25     C      100 IF(Y1(I).GT.YORIG)GO TO 200
      C      YORIG=Y1(I)
      C      200 CONTINUE
      C
      C      SPECIAL FOR THIS SET OF DATA
30     C
      C      IF(YORIG.LT..0)YORIG=YORIG*1.1
      C
      C      GO TO 400
35     C      300 READ(IUPLT,1)XORIG,XMAX,XSTP,YORIG,YMAX,YSTP
      C      400 WRITE(6,2)XORIG,XSTP,XMAX,YORIG,YSTP,YMAX
      C      JJ=JJ+1
      C      CALL BASALF('STANDARD')
      C      CALL MIXALF('SPECIAL')
      C      CALL PHYSOR(1.5,1.)

```

```

40      CALL PAGE(11.,8.5)
      CALL SETCLR('BLACK')
      IF(ITYPE.EQ.0)CALL AREA2D(8.5,6.0)
      IF(ITYPE.EQ.1)CALL AREA2D(6.0,6.0)
      CALL HEIGHT(.25)
45      CALL HEADIN(TITLE,10,1.5,1)
      CALL XNAME(LXNAME,13)
      CALL YNAME(LYNAME,13)
      CALL GRAF(XORIG,XSTP,XMAX,YORIG,YSTP,YMAX)
      IF(ITYPE.EQ.0)IMARK=0
50      IF(ITYPE.EQ.1)IMARK=100
      IF(ITYPE.EQ.1.AND.N4.EQ.0)IMARK=25
      IF(ICOLOR.EQ.1)CALL SETCLR('BLUE')
      CALL CURVE(X,Y1,NPT,IMARK)
      IF(ITYPE.EQ.0)GO TO 600
55      DO 500 II=1,NPT,50
      CALL RLVFC(X(II),Y1(II),X(II+5),Y1(II+5),2331)
500 CONTINUE
600 IF(ICOLOR.EQ.1)CALL SETCLR('RED')
      TL=.5
60      NMRK=2
      RAT(1)=6.
      RAT(2)=4.
      IF(ICOLOR.EQ.0)CALL MRSCOD(TL,NMRK,RAT)
      IF(Y2(1).NE.1.E100.AND.ITYPE.EQ.0)CALL CURVE(X,Y2,NPT,IMARK)
65      IF(Y2(1).NE.1.E100.AND.ITYPE.EQ.1)CALL CURVE(Y2,Y3,NPT,IMARK)
      CALL RESET('DOT')
      IF(ICOLOR.EQ.1)CALL SETCLR('GREEN')
      TL=.25
      IF(ICOLOR.EQ.0)CALL MRSCOD(TL,NMRK,RAT)
70      IF(Y3(1).NE.1.E100.AND.ITYPE.EQ.0)CALL CURVE(X,Y3,NPT,IMARK)
      CALL RESET('DASH')
      IF(ICOLOR.EQ.1)CALL SETCLR('GREEN')
      IMARK=-1
      IF(N4.GT.0)CALL CURVE(X4,Y4,N4,IMARK)
75      CALL ENDPL(JJ)
      RETURN
1  FORMAT(6E10.3)
2  FORMAT(' PLOT SCALES - ',6E13.5)
      END

```

```

1          SUBROUTINE PREDCT(NPLOTP)
          C
          C      THIS SUBROUTINE DOES A STRAIGHT LINE EXTRAPOLATION OF DATA FROM
          C      SENSORS 2 AND 3 TO THE POSITION OF SENSOR 1 AND THEN THE DATA
5          C      FROM THE PREDICTION IS COMPARED WITH THE DATA OF SENSOR 1. NEXT,
          C      THE MAGNITUDES AND PHASE ANGLES OF BOTH SETS OF DATA ARE CALCULATED.
          C      IN THE VICINITY OF LKEY (A TIME OF INTEREST, USUALLY SHOT EJECTION)
          C      THE DATA ARE AVERAGED OVER SHORT TIME SPANS AND THEIR MAGNITUDES
          C      AND PHASE ANGLES CALCULATED AND PRINTED. PLOTS ARE GENERATED IF
10         C      PLOTP .NE. 0.
          C
          DIMENSION AVG(4,10),AMPL(2,10),ANGL(2,10),MDAT(9),NDAT(9)
          COMMON/LEV1/DAT(6,2,2500),LABL(3,2,24),MIN(9),NIN(9),TSTART,DTIME,
15         * NPT,NPLT,LKEY
          PI2=6.283185307179865
          READ(5,1)DZ31,DZ32
          WRITE(6,2)DZ31,DZ32
          RAT=DZ31/DZ32
          DO 200 L=1,NPT
20         DO 100 N=1,2
          DAT(4,N,L)=DAT(3,N,L)+RAT*(DAT(2,N,L)-DAT(3,N,L))
100        CONTINUE
          DAT(6,1,L)=SQRT(DAT(1,1,L)**2+DAT(1,2,L)**2)
          DAT(5,1,L)=SQRT(DAT(4,1,L)**2+DAT(4,2,L)**2)
25         IF(DAT(1,1,L).EQ..0.AND.DAT(1,2,L).EQ..0)DAT(1,2,L)=1.E-5
          DAT(6,2,L)=ATAN2(DAT(1,1,L),DAT(1,2,L))
          IF(DAT(4,1,L).EQ..0.AND.DAT(4,2,L).EQ..0)DAT(4,2,L)=1.E-5
          DAT(5,2,L)=ATAN2(DAT(4,1,L),DAT(4,2,L))
          IF(DAT(6,2,L).LT..0)DAT(6,2,L)=DAT(6,2,L)+PI2
30         IF(DAT(5,2,L).LT..0)DAT(5,2,L)=DAT(5,2,L)+PI2
          DAT(6,2,L)=DAT(6,2,L)*360./PI2
          DAT(5,2,L)=DAT(5,2,L)*360./PI2
200        CONTINUE
          INC=7
35         IF(DTIME.EQ..02)INC=5
          INTV=4
          LINC=INC
          IF(DTIME.EQ..02)LINC=2
          LST=LKEY-INC-(INTV-1)*LINC+1

```

```

40      LSP=LKEY+INTV*LINC
        WRITE(6,4)
        J=0
        DO 400 L=LST,LSP,LINC
45      J=J+1
        S1=.0
        S2=.0
        S3=.0
        S4=.0
        DO 300 I=1,INC
50      S1=S1+DAT(1,1,L+I-1)
        S2=S2+DAT(1,2,L+I-1)
        S3=S3+DAT(4,1,L+I-1)
        S4=S4+DAT(4,2,L+I-1)
300     CONTINUE
55     AVG(1,J)=S1/FLOAT(INC)
        AVG(2,J)=S2/FLOAT(INC)
        AVG(3,J)=S3/FLOAT(INC)
        AVG(4,J)=S4/FLOAT(INC)
        AMPL(1,J)=SQRT(AVG(1,J)**2+AVG(2,J)**2)
60     AMPL(2,J)=SQRT(AVG(3,J)**2+AVG(4,J)**2)
        ANGL(1,J)=ATAN2(AVG(1,J),AVG(2,J))
        ANGL(2,J)=ATAN2(AVG(3,J),AVG(4,J))
        IF(ANGL(1,J).LT..0)ANGL(1,J)=ANGL(1,J)+PI2
        IF(ANGL(2,J).LT..0)ANGL(2,J)=ANGL(2,J)+PI2
65     ANGL(1,J)=ANGL(1,J)*360./PI2
        ANGL(2,J)=ANGL(2,J)*360./PI2
        LMID=L+INC/2
        WRITE(6,3)LMID,AVG(1,J),AVG(2,J),AMPL(1,J),ANGL(1,J),AVG(3,J),
70     * AV(4,J),AMPL(2,J),ANGL(2,J)
400    CONTINUE
        IF(NPLOTP.EQ.0)GO TO 600
        WRITE(6,7)
        IUPLT=3
75     READ(IUPLT,6)TIMEL,TIMER
        READ(IUPLT,5)LAXIS,ICOLOR
        NCURV=2
        N4=1

```

```

DO 500 I=1,NPLOT
ISC=1
80 ITYPE=0
IF(I.GE.5)ITYPE=1
IF(I.GE.6)NCURV=1
NCRV=NCURV*(ITYPE+1)
READ(IUPLT,5)(MDAT(K),NDAT(K),K=1,NCRV)
85 WRITE(6,8)(MDAT(K),NDAT(K),K=1,NCRV)
NCVV=NCURV
IF(I.EQ.7)N4=2
CALL DATA4(NCVV,MDAT,NDAT,ISC,ITYPE,LAXIS,ICOLOR,N4,TIMEL,TIMER,
* IUPLT)
90 500 CONTINUE
600 RETURN
1 FORMAT(8F10.2)
2 FORMAT(//,' DZ31, DZ32 ',2F10.2)
3 FORMAT(I5,9X,3F9.5,F12.2,10X,3F9.5,F12.2)
95 4 FORMAT(//' L BRL: HORIZONTAL VERTICAL MAGNITUDE ORIENTATION',
* ' HEL: HORIZONTAL VERTICAL MAGNITUDE ORIENTATION')
5 FORMAT(20I3)
6 FORMAT(2F5.0)
7 FORMAT(//,' PLOTTING IN SUBROUTINE PREDCT')
100 8 FORMAT(/,' "MDAT, NDAT" PAIRS -',20I3)
END

```



```

1      SUBROUTINE UNITV(NPLOTU,IPRINT,TST,LST,LSP,IU)
      C
      C      THIS SUBROUTINE CALCULATES THE TRANSLATION AND ROTATION
      C      PARAMETERS AS DESCRIBED IN SECTION 3.2.3, EQ.(3.16) IN
5      C      PARTICULAR
      C
      DIMENSION MDAT(9),NDAT(9)
      COMMON/LEV1/DAT(6,2,2500),LABL(3,2,24),MIN(9),NIN(9),TSTART,DTIME,
*      NPT,NPLT,LKEY
10     DO 400 J=1,3
      DO 100 L=1,NPT
      DEN=SQRT(1.+DAT(3,1,L)**2+DAT(3,2,L)**2)
      DN=SQRT(1.+DAT(3,1,L)**2)
      IF(J.GT.1)GO TO 60
15     DAT(6,1,L)=1./DN
      DAT(6,2,L)=.0
      DAT(1,1,L)=-DAT(3,1,L)*DAT(6,1,L)
      GO TO 100
      60  IF(J.GT.2)GO TO 80
      DAT(6,2,L)=DN/DEN
      DAT(1,1,L)=-DAT(3,2,L)/(DN*DEN)
      DAT(6,1,L)=DAT(1,1,L)*DAT(3,1,L)
      GO TO 100
      80  DAT(1,1,L)=1./DEN
25     DAT(6,1,L)=DAT(3,1,L)*DAT(1,1,L)
      DAT(6,2,L)=DAT(3,2,L)*DAT(1,1,L)
100    CONTINUE
      IF(NPLOTU.EQ.0.OR.J.NE.3)GO TO 300
      WRITE(6,3)
30     IUPLT=10
      REWIND IUPLT
      READ(IUPLT,2)TIMEL,TIMER
      READ(IUPLT,1)LAXIS,ICOLOR
      ISC=0
35     NCURV=1
      DO 200 I=1,NPLOTU
      ITYPE=0
      IF(I.EQ.3)ITYPE=1

```

```

LAXIS=0
40 IF(I.LE.2)LAXIS=1
N4=1
IF(ITYPE.EQ.1)N4=2
NCRV=NCURV*(ITYPE+1)
READ(IUPLT,1)(MDAT(K),NDAT(K),K=1,NCRV)
45 WRITE(6,4)(MDAT(K),NDAT(K),K=1,NCRV)
ISC=0
IF(ITYPE.EQ.1)ISC=1
IF(I.EQ.3.OR.I.EQ.4)ISC=1
CALL DATA4(NCURV,MDAT,NDAT,ISC,ITYPE,LAXIS,ICOLOR,N4,TIMEL,TIMER,
50 * IUPLT)
200 CONTINUE
300 IF(IPRINT.EQ.0)GO TO 400
NARR=3
MDAT(1)=6
55 MDAT(2)=6
MDAT(3)=1
NDAT(1)=1
NDAT(2)=2
NDAT(3)=1
60 CALL WRFILE(DAT,MDAT,NDAT,NARR,TST,LST,LSP,LABL,DTIME,IU)
400 CONTINUE
500 RETURN
1 FORMAT(20I3)
2 FORMAT(2F5.0)
65 3 FORMAT(//,' PLOTTING IN SUBROUTINE UNITV')
4 FORMAT(/,' "MDAT, NDAT" PAIRS -',20I3)
END

```

```

1          SUBROUTINE WRFILE(DAT,MDAT,NDAT,NARR,TST,LST,LSP,LABL,DTIME,IU)
      C
      C          THIS SUBROUTINE WRITES DATA ARRAYS TO AN OUTPUT FILE TO BE SAVED
      C          FOR FUTURE USE
5
      C          NARR = NUMBER OF ARRAYS TO BE WRITTEN
      C          MDAT AND NDAT CONTROL THE ORDER IN WHICH THE ARRAY IS WRITTEN
      C          MDAT = FIRST INDEX OF 3-DIMENSIONAL ARRAY DAT
      C          NDAT = SECOND INDEX OF 3-DIMENSIONAL ARRAY DAT
10         C          LST AND LSP CONTROL THE AMOUNT OF DATA WRITTEN BY SPECIFYING THE
      C          STARTING AND STOPPING ELEMENTS OF THE THIRD INDEX OF THE
      C          3-DIMENSIONAL ARRAY DAT
      C          LST = STARTING ELEMENT
      C          LSP = STOPPING ELEMENT
15
      C          DIMENSION DAT(6,2,2500),MDAT(9),NDAT(9),LABL(3,2,24),X(500)
      C          DO 200 I=1,NARR
      C          K=0
      C          DO 100 L=LST,LSP
      C          K=K+1
      C          X(K)=DAT(MDAT(I),NDAT(I),L)
77         100 CONTINUE
      C          WRITE(IU)(LABL(1,1,J),J=1,24)
      C          WRITE(IU)K
25         C          WRITE(IU)TST,DTIME
      C          WRITE(IU)(X(J),J=1,K)
      C          WRITE(6,1)MDAT(I),NDAT(I),(LABL(1,1,J),J=1,24)
      C          200 CONTINUE
      C          RETURN
30         1 FORMAT(' WRITING ARRAY ON FILE - INDICES ARE ',2I3,5X,24A2)
      C          END

```

### C.2.3. Listing Of Auxiliary FORTRAN Subroutines (MFA File DIFFATR)

```
1          SUBROUTINE DIFFER(Z,N,DTIME,IUD,IUF)
      C
      C          IF IUD .NE. 0, THIS SUBROUTINE DIFFERENTIATES AN ARRAY USING AN
      C          FIR DIFFERENTIATOR; USUALLY, THE ONE IN FILE DIFF1 IS USED.
5         C
      C          IF IUF .NE. 0, THEN THE ARRAY IS LOWPASS FILTERED.
      C
      C          DIMENSION Z(N),H(512)
      C          PI2=6.283185307179865
10        IF(IUD.EQ.0)GO TO 150
      C          C=PI2/DTIME
      C          CALL COEF2(NFLT,H,IUD,JTPE)
      C          REWIND IUD
      C          DO 100 I=1,NFLT
15        H(I)=H(I)*C
20        100 CONTINUE
      C          CALL CONVOL(H,Z,N,NFLT,JTPE)
      C          150 IF(IUF.EQ.0)GO TO 200
      C          CALL FILT(Z,N,IUF)
      C          200 RETURN
      C          END
```

```

1          SUBROUTINE COEF1(NFILT,H,IU)
          C
          C          READS IN COEFFICIENTS OF AN FIR LOWPASS OR HIGHPASS FILTER
          C
5          DIMENSION H(512)
          READ(IU)NFILT,FP,TBWID,DP,DS
          IF(ISW.NE.1)WRITE(6,1)
          IF(ISW.NE.1)WRITE(6,2)NFILT,FP,TBWID,DP,DS
          N=(NFILT+1)/2
10         READ(IU)(H(I),I=1,N)
          IF(ISW.NE.1)WRITE(6,3)
          IF(ISW.EQ.1)GO TO 200
          DO 100 I=1,N,5
          IST=I+4
15         IF(IST.GT.N)IST=N
          WRITE(6,4)I,(H(II),II=I,IST)
100        CONTINUE
          WRITE(6,5)
200       ISW=1
20         RETURN
          1 FORMAT(//,' FILTER PARAMETERS,')
          2 FORMAT(5X,' NFILT = ',I5,' FP = ',F10.5,' TBWID = ',F10.5,
          *' DP = ',F10.5,' DS = ',F10.5)
          3 FORMAT(5X,' FILTER COEFFICIENTS')
          4 FORMAT(5X,I5,5E15.8)
          5 FORMAT(//)
25         END

```

```
1          SUBROUTINE COEF2(NFILT,H,IU,JTYPE)
      C
      C          READ IN COEFFICIENTS OF AN FIR DIFFERENTIATOR
      C
5         DIMENSION H(64),EDGE(20),FX(10),WTX(10)
          IF(ISW.NE.1)WRITE(6,1)
          READ(IU)NFILT,JTYPE,NBANDS
          IF(ISW.NE.1)WRITE(6,2)NFILT,JTYPE,NBANDS
          JB=2*NBANDS
10        READ(IU)(EDGE(J),J=1,JB)
          IF(ISW.NE.1)WRITE(6,5)(EDGE(J),J=1,JB)
          READ(IU)(FX(J),J=1,NBANDS)
          IF(ISW.NE.1)WRITE(6,6)(FX(J),J=1,NBANDS)
          READ(IU)(WTX(J),J=1,NBANDS)
15        IF(ISW.NE.1)WRITE(6,7)(WTX(J),J=1,NBANDS)
          READ(IU)(H(J),J=1,64)
          IF(ISW.NE.1)WRITE(6,3)
          IF(ISW.EQ.1)GO TO 200
          N=NFILT/2+1
20        DO 100 I=1,N,5
          IST=I+4
          IF(IST.GT.N)IST=N
          WRITE(6,4)I,(H(II),II=I,IST)
100       CONTINUE
25        WRITE(6,8)
200       ISW=1
          RETURN
          1 FORMAT(//,' FILTER PARAMETERS')
          2 FORMAT(5X,' NFILT = ',I5,' JTYPE = ',I5,' NBANDS = ',I5)
30        3 FORMAT(5X,' FILTER COEFFICIENTS')
          4 FORMAT(5X,I5,5E15.8)
          5 FORMAT(5X,' EDGE ',20F6.4)
          6 FORMAT(5X,' FX ',10F6.2)
          7 FORMAT(5X,' WTX ',10F7.1)
35        8 FORMAT(//)
          END
```

```

1          SUBROUTINE CONVOL(H,X,NDIM,NFILT,JTYPE)
      C
      C          THIS CONVOLUTION IS VALID ONLY FOR NFILT = ODD INTEGER
      C          NFILT MAX. SET TO 1023 - CAN BE RESET BE REDIMENSIONING ARRAYS
5         C          IF JTYPE = 1, EVEN SYMMETRY ASSUMED FOR REFLECTION AT ENDPOINTS
      C          IF JTYPE = 2, ODD SYMMETRY ASSUMED FOR REFLECTION AT ENDPOINTS
      C

      DIMENSION H(512),X(NDIM),S(1030),T(1030)
      IF(JTYPE.EQ.1)SGN=1.
10        IF(JTYPE.EQ.2)SGN=-1.
          IF(JTYPE.EQ.1)A=0.
          IF(JTYPE.EQ.2)A=2.
          IF(JTYPE.LT.1.OR.JTYPE.GT.2)WRITE(6,1)
          IF(JTYPE.LT.1.OR.JTYPE.GT.2)STOP
15        L=NFILT-1
          NCOEF=NFILT/2+1
          J=NCOEF
          K=J-1
          DO 10 I=1,NCOEF
81 20        S(I)=SGN*X(NCOEF-I+1)+A*X(1)
          S(NFILT-I+1)=X(J)
          T(NCOEF+I-1)=SGN*X(NDIM-I+1)+A*X(NDIM)
          J=J-1
10        CONTINUE
25        DO 40 I=1,NDIM
          X(I)=.0
          DO 20 J=1,K
          X(I)=X(I)+H(J)*(SGN*S(J)+S(NFILT-J+1))
20        CONTINUE
30        X(I)=X(I)+H(NCOEF)*S(NCOEF)
          IF(I.EQ.NDIM)GO TO 50
          DO 30 J=1,L
          S(J)=S(J+1)
35        CONTINUE
          IF(I.LE.NDIM-NCOEF)S(NFILT)=X(I+NCOEF)
          IF(I.GT.NDIM-NCOEF)S(NFILT)=T(I+NFILT-NDIM+1)
40        CONTINUE
50        RETURN
      1 FORMAT(' ERROR IN SUB CONVOL - JTYPE NOT EQUAL TO 1 OR 2')
40        END

```

1

SUBROUTINE FILT(X,NPT,IU)

C  
C  
C

THIS SUBROUTINE LOWPASS OR HIGHPASS FILTERS A DATA ARRAY

5

DIMENSION H(512),X(NPT)

JTYP=1

CALL COEF1(NFILT,H,IU)

REWIND IU

10

200 CALL CONVOL(H,X,NPT,NFILT,JTYP)

RETURN

END



C.2.4. Card Image Formats That Are Required For The Input Data Section of MFA File MUZPRED/UN=BOOTS

TABLE C.2. INPUT DATA FORMATS FOR TAPE UNIT 5

<u>Card</u>	<u>Condition*</u>	<u>Column</u>	<u>Format</u>	<u>Variable</u>	<u>Calling Subroutine</u>	<u>Description</u>
1		1-3	I3	NCH	MAIN	No. of data sets to be inputted
		4-6	I3	NPLOTP		No. of plots to be generated in sub. PREDCT
		7-9	I3	NPLOTG		No. of plots to be generated in sub. CALCZ
		10-12	I3	NPLOTU		No. of plots to be generated in sub. UNITV
		13-15	I3	IPRINT		If IPRINT ≠ 0, output data file is generated.
2		1-3	I3	MIN(I)	MAIN	First index for placement of data into array DAT
		4-6	I3	NIN(I)		Second index for placement of data into array DAT
		7-9	I3	IU		Tape unit no. on which data file resides
3	Repeat card 2 until NCH cards are inputted.					
4		1-5	I5	LKEY	MAIN	Index at which to make time = 0.
5		1-10	F10.2	DZ31	PREDCT	Distance from sensor 3 to sensor 1, cm
		11-20	F10.2	DZ32	PREDCT	Distance from sensor 3 to sensor 2, cm
6		1-5	I5	LZM	CALCZ	Index of start of recoil motion (earlier experiment)
		6-10	I5	LPM		Index of peak pressure (earlier experiment)
		11-15	I5	LEM		Index of shot exit (earlier experiment)

\* Omit card if condition is not met.

TABLE C.2. INPUT DATA FORMATS FOR TAPE UNIT 5 (continued)

<u>Card</u>	<u>Condition</u>	<u>Column</u>	<u>Format</u>	<u>Variable</u>	<u>Calling Subroutine</u>	<u>Description</u>
7		1-5	I5	LPD	CALCZ	Index of peak pressure (this experiment)
		6-10	I5	LED		Index of shot exit (this experiment)
8		1-5	I5	MPOLY	CALCZ	Degree of polynomial to be inputted (earlier experiment)
9		1-10	E10.3	C(1)	CALCZ	Coefficients of polynomial (earlier experiment)
		11-20	E10.3	C(2)		
		•	•	•		
		•	•	•		
		•	•	•		
		•	•	C(MPOLY+1)		
10		1-10	E10.3	Z(1,1)	CALCZ	Distance of sensor 1 (horiz) from muzzle face, cm
		11-20	E10.3	Z(1,2)		Distance of sensor 1(vert.) from muzzle face, cm
		21-30	E10.3	Z(2,1)		Distance of sensor 2 from muzzle face, cm
		31-40	E10.3	Z(3,1)		Distance of sensor 3 from muzzle face, cm
11		1-3	I3	NZREF	CALCZ	No. of times the displacement and muzzle-pointing calculations are to be done
12		1-10	E10.3	ZREF	CALCZ	Distance from muzzle face at which the displacement and muzzle-pointing calculations are to be done

TABLE C.2. INPUT DATA FORMATS FOR TAPE UNIT 5 (continued)

<u>Card</u>	<u>Condition</u>	<u>Column</u>	<u>Format</u>	<u>Variable</u>	<u>Calling Subroutine</u>	<u>Description</u>
13	IPRINT#0	1-3	I3	MDAT(1)	CALCZ	First index in array DAT of first set of data to be written to output file
		4-6	I3	NDAT(1)		Second index in array DAT of first set of data to be written to output file
		7-9	I3	MDAT(2)		First index of second set
		10-12	I3	NDAT(2)		Second index of second set
		13-15	I3	MDAT(3)		First index of third set
		16-18	I3	NDAT(3)		Second index of third set
14	Repeat cards 12 and 13 for NZREF times.					

TABLE C.3. INPUT DATA FORMATS FOR TAPE UNITS 3,7, AND 10

<u>Card</u>	<u>Condition*</u>	<u>Column</u>	<u>Format</u>	<u>Variable</u>	<u>Description</u>
1		1-5	F5.0	TIMEL	Time to start plotting (time = .0 at LKEY), ms
		6-10	F5.0	TIMER	Time to stop plotting, ms
2		1-3	I3	LAXIS	=1 Plot axis labels to be inputted ≠1 Plot axis labels are blank
		4-6	I3	ICOLOR	=0 Black/white plot =1 Color plot
3		1-3	I3	MDAT(1)	First index in array DAT of first set of data to be plotted
		4-6	I3	NDAT(1)	Second index in array DAT of first set of data to be plotted
		7-9	I3	MDAT(2)	First index of second curve
		10-12	I3	NDAT(2)	Second index of second curve
					• • • MDAT(NCRV) NDAT(NCRV)
4	N4>0	1-10	F10.0	X4(1)	X-coordinate of a point to be symbol-plotted
		11-20	F10.0	Y4(1)	Y-coordinate of a point to be symbol-plotted
5	LAXIS=1	1-10	A10	LXNAME	Label for x-axis
		11-20	A10	LYNAME	Label for y-axis
6	ISC≠0	1-10	E10.3	XORIG	Minimum value of x-axis
		11-20	E10.3	XMAX	Maximum value of x-axis
		21-30	E10.3	XSTP	Interval between tic-marks on x-axis
		31-40	E10.3	YORIG	Minimum value of y-axis
		41-50	E10.3	YMAX	Maximum value of y-axis
		51-60	E10.3	YSTP	Interval between tic-marks on y-axis
7		Repeat cards 3 through 6 for NPLOTP, NPLOTG, or NPLOTU times, depending on whether the calling subroutine is PREDCT, CALCZ, OR UNITV.			

\* Omit card if condition is not met.

APPENDIX D  
SAMPLE PROBLEM

## APPENDIX D

### SAMPLE PROBLEM

As alluded to earlier in this report, the computer programs have been developed for the analysis of muzzle displacements collected in a collaborative experiment between BRL and RARDE in May and June 1984 at RARDE, Fort Halstead [5]. This experiment, carried out with a 40mm rifled gun, had the objective to assess the SDT measurement technique as a means to define projectile launch. It included the measurement of the projectile dynamics with respect to the muzzle during shot exit as well as the motion of the muzzle with respect to the ground. The latter was monitored by three orthogonal displacement transducers employing a SDT instrumentation for sensor 1 and electrooptical displacement transducers [A-8] for sensors 2 and 3. The three data sets for round #5 plus the muzzle recoil velocity recorded by an earlier experiment (see Section 4.3.1) form the input to the sample problem. Since the result of the analysis of the data from the collaborative experiment [6] will be discussed in a separate BRL technical report, only sample outputs including plots are shown for this round.

D.1. Program MUZMO40

D.1.1. Sample Input Card Images

0	0	0	1						
6	1	0	1						
1	1	1							
1	2	2							
2	1	8							
2	2	9							
3	1	10							
3	2	11							
	202.52	.00221	.00444	215.11	.00349	.00221			
	108.9	242.1							
	263.9	227.8							
1	1	.0024414	.9985	1.					
1	2	.0024414	.99925	1.					
2	1	.0048828	.99925	1.					
2	2	.0048828	.99925	1.					
3	1	.0048828	.9985	1.					
3	2	.0048828	1.001	1.					

APPENDIX D

D.1.2. Sample Printed Output (Program MUZMO40)

IPLT1 = 0 IPLT2 = 0 IPLT3 = 0 IPRT = 1  
NCH = 6 ICVT = 1 IFILT = 0 IDERIV = 1

INPUT DATA CHANNELS

1 1 1  
1 1 BR0512 1 1 1BRL TUBE HOR  
4095 0.00000 .01000  
1 2 2  
1 2 BR0511 1 1 1BRL TUBE VERT  
4095 0.00000 .01000  
2 1 8  
2 1 BR0509 1 1 1HEL TUBE FWD HOR  
4095 0.00000 .01000  
2 2 9  
2 2 BR0508 1 1 1HEL TUBE FWD VERT  
4095 0.00000 .01000  
3 1 10  
3 1 BR0510 1 1 1HEL TUBE REAR HOR  
4095 0.00000 .01000  
3 2 11  
3 2 BR0507 1 1 1HEL TUBE REAR VERT  
4095 0.00000 .01000

06



**CALIBRATION CONSTANTS**

202.52000 .00221 .00444 215.11000 .00349 .00221  
108.90000 242.10000  
263.90000 227.80000  
1 1 .00244 .99850 1.00000 .00245  
1 2 .00244 .99925 1.00000 .00244  
2 1 .00488 .99925 1.00000 .00489  
2 2 .00488 .99925 1.00000 .00489  
3 1 .00488 .99850 1.00000 .00489  
3 2 .00488 1.00100 1.00000 .00488  
1 1 .00245 202.52000  
1 2 .00244 215.11000  
2 1 .00489 108.90000  
2 2 .00489 242.10000  
3 1 .00489 263.90000  
3 2 .00488 227.80000

**FILTER PARAMETERS**

NFILT = 31 JTYPE = 2 NRANDS = 1  
EDGE 0.0000 .4000  
FX 1.00  
WTX 1.0

**FILTER COEFFICIENTS**

1 .16166620E-04 -.74131438E-04 .21102257E-03 -.49246632E-03 .10096462E-02  
6 -.18862205E-02 .32833366E-02 -.54084061E-02 .85345464E-02 -.13047140E-01  
11 .19559239E-01 -.29218184E-01 .44647104E-01 -.73733156E-01 .15615738E+00  
16 0.

CHANNEL BR0512

1 1 1BRL TUBE HOR

HAS BEEN DIFFERENTIATED

**FILTER PARAMETERS,**

NFILT = 127 FP = .00500 TBWID = .01541 DP = .01000 DS = .01000

FILTER COEFFICIENTS

1	-.57611818E-02	-.13120665E-02	-.14458869E-02	-.15779811E-02	-.17054889E-02
6	-.18272702E-02	-.19407950E-02	-.20444951E-02	-.21345667E-02	-.22110148E-02
11	-.22685610E-02	-.23074309E-02	-.23235239E-02	-.23165943E-02	-.22818637E-02
16	-.22201999E-02	-.21269670E-02	-.20019212E-02	-.18400413E-02	-.16423613E-02
21	-.14040333E-02	-.11271255E-02	-.80807552E-03	-.45054632E-03	-.49316320E-04
26	.39177683E-03	.88090117E-03	.14120564E-02	.19883328E-02	.25922726E-02
31	.32498950E-02	.39438586E-02	.46685324E-02	.54340488E-02	.62277021E-02
36	.70536956E-02	.79036343E-02	.87797060E-02	.96719531E-02	.10582451E-01
41	.11502901E-01	.12431251E-01	.13361246E-01	.14291479E-01	.15214561E-01
46	.16127318E-01	.17023636E-01	.17900295E-01	.18750877E-01	.19572419E-01
51	.20359358E-01	.21108628E-01	.21814687E-01	.22474542E-01	.23082659E-01
56	.23637514E-01	.24135636E-01	.24573834E-01	.24947050E-01	.25256526E-01
61	.25501145E-01	.25673888E-01	.25780396E-01	.25814786E-01	

26

CHANNEL BR0512	1 1 1BRL TUBE HOR	HAS BEEN FILTERED
CHANNEL BR0512	1 1 1BRL TUBE HOR	HAS BEEN DIFFERENTIATED
CHANNEL BR0512	1 1 1BRI TUBE HOR	HAS BEEN FILTERED
CHANNEL BR0511	1 1 1BRL TUBE VERT	HAS BEEN DIFFERENTIATED
CHANNEL BR0511	1 1 1BRL TUBE VERT	HAS BEEN FILTERED
CHANNEL BR0511	1 1 1BRL TUBE VERT	HAS BEEN DIFFERENTIATED
CHANNEL BR0511	1 1 1BRL TUBE VERT	HAS BEEN FILTERED
CHANNEL BR0509	1 1 1HEL TUBE FWD HOR	HAS BEEN DIFFERENTIATED
CHANNEL BR0509	1 1 1HEL TUBE FWD HOR	HAS BEEN FILTERED
CHANNEL BR0509	1 1 1HEL TUBE FWD HOR	HAS BEEN DIFFERENTIATED
CHANNEL BR0509	1 1 1HEL TUBE FWD HOR	HAS BEEN FILTERED
CHANNEL BR0508	1 1 1HEL TUBE FWD VERT	HAS BEEN DIFFERENTIATED
CHANNEL BR0508	1 1 1HEL TUBE FWD VERT	HAS BEEN FILTERED
CHANNEL BR0508	1 1 1HEL TUBE FWD VERT	HAS BEEN DIFFERENTIATED
CHANNEL BR0508	1 1 1HEL TUBE FWD VERT	HAS BEEN FILTERED
CHANNEL BR0510	1 1 1HEL TUBE REAR HOR	HAS BEEN DIFFERENTIATED
CHANNEL BR0510	1 1 1HEL TUBE REAR HOR	HAS BEEN FILTERED

CHANNEL BR0510	1 1	1HEL TUBE REAR HOR	HAS BEEN DIFFERENTIATED
CHANNEL BR0510	1 1	1HEL TUBE REAR HOR	HAS BEEN FILTERED
CHANNEL BR0507	1 1	1HEL TUBE REAR VERT	HAS BEEN DIFFERENTIATED
CHANNEL BR0507	1 1	1HEL TUBE REAR VERT	HAS BEEN FILTERED
CHANNEL BR0507	1 1	1HEL TUBE REAR VERT	HAS BEEN DIFFERENTIATED
CHANNEL BR0507	1 1	1HEL TUBE REAR VERT	HAS BEEN FILTERED

INPUT DATA - UNFILTERED

WRITING ON FILE - BR0512	1 1	1BRL TUBE HOR
WRITING ON FILE - BR0511	1 1	1BRL TUBE VERT
WRITING ON FILE - BR0509	1 1	1HEL TUBE FWD HOR
WRITING ON FILE - BR0508	1 1	1HEL TUBE FWD VERT
WRITING ON FILE - BR0510	1 1	1HEL TUBE REAR HOR
WRITING ON FILE - BR0507	1 1	1HEL TUBE REAR VERT

FIRST DERIVATIVE - FILTERED

WRITING ON FILE - BR0512	1 1	1BRL TUBE HOR
WRITING ON FILE - BR0511	1 1	1BRL TUBE VERT
WRITING ON FILE - BR0509	1 1	1HEL TUBE FWD HOR
WRITING ON FILE - BR0508	1 1	1HEL TUBE FWD VERT
WRITING ON FILE - BR0510	1 1	1HEL TUBE REAR HOR
WRITING ON FILE - BR0507	1 1	1HEL TUBE REAR VERT

SECOND DERIVATIVE - FILTERED

WRITING ON FILE - BR0512	1 1	1BRL TUBE HOR
WRITING ON FILE - BR0511	1 1	1BRL TUBE VERT
WRITING ON FILE - BR0509	1 1	1HEL TUBE FWD HOR
WRITING ON FILE - BR0508	1 1	1HEL TUBE FWD VERT
WRITING ON FILE - BR0510	1 1	1HEL TUBE REAR HOR
WRITING ON FILE - BR0507	1 1	1HEL TUBE REAR VERT

END OF DISSPLA 8.2 -- 0 VECTORS GENERATED IN 0 PLOT FRAMES.  
 -ISSCO- 4186 SORRENTO VALLEY BLVD., SAN DIEGO CALIF. 92121

DISSPLA IS A CONFIDENTIAL PROPRIETARY PRODUCT OF ISSCO AND ITS USE  
 IS SUBJECT TO A NONDISSEMINATION AND NONDISCLOSURE AGREEMENT.

APPENDIX D

D.2. Program MUZPRED

D.2.1. Sample Input Card Images From Tape Unit 5 (Normal Input)

```
8 7 6 3 1
1 1 1
1 2 1
2 1 1
2 2 1
3 1 1
3 2 1
1 1 4
1 2 4
2059
-45.36 -12.00
2175 2342 3474 .005
1490 2059
5
-.33679E-2 3.7657 .41978 -15.709 23.535 -10.359
-2.94 -3.25 -36.56 -48.56
2
.0
6 2 2 1 2 2
-7.52
6 2 2 1 2 2
```

D.2.2 Sample Input Card Images From Tape Unit 3 (MFA File DISPL40)

```

-9. 3.
1 0
1 1 4 1
2059. .0
TIME, MS HORIZONTAL
-9. 3. 3. -.06 .04 .02
1 2 4 2
2059. .0
TIME, MS VERTICAL
-9. 3. 3. -.10 .06 .04
6 1 5 1
2059. .05
TIME, MS MAGNITUDE
-9. 3. 3. .0 .10 .02
6 2 5 2
2059. 260.
TIME, MS ANGLE
-9. 3. 3. 60. 360. 100.
1 1 1 2 4 1 4 2
2059. .0
HORIZONTAL VERTICAL
-.08 .08 .04 -.10 .06 .04
1 1 1 2
2059. .0
HORIZONTAL VERTICAL
-.08 .08 .04 -.10 .06 .04
1 1 1 2
2059. .0
HORIZONTAL VERTICAL
-.02 .03 .01 -.02 .03 .01

```

D.2.3. Sample Input Card Images From Tape Unit 7 (MFA File RECL40)

-9.	3.					
1	0					
2	1					
	2059.	.0				
(0)MS(1)			(0)CM(1)			
2	2					
	2059.	.0				
(0)MS(1)			(0)CM(1)			
2	1 2 2					
	2059.	.0				
(0)CM(1)			(0)CM(1)			
	-.02	.02	.01	-.02	.02	.01
3	1					
	2059.	.0				
(0)MS(1)			(0)CM/MS(1)			
	-10.	4.	2.	-.015	.015	.005
3	2					
	2059.	.0				
(0)MS(1)			(0)CM/MS(1)			
3	1 3 2					
	2059.	.0				
(0)CM/MS(1)			(0)CM/MS(1)			
	-.02	.02	.01	-.02	.02	.01

D.2.4. Sample Input Card Images From Tape Unit 10 (MFA File UVECT40)

```
-1.  1.  
1  0  
6  1  
   2059.      .0  
(0)MS(1)  
6  2  
   2059.      .0  
(0)MS(1)  
6  1  6  2  
   2059.      .0  
  -.0005     .0005     .0005     -.0005     .0005     .0005
```

APPENDIX D

D.2.5. Sample Printed Output (Program MUZPRED)

93

```

NCH, NPLOTP, NPLOTG, NPLOTU, IPRINT - 8 7 6 3 1
MIN, NIN, IU - 1 1 1
  1 1 BR0512          1 1 1BRL TUBE HOR
NDATA, TSTART, DTIME - 4095 0.00000 .01000
MIN, NIN, IU - 1 2 1
  1 2 BR0511          1 1 1BRL TUBE VERT
NDATA, TSTART, DTIME - 4095 0.00000 .01000
MIN, NIN, IU - 2 1 1
  2 1 BR0509          1 1 1HEL TUBE FWD HOR
NDATA, TSTART, DTIME - 4095 0.00000 .01000
MIN, NIN, IU - 2 2 1
  2 2 BR0508          1 1 1HEL TUBE FWD VERT
NDATA, TSTART, DTIME - 4095 0.00000 .01000
MIN, NIN, IU - 3 1 1
  3 1 BR0510          1 1 1HEL TUBE REAR HOR
NDATA, TSTART, DTIME - 4095 0.00000 .01000
MIN, NIN, IU - 3 2 1
  3 2 BR0507          1 1 1HEL TUBE REAR VERT
NDATA, TSTART, DTIME - 4095 0.00000 .01000
MIN, NIN, IU - 1 1 4
  1 1 BR0512          1 1 1BRL TUBE HOR
NDATA, TSTART, DTIME - 4095 0.00000 .01000
MIN, NIN, IU - 1 2 4
  1 2 BR0511          1 1 1BRL TUBE VERT
NDATA, TSTART, DTIME - 4095 0.00000 .01000

```

LKEY = 2059

DZ31, DZ32 -45.36 -12.00



L	BRL:	HORIZONTAL	VERTICAL	MAGNITUDE	ORIENTATION	HEL:	HORIZONTAL	VERTICAL	MAGNITUDE	ORIENTATION
2035		-.02361	-.06044	.06489	201.34		-.01174	-.04890	.05029	193.51
2042		-.02248	-.06166	.06563	200.03		-.01166	-.05164	.05294	192.73
2049		-.02118	-.06319	.06664	198.53		-.01212	-.05455	.05588	192.52
2056		-.02036	-.06520	.06830	197.34		-.01292	-.05751	.05894	192.66
2063		-.02049	-.06730	.07035	196.93		-.01385	-.06032	.06189	192.93
2070		-.02152	-.06952	.07278	197.20		-.01472	-.06288	.06458	193.17
2077		-.02317	-.07164	.07530	197.92		-.01546	-.06506	.06687	193.37
2084		-.02448	-.07340	.07737	198.44		-.01616	-.06666	.06859	193.63

**PLOTTING IN SUBROUTINE PREDCT**

"MDAT, NDAT" PAIRS - 1 1 4 1  
SPECIAL COORDINATES 20.590 0.000  
PLOT LIMITS - 1160 2359 -9.0000 2.9900  
TIME, MS HORIZONTAL  
PLOT SCALES - -.90000E+01 .30000E+01 .30000E+01 -.60000E-01 .20000E-01 .40000E-01

96 "MDAT, NDAT" PAIRS - 1 2 4 2  
SPECIAL COORDINATES 20.590 0.000  
PLOT LIMITS - 1160 2359 -9.0000 2.9900  
TIME, MS VERTICAL  
PLOT SCALES - -.90000E+01 .30000E+01 .30000E+01 -.10000E+00 .40000E-01 .60000E-01

"MDAT, NDAT" PAIRS - 6 1 5 1  
SPECIAL COORDINATES 20.590 .050  
PLOT LIMITS - 1160 2359 -9.0000 2.9900  
TIME, MS MAGNITUDE  
PLOT SCALES - -.90000E+01 .30000E+01 .30000E+01 0. .20000E-01 .10000E+00

"MDAT, NDAT" PAIRS - 6 2 5 2  
SPECIAL COORDINATES 20.590 260.000  
PLOT LIMITS - 1160 2359 -9.0000 2.9900  
TIME, MS ANGLE  
PLOT SCALES - -.90000E+01 .30000E+01 .30000E+01 .60000E+02 .10000E+03 .36000E+03

100

"MDAT, NDAT" PAIRS - 1 1 1 2 4 1 4 2  
 SPECIAL COORDINATES 20.590 0.000  
 PLOT LIMITS - 1160 2359 -.0236 -.0291  
 HORIZONTAL VERTICAL  
 PLOT SCALES - -.80000E-01 .40000E-01 .80000E-01 -.10000E+00 .40000E-01 .60000E-01

"MDAT, NDAT" PAIRS - 1 1 1 2  
 SPECIAL COORDINATES 20.590 0.000  
 PLOT LIMITS - 1160 2359 -.0236 -.0291  
 HORIZONTAL VERTICAL  
 PLOT SCALES - -.80000E-01 .40000E-01 .80000E-01 -.10000E+00 .40000E-01 .60000E-01

"MDAT, NDAT" PAIRS - 1 1 1 2  
 SPECIAL COORDINATES 20.590 0.000 0.000 0.000  
 COORDINATES AT SHOT EJECTION - -.20104E-01 -.66116E-01  
 PLOT LIMITS - 1160 2359 -.0035 -.0090  
 HORIZONTAL VERTICAL  
 PLOT SCALES - -.20000E-01 .10000E-01 .30000E-01 -.20000E-01 .10000E-01 .30000E-01

SUBROUTINE CALCZ - SCALING PARAMETERS

2175 2342 3474

1406 1490 2059

COEFFICIENTS OF RECOIL MOTION CURVE

-.337E-02 .377E+01 .420E+00 -.157E+02 .235E+02 -.104E+02

Z-ARRAY

-.294E+01 -.366E+02 -.486E+02 -.325E+01 -.366E+02 -.486E+02

NZREF = 2

ZREF = 0.00000

"MDAT, NDAT" PAIRS - 6 2 2 1 2 2

WRITING ARRAY ON FILE - INDICES ARE	6 2	BR0512	1 1	1BRL TUBE HOR
WRITING ARRAY ON FILE - INDICES ARE	2 1	BR0512	1 1	1BRL TUBE HOR
WRITING ARRAY ON FILE - INDICES ARE	2 2	BR0512	1 1	1BRL TUBE HOR
WRITING ARRAY ON FILE - INDICES ARE	6 1	BR0512	1 1	1BRL TUBE HOR
WRITING ARRAY ON FILE - INDICES ARE	6 2	BR0512	1 1	1BRL TUBE HOR
WRITING ARRAY ON FILE - INDICES ARE	1 1	BR0512	1 1	1BRL TUBE HOR
WRITING ARRAY ON FILE - INDICES ARE	6 1	BR0512	1 1	1BRL TUBE HOR
WRITING ARRAY ON FILE - INDICES ARE	6 2	BR0512	1 1	1BRL TUBE HOR
WRITING ARRAY ON FILE - INDICES ARE	1 1	BR0512	1 1	1BRL TUBE HOR

**PLOTTING IN SUBROUTINE UNITV**

"MDAT, NDAT" PAIRS - 6 1  
 SPECIAL COORDINATES 20.590 0.000  
 PLOT LIMITS - 1960 2159 -1.0000 .9900  
 (0)MS(1)  
 PLOT SCALES - -.10000E+01 .26257E+72 .99000E+00 -.53397E-03 .26257E+72 -.11864E-03

"MDAT, NDAT" PAIRS - 6 2  
 SPECIAL COORDINATES 20.590 0.000  
 PLOT LIMITS - 1960 2159 -1.0000 .9900  
 (0)MS(1)  
 PLOT SCALES - -.10000E+01 .26257E+72 .99000E+00 -.31739E-02 .26257E+72 -.10133E-02

"MDAT, NDAT" PAIRS - 6 1 6 2  
 SPECIAL COORDINATES 20.590 0.000 0.000 0.000  
 COORDINATES AT SHOT EJECTION - -.11864E-03 -.24520E-02  
 PLOT LIMITS - 1960 2159 -.0004 -.0002  
 PLOT SCALES - -.50000E-03 .50000E-03 .50000E-03 -.50000E-03 .50000E-03 .50000E-03  
 WRITING ARRAY ON FILE - INDICES ARE 6 1 BR0512 1 1 1BRL TUBE HOR  
 WRITING ARRAY ON FILE - INDICES ARE 6 2 BR0512 1 1 1BRL TUBE HOR  
 WRITING ARRAY ON FILE - INDICES ARE 1 1 BR0512 1 1 1BRL TUBE HOR

FILTER PARAMETERS  
 NFILT = 31 JTYPE = 2 NBANDS = 1  
 EDGE 0.0000 .4000  
 FX 1.00  
 WTX 1.0

FILTER COEFFICIENTS  
 1 .16166620E-04 -.74131438E-04 .21102257E-03 -.49246632E-03 .10096462E-02  
 6 -.18862205E-02 .32833366E-02 -.54084061E-02 .85345464E-02 -.13047140E-01  
 11 .19559239E-01 -.29218184E-01 .44647104E-01 -.73733156E-01 .15615738E+00  
 16 0.

101

**FILTER PARAMETERS**

NFILT = 127 FP = .00500 TBWID = .01541 DP = .01000 DS = .01000

**FILTER COEFFICIENTS**

1	-.57611818E-02	-.13120665E-02	-.14458869E-02	-.15779811E-02	-.17054889E-02
6	-.18272702E-02	-.19407950E-02	-.20444951E-02	-.21345667E-02	-.22110148E-02
11	-.22685610E-02	-.23074309E-02	-.23235239E-02	-.23165943E-02	-.22818637E-02
16	-.22201999E-02	-.21269670E-02	-.20019212E-02	-.18400413E-02	-.16423613E-02
21	-.14040333E-02	-.11271255E-02	-.80807552E-03	-.45054632E-03	-.49316320E-04
26	.39177683E-03	.88090117E-03	.14120564E-02	.19883328E-02	.25922726E-02
31	.32498950E-02	.39438586E-02	.46685324E-02	.54340488E-02	.62277021E-02
36	.70536956E-02	.79036343E-02	.87797060E-02	.96719531E-02	.10582451E-01
41	.11502901E-01	.12431251E-01	.13361246E-01	.14291479E-01	.15214561E-01
46	.16127318E-01	.17023636E-01	.17900295E-01	.18750877E-01	.19572419E-01
51	.20359358E-01	.21108628E-01	.21814687E-01	.22474542E-01	.23082659E-01
56	.23637514E-01	.24135636E-01	.24573834E-01	.24947050E-01	.25256526E-01
61	.25501145E-01	.25673888E-01	.25780396E-01	.25814786E-01	

102

**PLOTTING IN SUBROUTINE CALCZ**

"MDAT, NDAT" PAIRS - 2 1

SPECIAL COORDINATES 20.590 0.000

PLOT LIMITS - 1160 2359 -9.0000 2.9900

(0)MS(1) (0)CM(1)

PLOT SCALES - -.90000E+01 .26257E+72 .29900E+01 -.41374E-01 .26257E+72 -.20370E-01

"MDAT, NDAT" PAIRS - 2 2

SPECIAL COORDINATES 20.590 0.000

PLOT LIMITS - 1160 2359 -9.0000 2.9900

(0)MS(1) (0)CM(1)

PLOT SCALES - -.90000E+01 .26257E+72 .29900E+01 -.96551E-01 .26257E+72 .12158E-02

"MDAT, NDAT" PAIRS - 2 1 2 2

SPECIAL COORDINATES 20.590 0.000 0.000 0.000

COORDINATES AT SHOT EJECTION - -.20370E-01 -.72367E-01

PLOT LIMITS - 1160 2359 -.0040 -.0095

(0)CM(1) (0)CM(1)

PLOT SCALES - -.20000E-01 .10000E-01 .20000E-01 -.20000E-01 .10000E-01 .20000E-01

"MDAT, NDAT" PAIRS - 3 1  
 SPECIAL COORDINATES 20.590 0.000  
 PLOT LIMITS - 1160 2359 -9.0000 2.9900  
 (0)MS(1) (0)CM/MS(1)  
 PLOT SCALES - -.10000E+02 .20000E+01 .40000E+01 -.15000E-01 .50000E-02 .15000E-01

"MDAT, NDAT" PAIRS - 3 2  
 SPECIAL COORDINATES 20.590 0.000  
 PLOT LIMITS - 1160 2359 -9.0000 2.9900  
 (0)MS(1) (0)CM/MS(1)  
 PLOT SCALES - -.90000E+01 .26257E+72 .29900E+01 -.56225E-01 .26257E+72 .39069E-01

"MDAT, NDAT" PAIRS - 3 1 3 2  
 SPECIAL COORDINATES 20.590 0.000 0.000 0.000  
 COORDINATES AT SHOT EJECTION - -.12763E-02 -.28196E-01  
 PLOT LIMITS - 1960 2159 .0091 -.0032  
 (0)CM/MS(1) (0)CM/MS(1)  
 PLOT SCALES - -.20000E-01 .10000E-01 .20000E-01 -.20000E-01 .10000E-01 .20000E-01

ZREF = -7.52000

"MDAT, NDAT" PAIRS - 6 2 2 1 2 2  
 WRITING ARRAY ON FILE - INDICES ARE 6 2 BR0512 1 1 1BRL TUBE HOR  
 WRITING ARRAY ON FILE - INDICES ARE 2 1 BR0512 1 1 1BRL TUBE HOR  
 WRITING ARRAY ON FILE - INDICES ARE 2 2 BR0512 1 1 1BRL TUBE HOR  
 WRITING ARRAY ON FILE - INDICES ARE 6 1 BR0512 1 1 1BRL TUBE HOR  
 WRITING ARRAY ON FILE - INDICES ARE 6 2 BR0512 1 1 1BRL TUBE HOR  
 WRITING ARRAY ON FILE - INDICES ARE 1 1 BR0512 1 1 1BRL TUBE HOR  
 WRITING ARRAY ON FILE - INDICES ARE 6 1 BR0512 1 1 1BRL TUBE HOR  
 WRITING ARRAY ON FILE - INDICES ARE 6 2 BR0512 1 1 1BRL TUBE HOR  
 WRITING ARRAY ON FILE - INDICES ARE 1 1 BR0512 1 1 1BRL TUBE HOR

**PLOTTING IN SUBROUTINE UNITV**

"MDAT, NDAT" PAIRS - 6 1  
SPECIAL COORDINATES 20.590 0.000  
PLOT LIMITS - 1960 2159 -1.0000 .9900  
(0)MS(1)  
PLOT SCALES - -.10000E+01 .26257E+72 .99000E+00 -.53124E-03 .26257E+72 -.11726E-03

"MDAT, NDAT" PAIRS - 6 2  
SPECIAL COORDINATES 20.590 0.000  
PLOT LIMITS - 1960 2159 -1.0000 .9900  
(0)MS(1)  
PLOT SCALES - -.10000E+01 .26257E+72 .99000E+00 -.31721E-02 .26257E+72 -.10128E-02

"MDAT, NDAT" PAIRS - 6 1 6 2  
SPECIAL COORDINATES 20.590 0.000 0.000 0.000  
COORDINATES AT SHOT EJECTION - -.11726E-03 -.24504E-02  
PLOT LIMITS - 1960 2159 -.0004 -.0002  
PLOT SCALES - -.50000E-03 .50000E-03 .50000E-03 -.50000E-03 .50000E-03 .50000E-03  
WRITING ARRAY ON FILE - INDICES ARE 6 1 BR0512 1 1 1BRL TUBE HOR  
WRITING ARRAY ON FILE - INDICES ARE 6 2 BR0512 1 1 1BRL TUBE HOR  
WRITING ARRAY ON FILE - INDICES ARE 1 1 BR0512 1 1 1BRL TUBE HOR

104

**PLOTTING IN SUBROUTINE CALCZ**

"MDAT, NDAT" PAIRS - 2 1  
SPECIAL COORDINATES 20.590 0.000  
PLOT LIMITS - 1160 2359 -9.0000 2 9900  
(0)MS(1) (0)CM(1)  
PLOT SCALES - -.90000E+01 .26257E+72 .29900E+01 -.35949E-01 .26257E+72 -.19480E-01

"MDAT, NDAT" PAIRS - 2 2  
SPECIAL COORDINATES 20.590 0.000  
PLOT LIMITS - 1160 2359 -9.0000 2.9900  
(0)MS(1) (0)CM(1)  
PLOT SCALES - -.90000E+01 .26257E+72 .29900E+01 -.72686E-01 .26257E+72 .20543E-02

"MDAT, NDAT" PAIRS - 2 1 2 2  
SPECIAL COORDINATES 20.590 0.000 0.000 0.000  
COORDINATES AT SHOT EJECTION - -.19480E-01 -.53931E-01  
PLOT LIMITS - 1160 2359 -.0028 -.0073  
(0)CM(1) (0)CM(1)  
PLOT SCALES - -.20000E-01 .10000E-01 .20000E-01 -.20000E-01 .10000E-01 .20000E-01

"MDAT, NDAT" PAIRS - 3 1  
SPECIAL COORDINATES 20.590 0.000  
PLOT LIMITS - 1160 2359 -9.0000 2.9900  
(0)MS(1) (0)CM/MS(1)  
PLOT SCALES - -.10000E+02 .20000E+01 .40000E+01 -.15000E-01 .50000E-02 .15000E-01

"MDAT, NDAT" PAIRS - 3 2  
SPECIAL COORDINATES 20.590 0.000  
PLOT LIMITS - 1160 2359 -9.0000 2.9900  
(0)MS(1) (0)CM/MS(1)  
PLOT SCALES - -.90000E+01 .26257E+72 .29900E+01 -.39433E-01 .26257E+72 .27812E-01

"MDAT, NDAT" PAIRS - 3 1 3 2  
SPECIAL COORDINATES 20.590 0.000 0.000 0.000  
COORDINATES AT SHOT EJECTION - -.19140E-02 -.22843E-01  
PLOT LIMITS - 1960 2159 .0063 -.0027  
(0)CM/MS(1) (0)CM/MS(1)  
PLOT SCALES - -.20000E-01 .10000E-01 .20000E-01 -.20000E-01 .10000E-01 .20000E-01

## APPENDIX D

### D.2.6. Sample Plotted Output

These plots (Figures D.1 through D.25) are representative of the ones available from the program. In Figures D.1. through D.5, the solid line refers to the data from sensor 1 while the dashed line refers to the extrapolation of the data from sensors 2 and 3 to the position of sensor 1.



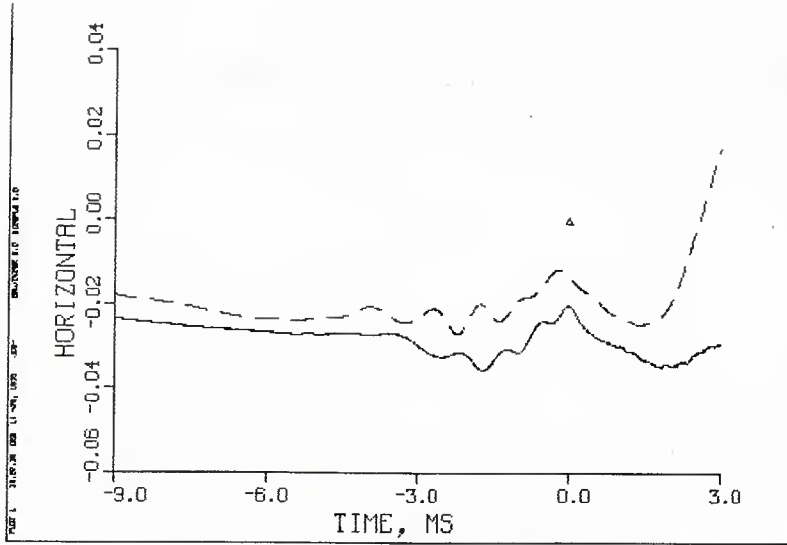

Figure D.1. Horizontal Displacement, cm.

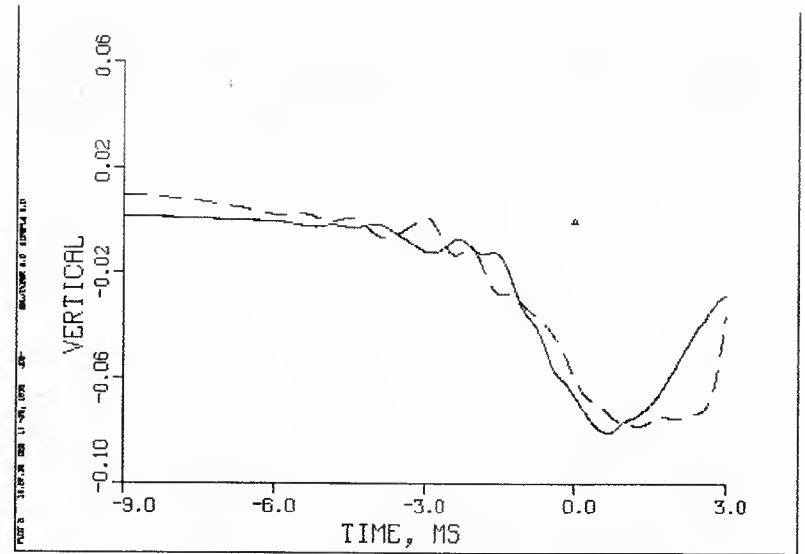

Figure D.2. Vertical Displacement, cm

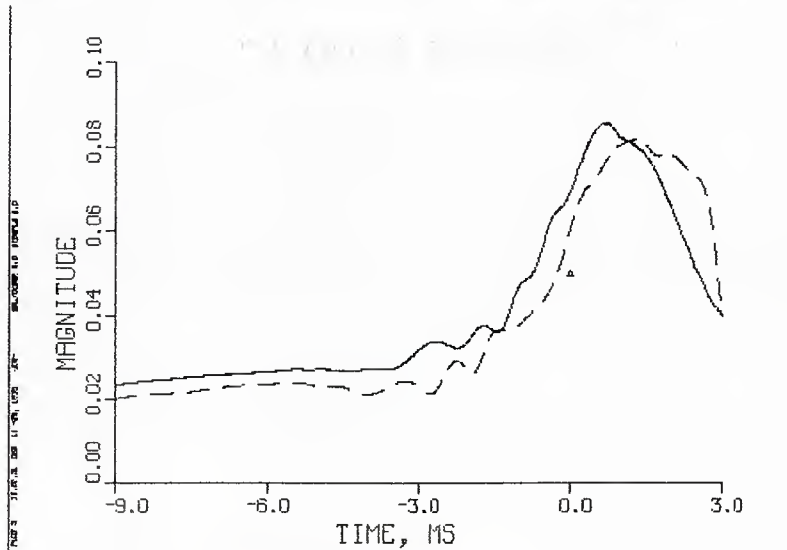

Figure D.3. Magnitude, cm

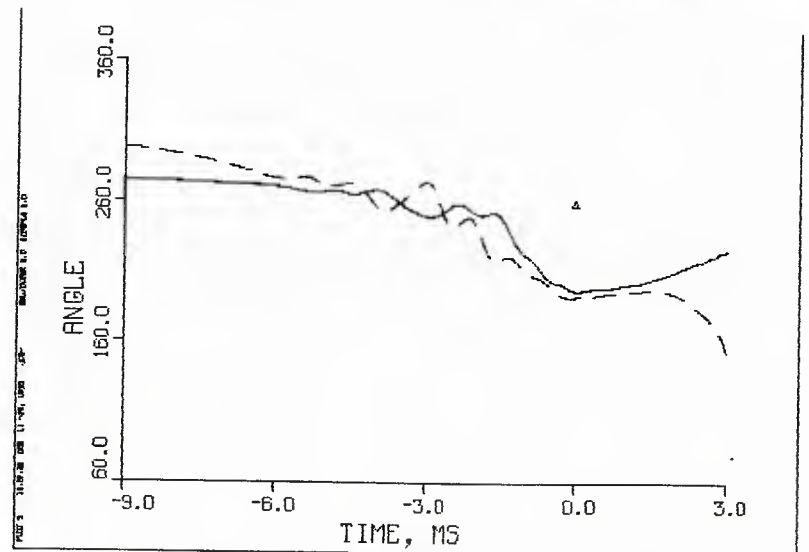

Figure D.4. Phase Angle, deg.

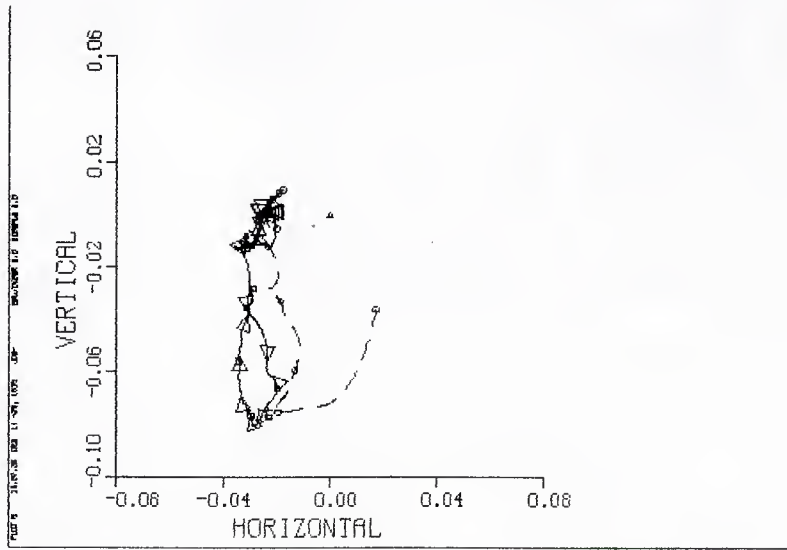

Figure D.5. X-Y Plot Of Displacement, cm

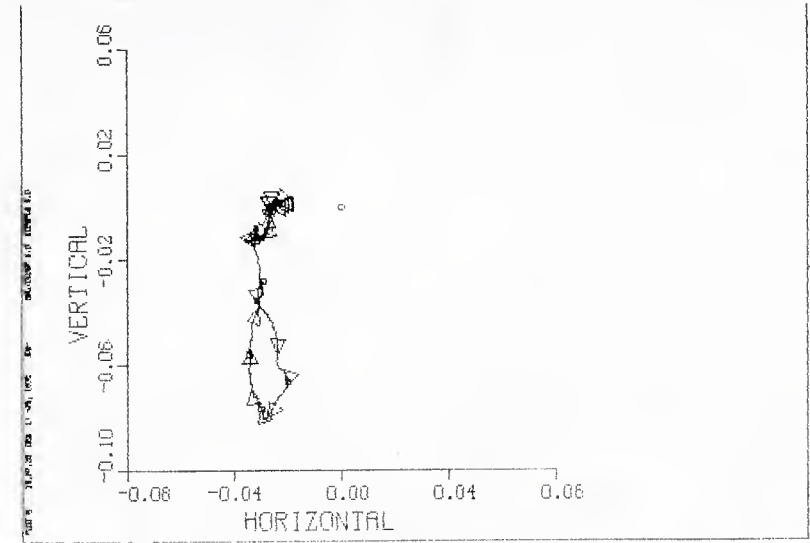

Figure D.6. X-Y Plot Of Sensor 1 Displacement, cm

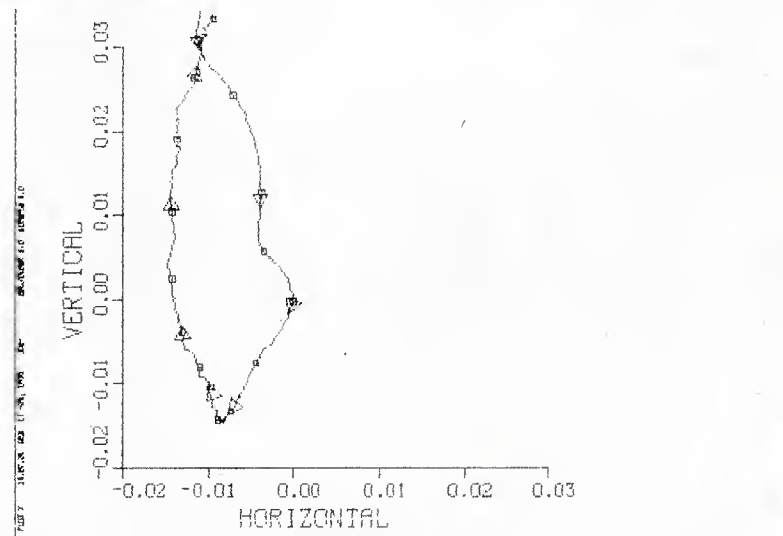

Figure D.7. X-Y Plot Of Sensor 1 Displacement, Amplitude Zeroed At Time Of Shot Ejection

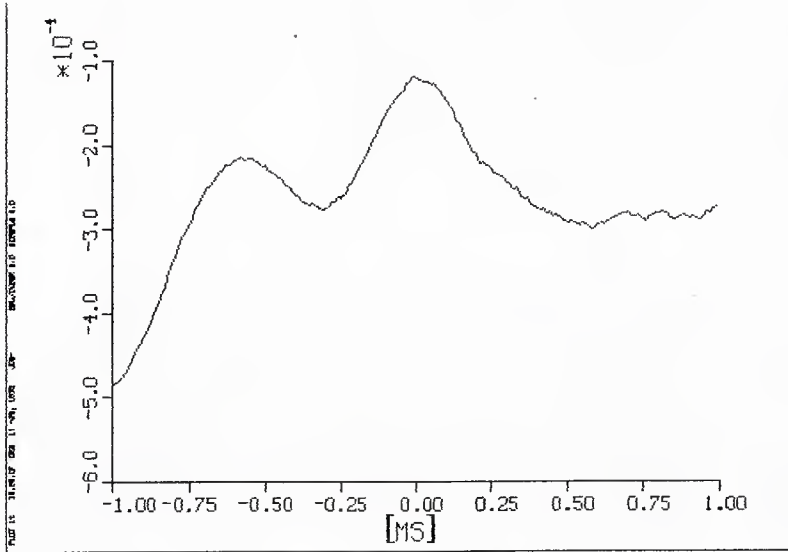

Figure D.8.  $e'_{31}$  At ZREF = .0

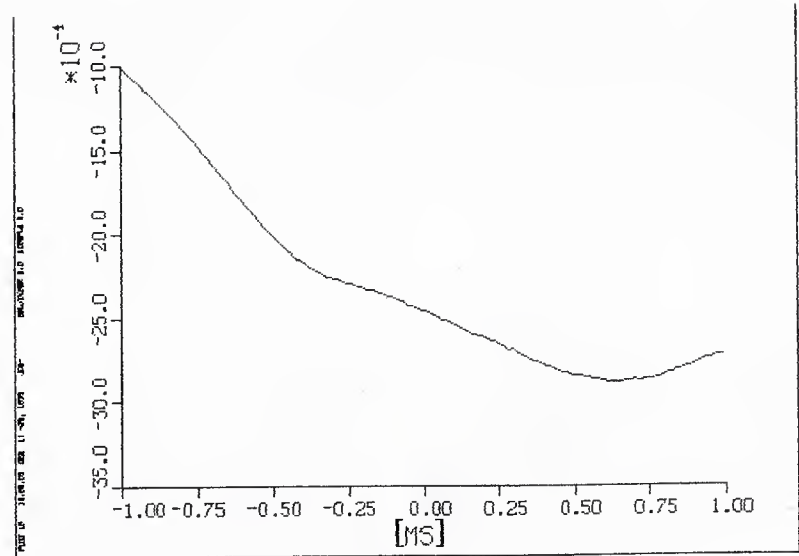

Figure D.9.  $e'_{32}$  At ZREF = .0

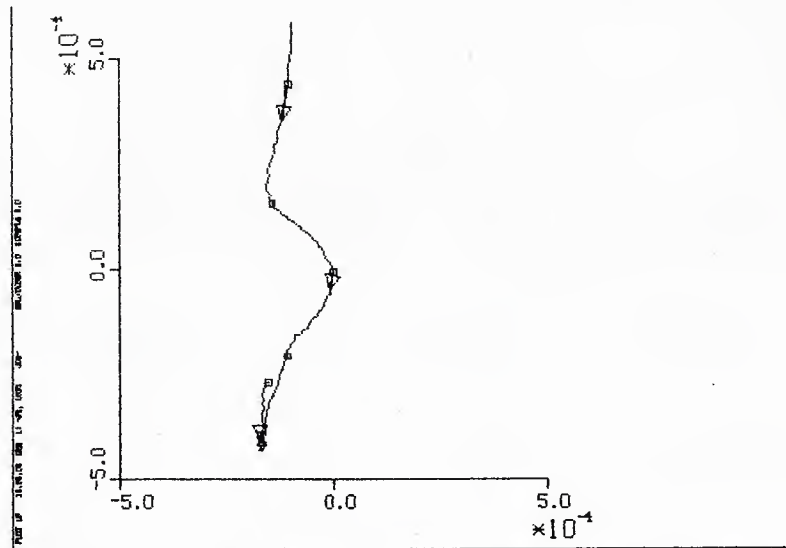

Figure D.10. X-Y Plot Of  $e'_{31}$  And  $e'_{32}$  At ZREF = 0

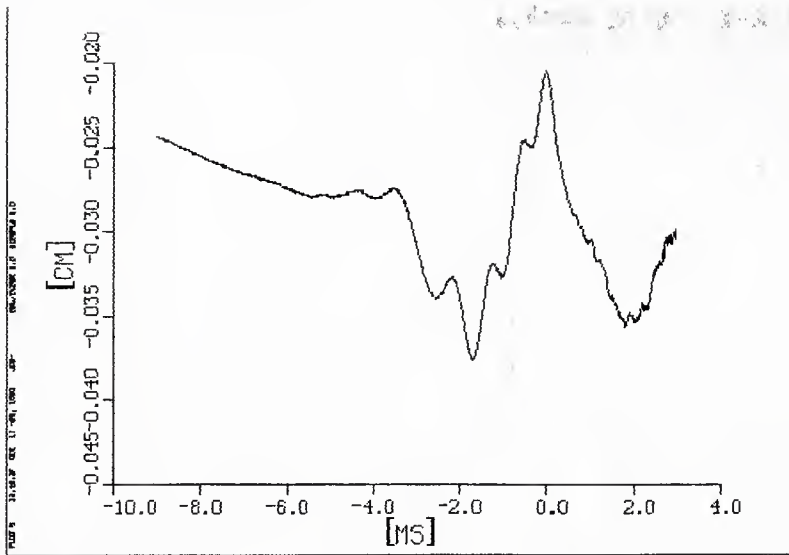

Figure D.11. Horizontal Displacement At ZREF = .0, cm

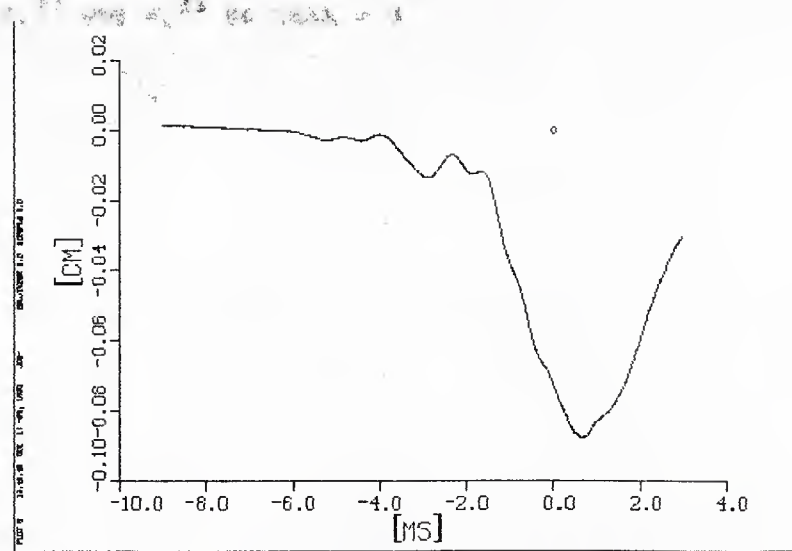

Figure D.12. Vertical Displacement At ZREF = .0, cm

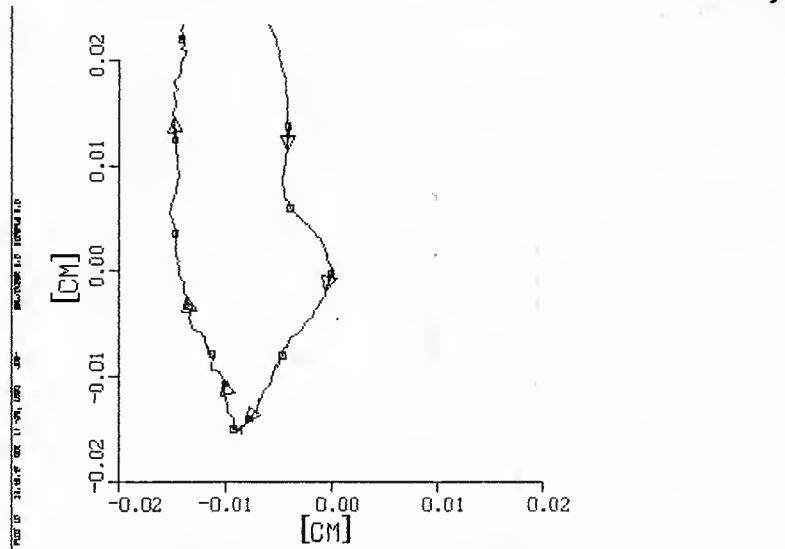

Figure D.13. X-Y Plot Of Displacement At ZREF = .0, cm

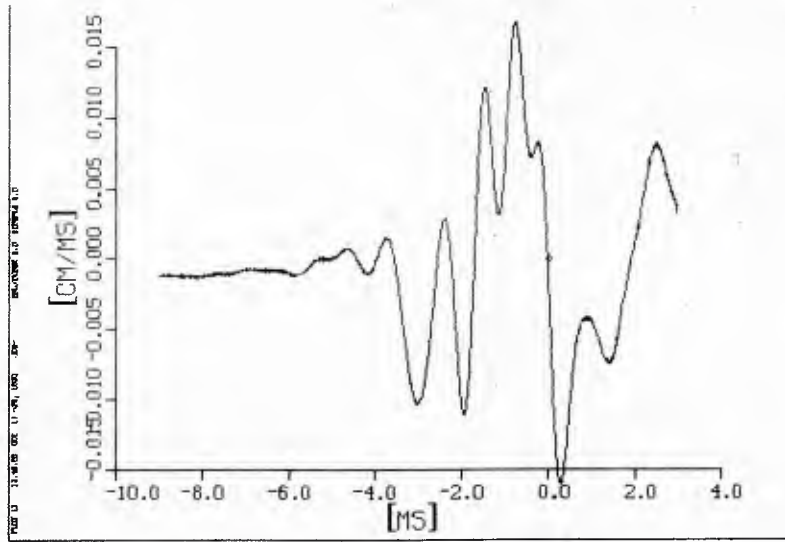

Figure D.14. Horizontal Velocity At ZREF = .0, cm/ms

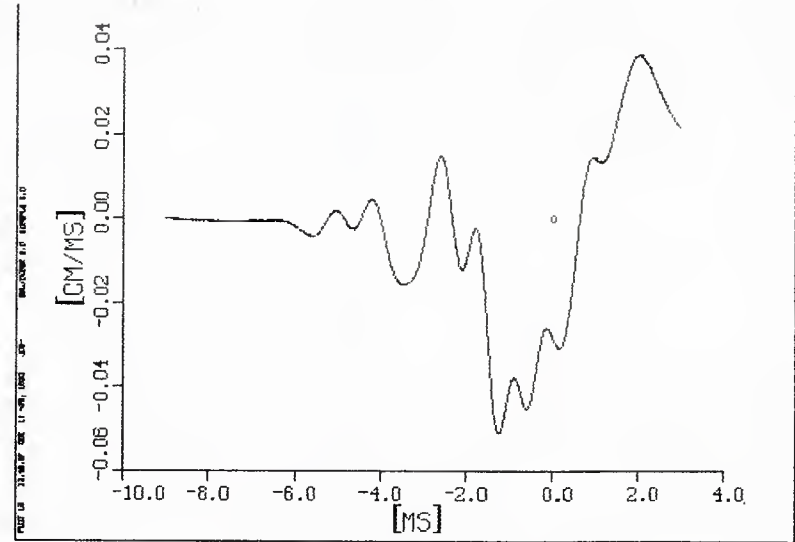

Figure D.15. Vertical Velocity At ZREF = .0, cm/ms

177

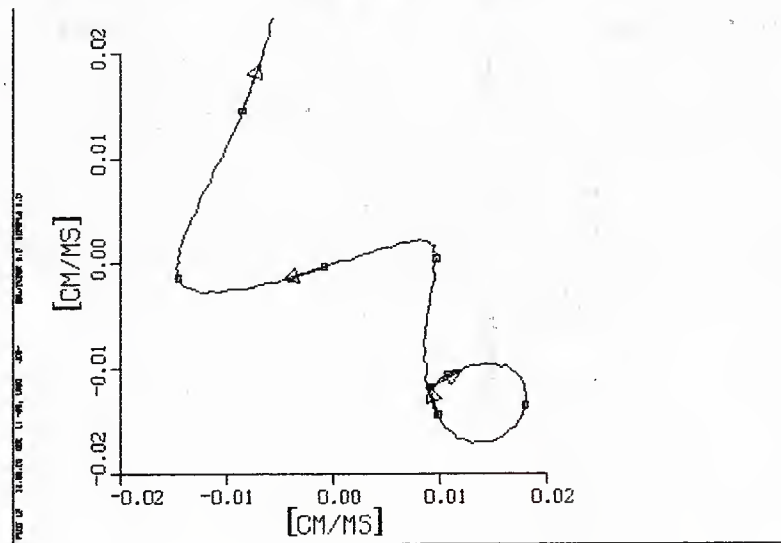

Figure D.16. X-Y Plot Of Velocity At ZREF = .0, cm/ms

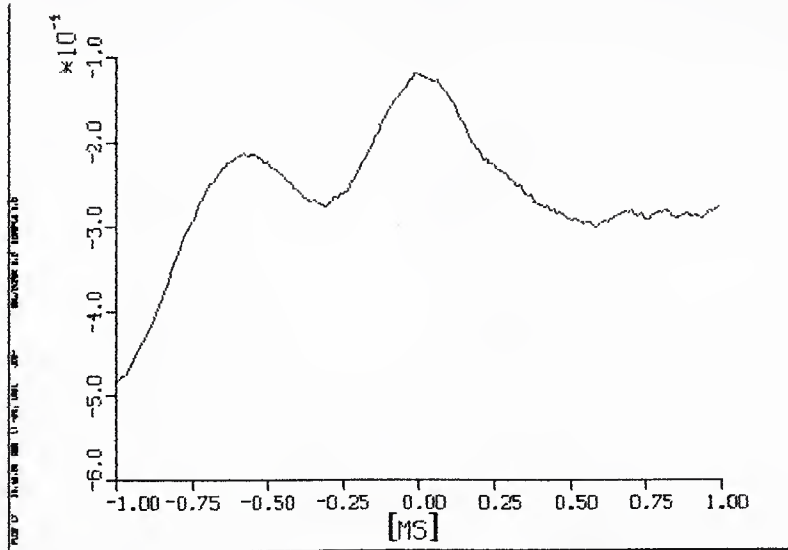

Figure D.17.  $e'_{31}$  At ZREF = - 7.524 cm

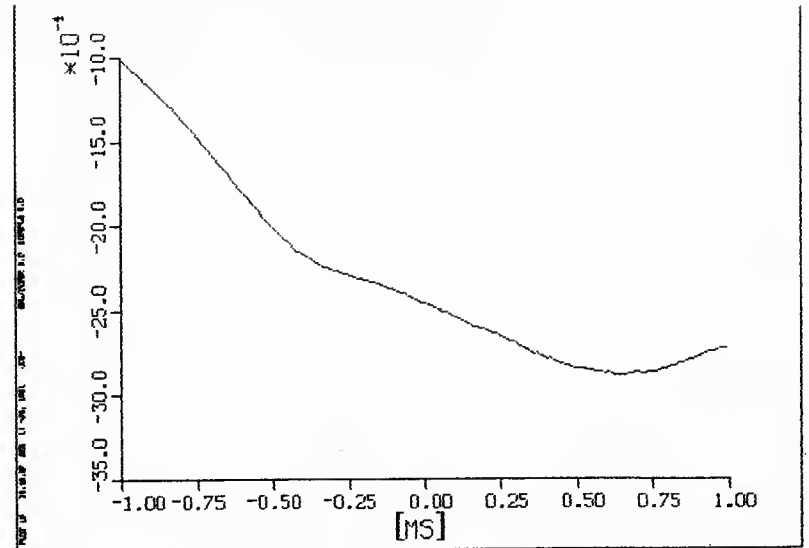

Figure D.18.  $e'_{32}$  At ZREF = - 7.524 cm

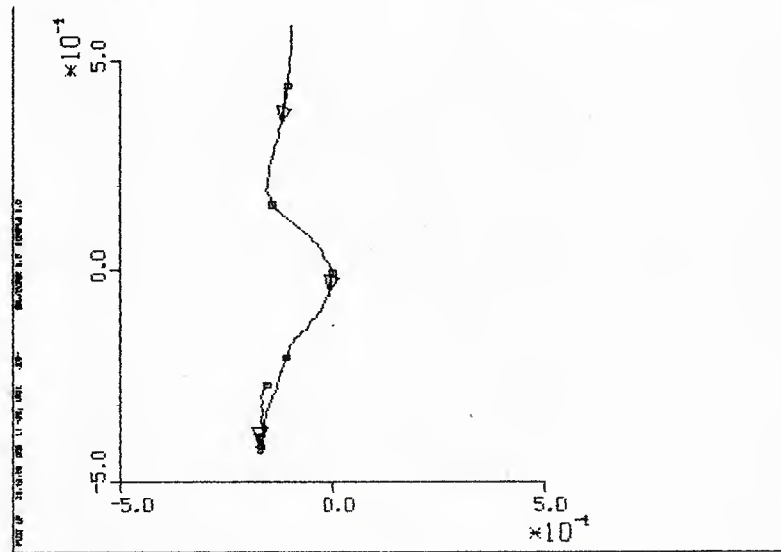
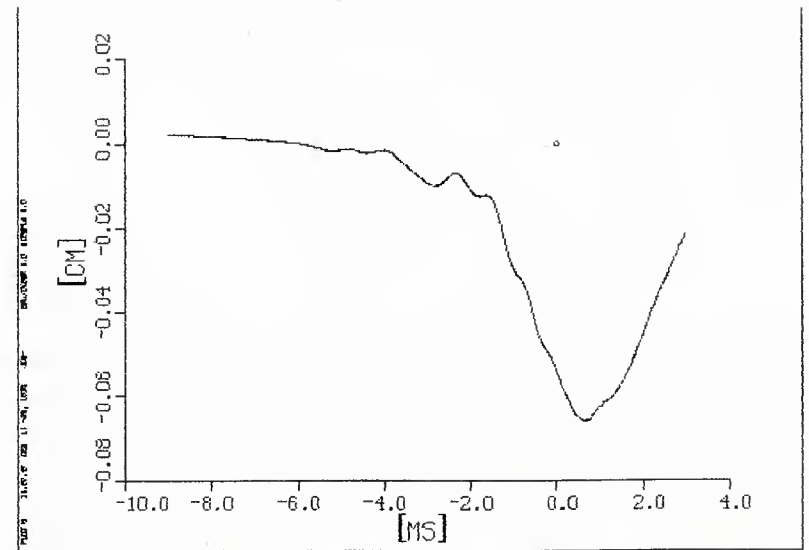
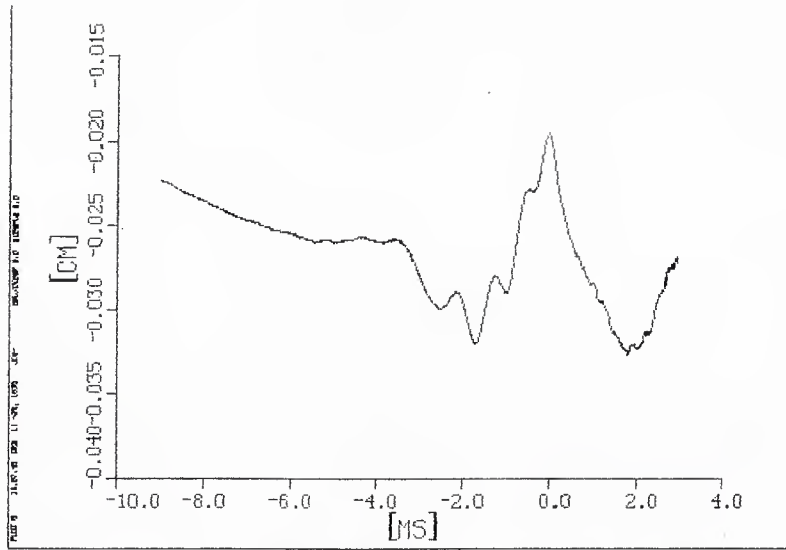

Figure D.19. X-Y Plot Of  $e'_{31}$  And  $e'_{32}$  At ZREF = - 7.524 cm



113

**Figure D.20. Horizontal Displacement At ZREF = - 7.524 cm**

**Figure D.21. Vertical Displacement At ZREF = - 7.524 cm**

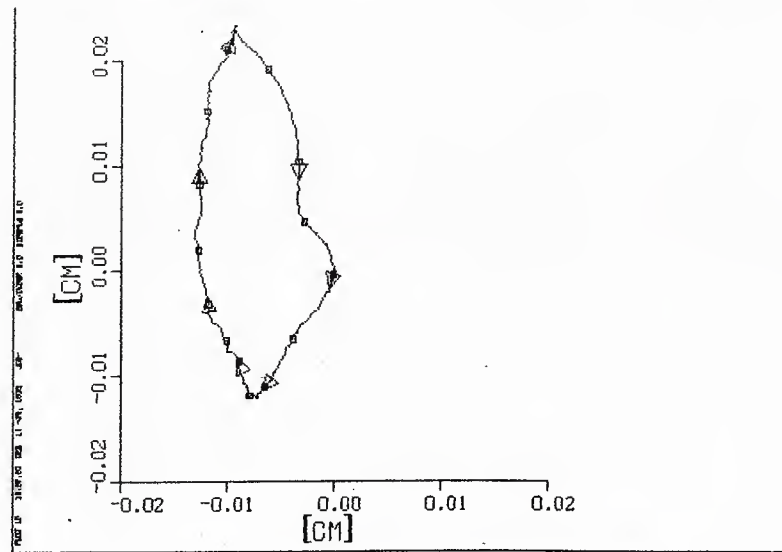

**Figure D.22. X-Y Plot Of Displacement AT ZREF = - 7.524 cm**

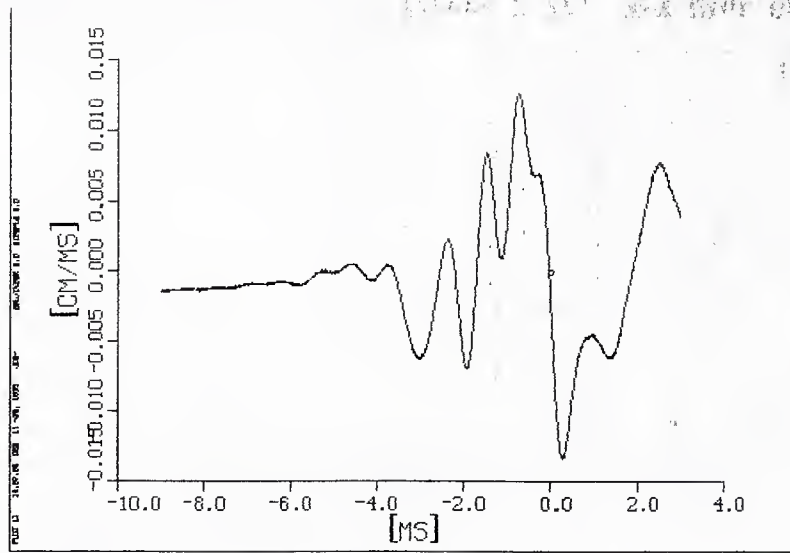

Figure D.23.  $e'_{31}$  At ZREF = - 7.524 cm

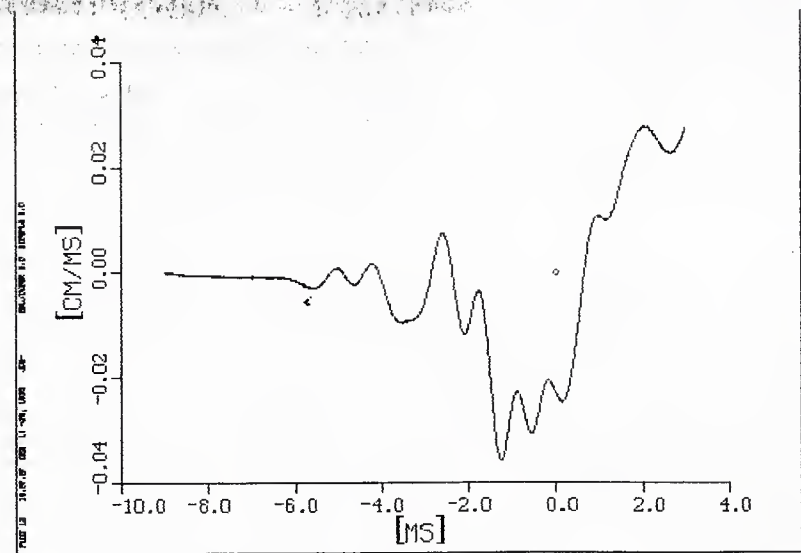

Figure D.24.  $e'_{32}$  At ZREF = - 7.524 cm

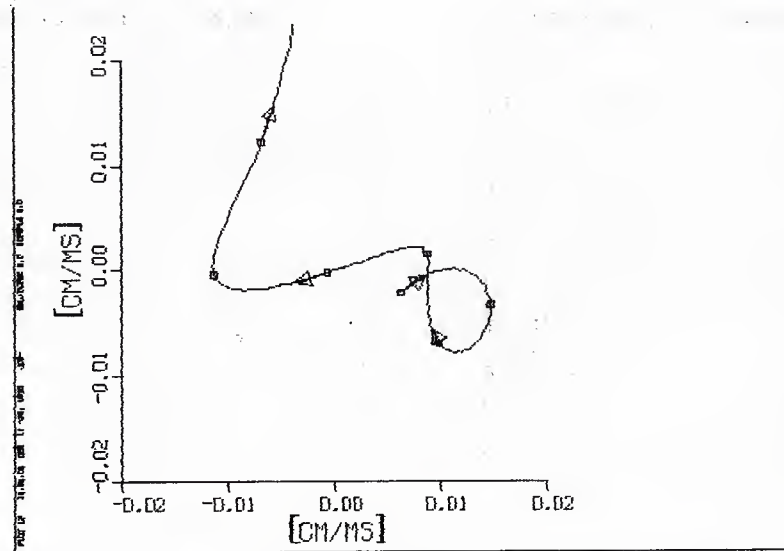

Figure D.25. X-Y Plot Of  $e'_{31}$  And  $e'_{32}$  At ZREF = - 7.524 cm



**DISTRIBUTION LIST**

<u>No. of Copies</u>	<u>Organization</u>	<u>No. of Copies</u>	<u>Organization</u>
2	Administrator Defense Technical Info Center ATTN: DTIC-DDA Cameron Station Alexandria, VA 22304-6145	5	Commander USA AMCCOM, ARDC ATTN: SMCAR-SC SMCAR-SCA SMCAR-SCF SMCAR-SCM SMCAR-SCS Dover, NJ 07801
1	Director Defense Advanced Research Projects Agency 1400 Wilson Boulevard Arlington, VA 22209	10	Commander USA AMCCOM, ARDC ATTN: SMCAR-AC (1 cy) SMCAR-ASP (2 cys) SMCAR-DP (2 cys) SMCAR-FU (1 cy) SMCAR-NS (1 cy) SMCAR-SA (1 cy) SMCAR-SE (2 cys) Dover, NJ 07801
3	Director Defense Nuclear Agency ATTN: STSP STTI STRA Washington, DC 20305	2	Commander USA AMCCOM, ARDC ATTN: AMSMC-QA (2 cys) Dover, NJ 07801
1	Commander US Army BMD Advanced Technology Center ATTN: BMDATC-M, P. Boyd P.O. Box 1500 Huntsville, AL 35807	4	Commander USA AMCCOM, ARDC ATTN: SMCAR-TD SMCAR-TDA SMCAR-TDC SMCAR-TDS Dover, NJ 07801
1	Commander US Army Materiel Command ATTN: AMCDMD-ST 5001 Eisenhower Avenue Alexandria, VA 22333-0001	1	Commander USA AMCCOM, ARDC ATTN: SMCAR-TSS Dover, NJ 07801
8	Commander USA AMCCOM, ARDC ATTN: SMCAR-LC SMCAR-LCA SMCAR-LCG SMCAR-LCM SMCAR-LCN SMCAR-LCS SMCAR-LCU SMCAR-LCW Dover, NJ 07801	4	Commander USA AMCCOM, ARDC ATTN: SMCAR-LCA, S.H. Chu T.E. Davidson B. Knutelski C. Larson Dover, NJ 07801
1	Commander USA AMCCOM, ARDC ATTN: SMCAR-LCS Dover, NJ 07801		

**DISTRIBUTION LIST**

<u>No. of Copies</u>	<u>Organization</u>	<u>No. of Copies</u>	<u>Organization</u>
1	Commander USA AMCCOM, ARDC Benet Weapons Laboratory ATTN: SMCAR-LCB-TL Watervliet, NY 12189	3	Commander US Army Armament, Munitions & Chemical Command ATTN: AMSMC-QA AMSMC-MS AMSMC-AS Rock Island, IL 61299
1	Commander US Army Aviation Research and Development Command ATTN: AMSAV-E 4300 Goodfellow Blvd. St. Louis, MO 63120	1	Commander USA Missile Command ATTN: AMSMI-R Redstone Arsenal, AL 35898
1	Director US Army Air Mobility Research and Development Laboratory Ames Research Center Moffett Field, CA 94035	1	Commander US Army Belvoir R&D Center ATTN: STRBE-WC Tech Lib (Vault), Bldg. 315 Fort Belvoir, VA 22060-5606
1	Commander US Army Communications- Electronics Command ATTN: AMSEL-ED Fort Monmouth, NJ 07703-5301	1	Commander US Army Tank Automotive Cmd ATTN: AMSTA-TSL Warren, MI 48090
1	Commander US Army Electronics Research and Development Command Technical Support Activity ATTN: AMSEL-ED Fort Monmouth, NJ 07703-5301	2	Commander US Army Jefferson Proving Ground ATTN: STEJP-TD-O STEJP-TD-E Madison, IN 47251
1	Commander US Army Harry Diamond Laboratories 2800 Powder Mill Road Adelphi, MD 20783	1	Director US Army TRADOC Systems Analysis Activity ATTN: ATAA-SL White Sands Missile Range, NM 88002
1	Director US Army Research & Technology Laboratories (AVRADCOM) Ames Research Center Moffett Field, CA 94035	1	Commandant US Army Infantry School ATTN: ATSH-CD-CSO-OR Fort Benning, GA 31905
2	Commander US Army Armament, Munitions & Chemical Command ATTN: SMCAR-ESP-L SMCAR-ES Rock Island, IL 61299	1	Commander US Army Yuma Proving Ground ATTN: STEYP-MTW Yuma, AZ 85365

**DISTRIBUTION LIST**

<u>No. of Copies</u>	<u>Organization</u>	<u>No. of Copies</u>	<u>Organization</u>
3	Commander USA Harry Diamond Laboratories ATTN: DELHD-I-TR, H.D. Curchak H. Davis DELHD-S-DE-ES, B. Banner 2800 Powder Mill Road Adelphi, MD 20783	1	Commander US Army Research Office P.O. Box 12211 Research Triangle Park, NC 27709-2211
1	Program Manager XM1 Abrams Tank System ATTN: AMCPM-GCM-SA Warren, MI 48090	1	Department of the Army Program Manager Advanced Attack Helicopter, AMC 4300 Goodfellow Boulevard St. Louis, MO 63120
1	Project Manager Nuclear Munitions ATTN: AMCPM-NUC Dover, NJ 07801	1	Superintendent Naval Postgraduate School ATTN: Dir of Lib Monterey, CA 93940
1	Project Manager Tank Main Armament Systems ATTN; AMCPM-TMA Dover, NJ 07801	1	Commander Naval Air Development Center Johnsville Warminster, PA 18974
1	Project Manager Sergeant York ATTN: AMCPM-ADG	1	Commander Pacific Naval Missile Center Point Mugu, CA 93042
3	Project Manager US Army AMCCOM, ARDC Cannon Artillery Weapons Systems ATTN: AMCPM-CAWS Dover, NJ 07801	1	Commander Naval Research Laboratory ATTN: Code 7908, A.E. Williams Washington, DC 20375
1	Product Manager for 30mm Ammo. ATTN: AMCPM-AAH-30mm Dover, NJ 07801	1	Commander Naval Ship Research and Development Center ATTN: D. W. Taylor Bethesda, MD 20084
1	Product Manager M110E2 Weapon System, DARCOM ATTN: AMCPM-M110E2 Rock Island, IL 61299	4	Commander Naval Surface Weapon Center ATTN: G-13, W.D. Ralph Code G-33, T.N. Tschirn Code N-43, J.J. Yagla Code TX, W.G. Soper Dahlgren, VA 22448
2	Director US Army Mechanics and Materials Research Center ATTN: AMXMR-STN, O.R. Gericke AMXMR-ATL Watertown, MA 02172		

DISTRIBUTION LIST

<u>No. of Copies</u>	<u>Organization</u>	<u>No. of Copies</u>	<u>Organization</u>
1	Commander Naval Air Systems Command ATTN: AIR-604 Washington, DC 20360	1	Director National Aeronautics and Space Administration Ames Research Center ATTN: N237-1, C. DeRose Moffett Field, CA 94035
1	Commander Naval Sea Systems Command Washington, DC 20362	1	Director National Aeronautics and Space Administration Langley Research Center Langley Station Hampton, VA 23365
1	Commander Naval Weapons Center China Lake, CA 93555	3	Commander US Air Force Armament Laboratory ATTN: AFATL-DLA, AFATL-DLD, AFATL-OL00L Eglin AFB, FL 32542  AFWL-SUL Kirtland AFB, NM 87117
1	Commander Naval Ordnance Station Indian Head, MD 20640	1	Director Los Alamos Scientific Laboratory P.O. Box 1663 Los Alamos, NM 87545
2	Commander Marine Corps Development and Education Command (MCDEC) ATTN: MCDEC/D-092 MCDEC/LAV Directorate Quantico, VA 22134	2	Director Sandia Laboratories ATTN: LIB Div 5534, L.C. Chhakildas Albuquerque, NM 87185
1	Commander Naval Surface Weapons Center Silver Spring, MD 20910	1	Director National Aeronautics and Space Administration Lyndon B. Johnson Space Center ATTN: Library Houston, TX 77058
1	Commander Naval Surface Weapons Center Silver Spring, MD 20910		
1	Director Lawrence Livermore Laboratory ATTN: LIB P.O. Box 808 Livermore, CA 94550		
1	Director Lawrence Livermore Laboratory ATTN: L-368, C. Honodel P.O. Box 808 Livermore, CA 94550		
1	Headquarters National Aeronautics and Space Administration Washington, DC 20546		

## DISTRIBUTION LIST

<u>No. of Copies</u>	<u>Organization</u>
1	HQDA DAMA-ART-M Washington, DC 20310
1	Commander US Army Missile Command ATTN: AMSMI-YDL Redstone Arsenal, AL 35898
1	Commander US Army Development & Employment Agency ATTN: MODE-TED-SAB Fort Lewis, WA 98433

### Aberdeen Proving Ground

Dir, USAMSAA  
ATTN: AMXSY-D  
AMXSY-MP, H. Cohen  
AMXSY-G, E. Christman  
AMXSY-OSD, H. Burke  
AMXSY-G, R.C. Conroy  
AMXSY-LM, J.C.C. Fine

Cdr, USATECOM  
ATTN: AMSTE-TO-F

Cdr, CRDC, AMCCOM  
ATTN: SMCCR-RSP-A  
SMCCR-MU  
SMCCR-SPS-IL  
SMCCR-RSP  
SMCCR-MS

Dir, USAHEL  
ATTN: A.H. Eckles, III

Dir, USACSTA  
ATTN: STECS-AS

USER EVALUATION SHEET/CHANGE OF ADDRESS

This Laboratory undertakes a continuing effort to improve the quality of the reports it publishes. Your comments/answers to the items/questions below will aid us in our efforts.

1. BRL Report Number \_\_\_\_\_ Date of Report \_\_\_\_\_

2. Date Report Received \_\_\_\_\_

3. Does this report satisfy a need? (Comment on purpose, related project, or other area of interest for which the report will be used.) \_\_\_\_\_  
\_\_\_\_\_  
\_\_\_\_\_

4. How specifically, is the report being used? (Information source, design data, procedure, source of ideas, etc.) \_\_\_\_\_  
\_\_\_\_\_  
\_\_\_\_\_

5. Has the information in this report led to any quantitative savings as far as man-hours or dollars saved, operating costs avoided or efficiencies achieved, etc? If so, please elaborate. \_\_\_\_\_  
\_\_\_\_\_  
\_\_\_\_\_

6. General Comments. What do you think should be changed to improve future reports? (Indicate changes to organization, technical content, format, etc.) \_\_\_\_\_  
\_\_\_\_\_  
\_\_\_\_\_

CURRENT ADDRESS  
Name \_\_\_\_\_  
Organization \_\_\_\_\_  
Address \_\_\_\_\_  
City, State, Zip \_\_\_\_\_

7. If indicating a Change of Address or Address Correction, please provide the New or Correct Address in Block 6 above and the Old or Incorrect address below.

OLD ADDRESS  
Name \_\_\_\_\_  
Organization \_\_\_\_\_  
Address \_\_\_\_\_  
City, State, Zip \_\_\_\_\_

(Remove this sheet, fold as indicated, staple or tape closed, and mail.)

FOLD HERE

Director  
US Army Ballistic Research Laboratory  
ATTN: DRXBR-OD-ST  
Aberdeen Proving Ground, MD 21005-5066



NO POSTAGE  
NECESSARY  
IF MAILED  
IN THE  
UNITED STATES

OFFICIAL BUSINESS  
PENALTY FOR PRIVATE USE, \$300

**BUSINESS REPLY MAIL**  
FIRST CLASS PERMIT NO 12062 WASHINGTON, DC  
POSTAGE WILL BE PAID BY DEPARTMENT OF THE ARMY

Director  
US Army Ballistic Research Laboratory  
ATTN: DRXBR-OD-ST  
Aberdeen Proving Ground, MD 21005-9989



FOLD HERE

U235040

11-11-11