

NO-A190 306

SDIO/IST ULTRASHORT WAVELENGTH LASER MOSSBAUER EFFECT  
IN GAMMA-RAY LASERS(U) OLD DOMINION UNIV NORFOLK VA  
G R HOY ET AL. MAR 87 N00014-86-C-2356

1/1

UNCLASSIFIED

F/G 9/3

ML

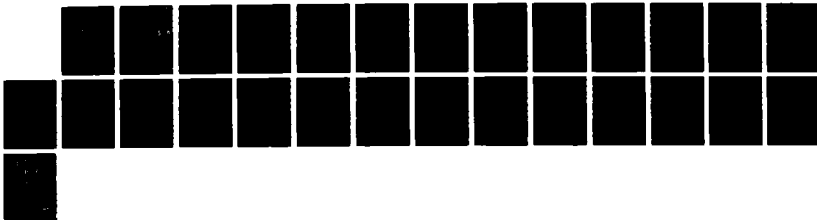

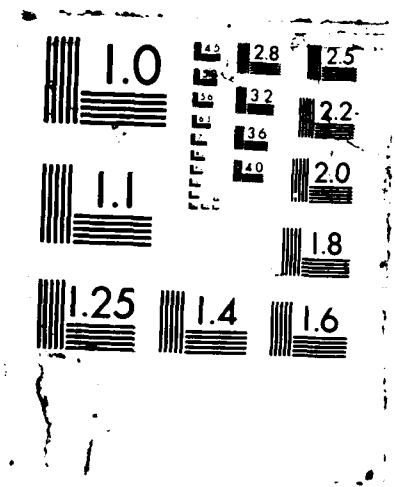

AD-A190 306

DEPARTMENT OF PHYSICS  
COLLEGE OF SCIENCES  
OLD DOMINION UNIVERSITY  
NORFOLK, VIRGINIA 23508

2

M

DTIC FILE COPY

SDIO/IST ULTRASHORT WAVELENGTH LASER  
"Mossbauer Effect in Gamma-Ray Lasers"

By  
Gilbert R. Hoy, Principal Investigator  
and  
R. Dean Taylor

Interim Report  
For the period ended February 28, 1987

DTIC  
ELECTE  
JAN 14 1988  
S D

Prepared for the  
Naval Research Laboratory  
4555 Overlook Ave., SW  
Washington, D.C. 20375-5000  
Attn: Code 4720

Under  
Contract Number N00014-86-C-2356  
Dr. P. Kepple, Technical Representative

Submitted by the  
Old Dominion University Research Foundation  
P.O. Box 6369  
Norfolk, Virginia 23508

March 1987

DISTRIBUTION STATEMENT A  
Approved for public release;  
Distribution Unlimited

!

200  
87

## SDIO/IST ULTRASHORT WAVELENGTH LASER

### "Mossbauer Effect in Gamma-Ray Lasers"<sup>+</sup>

Gilbert R. Hoy\* and R. Dean Taylor  
Los Alamos National Laboratory, Los Alamos, NM 87545

#### Introduction (Fig. 1 - Outline)

In order to gain some perspective on the relationship of the Mossbauer effect to the possible development of gamma ray lasers, it is useful to review the Mossbauer effect literature. The relevant literature in this field we will call gamma ray optics starts in 1960.<sup>1</sup> These results show (Fig. 2 - Previous results)<sup>2-4</sup> that: 1) Rayleigh and nuclear resonant scattering are coherent,<sup>4-4</sup> 2) one can obtain pure nuclear resonant diffraction by scattering from a sample for which the structure factor for Rayleigh scattering is small,<sup>5,6</sup> 3) nuclear anomalous dispersion occurs,<sup>7</sup> 4) interference can occur between nuclear hyperfine components in nuclear resonant diffraction,<sup>8</sup> 5) in nuclear resonant Bragg scattering, processes having different final nuclear spin projections are incoherent,<sup>9</sup> and 6) there can be anomalously deep penetration and high reflectivity using single crystals as a result of the "suppression of inelastic channels."<sup>10-16</sup> Essentially no experimental research has been done in this field in the United States. (Fig. 3 - Some previous experimental results.) However, there has been a great deal of theoretical effort by G. T. Trammell, J. P. Hannon and collaborators.<sup>17-21</sup>

<sup>+</sup>Work supported by IST/SDIO and Directed by Naval Research Laboratory

\*Permanent address: Physics Department, Old Dominion University, Norfolk, VA 23508.

Some recent experiments have involved the use of synchrotron radiation.<sup>22,23</sup> In these experiments Mossbauer diffraction was observed using a synchrotron as the source. One important result, stressed by the Russian group,<sup>22</sup> was that the decay of the resonantly excited nuclei in the single crystal was directional and more rapid than expected from the value of the nuclear lifetime. The same effect was also seen in ordinary nuclear resonant scattering experiments<sup>15</sup> by observing that in the scattered spectrum, in the Bragg direction, the lines were about fifteen times natural linewidth. Subsequent experimental results have dealt with further amplification of the consequences of the effects mentioned above concerning coherent effects in nuclear resonant diffraction.<sup>24-31</sup>

Experiments in Progress and in the Planning Stage

The development of gamma ray lasers (GRASER) will, most probably, depend on the utilization of recoilless, nuclear, gamma transitions, i.e. the Mossbauer effect. Furthermore, GRASER development benefits when the photon emission linewidth is as narrow as possible. Is there a fundamental or even a practical limit on the narrowness of a recoilless, nuclear gamma ray transition? It has been suggested, for example, that the nuclear dipole-dipole interaction effectively limits the linewidth.

The first excited states of <sup>107</sup>Ag and <sup>109</sup>Ag each have lifetimes of about forty seconds and corresponding linewidths of approximately  $1 \times 10^{-17}$  eV. (Fig. 4 - Silver decay schemes.) Such transitions provide an obviously severe test for the observance of the Mossbauer effect and hence may be able to shed light on the linewidth question. Three short papers<sup>32-34</sup> exist which purport to having observed the Mossbauer effect in these transitions. It is fair to say that the

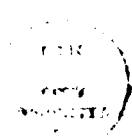

per ltr	
Date	
Library Codes	
Date	Area and/or Special
A-1	

scientific community at large has been skeptical of these assertions. We have proposed some possible experimental techniques which, if successful, will confirm the observation of the Mossbauer effect in  $^{109}\text{Ag}$ . This isotope was selected because of the favorable lifetime (460 days) of the parent  $^{109}\text{Cd}$ . The methods proposed (Fig. 5 - Proposed methods to observe the Mossbauer effect in  $^{109}\text{Ag}$ ) are 1) coincidence Mossbauer spectroscopy,<sup>35-42</sup> 2) conversion electron Mossbauer spectroscopy,<sup>43</sup> 3) gravitational line sweeping based on the gravitational red shift,<sup>44</sup> and 4) temperature dependence of self absorption.

In order to get started on the  $^{109}\text{Ag}$  experiments, one millicurie of carrier free  $^{109}\text{Cd}$  was purchased from New England Nuclear. In addition, two single crystals of silver were purchased from Monocrystals Co. These single crystals are in the form of disks of nominal half inch diameter and thicknesses of 0.4 mm and 0.8 mm. Each had been grown in the (111) orientation. Silver is 48.7%  $^{109}\text{Ag}$  and 51.3%  $^{107}\text{Ag}$ .

A special cell was designed so that the  $^{109}\text{Cd}$  could be electroplated onto the silver single crystal specimen. The thinner silver single crystal sample was selected for plating. After the  $^{109}\text{Cd}$  had been deposited on the single crystal, the sample was placed in a tube furnace for annealing. The sample was annealed for one hour at  $400^{\circ}\text{C}$  and then for six hours at  $350^{\circ}\text{C}$  in an argon-hydrogen atmosphere. Because the Cd has a rather high vapor pressure at  $400^{\circ}\text{C}$ , care had to be taken to avoid having  $^{109}\text{Cd}$  vapor deposited on the backside, i.e. non-plated side, of the single crystal specimen.

The spectrum of the  $^{109}\text{Cd}$  was determined by using an intrinsic germanium solid state detector. The spectrum is relatively simple consisting of: silver  $K_{\alpha}$  and  $K_{\beta}$  x-rays, the 88-keV gamma ray, and the associated escape peaks and

Compton background. (We do not, as yet, have a Compton suppression detector.) The spectra of the single crystal specimen were taken from both the "front" and "back" side of the sample before and after each stage of the annealing process. The mass absorption coefficients of silver metal are 14, 10.5, and 2.02 cm<sup>2</sup>/gram, respectively, for photon energies of 22 keV, 25 keV, and 88 keV. The density of silver is 10.5 gram/cm<sup>3</sup>. Using these numbers and our measured counting rates from the front and back sides of the sample, it was determined that the <sup>109</sup>Cd diffused into the silver to an effective average depth of approximately 94 ± 2 μm (~3.7 x 10<sup>-3</sup> inches). (Fig. 6 - Schematic representation of sample.)

Before attempting to do the more elaborate experiments mentioned above, it was decided to try first to observe the Mossbauer effect itself in a fairly straightforward manner. If one observes the pulse height spectrum of the sample from the "back side" using the Ge solid state detector as a function of temperature of the sample, it should be possible to discern the Mossbauer effect. The idea is as follows. Since the recoilless fraction (*f*) for <sup>109</sup>Ag is ~3.5% at liquid helium temperature and only 0.3% at liquid nitrogen temperature (Fig. 7 - Temperature dependence of *f*), one would expect that due to Mossbauer self-absorption the number of gamma rays would decrease and the number of x-rays, following internal conversion, would increase as the temperature decreases. Thus, the ratio of the number of x-rays to γ-rays reaching the detector after passing through the remaining portion of the sample should be higher at liquid helium temperature than at liquid nitrogen temperature.

Experiments of this sort are now in progress and although we have some indications that the Mossbauer effect is occurring at 4 K, we have not as yet convinced ourselves that the effect is real. Figure 8 shows the pulse height

spectrum of our sample containing  $^{109}\text{Cd}$  diffused into the silver single crystal. This spectrum was taken from the back side when the sample was at 75 K. We define three regions of interest; one containing the  $K_{\alpha}$  x-ray contribution, the second for the  $K_{\beta}$  contribution, and the third for the  $\gamma$ -ray contribution. We define  $R_{\alpha\gamma}$  to be the ratio of the number of counts in the  $K_{\alpha}$  x-ray portion to that of the  $\gamma$ -ray portion and  $R_{\beta\gamma}$  to be a similar ratio for  $K_{\beta}$  to  $\gamma$ . Table I contains a representative set of preliminary data (Fig. 9). As seen in Table I,

the ratios  $R_{\alpha\gamma}$  for the 4 K data are greater than the  $R_{\alpha\gamma}$  for the data  $>10$  K with only a few exceptions. We are in the process of refining our experimental design to provide constancy of spurious scattering and to allow temperature control in the region 2-50 K. If the Mossbauer effect indeed turns out to be real, we will proceed with the more elaborate experiments.

Another aspect of our research deals with the possible observation of multibeam Borrmann modes resulting from the emission of Mossbauer  $\gamma$ -rays from nuclei deep inside single crystals. (Professor G. Trammell will present a report on this topic at this meeting.) G. T. Trammell, J. P. Hannon, and collaborators have predicted that such effects do exist (Fig. 10) and will have substantial practical advantage for GRASER development.<sup>19,45-49</sup> We are considering various possible experimental techniques for viewing these multibeam Borrmann modes. These include the use of microchannel plates incorporating various commercial read-out mechanisms (e.g. Hamamatsu Corporation) and schemes for looking at the single crystal sources along certain directions using Ge solid state detectors and interposing rotating, collimating, absorption screens containing prescribed patterns of holes. (Fig. 11 - Proposed experimental configuration for observing multibeam Borrmann modes.)



### Conclusions and Possible Future Experiments

A great deal of research has been done outside this country on nuclear resonant diffraction. This has involved the study of single crystals used in the scattering or transmission geometry. The so-called "suppression of inelastic channels" has apparently been established. In addition, it appears that nuclear, coherent, macroscopic radiating states have been prepared by illuminating single crystal samples with nuclear resonant radiation. No experimental results have been obtained on the study of single crystal sources themselves.

The status of the Mossbauer effect in  $^{109}\text{Ag}$  is unclear at this point, but the experiments are encouraging. Experiments are in the planning stage for determining the existence of multibeam Borrmann modes and measuring the coupling coefficients using single crystal Mossbauer sources.

There seems to be a number of practical questions that could benefit greatly from additional Mossbauer effect studies. Can one produce narrow single line sources in single crystals? Can radioactive nuclei be put in perfect single crystals having a high recoilless fraction and still give a narrow line spectrum? How perfect do the single crystals really have to be? What way is best for producing these sources; ion implantation, chemical deposition, etc.? Are there rapid ways of converting non-single crystalline materials into single crystals e.g. by laser annealing? (Fig. 12 - Needed Mossbauer effect studies.)

In addition, there are the fundamental questions. We are in the process of attempting to answer some of these. What is the narrowest line possible? Can one observe the multibeam Borrmann modes and then measure the resonant nuclear coupling coefficients?

Another area where the Mossbauer effect may be helpful is in the study of materials subjected to very short, high intensity, laser pulses. It appears that under such conditions, the crystal retains its crystalline structure for some period of time after the laser pulse.<sup>50</sup>

As has been mentioned above, there has been essentially no experimental work done in the field of gamma ray optics as applied to sources. The results of the nuclear resonant scattering experiments which show the existence of nuclear, coherent, radiating states produced in the scatterer, make us wonder if such radiating states may exist in single crystal Mossbauer sources themselves. Interestingly, this is not a new idea. Theoretical papers do exist on this subject.<sup>51-56</sup> Is it possible to produce radioactive sources in the form of single crystals which will radiate in certain directions with a lifetime much shorter than the ordinary lifetime of the individual radioactive nuclei? If this is true, one can crudely imagine a new approach to solving the GRASER problem. Consider a sample of non-single crystalline material. Implant into that material a nuclear isomer having a long lifetime. Now rapidly anneal the resulting sample into a single crystal. The nuclear, collective, coherent radioactive state will now be produced and the sample will radiate rapidly in certain Bragg directions. The power of such a system would depend on the particular isomer chosen, and the number of nuclei participating in the nuclear collective process. (Fig. 13 - Possible new model for GRASERs.)

The amount of Mossbauer effect research that needs to be done in connection with the GRASER project seems to us to be enormous. However, such research may produce important, exciting, new physics.

## References

1. P. J. Black and P. B. Moon, *Nature* 186, 481 (1960).
2. P. J. Black, D. E. Evans, and D. A. O'Connor, *Proc. Roy. Soc. A* 270, 168 (1962).
3. P. J. Black, G. Longworth and D. A. O'Connor, *Proc. Phys. Soc.* S3, 925 (1964).
4. D. A. O'Connor and P. J. Black, *Proc. Phys. Soc.* S3, 941 (1964).
5. P. J. Black and I. P. Duerdoth, *Proc. Phys. Soc.* S4, 169 (1964).
6. G. V. Smirnov, V. V. Sklyarevskii, R. A. Voskanyan, and A. N. Artem'ev, *ZhETF Pis. Red.* 9, 123 (1969).
7. S. Bernstein and E. C. Campbell, *Phys. Rev.* 132, 1625 (1963).
8. E. P. Stepanov, A. N. Artem'ev, I. P. Perstnev, V. V. Sklyarevskii, and G. V. Smirnov, *Sov. Phys. - JETP* 39, 562 (1974).
9. A. N. Artem'ev, V. V. Sklyarevskii, G. V. Smirnov, and E. P. Stepanov, *Sov. Phys. - JETP* 36, 736 (1973).
10. G. T. Trammell "Chemical Effects of Nuclear Transformations (Vienna: International Atomic Energy Agency) Vol. 1, p. 75-85 (1961).
11. A. M. Afanas'ev and Yu. Kagan, *Sov. Phys. - JETP* 21, 215 (1965).
12. Yu. Kagan, A. M. Afanas'ev, and I. P. Perstnev, *Sov. Phys. - JETP* 27, S19 (1968).
13. G. V. Smirnov, N. A. Semioshkina, V. V. Sklyarevskii, S. Kadechkova, and B. Shestak, *Sov. Phys. - JETP* 45, 180 (1977).

14. U. van Burck, G. V. Smirnov, R. L. Mossbauer, F. Parak, and N. A. Semioschkina, J. Phys. C: Solid State Phys. 11, 2305 (1978).
15. U. van Burck, G. V. Smirnov, R. L. Mossbauer, H. J. Maurus, and N. A. Semioschkina, J. Phys. C: Solid State Phys. 13, 4511 (1980).
16. G. V. Smirnov and Yu. V. Shvyd'ko, Pis'ma Zh. Eksp. Teor. Fiz. 35, 409 (1982).
17. J. P. Hannon and G. T. Trammell, Phys. Rev. 169, 315 (1968).
18. J. P. Hannon and G. T. Trammell, Phys. Rev. 186, 306 (1969).
19. J. P. Hannon and G. T. Trammell, Mossbauer Effect Methodology, Vol. 8, ed. I. J. Gruverman (Plenum Press, New York, 1973) pp. 25-40.
20. J. P. Hannon, N. J. Carron, and G. T. Trammell, Phys. Rev. B 9, 2810 (1974).
21. J. P. Hannon, N. J. Carron, and G. T. Trammell, Phys. Rev. B 9, 2791 (1974).
22. A. I. Chechin, N. V. Andronova, M. V. Zelepukhin, A. N. Artem'ev, and E. P. Stepanov, JETP Lett. 37, 633 (1983).
23. E. Gerdau, R. Ruffer, H. Winkler, W. Tolksdorf, C. P. Klages, and J. P. Hannon, Phys. Rev. Lett. 54, 835 (1985).
24. G. V. Smirnov, Yu. V. Shvyd'ko and E. Realo, Pis'ma Zh. Eksp. Teor. Fiz. 39, 33 (1984).
25. U. van Burck, H. J. Maurus, G. V. Smirnov, and R. L. Mossbauer, J. Phys. C: Solid State Phys. 17, 2003 (1984).
26. H. J. Maurus, U. van Burck, G. V. Smirnov, and R. L. Mossbauer, J. Phys. C: Solid State Phys. 17, 1991 (1984).

27. G. V. Smirnov, Yu. V. Shvyd'ko, O. S. Kolotoz, V. A. Pogozen, M. Kotrbova, S. Kadechkova, and I. Novak, *Sov. Phys. JETP* 59, 875 (1984).
28. P. P. Kovalenko, V. C. Labushkin, A. K. Ovsepyan, E. R. Sarkisov, and S. V. Smirnov, *Sov. Phys. - JETP Lett.* 39, 573 (1984).
29. G. V. Smirnov and A. I. Chumakov, *Sov. Phys. JETP* 62, 673 (1985).
30. G. V. Smirnov, *Hyperfine Int.* 27, 203 (1986).
31. U. van Burck, G. V. Smirnov, H. J. Maurus, and R. L. Mossbauer, *J. Phys. C: Solid State Phys.* 19, 2557 (1986).
32. G. E. Bizina, A. G. Beda, N. A. Burgov, and A. V. Davydov, *Sov. Phys. JETP* 18, 973 (1964).
33. V. G. Apatov, A. G. Beda, G. E. Bizina, A. V. Davydov, and M. M. Korotokov, *Proc. Int. Conf. on Mossbauer Spectroscopy, Bucharest, Romania* (1977).
34. W. Wildner and U. Gonser, *J. de Phys.* 40, C2-47 (1979).
35. G. R. Hoy, D. W. Hamill, and P. P. Wintersteiner in Mossbauer Effect Methodology, ed. I. J. Gruverman (Plenum, New York, 1971), Vol. 6.
36. R. E. Holland, F. J. Lynch, G. J. Perlow, and S. S. Hanna, *Phys. Rev. Lett.* 4, 181 (1960).
37. F. J. Lynch, R. E. Holland, and M. Hamermesh, *Phys. Rev.* 120, 513 (1960).
38. C. S. Wu, Y. K. Lee, N. Benczer-Koller, and P. Simms, *Phys. Rev. Lett.* 5, 432 (1960).
39. D. W. Hamill and G. R. Hoy, *Phys. Rev. Lett.* 21, 724 (1968).
40. G. R. Hoy and P. P. Wintersteiner, *Phys. Rev. Lett.* 28, 877 (1972).
41. G. C. Baldwin, *Nucl. Instrum. Methods* 159, 309 (1979).

42. G. C. Baldwin and V. I. Gol'danskii, Nucl. Instrum. Methods 169, 5S1 (1980).
43. See, for example, M. J. Tricker, in Mossbauer Spectroscopy and Its Chemical Applications, eds. J. G. Stevens and G. K. Shenoy (American Chemical Society, Washington, D.C., 1981)
44. R. V. Pound and G. A. Rebka, Jr., Phys. Rev. Lett. 4, 274 (1960).
45. J. P. Hannon, N. J. Carron, and G. T. Trammell, Phys. Rev. B 9, 2S10 (1974).
46. J. P. Hannon, N. J. Carron, and G. T. Trammell, Phys. Rev. B 9, 2791 (1974).
47. G. T. Trammell and J. P. Hannon, Optics Commun. 15, 325 (1975).
48. G. T. Trammell, J. T. Hutton, and J. P. Hannon in Proceeding of the IST/IDA Gamma-Ray Laser Workshop (IDA Memorandum Report M-162), January 1986.
49. J. T. Hutton, "Gamma Ray Optics of Multi-Beam Borrmann Modes with Possible Applications to Nuclear Lasing," Ph.D. dissertation, Rice University, August 1986.
50. G. Mourou, presented at the Los Alamos GRASER Workshop, August 25, 1986.
51. M. I. Podgoretskii and I. I. Roizen, Sov. Phys. - JETP 12, 1023 (1961).
52. V. L. Lyuboshitz, Sov. Phys. - JETP 26, 937 (1968).
53. V. M. Fain and Ya. I. Khanin, Kvantovaya radiofizika (Quantum Radiophysics), Soviet Radio, 1965.
54. A. M. Afanas'ev and Yu. Kagan, Sov. Phys. - JETP 25, 124 (1967).
55. P. Z. Hien, Sov. Phys. - JETP 31, 83 (1970).
56. P. A. Aleksandrov and Yu. Kagan, Sov. Phys. - JETP 32, 942 (1971).

TABLE I. Preliminary data on the self absorption measurement

Run #	$R_{\alpha\gamma}$	$R_{\beta\gamma}$	sample temperature	comments
1	$2.36 \pm 0.003$	$0.74 \pm 0.003$	75 K	first set-up, 0.015" $\ell N_2$ in path
4	$2.40 \pm 0.004$	$0.79 \pm 0.01$	4 K	first set-up, reset sample, 0.015" liquid He
5	$2.35 \pm 0.002$	$0.77 \pm 0.002$	(10 - 75 K)	gaseous He
6	$2.39 \pm 0.004$	$0.78 \pm 0.01$	4 K	liquid He
7	$2.40 \pm 0.01$	$0.78 \pm 0.01$	4 K	liquid He
8	$2.34 \pm 0.002$	$0.76 \pm 0.002$	< 75 K	gaseous He
9	$2.35 \pm 0.003$	$0.77 \pm 0.004$	$75 \pm 30$ K	gaseous He
11	$2.44 \pm 0.003$	$0.77 \pm 0.01$	75 K	$\ell N_2$
12	$2.39 \pm 0.002$	$0.77 \pm 0.002$	~50 K	solid $N_2$
<hr/>				
21	$2.31 \pm 0.01$	$0.77 \pm 0.01$	R.T.	second set-up, air
22	$2.39 \pm 0.01$	$0.80 \pm 0.01$	150 K	100 torr He gas, reset
23	$2.37 \pm 0.004$	$0.78 \pm 0.004$	4 K	50 torr He gas
24	$2.36 \pm 0.003$	$0.78 \pm 0.004$	4 K	50 torr He gas
25	$2.34 \pm 0.005$	$0.77 \pm 0.01$	4 K	50 torr He gas
26	$2.36 \pm 0.004$	$0.78 \pm 0.004$	75 K	100 torr He gas
27	$2.36 \pm 0.004$	$0.78 \pm 0.004$	75 K	100 torr He gas
<hr/>				
30	2.315		75 K	third set-up, lowered detector
31	2.289		75 K	100 torr He gas
32	2.315		75 K	100 torr He gas
34	2.334		75 K	100 torr He gas
35	2.327		4 K	25 torr He gas
36	2.325		4 K	25 torr He gas

- I. Introduction - Review of past relevant research
- II. Experiments in progress and in the planning stage
- III. Conclusions

Figure 1



## PREVIOUS RESULTS

Previous results show that:

- 1) Rayleigh and nuclear resonant scattering are coherent.
- 2) Pure nuclear resonant scattering is possible using samples for which the structure factor for Rayleigh is small.
- 3) Nuclear anomalous dispersion occurs.
- 4) Interference can occur between nuclear hyperfine components in nuclear resonant diffraction.
- 5) In nuclear resonant Bragg scattering, processes having different final nuclear spin projections are incoherent.
- 6) Effects of "suppression of inelastic channels" have been observed.

## SOME PREVIOUS EXPERIMENTAL RESULTS

Pure nuclear resonant diffraction.

A Interference between nuclear hyperfine components

B Note linewidth in B compared to C and D

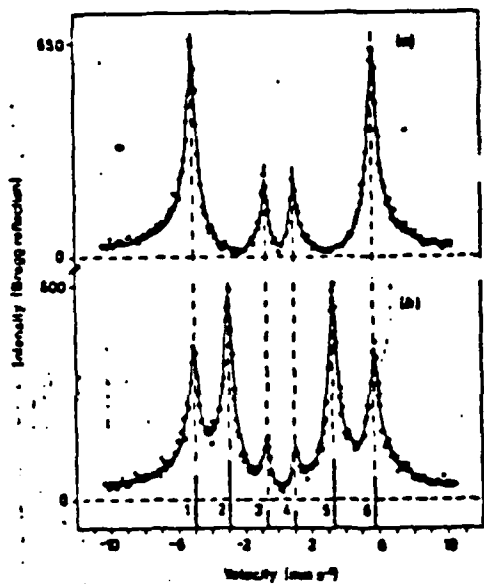
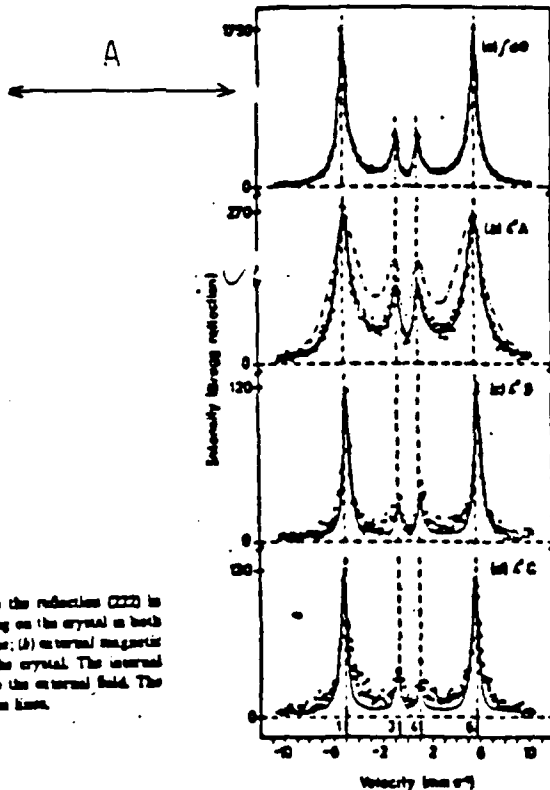
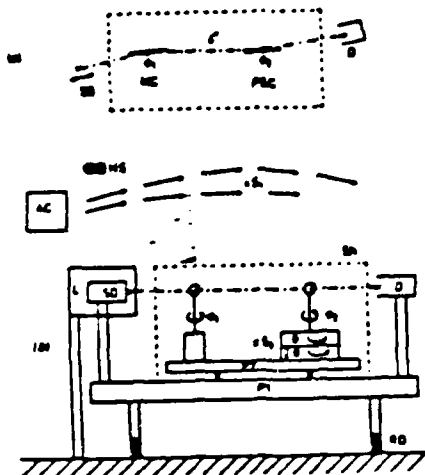

Figure 3. Mössbauer diffraction spectra of the  $^{57}\text{FeBO}_3$  crystal in the reflection (222) in Bragg geometry. An incident beam of about  $10^\circ$  divergence was falling on the crystal in both cases. (a) External magnetic field perpendicular to the scattering plane; (b) external magnetic field lying in the scattering plane parallel to the (111) planes of the crystal. The internal magnetic fields are always in the (111) planes and perpendicular to the external field. The positions of the hyperfine resonance energies are indicated by broken lines.



← on Bragg angle (B)  
 ← angle slightly above Bragg (C)  
 ← angle slightly below Bragg (D)

Figure 4. Mössbauer diffraction spectra of the  $^{57}\text{FeBO}_3$  crystal in the reflection (111) in Bragg geometry. The external magnetic field was perpendicular to the scattering plane in all cases. (a) A beam of about  $10^\circ$  divergence was incident on the crystal. (b)-(d) The incident beam was collimated by the  $54(111)$  monochromator-collimator to  $4^\circ$  to compare the extreme set-up of figure 1(a). The spectra were measured at fixed angular positions marked in the rocking curve of figure 2(b). (b) Central position A; (c) position B at an angle about  $75^\circ$  higher than A; (d) position C at an angle about  $125^\circ$  lower than A. The positions of the hyperfine resonance energies are indicated by broken lines.



Van Burck et al., J. Phys. C. Solid State 13, 4511 (1980).

# SILVER DECAY SCHEMES

(photon falling 10,000 Å gains one linewidth in energy)

$^{109}\text{Ag}$  (48.7% abundance)

$$\Gamma \sim 1 \times 10^{-17} \text{ eV}$$

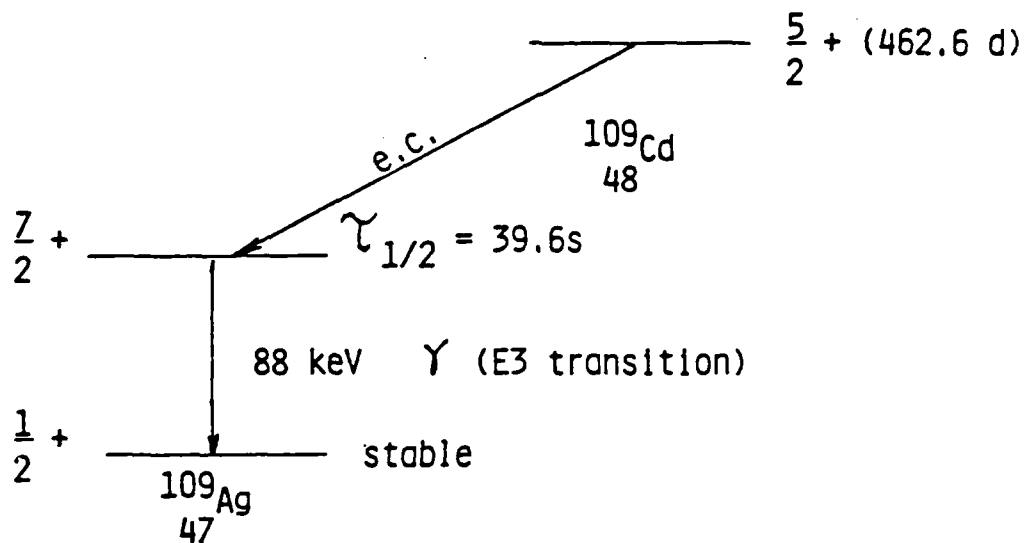

$^{107}\text{Ag}$  (51.3% abundance)

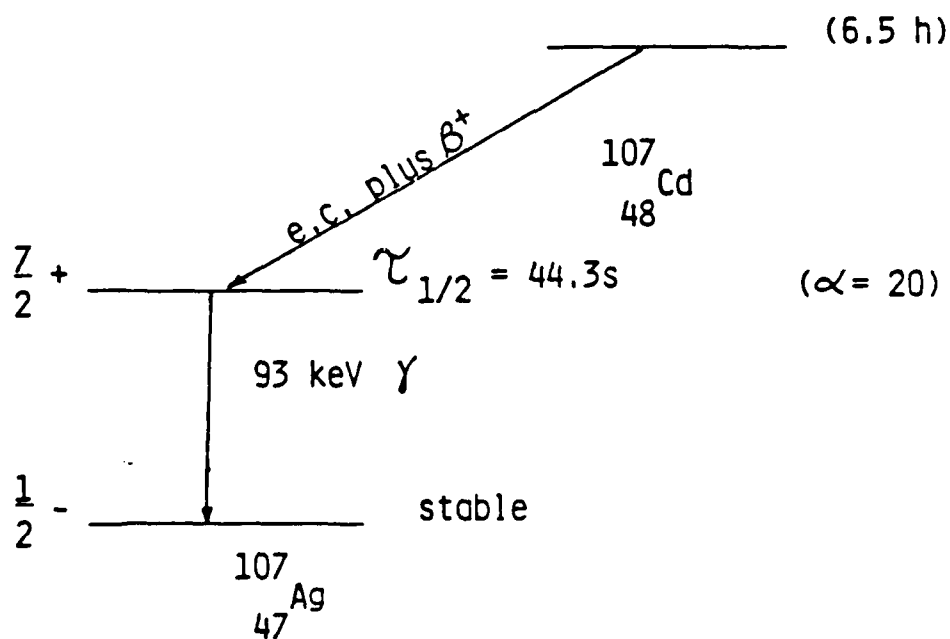
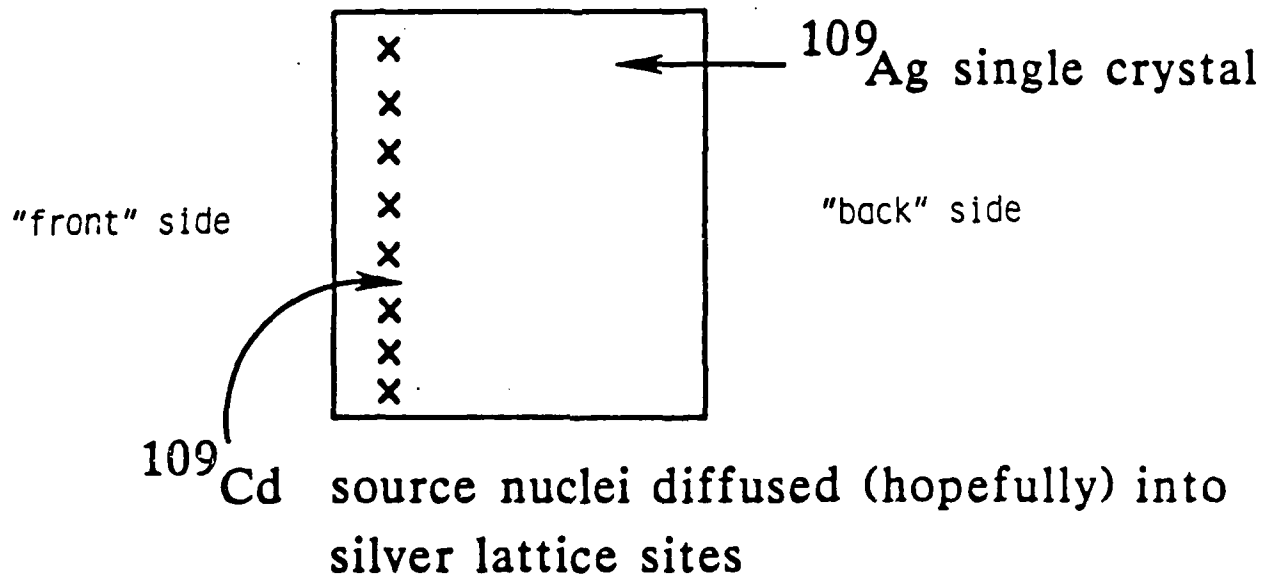

Figure 4

PROPOSED METHODS TO OBSERVE THE  
MOSSBAUER EFFECT IN  $^{109}\text{Ag}$

- 1) Coincidence Mossbauer spectroscopy (time differential Mossbauer spectroscopy).
- 2) Conversion electron Mossbauer spectroscopy (CEMS).
- 3) Gravitational line sweeping using the gravitational red shift.
- 4) Temperature dependence of self absorption.

## SCHEMATIC REPRESENTATION OF SAMPLE



(Notice one can do "on-off" experiments by diffusing the <sup>109</sup>Cd into a <sup>107</sup>Ag single crystal.)

TEMPERATURE DEPENDENCE OF THE RECOILLESS FRACTION (f)  
OF THE 88 keV  $\gamma$ -RAY TRANSITION IN SILVER

( $\theta_D = 226$  K)

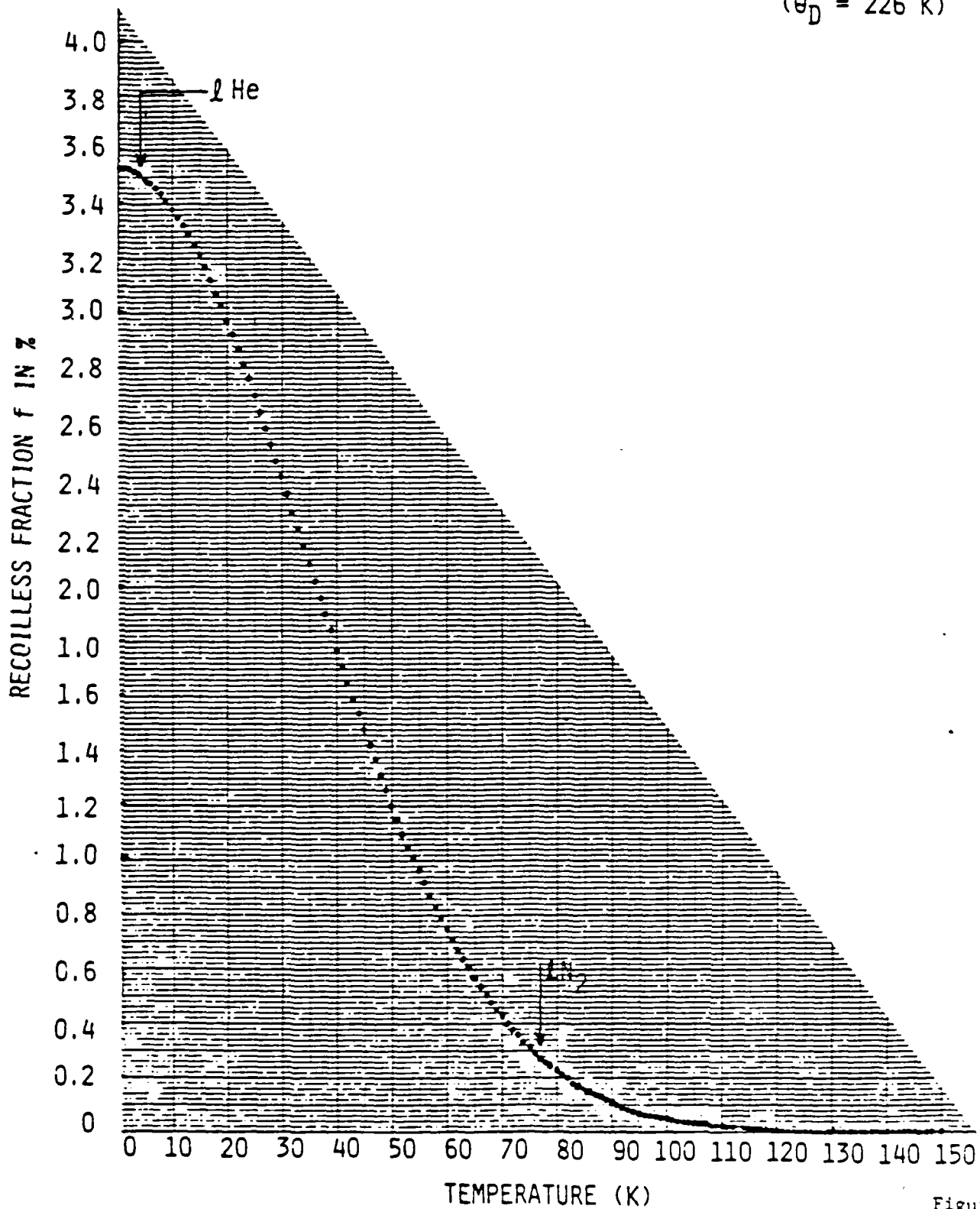

Figure 7

PULSE HEIGHT SPECTRUM OF  $^{109}\text{Cd}$  IN SILVER  
SINGLE CRYSTAL SAMPLE  
(75 K, viewed from "back" side)

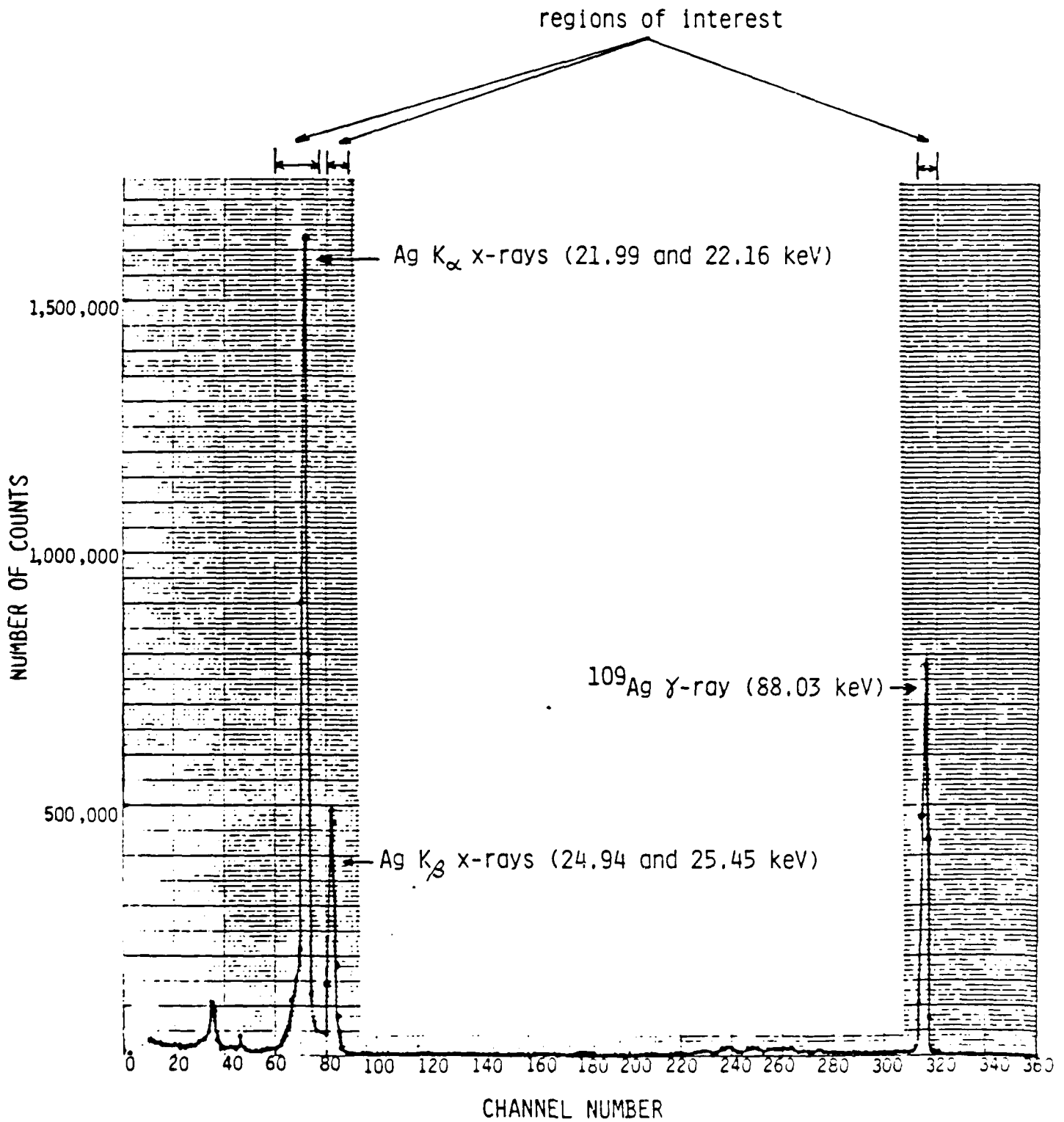

Figure 8

TABLE I. Preliminary data on the self absorption measurement

Run #	$R_{\alpha\gamma}$	$R_{\beta\gamma}$	sample temperature	comments
1	$2.36 \pm 0.003$	$0.74 \pm 0.003$	75 K	first set-up, 0.015" $\ell N_2$ in path
4	$2.40 \pm 0.004$	$0.79 \pm 0.01$	4 K	first set-up, reset sample, 0.015" liquid He
5	$2.35 \pm 0.002$	$0.77 \pm 0.002$	(10 - 75 K)	gaseous He
6	$2.39 \pm 0.004$	$0.78 \pm 0.01$	4 K	liquid He
7	$2.40 \pm 0.01$	$0.78 \pm 0.01$	4 K	liquid He
8	$2.34 \pm 0.002$	$0.76 \pm 0.002$	< 75 K	gaseous He
9	$2.35 \pm 0.003$	$0.77 \pm 0.004$	$75 \pm 30$ K	gaseous He
11	$2.44 \pm 0.003$	$0.77 \pm 0.01$	75 K	$\ell N_2$
12	$2.39 \pm 0.002$	$0.77 \pm 0.002$	~50 K	solid $N_2$
<hr/>				
21	$2.31 \pm 0.01$	$0.77 \pm 0.01$	R.T.	second set-up, air
22	$2.39 \pm 0.01$	$0.80 \pm 0.01$	150 K	100 torr He gas, reset
23	$2.37 \pm 0.004$	$0.78 \pm 0.004$	4 K	50 torr He gas
24	$2.36 \pm 0.003$	$0.78 \pm 0.004$	4 K	50 torr He gas
25	$2.34 \pm 0.005$	$0.77 \pm 0.01$	4 K	50 torr He gas
26	$2.36 \pm 0.004$	$0.78 \pm 0.004$	75 K	100 torr He gas
27	$2.36 \pm 0.004$	$0.78 \pm 0.004$	75 K	100 torr He gas
<hr/>				
30	2.315		75 K	third set-up, lowered detector
31	2.289		75 K	100 torr He gas
32	2.315		75 K	100 torr He gas
34	2.334		75 K	100 torr He gas
35	2.327		4 K	25 torr He gas
36	2.325		4 K	25 torr He gas



G. T. TRAMMELL, J. P. HANNON AND COLLABORATORS<sup>19,45-49</sup> HAVE PREDICTED THAT MOSSBAUER NUCLEI DEEP INSIDE SINGLE CRYSTALS CAN RADIATE TO THE OUTSIDE.\*

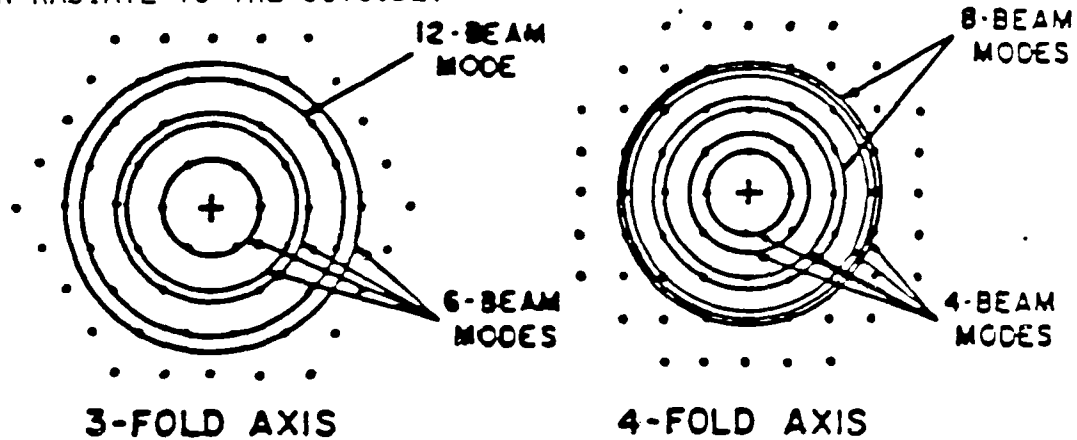

Multi-beam modes possible in crystals whose reciprocal lattices contain 3 and 4-fold symmetry axes. The points denote a plane through the reciprocal lattice. Any circle in this plane which intersects more than one reciprocal lattice point can form the base of the cone defining a set of modes. The modes with the most beams occur when the center of the circle lies on a high symmetry axis of the plane. This figure shows the case where that point is a reciprocal lattice point; similar modes occur when the center of the circle coincides with an interstitial point.

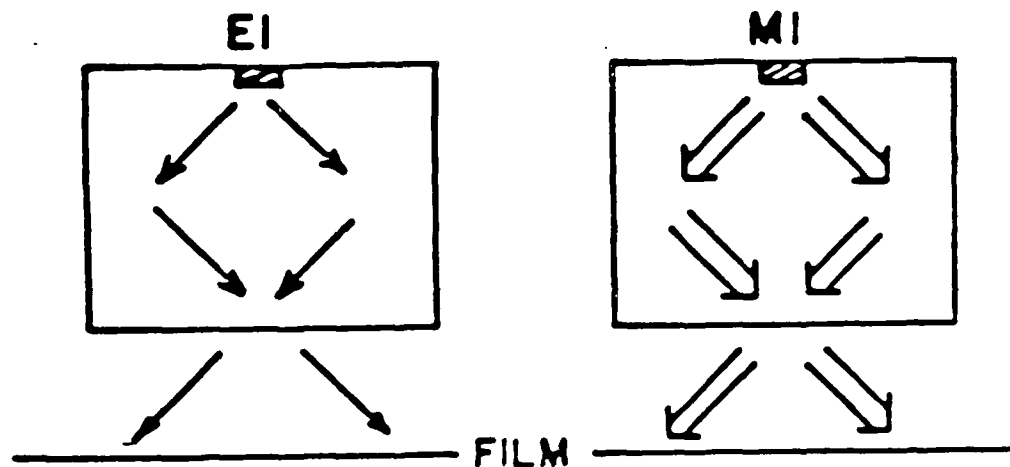

A simple experiment to verify the anomalous emission effect.

\*This figure taken from J. T. Hutton, Ph.D. dissertation, Rice University, 1986.

Copy available to EITC donor  
 contact: [illegible] [illegible]

PROPOSED EXPERIMENTAL CONFIGURATION FOR  
OBSERVING MULTIBEAM BORRMANN MODES

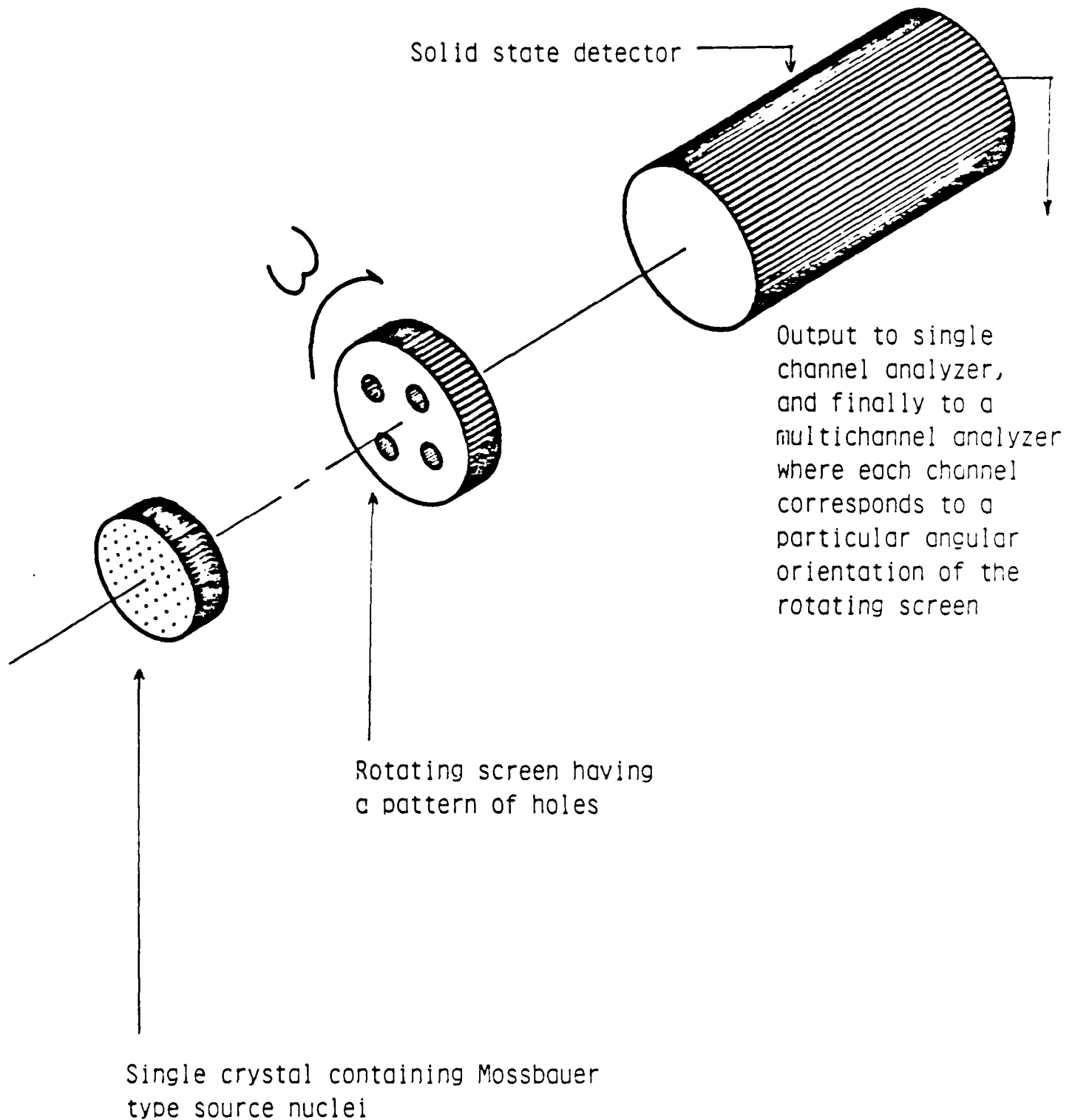

Figure 11

## NEEDED MOSSBAUER EFFECT STUDIES

### A. Practical

Can one introduce radioactive parent nuclei substitutionally into single crystals?

Can radioactive nuclei be put in high  $\theta_D$  single crystals to provide a high recoilless fraction and still give narrow lines?

How perfect do the single crystals have to be?

Need to consider a number of Mossbauer isotopes.

What is the best way for producing good single crystal sources; ion implantation, electroplating, sputtering, evaporation, nuclear reactions, etc.

### B. Fundamental

What is the narrowest Mossbauer line possible?

What is the role of isotopic abundance in forming the nuclear coherent state?

Can multibeam Borrmann modes be observed and the resonant nuclear coupling coefficients measured?

Can the Mossbauer effect itself help in the study of crystal structure of materials subjected to short, intense, laser pulses?

Can one observe collective, nuclear, recoilless, coherent state in single crystal sources?

## POSSIBLE NEW MODEL FOR GRASERS

(Based on the existence of collective, coherent, recoilless nuclear radiating states in the single crystals . . . ?  
The control becomes the single crystalline nature and  $f$  value of the sample.)



Start with a polycrystalline host.

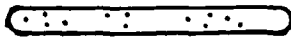

Incorporate long-lived, excited state, Mossbauer nuclei into the polycrystalline host. Nuclei decay independently with their ordinary lifetime.

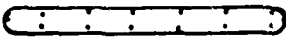

"Re-grow" the sample into a single crystal.

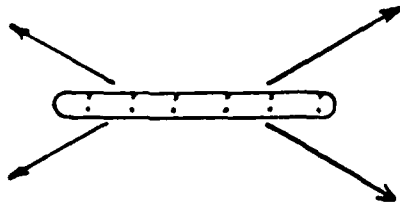

Cool the crystal to improve  $f$ . The system will rapidly emit coherent, recoilless  $\gamma$ -radiation into Bragg directions.

END

DATE

FILMED

4-88

DTIC