

AD-A189 855

AIRCRAFT ELECTROMAGNETIC COMPATIBILITY(II) BOEING
COMMERCIAL AIRPLANE CO SEATTLE WA C A CLARKE ET AL.

1/2

UNCLASSIFIED

JUN 87 D6-53848 DOT/FAA/CI-86/48 NAS2-12261

F/G 28/14

NL



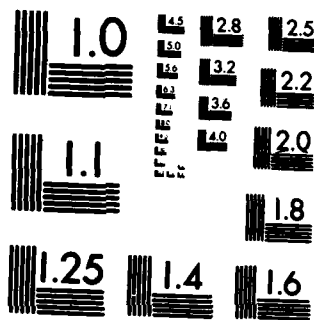

MICROCOPY RESOLUTION TEST CHART
NATIONAL BUREAU OF STANDARDS-1963-A

AD-A189 055

2

DTIC FILE COPY

DOT/FAA/CT-86/40

**FAA Technical Center
Atlantic City International Airport
N.J. 08405**

Aircraft Electromagnetic Compatibility

**Clifton A. Clarke
Boeing Commercial Airplane Company
Seattle, WA 98124**

**William E. Larsen
FAA Technical Field Office
Moffett Field, CA 94035**

June 1987

Final Report

**This document is available to the U.S. public
through the National Technical Information
Service, Springfield, Virginia 22161.**



**U.S. Department of Transportation
Federal Aviation Administration**

**DTIC
ELECTE
NOV 20 1987
S E D**

87 11 3 222

NOTICE

This document is disseminated under the sponsorship of the Department of Transportation in the interest of information exchange. The United States Government assumes no liability for the contents or use thereof.

The United States Government does not endorse products or manufacturers. Trade or manufacturer's names appear herein solely because they are considered essential to the object of this report.

1. Report No. DOT/FAA/CT-86/40		2. Government Accession No.		3. Recipient's Catalog No.	
4. Title and Subtitle Aircraft Electromagnetic Compatibility				5. Report Date June 1987	
				6. Performing Organization Code	
7. Author(s) C. A. Clarke, W. E. Larsen				8. Performing Organization Report No. D6-53840	
9. Performing Organization Name and Address Boeing Commercial Airplane Company P.O. Box 3707 Seattle, WA 98124				10. Work Unit No.	
				11. Contract or Grant No. NAS2-12261	
				13. Type of Report and Period Covered Final Report; September 1985 to June 1987	
12. Sponsoring Agency Name and Address U.S. Department of Transportation Federal Aviation Administration Technical Center Atlantic City Airport, NJ 08405				14. Sponsoring Agency Code	
15. Supplementary Notes					
16. Abstract					
<p>This aircraft electromagnetic compatibility document is for those individuals associated with the engineering design and test of commercial aircraft. The document illustrates aircraft architecture, electromagnetic interference environments, electromagnetic compatibility protection techniques, program specifications, tasks, and verification and validation procedures. The environments of 400-Hz power, electrical transients, and radio frequency fields are portrayed and related to thresholds of avionics electronics. Five layers of protection for avionics are defined. Recognition is given to some present-day electromagnetic compatibility weaknesses and issues which serve to re-emphasize the importance of EMC verification of equipment and parts, and their ultimate EMC validation on the aircraft.</p> <p>Proven standards of grounding, bonding, shielding, wiring, and packaging are laid out to help provide a foundation for a comprehensive approach to successful future aircraft design and an understanding of cost-effective EMC in an aircraft setting. The bibliography contains excellent in-depth articles on specific aspects of electromagnetic compatibility for those who desire further study.</p>					
17. Key Words (Suggested by Author(s)) Electromagnetic Compatibility, Electromagnetic Interference, Bonding, Grounding, Shielding, Wiring				18. Distribution Statement This document is available to the U.S. public through National Technical Information Service, Springfield, VA 22161	
19. Security Classif. (of this report)		20. Security Classif. (of this page)		21. No. of Pages	22. Price

FOREWORD

This document is based on work performed by the Boeing Commercial Airplane Company, P.O. Box 3707, Seattle, Washington 98124, under NASA contract NAS2-12261 for the Federal Aviation Administration, NASA/Ames Research Center, Moffett Field, CA 94035. The contract was firm fixed price, level-of-effort term from September 1985 to September 1986 with an extension to June 1987. Contracting officers were W. C. Botts, Boeing and A. N. Johnson, NASA. The FAA contracting officer's technical representative was William E. Larsen. Deliverables were an Interim Report (Draft) and an Interim Report (Final). The program manager was Robert D. Force, and principal investigator, Clifton A. Clarke.

Bob Force, who helped put the program together, played a central part in managing the planning and organization of the total document. The Section 2.1, "Existing Systems," is derived from the valuable "Active Controls Technology" report which Bob co-authored. Bill Larsen provided extensive expertise taken from his own experience, and through constructive source material. He also provided sound and highly regarded recommendations for content and organization. Dale R. Reed collaborated on the wiring-induced voltages and worked some of the indepth computations. He offered very profitable perspectives on the approach to aircraft engineering analysis and design; his forbearance and tenacity are appreciated.

Special contributions were made by John Tinner and John Bishop who consulted on significant aircraft test and troubleshooting procedures, helping to fill in the picture of aircraft electromagnetic interference. Veteran EMC engineers who supplied valued and time-tested data that form a part of this report were Jerry Carter, John Foster, and George Ketterling. Thanks are also due those individuals mentioned or quoted in the text.

Many people contributed important comments and helpful criticisms to the Interim Report (Draft). Chris Kendall supplied valuable consultations and comments along with Roger McConnell of CKC Associates. Henrietta Gilbert, FAA; Richard Hess, Sperry Corp.; Russell Carstensen, Naval Air Systems Command; and Kary Miller of Collins generously took time to review and comment with useful corrections and suggestions. My thanks are also owed to Nancy Clarke for helpful editorial comments. Fellow EMC engineers Glenn Olson, Kieth Kalanquin, Charles King, and Sy O'Young (who worked on the proposal) contributed their thoughts.

The document format and graphics were expertly delineated by Primo Mattieligh and drawn by Irene Ohashi. Their generosity and patience are much appreciated. Gary Breidenstein offered expert aid in the editing, and was a source of inspiration in the preparation of the final copy. Nancy Eaton not only supervised the typing, but helped proof the manuscript.

This document would not be possible without the unparalleled IEEE Symposium Records and the periodical "ITEM", R & B Enterprises, whose presentations were a source of valuable data applicable to an aircraft. I am collectively indebted.

TABLE OF CONTENTS

	PAGE
1.0 INTRODUCTION.....	1
1.1 Background and Scope	1
1.1.1 A Case of Engine Shutdown.....	1
1.1.2 Electromagnetic Compatibility	2
1.2 Electromagnetic Compatibility Priorities	7
1.2.1 Responsibilities and Policies	7
1.2.2 Documentation.....	10
1.3 How to Use This Document	10
2.0 AIRPLANE AVIONICS AND CRITICALITIES	13
2.1 Existing Systems.....	13
2.2 Future Aircraft	28
2.3 Criticalities.....	37
2.3.1 Measures and Definitions.....	37
2.3.2 Critical Equipment	38
2.4 Packaging and Architecture.....	40
2.5 Issues	43
2.5.1 An Early Start.....	43
2.5.2 Design.....	44
2.5.3 Environment and Test	44
2.6 Variances in Electromagnetic Compatibility	46
2.6.1 Diagnostics and Troubleshooting	46
2.6.2 Table of Variances.....	48
2.6.3 Corrective Action and Modeling	48
3.0 AVIONICS THRESHOLDS AND PROTECTION.....	53
3.1 Hardware Tolerance	53
3.2 EMI and Software	55
3.3 Digital and Discrete Circuits.....	57
3.3.1 ARINC 429 Drivers and Receivers	57
3.3.2 Circuit and Shield Grounds	58
3.3.3 Discretes.....	60
3.4 Equipment/Wiring Isolation and Separation	60
3.4.1 Quality of Wiring Design.....	60
3.4.2 Power and Energy Levels.....	64
3.4.3 EMC Quality in Maintenance	67
3.4.4 Shielding and Shield Ties.....	68
3.5 Aircraft Protection Measures.....	68
3.5.1 Structure Conductivity.....	68
3.5.2 Shielding	71
3.5.3 Safety in Grounding and Returns.....	77
3.5.4 Resistance	78
3.5.5 Resonance.....	82
3.6 Composites	82

4.0	EMC ANALYSIS AND ENVIRONMENT	87
4.1	Radiated Environment	87
4.1.1	Radio Frequency Field Distribution	87
4.1.2	Magnetic and Electric Field Distribution	93
4.1.3	Transients	96
4.2	Aircraft Protection	97
4.2.1	Shielding and Ground Reference	97
4.2.2	Apertures and Electrical Bonding	99
4.2.3	External Wiring Interface Circuits	99
4.2.4	Circuit Protection	100
4.3	Trades	101
5.0	ACTIVITIES AND DOCUMENTS	107
5.1	Specifications/Documents	107
5.2	Tasks/Activities	108
6.0	EQUIPMENT SPECIFICATION	111
6.1	New and Existing	111
6.2	Aircraft Equipment Categories	112
6.3	Suppliers	114
7.0	VERIFICATION AND VALIDATION	117
7.1	Key EMC Designs	117
7.2	Validation Plans	117
7.3	Validation Procedure	118
7.4	Program Design Reviews	120
8.0	BIBLIOGRAPHY	123
	APPENDIX A Glossary of Terms	131
	APPENDIX B Test and Test Limits	139

Accession For	
NTIS GRA&I	<input checked="" type="checkbox"/>
DTIC TAB	<input type="checkbox"/>
Unannounced	<input type="checkbox"/>
Justification	
By _____	
Distribution/	
Availability Codes	
Dist	Avail and/or Special
A-1	



LIST OF FIGURES

NUMBER	TITLE	PAGE
E-1	Postulated Percentages	vi
1.1-1	Representative EMI Sources	3
1.1-2	EMI Environment in Aircraft	4
1.1-3	Percent Troubleshooting—A/C	5
1.1-4	Electromagnetic Interference Effects	5
1.1-5	Radio Frequency Range	6
1.2-1	Cost-Effective Subsystem Testing	8
1.2-2	Key EMC Facilitators	9
1.3-1	Representative "E" Field Coupling	11
2.1-1	Present-Day Aircraft Systems	14
2.1-2	Avionics Bays	15
2.1-3	Wiring	15
2.1-4	Main Bay Aluminum Structure	15
2.1-5	Structure Return	16
2.1-6	Induced Noise	16
2.1-7	Noise Voltages	17
2.1-8	Nonmetallic Interfaces	17
2.1-9	Separation Example	19
2.1-10	Flight Control Autopilot Redundancy	19
2.1-11	Electronic Engine Control	20
2.1-12	Transmitters-Receivers	20
2.1-13	Flight Instrument System	21
2.1-14	Roll Control System	21
2.1-15	Navigation	22
2.1-16	Communication	23
2.1-17	Line Replaceable Unit	24
2.1-18	Flight Management Systems	25
2.1-19	Equipment/Wiring Location Complexities	27
2.1-20	Radiated Emission	28
2.2-1	EMC and Aircraft Systems Development	29
2.2-2	Data Bus Architecture	29
2.2-3	Line-of-Sight Display and Voice Control	30
2.2-4	Hypothetical Architecture	31
2.2-5	Data Bus Comparison	32
2.2-6	Digital Data Buses	32
2.2-7	Performance and Status Monitors	33
2.2-8	Microprocessor Evolution	34
2.2-9	Avionics Technology Progress	34
2.2-10	Materials Distribution	35
2.2-11	1990s ATC Implementation	35
2.3-1	Probability Versus Consequence	39
2.3-2	Three-Stage Subsystem Testing	39
2.3-3	Projected Criticalities	41
2.6-1	A Discrepancy	47
2.6-2	Postulated Hallmarks of Variances	51
3.1-1	Microcircuit Tolerance	54
3.1-2	Noise Margin	54

3.2-1	Transient Events	56
3.3-1	Circuit Noise Rejection (a b c d e f)	59
3.4-1	Circuit Response to EMI	61
3.4-2	Wiring Categories	63
3.4-3	Critical Circuits Wire Separation	64
3.4-4	Selected EMI Levels	66
3.4-5	Laboratory Test Setup	67
3.4-6	Shield Ties	69
3.5-1	The Grounding Steps	69
3.5-2	Structure EMC Roles	70
3.5-3	Details and Installation	72
3.5-4	The Seven Earth Ground Connections	73
3.5-5	EMC Anatomy Block Diagram	73
3.5-6	Magnetic Field SE of Aluminum	74
3.5-7	Loss of SE with Joint Finish	74
3.5-8	SE Comparison	75
3.5-9	Wire SE Comparison at HF-VHF	76
3.5-10	Material/Configuration SE Overview	76
3.5-11	Power Returns	77
3.5-12	Material/Resistance Overview	79
3.5-13	Configuration/Resistance Overview	80
3.5-14	Resistance Plot—Copper Plane	81
3.5-15	Resistance Versus Pressure	81
3.5-16	Joint Finish Resistance	82
3.5-17	Aircraft and Strap Resonance	83
3.6-1	Typical Nonmetallic Applications	83
3.6-2	Graphite-Epoxy Resistance	84
3.6-3	Graphite-Epoxy SE Shortfall	85
3.6-4	Graphite-Epoxy Details and Installation	85
4.1-1	HF-VHF Range	88
4.1-2	Selected RF Fields: HF-VHF Range	88
4.1-3	Expected Wire Voltage—Eight Feet	89
4.1-4	Environments, Safety, and Test	89
4.1-5	A Transistor Threshold	90
4.1-6	Representative Coax Voltage Coupling	90
4.1-7	Representative Secondary Coupling	91
4.1-8	Graphite-Epoxy or Al Shielding Added	91
4.1-9	"H" Field Coupling	93
4.1-10	"E" Field Coupling	94
4.1-11	Coupling Versus Separation	94
4.1-12	Magnetic Fields	95
4.1-13	Transient Ringing	96
4.1-14	Electrical Transients	97
4.2-1	Layered Design	98
4.3-1	Trade—Equipment Location	102
4.3-2	Trade—Wire Length/Separation	103
4.3-3	Trade—Digital Circuits	104
B-1	EMI Test Limits (SH 1, 2, 3, 4)	142

EXECUTIVE SUMMARY

The Aircraft Electromagnetic Compatibility guidelines document deals with electromagnetic compatibility in a commercial transport aircraft: the specifications, the activities, the design, and the tests to verify and validate compatibility.

Objectives are to view architecture, equipment and wiring location, material properties, circuit susceptibilities, and environment as seen from the electromagnetic compatibility design perspective of balanced circuits, filters, electrical bonding, grounding, and shielding.

Even today digital electronics are much more common in aircraft. Automated flight controls of future aircraft will operate under the control of digital clocks, data buses, switching regulators, pulse width modulated power, and radio frequency transmitters on the one hand, and on the other, sensitive analog and digital instrumentation.

Safe and efficient flight will depend on the performance of electronics. It will be important to understand the electromagnetic interference types and the electromagnetic interference paths (figure E1).

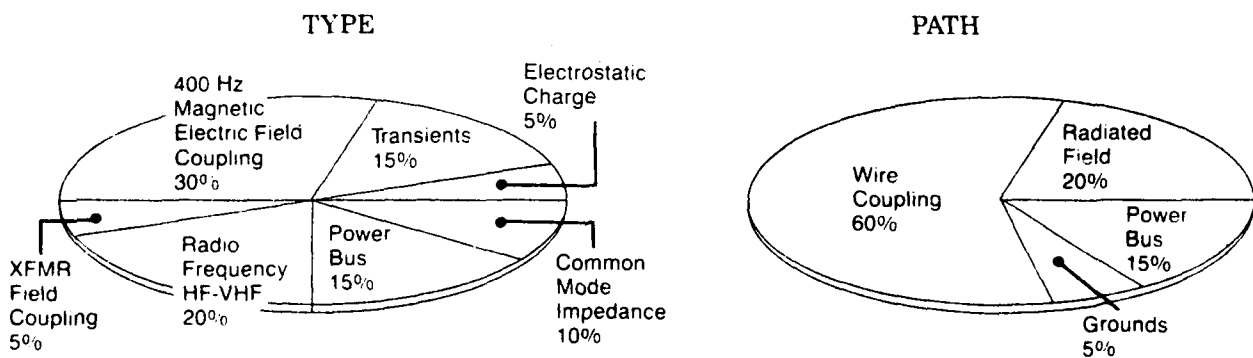

Figure E-1 Postulated Percentages

The EMI types are set forth in this document by showing a profile of the magnetic and electric fields from power lines; some military, urban, and rural radio frequency field strengths; and the properties of transients. Significance of the wire circuit return, the balanced circuit, grounding, shielding, and software highlight the protection techniques of a layered design which will block paths of electromagnetic interference and maintain interface signal quality. Design specifications, activities, and reviews are proposed to help set up guidelines for equipment verification and aircraft validation.

1.0 INTRODUCTION

1.1 BACKGROUND AND SCOPE

1.1.1 A Case of Engine Shutdown

Captain Hoag thought briefly of the moment when he left home last night. His son, daughter, and wife were all there. They had joked about their planned upcoming vacation, their first together in two years.

A voice broke into his short reverie: "Flight 211, you're low and to the left—please maintain 023—you have a cell at 2 o'clock."

Hoag said to the first officer, John Pearson: "John, push it forward and bring 'er up."

John said: "Gotcha covered. I flew one of these new ones two weeks ago into Loridan International—they sure do handle smoothly."

"Okay—uh huh." "Gear down."

Flight 211, Atlantic Air, was on approach to Keithrode International Airport (KIA). It was 16:45 on October 16. Two hundred and twenty-seven passengers were on board. The weather had been partly cloudy with thunderstorms predicted and cell activity in the proximity of the air terminal.

Tower: "Flight 211, you are cleared on Runway 3. You are still low."

Captain Hoag: "John, bring 'er up."

A lightning flash occurred off to the left. Then, instantly, a blinding flash, an overwhelming shudder, and the aircraft metal structure and body seemed to vibrate under a massive pressure and energy wave.

Hoag: "We've lost number 1! Push it all the way forward!"

Pearson: "Okay"

Hoag: "All the way forward—all the way forward—oh."

The plane hit the earth with a great screech, scrape, a shower of sparks, and a grinding of metal. It then rose again, lumbering and awry, as if struggling to be airborne—struggling—then it smashed again to the ground. The tail buckled. Flames broke out.

Fifty-six people were killed, including the crew. A number were injured.

HYPOTHESIS NO. 1: The piercing lightning strike to the left-hand engine caused a large atmospheric pressure wave. This wave traveled through the engine intake into the main engine chamber and snuffed out the flame, and thus the engine power.

HYPOTHESIS NO. 2: The lightning strike to the engine established a large electrical current flow in the engine structure and cowling. Electrical circuits connected to the structure experienced voltage transients causing valve malfunction and leading to an engine shutdown.

This case is dramatic. It is awesome. It commands attention. We recognize that we must protect against this type of event, model it, and develop reiterative computations and tests to uncover the boundaries of transient energies invading important electrical circuits.

This case is given to illustrate the contrast between a very visible and threatening electrical upset or damage phenomenon and the usual run of invisible electromagnetic interference (EMI) that few airline passengers know about. Normal electromagnetic interference environmental problems ordinarily have not carried with them the drama of the case above. Aircraft have been constructed with controls and electrical apparatus having electromagnetic interference problems, but not having any influence on safety.

Knowledge of and protection against induced noise voltages are necessary today and will be even more necessary in future aircraft where vital and critical control functions are being taken over by avionics interconnected by digital data buses that could impair safety if beset by electrical noise. We need access to knowledge of the various types of noise. There is a growing awareness of electromagnetic interference and electromagnetic compatibility (EMC).

1.1.2 Electromagnetic Compatibility

Electromagnetic interference could cause a flight delay or endanger the operation of an aircraft at 30,000 feet. Generators of electromagnetic interference for aircraft (figure 1.1-1) take on several forms:

- 1) Transmitters of radio frequencies that may be installed on the aircraft itself, such as high-frequency (HF) or very high frequency (VHF) communication links, or high-energy sources located on the ground such as our everyday frequency modulated (FM) radio or HF-VHF-UHF broadcast stations
- 2) The aircraft power line 400-Hz electric and magnetic fields
- 3) The computer and avionics microprocessor timing and control clock signal circuits that generate radio frequencies of one MHz or higher
- 4) The aircraft power switching regulators which are used to convert from one level of power to another
- 5) Electrical switching transients sparked by the turn on and off of aircraft lights, fans, and engines or by the operation of control surfaces, ailerons, slats, and flaps
- 6) Electrostatic discharges including lightning

These transients and electromagnetic waves may transfer into wiring and cause "electromagnetic interference" to microcircuits inside electrical equipment and avionics, possibly resulting in a trifling disorder in a flight deck display or, more seriously, an engine shutdown.

The conductive paths of electrical wiring provide an avenue to usher electromagnetic interference directly to airplane avionics and signal inputs. Eliminate wiring, and electromagnetic interference almost vanishes. Wiring is the most important factor in electromagnetic interference and electromagnetic compatibility. Of much lesser importance is the electromagnetic

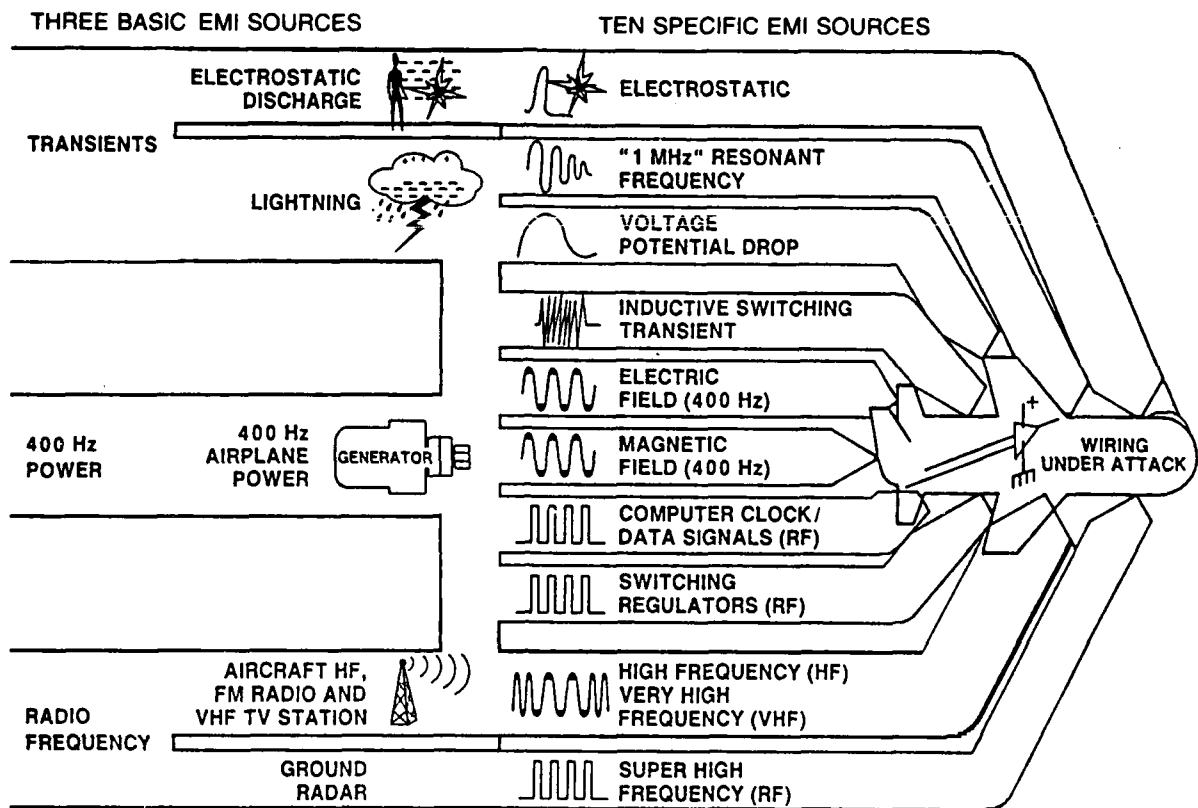

Figure 1.1-1 Representative EMI Sources

interference path through the avionic equipment metal housing or case. Wiring is the electrical interface and connection between avionic equipment. Its designated job is to transfer avionics signals, data, and information. But, in that function, it can often act to transfer electromagnetic interference energy to other wires in a wire bundle. It also sprays or radiates like a transmitting antenna and very efficiently receives radio frequency energy like a receiving antenna.

Recently, an experienced electromagnetic compatibility engineer, "an old hand," was asked, "What's the number one requirement for an electromagnetic compatibility design program that will rule out electromagnetic interference problems?"

His answer, "Zero net current flow in a shielded, balanced, isolated circuit." In other words, always route the signal wire and return or the power wire and its return together — twisted pair, coax, or shielded pair, which means that aircraft basic structure is not used as the return path for the circuit (figure 1.1-2). This will almost eliminate the three electromagnetic interference avenues of entry: common mode impedance paths, magnetic field coupling, and electric field coupling. (Common mode impedance conditions exist when two circuits share a portion of the same electrical path.)

So, that's it: Use a return wire and use a shield for each circuit.

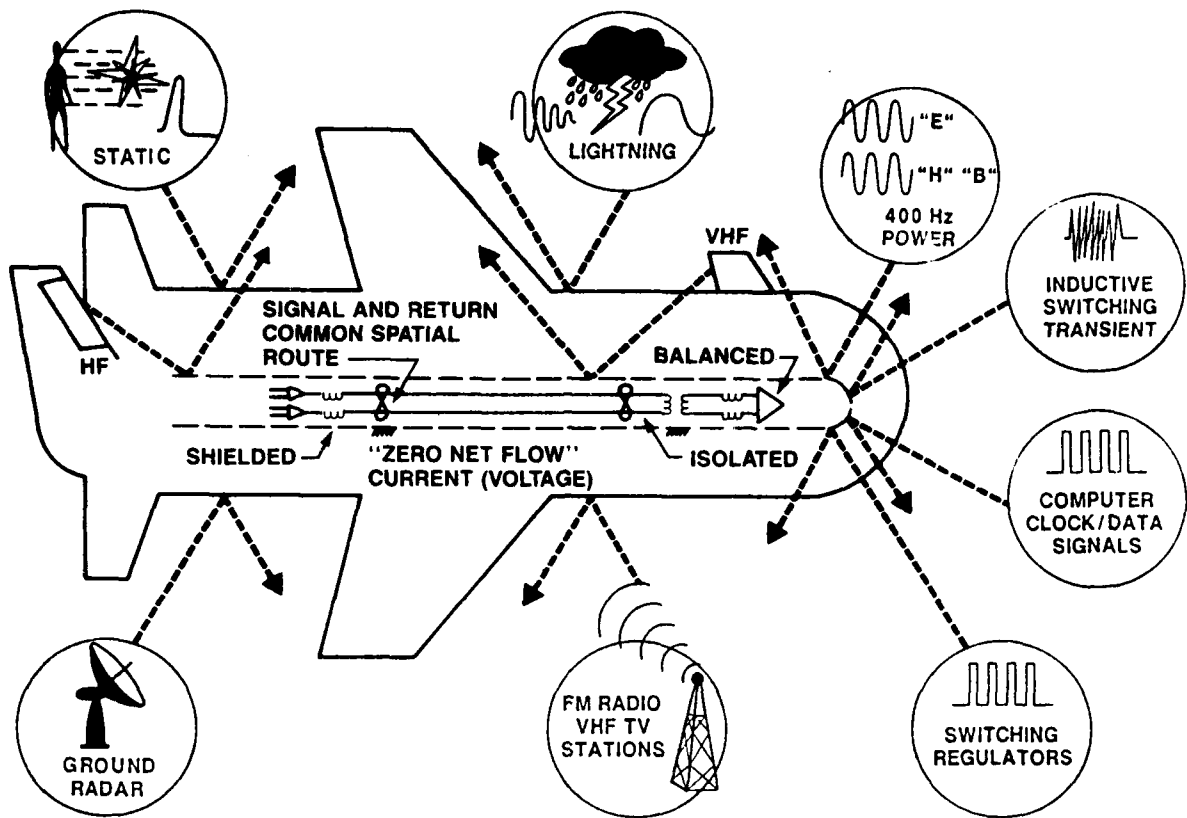

Figure 1.1-2 EMI Environment in Aircraft

Without good shielding, the results are predictable. Removing the shield from the circuit and separating the return from the signal wire not only destroys the efficiency of the circuit, it also opens up the circuit to intervention from stray electric and magnetic fields providing an avenue directly to the microprocessor memories, computers, and controllers that are needed for aircraft operation and for processing and control of flight deck displays and instruments. A recent estimate of airplane problems (figure 1.1-3) indicates that power line electric and magnetic field coupling (30%) radio frequency fields (20%), transients (15%), and common mode impedance paths (10%) make up a total of 75% of deficiencies. These can be largely corrected with proper wiring design. Electromagnetic interference may occur in many of the aircraft subsystems (figure 1.1-4). If uncontrolled, it appears as radio tones, static, or 400-Hz hum on the passenger entertainment systems. It can show up as flight deck display distortion or illegibility, impaired data transmissions, computer memory loss, and may even result in suspension of equipment operation. Radio frequencies are becoming more of a concern. Today, the predominant radio frequency fields that impair avionic equipment operation fall into the HF-VHF radio frequency spectrum (figure 1.1-5); in future aircraft, the range may vary. (See Section 8.0, Bibliography, ECAC Study.) Electromagnetic compatibility requirements encompass almost every subsystem on an aircraft.

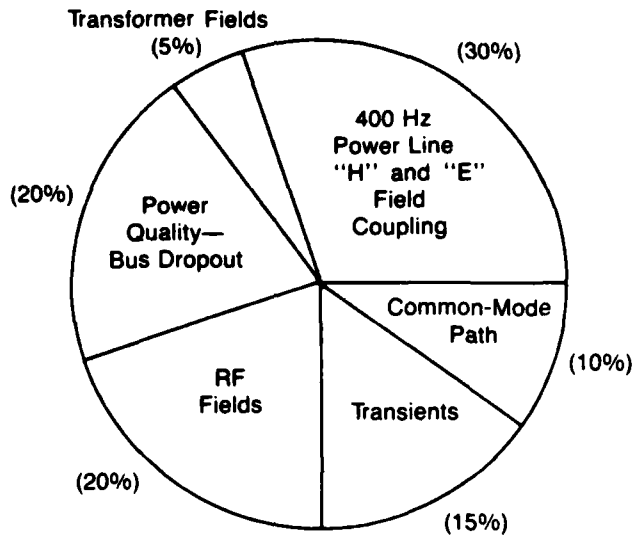

Figure 1.1-3 Percent Troubleshooting—A/C

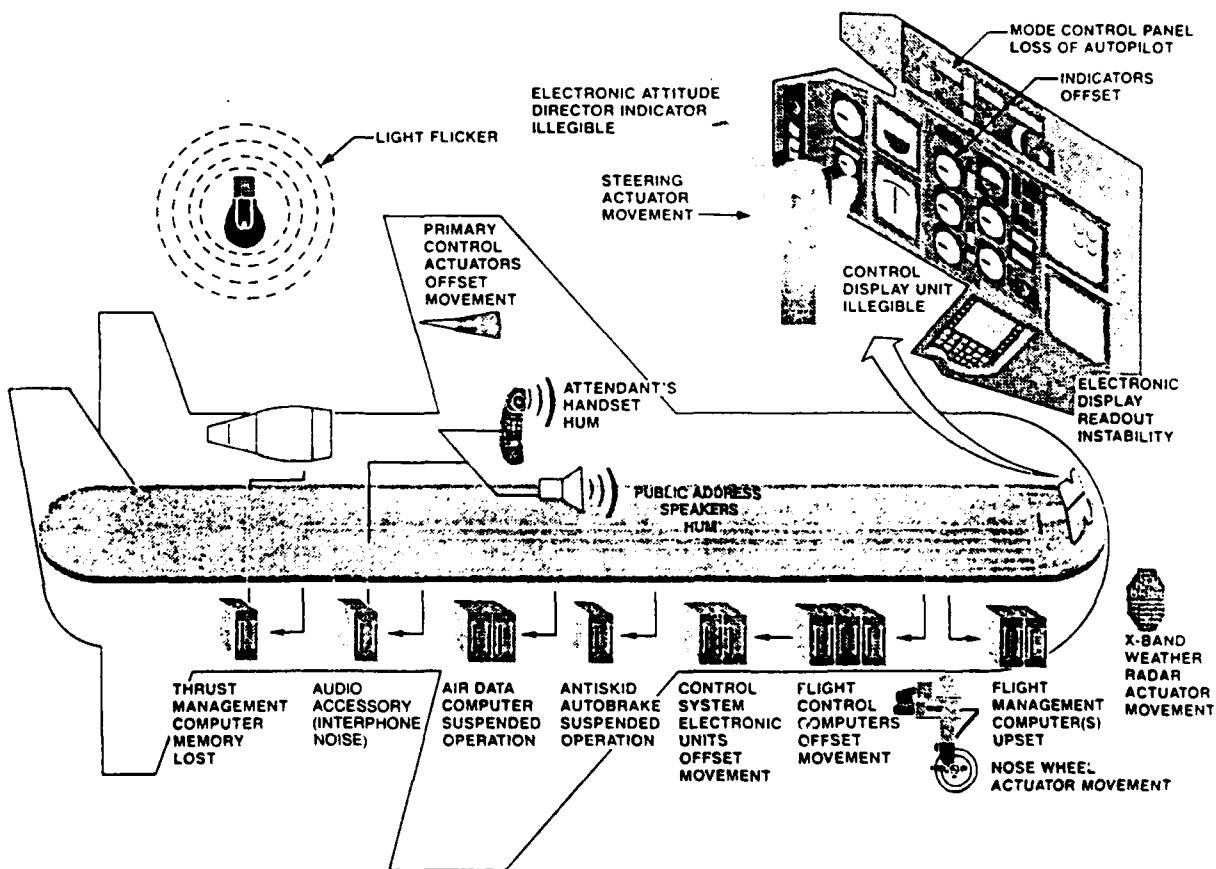

Figure 1.1-4 Electromagnetic Interference Effects

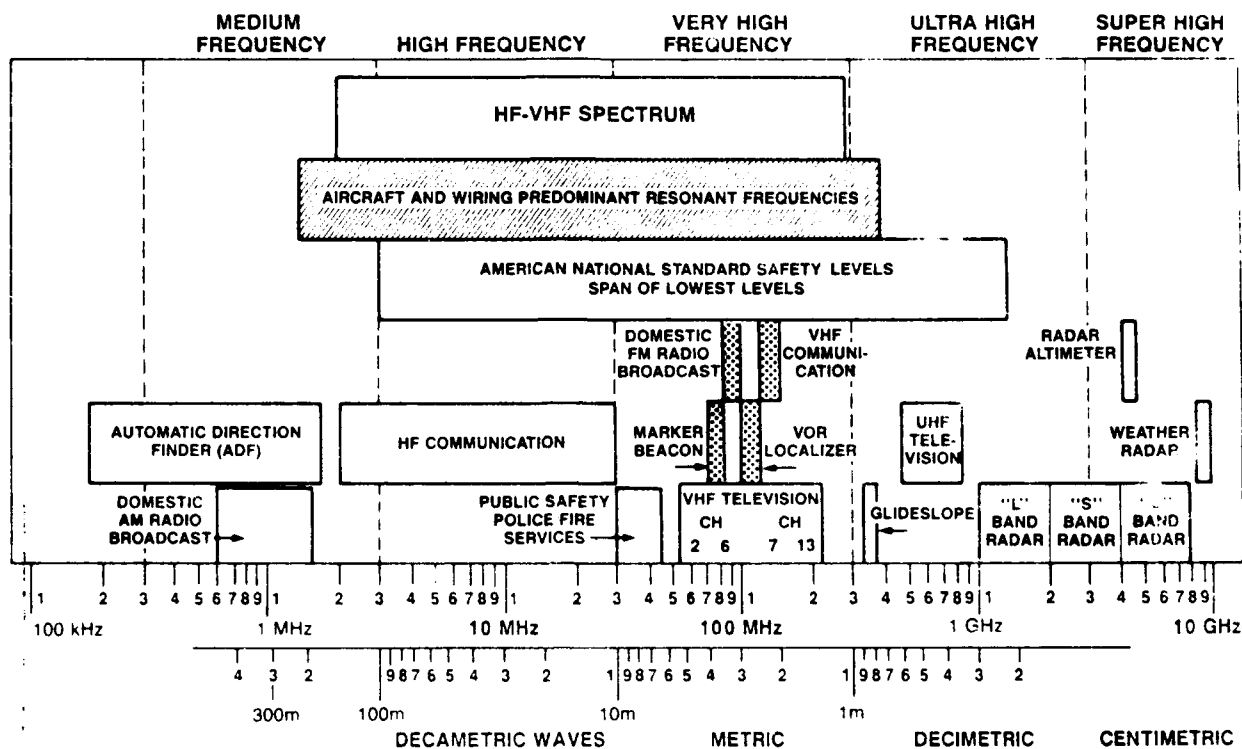

Figure 1.1-5 Radio Frequency Range

The field of electromagnetic compatibility is not only a discipline in itself, it is also the proper application of other engineering technologies. Good engineering design techniques employed in the areas of avionics, wiring and cabling, electrical bonding and grounding, lightning protection, and others, go a long way in achieving electromagnetic compatibility. Electromagnetic fields are produced by the generation, transmission, and utilization of electrical energy. Stray electromagnetic energy is generally not desired, and quite often interferes with the operation of electrical/electronic equipment, hence, the name electromagnetic interference. Control specifications for electromagnetic interference generation and electromagnetic interference susceptibility are required to achieve electromagnetic compatibility. With proper wiring, shielding, and application of voltage limiters in a good electromagnetic compatibility design, there is increased confidence in equipment operation which converts directly to the bottom line of on-time dispatch for the airlines and their passengers.

The steps to reach electromagnetic compatibility in an airline are basically threefold: 1) procure equipment and wiring according to EMC specifications, 2) package the equipment and wiring in the aircraft to obtain protection from structure, and 3) measure and test the equipment and wiring for all aspects of EMI during the program to guarantee verification and validation of EMC (See Section 7.0, Verification and Validation.)

EMC specifications for the commercial airplane are covered by Federal Aviation Regulations and are specified in terms of system operation. FAR, Part 25.1353, Paragraph A, covers electrical equipment: "Electrical equipment controls and wiring must be installed so that operation of any one unit or system of units will not adversely affect the simultaneous operation of any other electrical unit or system essential to safe operation."

Federal Aviation Regulation, Part 25.1431, Paragraph C, covers electronic equipment: "Radio and electronic equipment, controls and wiring must be installed so that operation of any one unit or system of units will not adversely affect the simultaneous operation of any other radio or electronic unit or system of units, required by this chapter."

Environmental and emission control specifications for electronic equipment intended for installation in aircraft are documented in the current revision of "Radio Technical Commission for Aeronautics" (RTCA) Environmental Specification DO-160. (See Section 5.0 and Appendix B.)

1.2 ELECTROMAGNETIC COMPATIBILITY PRIORITIES

1.2.1 Responsibilities and Policies

A new airplane presents a challenge of equipment location, packaging, assessment of environment and resolution of new technology problems. The airframe manufacturer takes on the responsibility in the electromagnetic compatibility design to outline the operational-temporal-spatial anatomy of the airplane early in the conceptual stage. It is a difficult and extensive task. (See Section 4.2 and 4.3.)

Equipment location, wiring, transmitters, receivers, 400-Hz power, lightning diversion, and static dissipation are all familiar items to be pursued, tracked down, identified, and recorded. They absorb many labor hours.

Even with the rapid advance of technology, many components, characteristics, and parameters on a new airplane do not change. The electromagnetic compatibility engineer has a responsibility to know the off-the-shelf equipment. A productive policy is to seek out and rely on existing specifications and designs to the greatest extent possible, thereby sidestepping duplication of effort in analysis, scheduling, and testing. EMI test levels documented in the current issue of the RTCA Document DO-160, in many instances, represent today's environment. (They do not take into account the affects of new composite structures.) The test levels have been developed over the years. Airframe manufacturers and subcontractors can take good advantage of existing specifications and test data.

So, the first priority of the airframe manufacturer is to take on the task of defining the electromagnetic compatibility anatomy—existing equipment, new equipment, new environment, and locations.

Location often sets the electromagnetic compatibility requirements for avionics. Electronics or lack of it influences design requirements for equipment. (See Section 6.0.)

The first priority of the avionics supplier or subcontractor (including inhouse suppliers) is to know the electromagnetic interference environment and then identify, design, and protect each power input and signal input to guarantee that the equipment will operate within performance standards in that environment. The designer must shoulder the responsibility of knowing the interface wiring; often the designer is concerned with operational requirements and must make a special effort to recognize the noise requirements. DO-160 is the basic industry standard. (See Section 3.4.2 and Appendix B.)

The airframe manufacturer deals with new materials and properties, wiring, electrical bonding, shielding effectiveness, and definition of environment.

The avionics supplier deals with input/output circuit protection, internal grounding, circuit card layout, and interface wiring. The supplier must observe in a real-time interactive setting the board-level noise thresholds to ensure no "state changes" and to ensure adequate containment of electromagnetic interference at the box level. The equipment engineer designs devices to be tolerant to magnetic fields from 400-Hz power (400-mV induced), 400-Hz electric field (up to 1000V induced in test), radio frequencies (1V induced), transients from coils and lightning (600V), and electrostatic discharge (10,000V or higher). Future aircraft having critical fly-by-wire systems may require higher levels, especially for radio frequency fields. The designer must also install filters to control and contain emissions from oscillator and switching regulator clock and harmonic radio frequencies. Interface wiring must be designed and agreed upon and documented in an interface control drawing, otherwise hardware would require multiple electromagnetic interference designs.

Along with the size of a new program and the extent of its new technology, three pivotal factors influence the level of effort and are sine qua non to success: 1) management support, 2) the electromagnetic compatibility engineer's product experience, and 3) the electromagnetic compatibility experience of other participating engineers on the program. Management support means setting the priority for early resolution of requirements before formal document release of vendor technical specifications and statements of work. Product experience means minimum duplication and maximum productive effort. Experienced participating engineers means satisfactory coverage of subcontractor requirements, good electrical bonding and wiring practices.

On a recent airplane development program, extensive subsystem testing was performed on engineering models and also production models with these three recognized benefits: 1) proof and verification of equipment performance, 2) good diagnostic testing, and 3) knowledge of equipment operation. Diagnostic/troubleshooting tests can be run in cooperation with the subcontractor. Subsystem testing is becoming a key element in a successful program (figure 1.2-1). (See Section 7.0.)

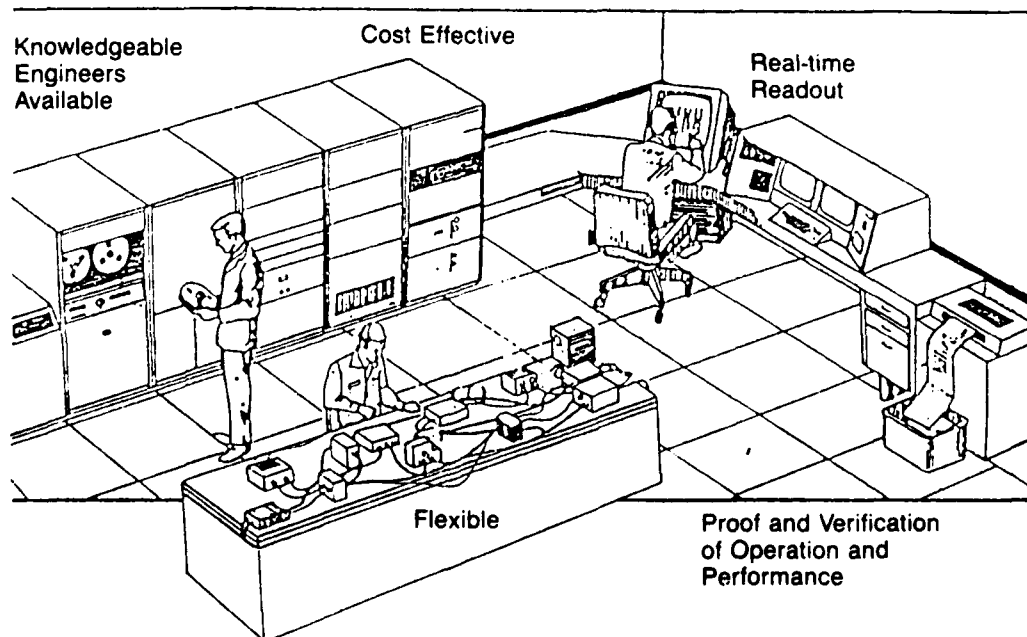

Figure 1.2-1 Cost-Effective Subsystem Testing

Entering into a new program incurs a commitment effort (figure 1.2-2), a commitment sized by the new technology and environment, and a commitment that dissipates with the settling of each subcontractor requirement, each design, each test, and each verification. Early adoption and documentation of known steps for successful electromagnetic compatibility are established on these baseline technical priorities: 1) zero net current flow in a balanced, isolated, shielded circuit, 2) total, all-inclusive electrical bonding of every structure and every detail (including conductive paint on external dielectric surfaces), and 3) optimum avionic equipment inline design and location making maximum use of structural shielding.

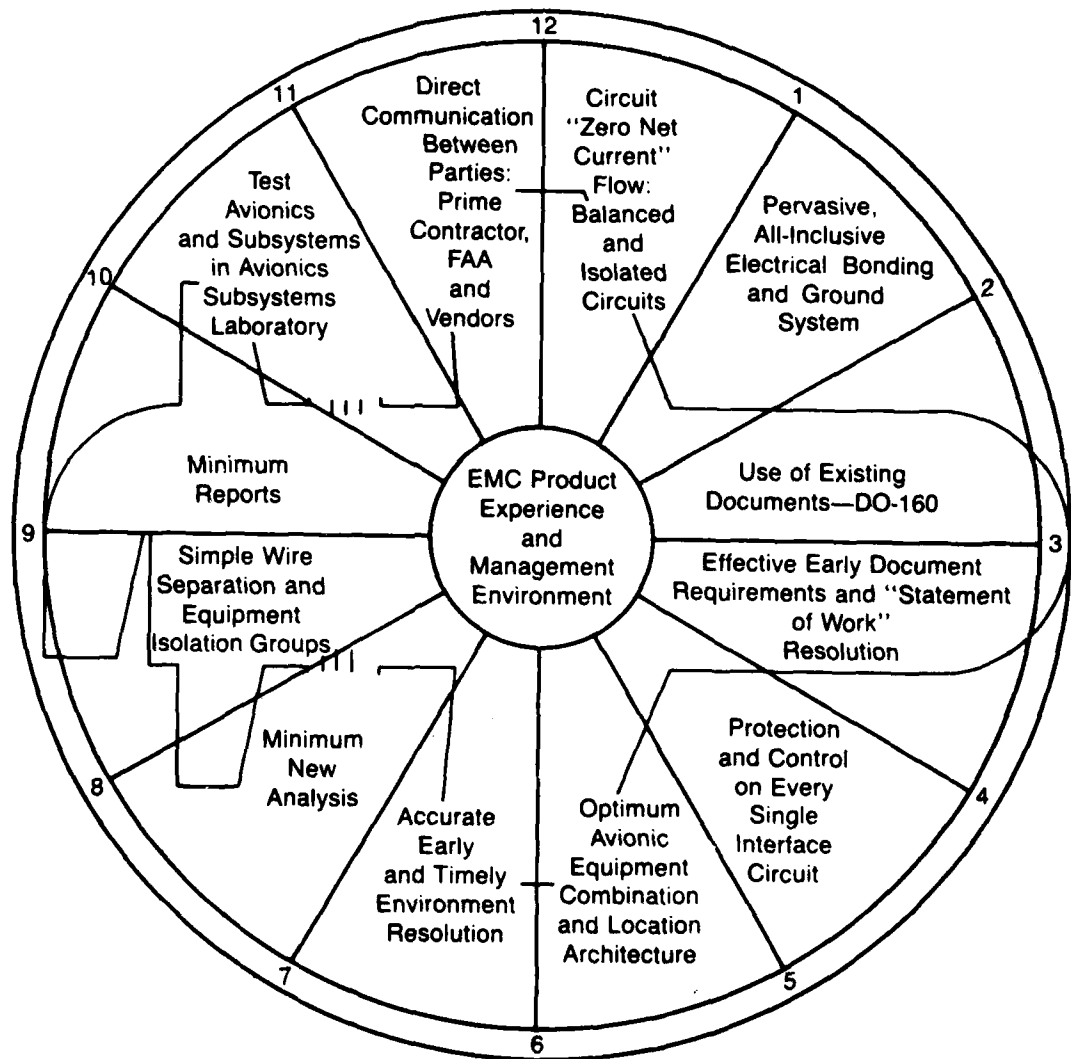

Figure 1.2-2 Key EMC Facilitators

1.2.2 Documentation

To provide a foundation, baseline, reference, and continuity, there are these key documents: system level specification (possibly a paragraph or two), electromagnetic compatibility plan (may be brief), electromagnetic compatibility requirements (extensive and detailed), procurement specifications (with statements of work), interface identification, equipment test (procedure and report), and airplane test (procedure and report). (See Section 5.0 and 6.0).

Procurement specifications must be finalized before contract formal approval.

The fact that minimum documentation leads to a more productive program is as fundamental as the fact that there are certain program top documents that must be instituted to define scope and intent and to reference industry specifications. The documentation of many of the tasks, analyses, and tests on a program can be covered by brief individual memorandums or reports. Some programs issue design notes, a practice that is an efficient method of recording and disseminating design requirements, rationale, and information.

1.3 HOW TO USE THIS DOCUMENT

The purpose of this Aircraft Electromagnetic Compatibility document is to digest, unify, highlight, and give perspective to the substantive aspects of electromagnetic compatibility applied to a commercial transport aircraft. The material in this document is not new. A very important resource to the electromagnetic compatibility engineer is the electromagnetic compatibility knowledge of other individuals associated with a program. Beliefs exist that graphite-epoxy is an insulator; that box-to-box radiation is important (it is the interface wiring that is the key to EMC); that shield tie (pigtail) length is not critical; that every single interface line does not need to be analyzed for protection and emission control; that ground planes are not required; that single-point grounding is always good (it is good for power, but not good for digital circuitry); and that extensive verification procedures can be ignored and are not essential.

The 1970s and 1980s have seen a striking rise in the quality and extent of EMC/EMI design engineering knowledge that has important consequences for EMC. This document attempts to collect and apply that information to the airplane. Derivations and fundamentals of EMC are not elucidated. This document is limited in that sense. Reference can be made to the bibliography for some excellent articles.

EMC information not found herein:

- Fundamentals or basics of EMC
- Formulas, models, derivations
- Antenna-to-antenna coupling
- Power system quality
- Lightning

EMC information included:

- Aircraft-applied EMC
- Architecture, equipment layout
- Dominant EMI environments
- Circuit susceptibilities
- Bonding, grounding, shielding
- Wiring design
- Verification, validation

It is recommended that this document be read through before concentrating on specific sections. This document is not a design document or a "design cookbook." It in no way can replace specific analysis and design effort. It is a set of guidelines to outline and scope deficiencies and qualities in present day aircraft that may aid in the approach to future designs. The information and data is illustrative and advisory to provide definition and make comparisons of parametric properties and behavior, and it is not for use or adaptation to specific designs. For example, Figure 1.3-1 maps the expected voltages induced in a single aircraft wire circuit (having resistive loads) from an adjacent 115V, 400-Hz power wire where both have their returns in aircraft structure. This figure illustrates the significance of length of coupling, resistive loads, and gives a rough estimate of amplitudes. But, there are other interacting parameters that might be considered; ergo, each circuit type in the aircraft must be evaluated separately.

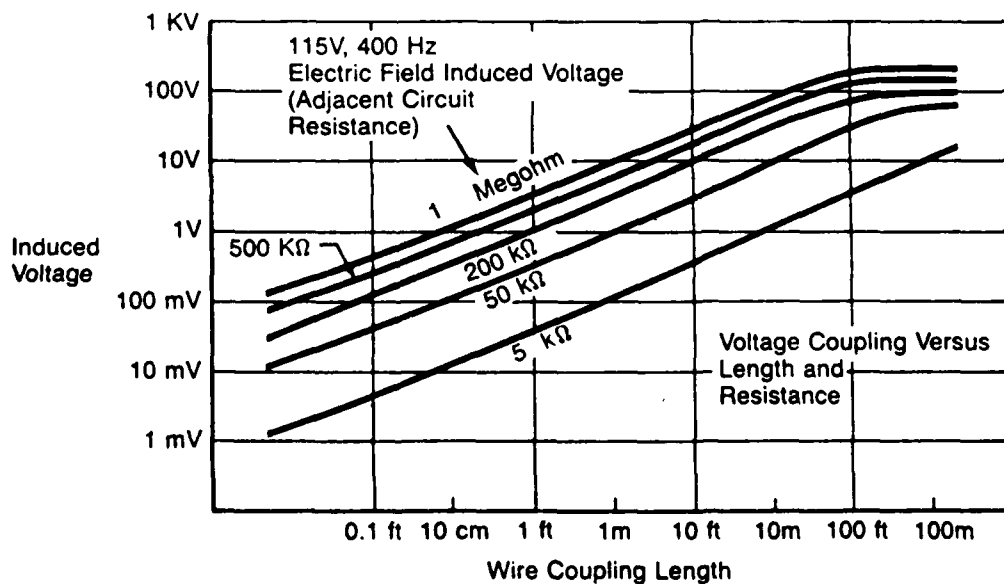

Figure 1.3-1 Representative "E" Field Coupling

Much emphasis on wiring design exists herein. The soul of EMC is a balanced, isolated, shielded interface circuit. It closes the door on EMI. It rejects transients, radio frequencies, and 400-Hz fields. It is practically impervious to conductive, inductive, and capacitive transfer of energy.

Linearity rises as one of the elegant attributes of electromagnetics, giving simplicity to variations in the electromagnetic dependent and independent parameters: length, height, resistance, voltage, time, over much of their range. These parameters often vary on a 1:1 ratio (20 dB per decade) or an exponential ratio, possibly 40 dB per decade. The linear relationship breaks down or changes at corner frequencies, 3 dB points, and resonant nodes where the dominance of electrical parameters make a transition from one to the other.

Ratios and the decibel relationship will be used throughout. The decibel, abbreviated dB, is a unit expressing the ratio between two amounts of power, P_1 and P_2 , existing at two points. By definition, the number of dB equals $10 \log$ to the base 10 (P_1 divided by P_2). For special cases where P_2 equals 1 mW or 1W, the dB ratio is defined as "dBm" or "dBW." For power, a factor of 10 equals 10 dB. Since power P equals V^2 divided by R , or I^2 times R , decibels can be used to express voltage and current ratios where the voltages and currents are measured at places having identical impedances. By definition, dB equals $20 \log$ of (V_1 divided by V_2), and dB equals $20 \log$ (I_1 divided by I_2). For convenience, V_2 or I_2 are often chosen as $1 \mu\text{V}$, and $1 \mu\text{A}$, and the dB ratio defined as dB above a microvolt or dB above a microamp. Also for convenience, these ratios are more often used whether or not they are referenced to identical impedances. A factor of 10 equals 20 dB. Memorize these voltage-current ratios: 6 dB = 2X, 10 dB = 3X, 12 dB = 4, 20 dB = 10, 40 dB = 100, and 60 dB = 1000.

2.0 AIRPLANE AVIONICS AND CRITICALITIES

2.1 EXISTING SYSTEMS

One-hundred and fifty paying passengers or more; flight attendants; airline competition; scheduled dispatch; fixed cost; aisleways; lavatories; galleys; and video entertainment: These are the well-known hallmarks of a commercial transport aircraft (figure 2.1-1).

The necessary control of capital cost and running expenses, the need for quick and easy equipment maintenance, and the desire for on-time dispatch: these goals urge the airframe manufacturer to focus on a well-designed, well-planned electrical architecture, including electromagnetic compatibility. Standardized avionic "line replaceable units" are motivation for low cost and competition among subcontractors (figure 2.1-2). Cost, airworthiness, and safety are the critical drivers for avionics.

Most passengers are unaware of the safety built into the interface wiring and electrical/electronic systems (figure 2.1-3). Passenger and crew safety, with regard to protection from hazards of high voltages, has been guaranteed historically by the ubiquitous aluminum housings, spars, supports, and structure. The high-quality structural aluminum grounding paths inherently are the electrical return or an electrical reference for digital signals, shield ties, motor power current, and fault currents (figure 2.1-4). This structure bypasses the need for separately installed wires or buses to fulfill those functions (figure 2.1-5). Also enhancing the electrical sinking and conducting properties of structure are the extensive air-conditioning, water, and hydraulic systems that form a skeleton of metallic and composite materials throughout the flight deck, cabin, cargo bay, wheelwells, and wing leading and trailing edges. Many of these shielding and sinking properties today help to contain or divert electromagnetic interference from electronic game signals, electrostatic discharge, lightning transients, and high-energy broadcast radio frequencies (figure 2.1-6 and 2.1-7).

Aluminum alloys form the wing, fuselage, and empennage structure, but these metal alloys must mate with materials like fiberglass, Kevlar, and moderately conductive materials like graphite-epoxy. The interfaces at fairings, doors, ducting, and fasteners open up possibilities of apertures and gaps. These mating surfaces must be electrically bonded so that power currents, fault currents, electrostatic charge, and lightning currents flow (figure 2.1-8).

With each new program, we build on the safety and electromagnetic compatibility practices of past experience and, as the program progresses, we purchase and install units of avionic equipment which were designed and built and tested years ago—existing equipment, "off-the-shelf" equipment. So, years of inservice experience with existing equipment are brought together with the new technology designs on the new program. We cannot overlook the fact that electromagnetic compatibility and safety standards have been well established. Hence, this document does not hold any revealing secrets or creative innovations. Many of the requirements for electromagnetic compatibility are very well known having been spawned, tried, and steadily refined over the years.

With an experienced eye on airworthiness and reliability, traditional electrical and electronic functions have been carefully shaped by the airframe manufacturer and subcontractors to provide and enhance engine instrumentation (safety), communication and navigational aids (safety and convenience), autopilot equipment (pilot workload), and aircraft utilities (safety

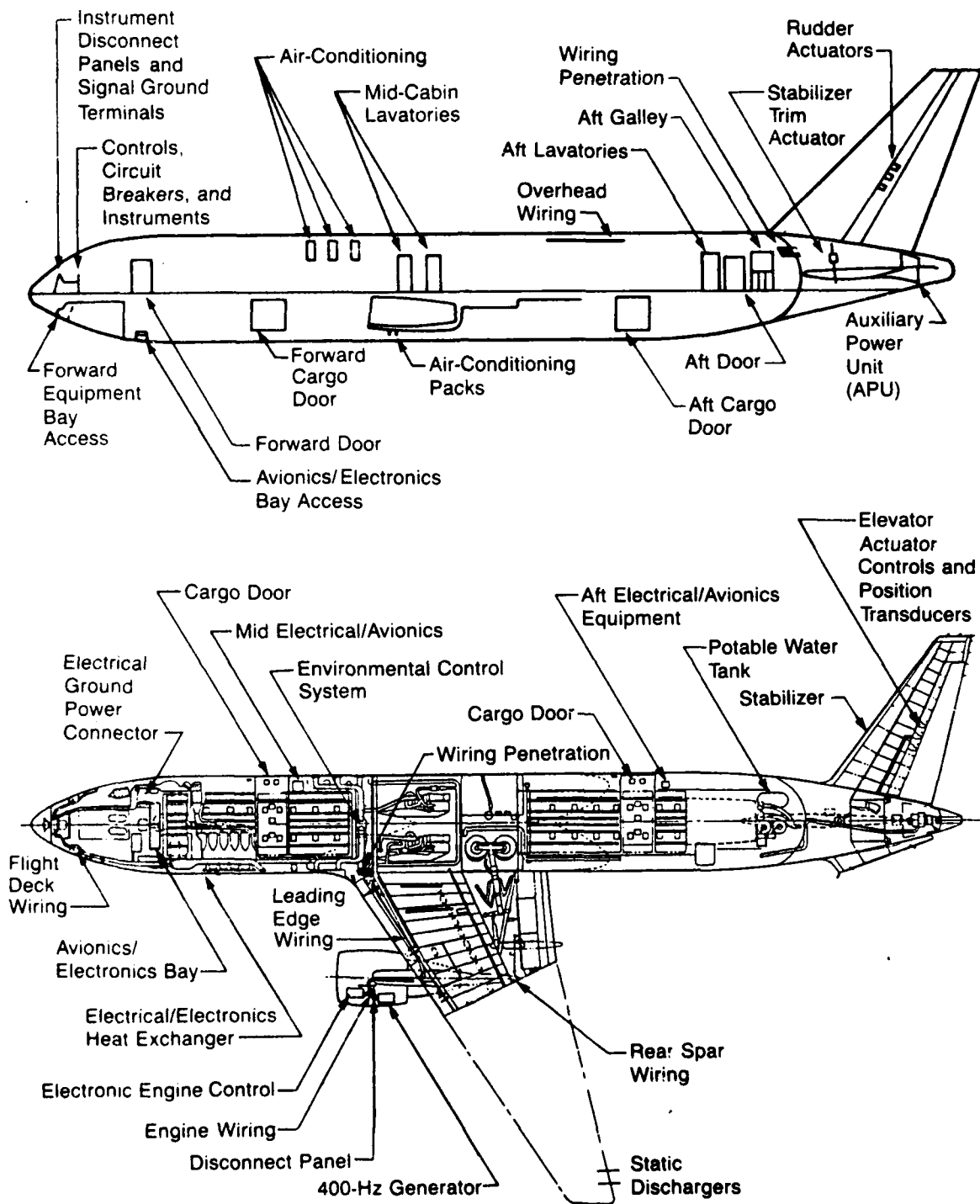

Figure 2.1-1 Present-Day Aircraft Systems

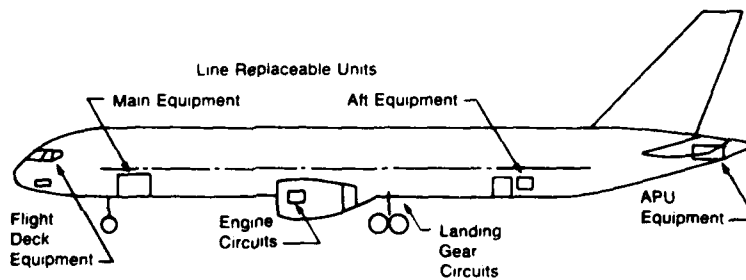

Figure 2.1-2 Avionics Bays

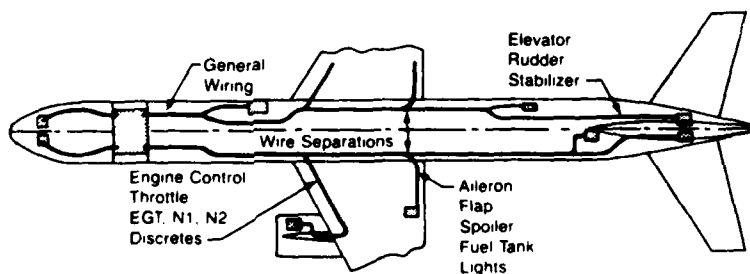

Figure 2.1-3 Wiring

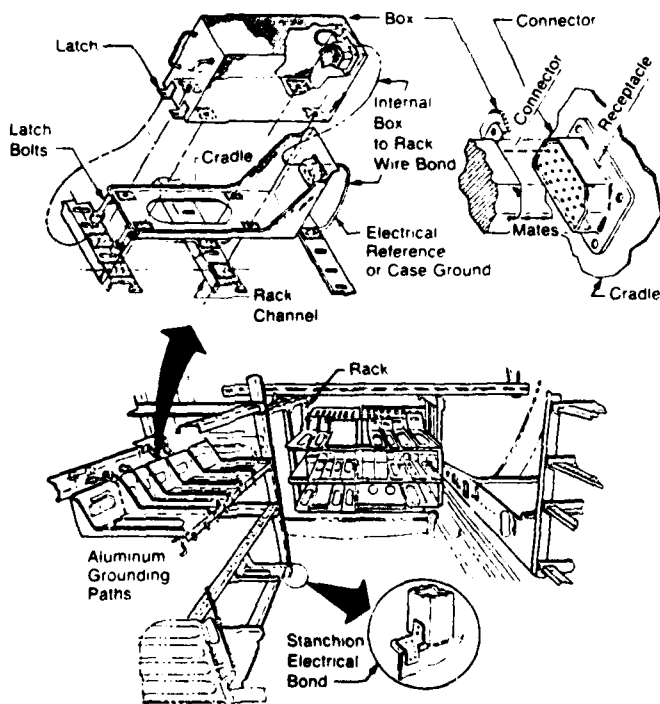

Figure 2.1-4 Main Bay Aluminum Structure

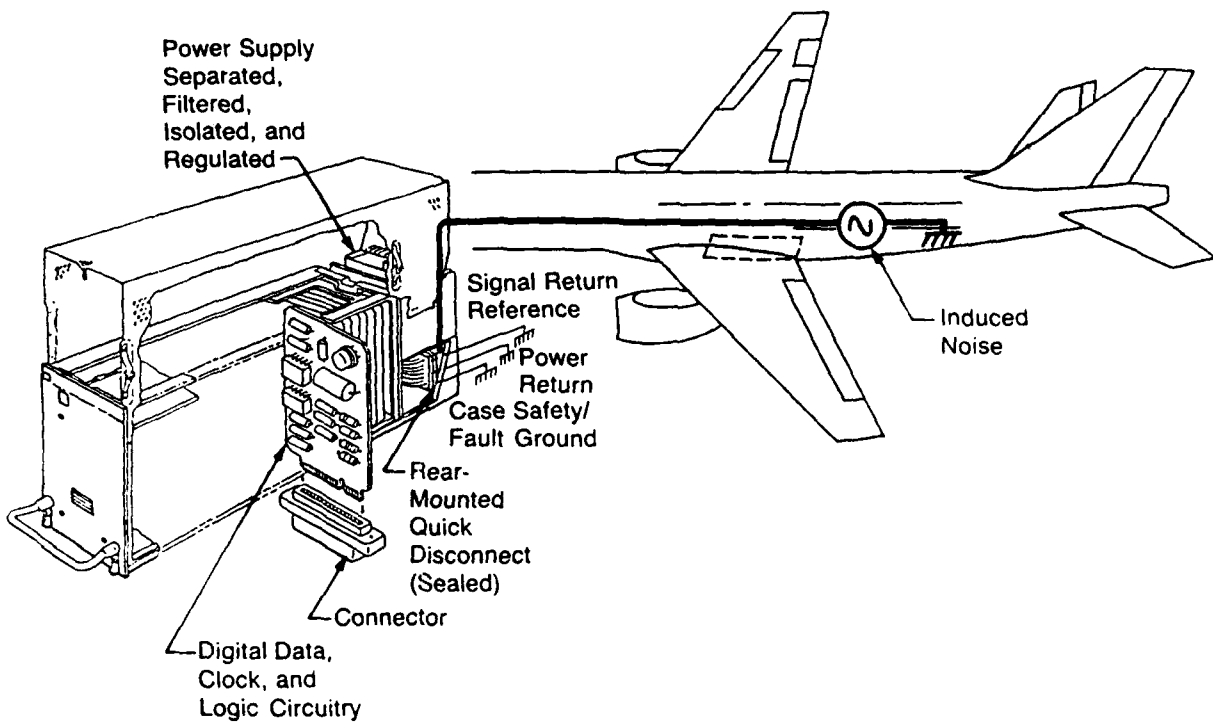

Figure 2.1-5 Structure Return

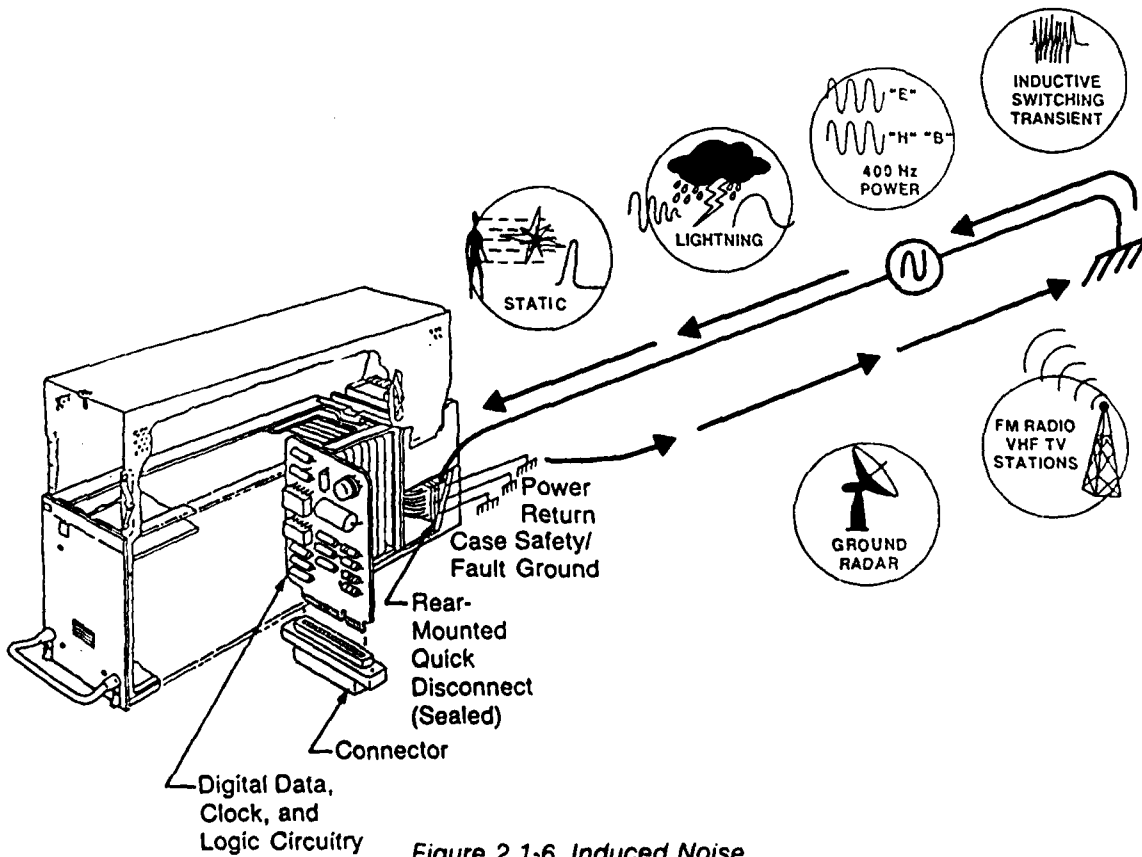

Figure 2.1-6 Induced Noise

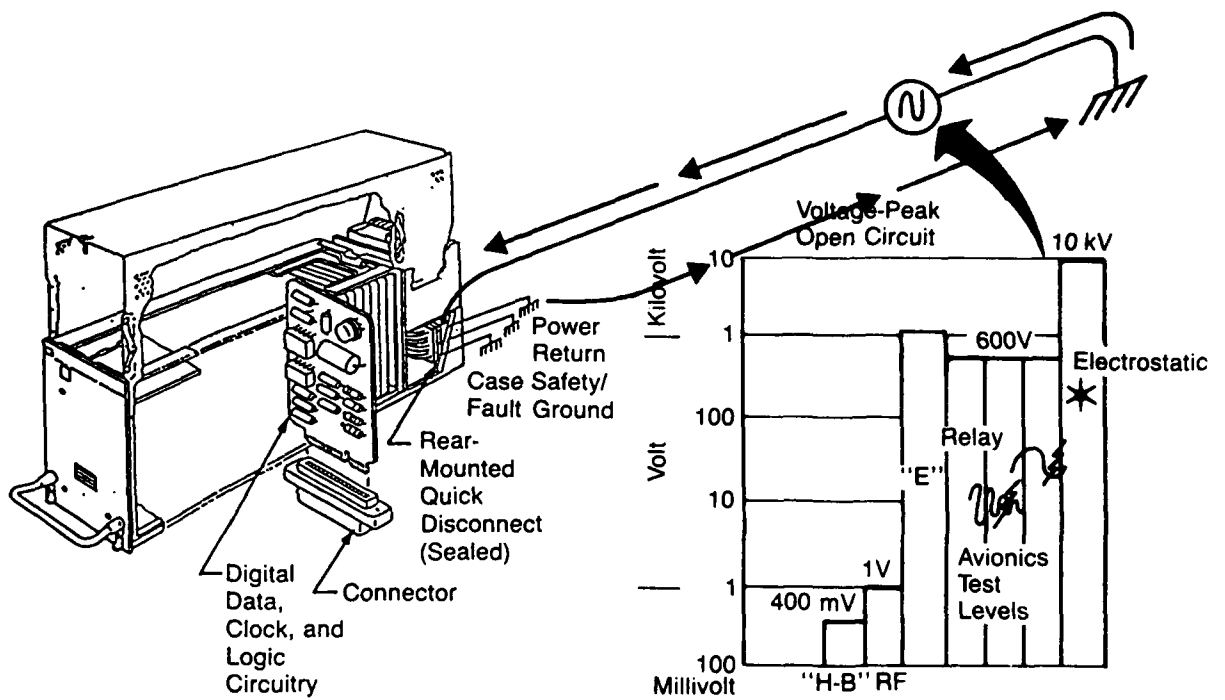

Figure 2.1-7 Noise Voltages

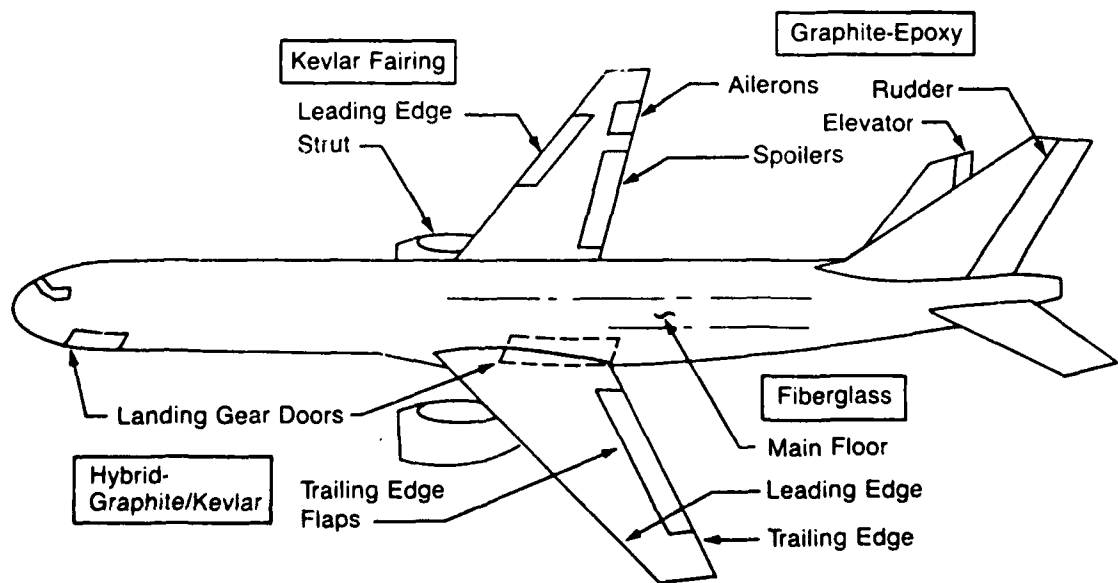

Figure 2.1-8 Nonmetallic Interfaces

and passenger comfort). Redundancy of avionics functions and components has become a de facto standard. Avionics equipment in today's aircraft (1986) strongly contribute to the desired levels of performance and safe flight through separation and duality (figure 2.1-9). Any one single part or unit in a fully operational and functioning aircraft is not vital and crucial to continued flight. Triple redundant flight control computers and data buses, for instance, practically guarantee continuous operation and provide a confident reliance on the automatic pilot system (figure 2.1-10). Electromagnetic compatibility is important and must be "designed in" to be cost effective or the avionic equipment will not work, but electromagnetic compatibility has not been critical to aircraft safety.

Engine monitors or sensors are becoming critical, especially on the new electronic engine controls (figure 2.1-11). Left engine circuits are separated from the right for safety. Selected circuits on each engine are separated from each other. Oil pressure transducers, engine temperature thermocouples, exhaust gas temperatures (EGT), and speed sensors (N1, N2) provide information on performance and operational boundaries and status. Knowledge of the status of hydraulics, oil, and fuel systems helps avert critical situations. Throttle lever angle position must be known, and of course, fire detection is mandatory. Electromagnetic interference must be designed out of these circuits early in any program.

Communication receivers and transmitters are the key in today's flight schedules and goals of smooth flight and fuel economy (figure 2.1-12). Noise must be at a minimum to keep from degrading receiver thresholds. Broadband noise will reduce communication range. Narrowband noise will induce unwanted tones. The flight crew does not want to hear static, 400-Hz hum, or popping, even though this electromagnetic compatibility problem may only be a nuisance.

Automatic controls reduce pilot workload and assist in long flights and optimum flight profiles (figure 2.1-10). We still see the old-fashioned compass installed in the instrument panel on the flight deck, but the "horizontal situation indicator" is now a cathode ray tube (which, by the way, is very susceptible to 400-Hz magnetic fields) and is designated as the electronic horizontal situation indicator (EHSI). There are two EHSIs to rely on besides the old-fashioned backup compass (figure 2.1-13). Future aircraft will see flat panel displays that must be protected from radio frequencies and transients that induce "snow," "banding," "lines," or "ripple" on the screen.

Today's professional pilot "flies" the plane with the steering column having steel cable strung from the column to hydraulic actuators which then amplify the force and operate control surfaces (figure 2.1-14). The engine throttle is operated by a steel cable. A steel cable does not recognize electromagnetic interference.

Navigation equipment with ground systems that locate and track have grown more and more sophisticated, accurate, and reliable (figure 2.1-15). Specifications and requirements have been developed over the years (table 2.1-1). VHF and HF communications are used over land and sea, all along the airways, and in high-volume areas (figure 2.1-16). Communication avionic units are standalone components that can be individually replaced in the electronic equipment bay or on the flight deck (figure 2.1-16). Because of the excellent flexibility of unit replacement, ease of maintenance and substantially lower unit costs, there has been little or no historical incentive for large-scale integration of functions on present day airplanes (figure 2.1-17). Most equipment today is basically digital, but some is still analog (figure 2.1-18). Future aircraft will probably see almost total use of digital circuitry.

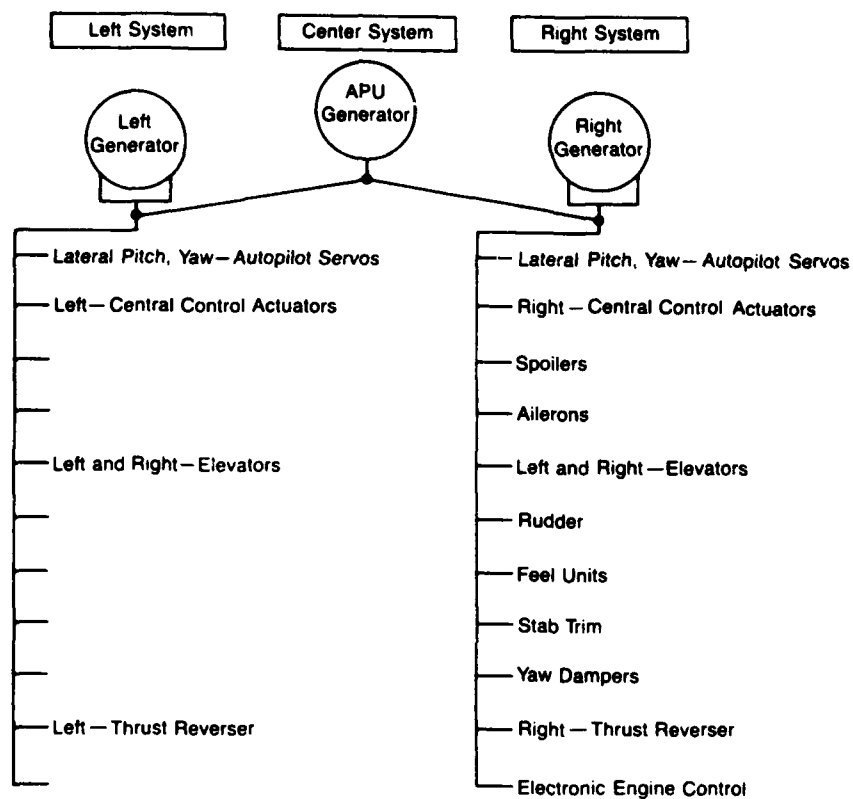

Figure 2.1-9 Separation Example

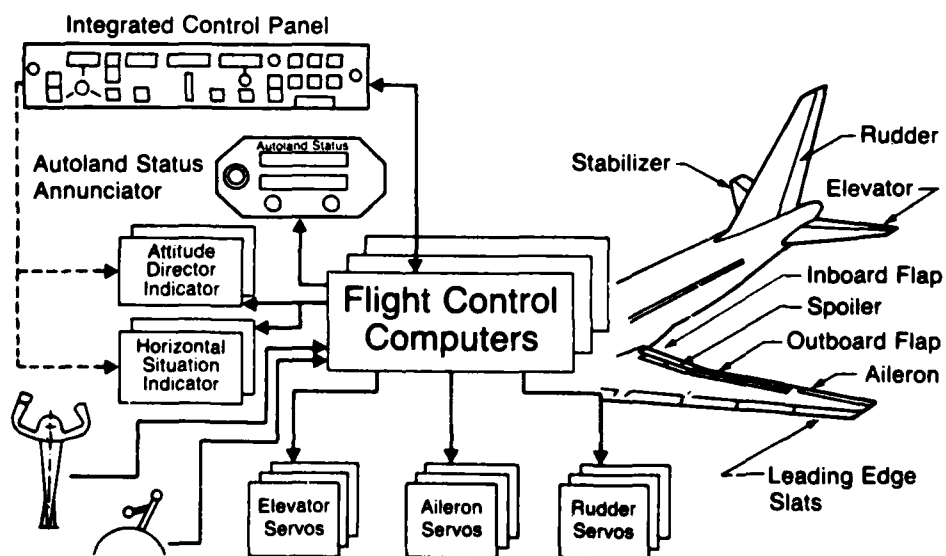

Figure 2.1-10 Flight Control Autopilot Redundancy

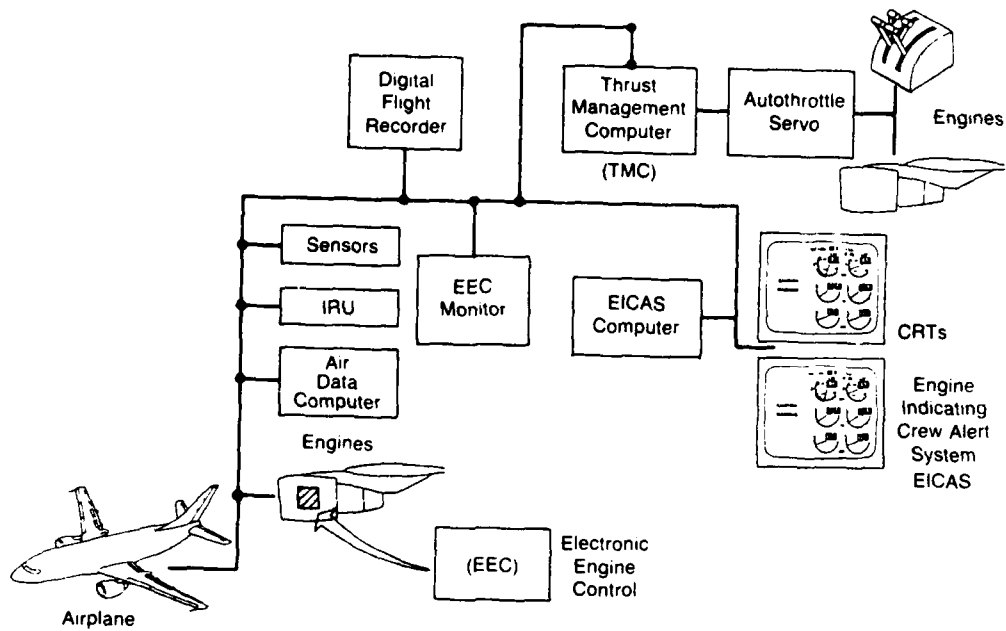

Figure 2.1-11 Electronic Engine Control

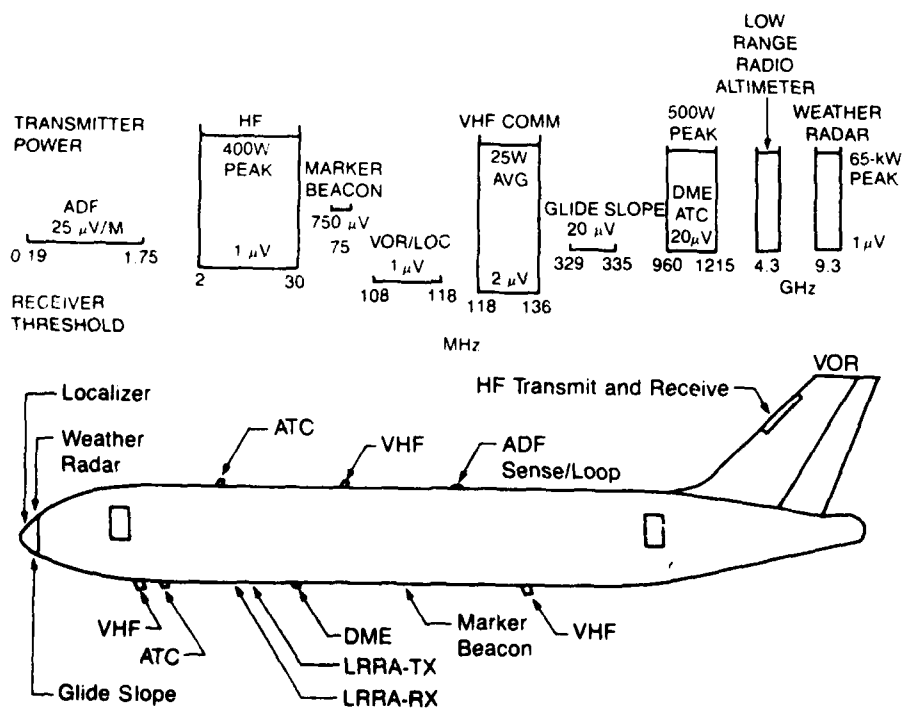

Figure 2.1-12 Transmitters-Receivers

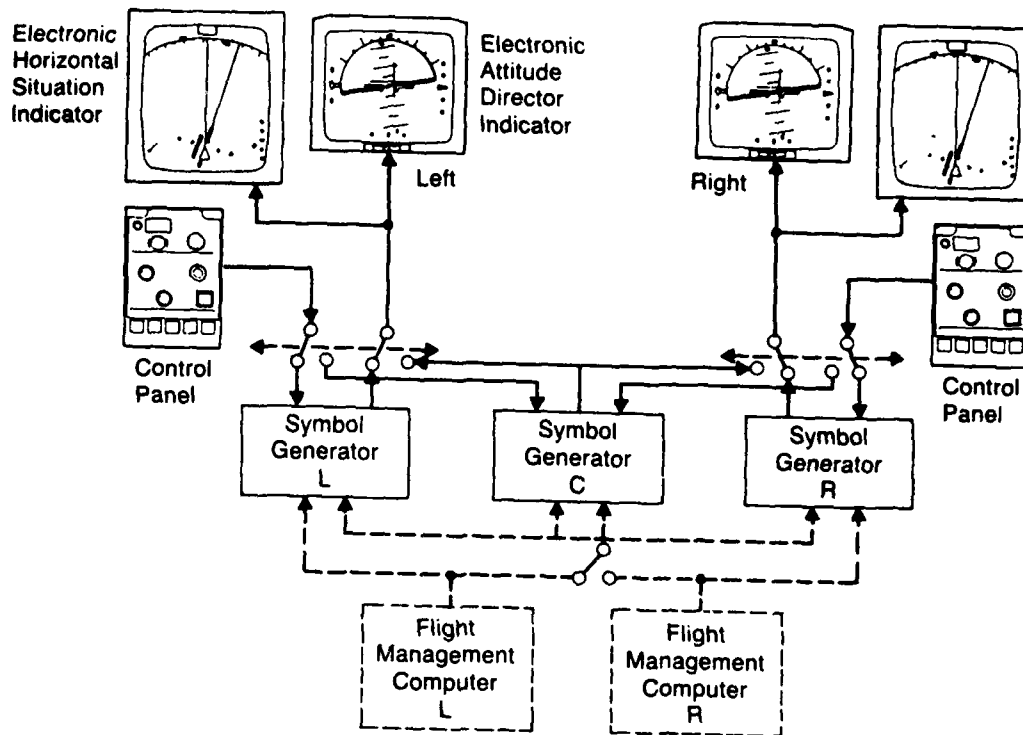
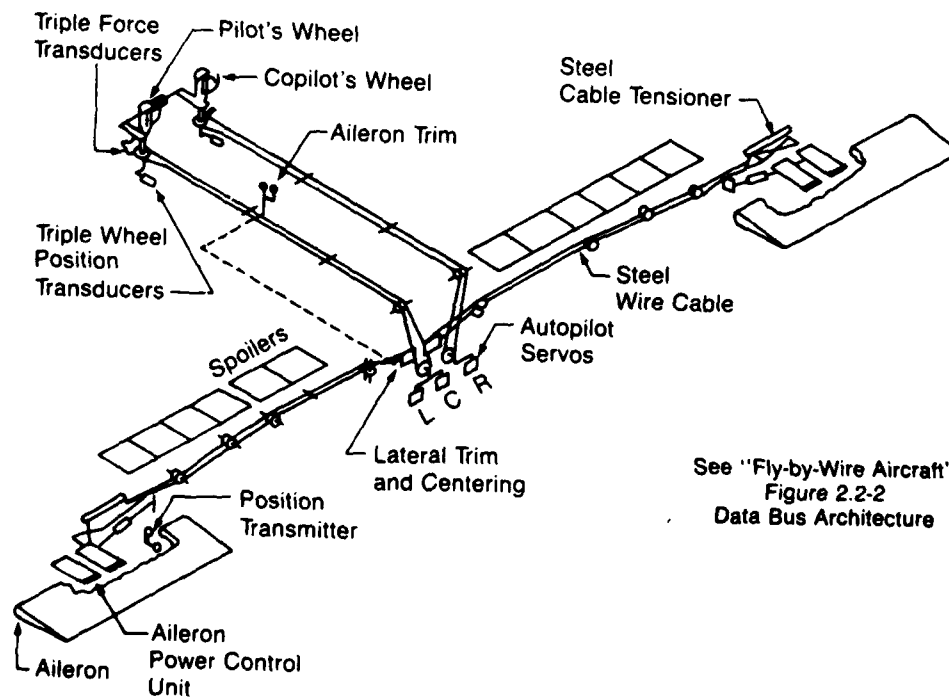

Figure 2.1-13 Flight Instrument System



See "Fly-by-Wire Aircraft"
Figure 2.2-2
Data Bus Architecture

Figure 2.1-14 Roll Control System

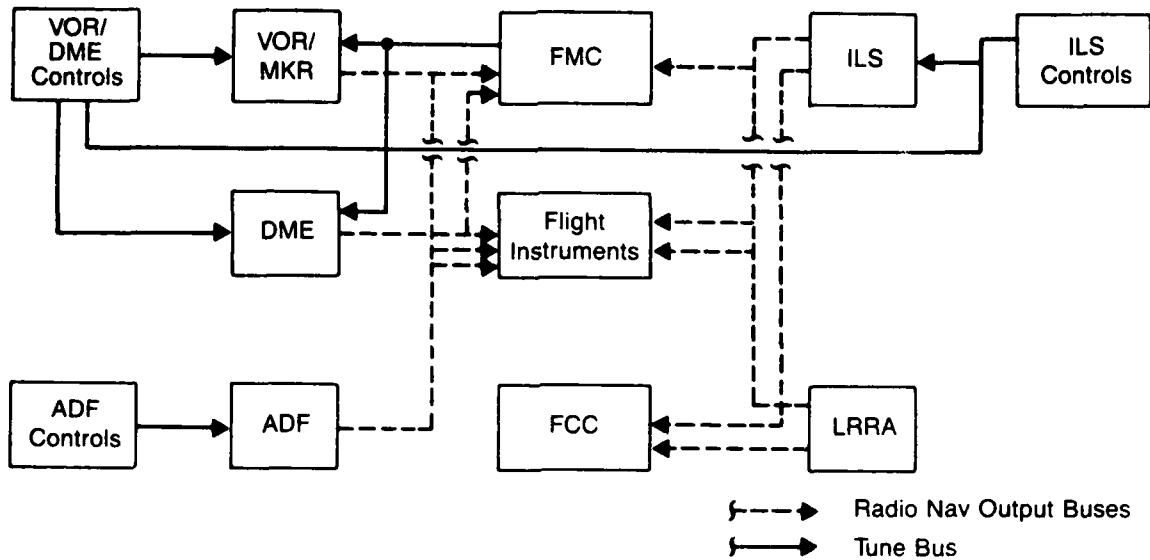

Figure 2.1-15 Navigation

Navigation Equipment	Federal Aviation Regulation (FAR)	Technical Standard Order (TSO)	Advisory Circular	Number Required
VOR	121.349a,e	C40a	90-45A	2
DME	121.349c	C66a	90-45A	1
LOC/GS	121.349a	C34b	120-28A	1
		C36b	120-29	—
MB	121.349a	C35c	—	1
ADF	121.349b	C41b	20-63	1
INS/ISS	121.355	—	25-4	2
	121, App. G	—	121-13	—
RNAV	—	—	90-45A	—
Omega	—	—	120-31	—

Table 2.1-1 Navigation Equipment Documentation

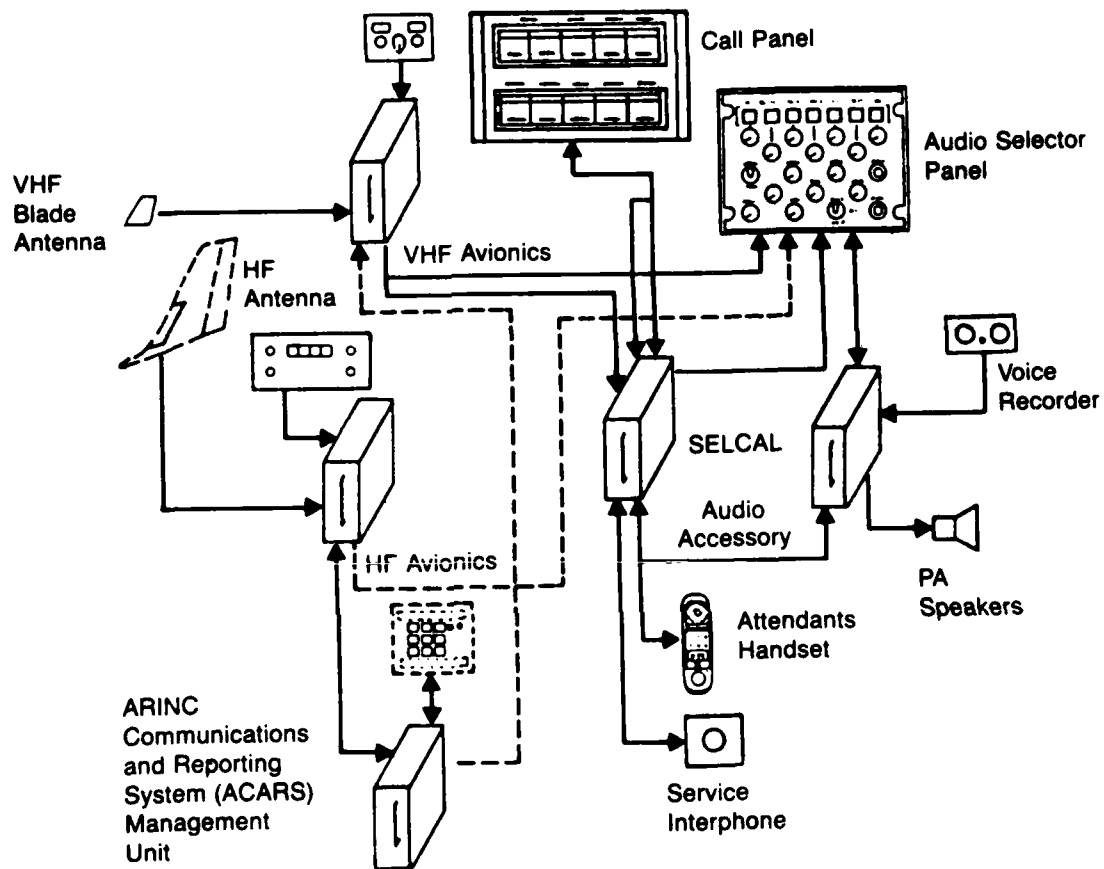

Figure 2.1-16 Communication

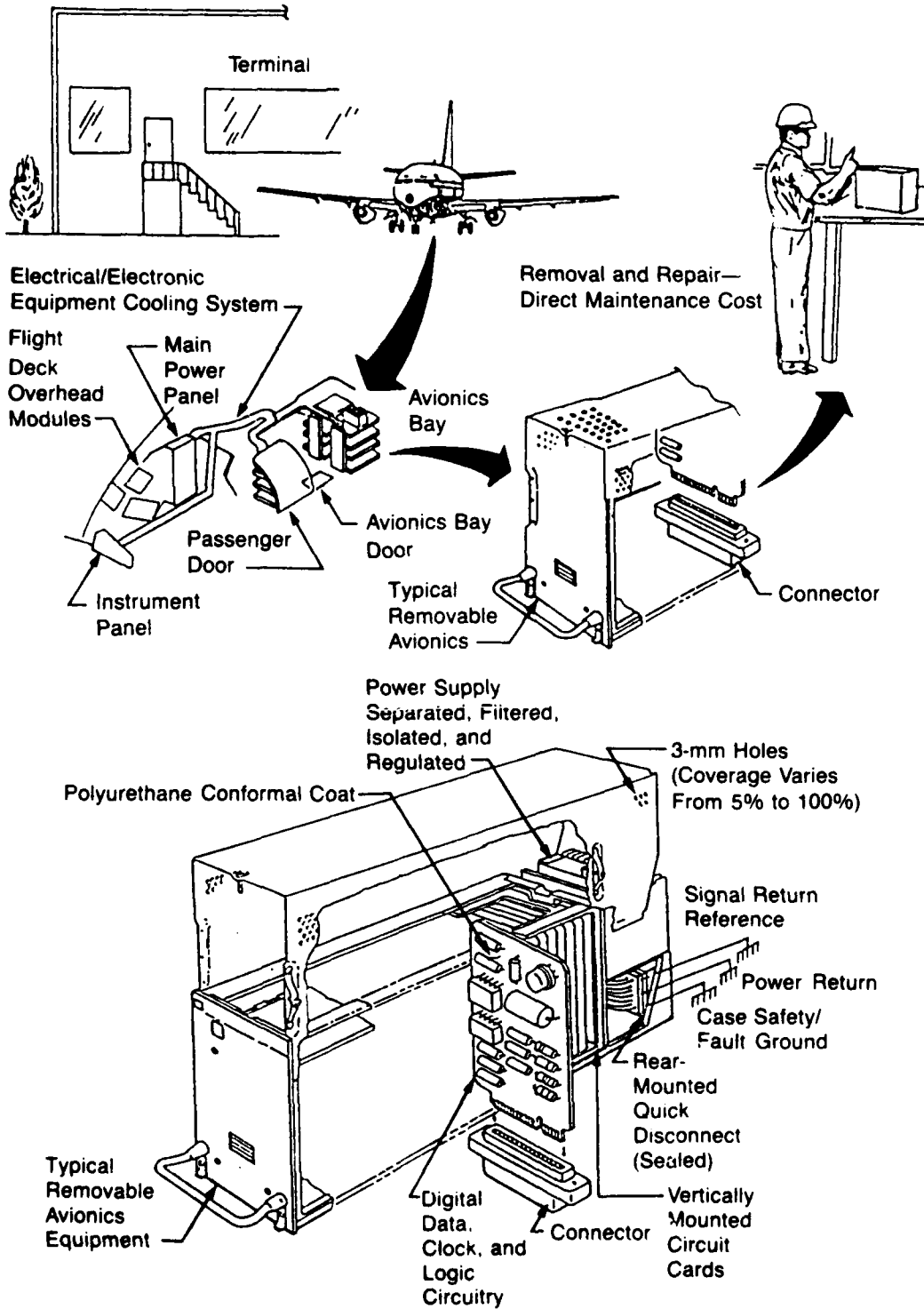

Figure 2.1-17 Line Replaceable Unit

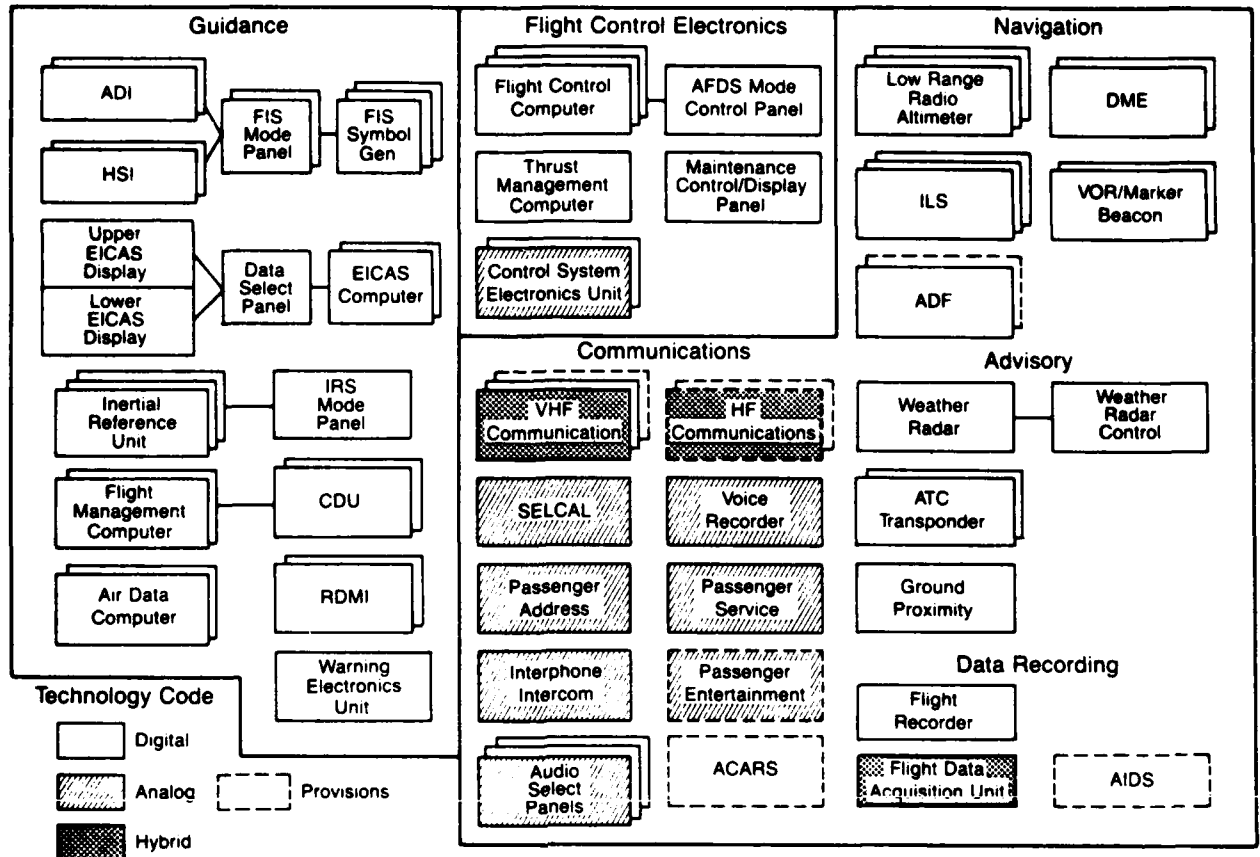

Figure 2.1-18 Flight Management Systems

Aircraft utilities, of course, are basic to commercial transport operation. Fluorescent lights in the cabin are noisy. Pressurization controls, cooling fans, and window heaters contribute to aircraft magnetic fields. Cargo handling and windshield wiper motors, fans, and galley heaters inflict broadband noise on digital and analog circuits. Future systems may have pulse width modulated voltages that will contribute to noise.

Today's interface circuits span the systems from engine instrumentation to navigation to flight control to utilities, but electromagnetic compatibility engineers do not deal with flight systems. They deal with circuit types, and basically those types can be counted on your fingers. The types can be boiled down to digital data, radio frequency signals, analog signals, discrete state changes, and 400-Hz 115V or 28V-dc power and in the future pulsed dc power.

If one were to look at the specific types of interconnecting circuits, here are some examples of the electrical/electronic characteristics and parameters:

CIRCUIT	LEVEL	EXAMPLES RATE/FREQUENCY	THRESHOLD
1) Digital data:	+5V	12 kHz	2.5V
(ARINC 429 transmitter/receivers: information transfer, altitude, airspeed, direction, positions.)			
2) Pulse circuits:	+50V pulse	1 pps	mV
(Fuel flow; engine speed)			
3) "Discrete"	+30V	Event ON/OFF	10V
(Status: Pumps, valves, relays, heaters)			
4) Analog	0V to 10V	Continuous	mV
(Position indicators)			
5) Power	28V dc 115V ac	(sw. reg. 10 to 100 kHz) 400 Hz and harmonics	- -
(Avionics, pumps, lights, motors, generator feeders.)			
6) RF	Volts	Variable	μ V

The electromagnetic compatibility engineer helps to simplify and forge the layout of the equipment and routing of the wires (figure 2.1-19). He pays particular attention to radiated emission from wiring and radio frequency fields imposed on wiring (figure 2.1-20). Equipment location has been settled usually in the past by greater attention to and emphasis on temperature characteristics, size, separation, accessibility, and center of gravity factors rather than electromagnetic compatibility. And, rightly so. Wiring, wire clamps, shield ties to structure, and routing of wire bundle installations have been shaped by the space available, structure geometry, and have been installed as an "add-on" while all the time being given the appellation of weight penalty. Conduit or metallic ground planes have not been needed. Shielding could be added any time.

We and our predecessors seldom created and documented substantive and comprehensive input/output interface circuit drawings to provide an analysis on a systematic basis of the noise sources and the major avenues of coupling. Electromagnetic interference sometimes has been most elusive and difficult to analyze, model, and predict.

Avionic equipment units have been designed and tested to industry electromagnetic compatibility specifications and then, along with their interconnecting wiring, installed directly in the aircraft. They almost always perform properly. This method has been cost effective and not at odds with safety. Fixes to equipment or the airplane sometimes can be made fairly easily and inexpensively, although often done in a hurry and with the ever-present specter of the very expensive "retrofit."

As we look back, it is recognized that the electromagnetic compatibility effort has been reactionary, not anticipatory.

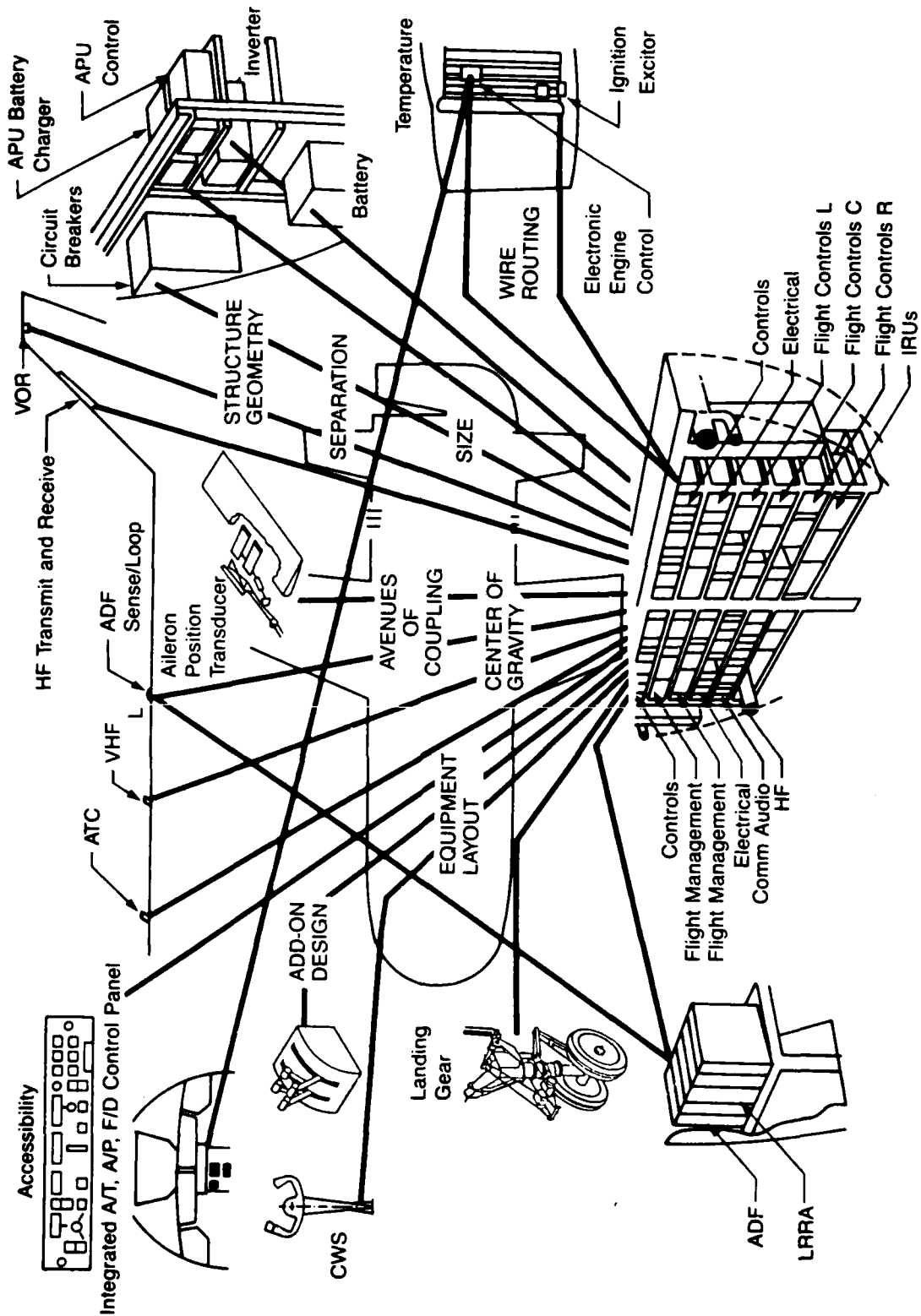

Figure 2.1-19 Equipment/Wiring Location Complexities

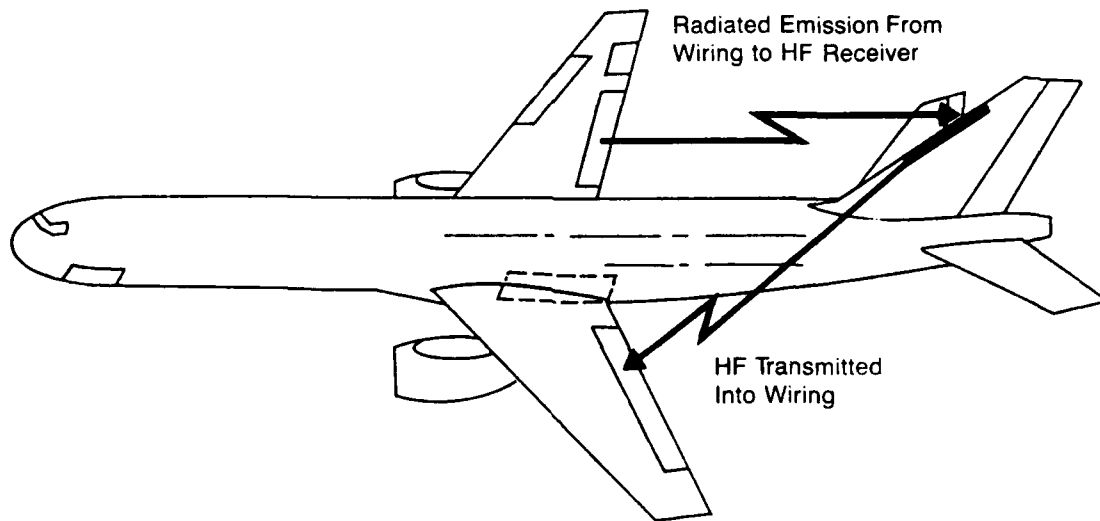

Figure 2.1-20 Radiated Emission

2.2 FUTURE AIRCRAFT

Turn now and look ahead to a hypothetical future aircraft.

A view of a system avionic architecture might focus on the technologies of digital buses, electric actuators, and composite structural materials as having the greatest interest for the electromagnetic compatibility engineer or airworthiness specialist (figure 2.2-1). A system of communication and control designed around fly-by-wire digital data buses and electric actuators will have an impact on analysis tasks; that is, greater effort will be needed to assure absence of electromagnetic interference in the data bus and control of electromagnetic interference from the actuators and pulsed dc.

Connection of autonomous electronics through a multiple access two-way data bus will remove dependence on a centralized controlling processor (figure 2.2-2).

There will be a number of new aircraft technologies that will moderate problems but will mean new areas of expertise and study:

- 1) All-electric airplane (electric actuators), pulsed dc.
- 2) Autonomous, multiple-access data bus with decentralized computers (dual redundant)
- 3) Self-diagnostics, self-test, error control, and record keeping
- 4) Electronic keyboard actuation of power and avionics
- 5) Side-stick controllers
- 6) Single point of entry program loading
- 7) Flat panel and head up displays
- 8) Voice control

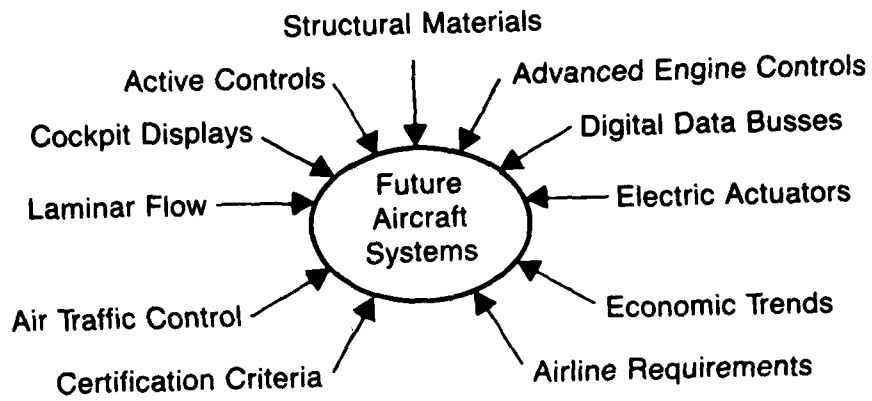

Figure 2.2-1 EMC and Aircraft Systems Development

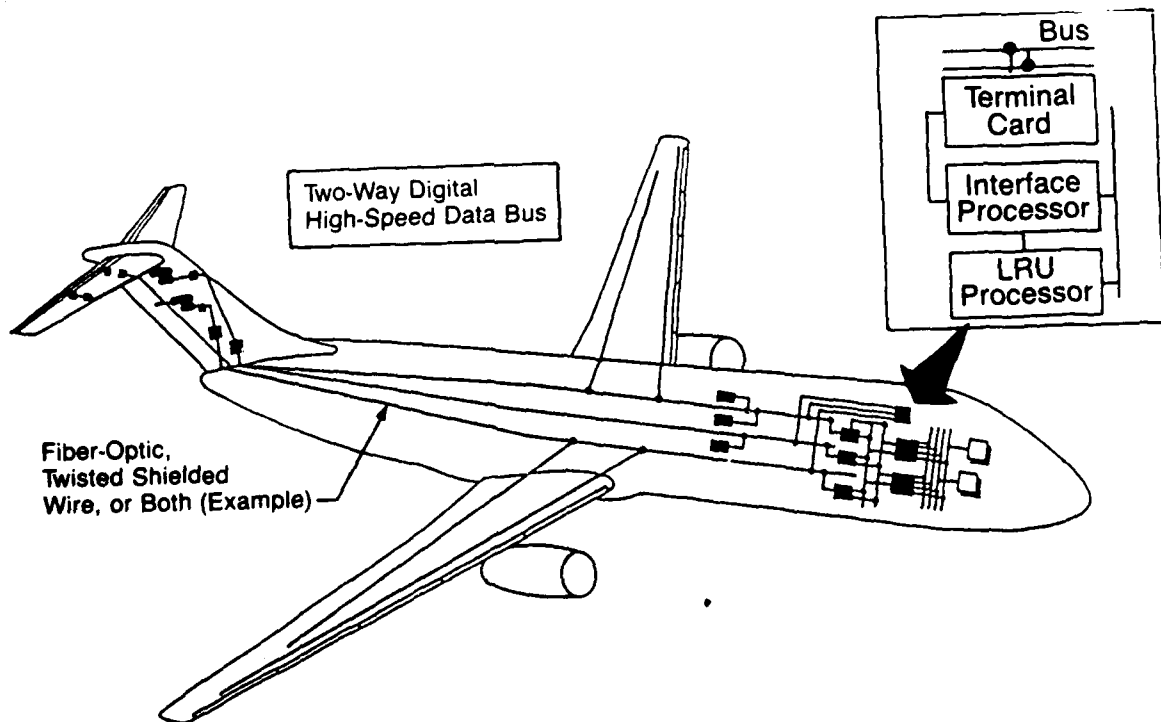

Figure 2.2-2 Data Bus Architecture

What will be the impact of these systems on electromagnetic compatibility? More inductive switching transient control? Electrostatic transient control? Better high-energy radio frequency fields rejection and control?

Flat panel displays collocated with their own microprocessor avionics on the flight deck, depending on design, will mean less wiring and fewer coupling paths, less susceptibility, less electromagnetic radiation and electromagnetic interference. An improved flight management system will integrate navigation, communication, guidance, and energy management. Moreover, there will be expanded management capability of all of the systems (figure 2.2-3).

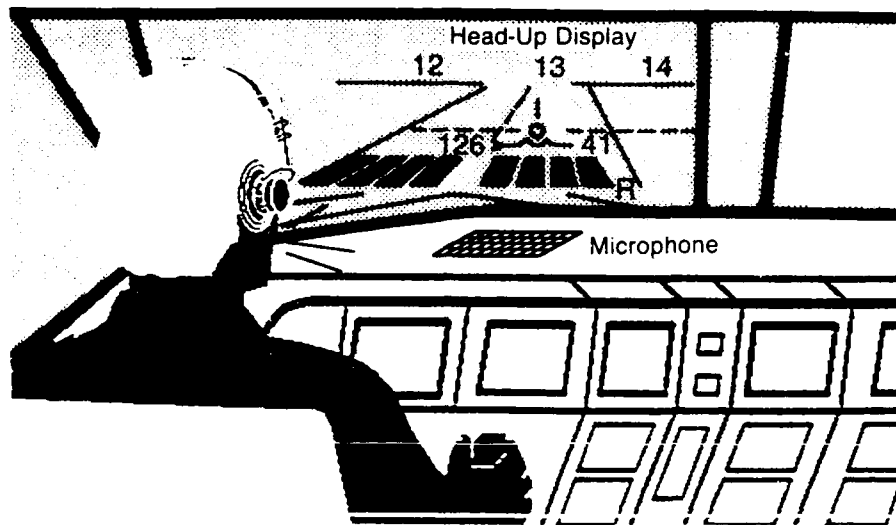

Figure 2.2-3 Line-of-Sight Display and Voice Control

Multifunction keyboards will permit speed and flexibility and maximum accessibility of options and data selection initiated by voice (figure 2.2-4). Side-stick controllers, electronic throttle, and flap control will not only facilitate operation and open up the instrument panel viewing area, but also will demand guarantees of safe operation and freedom from noise. Head up displays and electronically controlled relays and actuators will help clear and simplify instrumentation and add more power and versatility to aircraft control on the flight deck.

One of the key elements in a future aircraft is the data bus, where wire and weight savings will be dramatic. The number of interface circuits will decrease (figure 2.2-5). Research on digital buses will be required to better define susceptibilities to high-energy radio frequencies and transients. It is expected that some form of multiple access bus will be available for future aircraft (figure 2.2-6). Commercial transport planes are now using the ARINC 429 bus, a 12-kHz or 100-kHz, unidirectional, twisted pair shielded bus that operates from each transmitter to multiple receivers with a binary-coded decimal format. The military bus is MIL-STD-1553: a 1-MHz, bidirectional, twisted pair shielded, transformer-isolated bus totally run from a centralized 1553 bus controller with a serial, Manchester II, bi-phase format. (See Section 8.0, Bibliography, ARINC 429 and MIL STD 1553 bus system.) New systems are being developed to provide multiple access and decentralized processing. One such is called DATAC, a 1-MHz, bidirectional, twisted pair or fiber-optic bus with controlled specifications of protocol to facilitate transmission and reception.

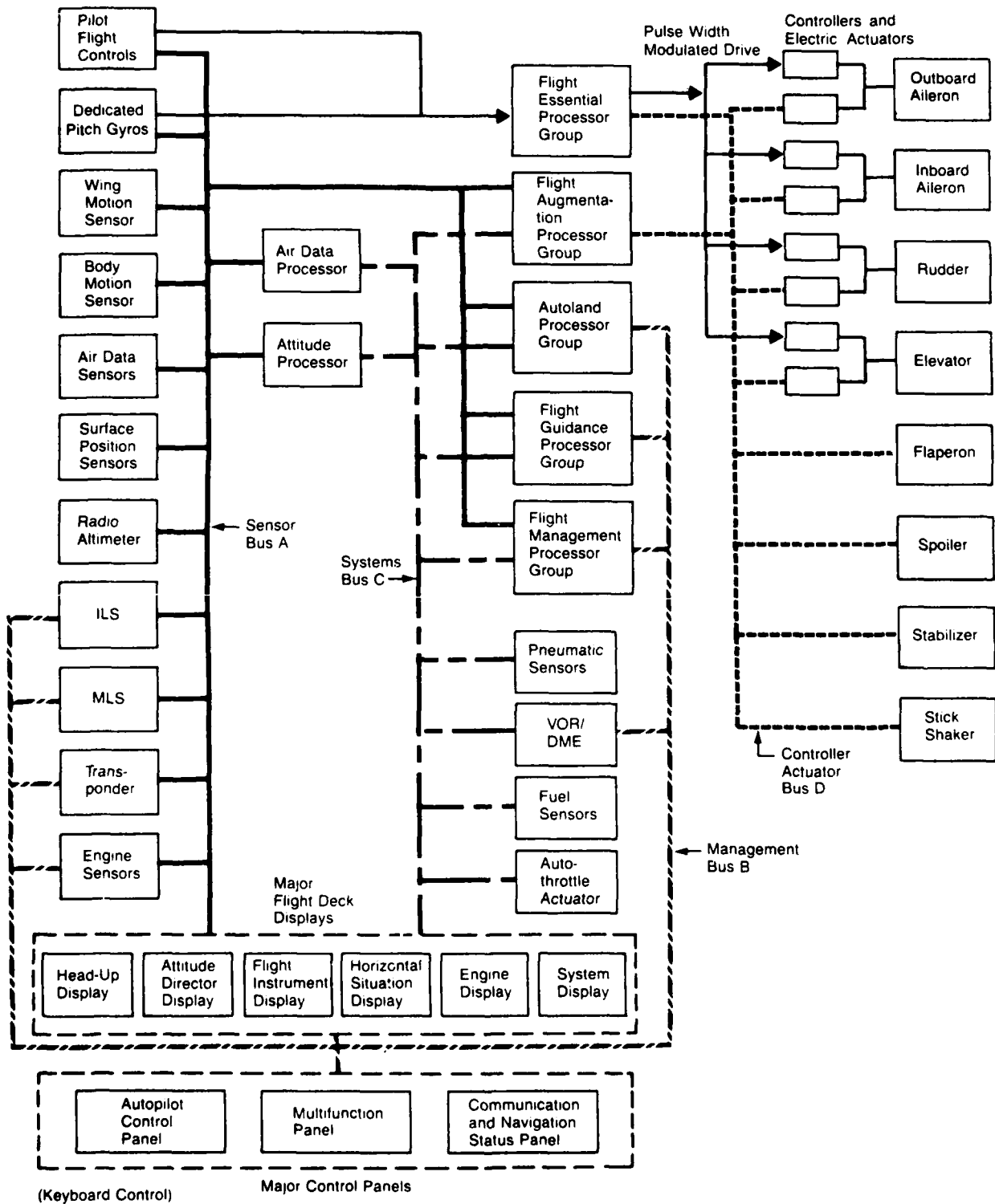

Figure 2.2-4 Hypothetical Architecture

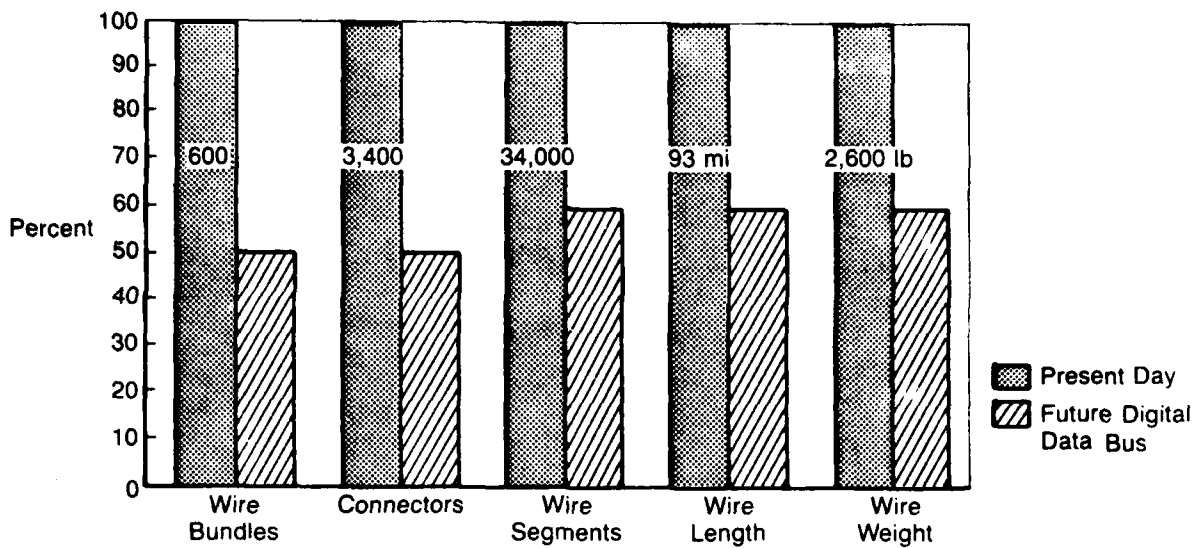
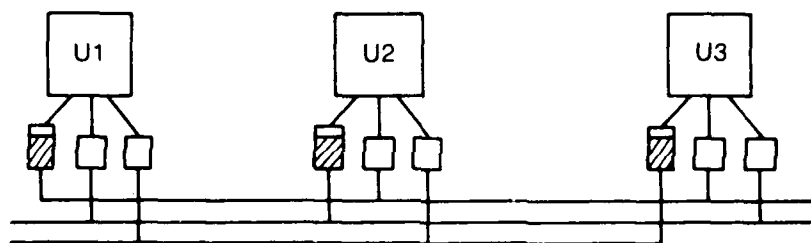
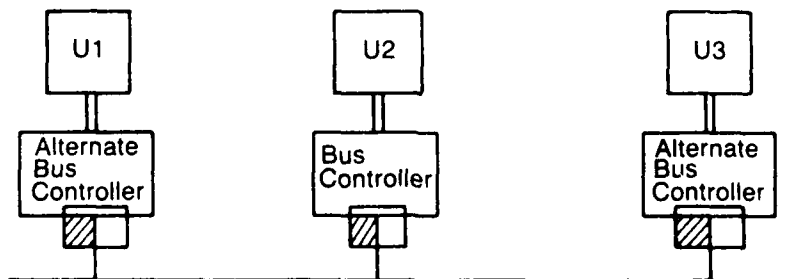

Figure 2.2-5 Data Bus Comparison



(a) ARINC 429



(b) MIL-STD-1553B

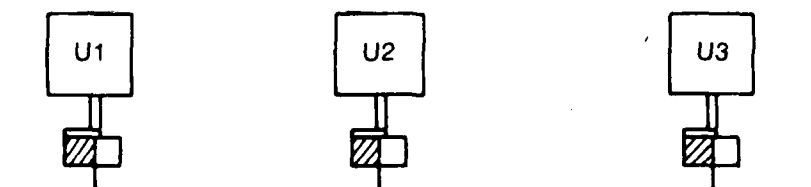

(c) DATAC System



Figure 2.2-6 Digital Data Buses

Possibly one of the most revolutionary changes to come about for electromagnetic compatibility will be the increased introduction of self-test and self-diagnostic capabilities in avionics allowing real-time readout or a history of equipment susceptibilities to noise (figure 2.2-7). Microprocessor evolution is speeding the development of these systems, and dramatic changes will occur in the immediate future (figure 2.2-8 and figure 2.2-9).

Hydraulic actuators powering control surfaces and other aircraft items such as landing gears and doors may be replaced by all-electric actuators now being developed. The actuator controllers contain "pulse width modulated" signals driving stepper motors. They are relatively high-voltage devices, are noisy, and the pulses need to be contained.

New composite and metallic alloy structural materials will mean greater efforts in the evaluation of the cornerstones of electromagnetic compatibility—the grounding and bonding designs that maintain current paths and stable electrical references (figure 2.2-10).

Many existing systems are being advanced and improved (table 2.2-1 and figure 2.2-11).

The air traffic control radar beacon system (ATCRBS) operation (based on a ground interrogation of an airplane transponder to assess flight identity, altitude, range, and azimuth) is being upgraded with a new beacon mode, called Mode-S, which is a two-way digital link, to selectively address each aircraft. Surveillance en route and at terminals during approach starts at about 6000 ft (1830m) above ground level.

The airport surface detection system (ASDS), a primary radar system, is being implemented to transmit a pictorial presentation of the terminal surface area in order to expedite traffic.

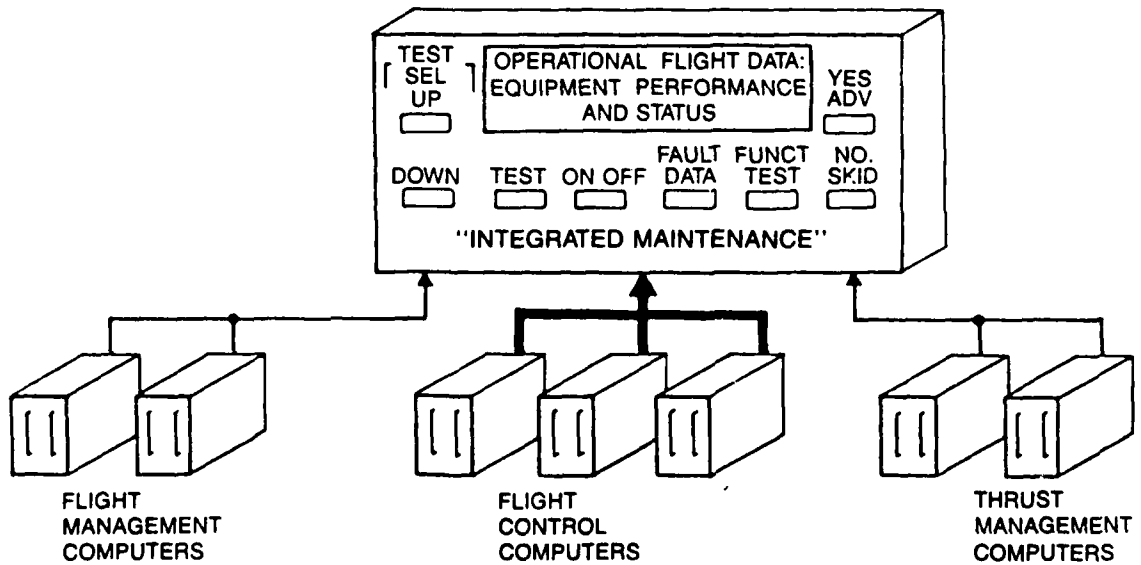

Figure 2.2-7 Performance and Status Monitors

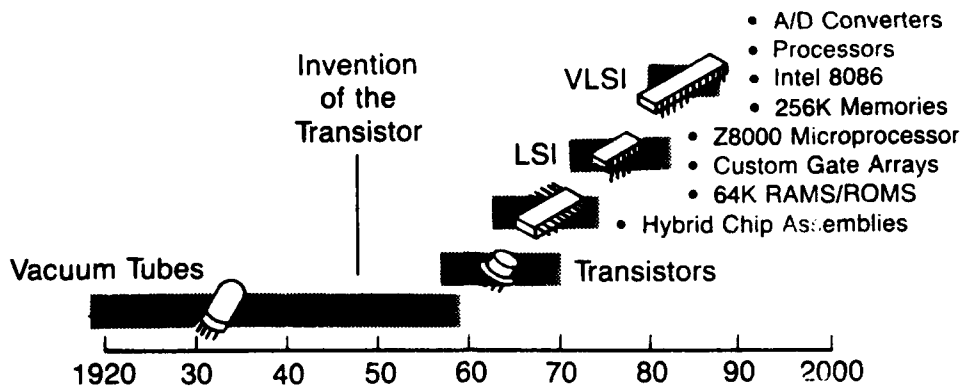

Figure 2.2-8 Microprocessor Evolution

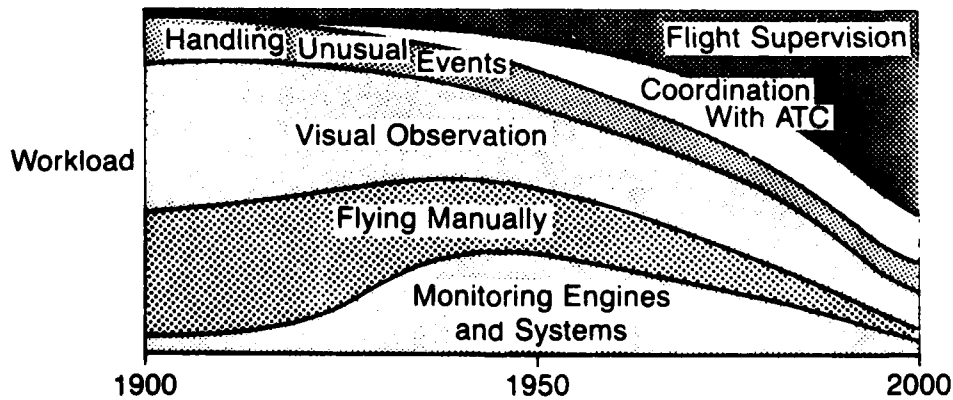
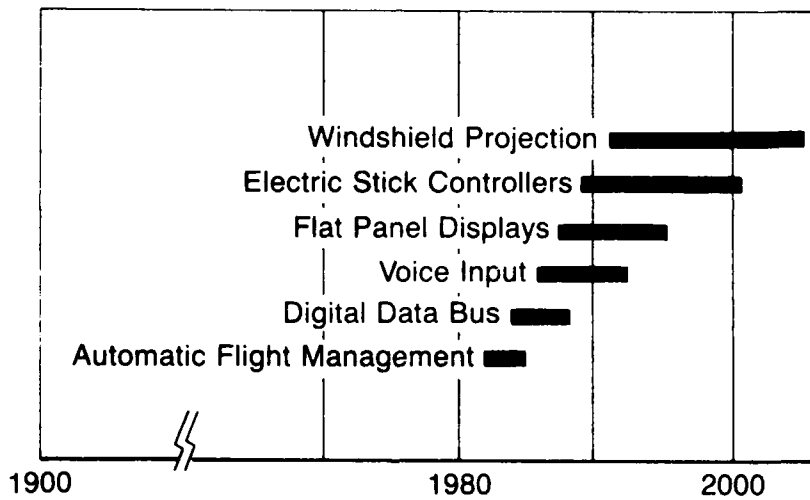

Figure 2.2-9 Avionics Technology Progress

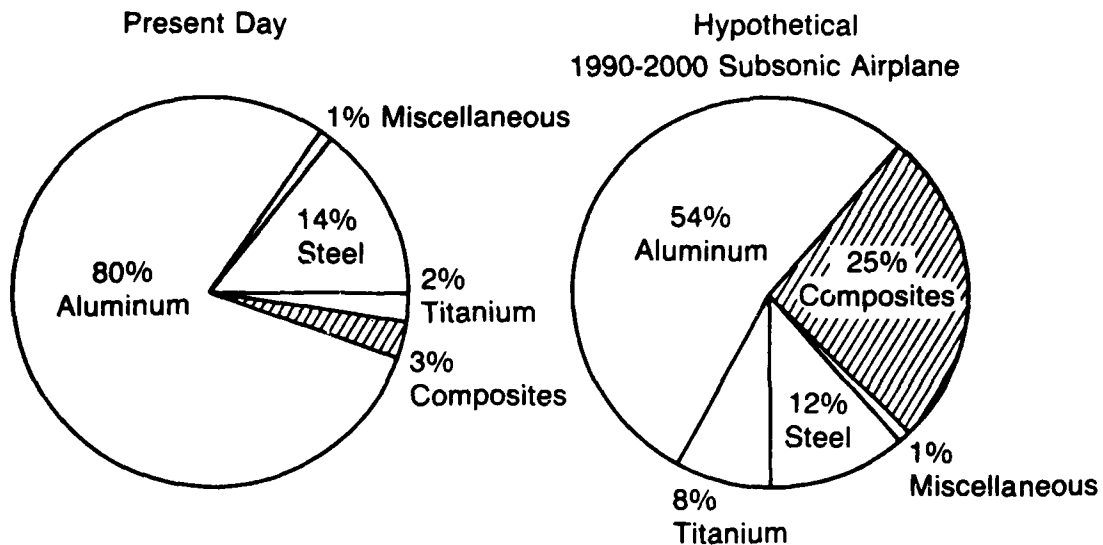

Figure 2.2-10 Materials Distribution

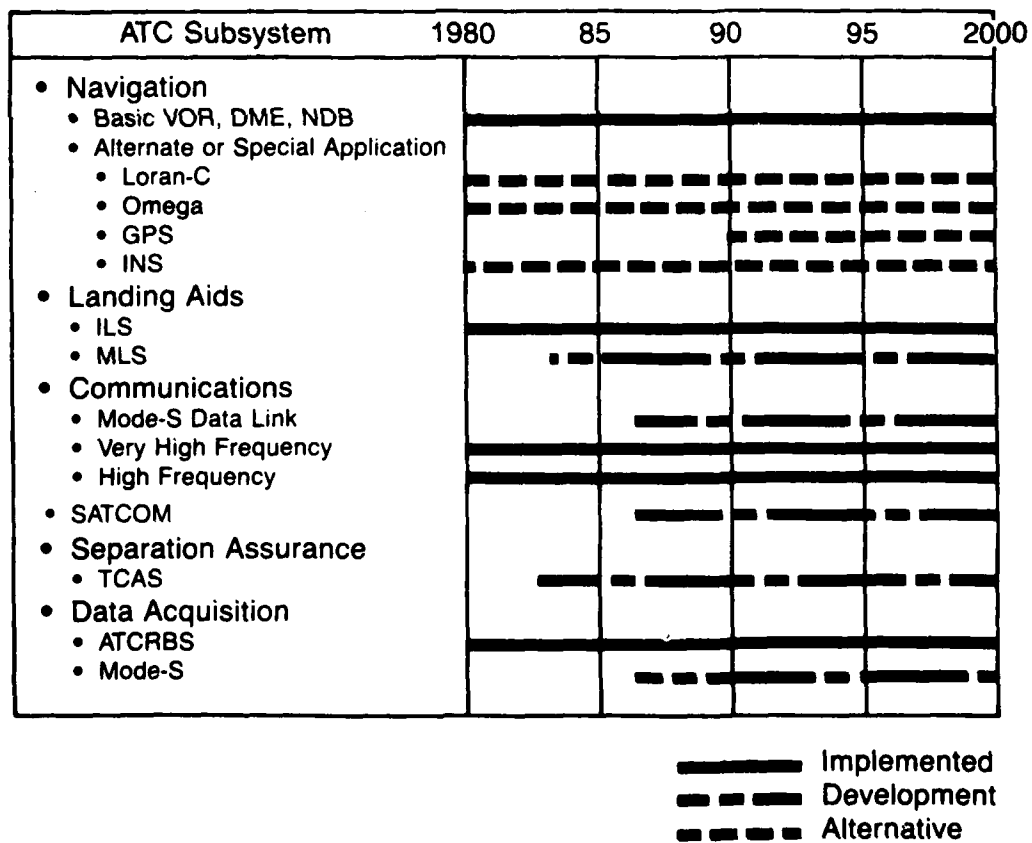

Figure 2.2-11 1990s ATC Implementation

SYSTEM	APPLICATION	AVIONICS
<ul style="list-style-type: none"> • DATA ACQUISITION • ATCRBS WITH MODE-S 	<ul style="list-style-type: none"> • Mode-S-Equipped Transponder Required on Air Carrier Aircraft 	<ul style="list-style-type: none"> • Mode-S Transponder
<ul style="list-style-type: none"> • SEPARATION ASSURANCE • TCAS 	<ul style="list-style-type: none"> • Required for All Air Carriers 	<ul style="list-style-type: none"> • Interrogator, Controls, and Displays
<ul style="list-style-type: none"> • COMMUNICATIONS • VHF VOICE • MODE-S D/L • HF SSB • SATCOM 	<ul style="list-style-type: none"> • Most U.S. Domestic and Foreign ATC Operations • High-Density U.S. Airspace • Overocean and Lesser Developed Overland Air Routes • Overocean Voice and Data 	<ul style="list-style-type: none"> • VHF Transceiver • Mode-S Data Link Modem and I/O Devices • HF SSB Transceiver • Data Unit and RF Unit
<ul style="list-style-type: none"> • NAVIGATION AIDS • VOR • DME • NDB • INS • OMEGA • GPS 	<ul style="list-style-type: none"> • Required for Short-Range Navigation • Required for Short-Range Navigation • Needed for Navigation and Approach Guidance in Some Areas • Used for Long-Range Navigation Independently or With Other Systems (e.g., for Position Fixing) • Used for Long-Range Navigation Independently or To Position-Fix INS in Either VLF or Omega Modes • May Find use for Either Short- or Long-Range Navigation or To Position-Fix INS 	<ul style="list-style-type: none"> • Receiver • Interrogator • Automatic Direction Finder <p>One or More Types Needed for Long-Range Navigation; INS Installation Must Be at Least a Dual System</p>
<ul style="list-style-type: none"> • LANDING AIDS • ILS • MLS 	<ul style="list-style-type: none"> • Required Until 1995 or Until All Destination Runways Have MLS • Required After 1995 but Needed Before To Obtain Improved Landing Guidance Available at Runways Where Implemented 	<ul style="list-style-type: none"> • ILS Localizer, Glideslope, and Marker Beacon Receivers • MLS Receiver

Table 2.2-1 1990's ATC Implementation

The instrument landing system (ILS) consists of a 108- to 112-MHz localizer for horizontal, a 328- to 335-MHz glide slope for vertical, and two 75-MHz marker beacons for distance to provide position starting at 33 km from the runway (18 nmi). The system is used extensively and will be augmented with a new microwave landing system (MLS) to provide landing in zero visibility utilizing a ground-transmitted signal to the aircraft to establish elevation, azimuth, and distance and is now collocated with the ILS until replacing it.

Navigation systems will expand in extent and capability. The traffic alert and collision avoidance system (TCAS) requires a transponder trace, and interrogator to detect, track, and compute aircraft flightpath projections and initiate selected levels of warning and avoidance maneuver advisories.

The very high frequency omnidirectional range (VOR) establishes a magnetic bearing, is a short-range aid, and is generally collocated with a distance measuring equipment (DME) station, which provides for more precise distance measurement from the VOR.

The automatic direction finder (ADF) uses nondirectional beacons (200 to 415 kHz) to provide a bearing (± 3 deg) at a range of 18 to 650 km (10 to 350 nmi).

Loran-C covers about 1850 km (1000 nmi) with pulses at 100 Hz with a positioning accuracy of 0.46 km (0.25 nmi), repeatable to 18m to 90m (60 to 300 ft) and is operated by the Coast Guard along the contiguous U.S. and Alaska, but is presently not being installed by scheduled air carriers.

Many of these systems will be supported or replaced by the global positioning system (GPS) which in future years will provide worldwide, accurate, all-weather positioning.

Communication systems will see unparalleled improvement in reliability and flexibility.

Very high frequency (VHF) voice communication, the continental U.S. air traffic control system to airport towers and control centers, operates between 116 and 136 MHz with projected bandwidth spacing of 25 kHz at a receiver sensitivity of around a microvolt.

High-frequency (HF) voice communication, for use over water, operates at 2 to 30 MHz with a receiver threshold of about $2\mu\text{V}$ and transmitter output of possibly 400W peak effective power.

2.3 CRITICALITIES

2.3.1 Measures and Definitions

By any measure, airplanes are safe. Airplane avionics are a part of that safety picture. And electromagnetic compatibility is a part of the proper operation of avionics.

Although safety records have been built and established over the years, the criticality of avionics and their interconnecting wiring is not an unchanging situation. Of course, mathematically finite possibilities of avionics performance errors or malfunctions always exist, and it almost goes without saying that absolute, definitive resolution of the exact probabilities and reliability of critical circuits is elusive.

"The simultaneous failure of two reliable independent systems, each of which has dual redundancy," states FAA Advisory Circular AC No:25.1309-1, "is expected to be extremely improbable." But still, the performance of critical avionics equipment cannot be allowed to be affected by the noise in the airplane.

Critical circuits need evaluation. Evaluation is needed on nonessential systems for their affect on critical circuits. Flight crews must not be given misleading information. Noise effects can be barred with shielding, rejected by balanced circuits, diverted and contained with filtering, or neutralized by software.

Table 2.3-1 itemizes some equipment criticality categories and definitions, and Figure 2.3-1 charts a general relationship of probability and consequence.

Cat A Critical	Prevent safe flight	Extremely improbable (per 1 hr)	10^{-9}
B Essential	Impaired ability to cope	Improbable	10^{-3} to 10^{-9}
C Nonessential	No significant degradation	Maintenance repair cost limits	

Table 2.3-1 Categories of Criticality

Toward the end of an airplane program, malfunctions or upsets can practically be brought to zero by repeated subsystem testing by the airframe manufacturer in conjunction with the avionics manufacturer of, first, prototypes, then engineering models, and finally production units. The avionics operation in a simulated noisy environment will be understood, and verified, and the data and experience will help contribute to aircraft validation (figure 2.3-2).

2.3.2 Critical Equipment

What makes equipment critical? What conditions influence criticalities? Here are some defining generalities:

Function:

- Does the unit support safety of flight or is it for convenience, comfort, work relief, or economy?
- Is the unit employed to maintain flight, or is it needed to proceed to the nearest airport, or to continue to destination?

Redundancy:

- Is the unit triple or quadruple redundant?
- If the first unit fails and the second unit fails, can loss of aircraft be averted?

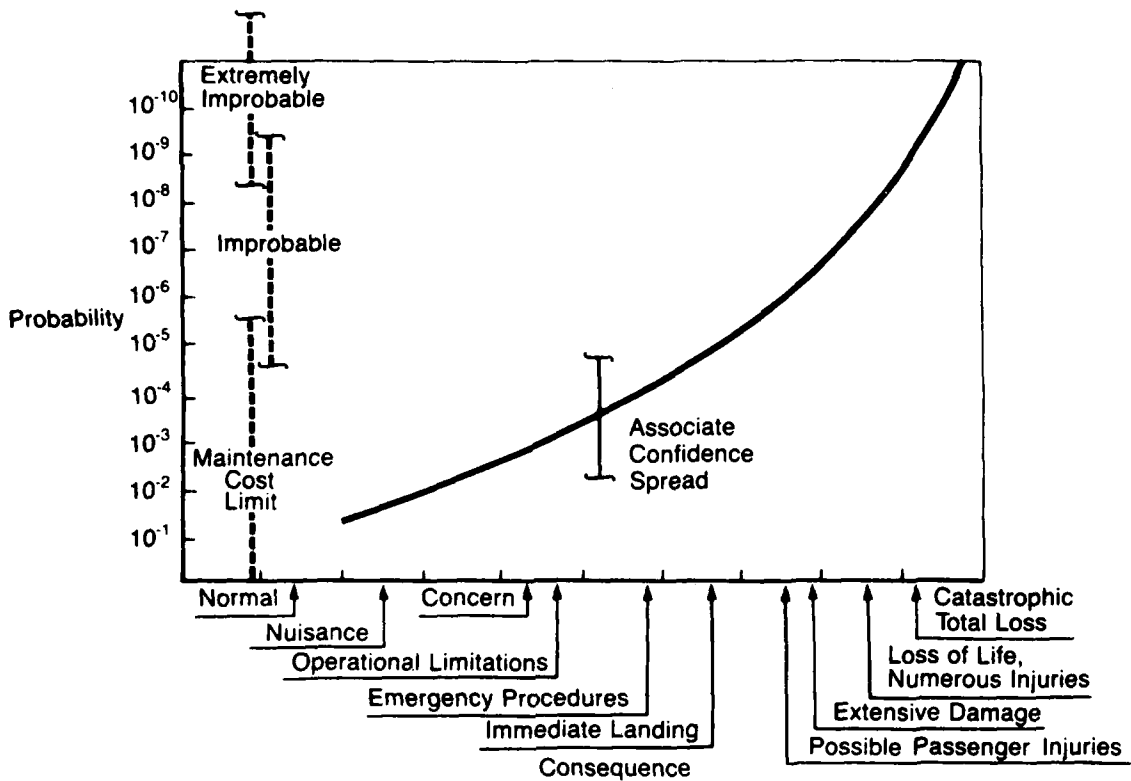

Figure 2.3-1 Probability Versus Consequence

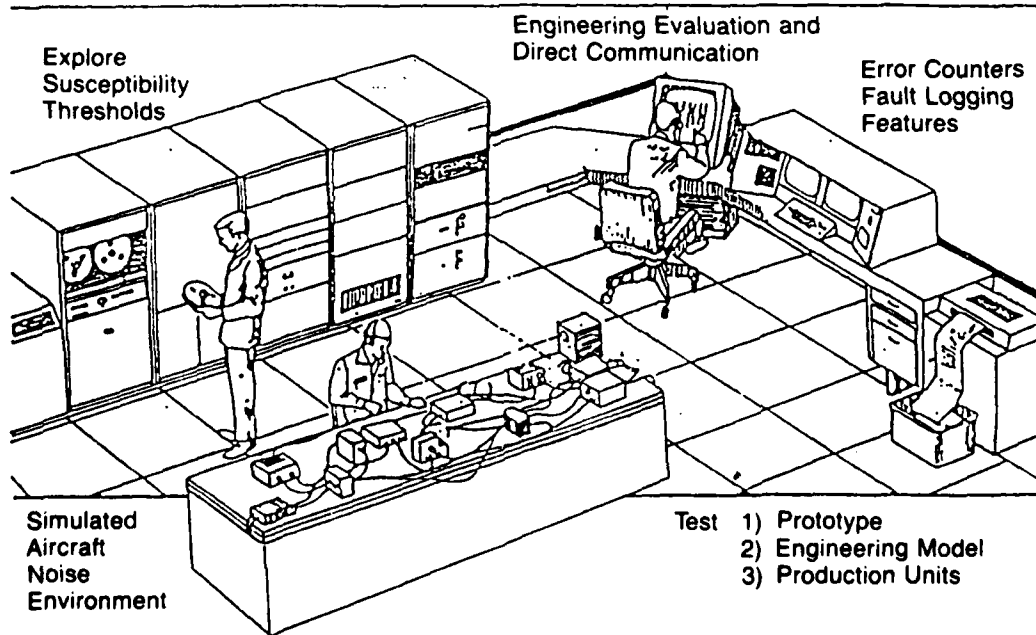

Figure 2.3-2 Three-Stage Subsystem Testing

History:

- What is the history, condition, and age of the unit or the aircraft?
- Are all units operating at flight dispatch?

Flight conditions:

- Is criticality based on phase of flight: takeoff, climbout, cruise, landing?
- Is criticality based on type of flight: deficient or lack of navigation facilities, instrument flight, heavy weather, long flight, over water, nighttime operation?
- Is flight safety dependent on automated electronic controls, instruments and sensors?

What circuits are classified as critical? Certain circuits or functions must be extracted and given special attention for electromagnetic compatibility. Circuits that might be considered include these illustrative examples:

- Flight control/flight management: control surface actuators, displacement transducers, servo valves, position indicators, switches/valves; electric controllers/actuators; negative stability controllers; augmentation controllers; air data, attitude, altitude, airspeed, and situation indicators, displays, control panels and their backups; automated landing system
- Navigation/communication: VHF transceivers, voice recorder, tape recorder, ADF, radio altimeter, instrument landing system, marker beacon
- Power: standby power, instrument lights, standby instruments
- Advisory flight instrumentation: actuators, position indicators, displays, test circuits, pressure, temperature, quantities
- Fire detection systems
- Landing gear: antiskid control
- Engine: controller actuators, computers, displays, temperatures, speeds, pressures, quantities, restart/shutdown, thrust reversers

Figure 2.3-3 delineates a block diagram of some hypothetical categories of future aircraft systems.

2.4 PACKAGING AND ARCHITECTURE

The aircraft is an electrical/electronic package. Right from the start, the aircraft packaging design must include a layout and topology that optimizes electromagnetic compatibility. Here are the dominant EMC desired designs:

- 1) Major subsystems are grouped together for an inline equipment design, input to output, to draw out the shortest possible wire bundle routing.
- 2) Major incompatible wiring groups are separated: power feeders from electronics; analog (with single point ground) from digital; high voltage/high frequency from digital; low-level sensitive from power.
- 3) The aircraft has a designed system-level shielding barrier combined with a designed, controlled, equipotential ground plane system.

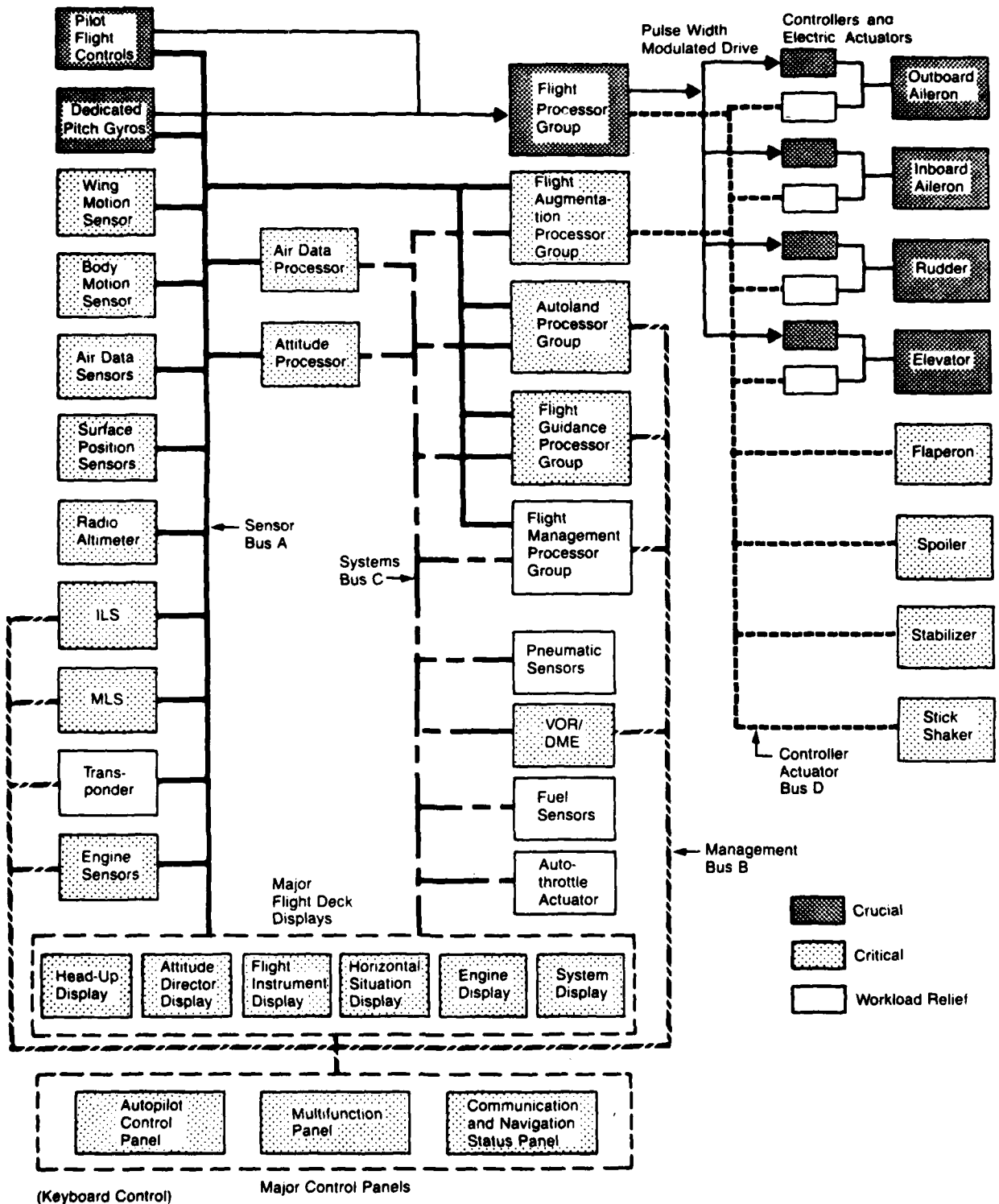

Figure 2.3-3 Projected Criticalities

- 4) Every interface circuit, electronics and power, is filtered and protected. Controlled transmission line design techniques are employed for susceptible and digital interface circuits.
- 5) Every installed unit of equipment meets the EMC qualification test requirements.

All of these designs and technologies need early conceptual consideration, planning, and layout. A mockup is invaluable. Inline design is the best. Locate equipment to minimize wiring lengths. Electromagnetic coupling increases with length. Make wire connections short. It's good for weight. It's excellent for electromagnetic compatibility.

Here is a more detailed checklist.

Grounding:

- Ground connections cleaned and burnished, no paint, must verify
- Ground wires evaluated for resonance, capacity, and continuity
- Avionics case grounded with a low resistance (and verified)
- Grounding paths and references designated on drawing
- Trays, conduit, metal liners, foils designed for return currents
- Graphite-epoxy not used as structure return
- Analog circuits are single point grounded or isolation provided
- Each avionic unit return/ground identified
- Engine circuit return/ground analyzed for wire length and impedance

Bonding:

- Structure electrically bonded and aperture bonds confirmed
- Electrostatic conductive paints applied to external dielectric or nonconductive surfaces
- Equipment bonding to structure verified
- All isolated metal objects bonded

Shielding:

- 360 deg, peripheral shield connections used
- Backshell continuity defined and checked
- All circuits evaluated for shielding
- All low-level, sensitive circuits shielded
- Shield noise not carried inside case confirmed

Wiring:

- Landing gear wiring installed in conduit and flexible overbraid
- No wiring routed under unshielded fairings
- Wiring installed close to structure
- Shielded, balanced, isolated interface circuits employed

- Power feeders given a power line and a wire return
- Signal lines given a signal line and a wire return
- Twisted pair used for audio circuits
- Oscillator harmonic frequencies emanating from clocks, switching regulators, pulse width modulators, and digital data lines shielded. Conducted and radiated emissions, close to receivers, may need to be controlled below DO-160 limits

Packaging/installation:

- Test data dug out to verify equipment complies with specification
- Equipment tested to up-to-date requirements
- Transformers separated from CRTs and audio circuits
- Environmental control, flight control/electric actuators, flight management, radio transmitters and receivers, power, and engine control systems unearthed, defined, grouped, and aligned
- Mockup constructed to settle on equipment topology
- Functional or subsystem grouping provided for environmental control electronics, switching units, valves, fans; flight control, electric controllers located next to stepper motors; air data, caution advisory computers next to their transducers; radio frequency units, power supply, electronics, amplifier, antennas; heavy power generators, converter regulators, transformer rectifiers, switching contactors, power switching unit installed together, and separated from avionics; power "single point grounds" positioned next to power regulator or distribution unit; power switching unit centrally located; dedicated avionic power supplies installed next to the unit they supply; electronic engine controllers positioned to shorten and minimize wiring to engine sensors and controls
- All circuits evaluated for filtering
- Equipment input and output wiring not doubled back upon itself
- All circuits evaluated for categories and separation

These are not all the answers but they will help.

2.5 Issues

2.5.1 An Early Start

The whole EMC scenario rises up and needs resolution at the concept of the program. This is an issue. The scope and depth are resolved first—is it a proposal? — proof of concept? — or full production program? What are the funding boundaries?

Environmental assessment quickly follows, all of the environment inside and outside of the airplane. This is an issue.

Early in the program, light must be shed on the "tailored" design requirements or waivers for subcontractors. New systems demand definition. Policy and schedule come into focus in a brief EMC plan. These are large tasks and they are all at issue. Bringing two or three people on board early is an added expense. It seems unnecessary. Electromagnetic compatibility design does not start at the design stage, it starts at the concept stage.

2.5.2 Design

2.5.2.1 Shielding

Shielding is one of the best ways, the most all-around effective ways to protect a circuit. Shielding diverts almost all of the energies of noise. Shielding stops transients as well as radio frequencies. It protects against electric fields. It helps to maintain controlled stripline impedance. It guards against arcing and sparking. But, it adds weight to the aircraft, requires maintenance, and costs more. Shields require shield ties—difficult to install, particularly for panel-mounted equipment. With adequate modeling and design effort, shielding can be judiciously applied.

2.5.2.2 Power and Signal Returns and Wire Grounds

Sometimes a wire is good, sometimes bad. Many of today's circuits or case housings are referenced to structure ground with a wire, which may resonate. Many of the interface circuits between equipment do not have a wire return, which will open the circuit up to noise. Both of these practices are detrimental to EMC but they save on weight. Wiring is good as a signal return and bad as a circuit reference.

2.5.2.3 Dielectrics

By specification, wiring and connector insulations have dielectric withstand strengths at sea level of 1500V, 400-Hz steady state. That 1500V, weakens as one goes up in altitude. It can be down around 300V, its lowest point, at an altitude of 250,000 ft. In the future, as power line voltages rise and aircraft altitudes increase, dielectric strengths and corona will become more of a concern.

2.5.3 Environment and Test

2.5.3.1 High-Energy Radio Frequency Fields

Magnitude, pattern, frequency, polarization, modulation, and geographical location of high-energy radio frequency and radar transmitters are needed. To evaluate aircraft circuit immunity, a systems approach must be implemented to study shielding, induced voltages, circuit protection, and software correction techniques. An industry susceptibility test specification is needed. In areas such as this, compliance to D0-160 may not guarantee system-level compatibility. Efforts are underway to provide an update of high-energy radio frequency field environments and protection techniques. (See Section 8.0, Bibliography, ECAC study on Electromagnetic Environment.)

2.5.3.2 Fields From 400 Hz and Transients

Some say that the power system 400-Hz is the most troublesome electromagnetic environment on the aircraft causing 50% or more of the shortcomings in EMC quality. Audio 400-Hz "hum" derives from magnetic ("H") field. Electric ("E") fields can trigger a comparator circuit that has high-input impedance, and it's well known that powerline transients cause logic upset resulting in lockup or even equipment shutdown until the flaws are found and rooted out. Through better definition, analysis, and modeling techniques, avionics designers must be made aware that their equipment is operating in this environment. Higher design and test levels are appropriate in some instances coupled with more attention to finding interface circuit thresholds during test. It is controversial.

2.5.3.3 Test Conditions

In the laboratory during development or qualification testing, it is expensive, difficult, and unmeaningful to strive to recreate actual aircraft installation or production configurations. There are wire lengths, resonant conditions, and test coupling conditions that may not adequately simulate the aircraft and, because of this test deficiency, may ultimately lead to an upset occurring on the aircraft. Possibly one answer is to verify that test levels are high enough with an adequate safety margin. Subsystem tests offer information on EMI characteristics to help moderate this dilemma. Aircraft tests authenticate the final EMC design.

2.5.3.4 Emission Variances

Today's conducted and radiated emission limits are restrictive under some conditions (see Appendix B). Computers, with digital clocks and switching regulators, sometimes emit harmonics in the HF megahertz region that defy total containment and consequently emissions may be a few dB above limits. Cases exist where it is uneconomical and unnecessary to go to extraordinary efforts to filter those emissions if it can be shown that they will not in any way radiate to local receiving antennas. Infringements may be approved and deviations granted without adverse effects on neighboring circuits. The present radiated emission limit in the VHF range is not too restrictive and, in fact, could be tightened (lowered). Deviations should almost never be granted for susceptibility tests. It is necessary to apply discretion.

2.5.3.5 Subsystem Testing

Subsystem testing is different in intent from equipment qualification testing. Subsystem testing, usually held at the airframe manufacturer's facility with support from the avionics supplier, provides insight into the susceptibility thresholds and emission levels while simulating noise environments of the airplane.

The tests are for engineering evaluation and they provide significant information on computer processing performance and interface data quality. Test software exercises the processing functions and the interfaces between avionics units, and further, it monitors processing, memory, and transmissions of data for any abnormal conditions. Error counters or fault logging features examine operation in real time and provide capability for hard copy printout. Formal pass or fail standards for susceptibility and emission do not apply. Completion of the specific test procedures and the investigation is the gauge for determining success.

The features are that many interface circuits are per manufacturer's configuration, software is up to date, and observation is real time. At this stage of the program, the equipment avionics engineer is available to provide rapid evaluations and judgments. Re-evaluation and decisions on rework or test changes are easy and flexible. Often these tests can be performed on a "noninterference" basis using informal procedures. They establish standards for the airplane test. Costs are low.

2.5.3.6 Aircraft Testing

Aircraft testing is the final authentic proof. It offers first hand "real-world" validation. Wiring, equipment, and installations are the final design. It is expensive, however. It is expensive beginning with the test procedure (step-by-step development and approvals), then the aircraft test itself (a labor intensive operation compounded on top of a costly unit of equipment), then continuing with the formal documentation of unplanned events during the test, and ultimately ending with an elaborate final report.

2.6 VARIANCES IN ELECTROMAGNETIC COMPATIBILITY

2.6.1 Diagnostics and Troubleshooting

Flight Test phoned Project. Project called Flight Deck instrumentation staff. Then staff contacted the electromagnetic compatibility engineers.

A new aircraft on the flight line had a discrepancy in the left engine fuel flow reading. The fuel flow digital readout on the display screen of the criticality advisory system (CAS) was variable and erratic whenever the 400-Hz power to the engine Mach probe heater was energized. What was happening and what was the cause? A work authorization was quickly approved; time on the airplane scheduled; and laboratory test support called in.

On the airplane in cramped quarters next to the electronics bay, investigators used an oscilloscope to troubleshoot the problem on the circuits running from the fuel flow meter on the left wing engine to the CAS computer located in the electronics bay. Connectors were hard to reach and remove with care. Knuckles got scraped. Equipment was difficult to move. Engine run time was expensive. As a part of the investigation, the left engine wire bundle was disconnected from the left CAS computer and reconnected to the right CAS computer to see if the problem would "follow" the bundle. It did, and that showed that the CAS computer itself was not totally at fault and that 400-Hz, 115V power in a wing wire bundle was being coupled to the fuel flow circuit.

The 400-Hz, 115V power wire to the mach probe heater, traced out on the wiring diagrams, starts in the electronics bay and runs out to the engine; but then the 115V heater return wire is taken from the engine back onto the engine strut; the wire is there connected to structure with structure being used as return back to the power source in the electronics bay. So the "high side" of the 115V power wire runs in the same bundle in the leading edge for 100 ft next to the unshielded, fuel flow circuit. There is 100 ft of "electric field" capacitive coupling.

On the other hand, the fuel flow circuit is three wire balanced, has the meter wires isolated on the engine, and has a high-resistance input to an operational amplifier in the CAS computer protected at the input by 5 k Ω resistors and diodes to ground. The two, 350-mV pulses generated by the fuel flow meter have a working period approximating the period of the 400 cycles per second. The 115V, 400-Hz noise was induced right on the 350 mV.

The fuel flow circuits were rapidly set up and simulated in the laboratory and they malfunctioned under the DO-160 power line "electric field" test just as had occurred on the aircraft. It took only 40V at 10 ft (400 Vft), equivalent to 4V at 100 ft, of coupling to cause upset (figure 2.6-1). The test requirement is 120V at 100 ft (12,000 Vft). Other DO-160 tests caused no upset. Once the simulated circuits with the proper pulses had been developed and the thresholds and boundary characteristics of the upset outlined, the test was scheduled, set up, and run in an avionics laboratory with a production configuration CAS system. With management approval, communication was established through Project with the subcontractor. He was able to duplicate the condition.

The long, 100-ft wiring run, all the way from the electronic bay through the wing pressure seal, then along the wing leading edge to the engine strut and down into the engine, had provided an extensive opportunity for electric field coupling into the operational amplifier wiring. What will correct electric field coupling? A low resistance or shield will.

Wire shielding, installed on the airplane fuel flow circuit, provided an excellent barrier against the electric field and was a quick solution.

The operational amplifier design in the CAS computer, although a balanced circuit, did not offer proper noise rejection to stop the upset. It turned out that that circuit design was inherently difficult to balance, partly because of resistor mismatch, partly because of capacitor imbalance, and possibly because of a phase shift occurring in the signal return.

This "variance" from electromagnetic compatibility on the aircraft took months to resolve. Flight test, project, manufacturing, management, and subcontractors: all were involved. Work authorizations, reviews, justifications, and documentation were invoked, processed, approved, and completed. A necessary, but costly, effort.

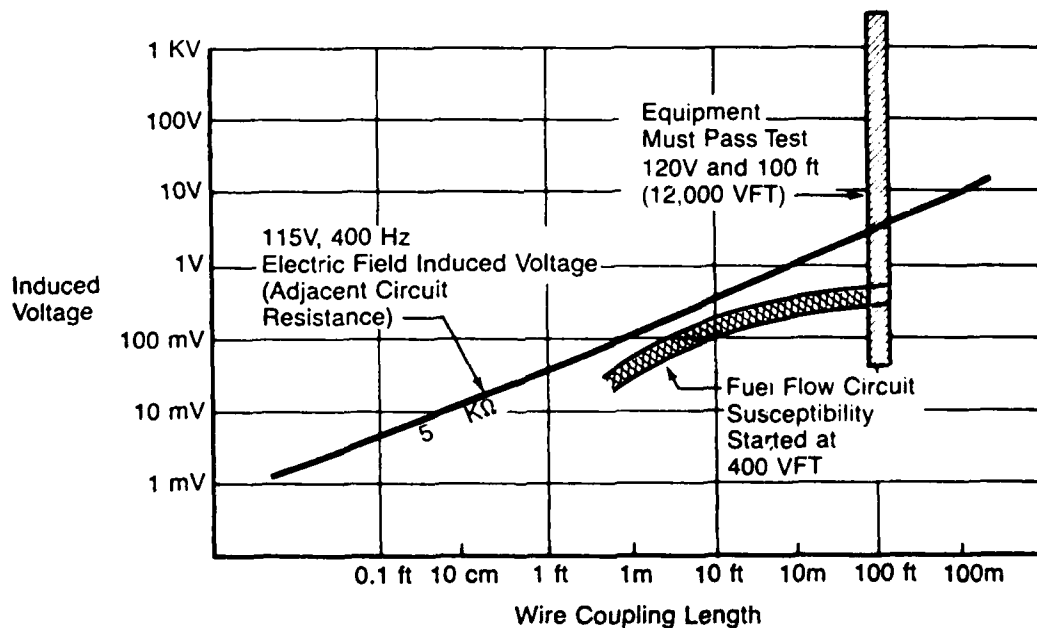

Figure 2.6-1 A Discrepancy

2.6.2 Table of Variances

2.6.2.1 Commercial

Diagnostics and troubleshooting of electronics are continuously demanded because of avionic circuit susceptibility to transients, 400-Hz electric ("E") and magnetic ("H") fields, radio frequencies (HF-VHF) including clock and switching regulator harmonics, and power quality. Knowledge of past lessons may help save design and troubleshooting expense (table 2.6.1). The bottom line is adequacy of specifications. In Table 2.6-1, under the DO-160 column, recommendations are made on possible increases in test levels to improve aircraft electromagnetic compatibility.

2.6.2.2 Air Force

The Air Force has documented troubleshooting experience. "The coupling of fields through the unintentional antennas formed by aircraft wiring," Zenter, the author, says, "is the cause of many interference problems." (table 2.6.2)

2.6.3 Corrective Action and Modeling

A comprehensive study of troubleshooting is needed before accurate corrections to the aircraft system specifications or the RTCA DO-160 equipment specification can be recommended. Documented, statistical groupings of troubleshooting experience concerning historical EMI characteristics and cost factors do not exist, but one might postulate some possible categories and hypothetical percentages as shown in the accompanying pie charts (figure 2.6-2).

A study of categories such as these might reveal that analysis and modeling of analog/audio circuit susceptibility is most beneficial, or possibly better models of aircraft wire coupling might help, or even modeling and documenting of the most popular fixes.

TABLE 2.6-1 VARIANCES IN EMC							
EMI CLASSIFICATION	SOURCE	EQUIPMENT RECEPTOR	PATH	SYMPTOMS	REMEDY	DO-160	
Static:	1 windshld	captr	dsch	dis captr	gnd wndshld	add test	ant-antenna aud-audio hum or tones cab-cabin cap-capacitor captr-computer CRT-cathode ray tube del-change or movement dis-disengage dsch-discharge "E"-electric field eq-equipment FF-fuel flow fil-filter gl-ground loop lgnd-single point ground "H"-magnetic field HUD-head up display inc-increase ind-indicator change intrphn-interphone intrpt-interrupt iso-isolate lt-light N2-engine speed prx-proximity switch rad-transceivers rcdrs-recorders rcv-receiver rdr-radar RE-radiated emission sep-separation shld-shield sup-suppression txf-transformer TP-twisted pair trnsnt-transient tx-transmitter wc-wire coupling wx-weather
	2 covers/pan	VHF rcv	"	aud	bnd covers		
	3 duct	ADF rcv	"	"	gnd duct		
	4 ant cover	"	"	"	paint covr		
Sw.trnsnt:	1 powerline	captr	wc	del rud/ dis captr	lgnd	inc trnsnt	
	2	"	"	lock up	cap/softwr		
	3	"	"	false cad	"		
400Hz "E" field:	1 powerline	captr	"	ind- FF	shld	inc "E" field level	
	2	N2 ind	"	ind- N2	"		
	3	captr	"	ind-F/qty	"		
	4	aud cir	"	aud	"		
400Hz "H" field:	1 powerline	intrphn	gl	"	lgnd	inc "H" field level	
	2	headset	"	"	"		
	3	VHF rcv	"	del CRT	Txf iso,lgnd		
	4	videocoax	"	"	TP & sep		
	5	CRT	wc	"	"		
	6	tape head	"	aud	fil,sep		
	7	aud cir	"	"	TP,sep,lgnd		
Clock hrncs:	1 wx rdr	ILS rcv	"	"	sep	inc RF level	
	2 portble rad/rcdrs	omega rcv	"	ind del: spd,course	shld		
Sw.reg.hrncs:	1 captr	VHF rcv	"	aud	sep, shld	inc RF level	
HF-VHF freq:	1 VHF tx	handset	RE	"	fil micrphn	inc RF level	
	2 VHF tx	headset	"	"	txf iso		
	3 HF tx	captr	wc	cab press	fil, cap		
	4 "	aud cir	"	aud	dubshld		
	5 "	"	"	ind	"		
	6 HF eq	VHF eq	"	aud	"		
"Crosstalk":	1 VHF, DME	aud cir	"	"	sep,lgnd		
Radar:	1 airport rdr	prx sw	RE	ind lts	shld		
Power qualty:	1 powerline	captr	28vac	ind	fil		
	2	"	115v	no-land	"		
	3	"	"	pwr intrpt	cap, softwr		
	4	"	"	del CRT	softwr		

TABLE 2.6-2
AIRFORCE VARIANCES

EMI CLASSIFICATION	SOURCE	EQUIPMENT RECEPTOR	PATH	SYMPTOMS	REMEDY	MS461
Static:	1 canopy	UHF rcv	dsch	aud	sep	add test
	2 "	"	"	"	bnd,gnd	
	3 ant	"	"	"	"	
	4 "	"	"	"	"	
Sw.trnsnt:	1 powerline	captr	wc	ind-rdr warn	shld,fil	add test
	2			IFF code tx	diode sup,	
	3			ind-HUD cam op	softwr	
	4			bomb disarm		
	5			ind-flare		
	6			del-captr memry		
	7			ind-teran fol rdr		
	8	intrphn		aud		
400Hz"E"field:	1 powerline	omega rcv	RE	ind-del	sep	add test
	2	VLF rcv		aud	fil	
400Hz"H"field:	1 powerline	intrphn	wc	aud	ignd	inc "H" field level
	2	captr		del CRT	sep	
	3	"		ind oxy	"	
Clock hrncs:	1 captr	ant	RE	aud	fil,shld	
Sw.reg.hrncs:		--none				
HF-VHF-UHF:	1 tx	captr	RE	del-cntrl surfce	fil,bnd,shld	inc RF level
	2	wiring		del-steer gear		
	3	"		del-rdr ant		
	4	"		del-winch		
	5	"		del-eng speed		
	6	"		ind-altimeter		
	7	"		aud-intrphn		
	8	"		del-A/C headng		
	9	"		del-nav flag		
	10 vid sig	ant rcv		aud		
	11 strb sig	"		aud,del-stick		
	12 dig sig	"		aud		
Radar:	1 rdr	prx sw	RE	lose antiskid	fil,bnd,shld	inc RF level
	2 HF tx	captr		ind-lts		
Power quality:	1 powerline	captr	26v	del captr	fil,bnd,shld	
	2	"	115v	dis captr		

EQUIPMENT/CIRCUIT TYPE

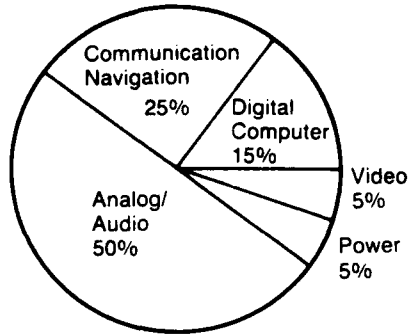

RANGE OF EXPENSE

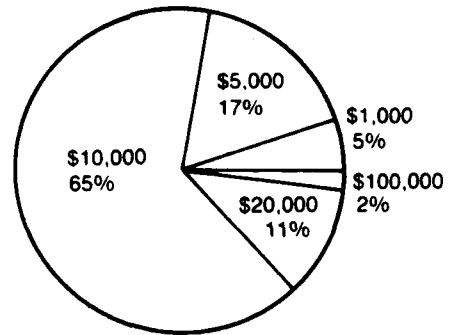

EMI TYPE

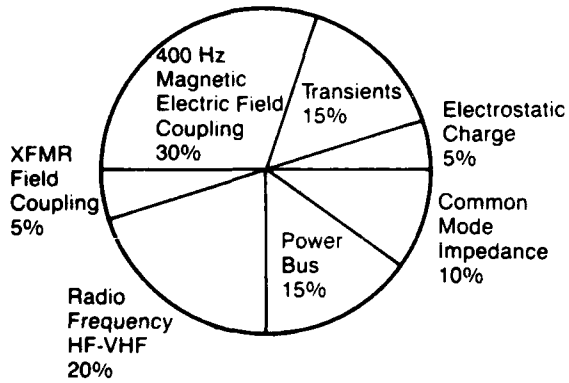

EMI LOCATION

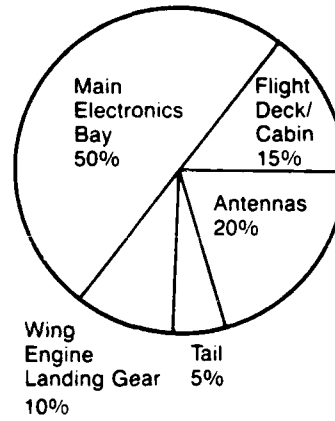

EMI PATH

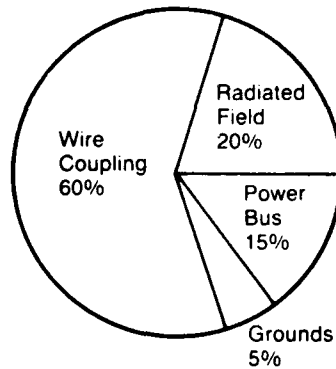

FIXES

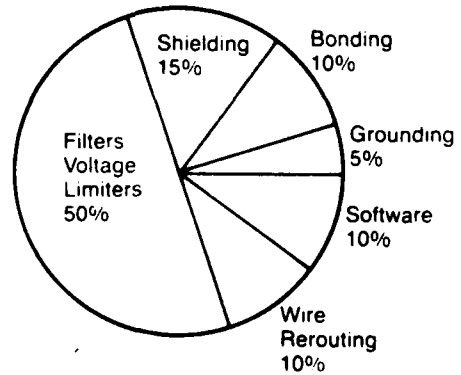

Figure 2.6-2 Postulated Hallmarks of Variances

3.0 AVIONICS THRESHOLDS AND PROTECTION

3.1 HARDWARE TOLERANCE

Recognizing the conditions of proper interface wiring design, circuit protection, and the contributions of aircraft structural shielding protection is of course important in a "top-down" electromagnetic compatibility design of an aircraft, but these recognitions must also be tied closely to a knowledge of the noise tolerances and noise thresholds of transistors, microcircuits, and logic. The lines can be drawn: environment, protection, threshold.

Airplane environmental noise voltages flourish far above the transistor and microcircuit thresholds of damage, upset, or offset, which means that microcircuits demand protection in every case. Transistor-transistor-logic gates and microprocessors do not have even a modest tolerance to the run-of-the-mill aircraft noise types, such as: electrostatic pulses, lightning-induced transients, inductive switching transients, or even some high-energy radio frequency signals.

A TTL logic gate will "change state" at a threshold of about 800 mV when radio frequencies are injected starting at low frequencies and on up into the megahertz range, but in the tens to hundreds of megahertz the threshold rises to greater than 5V before upset occurs. Figure 3.1.1 maps that threshold. Whereas a gate will operate or change state at 800 mV, it may be damaged if subjected to much greater than 10V at low frequencies and can usually survive about 100V transients that are of microsecond or nanosecond duration depending on thermal dissipation. As shown in the figure, a transistor or semiconductor "PN" junction will detect power levels as low as 100 μ W under certain conditions.

Microprocessor chips are high density and high speed. Microprocessor circuits may be upset, change state, or change performance when signals with noise power levels down to 10 μ W are injected on signal, address, or clock lines. As frequency is increased beyond the operational range of a microprocessor, the power required to cause upset and damage increases. These levels change with conditions such as loading, circuit geometry, radio frequency paths, and sometimes software design. Operational factors such as address or memory or timing or process changes affect the definition of upset. Under the onslaught of steady state, low-frequency signals, microcircuits can be damaged at power amplitudes of less than 1W, but high frequencies or fast narrow pulses require much higher wattage levels—ten to hundreds of watts.

Individual pulses, measured by their energy content, require anywhere from 10 mJ to 1 μ J to cause damage as shown on the figure. Pulse durations are microseconds to nanoseconds. Awareness of these levels is important when designing the shielding for the aircraft or avionics wiring to protect against high-frequency transients or resonances.

Shielding protection or voltage limiting must be provided to reduce transient noise signals below the damage threshold. Protection must also be designed to keep continuous wave radio frequencies below the TTL or integrated circuit operational thresholds (figure 3.1-2). Software can be designed to correct for random, nonrepetitious transients.

Extensive effort in testing, modeling, measuring, and graphing operational upset and damage levels has been documented in the industry. Minimum and maximum spreads are available. Voltage damage amplitudes may vary by a factor of two or three, say from 100V to 300V, from

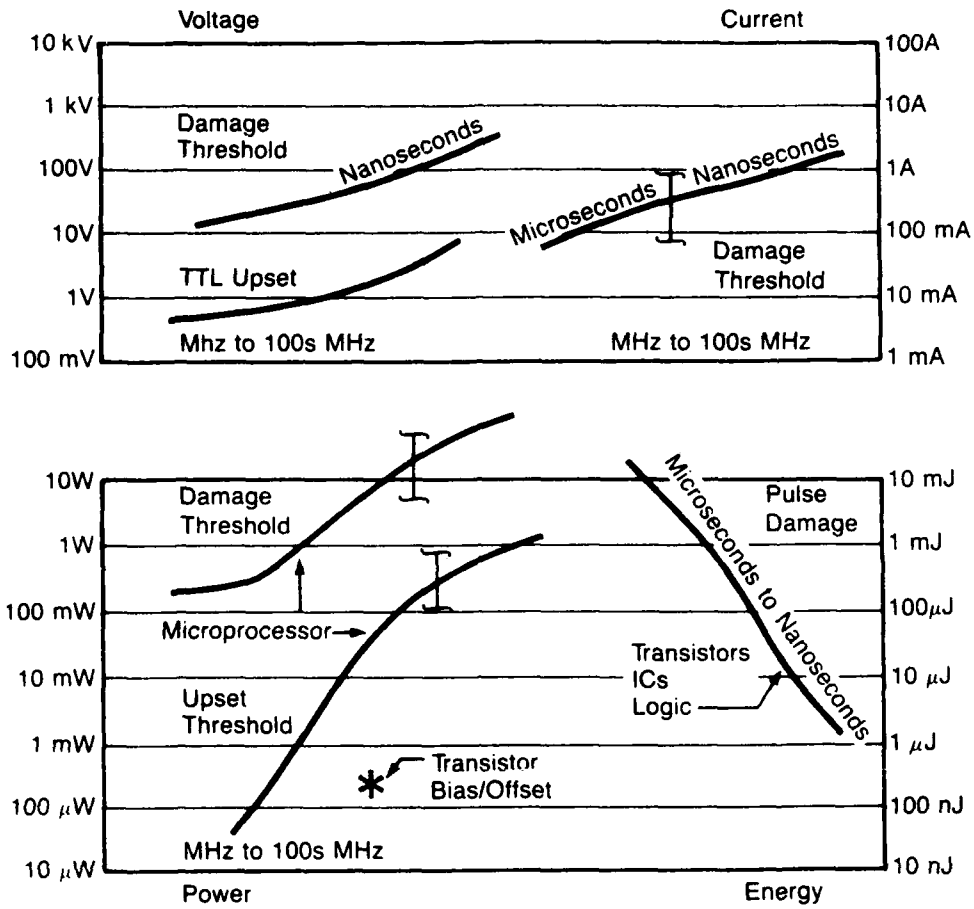
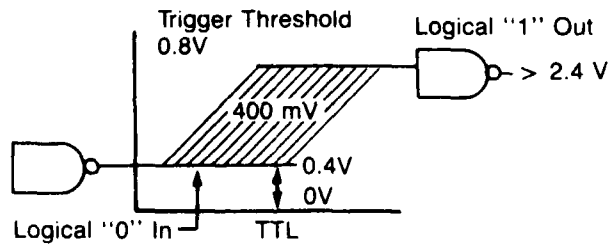

Figure 3.1-1 Microcircuit Tolerance



	Transistor-Transistor Logic TTL	Emitted Coupled Logic ECL	High-Threshold Logic HTL	Complementary Metal Oxide Logic CMOS
Average	1.2V	100 mV	7.5V	2.2V
Minimum	400 mV	—	5V	1.5V

Figure 3.1-2 Noise Margin

one manufacturer to another, or from one lot to another. The threshold of operation may vary from 800 mV to 1.5V from one transistor to another. Damage thresholds change by a factor of ten or more with the number of transient pulses and the rate of applying them. The spreads and averages are interesting in the study of susceptibilities, but at the bottom line is this: protection must be built in to account for the minimums—for example, 100V for transient damage, 800 mV or less for TTL gate state change, and 10 μ W for microcircuit performance alteration. It is necessary to constrain radio frequency power and stored transient energy access to avionics by diverting and/or blocking the noise with balanced circuits, filters, or shields on every input-output interface circuit.

When two conductors are spaced 100 mils (2.5 mm, 2500 μ m) apart, and the voltage between them is slowly increased, an arc will start (at sea level, atmospheric pressure) and establish itself at around 2000V or 3000V. If there is only 20 mils of spacing (0.5 mm, 500 μ m) between the conductors, the arc will start at 1000V. Circuit card conductors have these close spacings. So it is easy to understand when microcircuits, chips, and thin-film devices with substrate circuit separations of a few microns fail at 100V.

3.2 EMI AND SOFTWARE

It is difficult to know where to start in the treatment of electromagnetic interference relative to software in an aircraft context. What is special about an aircraft? How does aircraft electromagnetic interference uniquely relate to software?

Not by component failure or damage: damage may appear anywhere, anytime—broken parts—vibration—faults—mishandling.

Not by errors or deficiencies in software itself: this is the purview of the software designer; he must compensate for these regardless of aircraft electromagnetic interference. And also, not especially by the internally generated noise from power and switching regulators, or clocks and data lines: noise sources found in any electronic package.

The aircraft associated electromagnetic interference arises from power line 400 Hz, radio frequencies, electrical transients, and power bus momentary interruptions. They are very different in their characteristics, their occurrence, and their threat of upset. Two of these noise threats must be eliminated from software concerns right away.

First, 400 Hz is simply 400 cycles per second of a noise voltage from the power line imposed on a neighboring circuit. Cycle duration time is 2.5 ms; with zero to peak being 625 μ s; the positive risetime repeats every 2.5 ms. If a balanced circuit is slightly unbalanced and responsive for any reason, the 400 Hz will trigger operation of the balanced circuit continually or, much worse, in an intermittent fashion. If there is an error or disorder from 400 Hz, then there has been an error in the original design that must be fixed. Four-hundred Hertz must be controlled and kept out of interface circuits.

And second, radio frequencies can also be eliminated from software concerns. Aircraft wiring cannot be allowed in a radio frequency field stronger than the original design specification. If a digital circuit sees an overlay of an unwanted radio frequency (not damaging, but causing loss of data), the software will not be able to correct upset. The radio frequency environment must be known, documented, and immunity designed in to the interface circuits. Transmitter radio frequency noise and digital data are in the same frequency range, the most important being HF-VHF, 1 to 300 MHz.

Transients are the problem. Electrical transients have existed in the past, they exist today, and will continue to exist on the airplane as well as in the laboratory. Electrostatic discharge, lightning, or powerline inductive switching transients are usually of large magnitude (hundreds to thousands of volts). The amplitudes are reduced below circuit damage level (100V; a few amps) by design, but transients are sometimes not totally rejected and they result in short-term destruction of data words. It is the responsibility of the EMC engineer to supply threat transient levels and repetition rates to hardware/software designers to assure proper programming of fault tolerance and detection. What, then, are the time characteristics of transients relative to data words that the software designer must know to override noise or make software tolerant to noise?

Some inductive switching transients have ringing frequencies of 10 MHz reoccurring at a 1-MHz repetition rate and lasting for around 1000 μ s (figure 3.2-1). During test, the transient is repeated every two seconds. (DO-160 specifies 8-10 pulses per second for 10 seconds.) A 12-kHz, ARINC 429 signal has a bit width of 80 μ s and the 32-bit word has a duration of 256 μ s. A 1000 μ s, inductive switching transient can decimate a 256 μ s data word.

An electrostatic discharge, on the other hand, is a very fast 100-ns event (figure 3.2-1) and probably does not reoccur until after sufficient time, possibly 4 or 5 sec, to recharge the object originally collecting the charge. This transient might only affect one bit.

Lightning transients have low frequencies, 10 μ s or longer, and ringing high frequencies, for instance at 1 MHz, 3 MHz, and 7 MHz, set up by the electrical resonant lengths of an aircraft and damped out in a few microseconds, but then they may reoccur again and again under multiple strokes of a total lightning flash lasting for possibly one second (figure 3.2-1). A lightning flash might result in disorder in a number of words.

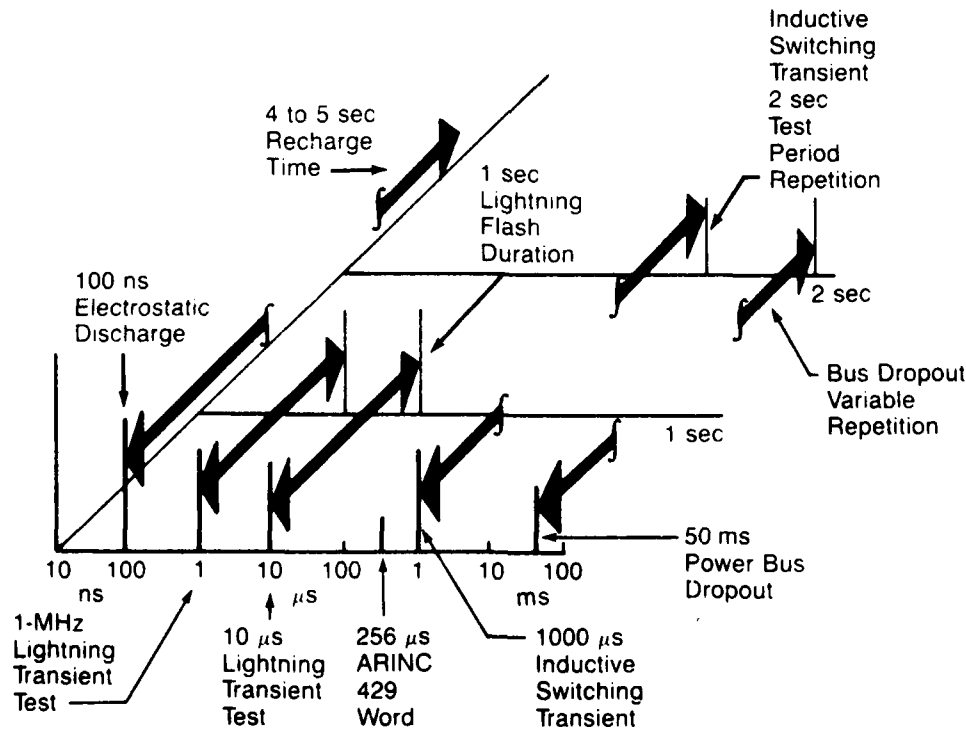

Figure 3.2-1. Transient Events

Of important concern is the momentary interruption of the power bus, referred to as a "bus switching" or "dropout" transient, where power drops or decays to zero for up to 50 ms (figure 3.2-1) when the power supply is transferred from ground power to engine power or from one engine generator to another. (DO-160 has a test requirement of a 200 ms interrupt for ac equipment, and a 1-second interrupt for dc equipment.) Software control may be required to ensure a graceful shutdown, proper data storage, or even continued processing.

So the software designer institutes techniques to control equipment operation, override errors, and make software tolerant to noise when transients and power shutdown occur.

There are a number of methods employed for data correction and resetting, such as:

- Microprocessor reset to initial state ("backward")
- Microprocessor forced to known state ("forward")
- Functionally equivalent, but dissimilar backup system
- Data word repetition or redundant data supply

There are also a number of means of detecting errors of data, flow, or hardware operation, such as:

For data checks -

- Read after write on output data line
- Data bus activity, reasonableness check, data averaging
- Bits per word, parity, status bits
- Check sums: averages, spreads, maximums, minimums

For flow checks -

- Out of sequence, out of loop
- Excess or deficient time
- Event record of activity ratioed to total program execution ("state activity")

It may be postulated that the aircraft has five layers of protection: 1) structure shielding, 2) circuit shielding, 3) balanced circuit, 4) voltage/ current limiting, 5) software. Software is the last line of defense.

3.3 DIGITAL AND DISCRETE CIRCUITS

3.3.1 ARINC 429 Drivers and Receivers

The ARINC 429 bus, a digital transmission interface system, fans out from the main equipment bay to the flight deck and to external sections in the wing, engine, or empennage. With two or more 429 circuits per unit, there could be two- to three-hundred individual buses. They may reach 100 ft (30m) in length, and are routed in bundles where they encounter transients, radio frequencies, and power line noise. The ARINC 429 "MARK 33" Digital Information Transfer System (DITS) offers immunity to noise by using a well designed combination of a

balanced circuit, a relatively high-trigger threshold, a "high-resistance" input, and finally, wire braid shielding. Parity, status bit, and "bits per word" software checks help to extend protection even further.

The output signal of the 429 transmitter measures at the high level, $10 \pm 1V$ "line to line" and at the low level, $0 \pm 0.5V$. At the other end of the line, the receiver must operate with an input signal at a high level of 6.5V to 13V and be at a low below 2.5V. The margin from 2.5V to 6.5V is undefined.

The trigger threshold of operation, therefore, can be 2.5V.

The transmitter driver output resistance is 70Ω to 80Ω "line to line" and the receiver input resistance is $12 K\Omega$ or greater in each line so that there is at least $12 K\Omega$ resistance in the circuit from transmitter to receiver. That is an important resistance for protection against transients. The high resistance provides immunity. Just ignoring the shield for a moment, if a 600V transient occurs on the wire and appears at the $12-K\Omega$ input, the resulting current amounts to only 50 mA, a very low "transient" current and not enough energy for damage.

The ARINC specification does not define the circuit ground nor case ground. For shields, the specification states that: "the circuit should be twisted pair shielded from data source to sink with the shield grounded at both ends at an aircraft ground close to the rack connector." Shield tie length is not defined. The 429 system has been subjected to the RTCA DO-160 electromagnetic interference tests and passed. Three factors, in implementing this digital bus design, demand extra effort in manufacture to ensure quality: 1) electrical tolerances of components (avionics supplier responsibility), 2) shield tie to ground (airframe manufacturer and supplier), and 3) case ground (airframe manufacturer and supplier). Future digital buses may have similar noise characteristics and rejection capabilities.

The 429 is a balanced circuit and balanced circuits are important; and also the installation of shields is important; but grounding decides effectiveness of receiver immunity: the grounding of the box, the grounding of the circuit, and the grounding of the shields.

3.3.2 Circuit and Shield Grounds

Noise on a single wire in space with no connection to a ground plane cannot be measured, and no current flows for an "electrically short" wire.

Connect one end to a ground plane and an induced noise voltage in the wire of 1V can be measured at the other end, the ungrounded end. This is a single wire over ground (figure 3.3-1a) and is the technique used to install the "discrete" circuits on the aircraft. It is susceptible over the entire frequency range.

If the ungrounded end is left unconnected, practically no current flows and no energy dissipated. That's an incredibly significant fact when analyzing for protection against damage. If no current flows, components cannot be damaged. Where circuits are exposed to high-level transients on the wing, isolate them at one end if possible.

Now, two wires over a ground plane with resistors between them at each end to form a circuit and one end connected to ground, say the source end, sets up the same condition—all the voltage will be measured at the load end relative to ground, with practically no voltage across

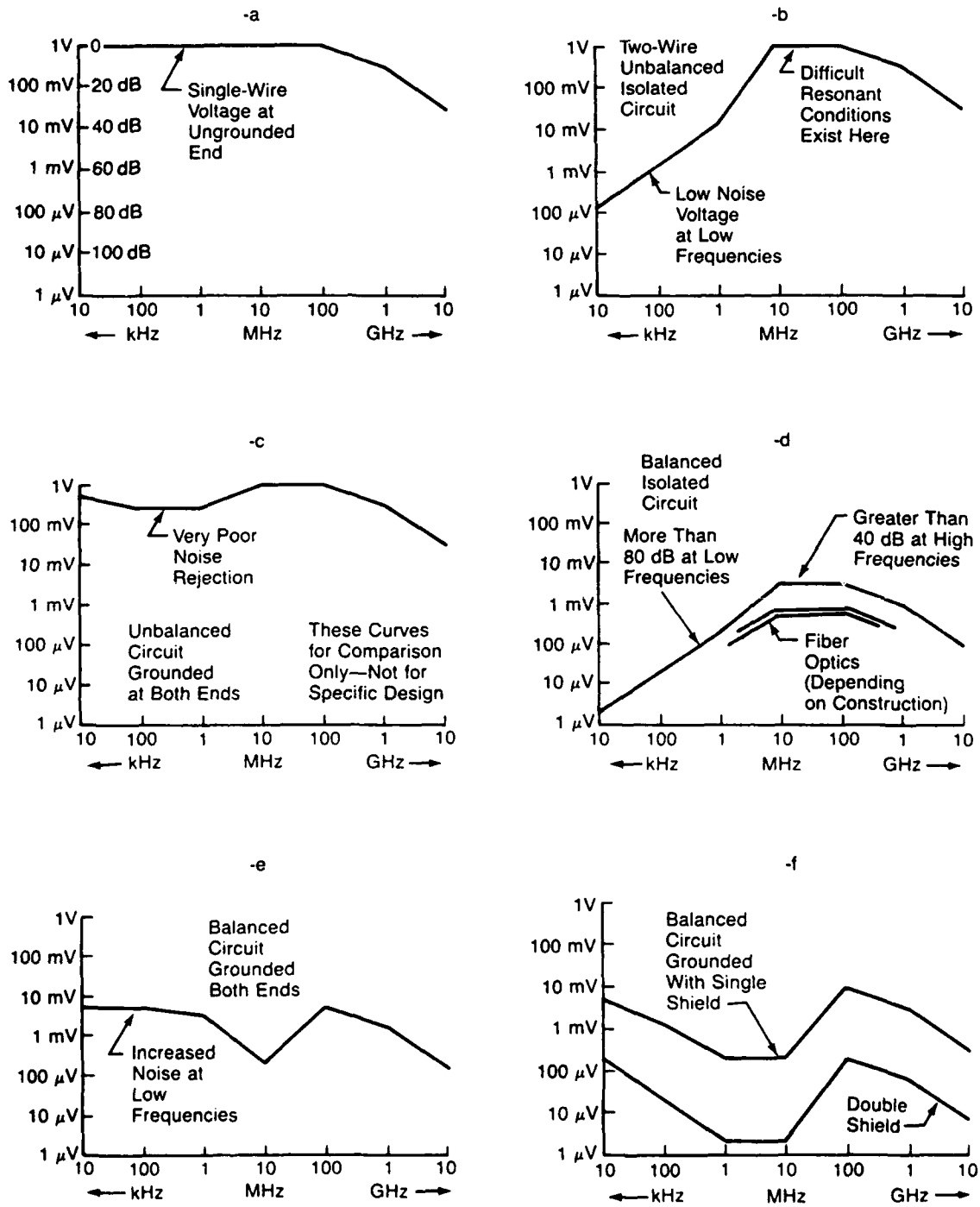

Figure 3.3.1 Circuit Noise Rejection (a b c d e f)

the load resistor at low frequencies. This is a two wire, unbalanced circuit (figure 3.3-1b). At the higher frequencies, resonance exists and voltages appear.

A two wire, unbalanced circuit grounded at both ends, source and load, offers practically no noise rejection, maybe 10 dB or so (figure 3.3-1c). The noise rejection is lost at low frequencies.

Make the circuit a balanced circuit, as the 429 is, and it can establish more than 40 dB of noise rejection for "differential mode" line-to-line voltages (figure 3.3-1d) at the higher frequencies. The line to ground noise, called "common mode," remains the same as the unbalanced circuit.

In an aircraft installation, it is optional whether or not the balanced circuit is grounded. Grounding loses some of the low frequency protection (figure 3.3-1e). The balanced, isolated design can offer 80 to 100 dB at low frequencies, just about equivalent to fiber optics or transformer isolation under practical installation conditions.

Figure 3.3-1f shows a comparison of one shield (like 429) and two shields grounded at both ends with the circuit and equipment case grounded. If either the circuit or case were lifted from ground, the circuit would have much more low frequency isolation and protection.

A balanced circuit (either grounded or isolated) that is double shielded with shields tied to the case connector and the base surface of the enclosure case grounded is almost always the best. The circuit can be isolated with a transformer, optical device, or fiber optics. This is the optimum practical design for low and high frequencies.

3.3.3 Discretes

A "discrete" circuit is designed and installed to indicate events, such as on or off, engaged or open. Sometimes it is constructed using a single wire (figure 3.3-1a) from the electronics bay out to a unit on the wing where a switch, to provide indication, grounds it to structure using the structure as the return. Their thresholds are high and, therefore, radio frequency noise is usually not a problem. But these circuits can be hit with the full force of transients and need to be protected with shielding, voltage or current limiting, or increased power ratings.

3.4 EQUIPMENT/WIRING ISOLATION AND SEPARATION

3.4.1 Quality of Wiring Design

If there are no wires, there is no electromagnetic interference. Wiring takes on different characters in its role as a conductor of signals. It is a signal conductor, driver to receiver. It acts as a transmitting radiating antenna or a very efficient receiving antenna; it is a party in transformer action to participate in voltage-current-energy transfer when in a cable bundle; and it also acts as an intermediary or a transfer agent to import electrical energy, then retransfer that energy to other wiring—sometimes called secondary coupling.

The wiring design is a fabric, a multiweave electrical mosaic. There is a mosaic of conditions: wire size, grounding, returns, shields, shield ties, separation, and wire length. There is a mosaic of properties: metals, dielectrics, resistance, inductance, capacitance, impedance, and *nonlinear effects*. Careful analysis and development of the design will bring about an acceptable level of electromagnetic interference and a cost-effective electromagnetic compatibility.

The complexities of the mosaic could be largely dispelled through the simple use of a twisted-pair-shielded (or coax), balanced-isolated circuit design that reduces noise, and sustains signal quality. See in figure 3.4-1 how the twisted pair shielded, balanced circuit has reduced noise to an acceptable level. This design provides a winning combination. It is the king of avionic interface design, boasting a possible noise rejection of 80 dB (10,000 times) and finding widespread use in digital communication or control circuits where stability, quality, and signal fidelity guarantee performance and confidence. Figure 3.4-1 was constructed to illustrate the general levels of improvement for comparison, but is not appropriate to be used or adapted to specific designs.

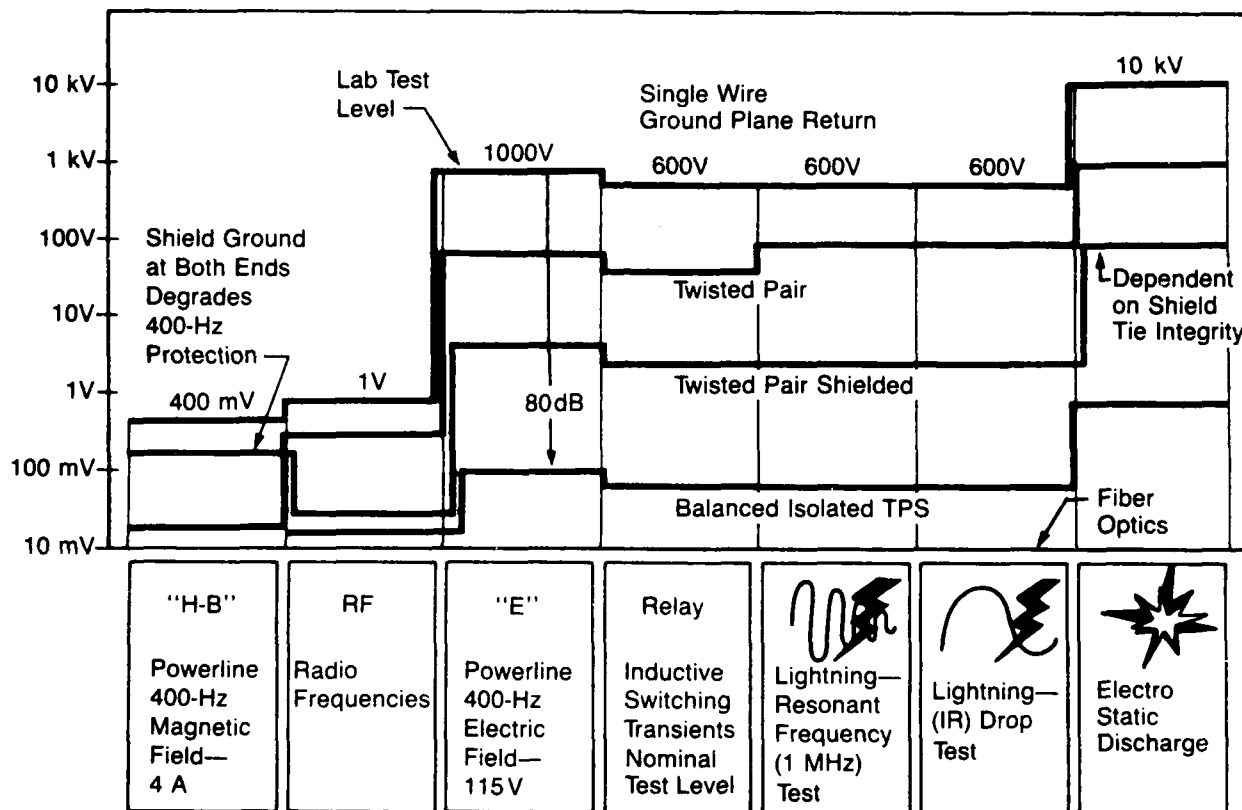

Figure 3.4-1 Circuit Response to EMI

The building blocks to signal wiring quality are threefold: twisted pair for minimum magnetic field induction, down by 60 dB; shield for minimum electric fields, down by 30 dB or more; and balanced isolated design for a minimum common impedance, down by 40 dB. For future aircraft, it will be necessary to accurately model types of circuits on an aircraft to understand the induced noise levels and assure desired signal quality. Determination of the actual voltage, current, power, or energy on the wire circuit is the goal. Current and power become important when designing the rating or sizing of circuit protection.

There is no easy answer to avionic interface wiring design. Interface circuits can be built (by careful engineering evaluation, assessment, and construction) to offer optimum circuit compatibility through four fundamental approaches:

- 1) Equipment and wiring location/grouping/organization design
- 2) Connector choice and wiring assignment
- 3) Return current rule
- 4) Coupling and modeling analysis

Definition of the total circuit is required: the driver, the wiring, the receiver, operating frequency, and intercircuit connections. The following tasks are applicable: identification of all identical circuits; identification of all common circuits, common returns, every ground connection, capacitor, or resistor connection; determination of output and input impedances, balanced and unbalanced impedances to ground. A check of other current paths that are not intentionally designed is often appropriate, such as, circuit paths from ground wires through mutual capacitances (leakage capacitance), through other ground conductors or transformers, shields, and circuit card grounds.

Identical or common circuits are best assigned to the same connector. Circuit currents should exit and return in the same connector. Low-frequency signals, less than 1 kHz, may return in a well-designed aluminum or copper grounding structure where transmission line design techniques are not necessary.

These rules are constructive:

- Separate power and signal (if power must be in the same connector as signal, separate power and signal by ground pins)
- Separate families of circuits in individual connectors by frequency: audio, digital, pulse width modulation (PWM), video
- Position wires for shortest practical route to other equipment
- Assign connectors for optimum wire routing to other equipment

Current paths returning in structure are designed to follow immediately adjacent to the cable (an image path). Currents should not be forced to take a wide path through distant connectors and structure. This is sometimes called the return current rule.

A simple way to achieve electromagnetic compatibility in wiring or in equipment is by functional or subsystem grouping (figure 3.4-2)—that is, keeping units or equipment of the same subsystem close together. An early definition and visibility of the system design, configuration, and function must be obtained. Equipment and subsystems and their locations must be known:

- 1) Primary power, secondary power, distribution boxes, heavy switching (solenoids), lighting
- 2) Electronic flight control, electronic flight instrumentation, engine electronic controllers
- 3) Navigation, VOR, ILS, and DME
- 4) Radio transmitter/receivers, HF, VHF

An early developmental wiring mockup is a requirement for good wiring design. The best design is grouping the subsystems close together in an inline design. Generator to receiver, input to output, and source to load. Individual connectors can be dedicated with common groups of circuits. Functional grouping can often be extended in the aircraft between units

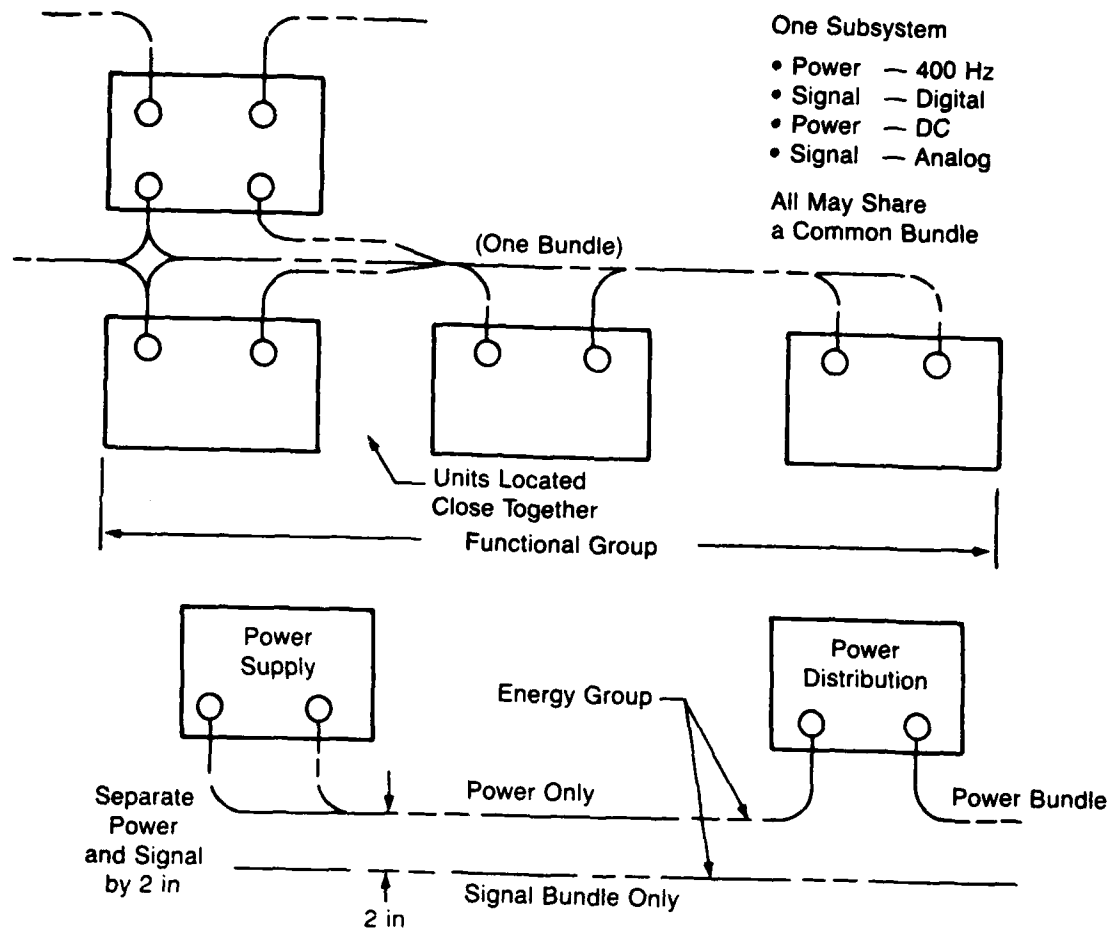

Figure 3.4-2 Wiring Categories

that are widely separated. Here, engineering judgment and analysis is important. Where functional grouping is used, bundles are more easily separated to comply with redundancy and safety requirements or a separation of wiring to protect against physical damage to redundant critical equipment such as engine-mounted electronic controllers.

On long wire runs, functional grouping may result in excessive coupling between noisy lines and susceptible or sensitive lines. Where space is available, it is recommended that wiring be separated by "signal/energy" categories as follows:

- 1) Ac feeder power bus; large ac control circuits; heavy current dc or secondary ac switching circuits valves, motor, or actuator drives; large inductive loads
- 2) Standard 115V and 28V power; signal circuits and regulated power circuits
- 3) Low-level, sensitive circuits such as audio, analog, dc reference, or dc secondary power
- 4) High-power radio frequency circuits (coax) or high-level pulse width modulated (PWM) circuits

Wire separation is not the best way to reduce noise between circuits, but it is often necessary. Separation is very effective when used for isolation and redundancy and safety (figure 3.4-3). Independent computer controls, instruments, power sources, or standby instrumentation are isolated to increase reliability. Left and right engine powerlines and circuits, as well as engine indication signals, are separated and isolated. Communication, EICAS systems, ILS, LRRRA, DME, and computer control devices, FMC, ADC, are separated and isolated. Primary controls, for example—roll, pitch, and yaw and stabilizer or spoiler controls and position sensors—are isolated.

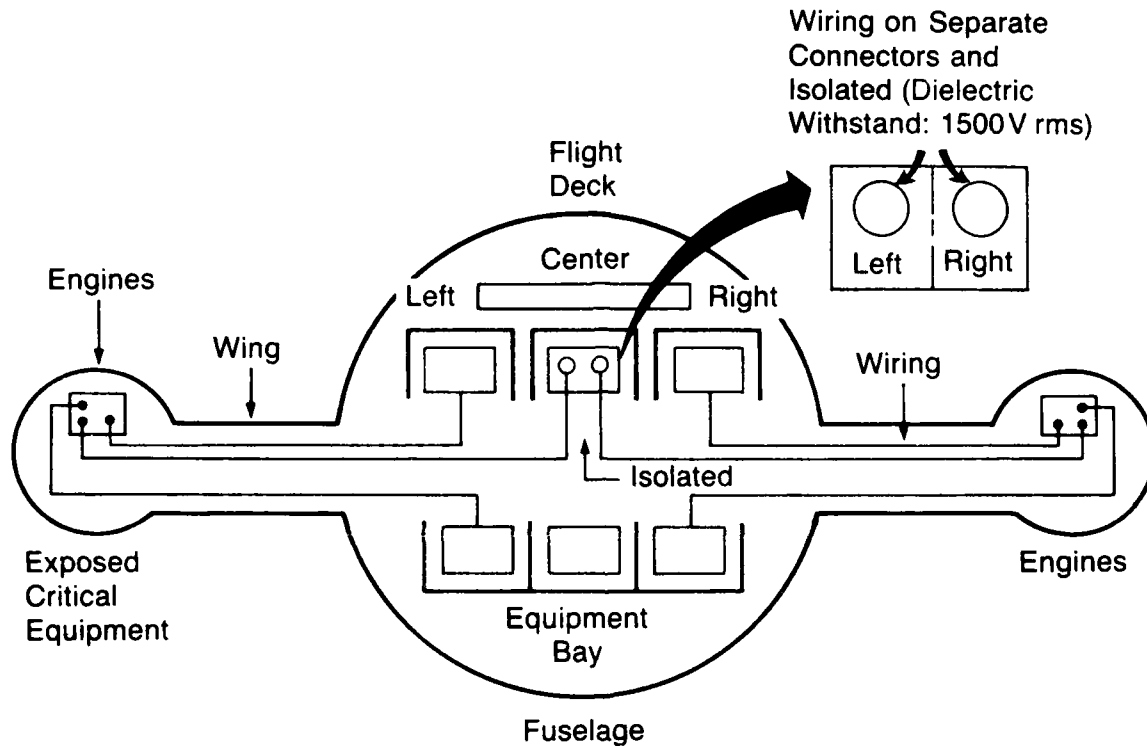

Figure 3.4-3 Critical Circuits Wire Separation

3.4.2 Power and Energy Levels

A twisted pair shielded, balanced, isolated circuit, properly designed into the system as an interface circuit, minimizes the possibilities of noise-induced damage and establishes a basic, high-quality design. But not all circuits are balanced and use a return wire; some interface circuits on the airplane have a ground return (structure return).

It is helpful and instructive in the initial design stage of a program to have a concept of the magnitudes of not only the noise voltage amplitudes but also the power and energy levels of radio frequency signals, 400-Hz power, and transient noise that can be imposed on a circuit that uses structure as the return path. It is important to analyze and define the power level (for continuous signals) and the energy levels (for transients).

One way to do this is by looking at selected electromagnetic interference laboratory test levels (figure 3.4-5). The test levels shown here are the avionic equipment test levels seen by equipment itself and are not the actual environmental magnitudes that may exist on the aircraft that the airframe manufacturer must consider, such as, higher levels of radio frequency signals or lightning transients.

Seven electromagnetic interference types can be listed for the purposes of identifying, summarizing, and comparing their voltage-current-energy and power profiles. In these selected laboratory test setups, certain circuit parameters and conditions must be arbitrarily defined. Therefore, the levels shown in the figure are illustrative and helpful for making comparisons, but are not appropriate for detail design conditions and must not be used or adapted to specific designs. The electrostatic discharge test is not an industry standard test level and is shown here for comparison to the other forms of noise. The amplitude is arbitrarily set at 10 kV, a nominal value out of an actual range of about 3 kV to 50 kV. Referring to figures 3.4-4 and 3.4-5:

- 1) The radio frequency test induces a low voltage, 1V, and a low current, approximately 100 mA, on a single wire that has a ground plane return. Observe on the bar chart the radio frequency voltage level of 1V and then the radio frequency current level of less than 100 mA, now move down to the power bar chart and see the radio frequency power level of 3 mW. The power level is shown because its a continuous signal. This test is performed in the laboratory using a current probe to induce the radio frequency voltage measured as an open circuit voltage (figure 3.4.5). The test level here is chosen as 1V (in the HF-VHF range) induced into a wire that is 5m (15-ft) long, the calculated current is the short circuit current, and the load resistance is adjusted for maximum power.

These radio frequency signal products come from aircraft microprocessor clock and switching regulator stray noise signals as well as HF-VHF aircraft communication and HF-VHF television and FM radio broadcast transmitters. Radio frequency carries with it the ability to sneak through avionics internal circuit capacitors or diodes connected to power supplies and on a circuit card it will pass from etched circuit trace to trace. The radio frequencies are not damaging, but they can alter circuit operation and performance.

- 2) The power line 400-Hz magnetic field, designated as "H-B" on the chart, delivers a low-frequency effect into analog circuits or operational amplifiers. Mark on the chart how the magnetic field might impose 400 mV with a power of 130 mW.

For this laboratory setup, a 40A current is coupled into a 3m (10-ft) section of wire, with a 0.5-cm (0.2 inch) separation, and positioned 5 cm (2 inch) above the ground plane. This simulates a 4A, 30m (100A-ft) maximum coupling condition on an aircraft. The power is calculated for a load resistance equal to the 5m wire resistance.

- 3) The power line 400-Hz electric field ("E") also delivers a low-frequency effect into analog circuits or operational amplifiers. See how the electric field ("E") is about 1000V, but note the extremely low current, less than 1 mA (off the chart). The power level is low but easily large enough for upset or alteration of equipment performance. Notice here that the power line test is performed at 10 times the 115V line level, or 1150V, in order to use a 10-ft coupling length. This simulates a 115V, 100-ft maximum coupling condition on an aircraft.

- 4) The electrical switching transient test (relay induced transient) may impose voltages of 600V or higher with currents of just a few amps and energies in the range of millijoules—large enough to damage sensitive solid state devices. For this test, the electrical parameters were estimated with the following values chosen. Voltage: 600V peak to peak; 2A current; a 1-MHz damped sine wave, repeated 1000 times to simulate a transient of 1-ms total duration. This is an arbitrary electrical switching transient for illustration only.
- 5) The 1-MHz lightning-induced transient (designated by the damped sine on the bar chart) is a damped cosinusoid, has a set 600V amplitude, is transformer-induced into the wire, has an initial fast risetime of about 100 ns (3 MHz), and is to simulate lightning resonance on the aircraft. The induced current is high but the energy is fairly low.

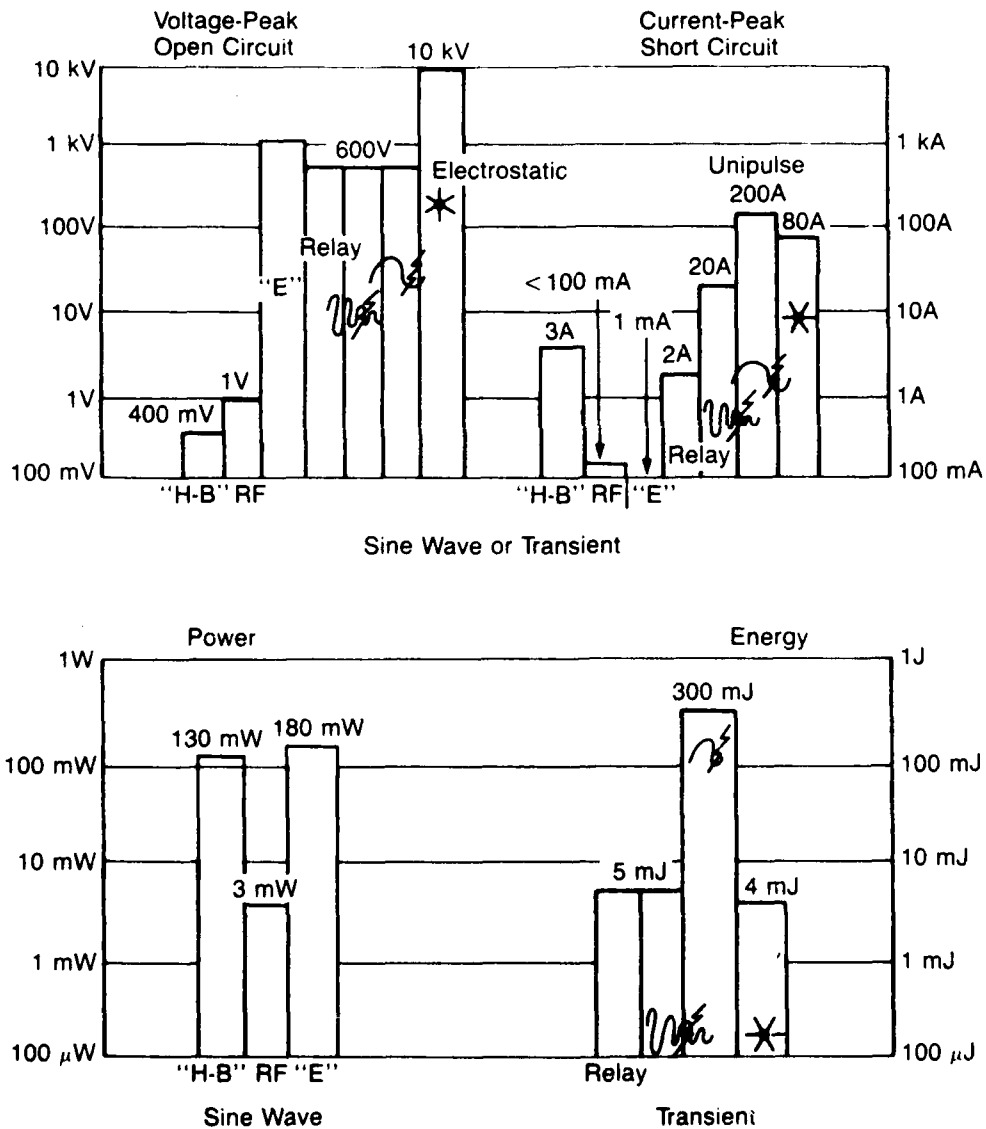

Figure 3.4-4 Selected EMI Levels

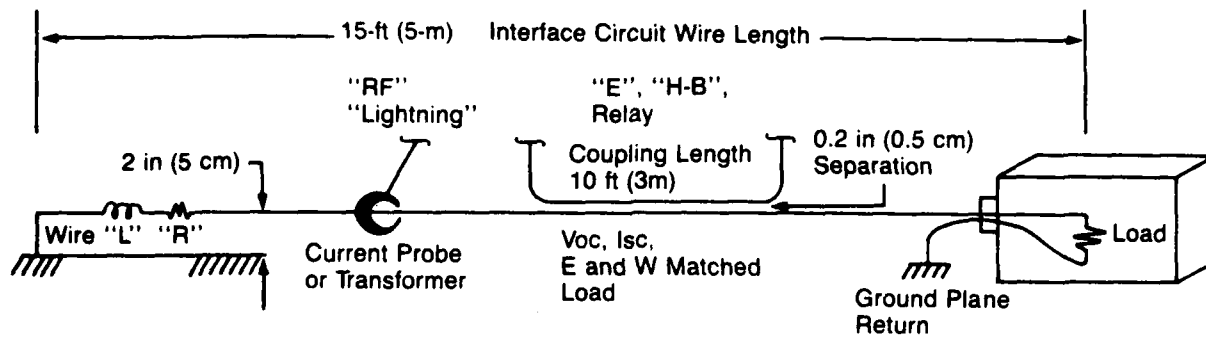

Figure 3.4-5 Laboratory Test Setup

- 6) The so-called "ground potential test" (designated by the pulse waveform on the bar chart) is a 600V, 10 μ s unipulse or "double exponential" waveform to simulate a controlled lightning induced current transient in structure. Observe on the figure the dramatically higher current, 200A, and much higher energy of the unipulse. The unipulse is a very powerful noise source. It carries a considerable amount of energy and can easily damage and destroy electronic components. A balanced circuit design or substantial protection is needed to divert or block this transient. The test setup is different from that shown in the figure. The 600V waveform from the transient source is preestablished on a 5 Ω load, then the voltage is applied with a "source" transformer connected between ground and the avionics case/housing (and any signal return) where the resulting waveform will vary depending on avionic equipment circuit loading and wiring design. Any circuit using structure as return will receive the full impact of this transient.
- 7) The profile of the electrostatic discharge transient (designated by the "star" on the bar chart) shows an exceedingly high-voltage pulse of 10 kV, which is capable of causing dielectric breakdown of insulation rather than the usual condition of thermal burnout of a semiconductor or microcircuit. The short circuit current can be high but the width or duration of the pulse is so narrow or short that it results in a low energy level. The application is different from that shown in the test setup figure. The transient is applied directly to the circuit wire or connector pin. These electrical parameters apply: 150-pF, 50 Ω source through a 1- μ H, 1m wire to a simulated 50 Ω load for maximum power transfer.

3.4.3 EMC Quality in Maintenance

Structural shielding, wire shielding, and interface circuit protection—must be maintained through the life of the aircraft. Here are some of the most important items:

- 1) Keep the controlled wire routing and the wire separation design intact. The original design of wiring is formulated to ensure that faults will not propagate, that critical functions are redundant, and that electrically noisy circuits are separated from vulnerable circuits.
- 2) Concentrate on maintaining short shield ties to the structure or to "line replaceable unit" (LRU) box if structure is graphite-epoxy. Shield ties or "pigtailed" do not usually receive the attention they warrant. Shield tie length is extremely important in the effec-

tiveness and quality of shielding. A shield tie that is short, less than 2 or 3 inches, is highly desirable; longer lengths, 6 inches or more, degrade the entire shield. The best termination is to the connector backshell. Future connectors will have backshells and filter pins that will need maintenance.

- 3) Maintain electrical bonding and grounding quality. Careful surface preparation, proper joining techniques, care of bonding straps, and finally adequate conductive sealing of joints and seams ensure the continuation of the excellent shielding and electrical grounding provided by structure.
- 4) Be aware of electrostatic discharge. Electrostatic discharge is a key intruder in handling and maintenance procedures. Microcircuits may be impaired or destroyed by a pulse from a hand or an item of clothing. The event can go unnoticed. Conductive materials and grounding procedures, along with a training program, will provide techniques for failure prevention.

3.4.4 Shielding and Shield Ties

Shields may be single braid; double braid; braid and foil; shields inside an overall bundle shield; solid conduit, tray, or cableway; and aircraft structure.

The shielding effectiveness (SE) of shields is based on materials and dimensions and circuit connections and impedances and shield tie lengths and has been one of the most elusive electromagnetic compatibility protective defenses to pin down. (A significant issue for future aircraft needing to be addressed is that of the wiring lengths installed during laboratory tests versus the actual aircraft installed length.) Length influences SE and SE can dictate length or design. A single braided shield with a 2-inch shield tie may offer less than 25 dB of protection over the span of 10 kHz to 100 MHz. A long wire, 100 ft (30m), may only show 10 dB above 1 MHz at some resonant frequencies under certain conditions. A solid 360-deg connection to a backshell can improve protection. Conditions that establish the grounding of shields vary, but there are some that need emphasis:

- 1) Ground audio or analog shields at receiver end only
- 2) Ground digital or wideband signal circuit shields at both ends
- 3) Ground shields subjected to high frequencies (greater than 50 kHz) at both ends
- 4) Ground shields that contain or are a barrier to transients at both ends
- 5) When audio and high-frequency requirements conflict then the circuits and installation must be evaluated. (Solution may be rerouting of wires or double shielding.)

Carrying a shield tie through an avionics unit connector, into the internal wiring harness, and to a circuit card connector is poor wiring practice. A 360-deg, peripheral shield connection to the backshell is the best (figure 3.4-6).

3.5 AIRCRAFT PROTECTION MEASURES

3.5.1 Structure Conductivity

Conductivity is the predominant electromagnetic compatibility consideration of materials in the basic steps to a unified aircraft structure design (figure 3.5-1). What are the separate electrical functions so highly dependant on conductivity (figure 3.5-2).

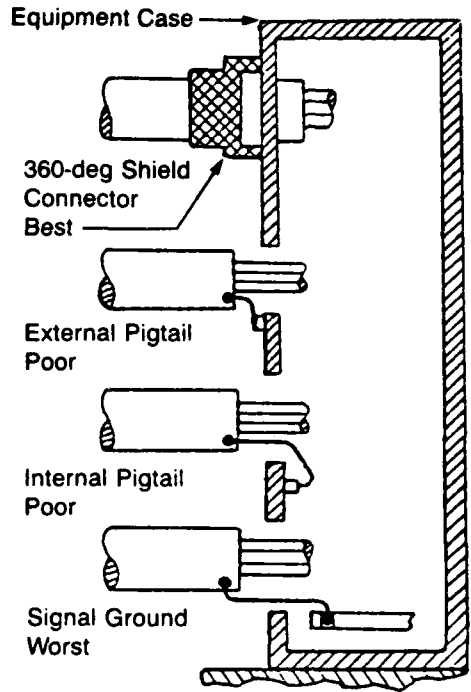

Figure 3.4-6 Shield Ties

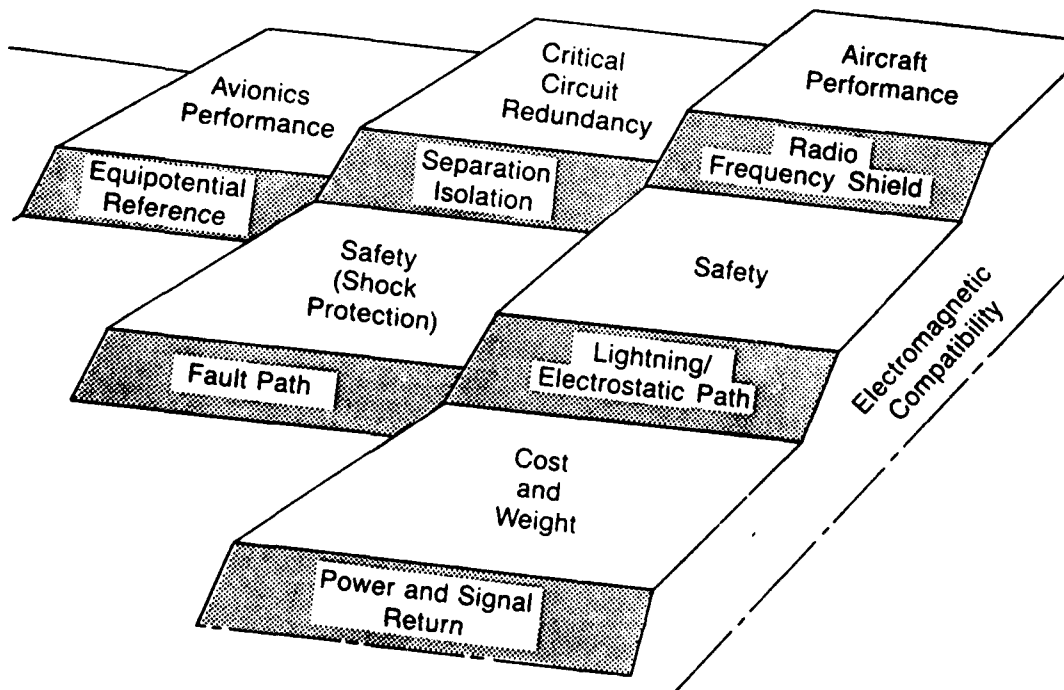
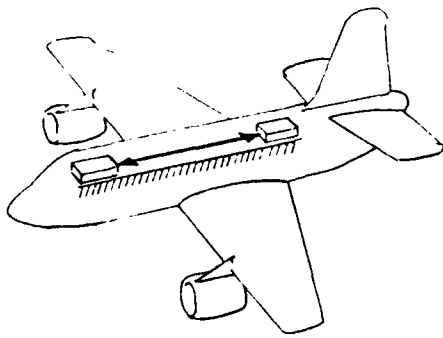
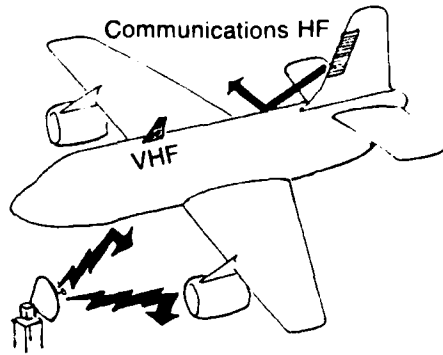

Figure 3.5-1 The Grounding Steps



Equipotential Ground Plane Reference (Stability and Performance)



Radio Frequency Shield
 • Radar (Critical
 • Radio or Equipment
 • Television Operation)

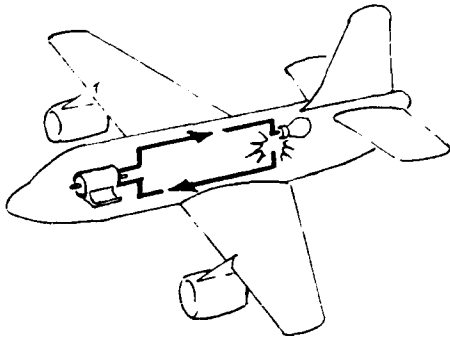

Safety Fault Path (Passenger and Personnel Protection)

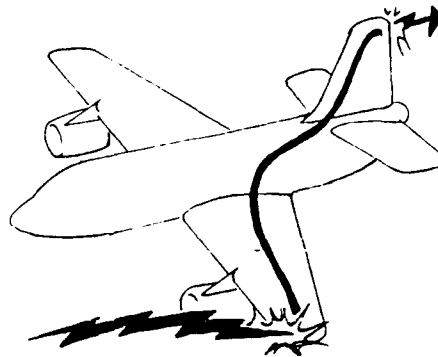

Lightning Diversion Path Electrostatic Drain (Passenger Safety and Equipment Protection)

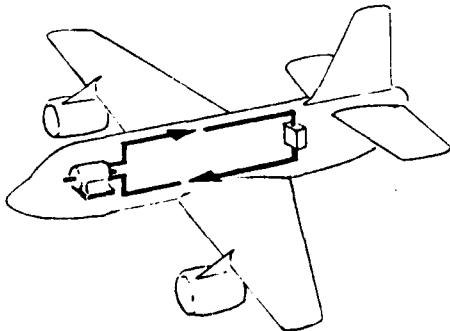

Power and Signal Return Path (Weight and Cost Reduction)

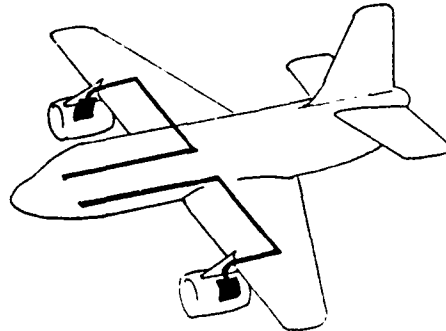

Separation-isolation Redundancy (Critical Equipment Operation)

Figure 3.5-2 Structure EMC Roles

- 1) **Electrical stability:** A low noise ground reference plane—a stable zero reference foundation for electrical and electronic circuit and shield ties (may have less than 500-mV ground noise). This electrical “ground” embodies structure, shelving, skin, spars, equipment chassis, and possibly uniquely installed grids, sheets, and foil.
- 2) **Shielding:** Aircraft structure, skin panels—foils, flame spray, plating, paint—shelves, equipment enclosures, and wire shields. Shielding affords a barrier to external and internal radio frequencies, 400-Hz electric fields, and 600V transients.
- 3) **Fault path:** Structure, skin panels, cable shields, safety wiring (green wire). The engineered fault paths divert currents to assure safety of passengers and personnel, prevent hazardous voltages, avoid ignition of combustibles (fire prevention), and limit equipment failure and upset.
- 4) **“Diverter”:** Structure, skin panels. The aluminum aircraft inherently offers the current control paths and bypass to eliminate shock hazard and damage from electrostatic charge and lightning.
- 5) **Signal return and power return:** Cost and weight savings accrue through the use of structure as a return instead of the installation of wire.
- 6) **Reliability and redundancy:** Parts of the aircraft may be employed as a baffle or wall to provide separation of wiring or equipment.

The engineering of the structure, et al., to accommodate all of the electrical functions, entails detail design of electrical interfaces, bonding straps, foils, paints, etc. (figure 3.5-3). Bonding resistance tests can be made during the aircraft EMC test (see Section 7.0).

It is illustrative and instructive to compare an aircraft with an electronics facility to help recognize the significance of the aluminum structure as a substantive electrical component (figure 3.5-4). Except for framing, many of the facility building materials are not conductive.

The electrical functions so freely supplied by the airplane structure must be built into a properly constructed facility using extra materials and supports. Whereas the airplane unifies the functions, in the facility they are separate (figure 3.5-5).

3.5.2 Shielding

Aluminum, after copper, is one of the best electromagnetic shields. Its effectiveness varies with thickness and frequency. One or two thousandths (1 or 2 mils) is good (figure 3.5-6).

Wherever shielding, grounding, or conductive properties are lost at joints and seams (figure 3.5-7) or are not available from structure and therefore continuity is compromised, shielding must be added. Aluminum foil, flame spray, plating, and paint are candidate solutions (figure 3.5-8).

Foil (aluminum or copper) is a good shield, conductor, and reference plane. Foil may bring with it an increased effort to establish quality of bonding to adjacent parts, reliability under environment and vibration, and integrity and durability. Moreover, the foil size, thickness, and geometric configuration dictate its economy of installation. Foil can make a good wire shield.

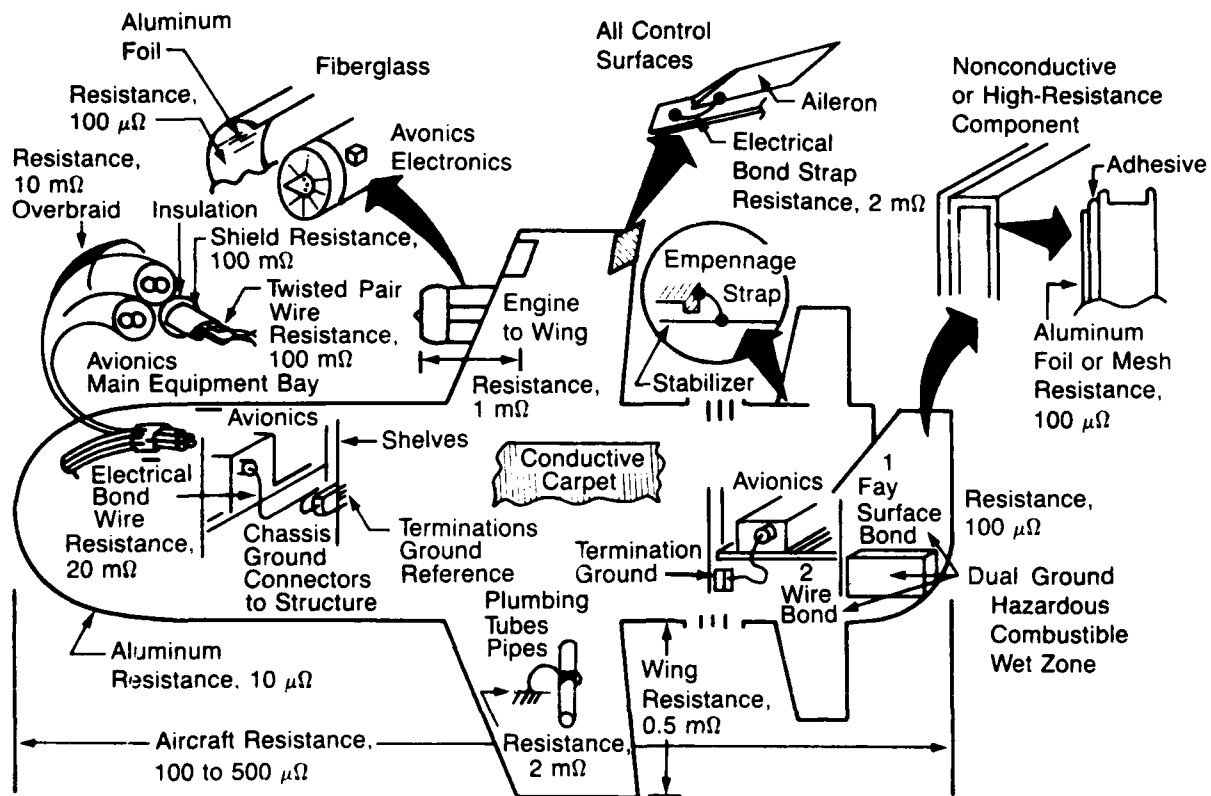

Aircraft Electrical Bond:
 All structure, panels, skin, pumps, valves, tubes, flanges, mountings, avionics, housings, doors, foil, and mesh.
 "Any conductive part greater than 3 in (7.6 cm) on a side"

Total Electrical Bonding and Conductivity

Figure 3.5-3 Details and Installation

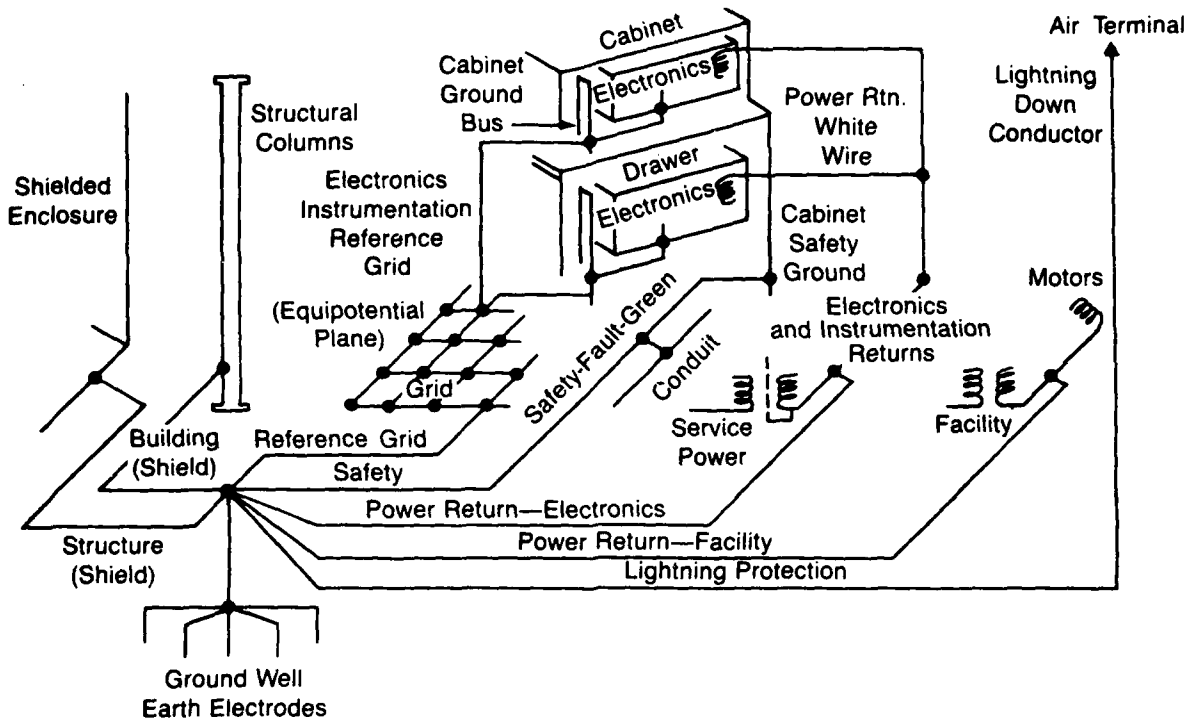

Figure 3.5-4 The Seven Earth Ground Connections

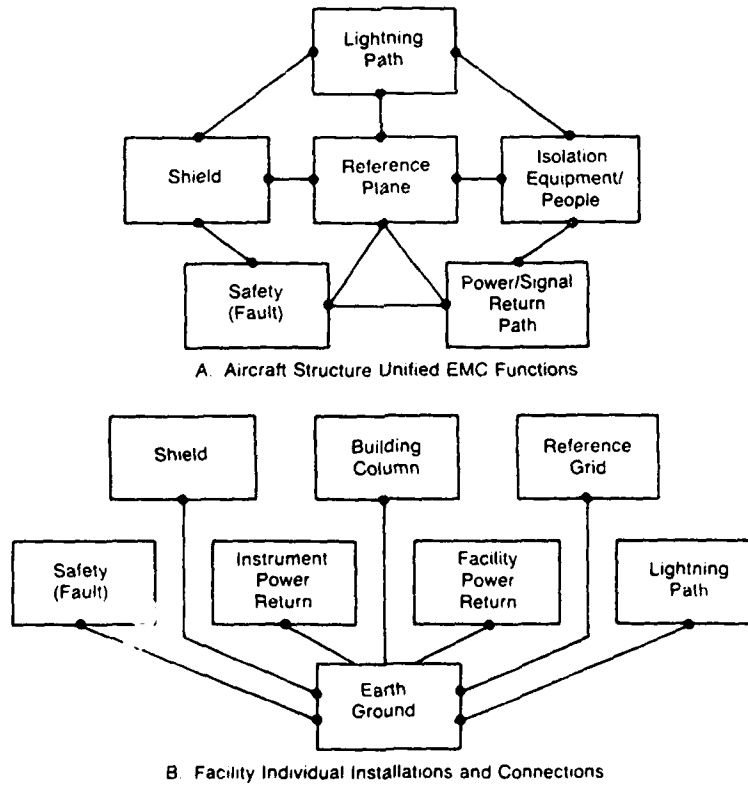

Figure 3.5-5 EMC Anatomy Block Diagram

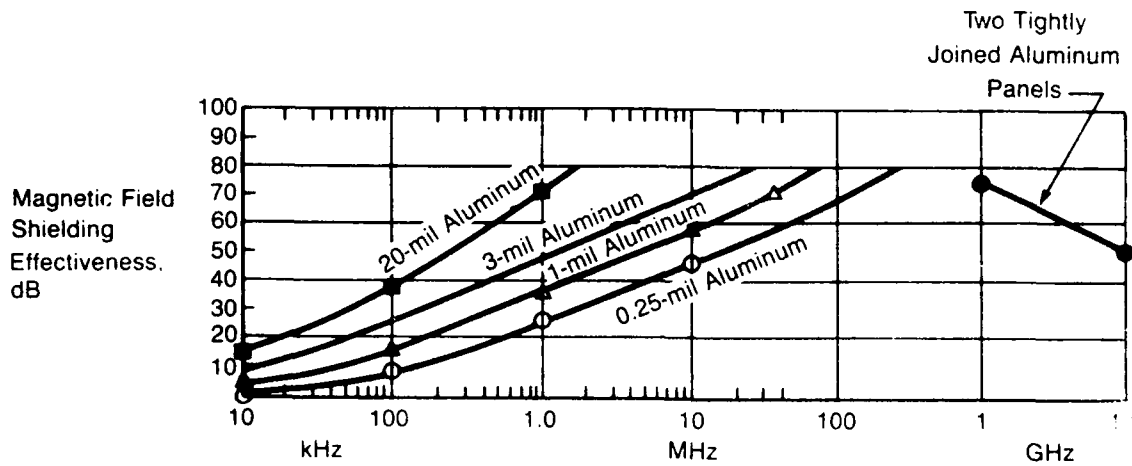

Figure 3.5-6 Magnetic Field SE of Aluminum

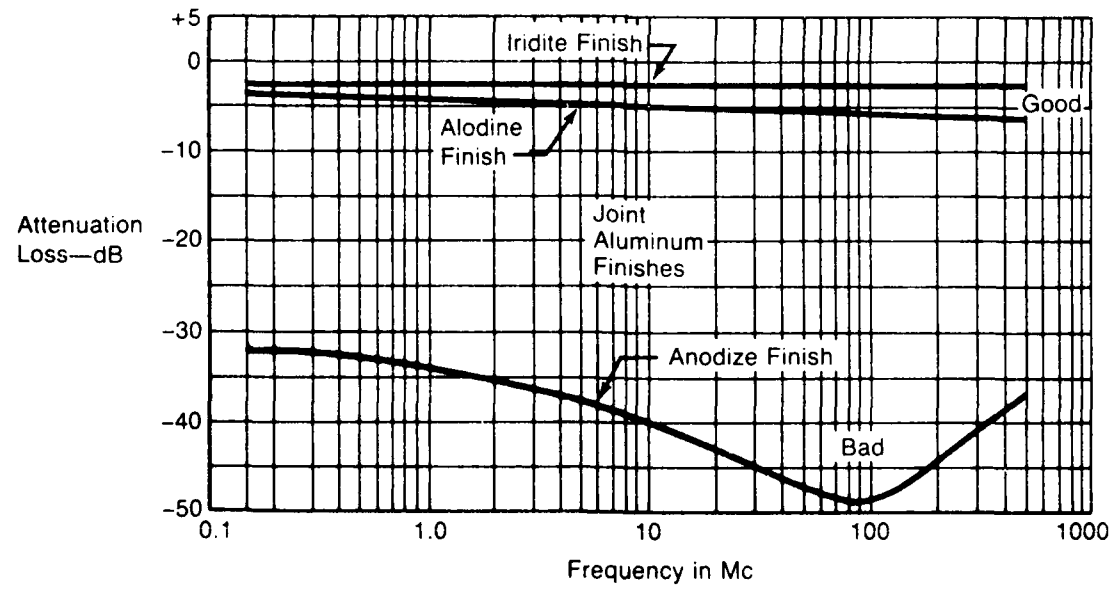

Figure 3.5-7 Loss of SE with Joint Finish

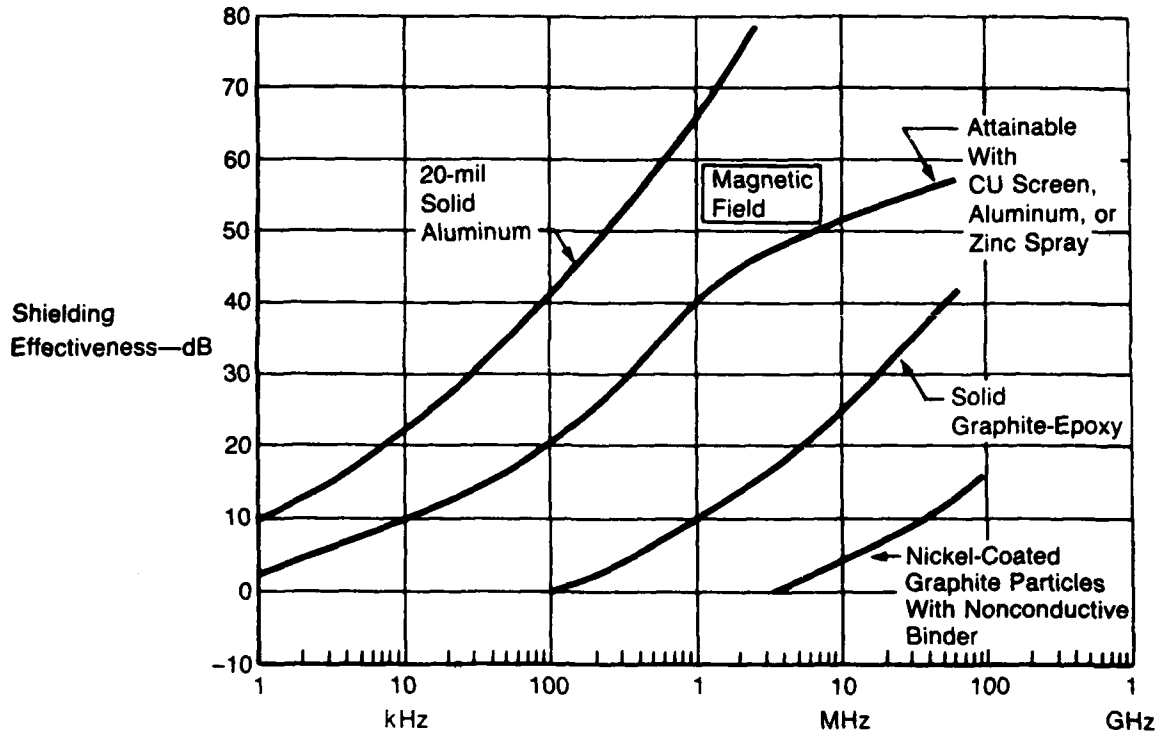

Figure 3.5-8 SE Comparison

Flame spray applications (aluminum, copper, or zinc), even by skilled operators, can be difficult to apply in a controlled fashion. The resistance of flame spray coatings is higher and shielding effects lower even with greater thicknesses than foil. Its dense coat and coarse finish on a substrate can lead to flaking or cracking under vibration and moisture conditions with obvious loss of qualities.

Paints (metal or containing conductive agents or fillers) provide good shielding and are used successfully. Insulating or moderately resistive material (graphite-epoxy) may be painted to provide shielding or conductivity or they may be overlaid with aluminum mesh or foil.

Wire shielding provides another layer of protection (figure 3.5-9). Aircraft structural shielding is an important companion to wire shielding. The levels of shielding effectiveness are computed for each wiring run location and configuration to determine the accurate values and these can then be combined with modeled and calculated values of structural shielding. Figure 3.5-10 shows some SE levels for silver or gold film that might be deposited on glass and aluminum or copper screen that could be for shielding ventilation ports on equipment. The front and rear spar areas exhibit very poor shielding. The figures depict nominal or typical estimated levels. Shielding exhibits such wide spreads and variations around these levels (dependant on conditions), and especially as frequency varies that these summary representations are useful as a tutorial tool, but are not appropriate as a design tool.

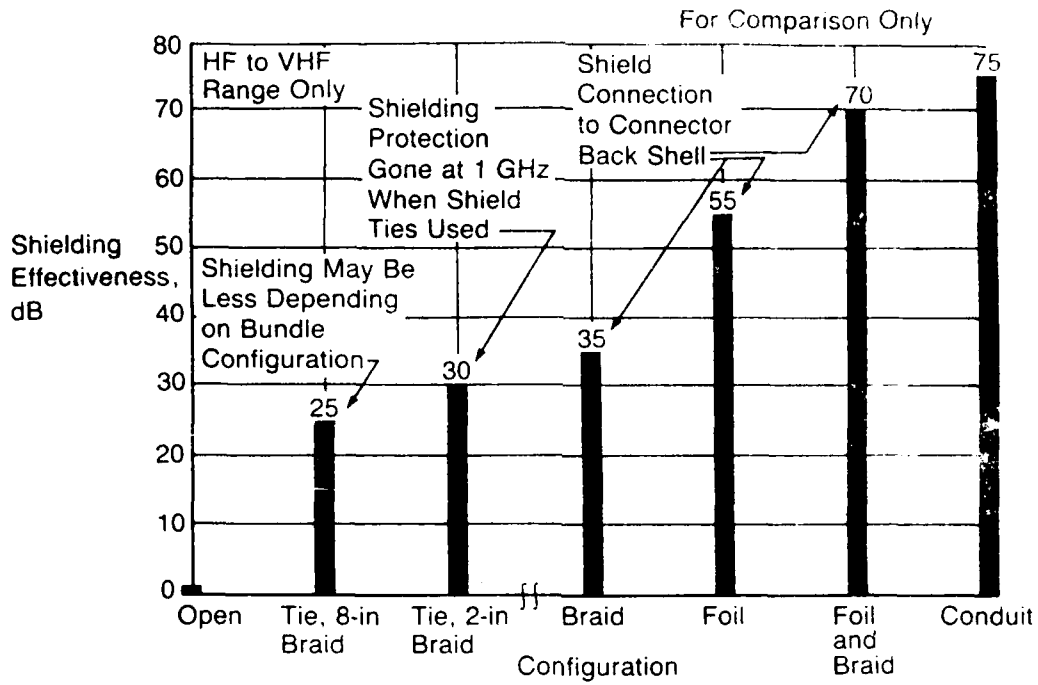

Figure 3.5-9 Wire SE Comparison at HF-VHF

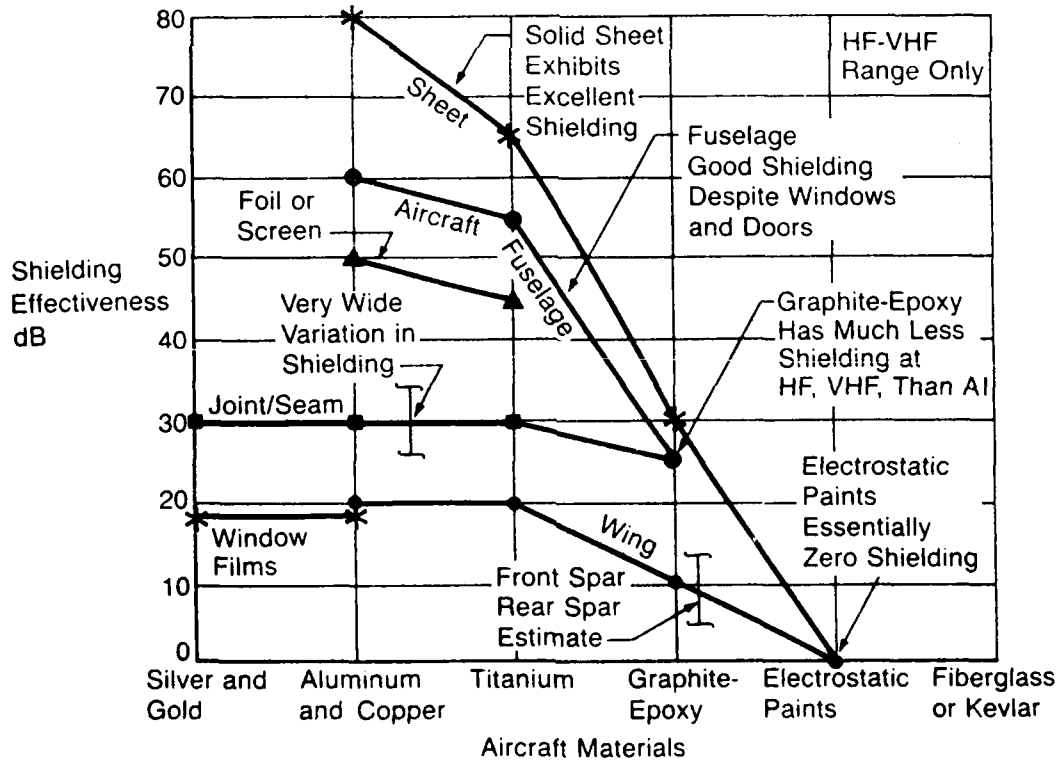

Figure 3.5-10 Material/Configuration SE Overview

3.5.3 Safety in Grounding and Returns

Structure is a ground and a return. Seven separate grounds or returns on electrical/electronic equipment can be identified. Some of these ground/returns are interconnected and perform common functions. Certain individual grounds are always separated to avert mixing noisy and sensitive circuits.

- 1) Case enclosures or housings (electrical/electronic equipment) ground: May be a wire or the case surface. This case enclosure ground acts as a safety ground (fault return), a static ground, and a radio frequency ground. It sometimes is a signal return and possibly a 115V, 400-Hz return.
- 2) 115V, 400-Hz return: Isolated and brought out of the equipment on a separate wire (figure 3.5-11). A twisted pair power supply circuit will improve electromagnetic compatibility.

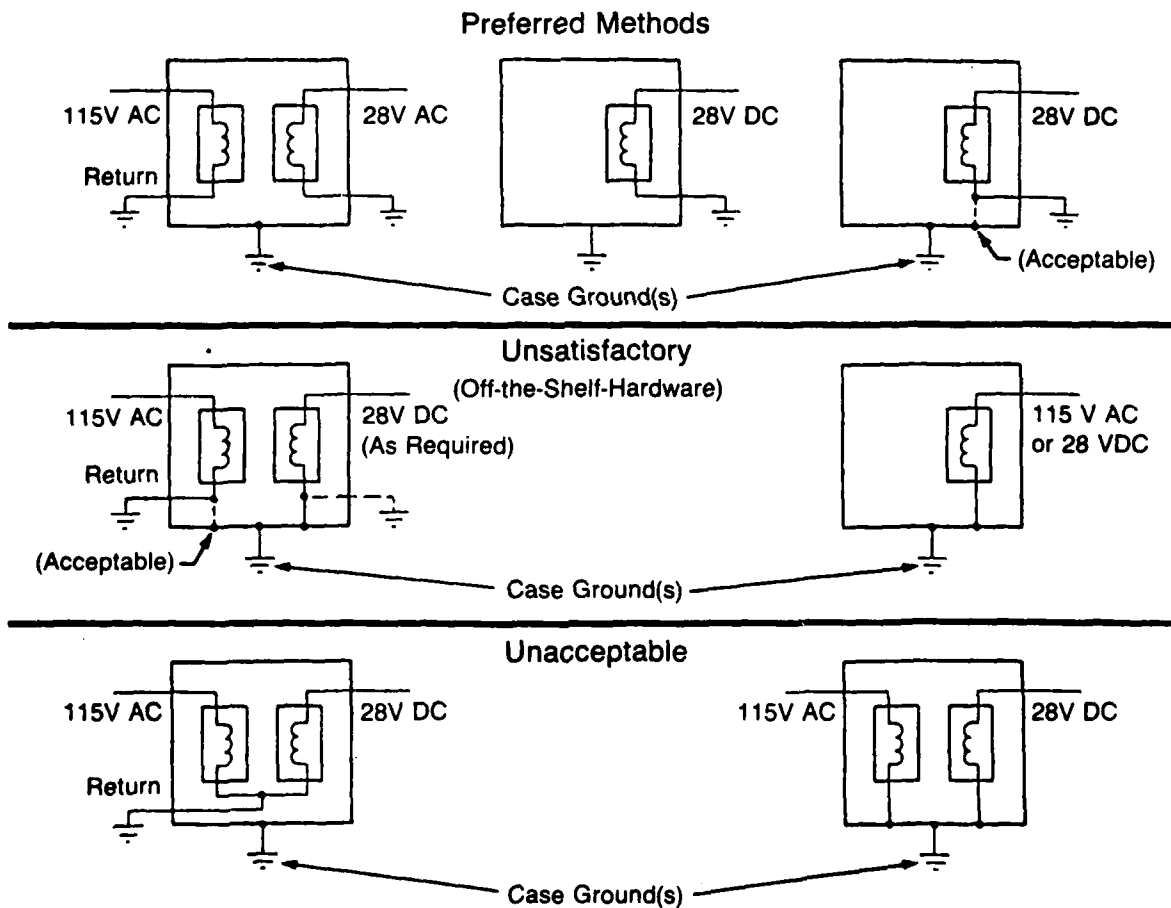

Figure 3.5-11 Power Returns

- 3) 28V, 400-Hz return.
- 4) 28V, dc return.
- 5) Audio or analog circuit return.
- 6) Digital circuit return.
- 7) Shield ties (pigtailed).

Certain case enclosures require dual grounding in a flammable leakage zone or water exposure area possibly around wing, cargo, and tail locations to offer redundancy and safety in case of electrical fault. Power returns are brought out of these zones before being terminated to structure. Each circuit is exhaustively reviewed for voltage, current, resistance, and potential voltage drop at each connection. MIL-B-5087 gives resistance limits of 6 m Ω to 11 $\mu\Omega$ maximum when computed fault currents are 50A to 7 kA.

3.5.4 Resistance

Two and one-half milliohms (0.0025 Ω) is the most often quoted resistance maximum for a termination or connection when designing for electromagnetic compatibility. It is applied to wire terminations, case enclosures, mounts, shelves, panels, doors, and radio frequency components. The 2.5-m Ω limit is appropriate wherever any component or structure forms a part of the ground plane, shielding, fault path, or power or signal return.

Panels, rails, frames, access doors, all conductive items in the flight deck are bonded especially to reduce electrostatic discharge.

Pumps, valves, flanges, lines, vents, and penetrations in the fuel tank are bonded especially to prevent arcing from lightning. Transport aircraft undergo thorough research and assessment of conductivity or resistance. It is sometimes difficult to attain 2.5 m Ω . The resistance of aluminum is a good basis for comparison of other materials (figure 3.5-12 and figure 3.5-13).

Ground planes establish the electrical foundation for any system. Copper is practical, affordable, and is usually employed in the electromagnetic compatibility laboratory (figure 3.5-14). Currents flowing in copper have a low IR drop and therefore provide a low noise system. Aluminum usually offers good conductivity through faying surface bonds or permanent joints. A number of factors affect resistance; pressure and surface finish are significant (figure 3.5-15 and 3.5-16).

When components do not form a part of the electrical design but must be grounded for safety, a 1 Ω resistance is often adequate. Where electrostatic charge buildup is of concern on nonconductive materials such as on external dielectric surfaces, the resistance limit may be allowed to be much higher. Military Handbook 263 gives 500 k Ω to 100 M Ω as the range to adequately drain away electrostatic charge.

In summary, the complexity of the joining process and its maintenance is contrasted by the simplicity of the electrical bonding resistance limit: 2.5 m Ω . Aluminum is the grand conductive foundation. The part that it plays cannot be overstated. It stabilizes, shields, conducts, isolates, and protects.

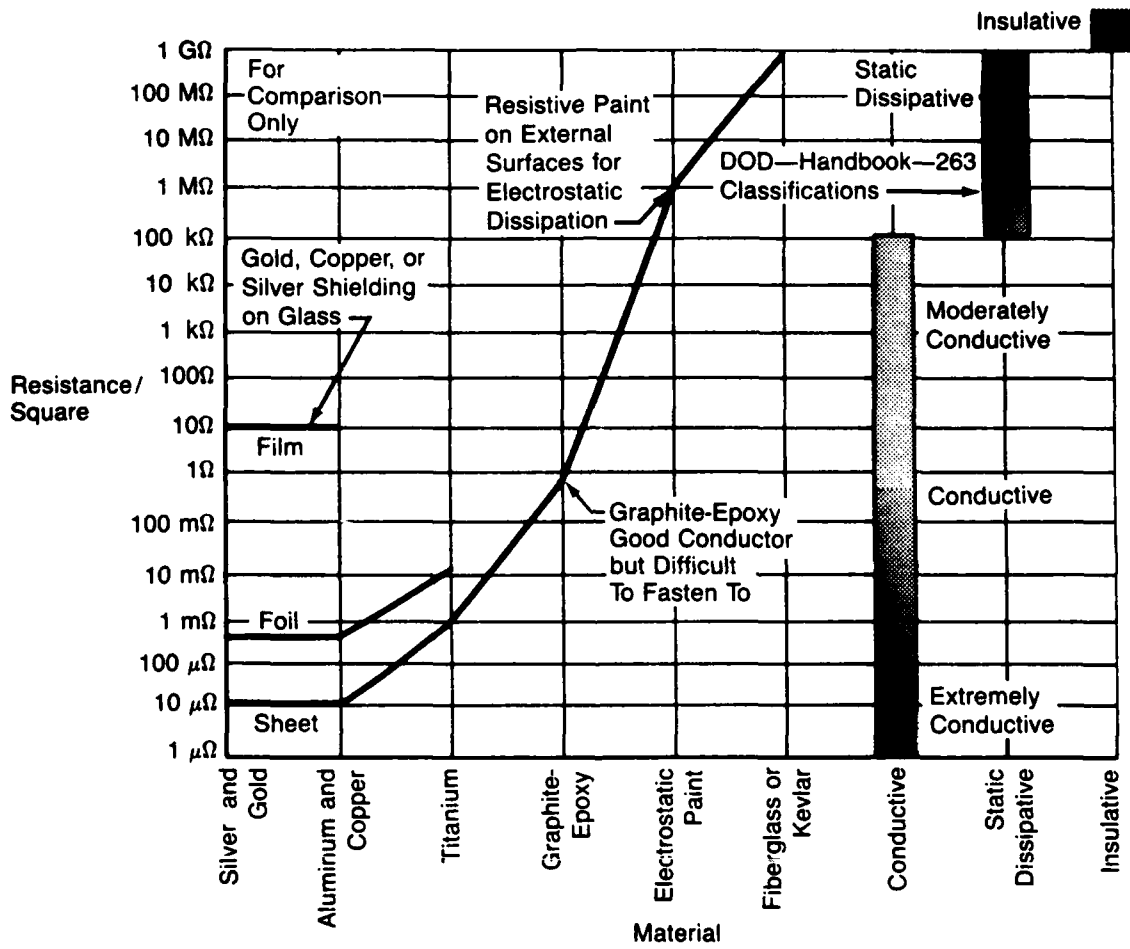

Figure 3.5-12 Material/Resistance Overview

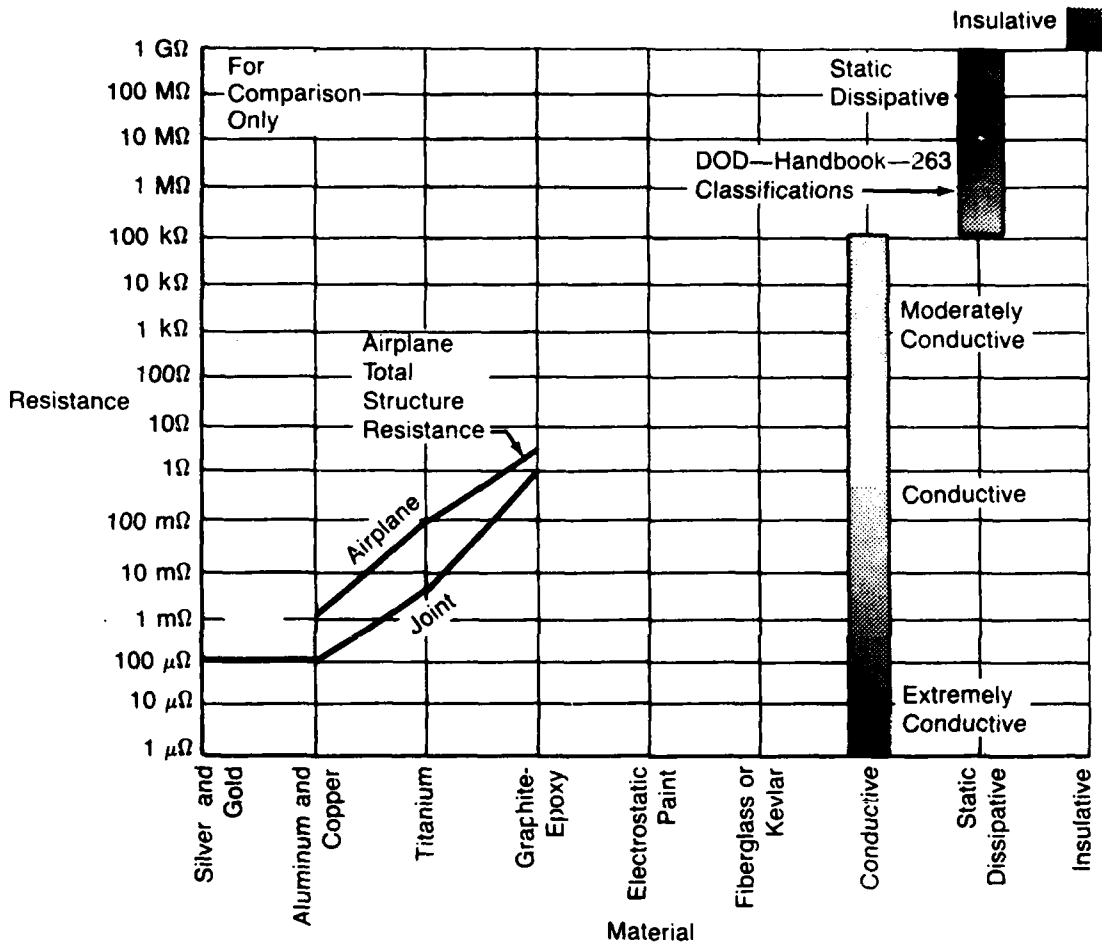

Figure 3.5-13 Configuration/Resistance Overview

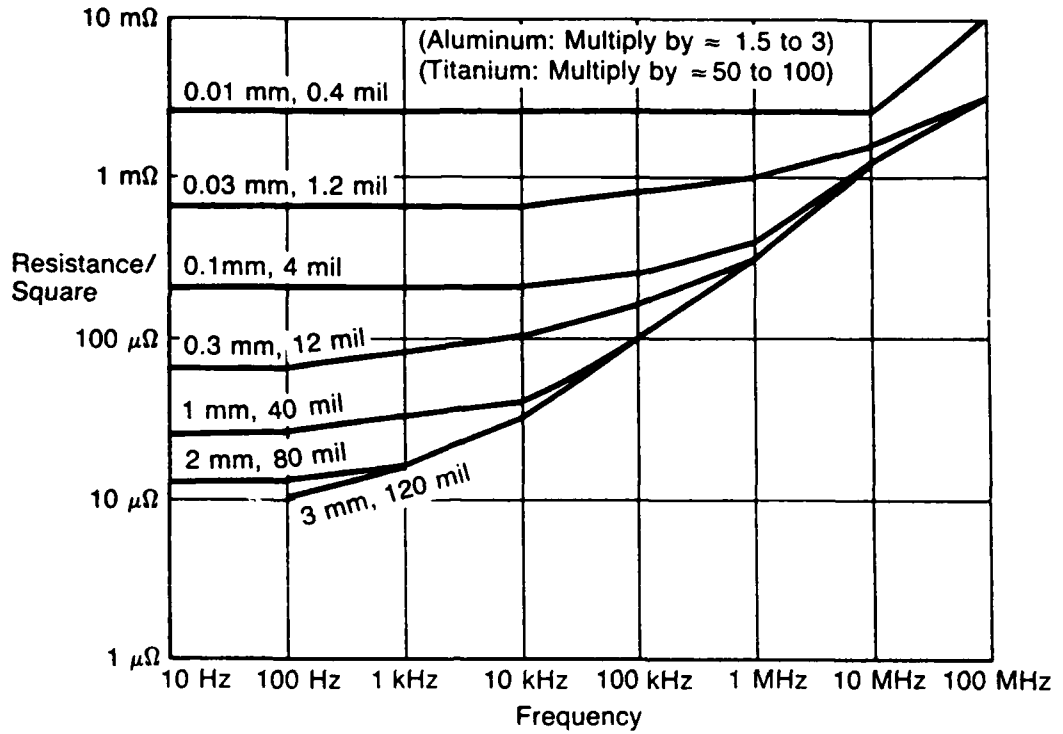
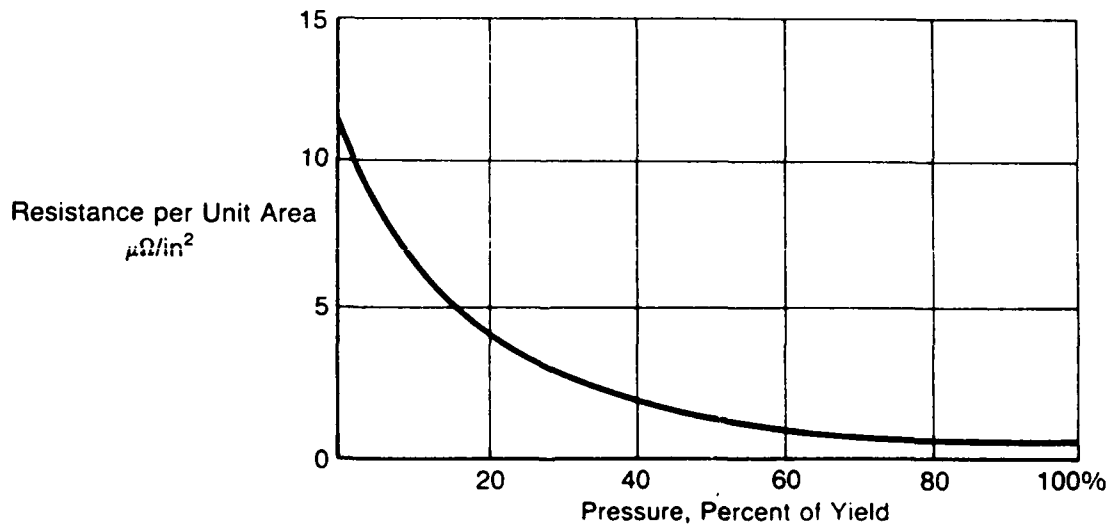

Figure 3.5-14 Resistance Plot—Copper Plane



Sections of 2024 Aluminum Alloy Under
Compression With Joint Sanded Prior to Test

Figure 3.5-15 Resistance Versus Pressure

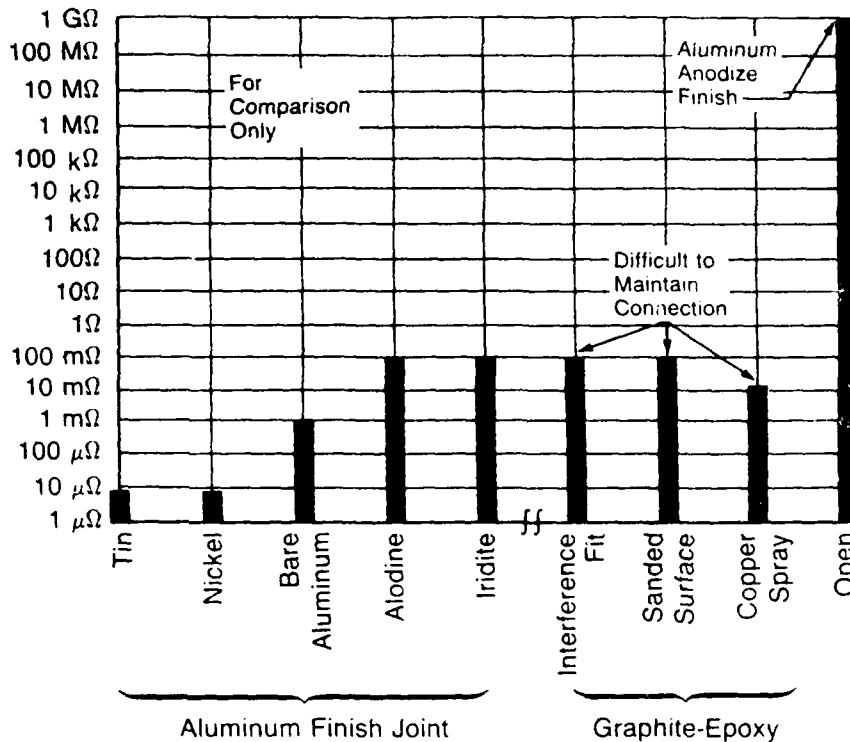

Figure 3.5-16 Joint Finish Resistance

3.5.5 Resonance

Aluminum structure and single wires as conductors have a drawback. They resonate (figure 3.5-17). Structure and single wires must be avoided in high-frequency circuit design.

3.6 COMPOSITES

Graphite-epoxy is a fair to good conductor and shield.

Kevlar and fiberglass are insulators and have no affect on radio frequency fields. Dielectric structural materials need to be modified to provide electromagnetic shielding

Nonmetallic materials form many parts in today's aircraft (figure 3.6-1) and are expected to increase in the future. When varieties of materials are brought together, the interfaces lead to escalating possibilities of material mismatch between finishes, fasteners, and adhesives with possible adverse implications for the quality of electromagnetic compatibility.

Graphite-epoxy will conduct and will shield. Electric field shielding is very good. Following is a comparison of appropriate electromagnetic compatibility-related characteristics:

- 1) Dc resistivity: more than 1000 times greater than aluminum in longitudinal direction and 100 thousand to 1 million in the transverse direction.
- 2) Joint resistance: 30 m Ω to 1 Ω or higher. Graphite-epoxy is first, difficult to fasten to electrically, and second, the connection is difficult to maintain. New techniques and better procedures are being developed. Today, graphite-epoxy cannot be used as a power or signal return.

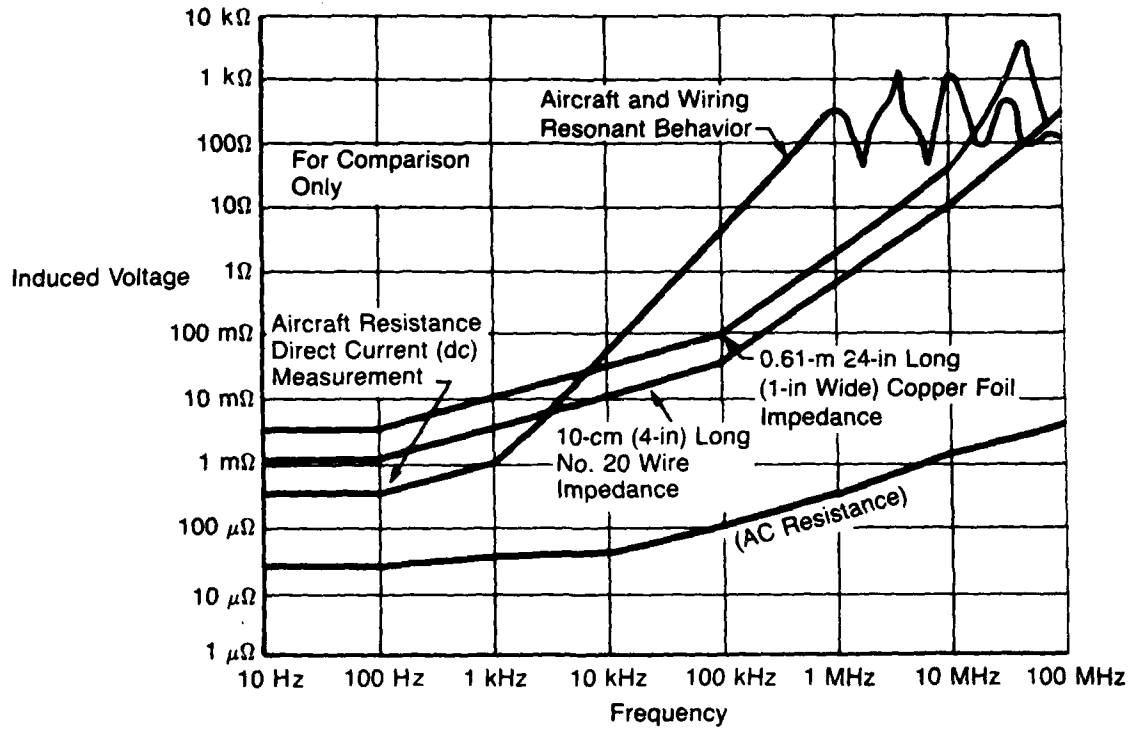

Figure 3.5-17 Aircraft and Strap Resonance

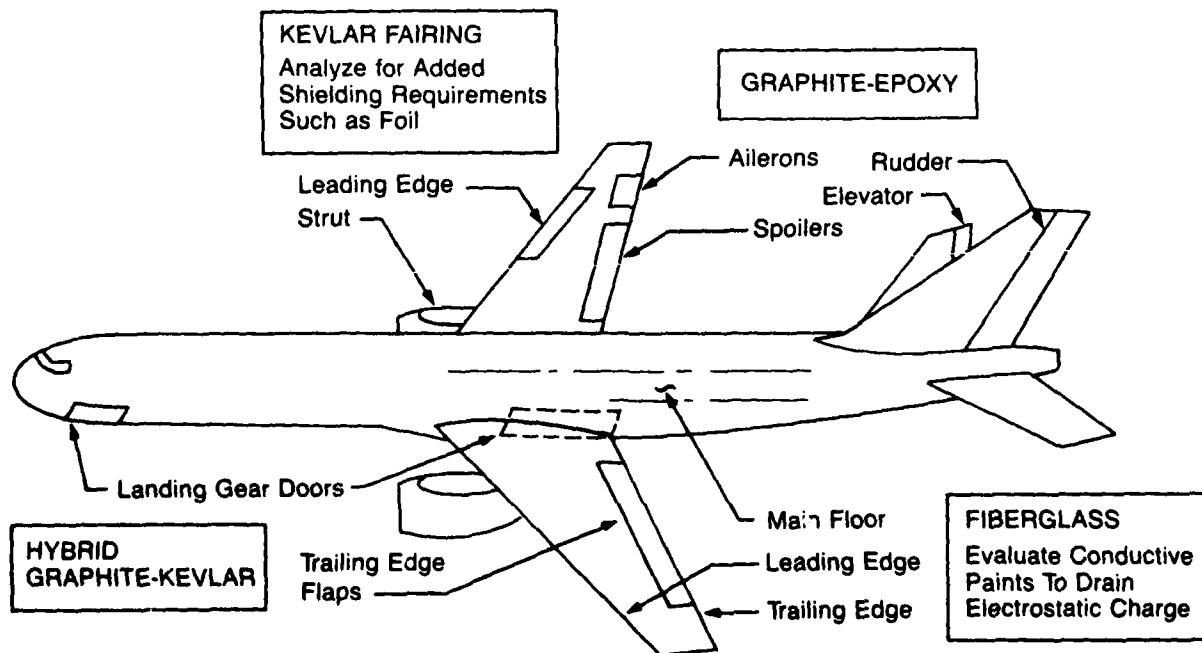

Figure 3.6-1 Typical Nonmetallic Applications

- 3) Magnetic shielding starts at about 1 MHz, rises to 60 dB at 100 MHz with about 35 dB in the HF-VHF range.

If graphite-epoxy is not well bonded at seams and joints, it will not act as a shield.

If composites are used extensively for structure, the greatest impact is in providing for a ground plane, and the signal return system, and the power return system, which will require their own installations of wire, conductive foils, strip, or cableways. Graphite-epoxy resistance is too high to provide an adequate ground plane (except for antennas). Figure 3.6-2 shows the general level of resistance of a large cylinder or tube, and indicates that its use as a power return path and signal return path is unsatisfactory.

If graphite-epoxy or insulating materials are built into the structure, loss of shielding may open up a path for noise from fluorescent lights, switching regulator and clock oscillator harmonics to reach the ADF, HF, or VHF receivers. Or, in turn, HF frequencies may enter wiring and the avionics. The effects of radio frequency electromagnetic interference are becoming more of a concern (figure 3.6-3). Figure 3.6-4 illustrates some of the resistance levels that might be encountered and shows the use of twisted pair or twisted pair shielded wire.

In the world of electromagnetic compatibility, our protection and safety lies in an integrated design: architectural or structural shielding, shielded wiring, interface circuit voltage limiters, and software correction techniques. The soul of electromagnetic compatibility is a balanced, isolated, shielded interface circuit. It is practically impervious to conductive, inductive, and capacitive attack of electrical noise.

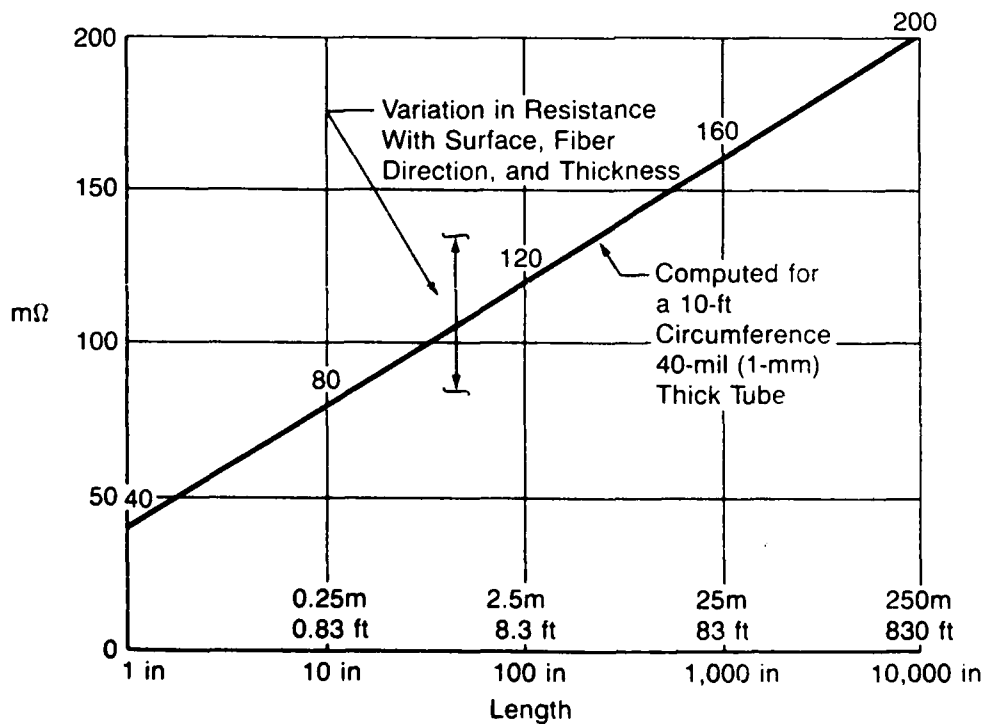

Figure 3.6-2 Graphite-Epoxy Resistance

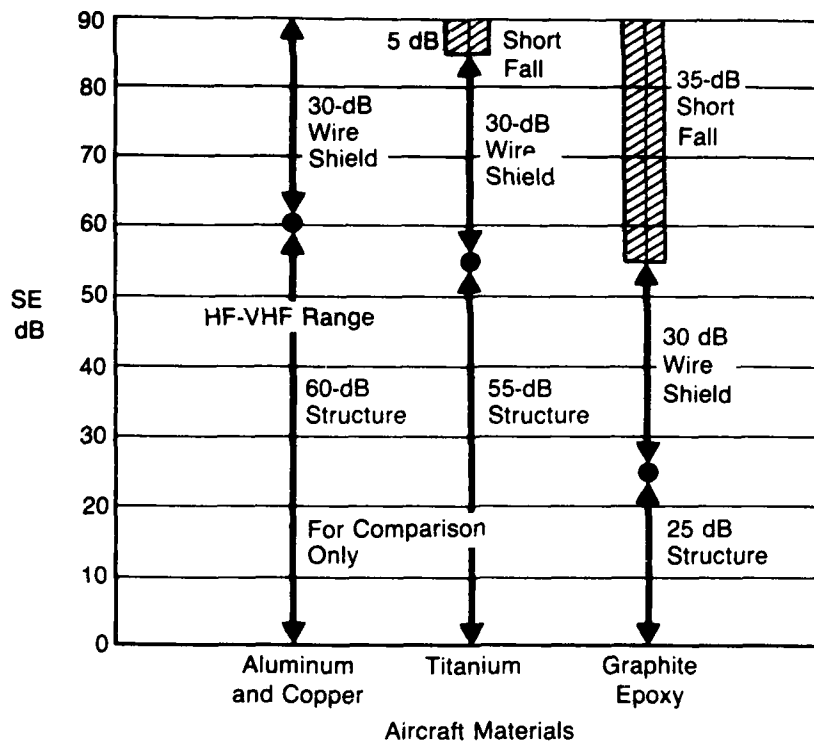

Figure 3.6-3 Graphite-Epoxy SE Shortfall

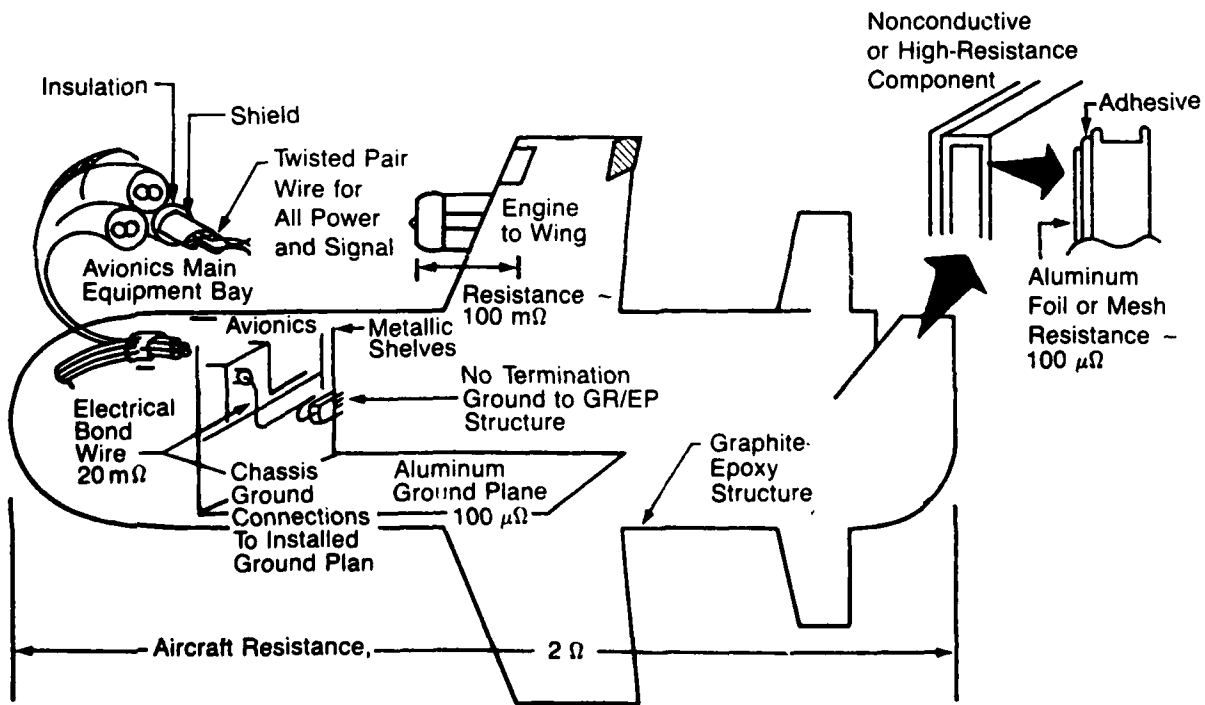

Figure 3.6-4 Graphite-Epoxy Details and Installation

4.0 EMC ANALYSIS AND ENVIRONMENT

4.1 RADIATED ENVIRONMENT

4.1.1 Radio Frequency Field Distribution

4.1.1.1 Environment

The electromagnetic radio frequency spectrum is vast. Electromagnetic radio frequency field strengths—measured in volts per meter—vary widely. But, how do we bind them and treat them so we understand their significance? Well, for the purposes of electromagnetic interference simplicity, one might say we, as humans, and the aircraft, as an object, exist in a dimensional world of roughly 300m to 1m which, converted to radio waves, is 1 MHz to 300 MHz.

That is very important for electromagnetic compatibility.

The ANSI radio frequency protection guide for personnel has the strongest field strength limitation over the span of 3 to 300 MHz. People, airplanes, wiring, and the avionics equipment itself are most susceptible to the frequency spectrum spanning the range of 1 to 300 MHz. This is the HF-VHF range (figure 4.1-1). The conditions and behavior of radio frequencies are sometimes so complex that radio frequency measurement and design efforts have often been given the title of "black art." Stray fields, cavities, diffraction, absorption, resonance, constructive interference, destructive interference: all of these interact to make the details of radio frequency studies conceptionally difficult over some of the transitional frequency ranges.

The spectrum of radio frequency fields that penetrate aircraft wiring and enter into the avionic inputs to attack integrated circuits can be bounded and summarized over three basic regions:

- 1) A low-frequency below 1 MHz where radio frequency noise is normally less of a concern because fields are very inefficiently received on a wire.
- 2) The high-frequency and very high frequency region, 1 to 300 MHz, where radio frequency fields are very much of a concern and aircraft wiring acting as an antenna is efficient.
- 3) An upper frequency range above 300 MHz where induced voltages in wiring drop off rapidly with increasing frequency and are easier to control.

High-frequency (HF) and very high frequency (VHF), ground-based FM radio and TV broadcast signals join with their airborne companions, the aircraft HF and VHF communication links, to induce significant voltages on aircraft wiring in the 1- to 300-MHz range. HF-VHF field strengths measured at ground level for selected urban, suburban, and rural areas are plotted in Figure 4.1-2. At altitude, stronger fields can exist (see Section 8.0, Bibliography, ECAC study). The American National Standard (ANSI) personnel safety limit and the Military Handbook 235 Environmental Test Specification are plotted for comparison.

Figures 4.1-3 through 4.1-8 give a general view of the expected induced voltages (in some specific wires under selected conditions) and also a comparison of related environments. This information and data is illustrative and advisory to resolve significance and make comparisons of parametric properties and behavior and is not for use or adaptation to specific designs.

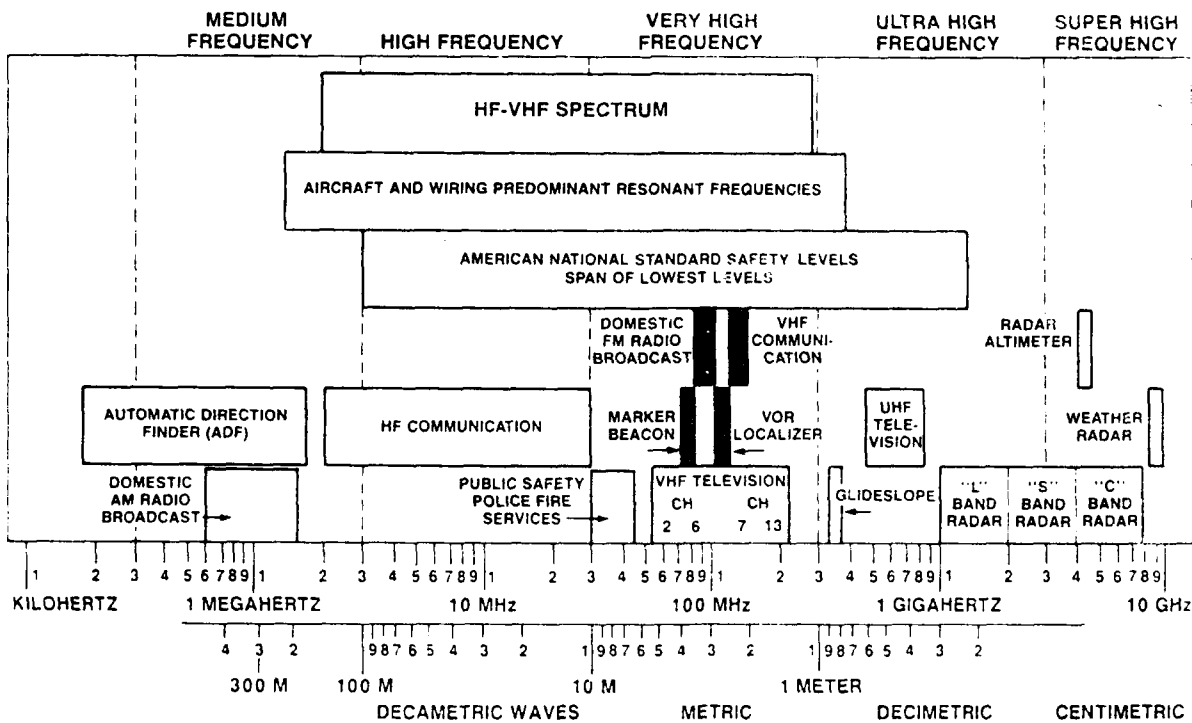

Figure 4.1-1 HF-VHF Range

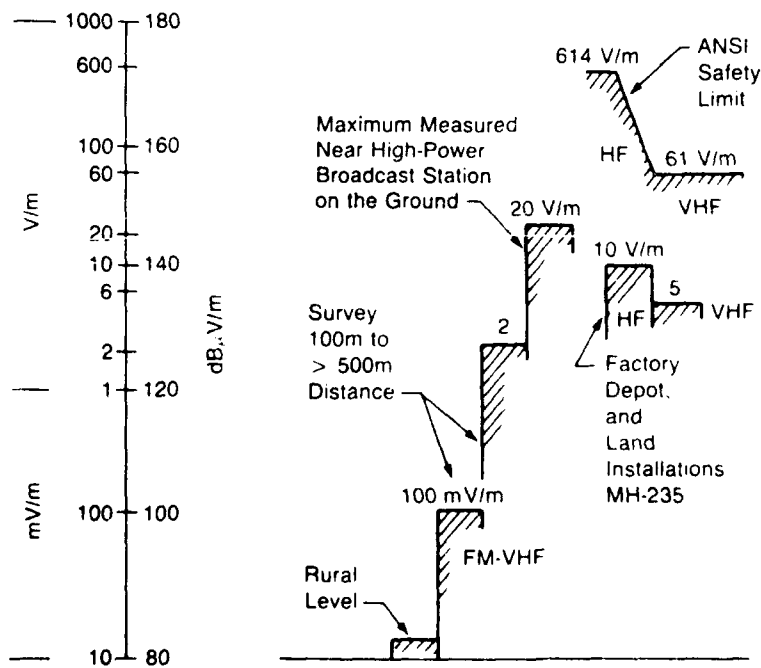

Figure 4.1-2 Selected RF Fields: HF-VHF Range

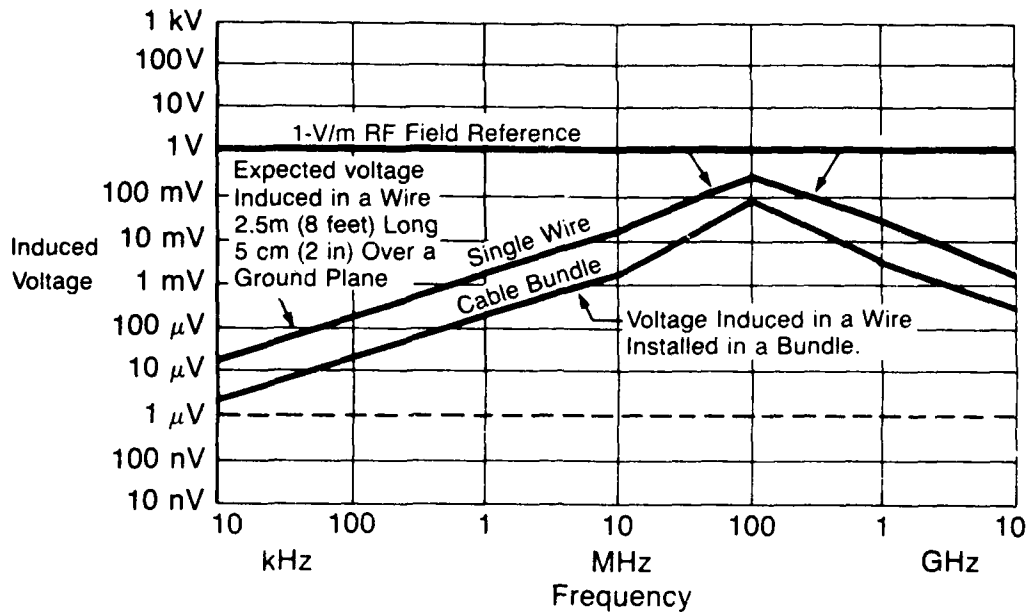

Figure 4.1-3 Expected Wire Voltage—Eight Feet

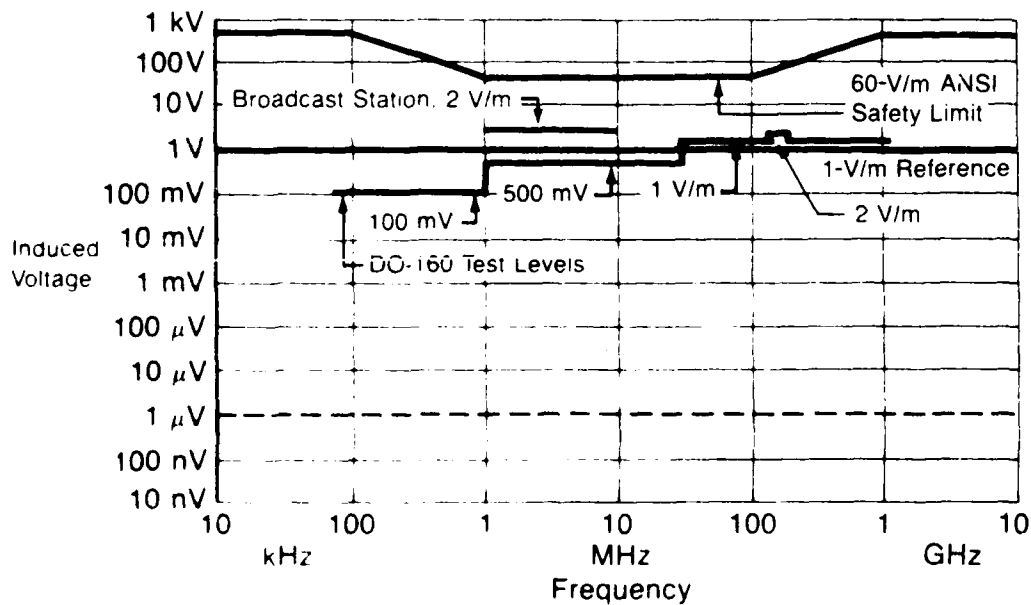

Figure 4.1-4 Environments, Safety, and Test

AD-A189 855

AIRCRAFT ELECTROMAGNETIC COMPATIBILITY(U) BOEING
COMMERCIAL AIRPLANE CO SEATTLE WA C A CLARKE ET AL.

2/2

UNCLASSIFIED

JUN 87 DG-33848 DOT/FAR/CI-86/48 NAS2-12261

F/G 28/14

ML

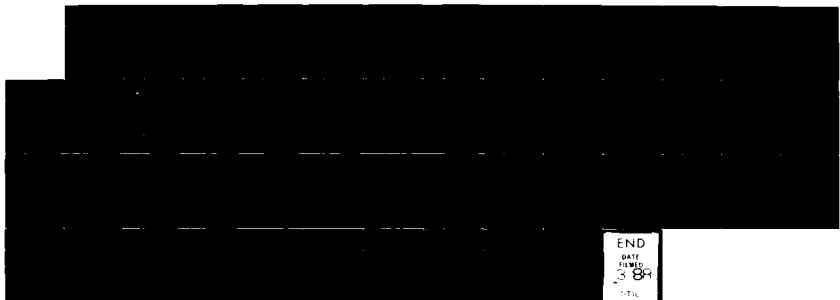

END
DATE
FILMED
3 88
DTIC

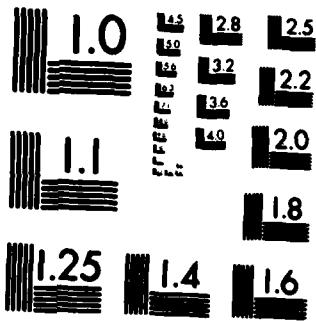

MICROCOPY RESOLUTION TEST CHART
NATIONAL BUREAU OF STANDARDS-1963-A

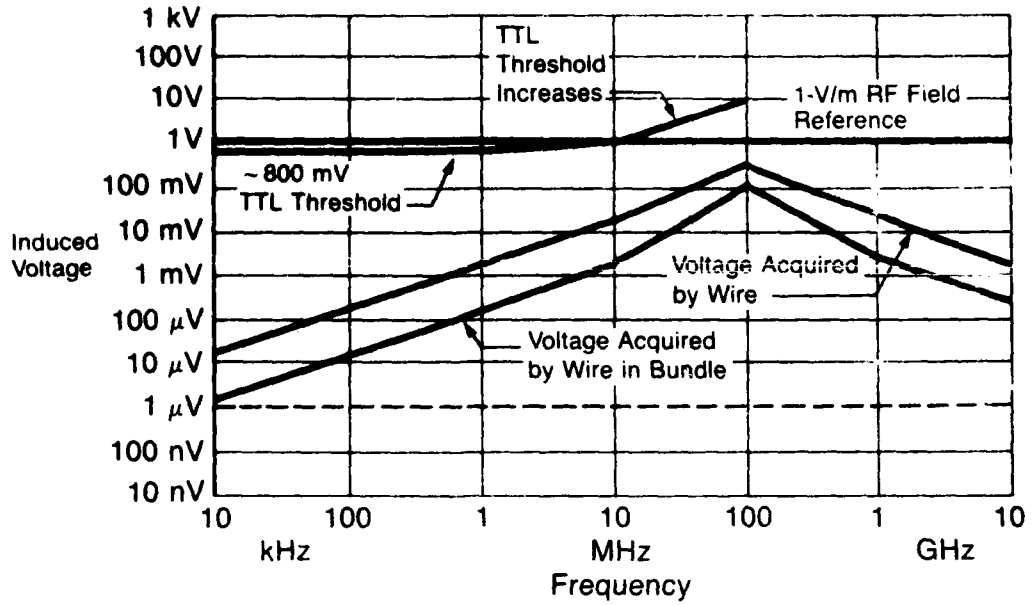

Figure 4.1-5 A Transistor Threshold

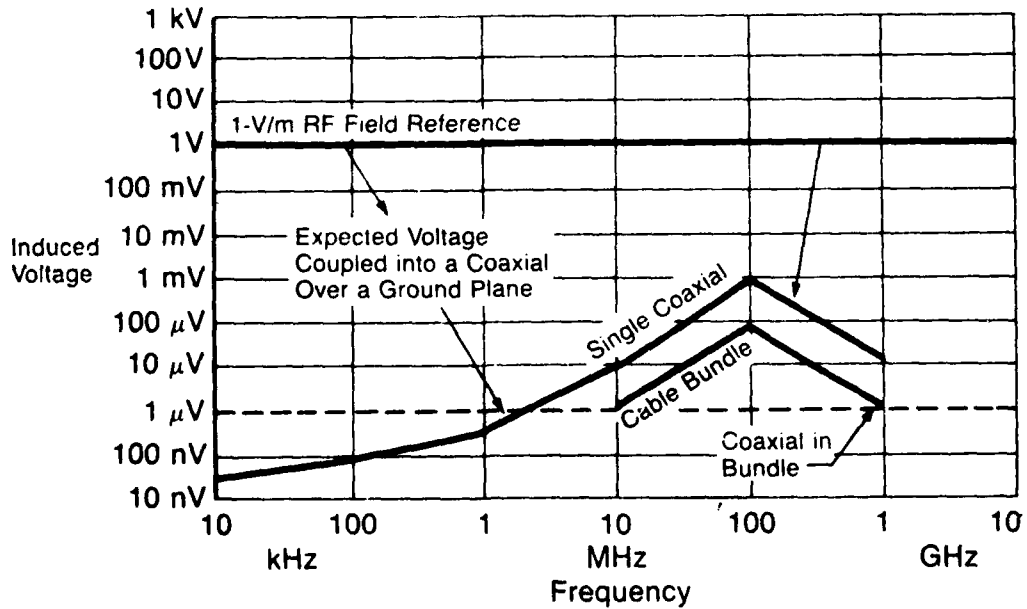

Figure 4.1-6 Representative Coax Voltage Coupling

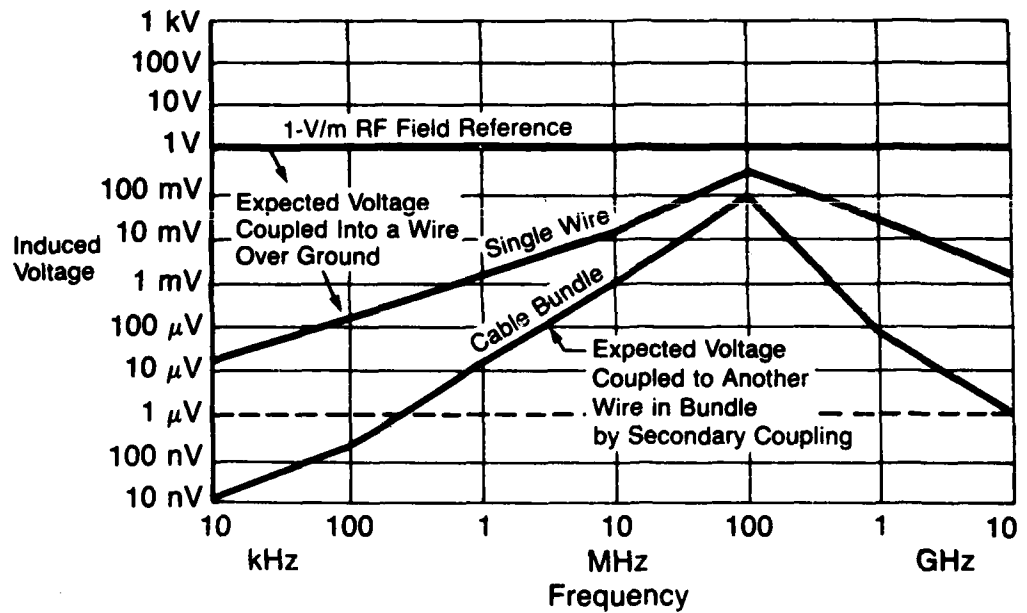

Figure 4.1-7 Representative Secondary Coupling

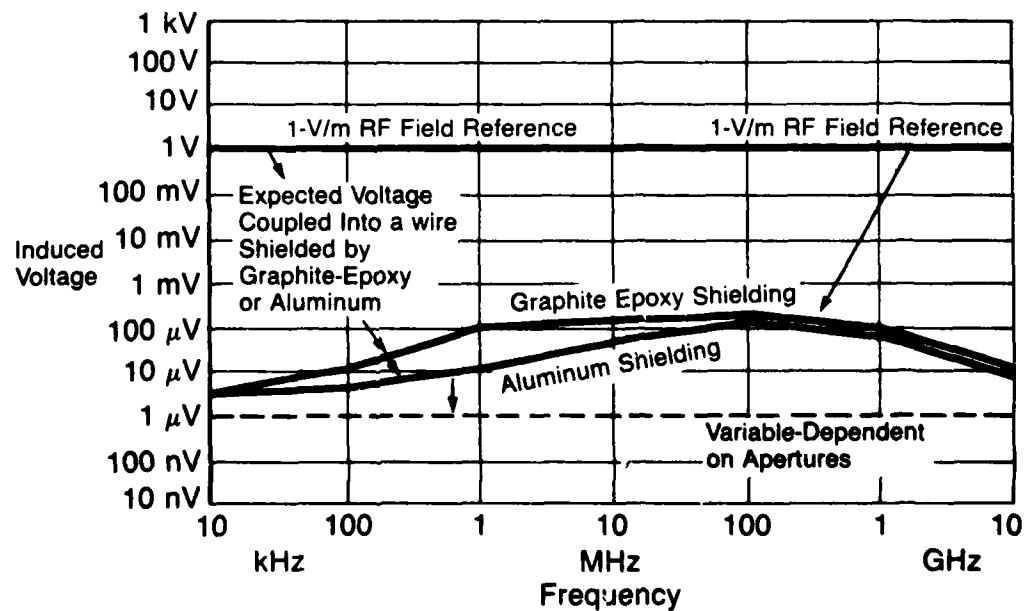

Figure 4.1-8 Graphite-Epoxy or Al Shielding Added

Aircraft structures and avionics are engineered and designed by the airframe manufacturer and subcontractors to limit and control these fields. Some lines are shielded, some filtered, and others incorporate a balanced circuit design that will very effectively reject most radio frequencies.

Another main defense against HF-VHF radio frequency signals is a comprehensive and all-inclusive electrical bonding system of all aircraft structural shielding materials to eliminate resistive seams and open seams or apertures. During a specific design program, it is becoming more and more necessary to develop a sophisticated set of models and computations to characterize and define the particular installation and uncover the behavior of the radio frequency fields and induced voltages.

So, in summary, the HF-VHF frequencies are important to aircraft designers because the wiring, equipment, structure, and the aircraft itself, having the same dimensions as the radio frequencies, become efficient antennas.

4.1.1.2 Resonant Behavior

Resonance is the ingredient that brings the arcane aspect to electromagnetic interference. Resonance, standing waves, and reflections share a commonality with black magic in their illusory and unseen character. Electrical parameters, voltage, and current, under the influence of the infinite variability of resistance, capacitance, and inductance, depending on the number of electrical poles, and when viewed over the frequency spectrum, may start out with high impedance and fall quickly to a short circuit minima, then curve back to a maximum, or on the other hand, the impedance may start low and rise to open circuit values. Voltage and current in RLC circuits may rise and fall with periodicity or in one simple cycle. They may reach constant highs and lows, or may vary with inconsistency. Resistance, capacitance, and inductance vary endlessly with material electrical properties and length, size, and height above ground. But, they are bounded by maximum and minimum envelopes and the spreads, although large, are limited.

In a shield room, standing waves on wiring may rise up at around 10 MHz. Shield room resonance itself usually is around 50 MHz depending on size. On a large transport aircraft, resonance may occur around 1 MHz and continue into the higher frequencies. The fuselage may resonate at 1 MHz, the wing and other structural details at higher frequencies.

In a balanced transmission line circuit, resonance is kept to a minimum; signal stability and quality are maintained.

Single wires and braids (at their resonant frequencies in the 10s and 100s of MHz) offer very high impedances. A 40-inch, or 24-inch, or 9-inch wire or braid at 70 MHz (the VHF range) may have an impedance that has risen to 10 k Ω . A 4-inch long braid or a #20 wire exhibits about 500 Ω at 100 MHz, roughly the same frequency range. With this kind of impedance increase and resonant condition, adding a wire connection between a circuit and ground may alter the surrounding field strength levels by 10 or 20 dB. The significant consideration here is that they are not stable conductors. As soon as appreciable capacitance and inductance are added, conductor quality is lost in a single wire or braid.

In unencumbered space, radio frequencies behave linearly, constantly, and predictably. Introduce conductors, metallic planes, and a range of materials, resistance, dielectrics, and vary

the structure and cabling shape orientation and location, then only modeling and measurement techniques can focus on and map the radio frequency fields with any accuracy and reliability.

Even though there is a wide range of variation in the HF-VHF radio frequency region, the testing and measuring is performed in an equivalent shield room, metallic environment, complementary to the aircraft fuselage metallic environment. Increased field strengths from resonant and reflection activity in the shield room have been, in fact, a rough emulation of the final installation.

4.1.2 Magnetic and Electric Field Distribution

From the 400-Hz powerline, those ubiquitous unidentical twins, electric field and magnetic field, although easy to contain or block, nevertheless criss-cross the length and breadth of today's aircraft and are present in every bundle and on every circuit. The magnetic field permeates all materials. It may couple to other wires. A wire with 4A may cause noise voltages up to 400 mV (figure 4.1-9) depending on wire length. These noise voltages can mar the signal fidelity of input circuitry of analog sensors, passenger entertainment, radio headsets or interphones. The electric field charges all materials. It can induce high voltages. A 100-ft wire with 160V peak, 115V rms, may induce over 100V peak (figure 4.1-10) onto high-resistance circuits. These noise voltages will pester operational amplifiers or comparator circuits, although they will ignore low-resistance analog or digital signal drivers.

These twin marauders, almost always together, are strengthened with increasing bundle length and encouraged by proximity of common wire routing. The magnetic field and electric field induced voltages of Figure 4.1-9 and 4.1-10 have been plotted together on Figure 4.1-11 and shown with the added variable of wire separation—the other dominant wire coupling parameter. See in Figure 4.1-11 how the induced voltage drops with wire separation.

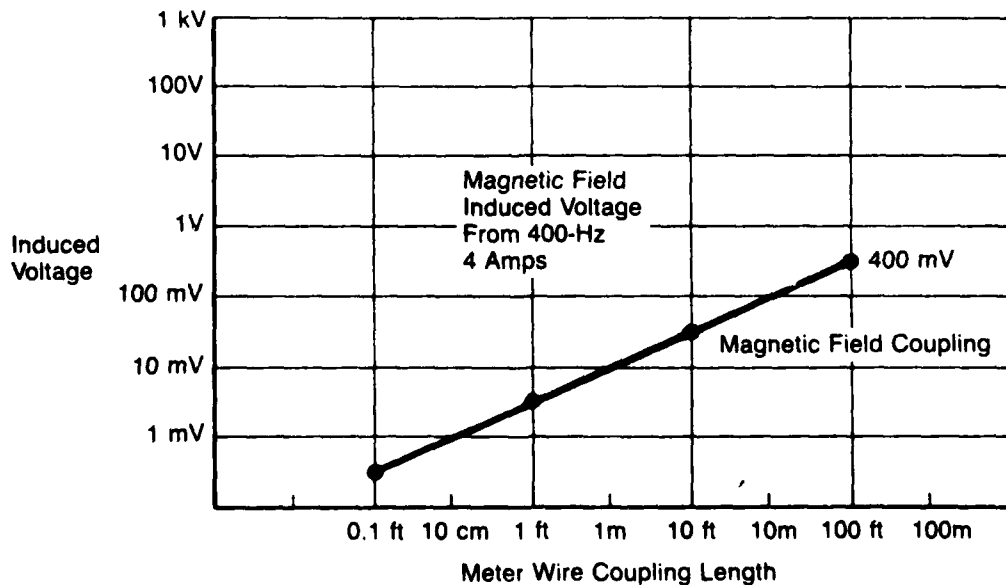

Figure 4.1-9 "H" Field Coupling

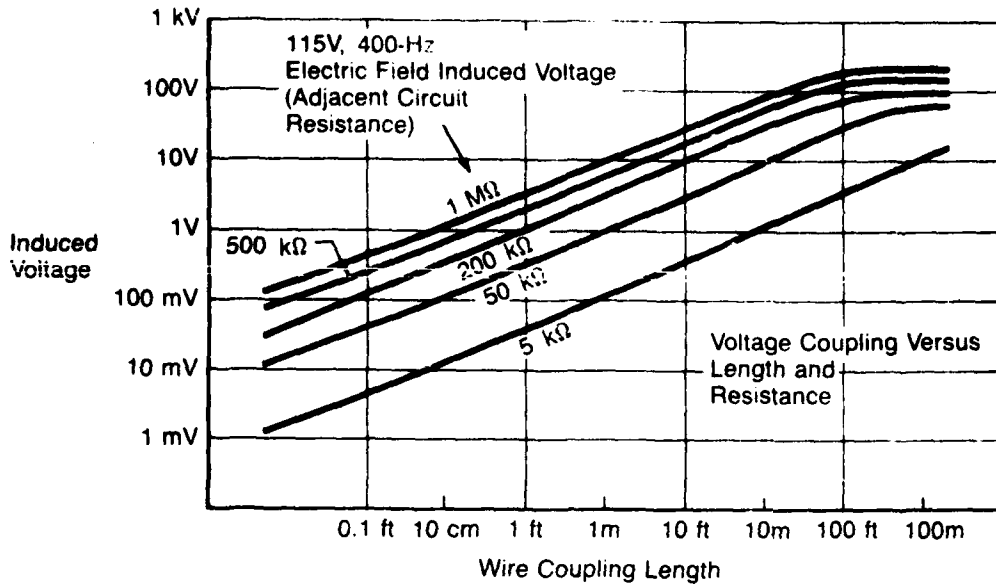

Figure 4.1-10 "E" Field Coupling

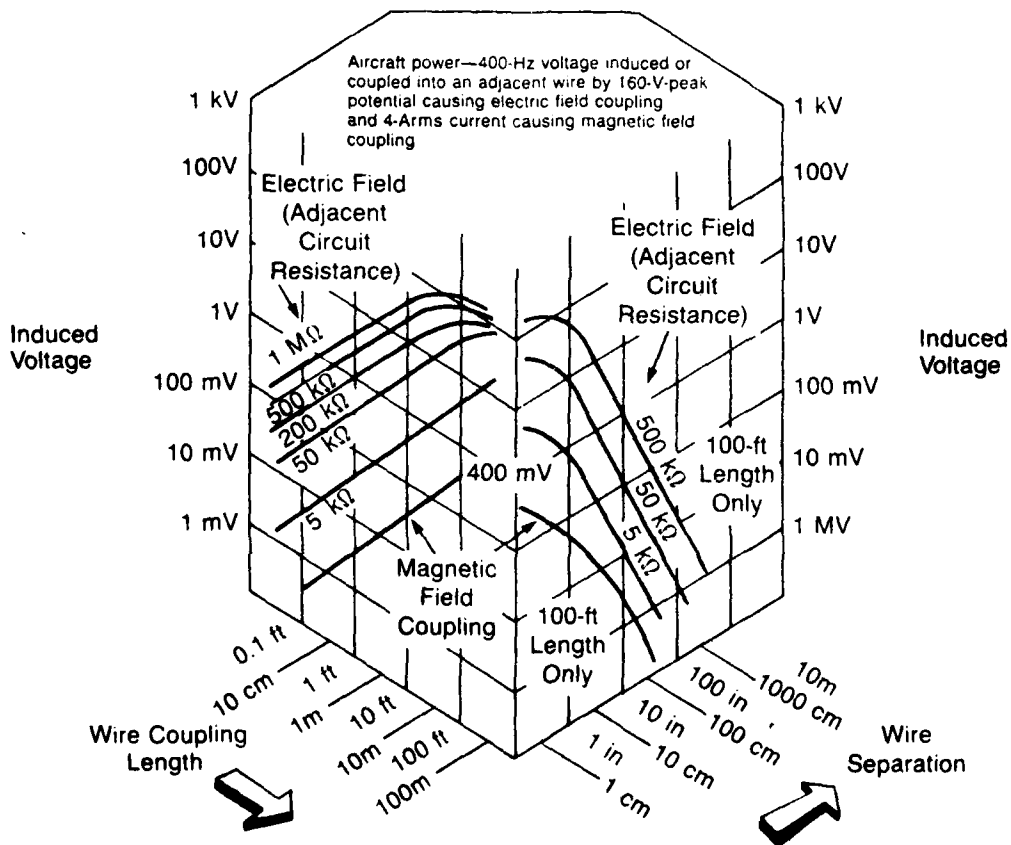

Figure 4.1-11 Coupling Versus Separation

Now, there is one exception to the design panacea of using a twisted pair shielded circuit as the perfect defense against electromagnetic interference. On present day aircraft, a circuit, even though it is twisted pair, will be subject to magnetic field induced voltages if it has a shield and the shield and the circuit are grounded at both ends. (Aluminum aircraft structure carries the 400-Hz power line return currents. The 400-Hz current will thus travel in shields grounded at both ends. The shield current then transfers a voltage to the internal circuit.) A balanced isolated circuit design or double shielding will compensate. The first twin, magnetic field, induces voltages on other wires in a bundle, but it also radiates out from the bundles into the aircraft interior space and into equipment (figure 4.1-12). The radiated magnetic field emanating from the power lines varies in field strength from microgauss to gauss (milliamps per meter to amps to meter). The fields are of interest when flight deck cathode ray tube displays, hand-held transceivers, and microphones are present whose operational function rely on the use of magnetics for control or display processes. The magnetic field will easily cause distortion or "banding" on display tubes or will develop the sound of a 400-Hz "hum" in a speaker. Magnetic fields drop off in magnitude very rapidly with distance.

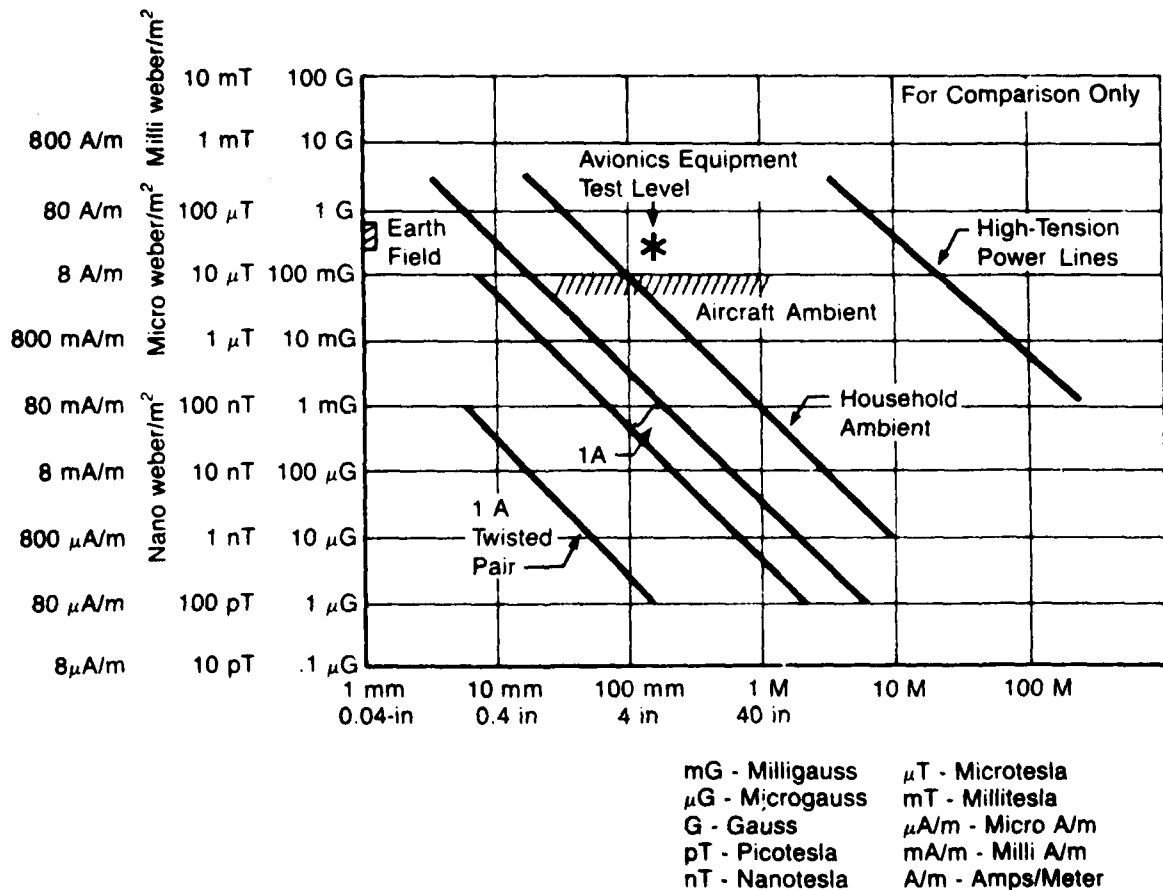

Figure 4.1-12 Magnetic Fields

The second twin, the 115V electric field from 400-Hz power lines, is in almost every aircraft cable bundle. The power line wire has a 115V rms (160V peak) potential. Another wire circuit brought into proximity of the 115V wire holds the 115V potential unless it is destroyed by the "electrical resistor divider" action of a low resistance on the adjacent or "victim" circuit. Figure 4.1-11 shows the reduction of voltage with reduced resistance on the adjacent circuit. The resistance is the parallel resistance of source and load. Either a low resistance or a shield will stop electric field coupling.

Electric and magnetic fields are protected against and dealt with by careful attention to wiring details and design such as the use of twisted pair wire, shielding, balanced circuits, or fiber optics.

4.1.3 Transients

A 115V power line supplying an inductive load, when interrupted with opening of a switch or circuit breaker, will create an electrical switching transient often called an "inductive switching transient" or a "relay-induced transient." Electrical switching transients from lights, fans, pumps, or control surface actuator operation reach levels of 600V. Their duration can be over 1 ms, and their rise times nanosecond to microseconds. They harbor repetitive ringing waveforms or pulses (figure 4.1-13). These recurring ringing frequencies span the 1 to 10-MHz range. The switch opens, an electrical arc is started, and an inductive coil unloads stored energy through the arc in repetitive pulses onto a wire—a wire that may be bundled with other circuits carrying digital data or analog signals. The high-frequency energy is transferred capacitively and inductively to those circuits and directly into the internal harnessing and etched circuit card traces and microcircuits of an avionic unit. The electrical transient distributes to microprocessor clock, timing, or data lines.

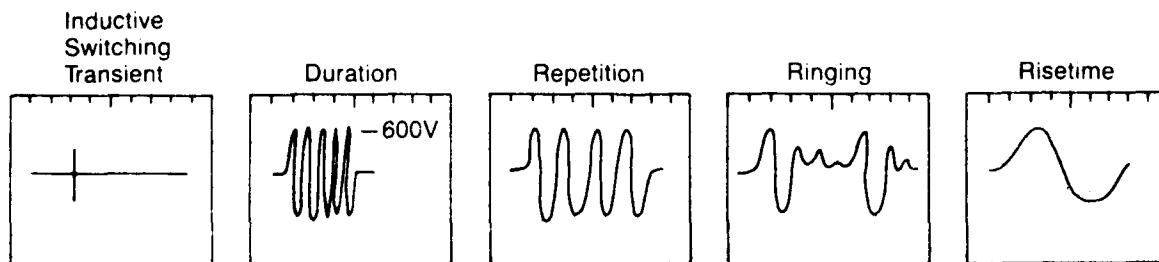

Figure 4.1-13 Transient Ringing

Very extensive measurements have been made of transients and their characteristics. L. Bachman states in his 1981 report: "This paper summarizes the results of the most comprehensive study ever conducted of U. S. Navy shipboard power line transients. Transient data was acquired on 13 ships—over 9400 hours of monitoring time—2300 transients were encountered." Figure 4.1-14 is a summary. This study is remarkable in its extent and completeness. These transients show very similar, if not identical, characteristics of magnitude, risetime, and duration to those measured on commercial aircraft. In contrast to the high-level, inductive switching transient, the power bus may also experience momentary power interruptions, where the voltage drops to zero for as long as 50 ms.

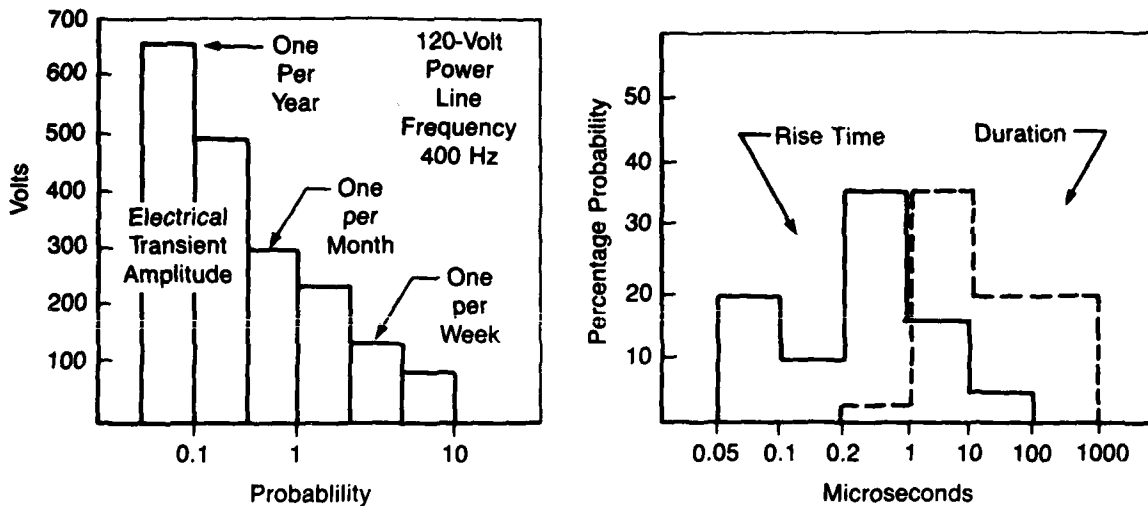

Figure 4.1-14 Electrical Transients

Electrostatic discharge is another form of transient that can suddenly erupt under the right conditions of humidity, air or fluid flow, and juxtaposition of materials. Electrostatic discharges have much higher voltages up to and over 10 kV, but much narrower pulse widths, possibly a 100-ns duration. A person on a dry Arizona-like day touching an avionic unit may discharge 10,000V onto the housing or wiring.

One of the most evident electrical discharges, of course, is lightning. Large currents flow on the wing structure, fuselage, landing gear, or empennage leaving induced voltages in unprotected circuits. These induced voltages have resonant behavior often established by the characteristic of the size of the aircraft and length of wiring. Lightning protection is engineered to divert and contain voltages and currents in metallic structure to avoid damage to electrical wiring and parts. The transient voltage levels induced in wiring are required to be less than 600V. Induced voltages are usually less than 200V for the most severe strikes.

So you see, HF-VHF radio frequencies, 400-Hz power, and the various transients are electromagnetic interference or noise forms that are freely distributed and transferred into microprocessors to affect aircraft performance unless constrained and controlled by carefully integrated wiring and avionic and structure design.

4.2 AIRCRAFT PROTECTION

4.2.1 Shielding and Ground Reference

Aircraft and circuit protection is formed in a layered design: 1st layer, structural shielding, liners, trays, overbraid; 2nd layer, circuit shield; 3rd, balanced, isolated circuit; 4th, voltage, current limiting; and 5th, software.

Double shielding (two layers of shielding) fends off lightning and radio frequencies. There is just no getting around it—for critical circuits having exposed wiring, double shielding is necessary.

Structure, skin, and panels of the aircraft form the first major level of shielding, and it is the system level barrier. Fuselage shielding is extended into open sections or unshielded areas, such as leading and trailing edge or landing gear, with a cableway, overbraid, or foil (figure 4.2-1). Radio frequencies—electrostatic charge—lightning—safety fault return—ground reference: all call for a highly conductive material. Liners can be installed in nonmetallic, electronic bay sections. Where spar, skin, or panel shielding is not inherent in structure, then foil, metal spray, or metal mesh (figure 4.2-1) can be designed into or onto nonconductive parts. Leading and trailing edges, engine bays, wheel wells, bulkheads, tail sections: all need evaluation to delineate the shielding and ground planes. Nonconductors, composites, and graphite-epoxy are not a ground or current return.

The second level or layer of shielding is individual circuit shielding continued (with backshells) to the avionics enclosure shield. The second level offers protection against external threats and internal noise in wiring bundles too. The second level is connected, “grounded,” to the first level.

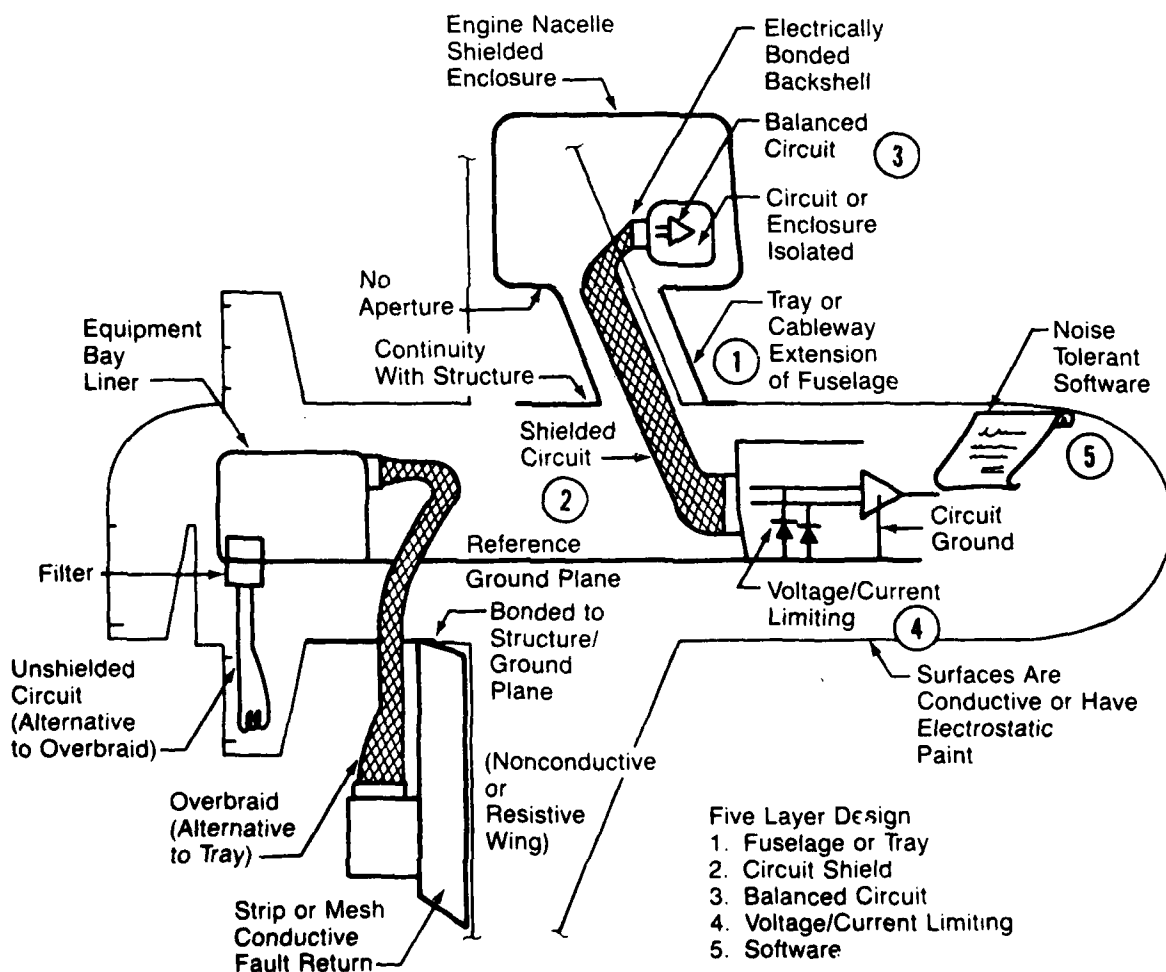

Figure 4.2-1 Layered Design

4.2.2 Apertures and Electrical Bonding

Conductive panels, foil, or paint form and continue the shielding enclosure on skin panels and trays and, unless electrically bonded, will develop harmful voltages or electrostatic charge centers. (See excellent reports in bibliography by L. O. Hoeft on shielding and aperture losses.) Often good continuity is provided by fasteners. External items are electrically bonded and grounded to provide static discharge paths. Conductive paint is applied to external nonconductive surfaces.

Everything is searched out to check resistance.

- **Materials:** titanium, steel, stainless steel, aluminum alloys, fiber glass, graphite-epoxy, Kevlar, phosphor bronze, composites
- **Parts:** instrument panels, keyboards, switching panels, seats, frames, window films or mesh, quick access doors, skin panels, cowls, fairings, trays, overbraid, backshells, plumbing, brackets, covers, control surfaces
- **Liners:** foil, mesh, plating, depositions
- **Finishes:** alodine, anodize, iridite, organic applications, copper plating, tin, silver, nickel
- **Sealants:** paint, film, special substances

Bonding is detail work and often research and development is needed on new materials and techniques. Materials and procedures are recorded in a bonding and corrosion prevention document.

4.2.3 External Wiring Interface Circuits

Long wiring runs extending out to the wing and to the engines are unintentional antennas that collect noise. Data, control, and sensor lines, outside of the shielding of the fuselage, demand protection against radio frequencies impinging on engine struts or mounts, leading and trailing edges, and landing gear.

Engine instruments, pressure, temperature, speed, thrust control, air data, fire, flight control computers (circuits for actuators and control surfaces), proximity switches, position indicators, temperatures, and braking circuits are candidates for analysis and protection. Circuits are categorized by criticality. Line replaceable units may number from 50 to 100 units and digital buses, 200 to 300, but the buses will reduce to 30 or so different types with only 5 or 10 types being external to the fuselage. Future systems may have less than 10 digital buses. Discrete circuits number 30 or 40 different types, with around 10 external. They can be thoroughly analyzed.

Good rules for external circuits (there are exceptions):

Grounding:

- Circuits isolated from structure at exposed end
- EMI tests applied to returns/grounds of units not on a ground plane
- Primary to secondary power isolated

Bonding:

- Case bonded to ground plane (when circuits isolated from case)
- Case isolated from ground plane (when circuits grounded to case)
- Backshell/connector bonded to case

Shielding:

- Double shielding installed on transmitter lines
- Internal shield grounded internally
- External shield grounded externally (to backshell)

Input/output:

- Interface circuits balanced; clock and data signals routed together
- Interface circuits isolated: transformer, LEDs, fiber optics
- High resistance (greater than 10 k Ω) designed into circuits
- All circuits filtered
- No shared power wire returns

Wiring/packaging:

- Return wire twisted with signal wire
- No wires installed across an aperture (apertures bonded)
- Line drivers/receivers packaged close to connector
- Connectors on equipment case placed in one local area

4.2.4 Circuit Protection

Protection depends upon electronics design, packaging and, especially for external wiring, the voltage stress conditions: stress on insulation, thin films, integrated circuits, and trace spacing. Solenoids and motors with heavy insulation and no electronics usually do not require protection. Thin film and integrated circuits do. (See comprehensive reports in bibliography by R. L. Carney, R. A. McConnell, and D. L. Sommer for excellent treatment of protection devices.)

Every interface circuit needs analysis and voltage/current limiting. Naturally, the transient or radio frequency threat must be known; first define the open circuit voltage; second the surge or characteristic impedance of the wiring and the input impedance of the input capacitor, resistor, or diode; then determine short circuit current; and finally the transient time and energy, or radio frequency power. The following are variable, but important, voltage withstand requirements or test levels that apply to insulations, parts, and electronics and are usable benchmarks.

No protection usually required:

- 1500V rms, 2100V peak, 400-Hz signal, impressed for one minute; this is the voltage withstand specification for insulation (solenoids, motors)

- 3000V or greater, one microsecond transient withstand for insulation, varies with humidity, configuration, altitude, time
- 1500V, one microsecond transient, discrete resistor (molded part)
- 1500V, fifteen mil circuit card spacing (at sea level)

Protection required:

- 200V or less, thin film, transient withstand voltage
- 200 to 800V, receivers protected by integrated circuit diodes
- 100V, transistors
- 30V or less, operational amplifier receiver
- 360V or less, fifteen mil circuit card trace spacing, at 100,000 ft
- 360V or less, corona initiation at 100,000 ft, varies with shape

The five layers of protection: 1) structural shielding, overbraid, cableway, 2) circuit shields, 3) balanced, isolated circuit, 4) voltage/current limiting, and 5) software combined with a stable ground reference plane help to guarantee compatibility.

4.3 TRADES

It is critical to first know program design requirements—and the environment. Dissect the electromagnetic topology of the aircraft including digital transmission, power system, antenna fields. Round up new and off-the-shelf equipment and bay locations. Search out aircraft structural and skin panel materials. Define the exposed critical circuits and equipment.

1st Major Trade: Location of equipment, categories, and tailoring of electromagnetic compatibility requirements of each unit. The wiring and the equipment is kept shielded under aluminum or graphite-epoxy and away from radio frequency fields (figure 4.3-1). Units of a subsystem colocated in a protected environment may have the design/test levels eased: lowered for susceptibility, raised for emission. Units not on the wing will not experience resonant conditions. Off-the-shelf equipment is often unchangeable at the input/output interface, and if located internally may save on shielding or externally mounted filters.

2nd Major Trade: Wire length and separation. Shortened wiring or elimination of wiring. Equipment location, equipment combination, wiring deletion, are waiting for evaluation, for example: on-engine electronics supplied with on-engine power; major interfacing units physically located close together. Noise amplitude is proportional to length. Metallic wiring may be replaced with fiber optics to save tens to hundreds of pounds and 25% to 50% reduction of wires (figure 4.3-2) and major reduction of EMI.

3rd Major Trade: Digital, balanced, isolated circuits versus analog circuits and single-ended or discrete circuits. Delete or reduce open wiring. Reduction of wiring, shielding, transformers, power, weight through use of multiplexed digital bus (figure 4.3-3).

4th Major Trade: The five levels of layered protection. If structure shielding not available, then trade cableway versus overbraid versus exposed wiring with filter/voltage/current limiting. For one or two wires on noncritical circuit, filter may trade off better than overbraid or cableway.

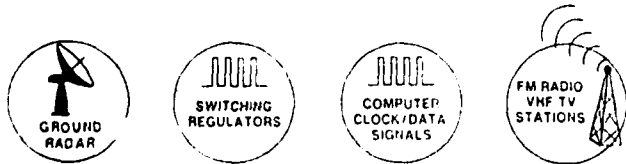
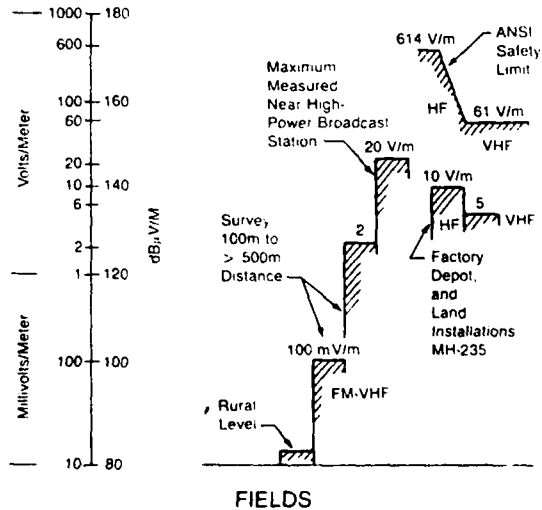
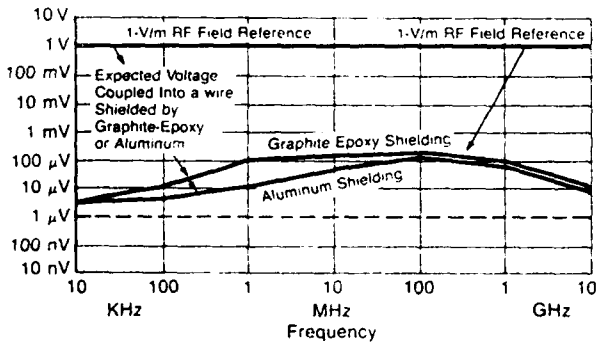
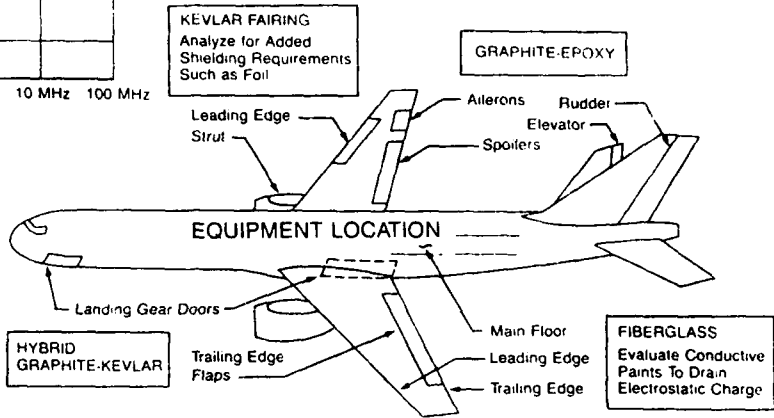
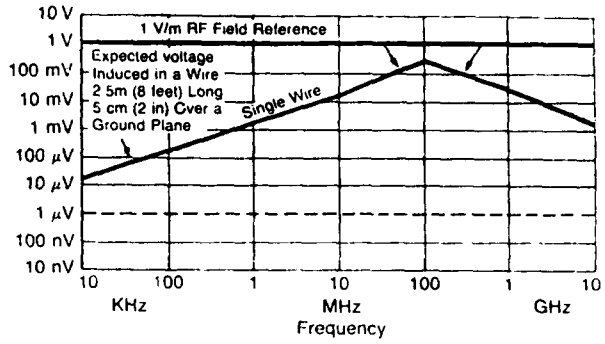
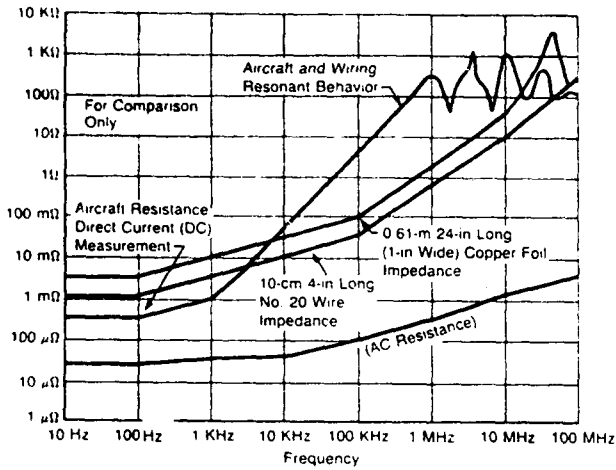
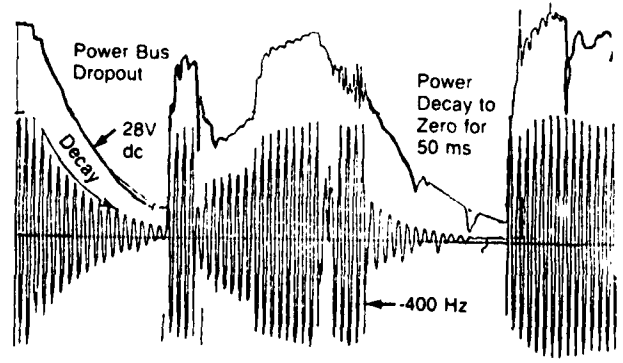
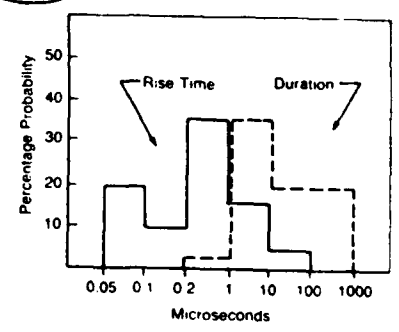
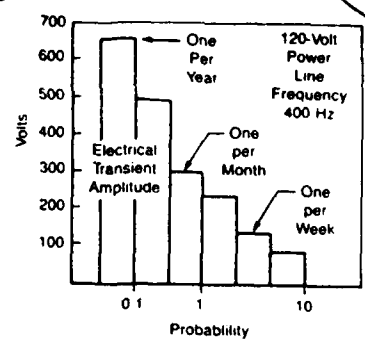
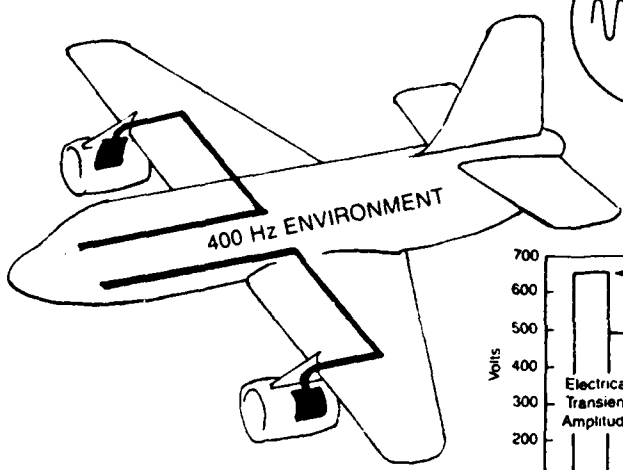
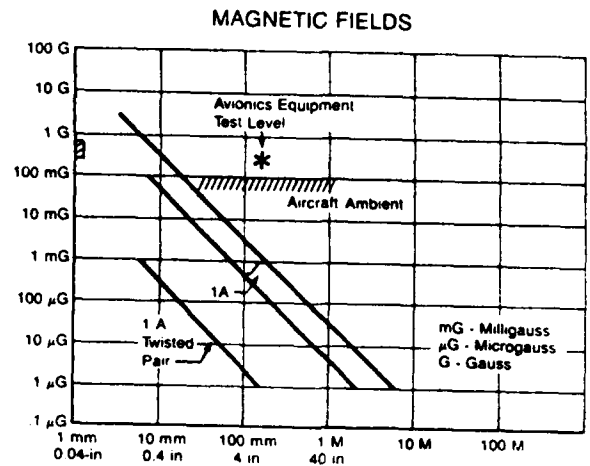
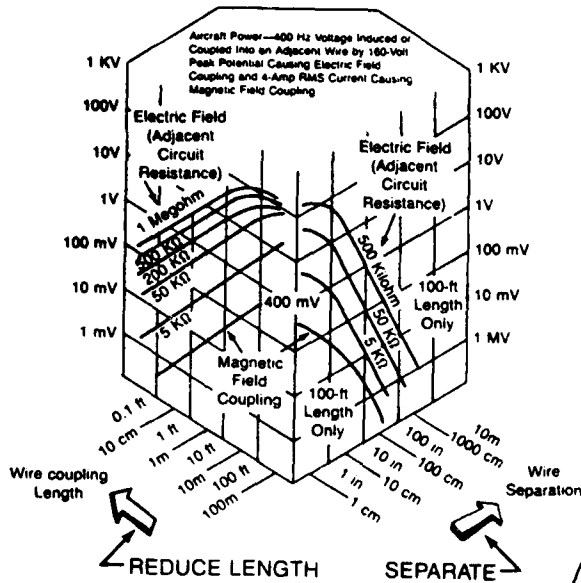

Figure 4.3-1 Trade—Equipment Location



SEPARATE SIGNAL FROM POWER FEEDERS

Figure 4.3-2 Trade—Wire Length/Separation

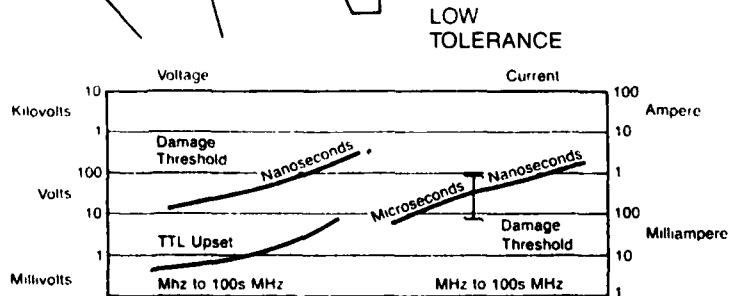
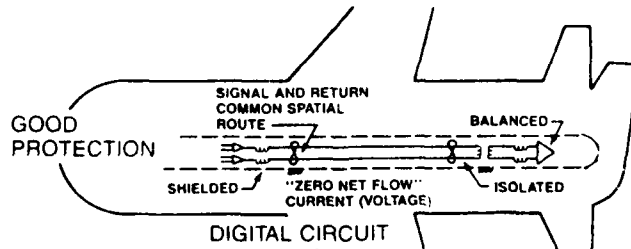
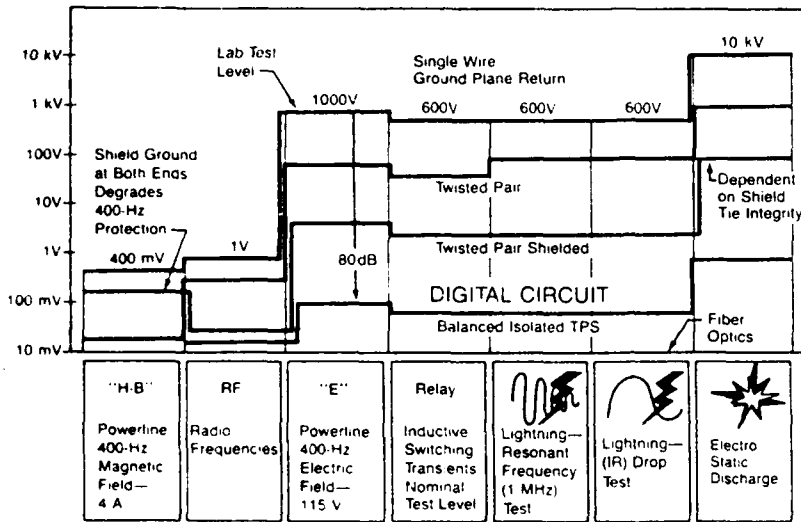
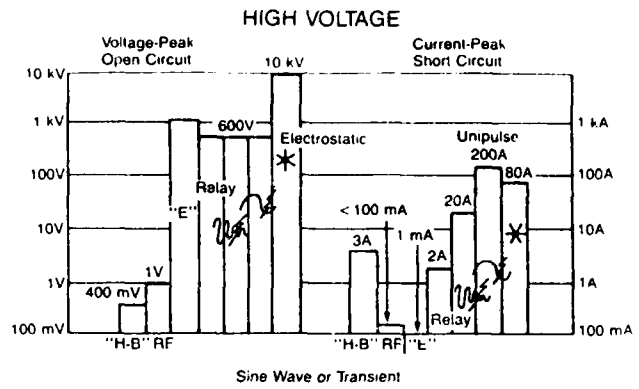
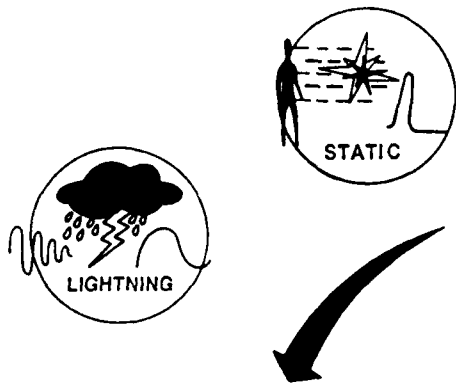

Figure 4.3-3 Trade—Digital Circuits

A recent large program relied on the fuselage for the major portion of circuit shielding. Wheelwells, engine bays, outer wing sections, and radome areas were shielded. Quick access often is necessary. Overbraid (20% of the bundles) was installed for critical flight control circuits to "extend" the airframe. It was indicated that in that design the use of metal overbraid on all bundles might be 10 times heavier than reliance on the fuselage. Also, complexity of the topology limited the use of overbraid, and in certain areas a combination of protection was needed. For circuits inside the fuselage, filter pins were used; for outside circuits, voltage limiters. Discrete filters for each circuit were not pursued because of excessive volume and weight.

If it is at all possible to install a cableway, tray or liner, it may be better in the long run. Consider these facts in favor of a tray:

Design:

- Proven designs/models and inservice experience
- Easily formed, integrated with structure
- Fewer electronics and "sneak paths"
- Freedom from reliability studies

Protection:

- Line replaceable units installed with known protection
- Freedom from frail electronics
- Excludes high voltages and arcs
- Rugged and durable

Test:

- Lower test levels on electronics
- Freedom from complex verifications

Life cycle cost:

- Reduced engineering, part control, troubleshooting, maintenance
- Easy inservice monitoring
- Long life

Computerized design procedures will speed the capability to make trades.

5.0 ACTIVITIES AND DOCUMENTS

5.1 SPECIFICATIONS/DOCUMENTS

Some have postulated that most of the electromagnetic compatibility designs and trades at the airframe manufacturer's level must be quickly accomplished before go-ahead or at least at the very beginning of the program, that is: all of the major specifications must be set up—the equipment located and categorized—the environment documented—procurements contracted.

This may not, however, be as extensive an effort as it sounds because most specifications for environments and existing technologies are already available from other programs and need only to be reworked, shaped, and adapted.

Specifications set guidelines—standards—requirements. They are the foundation for any program, and a path that provides a reference and continuity. They help bypass unproductive squabbles and unnecessary changes. They sidestep duplication: "reinventing the wheel." They even help tie into the next program.

From the top documents, which outline the intent and scope, down to the lower tier designs, look for these specifications:

Industry:

- FAA Code of Federal Regulations, Aeronautics and Space #14, Parts 1-59; Part 25 Airworthiness Standards: Transport category Airplanes, reference 25.1309, 25.1353, and 25.1431; Part 23 Rotorcraft, 23.1309; Part 27 General Aviation, 27.1309.
- RTCA/DO-160B "Environmental Conditions and Test Procedures for Airborne Equipment," July 20, 1984, Sections 1 to 3, and 15 to 22.
- (A generic industry system specification here would be appropriate.)

Program:

- "Program System Specification": Simple one or two paragraph delineation of top EMC references, generic system requirements, or scope.
- "System Electromagnetic Compatibility Design Requirements": Organized sections of system and aircraft program requirements for external environment, equipment categories, interface circuit policy, grounding, bonding, shielding, wiring, isolation, electrostatics, aircraft shield policy, special analyses, applicable EMC document list, and policy for critical equipment.
- "Equipment Electromagnetic Environmental Requirements Specification": Explicit equipment level design and test requirements including test setup and conditions—patterned after the industry standard DO-160.
- All Procurement Specifications: Reference in the design section to the "Equipment Electromagnetic Environmental Requirements Specification." List of deviations. Requirements for power, dielectrics, circuit interfaces, grounding, bonding, shielding. Table of tests. Statement of Work: Developmental analysis and breadboard test report, analysis of off-the-shelf equipment, technical exchange meetings, qualification test plan and report.

- Design Handbook Guidelines Design Notes: Interpretation and conversion of program design and test requirements into protection techniques.
- System Test Plan: Test policy and outline. Subsystem tests. Aircraft tests: ground test, environment test, electrical bonding measurements, power switching test, flight test.

Related specifications:

- "Power and Electrical Requirements Specification": Aircraft and external ground power quality, returns and grounding design
- "Wiring and Shielding Design and Manufacturing Procedure": Wire separation, shield construction
- "Electrical Bonding and Corrosion Prevention": Materials, compatibility, fasteners, surface preparation, joining and sealing

5.2 TASKS/ACTIVITIES

At the beginning of the program, some participants think immediately of the analytical tasks and modeling. Some think of staffing, and organization, and people. Others think of schedules. The EMC engineer must pursue the design; he thinks of what the new aircraft is: new materials, new equipment, old equipment, size, layout, wiring runs. Defining the aircraft for electromagnetic compatibility is a monumental effort. The effort cannot be delayed. It must be done quickly. Some details will not be available. There are roadblocks, but these are the engineering tasks.

- Identify in a table or spreadsheet all equipment: new and off the shelf; inhouse and vendor; supplying agency; purchasing specification number. List the equipment versus applicable EMC requirements (including outmoded EMC limits), deviations, waivers, and approvals.
- Assess aircraft and equipment architecture: flight deck, electronic bays, externally mounted units, engine units, power and signal circuitry. Identify each equipment and installation and focus on grounding, bonding, shielding, materials and wiring.
- Set up electromagnetic compatibility design categories groups.
- Track down procurement specifications: remove or add limits and EMC interfaces; establish the developmental, engineering model, qualification, and acceptance tests; communicate with Procurement, Project, and the subcontractor.
- Define topology, field patterns, power of transmitters, and dig out the receiver thresholds.
- Extract power system type, power quality, ground returns and ground points.
- Chase down aircraft advanced technologies and materials. Unearth the differences from past programs.
- Dissect the new environments, external and internal, that are different from DO-160.
- Document new test equipment needs.

With the aircraft definition in hand, the electromagnetic compatibility engineer can take each of the EMC program documents and cut and fit them together: no overlap, no deficiencies, just acceptable coverage. He tailors the requirements based on: 1) past experience, 2) new environ-

ments and technologies 3) equipment location, 4) critical circuits, 5) weight, volume, and 6) test. Important: aircraft specifications are finalized more easily before formal design release has been invoked.

Analysis can't wait. Analysis and models feed on physical dimensions: fuselage—wing—landing gear, length, width, height; and electrical parameters: resistance, capacitance, inductance. Computer models are bringing new capabilities for quick evaluation of multiple design alternatives, and keyboard editing speeds the rapid reevaluation and turnaround when changes are proposed.

The apertures, seams, wire routing, overbraid, isolation, and the shielding effectiveness of aluminum, titanium, graphite-epoxy, steel must be known along with interface protective designs that must be pulled out of the schematics: filter pins, discrete filters, balanced circuits, transformer isolators, fiber optics. Getting an early handle on these items expedites the many wire coupling and radiation analyses of common noise sources, for instance: power frequencies and ripple; pulse width modulated power; transients from solenoids, valves, motors; and clock oscillator harmonics.

Just a word about responsibility. The electromagnetic compatibility engineer is usually responsible for either a system and product or, conversely, for a technology or even a combination of both. Becoming knowledgeable in a technology area is often the best. For example, for technology:

- Computers digital circuits, software
- Radio frequency transmitters, receivers, antennas
- Power quality, generators, switching regulators
- Analog instrumentation, transducers, sensors, fiber optics
- Grounding bonding shielding wiring/packaging
- Dielectrics, corona, and materials

And for example, product or system:

- Environmental control and cargo (power)
- Flight control management (digital/software)
- Communication/navigation (radio frequencies)
- Power and lighting and fuel
- Air data, flight instruments (video, analog, CRTs, displays)

The definition and specification of electromagnetic compatibility on an airplane program is a sporty task. It must be initiated early. Most airplane programs need at least three engineers; future programs with advanced avionics and flight control systems may require four or five.

6.0 EQUIPMENT SPECIFICATION

6.1 NEW AND EXISTING

The countdown is on until the specifications on every last unit of new and existing equipment are found, cut apart, organized, and set straight. Equipment "procurement specifications" are the bottom line. They define design and test requirements and waivers or deviations. If a unit meets its tailored, allocated electromagnetic compatibility specifications, then electromagnetic compatibility on the aircraft is almost always assured. Deliberate on and wring out every last detail:

- Tailored requirements for the each unit (per RTCA/DO-160B)
- Each bonding/grounding/shielding interface (between the supplier and airframe manufacturer)
- Power quality specific requirements
- Dielectric voltage withstand levels
- Circuit interface wiring design
- Detailed unit tests: developmental, engineering model, qualification, acceptance

The specifications on new and existing units give exact requirements, item by item, on electrical and physical parameters and tolerances.

Existing equipment has already proven itself with its "inservice history," and treatment is different from new equipment. Existing equipment is addressed with attention to conformance to past specifications and any new program requirements. On a new program, old requirements may not be adequate: transients may need redefinition and reapplication depending on unit location; electric field protection may need to be increased; radio frequency susceptibility tests may need strengthening; and power bus momentary interruptions may be a problem. Development tests cannot be overemphasized for new and even existing units. The policy is "make it upset" in order to find margins. Development tests are important and are a major element of successful programs. EMI protection cannot be competently added after the finalized design.

At some point the packaging engineer and circuit designer at the supplier have to know what the overall design policy is for new and old equipment, and what their interface design is going to be. Key design requirements may be spread about in various documents, but should be either in a system specification or in the equipment procurement specification. Policies or requirements vary from program to program, product to product; these are some standards:

Grounding:

- Designed, controlled, equipotential ground plane system
- Optional digital circuit ground to case
- No analog (audio) circuit ground to case without approval
- Primary to secondary power isolation (transformer electrostatic shield)
- Power single point ground system; "star" architecture

- No power current in nonmetallic structure
- EMI requirements apply to returns/grounds of units not on ground plane

Bonding:

- Case bonded directly to ground plane or
- Connector pin for case ground wire
- Backshell/connector bonded to case

Shielding:

- Internal shield grounded internally
- External shield grounded externally (to backshell)
- Shields grounded at both ends (except analog)
- No circuit current on shield (except coax)
- Double shield on transmitter lines

Input/output circuits:

- Interface circuits balanced; clock and data signals routed together
- Interface circuits isolated; transformer, LED, fiber optics
- Increased circuit power ratings at outputs
- Return wires run twisted with the signal wires
- Connector pin for circuit ground
- Connector pin for case ground or fault wire
- Voltage/current limit all interface circuits
- No shared power returns

Packaging:

- Separation/isolation of power from signal
- Power, signal, and ground returns on separate pins
- Line drivers/receivers close to the connector
- High-frequency circuits close to the connector
- Low-frequency circuits at back of the box
- Connectors on equipment case placed in one local area

6.2 AIRCRAFT EQUIPMENT CATEGORIES

Category definition needs immediate attention. Avionics must not be over or under designed. Equipment categories represent the modification and tailoring of DO-160 requirements to units of equipment having widely variant properties or environment:

- Computers, power generators, transducers, motors

- Units with extra long interface wiring
- Units placed on or off the aircraft ground plane
- Equipment exposed or not exposed to high-energy radio frequency

Here are some typical categories:

Category 1A:

Energy storage devices (having no electronics): inductors, valves, motors, solenoids, and relays switched continuously or automatically. The items in this category are designed and tested to conducted emission and radiated emission requirements only. They do not require susceptibility tests.

Category 1B:

Energy storage devices operating on an intermittent basis, less than once every three minutes. The conducted emission and radiated emission requirements are raised (relaxed) 20 dB.

Category 1C:

Energy storage devices having short duration transients and operating two times or less per flight. Emission and susceptibility requirements are waived.

Category 2A:

Electrical/electronic equipment: avionics, power equipment, any unit having electronics located within the fuselage and protected by the fuselage metallic structure. All of the standard equipment electromagnetic compatibility requirements, equivalent to DO-160, apply: conducted emission, radiated emission, conducted susceptibility, radiated susceptibility.

Category 2B:

Electrical/electronic equipment within the fuselage, but having long wiring runs, over 100 ft. All standard requirements apply along with a raised (possibly 3 dB) 400-Hz electric/magnetic field and radio frequency field tests.

Category 2C:

Transmitters/receivers: All standard requirements, and with antenna terminal conducted emission and susceptibility tests added.

Category 3A:

Electrical/electronic equipment outside the fuselage and well shielded, but exposed to higher lightning induced transient activity. All standard requirements plus lightning induced transient requirements.

Category 3B:

Electrical/electronic equipment unshielded under nonconductive material or on external mountings. All standard requirements apply and lightning plus increased radio frequency susceptibility test levels (possibly 100 V/m).

Category 3C:

Electrical/electronic equipment not on a ground plane. All standard requirements apply and susceptibility and emission requirements are also applied to the equipment circuit ground, power ground, and case ground interface wires.

Category 4:

Support equipment associated with the aircraft. Apply radiated emission and conducted emission requirements on power that connects to aircraft.

Category 5:

Flight-test equipment: Apply radiated emission requirements and radiated susceptibility requirements for external equipment. Flight equipment is isolated from aircraft circuits.

6.3 SUPPLIERS

Early in the program the EMC engineer hastens to know the supplier (vendor or subcontractor). It is important to record and establish a file of equipment identification, electrical characteristics and the tailored requirements:

- Unit: name, acronym, model, unique identifications
- Company: name, location, engineers, organization
- Affiliated paper: procurement specification, interface control drawing, statement of work, interface schematics
- Unit history: new, existing, modified, previous program usage, inservice experience, equipment similarities, deviations, waivers
- Schedule: technical meetings, prototype/engineering models, test dates, qualification test procedure
- Grounds/bonds/shields: internal ground, interface bonding
- Test: development, engineering model, qualification, acceptance
- Subsystem: project engineer, staff engineer, contracts engineer

At program startup, there may be specific candidate proposals and subcontractor control plans or procedures to evaluate. These are important attributes to look for:

- Treatment and awareness of specification requirements
- Unit inservice use on previous programs
- Past programs experience and success
- Evaluation and analysis capabilities
- Implementation of design techniques
- Inhouse or provisions for testing facilities

Of course, the size of the program will dictate the extent of the subcontractor effort, but this might be a typical statement of work:

"The subcontractor shall conduct an early investigation and developmental EMC analysis and test on the breadboard or prototype hardware for new or modified equipment.

A developmental test report and evaluation shall be forwarded to the prime contractor containing information on noise measurements of interface circuits and proposed wiring, protection, and emission control techniques.

The subcontractor shall obtain available EMC data and inservice history on existing, off-the-shelf equipment; determine compliance with the program requirements; and, where noncompliant, recommend options for equipment modifications, deviations, or waivers.

The subcontractor shall conduct timely technical exchange meetings and present grounding, shielding, hardware, and software protection. A qualification test plan and report shall be submitted for comment and approval."

The statement of work for the subcontractor may be more or less detailed depending on complexity and size of the equipment or subsystem.

Subcontractor equipment design changes are made throughout the entire program. An EMC engineer cannot monitor or assess all engineering changes on all equipment, but a change involving electrical properties may require some reevaluation or retest. For example, anytime a change deals with new coupling characteristics, that is: wiring harness rerouting, new input/output circuits, different circuit board layout, extensive software modification that changes timing sequence or adds new loops, then an analysis or susceptibility retest is appropriate. The vendor maintains complete responsibility and accountability for design and test verification of his unit or subsystem to fully utilize his own facilities, experience, test equipment and software capabilities.

7.0 VERIFICATION AND VALIDATION

7.1 KEY EMC DESIGNS

Verification: Equipment qualification test at a supplier to prove that a design meets specification. The qualification test of equipment forms the very keystone of verification.

Verification is also accomplished in the airframe manufacturer's laboratories to prove performance of key EMC designs and properties, such as:

- Grounding of digital or analog circuits
- Bonding resistance of aircraft part, wire, or joint
- Shielding properties of new materials
- Leakage of joints and apertures
- Emissions of pulse width modulated power
- *Wiring design and coupling conditions*
- Aspects of aircraft mounted filters and limiters
- Susceptibility thresholds of interface circuits

Verification tests quickly lead to the ultimate proper operation on the aircraft. Measurement reveals thresholds and noise upset margins. Verification lays a groundwork before validation.

Validation: Demonstration of and confidence in proper equipment function along with acceptable control of noise during aircraft operation in its intended environment.

Demonstration: a two part measurement and test:

- 1) Operation of an aircraft (or subsystem) through its normal modes while operating equipment and devices, and
- 2) Introduction of jeopardizing noise environments to stress equipment: all the while monitoring functioning flight deck instruments and aircraft circuit operation internally and externally: internally with built in test circuits/equipment (BITE) and externally with meters, transient recorders, oscilloscopes, spectrum analyzers, and digital bus analyzers.

An airplane program must be structured on a foundation of solid verification and validation (see Appendix B).

7.2 VALIDATION PLANS

First, hasten to collect, document, and rely on existing qualification data, existing validated technologies, and validation by similarity.

Otherwise, validation tests can be run at the subsystem level in a flight avionics laboratory or on the production aircraft.

When considering subsystem versus aircraft test, assess the following deficiencies and benefits in cost, effectiveness, flexibility, and timeliness:

COST	CAPITAL EQUIPMENT	ATTENDANT PERSONNEL	EQUIPMENT REWORK	TEST EQUIPMENT	LEARNING CURVE
Subsystem Airplane	Very Low High	Low High	Low High	Low High	Low High
ENVIRONMENT	EQUIPMENT COLOCATION	RF SIMULATION	GROUNDS/SHIELDS	RESONANT CONDITIONS	
Subsystem Airplane	Poor Actual	Good Good	Poor Actual	Different Actual	
DESIGN	FINAL HARDWARE	FINAL SOFTWARE	TEST SOFTWARE	FINAL WIRING	ENGINEER AVAILABLE
Subsystem Airplane	Good Excel	Good Excel	Excel Excel	Fair Actual	Good Fair
PROCEDURE	APPROVAL SIGNATURES	FORMAL SEQUENCE	DECISIONS/ DIAGNOSTICS	CHANGE CONTROL	PROGRAM TIMING
Subsystem Airplane	Few Many	No Yes	Best Fair	Good Good	Fair Late

Table 7.2-1 Subsystem Versus Aircraft Test

Aircraft offers fidelity, but demands a high price with inflexibility in a dedicated airplane outfitted with test equipment. The avionics laboratory is an active testing and simulation facility and testing can often be done speedily on a "noninterference" basis when test time is slack. Circuit access panels already exist. Testing can be easy, informal, flexible and promote diagnostics and real-time knowledge of noise behavior. A range of tests can be run at the subsystem level with selected tests on the aircraft.

7.3 VALIDATION PROCEDURE

The subsystem or aircraft configuration, setup, test equipment, and modes are identified and recorded paragraph by paragraph for each separate mode. The procedure then records step-by-step operation of equipment.

CONFIGURATION: Model, make, serial numbers, outstanding engineering changes or deviations, wiring or customer configuration, software, test software, test date, location.

TEST SETUP: Equipment bay lights, test stands, ground planes, shield ties, ground wires, unique simulations, monitors.

TEST EQUIPMENT: List by paragraph section test equipment and installation for the following systems:

- **Flight control/flight management:** computer breakout boxes, digital bus analyzers, oscilloscopes
- **Communication/navigation:** interphone electronics breakout boxes, receiver breakout boxes, interphone headsets, RF voltmeters, spectrum analyzer
- **Power:** power supply breakout boxes, chart recorders, transient analyzers, peak reading (transient) voltmeters

- Flight indicating/recording: flight instrument breakout boxes, digital bus analyzers
- Engine: monitors, indicators
- Environment: magnetic field measuring instruments, spectrum analyzer and current probe (wiring) and antennas (radiated emission), signal generators

PERSONNEL: Knowledgeable subsystem or equipment engineers, experienced EMC engineers and technicians. Monitor and record all initial settings, indicator light status, measurement instrumentation, BITE readouts. On functioning displays, observe and record status of flight instruments, CRT panels on flight deck, left, right, and center control panels, power panels. During step-by-step procedure, record upsets, circuit breaker disconnects, state changes/events, autopilot disconnect, warning signals/flags, annunciations, CRT distortion on all subsystems.

SOFTWARE: Identify software installation and initiation for each mode. Automated test software routines exercise processing functions and interfaces and monitor the data, status, error counters, or fault logging in real time or on printout.

MODES OR PRESETS: Establish modes and settings for all systems:

- Environmental control: pressurization, temperature, air control
- Flight control/management: mode control panel, autopilot engage at "left or right command"; test software installation, flight management computer; control display unit, flightpath program, takeoff, cruise, landing, autoland; engine control operation
- Communication/navigation: ADF, HF, VHF, ATC transmit/receive frequency modes and settings, IRS navigation modes, selector panel interphone left and right settings
- Power: circuit breakers engaged/disengaged
- Fuel and hydraulics: pumps, valves
- Flight instruments and recorders: flight instrument, caution/advisory readouts, recorders
- Lighting: light settings, dimmers, strobes
- Engine: electronic engine control settings, indicators
- Degraded modes: loss of redundant unit, low battery

FUNCTIONAL SWITCHING TEST PROCEDURE: Establish a step-by-step procedure paragraph for each mode and possibly for each major subsystem. For chosen mode perform "functional switching test." That is: operate, switch on/off, cycle, or exercise all units:

- Environmental control: pressurization, temperature, fans
- Flight control/flight management: motors, actuators, flaps, slats
- Communication/navigation: HF-VHF transmit
- Power: all circuit breakers
- Fuel and hydraulics: pumps, valves, solenoids
- Flight indicating/recording: flight instruments, CRTs, recorders
- Lighting: cabin, flight deck, strobe, and landing lights
- Engine: electronic controls, indicators, actuators, ignitors

A subsystem or airplane EMC validation test procedure demonstrates the absence of malfunction or undesirable noise and authenticates that the repeatability, accuracy, and reality of operation in normal modes of an airplane baseline production configuration meets the Federal Aviation Regulations and the Aircraft System Specification.

ENVIRONMENTAL STRESS TEST PROCEDURE: Establish separate paragraph for each mode or subsystem as above and operate equipment while introducing transients or radio frequency energy. The policy is "make it upset" not "show success." If noise is transient, vary pulse repetition rates relative to computer processing control cycles. Equipment should operate within performance specification and also demonstrate:

- Maintenance of proper internal configuration
- Successful automatic restart
- Continued operation
- No permanent faults
- No adverse control surface motion
- Automatic transfer to secondary systems

NOISE MEASUREMENT: Measure and characterize the signature of noise on the digital data bus, communication circuits or cables, interphone circuits, powerline bus, analog instrument circuits, and in the aircraft ambient to assist in validating operation and establishing a data base for diagnostics, not only for the existing program, but for future programs. Establish a separate paragraph for each mode. The following are noise types or thresholds:

- Clock oscillator harmonics or HF-VHF transmitter signals on circuits and cables
- ADF-HF-VHF threshold sensitivity; passenger address circuits, voice recorder, crew interphones noise and thresholds
- Powerline switching transients at circuit breakers and equipment terminals, switching regulator harmonics on buses and on cables
- 400-Hz electric and magnetic field strengths, HF-VHF field strengths

BONDING RESISTANCE TEST: Measure resistance of structure joints, skin panels, electrostatic paints, liners, foils, doors, flight deck panels, strut fairings and wing.

Testing and test assessment rests so heavily on a product's history and the intent of the product's function and future use, that it is, of course, an individual or program responsibility to define test concepts, requirements and procedures. This validation test information, therefore, represents possible guides or techniques, but must be considered as not being appropriate for a specific test.

7.4 PROGRAM DESIGN REVIEWS

During a program there is no quicker way to help improve the validity and timeliness of the design and specifications than by periodic reviews to establish agreement on perceived requirements and outcome. The following items are for consideration and might be selected and presented in a program preliminary design review or critical design review to help lay groundwork for verification, validation and certification:

- Program documentation, organization
- Aircraft system and RTCA/DO-160 design/test requirements
- Environment assessment, equipment EMC categories
- Subsystem, equipment architecture/topology
- Grounding system plan
- Bonding: radio frequency/static/safety
- Shielding: aircraft and wiring
- Wiring design, critical circuits
- New technologies analysis/models
- Equipment/subsystem/aircraft verification/validation plan

The prompt review of key documentation and requirements helps to start and keep the program on a successful path.

8.0 BIBLIOGRAPHY

1. AC NO.: 25.13091, "Advisory Circular-Systems Design Analysis," FAA September 7, 1982.
2. AFSC DH 1-4, "Air Force EMC Design Handbook," January 10, 1972.
3. Ahmad, S., *Shielding and Ageing Effects With Flexible Coaxial Cable*, 1985 IEEE EMC Symposium.
4. Annanpalo, Jaakko, *EMC Technology*, "Common-Mode Interference Rejection in Electrically Short Twisted Pairs," September 1986.
5. ANSI C95.1-1982, "American National Standard Safety Levels With Respect to Human Exposure to Radio Frequency Electromagnetic Fields, 300 KiloHertz to 100 GigaHertz."
6. ARINC 429-8, "Digital Information Transfer System (DITS)," October 31, 1978.
7. Bachman, L., *An Assessment of Shipboard Power Line Transients*, 1981 IEEE EMC Symposium.
8. Baker, D. M., D-18306, "Magnetic and Electrostatic Wire Coupling in the Audio Frequency Range," The Boeing Company, July 1956.
9. *Belden-Wiring and Shielding Data. Belden Electronic Wire and Cable*, Richmond, IN. 47375.
10. Belisle, K. M., *EMI Design Techniques for De-coupling and Isolation of Microcircuits*, 1983 IEEE EMC Symposium.
11. Biegon, R., "EMC Characteristics of RS-232 Cable Assemblies," *Connection Technology*, January 1986.
12. Birken, J. A., NAVAIR AIR-518-7, "Notebook on Electromagnetic Properties of Composite Materials Below 1 GHz," September 1981.
13. Bly, R. P., *The Inside and the Outside Are Not the Same—Experimental Investigations of Ground and Shield Topology*, 1982 IEEE EMC Symposium.
14. Boanen, V., *Designing Logic Circuits for High Noise Immunity*, IEEE Spectrum, January 1973.
15. Bodnar, G. D., *Shielding Effectiveness Measurements on Conductive Plastics*, 1979 IEEE EMC Symposium.
16. Brettle, J., *Electrical Bonding in Aircraft*, 1979 IEEE EMC Symposium.
17. Brooks, P., *Physical Design and Electronic Packaging Part 1*, EDN, September 5, 1973.

18. Carney, R. L., *D180-27423-49*, Part IV, "Design Guides for Air Vehicles," February 1987.
19. Chesworth, E. T., *EMC Technology*, "Electromagnetic Interference Control in Structures and Buildings," January-February 1986.
20. Clayton, R. E., *Transmission Line Electromagnetic Compatibility*, 1975 IEEE EMC Symposium.
21. *Code of Federal Regulations (CFR) 14, Part 25 Airworthiness Standards*, "Transport Category Airplanes, Sub Part F Equipment:"
 - 25.1301, Function and Installation
 - 25.1309, Equipment, Systems, and Installations
 - 25.1351, General
 - 25.1353, Electrical Equipment and Installations
 - 25.1431, Electronic Equipment
22. Cowdell, R. B., *Simple Equations Compute Radiated Emissions*, 1983 IEEE EMC Symposium.
23. Crawford, M. L., *Comparing EM Susceptibility Measurement Results Between Reverberation and Anechoic Chambers*, 1985 IEEE EMC Symposium.
24. Creason, R. R., *Measurement of the Magnetic Field From Long Two-Wire Lines at Low Frequencies*, 1983 IEEE EMC Symposium.
25. DeMario, W. F., *Aerospace America*, "New World for Aerospace Composites," October 1985.
26. Dillon, W. L., *Antenna to Antenna Analysis of the E-4A Advanced Airborne Command Post*, 1974 IEEE EMC Symposium.
27. Ditton, V. R., *Coupling to Aerospace Cables at Microwave Frequencies*, 1975 IEEE EMC Symposium.
28. Dixon, D. S., *Low Frequency Radiated Magnetic Field Emissions: Rationale for a MIL STD 461B, RE-01 Limit Change*, 1984 IEEE EMC Symposium.
29. *DOD-HDBK-263*, "Electrostatic Discharge Control Handbook for Protection of Electrical and Electronic Parts, Assemblies, and Equipment (Excluding Electrically Initiated Explosive Devices)," May 2, 1980.
30. *D6-16018*, "Electric Bonding and Grounding Design Requirements," The Boeing Company.
31. *D6-16050-2*, "Electromagnetic Interference Control Requirements," The Boeing Company.
32. Don White Consultants, Inc., *DM-S81*, "Syllabus EMC – Design and Measurement for Control of EMI," March 9, 1981.

33. Dubil, E. F., *Electrostatic Discharge Special Supplement Douglas Service*, Vol. 42, October 1985.
34. *Final Environmental Impact Statement for Seattle City Light, Highline 230 KV Transmission Project*.
- 34A. *ECAC Study, "A320 Electromagnetic Environment (A320 EME),"* by IIT Research Institute, (Contract F19628-85-C-0071 prepared for Federal Aviation Administration).
35. Force, R. D., *ACT/Control/Guidance System Study—Volume I, "Integrated Application of Active Controls (IAAC) Technology to an Advanced Subsonic Transport Project,"* NASA CR-165963, December 1982.
36. Force, R. D., *Report D180-20186-4, "Investigation of Effects of Electromagnetic Energy on Advanced Composite Aircraft Structures and Their Associated Avionic/Electrical Equipment,"* September 1977.
37. Gibbons, Randy, *Electronic Design*, "Performance Analysis Helps Designers Fine Tune Software," October 18, 1984.
38. Glancy, Donald, *Test and Measurement World*, "Preventing EMI in ATE Systems," January 1987.
39. Gormady, J., *Random Susceptibility of an IC 7400 TTL Nand Gate*, 1983 IEEE EMC Symposium.
40. Hafer, J. W., *The Effects of Shield Grounding Techniques for Isolation to Electromagnetic Waves*, 1981 IEEE EMC Symposium.
41. Hariya, E., *Instruments for Measuring the Electromagnetic Shielding Effectiveness*, 1984 IEEE EMC Symposium.
42. Hart, A. R., *LSI Design Considerations for ESD Protection Structures Related to Process and Layout Variations*, Hewlett Packard Company.
43. Heirman, D. N., *Education and Training of the Industrial Regulatory Compliance Test Team*, 1981 IEEE EMC Symposium.
44. Hitt, E. F., *DOT/FAA/CT-82-115, "Validation of Digital System Avionics and Flight Control Applications,"* December 1982.
45. Hjellen, G. A., *A Thermal Damaged Model for Bi-Polar Semi-Conductors*, IEEE EMC Symposium.
46. Hoefl, L. O., *A Simple Theory for Predicting the Electromagnetic Performance of Enclosures*, 1985 IEEE EMC Symposium.
47. Hoefl, L. O., *Current Division and Shielded Conductive Cables*, 1983 IEEE EMC Symposium.

48. Hoeft, L. O., *How Big a Hole is Allowable in a Shield*, 1986 IEEE EMC Symposium.
49. Hoeft, L. O., *Measured Magnetic Field Reduction of Copper Sprayed Wood Panels*, 1985 IEEE EMC Symposium.
50. Jarrett, Dick, *Electronic Design*, "Software Fault Tolerance Staves Off the Errors that Besiege Microprocessor Systems," August 9, 1984.
51. *IPC-D-317*, "Design Standard for Electronic Packaging Utilizing High-Speed Techniques," August 1985.
52. *ITEM Interference Technology Engineers' Master*, Robar Industries, Inc., R & B Enterprises Division.
53. Kashyap, S., *Feed Cable Resonance in a TEM Cell*, 1985 IEEE EMC Symposium.
54. Kendall, C. M., *DOT/FAA/CT 83/49*, "Aircraft Generated Electromagnetic Interference on Future Electronic Systems," December 1983.
55. Kendall, C. M., *Data Processing Grounding A Need For Circuit Isolation*, 1982 IEEE EMC Symposium.
56. Kendall, C. M., *EMC Control in Mainframe Computing Systems*, 1985 IEEE EMC Symposium.
57. Kendall, C. M., *Microfiltering of Input/Output Cables*, 1978 IEEE EMC Symposium.
58. Ketterer, J. R., *The Navy F/A-18A Hornet Electromagnetic Compatibility Program*, 1981 IEEE EMC Symposium.
59. Koeritz, K. W., *A Systems and Environmental EMC Control Program for the Airtrans Automated Ground Transportation System*, 1974 IEEE EMC Symposium.
60. Larsen, E., *IEEE Transactions on EMC*, "A Modified Ebers-Moll Transistor Model for RF Interference Analysis," November 4, 1979.
61. Larsen, William, *Paper No. 84-2605-CP*, 6th DASC, "An Overview of the Digital Avionics Assessment Activities Being Conducted by the FAA at NASA-AMES," December 1984.
62. Larsen, W. E., *D.O.T./FAA/CT-84/9*, "The Effect of Aircraft Generated Electromagnetic Interference (EMI) on Future Avionic Systems A Compendium," April 1984.
63. Liao, S. Y., *Light Transmittance and RF Shielding Effectiveness of a Metallic Film Coating on a Plastic Substrate*, 1977 IEEE EMC Symposium.
64. Lowe, Ken, *Electronic Design*, "Noise-margin Analysis Automatically Lays Bare Hidden Logic Problems," October 18, 1984.

65. Madle, P. J., *Cable and Connector Shielding Attenuation and Transfer Impedance Measurements Using Quadaxial and Quintaxial Test Methods*, 1975 IEEE EMC Symposium.
66. March, D. N., *Siting Considerations for Industrial Facilities That Generate Environmental Electromagnetic Noise*, 1980 IEEE EMC Symposium.
67. Martin, A. R., *Shielding Effectiveness of Long Cables*, 1979 IEEE EMC Symposium.
68. McAteer, O. J., *Military Electronics/Counter-Measures*, "Shocking Blow to Military Electronics," June 1979.
69. McBrayer, P., *RF Compatibility-Environment to Component Part*, IEEE EMC Symposium.
- 69A. McConnell, R. A., DOT/FAA-CT87/19, Contract NAS2-12448, "Avionics System Design for High Energy Fields."
70. MIL-HDBK-235-1A, "Electromagnetic (Radiated) Environment Considerations for Design and Procurement of Electrical and Electronic Equipment," June 23, 1972.
71. MIL-HDBK-35 (USAF), "Management and Design Guidance Electromagnetic Radiation Hardness for Air Launched Ordnance Systems," January 15, 1981.
72. MIL-STD 461B, "Electromagnetic Emission and Susceptibility Requirements for the Control of EMI," April 1, 1980.
73. MIL STD 1250 (MI), "Corrosion, Prevention, and Deterioration Control in Electronic Components and Assemblies," March 31, 1967.
74. MIL STD 1553B, "Digital Databus System."
75. MIL C 5541A, "Chemical Films and Chemical Film Materials for Aluminum and Aluminum Alloys," March 31, 1964.
76. Morgan, G. E., *Examples of System Engineering in the EMP Hardening of Facilities and Aircraft*, IEEE EMC Symposium, 1983.
77. Morgan, M. Granger, *Power Line Fields and Human Health*, 1985 IEEE EMC Symposium.
78. Moser, J. R., *IEEE Transactions on EMC*, "Peripheral Cable Shield Termination: The System EMC Kernel," February 1986.
79. *National Research Council*, "Aeronautics Technology Possibilities for 2000: Report of a Work Shop, Aeronautics and Space Engineering Board, Commission on Engineering and Technical Systems," 1984.
80. Olsen, R. G., *A Simple Model for Weakly Coupled Lossy Transmission Lines of Finite Length*, 1984 IEEE EMC Symposium.

81. Ott, H. W., *Digital Circuit Grounding and Interconnection*, 1981 IEEE EMC Symposium.
82. Palmgren, C. M., *Shielded Flat Cables for EMI and ESD Reduction*, 1981 IEEE EMC Symposium.
83. Paul, C. R., *Affect of Pigtails on Coupling to Shielded Wires*, 1979 IEEE EMC Symposium.
84. Paul, C. R., *Coupling of Electromagnetic Fields to Transmission Lines*, 1981 IEEE EMC Symposium.
85. Paul, C. R., *Prediction of Cross Talk in Flat Pack, Coaxial Cables*, 1984 IEEE EMC Symposium.
86. Paul, C. R., *Printed Circuit Board Cross Talk*, 1985 IEEE EMC Symposium.
87. Paul, C. R., *Sensitivity of Multiconductor Cable Coupling to Parameter Variations*, 1974 IEEE EMC Symposium.
88. Regan, J. J., *Plastics Technology*, "EMI Shielding: What You Need to Know And Why," January 1980.
89. Rhoades, W. T., *Achieving ESD Equipment Protection With Emission Controls*, 1985 IEEE EMC Symposium.
90. Rhoades, W. T., *Designing Commercial Equipment for Conducted Susceptibility*, 1979 IEEE EMC Symposium Records.
91. Rhoades, W. T., *Development of Power Main Transient Protection for Commercial Equipment*, 1980 IEEE EMC Symposium.
92. *RTCA/DO-160B*, "Environmental Conditions and Test Procedures for Airborne Equipment," July 20, 1984.
93. Schneider, L. M., *Noise Source Equivalent Circuit Model for Off-line Converters and Its Use in Input Filter Design*, 1983 IEEE EMC Symposium.
94. "Shielding Against Electromagnetic Interference," *Plastics Design Forum*, March/April 1979.
95. Shimayama, T., *Measurement of the Suppression Characteristic of Filter Network*, 1984 IEEE EMC Symposium.
96. Shores, M. W., *EMC Language in Perspective*, 1981 IEEE EMC Symposium.
97. Small, John, *Document* (to be issued), "Study of the Non-Damage Effects of Lightning on Avionics Systems," The Boeing Company.
98. Sommer, D. L., *AFWAL-TR-81-2117*, "Protection of Advanced Electrical Power Systems from Atmospheric Electromagnetic Hazards," December 1981.

99. Sommer, D. L., *D180-27423-17*, Part 3, "Atmospheric Electricity Hazards Balanced Protection Schemes," September 1984.
100. Strawe, D., *D180-18879-1 (AFWL-TR-75-141)*, "Interaction of Advanced Composites With Electromagnetic Pulse (EMP) Environment," September 1975.
101. Tell, R. A., *Recent Results on Determining Population Exposure to VHF and UHF Broadcast Radiation in the United States*, 1979 IEEE EMC Symposium.
102. Tenning, C. B., *T6-2408*, "Inductive Switching Transients on the KC-135 Airplane," The Boeing Company, March 1964.
103. Thomas, D. E., *Measurements and Calculations of the Cross Talk Due to Capacitive Coupling Between Connector Pins*, 1983 IEEE EMC Symposium.
104. Turner, T. E., *Electrostatic Sensitivity of Various Input Protection Networks*, Mostek Corp.
105. Vance, R. D., *ITEM 1977*, "Magnetic Shielding."
106. Violette, M. F., *EMC Technology*, Vol. 5, Number 2, "EMI Control in the Design and Layout of Printed Circuit Boards," April 1986.
107. Weinstock, G. L., *Electromagnetic Integration of Composite Structure in Aircraft*, McDonnell Aircraft Company.
108. Weinstock, G. L., *Intra-Vehicle Electromagnetic Compatibility Analysis*, AFAL-TR-71-155, Part 1, July 1971.
109. White, D. R. J., *Building Attenuation and the Impact on Products Susceptibility*, 1974 IEEE EMC Symposium.
110. White, D. R. J., "EMI Control in the Design of Printed Circuit Boards," *EMC Technology*, January 1982.
111. White, D. R. J., *Taming EMI in Microprocessor Systems*, *IEEE Spectrum*, December 1985.
112. Whittlesey, A. C., *Electric Welding Hazard to Spacecraft Electronics*, 1981 IEEE EMC Symposium.
113. Woody, J. A., *Modeling Techniques for Discrete Passive Components to Include Parasitic Effects in EMC Analysis and Design*, 1980 IEEE EMC Symposium.
114. Zajac, H., *Study of Effects of Electrostatic Discharge on Solid State Devices*, Tektronix, Inc.
115. Zenter, J. C., *Aircraft EMC Problems and Their Relationship to Subsystem EMI Requirements*, ASD, EMC and Power Branch, WPAFB, Ohio, Proceedings IEEE, Vol. I, National Aerospace and Electronics Conference, May 17, 1983, Dayton, Ohio.

APPENDIX A

GLOSSARY OF TERMS

Absorption Loss: Attenuation or retention of electromagnetic energy passing through a material, a shield. Absorption loss and reflection loss contribute to total shielding effectiveness (SE).

Anodize: A preparation by electrolytic process that deposits a protective oxide, insulating film on a metallic surface (aluminum). The oxide defeats electrical bonding. Alodine and iridite finishes on aluminum are conductive.

Aperture: An opening, such as a nonconductive panel joint, slot or crack, allowing electromagnetic energy to pass through a shield.

Audio Frequency (AF): The spectrum (20 to 20,000 Hz) of human hearing, often defined as extending from approximately 20 Hz to 50 kHz and sometimes to 150 kHz. Audio noise is nuisance hum, static, or tones from powerline 400 Hz, switching regulator and digital clock harmonics, or HF,VHF transmitter frequencies.

Backshell: Metal shell connecting circuit shields or overbraid to an electrical connector.

Balanced Circuit: A signal, acting line to line, between two conductors having symmetrical voltages identical and equal in relation to other circuits and to ground. "Differential mode" is line to line; "common mode" is line to ground.

Bandwidth (BW): Frequencies bounded by an upper and lower limit in a given band associated with electronic devices, filters, and receivers.

Bond, Electrical: Electrical connection at two metallic surfaces securely joined to assure good conductivity often 2.5-m Ω maximum for electrical/electronic units and 1 Ω for electrostatic dissipation or safety. A "faying surface" bond maintains contact between relatively large or long surfaces. Inherently bonded parts are permanently assembled and conductivity exists without special preparation: such as with welding, brazing.

Braid, overbraid: Fine metallic conductors woven to form a flexible conduit or cableway and installed around insulated wires to provide protection against electric fields and radio frequencies. Best when peripherally connected to backshells. A grounding strap/jumper may be made of braid.

Cable or harness: A bundle of separate, insulated, electrical circuits, shielded or unshielded, usually long and flexible and having breakouts, terminations, overbraid, and mounting provisions completely assembled.

Cableway: A solid metallic housing (liner, foil, coating) surrounding and shielding insulated electrical conductors. Also called conduit, tray, or raceway. Crosswise or transverse openings or breaks in the metallic cableway cause noise voltages to be transferred to internal wire circuits.

Common Mode (CM) Impedance: Impedance or resistance shared by two or more circuits so that noise voltages/currents generated by one are impressed on the others.

Common Mode Rejection: The ability of wiring or an electronic device to reject common mode (line-to-ground) signals and maintain fidelity of differential mode (line-to-line) signals.

Common Mode Signal: Identical and equal signals on input conductors or at the terminals of a device relative to ground.

Conducted Emission (CE) or Interference: Voltage/current noise signals entering or leaving a unit on interface conductors—emission is the general term, interference is undesired noise.

Coupling: The transfer of energy between wires or components of a circuit electrostatically, electromagnetically, or directly.

Cross Coupling (Crosstalk): Transfer of signals from one channel, circuit, or conductor to another as an undesired or nuisance signal or the resulting noise.

Damage: The irreversible failure of a component.

Decibel (dB): Decibel expresses the ratio between two amounts of power, P_1 and P_2 , at two separate points in a circuit. By definition, the number of dB = $10 \log$ to the base 10 of (P_1/P_2) . For special cases, when a standard power level $P_2 = 1 \text{ mW}$ or 1 W or 1 kW , then the ratio is defined as "dBm," "dBw," or "dBkW." Moreover, because $P = V^2/R$ and also I^2/R , decibels express voltage and current ratios. Ideally, the voltages and currents are measured at two points having identical impedances. By definition, $\text{dB} = 20 \log V_1/V_2$ and $\text{dB} = \log I_1/I_2$. For convenience, V_2 or I_2 are often chosen as $1 \mu\text{V}$ or $1 \mu\text{A}$ and the ratio is defined as dB above a μV or dB above a μA when graphing emission or susceptibility limits.

Dielectric Strength: Voltage withstand capability that an insulating material sustains before destructive arcing and current flow, usually expressed in volts per mil thickness. Dielectric withstand voltage is the voltage level at which insulation breakdown occurs.

Differential Mode (DM) signal: The signal in a two wire circuit measured from line to line.

Dual Ground: Equipment case ground return through two independent circuit paths to structure implemented in flammable zones and water leakage areas— each path meeting electrical conductivity (resistance) requirements.

Electric Field: High-impedance, radiated voltage field, positive or negative, from a voltage source as contrasted to a low-impedance magnetic field from a current source.

Electromagnetic Compatibility (EMC): Operation within performance specification in the intended electromagnetic interference environment.

Electromagnetic Interference (EMI): Conducted and radiated voltage/current noise signals, broadband (BB) or narrowband (NB), that degrade the specified performance of equipment.

Electrostatic Charge: Electric potential energy with a surrounding electric field, uniform or nonuniform, moving or at rest, on a material.

Emission: Voltage/current noise on a wire or in space. Broadband emission has uniform spectral energy over a wide frequency range and can be identified by the response of a measuring receiver not varying when tuned over several receiver "bandwidths." Or, energy present over a bandwidth greater than the resolution bandwidth where individual spectral components cannot be resolved. Broadband (BB) may be of two types: 1) impulse and coherent varies 20 dB per decade of bandwidth and 2) random or statistical, varies 10 dB per decade. A narrowband (NB) emission or signal, sometimes called continuous wave, occurs at a discrete frequency and does not vary with bandwidth.

Fault Current: The maximum current (magnitude and duration) flowing through a fault point—equal to the supply voltage divided by the dc resistance of powerline leads, circuit breakers, and the current return in wire or structure.

Filtering: Device or unit that passes or rejects a frequency band and designed to block noise from entering or leaving a circuit or unit.

Ground: A generic term having multiple meanings and indicating a circuit return path or a voltage reference: not "zero" voltage reference. Four-hundred millivolts of noise voltage is common on "quiet" grounds. There are several types of returns and references.

Return:

- Structure, for power, fault, and "discrete" circuits
- A grid of wires, solid sheet, or foil
- A wire from circuit load back to source or to case
- Circuit card "ground plane." also a reference and shield

Reference:

- Structure, for electronics, shields, power
- A grid of wires, solid sheet, or foil
- A wire from circuit to grounding block or case
- A wire from circuit to structure
- Shield tie
- Earth

Immunity: Capability of a circuit or unit to operate within performance specification in a specified electromagnetic interference environment.

Isolation: Electrical separation and insulation of circuits from ground and other circuits or arrangement of parts to provide protection and prevention of uncontrolled electrical contact.

Jumper/strap: A short wire, strip, strap, or braid conductor installed to make a safety ground connection, to dissipate electrostatic charge, or establish continuity around a break in a circuit.

Limiting, Voltage/Current: Semiconductor components, diodes, Transorb, or filter designed to clip and shunt to ground an applied transient or steady-state voltage. Used to protect against noise frequencies, faults, lightning, and inductive switching transients.

Magnetic field: A radiated, low-impedance field having lines of "flux" or magnetomotive force associated with an electrical current.

Malfunction: Failure or degradation in performance that compromises flight safety.

Noise: Conducted or radiated emission causing circuit upset, performance disorder, or undesired sound.

Precipitation static (P-static): Electrostatic discharge, corona, arcing, and streamering, steady state or impulsive, causing circuit upset, receiver noise or component damage.

Radiated emission (RE): Electromagnetic energy transmitted and propagated in space usually considered as audio frequency or radio frequency noise.

Radio frequency (RF): Frequencies in the electromagnetic spectrum used for radio communications extending from kilohertz to gigahertz.

Radio frequency interference (RFI): Electromagnetic interference in the radio frequency range.

Sealant: An applied substance enclosing and protecting the integrity of a joint, fastener, or electrical bond from moisture, contaminants, oxidation, and acid or alkaline corrosion.

Shield: A conductive material, opaque to electromagnetic energy, for confining or repelling electromagnetic fields. A structure, skin panel, case, cover, liner, foil, coating, braid, or cableway that reduces electric and magnetic fields into or out of circuits or prevents accidental contact with hazardous voltages.

Shield effectiveness (SE): The ability of a shield to reject electromagnetic fields. A measure of attenuation in field strength at a point in space caused by the insertion of a shield between the source and the point.

Signal return: A wire conductor between a load and the signal or driving source. Structure can be a signal and power return. Commonly, it is the low voltage side of the closed loop energy transfer circuit.

Single-ended circuit: A circuit with source and load ends grounded to case and structure and using structure as return.

Structure: Basic members, supports, spars, stanchions, housing, skin panels, or coverings that may or may not provide conductive return paths and shields for electrical-electronic circuits.

Susceptibility: Upset behavior or characteristic response of an equipment when subjected to specified electromagnetic energy—identified with the point, threshold, or onset of operation outside of performance limits. Conducted Susceptibility (CS) applies to energy on interface conductors; Radiated Susceptibility (RS) to radiated fields.

Threshold, noise: The lowest electromagnetic interference signal level that produces onset of susceptibility.

Upset: Temporary interruption of performance that is self-correcting or reversible by manual or automatic process.

Unacceptable Response: Upset, degradation of performance, or failure, not designated a malfunction, but is detrimental or compromising to cost, schedule, comfort, or workload.

Undesirable response: Change of performance and output, not designated a malfunction or safety hazard, that is evaluated as acceptable as is because of minimum nuisance effects and excessive cost burdens to correct.

Validation: Demonstration and authentication that a final product operates in all modes and performs consistently and successfully under all actual operational and environmental conditions founded upon conformance to the applicable specifications.

Verification: Demonstration by similarity, previous inservice experience, analysis, measurement, or operation that the performance, characteristics, or parameters of equipment and parts demonstrate accuracy, show the quality of being repeatable, and meet or are acceptable under applicable specifications.

ABBREVIATIONS AND ACRONYMS

A/C	Aircraft
ACARS	ARINC Communications Addressing and Reporting System
ACT	Active Controls Technology
ADC	Air Data Computer
AF	Audio Frequency
ADF	Automatic Direction Finder
AFCS	Automatic Flight Control System
APU	Auxiliary Power Unit
ARINC	Aeronautical Radio Inc.
BB	Broadband
BITE	Built-In Test Equipment
BW	Bandwidth
CDU	Control Display Unit
CE	Conducted Emission
CM	Common Mode
CRT	Cathode Ray Tube
CS	Conducted Susceptibility
DFDAU	Digital Flight Data Acquisition Unit
DFDR	Digital Flight Data Recorder
DITS	Digital Information Transfer System
DM	Differential Mode
DME	Distance Measuring Equipment
E ³	Electromagnetic Environmental Effects
EADI	Electronic Attitude Director Indicator
ECAC	Electromagnetic Compatibility Analysis Center
ECS	Environmental Control System
E/E	Electrical/Electronic
EEC	Electronic Engine Control
EED	Electro-Explosive Device
E-FIELD	Electric Field
EFIS	Electronic Flight Instrument System
EGT	Exhaust Gas Temperature
EHSI	Electronic Horizontal Situation Indicator
EICAS	Engine Indication and Crew Alerting System
EM	Electromagnetic
EMC	Electromagnetic Compatibility
EME	Electromagnetic Effects
EMI	Electromagnetic Interference
EMIC	Electromagnetic Interference/Compatibility
EMP	Electromagnetic Pulse
EPR	Engine Pressure Ratio
ESD	Electrostatic Discharge
ESE	Electric (field) Shield Effectiveness
FCC	Flight Control Computer
FDEP	Flight Data Entry Panel
FMC	Flight Management Computer
Gr/Ep	Graphite/Epoxy
GPS	Global Positioning System

GPWS	Ground Proximity Warning System
HF	High Frequency
H-FIELD	Magnetic Field
IAAC	Integrated Application of Active Controls Technology (to an Advanced Subsonic Transport Project)
IDG	Integrated Drive Generator
ILS	Instrument Landing System
INS	Inertial Navigation System
IRS	Inertial Reference System
LCC	Life Cycle Cost
LOC	Localizer
LRRA	Low Range Radio Altimeter
LRU	Line Replaceable Unit
MCDP	Maintenance Control and Display Panel
MCP	Mode Control Panel
mil	One thousandths of an inch (0.001)
MSE	Magnetic (field) Shielding Effectiveness
NB	Narrowband Signal
N1	Fan Speed
N2	Core Engine Speed
OMEGA	Very low frequency navigation
PCU	Power Control Unit
PRF	Pulse Repetition Frequency
P-Static	Precipitation Static
RDMI	Radio Distance Magnetic Indicator
RE	Radiated Emission
RF	Radio Frequency
RFI	Radio Frequency Interference
RS	Radiated Susceptibility
S/A	Spectrum Analyzer
SE	Shielding Effectiveness
SHF	Super High Frequency
TLA	Thrust Lever Angle
TMC	Thrust Management Computer
UHF	Ultra High Frequency
VHF	Very High Frequency
VLF	Very Low Frequency
VOR	VHF Omnidirectional Range
VORTAC	VHF Omnidirectional/Tactical Air Navigation
VSI	Vertical Speed Indicator
WRU	Weapons Replaceable Unit

APPENDIX B

TEST AND TEST LIMITS

Early EMC history has seen the radio receiver as the centerpiece of electromagnetic field testing. It was necessary to find the source of noise entering aircraft audio circuits and radios. The keys today, in measuring emission and susceptibility parameters, are the oscilloscope and spectrum analyzer; the need for noise control spread to instrumentation and automatic pilot circuits.

We are now seeing the need for digital logic analyzers, bus controllers, and automatic, interactive testing capability to measure performance in fly-by-wire, negative stability, aircraft systems.

Spectrum analyzers and storage oscilloscopes are proven and powerful troubleshooting tools in the measurement of noise. The scope displays the analog time domain waveform. The spectrum analyzer lays out the frequency components of that waveform. The scope shows peak amplitude. The spectrum analyzer reveals amplitudes versus frequency. With a scope, the pulse repetition rate is measurable. And with the spectrum analyzer, harmonics are caught in any frequency band. But, although spectrum analyzers and digitizing oscilloscopes are useful in finding and characterizing noise, it is ineffective to apply them to the task of detection of errors or noise margins in computers. The EMC community now needs these units to be paired with high-speed data bus analyzers and logic analyzers in order to provide even simple measurements of computer processor operations, such as: timing sequence, state activity, and bus status.

Recently, the processing functions of an avionic computer were upset by noise causing the unit to suspend operation, to "lock up." It then required recycling of power to reinitiate operation. Personnel from the electromagnetic compatibility group were asked to help diagnose the unpredictable upsets. An oscilloscope (analog waveforms) and the spectrum analyzer (frequency components) displayed noise occurring on the wire returns, grounds, and logic power supply lines; the noise levels were high enough to interfere with clock and data signals; wavering clock timing pulses destabilized the processing sequences; noise and unstable signals appeared everywhere on the circuit boards traces.

Many days were spent on this problem, but with "analog" instrumentation a solution could not be found until logic analyzers and bus controllers were brought in. Without the capability to control data entry formats, observe and evaluate output activity, timing sequences, and to correlate state changes with noise events, timely solutions to complex problems become impossible.

Future validation testing on automated aircraft systems will require laboratory personnel to monitor simultaneously occurring events, to visually correlate timing, logic state changes, and to automatically record data, decoded and converted, in real time under a number of aircraft modes. Digital interface bus analyzers, logic analyzers, and interactive computer controllers will offer fast solutions and bring about professional insights to noise problems on new digital avionics.

Laboratory personnel are called upon to execute a variety of tasks:

- Circuit research
- Test equipment construction
- Diagnostics and troubleshooting
- Evaluation of avionics performance
- Avionics and airplane qualification testing

And laboratory personnel diagnose problems in a variety of aircraft units: computers, power controllers, transmitter/receivers amplifiers, motors/generators, analog sensors, all of which encompass a wide range of characteristics. Functions of the aircraft, in a flight context, span the systems of environmental control, flight control, flight management, fuel, communication, navigation, power, and engine controls, but to the EMC engineer and laboratory technician these functions bring to mind susceptibilities and emissions:

- Power: 400-Hz, dc buses, motors, relays, switching events
- Dc-to-dc switching regulators, pulse width modulation controllers
- Radio frequency receiver thresholds and transmitter antennas fields
- Data transmission and clock oscillators
- Sensitive analog (audio) sensors and circuits

Data, information, and histories already exist on environmental levels and are documented in the RTCA/DO-160B and MIL STD 461 specification (see table B1).

But, for noise effects on data, transmission and timing sequences relative to conditions of circuit stability and upset margins, the EMC community today does not have an adequate data base.

Speeds of future systems will increase, voltage levels will rise, and sensor and receiver thresholds will be lower and more sensitive. Emerging flat panel displays, microprocessor controls, voice controlled systems, dc power systems, and pulse width modulated, electric actuators will be available soon for full authority flight controls and will be beyond the reach of engineers in the EMC community for test and analysis.

In the shield room, the controlled environment and standard electrical references (for instance, voltage, current, impedance, frequency meters, and ground planes) offer established laboratory conditions for analysis and tradeoffs of digital flight control designs. But, most of the time during today's EMI tests, current probe factors, antenna factors, line losses, attenuation factors, and bandwidth conversions are now essentially hand calculated and joined with raw data almost on a point by point basis in an anachronistic, time consuming process. These computations are a hindrance, but the more important loss is inability to assess trends and compare, in real time, circuit operational changes in a controlled and repeatable manner under various noise levels.

Controlling, probing, comparing, and recording status and data transmissions (being digital in nature) against the itinerant noise occurrences (having analog waveforms) stands or falls on the test and simulation capability.

Effectiveness resides in the technician's skill and his experience coupled with the tools and equipment with which that skill and experience is implemented. New, modern equipment having automatic microprocessor controls and automatic data readout is becoming available to provide interactive test decisions. Equipment and tools of the "analog" 1960s and 1970s cannot carry the load or be compatible with the flight controls of the "full-authority," "fly-by-wire" 1990s.

TEST	160B	461B
POWER BUS:		
Conducted Emission	21.3a	CE03
Switching Transients CE	None	CE07
Conducted Susceptibility (CS):		
Audio Frequency CS	18.3	CS01
Radio Frequency CS	20.4a	CS02
Power Line Spike	17.3	CS06
Bus Momentary Interruption	16.5.1.4	None
EQUIPMENT AND SIGNAL CABLE:		
Conducted Emission Cable	21.3b	None
Induced into equipment and cable:		
Magnetic "H" Field Equipment	19.3.1	RS02
Magnetic "H" Field Cable	19.3.2	RS02
Transient Spike: 200V	None	RS02
Electric "E" Field Cable	19.3.3	None
Inductive Switching Transient	19.3.4	None
Radio Frequency CS Cable	20.4b	None
EQUIPMENT & INTERCONNECTING CABLE:		
Radiated Emission	21.4	RE02
Radiated Susceptibility	20.5	RS03

*Table B1 DO-160B and MIL STD 461B Test Cross Reference
(See Figure B1)*

POWER LINE CONDUCTED EMISSION

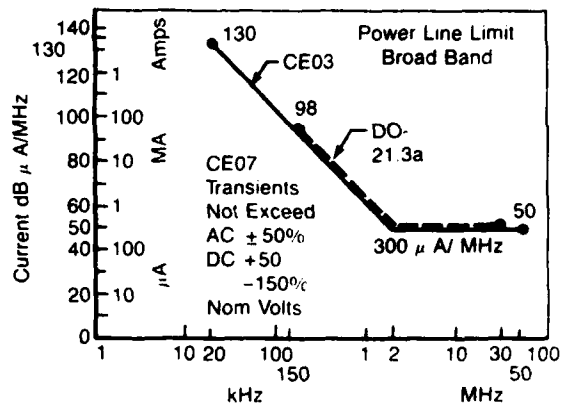
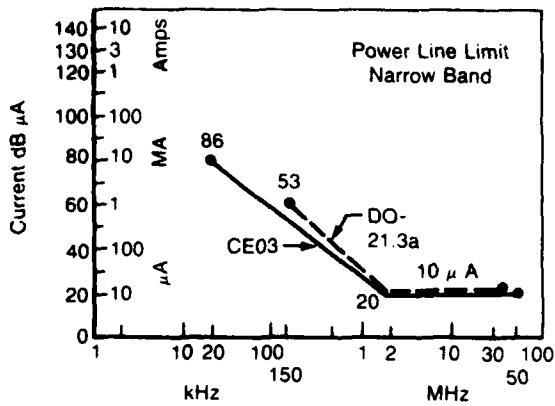

CONDUCTED SUSCEPTIBILITY

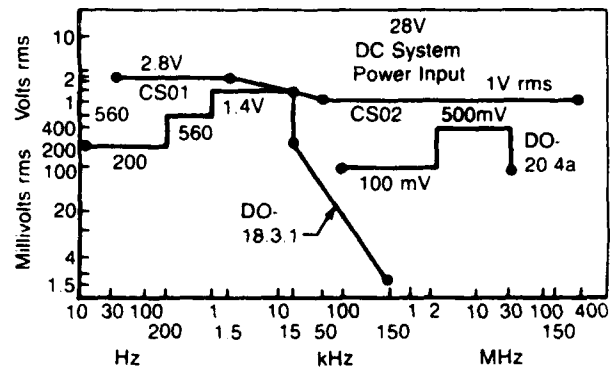
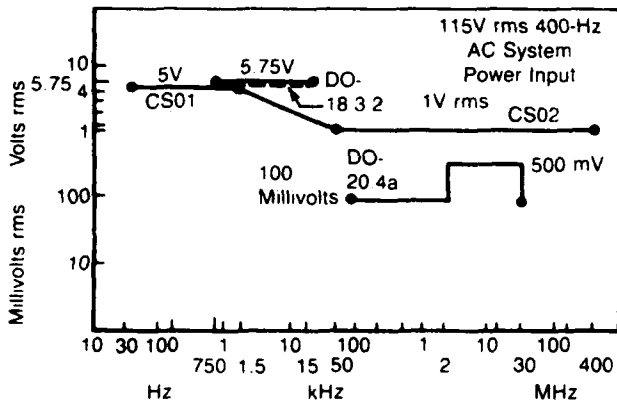

Power Input Transient

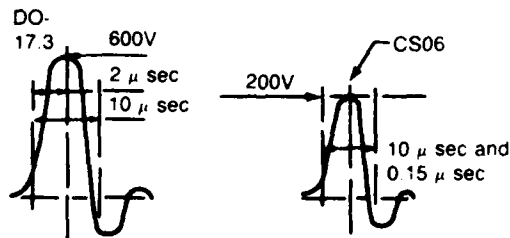

Note: The "DO-" indicates the RTCA/DO-160B paragraph

Figure B1. EMI Test Limits

SIGNAL INTERCONNECTING CABLES CONDUCTED EMISSION

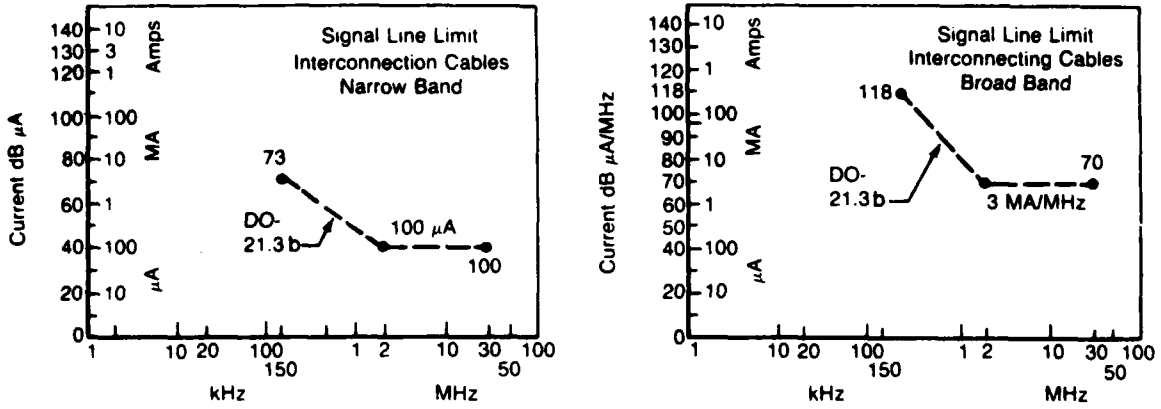

INDUCED FIELDS—EQUIPMENT-CABLE

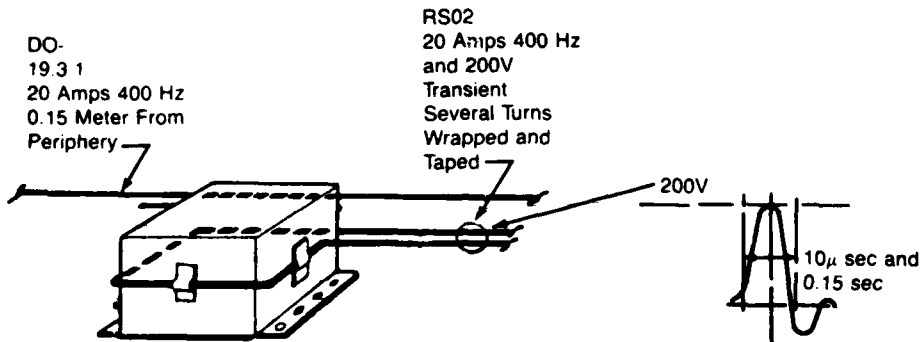

SIGNAL INTERCONNECTING CABLE MAGNETIC ("H") FIELD

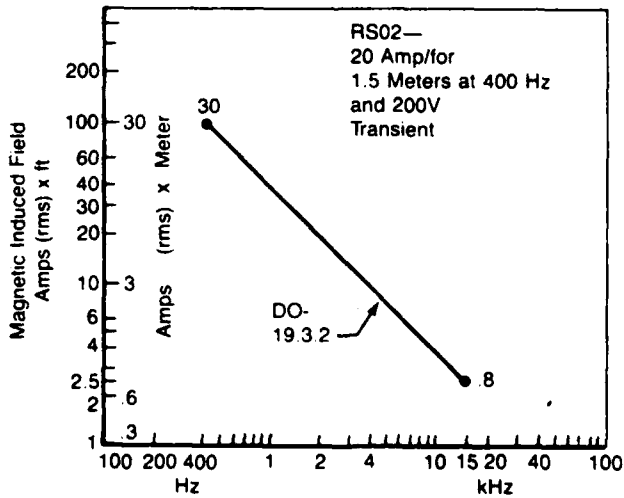

Figure B1. EMI Test Limits (Continued)

INDUCED FIELD—EQUIPMENT-CABLE (CONTINUED)

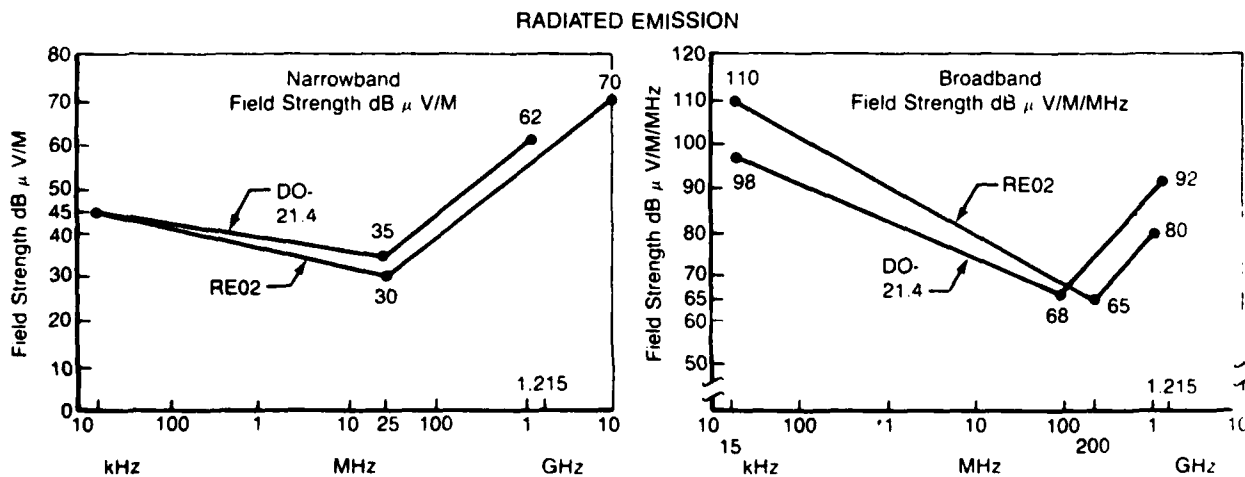
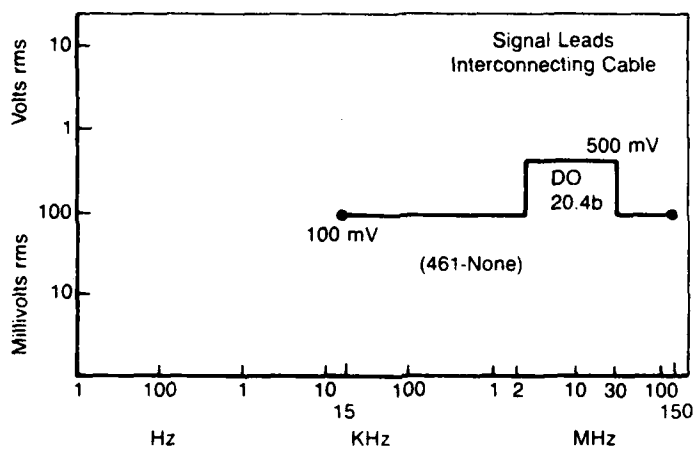
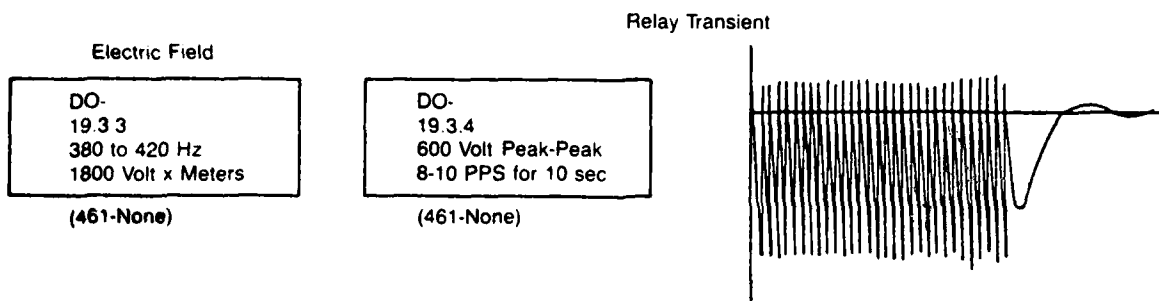

Figure B1. EMI Test Limits (Continued)

RADIATED SUSCEPTIBILITY

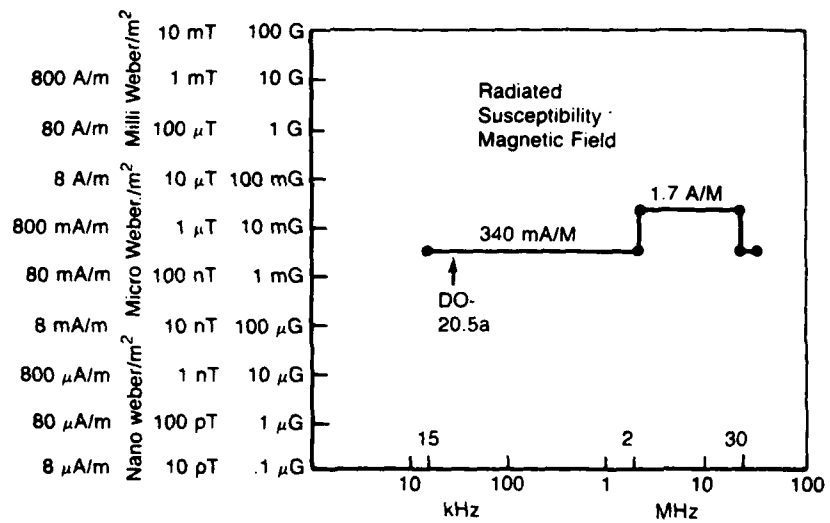
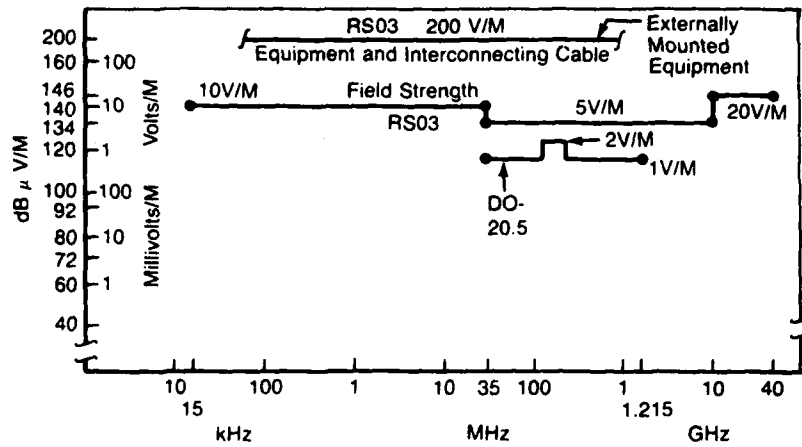

Figure B1. EMI Test Limits (Continued)

DATE
L MED
88