

NO-A183 800

NORDIC SEAS SEDIMENTATION DATA FILE VOLUME 1 PARTICLE

1/1

FLUXES NORTH-EASTER (U) WOODS HOLE OCEANOGRAPHIC

INSTITUTION MR S HONJO ET AL APR 87 WHOI-87-17

UNCLASSIFIED

N00014-85-C-0001

F/G 8/3

NL

END
9-87
DTIC

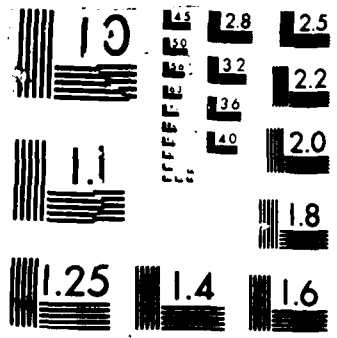

DTIC FILE COPY

WHOI-87-17

Joint Program:
Woods Hole Oceanographic Institution, USA
University of Kiel, FRG

2

NORDIC SEAS SEDIMENTATION
DATA FILE, Vol. 1, 1987

AD-A183 800

**Particle Fluxes,
Northeastern Nordic Seas
1983 - 1986**

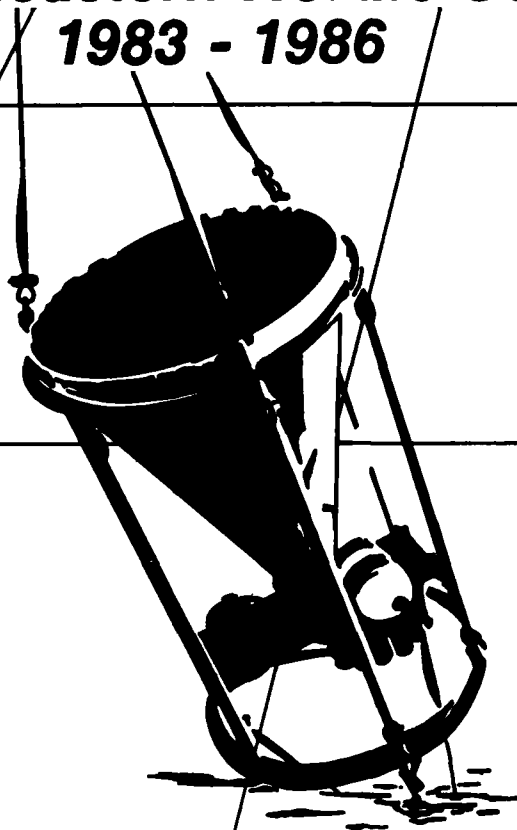

DTIC
COLLECTED
AUG 11 1987
E

Sponsored by
Office of Naval Research
Arlington, Virginia USA

87 8 3 078

WHOI-87-17

Particle Fluxes, North-Eastern Nordic Seas: 1983-1986

(Nordic Seas Sedimentation Data File, Vol. 1)

by

Susumu Honjo, Steven J. Manganini, Amy Karowe, Bonnie L. Woodward

Woods Hole Oceanographic Institution
Woods Hole, Massachusetts 02543

April, 1987

Technical Report

Funding was provided by the Office of Naval Research
under Grant Number N00014--85-C-0001.

Reproduction in whole or in part is permitted for any purpose of
The United States Government. This report should be cited as:
Woods Hole Oceanog. Inst. Tech. Rept. WHOI-87-17.

Approved for publication; distribution unlimited

Approved for Distribution:



David A. Ross, Chairman
Geology and Geophysics Department

Joint Program:

Woods Hole Oceanographic Institution
and
University of Kiel, University of Bremen, FRG

NORDIC SEAS SEDIMENTATION

DATA FILE, Vol. 1

PARTICLE FLUXES,

NORTH-EASTERN NORDIC SEAS:

1983 - 1986

| | |
|--------------------|-------------------------------------|
| Accession For | |
| NTIS GRA&I | <input checked="" type="checkbox"/> |
| DTIC TAB | <input type="checkbox"/> |
| Unannounced | <input type="checkbox"/> |
| Justification | |
| By | |
| Distribution/ | |
| Availability Codes | |
| Dist | Recall and/or Special |
| A-1 | |

Sponsored by
Office of Naval Research
Arlington, Virginia USA

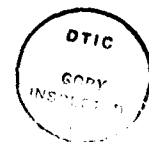

Table of Contents

| | Page |
|---|------|
| Abstract | 1 |
| Introduction | 1 |
| Field Program | 3 |
| Laboratory Analysis | 3 |
| Results | 4 |
| Acknowledgments | 5 |
| References | 6 |
| | |
| Table 1. Sediment trap moorings, 1983-1987 | 7 |
| Table 2. Average mass fluxes in the northern Nordic Seas, 1983-1986 . | 10 |
| Table 3. Comparison of mass fluxes between stations in the northern Nordic Seas, 1983-1986 | 11 |
| | |
| Figure 1. Location of map of sediment trap moorings | 12 |
| Figure 2. PARFLUX Mark 5 and 6 sediment traps | 13 |
| Figure 3. Analytical procedure | 14 |
| | |
| Flux Data Files: | |
| | |
| Norwegian-Atlantic Current Area | 15 |
| LB-1 East Lofoten Basin | 16 |
| BI-1 Bear Island-West of Starfjord | 26 |
| NA-1 Aegir Ridge | 36 |
| NB-1 East of Jan Mayen | 46 |
| | |
| East Greenland/Fram Strait Area | 56 |
| FS-1 Central Fram Strait | 57 |
| GB-2.2K Greenland Basin, 1,966 m | 67 |
| GB-2.3K Greenland Basin, 2,817 m | 75 |

Nordic Seas Sedimentation Data File, Volume 1

Particle Fluxes, North-Eastern Nordic Seas: 1983 - 1986

by

Susumu Honjo, Steven J. Manganini, Amy Karowe, Bonnie L. Woodward

Woods Hole Oceanographic Institution
Woods Hole, Massachusetts 02543

April, 1987

Abstract

Seventy-nine particle flux samples were collected from 1983 to 1986 using 7 automated time-series sediment traps at 6 stations distributed in the northern and eastern portion of the Nordic Seas as part of a German/U.S. joint program on arctic sedimentation studies. Each sample represents either one month or two weeks of sedimentation at approximately 400 m above the sea floor. In this data file the results of laboratory analysis conducted at the Woods Hole Oceanographic Institution, U.S.A. of the main sedimentological criteria: total mass, carbonate, opal, combustible, organic carbon, nitrogen, and lithogenic mass are presented in both tabular and histogram form. Results from the southern and western portion of the Nordic Seas will be published as they become available.

Introduction

Supported by the United States Office of Naval Research, the Woods Hole Oceanographic Institution (WHOI), with the cooperation of the University of Kiel and the University of Bremen, Federal Republic of Germany, has conducted a basin-wide sedimentological research program in the Nordic Sea since the summer of 1983. One of the major field experiments was deployment of 16 sets of sediment trap-current meter moorings for a period of about one year each throughout the basin. During the first half of the program we deployed 6 year-round moorings between August 1983 and August 1986 in the Fram Strait and Norwegian Basin. Details of mooring positions, depths, duration of deployment are summarized in Table 1. During the second part of the program, sediment trap mooring deployments and laboratory analyses of incoming samples will continue around Iceland, coastal Greenland and selected stations in cooperation with the Marine Research Institute, Reykjavik. The

University of Hamburg maintains 3 sediment trap mooring stations in the southern North Sea and we cooperate with their program on some of the laboratory analyses (Fig. 1).

The Nordic Sea is a basin, approximately 2.5 million square kilometers, defined by the east coast of Greenland to the west, Iceland to the south, the Norwegian coast to the east, and Spitsbergen to the north. It connects to the Arctic Ocean via the Fram Strait and to the North Atlantic via the Faeroe and Denmark straits (Hurdle, 1986). In short, the Nordic Sea is the bridge between the Arctic Ocean and the North Atlantic Ocean, and therefore is of global significance in regard to the Atlantic environment.

Most of the Nordic Sea lies north of the Arctic Circle. The net solar energy input is strongly limited in this basin due to low angle insolation during the summer and day-long darkness in the winter. Three longitudinal zones of ocean characteristics can be distinguished in this basin: 1) a zone along the east coast of Greenland which is covered by southerly flowing ice packs and floes in the East Greenland Current combined with fast-ice conditions on the immediate coast (Vinje, 1977). The surface temperature in this zone is 0°C throughout the year; 2) a zone on the east side of the basin where the warm, saline northward-flowing Norwegian-Atlantic Current prevails (Gathman, 1986); and 3) a zone in the central gyre which is often associated with mixed ice conditions where the other two zones meet in the middle of the basin (Wadhams, 1986; Swift, 1986). This unique arrangement of currents form several ocean fronts (Johannessen, 1986) and strong contrasts of oceanic conditions are seen within this relatively small basin. For example, the summer surface temperature difference between the east and west side of the basin along the 70th latitude (off Tromso, Norway to Scoresby Sound, Greenland, which are only about 1,000 km apart) is as great as 10°C in some years (Detrich, 1969). Thus the Nordic Sea embodies highly diversified specific environments within the basin boundary.

Very little is known about particle sedimentation and recycling schemes in the North Sea environment. Ocean particles in the Nordic Basin also involve specific origins, flux and processes which reflect varied oceanic characteristics. Questions include: how much of the particulate carbon and other biogenic particles settle down to the sea floor and how do they compare with surface production which is produced under severely limiting Arctic conditions? What is the sedimentary mechanism of lithogenic particles in the Arctic open ocean environment? How are these sedimentary particle processes related to ice coverage and mixed ice zone conditions? This research aims to answer these questions and, optimally, to draw a realistic model of particle flux and sedimentation in relation to other critical high latitude ocean environmental factors.

Field Program

Experimental logistics in the Nordic Sea are generally very difficult compared to lower latitude oceanographic endeavors; winter storms and ice coverage hinder deployment and recovery of large bottom tethered mooring arrays. Because of strong seasonality, flux measurements in high latitudes must cover at least a one-year cycle of seasons. We have used automated time-series sediment traps left unattended for about one year. A sediment trap used in this environment requires a large opening in order to collect enough volume of sample during the winter months when the flux is estimated to be extremely small. We used a PARFLUX Mark 5 and Mark 6 whose apertures are 1.2 and 0.5 m² with 12 and 13 sampling increments, respectively (Honjo and Doherty, 1987, in press) (Table 1, Fig. 2). The sediment traps were deployed at approximately 400 m above the sea floor at most mooring sites. The exception was a mooring with two sediment traps deployed along a taut line which was set in the Greenland Basin. One to three current meters were deployed with each sediment trap mooring. A transmissometer was deployed with two Fram Strait moorings for one year, 1984-1985. The results from the current meter and transmissometer experiments will be published elsewhere. The deployment/recovery procedure for sediment trap mooring arrays was described in a separate paper (Honjo and Doherty, 1987, in press) We used sodium azide as a preservative (Honjo, 1980).

Laboratory Analysis

Recovered samples were refrigerated throughout the transportation and storage period. Each sample was equally shared with Dr. Gerold Wefer's laboratory (University of Bremen). Our responsibility at WHOI was to clarify the nature of the sediment trap collected samples with regard to basic sedimentological criteria. Dr. Wefer's group is investigating stable isotopes in planktonic foraminiferal tests and some biocoenosis composition in the samples.

Upon arrival at WHOI, each sample was sieved through a 1mm Nylon mesh. This was necessary to maintain precise sample splitting. Particles smaller than 1 mm were further split into smaller aliquots by a precision wet sample splitter (Honjo, 1980). The split aliquots were further sieved through a 62 micron mesh for the LB-1, FS-1, and BI-1 samples in order to separate foraminiferal tests and radiolarian shells in this size category more efficiently. We analyzed individually samples in each size category for the following criteria. All results were normalized to flux values in mg m²day (Honjo, 1980).

Total mass
Carbonate mass
Combustible mass

Noncombustible mass
Opal mass
Lithogenic mass
Organic carbon, nitrogen, and hydrogen mass

A detailed description of the analytical methods applied to this research will be published elsewhere. In summary as illustrated in Fig. 3, the total mass flux was obtained as the average of dry mass weight of the three 16th aliquots. The carbonate content was obtained from the dry weight difference before and after decalcification by 1N acetic acid at room temperature. A decalcified aliquot was combusted for 3 hours at 500°C to obtain the mass of combustible organic matter as the difference between a decalcified sample and ash weight. Biogenic silica, or opal, content was analyzed by the sodium carbonate leaching method modified from Eggiman *et al.*, 1980, on decalcified aliquots. Lithogenic particle flux, mostly clay and fine rock-forming detritus, was gained by subtracting the opal flux from the noncombustible flux. Organic carbon, nitrogen, and hydrogen content were analyzed using a Perkin-Elmer Elemental Analyzer, type 240C. We used at least 100 mg of decalcified samples (Fig. 3).

Total flux, therefore, is equal to the sum of carbonate, noncombustible, and combustible fluxes. The sum of biogenic opal and lithogenic fluxes should be the noncombustible flux. Insignificant discrepancies appear in some total flux values in this data file due to the rounding out processes during calculation. We regard the combustible portion of the flux as organic matter flux (Honjo, 1980). Combustible flux consists of organic carbon, nitrogen, and hydrogen balanced with oxygen and other unidentifiable ignition loss. The amount of organic nitrogen in the GB-1 sample was too small to analyze within our level of confidence. The opal content in the GB-2, 1966 trap sample was also too small to analyze with the leaching method at the time but we are making an effort to bring up significant numbers.

The phosphorus flux from this area will be published in a separate file. The results of analysis of 15 trace elements from all time-series sediment trap samples treated in the present data file (total of 1,185 analyses) will be published in a separate volume.

Results

The purpose of this data file is to publish a summary of available data on the flux in the north-eastern Nordic Sea for public use. Scientific interpretations and models will not be included in this publication.

The annual averages in two major areas, Norwegian-Atlantic current area and the East Greenland current area (sea ice prevailed) based upon fluxes from 6 stations presented in this report, is given in Table 2. The annual fluxes of sedimentary components from 6 stations are tabulated in Table 3 for comparison. At the beginning of each data file for individual stations are given the sample identification numbers, opening and closing dates, length of collection period and mid-point date during which the samples were collected. On subsequent pages are given the percentages of total flux of three size categories: particles which passed through 62 micrometer mesh ($< 63 \mu\text{m}$), particles retained in a 1 mm mesh ($> 1 \text{mm}$), and particles in between ($63 \mu\text{m} - 1 \text{mm}$). In the rightmost column of the table, the total flux of size categories combined is given. The columns of each histogram are labeled according to mid-point day of the sampling period. The six flux categories listed in the previous section are included in each data set.

Acknowledgments

Without the encouragement and support of Dr. G. Leonard Johnson, Office of Naval Research, this first entire ocean basin sedimentation study applying the flux concept would never have been started. We sincerely thank him for his insight and strong commitment to excellent science.

The Nordic Sea is one of the most difficult oceans with regard to experimental logistics. We have received a large amount of good will support from international colleagues; a large part of our success is due to them and even the unusually long acknowledgment in this paper may cover only a portion. In particular, the Alfred Wegener Institution of Polar and Marine Research, Bremerhaven provided us with vital shiptime on board R/V Polarstern for this experiment. Dr. Jörn Thiede, Chief Scientist of the 1984 and 1985 legs, took every possible opportunity to help us with his professional competence and personal care during this experiment. We also thank the R/V Meteor (old) and the Deutsche Hydrographische Institute, Hamburg, which supported us in a difficult mission to recover a malfunctioned mooring system and to deploy a large array in the Greenland Sea during the summer of 1985. We also thank the R/V Meteor (new) and R/V Valdivia, University of Hamburg, for their high quality support of the mooring experiments in 1986.

The Nordic Sea program has been carried out under the mutual cooperation among the University of Bremen, University of Kiel and Woods Hole Oceanographic Institution. Dr. Gerold Wefer, our partner, has provided many useful suggestions in research and has been very helpful in providing vital logistic support. We own him our sincere gratitude. We thank for their dedication and imagination: Dr. Vernon L. Asper,

University of Southern Mississippi, and Dorinda Ostermann, WHOI, who made it possible to deploy and recover the first 4 mooring arrays in the northern Nordic Sea in 1983 and 1984; Peter Clay and Thomas Crook who provided vital assistance in recovering a stranded GB-1 mooring in the summer of 1985; Emily Evans who took care of communication traffic and data editing during this program.

References

- Detrich, G., 1969. Atlas of the Hydrography of the Northern North Atlantic, International Council for the Exploration of the Sea. Copenhagen.
- Eggimann, D.W., Manheim, F.T. and Betzer, P.R., 1980. Dissolution and Analysis of Amorphous Silica in Marine Sediments. *Journal of Sedimentary Petrology*, 50(1): 215-225.
- Gathman, S.G., 1986. Climatology. In: *The Nordic Seas* (Hurdle, B.G., ed.), 1-18, Springer-Verlag, New York, 777 pp.
- Hurdle, B.G. (ed.), 1986. *The Nordic Seas*. Springer-Verlag, New York, 777 pp.
- Honjo, S., 1980. Material Fluxes and Modes of Sedimentation in the Mesopelagic and Bathypelagic zones. *Journal of Marine Research*, 38: 53-97.
- Honjo, S. and Doherty, K.W., 1987 (in press). Large Aperture Time-Series Oceanic Sediment Traps; Design Objectives, Construction and Applications. *Deep-Sea Research*.
- Johannessen, O., 1986. Brief overview of Physical Oceanography. In: *The Nordic Seas* (Hurdle, B.G., ed.), 103-127, Springer-Verlag, New York, 777 pp.
- Swift, J.H., 1986. The Arctic Waters. In: *The Nordic Seas* (Hurdle, B.G., ed.), 129-153, Springer-Verlag, New York, 777 pp.
- Vinje, T.E., 1977. Sea Ice Conditions in the European Sector of the Marginal Sea of the Arctic, 1966-75. *Norsk Polarinstitutt Arbok*, 1975: 163-174.
- Wadhams, P., 1986. The Ice Cover. In: *The Nordic Seas* (Hurdle, B.G., ed.), 21-84, Springer-Verlag, New York, 777 pp.

March 20, 1985
 Revised: September 26, 1985
 Revised: August 26, 1986
 Revised: February 24, 1987
 Revised: April 13, 1987

SEDIMENT TRAP MOORINGS IN THE GREENLAND BASIN/NORWEGIAN SEA, 1983-1987.

SUPPORTED BY ONR (WHOI), DFG/GHIS (KIEL UNIV.), GHIS (HAMBURG UNIV.)
 COORDINATED BY WHOI/ONR

Table 1a

| No. Year | ID No. | Location | Latitude/ Longitude | Water depth (m) | Mooring height (m) | No. 50lb spheres | Trap type and number/mooring | Trap depth, m (off floor) | Cups/ duration dys:hrs | Extra Instrs. | Deploy/ Recov: | Ship: dep/rec |
|--|--------|-------------------------|--|-----------------------|--------------------------|---------------------|---------------------------------|---------------------------------|------------------------------|------------------------|--------------------|----------------------|
| 1 | 1983 | LB-1 | Lofoten Basin 69°30.11'N 10°00.02'E | 3,161 | 432 | 25 | Mark 5 (1) | 2,761 (400) | 12/ 30:0 | 2 CM 2 DEP | 8/11/83 8/15/84 | Pstern/ Pstern |
| Same mooring moved north as BI-1 in 1984. | | | | | | | | | | | | |
| 2 | 1983 | GB-1 | Greenland Basin 74°32.31'N 06°39.82'W | 3,417 | 2,008 | 34 | Mark 5 (2) | 2,817 (600) 1,452 | 12/ 30:0 | 2 CM 3 DEP | 8/1/83 7/30/85 | Pstern/ Meteor |
| Recovery delayed 1 year due to release battery problem. Successfully recovered in 1985. (1965) | | | | | | | | | | | | |
| 3 | 1984 | BI-1 | West of Storfjord 75°51.35'N 11°28.01'E | 2,123 | 473 | 25 | Mark 5 (1) | 1,700 (418) | 12/ 30:4 | 1 CM 2 DEP | 8/12/84 8/17/85 | Pstern/ Pstern |
| Last cup closed 14:00: 8/10/85. To be moved to LB-2 in '85 w/Kiel release. | | | | | | | | | | | | |
| 4 | 1984 | FS-1 | Central Fram Str. 78°51.9'N 01°22.0'E | 2,527 | 2,079 | 15 | Mark 6 (1) | 2,452 (381) | 13/ 27:5 | 1 CM 1 TMM 2 DEP | 8/20/84 7/30/85 | Pstern/ Meteor |
| #13 closed 0900: 7/19/85. Transmissometer worked all year long. Redeployed in FS-2 location; app. 50 miles east. | | | | | | | | | | | | |
| 5 | 1985 | NS.SK-1 West to 4 | Skagerrak 57°55'N 06°31'E | 400 | 220 | 10 | Mark 6 (1) | 300 (100) | 13/ 14:0 | ICM | 3/12/85 9/15/87 | Valdivia Valdivia |
| Will continue as NS.SK3 after 4/17/86 (U. Hamburg, S. Kempe, P.I.). | | | | | | | | | | | | |
| 6 | 1985 | NS.BF-1 West of to 4 | Bergen Fjord 62°00'N 03°35'E | 450 | 220 | 10 | Mark 6 (1) | 350 (100) | 13/ 14:0 | ICM | 3/22/85 9/25/87 | Valdivia Valdivia |
| Will continue as NS.BF3 after 4/27/86 (U. Hamburg, S. Kempe, P.I.). | | | | | | | | | | | | |

March 20, 1985
 Rev: September 26, 1985
 Rev: February 24, 1987
 Rev: April 13, 1987

Table 1b

| No. Year | ID No. | Location | Latitude/ Longitude | Water depth (m) | Mooring height (m) | No. 50lb spheres | Trap type and number/mooring | Trap depth, m (off floor) | Cups/ duration dys:hrs | Extra Instrs. | Deploy/ Recov: | Ship: dep/rec |
|--|---------------------|-------------------------|------------------------|-----------------------|--------------------------|---------------------|---------------------------------|------------------------------------|------------------------------|------------------|--------------------|------------------------|
| 7 | 1985 GB-2 | Greenland Basin | 74°35'N 06°43'W | 3,445 | 2,008 | 34 | Mark 5 (2) | 2,823 (622) 881 (2564) | 25/ 14:0 | None | 8/02/85 8/23/86 | Meteor Valdivia |
| All equipment worked. | | | | | | | | | | | | |
| 8 | 1985 FS-2 | Central Fram Str. | 79°00'N 04°55.0'E | 2,430 | 1,862 | 32 | Mark 6 (2) | 1,929 (501) 1,000 (1,500) | 13/ 27:0 | 1 CM 1 TMM | 7/29/85 8/17/86 | Pstern Valdivia |
| Only 5 cups worked. Transmissometer flooded. Current record OK. | | | | | | | | | | | | |
| 9 | 1985 NB-1 | W. Norwegian Sea | 70°00'N 01°58'W | 3,296 | 2,773 | 15 | Mark 6 (1) | 2,749 (520) | 13/ 30:0 | 2 DEP | 8/18/85 7/15/86 | Pstern Meteor (new) |
| New 25 cup system; 17 samples recovered (U. Bremen, G. Wefer, P.I.). | | | | | | | | | | | | |
| 10 | 1985 NA-1 | Norway Abyssal Plain | 65°31'N 00°64'E | 3,058 | 2,558 | 15 | Mark 6 (1) | 2,630 (428) | 13/ 30:0 | 2 DEP | 8/19/85 7/18/86 | Pstern Meteor (new) |
| New electronics. 13 samples recovered. | | | | | | | | | | | | |
| 11 | 1985 LB-2 (Kiel) | Lofoten Basin | 69°30'N 10°00'E | 3,160 | 432 | 25 | Mark 5 (1) | 2,760 (400) (157) | 12/ (25?) 30/ | 2 CM 2 DEP | 8/9/85 8/86 | Pstern Valdivia |
| Permanent station for Bremen group to be funded by RG-95, DFG, after 1986 (U. Bremen, G. Wefer, P.I.). | | | | | | | | | | | | |

March 20, 1985
 Rev: September 26, 1985
 Rev: February 24, 1987
 Rev: April 13, 1987

Table 1c

| No. Year | ID No. | Location | Latitude/ Longitude | Water depth (m) | Mooring height (m) | No. 501b spheres | Trap type and number/mooring | Trap depth, m (off floor) | Cups/ duration dys:hrs | Extra Instrs. (depth, m) | Deploy/ Recov: | Ship: dep/rec |
|----------|------------|----------------------|------------------------|-----------------------|--------------------------|---------------------|---------------------------------|---------------------------------|------------------------------|--------------------------------|----------------------|------------------|
| □ 12 | 1986 IP-1 | Iceland Plateau | 68°01'N 12°39'W | 1,884 | 458 | 10 | Mark 6 (1) | 1,454 (430) | 13/ 30:0 | 1 CM (1458) | 10/20/86 10/27/87 | Smdsn Smdsn |
| □ 13 | 1986 MRI-1 | South Iceland | 62°58'N 21°32'W | 1,004 | 459 | 10 | Mark 5 (1) | 574 (430) | 13/ 30:0 | 1 CM (577) | 10/3/86 10/27/87 | Smdsn Smdsn |
| □ 14 | 1986 NDS-1 | N. Denmark Strait | 69°30'N 21°13'W | 446 | 156 | 20 | Mark 6 (1) | 136 (100) | 13/ 30:0 | 1 CM (350) | 10/14/86 9/27/87 | Smdsn Smdsn |

Very high-tension mooring.

ONR: Office of Naval Research, Code 1125AR
 WHOI: Woods Hole Oceanographic Institution
 DFG: Deutsche Forschungsgemeinschaft
 GMIS: German Ministry of Industry and Science
 DHI: Deutsche Hydrographische Institute
 MRI: Marine Research Institute, Iceland

CM: Current meter
 TMH: Transmissometer
 DEP: Dissolution experiment package

ID No: ONR/WHOI mooring identification number
 Ship, deployment and recovery:
 Pstern: R/V Polarstern, Bremerhaven
 Meteor: R/V Meteor, Hamburg
 Valdivia: R/V Valdivia, Hamburg
 Smdsn: R/V Bjarni Saemundsson, Reykjavik

Table 2. Average Mass Fluxes; Northern Nordic Seas, 1983-1986.
Average Fluxes and (standard deviation) $\text{mg m}^{-2}\text{day}^{-1}$.

| | Norwegian-Atlantic Current Area: | E. Greenland and Fram Strait Area: |
|---------------------|-------------------------------------|---------------------------------------|
| Moorings: | LB-1, BI-1, NA-1, NB-1 | FS-1, GB-21, GB-23 |
| Total Flux | 21.31 (5.39) | 8.45 (1.81) |
| Carbonate Flux | 9.03 (1.96) | 2.42 (0.95) |
| Noncombustible Flux | 9.14 (4.87) | 4.56 (1.05) |
| Combustible Flux | 3.24 (1.55) | 1.55 (0.83) |
| Biogenic Opal Flux | 1.55 (0.36) | --- * |
| Lithogenic Flux | 7.55 (4.69) | --- * |
| Organic Carbon Flux | 1.34 (1.00) | 0.58 (0.31) |
| Nitrogen Flux | 0.16 (0.11) | 0.09 (0.06) |

* Not detectable

Trap Station Codes:

LB-1: East Lofoten Basin
 FS-1: Central Fram Strait
 BI-1: Bear Island - west of Storfjord
 NA-1: Aegir Ridge
 NB-1: East of Jan Mayen
 GB-21: Greenland Basin (shallow)
 GB-23: Greenland Basin (deep)

Table 3. Comparison of mass fluxes between 6 stations in the Northern Nordic Seas, 1983-1986.

| Area: | Norwegian-Atlantic Current | | | | East Greenland/Fram Strait | | |
|---------------------|----------------------------|--------|--------|--------|----------------------------|--------|--------|
| | LB-1 | BI-1 | NA-1 | NB-1 | FS-1 | GB-21 | GB-23 |
| Trap Station: | LB-1 | BI-1 | NA-1 | NB-1 | FS-1 | GB-21 | GB-23 |
| Latitude | 69°30N | 75°51N | 65°31N | 70°00N | 78°52N | 74°35N | 75°35N |
| Longitude | 10°00E | 11°28E | 00°64E | 01°58W | 01°22E | 06°43W | 06°43W |
| Trap Depth | 2,760m | 1,700m | 2,630m | 2,749m | 2,440m | 1,966m | 2,871m |
| Total Flux** | 22.80 | 28.40 | 17.36 | 16.79 | 7.20 | 8.79 | 10.21 |
| Carbonate Flux | 11.40 | 6.61 | 9.18 | 8.93 | 1.40 | 2.59 | 3.28 |
| Noncombustible Flux | 8.07 | 16.31 | 5.94 | 6.24 | 4.26 | 3.65 | 5.73 |
| Combustible Flux | 3.37 | 5.35 | 2.31 | 1.90 | 0.92 | 2.50 | 1.23 |
| Biogenic Opal Flux | 1.12 | 1.96 | 1.68 | 1.44 | 0.60 | --- | 2.61 |
| Lithogenic Flux | 6.95 | 14.35 | 4.26 | 4.65 | 4.00 | --- | 3.12 |
| Organic Carbon Flux | 1.37 | 2.85 | 0.59 | 0.53 | 0.41 | 0.94 | 0.40 |
| Nitrogen Flux | 0.18 | 0.30 | 0.08 | 0.08 | 0.06 | 0.16 | 0.06 |

** Flux is in mg m²day

Trap Station Codes:

LB-1: East Lofoten Basin
 FS-1: Central Fram Strait
 BI-1: Bear Island - west of Storfjord
 NA-1: Aegir Ridge
 NB-1: East of Jan Mayen
 GB-21: Greenland Basin (shallow)
 GB-23: Greenland Basin (deep)

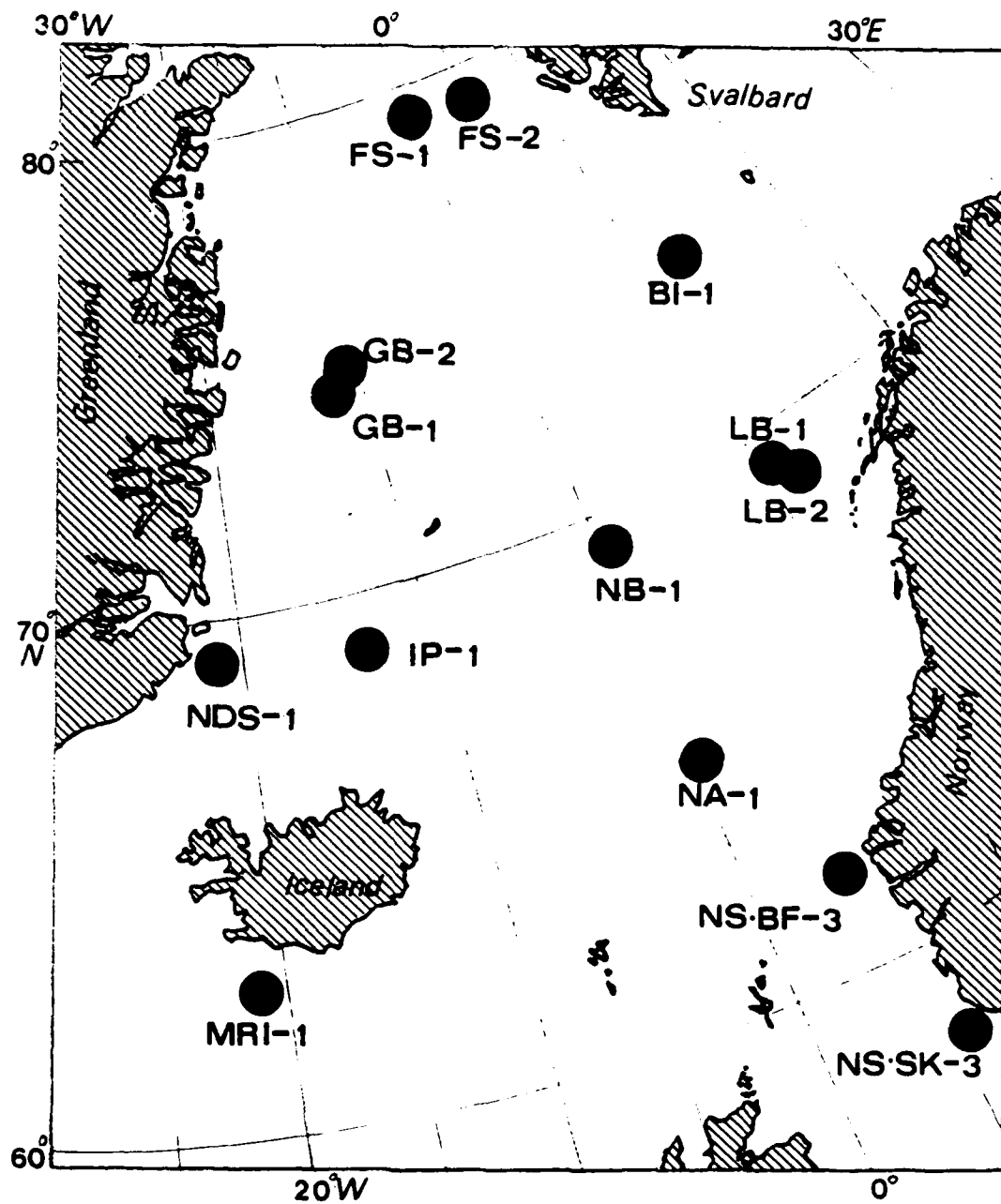
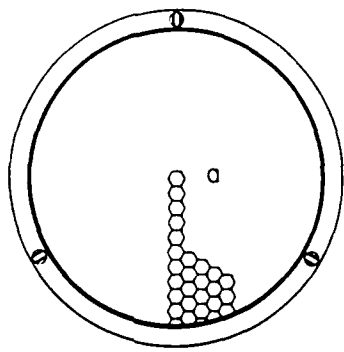
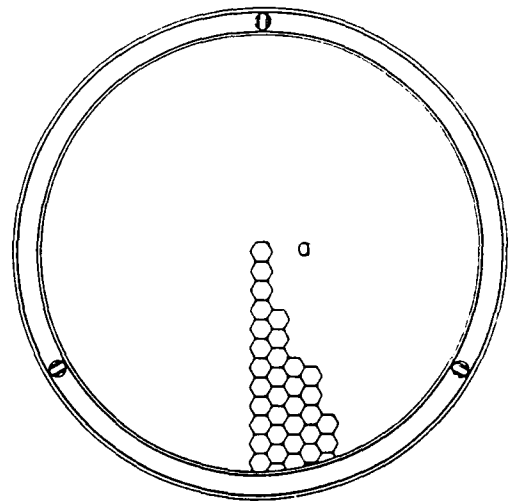

Figure 1. Approximate positions of sediment trap-current meter moorings in the Nordic Seas, 1983-1987.



91cm

Mark 6-13 (0.5 m^2 aperture with 13 sampling bottles).



135cm

Mark 5-12 (1.2 m^2 aperture with 12 sampling bottles).

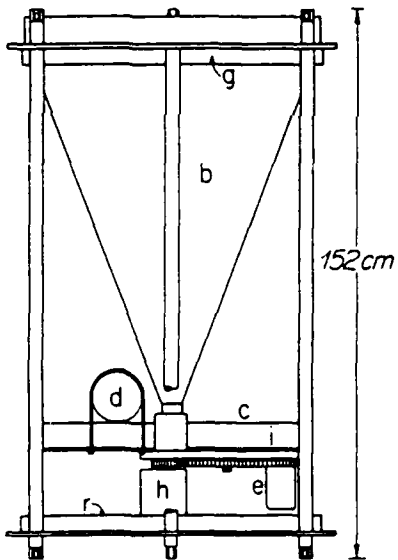
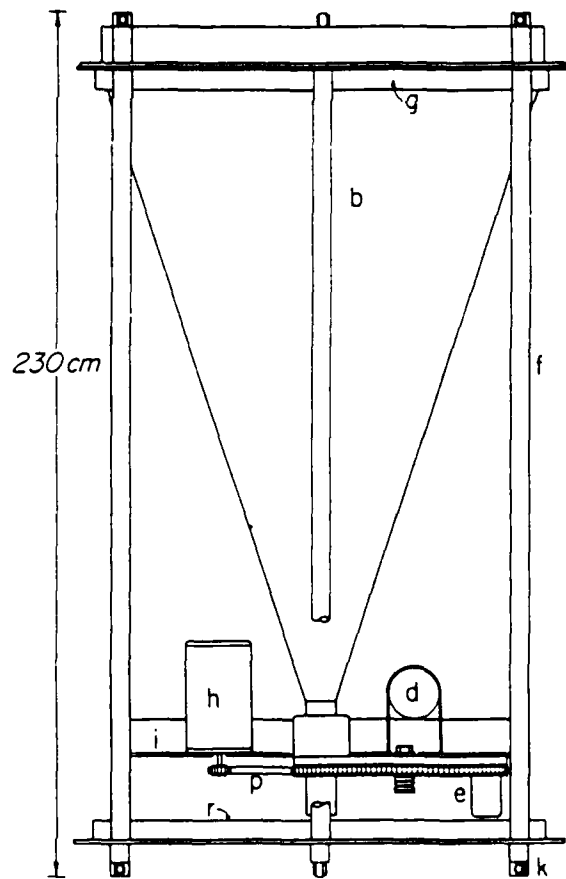

Figure 2. PARFLUX Mark 5 and 6 sediment traps (from Honjo and Doherty, 1987, Fig. 2).



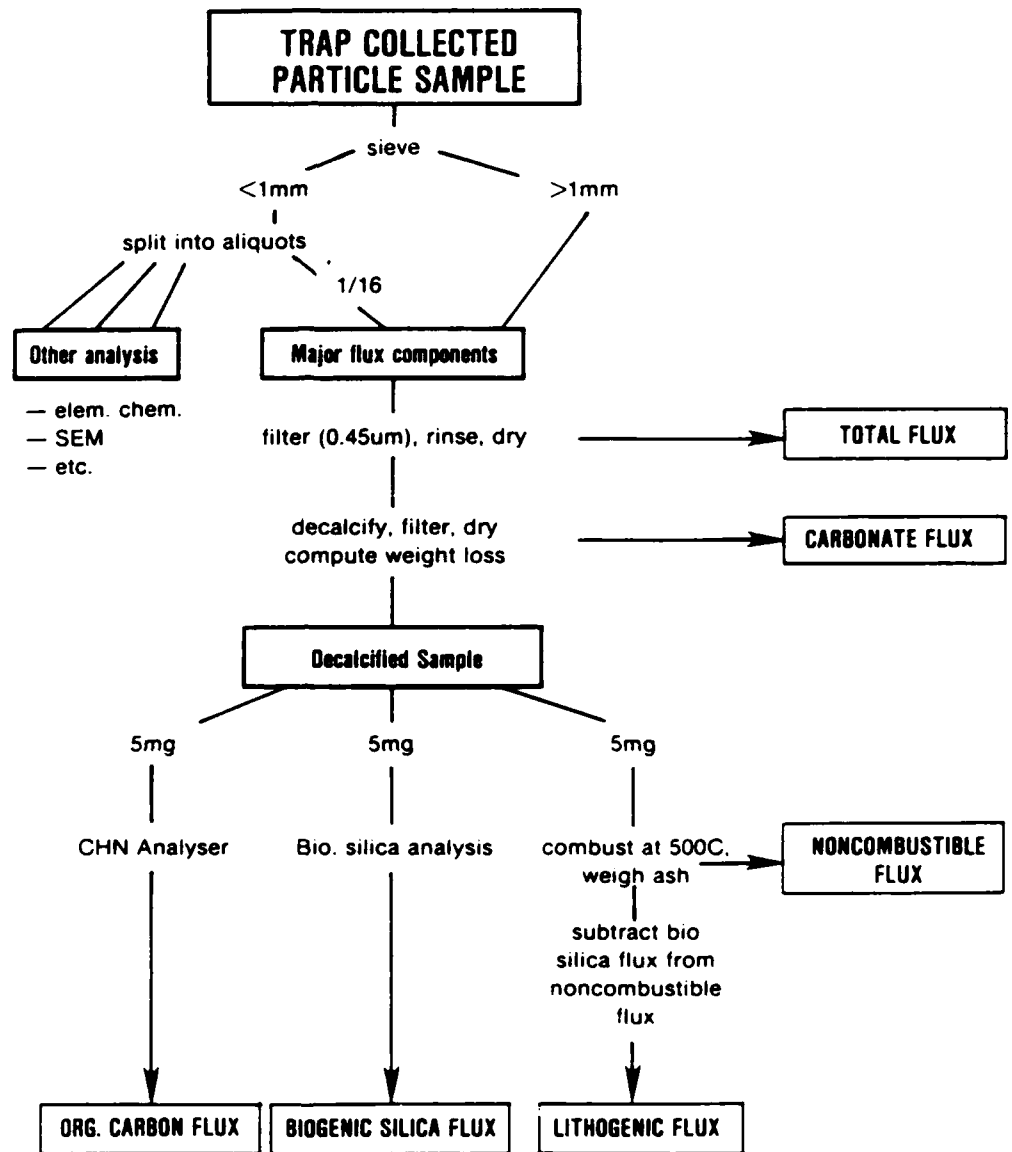

Figure 3. Sample process flow diagram for sedimentological analysis of Nordic Sea flux samples.

NORWEGIAN-ATLANTIC CURRENT AREA

LB-1

EAST LOFOTEN BASIN

69°30' N, 10°00' E

Trap depth: 2,760m Water depth: 3,160m

Annual Fluxes. (g/m/yr):

Total.....22.80

Carbonate.....11.40

Noncombustible.....8.07

Combustible.....3.37

Opal.....1.12

Lithogenic.....6.95

Organic C.....1.37

N.....0.18

PARFLUX Mark 5-12

| Sample ID | Opening Date | Closing Date | Span | Mid. Date |
|----------------|--------------|--------------|-------|-----------|
| 1 LB1-2600-1 | 15-AUG-83 | 13-SEP-83 | 29.33 | 30-AUG-83 |
| 2 LB1-2600-2 | 13-SEP-83 | 12-OCT-83 | 29.33 | 28-SEP-83 |
| 3 LB1-2600-3 | 12-OCT-83 | 11-NOV-83 | 29.33 | 27-OCT-83 |
| 4 LB1-2600-4 | 11-NOV-83 | 10-DEC-83 | 29.33 | 26-NOV-83 |
| 5 LB1-2600-5 | 10-DEC-83 | 08-JAN-84 | 29.33 | 25-DEC-83 |
| 6 LB1-2600-6 | 08-JAN-84 | 07-FEB-84 | 29.33 | 23-JAN-84 |
| 7 LB1-2600-7 | 07-FEB-84 | 07-MAR-84 | 29.33 | 22-FEB-84 |
| 8 LB1-2600-8 | 07-MAR-84 | 05-APR-84 | 29.33 | 22-MAR-84 |
| 9 LB1-2600-9 | 05-APR-84 | 05-MAY-84 | 29.33 | 20-APR-84 |
| 10 LB1-2600-10 | 05-MAY-84 | 03-JUN-84 | 29.33 | 20-MAY-84 |
| 11 LB1-2600-11 | 03-JUN-84 | 02-JUL-84 | 29.33 | 18-JUN-84 |
| 12 LB1-2600-12 | 02-JUL-84 | 01-AUG-84 | 29.33 | 17-JUL-84 |

Total Flux at Lofoten Basin (LB-1), 2600m, 1983-1984

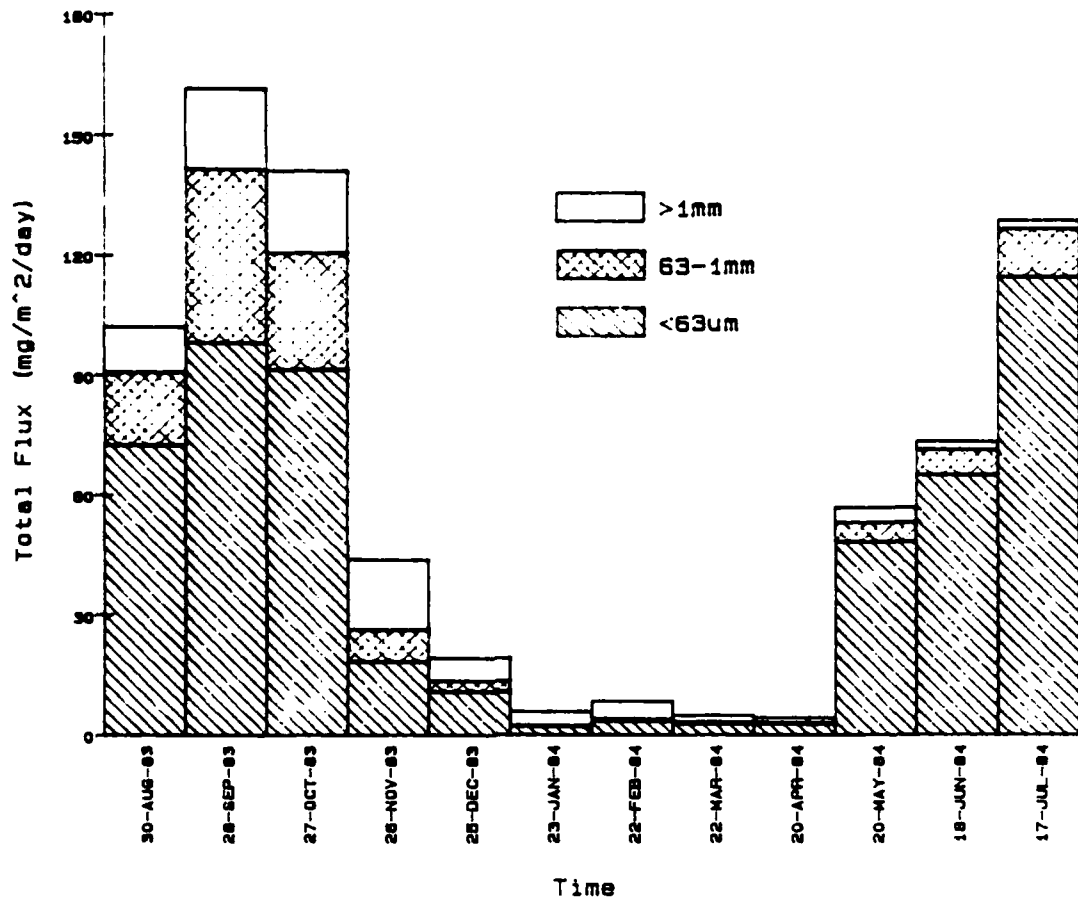

Lofoten Basin I had 12 cups each open 29.33 days.

Mark 5 trap open from August 15 1983 to August 1 1984 at 2600 meters.

TOTAL FLUX (mg / m² / day)

Ttl is total Flux in all size classes

| Cup # | < 63um | | 63um - 1 | | > 1mm | | TOTAL | |
|-------|----------|--------|----------|-------|----------|-------|----------|--------|
| | % of Ttl | FLUX | % of Ttl | FLUX | % of Ttl | FLUX | % of Ttl | FLUX |
| 1 | 70.74 | 72.41 | 17.90 | 18.32 | 11.36 | 11.63 | 100.00 | 102.36 |
| 2 | 60.82 | 98.24 | 26.73 | 43.17 | 12.45 | 20.11 | 100.00 | 161.52 |
| 3 | 64.75 | 91.36 | 20.72 | 29.24 | 14.53 | 20.51 | 100.00 | 141.10 |
| 4 | 41.90 | 18.37 | 17.84 | 7.82 | 40.26 | 17.65 | 100.00 | 43.84 |
| 5 | 55.73 | 10.74 | 13.75 | 2.65 | 30.50 | 5.88 | 100.00 | 19.27 |
| 6 | 37.26 | 2.28 | 6.70 | .41 | 56.20 | 3.44 | 100.00 | 6.12 |
| 7 | 40.92 | 3.43 | 6.56 | .55 | 52.51 | 4.40 | 100.00 | 8.38 |
| 8 | 58.69 | 2.84 | 8.89 | .43 | 32.28 | 1.56 | 100.00 | 4.84 |
| 9 | 60.09 | 2.68 | 7.62 | .34 | 32.26 | 1.44 | 100.00 | 4.46 |
| 10 | 85.00 | 48.28 | 8.26 | 4.69 | 6.75 | 3.84 | 100.00 | 56.80 |
| 11 | 88.39 | 64.87 | 8.61 | 6.32 | 3.00 | 2.20 | 100.00 | 73.39 |
| 12 | 89.13 | 114.52 | 9.23 | 11.86 | 1.64 | 2.11 | 100.00 | 128.49 |

Carbonate Flux at Lofoten Basin (LB-1), 2600m, 1983-1984

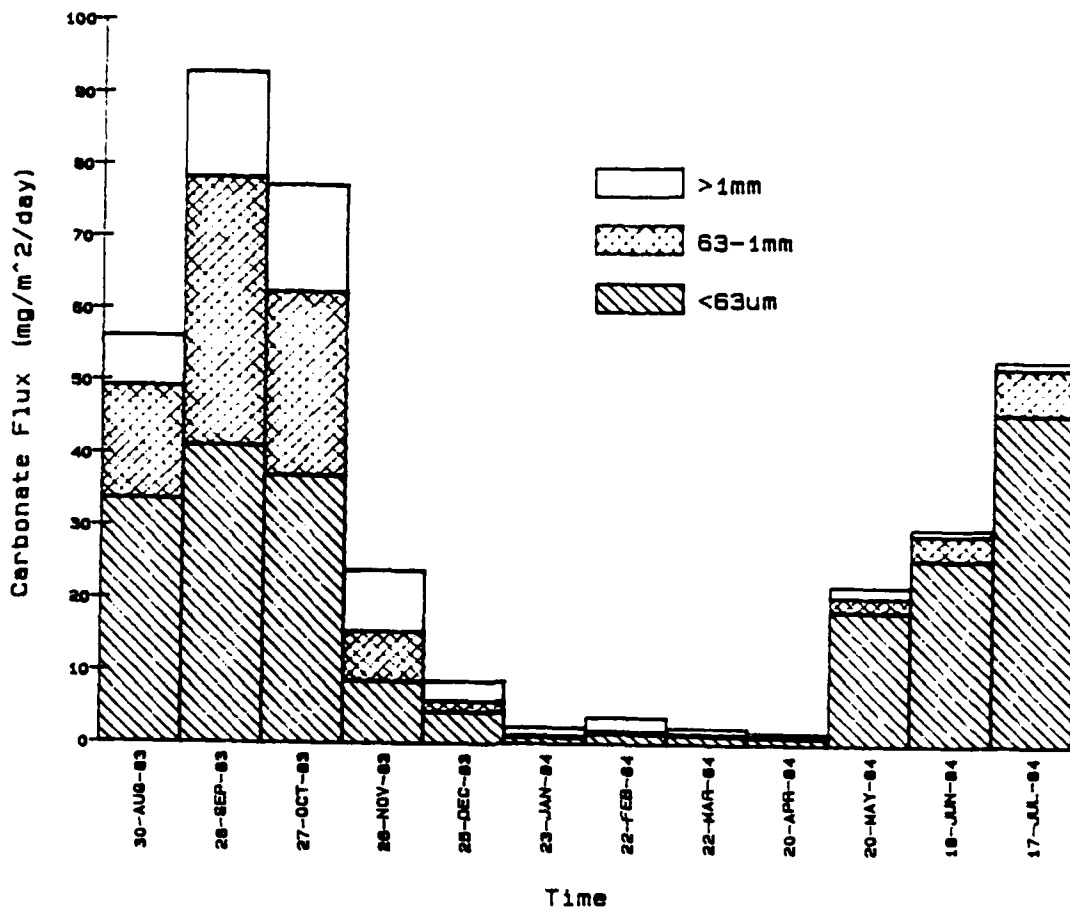

Lofoten Basin I had 12 cups each open 29.33 days.

Mark 5 trap open from August 15 1983 to August 1 1984 at 2600 meters.

Carbonate Flux

Ttl is total Flux in all size classes

| Cup # | < 63um | | 63um - 1 | | > 1mm | | TOTAL | |
|-------|----------|-------|----------|-------|----------|-------|----------|-------|
| | % of Ttl | FLUX | % of Ttl | FLUX | % of Ttl | FLUX | % of Ttl | FLUX |
| 1 | 32.92 | 33.69 | 15.18 | 15.54 | 6.81 | 6.97 | 54.91 | 56.20 |
| 2 | 25.46 | 41.13 | 22.92 | 37.01 | 9.02 | 14.56 | 57.40 | 92.71 |
| 3 | 26.19 | 36.95 | 17.96 | 25.34 | 10.58 | 14.93 | 54.73 | 77.23 |
| 4 | 19.56 | 8.58 | 15.52 | 6.80 | 19.38 | 8.50 | 54.46 | 23.88 |
| 5 | 22.72 | 4.38 | 7.57 | 1.46 | 14.13 | 2.72 | 44.43 | 8.56 |
| 6 | 14.62 | .89 | 3.22 | .20 | 18.57 | 1.14 | 36.41 | 2.23 |
| 7 | 17.43 | 1.46 | 3.16 | .26 | 23.57 | 1.98 | 44.16 | 3.70 |
| 8 | 24.67 | 1.19 | 4.83 | .23 | 17.51 | .85 | 47.02 | 2.28 |
| 9 | 23.20 | 1.03 | 3.55 | .16 | 10.75 | .48 | 37.50 | 1.67 |
| 10 | 32.73 | 18.59 | 3.31 | 1.88 | 2.64 | 1.50 | 33.69 | 21.97 |
| 11 | 35.03 | 25.71 | 4.57 | 3.35 | 1.25 | .92 | 40.85 | 29.98 |
| 12 | 35.70 | 45.87 | 4.89 | 6.28 | .84 | 1.08 | 41.43 | 53.23 |

Noncombustible Flux at Lofoten Basin (LB-1), 2600 m, 1983-84

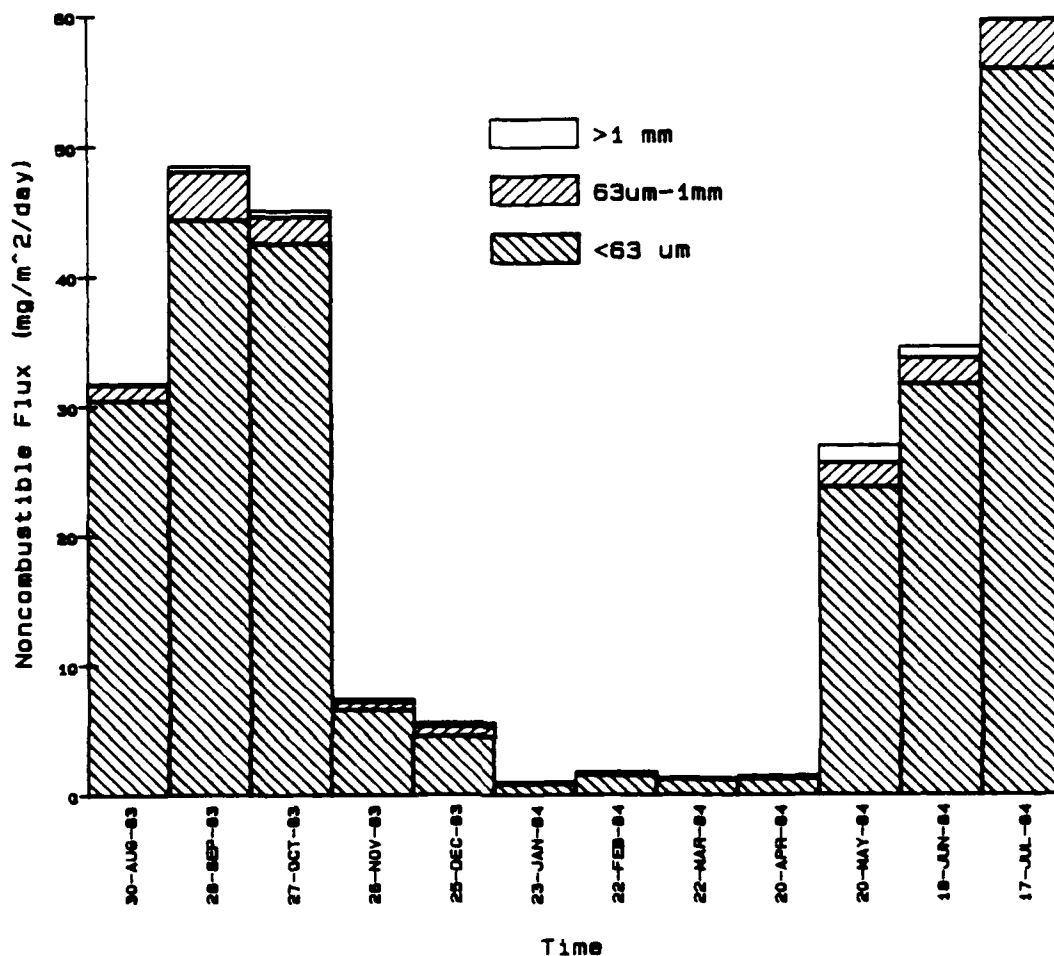

Lofoten Basin I had 12 cups each open 29.33 days.

Mark 5 trap open from August 15 1983 to August 1 1984 at 2600 meters.

NON COMBUSTIBLE FLUX (mg / m² / day)

Ttl is total Flux in all size classes

| Cup # | < 63um | | 63um - 1 | | > 1mm | | TOTAL | |
|-------|----------|-------|----------|------|----------|------|----------|-------|
| | % of Ttl | FLUX | % of Ttl | FLUX | % of Ttl | FLUX | % of Ttl | FLUX |
| 1 | 29.76 | 30.46 | 1.15 | 1.18 | .14 | .15 | 31.06 | 31.79 |
| 2 | 27.47 | 44.37 | 2.29 | 3.69 | .30 | .48 | 30.05 | 48.54 |
| 3 | 30.15 | 42.55 | 1.45 | 2.05 | .32 | .45 | 31.93 | 45.05 |
| 4 | 15.00 | 6.57 | 1.35 | .59 | .58 | .26 | 16.93 | 7.42 |
| 5 | 23.62 | 4.55 | 3.72 | .72 | 1.78 | .34 | 29.12 | 5.61 |
| 6 | 14.30 | .87 | 2.03 | .12 | .83 | .05 | 17.16 | 1.05 |
| 7 | 18.51 | 1.55 | 2.14 | .18 | .44 | .04 | 21.10 | 1.77 |
| 8 | 24.04 | 1.14 | 2.63 | .13 | .00 | .00 | 26.68 | 1.29 |
| 9 | 27.97 | 1.25 | 2.11 | .09 | 4.28 | .19 | 34.36 | 1.53 |
| 10 | 41.79 | 23.74 | 3.33 | 1.89 | 2.44 | 1.38 | 47.55 | 27.01 |
| 11 | 43.15 | 31.64 | 2.67 | 1.96 | 1.28 | .94 | 47.10 | 34.57 |
| 12 | 43.49 | 55.88 | 2.89 | 3.71 | .05 | .06 | 46.43 | 59.65 |

Combustible Flux at Lofoten Basin (LB-1), 2600 m. 1983-84

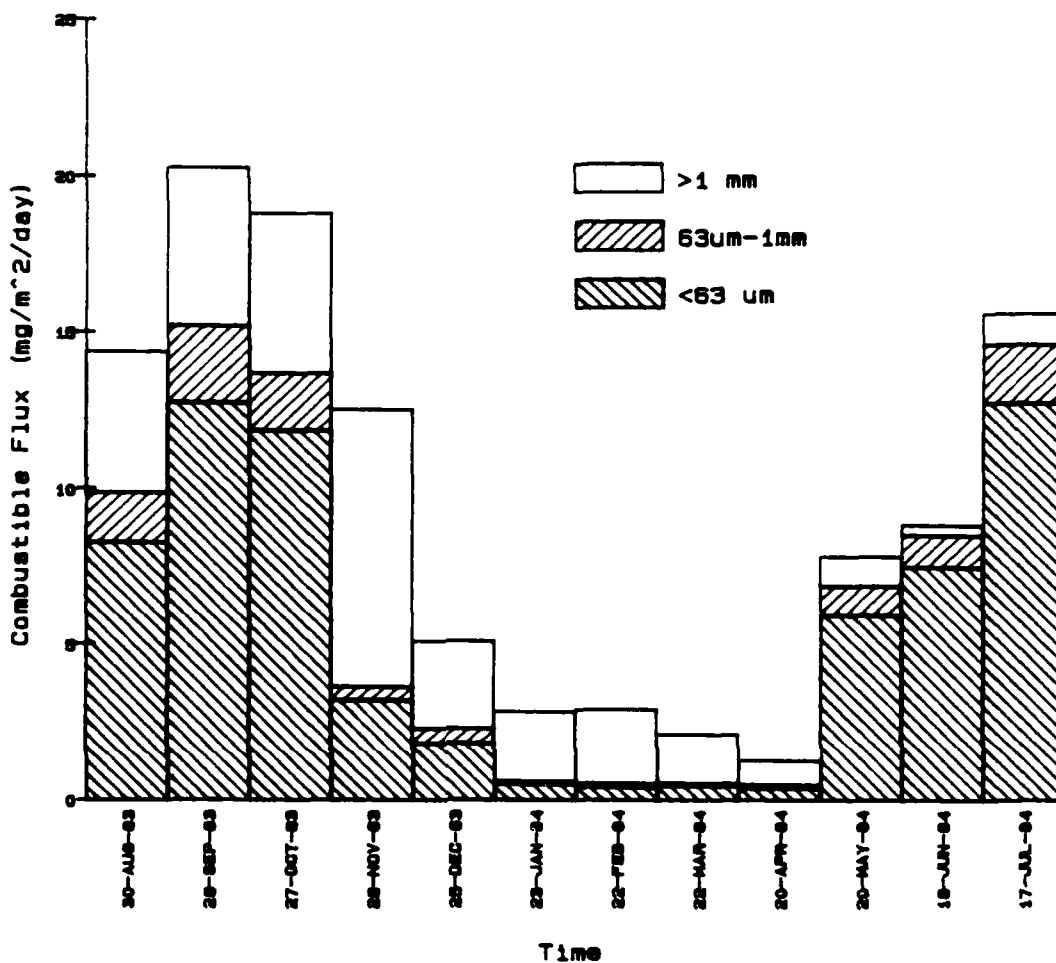

Lofoten Basin I had 12 cups each open 29.33 days.

Mark 5 trap open from August 15 1983 to August 1 1984 at 2600 meters.

Combustible Flux

Ttl is total Flux in all size classes

| Cup # | < 63um % of Ttl | FLUX | 63um - 1 % of Ttl | FLUX | > 1mm % of Ttl | FLUX | TOTAL % of Ttl | FLUX |
|-------|--------------------|-------|----------------------|------|-------------------|------|-------------------|-------|
| 1 | 8.07 | 8.26 | 1.56 | 1.60 | 4.41 | 4.51 | 14.04 | 14.37 |
| 2 | 7.89 | 12.74 | 1.52 | 2.46 | 3.14 | 5.07 | 12.55 | 20.27 |
| 3 | 8.41 | 11.86 | 1.31 | 1.84 | 3.63 | 5.12 | 13.34 | 18.85 |
| 4 | 7.34 | 3.22 | .97 | .42 | 20.30 | 8.90 | 28.61 | 12.54 |
| 5 | 9.39 | 1.81 | 2.46 | .47 | 14.59 | 2.81 | 26.43 | 5.09 |
| 6 | 8.34 | .51 | 1.45 | .09 | 36.80 | 2.25 | 46.59 | 2.85 |
| 7 | 4.98 | .42 | 1.26 | .11 | 28.50 | 2.39 | 34.74 | 2.91 |
| 8 | 9.97 | .48 | 1.42 | .07 | 0.00 | 0.00 | 11.39 | .55 |
| 9 | 8.92 | .40 | 1.97 | .09 | 17.23 | .77 | 28.12 | 1.25 |
| 10 | 10.48 | 5.95 | 1.62 | .92 | 1.68 | .95 | 13.77 | 7.82 |
| 11 | 10.21 | 7.50 | 1.37 | 1.00 | .46 | .34 | 12.05 | 8.84 |
| 12 | 9.94 | 12.77 | 1.45 | 1.87 | .76 | .98 | 12.15 | 15.61 |

Biogenic Silica flux at Lofoten Basin (LB-1), 2600m, 1983-1984

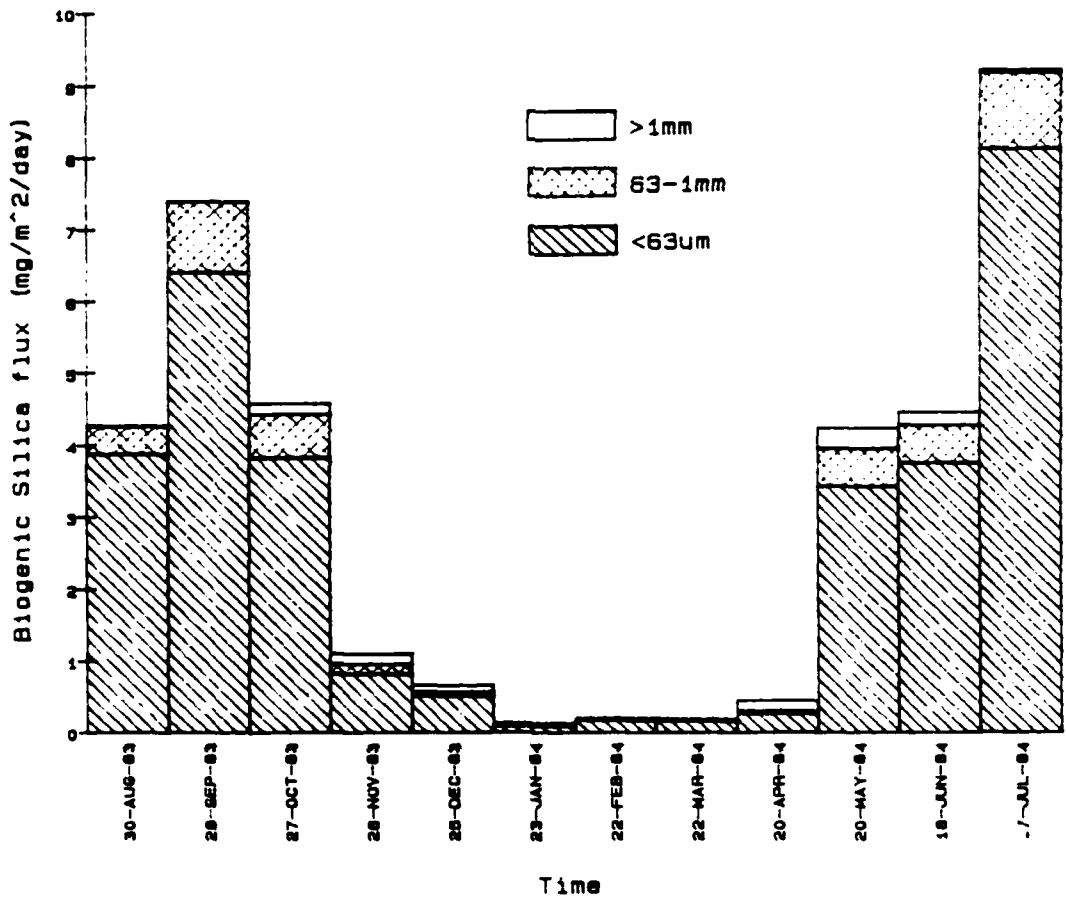

| Sample ID# | OPAL 63 | OPAL % tot. <63 | OPAL 63-1 | OPAL % tot. 63-1 | OPAL >1 | OPAL % tot. >1 | OPAL total | OPAL % of total |
|----------------|---------|-----------------|-----------|------------------|---------|----------------|------------|-----------------|
| 1 LB1-2600-1 | 3.87 | 3.78 | 0.38 | 0.37 | 0.03 | 0.03 | 4.28 | 4.19 |
| 2 LB1-2600-2 | 6.40 | 3.96 | 0.99 | 0.61 | 0.01 | 0.01 | 7.40 | 4.58 |
| 3 LB1-2600-3 | 3.82 | 2.71 | 0.80 | 0.43 | 0.16 | 0.11 | 4.78 | 3.24 |
| 4 LB1-2600-4 | 0.82 | 1.87 | 0.13 | 0.30 | 0.15 | 0.35 | 1.10 | 2.80 |
| 5 LB1-2600-5 | 0.51 | 2.65 | 0.35 | 0.25 | 0.10 | 0.54 | 0.86 | 3.48 |
| 6 LB1-2600-6 | 0.29 | 1.47 | 0.09 | 0.02 | 0.00 | 0.03 | 0.38 | 1.47 |
| 7 LB1-2600-7 | 0.17 | 2.03 | 0.03 | 0.32 | 0.19 | 2.27 | 0.39 | 4.68 |
| 8 LB1-2600-8 | 2.18 | 2.61 | 0.25 | 0.64 | 0.06 | 1.23 | 0.28 | 6.17 |
| 9 LB1-2600-9 | 3.28 | 4.25 | 0.25 | 0.67 | 0.15 | 3.31 | 0.41 | 6.17 |
| 10 LB1-2600-10 | 1.40 | 6.02 | 0.53 | 0.83 | 0.30 | 0.50 | 4.19 | 7.47 |
| 11 LB1-2600-11 | 3.28 | 5.11 | 0.52 | 0.71 | 0.18 | 0.24 | 4.48 | 6.06 |
| 12 LB1-2600-12 | 6.40 | 6.32 | 1.04 | 0.81 | 0.05 | 0.04 | 8.21 | 6.17 |

Figure 13. Biogenic Silica flux.

Lithogenic Flux at Lofoten Basin (LB-1) 2600m, 1983-84

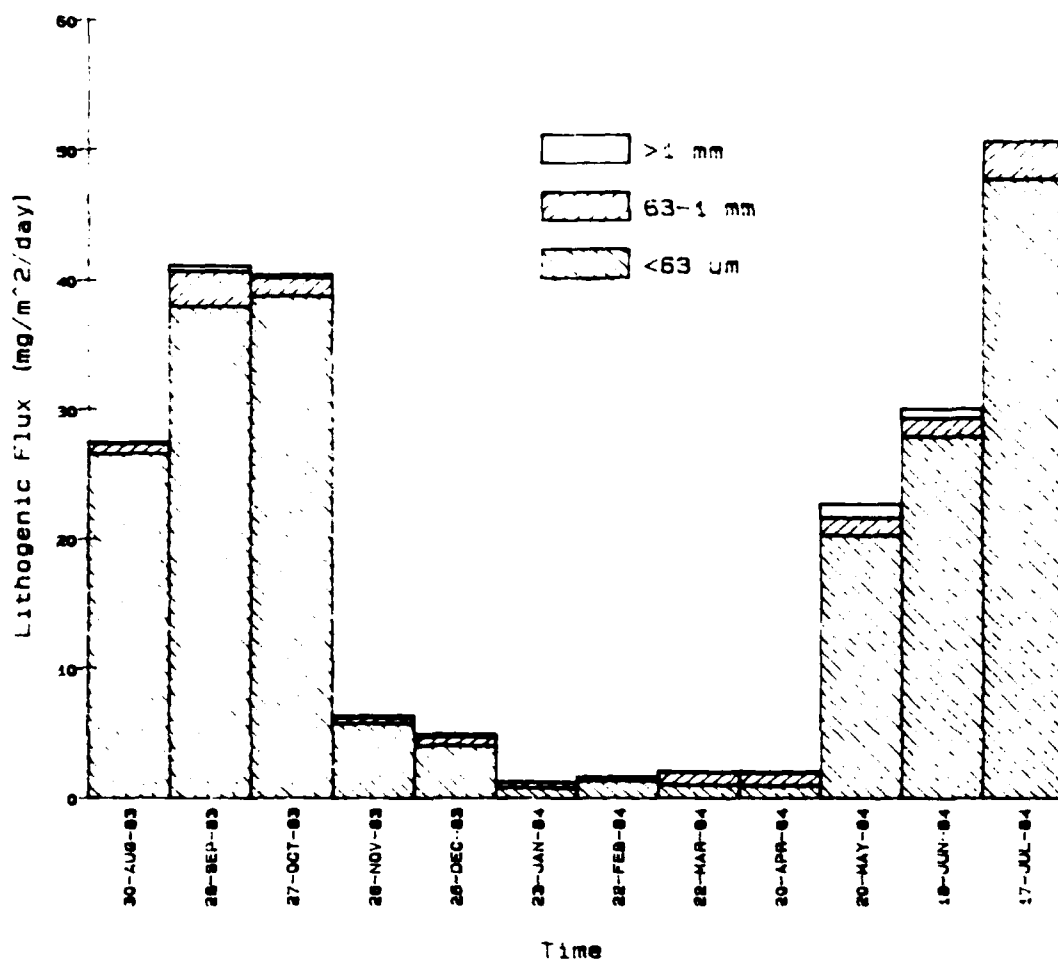

| Sample I.D. | LITH <63 | LITH <63 %tot. | LITH 63-1 | LITH 63-1 %tot. | LITH >1 | LITH >1 %tot. | LITH total | LITH % total |
|----------------|----------|----------------|-----------|-----------------|---------|---------------|------------|--------------|
| 1 LB1-2600-1 | 26.59 | 25.98 | 0.80 | 0.78 | 0.12 | 0.12 | 27.51 | 26.88 |
| 2 LB1-2600-2 | 37.97 | 23.51 | 2.71 | 1.68 | 0.47 | 0.29 | 41.15 | 35.48 |
| 3 LB1-2600-3 | 38.73 | 27.45 | 1.45 | 1.03 | 0.29 | 0.21 | 40.47 | 38.68 |
| 4 LB1-2600-4 | 5.75 | 13.11 | 0.46 | 1.05 | 0.11 | 0.25 | 6.32 | 14.42 |
| 5 LB1-2600-5 | 4.04 | 20.96 | 0.67 | 3.48 | 0.24 | 1.25 | 4.95 | 15.69 |
| 6 LB1-2600-6 | 0.78 | 12.75 | 0.43 | 7.03 | 0.05 | 0.82 | 1.26 | 10.69 |
| 7 LB1-2600-7 | 1.38 | 16.46 | 0.18 | 2.15 | 0.04 | 0.48 | 1.60 | 19.09 |
| 8 LB1-2600-8 | 1.01 | 20.87 | 0.99 | 20.46 | 0.04 | 0.93 | 21.04 | 42.16 |
| 9 LB1-2600-9 | 0.99 | 22.20 | 0.99 | 22.20 | 0.04 | 0.90 | 23.02 | 45.29 |
| 10 LB1-2600-10 | 20.31 | 35.76 | 1.36 | 2.39 | 1.08 | 1.98 | 22.75 | 40.35 |
| 11 LB1-2600-11 | 27.91 | 38.03 | 1.43 | 1.95 | 0.76 | 1.04 | 30.10 | 41.31 |
| 12 LB1-2600-12 | 47.76 | 37.17 | 2.87 | 2.23 | 0.01 | 0.01 | 50.64 | 59.41 |

Flux is in mg/m²/day

Carbon Flux at Lofoten Basin (LB-1), 2600 m, 1983-84

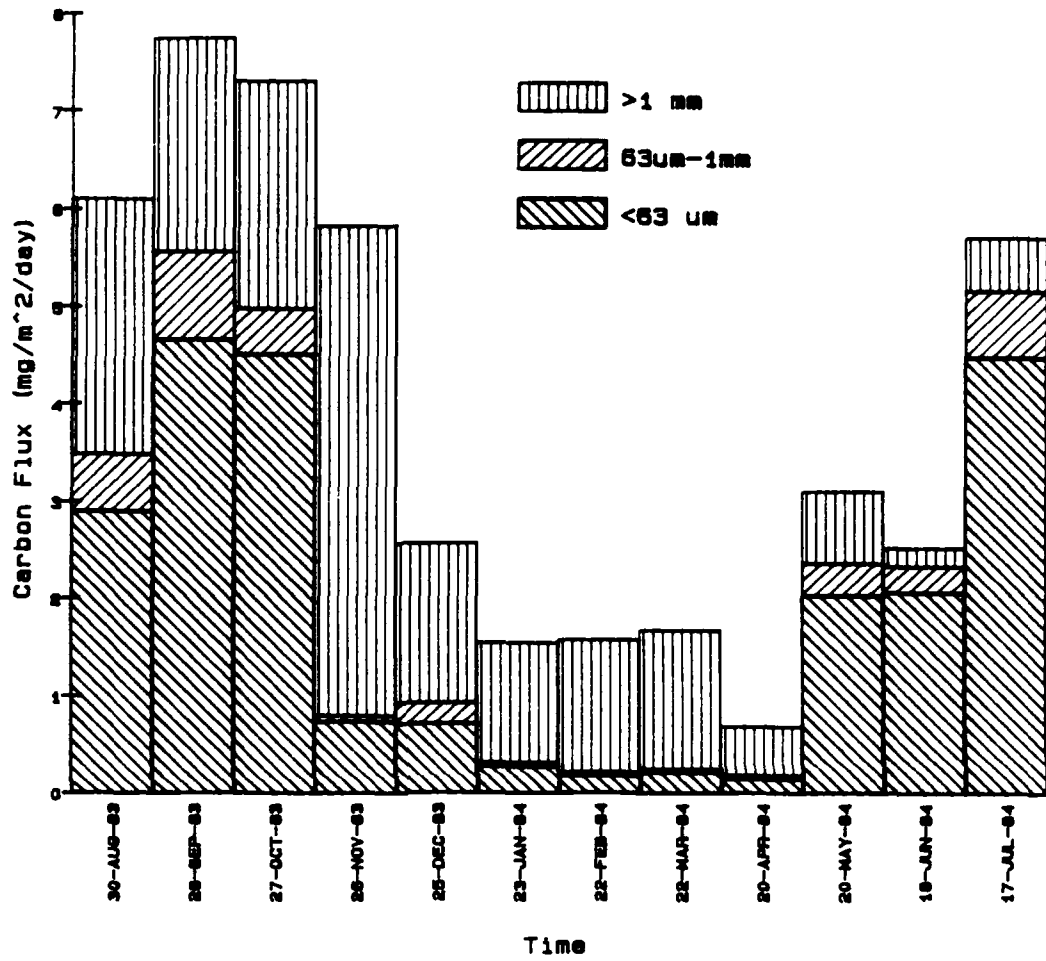

| Sample I.D. | NTGN .63 | NTGN <63 %cmbf. | NTGN 63-1 | NTGN 63-1 %cmbf. | NTGN 1 | NTGN 1 %cmbf. | NTGN total | NTGN total %cmbf. |
|----------------|----------|-----------------|-----------|------------------|--------|---------------|------------|-------------------|
| 1 LB1-2600-1 | 0.40 | 4.84 | 0.16 | 1.11 | 0.21 | 1.46 | 0.76 | 5.23 |
| 2 LB1-2600-2 | 0.76 | 3.75 | 0.19 | 0.94 | 0.36 | 1.78 | 1.31 | 6.46 |
| 3 LB1-2600-3 | 0.66 | 3.51 | 0.10 | 0.53 | 0.30 | 1.59 | 1.06 | 5.82 |
| 4 LB1-2600-4 | 0.11 | 0.88 | 0.01 | 0.08 | 0.44 | 3.51 | 0.56 | 4.47 |
| 5 LB1-2600-5 | 0.10 | 1.96 | 0.03 | 0.59 | 0.21 | 4.13 | 0.34 | 6.68 |
| 6 LB1-2600-6 | 0.04 | 1.27 | 0.00 | 0.02 | 0.13 | 4.56 | 0.17 | 5.85 |
| 7 LB1-2600-7 | 0.02 | 0.69 | 0.01 | 0.34 | 0.13 | 4.47 | 0.16 | 5.50 |
| 8 LB1-2600-8 | 0.03 | 1.42 | 0.01 | 0.47 | 0.10 | 4.50 | 0.04 | 5.40 |
| 9 LB1-2600-9 | 0.02 | 1.60 | 0.00 | 0.00 | 0.06 | 4.50 | 0.08 | 5.40 |
| 10 LB1-2600-10 | 0.25 | 3.20 | 0.06 | 0.77 | 0.08 | 1.02 | 0.39 | 4.94 |
| 11 LB1-2600-11 | 0.25 | 2.83 | 0.04 | 0.45 | 0.03 | 0.34 | 0.32 | 3.62 |
| 12 LB1-2600-12 | 0.60 | 3.84 | 0.14 | 0.90 | 0.07 | 0.45 | 0.61 | 5.13 |

Flux is in mg/m²/day.

%cmbf = % of combustible flux.

Nitrogen Flux at Lofoten Basin (LB-1), 2600 m, 1983-84

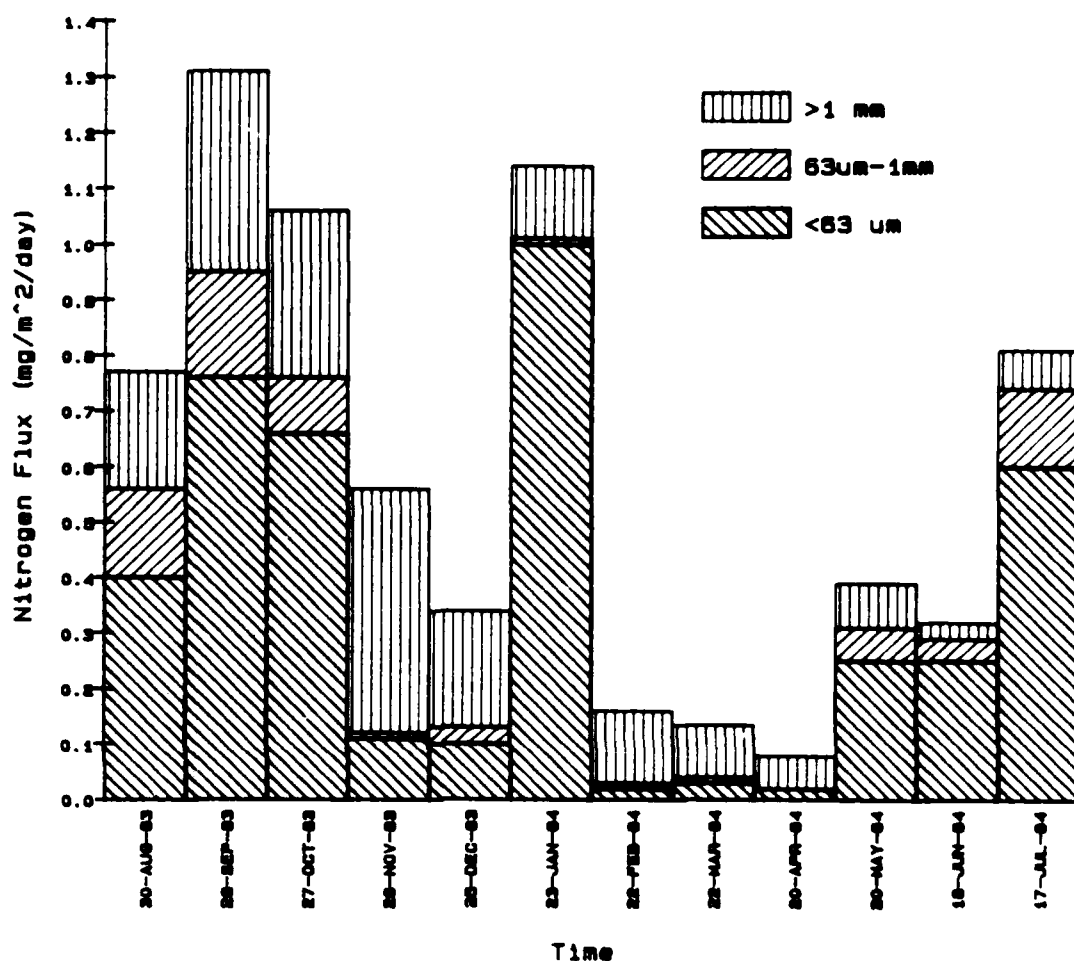

Lofoten Basin I had 12 cups each open 29.33 days.

Mark 5 trap open from August 15 1983 to August 1 1984 at 2600 meters.

NITROGEN FLUX (mg / m² / day)

Ttl is Total Flux in all size classes.

| Cup # | < 63um | | 63um - 1 | | > 1mm | | TOTAL | |
|-------|----------|------|----------|------|----------|------|----------|------|
| | % of Ttl | FLUX | % of Ttl | FLUX | % of Ttl | FLUX | % of Ttl | FLUX |
| 1 | .39 | .40 | .15 | .16 | .20 | .21 | .75 | .76 |
| 2 | .47 | .76 | .12 | .19 | .22 | .36 | .81 | 1.31 |
| 3 | .47 | .66 | .07 | .10 | .21 | .30 | .75 | 1.06 |
| 4 | .24 | .11 | .02 | .01 | 1.01 | .44 | 1.27 | .56 |
| 5 | .53 | .10 | .17 | .03 | 1.08 | .21 | 1.78 | .34 |
| 6 | .60 | .04 | .10 | .01 | 2.09 | .13 | 2.79 | .17 |
| 7 | .27 | .02 | .09 | .01 | 1.58 | .13 | 1.94 | .16 |
| 8 | .69 | .03 | .12 | .01 | .00 | .00 | .81 | .04 |
| 9 | .43 | .02 | .11 | .00 | 1.28 | .06 | 1.82 | .08 |
| 10 | .44 | .25 | .11 | .06 | .14 | .08 | .68 | .39 |
| 11 | .35 | .25 | .06 | .04 | .04 | .03 | .44 | .32 |
| 12 | .46 | .60 | .11 | .14 | .06 | .07 | .63 | .81 |

Hydrogen Flux at Lofoten Basin (LB-1), 2600 m, 1983-84

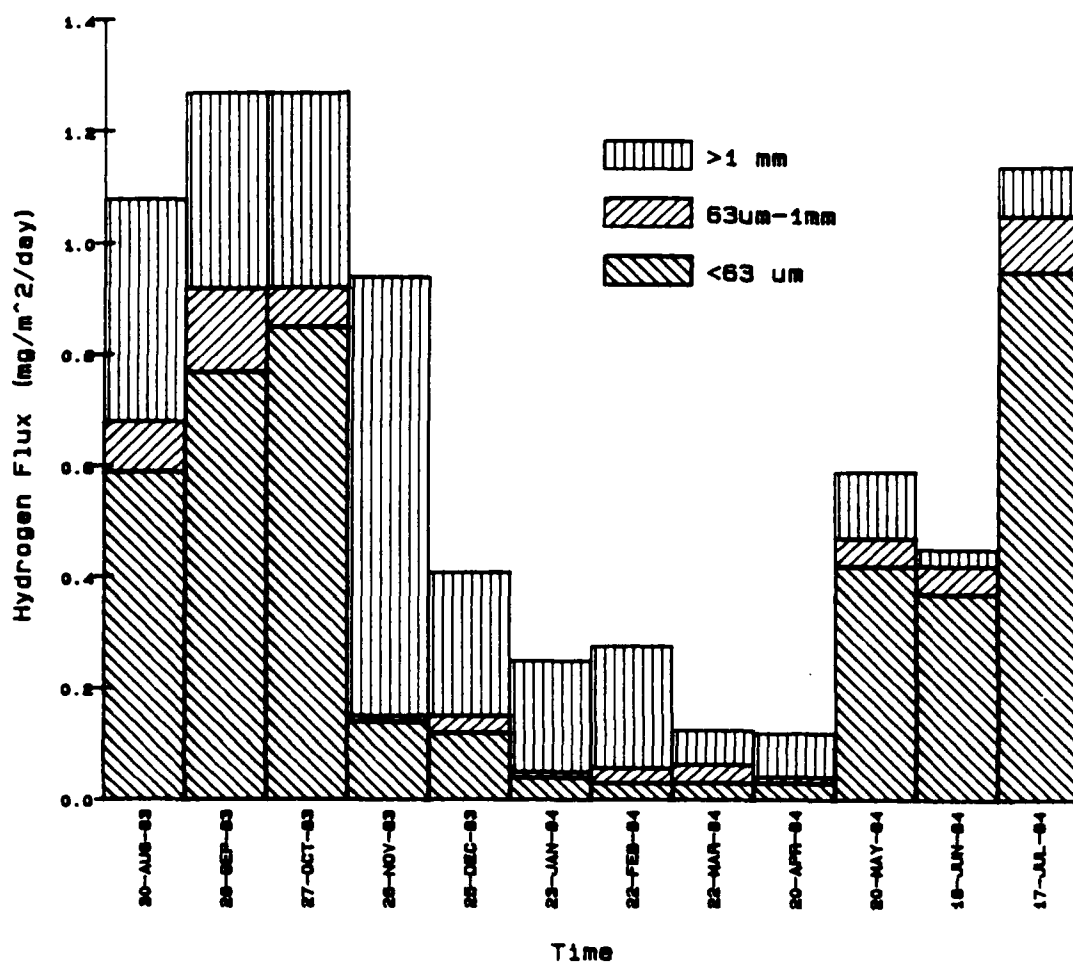

| Sample I.D. | HYDC 63 | HYDC-63 %cmbf. | HYDC 63-1 | HYDC63-1 %cmbf. | HYDC 1 | HYDC-1 %cmbf. | HYDC total | HYDCtot. %cmbf. |
|----------------|---------|----------------|-----------|-----------------|--------|---------------|------------|-----------------|
| 1 LB1-2600-1 | 0.59 | 4.11 | 0.09 | 0.63 | 0.40 | 2.78 | 1.08 | 7.52 |
| 2 LB1-2600-2 | 0.77 | 3.80 | 0.15 | 0.74 | 0.35 | 1.73 | 1.26 | 6.22 |
| 3 LB1-2600-3 | 0.85 | 4.51 | 0.07 | 0.37 | 0.35 | 1.86 | 1.28 | 6.50 |
| 4 LB1-2600-4 | 0.14 | 1.12 | 0.01 | 0.08 | 0.79 | 6.30 | 0.94 | 7.50 |
| 5 LB1-2600-5 | 0.12 | 2.36 | 0.03 | 0.59 | 0.26 | 5.11 | 0.41 | 9.06 |
| 6 LB1-2600-6* | 0.04 | 1.40 | 0.01 | 0.35 | 0.20 | 7.02 | 0.24 | 9.42 |
| 7 LB1-2600-7* | 0.03 | 1.03 | 0.03 | 0.92 | 0.22 | 7.56 | 0.25 | 9.59 |
| 8 LB1-2600-8* | 0.03 | 1.42 | 0.03 | 1.56 | 0.06 | 2.93 | 0.04 | 1.90 |
| 9 LB1-2600-9* | 0.03 | 2.40 | 0.01 | 0.80 | 0.08 | 6.40 | 0.11 | 8.50 |
| 10 LB1-2600-10 | 0.42 | 5.37 | 0.05 | 0.64 | 0.12 | 1.53 | 0.59 | 7.54 |
| 11 LB1-2600-11 | 0.37 | 4.19 | 0.05 | 0.57 | 0.03 | 0.34 | 0.45 | 5.09 |
| 12 LB1-2600-12 | 0.95 | 6.09 | 0.10 | 0.64 | 0.09 | 0.58 | 1.15 | 7.37 |

Flux is in mg/m² day.
 %cmbf = % of combustible flux.

BI-1

BEAR ISLAND - WEST OF STORFJORD

75°51'N, 11°28'E

Trap depth: 1,700m Water depth: 2,123m

Annual Fluxes. (g/m²/yr):

Total.....28.30

Carbonate.....6.61

Noncombustible.....16.31

Combustible.....5.38

Biogenic Opal.....1.96

Lithogenic.....14.35

Organic C.....2.85

N.....0.30

PARFLUX Mark 5-13

| Sample ID | Opening Date | Closing Date | Span | Mid. Date |
|----------------|--------------|--------------|-------|-----------|
| 26 BII-1700-1 | 12-AUG-84 | 11-SEP-84 | 30.17 | 27-AUG-84 |
| 27 BII-1700-2 | 11-SEP-84 | 11-OCT-84 | 30.17 | 26-SEP-84 |
| 28 BII-1700-3 | 11-OCT-84 | 11-NOV-84 | 30.17 | 27-OCT-84 |
| 29 BII-1700-4 | 11-NOV-84 | 11-DEC-84 | 30.17 | 26-NOV-84 |
| 30 BII-1700-5 | 11-DEC-84 | 12-JAN-85 | 30.17 | 27-DEC-84 |
| 31 BII-1700-6 | 12-JAN-85 | 11-FEB-85 | 30.17 | 27-JAN-85 |
| 32 BII-1700-7 | 11-FEB-85 | 12-MAR-85 | 30.17 | 26-FEB-85 |
| 33 BII-1700-8 | 12-MAR-85 | 11-APR-85 | 30.17 | 27-MAR-85 |
| 34 BII-1700-9 | 11-APR-85 | 12-MAY-85 | 30.17 | 27-APR-85 |
| 35 BII-1700-10 | 12-MAY-85 | 11-JUN-85 | 30.17 | 27-MAY-85 |
| 36 BII-1700-11 | 11-JUN-85 | 11-JUL-85 | 30.17 | 26-JUN-85 |
| 37 BII-1700-12 | 11-JUL-85 | 10-AUG-85 | 30.17 | 26-JUL-85 |

Total Flux at Bear Island (BI-1), 1700m, 1964-1965

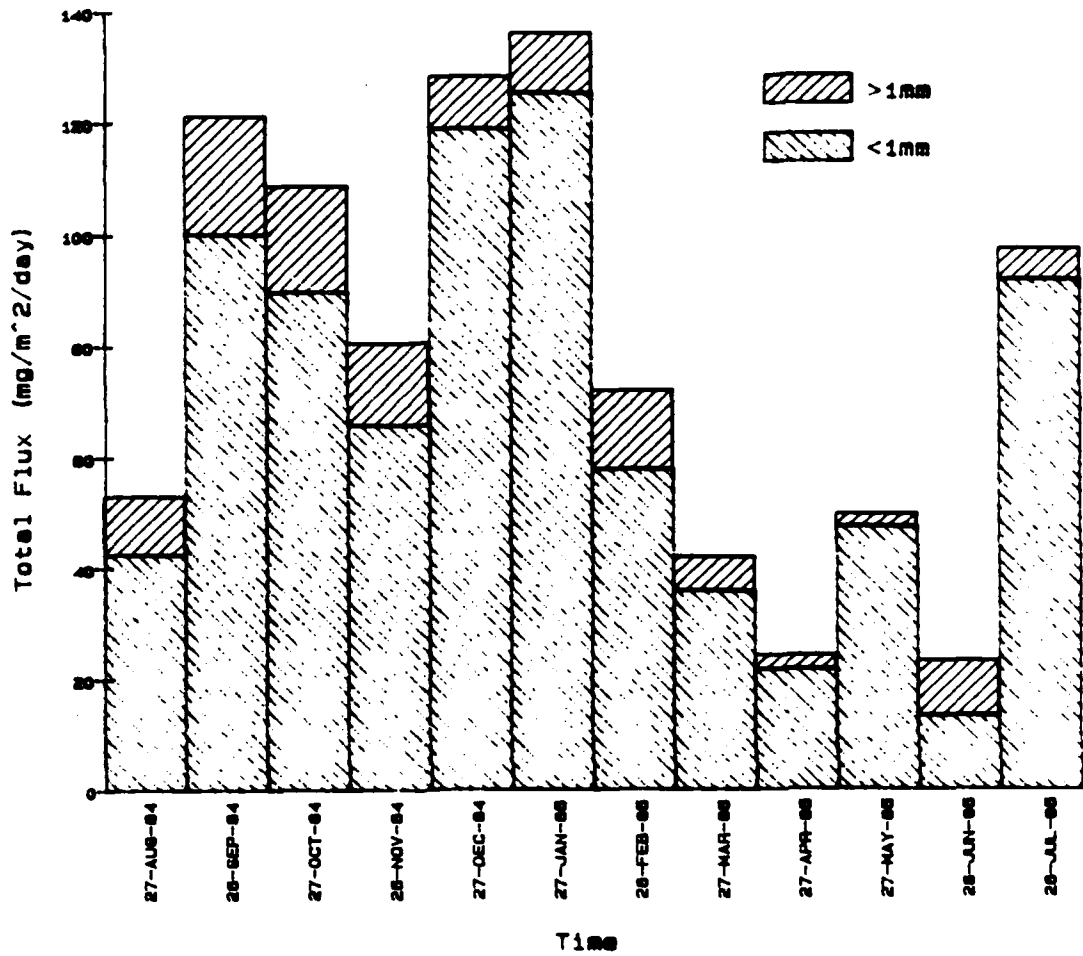

| Sample I.D. | TTLF <1 | <1 % of total | TTLF >1 | >1 % of total | TTLF total |
|----------------|---------|---------------|---------|---------------|------------|
| 26 BI1-1700-1 | 42.41 | 79.97 | 10.62 | 20.03 | 53.03 |
| 27 BI1-1700-2 | 100.12 | 82.55 | 21.17 | 17.45 | 121.29 |
| 28 BI1-1700-3 | 89.79 | 82.63 | 18.88 | 17.37 | 108.67 |
| 29 BI1-1700-4 | 65.74 | 81.60 | 14.82 | 18.40 | 80.56 |
| 30 BI1-1700-5 | 118.82 | 92.68 | 9.38 | 7.32 | 128.20 |
| 31 BI1-1700-6 | 125.34 | 92.12 | 10.72 | 7.88 | 136.06 |
| 32 BI1-1700-7 | 57.91 | 80.41 | 14.08 | 19.59 | 71.99 |
| 33 BI1-1700-8 | 35.88 | 85.41 | 6.13 | 14.59 | 42.01 |
| 34 BI1-1700-9 | 21.65 | 89.65 | 2.50 | 10.35 | 24.15 |
| 35 BI1-1700-10 | 47.31 | 95.42 | 2.27 | 4.58 | 49.53 |
| 36 BI1-1700-11 | 13.22 | 56.98 | 9.98 | 43.02 | 23.20 |
| 37 BI1-1700-12 | 91.78 | 94.35 | 5.50 | 5.65 | 97.23 |

Flux is in mg/m²/day.

Carbonate Flux at Bear Island (BI-1), 1700m, 1984-1985

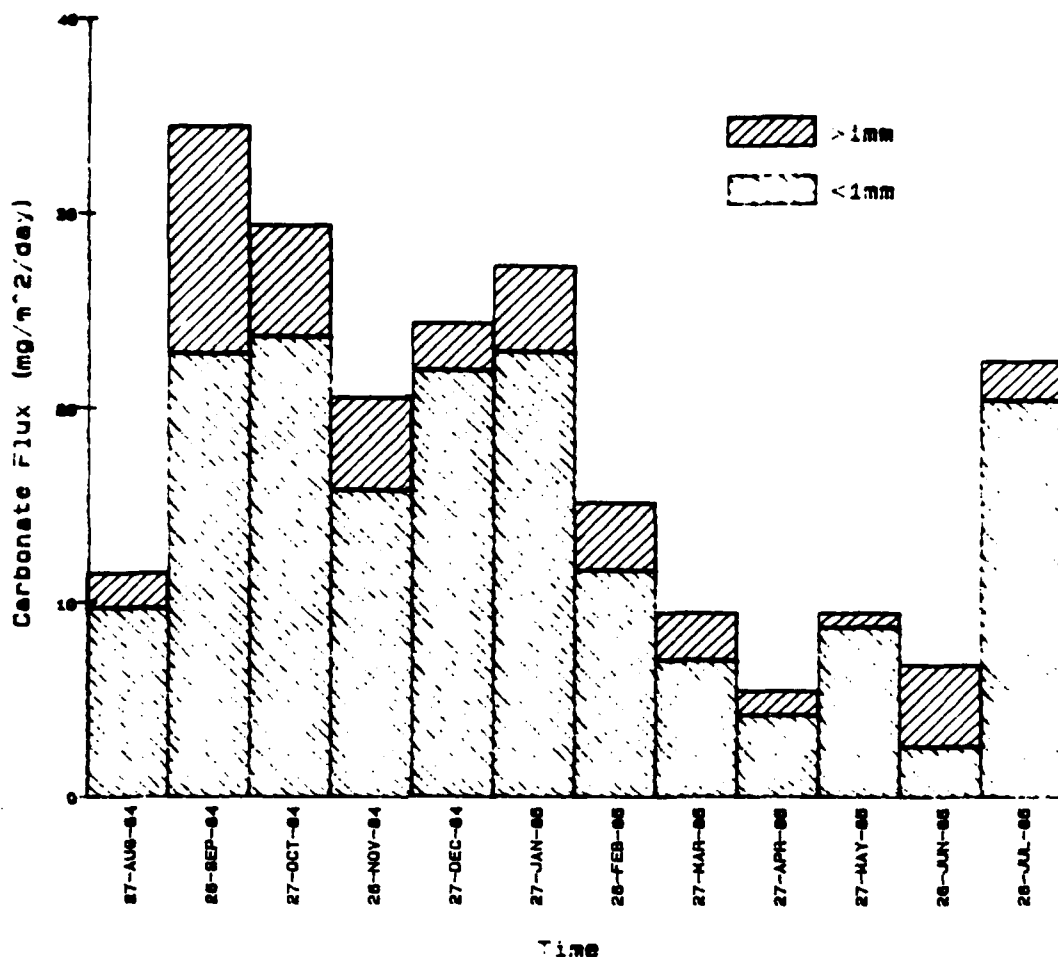

| Sample I.D. | CRTA <1 | CRTA % tot.<1 | CRTA >1 | CRTA % tot.>1 | CRTA total | CRTA % total |
|----------------|---------|---------------|---------|---------------|------------|--------------|
| 25 BI1-1700-1 | 9.80 | 18.48 | 1.77 | 3.34 | 11.56 | 21.60 |
| 27 BI1-1700-2 | 22.83 | 18.82 | 11.61 | 9.57 | 34.44 | 29.29 |
| 28 BI1-1700-3 | 23.67 | 21.78 | 5.66 | 5.21 | 29.55 | 27.13 |
| 29 BI1-1700-4 | 15.80 | 19.61 | 4.75 | 5.90 | 20.73 | 25.73 |
| 30 BI1-1700-5 | 21.95 | 17.12 | 2.42 | 1.89 | 24.52 | 19.13 |
| 31 BI1-1700-6 | 22.88 | 16.82 | 4.38 | 3.22 | 27.31 | 20.07 |
| 32 BI1-1700-7 | 11.63 | 16.19 | 3.47 | 4.83 | 15.26 | 21.23 |
| 33 BI1-1700-8 | 7.04 | 16.76 | 2.41 | 5.74 | 9.62 | 22.30 |
| 34 BI1-1700-9 | 4.18 | 17.31 | 1.25 | 5.18 | 5.56 | 23.02 |
| 35 BI1-1700-10 | 8.74 | 17.63 | 0.72 | 1.45 | 9.52 | 19.20 |
| 36 BI1-1700-11 | 2.56 | 11.03 | 4.20 | 18.10 | 6.81 | 29.35 |
| 37 BI1-1700-12 | 20.38 | 20.95 | 2.00 | 2.06 | 22.56 | 23.19 |

Flux is in mg/m² day.

Noncombustible Flux at Bear Island 1, 1700m, 1984-85

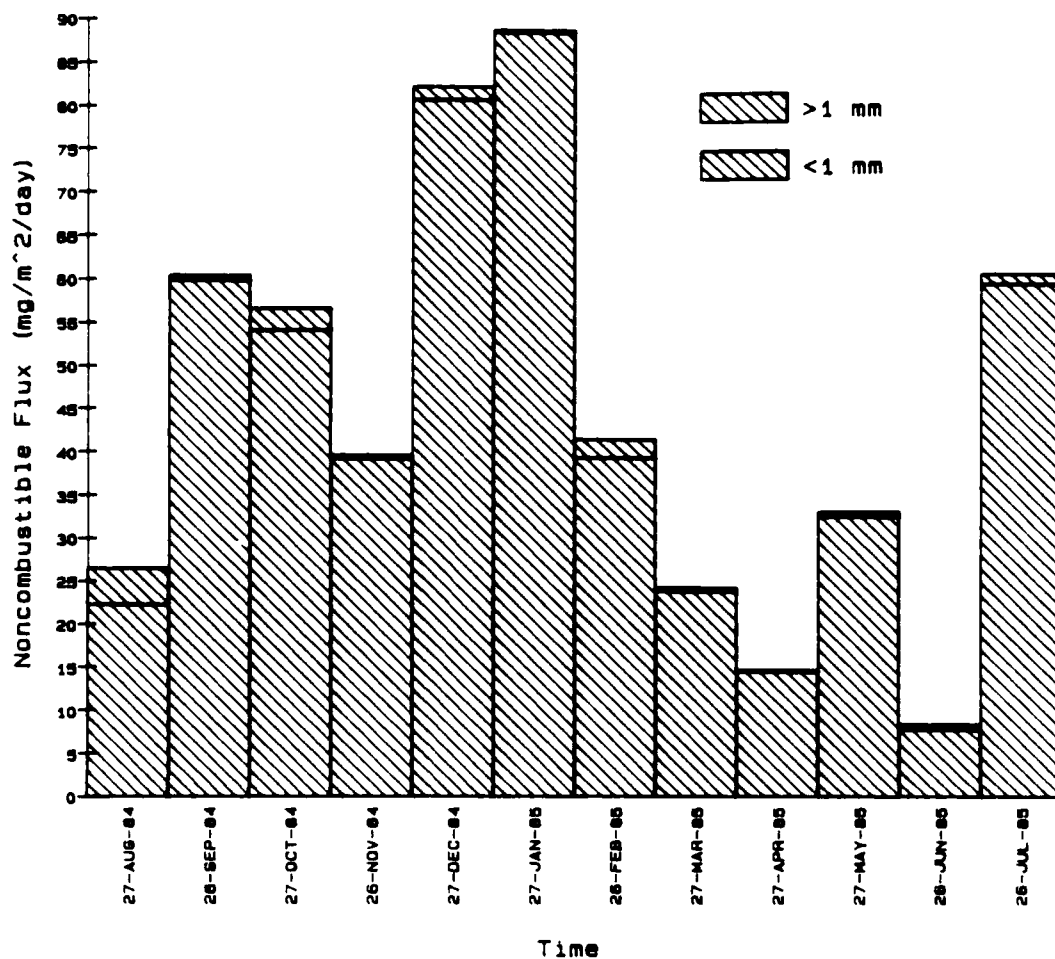

| Sample ID# | NONC <1 | NONC % tot. <1 | NONC >1 | NONC % tot. >1 | NONC total | NONC % total |
|-----------------|---------|----------------|---------|----------------|------------|--------------|
| 26 BII-1700-1* | 22.26 | 41.98 | 4.25 | 8.01 | 26.52 | 50.01 |
| 27 BII-1700-2* | 59.87 | 49.36 | 0.56 | 0.46 | 60.43 | 49.32 |
| 28 BII-1700-3* | 54.04 | 49.73 | 2.59 | 2.38 | 56.63 | 52.11 |
| 29 BII-1700-4* | 39.17 | 48.62 | 0.39 | 0.48 | 39.56 | 49.11 |
| 30 BII-1700-5* | 80.57 | 62.85 | 1.55 | 1.21 | 82.12 | 64.25 |
| 31 BII-1700-6* | 88.35 | 64.93 | 0.24 | 0.13 | 88.59 | 65.11 |
| 32 BII-1700-7* | 39.29 | 54.65 | 2.14 | 2.98 | 41.43 | 57.52 |
| 33 BII-1700-8* | 23.82 | 56.70 | 0.46 | 1.09 | 24.28 | 57.62 |
| 34 BII-1700-9* | 14.51 | 60.08 | 0.13 | 0.54 | 14.64 | 50.53 |
| 35 BII-1700-10* | 32.45 | 65.45 | 0.62 | 1.25 | 33.07 | 66.72 |
| 36 BII-1700-11* | 7.96 | 33.88 | 0.58 | 2.50 | 8.54 | 36.39 |
| 37 BII-1700-12* | 59.40 | 61.06 | 1.21 | 1.24 | 60.61 | 62.22 |

Flux is in mg/m²/day.

Combustible Flux at Bear Island (BI-1), 1700m, 1984-85

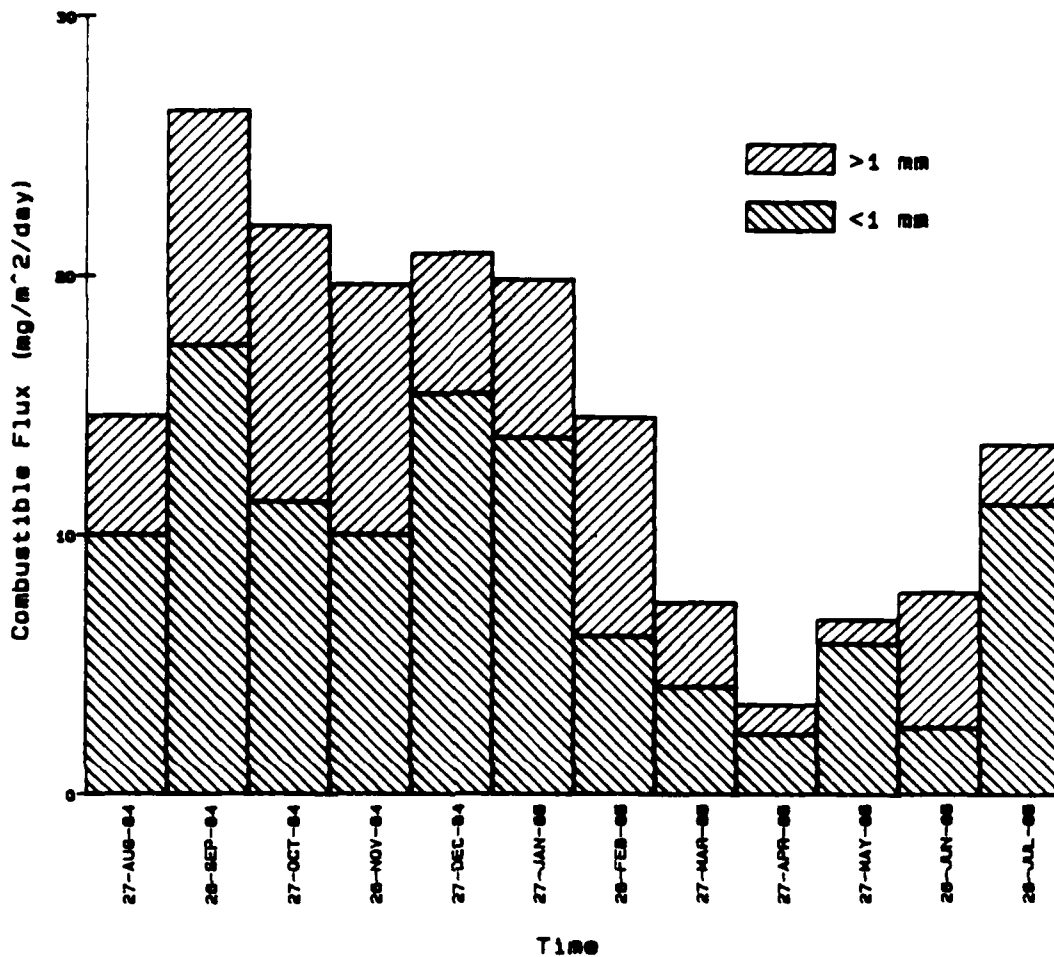

| Sample ID# | COMB <1 | COMB % tot.<1 | COMB >1 | COMB % tot. >1 | COMB TOTAL | COMB % total |
|-----------------|---------|---------------|---------|----------------|------------|--------------|
| 26 BI1-1700-1* | 10.03 | 18.91 | 4.60 | 8.67 | 14.64 | 27.55 |
| 27 BI1-1700-2* | 17.33 | 14.29 | 9.00 | 7.42 | 26.33 | 31.71 |
| 28 BI1-1700-3* | 11.29 | 10.39 | 10.62 | 9.77 | 21.91 | 20.16 |
| 29 BI1-1700-4* | 10.03 | 12.45 | 9.67 | 12.00 | 19.71 | 24.47 |
| 30 BI1-1700-5* | 15.48 | 12.07 | 5.42 | 4.23 | 20.90 | 16.30 |
| 31 BI1-1700-6* | 13.78 | 10.13 | 6.10 | 4.48 | 19.87 | 14.60 |
| 32 BI1-1700-7* | 6.08 | 8.46 | 8.47 | 11.78 | 14.55 | 20.24 |
| 33 BI1-1700-8* | 4.14 | 9.35 | 3.27 | 7.78 | 7.41 | 17.64 |
| 34 BI1-1700-9* | 2.31 | 9.57 | 1.12 | 4.64 | 3.43 | 14.20 |
| 35 BI1-1700-10* | 5.80 | 11.70 | 0.93 | 1.88 | 6.73 | 13.57 |
| 36 BI1-1700-11* | 2.58 | 11.12 | 5.20 | 22.41 | 7.78 | 33.63 |
| 37 BI1-1700-12* | 11.22 | 11.53 | 2.29 | 2.35 | 13.51 | 13.63 |

FIG. 13. In mg/m²/day.

Biogenic Silica Flux at Beer Island 1, 1700m, 1984-85

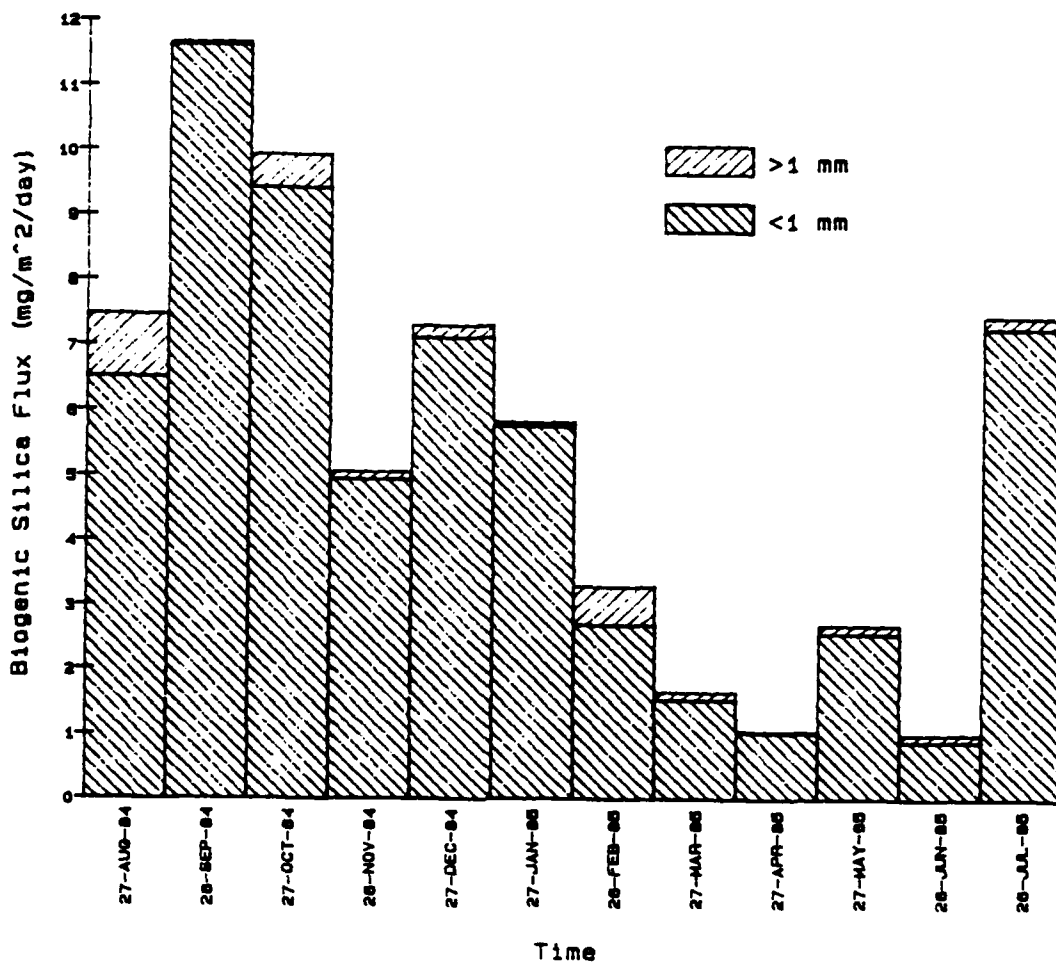

| Sample ID# | OPAL <1 | OPAL <1 %Ncmb. | OPAL >1 | OPAL >1 %Ncmb. | OPAL total | OPAL %Ncmb. | OPAL %total |
|----------------|---------|----------------|----------|----------------|------------|-------------|-------------|
| 26 BI1-1700-1 | 6.51 | 24.56 | 0.959340 | 3.62 | 7.47 | 28.17 | 14.09 |
| 27 BI1-1700-2 | 11.62 | 19.22 | 0.061184 | 0.10 | 11.68 | 19.32 | 9.63 |
| 29 BI1-1700-3 | 9.41 | 16.62 | 0.520868 | 0.92 | 9.93 | 17.54 | 9.14 |
| 29 BI1-1700-4 | 4.94 | 12.49 | 0.123738 | 0.31 | 5.07 | 12.81 | 6.29 |
| 30 BI1-1700-5 | 7.12 | 9.67 | 0.191400 | 0.23 | 7.31 | 8.90 | 5.70 |
| 31 BI1-1700-6 | 5.75 | 6.50 | 0.065302 | 0.07 | 5.82 | 6.57 | 4.28 |
| 32 BI1-1700-7 | 2.69 | 6.50 | 0.595221 | 1.44 | 3.29 | 7.93 | 4.57 |
| 33 BI1-1700-8 | 1.53 | 6.28 | 0.119040 | 0.49 | 1.64 | 6.77 | 3.91 |
| 34 BI1-1700-9 | 1.04 | 7.08 | 0.020000 | 0.14 | 1.06 | 7.21 | 4.37 |
| 35 BI1-1700-10 | 2.56 | 7.74 | 0.136090 | 0.41 | 2.70 | 8.15 | 5.44 |
| 36 BI1-1700-11 | 0.90 | 10.66 | 0.115022 | 1.36 | 1.01 | 12.02 | 4.37 |
| 37 BI1-1700-12 | 7.27 | 12.00 | 0.186550 | 0.31 | 7.46 | 12.31 | 7.67 |

Flux is in mg/m²/day.
 %Ncmb. is "% noncombustible flux".

Lithogenic Flux at Bear Island 1, 1700m, 1984-85

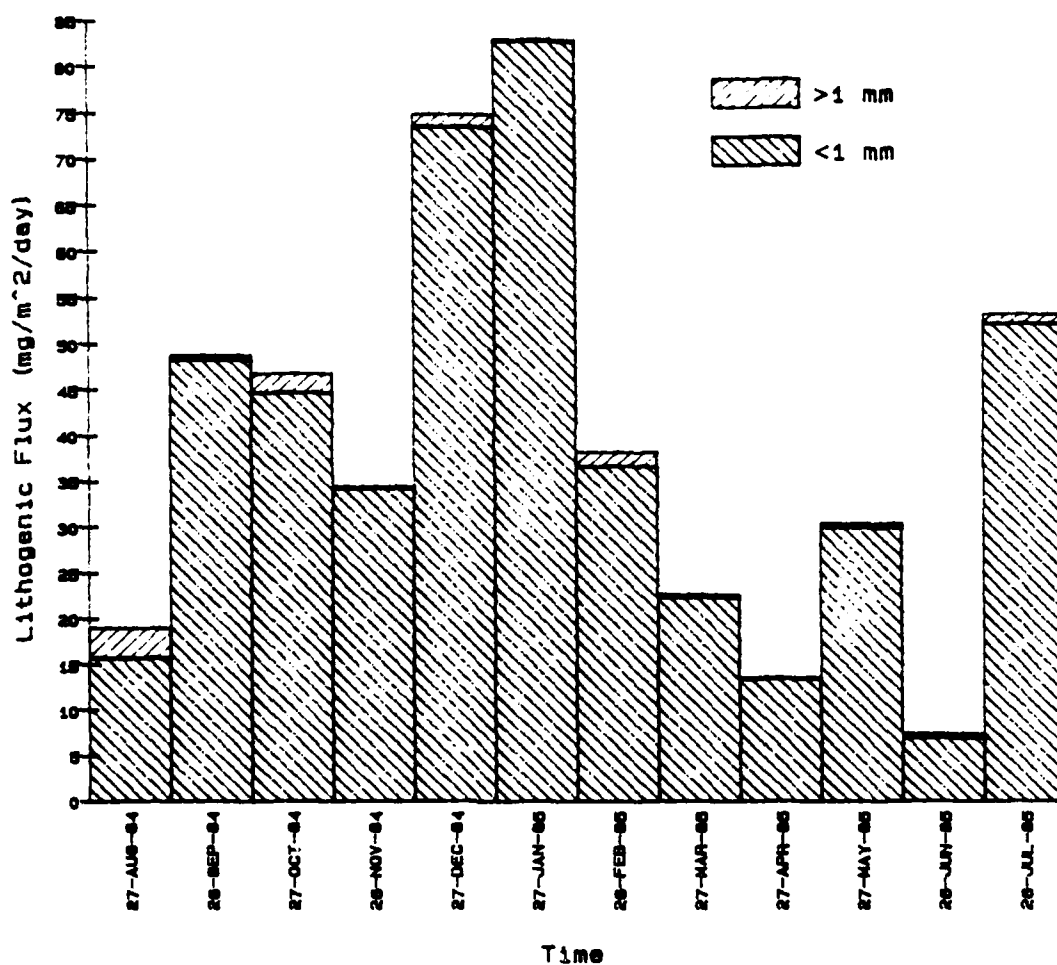

| Sample ID# | LITH total | LITH <1 %Ncmb. | LITH >1 total | LITH >1 %Ncmb. | LITH total | LITH %Ncmb. |
|----------------|---------------|-------------------|------------------|-------------------|------------|----------------|
| 26 BII-1700-1 | 15.75 | 59.38 | 3.29 | 12.41 | 19.04 | 71.79 |
| 27 BII-1700-2 | 48.25 | 79.95 | 0.50 | 0.83 | 48.75 | 80.63 |
| 28 BII-1700-3 | 44.53 | 78.81 | 2.07 | 3.65 | 46.60 | 92.46 |
| 29 BII-1700-4 | 34.23 | 86.52 | 0.27 | 0.67 | 34.49 | 97.19 |
| 30 BII-1700-5 | 73.45 | 89.45 | 1.36 | 1.55 | 74.81 | 91.11 |
| 31 BII-1700-6 | 82.60 | 93.23 | 0.17 | 0.20 | 82.77 | 93.43 |
| 32 BII-1700-7 | 36.60 | 98.34 | 1.54 | 3.73 | 38.14 | 92.07 |
| 33 BII-1700-8 | 22.29 | 91.82 | 0.34 | 1.40 | 22.64 | 93.23 |
| 34 BII-1700-9 | 13.47 | 92.10 | 0.11 | 0.75 | 13.58 | 92.36 |
| 35 BII-1700-10 | 29.89 | 90.35 | 0.48 | 1.46 | 30.37 | 91.32 |
| 36 BII-1700-11 | 6.96 | 82.47 | 0.46 | 5.51 | 7.43 | 87.36 |
| 37 BII-1700-12 | 52.13 | 86.01 | 1.02 | 1.69 | 53.15 | 87.69 |

Flux is in mg/m²/day.

%Ncmb. is % of noncombustible flux.

Carbon Flux at Bear Island 1, 1700m, 1984-85

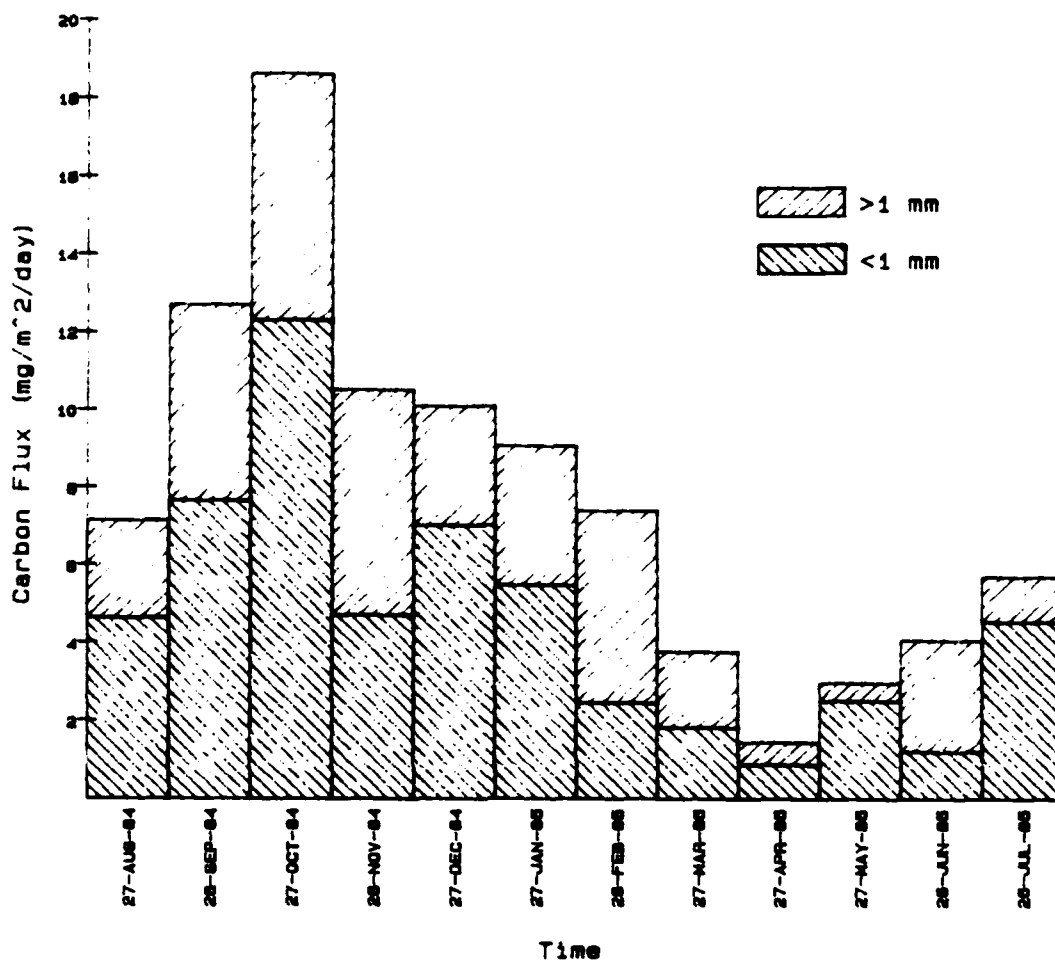

| Sample I.D. | CRNC <1 | CRNC <1 %comb. | CRNC >1 | CRNC >1 %comb. | CRNC total | CRNCtot. %comb. |
|-----------------|---------|----------------|---------|----------------|------------|-----------------|
| 26 B11-1700-1* | 4.65 | 31.76 | 2.54 | 17.35 | 7.19 | 49.11 |
| 27 B11-1700-2* | 7.66 | 29.09 | 5.06 | 19.20 | 12.72 | 48.29 |
| 28 B11-1700-3* | 12.31 | 56.18 | 6.35 | 29.98 | 18.66 | 85.17 |
| 29 B11-1700-4* | 4.72 | 23.96 | 5.82 | 29.55 | 10.55 | 53.51 |
| 30 B11-1700-5* | 7.04 | 33.58 | 3.07 | 14.69 | 10.11 | 48.37 |
| 31 B11-1700-6* | 5.50 | 27.67 | 3.61 | 18.15 | 9.11 | 45.82 |
| 32 B11-1700-7* | 2.48 | 17.04 | 4.97 | 34.16 | 7.45 | 51.20 |
| 33 B11-1700-8* | 1.83 | 24.58 | 1.96 | 26.46 | 3.79 | 51.15 |
| 34 B11-1700-9* | 0.88 | 25.66 | 0.59 | 17.20 | 1.47 | 42.66 |
| 35 B11-1700-10* | 2.54 | 37.71 | 0.47 | 7.02 | 3.01 | 44.73 |
| 36 B11-1700-11* | 1.23 | 15.81 | 2.38 | 37.02 | 4.11 | 52.83 |
| 37 B11-1700-12* | 4.57 | 33.84 | 1.16 | 8.61 | 5.74 | 42.45 |

Flux is in mg/m²/day.
 %comb = "% of combustible flux"

Nitrogen Flux at Bear Island 1, 1700m, 1984-1985

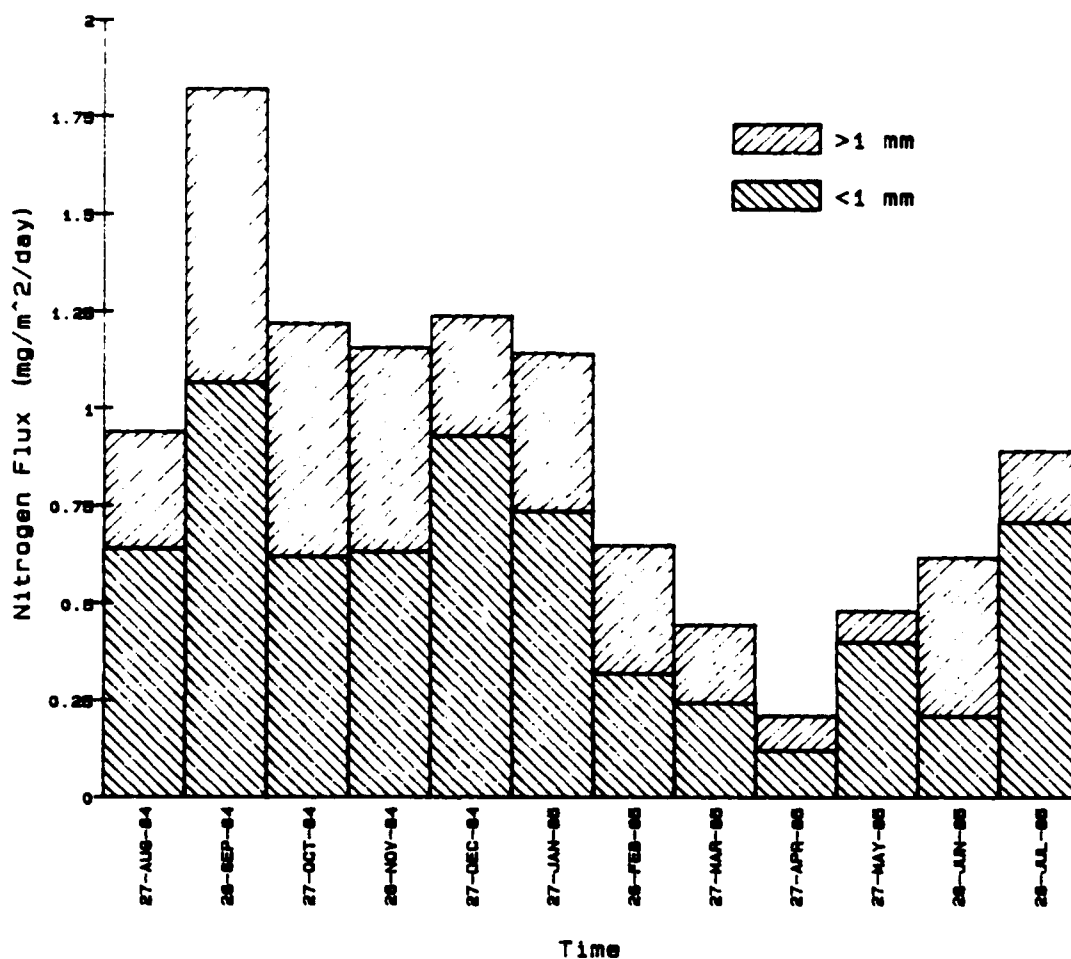

| Sample I.D. | NTGN <1 | NTGN<1 %cmbf. | NTGN >1 | NTGN>1 %cmbf. | NTGN total | NTGNtot. %cmbf. |
|-----------------|---------|---------------|---------|---------------|------------|-----------------|
| 26 BII-1700-1* | 0.64 | 4.37 | 0.30 | 2.05 | 0.94 | 6.42 |
| 27 BII-1700-2* | 1.07 | 4.05 | 0.76 | 2.37 | 1.82 | 6.92 |
| 28 BII-1700-3* | 0.62 | 2.83 | 0.60 | 2.74 | 1.22 | 6.67 |
| 29 BII-1700-4* | 0.63 | 3.21 | 0.53 | 2.66 | 1.16 | 6.37 |
| 30 BII-1700-5* | 0.93 | 4.45 | 0.31 | 1.48 | 1.24 | 6.83 |
| 31 BII-1700-6* | 0.74 | 3.71 | 0.41 | 2.04 | 1.14 | 6.75 |
| 32 BII-1700-7* | 0.32 | 2.20 | 0.33 | 2.27 | 0.65 | 4.47 |
| 33 BII-1700-8* | 0.24 | 3.29 | 0.20 | 2.73 | 0.45 | 6.21 |
| 34 BII-1700-9* | 0.12 | 3.50 | 0.09 | 2.62 | 0.21 | 6.12 |
| 35 BII-1700-10* | 0.40 | 5.95 | 0.08 | 1.21 | 0.48 | 7.16 |
| 36 BII-1700-11* | 0.21 | 2.70 | 0.41 | 5.27 | 0.62 | 7.87 |
| 37 BII-1700-12* | 0.71 | 5.26 | 0.18 | 1.35 | 0.89 | 6.65 |

Flux is in mg/m²/day.
 %cmbf. = % of combustible flux.

Hydrogen Flux at Bear Island 1, 1700m, 1984-85

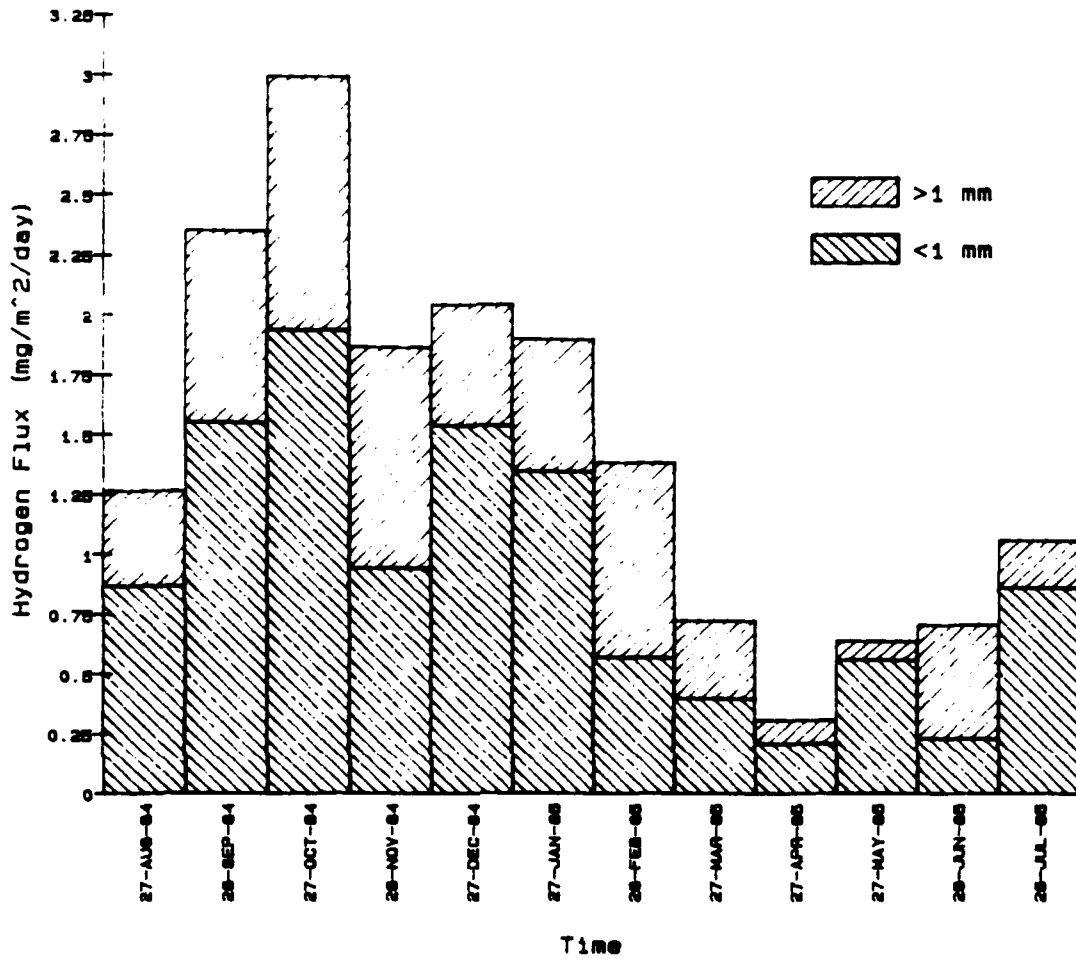

| Sample I.D. | HYDC I | HYDC %ombf. | HYDC I | HYDC %ombf. | HYDC total | HYDCtot. %ombf. |
|-----------------|--------|-------------|--------|-------------|------------|-----------------|
| 26 811-1700-1* | 0.67 | 5.94 | 0.40 | 2.73 | 1.27 | 9.67 |
| 27 811-1700-2* | 1.55 | 5.90 | 0.80 | 3.04 | 2.35 | 9.94 |
| 28 811-1700-3* | 1.94 | 8.85 | 1.06 | 4.34 | 3.00 | 13.59 |
| 29 811-1700-4* | 0.93 | 4.80 | 0.93 | 4.71 | 1.87 | 9.50 |
| 30 811-1700-5* | 1.54 | 7.37 | 0.51 | 2.44 | 2.05 | 9.91 |
| 31 811-1700-5* | 1.35 | 6.90 | 0.56 | 2.30 | 1.91 | 9.60 |
| 32 811-1700-7* | 0.57 | 3.92 | 0.32 | 5.64 | 1.39 | 9.55 |
| 33 811-1700-8* | 0.40 | 5.38 | 0.33 | 4.43 | 0.73 | 6.61 |
| 34 811-1700-9* | 0.21 | 5.12 | 0.10 | 2.92 | 0.31 | 8.04 |
| 35 811-1700-10* | 0.56 | 3.35 | 0.08 | 1.20 | 0.64 | 3.65 |
| 36 811-1700-11* | 0.13 | 2.96 | 0.48 | 5.17 | 0.71 | 8.10 |
| 37 811-1700-12* | 0.35 | 5.33 | 0.20 | 1.47 | 1.05 | 7.35 |

Fig. 13 is in mg/m²/day.
 %ombf. = % of combustible flux.

NA-1

AEGIR RIDGE

65°31'N, 00°64'E

Trap depth: 2,630m Water depth: 3,058m

Annual Fluxes (g/m²/yr):
Total.....17.36
Carbonate.....9.18
Noncombustible.....5.94
Combustible.....2.31
Lithogenic.....4.26
Biogenic Opal.....1.68
Organic C.....0.59
N0.08

PARFLUX Mark 6-13

| Sample ID | Opening Date | Closing Date | Span | Mid. Date |
|----------------|--------------|--------------|------|-----------|
| 57 NA1-3058-1 | 21-AUG-85 | 13-SEP-85 | 23 | 02-SEP-85 |
| 58 NA1-3058-2 | 13-SEP-85 | 06-OCT-85 | 23 | 25-SEP-85 |
| 59 NA1-3058-3 | 06-OCT-85 | 29-OCT-85 | 23 | 18-OCT-85 |
| 60 NA1-3058-4 | 29-OCT-85 | 21-NOV-85 | 23 | 10-NOV-85 |
| 61 NA1-3058-5 | 21-NOV-85 | 14-DEC-85 | 23 | 03-DEC-85 |
| 62 NA1-3058-6 | 14-DEC-85 | 06-JAN-86 | 23 | 26-DEC-85 |
| 63 NA1-3058-7 | 06-JAN-86 | 29-JAN-86 | 23 | 19-JAN-86 |
| 64 NA1-3058-8 | 29-JAN-86 | 21-FEB-86 | 23 | 10-FEB-86 |
| 65 NA1-3058-9 | 21-FEB-86 | 16-MAR-86 | 23 | 05-MAR-86 |
| 66 NA1-3058-10 | 16-MAR-86 | 08-APR-86 | 23 | 23-MAR-86 |
| 67 NA1-3058-11 | 08-APR-86 | 01-MAY-86 | 23 | 20-APR-86 |
| 68 NA1-3058-12 | 01-MAY-86 | 24-MAY-86 | 23 | 13-MAY-86 |
| 69 NA1-3058-13 | 24-MAY-86 | 16-JUN-86 | 23 | 05-JUN-86 |

Total Flux at Aegir Ridge (NA1), 3058m, 1985-1986

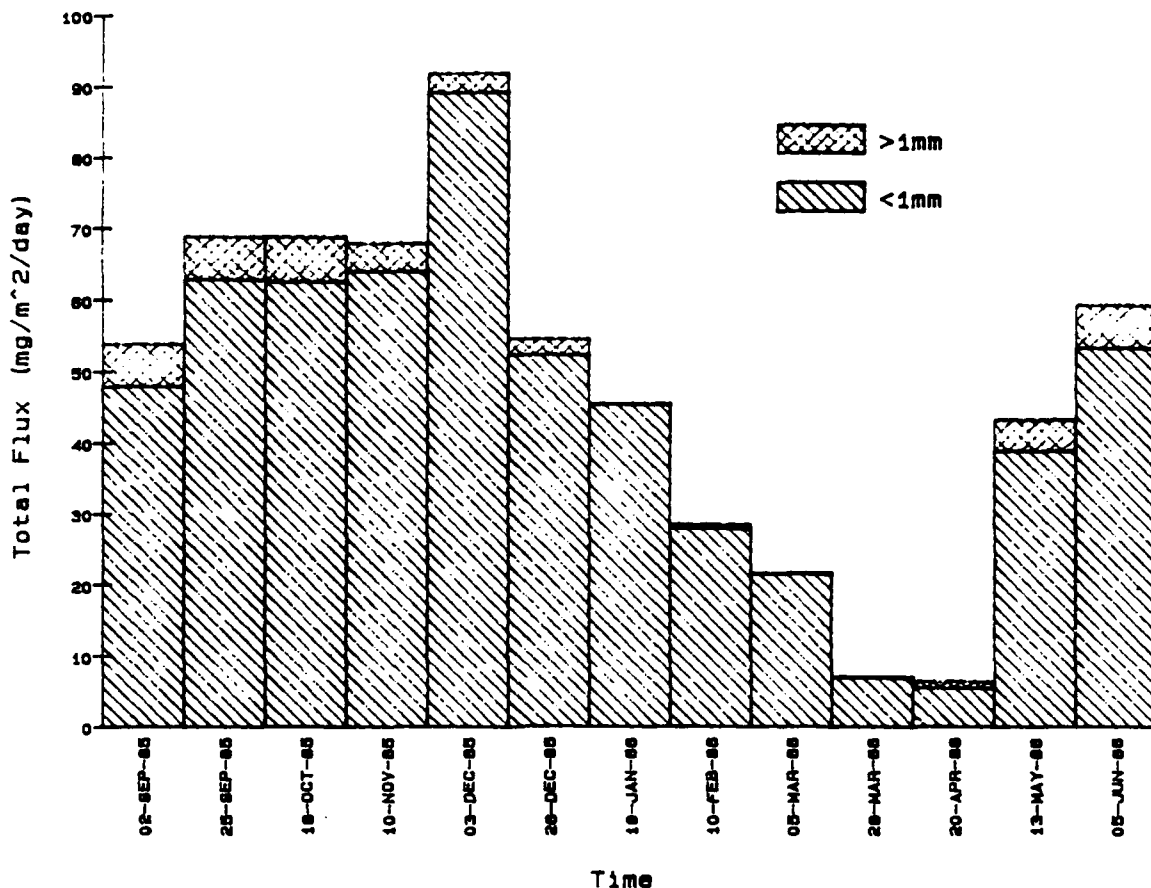

| Sample I.D. | TTLF | <1 % of total | TTLF | >1 % of total | TTLF total |
|----------------|-------|---------------|------|---------------|------------|
| 57 NA1-3058-1 | 47.97 | 89.03 | 5.91 | 10.97 | 53.89 |
| 58 NA1-3058-2 | 62.76 | 91.27 | 6.01 | 8.73 | 68.76 |
| 59 NA1-3058-3 | 62.53 | 90.83 | 6.32 | 9.17 | 68.84 |
| 60 NA1-3058-4 | 63.93 | 94.15 | 3.97 | 5.85 | 67.90 |
| 61 NA1-3058-5 | 89.06 | 97.02 | 2.73 | 2.98 | 91.79 |
| 62 NA1-3058-6 | 52.31 | 95.90 | 2.23 | 4.10 | 54.54 |
| 63 NA1-3058-7 | 45.37 | 99.78 | 0.10 | 0.22 | 45.47 |
| 64 NA1-3058-8 | 27.87 | 97.70 | 0.65 | 2.30 | 28.52 |
| 65 NA1-3058-9 | 21.54 | 99.56 | 0.10 | 0.44 | 21.63 |
| 66 NA1-3058-10 | 6.89 | 98.73 | 0.09 | 1.27 | 6.98 |
| 67 NA1-3058-11 | 5.44 | 85.35 | 0.93 | 14.65 | 6.38 |
| 68 NA1-3058-12 | 38.72 | 99.64 | 4.48 | 10.36 | 43.20 |
| 69 NA1-3058-13 | 53.18 | 89.73 | 6.09 | 10.27 | 59.27 |

Flux is in mg/m²/day.

Carbonate Flux at Aegir Ridge 1 (NA-1), 3058 m, 1985-1986

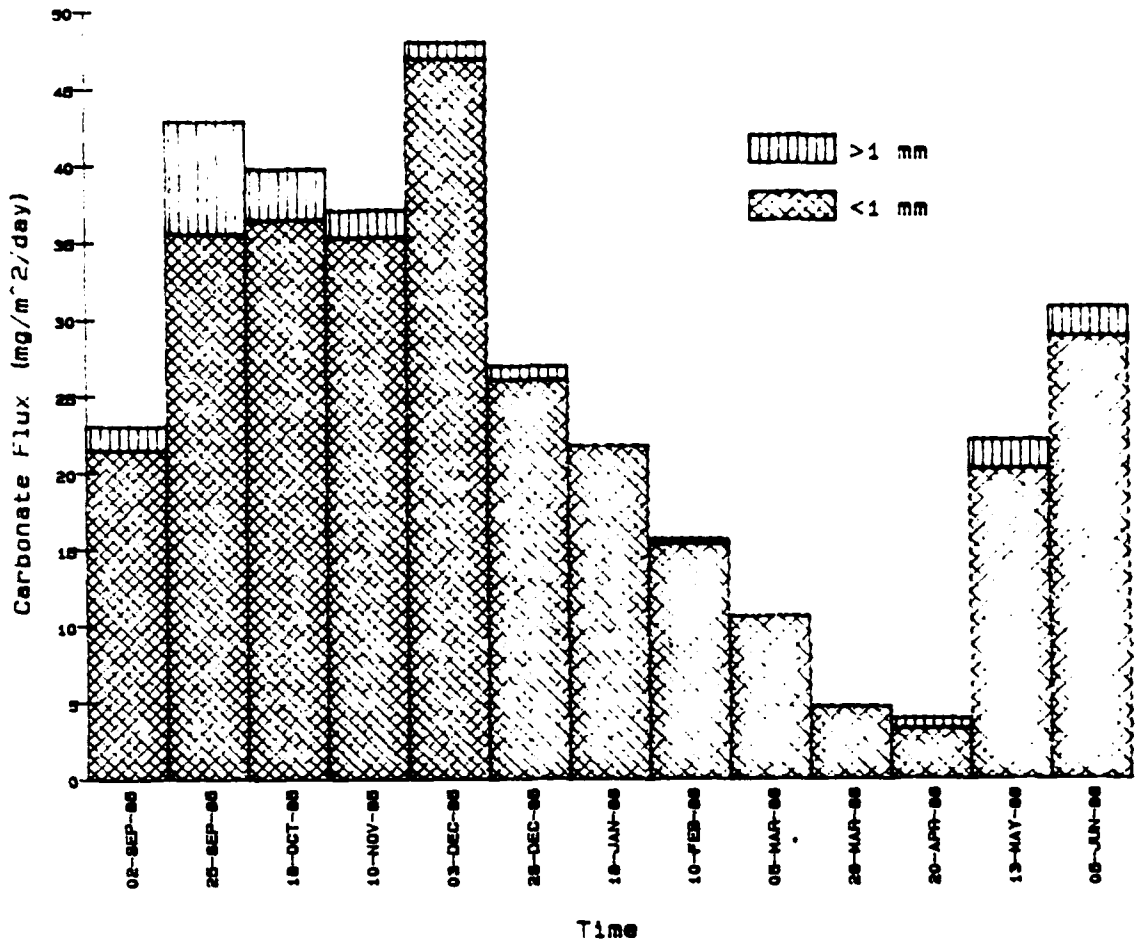

| Sample No. | ORTA | ORTA 1 | ORTA 2 | ORTA 3 | ORTA 4 | ORTA total |
|------------|-------|--------|--------|--------|--------|------------|
| 01 | 21.94 | 38.97 | 1.95 | 2.38 | 25.28 | 42.16 |
| 02 | 38.94 | 51.35 | 1.97 | 2.10 | 42.37 | 62.73 |
| 03 | 38.44 | 51.33 | 3.71 | 4.38 | 58.86 | 67.27 |
| 04 | 35.29 | 51.37 | 1.98 | 2.88 | 51.52 | 57.17 |
| 05 | 48.88 | 51.27 | 1.98 | 1.24 | 41.81 | 43.47 |
| 06 | 19.00 | 41.80 | 3.31 | 1.97 | 38.31 | 43.11 |
| 07 | 11.75 | 41.38 | 3.02 | 2.24 | 41.75 | 43.12 |
| 08 | 18.11 | 51.88 | 3.74 | 1.75 | 58.48 | 64.18 |
| 09 | 12.80 | 48.33 | 3.02 | 3.00 | 58.00 | 63.82 |
| 10 | 4.75 | 33.75 | 3.00 | 3.00 | 41.75 | 43.51 |
| 11 | 3.25 | 51.71 | 3.65 | 2.88 | 58.34 | 61.59 |
| 12 | 13.10 | 48.10 | 1.75 | 1.25 | 58.10 | 61.20 |
| 13 | 13.50 | 41.87 | 1.85 | 1.10 | 58.72 | 61.57 |

Noncombustible Flux at Aegir Ridge (NA-1), 3058m, 1985-1986

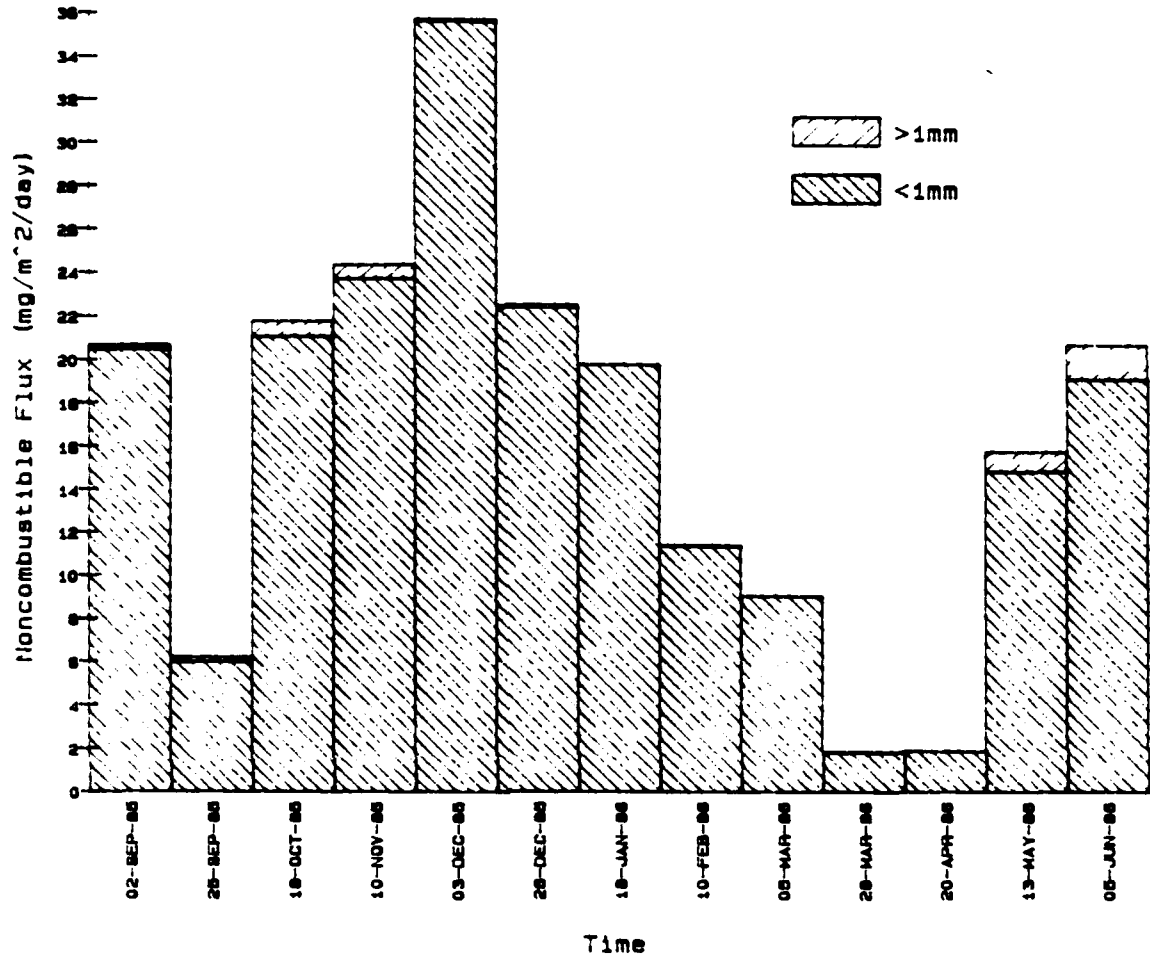

| Sample ID# | NONC (1) | NONC % tot.(1) | NONC (2) | NONC % tot.(2) | NONC total | NONC % total |
|----------------|-------------|-------------------|-------------|-------------------|---------------|-----------------|
| 57 NA1-3058-1 | 20.46 | 37.96 | 0.24 | 0.45 | 20.70 | 38.42 |
| 58 NA1-3058-2 | 5.99 | 8.71 | 0.25 | 0.37 | 6.24 | 9.09 |
| 59 NA1-3058-3 | 21.05 | 30.58 | 0.73 | 1.06 | 21.79 | 31.65 |
| 60 NA1-3058-4 | 23.74 | 34.95 | 0.63 | 0.93 | 24.38 | 35.90 |
| 61 NA1-3058-5 | 35.60 | 38.79 | 0.11 | 0.12 | 35.71 | 38.91 |
| 62 NA1-3058-6 | 22.42 | 41.10 | 0.13 | 0.24 | 22.55 | 41.33 |
| 63 NA1-3058-7 | 19.74 | 43.41 | 0.00 | 0.01 | 19.74 | 43.42 |
| 64 NA1-3058-8 | 11.34 | 39.77 | 0.03 | 0.10 | 11.37 | 39.87 |
| 65 NA1-3058-9 | 9.04 | 41.90 | 0.02 | 0.07 | 9.06 | 41.97 |
| 66 NA1-3058-10 | 1.84 | 26.34 | 0.04 | 0.50 | 1.87 | 26.84 |
| 67 NA1-3058-11 | 1.91 | 29.31 | 0.01 | 0.23 | 1.92 | 30.14 |
| 68 NA1-3058-12 | 14.31 | 34.29 | 0.92 | 2.13 | 15.23 | 36.41 |
| 69 NA1-3058-13 | 19.06 | 32.15 | 1.60 | 2.70 | 20.66 | 34.86 |

Fig. 15. In mg/m²/day.

Combustible Flux at Aegir Ridge (NA-1), 3058m, 1985-86

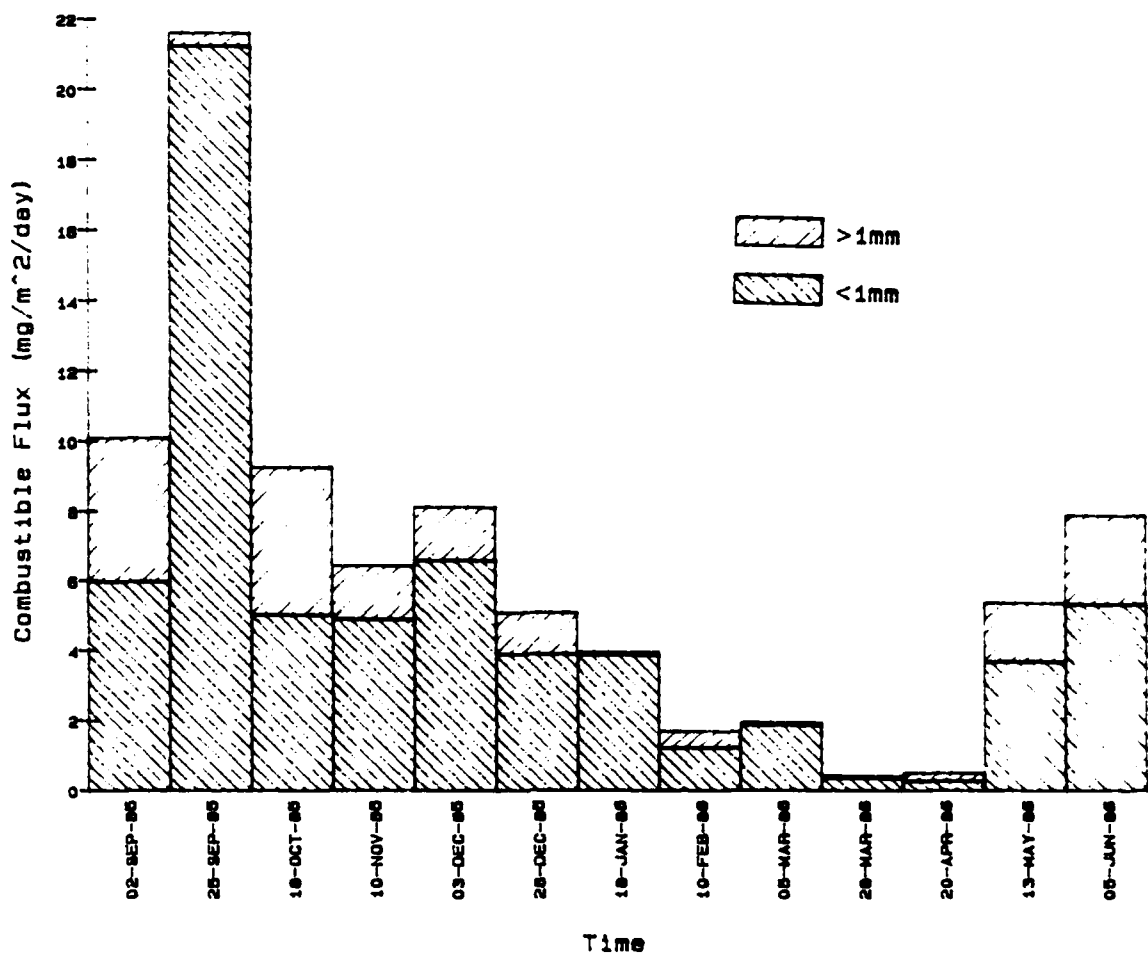

| Sample ID# | COMB <1 | COMB % tot.<1 | COMB >1 | COMB % tot.>1 | COMB TOTAL | COMB % total |
|----------------|---------|---------------|---------|---------------|------------|--------------|
| 57 NA1-3058-1 | 5.97 | 11.08 | 4.12 | 7.64 | 10.09 | 19.72 |
| 58 NA1-3058-2 | 21.23 | 30.88 | 0.39 | 0.56 | 21.62 | 31.44 |
| 59 NA1-3058-3 | 5.04 | 7.31 | 4.22 | 6.13 | 9.25 | 13.44 |
| 60 NA1-3058-4 | 4.90 | 7.21 | 1.54 | 2.26 | 6.43 | 9.47 |
| 61 NA1-3058-5 | 6.58 | 7.17 | 1.53 | 1.66 | 8.11 | 8.93 |
| 62 NA1-3058-6 | 3.89 | 7.14 | 1.19 | 2.18 | 5.08 | 9.32 |
| 63 NA1-3058-7 | 3.87 | 8.52 | 0.08 | 0.17 | 3.95 | 8.69 |
| 64 NA1-3058-8 | 1.22 | 4.27 | 0.48 | 1.68 | 1.70 | 5.96 |
| 65 NA1-3058-9 | 1.98 | 8.68 | 0.08 | 0.39 | 1.96 | 9.07 |
| 66 NA1-3058-10 | 0.35 | 5.05 | 0.05 | 0.79 | 0.41 | 5.84 |
| 67 NA1-3058-11 | 0.27 | 4.27 | 0.24 | 3.69 | 0.51 | 7.97 |
| 68 NA1-3058-12 | 3.68 | 8.52 | 1.68 | 3.99 | 5.36 | 12.40 |
| 69 NA1-3058-13 | 5.31 | 8.96 | 2.54 | 4.28 | 7.85 | 13.25 |

Flux is in mg/m²/day.

Biogenic Silica Flux at Aegir Ridge (NA-1), 3056m, 1985-86

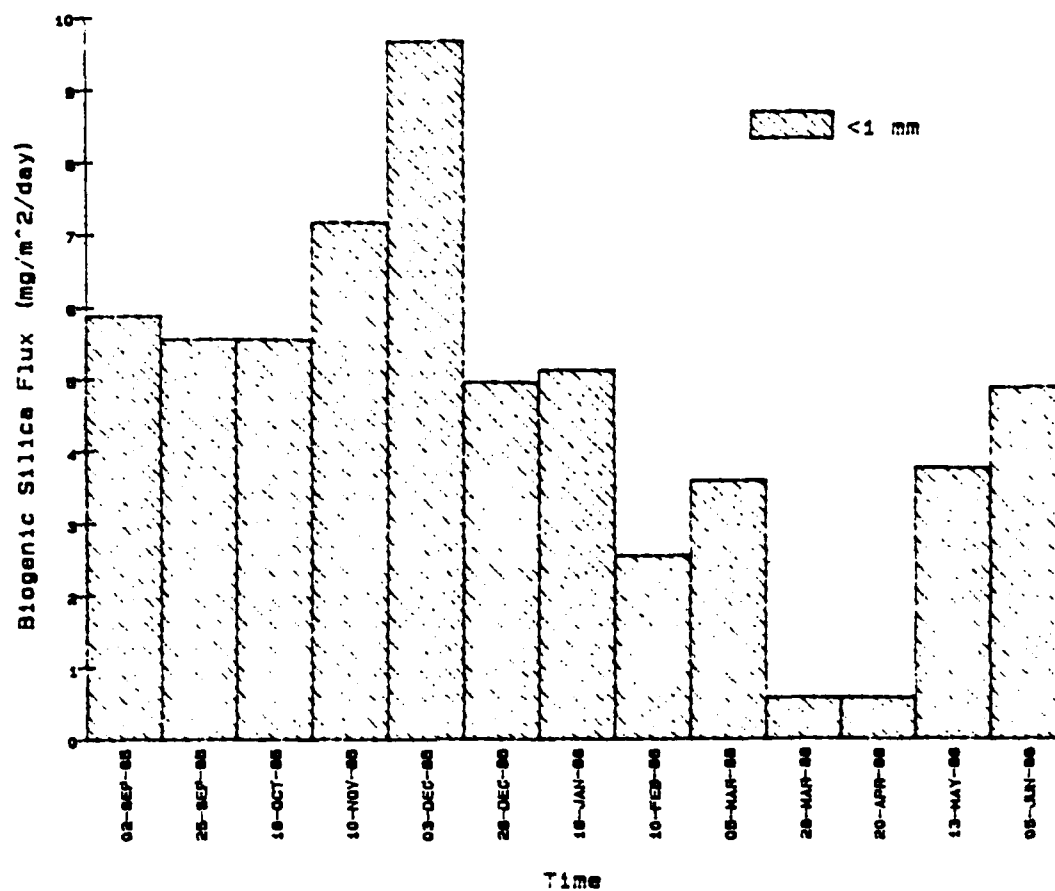

| Sample ID# | OPAL | OPAL % Ncf. <1 | OPAL % tot. <1 |
|----------------|------|----------------|----------------|
| 57 NA1-3058-1 | 5.38 | 28.40 | 10.91 |
| 58 NA1-3058-2 | 5.56 | 89.07 | 8.09 |
| 59 NA1-3058-3 | 5.55 | 25.47 | 8.06 |
| 60 NA1-3058-4 | 7.17 | 29.41 | 10.56 |
| 61 NA1-3058-5 | 9.57 | 27.08 | 10.53 |
| 62 NA1-3058-6 | 4.95 | 21.96 | 9.08 |
| 63 NA1-3058-7 | 5.12 | 25.93 | 11.26 |
| 64 NA1-3058-8 | 2.55 | 22.42 | 8.94 |
| 65 NA1-3058-9 | 3.59 | 39.63 | 16.59 |
| 66 NA1-3058-10 | 0.58 | 30.98 | 8.31 |
| 67 NA1-3058-11 | 0.58 | 30.18 | 9.10 |
| 68 NA1-3058-12 | 3.76 | 23.90 | 8.70 |
| 69 NA1-3058-13 | 4.67 | 23.57 | 8.22 |

Flux is in mg/m²/day.

Not enough sample in <1 mm fraction to analyze for Opal.

%Ncf. = % of noncombustible flux.

Lithogenic Flux at Aegir Ridge (NA-1), 3058 m, 1985-8

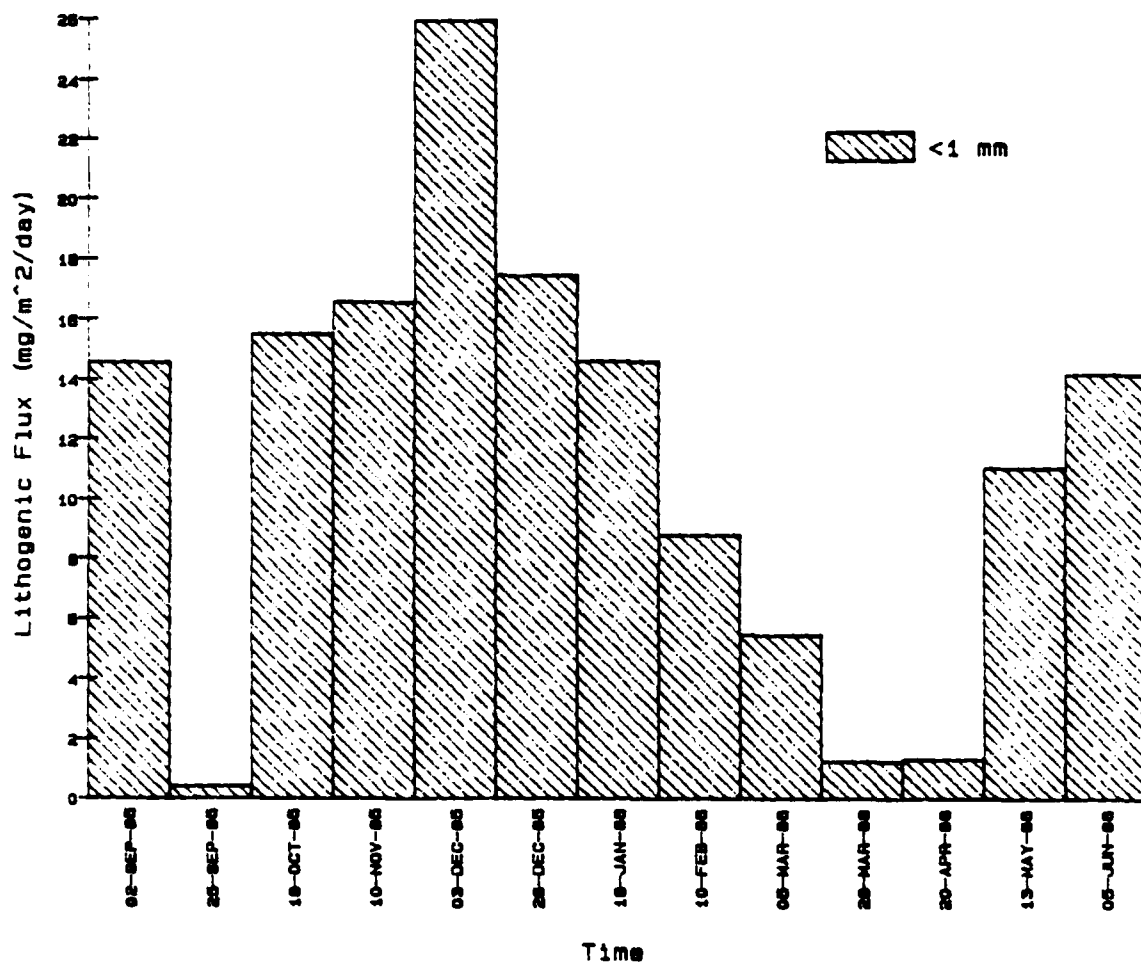

| Sample I.D. | LITH (1) | LITH-1 %Nomb. | LITH-1 %tot. |
|----------------|-------------|------------------|-----------------|
| S1 NA1-3058-1 | 14.58 | 70.42 | 27.05 |
| S2 NA1-3058-2 | 0.43 | 6.86 | 0.62 |
| S3 NA1-3058-3 | 15.50 | 71.16 | 22.52 |
| S4 NA1-3058-4 | 16.57 | 67.99 | 24.41 |
| S5 NA1-3058-5 | 25.93 | 72.61 | 29.25 |
| S6 NA1-3058-6 | 17.47 | 77.47 | 32.02 |
| S7 NA1-3058-7 | 14.62 | 74.05 | 32.15 |
| S8 NA1-3058-8 | 8.79 | 77.31 | 30.92 |
| S9 NA1-3058-9 | 5.45 | 60.19 | 25.20 |
| S6 NA1-3058-10 | 1.25 | 67.15 | 18.02 |
| S7 NA1-3058-11 | 1.33 | 69.07 | 20.82 |
| S9 NA1-3058-12 | 11.05 | 70.25 | 25.58 |
| S9 NA1-3058-13 | 14.19 | 68.67 | 23.94 |

Flux is in mg/m²/day.

%Nomb. = % of noncombustible flux.

Not enough <1 mm fraction to do analysis.

Carbon Flux at Aegir Ridge (NA-1). 3058m. 1985-86

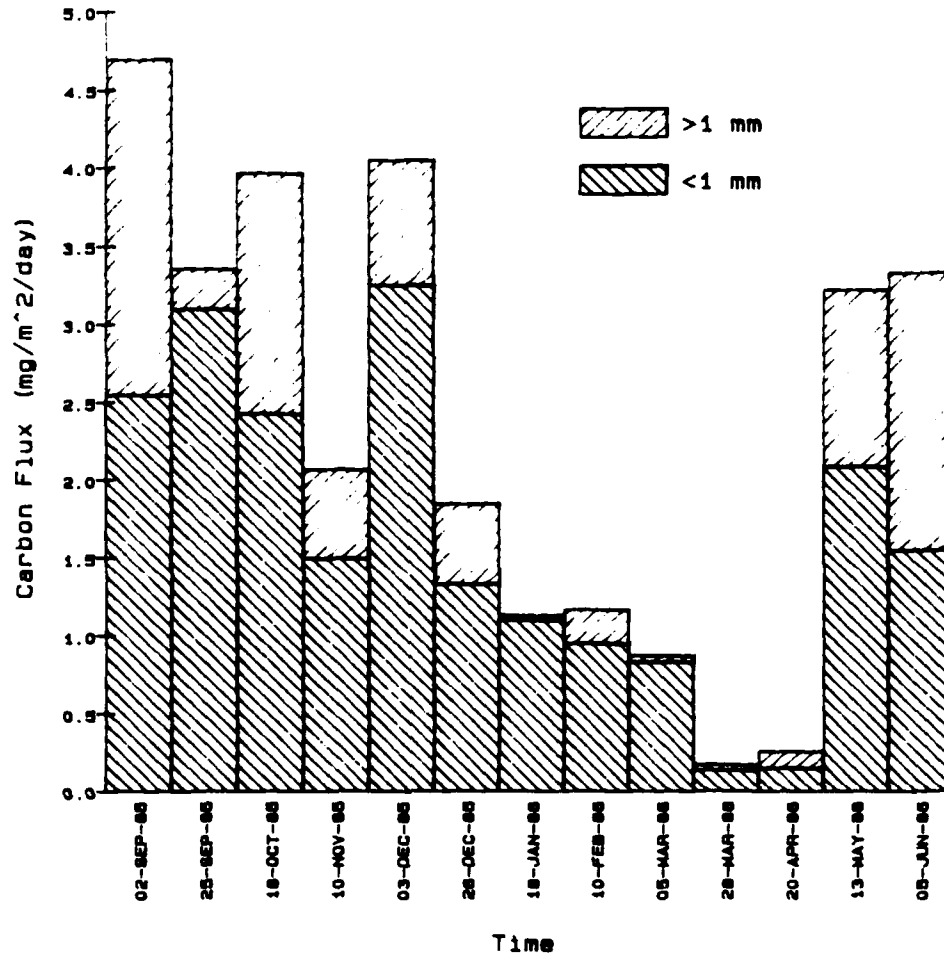

| Sample I.D. | CRNC -1 | CRNC-1 %cmbf. | CRNC -1 | CRNC-1 %cmbf. | CRNC total | CRNCtot. %cmbf. |
|----------------|------------|------------------|------------|------------------|---------------|--------------------|
| 57 NA1-3058-1 | 2.55 | 25.25 | 2.16 | 21.36 | 4.70 | 46.62 |
| 58 NA1-3058-2 | 3.10 | 14.33 | 0.26 | 1.19 | 3.36 | 15.52 |
| 59 NA1-3058-3 | 2.43 | 26.28 | 1.54 | 16.62 | 3.97 | 42.90 |
| 60 NA1-3058-4 | 1.50 | 23.37 | 0.58 | 9.97 | 2.08 | 32.34 |
| 61 NA1-3058-5 | 3.26 | 40.17 | 0.80 | 9.90 | 4.06 | 50.06 |
| 62 NA1-3058-6 | 1.34 | 26.29 | 0.52 | 10.25 | 1.86 | 36.94 |
| 63 NA1-3058-7 | 1.10 | 27.99 | 0.04 | 0.89 | 1.14 | 23.66 |
| 64 NA1-3058-8 | 0.95 | 56.04 | 0.22 | 13.16 | 1.13 | 69.21 |
| 65 NA1-3058-9 | 0.34 | 42.58 | 0.04 | 2.23 | 0.98 | 44.61 |
| 66 NA1-3058-10 | 0.14 | 33.53 | 0.04 | 9.68 | 0.13 | 40.21 |
| 67 NA1-3058-11 | 0.15 | 29.44 | 0.11 | 21.56 | 0.26 | 51.02 |
| 68 NA1-3058-12 | 2.09 | 39.02 | 1.14 | 21.27 | 3.23 | 60.29 |
| 69 NA1-3058-13 | 1.55 | 19.77 | 1.79 | 22.74 | 3.34 | 42.51 |

Flux is in mg/m²/day.

%cmbf = % of combustible flux

Nitrogen Flux at Aegir Ridge (NA-1), 3058m, 1985-86

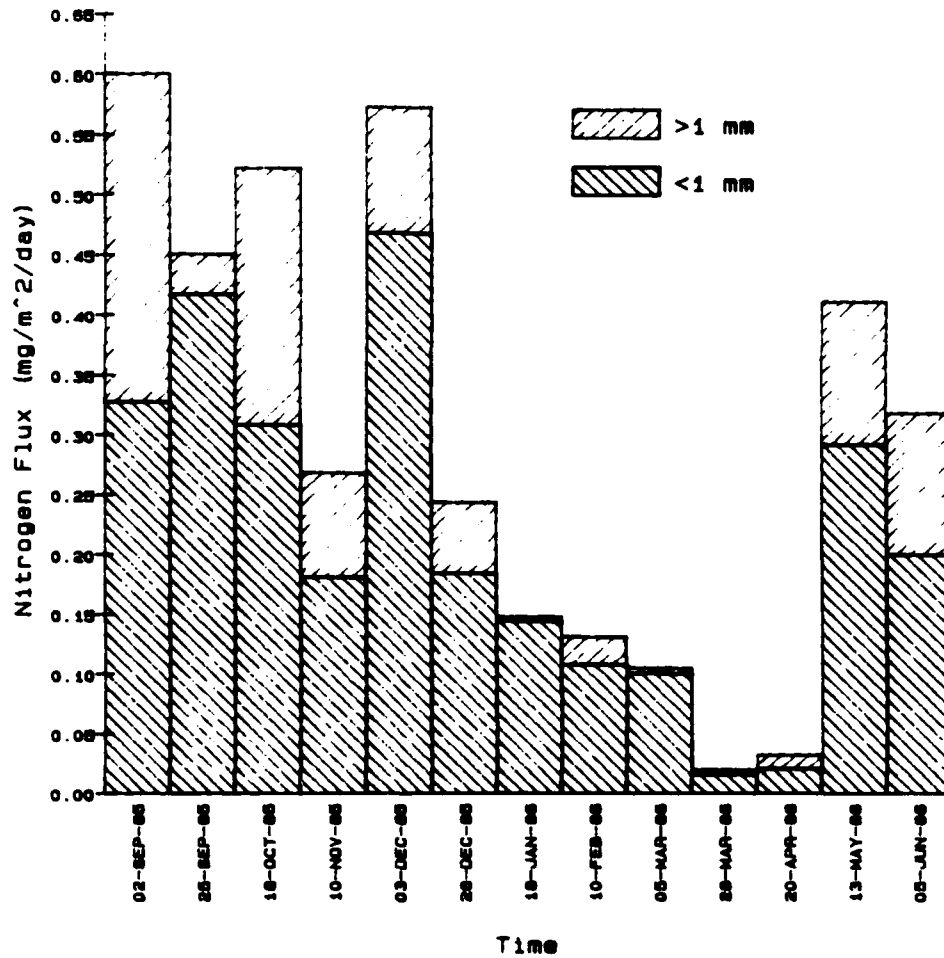

| Sample I.D. | NTGN <1 | NTGN >1 %cmbf. | NTGN 1 | NTGN >1 %cmbf. | NTGN total | NTGNtot. %cmbf. |
|----------------|---------|----------------|--------|----------------|------------|-----------------|
| 57 NA1-3058-1 | 0.33 | 3.25 | 0.27 | 2.71 | 0.60 | 5.95 |
| 58 NA1-3058-2 | 0.42 | 1.93 | 0.03 | 0.16 | 0.45 | 2.38 |
| 59 NA1-3058-3 | 0.31 | 3.33 | 0.21 | 2.32 | 0.52 | 6.54 |
| 60 NA1-3058-4 | 0.18 | 2.80 | 0.09 | 1.37 | 0.27 | 4.17 |
| 61 NA1-3058-5 | 0.47 | 5.78 | 0.11 | 1.30 | 0.57 | 7.07 |
| 62 NA1-3058-6 | 0.18 | 3.62 | 0.06 | 1.18 | 0.24 | 4.31 |
| 63 NA1-3058-7 | 0.14 | 3.55 | 0.00 | 0.09 | 0.15 | 3.74 |
| 64 NA1-3058-8 | 0.11 | 6.36 | 0.02 | 1.38 | 0.13 | 7.74 |
| 65 NA1-3058-9 | 0.10 | 5.12 | 0.00 | 0.23 | 0.11 | 5.35 |
| 66 NA1-3058-10 | 0.02 | 3.98 | 0.00 | 1.02 | 0.02 | 4.39 |
| 67 NA1-3058-11 | 0.02 | 4.12 | 0.01 | 2.27 | 0.03 | 6.39 |
| 69 NA1-3058-12 | 0.29 | 5.45 | 0.12 | 2.24 | 0.41 | 7.63 |
| 69 NA1-3058-13 | 0.20 | 2.55 | 0.12 | 1.51 | 0.32 | 4.35 |

Flux is in mg/m²/day.

"%cmbf" = "% of combustible flux"

Hydrogen Flux at Aegir Ridge (NA-1), 3058m, 1985-86

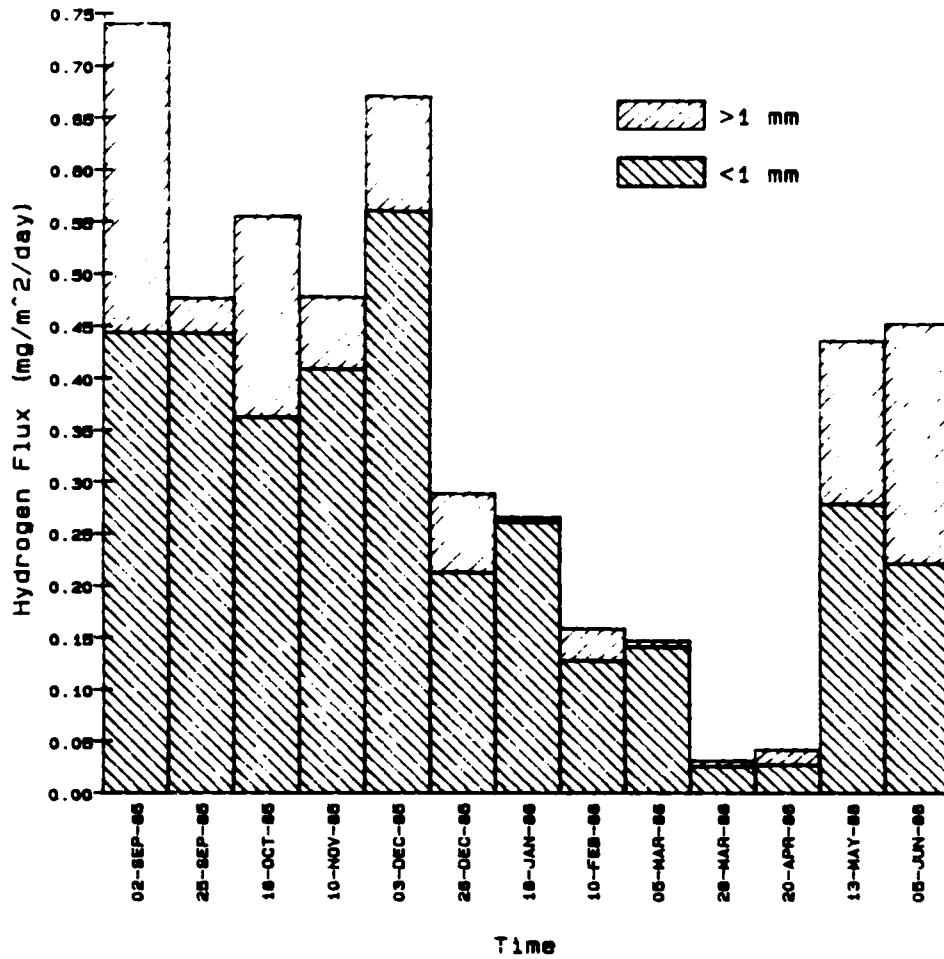

| Sample I.D. | HYDC fl | HYDC fl %comb. | HYDC fl | HYDC fl %comb. | HYDC total | HYDC tot. %comb. |
|----------------|------------|-------------------|------------|-------------------|---------------|---------------------|
| 57 NA1-3058-1 | 0.44 | 4.40 | 0.30 | 2.94 | 0.74 | 7.34 |
| 58 NA1-3058-2 | 0.44 | 2.05 | 0.03 | 0.16 | 0.48 | 2.21 |
| 59 NA1-3058-3 | 0.36 | 3.92 | 0.19 | 2.09 | 0.56 | 6.01 |
| 60 NA1-3058-4 | 0.41 | 6.37 | 0.07 | 1.08 | 0.48 | 7.44 |
| 61 NA1-3058-5 | 0.56 | 6.92 | 0.11 | 1.38 | 0.67 | 8.30 |
| 62 NA1-3058-6 | 0.21 | 4.19 | 0.08 | 1.51 | 0.29 | 5.78 |
| 63 NA1-3058-7 | 0.26 | 6.64 | 0.00 | 0.12 | 0.27 | 6.76 |
| 64 NA1-3058-8 | 0.13 | 7.54 | 0.03 | 1.82 | 0.16 | 8.36 |
| 65 NA1-3058-9 | 0.14 | 7.24 | 0.01 | 0.31 | 0.15 | 7.54 |
| 66 NA1-3058-10 | 0.03 | 6.50 | 0.01 | 1.34 | 0.03 | 7.34 |
| 67 NA1-3058-11 | 0.03 | 5.45 | 0.02 | 2.99 | 0.04 | 8.44 |
| 68 NA1-3058-12 | 0.28 | 5.21 | 0.16 | 2.94 | 0.44 | 8.15 |
| 69 NA1-3058-13 | 0.22 | 2.82 | 0.23 | 2.95 | 0.45 | 5.76 |

Flux is in mg/m²/day.

"%comb." = % of combustible flux.

NB-1

EAST OF JAN MAYEN

(NB-1) 70°00'N, 01°58'W

Trap depth: 2,749m Water depth: 2,773m

Annual Fluxes (g/m²/yr):
Total.....16.78
Carbonate.....8.93
Noncombustible.....6.24
Lithogenic.....4.65
Combustible.....1.90
Biogenic Opal.....1.44
Organic C.....0.53
N0.08

PARFLUX Mark 5-25

| Sample ID | Opening Date | Closing Date | Span | Mid. Date |
|----------------|--------------|--------------|------|-----------|
| 70 NB1-2815-1 | 20-AUG-85 | 01-SEP-85 | 12 | 26-AUG-85 |
| 71 NB1-2815-2 | 01-SEP-85 | 13-SEP-85 | 12 | 07-SEP-85 |
| 72 NB1-2815-3 | 13-SEP-85 | 25-SEP-85 | 12 | 19-SEP-85 |
| 73 NB1-2815-4 | 25-SEP-85 | 07-OCT-85 | 12 | 01-OCT-85 |
| 74 NB1-2815-5 | 07-OCT-85 | 19-OCT-85 | 12 | 13-OCT-85 |
| 75 NB1-2815-6 | 19-OCT-85 | 31-OCT-85 | 12 | 25-OCT-85 |
| 76 NB1-2815-7 | 31-OCT-85 | 12-NOV-85 | 12 | 06-NOV-85 |
| 77 NB1-2815-8 | 12-NOV-85 | 24-NOV-85 | 12 | 18-NOV-85 |
| 78 NB1-2815-9 | 24-NOV-85 | 06-DEC-85 | 12 | 30-NOV-85 |
| 79 NB1-2815-10 | 06-DEC-85 | 18-DEC-85 | 12 | 12-DEC-85 |
| 80 NB1-2815-11 | 18-DEC-85 | 30-DEC-85 | 12 | 24-DEC-85 |
| 81 NB1-2815-12 | 30-DEC-85 | 30-DEC-85 | 12 | 05-JAN-86 |
| 82 NB1-2815-13 | 30-DEC-85 | 11-JAN-86 | 12 | 05-JAN-86 |
| 83 NB1-2815-14 | 11-JAN-86 | 23-JAN-86 | 12 | 17-JAN-86 |
| 84 NB1-2815-15 | 23-JAN-86 | 04-FEB-86 | 12 | 29-JAN-86 |
| 85 NB1-2815-16 | 04-FEB-86 | 16-FEB-86 | 12 | 10-FEB-86 |
| 86 NB1-2815-17 | 16-FEB-86 | 28-FEB-86 | 12 | 22-FEB-86 |
| 87 NB1-2815-18 | 28-FEB-86 | 12-MAR-86 | | 06-MAR-86 |
| 88 NB1-2815-19 | 12-MAR-86 | 24-MAR-86 | | 18-MAR-86 |

Total Flux at Jan Mayen (NB1), 2815m, 1985-1986

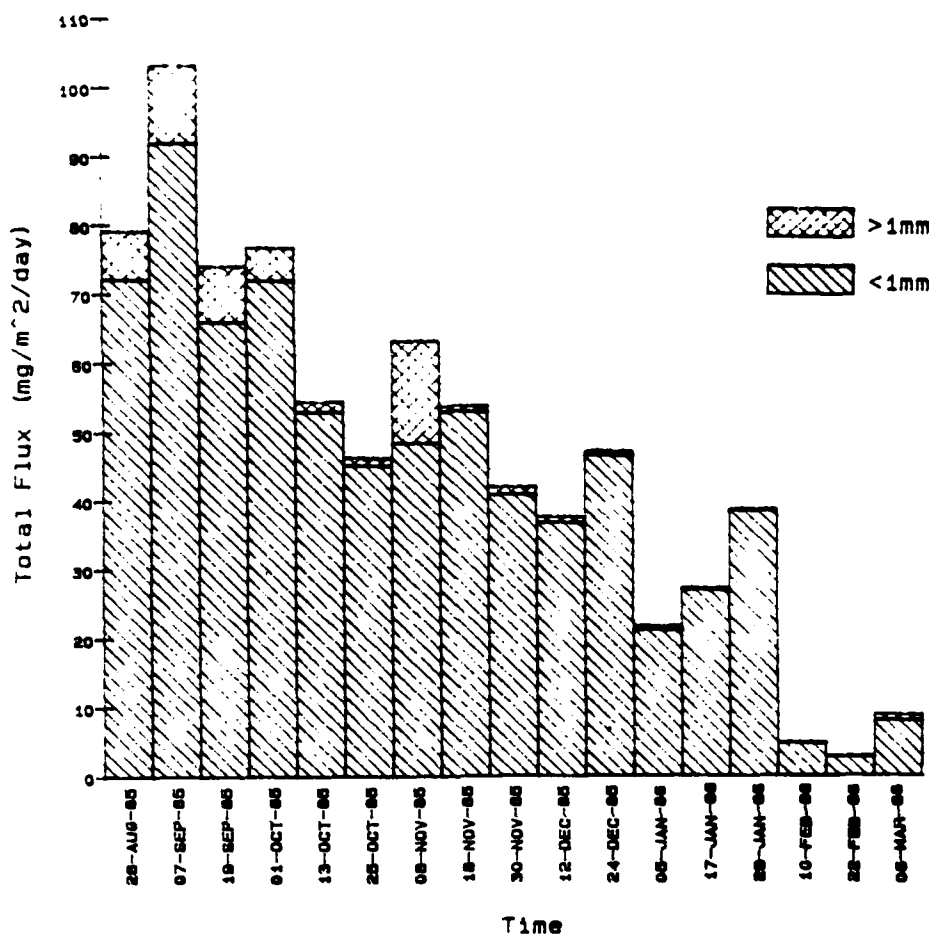

| Sample No. | TTLF | % of total | TTLF | % of total | TTLF total |
|----------------|-------|------------|-------|------------|------------|
| 70 NB1-2815-1 | 72.19 | 91.14 | 7.01 | 8.86 | 79.21 |
| 71 NB1-2815-2 | 91.93 | 89.06 | 11.29 | 10.94 | 103.22 |
| 72 NB1-2815-3 | 65.98 | 39.10 | 9.07 | 10.90 | 74.05 |
| 73 NB1-2815-4 | 71.94 | 93.86 | 4.71 | 6.14 | 76.65 |
| 74 NB1-2815-5 | 52.90 | 97.22 | 1.51 | 2.79 | 54.41 |
| 75 NB1-2815-6 | 45.13 | 97.55 | 1.13 | 2.45 | 46.26 |
| 76 NB1-2815-7 | 48.36 | 76.51 | 14.85 | 23.49 | 63.21 |
| 77 NB1-2815-8 | 52.95 | 98.41 | 0.35 | 1.59 | 53.30 |
| 78 NB1-2815-9 | 40.77 | 97.33 | 1.12 | 2.67 | 41.89 |
| 79 NB1-2815-10 | 36.70 | 97.73 | 0.95 | 2.27 | 37.65 |
| 80 NB1-2815-11 | 46.52 | 38.56 | 0.68 | 1.44 | 47.96 |
| 81 NB1-2815-12 | 21.13 | 97.30 | 0.59 | 2.70 | 21.72 |
| 82 NB1-2815-13 | 26.87 | 98.79 | 0.33 | 1.21 | 27.20 |
| 83 NB1-2815-14 | 38.43 | 39.13 | 0.34 | 0.87 | 38.77 |
| 84 NB1-2815-15 | 4.70 | 33.10 | 0.09 | 1.90 | 4.79 |
| 85 NB1-2815-16 | 2.72 | 37.75 | 0.06 | 2.25 | 2.78 |
| 85 NB1-2815-17 | 8.00 | 30.12 | 0.85 | 9.85 | 8.91 |

FIG. 13. Total flux (mg/m²/day).

Carbonate Flux at Jan Mayen (NB-1), 2815m, 1985-1986

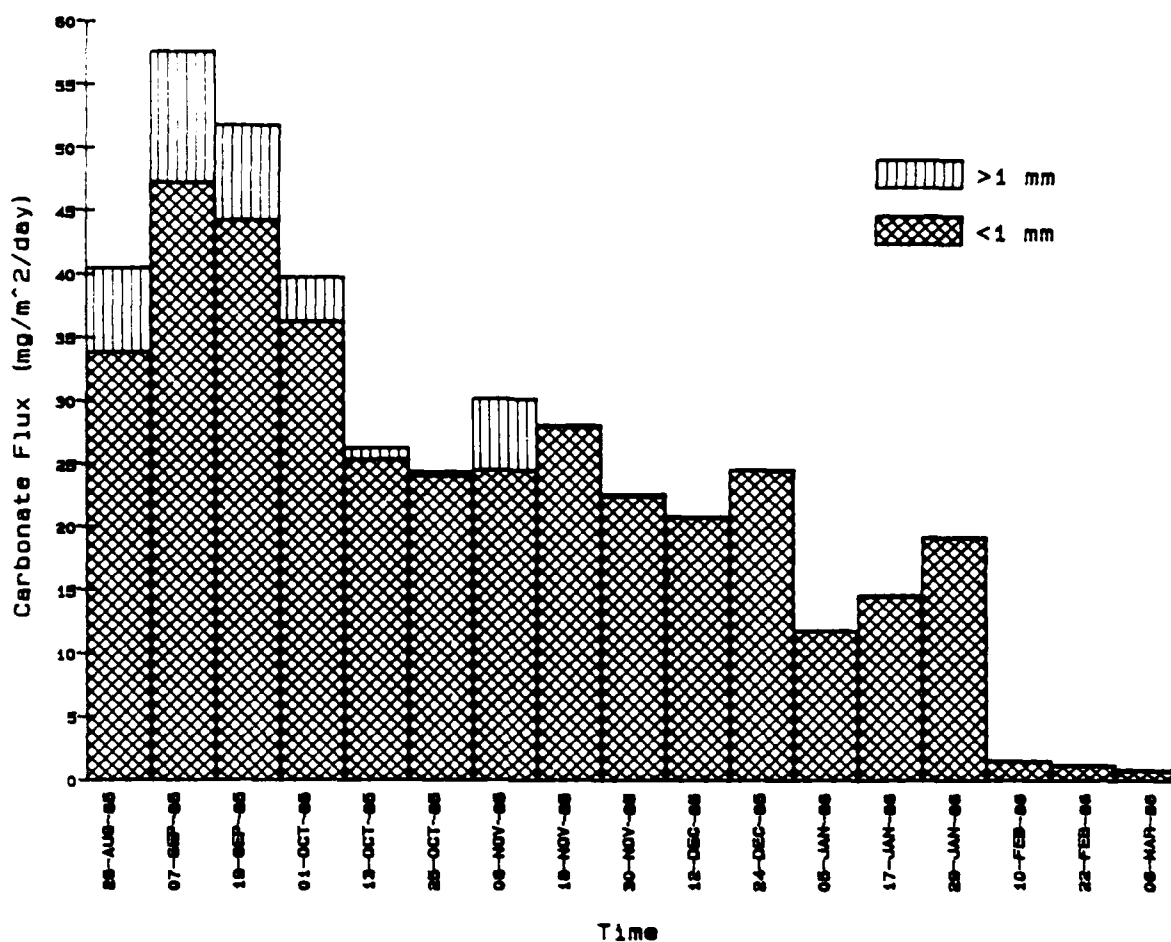

| Sample I.D. | CRTA cl | CRTA % total | CRTA l | CRTA % total | CRTA total | CRTA % total |
|----------------|------------|-----------------|-----------|-----------------|---------------|-----------------|
| 70 NB1-2815-1 | 33.84 | 42.72 | 6.66 | 9.41 | 40.50 | 51.13 |
| 71 NB1-2815-2 | 47.13 | 45.72 | 10.35 | 10.03 | 57.54 | 55.74 |
| 72 NB1-2815-3 | 44.21 | 59.70 | 7.59 | 10.25 | 51.80 | 69.35 |
| 73 NB1-2815-4 | 36.25 | 47.29 | 3.49 | 4.55 | 39.74 | 51.35 |
| 74 NB1-2815-5 | 25.33 | 46.55 | 0.89 | 1.64 | 26.22 | 48.13 |
| 75 NB1-2815-6 | 24.04 | 51.96 | 0.32 | 0.69 | 24.36 | 52.65 |
| 76 NB1-2815-7 | 24.50 | 38.76 | 5.67 | 8.97 | 30.17 | 47.22 |
| 77 NB1-2815-8 | 28.01 | 52.06 | 0.13 | 0.24 | 28.14 | 52.30 |
| 78 NB1-2815-9 | 22.43 | 53.54 | 0.15 | 0.36 | 22.58 | 53.80 |
| 79 NB1-2815-10 | 20.74 | 55.24 | 0.07 | 0.19 | 20.81 | 55.42 |
| 80 NB1-2815-11 | 24.52 | 51.95 | 0.07 | 0.15 | 24.59 | 52.10 |
| 81 NB1-2815-12 | 11.80 | 54.34 | 0.12 | 0.00 | 11.90 | 54.34 |
| 82 NB1-2815-13 | 14.59 | 53.64 | 0.10 | 0.37 | 14.69 | 54.02 |
| 83 NB1-2815-14 | 19.14 | 49.38 | 0.05 | 0.13 | 19.19 | 49.51 |
| 84 NB1-2815-15 | 1.55 | 32.38 | 0.06 | 1.25 | 1.61 | 23.64 |
| 85 NB1-2815-16 | 1.23 | 44.14 | 0.04 | 1.44 | 1.27 | 48.63 |
| 86 NB1-2815-17 | 0.80 | 9.21 | 0.14 | 1.57 | 0.94 | 10.64 |

Flux is in mg/m²/day.

Noncombustible Flux at Jan Mayen (NB-1), 2815m, 1985-1986

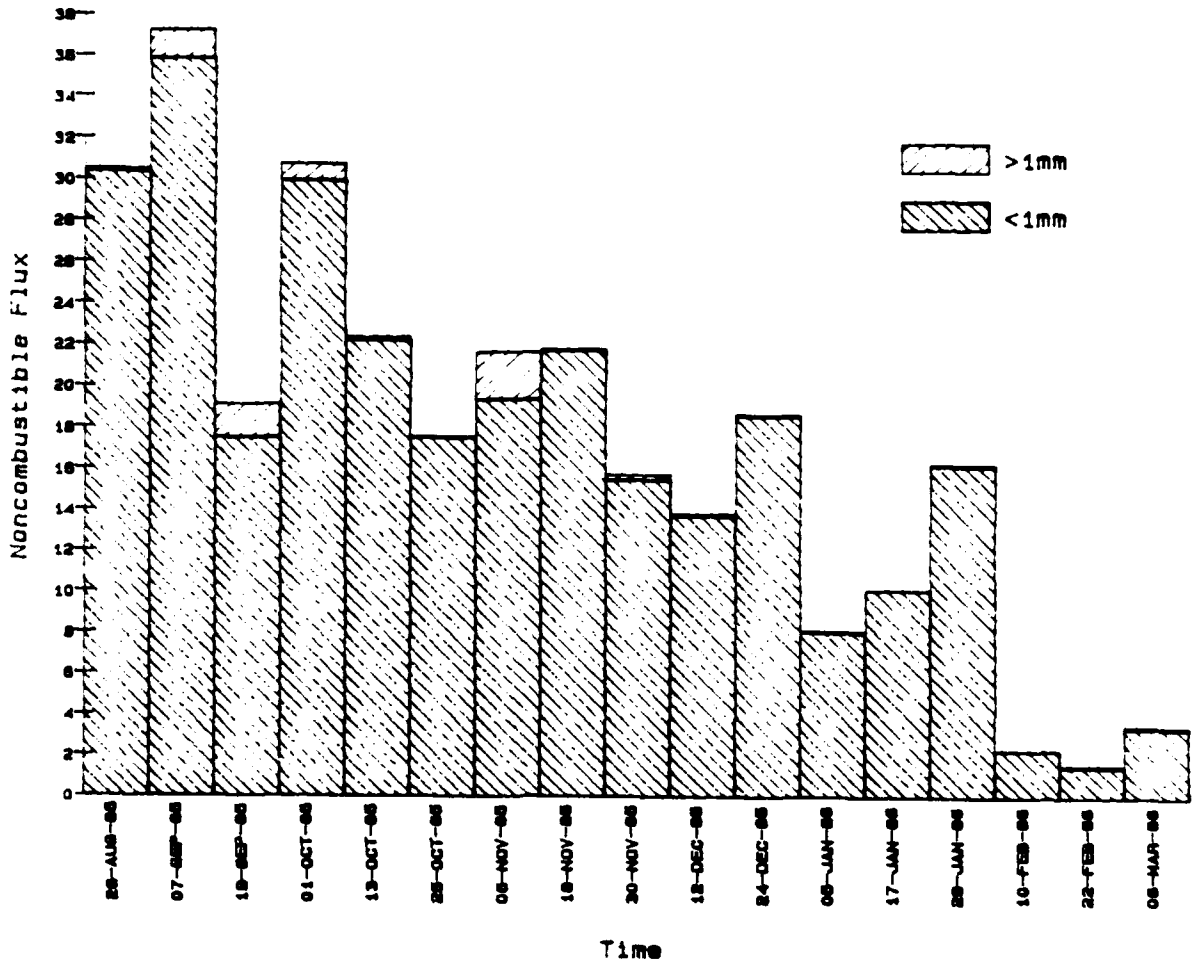

| Sample ID# | NONC | NONC % | NONC | NONC % | NONC | NONC % |
|----------------|-------|--------|-------|--------|-------|--------|
| | total | total | total | total | total | total |
| 70 NB1-2815-1 | 30.57 | 39.55 | 0.14 | 0.17 | 30.71 | 39.72 |
| 71 NB1-2815-2 | 35.84 | 34.72 | 1.42 | 1.37 | 37.26 | 36.09 |
| 72 NB1-2815-3 | 17.49 | 23.51 | 1.50 | 2.16 | 18.99 | 25.67 |
| 73 NB1-2815-4 | 29.94 | 39.07 | 0.31 | 1.06 | 30.25 | 40.12 |
| 74 NB1-2815-5 | 22.22 | 40.34 | 0.13 | 0.34 | 22.35 | 41.07 |
| 75 NB1-2815-6 | 17.48 | 37.79 | 0.03 | 0.05 | 17.51 | 37.85 |
| 76 NB1-2815-7 | 19.30 | 30.53 | 2.34 | 3.71 | 21.65 | 34.24 |
| 77 NB1-2815-8 | 21.70 | 40.33 | 0.07 | 0.13 | 21.77 | 40.46 |
| 78 NB1-2815-9 | 15.42 | 36.32 | 0.24 | 0.57 | 15.66 | 37.09 |
| 79 NB1-2815-10 | 13.68 | 36.43 | 0.09 | 0.24 | 13.77 | 36.67 |
| 80 NB1-2815-11 | 18.57 | 39.34 | 0.05 | 0.10 | 18.62 | 39.44 |
| 81 NB1-2815-12 | 8.05 | 37.08 | 0.05 | 0.03 | 8.10 | 37.11 |
| 82 NB1-2815-13 | 10.13 | 37.24 | 0.01 | 0.04 | 10.14 | 37.28 |
| 83 NB1-2815-14 | 16.17 | 41.70 | 0.02 | 0.06 | 16.19 | 41.76 |
| 84 NB1-2815-15 | 2.31 | 48.17 | 0.00 | 0.02 | 2.31 | 48.19 |
| 85 NB1-2815-16 | 1.43 | 50.48 | 0.03 | 1.21 | 1.62 | 54.69 |
| 86 NB1-2815-17 | 0.43 | 39.43 | 0.04 | 0.48 | 0.47 | 39.91 |

Flux is in g/cm² day.

Combustible Flux at Jan Mayen (NB-1), 2815m, 1985-86

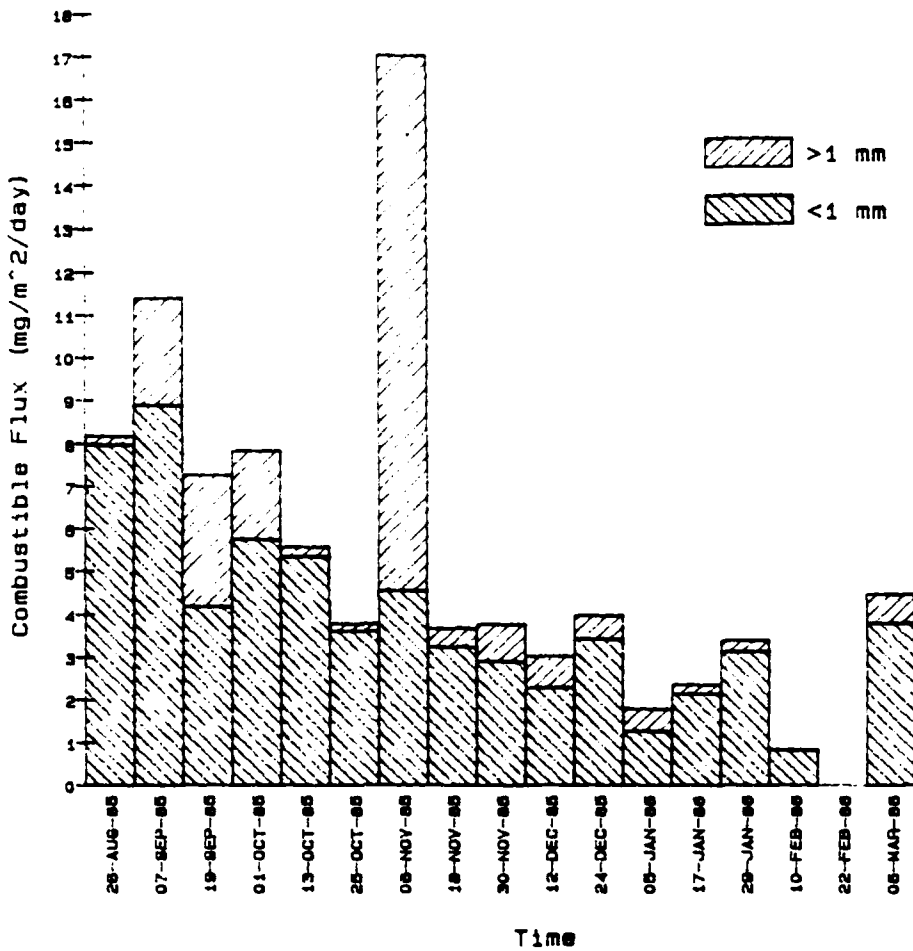

| Sample No. | DATE | COMB Flux | COMB % tot. | COMB Flux | COMB % tot. | COMB TOTAL | COMB total |
|---------------|----------|--------------|----------------|--------------|----------------|---------------|---------------|
| 10 | 28-08-85 | 7.98 | 10.07 | 0.21 | 0.27 | 8.19 | 10.34 |
| 11 | 07-09-85 | 8.90 | 8.63 | 2.60 | 2.43 | 11.51 | 11.25 |
| 12 | 19-09-85 | 4.18 | 5.65 | 3.10 | 4.19 | 7.28 | 9.84 |
| 13 | 01-10-85 | 5.75 | 7.50 | 2.10 | 2.74 | 7.85 | 10.24 |
| 14 | 13-10-85 | 5.35 | 8.93 | 0.24 | 0.44 | 5.59 | 10.27 |
| 15 | 25-10-85 | 3.61 | 7.60 | 0.19 | 0.42 | 3.80 | 6.22 |
| 16 | 08-11-85 | 4.66 | 7.21 | 12.49 | 19.75 | 17.14 | 26.86 |
| 17 | 18-11-85 | 3.24 | 6.03 | 0.44 | 0.82 | 3.68 | 6.84 |
| 18 | 30-11-85 | 3.32 | 6.96 | 0.38 | 1.11 | 3.70 | 6.07 |
| 19 | 12-12-85 | 2.29 | 6.08 | 0.75 | 2.02 | 3.04 | 6.10 |
| 20 | 24-12-85 | 3.43 | 7.27 | 0.56 | 1.20 | 4.00 | 6.47 |
| 21 | 05-01-86 | 1.29 | 5.89 | 0.54 | 2.48 | 1.82 | 3.07 |
| 22 | 17-01-86 | 2.16 | 7.90 | 0.22 | 0.80 | 2.37 | 6.71 |
| 23 | 29-01-86 | 3.12 | 8.06 | 0.27 | 0.69 | 3.39 | 6.78 |
| 24 | 10-02-86 | 0.34 | 17.64 | 0.01 | 0.19 | 0.35 | 17.60 |
| 25 | 22-02-86 | 0.00 | 0.00 | 0.01 | 0.22 | 0.01 | 0.22 |
| 26 | 06-03-86 | 0.30 | 42.64 | 0.70 | 7.81 | 4.60 | 52.48 |

Biogenic Silica Flux at Jan Mayen (NB-1), 2815m, 1986

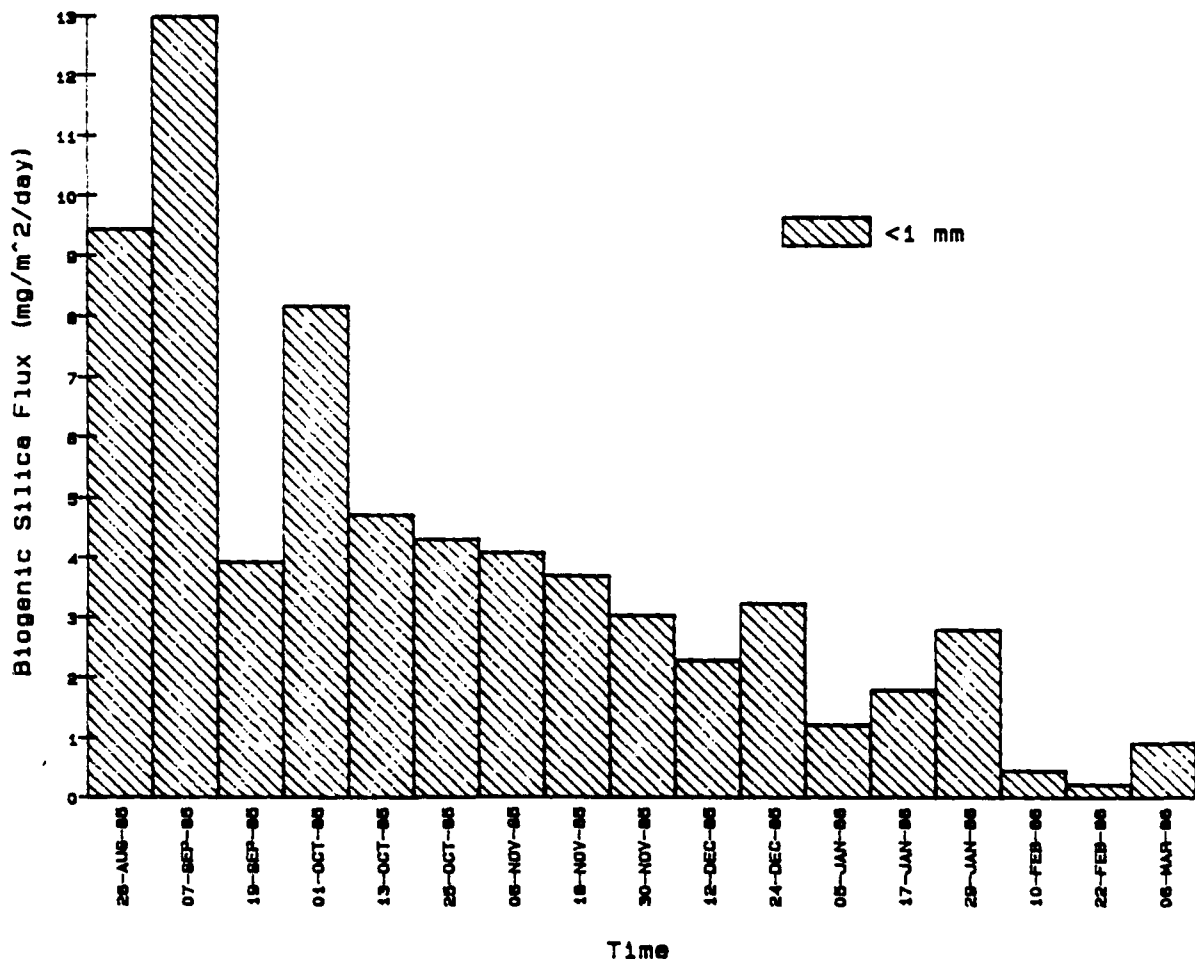

| Sample ID# | OPAL (%) | OPAL % Ncf.!! | OPAL % tot.!! |
|----------------|----------|---------------|---------------|
| 70 NB1-2815-1 | 9.44 | 30.94 | 11.92 |
| 71 NB1-2815-2 | 12.99 | 34.87 | 12.58 |
| 72 NB1-2815-3 | 3.91 | 20.49 | 5.28 |
| 73 NB1-2815-4 | 8.17 | 26.57 | 10.66 |
| 74 NB1-2815-5 | 4.70 | 20.98 | 8.64 |
| 75 NB1-2815-6 | 4.30 | 24.56 | 9.29 |
| 76 NB1-2815-7 | 4.08 | 18.85 | 6.45 |
| 77 NB1-2815-8 | 3.69 | 16.95 | 6.86 |
| 78 NB1-2815-9 | 3.03 | 19.35 | 7.23 |
| 79 NB1-2815-10 | 2.28 | 16.56 | 6.07 |
| 80 NB1-2815-11 | 3.23 | 17.35 | 6.84 |
| 81 NB1-2815-12 | 1.22 | 15.06 | 5.62 |
| 82 NB1-2815-13 | 1.79 | 17.67 | 6.58 |
| 83 NB1-2815-14 | 2.80 | 17.32 | 7.22 |
| 84 NB1-2815-15 | 0.46 | 19.91 | 9.60 |
| 85 NB1-2815-16 | 0.22 | 14.77 | 7.89 |
| 86 NB1-2815-17 | 0.92 | 26.92 | 10.33 |

Flux is in mg/m²/day.

Not enough sample in <1 mm fraction to analyze for Opal.

!!Ncf.!! = % of noncombustible flux.

Lithogenic Flux at Jan Mayen (NB-1), 2815, 1986

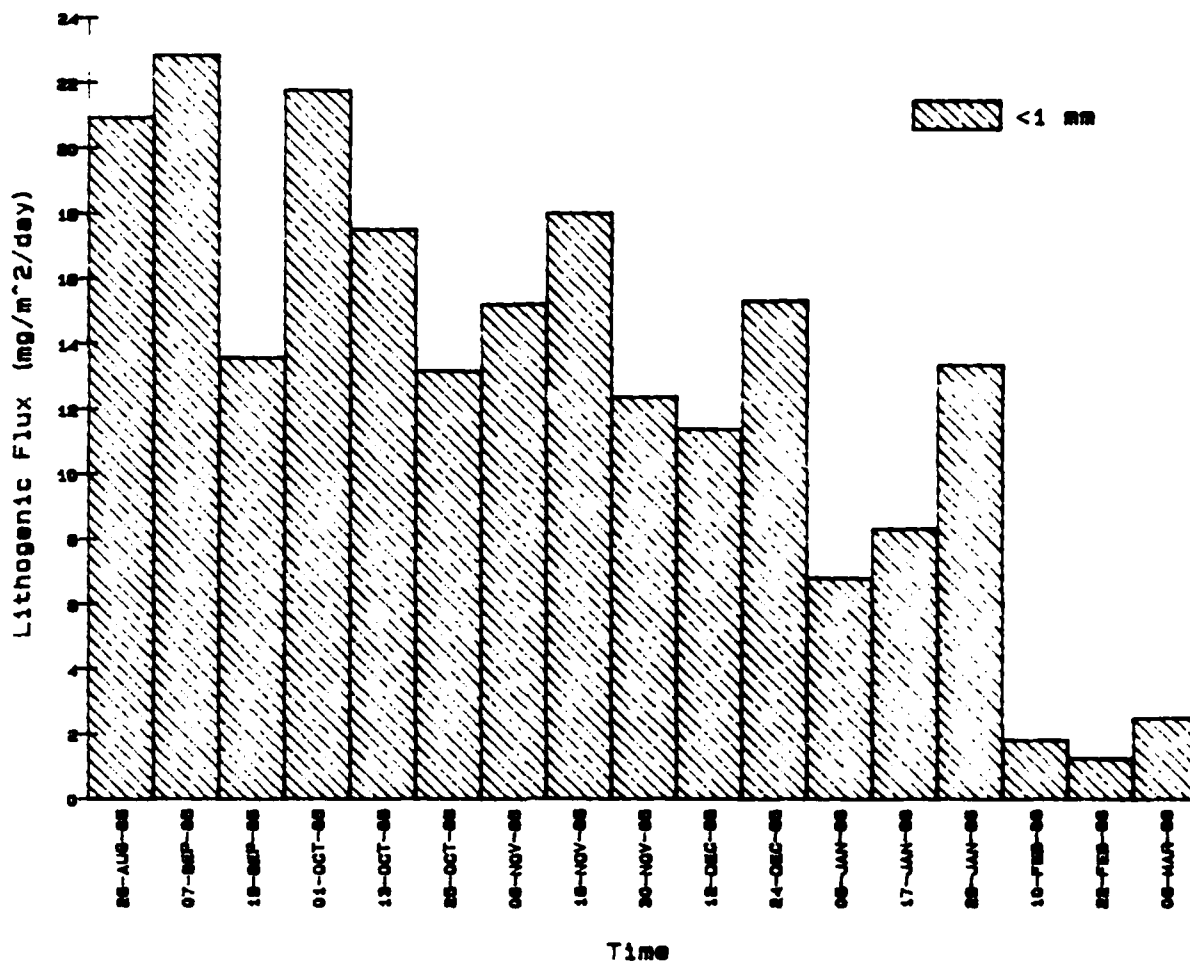

| SAMPLE I.D. | LITH (1) | LITH-1 %Nemb. | LITH-1 %total |
|-------------|----------|---------------|---------------|
| NB1-2815-1 | 20.93 | 68.61 | 26.43 |
| NB1-2815-2 | 22.85 | 61.33 | 22.13 |
| NB1-2815-3 | 13.58 | 71.14 | 18.33 |
| NB1-2815-4 | 21.77 | 70.90 | 28.41 |
| NB1-2815-5 | 17.52 | 78.21 | 32.20 |
| NB1-2815-6 | 13.18 | 75.30 | 28.50 |
| NB1-2815-7 | 15.22 | 70.33 | 24.08 |
| NB1-2815-8 | 18.01 | 82.72 | 33.47 |
| NB1-2815-9 | 12.39 | 79.14 | 29.58 |
| NB1-2815-10 | 11.40 | 82.79 | 30.36 |
| NB1-2815-11 | 15.34 | 82.40 | 32.50 |
| NB1-2815-12 | 6.83 | 84.32 | 31.46 |
| NB1-2815-13 | 9.34 | 82.24 | 30.66 |
| NB1-2815-14 | 13.37 | 82.56 | 34.48 |
| NB1-2815-15 | 1.85 | 80.02 | 38.56 |
| NB1-2815-16 | 1.27 | 83.35 | 45.58 |
| NB1-2815-17 | 0.51 | 72.22 | 28.11 |

Flux is in mg.m⁻².day.
 Insufficient material to analyze < 1mm fraction.

Carbon Flux at Jan Mayen (NB-1), 2815m, 1985-86

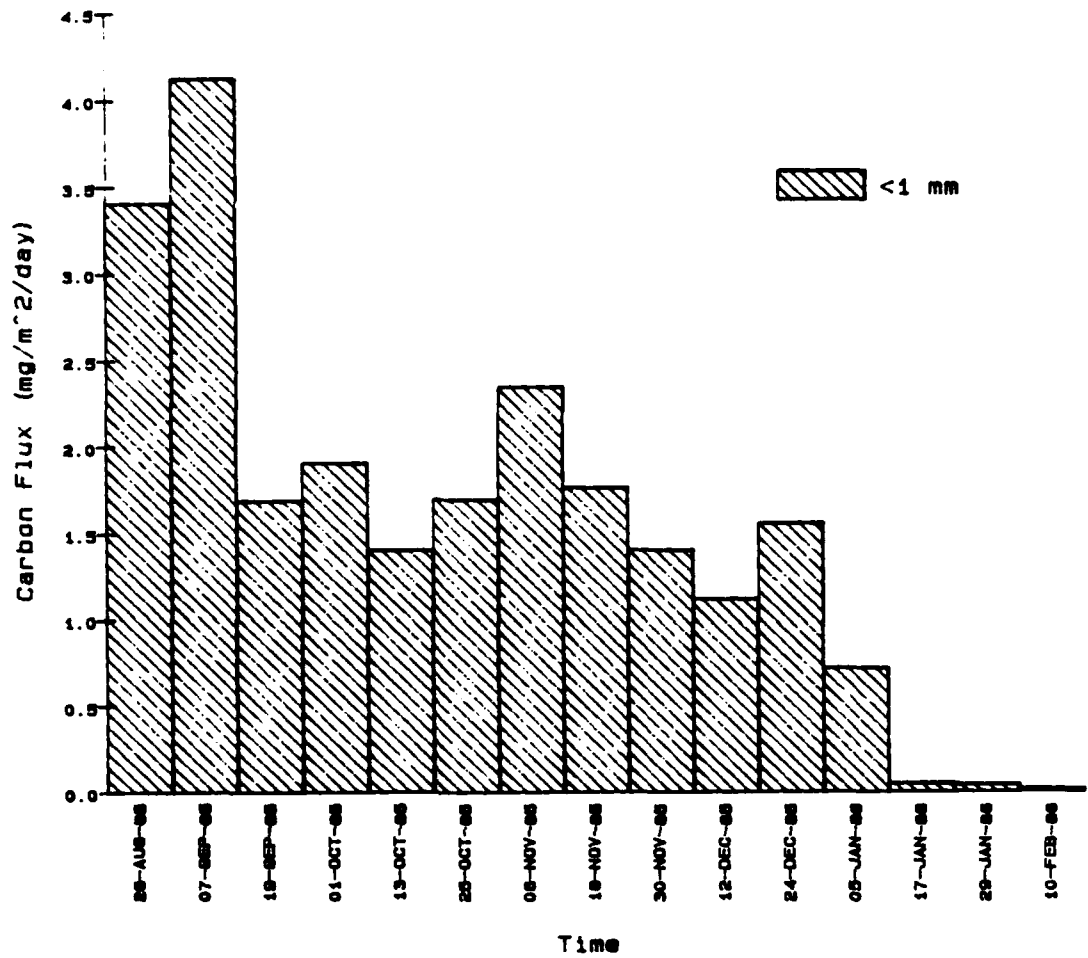

| Sample No. | CRNC 1 | CRNC 1 % combf. |
|----------------|--------|-----------------|
| 70 NB1-2815-1 | 3.41 | 41.63 |
| 71 NB1-2815-2 | 4.13 | 36.16 |
| 72 NB1-2815-3 | 1.69 | 23.20 |
| 73 NB1-2815-4 | 1.91 | 24.29 |
| 74 NB1-2815-5 | 1.41 | 25.17 |
| 75 NB1-2815-6 | 1.70 | 44.72 |
| 76 NB1-2815-7 | 2.35 | 13.77 |
| 77 NB1-2815-8 | 1.77 | 47.97 |
| 78 NB1-2815-9 | 1.41 | 37.03 |
| 79 NB1-2815-10 | 1.12 | 36.93 |
| 80 NB1-2815-11 | 1.56 | 39.03 |
| 81 NB1-2815-12 | 0.72 | 39.43 |
| 82 NB1-2815-13 | 0.05 | 2.23 |
| 83 NB1-2815-14 | 0.04 | 1.31 |
| 84 NB1-2815-15 | 0.02 | 1.99 |

Flux is in mg/m²/day.

% combf. = % of combustible flux.

Not enough <1 mm fraction to do analysis.

Nitrogen Flux at Jan Mayen (NB-1), 2815m, 1985-86

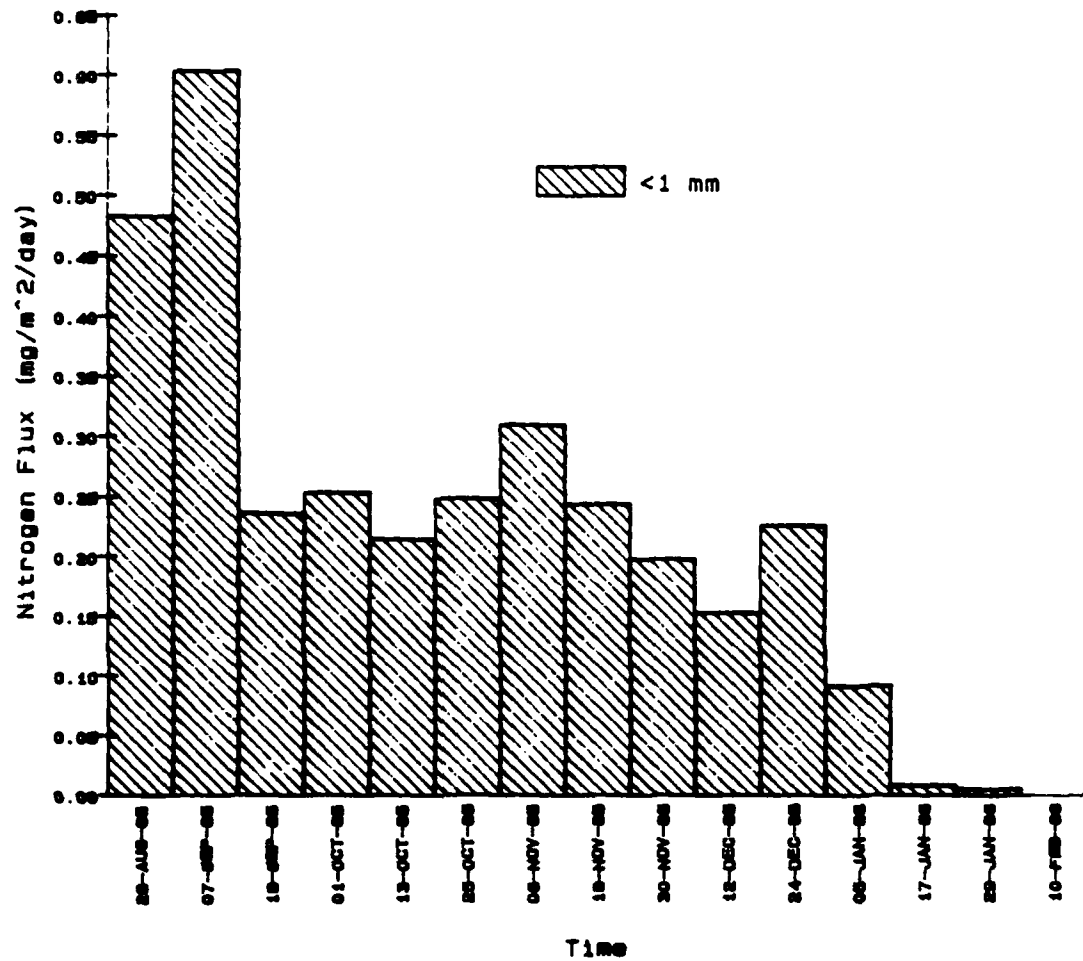

| Sample I.D. | NTGN <1 | NTGN<1 %cmbf. |
|----------------|---------|---------------|
| 70 NB1-2815-1 | 0.48 | 5.90 |
| 71 NB1-2815-2 | 0.60 | 5.29 |
| 72 NB1-2815-3 | 0.24 | 3.24 |
| 73 NB1-2815-4 | 0.25 | 3.23 |
| 74 NB1-2815-5 | 0.22 | 3.85 |
| 75 NB1-2815-6 | 0.25 | 6.55 |
| 76 NB1-2815-7 | 0.31 | 1.82 |
| 77 NB1-2815-8 | 0.24 | 6.64 |
| 78 NB1-2815-9 | 0.20 | 5.21 |
| 79 NB1-2815-10 | 0.15 | 5.04 |
| 80 NB1-2815-11 | 0.23 | 5.67 |
| 81 NB1-2815-12 | 0.09 | 5.08 |
| 82 NB1-2815-13 | 0.01 | 0.36 |
| 83 NB1-2815-14 | 0.01 | 0.17 |
| 84 NB1-2815-15 | 0.00 | 0.00 |

Flux is in mg/m²/day.

'%cmbf' = % of combustible flux.

Not enough <1 mm fraction to do analysis.

Hydrogen Flux at Jan Mayen (NB-1), 2815m, 1985-86

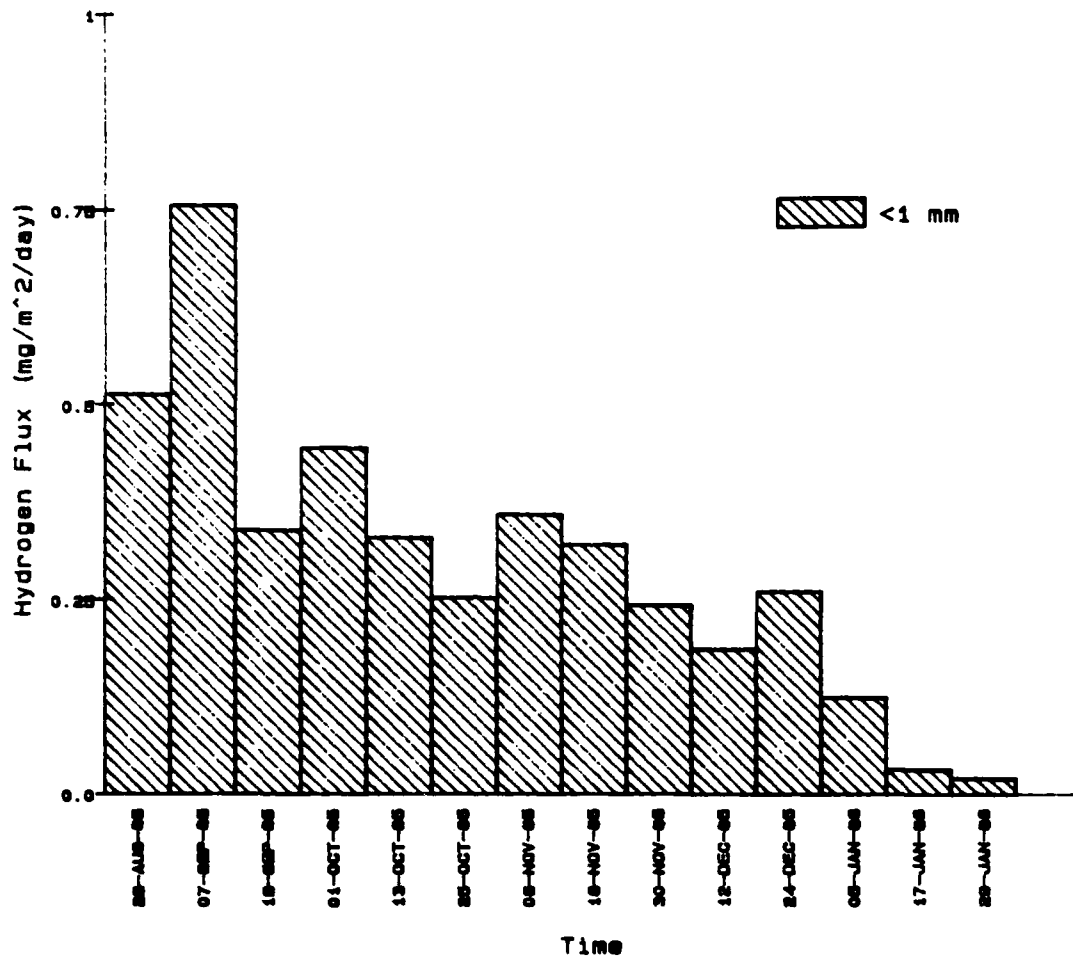

| Sample I.D. | HYDC <1 | HYDC<1 %cmbf. |
|----------------|---------|---------------|
| 70 NB1-2815-1 | 0.51 | 6.28 |
| 71 NB1-2815-2 | 0.76 | 6.63 |
| 72 NB1-2815-3 | 0.34 | 4.67 |
| 73 NB1-2815-4 | 0.45 | 5.69 |
| 74 NB1-2815-5 | 0.33 | 5.92 |
| 75 NB1-2815-6 | 0.25 | 6.66 |
| 76 NB1-2815-7 | 0.36 | 2.11 |
| 77 NB1-2815-8 | 0.32 | 8.74 |
| 78 NB1-2815-9 | 0.24 | 6.42 |
| 79 NB1-2815-10 | 0.19 | 6.14 |
| 80 NB1-2815-11 | 0.26 | 6.55 |
| 81 NB1-2815-12 | 0.13 | 6.88 |
| 82 NB1-2815-13 | 0.03 | 1.35 |
| 83 NB1-2815-14 | 0.02 | 0.63 |

Flux is in mg/m²/day.

"%cmbf" = "% of combustible flux".

Not enough < 1 mm fraction to do analysis.

EAST GREENLAND/FRAM STRAIT AREA

FS-1

CENTRAL FRAM STRAIT

78°52' N, 01°22' E

Trap depth: 2,440m Water depth: 2,527m

Annual Fluxes (g/m²/yr):

Total.....6.61
Carbonate.....1.40
Noncombustible.....4.26
Combustible.....0.92
Lithogenic.....4.00
Biogenic Opal.....0.60
Organic C.....0.41
N.....0.06

REPUBLIC MARINE 8-10

| Sample ID | Opening Date | Closing Date | Span | Mid. Date |
|----------------|--------------|--------------|------|-----------|
| 13 FS1-2000-1 | 20-AUG-84 | 17-SEP-84 | 27.5 | 03-SEP-84 |
| 14 FS1-2000-2 | 17-SEP-84 | 15-OCT-84 | 27.5 | 01-OCT-84 |
| 15 FS1-2000-3 | 15-OCT-84 | 11-NOV-84 | 27.5 | 29-OCT-84 |
| 16 FS1-2000-4 | 11-NOV-84 | 09-DEC-84 | 27.5 | 25-NOV-84 |
| 17 FS1-2000-5 | 09-DEC-84 | 07-JAN-85 | 27.5 | 24-DEC-84 |
| 18 FS1-2000-6 | 07-JAN-85 | 03-FEB-85 | 27.5 | 21-JAN-85 |
| 19 FS1-2000-7 | 03-FEB-85 | 03-MAR-85 | 27.5 | 17-FEB-85 |
| 20 FS1-2000-8 | 03-MAR-85 | 30-MAR-85 | 27.5 | 17-MAR-85 |
| 21 FS1-2000-9 | 30-MAR-85 | 27-APR-85 | 27.5 | 13-APR-85 |
| 22 FS1-2000-10 | 27-APR-85 | 25-MAY-85 | 27.5 | 11-MAY-85 |
| 23 FS1-2000-11 | 25-MAY-85 | 21-JUN-85 | 27.5 | 08-JUN-85 |
| 24 FS1-2000-12 | 21-JUN-85 | 19-JUL-85 | 27.5 | 05-JUL-85 |
| 25 FS1-2000-13 | 19-JUL-85 | 15-AUG-85 | 27.5 | 02-AUG-85 |

Total Flux at Fram Strait (FS-1), 2000m, 1984-1985

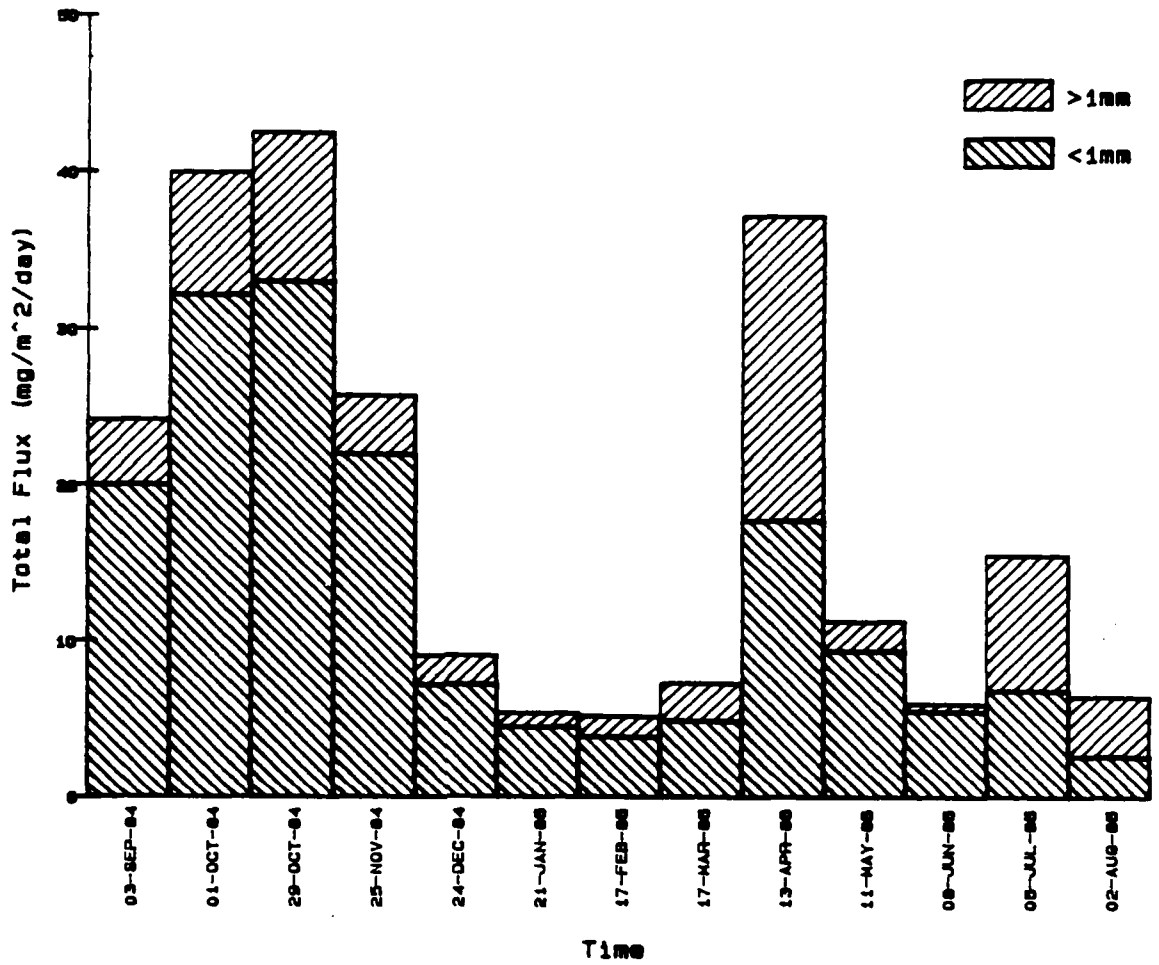

FRAM STRAIT 1 POISONED WITH Hg CL2 359 DAYS

Mark 5 trap open from AUGUST 20 1984 to AUGUST 15 1985 at 2000 meters.

TOTAL FLUX (mg / m² / day)

Ttl is total Flux in all size classes

| Cup # | < 63um | | 63um - 1 | | > 1mm | | TOTAL | |
|-------|----------|-------|----------|-------|----------|-------|----------|-------|
| | % of Ttl | FLUX | % of Ttl | FLUX | % of Ttl | FLUX | % of Ttl | FLUX |
| 1 | 57.18 | 12.30 | 23.52 | 5.06 | 19.29 | 4.15 | 100.00 | 21.51 |
| 2 | 63.02 | 25.34 | 17.56 | 7.06 | 19.42 | 7.81 | 100.00 | 40.21 |
| 3 | 64.12 | 29.17 | 14.99 | 6.82 | 20.88 | 9.50 | 100.00 | 45.49 |
| 4 | 50.03 | 9.05 | 29.41 | 5.32 | 20.56 | 3.72 | 100.00 | 18.09 |
| 5 | 63.83 | 6.46 | 17.89 | 1.81 | 18.28 | 1.85 | 100.00 | 10.12 |
| 6 | 52.92 | 3.90 | 34.60 | 2.55 | 12.48 | .92 | 100.00 | 7.37 |
| 7 | 59.75 | 2.91 | 12.73 | .62 | 27.52 | 1.34 | 100.00 | 4.87 |
| 8 | 51.98 | 3.80 | 15.18 | 1.11 | 32.83 | 2.40 | 100.00 | 7.31 |
| 9 | 24.86 | 14.00 | 27.73 | 15.62 | 47.41 | 26.70 | 100.00 | 56.32 |
| 10 | 36.46 | 3.81 | 45.45 | 4.75 | 18.09 | 1.89 | 100.00 | 10.45 |
| 11 | 72.32 | 4.39 | 19.60 | 1.19 | 8.07 | .49 | 100.00 | 6.07 |
| 12 | 31.80 | 5.31 | 16.11 | 2.69 | 52.10 | 8.70 | 100.00 | 16.70 |
| 13 | 31.56 | 2.13 | 12.00 | .81 | 56.44 | 3.81 | 100.00 | 6.75 |

Carbonate Flux at Frem Strait (FS-1), 2000m, 1984-1985

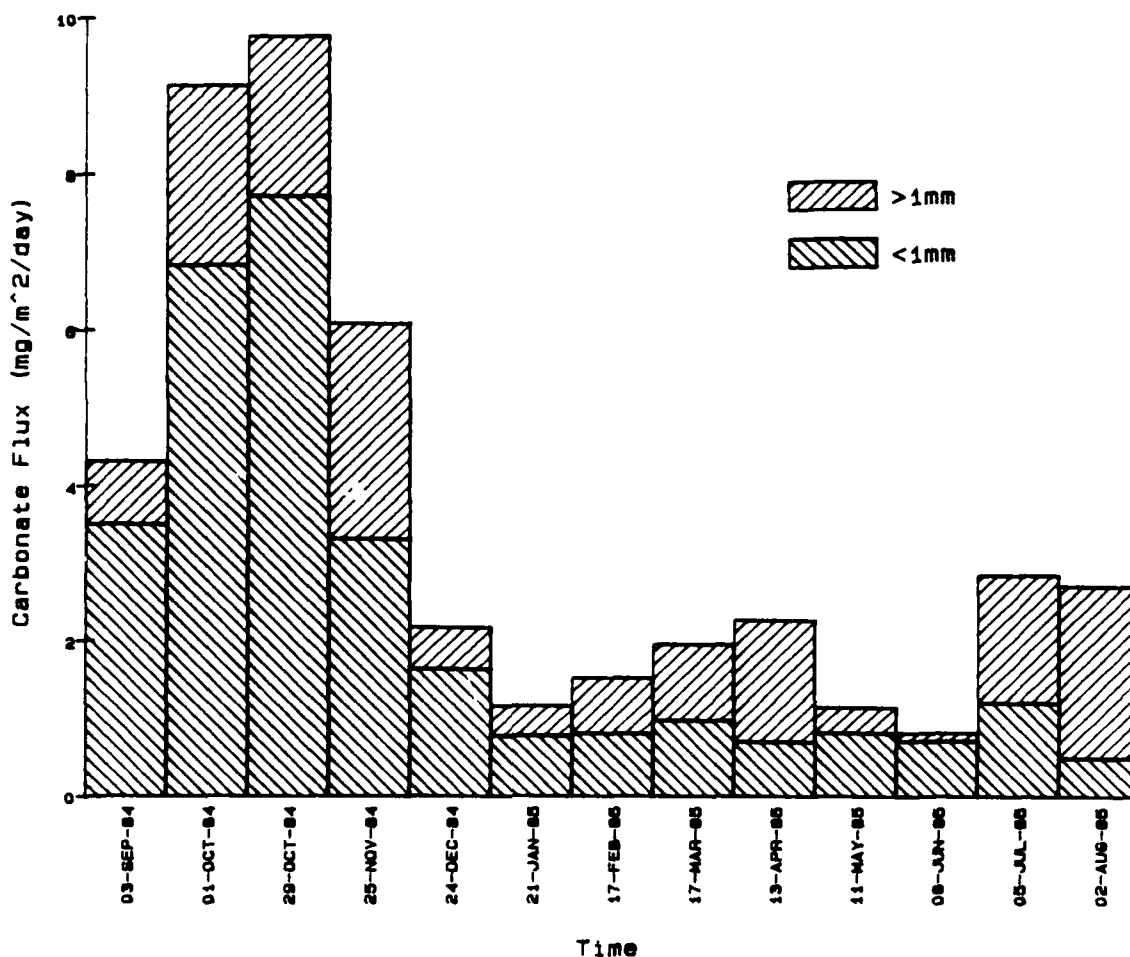

| Sample I.D. | CRTA (%) | CRTA % total | CRTA (%) | CRTA % total | CRTA total | CRTA % total |
|----------------|----------|--------------|----------|--------------|------------|--------------|
| 13 FS1-2000-1 | 3.51 | 14.52 | 0.91 | 3.77 | 4.32 | 3.35 |
| 14 FS1-2000-2 | 6.84 | 17.13 | 2.30 | 5.72 | 9.14 | 5.76 |
| 16 FS1-2000-3 | 7.72 | 18.16 | 2.05 | 4.51 | 9.77 | 4.82 |
| 15 FS1-2000-4 | 3.31 | 18.33 | 2.78 | 15.37 | 6.09 | 15.39 |
| 17 FS1-2000-5 | 1.64 | 18.10 | 0.54 | 5.34 | 2.18 | 5.96 |
| 18 FS1-2000-6 | 0.78 | 14.44 | 0.39 | 3.85 | 1.17 | 7.22 |
| 19 FS1-2000-7 | 0.81 | 15.52 | 0.72 | 9.78 | 1.53 | 13.79 |
| 20 FS1-2000-8 | 0.98 | 13.44 | 0.98 | 13.41 | 1.96 | 13.44 |
| 21 FS1-2000-9 | 0.71 | 1.60 | 1.57 | 2.79 | 2.28 | 3.53 |
| 22 FS1-2000-10 | 0.82 | 7.27 | 0.33 | 3.16 | 1.15 | 2.93 |
| 23 FS1-2000-11 | 0.72 | 11.98 | 0.10 | 1.65 | 0.82 | 1.65 |
| 24 FS1-2000-12 | 1.21 | 7.79 | 1.64 | 9.80 | 2.85 | 10.58 |
| 25 FS1-2000-13 | 0.50 | 7.76 | 2.21 | 32.74 | 2.71 | 34.32 |

Flux is in mg/m²/day.

Noncombustible Flux at Fram Strait 1, 2000 m, 1984-85

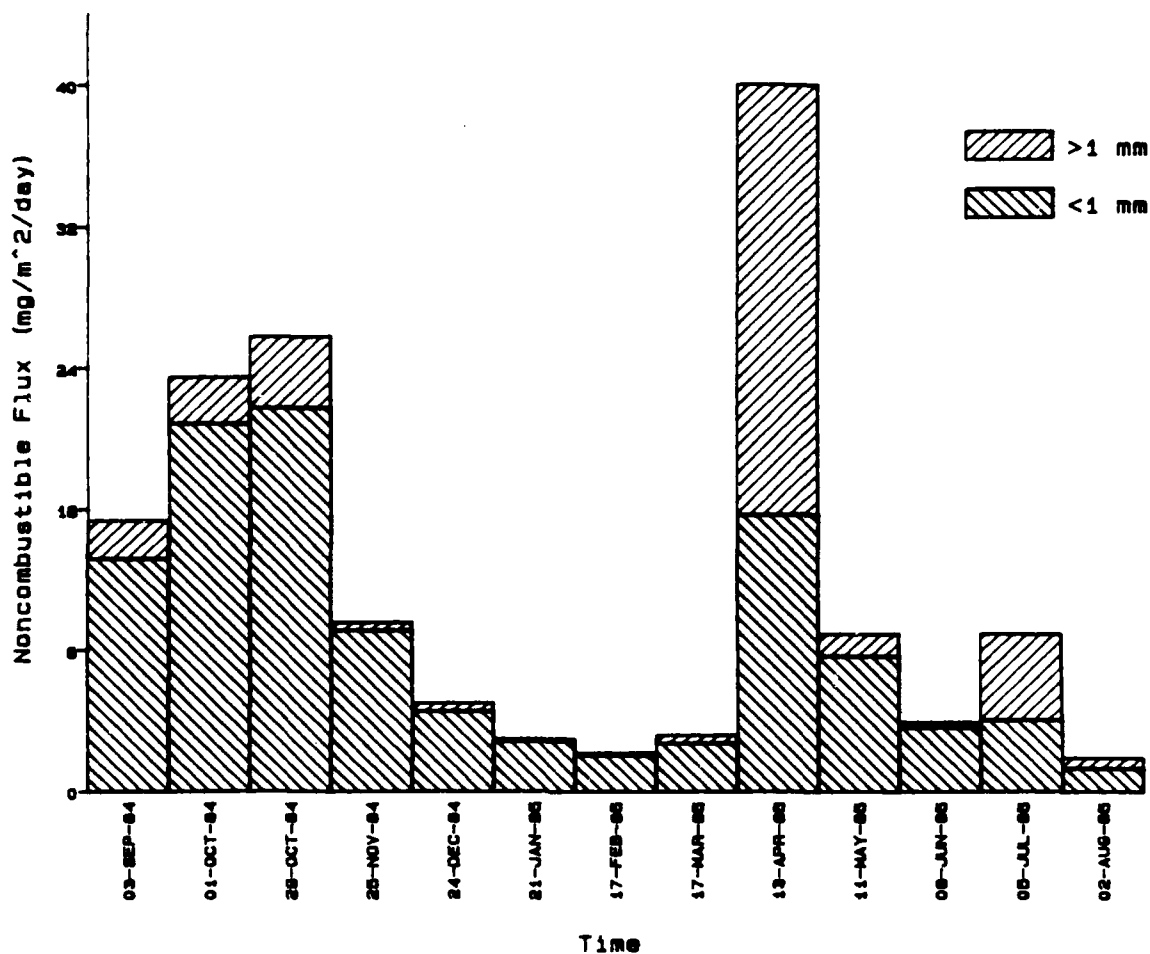

| Sample ID# | NONC | NONC % | NONC | NONC % | NONC | NONC % |
|-----------------|-------|--------|-------|--------|-------|--------|
| | total | total | total | total | total | total |
| 13 FSI-2000-1* | 13.22 | 54.67 | 2.14 | 8.85 | 15.36 | 63.52 |
| 14 FSI-2000-2* | 20.86 | 52.23 | 2.64 | 6.61 | 23.50 | 58.84 |
| 15 FSI-2000-3* | 21.77 | 51.21 | 4.02 | 9.46 | 25.79 | 60.67 |
| 16 FSI-2000-4* | 9.16 | 50.72 | 0.45 | 2.49 | 9.61 | 53.21 |
| 17 FSI-2000-5* | 4.56 | 50.33 | 0.45 | 4.97 | 5.01 | 55.30 |
| 18 FSI-2000-6* | 2.97 | 53.15 | 0.13 | 2.41 | 3.00 | 55.56 |
| 19 FSI-2000-7* | 2.06 | 39.46 | 0.13 | 2.49 | 2.29 | 43.67 |
| 20 FSI-2000-8* | 2.75 | 37.72 | 0.47 | 6.45 | 3.22 | 44.17 |
| 21 FSI-2000-9* | 15.74 | 35.43 | 24.30 | 54.69 | 40.04 | 90.12 |
| 22 FSI-2000-10* | 7.67 | 58.00 | 1.23 | 10.90 | 8.90 | 79.90 |
| 23 FSI-2000-11* | 3.67 | 61.06 | 0.29 | 4.83 | 3.96 | 65.89 |
| 24 FSI-2000-12* | 4.09 | 26.34 | 4.92 | 31.68 | 9.01 | 58.02 |
| 25 FSI-2000-13* | 1.35 | 20.96 | 0.59 | 9.16 | 1.94 | 30.12 |

Flux is in mg/m²/day.

Combustible Flux at Fram Strait 1, 2000 m, 1984-85

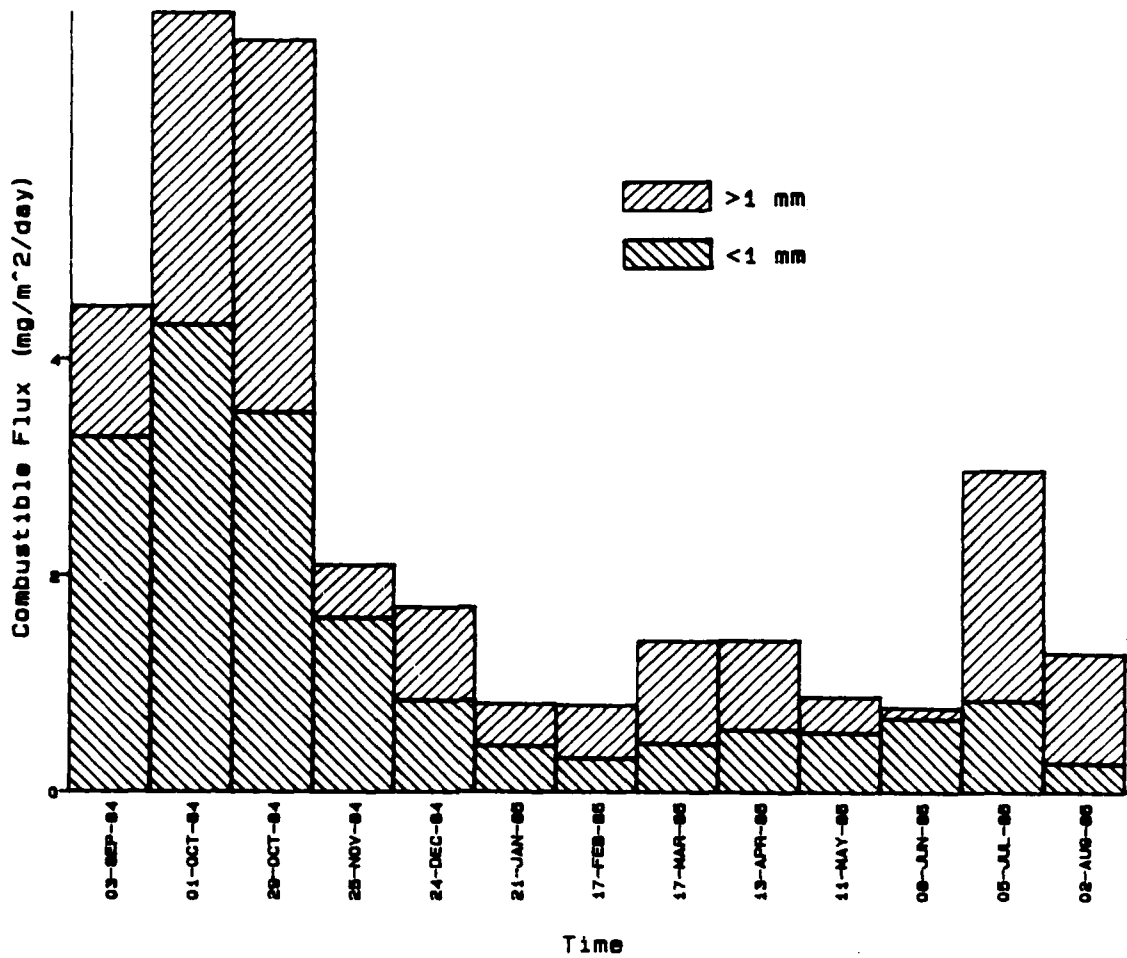

| Sample ID# | COMB % | COMB % tot. % | COMB % | COMB % tot. % | COMB TOTAL | COMB % total |
|-----------------|--------|---------------|--------|---------------|------------|--------------|
| 13 FSI-2000-1* | 3.28 | 13.56 | 1.21 | 5.00 | 4.49 | 19.57 |
| 14 FSI-2000-2* | 4.32 | 10.82 | 2.87 | 7.19 | 7.19 | 18.00 |
| 15 FSI-2000-3* | 3.51 | 9.26 | 3.43 | 8.07 | 6.94 | 16.33 |
| 16 FSI-2000-4* | 1.61 | 8.91 | 0.49 | 2.71 | 2.10 | 11.63 |
| 17 FSI-2000-5* | 0.85 | 9.38 | 0.86 | 9.49 | 1.71 | 18.87 |
| 18 FSI-2000-6* | 0.43 | 7.96 | 0.39 | 7.22 | 0.82 | 15.19 |
| 19 FSI-2000-7* | 0.31 | 5.94 | 0.49 | 9.39 | 0.80 | 15.33 |
| 20 FSI-2000-8* | 0.45 | 6.17 | 0.95 | 13.03 | 1.40 | 19.20 |
| 21 FSI-2000-9* | 0.58 | 1.31 | 0.83 | 1.87 | 1.41 | 3.17 |
| 22 FSI-2000-10* | 0.55 | 4.88 | 0.33 | 2.93 | 0.88 | 7.80 |
| 23 FSI-2000-11* | 0.58 | 11.31 | 0.10 | 1.66 | 0.78 | 12.99 |
| 24 FSI-2000-12* | 0.35 | 5.47 | 2.13 | 13.72 | 2.98 | 19.19 |
| 25 FSI-2000-13* | 0.27 | 4.19 | 1.01 | 15.58 | 1.28 | 19.66 |

Flux is in mg/m²/day.

Biogenic Opal Flux at Fram Strait 1, 2000m, 1984-85

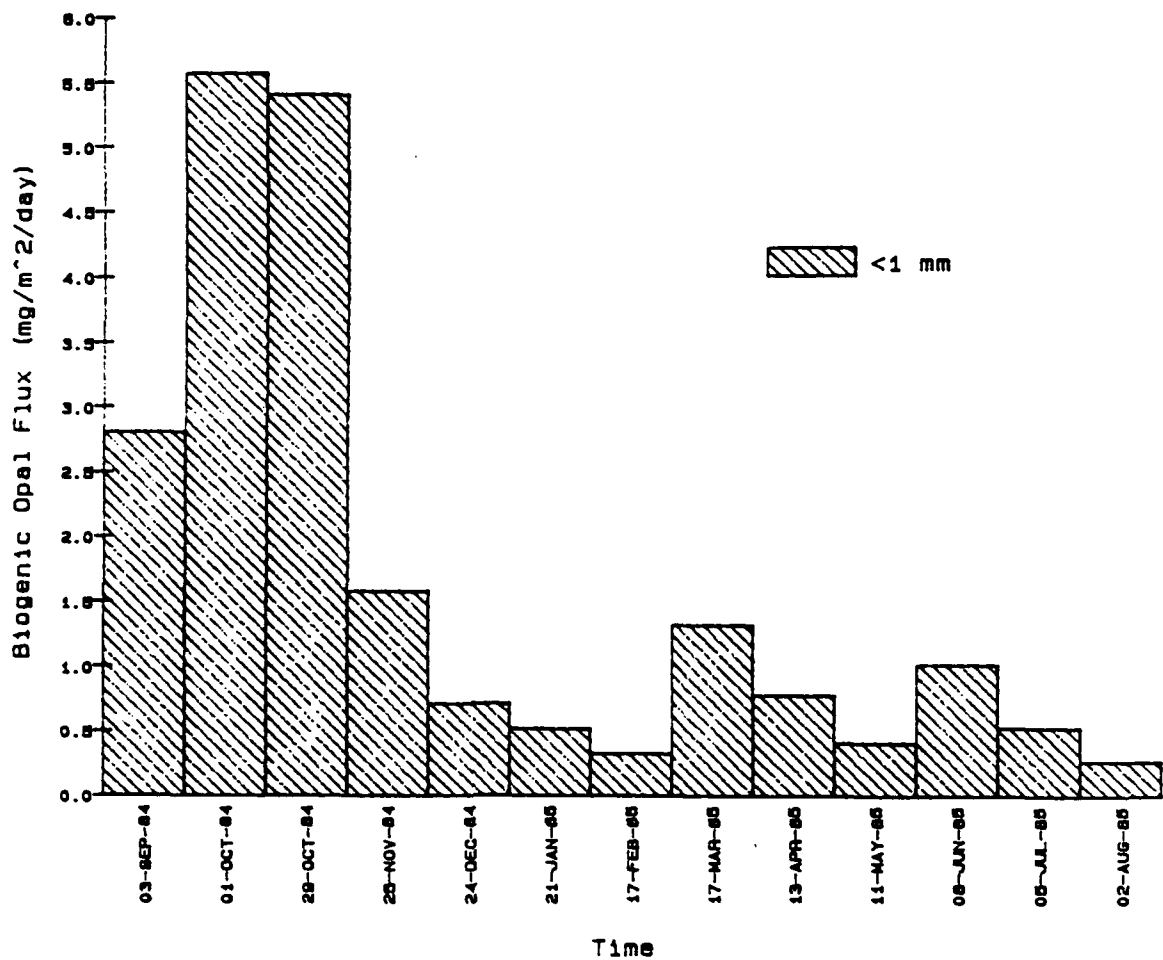

| Sample ID# | OPAL | OPAL<1 %Ncmb. | OPAL<1 %Total |
|----------------|------|---------------|---------------|
| 13 FSI-2000-1 | 2.81 | 18.28 | 11.61 |
| 14 FSI-2000-2 | 5.58 | 23.73 | 13.96 |
| 15 FSI-2000-3 | 5.41 | 20.98 | 12.73 |
| 16 FSI-2000-4 | 1.58 | 16.46 | 8.76 |
| 17 FSI-2000-5 | 0.71 | 14.23 | 7.87 |
| 18 FSI-2000-6 | 0.52 | 17.33 | 9.63 |
| 19 FSI-2000-7 | 0.33 | 14.47 | 6.35 |
| 20 FSI-2000-8 | 1.32 | 40.91 | 18.07 |
| 21 FSI-2000-9 | 0.78 | 1.95 | 1.75 |
| 22 FSI-2000-10 | 0.41 | 4.63 | 3.65 |
| 23 FSI-2000-11 | 1.02 | 25.73 | 16.96 |
| 24 FSI-2000-12 | 0.53 | 5.93 | 3.44 |
| 25 FSI-2000-13 | 0.27 | 14.14 | 4.26 |

Flux is in mg/m²/day.

%Ncmb. is "% noncombustible flux".

Not enough <1 mm fraction to do analysis.

Lithogenic Flux at Fram Strait 1, 2000m, 1984-85

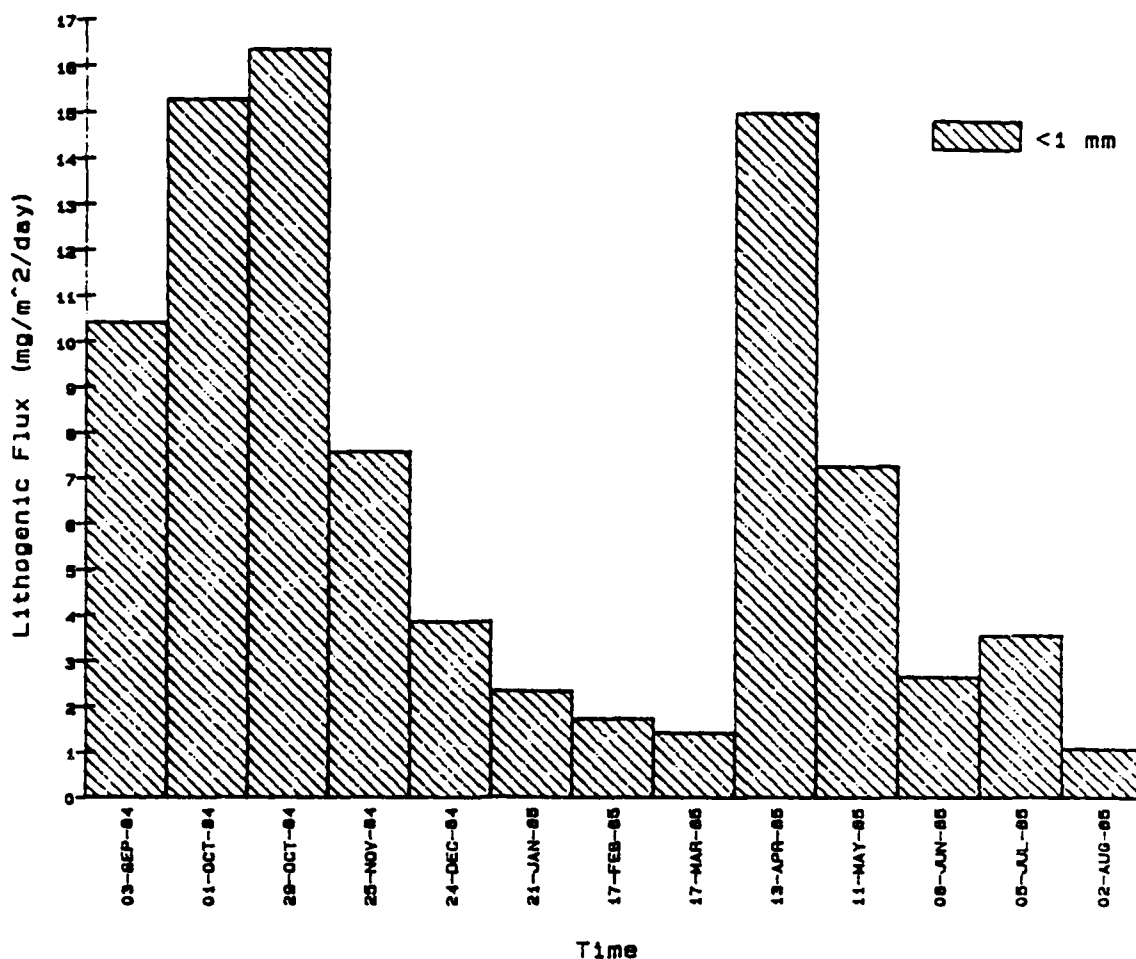

| Sample ID# | LITH <1 | LITH<1 %Ncmb. |
|----------------|---------|---------------|
| 13 FSI-2000-1 | 10.41 | 67.79 |
| 14 FSI-2000-2 | 15.28 | 65.03 |
| 15 FSI-2000-3 | 16.36 | 63.44 |
| 16 FSI-2000-4 | 7.58 | 78.86 |
| 17 FSI-2000-5 | 3.85 | 76.79 |
| 18 FSI-2000-6 | 2.35 | 78.34 |
| 19 FSI-2000-7 | 1.73 | 75.49 |
| 20 FSI-2000-8 | 1.43 | 44.49 |
| 21 FSI-2000-9 | 14.96 | 37.36 |
| 22 FSI-2000-10 | 7.26 | 81.55 |
| 23 FSI-2000-11 | 2.65 | 66.94 |
| 24 FSI-2000-12 | 3.56 | 39.46 |
| 25 FSI-2000-13 | 1.08 | 55.45 |

Flux is in mg/m²/day.

%Ncmb. is "% noncombustible flux".

Not enough <1 mm fraction to do analysis.

Carbon Flux at Fram Strait 1, 2000m, 1984-85

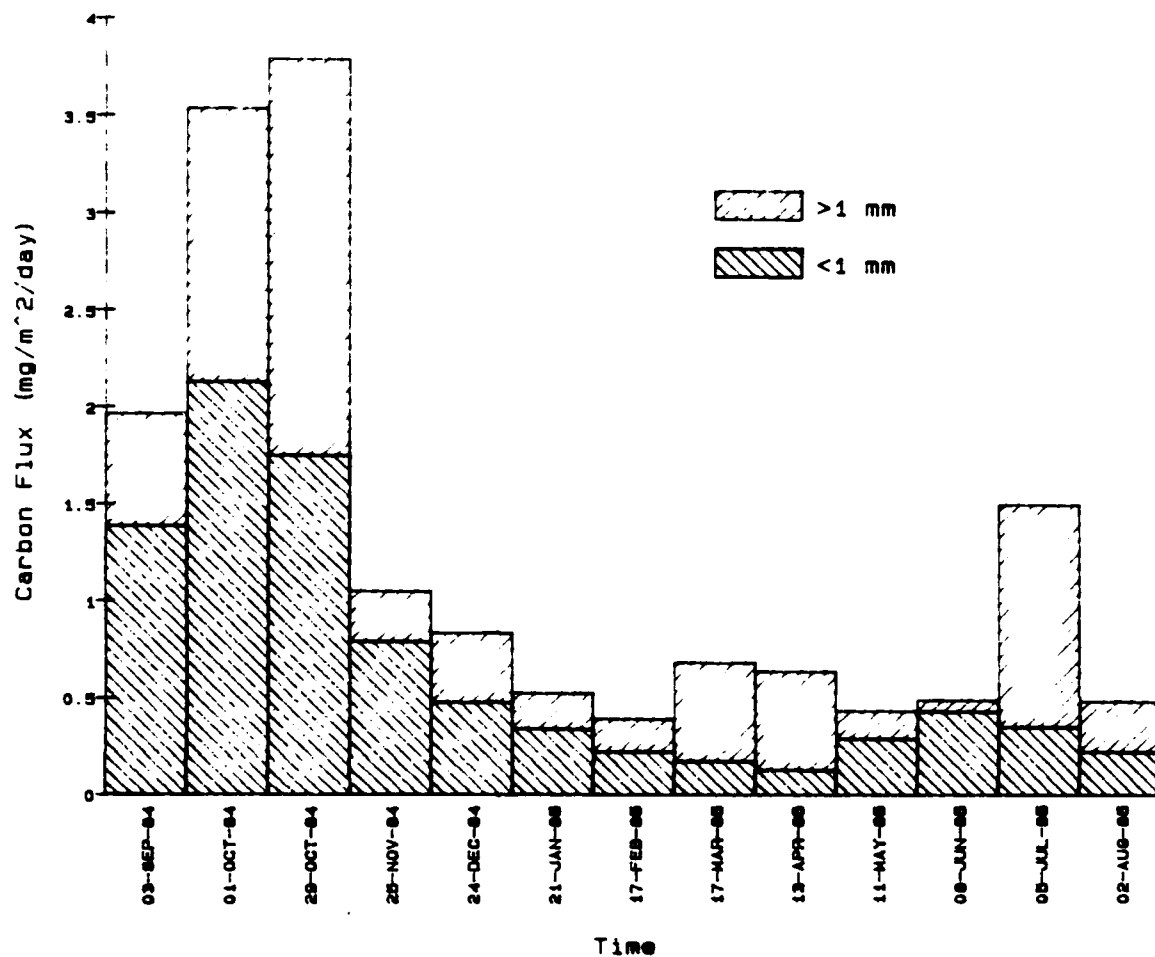

| Sample I.D. | CRNC 1 | CRNC<1 %mbf. | CRNC >1 | CRNC>1 %mbf. | CRNC total | CRNCtot. %mbf. |
|-----------------|-----------|-----------------|------------|-----------------|---------------|-------------------|
| 13 F81-2000-1* | 1.39 | 30.99 | 0.58 | 12.92 | 1.97 | 43.81 |
| 14 F81-2000-2* | 2.13 | 29.62 | 1.41 | 19.61 | 3.54 | 49.23 |
| 15 F81-2000-3* | 1.75 | 25.25 | 2.04 | 29.39 | 3.79 | 54.65 |
| 16 F81-2000-4* | 0.79 | 37.66 | 0.26 | 12.38 | 1.05 | 50.04 |
| 17 F81-2000-5* | 0.48 | 27.90 | 0.36 | 21.05 | 0.84 | 48.85 |
| 18 F81-2000-6* | 0.34 | 41.45 | 0.19 | 22.71 | 0.53 | 64.16 |
| 19 F81-2000-7* | 0.22 | 27.77 | 0.17 | 21.25 | 0.39 | 49.02 |
| 20 F81-2000-8* | 0.18 | 12.86 | 0.51 | 36.48 | 0.69 | 49.29 |
| 21 F81-2000-9* | 0.13 | 9.08 | 0.51 | 36.17 | 0.64 | 45.25 |
| 22 F81-2000-10* | 0.29 | 32.92 | 0.14 | 16.22 | 0.43 | 49.14 |
| 23 F81-2000-11* | 0.43 | 55.10 | 0.06 | 7.69 | 0.49 | 62.79 |
| 24 F81-2000-12* | 0.35 | 11.81 | 1.15 | 38.59 | 1.50 | 50.40 |
| 25 F81-2000-13* | 0.22 | 17.39 | 0.26 | 20.31 | 0.48 | 37.70 |

Flux is in mg m⁻² day⁻¹.

%mbf = % of combustible flux.

Nitrogen Flux at Fram Strait, 2000m, 1984-85

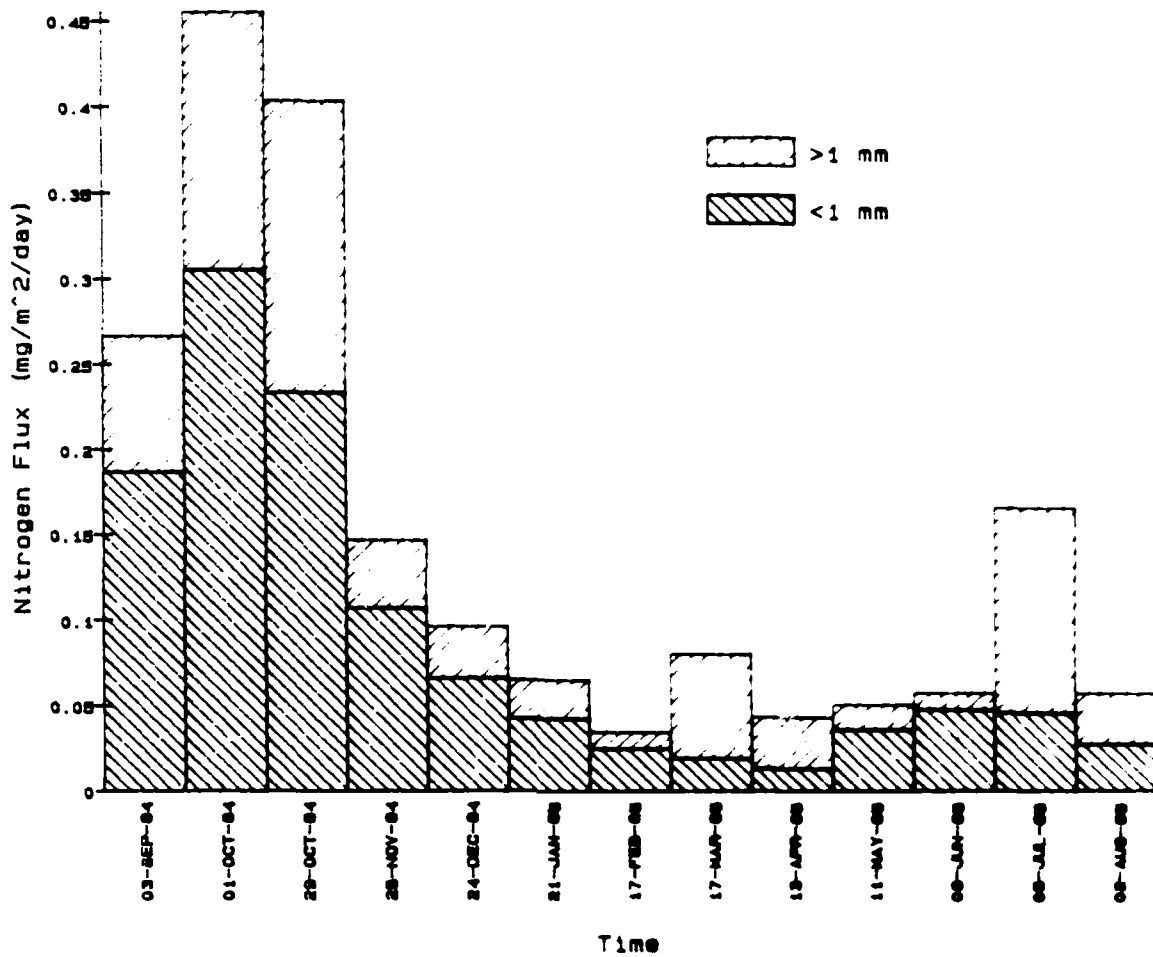

| Sample I.D. | NTGN -1 | NTGN-1 %compf. | NTGN -1 | NTGN-1 %compf. | NTGN total | NTGN-1 %compf. |
|-----------------|------------|-------------------|------------|-------------------|---------------|-------------------|
| 13 FSI-2000-1* | 0.19 | 4.17 | 0.08 | 1.73 | 2.07 | 4.44 |
| 14 FSI-2000-2* | 0.30 | 4.24 | 0.15 | 2.09 | 2.46 | 4.44 |
| 15 FSI-2000-3* | 0.23 | 3.36 | 0.17 | 2.45 | 2.60 | 4.44 |
| 16 FSI-2000-4* | 0.11 | 3.09 | 0.04 | 1.30 | 1.41 | 4.44 |
| 17 FSI-2000-5* | 0.07 | 3.36 | 0.03 | 1.26 | 1.33 | 4.44 |
| 18 FSI-2000-6* | 0.04 | 3.21 | 0.02 | 1.11 | 1.15 | 4.44 |
| 19 FSI-2000-7* | 0.02 | 3.11 | 0.01 | 1.05 | 1.07 | 4.44 |
| 20 FSI-2000-8* | 0.14 | 3.97 | 0.05 | 4.15 | 4.30 | 4.44 |
| 21 FSI-2000-9* | 0.01 | 3.35 | 0.03 | 2.70 | 2.74 | 4.44 |
| 22 FSI-2000-10* | 0.04 | 4.23 | 0.01 | 1.36 | 1.41 | 4.44 |
| 23 FSI-2000-11* | 0.05 | 3.13 | 0.01 | 1.23 | 1.29 | 4.44 |
| 24 FSI-2000-12* | 0.05 | 3.54 | 0.02 | 4.31 | 4.38 | 4.44 |
| 25 FSI-2000-13* | 0.03 | 2.14 | 0.03 | 1.14 | 1.17 | 4.44 |

Flux is in mg/m² day.

%compf = % of combustible flux.

Hydrogen Flux at Fram Strait, 2000m, 1984-1985

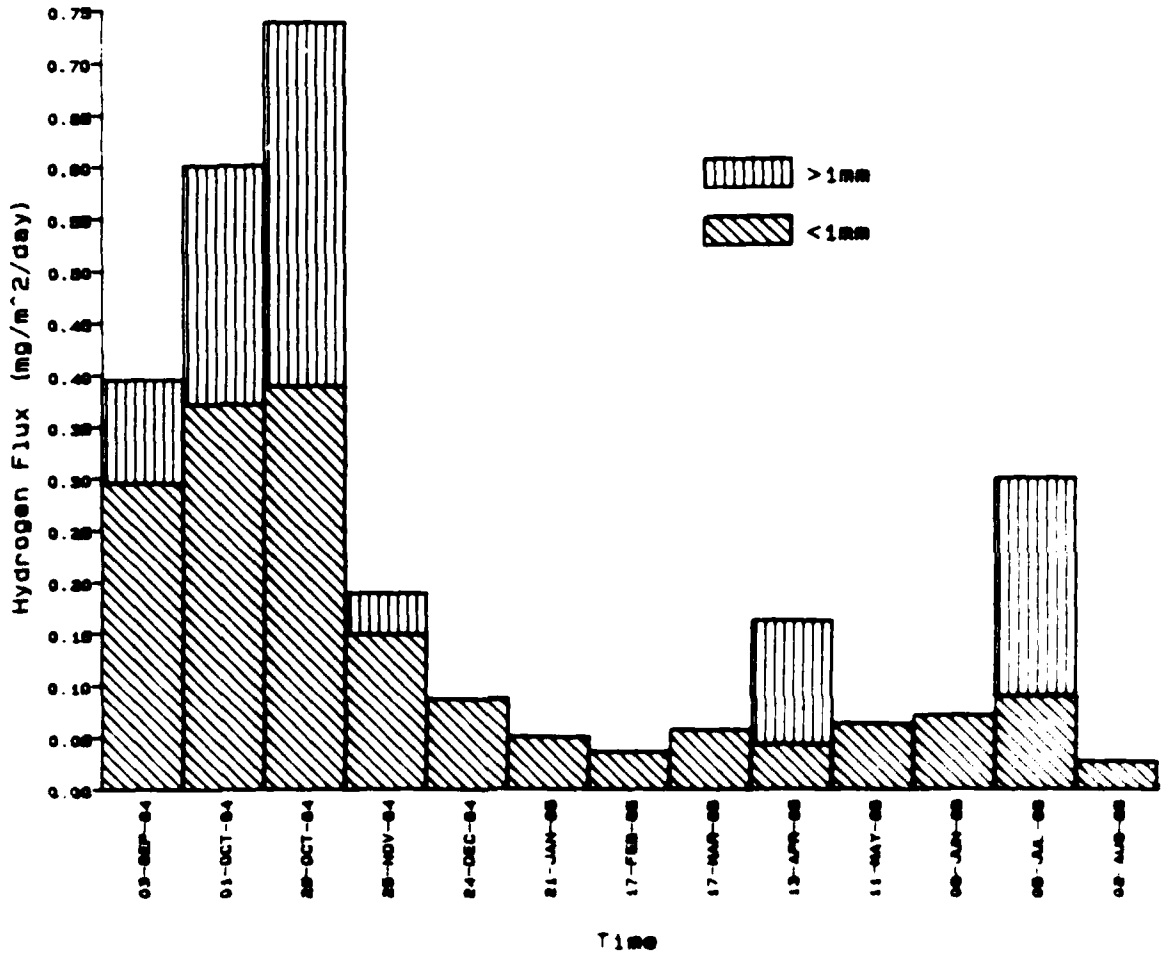

| Station | 1984 | 1985 | 1986 | 1987 | 1988 | 1989 |
|---------|------|------|------|------|------|------|
| 2000 | 0.15 | 0.25 | 0.10 | 0.05 | 0.03 | 0.02 |
| 2001 | 0.18 | 0.30 | 0.12 | 0.06 | 0.04 | 0.03 |
| 2002 | 0.20 | 0.35 | 0.15 | 0.08 | 0.05 | 0.04 |
| 2003 | 0.22 | 0.40 | 0.18 | 0.10 | 0.06 | 0.05 |
| 2004 | 0.25 | 0.45 | 0.20 | 0.12 | 0.07 | 0.06 |
| 2005 | 0.28 | 0.50 | 0.25 | 0.15 | 0.09 | 0.08 |
| 2006 | 0.30 | 0.55 | 0.30 | 0.18 | 0.11 | 0.10 |
| 2007 | 0.35 | 0.60 | 0.35 | 0.20 | 0.13 | 0.12 |
| 2008 | 0.40 | 0.65 | 0.40 | 0.25 | 0.15 | 0.14 |
| 2009 | 0.45 | 0.70 | 0.45 | 0.30 | 0.18 | 0.17 |
| 2010 | 0.50 | 0.75 | 0.50 | 0.35 | 0.20 | 0.19 |
| 2011 | 0.55 | 0.80 | 0.55 | 0.40 | 0.22 | 0.21 |
| 2012 | 0.60 | 0.85 | 0.60 | 0.45 | 0.25 | 0.24 |
| 2013 | 0.65 | 0.90 | 0.65 | 0.50 | 0.28 | 0.27 |
| 2014 | 0.70 | 0.95 | 0.70 | 0.55 | 0.30 | 0.29 |
| 2015 | 0.75 | 1.00 | 0.75 | 0.60 | 0.32 | 0.31 |

GB-2 (1,900m)

GREENLAND BASIN

74°35'N, 06°43'W

Trap depth: 881m Water depth: 3,445m

Annual Fluxes (g/m²/yr):

Total.....8.79

Carbonate.....2.59

Noncombustible..... 3.69

Combustible.....2.50

Organic C.....0.94

N0.16

APPENDIX Mark 5-10

| Core No. | Depth (m) | Opening Date | Closing Date | Span | Mid. Date |
|----------|-----------|--------------|--------------|------|-----------|
| 1000 | 000 | 25 APR 65 | 25 SEP 65 | 12 | 25 SEP 65 |
| 1000 | 000 | 25 SEP 65 | 25 OCT 65 | 12 | 25 SEP 65 |
| 1000 | 000 | 25 OCT 65 | 24 NOV 65 | 12 | 25 OCT 65 |
| 1000 | 000 | 24 NOV 65 | 24 DEC 65 | 12 | 24 NOV 65 |
| 1000 | 000 | 24 DEC 65 | 21 JAN 66 | 12 | 24 DEC 65 |
| 1000 | 000 | 21 JAN 66 | 21 FEB 66 | 12 | 21 JAN 66 |
| 1000 | 000 | 21 FEB 66 | 24 MAR 66 | 12 | 21 FEB 66 |
| 1000 | 000 | 21 MAR 66 | 21 APR 66 | 12 | 21 MAR 66 |
| 1000 | 000 | 21 APR 66 | 21 MAY 66 | 12 | 21 APR 66 |
| 1000 | 000 | 21 MAY 66 | 21 JUN 66 | 12 | 21 MAY 66 |
| 1000 | 000 | 21 JUN 66 | 21 JUL 66 | 12 | 21 JUN 66 |
| 1000 | 000 | 21 JUL 66 | 21 AUG 66 | 12 | 21 JUL 66 |
| 1000 | 000 | 21 AUG 66 | 21 SEP 66 | 12 | 21 AUG 66 |

Total Flux at Greenland Basin 2, 1900m, 1985-86

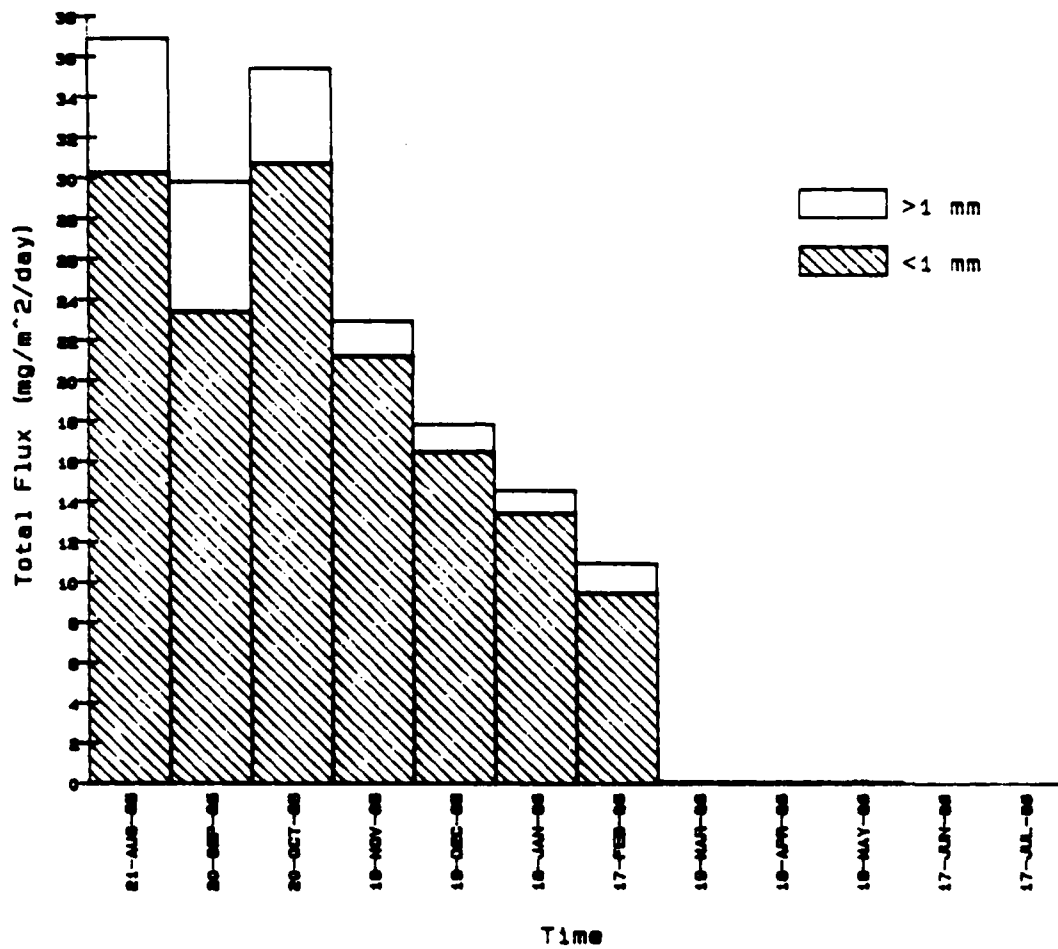

| Sample No. | TTLF | % of total | TTLF | % of total | TTLF |
|-----------------|-------|------------|------|------------|-------|
| 89 GB2-1900-1 | 20.25 | 32.01 | 6.63 | 17.99 | 36.88 |
| 90 GB2-1900-2 | 20.44 | 79.53 | 6.41 | 21.47 | 28.86 |
| 91 GB2-1900-3 | 20.75 | 86.77 | 4.69 | 13.23 | 35.44 |
| 92 GB2-1900-4 | 21.01 | 32.38 | 1.75 | 7.62 | 22.76 |
| 93 GB2-1900-5 | 15.44 | 92.42 | 1.35 | 7.68 | 17.09 |
| 94 GB2-1900-6 | 13.42 | 92.37 | 1.12 | 7.73 | 14.54 |
| 95 GB2-1900-7 | 9.45 | 36.77 | 1.44 | 10.23 | 10.81 |
| 96 GB2-1900-8 | 0.10 | 100.00 | | | 0.10 |
| 97 GB2-1900-9 | 0.10 | 100.00 | | | 0.10 |
| 99 GB2-1900-10 | 0.08 | 100.00 | | | 0.08 |
| 99 GB2-1900-11 | | | | | |
| 100 GB2-1900-12 | | | | | |

Flux is in mg/m²/day.
 Trap malfunctioned beginning at cup #8.

Carbonate Flux at Greenland Basin 2, 1900m, 1985-86

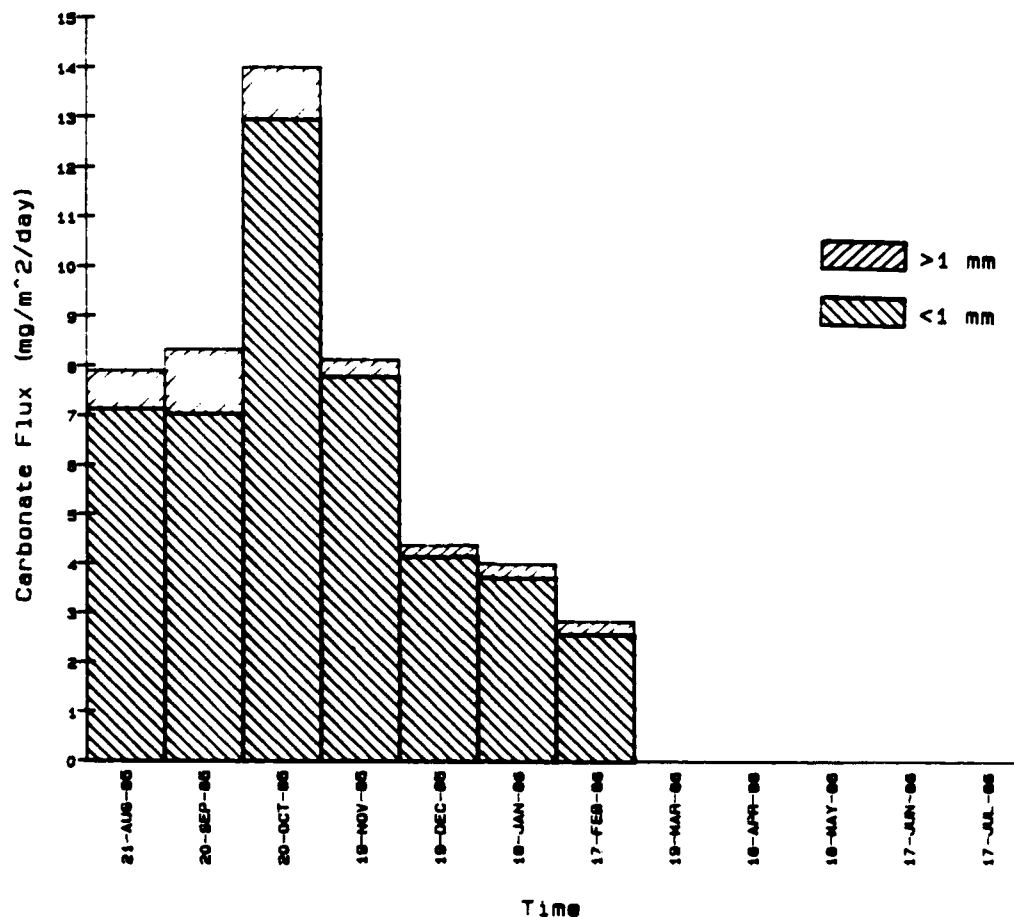

| Sample No. | CRTA | CRTA % tot. | CRTA | CRTA % tot. | CRTA total | CRTA % total |
|----------------|-------|-------------|------|-------------|------------|--------------|
| 99 682-1900-1 | 7.14 | 19.35 | 0.73 | 2.11 | 7.87 | 21.47 |
| 90 682-1900-2 | 7.03 | 23.57 | 1.30 | 4.06 | 8.33 | 23.80 |
| 91 682-1900-3 | 12.76 | 36.57 | 1.04 | 2.95 | 13.80 | 38.33 |
| 92 682-1900-4 | 7.79 | 30.91 | 0.35 | 1.50 | 8.14 | 26.44 |
| 93 682-1900-5 | 4.14 | 23.29 | 0.23 | 1.27 | 4.37 | 24.66 |
| 94 682-1900-6 | 3.72 | 29.91 | 0.29 | 1.97 | 4.01 | 27.43 |
| 95 682-1900-7 | 2.58 | 23.56 | 0.26 | 2.06 | 2.84 | 26.22 |
| 96 682-1900-8 | | | | | | |
| 97 682-1900-9 | | | | | | |
| 98 682-1900-10 | | | | | | |
| 99 682-1900-11 | | | | | | |
| 00 682-1900-12 | | | | | | |

Flux is in mg/m²/day.
 Total flux declined beginning at sup #8.

Noncombustible Flux at Greenland Basin 2, 1900m, 1985-86

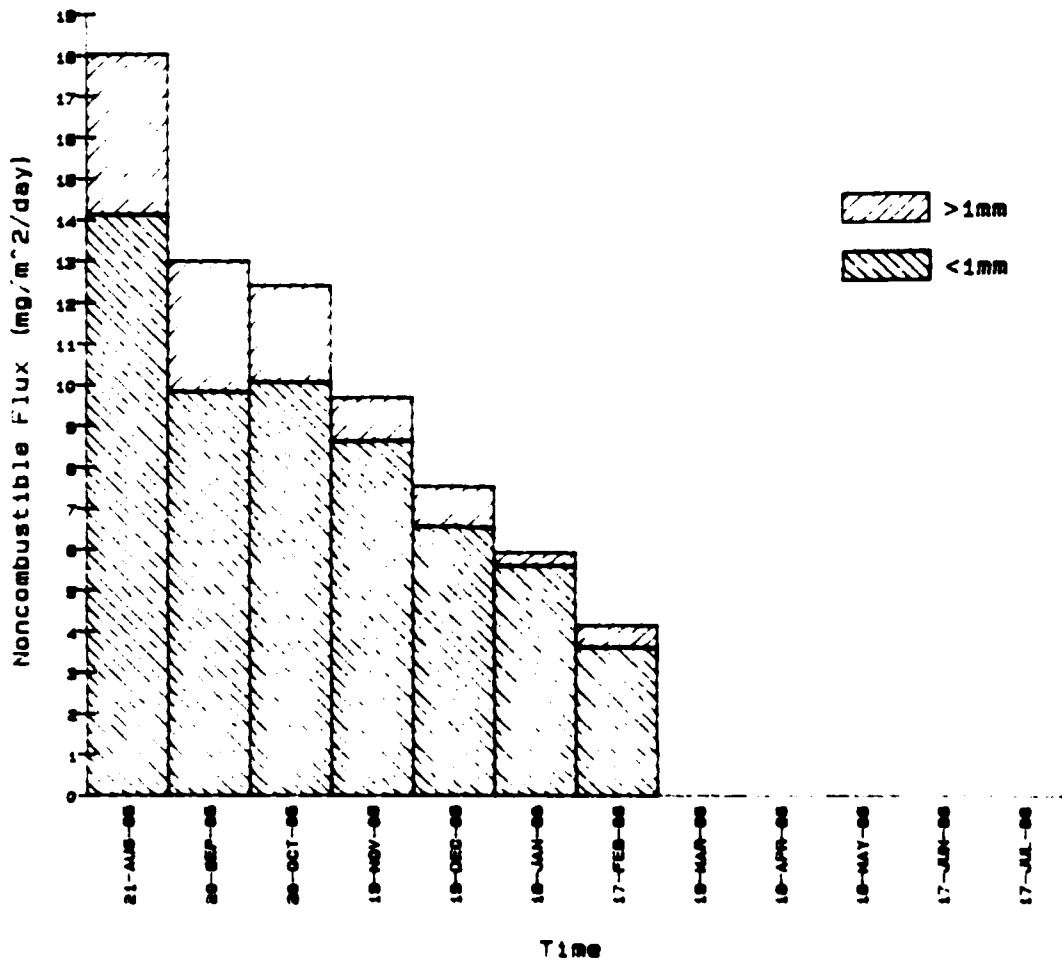

| Sample No. | NONC | NONC % | NONC | NONC % | NONC | NONC % |
|----------------|-------|--------|-------|--------|-------|--------|
| | total | total | total | total | total | total |
| 39 882-1900-1 | 14.00 | 28.03 | 5.00 | 10.53 | 19.00 | 47.56 |
| 30 882-1900-2 | 9.50 | 22.95 | 5.50 | 10.56 | 15.00 | 47.56 |
| 31 882-1900-3 | 10.00 | 28.28 | 5.00 | 6.88 | 15.00 | 28.28 |
| 32 882-1900-4 | 8.50 | 27.50 | 1.50 | 4.54 | 10.00 | 47.56 |
| 33 882-1900-5 | 8.50 | 26.53 | 1.50 | 6.54 | 10.00 | 47.56 |
| 34 882-1900-6 | 6.50 | 25.43 | 1.50 | 2.53 | 8.00 | 47.56 |
| 35 882-1900-7 | 6.50 | 22.06 | 3.50 | 4.21 | 10.00 | 47.56 |
| 36 882-1900-8 | | | | | | |
| 37 882-1900-9 | | | | | | |
| 38 882-1900-10 | | | | | | |
| 39 882-1900-11 | | | | | | |
| 30 882-1900-12 | | | | | | |

Combustible Flux at Greenland Basin 2, 1900m, 1985-86

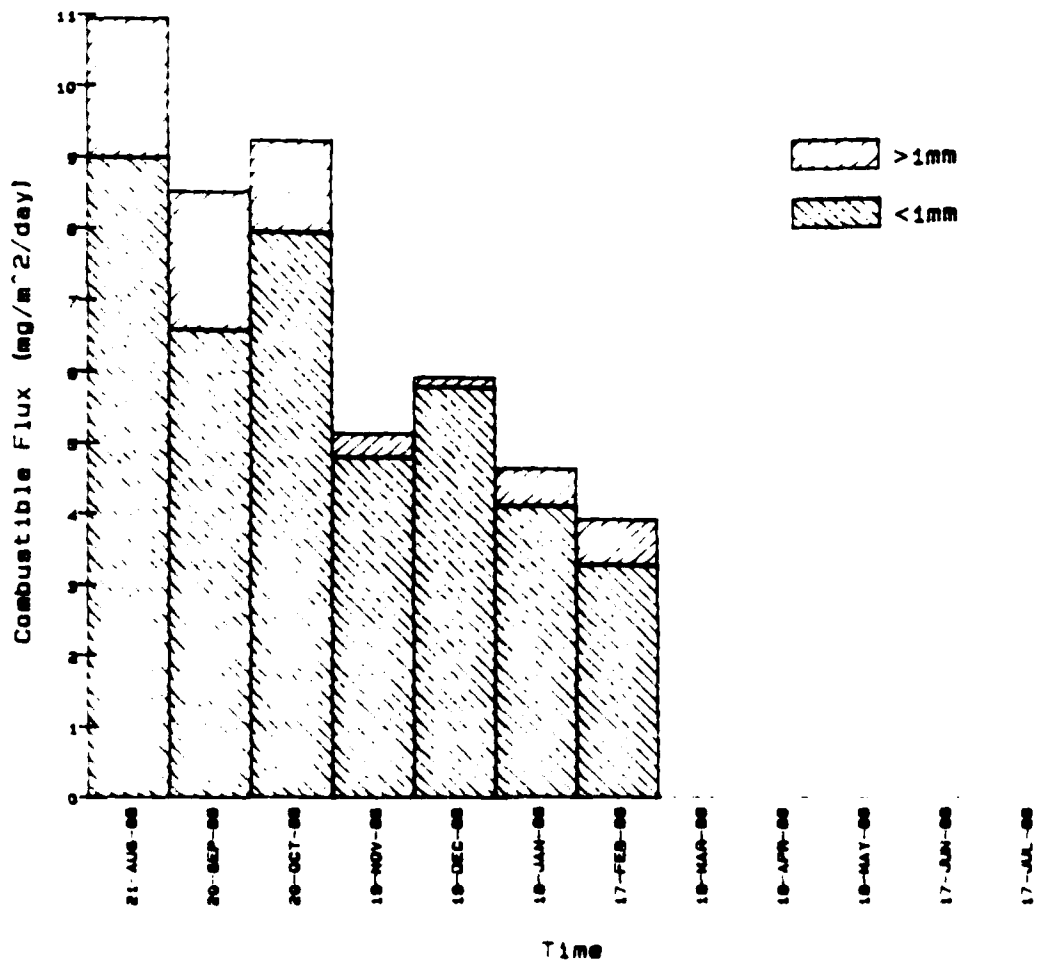

Carbon Flux at Greenland Basin 2, 1900m, 1985-86

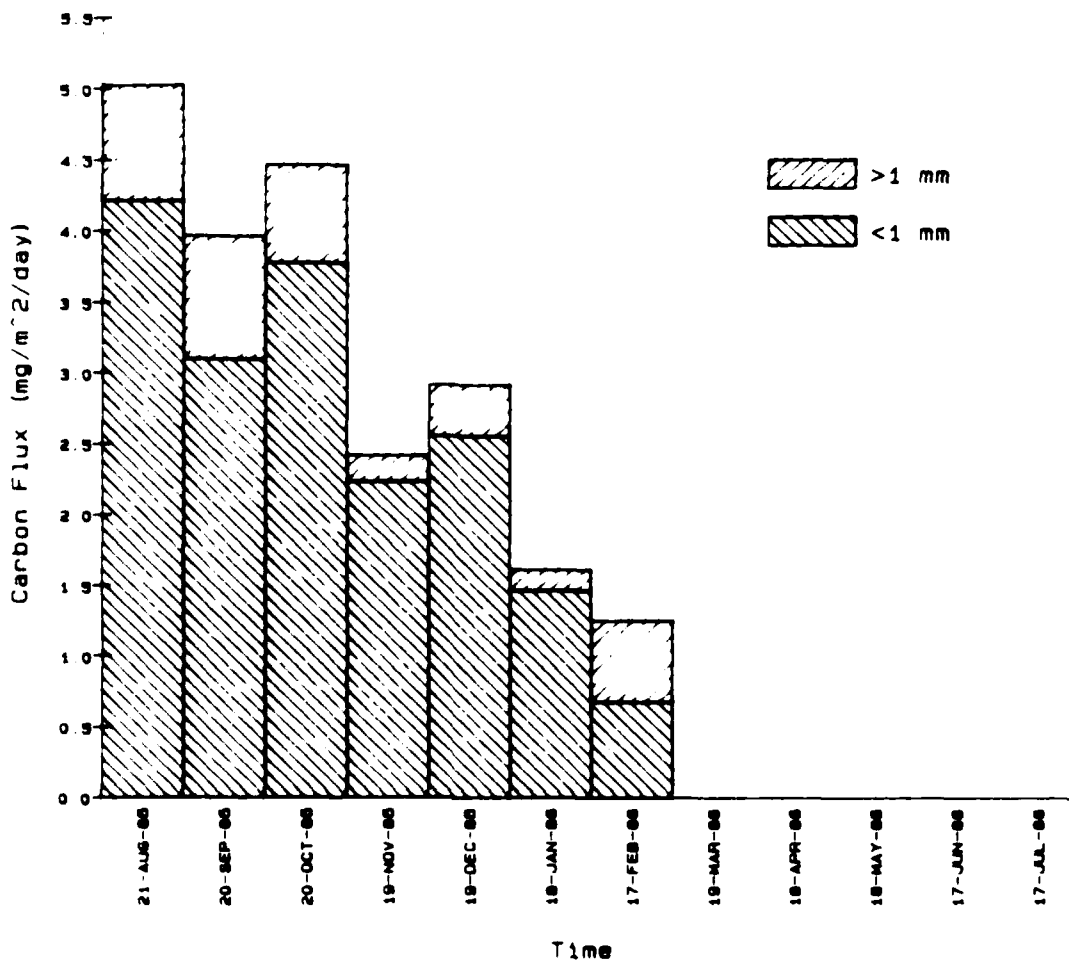

| Sample | DRNC | DRNC | DRNC | DRNC | DRNC | DRNC total | |
|--------|--------|------|--------|------|-------|------------|-------|
| | 1 | 1 | 1 | 1 | total | total | |
| | Nombf. | | Nombf. | | | Nombf. | |
| 1 | 300 | 4.21 | 09.50 | 0.82 | 7.46 | 5.00 | 49.98 |
| 2 | 300 | 3.70 | 06.43 | 0.87 | 10.21 | 3.87 | 46.17 |
| 3 | 300 | 3.78 | 41.02 | 0.69 | 7.49 | 4.47 | 46.44 |
| 4 | 300 | 3.24 | 43.70 | 0.19 | 3.65 | 2.43 | 47.44 |
| 5 | 300 | 2.66 | 43.32 | 0.26 | 6.15 | 2.92 | 43.44 |
| 6 | 300 | 3.45 | 02.00 | 0.15 | 3.28 | 1.92 | 35.21 |
| 7 | 300 | 2.68 | 17.49 | 0.57 | 14.68 | 1.26 | 21.37 |
| 8 | 300 | | | | | | |
| 9 | 300 | | | | | | |
| 10 | 300 | | | | | | |
| 11 | 300 | | | | | | |
| 12 | 300 | | | | | | |
| 13 | 300 | | | | | | |
| 14 | 300 | | | | | | |
| 15 | 300 | | | | | | |
| 16 | 300 | | | | | | |
| 17 | 300 | | | | | | |
| 18 | 300 | | | | | | |
| 19 | 300 | | | | | | |
| 20 | 300 | | | | | | |
| 21 | 300 | | | | | | |
| 22 | 300 | | | | | | |
| 23 | 300 | | | | | | |
| 24 | 300 | | | | | | |
| 25 | 300 | | | | | | |
| 26 | 300 | | | | | | |
| 27 | 300 | | | | | | |
| 28 | 300 | | | | | | |
| 29 | 300 | | | | | | |
| 30 | 300 | | | | | | |
| 31 | 300 | | | | | | |
| 32 | 300 | | | | | | |
| 33 | 300 | | | | | | |
| 34 | 300 | | | | | | |
| 35 | 300 | | | | | | |
| 36 | 300 | | | | | | |
| 37 | 300 | | | | | | |
| 38 | 300 | | | | | | |
| 39 | 300 | | | | | | |
| 40 | 300 | | | | | | |
| 41 | 300 | | | | | | |
| 42 | 300 | | | | | | |
| 43 | 300 | | | | | | |
| 44 | 300 | | | | | | |
| 45 | 300 | | | | | | |
| 46 | 300 | | | | | | |
| 47 | 300 | | | | | | |
| 48 | 300 | | | | | | |
| 49 | 300 | | | | | | |
| 50 | 300 | | | | | | |
| 51 | 300 | | | | | | |
| 52 | 300 | | | | | | |
| 53 | 300 | | | | | | |
| 54 | 300 | | | | | | |
| 55 | 300 | | | | | | |
| 56 | 300 | | | | | | |
| 57 | 300 | | | | | | |
| 58 | 300 | | | | | | |
| 59 | 300 | | | | | | |
| 60 | 300 | | | | | | |
| 61 | 300 | | | | | | |
| 62 | 300 | | | | | | |
| 63 | 300 | | | | | | |
| 64 | 300 | | | | | | |
| 65 | 300 | | | | | | |
| 66 | 300 | | | | | | |
| 67 | 300 | | | | | | |
| 68 | 300 | | | | | | |
| 69 | 300 | | | | | | |
| 70 | 300 | | | | | | |
| 71 | 300 | | | | | | |
| 72 | 300 | | | | | | |
| 73 | 300 | | | | | | |
| 74 | 300 | | | | | | |
| 75 | 300 | | | | | | |
| 76 | 300 | | | | | | |
| 77 | 300 | | | | | | |
| 78 | 300 | | | | | | |
| 79 | 300 | | | | | | |
| 80 | 300 | | | | | | |
| 81 | 300 | | | | | | |
| 82 | 300 | | | | | | |
| 83 | 300 | | | | | | |
| 84 | 300 | | | | | | |
| 85 | 300 | | | | | | |
| 86 | 300 | | | | | | |
| 87 | 300 | | | | | | |
| 88 | 300 | | | | | | |
| 89 | 300 | | | | | | |
| 90 | 300 | | | | | | |
| 91 | 300 | | | | | | |
| 92 | 300 | | | | | | |
| 93 | 300 | | | | | | |
| 94 | 300 | | | | | | |
| 95 | 300 | | | | | | |
| 96 | 300 | | | | | | |
| 97 | 300 | | | | | | |
| 98 | 300 | | | | | | |
| 99 | 300 | | | | | | |
| 100 | 300 | | | | | | |

Nitrogen Flux at Greenland Basin 2, 1900m, 1985-86

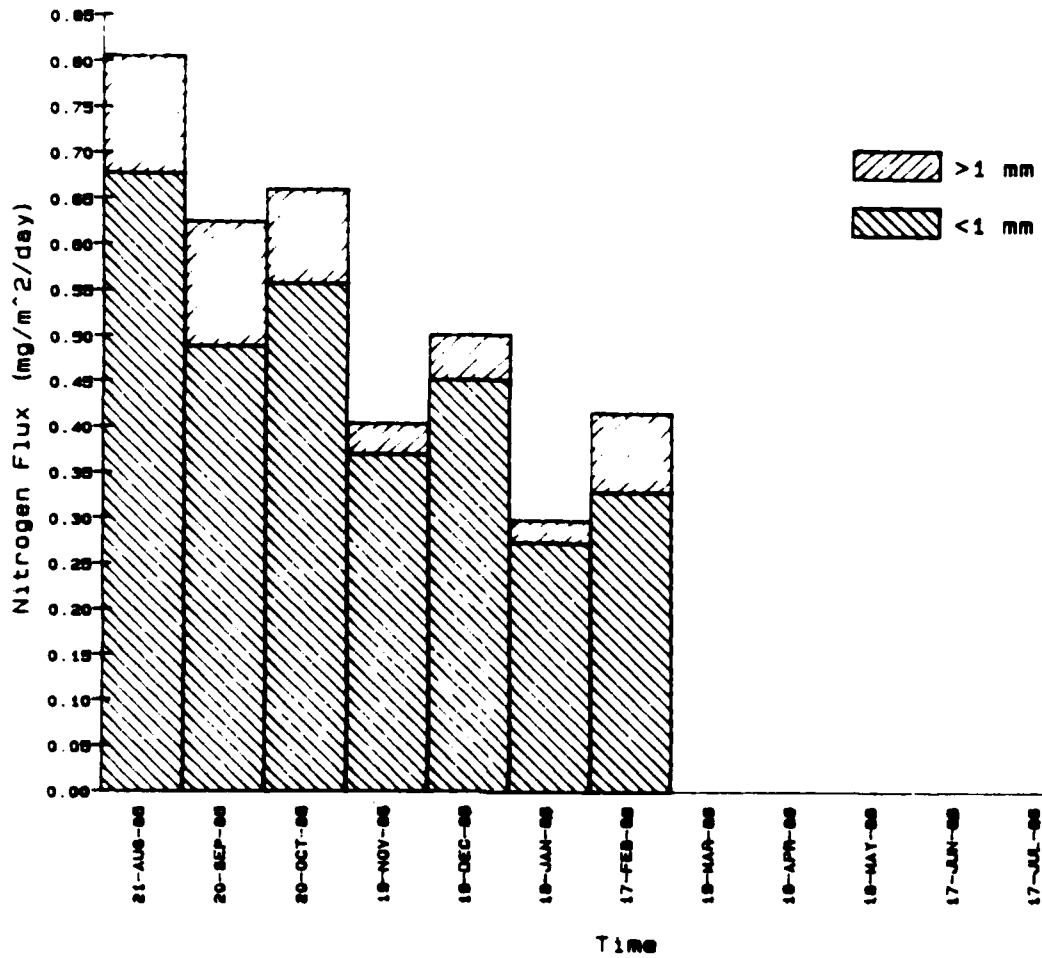

| Sample No. | NTGN | NTGN 1 %mbf. | NTGN 1 | NTGN 1 %mbf. | NTGN total | NTGNtot. %mbf. |
|----------------|------|--------------|--------|--------------|------------|----------------|
| 33 882-1900-1 | 0.68 | 6.19 | 0.13 | 1.17 | 0.81 | 7.36 |
| 32 882-1900-2 | 0.49 | 5.76 | 0.14 | 1.61 | 0.63 | 7.39 |
| 31 882-1900-3 | 0.66 | 6.05 | 0.05 | 1.11 | 0.71 | 7.16 |
| 30 882-1900-4 | 0.37 | 7.23 | 0.03 | 0.66 | 0.40 | 7.89 |
| 29 882-1900-5 | 0.45 | 7.66 | 0.05 | 0.95 | 0.50 | 8.16 |
| 24 882-1900-6 | 0.27 | 6.32 | 0.02 | 0.94 | 0.30 | 6.49 |
| 25 882-1900-7 | 0.33 | 6.44 | 0.09 | 0.22 | 0.42 | 6.66 |
| 26 882-1900-8 | | | | | | |
| 27 882-1900-9 | | | | | | |
| 28 882-1900-10 | | | | | | |
| 29 882-1900-11 | | | | | | |
| 20 882-1900-12 | | | | | | |

Hydrogen Flux at Greenland Basin 2, 1900m, 1985-86

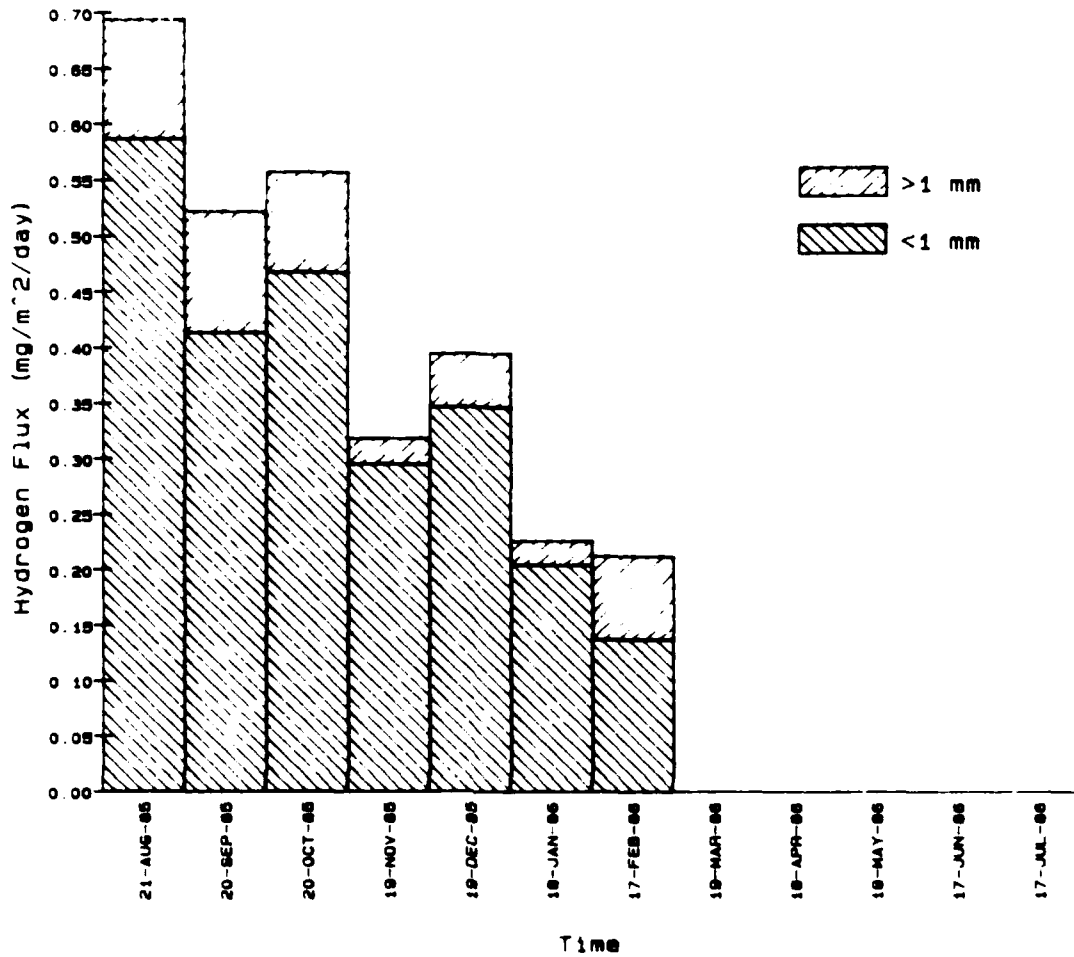

| Sample No. | HYDC | HYDC Temp. | HYDC | HYDC Temp. | HYDC total | HYDC total Temp. |
|----------------|------|------------|------|------------|------------|------------------|
| 88 882-1900-1 | 0.59 | 5.37 | 0.11 | 0.38 | 0.59 | 5.75 |
| 89 882-1900-2 | 0.43 | 4.37 | 0.14 | 1.27 | 0.57 | 5.74 |
| 90 882-1900-3 | 0.47 | 5.07 | 0.09 | 0.38 | 0.56 | 5.25 |
| 91 882-1900-4 | 0.30 | 5.75 | 0.03 | 0.45 | 0.33 | 5.77 |
| 92 882-1900-5 | 0.35 | 5.87 | 0.05 | 0.62 | 0.40 | 5.86 |
| 93 882-1900-6 | 0.22 | 4.43 | 0.03 | 0.47 | 0.25 | 4.73 |
| 94 882-1900-7 | 0.16 | 5.52 | 0.06 | 1.32 | 0.22 | 5.44 |
| 95 882-1900-8 | | | | | | |
| 96 882-1900-9 | | | | | | |
| 97 882-1900-10 | | | | | | |
| 98 882-1900-11 | | | | | | |
| 99 882-1900-12 | | | | | | |

... 24 ... 19 ...
 ... 2 ... 20 ...

GB-2 3,000m

GREENLAND BASIN

74°35'N, 06°43'W

Trap depth: 2,823m Water depth: 3,445m

Annual Fluxes (g/m²/yr):

Total.....10.21
Carbonate.....3.28
Noncombustible.....5.73
Combustible.....1.23
Biogenic Opal.....2.61
Lithogenic.....3.12
Organic C.....0.40
N0.06

PARFLUX Mark 6-13

| Sample ID | Opening Date | Closing Date | Span | Mid. Date |
|-----------------|--------------|--------------|------|-----------|
| 101 682-3000-1 | 04-AUG-85 | 01-SEP-85 | 28 | 19-AUG-85 |
| 102 682-3000-2 | 01-SEP-85 | 29-SEP-85 | 28 | 15-SEP-85 |
| 103 682-3000-3 | 29-SEP-85 | 27-OCT-85 | 28 | 13-OCT-85 |
| 104 682-3000-4 | 27-OCT-85 | 24-NOV-85 | 28 | 10-NOV-85 |
| 105 682-3000-5 | 24-NOV-85 | 22-DEC-85 | 28 | 28-DEC-85 |
| 106 682-3000-6 | 22-DEC-85 | 19-JAN-86 | 28 | 05-JAN-86 |
| 107 682-3000-7 | 19-JAN-86 | 16-FEB-86 | 28 | 02-FEB-86 |
| 108 682-3000-8 | 16-FEB-86 | 16-MAR-86 | 28 | 02-MAR-86 |
| 109 682-3000-9 | 16-MAR-86 | 13-APR-86 | 28 | 02-MAR-86 |
| 110 682-3000-10 | 13-APR-86 | 11-MAY-86 | 28 | 07-APR-86 |
| 111 682-3000-11 | 11-MAY-86 | 08-JUN-86 | 28 | 05-MAY-86 |
| 112 682-3000-12 | 08-JUN-86 | 06-JUL-86 | 28 | 02-JUN-86 |
| 113 682-3000-13 | 06-JUL-86 | 03-AUG-86 | 28 | 02-JUL-86 |

Total Flux at Greenland Basin 2, 3000m, 1985-86

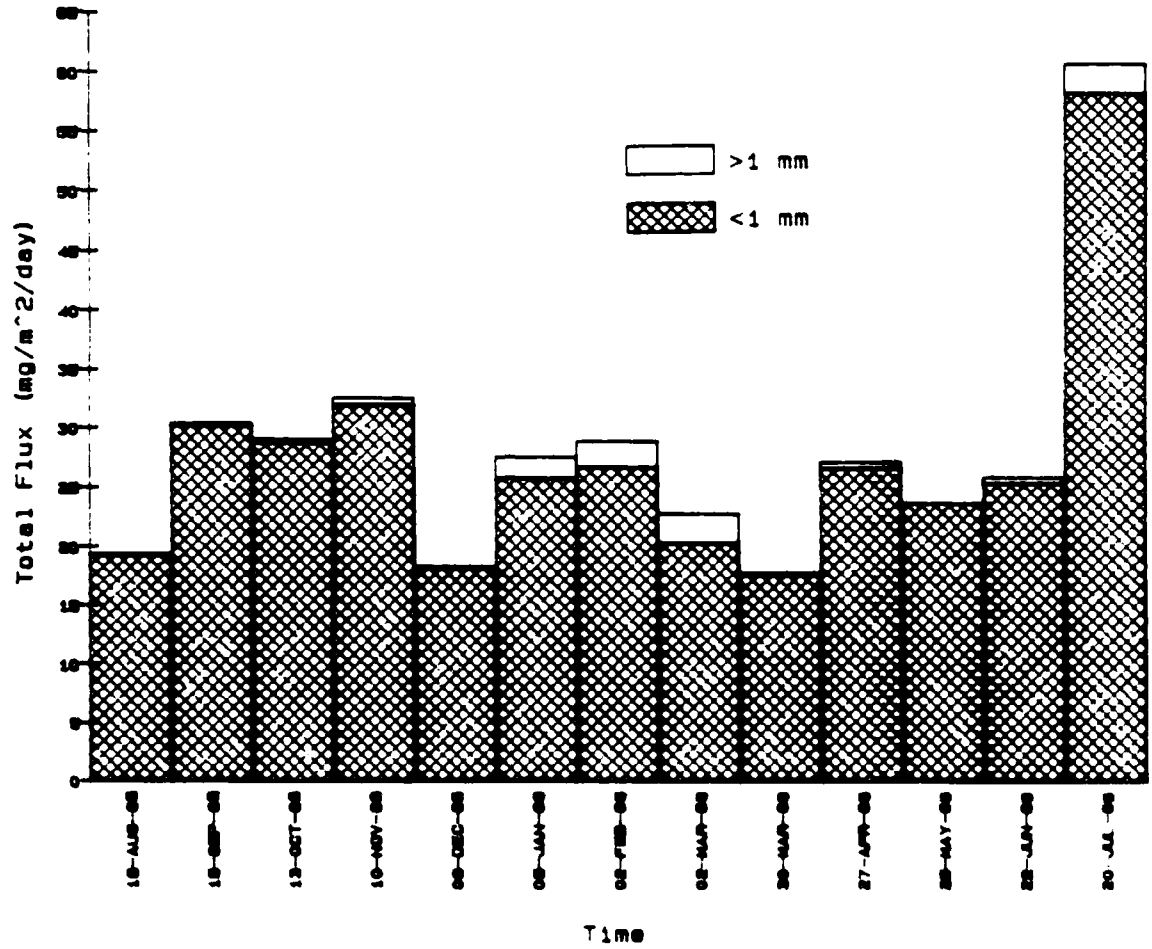

| Sample | DATE | TIME | DEPTH | FLUX | FLUX | FLUX | FLUX |
|--------|------|------|-------|-------|-------|-------|-------|
| NO. | | | | TOTAL | >1 mm | <1 mm | TOTAL |
| 21 | 382 | 3000 | - | 4.28 | 3.9 | 0.38 | 4.28 |
| 22 | 382 | 3000 | -1 | 4.28 | 3.9 | 0.38 | 4.28 |
| 23 | 382 | 3000 | -1.1 | 4.28 | 3.9 | 0.38 | 4.28 |
| 24 | 382 | 3000 | -1.4 | 4.28 | 3.9 | 0.38 | 4.28 |
| 25 | 382 | 3000 | -1.5 | 4.28 | 3.9 | 0.38 | 4.28 |
| 26 | 382 | 3000 | -1.5 | 4.28 | 3.9 | 0.38 | 4.28 |
| 27 | 382 | 3000 | -1.7 | 4.28 | 3.9 | 0.38 | 4.28 |
| 28 | 382 | 3000 | -1.8 | 4.28 | 3.9 | 0.38 | 4.28 |
| 29 | 382 | 3000 | -1.8 | 4.28 | 3.9 | 0.38 | 4.28 |
| 30 | 382 | 3000 | -2 | 4.28 | 3.9 | 0.38 | 4.28 |
| 31 | 382 | 3000 | -2 | 4.28 | 3.9 | 0.38 | 4.28 |
| 32 | 382 | 3000 | -2 | 4.28 | 3.9 | 0.38 | 4.28 |
| 33 | 382 | 3000 | -2 | 4.28 | 3.9 | 0.38 | 4.28 |
| 34 | 382 | 3000 | -2 | 4.28 | 3.9 | 0.38 | 4.28 |
| 35 | 382 | 3000 | -2 | 4.28 | 3.9 | 0.38 | 4.28 |
| 36 | 382 | 3000 | -2 | 4.28 | 3.9 | 0.38 | 4.28 |
| 37 | 382 | 3000 | -2 | 4.28 | 3.9 | 0.38 | 4.28 |
| 38 | 382 | 3000 | -2 | 4.28 | 3.9 | 0.38 | 4.28 |
| 39 | 382 | 3000 | -2 | 4.28 | 3.9 | 0.38 | 4.28 |
| 40 | 382 | 3000 | -2 | 4.28 | 3.9 | 0.38 | 4.28 |
| 41 | 382 | 3000 | -2 | 4.28 | 3.9 | 0.38 | 4.28 |
| 42 | 382 | 3000 | -2 | 4.28 | 3.9 | 0.38 | 4.28 |
| 43 | 382 | 3000 | -2 | 4.28 | 3.9 | 0.38 | 4.28 |
| 44 | 382 | 3000 | -2 | 4.28 | 3.9 | 0.38 | 4.28 |
| 45 | 382 | 3000 | -2 | 4.28 | 3.9 | 0.38 | 4.28 |
| 46 | 382 | 3000 | -2 | 4.28 | 3.9 | 0.38 | 4.28 |
| 47 | 382 | 3000 | -2 | 4.28 | 3.9 | 0.38 | 4.28 |
| 48 | 382 | 3000 | -2 | 4.28 | 3.9 | 0.38 | 4.28 |
| 49 | 382 | 3000 | -2 | 4.28 | 3.9 | 0.38 | 4.28 |
| 50 | 382 | 3000 | -2 | 4.28 | 3.9 | 0.38 | 4.28 |
| 51 | 382 | 3000 | -2 | 4.28 | 3.9 | 0.38 | 4.28 |
| 52 | 382 | 3000 | -2 | 4.28 | 3.9 | 0.38 | 4.28 |
| 53 | 382 | 3000 | -2 | 4.28 | 3.9 | 0.38 | 4.28 |
| 54 | 382 | 3000 | -2 | 4.28 | 3.9 | 0.38 | 4.28 |
| 55 | 382 | 3000 | -2 | 4.28 | 3.9 | 0.38 | 4.28 |
| 56 | 382 | 3000 | -2 | 4.28 | 3.9 | 0.38 | 4.28 |
| 57 | 382 | 3000 | -2 | 4.28 | 3.9 | 0.38 | 4.28 |
| 58 | 382 | 3000 | -2 | 4.28 | 3.9 | 0.38 | 4.28 |
| 59 | 382 | 3000 | -2 | 4.28 | 3.9 | 0.38 | 4.28 |
| 60 | 382 | 3000 | -2 | 4.28 | 3.9 | 0.38 | 4.28 |
| 61 | 382 | 3000 | -2 | 4.28 | 3.9 | 0.38 | 4.28 |
| 62 | 382 | 3000 | -2 | 4.28 | 3.9 | 0.38 | 4.28 |
| 63 | 382 | 3000 | -2 | 4.28 | 3.9 | 0.38 | 4.28 |
| 64 | 382 | 3000 | -2 | 4.28 | 3.9 | 0.38 | 4.28 |
| 65 | 382 | 3000 | -2 | 4.28 | 3.9 | 0.38 | 4.28 |
| 66 | 382 | 3000 | -2 | 4.28 | 3.9 | 0.38 | 4.28 |
| 67 | 382 | 3000 | -2 | 4.28 | 3.9 | 0.38 | 4.28 |
| 68 | 382 | 3000 | -2 | 4.28 | 3.9 | 0.38 | 4.28 |
| 69 | 382 | 3000 | -2 | 4.28 | 3.9 | 0.38 | 4.28 |
| 70 | 382 | 3000 | -2 | 4.28 | 3.9 | 0.38 | 4.28 |
| 71 | 382 | 3000 | -2 | 4.28 | 3.9 | 0.38 | 4.28 |
| 72 | 382 | 3000 | -2 | 4.28 | 3.9 | 0.38 | 4.28 |
| 73 | 382 | 3000 | -2 | 4.28 | 3.9 | 0.38 | 4.28 |
| 74 | 382 | 3000 | -2 | 4.28 | 3.9 | 0.38 | 4.28 |
| 75 | 382 | 3000 | -2 | 4.28 | 3.9 | 0.38 | 4.28 |
| 76 | 382 | 3000 | -2 | 4.28 | 3.9 | 0.38 | 4.28 |
| 77 | 382 | 3000 | -2 | 4.28 | 3.9 | 0.38 | 4.28 |
| 78 | 382 | 3000 | -2 | 4.28 | 3.9 | 0.38 | 4.28 |
| 79 | 382 | 3000 | -2 | 4.28 | 3.9 | 0.38 | 4.28 |
| 80 | 382 | 3000 | -2 | 4.28 | 3.9 | 0.38 | 4.28 |
| 81 | 382 | 3000 | -2 | 4.28 | 3.9 | 0.38 | 4.28 |
| 82 | 382 | 3000 | -2 | 4.28 | 3.9 | 0.38 | 4.28 |
| 83 | 382 | 3000 | -2 | 4.28 | 3.9 | 0.38 | 4.28 |
| 84 | 382 | 3000 | -2 | 4.28 | 3.9 | 0.38 | 4.28 |
| 85 | 382 | 3000 | -2 | 4.28 | 3.9 | 0.38 | 4.28 |
| 86 | 382 | 3000 | -2 | 4.28 | 3.9 | 0.38 | 4.28 |
| 87 | 382 | 3000 | -2 | 4.28 | 3.9 | 0.38 | 4.28 |
| 88 | 382 | 3000 | -2 | 4.28 | 3.9 | 0.38 | 4.28 |
| 89 | 382 | 3000 | -2 | 4.28 | 3.9 | 0.38 | 4.28 |
| 90 | 382 | 3000 | -2 | 4.28 | 3.9 | 0.38 | 4.28 |
| 91 | 382 | 3000 | -2 | 4.28 | 3.9 | 0.38 | 4.28 |
| 92 | 382 | 3000 | -2 | 4.28 | 3.9 | 0.38 | 4.28 |
| 93 | 382 | 3000 | -2 | 4.28 | 3.9 | 0.38 | 4.28 |
| 94 | 382 | 3000 | -2 | 4.28 | 3.9 | 0.38 | 4.28 |
| 95 | 382 | 3000 | -2 | 4.28 | 3.9 | 0.38 | 4.28 |
| 96 | 382 | 3000 | -2 | 4.28 | 3.9 | 0.38 | 4.28 |
| 97 | 382 | 3000 | -2 | 4.28 | 3.9 | 0.38 | 4.28 |
| 98 | 382 | 3000 | -2 | 4.28 | 3.9 | 0.38 | 4.28 |
| 99 | 382 | 3000 | -2 | 4.28 | 3.9 | 0.38 | 4.28 |
| 100 | 382 | 3000 | -2 | 4.28 | 3.9 | 0.38 | 4.28 |

Carbonate Flux at Greenland Basin 2, 3000m, 1985-86

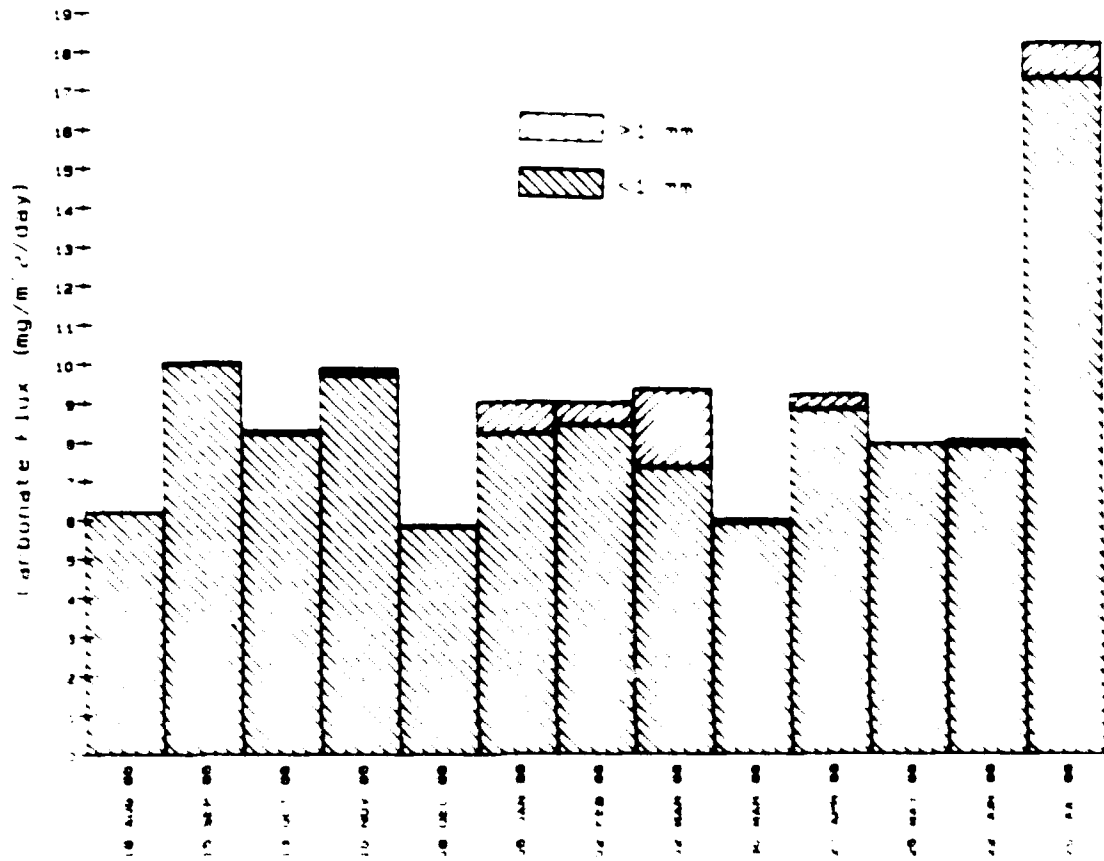

Noncombustible Flux at Greenland Basin 2, 3000m, 1985-6

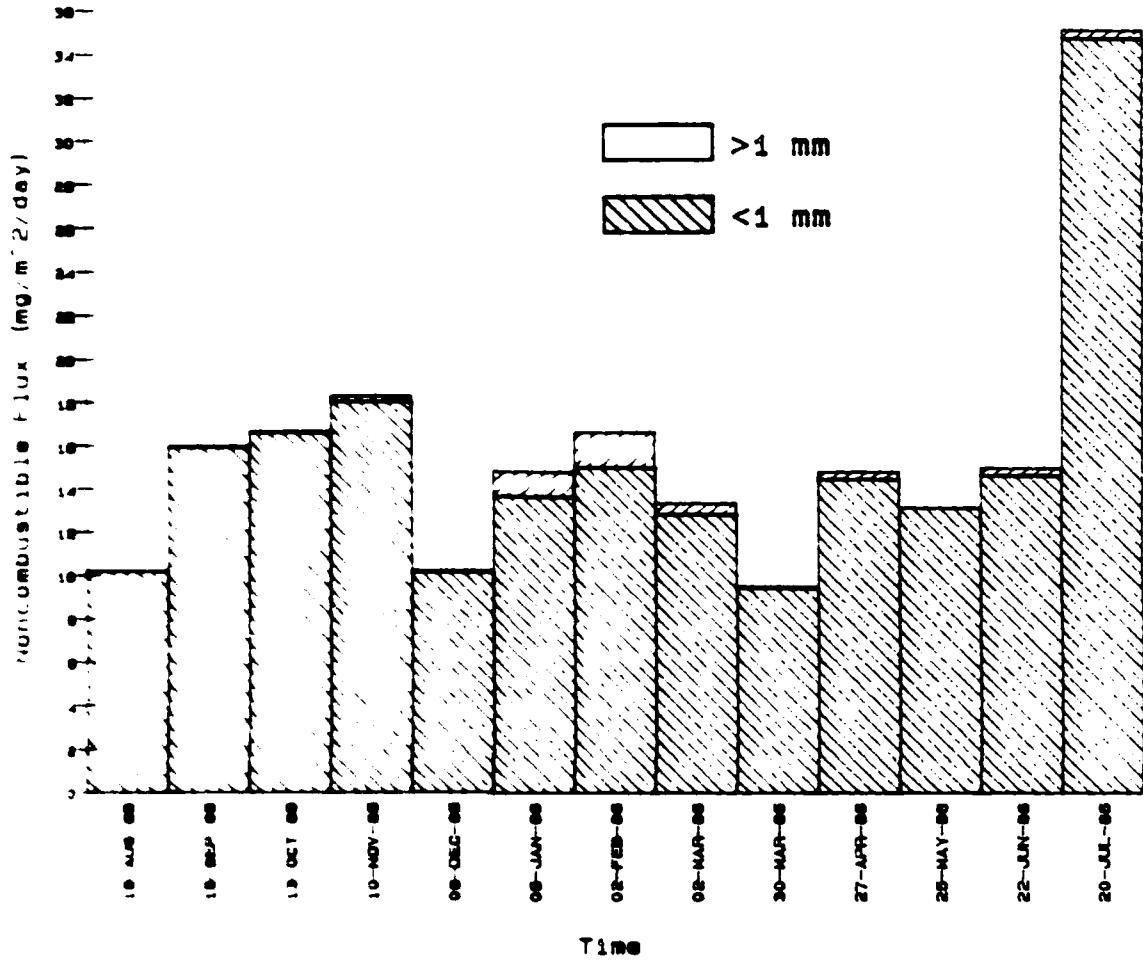

| | NONC | NONC % | NONC | NONC % | NONC | NONC % |
|------|------|--------|------|--------|-------|--------|
| | | total | | total | | total |
| 0.00 | 0.00 | 52.55 | 0.04 | 0.20 | 10.23 | 52.75 |
| 0.00 | 0.00 | 52.49 | 0.07 | 0.23 | 16.03 | 52.71 |
| 0.00 | 0.00 | 52.23 | 0.08 | 0.28 | 16.69 | 52.57 |
| 0.00 | 0.04 | 55.59 | 0.29 | 0.36 | 18.32 | 58.14 |
| 0.00 | 0.00 | 55.81 | 0.06 | 0.30 | 10.21 | 55.81 |
| 0.00 | 0.00 | 49.86 | 1.15 | 4.18 | 14.31 | 53.84 |
| 0.00 | 0.04 | 52.16 | 1.62 | 5.63 | 16.66 | 57.79 |
| 0.00 | 0.00 | 58.62 | 0.49 | 0.19 | 13.35 | 58.79 |
| 0.00 | 0.44 | 53.02 | 0.06 | 0.03 | 9.50 | 53.65 |
| 0.00 | 0.00 | 53.90 | 0.35 | 1.09 | 14.95 | 54.79 |
| 0.00 | 0.00 | 55.98 | | | 13.14 | 55.58 |
| 0.00 | 0.00 | 56.81 | 0.32 | 1.25 | 14.98 | 58.07 |
| 0.00 | 0.00 | 57.10 | 0.38 | 0.62 | 35.14 | 57.82 |

Combustible Flux at Greenland Basin 2, 3000m, 1985-86

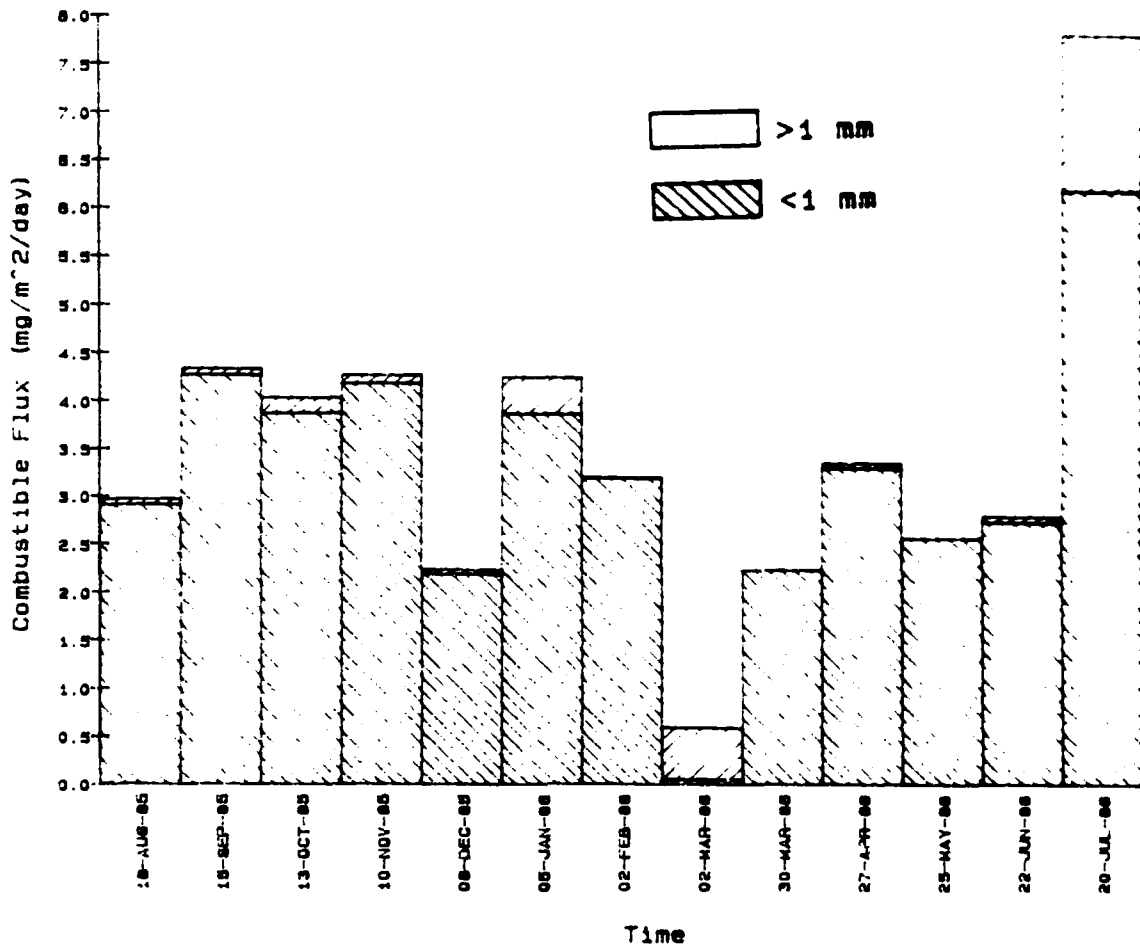

| Sample ID# | COMB ml | COMB % tot. l | COMB l | COMB % tot. l | COMB TOTAL | COMB % total |
|----------------|------------|------------------|-----------|------------------|---------------|-----------------|
| 18-SEP-1985-1 | 2.91 | 15.00 | 0.06 | 0.30 | 2.97 | 15.30 |
| 18-SEP-1985-2 | 4.27 | 14.04 | 0.07 | 0.23 | 4.34 | 14.26 |
| 13-OCT-1985-3 | 3.67 | 13.35 | 0.16 | 0.56 | 4.03 | 13.92 |
| 10-NOV-1985-4 | 4.18 | 12.67 | 0.09 | 0.28 | 4.27 | 13.15 |
| 08-DEC-1985-5 | 2.18 | 11.96 | 0.06 | 0.30 | 2.24 | 12.26 |
| 08-JAN-1986-6 | 3.65 | 14.01 | 0.39 | 1.40 | 4.24 | 15.41 |
| 02-FEB-1986-7 | 3.19 | 11.06 | 0.01 | 0.02 | 3.20 | 11.08 |
| 02-MAR-1986-8 | 0.05 | 0.23 | 0.54 | 2.39 | 0.59 | 2.61 |
| 30-MAR-1986-9 | 2.23 | 12.59 | 0.00 | 0.00 | 2.23 | 12.59 |
| 27-APR-1986-10 | 3.23 | 12.14 | 0.06 | 0.22 | 3.29 | 12.35 |
| 25-MAY-1986-11 | 2.56 | 10.92 | 0.00 | 0.00 | 2.56 | 10.92 |
| 22-JUN-1986-12 | 2.70 | 10.93 | 0.07 | 0.23 | 2.80 | 10.96 |
| 20-JUL-1986-13 | 7.80 | 12.73 | 1.53 | 2.59 | 7.81 | 12.93 |

Biogenic Siliceous Flux at Greenland Basin 2 3000m 1985-88

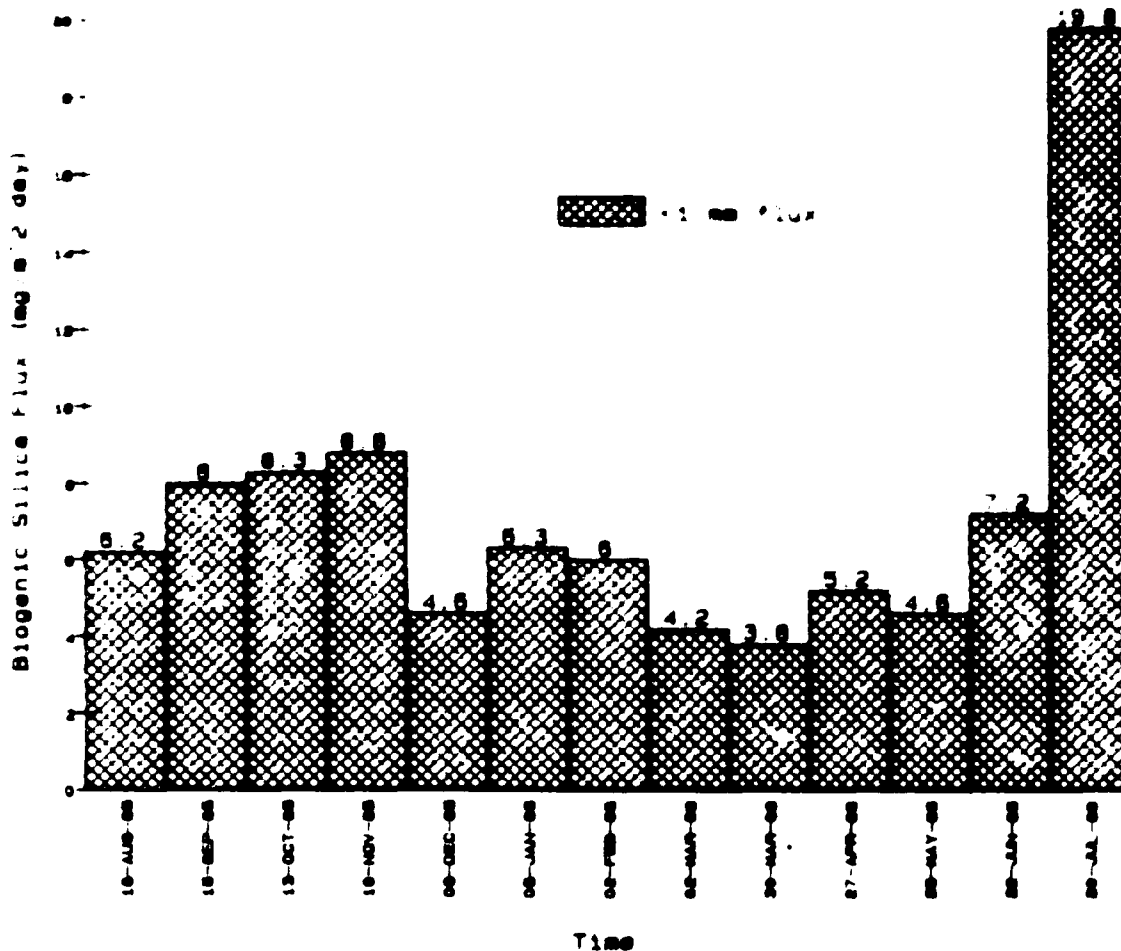

| Sample ID# | OPAL | OPAL % | OPAL % |
|-----------------|-------|--------|---------|
| | (mg) | (Ncf.) | (total) |
| 101 GB2-3000-1 | 5.18 | 50.40 | 31.56 |
| 102 GB2-3000-2 | 7.99 | 49.86 | 26.23 |
| 103 GB2-3000-3 | 8.34 | 49.37 | 29.77 |
| 104 GB2-3000-4 | 8.31 | 48.09 | 27.74 |
| 105 GB2-3000-5 | 4.58 | 44.84 | 25.07 |
| 106 GB2-3000-6 | 6.25 | 42.21 | 22.72 |
| 107 GB2-3000-7 | 5.99 | 35.96 | 20.78 |
| 108 GB2-3000-8 | 4.17 | 31.23 | 18.36 |
| 109 GB2-3000-9 | 3.78 | 39.81 | 21.36 |
| 110 GB2-3000-10 | 5.23 | 35.23 | 19.30 |
| 111 GB2-3000-11 | 4.60 | 35.01 | 19.46 |
| 112 GB2-3000-12 | 7.12 | 47.52 | 27.59 |
| 113 GB2-3000-13 | 19.83 | 56.43 | 32.69 |

Flux is in mg/m²/day.

(%Ncf.) = % of noncombustible flux.

Not enough 1 mm fraction to do analysis.

Lithogenic Flux at Greenland Basin 2, 3000 m, 1985-86

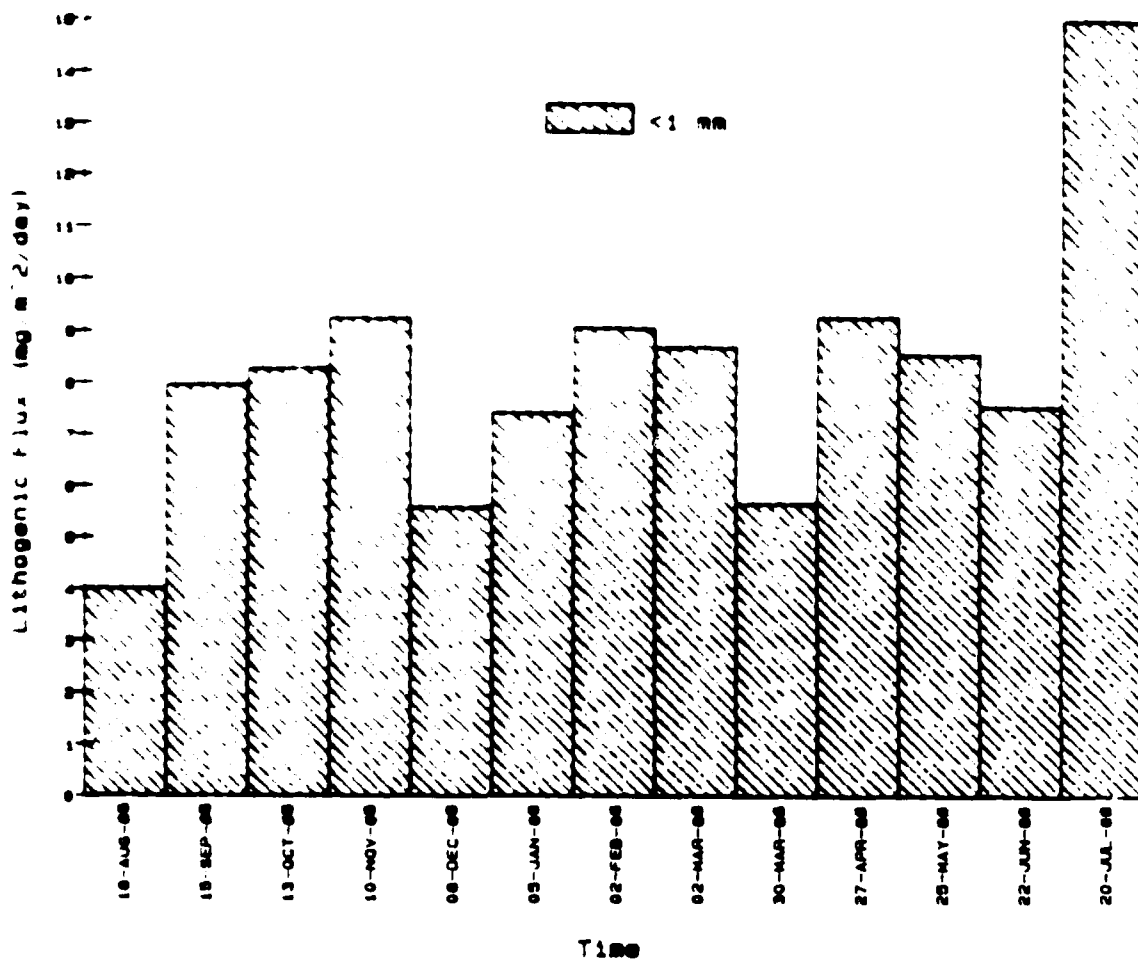

| Sample I.D. | LITH Fl | LITH<1 %Ncmb. | LITH<1 %tot. |
|-----------------|------------|------------------|-----------------|
| 101 GB2-3000-1 | 4.01 | 39.22 | 20.69 |
| 102 GB2-3000-2 | 7.97 | 49.71 | 26.20 |
| 103 GB2-3000-3 | 8.27 | 49.55 | 28.52 |
| 104 GB2-3000-4 | 9.23 | 50.39 | 28.44 |
| 105 GB2-3000-5 | 5.58 | 54.62 | 30.54 |
| 106 GB2-3000-6 | 7.41 | 50.03 | 26.93 |
| 107 GB2-3000-7 | 9.05 | 54.30 | 31.37 |
| 108 GB2-3000-8 | 8.69 | 78.70 | 38.26 |
| 109 GB2-3000-9 | 5.66 | 59.58 | 31.96 |
| 110 GB2-3000-10 | 9.27 | 62.41 | 34.20 |
| 111 GB2-3000-11 | 8.54 | 64.99 | 36.12 |
| 112 GB2-3000-12 | 7.54 | 50.32 | 29.22 |
| 113 GB2-3000-13 | 14.93 | 42.49 | 24.61 |

Flux is in mg/m²/day.

%Ncmb. = % of noncombustible flux.

Not enough <1 mm fraction to do analysis.

Carbon Flux at Greenland Basin 2, 3000m, 1985-86

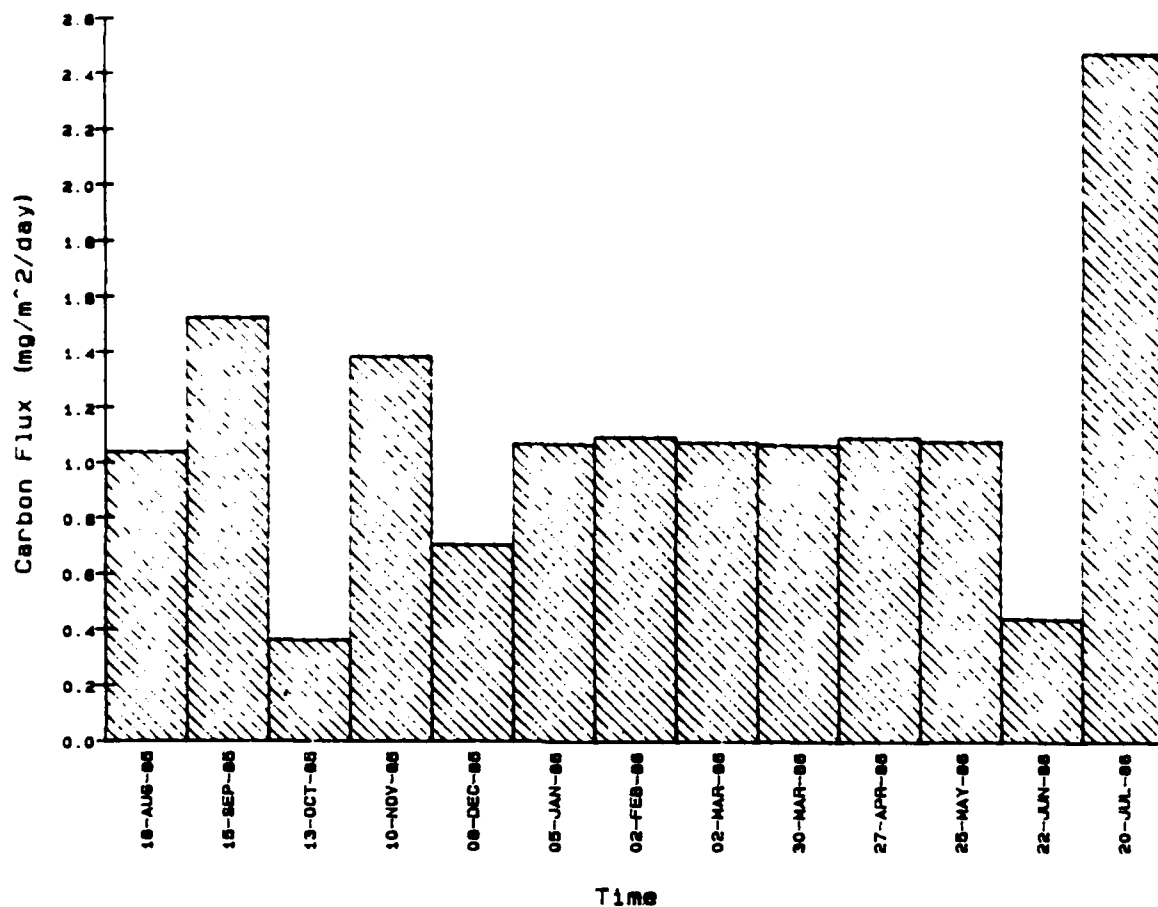

| Sample I.D. | CRNC | CRNC:1 |
|-----------------|------|----------|
| | (1) | % combf. |
| 101 GB2-3000-1 | 1.04 | 35.06 |
| 102 GB2-3000-2 | 1.52 | 35.12 |
| 103 GB2-3000-3 | 0.36 | 8.99 |
| 104 GB2-3000-4 | 1.38 | 32.43 |
| 105 GB2-3000-5 | 0.70 | 31.47 |
| 106 GB2-3000-6 | 1.07 | 25.21 |
| 107 GB2-3000-7 | 1.09 | 34.22 |
| 108 GB2-3000-8 | 1.08 | 37.24 |
| 109 GB2-3000-9 | 1.07 | 47.91 |
| 110 GB2-3000-10 | 1.10 | 32.72 |
| 111 GB2-3000-11 | 1.08 | 42.25 |
| 112 GB2-3000-12 | 0.44 | 15.77 |
| 113 GB2-3000-13 | 2.48 | 31.70 |

Flux is in mg/m²/day.

"% combf" = "% of combustible flux".

Not enough 1 mm fraction to do analysis.

Nitrogen Flux at Greenland Basin 2, 3000m, 1985-86

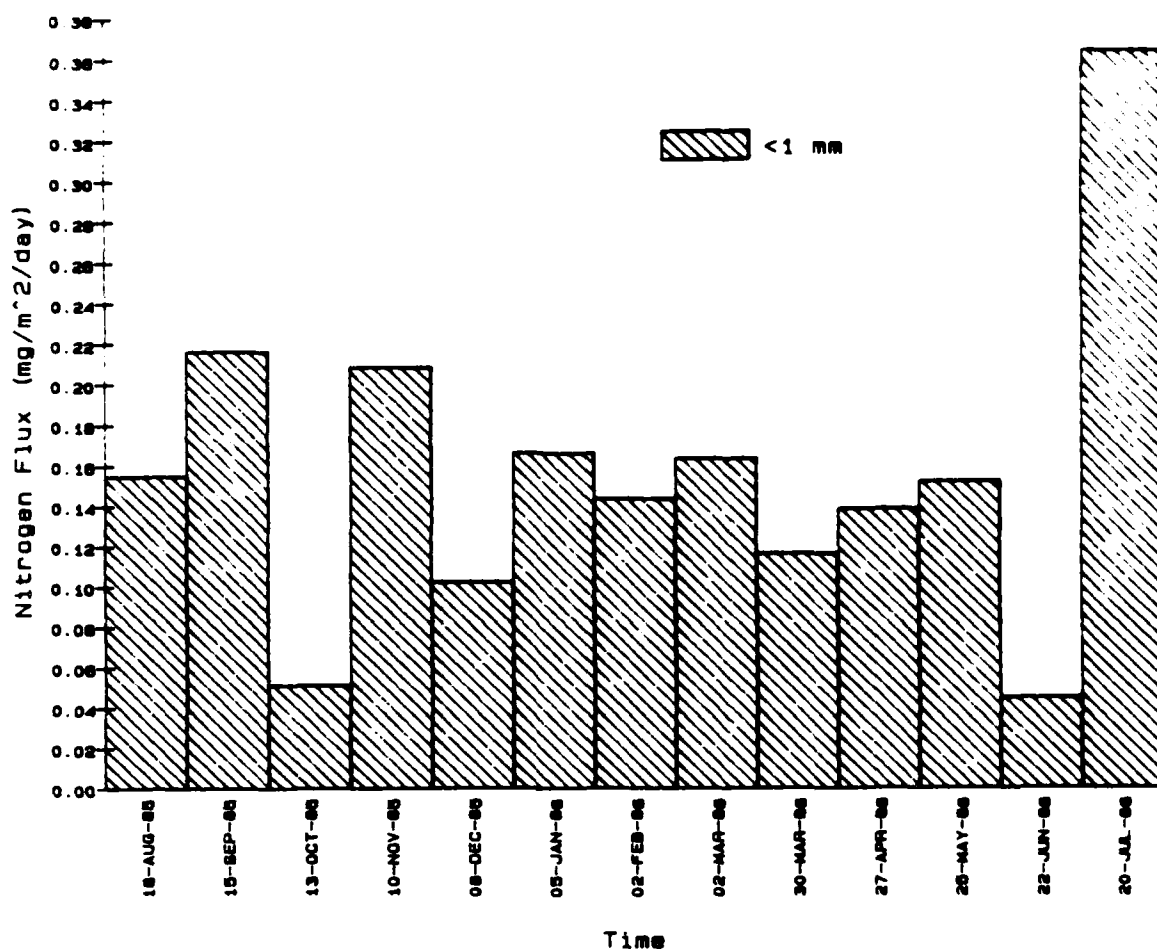

| Sample I.D. | NTGN %1 | NTGN-1 %cmbf. |
|-----------------|------------|------------------|
| 101 682-3000-1 | 0.15 | 5.21 |
| 102 682-3000-2 | 0.22 | 4.99 |
| 103 682-3000-3 | 0.05 | 1.27 |
| 104 682-3000-4 | 0.21 | 4.39 |
| 105 682-3000-5 | 0.10 | 4.57 |
| 106 682-3000-6 | 0.17 | 3.93 |
| 107 682-3000-7 | 0.14 | 4.51 |
| 108 682-3000-8 | 0.16 | 5.52 |
| 109 682-3000-9 | 0.12 | 5.24 |
| 110 682-3000-10 | 0.14 | 4.14 |
| 111 682-3000-11 | 0.15 | 5.95 |
| 112 682-3000-12 | 0.05 | 1.61 |
| 113 682-3000-13 | 0.36 | 4.66 |

Flux is in mg/m²/day.

"%cmbf" = "% of combustible flux".

Not enough <1 mm fraction to do analysis.

Hydrogen Flux at Greenland Basin 2, 3000m, 1985-86

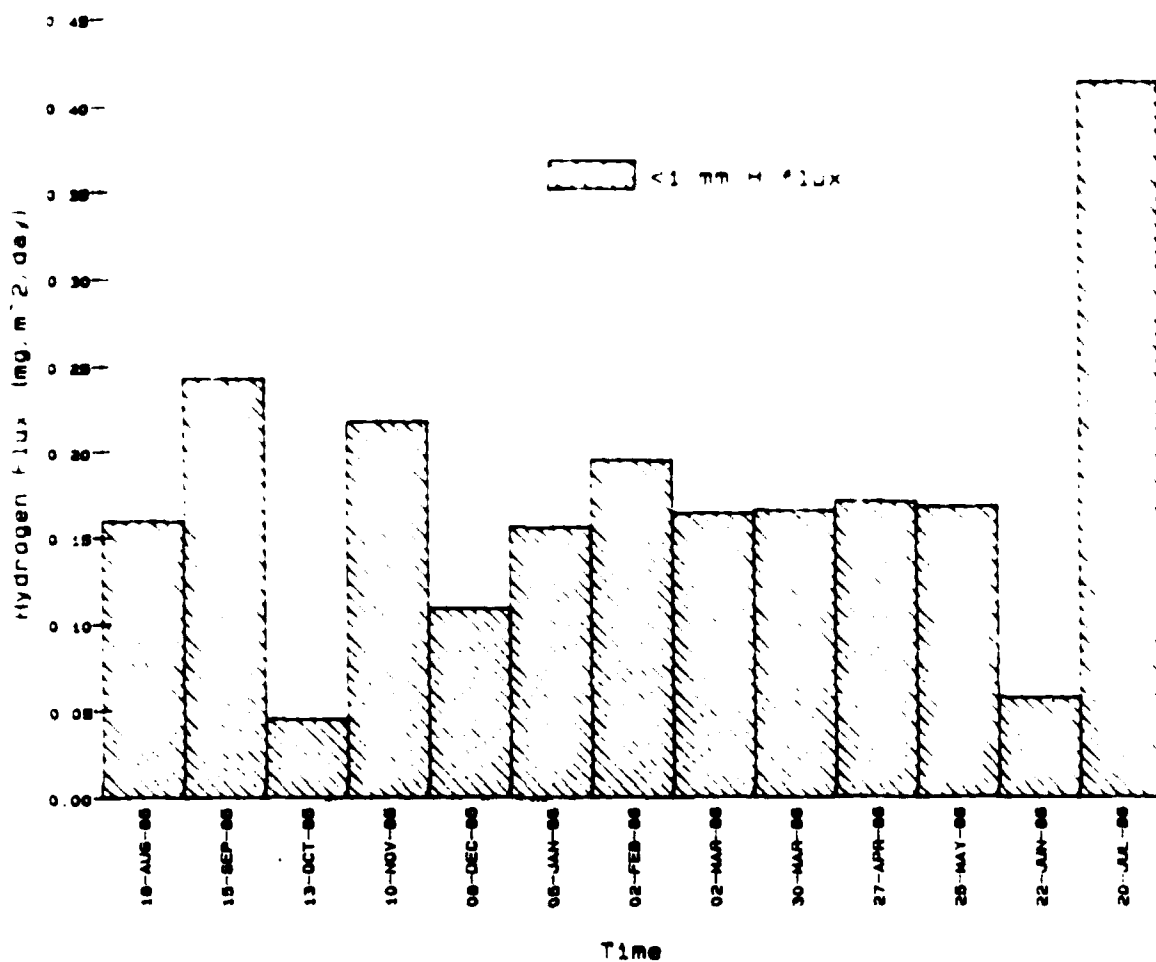

| Sample I.C. | HYDC | HYDC 1 |
|-----------------|------|----------|
| | % | % combf. |
| 101 682-3000-1 | 0.16 | 5.39 |
| 102 682-3000-2 | 0.24 | 5.60 |
| 103 682-3000-3 | 0.05 | 1.12 |
| 104 682-3000-4 | 0.22 | 5.10 |
| 105 682-3000-5 | 0.11 | 4.35 |
| 106 682-3000-6 | 0.16 | 3.68 |
| 107 682-3000-7 | 0.20 | 6.10 |
| 108 682-3000-8 | 0.16 | 5.52 |
| 109 682-3000-9 | 0.17 | 7.43 |
| 110 682-3000-10 | 0.17 | 5.10 |
| 111 682-3000-11 | 0.17 | 6.56 |
| 112 682-3000-12 | 0.06 | 2.05 |
| 113 682-3000-13 | 0.41 | 5.29 |

Flux is in mg/m²/day.
 "combf" = "% of combustible flux".
 Not enough < 1 mm fraction to do analysis.

REPORT DOCUMENTATION PAGE

1. REPORT NO
 WHOI-87-17

2. Recipient's Accession No

3. Report Date
 April 1988

4.

5. Performing Organization Report No
 WHOI-87-17

6. Project/Task/Work Unit No

7. Contract/Grant or Grant/Order No

(a)

(b) 50001-1-3-0-0001

8. Type of Report & Period Covered

Technical

9.

4. Title and Subtitle

Particle Fluxes in the Eastern Nordic Seas, 1983-1986
 Nordic Seas Sedimentation Data File, 1988

7. Author(s) Susumu Hori, Stephen J. Mangum, Amy J. W. W. Smithe, J. Woodward

9. Performing Organization Name and Address

Woods Hole Oceanographic Institution
 Woods Hole, Massachusetts 02543

12. Sponsoring Organization Name and Address

Office of Naval Research

15. Supplementary Notes

This report should be cited as: Woods Hole Oceanogr. Inst. Tech. Rept. WHOI-87-17

16. Abstract (Limit: 200 words)

Seventy-nine particle flux samples were collected from 1983 to 1986 using 7 automated time-series sediment traps at 6 stations distributed in the northern and eastern portion of the Nordic Seas as part of a German/U.S. joint program on arctic sedimentation studies. Each sample represents either one month or two weeks of sedimentation at approximately 400 m above the sea floor. In this data file the results of laboratory analysis conducted at the Woods Hole Oceanographic Institution, U.S.A. of the main sedimentological criteria: total mass, carbonate, opal, combustible, organic carbon, nitrogen, and lithogenic mass are presented in both tabular and histogram form. Results from the southern and western portion of the Nordic Seas will be published as they become available.

17. Document Analysis a. Descriptors

1. Nordic Seas
2. Material flux
3. Sediment trap

b. Identifiers/Open-Ended Terms

c. COSATI Field/Group

18. Availability Statement:

Approved for publication; distribution unlimited

19. Security Class (This Report)

UNCLASSIFIED

21. No. of Pages

84

20. Security Class (This Page)

22. Price

DOCUMENT LIBRARY

November 21, 1986

Distribution List for Technical Report Exchange

Institute of Marine Sciences Library
University of Alaska
O'Neill Building
905 Koyukuk Ave., North
Fairbanks, AK

Attn: Stella Sanchez-Wade
Documents Section
Scripps Institution of Oceanography
Library, Mail Code C-075C
La Jolla, CA 92093

Hancock Library of Biology & Oceanography
Alan Hancock Laboratory
University of Southern California
University Park
Los Angeles, CA 90089-0371

Gifts & Exchanges
Library
Bedford Institute of Oceanography
P.O. Box 1006
Dartmouth, NS, B2Y 4A2, CANADA

Office of the International
Ice Patrol
c/o Coast Guard R & D Center
Avery Point
Groton, CT 06340

Library
Physical Oceanographic Laboratory
Nova University
8000 N. Ocean Drive
Dania, FL 33304

NOAA, EDIS Miami Library Center
4301 Rickenbacker Causeway
Miami, FL 33149

Library
Skidaway Institute of Oceanography
P.O. Box 13687
Savannah, GA 31416

Institute of Geophysics
University of Hawaii
Library Room 252
2525 Correa Road
Honolulu, HI 96822

Library
Chesapeake Bay Institute
4800 Atwell Road
Shady Side, MD 20876

MIT Libraries
Serial Journal Room 14E-210
Cambridge, MA 02139

Director, Ralph M. Parsons Laboratory
Room 48-311
MIT
Cambridge, MA 02139

Marine Resources Information Center
Bldg. E38-320
MIT
Cambridge, MA 02139

Library
Lamont-Doherty Geological Observatory
Columbia University
Palisades, NY 10964

Library
Serials Department
Oregon State University
Corvallis, OR 97331

Pell Marine Science Library
University of Rhode Island
Narragansett Bay Campus
Narragansett, RI 02882

Working Collection
Texas A&M University
Dept. of Oceanography
College Station, TX 77843

Library
Virginia Institute of Marine Science
Gloucester Point, VA 23062

Fisheries-Oceanography Library
151 Oceanography Teaching Bldg.
University of Washington
Seattle, WA 98195

Library
R.S.M.A.S.
University of Miami
4600 Rickenbacker Causeway
Miami, FL 33149

Maury Oceanographic Library
Naval Oceanographic Office
Bay St. Louis
NSTL, MS 39522-5001
ATTN: Code 4601

END

9-87

DTIC