

AD-A181 907

GRID COMPAS COMPUTERS ENGINEERING EVALUATION(U)
ENGINEERING DEVELOPMENT ESTABLISHMENT MARIBURNONG
(AUSTRALIA) J MUIR 22 MAY 87 EDE-4/87

1/1

UNCLASSIFIED

F/G 12/6

ML

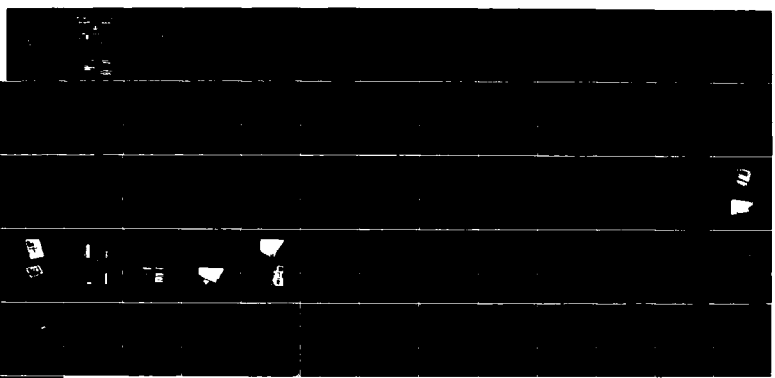

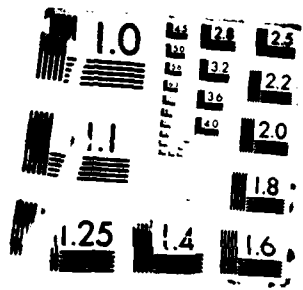

DTIC FILE COPY



AD-A181 907



AUSTRALIAN ARMY

DTIC
LECTURE
NOV 4 87

D
A



D

ENGINEERING DEVELOPMENT ESTABLISHMENT

GRID COMPASS COMPUTERS

ENGINEERING EVALUATION

EDE-PUBLICATION 4/87 ✓

APPROVED
FOR PUBLIC RELEASE

DEFENCE SYSTEMS
Approved by public release
Authority Unknown

[Faded stamp]

[Faded stamp]

DT 6 23 87

12

AR-002-724



AUSTRALIAN ARMY

DTIC
ELECTE
JUN 24 1987
S D D



ENGINEERING DEVELOPMENT ESTABLISHMENT

GRID COMPASS COMPUTERS

ENGINEERING EVALUATION

EDE-PUBLICATION 4/87 ✓

Prepared and issued under my direction.

MARIBYRNONG VICTORIA

PRIVATE BAG 12
PO ASCOT VALE
VICTORIA 3032

(G.T. Salmon)
Brigadier
Commander

22 May 87

DISTRIBUTION STATEMENT II
Approved for public release
Distribution Unlimited

ENGINEERING DEVELOPMENT ESTABLISHMENT

GRID COMPASS COMPUTERS

ENGINEERING EVALUATION

BY

J. MUIR

SUMMARY

1. This report gives details of an engineering evaluation made by Engineering Development Establishment (EDE) of two GRID Compass portable computers, one of which is Tempest certified.

2. It is concluded that the units are suitable for field use provided they are handled with care, are provided with a transit case for transport, and measures are taken to protect the equipment from direct exposure to dust and direct sunlight. If mounted in tracked vehicles suitable vibration isolation techniques would need to be employed. Durability performance could be significantly improved by more secure mounting of certain components within the units.

3. It is noted that there are many similar computers available which provide increased performance and/or functionality at less cost than the GRID Compass computers. However, for field use their environmental/durability performance would have to be investigated. Annex C contains a preliminary survey of commercially available portable computers which are similar in concept to the GRID Compass range and which could provide a suitable alternative to the Grid models.



Accession For	
NTIS CRA&I	<input checked="" type="checkbox"/>
DTIC TAB	<input type="checkbox"/>
Unannounced	<input type="checkbox"/>
Justification	
By	
Distribution/	
Availability Codes	
Dist	Avail and/or Special
A-1	

CONTENTS

	<u>Page</u>
SUMMARY	ii
CONTENTS	iii
DISTRIBUTION	v
	 <u>Para</u>
INTRODUCTION	1
AIM	2
GENERAL	3
Equipment Supplied	3
Equipment Specification	6
HARDWARE EVALUATION	8
Construction	8
Communications Capability	14
Expansion Capability	19
Floppy Disk	20
Bubble Memory	21
Display	23
Keyboard	29
Power Consumption	31
Rechargeable Battery System	35
SOFTWARE EVALUATION	37
MSDOS Software	39
GRIDOS Software	41
PERFORMANCE EVALUATION	44
Mass Storage Benchmarks	45
CPU Performance Benchmarks	48
EMI/EMC EVALUATION	51
Radiated and Conducted Emissions	55
Radiated and Conducted Susceptibility	70
CLIMATIC EVALUATION	73
High Temperature, Low Humidity	73
Constant High Temperature, Low Humidity	86
Constant Low Temperature	89
Low Temperature, Low Pressure	95
High Temperature, High Humidity	100
Dust	102
Salt Corrosion	108
DURABILITY EVALUATION	112
Resonance Search	114
Vibration (Random, Tracked Vehicles)	119
Vibration (Random, Wheeled Vehicles)	124
Shock	126
Bump	128
Free Fall	131
CONCLUSIONS	136
RECOMMENDATIONS	137

CONTENTS

	<u>Para</u>
ANNEX A - CPU PERFORMANCE BENCHMARK	
ANNEX B - EMI/EMC RESULTS	
ANNEX C - SURVEY OF COMMERCIALY AVAILABLE PORTABLE COMPUTERS	
INTRODUCTION	1
SURVEYED MACHINES	3
Compaq Portable II	6
Dulmont Magnum Portable (alias Kookaburra)	9
GRIDCASE Plus 2 and Plus 3	12
Hewlett Packard Portable PLUS	15
IBM PC Convertible	18
Sharp PC-7000	21
Toshiba T1100 Plus	24
Toshiba T3100	27
CONCLUSIONS	30

DISTRIBUTION

<u>Addressees</u>	<u>No of Copies</u>
<u>Army Office</u>	
OPS BR	4
LOG BR	1
MAT BR	
DGAQA	1
DVP	1
DCCP	6
DEGP	1
DAP	1
<u>Navy Office</u>	
DNED	1
DNWD	1
DNCD	1
DCDSC	1
<u>Air Office</u>	
DRR-AF	1
DGOR-AF	1
DCE-AF	1
<u>Defence Central</u>	
DGJCE	1
<u>Defence Science and Technology Organization</u>	
DRCS	
SUP CEE DIV, AEL	1
SUP EW DIV, ERL	1

AddresseesNo of CopiesLibraries

Defence Central - Technical Report Centre (Campbell Park)	1
Defence Regional - Victoria	1
ARL	1
MRL	1
DRCS	1

Internal

CE(S)	1
CE(T)	1
CE(A)	1
CE(C)	1
Library	1
Author	1
File	2
S&P	1

Total	<u>1</u> 39
-------	----------------

ENGINEERING DEVELOPMENT ESTABLISHMENT

GRID COMPASS COMPUTERS

ENGINEERING EVALUATION

BY

J. MUIR

REFERENCES

- A. Minute CMAT 385/84 A83/4178 dated 26 October 84
- B. Military Standard MIL-STD-461B, Part 4
- C. Military Standard MIL-STD-462 Notice 3 of Feb 71
- D. DEF STAN 07-55 Part 2 Section 1/1
- E. DEF STAN 07-55 Part 2 Section 2/1
- F. DEF STAN 07-55 Part 2 Section 3/1
- G. DEF STAN 07-55 Part 2 Section 4/1

INTRODUCTION

1. The GRID Compass range of portable computers is manufactured by GRID Systems Corporation (USA). The computers are based on Intel 8086/8087 microprocessors and operate with either Microsoft's MSDOS operating system or a proprietary operating system of GRID Systems called GRIDOS. Reference A requested that Engineering Development Establishment (EDE) evaluate Standard Model 1100 GRID Compass and Tempest Model 1107 GRID Compass computers procured under CAPO N.143460. The Tempest Model 1107 GRID Compass computer is Tempest certified to the requirements of NACSIM 5100A. The evaluation was to cover :-

- a. EMC/EMI and mechanical/environmental characteristics.
- b. performance, including operation beyond the limits specified by the manufacturer (eg. temperature) in order to determine the potential for survival in a military environment.

- c. expansion capacity including use with other peripheral or main processing equipments.
- d. operation over Telecom and military communication links.

AIM

2. The aim of this document is to report on the results of EDE conducted tests and trials of the GRID Compass computers and to make recommendations regarding their suitability for use in a military role.

GENERAL

Equipment Supplied

3. The following equipment was supplied for evaluation :-
- a. Standard Model 1100 GRID Compass Computer (serial number 007394)
 - b. Tempest Model 1107 GRID Compass Computer (serial number 009418).

4. Internal modems were not supplied with either computer thereby limiting the evaluation of the computers communications capability.

5. Throughout this report the Standard Model 1100 GRID Compass computer is referred to as the Standard GRID computer and the Tempest Model 1107 GRID Compass computer as the Tempest GRID computer.

Equipment Specification

6. The GRID Compass range of computers are mains powered portable self contained computers with the following features :-

- | | |
|-----------|--|
| Processor | - Intel 8086, 6MHz clock
Intel 8087 coprocessor, 4 MHz clock |
| Memory | - 384 KByte bubble memory, plus:
256 KByte random access memory (RAM) for the Standard Model 1100 GRID computer
512 KByte RAM for the Tempest Model 1107 GRID computer |
| Keyboard | - QWERTY layout, 57 keys |

- Display** - Electro-luminescent flat panel (amber)
6 inch (15 cm) diagonal
Up to 24 line by 80 column text display
depending on the character font
320 by 240 pixel graphic display
66 Hz refresh rate
- Interfaces** - GPIB interface (IEEE-488)
RS232C/RS422 serial port (asynchronous and
synchronous)
- Real time clock** - Lithium battery powered
- Dimensions** - 38 x 29 x 5 cm
- Weight** - 4.9 Kilograms for Standard Model 1100 GRID
6.1 Kilograms for Tempest Model 1107 GRID
- Power** - 90V to 140V or 160V to 280V user selectable
47Hz to 66Hz
Approximately 60 Watts

7. The manufacturer claims the following environmental specifications :-

- Operating** - +10°C to +40°C for Standard Model 1100 GRID
+10°C to +55°C for Tempest Model 1107 GRID
up to 3000 metres altitude
5% to 95% relative humidity non-condensing
- Storage** - -40°C to +65°C
up to 12000 metres altitude
- Shock** - 100 g 40ms half sine pulse (operating)
- Vibration** - 0.5 g 3 Hz to 300 Hz (operating)

HARDWARE EVALUATION

Construction

8. The GRID Compass range of computers (Fig 1) are packaged in a cast magnesium metal case with a protective matt black surface finish. The display is enclosed within a hinged panel which folds down to cover the keyboard. The connectors for the power supply and serial and GPIB interfaces along with the power on/off switch, fuse and power supply voltage selector (110 Volt or 220 Volt) are all mounted on the rear panel (Fig 2).

9. The internal layout of the Standard GRID computer is shown in Fig 3. The main multi-layer printed circuit board is mounted with the component side face down. The bubble memory modules and a lithium battery for maintaining power to the real time clock are mounted on the solder side of the main printed circuit board. The keyboard connects to the main board via a flexible circuit board and connector. The power supply is mounted at the right rear with the component side down. A heat sink on the power supply board makes thermal contact with the base of the case. The serial and GPIB connectors on the rear panel connect to the main board via multi-way connectors.

10. The electro-luminescent display is an original equipment manufacturer (OEM) module manufactured by Sharp Electronics of Japan. It is encased in a hinged panel which covers the keyboard when closed. Electrical connections from the display to the main circuit board are made via a single multi-way connector. The internal layout of the display panel for the Standard GRID computer is shown in Fig 4.

11. The Model 1107 GRID computer is Tempest certified and has an identical internal layout to the Standard GRID computer but includes extensive shielding of the main printed circuit board and display (Fig 5). The main printed circuit board is contained in a steel enclosure with adhesive copper tape used to patch any gaps. The serial and GPIB ports have additional filter circuitry. The power supply has no additional shielding or filtering. The display module (Fig 6) is enclosed in a shield constructed of copper sheet and adhesive copper tape with a conductive but transparent screen over the display area.

12. A slot on each side of the case near the display hinges provides some limited air ventilation but will also allow the ingress of dust and moisture. In addition, the Tempest GRID computer has a small fan for forced air flow through the unit. The air inlet for the fan is on the rear panel. No dust filter is provided.

13. Discussion. The GRID Compass computers are considered to be of good commercial build standard.

Communications Capability

14. The GRID Compass computers have the following communications capabilities :-

- a. One RS232/RS422 asynchronous/synchronous serial communications port capable of operating at speeds up to 9600 baud.
- b. One GPIB (IEEE-488) port.

15. The GPIB port is used as a general purpose interface for the external floppy disk and printer. Extra devices can be 'daisy chained' onto the port and can be utilized provided the appropriate device drivers are integrated into the operating system.

16. An internal BELL standard 300/1200 baud modem is available for the computers but this was not made available to EDE for testing.

17. The communications capability of the machines, via the serial port, was tested using the VT100/Reformat communications package supplied with the machines. Successful communications and file transfer was achieved between the GRID computers and a number of other computers at EDE.

18. Discussion. The GRID computers are limited to communications through a single serial port. Consequently concurrent communications with multiple devices (eg. a host computer and a communications link) is not possible.

Expansion Capability

19. Expansion capability of both GRID Computers is limited to the GPIB interface. Extra peripherals are 'daisy chained' to this port. There is no provision for upgrading the bubble or system memory capacity or for adding extra I/O ports.

Floppy Disk

20. The GRID Compass computers were supplied with an external 360 KByte IBM PC format 5 $\frac{1}{4}$ " floppy disk unit which is accessed via the GPIB port. No environmental/durability or EMI/EMC testing was performed on this unit but the nature of floppy disk units limits their use to office type environments.

Bubble Memory

21. Both the Standard and Tempest GRID Compass computers incorporate 384 KBytes of internal bubble memory, based on Intel devices, which is accessed by the operating system as a device similar to a floppy disk. This feature allows the units to be independent of any external mass storage devices. A discussion of bubble memory performance is included in the performance evaluation (paragraphs 45 to 47).

22. Discussion. There are a number of negative aspects which should be noted concerning the use of bubble memories :-

- a. Bubble memories are burdened by high power consumption (for the implementation in the GRID Compass computers the active power consumption is approximately 4.5 watts) and are generally not suitable for roles where equipment must be battery powered.
- b. Bubble memories are considered a security risk for storing classified information. With the exception of physical destruction, the only satisfactory way to erase the contents of a bubble memory is to either reformat it, which takes approximately three minutes in the case of the GRID Compass, or to expose it to an intense magnetic field. Exposure to a magnetic field will probably render the device totally inoperable and require specialized equipment to restore operation. In any case, both processes require electrical power to erase the data, and this may not be available during an emergency. By contrast, battery backed up CMOS static RAM has a much lower power consumption, is faster than bubble memory and can be erased rapidly by removing the power source.
- c. The future of bubble memories in both the military and commercial sectors appears to be uncertain with the recent announcement by Intel (October 86) that it will no longer be manufacturing bubble memories due to the non profitability of the technology. This leaves Fujitsu and Hitachi of Japan as the only manufacturers currently producing bubble memories.

Display

23. The display of the Standard and Tempest GRID computers is a 15 cm (diagonal) electro-luminescent type manufactured as an OEM item by Sharp Electronics of Japan. The units are memory mapped allowing rapid display of graphics and text.

24. There are two text character fonts. The character font available with the GRIDOS operating system is selectable from either a 5 by 3 matrix for 80 column displays or 7 by 5 matrix for 53 column displays. With MSDOS the narrow 5 by 3 size font is the only font available. Note that later models of the GRID Compass computers have a physically wider display which allows a 7 by 5 size character font with 80 columns under MSDOS.

25. The display also offers a graphics capability with a display resolution of 320 (horizontal) by 240 (vertical) pixels. An evaluation of real time graphics was not possible due to the unavailability of suitable software. Graphical display of data was performed using the LOTUS 123 spreadsheet software.

26. Discussion. The display resolution is considered adequate for display of information requiring low resolution such as simple graphs from spreadsheets. It is inadequate for display of more complex data such as geographical maps.

27. The narrow 5 by 3 size font is very difficult to read with characters such as 'M' and 'N' being virtually indistinguishable. The 7 by 5 size font is considered to be the minimum size font which allows for adequate character recognition.

28. The display has good readability in dim to bright lighting situations. Direct incident light makes the display extremely difficult to read. The addition of the transparent conductive screen covering the display of the Tempest GRID computer attenuates the light emitted resulting in further degradation of readability in difficult lighting conditions.

Keyboard

29. The keyboard for the GRID computers is a full travel type with 57 membrane type switches. Key action/tactile feel is provided by a collapsible rubber boot. The key tops are of injection molded plastic and are removable. The keyboard uses a QWERTY layout but does not include characters such as '[', ']', '{', '}', '~', '|', '^' or '\` on the key tops. This necessitates the simultaneous pressing of several keys to obtain these characters. For example to obtain the back-slash character '\` the keys 'CODE', 'SHIFT' and ';' must be pressed simultaneously.

30. Discussion. The keyboard has adequate tactile feedback and key size but is awkward and inefficient to use if the special keys listed in paragraph 29 are frequently required.

Power Consumption

31. Measured power consumption of the Standard GRID computer was 55 watts and that of the Tempest GRID computer was 57 watts.

32. Discussion. The power consumption is excessive for sustained operation from any type of battery system.

Rechargeable Battery System

33. During the evaluation EDE also examined the rechargeable battery system available for the GRID computers. The system consists of the following items :-

- a. a 12 Volt 4.5 Amp capacity nickel cadmium battery (20 x 13 x 4 cm, 1.8 kg) with a resealable safety vent and a maximum output of 100 watts.
- b. a separate 12 Volt DC to 220 Volt AC inverter (8 x 4 x 5.5 cm, 0.3 kg).
- c. a 240 Volt AC to 12 Volt 500 mA plug pack (9 x 6 x 5.5 cm, 0.6 kg) to recharge the battery.

34. The inverter is powered by the battery pack and generates 220 Volt AC for direct connection to the mains power input of the computer. A low battery indicator activates a buzzer when power failure is imminent. This alarm activates 30 seconds before the computer ceases operation.

35. Results. Several battery life tests were performed. In all tests the battery was charged continuously for 20 hours and the computer powered up and left to idle at the operating system prompt. No external devices were attached. The maximum operating life obtained was 1 hour 5 minutes.

36. Discussion. The battery/inverter is compact and suited to portable requirements although battery life is short due to heavy power consumption. The warning time of 30 seconds before power failure is usually insufficient to save all the data being processed.

SOFTWARE EVALUATION

37. Two operating systems are currently available for the GRID Compass computers. They are GRID Systems GRIDOS and Microsoft's MSDOS (Version 2.11) which has become a default industry standard for computers using 16 bit Intel microprocessors.

38. Discussion. Although the GRID computers run MSDOS, they are not compatible with the IBM PC range of computers. Consequently they cannot run the vast majority of software available for IBM PC's.

MSDOS Software

39. To evaluate the compatibility of the GRID Compass computers with MSDOS software, the following MSDOS software packages were tested :-

- a. MDBS KnowledgeMan V1.06
- b. LOTUS 123 Version 1A with GRID Compass screen driver
- c. Microsoft MSDOS BASIC Compiler Version 5.56
- d. Microsoft MSDOS BASIC Interpreter Version 5.28
- e. Microsoft MSDOS C Compiler Version 3.00
- f. Microsoft MSDOS Macro Assembler Version 3.00
- g. Microsoft MSDOS Pascal Version 3.30
- h. Norton Utilities V3.0 (IBM PCDOS version)
- i. Borland Turbo Pascal V3.01A with 8087 and BCD options (MSDOS version)
- j. MicroPro Wordstar V3.3 with GRID Compass screen driver

40. Results. In all cases the computer and software operated correctly.

GRIDOS Software

41. GRID Systems proprietary operating system, GRIDOS, is menu driven and has a number of business tools available from the manufacturer including word processing and spreadsheet/graphics software. The evaluation of both computers operating with GRIDOS was limited due to the unavailability of this applications software.

42. Results. The only application program available to EDE for GRIDOS was VT100/Reformat, a communications package. It operated correctly, providing satisfactory communications with several other different computer systems.

43. Discussion. The menu structure of GRIDOS is rigid and considered to be a hindrance to the experienced user since all commands must be entered via menus. GRIDOS appears to offer no functional or performance advantage over MSDOS and suffers from the lack of third party applications software.

PERFORMANCE EVALUATION

44. To evaluate the performance of the GRID computers, mass storage and CPU intensive benchmark tests were run. As a comparison the same benchmarks were performed on several other microcomputer systems available at EDE. These systems included both floppy and hard disk based mass storage facilities but no bubble memory storage. The other microcomputer systems and their features are as follows :-

- a. IBM PC/2
 - one 5 $\frac{1}{4}$ " floppy disk
 - one 25 MByte hard disk (stepper motor head positioning)
 - 512 KBytes of RAM
 - 8088 processor
 - 8087 coprocessor
 - 4.77 MHz clock
 - Running PC-DOS 3.1

- b. Intel 310/286
 - one 5 $\frac{1}{4}$ " floppy disk
 - one 17 MByte hard disk (stepper motor head positioning)
 - 512 KBytes of RAM
 - 80286 processor
 - 80287 coprocessor
 - 5 MHz clock
 - Running Intel 310 MSDOS 2.11

- c. Dulmont Magnum Portable (alias Kookaburra)
 - two 5 $\frac{1}{4}$ " floppy disks
 - 256 KBytes of RAM
 - 80186 processor
 - 6 MHz clock
 - Running MSDOS 2.11

Mass Storage Benchmarks

45. The Standard and Tempest GRID computers both include an internal bubble memory storage capacity of 384 KBytes and are capable of interfacing to an external 5 $\frac{1}{4}$ " floppy disk drive via the GPIB interface. To test the relative speed of the GRID computers bubble memory and floppy disk based storage systems a text file of 113 KBytes was copied from one storage device to another physical location on the same storage device using the operating system COPY command. Similar tests were performed on the other computers referred to in paragraph 44. In all cases the operating systems' automatic 'verify after write' was disabled.

46. Results and Discussion The results, presented in Table 1 and shown graphically in Fig 7, indicate the GRID Compass computers to be relatively slow when accessing the floppy and bubble memory storage devices. The 'floppy disk' copy times are almost four (4) times that of the IBM PC. The 'bubble memory' copy times are approximately two (2) times that of the IBM PC 'floppy disk' copy times. The 'floppy disk' copy times for the Intel 310/286 and Magnum are also relatively slow with copy times approximately the same as the GRID computers. The 'hard disk' copy times for the IBM PC and Intel 310 are much faster than any of the floppy or bubble copy times.

47. In summary the mass media transfer rate of the GRID computers is considered to be poor when compared to an IBM PC. Mass storage intensive programs can be expected to run much slower (possibly up to 3 to 4 times slower) than they would on an IBM PC.

CPU Performance Benchmarks

48. The Standard and 1107 GRID Compass computers have Intel 8086 main processors with an 8087 co-processor available for floating point arithmetic. To test the relative performance of the two GRID computers a Sieve prime number generating program compiled with MicroSoft C Version 3.0 was used as a CPU intensive benchmark program. The program, listed in Annex A, was written using floating point variables to allow evaluation of the co-processor performance. The same compiled code was also run on the other computers referred to in paragraph 44.

49. Results and Discussion. The results relative to an IBM PC with no 8087 are presented in Table 2 and shown graphically in Fig 8. An IBM PC with no 8087 has a relative index of 1.0. Therefore a computer with twice the performance would have a relative index of 2.0. Without the 8087, the GRID computers exhibit approximately a 40% performance improvement over a standard IBM PC but have approximately half the performance of the Intel 310/286 machine. With the 8087 the GRID computers performance improves dramatically and is on a par with the Intel 310 when using its 80287 co-processor.

50. Note that these benchmarks give only a relative performance for different computers when main processor and co-processor (floating point arithmetic) intensive programs are in execution. Application programs which have poorly written co-processor support or are not very co-processor intensive will not exhibit such dramatic speed improvements.

51. In summary, the GRID computers have a processor performance which is slightly faster than a standard IBM PC. The GRID computers are considered to have adequate performance for most applications not requiring extensive processing power (eg word processing, communications). For applications requiring extensive processing power (eg. graphics, matrix manipulations) the performance of the GRID computers may be found inadequate unless the application software makes specific use of the 8087 coprocessor.

EMI/EMC EVALUATION

52. Both GRID computers were tested for radiated and conducted broadband and narrowband emissions in general accordance with methods RE02 and CE03 of Ref C. Both GRID computers were also subjected to radiated and conducted susceptibility tests in general accordance with methods RS03, CS02, CS06 of Ref C.

53. The tests were performed in a screened room measuring approximately 14m x 10m x 6m with a 3 metre long shielded two core cable connected to the computer's RS232C/RS422 serial port.

54. Radiated and conducted emissions tests were performed with the test equipment and personnel being located in a small annex to the main screened room.

55. The results of all tests are presented graphically in figures 15 to 29 of Annex B and summarized in Table 3. Paragraphs 56 to 72 are a detailed description of the test procedures and results.

Radiated and Conducted Emissions

56. Test Procedure. Before commencing testing, the GRID computers were probed to determine the region of maximum radiated emissions. During this initial probing, with the display panel open, the computers were exercised with each one of the following five programs :-

- a. Send 'Quick Brown Fox' message to screen.
- b. Send 'Quick Brown Fox' message to serial port.
- c. Send ASCII 'U' character to screen.
- d. Send ASCII 'U' character to serial port.
- e. Continuous program loop.

57. Maximum radiated emissions were detected with the probe directly in front of the display panel. The level of radiated emissions was not governed by any of the five program options listed in paragraph 56.

58. The GRID computers were tested for radiated and conducted broadband and narrowband emissions with the exercising program 'a' in paragraph 56.

59. All radiated emissions were performed with the computers mounted on a 1 metre high pedestal and the antennae located in front of the opened display panel (ie. the area of maximum emissions). The distance between the antennae and the display was 1 metre as required by Ref C. An approximate 1 metre length of the RS232 serial cable was routed to the floor down the vertical surface of the pedestal closest to the antennae. The remaining length (approx 2 metres) was laid straight on to the ground plane area of the room.

60. Extra radiated narrowband emissions tests were performed on both computers with modified test conditions as follows :-

- a. The RS232 serial port connector was disconnected from the back of the computer but the cable was left routed as outlined in paragraph 59.
- b. The display panel was closed to cover the keyboard.

61. Results. Test results for each GRID computer are presented graphically in Annex B figures 15 to 29 and summarized in Table 3.

62. Conducted Broadband Results. The Tempest GRID computer failed to meet the specification limit CE03 of Ref B for conducted broadband emissions over the frequency range 1.2 MHz to 2.5 MHz by up to 5 dB on both the active (Annex B Fig 16) and neutral (Annex B Fig 18) power supply lines. The Standard GRID computer met this specification limit on the active (Annex B Fig 15) and neutral lines (Annex B Fig 17).

63. Conducted Narrowband Results. Both GRID computer models meet the specification limit CE03 of Ref B for conducted narrowband emissions for both the active and neutral power supply lines. Fig 19 (Standard GRID) and Fig 20 (Tempest GRID) of Annex B show the results for the active line. Fig 21 (Standard GRID) and Fig 22 (Tempest GRID) of Annex B show the results for the neutral line.

64. Comment. Oddly the Tempest GRID Compass produced higher levels of conducted broadband and narrowband emissions than the Standard GRID - there is no apparent reason for this.

65. Radiated Narrowband Results. Using the test setup described in paragraph 59, both GRID models failed to meet the specification limit RS02 of Ref B. The radiated emissions tests on both GRID computers show that the Standard GRID computer generates a much higher level (approximately 40 dBuV/m) of electromagnetic interference over the entire frequency range from 18 kHz to 429 MHz (Annex B Fig 23) than does the Tempest GRID computer (Annex B Fig 24).

66. Radiated Narrowband Results (No serial cable). Disconnecting the RS232 serial cable produced a noticeable drop in high frequency emissions (Annex B Fig 26) for the Tempest GRID computer when compared to the results with the serial cable shown in Annex B Fig 24. The Standard GRID computer showed no drop in emissions level (Annex B Fig 25) when compared to the results with the serial cable shown in Annex B Fig 23.

67. Radiated Narrowband Results (Panel down). Folding down the display panel produced a significant drop in radiated narrowband emission levels for both computers across the whole frequency range of 18 kHz to 420 MHz. The results are shown in Annex B Fig 27 for the Standard GRID computer and in Annex B Fig 28 for Tempest GRID computer. The Tempest GRID computer almost meets the specification limit RE02 of Ref B with the display panel folded down. The Standard GRID computer fails to meet the specification. Note that operation with the display panel down would not be the normal operating normal mode.

68. Radiated Narrowband Results (1GHz to 10 GHz). No radiated narrowband emissions were detected over the frequency range 1 GHz to 10 GHz from both GRID computers; no graphs are provided.

69. Radiated Broadband Results. The Tempest GRID computer failed to meet the specification limit RE02 of Ref B for radiated broadband emissions over the frequency range 15 kHz to 120 kHz and 4 MHz to 6 MHz by up to 10 dBuV/m/MHz (Annex B Fig 29). The Standard GRID computer failed to meet the specification and exhibited numerous radiated broadband emissions. Accurate broadband emissions measurements were not taken for the Standard GRID computer as they serve no useful purpose in a unit which also exhibits a large amount of narrowband emissions; therefore no graph is provided.

Radiated and Conducted Susceptibility

70. Test Procedure. Radiated and conducted susceptibility tests were performed with both computers being exercised with program option 'b' of paragraph 56. The RS232 cable was terminated at a second computer outside the screened room area, which was employed to display possible corruption in messages under the influence of the irradiating source. The intensity of the irradiating source for test RS03 of Ref B was as follows :-

Frequency (MHz)	Electric Field Intensity (Volts/metre)	
	Specification	Test Condition
0.014 to 2	1	20
2 to 30	10	20
30 to 200	5	20
200 to 1000	5	10
1000 to 8000	5	7
8000 to 10000	5	2

71. Radiated Susceptibility Results. Neither GRID computer was affected when subjected to an electric field intensity as detailed in paragraph 70. The electric field was approximately 2 to 4 times the required specification limit RS03

of Ref B over the frequency range 14 kHz to 1 GHz. Due to equipment limitations the field intensity in the range 1 GHz to 10 GHz was restricted to approximately the level specified in the specification limit RS03 of Ref B. No graphs are shown thereof in Annex B.

72. Conducted Susceptibility Results. Both GRID computers also met the conducted susceptibility specifications limit CS02 and CS06 of Ref B. No graphs are provided.

CLIMATIC EVALUATION

73. Both GRID computers were subjected to the following climatic tests in accordance with Ref E :-

- a. Constant High Temperature, Low Humidity Test B1
- b. High Temperature, High Humidity Test B2
- c. Constant Low Temperature Test B4
- d. High Temperature, High Humidity Test B6
- e. Low Temperature, Low Pressure Test B12

74. A cast magnesium removable panel of the Standard GRID computer was subjected to a Salt Corrosion test as outlined in Ref F Test C1.

75. The Standard GRID computer was subjected to a dust test as outlined in Ref G Test D1.

76. During all of the climatic tests except dust and salt corrosion the GRID computers were setup to allow operation in the test chamber. The computers were running a test program when required. The test program which wrote a 'Quick Brown Fox' message to the bubble memory of the GRID computer, then read that message back and sent it to the GRID computer display and serial port, was monitored by another computer external to the test chamber. Any corruption of data at the serial port would have been detected by the external computer.

77. Table 5 summarizes the results of the tests performed. Paragraphs 78 to 111 are a detailed description of the test procedures and results.

High Temperature, Low Humidity

78. Test Procedure. Both GRID computers were subjected to a High Temperature, Low Humidity test as outlined in Ref E Test B2 Procedure B Severity A, with a temperature of 55°C for one cycle.

79. Both computers were placed in the test chamber and operated with the test program described in paragraph 76. The chamber temperature was held at 30°C for 5 hours and then increased to 55°C over a period of 12 hours. This temperature was to be held constant for 4 hours and then allowed to fall to 30°C over the next 10 hours.

80. Tempest GRID Computer Results. The Tempest GRID computer was found to have blown its power fuse when the computer was first checked after 3½ hours at 55°C. After the fuse was replaced and correct operation established, the Tempest GRID computer was reinserted into the chamber. Following this incident the test time at 55°C was extended in an attempt to promote further failures.

81. After a further hour the Tempest GRID computer display developed background 'hash' but the 'Quick Brown Fox' message being sent to the screen and serial port was uncorrupted. The background 'hash' appeared as random vertical and horizontal lines with irregular intensity, physical length and display duration.

82. After 5 hours at 55°C the temperature was brought down to 30°C over a period of 10 hours. At 50°C the 'hash' on the Tempest GRID computer was confined to the 2nd line from the top of the display. At 49°C the 'hash' had completely disappeared.

83. Standard GRID Computer Results. At 55°C the Standard GRID computer was noted to be transmitting half as many 'Quick Brown Fox' messages as normal. Investigation revealed that its bubble memory was running at half normal access speed. It is believed that the main clock to the bubble memory controller was operating at half its normal rate due to a malfunctioning frequency divider.

84. After 5 hours at 55°C the temperature was brought down to 30°C over a period of 10 hours. At 38°C case temperature the Standard GRID computers' bubble memory was still running at half its normal speed. The test schedule did not permit the determination of the temperature at which the the Standard GRID computers' bubble memory began operating at normal speed.

85. In all other respects both computers, including keyboards, operated normally throughout the test.

Constant High Temperature, Low Humidity

86. Test Procedure. Both GRID computers were subjected to a Constant High Temperature, Low Humidity test as outlined in Ref E Test B1 with a temperature of 70°C for 16 hours. This was a storage test with both computers powered down.

87. Results. After 15½ hours both computers were powered up at 70°C. This simulates operation in direct sunlight. The Standard GRID computer operated normally except the bubble memory exhibited the same bubble memory access time fault as described in the High Temperature, Low Humidity test B2 (paragraph 83).

88. The Tempest GRID computer operated correctly, including the keyboard, except the display exhibited the same 'hash' problem as described in the High Temperature, Low Humidity test B2 (paragraph 81).

Constant Low Temperature

89. Test Procedure. Both GRID computers were subjected to a Constant Low Temperature test as outlined in Ref E Test B4 with a temperature of -40°C for 16 hours. This was a storage test with both computers powered down.

90. Results. After 15 hours 45 minutes at -40°C both computers were powered up with the temperature still at -40°C. Both computer displays remained dark and there was no activity from either serial port. The fuses were checked and found to be intact. The chamber temperature was raised to -25°C and allowed to stabilize for 1 hour 15 minutes.

91. With the chamber at -25°C both computers were again powered up. The Standard GRID computer displayed random stationary specks on the display. No data was being transmitted out of the serial port although there was power available at the port.

92. The Tempest GRID computer showed some overall background illumination of the display but no specks or text characters were evident. There was power available to the serial port but no data being transmitted.

93. Both computers were left operating for 5 minutes. They were then powered down and then up again. The Standard GRID computer still did not operate. The display had a slight background illumination but no specks or text. The serial port was inactive although power was available. The Tempest GRID computer operated correctly with the display and serial port producing uncorrupted data.

94. The chamber temperature was raised to -10°C and allowed to stabilize for 1 hour. The Standard GRID computer still failed to operate. The Tempest GRID computer operated correctly including correct operation of the keyboard.

95. The chamber temperature was progressively raised to +10°C over the next 4½ hours with no change in the condition of both computers. The Tempest GRID computer survived the test.

The Standard GRID computer still failed to operate when at +10°C. After examination it was determined that the bubble memory contents had been corrupted. Reformatting of the bubble memory restored the computer to full operation.

96. It was suspected that operating the Standard GRID computer at -40°C was the cause of the corruption. To verify this, the test was repeated with the Standard GRID computer stored at -40°C for 16 hours and then brought back to room temperature before any operational tests were carried out. The computer operated correctly after this test.

97. Discussion. Operation at -40°C was a significant over test when compared to the manufacturers' lower operating limit of +10°C. The test was designed to determine the limits of the technology used in the GRID computers and the result was surprisingly good. Normally such equipment would only be operated at temperatures down to -10°C.

Low Temperature, Low Pressure

98. Test Procedure. Both GRID computers were subjected to a Low Temperature, Low pressure test as outlined in Ref E Test B12 with a temperature of -20°C at 700 millibars (equivalent altitude of 3,000 feet) for 6 hours. This was a storage test with both computers powered down.

99. Results. At the completion of 6 hours the computers were powered up whilst still in the chamber and at reduced pressure. The Tempest GRID computer operated correctly. The Standard GRID computer showed no display or serial port activity. Turning the power OFF then ON resulted in the Standard GRID computer operating correctly. The initial failure to operate may be due to the switch mode power supply failing to start. The access times to the bubble memories were normal (see discussion for the High Temperature, Low Humidity test B2 in paragraph 83).

High Temperature, High Humidity

100. Test Procedure. Both GRID computers were subjected to a High Temperature, Diurnal Cycle - High Humidity test as outlined in Ref E Test B6 Severity A Procedure A with a cyclic temperature of 40°C maximum for 16 hours. Both computers were placed in the test chamber and operated with the test program. The humidity and temperature test conditions are shown in Fig 9.

101. Results. Both GRID Compass computers operated correctly throughout the test cycle. The displays, keyboards and serial ports all operated correctly. The access times to the bubble memories were normal (see discussion for the High Temperature, Low Humidity test B2 in paragraph 83).

Dust

102. Test Procedure. The Standard GRID computer was subjected to a Dust Test in general accordance with Ref G Test D1. The computer was placed in its protective carry satchel and exposed to the dust for two (2) hours. Following this the computer was exposed out of the carry satchel for 30 minutes with the display panel in the closed position.

103. Results. After exposure for one hour in the carry satchel the computer was removed from the dust chamber and examined. The only ingress of dust into the satchel was through small gaps at each end of the zip fastener. This dust ingress was very slight. Little extra dust ingress was noticed following the remaining one hour exposure.

104. In general the carry satchel is a very effective dust barrier.

105. The unprotected computer was first examined after five (5) minutes exposure to the dust with the display panel in the closed position. There was no dust in or around the keyboard or display at this time. Some grit was noticed in the operation of the display panel latches particularly the right hand latch. As a consequence the display panel would not 'click' closed, as it did before the test, due to grit in the right hand latch. The fold down stand mechanism at the rear of the computer and the display panel hinges were also 'gritty' in operation.

106. The unprotected computer with the display panel closed was exposed to the dust for a further 25 minutes (total 30 minutes) and re-examined. The display panel left hand latch was free but the right hand latch was still 'gritty' and required manual movement to allow the display panel to be closed. There was a light coating of dust over the keyboard. The 19 pin 'D' type serial port connector had some dust around the pins. A plug was inserted and found to require more than normal force for engagement. The stand mechanism and display panel hinges were also 'gritty' but were still functional.

107. The computer was disassembled and further examined for ingress of dust. It was found that a significant quantity of dust had entered the unit through the two ventilation vents on each side of the computer just to the rear of the display panel hinges. The main circuit board had a heavy coating of dust around its edges which reduced to a fine light mist in the centre of the board. The hinges of the display panel had a thick coating of dust. A layer of dust about 3mm deep was present on the base of the unit near the ventilation vents. During refurbishing of this unit it is estimated that a quantity of dust equivalent to four level teaspoons full was found inside the unit.

108. Discussion. It is recommended from the results of this test, that the units should not be operated in a dusty environment. The dust can cause the malfunctioning of hinges and latches and accumulated dust would attract moisture with the possibility of circuit malfunction. The units may be stored for short periods only in such an environment if they are protected by the carry satchel or some other dust barrier.

Salt Corrosion

109. Test Procedure. The removable cast magnesium panel behind the display of the Standard GRID computer was subjected, as a representative sample of the case construction, to a Salt Corrosion test as outlined in Ref F Test C1 for a duration of four weeks.

110. Results. After exposure for one week there was slight corrosion evident at several points where the original surface finish was damaged. After three weeks there was some corrosion beneath the finished surface around the panel mounting points which secure it to the rear panel. At the completion of the test of four weeks the corrosion effects were generally slight with significant corrosion having only occurred around the mounting points which secure the panel to the rear panel of the computer. This corrosion did not affect the function of the panel in any way.

111. Discussion. The salt corrosion test produced surprisingly little corrosion for a magnesium based component and indicates a good surface treatment and finishing.

DURABILITY EVALUATION

112. The GRID Computers were subjected to a resonance search and the following durability tests in accordance with Ref D :-

- a. Vibration (Random, Tracked Vehicles) Test A2
- b. Vibration (Random, Wheeled Vehicles) Test A2
- c. Shock Test A3
- d. Bump Test A5
- e. Free Fall Test A9

113. The results of these tests are summarized in Table 5.

Resonance Search

114. Test Procedure. The Standard GRID computer was subjected to a resonance search at an acceleration of 1 g through the range 5 to 500 Hz. The computer was rigidly fixed to the

vibration platform in normal operating attitude and the search performed with excitation in all three planes. The panel behind the display was removed to allow viewing of the interior of the unit during the test.

115. Results. During the search with vibration applied in the vertical plane the following movements were noted :-

Frequency Hz	Observation
85	Slight flexing (less than 1 mm) of the main circuit board at the left rear corner. Slight movement of the GPIB connector on the main board.
130	Small globules of solder at various points on the main circuit board became detached and were moving freely.
165	Slight flexing (less than 1 mm) of the panel covering the keyboard.
180	Slight flexing (less than 1 mm) of the power supply board.

116. During the search with vibration applied in the fore-aft plane the following movements were noted :-

Frequency Hz	Observation
50	Slight flexing (less than 1 mm) of the panel covering the keyboard.
380	Slight movement (less than 1 mm) of the serial port connector on the main board.

117. During the search with vibration applied in the lateral plane the following movements were noted :-

Frequency Hz	Observation
170	Movement (less than 2 mm) of the lithium battery which was secured to the main board by flying leads and some silastic compound.

118. Discussion. The resonance search indicated the computer to be structurally sound but requiring some additional PCB restraint and more secure mounting of the battery and connectors. No movement was noted for any other components.

Vibration (Random, Tracked Vehicles)

119. Test Procedure. The Standard GRID computer was subjected to a Vibration (Random) test as outlined in Ref D Test A2. The test was for a tracked vehicle at level 1 ($0.1g^2/Hz$), 20-500 Hz for a duration of 2 hours in each plane. This test is designed to simulate rigid mounting in a tracked vehicle.

120. Results. After approximately 1½ hours of testing in the lateral plane, unusual sounds from the computer/jig assembly suggested that something may have come adrift inside the computer. The vibration platform was switched off and the computer opened for inspection.

121. The following damage was observed :-

- a. The body of the lithium battery had broken from its mounting due to broken leads and failure of the bonding of the silastic-type compound securing it to the board.
- b. Two large electrolytic capacitors had broken from their mounting points on the power supply board due to broken leads.
- c. On the display board two smaller electrolytic capacitors, two transistors, a ceramic filter, and one edge connector for flexible circuit boards had become free as a result of broken leads.
- d. One bracket securing the the electro-luminescent display panel to its printed circuit board was fractured and bent out of shape such that the display was not longer securely mounted.

122. The components discussed in paragraph 121 (a) to (c) are shown in Fig 10.

123. Discussion. It is relatively straight forward to prevent the type of failures discussed in paragraph 121 by applying a structural adhesive to stabilise insecurely mounted components, and by manufacturing more substantial mounting brackets for the display. It is recommended that vibration mounts be used if the computers are installed in tracked vehicles.

Vibration (Random, Wheeled Vehicles)

124. Test Procedure. The Tempest GRID computer was subjected to a Vibration (Random) test as outlined in Ref D Test A2. The test was for a wheeled vehicle at $0.02g^2/Hz$ for 20 to 50 Hz reducing to $0.001g^2$ at 500 Hz. The duration was for 2 hours in each plane. This test is designed to simulate rigid mounting in a wheeled vehicle.

125. Results. The Tempest GRID computer was fully operational at the end of this test. No deterioration in the surface finish or mechanical integrity of the computer was noted.

Shock

126. Test Procedure. The Tempest GRID computer was to be subjected to a Shock test as outlined in Ref D Test A3 with a severity of 3 shocks of 100g 4 ms duration to be applied in both directions of each plane. However due to limitations of the vibration platform the shock severity was limited to 70g 3 ms duration.

127. Results. The Tempest GRID computer was fully operational at the end of this test. No deterioration in the surface finish or mechanical integrity of the computer was noted.

Bump

128. Test Procedure. The Tempest GRID computer was rigidly mounted and subjected to a Bump test as outlined in Ref D Test A5 with a severity of 1000 bumps of 40g 6 ms duration in the vertical plane. This test simulates carriage as loose cargo without a carry satchel or transit case. Note that such carriage is not recommended.

129. Results. At the conclusion of this test the keyboard key tops on keys '7', '8', '9', 'Y', 'U', 'J', 'K' and 'L' had completely dislodged from their switches. The keys tops of keys '5', 'T', 'B', '<', '6' and 'I' had become partially dislodged from their fully attached position. All key tops were easily pushed back onto their respective switches. Where the keys had become totally dislodged they had impacted against the display panel and caused some slight rubbing marks on the protective surface of the display area.

130. The Tempest GRID computer was fully operational at the end of this test.

Free Fall

131. Test Procedure. The Tempest GRID computer was subjected to a Free Fall test as outlined in Ref D Test A9. Initially the computer (not in its carry satchel) was to be dropped on all faces and the four corners from a height of 15 cm

on to 19 mm thick pineboard. Fig 11 shows the face and corner labelling. If the computer passed this test a drop test would then be conducted with the computer in its carry satchel from a height of 80 cm on to 19 mm thick pineboard. 80 cm is the average height from the ground of an item being carried like a brief case.

132. Results. The computer passed the drop tests from 15 cm and was fully operational without any noticed surface damage. When dropped onto face B and corner BE the display panel sprung open approximately 30°.

133. The free fall test from 80 cm with the computer in the carry satchel produced the following results :-

Face	Observation
F	The right display panel latch broke off when a thermal weld within the latch failed (see Fig 12). The computer was still operational. The display panel was secured in the closed position by large rubber bands in order to continue the test.
A	No further damage.
E	A small fragment of the case broke away from the left rear corner of the computer (see Fig 13). The TAB key top was broken from its switch probably due to side ways movement of the display panel (see Fig 14). The computer was still operational.
B	Some mis-alignment and case cracking near the left hand pivot of the display panel was evident. The computer was still operational.

134. At this stage a decision was made to abort the remainder of this test.

135. Discussion. The magnesium case and general construction of the GRID computers is not sufficiently robust to withstand free fall drops from carrying height on to a hard surface. However, the capability to withstand drops could be improved significantly if the existing carry satchel is replaced by an appropriately designed transit case.

CONCLUSIONS

136. The following conclusions have been reached during this evaluation of the Standard Model 1100 and Tempest Model 1107 GRID Compass computers:

- a. Bubble Memory - Security Risk. Bubble memories are considered a security risk for storing classified information. With the exception of physical destruction, the only satisfactory way to erase the contents of a bubble memory is to either reformat it, which takes approximately three minutes in the case of the GRID Compass, or to expose it to an intense magnetic field. Exposure to a magnetic field will probably render the device totally in-operable and require specialized equipment to restore operation. In any case, both processes require electrical power to erase the data which may not be available during an emergency. By contrast, non-volatile storage provided by battery backed up CMOS static RAM has a much lower power consumption, is faster than bubble memory and can be erased rapidly by removing the power source.
- b. Bubble Memory - Commercial Viability. The future of bubble memories in both the military and commercial sectors appears to be uncertain with the recent announcement by Intel (October 86) that it will no longer be manufacturing bubble memories due to the non profitability of the technology. This leaves Fujitsu and Hitachi of Japan as the only manufacturers currently producing bubble memories.
- c. Climatic Evaluation. The units satisfactorily passed the climatic tests performed to DEF STAN 07-55 Part 2 Sections 2/1 and 3/1. The Standard Model 1100 GRID computer failed to operate during the -40°C Constant Low Temperature test B4 due to corruption of the bubble memory. This is not considered significant because the corruption occurred when the unit was powered up at -40°C. The unit survived a repeat of the test when operated only after the temperature had returned to room ambient. Operation at -40°C was a significant over test designed to determine the limits of the technology used in the GRID computers. The results were surprisingly good considering the manufacturers' claimed lower operating limit of +10°C. The Tempest Model 1107 GRID exhibited a display 'hash' problem and the Standard Model 1100 GRID exhibited slower bubble memory access times during the high temperature

tests. These are not considered failures because the units were still operational and a larger number of units would need to be tested to provide conclusive evidence of any design deficiency. The results are summarized in Table 5.

- d. Cost Versus Performance. Significantly greater computing performance can be obtained in portable computers from other manufacturers at equivalent cost to the GRID Compass. Conversely, equivalent performance to the GRID Compass can be obtained from other manufacturers at a far less cost, however, the environmental/durability performance of these alternate items is unknown. It should be noted that the GRID Compass range of computers are not IBM compatible and cannot run the vast majority of software available for the IBM PC range of computers.
- e. CPU Performance. The processing power of the GRID computers is considered to be average when compared to other microcomputers (including portables).
- f. Display Readability. The display is an electro-luminescent type with good readability in dim to bright lighting situations. Very bright light or direct incident light makes the display extremely difficult to read. The units supplied had a physically narrow display with poor character font definition. Later models have a wider display with improved character font definition.
- g. Durability Evaluation. Both computers are considered to be of good commercial build quality. The units satisfactorily passed vibration, shock and bump tests for wheeled vehicles performed to DEF STAN 07-55 Part 2 Section 1/1. The units failed vibration testing for rigid mounting in tracked vehicles and some fracturing of the case was experienced during free fall testing. If installed in tracked vehicles suitable vibration isolation techniques would need to be employed and the type of failures discussed in paragraph 121 would be relatively simple to prevent by securing with structural adhesive inadequately restrained components, and manufacturing more substantial mounting brackets for the display. The results are summarized in Table 6.
- h. Dust. Exposure to dusty environments during operation is not recommended. The units may be stored for a short time in a dusty environment provided they are protected by the manufacturer's

carry satchel or some other effective dust barrier. Exposure to dust without the protection of the carry satchel or other protective case is likely to result in the impaired operation of the display securing latches and the entrapment of moisture in contact with electronic circuitry.

- i. EMC/EMI Evaluation. The Tempest Model 1107 GRID computer satisfactorily passed most EMI/EMC tests conducted in accordance with MIL-STD-461B Part 4. The failures were marginal. The Standard Model 1100 GRID computer failed, as expected, to meet the standard. The results are summarized in Tables 3 and 4. Oddly the Tempest certified Model 1107 GRID computer produced higher levels of conducted narrowband and broadband emissions than the Standard Model 1100 GRID - there is no apparent reason for this. The effect of screening in the Tempest GRID to meet Tempest requirements has reduced radiated narrowband emissions by as much as 40 dBuV/m when compared to the Standard GRID.
- j. Mass Storage Performance. The access times to the internal bubble memory and external floppy disk drive are relatively slow. This limits the performance of applications software requiring extensive access to these mass media devices.
- k. Power Requirements. The electro-luminescent display and bubble memory burden the units with high power consumption and limited operating life from external battery packs.
- l. Summary. The GRID Compass computers are suitable for field use provided measures are taken to ensure gentle handling when only the existing carrying satchel is used for protection. Complete protection could be provided by a transit case specially designed for the purpose. It will also be necessary to protect the equipment from exposure to dust and direct sunlight during use. If installed in tracked vehicles suitable vibration isolation techniques should be employed. Full performance at 44°C shade temperatures (1% risk of occurrence within Australia) has not been assessed. However, based on results of the 70°C and 40°C tests performed, reasonable confidence is held that the Standard Model 1100 GRID computer will exhibit adequate performance at 44°C despite the 40°C upper operating limit claimed by the manufacturer (further checking will be necessary). Note that the Tempest Model 1107 GRID computer is rated by the manufacturer as having a 55°C upper

operating limit. This strongly suggests, given the virtually identical electronic design of the Standard and Tempest models, that a component change (possibly the bubble memory modules) may be all that is necessary to achieve an increase in the upper operating temperature limit.

RECOMMENDATIONS

137.

It is recommended that :-

- a. Where an application is identified for which a portable computing capability is required then a survey and determination of suitability (including environmental/durability aspects) of currently available commercial grade computers should first be undertaken. It is believed that in many instances a low cost commercial equipment will be entirely satisfactory and adequate for the application. Annex C contains a survey of commercially available portable computers which could provide a suitable functional alternative to the GRID Compass; environmental data is not currently available.
- b. At the present time any general purpose computing facility intended for portable roles should be IBM PC compatible to draw on the economies of the large base of software available.
- c. If a requirement exists for a full military specified rugged equipment designed for field use then the GRIDSET (Set Environment and Tempest) item could be considered (approximate cost is \$45000). However, the much cheaper Standard Model 1100 GRID Compass computer (approximate cost is \$12000), whose performance and build standard is very respectable, could be improved by relatively simple modifications and would serve well in many military applications provided Tempest capability is not required. (EDE is developing schemes to repackage commercial grade portable computers so that a low cost alternative to the GRIDSET is available. The cost is expected to be approximately that of the Standard Model 1100 GRID Compass.)

TABLE 1 - MASS STORAGE BENCHMARK TEST RESULTS (SECONDS)

	IBM PC/2	Magnum	Intel 310	GRID
Bubble to bubble	-	-	-	32.6
Floppy disk to floppy disk	16.1	61.7	54.6	58.9
Hard disk to hard disk	6.5	-	3.3	-

TABLE 2 - CPU PERFORMANCE BENCHMARK TEST RESULTS
(IBM PC WITH NO 8087 = 1.0)

	IBM PC/2	Magnum	Intel 310	GRID
Without coprocessor	1.0	1.7	2.6	1.4
With coprocessor	7.1	-	12.9	10.0

TABLE 3 - EMISSION TEST RESULTS

Emission Test	Standard GRID Model 1100		TEMPEST GRID Model 1107	
	Fig # Annex B	Result	Fig # Annex B	Result
Conducted Broadband (Active) MIL-STD-461B CE03, Part 4 15 kHz to 50 MHz	15	Pass	16	Marginal fail
Conducted Broadband (Neutral) MIL-STD-461B CE03, Part 4 15 kHz to 50 MHz	17	Pass	18	Marginal fail
Conducted Narrowband (Active) MIL-STD-461B CE03, Part 4 15 kHz to 50 MHz	19	Pass	20	Pass
Conducted Narrowband (Neutral) MIL-STD-461B CE03, Part 4 15 kHz to 50 MHz	21	Pass	22	Pass
Radiated Narrowband (Electric) MIL-STD-461B RE02, Part 4 14 kHz to 1 GHz	23	Fail	24	Marginal Fail
Radiated Narrowband (Electric) MIL-STD-461B RE02, Part 4 14 kHz to 1 GHz Serial port disconnected	25	Fail	26	Marginal Fail
Radiated Narrowband (Electric) MIL-STD-461B RE02, Part 4 14 kHz to 1 GHz Display panel folded down	27	Fail	28	Marginal fail
Radiated Narrowband (Electric) MIL-STD-461B RE02, Part 4 1 GHz to 10 GHz	-	Pass	-	Pass
Radiated Broadband (Electric) MIL-STD-461B RE02, Part 4 14 kHz to 1 GHz	-	Fail	29	Marginal Fail

TABLE 4- SUSCEPTIBILITY TEST RESULTS

Susceptibility Test	Result	
	Standard GRID Model 1100	TEMPEST GRID Model 1107
Conducted Susceptibility MIL-STD-461B CS02, Part 4	Pass	Pass
Conducted Susceptibility MIL-STD-461B CS06, Part 4	Pass	Pass
Radiated Susceptibility MIL-STD-461B RS03, Part 4	Pass	Pass

TABLE 5 - ENVIRONMENTAL TEST RESULTS

Climatic Test	Result	
	Standard GRID Model 1100	TEMPEST GRID Model 1107
Constant High Temperature, Low Humidity DEF STAN 07-55 Part 2 Section 2/1 Test B1 70°C 16 hours	Pass	Pass
High Temperature, Low Humidity DEF STAN 07-55 Part 2 Section 2/1 Test B2 Procedure B Severity A 55°C 12 hours	Pass (Bubble memory access slowed down. See para 83 and 84)	Pass
Constant Low Temperature DEF STAN 07-55 Part 2 Section 2/1 Test B4 -40°C 16 hours	Pass	Pass
High Temperature, High Humidity DEF STAN 07-55 Part 2 Section 2/1 Test B6 40°C 16 hours	Pass	Pass
Low Temperature, Low Pressure DEF STAN 07-55 Part 2 Section 2/1 Test B12 -20°C 700 millibars 6 hours	Pass	Pass

TABLE 6 - DURABILITY TEST RESULTS

Durability Test	Result	Model GRID Tested
Vibration (Random, Tracked Vehicles) DEF STAN 07-55 Part 2 Section 1/1 Test A2	Fail	Standard Model 1100
Vibration (Random, Wheeled Vehicles) DEF STAN 07-55 Part 2 Section 1/1 Test A2	Pass	TEMPEST Model 1107
Shock DEF STAN 07-55 Part 2 Section 1/1 Test A3	Pass	TEMPEST Model 1107
Bump DEF STAN 07-55 Part 2 Section 1/1 Test A5	Pass	TEMPEST Model 1107
Free Fall DEF STAN 07-55 Part 2 Section 1/1 Test A9	Fail	TEMPEST Model 1107

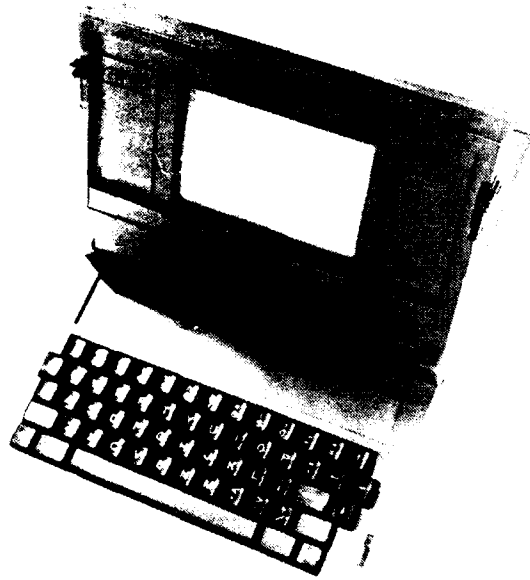

8887 II

FIG 1 - GRID COMPUTER WITH DISPLAY PANEL RAISED

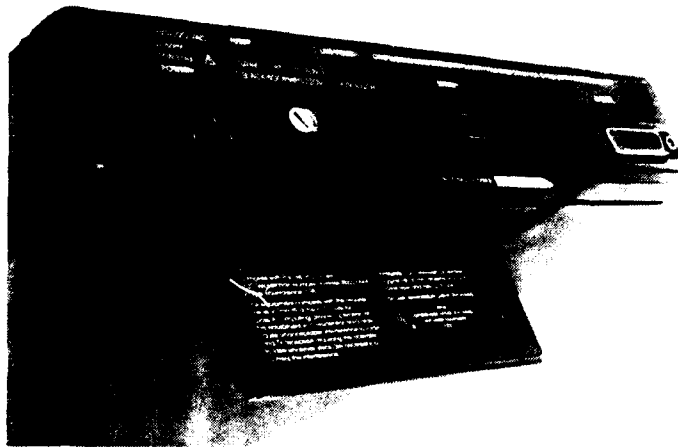

8887 I

FIG 2 - REAR PANEL OF GRID COMPUTER

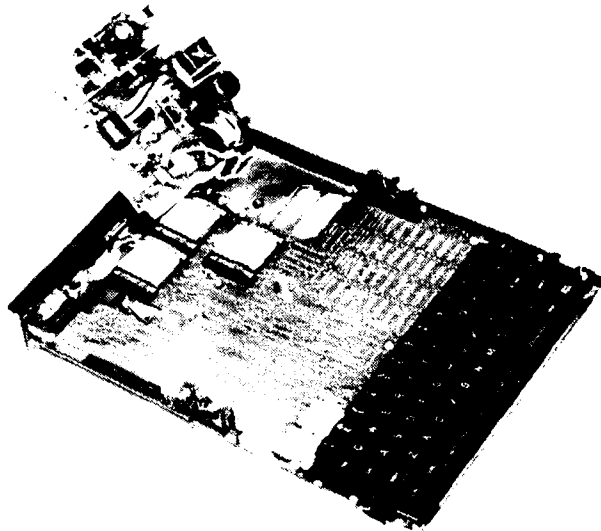

8887 E

FIG 3 - INTERNAL VIEW OF STANDARD MODEL 1100
GRID COMPUTER

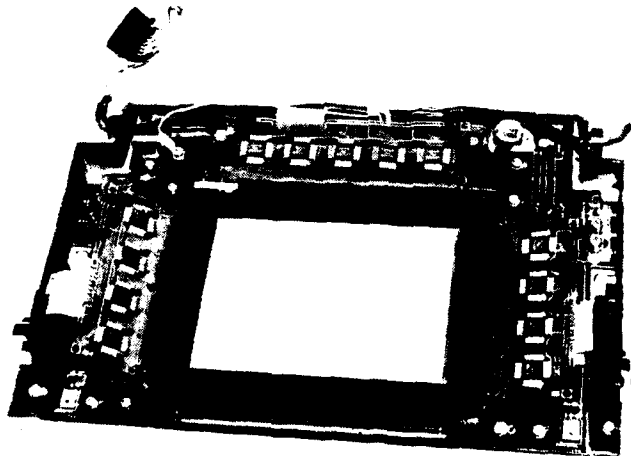

8887 D

FIG 4 - INTERNAL VIEW OF DISPLAY PANEL OF
STANDARD MODEL 1100 GRID COMPUTER

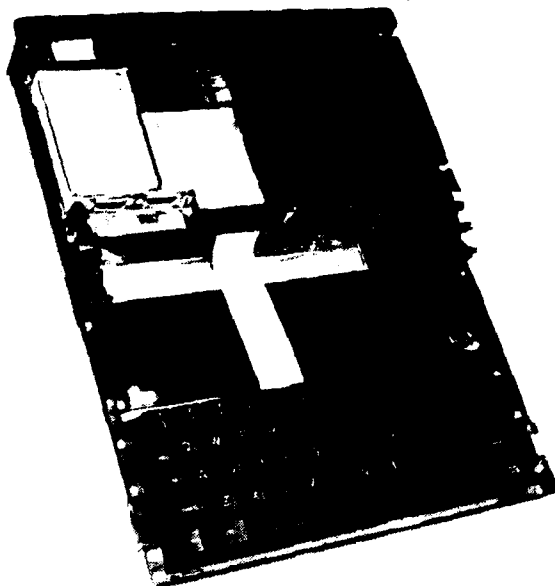

8887 L

FIG 5 - INTERNAL VIEW OF TEMPEST MODEL 1107 GRID COMPUTER

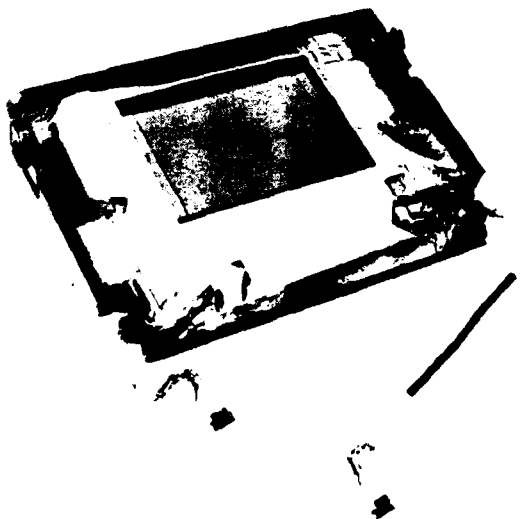

8887 O

FIG 6 - INTERNAL VIEW OF DISPLAY PANEL OF
TEMPEST MODEL 1107 GRID COMPUTER

MASS STORAGE BENCHMARK (Copying one 113 Kbyte file)

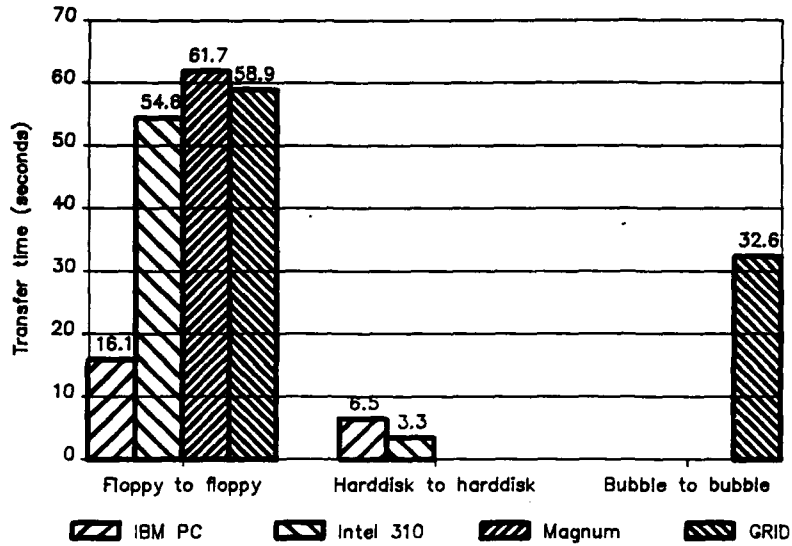

FIG 7 - MASS STORAGE BENCHMARK RESULTS

CPU PERFORMANCE BENCHMARK (Sieve prime number generator)

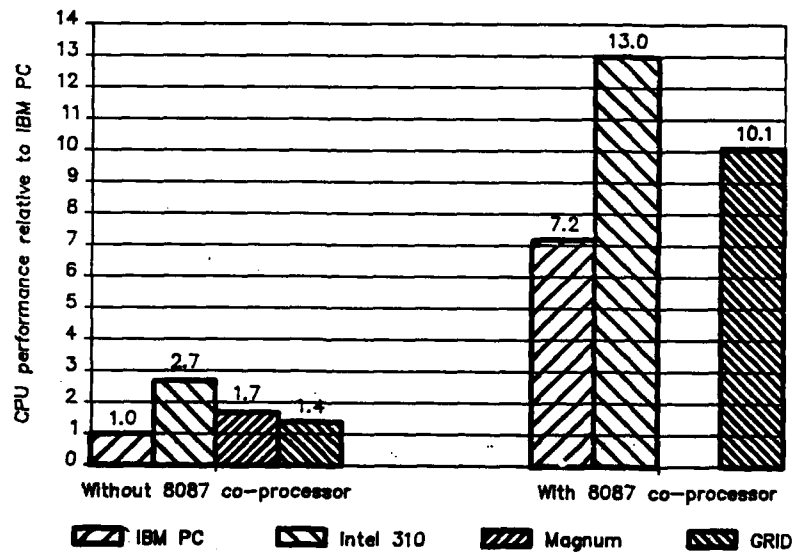

FIG 8 - CPU PERFORMANCE BENCHMARK RESULTS

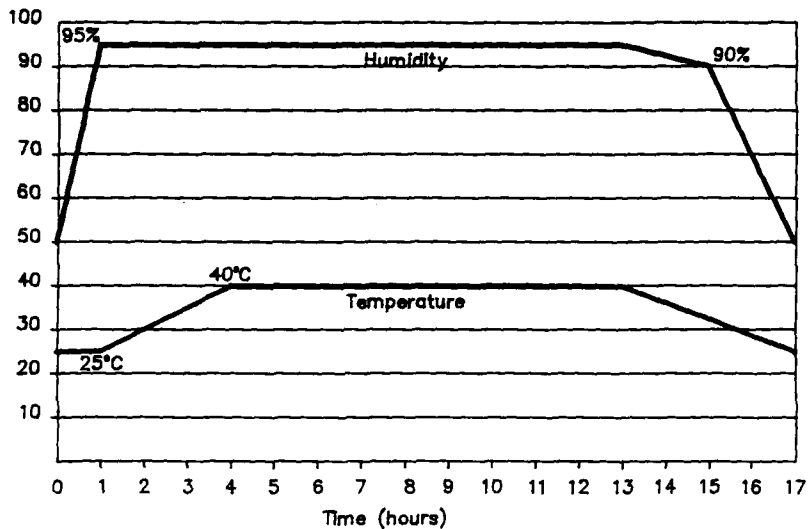
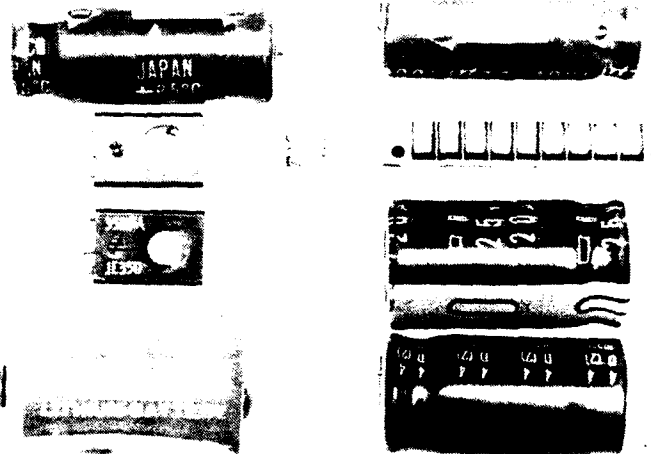

FIG 9 - HIGH TEMPERATURE, HIGH HUMIDITY CHARACTERISTICS
DEF STAN 07-55 PART 2 SECTION 2/1 TEST B6 SEVERITY A



8887 H

FIG 10 - COMPONENTS OF STANDARD MODEL 1100 GRID COMPUTER THAT
CAME ADRIFT DURING VIBRATION TEST (RANDOM, TRACKED
VEHICLES) DEF STAN 07-55 PART 2 SECTION 1/1 TEST A2

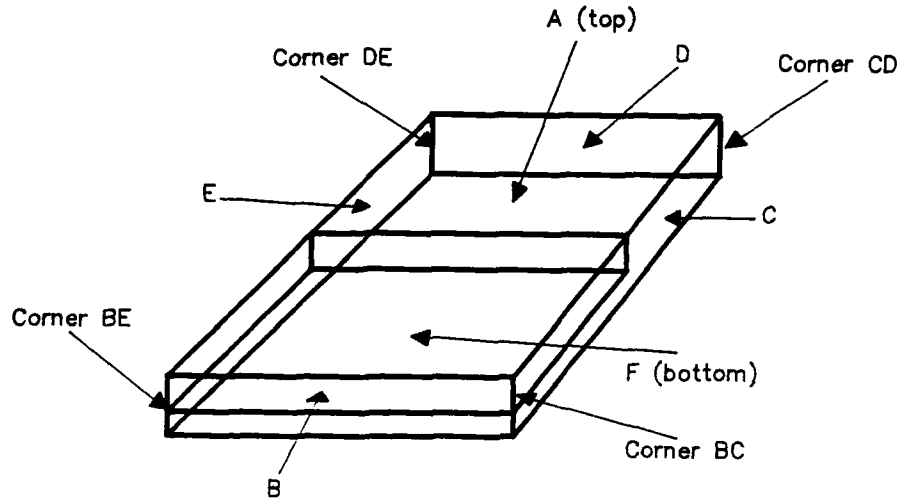
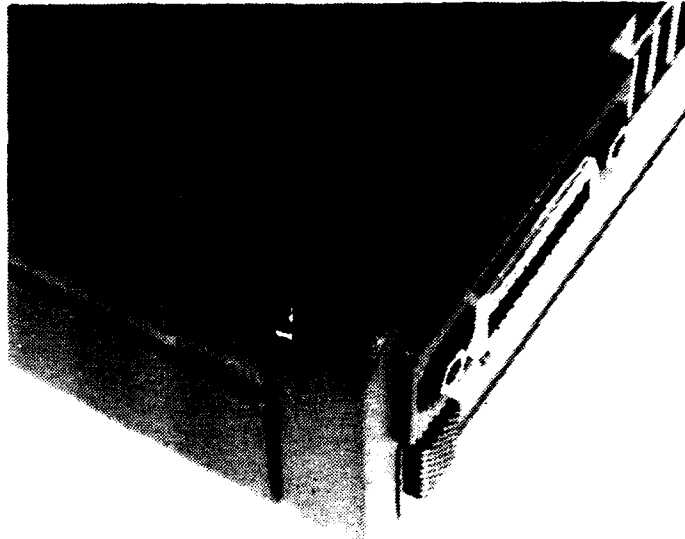

FIG 11 - FACE AND CORNER LABELLING FOR FREE FALL TEST
DEF STAN 07-55 PART 2 SECTION 1/1 TEST A9



8887 J

FIG 12 - DISPLAY LATCH FAILURE OF TEMPEST MODEL 1107 GRID
COMPUTER FROM FREE FALL TEST DEF STAN 07-55 PART 2
SECTION 1/1 TEST A9



8887 P

FIG 13 - CASE FRACTURE AT LEFT REAR CORNER OF TEMPEST MODEL
1107 GRID COMPUTER FROM FREE FALL TEST
DEF STAN 07-55 PART 2 SECTION 1/1 TEST A9

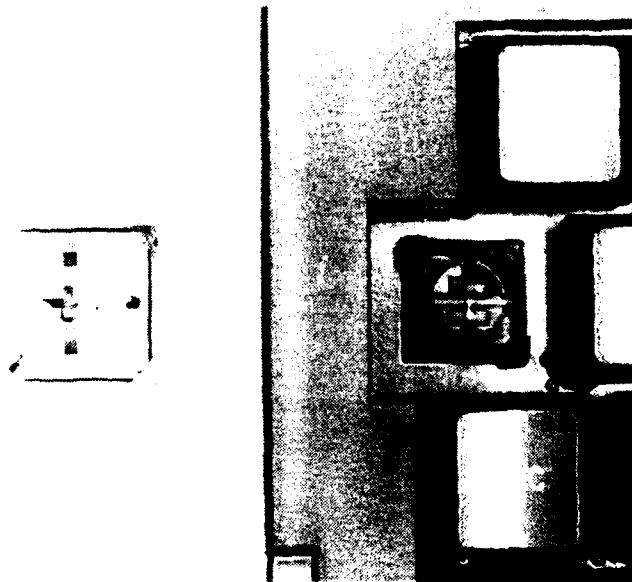

8887 K

FIG 14 - TAB KEY FAILURE OF TEMPEST MODEL 1107 GRID
FROM FREE FALL TEST DEF STAN 07-55 PART 2
SECTION 1/1 TEST A9

ANNEX A
TO EDE 4/87

ANNEX A

CPU PERFORMANCE BENCHMARK

SIEVE PRIME NUMBER GENERATOR WRITTEN IN MICROSOFT C

SIEVE PRIME NUMBER GENERATOR WRITTEN IN MICROSOFT C

```
/* sieve.c
/* Eratosthenes Sieve Prime Number Program in C from Byte Jan 1983 to compare the speed. */

#define TRUE 1
#define FALSE 0
#define SIZE 8190

char flags[SIZE+1];

main()
{
    register int i,k;
    float ch,count;
    float prime,iter;

    ch=getch(); /* wait for keypress */

    printf("2 iterations. Float variable type.\n");

    for (iter = 1; iter <= 2; iter++) { /* do program 2 times */
        count = 0; /* initialize counter */
        for (i = 0; i <= SIZE; i++) /* set all flags true */
            flags[i] = TRUE;
        for (i = 0; i <= SIZE; i++) {
            if (flags[i]) { /* found a prime */
                prime = i + i + 3; /* twice index + 3 */
                for (k = i + prime; k <= SIZE; k += prime)
                    flags[k] = FALSE; /* kill all multiples */
                count++; /* primes found */
            }
        }
    }

    printf("Xf primes.\n",count); /* primes found in 2nd pass */
    printf("sieve.c finished\n");
}
```

ANNEX B

EMI/EMC RESULTS

ENGINEERING DEVELOPMENT ESTABLISHMENT
ELECTRICAL LABORATORIES

TEST SAMPLE: GRID COMPUTER MODEL No 1100
MIL-STD-461B CE03, PART 4
MODE OF TEST: SEND QUICK BROWN FOX TO SCREEN
REMARKS:

TEST NUMBER: 15
DATE: 1/5/86
TESTER

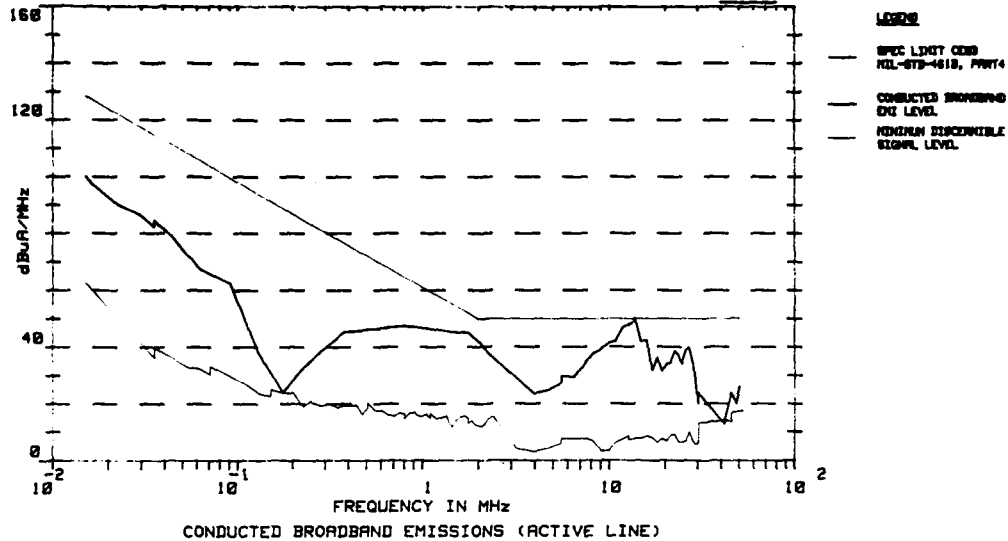

FIG 15 - STANDARD MODEL 1100 GRID COMPUTER
CONDUCTED BROADBAND EMISSIONS (ACTIVE LINE)

ENGINEERING DEVELOPMENT ESTABLISHMENT
ELECTRICAL LABORATORIES

TEST SAMPLE: GRID COMPUTER MODEL No 1107
MIL-STD-461B CE03, PART 4
MODE OF TEST: SEND QUICK BROWN FOX TO SCREEN
REMARKS:

TEST NUMBER: 3
DATE: 5/5/86
TESTER

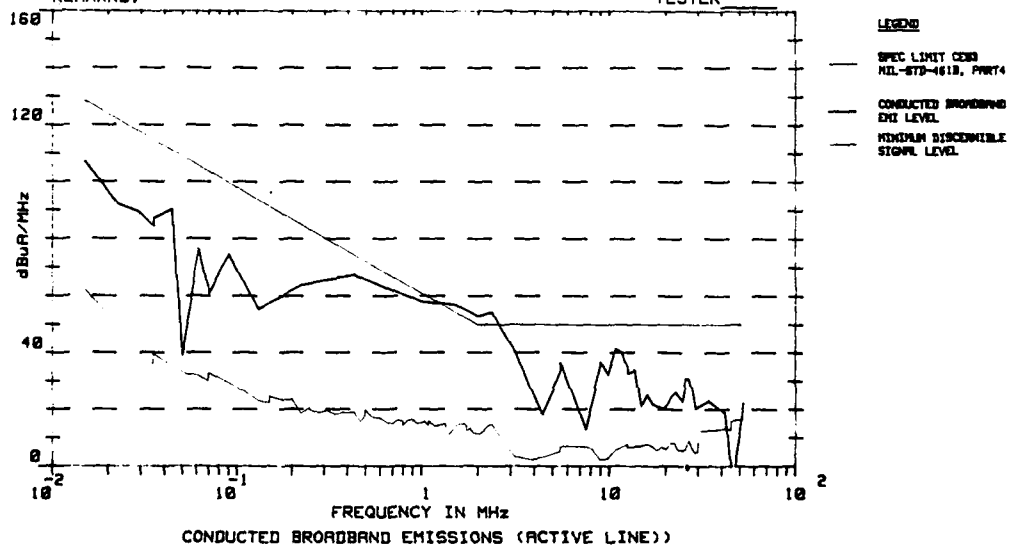
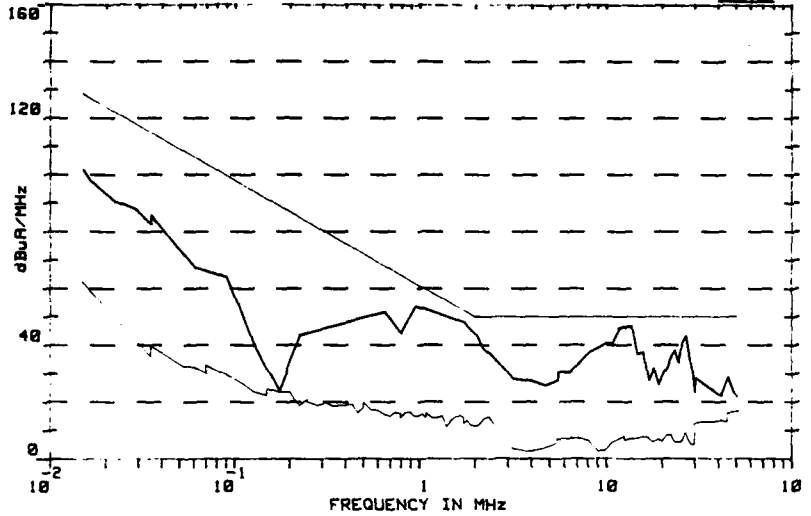

FIG 16 - TEMPEST MODEL 1107 GRID COMPUTER
CONDUCTED BROADBAND EMISSIONS (ACTIVE LINE)

TEST SAMPLE: GRID COMPUTER MODEL No 1100
MIL-STD-461B CE03, PART 4
MODE OF TEST: SEND QUICK BROWN FOX TO SCREEN
REMARKS:

TEST NUMBER: 14
DATE: 1/5/86
TESTER



LEGEND

- SPEC LIMIT CURVE
MIL-STD-461B, PART 4
- CONDUCTED BROADBAND
EMISSION LEVEL
- MEDIUM DISCERNIBLE
SIGNAL LEVEL

CONDUCTED BROADBAND EMISSIONS NEUTRAL LINE
FIG 17 - STANDARD MODEL 1100 GRID COMPUTER
CONDUCTED BROADBAND EMISSIONS (NEUTRAL LINE)

TEST SAMPLE: GRID COMPUTER MODEL No 1107
MIL-STD-461B CE03, PART 4
MODE OF TEST: SEND QUICK BROWN FOX TO SCREEN
REMARKS:

TEST NUMBER: 4
DATE: 5/5/86
TESTER

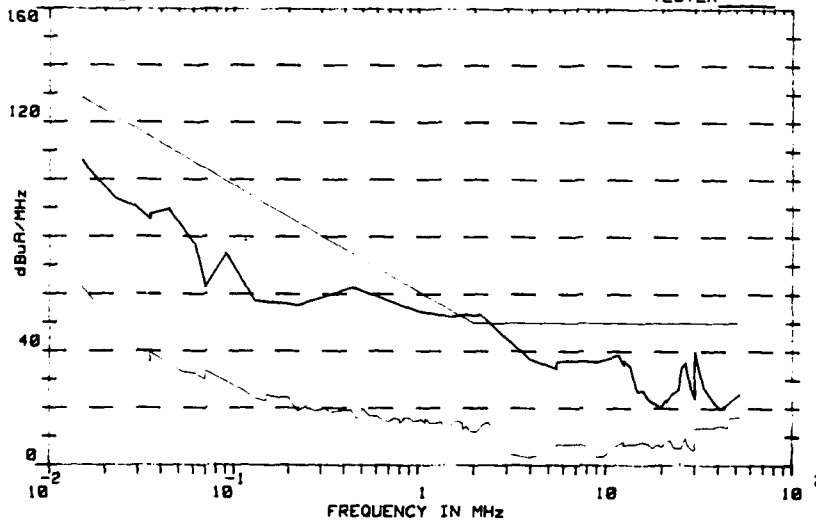

LEGEND

- SPEC LIMIT CURVE
MIL-STD-461B, PART 4
- CONDUCTED BROADBAND
EMISSION LEVEL
- MEDIUM DISCERNIBLE
SIGNAL LEVEL

CONDUCTED BROADBAND EMISSIONS (NEUTRAL LINE)
FIG 18 - TEMPEST MODEL 1107 GRID COMPUTER
CONDUCTED BROADBAND EMISSIONS (NEUTRAL LINE)

ENGINEERING DEVELOPMENT ESTABLISHMENT
ELECTRICAL LABORATORIES

TEST SAMPLE: GRID COMPUTER MODEL No 1100
MIL-STD-461B CE03, PART 4
MODE OF TEST: SEND QUICK BROWN FOX TO SCREEN
REMARKS:

TEST NUMBER: 12
DATE: 1/5/86
TESTER

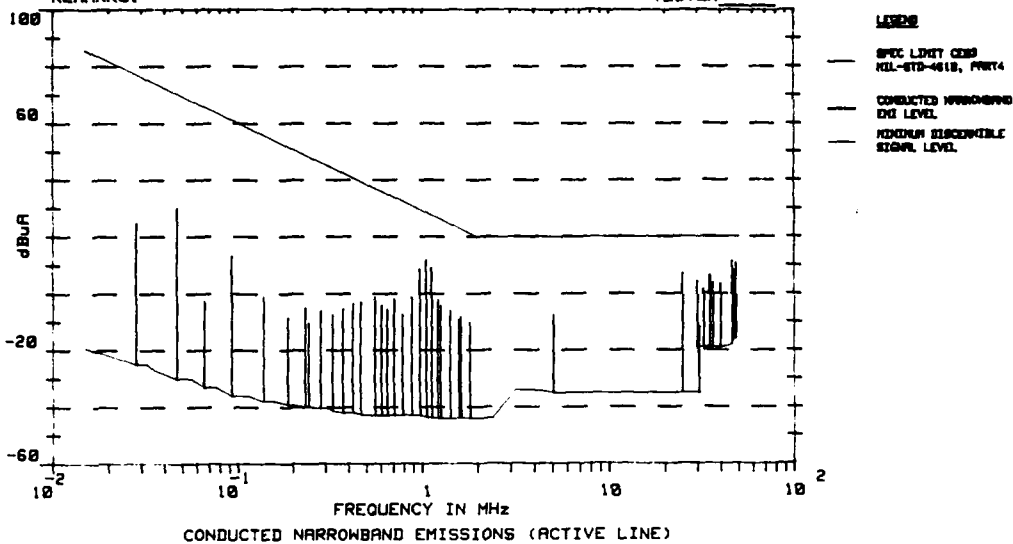

FIG 19 - STANDARD MODEL 1100 GRID COMPUTER
CONDUCTED NARROWBAND EMISSIONS (ACTIVE LINE)

ENGINEERING DEVELOPMENT ESTABLISHMENT
ELECTRICAL LABORATORIES

TEST SAMPLE: GRID COMPUTER MODEL No 1107
MIL-STD-461B CE03, PART 4
MODE OF TEST: SEND QUICK BROWN FOX TO SCREEN
REMARKS:

TEST NUMBER: 1
DATE: 2/5/86
TESTER

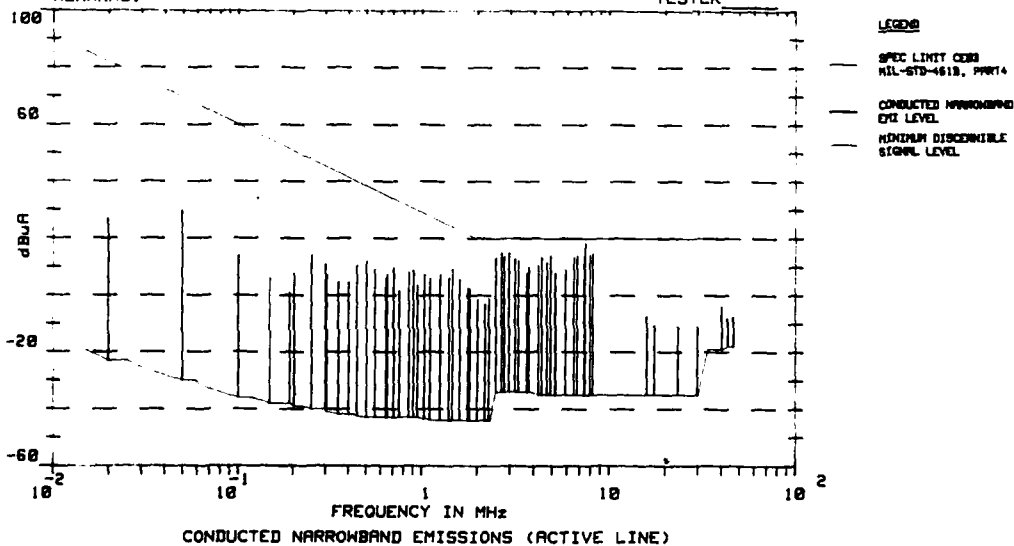
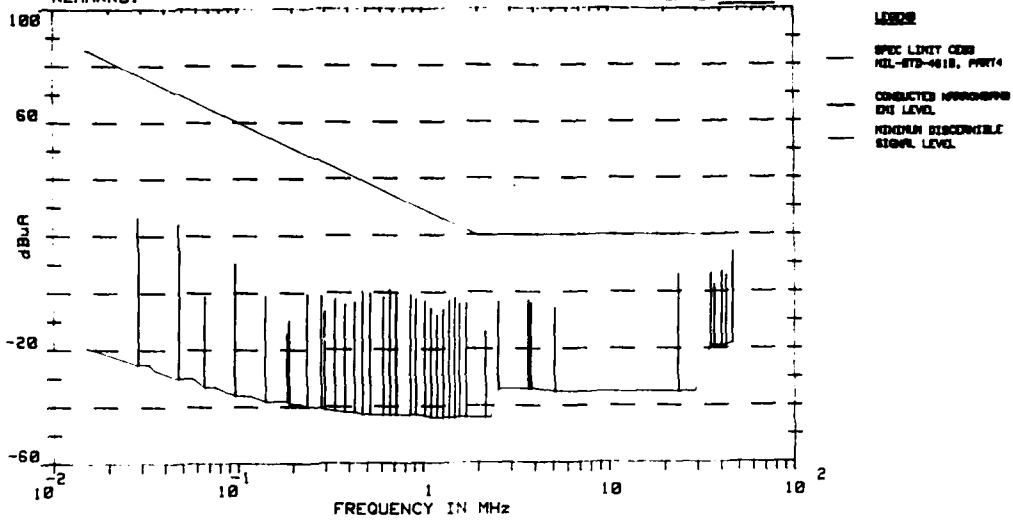

FIG 20 - TEMPEST MODEL 1107 GRID COMPUTER
CONDUCTED NARROWBAND EMISSIONS (ACTIVE LINE)

ENGINEERING DEVELOPMENT ESTABLISHMENT
ELECTRICAL LABORATORIES

TEST SAMPLE: GRID COMPUTER MODEL No 1100
MIL-STD-461B CE03, PART 4
MODE OF TEST: SEND QUICK BROWN FOX TO SCREEN
REMARKS:

TEST NUMBER: 13
DATE: 1/5/86
TESTER



CONDUCTED NARROWBAND EMISSIONS (NEUTRAL LINE)

FIG 21 - STANDARD MODEL 1100 GRID COMPUTER
CONDUCTED NARROWBAND EMISSIONS (NEUTRAL LINE)

ENGINEERING DEVELOPMENT ESTABLISHMENT
ELECTRICAL LABORATORIES

TEST SAMPLE: GRID COMPUTER MODEL No 1107
MIL-STD-461B CE03, PART 4
MODE OF TEST: SEND QUICK BROWN FOX TO SCREEN
REMARKS:

TEST NUMBER: 2
DATE: 2/5/86
TESTER

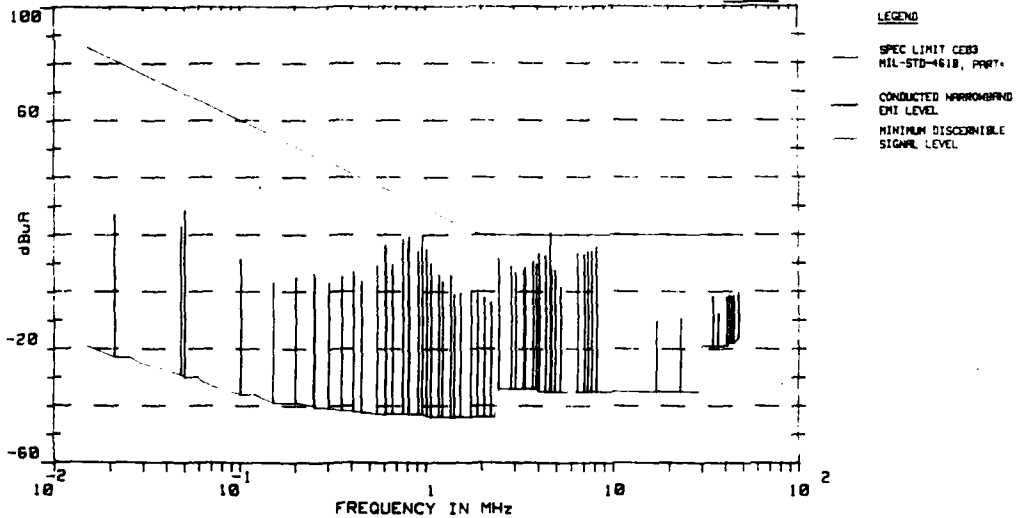

CONDUCTED NARROWBAND EMISSIONS (NEUTRAL LINE)

FIG 22 - TEMPEST MODEL 1107 GRID COMPUTER
CONDUCTED NARROWBAND EMISSIONS (NEUTRAL LINE)

ENGINEERING DEVELOPMENT ESTABLISHMENT
ELECTRICAL LABORATORIES

TEST SAMPLE: GRID COMPUTER MODEL No 1100
MIL-STD-461B RE02, PART 4
MODE OF TEST: SEND QUICK BROWN FOX TO SCREEN
REMARKS:

TEST NUMBER: 11
DATE: 30/4/86
TESTER

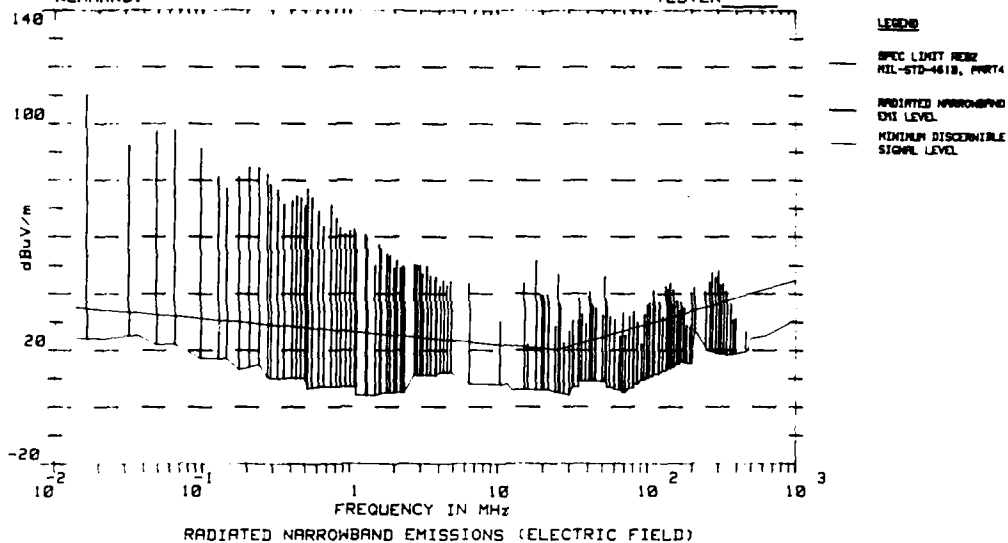

FIG 23 - STANDARD MODEL 1100 GRID COMPUTER
RADIATED NARROWBAND EMISSIONS (ELECTRIC)

ENGINEERING DEVELOPMENT ESTABLISHMENT
ELECTRICAL LABORATORIES

TEST SAMPLE: GRID COMPUTER MODEL No 1107
MIL-STD-461B RE02, PART 4
MODE OF TEST: SEND QUICK BROWN FOX TO SCREEN
REMARKS:

TEST NUMBER: 5
DATE: 6/5/86
TESTER

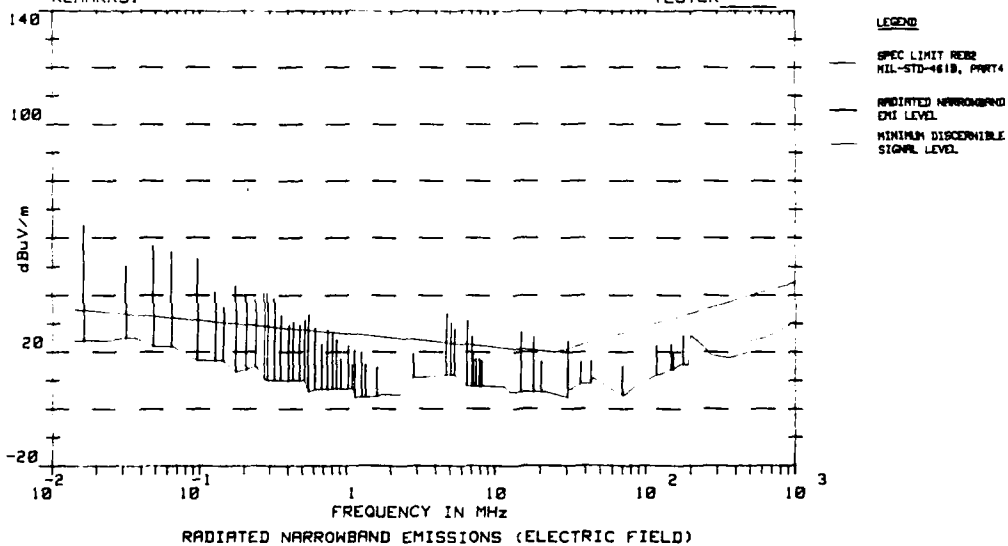
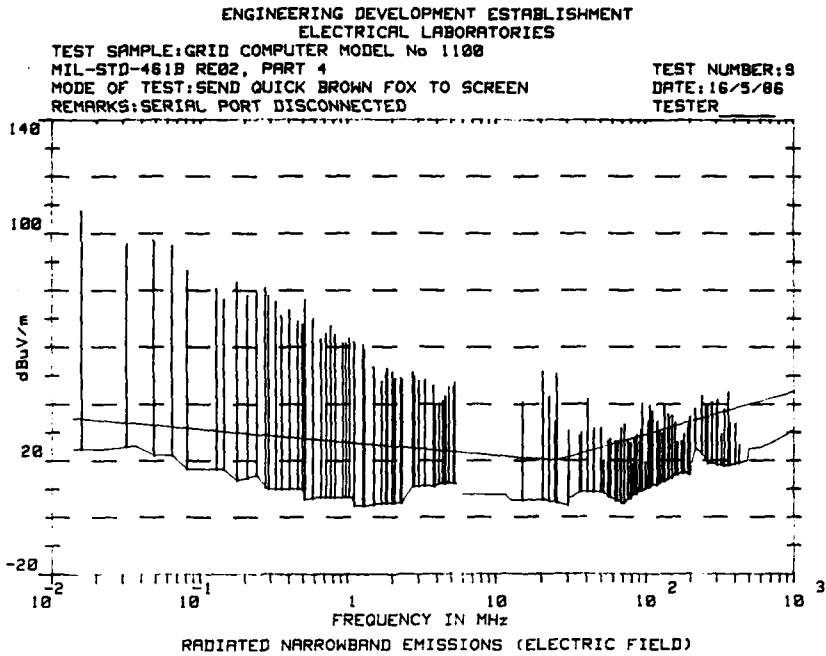
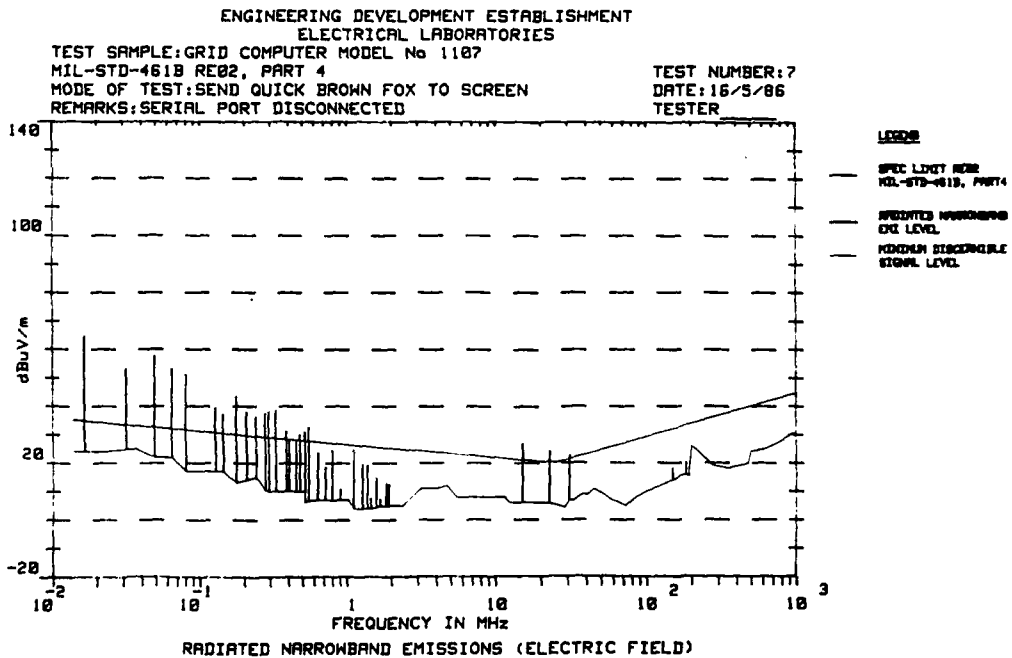

FIG 24 - TEMPEST MODEL 1107 GRID COMPUTER
RADIATED NARROWBAND EMISSIONS (ELECTRIC)



**FIG 25 - STANDARD MODEL 1100 GRID COMPUTER
RADIATED NARROWBAND EMISSIONS (ELECTRIC)
SERIAL CABLE DISCONNECTED**

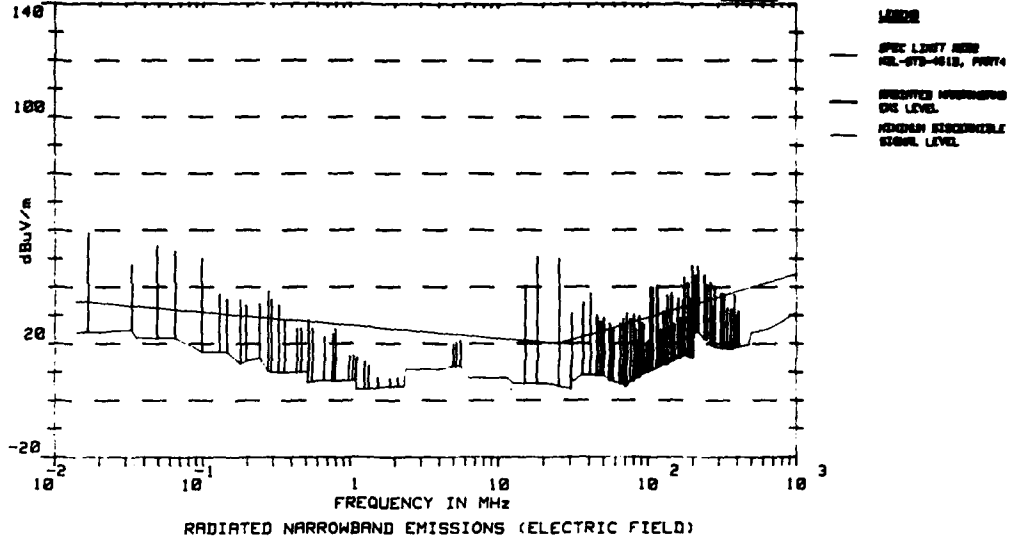

**FIG 26 - TEMPEST MODEL 1107 GRID COMPUTER
RADIATED NARROWBAND EMISSIONS (ELECTRIC)
SERIAL CABLE DISCONNECTED**

ENGINEERING DEVELOPMENT ESTABLISHMENT
ELECTRICAL LABORATORIES

TEST SAMPLE: GRID COMPUTER MODEL No 1106
MIL-STD-461B RE02, PART 4
MODE OF TEST: SEND QUICK BROWN FOX TO SCREEN
REMARKS: DISPLAY PANEL FOLDED DOWN

TEST NUMBER: 18
DATE: 16/5/86
TESTER

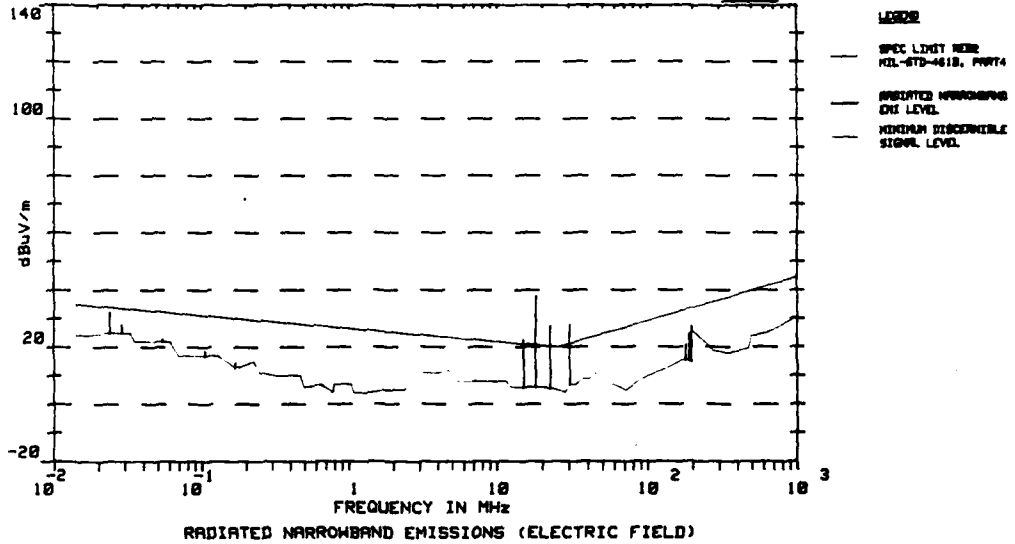

**FIG 27 - STANDARD MODEL 1100 GRID COMPUTER
RADIATED NARROWBAND EMISSIONS (ELECTRIC)
DISPLAY PANEL FOLDED DOWN**

ENGINEERING DEVELOPMENT ESTABLISHMENT
ELECTRICAL LABORATORIES

TEST SAMPLE: GRID COMPUTER MODEL No 1107
MIL-STD-461B RE02, PART 4
MODE OF TEST: SEND QUICK BROWN FOX TO SCREEN
REMARKS: DISPLAY PANEL FOLDED DOWN

TEST NUMBER: 8
DATE: 16/5/86
TESTER



**FIG 28 - TEMPEST MODEL 1107 GRID COMPUTER
RADIATED NARROWBAND EMISSIONS (ELECTRIC)
DISPLAY PANEL FOLDED DOWN**

ENGINEERING DEVELOPMENT ESTABLISHMENT
ELECTRICAL LABORATORIES

TEST SAMPLE: GRID COMPUTER MODEL No 1107
MIL-STD-461B RE02, PART 4
MODE OF TEST: SEND QUICK BROWN FOX TO SCREEN
REMARKS:

TEST NUMBER: 6
DATE: 6/5/86
TESTER:

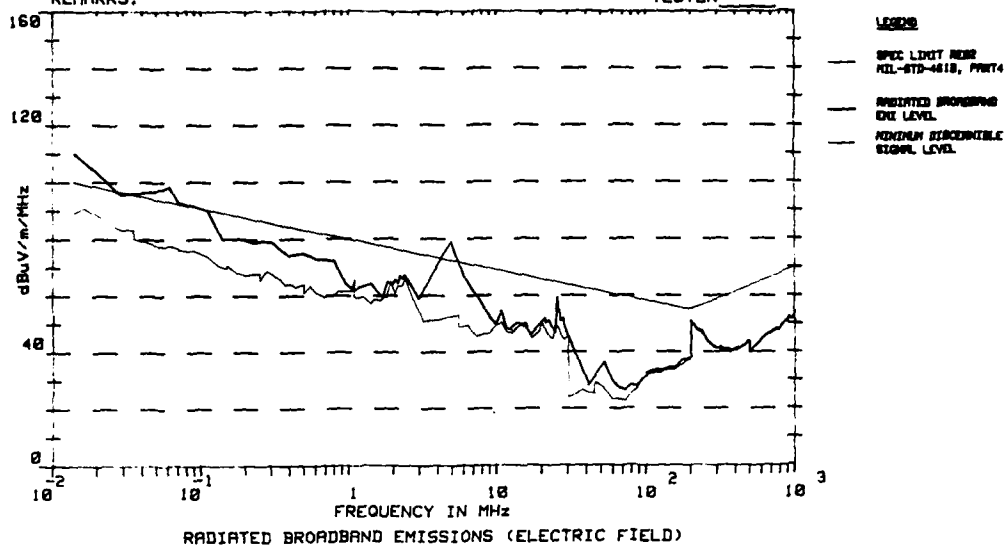

FIG 29 - TEMPEST MODEL 1107 GRID COMPUTER
RADIATED BROADBAND EMISSIONS (ELECTRIC)

ANNEX C

SURVEY OF COMMERCIALY AVAILABLE PORTABLE COMPUTERS

SURVEY OF COMMERCIALY AVAILABLE PORTABLE COMPUTERS

INTRODUCTION

1. This annex has been compiled by EDE as part of a preliminary market survey of portable computers which may have an application within Army. All of these units are similar in concept to the GRID Compass. They generally offer improved performance and more features (eg IBM compatibility) at a similar cost to the GRID Compass or similar capability at a reduced cost. Details provided for each machine include a general description, technical specification, price, and discussion of the machines disadvantages/advantages.

2. The machines included in this survey have been chosen because they have some particularly attractive feature such as low power consumption, low cost, light weight, high performance, large storage capacity etc. There are many other machines available which have not been included because they have features or design attributes represented by one of the machines included in the survey.

SURVEYED MACHINES

3. The machines examined are as follows :-

- a. Compaq Portable 11
- b. GRIDCASE Plus 2 and Plus 3
- c. Hewlett Packard Portable PLUS Personal Computer
- d. IBM PC Convertible
- e. Dulmont Magnum Portable Computer (alias Kookaburra manufactured by HRC Time Office of Sydney)
- f. Sharp PC-7000
- g. Toshiba T1100 Plus and T3100

4. The machines surveyed fall into three distinct categories :-

- a. Battery operated non IBM PC compatible machines with LCD displays and RAM disk storage but no built-in floppy disk or hard disk storage (Dulmont Magnum and Hewlett Packard Portable PLUS).
- b. Battery operated IBM PC compatible machines with LCD displays and built-in floppy disk storage (GRIDCASE Plus 2, IBM PC Convertible, Toshiba T1100 Plus).

- c. Battery/mains operated IBM PC compatible machines with high power consumption displays such as backlit LCD, CRT, plasma or electro-luminescent with built-in floppy disk or hard disk storage (Compaq Portable II, GRIDCASE Plus 3, Sharp PC-7000, Toshiba T3100).

5. The following paragraphs summarize the characteristics of each of the machines. Note that the term 'clam shell' is used to describe the flat style of case with a hinged display panel which folds down to cover the keyboard. The GRID Compass has a 'clam shell' style case (see Fig 1 of main report).

Compaq Portable II

6. The Compaq Portable II is an IBM AT compatible machine with a small CRT display and internal hard and floppy disk drives. It is a large machine packaged in a 'sewing machine' style case.

7. The Compaq Portable II has the following specifications:-

Processor	- 80286, 8 MHz clock 80287 coprocessor
Display	- CRT (monochrome) 17.8 cm x 14 cm viewing area 25 line by 80 column text display 640 x 200 pixel graphic display
Memory	- 640 KByte random access (expandable to 8 MByte)
Keyboard	- Full size QWERTY layout with full-stroke keys
Internal Storage	- One 5¼" 360 KByte floppy disk One 20 MByte hard disk
Interfaces	- RS232C serial port (asynchronous) Centronics parallel printer port RGB and composite display monitors 2 IBM PC/AT bus compatible expansion slots
IBM PC Compatible	- Yes (IBM AT compatible)
Operating System	- PC/MSDOS
Dimensions	- 19 x 44.5 x 35 cm
Weight	- 12.2 Kilograms
Power	- 240 Volt AC

Cost - \$7336 ex tax (Computerland, South Melbourne
Phone (03) 266 8647)

8. The Compaq Portable II is a high performance machine with a large amount of mass storage and is suited to applications requiring extensive processing power and/or large amounts of on-line data. It requires access to a 240 Volt AC power supply and would be suitable for limited field use if protected from the environment.

Dulmont Magnum Portable (alias Kookaburra)

9. The Dulmont Magnum Portable is now called the Kookaburra and is manufactured by HRC Time of Sydney. It is a battery powered MSDOS machine which is packaged in a 'clam shell' style case.

10. The Dulmont Magnum has the following specifications :-

Processor	- 80186, 6 MHz clock No coprocessor
Display	- LCD 23 cm x 6 cm viewing area 16 line by 80 column text display (25 line display expected to be available during March 86)
Memory	- 256 KByte random access 160 KByte used as RAM disk
Keyboard	- QWERTY layout, 76 full-stroke keys
Internal Storage	- 160 KByte RAM disk
Interfaces	- Two RS232C serial port (asynchronous) Centronics parallel printer port 25 line by 80 column composite video Processor expansion bus (two 5 $\frac{1}{4}$ " floppy disks can be attached to this bus)
IBM PC Compatible	- No
Operating System	- MSDOS
Dimensions	- 32.5 cm x 28.5 cm x 5.8 cm
Weight	- 4 kilograms
Power	- 6 Volt DC internally with eight hours running time, 240 Volt AC recharger.
Cost	- \$1250 ex tax (HRC Time, Sydney Phone (02) 439 8544)

11. The use of an 80186 processor in the Dulmont Magnum gives it an approximate 70% performance improvement over the 8088 based machines in this survey. EDE has under taken a program to repackage the Magnum into a sealed and robust case and to develop large capacity RAMdisks (1 MByte). The Magnum was chosen due to ready access to design information from the manufacturer located in Sydney. It is envisaged that the repackaged Magnum will be capable of storing large amounts of data in solid state memory and also be able to endure the rigours of field use. The cost of the repackaged machine is expected to be in the same order as the GRID Compass and GRIDCASE range of computers.

GRIDCASE Plus 2 and Plus 3

12. The GRIDCASE Plus 2 and Plus 3 computers are portable IBM PC compatible machines which are packaged in a cast magnesium case virtually identical in appearance to the GRID Compass computers tested by EDE. They incorporate an internal 10 Mbyte hard disk or 3½" 720 KByte floppy disk (but not both) and the choice of enhanced LCD or red plasma displays.

13. The GRIDCASE range of computers have the following specifications:-

Processor	- CMOS 8086, 4.77 MHz clock 8087 coprocessor
Display	- GRIDCASE 2 - Enhanced LCD GRIDCASE 3 - Plasma (red) 22.5 cm x 10.4 cm viewing area 25 line by 80 column text display 640 by 200 pixel graphic display
Memory	- 640 KByte random access
Keyboard	- QWERTY layout, 57 full-stroke keys
Internal Storage	- One 3½" 720 KByte floppy or one 3½" 10 MByte hard disk (not both)
Interfaces	- RS232C serial port (asynchronous) Centronics parallel printer port RGB display monitors 300/1200 baud modem Connection to external IBM PC keyboard Processor bus expansion
IBM PC Compatible	- Yes
Operating System	- PC/MSDOS
Dimensions	- 38.1 x 29.2 x 5.7 cm
Weight	- 5.5 Kilograms

- Power** - 12 Volt DC internal battery with 4.5 hours running time for GRIDCASE 1 and 2 and 1 hours running time for GRIDCASE 3, 240 Volt AC recharger
- Cost** - GRIDCASE Plus 2 - \$8537 ex tax
 GRIDCASE Plus 2 with hard disk - \$10230 ex tax
 GRIDCASE Plus 3 - \$9090 ex tax
 GRIDCASE Plus 3 with hard disk - \$10783 ex tax
 (Vicom, South Melbourne Phone (03) 6909399)

14. Since the GRIDCASE computers are very similar to the GRID Compass range, it is believed that they would be suitable for limited field use if they are protected from the environment (particularly the floppy disk drives). Current technology 3½" hard disk drives claim to be relatively shock resistant and may be suitable for field use. The GRIDCASE computers are of average performance and are much more expensive than equivalent computers examined in this report.

Hewlett Packard Portable PLUS

15. The HP Portable PLUS computer runs MSDOS but is not an IBM PC compatible machine. It is packaged in a 'clam shell' style plastic case and is claimed to be capable of with standing shocks of up to 100 g. It incorporates an LCD display and battery backed up RAM as mass storage.

16. The HP Portable PLUS computer has the following specifications:-

- Processor** - CMOS 8086, 5.33 MHz clock
 No coprocessor
- Display** - LCD
 25 line by 80 column text display
 480 by 200 pixel graphic display
- Memory** - 1.28 MByte random access
- Keyboard** - QWERTY layout, 75 full-stroke keys
- Internal Storage** - RAMdisk (external 3½" floppy available)
 Plug in applications software in the form of ROM modules
- Interfaces** - RS232C serial port (asynchronous)
 Composite video output
 HP-IL
 Optional internal 1200/300 baud modem
- IBM PC Compatible** - No

Operating System	- MSDOS 2.11
Dimensions	- 33 x 25.4 x 7.6 cm
Weight	- 3.9 Kilograms
Power	- 12 Volt DC internal with 20 hours running time and 8 hours recharging, 240 Volt AC recharger
Cost	- \$7650 ex tax (Hewlett Packard, Blackburn Phone (03) 895 2895)

17. The HP Portable PLUS computer has the advantage over other equipments surveyed of light weight and solid state mass storage. It is therefore independent of any mechanical mass storage devices with their associated dust and vibration problems. It has an exceptionally long battery life (up to 20 hours per charge) and if repackaged would be well suited to a totally portable military role with limited access to power.

IBM PC Convertible

18. The IBM PC Convertible is an IBM PC compatible machine which is packaged in a plastic 'clam shell' style case. It features two internal 3 $\frac{1}{4}$ " 720 KByte floppy disk drives and a liquid crystal display.

19. The IBM PC Convertible has the following specifications:-

Processor	- CMOS 8088, 4.77 MHz clock No coprocessor
Display	- LCD 26.7 cm x 10 cm 25 line by 80 column text display 640 by 200 pixel graphic display
Memory	- 640 KByte random access
Keyboard	- QWERTY layout, 78 full-stroke keys
Internal Storage	- Two 3 $\frac{1}{4}$ " 720 KByte floppy drives
Interfaces	- RS232C serial port (asynchronous) Centronics parallel printer port External color and monochrome monitors Processor expansion bus Internal modem
IBM PC Compatible	- Yes
Operating System	- PC/MSDOS

Dimensions	- 37.4 x 32.5 x 6.9 cm
Weight	- 5.7 Kilograms
Power	- Internal rechargeable battery, 240 Volt AC recharger.
Cost	- \$3665 ex tax (Computerland, South Melbourne Phone (03) 268 8647)

20. The IBM PC Convertible is similar in features to the Toshiba T1100 Plus. Therefore the comments for the Toshiba T1100 equally apply to the IBM PC Convertible. It is included in this survey because IBM is the originator of the desktop machine which most of these portables attempt to emulate.

Sharp PC-7000

21. The Sharp PC-7000 is an IBM PC compatible machine which is packaged in a plastic 'sewing machine' style case. It features two internal 5¼" 360 KByte floppy disk drives, a liquid crystal display and detachable printer.

22. The Sharp PC-700 has the following specifications:-

Processor	- 8086, 7.37 MHz clock Optional coprocessor
Display	- LCD (optional backlit) 25 line by 80 column text display 640 by 200 pixel graphic display
Memory	- 768 KByte random access
Keyboard	- QWERTY layout, 84 full-stroke keys
Internal Storage	- Two 5¼" 360 KByte floppy disk drives
Interfaces	- RS232C serial port (asynchronous) Centronics parallel printer port (for optional printer which clips on to the main unit for transport) RGB display monitor 10 MByte hard disk expansion
IBM PC Compatible	- Yes
Operating System	- PC/MSDOS
Printer	- 72 Characters per second Impact dot matrix Paper width 30 cm

Dimensions	- 41 x 21.5 x 16 cm (without printer) 41 x 21.5 x 20 cm (with printer)
Weight	- 8.5 Kilograms (without printer) 13.7 Kilograms (with printer)
Power	- 240 Volt AC
Cost	- \$4800 ex tax (Sharp Australia, Scoresby Phone (03) 763 9444)

23. Compared to the other machines in this survey the Sharp PC-7000 is unique because a printer (paper width of 30 cm) is integrated into the design. The printer clips onto the side of the case for transport but is fully detached when in use. The use of an 8086 with a clock speed of 7.37 MHz gives the machine a performance advantage over the 8088 based machines in this survey.

Toshiba T1100 Plus

24. The Toshiba T1100 Plus is an IBM PC compatible machine with an LCD display and two internal 3½" disk drives. It is packaged in a 'clam shell' style plastic case.

25. The Toshiba T1100 Plus has the following specifications:-

Processor	- CMOS 8088, 7.16 MHz clock switchable to 4.77 MHz No coprocessor
Display	- LCD 22.9 cm x 10.1 cm viewing area 25 line by 80 column text display 640 by 200 pixel graphic display
Memory	- 512 KByte random access
Keyboard	- QWERTY layout, 83 full-stroke keys
Internal Storage	- Two 3½" 720 KByte floppy disk drives
Interfaces	- RS232C serial port (asynchronous) Centronics parallel printer port RGB and composite display monitors Optional internal 300/1200 baud modem
IBM PC Compatible	- Yes
Operating System	- PC/MSDOS
Dimensions	- 30.5 x 30 x 6.4 cm

- Weight - 4.1 Kilograms
- Power - 12 Volt DC internally with six hours running time, 240 Volt AC recharger
- Cost - \$3125 ex tax (Toshiba Australia, Mulgrave Phone (03) 566 1700)

26. The Toshiba T1100 Plus has a relatively long battery life and is well suited to applications which have no ready access to external power. It has adequate I/O capability and features full IBM PC compatibility. It must currently use floppy disks which are not particularly suited to some field applications. It would be a suitable candidate for repackaging into a robust case. The provision of a battery backed-up RAMdisk would remove its dependence on floppy disks.

Toshiba T3100

27. The Toshiba T3100 is an IBM PC compatible machine which is packaged in a plastic 'clam shell' style case. It features a 3½" 720 KByte floppy disk, optional internal 10 MByte hard disk and an amber plasma display.

28. The Toshiba T3100 has the following specifications :-

- Processor - CMOS 80286, 7.74 MHz clock switchable to 4.77 MHz
Optional 80287 coprocessor
- Display - Plasma (amber)
25 line by 80 column text display
640 by 400 pixel graphic display
- Memory - 640 KByte random access (expandable to 2.6 MBytes internally)
- Keyboard - QWERTY layout, 81 full-stroke keys
- Internal Storage - One 3½" 720 KByte floppy disk
One 10 MByte hard disk
- Interfaces - RS232C serial port (asynchronous)
Centronics parallel printer port
RGB display monitor
Disk expansion
Processor bus expansion
Optional internal 300/1200 baud modem
- IBM PC Compatible - Yes
- Operating System - PC/MSDOS
- Dimensions - 36 x 30 x 8 cm

Weight - 6.6 Kilograms
Power - 240 Volt AC
Cost - \$6750 ex tax with hard disk (Toshiba
Australia, Mulgrave Phone (03) 566 1700)

29. The Toshiba T3100 is a very powerful machine in a small package. The 80286 processor and internal hard disk make the machine well suited to applications requiring extensive processing power and/or large amounts of on-line data. EDE believes that the machine may be suitable for limited field use. Repackaging the machine would result in an exceptionally powerful and durable machine at a fraction of the cost of an off the shelf militarized computer, however operation, due to disk drives, would be restricted to static roles.

CONCLUSIONS

30. The following conclusions have been reached during this preliminary survey of commercially available portable computers:-

- a. There are many portable computers available which are similar in concept to the GRID Compass but which offer either improved performance and features at a similar cost or identical performance and features at a reduced cost.
- b. Repackaging the electronics of a commercially available computer in a sealed metal case should yield a machine of comparable durability and performance to militarized computers such as the GRIDSET but at a significantly reduced cost.

DOCUMENT CONTROL DATA

1.a. AR No AR-002-724	1.b. Establishment No EDE 4/87	2. Document Date 22 May 1987	3. Task No CC8601
4. Title Grid Compass Computers Engineering Evaluation		5. Security a. document (U) b. title (U) c. abstract (U)	6. No Pages 69
		7. No Refs	
8. Author(s) J. Muir		9. Downgrading Instructions	
10. Corporate Author and Address Engineering Development Establishment Maribyrnong Victoria		11. Authority (as appropriate) a. Sponsor COMD EDE b. Security COMD EDE c. Downgrading COMD EDE d. Approval COMD EDE	
12. Secondary Distribution (of this document) Approved for Public Release			
13.a. This document may be ANNOUNCED in catalogues and awareness services available to... No limitations.			
14. Descriptors Digital Computers General Purpose Computers Low Weather Tests, High Temperature Tests Corrosion Tests, EMC Tests, EMI Tests			15. DRDA Category 0062A
16. Abstract 1. This report gives details of an engineering evaluation made by Engineering Development Establishment (EDE) of two GRID Compass portable computers, one of which is TEMPEST certified. 2. It is concluded that the units are suitable for field use provided they are handled with care, are provided with a transit case for transport, and measures are taken to protect the equipment from direct exposure to dust and direct sunlight. If mounted in tracked vehicles suitable vibration isolation techniques would need to be employed. Durability performance could be significantly improved by more secure mounting of certain components within the units. 3. It is noted that there are many similar computers available which provide increased performance and/or functionality at less cost than the GRID Compass computers. However, for field use their environmental/ durability performance would have to be investigated.			

END

DATE
FILMED

-87