

AD-A181 776

SLOPING FLOAT BREAKWATER STUDY OREGON INLET NORTH
CAROLINA COASTAL MODEL INVESTIGATION(U) COASTAL
ENGINEERING RESEARCH CENTER VICKSBURG MS
R D CARVER ET AL. APR 87 CERC-TR-87-5

1/3

UNCLASSIFIED

F/G 13/2

NL

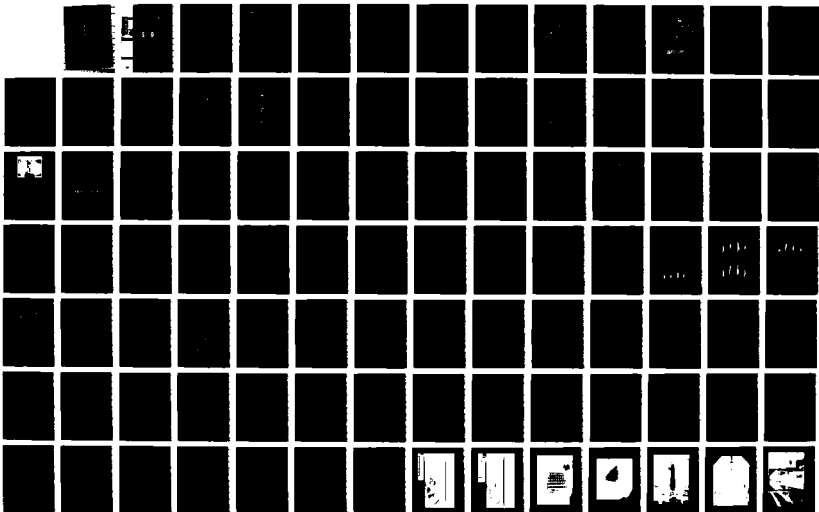

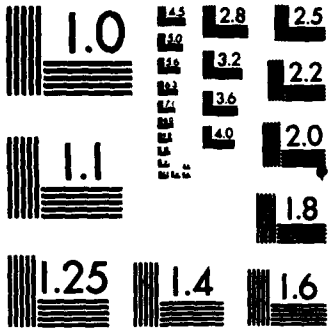

MICROCOPY RESOLUTION TEST CHART
NATIONAL BUREAU OF STANDARDS-1963-A

12

TECHNICAL REPORT CERC-87-5



US Army Corps of Engineers

SLOPING FLOAT BREAKWATER STUDY OREGON INLET, NORTH CAROLINA

Coastal Model Investigation

by **DTIC** FILE COPY

Robert D. Carver, Dennis G. Markle, Willie G. Dubose,
Robert E. Jensen

Coastal Engineering Research Center

DEPARTMENT OF THE ARMY
Waterways Experiment Station, Corps of Engineers
PO Box 631, Vicksburg, Mississippi 39180-0631

DTIC
ELECTE
JUN 26 1987
S D D

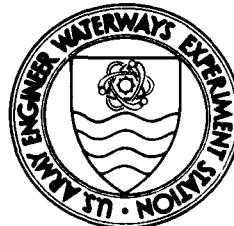

April 1987
Final Report

Approved For Public Release; Distribution Unlimited

Prepared for US Army Engineer District, Wilmington
Wilmington, North Carolina 28042

87 6 25 001

AD-A181 776

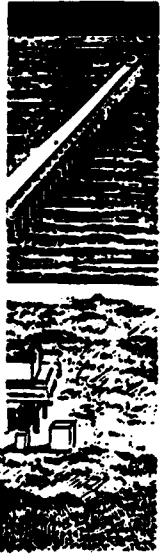

Unclassified

SECURITY CLASSIFICATION OF THIS PAGE

ADA181776

REPORT DOCUMENTATION PAGE				Form Approved OMB No 0704-0188 Exp Date Jun 30, 1986	
1a. REPORT SECURITY CLASSIFICATION Unclassified		1b. RESTRICTIVE MARKINGS			
2a. SECURITY CLASSIFICATION AUTHORITY		3. DISTRIBUTION/AVAILABILITY OF REPORT Approved for public release; distribution unlimited			
2b. DECLASSIFICATION/DOWNGRADING SCHEDULE					
4. PERFORMING ORGANIZATION REPORT NUMBER(S) Technical Report CERC-87-5		5. MONITORING ORGANIZATION REPORT NUMBER(S)			
6a. NAME OF PERFORMING ORGANIZATION USAEWES, Coastal Engineering Research Center		6b. OFFICE SYMBOL (if applicable)	7a. NAME OF MONITORING ORGANIZATION		
6c. ADDRESS (City, State, and ZIP Code) PO Box 631 Vicksburg, MS 39180-0631		7b. ADDRESS (City, State, and ZIP Code)			
8a. NAME OF FUNDING/SPONSORING ORGANIZATION US Army Engineer District, Wilmington		8b. OFFICE SYMBOL (if applicable)	9. PROCUREMENT INSTRUMENT IDENTIFICATION NUMBER		
8c. ADDRESS (City, State, and ZIP Code) PO Box 1890 Wilmington, NC 28042		10. SOURCE OF FUNDING NUMBERS			
		PROGRAM ELEMENT NO.	PROJECT NO.	TASK NO.	WORK UNIT ACCESSION NO.
11. TITLE (Include Security Classification) Sloping Float Breakwater Study, Oregon Inlet, North Carolina: Coastal Model Investigation					
12. PERSONAL AUTHOR(S) Carver, Robert D., Markle, Dennis G., Dubose, Willie G., Jensen, Robert E.					
13a. TYPE OF REPORT Final report		13b. TIME COVERED FROM Jan '81 TO Jul '84	14. DATE OF REPORT (Year, Month, Day) April 1987		15. PAGE COUNT 221
16. SUPPLEMENTARY NOTATION Available from National Technical Information Service, 5285 Port Royal Road, Springfield, VA 22161.					
17. COSATI CODES			18. SUBJECT TERMS (Continue on reverse if necessary and identify by block number)		
FIELD	GROUP	SUB-GROUP	Barges		
			Mooring lines		
			Floating breakwaters		
			Oregon Inlet, North Carolina		
			Hydraulic models		
			Waves		
19. ABSTRACT (Continue on reverse if necessary and identify by block number)					
<p>Two-dimensional (2-D) and three-dimensional (3-D) hydraulic model investigations were conducted at an undistorted linear scale of 1:25 (model to prototype) to acquire data on transmitted wave heights, mooring line forces, intermodule connector forces, bottom impact velocities, and barge angularities as a function of wave climate. These data were needed as input to optimize the design of the sloping float breakwater (SFB) concept whose function would be to protect floating dredges being used for sand bypassing at Oregon Inlet, N. C.</p> <p>The 2-D tests indicated that for the 89.6- and 118.4-ft SFB's (a) the transmission response of both structures is strongly dependent on wave period; (b) increasing the water depth significantly decreases the wave-attenuating capabilities of both structures; (c) for most wave conditions, mooring forces are similar for both SFB lengths and tend to</p>					
(Continued)					
20. DISTRIBUTION/AVAILABILITY OF ABSTRACT <input checked="" type="checkbox"/> UNCLASSIFIED/UNLIMITED <input type="checkbox"/> SAME AS RPT <input type="checkbox"/> DTIC USERS			21. ABSTRACT SECURITY CLASSIFICATION Unclassified		
22a. NAME OF RESPONSIBLE INDIVIDUAL			22b. TELEPHONE (Include Area Code)		22c. OFFICE SYMBOL

19. ABSTRACT (Continued).

increase with increasing depth; and (d) peak flow velocities under the structure are generally higher for the longer SFB.

The 3-D tests revealed that the existing barge connector concept would be subjected to extremely high forces during impact on a rigid bottom. A softer seafloor condition greatly reduced the connector forces, but since a soft bottom condition could not be guaranteed at all prototype sites, it was determined that the design of the existing connector system for highly rigid bottom-impact forces was not economically feasible. A connector system design that is isolated from these highly rigid bottom-impact forces is feasible, but needs further indepth study.



Accession For	
NTIS CRA&I	<input checked="" type="checkbox"/>
DTIC TAB	<input type="checkbox"/>
Unannounced	<input type="checkbox"/>
Justification	
By	
Distribution /	
Availability Codes	
Dist	Avail and/or Special
A-1	

PREFACE

The model investigations reported herein were requested by the US Army Engineer District, Wilmington (SAW), during a December 1979 telephone conversation with the US Army Engineer Waterways Experiment Station (WES) Coastal Engineering Research Center (CERC). Funding authorization was granted by SAW on Intra-Army Order No. SAWEN-PC-80-225 dated 1 April 1980 and Change Orders numbers 1 through 8 dated 22 December 1980, 8 January 1982, 23 March 1982, 22 July 1982, 12 October 1982, 10 November 1982, 27 January 1983, and 30 November 1983, respectively.

Model tests were conducted at WES during the period January 1981 to July 1984, under the general direction of Mr. H. B. Simmons, former Chief, Hydraulics Laboratory, Dr. J. R. Houston, Chief, CERC, and Mr. C. C. Calhoun, Jr., Assistant Chief, and Mr. C. E. Chatham, Chief, Wave Dynamics Division, and Mr. D. D. Davidson, Chief, Wave Research Branch. The Wave Dynamics Division and its personnel were transferred to the Coastal Engineering Research Center under the direction of Dr. R. W. Whalin, Chief of CERC on 1 July 1983. The model tests were planned and conducted by Messrs. R. D. Carver and D. G. Markle, Research Hydraulic Engineers, and Mr. W. G. Dubose, Engineering Technician, with the assistance of Mr. C. L. Lewis, Engineering Technician, Mr. K. A. Turner, Computer Specialist, Mr. H. C. Greer, Electronics Engineer, and Messrs. L. B. Smithhart, S. W. Guy, and L. L. Friar, Electronics Technicians. Prototype information was provided by and model test plans were coordinated through Messrs. Tom Jarrett, Bill Dennis, and Lim Vallianos, SAW. Additional technical assistance was provided by Messrs. Bob Taylor and Don Jones, Naval Civil Engineering Laboratory and Drs. Maxwell Cheung and Charles Babcock, MCA Engineers, Inc. Dr. Robert Jensen prepared Part III of this report. The remainder of this report was prepared by Messrs. Carver, Markle, and Dubose.

Liaison was maintained during the course of the investigation by means of conferences, progress reports, and telephone conversations.

Commander and Director of WES during the preparation and publication of this report was COL Dwayne G. Lee, CE. Technical Director was Dr. Robert W. Whalin.

CONTENTS

	<u>Page</u>
PREFACE.....	1
CONVERSION FACTORS, US CUSTOMARY TO METRIC (SI) UNITS OF MEASUREMENT.....	3
PART I: INTRODUCTION.....	4
Background.....	4
Description of the SFB Concept.....	6
Purpose of Model Study.....	6
PART II: THE MODELS.....	9
Design of Models.....	9
Test Facilities and Equipment.....	17
Data Acquisition and Control System (Both Models).....	17
Test Procedures.....	20
PART III: SPECTRAL WAVE SIMULATION.....	28
Selection of Spectral Shapes.....	28
Initialization.....	32
Comparisons.....	32
PART IV: TESTS AND RESULTS FOR THE FUNCTIONAL MODEL.....	38
Monochromatic Wave Tests.....	38
Spectral Wave Tests.....	40
PART V: TESTS AND RESULTS FOR SIDE-CONNECTOR TESTS.....	45
Test Conditions.....	45
Monochromatic Wave Tests.....	46
PART VI: CONCLUSIONS.....	56
REFERENCES.....	58
TABLES 1-33	
PHOTOS 1-39	
PLATES 1-91	
APPENDIX A: NOTATION.....	A1

CONVERSION FACTORS, NON-SI TO SI (METRIC)
UNITS OF MEASUREMENT

Non-SI units of measurement used in this report can be converted to SI (metric) units as follows:

<u>Multiply</u>	<u>By</u>	<u>To Obtain</u>
feet	0.3048	metres
feet per second	0.3048	metres per second
feet per second per second	0.3048	metres per second per second
inches	25.4	millimetres
kip	4448.222	newtons
knots (international)	0.5144444	metres per second
pounds (force)	4.448222	newtons
pounds (force) per inch	175.1268	newtons per metre
pounds (mass)	0.4535924	kilograms
pounds (mass) square feet	0.028317	kilograms square metres

SLOPING FLOAT BREAKWATER STUDY

OREGON INLET, NORTH CAROLINA

Coastal Model Investigation

PART I: INTRODUCTION

Background

1. Oregon Inlet (Figure 1), the northernmost opening through the barrier reef of the North Carolina coast, is of major hydrological significance in that it is the only existing communicator between the sounds of northeastern North Carolina and the Atlantic Ocean. The area immediately adjacent to Oregon Inlet includes all of Dare County. Principal economic activities include services, recreation, commercial fishing, seafood processing, and boat building.

2. The existing project channel depth of 14 ft* across the ocean bar at Oregon Inlet is neither deep enough nor stable enough for safe navigation by operators of commercial fishing vessels from North Carolina and other out-of-state ports. In an effort to provide safe passage for commercial fishing craft and other commercial ships, the US Army Engineer District, Wilmington (SAW), has proposed a channel improvement and stabilization project for Oregon Inlet. The proposed project will include a 20-ft-deep and 400-ft-wide channel through the ocean bar at Oregon Inlet. Protection for the new channel will be provided by rubble-mound jetties.

3. It is anticipated that net differences in north-south longshore transport rates will necessitate bypassing (dredging) significant quantities of sand. The primary system for sand bypassing at Oregon Inlet would involve the use of a conventional cutter-suction pipeline dredge to remove material directly from the accretion fillet that would form updrift of the stabilized inlet. Due to the severity of the wave climate in the project area, the efficiency of the sand bypassing operation would be maximized through the use of a transportable breakwater that would be deployed seaward of the fillet borrow

* A table of factors for converting non-SI units of measurement to SI (metric) units is presented on page 3.

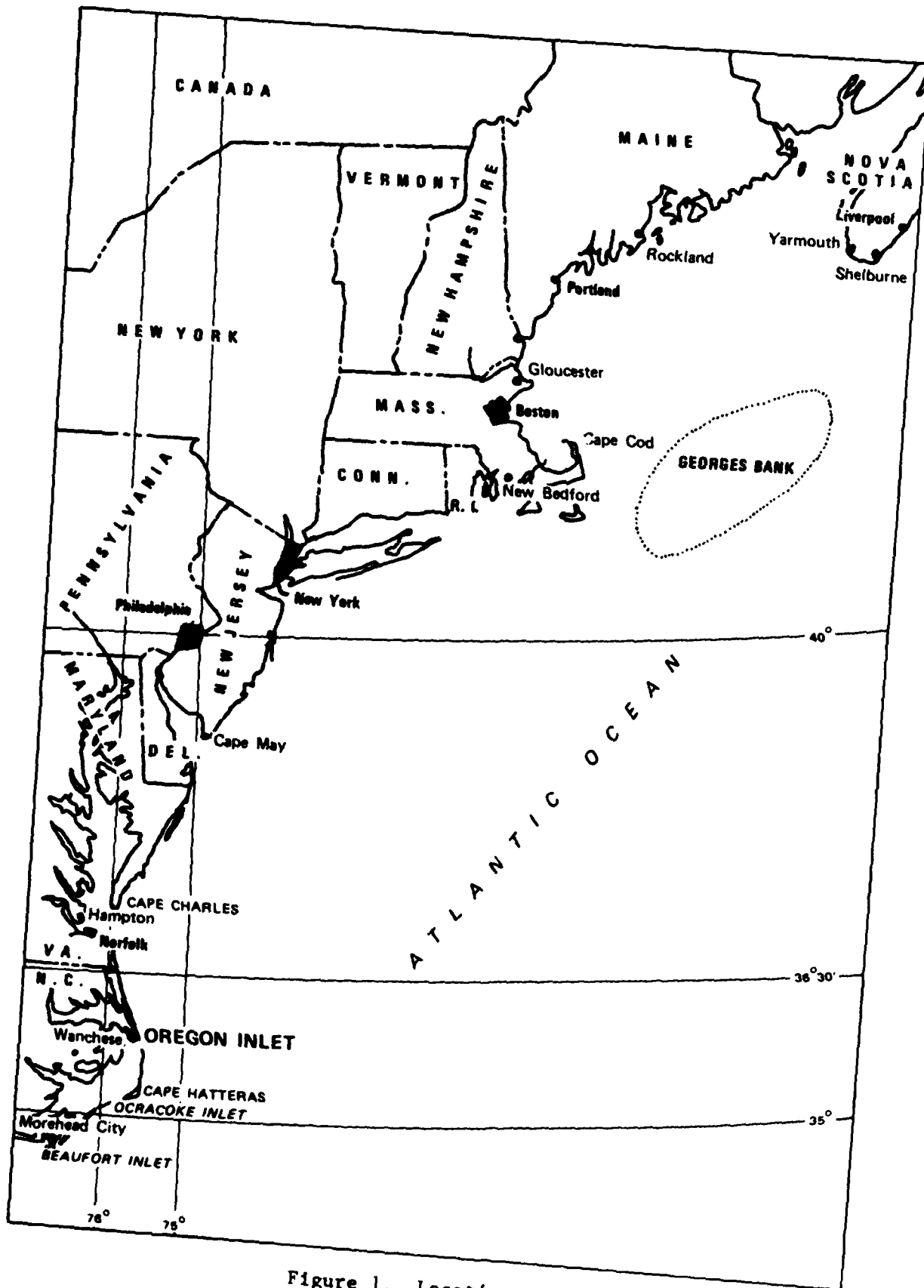

Figure 1. Location map

area. The breakwater would remain onsite during the dredging operation after which it would be removed and stored in a protected area or possibly used at other project sites. Advantage would be taken of the seasonal variability of the wave climate by scheduling sand bypassing during the low wave energy period that extends from May to August of each year. Based on an extensive literature review and analysis of available model and prototype performance data, SAW determined that the sloping float breakwater (SFB) concept (Patrick 1951, Raichlen and Lee 1978, and Raichlen 1981) is the most promising alternative available.

Description of the SFB Concept

4. The SFB is a wave barrier that consists of a row of flat slabs or panels whose weight distribution is such that each panel rests with one end above the water surface and the other end on the bottom. Various types of construction are possible; however, hollow steel or concrete barges appear to have the most promise (Jones 1980). Deployment would consist of assembling unballasted modules at the surface and then partially flooding the barges so the stern sinks and rests on the bottom and the bow floats above the water surface. The height of protrusion of the bow above the water surface (freeboard) is controlled by flooding a selected number of pontoons or barge compartments. Barges are positioned so that the bow faces into the primary direction of wave attack and mooring lines are attached between the barge and a bottom anchor. Figure 2 shows two barges moored together and Figure 3 illustrates a possible arrangement for groups of eight barges.

Purpose of Model Study

5. A need for hydraulic model tests arose from the intent of SAW to select a SFB configuration which is optimum in terms of cost-effectiveness; (i.e., the selection of breakwater length, positioning, connectors, and mooring system is to be based on a least-cost alternative in terms of combined capitalized initial construction costs and expected annual operational and maintenance costs). Determination of these costs necessitated as inputs the determination of transmitted wave heights, mooring line forces, intermodule connector forces, bottom impact velocities, and barge angularities as a

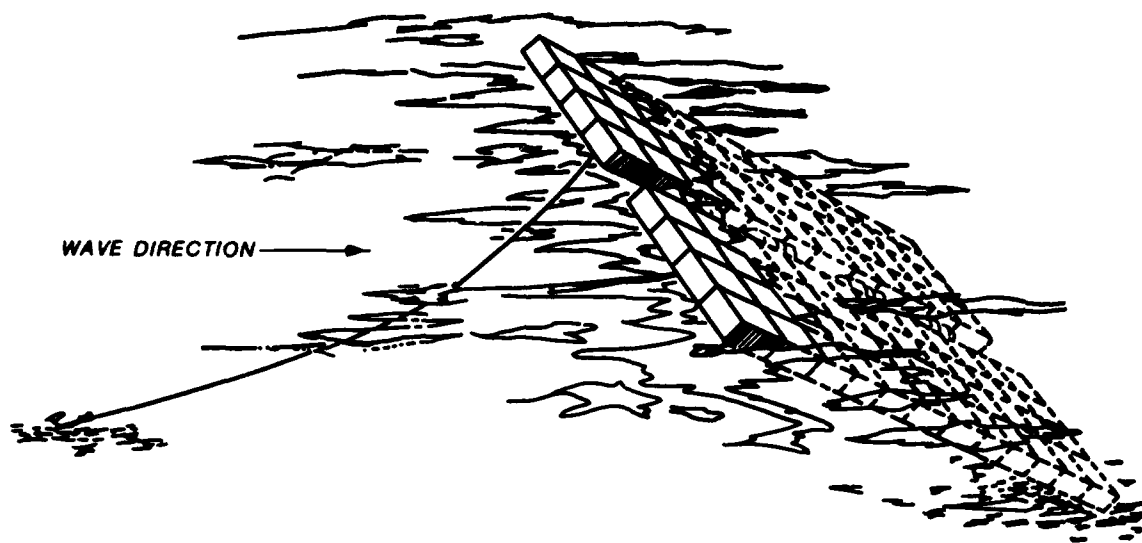

Figure 2. The SFB--an artist's conception

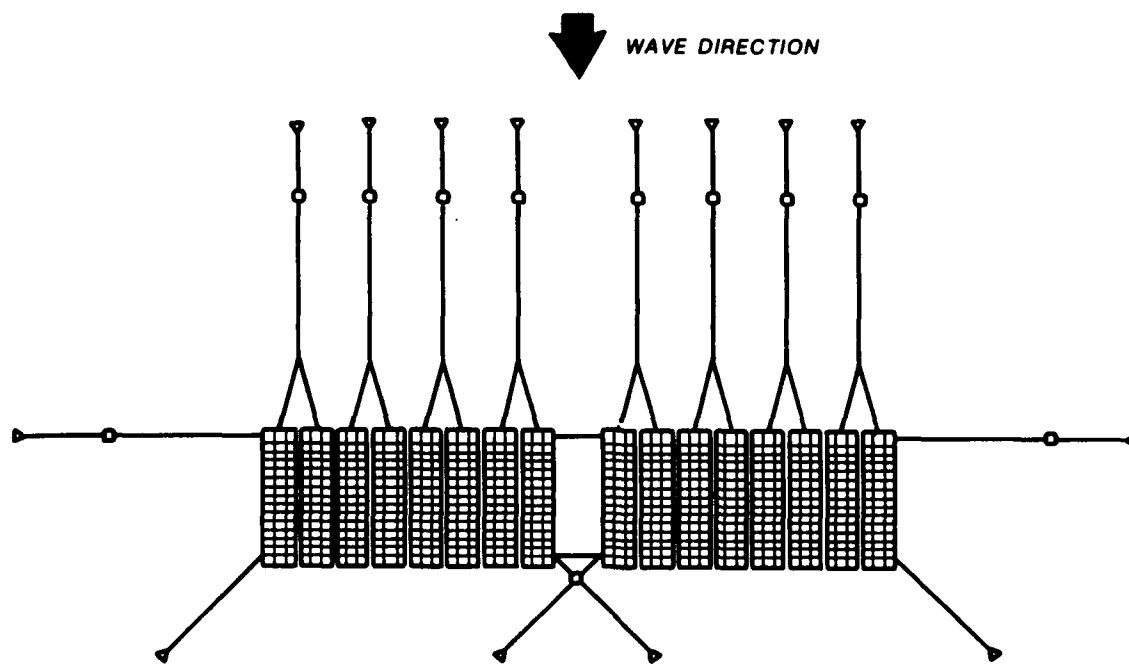

Figure 3. Two groups of SFB's

function of wave climate. The purposes of the model studies were to conduct a sufficient number of tests, both two-dimensional (2-D) (functional tests) and three-dimensional (3-D) (side-connector tests), to provide the data required for this design optimization.

PART II: THE MODELS

Design of Models

Scale selection

6. It is imperative in any model investigation of wave structure interaction that model dimensions (i.e., model scales) are made large enough to preclude any significant scale effects. Descriptions of numerous floating breakwater model studies are found in the literature; however, no comprehensive investigation of possible scale effects has been performed. Prototype flow phenomena and structure motions are primarily controlled by gravitational forces; consequently, models of this type are designed and operated in accordance with Froude's model law, while Reynolds numbers are not in similitude. This dissimilarity has no effect on the validity of test results if model Reynolds numbers are large enough to ensure turbulent flow for all test conditions. Since the Reynolds number is directly proportional to the product of a characteristic length and velocity, its values are maximized by making the model as large as possible.

7. Considering (a) capabilities (wave board velocities, electronic control accuracy, etc.) of the largest monochromatic/spectral wave generators available for the study, (b) maximum stable wave convergence, and (c) the required range of test conditions it was determined that a scale ratio of 1:25 was the largest practical value to use (most importantly, this value would ensure turbulent flow for all test conditions). Based on Froude's model law and the linear scale of 1:25, the following model-to-prototype relations were derived for the 2-D and 3-D models:

<u>Characteristic</u>	<u>Dimension</u>	<u>Model-to-Prototype Scale Relation</u>
Length	L	$L_r = 1:25$
Area	L^2	$A_r = L_r^2 = 1:625$
Volume	L^3	$V_r = L_r^3 = 1:15625$
Time	T	$T_r = L_r^{1/2} = 1:5$
Weight	F	$W_r = L_r^3(64/62.4) = 1:16026$

Dimensions are in terms of force (F), length (L), and time (T).*

* Symbols and abbreviations are listed in the Notation (Appendix A).

Design of model SFB's (functional tests)

8. The functional model tests were conducted with SFB's that simulated Navy Lightered (NL) pontoon-type barges that measured 72.3, 89.6, and 118.4 ft long. The barges are 21 ft wide and 5 ft deep. Bow and stern pontoons are 7 ft by 7 ft in plan and those comprising the interior rows are 5 ft by 7 ft. All pontoons are 5 ft deep. Structural steel assembly angles (6 by 6 by 1/2 in. thick) are used to connect the pontoons. Exact geometric details of the prototype barges, needed for model design, were obtained from "Pontoon Gear Handbook Navy Lightered (NL) Equipment P-Series" (Naval Facilities Engineering Command 1974). The NL pontoon structures were initially considered since the previous developmental work by the Navy, which included some field tests of prototype units, was based on the use of modified pontoon barges.

9. As previously discussed, the bow freeboard and the angle of inclination are controlled by flooding a specified number of pontoons. The structures tested herein represented ballasted conditions that allowed for about 5 ft of free-board. Required ballasting was as follows:

SFB Length, ft	Number of Rows of Pontoons		Weight, lb		
	<u>Total</u>	<u>Flooded</u>	<u>Unballasted SFB</u>	<u>Ballast</u>	<u>Total</u>
72.3	12	8	108,000	266,000	374,000
89.6	15	11	134,000	366,000	500,000
118.4	20	14	177,000	467,000	644,000

10. Important geometric and dynamic details of the prototype barge were considered in the design and the construction of the model sections. Overall prototype dimensions were precisely reproduced and all major parameters that control dynamic response (i.e., weight, center of gravity, mass moments of inertia, and angle of inclination) were reproduced within ± 1.0 percent. It should be noted that the model structures were 2.96 ft wide. Thus, a prototype width of 74.0 ft (or 3.5, 21-ft-wide barges) was represented. Because of the 2-D nature of the tests, this dissimilarity had no effect on model results even though the model structures represent 3.5 widths of a 21-ft-wide barge. All model results are presented relative to a normal 21-ft-wide barge. The model SFB's were constructed from marine plywood, aluminum plate, and styro-foam. Photos 1 and 2 show the 89.6- and 118.4-ft model structures, respectively.

Design of model SFB's
(side-connector tests)

11. Based on both technical and economic analyses of data gathered during the Navy field tests and the 2-D functional model tests, the structural design of the SFB was changed to a prestressed concrete barge that measured 130 ft wide, 90 ft long, and 5.5 ft deep with consideration given to possibly connecting two such barges along their 90-ft sides (Figure 4). Connectors would be located 6.75 ft inward from the bow and stern and at the center of the 90-ft sides. The bow and stern connectors would resist vertical loads and loads along the 130-ft barge axis while the center connector would resist loads along the 90-ft length. These connectors would give the two barges freedom of movement analogous to a door hinge. The barge interior would be compartmentalized and a portion of the compartments toward the stern of the barge would be ballasted with seawater so that one of its 130-ft-long sides (stern) would rest on the seafloor while the other (bow) would be above water and facing the open ocean. Each of the barges would have ballasted and unballasted weights of 3,566,600 and 2,175,000 lb, respectively. Mass moments of inertia and centers of gravity would be as shown in Figure 4. This amount of ballast will cause the SFB to float at an angle of 14.5 deg relative to the horizontal when the stern of the SFB is placed in a 20-ft water depth.

12. The model barges were constructed of aluminum plates of various thicknesses and alloy types (Photos 3 and 4). The model barges were designed and constructed so they could be ballasted and deballasted with fresh water and were scaled to reproduce the overall geometry, weight, mass moments of inertia, and centers of gravity of the ballasted and unballasted prototype barges.

13. The model SFB barges were connected by two instrumented connectors that were centered on the 5.5-ft (prototype) dimension of the barges and located 6.75 ft (prototype) from the bow and stern (Figures 4-7 and Photo 5). The spacing between the prototype barges was not specified prior to model construction. Guidelines from SAW only specified that the connectors be kept as compact as possible. The resulting assembled model connector length corresponded to a prototype barge spacing of 4.7 ft. The model did not incorporate the third connector, but, instead, simulated its resistance in the other two model connectors. Thus, forces along the 90-ft axes could be measured at the two simulated connectors and then the loadings could be

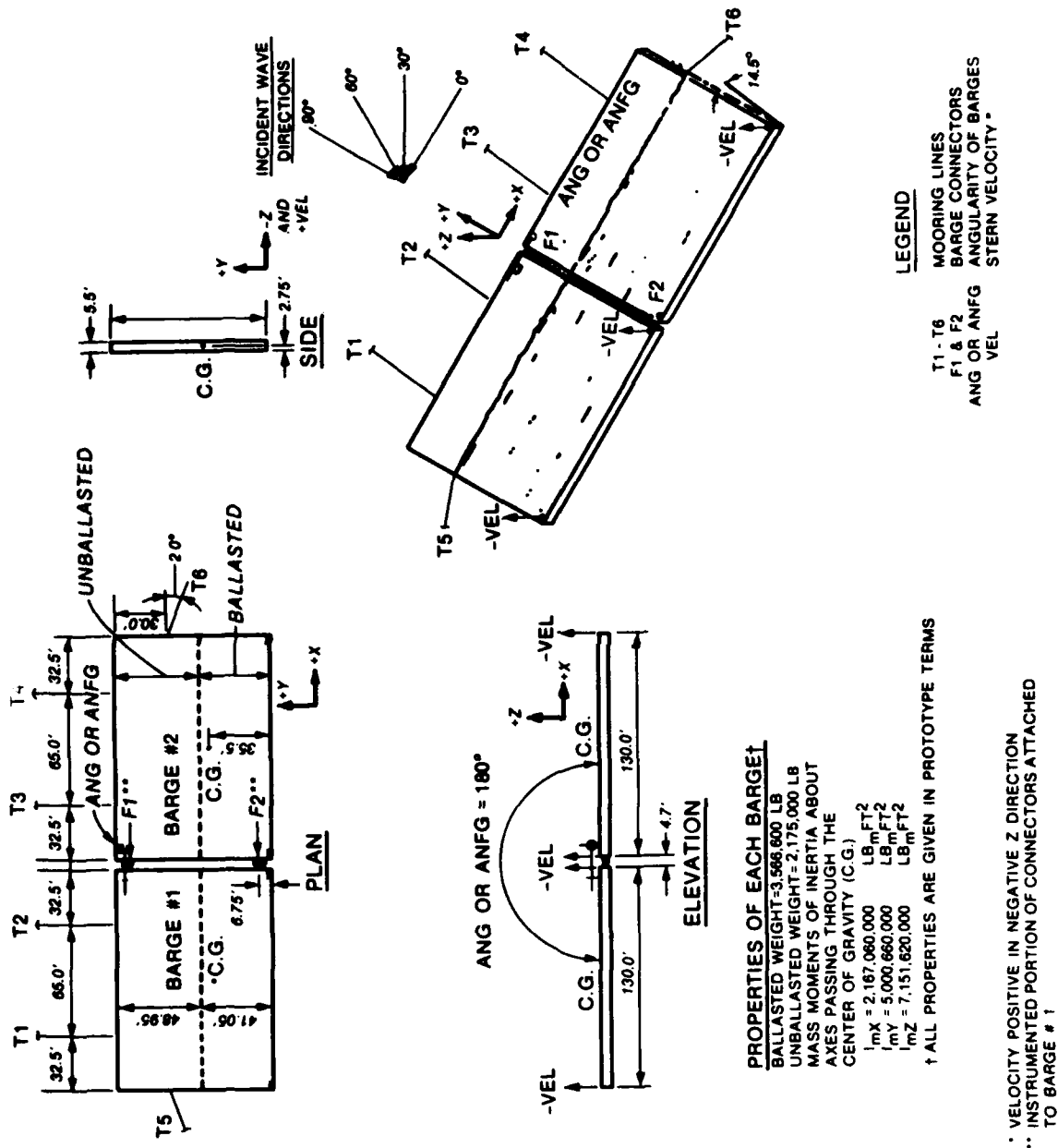

Figure 4. SFB characteristics, mooring line locations, and title and locations of model data channels

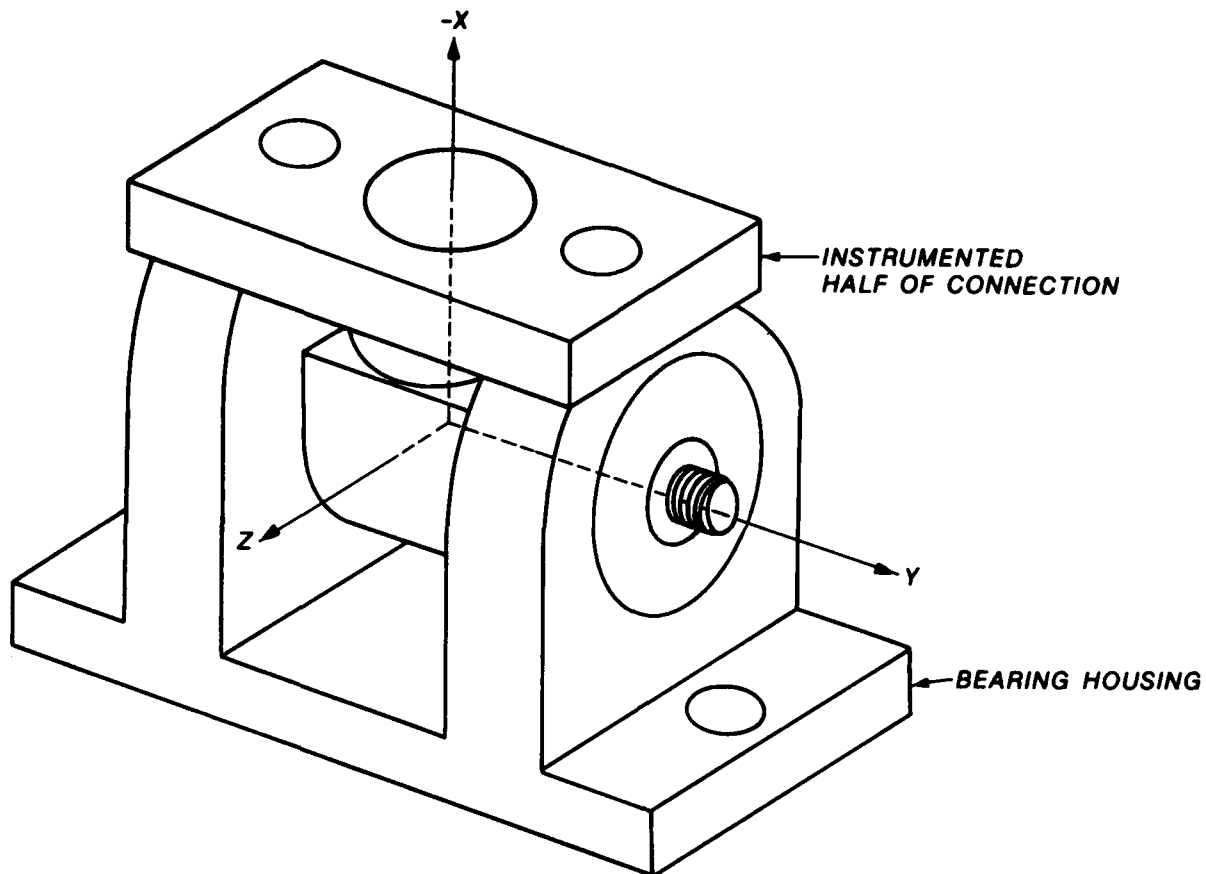

Figure 5. Model connector assembly

numerically transferred to the proper location (center of the 90-ft sides) during the analysis of the model data.

Model mooring system (functional tests)

14. The functional model tests were conducted with a mooring system that simulated a 150-ft-long, 8-in. circumference, double braided nylon rope. The breaking strength of this line is 230,000 lb. With one line attached to each 21-ft-wide NL pontoon barge, the breaking strength of the mooring line per foot of breakwater width was about 11,000 lb/ft. The stress-strain diagram for this material is nonlinear; therefore, restoring force characteristics are also nonlinear.

15. The nonlinear restoring force characteristics of the nylon line were simulated with a series of four linear springs (see Photo 6). The spring system was designed and fabricated by Dr. Fredric Raichlen, California Institute of Technology, and a detailed description of design considerations and procedures is presented in "Experiments with a Sloping Float Breakwater in

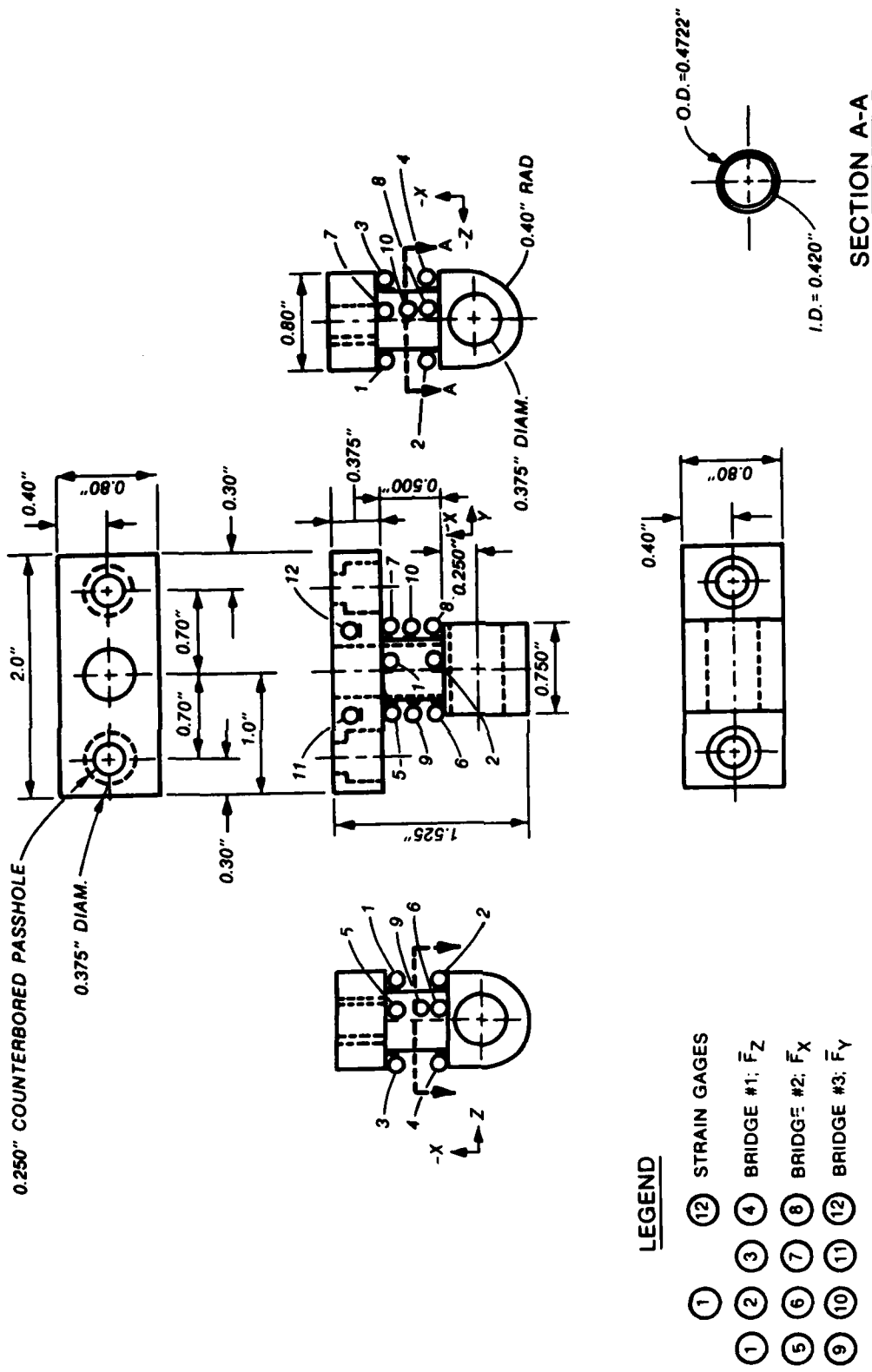

Figure 6. The instrumented half of the model connector

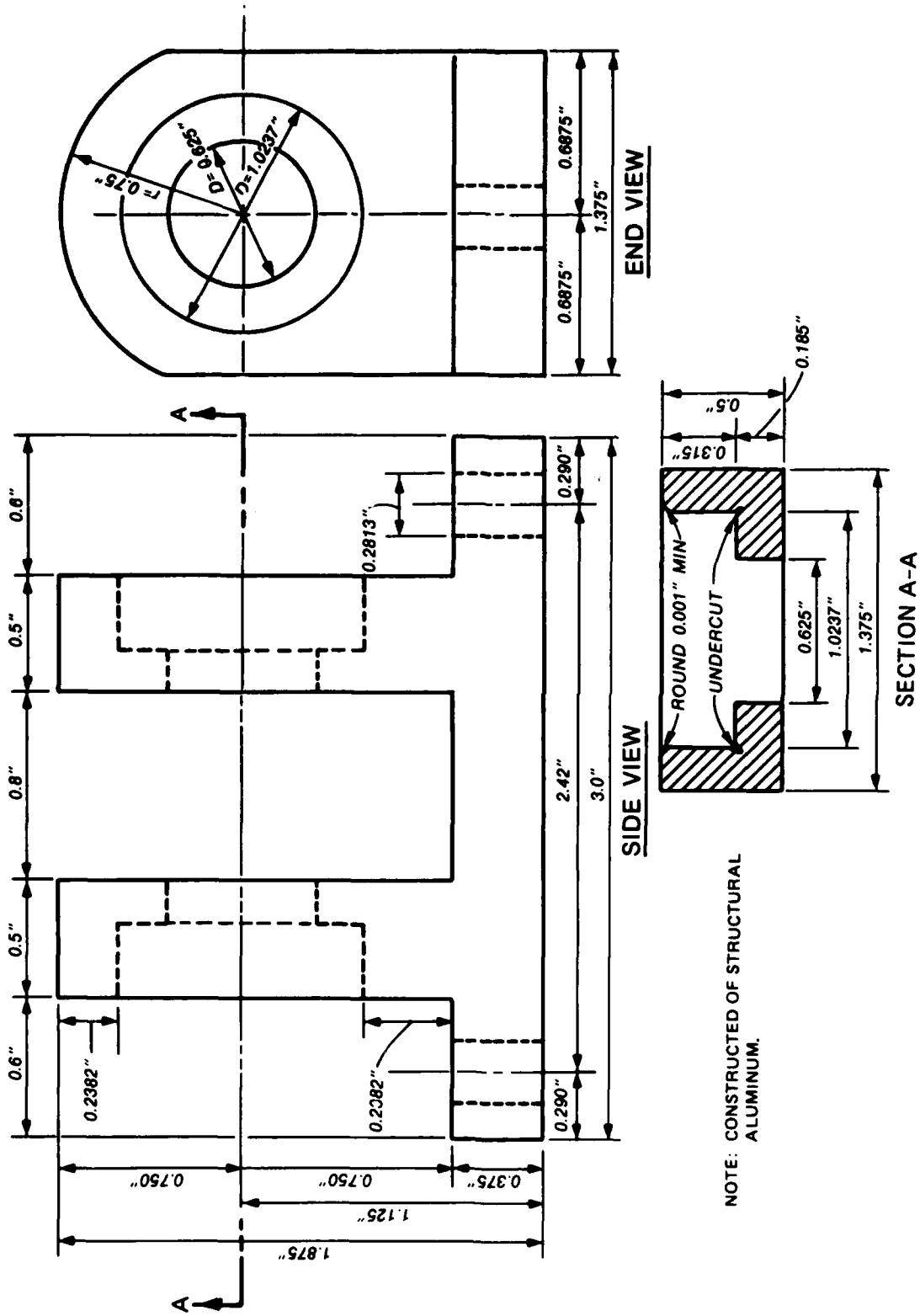

Figure 7. Bearing housing half of model connector

Water Waves-Phase I" (Raichlen 1981). The spring system functions as follows: for small deflections all springs act in series; however, after a pre-determined deflection a stop is reached and only three of the springs can deflect further. After the system deflects a certain additional amount another stop is reached and two springs act. Finally, a third stop is reached and only one spring continues to elongate.

16. The spring system with the intermediate stops was calibrated by attaching weights and measuring the deflection. Results of calibration were in excellent agreement with the desired force-displacement relationship (± 2.0 percent).

Model mooring system
(side-connector tests)

17. As previously noted, the structural design of the SFB was changed to a 130-ft-wide post-tensioned concrete barge prior to the initiation of the 3-D side connector tests. In addition, the mooring arrangement was modified from that used in the 2-D functional test and consisted of six mooring lines arranged as shown in Figure 4. Each mooring line would be 245 ft long and composed of 110 ft of steel chain and 135 ft of 20-in. circumference, 2 in 1 braided nylon rope. The nylon rope has wet and dry breaking strengths of 992,000 lb and 1,050,000 lb, respectively. Based on the wet breaking strength of the nylon rope, the breaking strength of the mooring system was equivalent to 14,200 lb/ft of breakwater or slightly stronger than the breaking strength used in the functional tests. Six spring systems were designed, constructed, and calibrated to simulate the elasticity of the 135-ft-long nylon portion of the prototype mooring line. A spring system was installed on each of the six mooring lines. It was necessary to suspend the spring systems above the water; therefore, a pulley was designed and constructed of Plexiglas and Teflon. The pulleys were attached to the flume floor in positions that corresponded to the prototype anchor weight locations, and a monofilament line was attached between the barges and each spring system. Due to the limited space in the test facility, the model mooring line length between the barge and pulley corresponded to a prototype length of 150 ft. This represented 15 ft of chain and 135 ft of nylon line. The use of the shorter overall length of the mooring line did not impact on the test results since the elasticity of the mooring system had been simulated.

Test Facilities and Equipment

Test facility (functional tests)

18. All tests were conducted in a 260-ft-long concrete wave flume (Figure 8) which converges from a width of 10.1 ft at the wave generator to a width of 3.2 ft in the area of the test sections (Photo 7). Filters were installed immediately shoreward of the generator to minimize reflected wave heights. The location of test sections was 160 ft from the wave generator. Local prototype bathymetry was represented by a 1V-on-50H slope for a simulated prototype distance of 1,500 ft (60 ft, model) seaward of the test section. The flume was equipped with a horizontal displacement hydraulic-actuated wave generator capable of producing both monochromatic and spectral wave conditions.

Test facility (side-connector tests)

19. All tests were conducted in a T-shaped wave basin 164 ft long, 43 and 15 ft wide at the top and bottom of the T, respectively, and 3.3 ft deep (Figure 9). The flume was equipped with a horizontal displacement, hydraulic-actuated wave generator capable of producing both monochromatic and spectral waves. Like the functional tests, prototype bathymetry was represented by a 1V-on-50H slope for a simulated prototype distance of 1,500 ft (60 ft, model) seaward of where the stern of the prototype barge would rest on the seafloor in a 20-ft water depth. This placed the stern of the model barge approximately 130 ft (model) from the generator.

Data Acquisition and Control System (Both Models)

20. Because of the complexity of the study and anticipated volume of model data to be collected, an automated data acquisition and control system (ADACS) with supporting software for model control, data acquisition, and analyses was used. Important characteristics and capabilities of the system are as follows:

a. Model wave characteristics.

- (1) Wave frequencies as high as 2 Hz (wave period range of 0.50 to 25.00 sec).
- (2) Wave heights in an operating range of 0.01 to 1.0 ft.
- (3) Wave-height accuracy of ± 0.001 ft.

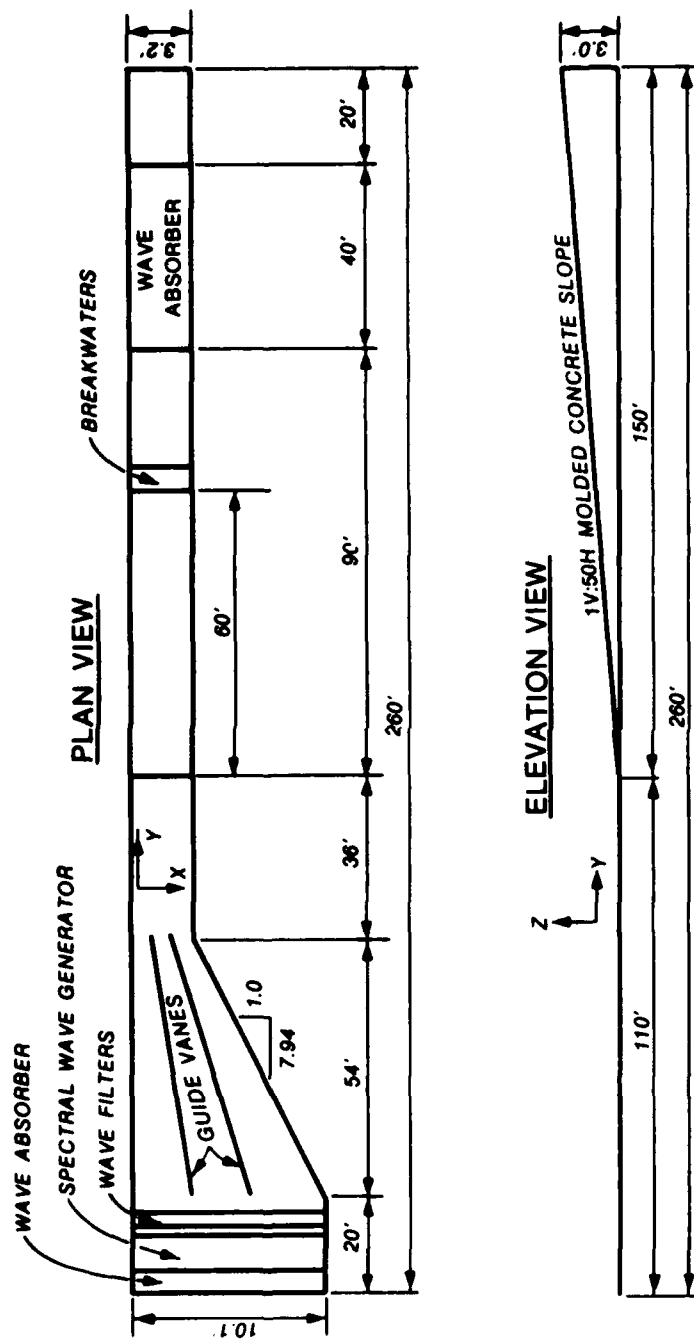

NOTE: X AND Z DISTANCES ARE AMPLIFIED 4 TIMES (RELATIVE TO Y DISTANCES) TO ENHANCE DETAIL

Figure 8. Test facility layout (functional tests)

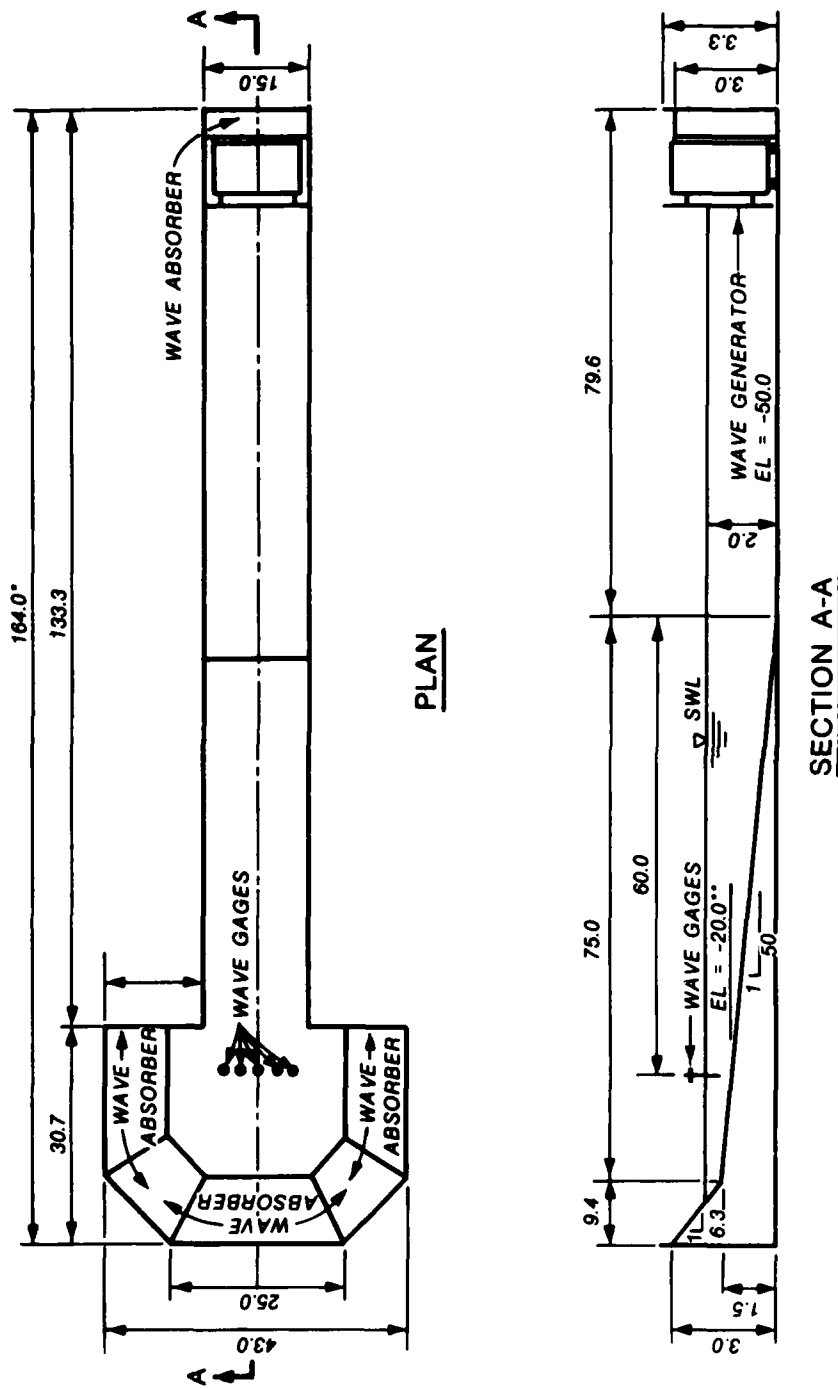

* LINEAR DIMENSIONS ARE IN MODEL FEET
 ** ELEVATIONS ARE IN PROTOTYPE FEET REFERRED TO NATIONAL GEODETIC VERTICAL DATUM

Figure 9. Test flume geometry and wave gage locations (side-connector tests)

b. Sampling techniques.

- (1) Data collected over at least 150 wave periods.
- (2) Sampling frequency variable and high enough to define the first three harmonics of the 2-Hz wave frequency (minimum sampling rate of 60 samples per cycle).
- (3) Minimum time delay (not to exceed 6 m/sec) between sampling digitally the first and last wave gage during any one scan of the gages, and this time delay should be constant and independent of the sampling frequency.
- (4) Time interval between scans of all gages should be controlled to within a few microseconds.

c. Recording modes.

- (1) Digital recording of data from all channels in binary code with provisions for BCD recording of specific information regarding test identification and data analysis.
- (2) Digital data recorded on 9-track magnetic tape with IBM compatible record format.
- (3) Continuous analog recording of all channels.
- (4) Time correlation of digital and analog recording modes.

d. Calibration of wave gages.

- (1) Efficient and accurate means of calibrating the wave gages before a series of wave tests.
- (2) Recording of calibration data in digital and analog modes.

21. The system configuration (Figure 10) of ADACS consists of the following subsystems:

- a. Digital data recording and controls.
- b. Analog recorders and channel selection circuits.
- c. Wave and force sensors and interfacing equipment.
- d. Wave generator unit and control equipment.

22. The analog recording subsystem acts as a backup for ADACS and a visual display for operator inspection of analog signals from wave sensors. This subsystem has manual or automated selection and control of five 12-channel oscillographs.

Test Procedures

Calibration of test facility (both models)

23. The normal procedure at the US Army Engineer Waterways Experiment Station (WES) is to calibrate the wave facility without the test section in

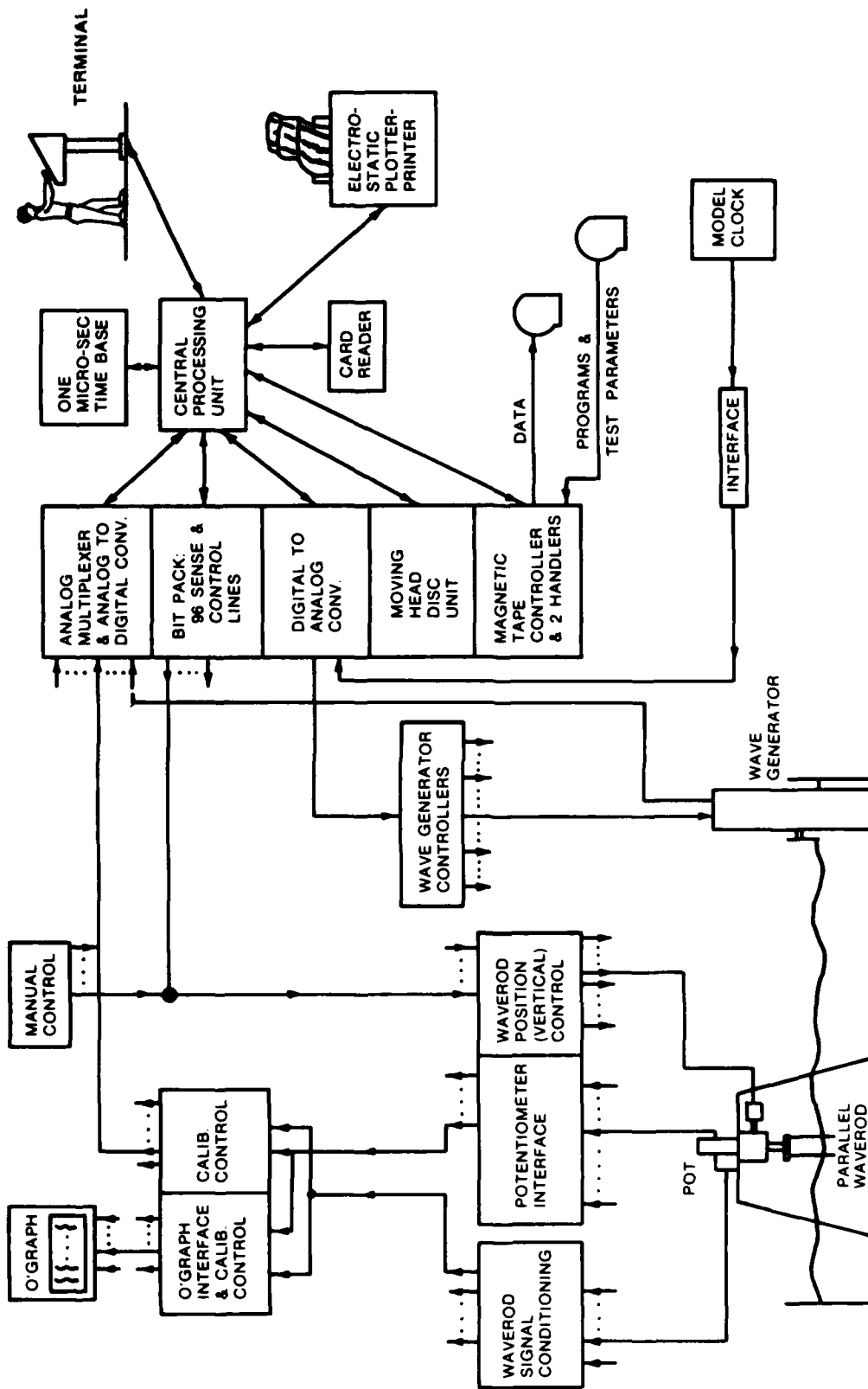

Figure 10. ADACS for hydraulic wave models

the facility. This is the most accurate means of calibrating and is analogous to the prototype conditions for which the measured and/or hindcast wave data were determined. In both test facilities, electrical resistance-type wave gages were positioned in the wave flume at a point that would coincide with the location of the proposed breakwater, and the wave generator was calibrated for various selected wave conditions.

24. Monochromatic wave calibration was achieved by simply varying the amplitude of the wave board motion for various frequencies, thus obtaining wave height as a function of wave board amplitude and frequency of motion. An iterative procedure was used in the spectral wave calibration. For each combination of peak spectral wave period T_p , spectrally based wave height H_{mo} , and energy-frequency distribution, a command signal was generated that assumed the amplitude of the wave board motion was equal to the wave height. Characteristics of the resulting spectrum were measured, compared with the desired distribution, and the command signal modified. This procedure was repeated until the desired wave characteristics were obtained at the wave gages. Typically, four or five iterations per spectral condition were required to obtain the final wave board command signals. Part III presents a detailed description of how the spectra wave conditions were selected and developed.

Test setup (functional tests)

25. The mooring system of the SFB's was represented by the linear spring system described in paragraphs 14-16. Mooring forces were measured by a load cell (Force Gage 1) connected to the spring mooring system and a load link (Force Gage 2) which was part of an inextensible line extending from the spring system through a laboratory-quality Teflon pulley and, finally, to the bow of the barge. Photo 7 shows a general view of the model setup. Photo 6 shows a close-up view of Force Gage 1 and the spring mooring system and Photo 8 shows a close-up view of Force Gage 2.

26. Wave heights were measured by water-surface piercing, parallel-rod wave gages (visible in the background of Photos 6 and 7). Each wave gage was connected to a Wheatstone bridge (Figure 11) which measured the conductance of the water. The output of each gage was routed through shielded cables to its signal conditioning equipment where it was processed for recording. The output of the signal conditioning equipment was connected through shielded cables to analog oscillographs where an analog time history was recorded and to the analog multiplexer of the digital recording subsystem where it was digitized

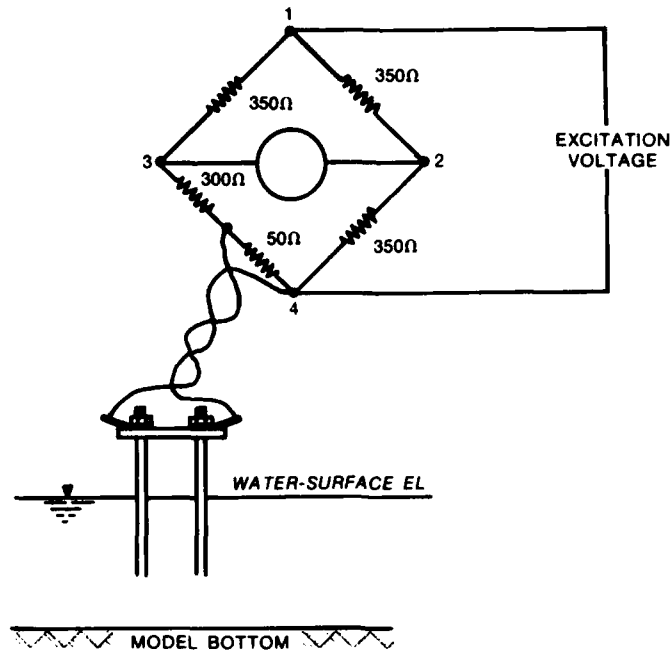

Figure 11. Schematic of parallel-rod Wheatstone bridge transducer

and recorded in a binary format on magnetic tape and/or disc. The signal conditioning equipment (Figure 12) consists of a carrier amplifier and various power supplies. This system can detect changes in water-surface elevations to an accuracy of ± 0.001 ft. Wave gages, to measure transmitted wave heights, were positioned at locations that correspond to one half of the wavelength shoreward of the SFB for the various wave periods investigated.

27. Velocities were obtained with a Teledyne Gurley Model 700 flow meter. The sensor was positioned about 1 ft (prototype) shoreward of the SFB and about 1.25 ft (prototype) above the flume bottom.

Test setup (side-connector tests)

28. The barge connectors described in paragraph 13 were composed of an instrumented section and a bearing housing section. The instrumented portions of the connectors (Figure 6 and Photo 9) were strain gaged and calibrated in such a manner that positive and negative loads in the x-, y-, and z-directions (Figures 4-7) could be resolved based on output voltages of three Wheatstone bridges incorporated into the connectors' instrumented circuitry.

29. A potentiometer was connected to the bow of one barge to measure the time history of the angularity of the barges relative to one another during their exposure to wave attack (Figure 4 and Photo 5). An angle of 180 deg

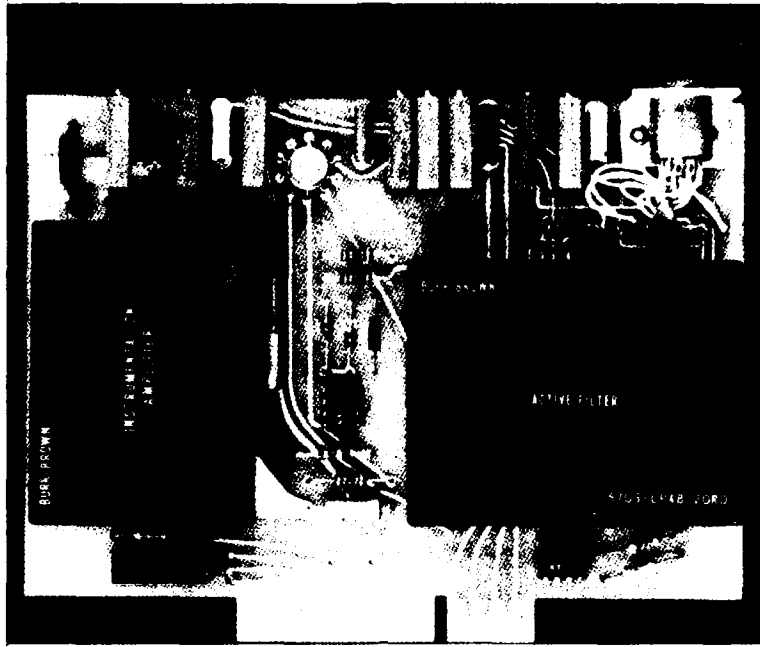

Figure 12. Signal conditioning equipment for wave rod amplifiers

(Figure 4) was defined as the static reference angle. Angle measurements less than or greater than 180 deg were defined as corresponding to the barges being concave upward and downward, respectively.

30. In order to measure the impact velocity of the stern of either barge on the model floor, a velocity transducer was positioned over and connected to the model barges by means of a monofilament line. The velocity transducer was positioned so that the line connecting it to the model barge was as close as possible to perpendicular to the top of the barge at the time of bottom impact. Thus, the output voltage of the velocity transducer corresponded to the velocity component that was perpendicular to the barge top just prior to bottom impact. Attachment points were provided on the stern corners of the model barges (Figure 4 and Photo 5). This allowed impact velocity measurements at either the inside or outside corners of either of the connected model barges.

31. In order to measure tensions in the mooring line systems described in paragraph 17, strain gaged load links were incorporated into a nonexpanding monofilament line that connected the spring systems to the barges. These load links were calibrated prior to installation on the model, and, thus, their output voltages could be transformed to mooring line tensions. Photos 10

and 11 show the SFB installed in the facility for testing with an incident wave direction of 90 deg.

32. Wave height measurements made during calibration of the side-connector test facility were carried out in the same manner as described in paragraphs 24 and 26 for the functional tests.

33. During the SFB testing, the mooring line tensions, SFB angularities, connector forces, and stern impact velocities were defined with sampling rates that varied from 100 to 300 times per second. Thus, for each data channel (labeling of data channels is defined in the legend of Figure 4) a time history of its responses to each test condition was defined and plotted. Figure 13 shows an example of a time history plot of the forces measured in the

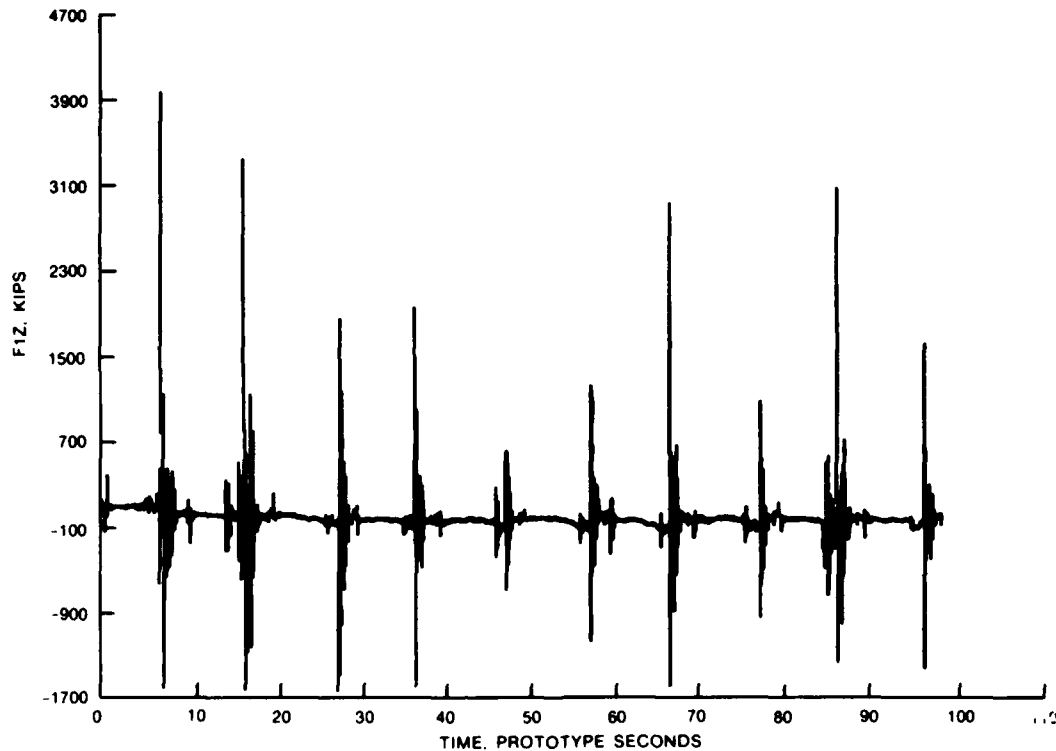

Figure 13. Typical time history plot of data channel for side-connector tests (Test 1, Table 1)

z-direction of connector F1 during the SFB's exposure to 10 sec, 10-ft monochromatic waves from 90 deg (Test 1, Table 1). In addition to plotted time histories, a data analysis routine was developed that defined the maximum and minimum value found in each time history and when these values occurred during a test. When a maximum or minimum value was found in a data channel, all values in the other data channels being monitored were defined at that same

instant in time. Figure 14 is the output data for the analysis of the time-history shown in Figure 13. A maximum value in the positive z-direction was found in connector F1 at 7.2 sec into the test run; this was extracted from the data and printed out along with the corresponding values in all the other data channels at that same instant in time. The lower portion of Figure 14 shows where a minimum value (maximum negative value) in the z-direction for connector F1 was found at 28.3 sec into the test.

GAGE F1Z		TIMES IN PROTOTYPE SEC IN THE ANALYZED DATA THAT MAXIMUMS WERE FOUND		MAXIMUM FORCE IN F1 IN POSITIVE Z-DIRECTION	
POSITIVE MAXIMUM -- TIME	7.2000	MODEL	PROTOTYPE	KIPS	VALUES OF OTHER DATA CHANGES AT POINT IN TIME WHEN MAXIMUM POSITIVE F1Z WAS FOUND
> F1Z		247.5440 LB	3987.0503	KIPS	
F1Y		18.1433 LB	290.7574	KIPS	
F1X		-44.1376 LB	-707.3329	KIPS	
F2Z		-251.9658 LB	-4037.9106	KIPS	
F2Y		13.2062 LB	211.6374	KIPS	
F2X		-125.0584 LB	-2004.1416	KIPS	
T1		.0800 LB	1.2821	KIPS	
T2		.0797 LB	1.2772	KIPS	
T3		.0000 LB	.0000	KIPS	
T4		.0871 LB	1.3983	KIPS	
T5		2.4166 LB	38.7281	KIPS	
T6		.8670 LB	13.8935	KIPS	
ANG		180.6472 DEGREES	180.6472	DEGREES	
NEGATIVE MAXIMUM -- TIME		TIMES IN PROTOTYPE SEC IN THE ANALYZED DATA THAT MAXIMUMS WERE FOUND		MAXIMUM FORCE IN F1 IN NEGATIVE Z-DIRECTION	
NEGATIVE MAXIMUM -- TIME	28.3000	MODEL	PROTOTYPE	KIPS	VALUES OF OTHER DATA CHANGES AT POINT IN TIME WHEN MAXIMUM NEGATIVE F1Z WAS FOUND
> F1Z		-101.7035 LB	-1628.8633	KIPS	
F1Y		-19.4748 LB	-312.0967	KIPS	
F1X		-38.6046 LB	-618.6632	KIPS	
F2Z		-19.9233 LB	-319.2833	KIPS	
F2Y		5.3746 LB	86.1317	KIPS	
F2X		12.1595 LB	194.8637	KIPS	
T1		.5700 LB	9.1346	KIPS	
T2		.8169 LB	13.0911	KIPS	
T3		.3327 LB	5.3324	KIPS	
T4		.2227 LB	3.5683	KIPS	
T5		2.5658 LB	41.1187	KIPS	
T6		.0797 LB	1.2776	KIPS	
ANG		181.5609 DEGREES	181.5609	DEGREES	

NOTE: INDICATORS PLACED BY ANALYSIS PROGRAM TO SHOW WHICH MAXIMUM VALUES ARE BEING DEFINED ON EACH OUTPUT PAGE

Figure 14. Example of numerical data extracted from analysis of the time history plot in Figure 13. No impact velocities were measured (side-connector Test 1, Table 1)

PART III: SPECTRAL WAVE SIMULATION

Selection of Spectral Shapes

34. Spectral wave tests were conducted with a T_p range of 6 to 14 sec for H_{mo} of 2, 4, 6, and 8 ft. This range of wave conditions would provide a database that would allow (a) selection of an optimum SFB length in terms of total cost as a function of wave protection received, (b) final mooring line and anchoring selection, (c) estimation of bottom-scour potential at the stern of the SFB, and (d) load determination for the design of barge connectors.

35. Measured shallow-water wave spectra, obtained at a depth of 16.4 ft, were available from Thompson (1980) for Nags Head, N. C. The Nags Head data could reasonably be used to develop the energy-frequency distributions needed in the present investigation because of (a) the geographic proximity of Nags Head and Oregon Inlet, (b) intermediacy of the 16.4-ft depth relative to the proposed testing depths, and (c) observations that, based on available measured wave spectra, energy-frequency distributions do not appear to vary significantly along that portion of the North Carolina Coast.

36. The selection of spectral wave conditions plays a critical role in studies of this type. Extensive research has been performed in scientific and engineering communities to quantify a consistent shallow-water spectral form (Vincent 1982). The basis of this work is derived from similarity principles between deep- and shallow-water spectral shapes in wave number space (Kitaigorodskii et al. 1975). Comparisons between measured (laboratory and field) spectral shapes and the theoretical shape have been found to be very similar (Goda 1974, Thornton 1977, Ou 1980, Iwata 1980, Vincent 1982, and Jensen 1983). The equilibrium range in the spectrum of wind-generated surface waves is defined by

$$E(f) = \alpha g^2 (2\pi)^{-4} f^{-5} \psi \left(\frac{f}{f_m} \right) \phi(\omega_d) \quad f > f_m \quad (1)$$

where

- $E(f)$ = the energy density at a given frequency f
- α = Phillip's equilibrium constant
- g = acceleration due to gravity

$\psi\left(\frac{f}{f_m}\right)$ = spectral shape function dependent on f and f_m (peak frequency), the frequency at which the maximum energy density occurs

$\phi(\omega_d)$ = a nondimensional dispersion function dependent on ω_d given by

$$\omega_d = 2\pi f \left(\frac{d}{g}\right)^{1/2} \quad (2)$$

37. The function $\phi(\omega_d)$ in its complete form (Grosskopf and Vincent 1982) is a transcendental equation that can be solved through trial and error procedures. In deep water the function $\phi(\omega_d)$ approaches 1.0; when ω_d is less than 1.0, $\phi(\omega_d)$ can be approximated by

$$\phi(\omega_d) \approx \frac{1}{2} \omega_d^2$$

and therefore,

$$E(f) = \frac{1}{2} \alpha g d (2\pi)^{-2} f^{-3} \psi\left(\frac{f}{f_m}\right) \quad f > f_m \quad (3)$$

The spectral shape changes from an f^{-5} to an f^{-3} in the tail of the energy density spectrum and, more importantly, becomes a function of the water depth.

38. The forward face of the spectrum is represented by

$$E(f) = \alpha g^2 (2\pi)^{-4} f_m^{-5} \exp \left[1 - \left(\frac{f}{f_m}\right)^{-4} \right] \phi'(\omega_d) \quad f \leq f_m \quad (4)$$

where $\phi'(\omega_d)$ is evaluated from the ω_d defined at f_m . Equation 4 has been shown to generate very consistent results when compared with field wave data (Garcia and Jensen 1983, and Jensen 1983).

39. The only unknowns involved in the evaluation of the spectral shape are the peak frequency, Phillips' equilibrium constant, and the total energy E_0 . The peak frequency is given by the design specifications requested by SAW. The peak frequency will shift toward a lower frequency from deep to

shallow water. The mechanisms that cause this change are derived from the nonlinear transfers of energy, or wave-wave interactions (Hasselmann 1962). The energy transfers act conservatively, although a portion of the energy is transferred into the high frequency end of the spectrum and is lost because of wave breaking (like "white capping"). Phillips' equilibrium constant is related (nondimensionally) to the fetch length, wind speed, and peak frequency. A wind speed of approximately 40 knots is selected as a reasonable estimate for wind conditions occurring in a storm passing the area. Therefore, α is given as a function of peak wave period, derived from Vincent (1982) in the following tabulation

f_m 1/sec	T_p sec	α^*
0.167	6	0.0166
0.125	8	0.0131
0.100	10	0.0117
0.083	12	0.0100
0.071	14	0.0093

* For wind speeds equal to 40 knots.

40. The remaining unknown E_o (total energy), is related to the significant wave height H_{mo} by the following equation:

$$H_{mo} = 4\sqrt{E_o} \quad (5)$$

where

$$E_o = \int_0^{\infty} E(f)df \quad (6)$$

Since the range of H_{mo} was specified by SAW (of 2, 4, 6, and 8 ft), it becomes a matter of distributing the energy over the frequency range of the spectrum (Equations 3 and 4).

41. The theoretical spectrum is evaluated for each discrete frequency band (knowing f_m and α), and then integrated over the range of frequencies (Equation 6). The resulting total energy is then scaled according to the

total energy obtained from the H_{mo} desired conditions. That ratio (desired H_{mo} /theoretical H_{mo}) is reapplied to the spectrum, and the resulting spectrum is now referenced with respect to the desired H_{mo} wave conditions for a particular f_m . The derived spectral shape represents the "true" shape sought in the model study.

42. During preliminary model testing, problems were encountered as the peak frequency decreased to 0.083 Hz. The measured spectral shape would not correspond to the theoretically derived spectral shape (Equations 3 and 4). From the measured spectra (in 15 ft), the model was "excited" in frequency bands just above the peak frequency. The energy level was nearly as high as that observed at f_m . Between the two peaks was a significant drop in the spectral energy as if an energy sink existed somewhere in the wave tank. This selective removal of energy from discrete frequency bands and the transformation of the single peaked spectra into two-peaked spectra could not be explained. Therefore, an alternate method of solution was adopted to control the excitation and thus produce a single peaked spectrum in shallow water.

43. Two alternate solution techniques could be adopted to model the long-period wave condition found at Oregon Inlet. The first technique would assume that swell waves could be approximated by a monochromatic, unidirectional wave form (for example, Hasselmann et al. (1973) and Jensen (1983)). A wave train with a single frequency and wave height could be input (linear wave train) at the deep-water section and, through shoaling and refraction (caused by convergence of the side walls in the wave tank) effects, a single wave train would result in shallow water. The second solution technique requires the specification of some spectral shape that would transform into a distribution represented by Equations 3 and 4 without adversely exciting the wave tank producing a double peaked spectrum. The deep-water (at the forcing end where $d = 50$ ft) spectral shape is governed by the form given below:

$$E(f) = \lambda \alpha g^2 (2\pi)^{-4} f_m^{-8} \exp \left[1 - \left(\frac{f}{f_m} \right)^{-6} \right] \quad f \leq f_m \quad (7a)$$

$$= \lambda \alpha g^2 (2\pi)^{-4} f^{-8} \quad f > f_m \quad (7b)$$

The constant λ balances out the dimensions on the righthand side of the equation set so that $E(f)$ is given in the form of length²-time. The justification for Equations 7a,b is found through comparisons of the resulting laboratory spectral shapes in shallow water (15 ft) with swell-dominated prototype data observed at Nags Head, N. C. (Thompson 1977). Many alternate shapes were used (varying the powers of f , f_m , and the ratio of f/f_m). It was found that the resulting shallow-water spectral shape derived from Equations 7a,b reproduced the expected theoretical shape, as well as the prototype data, more consistently than any other approximated form.

Initialization

44. The actual input conditions to the wave generator are given in deep water. However, wave spectra must be estimated from shallow-water design conditions. The problem is easily solved because the model study is simulating conservative processes of wave refraction (constricted wave tank), shoaling (sloping bottom), and nonlinear transfers of energy (wave-wave interactions, although a portion of the energy is lost in the high frequency end of the spectrum). The spectral shape can be transformed into deep water by employing the linear wave theory as a basis to compute the individual phase speeds (dependent on each discrete frequency) and the group celerity (assumed to be derived from the peak frequency). The generation of deep-water swell spectra does not pose significant problems since the spectral shape is computed for deep-water conditions. The deep-water total energy of these tests is controlled by an *a priori* knowledge of the expected H_{mo} in the 15-ft-water depth, again using linear theory to estimate refraction and shoaling effects.

Comparisons

45. Comparisons were made between the wave spectra measured in the model and theoretically derived spectra, for wave conditions in a water depth of 15 ft. These tests verify that: (a) the given "sea" wave spectra conform to the assumed shape in a 15-ft-water depth, and (b) the input description of the "swell" wave spectra collapse into a similar water-depth-dependent spectral shape given in Equations 3 and 4. The test series employing an H_{mo} equal to 6.0 ft is used to demonstrate the consistency of test results.

46. Figure 15 shows results of the measured and theoretical spectra for the 6.0-sec peak-period wave test. The energy density is plotted against a nondimensional frequency based on f_m . Unlike the monochromatic tests, the peak period is not conserved (i.e. remaining constant) from deep water ($d = 50$ ft at the wave paddle) to shallow water ($d = 15$ ft at the gage). The nonlinear transfers will shift f_m to a lower frequency (as shown in Figure 16). Rather than attempt to control the transfer rate (and the shift in f_m) from deep to shallow water, it was decided to input the specified f_m at the wave generator and allow for the shift in peak frequency. The maximum error between the required f_m and the measured f_m was 5.0 percent (with a mean error of 2.7 percent). Returning to Figure 15 one notices that the measured data follow the theoretically derived data quite closely. There is a small overestimation in the measured data set near the spectral peak and a strong divergence between $E(f)$ values near $f/f_m = 2.0$. The reason for this trend is unknown.

47. The second verification test involves H_{mo} and T_p conditions of 6.0 ft and 8.0 sec, respectively. As shown in Figure 17, the measured data nearly replicate theoretical results. Minor oscillations exist in the measured data above and below the computed spectral shape, but, in general, the trends are very similar. The last locally generated "sea" wave condition (Figure 18) is for H_{mo} equal to 5.9 ft, and f_m equal to 0.11 Hz ($T_p \cong 9$ sec). As in the three previous cases, the measured $E(f)$ corresponds to the theoretical spectral shape. There is a small underestimation of the energy density near the spectral peak, but it is only on the order of -7.0 percent. There is a lobe of energy at the base of the forward face of the measured spectra, probably caused by a cross oscillation in the wave channel or created by the convergence in the sidewalls of the tank. However, the amount of energy in the lobe is small compared to the energy in the primary spectra and therefore contamination in the test results from the added energy packet was insignificant.

48. The final two tests (Figures 19 and 20) are used as examples to simulate distant swell wave conditions. As previously discussed, the swell spectral tests are performed using a slightly different procedure. An assumed deep-water spectral shape is specified as input conditions, and the spectrum is allowed to transform into a stable shape at the 15-ft water depth. Applying similarity principles (Kitaigorodskii et al. 1975), a theoretical spectral

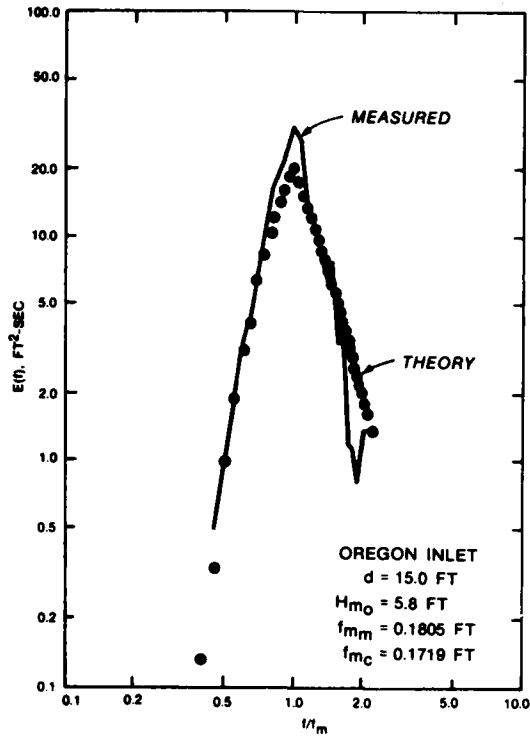

Figure 15. Theoretical and measured spectra for 6-sec peak period

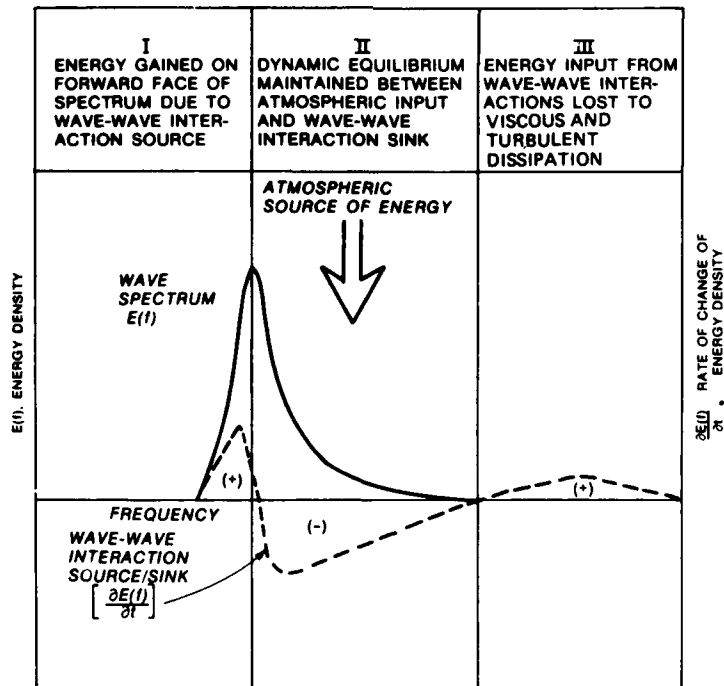

Figure 16. Shifting of f_m to a lower frequency caused by nonlinear transfers

Figure 17. Theoretical and measured spectra for the 8-sec peak period

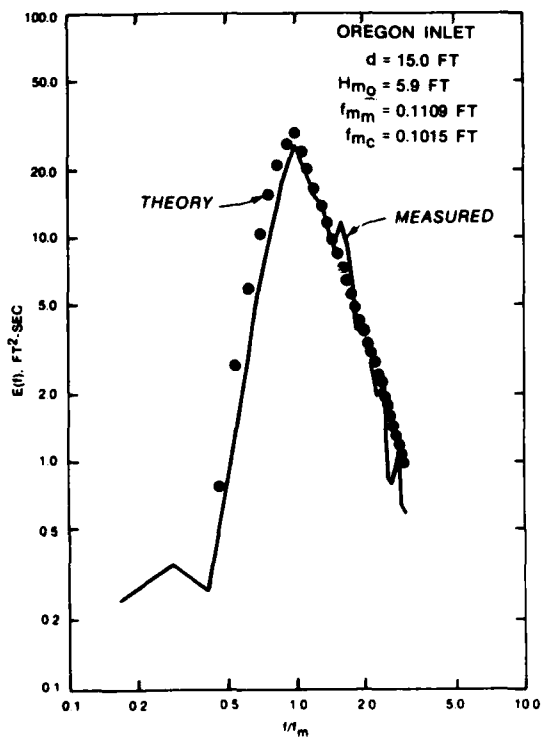
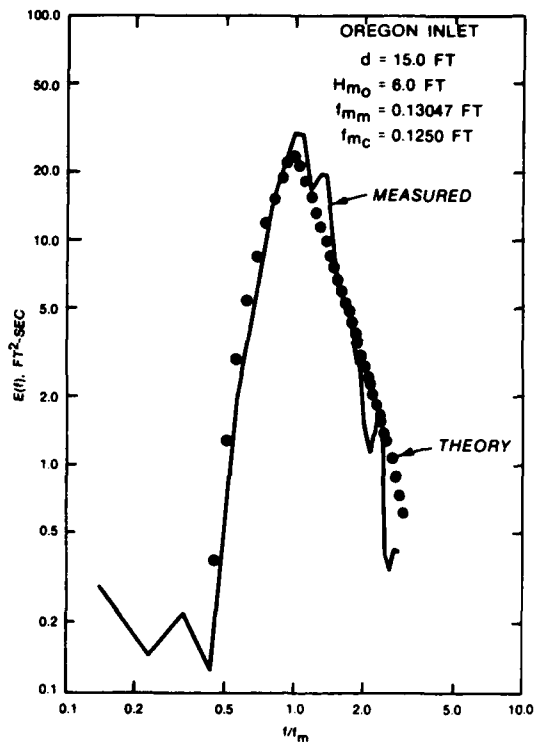

Figure 18. Theoretical and measured spectra for the 10-sec peak period

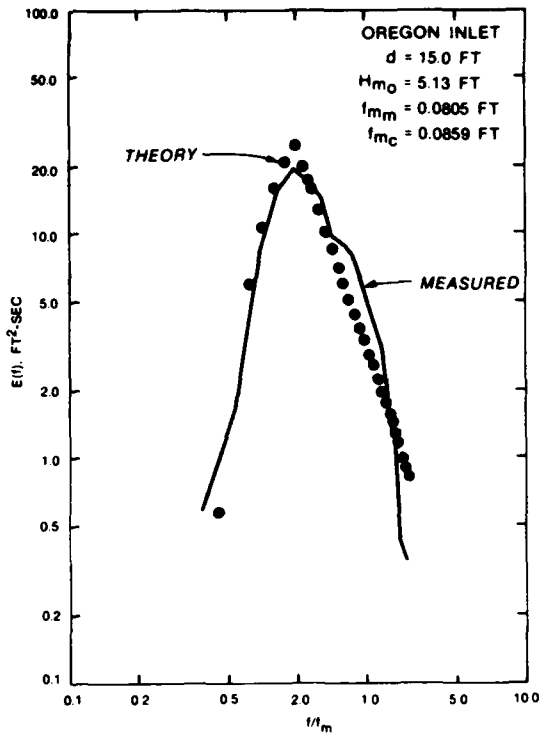
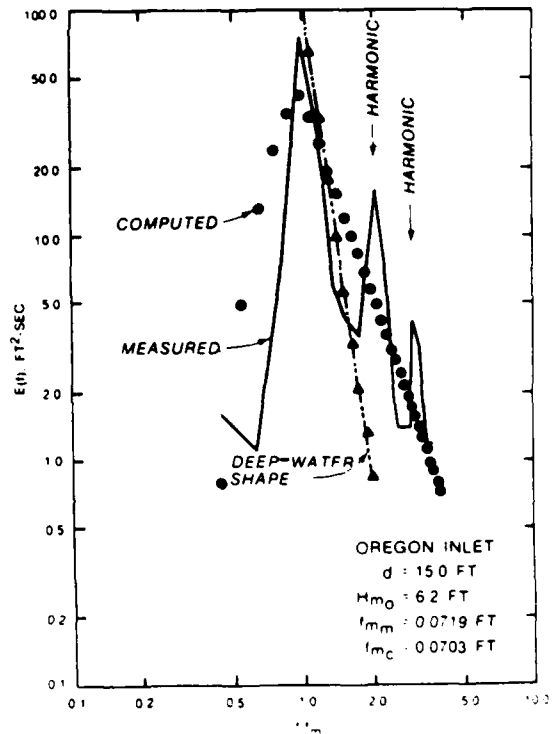

Figure 19. Theoretical and measured spectra for the 12-sec peak period

Figure 20. Theoretical and measured spectra for the 14-sec peak period



shape can be generated and compared with the measured spectra. Although the "fine-tuning" of the measured spectral shape is based on the deep-water version, the shallow-water shape must be consistent with the theoretical data set. Figure 19 represents an H_{mo} condition equal to 5.1 ft and a T_p condition equal to 12.4 sec. The measured spectral results compare very favorably with the theoretical data set. There appears to be a divergence in the measured spectral shape for $f/f_m > 2.5$ where the slope is approximately twice as steep for similar conditions found in the theoretical shape. In all other regions, the measured $E(f)$ is of the same form represented in the theoretical spectral shape verifying the consistency in the model results for spectral conditions in 15-ft water depths. The final test (Figure 20) displays the theoretical and measured spectral shapes for H_{mo} and T_p wave conditions of 6.2 ft and 14 sec, respectively. The comparisons between theory and measured results are not favorable as in previous tests. The reason for the poor comparison is based principally on the processes occurring in the wave channel. The input wave spectrum is nearly of the form of a monochromatic wave train (i.e. a spectrum with all of its energy concentrated in a single frequency band). As the spectrum propagates into shallow water, an energy exchange occurs that has been caused by the nonlinear interactions. Since the spectrum is very narrow banded (relative to all others tested), there will be a strong decomposition of that shape splitting the energy between the primary and secondary harmonics. The "spikes" found in the measured spectrum are a result of these processes. However, the theory employed cannot resolve the resonant interaction between primary and secondary harmonics; thus, a poor comparison between measured and theoretical data sets is shown. The measured spectral shape remains nearly unchanged from its input shape (excluding the secondary harmonics). The theoretical spectral shape found in Figure 18 (closed circles) represents a scaled (via H_{mo}), saturated, swell wave condition in 15-ft-water depths. The measured spectral energy is approximately 1.5 times less than saturated conditions in that particular water depth. Therefore, the measured data should not reflect the saturated spectral shape, but remain nearly unchanged from a deep-water condition. Hence, the model test for the long-period (defined here as swell) spectral wave shapes is also well represented.

PART IV: TESTS AND RESULTS FOR THE FUNCTIONAL MODEL

Monochromatic Wave Tests

Performance tests

49. Monochromatic performance tests were conducted with the 89.6-ft SFB exposed to 2-, 4-, and 6-ft waves for periods from 4 to 14 sec. Specific test conditions and corresponding values of relative depth (d/L), wave steepness (H/L), relative wave height (H/d), and relative structure length (L_{SFB}/L) are presented in Table 2. Typical test views for 6-, 10-, and 14-sec waves are presented in Photos 12-17. All tests were conducted on a 1V:50H bottom slope in a water depth of 15.0 ft (measured at the stern of the SFB). Tests were conducted in a 3.20-ft-wide flume and the model SFB was 2.96-ft wide; consequently, when the SFB was centered between flume walls, a gap of about 1.5 in. existed between the structure and walls. Initially, it was felt that this gap (Condition 1; 1.5-in. gaps without absorber) would not have a significant effect on tests results. However, to quantify the effect of the 1.5-in. gaps on experimental results, tests were conducted for Condition 2 (1.5-in. gaps filled with fibrous wave absorber) and results were compared with those of Raichlen (1981).

50. Wave attenuation test results are presented in Table 3 for the three modeling conditions. Data for Conditions 1 and 2 were obtained in the present investigation; Condition 3 data were extracted from "Experiments with a Sloping Float Breakwater in Water Waves - Phase I" (Raichlen 1981). Transmission coefficients, C_t , from Table 3 are graphically depicted as functions of wave period (Plates 1 and 2) and relative structure width (Plate 3). These data show that

- a. Condition 2 generally yielded lower values of C_t than Condition 1; however, when C_t is plotted as a function of L_{SFB}/L , the differences are small.
- b. Condition 3 C_t 's are generally less than either Condition 1 or 2 but some specific values are significantly larger (4-sec, 6-ft and 8-sec, 4-ft waves).
- c. There is relatively little difference in the maximum C_t for a given value of L_{SFB}/L .
- d. The general quality of experimental data for Conditions 1 and 2 appears to be more consistent than for Condition 3 since there is less variation of C_t for constant values of L_{SFB}/L .

51. For direct comparison with Raichlen's data, all mooring force data reported herein are expressed as the force that would exist on one mooring line for the case of a single 21-ft-wide barge. Mooring force test results, obtained from Force Gage 1, are presented in Table 4 and Plates 4 and 5. These data show that (a) in general, Condition 1 produced the highest mooring forces followed by Conditions 2 and 3, respectively; and (b) model data obtained for Conditions 1 and 2 appear to be more consistent (force increasing with increasing wave height) than those obtained for Condition 3 (note in Table 4, Condition 3 test results for 8-, 10-, and 12-sec wave periods). Force Gage 2 test results are presented in Table 5. Recalling that Force Gages 1 and 2 were connected in series and separated by the Teflon pulley, it would be expected that results are the same for both gages, except for a small frictional loss at the pulley. Comparisons of Tables 4 and 5 show this expectation is realized.

52. Flow velocity measurements for modeling Conditions 1 and 2 are shown in Table 6 and Plates 6 and 7. The minimum, average, and maximum values presented therein were obtained from the maximum velocities observed for each wave cycle of a specific incident wave condition; thus, depending on wave period, flow velocity measurements represent the distribution of 10 to 40 individual readings. The large differences (spread) between the minimums and maximums are not unexpected when one considers the highly turbulent and unsteady flow conditions under the SFB.

53. In summary, it is recommended that test results for Condition 1 be used for design purposes. Discussions with SAW personnel revealed that each module might be moored separately or in small groups of modules producing a condition more analogous to Condition 1, which resulted in the largest forces and transmission coefficients. When one considers the small differences in maximum C_t 's, mooring forces, and velocities, it becomes apparent that any of the modeling conditions will yield nearly the same design values. For Condition 1 a maximum C_t of 0.75 was observed for 14-sec, 2-ft waves; the maximum peak mooring force of 24.7 kips was observed at Force Gage 2 during attack of 12-sec, 6-ft waves; and a maximum peak velocity of 8.0 ft/sec was recorded during attack of 8- and 10-sec, 6-ft waves.

Survival (storm wave) tests

54. Limited tests were conducted to aid in determination of the survival probabilities of the SFB, should it be subjected to storm wave

conditions. Reviews of historical wave data for Nags Head showed the largest storm of record occurred in 1966 and had a significant wave height of 15.5 ft at a significant period of about 10 sec. Therefore, monochromatic tests were conducted with the 10-sec period for wave heights up through the maximum, depth-limited breaking wave height ($H = 12.7$ ft) that could be supported in the 15-ft depth. Tests conditions are listed in Table 7.

55. Based on previous performance test results, it was decided to consider only Model Condition 1 (1.5-in. gap with no absorber) during the storm wave tests. Transmitted wave heights, mooring forces, and flow velocities are presented in Tables 8-10 and Plates 8-10. Maximum transmitted wave heights and mooring forces of 7.5 ft and 27.0 kips were observed. Both occurred during attack of 12.7-ft waves. A maximum flow velocity of 11.0 ft/sec was produced by the 10-ft wave condition.

56. During both performance and survival tests, large amounts of lift were observed at the structure's stern (see Photos 18 and 19 for examples of extreme conditions). Based on model observations, maximum vertical lifts were estimated to be 1 to 2 ft for the 4- and 6-ft waves and 3 to 4 ft for the 10- to 12.7-ft waves.

Spectral Wave Tests

57. Spectral tests were conducted using 72.3-, 89.6-, and 118.4-ft-long SFBs anchored in water depths of 13, 15, 18, and 21 ft. The 89.6- and 118.4-ft-long structures were tested in all depths; however, the 72.3-ft-long structure was tested only in the 15-ft depth as its wave-attenuating capabilities proved inadequate to make it a viable alternative. Breakwaters were anchored with a 150-ft-long mooring line which had a breaking strength of 230 kips (with the exception of limited mooring line length effect tests, which are described in a later section of this part). Peak periods T_p of the spectra ranged from 6 to 14 sec and the significant wave heights H_{mo} were 2, 4, 6, and 8 ft.

Wave attenuation tests

58. Wave attenuation test results are presented in Tables 11-14 and Plates 11-19. These data show that transmitted wave heights are consistently lower for the 118.4-ft SFB, and the transmission response of the structures is strongly dependent on wave period. The transmission coefficient variations

for a given wave period tend to be slightly larger for the 118.4-ft SFB. Performance of the structures decreased as the water depth increased.

59. Photos 20-37 show the model breakwaters under attack of 6-sec, 4- and 6-ft waves and 10- and 14-sec, 4- and 8-ft waves in the 15-ft depth. It should be noted that every possible effort was made to take the photos at a point in the test where the barges were under attack of a wave that approximated the significant height of the spectrum. However, for a given spectral condition, photos of the structures were not necessarily taken at exactly the same point in the wave train; therefore, they are generally illustrative of the SFB's responses, but exact comparisons of displacement and wave height should not be attempted.

Mooring force tests

60. Mooring force data are presented in Tables 15-18 and Plates 20-28. These data show average and, particularly, peak mooring forces are dependent on wave period, wave height, and water depth. For a constant wave period, peak mooring forces increased with increasing wave height, and for a constant wave height (with the exception of the 2-ft height) peak mooring forces generally increased with increasing wave period. The deviation of results for the 2-ft spectra from the trends observed for the 4-, 6-, and 8-ft spectra merits explanation. For wave heights of 4 ft and greater, the structures are alternately lifted from and dropped back to the seafloor. Thus, mooring forces result from both a shoreward translation of the SFB and rotation about the bottom contact point. However, 2-ft waves do not significantly lift the structures, and most of the mooring force results from rotation about the bottom contact point. Based on model observations, rotation appears to increase as the wave period is increased from 6 to 10 sec and then decrease at the 12- and 14-sec periods. This trend is approximately reflected in the mooring force data. For most wave conditions, mooring forces are similar for both SFB lengths and tend to increase with increasing depth. The 14-sec, 8-ft spectrum produced the highest peak mooring forces (64.4 and 61.6 kips for the 89.6 and 118.4-ft structures, respectively) of all conditions investigated.

Flow velocity tests

61. Results of flow velocities tests are presented in Tables 19-22 and Plates 29-32. Examination of these data shows that (a) peak flow velocities are dependent on SFB length, wave height, wave period, and water depth; (b) for constant structure length and wave period, flow velocities generally

increase with increasing wave height; (c) for constant structure length and wave height, flow velocities generally increase with increasing wave period; and (d) peak flow velocities are generally higher for the 118.4-ft SFB. Maximum values of 11.0, 12.5, and 15.5 ft/sec were observed for the 72.3-, 89.6-, and 118.4-ft structures, respectively.

Mooring line length effect tests

62. Limited tests were conducted to investigate effects of increasing the mooring line length from 150 to 250 ft. Prior to initiation of testing, it was hypothesized that the longer mooring line, because of its increased elasticity, might decrease average and peak mooring forces for the higher wave heights without adversely affecting wave attenuation at the lower wave heights.

63. Tests were conducted with both monochromatic and spectral waves. The monochromatic conditions (10-sec, 10-, 12-, 14-, and 15-ft waves) were representative of observed prototype storm conditions. Spectral tests encompassed peak periods of 6 to 14 sec for wave heights of 4 and 8 ft. SFB lengths of 89.6 and 118.4 ft were investigated. The structures were anchored in a water depth of 21 ft using 150- and 250-ft-long mooring lines which had a breaking strength of 230 kips.

64. Wave attenuation, mooring force, and flow velocity results for the monochromatic wave tests are presented in Tables 23-25, respectively. Transmitted wave height is presented as a function of incident wave height in Plate 33. Plate 34 depicts peak mooring force as a function of incident wave height. These data show that for the 250-ft line, as opposed to the 150-ft line, (a) transmitted wave heights are slightly lower; (b) average mooring forces are similar, but peak mooring forces are consistently reduced with the relative reduction being greater for the 118.4-ft SFB; and (c) peak flow velocities tend to be slightly lower.

65. Spectral wave attenuation results are summarized in Table 26 and coefficients of transmission are presented as a function of wave period in Plates 35 and 36. These data show that the wave-attenuating capability of the breakwaters is essentially unaffected when the mooring line length is increased from 150 to 250 ft. Average and peak mooring forces are listed in Table 27. Peak mooring forces are depicted as a function of wave period for the 89.6- and 118.4-ft structures in Plates 37 and 38, respectively. These data show that in general both average and peak mooring forces are reduced

when the mooring line length is increased with the reduction being the most significant for the peak forces observed at the 8-ft wave heights. Table 28 presents flow velocities observed at the stern of the structures. These results are generally similar for both mooring line lengths with the 250-ft line appearing to have a slight advantage for a few specific wave conditions.

Summary of spectral wave test results

66. As evidenced in the preceding sections, coefficients of transmission are relatively insensitive to wave height (for 2- to 8-ft waves and constant wave period). Therefore, it is felt that the average coefficient of transmission \bar{C}_t is representative of SFB performance. Plates 39 and 40 present \bar{C}_t as a function of water depth and wave period. These data show that the performance of the SFB decreases as the wave period and/or water depth increases, and the longer SFB performs consistently better than the shorter structure.

67. Peak mooring force is presented as a function of wave period and water depth in Plates 41-48 for 2-, 4-, 6-, and 8-ft incident wave heights. These plots show that peak mooring force generally increases with increasing wave period and/or water depth, and the largest values occur for 14-sec, 8-ft waves at the 21-ft depth. It is interesting to note that the largest value observed (64.4 kips) is only 28 percent of the mooring line's breaking strength.

68. Peak flow velocity is depicted as a function of wave period and water depth in Plates 49-54 for 4-, 6-, and 8-ft waves. These data show that peak flow velocities generally increase with increasing wave period and/or wave height and tend to decrease as the water depth increases. Also, the data become more narrow banded as the wave height increases; i.e., effects of wave period are less pronounced for larger wave heights.

69. Based on the data presented herein, it appears that wave attenuation will be at a maximum and peak mooring forces will be at a minimum when the SFB is moored in 13 ft of water. The purpose of testing the SFB in variable water depths was to define its performance over a complete range of tide.

Nondimensionalized wave attenuation test results

70. Examination of wave attenuation test results shows that coefficients of transmission appear to primarily depend on wave period or length, SFB length, and water depth, i.e.,

$$C_t = f(L_p, L_{SFB}, d)$$

The variables L_p , L_{SFB} , and d are defined as the wavelength of the peak spectral period, length of the SFB, and water depth, respectively. Values of C_t and relative SFB length (L_{SFB}/L_p) are given in Tables 29 through 32, and Plates 55 through 58 present C_t as a function of L_{SFB}/L_p for constant depths. These data show that, for the range of SFB lengths investigated, the value of C_t associated with a given value of L_{SFB}/L_p is independent of SFB length. Therefore, these plots could be used to predict the performance of an intermediate SFB length over the range of wave conditions investigated.

71. It should be noted that Plates 55-58 also show that for the range of conditions tested, relative mass moments of inertia do not significantly influence SFB performance over the range of lengths investigated. Since the mass moment of inertia varies with L_{SFB}^2 (approximately), a dependence of C_t on the relative mass moments of inertia would have necessitated a family of curves when C_t was plotted as a function of L_{SFB}/L_p .

PART V: TESTS AND RESULTS FOR SIDE-CONNECTOR TESTS

Test Conditions

72. The side-connector tests were conducted with the SFB's moored in a 20-ft water depth. The use of the 20-ft mooring depth allowed the side-connected SFB's to be subject to the following rather severe monochromatic and spectral wave condition:

Monochromatic Waves	
Wave Period sec	Wave Height ft
10	10
10	12.5
10	15
12	10
12	12.5
12	15
14	10
14	12.5
14	15

Spectral Waves	
Period of Peak Energy Density, T_p sec	Wave Height $H_{mo} = 4\sqrt{E^*}$ ft
6	6
8	6
8	8
10	6
10	8
12	6
12	8
14	6
14	8

* E = total energy of spectrum (defined by the area under the curve of the spectral energy density versus frequency plots).

The test program was initiated in order to expose the side-connected SFB to waves from the four incident wave directions described in Figure 4.

Monochromatic Wave Tests

73. A total of 20 tests were run with monochromatic waves incident from 90 deg (Table 1). For all tests, the barges were ballasted, connected together, and floated at an angle of 14.5 deg relative to the horizontal with their sterns resting on the bottom in a 20-ft water depth. Photos 38 and 39 show the model SFB during monochromatic wave attack (90-deg incident wave direction).

74. Tests 1-9 covered the full range of monochromatic waves with all mooring lines attached. Time histories of the output for all but the stern impact velocity data channel were recorded. The time histories for stern impact velocities were only recorded for what were observed to be the most severe bottom impact conditions. Plates 59-72 are typical examples of the time histories recorded for all tests. These examples are taken from Test 2. The time histories were then analyzed for maximums and minimums by using the method described in paragraph 33 and Figure 14. Plates 73-86 are the analyses outputs for Test 2. Because of the massive amount of data plots and tabulations created by these tests, the maximums for the connector forces, mooring line tensions, and impact velocities; and range of barge angularities were extracted and are presented in Table 33.

75. With the possibility of mooring line breakage, concern arose as to the effect this would have on tension in the remaining mooring lines, forces in the connectors, stern impact velocities, and barge motion (angularity time history). For this reason, Tests 10-13 were conducted using 15-ft waves with periods of 12 and 14 sec, as these wave conditions appeared to be the most severe for the 90-deg wave direction. The results of these tests are summarized in Table 33. During Test 11, the load in connector F2 exceeded its model design load which resulted in a slight deformation in the thin wall portion of the connector. This was not found until the end of the day when Tests 10-13 had been completed. Thus, the offset in the calibration for connector F2, due to it being overloaded, could not be compensated for. For this reason, the validity of the magnitudes of the forces measured in connector F2 are questionable for these latter tests, but since the connector was damaged, it is known that the load was quite high (equal to or greater than the -6,854 kips reported in Table 33 for F2Z).

76. Following Test 13, the calibrations of connector F2 were corrected in order to compensate for the offset which occurred during Test 11. By doing this, and with the assumption that the set was minor enough to not cause non-linearity in the connector calibrations, some degree of confidence could be placed in data gathered with connector F2 as long as no additional yielding of the connector occurred. In an effort to avoid additional connector damage, the remaining tests were conducted with 10-ft, 10- and 14-sec monochromatic waves.

77. A discussion arose during the review of Tests 1-13 as to what effect, if any, the mass weights suspended from the spring systems were having on the mooring line tension measurements. Depending on the spring constant and the design of a spring, some magnitude of initial tension needs to be exceeded before elongation of the spring is initiated. The mass weights were suspended from the spring system so that when the mooring line tension exceeded a magnitude of zero, no matter how small the tension, spring elongation began. This assured that the spring system would respond immediately, but it failed to take into consideration the inertial effects of the mass weights.

78. It was observed in the data from Tests 1-13 that the maximum connector forces coincided with the instant in time when the stern of the barges impacted on the concrete floor of the test flume. Some discussion arose as to conservatism in this condition relative to the prototype where the barges would be in contact with a sand bottom. Maxwell Cheung and Associates, Inc. (MCA), provided a theoretical force deflection curve that they felt would be representative of the barges as they impacted and dug into a prototype sand bottom.

79. MCA felt that if they had some idea of the natural frequency of the connected free floating ballasted barges, it would aid them in their analysis of the side-connector force data.

80. Tests 14-20 (Table 1) were conducted to help answer the questions discussed in the four previous paragraphs. Tests 14 and 15 were run as control tests with no modifications in the sterns or spring systems. With calibrations for connector F2 being modified because of yielding during Test 11, these tests provided data for comparison with the data to be gathered with the modified spring systems and bumpered barge sterns. A summary of the maximum connector forces, mooring line tensions, impact velocities, and barge angularities measured during Tests 14 and 15 are presented in Table 33.

81. Test 16, referred to as the "ping test," was conducted to look at the natural frequency of the connected, ballasted, and moored barges. During Test 16, a small rubber hammer was used to ping barge number 1 along the top of its bow. The barge was pinged twice on the outside corner, then the middle, and lastly the inside corner (nearest the connectors). During the ping test, the barges were connected and floating in the water; all mooring lines were attached; and the inside and outside stern corners of each barge were positioned on 1/4-in.-diam steel rods. As an example of the data gathered, Plates 87 and 88 show the response of connector F1 in the z-direction during the ping test. To aid in the measurement of the frequencies, the x-axis prototype time scales were expanded for the second pings on the outside and middle and first ping on the inside corner and are presented on Plates 89-91, respectively.

82. Prior to Tests 17 and 18 (Table 1), the mass weights were removed from the model mooring line spring systems and the spring systems were recalibrated. The calibration curve for the modified spring system was slightly stiffer than the original spring system, which in turn was slightly stiffer than the 135-ft length of the 20-in. circumference 2-in-1 braided nylon line which it was representing (Figure 21). Table 33 shows the maximums recorded for all the data channels during these tests. Figures 22-27 and 28-33 are the time histories of the mooring line tensions for a portion of Tests 15 and 18, respectively. Comparison of these plots and the data in Table 33 shows that removal of the mass weights eliminated the higher frequencies in the mooring line data.

83. Five bumpering materials were developed and tested to see how well they would represent the force-compression equation provided by MCA (Figure 34). Up to a load level of 15 lb/in. of model bumper, material C had the closest fit to the theoretical force-compression curve. Assuming that the load would not exceed 15 lb/in. in the model, a 1-in.-wide strip of bumper material C was added to the bottom of the sterns of both barges, and Tests 19 and 20 were conducted with the modified spring systems. The softening of the barge impact on the concrete floor resulted in a significant reduction in the forces measured in the connectors (Table 33).

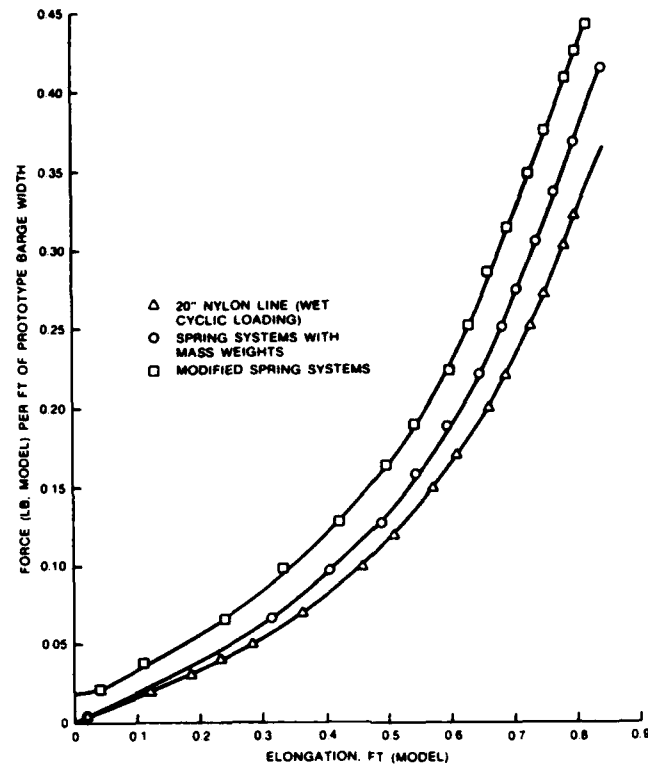

Figure 21. Force-elongation curves for side-connector tests, model mooring line spring systems

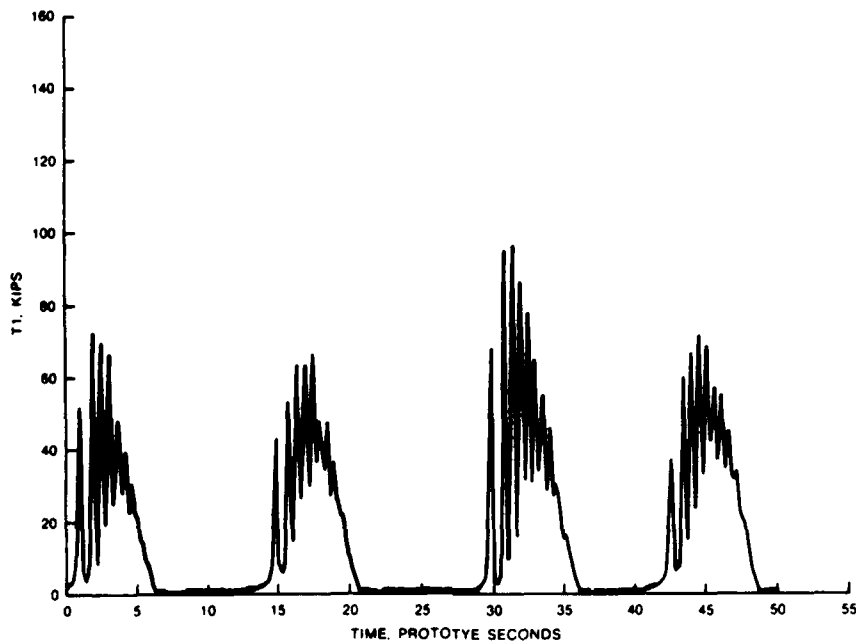

Figure 22. Mooring line T1's tension time history for Test 15 of side-connector tests

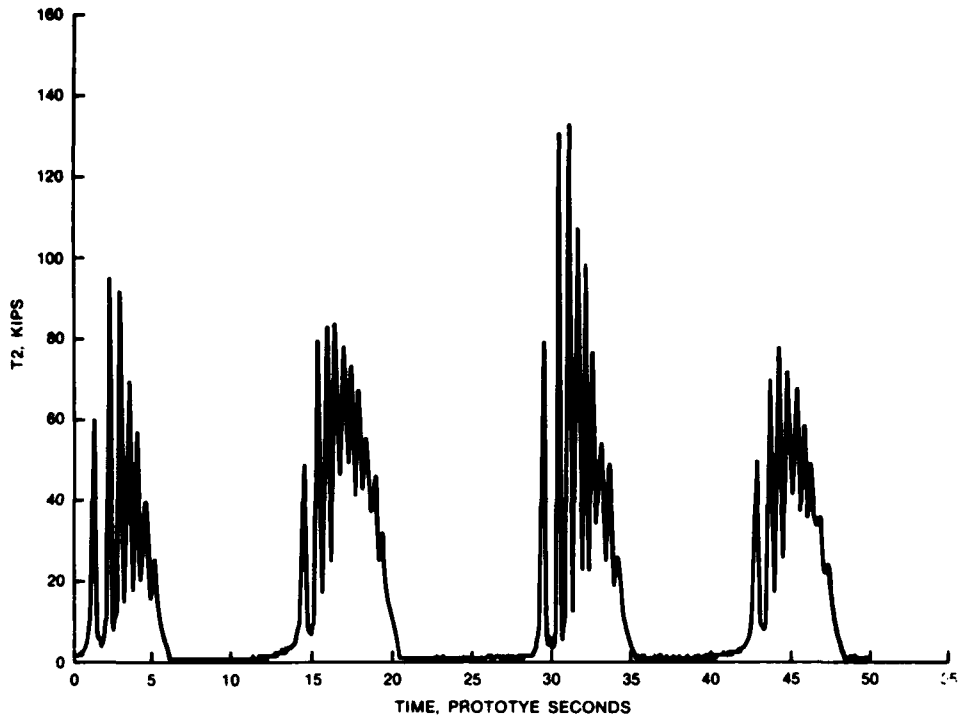

Figure 23. Mooring line T2's tension time history for Test 15 of side-connector tests

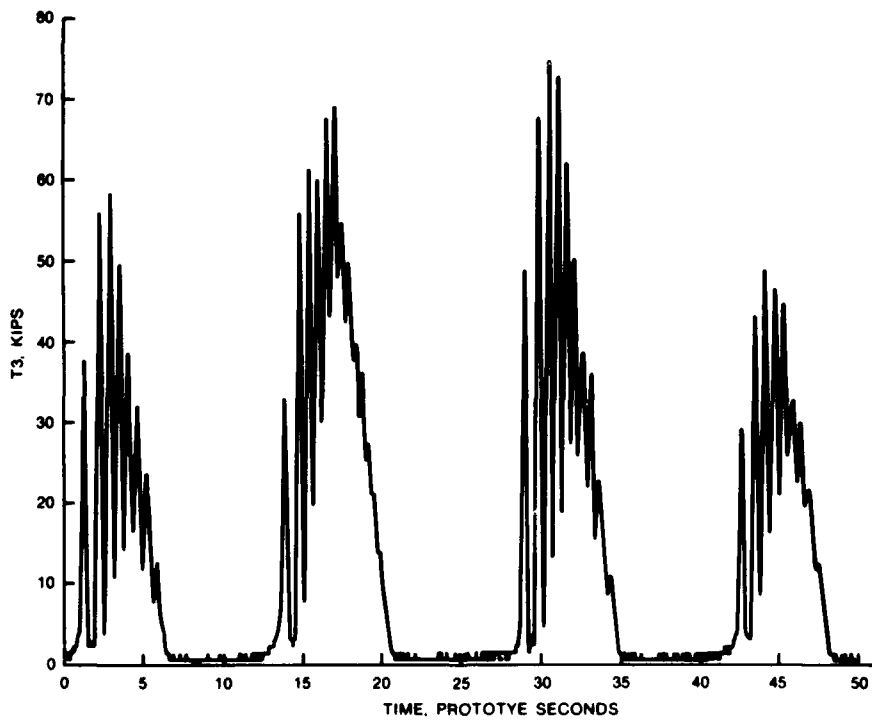

Figure 24. Mooring line T3's tension time history for Test 15 of side-connector tests

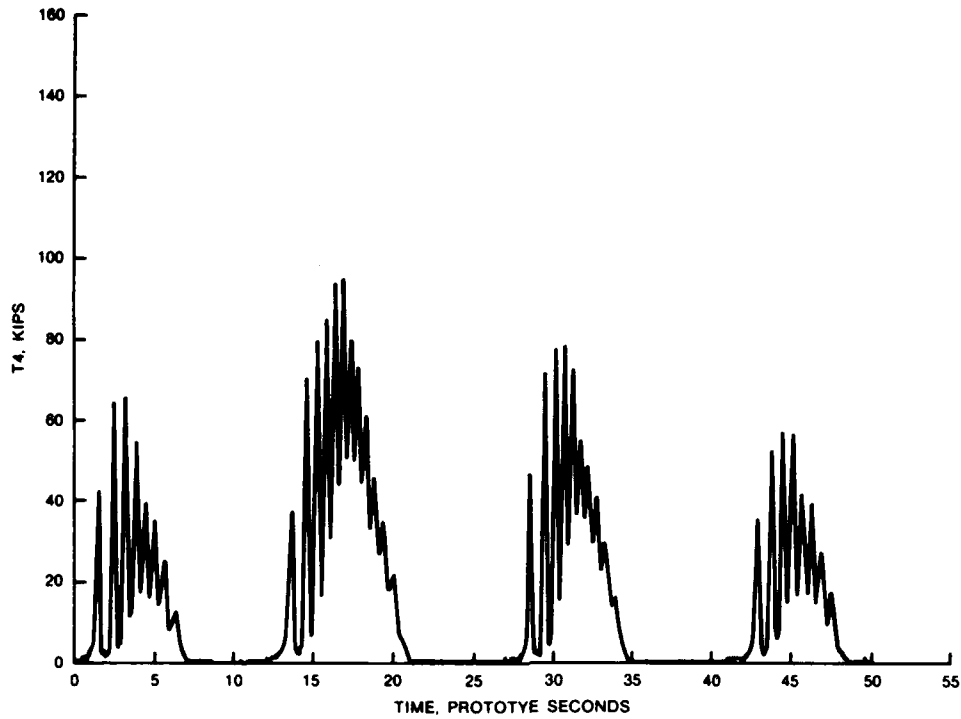

Figure 25. Mooring line T4's tension time history for Test 15 of side-connector tests

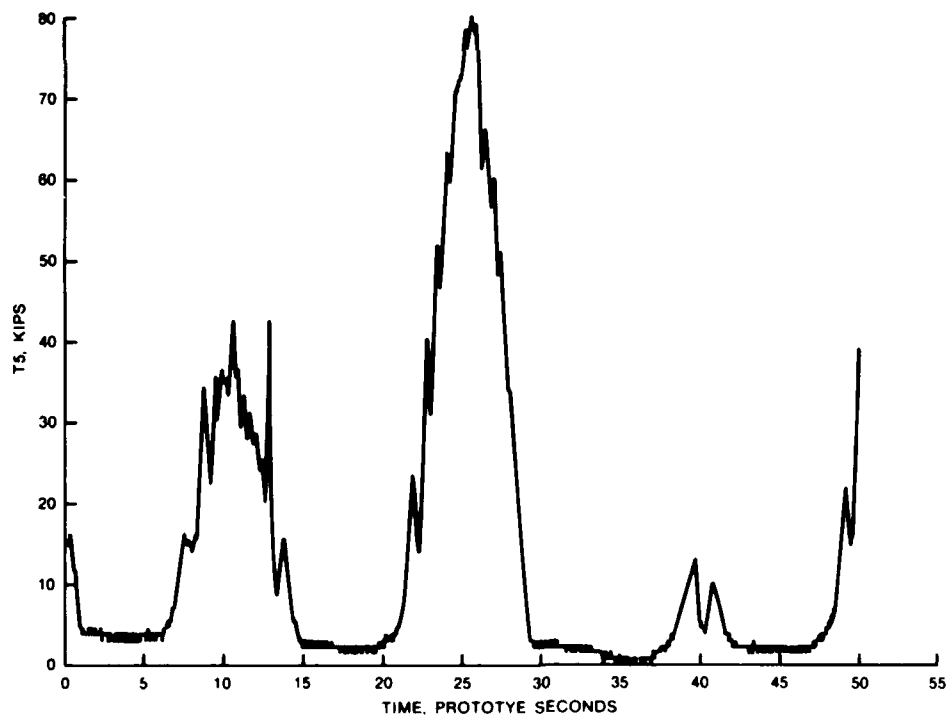

Figure 26. Mooring line T5's tension time history for Test 15 of side-connector tests

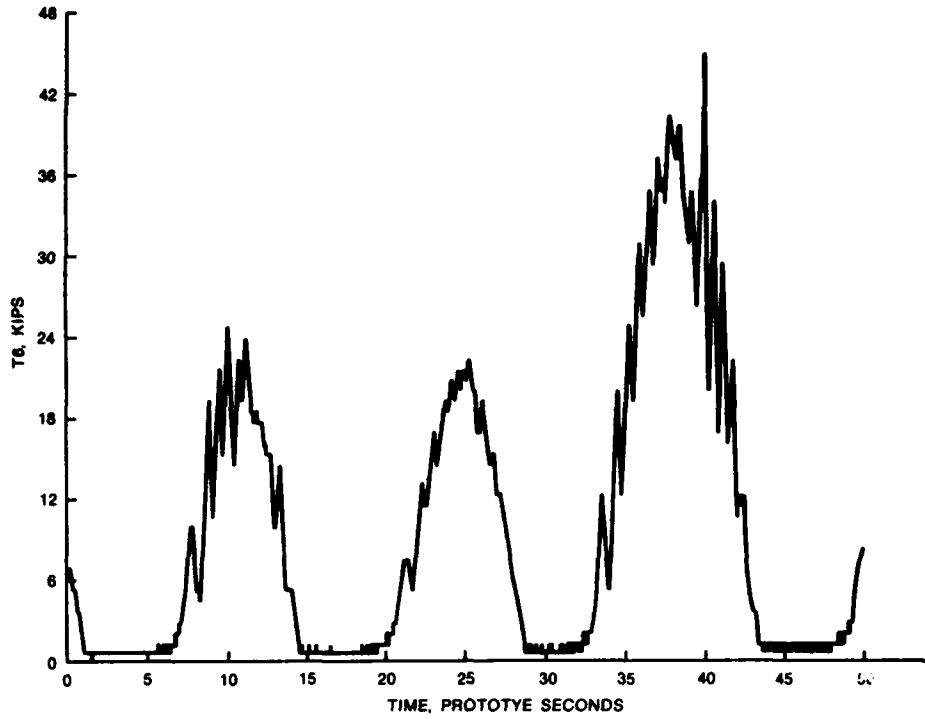

Figure 27. Mooring line T6's tension time history for Test 15 of side-connector tests

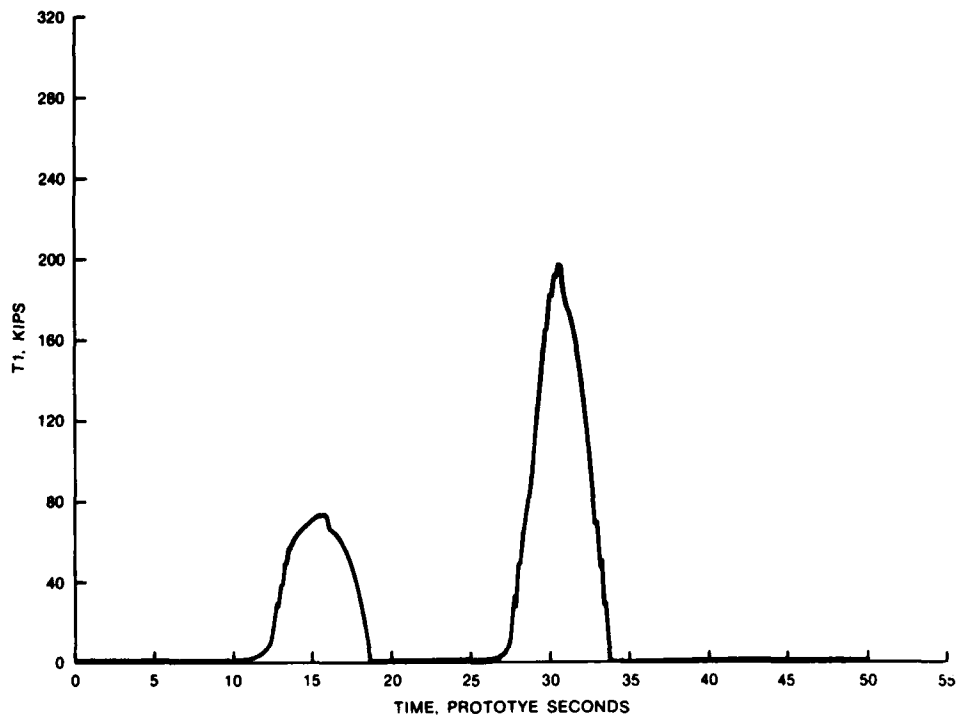

Figure 28. Mooring line T1's tension time history for Test 18 of side-connector tests

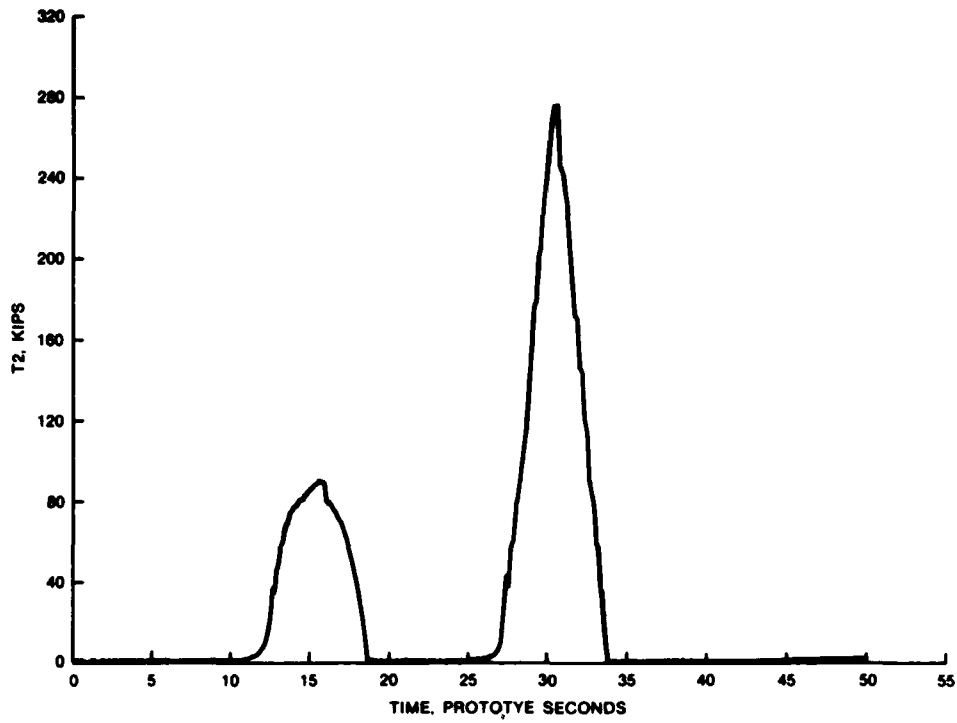

Figure 29. Mooring line T2's tension time history for Test 18 of side-connector tests

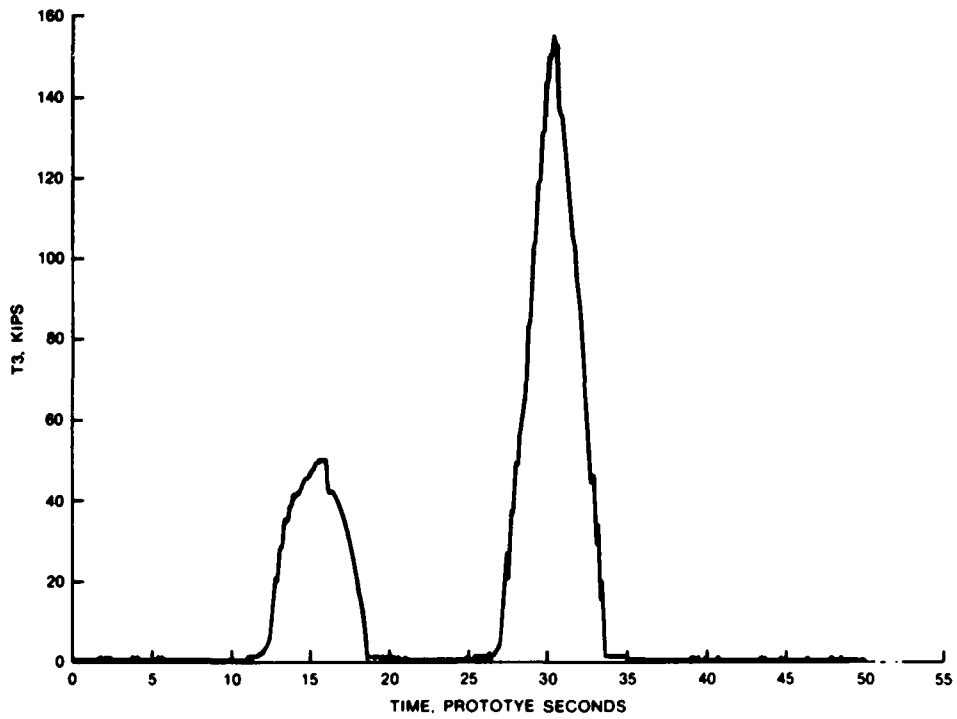

Figure 30. Mooring line T3's tension time history for Test 18 of side-connector tests

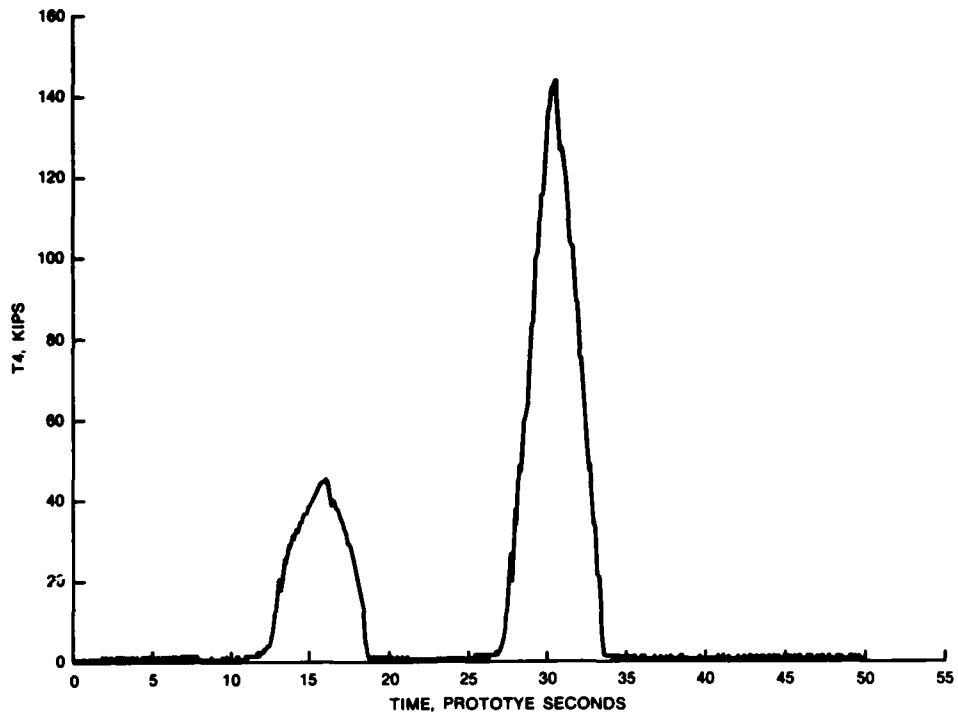

Figure 31. Mooring line T4's tension time history for Test 18 of side-connector tests

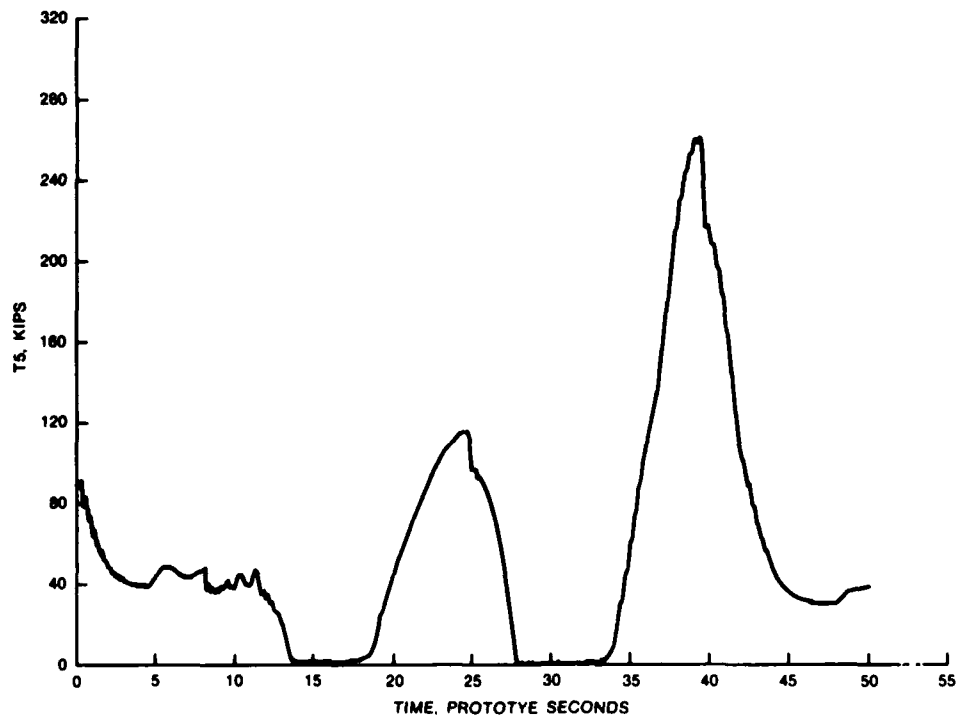

Figure 32. Mooring line T5's tension time history for Test 18 of side-connector tests

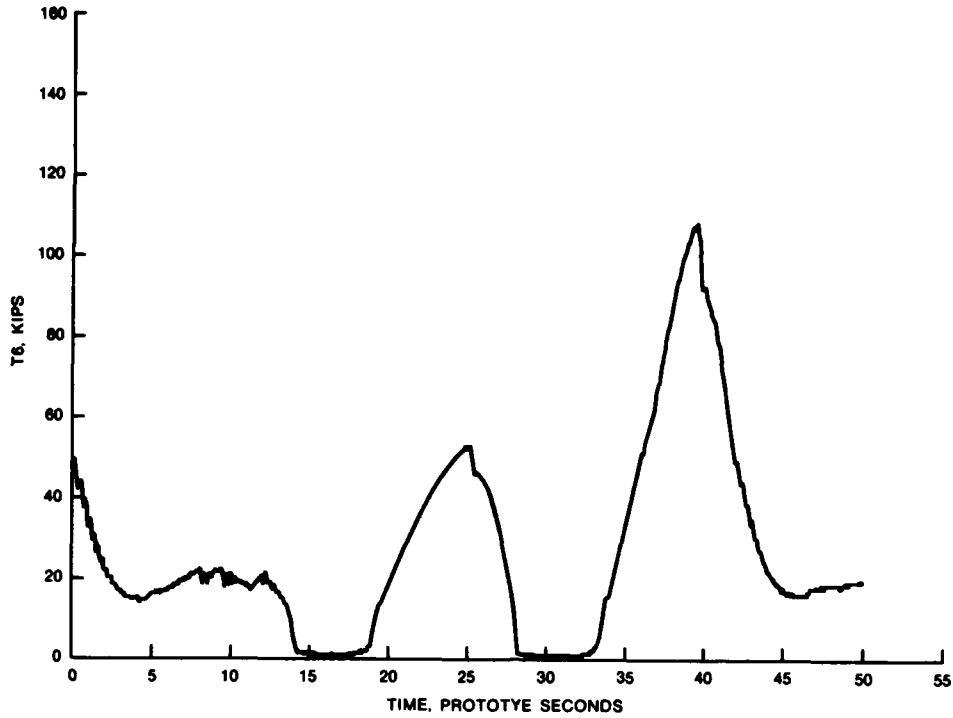

Figure 33. Mooring line T6's tension time history for Test 18 of side-connector tests

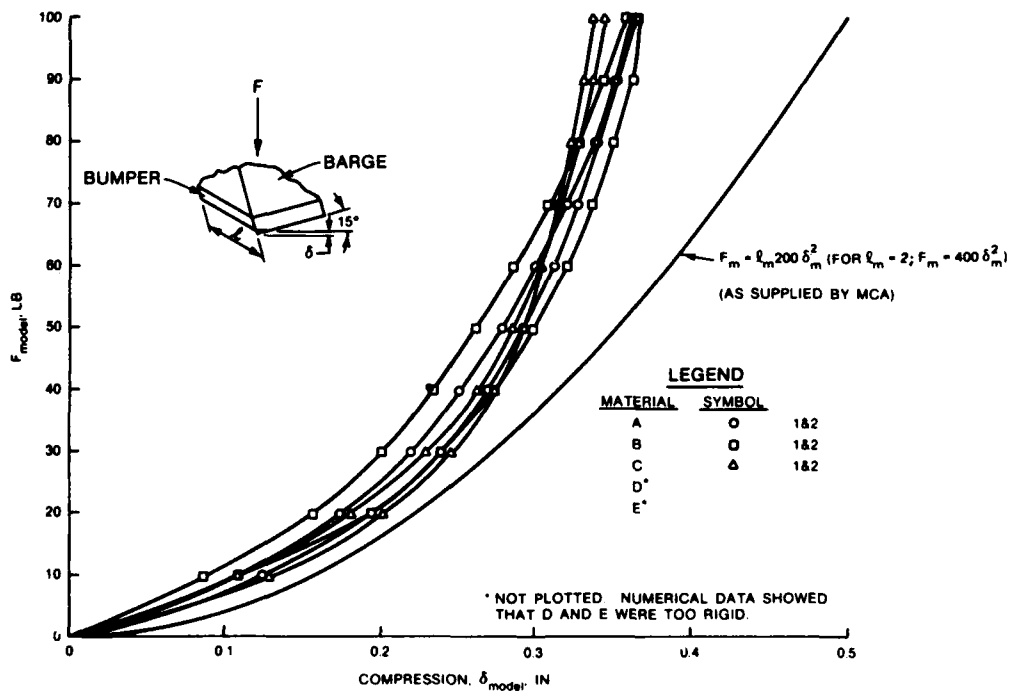

Figure 34. Force-compression curve for 2-in. length ($l_m = 2$) of model bumper material

PART VI: CONCLUSIONS

84. Based on assumptions, tests, and results reported herein, it is concluded from the functional tests that:

- a. For an 89.6-ft SFB moored in 15 ft of water using a mooring line length of 150 ft and subjected to monochromatic waves:
 - (1) Test results from Model Condition 1 (1.5-in. gap with no absorber beside SFB) should be used for design purpose.
 - (2) For maximum wave heights of 6 ft in a wave period range of 4 to 14 sec, maximum C_t 's, mooring forces, and flow velocities were 0.75, 1.18 kips/ft of breakwater, and 8.0 ft/sec, respectively.
 - (3) Exposure of the SFB to the maximum possible wave height in a 15-ft water depth for a 10-sec wave period results in a maximum transmitted wave height of 7.5 ft, a peak mooring force of 1.29 kips/ft of breakwater, and an extreme flow velocity of 11.0 ft/sec.
- b. For 89.6- and 118.4-ft SFBs moored in 13, 15, 18, and 21 ft of water using a mooring line length of 150 ft and subjected to spectral waves:
 - (1) Transmitted wave heights are consistently lower for the 118.4-ft SFB, and the transmission response of both structures is strongly dependent on wave period.
 - (2) Increasing the water depth significantly decreases the wave-attenuating capabilities of both structures.
 - (3) For most wave conditions, mooring forces are similar for both SFB lengths and tend to increase with increasing depth.
 - (4) The 14-sec, 8-ft spectrum produced the highest peak mooring forces (3.07 and 2.93 kips/ft of breakwater for the 89.6-ft and 118.4-ft structures, respectively) of all conditions investigated.
 - (5) Peak flow velocities are generally higher for the longer SFB, and maximum values of 12.5 and 15.5 ft/sec were observed for the 89.6- and 118.4-ft structures, respectively.
- c. For the 250-ft mooring line, as opposed to the 150-ft mooring line:
 - (1) For attack of 10-sec, 10- to 15-ft storm waves:
 - (a) Transmitted wave heights are slightly lower.
 - (b) Average mooring forces are similar and peak mooring forces are consistently reduced.
 - (c) Peak flow velocities are slightly lower.
 - (2) For subjection to 6- to 14-sec, 4- and 8-ft spectral waves:

- (a) Wave attenuation is essentially unaffected.
- (b) Generally, both average and peak mooring forces are reduced with the reduction being the most significant for the peak forces associated with the 8-ft wave heights.
- (c) Peak flow velocities are similar for most wave conditions; however, the longer mooring line appears to have a slight advantage for a few specific conditions.

85. Based on the test conditions, test results, and the test data analysis carried out and reported on by MCA Engineers, Inc. (MCA 1984), for Tests 1-20 of the side-connector tests, it is concluded that:

- a. The mooring line test data are valid for all tests. The mass weights in the model mooring line spring systems did not have an affect on the mean peak mooring line tensions recorded during Tests 1-15.
- b. The connector forces measured during the rigid bottom tests (Tests 1-15, 17 and 18) are of such a large magnitude that it does not appear to be economically feasible to design the connector type used in these tests if the rigid-bottom impact case is a design requirement.
- c. The bumping, which simulated a soft seafloor condition, reduced the connector forces to values that would make the connector design a feasible task, but the connector system design would only be adequate for seafloor conditions equal to or softer than the condition simulated in the model tests. Since this seafloor condition cannot be guaranteed for all prototype site conditions, it would be essential to provide a bumper or fendering system on the stern of the barges. A fendering system had been considered as a method of alleviating structural loadings in the barges, but it was ruled out as being too complicated.
- d. With the barges being adequately designed to withstand impact loadings, the connector loads could possibly be reduced through the incorporation of an absorber in the connector design that would reduce the impact-induced connector forces. This is a feasible alternative, but it requires further in-depth study.
- e. Since major modifications of the connector design were deemed essential, it was decided that testing of the existing connector design for other angles of wave attack and with spectral wave conditions was not needed.

REFERENCES

- Garcia, A. W., and Jensen, R. E. 1983 (Jun). "Wave Data Acquisition and Hindcast for Saginaw Bay," Technical Report HL-83-14, US Army Engineer Waterways Experiment Station, Vicksburg, Miss.
- Goda, Y. 1974. "Estimation of Wave Statistics from Spectral Information," Proceedings, International Symposium on Ocean Wave Measurement and Analysis; American Society of Civil Engineers, Vol 1, pp 320-337.
- Grosskopf, W. G., and Vincent, C. L. 1982 (Feb). "Energy Losses of Waves in Shallow Water," Rep. CETA 82-2, US Army Coastal Engineering Research Center, CE, Fort Belvoir, Va.
- Hasselmann, K. 1962. "On the Non-Linear Energy Transfer in a Gravity Wave Spectrum-General Theory," Journal of Fluid Mechanics, Vol 12, Part 1, pp 481-500.
- Hasselmann, K., et al. 1973. "Measurements of Wind-Wave Growth and Swell Decay During the Joint North Sea Wave Project JONSWAP," Dtsch, Hydrogr. Z., Vol 8, Supplement A8, No. 12.
- Iwata, K. 1980. "Wave Spectrum Changes due to Shoaling and Breaking; I - Minus - Three - Power - Law of Frequency Spectrum," Osaka University, Technical Report, Vol 30, No. 1517-1550, pp 269-278.
- Jensen, R. E. 1983 (April). "Mississippi Sound Wave Hindcast Study," Technical Report HL-83-8, US Army Engineer Waterways Experiment Station, Vicksburg, Miss.
- _____. 1983 (Sep). "Methodology for the Calculation of a Shallow-Water Wave Climate," WIS Report 8, US Army Engineer Waterways Experiment Station, Vicksburg, Miss.
- Jones, D. B. 1980. "Sloping Float Breakwater: Interim Data Summary," TN No. N-1568, Civil Engineering Laboratory, Naval Construction Battalion Center, Port Hueneme, Calif.
- Kitaigorskii, S. A., Krasitskii, V. P., and Zaslavaskii, M. M. 1975 (Jul). "On Phillips' Theory of Equilibrium Range in the Spectra of Wind-Generated Gravity Waves," Journal of Physical Oceanography, Vol 5, No. 3, pp 410-420.
- MCA Engineers, Inc. 1984. "Sloping Float Breakwater Three Dimensional Connector Tests," MCA Engineers, Inc., Newport Beach, Ca. 92660.
- Naval Facilities Engineering Command. 1974. "Pontoon Gear Handbook Navy Lightered (N.L.) Equipment P-Series," Report No. NAVFAC P-401, Department of Navy, Washington, D.C.
- Ou, Shan-Hwei. 1980 (Sep). "The Equilibrium Range in the Frequency Spectra of the Wind Generated Gravity Waves," Proceedings, 4th Conference on Ocean Engineering in the Republic of China.
- Patrick, D. A. 1951. "Model Study of Amphibious Breakwaters," Report 3-332, Institute of Engineering Research, University of California at Berkeley, Berkeley, Calif.
- Raichlen, F. 1981. "Experiment with a Sloping Float Breakwater in Water Waves - Phase I," Pasadena, Calif.

Raichlen, F., and Lee, J. J. 1978. "The Behavior of an Inclined Pontoon Breakwater in Water Waves," PO No. N62583/78 M R552, Civil Engineering Laboratory, Naval Construction Battalion Center, Port Hueneme, Calif.

Thompson, E. F. 1977 (Jan). "Wave Climate at Selected Locations Along U. S. Coasts," Technical Report No. 77-1, US Army Coastal Engineering Research Center, CE, Fort Belvoir, Va.

_____. 1980 (Feb). "Energy Spectra in Shallow U. S. Coastal Waters," Technical Paper No. 80-2, US Army Coastal Engineering Research Center, CE, Fort Belvoir, Va.

Thornton, E. B. 1977. "Rederivation of the Saturation Range in a Frequency Spectrum of Wind-Generated Gravity Waves," Journal of Physical Oceanography, Vol 7, pp 137-140.

Vincent, C. L. 1982 (May). "Shallow Water Wave Modeling," 1st International Conference on Meteorology and Air-Sea Interaction in the Coastal Zone, The Hague.

Table 1
Wave Conditions and Test Setup for Side-Connector Tests
Monochromatic Waves, 90 deg

Test No.	Wave		Mooring Line(s) Unhooked	Spring Systems, Modified (M) or Unmodified (U)	SFB Stern, Rigid (R) or Bumpered (B)
	Period, sec	Height, ft			
1	10	10.0	--	U	R
2	10	12.5	--	U	R
3	10	15.0	--	U	R
4	12	10.0	--	U	R
5	12	12.5	--	U	R
6	12	15.0	--	U	R
7	14	10.0	--	U	R
8	14	12.5	--	U	R
9	14	15.0	--	U	R
10	14	15.0	T6	U	R
11	12	15.0	T6	U	R
12	12	15.0	T4 & T6	U	R
13	14	15.0	T4 & T6	U	R
14	10	10.0	--	U	R
15	14	10.0	--	U	R
16	Ping tests		--	U	R
17	10	10.0	--	M	R
18	14	10.0	--	M	R
19	10	10.0	--	M	B
20	14	10.0	--	M	B

Table 2

Characteristics of Monochromatic Test Waves; d = 15.00 ft

<u>T, sec</u>	<u>H, ft</u>	<u>d/L</u>	<u>H/L</u>	<u>H/d</u>	<u>L_{SFB}/L</u>
4.0	2.0	0.2107	0.0281	0.133	1.237
4.0	4.0	0.2107	0.0562	0.267	1.237
4.0	6.0	0.2107	0.0843	0.400	1.237
6.0	2.0	0.1244	0.0166	0.133	0.731
6.0	4.0	0.1244	0.0332	0.267	0.731
6.0	6.0	0.1244	0.0498	0.400	0.731
8.0	2.0	0.0896	0.0119	0.133	0.526
8.0	4.0	0.0896	0.0239	0.267	0.526
8.0	6.0	0.0896	0.0358	0.400	0.526
10.0	2.0	0.0705	0.0094	0.133	0.414
10.0	4.0	0.0705	0.0188	0.267	0.414
10.0	6.0	0.0705	0.0282	0.400	0.414
12.0	2.0	0.0581	0.0077	0.133	0.341
12.0	4.0	0.0581	0.0155	0.267	0.341
12.0	6.0	0.0581	0.0232	0.400	0.341
14.0	2.0	0.0495	0.0066	0.133	0.291
14.0	4.0	0.0495	0.0132	0.267	0.291
14.0	6.0	0.0495	0.0198	0.400	0.291

Table 3

Wave-Attenuating Capabilities of 89.6-ft SFB;
Monochromatic Waves; d = 15.0 ft

Incident Wave		Condition 1		Condition 2		Condition 3	
T, sec	H, ft	H _t , ft	C _t	H _t , ft	C _t	H _t , ft	C _t
4.0	2.0	0.50	0.25	0.45	0.23	0.25	0.13
4.0	4.0	1.30	0.33	0.60	0.15	0.95	0.24
4.0	6.0	1.55	0.26	0.80	0.13	2.30	0.38
6.0	2.0	0.40	0.20	0.45	0.23	0.35	0.18
6.0	4.0	1.05	0.26	0.80	0.20	1.00	0.25
6.0	6.0	2.20	0.37	1.80	0.30	1.30	0.22
8.0	2.0	0.65	0.33	0.50	0.25	0.30	0.15
8.0	4.0	1.40	0.35	1.15	0.29	1.50	0.38
8.0	6.0	2.65	0.44	2.40	0.40	2.20	0.37
10.0	2.0	1.25	0.63	1.10	0.55	0.70	0.35
10.0	4.0	2.15	0.54	1.90	0.48	1.45	0.36
10.0	6.0	3.25	0.54	3.10	0.52	2.80	0.47
12.0	2.0	1.35	0.68	1.40	0.70	1.25	0.63
12.0	4.0	2.70	0.68	2.40	0.60	1.85	0.46
12.0	6.0	4.05	0.68	3.55	0.59	2.90	0.48
14.0	2.0	1.50	0.75	1.35	0.68	1.30	0.65
14.0	4.0	2.50	0.63	2.30	0.58	2.25	0.56
14.0	6.0	3.20	0.53	3.20	0.53	3.60	0.60

NOTES: Condition 1 tests were conducted with a 1.5-in. gap between the SFB's edge and the flume walls.

Condition 2 was the same as Condition 1 except the 1.5-in. gap was filled with a fibrous wave absorber.

Condition 3 tests were conducted with a 0.25-in. gap between the SFB's edge and the flume walls (Raichlen 1981).

Table 4

Average and Peak Mooring Forces Observed at Gage 1; 89.6-ft SFB;
Monochromatic Waves; d = 15.0 ft

Incident Wave		Mooring Force, kips/21-ft Barge Width					
		Condition 1		Condition 2		Condition 3	
T, sec	H, ft	Average	Peak	Average	Peak	Average	Peak
4.0	2.0	1.3	1.5	1.4	1.6	*	2.2
4.0	4.0	2.2	2.3	4.8	5.2	*	4.8
4.0	6.0	4.3	5.0	5.3	5.9	*	3.0
6.0	2.0	3.3	3.7	1.9	2.6	*	5.8
6.0	4.0	12.9	13.9	12.0	12.4	4.8	5.4
6.0	6.0	12.9	14.4	11.1	11.7	3.0	8.6
8.0	2.0	12.5	14.2	12.8	13.6	8.0	10.0
8.0	4.0	17.2	17.4	15.8	16.1	8.0	8.8
8.0	6.0	20.2	20.7	16.4	16.9	4.0	15.2
10.0	2.0	16.7	17.4	12.4	13.1	*	13.8
10.0	4.0	20.6	21.3	19.4	19.9	11.6	12.0
10.0	6.0	20.8	22.9	18.9	20.2	7.4	13.6
10.0	2.0	12.8	13.8	5.0	6.1	*	11.8
12.0	4.0	20.0	21.3	19.2	20.5	*	15.2
12.0	6.0	21.2	22.9	20.3	21.3	10.0	13.6
14.0	2.0	8.1	8.2	6.2	6.3	*	6.8
14.0	4.0	20.7	21.0	20.7	21.2	*	16.8
14.0	6.0	21.8	22.8	20.5	21.0	14.2	20.4

NOTES: Condition 1 tests were conducted with a 1.5-in. gap between the SFB's edge and the flume walls.

Condition 2 was the same as Condition 1 except the 1.5-in. gap was filled with a fibrous wave absorber.

Condition 3 tests were conducted with a 0.25-in. gap between the SFB's edge and the flume walls (Raichlen 1981).

* No value reported.

Table 5

Average and Peak Mooring Forces Observed at Gage 2; 89.6-ft SFB;
Monochromatic Waves; d = 15.0 ft

Incident Wave		Mooring Force, kips/21-ft Barge Width			
		Condition 1		Condition 2	
T, sec	H, ft	Average	Peak	Average	Peak
4.0	2.0	1.4	1.7	1.5	1.7
4.0	4.0	2.3	2.5	5.1	5.5
4.0	6.0	4.6	5.4	5.5	6.2
6.0	2.0	3.5	3.9	2.3	3.0
6.0	4.0	13.8	14.8	12.6	13.0
6.0	6.0	13.4	15.0	11.7	12.3
8.0	2.0	12.9	14.6	13.5	14.2
8.0	4.0	19.0	19.5	16.5	16.8
8.0	6.0	21.3	21.8	16.8	17.4
10.0	2.0	17.8	18.6	12.9	13.6
10.0	4.0	22.1	22.8	20.2	20.7
10.0	6.0	22.1	24.4	19.6	21.0
12.0	2.0	13.7	14.6	5.2	6.3
12.0	4.0	21.5	23.0	19.9	21.3
12.0	6.0	22.7	24.7	21.0	22.1
14.0	2.0	8.7	8.8	6.4	6.5
14.0	4.0	22.1	22.5	21.3	21.8
14.0	6.0	22.8	24.0	21.4	21.9

NOTES: Condition 1 tests were conducted with a 1.5-in. gap between the SFB's edge and the flume walls.

Condition 2 was the same as Condition 1 except the 1.5-in. gap was filled with a fibrous wave absorber.

Table 6
Peak Flow Velocities Observed at Stern of SFB; 89.6-ft SFB;
Monochromatic Waves; d = 15.0 ft

Incident Wave		Peak Flow Velocity, ft/sec					
		Condition 1			Condition 2		
		Minimum	Average	Maximum	Minimum	Average	Maximum
T, sec	H, ft						
4.0	4.0	1.5	1.9	2.5	1.0	1.6	2.0
4.0	6.0	2.0	2.7	3.0	1.5	2.6	3.0
6.0	4.0	3.0	3.8	4.5	3.0	3.4	4.0
6.0	6.0	3.5	4.7	6.0	3.0	4.4	5.5
8.0	4.0	3.0	4.1	4.5	3.0	3.7	4.5
8.0	6.0	5.0	6.7	8.0	5.5	6.9	7.5
10.0	4.0	2.5	3.9	5.0	3.0	4.0	5.5
10.0	6.0	4.0	6.2	8.0	4.5	5.8	8.0
12.0	4.0	3.5	4.2	5.5	4.0	4.8	6.0
12.0	6.0	4.0	5.5	7.0	4.0	6.1	8.0
14.0	4.0	3.5	4.4	5.5	4.5	5.6	6.5
14.0	6.0	4.0	5.6	7.0	4.5	5.5	8.0

NOTES: Condition 1 tests were conducted with a 1.5-in. gap between the SFB's edge and the flume walls.

Condition 2 was the same as Condition 1 except the 1.5-in. gap was filled with a fibrous wave absorber.

Table 7
Characteristics of Monochromatic Storm Waves;
d = 15.0 ft; T = 10.0 sec*

H, ft	H/L	H/d
2.0	0.0094	0.133
4.0	0.0188	0.267
6.0	0.0282	0.400
8.0	0.0376	0.533
10.0	0.0470	0.667
11.0	0.0517	0.733
12.0	0.0564	0.800
12.5	0.0588	0.833
12.7	0.0597	0.847

* $d/L = 0.0705$; $L_{SFB}/L = 0.414$.

Table 8
Wave-Attenuating Capabilities of 89.6-ft SFB;
Monochromatic Storm Waves;
d = 15.0 ft; T = 10 sec
(Survival Tests)

<u>H, ft</u>	<u>H_t, ft</u>	<u>C_t</u>
2.0	1.25	0.63
4.0	2.15	0.54
6.0	3.25	0.54
8.0	4.20	0.53
10.0	6.15	0.62
11.0	6.60	0.60
12.0	7.10	0.59
12.5	7.40	0.59
12.7	7.50	0.59

Table 9
Average and Peak Mooring Forces; Monochromatic Storm Waves;
89.6-ft SFB; d = 15.0 ft; T = 10 sec
(Survival Tests)

<u>H, ft</u>	<u>Mooring Force, kips/21-ft Barge Width</u>			
	<u>Gage 1</u>		<u>Gage 2</u>	
	<u>Average</u>	<u>Peak</u>	<u>Average</u>	<u>Peak</u>
2.0	16.7	17.4	17.8	18.6
4.0	20.6	21.3	22.1	22.8
6.0	20.8	22.9	22.1	24.4
8.0	19.8	22.2	20.4	22.7
10.0	17.9	21.0	18.4	21.9
11.0	18.3	22.0	18.7	22.9
12.0	17.4	23.9	18.5	24.6
12.5	17.6	26.0	17.9	27.0
12.7	17.8	26.3	18.3	27.0

Table 10
Peak Flow Velocities Observed at Stern of SFB;
Monochromatic Storm Waves; 89.6 ft SFB;
d = 15.0 ft; T = 10 sec
(Survival Tests)

H, ft	Peak Flow Velocity, ft/sec		
	Minimum	Average	Maximum
4.0	2.5	3.9	5.0
6.0	4.0	6.2	8.0
8.0	6.0	8.1	9.5
10.0	7.0	9.0	11.0
11.0	7.0	8.9	10.5
12.0	7.0	9.0	10.5
12.5	6.5	8.4	10.0
12.7	6.5	8.4	9.5

Table 11
Wave Attenuation Test Results; Spectral Waves; d = 13.0 ft

Incident Spectrum		Transmitted Wave Heights and Coefficients of Transmission for Indicated SFB Length			
		89.6 ft		118.4 ft	
T_p , sec	H_{mo} , ft	H_t , ft	C_t	H_t , ft	C_t
6.0	2.0	0.50	0.25	0.30	0.15
6.0	4.0	1.05	0.26	0.75	0.19
6.0	6.0	2.10	0.35	1.75	0.29
8.0	2.0	0.70	0.35	0.45	0.23
8.0	4.0	1.45	0.36	1.10	0.28
8.0	6.0	2.75	0.46	2.25	0.38
8.0	8.0	3.90	0.49	3.45	0.43
10.0	2.0	0.95	0.48	0.65	0.33
10.0	4.0	1.90	0.48	1.40	0.35
10.0	6.0	3.15	0.53	2.50	0.42
10.0	8.0	4.65	0.58	3.90	0.49
12.0	2.0	1.25	0.63	0.80	0.40
12.0	4.0	2.45	0.61	1.75	0.44
12.0	6.0	3.65	0.61	2.95	0.49
12.0	8.0	4.95	0.62	4.30	0.54
14.0	2.0	1.45	0.73	1.15	0.58
14.0	4.0	2.55	0.64	2.05	0.51
14.0	6.0	3.90	0.65	3.30	0.55
14.0	8.0	5.20	0.65	4.80	0.60

Table 12

Wave Attenuation Test Results; Spectral Waves; d = 15.0 ft

Incident Spectrum		Transmitted Wave Heights and Coefficients of Transmission for Indicated SFB Length					
T_p , sec	H_{mo} , ft	72.3 ft		89.6 ft		118.4 ft	
		H_t , ft	C_t	H_t , ft	C_t	H_t , ft	C_t
6.0	2.0	0.85	0.43	0.55	0.28	0.40	0.20
6.0	4.0	1.65	0.41	1.15	0.29	0.85	0.21
6.0	6.0	2.65	0.44	2.20	0.37	1.90	0.32
8.0	2.0	1.10	0.55	0.80	0.40	0.55	0.28
8.0	4.0	2.05	0.51	1.60	0.40	1.15	0.29
8.0	6.0	3.35	0.56	2.90	0.48	2.15	0.36
8.0	8.0	4.85	0.61	4.25	0.53	3.50	0.44
10.0	2.0	1.30	0.65	1.10	0.55	0.80	0.40
10.0	4.0	2.45	0.61	2.10	0.53	1.55	0.39
10.0	6.0	3.65	0.61	3.20	0.53	2.55	0.43
10.0	8.0	5.45	0.68	4.80	0.60	4.05	0.51
12.0	2.0	1.50	0.75	1.45	0.73	1.25	0.63
12.0	4.0	2.95	0.74	2.50	0.63	1.95	0.49
12.0	6.0	4.40	0.73	3.70	0.62	3.25	0.54
12.0	8.0	5.75	0.72	5.10	0.64	4.55	0.57
14.0	2.0	1.45	0.73	1.45	0.73	1.40	0.70
14.0	4.0	2.95	0.74	2.75	0.69	2.35	0.59
14.0	6.0	4.40	0.73	4.05	0.68	3.55	0.59
14.0	8.0	5.95	0.74	5.65	0.71	5.35	0.67

Table 13

Wave Attenuation Test Results; Spectral Waves; d = 18.0 ft

Incident Spectrum		Transmitted Wave Heights and Coefficients of Transmission for Indicated SFB Length			
T_p , sec	H_{mo} , ft	89.6 ft		118.4 ft	
		H_t , ft	C_t	H_t , ft	C_t
6.0	2.0	0.65	0.33	0.45	0.23
6.0	4.0	1.40	0.35	0.90	0.23
6.0	6.0	2.55	0.43	1.80	0.30
8.0	2.0	1.00	0.50	0.65	0.33
8.0	4.0	1.90	0.48	1.25	0.31
8.0	6.0	3.20	0.53	2.40	0.40
8.0	8.0	5.05	0.63	3.90	0.49
10.0	2.0	1.30	0.65	0.90	0.45
10.0	4.0	2.30	0.58	1.70	0.43
10.0	6.0	3.80	0.63	2.90	0.48
10.0	8.0	5.60	0.70	4.60	0.58
12.0	2.0	1.65	0.83	1.40	0.70
12.0	4.0	3.20	0.80	2.45	0.61
12.0	6.0	4.55	0.76	3.85	0.64
12.0	8.0	6.35	0.79	5.35	0.67
14.0	2.0	1.75	0.88	1.60	0.80
14.0	4.0	3.35	0.84	2.85	0.71
14.0	6.0	5.10	0.85	4.25	0.71
14.0	8.0	6.50	0.81	5.85	0.73

Table 14

Wave Attenuation Test Results; Spectral Waves; d = 21.0 ft

Incident Spectrum		Transmitted Wave Heights and Coefficients of Transmission for Indicated SFB Length			
		89.6 ft		118.4 ft	
T_p , sec	H_{mo} , ft	H_t , ft	C_t	H_t , ft	C_t
6.0	2.0	0.75	0.38	0.55	0.28
6.0	4.0	1.50	0.38	1.05	0.26
6.0	6.0	2.60	0.43	1.75	0.29
8.0	2.0	1.15	0.58	0.80	0.40
8.0	4.0	2.15	0.54	1.55	0.39
8.0	6.0	3.35	0.56	2.50	0.42
8.0	8.0	5.20	0.65	4.20	0.53
10.0	2.0	1.40	0.70	1.10	0.55
10.0	4.0	2.60	0.65	1.95	0.49
10.0	6.0	3.90	0.65	3.10	0.52
10.0	8.0	5.70	0.71	4.90	0.61
12.0	2.0	1.75	0.88	1.50	0.75
12.0	4.0	3.50	0.88	2.90	0.73
12.0	6.0	4.75	0.79	4.05	0.68
12.0	8.0	6.55	0.82	5.55	0.69
14.0	2.0	1.80	0.90	1.70	0.85
14.0	4.0	3.60	0.90	3.15	0.79
14.0	6.0	5.20	0.87	4.50	0.75
14.0	8.0	6.90	0.86	6.00	0.75

Table 15

Average and Peak Mooring Forces; Spectral Waves; d = 13.0 ft

Incident Spectrum		Average and Peak Mooring Forces, kips/21-ft Barge Width, for Indicated SFB Length			
T_p , sec	H_{mo} , ft	89.6 ft		118.4 ft	
		Average	Peak	Average	Peak
6.0	2.0	4.1	9.5	1.2	2.5
6.0	4.0	10.9	15.3	7.5	11.0
6.0	6.0	9.4	16.5	6.7	16.2
8.0	2.0	9.9	14.3	1.6	3.2
8.0	4.0	13.0	16.9	11.5	15.7
8.0	6.0	12.0	21.5	10.2	19.7
8.0	8.0	13.2	27.9	12.9	22.3
10.0	2.0	7.7	15.8	2.5	7.2
10.0	4.0	16.2	20.9	12.9	17.7
10.0	6.0	15.6	27.8	14.0	22.6
10.0	8.0	15.6	42.4	15.6	38.1
12.0	2.0	10.8	19.1	9.7	16.3
12.0	4.0	19.8	23.6	16.9	20.3
12.0	6.0	18.3	29.6	18.3	25.2
12.0	8.0	16.9	34.2	16.5	30.4
14.0	2.0	13.5	18.0	11.4	14.5
14.0	4.0	19.9	22.9	19.5	23.5
14.0	6.0	17.9	32.3	17.8	35.9
14.0	8.0	16.3	46.4	17.3	44.6

Table 16

Average and Peak Mooring Forces; Spectral Waves; d = 15.0 ft

Incident Spectrum		Average and Peak Mooring Forces, kips/21-ft Barge Width, for Indicated SFB Length					
T_p , sec	H_{mo} , ft	72.3 ft		89.6 ft		118.4 ft	
		Average	Peak	Average	Peak	Average	Peak
6.0	2.0	10.0	14.4	3.7	7.5	2.7	5.4
6.0	4.0	13.5	18.8	12.5	17.3	11.5	15.1
6.0	6.0	15.0	21.3	12.7	19.4	11.4	16.2
8.0	2.0	12.9	17.2	11.8	16.4	9.4	13.9
8.0	4.0	15.6	22.9	15.3	19.4	13.8	17.0
8.0	6.0	17.0	27.2	14.8	21.7	14.0	19.3
8.0	8.0	18.0	39.6	16.2	27.9	15.9	24.6
10.0	2.0	12.5	18.1	10.0	17.8	10.1	15.5
10.0	4.0	16.4	24.7	17.3	26.0	15.6	19.7
10.0	6.0	17.8	34.4	17.6	28.3	16.2	22.2
10.0	8.0	19.2	44.3	19.1	43.3	19.0	41.7
12.0	2.0	8.6	18.3	11.8	19.9	14.7	18.8
12.0	4.0	17.1	27.7	19.8	24.7	18.3	22.8
12.0	6.0	19.8	43.0	20.8	34.8	19.9	27.9
12.0	8.0	20.3	47.2	19.3	37.1	19.3	45.2
14.0	2.0	15.0	18.6	9.7	19.8	15.2	19.5
14.0	4.0	18.6	27.5	20.4	24.5	19.8	23.6
14.0	6.0	20.6	34.7	21.3	32.4	20.0	28.3
14.0	8.0	20.9	54.6	18.9	56.0	21.1	52.0

Table 17

Average and Peak Mooring Forces; Spectral Waves; d = 18.0 ft

Incident Spectrum		Average and Peak Mooring Forces, kips/21-ft Barge Width, for Indicated SFB Length			
T_p , sec	H_{mo} , ft	89.6 ft		118.4 ft	
		Average	Peak	Average	Peak
6.0	2.0	4.7	14.6	2.2	6.0
6.0	4.0	16.6	22.6	15.1	19.5
6.0	6.0	16.4	25.4	15.4	20.8
8.0	2.0	14.9	20.0	8.8	13.6
8.0	4.0	18.9	26.0	17.7	22.0
8.0	6.0	19.8	30.3	19.0	28.1
8.0	8.0	20.8	37.3	20.0	34.0
10.0	2.0	9.1	19.9	10.5	17.4
10.0	4.0	20.7	28.3	20.1	24.7
10.0	6.0	24.0	34.5	20.4	28.4
10.0	8.0	23.3	49.1	21.9	44.3
12.0	2.0	4.6	10.8	13.0	21.0
12.0	4.0	21.7	31.0	24.4	29.1
12.0	6.0	23.9	39.0	26.1	36.1
12.0	8.0	26.4	54.5	26.3	51.2
14.0	2.0	2.2	3.5	2.7	7.3
14.0	4.0	23.0	30.4	25.0	32.0
14.0	6.0	25.5	41.7	27.7	42.6
14.0	8.0	24.7	61.4	29.2	59.5

Table 18

Average and Peak Mooring Forces; Spectral Waves; $d = 21.0$ ft

Incident Spectrum		Average and Peak Mooring Forces, kips/21-ft Barge Width, for Indicated SFB Length			
T_p , sec	H_{mo} , ft	89.6 ft		118.4 ft	
		Average	Peak	Average	Peak
6.0	2.0	9.5	14.0	1.5	5.5
6.0	4.0	17.1	23.1	19.3	21.8
6.0	6.0	18.3	26.4	18.9	23.7
8.0	2.0	12.6	19.5	10.5	16.1
8.0	4.0	19.4	27.2	21.4	26.5
8.0	6.0	21.4	33.1	22.5	38.0
8.0	8.0	21.6	42.9	25.3	43.5
10.0	2.0	6.3	14.8	10.3	17.2
10.0	4.0	21.2	30.3	23.8	30.5
10.0	6.0	21.4	35.5	24.6	36.4
10.0	8.0	23.2	56.7	25.6	47.0
12.0	2.0	3.9	7.9	9.2	16.6
12.0	4.0	22.0	31.0	29.0	35.5
12.0	6.0	24.7	43.2	31.2	42.3
12.0	8.0	25.0	60.1	31.4	51.9
14.0	2.0	0.8	1.7	3.6	6.9
14.0	4.0	21.9	33.0	28.5	35.9
14.0	6.0	24.9	44.3	31.4	47.9
14.0	8.0	27.3	64.4	32.6	61.6

Table 19

Peak Flow Velocities Observed at Stern of SFB; Spectral Waves; $d = 13.0$ ft

Incident Spectrum		Peak Flow Velocity, ft/sec, for Indicated SFB Length	
T_p , sec	H_{mo} , ft	89.6 ft	118.4 ft
		6.0	4.0
6.0	6.0	6.5	4.5
8.0	4.0	5.5	6.0
8.0	6.0	7.0	9.0
8.0	8.0	9.5	11.5
10.0	4.0	7.5	8.0
10.0	6.0	9.0	11.5
10.0	8.0	11.0	13.5
12.0	4.0	8.0	12.5
12.0	6.0	10.0	15.0
12.0	8.0	12.0	14.5
14.0	4.0	9.0	13.0
14.0	6.0	11.5	15.0
14.0	8.0	12.5	14.5

Table 20

Peak Flow Velocities Observed at Stern of SFB; Spectral Waves; d = 15.0 ft

Incident Spectrum		Peak Flow Velocity, ft/sec, for Indicated SFB Length		
<u>T_p, sec</u>	<u>H_{mo}, ft</u>	<u>72.3 ft</u>	<u>89.6 ft</u>	<u>118.4 ft</u>
6.0	4.0	3.0	4.0	1.5
6.0	6.0	6.0	7.0	4.5
8.0	4.0	6.0	6.5	4.5
8.0	6.0	6.5	8.0	9.0
8.0	8.0	8.0	8.5	11.5
10.0	4.0	6.0	7.5	6.0
10.0	6.0	7.0	9.0	9.5
10.0	8.0	9.0	11.5	13.0
12.0	4.0	6.0	8.0	12.0
12.0	6.0	9.0	10.5	15.5
12.0	8.0	10.0	11.0	14.5
14.0	4.0	9.0	9.5	12.0
14.0	6.0	11.0	12.0	15.0
14.0	8.0	11.0	12.0	14.0

Table 21

Peak Flow Velocities Observed at Stern of SFB; Spectral Waves; d = 18.0 ft

Incident Spectrum		Peak Flow Velocity, ft/sec, for Indicated SFB Length	
<u>T_p, sec</u>	<u>H_{mo}, ft</u>	<u>89.6 ft</u>	<u>118.4 ft</u>
6.0	4.0	4.5	3.0
6.0	6.0	6.5	5.5
8.0	4.0	5.5	4.5
8.0	6.0	7.5	9.0
8.0	8.0	9.0	11.0
10.0	4.0	7.0	6.0
10.0	6.0	9.5	11.0
10.0	8.0	10.5	12.0
12.0	4.0	7.0	10.0
12.0	6.0	9.5	14.0
12.0	8.0	10.0	14.0
14.0	4.0	6.0	10.5
14.0	6.0	11.0	14.5
14.0	8.0	12.0	13.5

Table 22

Peak Flow Velocities Observed at Stern of SFB; Spectral Waves; d = 21.0 ft

Incident Spectrum		Peak Flow Velocity, ft/sec, for Indicated SFB Length	
T_p , sec	H_{mo} , ft	89.6 ft	118.4 ft
6.0	4.0	4.5	4.0
6.0	6.0	7.0	6.0
8.0	4.0	6.0	5.0
8.0	6.0	8.0	9.5
8.0	8.0	10.5	11.0
10.0	4.0	5.5	7.0
10.0	6.0	8.0	10.0
10.0	8.0	9.0	11.5
12.0	4.0	6.0	10.0
12.0	6.0	9.5	13.5
12.0	8.0	10.0	13.5
14.0	4.0	6.0	8.5
14.0	6.0	11.0	13.0
14.0	8.0	11.0	13.5

Table 23

Mooring Line Length-Effect Tests; Monochromatic Wave Attenuation
Results; d = 21.0 ft; T = 10.0 sec

Incident Wave Height, ft	Transmitted Wave Heights and Coefficients of Transmission for Indicated Mooring Line Length			
	150.0 ft		250.0 ft	
	H_t , ft	C_t	H_t , ft	C_t
	<u>89.6-ft SFB</u>			
10.0	8.05	0.81	7.00	0.70
12.0	9.40	0.78	8.70	0.73
14.0	11.30	0.81	11.00	0.79
15.0	11.60	0.77	11.70	0.78
	<u>118.4-ft SFB</u>			
10.0	5.50	0.55	5.35	0.54
12.0	7.35	0.61	6.80	0.57
14.0	9.40	0.67	9.00	0.64
15.0	10.45	0.70	10.05	0.67

Table 24

Mooring Line Length-Effect Tests; Average and Peak Mooring Forces;
Monochromatic Waves; d = 21.0 ft; T = 10.0 sec

<u>Incident Wave Height, ft</u>	Average and Peak Mooring Forces, kips/21-ft Barge Width for Indicated Mooring Line Length			
	<u>150.0 ft</u>		<u>250.0 ft</u>	
	<u>Average</u>	<u>Peak</u>	<u>Average</u>	<u>Peak</u>
	<u>89.6-ft SFB</u>			
10.0	30.1	37.2	29.9	31.7
12.0	28.8	35.8	27.9	33.1
14.0	23.7	35.9	24.1	32.1
15.0	21.0	36.7	23.9	34.8
	<u>118.4-ft SFB</u>			
10.0	37.5	41.1	31.6	33.3
12.0	36.0	38.6	32.2	34.1
14.0	32.8	40.1	31.1	33.3
15.0	31.1	40.4	30.2	34.0

Table 25

Mooring Line Length-Effect Tests; Peak Flow Velocities
Observed at Stern of SFB; Monochromatic Waves;
d = 21.0 ft; T = 10.0 sec

<u>Incident Wave Height, ft</u>	Peak Flow Velocity, ft/sec, for Indicated Mooring Line Length	
	<u>150.0 ft</u>	<u>250.0 ft</u>
		<u>89.6-ft SFB</u>
10.0	10.5	9.5
12.0	11.0	11.0
14.0	12.0	11.5
15.0	11.5	11.5
	<u>118.4-ft SFB</u>	
10.0	11.0	11.0
12.0	11.0	10.5
14.0	12.0	11.5
15.0	12.0	11.0

Table 26

Mooring Line Length-Effect Tests; Spectral Wave
Attenuation Results; d = 21.0 ft

Incident Spectrum		Transmitted Wave Heights and Coefficients of Transmission for Indicated Mooring Line Length			
		150.0 ft		250.0 ft	
<u>T_p, sec</u>	<u>H_{mo}, ft</u>	<u>H_t, ft</u>	<u>C_t</u>	<u>H_t, ft</u>	<u>C_t</u>
<u>89.6-ft SFB</u>					
6.0	4.0	1.50	0.38	1.55	0.39
8.0	4.0	2.15	0.54	2.10	0.53
10.0	4.0	2.60	0.65	2.60	0.65
12.0	4.0	3.50	0.88	3.45	0.86
14.0	4.0	3.60	0.90	3.55	0.89
8.0	8.0	5.20	0.65	5.15	0.64
10.0	8.0	5.70	0.71	5.80	0.73
12.0	8.0	6.55	0.82	6.50	0.81
14.0	8.0	6.90	0.86	6.65	0.83
<u>118.4-ft SFB</u>					
6.0	4.0	1.05	0.26	1.05	0.26
8.0	4.0	1.55	0.39	1.45	0.36
10.0	4.0	1.95	0.49	1.90	0.48
12.0	4.0	2.90	0.73	2.85	0.71
14.0	4.0	3.15	0.79	3.10	0.78
8.0	8.0	4.20	0.53	4.05	0.51
10.0	8.0	4.90	0.61	4.80	0.60
12.0	8.0	5.55	0.69	5.65	0.71
14.0	8.0	6.00	0.75	6.00	0.75

Table 27

Mooring Line Length-Effect Tests; Average and Peak
Mooring Forces; Spectral Waves; d = 21.0 ft

Incident Spectrum		Average and Peak Mooring Forces, kips/21-ft Barge Width, for Indicated Mooring Line Length			
		150.0 ft		250.0 ft	
<u>T_p, sec</u>	<u>H_{mo}, ft</u>	<u>Average</u>	<u>Peak</u>	<u>Average</u>	<u>Peak</u>
<u>89.6-ft SFB</u>					
6.0	4.0	17.1	23.1	17.9	22.9
8.0	4.0	19.4	27.2	19.4	25.3
10.0	4.0	21.2	30.3	20.3	25.2
12.0	4.0	22.0	31.0	20.8	28.9
14.0	4.0	21.9	33.0	21.2	29.3
8.0	8.0	21.6	42.9	20.6	36.1
10.0	8.0	23.2	56.7	20.6	43.5
12.0	8.0	25.0	60.1	22.9	47.2
14.0	8.0	27.3	64.4	23.8	56.0
<u>118.4-ft SFB</u>					
6.0	4.0	19.3	21.8	16.8	19.2
8.0	4.0	21.4	26.5	19.5	24.6
10.0	4.0	23.8	30.5	20.4	25.6
12.0	4.0	29.0	35.5	24.5	29.6
14.0	4.0	28.5	35.9	24.0	28.4
8.0	8.0	25.3	43.5	22.0	29.7
10.0	8.0	25.6	47.0	23.6	36.6
12.0	8.0	31.4	51.9	27.3	41.4
14.0	8.0	32.6	61.6	25.5	52.0

Table 28

Mooring Line Length-Effect Tests; Peak Flow Velocities Observed
at Stern of SFB; Spectral Waves; d = 21.0 ft

<u>Incident Spectrum</u>		<u>Peak Flow Velocity, ft/sec, for</u> <u>Indicated Mooring Line Length</u>	
<u>T_p, sec</u>	<u>H_{mo}, ft</u>	<u>150.0 ft</u>	<u>250.0 ft</u>
<u>89.6-ft SFB</u>			
6.0	4.0	4.5	4.0
8.0	4.0	6.0	6.0
10.0	4.0	5.5	5.0
12.0	4.0	6.0	6.0
14.0	4.0	6.0	4.5
8.0	8.0	10.5	9.5
10.0	8.0	9.0	10.0
12.0	8.0	10.0	10.0
14.0	8.0	11.0	9.5
<u>118.4-ft SFB</u>			
6.0	4.0	4.0	3.5
8.0	4.0	5.0	5.0
10.0	4.0	7.0	6.0
12.0	4.0	10.0	8.5
14.0	4.0	8.5	9.0
8.0	8.0	11.0	10.0
10.0	8.0	11.5	10.5
12.0	8.0	13.5	11.5
14.0	8.0	13.5	12.0

Table 29

Coefficients of Transmission and Relative SFB Lengths;
Spectral Waves; d = 13.0 ft

Incident Spectrum		Values of C_t and L_{SFB}/L_p for Indicated SFB Length			
		89.6 ft		118.4 ft	
T_p , sec	H_{mo} , ft	C_t	L_{SFB}/L_p	C_t	L_{SFB}/L_p
6.0	2.0	0.25	0.79	0.15	1.04
6.0	4.0	0.26	0.79	0.19	1.04
6.0	6.0	0.35	0.79	0.29	1.04
8.0	2.0	0.35	0.57	0.23	0.75
8.0	4.0	0.36	0.57	0.28	0.75
8.0	6.0	0.46	0.57	0.38	0.75
8.0	8.0	0.49	0.57	0.43	0.75
10.0	2.0	0.48	0.45	0.33	0.59
10.0	4.0	0.48	0.45	0.35	0.59
10.0	6.0	0.53	0.45	0.42	0.59
10.0	8.0	0.58	0.45	0.49	0.59
12.0	2.0	0.63	0.37	0.40	0.49
12.0	4.0	0.61	0.37	0.44	0.49
12.0	6.0	0.61	0.37	0.49	0.49
12.0	8.0	0.62	0.37	0.54	0.49
14.0	2.0	0.73	0.32	0.58	0.42
14.0	4.0	0.64	0.32	0.51	0.42
14.0	6.0	0.65	0.32	0.55	0.42
14.0	8.0	0.65	0.32	0.60	0.42

Table 30

Coefficients of Transmission and Relative SFB Lengths;
Spectral Waves; d = 15.0 ft

Incident Spectrum		Values of C_t and L_{SFB}/L_p for Indicated SFB Length					
		72.3 ft		89.6 ft		118.4 ft	
T_p , sec	H_{mo} , ft	C_t	L_{SFB}/L_p	C_t	L_{SFB}/L_p	C_t	L_{SFB}/L_p
6.0	2.0	0.43	0.60	0.28	0.74	0.20	0.98
6.0	4.0	0.41	0.60	0.29	0.74	0.21	0.98
6.0	6.0	0.44	0.60	0.37	0.74	0.32	0.98
8.0	2.0	0.55	0.43	0.40	0.54	0.28	0.71
8.0	4.0	0.51	0.43	0.40	0.54	0.29	0.71
8.0	6.0	0.56	0.43	0.48	0.54	0.36	0.71
8.0	8.0	0.61	0.43	0.53	0.54	0.44	0.71
10.0	2.0	0.65	0.34	0.55	0.42	0.40	0.56
10.0	4.0	0.61	0.34	0.53	0.42	0.39	0.56
10.0	6.0	0.61	0.34	0.53	0.42	0.43	0.56
10.0	8.0	0.68	0.34	0.60	0.42	0.51	0.56
12.0	2.0	0.75	0.28	0.73	0.35	0.63	0.46
12.0	4.0	0.74	0.28	0.63	0.35	0.49	0.46
12.0	6.0	0.73	0.28	0.64	0.35	0.54	0.46
12.0	8.0	0.72	0.28	0.64	0.35	0.57	0.46
14.0	2.0	0.73	0.24	0.73	0.30	0.70	0.39
14.0	4.0	0.74	0.24	0.69	0.30	0.59	0.39
14.0	6.0	0.73	0.24	0.68	0.30	0.59	0.39
14.0	8.0	0.74	0.24	0.71	0.30	0.67	0.39

Table 31
Coefficients of Transmission and Relative SFB Lengths;
Spectral Waves; d = 18.0 ft

Incident Spectrum		Values of C_t and L_{SFB}/L_p			
		for Indicated SFB Length			
T_p , sec	H_{mo} , ft	89.6 ft		118.4 ft	
		C_t	L_{SFB}/L_p	C_t	L_{SFB}/L_p
6.0	2.0	0.33	0.69	0.23	0.91
6.0	4.0	0.35	0.69	0.23	0.91
6.0	6.0	0.43	0.69	0.30	0.91
8.0	2.0	0.50	0.49	0.33	0.65
8.0	4.0	0.48	0.49	0.31	0.65
8.0	6.0	0.53	0.49	0.40	0.65
8.0	8.0	0.63	0.49	0.49	0.65
10.0	2.0	0.65	0.39	0.45	0.51
10.0	4.0	0.58	0.39	0.43	0.51
10.0	6.0	0.63	0.39	0.48	0.51
10.0	8.0	0.70	0.39	0.58	0.51
12.0	2.0	0.83	0.32	0.70	0.42
12.0	4.0	0.80	0.32	0.61	0.42
12.0	6.0	0.76	0.32	0.64	0.42
12.0	8.0	0.79	0.32	0.67	0.42
14.0	2.0	0.88	0.27	0.80	0.36
14.0	4.0	0.84	0.27	0.71	0.36
14.0	6.0	0.85	0.27	0.71	0.36
14.0	8.0	0.81	0.27	0.73	0.36

Table 32

Coefficients of Transmission and Relative SFB Lengths;
Spectral Waves; d = 21.0 ft

Incident Spectrum		Values of C_t and L_{SFB}/L_p			
		for Indicated SFB Length			
T_p , sec	H_{mo} , ft	89.6 ft		118.4 ft	
		C_t	L_{SFB}/L_p	C_t	L_{SFB}/L_p
6.0	2.0	0.38	0.65	0.28	0.86
6.0	4.0	0.38	0.65	0.26	0.86
6.0	6.0	0.43	0.65	0.29	0.86
8.0	2.0	0.58	0.46	0.40	0.61
8.0	4.0	0.54	0.46	0.39	0.61
8.0	6.0	0.56	0.46	0.42	0.61
8.0	8.0	0.65	0.46	0.53	0.61
10.0	2.0	0.70	0.36	0.55	0.48
10.0	4.0	0.65	0.36	0.49	0.48
10.0	6.0	0.65	0.36	0.52	0.48
10.0	8.0	0.71	0.36	0.61	0.48
12.0	2.0	0.88	0.30	0.75	0.39
12.0	4.0	0.88	0.30	0.73	0.39
12.0	6.0	0.79	0.30	0.68	0.39
12.0	8.0	0.82	0.30	0.69	0.39
14.0	2.0	0.90	0.25	0.85	0.33
14.0	4.0	0.90	0.25	0.79	0.33
14.0	6.0	0.87	0.25	0.75	0.33
14.0	8.0	0.86	0.25	0.75	0.33

Table 33

Maximum Connector Forces, Mooring Line Tensions, Barge Angularities, and Impact Velocities

Side-Connector Tests

Test No.	FIX* kips	FIY kips	FIZ kips	F2X* kips	F2Y kips	F2Z kips	T1 kips	T2 kips	T3 kips	T4 kips	T5 kips	T6 kips	ANG or ANFG deg	VEL ft/sec
1	137 -1,831	674 -1,164	3,967 -1,630	1,419 -2,004	476 -432	2,862 -4,038	129	149	98	107	94	26	183.6 177.7	-- --
2	764 -2,821	825 -1,624	4,232 -4,976	1,819 -825	486 -1,277	4,058 -2,921	171	235	119	144	95	34	183.9 177.0	1.8** --
3	356 -2,228	798 -728	4,820 -2,772	1,647 -1,651	479 -580	3,189 -4,087	248	189	154	106	106	47	183.8 177.5	-- --
4	621 -2,293	550 -362	2,850 -2,586	1,353 -807	396 -240	2,805 -2,957	165	114	127	76	90	35	182.6 177.7	1.4** --
5	967 -3,262	683 -573	3,378 -5,564	1,248 -2,193	512 -1,016	5,625 -5,122	179	135	120	143	136	57	183.1 176.4	-- --
6	892 -2,969	1,057 -2,102	3,574 -4,554	2,234 -1,432	842 -569	4,437 -3,867	307	323	133	144	163	61	182.9 177.3	1.8** --
7	2,048 -1,758	528 -474	2,698 -3,788	1,172 -969	255 -718	4,300 -1,937	136	178	98	91	132	77	182.8 176.9	-- --
8	331 -2,093	589 -608	3,003 -3,753	1,306 -969	218 -604	3,373 -2,748	323	360	174	121	233	102	182.8 176.7	-- --
9	301 -1,318	538 -464	2,741 -3,073	906 -858	242 -540	3,301 -2,196	394	525	259	245	314	142	184.9 176.7	0.8** --
10	624 -3,385	1,081 -1,332	4,573 -5,569	1,467 -1,328	667 -638	5,649 -4,782	244	312	166	171	131	Unhooked	183.4 177.0	2.0** 2.0†

(Continued)

* The validity of data is questionable for these two channels. During calibration, these two channels reacted when loading was purely in the y- or z-axis.

** Stern impact velocity measured at inside corner of Barge No. 2.

† Stern impact velocity measured at outside corner of Barge No. 2.

Table 33 (Concluded)

Test No.	FIY* kips	FIZ kips	F2X* kips	F2Y kips	F2Z kips	T1 kips	T2 kips	T3 kips	T4 kips	T5 kips	T6 kips	ANG or ANFG deg	VEL ft/sec	
11	1,142 -2,804	1,262 -1,233	4,129 -3,751	1,901†† -1,800††	1,159†† -778††	4,766†† -6,854††	200	247	139	160	77	Unhooked	183.5 177.2	2.8** --
12	280 -3,111	440 -505	2,691 -6,294	308†† -1,015††	169†† -1,056††	†† ††	147	257	249	Unhooked	71	Unhooked	182.3 177.1	1.3** --
13	312 -2,348	696 -524	1,537 -4,695	931†† -917††	402†† -739††	†† ††	143	257	264	Unhooked	106	Unhooked	184.0 177.8	2.2** --
14	1,414 -2,632	871 -958	3,327 -3,745	1,845 -1,100	608 -649	2,539 -3,331	150	180	95	89	96	26	183.9 177.3	1.5** --
15	670 -1,407	273 -539	1,507 -3,272	1,221 0	466 -1,495	1,664 -1,218	136	140	76	95	103	45	180.5 176.9	0.6** --
16	Ping Tests													
17	948 -3,495	412 -483	3,214 -5,060	2,193 -1,215	1,167 -1,828	2,692 -3,314	138	173	102	97	102	46	182.4 177.2	1.58** --
18	287 -2,079	353 -261	2,659 -2,449	2,292 0	1,011 -1,670	4,102 -3,305	197	276	155	144	261	108	183.0 177.4	1.35** --
19	86 -554	179 -131	1,036 -929	661 0	204 -154	521 -1,064	†	176	123	80	†	46	††	1.55** --
20	188 -416	162 -69	767 -350	406 0	97 -77	281 -705	†	316	132	125	†	90	182.5 177.5	1.02** --

* The validity of data is questionable for these two channels. During calibration, these two channels reacted when loading was purely in the y- or z-axis.

** Stern impact velocity measured at inside corner of Barge No. 2.

†† Validity of data is questionable due to offset that occurred in connector F2 during Test 11.

† Gage inoperable.

†† Gage malfunctioned.



Photo 1. Side view of 89.6-ft SFB



Photo 2. Side view of 118.4-ft SPB



Photo 3. View of model barges with and without the top decks attached (side-connector tests)



Photo 4. View of model barges with top decks in place
(side-connector tests)

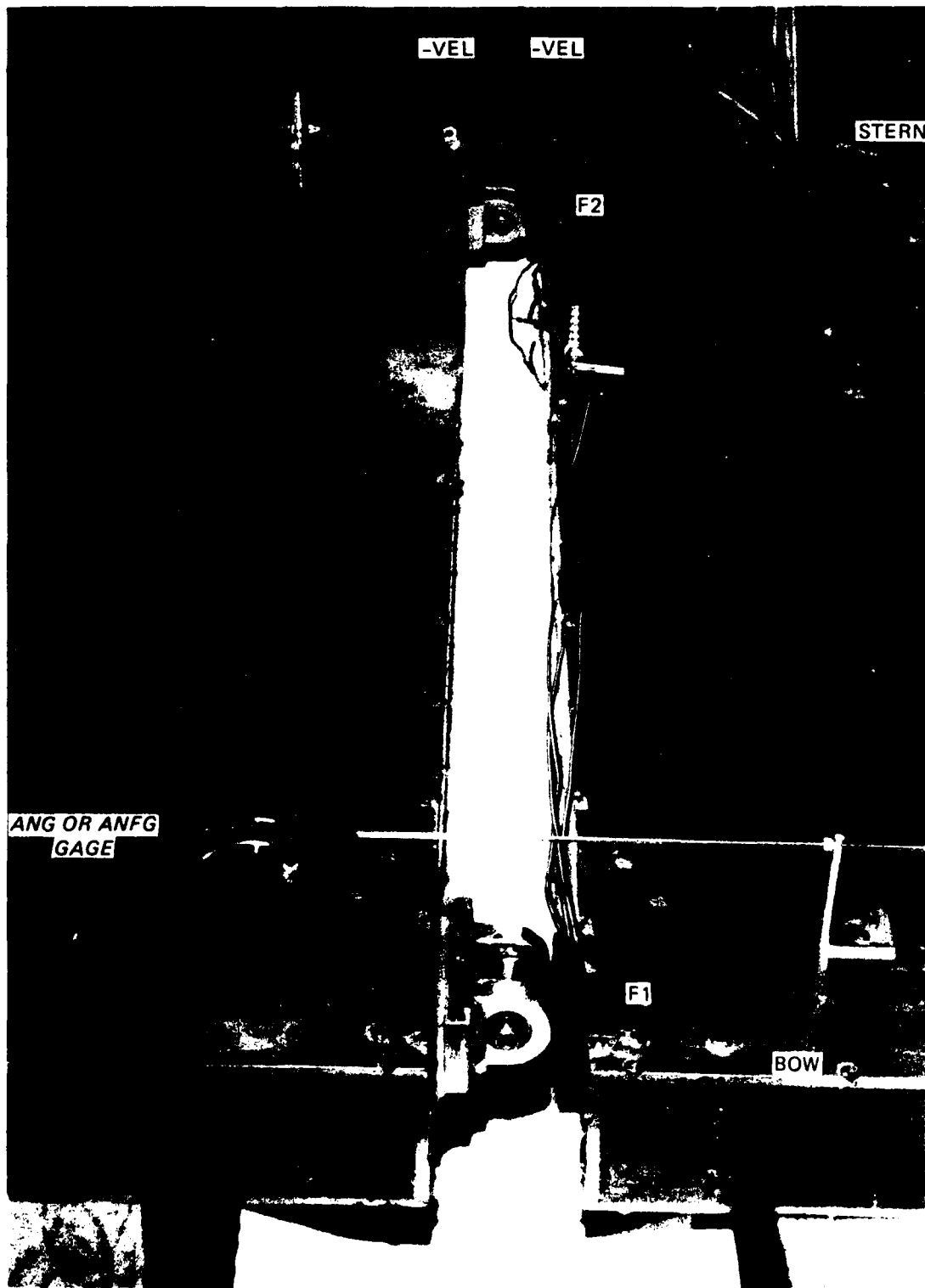

Photo 5. Bow view of model barge connectors and angularity gage
(side-connector tests)

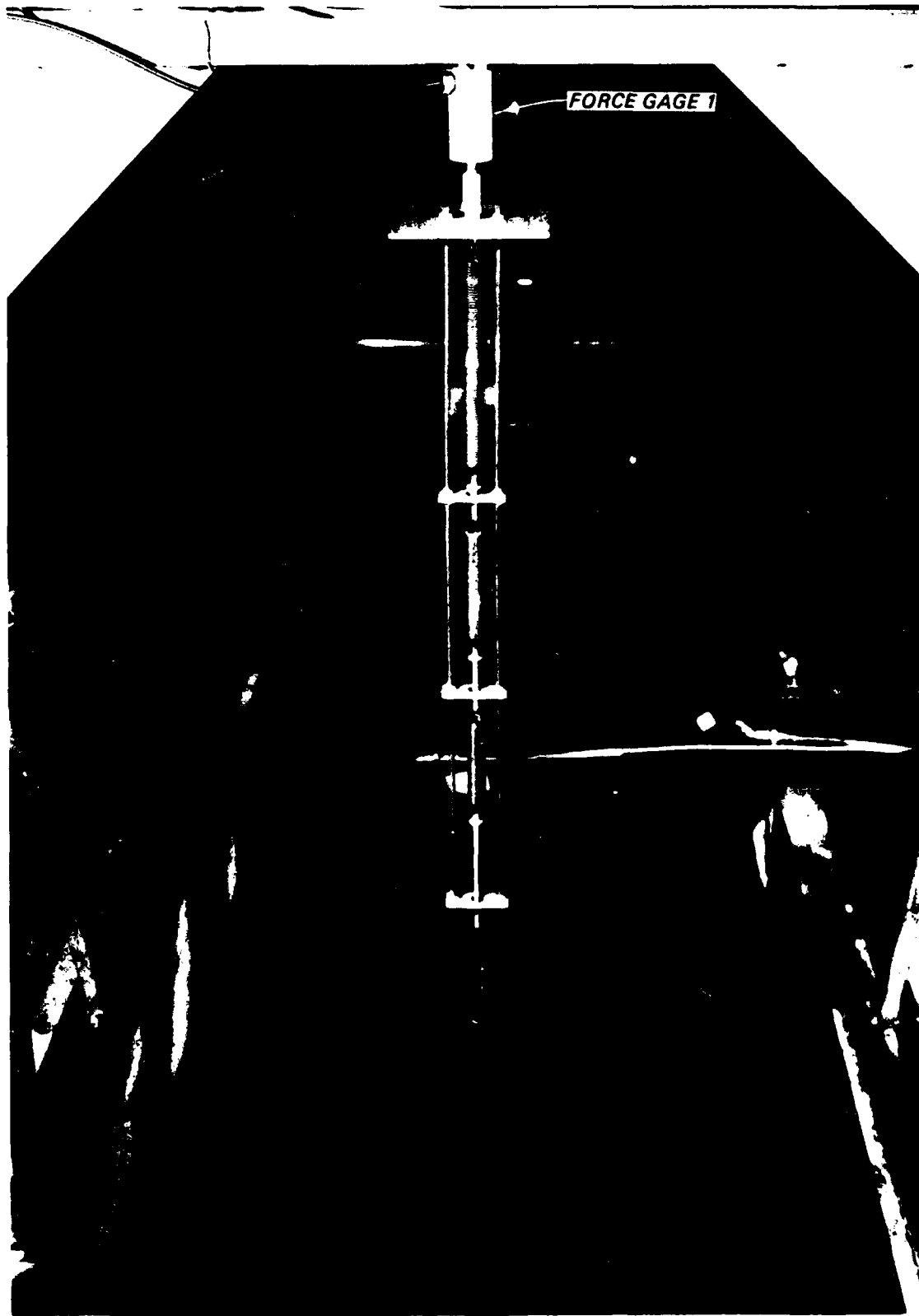

Photo 6. Close-up view of Force Gage 1 and spring mooring system

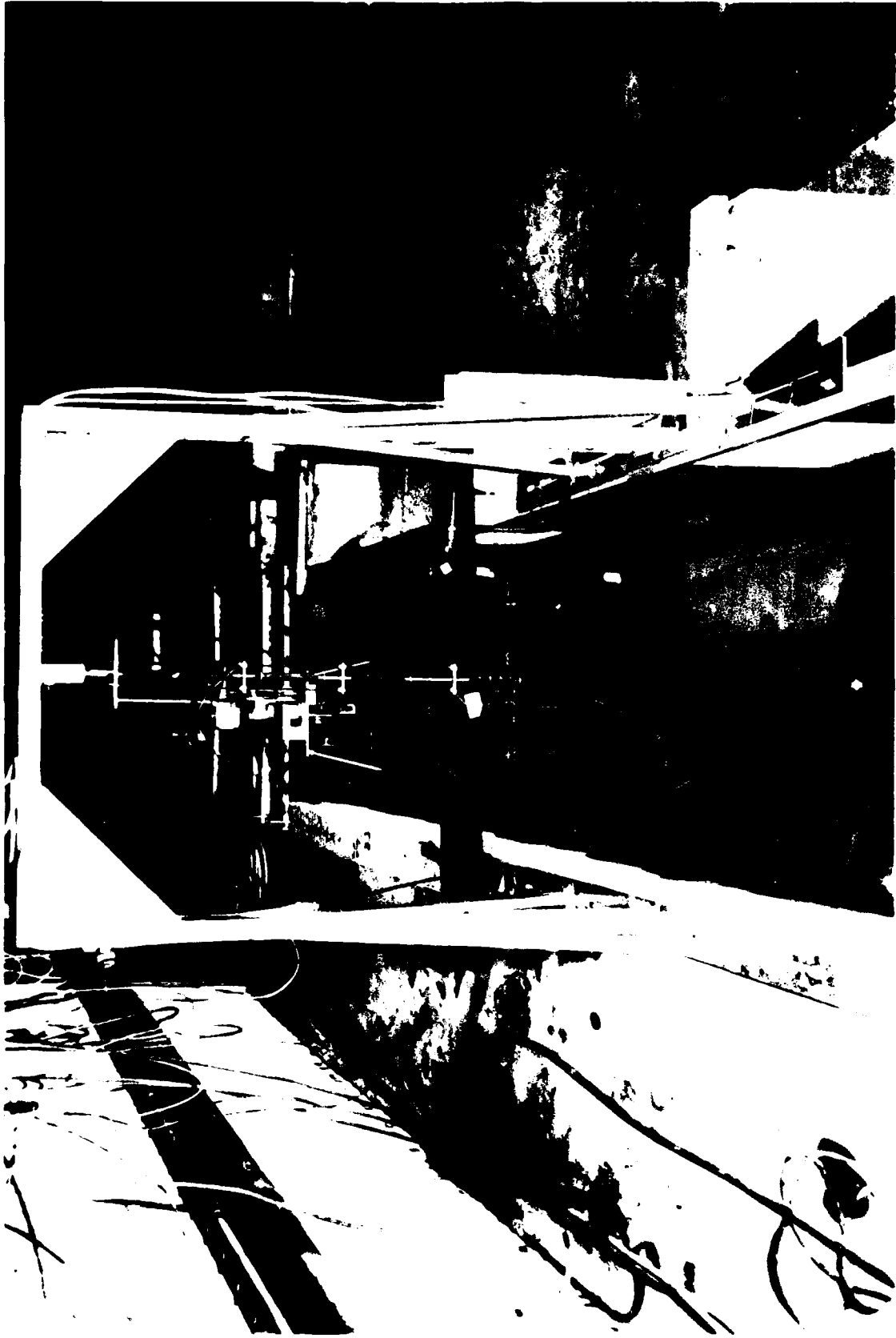

Figure 1. General view of test setup for functional tests

AD-A181 776

SLOPING FLOAT BREAKWATER STUDY OREGON INLET NORTH
CAROLINA COASTAL MODEL INVESTIGATION(U) COASTAL
ENGINEERING RESEARCH CENTER VICKSBURG MS
R D CARVER ET AL. APR 87 CERC-TR-87-5

2/3

UNCLASSIFIED

F/G 13/2

NL

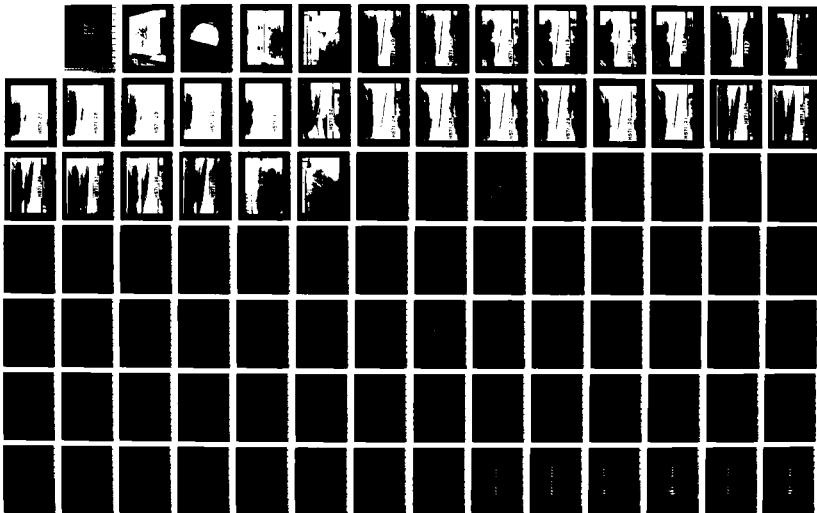

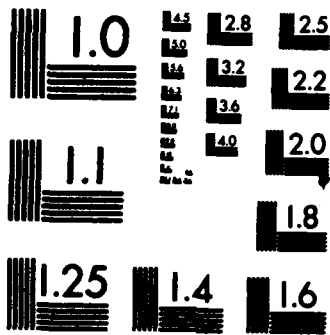

MICROCOPY RESOLUTION TEST CHART
NATIONAL BUREAU OF STANDARDS-1963-A



Photo 8. Close-up view of Force Gage 2

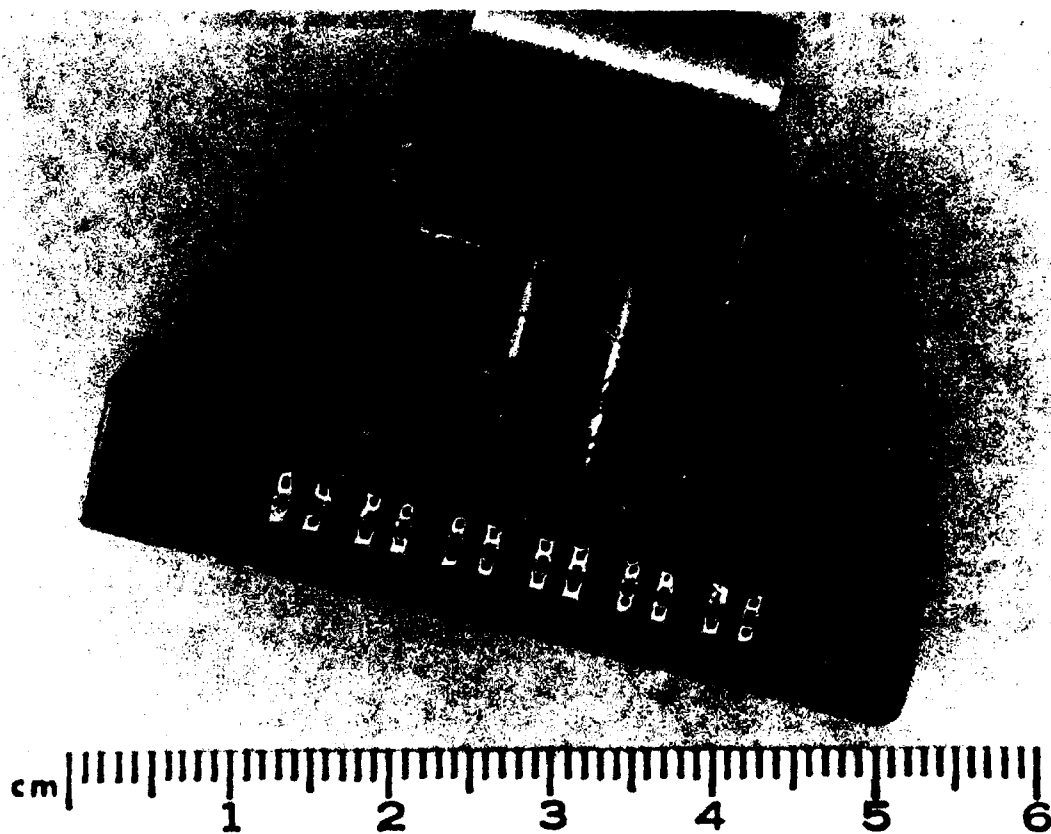

Photo 9. Instrumented half of model barge connector prior to placement of waterproofing sealer (side-connector tests)

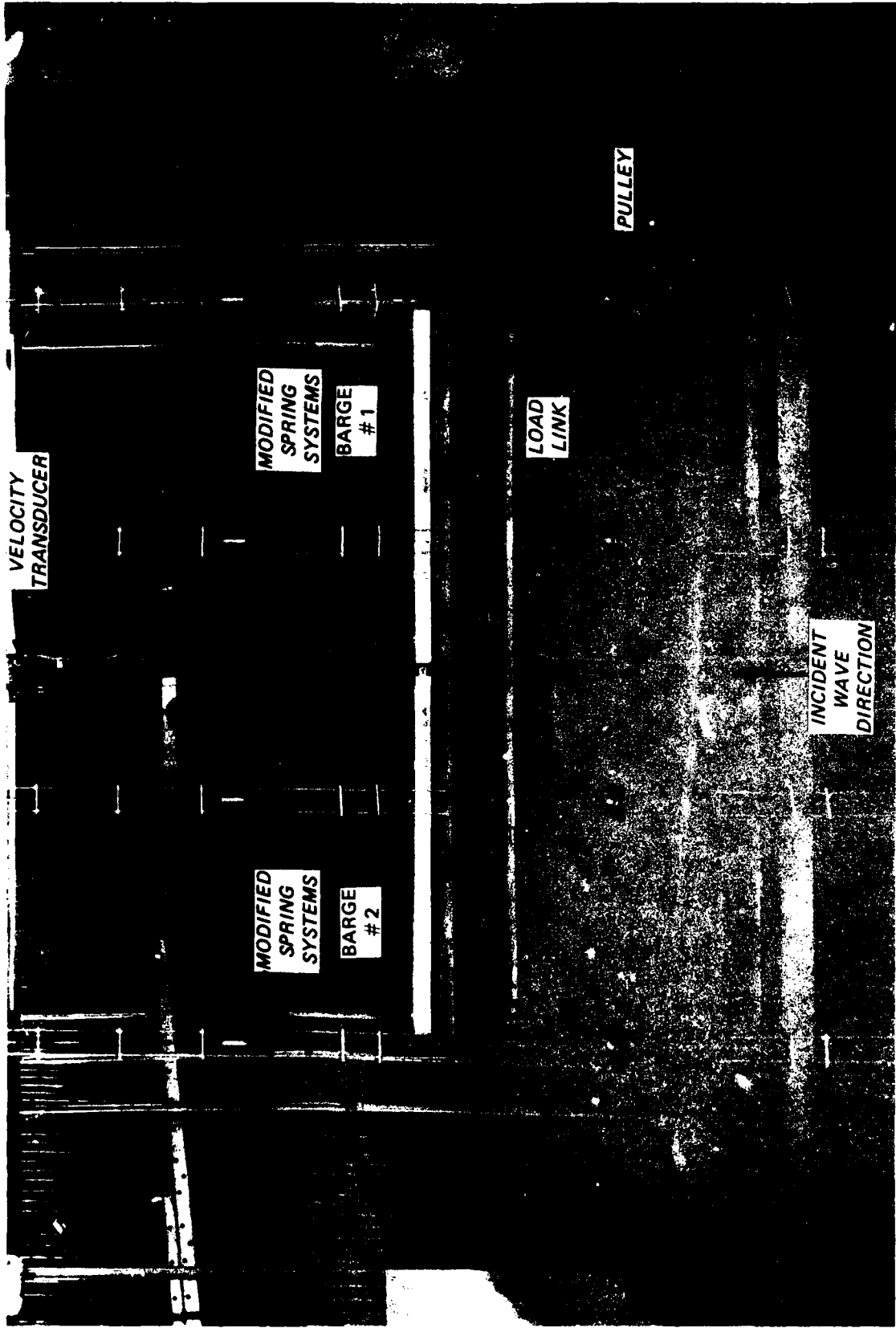

Photo 10. Seaside view of the SFB setup for 90-deg wave attack (side-connector tests)



Photo 11. Side view of the SFB setup for 90-deg wave attack (side-connector tests)



Photo 12. Side view of 89.6-ft SFB under attack of 6-sec, 4-ft monochromatic waves in a water depth of 15 ft

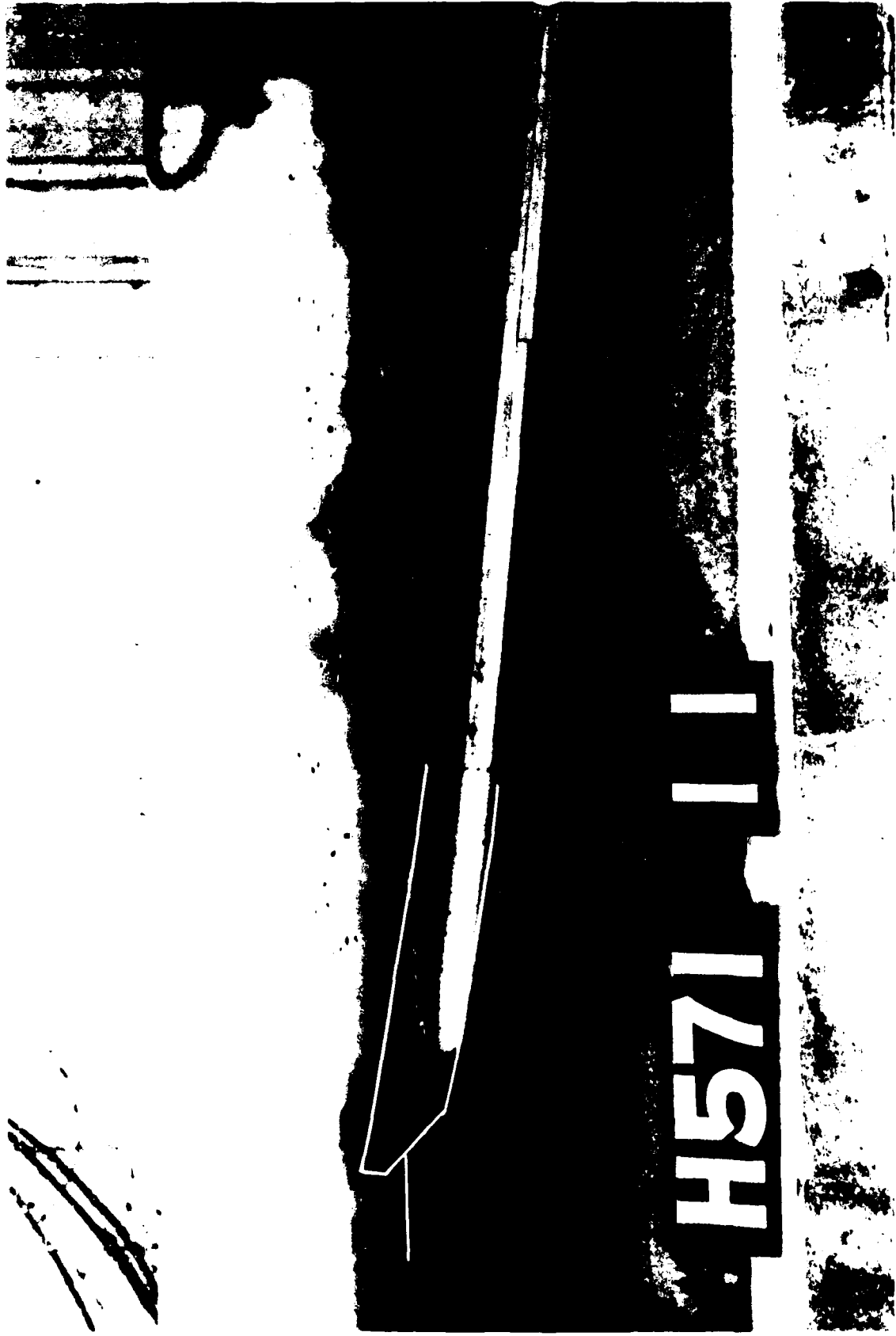

Photo 13. Side view of 89.6-ft SFB under attack of 6-sec, 6-ft monochromatic waves in a water depth of 15 ft



Photo 14. Side view of 89.6-ft SFB under attack of 10-sec, 4-ft monochromatic waves in a water depth of 15 ft



Photo 15. Side view of 89.6-ft SFB under attack of 10-sec, 6-ft monochromatic waves in a water depth of 15 ft



Photo 16. Side view of 89.6-ft SFB under attack of 14-sec, 4-ft monochromatic waves in a water depth of 15 ft



Photo 17. Side view of 89.6-ft SFB under attack of 14-sec, 6-ft monochromatic waves in a water depth of 15 ft



Photo 18. Side view of 89.6-ft SFB under attack of 10-sec, 10-ft monochromatic waves in a water depth of 15 ft

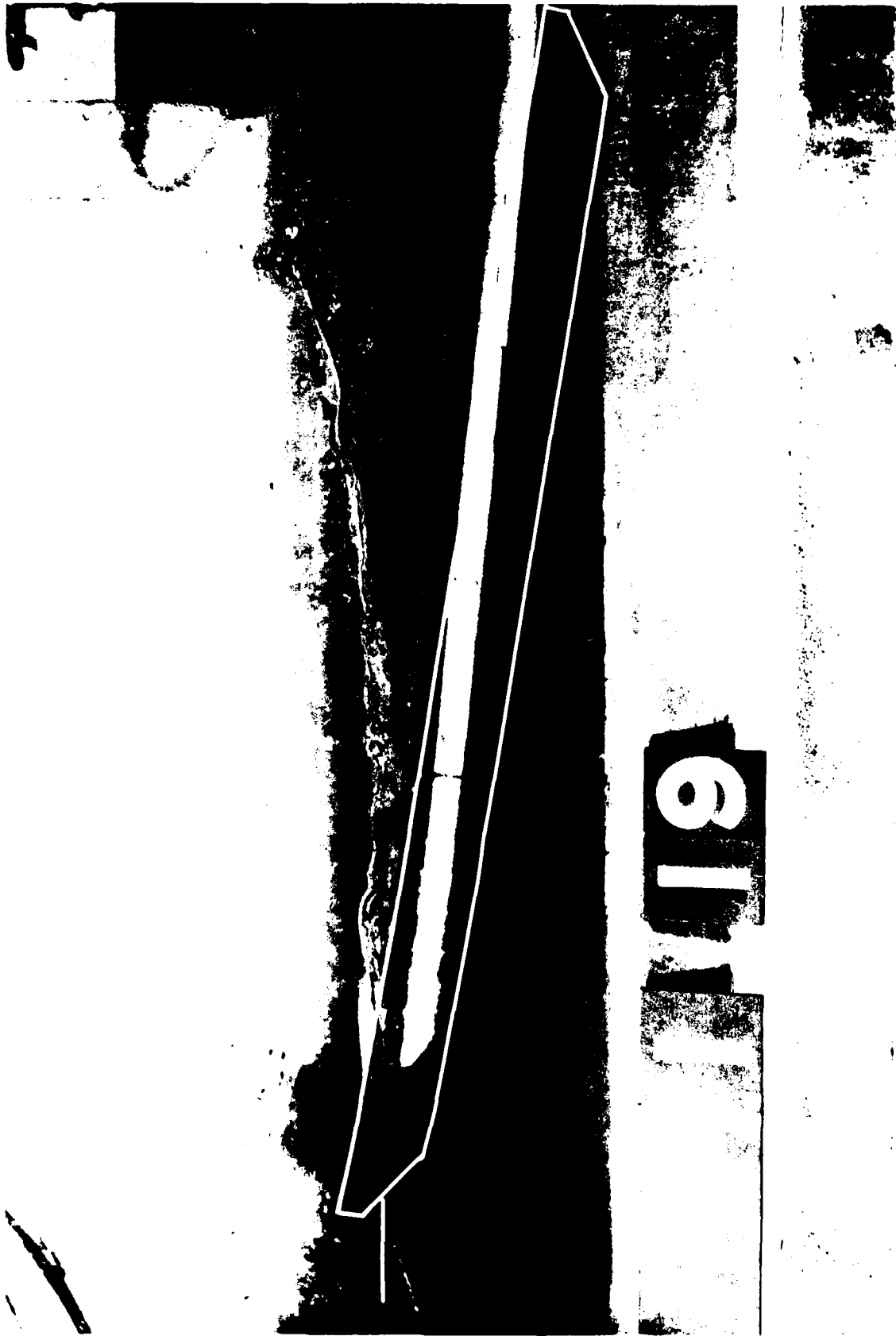

Photo 19. Side view of 89.6-ft SFB under attack of 10-sec, 12-ft monochromatic waves in a water depth of 15 ft

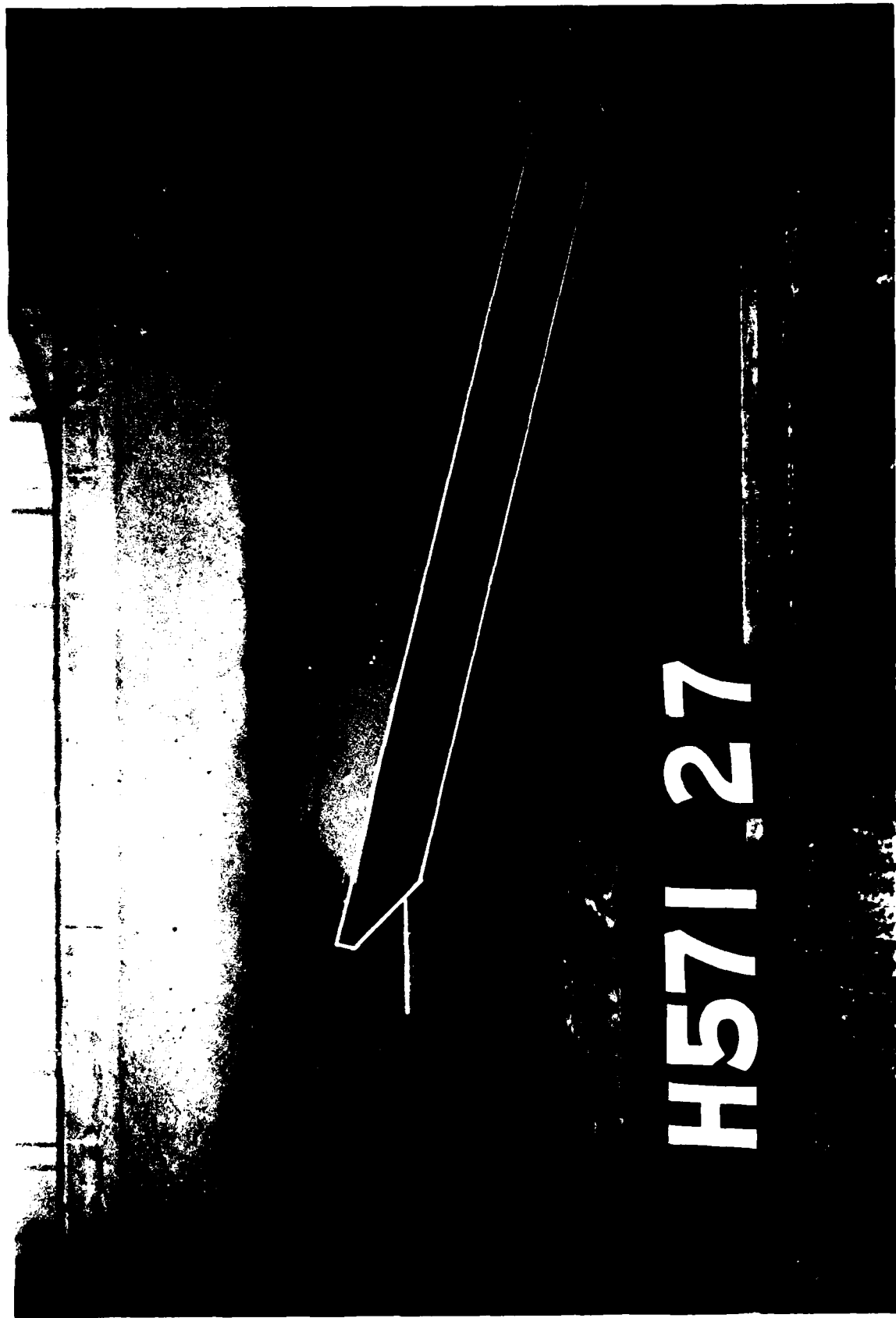

Photo 20. Side view of 72.3-ft SFBB under attack of 6-sec, 4-ft spectral waves in a water depth of 15 ft



Photo 21. Side view of 72.3-ft SF8 under attack of 6-sec, 6-ft spectral waves in a water depth of 15 ft

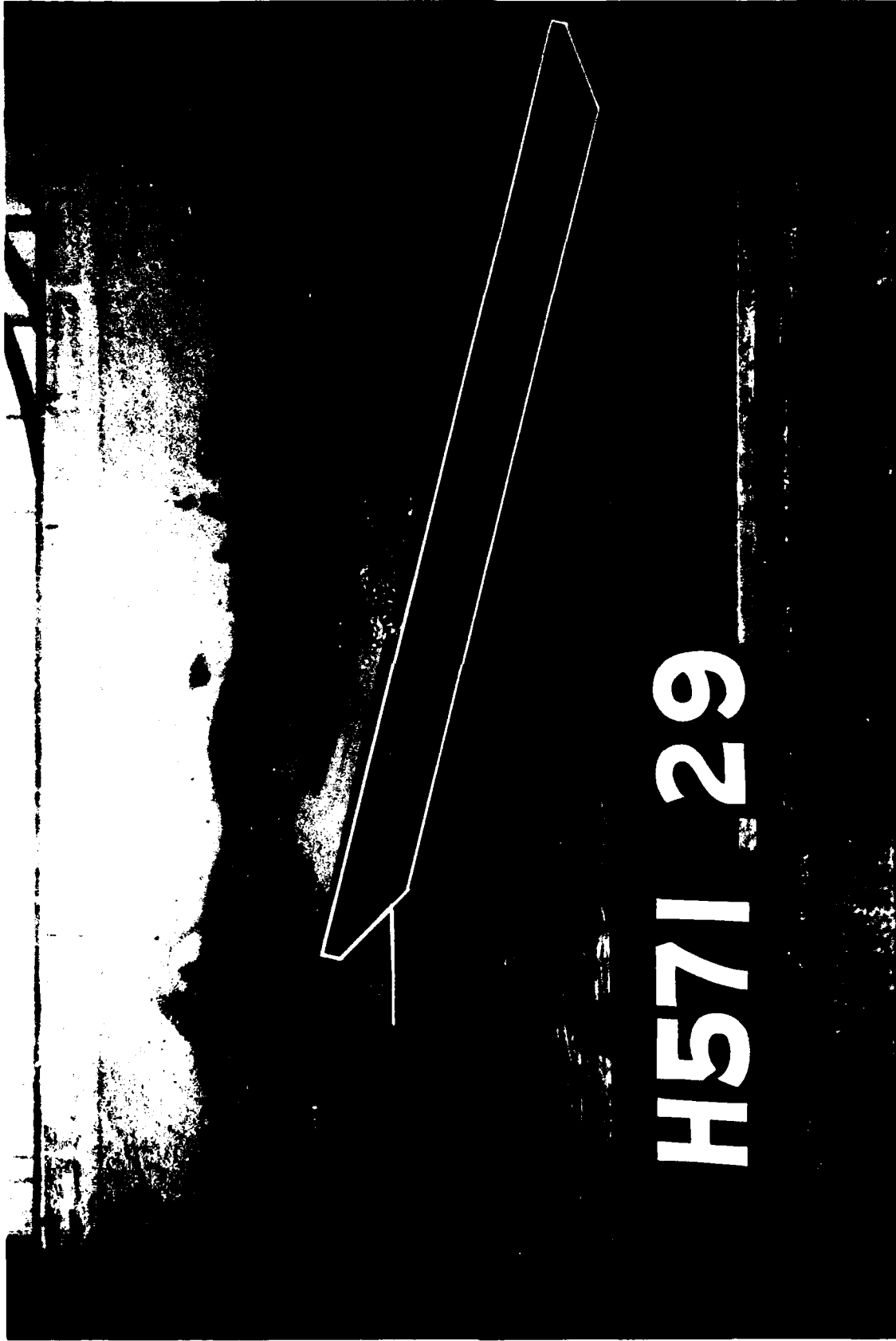

Photo 22. Side view of 72.3-ft SFB under attack of 10-sec, 4-ft spectral waves in a water depth of 15 ft

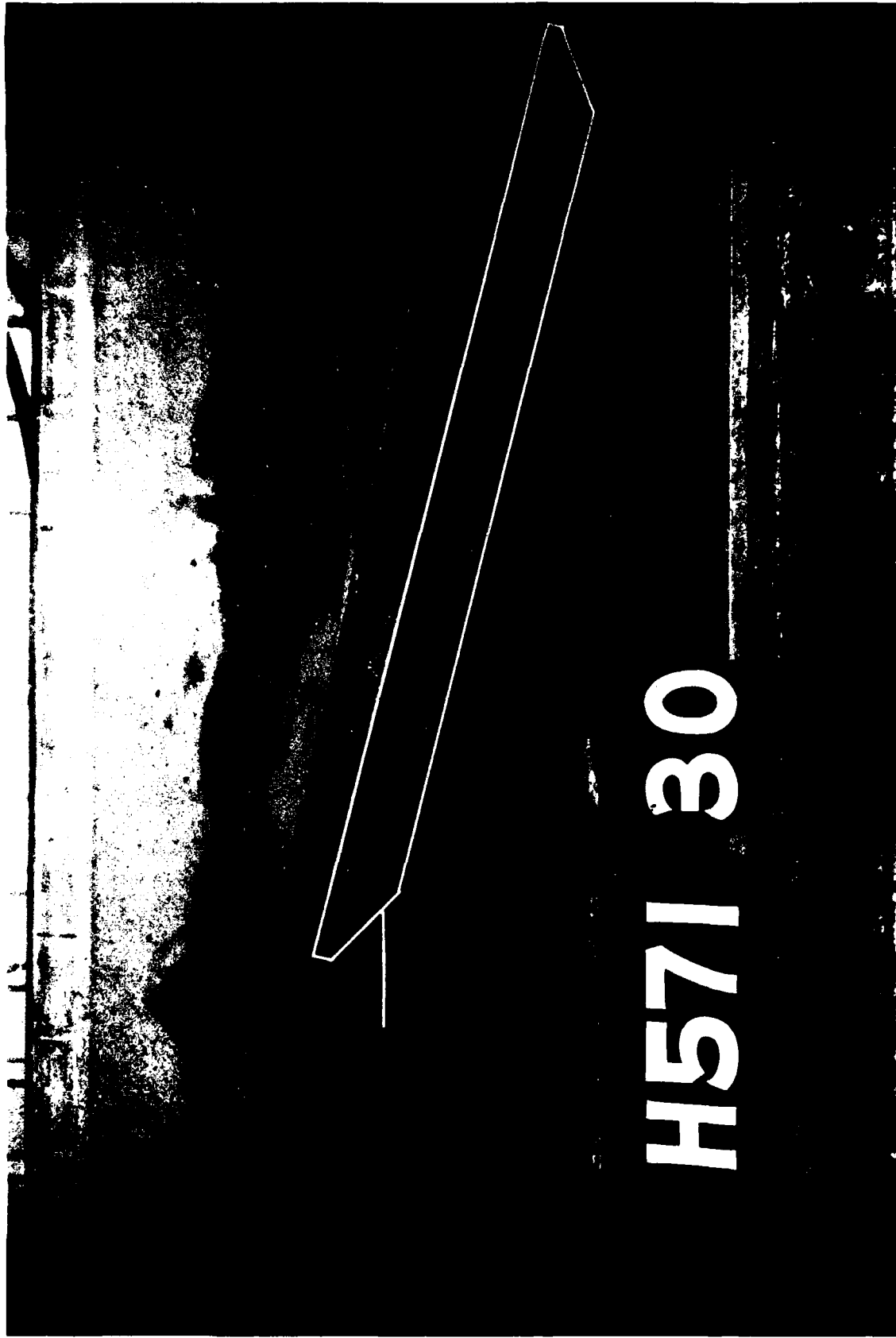

Photo 23. Side view of 72.3-ft SFB under attack of 10-sec, 8-ft spectral waves in a water depth of 15 ft

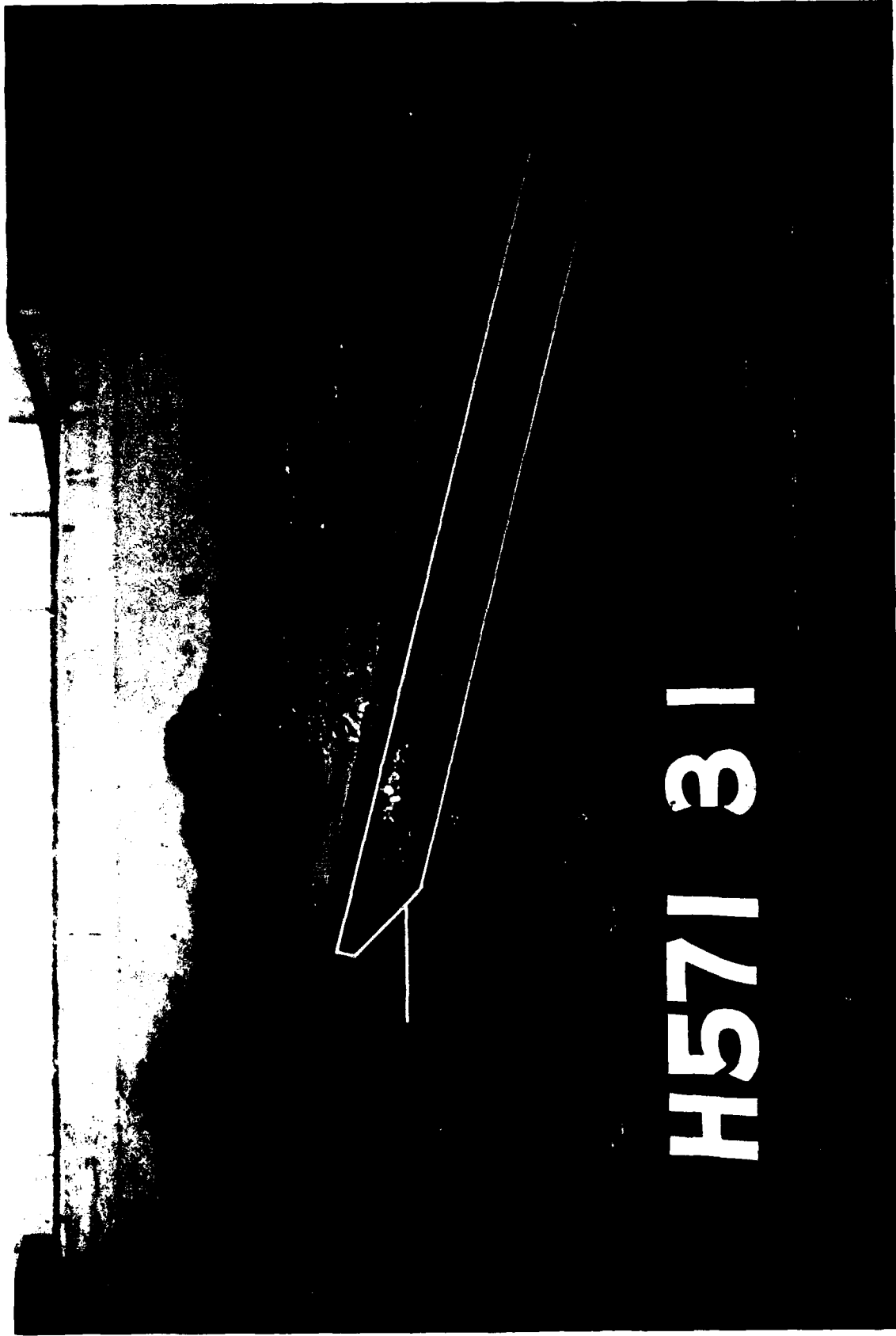
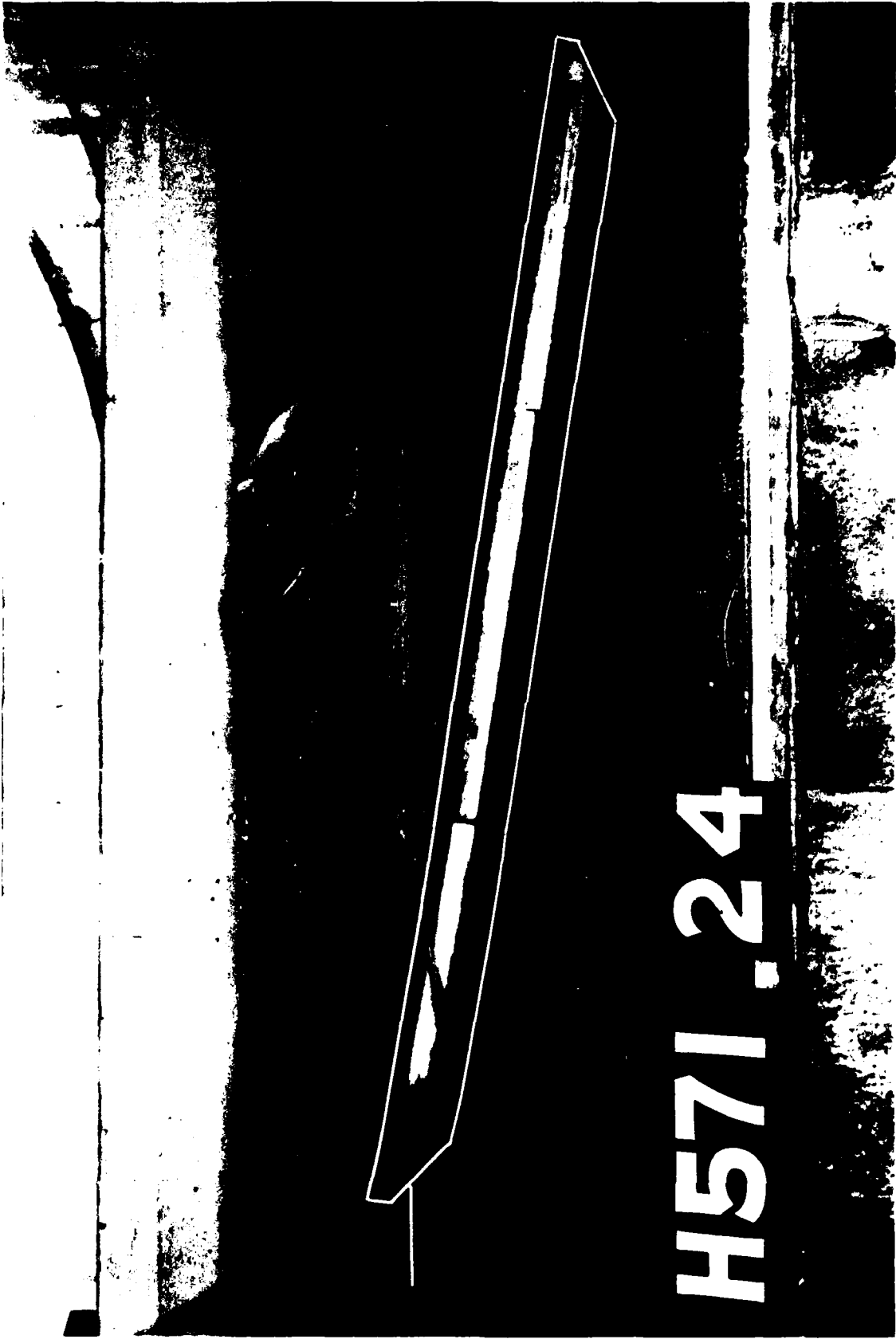

Photo 24. Side view of 72.3-ft SFB under attack of 14-sec, 4-ft spectral waves in a water depth of 15 ft



H571,32

Photo 25. Side view of 72.3-ft SFB under attack of 14-sec, 8-ft spectral waves in a water depth of 15 ft



H571.24

Photo 26. Side view of 89.6-ft SFB under attack of 6-sec, 4-ft spectral waves in a water depth of 15 ft



Photo 27. Side view of 89.6-ft SFBB under attack of 6-sec, 6-ft spectral waves in a water depth of 15 ft



H571.22

Photo 28. Side view of 89.6-ft SFB under attack of 10-sec, 4-ft spectral waves in a water depth of 15 ft



Photo 29. Side view of 89.6-ft SFB under attack of 10-sec, 8-ft spectral waves in a water depth of 15 ft

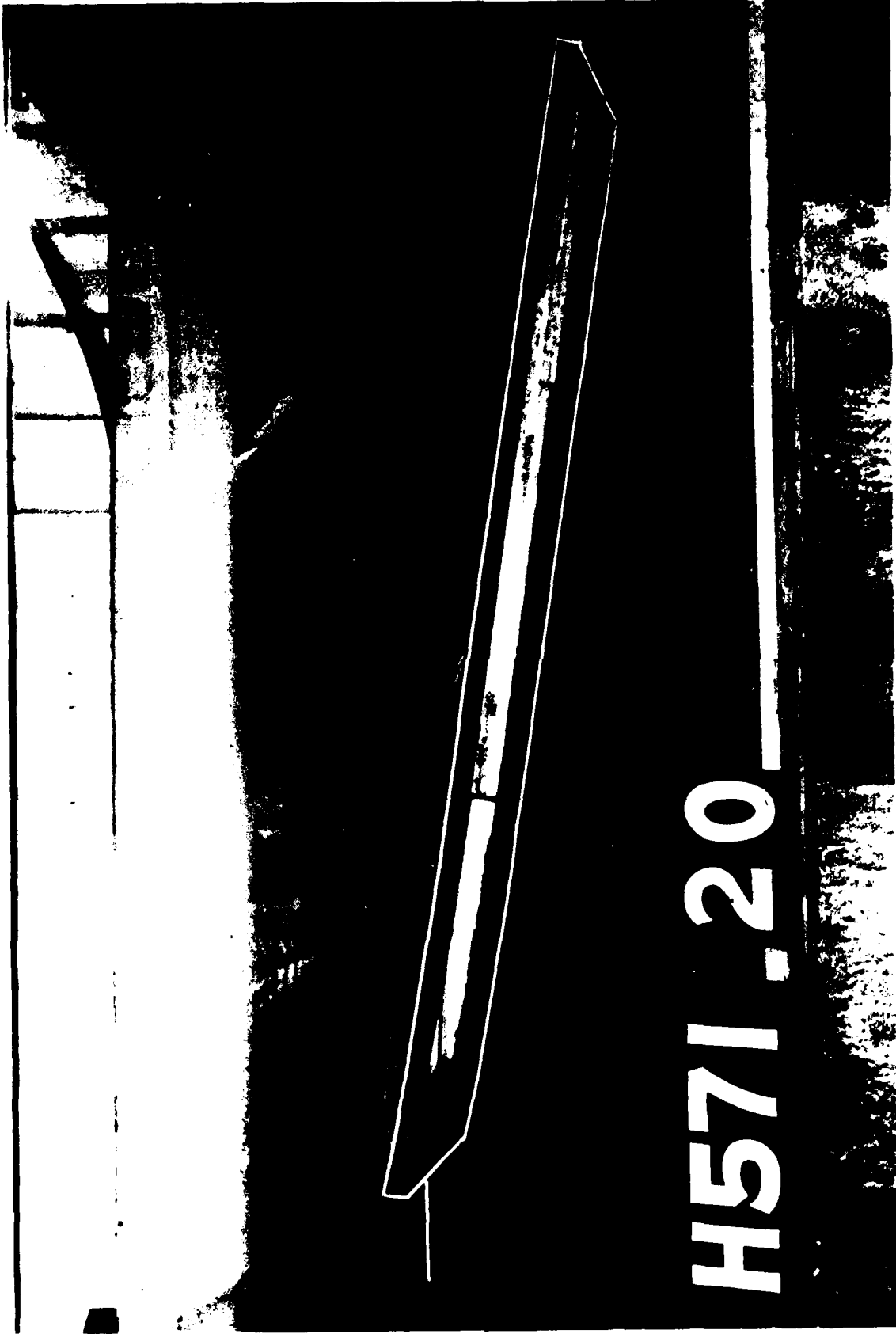

Photo 30. Side view of 89.6-ft SFB under attack of 14-sec, 4-ft spectral waves in a water depth of 15 ft

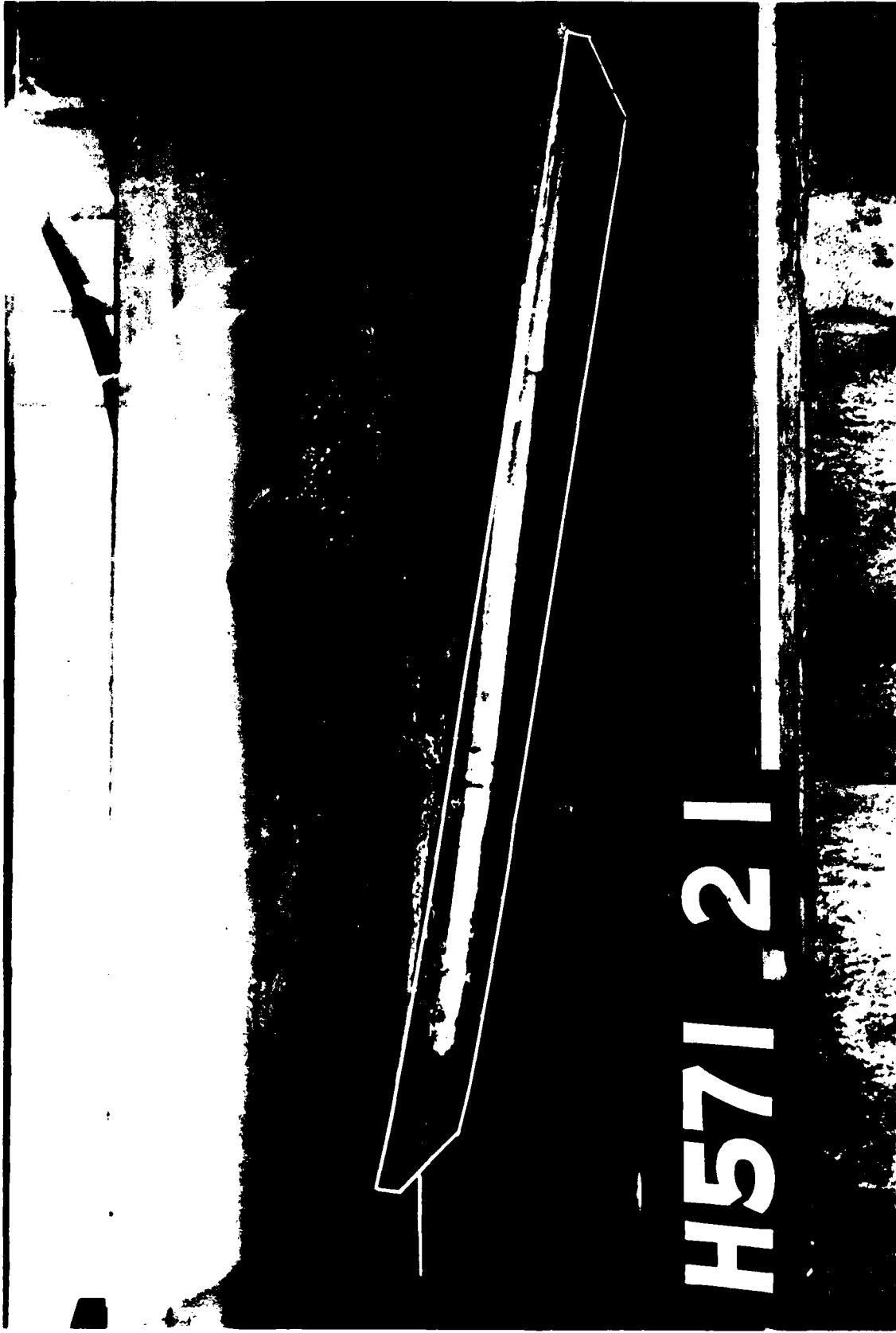

Photo 31. Side view of 89.6-ft SFB under attack of 14-sec, 8-ft spectral waves in a water depth of 15 ft



Photo 32. Side view of 118.4-ft SFB under attack of 6-sec, 4-ft spectral waves in a water depth of 15 ft



Photo 33. Side view of 118.4-ft SFBS under attack of 6-sec, 6-ft spectral waves in a water depth of 15 ft



Photo 34. Side view of 118.4-ft SFB under attack of 10-sec, 4-ft spectral waves in a water depth of 15 ft



Photo 35. Side view of 118.4-ft SFB under attack of 10-sec, 8-ft spectral waves in a water depth of 15 ft



Photo 36. Side view of 118.4-ft SFB under attack of 14-sec, 4-ft spectral waves in a water depth of 15 ft



Photo 37. Side view of 118.4-ft SFB under attack of 14-sec, 8-ft spectral waves in a water depth of 15 ft

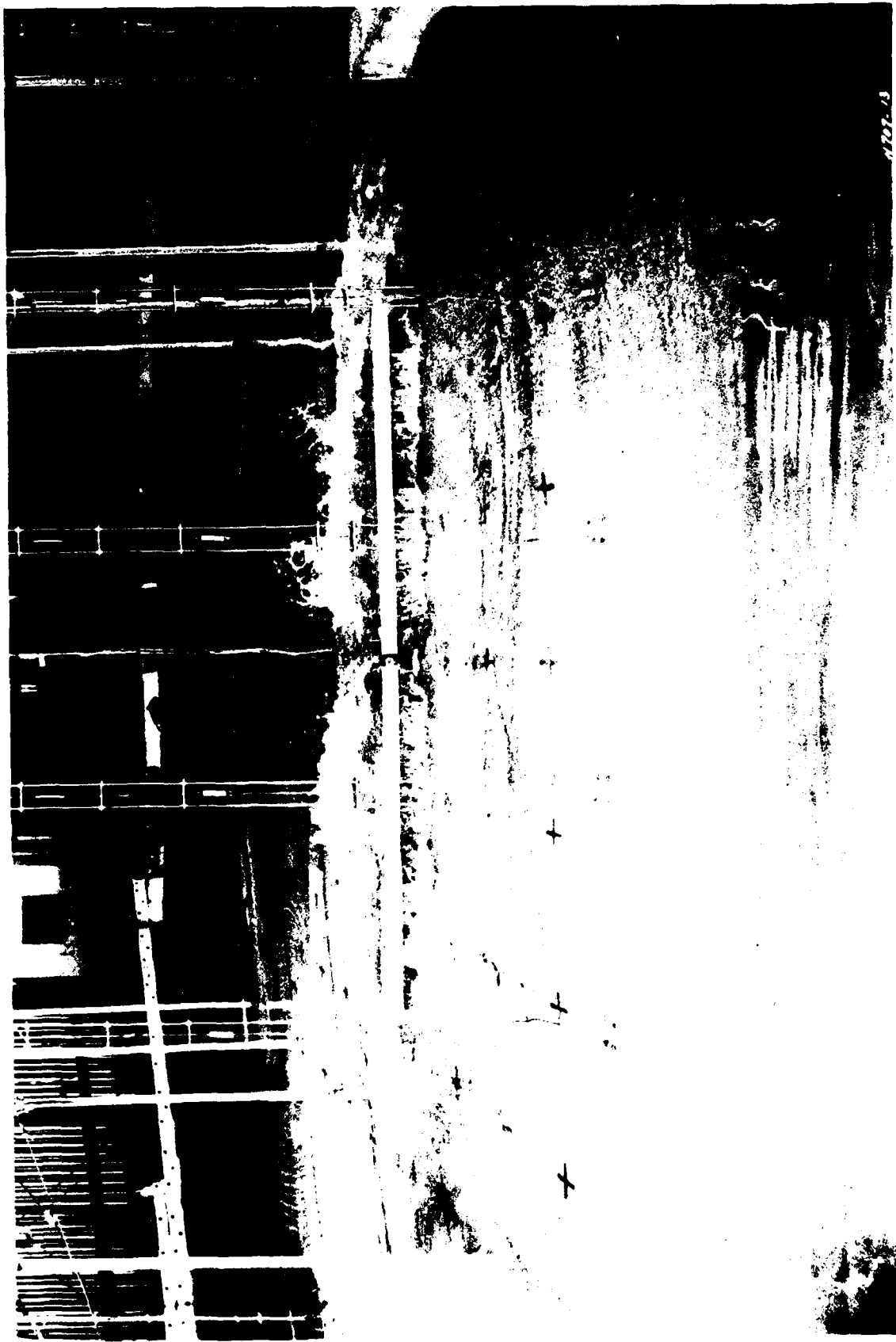
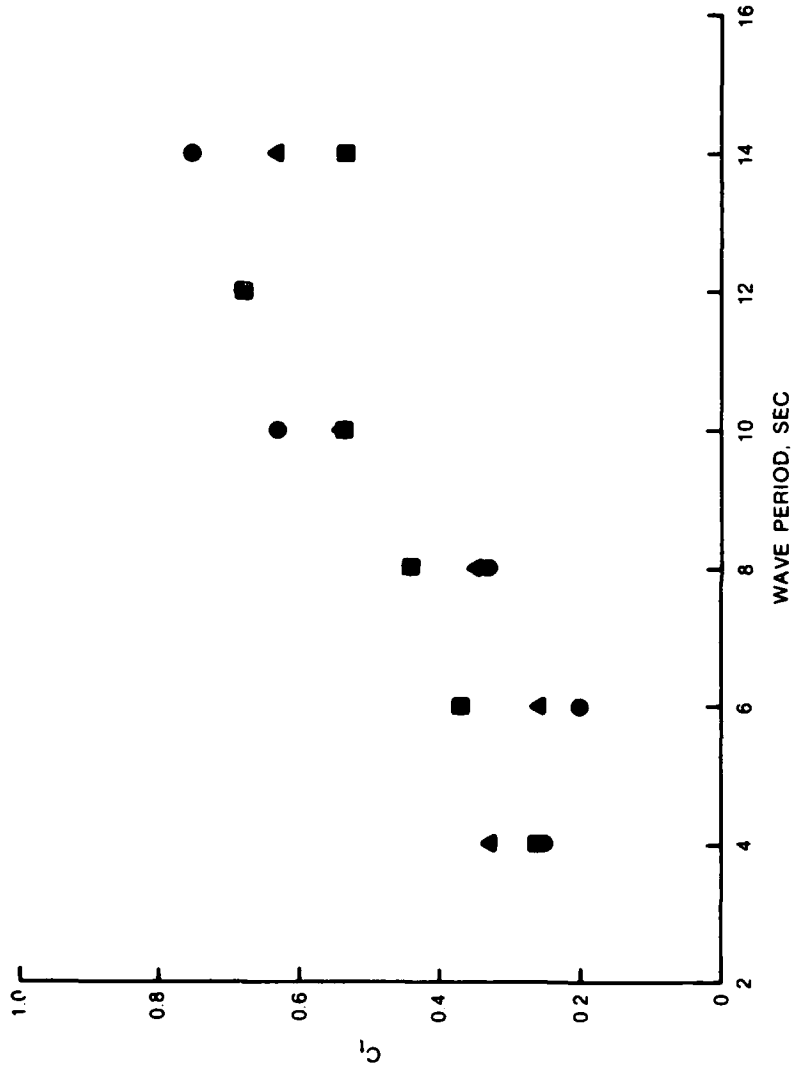

Photo 38. Seaside view of SFB during 90-deg monochromatic wave attack (side-connector tests)



Photo 39. Side view of SFB during 90-deg monochromatic wave attack (side-connector tests)



COEFFICIENT OF TRANSMISSION (C_t)
 VERSUS WAVE PERIOD
 1.5-INCH GAP; NO ABSORBER

LEGEND

SYMBOL	H. FT
●	2
▲	4
■	6

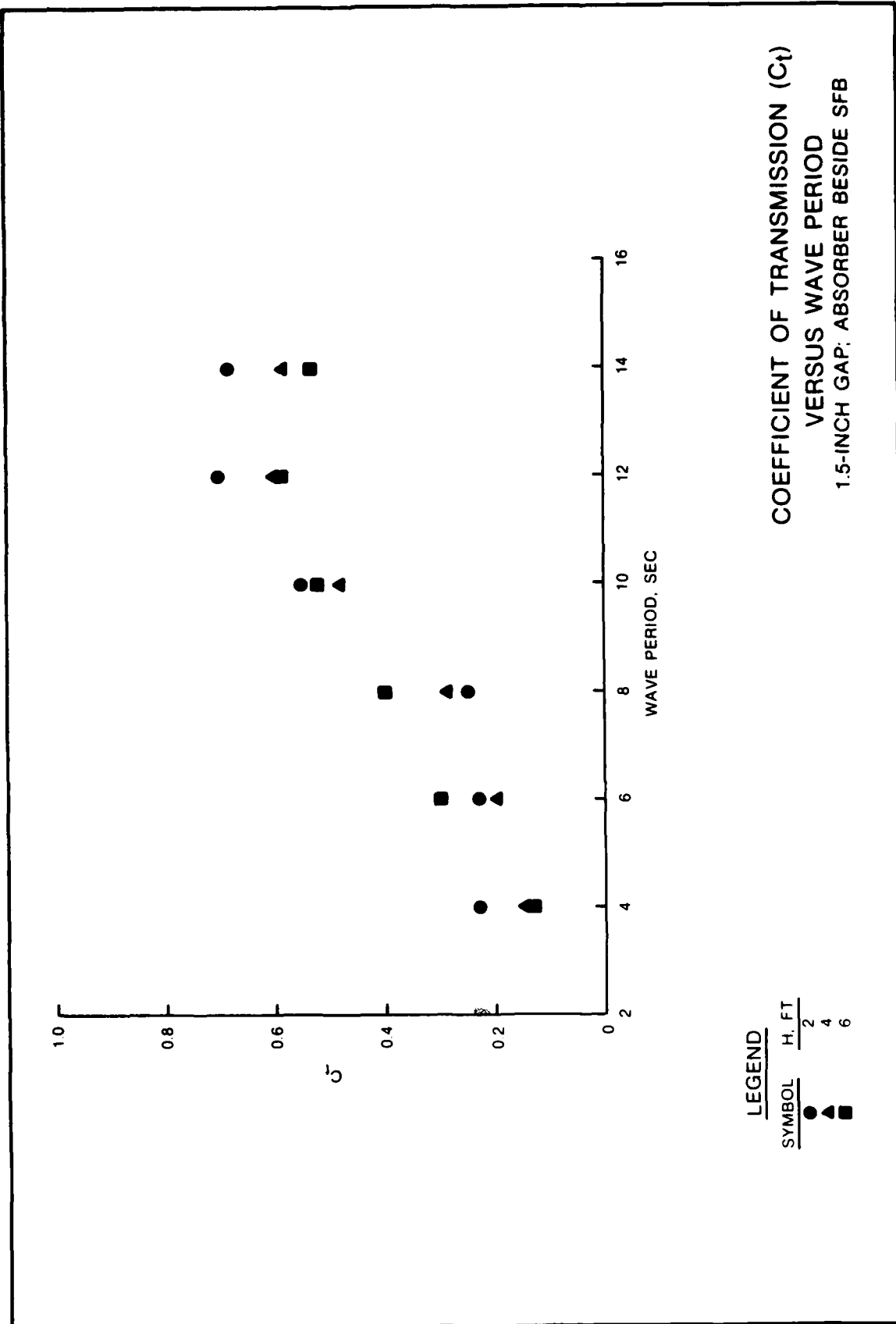
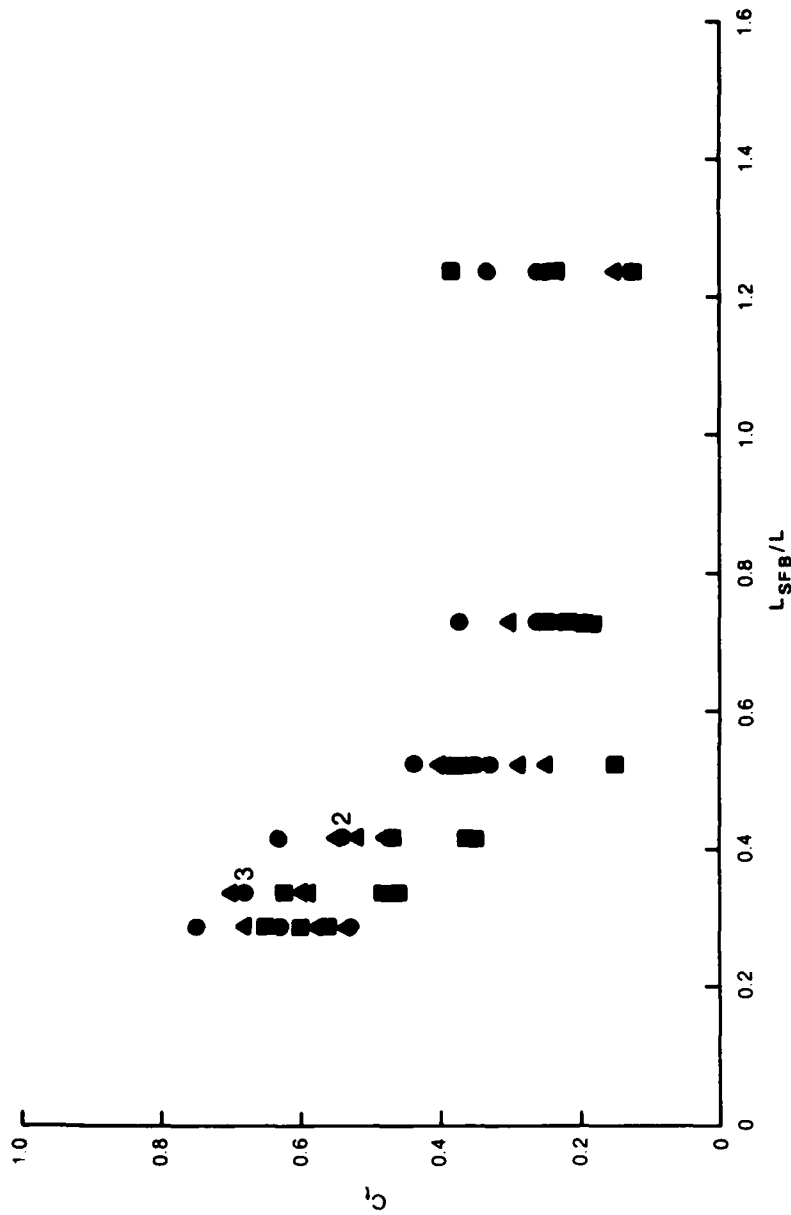

PLATE 2



NOTE: NUMBERS BESIDE DATA POINTS INDICATE THAT THE NUMBER OF DATA POINTS EXCEEDS ONE.

LEGEND

SYMBOL	CONDITION
●	1 (1.5-INCH GAP, NO ABSORBER)
▲	2 (1.5-INCH GAP, ABSORBER BESIDE SFB)
■	3 (RAICHLIN, 1981)

COEFFICIENT OF TRANSMISSION (C_t) VERSUS RELATIVE STRUCTURE WIDTH (L_{SFB}/L)

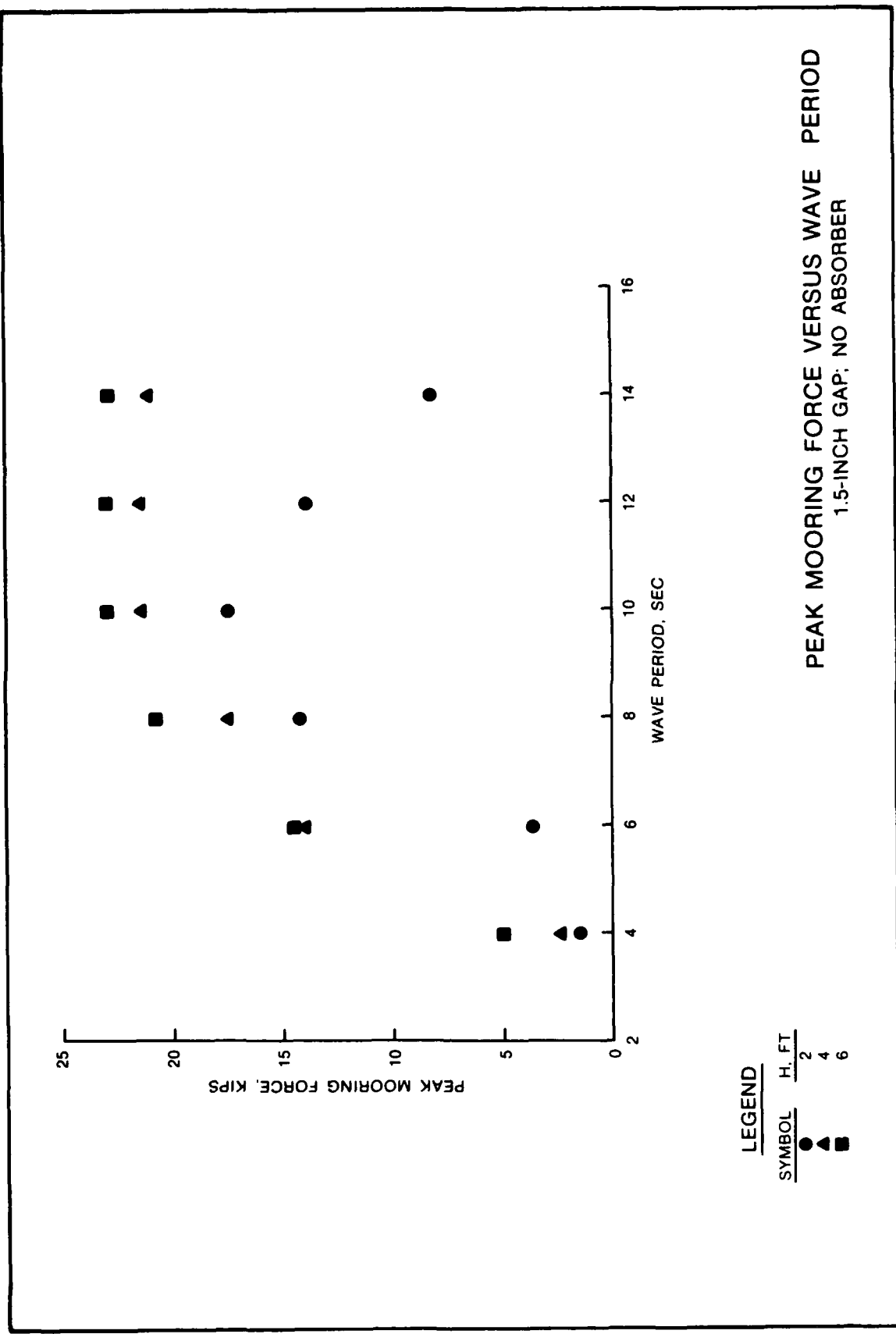
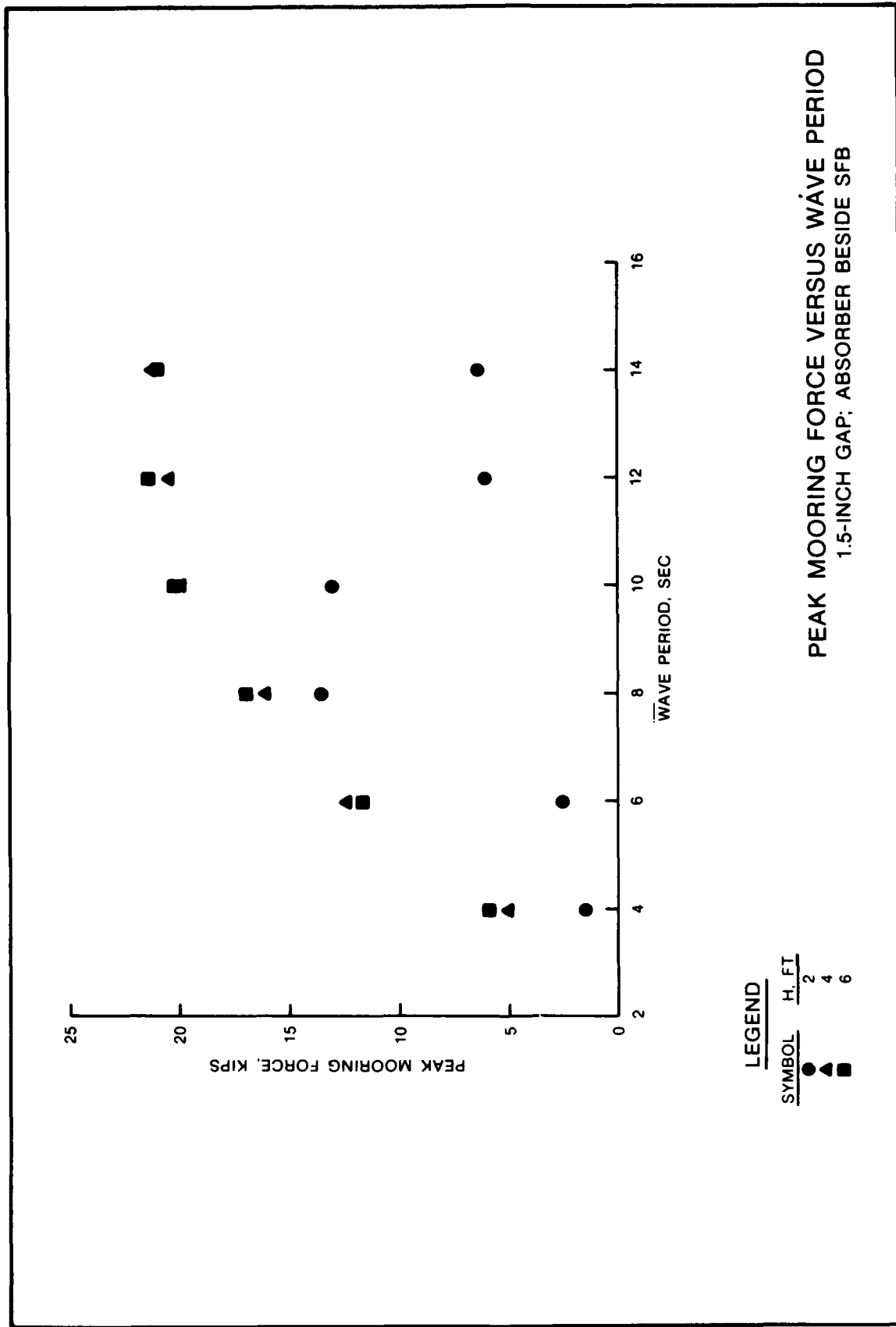
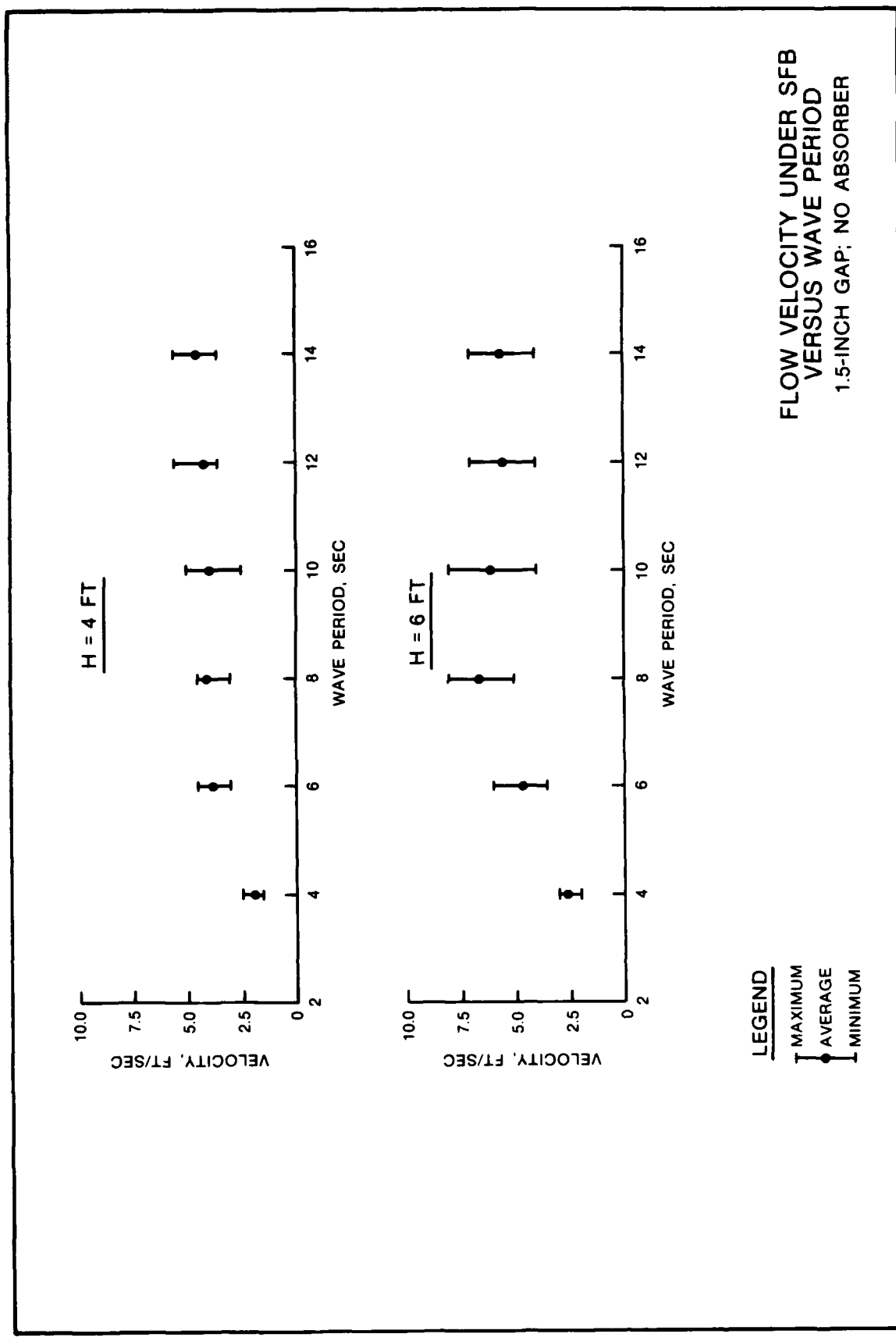

PLATE 4



LEGEND

SYMBOL	H. FT
●	2
▲	4
■	6



FLOW VELOCITY UNDER SFB
VERSUS WAVE PERIOD
1.5-INCH GAP; NO ABSORBER

LEGEND
MAXIMUM
AVERAGE
MINIMUM

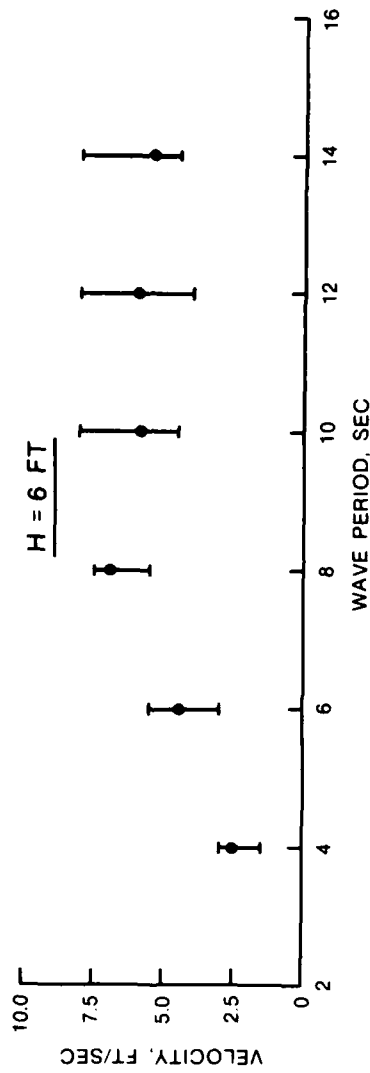
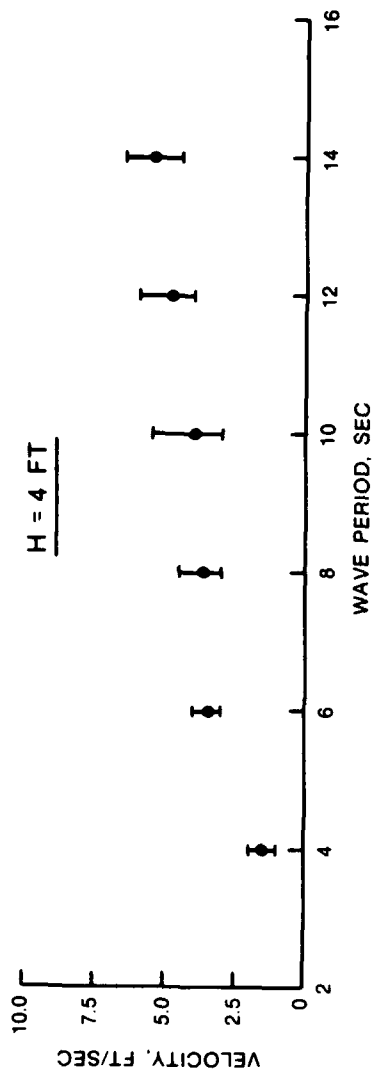

LEGEND

┌───┐ MAXIMUM
 │ │ AVERAGE
 └───┘ MINIMUM

FLOW VELOCITY UNDER SFB
 VERSUS WAVE PERIOD
 1.5-INCH GAP; ABSORBER BESIDE SFB

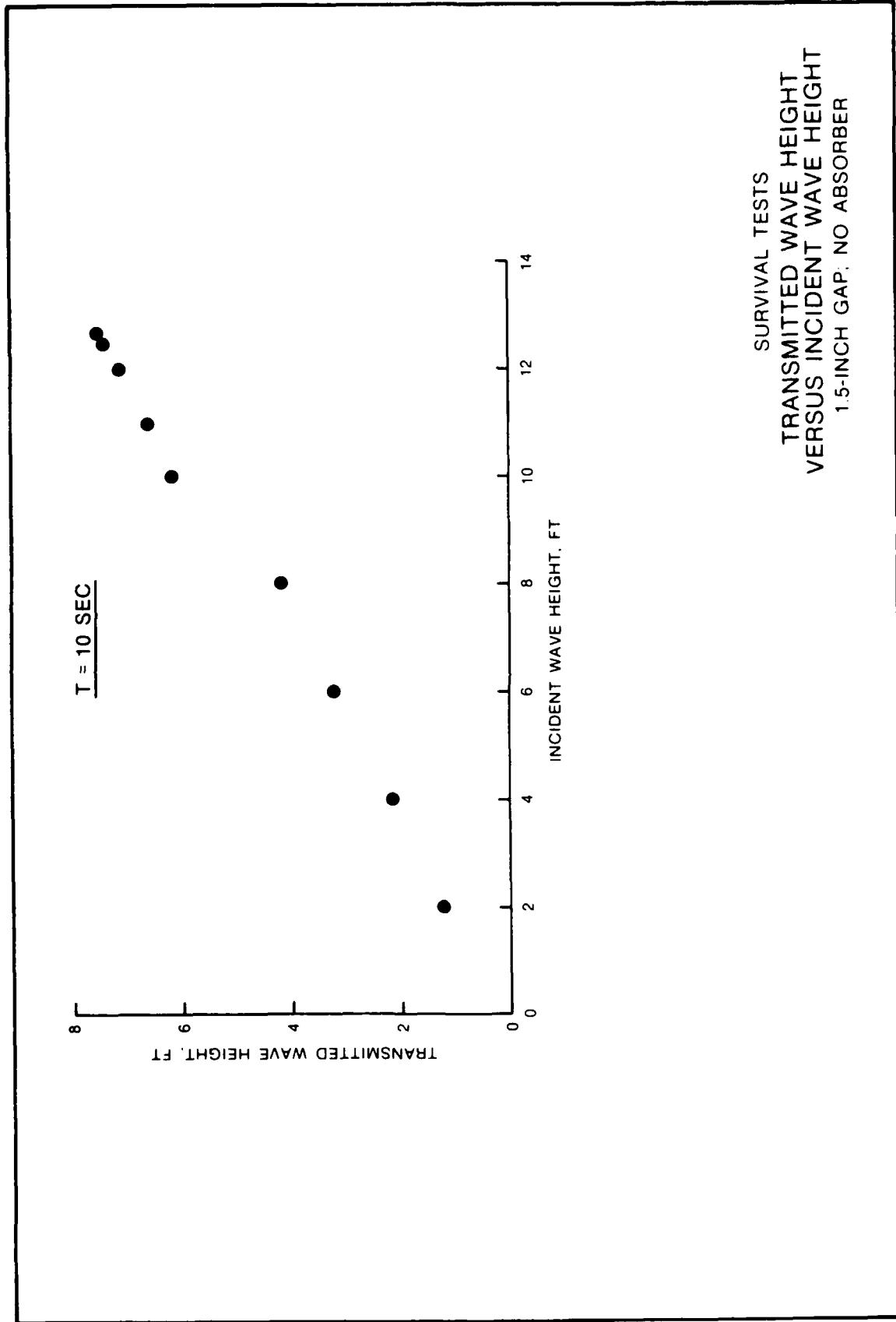
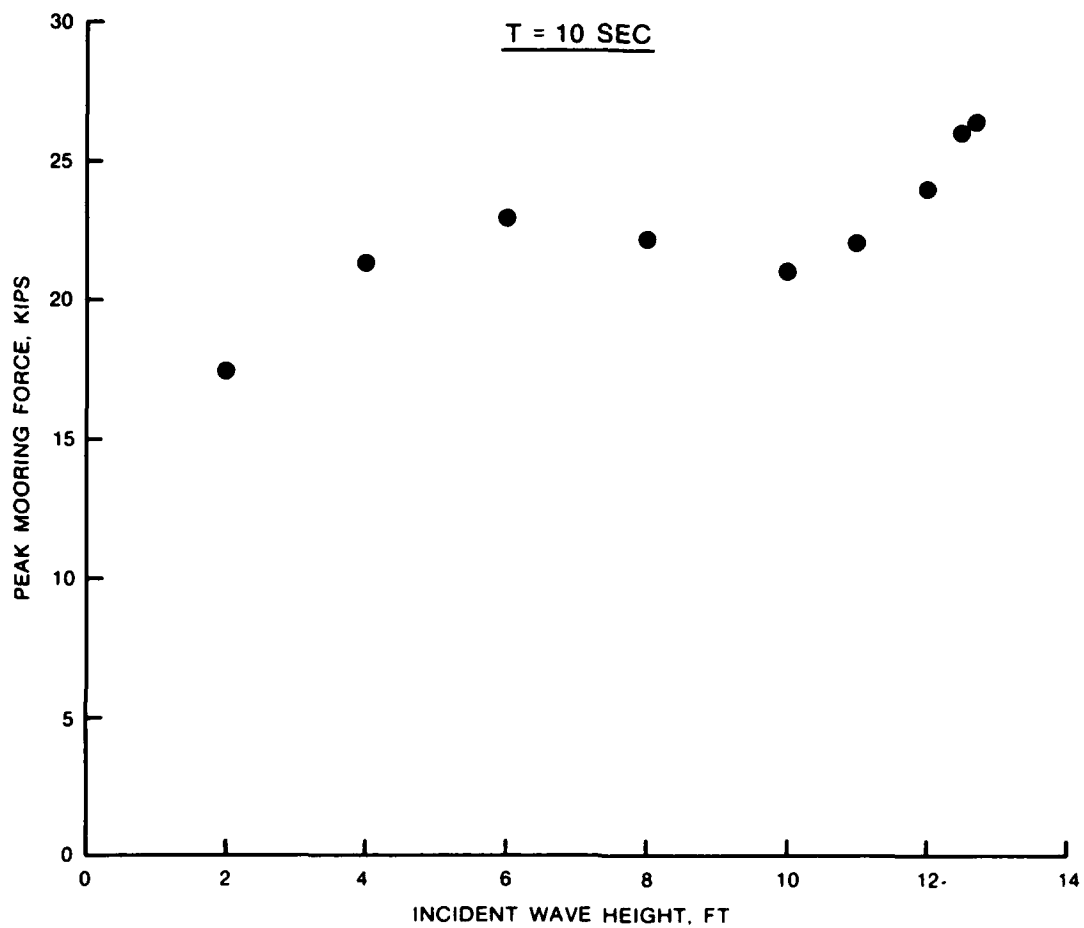
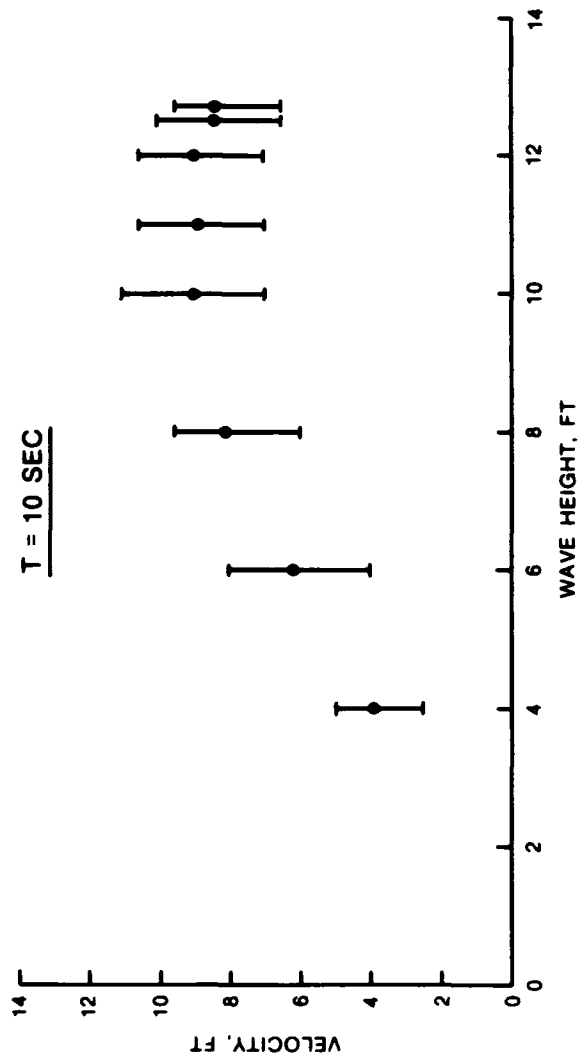

PLATE 8



SURVIVAL TESTS
PEAK MOORING FORCE
VERSUS INCIDENT WAVE HEIGHT
1.5-INCH GAP; NO ABSORBER



SURVIVAL TESTS
 FLOW VELOCITY UNDER SFB
 VERSUS WAVE HEIGHT
 1.5-INCH GAP; NO ABSORBER

LEGEND
 MAXIMUM
 AVERAGE
 MINIMUM

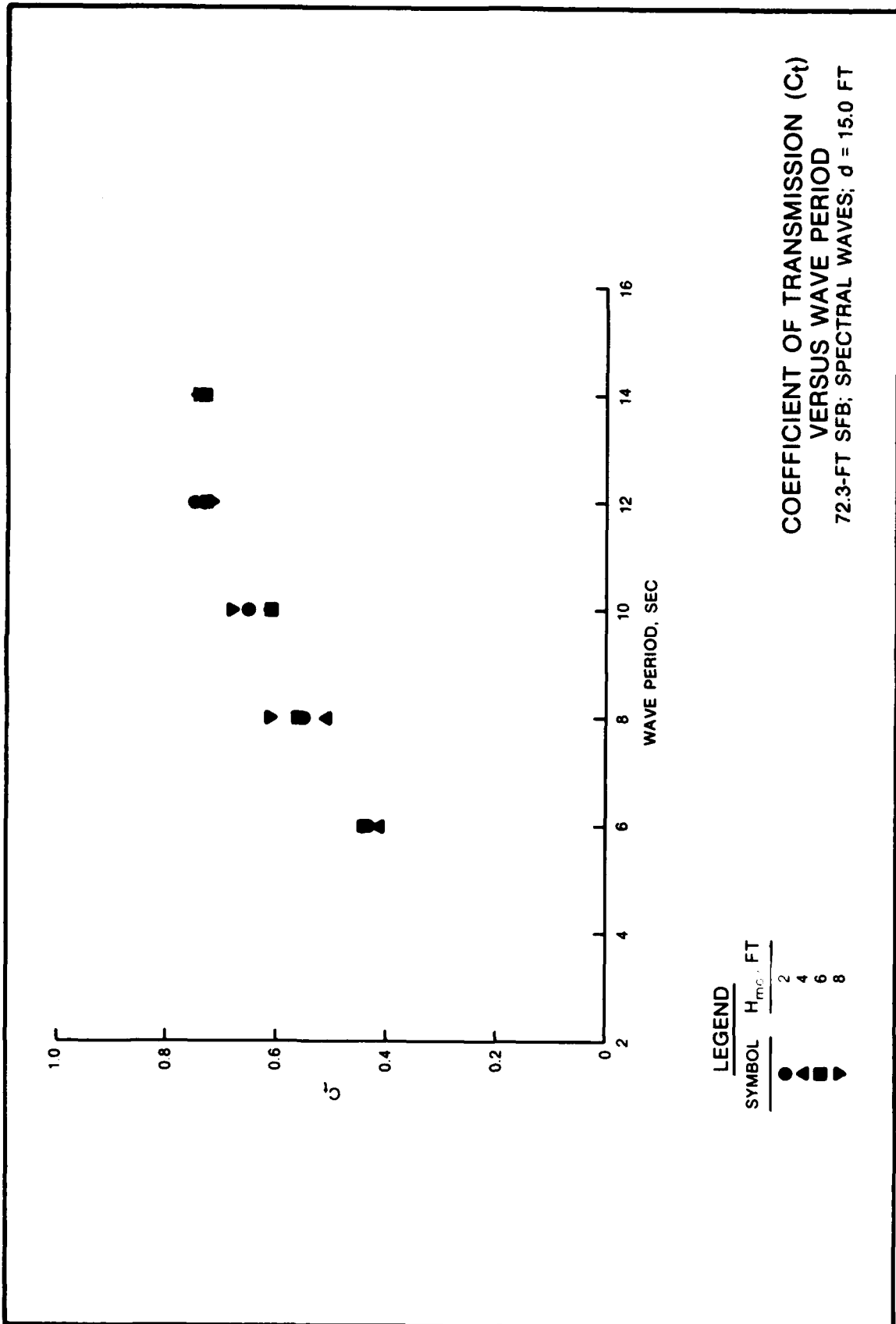

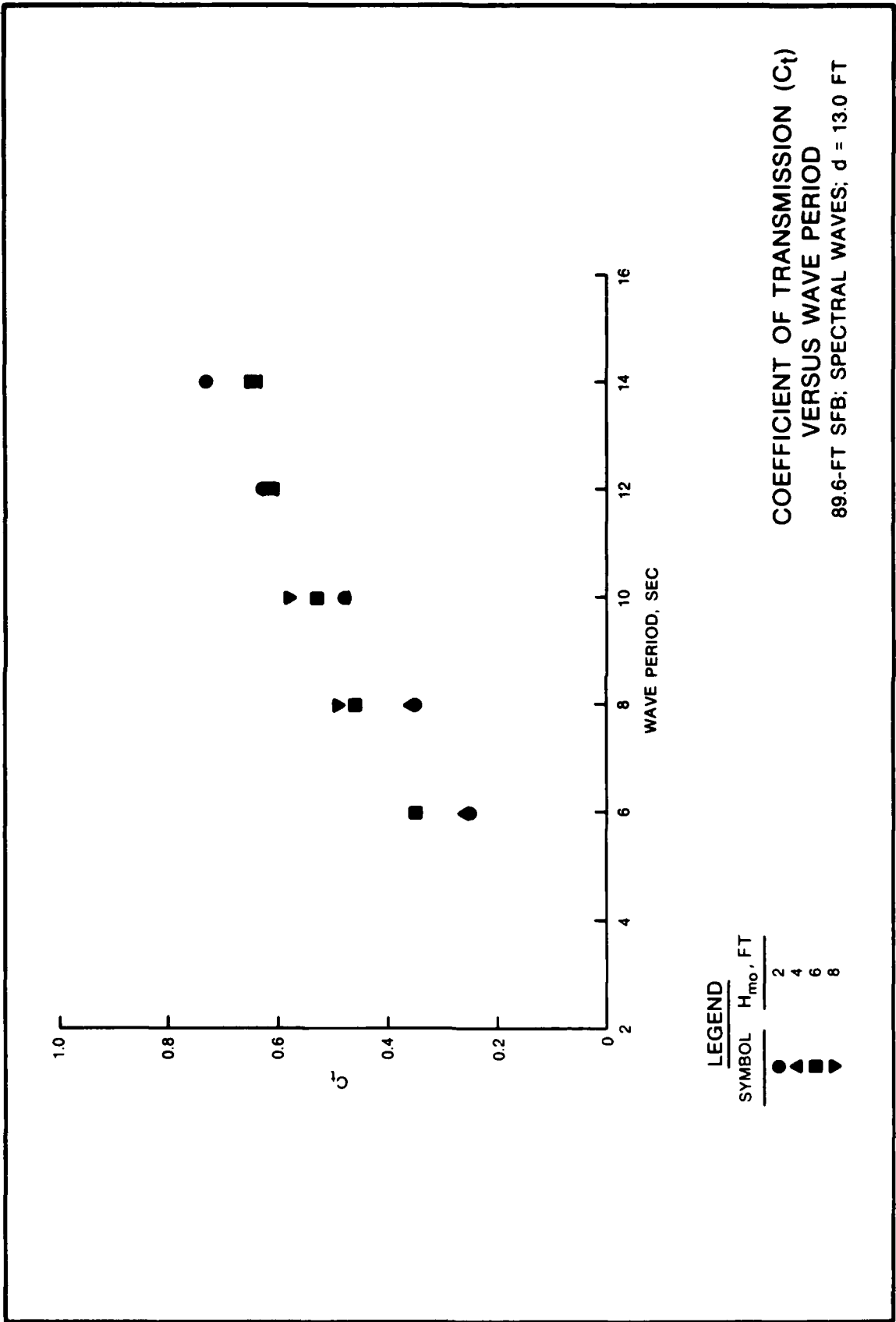
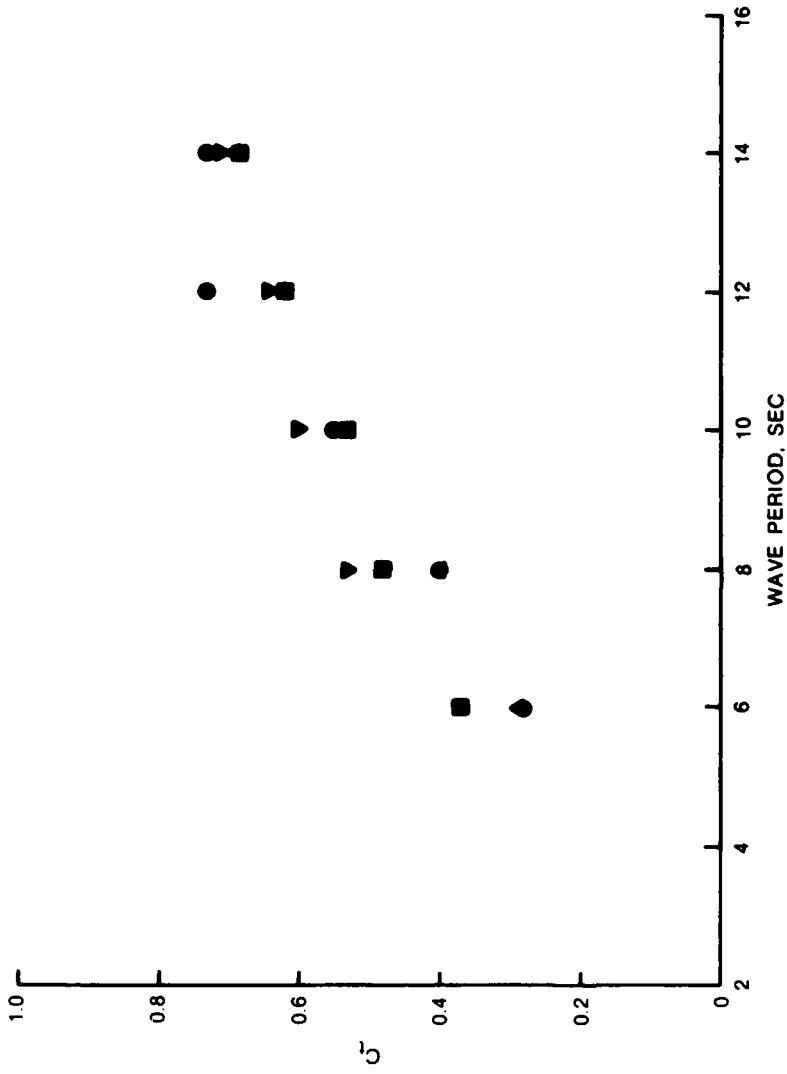

PLATE 12



LEGEND

SYMBOL	H _{mo} , FT
●	2
▲	4
■	6
▼	8

**COEFFICIENT OF TRANSMISSION (C_t)
VERSUS WAVE PERIOD**
89.6-FT SFB; SPECTRAL WAVES; $d = 15.0$ FT

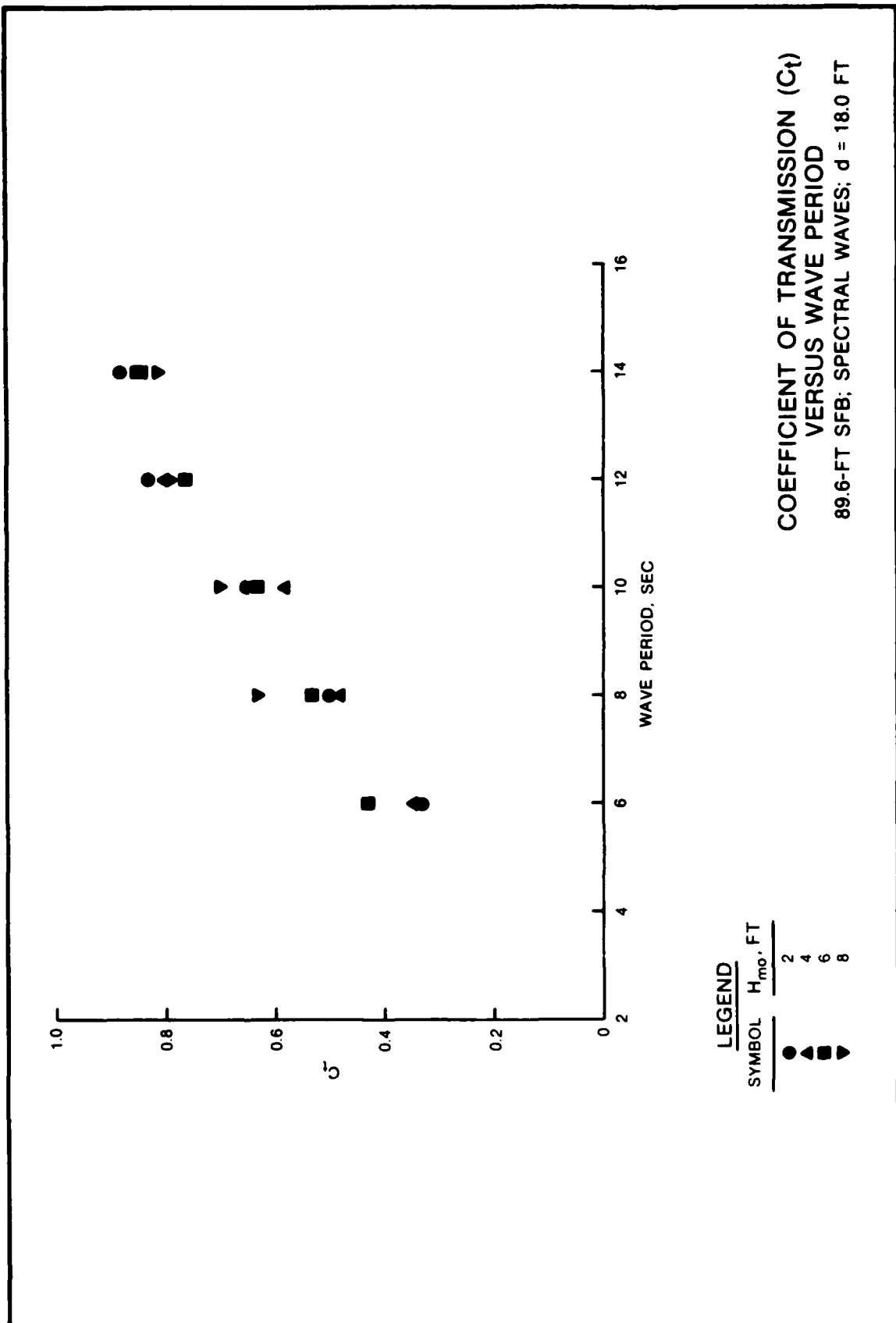

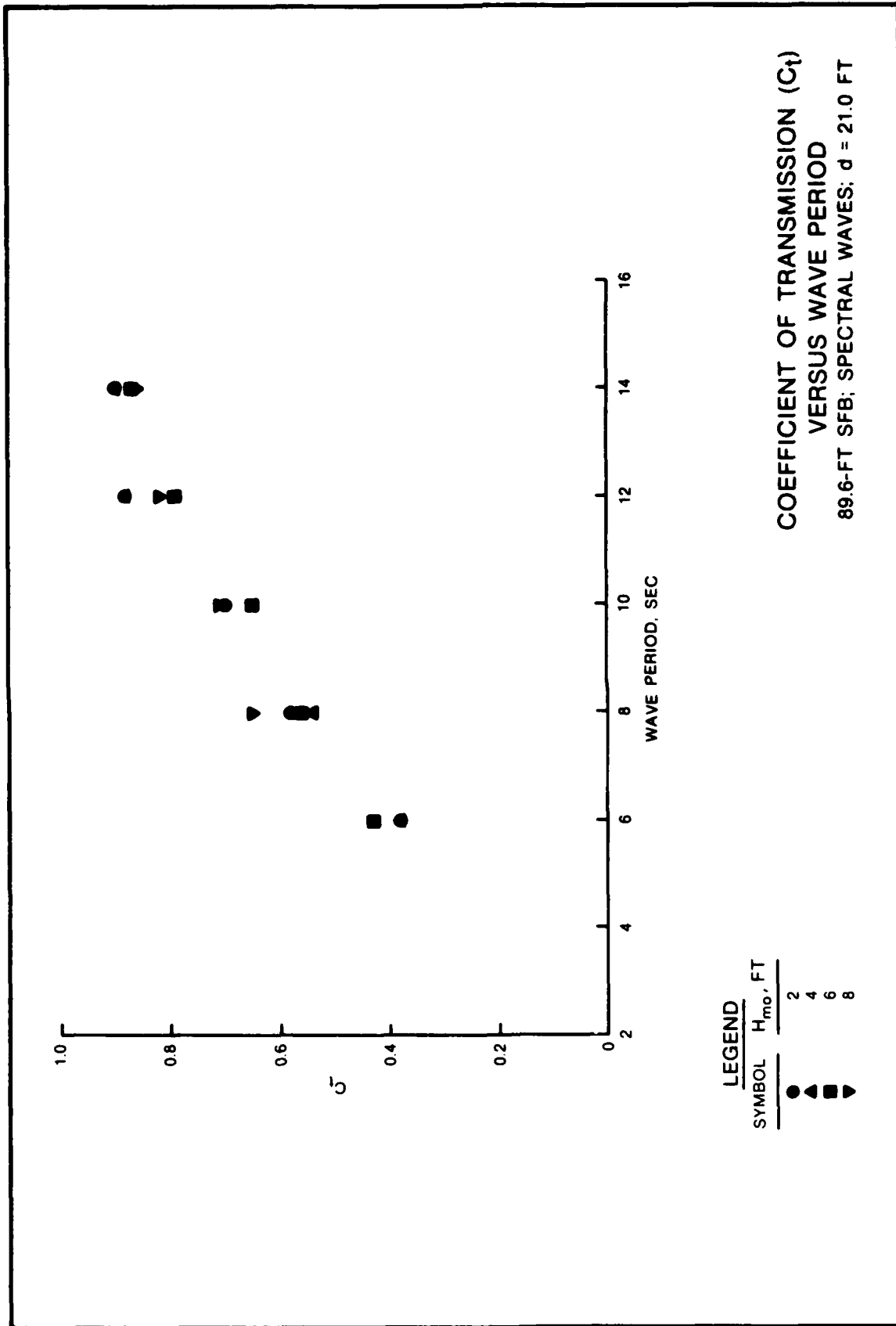

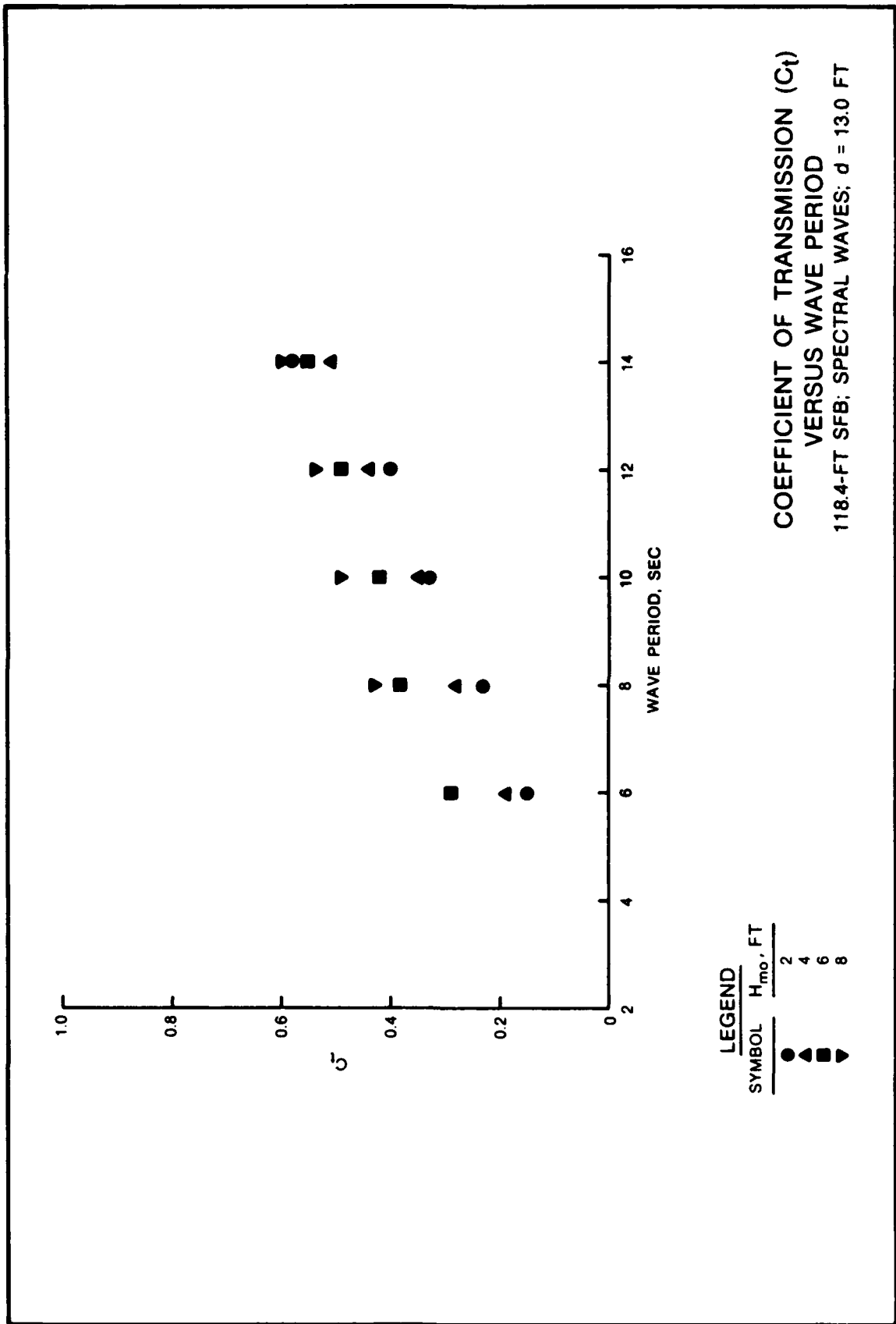

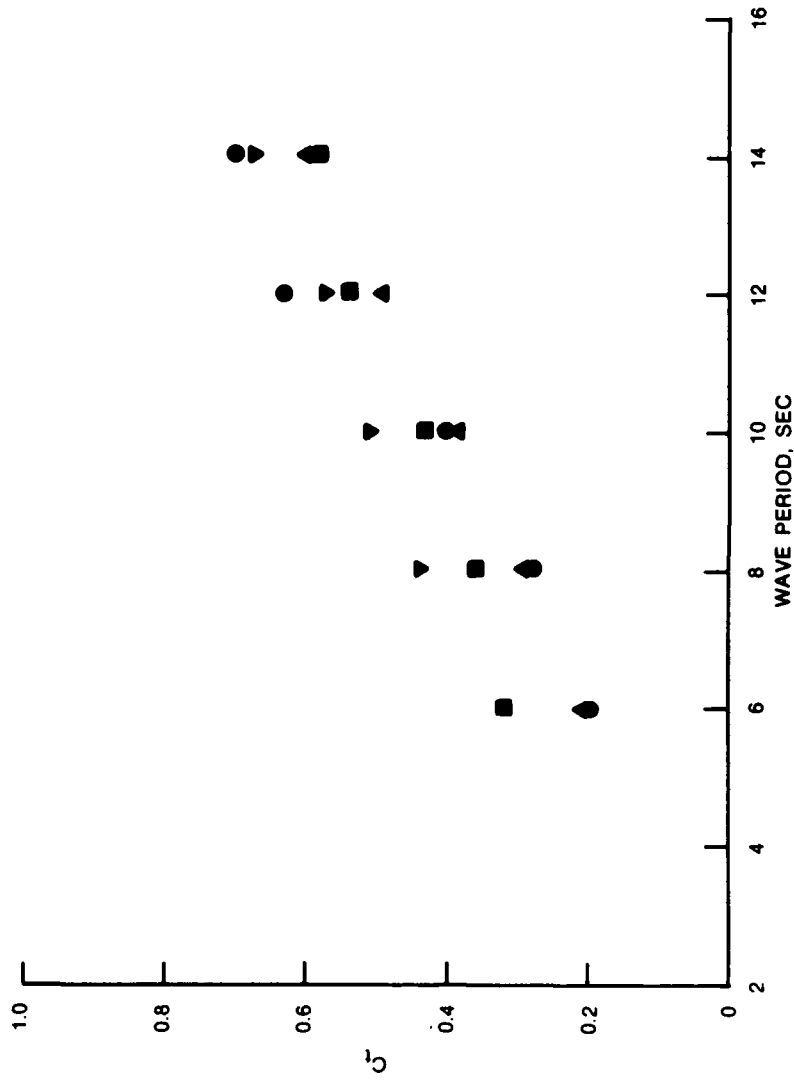

LEGEND

SYMBOL	H_{mo} , FT
●	2
▲	4
■	6
▼	8

**COEFFICIENT OF TRANSMISSION (C_t)
VERSUS WAVE PERIOD
118.4-FT SFB; SPECTRAL WAVES; $d = 15.0$ FT**

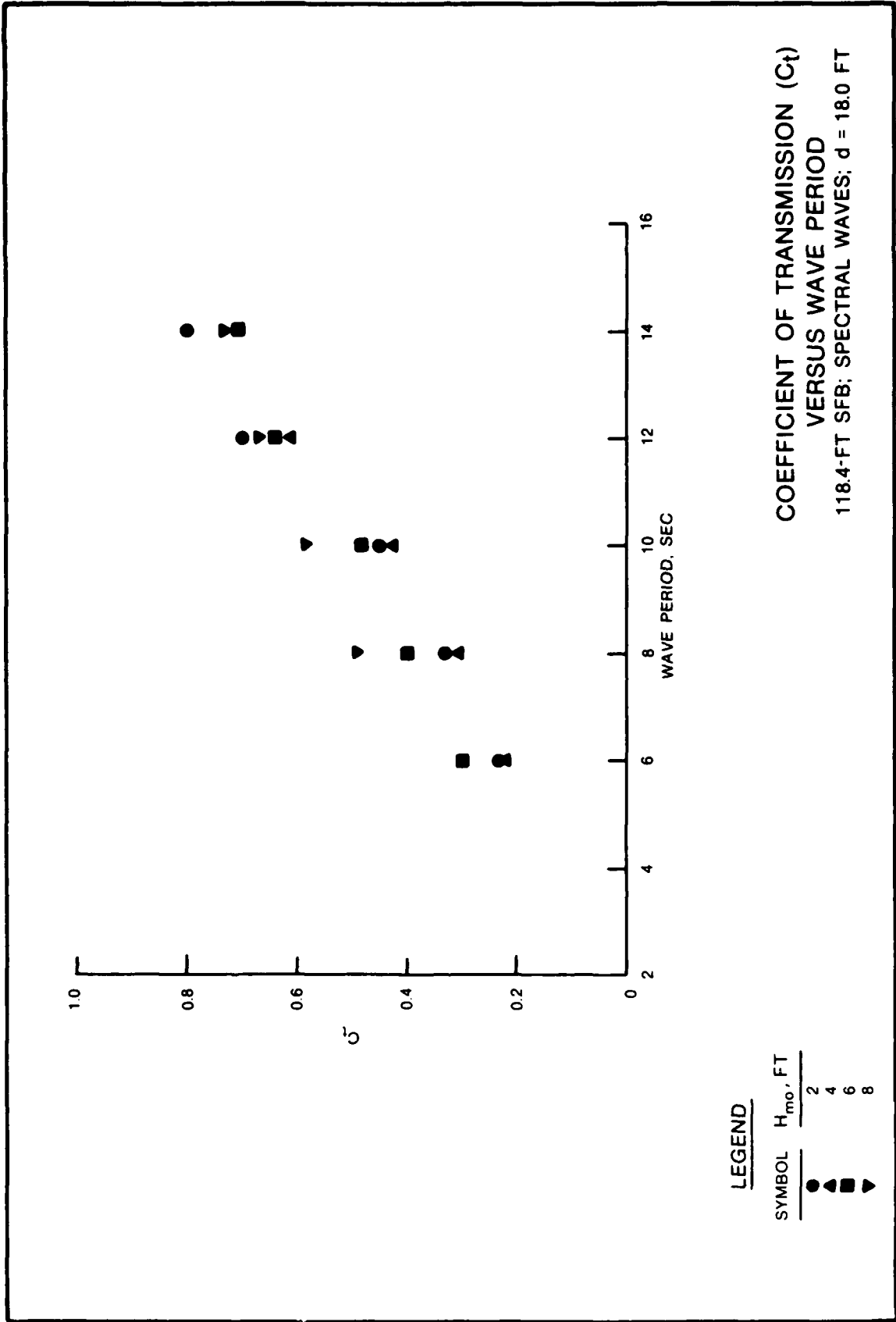
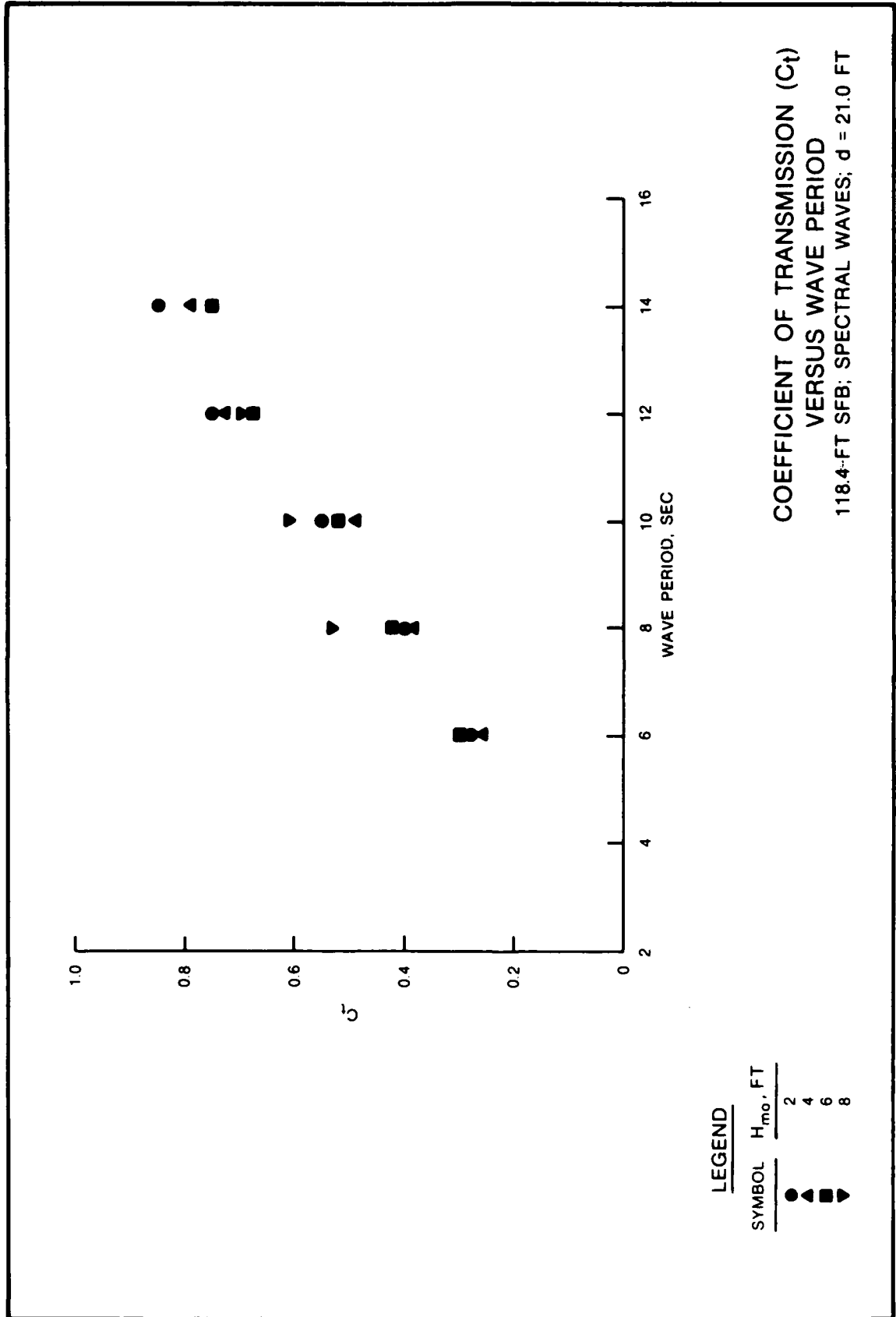
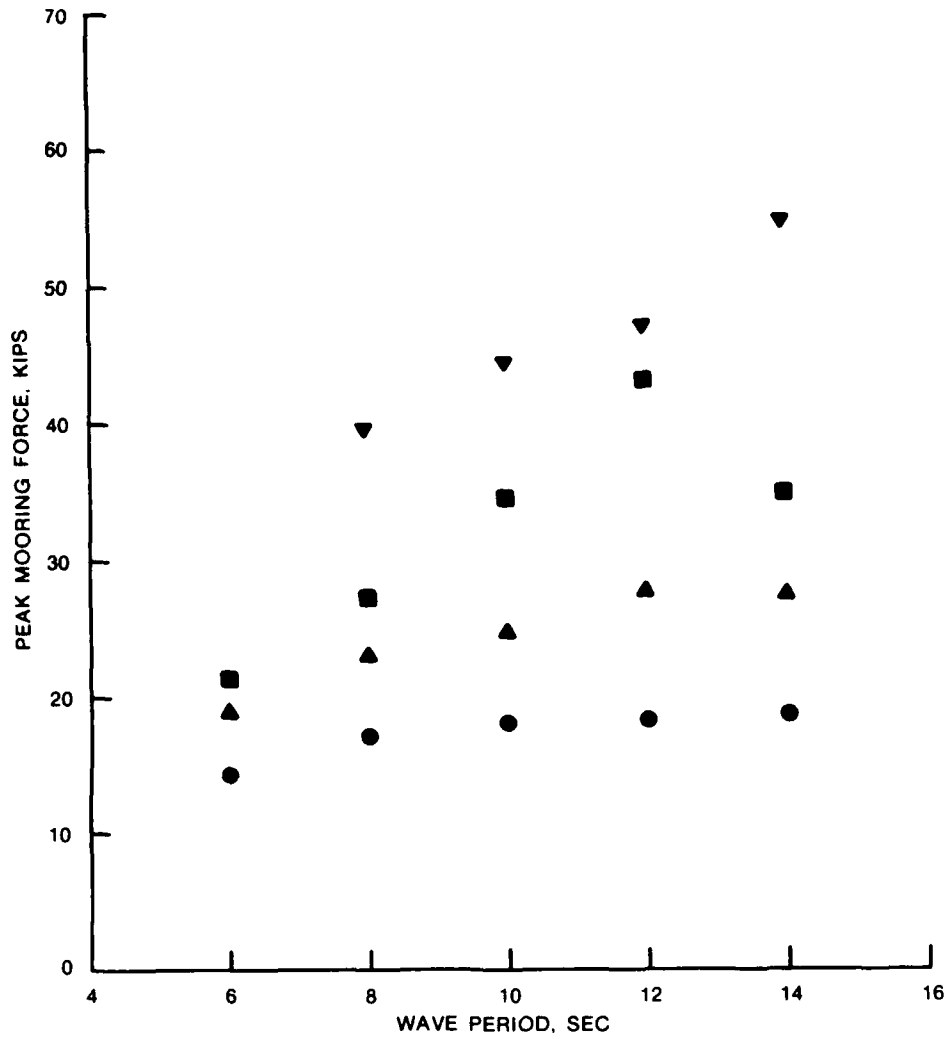

PLATE 18





LEGEND

SYMBOL	H_{mo} , FT
●	2
▲	4
■	6
▼	8

PEAK MOORING FORCE
 VERSUS WAVE PERIOD
 72.3-FT SFB; SPECTRAL
 WAVES; $d = 15.0$ FT

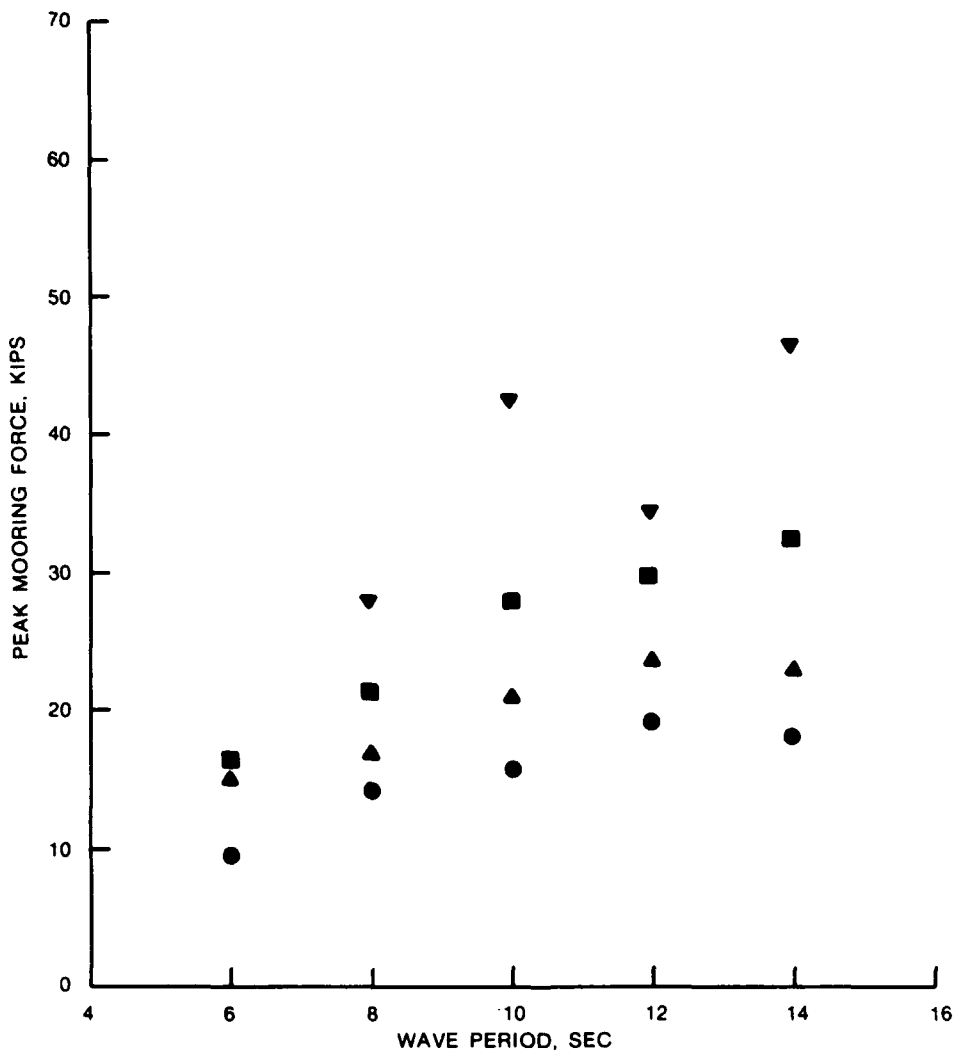

LEGEND

SYMBOL	H _{mo} , FT
●	2
▲	4
■	6
▼	8

PEAK MOORING FORCE
 VERSUS WAVE PERIOD
 89.6-FT SFB; SPECTRAL
 WAVES; d = 13.0 FT

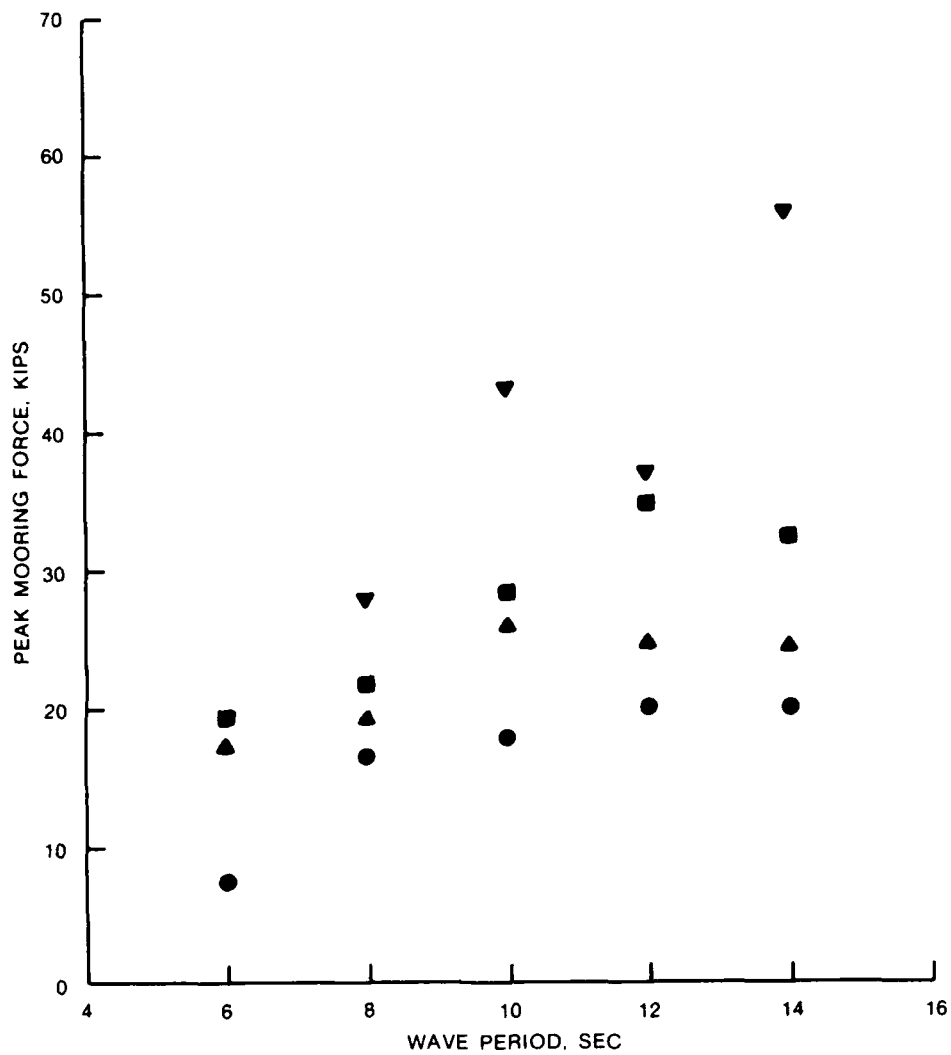

LEGEND

SYMBOL	H _{mo} , FT
●	2
▲	4
■	6
▼	8

PEAK MOORING FORCE
 VERSUS WAVE PERIOD
 89.6-FT SFB; SPECTRAL
 WAVES; d = 15.0 FT

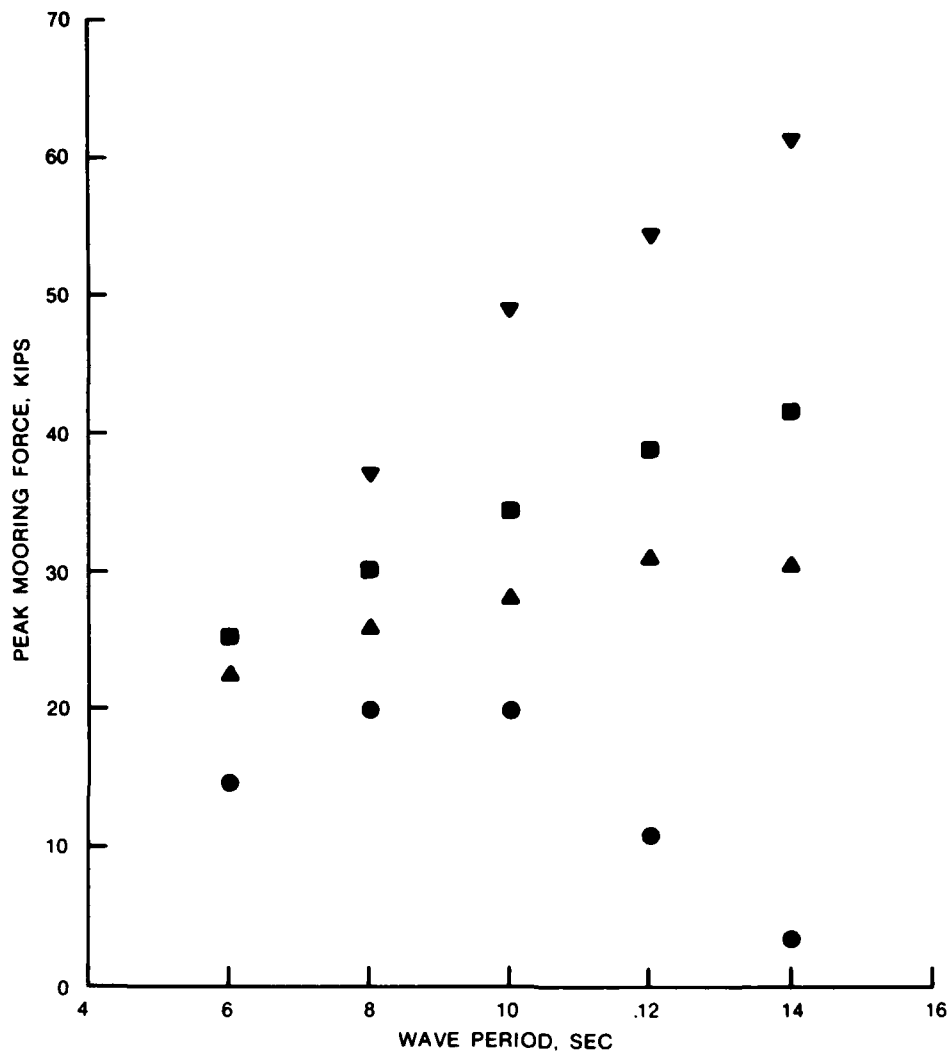

LEGEND

SYMBOL	H _{mo} , FT
●	2
▲	4
■	6
▼	8

PEAK MOORING FORCE
 VERSUS WAVE PERIOD
 89.6-FT SFB; SPECTRAL
 WAVES; d = 18.0 FT

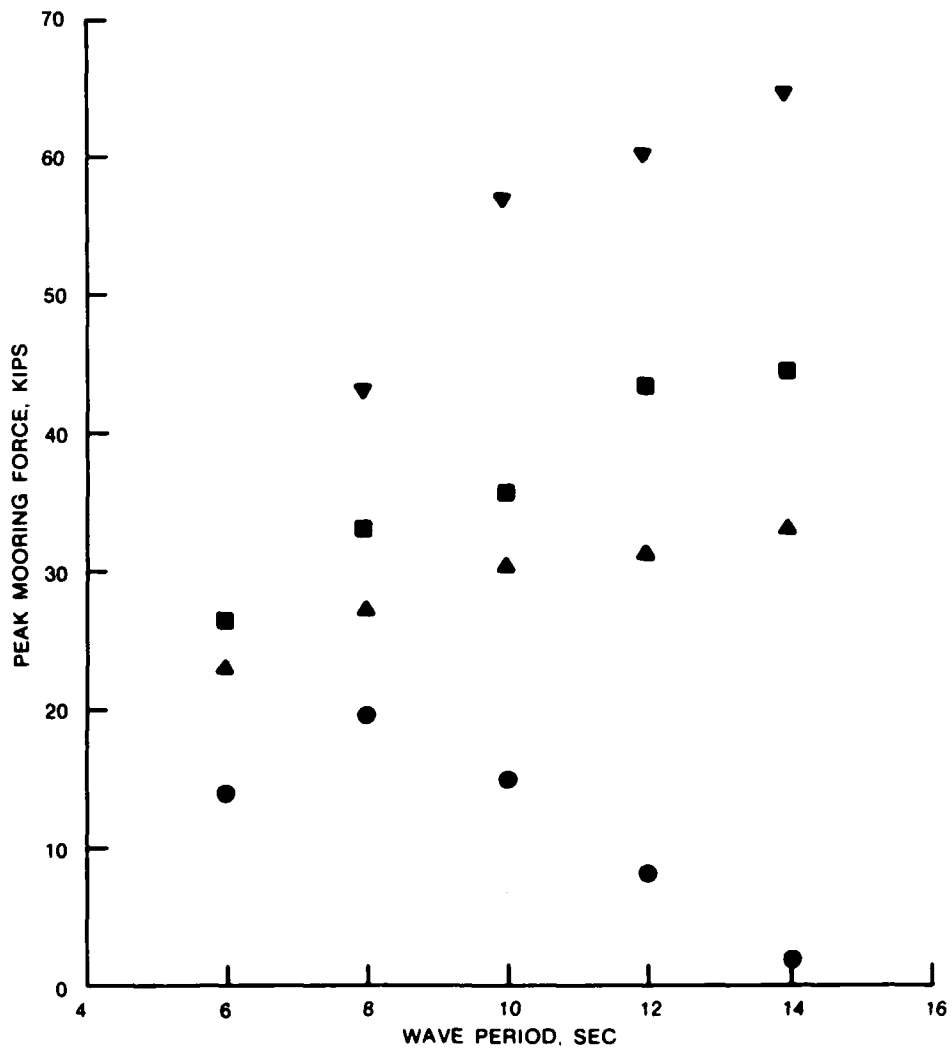

LEGEND

SYMBOL	H _{mo} , FT
●	2
▲	4
■	6
▼	8

PEAK MOORING FORCE
 VERSUS WAVE PERIOD
 89.6-FT SFB; SPECTRAL
 WAVES; d = 21.0 FT

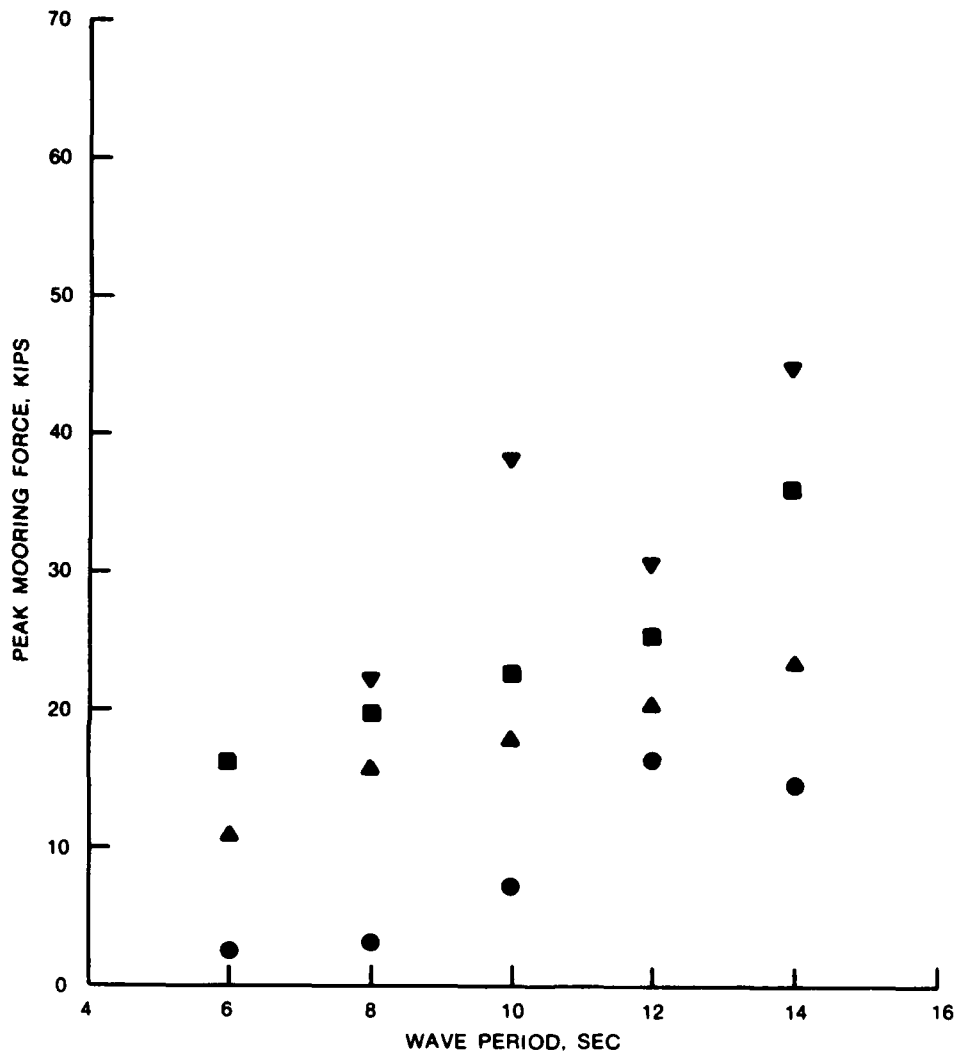

LEGEND

SYMBOL	H _{mo} , FT
●	2
▲	4
■	6
▼	8

PEAK MOORING FORCE
 VERSUS WAVE PERIOD
 118.4-FT SFB; SPECTRAL
 WAVES; d = 13.0 FT

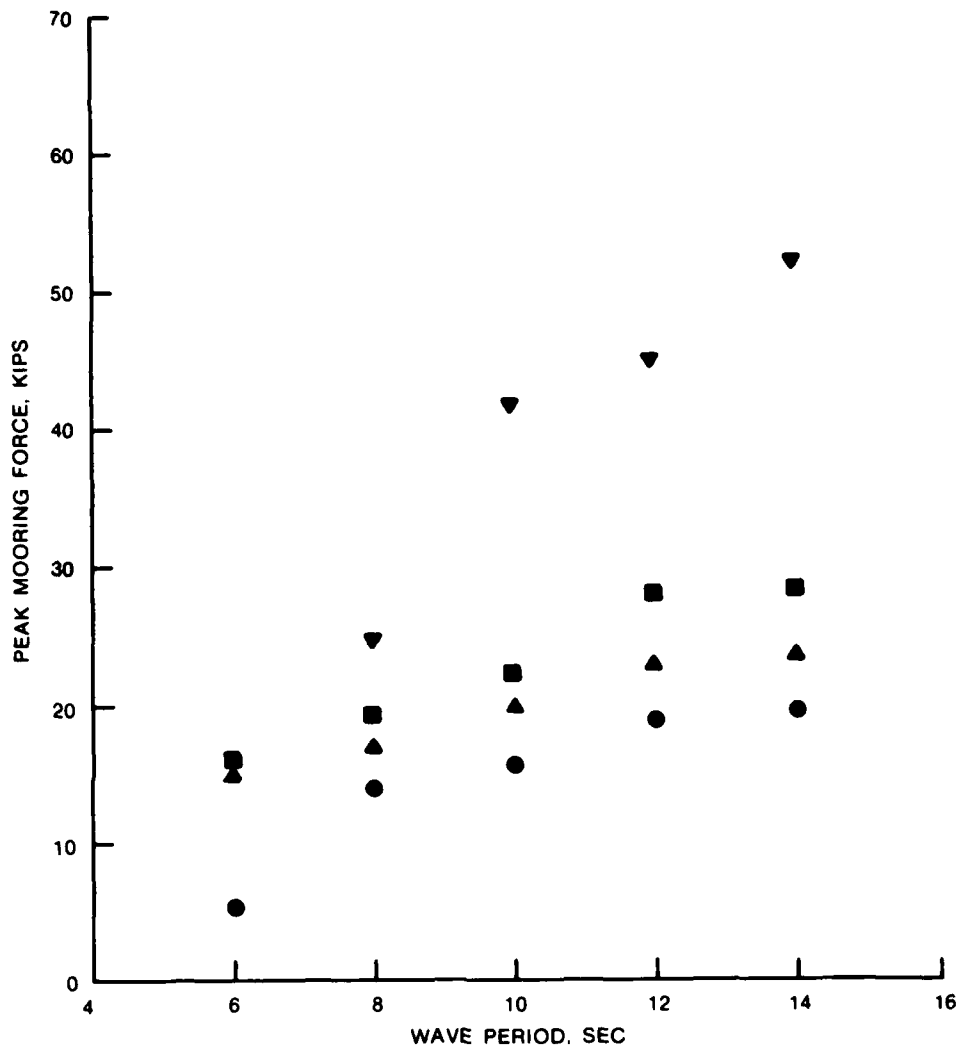

LEGEND

SYMBOL	H _{mo} , FT
●	2
▲	4
■	6
▼	8

PEAK MOORING FORCE
 VERSUS WAVE PERIOD
 118.4-FT SFB; SPECTRAL
 WAVES; d = 15.0 FT

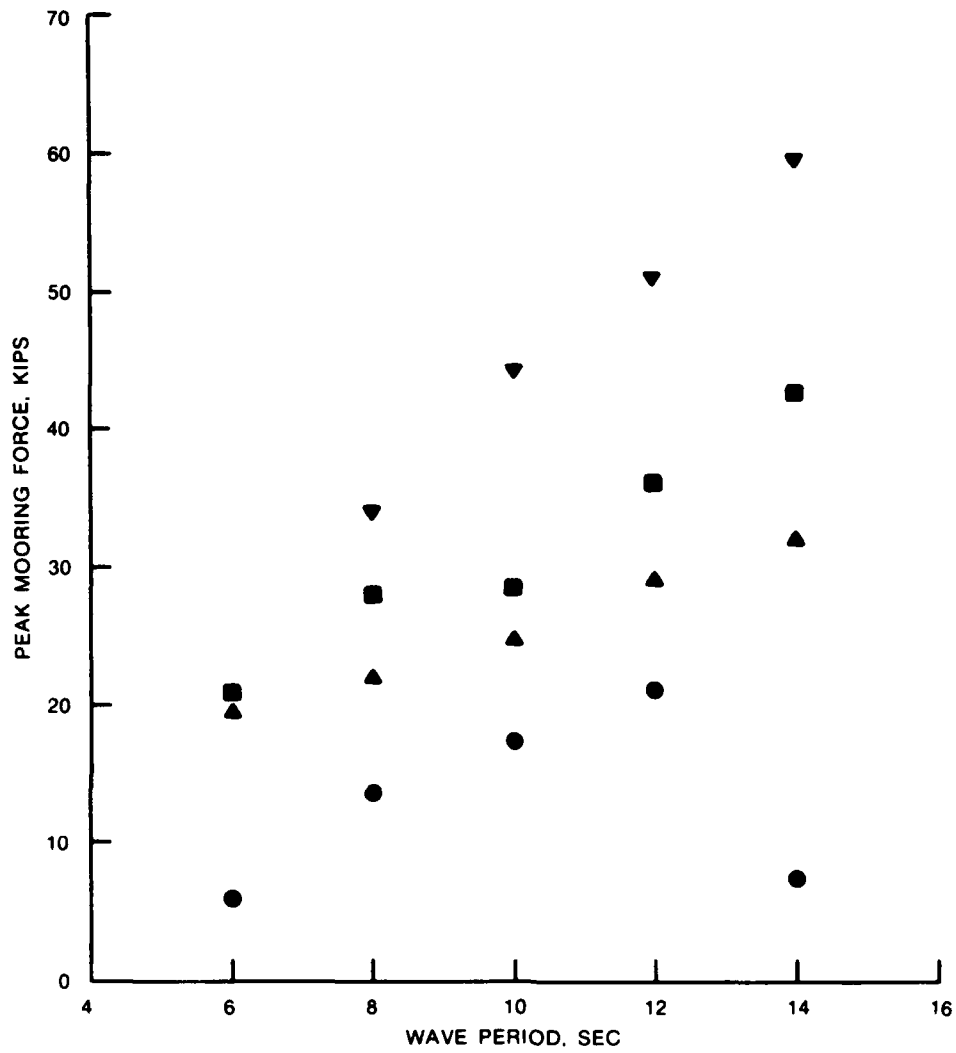

LEGEND

SYMBOL	H_{mo} , FT
●	2
▲	4
■	6
▼	8

PEAK MOORING FORCE
 VERSUS WAVE PERIOD
 118.4-FT SFB; SPECTRAL
 WAVES; $d = 18.0$ FT

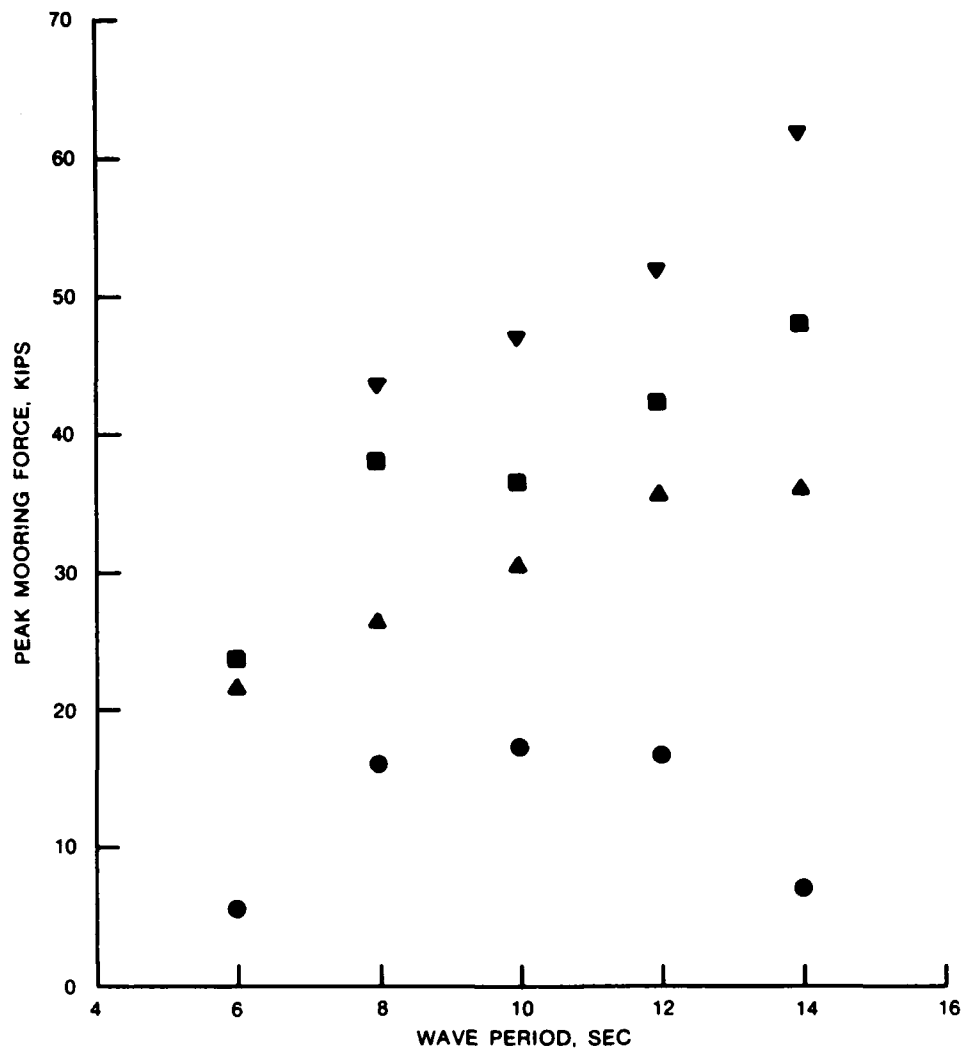

LEGEND

SYMBOL	H _{mo} , FT
●	2
▲	4
■	6
▼	8

PEAK MOORING FORCE
 VERSUS WAVE PERIOD
 118.4-FT SFB; SPECTRAL
 WAVES; d = 21.0 FT

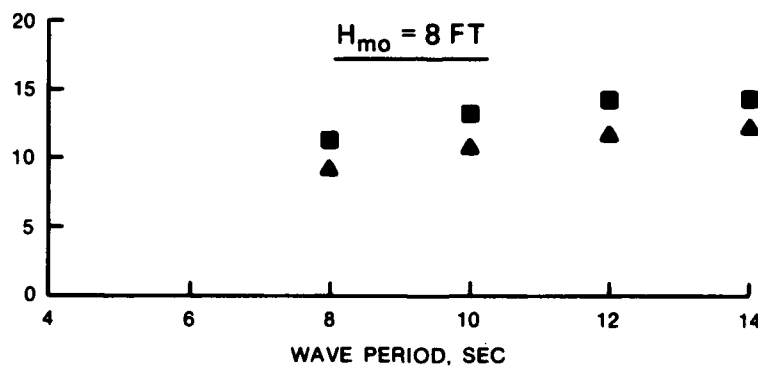
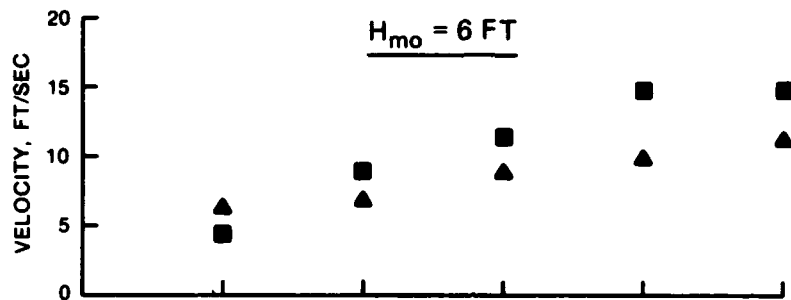
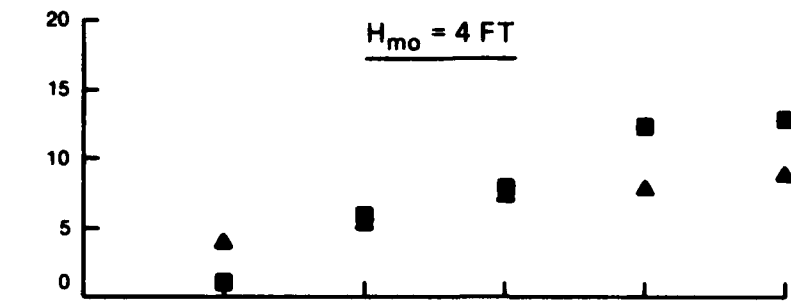

LEGEND

<u>SYMBOL</u>	<u>SFB LENGTH, FT</u>
▲	89.6
■	118.4

**PEAK FLOW VELOCITY UNDER
SFB VERSUS WAVE PERIOD
SPECTRAL WAVES; $d = 13$ FT**

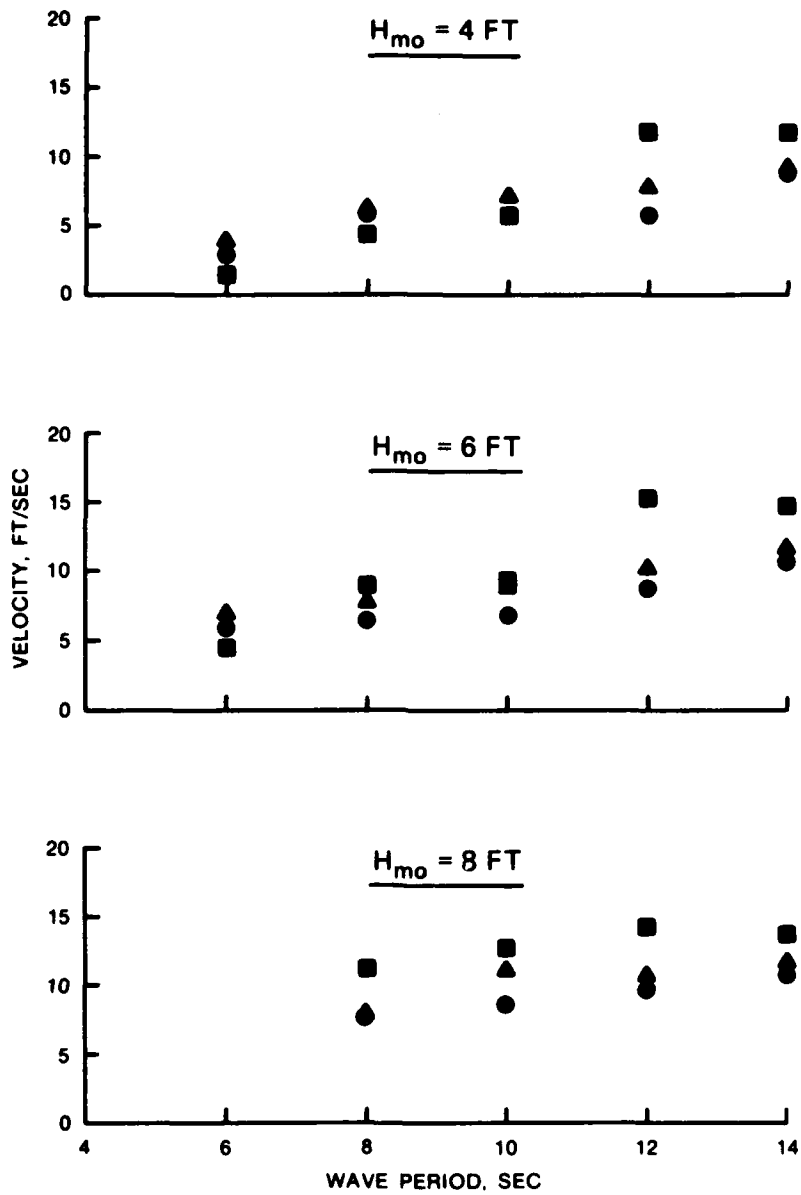

LEGEND

SYMBOL	SFB LENGTH, FT
●	72.3
▲	89.6
■	118.4

PEAK FLOW VELOCITY UNDER
SFB VERSUS WAVE PERIOD
SPECTRAL WAVES; $d = 15$ FT

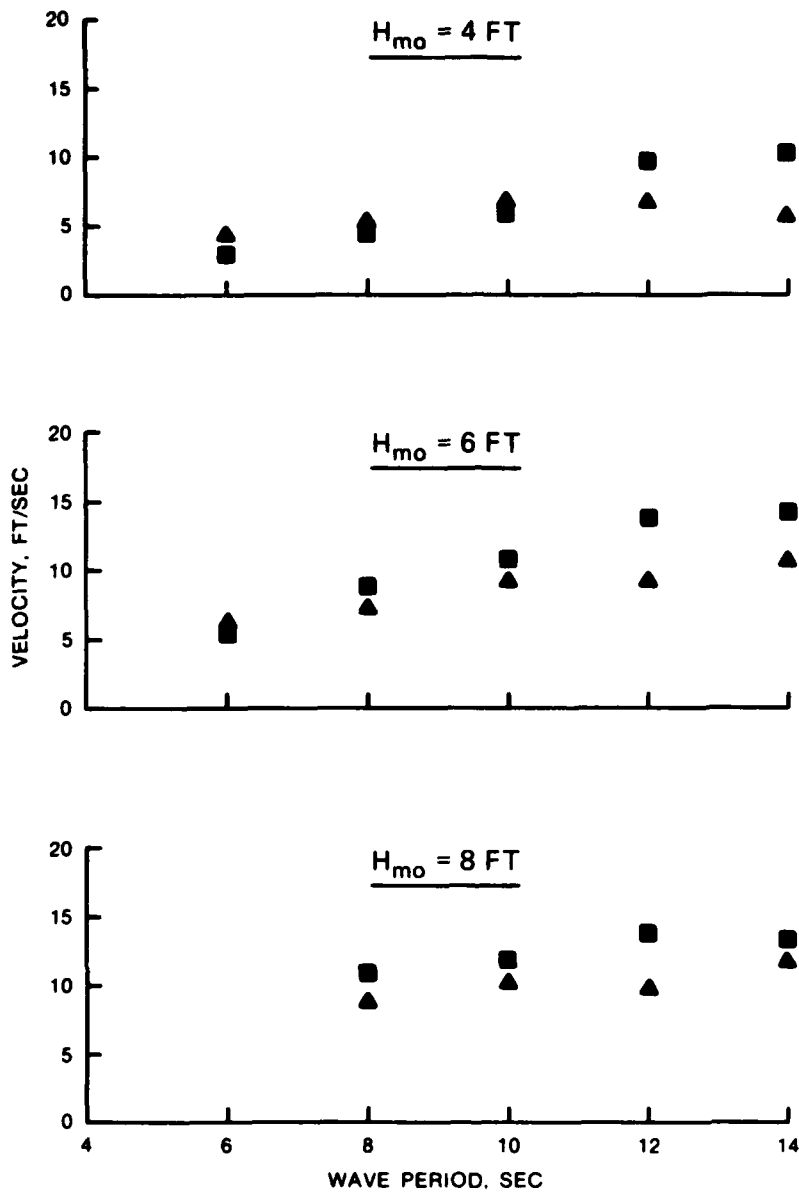

LEGEND

SYMBOL	SFB LENGTH, FT
▲	89.6
■	118.4

PEAK FLOW VELOCITY UNDER
SFB VERSUS WAVE PERIOD
SPECTRAL WAVES: $d = 18$ FT

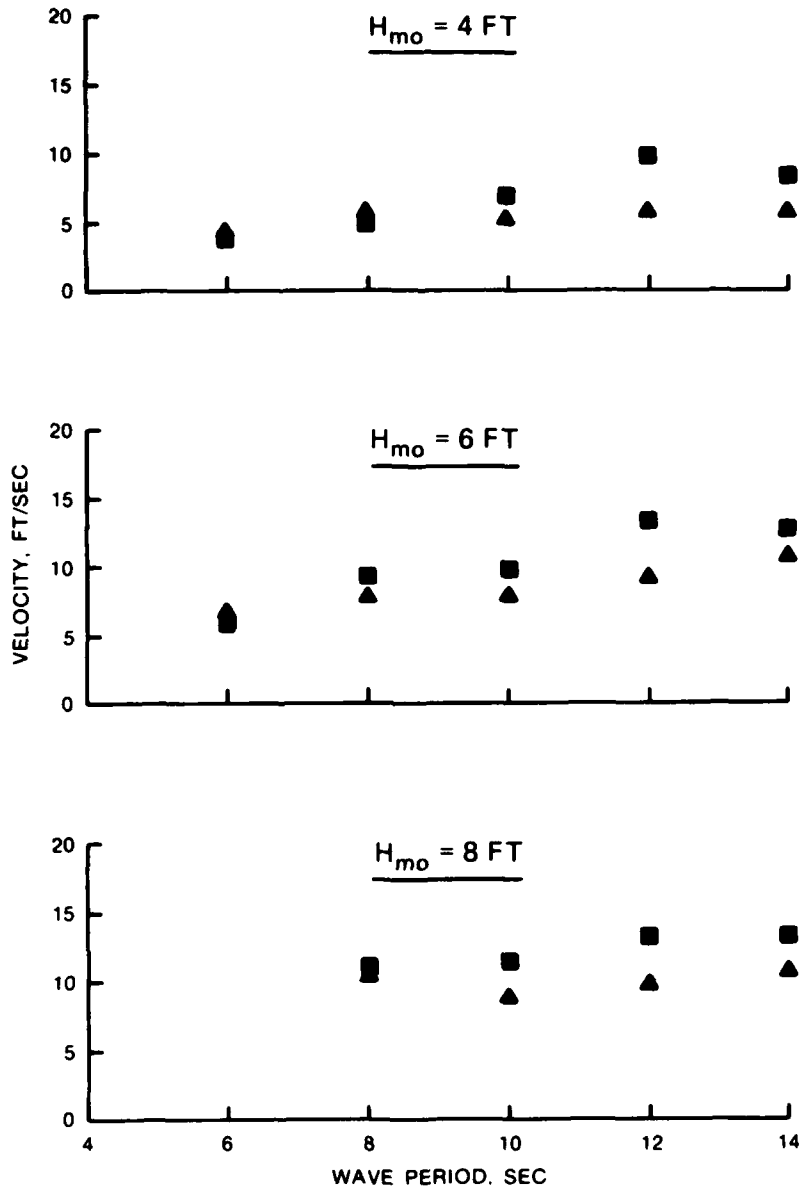

LEGEND

SYMBOL	SFB LENGTH, FT
▲	89.6
■	118.4

PEAK FLOW VELOCITY UNDER SFB VERSUS WAVE PERIOD
SPECTRAL WAVES; $d = 21$ FT

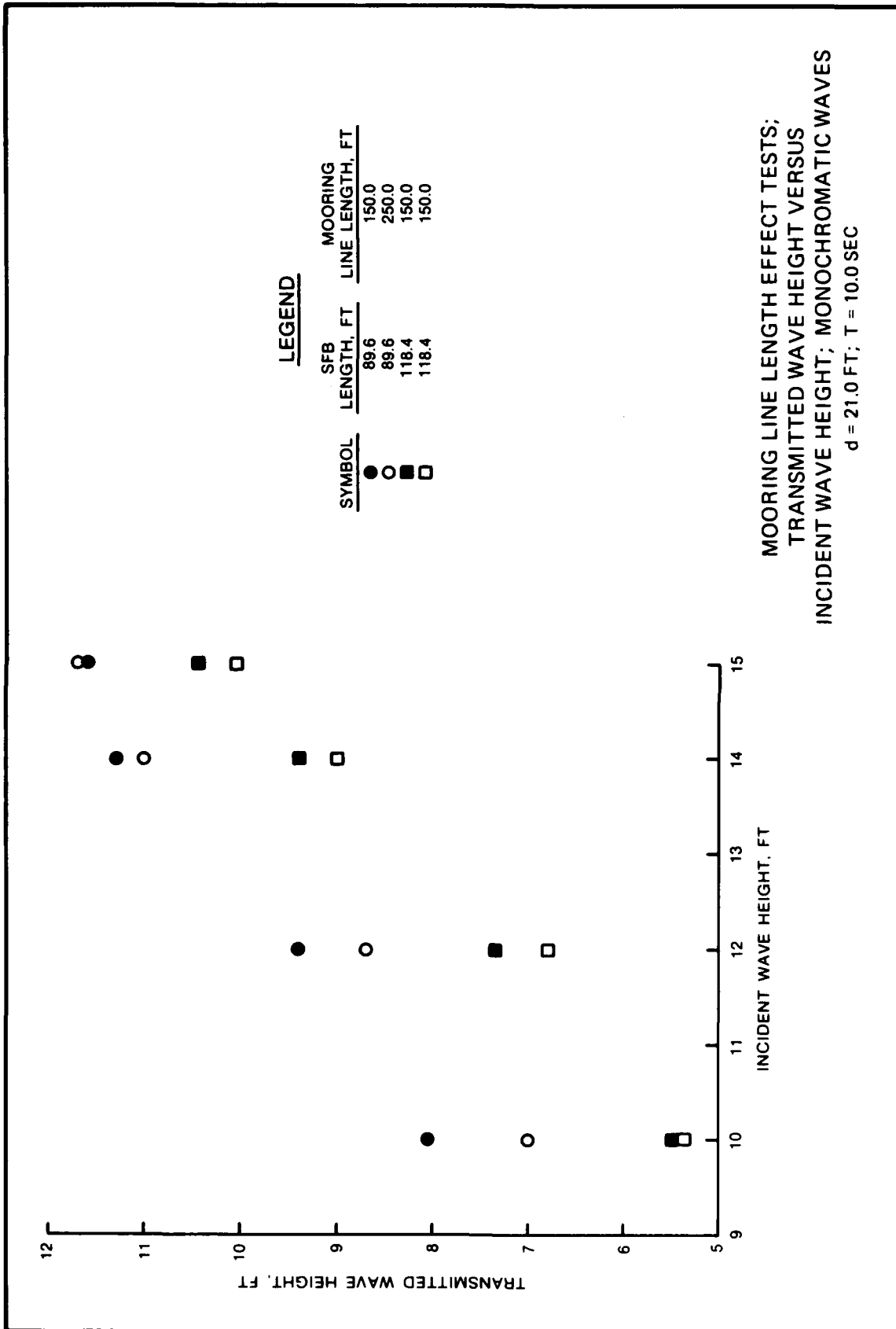

LEGEND

SYMBOL	SFB LENGTH, FT	MOORING LINE LENGTH, FT
●	89.6	150.0
○	89.6	250.0
■	118.4	150.0
□	118.4	150.0

MOORING LINE LENGTH EFFECT TESTS;
 TRANSMITTED WAVE HEIGHT VERSUS
 INCIDENT WAVE HEIGHT; MONOCHROMATIC WAVES
 $d = 21.0$ FT; $T = 10.0$ SEC

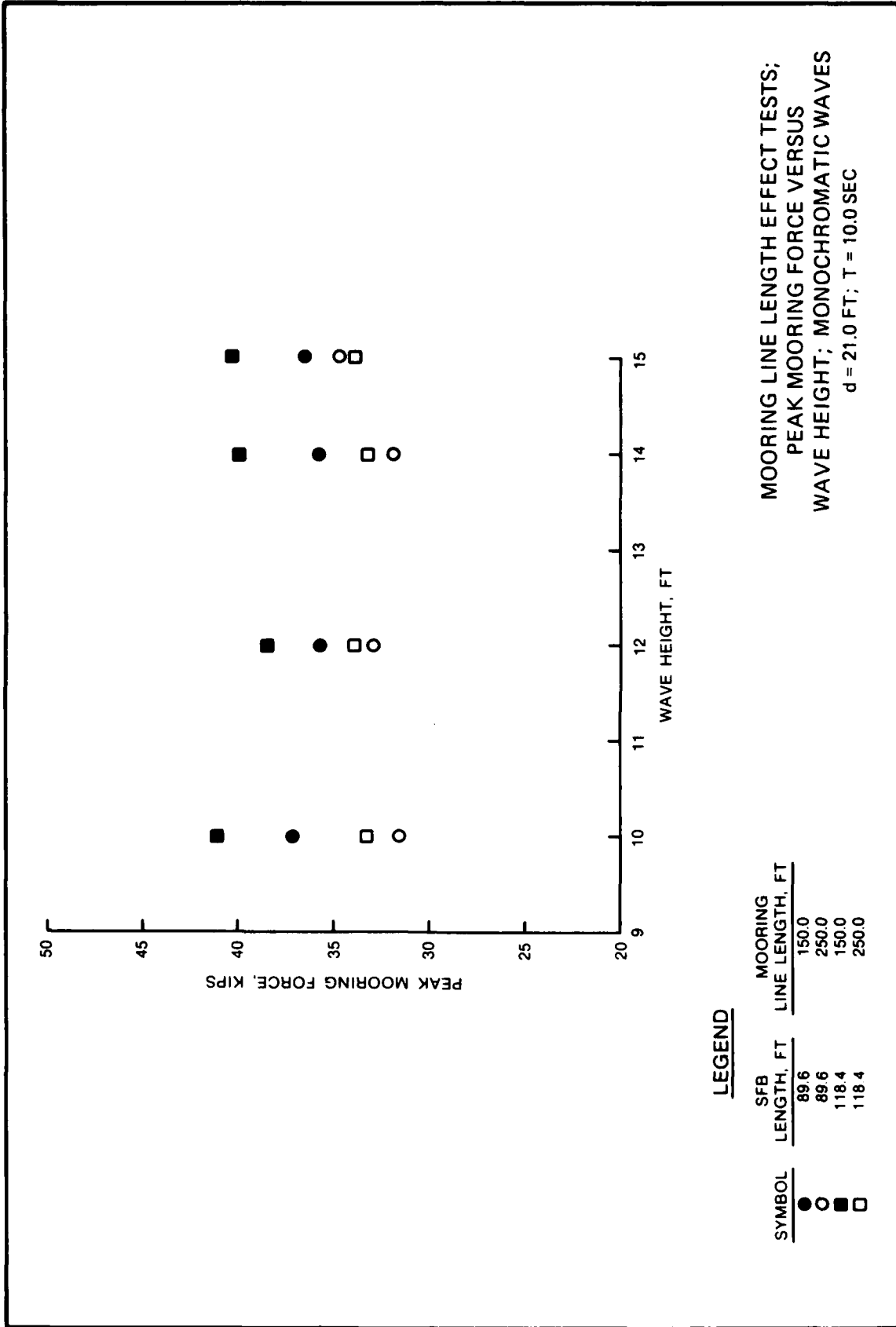
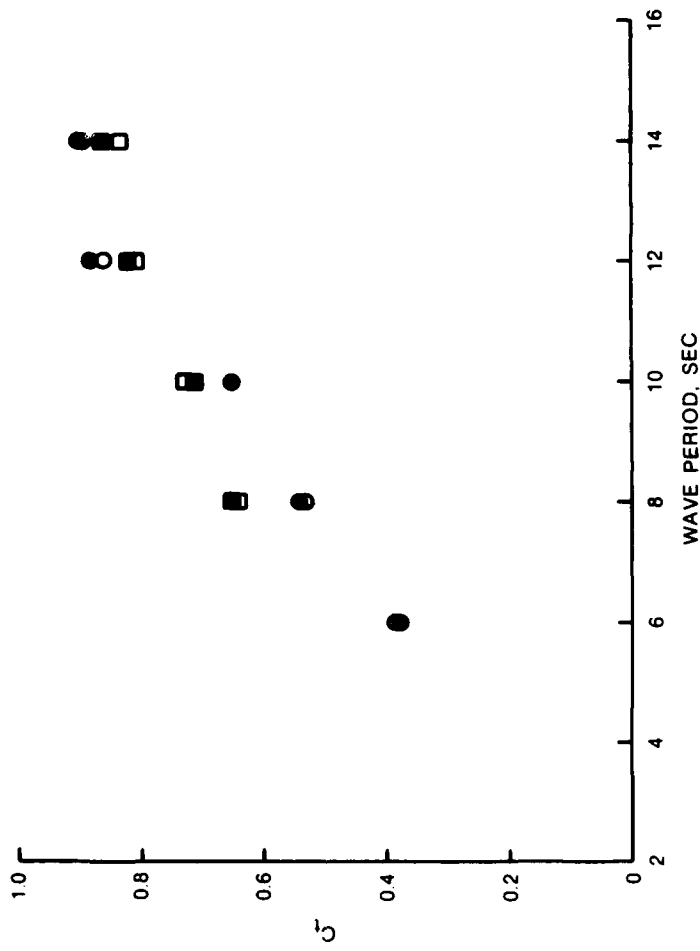

PLATE 34



MOORING LINE LENGTH EFFECT TESTS;
 COEFFICIENT OF TRANSMISSION (C_t)
 VERSUS WAVE PERIOD;
 89.6-FT SFB; $d = 21.0$ FT;
 SPECTRAL WAVES

LEGEND

SYMBOL	MOORING	
	H_{mo} , FT	LINE LENGTH, FT
●	4	150.0
○	4	250.0
■	8	150.0
□	8	250.0

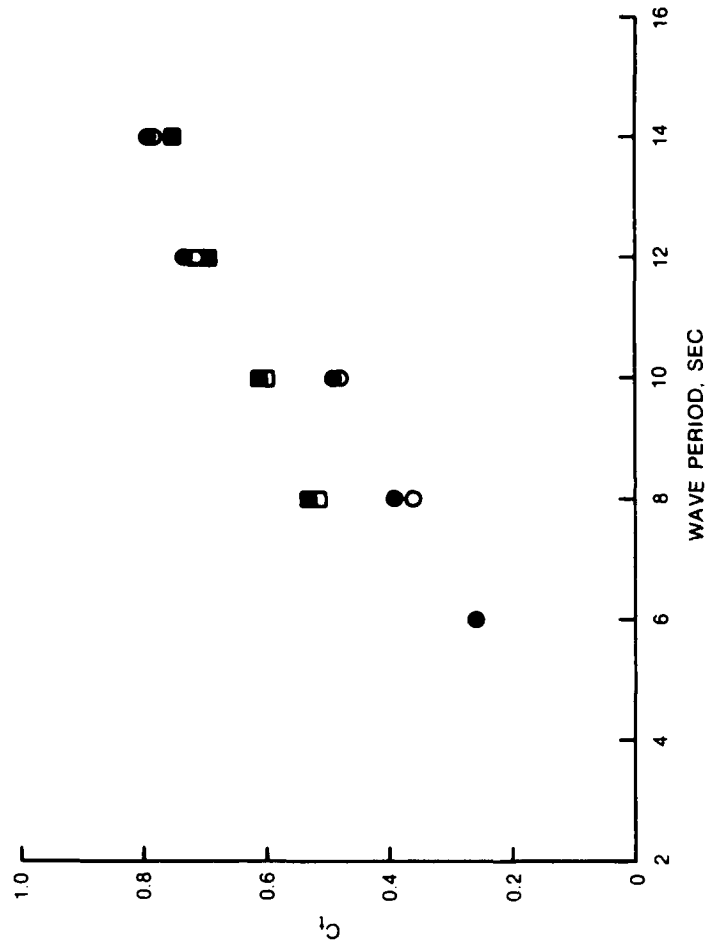

**MOORING LINE LENGTH EFFECT TESTS;
COEFFICIENT OF TRANSMISSION (C_t)
VERSUS WAVE PERIOD;
118.4-FT SFB; $d = 21.0$ FT;
SPECTRAL WAVES**

LEGEND

SYMBOL	H_{mo} , FT	LINE LENGTH, FT	MOORING LINE LENGTH, FT
●	4	1500	1500
○	4	2500	2500
■	8	1500	1500
□	8	2500	2500

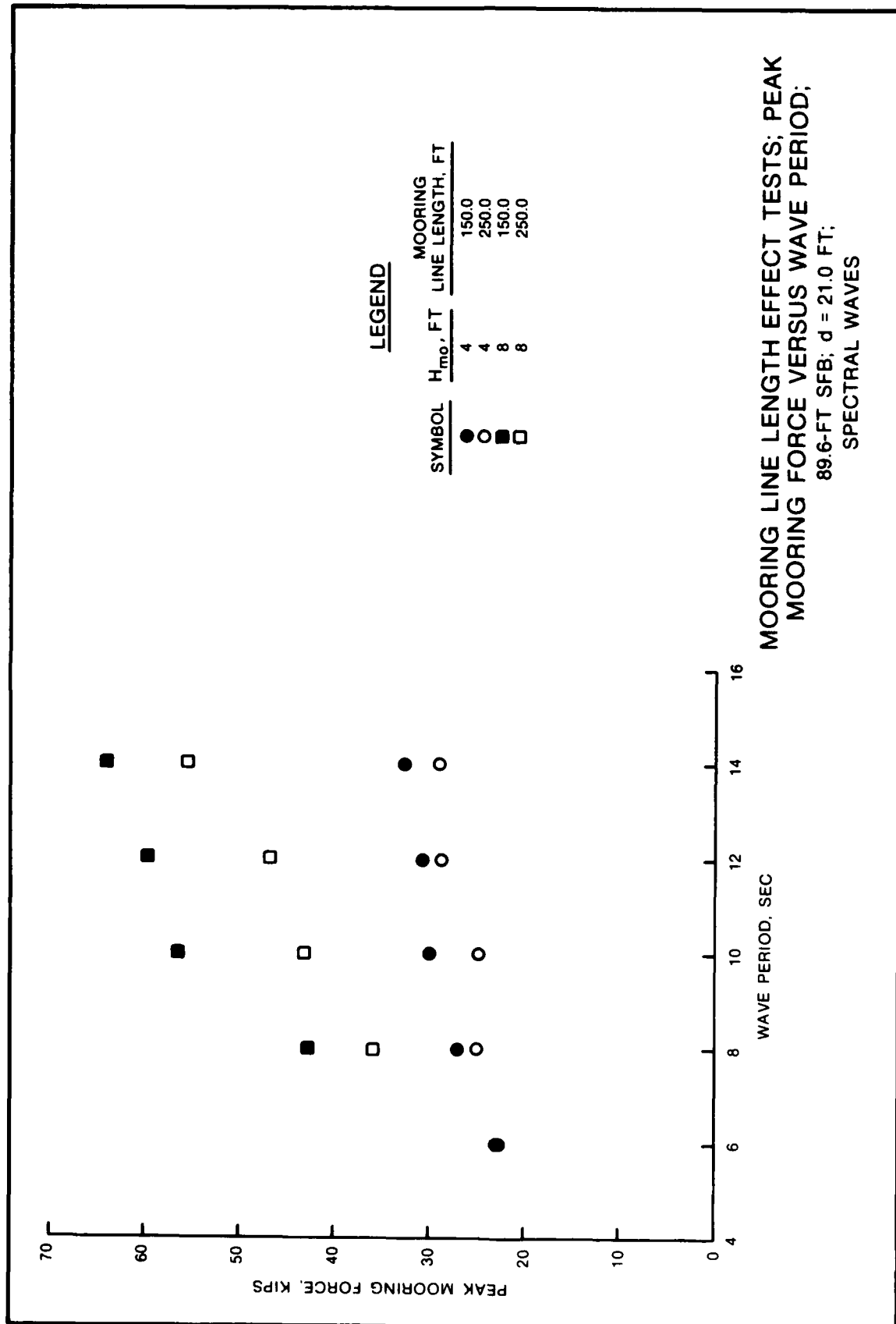

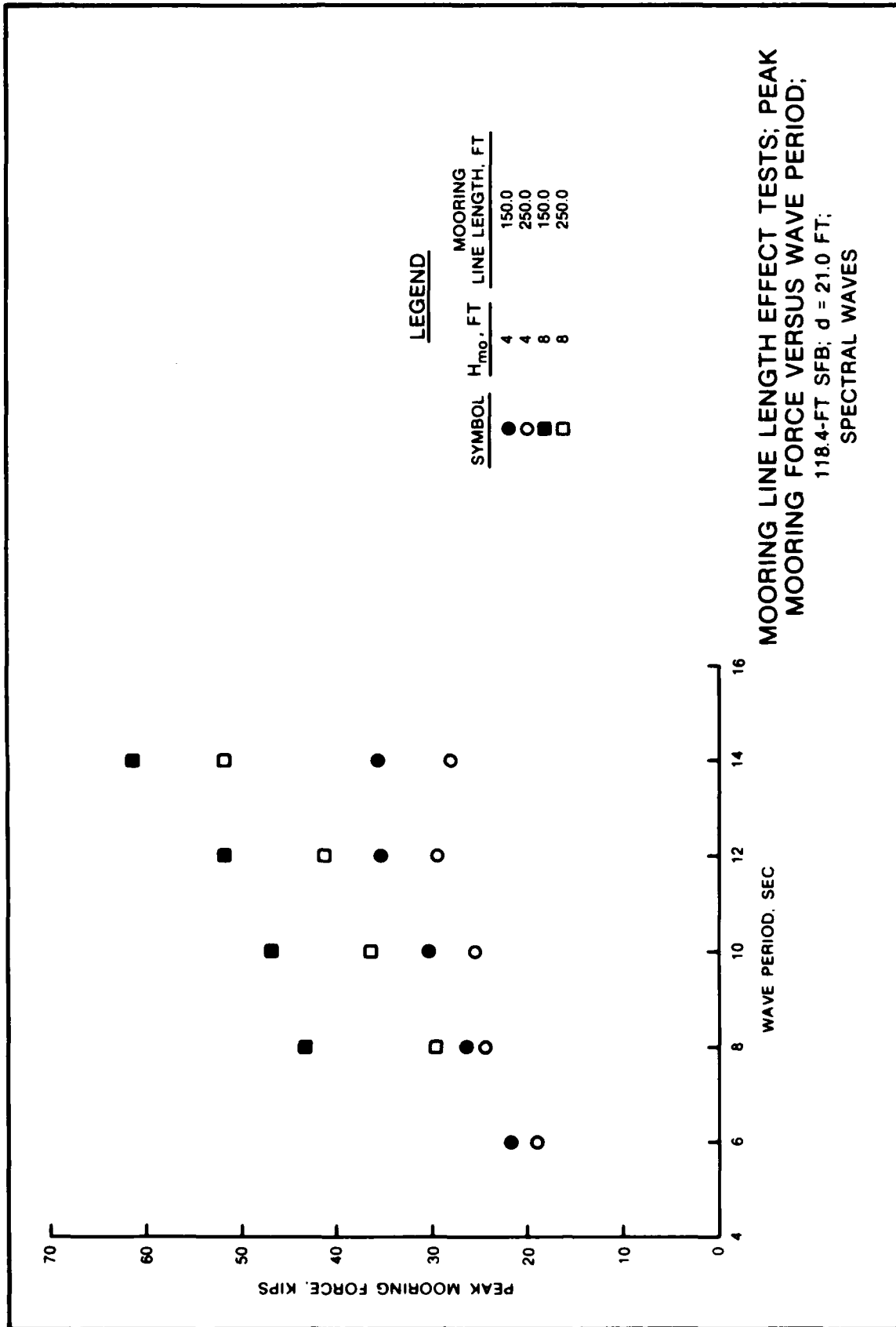

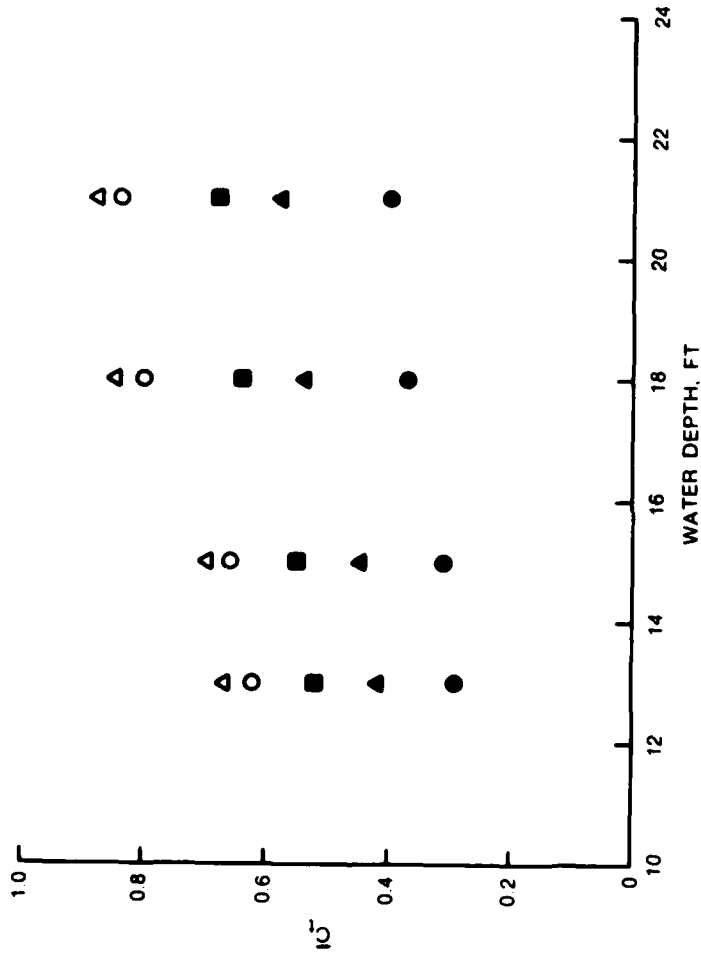

LEGEND

SYMBOL	T _p , SEC
●	6
▲	8
■	10
○	12
△	14

AVERAGE COEFFICIENT OF TRANSMISSION
 (\bar{C}_t) VERSUS WATER DEPTH
 89.6-FT SFB; $H_{mo} = 2.0, 4.0, 6.0, \text{ AND } 8.0 \text{ FT}$

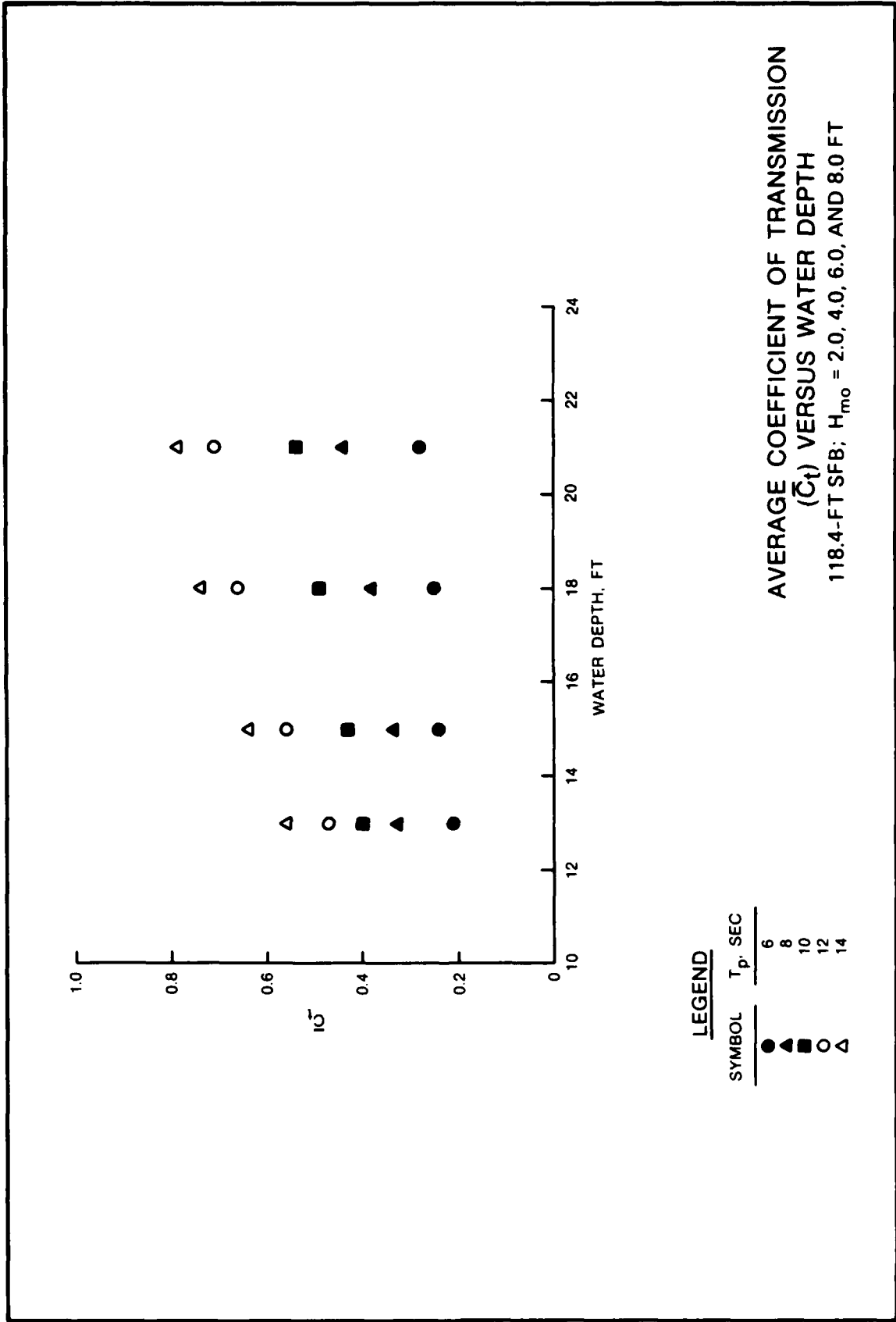

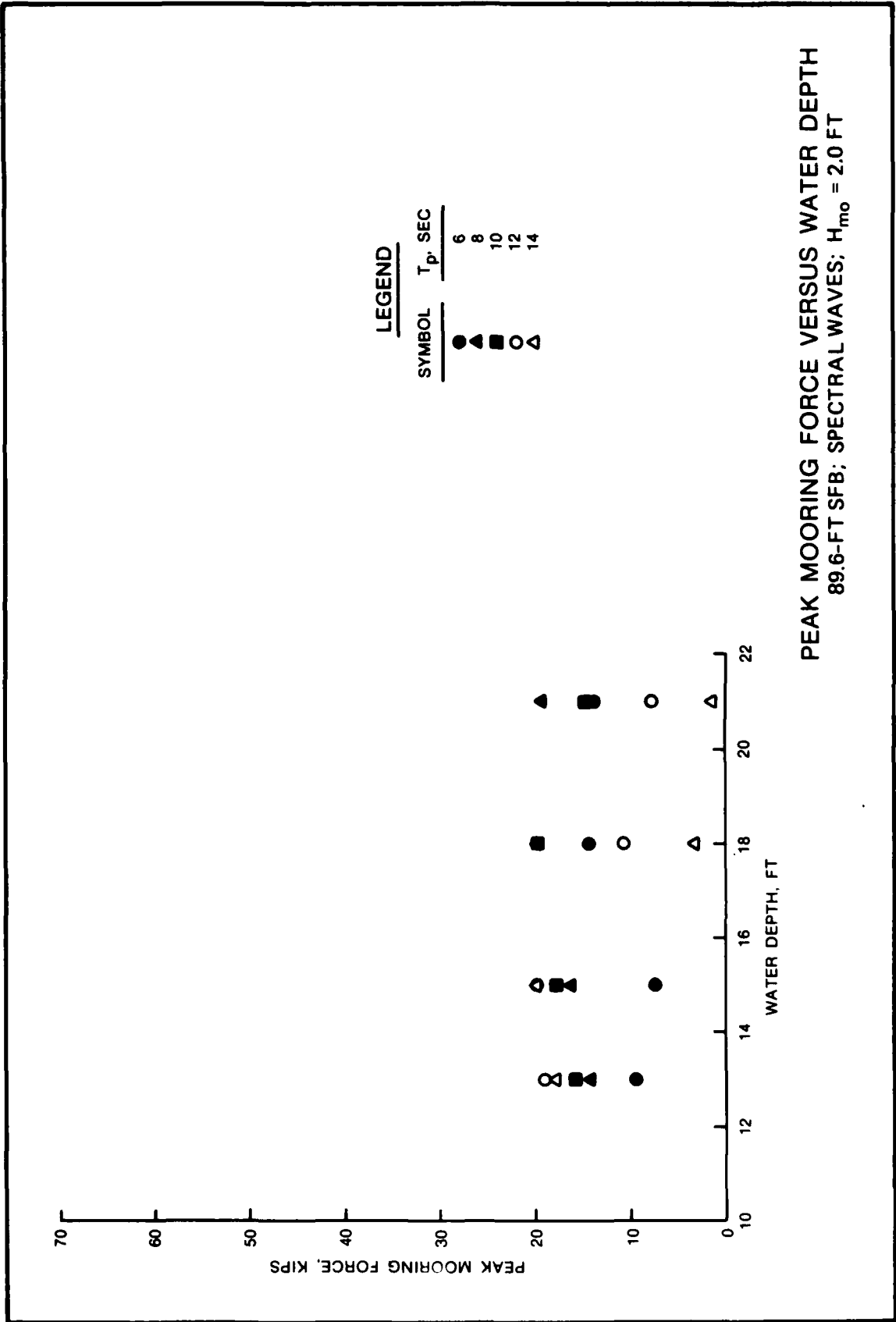

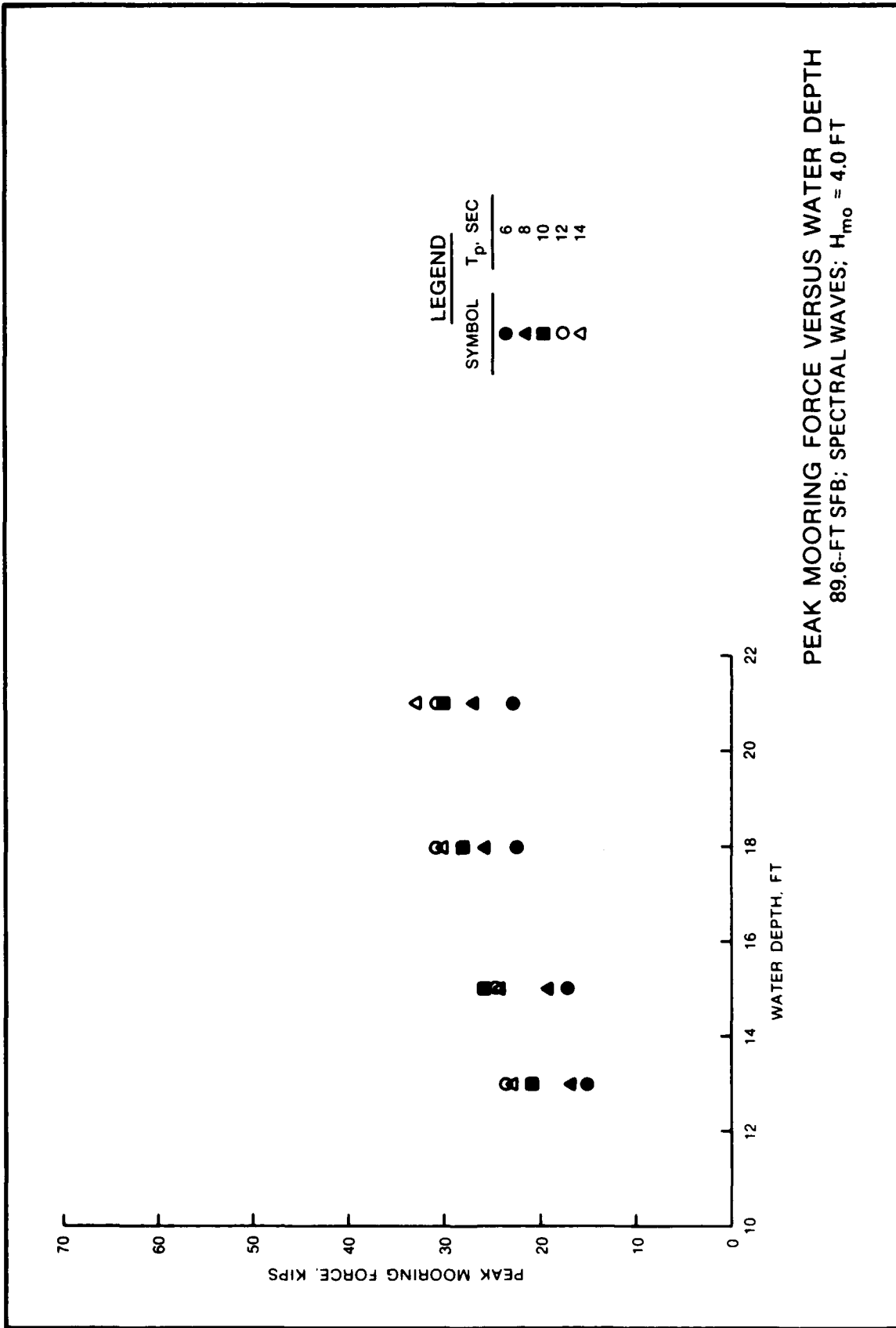

LEGEND

SYMBOL	T_p , SEC
●	6
▲	8
■	10
○	12
△	14

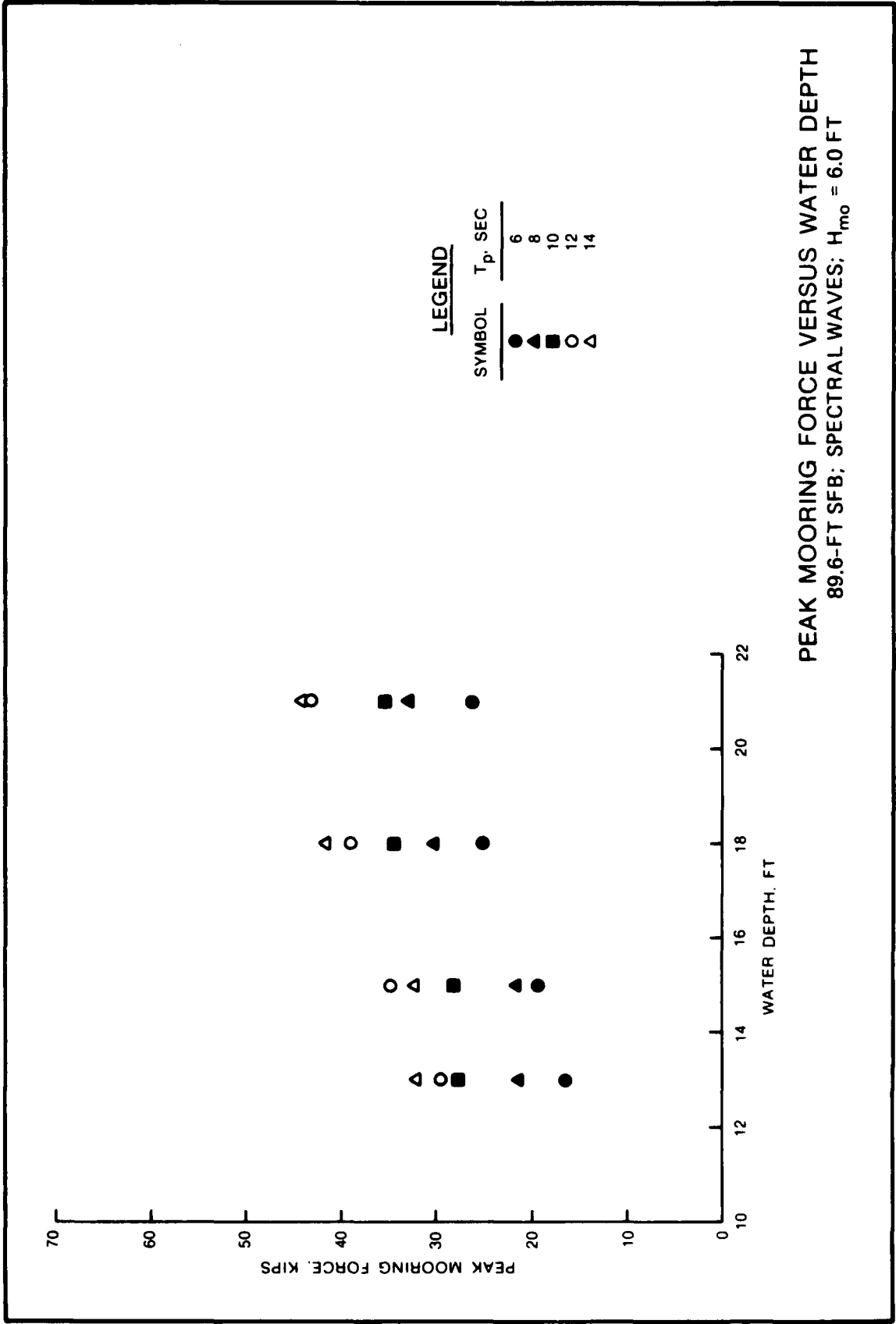

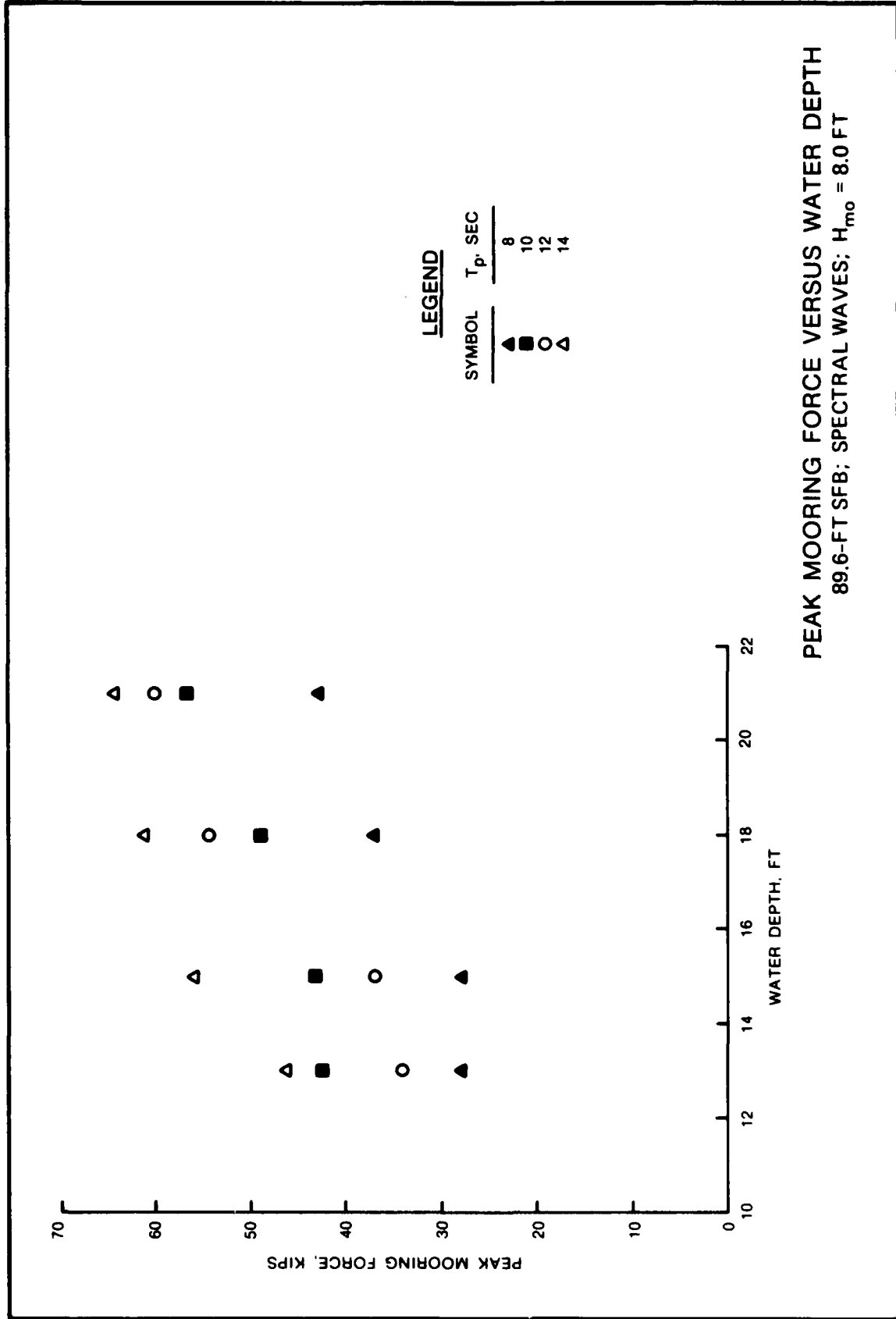

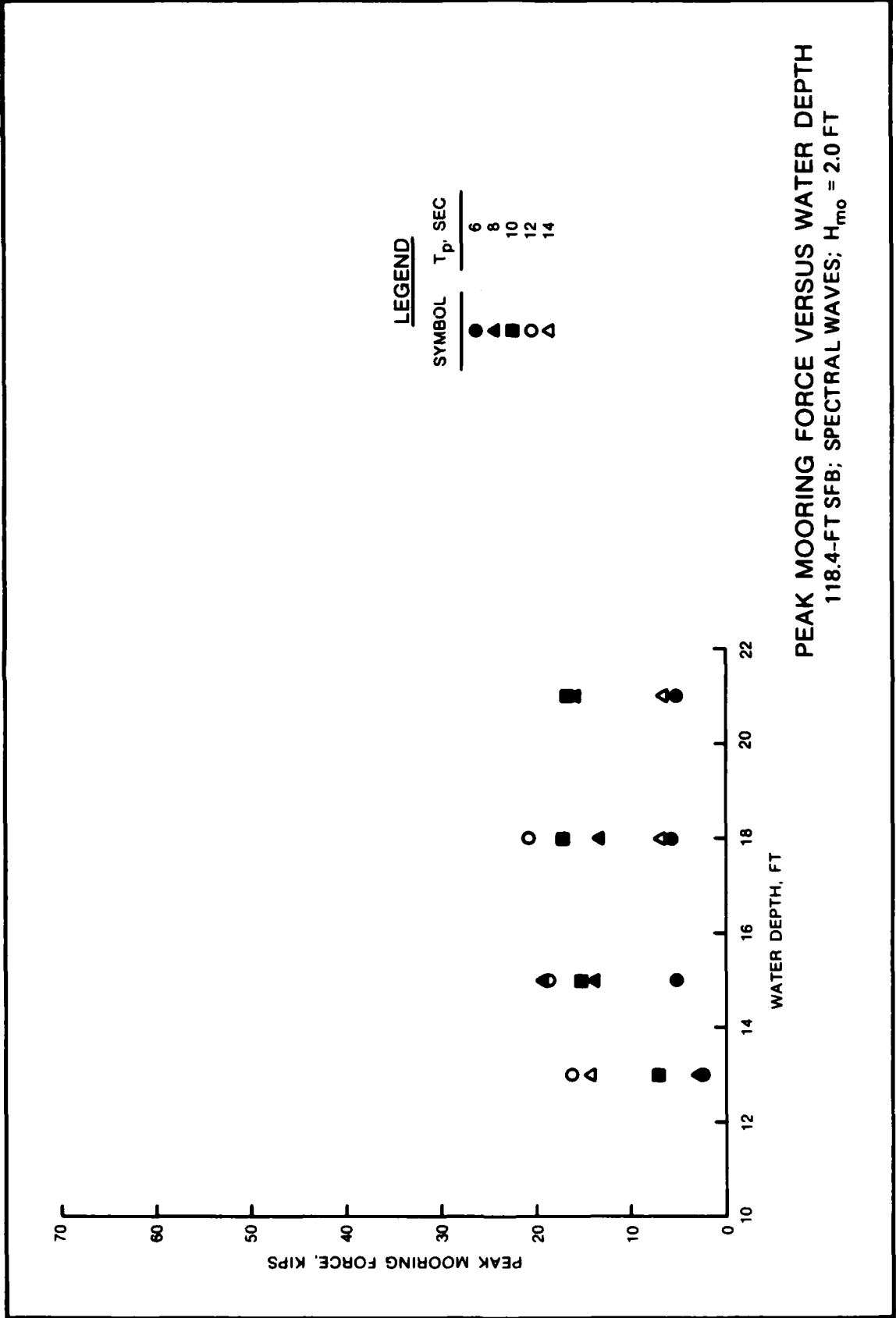

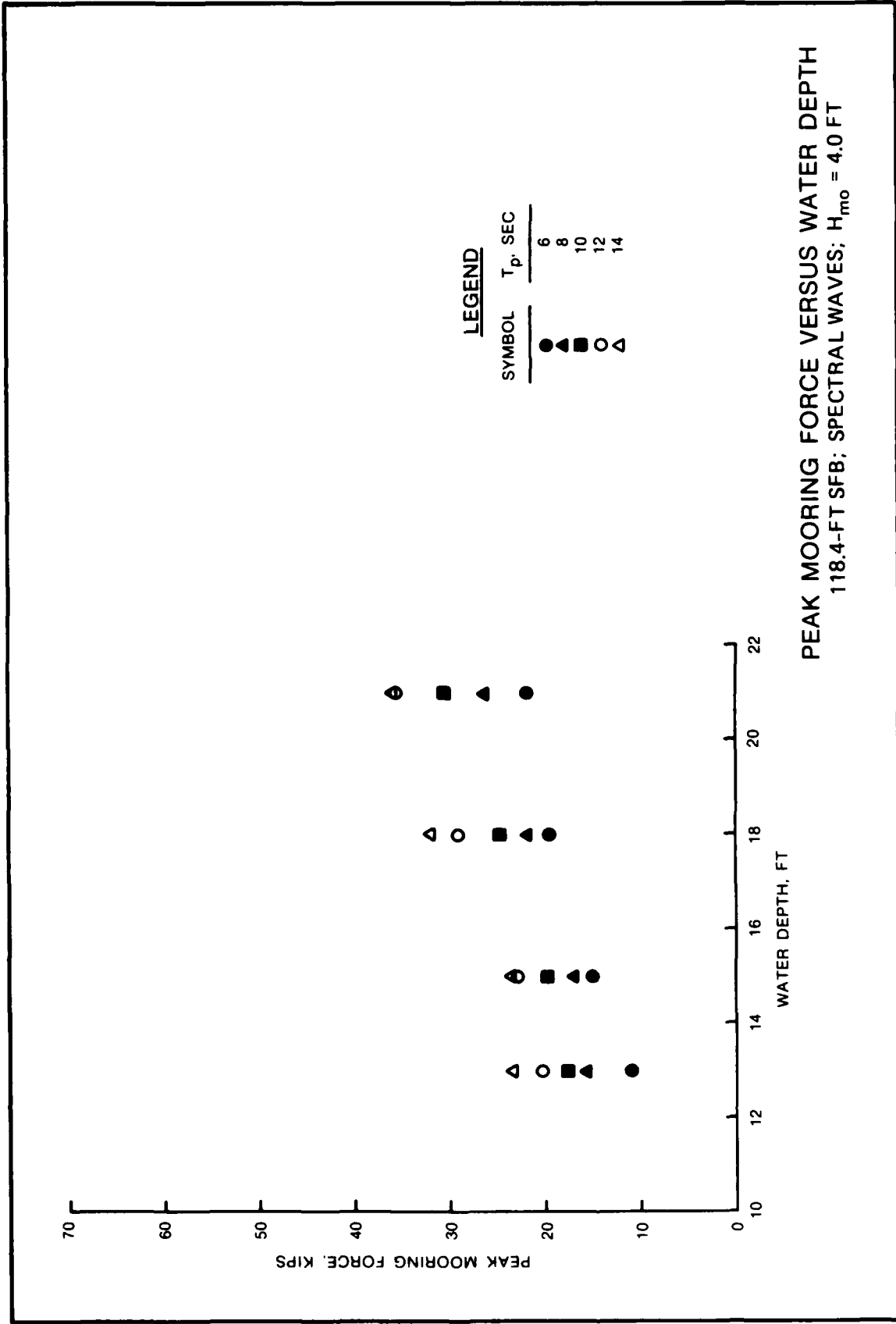

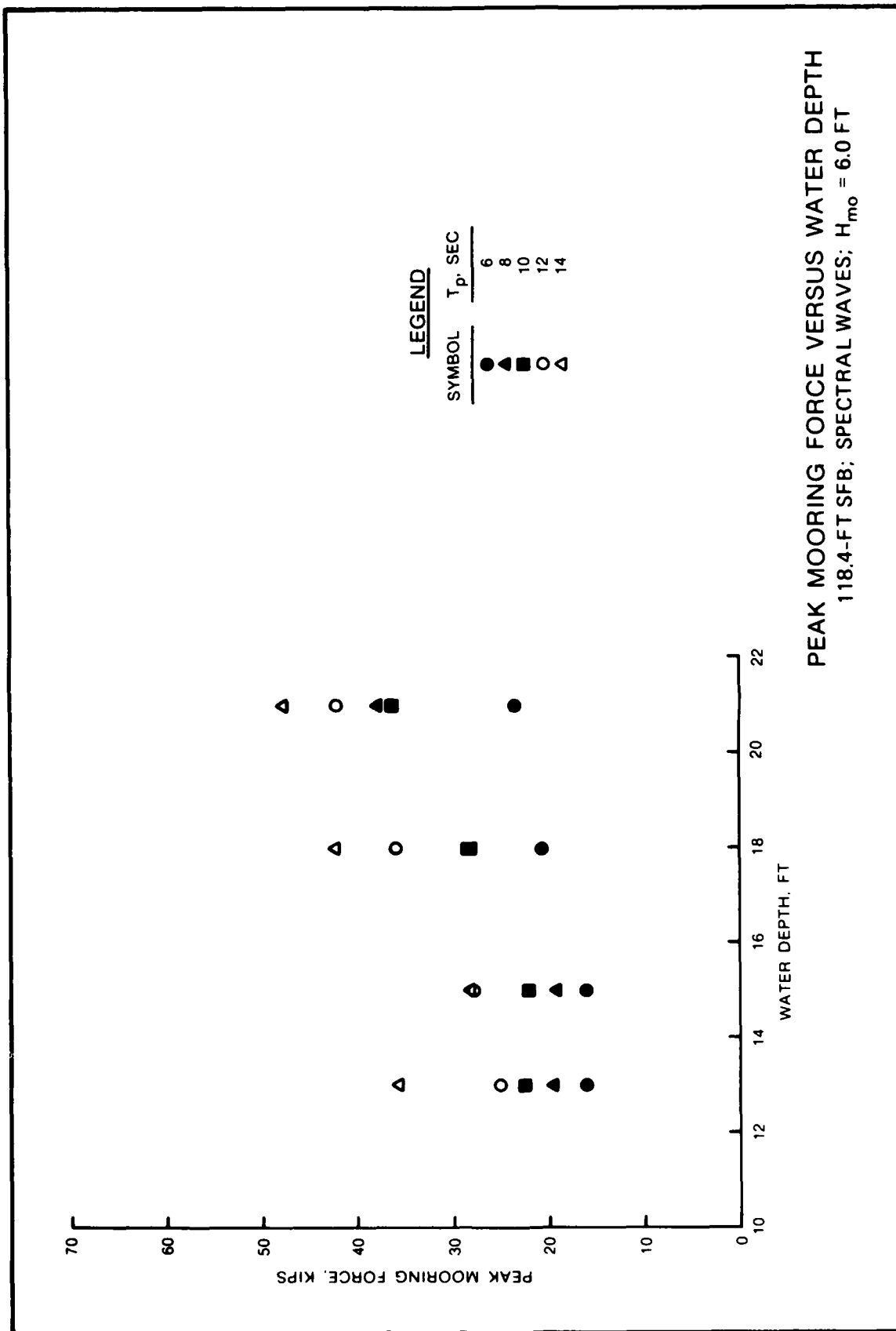

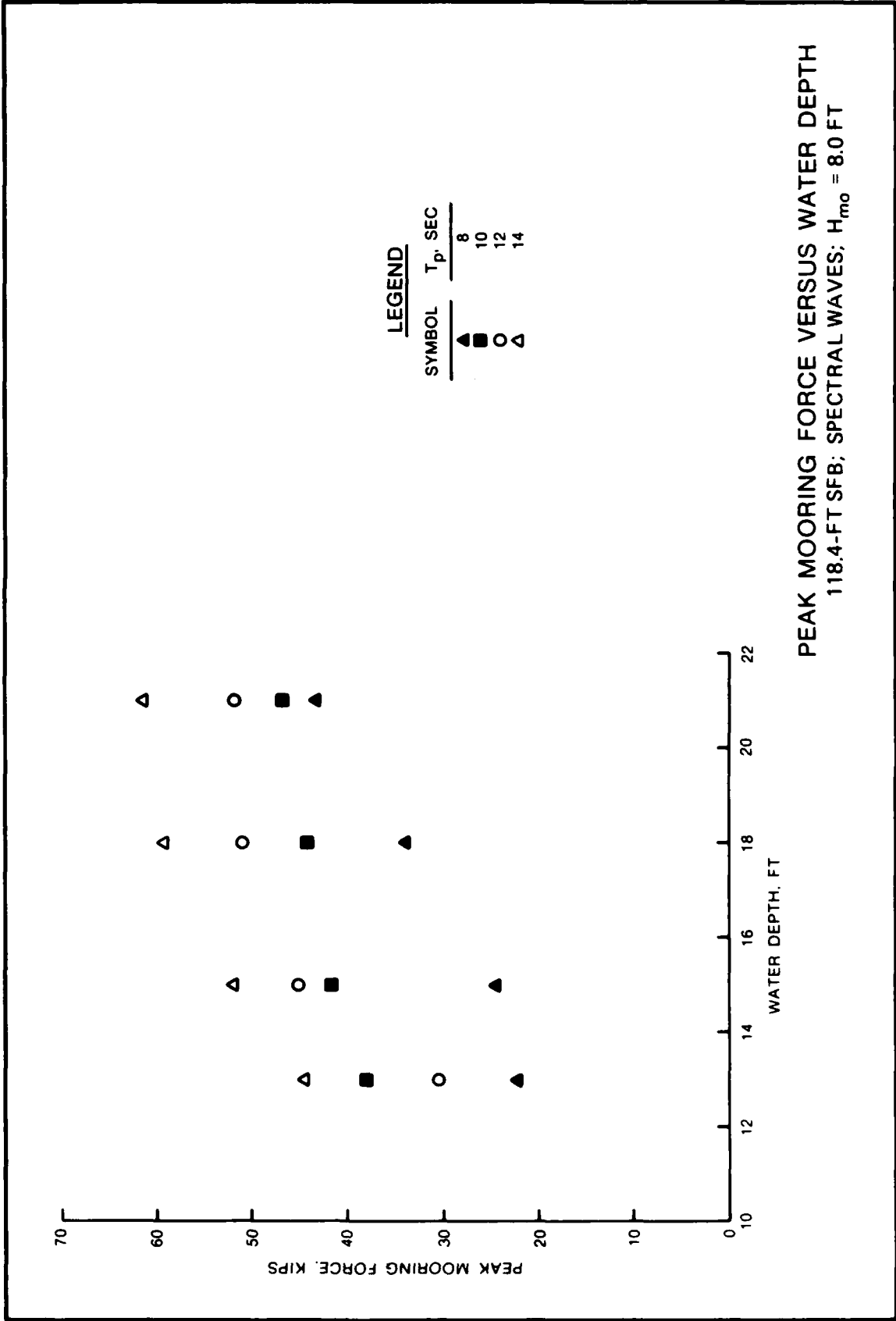

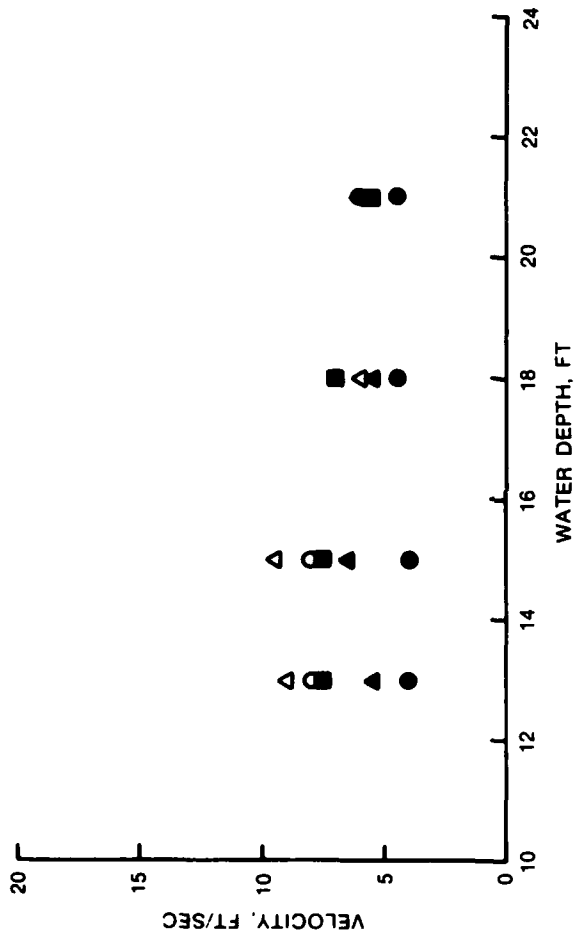

LEGEND

SYMBOL	T_p , SEC
●	6
▲	8
■	10
○	12
△	14

PEAK FLOW VELOCITY UNDER SFB
 VERSUS WATER DEPTH
 89.6-FT SFB; SPECTRAL WAVES; $H_{mo} = 4.0$ FT

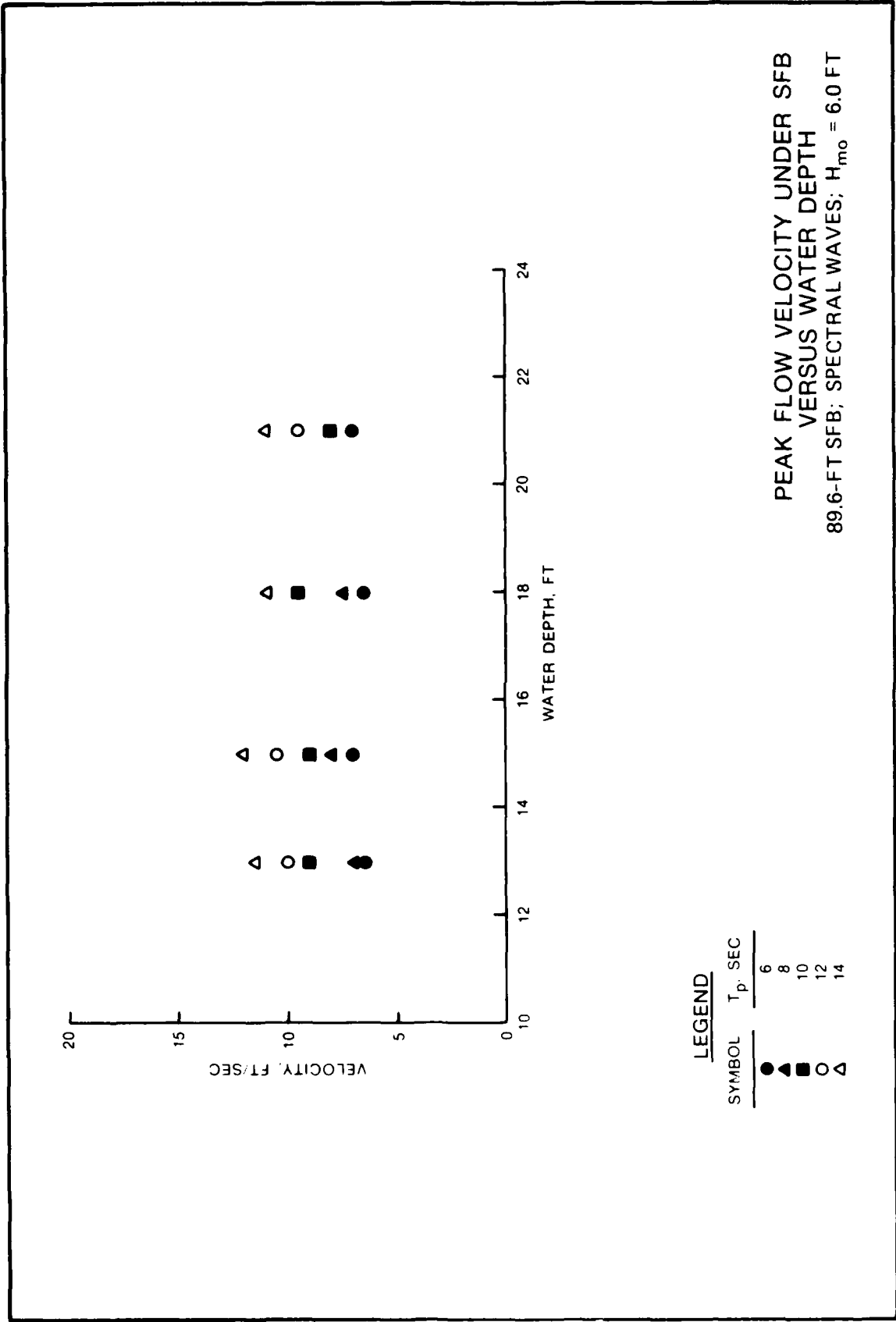

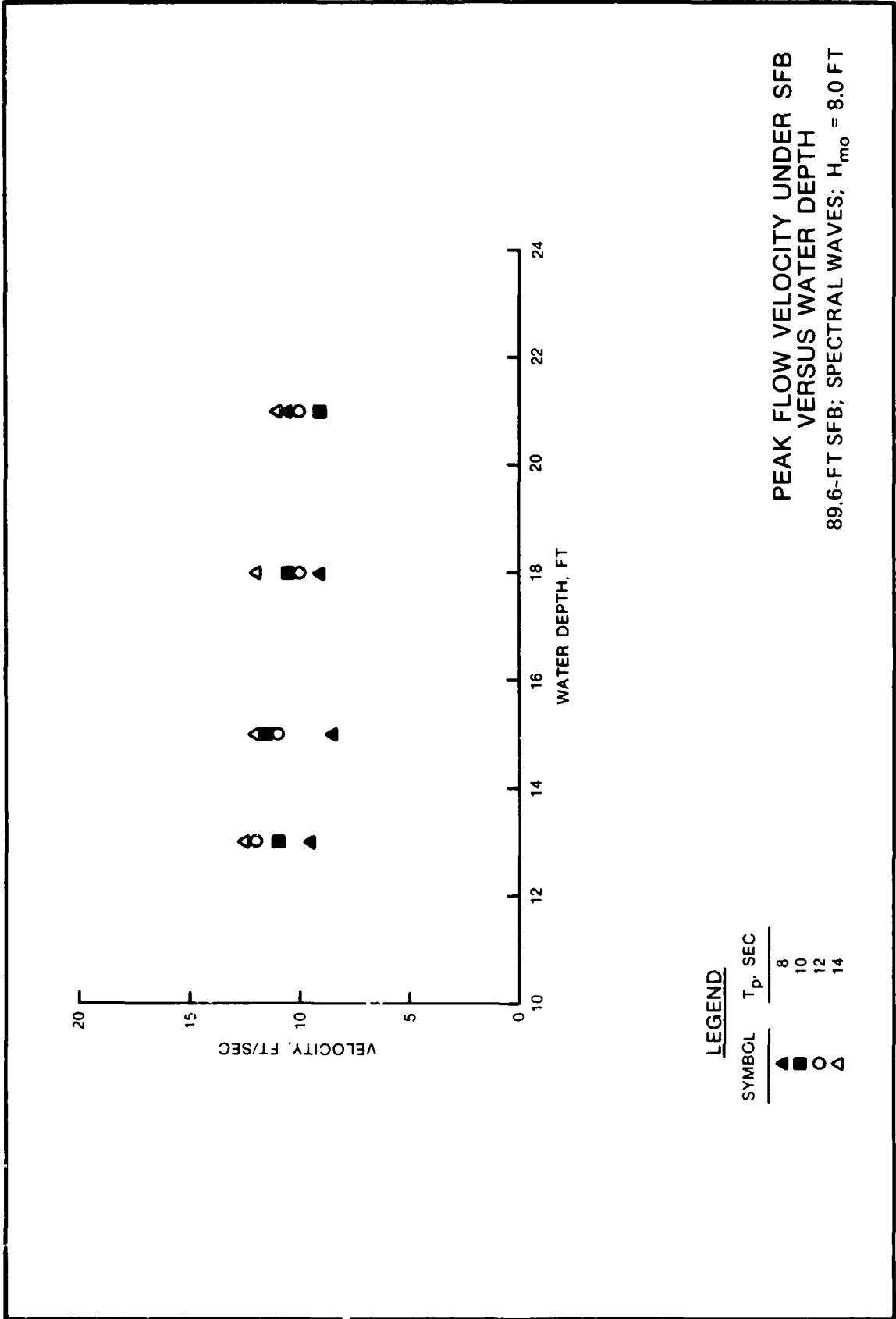

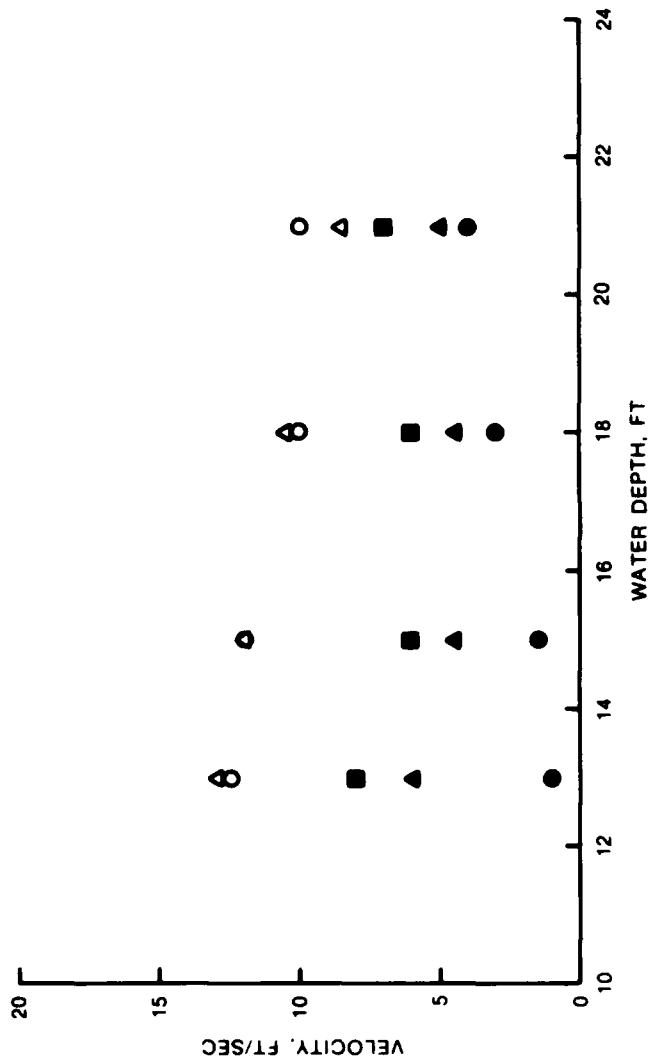

LEGEND

SYMBOL	T_p , SEC
●	6
▲	8
■	10
○	12
△	14

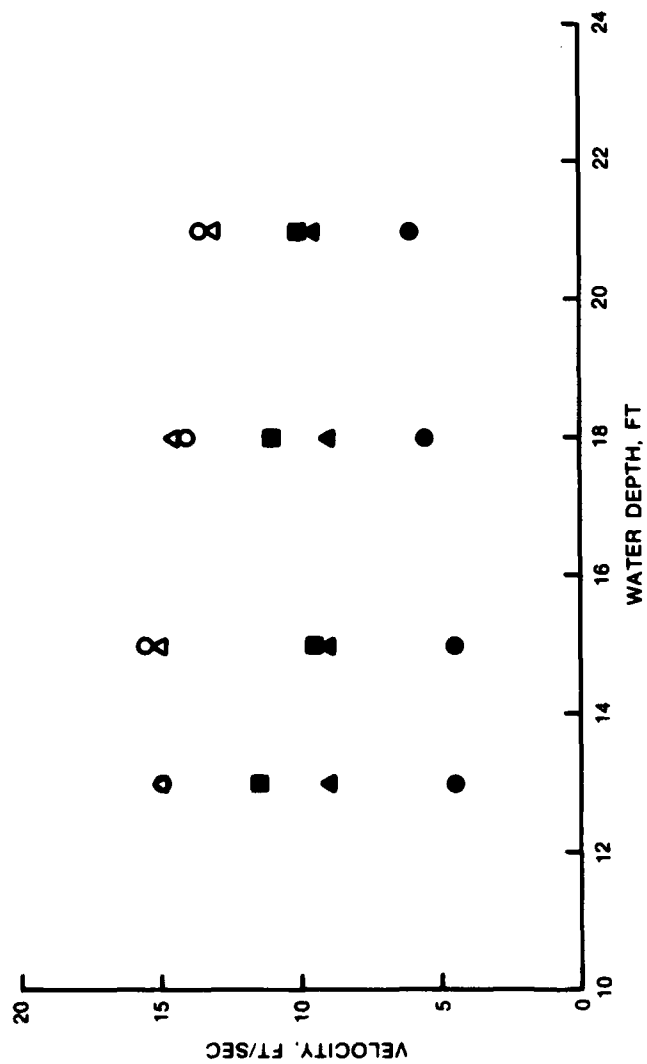

LEGEND

SYMBOL	T _p , SEC
●	6
▲	8
■	10
○	12
△	14

PEAK FLOW VELOCITY UNDER SFB
 VERSUS WATER DEPTH
 118.4-FT SFB; SPECTRAL WAVES; H_{mo} = 6.0 FT

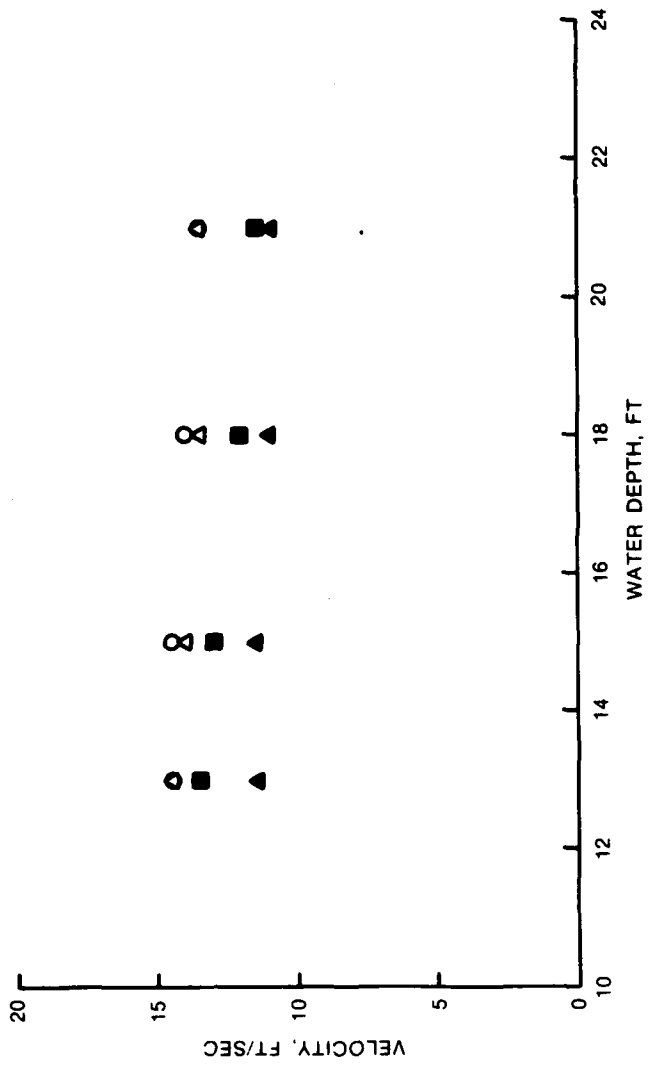

LEGEND

SYMBOL	T_p , SEC
▲	8
■	10
○	12
◇	14

PEAK FLOW VELOCITY UNDER SFB
 VERSUS WATER DEPTH
 118.4-FT SFB; SPECTRAL WAVES; $H_{mo} = 8.0$ FT

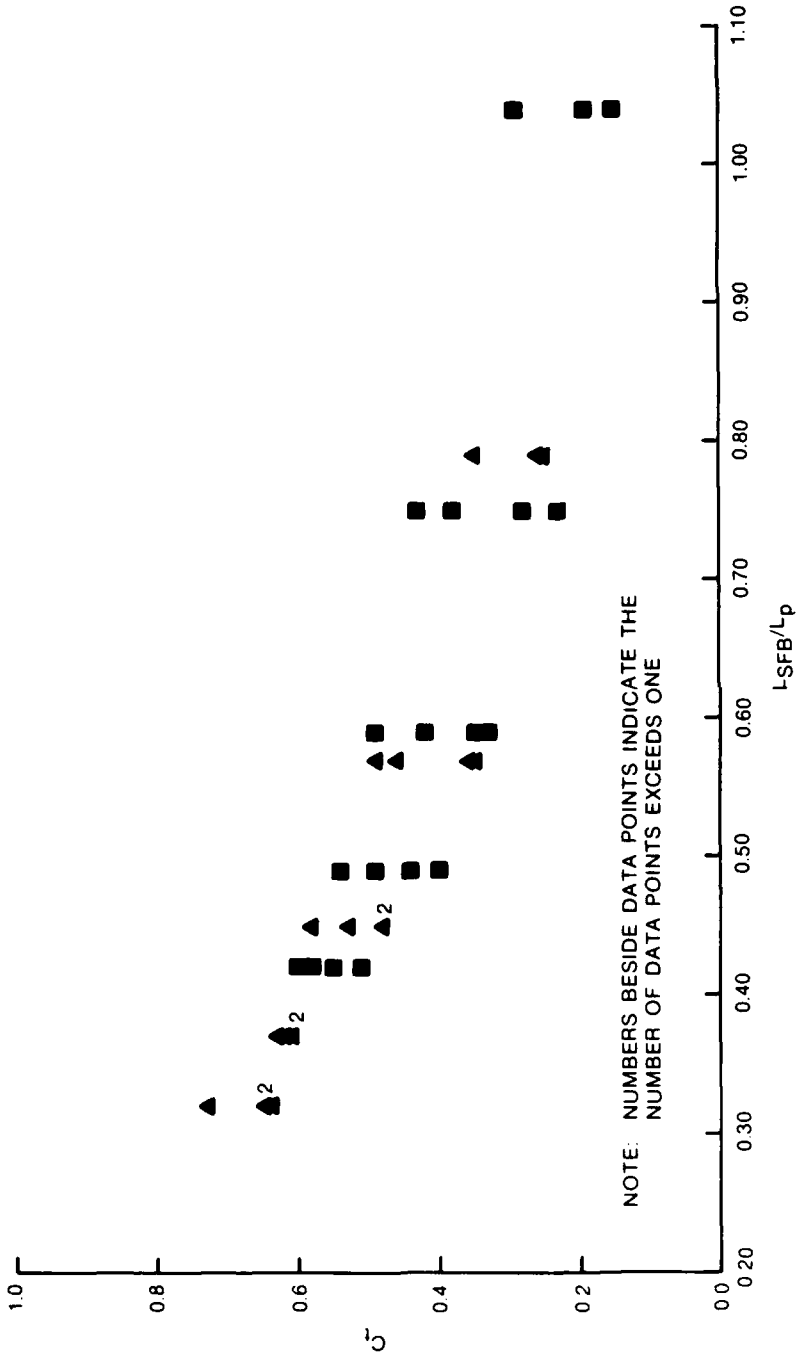

NOTE: NUMBERS BESIDE DATA POINTS INDICATE THE NUMBER OF DATA POINTS EXCEEDS ONE

LEGEND

SYMBOL	SFB LENGTH, FT
▲	89.6
■	118.4

COEFFICIENT OF TRANSMISSION (C_t) VERSUS
 RELATIVE SFB LENGTH (L_{SFB}/L_p);
 $d = 13.0$ FT; SPECTRAL WAVES

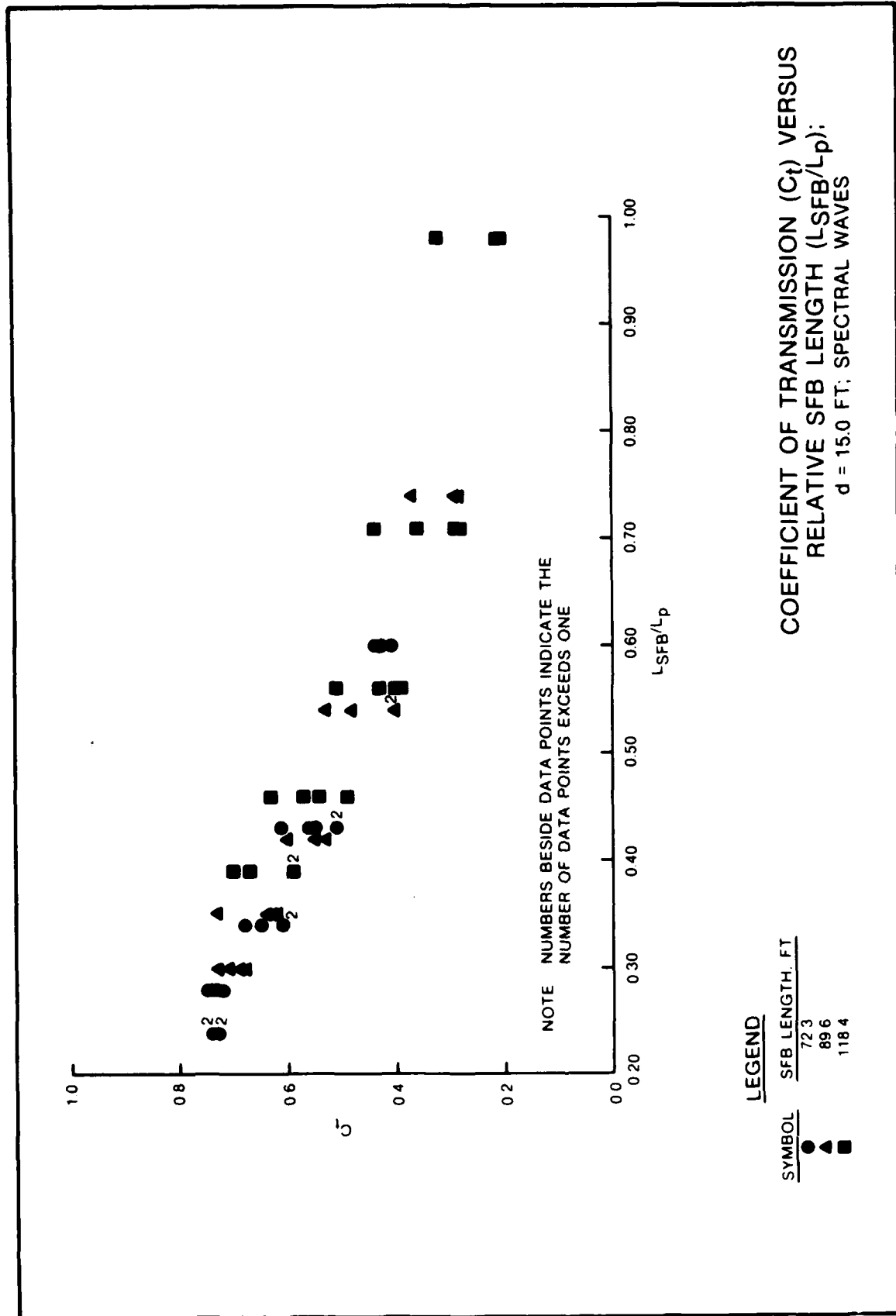

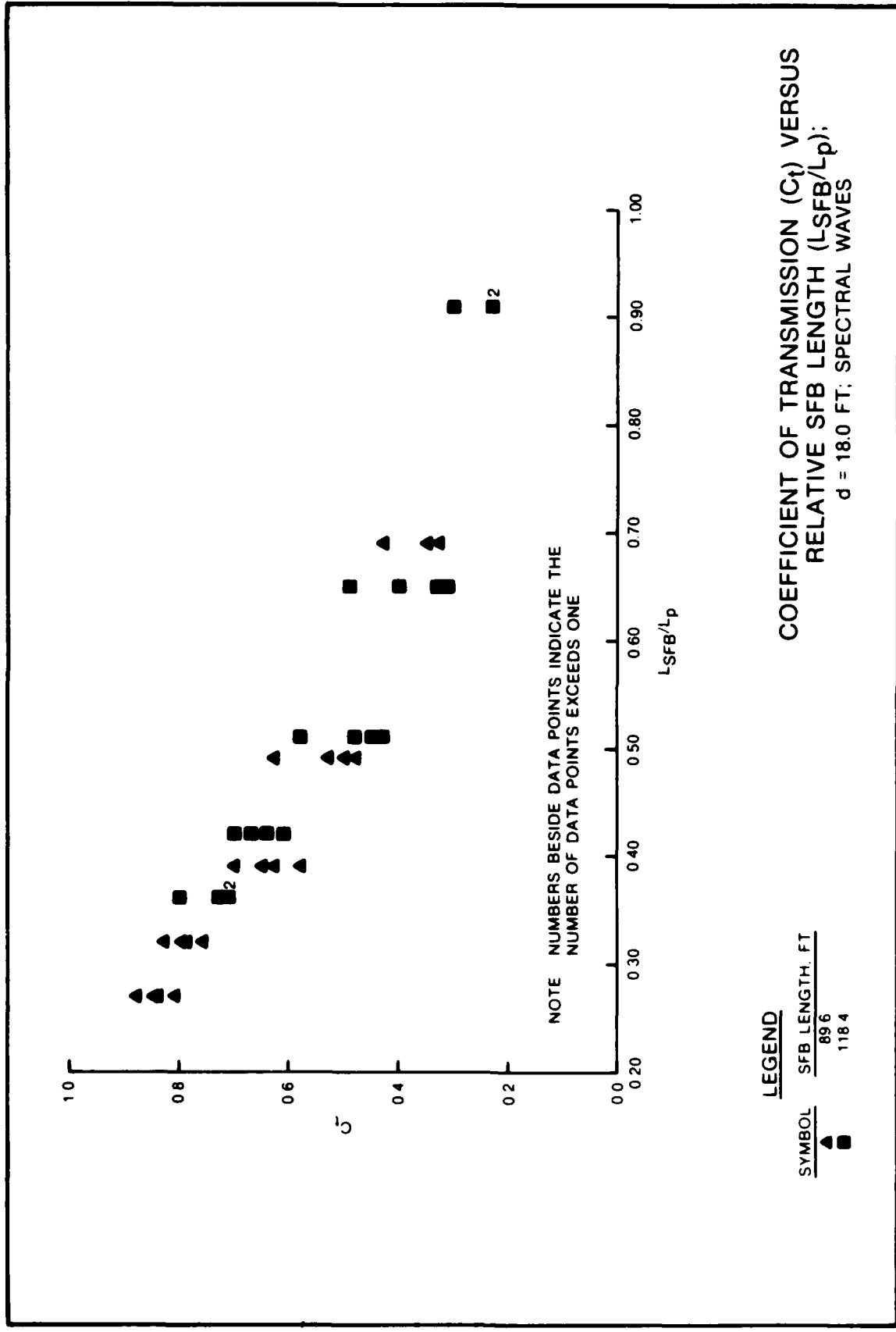

COEFFICIENT OF TRANSMISSION (C_t) VERSUS
RELATIVE SFB LENGTH (L-SFB/L_p):
d = 18.0 FT; SPECTRAL WAVES

LEGEND

SYMBOL	SFB LENGTH, FT
▲	896
■	118.4

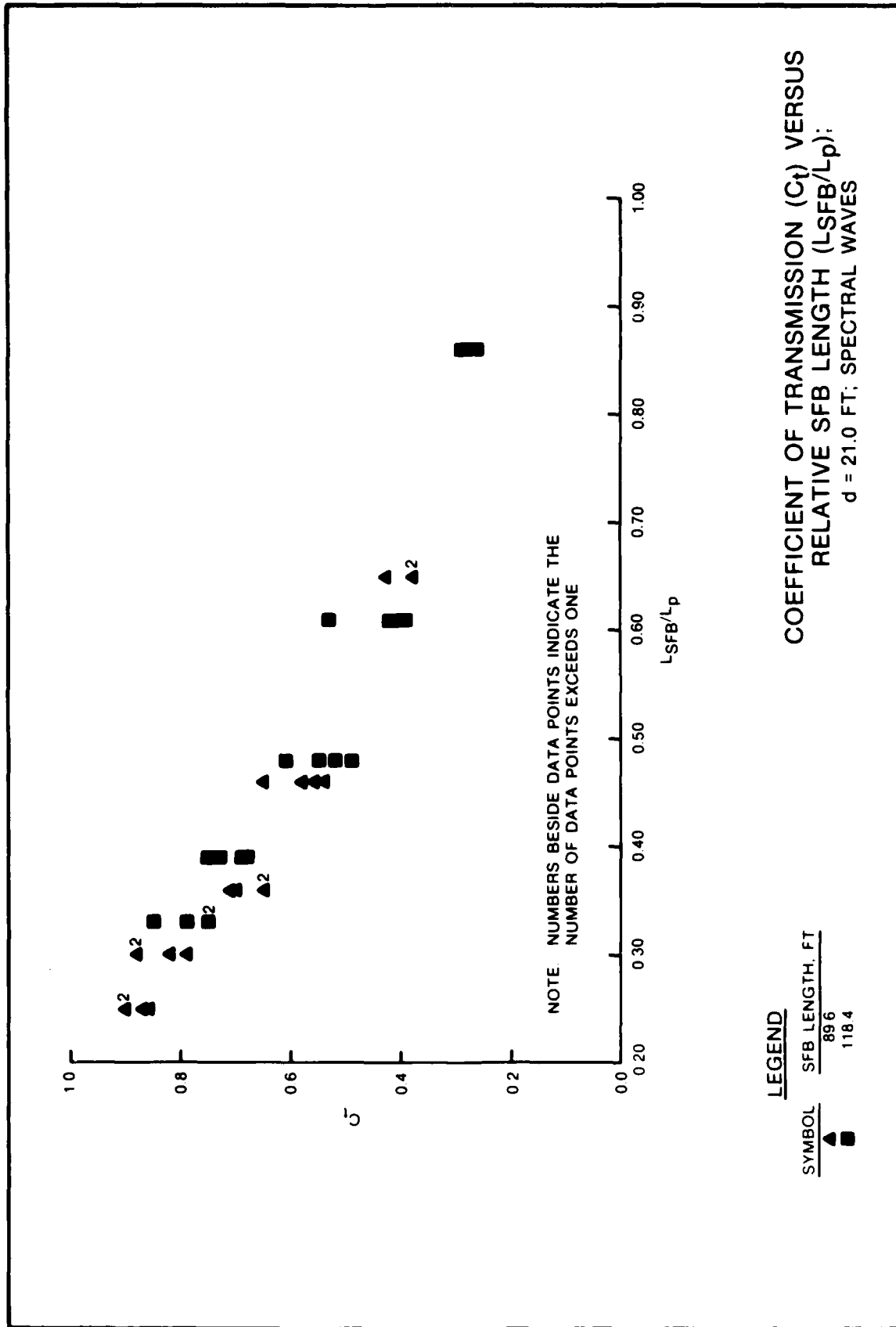

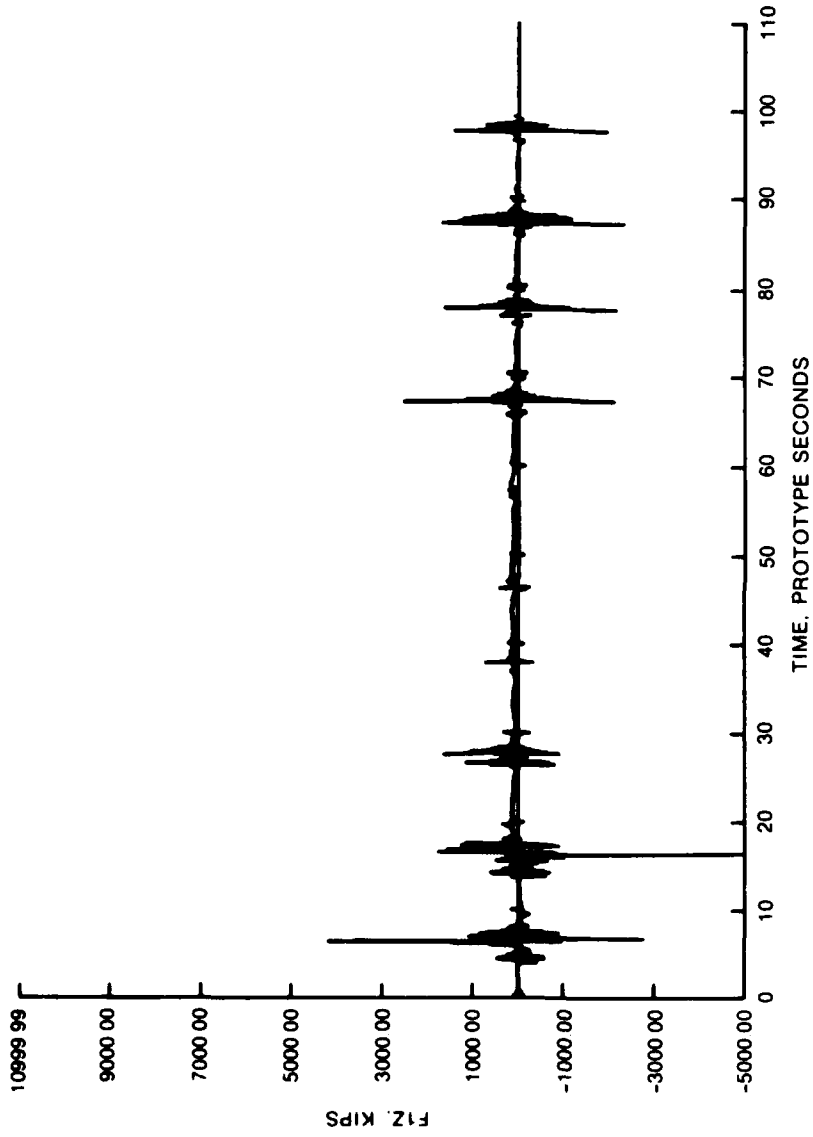

F1Z VERSUS TIME
FOR SIDE-CONNECTOR
TEST 2

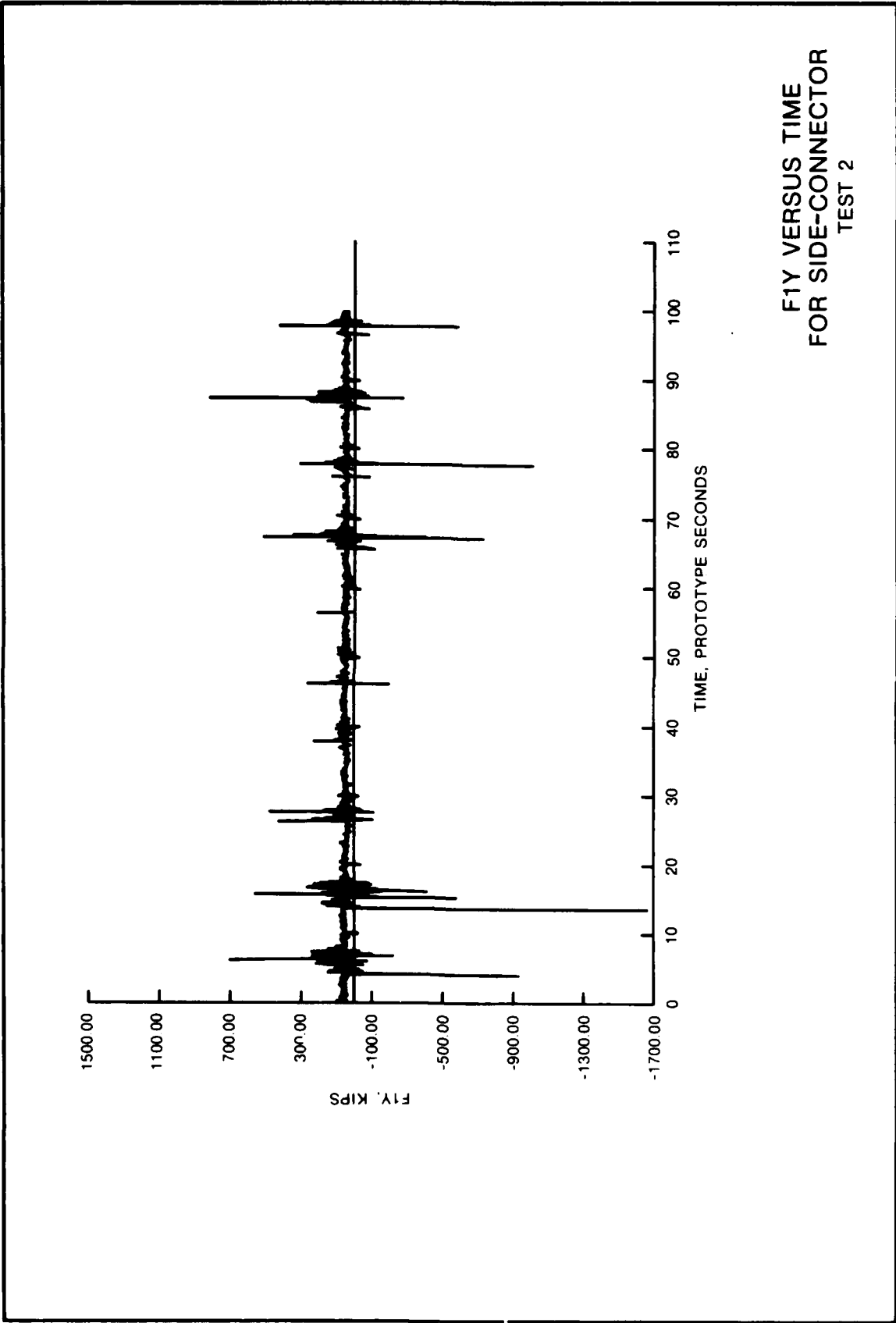

F1Y VERSUS TIME
FOR SIDE-CONNECTOR
TEST 2

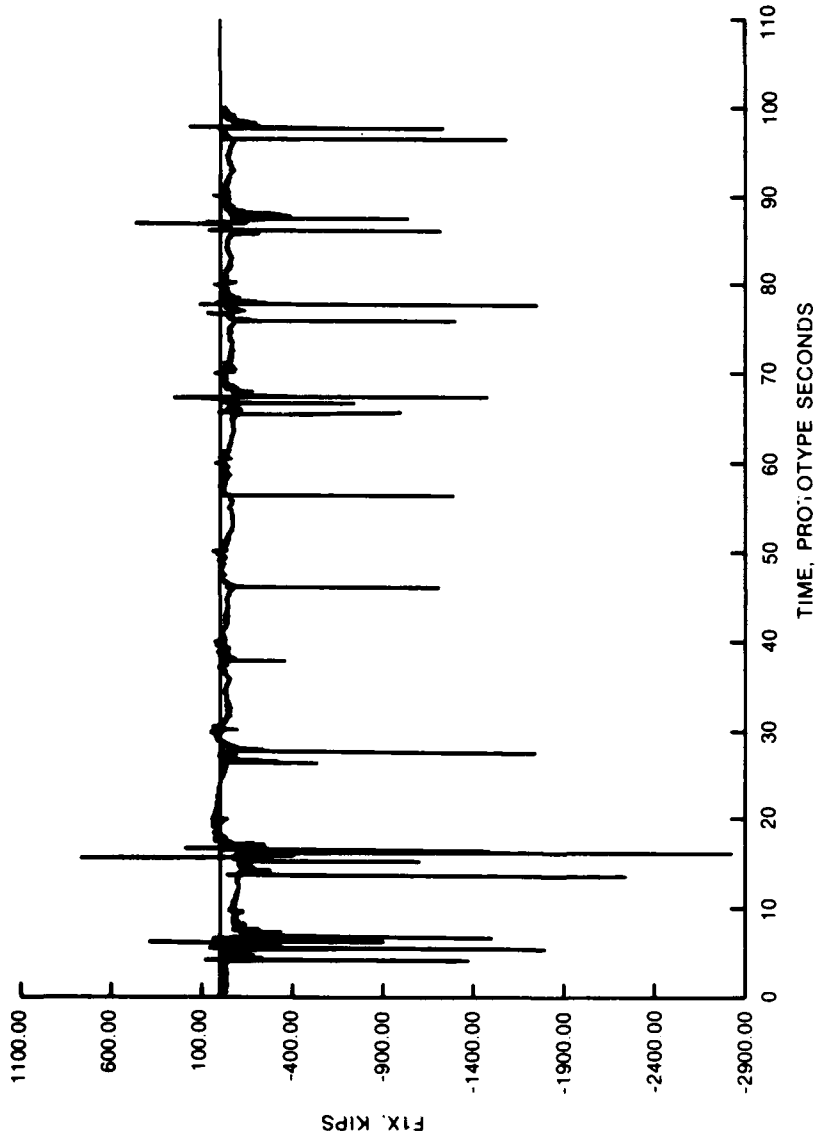

F1X VERSUS TIME
FOR SIDE-CONNECTOR
TEST 2

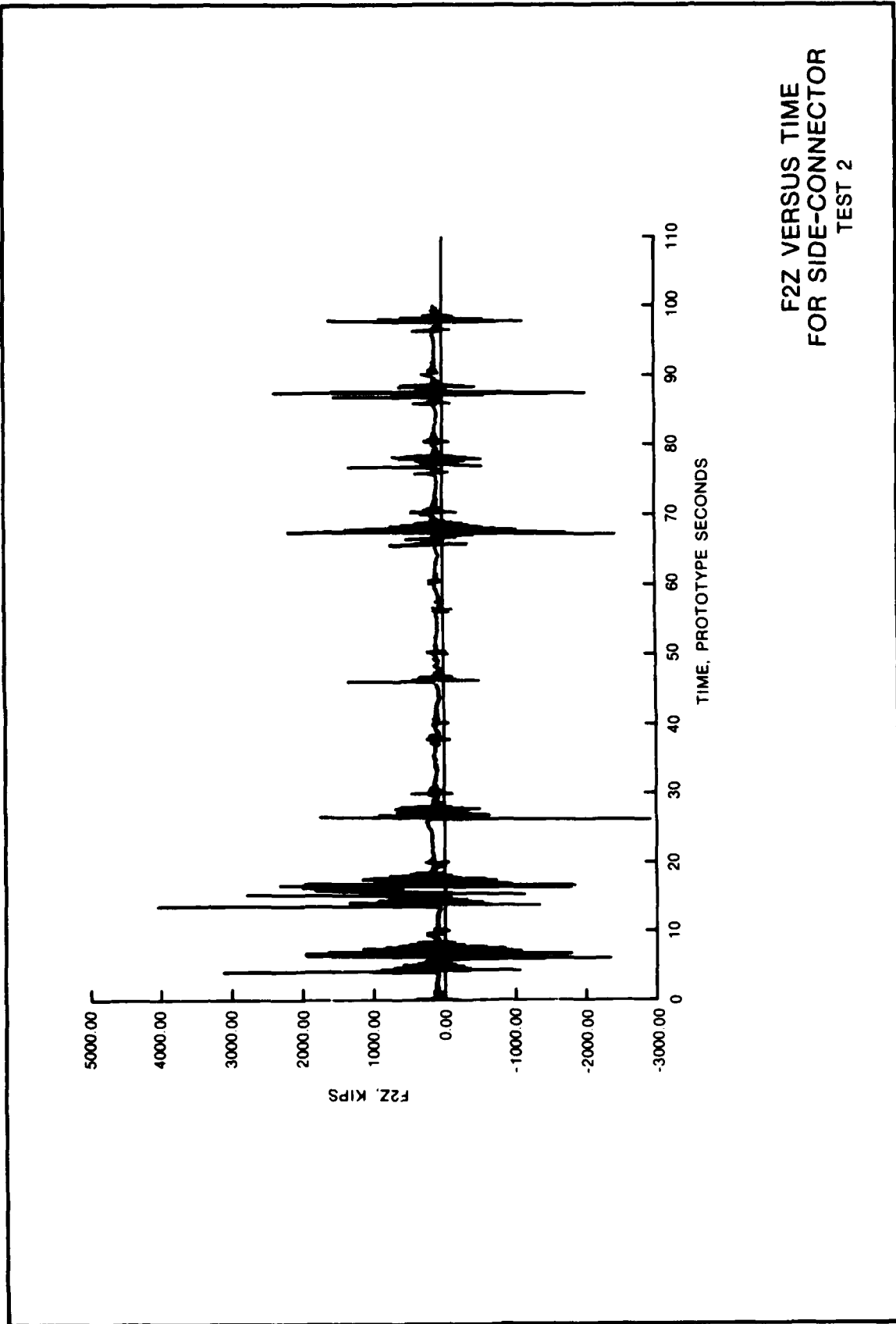

F2Z VERSUS TIME
FOR SIDE-CONNECTOR
TEST 2

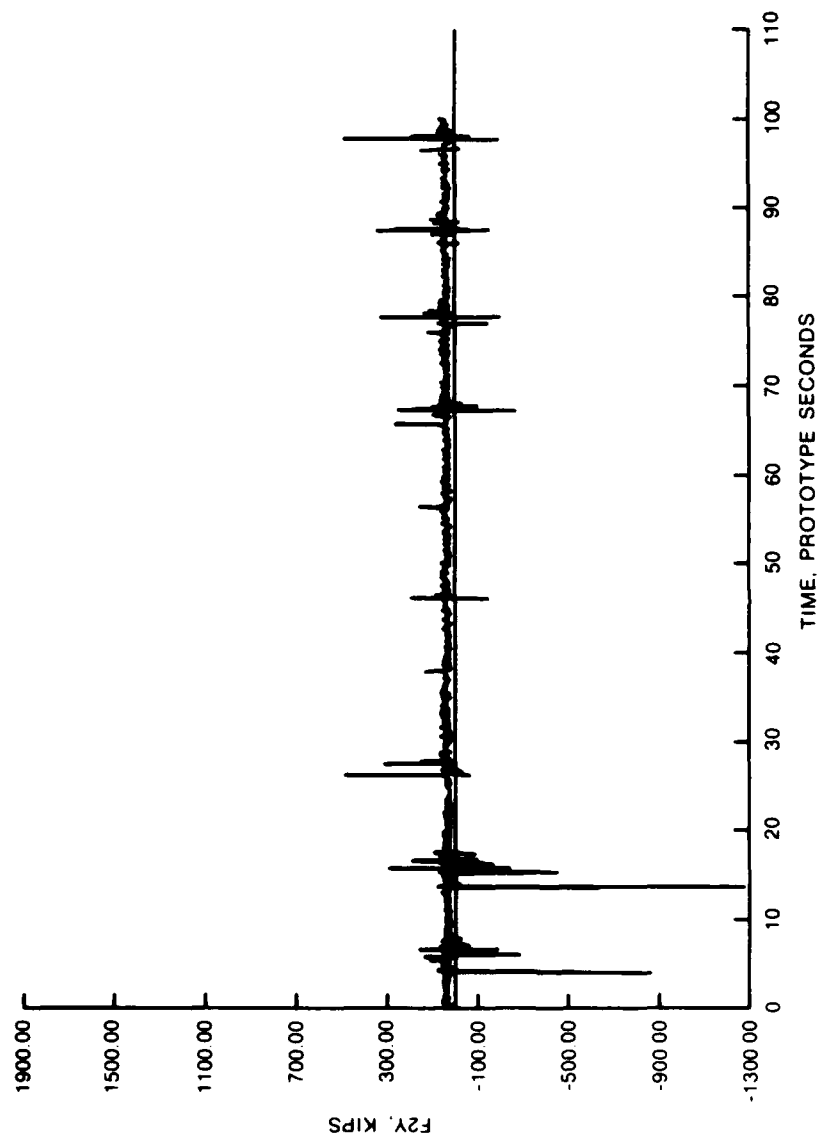

F2Y VERSUS TIME
FOR SIDE-CONNECTOR
TEST 2

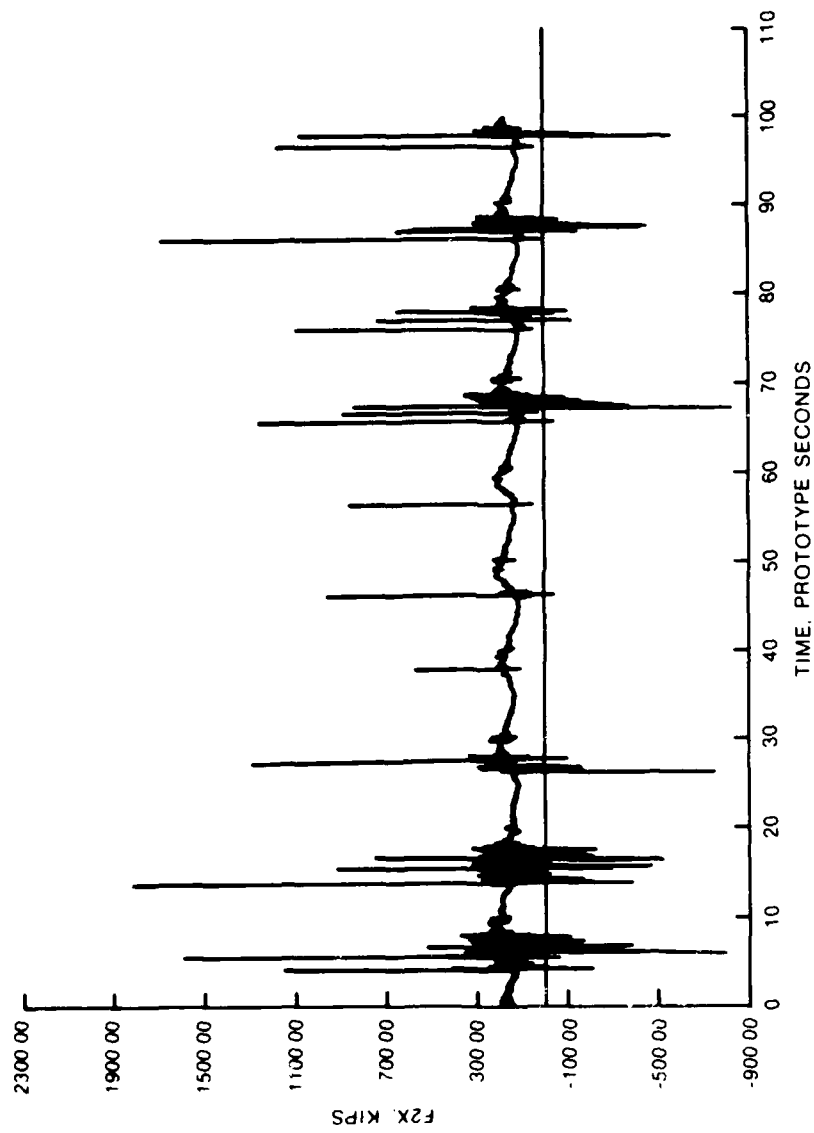

F2X VERSUS TIME
FOR SIDE-CONNECTOR
TEST 2

NO-A181 776

SLOPING FLOAT BREAKWATER STUDY OREGON INLET NORTH
CAROLINA COASTAL MODEL INVESTIGATION(U) COASTAL
ENGINEERING RESEARCH CENTER VICKSBURG MS
R D CARVER ET AL. APR 87 CERC-TR-87-5

3/3

UNCLASSIFIED

F/G 13/2

NL

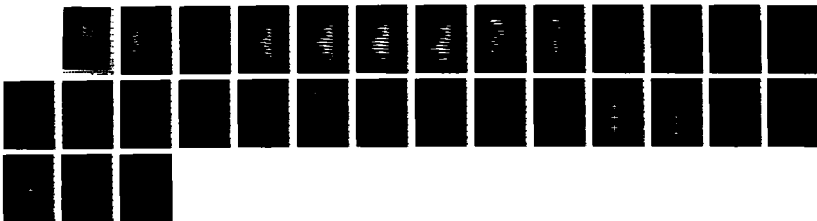

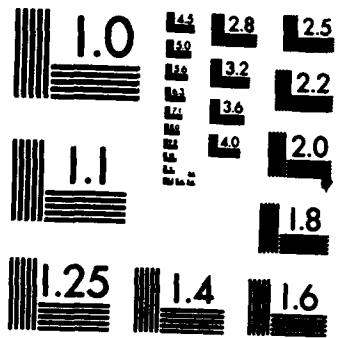

MICROCOPY RESOLUTION TEST CHART
NATIONAL BUREAU OF STANDARDS-1963-A

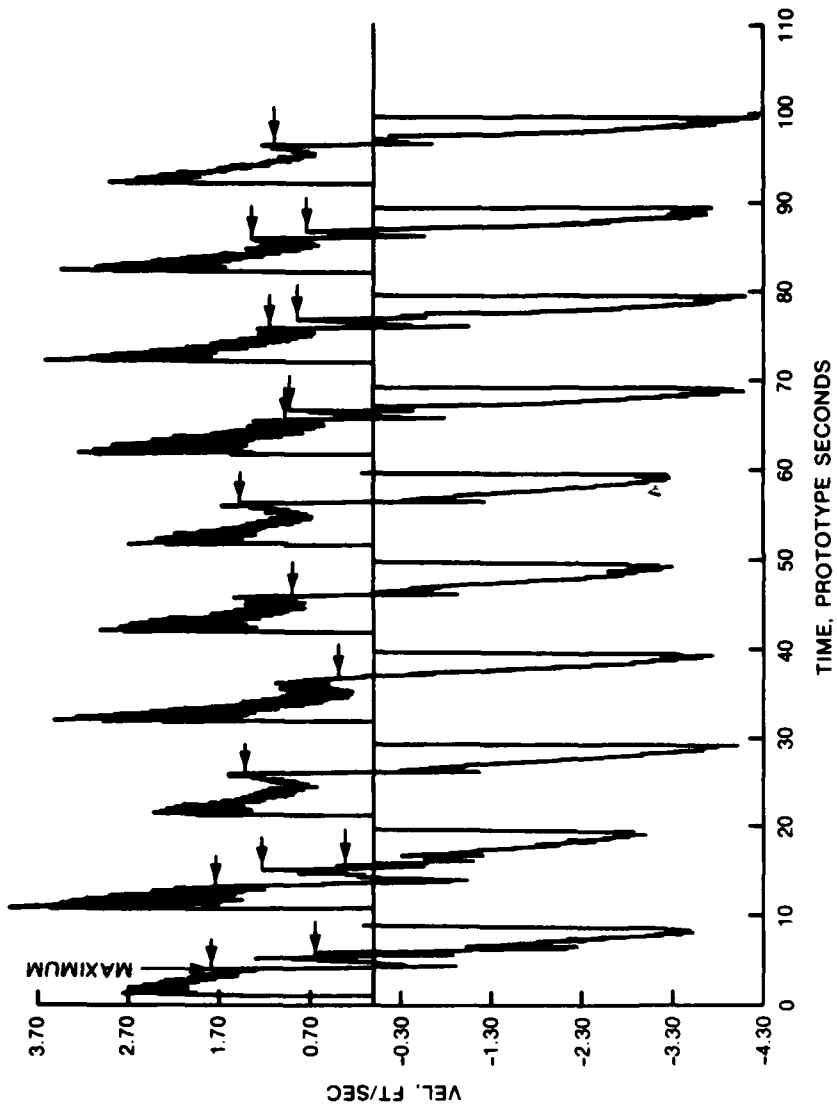

VEL VERSUS TIME
FOR SIDE-CONNECTOR
TEST 2

↓ INDICATES PROBABLE
IMPACT VELOCITIES. IT
APPEARS THAT MAXIMUM
OCCURRED AT ~2.0 TO
3.0 SEC PROTOTYPE AND
HAD A VALUE OF ~1.8
FT/SEC/PROTOTYPE.

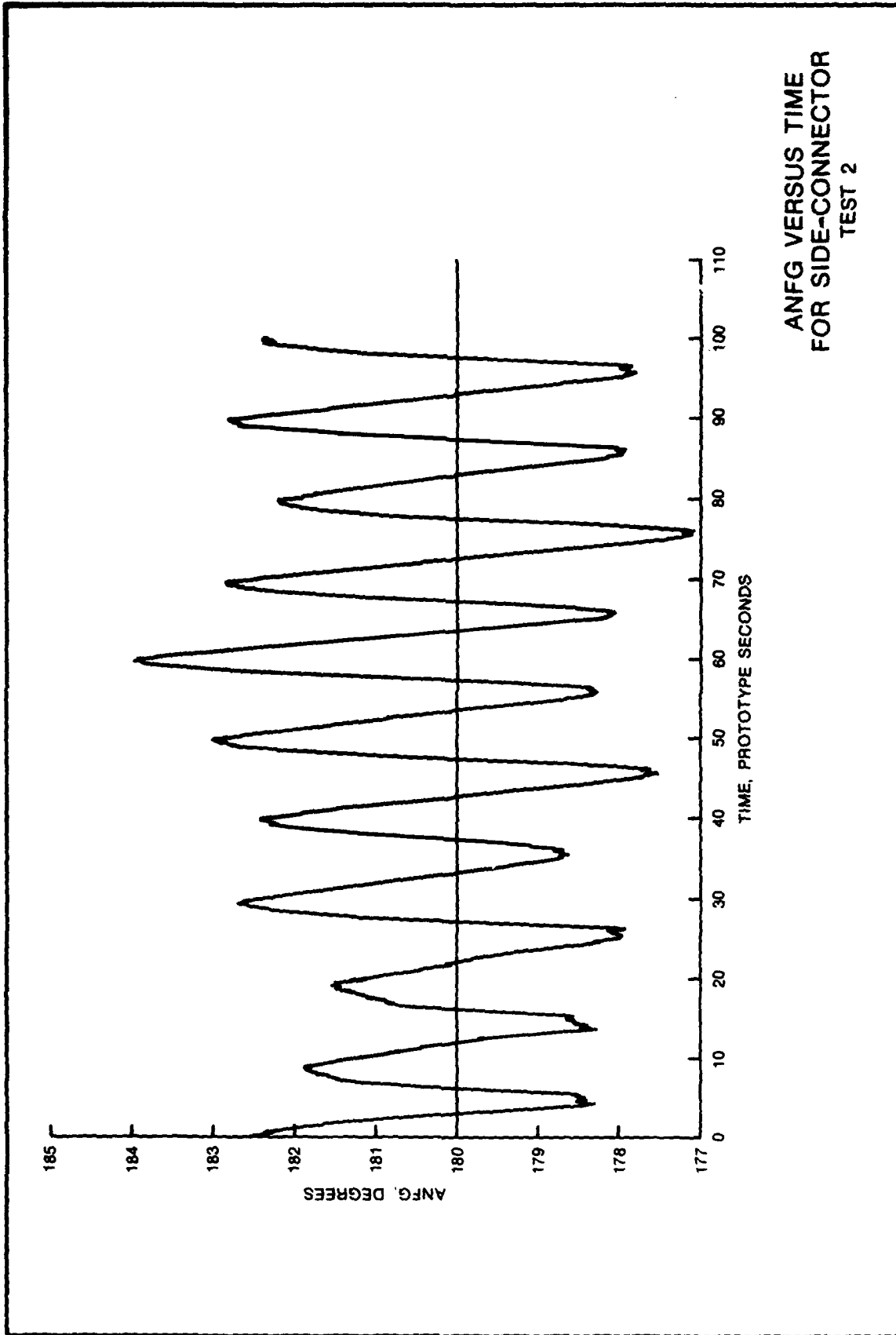

ANFG VERSUS TIME
FOR SIDE-CONNECTOR
TEST 2

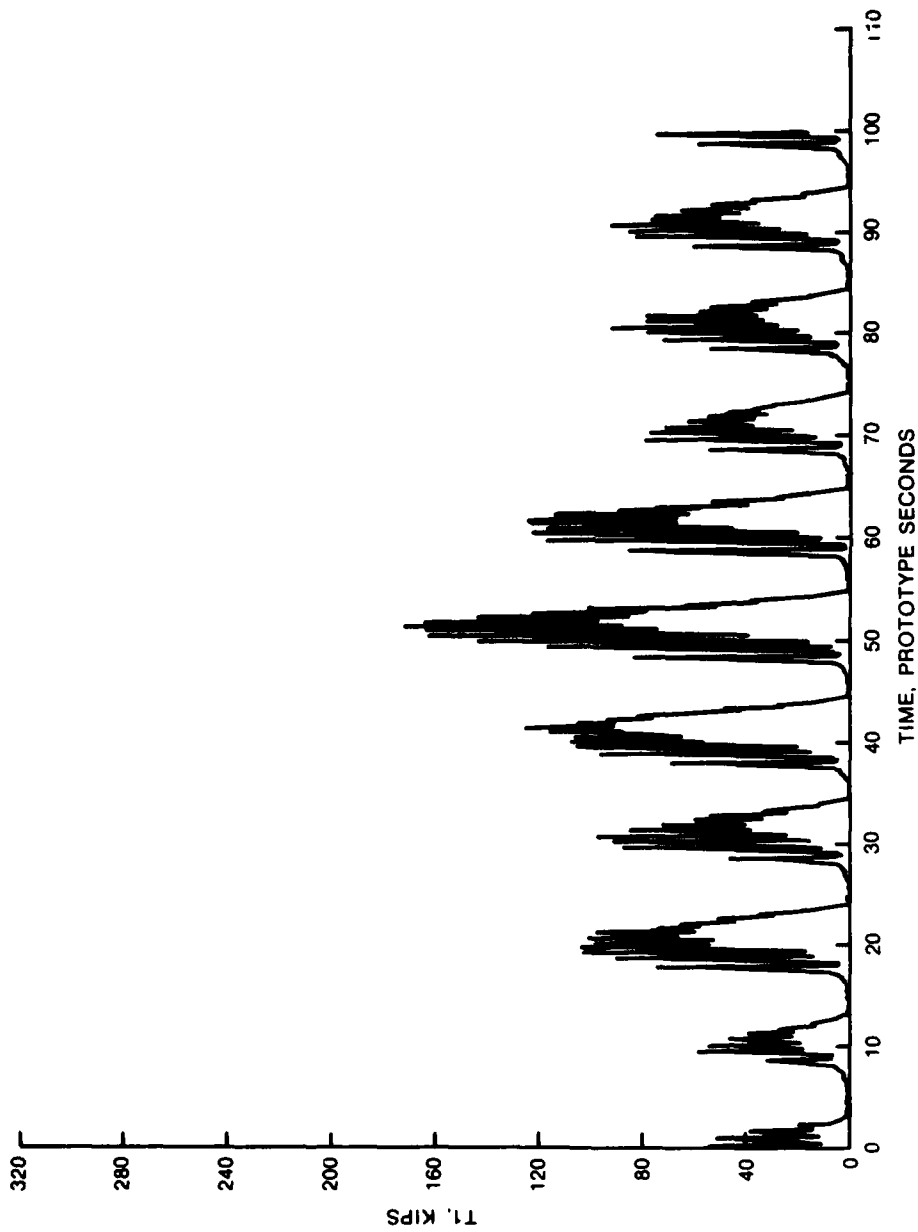

T1 VERSUS TIME
FOR SIDE-CONNECTOR
TEST 2

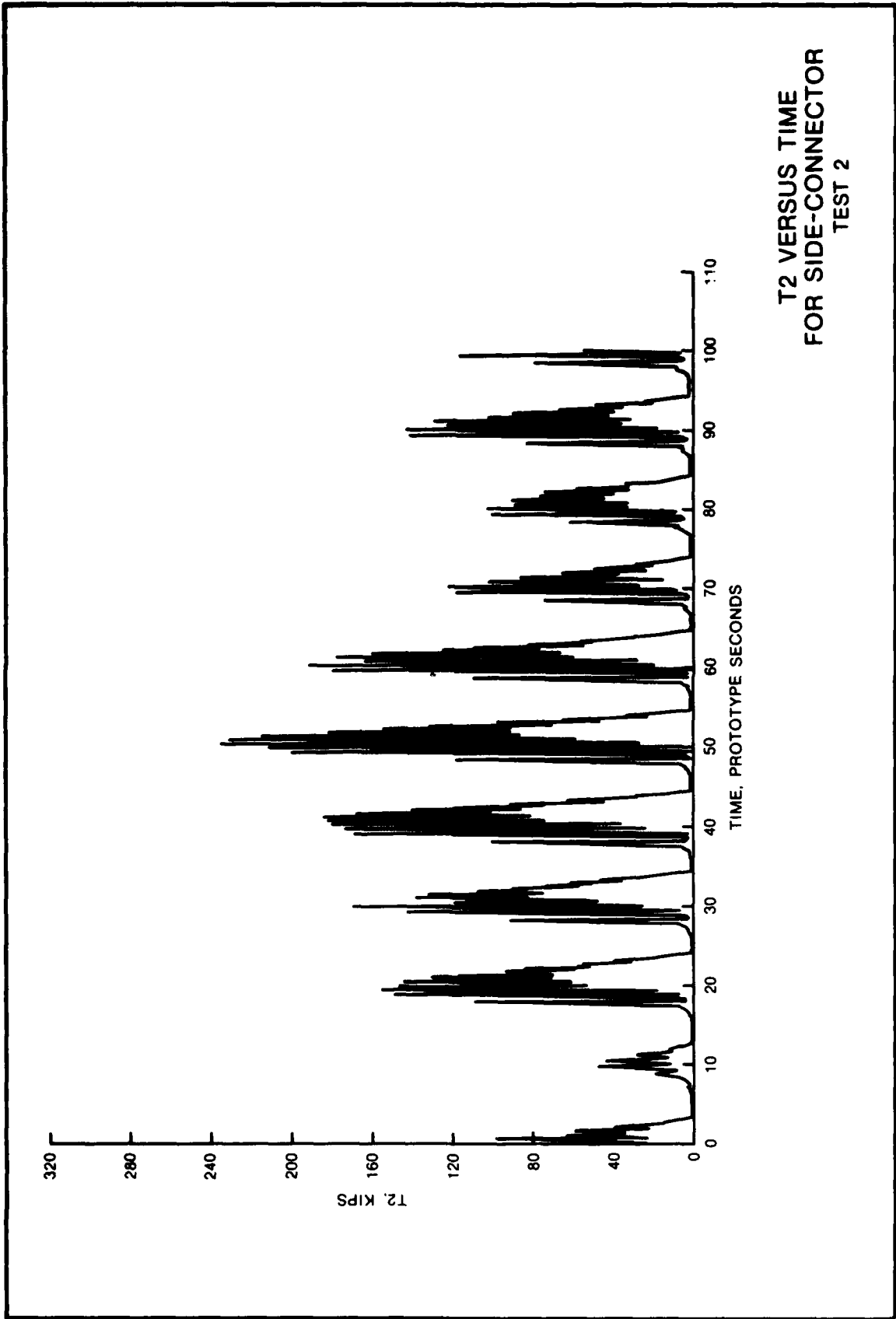
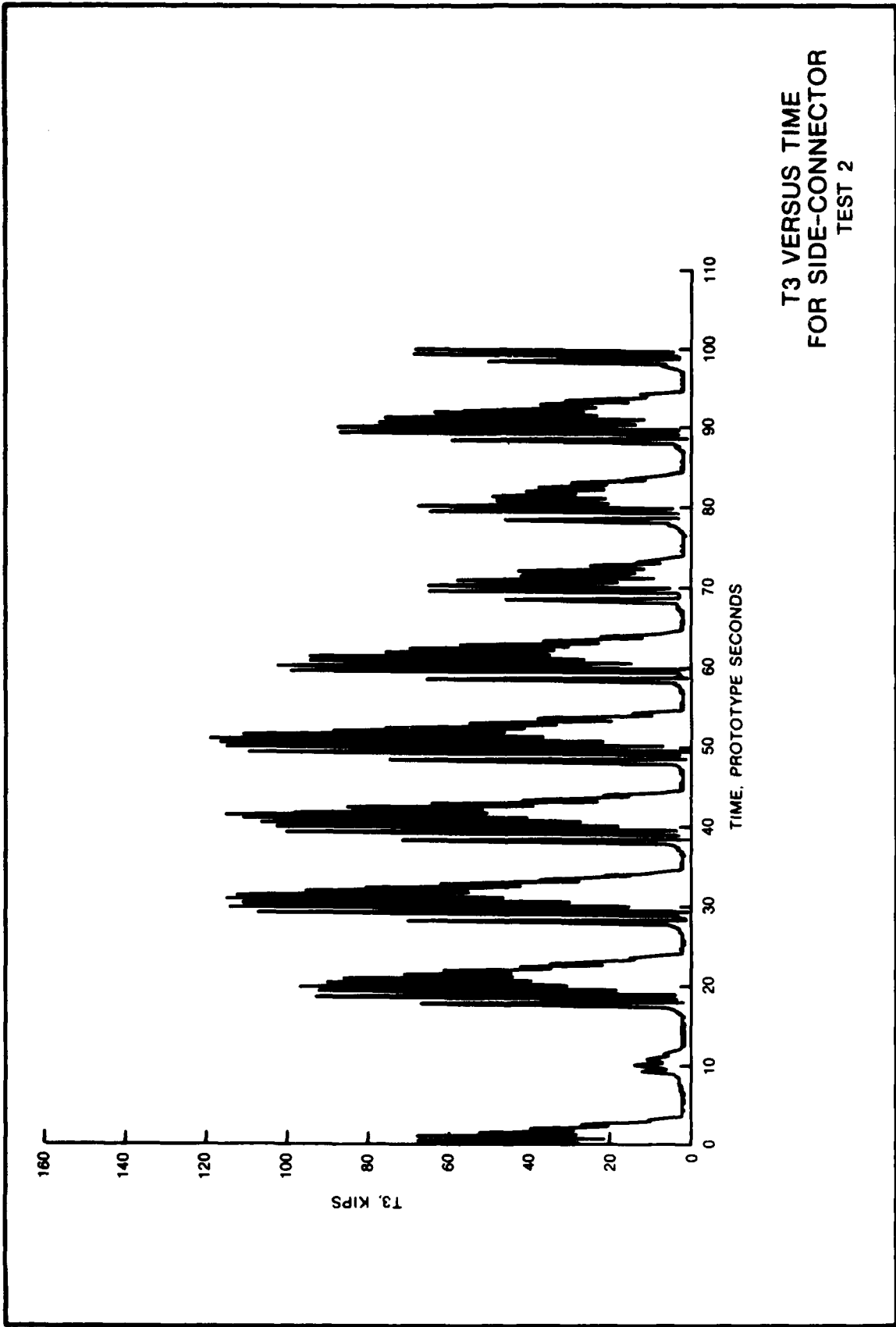
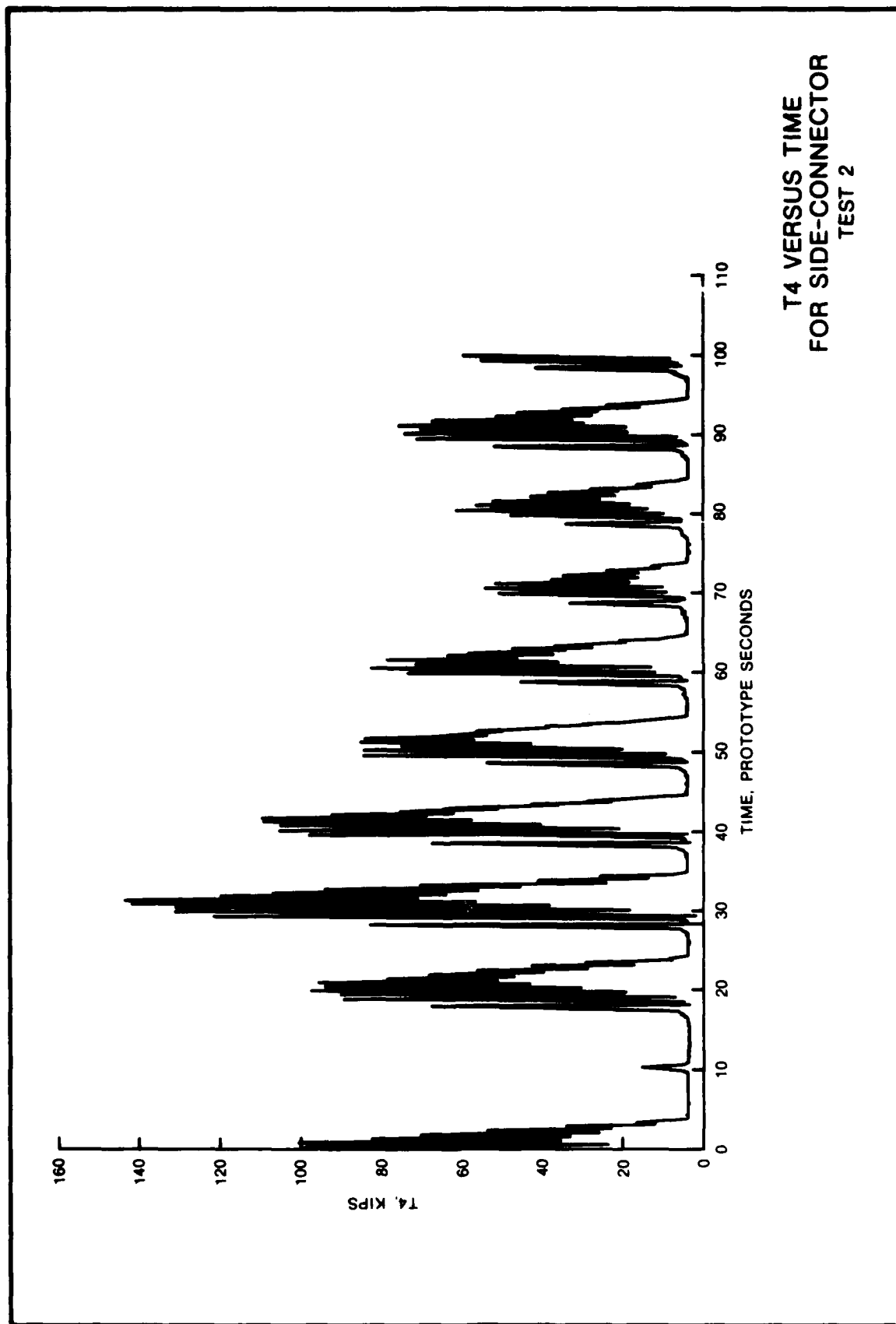

PLATE 68



T3 VERSUS TIME
FOR SIDE-CONNECTOR
TEST 2



T4 VERSUS TIME
FOR SIDE-CONNECTOR
TEST 2

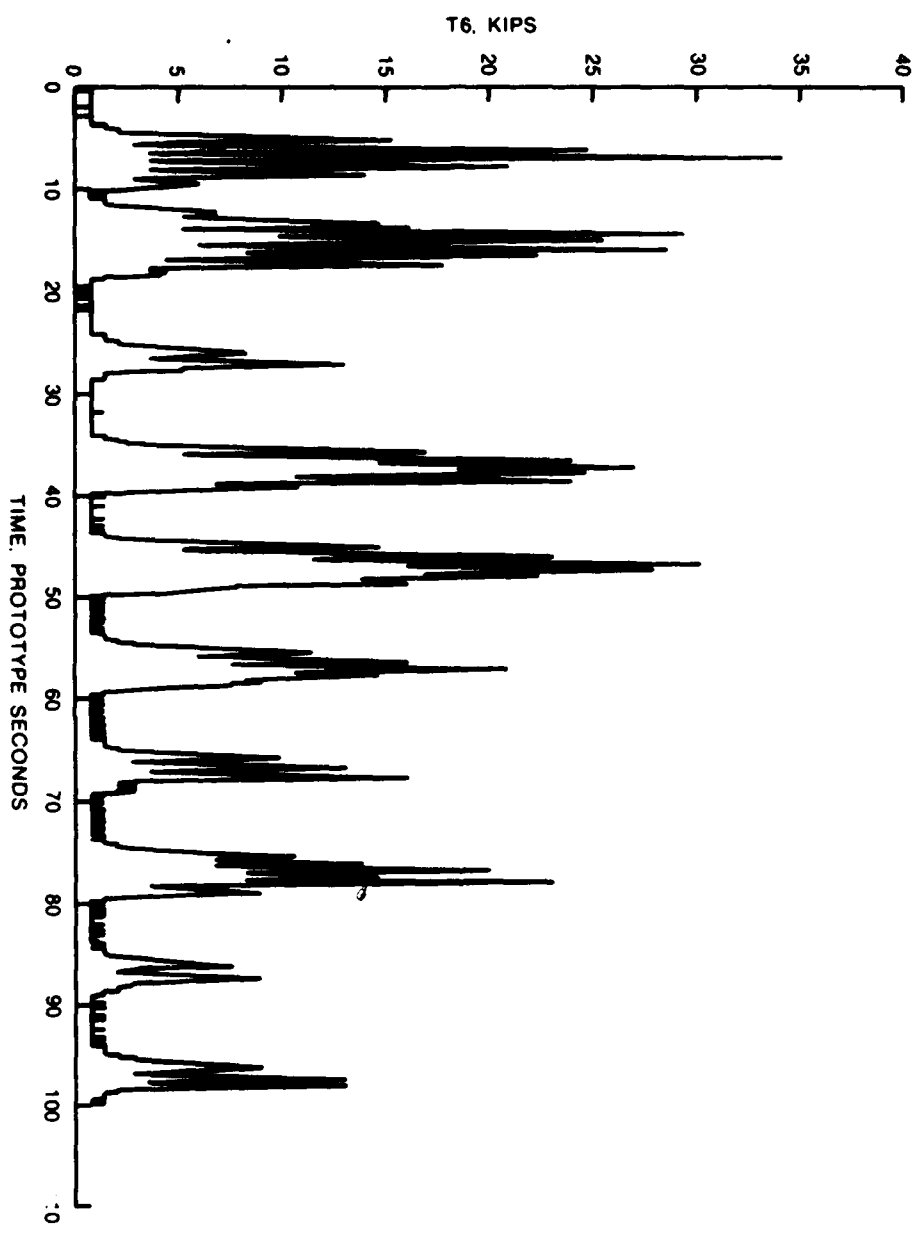

T6 VERSUS TIME
FOR SIDE-CONNECTOR
TEST 2

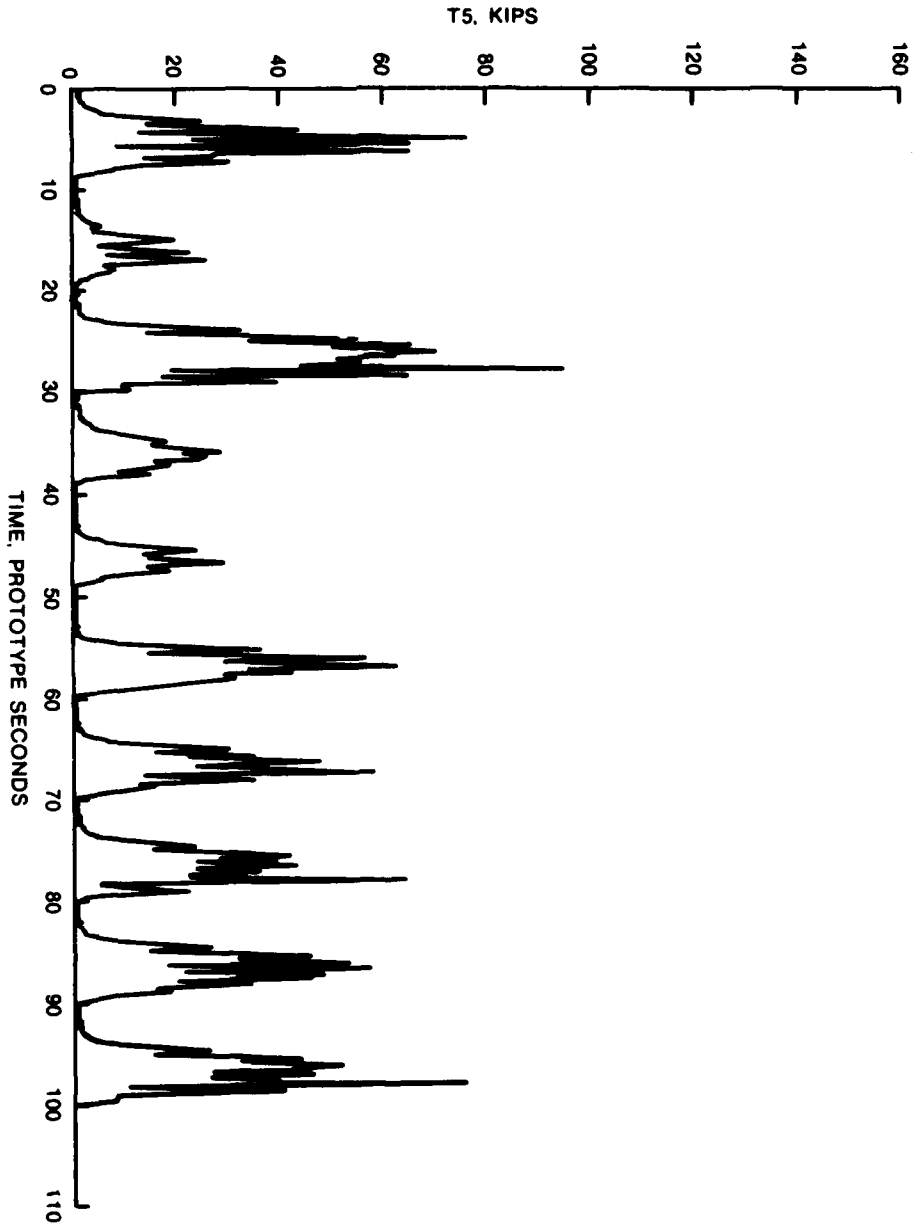

T5 VERSUS TIME
FOR SIDE-CONNECTOR
TEST 2

POSITIVE MAXIMUM -- TIME 6.2667

> F1Z
F1Y
F1X
F2Z
F2Y
F2X
VEL
ANFG

MODEL
264.1267 LB
43.9586 LB
-42.7794 LB
-139.4329 LB
3.6397 LB
-30.2207 LB
-4028 FT/SEC
180.1103 DEGREES
T1 .1000 LB
T2 .0996 LB
T3 .1311 LB
T4 .2323 LB
T5 3.0929 LB
T6 1.1559 LB

PROTOTYPE
4232.7988 KIPS
704.4648 KIPS
-685.5674 KIPS
-2234.5015 KIPS
58.3291 KIPS
-484.3067 KIPS
-2.0141 FT/SEC
180.1103 DEGREES
1.6026 KIPS
1.5965 KIPS
2.1006 KIPS
3.7235 KIPS
49.5656 KIPS
18.5247 KIPS

NEGATIVE MAXIMUM -- TIME 16.2000

> F1Z
F1Y
F1X
F2Z
F2Y
F2X
VEL
ANFG

MODEL
-310.5099 LB
-16.5121 LB
-176.0784 LB
94.2527 LB
-7.0359 LB
-8.9813 LB
-2013 FT/SEC
180.1483 DEGREES
T1 .1000 LB
T2 .0996 LB
T3 .1311 LB
T4 .2323 LB
T5 1.3028 LB
T6 .6178 LB

PROTOTYPE
-4976.1201 KIPS
-264.6163 KIPS
-2821.7690 KIPS
1510.4600 KIPS
-112.7547 KIPS
-143.9312 KIPS
-1.0063 FT/SEC
180.1483 DEGREES
1.6026 KIPS
1.5965 KIPS
2.1006 KIPS
3.7235 KIPS
20.8781 KIPS
9.9011 KIPS

F1Z MAXIMUMS FOR
SIDE-CONNECTOR
TEST 2

NEGATIVE MAXIMUM -- TIME		13.6000
GAGE		
F1Z		
> F1Y		
F1X		
F2Z		
F2Y		
F2X		
VEL		
ANFG		
T1		
T2		
T3		
T4		
T5		
T6		
POSITIVE MAXIMUM -- TIME		87.3667
GAGE		
F1Z		
> F1Y		
F1X		
F2Z		
F2Y		
F2X		
VEL		
ANFG		
T1		
T2		
T3		
T4		
T5		
T6		

MODEL	PROTOTYPE
-19.6529 LB	-314.9503 KIPS
-103.2018 LB	-1653.8752 KIPS
-139.5917 LB	-2237.0459 KIPS
195.5755 LB	3134.2227 KIPS
-79.6626 LB	-1276.6433 KIPS
113.5269 LB	1819.3416 KIPS
.0000 FT/SEC	.0000 FT/SEC
178.2734 DEGREES	178.2734 DEGREES
.0500 LB	8013 KIPS
.0498 LB	.7982 KIPS
.1311 LB	2.1006 KIPS
.1936 LB	3.1029 KIPS
.3282 LB	5.2594 KIPS
.9168 LB	14.6920 KIPS
MODEL	PROTOTYPE
95.9459 LB	1537.5942 KIPS
51.5037 LB	825.3795 KIPS
-8.5866 LB	-153.6320 KIPS
-63.6131 LB	-1019.4404 KIPS
21.3448 LB	342.0643 KIPS
18.4874 LB	296.2717 KIPS
-.3372 FT/SEC	-1.6859 FT/SEC
180.1825 DEGREES	180.1825 DEGREES
.2300 LB	3.6859 KIPS
.3287 LB	5.2694 KIPS
.2319 LB	3.7165 KIPS
.3195 LB	5.1198 KIPS
2.0785 LB	33.3094 KIPS
.5182 LB	8.3042 KIPS

F1Y MAXIMUMS FOR
SIDE-CONNECTOR
TEST 2

POSITIVE MAXIMUM -- TIME 15.6667

GAGE	MODEL	PROTOTYPE
F1Z	14.8538 LB	238.0417 KIPS
F1Y	34.8826 LB	559.0166 KIPS
> F1X	47.7195 LB	764.7349 KIPS
F2Z	60.3031 LB	866.3864 KIPS
F2Y	18.7343 LB	300.2290 KIPS
F2X	-12.1585 LB	-194.8472 KIPS
VEL	-0.0059 FT/SEC	-0.0297 FT/SEC
ANFG	179.1862 DEGREES	179.1862 DEGREES
T1	.0500 LB	.8013 KIPS
T2	.0996 LB	1.5965 KIPS
T3	.1311 LB	2.1006 KIPS
T4	.2323 LB	3.7235 KIPS
T5	.3779 LB	6.0562 KIPS
T6	1.0563 LB	16.9277 KIPS

NEGATIVE MAXIMUM -- TIME 16.2000

GAGE	MODEL	PROTOTYPE
F1Z	-310.5099 LB	-4976.1201 KIPS
F1Y	-16.5121 LB	-264.6163 KIPS
> F1X	-176.0784 LB	-2821.7690 KIPS
F2Z	94.2527 LB	1510.4600 KIPS
F2Y	-7.0359 LB	-112.7547 KIPS
F2X	-8.9813 LB	-143.9312 KIPS
VEL	-2.2013 FT/SEC	-1.0063 FT/SEC
ANFG	180.1483 DEGREES	180.1483 DEGREES
T1	.1000 LB	1.6026 KIPS
T2	.0996 LB	1.5965 KIPS
T3	.1311 LB	2.1006 KIPS
T4	.2323 LB	3.7235 KIPS
T5	1.3028 LB	20.8781 KIPS
T6	.6178 LB	9.9011 KIPS

F1X MAXIMUMS FOR
SIDE-CONNECTOR
TEST 2

POSITIVE MAXIMUM -- TIME 13.6667

GAGE	MODEL	PROTOTYPE
F1Z	-28.9738 LB	-464.3237 KIPS
F1Y	-51.7154 LB	-828.7729 KIPS
F1X	-108.6582 LB	-1741.3171 KIPS
> F2Z	253.1905 LB	4057.5386 KIPS
F2Y	-45.7755 LB	-733.5817 KIPS
F2X	72.4740 LB	1161.4426 KIPS
VEL	.0684 FT/SEC	3422 FT/SEC
ANFG	178.3495 DEGREES	178.3495 DEGREES
T1	.0500 LB	8013 KIPS
T2	.0498 LB	7982 KIPS
T3	.0907 LB	1.4543 KIPS
T4	.1936 LB	3.1029 KIPS
T5	.3282 LB	5.2594 KIPS
T6	1.0065 LB	16.1292 KIPS

NEGATIVE MAXIMUM -- TIME 26.2333

GAGE	MODEL	PROTOTYPE
F1Z	24.7565 LB	396.7388 KIPS
F1Y	18.9177 LB	303.1682 KIPS
F1X	-17.9271 LB	-287.2926 KIPS
> F2Z	-182.3000 LB	-2921.4746 KIPS
F2Y	19.5021 LB	312.5335 KIPS
F2X	-39.8773 LB	-639.0593 KIPS
VEL	-.0012 FT/SEC	-.0063 FT/SEC
ANFG	178.0148 DEGREES	178.0148 DEGREES
T1	.0500 LB	8013 KIPS
T2	.0996 LB	1.5965 KIPS
T3	.1311 LB	2.1006 KIPS
T4	.2323 LB	3.7235 KIPS
T5	3.8686 LB	61.9969 KIPS
T6	.3288 LB	5.2699 KIPS

F2Z MAXIMUMS FOR
SIDE-CONNECTOR
TEST 2

NEGATIVE MAXIMUM -- TIME	13.6000	GAGE	MODEL	PROTOTYPE
F1Z			-19.6529 LB	-314.9503 KIPS
F1Y			-103.2018 LB	-1653.8752 KIPS
F1X			-139.5917 LB	-2237.0459 KIPS
F2Z			195.5755 LB	3134.2227 KIPS
> F2Y			-79.6626 LB	-1276.6433 KIPS
F2X			113.5269 LB	1819.3416 KIPS
VEL			.0000 FT/SEC	.0000 FT/SEC
ANFG			178.2734 DEGREES	178.2734 DEGREES
T1			.0500 LB	.8013 KIPS
T2			.0498 LB	.7982 KIPS
T3			.1311 LB	2.1006 KIPS
T4			.1936 LB	3.1029 KIPS
T5			.3282 LB	5.2594 KIPS
T6			.9168 LB	14.6920 KIPS
POSITIVE MAXIMUM -- TIME	26.1333	GAGE	MODEL	PROTOTYPE
F1Z			12.1581 LB	194.8409 KIPS
F1Y			26.3534 LB	422.3305 KIPS
F1X			-28.4423 LB	-455.8065 KIPS
F2Z			-102.5259 LB	-1643.0430 KIPS
> F2Y			30.3281 LB	486.0267 KIPS
F2X			-24.1166 LB	-386.4839 KIPS
VEL			.2212 FT/SEC	1.1062 FT/SEC
ANFG			178.0719 DEGREES	178.0719 DEGREES
T1			.0500 LB	.8013 KIPS
T2			.0996 LB	1.5965 KIPS
T3			.1311 LB	2.1006 KIPS
T4			.2323 LB	3.7235 KIPS
T5			3.8686 LB	61.9969 KIPS
T6			.3787 LB	6.0684 KIPS

F2Y MAXIMUMS FOR
SIDE-CONNECTOR
TEST 2

POSITIVE MAXIMUM -- TIME 67.2687

GAGE
 F1Z
 F1Y
 F1X
 F2Z
 F2Y
 > F2X
 VEL
 ANFG
 T1
 T2
 T3
 T4
 T5
 T6

MODEL
 -19.6529 LB
 -103.2018 LB
 -139.5917 LB
 195.5755 LB
 -79.6626 LB
 113.5289 LB
 .0000 FT/SEC
 178.2734 DEGREES
 .0500 LB
 .0498 LB
 .1311 LB
 .1936 LB
 .3282 LB
 .9168 LB

PROTOTYPE
 -314.9503 KIPS
 -1653.8752 KIPS
 -2237.0459 KIPS
 3134.2227 KIPS
 -1276.6433 KIPS
 1819.3416 KIPS
 .0000 FT/SEC
 178.2734 DEGREES
 .8013 KIPS
 .7982 KIPS
 2.1006 KIPS
 3.1029 KIPS
 5.2594 KIPS
 14.6920 KIPS

NEGATIVE MAXIMUM -- TIME 13.6000

GAGE
 F1Z
 F1Y
 F1X
 F2Z
 F2Y
 > F2X
 VEL
 ANFG
 T1
 T2
 T3
 T4
 T5
 T6

MODEL
 160.4235 LB
 22.6356 LB
 -15.1399 LB
 -151.2386 LB
 4.0441 LB
 -51.4852 LB
 -.2913 FT/SEC
 180.0912 DEGREES
 .1800 LB
 .2291 LB
 .1815 LB
 .3195 LB
 2.4166 LB
 .3787 LB

PROTOTYPE
 2570.8882 KIPS
 362.7493 KIPS
 -242.6263 KIPS
 -2423.6948 KIPS
 64.8095 KIPS
 -925.0833 KIPS
 -1.4563 FT/SEC
 180.0912 DEGREES
 2.8846 KIPS
 3.6719 KIPS
 2.9086 KIPS
 5.1198 KIPS
 38.7281 KIPS
 6.0684 KIPS

F2X MAXIMUMS FOR
 SIDE-CONNECTOR
 TEST 2

POSITIVE MAXIMUM -- TIME 11.0667
 > VEL ANFG
 T1
 T2
 T3
 T4
 T5
 T6
 GAGE
 F1Z
 F1Y
 F1X
 F2Z
 F2Y
 F2X
 > VEL ANFG
 T1
 T2
 T3
 T4
 T5
 T6

MODEL
 -1.8157 LB
 3.3901 LB
 -5.0469 LB
 5.8436 LB
 2.4266 LB
 11.6577 LB
 .7978 FT/SEC
 180.5552 DEGREES
 1.6500 LB
 1.4445 LB
 .5243 LB
 .2323 LB
 .0497 LB
 .0897 LB
 MODEL
 4.3459 LB
 2.4080 LB
 -1.7530 LB
 5.5514 LB
 3.2354 LB
 11.5326 LB
 -.8497 FT/SEC
 182.2818 DEGREES
 1.4000 LB
 7.2324 LB
 1.1192 LB
 1.0746 LB
 .5271 LB
 .0498 LB

PROTOTYPE
 -29.0983 KIPS
 54.3292 KIPS
 -80.8800 KIPS
 93.6474 KIPS
 38.8877 KIPS
 186.8223 KIPS
 3.9891 FT/SEC
 180.5552 DEGREES
 26.4423 KIPS
 23.1489 KIPS
 8.4025 KIPS
 3.7235 KIPS
 .7969 KIPS
 1.4373 KIPS
 PROTOTYPE
 69.6465 KIPS
 38.5577 KIPS
 -28.0925 KIPS
 88.9653 KIPS
 51.8486 KIPS
 184.8178 KIPS
 -4.2484 FT/SEC
 182.2818 DEGREES
 22.4359 KIPS
 115.9040 KIPS
 17.9361 KIPS
 17.2210 KIPS
 8.4469 KIPS
 .7985 KIPS

← POSITIVE VELOCITY INDICATES
 THAT BARGE MOTION IS IN THE
 NEGATIVE Z DIRECTION (TOWARD
 BOTTOM). THIS OUTPUT GIVES
 MAXIMUM VELOCITIES, BUT IT
 MUST BE COMPARED WITH TIME
 HISTORY PLOT TO DETERMINE
 MAXIMUM IMPACT VELOCITIES.

← NEGATIVE VELOCITY INDICATES
 THAT BARGE MOTION IS IN THE
 POSITIVE Z DIRECTION

VEL MAXIMUMS FOR
 SIDE-CONNECTOR
 TEST 2

NEGATIVE MAXIMUM -- TIME		59.7667			PROTOTYPE	
GAGE						
F1Z	6.2165	LB			99.6226	KIPS
F1Y	2.8434	LB			45.5672	KIPS
F1X	-2.2597	LB			-36.2136	KIPS
F2Z	7.8303	LB			125.4859	KIPS
F2Y	2.8310	LB			45.3682	KIPS
F2X	12.8585	LB			206.0662	KIPS
VEL	-0.0012	FT/SEC			-0.0063	FT/SEC
> ANFG	183.9551	DEGREES			183.9551	DEGREES
T1	2.0900	LB			33.4936	KIPS
T2	.0000	LB			.0000	KIPS
T3	.1815	LB			2.9086	KIPS
T4	4.5791	LB			73.3832	KIPS
T5	.0497	LB			.7969	KIPS
T6	.0897	LB			1.4373	KIPS
<p style="text-align: center;">← MAXIMUM CONCAVE UPWARDS</p>						
<p style="text-align: center;">PROTOTYPE</p>						
POSITIVE MAXIMUM -- TIME		76.0000			PROTOTYPE	
GAGE						
F1Z	-3.4112	LB			-54.6662	KIPS
F1Y	8.2015	LB			131.4342	KIPS
F1X	-2.8721	LB			-46.0267	KIPS
F2Z	14.9591	LB			239.7298	KIPS
F2Y	4.0441	LB			64.8095	KIPS
F2X	3.9525	LB			63.3410	KIPS
VEL	-2.103	FT/SEC			-1.0516	FT/SEC
> ANFG	177.0679	DEGREES			177.0679	DEGREES
T1	.0500	LB			.8013	KIPS
T2	.0996	LB			1.5965	KIPS
T3	1.311	LB			2.1006	KIPS
T4	.2323	LB			3.7235	KIPS
T5	2.4664	LB			39.5250	KIPS
T6	8670	LB			13.8935	KIPS
<p style="text-align: center;">← MAXIMUM CONVEX UPWARDS</p>						

ANFG RANGE LIMITS FOR
SIDE-CONNECTOR
TEST 2

NEGATIVE MAXIMUM -- TIME 51.1667

GAGE	MODEL	PROTOTYPE
F1Z	-15.2171 LB	-243.8630 KIPS
F1Y	-3.5545 LB	-56.9624 KIPS
F1X	-67.8429 LB	-1087.2263 KIPS
F2Z	159.3471 LB	2553.6382 KIPS
F2Y	-3.0730 LB	-49.2463 KIPS
F2X	21.6645 LB	347.1877 KIPS
VEL	.0531 FT/SEC	.2656 FT/SEC
ANFG	178.4218 DEGREES	178.4218 DEGREES
> T1	.0000 LB	.0000 KIPS
T2	.0996 LB	1.5965 KIPS
T3	.1311 LB	2.1006 KIPS
T4	.2323 LB	3.7235 KIPS
T5	2.7050 LB	43.3500 KIPS
T6	.0897 LB	1.4373 KIPS

POSITIVE MAXIMUM -- TIME 4.1000

GAGE	MODEL	PROTOTYPE
F1Z	7.0417 LB	112.8474 KIPS
F1Y	1.4910 LB	23.8939 KIPS
F1X	-1.0139 LB	-16.2491 KIPS
F2Z	4.9671 LB	79.6010 KIPS
F2Y	1.6178 LB	25.9268 KIPS
F2X	10.3068 LB	165.1730 KIPS
VEL	.0000 FT/SEC	.0000 FT/SEC
ANFG	181.8939 DEGREES	181.8939 DEGREES
> T1	10.6800 LB	171.1538 KIPS
T2	8.7466 LB	140.1704 KIPS
T3	5.2028 LB	83.3786 KIPS
T4	5.3342 LB	85.4845 KIPS
T5	.0497 LB	.7969 KIPS
T6	.0498 LB	.7985 KIPS

T1 MAXIMUM FOR
SIDE-CONNECTOR
TEST 2

Negative Maximum -- Time 50.3667

GAGE	MODEL	PROTOTYPE
F1Z	7.3168 LB	117.2556 KIPS
F1Y	3.9369 LB	63.0911 KIPS
F1X	-1.5418 LB	-24.7087 KIPS
F2Z	6.6617 LB	106.7574 KIPS
F2Y	3.2354 LB	51.6486 KIPS
F2X	13.3589 LB	214.0845 KIPS
VEL	-5188 FT/SEC	-2.5938 FT/SEC
ANFG	182.0764 DEGREES	182.0764 DEGREES
T1	.2800 LB	4.4872 KIPS
> T2	.0000 LB	.0000 KIPS
T3	.1311 LB	2.1006 KIPS
T4	3.3496 LB	53.6799 KIPS
T5	.2287 LB	3.6656 KIPS
T6	1.0065 LB	16.1292 KIPS

Positive Maximum -- Time 48.5333

GAGE	MODEL	PROTOTYPE
F1Z	1.6502 LB	26.4456 KIPS
F1Y	2.4060 LB	38.5577 KIPS
F1X	-1.2251 LB	-19.6329 KIPS
F2Z	3.5674 LB	57.1268 KIPS
F2Y	2.8310 LB	45.3682 KIPS
F2X	9.3311 LB	149.5374 KIPS
VEL	.0000 FT/SEC	.0000 FT/SEC
ANFG	182.5974 DEGREES	182.5974 DEGREES
T1	5.5100 LB	86.3013 KIPS
> T2	14.6740 LB	235.1607 KIPS
T3	2.3998 LB	38.4576 KIPS
T4	1.2198 LB	19.5482 KIPS
T5	.0000 LB	.0000 KIPS
T6	.0498 LB	.7985 KIPS

T2 MAXIMUM FOR
SIDE-CONNECTOR
TEST 2

NEGATIVE MAXIMUM -- TIME 51.0667

GAGE	MODEL	PROTOTYPE
F1Z	7.5918 LB	121.6639 KIPS
F1Y	3.3901 LB	54.3292 KIPS
F1X	-2.2597 LB	-36.2136 KIPS
F2Z	6.3495 LB	102.0752 KIPS
F2Y	2.8310 LB	45.3682 KIPS
F2X	13.8090 LB	218.0936 KIPS
VEL	-6300 FT/SEC	-3.1500 FT/SEC
ANFG	182.9131 DEGREES	182.9131 DEGREES
T1	1.1600 LB	18.5897 KIPS
T2	.6176 LB	9.8981 KIPS
T3	.0000 LB	.0000 KIPS
T4	4.9567 LB	79.4338 KIPS
T5	.0497 LB	.7969 KIPS
T6	.2790 LB	4.4715 KIPS

>

POSITIVE MAXIMUM -- TIME 49.5333

GAGE	MODEL	PROTOTYPE
F1Z	7.0417 LB	112.8474 KIPS
F1Y	2.8434 LB	45.5672 KIPS
F1X	-1.8585 LB	-29.7844 KIPS
F2Z	7.5382 LB	120.8037 KIPS
F2Y	2.8310 LB	45.3682 KIPS
F2X	11.2825 LB	180.8087 KIPS
VEL	.0000 FT/SEC	.0000 FT/SEC
ANFG	182.0764 DEGREES	182.0764 DEGREES
T1	8.6300 LB	138.3013 KIPS
T2	3.8354 LB	61.4643 KIPS
T3	7.4211 LB	118.9277 KIPS
T4	4.4339 LB	71.0560 KIPS
T5	.0497 LB	.7969 KIPS
T6	.0498 LB	.7985 KIPS

T3 MAXIMUM FOR
SIDE-CONNECTOR
TEST 2

NEGATIVE MAXIMUM -- TIME 31.2667

GAGE	MODEL	PROTOTYPE
F1Z	18.0447 LB	289.1774 KIPS
F1Y	6.1239 LB	98.1388 KIPS
F1X	-1.905 LB	-3.0522 KIPS
F2Z	6.3695 LB	102.0752 KIPS
F2Y	2.0222 LB	32.4073 KIPS
F2X	11.6577 LB	186.8223 KIPS
VEL	-6147 FT/SEC	-3.0734 FT/SEC
ANFG	182.0042 DEGREES	182.0042 DEGREES
T1	1.5000 LB	24.0385 KIPS
T2	3.2974 LB	52.8433 KIPS
T3	.0907 LB	1.4543 KIPS
> T4	.0000 LB	.0000 KIPS
T5	3.8288 LB	61.3594 KIPS
T6	.0897 LB	1.4373 KIPS

POSITIVE MAXIMUM -- TIME 28.3667

GAGE	MODEL	PROTOTYPE
F1Z	2.7505 LB	44.0787 KIPS
F1Y	2.8434 LB	45.5672 KIPS
F1X	-2.1542 LB	-34.5217 KIPS
F2Z	9.8170 LB	157.3243 KIPS
F2Y	2.0222 LB	32.4073 KIPS
F2X	10.4319 LB	167.1776 KIPS
VEL	.0000 FT/SEC	.0000 FT/SEC
ANFG	181.5402 DEGREES	181.5402 DEGREES
T1	5.1200 LB	82.0513 KIPS
T2	6.4554 LB	103.4515 KIPS
T3	6.5338 LB	104.7081 KIPS
> T4	8.9743 LB	143.8187 KIPS
T5	.0497 LB	.7969 KIPS
T6	.0498 LB	.7985 KIPS

T4 MAXIMUM FOR
SIDE-CONNECTOR
TEST 2

NEGATIVE MAXIMUM -- TIME 27.7000

GAGE	MODEL	PROTOTYPE
F1Z	-13.5887 LB	-217.7676 KIPS
F1Y	2.8434 LB	45.5672 KIPS
F1X	-7.3062 LB	-117.0868 KIPS
F2Z	14.3748 LB	230.3656 KIPS
F2Y	2.0222 LB	32.4073 KIPS
F2X	14.5847 LB	233.7292 KIPS
VEL	.0000 FT/SEC	.0000 FT/SEC
ANFG	181.5022 DEGREES	181.5022 DEGREES
T1	3.6000 LB	57.6923 KIPS
T2	.9663 LB	15.4858 KIPS
T3	.5747 LB	9.2104 KIPS
T4	.2323 LB	3.7235 KIPS
T5	.0000 LB	.0000 KIPS
T6	.3787 LB	6.0684 KIPS

POSITIVE MAXIMUM -- TIME 9.4667

GAGE	MODEL	PROTOTYPE
F1Z	66.1278 LB	1059.7397 KIPS
F1Y	11.4820 LB	184.0058 KIPS
F1X	-3.0832 LB	-49.4105 KIPS
F2Z	40.9034 LB	655.5029 KIPS
F2Y	.0812 LB	1.3012 KIPS
F2X	18.2372 LB	292.2625 KIPS
VEL	-.4453 FT/SEC	-2.2266 FT/SEC
ANFG	181.1865 DEGREES	181.1865 DEGREES
T1	.2300 LB	3.6859 KIPS
T2	.3786 LB	6.0666 KIPS
T3	.4336 LB	6.9482 KIPS
T4	.4647 LB	7.4469 KIPS
T5	5.9173 LB	94.8281 KIPS
T6	.1295 LB	2.0760 KIPS

T5 MAXIMUM FOR
SIDE-CONNECTOR
TEST 2

NEGATIVE MAXIMUM -- TIME		6.9333	PROTOTYPE	
GAGE	MODEL			
F1Z	-7.2072 LB		-115.5001 KIPS	
F1Y	3.3901 LB		54.3292 KIPS	
F1X	.6119 LB		9.8062 KIPS	
F2Z	10.4014 LB		166.6886 KIPS	
F2Y	1.6178 LB		25.9268 KIPS	
F2X	10.9072 LB		174.7950 KIPS	
VEL	.0000 FT/SEC		.0000 FT/SEC	
ANFG	182.4111 DEGREES		182.4111 DEGREES	
T1	.7200 LB		11.5385 KIPS	
T2	3.8354 LB		61.4643 KIPS	
T3	3.9223 LB		62.8571 KIPS	
T4	3.1560 LB		50.5770 KIPS	
T5	.0497 LB		.7969 KIPS	
T6	.0000 LB		.0000 KIPS	
>				
POSITIVE MAXIMUM -- TIME		0.4667	PROTOTYPE	
GAGE	MODEL			
F1Z	70.4198 LB		1128.5085 KIPS	
F1Y	12.4661 LB		199.7773 KIPS	
F1X	-9.1643 LB		-146.8643 KIPS	
F2Z	-112.3257 LB		-1800.0918 KIPS	
F2Y	.0812 LB		1.3012 KIPS	
F2X	-20.8144 LB		-333.5633 KIPS	
VEL	-3875 FT/SEC		-1.9375 FT/SEC	
ANFG	181.2436 DEGREES		181.2436 DEGREES	
T1	.1400 LB		2.2436 KIPS	
T2	.1395 LB		2.2351 KIPS	
T3	.1311 LB		2.1006 KIPS	
T4	.2323 LB		3.7235 KIPS	
T5	.8652 LB		13.8656 KIPS	
T6	2.1325 LB		34.1748 KIPS	
>				

T6 MAXIMUM FOR
SIDE CONNECTOR
TEST 2

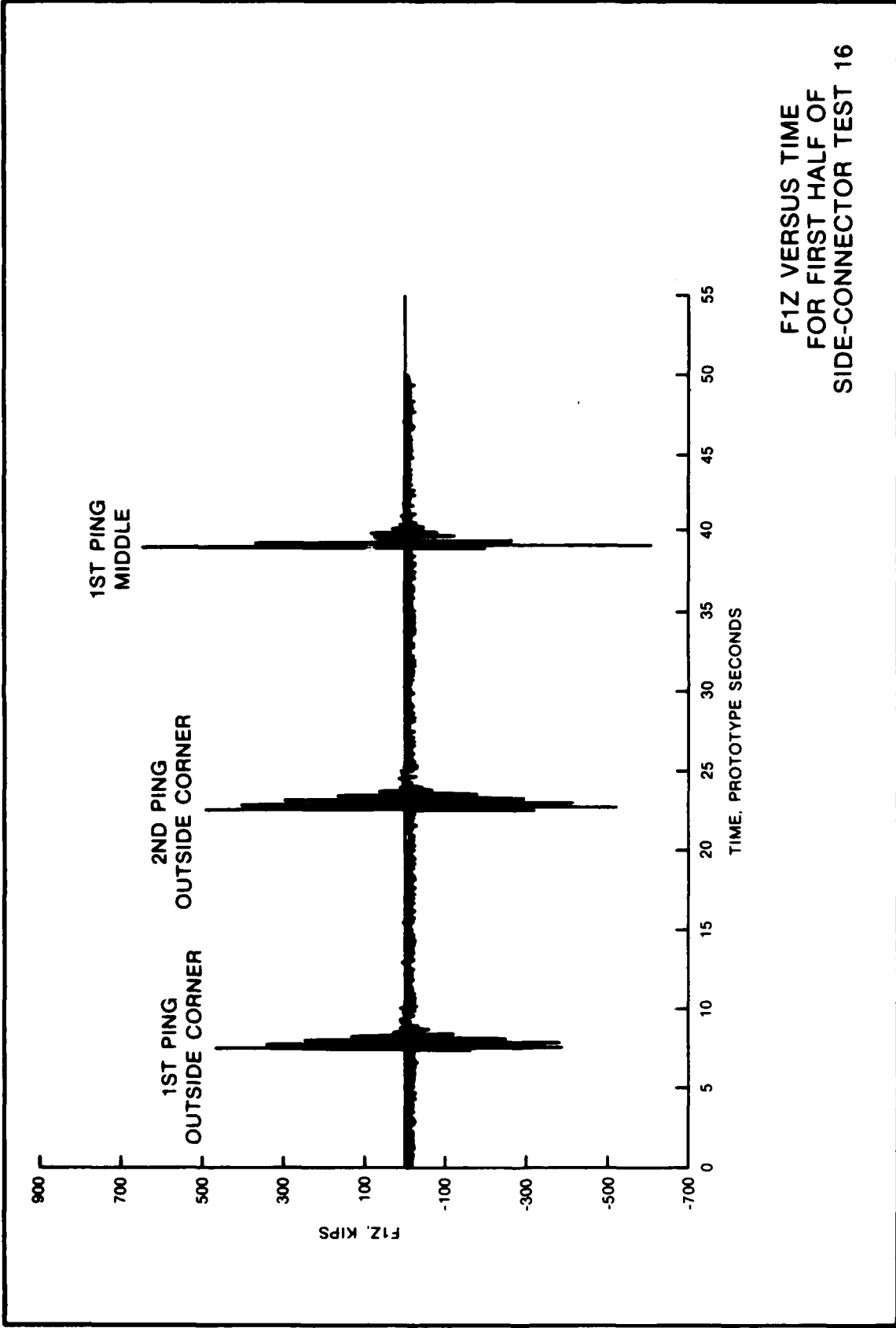

F1Z VERSUS TIME
FOR FIRST HALF OF
SIDE-CONNECTOR TEST 16

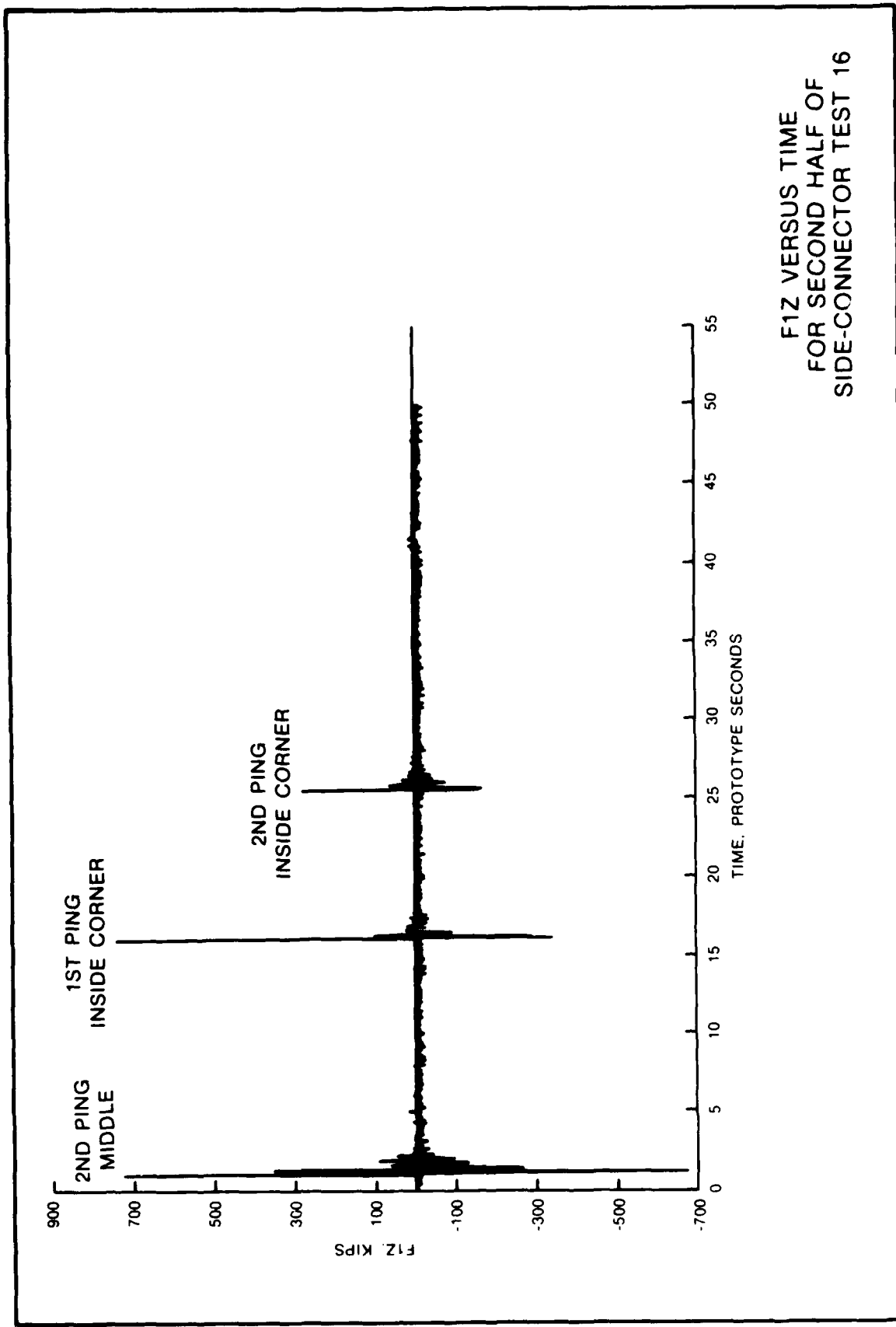

F1Z VERSUS TIME
FOR SECOND HALF OF
SIDE-CONNECTOR TEST 16

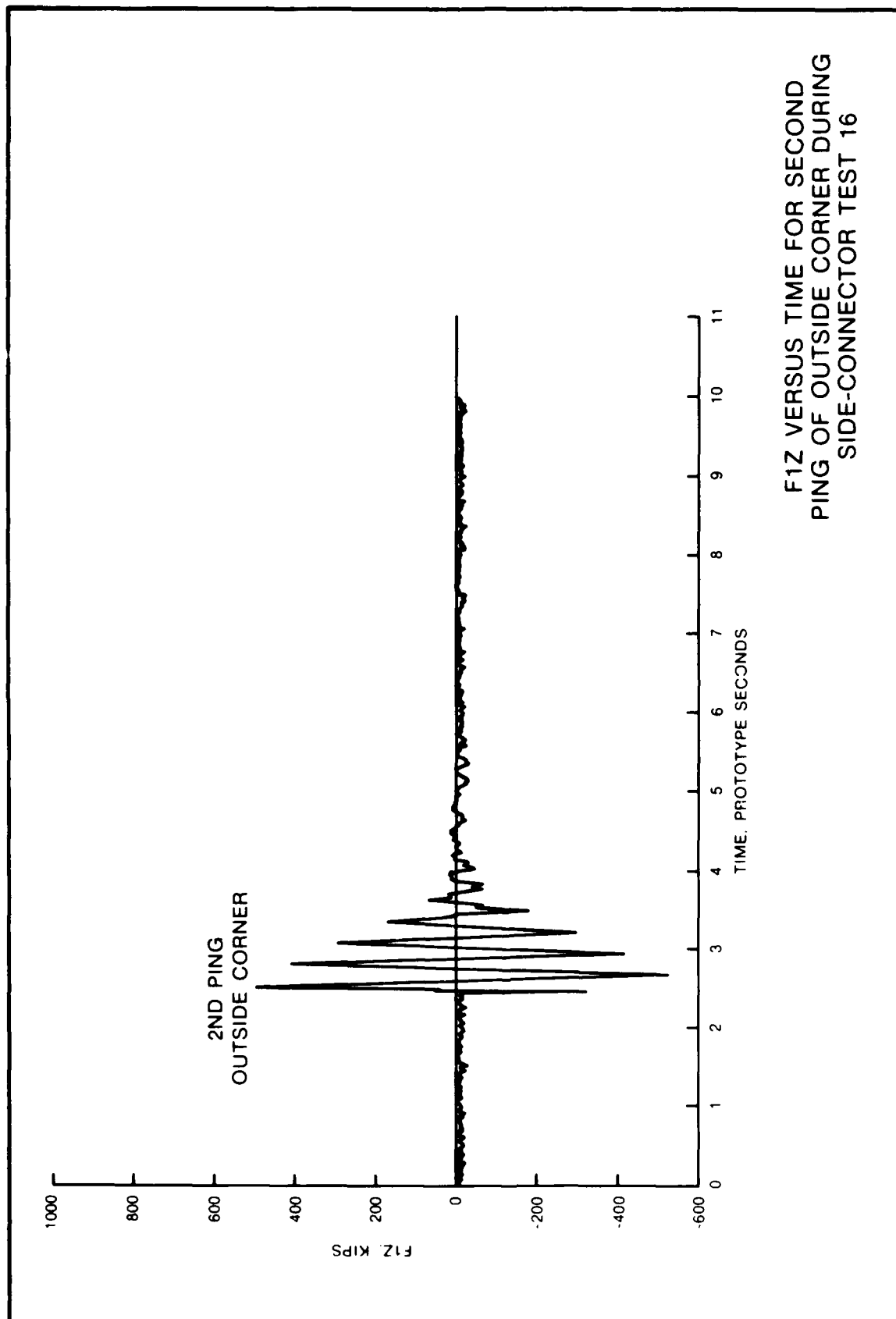

F1Z VERSUS TIME FOR SECOND
PING OF OUTSIDE CORNER DURING
SIDE-CONNECTOR TEST 16

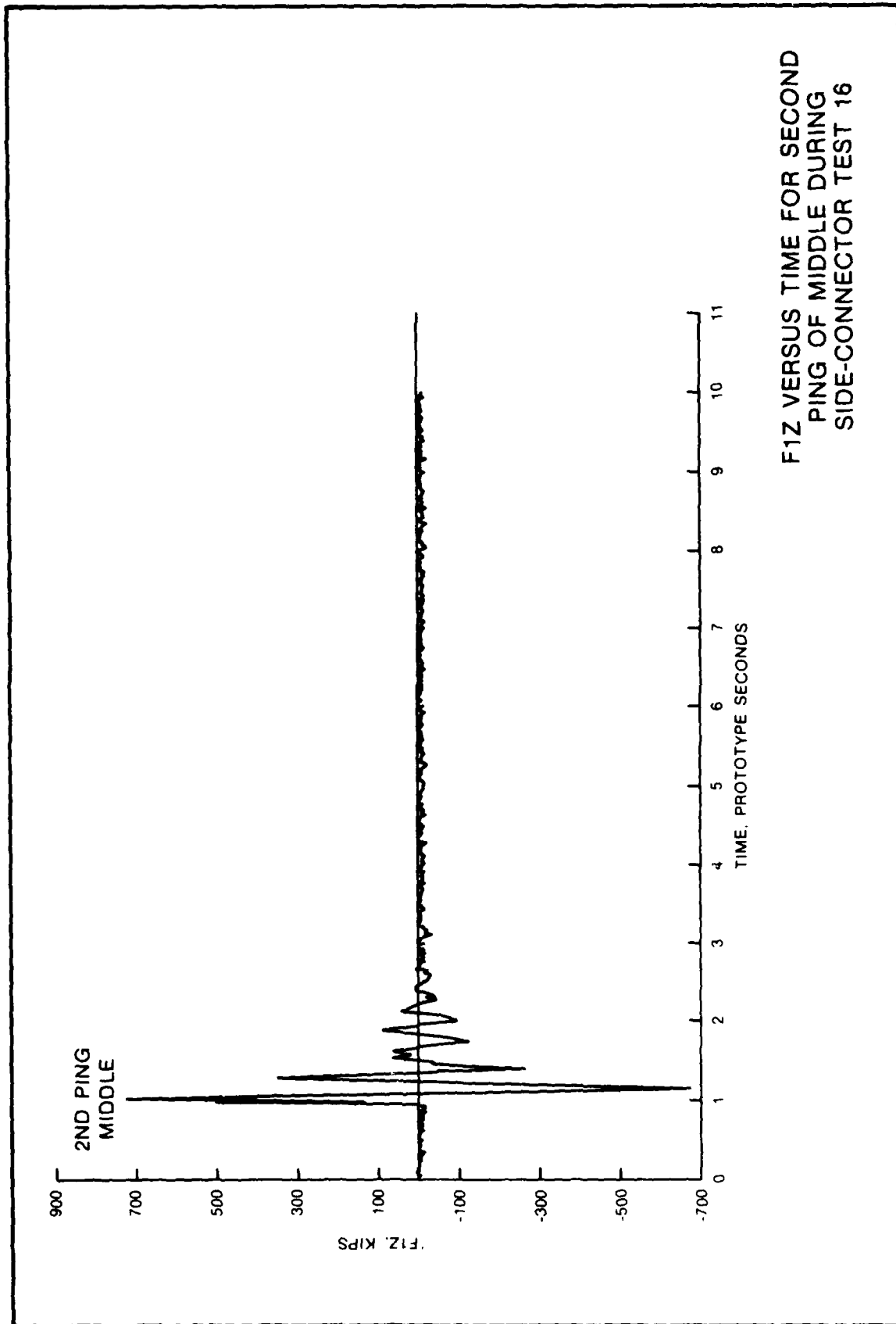

F1Z VERSUS TIME FOR SECOND PING OF MIDDLE DURING SIDE-CONNECTOR TEST 16

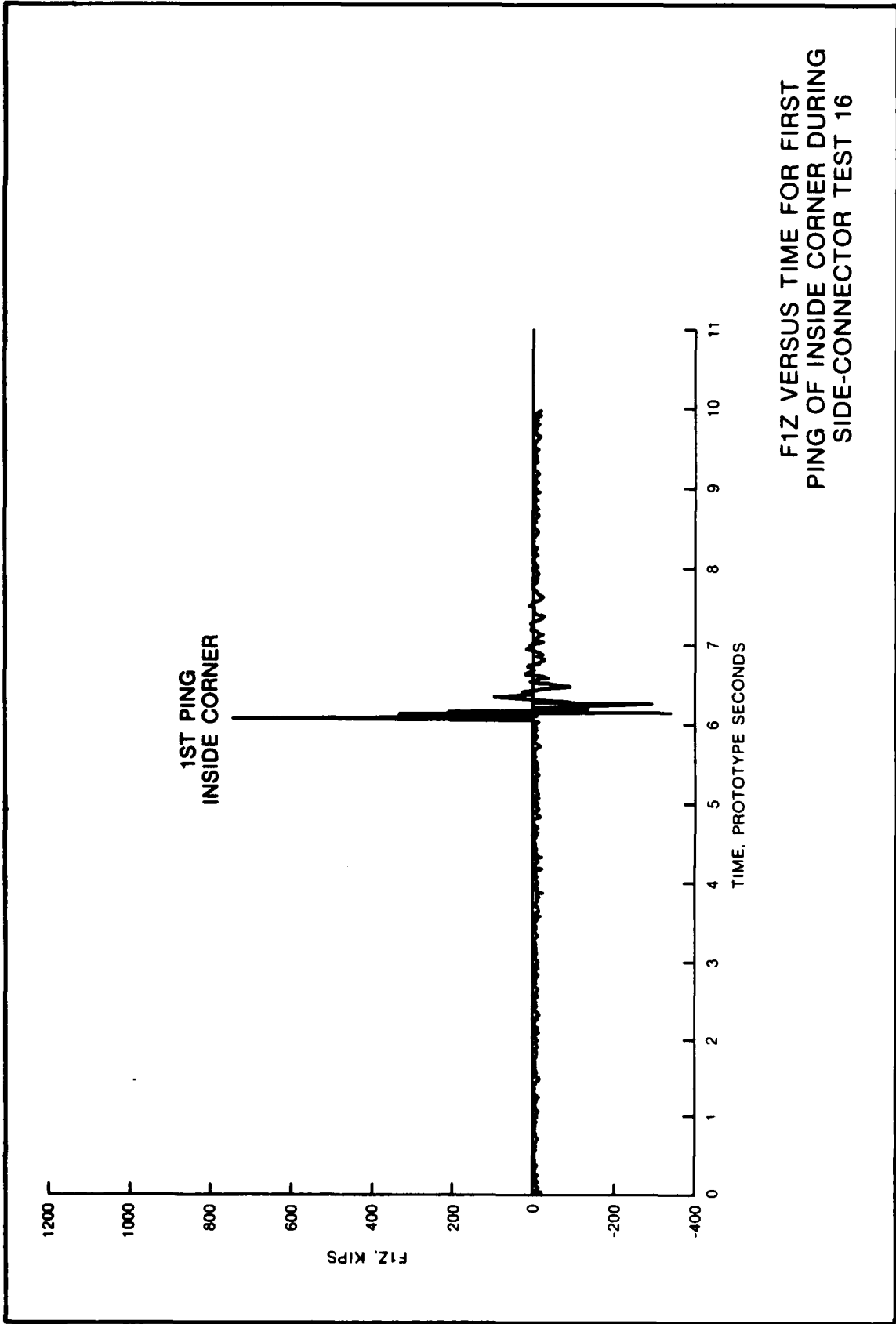

F1Z VERSUS TIME FOR FIRST PING OF INSIDE CORNER DURING SIDE-CONNECTOR TEST 16

APPENDIX A: NOTATION

A	Area, ft ²
\bar{C}_t	Average wave transmission coefficient
C_t	Wave transmission coefficient
d	Water depth, ft
E(f)	Spectral energy density function
E_o	Spectral energy
f	Frequency, sec ⁻¹
f_m	Peak frequency, sec ⁻¹
F	Force, lb or kips
g	Gravity, ft/sec ²
H_{mo}	Deep-water significant wave height, ft
H	Wave height, ft
H_s	Significant wave height, ft
H_t	Transmitted wave height, ft
I	Mass moment of inertia, lb (mass)/ft ²
L	Length or wavelength, ft
L_p	Wavelength of peak spectral period
T or t	Time or wave period, sec
T_p	Spectral peak wave period
V	Volume, ft ³
W	Width, ft

ENO

7-87

Dtic