

AD-A171 828

SPIN FREQUENCY DETECTION IN THE SPECTRAL DOMAIN(U)
WHITE SANDS MISSILE RANGE NM INSTRUMENTATION
DIRECTORATE D S JINAREZ MAR 86 STENS-ID-86-1

1/2

UNCLASSIFIED

F/G 17/9

NL

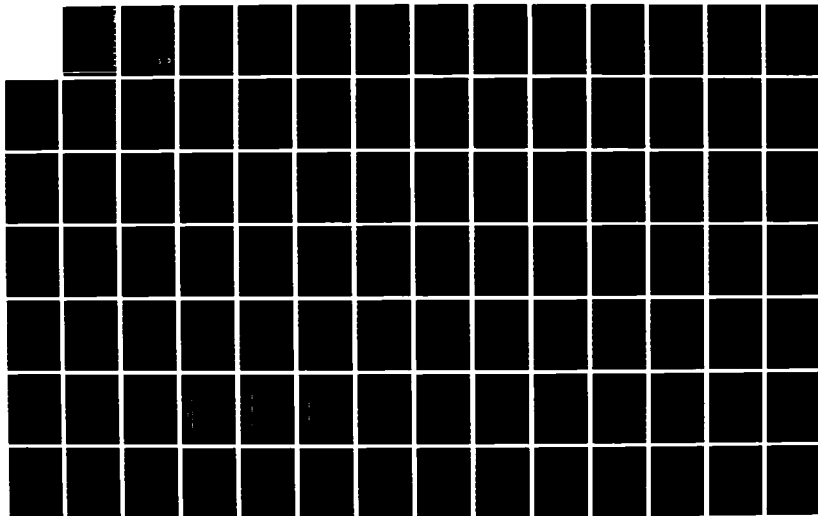

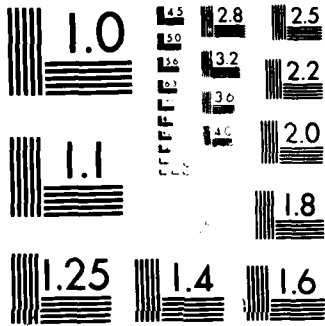

MICROCOPY RESOLUTION TEST CHART
NATIONAL BUREAU OF STANDARDS 1963-A

12

TECHNICAL REPORT
STEWS-ID-86-1

AD-A171 828

SPIN FREQUENCY DETECTION IN THE SPECTRAL DOMAIN

DAVID JIMAREZ
Electronics Engineer

March 1986

Approved for public release; distribution is unlimited.

DTIC FILE COPY

DTIC
ELECTE
SEP 16 1986
S E D

INSTRUMENTATION DIRECTORATE
U.S. ARMY WHITE SANDS MISSILE RANGE
WHITE SANDS MISSILE RANGE, NEW MEXICO 88002

86 9 15 00

DESTRUCTION NOTICE

Destroy this report when no longer needed. Do not return it to the originator.

UNCLASSIFIED

SECURITY CLASSIFICATION OF THIS PAGE

A D-A 171824

REPORT DOCUMENTATION PAGE				Form Approved OMB No 0704 0188 Exp Date Jun 30 1986	
1a REPORT SECURITY CLASSIFICATION UNCLASSIFIED		1b RESTRICTIVE MARKINGS			
2a SECURITY CLASSIFICATION AUTHORITY		3 DISTRIBUTION / AVAILABILITY OF REPORT Approved for public release; distribution unlimited			
2b DECLASSIFICATION / DOWNGRADING SCHEDULE					
4 PERFORMING ORGANIZATION REPORT NUMBER(S) STEWS-ID-86-1		5 MONITORING ORGANIZATION REPORT NUMBER(S)			
6a NAME OF PERFORMING ORGANIZATION Instrumentation Directorate		6b OFFICE SYMBOL (If applicable) STEWS-ID-T	7a NAME OF MONITORING ORGANIZATION		
6c ADDRESS (City, State, and ZIP Code) U. S. Army White Sands Missile Range White Sands Missile Range, NM 88002-5143			7b ADDRESS (City, State, and ZIP Code)		
8a NAME OF FUNDING / SPONSORING ORGANIZATION		8b OFFICE SYMBOL (If applicable)	9 PROCUREMENT INSTRUMENT IDENTIFICATION NUMBER		
8c ADDRESS (City, State, and ZIP Code)		10. SOURCE OF FUNDING NUMBERS			
		PROGRAM ELEMENT NO	PROJECT NO.	TASK NO	WORK UNIT ACCESSION NO
11 TITLE (Include Security Classification) SPIN FREQUENCY DETECTION IN THE SPECTRAL DOMAIN					
12 PERSONAL AUTHOR(S) Jimarez, David S.					
13a TYPE OF REPORT Final		13b TIME COVERED FROM _____ TO _____	14 DATE OF REPORT (Year, Month, Day) March 1986		15 PAGE COUNT 145
16 SUPPLEMENTARY NOTATION					
17 COSATI CODES			18 SUBJECT TERMS (Continue on reverse if necessary and identify by block number)		
FIELD	GROUP	SUB-GROUP			
			Instrumentation radar Radar data processing Doppler processing Heuristics		
19 ABSTRACT (Continue on reverse if necessary and identify by block number) This research involves the development, implementation and optimization of algorithms for tracking the spectral spin frequency representations of a revolving cylindrical target having four protruding scatterers. The investigation is limited to coherent phase and amplitude data that are constant to within a few millimeters per second with respect to the base of the cylinder, spin frequencies between five and fifteen Hz, and an absolute spin frequency rate of change less than 1.25 Hz per second. The research was conducted such that the algorithms and procedures that were developed could be performed by analysts who are relatively unskilled in this analysis. The heuristic methodology utilized in this effort is one wherein a working model of the expert analyst's problem-solving approach is obtained by observing him perform the manual procedure, generating the associated protocols, and then programming this intelligence into the machine. The manual procedure was easy to understand and to implement in the machine.					
20 DISTRIBUTION AVAILABILITY OF ABSTRACT <input checked="" type="checkbox"/> UNCLASSIFIED-UNLIMITED <input type="checkbox"/> SAME AS RPT <input type="checkbox"/> DTIC USERS			21 ABSTRACT SECURITY CLASSIFICATION UNCLASSIFIED		
22a NAME OF RESPONSIBLE INDIVIDUAL M. Helene Essary			22b TELEPHONE (Include Area Code) (505) 678-5818		22c OFFICE SYMBOL STEWS-ID-A

TABLE OF CONTENTS

	<u>Page No.</u>
LIST OF ILLUSTRATIONS	v
INTRODUCTION	1
THEORY	1
TRACKING PROBLEMS AND THE MANUAL TRACKING PROCEDURE	4
INITIAL TRACKING PROCEDURES	6
AUTOMATIC TRACKING ALGORITHM DEVELOPMENT	9
KNOWLEDGE BASED SYSTEM DEVELOPMENT	11
CONCLUSION	12
REFERENCES	70
APPENDIX A. PROGRAMS	71
APPENDIX B. DATA SETS	109
DISTRIBUTION LIST	135

Accession For	
NTIS GRA&I	<input checked="" type="checkbox"/>
DTIC TAB	<input type="checkbox"/>
Unannounced	<input type="checkbox"/>
Justification	
By _____	
Distribution/ _____	
Availability Codes	
Dist	Avail and/or Special
A-1	



LIST OF ILLUSTRATIONS

	<u>Page No.</u>
Figure 1. Typical doppler history plot	13
Figure 2. Target scattering center orientation	14
Figure 3. Target aspect angle	15
Figure 4(a). Single scattering center	16
Figure 4(b). Relationship of spectral content to Fourier transform size	17
Figures 5(a)-(t). Doppler history plot with Fourier transform window equal to 1/5 cycle of spin	18 - 37
Figures 6(a)-(j). Doppler history plot with Fourier transform window equal to 2/5 cycle of spin	38 - 47
Figures 7(a)-(e). Doppler history plot with Fourier transform window equal to 4/5 cycle of spin	48 - 52
Figures 8(a)-(c). Doppler history plot with Fourier transform window equal to 8/5 cycle of spin	53 - 55
Figures 9(a)-(b). Doppler history plot with Fourier transform window equal to 16/5 cycle of spin	56 - 57
Figure 10. Doppler history plot with Fourier trans- form window equal to 32/5 cycle of spin	58
Figures 11(a)-(b). Doppler history plot with Fourier transform window equal to 32/5 cycle of spin and lag equal to 16/5 cycles of spin	59 - 60
Figures 12(a)-(b). Doppler history plot representa- tive of noise	61 - 62
Figure 13. Doppler history plot illustrative of fading of spin traces	63
Figure 14. Doppler history plot illustrative of aliasing and crossover	64
Figure 15. Manual analysis of a doppler history plot	65
Figure 16. Selection of candidate spin returns	66
Figure 17. Knowledge based system	67
Figure 18. Interface and knowledge base	68
Figure 19. Cognitive engine	69
Figure B-1. Data set 1	109
Figure B-2. Data set 2	123
Figure B-3. Data set 3	128

INTRODUCTION

This research involves the development, implementation and optimization of algorithms for tracking the spectral spin frequency representations of a revolving cylindrical target having four protruding scatterers. The investigation is limited to coherent phase and amplitude data that are constant to within a few millimeters per second with respect to the base of the cylinder, spin frequencies between five and fifteen Hertz (Hz), and an absolute spin frequency rate of change less than 1.25 Hz per second. The research was conducted such that the algorithms and procedures that were developed could be performed by analysts who are relatively unskilled in this analysis. The heuristic methodology utilized in this effort is one wherein a working model of the expert analyst's problem-solving approach is obtained by observing him perform the manual procedure, generating the associated protocols, and then programming this intelligence into the machine. The manual procedure was easy to understand and to implement in the machine.

THEORY

In the coherent doppler processing of radar data from targets with multiple scattering centers, a frequently used method for information display is the doppler history plot. In this plot, the doppler content of the signal, i.e., the velocities of the various scattering centers relative to the radar are displayed as a function of time. The plot is generated by moving a window of predetermined size through the amplitude and phase data, at an appropriate lag, and mapping the contents of each window into the spectral domain. Next the spectra are sequentially plotted, equispaced, one behind the other, using hidden line plotting techniques. Figure 1 shows an example of a typical doppler history plot.[1]

In this plot, each peak's location in the frequency spectrum is directly proportional to the average relative velocity of the scattering center it represents. A peak in the positive portion of the spectrum represents a scattering center moving towards the radar, while a peak in the negative portion represents a scattering center moving away from the radar. Radial velocities corresponding to the spectral frequencies are shown in meters per second in the bottom scale. The relationship between radial velocity and doppler frequency is directly proportional to the wavelength of the radar, as seen in Equation 1.

$$\dot{R} = \lambda/2f_d \quad (1)$$

where \dot{R} = radial velocity (m/sec)

λ = radar wavelength (m)

f_d = doppler frequency

If a scattering center has an associated velocity too large to be represented on one side of a spectrum a velocity ambiguity occurs and the peak

representation appears wrapped around to the other side of the spectrum. This particular effect is classically known as "aliasing," and occurs when the Nyquist criterion is not met, i.e., when the sampling rate is less than twice the highest frequency component present in the data.

The first two steps in the investigation involve associating the velocity information in the doppler history plot with the spin frequencies of the subject target, and then determining the variation of doppler processing which best displays the spin frequency content for subsequent tracking. The first step is achieved by examining the scattering center orientation of the target, with respect to the radar line of sight. The second step requires examination of long-term Fourier transforms, those encompassing several cycles of spin, which bring up the FM sidebands of the spin modulation.^[2]

Examination of target scattering center orientation began with the analysis of Figure 2.

As shown, the four scattering centers that produce spin frequency effects in the doppler history plot are symmetrically located with respect to the axis of the cylinder. Dominance of the spectral spin information is due to the relatively long distance they extend out from the cylinder, as opposed to any other scatterers which may exist near the surface. Since this distance and the carrier frequency are constant, the spin doppler excursion is determined by the target aspect angle, Ω . As shown in Figure 3, Ω , which varies between 0 and 90 degrees, is defined to be the angle between the radar line of sight and the spin axis of the target. The mathematical relationship for the excursion of spin doppler is expressed in Equation 2.

$$\Delta f = 4\pi f_s \frac{df_c}{c} \sin \Omega \quad (2)$$

where

Δf = excursion of spin doppler

f_s = spin frequency

d = distance from spin axis to scatterers

f_c = carrier frequency

c = speed of light

Ω = angle between radar line of sight and spin axis

Equation 2 shows that spin doppler varies sinusoidally from 0 when $\Omega = 0^\circ$, i.e., the radar line of sight is aligned with the axis of the target, to a maximum when $\Omega = 90^\circ$, i.e., the radar line of sight is perpendicular to the axis

of the target. Alternately, this information can be expressed in terms of the modulation index, K , as shown in Equation 3.

$$B = \frac{\Delta f}{f_s} = 4\pi d \frac{f}{c} \sin \Omega \quad (3)$$

The modulation index also increases as Ω tends toward 90° , thus placing more of the power into the FM sidebands of the spin information. However, due to the four-fold symmetry of the scatterers, only multiples of four times the spin frequency appear in the sidebands, as opposing doppler returns from the symmetric scatterers usually cause cancellation of all intermediate returns.

The next step in the research involved examination of long-term Fourier transforms, those encompassing several cycles of spin, in order to develop a reasonable display of the sidebands present. This effort began by considering the situation depicted in Figure 4a. Here, a single scattering center is shown spinning about its tip, with the radar line of sight in the plan of rotation, i.e., $\Omega = 90^\circ$.

Next, Figure 4b was developed, depicting representative spectral information that would be received by the radar in this case. The left-hand side of Figure 4b shows a doppler history plot encompassing two cycles of this target's spin, where a very narrow transform window would need to have been used for near instantaneous frequency representation. The right-hand side of Figure 4b shows the corresponding single spectrum contents of windows, which contain a negative half cycle, a full cycle, and a positive half cycle of spin, from top to bottom, respectively. This figure indicates that only a transform window, encompassing at least a full cycle of spin, can contain all the FM sidebands of spin modulation.

As a proof of this indication, doppler histories were generated from typical amplitude and phase data from the subject target for Fourier transform windows encompassing $1/5$, $2/5$, $4/5$, $8/5$, $16/5$, and $32/5$ cycles of spin. These doppler histories are displayed in Figures 5 through 10, respectively. Inspection of these doppler histories gave evidence of the spin sideband tendency to settle into a single spectrum as the transform window approaches a full cycle of spin. Further, as the transform window expands to encompass several cycles of spin, fewer sidebands are lost due to temporary destructive interference; and their representations sharpen, due to the increased number of points in the window. This effect allows for more precise manual frequency determination.

Two other points are worthy of note in Figures 5 through 10. First, the total normalized power in each of the spectra is equal, as was the case in Figure 4b between the $1/2$ cycle and full cycle spectral displays. Therefore, increasing the length of the Fourier transform window has no effect on the total normalized power in each spectrum, but rather on how the power is distributed, i.e., according to the spectral content. Second, the lag used in moving the transform window through the data was equal to the length of the transform window. This implies uncorrelated spectra, i.e., no common time domain data is used in the production of previous or successive spectra. Figure 11 is

equivalent to Figure 10, except that each adjacent pair of spectra is correlated. Using a lag of 1/2 the size of the transform window, each spectrum is computed with 1/2 of the time domain data used to compute each of its adjacent neighbors. Correlated spectra is frequently produced in doppler history displays to achieve the effect of smearing the spectral peaks as a function of time, thus leaving traces of scattering center velocities which are more pleasing to the human eye.

For the subject target, the number of points in each transform window was chosen to be 256, so as to encompass at least four cycles of spin and to give reasonably sharp spin traces. Production of noncorrelated spectra, i.e., lag equal to 256, was chosen for subsequent tracking, as the human eye was not intended to be part of the automated process; and also in that this reduces the computational workload. It was noted that reduction of a given lag, by a factor of two, doubles the number of spectra that must be produced and subsequently handled. A lag greater than the transform window would further reduce the computational workload; but this was determined unfeasible, as information would be lost in the doppler display.

As noted in the introduction, the phase and amplitude data that are used are constant to within a few millimeters per second, or normalized with respect to the base of the cylindrical target. Unfortunately, the relatively large amplitude of the base return frequently causes spin returns not to be seen in the normalized doppler history display. Therefore, for the spin doppler history displays presented in this paper, the base return has been filtered out of each spectrum after normalization, in order to bring up the sidebands of the spin modulation.[3]

TRACKING PROBLEMS AND THE MANUAL TRACKING PROCEDURE

This research has identified four classes of problems in the doppler history data which have, to date, inhibited the development of an automated process for tracking spin frequencies. These problems, which may occur in any combination, are:

- Noise, used here in a general context to describe both random noise and undesired clutter returns.
- Periodic fading or cancellation of spin frequency returns.
- Wraparound or aliasing of the higher spin frequency multiples.
- Crossover of nonwrapped and wrapped spin returns.

For testing of automated spin line tracking algorithms to be developed, three sets of data were selected which exhibit various combinations and intensities of all four classes of problems. Data Set 1, shown in Figure 12, exhibits

fading and spin multiple crossover in a severe noise environment. Noise, as illustrated in this figure, may appear at any frequency, singularly or in clusters, and with amplitudes often larger than those of the spin returns. Data Set 2, shown in Figure 13, illustrates an example of severe fading and cancellation of spin frequency returns while in a relatively low noise environment. Such fading is due to variation in radar orientation (target's aspect angle) and destructive interference from other returns. Data Set 3, shown in Figure 14, exhibits very prominent higher spin multiples, which alias and make distinction difficult at points where they cross over lower spin multiples. Another problem is an occasional strong 60 Hertz line caused by interference; however it was considered too rare to be included as another main class problem.

The first step in the development of an automated spin frequency tracker was to observe a skilled analyst while performing such a data reduction. The following steps describe the procedure obtained from these observations.

1. A doppler history plot is generated with the following characteristics:
 - a. A transform window, large enough to produce reasonably sharp spin traces.
 - b. A lag, half the size of the transform window, to produce smearing of the spectral peaks.
 - c. High pass filtering, to remove the relatively large base representation.
2. Next, traces of spin frequency multiples in the doppler history plot are identified and marked. These multiples are denoted as mf_S where f_S is the spin frequency and, $m = \pm 4, \pm 8, \pm 12, \dots$. Here again, it is noted that, generally, only multiples of $4f_S$ are present.
3. On a spectrum-by-spectrum basis, the largest mf_S , which can be identified and is not aliased, is then selected for tracking. The spin history is then calculated by measuring the zero doppler offset of these multiples, dividing by the corresponding multiple, and recording the results as a function of time.

In identifying the spin frequency traces, the analyst utilized the apriori knowledge that the actual spin frequency will be between 5 and 15 Hz, with rare exception. Using this information the analyst identifies the $4f_S$ multiple as the lowest spin frequency trace in the interval 20 Hz to 60 Hz. The $-4f_S$ multiple is identified in a similar manner. Higher multiples are subsequently identified by searching in the area of the appropriate doppler offset for that multiple. For example, if the $4f_S$ trace was located at approximately 20 Hz, the $8f_S$ multiple would be searched for around 40 Hz, the $12f_S$ multiple at around 60 Hz, and so forth. Since the error in frequency measurement for identifiable multiples is approximately equal, selection of the highest multiple minimizes error in the calculated spin frequency as the measurement is divided by that multiple. Aliased multiples are not considered, due to their

generally lower relative amplitude, and due to the additional constant that must be included in the calculations. When fading occurs, the next lower, identifiable multiple is selected for tracking. When higher multiples alias and crossover traces currently being tracked, the analyst has the advantage of following the general trend of the trace under track and, thus, usually avoids confusion between spin representations. In cases where no spin multiples are identifiable due to noise and/or fading the analyst usually interpolates these areas with the values of previously and successively tracked spin frequencies. Noting that such measurements and calculations are very labor intensive on a spectrum-by-spectrum basis for long periods of track, the analyst will frequently make measurements only on every third or fifth spectrum and interpolate the others as long as the data are relatively clean and this can be done without loss of continuity or track. Obviously this is not always the case due to the tracking problems that are involved. Figure 15 illustrates the manual analysis where only three spin frequencies have been calculated.

INITIAL TRACKING PROCEDURES

As an adjunct to observing the skilled analyst perform the manual tracking process, work on a similar problem by graduate students at the Cognitive System Laboratory, University of California at Los Angeles (UCLA) was also reviewed. In this work spin doppler returns from a similar target were simulated in order to develop like tracking algorithms. These algorithms were developed on the basis of two fundamental assumptions.

First, a given candidate spin representation in a particular positive half spectrum should have a like representation in the negative half spectrum. Second, an algorithm should be able to locate, in previous and successive spectra, similar candidate returns which follow a particular spin frequency trend. Therefore positive frequency trends should be correlatable with their counter representations in the respective negative half spectrum. This process started with a Monte Carlo type simulation, where positive and negative spin frequency representations were generated and then combined, constructively and destructively, with randomly generated noise, and used as the basis to compute the doppler power spectra. Next, the tracking algorithms would, for each spectrum, select symmetrically located peaks as candidate spin frequency returns. Previous and successive spectra would then be examined, to determine if the candidate returns fit within candidate spin frequency trends. Those candidate returns which did not fit would then be eliminated. Finally, the chosen spin frequency trends would be selected, using the a priori knowledge that they should be multiples of four times the fundamental spin frequency and should last, for the most part, for the duration of the data, i.e., short spurious trends would be eliminated. The spin frequency as a function of time would then be calculated from these trends.

This process proved difficult to implement on available computational hardware, slow in terms of total execution time, and usually failed to obtain the correct spin frequencies when applied to real data. Processing equipment used for the implementation was a Digital Equipment Corporation PDP-11/55 with floating point hardware, 256 kilobytes of memory, a 176 megabyte storage disk, 128 kilobytes

of fast access disk emulator storage, an array processor which had not been implemented in software, 7 and 9 track magnetic tape capabilities, and a graphics terminal with hard copy. The first problem in the hardware implementation of the process was the limited memory available for the doppler history data which the algorithms operated upon. Since the fast access disk emulator storage was too limited to contain all of the data, it was necessary to store it on the substantially slower disk, and frequently swap small portions of it in and out of main memory as the processing algorithms required them. This continuous swapping, in addition to the time required for processing of the algorithms and the time needed to conformally map the data to the spectral domain, further made the entire process intollerably slow. The major drawback of the process, however, was the frequent failure to obtain the proper spin frequencies. Intensive manual analysis of the process and results showed the failures to be primarily due to the assumption that candidate spin returns will appear symmetrically about zero doppler. In the simulations conducted at UCLA, this was not a problem as the simulated doppler histories were produced noncoherently, thus insuring symmetric representations. For the real data used in this application, however, such was not the case as it is processed coherently. Attempts to modify the process and remove the symmetry requirements of candidate spin representations showed insufficient improvement in proper spin frequency identification.

While the process developed at UCLA appeared inadequate for the problem at hand, it did demonstrate that available memory and speed of conformal mapping were problems to be reckoned with. Indeed, any tracking algorithms developed would need conformally mapped data to operate on, as well as a place to store it. In order to speed up the mapping process, implementation of the array processor was investigated. The result of the effort was the development of software which performed Fast Fourier Transformations (FFT) through a series of subsequent calls to array processor subroutines. The software also used the array processor to compute the doppler power spectrum. This software is listed in Appendix A as subroutine FFT2. While benchmark speed tests of the software showed that, after initialization, the array processor performed the required function more than 25 times as fast as the main processor, there were still additional drawbacks associated with its use. The first drawback was the 16 kilobyte main memory requirement for array processor software storage. The second drawback was the fact that if the software was swapped out of main memory or windowed out of the 64 kilobyte execution window in main memory, the array processor would need to be reinitialized before its next use. This was a major problem in that initialization, along with the performance of only one FFT by the array processor, took three times as long as performance of the same operation by the main processor. In other words, the advantage of using the array processor lies only in the performance of many operations between initializations. Thus, utilization of the array processor for increased conformal mapping speed placed even greater restrictions on already inadequate executable memory. It is worthy of note that a 16 bit processor such as the PDP-11/55 has an instantaneous execution window of only 2^{16} or 65,536 bytes of main memory. Further, while memory mapping allows this segment to be split into as many as eight subelements anywhere within the 256 kilobyte total allocation at any one time, the subelements must be multiples of 4096.

This, then, defines the upper subelement, array processor memory requirement of 16 kilobytes, where a kilobyte is defined to be 2^{10} or 1024 bytes.

With even more stringent requirements placed upon available main memory, due to array processor overhead, emphasis at this stage of the research was placed upon requirements for storage of doppler history data. While review of procedures used at UCLA to obtain spin frequencies showed little promise of solving this problem, a look at the manual preanalysis normalization proved to be of great value. The process first involved precise doppler alignment, to within a few millimeters per second, of the subject target's base. Next, because of the relatively large amplitude of the base return to that of the fins, the spectra were high pass filtered, to remove base effects and bring up spin representations, for easier identification in tracking. At this point it was noted, while observing the analyst perform the manual tracking procedure, that the spin representations often had the largest amplitude. Utilizing this information, it was decided to try storing only a small number of the largest remaining returns in each spectrum as an information base of candidate spin returns. First, each spectrum was further high pass filtered, up to the minimum $\pm 4 f_s$ requirement in this effort, i.e., $\pm 4 f_s \text{ min} = \pm 4 \times 5 \text{ Hz} = \pm 20 \text{ Hz}$. This had the effect of removing any additional undesired returns of large amplitude in this interval from consideration. Next, thirty was chosen as the number of peaks with largest amplitudes to be considered as candidate spin returns in each spectrum. Thirty was chosen simply as a worst case guess, based on observation of data at hand. However, after analysis of candidate peak selections for different sets of data, it was discovered that many candidates often described the same peak. This was primarily due to the fact that the peaks were not of infinitesimal width. Consider Figure 16, selection of candidate spin returns, which denotes (as circled) the five largest amplitudes of twenty. While these points indeed represent the largest amplitudes, in reality the dominant peaks are those indicated by vertical arrows. After only short-term manual analysis, the solution to the problem appeared obvious. The peaks represent points at which the slope changes from positive to negative with left to right taken as a positive direction. Utilizing this fact, points of positive-to-negative slope change are first selected as precandidate spin returns. In the case of Figure 16, element numbers 3, 7, 9, 11, 14 and 18 would be chosen. The largest of these would then be chosen as candidate spin returns. Again, in the case of Figure 16, this would correspond to elements 3, 7, 11, 14, and 18 for the five largest elements. Further, trials of this algorithm were then run on the data selected, with analysis of results showing that (in general) selection of only the 16 largest peaks gave rise to a sufficient candidate peak base for subsequent tracking. Storing only the amplitude and location of 16 points for each spectrum reduced storage requirements by 97 percent and allowed the utilization of only main memory, as opposed to main memory and the slow access mass storage media. The selection of 16 points per spectrum is based on the following assumptions:

- Try to keep the data base small without losing too much information on the spin frequency lines.
- Try to reduce the number of noise peaks in the data base.

After reviewing several sets of data it was found that, usually, the maximum unwrapped multiple is the $+16 f_s$; however, not every multiple shows in each spectrum. Therefore, 16 points per spectrum proved to be a reasonable tradeoff between information content and memory restrictions.

In order to further reduce the congestion of main processor memory, it was decided to make this portion of the process separate from the actual spin frequency tracking and computation. This had the advantage of removing the overhead software that would need to be stored in main memory to concatenate the two processes, and allowed for the independent creation (from raw data) of data bases to which tracking a spin frequency computation algorithms could be applied. The complete software development to perform this process is listed in Appendix A as main routine PEAKS1, with associated subroutines FFT2, PICK, SORTAG. Also included in this process is subroutine CONVER, which will be described later, at the point of its development in this research.

AUTOMATIC TRACKING ALGORITHM DEVELOPMENT

With the establishment of a satisfactory data base, the next step in the research was to develop tracking algorithms which duplicated the expert analyst's approach. The expert analyst, however, has the advantage of being able to visually locate the spin frequency traces while surveying the entire doppler history plot. Working with a considerably more limited data base, this luxury was not available. Therefore a method had to be devised which would properly provide initial frequency identification.

Initially, the first spectrum was simply searched for the return of largest amplitude and its location assigned to the $4f_s$ spin multiple. This selection was based on the assumptions that, generally, only multiples of $4f_s$ would be contained in the data base, with those in the lower portion of the spectrum containing the most power. Trial runs on real data were then made to check the frequency selections. Results showed that, except in cases of very clean data, undesired returns were often selected due to clutter and spin return fading in the spectrum. In order to compensate for the problem it was decided to make the program interactive and query the user. The selected return and its location are presented to the user, along with the query, if it corresponds to any spin multiple. If the user response is positive, then he is asked to enter the corresponding multiple. If the user response is negative, then he is asked to calculate and enter the initial frequency.

Once a method of obtaining the initial spin frequency was established, the actual tracking algorithm development began. The location in the first spectrum of the $16f_s$ multiple is computed and the location of each of the eight candidates for that spectrum is checked for a match, to within ± 2 Hz. If no match is found, the location of the $-16f_s$ multiple is checked for a match, and so on, successively utilizing the $+12f_s$, $-12f_s$, $+8f_s$, $-8f_s$, $+4f_s$, $-4f_s$ locations, until a match is found. Once a match is found, the spin frequency for that period is computed by dividing the location of the multiple by that multiple. Higher multiples that do not alias are searched first, since for a constant error in actual peak location division of a spin multiple by a higher

multiple minimizes spin frequency error. The 4 Hz window, used for the search, was chosen as the basis of careful hand analysis of doppler history data. This window generally seemed wide enough to accommodate for rate of change of spin frequency when used in conjunction with extrapolation techniques, and still minimize the presence of unwanted returns in the window. The candidate search frequency for the second window is taken to be the same as for the first, while the candidate search frequency for the third spectrum is a linear extrapolation of the frequencies found for the first and second spectra. Successive spectra use a three-point linear least squares extrapolation of frequencies found for the previous three spectra. This procedure was tested on several sets of very clean data and was shown to produce extremely good results. However, when subjected to data which contained much noise, fading, and/or aliasing of spin lines, the procedure frequently failed. More work was needed to overcome these problems.

Analyzing results after using the tracker in data that faded, showed that when unable to pick any frequencies, track was lost. To correct this problem, it was felt that more interactivity between the user and the program was needed. Therefore an algorithm which checked for the absence of candidate peaks was implemented. If no peaks are found for multiples of the calculated candidate spin frequency, the program then asked the user to enter the spin frequency for that particular spectrum. This approach solved the problem but also introduced another. When fading occurred for large periods, the user is queried much too frequently to supply the correct spin frequency. Since it is not necessary to calculate a spin frequency for every spectrum (as interpolation could be used afterward) selective processing was implemented in the algorithms. In this approach the user selects the portions of data he wants to process, leaving out those where fading is severe. This new approach also has the advantage of leaving out those portions where noise obscures the spin frequency lines. Another problem that arose when testing these algorithms occurred at the crossover point of aliased spin frequency lines. Analyzing the data it was found that, when crossing occurred, the tracker found at least two peaks in the window; and if the rate of change was small, it sometimes lost track. Since this problem does not occur often in each run, the algorithm was modified to prompt the user to select between the candidate peaks. The selection is kept as simple as possible, such that just a quick glance at the doppler plot will usually suggest to the user which is the correct peak to select. This approach also solved the problem of spurious noisy spikes in the search window by the spin frequency peaks. Finally, as a check to the spin frequencies obtained, the algorithms were further modified for selective application to the data in reverse order. Results of forward and backward processing could then be checked by the user for consistency.

Testing of the sets of data selected was performed and the results obtained agreed with the results an experienced analyst would have obtained by doing it manually. These results are shown in Appendix B.

For Data Set 1, the two problems encountered are noise and fading. Noise, being especially severe at the beginning and at the end of the run, will be avoided by skipping processing in these areas. Fading is more severe from 55 to 77 seconds; therefore this part is not processed. Once the run is completed

in the range from 10 to 55 seconds, the results shown are satisfactory and they agree with the results obtained by manual calculation of the spin frequencies.

Also in Appendix B, runs on Data Sets 2 and 3 are shown. Data Set 2 shows some fading, and Data Set 3 shows crossover of spin lines. Both runs were successful, and the results shown agree with manual calculations performed on the doppler plots.

KNOWLEDGE BASED SYSTEM DEVELOPMENT

Since the problem of noise, fading, and crossover of spin multiples often require more experienced analysis, consideration was given to making the developed software more 'user friendly' for easier application by a more novice analyst. After detailed analysis of the entire process, it was decided that implementation of a software superstructure, based on a generalized knowledge-based system (KBS), would normally produce better results.^[4], ^[5] The process was, therefore, broken down into KBS's three primary elements:

- The interface.
- The cognitive engine.
- The knowledge base (as seen in Figure 17).

The interface, as seen in Figure 18 (which breaks down into external data, user, and expert interface), primarily functions as the user's two-way communication link to the expert knowledge modules and fact files which comprise the knowledge base. The external data interface is first used to create the fact files, where the current information to be processed is stored. The user interface then utilizes statistical and expert information, stored in the expert knowledge modules, to guide the user step by step through the process. These modules contain statistical averages from previously successful reductions, suggested defaults, and descriptions of what is happening at every stage of the reduction. Further, each user input is parsed and analyzed for content so that part or all of this information is available even though a numeric input is requested. This algorithm is listed as subroutine CONVER in Appendix A. Statistics on the current reduction are also available to the user, and are used to update the permanent statistics if the user feels the process was successful. Finally, the expert user interface duplicates the user interface, except for the capability of altering the expert knowledge module.

The cognitive engine, as seen in Figure 19, is the active processing element containing the generator and evaluator functions, as well as the inference and reasoning algorithms that interact with the current problem state. Candidate spin returns are first generated as the largest returns in a given line, where the number generated is generally equal to the number of spin traces that do not alias. As mentioned previously, this function is based on the heuristic that most spin multiples present will probably constitute the larger returns, with most power contained in the lower, unaliased multiples. The evaluator function then works like the analyst, using a small search window to locate a spin return. The window center is first extrapolated to the expected areas of

the largest multiples, on each side of the spectrum, and then to successive lower multiples if a peak is not found. Problems of clutter, aliasing, and finding no peaks are then handled interactively through the use of the inference and reasoning algorithms. For example, if no peak (or more than one peak) is found, tracking is halted and the user is made aware of the problem and the location. The user then has the option of allowing the process to make its best guess, based on the current state of the problem, or to enter an overriding location. Statistics are also compiled on the number and nature of such interruptions, for the purpose of later advising the user in the event results are unsatisfactory. For instance, finding multiple peaks more often than not might indicate that a smaller search window would have greater success. In the event that an inexperienced analyst has exhausted the resources of the process and is still unsatisfied, presentation of results and statistics to a trained analyst can usually gain an expeditious solution.

CONCLUSION

The resulting product of this research contains many heuristic-based features, used by trained analysts in processing spin information, including forward, backward, segmented processing, and extraneous frequency rejection. It is worth noting that, collectively, it has made a significant advance in obtaining spin information for the subject target. The process successfully tracks the spin frequency through fading, clutter, and the aliasing of higher spin multiples back onto lower spin multiples with better than 90 percent reliability in routine reductions. Primarily, this was achieved by placing the techniques of the highly trained analyst into the process and at the immediate disposal of the inexperienced analyst. Routine processing of these parameters can now be performed in less than a tenth of the time previously required by a trained analyst. The analyst's capability to update the expert knowledge modules also reduces future reduction time by making inexperienced analysts even less dependent on their presence.

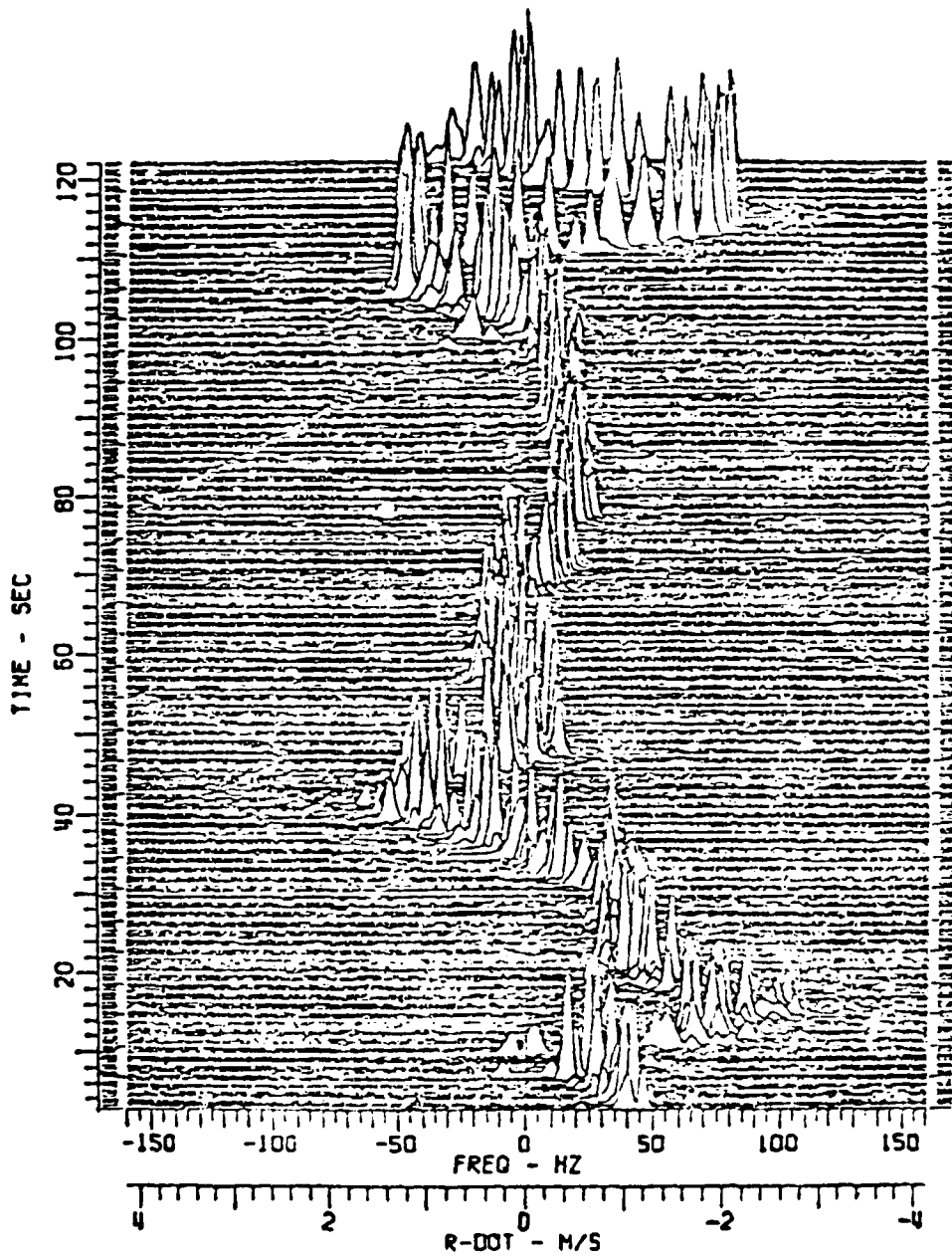

Figure 1. typical doppler history plot.

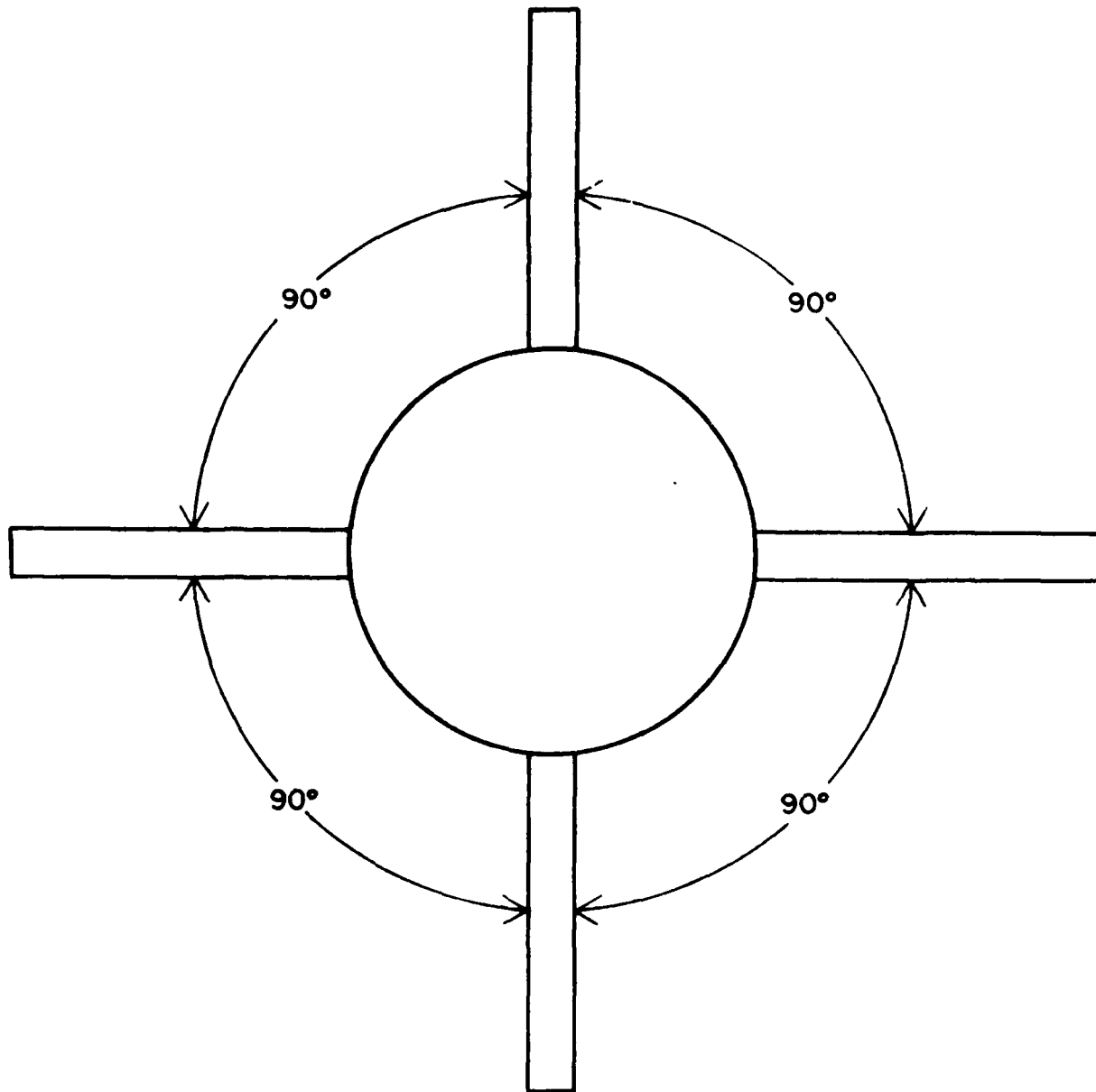

Figure 2. Target scattering center orientation.

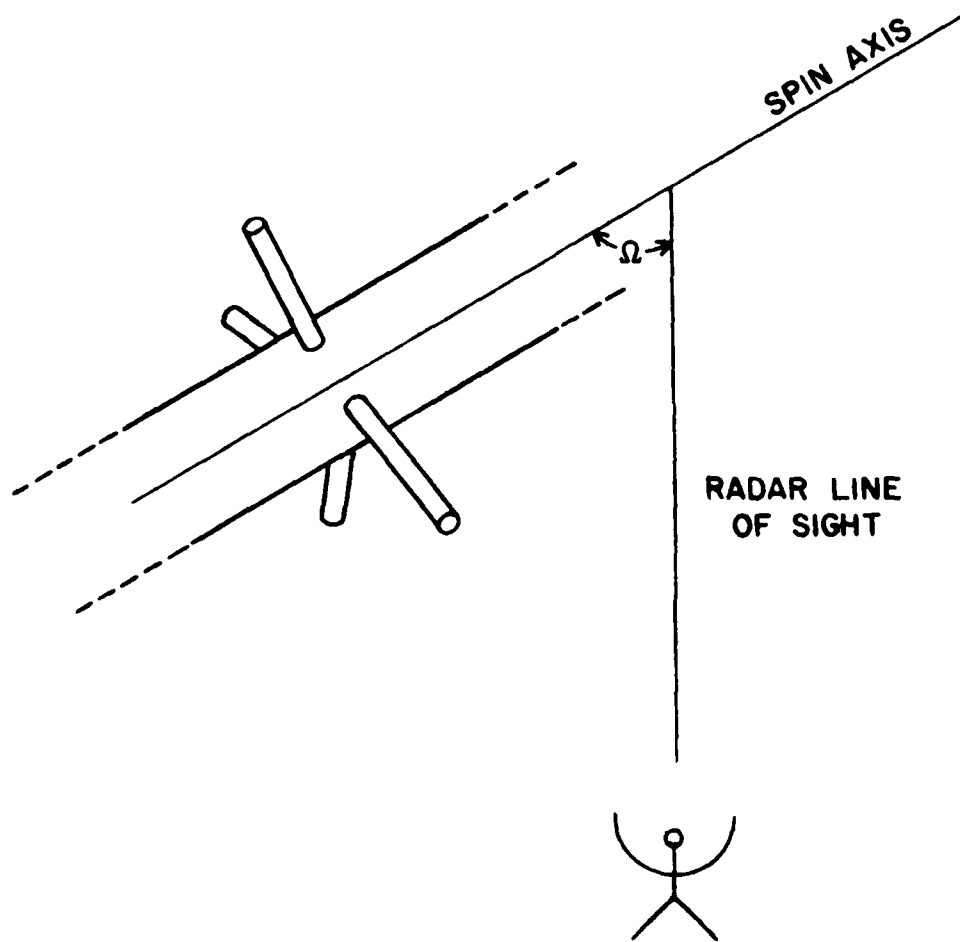

Figure 3. Target aspect angle.

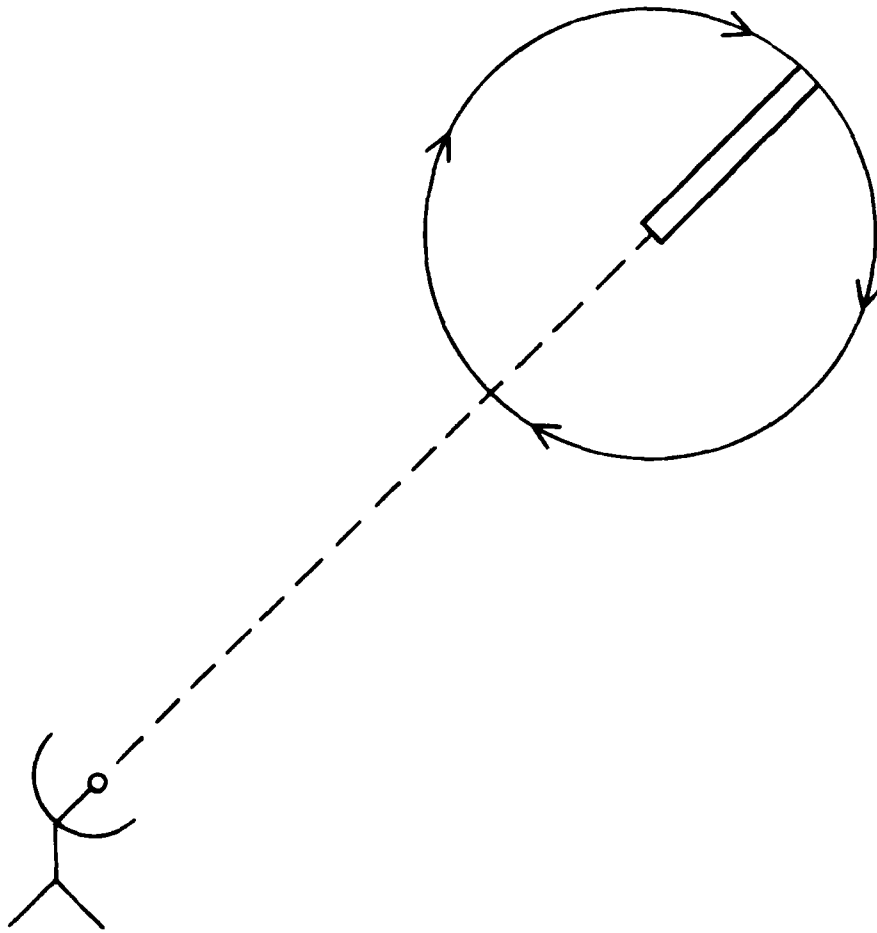

Figure 4(a). Single scattering center.

DOPPLER HISTORY PLOT
OF INSTANTANEOUS SPIN
SPECTRAL CONTENT

FOURIER TRANSFORM
WINDOW SIZE

SPECTRAL CONTENT

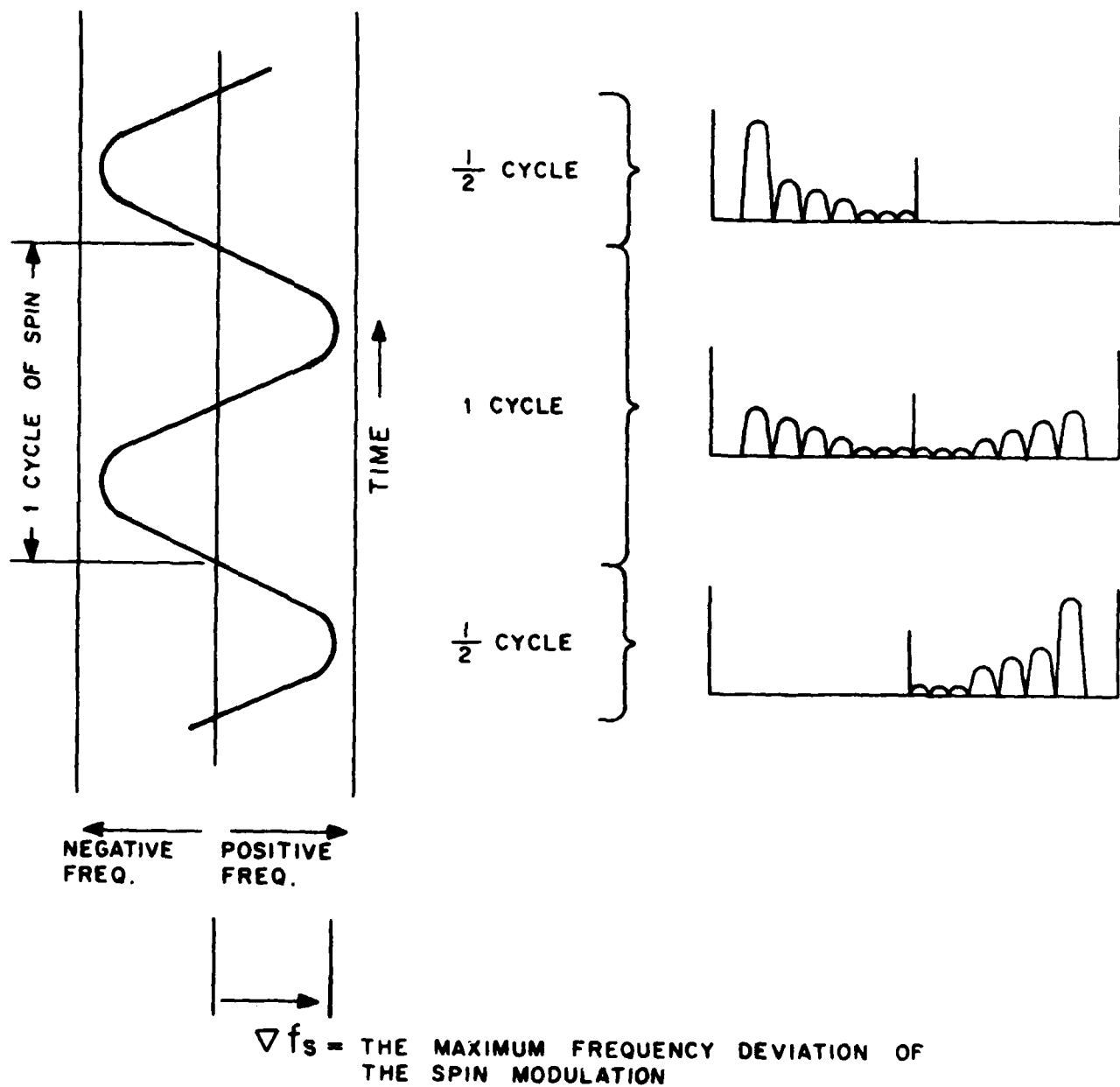

Figure 4(b). Relationship of spectral content to Fourier transform size.

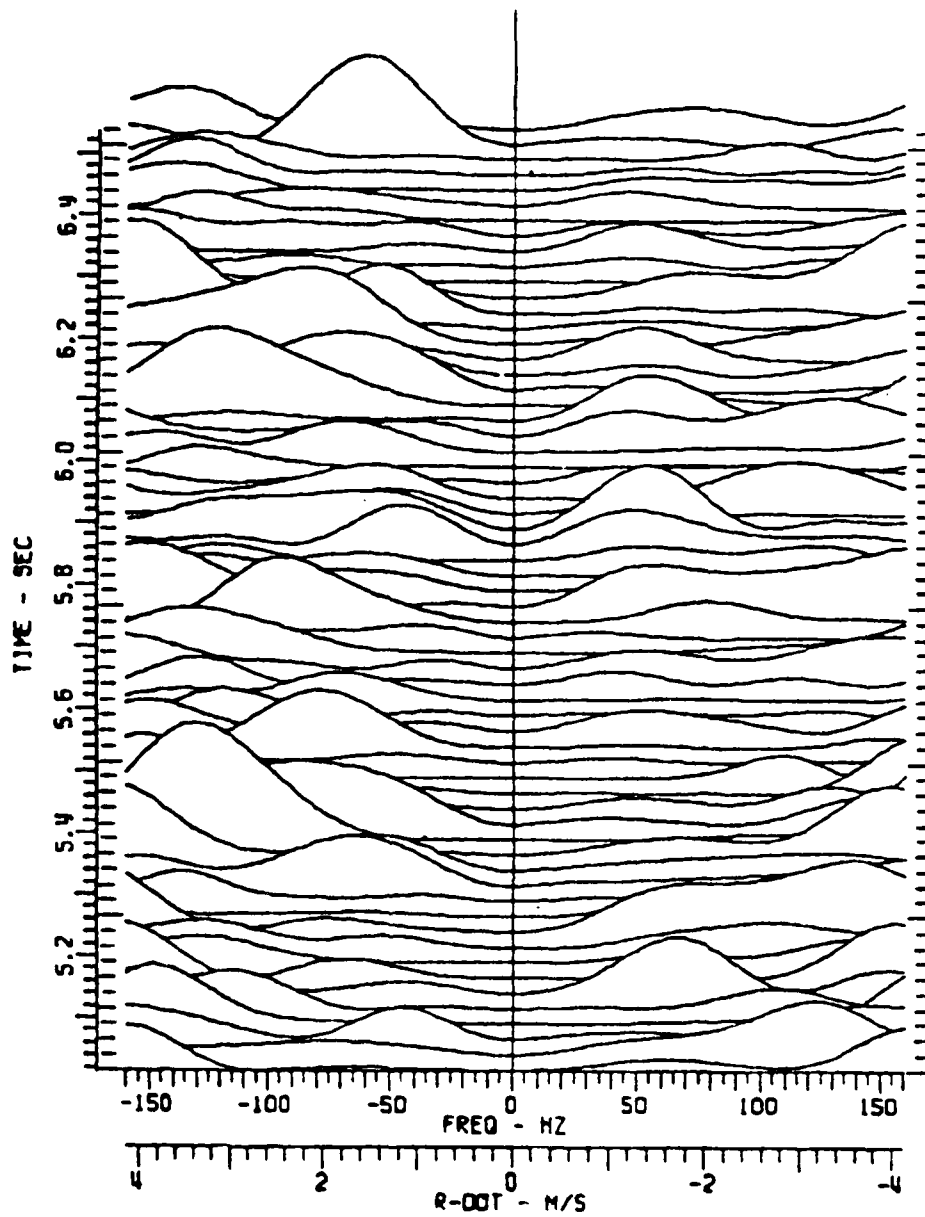

Figure 5(a). Doppler history plot with Fourier transform window equal to 1/5 cycle of spin.

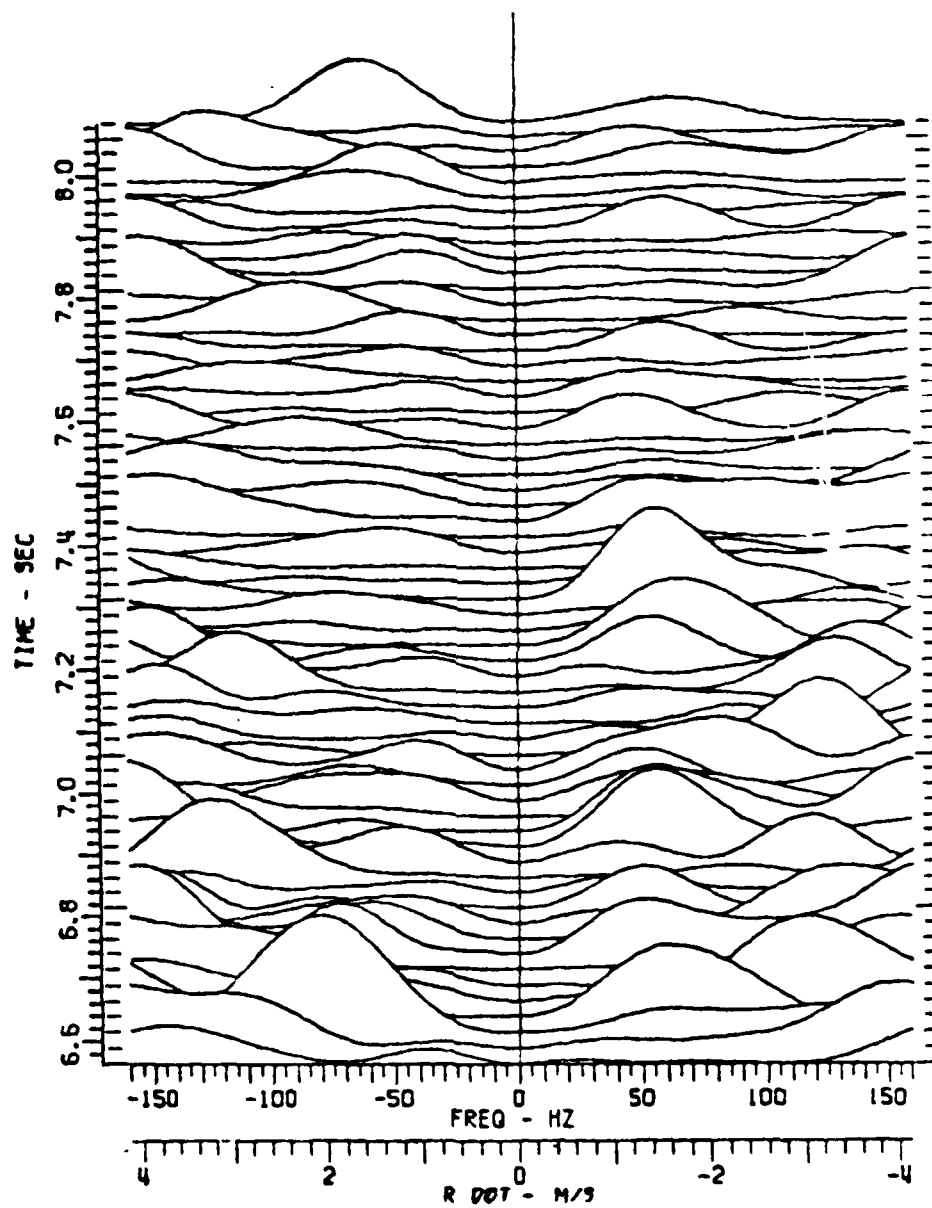

Figure 5(b). Doppler history plot with Fourier transform window equal to 1/5 cycle of spin.

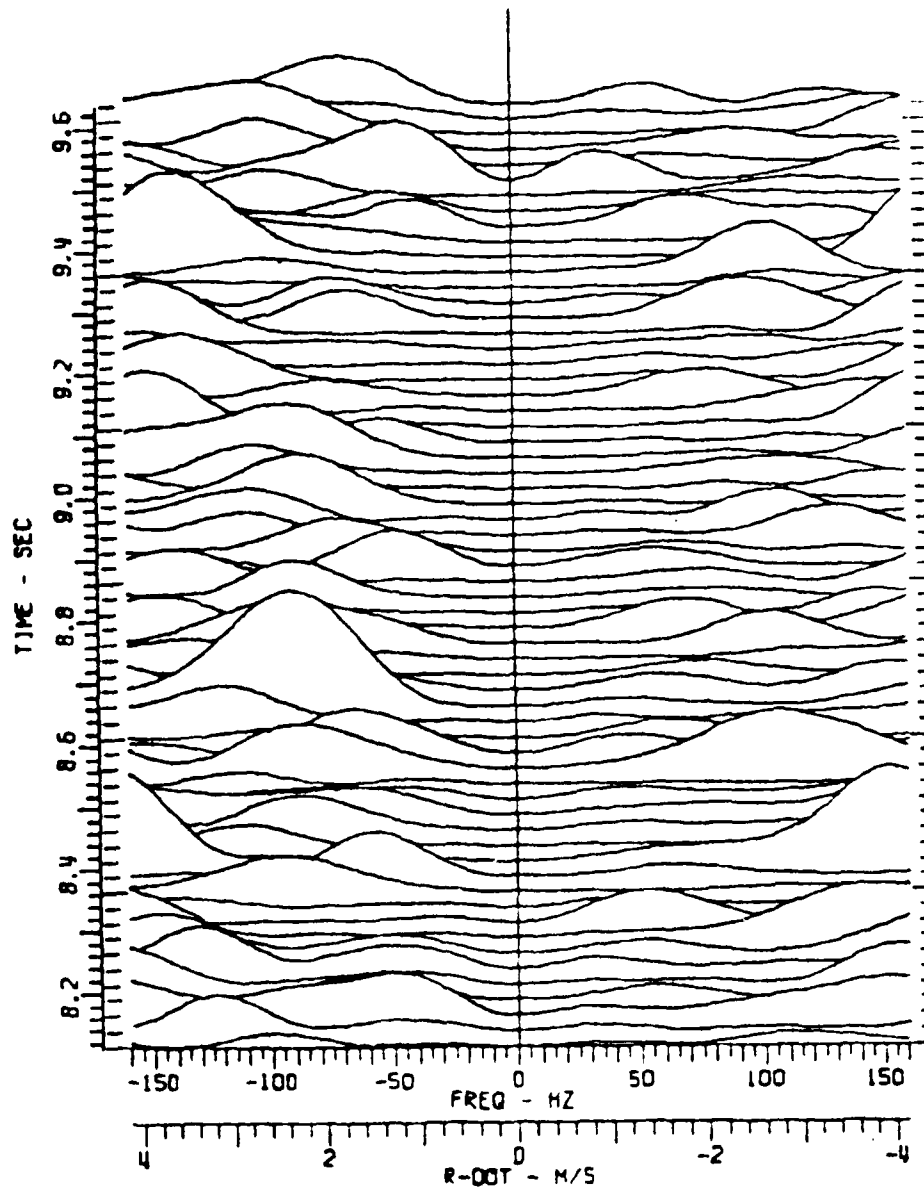

Figure 5(c). Doppler history plot with Fourier transform window equal to 1/5 cycle of spin.

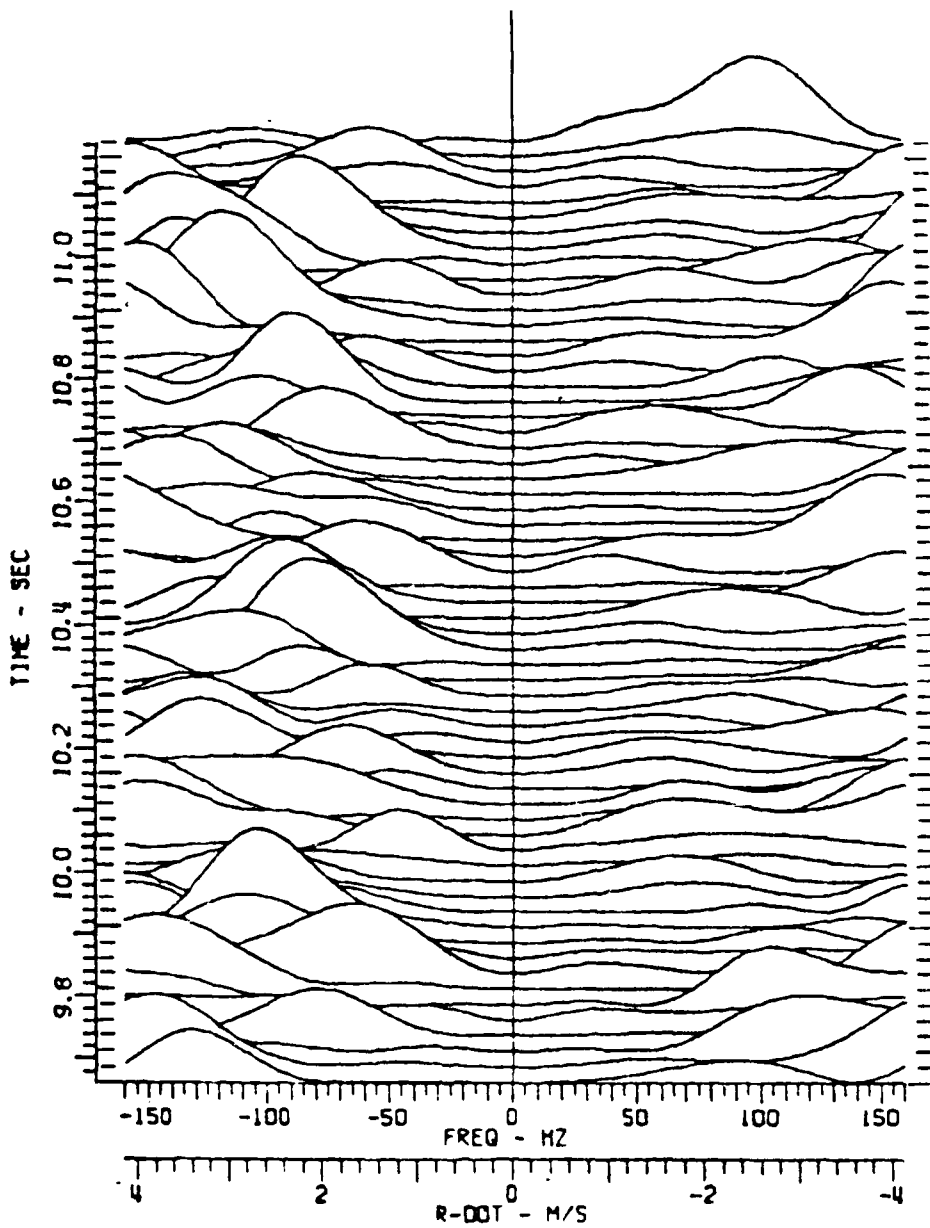

Figure 5(d). Doppler history plot with Fourier transform window equal to 1/5 cycle of spin.

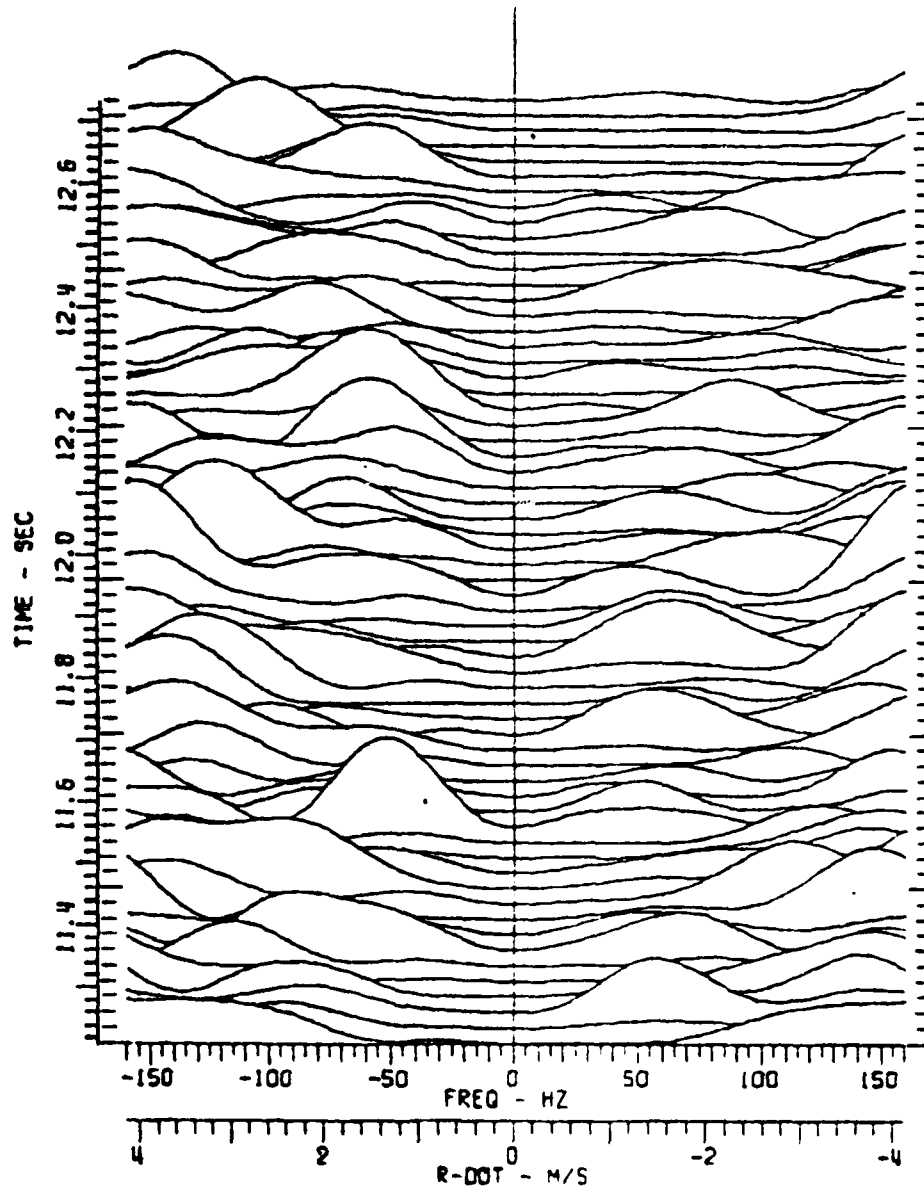

Figure 5(e). Doppler history plot with Fourier transform window equal to 1/5 cycle of spin.

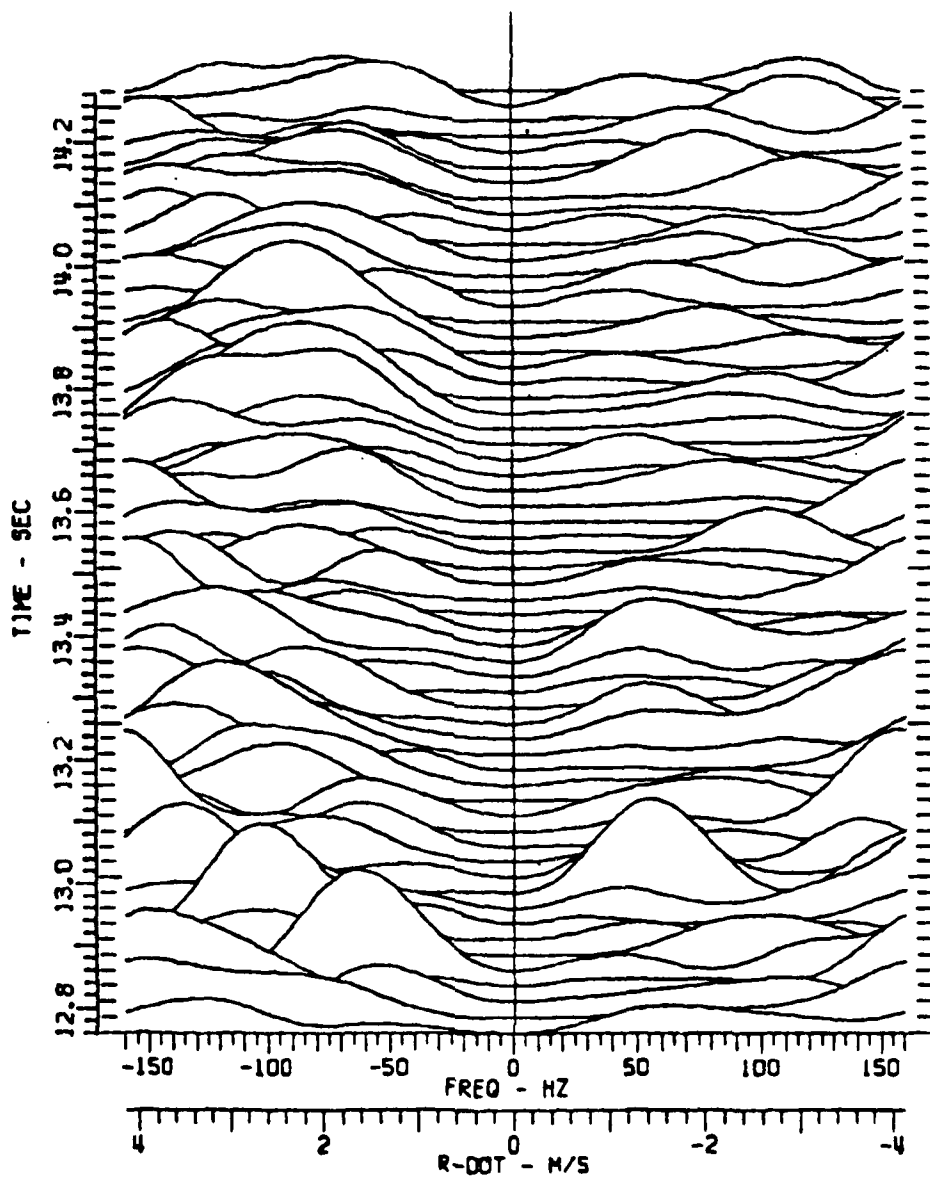

Figure 5(f). Doppler history plot with Fourier transform window equal to 1/5 cycle of spin.

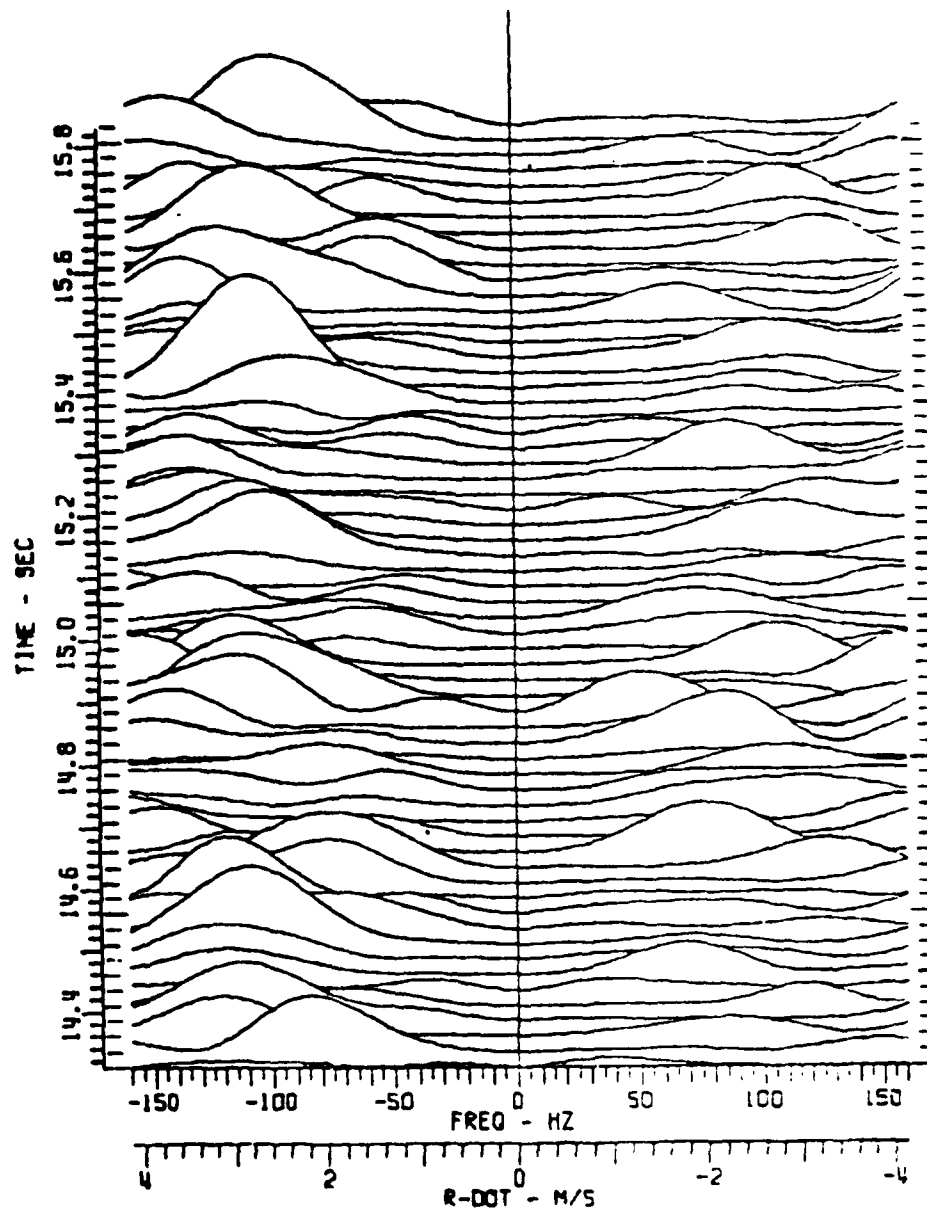

Figure 5(g). Doppler history plot with Fourier transform window equal to 1/5 cycle of spin.

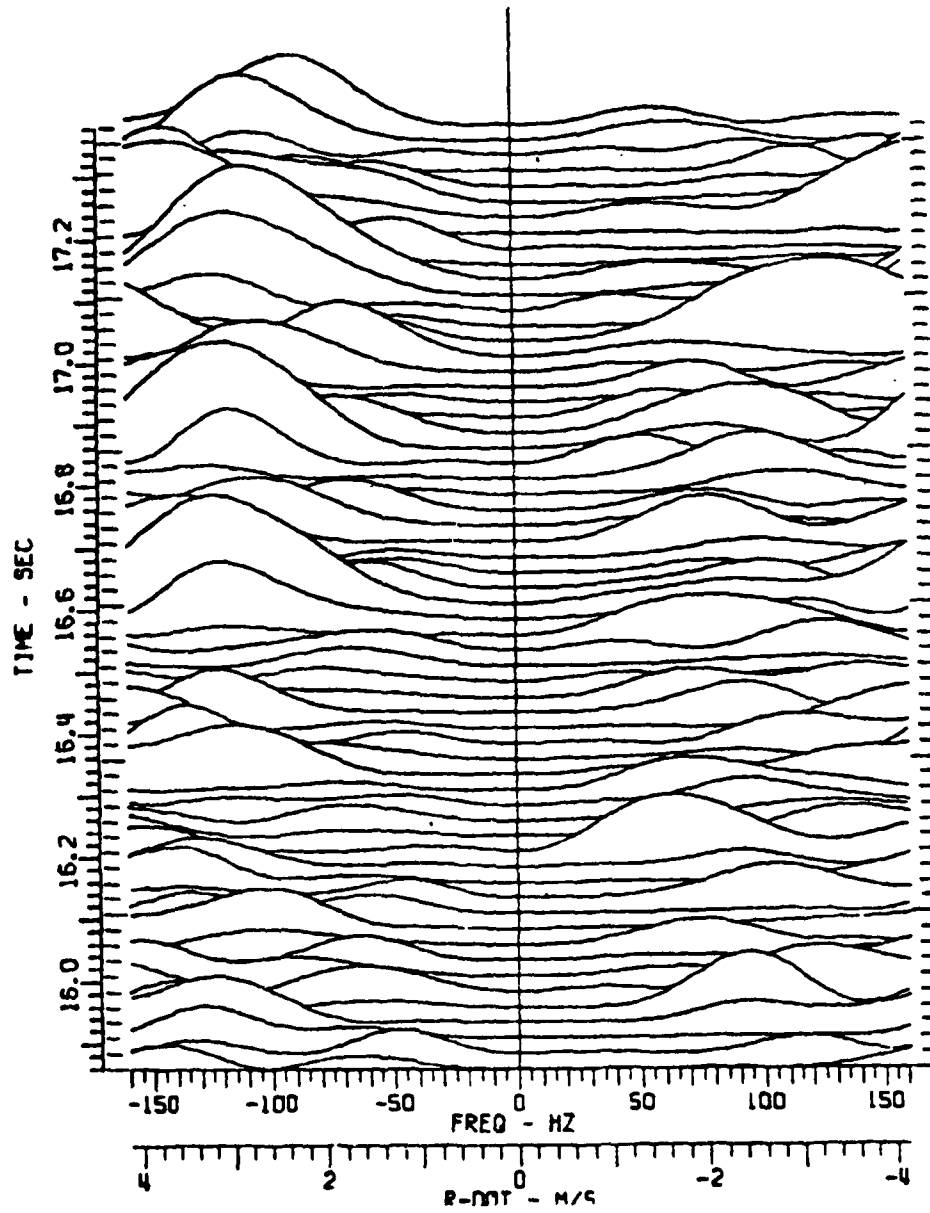

Figure 5(h). Doppler history plot with Fourier transform window equal to 1/5 cycle of spin.

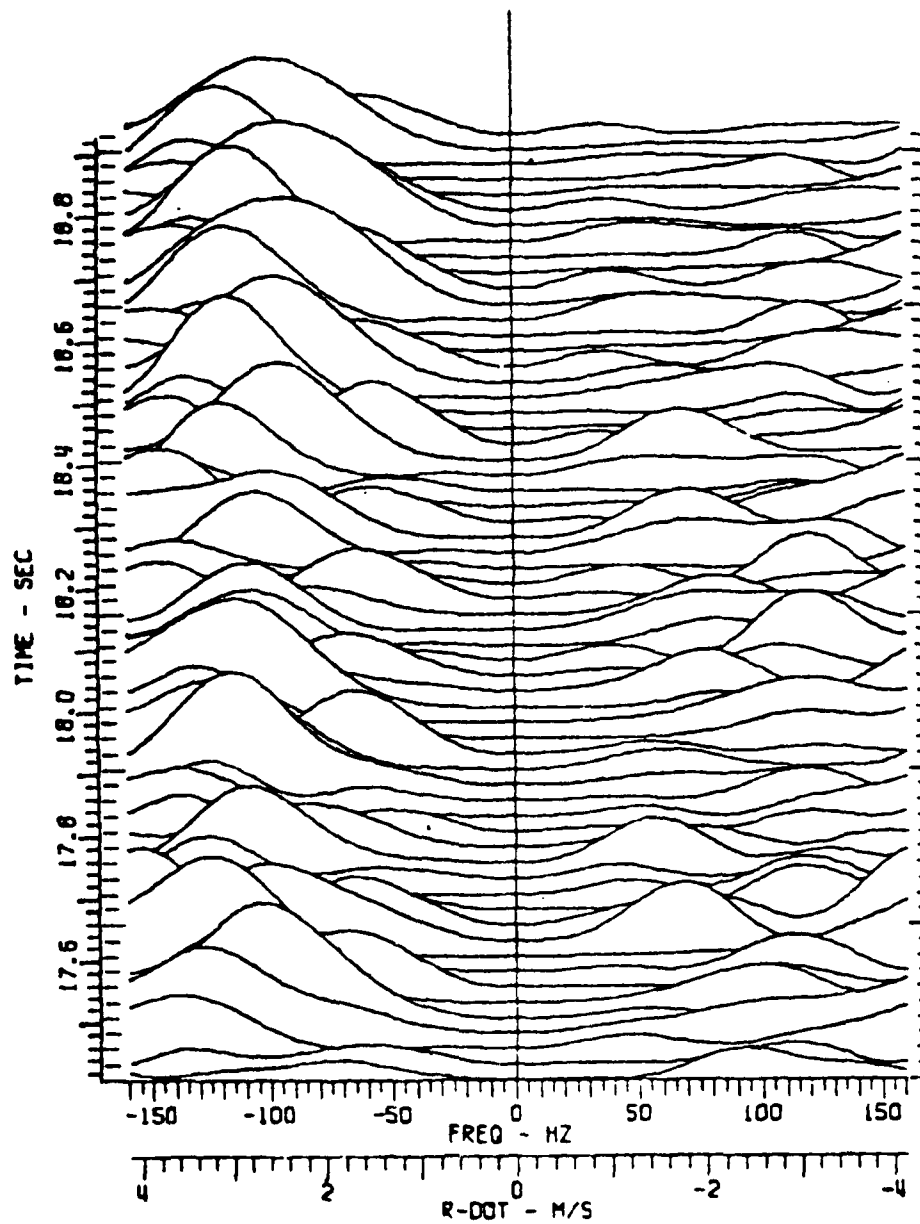

Figure 5(i). Doppler history plot with Fourier transform window equal to 1/5 cycle of spin.

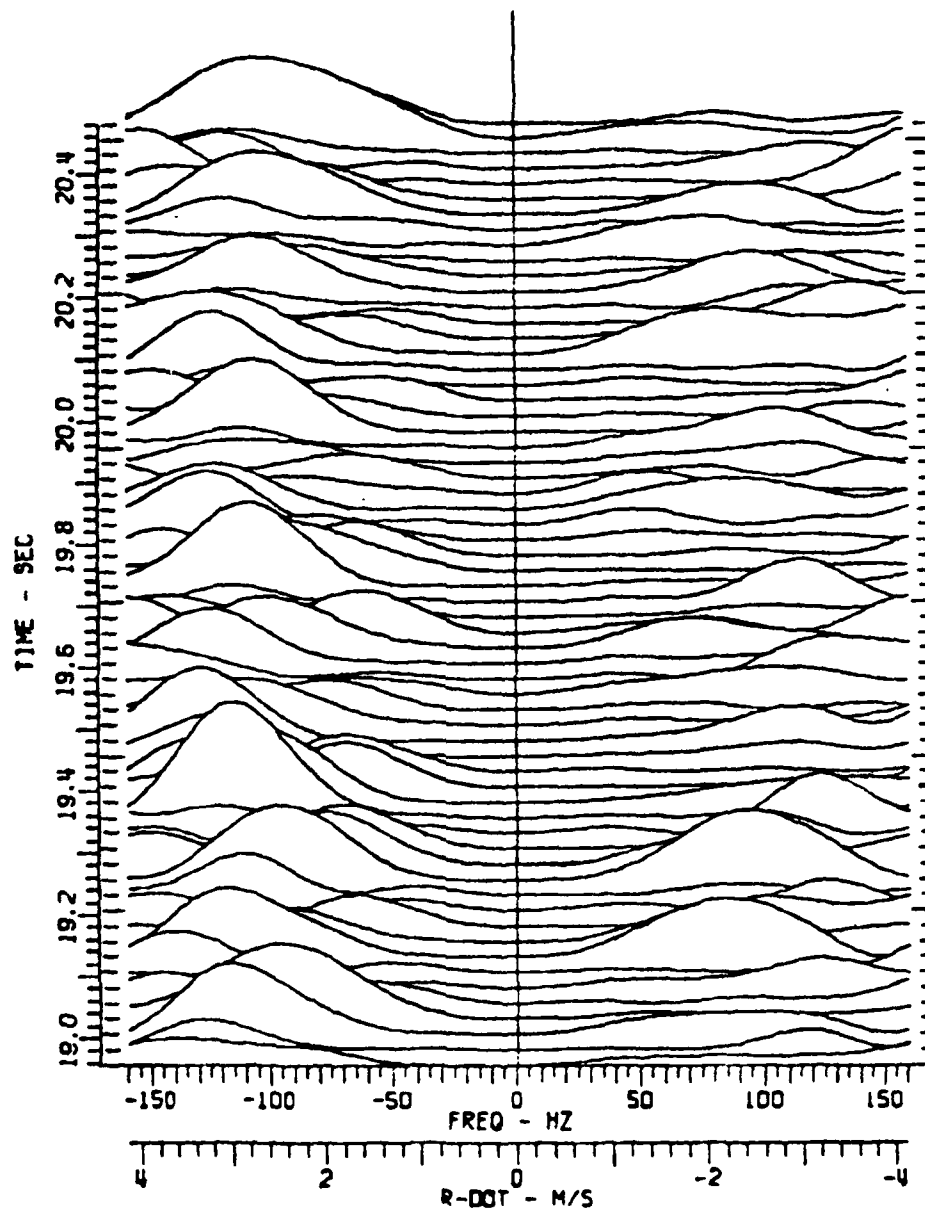

Figure 5(j). Doppler history plot with Fourier transform window equal to 1/5 cycle of spin.

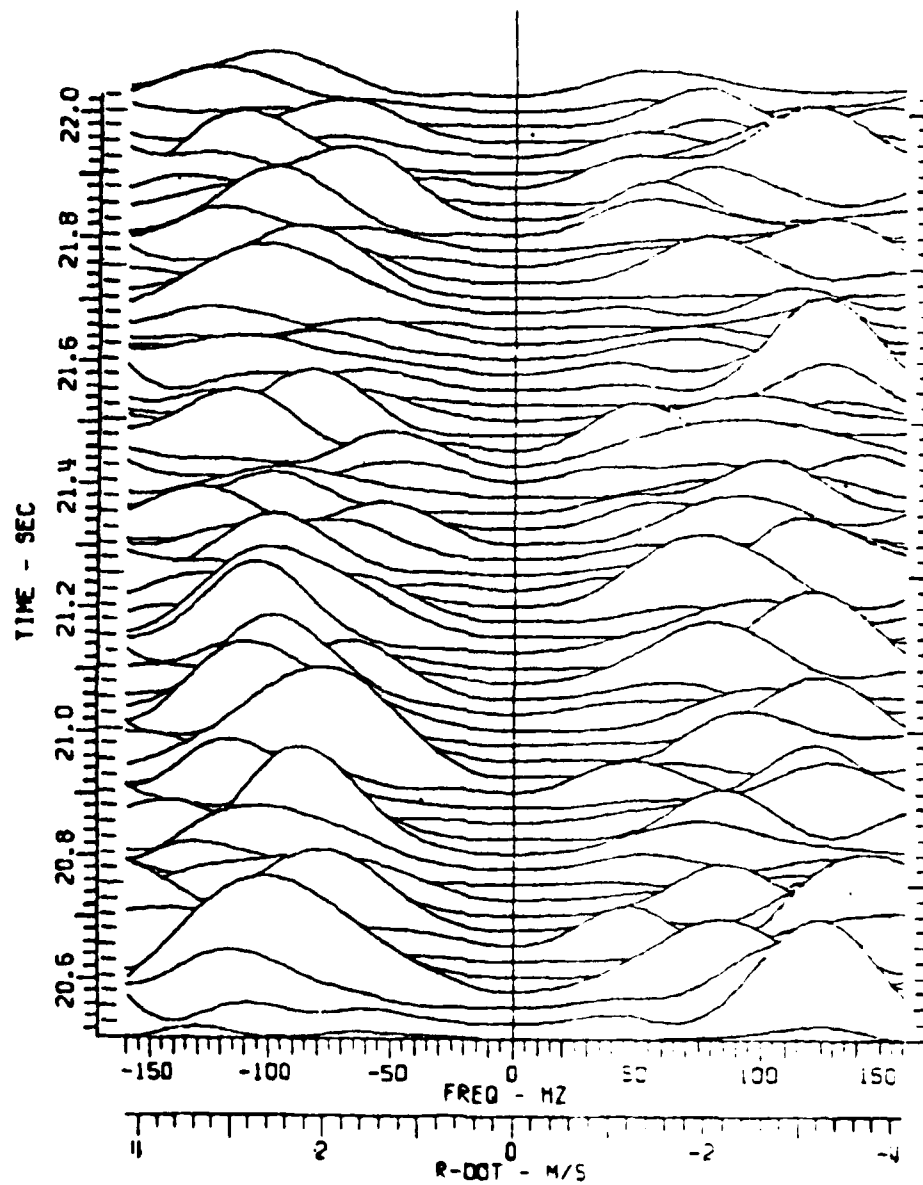

Figure 5(k). Doppler history plot with Fourier transform window equal to 1/5 cycle of spin.

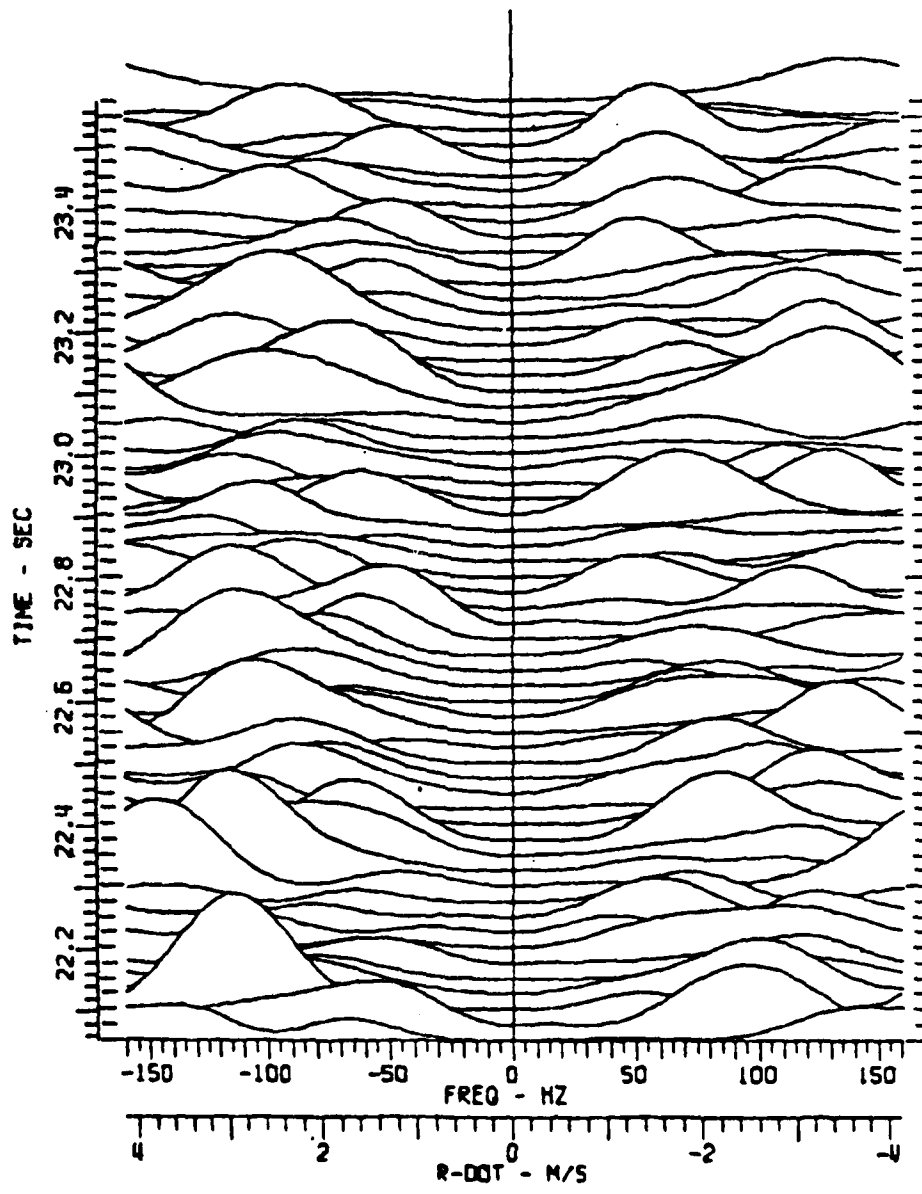

Figure 5(1). Doppler history plot with Fourier transform window equal to 1/5 cycle of spin.

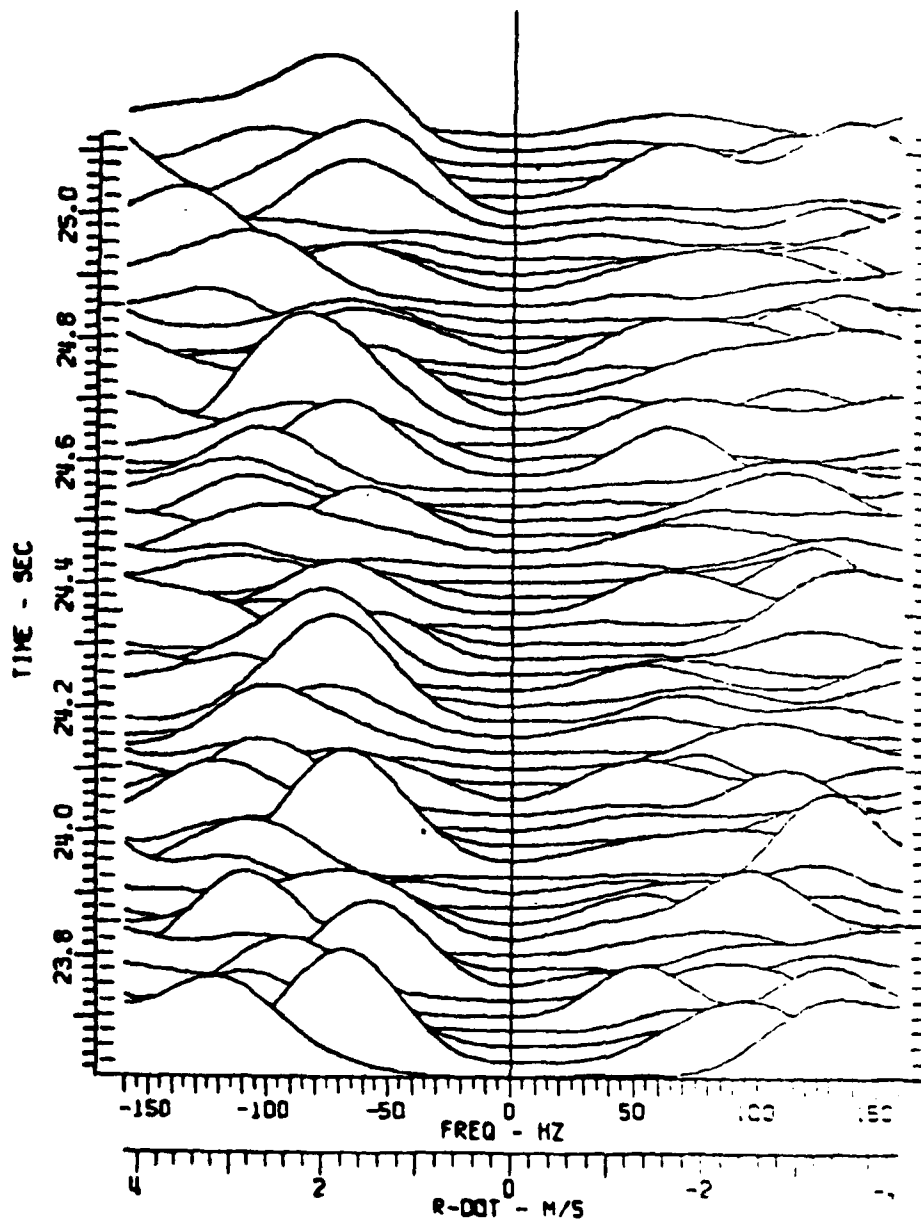

Figure 5(m). Doppler history plot with Fourier transform window equal to 1/5 cycle of spin.

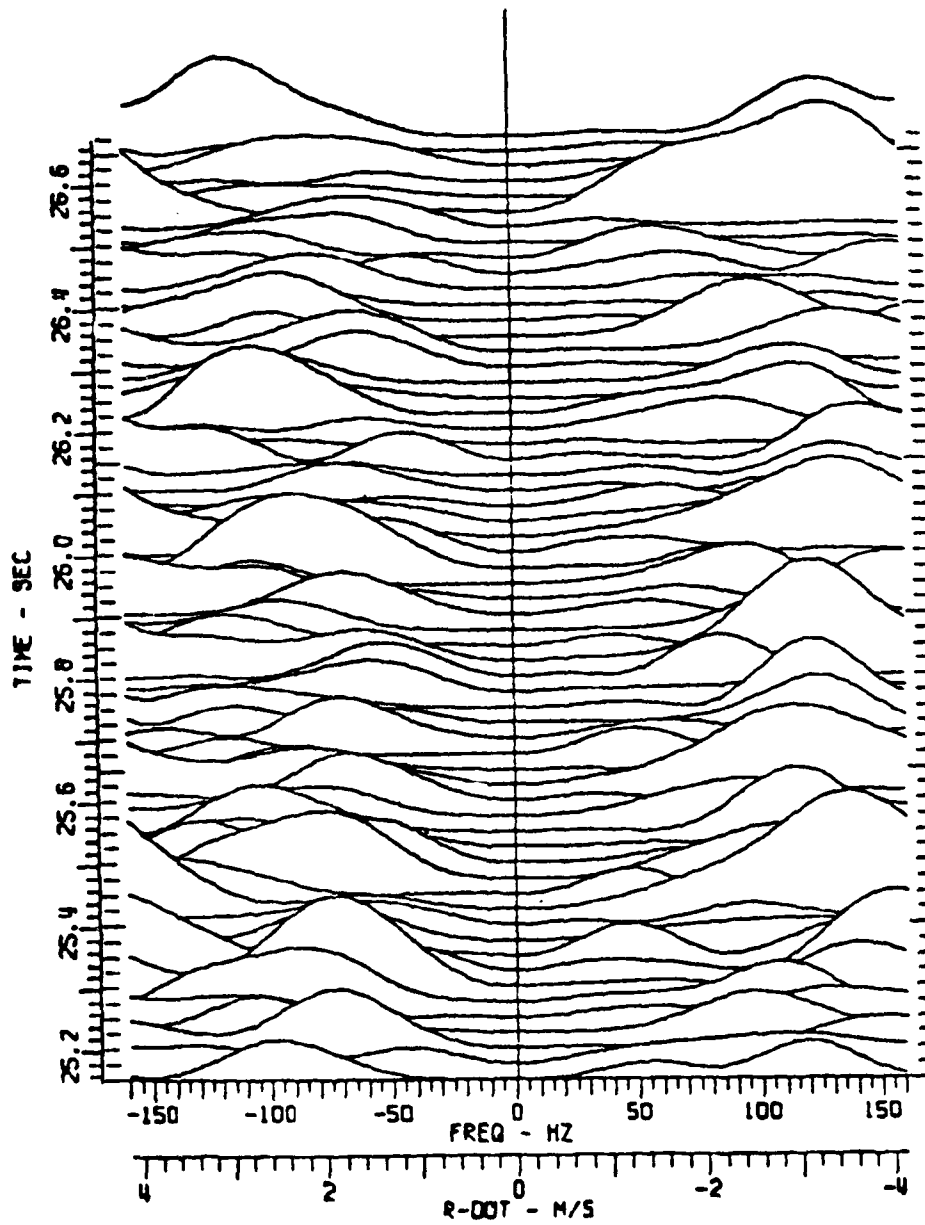

Figure 5(n). Doppler history plot with Fourier transform window equal to 1/5 cycle of spin.

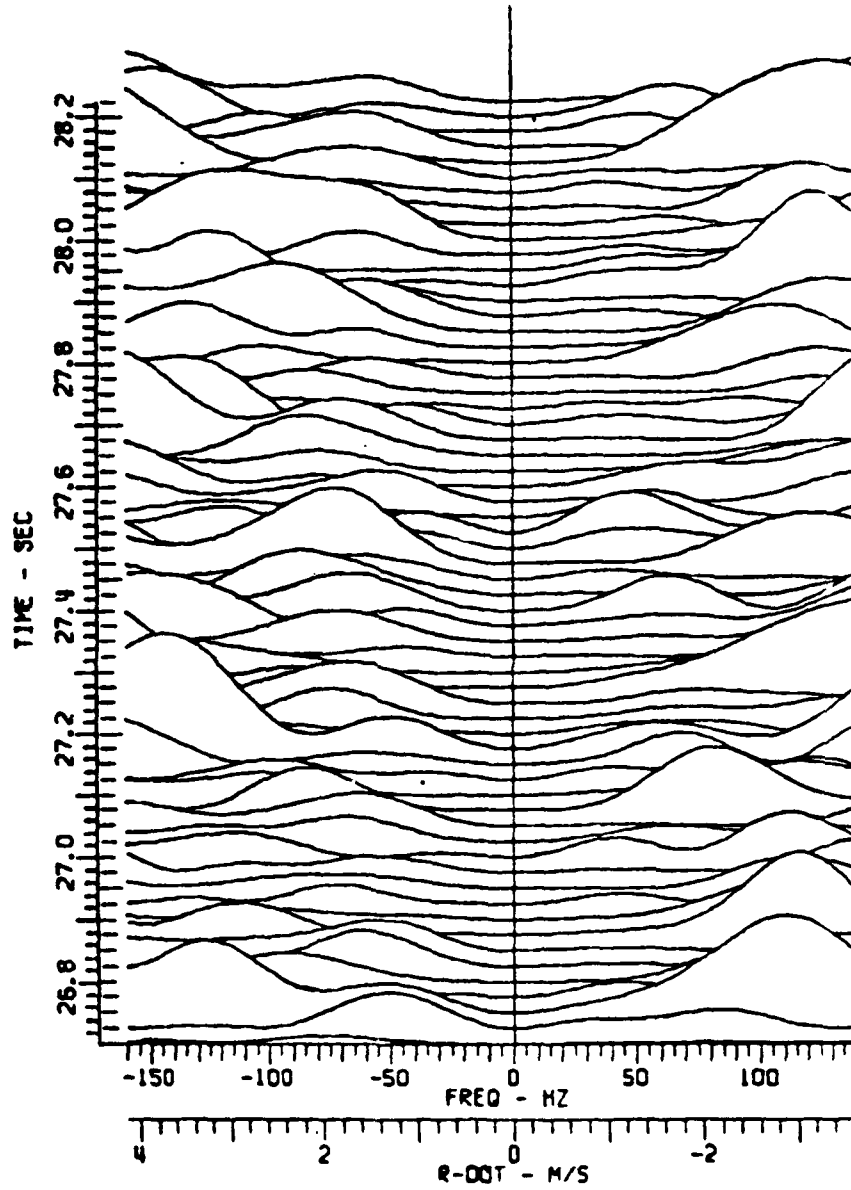

Figure 5(o). Doppler history plot with Fourier transform window equal to 1/5 cycle of spin.

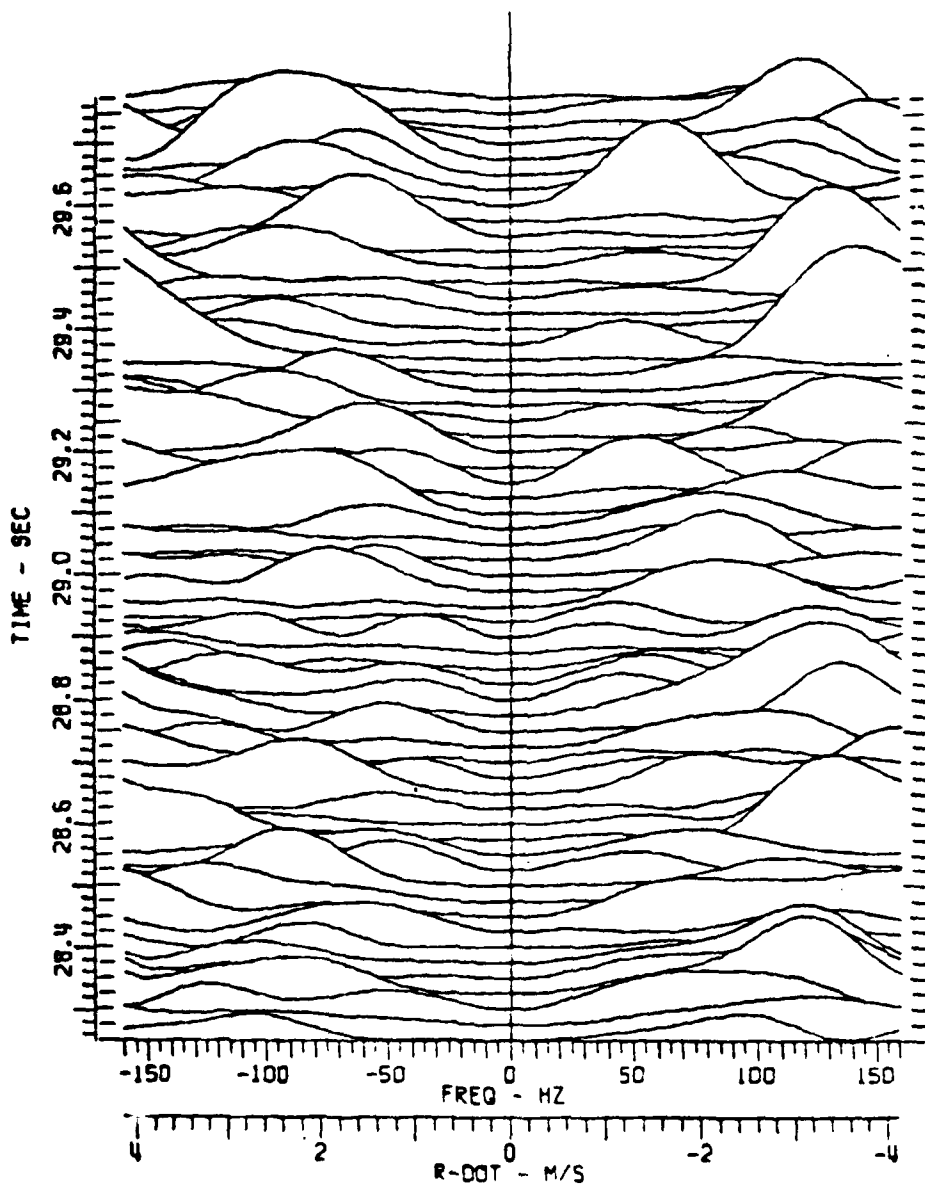

Figure 5(p). Doppler history plot with Fourier transform window equal to 1/5 cycle of spin.

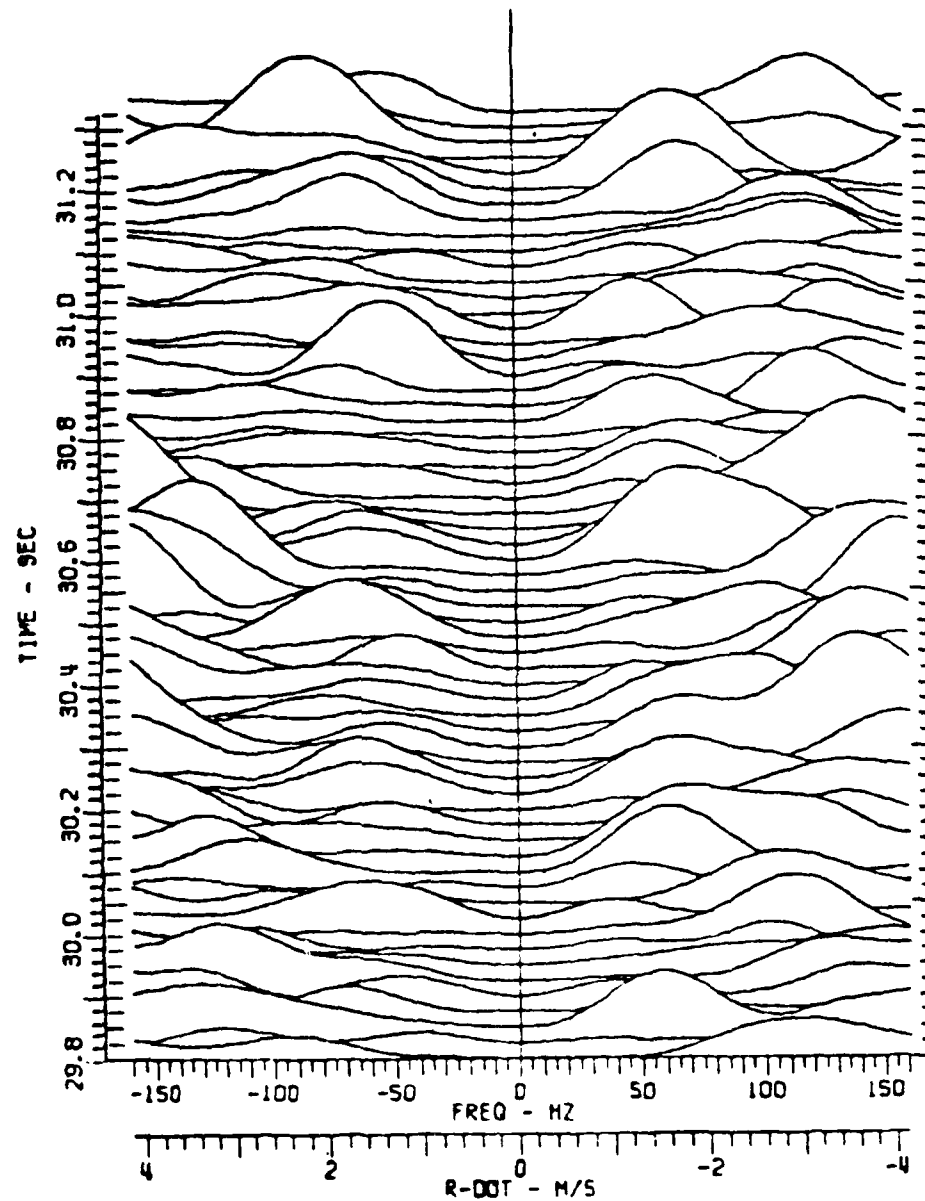

Figure 5(q). Doppler history plot with Fourier transform window equal to 1/5 cycle of spin.

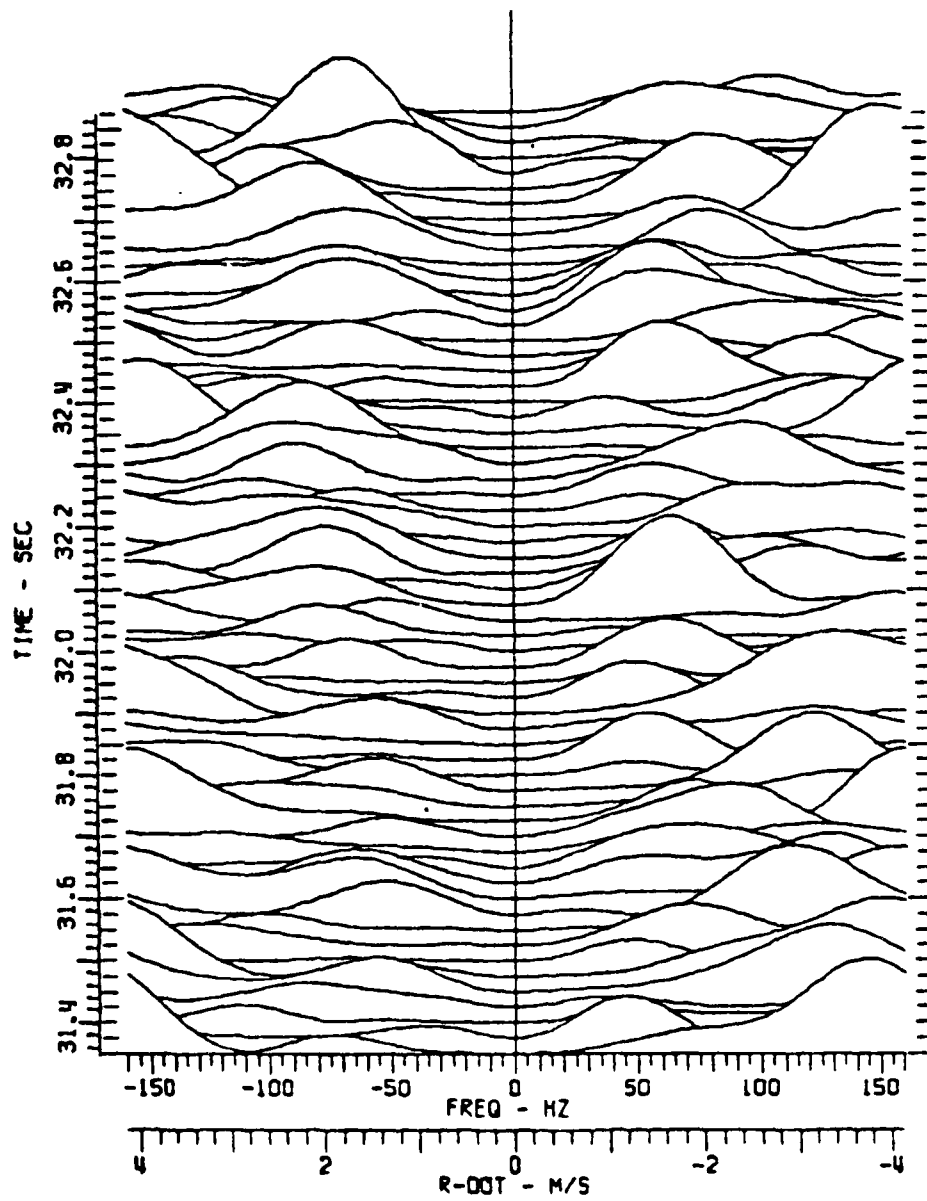

Figure 5(r). Doppler history plot with Fourier transform window equal to 1/5 cycle of spin.

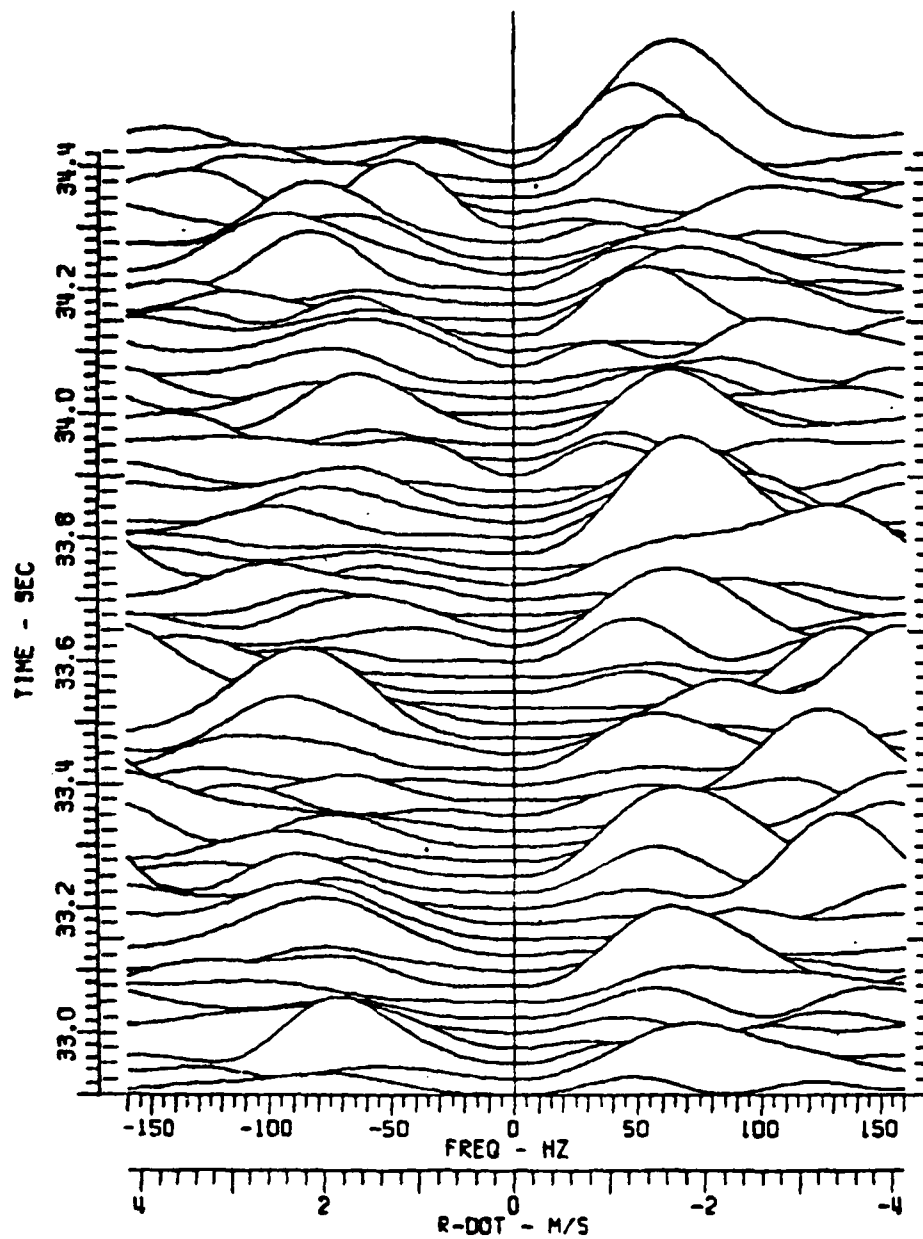

Figure 5(s). Doppler history plot with Fourier transform window equal to 1/5 cycle of spin.

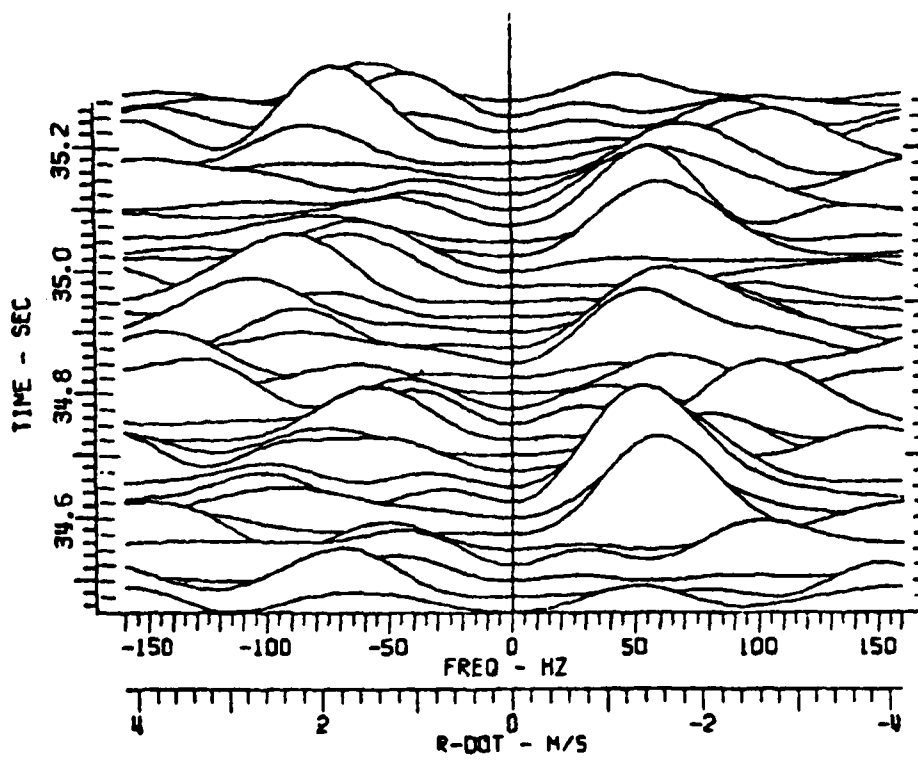

Figure 5(t). Doppler history plot with Fourier transform window equal to 1/5 cycle of spin.

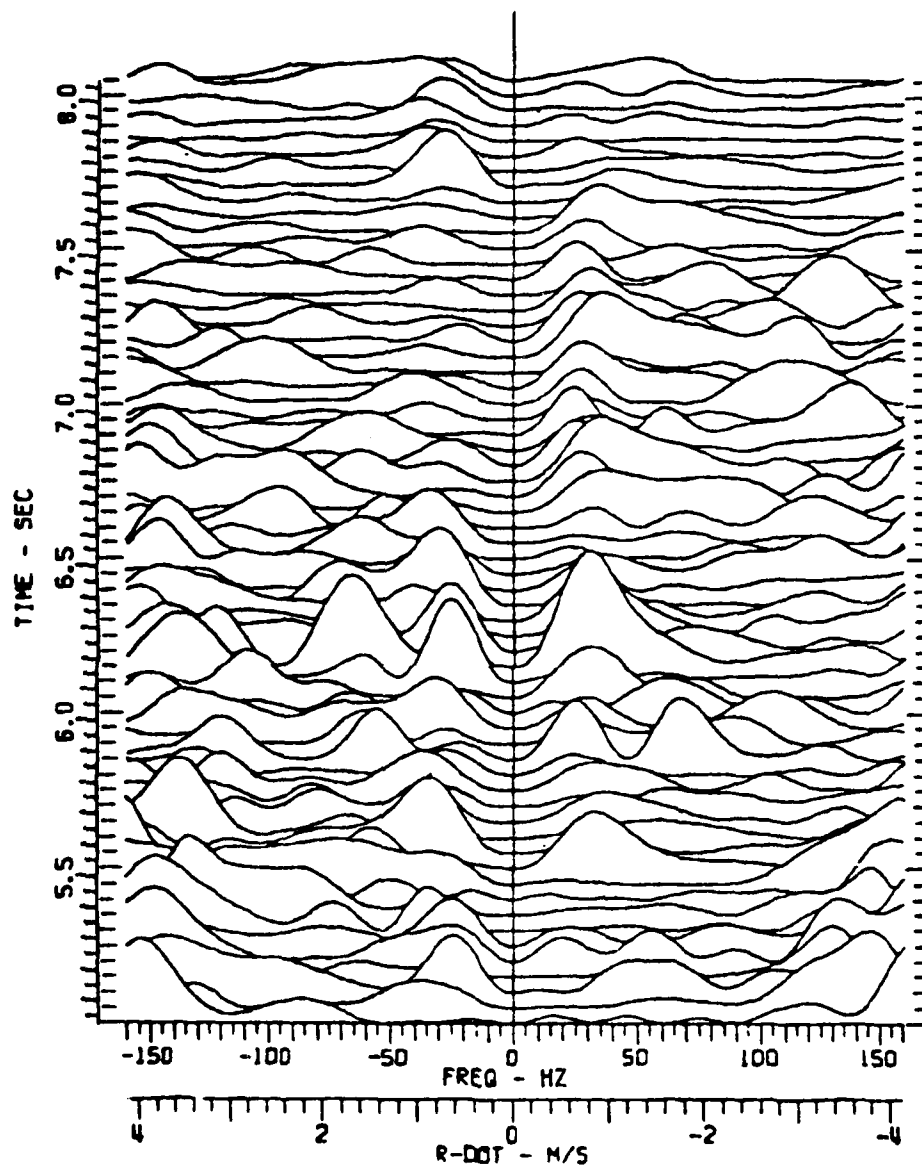

Figure 6(a). Doppler history plot with Fourier transform window equal to 2/5 cycle of spin.

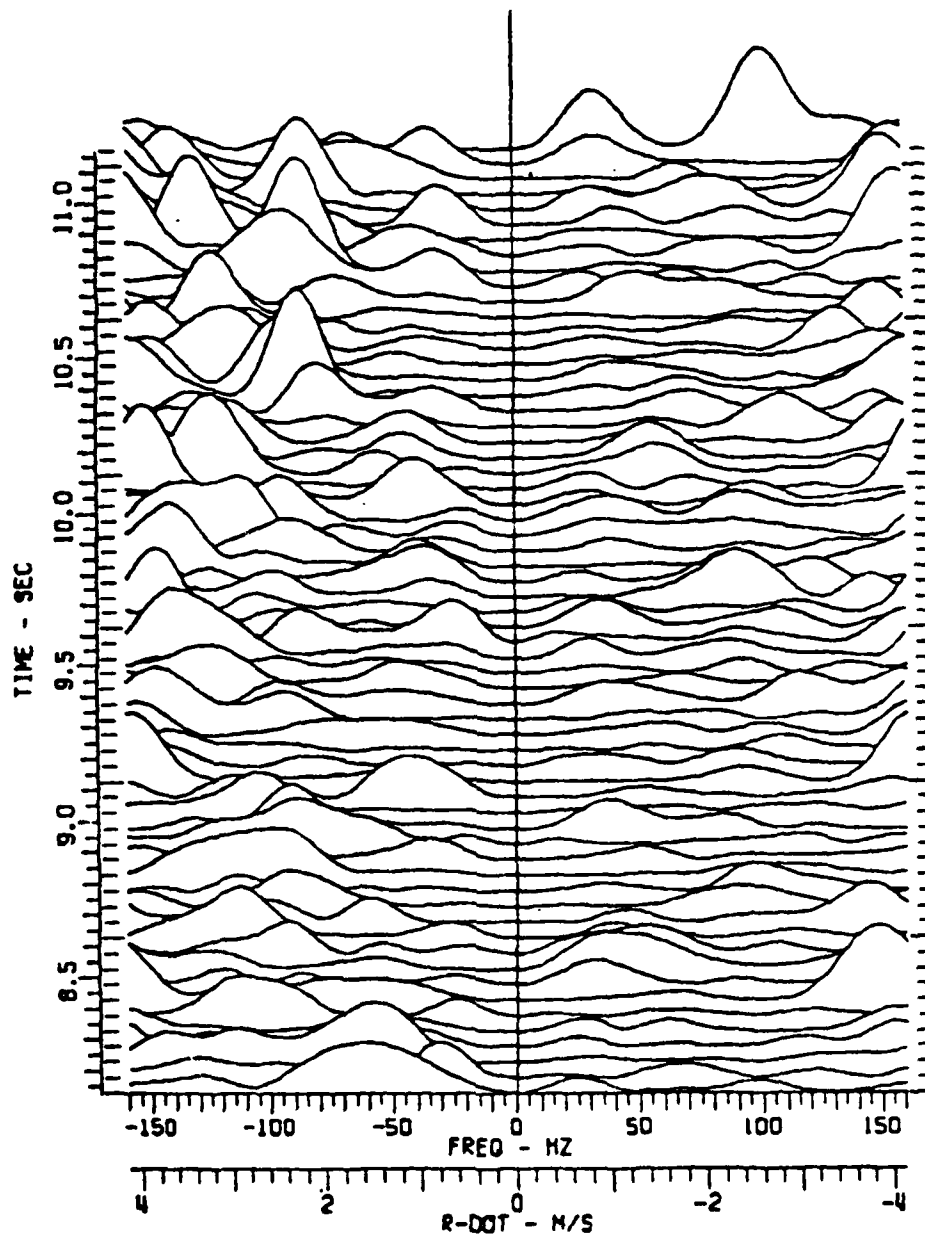

Figure 6(b). Doppler history plot with Fourier transform window equal to 2/5 cycle of spin.

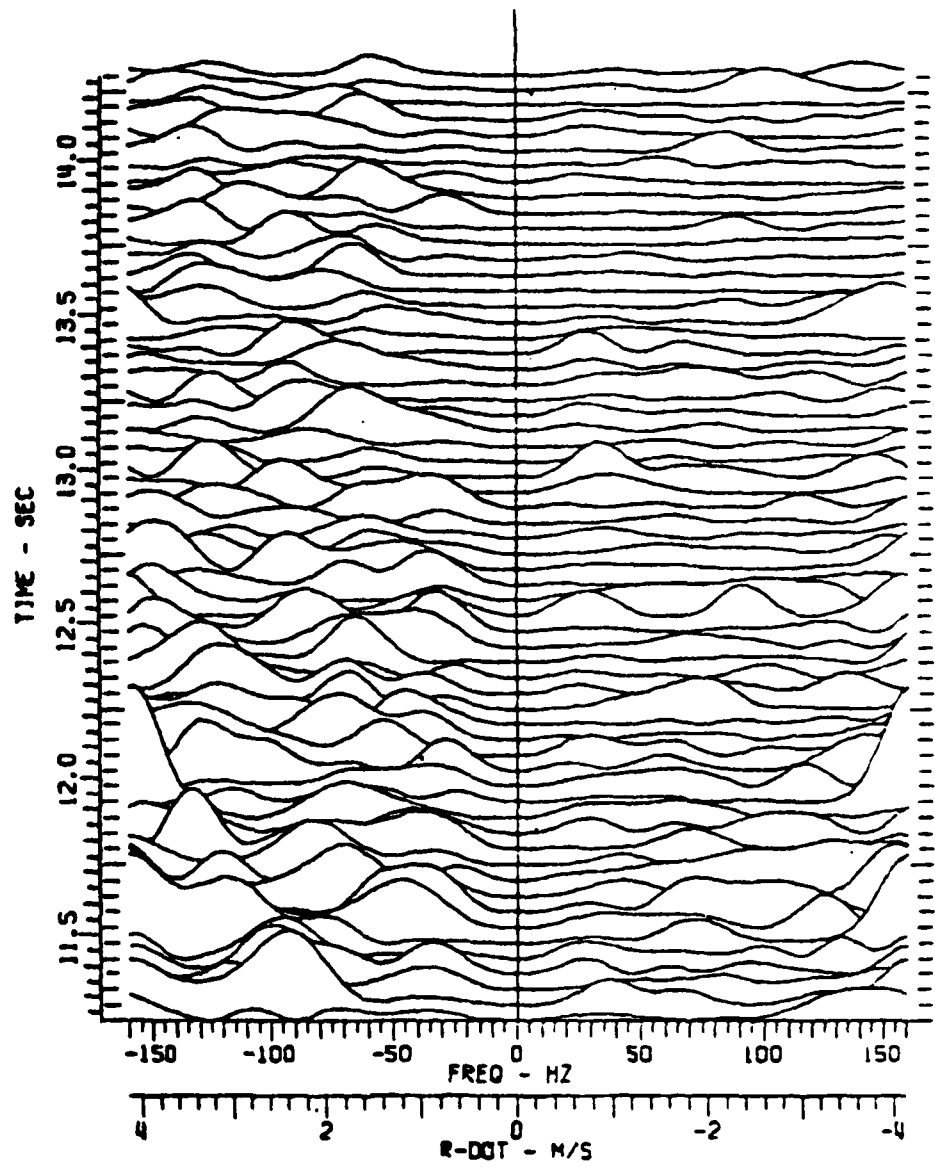

Figure 6(c). Doppler history plot with Fourier transform window equal to 2/5 cycle of spin.

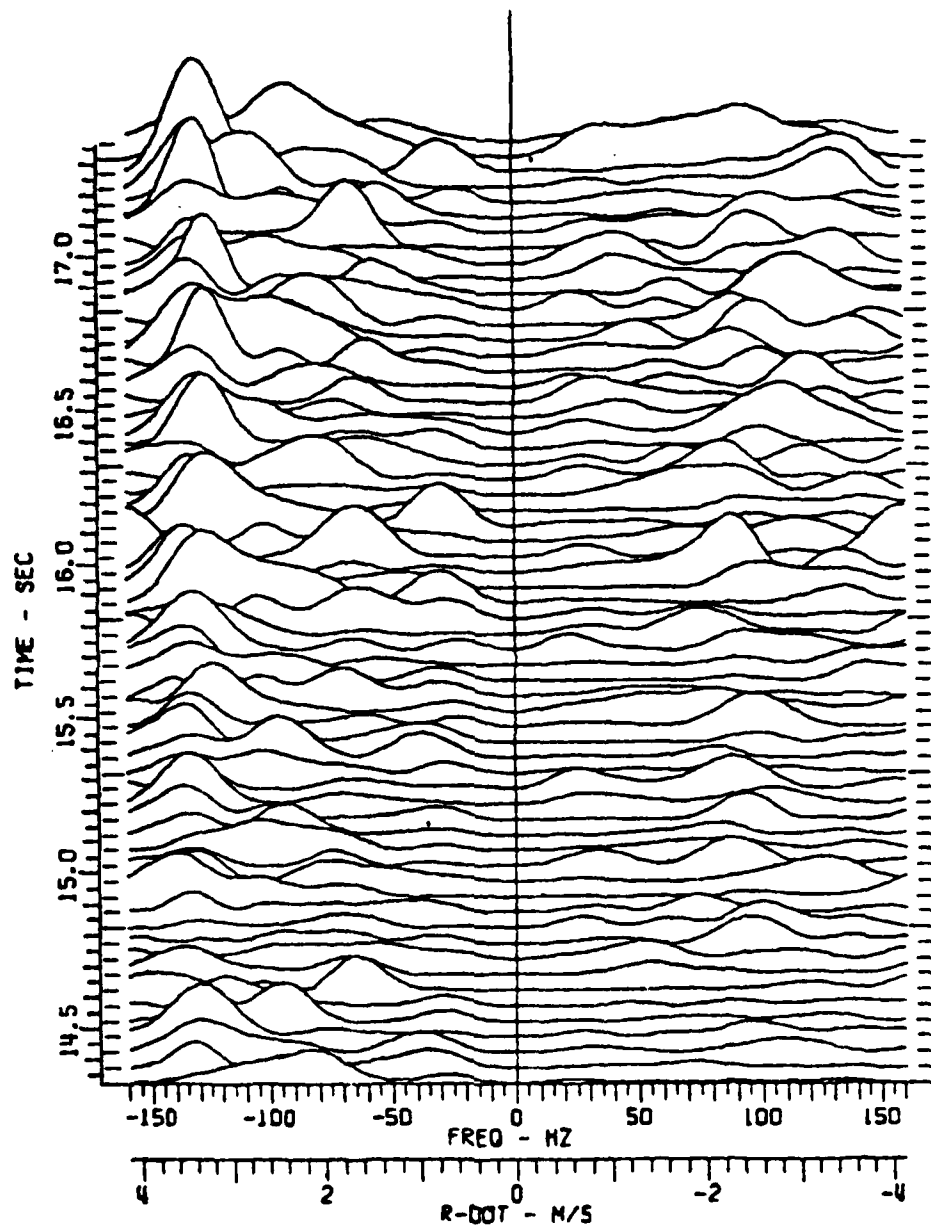

Figure 6(d). Doppler history plot with Fourier transform window equal to 2/5 cycle of spin.

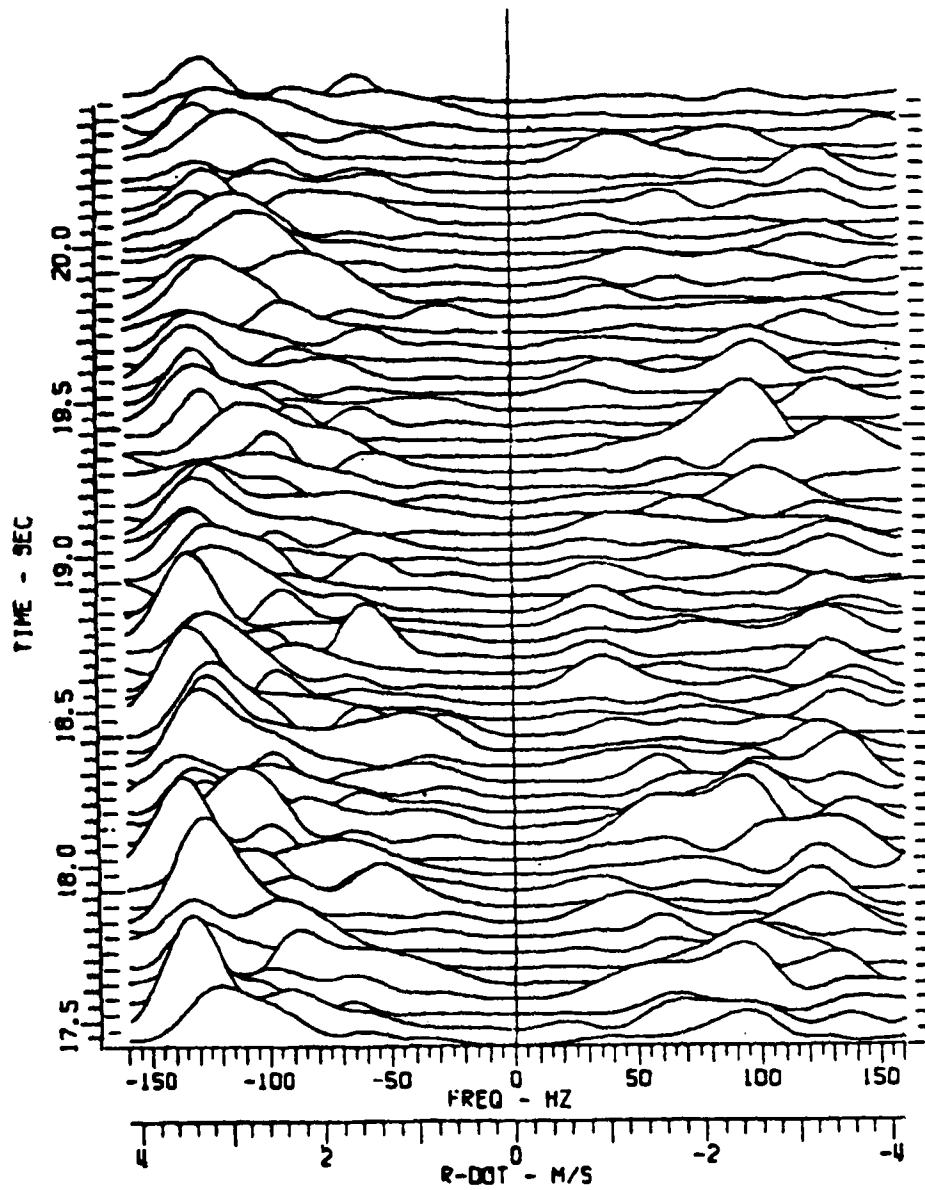

Figure 6(e). Doppler history plot with Fourier transform window equal to 2/5 cycle of spin.

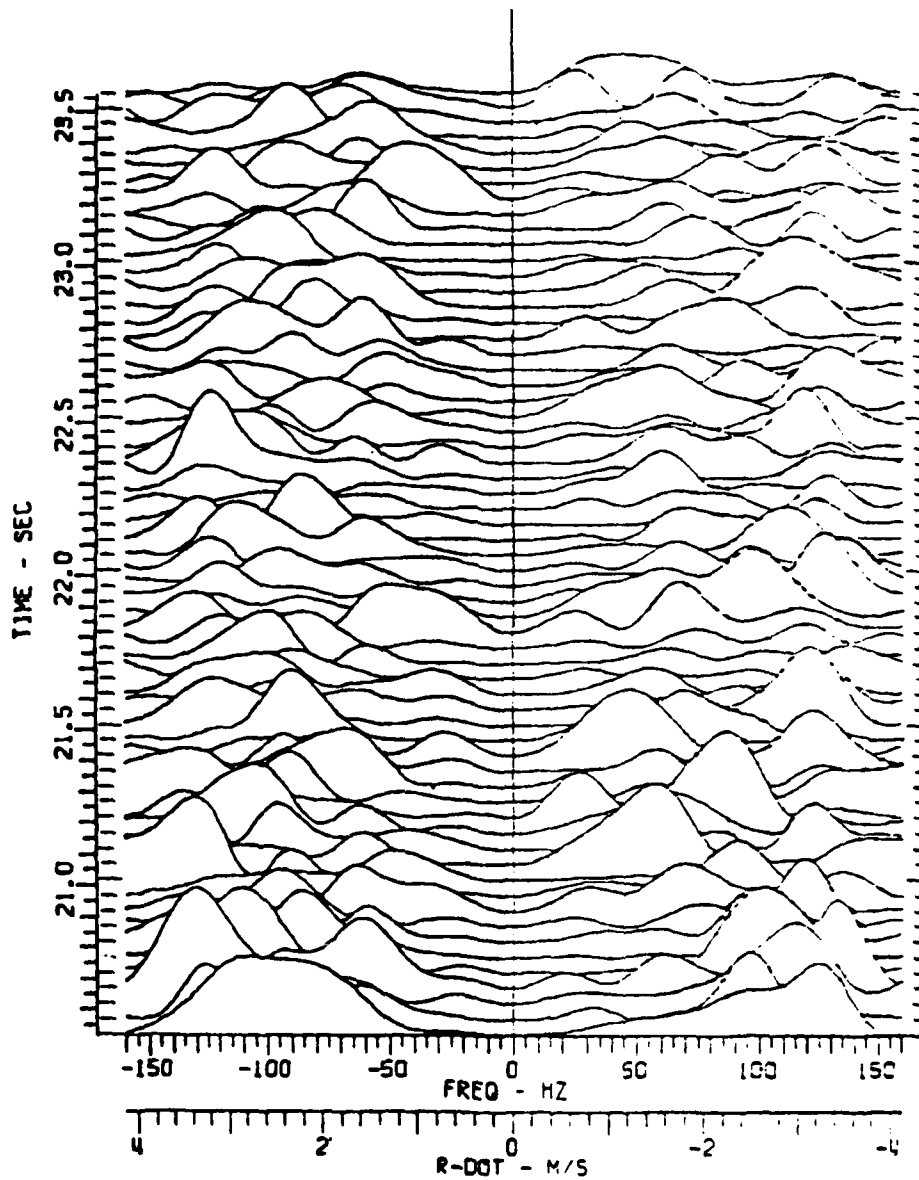

Figure 6(f). Doppler history plot with Fourier transform window equal to 2/5 cycle of spin.

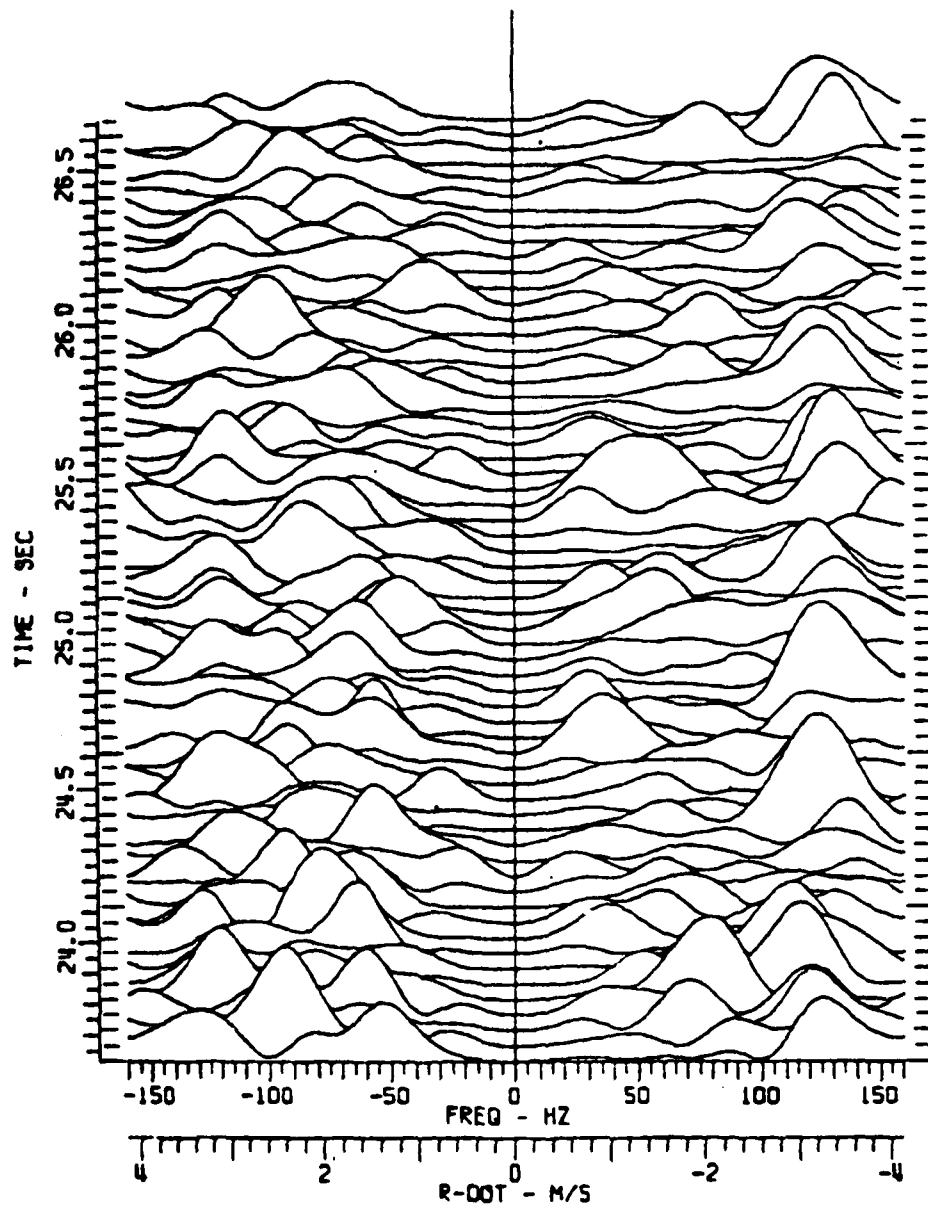

Figure 6(g). Doppler history plot with Fourier transform window equal to 2/5 cycle of spin.

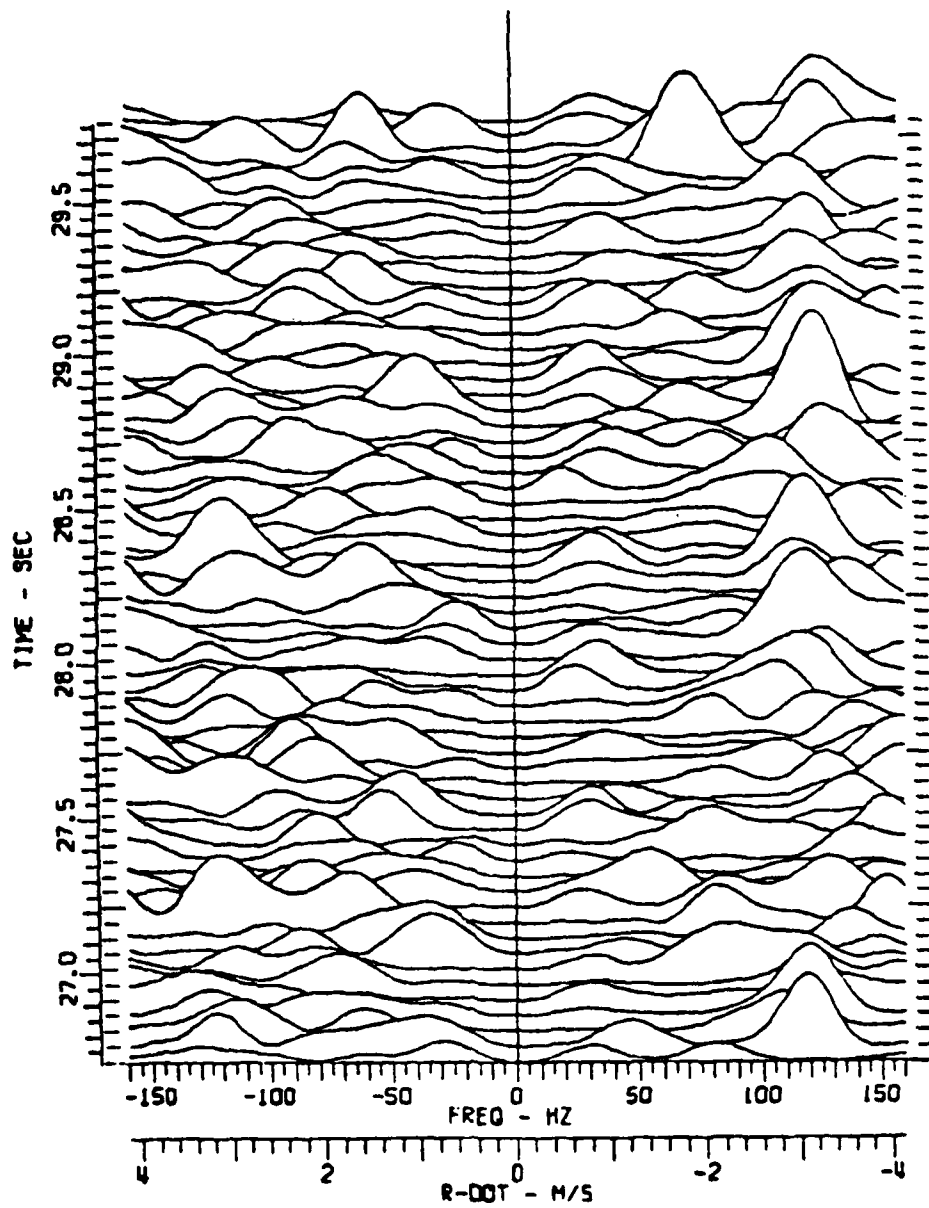

Figure 6(h). Doppler history plot with Fourier transform window equal to 2/5 cycle of spin.

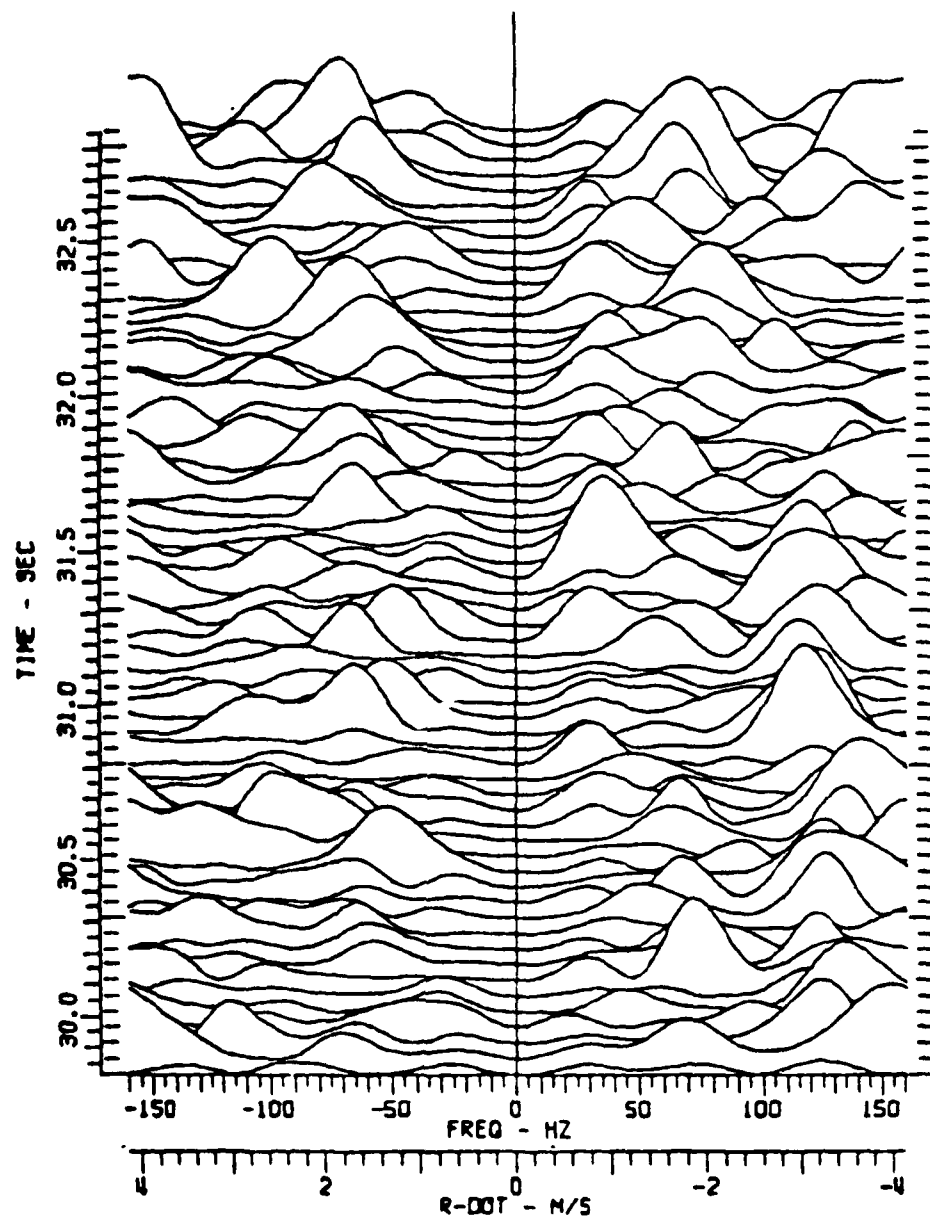

Figure 6(i). Doppler history plot with Fourier transform window equal to 2/5 cycle of spin.

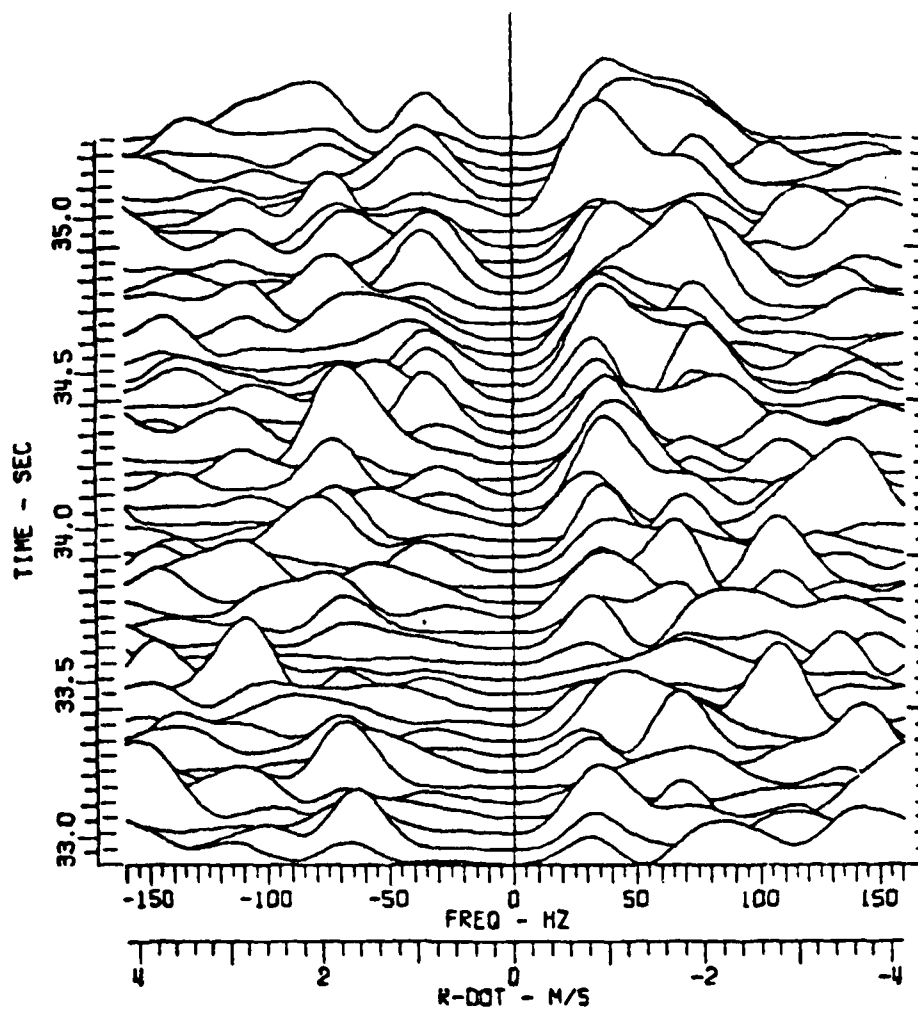

Figure 6(j). Doppler history plot with Fourier transform window equal to 2/5 cycle of spin.

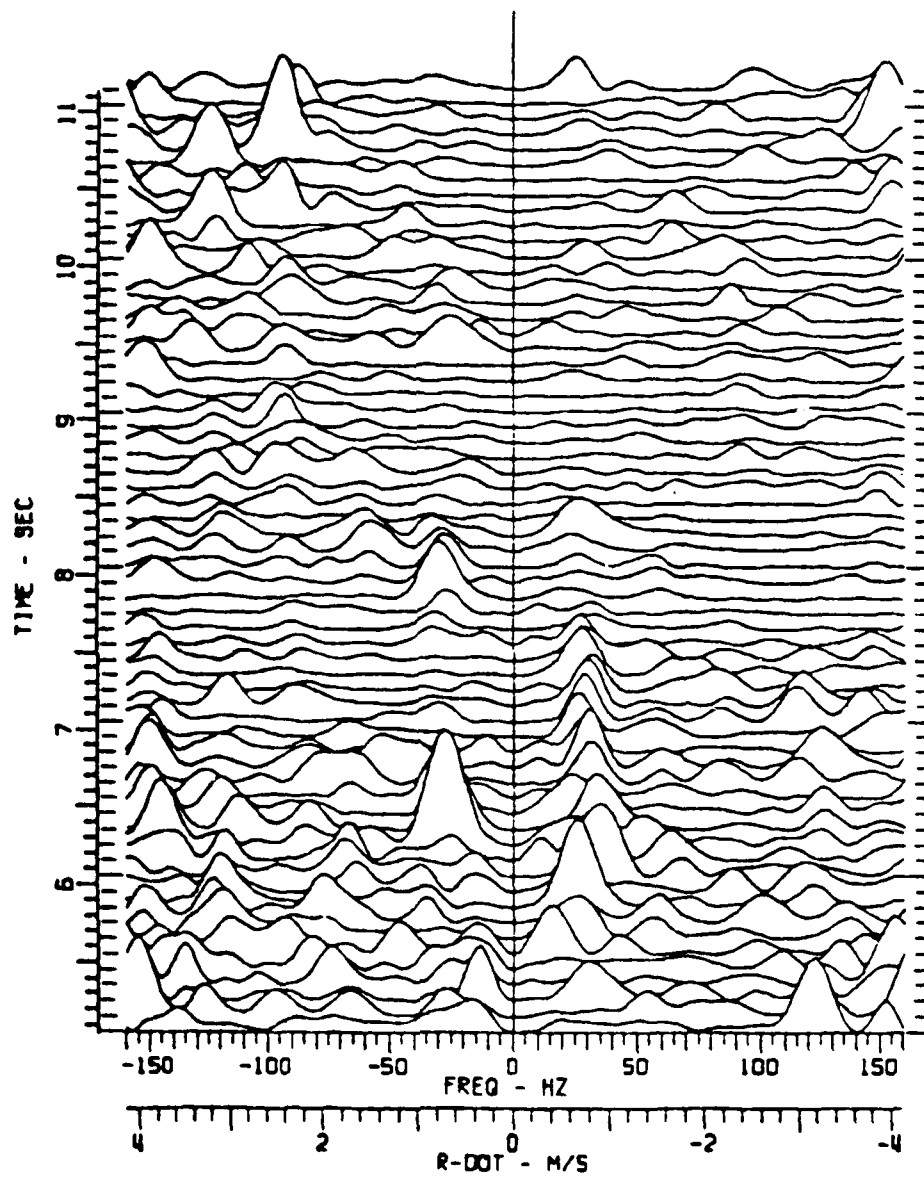

Figure 7(a). Doppler history plot with Fourier transform window equal to 4/5 cycle of spin.

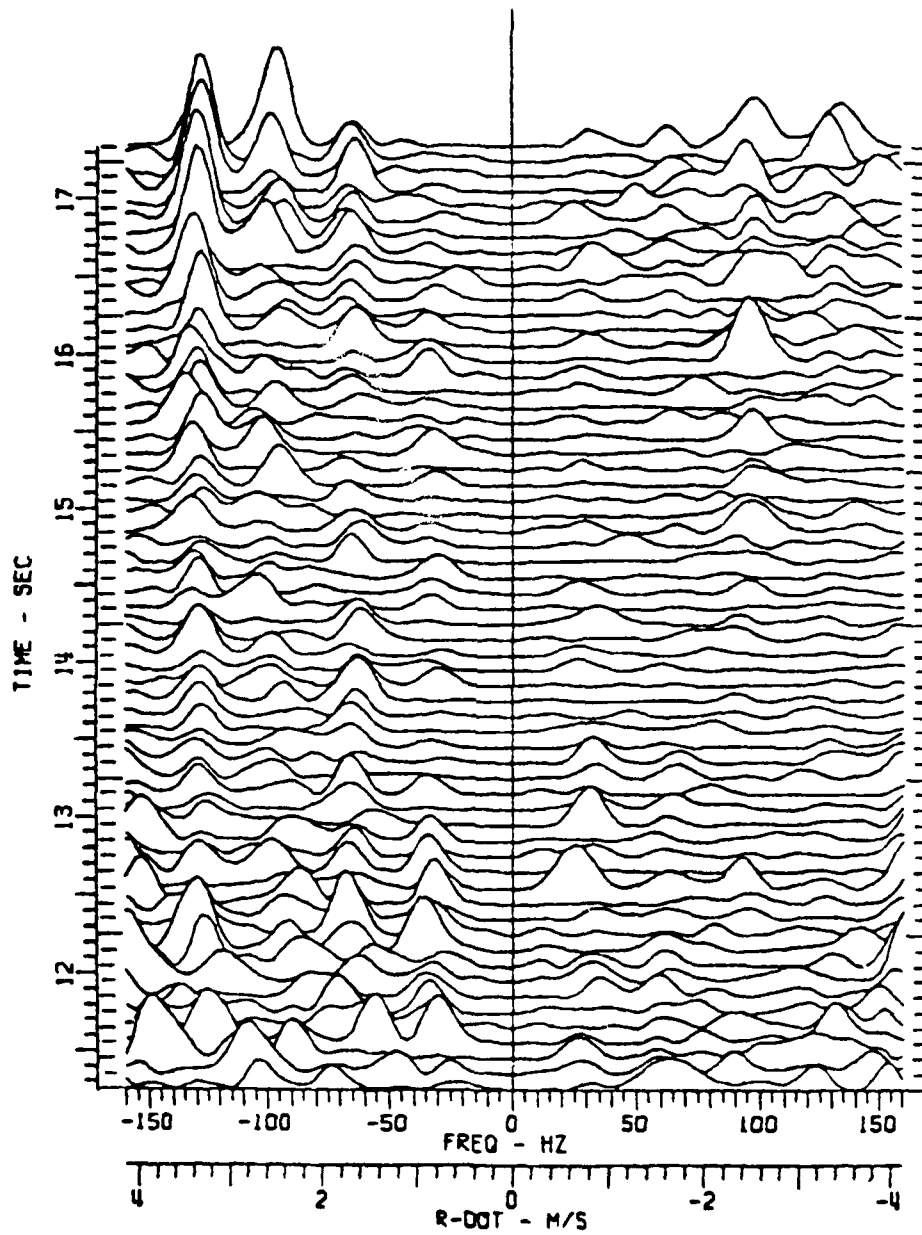

Figure 7(b). Doppler history plot with Fourier transform window equal to 4/5 cycle of spin.

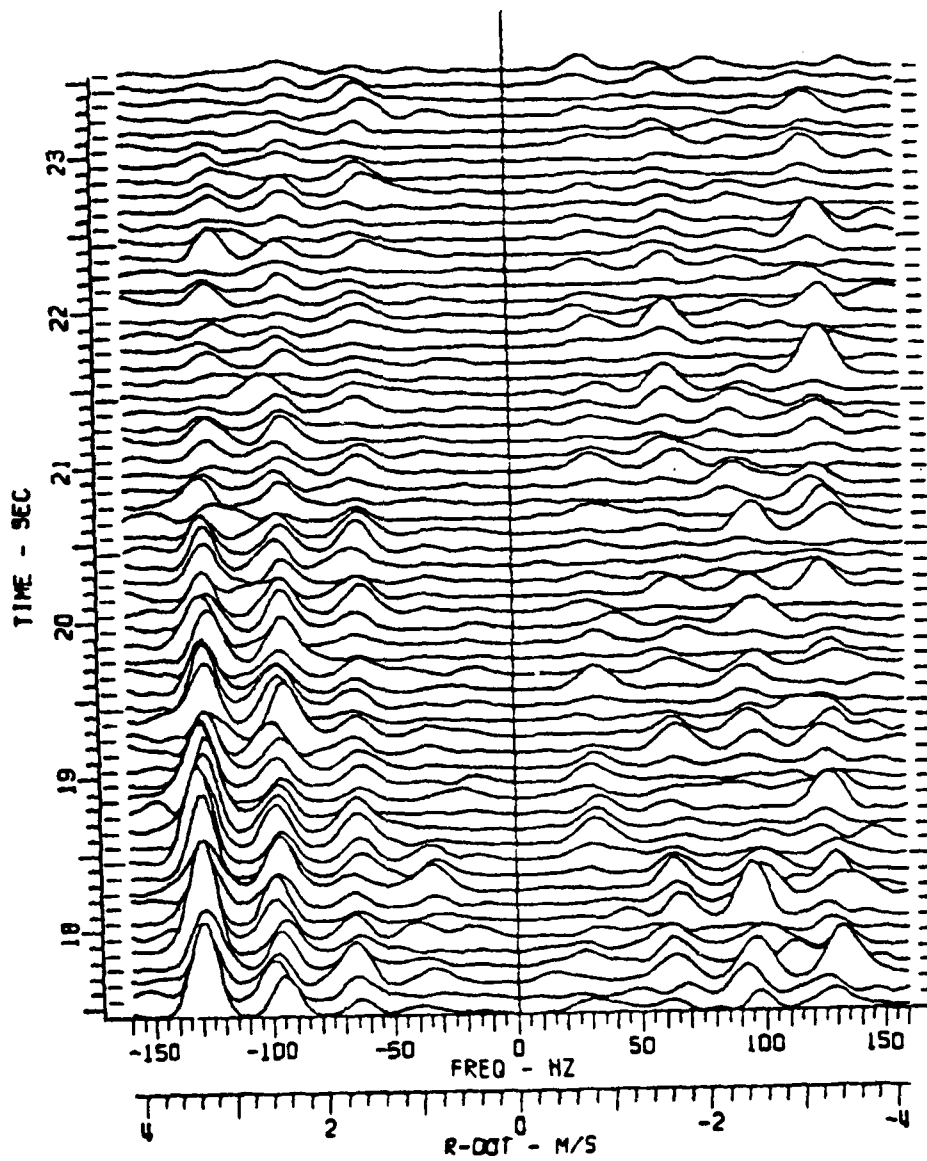

Figure 7(c). Doppler history plot with Fourier transform window equal to 4/5 cycle of spin.

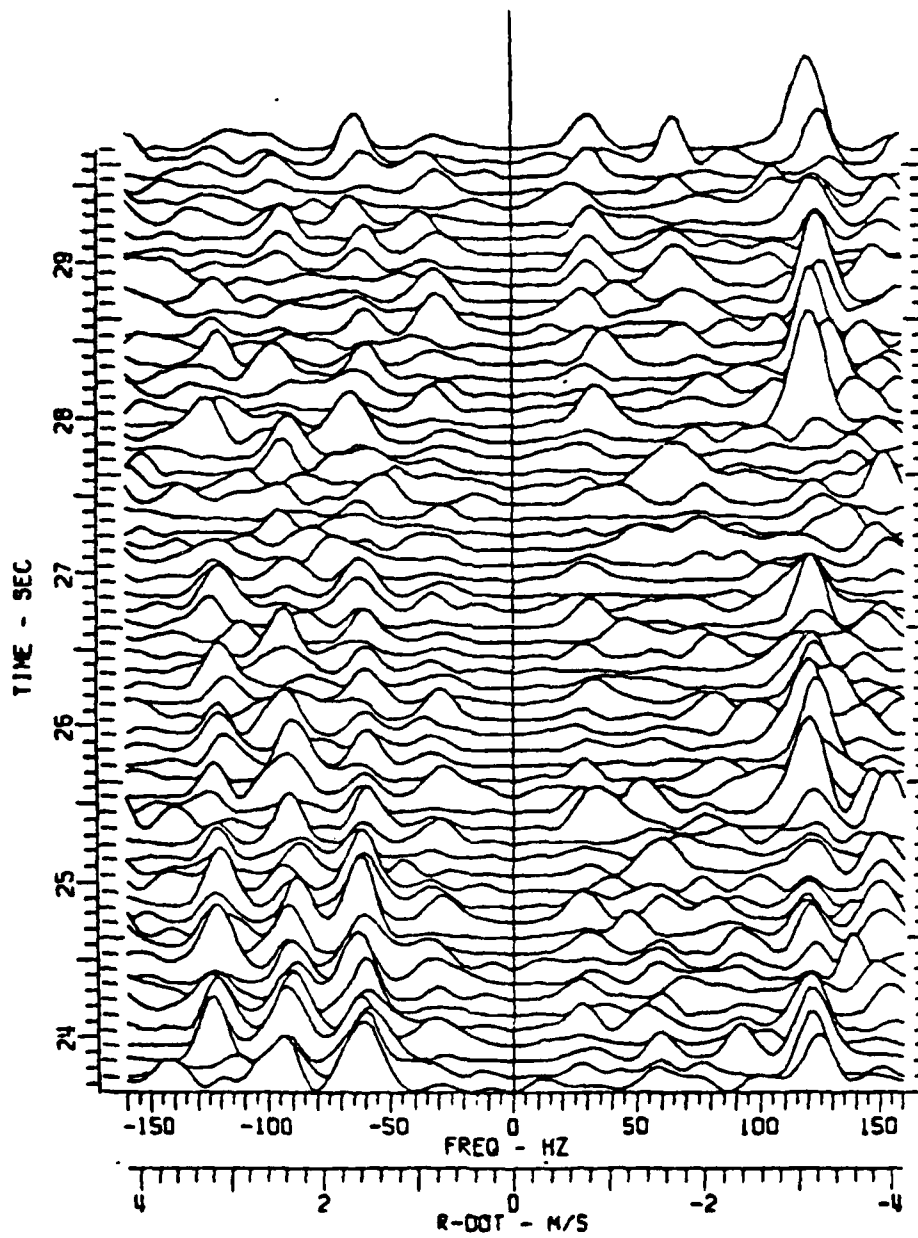

Figure 7(d). Doppler history plot with Fourier transform window equal to $4/5$ cycle of spin.

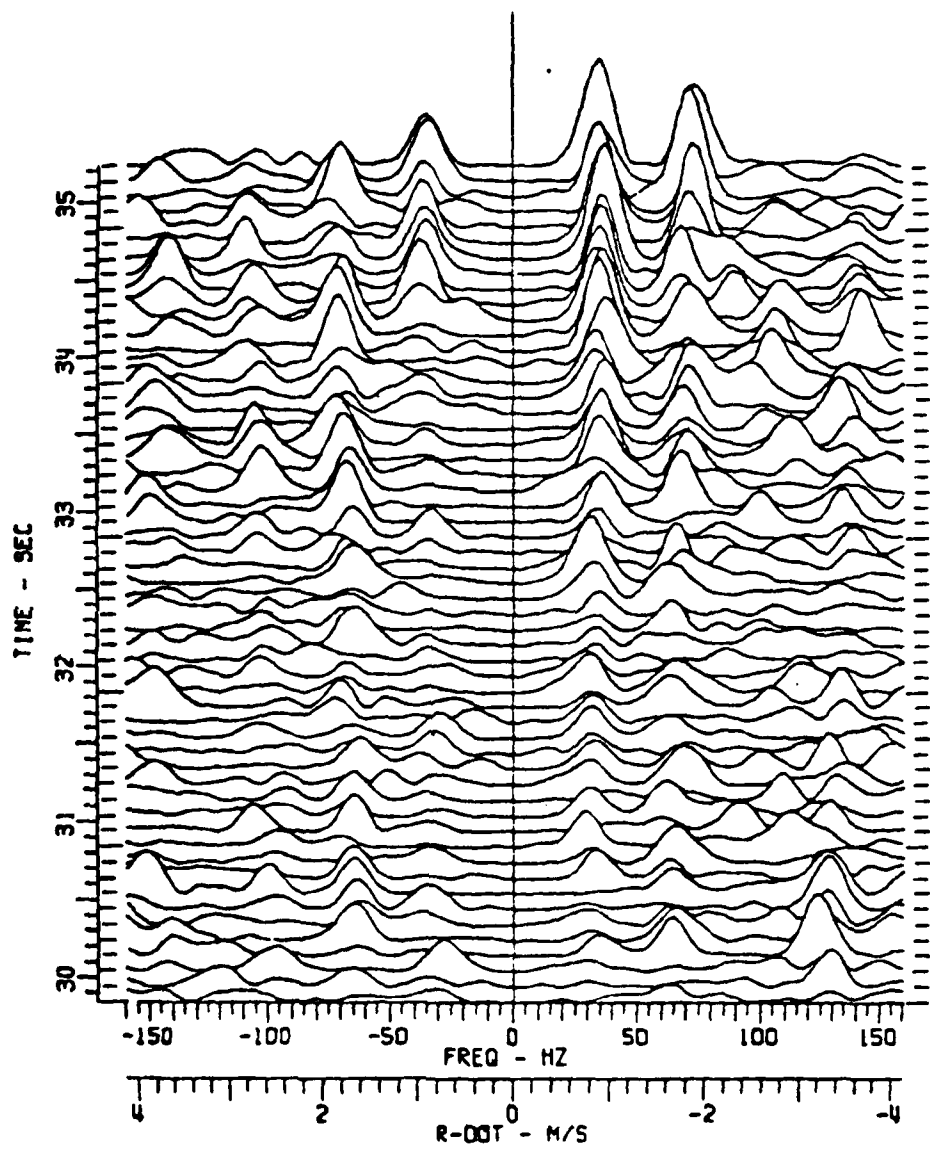

Figure 7(e). Doppler history plot with Fourier transform window equal to 4/5 cycle of spin.

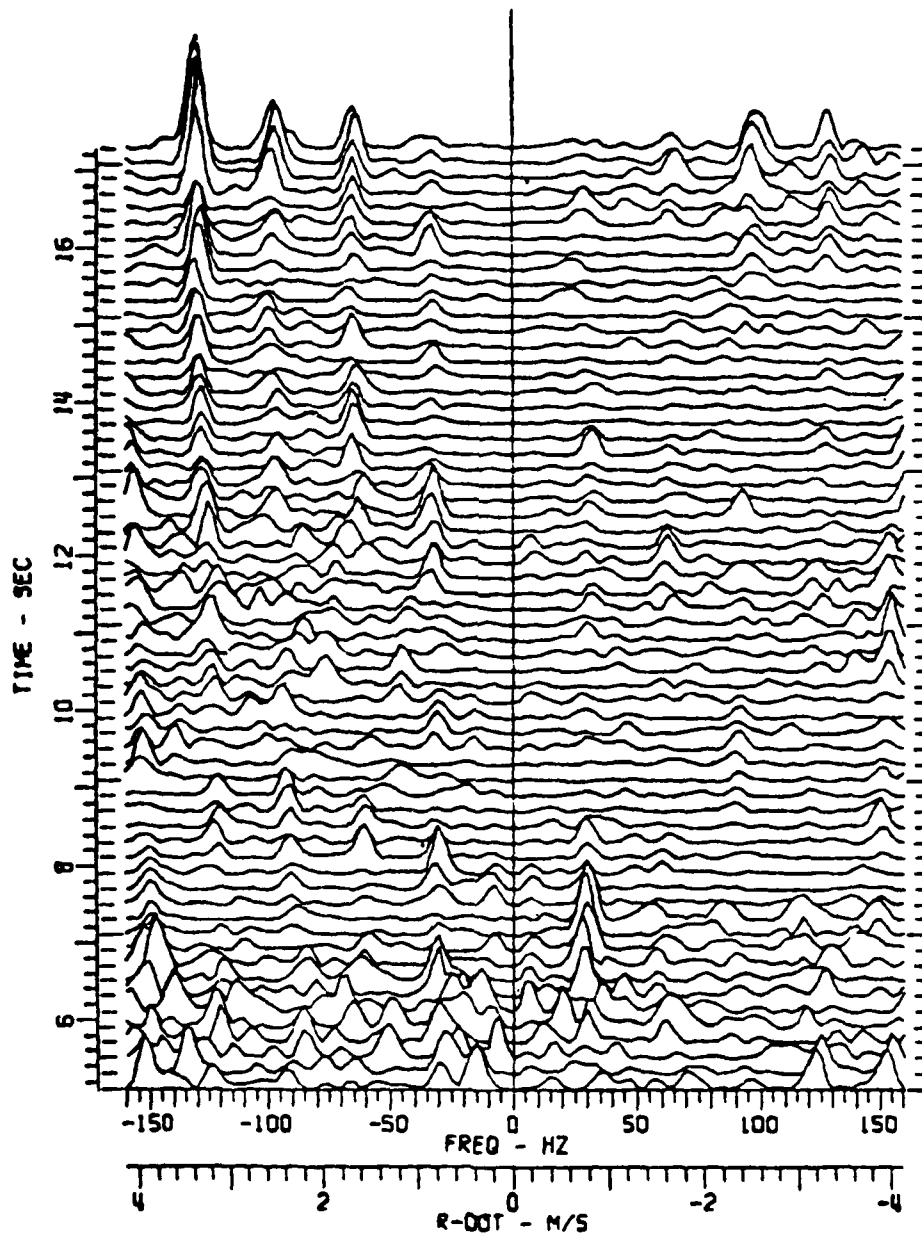

Figure 8(a). Doppler history plot with Fourier transform window equal to 8/5 cycle of spin.

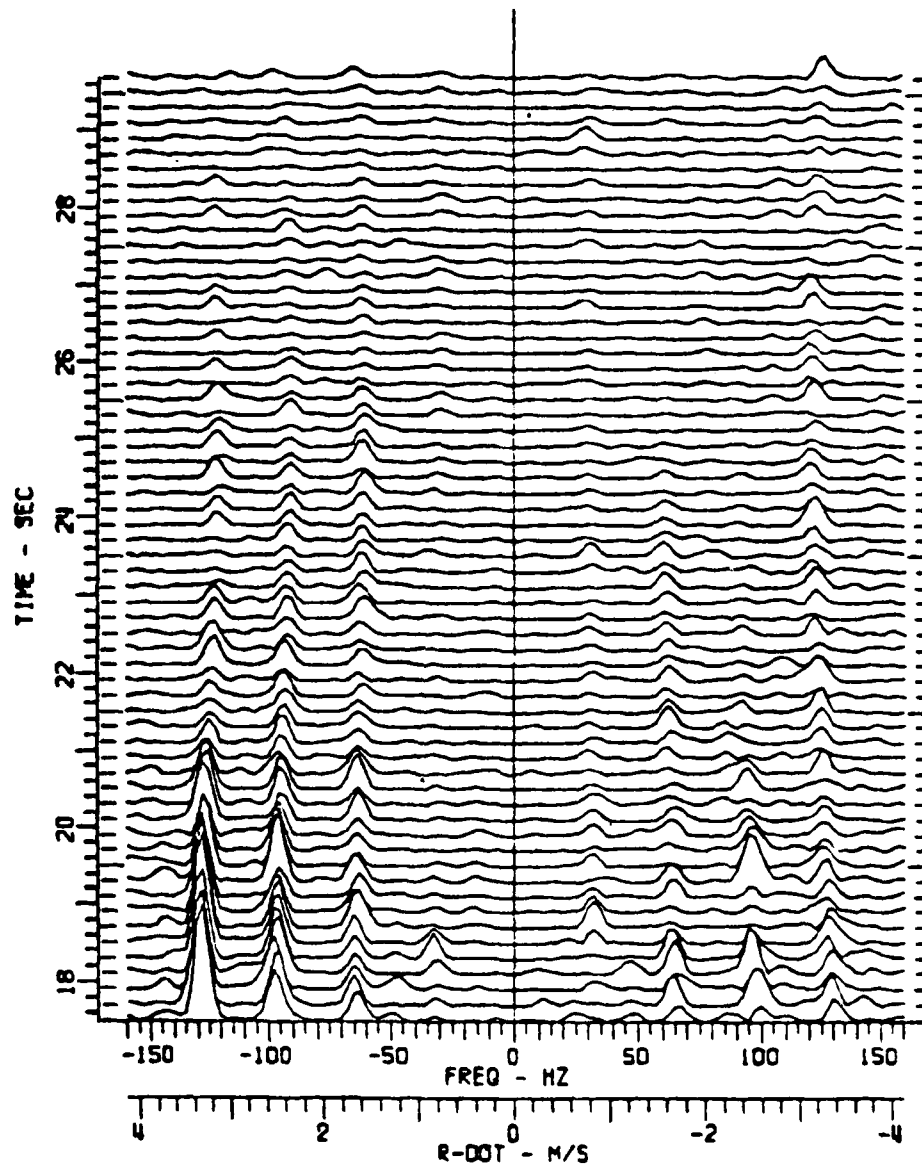

Figure 8(b). Doppler history plot with Fourier transform window equal to 8/5 cycle of spin.

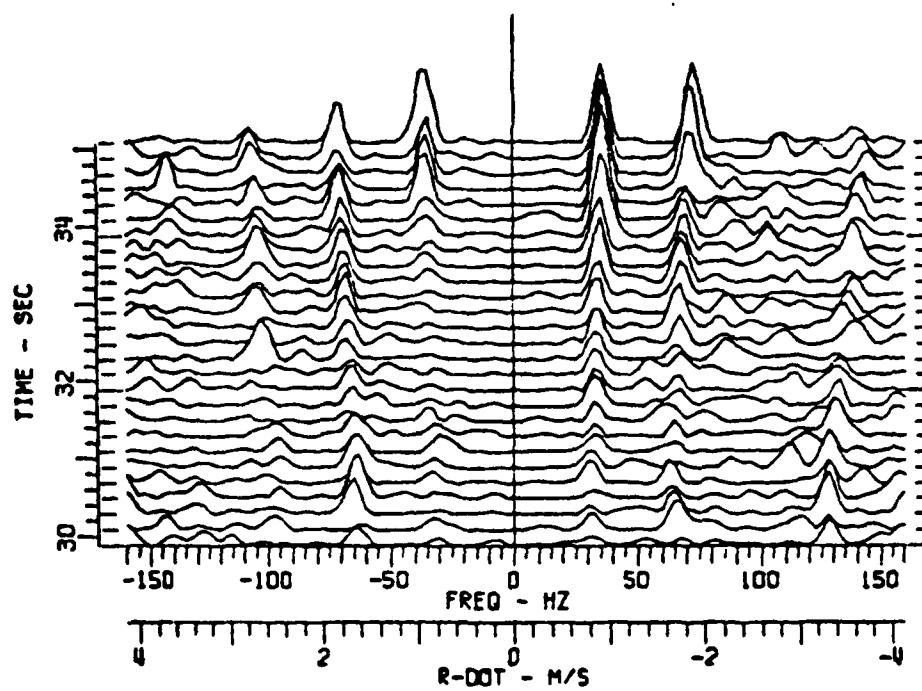

Figure 8(c). Doppler history plot with Fourier transform window equal to 8/5 cycle of spin.

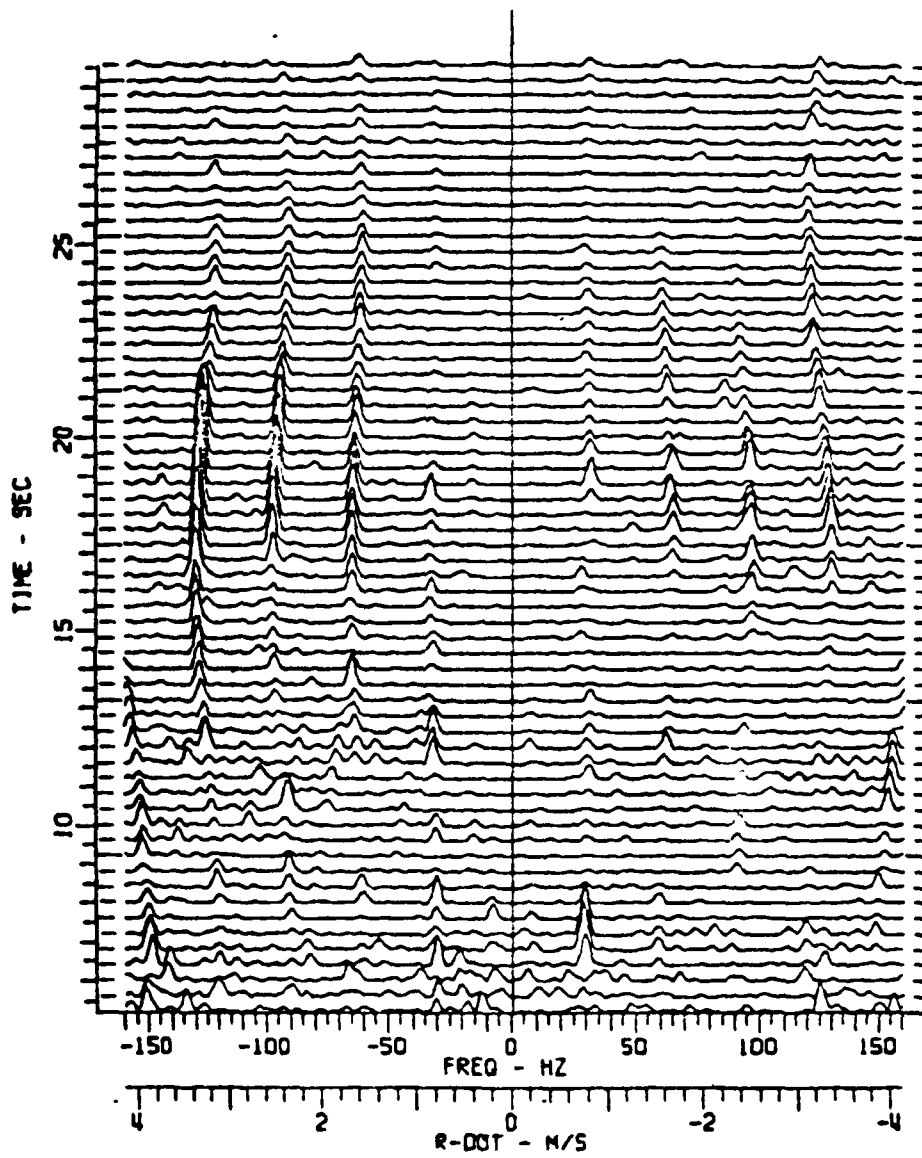

Figure 9(a). Doppler history plot with Fourier transform window equal to 16/5 cycle of spin.

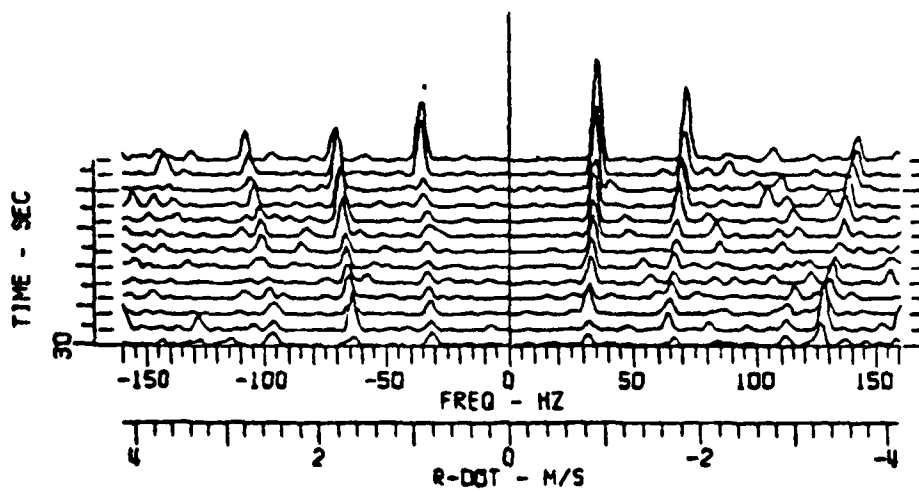

Figure 9(b). Doppler history plot with Fourier transform window equal to $16/5$ cycle pf spin.

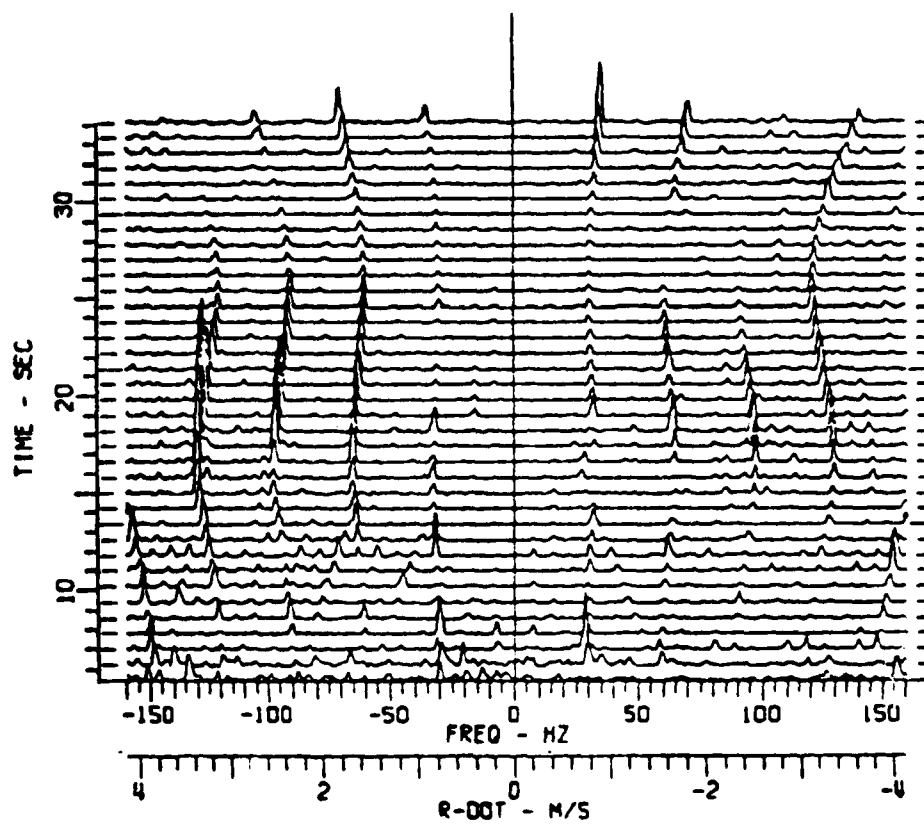

Figure 10. Doppler history plot with Fourier transform window equal to $32/5$ cycle of spin.

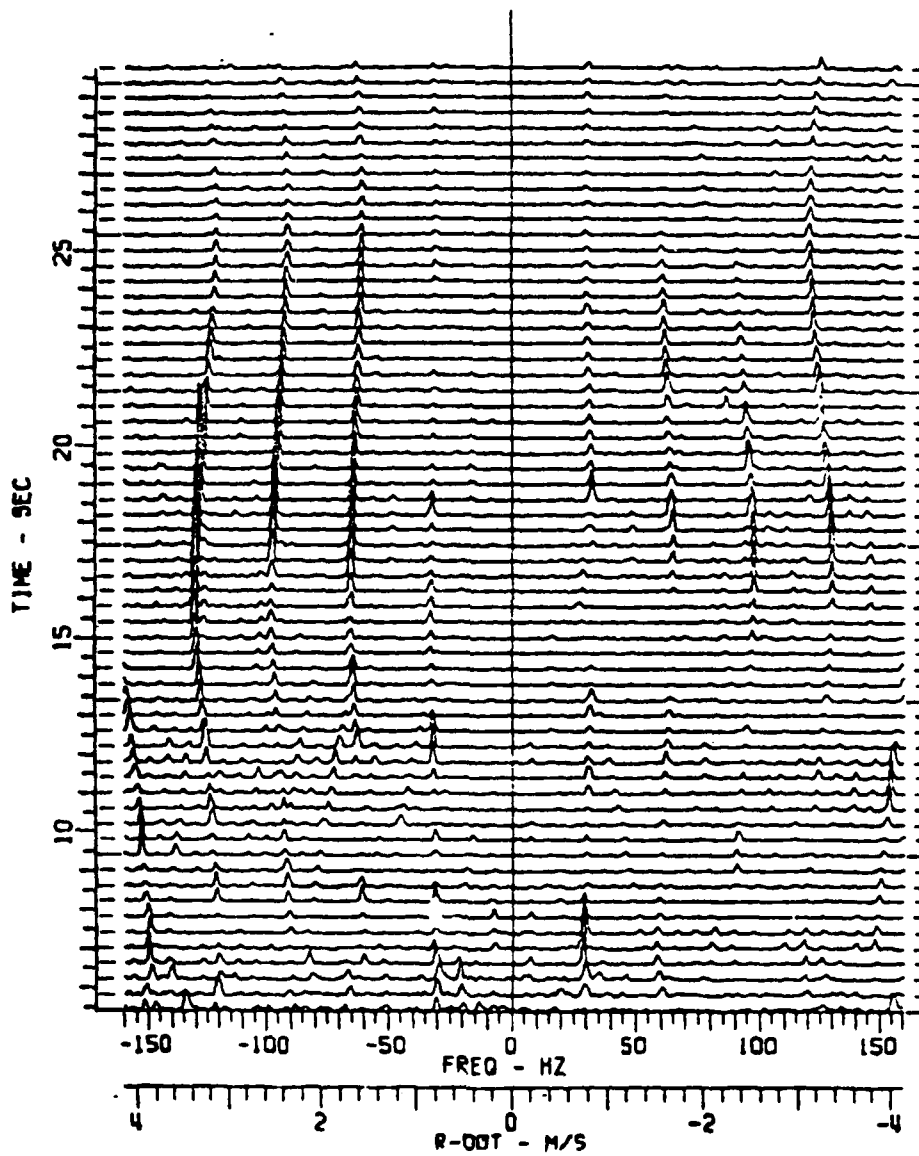

Figure 11(a). Doppler history plot with Fourier transform window equal to $32/5$ cycle of spin and lag equal to $16/5$ cycles of spin.

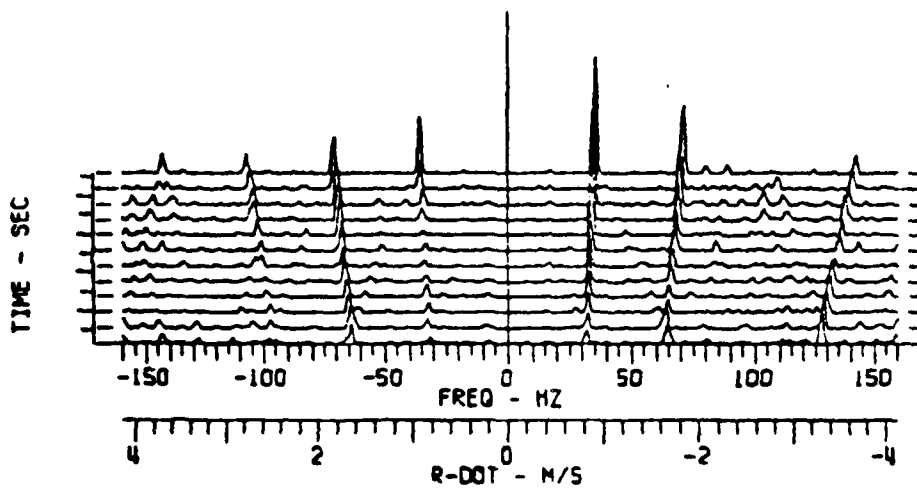

Figure 11(b). Doppler history plot with Fourier transform window equal to $52/5$ cycle of spin and lag equal to $16/5$ cycles of spin.

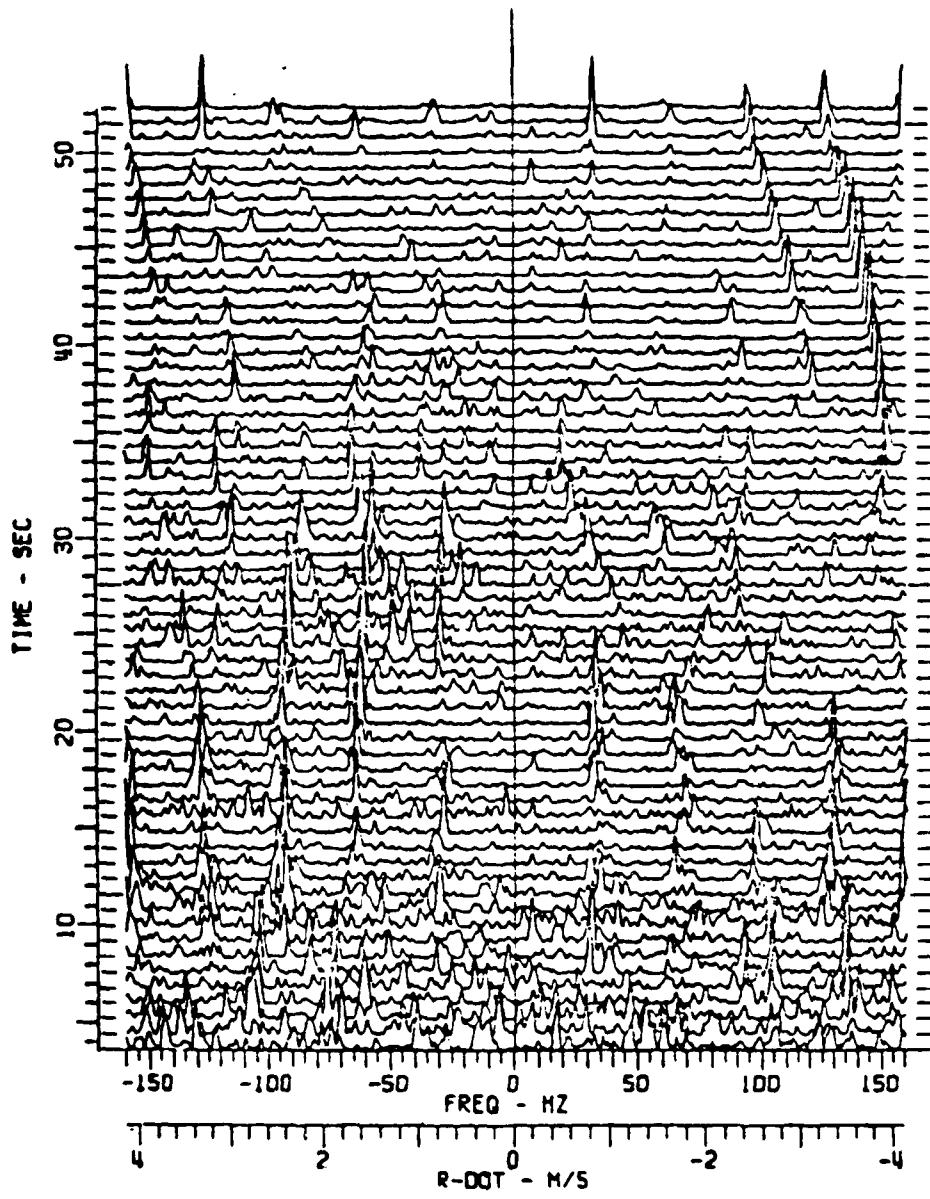

Figure 12(a). Doppler history plot representative of noise.

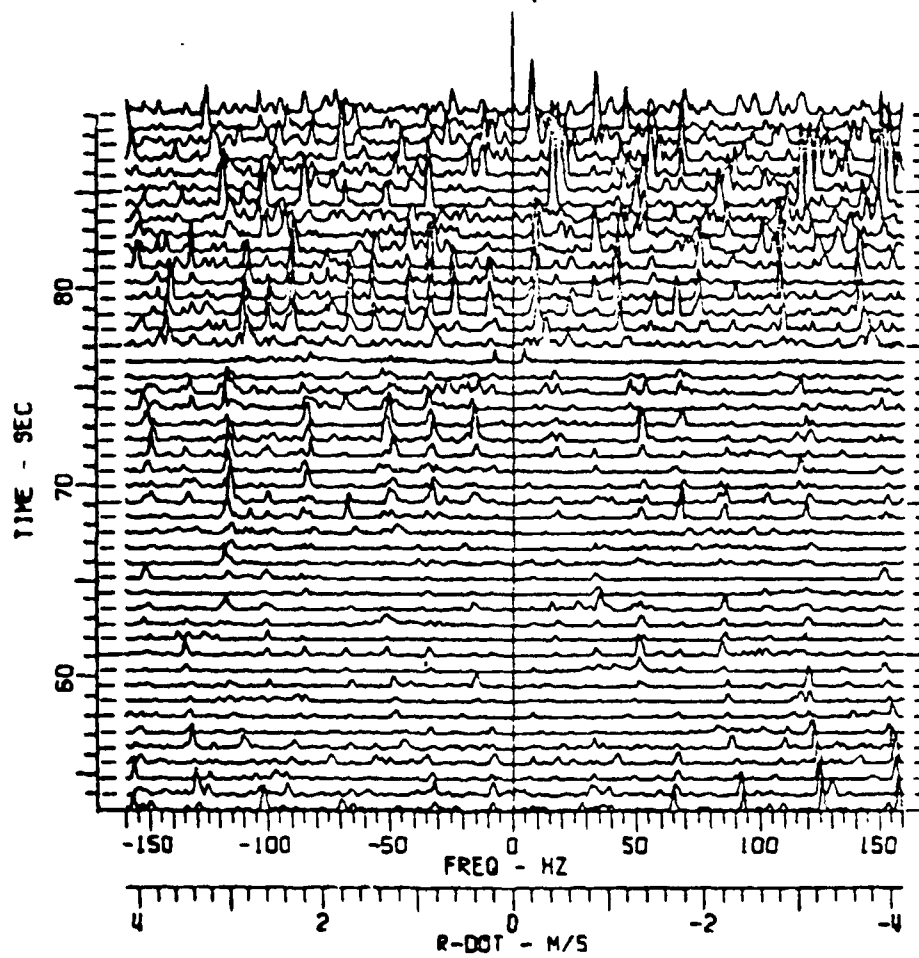

Figure 12(b), Doppler history plot representative of noise.

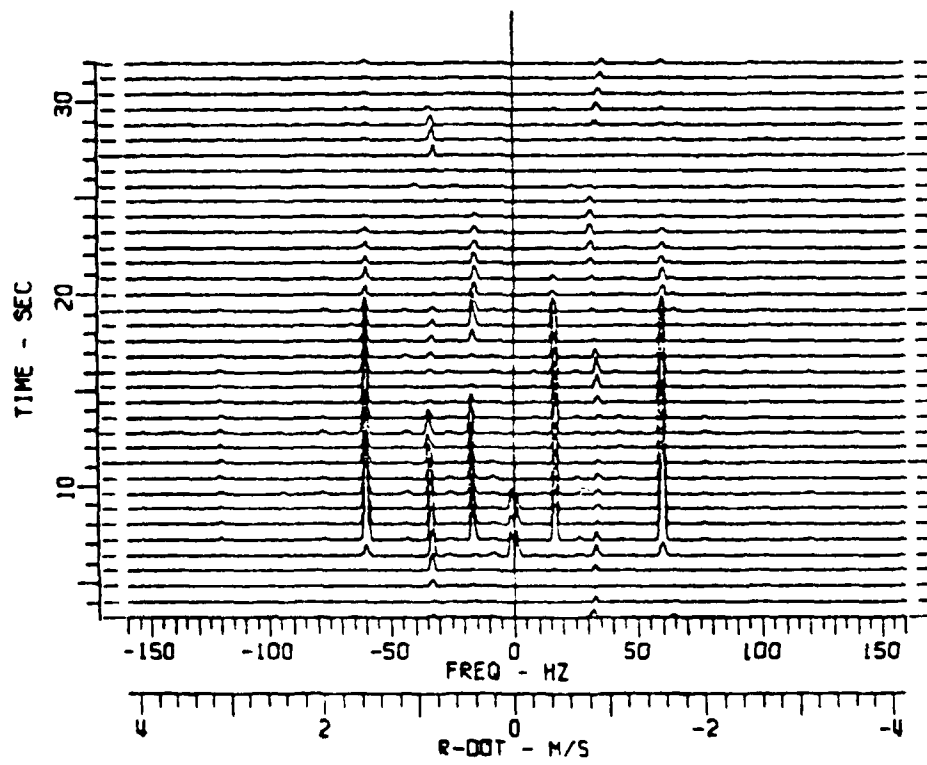

Figure 13. Doppler history plot illustrative of fading of spin traces.

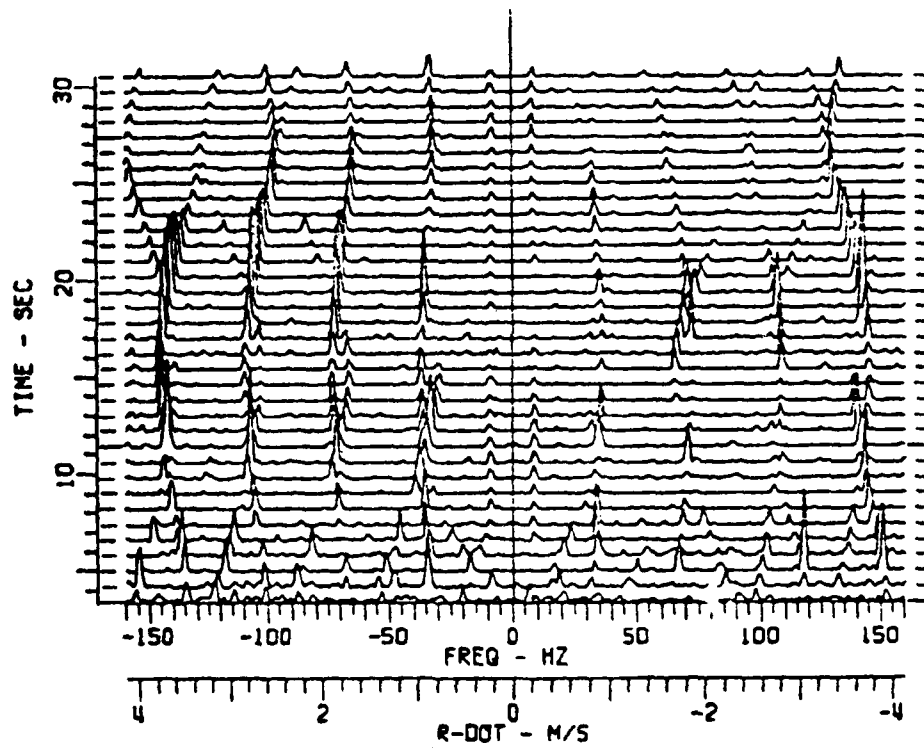

Figure 14. Doppler history plot illustrative of aliasing and crossover.

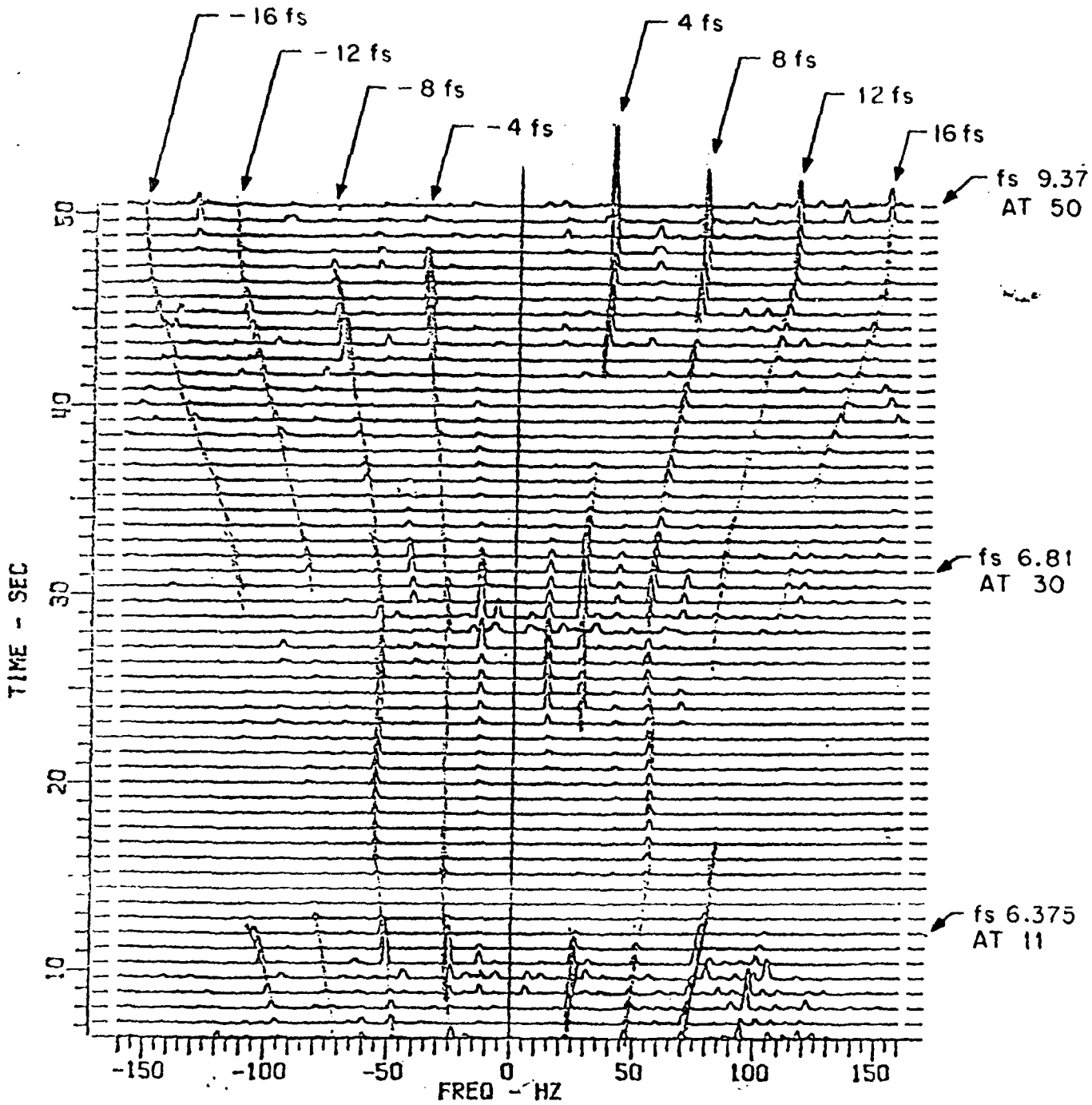

Figure 15. Manual analysis of a doppler history plot.

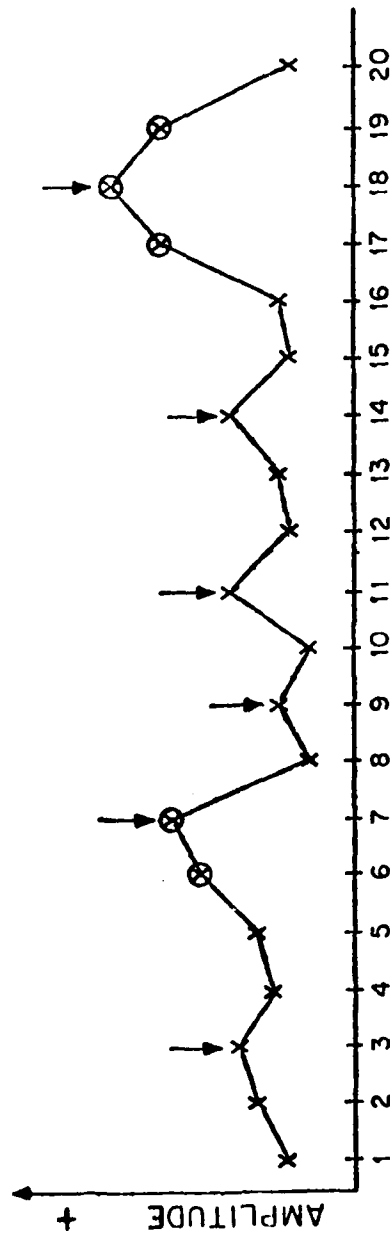

Figure 16. Selection of candidate spin returns.

GENERALIZED KNOWLEDGE BASED SYSTEM (KBS)

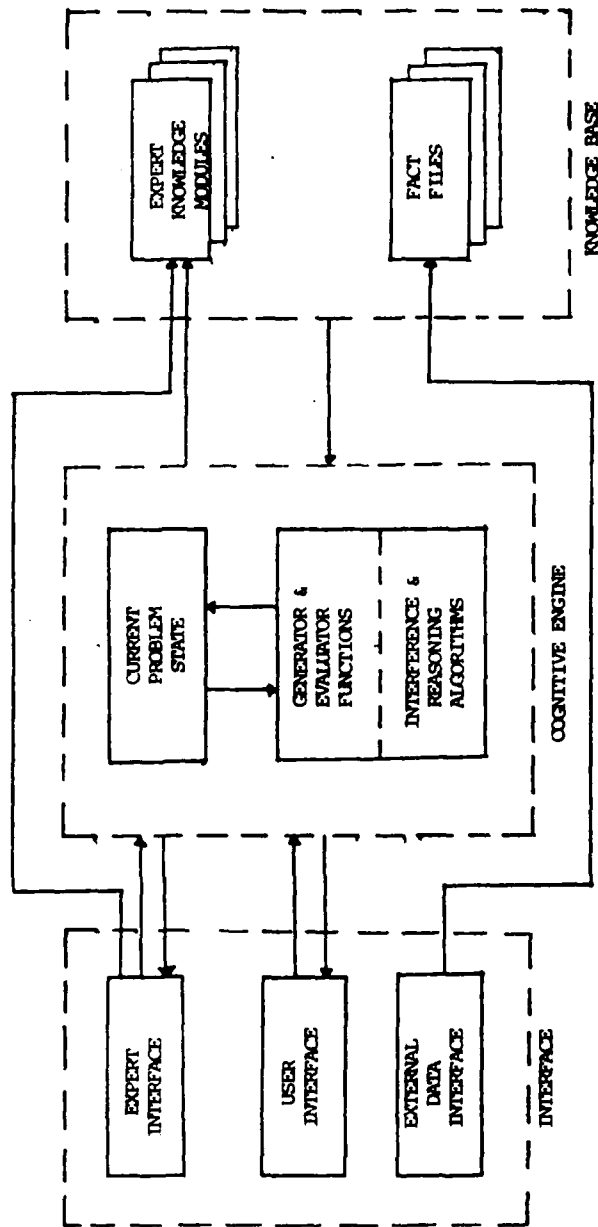

Figure 17. Knowledge based system.

INTERFACE & KNOWLEDGE BASE

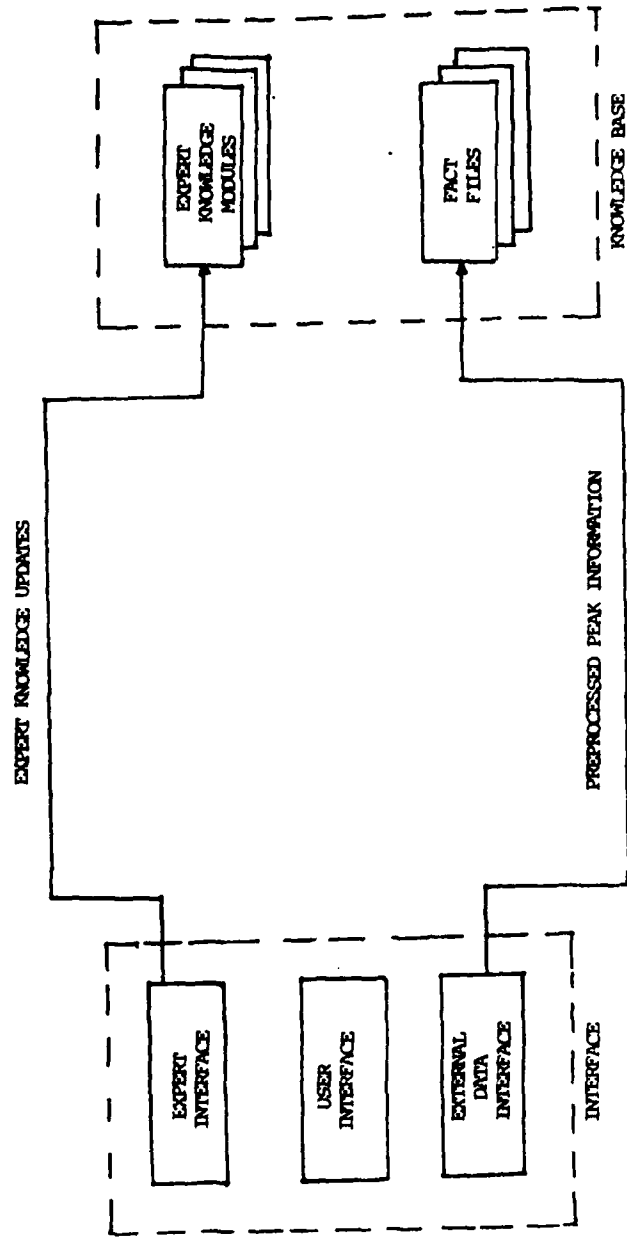

Figure 18. Interface and knowledge base.

COGNITIVE ENGINE

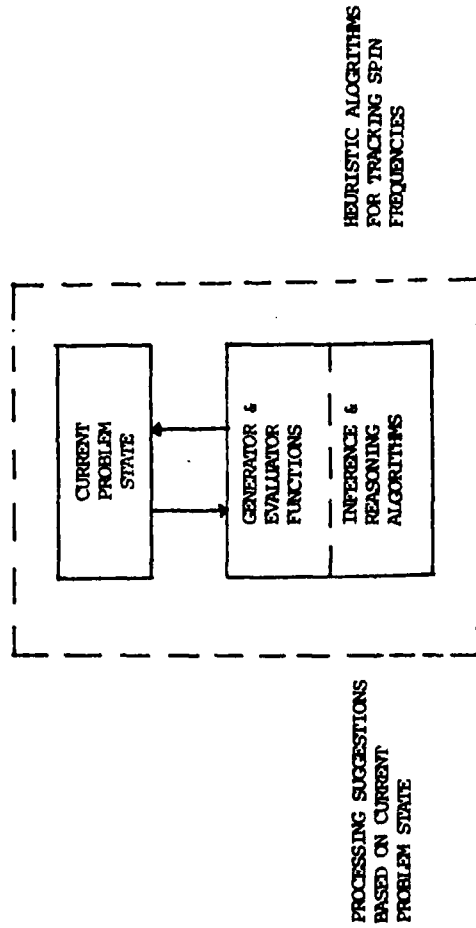

Figure 19. Cognitive engine.

REFERENCES

1. Nunn, Elwin C. "The US Army White Sands Missile Range Development of Target Motion Resolution," EASCON 1980 record, IEEE Electronics and Aerospace Systems Convention, IEEE Publication 80CH1578-4AES, 1980. ISSN: 0531-6863.
2. Taub, Herbert and Donald L. Schilling, Principles of Communication Systems, McGraw-Hill, Inc., New York, NY, pp. 1-42, 113-155, 1971.
3. Hynes, John N., "A Spectral Peak Tracker," Technical Report STEWS-ID-81-1, STEWS-ID, White Sands Missile Range, New Mexico, January 1981. DTIC No. B057745L.
4. Rebane, George J. "Recommendations for Application of Knowledge Based systems Technology to Target Motion Resolution," Report No. 308-1, Integrated Sciences Corporation, Santa Monica, California, June 1979.
5. Jackson, Philip C., Introduction to Artificial Intelligence, Petrocelli Books, New York, NY, pp. 94-102, 1974.

APPENDIX A. Programs.

```

PROGRAM PEAKS1
)
)
)
INITIALIZATION
DIMENSION A(1536), B(512), C(512)
COMMON/FFTINI/INI, LOADED
LOGICAL X1 FNAME(40), PNAME(40), BUF(100)
LOGICAL LOADED, IFILTR
LOGICAL HELP, STRING(10)
DATA KBUF, NVAL/1, 1/
DATA INI, LOADED/0, .FALSE./
NCOUNT=0
OPEN(UNIT=4, NAME='DK2:ES0,50JSPINSTAT.DAT', TYPE='OLD',
1FORM='UNFORMATTED')
REWIND(4)
READ(4)NRUNS
READ(4)NAVEPE
READ(4)AVE4FS
READ(4)N60HZ
READ(4)SPFREQ
READ(4)IFILTR
READ(4)NCOUNT
READ(4)NSEG
READ(4)WINAVE
READ(4)PCNT1
READ(4)PCNT2
READ(4)PCNT3
READ(4)PCNT4
TYPE 50
FORMAT(1X, 'ENTER INPUT FILE NAME WITH DEVICE')
READ(5,100)M,FNAME
FORMAT(0,40A1)
FNAME(M+1)=0
TYPE 60, FNAME
50
100

```

Appendix A (cont)

```

60  FORMAT(1X,40A1)
51  TYPE 51
    FORMAT(1X,'ENTER OUTPUT FILE NAME WITH DEVICE')
    READ(5,100)M,PNAME
    PNAME(M+1)=0
    TYPE 60,PNAME
    TYPE X,'IF YOU NEED HELP TO ANSWER ANY'
    TYPE X,'QUESTION ,ENTER HELP'
    TYPE 200
600  FORMAT(1X,'ENTER STARTING TIME BIAS')
200  ACCEPT 20,(STRING(I),I-1,10)
    20  FORMAT(10A1)
    CALL CONVER(STRING,HELP,TBIAS)
    IF(HELP)GO TO 500
    LAG=256
    LAG-LAG*X2
610  TYPE X,'ENTER NUMBER OF PEAKS PER SPECTRUM YOU WANT TO SAVE'
    ACCEPT 20,(STRING(I),I-1,10)
    CALL CONVER(STRING,HELP,ANUM)
    IF(HELP)GO TO 510
    NPEAKS=INT(ANUM)
620  TYPE X,'ENTER MINIMUM FREQUENCY FOR THE 4FS LINE'
    ACCEPT 20,(STRING(I),I-1,10)
    CALL CONVER(STRING,HELP,SPFREQ)
    IF(HELP)GO TO 520
    SPFREQ=SPFREQ-2
    TYPE X,'SPFREQ=',SPFREQ
    TYPE X,'DO YOU WANT TO FILTER OUT THE +/-60HERTZ'
    TYPE X,'LINE? ,ENTER Y OR N OR H (H IS FOR HELP)'
    ACCEPT 21,ICHAR
630  FORMAT(A1)
    21  IF(FILTR=.FALSE.)
        IF(ICHAR.EQ.'Y')IFILTR=.TRUE.
        IF(ICHAR.NE.'N')GO TO 530

```

Appendix A (cont)

```

C C MAP 512 POINTS TO 320 HERTZ WINDOW
C C DELTA=320.1729/512.
C C DO 1400 I=1,512
C C B(I)=-160.08645+(I-1)*DELTA
C C C(I)=B(I)
C C 1400
C C OPEN WORK FILES
C C OPEN(UNIT=1,NAME=FNAME,TYPE='OLD',READONLY,FORM='UNFORMATTED')
C C OPEN(UNIT=2,NAME=PNAME,TYPE='NEW',FORM='UNFORMATTED')
C C WRITE(2)NPEAKS
C C READ HEADER
C C READ (1)IBUF
C C IBUF=4*IBUF
C C READ (1) (BUF(N),N=1,IBUF)
C C TYPE 300,IBUF,BUF
C C 300 FORMAT(1X,I5,2X,100A1)
C C READ DATA BUFFER
C C 1000 READ(1,END=9001)IUF5ZE
C C IUF5ZE=IUF5ZE+NVAL-1
C C REF.(1)(APBUF(I),I=NVAL,IUF5ZE)
C C FIND LOCATION OF FIRST AMP/PHASE AT STARTING TIME
C C 1ST=1
C C IF(KBUF.NE.1)GO TO 1005
C C TBIAS=AMAX1(TBIAS,APBUF(1))
C C WRITE(2)TBIAS
C C 1ST=640.3448*(TBIAS-APBUF(1))+4.

```

Appendix A (cont)

```

ICK=IST/2
ICK1=IST-2*ICK
IF(ICK1.EQ.0)IST=IST+1
C FIND BUFFER WITH CORRECT START TIME
C
    NVAL=IST
    IF(IST.LT.1024) GO TO 1005
    IST=IST-1024
    NVAL=IST
    READ(1,END=9001)IUFSZE
    READ(1)(APBUF(I),I=1,IUFSZE)
    GO TO 1050
C COMPUTE THE QUADRATURE COMPONENTS
C
    1005    KSIZE=IUFSZE-1
           DO 1010 K=NVAL,KSIZE,2
           TEMP=APBUF(K)
           APBUF(K)=TEMP*COS(APBUF(K+1))
           APBUF(K+1)=TEMP*SIN(APBUF(K+1))
    1010
C SHIFT APBUF() DATA FOR NEW READ IF NECESSARY
C
    1100    IF((IUFSZE-IST).GE.512)GO TO 1200
           K=0
           DO 1150 M=IST,IUFSZE
           K=K+1
           APBUF(K)=APBUF(M)
           KBUF=KBUF+1
           NVAL=IUFSZE-IST+2
           GO TO 1000
C LOAD FFT ARRAY
C

```

```

1200 K=-1
      IST511-IST+511
      DO 1250 M=IST,IST511,2
      K=K+2
      A(K)=APBUF(M)
      A(K+1)=APBUF(M+1)
1250 CALL ARRAY PROCESSOR
      CALL FFT2(A,DUMMY,512,-2)
      SHIFT TRANSFORMED DATA
1350 DO 1350 I=1,256
      TEMP=A(I)
      A(I)=A(I+256)
      A(I+256)=TEMP
      IST=IST+LAG
      LOAD FREQUENCY ARRAY WITH VALUES
1500 IEOF=0
      DO 1500 I=1,512
      B(I)=C(I)
      PICK UP PEAKS
      CALL PICK(A,B,M,SPFREQ,IFILTR)
      ORDER FREQUENCY ACCORDING TO MAGNITUDE IN DESCENDING ORDER
      CALL SORTAG(A,M,B)
      WRITE INTO DISK LARGEST PEAKS

```

Appendix A (cont)

```

500 WRITE(2)((B(I),A(I)),I=1,NPEAKS)
    NCOUNT-NCOUNT+1
    GO TO 1100
    TYPEX, 'STARTING TIME BIAS IS THE TIME,'
    TYPEX, 'WHERE YOU WANT TO START PROCESSING,'
    TYPEX, 'A 0 WILL DEFAULT TO THE FIRST TIME ON TAPE.'
510 GO TO 600
    TYPEX, 'THIS IS THE NUMBER OF PEAKS/SPECTRUM,'
    TYPEX, 'THAT WILL BE SAVED FOR SUBSEQUENT,'
    TYPEX, 'TRACKING. USUALLY IT WILL BE THE NUMBER,'
    TYPEX, 'OF NON-WRAPPED SPIN LINES THAT CAN BE,'
    TYPEX, 'IDENTIFIED IN THE DOPPLER PLOT,'
    TYPEX, 'REMEMBER EACH POSITIVE AND NEGATIVE,'
    TYPEX, 'LINE COUNT AS 1,'
    TYPEX, 'IN THE PRESENCE OF LARGE,'
    TYPEX, 'NOISE PEAKS RELATIVE TO THE SPIN LINE,'
    TYPEX, 'PEAKS, YOU MAY GET BETTER RESULTS BY,'
    TYPEX, 'INCREASING THE NUMBER YOU ENTER BY,'
    TYPEX, '2 OR 3,'
    TYPEX, 'FOR THE LAST', NRUNS, 'RUNS, THE',
    TYPEX, 'AVERAGE NUMBER OF PEAKS SAVED WAS',
    TYPEX, NAVEPE
520 GO TO 610
    TYPEX, 'THIS IS THE MINIMUM FREQUENCY VALUE THAT',
    TYPEX, 'THE +/- 4FS LINE WILL TAKE THROUGHOUT',
    TYPEX, 'THE DOPPLER PLOT, AN ANSWER TO THE',
    TYPEX, 'NEAREST HERTZ IS SUFFICIENT. IF YOU',
    TYPEX, 'ARE NOT ABLE TO IDENTIFY THE 4FS LINE',
    TYPEX, 'ENTER 20 AS THE MINIMUM FREQUENCY.',
    TYPEX, 'THE MINIMUM FREQUENCY FOR THE 4FS LINE',
    TYPEX, 'IS BETWEEN 20 AND 60 HERTZ, THE AVERAGE',
    TYPEX, 'MINIMUM FROM THE LAST', NRUNS, 'IS', AVE4FS
    GO TO 620
530 TYPEX, 'THERE MAY BE A VERY STRONG LINE AT',
    TYPEX, '+/-60 HERTZ THAT DOES NOT SEEM TO BE'

```

Appendix A (cont)

TYPEX, 'A SPIN LINE. IF YOU WISH TO HAVE THIS'
TYPEX, 'REMOVED BEFORE TRACKING ,ANSUER Y,'

GO TO 630
REWIND (4)
WRITE(4)NRUNS
WRITE(4)NAVEPE
WRITE(4)AVE4FS
WRITE(4)N60HZ
WRITE(4)SPFREQ
WRITE(4)IFILTR
WRITE(4)NCOUNT
WRITE(4)NSEG
WRITE(4)WNAVE
WRITE(4)PCNT1
WRITE(4)PCNT2
WRITE(4)PCNT3
WRITE(4)PCNT4
STOP
END

9001

Appendix A (cont)

```
SUBROUTINE SORTAG(UIN,NSIZE,AIN)
DIMENSION AIN(1),VIN(1)
ITOP=NSIZE-1
DO 100 I=1,ITOP
  JBOT=I+1
  DO 90 J=JBOT,NSIZE
    IF(VIN(J).LT.VIN(I))GO TO 90
    USAVE=VIN(J)
    ASAVE=AIN(J)
    VIN(J)=VIN(I)
    AIN(J)=AIN(I)
    VIN(I)=USAVE
    AIN(I)=ASAVE
  CONTINUE
CONTINUE
RETURN
END
```

90
100

>

Appendix A (cont)

```
SUBROUTINE PICK(A,B,M,FREQ,IFILTR)
DIMENSION A(1),B(1)
LOGICAL IFILTR
IFLAG=1
M=0
TEST=A(1)
DO 100 I=1,511
IF(TEST.GT.A(I+1))GO TO 20
IFLAG=1
GO TO 100
IF(IFLAG.EQ.0)GO TO 100
IFLAG=0
IF(ABS(B(I)).LT.FREQ)GO TO 100
IF(IFILTR.AND.ABS(B(I)).EQ.60.)GO TO 100
M=M+1
A(M)=TEST
B(M)=B(I)
TEST=A(I+1)
RETURN
END
```

20

100

>

Appendix A (cont)

```
SUBROUTINE FFT2(DATA, DUMMY, NFFT, KEY)
LOGICAL LOADED
COMMON/FFTINI/INI, LOADED
IF(KEY.NE.-2)STOP 'FFT2 KEY'
IF(NFFT.LT.4)STOP 'FFT2 NFFT'
NN=ALOG(FLOAT(NFFT))*1.442695+.01
NFFT=2**NN
IF(NFFT.GT.1024)STOP 'FFT2 1024NFFT'
IF(NFFT.EQ.INI)GO TO 100
IF(LOADED)GO TO 80
CALL APAVAL(1)
IF(INI.NE.0)STOP 'NO AP-400'
CALL KSETIW(0)
CALL KRESET
CLOSE (UNIT=3)
CALL KLOAD(3, 'DB:[50,50]SUBFFT21.APO')
LOADED=.TRUE.
CALL KALDB(2*NFFT,3)
INI=NFFT
GO TO 100
CALL KRDBS
CALL KALDB(2*NFFT,3)
INI=NFFT
CALL KHFB(DATA,3,NFFT)
CALL KZPDB(3,NFFT+1,NFFT)
CALL KFFTC1(2*NFFT,3,3)
CALL KBRVC(3,3)
CALL KCMGS(3,3)
CALL KABHF(DATA,3,NFFT)
CALL KWAIT
RETURN
END
```

80

100

>

Appendix A (cont)

```

SUBROUTINE CONVER(A,HELP,B)
LOGICAL A(1)
LOGICAL HELP,NEG
CHECK FOR INVALID DATA
NEG=.FALSE.
HELP=.FALSE.
DO 10 I=1,10
IF(A(I).NE.' ' .AND.(A(I).LT.' ' .OR.A(I).GT.
1'9' ))HELP=.TRUE.
IF(A(I).EQ.'/' )HELP=.TRUE.
IF(A(I).EQ.'+' .OR.A(I).EQ.'-' )HELP=.FALSE.
IF(HELP)RETURN
SCRUNCH LEADING BLANKS
IF(A(I).NE.' ')GO TO 40
DO 30 I=1,9
A(I)=A(I+1)
A(10)=' '
GO TO 20
CALCULATE NUMBER
J=1
IF(A(1).EQ.'+' )J=2
IF(A(1).NE.'-' )GO TO 45
J=2
NEG=.TRUE.
IFLAG=0
B=0
C=0
DO 100 I=J,10

```

C C C

10

C C C

20

30

C C C 40

45

Appendix A (cont)

```
IF(A(I)).EQ.'')GO TO 110
IF(A(I)).NE.'')GO TO 50
IFLAG=1
GO TO 100
IF(IFLAG.GT.0)GO TO 60
B=B*X10+(A(I)-'0')
GO TO 100
C1=A(I)-'0'
C=C+C1/10.**IFLAG
IFLAG=IFLAG+1
CONTINUE
B=B+C
IF(NEG)B=-B
RETURN
END
```

50

60

100
110

>

Appendix A (cont)

```

C*****
C** PROGRAM MAIN
C*****
C** THIS PROGRAM IS GOING TO READ A FILE OF PEAKS
C** AND IDENTIFY THE SPIN FREQUENCY FOR EACH TIME
C** SPECTRUM.
C*****
C** DIMENSION PEAKY(40), AMPEAK(40), CAND(20), B(20), TIMES(120), SPFR(120,
2)
1, TGOOD(120), SGOOD(120)
LOGICAL X1 PNAME(40)
COMMON /STAT/NRUNS, NAVPE, AVE4FS, N60HZ, SPFREK, IFILTR, NUMLIN
1, NSEG, WINAVE, PCNT1, PCNT2, PCNT3, PCNT4
COMMON /STAT1/NSEG1, WIN1, IC1(2), IC2(2), IC3(2), IC4(2),
1PC1, PC2, PC3, PC4
COMMON /TIEMPO/TIMELY(10,2)
LOGICAL HELP, STRING(10), IFILTR, INIT
TYPEX, ENTER, INPUT FILE NAME WITH DEVICE'
READ(5,12)M, PNAME
FORMAT(Q,40A1)
PNAME(M+1)=0
INIT=.FALSE.
12
C C C
OPEN WORKING FILES
OPEN(UNIT=1, NAME=PNAME, TYPE='OLD', FORM='UNFORMATTED')
OPEN(UNIT=2, NAME='PEAKFRE.DAT', TYPE='SCRATCH', FORM='UNFORMATTED')
OPEN(UNIT=3, NAME='DK2:ES0,50JSPINSTAT.DAT', TYPE='OLD',
1FORM='UNFORMATTED')
ITIME=0
IC0=1

```

Appendix A (cont)

```

CALL INICLO(INIT)
INIT=.TRUE.
TYPEX,'IF YOU NEED HELP TO ANSWER'
TYPEX,'ANY OF THE QUESTIONS,ENTER HELP'

CALCULATE TIME FOR EACH LINE AND FINAL TIME

READ(1)NPEAKS
READ(1)STIME
STIME=STIME+128.5/320.1729
DO 950 KL=1,120
  TIMES(KL)=STIME+(KL-1)*.799568
  FTIME=TIMES(NUMLIN)

PROCESS ONE SPECIFIC TIME INTERVAL

ITIME=ITIME+1
TYPE X,'ENTER TRACK WINDOW LENGTH'
ACCEPT 20,(STRING(I),I=1,10)
FORMAT(10A1)
CALL CONVER(STRING,HELP,WINLEN)
IF(HELP)GO TO 700
TYPEX,'ENTER MAXIMUM MULTIPLE TO LOOK FOR'
ACCEPT 20,(STRING(I),I=1,10)
CALL CONVER(STRING,HELP,A)
IF(HELP)GO TO 710
MAXMUL=INT(A)
REWIND 1
REWIND 2
READ(1) NPEAKS
READ(1) STIME
DO 2090 I=1,2
  IC1(I)=0
  IC2(I)=0
  IC3(I)=0

```

C
C
C

950

C
C
C

900
800

20

810

Appendix A (cont)

```

2090 IC4(I)=0
      TYPEX,'START TIME IS-',STIME
      TYPEX,'FINAL TIME IS-',FTIME
C
C
C 1000 ACCEPT TIME INTERVAL TO BE PROCESSED
      TYPEX,'ENTER TIME YOU WANT TO START AT'
      ACCEPT 20,(STRING(I),I-1,10)
      CALL CONVER(STRING,HELP,TIME1)
      IF(HELP)GO TO 720
      IF(TIME1.LT.(STIME-1).OR.TIME1.GT.(FTIME+1))GO TO 1000
1100 TYPEX,'ENTER TIME YOU WANT TO STOP AT'
      ACCEPT 20,(STRING(I),I-1,10)
      CALL CONVER(STRING,HELP,TIME2)
      IF(HELP)GO TO 730
      IF(TIME2.LT.(STIME-1).OR.TIME2.GT.(FTIME+1))GO TO 1100
      CALL TIMEIN(IFL,TIME1,TIME2,ITIME)
      IF(IFL.EQ.1)GO TO 1000
      GO TO 1200
C
C
C 200 REVERSE DATA FOR BACKWARDS PROCESSING
      TYPEX,'BACKWARDS PROCESSING STARTS'
      LUN=2
      IFLAGY=2
      CALL REVERS(NLINES,NPEAKS)
      REWIND 2
      GO TO 35
C
C
C 1200 PROCESS FORWARD AND SKIP LINES IF FIRST TIME NOT STIME
      TYPEX,'FORWARD PROCESSING STARTS'
      LUN=1
      IFLAGY=1
      IGO=0

```

Appendix A (cont)

```

NLINES=0
DO 450 L=1,120
IF (TIMES(L).GE.TIME1)GO TO 350
IGO=IGO+1
DO 550 L=IGO+1,120
IF (TIMES(L).GT.TIME2)GO TO 650
NLINES=NLINES+1
IF (IGO.EQ.0)GO TO 35
DO 40 L=1,IGO
READ(1)((PEAKY(J),AMPEAK(J)),J=1,NPEAKS)
ICOUNT=1
ITIME=IGO+NLINES+1

READ IN ONE TIME SPECTRUM AT A TIME AND PROCESS IT

READ(LUN)((PEAKY(J),AMPEAK(J)),J=1,NPEAKS)
ITIME=ITIME-1
T1=TIMES(ITIME)
IF (IFLAGY.EQ.2)GO TO 101
ITIME=IGO+ICOUNT
T1=TIMES(ITIME)
WRITE(2)((PEAKY(J),AMPEAK(J)),J=1,NPEAKS)
IF (ICOUNT.NE.1)GO TO 10

101
C
C IDENTIFY ONE OF THE SPIN LINES AND PROMPT USER FOR CORRECTNESS
C
CALL MENU(PEAKY,AMPEAK,SPFREQ,T1,IC1,IFLAGY)
C
TRACK SPIN LINES FOR PARTICULAR TIME SPECTRUM
C
CALL SPTRK1(WINLEN,MAXMUL,NPEAKS,SPFREQ,PEAKY,AMPEAK,T1,IFLAGY)
SPFR(IC0,IFLAGY)=SPFREQ
IF (ICOUNT.EQ.1)GO TO 50
IF (ICOUNT.NE.2)GO TO 60
C

```

Appendix A (cont)

```

33      CALCULATE THE SECOND SPIN FREQUENCY
34      SPFREQ=2*SPFR(ICO,IFLAGY)-SPFR(ICO-1,IFLAGY)
35      GO TO 50
36
37      MAKE A 3 POINT LEAST SQUARES PREDICTION OF NEXT SPIN FREQ.
38
39      CALL SPFIT(SPFR,SPFREQ,ICO,IFLAGY)
40      ICOUNT=ICOUNT+1
41      ICO=ICO+1
42      IF(ICOOUNT.LE.NLINES)GO TO 100
43      ICO=ICO-NLINES
44      IF(IFLAGY.EQ.1)GO TO 200
45
46      PRINT OUT SPIN FREQUENCIES FOUND,WITH ASSOCIATED TIME
47
48      TYPE 70
49      FORMAT(SX,'TIME',10X,'FORWARD PROCESS',10X,'BACKWARD PROCESS')
50      CALL REVDAT(SPFR,ICO,NLINES)
51      DO 11 I=ICO,ICO+NLINES-1
52      IGO=IGO+1
53      TYPE 1300,TIMES(IGO),SPFR(I,1),SPFR(I,2)
54      FORMAT(F10.5,12X,F10.5,14X,F10.5)
55      TYPEX,'DO YOU AGREE WITH THE DATA?,'
56      TYPEX,'EITHER FORWARD OR BACKWARDS,'
57      TYPEX,'ENTER Y OR N,'
58      ACCEPT 1,ANSW
59      IF(ANSW.EQ.'Y')GO TO 2000
60      IF(ANSW.EQ.'N')GO TO 2010
61      TYPEX,'THERE IS NO HELP TO THIS QUESTION'
62      TYPEX,'ENTER Y OR N PLEASE,'
63      GO TO 2020
64      TYPEX,'DO YOU WANT TO SAVE THE FORWARD'
65      TYPEX,'OR THE BACKWARD DATA? ENTER,'
66      TYPEX,'1 FOR THE FORWARD DATA'

```

Appendix A (cont)

```

2050 TYPEX, '2 FOR THE BACKWARD DATA'
ACCEPTX, NFB
IF(NFB.EQ.1.OR.NFB.EQ.2)GO TO 2030
TYPEX, 'PLEASE ENTER EITHER 1 OR 2,'
GO TO 2050
2030 DO 2040 I=ICO,ICO+NLINES-1
IGO=IGO+1
TGOOD(I)=TIMES(IGO)
SGOOD(I)=SPFR(I,NFB)
ICO=ICO+NLINES
CALL COMPUT(NLINES,NFB,WINLEN)
TYPEX, 'DO YOU WANT TO PROCESS MORE'
TYPEX, 'SEGMENTS OF DATA? ENTER Y OR N'
ACCEPT 1,ANSW
FORMAT(A1)
IF(ANSW.EQ.'Y')GO TO 900
TYPEX, 'DO YOU AGREE WITH THIS RUN?'
TYPEX, 'ENTER Y OR N,'
ACCEPT 1,ANSW
IF(ANSW.NE.'Y')GO TO 2070
CALL COMFIN(NPEAKS)
TYPEX, 'DO YOU WANT TO SEE THE STATISTICS'
TYPEX, 'OF THIS RUN? ENTER Y OR N,'
ACCEPT1,ANSW
IF(ANSW.EQ.'Y')CALL PRINTS(NPEAKS)
CALL INICLO(INIT)
STOP
2070 TYPEX, 'I CAN GIVE YOU SOME SUGGESTIONS THAT'
TYPEX, 'WILL PROBABLY IMPROVE YOUR OUTPUT,'
TYPEX, 'ENTER Y OR N,'
ACCEPT 1,ANSW
IF(ANSW.NE.'N')CALL SUGB
TYPEX, 'STATISTICS WILL NOT BE SAVED FOR'
TYPEX, 'THIS RUN,'
STOP

```

Appendix A (cont)

```

2010 TYPEX, 'DO YOU WANT ANY SUGGESTIONS THAT WILL'
TYPEX, 'PROBABLY IMPROVE YOUR OUTPUT?'
TYPEX, 'ENTER Y OR N'
ACCEPT 1, ANSW
IF(ANSW.NE.'N')CALL SUG1(NLINES,MAXMUL)
TYPEX, 'DO YOU WANT TO PROCESS THIS SEGMENT AGAIN?'
TYPEX, 'ENTER Y OR N'
ACCEPT 1, ANSW
IF(ANSW.NE.'Y')GO TO 95
GO TO 800
700 TYPEX, 'THIS IS THE TOLERANCE TO '
TYPEX, 'FIND THE PEAKS CORRESPONDII.G'
TYPEX, 'TO THE SPIN LINES'
TYPEX, 'IF THE WINDOW LENGTH IS TOO BIG,'
TYPEX, 'YOU WILL PROBABLY PICK UP NOISY PEAKS'
TYPEX, 'IF IT IS TOO SMALL THEN YOU WILL MISS'
TYPEX, 'SOME OF THE CORRECT PEAKS AND WILL'
TYPEX, 'BE ASKED TO INPUT THE CORRECT FREQUENCY'
TYPEX, 'THE AVERAGE WINDOW LENGTH FOR THE'
TYPEX, 'PREVIOUS',NSEG,'SEGMENTS PROCESSED IS',WINAVE
GO TO 800
710 TYPEX, 'THIS IS THE MAX MULTIPLE THAT'
TYPEX, 'THE TRACKER WILL SEARCH FOR,'
TYPEX, 'THE MULTIPLE TO SELECT IS THE MAX SPIN'
TYPEX, 'LINE THAT DO NOT WRAP AROUND,'
TYPEX, 'SELECT A SMALLER MULTIPLE IF'
TYPEX, 'THE HIGHER MULTIPLES ARE'
TYPEX, 'OBSCURED BY NOISE'
GO TO 810
720 TYPEX, 'THIS IS THE TIME WHERE'
TYPEX, 'PROCESSING BEGIN,IT CAN NOT'
TYPEX, 'BE OUT OF THE RANGE FOR THE DATA.'
GO TO 1000
730 TYPEX, 'THIS IS THE TIME WHERE'
TYPEX, 'PROCESSING OF THIS SEGMENT WILL'

```

Appendix A (cont)

TYPEX, 'STOP, IT CAN NOT BE OUT OF THE'
TYPEX, 'RANGE FOR THE DATA, AND CAN NOT BE'
TYPEX, 'SMALLER THAN THE START TIME.'
GO TO 1100
END

>

Appendix A (cont)

```

SUBROUTINE INICLO(INIT)
COMMON /STAT/NRUNS,NAVEPE,AVE4FS,N60HZ,SPFREK,IFILTR,NUMLIN,
1NSEG,WINAVE,PCNT1,PCNT2,PCNT3,PCNT4
COMMON /STAT1/NSEGI,WIN1,IC1(2),IC2(2),IC3(2),IC4(2),
1PC1,PC2,PC3,PC4
LOGICAL IFILTR,INIT
IF(INIT)GO TO 10
REWIND(3)
NRUNS IS THE NUMBER OF TIMES THE PROGRAM HAVE RUN SUCCESSFULLY
READ(3)NRUNS
NAVEPE IS THE AVERAGE NUMBER OF PEAKS SAVED IN PEAKS1 PROGRAM
READ(3)NAVEPE
AVE4FS IS THE AVERAGE FREQUENCY OF THE 4FS SPIN LINE
READ(3)AVE4FS
N60HZ IS THE NUMBER OF TIMES THE 60 HERTZ LINE HAS BEEN REMOVED
READ(3)N60HZ
SPFREK IS THE 4FS FREQUENCY FOR THIS RUN
READ(3)SPFREK
IFILTR IS TRUE IF THE 60 HZ LINE IS REMOVED IN THIS RUN
READ(3)IFILTR
NUMLIN IS THE NUMBER OF LINES IN THE CURRENT DATA
READ(3)NUMLIN
NSEG IS THE NUMBER OF SEGMENTS RUN UP TO THIS CURRENT RUN
READ(3)NSEG
WINAVE IS THE AVERAGE WINDOW TOLERANCE OF ALL THE RUNS
READ(3)WINAVE
PCNT1 IS THE NUMBER OF TIMES THE LARGEST PEAK CORRESPONDED
TO A SPIN LINE, ACCORDING TO THE NUMBER OF SEGMENTS
READ(3)PCNT1
PCNT2 IS THE PERCENTAGE THAT THE USER WAS REQUESTED TO
INPUT THE CORRECT SPIN FREQUENCY
READ(3)PCNT2
PCNT3 IS THE PERCENTAGE THAT THE PROGRAM CAME OUT
WITH THE RIGHT FREQUENCY

```

AD-A171 928

SPIN FREQUENCY DETECTION IN THE SPECTRAL DOMAIN(U)
WHITE SANDS MISSILE RANGE NM INSTRUMENTATION
DIRECTORATE D 5 JIMAREZ MAR 86 STENS-ID-86-1

2/2

UNCLASSIFIED

F/G 17/9

NL

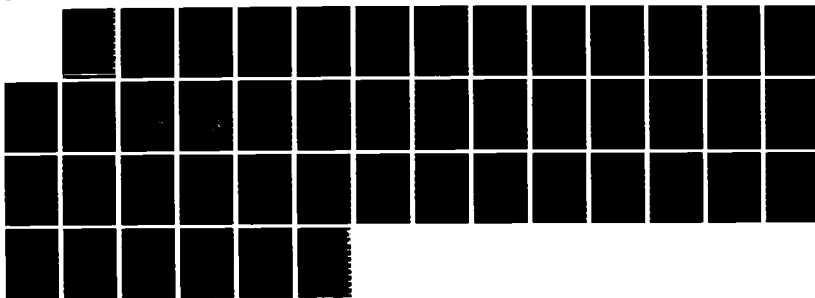

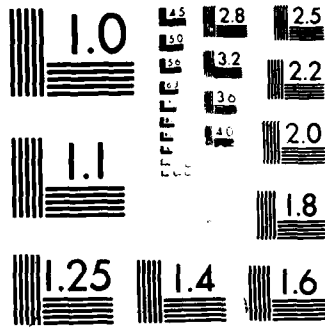

MICROCOPY RESOLUTION TEST CHART
NATIONAL BUREAU OF STANDARDS-1963-A

Appendix A (cont)

```
READ(3)PCNT3
PCNT4 IS THE PERCENTAGE THAT THE USER WAS REQUESTED TO
SELECT OUT OF SEVERAL FREQUENCIES THE RIGHT ONE
READ(3)PCNT4
WIN1=0
NSEG1=0
PC1=0
PC2=0
PC3=0
PC4=0
RETURN
REWIND 3
WRITE(3)NRUNS
WRITE(3)NAVEPE
WRITE(3)AVE4FS
WRITE(3)N60HZ
WRITE(3)SPFREK
WRITE(3)IFILTR
WRITE(3)NUMLIN
WRITE(3)NSEG
WRITE(3)WINAVE
WRITE(3)PCNT1
WRITE(3)PCNT2
WRITE(3)PCNT3
WRITE(3)PCNT4
RETURN
END
```

C
C

10

>

Appendix A (cont)

```

C*****
C** SUBROUTINE TIMEIN(IFL, TIME1, TIME2, ITIME) *****
C** THIS ROUTINE WILL CHECK IF THE TIME INTERVAL *****
C** IS NOT OVERLAPING WITH A PREVIOUS ONE *****
C** *****
C***** COMMON /TIEMPO/TIMELY(10,2) *****
IFL=0
TIMELY(ITIME,1)-TIME1
TIMELY(ITIME,2)-TIME2
IF(ITIME.LE.1)RETURN
DO 10 I=1,ITIME-1
IF(TIMELY(ITIME,1).GT.TIMELY(I,1).AND.
1TIMELY(ITIME,1).LT.TIMELY(I,2))GO TO 20
IF(TIMELY(ITIME,2).GT.TIMELY(I,1).AND.
1TIMELY(ITIME,2).LT.TIMELY(I,2))GO TO 20
CONTINUE
RETURN
TYPEX,'TIME OVERLAP, TRY AGAIN'
IFL=1
RETURN
END
10
20
>

```

Appendix A (cont)

```
CXXXXXXXXXXXXXXXXXXXXXXXXXXXXXXXXXXXXXXXXXXXXXXXXXXXXXXXXXXXXXXXXXXXXX
CX  SUBROUTINE REVERS(NLINES,NPEAKS)                                XXX
CX  THIS ROUTINE WILL REVERSE A FILE WITH NLINES                XXX
CX  DIMENSION PEAKS(60,40),AMPEAK(60,40)                        XXX
C  READ AND THEN STORE IN REVERSE ORDER THE DATA
C
C  REWIND 2
DO 10 I=1,NLINES
  READ(2)((PEAKS(I,J),AMPEAK(I,J)),J=1,NPEAKS)
  REWIND 2
DO 30 K=NLINES,1,-1
  WRITE(2)((PEAKS(K,J),AMPEAK(K,J)),J=1,NPEAKS)
  RETURN
END
10
30
>
```

Appendix A (cont)

```

CXX*****SUBROUTINE MENU (X,Y,FREQ,T1,IC1,IFLAGY)*****
CXX*****
CXX      THIS ROUTINE OFFERS THE USER THE OPPORTUNITY TO
CXX      CORRECT THE CALCULATED SPIN FREQUENCY, ACCORDING
CXX      TO HIS MANUAL CALCULATIONS.
CXX*****
CXX      DIMENSION IC1(2),X(1),Y(1)
CXX      LOGICAL HELP,STRING(10)
CXX      TYPEX,'AT',T1,'SECONDS,IS',X(1)
CXX      TYPEX,'DOES THIS FREQUENCY CORRESPONDS TO ANY OF
CXX      TYPEX,'THE SPIN LINES? Y OR N OR H (FOR HELP)',
CXX      ACCEPT 10,ANSU
CXX      FORMAT(A1)
CXX      IF (ANSU.EQ.'Y')GO TO 30
CXX      IF (ANSU.NE.'N')GO TO 100
CXX      TYPEX,'ENTER THE RIGHT FREQUENCY FOR THIS LINE'
CXX      ACCEPT 20,(STRING(I),I-1,10)
CXX      FORMAT(10A1)
CXX      CALL CONVER(STRING,HELP,FREQ)
CXX      IF(HELP)GO TO 110
CXX      RETURN
CXX      TYPEX,'THE LARGEST PEAK IN THIS LINE WAS'
CXX      TYPEX,'CHOSEN,IF THIS PEAK CORRESPONDS TO'
CXX      TYPEX,'ANY OF THE SPIN LINES ENTER Y,ELSE'
CXX      TYPEX,'ENTER N.'
CXX      GO TO 200
CXX      TYPEX,'IF THE FREQUENCY OF THE PEAK DOES'
CXX      TYPEX,'NOT CORRESPONDS TO ANY OF THE SPIN'
CXX      TYPEX,'LINES THEN ENTER YOUR CALCULATED'

```

Appendix A (cont)

```
TYPEX, 'FREQUENCY AT THIS TIME.'  
GO TO 210  
IC1(IFLAGY)-IC1(IFLAGY)+1  
TYPEX, 'ENTER THE SPIN LINE NUMBER'  
ACCEPT 20, (STRING(I), I=1, 10)  
CALL CONVER(STRING, HELP, FR)  
IF(HELP)GO TO 120  
FREQ=X(1)/FR  
RETURN  
TYPEX, 'THIS QUESTION REFERS TO THE'  
TYPEX, 'NUMBER OF THE SPIN LINE THAT'  
TYPEX, 'CONTAINS THE PEAK IN QUESTION'  
TYPEX, 'PLEASE ENTER THE NUMBER FOR'  
TYPEX, 'THAT LINE.'  
GO TO 220  
END
```

30

220

120

>

Appendix A (cont)

```

SUBROUTINE SPTRK1(X,MAX,N,FREQ,Y,Z,T1,IFLAGY)
DIMENSION Y(1),Z(1),P(5)
COMMON /STAT1/NSEG1,WIN1,IC1(2),IC2(2),IC3(2),IC4(2),
1PC1,PC2,PC3,PC4
DO 100 I=MAX,4,-4
FREQ1=FREQ*I+X
FREQ2=FREQ*I-X
NCOUNT=0
DO 90 J=1,N
IF(Y(J))10,20,20
IF(Y(J)).GT.(-FREQ2).OR.Y(J).LT.(-FREQ1))GO TO 90
GO TO 30
IF(Y(J)).GT.FREQ1.OR.Y(J).LT.FREQ2)GO TO 90
NCOUNT=NCOUNT+1
P(NCOUNT)=Y(J)
CONTINUE
NUM=I
IF(NCOUNT.NE.0) GO TO 110
CONTINUE
IF(NCOUNT.EQ.1)GO TO 125
IF(NCOUNT.EQ.0)GO TO 120
IF(NCOUNT.NE.2)GO TO 115
IF(ABS(P(1))+P(2)).LT.3.)GO TO 125
CALL MENU1(P,NCOUNT,NUM,T1)
IC4(IFLAGY)=IC4(IFLAGY)+1
GO TO 130
CALL MENU2(FREQ,T1)
IC2(IFLAGY)=IC2(IFLAGY)+1
RETURN
IC3(IFLAGY)=IC3(IFLAGY)+1
FREQ=ABS(P(1))/NUM
RETURN
END

```

10

20

30

90

100

110

115

120

125

130

>

Appendix A (cont)

```
CX*****  
SUBROUTINE SPFIT(SPFR,SPFREQ,ICOUNT,IFL)*****  
CX*****  
CX      THIS ROUTINE MAKES USE OF A 3 POINT LEAST *****  
CX      SQUARES APPROXIMATION TO PREDICT THE NEXT *****  
CX      WINDOW CENTER VALUE. *****  
CX*****  
CX      DIMENSION SPFR(120,2) *****  
CX      SUM=SPFR(ICOUNT,IFL)+SPFR(ICOUNT-1,IFL)+SPFR(ICOUNT-2,IFL)  
CX      SLOPE=SPFR(ICOUNT,IFL)+.5*(SPFR(ICOUNT-1,IFL)-SUM)  
CX      B=(1./3.)*SUM-SLOPE  
CX      SPFREQ=3.*SLOPE+B  
CX      RETURN  
CX      END
```

>

Appendix A (cont)

```
SUBROUTINE REUDAT(SPFR, ICO, NLINES)
DIMENSION SPFR(120,2),A(120)
K=ICO+NLINES-1
DO 10 I=ICO,ICO+NLINES-1
A(I)=SPFR(K,2)
K=K-1
DO 20 I=ICO,ICO+NLINES-1
SPFR(I,2)=A(I)
RETURN
END
```

10

20

>

Appendix A (cont)

```
SUBROUTINE COMPUT(NLINES,NFB,WINLEN)
COMMON /STAT1/NSEG1,WIN1,IC1(2),IC2(2),IC3(2),IC4(2),
1PC1,PC2,PC3,PC4
A=NLINES
NSEG1=NSEG1+1
WIN1=(WIN1+WINLEN)/2.
PC1=PC1+IC1(NFB)
PC2=(PC2+IC2(NFB))/A)/2.
PC3=(PC3+IC3(NFB))/A)/2.
PC4=(PC4+IC4(NFB))/A)/2.
RETURN
END
```

>

Appendix A (cont)

```
SUBROUTINE COMFIN(NPEAKS)
COMMON /STAT/NRUNS,NAVEPE,AVE4FS,N60HZ,SPFREK,IFILTR,NUMLIN,
INSEG,WINAVE,PCNT1,PCNT2,PCNT3,PCNT4
COMMON /STAT1/NSEG1,WIN1,IC1(2),IC2(2),IC3(2),IC4(2),
1PC1,PC2,PC3,PC4
LOGICAL IFILTR
NRUNS=NRUNS+1
NAVEPE=(NAVEPE+NPEAKS)/2
AVE4FS=(AVE4FS+SPFREK)/2
IF(IFILTR)N60HZ=N60HZ+1
NSEG=NSEG+NSEG1
WINAVE=(WINAVE+WIN1)/2
PCNT1=PCNT1+PC1
PCNT2=(PCNT2+PC2)/2
PCNT3=(PCNT3+PC3)/2
PCNT4=(PCNT4+PC4)/2
RETURN
END
```

Appendix A (cont)

```
10 SUBROUTINE MENU1(P, NCOUNT, NUM, T1)
    DIMENSION P(1)
    TYPEX, 'MORE THAN ONE PEAK WAS FOUND AT', T1
    TYPEX, 'SECONDS. THE PEAKS FOUND IN THE WINDOW GIVEN'
    TYPEX, 'ARE FOR EITHER THE + OR-', NUM, 'FS LINE'
    DO 10 J=1, NCOUNT
    TYPEX, J, P(J)
    TYPEX, 'I WILL CHOOSE THE FIRST ONE AS CORRECT, OTHERWISE,'
    TYPEX, 'DO YOU WANT TO TELL ME WHICH IS THE CORRECT ONE?Y,N'
    ACCEPT 15, ANSU
    FORMAT(A1)
    IF(ANSU.NE.'Y') RETURN
    TYPEX, 'IS ANY OF THE LISTED ONES RIGHT?Y,N'
    ACCEPT 15, ANSU
    IF(ANSU.EQ.'Y') GO TO 30
    TYPEX, 'ENTER THE RIGHT FREQUENCY FOR EITHER THE +OR-', NUM, 'FS LINE
    TYPEX, 'AT', T1, 'SECONDS'
    ACCEPTX, P(1)
    RETURN
    TYPEX, 'ENTER NUMBER FOR THE RIGHT ONE'
    ACCEPTX, I
    P(1)=P(I)
    RETURN
    END
    >
```

Appendix A (cont)

```
SUBROUTINE MENU2(FREQ,T1)
TYPEX,'I COULD NOT FIND ANY MULTIPLES OF THE SPIN AT'
TYPEX,T1,'SECONDS, FOR THE WINDOW GIVEN'
TYPEX,'PLEASE ENTER THE SPIN FREQUENCY AT THIS LOCATION'
ACCEPTX,FREQ
TYPEX,'THANK YOU'
RETURN
END
```

Appendix A (cont)

SUBROUTINE SUG1(NLINES, MAXMUL)
COMMON/STAT/NRUNS, NAVEPE, AUE4FS, N60HZ, SPFREK, IFILTR, NUMLIN,
INSEG, WINAVE, PCNT1, PCNT2, PCNT3, PCNT4
COMMON/STAT1/NSEG1, WIN1, IC1(2), IC2(2), IC3(2), IC4(2),
IPC1, PC2, PC3, PC4
LOGICAL IFILTR
TYPEX, MAXMUL, WAS THE MAXIMUM MULTIPLE TO
TYPEX, 'LOOK FOR IN THIS INTERVAL.'
TYPEX, 'YOU CAN ASK THE TRACKER TO LOOK FOR'
TYPEX, 'A SMALLER MULTIPLE IF THERE ARE.'
TYPEX, 'NOISY PEAKS CLOSER TO THE MAXIMUM.'
TYPEX, 'MULTIPLE, OR IF YOU SEE THAT A SMALLER'
TYPEX, 'MULTIPLE LINE IS STRONGER AND THIS'
TYPEX, 'IS THE ONE YOU WANT TO TRACK.'
TYPEX, '1'
TYPEX, 'OUT OF', NLINES, 'LINES TRACKED YOU'
TYPEX, 'WERE ASKED TO INPUT THE CORRECT FRE--'
TYPEX, 'QUENCY', IC2(1), 'TIMES IN THE FORWARD'
TYPEX, 'PROCESS, AND', IC2(2), 'TIMES IN THE'
TYPEX, 'BACKWARDS PROCESS. IF THESE TWO NUMBERS'
TYPEX, 'ARE TOO LARGE COMPARED TO THE NUMBER,
TYPEX, 'OF LINES IN THE INTERVAL, THIS MEANS,
TYPEX, 'THAT YOUR WINDOW IS TOO SMALL OR THAT'
TYPEX, 'THERE ARE LARGE NOISE PEAKS CLOSE TO'
TYPEX, 'THE CORRECT ONES. IF THE WINDOW LOOKS'
TYPEX, 'SMALL, TRY LOOSING IT UP A LITTLE,
TYPEX, 'BIT AND RUN IT AGAIN. IF THE PROBLEM'
TYPEX, 'IS NOISE THEN SEE IF YOU CAN DIVIDE,
TYPEX, 'THIS INTERVAL INTO SMALLER ONES AND,
TYPEX, 'AVOID PROCESSING THE NOISY INTERVALS.'
TYPEX, 'IF THE NOISE PEAKS SEEM TO BE FAR,
TYPEX, 'AWAY FROM THE SPIN LINES, AND YOU HAVE'
TYPEX, 'A LARGE WINDOW, RUN THIS INTERVAL AGAIN.'
TYPEX, 'WITH A TIGHTER WINDOW.'

Appendix A (cont)

TYPEX, 'THE AVERAGE WINDOW SIZE FOR PREVIOUS'
TYPEX, 'RUNS WAS, WINAWE, 'HERTZ, '
TYPEX, 'IF THE WHOLE INTÉRVAL IS CORRUPTED'
TYPEX, 'BY NOISE, DO NOT PROCESS IT, '
RETURN
END

>

Appendix A (cont)

```

SUBROUTINE SUG2
COMMON/STAT/NRUNS,NAVEPE,AVE4FS,N60HZ,SPFREK,IFILTR,NUMLIN,
INSEG,WINAVE,PCNT11,PCNT2,PCNT3,PCNT4
COMMON/STAT1/NSEG1,WIN1,IC1(2),IC2(2),IC3(2),IC4(2),
IPC1,PC2,PC3,PC4
LOGICAL IFILTR
TYPEX,'THE FOLLOWING SUGGESTIONS CAN PROBABLY'
TYPEX,'IMPROVE YOUR OUTPUT, IT IS NO GUARANTEE'
TYPEX,'BUT YOU CAN TRY THEM BEFORE DOING THE'
TYPEX,'TRACKING MANUALLY.'
TYPEX,'1'
TYPEX,'IF YOU HAVE ALREADY TRY TO ADJUST THE'
TYPEX,'WINDOW OR THE MAXIMUM MULTIPLE,OR THE'
TYPEX,'TIME INTERVALS IN THIS PROCESS,AND YOU'
TYPEX,'STILL DO NOT HAVE A SATISFACTORY RUN,'
TYPEX,'THEN THE FOLLOWING APPLY TO THE PEAKS1'
TYPEX,'PROGRAM,HERE ARE SOME STATISTICS FIRST'
TYPEX,'IN THIS RUN,'NSEG1,'SEGMENTS WERE PROCESSED'
TYPEX,'WITH AN AVERAGE WINDOW SIZE OF,'WIN1,'HERTZ'
TYPEX,'IF YOU HAVE BEEN ASKED FOR THE CORRECT'
TYPEX,'FREQUENCY MANY TIMES,AND ALREADY HAVE'
TYPEX,'ADJUSTED YOUR WINDOW, THEN THERE EXIST'
TYPEX,'THE POSSIBILITY THAT YOU HAVE NOT SAVED'
TYPEX,'ENOUGH PEAKS IN THE INPUT FILE TO ACCO-'
TYPEX,'MODATE THOSE THAT DEFINE THE SPIN LINES'
TYPEX,'RUN THE PEAKS1 PROGRAM AGAIN AND INCREASE'
TYPEX,'THE NUMBER OF PEAKS SAVED BY 2 OR 3,'
TYPEX,'CHECK IF THE +/- 60 HZ LINE IS IN THE'
TYPEX,'DATA AND SCRATCH IT,ALTHOUGH THIS IS NOT'
TYPEX,'A BIG PROBLEM,IF IT IS TOO STRONG IT WILL'
TYPEX,'PREVENT SOME OF THE PEAKS TO BE SAVED.'
TYPEX,'CHECK IF THE 4FS FREQUENCY IS CORRECT.'
TYPEX,'AND GOOD LUCK.'
RETURN
END

```

Appendix A (cont)

```

SUBROUTINE PRINTS(NPEAKS)
COMMON /STAT/NRUNS,NAUPE,AVE4FS,N60HZ,SPFREK,IFILTR,NUMLIN,
INSEG,WINAVE,PCNT1,PCNT2,PCNT3,PCNT4
COMMON/STAT1/NSEG1,WIN1,IC1(2),IC2(2),IC3(2),IC4(2),
IPC1,PC2,PC3,PC4
LOGICAL IFILTR
TYPEX,'THE FOLLOWING ARE THE STATISTICS FOR'
TYPEX,'THIS RUN, INCLUDING THE PARAMETERS FOR'
TYPEX,'THE PEAKS1 PROCESS PREVIOUSLY RUN.'
TYPEX,'THIS HAS BEEN RUN NUMBER',NRUNS
TYPEX,'THE NUMBER OF PEAKS SAVED'
TYPEX,'PER SPECTRUM WAS',NPEAKS,'PEAKS.'
TYPEX,'THE LOWEST FREQUENCY FOR THE'
TYPEX,'4FS LINE WAS',SPFREK,'HERTZ.'
TYPEX,'THE NUMBER OF SPECTRAL LINES'
TYPEX,'PROCESSED WAS',NUMLIN
TYPEX,'THE NUMBER OF SEGMENTS PROCESSED'
TYPEX,'WAS',NSEG1
IF(IFILTR)GO TO 10
TYPEX,'THE +/- 60 HZ LINE WAS NOT REMOVED'
GO TO 20
TYPEX,'THE +/- 60 HZ LINE WAS REMOVED'
TYPEX,'FOR THE SEGMENTS PROCESSED'
TYPEX,'THE PROGRAM FOUND THE FIRST'
TYPEX,'FREQUENCY',PC1,'TIMES'
TYPEX,'THE PERCENTAGE OF TIMES THAT'
TYPEX,'THE USER ENTERED THE RIGHT'
TYPEX,'FREQUENCY WAS',PC2,'%'
TYPEX,'THE PERCENTAGE OF TIMES THAT'
TYPEX,'THE PROGRAM FOUND MORE THAN'
TYPEX,'ONE FREQUENCY WAS',PC4,'%'
TYPEX,'THE PERCENTAGE OF TIMES THAT'
TYPEX,'THE PROGRAM FOUND THE RIGHT'
TYPEX,'FREQUENCY WAS',PC3,'%'
RETURN
END

```

10
20

APPENDIX B. Data Sets.

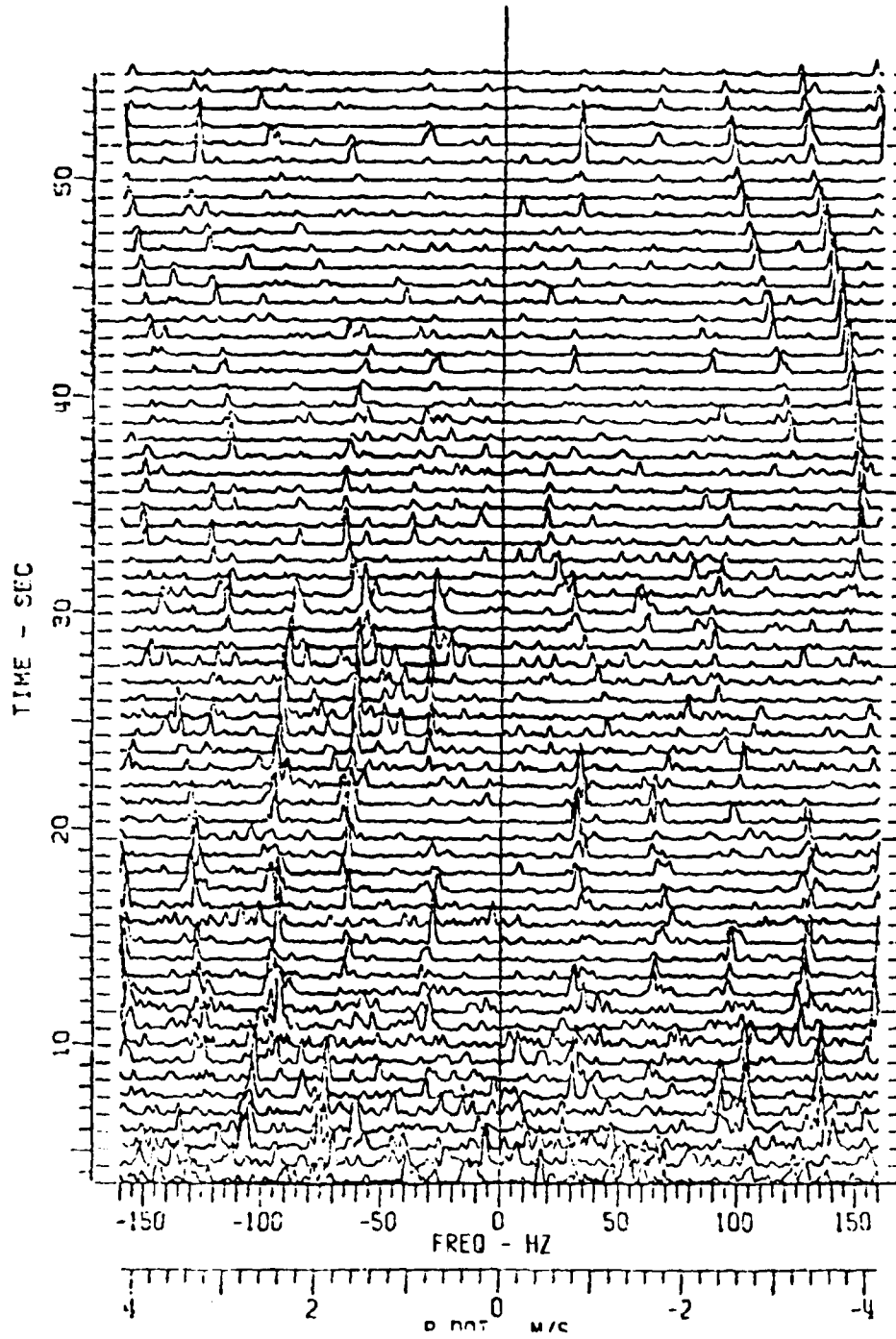

Figure B-1. Data set 1.

Appendix B (cont)

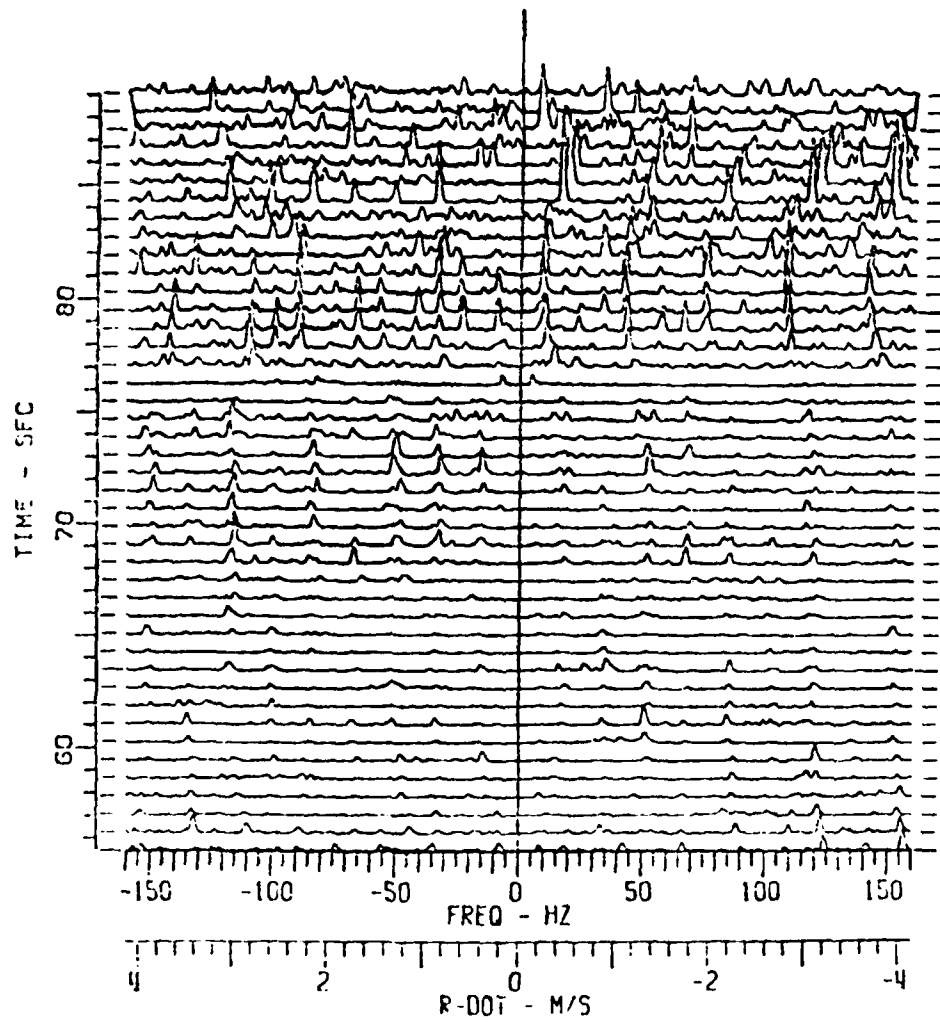

Figure B 1 (cont)

Appendix B (cont)

ENTER INPUT FILE NAME WITH DEVICE
CUM.COR;3
CUM.COR;3
ENTER OUTPUT FILE NAME WITH DEVICE
TEST1.DAT
TEST1.DAT
IF YOU NEED HELP TO ANSWER ANY
QUESTION, ENTER HELP
ENTER STARTING TIME BIAS
0 ENTER NUMBER OF PEAKS PER SPECTRUM YOU WANT TO SAVE
12
20 ENTER MINIMUM FREQUENCY FOR THE 4FS LINE
DO YOU WANT TO FILTER OUT THE +/-60HERTZ
LINE?, ENTER Y OR N OR H (H IS FOR HELP)
N
TT1 -- STOP
>

Appendix B (cont)

ENTER INPUT FILE NAME WITH DEVICE
TEST1.DAT
IF YOU NEED HELP TO ANSWER
ANY OF THE QUESTIONS, ENTER HELP
ENTER TRACK WINDOW LENGTH
2 ENTER MAXIMUM MULTIPLE TO LOOK FOR
16
START TIME IS- 3.125709
FINAL TIME IS- 89.08083
ENTER TIME YOU WANT TO START AT
10.5
ENTER TIME YOU WANT TO STOP AT
55
FORWARD PROCESSING STARTS
THE SPIN FREQUENCY FOR THE LARGEST PEAK
AT 10.72317 SECONDS, IS 157.5851
DOES THIS FREQUENCY CORRESPONDS TO ANY OF
THE SPIN LINES? Y OR N OR H (FOR HELP)
Y ENTER THE SPIN LINE NUMBER
20 MORE THAN ONE PEAK WAS FOUND AT 10.72317
SECONDS. THE PEAKS FOUND IN THE WINDOW GIVEN
ARE FOR EITHER THE + OR- 16 FS LINE
1 126.3182
2 -124.4422
3 124.4422
I WILL CHOOSE THE FIRST ONE AS CORRECT, OTHERWISE,
DO YOU WANT TO TELL ME WHICH IS THE CORRECT ONE? Y, N
N

Appendix B (cont)

MORE THAN ONE PEAK WAS FOUND AT 11.52273
SECONDS. THE PEAKS FOUND IN THE WINDOW GIVEN
ARE FOR EITHER THE + OR- 16 FS LINE

- 1 -127.5689
- 2 128.1942
- 3 125.0675

I WILL CHOOSE THE FIRST ONE AS CORRECT, OTHERWISE,
DO YOU WANT TO TELL ME WHICH IS THE CORRECT ONE?Y,N

MORE THAN ONE PEAK WAS FOUND AT 13.92144
SECONDS. THE PEAKS FOUND IN THE WINDOW GIVEN
ARE FOR EITHER THE + OR- 16 FS LINE

- 1 128.8196
- 2 -127.5689
- 3 127.5689
- 4 130.6956

I WILL CHOOSE THE FIRST ONE AS CORRECT, OTHERWISE,
DO YOU WANT TO TELL ME WHICH IS THE CORRECT ONE?Y,N

Y IS ANY OF THE LISTED ONES RIGHT?Y,N

Y ENTER NUMBER FOR THE RIGHT ONE

MORE THAN ONE PEAK WAS FOUND AT 17.11971
SECONDS. THE PEAKS FOUND IN THE WINDOW GIVEN
ARE FOR EITHER THE + OR- 12 FS LINE

- 1 -90.67397
- 2 -92.54998

I WILL CHOOSE THE FIRST ONE AS CORRECT, OTHERWISE,
DO YOU WANT TO TELL ME WHICH IS THE CORRECT ONE?Y,N

N

Appendix B (cont)

I COULD NOT FIND ANY MULTIPLES OF THE SPIN AT
23.51626 SECONDS, FOR THE WINDOW GIVEN
PLEASE ENTER THE SPIN FREQUENCY AT THIS LOCATION

7.6

THANK YOU

I COULD NOT FIND ANY MULTIPLES OF THE SPIN AT
26.71453 SECONDS, FOR THE WINDOW GIVEN
PLEASE ENTER THE SPIN FREQUENCY AT THIS LOCATION

7.8

THANK YOU

MORE THAN ONE PEAK WAS FOUND AT 27.51410
SECONDS. THE PEAKS FOUND IN THE WINDOW GIVEN
ARE FOR EITHER THE + OR - 4 FS LINE

1

-31.89223

2

-30.01620

I WILL CHOOSE THE FIRST ONE AS CORRECT, OTHERWISE,
DO YOU WANT TO TELL ME WHICH IS THE CORRECT ONE?, N

1

I COULD NOT FIND ANY MULTIPLES OF THE SPIN AT
29.11323 SECONDS, FOR THE WINDOW GIVEN
PLEASE ENTER THE SPIN FREQUENCY AT THIS LOCATION

7.5

THANK YOU

I COULD NOT FIND ANY MULTIPLES OF THE SPIN AT
31.51194 SECONDS, FOR THE WINDOW GIVEN
PLEASE ENTER THE SPIN FREQUENCY AT THIS LOCATION

7.8

Appendix B (cont)

THANK YOU
I COULD NOT FIND ANY MULTIPLES OF THE SPIN AT
34.71021 SECONDS, FOR THE WINDOW GIVEN
PLEASE ENTER THE SPIN FREQUENCY AT THIS LOCATION

3.8

THANK YOU
I COULD NOT FIND ANY MULTIPLES OF THE SPIN AT
38.70805 SECONDS, FOR THE WINDOW GIVEN
PLEASE ENTER THE SPIN FREQUENCY AT THIS LOCATION

3

THANK YOU
I COULD NOT FIND ANY MULTIPLES OF THE SPIN AT
40.30718 SECONDS, FOR THE WINDOW GIVEN
PLEASE ENTER THE SPIN FREQUENCY AT THIS LOCATION

3

THANK YOU
I COULD NOT FIND ANY MULTIPLES OF THE SPIN AT
41.90632 SECONDS, FOR THE WINDOW GIVEN
PLEASE ENTER THE SPIN FREQUENCY AT THIS LOCATION

3

THANK YOU
MORE THAN ONE PEAK WAS FOUND AT 42.70589
SECONDS. THE PEAKS FOUND IN THE WINDOW GIVEN
ARE FOR EITHER: THE + OR - 16 FS LINE

1

2

I WILL CHOOSE THE FIRST ONE AS CORRECT, OTHERWISE,
DO YOU WANT TO TELL ME WHICH IS THE CORRECT ONE?, N

4

Appendix B (cont)

MORE THAN ONE PEAK WAS FOUND AT 45.90416
SECONDS. THE PEAKS FOUND IN THE WINDOW GIVEN
ARE FOR EITHER THE + OR - 16 FS LINE

- 1 137.5743
- 2 135.6983

I WILL CHOOSE THE FIRST ONE AS CORRECT, OTHERWISE,
DO YOU WANT TO TELL ME WHICH IS THE CORRECT ONE? Y, N

Y BACKWARDS PROCESSING STARTS

THE SPIN FREQUENCY FOR THE LARGEST PEAK
AT 54.69941 SECONDS, IS 156.9598
DOES THIS FREQUENCY CORRESPONDS TO ANY OF
THE SPIN LINES? Y OR N OR H (FOR HELP)

Y ENTER THE SPIN LINE NUMBER

20

MORE THAN ONE PEAK WAS FOUND AT 50.70156
SECONDS. THE PEAKS FOUND IN THE WINDOW GIVEN
ARE FOR EITHER THE + OR - 16 FS LINE

- 1 -127.5689
- 2 128.1942
- 3 130.0703

I WILL CHOOSE THE FIRST ONE AS CORRECT, OTHERWISE,
DO YOU WANT TO TELL ME WHICH IS THE CORRECT ONE? Y, N

Y MORE THAN ONE PEAK WAS FOUND AT 45.90416

SECONDS. THE PEAKS FOUND IN THE WINDOW GIVEN
ARE FOR EITHER THE + OR - 16 FS LINE

- 1 137.5743
- 2 135.6983

I WILL CHOOSE THE FIRST ONE AS CORRECT, OTHERWISE,
DO YOU WANT TO TELL ME WHICH IS THE CORRECT ONE? Y, N

Y

Appendix B (cont)

MORE THAN ONE PEAK WAS FOUND AT 42.70589
SECONDS. THE PEAKS FOUND IN THE WINDOW GIVEN
ARE FOR EITHER THE + OR - 16 FS LINE

- 1 142.5770
- 2 -141.9517
- 3 144.4530

I WILL CHOOSE THE FIRST ONE AS CORRECT, OTHERWISE,
DO YOU WANT TO TELL ME WHICH IS THE CORRECT ONE? Y, N

MORE THAN ONE PEAK WAS FOUND AT 41.90632
SECONDS. THE PEAKS FOUND IN THE WINDOW GIVEN
ARE FOR EITHER THE + OR - 16 FS LINE

- 1 143.8277
- 2 -143.8277
- 3 145.7037

I WILL CHOOSE THE FIRST ONE AS CORRECT, OTHERWISE,
DO YOU WANT TO TELL ME WHICH IS THE CORRECT ONE? Y, N

MORE THAN ONE PEAK WAS FOUND AT 38.70805
SECONDS. THE PEAKS FOUND IN THE WINDOW GIVEN
ARE FOR EITHER THE + OR - 16 FS LINE

- 1 148.8304
- 2 146.9544

I WILL CHOOSE THE FIRST ONE AS CORRECT, OTHERWISE,
DO YOU WANT TO TELL ME WHICH IS THE CORRECT ONE? Y, N

MORE THAN ONE PEAK WAS FOUND AT 36.30934
SECONDS. THE PEAKS FOUND IN THE WINDOW GIVEN
ARE FOR EITHER THE + OR - 16 FS LINE

- 1 149.4557
- 2 150.7064
- 3 152.5824
- 4 -150.0811

I WILL CHOOSE THE FIRST ONE AS CORRECT, OTHERWISE,

Appendix B (cont.)

DO YOU WANT TO TELL ME WHICH IS THE CORRECT ONE?Y,N

Y IS ANY OF THE LISTED ONES RIGHT?Y,N

2 ENTER NUMBER FOR THE RIGHT ONE

MORE THAN ONE PEAK WAS FOUND AT 34.71021
SECONDS.THE PEAKS FOUND IN THE WINDOW GIVEN
ARE FOR EITHER THE + OR- 16 FS LINE

1 151.9571
2 153.2077

I WILL CHOOSE THE FIRST ONE AS CORRECT,OTHERWISE,
DO YOU WANT TO TELL ME WHICH IS THE CORRECT ONE?Y,N

N I COULD NOT FIND ANY MULTIPLES OF THE SPIN AT
29.91280 SECONDS,FOR THE WINDOW GIVEN
PLEASE ENTER THE SPIN FREQUENCY AT THIS LOCATION
7.5

THANK YOU

I COULD NOT FIND ANY MULTIPLES OF THE SPIN AT
27.51410 SECONDS,FOR THE WINDOW GIVEN
PLEASE ENTER THE SPIN FREQUENCY AT THIS LOCATION
8

THANK YOU

I COULD NOT FIND ANY MULTIPLES OF THE SPIN AT
25.91496 SECONDS,FOR THE WINDOW GIVEN
PLEASE ENTER THE SPIN FREQUENCY AT THIS LOCATION
8

Appendix B (cont)

THANK YOU
I COULD NOT FIND ANY MULTIPLES OF THE SPIN AT
24.31582 SECONDS, FOR THE WINDOW GIVEN
PLEASE ENTER THE SPIN FREQUENCY AT THIS LOCATION

8
THANK YOU
MORE THAN ONE PEAK WAS FOUND AT 17.11971
SECONDS. THE PEAKS FOUND IN THE WINDOW GIVEN
ARE FOR EITHER THE + OR- 4 FS LINE
1 31.89223
2 33.76823

I WILL CHOOSE THE FIRST ONE AS CORRECT, OTHERWISE,
DO YOU WANT TO TELL ME WHICH IS THE CORRECT ONE? Y, N

8
THANK YOU
I COULD NOT FIND ANY MULTIPLES OF THE SPIN AT
13.12187 SECONDS, FOR THE WINDOW GIVEN
PLEASE ENTER THE SPIN FREQUENCY AT THIS LOCATION

8
THANK YOU
I COULD NOT FIND ANY MULTIPLES OF THE SPIN AT
10.72317 SECONDS, FOR THE WINDOW GIVEN
PLEASE ENTER THE SPIN FREQUENCY AT THIS LOCATION

Appendix B (cont)

THANK YOU
TIME
10. 72317
11. 52273
12. 32230
13. 12187
13. 92144
14. 72101
15. 52057
16. 32014
17. 11971
17. 91928
18. 71885
19. 51842
20. 31798
21. 11755
21. 91712
22. 71669
23. 51626
24. 31582
25. 11539
25. 91496
26. 71453
27. 51410
28. 31366
29. 11323
29. 91280
30. 71237
31. 51194
32. 31150
33. 11107
33. 91064
34. 71021
35. 50977

FORWARD PROCESS

7. 89489
7. 97306
8. 09031
8. 02517
7. 97306
7. 93397
7. 71250
7. 55616
7. 55616
7. 66039
7. 73855
7. 89489
8. 05122
8. 12939
8. 20756
7. 60000
7. 60828
7. 13927
7. 03505
7. 80000
7. 97306
8. 59839
7. 50000
7. 42589
6. 64421
7. 80000
7. 54314
8. 12939
8. 20756
8. 80000
9. 22373

BACKWARD PROCESS

8. 00000
8. 75473
8. 09031
8. 00000
7. 76461
7. 76461
7. 77764
7. 97306
7. 97306
8. 20756
8. 23361
8. 05122
8. 01214
7. 86883
7. 76461
7. 76461
7. 81672
8. 00000
7. 73855
8. 00000
7. 50405
8. 00000
5. 51079
6. 82660
7. 50000
9. 26282
9. 34098
9. 38007
9. 45823
9. 41915
9. 49732
9. 45823

Appendix B (cont)

36. 30934
37. 10891
38. 70848
39. 50761
40. 30718
41. 10675
42. 90632
43. 50589
44. 30546
45. 10459
46. 90416
47. 70372
48. 50329
49. 30286
50. 10243
51. 90156
52. 70113
53. 50070
54. 30027
55. 10084
56. 69941

DO YOU WANT TO SAVE THE FORWARD
OR THE BACKWARD DATA? ENTER
1 FOR THE FORWARD DATA
2 FOR THE BACKWARD DATA

Y
2

9. 69273
10. 10963
11. 63074
12. 00000
13. 42589
14. 00000
15. 10648
16. 00000
17. 91106
18. 83290
19. 75473
20. 67656
21. 59839
22. 48114
23. 36389
24. 28572
25. 20756
26. 09031
27. 97306
28. 97306
29. 89489
30. 85580
31. 81672
32. 77764

9. 41915
9. 38007
9. 34098
9. 30190
9. 22373
9. 14557
9. 10648
8. 98923
8. 91106
8. 83290
8. 75473
8. 67656
8. 59839
8. 48114
8. 36389
8. 28572
8. 20756
8. 09031
7. 97306
7. 97306
7. 89489
7. 85580
7. 81672
7. 77764

Appendix B (cont)

DO YOU WANT TO PROCESS MORE
SEGMENTS OF DATA? ENTER Y OR N

DO YOU AGREE WITH THIS RUN?
ENTER Y OR N

DO YOU WANT TO SEE THE STATISTICS
OF THIS RUN? ENTER Y OR N.

FT1 --- STOP

Appendix B (cont)

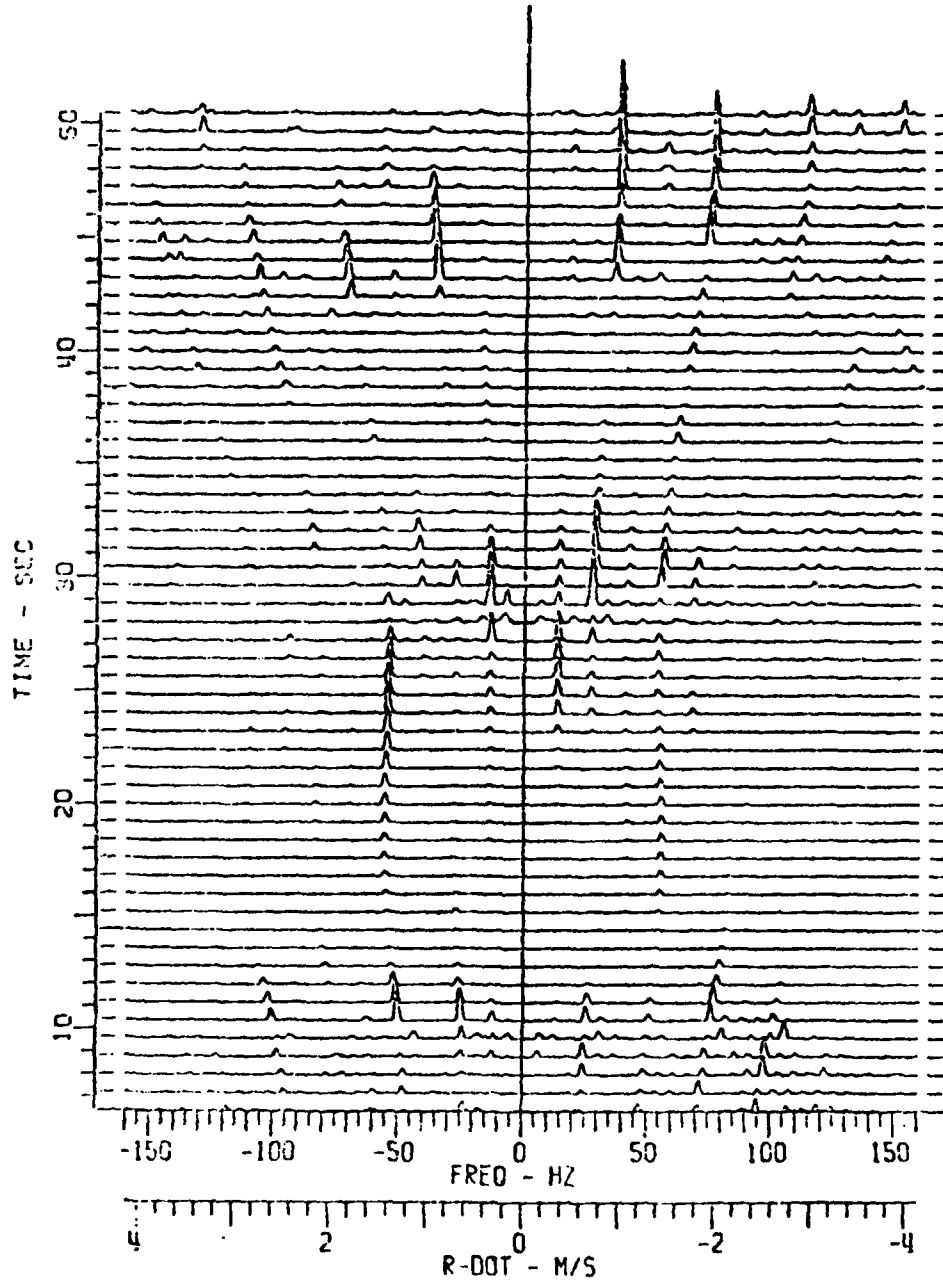

Figure B-2. Data set 2.

Appendix B (cont)

ENTER INPUT FILE NAME WITH DEVICE
UN. COR:4
CUM COR:4
ENTER OUTPUT FILE NAME WITH DEVICE
15:ST2.DAT
11S*2.DAT
IF YOU NEED HELP TO ANSWER ANY
QUESTION, ENTER HELP
ENTER STARTING TIME BIAS
7
ENTER NUMBER OF PEAKS PER SPECTRUM YOU WANT TO SAVE
8
ENTER MINIMUM FREQUENCY FOR THE 4FS LINE
20
DO YOU WANT TO FILTER OUT THE +/-60HERTZ
LINE?. ENTER Y OR N OR H (H IS FOR HELP)
N

TT2 -- STOP

Appendix B (cont)

ENTER INPUT FILE NAME WITH DEVICE
TEST2.DAT

IF YOU NEED HELP TO ANSWER
ANY OF THE QUESTIONS, ENTER HELP
ENTER TRACK WINDOW LENGTH

ENTER MAXIMUM MULTIPLE TO LOOK FOR

16

START TIME IS= 6.042116

FINAL TIME :S= 50.41970

ENTER TIME YOU WANT TO START AT

16

ENTER TIME YOU WANT TO STOP AT

50

FORWARD PROCESSING STARTS
THE SPIN FREQUENCY FOR THE LARGEST PEAK
AT 16.03828 SECONDS, IS 55.02972
DOES THIS FREQUENCY CORRESPONDS TO ANY OF
THE SPIN LINES? Y OR N OR H (FOR HELP)

Y

ENTER THE SPIN LINE NUMBER

8

BACKWARDS PROCESSING STARTS
THE SPIN FREQUENCY FOR THE LARGEST PEAK
AT 49.62013 SECONDS, IS 38.14560
DOES THIS FREQUENCY CORRESPONDS TO ANY OF
THE SPIN LINES? Y OR N OR H (FOR HELP)

Y

ENTER THE SPIN LINE NUMBER

4

Appendix B (cont)

16. 03928
16. 83785
17. 63741
18. 43698
19. 23655
20. 03612
20. 83569
21. 63525
22. 43482
23. 23439
24. 03396
24. 83353
25. 63309
26. 43266
27. 23223
28. 03180
28. 83137
29. 63093
30. 43050
31. 23007
32. 02964
32. 82920
33. 62877
34. 42834
35. 22791
36. 02748
36. 82705
37. 62661
38. 42618
39. 22575
40. 02532
40. 82489
41. 62445

FORWARD PROCESS
6. 87872
6. 91780
6. 93083
6. 93083
6. 93083
6. 91780
6. 87872
6. 87872
6. 83963
6. 80055
6. 77449
6. 76146
6. 72238
6. 72238
6. 72238
6. 80055
6. 80055
6. 80055
6. 95688
6. 98294
7. 07413
7. 19138
7. 24350
7. 34772
7. 50405
7. 62130
7. 77764
7. 93397
8. 09031
8. 20756
8. 36389
8. 52023
8. 65051

BACKWARD PROCESS
6. 87872
6. 91780
6. 93083
6. 93083
6. 93083
6. 91780
6. 87872
6. 87872
6. 83963
6. 80055
6. 77449
6. 76146
6. 72238
6. 72238
6. 72238
6. 80055
6. 80055
6. 80055
6. 98294
6. 98294
7. 07413
7. 19138
7. 24350
7. 34772
7. 50405
7. 62130
7. 77764
7. 93397
8. 09031
8. 20756
8. 36389
8. 52023
8. 65051

Appendix B (cont)

42. 42402
43. 22359
44. 02316
45. 82273
46. 62230
47. 42186
48. 22143
49. 02100
50. 82057
51. 62013

8. 79381
8. 91106
9. 02831
9. 14556
9. 22373
9. 38007
9. 43218
9. 48429
9. 48429
9. 49732

DO YOU AGREE WITH THE DATA?
EITHER FORWARD OR BACKWARDS
ENTER Y OR N.

Y DO YOU WANT TO SAVE THE FORWARD
OR THE BACKWARD DATA? ENTER
1 FOR THE FORWARD DATA
2 FOR THE BACKWARD DATA

N DO YOU WANT TO PROCESS MORE
SEGMENTS OF DATA? ENTER Y OR N
DO YOU AGREE WITH THIS RUN?
ENTER Y OR N

Y DO YOU WANT TO SEE THE STATISTICS
OF THIS RUN? ENTER Y OR N.

N TT2 -- STOP

>

Appendix B (cont)

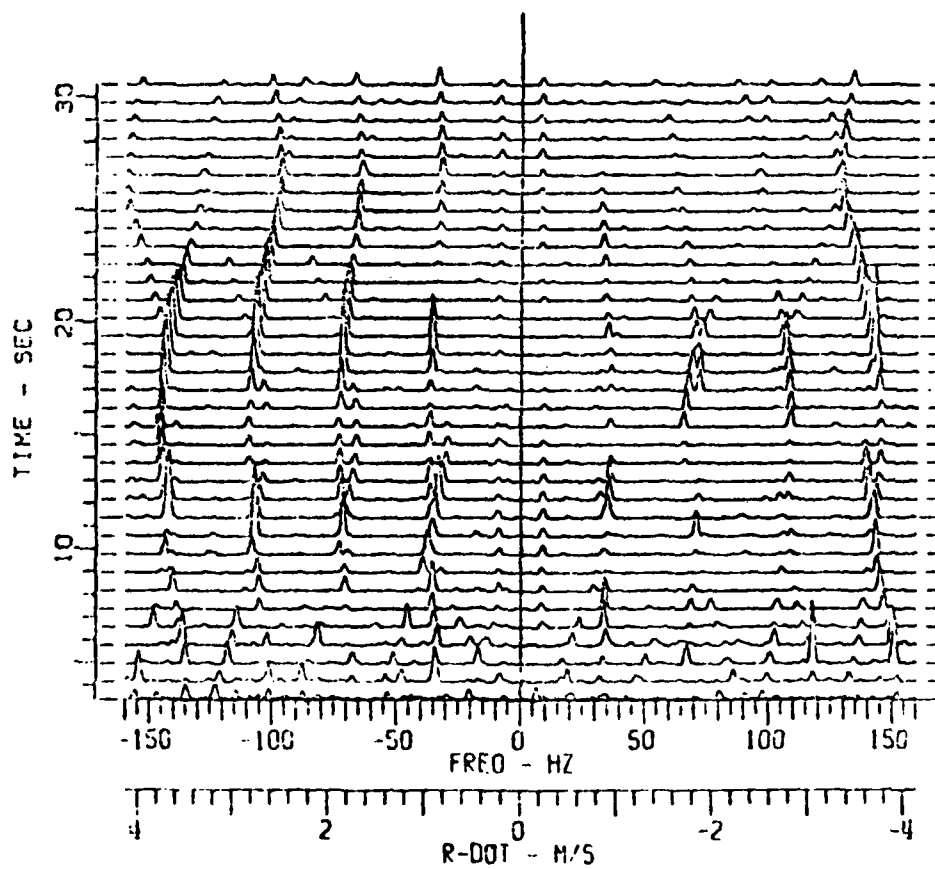

Figure B-3. Data set 3.

Appendix B (cont)

ENTER INPUT FILE NAME WITH DEVICE
CUM.COR:5
CUM.COR:5
ENTER OUTPUT FILE NAME WITH DEVICE
TEST3.DAT
TEST3.DAT
IF YOU NEED HELP TO ANSWER ANY
QUESTION, ENTER HELP
ENTER STARTING TIME BIAS
0 ENTER NUMBER OF PEAKS PER SPECTRUM YOU WANT TO SAVE
.2
25 ENTER MINIMUM FREQUENCY FOR THE 4FS LINE
DO YOU WANT TO FILTER OUT THE +/-60HERTZ
LINE?, ENTER Y OR N OR H (H IS FOR HELP)
N
TT2 -- STOP
>

Appendix B (cont)

ENTER INPJT FILE NAME WITH DEVICE
TESTS.DAT
IF YOU NEED HELP TO ANSWER
ANY OF THE QUESTIONS, ENTER HELP
ENTER TRACK WINDOW LENGTH

ENTER MAXIMUM MULTIPLE TO LOOK FOR

START TIME IS= 2.958024
FINAL TIME IS= 30.54456
ENTER TIME YOU WANT TO START AT

ENTER TIME YOU WANT TO STOP AT

FORWARD PROCESSING STARTS
THE SPIN FREQUENCY FOR THE LARGEST PEAK
AT 5.758054 SECONDS, IS 149.4557
DOES THIS FREQUENCY CORRESPONDS TO ANY OF
THE SPIN LINES? Y OR N OR H (FOR HELP)

ENTER THE SPIN LINE NUMBER

MORE THAN ONE PEAK WAS FOUND AT 9.755895
SECONDS. THE PEAKS FOUND IN THE WINDOW GIVEN
ARE FOR EITHER THE + OR -
16 FS LINE

1 143.2023
2 -143.8277
3 -141.9517

WILL CHOOSE THE FIRST ONE AS CORRECT, OTHERWISE,
DO YOU WANT TO TELL ME WHICH IS THE CORRECT ONE? Y, N

Appendix B (cont)

MORE THAN ONE PEAK WAS FOUND AT 10.55548
SECONDS. THE PEAKS FOUND IN THE WINDOW GIVEN
ARE FOR EITHER THE + OR- 16 FS LINE

- 1 -142.5770
- 2 -141.3263
- 3 141.3263

I WILL CHOOSE THE FIRST ONE AS CORRECT, OTHERWISE,
DO YOU WANT TO TELL ME WHICH IS THE CORRECT ONE? Y, N

Y IS ANY OF THE LISTED ONES RIGHT? Y, N

Y ENTER NUMBER FOR THE RIGHT ONE

2 MORE THAN ONE PEAK WAS FOUND AT 25.74725
SECONDS. THE PEAKS FOUND IN THE WINDOW GIVEN
ARE FOR EITHER THE + OR- 16 FS LINE

- 1 128.8196
- 2 126.9435
- 3 -126.9436

I WILL CHOOSE THE FIRST ONE AS CORRECT, OTHERWISE,
DO YOU WANT TO TELL ME WHICH IS THE CORRECT ONE? Y, N

Y IS ANY OF THE LISTED ONES RIGHT? Y, N

Y ENTER NUMBER FOR THE RIGHT ONE

2 MORE THAN ONE PEAK WAS FOUND AT 27.34639
SECONDS. THE PEAKS FOUND IN THE WINDOW GIVEN
ARE FOR EITHER THE + OR- 16 FS LINE

- 1 129.4449
- 2 126.3182
- 3 -126.3182

I WILL CHOOSE THE FIRST ONE AS CORRECT, OTHERWISE,
DO YOU WANT TO TELL ME WHICH IS THE CORRECT ONE? Y, N

Appendix B (cont)

1 IS ANY OF THE LISTED ONES RIGHT?Y,N
1 ENTER NUMBER FOR THE RIGHT ONE
2 BACKWARDS PROCESSING STARTS
THE SPIN FREQUENCY FOR THE LARGEST PEAK
AT 29.74509 SECONDS IS 131.9463
DOES THIS FREQUENCY CORRESPONDS TO ANY OF
THE SPIN LINES? Y OR N OR H (FOR HELP)
1 ENTER THE SPIN LINE NUMBER
16 MORE THAN ONE PEAK WAS FOUND AT 26.54682
SECONDS. THE PEAKS FOUND IN THE WINDOW GIVEN
ARE FOR EITHER THE + OR- 16 FS LINE
1 128.8196
2 126.9435
3 -128.8196
I WILL CHOOSE THE FIRST ONE AS CORRECT, OTHERWISE,
DO YOU WANT TO TELL ME WHICH IS THE CORRECT ONE?Y,N
MORE THAN ONE PEAK WAS FOUND AT 25.74725
SECONDS. THE PEAKS FOUND IN THE WINDOW GIVEN
ARE FOR EITHER THE + OR- 16 FS LINE
1 128.8196
2 126.9435
3 -126.9436
I WILL CHOOSE THE FIRST ONE AS CORRECT, OTHERWISE,
DO YOU WANT TO TELL ME WHICH IS THE CORRECT ONE?Y,N
Y

Appendix B (cont)

IS ANY OF THE LISTED ONES RIGHT?Y,N

ENTER NUMBER FOR THE RIGHT ONE

I COULD NOT FIND ANY MULTIPLES OF THE SPIN AT

19.35271 SECONDS, FOR THE WINDOW GIVEN

PLEASE ENTER THE SPIN FREQUENCY AT THIS LOCATION

8.75

THANK YOU

I COULD NOT FIND ANY MULTIPLES OF THE SPIN AT

17.75158 SECONDS, FOR THE WINDOW GIVEN

PLEASE ENTER THE SPIN FREQUENCY AT THIS LOCATION

8.7

THANK YOU

TIME

5.75805
6.55762
7.35719
8.15676
8.95633
9.75589
10.55546
11.35503
12.15460
12.95417
13.75373
14.55330
15.35287
16.15244
16.95201
17.75158
18.55114
19.35071
20.15028

FORWARD PROCESS

9.34098
9.30190
9.14557
9.06740
8.98923
8.95015
8.83290
8.87198
8.75473
8.71564
8.67656
8.63748
8.67656
8.54628
8.65051
8.59839
8.67656
8.80684
8.67656

BACKWARD PROCESS

9.34098
9.30190
9.14557
9.06740
8.98923
8.98923
8.91106
8.87198
8.59839
8.44206
8.28572
8.28572
8.28572
8.54628
8.65051
8.70000
8.91106
8.75000
8.91780

Appendix B (cont)

10. 94985
11. 74941
12. 54898
13. 34855
14. 14812
15. 94769
16. 74725
17. 54682
18. 34639
19. 14596
20. 94553
21. 74509
DO YOU AGREE WITH THE DATA?
EITHER FORWARD OR BACKWARDS
ENTER Y OR N

7. 07413
7. 19138
7. 34772
7. 54314
7. 73855
7. 89489
7. 93397
8. 05122
8. 09031
8. 12939
8. 16847
8. 24664

DO YOU WANT TO SAVE THE FORWARD
OR THE BACKWARD DATA? ENTER
1 FOR THE FORWARD DATA
2 FOR THE BACKWARD DATA

DO YOU WANT TO PROCESS MORE
SEGMENTS OF DATA? ENTER Y OR N

DO YOU AGREE WITH THIS RUN?
ENTER Y OR N

DO YOU WANT TO SEE THE STATISTICS
OF THIS RUN? ENTER Y OR N.

END -- STOP

DISTRIBUTION LIST

<u>Organization</u>	<u>No. of Copies</u>
STEWS-AG-AS-AM	1
STEWS-NR-A	1
STEWS-NR-D	4
STEWS-USAISC	2
STEWS-PL	1
STEWS-TE-TL	2
STEWS-ID-A	1
STEWS-ID-P	1
STEWS-ID-T	1
STEWS-ID-D	1
STEWS-ID-E	1
STEWS-ID-O	1
Commander U.S. Army Materiel Command ATTN: AMCRD 5001 Eisenhower Avenue Alexandria, Virginia 22304	1
Commander U.S. Army Materiel Command ATTN: AMCAD-P 5001 Eisenhower Avenue Alexandria, Virginia 22304	1
Commander U.S. Army Test and Evaluation Command Aberdeen Proving Ground Maryland 21005	2
Commander U.S. Army Test and Evaluation Command ATTN: AMSTE-RU Aberdeen Proving Ground, Maryland 21005	2
Commander U.S. Army Electronics Command ATTN: AMSEL-RD Fort Monmouth, New Jersey 07703	1
Director of Research and Development Headquarters, U.S. Air Force Washington, DC 20315	1

Distribution List (cont)

Director
U.S. Naval Research Laboratory
Department of the Navy
ATTN: Code 463
Washington, DC 20390 1

Commander
Air Force Cambridge Research Center
L. G. Hanscom Field
ATTN: AFCS
Bedford, Massachusetts 01731 1

Commander
U.S. Naval Ordnance Test Station
ATTN: Technical Library
China Lake, California 93555 2

Director
National Aeronautics and Space Administration
ATTN: Technical Library
Goddard Space Flight Center
Greenbelt, Maryland 20771 2

Commander
Air Proving Ground Center
ATTN: PGBAP-1
Eglin Air Force Base, Florida 32542 1

Commander
Pacific Missile Range
Point Mugu, California 93041 1

Commanding Officer
Naval Air Missile Test Center
Point Mugu, California 93041 2

Office of the Chief
Research and Development
Department of the Army
Washington, D. C. 20310 3

Commanding Officer
U.S. Army Electronics Command
Meteorological Support Activity
ATTN: Technical Library
Fort Huachuca, Arizona 85613 2

Commanding Officer
U.S. Army Ballistics Research Laboratories
Aberdeen Proving Ground, Maryland 21005 1

Distribution List (cont)

Commanding Officer
U.S. Army Research Office - Durham
Box CM, Duke Station
ATTN: Internal Research Division
Durham, North Carolina 27706 1

Commander
Atlantic Missile Range
Patrick Air Force Base, Florida 32925 1

Commanding Officer
U.S. Army Aviation Test Activity
Edwards Air Force Base, California 93523 1

Administrator
Defense Technical Information Center
ATTN: DTIC-DDAB
Cameron Station, Bldg 5
Alexandria, Virginia 22314 12

END

10-86

DTIC