

AD-A170 597

NERVE REGENERATION IN UITRO: COMPARATIVE EFFECTS OF  
DIRECT AND INDUCED CURRENT AND NGE(U) KENTUCKY UNIU  
RESEARCH FOUNDATION LEXINGTON B F SISKEN ET AL

1/2

UNCLASSIFIED

26 NOV 85 N00014-82-K-0105

F/G 6/3

ML



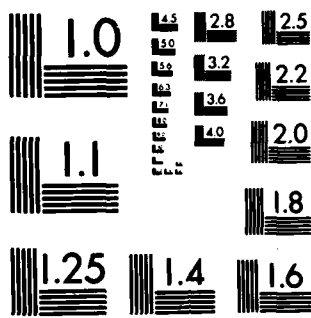

MICROCOPY RESOLUTION TEST CHART  
NATIONAL BUREAU OF STANDARDS-1963-A

FINAL REPORT  
1982-1985  
Office of Naval Research  
Contract Number N00014-82-K-0105  
University of Kentucky  
Betty F. Sisken

DTIC  
SELECTED  
AUG 05 1986  
S D  
D

Unclassified

SECURITY CLASSIFICATION OF THIS PAGE

*G* *19*

REPORT DOCUMENTATION PAGE

1a. REPORT SECURITY CLASSIFICATION None		1b. RESTRICTIVE MARKINGS N/A	
2a. SECURITY CLASSIFICATION AUTHORITY N/A		3. DISTRIBUTION / AVAILABILITY STATEMENT Unrestricted	
2b. DECLASSIFICATION / DOWNGRADING SCHEDULE N/A		<div style="border: 1px solid black; padding: 5px;"> <b>Approved for public release Distribution Unlimited</b> </div>	
4. PERFORMING ORGANIZATION REPORT NUMBER(S) None			
6a. NAME OF PERFORMING ORGANIZATION University of Kentucky Research Foundation		6b. OFFICE SYMBOL (if applicable) 513333	
6c. ADDRESS (City, State, and ZIP Code) Kinkead Hall, University of Kentucky Lexington, KY 40506		7a. NAME OF MONITORING ORGANIZATION DTIC ELECTE	
8a. NAME OF FUNDING / SPONSORING ORGANIZATION Office of Naval Research		8b. OFFICE SYMBOL (if applicable)	
8c. ADDRESS (City, State, and ZIP Code) 800 N. Quincy Street Arlington, VA 22217		9. PROCUREMENT INSTRUMENT IDENTIFICATION NUMBER N00014-82-K-0105	
10. SOURCE OF FUNDING NUMBERS			
		PROGRAM ELEMENT NO.	TASK NO.
		PROJECT NO.	WORK UNIT ACCESSION NO.
11 TITLE (Include Security Classification) Nerve Regeneration in Vitro: Comparative Effects of Direct and Induced Current and NGF			

**DTIC ELECTE**  
**S AUG 05 1986 D**

12. PERSONAL AUTHOR(S)  
Betty F. Sisken, Ph.D., Gary Ringham, Ph.D., and Steve Dyer, Ph.D.

13a. TYPE OF REPORT Final	13b. TIME COVERED FROM 1/1/82 TO 12/31/84	14. DATE OF REPORT (Year, Month, Day) 1985, November 26	15. PAGE COUNT 23
------------------------------	--	--	----------------------

16. SUPPLEMENTARY NOTATION

17. COSATI CODES			18. SUBJECT TERMS (Continue on reverse if necessary and identify by block number) Electric fields, neurite outgrowth, DC, PEMF neuronal differentiation, nerve/limb regeneration
FIELD	GROUP	SUB-GROUP	

19. ABSTRACT (Continue on reverse if necessary and identify by block number)  
 Our investigations have focused on the response of sensory neurons (DRG) obtained from young (8 day) and older (14 day) chick embryos and 15 day old rat fetuses to low levels of direct (DC) or induced (PEMF) current or NGF. Direct current (10 nA) was applied continuously for 3 days through tantalum electrodes immersed in the media; current was induced by exposing cultures to pulsed electromagnetic fields (PEMF) using a single pulse, 72 Hz, 12 hrs/day for 2 days with coils supplied by Electrobiolgy Inc. The data presented in the Appendix indicates the following: in 8 day cultures, the growth response obtained with NGF, PEMF or DC was significantly increased over controls at 3 days and this was maintained only with NGF or DC by 6 days. PEMF effects were correlated with current density only when the coils were oriented vertically. Significantly-increased protein content and incorporation of 3H-proline/ ganglia paralleled the increased growth response obtained with DC. In older (14 day) DRG, neurite outgrowth was enhanced only with DC. The growth response in 15 day fetal DRG was not influenced by PEMF or DC; only NGF stimulated growth. Neurophysiological studies found the resting potential of the DRG neurons to range from 30-60 mV; they exhibited overshooting potentials upon intracellular stimulation. Equivocal results were found in membrane potential changes when DC was applied.

20. DISTRIBUTION / AVAILABILITY OF ABSTRACT <input checked="" type="checkbox"/> UNCLASSIFIED/UNLIMITED <input type="checkbox"/> SAME AS RPT. <input type="checkbox"/> DTIC USERS		21. ABSTRACT SECURITY CLASSIFICATION Unclassified	
22a. NAME OF RESPONSIBLE INDIVIDUAL Betty F. Sisken		22b. TELEPHONE (Include Area Code) 606/257-2783	22c. OFFICE SYMBOL

19. ABSTRACT (Continuation)

Conductivity of tissue culture media was determined and constant current devices were fabricated to generate a growth response curve as a function of current density. Constant current levels of 30-60 nA (30-60 nA/cm<sup>2</sup>) produced the maximal growth response. To determine if DC-stimulation of growth is correlated with ion changes, ion substitution/ionophore studies were performed. Inhibitors of calcium influx (lanthanum, Verapamil) mimicked the DC-growth stimulation; increased external calcium or ionophore A23187 which allow calcium entry inhibited neurite outgrowth. These results agree with many reports of the deleterious effects of high levels of intraneuronal calcium and support our hypothesis that one mode of action of non-depolarizing levels of DC is to prevent calcium entry and indirectly promote growth and increase in protein content.

Other areas of study partially supported by this contract and found in the Appendix include: 1) DC-effects on neuroblastoma (N18) cells, 2) DC and PPMF stimulation of central nervous system (spinal cord) regeneration in culture, 3) PPMF effects on sciatic nerve regeneration in the rat, and (4) DC plus neural tissue implant stimulation of bone growth in amputated rat limbs.

NERVE REGENERATION IN VITRO: COMPARATIVE EFFECTS OF  
DIRECT AND INDUCED CURRENT AND NGF

FINAL REPORT

1982-1985

Office of Naval Research

Contract Number N00014-82-K-0105

University of Kentucky

Principal Investigator: Betty F. Sisken, Ph.D.

Wenner Gren Research Laboratory  
and Department of Anatomy  
University of Kentucky  
Lexington, Kentucky 40506

November 18, 1985



Accession For	
NTIS CRA&I	<input checked="" type="checkbox"/>
DTIC TAB	<input type="checkbox"/>
Unannounced	<input type="checkbox"/>
Justification	
By	
Distribution /	
Availability Codes	
Dist	Avail and/or Special
A-1	

## TABLE OF CONTENTS

	Page
Form DD 1473 (Abstract)	i
Table of Contents	2
Introduction	3
General Conclusions	5
Effects of NGF, Induced Current (PEMF) and Direct Current on neurite outgrowth, protein content and protein synthesis in 8 day chick embryo	6
Correlation of Current Density and Neurite Outgrowth	22
Maximum Current Level Determinations	25
Ionic Effects on Neurite Differentiation	32
Direct and Induced Current Effects on older (14 day) Chick Ganglia	37
Effects of Electric Fields on Fetal Rat Sensory Ganglia	37
Determination of Electrophysiological Parameters of Cultured Dorsal Root Ganglia Neurons under the Influence of DC	41
SUPPLEMENTARY PROJECTS	46
<u>In Vitro</u>	
Direct current effects on the differentiation of (N18) neuroblastoma cells	47
Direct current and PEMF effects on central nervous system regeneration (spinal cord)	63
<u>In Vivo</u>	
PEMF effects on normal chick development	75
PEMF effects on sciatic nerve regeneration in the Rat	91
Direct current and direct current plus neural implant stimulation in amputated rat limbs	95
APPENDIX (copies of abstracts and published papers)	109

## INTRODUCTION

The goal of our research over the last several years has been to describe the response of nervous tissue to low levels of externally-applied electric fields and to define the underlying mechanisms by which these effects occur. We chose an in vitro system to address these questions since one can more precisely define and control the physical and biological parameters used.

In these studies, we have tested both direct and induced current (PEMF) and identified a "window" of current wherein neuronal growth is stimulated; levels below this window are while those above are deleterious. Accurate determinations of effective and deleterious electric field levels may be of significant importance to the Department of Defense as the number of external electric fields of various magnitudes continues to increase in the environment of all working personnel using sophisticated electronic equipment.

As importantly, we have made progress in defining the mechanisms underlying the observed electric field effects. These experiments implicate current-induced modification of calcium ion concentration at the neuronal cell membrane.

The results of our studies performed under a contract from the Office of Naval Research are summarized here. Additional studies (presented under the heading Supplementary Studies) were included as natural consequences of our work and constitute new areas of investigations.

Two of these areas have explored other in vitro nerve preparations (the neuroblastoma cell as a model for "neuronal"



differentiation, and spinal cord explants as a model for electric field effects on central nervous system regeneration). The other three areas have addressed electric field effects on normal chick development, sciatic nerve regeneration in the rat, and the growth response to direct current in amputated rat limbs.

**General Conclusions from our Experiments  
using explants of Dorsal Root Ganglia**

1. DC, NGF stimulate neurite outgrowth. Neurite outgrowth is correlated with protein/ganglia and DPM/ganglia in these cultures. This correlation may reflect increased synthesis of membrane components and cytoskeletal proteins.
2. Cytosine arabinoside (ara C) triggers exaggerated neurite outgrowth in controls while not affecting PEMF and DC groups. Long term effects in NGF group may reflect relatively greater concentration of the growth substance since nonneuronal cells are depleted. Recovery from ara C is greatest in NGF group.
3. Constant current devices have been fabricated and tested. In 8 day chick embryos, maximal responses are obtained using current levels of 30-60 nA; in 14 day embryos, these levels are 90 nA. Conductivity measurements of tissue culture media at different temperatures have been made and new values for media at 37°C published.
4. A correlation of neurite outgrowth with current density has been found in: DC cultures (9 nA/cm<sup>2</sup> and above), and in PEMF cultures (at 0.7uA/cm<sup>2</sup>) with the coils oriented vertically.
5. Ion substitution studies show that calcium influx inhibitors (La<sup>+3</sup>, Verapamil) mimic neurite outgrowth. Increased external calcium or A23187 inhibit neurite outgrowth. There appears to be a correlation of DC effects with decreased calcium entry into neurons.
6. Membrane potentials were measured in neurons after 10-12 days in vitro. Values range from -30 to -62 mV in controls, -40 to -62 mV in DC. Acute application of 10, 30 or 90 nA constant current while recording intracellularly have shown no effect on membrane potential.

## Direct and Induced Current and NGF on 8 Day Chick Embryos

Dorsal root ganglia (DRG) from 7-8 chick embryos (Figure 1) were dissected in Dulbecco's phosphate buffered saline (Gibco), and 6-8 DRG were immediately placed in 5 or 8 ml culture medium in 60 mm Falcon culture dishes. Two types of culture media were used: complete medium consisting of Dulbecco's Modified Eagle's Medium with 10% dialyzed fetal calf serum (Gibco), 600 mg% glucose, glutamine (2 mM) and 1% penicillin/streptomycin, or, complete medium containing cytosine arabinoside (ara C, cytarabine, Upjohn) at a final concentration of 8 ug/ml. Since the addition of ara C has been used in many studies to inhibit proliferation of non-neuronal cells, a separate series of experiments in ara C-containing medium was performed to determine the effects of different levels of current density on explants consisting primarily of neuronal cells.

Each day's experiment contained four treatment groups: a control group (non-treated), a group treated with nerve growth factor (NGF) at a final concentration of 10 nM, a group treated with PEMF (single pulse, 72 Hz) for 12 hrs/day for 2 days, and a group treated for 3 days with 10 nA applied direct current (DC). Each group contained 2-4 dishes per experiment; each experiment was repeated 3-4 times.

Nerve growth factor (2.5s) was obtained from R. Bradshaw (Irvine, CA). Direct current was applied by connecting two tantalum electrodes suspended in the culture medium to a 1.4 V battery; subsequent experiments to determine optimum current levels utilized connections to constant current drivers. These electrodes were configured to create a non-uniform field on the bottom of the dish; the single center electrode was the cathode,

Figure 1. Eight Day Chick Embryo illustrating location of peripheral sensory ganglia (trigeminal and dorsal root ganglia) used for testing in vitro.

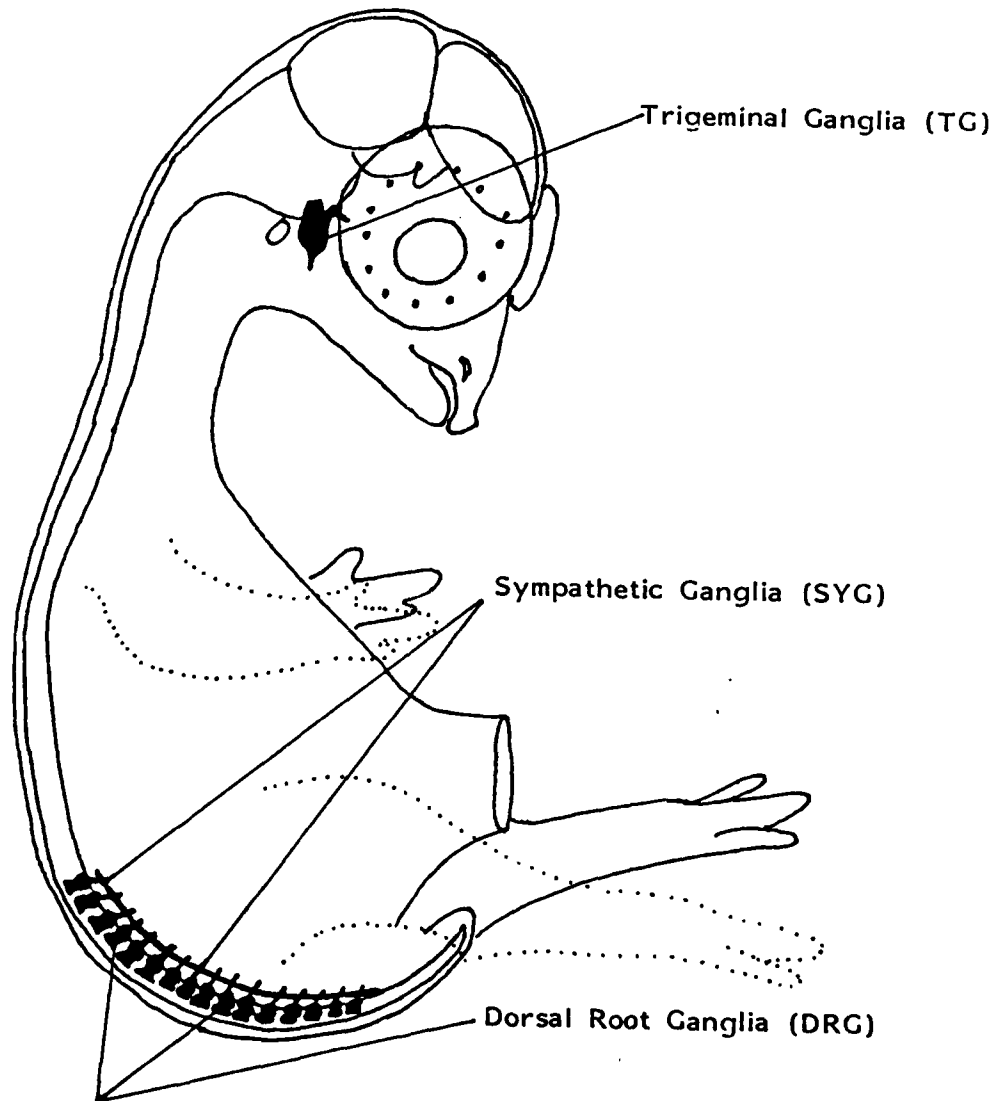

**EIGHT DAY CHICK EMBRYO**  
(Stage 34)

the large circular electrode was the anode (Figure 2A). The total current measured was 10 nA. Details of this system and the current/voltage relationships have been reported (Sechaud and Sicken, 1981). The current density and electric field on the bottom of the dish has been calculated and is presented in Figure 3A.

Pulsed electromagnetic fields were generated by Helmholtz coils provided by ElectroBiology Inc., NJ. The dishes were placed in a column between the vertically-oriented coils (Figure 2B); the current density in these dishes is zero at the edge of the dish, increases fairly rapidly to a level that is dependent upon the height of the medium in the dish, and remains constant until reaching the opposite edge of the dish where it drops to zero (Figure 3B).

All dishes were incubated in a 5%CO<sub>2</sub>, 95% air atmosphere for 6 days. In some dishes, 3H-proline at a final concentration of 4  $\mu$ C/ml was added 20 hours before fixation to determine protein synthetic capability. All cultures were fixed with 3.5% glutaraldehyde in 0.1M cacodylate buffer, and scored for neurite outgrowth. The cultures exposed to 3H-proline were prepared for radioautography by fixing overnight, rinsing in 0.1M cacodylate buffer (3 changes) then in distilled water and inverting them to drain. In the darkroom, they were covered with liquid emulsion (Kodak NTB2), drained until dry, and exposed in light-proof boxes for 3 weeks at 4°C. They were developed in Dektol: water (1:2), and fixed in Kodak fix solution.

Neurite outgrowth in the ganglia was determined after

Figure 2A. Culture dish top modified to deliver constant current (1 - 100 nA) to nerve tissue placed between the center cathode and peripheral anode.

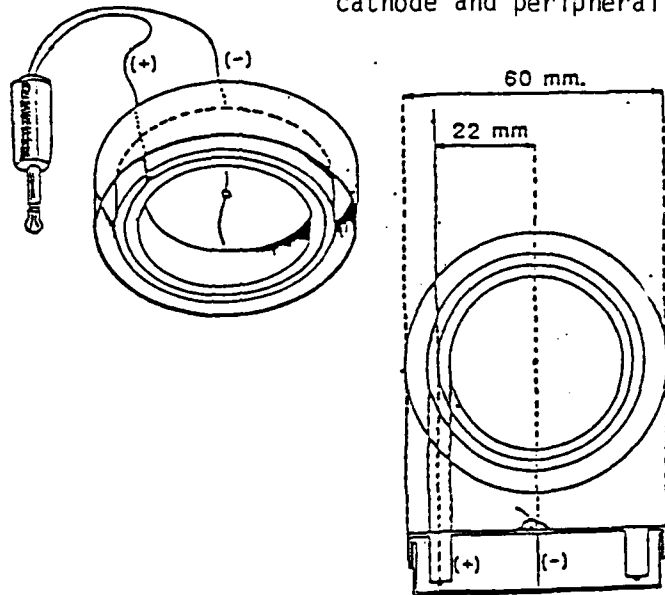

Figure 2B. Placement of culture dishes between coils for PEMF experiments and current density distribution as a function of diameter

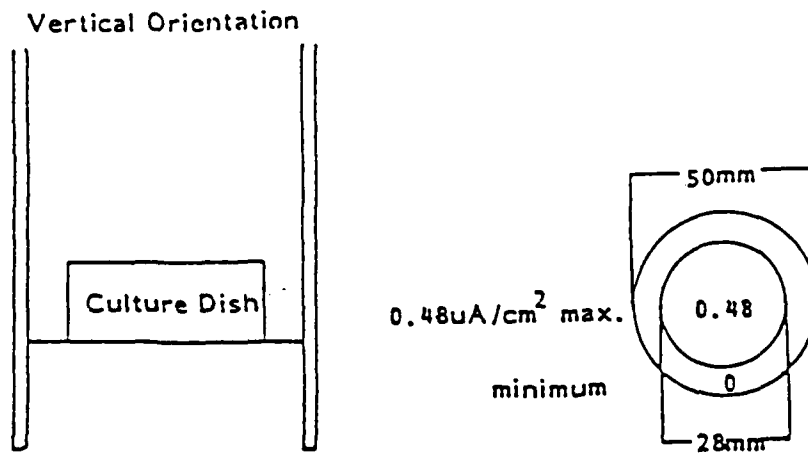
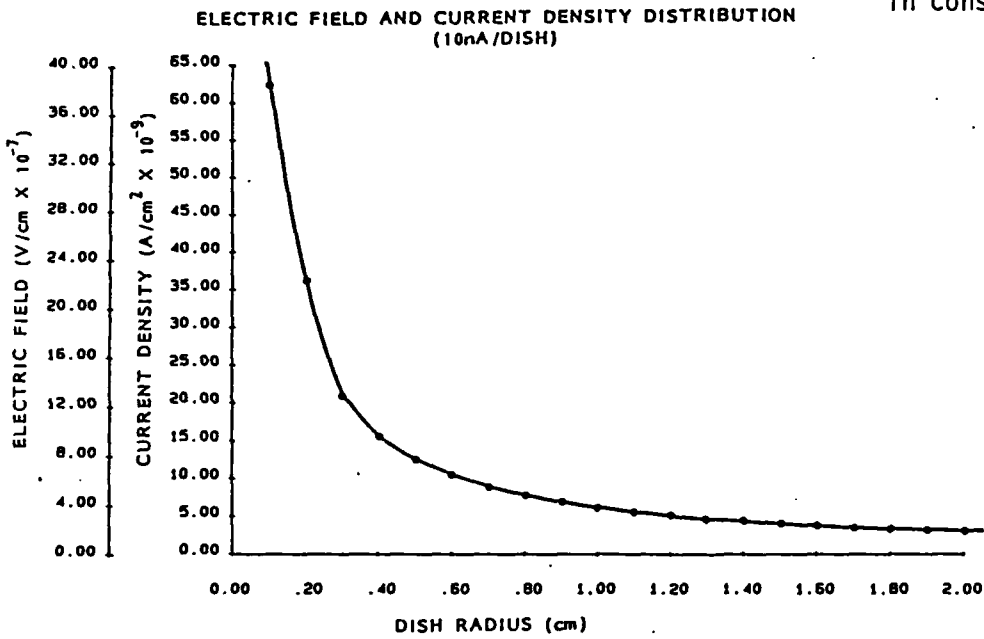

Figure 3A. Electric Field and Current Density—as a function of dish radius in constant current experiments



$$E = \frac{I \cdot R}{2 \pi r \cdot h}$$

$$J = \frac{E}{R}$$

$R = 59 \text{ ohm-cm}$   
 $r = \text{radius}$   
 $h = 0.255 \text{ cm}$

Figure 3B. Current density as a function of dish radius and height of media in PEMF experiments

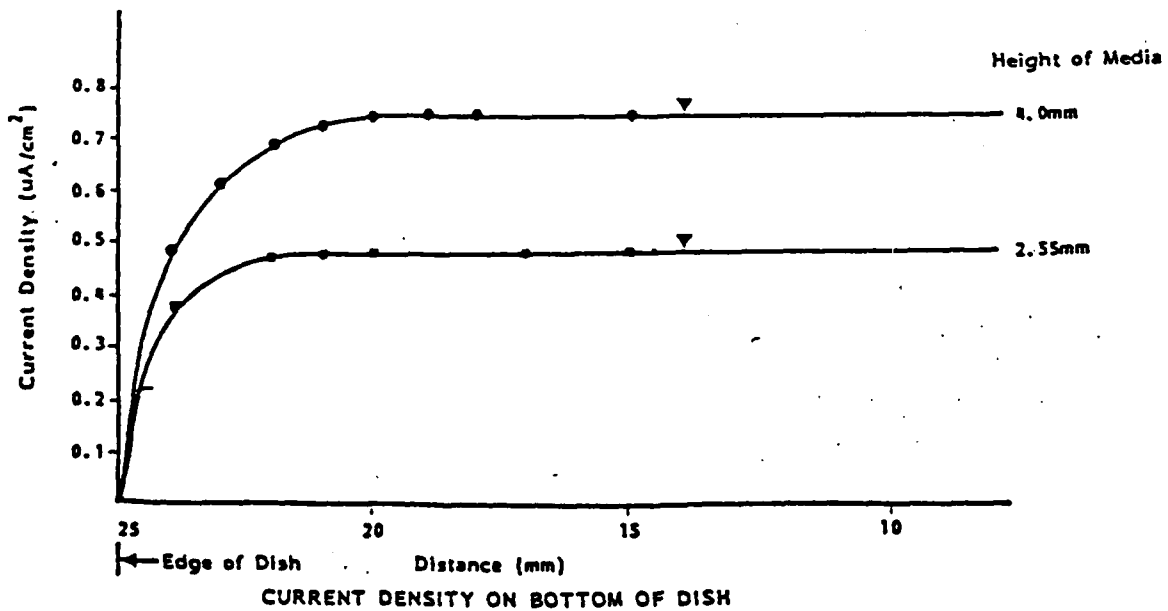

incubation according to the method of Fenton (1970). This method assigns a score to each ganglion based on the number, length, and degree of branching of the neurite emanating from the original explant. The scoring system assigns 0 to a ganglion with no outgrowth and +5 to a ganglion with maximal outgrowth. Treatment with  $10^{-8}$  M 2.5s NGF routinely yielded close to a +5 score at 3 days in vitro. To compare treatments, scores for all ganglia in their respective groups were pooled and means and standard deviations were obtained. Using NGF, most observers note the maximal response after 1 or 2 days in vitro, the response being somewhat more variable at 3 days. However, we have used this time period and 6 days as a later time period in experiments in which we determine long-term effects with a Cajal silver stain or autoradiographs to substantiate phase microscopic scoring of the neurite outgrowth.

The Lowry method was used to determine protein content; incorporation of  $^3\text{H}$ -proline into protein was assessed after incubation of the ganglia in isotope for the last 20 hours of incubation (4  $\mu\text{C}/\text{ml}$  final). At the end of the incubation period, the neurite outgrowth was determined under phase microscopy, the media removed and the ganglia washed 3X in buffered saline. The ganglia were homogenized by suspending them in 2cc distilled water and triturating them repeatedly with a 1 cc syringe with a 26 gauge needle. Aliquots of the suspension were taken for protein determinations and liquid scintillation counting; incorporation was determined on a DPM/ $\mu\text{g}$  protein basis or a DPM/ganglia basis.



The Dunnett's Multiple-Comparison Test was used to test significant differences between the mean of all control dishes and the mean of all dishes in the various treatment groups.

### Results

An example of the response of a sensory ganglia (trigeminal) to low levels of direct current is illustrated in a scanning electron microscope picture (Figure 4). Long branching neurites have grown from the parent neuronal cell bodies located close to or below the bottom of the explant. Similar growth responses to these levels of DC were obtained with dorsal root ganglia (Figure 5).

Comparison of neurite outgrowth in the four groups (control, nerve growth factor, pulsed electromagnetic fields-vertical and direct current) at 3 days in vitro are demonstrated in Figures 6-7. Figure 8 and Figure 9 illustrates neurite outgrowth, protein content and protein synthesis (incorporation of  $^3\text{H}$ -proline) in control, NGF, PEMF-V and DC as a function of age (3 or 6 days in vitro). In Figure 8, the experiments were performed in complete medium; those in Figure 9 were performed in complete medium containing mitotic inhibitor, ara C. Mean  $\pm$  SEM and significant differences from control are noted in each group; \* p = .05; \*\*p=.01; \*\*\*p=.005; \*\*\*\*p=.001 (Asymptotic z test). Note the correlation of neurite outgrowth, protein content and protein synthesis/ganglia in both the NGF and DC groups at 3 and 6 days in vitro; increased protein content may reflect increased production of membrane components and cytoskeletal proteins used for neurite production.

Figure 4. Scanning electron microscope picture of trigeminal ganglia treated for 3 days with 10 nA DC. The original explant containing most of the neurons is not in this picture; neurites emanating from these neurons are long, branched and numerous and have migrated on top of the non-neuronal mat. X260.



Figure 4

FIGURE 5

- A. Scanning electron microscope picture of 8 day DRG after 3 days stimulation with 10 nA direct current. Note the neurites (nt) that are elongated and branched and lay over the underlying nonneuronal cells. X1000.
- B. Transmission electron microscope picture of 8 day DRG after 2 days in vitro; control. Small nonneuronal cell aligned along neuritic process. The process is filled with neurotubules (t), neurofilaments (f), vesicles and mitochondria. X10,000.

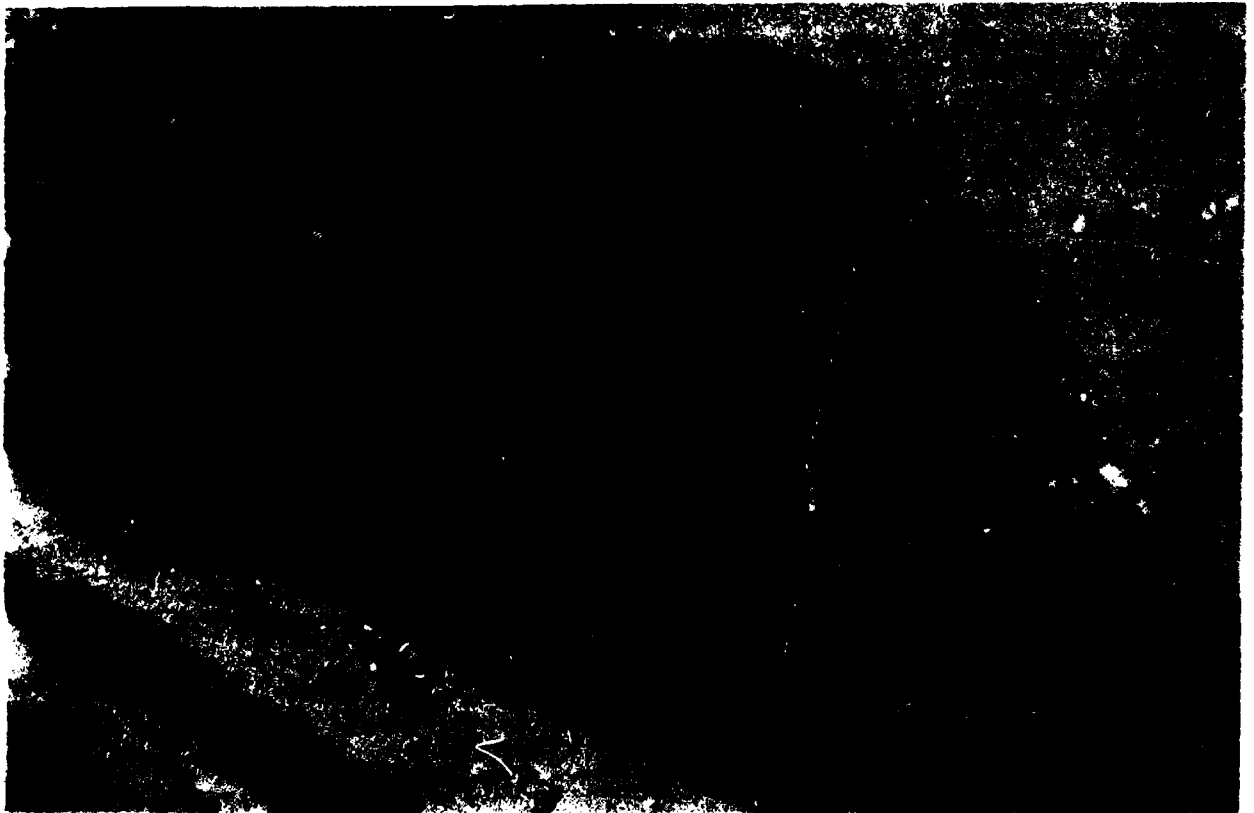
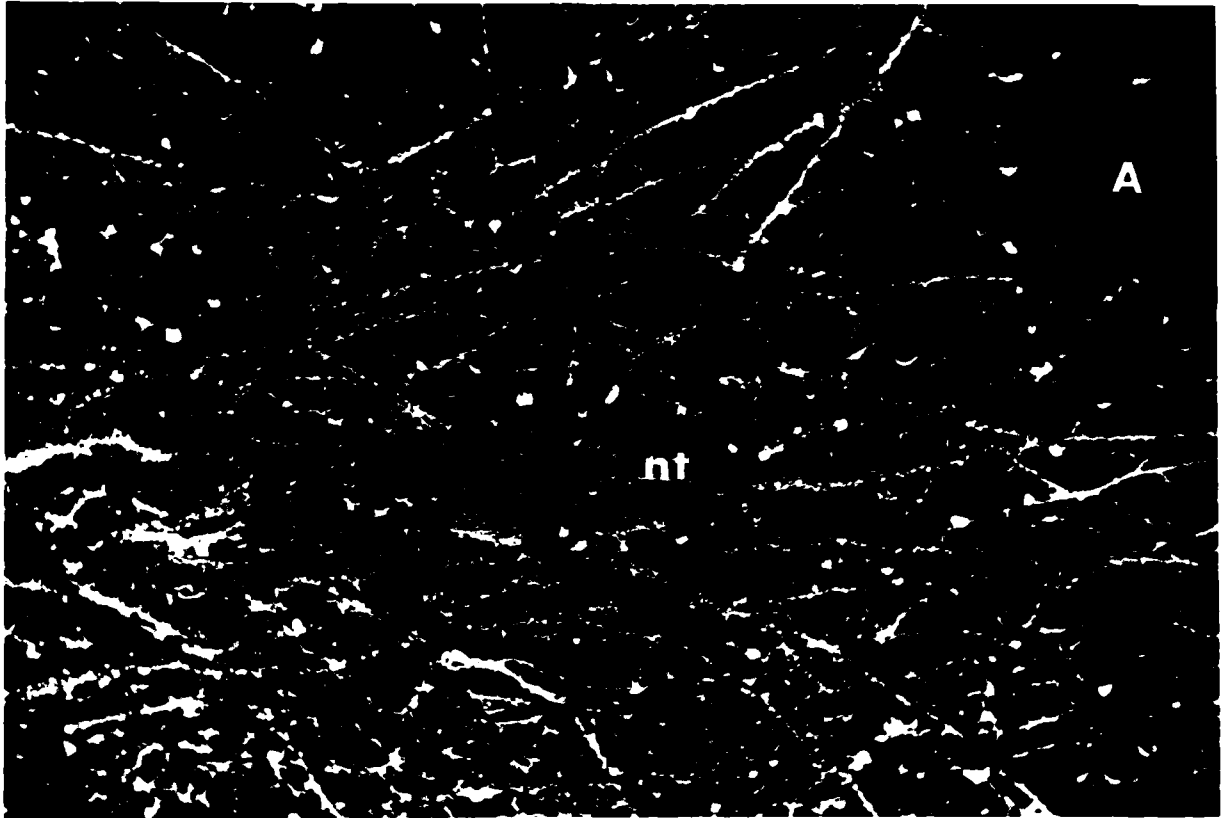

Figure 5

Figure 6. Cajal silver stain preparations used to assess neurite outgrowth in dorsal root ganglia at 3 days in vitro. The original explant containing most of the neurons is located on the left side of each picture with darkly-stained neurites growing over the non-neuronal cell mat emerging from these neurons. Note the many neurons (n) in D (DC) indicating increased migration of the neurons from the explant. C = control; NGF = 10 nM 2.5s NGF; V = PEMF (vertical orientation of coils) single pulse 12 hrs on/off for 2 days; DC = 10 nA direct current continuously for 3 days. Final magnification of A,B,C,D = X55.

Figure 7. Neurite outgrowth at 3 days in vitro in autoradiographs of dorsal root ganglia grown in the presence of 8 ug/ml cytosine arabinoside. <sup>3</sup>H-proline (4 uCi/ml final) was added to the media 20 hours prior to fixation. X139. C, N, V and D as in Figure 6. Note the black neurons (n) and neurites (arrows) indicating heavy incorporation of <sup>3</sup>H-proline into these cells and their processes.



Figure 6

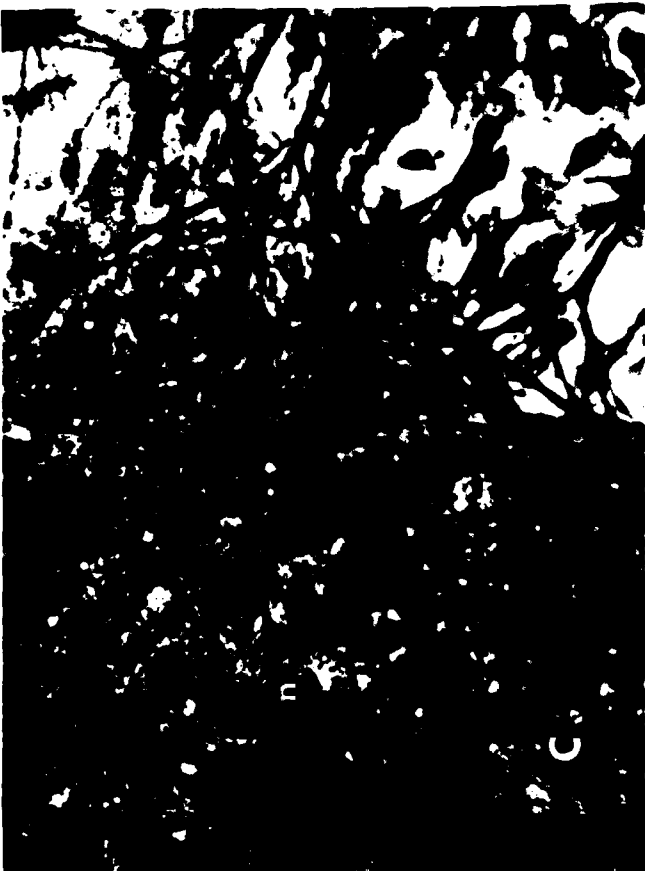

Figure 7



Figure 8

EFFECTS OF NGF, PEMF AND DC  
AT 3 AND 6 DAYS IN VITRO  
IN COMPLETE MEDIUM

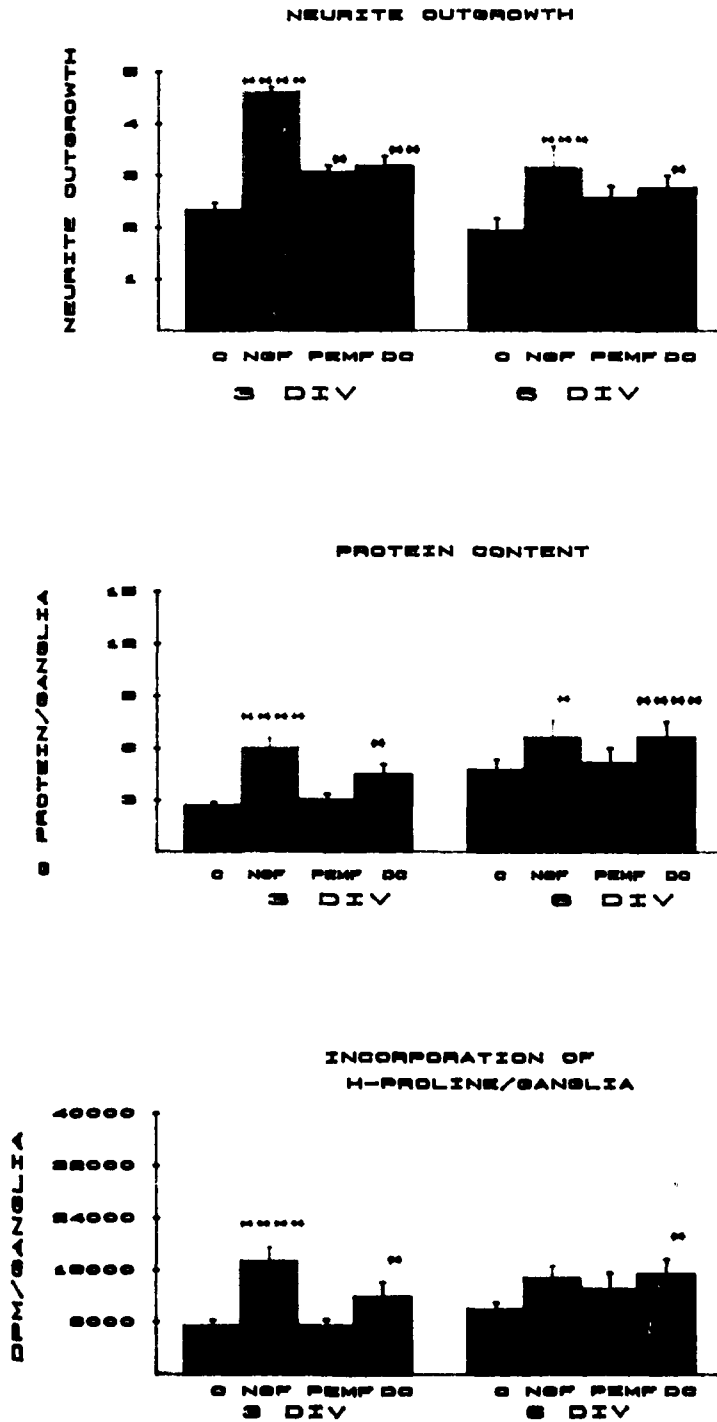
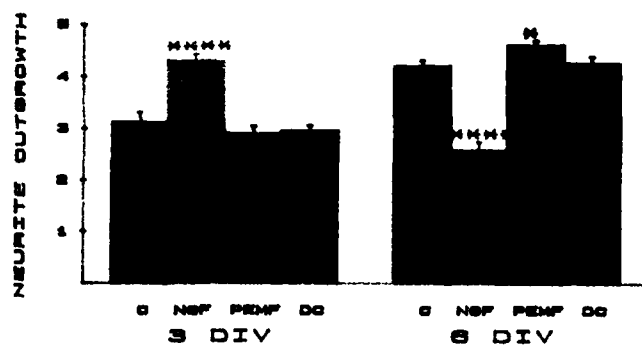

Figure 9

EFFECTS OF NGF, PEMF, AND DC  
AT 3 AND 6 DAYS  
IN VITRO IN 8 UG/ml ARA-C MEDIUM

NEURITE OUTGROWTH



PROTEIN CONTENT

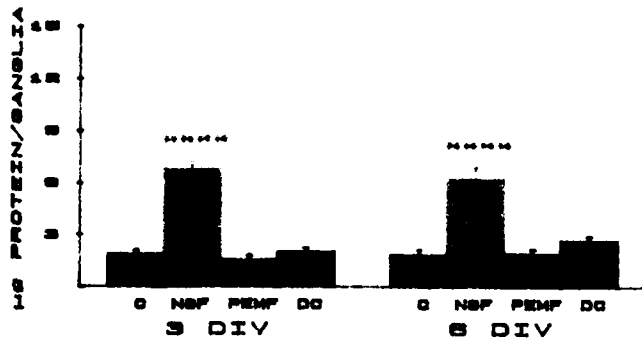

INCORPORATION OF  
3H-PROLINE/GANGLIA

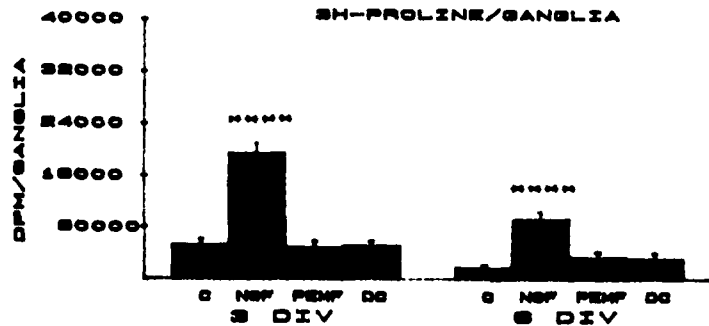

## Correlation of Current Density and Neurite Outgrowth

To determine whether there was any correlation of ganglia growth with radial position (current density), a transparent guide containing concentric rings was placed under the bottom of the culture dish. The position of each ganglia in all dishes was noted and the outgrowth scored. The paired t test for related measures was used to determine significance of growth relative to location in the dish. Only dishes that contained ganglia in both inner and outer rings were included in these analyses.

In our first series (Sisken, McLeod and Pilla, 1985), location effects (PEMF-vertical orientation) of various current densities at 2.55 mm (5 cc) or 4.0 mm (8 cc) height on neurite outgrowth at 6 days in vitro were obtained as were those untreated or treated with 10 nA DC, or NGF. The results illustrated in Tables 1-4 (taken from this publication and renumbered) indicate that in 5 cc of medium (height 2.55 mm) only ganglia growing in the inner (cathode-containing) ring of the DC dishes (av. current density of  $28.5 \text{ nA/cm}^2$ ) showed stimulated growth relative to those growing in the outer ring (Table 1). This difference was not seen with ara C added to the medium. In 8 cc medium (height 4.0 mm), the current density in the PEMF dishes is higher ( $0.74 \text{ uA/cm}^2$ ) in the inner ring and significantly higher growth scores were obtained.

TABLE 1

DORSAL ROOT GANGLIA -5CC COMPLETE MEDIUM  
NEURITE OUTGROWTH RELATIVE TO LOCATION IN DISH

GROUP	#DISHES	OUTER RING		INNER RING		p
		#GANGLIA	SCORE	#GANGLIA	SCORE	
Control	11	21	2.06 ± 1.01	39	2.30 ± .49	ns
NGF	9	26	3.66 ± .65	39	3.79 ± .37	ns
PEMF	6	15	2.50 ± .63	16	1.90 ± 1.4	ns
DC	11	28	2.49 ± .9	35	2.96 ± 1.09	.05

Paired T test for Related Measures, one tailed

TABLE 2

DORSAL ROOT GANGLIA - 5 CC COMPLETE MEDIUM + 8 UG/ML ARA C  
NEURITE OUTGROWTH RELATIVE TO LOCATION IN THE DISH

GROUP	#DISHES	OUTER RING		INNER RING		p
		#GANGLIA	SCORE	#GANGLIA	SCORE	
Control	9	27	4.2 ± .52	22	4.07 ± .83	ns
NGF	5	18	2.37 ± .63	12	2.72 ± .44	ns
PEMF	5	20	4.73 ± .43	11	4.53 ± .36	ns
DC	6	14	3.96 ± .4	15	4.33 ± .82	ns

Paired T test for Related Measures, one tailed

TABLE 3

DORSAL ROOT GANGLIA - 8CC COMPLETE MEDIUM  
NEURITE OUTGROWTH RELATIVE TO LOCATION IN DISH

GROUP	#DISHES	OUTER RING		INNER RING		p
		#GANGLIA	SCORE	#GANGLIA	SCORE	
Control	5	10	1.86 ± .89	25	2.0 ± .39	ns
PEMF	11	22	2.11 ± 1.10	45	3.02 ± 1.12	.025

Paired T Test for Related Measures, one-tailed

TABLE 4

DORSAL ROOT GANGLIA - 8CC COMPLETE MEDIUM  
COMPARISON OF NEURITE OUTGROWTH BETWEEN GROUPS

GROUP	#DISHES	#GANGLIA	MEAN SCORE + S.D.	p
CONTROL	8	35	1.35 ± .87	
PEMF	14	67	2.73 ± 1.06	.005

T-test Between Two Independent Means

When ganglia were exposed to the coils horizontally-oriented (Figure 10 and see Sissen, McLeod and Pilla, 1984) no significant differences were noted in ganglia growing in the inner ring (range of 0 - 3uA/cm<sup>2</sup>) relative to those growing in the outer ring (3 - 4.7 uA/cm<sup>2</sup>). Since the current density associated with stimulated growth (0.4-0.7 uA/cm<sup>2</sup>) in previous experiments was found in only a small portion of the dish in the present experiments, we may not have a biological system sensitive enough to note the differences. The data illustrating these findings are found in Tables 5 and 6.

#### Maximum Current Level Determinations

For experiments using constant direct current, the culture dish top was removed and replaced with one containing tantalum or platinum electrodes (see Figure 2A); the two electrodes emerging from the dish were inserted into a (male/female) plug which was connected to constant current drivers. The drivers were constructed according to schematics published in the National Semiconductor Linear Applications Handbook of 1978. In this system, levels of constant current in the range of 1-100 nAmp could be obtained; a Keithley Electrometer (602) was used to monitor the voltage.

Neurite outgrowth was determined in dorsal root ganglia in control and experimental dishes at constant current levels of 10-90 nA total current. In Figure 11, each point (at 10,30,60,90 nA) represents the mean score obtained from 6 dishes or more (six-eight ganglia per dish). Examples of these scores are presented in Figures 12 and 13.

Figure 10. PEMF, Horizontal Orientation

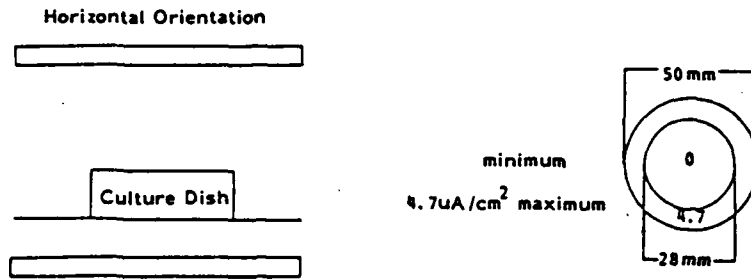

FIGURE 9.

(a) Pulse waveform generated by Helmholtz coils. (b) Placement of the culture dishes between the horizontally-oriented Helmholtz coils (left), and levels of current density within each culture dish (right).

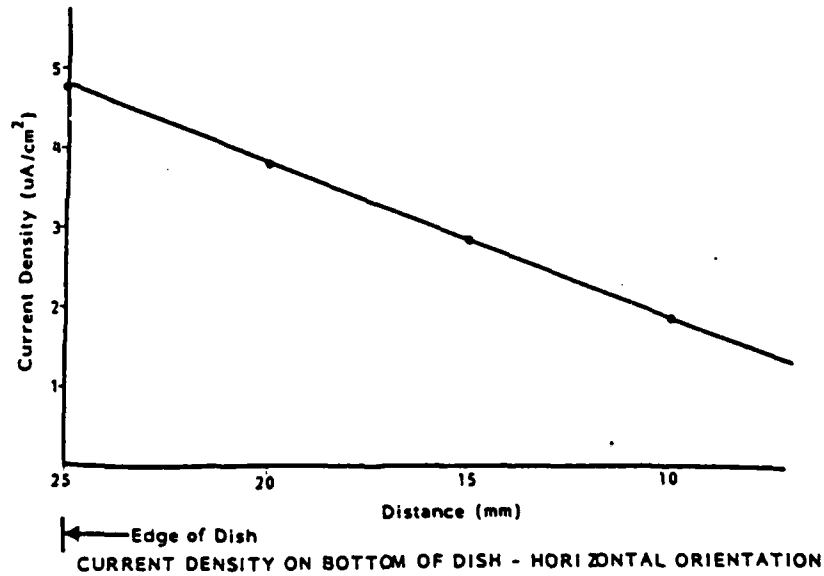

FIGURE 10.

Current Density (uA/cm<sup>2</sup>) as a function of dish radius, independent of height of the medium (PEMF).

TABLE 5

Dorsal Root Ganglia in 5 ml Complete Medium  
Neurite Outgrowth Relative to Location in Dish

Group	No. Dishes	Outer Ring		Inner Ring		P
		No. Ganglia	Score	No. Ganglia	Score	
Control	9	12	1.99 ± 1.04	24	1.7 ± .98	ns
PEMF, H	8	13	2.17 ± .52	27	1.83 ± .95	ns
	<u>17</u>					

TABLE 6

Dorsal Root Ganglia in 5 ml Complete Medium + 8 ug/ml ara C  
Neurite Outgrowth relative to Location in Dish

Group	No. Dishes	Outer Ring		Inner Ring		P
		No. Ganglia	Score	No. Ganglia	Score	
Control	5	13	3.95 ± .37	14	4.04 ± .3	ns
PEMF, H	8	27	3.85 ± .5	18	3.7 ± .82	ns
	<u>13</u>	<u>40</u>				



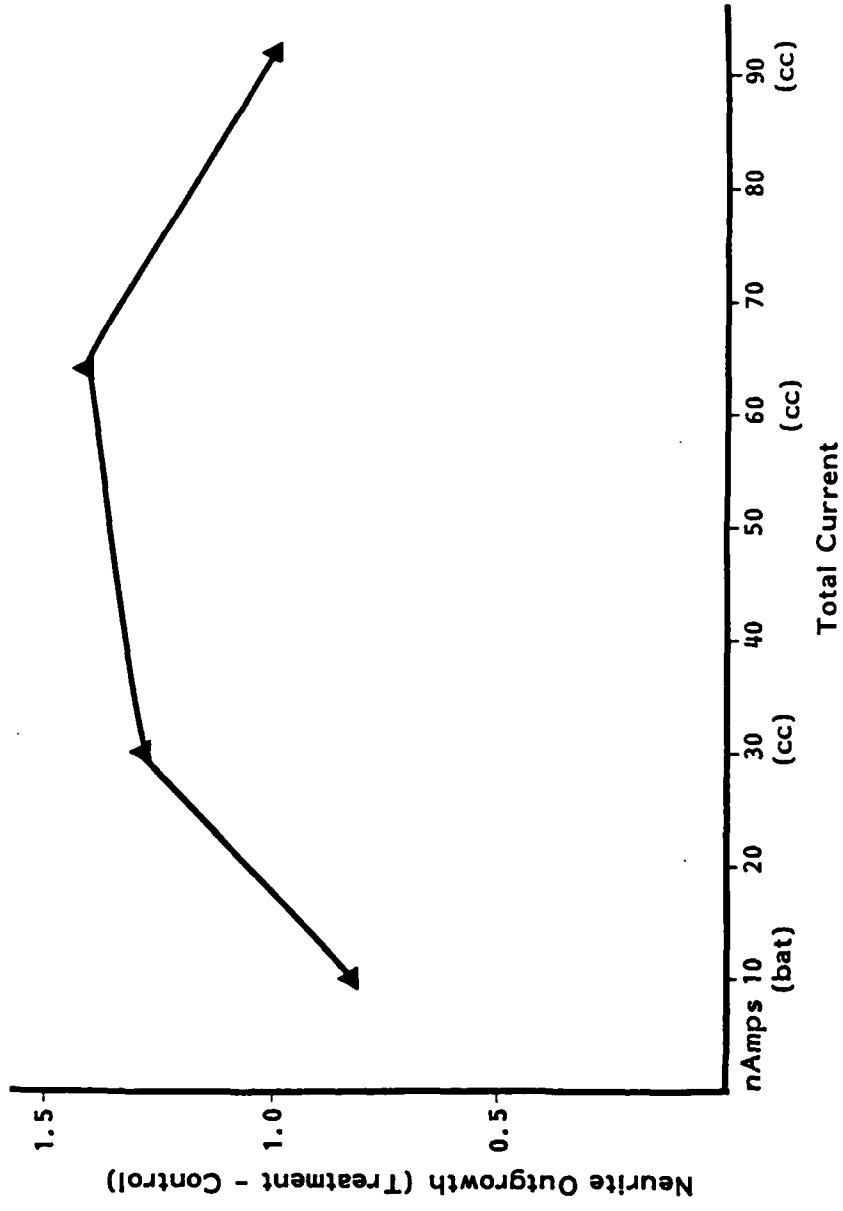

Figure 11. Neurite outgrowth (DC treatment - control) as a function of constant current applied in 8 day dorsal root ganglia, 6 days in vitro.

Figures 12 and 13. Neurite outgrowth at 6 days *in vitro* in autoradiographs of dorsal root ganglia treated with different levels of constant current or ion substitution experiments.  $^3\text{H}$ -proline (4 uCi/ml final) was added to the media 20 hours prior to fixation. Neurons and neurites (nt) are blackened indicating proline incorporation. Note the increased numbers of neurites (nt) in C, D, E, F (10 and 30 nA), the migrated neurons in F (30 nA DC) and the complete absence of neurons in G and H (ionophore treatment). A, B = control; C, D = 10 nA DC; E, F = 30 nA DC; G, H = 1 uM A23187 ionophore. A, C, E, G = X55; B, D, F, H = X139.

Figure 14. Neurite outgrowth at 6 days *in vitro* in autoradiographs of dorsal root ganglia;  $^3\text{H}$ -proline (4 uCi/ml final) was added to the media 20 hours prior to fixation. Neurons and neurites (nt) are blackened indicating proline incorporation. Note the lack of neurites in B (added calcium chloride) and increased numbers of neurites in C and D. A = control culture; B = culture treated with 12 mM calcium chloride; C = culture treated with 1 uM Verapamil; D = culture treated with 1 mM lanthanum chloride.



C

Figure 12

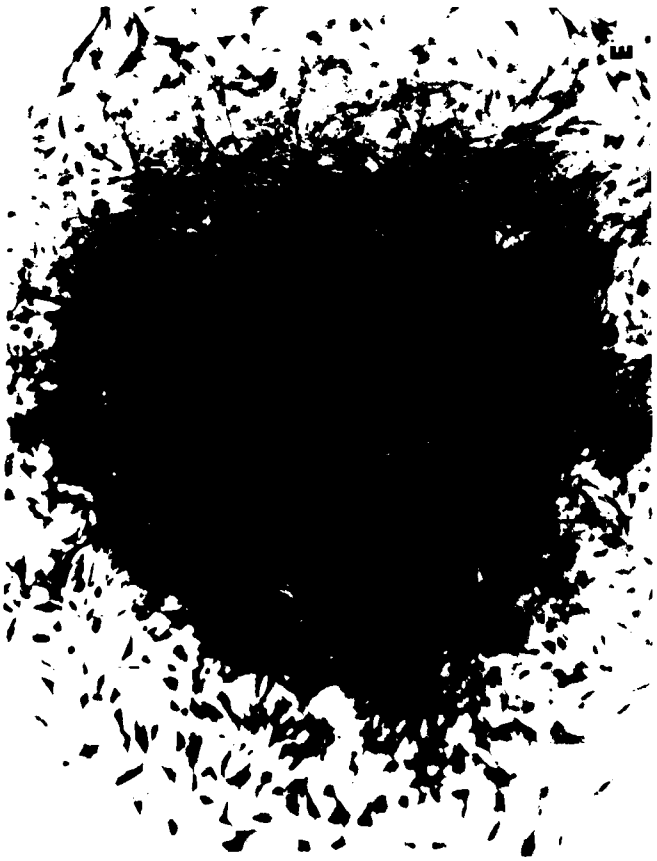

Figure 13

## Ionic Effects on Neurite Differentiation

Administration of current through a salt-containing medium necessarily involves ion movement; shifts in ion species around the cell may perturb the cell membrane resulting in cascade-like events in ion fluxes (sodium, potassium and calcium specifically). Calcium flux changes have been associated with proliferative signals or stimulus-response coupled activities in a variety of systems (7,9,10,11). Adey and his associates (1-4) demonstrated that acute application of electric fields to brain slices enhanced calcium efflux, and such studies have been confirmed by Blackman et al (5,6). In earlier studies we also demonstrated that current application was associated with decreased calcium influx and increased calcium efflux, indicating that relatively more calcium was bound to external membrane pools (18). Blocking calcium entry as a result of current application has been implicated in the stimulation of regeneration of the lamprey spinal cord in vivo by Cohen and his associates (12). The clinical use of standard biological solutions containing chemical agents that chelate calcium or block its entry has been reported by DeMedinaceli et al (8) as a means of enhancing peripheral nerve regeneration.

The aims of this study were to designed to compare the effects of direct current with the effects of various agents known to modify intracellular calcium levels.

Dorsal root ganglia (DRG) from 7-8 day chick embryos were dissected in Dulbecco's phosphate buffered saline and placed in Falcon 60 mm culture dishes containing 5 cc of Dulbecco's Modified Eagle's Medium with 10% dialyzed fetal bovine serum

(both from Gibco, NY), 0.6% added glucose, 2 mM glutamine and 1% penicillin/streptomycin (Gibco, NY). Each experiment included four replicate dishes per group and was repeated 3-5 times. The treatment groups were: control (untreated); constant current levels of 10, 30, 60, and 90 nA; nerve growth factor (NGF, 10 nM); calcium chloride (6- 12 mM); lanthanum chloride (0.1-1 mM); the calcium ionophore A23187 (Lilly, 1 uM); verapamil (Knoll Pharm., 1 uM).

All cultures were incubated in 95%air/5% CO<sub>2</sub> for 6 days; direct current was applied for 3 days and turned off for the remaining time. At 6 days, all cultures were fixed with 3.5% glutaraldehyde in 0.1 M phosphate buffer, and scored under phase microscopy. The scoring system for neurite outgrowth has been described (17,18); growth scores for each ganglion were determined and a mean score for each dish obtained. Mean dish values in each group were averaged so that comparisons between treatment groups could be made.

In Figure 13 (G and H) and Figure 14, typical examples of the effects of various agents on neurite outgrowth are illustrated. The difference in scores between each experimental group and the control group is plotted in Figure 15 as a function of molar concentration of the various calcium-modifying compounds. Those compounds known to inhibit calcium entry into cells (verapamil, lanthanum) produce stimulatory effects similar to those of direct current; neuritic processes extending from the centrally-placed neurons were prominent (Fig. 15 C,D). The optimal response was obtained with 0.5 mM lanthanum chloride or 1



Figure 14

Figure 15. Neurite Outgrowth (treated - control) in DC, NGF or ion substitution/addition experiments as a function of drug concentration.

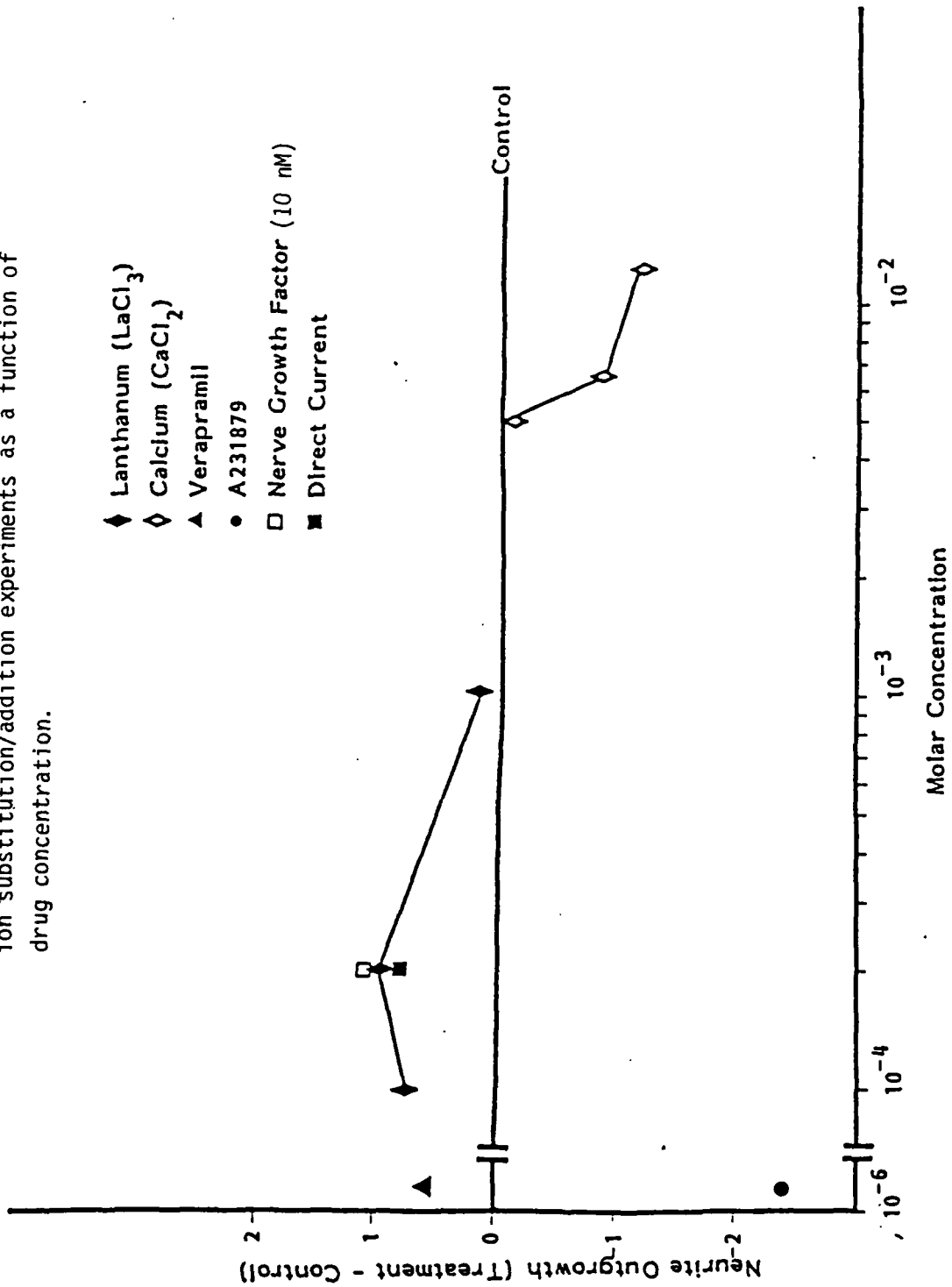

COMPARISON OF NEURITE OUTGROWTH BETWEEN GROUPS



$\mu\text{M}$  verapamil. On the other hand, increasing calcium entry by increasing extracellular calcium chloride to 6- 12 mM or by adding 1  $\mu\text{M}$  A23187 inhibited the growth response to below control values. After 6 days of constant exposure to A23187, however, no score was obtained since there were no nerve cells present; the ganglial explant consisted of glia and fibroblasts alone.

The ionic contribution to the current-induced regenerative response was studied by noting the effects of chemical agents that are known to affect intracellular levels of calcium. The data obtained support the accepted theory that regenerating neurites are inhibited by high levels of calcium ions. This agrees with the experiments of Schlaepfer et al (13-15) who demonstrated that degenerative changes occur in axonal microtubules and microfilaments of transected neurites exposed to high levels of calcium. Such changes were prevented when calcium was removed from the medium with the calcium chelator, EGTA. In our experiments, exposure to verapamil or lanthanum, agents known to block calcium entry, stimulated neurite production and growth. Increasing exogenous calcium, or adding the ionophore A23187 to the medium to increase calcium entry into cells inhibited neuritic growth. In fact, at a concentration of 1  $\mu\text{M}$ , the ionophore caused neuronal death.

Overall, the data suggests that the mechanism of action of direct current stimulation of neuronal regeneration may involve two factors: (1) current generated between the two electrodes causes the cells to migrate away from the ganglial center thereby exposing the neurons to the current-induced ion changes and minimizing non-neuronal overgrowth, and (2) the applied

current may reduce the influx of calcium by "electrostatic" attraction of calcium ions to the external cell membrane.

#### Direct and Induced Current Effects on Older (14 day) Chick Ganglia

The importance of testing electric field effects on ganglia obtained from older embryos is relevant because of the lack of response to growth substances as NGF; whereas young sensory and sympathetic ganglia are stimulated by NGF, older sensory ganglia are not responsive. A stimulatory response to an applied electric field constitutes a new and different finding.

Using our same protocol, we tested the effects of constant current and PEMF on 14 day dorsal root ganglia grown in complete medium and medium containing ara C. The results we obtained are found in Table 7 and illustrated in Figure 15. Only high levels of DC (90 nA) stimulated outgrowth significantly; the long fibers were observed extending to the end of the non-neuronal cell mat. In the presence of ara C used to inhibit fibroblast overgrowth, no differences were seen between treated and controls although DC-treated ganglia showed induction of remarkably long processes (Figure 15 C and D).

#### Effects of Electric Fields on Fetal Rat Sensory Ganglia

Although many experiments were performed on 15 day fetal rat sensory ganglia testing growth stimulation of either direct or induced current, no growth was noted; treatment with nerve growth factor however did produce a high growth response.

TABLE 7

14 Day Dorsal Root Ganglia in 5 ml Complete Medium  
Comparison of Neurite Outgrowth Between Groups

Group	Number Dishes	Mean Score $\pm$ SD
Control	12	0.91 $\pm$ 0.77
PEMF-V	8	0.25 $\pm$ 1.17
DC-CC(90nA)	11	2.84 $\pm$ 1.06

14 Day Dorsal Root Ganglia  
in 5 ml Complete Medium + 8 ug/ml Ara C  
Comparison of Neurite Outgrowth Between Groups

Group	Number Dishes	Mean Score $\pm$ SD
Control	7	2.57 $\pm$ 0.65
DC-CC (90nA)	9	2.68 $\pm$ 0.71

Figure 15. Representative pictures of 14 day dorsal root ganglia after 6 days in vitro. Long processes (arrows) have grown from the ganglia over the non-neuronal cells in A and B (90 nA direct current), phase microscopy. Autoradiographs of 14 day dorsal root ganglia (C and D) grown in 8 ug/ml cytosine arabinoside and treated with 10 nA DC; <sup>3</sup>H-proline (4 uCi/ml final) was added to the media 20 hours prior to fixation. Although no significant differences were found between control and DC cultures, application of DC appeared to produce longer neurites. A, C = X34; B, D = X85.6.

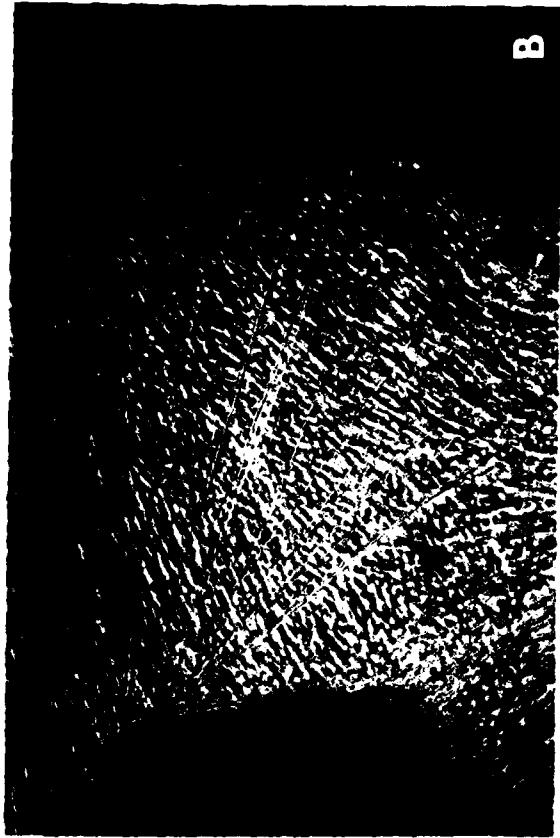

Figure 15

## Determination of Electrophysiological Parameters of Cultured Dorsal Root Ganglia under the Influence of DC

With Dr. Gary Ringham, we set up his neurophysiology equipment at Wenner Gren Laboratory, modifying an inverted Nikon phase microscope to hold a warming plate with circulating water to maintain the cultures at 35°C, and placing a micromanipulator (purchased with ONR funds) adjacent to it. After 6 months, Dr. Ringham left the university and was able to work on this project intermittently on week-ends. The data we have obtained from this work is not complete but is presented in Figures 16-18.

The equipment, culture dish containing electrodes for DC application, impalement of a dorsal root ganglion neuron and resulting action potentials obtained after intracellular injection of current are illustrated in Figure 16. Recordings from neurons previously treated with DC or PEMF are found in Figure 17 and 18. Application of 10-90 nA DC acutely to impaled neurons showed only small (1-3 mV) shifts in potential as recorded graphically but these were not consistent. Further investigation to determine whether this shift is valid was not completed.

Figure 16. Determination of electrophysiological parameters of cultured neurons. Picture (A) of inverted phase, bright field Nikon microscope with culture dish in place indicating micromanipulator (arrow), and tubes containing circulating warm water (w) to keep the temperature between 34-36 °C. In B, close-up of culture dish with the dish top (tp) cut away to allow penetration of the individual neurons with the microelectrode (me); the center and peripheral electrodes are attached to the remaining plastic to preserve the same geometry normally used in our culture experiments (see Figure 1). The wires emerging from the dish were connected to a battery source for application of DC. gd = ground. C= phase microscopy of a fresh preparation of 14 day dorsal root ganglia illustrating round neurons near the explant as well as one penetrated by the microelectrode. Action potentials generated by depolarization of these neurons is shown in D; spontaneous activity was rarely observed in cultured neurons but could easily be generated upon depolarization.

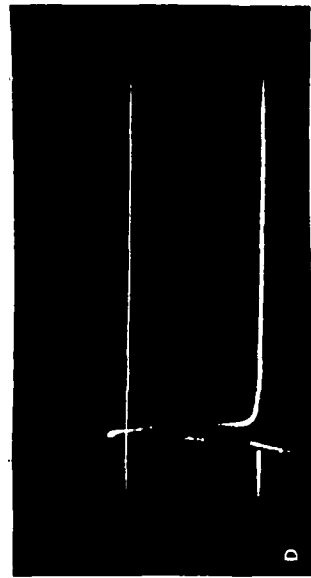
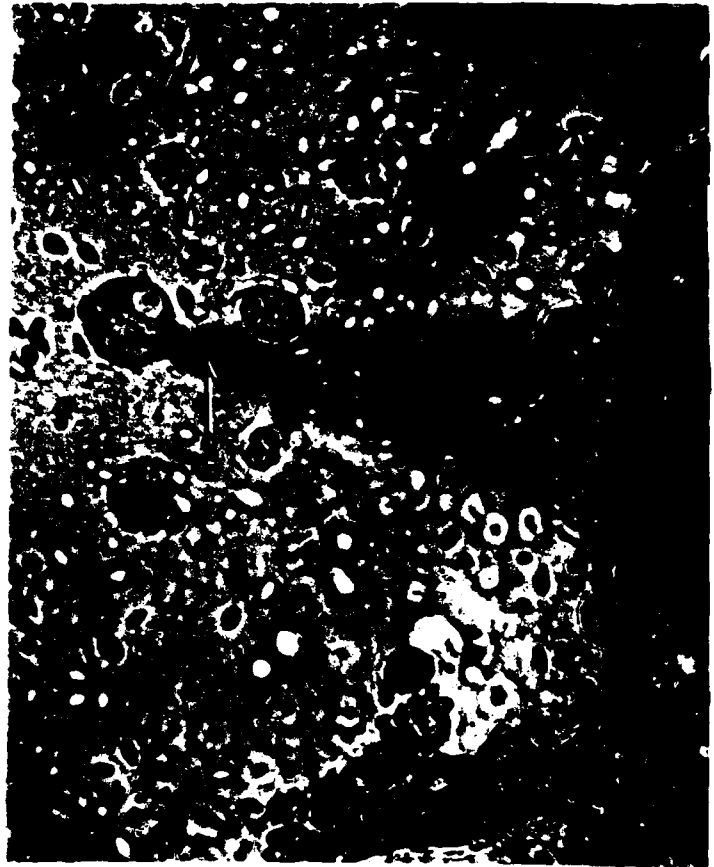
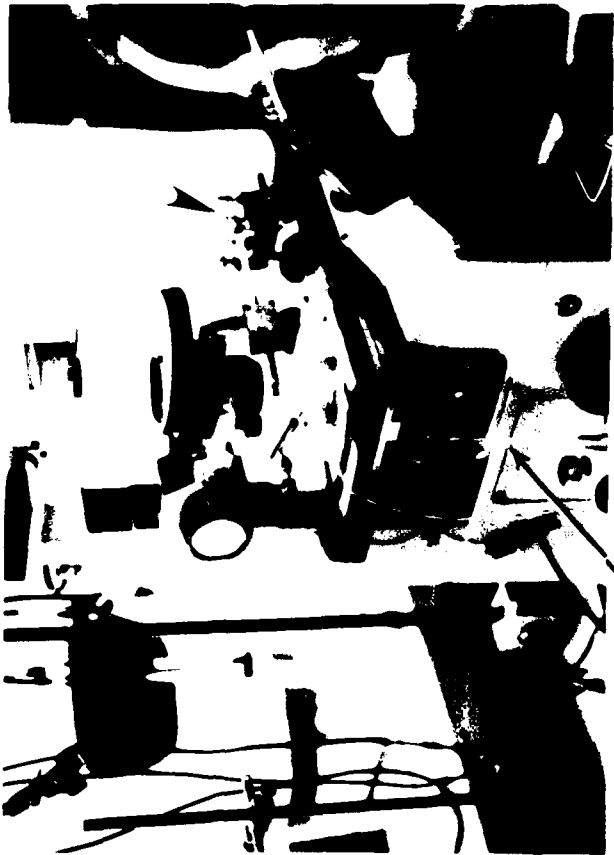

ACTION POTENTIALS RECORDED FROM CHICK DRG NEURONS

Figure 16



Figure 17

Intracellular Recordings from Dorsal Root Ganglia, 10-12 DIV  
 (Complete Medium plus 4.5mM CaCl<sub>2</sub>) ± S.E.M

Treatment	Number	Resting Membrane Potential	Height of Action Potential
Control	3	58 ± 3.11	70.6 ± 5.46
PEMF, Vertical	4	52.25 ± 2.6	69.3 ± 2.7
Direct Current	1	48	76
<hr/>			
15 day DRG, fresh	8	46.4 ± 3.8	

---

PEMF, Vertical

ara C 2 56.5 ± 3.8 71 ± 9.7

Direct Current

ara C 3 53 ± 4.4 50.5 ± 3.5

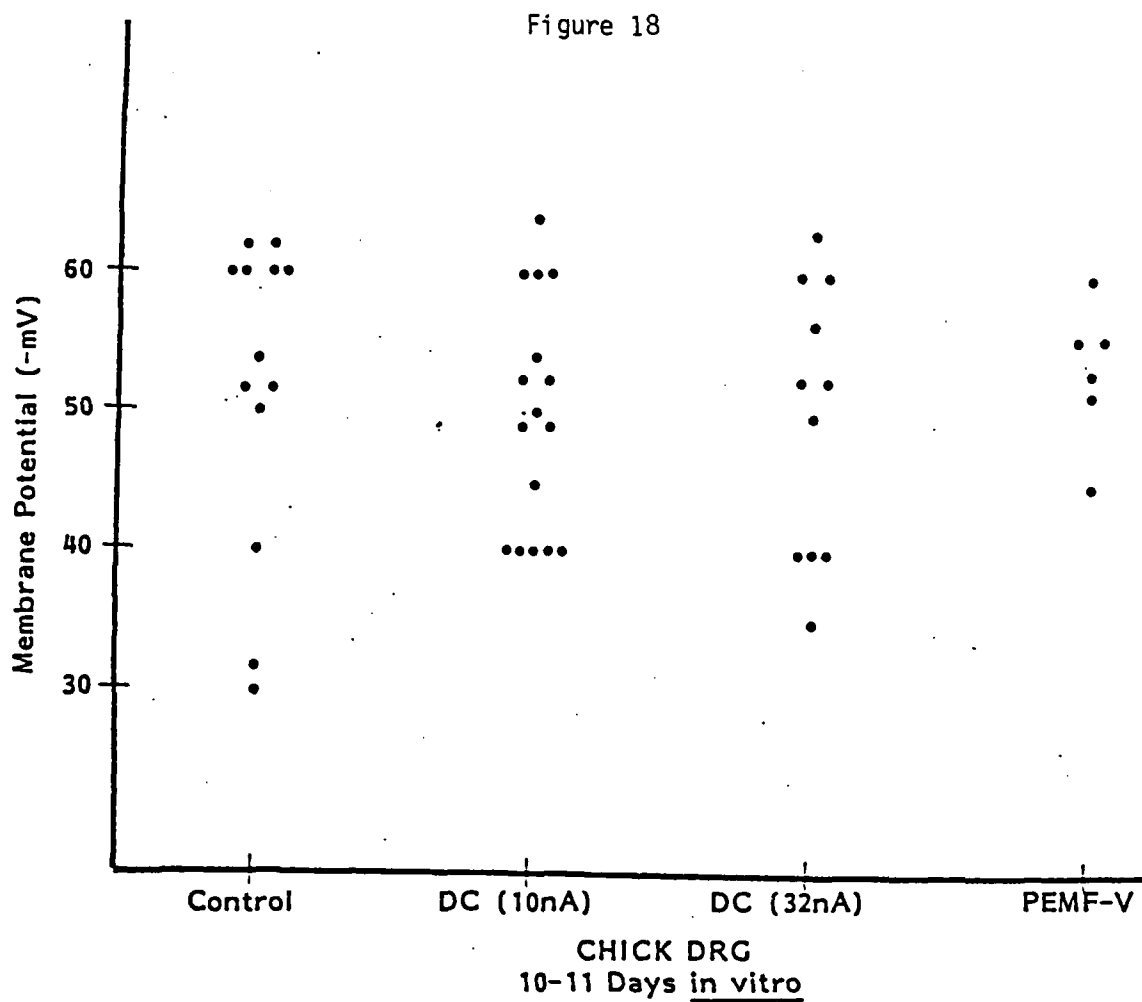

Figure 18. Membrane Potential Recordings after Treatment with Direct Current or PEMF-V for the first three days of incubation

SUPPLEMENTARY PROJECTS

In Vitro Studies:

DC Effects on Neuroblastoma (N18) Cell Differentiation  
DC and PEMF Effects on Central Nervous System Regeneration

In Vivo Studies

PEMF Effects on Normal Chick Development  
PEMF Effects on Sciatic Nerve Regeneration in the Rat  
DC and Neural Implant Effects on Amputated Rat Limbs

Poster Presentation at the  
Fourth Annual Meeting of the  
Bioelectric Repair and Growth Society  
November 5-8, 1984, Kyoto, Japan

**The Effects of Direct Current on Neurite Outgrowth in  
N18 Mouse Neuroblastoma Cells treated with Ara- C**

Betty F. Sissen and R. Scott Estes

Objectives:

1. To determine the effects of 10 nA constant current on neurite outgrowth (differentiation) and cell survival of N18 neuroblastoma cells in the presence of Ara- C (cytosine arabinoside)
2. To determine whether the percentage of differentiated cells differs as a function of location (current density).

THE EFFECTS OF DIRECT CURRENT ON NEURITE OUTGROWTH  
IN N18 MOUSE NEUROBLASTOMA CELLS TREATED WITH ARA-C

P12

B.F. Sisken and R.S. Estes

Our previous studies have demonstrated that direct current (DC) enhances neurite outgrowth in primary cultures of chick dorsal root ganglia (DRG). We have extended our investigations of this phenomenon by examining the response of N18, a mouse neuroblastoma cell line, to DC under similar conditions.

N18 cells were plated in 60mm dishes containing Dulbecco's Modified Eagle's Medium with 10% dialyzed fetal bovine serum, antibiotics, 0.6% additional dextrose and 2mM additional glutamine. The dishes were incubated in 5% CO<sub>2</sub> at 37°C for 24hr to allow for uniform attachment and one doubling of the cells. Ara-C was added to a final concentration of 0.5ug/ml to inhibit cell division and promote differentiation. Experimental dish tops were fitted with either tantalum or platinum electrodes; the center electrode was the cathode. Control dishes were without electrodes. DC was applied to experimental dishes, at either 10 or 32nA for 72hr. Dishes were then fixed with glutaraldehyde and five fields in similar regions of each dish were visually examined at 100X. The total number of cells per field, with and without neurites, was counted. The neurite outgrowth score (NO) was defined as the number of cells which developed neurites of a length greater than twice the diameter of the cell. Data were expressed as a proportion (NO/total number of cells) which was passed through a variance stabilizing transformation for statistical analysis.

Treatment with DC, at either 10 or 32nA, significantly increased the NO of N18 cells relative to controls, both in the center of the dish ( $p=.005$ ) and at the periphery ( $p=.01$ ). The neurites were long (0.25-1.5mm) and tended to form interconnections with the adjacent cells, neither of which was found consistently in control cultures. However, DC significantly ( $p=.01$ ) reduced the survival of N18 cells.

The effects of DC on N18 are quite similar to those observed in primary cultures of chick DRG (Sisken, *et al*, 1983) with significant enhancement of NO occurring near the cathode. However, we feel that the "effective current window" for the N18 cells is lower than that for primary cultures, which may account for the decreased survival. The N18 system may prove useful as a simple and reproducible tool for examining the basic mechanisms of action of DC on neuronal cultures at the cellular level.

This research was supported by the Office of Naval Research: ONR N00014-82-K-105.

Wenner Gren Research Laboratory  
and the Department of Anatomy,  
University of Kentucky,  
Lexington, KY, USA 40506

OUR PREVIOUS STUDIES HAVE DEMONSTRATED THAT DIRECT CURRENT (DC) ENHANCES NEURITE OUTGROWTH IN PRIMARY CULTURES OF CHICK DORSAL ROOT GANGLIA (DRG). WE HAVE EXTENDED OUR INVESTIGATIONS OF THIS PHENOMENON BY EXAMINING THE RESPONSE OF N18, A MOUSE NEUROBLASTOMA CELL LINE, TO DC UNDER SIMILAR CONDITIONS.

N18 CELLS WERE PLATED IN 60MM DISHES CONTAINING DULBECCO'S MODIFIED EAGLE'S MEDIUM WITH 10% DIALYZED FETAL BOVINE SERUM, ANTIBIOTICS, 0.6% ADDITIONAL DEXTROSE AND 2MM ADDITIONAL GLUTAMINE. THE DISHES WERE INCUBATED IN 5% CO<sub>2</sub> AT 37°C FOR 24HR TO ALLOW FOR UNIFORM ATTACHMENT AND ONE DOUBLING OF THE CELLS. ARA-C WAS ADDED TO A FINAL CONCENTRATION OF 0.5UG/ML TO INHIBIT CELL DIVISION AND PROMOTE DIFFERENTIATION. EXPERIMENTAL DISH TOPS WERE FITTED WITH EITHER TANTALUM OR PLATINUM ELECTRODES; THE CENTER ELECTRODE WAS THE CATHODE. CONTROL DISHES WERE WITHOUT ELECTRODES. DC WAS APPLIED TO EXPERIMENTAL DISHES, AT EITHER 10 OR 32NA FOR 72HR. DISHES WERE THEN FIXED WITH GLUTARALDEHYDE AND FIVE FIELDS IN SIMILAR REGIONS OF EACH DISH WERE VISUALLY EXAMINED AT 100X. THE TOTAL NUMBER OF CELLS PER FIELD, WITH AND WITHOUT NEURITES, WAS COUNTED. THE NEURITE OUTGROWTH SCORE (NO) WAS DEFINED AS THE NUMBER OF CELLS WHICH DEVELOPED NEURITES OF A LENGTH GREATER THAN TWICE THE DIAMETER OF THE CELL. DATA WERE EXPRESSED AS A PROPORTION (NO/TOTAL NUMBER OF CELLS) WHICH WAS PASSED THROUGH A VARIANCE STABILIZING TRANSFORMATION FOR STATISTICAL ANALYSIS.

TREATMENT WITH DC, AT EITHER 10 OR 32NA, SIGNIFICANTLY INCREASED THE NO OF N18 CELLS RELATIVE TO CONTROLS, BOTH IN THE CENTER OF THE DISH (P=.005) AND AT THE PERIPHERY (P=.01). THE NEURITES WERE LONG (0.25-1.5MM) AND TENDED TO FORM INTERCONNECTIONS WITH THE ADJACENT CELLS, NEITHER OF WHICH WAS FOUND CONSISTENTLY IN CONTROL CULTURES. HOWEVER, DC SIGNIFICANTLY (P=.01) REDUCED THE SURVIVAL OF N18 CELLS.

THE EFFECTS OF DC ON N18 ARE QUITE SIMILAR TO THOSE OBSERVED IN PRIMARY CULTURES OF CHICK DRG (SISKEN, ET AL, 1983) WITH SIGNIFICANT ENHANCEMENT OF NO OCCURRING NEAR THE CATHODE. HOWEVER, WE FEEL THAT THE "EFFECTIVE CURRENT WINDOW" FOR THE N18 CELLS IS LOWER THAN THAT FOR PRIMARY CULTURES, WHICH MAY ACCOUNT FOR THE DECREASED SURVIVAL. THE N18 SYSTEM MAY PROVE USEFUL AS A SIMPLE AND REPRODUCIBLE TOOL FOR EXAMINING THE BASIC MECHANISMS OF ACTION OF DC ON NEURONAL CULTURES AT THE CELLULAR LEVEL.

THIS RESEARCH WAS SUPPORTED BY THE OFFICE OF NAVAL RESEARCH:  
ONR N00014-82-K-105.

## METHODS

SERIES I: N18 CELLS WERE PLATED IN 60MM DISHES (FALCON 3001) CONTAINING DULBECCO'S MODIFIED EAGLE'S MEDIUM (GIBCO) WITH 10% DIALYZED FETAL BOVINE SERUM (GIBCO), PENICILLIN/STREPTOMYCIN, 0.6% ADDITIONAL GLUCOSE, AND 2MM ADDITIONAL GLUTAMINE. THE DISHES WERE INCUBATED IN A 5% CO<sub>2</sub> ATMOSPHERE AT 37°C FOR 24HRS TO ALLOW FOR UNIFORM ATTACHMENT AND ONE DOUBLING OF THE CELLS. ARA-C (CYTARABINE - UPJOHN) WAS ADDED TO A FINAL CONCENTRATION OF 0.5UG/ML TO INHIBIT CELL DIVISION. EXPERIMENTAL DISH TOPS WERE FITTED WITH EITHER TANTALUM OR PLATINUM ELECTRODES; THE CENTER ELECTRODE WAS THE CATHODE. CONTROL DISHES WERE WITHOUT ELECTRODES. DIRECT CURRENT (DC) WAS APPLIED TO THE EXPERIMENTAL DISHES AT EITHER 10 OR 32NA FOR 72HR. DISHES WERE THEN FIXED WITH GULTARALDEHYDE AND FIVE FIELDS IN SIMILAR REGIONS OF EACH DISH WERE VISUALLY EXAMINED AT 100X. THE TOTAL NUMBER OF CELLS PER FIELD, WITH AND WITHOUT NEURITES, WAS COUNTED. THE NEURITE OUTGROWTH SCORE (NO) WAS DEFINED AS THE TOTAL NUMBER OF CELLS WHICH DEVELOPED NEURITES OF A LENGTH GREATER THAN TWICE THE SMALLEST DIAMETER OF THE CELL. DATA WAS EXPRESSED AS A PROPORTION (NO/TOTAL NUMBER) AND WAS SUBJECTED TO A VARIANCE STABILIZING TRANSFORMATION (ARC SINE TRANSFORM) FOR STATISTICAL ANALYSIS.

SERIES II: METHODS AND CONDITIONS WERE AS ABOVE EXCEPT FOR THE ADDITION OF ONE ADDITIONAL CENTER FIELD TO THE DATA COLLECTION PROCEDURE AND A SERIES OF SHAM CONTROLS CONSISTING OF THE DC DISH TOP WITH NO APPLIED CURRENT WERE RUN CONCURRENTLY WITH THE CONTROL AND DC EXPERIMENTS.

Figure 19. Diagram of Dish used for constant current experiments and location effects

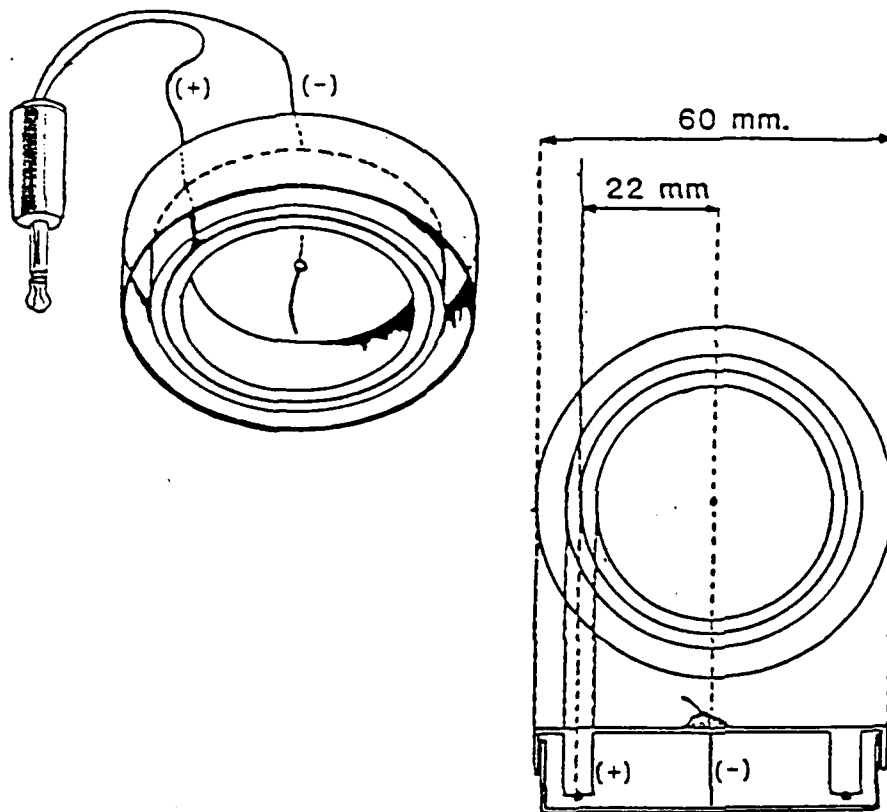

LOCATION PARAMETERS:

IN: 2-3MM FROM CENTER (CATHODE) ELECTRODE

OUT: 5MM FROM OUTSIDE (ANODE) ELECTRODE



Figure 20. Phase microscopy of (N18) neuroblastoma cells after 3 days in vitro grown in media containing 0.5 ug/ml cytosine arabinoside and treated with 10 nA direct current. Undifferentiated cells are round and phase bright; cells that have differentiated have neuronal-like processes that vary from 2-15X the smallest diameter. In A, three long processes extend from one cell (arrow), X384; in B the arrow points to a giant cell frequently found in all cultures that appears to result from fusion of ~8 cells. Processes of varying lengths are found in B and C (X256).

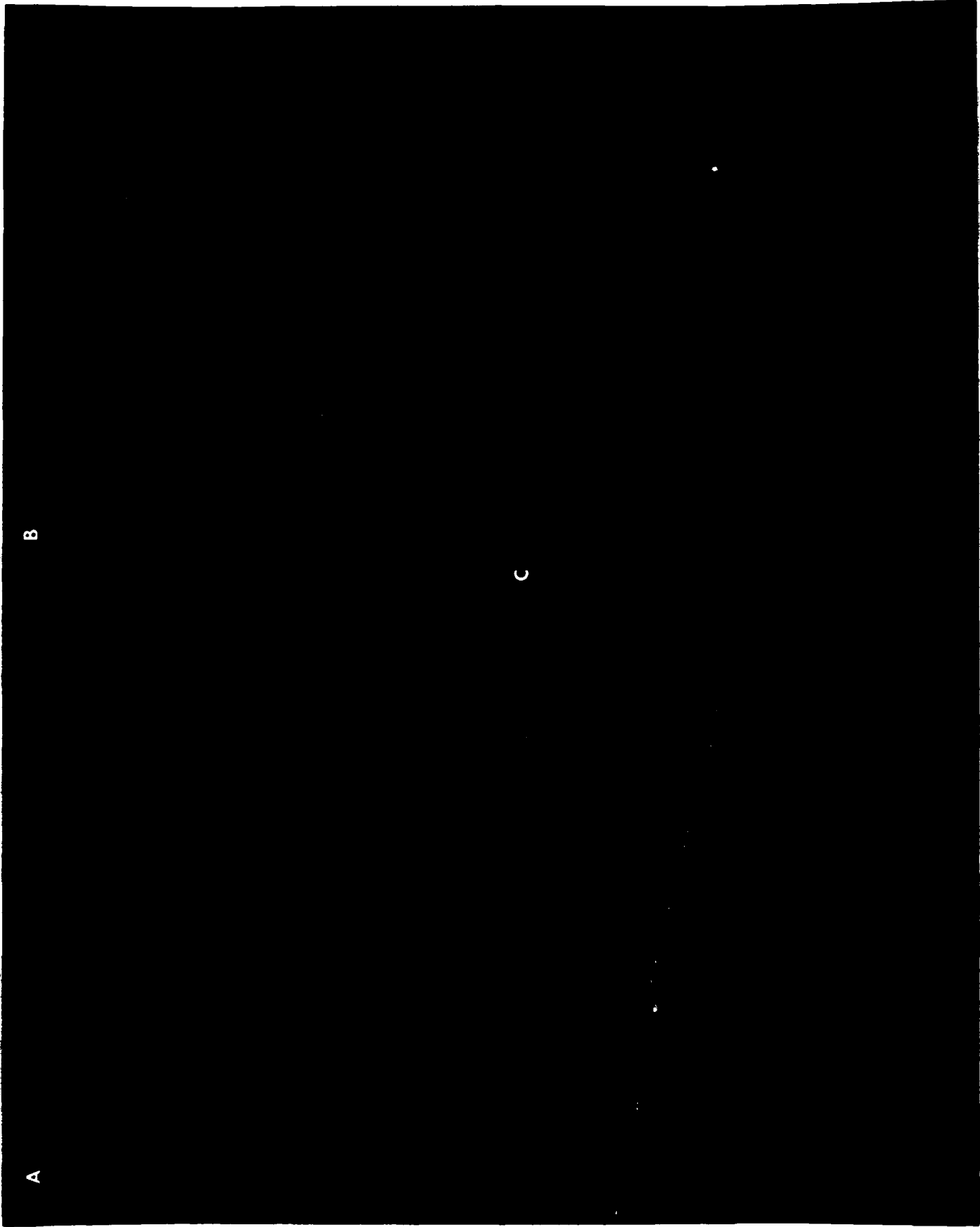

B

C

A

Figure 20

FIGURE 21

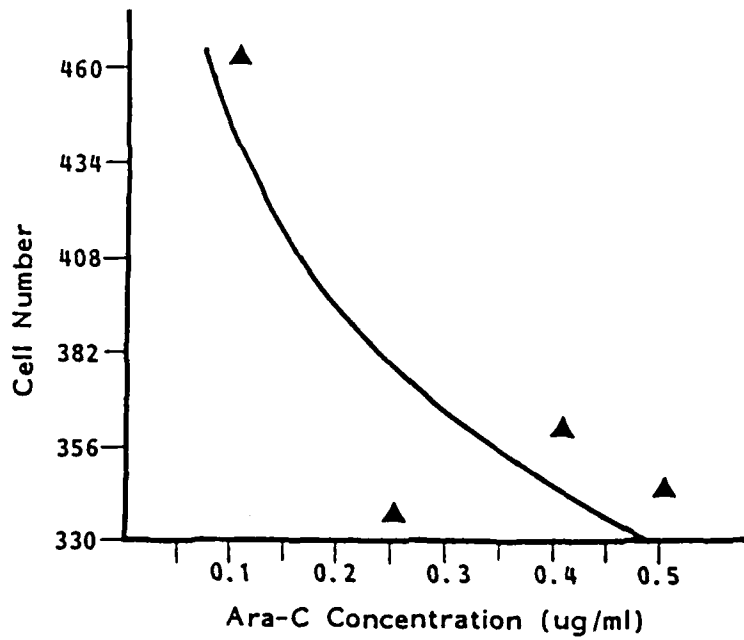
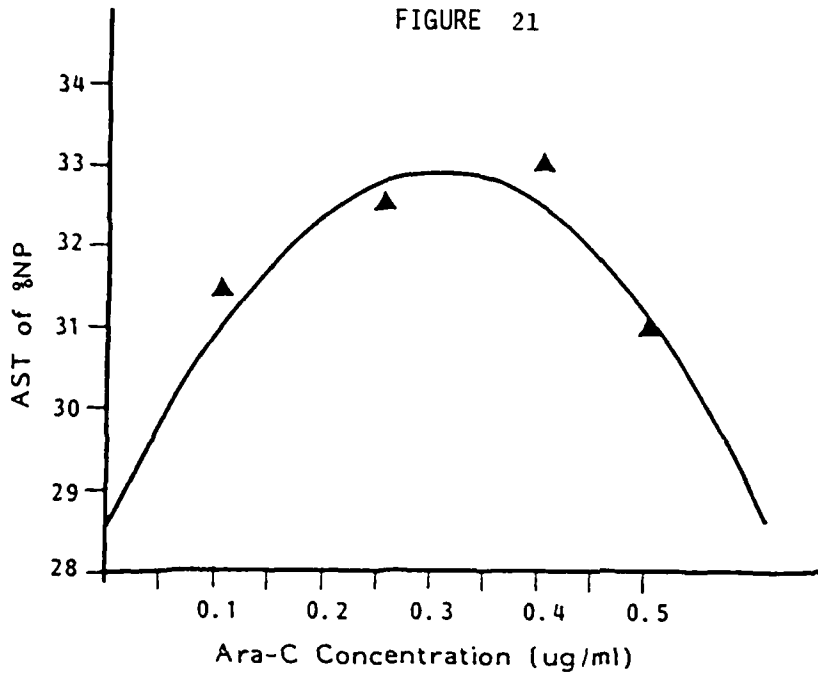

PERCENTAGE OF N18 CELLS WITH PROCESSES (NP [=NO]) AND CELL NUMBER AS A FUNCTION OF ARA-C CONCENTRATION

FIGURE 22

ARC SINE TRANSFORM OF NO/TOTAL CELL NUMBER

SERIES I

	<u>CONTROL</u>	<u>DIRECT CURRENT</u>
X <sub>IN±SEM</sub>	19.90 ± 2.17	27.73 ± 1.87
X <sub>OUT±SEM</sub>	16.66 ± 1.23	20.41 ± 0.86
X <sub>DIFF±SEM</sub>	3.24 ± 1.59	7.32 ± 1.50
N	13	19
	P=NS	P=0.05

SERIES II

	<u>CONTROL</u>	<u>DIRECT CURRENT</u>	<u>DC DISH-NO CURRENT</u>
X <sub>IN±SEM</sub>	25.90 ± 2.32	29.06 ± 2.85	31.74 ± 1.85
X <sub>OUT±SEM</sub>	25.77 ± 1.34	24.00 ± 2.33	28.14 ± 1.30
X <sub>DIFF±SEM</sub>	0.135 ± 2.94	4.76 ± 1.99	3.59 ± 2.56
N	16	16	16
	P=NS	P=0.025	P=NS

FIGURE 23

CELL SURVIVAL - TOTAL

SERIES I

	<u>CONTROL</u>	<u>DIRECT CURRENT</u>
$X_{TOTAL+SEM}$	662 ± 57.06	439.2 ± 34.63
		p=0.001

SERIES II

	<u>CONTROL</u>	<u>DIRECT CURRENT</u>	<u>DC DISH-NO CURRENT</u>
$X_{TOTAL+SEM}$	285.31 ± 17.81	225.07 ± 8.74	250.93 ± 14.11
	p=NS	p=0.001	p=NS

CELL SURVIVAL - LOCATION

	<u>CONTROL</u>	<u>DIRECT CURRENT</u>	<u>DC DISH-NO CURRENT</u>
$X_{IN+SEM}$	137.06 ± 23.46	93.38 ± 8.78	99.33 ± 15.04
$X_{OUT+SEM}$	148.25 ± 12.16	131.69 ± 8.70	151.60 ± 13.17
$X_{DIFF+SEM}$	-11.19 ± 28.22	-38.31 ± 12.05	-52.26 ± 19.50
	p=NS	p=0.001	p=0.01

## C O N C L U S I O N S

1. CONSTANT CURRENT (10nA) APPLIED VIA METAL ELECTRODES INCREASE THE PERCENT OF NEUROBLASTOMA CELLS THAT CONTAIN NEURITES (IE DIFFERENTIATE).
2. THERE IS A SIGNIFICANTLY GREATER PERCENTAGE OF CELLS THAT DIFFERENTIATE NEAR THE CATHODE THAN NEAR THE ANODE.
3. CONSTANT CURRENT (10nA) SIGNIFICANTLY DECREASES THE TOTAL CELL NUMBER. THIS DECREASE IS ASSOCIATED WITH CELLS LOCATED NEAR THE CATHODE, WHETHER CURRENT IS APPLIED OR NOT.
4. INCREASE IN NO AND DECREASE IN CELL SURVIVAL ARE CORRELATED WITH CURRENT DENSITY AND CATHODAL ORIENTATION.

\* DIRECT CURRENT EFFECTS ON NEUROBLASTOMA CELLS TREATED WITH ARA C

Betty F. Sisken and R. Scott Estes

Wenner Gren Research Laboratory and Dept. of Anatomy, University of Kentucky, Lexington, KY 40506, U.S.A

ABSTRACT

Synergism between ara C and direct current was tested on neuroblastoma cells *in vitro*. Using this electrical system, we have been able to quantitatively differentiate the effects of various current densities on total cell number and percent process-bearing cells. Direct current stimulation increased the percentage of cells containing processes and decreased the cell number relative to controls; a significant effect was correlated with location and current density.

INTRODUCTION

Neuroblastoma cell lines have been developed to serve as models for nerve cell investigations. The murine neuroblastoma (N18) line that we are using in our laboratory was obtained from Dr. Janet Morgan, School of Biological Sciences, Lexington, KY. It is unresponsive to nerve growth factor, but is induced to form neuritic processes in low serum medium, or by adding such agents as dibutyl cyclic AMP, or mitotic inhibitors as BUDR (6). We have employed cytosine arabinoside (ara C) as a mitotic inhibitor in studies on primary cultures of dorsal root ganglia to reduce the overgrowth of non-neuronal cells (9,10,11). Concentrations of ara C at a much-reduced level are effective in reducing cell division and promoting neurite process formation in neuroblastoma cultures (8).

The aim of this study was to determine whether synergistic effects could be obtained in neuroblastoma cells with the application of low levels of direct current (DC) to ara C-treated cultures.

MATERIALS AND METHODS

N18 cells were grown in flasks in Dulbecco's Modified Eagle's Medium with 10% dialyzed fetal bovine serum, 600 mg% dextrose, 2 mM glutamine, and penicillin-streptomycin. Cultures were changed to fresh media every 3-4 days; for experimental studies, each flask was split 1:4 and approximately  $2 \times 10^5$  cells were plated into 60 mm Falcon dishes. After 24 hours incubation at 37°C in 95% air, 5% CO<sub>2</sub>, ara C (Cytarabine, Cytosar-U, Upjohn Co.) was added to a final concentration of 0.5 ug/ml.

Supported by the Office of Naval Research N00014-82-K-0105

\* In: Proceedings, 4th Annual Bioelectrical Repair and Growth Society Meeting  
S. Inoue and H. Takahashi, Eds. Nishimura Co., Nigata, Japan

Direct current was administered to the cultures by replacing the dish top with a top containing tantalum or platinum electrodes. The electrodes were attached to a 1.4 V battery and 10 nA current was delivered for 3 days. The electrode configuration and current/time relationships of this system has been described (7,10). Each experiment contained 4-8 dishes per group and was repeated 3 different days.

After 3 days, the medium from control and experimental dishes was removed and 3.5% glutaraldehyde in 0.1M cacodylate buffer was added to fix the cells to the dish. In two experiments, cell viability was assessed before fixation; in each of two dishes from control and experimental groups, propidium iodide/fluorescein diacetate mix (5) was added to the medium. The number of cells not excluding propidium iodide and fluorescing red (nonviable) comprised less than 1% of the total cell population in either group.

Data on cell counts in fixed preparations were made at 100X magnification under a Wild inverted phase microscope with x-y coordinate settings. Settings for five fields were determined and used for cell counts/field in each dish. One field was located within 2 mm of the center cathode at a current density of 31 nA/cm<sup>2</sup> termed "center field". Each of the four fields was located 14 mm from the center cathode (current density of 4.4nA/cm<sup>2</sup>) and 6 mm from the peripheral anode in each quarter sector of the dish; an average of the four fields represented the "distal" field. The total cell number and the total numbers of cells containing processes (neurites) 2X the diameter of the cell were determined in each field. The data for the proportion of cells containing neurite processes were passed through a variance-stabilizing transformation for statistical analysis. These data are presented as an average per dish, or the average of each as a function of location within the dish, that is "center" or "distal". The Student's t test was used for the statistical analyses on total cell number and %cells with processes. A paired t test was used for statistically analyzing within-dish location effects.

## RESULTS

Addition of 0.5 ug/ml ara C to control cultures of neuroblastoma cells inhibited cell survival and induced neurite process formation in 16.82% of the cells, Table 1. When direct current was applied to sister cultures containing ara C, the neurite processes were notably longer (up to 1.5 mm) and significantly more numerous (21.19%, p= .01 Table 1). The total number of cells per dish after treatment with DC, however, was significantly lower (p =.02).

To determine if there was a difference between cells growing close to the cathode in comparison to those closer to the anode, within dish analyses were performed on the data (see Table 2). Significantly greater number of cells with processes were found in both locations in the DC group relative to the same locations in control dishes. In addition, there was a significant increase in these types of cells in the vicinity of the cathode relative to those near the anode (paired t test, p =.05) and appear to correlate with the higher current density. In contrast to neurite production, the



**TABLE 1**

Mean  $\pm$  S.E.M of total cell number and %cells with processes in control and direct current-treated dishes

Group	Number of Dishes	Total Cell Number	% Cells with Processes (Np)
Control	12	365.67 $\pm 30.2$	16.82 $\pm 1.0$
DC	19	268.05** $\pm 23.7$	21.19* $\pm 0.9$

Student's t test  
(two tailed)

\*p = .01  
\*\*p = .02

**TABLE 2**

Mean  $\pm$  S.E.M of total cell number and %cells with processes (Np) as a function of location (center = 2 mm from cathode; distal = 6 mm from anode).

Group	Number of Dishes	Center		Distal	
		Total cell #	%Np	Total cell #	%Np
Control	12	197.66 $\pm 19.52$	19.9 2.1	168 $\pm 15.3$	16.6 $\pm 1.2$
DC	19	158.21 $\pm 18.77$	27.7*** $\pm 1.8$	109.84* $\pm 8.67$	20.4** $\pm 0.8$

Student's t test  
(two tailed)

\*p = .01  
\*\*p = .02  
\*\*\*p = .05

total cell number in the dish center was not different from controls, but was significantly reduced ( $p=.01$ ) in the distal area.

It is apparent that using this electrical system allows us to quantitatively differentiate between the effects of various current densities on two biological parameters within the same dish.

#### DISCUSSION

At a concentration of 0.5 ug/ml ( $10^{-6}$  M), ara C reduces cell survival by approximately 33% (8) but, like other antineoplastic agents, also promotes cytoplasmic extensions that are similar to nerve axons/processes. Our intent was to ascertain if applied direct current would act synergistically with this agent to promote an increase in the numbers of process-containing cells, similar to what we have observed in primary sensory neuron cultures (10). The data presented in Tables 1 and 2 provide evidence that these fields do interact with the antineoplastic agent, yielding differential stimulation near the cathode. Cathodal stimulation has been previously reported by a number of investigators in hard (1,2) and soft (nerve) tissue studies (4,12,3).

The significant decrease in total cell number in DC-treated dishes has not been observed in primary cultures treated for the same time period and with similar current dosage. Moreover, the decrease in cell number (distal,  $p=.01$ ) is correlated with the lower current density - anodal electrode. It may be that the neuroblastoma cells are relatively more sensitive to the minute current levels applied. It is important to note that in a tumor cell line, inhibition in total cell population with concomitant increased cellular differentiation as we found after DC application, has clinical relevance. Further studies are needed to determine the mechanism of action of these fields on this neuroblastoma cell line.

## REFERENCES

1. Black, J., Brighton, C. T. (1979): Mechanisms of Stimulation of Osteogenesis by Direct Current, In *Electrical Properties of Bone and Cartilage*, eds. C. T. Brighton, J. Black and S. R. Pollack.
2. Brighton, C. T. and Hunt, R. M. (1979): Initial Ultrastructural Changes in the Vicinity of Active and Dummy Direct Current Cathodes in the Rabbit Medullary Canal, In *Electrical Properties of Bone and Cartilage*, eds. C. T. Brighton, J. Black and S. R. Pollack.
3. Jaffee, L. F. and Poo, M. (1979): Neurites grow faster towards the cathode than the anode in a steady field. *J. Exp. Zool.* 209, 115.
4. Marsh, G. and Beams, H. W. (1946): In Vitro control of growing chick nerve fibers by applied electric currents. *J. Cell. and Comp. Phys.* 27, 139.
5. Pavlik, E., Flanigan, R., van Nagell, J., Hanson, M., Donaldson, E., Keaton, K., Doss, B., Bartmas, B. and Kenady, D. Persistent esterase activity and exclusion of propidium iodide after proliferative inhibition by anticancer agents: phenomena relevant to chemosensitivity determinations. *Cancer Invest.*, in press.
6. Schubert, D. and Jacob, F. (1970): 5-Bromodeoxyuridine-induced differentiation of a neuroblastoma. *Proc. Nat. Acad. Sci.* 67, 237.
7. Sechaud, P. and Siskin, B. F. (1981): Electrochemical characteristics of tantalum electrodes used in culture medium. *Bioelectrochem. and Bioenerg.* 8, 633.
8. Siskin, B. F. and Estes, R. S. Direct current effects on neuroblastoma cells treated with ara C. Submitted 1985.
9. Siskin, B.F., Estes, R. S. and Kryscio, R. (1983): The effects of cytosine arabinoside on nerve regeneration, protein content and protein synthesis in NGF- or electrically-treated sensory ganglia in vitro. *Bioel. Repair and Growth Soc.*, 3, 17.
10. Siskin, B.F., McLeod, B. and Pilla, A. A. (1984): PEMF, direct current and neuronal regeneration; effect of field geometry and current density. *J. Bioelectricity*, 3, 81.
11. Siskin, B. F., Roberts, E. and Goetz, I. (1984): Triethanolamine, Tris, hepes, and cytosine arabinoside show neuritogenic activity in cultured chick embryo ganglia. Accepted *Exper. Neurology*.
12. Siskin, B. F. and Smith, S. D. (1975): The effects of minute direct electrical currents on cultured chick embryo trigeminal ganglia. *J. Emb. Exp. Morph.* 33, 29.

Platform Presentation at the  
Fifth Annual Meeting of the  
Bioelectric Repair and Growth Society  
October 13-16, 1985 in Boston, Mass.

**In Vitro Stimulation of Central Nervous System Regeneration  
by Direct Current and PEMF**

Betty F. Sisken

**Objectives:**

To determine whether levels of direct (constant) current or PEMF found to stimulate peripheral sensory neuron regeneration are effective in inducing regeneration of neurites from spinal cord explants

IN VITRO STIMULATION OF CENTRAL NERVOUS  
SYSTEM REGENERATION BY DIRECT CURRENT AND PEMF

53

B. F. Sisken

Previous studies have demonstrated stimulatory effects of direct current (DC) and pulsed electromagnetic fields (PEMF) on primary cultures of embryonic chick sensory neurons *in vitro*. Regeneration of long axonal processes from such peripheral ganglia occurs normally *in vivo*, while those from the central nervous system do not. Our aim was to determine whether the same electric field parameters were effective in enhancing neuronal regeneration (neurite production and neuronal survival) in cultures obtained from the central nervous system.

The spinal cord model that we have developed contains sensory, motor and interneuron populations of cells; each population can be identified using specific histochemical or immunohistochemical markers. Slices (100-300 $\mu$  thick) of spinal cord from 8 day chick embryos or 16 day rat fetuses were cultured in 60mm Falcon culture dishes and fed with tissue culture media containing 10% fetal bovine serum and varying concentrations of the mitotic inhibitor ara C (2, 5 or 8  $\mu$ g/ml). Control dishes or dishes exposed to 10 nA DC were placed in the top chamber of a double chamber incubator; dishes exposed to PEMF were placed in the lower chamber between Helmholtz coils (EBI, Inc.) oriented vertically. The signal measured between the coils was a 15 mV single pulse, repeating at 72 Hz. Cultures were exposed to DC for 72 hours continuously, or to PEMF for a total of 24 hours. The total incubation time was 6 days. In some series, , 3H-proline was added to the media twenty hours before the termination of the experiment to determine protein synthetic capability of the spinal cord neurons. Neuritic outgrowth from the spinal cord explants was quantified by measuring the total area of the neuritic outgrowth and normalizing this area as a percentage of total cellular outgrowth for each explant.

Outgrowth from rat spinal cord was consistently longer and more dense than that obtained from chick spinal cord; both responded to the two different electrical signals. Both DC and PEMF treatments produced a significantly larger increase in the area of neuritic outgrowth relative to control explants ( $p = .02-.05$ ); the differences between experimental and control explants varied as a function of ara C concentrations.

Since the stimulation obtained with DC (virtually no magnetic field component) and PEMF (magnetic field component of 2-20 g) resulted from exposure of approximately equal total coulombic charge, it appears that the primary stimulus is the electric current. Although the current may affect the surface charge of the dish, it does not have observable effects on the orientation of the matrix. We may conclude, therefore, that the response obtained is correlated with either a direct effect of electric current on the cells of the spinal cord or an interaction of surface charge with the cellular components.

Supported by ONR N00014-82-K-0105

Wenner Gren Research Laboratory  
and Department of Anatomy  
University of Kentucky  
Lexington, KY 40506, U.S.A.

5th Annual BRAGS, Boston, Mass. USA Oct. 13-17, 1985

## METHODS

1. Explants of spinal cord (~200 um) from 8 day chick embryos or 16 day rat fetuses were placed in plasma clots located 10-12 mm from dish center.
2. The culture medium contained Dulbecco's MEM, glucose, pen/strep and cytosine arabinoside (ara C) at 5 or 8 ug/ml.
3. The cultures were treated with 10 nA constant current (DC) for 72 hours, or PEMF-V for 24 hours (12/12). <sup>3</sup>Hproline was added to all cultures 20 hours before fixation at 6 days.
4. The following parameters were used to assess electric field effects:
  - a. measurements of the area of neurite outgrowth (method of Dribin and Barrett, 1982)
  - b. acetylcholinesterase localization
  - c. morphology on thick plastic sections
  - d. immunofluorescent localization of transferrin

FIGURE 24

Figure 1. Culture Dish Top modified to deliver constant current (10-100 nA) to nerve tissue placed between the center cathode and peripheral anode.

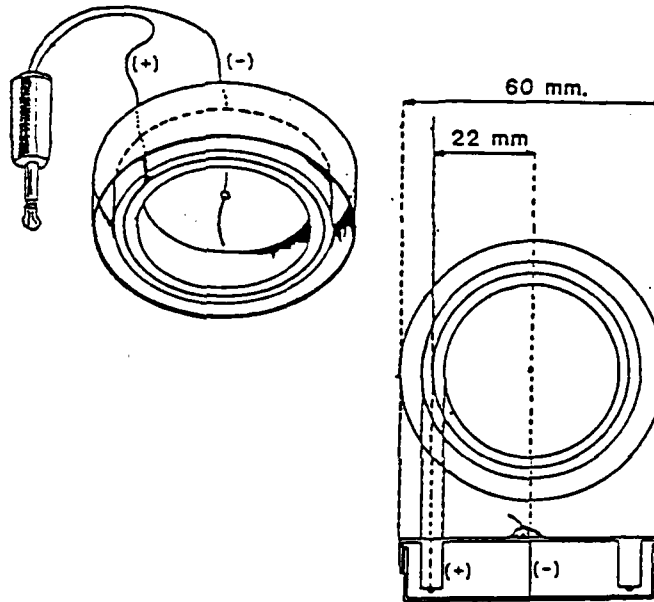

PEMF EXPERIMENTS

Vertical Orientation

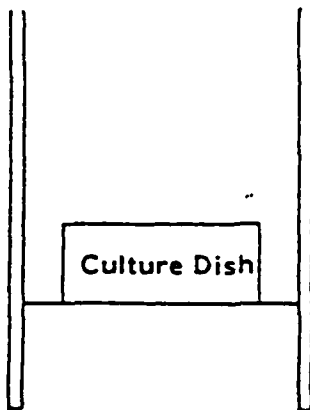

$0.48 \mu\text{A}/\text{cm}^2$  max.

minimum

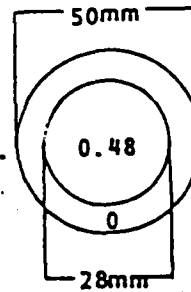

FIGURE 25

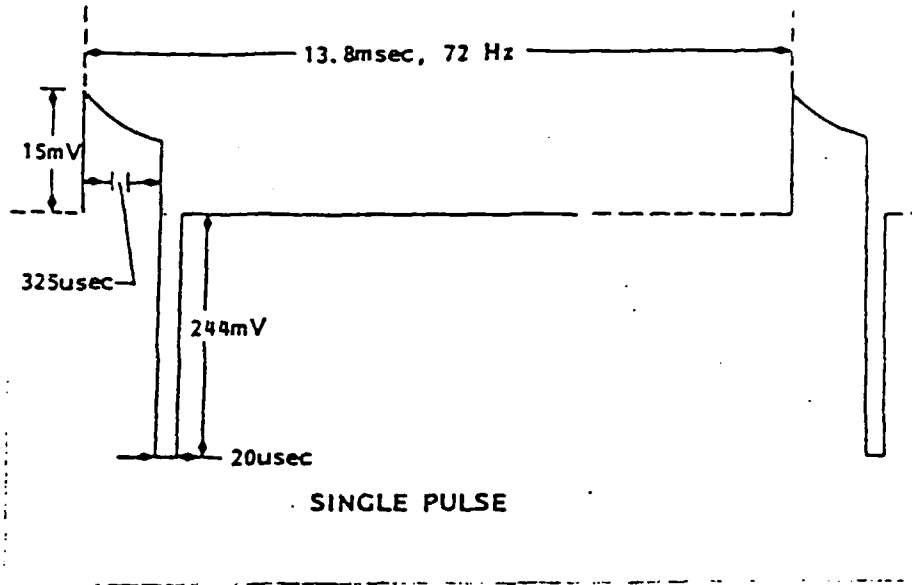

Figure 2. Single pulse waveform used in PEMF experiments.

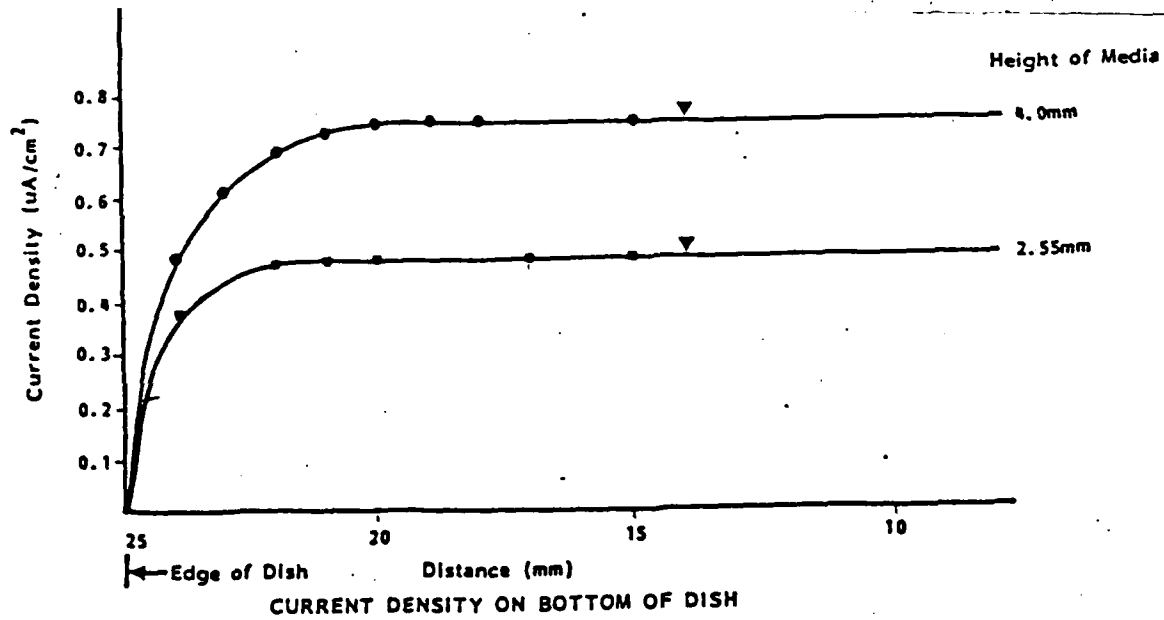

Figure 3. Current density ( $\mu\text{A}/\text{cm}^2$ ) as a function of dish radius and height of the medium.



Figure 26. Photographs of spinal cord explants obtained from 8 day chick embryos or 16 day fetal rats after 6 days in vitro. Autoradiographs of 8 day chick spinal cord treated for 2 days with PEMF-V in the presence of 2.5 ug/ml cytosine arabinoside. Note the blackened neurites (nts) grown from the original explant (expl) in A, and B. In A1 the method of determining the area of the neurite outgrowth is illustrated; the area of the total growth, and explant + neurites is digitized. The explant area is subtracted from the explant + neurite area yielding neurite area. In C, silver stained rat spinal cord treated with PEMF is illustrated. A, C = X 55; B= X139.



FIGURE 27

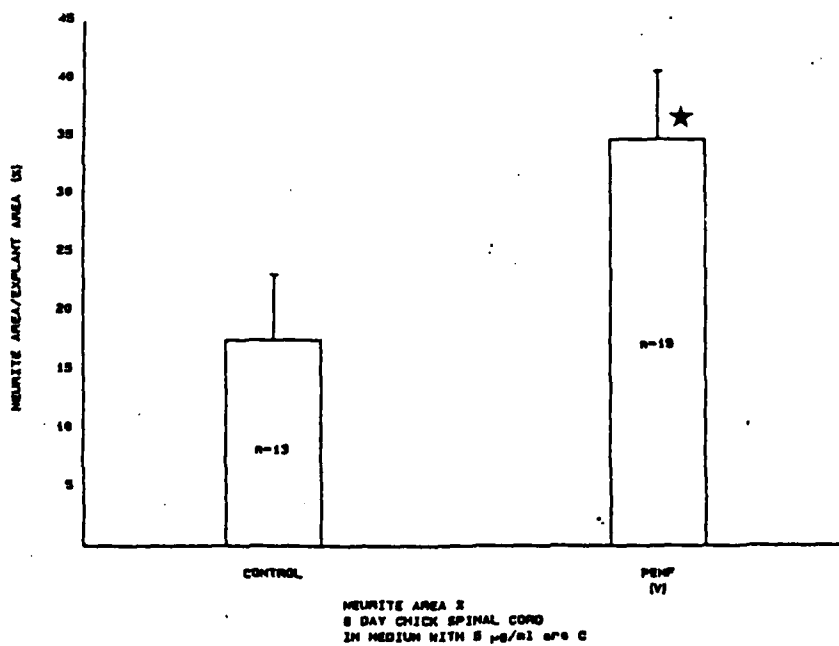
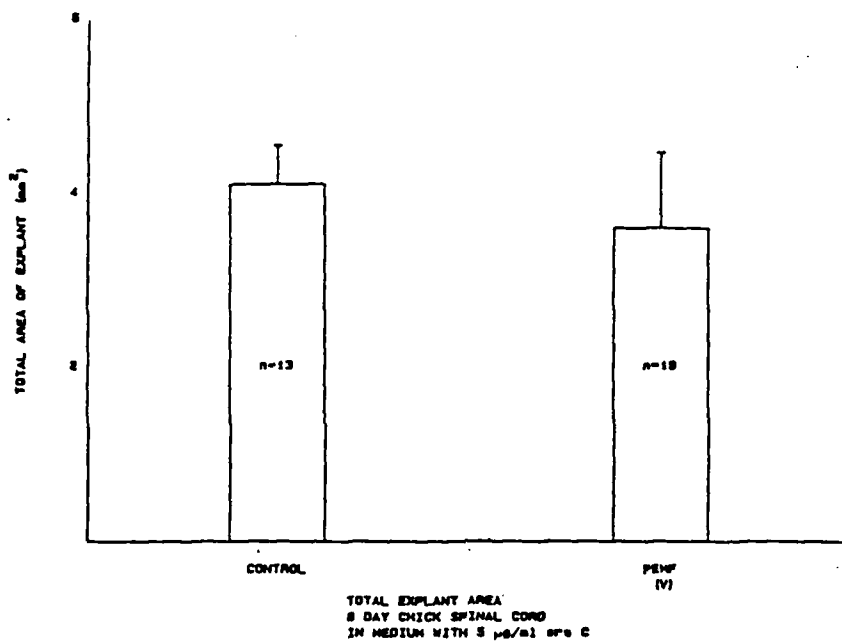

FIGURE 28

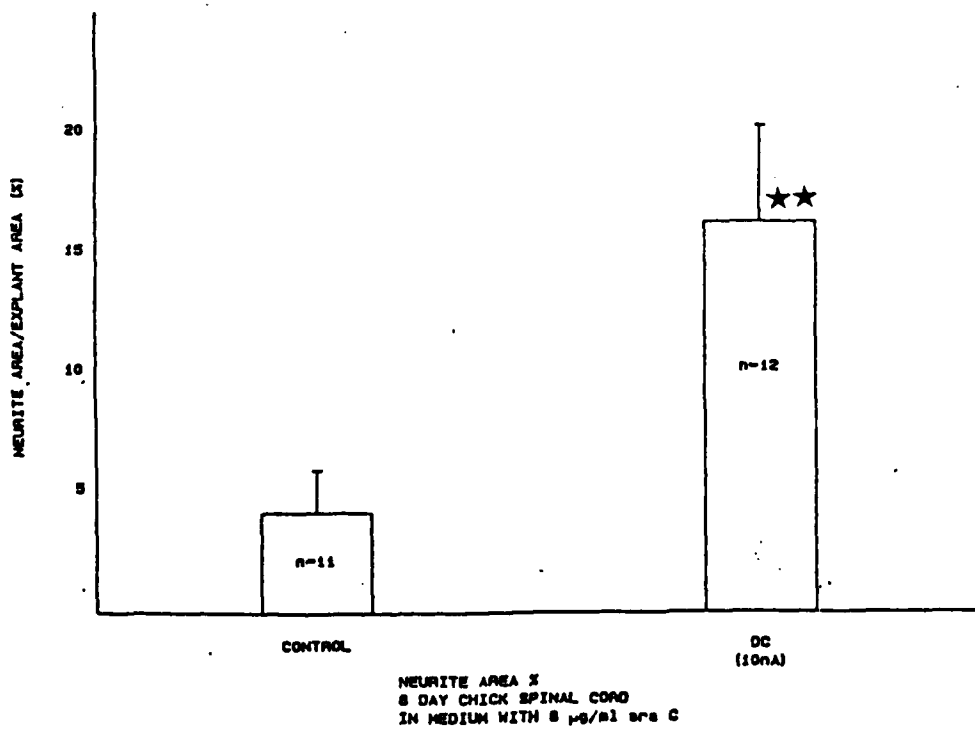
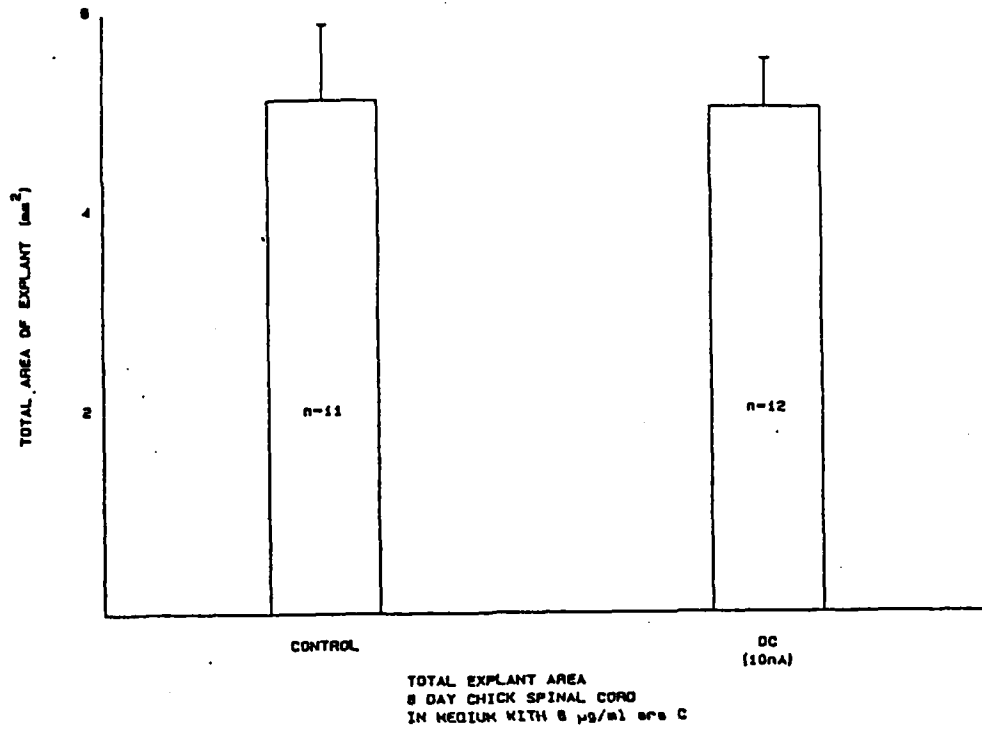
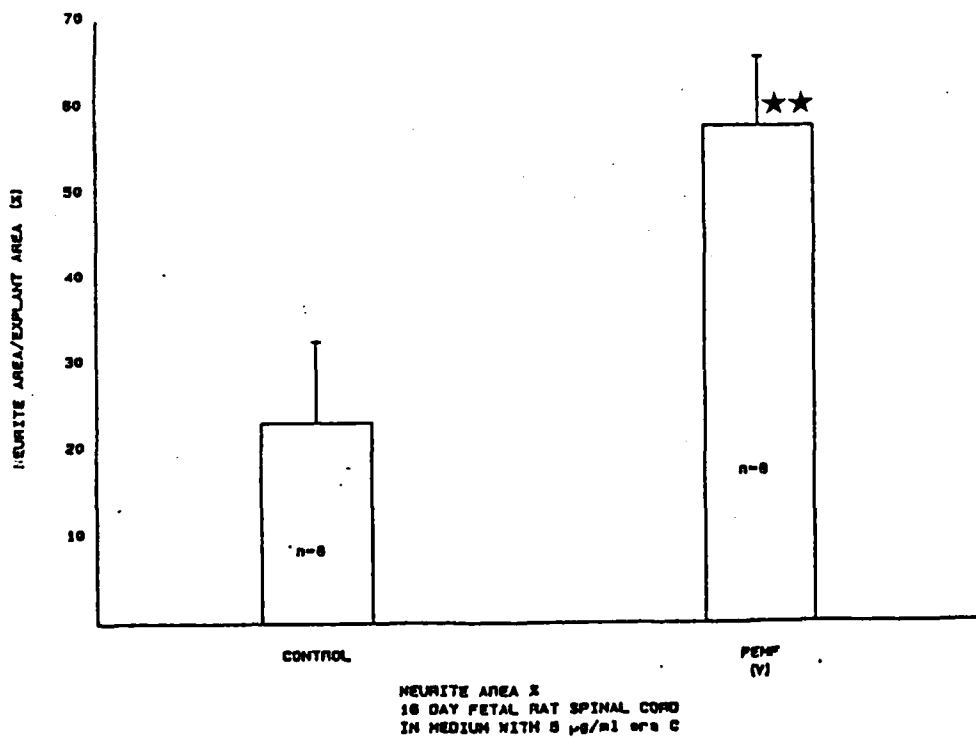
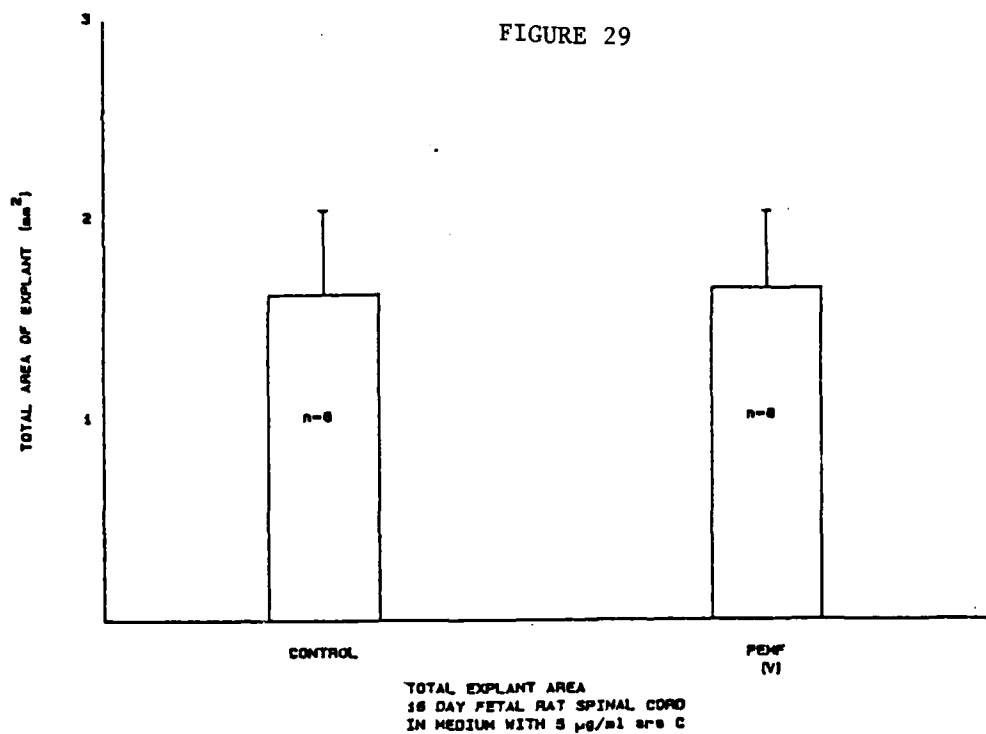

FIGURE 29



TABLE

(%) Neurite Outgrowth Area  
Total Explant Area ±S.E.M.

ARA C	Control	DC	PEMF-V	Diff
Chick				
IA-5	17.67 5.55		34.90 5.9	17.23
IA-8	4.14 1.78	16.26 4.02		12.12
Rat				
IA-5	23.25 9.4		57.64 7.89	34.39

## CONCLUSIONS

1. On radioautographs, protein synthetic activity was found in neurites and cell bodies; neurite outgrowth was quantified.
2. Presence of viable neurons was confirmed by cholinesterase activity, morphology and localization of transferrin in neurons and neuritic processes.
3. Area of neurite outgrowth was significantly increased by both DC and PEMF.
4. We propose that the growth stimulation is correlated with the electric current applied or induced in the tissue, although other mechanisms may be involved.

## PEMF EFFECTS ON NORMAL CHICK DEVELOPMENT (H-11)

Bioelectromagnetics Society Meeting

June 12-17, 1983

OF RATS EXPOSED IN UTERO TO MICROWAVE  
Sch\*, James Chrobak\*, John C. Prokasa\*,  
sa, Oklahoma 74104

were placed in individual plexiglas  
controlled anechoic chamber to 2450-MHz  
density of 30 mW/cm<sup>2</sup> for 6 hours daily  
Passive cage control and holder control  
statistical comparison. Twelve of the  
pups and these litters were culled to  
regularly for several aspects of behavior-  
included: body mass, righting, eye  
field, avoidance, and positioning and  
analysis on the developmental measures  
distinguishable from cage control  
significantly different from the other  
ts did not show differences in avoid-  
n placed in a runway heated to form a  
in the cooler sections of the runway.  
al sensitization only with regard to

H-11 THE EFFECTS OF PULSED ELECTROMAGNETIC FIELDS (PEMF) ON CHICK EMBRYOS AFTER LIMB  
AMPUTATION. Betty F. Sisken, Ira Fowler\* and Richard Kryscio\*, Wenner-Gren Research  
Lab, Dept. of Anatomy, Dept. of Statistics, Univ. of Kentucky, Lexington, KY 40506

We have data on a large sample of chick embryos that have been treated with two different PEMF signals demonstrating no significant effects on normal development. We have also investigated the effects of such signals on the induction of limb regeneration in amputated limbs of chick embryos. The right forelimb of 217 chick embryos (4 days of age) were amputated. Seventy-eight of these embryos were subsequently incubated in a conventional egg incubator and were designated as "controls". Four different PEMF signals were used on the remaining 139 embryos. In no group, control or treated, did we observe any induction of regeneration. However, using a chi square statistical test, we did see a significant (0.05-.001) increase in the incidence of body abnormalities, 6 days post-surgery, that was correlated directly with the total number of hours of exposure to any of the signals. The one exception was found in a group where the exposure to PEMF was delayed for the first 24 hours after surgery. We conclude from these studies that PEMF does not induce limb regeneration in our chick model, but that it does interfere with normal processes of development when combined with surgical procedures such as limb amputation. Supported by the Veteran's Administration Research Program.

Pařková, Institute of Hygiene  
vakis

e to solve the problem of possible  
c waves (EMW), when artificial EMW  
ent. Present state of knowing is  
l phases and tendency of research.  
ne different microgenetic systems,  
riod, but throughout the whole  
ed. The need to base the objective  
embryotoxicity also upon the func-  
postnatal period of life, is

H-12 THE EFFECTS OF PULSED ELECTROMAGNETIC FIELDS (PEMF) ON NORMAL CHICK DEVELOPMENT  
Betty F. Sisken, Ira Fowler\*, Chris Mayaud\* and Richard Kryscio\*, Wenner Gren Re-  
search Lab., Dept. of Anatomy & Dept. of Statistics, University of Kentucky, Lexing-  
ton, KY 40506, and Dept. Orthopaedic Surgery, Mt. Sinai Sch. Medicine, NY, NY 10028

A number of recent studies, using a comparatively small sample size, have reported on the effects of clinical-type PEMF signals on normal chick development. Our studies evaluated 1008 embryos. Two different pulse signals from research units provided by Electrobiolgy, Inc. were examined. Fertile eggs were exposed to these signals at 37°C either continuously for 7 days or for the first 24 hours only. Control eggs were placed in a different incubator, at 37°C, far removed from the coils. All embryos were collected after 7 days of incubation, fixed in formalin, coded and scored at a later time. Scoring was done in a double-blind fashion, and the data was analyzed using a chi square statistical test to determine the frequency of abnormalities. In 78 eggs treated with one signal in either a horizontal or vertical position, no significant differences were noted relative to the 73 matched control eggs. In 376 eggs treated with the second signal, no significant incidence of abnormality was found relative to 273 matched controls. A separate group of eggs were treated or untreated at 39°C to test the effects of PEMF with increased temperature. A significant increase in morphological abnormalities occurred in 84 treated relative to the 106 controls. Supported in part by the Veteran's Administration Research Program.



EXAMINATION OF DOSIMETRY IN STUDIES OF DEVELOPING CHICK EMBRYOS  
UNDER WEAK ELECTROMAGNETIC FIELD EXPOSURE.

24

Pilla, A.A., \*Sisken, B.F., \*Fowler, I., Mayaud, C., Ryaby, J.P.  
and Ryaby, J.T.

Weak pulsating electromagnetic fields have been demonstrated to affect a variety of in vivo and in vitro biological processes. Many studies show that both electrical and biological windows exist. For a defined cell/tissue geometry electrical dosage can be described by quantitating the actual cell-waveform interaction using knowledge of the passive electrical characteristics of the cell or tissue and the waveform parameters of the electrical signal at the cellular level. State of the art impedance measurements have provided data for some cells relevant to the kinetics of the cell's response to electrical current. Remarkably quantitative correlations have been obtained for the dependence of bioeffect upon induced voltage waveform parameters by defining a frequency spectrum of the power in electrically active pathways at the cell surface.

From the above, it can be seen that a quantitative assessment of electrical dosage actually applied to the developing chick embryo is necessary to comparatively examine the several reported studies on the effect of weak fields on chick embryo development. The impedance of a fertilized egg containing a chick embryo in various stages of development has not been experimentally quantitated. It is essential to know the time variation of the magnetic field (dB/dt) generated by the coil system employed. This can be easily obtained by knowledge of the coil inductance and resistance and the time variation of the current in the coil. Equally valid is a direct measurement of the shape of dB/dt by the use of a secondary probe coil. Either of the above approaches will give the shape of the induced electric field vector in both polarities. This, coupled with the peak magnetic field value is sufficient to define the voltage perturbation at the cellular level. If the coil/egg geometry is known, amplitude comparison is possible.

The parameters mentioned above have not been given in studies which have claimed that developmental deformities are caused by weak fields. In fact these studies provide only the coil driving voltage and the average magnetic field (erroneously determined using a Gaussmeter having a frequency response up to 1 kHz- too low for the frequency present). Finally, and particularly in developmental studies, it is important to establish that there is not sufficient current in the coils to cause heating in the spaces occupied by the egg or target cells. Studies carried out by the present authors on developing chick embryos with fields in clinical use for bone healing have produced no significant effect on embryogenesis. The embryos were exposed for 1 or 7 days and examined at 7 days. Coil environment temperature did not vary by more than 0.1°C. The two signals tested were repetitive bursts of bipolar voltage pulses. Signal A consisted of rectangular pulses having 250 usec main polarity and 6 usec opposite polarity durations respectively (this is dB/dt). This pulse was repeated at 3.8 kHz for a burst duration of 50 msec. Each burst was repeated at 2 Hz. The peak magnetic field is 2.5G and the average is 0.1G. Signal B consisted of a 200 usec main and 20 usec opposite polarity rectangular pulse. This was repeated at 4.4 kHz for a burst duration of 5 msec. The burst was repeated at 15 Hz. The peak magnetic field is 16G and the average 0.5G.

In conclusion, therefore, it is important to note that it is well established that the degree of bioeffect of electromagnetic fields does indeed depend upon the waveform of the induced electric field vector actually "seen" by the target cells and tissues. It is equally important to establish that any bioeffects observed are actually caused by the electromagnetic field. For this a proper description and measurement of the voltage actually applied to the target is essential. It is proposed that the parameters given in this study be adopted as physical descriptors when bioeffects of electromagnetic fields are reported. Bioelectrochemistry Laboratory, Department of Orthopaedic Surgery

Mt. Sinai School of Medicine, New York, NY. 10029

\*Wenner Gren Laboratory, Univ. of Kentucky, Lexington, KY 40506

Accepted (with revisions) J. Bioelectricity  
\*revisions not included

PULSED ELECTROMAGNETIC FIELDS AND NORMAL CHICK DEVELOPMENT

Betty F. Sisken and Ira Fowler  
Wenner-Gren Research Laboratory and Department of Anatomy  
University of Kentucky  
Lexington, KY 40506

Chris Mayaud, James Ryaby and Arthur A. Pilla  
Bioelectrochemistry Laboratory  
Department of Orthopedics  
Mt. Sinai School of Medicine  
New York, NY 10029

ABSTRACT

The effects of two clinical-type signals of pulsed electromagnetic fields (PEMF) were tested on a large sample of developing chick embryos by two independent laboratories. The embryos were examined after seven days of incubation to avoid the early stages when most spontaneous abnormalities occur. The data were pooled and analyzed statistically. Neither signal, when administered continuously for the first seven days of development, or for the first 24 hours, produced a significant increase in the incidence of malformations. These results are discussed in relation to those of other investigators claiming PEMF-related effects on normal development.

INTRODUCTION

The environment in which we live has a static geomagnetic field of about 0.5 gauss, and contains magnetic and electromagnetic pollution from various sources. Delgado et al (1) presented evidence that chick embryos exposed to very weak, low-frequency electromagnetic fields for the first 48 hours of development show significantly increased malformations in the nervous system, somites and blood vessels. Maffeo et al (2) failed to confirm these results and stated "In view of the obvious importance of the observations (of Delgado), other independent investigators are strongly encouraged to try to replicate the observations." This report presents the results of our attempts

to test for anomalies by exposure of chick embryos to pulsed electromagnetic fields (PEMF) that are in human and equine use.

The exposures of chick embryos to PEMF were conducted independently in laboratories at the University of Kentucky, Lexington, KY and Columbia University in New York, NY. Since growth and differentiation rates of the embryo are highly variable during early development of normal embryos, it is impossible to determine whether slow development represents abnormal retardation. In 48-hour chick embryos, body form has not been established, making it difficult and ambiguous to detect morphological deviations from the norm. Therefore, we terminated our experiments at 7 days of incubation when severe anomalies are easily detected by examination under low-power magnification.

#### MATERIALS AND METHODS

Fertile eggs from White Leghorn chickens were obtained from the poultry farm at the University of Kentucky and from Shamrock Farms, North Brunswick, N.J. The eggs were placed between two identical 10 cm x 10 cm coils wound with 50 turns of #14 B&S gauge copper magnet wire. The coils were placed in the horizontal position, 7.5 cm apart and were magnetically-aided to provide approximately Helmholtz conditions. The coils were powered by two different signals as provided by Electrobiolgy, Inc., N.J. The exposures were carried out in a 37°C incubator continuously for either seven days or for only the first 24 hours. Control eggs were incubated at the same temperature in a separate standard egg incubator approximately 5 feet from the coils. After seven days, the embryos were collected, fixed in formalin and assigned a number. The eggs exposed in N.Y. were collected, assigned a coded number and

## FIELDS AND NORMAL CHICK DEVELOPMENT

sent to Kentucky for morphological assessment. All scoring for gross abnormalities was done by two different investigators in a double-blind fashion in Lexington; the code was not broken until all of the data were collected.

The two signals tested were repetitive bursts of bipolar pulses. The first signal (A) consisted of pulses of 250  $\mu$ sec in the main polarity (i.e. while power is applied to the coils) and 6  $\mu$ sec opposite polarity (i.e. during magnetic field collapse). This pulse was repeated at 3.8 kHz for a burst duration of approximately 50  $\mu$ sec. Each burst was repeated at 2 Hz. The induced electric field amplitude in air of the main polarity pulse is 0.16 mV/cm (peak) as determined with a calibration probe 1.5 cm from the geometric center of the coils (3). The peak Gauss of this signal is 2.5 and the average Gauss is 0.1, dB/dt = 0.01 G/ s main polarity, 0.4 G/ s opposite polarity. The second signal tested (B) is commonly employed clinically for the repair of recalcitrant bone fractures (4,5). It consisted of a main polarity pulse of 200  $\mu$ sec duration and a 20  $\mu$ sec opposite polarity portion. This pulse was repeated at 4.4 kHz for a burst duration of approximately 5 msec. The burst was repeated at 15 Hz. Amplitude of the main polarity pulse is 1.5 mV/cm (peak) induced electric field in air (same measurement conditions as signal A). The peak magnetic field is 16 Gauss, average Gauss of 0.5; dB/dt = 0.08 G/ sec main polarity and 0.8 G/ sec opposite polarity.

The following criteria were used to denote abnormalities: gastroschisis (abdomen open and viscera exposed), thoraco-gastroschisis (thorax and abdomen open with heart and viscera exposed), spina bifida (open spinal canal with unformed vertebrae), encephalocele (meninges filled with fluid, brain exposed), microcephaly (small brain), microphthalmia (small eye) and

anophthalmia (eyes absent). Any one abnormal condition appearing in any egg was scored as abnormal. No abnormality occurred in the PEMF-treated group that was not also seen in the control group.

#### RESULTS

The data obtained from both Lexington and New York were pooled for each experiment and summarized in Tables 1-4. Note that the percentage of abnormalities in control embryos ranged from 8-22% across the three experiments, and are comparable to those obtained by Delgado (1) and Maffeo (2), Table 4. The percentage of abnormalities in PEMF-treated embryos ranged from 15-30%. The proportions of abnormalities in the control and PEMF-treated embryos were compared statistically by constructing a 1 degree of freedom, continuity corrected chi-square test for each table; none of these chi-square tests were significant at the 0.05 level (or even the 0.1 level) of significance.

If exposure of the embryos to these electric fields had any effects on development, we should have been able to detect these effects with the sample sizes in this study. In particular, with sample sizes of 73 embryos or more in each group, we had a 99% chance of detecting an increase of at least 30% in the percentage of abnormalities due to PEMF exposure. An increase in the percentage of abnormalities due to PEMF was observed in each experiment, but this increase was only modest (about 7%) and was not statistically significant. This is in direct contrast to Delgado et al (1) who reported a 40% increase in the incidence of abnormalities using similar but not identical fields.

## FIELDS AND NORMAL CHICK DEVELOPMENT

### DISCUSSION

Our aim in this study was to determine if low levels of pulsed electromagnetic fields induced an increased incidence of abnormal development in chick embryos. To eliminate experimental <sup>variation</sup> ~~bias~~, we conducted the experiments in two different laboratories, using a sufficiently large sample size so that the data could be subjected to statistical analyses.

The percentage of untreated (control) embryos that are abnormal depends upon a number of factors such as the time of year and climate. In general, eggs laid in cold or hot weather are more likely to develop into embryos with obvious malformations than are eggs laid during mild weather of spring or fall (personal observations). Since these experiments were done mostly during the winter, controls were incubated as a part of each experiment along with the eggs exposed to PEMF signals. Rough handling of eggs during transportation and extended egg storage can also increase the incidence of anomalies. To eliminate these factors as a possible influence upon our results, the control eggs and the eggs to be exposed to PEMF in each experiment were always obtained from the same batch. Genetic variability within the chicken flocks, over which we had no control, also added to the necessity for a large sample size.

It has been well established that extrinsic or environmental factors that have deleterious effects upon embryos usually affect development at critical periods during the formation of specific structures. For example, cortisone injected into pregnant mice at 12 days of gestation will cause cleft palate in the offspring (13). The same dose of cortisone injected earlier or later during pregnancy usually fails to produce cleft palate. The palate closes at 15 days of gestation in the mouse embryo; thus cortisone acts as a teratogenic

agent only during the critical phase of palatal development, 3 days prior to its closure. Since many teratogenic agents produce severe defects when applied during early phases of development, we exposed some embryos to PEMF only for the first 24 hours and allowed development to continue for an additional six days. In a second series of experiments, the embryos were exposed continuously for the entire seven days. During this period, development of all major systems is initiated and, in most systems, growth and differentiation has proceeded past the stages of development at which organs are most sensitive to environmental changes. Any deleterious effects of PEMF exposure during this period should have been expressed as visible morphological changes.

The question of dosimetry is obviously an important one in this as in any study using inductively-coupled signals. When considering this problem, it should be pointed out that a variety of studies have shown the existence of electrical as well as biological windows (6-12). Thus, for a fixed cell/tissue geometry system (which is not the case in this study, as will be shown below), the electrical dosage can be described by quantitating the cell-waveform interaction via a spectral (frequency) analysis of the power delivered to the potential dependent (electrochemical) pathways at the cell's surfaces (13,14). Such analyses show that knowledge of both dB/dt and pulse width are generally sufficient for adequate correlation with the bioeffect given the relative independence (for inductively-coupled signals) of bioeffect on both repetition rate, between 1-100 Hz, and burst width (11,12). The biological windows appear related to cell cycle stage, degree of confluency, extracellular composition, and the presence of non-resting situations, e.g. development and trauma (11).

## FIELDS AND NORMAL CHICK DEVELOPMENT

An analysis of the spectrum of power affecting an electrochemical pathway involving ion binding at the cell surface has been presented elsewhere (13,14) for the two signals utilized in this study. This analysis appears to show that the opposite polarity portions (6  $\mu$ s and 20  $\mu$ s for signals A and B respectively) of both signals provide power levels that can be correlated with ion binding in the proposed cell surface pathway. In other words the effective portions of both signals occurs during magnetic-field collapse. Note that both signals have similar values for dB/dt in the opposite polarity. Furthermore, a narrower pulse always requires lower induced voltage amplitudes for similar bioeffects (11). The lower opposite polarity dB/dt for signal A places it within the effective range of signal B.

To compare the electrical dosimetry of this study with those reported by Delgado (1), it would be necessary to compare the rise times and shapes of the induced electric field signals in both polarities. Unfortunately, these were not given by Delgado explicitly, since graphic data on the induced electric field were not provided. Only the coil driving voltage was shown. It is impossible to predict what amplitude relationship existed for each polarity. In addition, knowledge of the peak magnetic field during coil activation was not given. The field intensity listed by Delgado is only the average field. Furthermore, it must be pointed out that the gaussmeter used in the Delgado study (RFL Industries model 750AR) has a frequency response only up to 1 KHz. This is far too low to obtain an accurate value of the average magnetic field when the coils are driven with signals having rise times  $\leq 2$  sec. We estimate that the  $10^{-2}$  Gauss field (1 T) reported by Delgado is at least one order of magnitude too low for his signals B and D. This would make his average field approximately 0.1 G, i.e. similar to that used in this study



(see Materials and Methods). Furthermore, the Delgado study described two widely different coil systems which, when powered with the pulses described, would have resulted in dramatically different values for  $dB/dt$ , particularly in the opposite polarity. It is not clear from his study whether results from both coils were pooled for a given coil. The use of Delgado driving signals A-D with identical amplitudes will generate different initial values of  $dB/dt$ . The fact that signal D was reported to give a much stronger effect than signal A may be simply related to the initial  $dB/dt$  differences caused by the large variation in driving pulse rise times (A 100 sec vs B 2 sec). The fact that Delgado pulse C was reported to give little effect when driven at the same voltage as pulses B or D may simply reflect once again the initial  $dB/dt$  differences. For signal C the driving pulse risetime was 7 sec which would result in an initial induced voltage more than 3X less than that for signals B or D. Note, however, that without knowledge of the manner in which the magnetic field collapsed (i.e.  $dB/dt$  for the opposite polarity), it is impossible to assess this dosage difference in a rigorous quantitative fashion.

It has been shown elsewhere (3) that the presence of a non-homogeneous target, e.g. cells in an ionically conducting medium, creates large changes in electrical dosimetry. The passive electrical characteristics of the developing chick embryo have not been reported. Nevertheless it is clear that as the number of cells and their orientation change with development, the actual power applied to the biological target varies. Thus, as the impedance increases in any given induced current pathway due to increased cell number (density), the current density within the cell layer decreases. It is therefore difficult to quantify the actual electrical perturbation at the cellular

## FIELDS AND NORMAL CHICK DEVELOPMENT

level. It is essential, however, that the actual shape of the induced electric field, rather than the coil driving voltage, be measured for all experiments designed to test the bioeffects of PEMF's. In this manner, for any given geometric complexity, at least the driving voltage at the cell level can be evaluated.

## ACKNOWLEDGEMENTS

We wish to thank Dr. R. Kryscio for his statistical advice. Supported by Veterans Administration, Office of Naval Research N00014-82-K-0105 and Electrobiolgy Inc., N.J.

## REFERENCES

- (1) Delgado, J.R., Leal, J., Monteagudo, J.L. and Garcia, M.G.: Embryological Changes Induced by Weak, Extremely Low Frequency Electromagnetic Fields, *J. Anat.* 134, 533-551, 1982.
- (2) Maffeo, S., Miller, M.W. and Carstensen, E.L.: Lack of Effect of Weak Low Frequency Electromagnetic Fields on Chick Embryogenesis, *J. Anat.* 139, 613-618, 1984.
- (3) Pilla, A.A., Sechaud, P. and McLeod, B.R.: Electrochemical and Electrical Aspects of Low Frequency Electromagnetic Current Induction in Biological Systems, *J. Biol. Phys.* 11, 51-58, 1983.
- (4) Bassett, C.A.L., Pilla, A.A. and Pawluk, R.J.: A Non-Operative Salvage of Surgically-Resistant Pseudarthroses and Non-Unions by Pulsing Electromagnetic Fields, *Clin. Orthop.* 124, 128-143, 1977.
- (5) Bassett, C.A.L., et al.: Modifications of Fracture Repair with Selected Pulsing Electromagnetic Fields, *J. Bone and Joint Surg.* 64A, 888-895, 1982.
- (6) Chiabrera, A., et al.: Cytofluorometry of Electromagnetically Controlled Cell Dedifferentiation, *J. Histochem. and Cytochem.* 27, 375-381, 1979.
- (7) Assailly, J., Monet, J.D., Goureau, Y., Christel, P. and Pilla, A.A.: Effects of Weak Inductively Coupled Pulsating Currents on Calcium Uptake

- in Embryonic Chick Tibia Explants, *Bioelectrochem. and Bioenergetics* 8, 515-521, 1981.
- (8) Christel, P., Cerf, G. and Pilla, A.A.: Modulation of Rat Radial Osteotomy Repair Using Electromagnetic Current Induction, in *Mechanisms of Growth Control*, R.O. Becker, ed., Charles C. Thomas, Springfield, 237-250, 1981.
  - (9) Sisken, B.F., Lafferty, J.F. and Acree, D.: The Effects of Direct and Inductively Coupled Current, and Nerve Growth Factor on Nerve Regeneration In Vitro, in *Mechanisms of Growth Control*, R.O. Becker, ed., Charles C. Thomas, Springfield, 251-274, 1981.
  - (10) Smith, S.D. and Pilla, A.A.: Modulation of Newt Limb Regeneration by Electromagnetically Induced Low Level Pulsating Current, in *Mechanisms of Growth Control*, R.O. Becker, ed., Charles C. Thomas, Springfield, 137-152, 1981.
  - (11) Rein, G. and Pilla, A.A.: A New In Vitro Cell Adhesion Model System for Studying the Bioeffects of Induced Current Waveform Parameters, in *Proceedings 4th Annual Bioelectrical Repair and Growth Society Meeting*, S. Inoue and H. Takahashi, eds., Nishimura Co., Niigata, Japan, In Press, 1985.
  - (12) Mayaud, C., Pilla, A.A., Costa, F. and Rein, G.: The Effect of Pulsating Electromagnetically Induced Current on Classical Complement - Mediated Hemolysis, in *Proceedings 4th Annual Bioelectrical Repair and Growth Society Meeting*, S. Inoue and H. Takahashi, eds., Nishimura Co., Niigata, Japan, In Press, 1985.
  - (13) Pilla, A.A. and Kaufman, J.J.: Frequency Characterizations of Electromagnetically Induced Current Waveforms and the Electrical Window for Biological Effect, in *Proceedings 4th Annual Bioelectrical Repair and Growth Society Meeting*, S. Inoue and H. Takahashi, eds., Nishimura Co., Niigata, Japan, In Press, 1985.
  - (14) Pilla, A.A.: Electrochemical Information Transfer at Cell Surfaces and Junctions - Application to the Study and Manipulation of Cell Regulation, in *Bioelectrochemistry*, H. Keyzer and F. Gutmann, eds., Plenum Press, New York, 353-396, 1980.
  - (15) Fraser, F.C.: Etiologic Agens. II. Physical and Chemical Agents, in *Handbook of Congenital Malformations*, A. Ruben, ed., W.B. Sanders Co., Philadelphia, PA, 365-371, 1967.

FIELDS AND NORMAL CHICK DEVELOPMENT

TABLE 1

Exposure to PEMF Signal A for First 24 Hours Followed by Incubation Without Exposure

<u>GROUP</u>	<u>NORMAL</u>	<u>ABNORMAL</u>		<u>TOTAL</u>	<u>PERCENT ABNORMAL</u>
		<u>Dead</u>	<u>Live</u>		
Control	42	5	7	54	22.22
PEMF	97	16	25	138	29.71

Chi-square = 0.75 (ns)

TABLE 2

Continuous Treatment for 7 Days using Signal A.

<u>GROUP</u>	<u>NORMAL</u>	<u>ABNORMAL</u>		<u>TOTAL</u>	<u>PERCENT ABNORMAL</u>
		<u>Dead</u>	<u>Live</u>		
Control	187	5	25	217	13.8
PEMF	192	3	43	238	19.33

Chi-square = 2.09 (ns)

FIELDS AND NORMAL CHICK DEVELOPMENT

TABLE 3

Continuous Treatment for 7 Days using Signal B.

<u>GROUP</u>	<u>NORMAL</u>	<u>ABNORMAL</u>		<u>TOTAL</u>	<u>PERCENT ABNORMAL</u>
		<u>Dead</u>	<u>Live</u>		
Control	67	15	5	73	8.22
PEMF	66	2	10	78	15.38

Chi-square = 1.23 (ns)

TABLE 4

## Incidence of Abnormalities in Control Embryos

<u>REPORT</u>	<u>STAGE OF DEVELOPMENT</u>	<u>TOTAL NUMBER OF EGGS</u>	<u>FREQUENCY OF ABNORMALS</u>
Delgado (1)	2 days	26	18%
Maffeo (2)	2 days	72	18%
Sisken (combined)	7 days	344	14.7%

THE EFFECTS OF PULSED ELECTROMAGNETIC FIELDS (PEMF) ON RAT SCIATIC NERVE REGENERATION

19

B. Parker<sup>1</sup>, C. Bryant<sup>1</sup>, J. Apesos<sup>1</sup>, B. F. Sisken<sup>2,3</sup>, and T. Nickell<sup>2</sup>

The influence of pulsed electromagnetic fields (PEMF) on peripheral nerve regeneration was studied in a group of nine Sprague Dawley rats (400-500 gms.). In each rat the right sciatic nerve was surgically divided and the fascicles individually repaired; the left sciatic nerve remained intact and served as a within-animal unoperated control. After surgery, each rat was put into a non-metallic restrainer. The restrained rat was placed between two Helmholtz coils (EBI, Inc., NJ) so that the horizontal axis of the rat was perpendicular to the vertical direction of the magnetic field. Five rats were exposed to a clinical-type pulse burst PEMF for two hours a day for five days. Three control rats were restrained for the same time periods but were not subjected to PEMF. Twenty-eight days after surgery both the left, unoperated, and right, operated, sciatic nerves were removed. Two centimeter nerve segments were placed in a moist chamber containing platinum electrodes at either end. The proximal segment was crushed and the compound action potential (CAP) was recorded on each nerve by stimulating proximally and recording distally. All CAP's were recorded on an oscilloscope and photographed. The area under the curve was determined from the photographs with a MOP III Digitizer (Zeiss). After each recording, the nerves were fixed in 3.5% glutaraldehyde overnight for future histological studies. The area under the curve of the CAP is proportional to the total number of axons that have crossed the repair site and was used as the parameter to assess regeneration.

A Split Plot Analysis of Variance of the CAP area ( $\text{mm}^2$ ) revealed that there was a significant difference ( $\alpha = .05$ ) between the control left side (see Table 1) and the control right side. There was no significant difference between the left PEMF side and the right PEMF side, indicating that the total exposure of 10 hours of PEMF improved the rate of regeneration of the operated nerves. In addition, PEMF significantly increased the rate of regeneration of the right operated nerves in comparison to control right operated nerves. However, there was also a significant difference between the left unoperated control nerves and the left unoperated PEMF nerves suggesting that the PEMF may also alter normal neuronal function.

TABLE I. Area ( $\text{mm}^2$ )  $\pm$  S.E.M. of CAP in Control and PEMF Rats

	<u>Control (3)</u>	<u>PEMF (5)</u>
Left, unoperated	36,980 $\pm$ 4730	25,409 $\pm$ 5972
Right, operated	6,960 $\pm$ 1467	19,034 $\pm$ 5730

Supported by BRSG (Biomed. Res. Supp.  
Div. NIH) and ONR N00014-82-K-0105

1 Div Plastic Surgery, UK Med Center  
2 Wenner-Gren Laboratory, UK  
3 Dept. Anatomy, UK Med Center

3rd Annual BRAGS, San Francisco, California, October 2-5, 1983



FIGURE 30

PEMF Effects on Sciatic Nerve Regeneration in the Rat

Parker, B., Bryant, C., Apesos, J., Sisken, B.F. and Nickell, T.  
3rd Annual BRAGS San Francisco, CA October 2-5, 1983

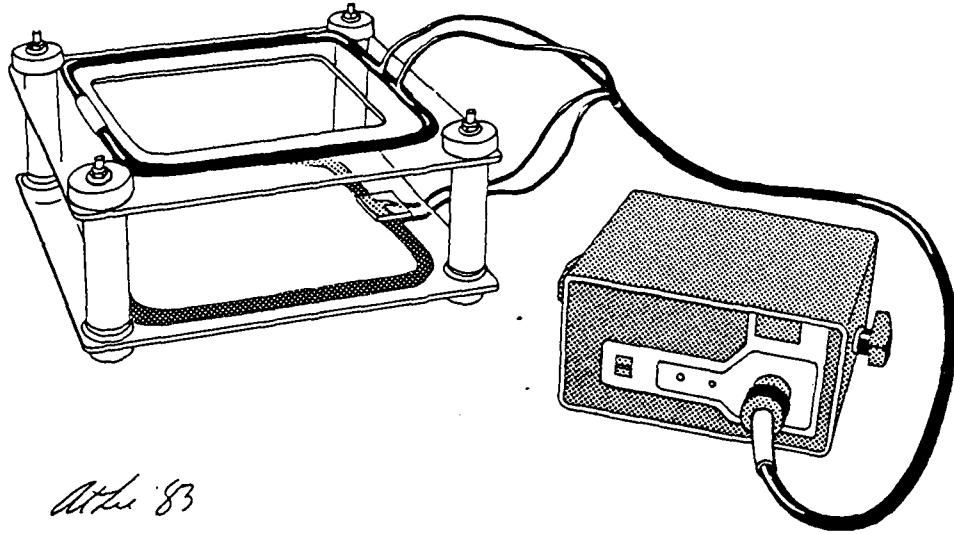

*Atkins 83*

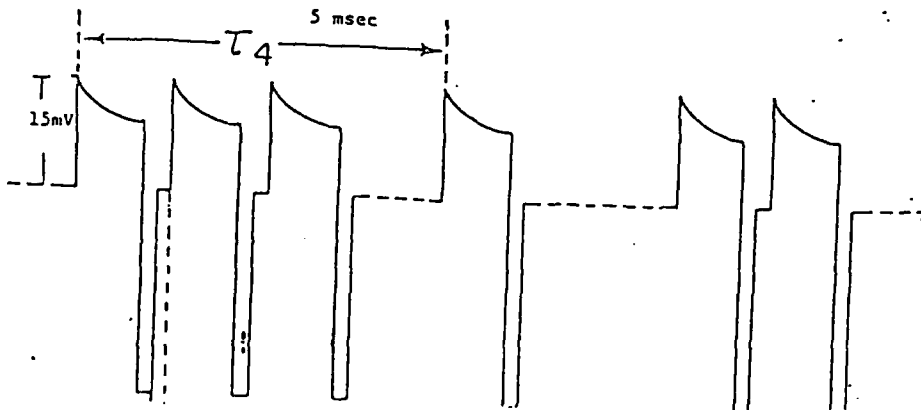
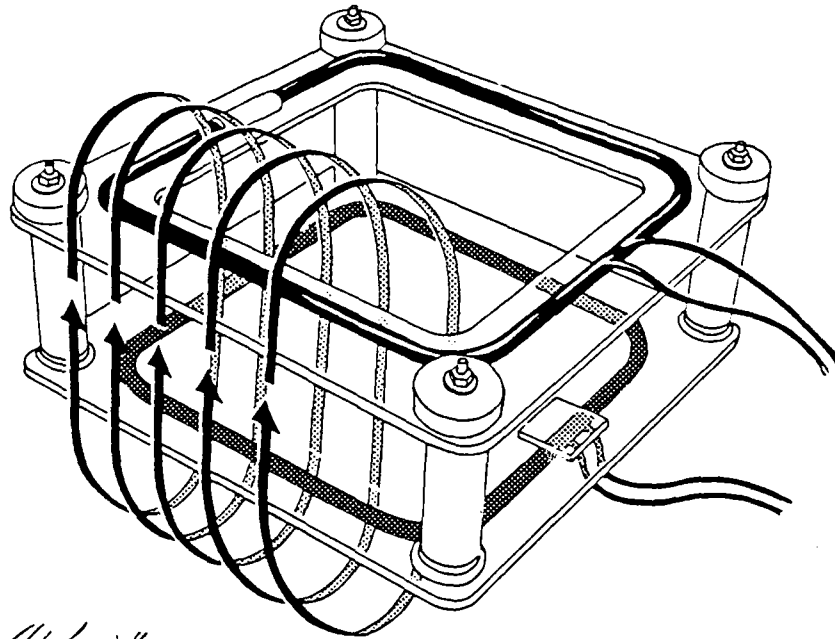

FIGURE 31

PEMF Effects on Sciatic Nerve Regeneration  
in the Rat

Parker et al, 1983



*Alt. Sci '83*



*Alt. Sci '83*

AD-A170 597

NERVE REGENERATION IN VITRO: COMPARATIVE EFFECTS OF  
DIRECT AND INDUCED CURRENT AND NGF(U) KENTUCKY UNIV  
RESEARCH FOUNDATION LEXINGTON B F SISKEN ET AL  
26 NOV 85 N00014-82-K-0105

2/2

UNCLASSIFIED

F/G 6/3

ML

ENVQ

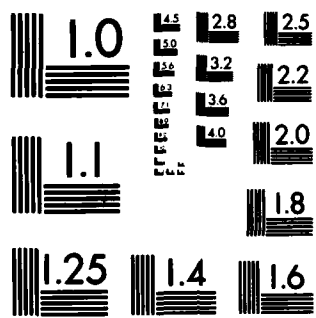

MICROCOPY RESOLUTION TEST CHART  
NATIONAL BUREAU OF STANDARDS-1963-A

FIGURE 32

PEMF Effects on Sciatic Nerve Regeneration in the Rat  
 Parker et al, 1983

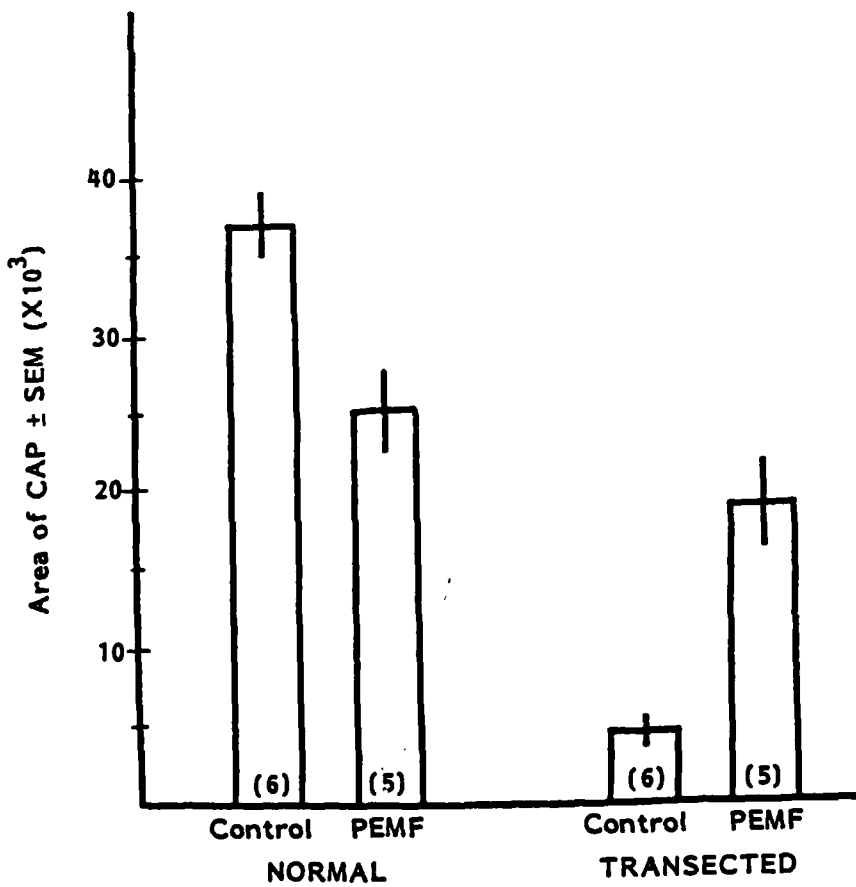
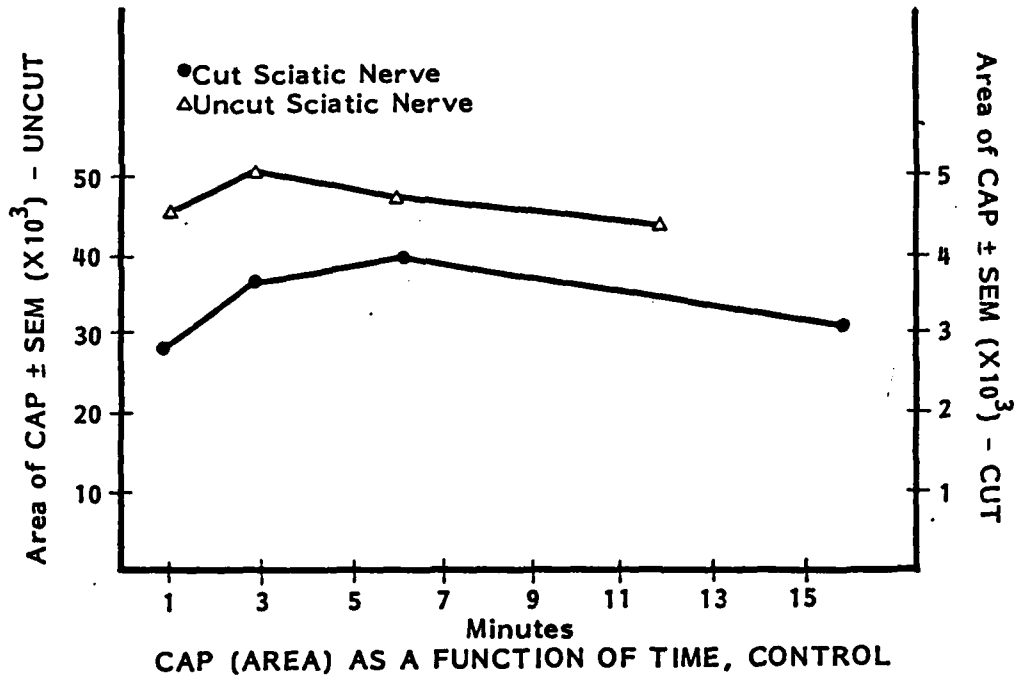

B.F. Sisken &amp; I. Fowler

Partial limb regeneration can be induced in embryonic, young, and adult stages of non-regenerating species of vertebrates (chick, opossum, rat and frog). To date, the most effective method appears to be augmentation of nerve supply to the amputated stump. In the rat, application of direct current or direct current with injections of nerve growth factor (NGF) also evokes regenerative responses. Recently, we reported the production of accessory "long" bones after mid-humeral amputation and implantation of embryonic spinal cord in young rats (3 weeks old). In some cases these bones lay adjacent to the humerus and achieved lengths approximating 1/3 that of the original humerus. The following experiments were designed to maximize this regenerative potential by implanting bimetallic electrodes with the embryonic nervous tissue. Male rats (inbred Harlan Fisher F344, 21-28 days old) were anesthetized with ether and the right fore-limbs were amputated at the mid-humeral level. Experimental animals received implants of fetal (14 day) brain or spinal cord obtained from pregnant Harlan Fisher F344 mothers. Twenty six animals received nervous tissue implants alone; 10 animals received implants strung on tantalum wire, and 11 animals received implants strung on platinum/silver bimetallic electrodes that generated direct current. Control animals received no implant or implants of heart tissues obtained from the same rat fetuses. After implantation, the animals were housed separately. At intervals 1, 2 and 3 months, animals from each group were sacrificed and the limbs fixed in either 10% formalin or Carnoy fixative. All limbs were x-rayed to determine the presence of new bone structures and prepared for histological examination by sectioning serially at 7 $\mu$  and staining with hematoxylin and eosin. In the experimental groups, 13 of 26 rats which received the neural tissue alone demonstrated a positive response (presence of accessory bones with epiphyseal plates, Fig. 2). Of the 10 rats that received the implant with tantalum wire alone, only 3 contained new bones adjacent to the original humerus. Of the 11 rats with bimetallic electrode plus neural tissue implant, none contained new bones, but 7 exhibited excessive growth of the humerus consisting of bone and cartilage. (Fig. 1) In all cases, increased amount of host nervous tissue was observed. In the control animals without neural tissue or electrodes, neither excessive growth of the host humerus or peripheral nerves, nor accessory bones were observed. Our preliminary results indicate that the addition of bimetallic electrodes with neural tissue implants appears to stimulate excessive bone formation of the amputated humerus. Supported in part by BRSG #507-RR-05374, Biomed. Res. Supp. Div. NIH, Wenner Gren Research Laboratory & Department of Anatomy, University of Kentucky, Lexington, KY.

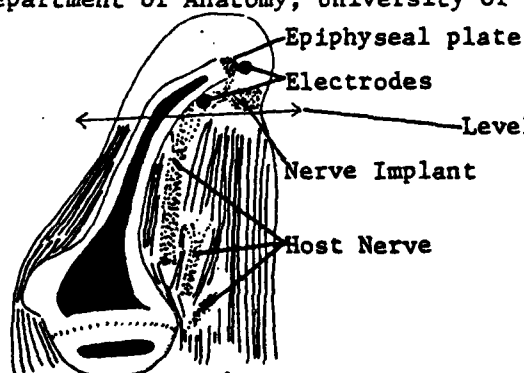

Figure 2

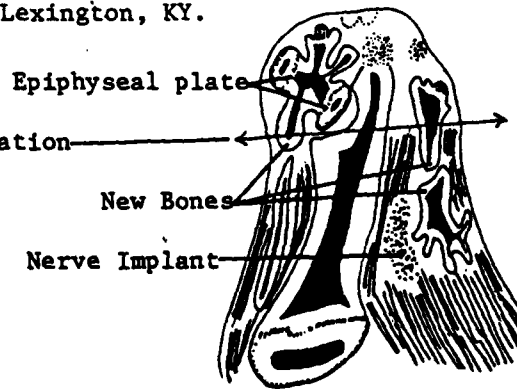

Figure 1

## Response of Amputated Rat Limbs to Fetal Nerve Tissue Implants and Direct Current

\*†Betty F. Sisken, †Ira Fowler, and ‡Sharon Romm

\**Wenner Gren Research Laboratory, †Department of Anatomy, and ‡Division of Plastic Surgery, University of Kentucky, Lexington, Kentucky*

---

**Summary:** We have previously shown that implanted fetal nerve tissue stimulates the regeneration of amputated chick limbs. The purpose of this study was to determine whether a similar phenomenon would occur in amputated rat limbs and if addition of applied direct current (DC) would affect this process. Thus, fetal nerve tissue was implanted into amputated stumps of 3-week-old rats; variable tissue regeneration was induced that was dependent on the age of the donor implant and the presence of applied DC. Twelve or 14 day fetal neural implants induced new accessory bones containing epiphyseal plates and marrow cavities and occasionally formed joint-like structures with the host humerus. Addition of DC to 12 day neural implants increased the number of new bones formed. Eighteen day neural tissue with applied DC did not induce new bone formation but stimulated the maximal elongation of the host humerus and outgrowth of nerve fibers to the cut surface. Implantation of fetal heart tissue or implantation of fetal neural tissue into unamputated limbs failed to induce new bone formation. Although true limb regeneration was not achieved, formation of new skeletal elements did occur and this effect was enhanced by applied DC. **Key Words:** Regeneration—Fetal implants—Rat limbs—Direct current.

---

Many attempts have been made to induce limb regeneration in higher vertebrates (adult frogs, chick embryos, newborn opossums, young rats). Experimental procedures that have been used in this pursuit include diversion of nerve fibers to the amputated limb (1,17), transplantation of adrenals (16), skin removal with application of salt solution (14), electrical stimulation (2,4,11,19,20), electrical stimulation with nerve growth factor injection (19), and implantation of fetal nervous tissue into the amputated stump (8,12). The only studies that demonstrated significant numbers of successful limb regenerates (including digits) were those of Mizell (12), who implanted fetal brain tissue prior to am-

putating the hindlimbs of newborn opossums, and our own studies of implantation of embryonic neural tube into amputated stumps of chick embryos (8). Additionally, reports of regrown fingertips of young children after amputation of digits distal to the last joint when the cut end was not sutured are significant (10). All of these studies indicate that higher vertebrates, including man, can exhibit varying degrees of regenerative ability under the appropriate stimulus (9).

Previous studies in rats by Becker (2), Sisken et al. (19), and Libbin et al. (11) demonstrated the extraordinary growth of the amputated humerus and tissue regeneration with formation of new skeletal elements after treatment with applied direct current (DC). The appearance of such new skeletal elements was also noted after the addition of embryonic nerve tissue in our chick embryo studies in

---

Address correspondence and reprint requests to Dr. Sisken at Department of Anatomy, University of Kentucky, Lexington, Kentucky 40536.

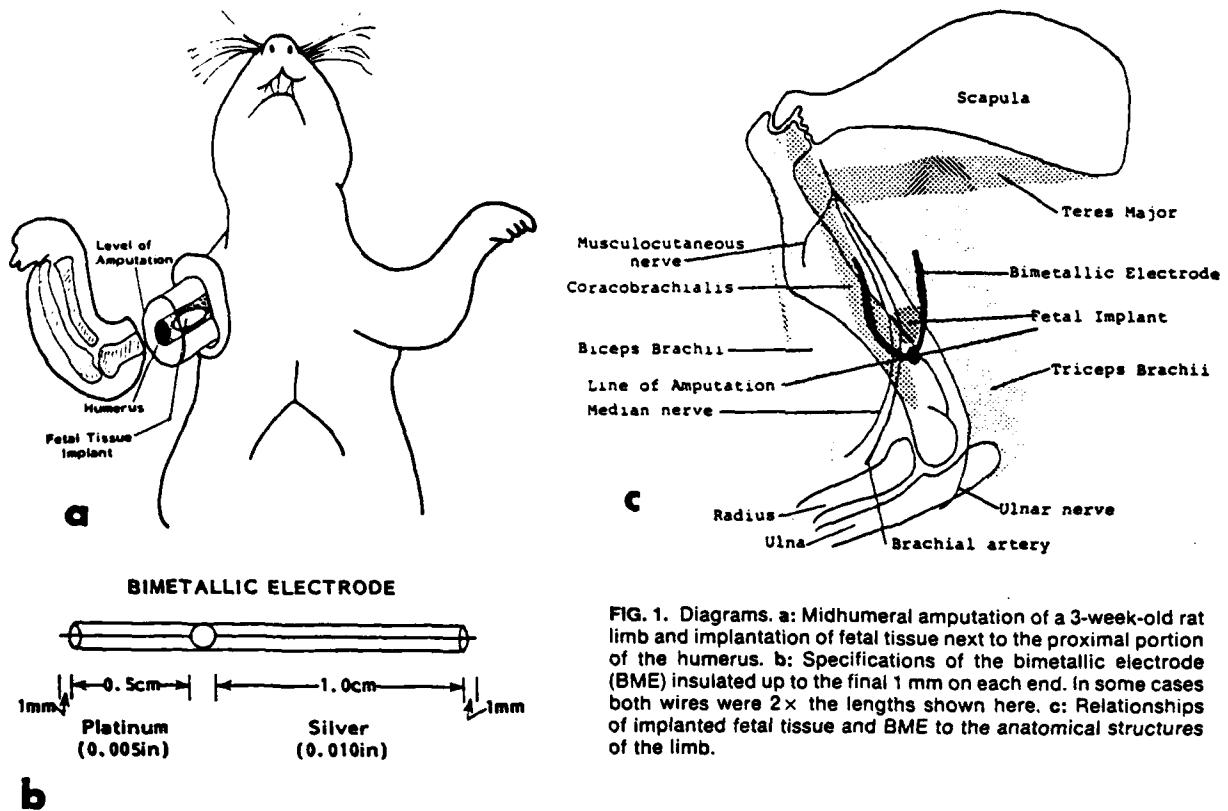

FIG. 1. Diagrams. a: Midhumeral amputation of a 3-week-old rat limb and implantation of fetal tissue next to the proximal portion of the humerus. b: Specifications of the bimetallic electrode (BME) insulated up to the final 1 mm on each end. In some cases both wires were 2x the lengths shown here. c: Relationships of implanted fetal tissue and BME to the anatomical structures of the limb.

those animals demonstrating partial, as well as complete, regeneration.

The aim of the present study was to use the same technique developed in the chick model (the insertion of fetal nervous tissue into the amputated stump) on the amputated rat limb. Not only did we test the inductive properties of implanted fetal nervous tissue alone but we also combined the implantation technique with the application of DC-yielding devices. We conclude from these studies that implanted neural tissue either alone or in combination with applied DC produces varying degrees of tissue regeneration that appears to be correlated with the age of the fetal implant as well as the treatment imposed.

#### MATERIALS AND METHODS

To minimize rejection of implanted tissue, a highly inbred strain of rats (Harlan Fisher F<sub>344</sub>; Harlan Sprague Dawley, Inc., Indianapolis, IN) was used. Limb amputations were performed on 3-

week-old male rats, weighing approximately 50 g each. Donor tissue was obtained from fetuses of the same inbred strain.

The animals were anesthetized with 0.05 ml sodium pentobarbital (65 mg/ml, Butler Co., Columbus, OH) and the right forelimb shaved. The skin was incised circumferentially, then retracted proximally. After ligation of the brachial artery, the forelimb was amputated at the midhumeral level by means of blunt scissors (Fig. 1a). To facilitate future identification of the level of amputation, the distal segments were numbered and placed in neutral formalin.

Pregnant females of the same inbred strain containing fetuses of 12–18 days gestation were anesthetized and their abdomens swabbed with 70% alcohol. Through a vertical incision, the two uteri containing the embryos were removed and placed in sterile buffered saline solution. Each embryo was freed from its extraembryonic membranes and placed in sterile Minimum Essential Medium buffered with 25 mM HEPES (Gibco, Grand Island, NY).



The heart or central nervous system (CNS) was dissected from these embryos and placed in separate sterile dishes containing tissue culture Minimum Essential Medium. The neural tissue implant included the brain, spinal cord with primordia of the peripheral nervous system, or the neural crest, which differentiated into unipolar sensory ganglion cells. The somatic efferent neurons of the ventral gray of implanted spinal cord sent axons into the tissues of the host limb.

Bimetallic electrodes (BME) were used to deliver DC (20). These consisted of platinum wire (0.005 inch) fused end-to-end with silver wire (0.010 inch, Medwire Corp., Mt. Vernon, NY) and insulated with plastic that was removed from the ends of the electrodes before use (Fig. 1b). The BME were implanted into the stump by inserting the platinum end next to the cut humerus; the silver wire was fixed in the triceps muscle (Fig. 1c). *In vitro* measurements of the current/voltage characteristics of these BME were made with a Keithley Electrometer (Model 602) in the following manner: 2 cm lengths of platinum wire and silver wire insulated except at the tips were separated by a distance of 0.5 or 1 cm and suspended from the top of a 50 mm Petri dish into 3 ml sterile Minimum Essential Medium. The dish was placed in a 37°C incubator, and readings of the current generated by the two dissimilar metals were taken at 1–5 min intervals for the first 60 min, and hourly thereafter for the next 4 h. Constant current levels of 28–30 nA were obtained. Since the two electrodes were placed in the stump approximately 0.5 cm apart, the current density delivered by the BME was approximately 6 nA/mm<sup>2</sup>.

Sixteen control animals were divided into three groups: six animals of Group I underwent limb amputation alone; five animals of Group II underwent limb amputation with fetal heart tissue implanted into residual stumps; five animals of Group III received fetal neural tissue implants but had no amputation.

Fifty-three experimental animals underwent amputation and were divided into four groups. Two (Group IV) were implanted with BME alone. Neural tissue from 12, 14, and 18 day fetuses was implanted into the limbs of 26 animals (Group V). This tissue consisted of cerebrum, brainstem, or spinal cord. Fifteen animals of Group VI received fetal neural tissue with BME (Fig. 1c). Ten animals (Group VII) had fetal nervous tissue and plain silver wire as a control for the BME. In both experimental and control animals, with the exception of Groups

III and IV, the fetal implant was placed next to the ligated brachial artery and median nerve beneath the remnants of the biceps muscle (Fig. 1a). In Group III animals the implant was placed between the intact biceps and the subjacent artery and nerve. After amputation and implantation, redundant skin was sutured over the stump. The animals were individually housed in wire-bottom cages for periods of 1, 2, and 3 months. At the end of each time period, animals from each group were anesthetized, and the right limbs removed and fixed in 10% neutral formalin. Each limb was X-rayed following fixation. The limbs were then decalcified, dehydrated, and embedded in paraffin. Eight micron serial sections of each limb were cut, mounted on slides, and stained in hematoxylin and eosin. All sections were evaluated with respect to the extent of growth of the humerus beyond the original amputation site, the number of new bones appearing in the limb stump, the presence of histologically normal implant tissue, and the growth of peripheral nerve beyond the level of amputation. The total humeral length and the length of growth of the humerus beyond the amputation line were measured (in millimeters) on histological sections under a dissecting microscope. A Student's *t* test was used to determine significance of effect.

## RESULTS

### Control Animals

The controls consisted in part of animals in which amputated limbs received no treatment (Group I) and those that received an implant of 14 day fetal heart tissue (Group II). In addition, the inductive capacities of implanted fetal neural tissue were tested by implanting 14 and 18 day fetal neural tissue into intact limbs (Group III). In Group III fetal implants were found in eight of 10 specimens. In no case did new bones develop, although a small mass of cartilage, oval in shape, was found in one of the specimens. X-ray films of control animals without implants (Group I) or with implants of heart tissue (Group II) showed no new bones formed and limited growth of the severed end of the humerus (Fig. 2a–c). Histological examination of a typical control animal that received an implant of fetal heart tissue revealed healthy cardiac muscle located near and growing into the triceps brachii muscle of the amputated limb (Fig. 2d). The distal end of the humerus of this specimen demonstrated wound re-

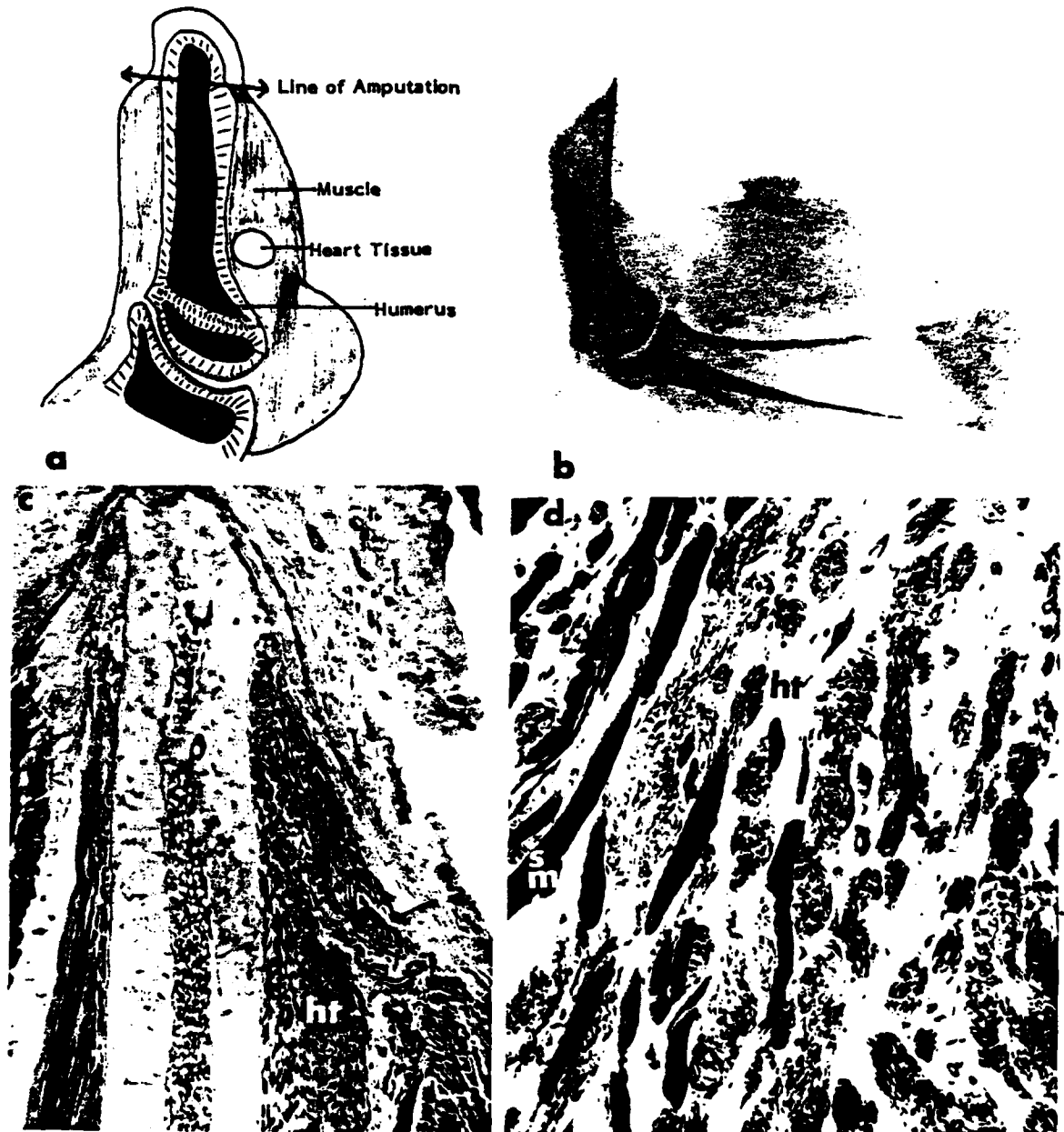

**FIG. 2.** Control rat, Group II, 2 months postamputation and implantation of 12 day fetal heart tissue. **a:** Diagram of the rat limb illustrates the line of amputation, location of the implanted heart tissue, and the healing of the cut surface of the amputated humerus. **b:** Photograph of X-ray film taken after fixation of the limb. **c:** Low-power photomicrograph of the histological section of this limb illustrates connective tissue growth over the cut surface of the humerus and the heart tissue (ht) growing between the humerus and the large skeletal muscle mass of the triceps brachii.  $\times 14$ . **d:** Photomicrograph of the heart tissue (ht) growing next to and within the triceps skeletal muscle (sm).  $\times 425$ .

TABLE 1. Comparison of control and experimental animals

Group	Implant	No.	Implant found	With new bones	Average No. bones
Control					
I	None	6	0	0	0
II	Heart	5	5	0	0
III	CNS without amputation	5	3	1 <sup>a</sup>	0
Subtotal		16	8	1	0
Experimental					
IV	BME	2	0	0	0
V	CNS	26	22	18	3
VI	CNS + BME	15	10	3	7
VII	CNS + WIRE	10	7	4	2
Subtotal		53	39	26	0
Total		69	47	26	0

BME, PtAg insulated bimetallic electrodes; CNS, fetal neural implant; WIRE, 0.005 inch insulated Pt or 0.01 inch Ag wire.

<sup>a</sup> Small amount of cartilage.

pair with dense irregular connective tissue adherent to surrounding large muscle masses (Fig. 2c). Figure 2a is a diagram that shows the position of the heart implant relative to host limb structures, the level of amputation, and the extent of humeral growth.

#### Experimental Animals

The experimental groups consisted of animals in which amputated limb stumps were treated to test the potential for elongation of the cut humerus and the induction of new bones (see Table 1 and Fig. 3). Two animals received a BME alone (Group IV). This group was made small since ample evidence from our previous work (19) had demonstrated that BME exposure did not stimulate new extra bones. The two animals used in this study conformed to the previous results. Twenty-six animals (Group V) had fetal neural tissue alone implanted in the stumps of the amputated limbs. This implant survived in 22 animals; the formation of new bones was noted in 18 of these (81.8%) with an average of three new bones in each limb. X-ray films of these animals showed the new bones near the distal end of the stump (Figs. 4a and b). On histological examination the bones were found on the anterior and posterior aspects of the humerus. In each case the new bones were juxtaposed to the fetal neural implant. The size and shape of the bones varied; all contained bone marrow and most had epiphyseal plates (Figs. 4c and d). Bones located near the distal end of the humerus frequently formed a joint like

relationship between the new bone and the humerus (Figs. 4c and d and diagrammed in 4a). In specimens sacrificed 6 months after amputation, host skeletal muscle was attached to some of the ectopic bones so that movement of the new bones was possible.

Group VI consisted of 15 animals that received a fetal neural tissue implant together with a BME designed to deliver DC to the limb (Fig. 1c). The neural tissue implant and the electrode were found in 10 animals and new bones developed in three (30%) with an average of seven new bones in each specimen. The three animals in which new bones formed received an implant of 12 day fetal neural tissue whereas the seven animals in which new bones failed to develop each received an implant of 18 day fetal neural tissue. The combination of 12 day neural tissue and BME thus appears to produce the greatest response (Figs. 5a-d). The average number of new bones in these animals was larger than in those that received the CNS implant alone (Table 2). The fetal neural tissue appeared healthy when examined and was surrounded by the individual new bones many of which contained epiphyseal plates (Fig. 5d). The implant contained many large neurons and glial elements (Fig. 5e).

Although 18 day fetal neural implants in combination with BME failed to induce new bones (Figs. 6a and c), additional bone formed on the distal end of the humerus in such animals significantly exceeded that seen in control animals (Figs. 6b and d and Fig. 3). The absolute (length of growth in millimeters) and relative changes (percent of new

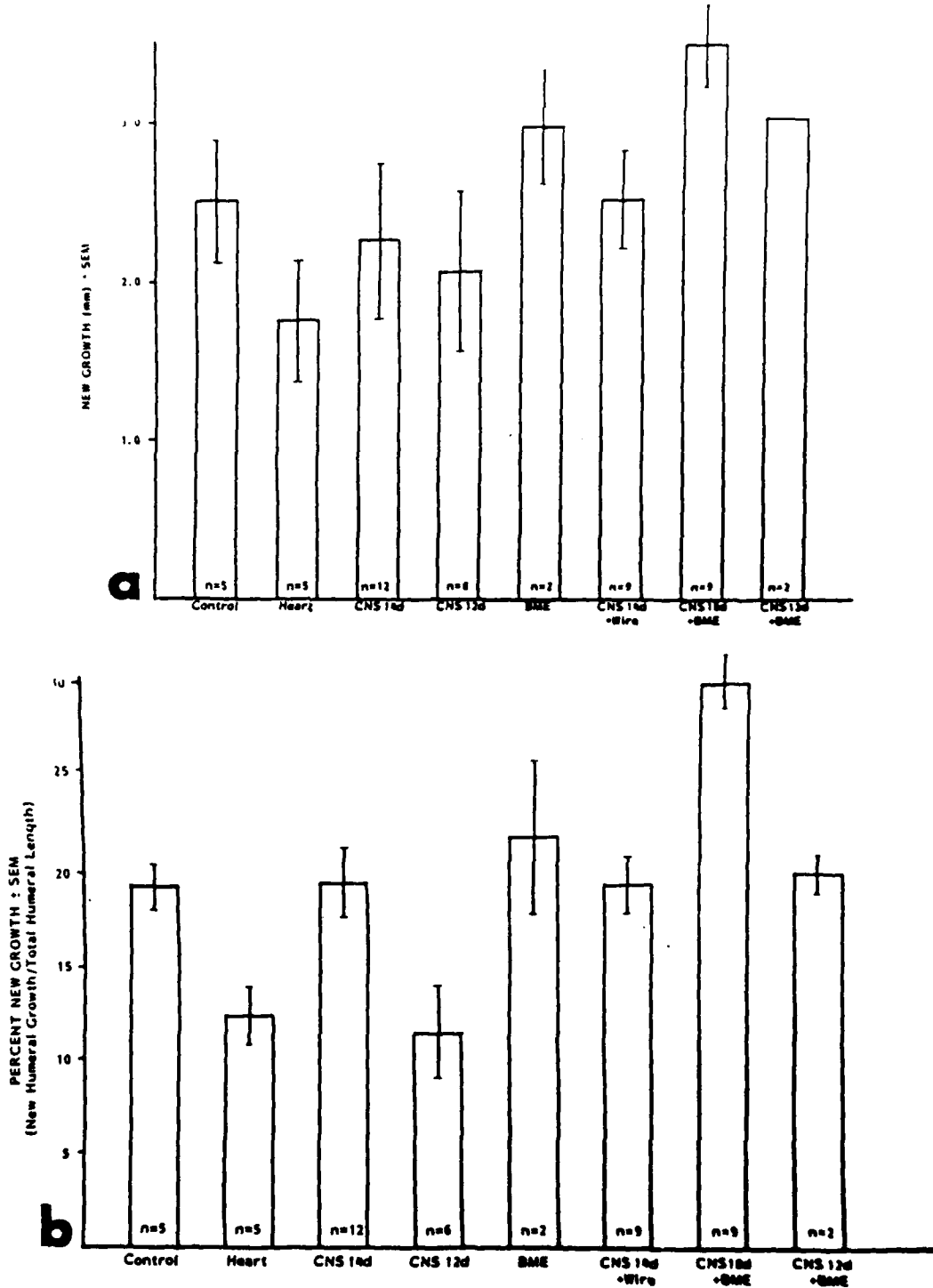

FIG. 3. Growth of the humerus beyond the level of amputation in all groups. a: New growth in millimeters. Rats implanted with 18 day fetal neural tissue with bimetallic electrode (BME) show a significant increase ( $p = 0.05$ ) in length relative to the control (no implant) group. b: Percent new growth in millimeters (new growth/total humeral length). Rats implanted with 18 day fetal neural tissue with BME show a significant increase ( $p = 0.025$ ) in growth relative to control animals (no implant).

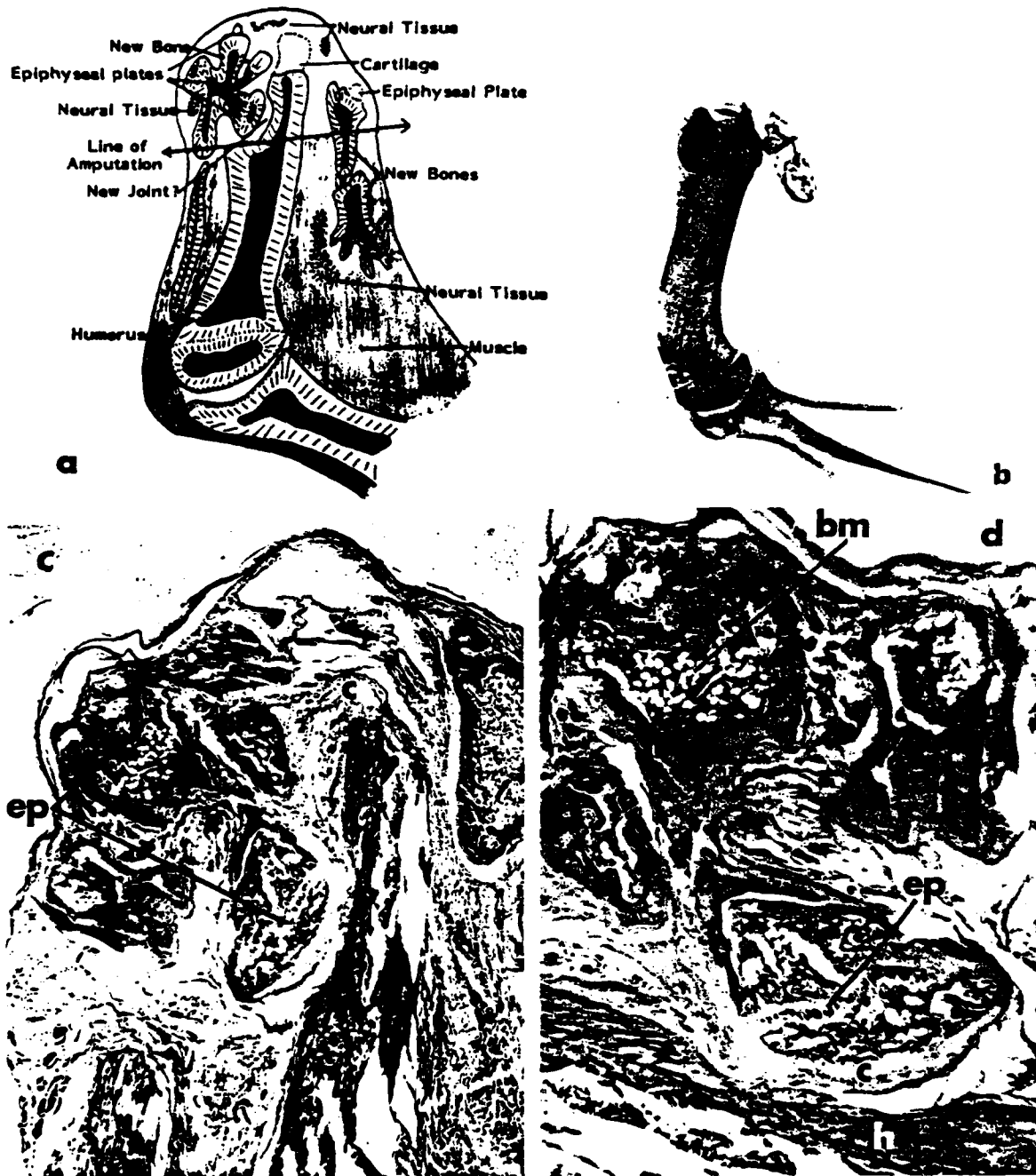
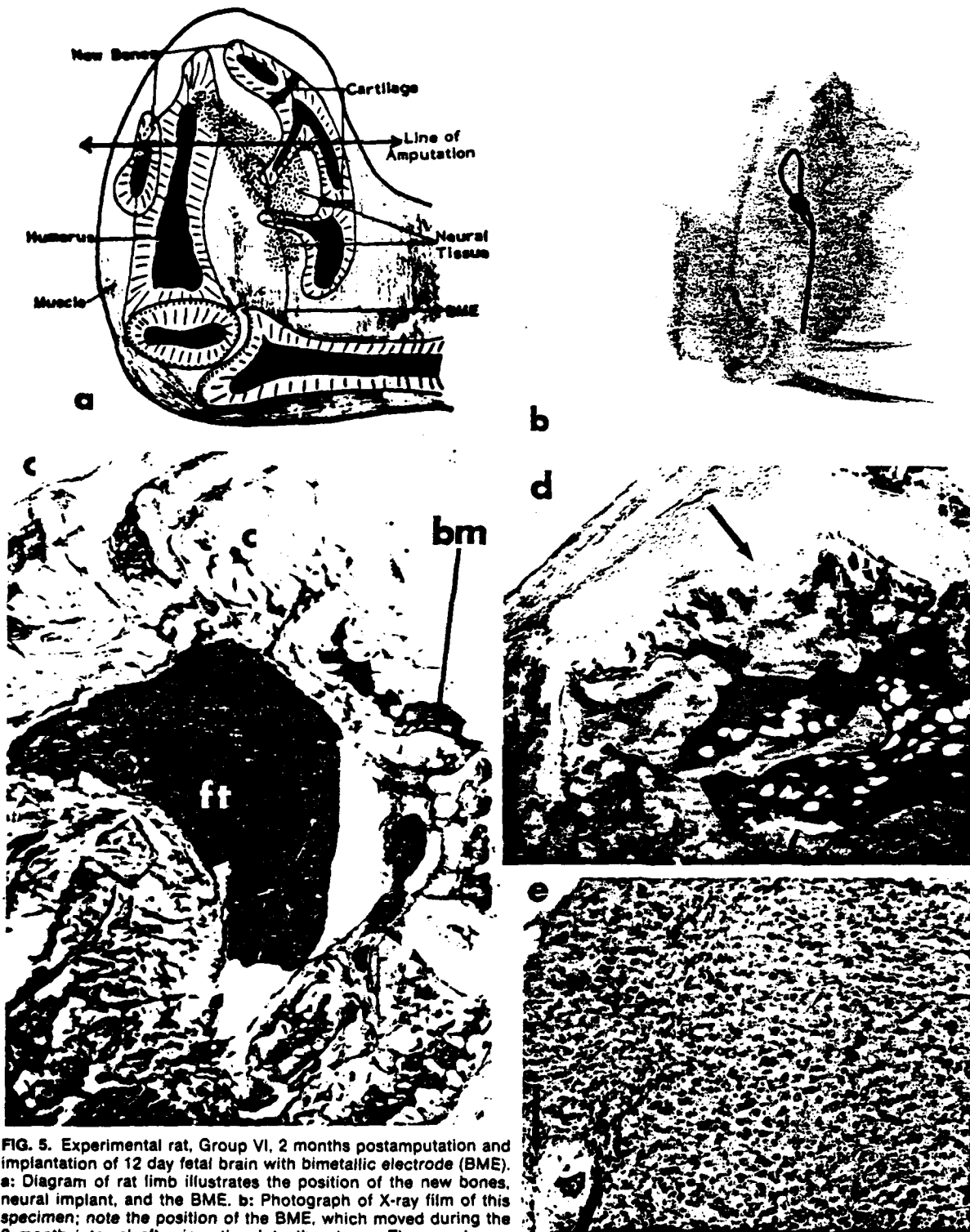

FIG. 4. Experimental rat, Group V, 2 months postamputation and implantation of 14 day fetal spinal cord. a: Diagram of rat limb illustrates the position of the new accessory bones relative to the implanted neural tissue and the distal part of the amputated humerus. b: Photograph of X-ray film of this specimen. Note the X-ray positive bones located on the anterior and posterior borders of the humerus. c: Low-power photomicrograph of a histological section of this limb. The new bones located near the anterior surface of the humerus contain epiphyseal plates (ep) and bone marrow; one new bone has formed a pseudojoint with the humerus. x 15. d: Enlargement of a portion of (c). Two bones contain cartilage (c), bone marrow (bm), and epiphyseal plates (ep). The joint-like relationship of one bone next to the humerus (h) is illustrated. x 30.



**FIG. 5.** Experimental rat, Group VI, 2 months postamputation and implantation of 12 day fetal brain with bimetallic electrode (BME). **a:** Diagram of rat limb illustrates the position of the new bones, neural implant, and the BME. **b:** Photograph of X-ray film of this specimen; note the position of the BME, which moved during the 2 month interval after insertion into the stump. The new bones in this view appear as gray masses at the distal portion of the stump. **c:** Low-power photomicrograph of the distal portion of the stump that contains new bones with bone marrow (bm) and cartilage (c) juxtaposed to, and formed around, the fetal neural implant (ft).  $\times 32$ . **d:** Deeper section of new bone in (c) demonstrates a wide epiphyseal plate (arrow).  $\times 80$ . **e:** Enlargement of the fetal implant in (c) to show the presence of large numbers of neurons. A portion of the implant (arrow) has grown into the underlying tissue, whereas the rest of the border is distinct.  $\times 192$ .

TABLE 2. Effect of age of fetal implant on formation of new bones

Fetal implant age (day)	No. implanted	Implant (group)	Implant found	With new bones	Average No. new bones
12	9	CNS (V)	9	9	4
	3	CNS + BME (VI)	3	3	7
	2	Heart (II)	2	0	0
Subtotal	14		14	12	4.75
14	17	CNS (V)	13	9	2
	9	CNS + WIRE (VII)	7	4	2
	3	CNS without amputation (III)	3	1 <sup>a</sup>	0
Subtotal	29		23	13	2
18	12	CNS + BME (VI)	7	0	0
	1	CNS + WIRE (VII)	0	0	0
	2	CNS without amputation (III)	0	0	0
Subtotal	3	Heart (II)	3	0	0
Subtotal	18		10	0	0
Total	61		47	25	3.32

See Table 1 for explanation of implant.

<sup>a</sup> Small amount of cartilage.

length/total humeral length) in the various groups sacrificed at 2 or 3 months postamputation were measured on histological sections and are presented in Fig. 3. In all cases maximum growth of bone at the severed end of the humerus occurred in the rats implanted with 18 day fetal neural tissue along with the BME. In addition, the BME appeared to enhance the growth of nerve fibers into the distal portion of the limb (Fig. 6d), a phenomenon previously noted when BME was implanted in amputated rat limbs (19) and when agar salt-bridge electrodes were implanted into amputated frog limbs (4).

Group VII consisted of 10 animals that received fetal neural tissue plus a single wire to investigate the effects of mechanical irritation on the bone-inducing capacity of fetal neural tissue. The implant was found in seven animals, and four of these (57%) contained new bones with an average of two bones each. Comparing these results with those of Group V, the single wire did appear to depress the formation of new bones by the fetal implants, while not affecting humeral growth to any extent.

There were obvious differences in the bone-inducing capacities of fetal neural tissue at the development ages used in this study (see Table 2). The graft survival was best and formation of new bones was greatest with 12 day fetal neural tissue. When CNS alone was implanted, all nine implants lived and all nine contained new bones with an average of four new bones in each limb. In combination with BME three of three 12 day implants survived with

an average of seven new bones in each limb. Using neural implants from 14 day fetuses, the survival rate dropped from 100 to 69% (nine of 13) with CNS alone and to 57% (four of seven) with CNS combined with BME with the average number of new bones reduced to two. With 18 day fetal neural tissue in combination with BME, there was a total failure to induce formation of new bones. However, new growth of the cut humerus was stimulated to the greatest degree in these animals. A synergistic action occurs with implanted BME and 18 day neural tissue since BME alone was not as effective as the combination of BME and older neural tissue. Thus, it appears that maximal tissue regeneration occurs with the younger neural implants in combination with BME, whereas maximal humeral growth is achieved with the older neural implants in combination with the BME.

## DISCUSSION

We have found that implantation of 12-14 day fetal neural tissues into amputated stumps of young rats induced the formation of multiple new bones containing bone marrow and epiphyseal plates. In each case the sites of these new skeletal elements correlate with the presence of differentiating fetal nervous tissue. In contrast, implants of fetal heart tissue induced no new bone formation. In animals implanted with neural tissue some of the new bones were juxtaposed to the severed end of the host hu-

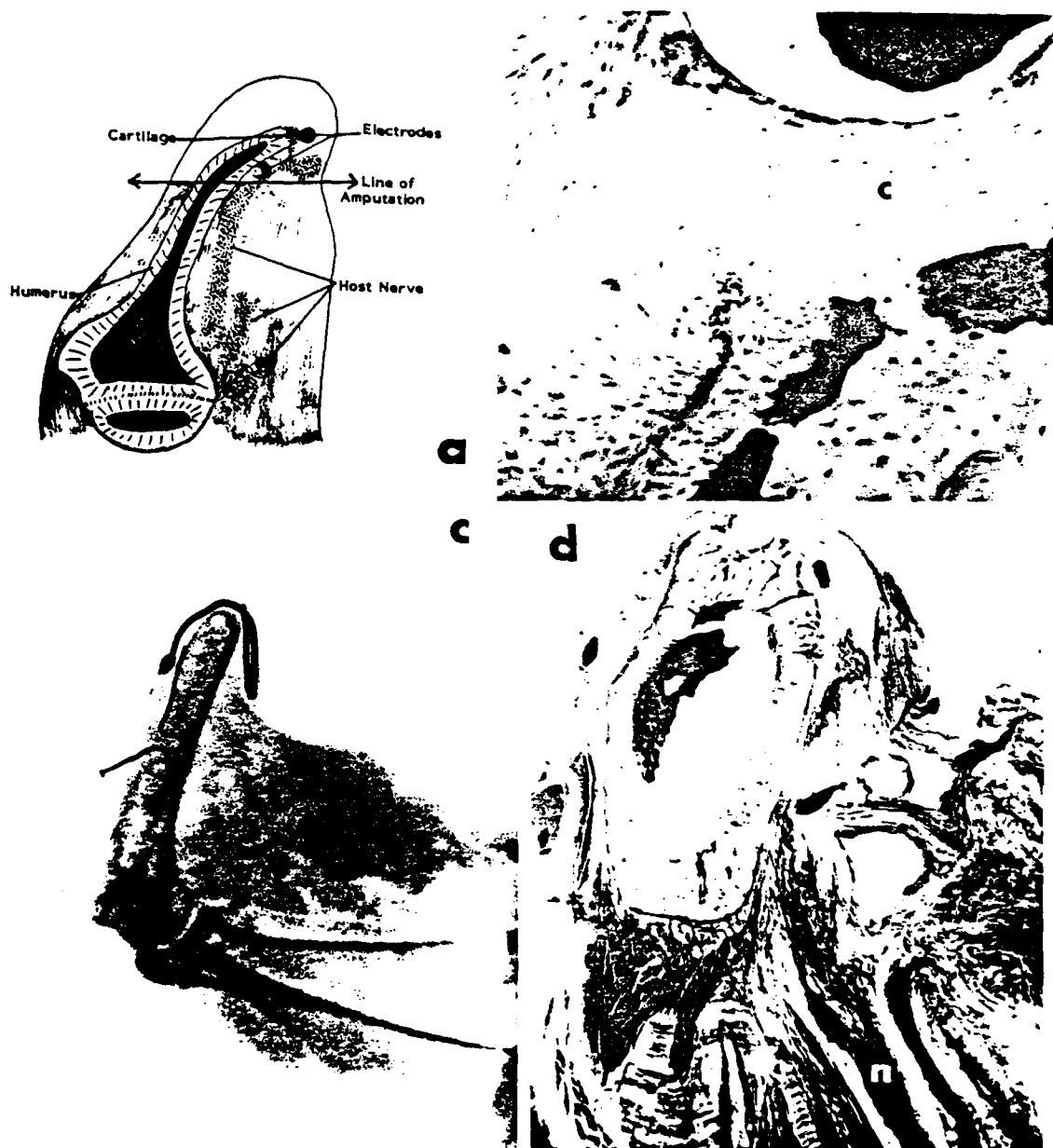

**FIG. 6.** Experimental rat, Group VI, 2 months postamputation and implantation of 18 day fetal spinal cord with bimetallic electrode (BME) a: Diagram of rat limb illustrates cross sections of the BME, elongation of the humerus beyond the line of amputation, cartilage at the end of this growth, and excessive host nerve tissue growing out toward the regenerated area. b: Enlargement of the most distal portion of the growing humerus. Cartilage (c) next to the electrode has been invaded by blood vessels.  $\times 374$ . c: Photograph of X-ray film of this specimen shows the final position of the BME at the time of sacrifice. d: Low-power photomicrograph of the most distal portion of the stump that includes the growing end of the humerus. The cross-sectioned electrodes are found next to the new bony portion of the humerus. Bundles of host nerve fibers (n) have grown into this area.  $\times 28$ .

merus, so that a pseudojoint was formed. The final location of the fetal CNS could not be controlled, perhaps due to limb movement. Therefore, structures resembling joints were found only in those

animals in which the implant grew near the distal end of the humerus.

The average number of new bones correlates directly with the age of the fetal nerve implant. The



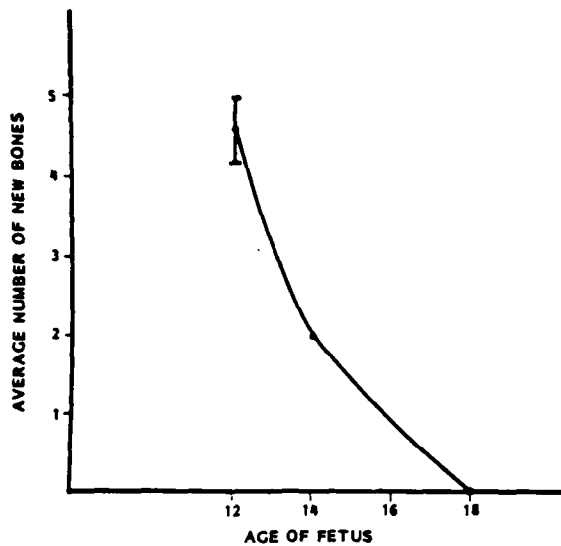

FIG. 7. Correlation of the numbers of new bones induced with the age of the fetus from which the implant was taken. The highest number of new bones formed (4.75) is obtained with 12 day fetal neural tissue implants.

younger the fetus from which the implant is taken, the greater the number of new bones formed (Fig. 7 and Table 2). These results suggest that younger neural tissue implants either grow better after transplantation than do older implants or have a greater capacity to induce new bones. Our material suggests that both factors may be involved. The younger implants contained fewer necrotic areas and appeared to grow larger than the older implants, demonstrating improved survival and proliferation. New bones found in association with the younger implants showed a greater tendency to develop in direct contact with the neural tissue than did those bones formed in response to the older implants. The effects noted may be interpreted as an indication of reduced inductive capacity as the neural tissue ages. Results of experiments in the chick embryo (unpublished results) show that by 8 days of incubation the neural tissue no longer has the capacity to induce regeneration of the middle and distal limb segments. This is in contrast to demonstrated inductive capacities at 2 and 4 days.

In Table 2 data obtained from animals with implanted fetal neural tissue alone were compared with that obtained from animals implanted with fetal neural tissue and BME. The combination of 12 day nerve implants with BME yielded the greatest number of new bones, seven, formed per animal. The source of the cells forming these new bones

has not been ascertained. Mesenchymal-like elements are likely candidates. These results are consistent with the well-documented effects of electric current on bone repair and new bone formation in animal models and in humans (reviewed in 22).

The results obtained in this study are not as dramatic as those obtained in chick embryos in which implantation of 2 day embryonic neural tube into 4 day amputated limbs (Type III response) resulted in regeneration of middle and distal segments. The growth of several tissues, however, is significant as it demonstrates that the rat has the potential to respond to provocative signals by forming completely new tissue. The response that we obtained in the young rat is directly comparable with the "Type II response" that was seen in chick embryos (8). In this group the implantation of 2 day neural tube resulted in tissue regeneration only, producing extra bones in the proximal segment.

In 1968 Mizell (12) reported that implants of nervous tissue effectively induced regeneration of the distal segment of hindlimbs of the newborn opossum. At birth the hindlimbs of the opossum are essentially in the fetal stage, so that one can assume that mammalian fetuses are able to undergo epimorphic regeneration under unique experimental conditions. Our objective was to determine the extent to which an older mammal can respond to implanted neural tissue.

This investigation is not the first to show that the rat is capable of extraordinary repair and has the capacity to form new bones. In 1972 Becker (2) demonstrated ectopic bone formation in amputated rat forelimbs as a result of DC stimulation. These bones were formed rapidly and disappeared with age. However, new epiphyseal plates at the cut end of the humerus were prominent. In 1979 Sisken et al. (19) and Libbin et al. (11) reported similar results using DC provided by BME in amputated rat forelimbs. Both groups of investigators found extraordinary epiphyseal plate formation on the distal portion of the humerus.

In our 1979 study we also injected nerve growth factor (NGF) into the amputated limbs of a group of animals; in 40% of the animals ectopic bones were formed. These new bones were small and were found only in rats sacrificed 1 month after amputation. The induction of new bones after administration of a neurotropic substance such as NGF or implantation of neural tissue supports the thesis proposed by Singer (18). He suggested that nerve tissue in the limb secretes neurotrophic substances that may be involved in the stimulation of

tissue and limb regeneration. The greater the number or caliber of nerves per unit amputation area, the larger the amount of trophic agent delivered. He and Rzehek found, for instance (15), that in the mammal (mouse) the limb contains only 16% of the number of nerves per unit area of amputated limb as that found in the newt. These nerves are also thinner. Such a paucity of innervation to an amputated limb would probably result in insufficient neurotrophic substance delivered, and thus a lack of regenerative ability. Augmentation of the innervation of the limb by implanted neural tissue appears to be a logical method to increase this ratio and in newborn opossum and chick embryos appears an adequate substitute for the nerve fiber deficiency, thereby facilitating replacement of the distal limb segments. However, in our experiments using older mammals there is an indication that an increase in nerve supply alone is inadequate to induce complete limb regeneration. New skeletal elements were found that could perhaps represent future elements of middle and distal segments, but true limb regeneration did not occur.

It is not surprising that new skeletal tissue was found after DC administration. Many cases have been cited in the literature on electric field stimulation of cartilage and bone *in vivo* and *in vitro* (2-4,6,7,11,13,19-22). In addition, the importance of the nervous system in bone growth has been illustrated by the experiments of Bunch et al. (5). Denervation of rat hindlimbs followed by below-knee amputation reduced the mass and length of the amputated tibia. There was a direct correlation between the absence of innervation and the decrease in rate of periosteal mitosis. In the present study supplementing the neural tissue implant with DC stimulated new mesenchymal differentiation and neurite outgrowth from the host peripheral nerves. However, this combination of treatments stimulated greater numbers of ectopic bones but failed to induce the proper relations of new skeletal elements in the amputated limbs.

The mechanisms by which implanted fetal nerve tissue stimulates osteogenesis in amputated limbs are as yet unknown. It appears from our work that amputation is necessary to activate this process, for implantation of fetal nerve tissue in normal limbs failed to induce ectopic bone formation. Our hypothesis is that bone formation may be induced by trophic substances produced by the implanted nerve cells. These substances may be similar to those that induce complete regeneration of ampu-

tated limbs in other vertebrates. Our observations indicate a direct relationship between the age of the nerve implant and the number of new bones formed, and an inverse relationship between the age of the implant and the number of neurons that survive. That is, the younger the implant, the more surviving neurons available to secrete trophic factors that induce a greater number of new bones.

This approach to the study of mammalian limb regeneration does appear to offer some hope for future success based on the following observations: (a) Many of the ectopic bones formed had the structure of a long bone, that is, they had an epiphyseal plate at each end, forming two epiphyses separated by a diaphysis. (b) In some cases there were apparent attempts to form synovial joints between the ectopic bones or between these bones and the host humerus. (c) Several of the specimens showed that host skeletal muscles achieved an attachment to the ectopic bones so that movement of the new bones could occur.

Functional replacement of a whole limb after ablation, which occurs naturally in salamanders, has yet to be accomplished in adult mammals. Future studies to determine the basis of the inductive capabilities of implanted fetal nerve tissue and applied DC on the reactive stump tissue should provide information to assist in achieving the ultimate goal of limb regeneration in adult mammals.

**Acknowledgment:** Supported in part by BRSR number 507-RR-0537, Biomedical Research Support Division, National Institutes of Health and Office of Naval Research N00014-82-K-0105. We are indebted to Mr. J. Starrs and Ms. M. J. Gumbert for the histological preparations and to Mr. R. S. Estes for the graphics. Preliminary data from these investigations were presented at the 1982 meetings of the American Association of Anatomists (*Anat Rec* 202:177A) and the annual meeting of the Bioelectric Repair and Growth Society (*Trans BRAGS* 2:40). Some of the data presented at these meetings were included in a review article "Nerve and Limb Regeneration" (*Eng Med Biol* 2:32,1983).

## REFERENCES

1. Bar-Maor JA, Gitlin G: Attempted induction of forelimb regeneration by augmentation of nerve supply in young rats. *Transplant Bull* 27:460-461, 1961
2. Becker RO: Stimulation of partial limb regeneration in rats. *Nature* 235:109-111, 1972
3. Black J, Brighton, CT: Mechanisms of stimulation of osteogenesis by direct current. In: *Electrical Properties of Bone and Cartilage*, ed by CT Brighton, J Black, S Pollack. New York, Grune and Stratton, 1979, pp 215-225
4. Borgens RB, Vanable JW, Jaffe LF: Bioelectricity and re-

- generation. I: Initiation of frog limb regeneration by minute currents. *J Exp Zool* 200:403-416, 1977
5. Bunch WH, Deck JD, Romer J: The effect of denervation on bony overgrowth after below knee amputation in rats. *Clin Orthop* 122:333-339, 1977
  6. Christel P, Cerf G, Pilla AA: Modulation of rat radial osteotomy repair using electromagnetic current induction. In: *Mechanisms of Growth Control*, ed RO Becker, Springfield, IL, CC Thomas, 1981, pp 237-250
  7. Connolly JF: Healing curve of fractures and the effect of bone growth stimulation. In: *Electrical Properties of Bone and Cartilage*, ed CT Brighton, J Black, S Pollack, New York, Grune and Stratton, 1979, pp 547-562
  8. Fowler I, Siskin BF: Effect of augmentation of nerve supply upon limb regeneration in the chick embryo. *J Exp Zool* 221:49-59, 1982
  9. Gross RJ: Prospects for regeneration in man. *Clin Orthop* 151:271-282, 1980
  10. Illingworth CM: Trapped fingers and amputated finger tips in children. *J Pediatr Surg* 9:853, 1974
  11. Libbin RM, Person S, Papierman S, Shah D, Nevid D, Grob H: Partial regeneration of the above-elbow amputated rat forelimb. II. Electrical and mechanical facilitation *J Morphol* 159:439-452, 1979
  12. Mizell M: Limb regeneration: Induction in the newborn opossum. *Science* 161:283-285, 1968
  13. Norton LA, Bourret LA, Rodan G: Molecular changes in hard tissue cells in response to bioelectric proliferative signals. In: *Mechanisms of Growth Control*, ed by RO Becker, Springfield, IL, CC Thomas, 1981, pp 180-191
  14. Rose SM: Methods of initiating limb regeneration in adult anura. *J Exp Zool* 95:149-170, 1944
  15. Rzehek K, Singer M: The number of nerve fibers in the limb of the mouse and its relation to regenerative capacity. *Anat Rec* 155:537-540, 1966
  16. Schotté OE, Wilber JF: Effects of adrenal transplants upon forelimb regeneration in normal and hypophysectomized adult frogs. *J Embryol Exp Morphol* 6:247-261, 1958
  17. Singer M: Induction of regeneration of the forelimb of the postmetamorphic frog by augmentation of the nerve supply. *J Exp Zool* 126:419-472, 1954
  18. Singer M: On the nature of the neurotrophic phenomenon in urodele limb regeneration. *Am Zool* 18:829-841, 1978
  19. Siskin BF, Smith SD, Lafferty JF: A comparison of the effects of direct current, nerve growth factor, and direct current plus nerve growth factor on amputated rat limbs. In: *Electrical Properties of Bone and Cartilage*, ed C Brighton, J Black, SR Pollack, New York, Grune and Stratton, 1979, pp 267-287
  20. Smith SD: Induction of partial limb regeneration in *Rana pipiens* by galvanic stimulation *Anat Rec* 158:89-97, 1967
  21. Smith SD, Pilla AA: Modulation of newt limb regeneration by electromagnetically-induced low level pulsating current. In: *Mechanisms of Growth Control*, ed by RO Becker, Springfield, IL, CC Thomas, 1981, pp 137-152
  22. Spadaro JA: Bioelectric stimulation of bone formation: Methods, models, and mechanisms. *J Bioelect* 1:99-128, 1982

1945