

MICROCOPY RESOLUTION TEST CHART
NATIONAL BUREAU OF STANDARDS 1963 A

1

SOFTech

THE SOFTWARE TECHNOLOGY COMPANY

DTIC
ELECTE
S D
AUG 04 1988
D

AD-A170 527

U
AFRIMS PROTOTYPE MODEL
(FINAL)
1013-2-4
30 April 1979
Contract No. MDA-903-76-C-0396

DTIC FILE COPY

Submitted to the
United States Air Force
Readiness Measurement Group (XOORM)

DISTRIBUTION STATEMENT A
Approved for public release;
Distribution Unlimited

86 7 31 107

TABLE OF CONTENTS

| <u>Section</u> | <u>Page</u> |
|--|-------------|
| 1.0 INTRODUCTION | |
| 1.1 Purpose and Scope | 1 |
| 1.2 Previous Contract Documents | 1 |
| 1.2.1 Users' View of AFIRMS | 1 |
| 1.2.2 AFIRMS Data Analysis | 2 |
| 1.2.3 Initial Functional Area Analyses | 3 |
| 1.3 Purpose and Utility of the Model | 4 |
| 1.4 Document Summary | 5 |
| 2.0 PROTOTYPE MODEL OVERVIEW | 5 |
| 3.0 COMMAND MODEL | 10 |
| 4.0 WING DEPLOYMENT READINESS MODEL | 26 |
| 5.0 WING COMBAT READINESS MODEL | 42 |

APPENDICIES

- A. How to Read SADT
- B. Wing General Operations Model
- C. Wing Deployment Model

| | |
|-----------------------|-------------------------------------|
| Accession For | |
| NTIS CRA&I | <input checked="" type="checkbox"/> |
| DTIC TAB | <input type="checkbox"/> |
| Unannounced | <input type="checkbox"/> |
| Justification | |
| By <i>str on file</i> | |
| Distribution / | |
| Availability Codes | |
| Dist | Avail and/or Special |
| <i>A-1</i> | |

Section 1
INTRODUCTION

1.1 Purpose and Scope

This study of an Air Force Integrated Readiness Measurement System has been undertaken by SofTech, Inc., to assist the Air Force in the determination of its readiness posture. The goal of AFIRMS is to provide readiness information which is accurate, timely, and germane to wing commanders, Air Staff, and levels in between. Specifically, the system will provide readiness information for crisis planning and management, day-to-day management, and for program and budget planning.

1.2 Previous Contract Documents

1.2.1 Users View of AFIRMS

This was the first document produced by the project team. It contains some ideas on what AFIRMS might look like and what it might do for its users. Interviews were conducted with potential users of readiness information at several deputates and directorates within the Air Staff. Interviews were also held with personnel at MAC and TAC.

On the basis of these interviews, four models were developed reflecting the users viewpoint (primarily Air Staff). These models reveal the relationships between various Air Force functions and also between these functions and readiness information. It was discovered that nearly all activities, i.e., plans, operations, personnel, and logistics could use accurate, timely readiness information. The models are:

A Generalized Air Force Model,
The Airlift Support Model,
The Logistics Support Model, and
The Command, Control, and Communications Model.

Two other diagrams show how a base level and a theater level AFIRMS might work.

1.2.2 AFIRMS Data Analysis

A data requirements study was undertaken to determine the data required to support AFIRMS. In addition, it was necessary to determine whether the data is available. The study was limited to MAC, SAC, and TAF, with the latter being represented by TAC and USAFE.

Models were developed for these three command areas using the Structured Analysis and Design Technique (SADT, Appendix A). The models are not complete enough for systems design. Decomposition was continued until the analysts felt that the majority of the data elements had been identified.

This document "AFIRMS Data Analysis" was produced to learn what must be included in potential data bases and the data flow within commands. Models and data tables are presented for Command Level, Tactical Air Force, Strategic Air Force (B52D non-nuclear role and KC135 only) and Military Airlift.

1.2.3 Initial Functional Area Analyses

This document expands the work begun with the Users View of AFIRMS, particularly the material on which the General Air Force Model was based. Activities within several Air Force Headquarters functions are described and depicted in example SADT diagrams. The activities are not synthesized into an overall functional model but are tied as closely as possible to specific Air Staff Organizations and personnel.

1.3 Purpose and Utility of the Model

The Prototype Model is required for use as a guide on several analytical steps which will be accomplished at a later time. It was realized early in the work that the total AFIRMS could not be produced and implemented as a turn key operation throughout the Air Force. A prototype would be necessary to test concepts and gain experience with more objective methods of measuring readiness than had been employed previously.

The functions described and decomposed in the model are the ones we believe AFIRMS will contain. This model will serve as the basis for further work in developing a prototype for AFIRMS. The accuracy and completeness of this model will be verified as work continues. For example, why are these functions necessary? Why weren't others included? Can other functions contribute more to the total system. Answering these questions and relating hypotheses against the model should move the analysts in productive directions resulting in a better overall model earlier than would otherwise be achieved.

1.4 Document Summary

The following sections will summarize the total model which is really a composite of four models. The first two are really one, i.e., a command model which can be used at Air Force Headquarters or a Major Command. The remaining two are a Wing Deployment Model for deploying TAC units and a Wing Combat Model for either PACAF, USAFE or TAC units after they have deployed and chopped to a using command.

The Appendicies relate how to read SADT diagrams and include two supporting models.

2.0 PROTOTYPE MODEL OVERVIEW

Diagram M350 presents the relationship between AFIRMS and Air Force operations as far as the prototype is concerned. Models to the right of the center line and higher are served by those to the left and lower.

A fully decomposed Air Staff operation's model has not been needed thus far, but an approach was made and is included in a "Users View of AFIRMS". A TAC operations model has not been done but

| | | | | | | |
|-----------------------------|-----------------|----------------|-------------|--------|------|----------|
| USED AT: | AUTHOR: MATHERS | DATE: 3 APR 79 | WORKING | READER | DATE | CONTEXT: |
| | PROJECT: AFIRMS | REV: | DRAFT | | | |
| NOTES: 1 2 3 4 5 6 7 8 9 10 | | | RECOMMENDED | | | |
| | | | PUBLICATION | | | |

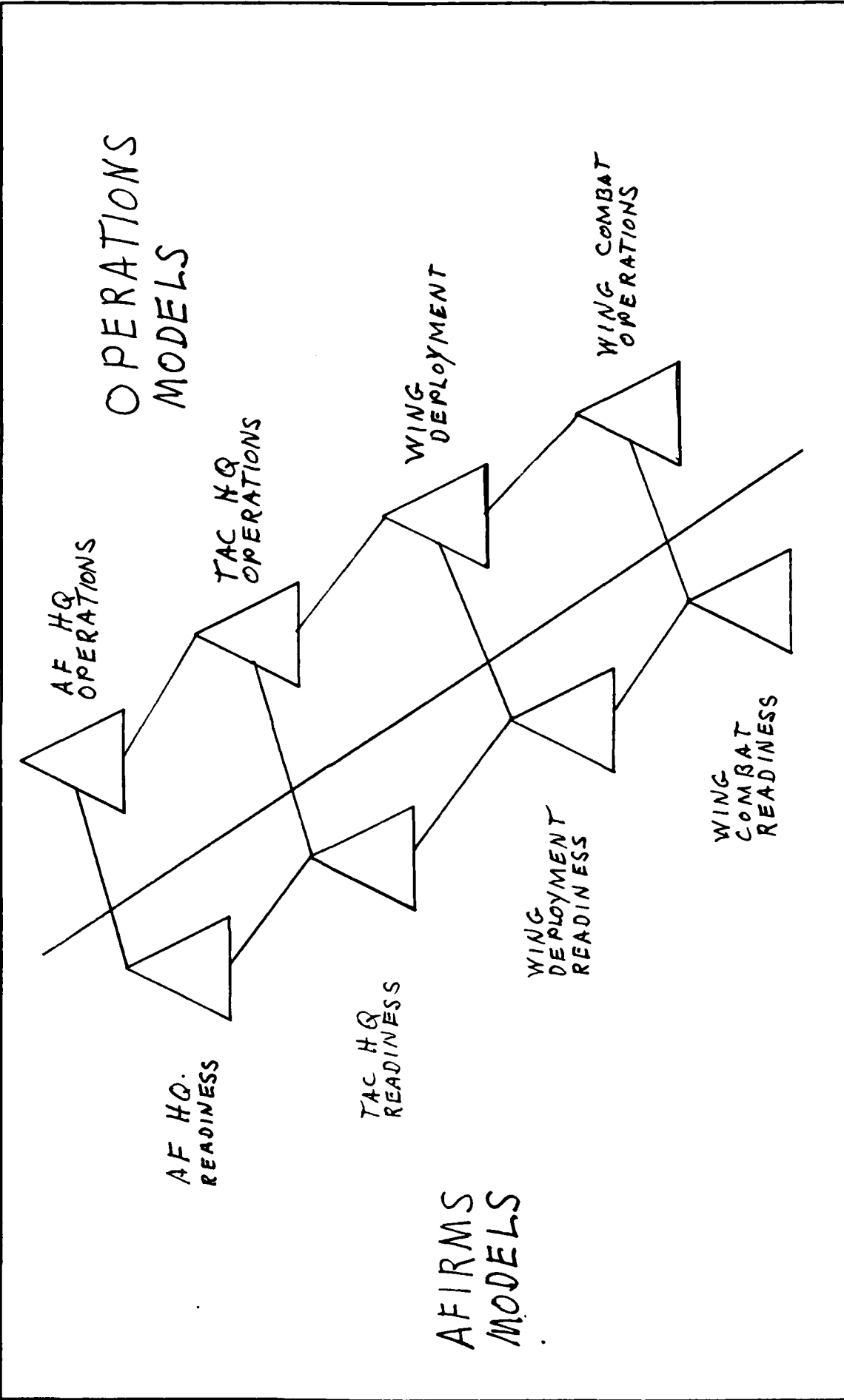

| | | |
|-------|----------------------------|---------------|
| NODE: | TITLE: MODEL RELATIONSHIPS | NUMBER: M 350 |
|-------|----------------------------|---------------|

will be accomplished prior to the prototype design stage. The appendix of this document contains a Wing Operations Model and a Wing Deployment Model. The Air Force AFIRMS Model and the TAC AFIRMS Model are the same and are presented in Section 3 as the Command Model. The Wing Deployment Readiness Model and the Wing Combat Readiness Model are presented in Sections 4 and 5.

Diagram M328 presents an overview of the AFIRMS Prototype. The Assess and Manage Air Force Readiness function will be at Air Force Headquarters in the Pentagon. The assess and Manage TAC Readiness function will be at TAC Headquarters on Langlie AFB. Both functions will operate on the WWMCCS computers and utilize WWMCCS interconnections. Both functions also have the same decomposition.

The remaining two functions: Assess Wing Deployment Readiness and Assess Wing Combat Readiness will either be simulated in the Prototype or be placed at a nearby wing and have special connections to TAC.

Queries received by AFIRMS at Air Force Headquarters are interpreted to determine if the answer can be provided there. If so, then current Air Force Readiness (box 1 output 1), Potential Air Force Readiness (box 1 output 2), or Readiness Management Recommendations can be displayed. If the query can only be answered by TAC or one of its subordinate units, it is formatted for TAC (box 1 output 4).

| | | | | | | |
|----------|-----------------------------|----------------|-------------|--------|------|----------|
| USED AT: | AUTHOR: MATHERS | DATE: 6 MAR 78 | WORKING | READER | DATE | CONTEXT: |
| | PROJECT: AFIRMS | REV: | DRAFT | | | |
| | | | RECOMMENDED | | | |
| | NOTES: 1 2 3 4 5 6 7 8 9 10 | | PUBLICATION | | | |

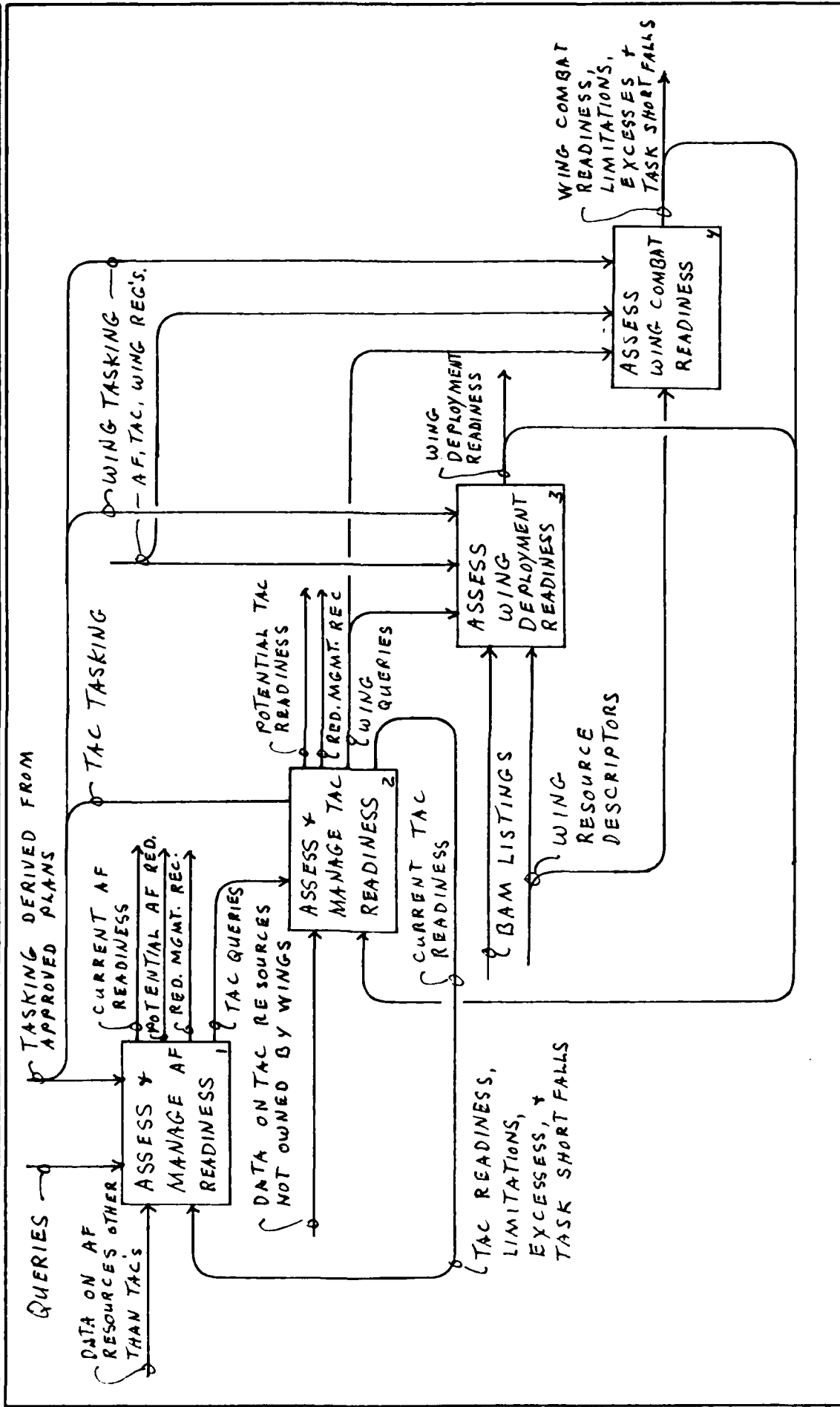

| | | |
|--------------|-------------------------|---------------|
| NODE: AN/A-1 | TITLE: AFIRMS PROTOTYPE | NUMBER: M 328 |
|--------------|-------------------------|---------------|

Queries received by AFIRMS at TAC or from Air Force Headquarters are interpreted to determine if the answer can be provided there. If so then the Current TAC Readiness is displayed (box 2 output 4) or passed upward to Air Force Headquarters; Potential TAC Readiness or Readiness Management Recommendations may also be displayed. If subordinate units must answer the query, it is formatted for them (box 2 output 3).

Requests for wing deployment readiness are interpreted and responses displayed locally or sent upward (box 3). Wing Combat Readiness queries are also interpreted and responses are displayed locally or sent upward (box 4).

The diagram reveals all of the major functions and their interconnections. Since the first two functions are the same, they are decomposed as one model. Level X can be either Air Force Headquarters or TAC Headquarters. The remaining two functions are decomposed as separate models.

Section 3

COMMAND MODEL

3.1 Introduction

The model in this section addresses command Level 'X' because 'X' can be applied to any command level above wing tasked in an approved plan. The model assumes that this command desires maximum readiness and needs to optimize distribution and use of resources to produce maximum readiness.

The command probably has limited capability to move resources. After determining shortages or any necessary redistributions, the command could make recommendations to a higher command and request assistance.

This portion of AFIRMS is controlled by tasking from an approved plan and directed by queries about some aspect of readiness to meet planned tasking. The model was developed to show the inputs required to obtain current and potential Level 'X' readiness.

3.2 Command Model

- A-0 Context: Assess and Manage Readiness
 - A0 Assess and Management Readiness
 - A1 Interpret and Direct Queries
 - A2 Determine Current Readiness
 - A3 Develop and Simulate Options
 - A4 Revise Level 'X' Readiness
 - A5 Develop Management Recommendations

| | | | | | | |
|----------|----------|-------|-------------|--------|------|----------|
| USED AT: | AUTHOR: | DATE: | WORKING | READER | DATE | CONTEXT: |
| | PROJECT: | REV: | DRAFT | | | |
| | | | RECOMMENDED | | | |
| | | | PUBLICATION | | | |

NOTES: 1 2 3 4 5 6 7 8 9 10

CMD /A-0 Assess and Manage Readiness

The model viewpoint is from a commander in a major command, the Chief of Staff, Air Force, or representative staffs. The model's purpose is to discover how readiness can be assessed and managed at Level 'X'.

When a readiness query is directed to the system, AFIRMS responds to the query based on current readiness measurements from one or more subordinates, model, design, series (MDS), or mission type. AFIRMS could also answer, if queried, "what if" questions about moving some specified resources where excesses occur (Command Headquarters) to fill shortages.

| | | |
|-------|--------|---------|
| NODE: | TITLE: | NUMBER: |
|-------|--------|---------|

| | | | | | | |
|----------|------------------------------------|-----------------|-------------|--------|------|------------------|
| USED AT: | AUTHOR: MATHERS PROJECT: AFIRMS | DATE: 12 OCT 77 | WORKING | READER | DATE | CONTEXT: NONE |
| | | REV: | DRAFT | | | |
| | | | RECOMMENDED | | | |
| | | | PUBLICATION | | | |

NOTES: 1 2 3 4 5 6 7 8 9 10

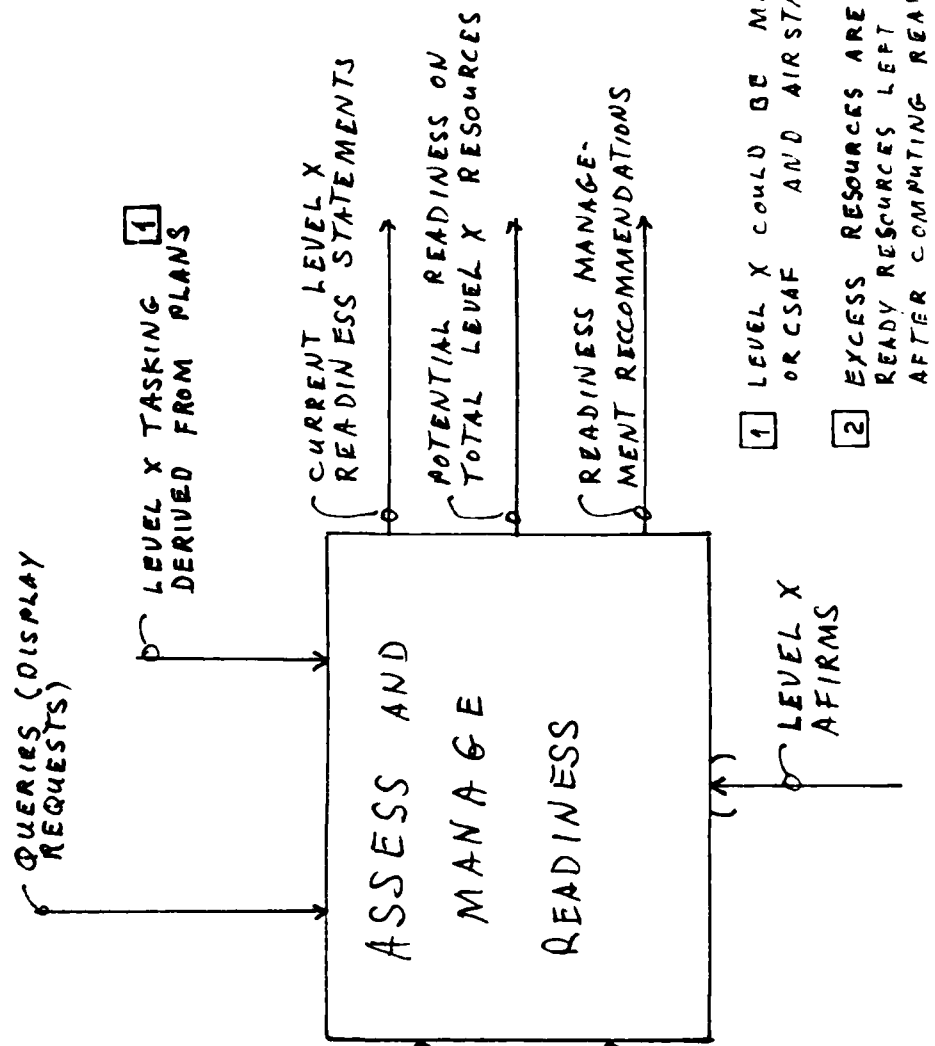

VIEW POINT: LEVEL X COMMANDER
 PURPOSE: TO DISCOVER HOW SUB-ORDINATE READINESS CAN BE AGGREGATED, MEASURED AGAINST LARGER PLAN SEGMENTS AND IMPROVED THROUGH RESOURCE MOVEMENT OPERATIONS

- 1 LEVEL X COULD BE MAJCOM OR CSAF AND AIRSTAF
- 2 EXCESS RESOURCES ARE THOSE READY RESOURCES LEFT OVER AFTER COMPUTING READINESS

| | | | | |
|---------------|------------------------------------|--------------|----|---|
| NODE: CMD/A-0 | TITLE: ASSESS AND MANAGE READINESS | NUMBER: M133 | 44 | B |
|---------------|------------------------------------|--------------|----|---|

| | | | | | | |
|-----------------------------|----------|-------|-------------|--------|------|----------|
| USED AT: | AUTHOR: | DATE: | WORKING | READER | DATE | CONTEXT: |
| | PROJECT: | REV: | DRAFT | | | |
| NOTES: 1 2 3 4 5 6 7 8 9 10 | | | RECOMMENDED | | | |
| | | | PUBLICATION | | | |

CMD/A0 Assess and Manage Readiness

Queries are interpreted (box 1) and sent to functions which can provide the required response. This might be a determination of current readiness (box 2) or a determination of potential readiness under optimum resource allocation (box 2 and 3). Options which provide this potential are evaluated and emerge as management recommendations (box 4).

The query interpretation (box 1) requires an assessment of local information to determine how a subordinate must be queried. If the query is for current readiness, this becomes a control on Determine Current Readiness (box 2), which combines subordinate readiness statements. Queries for potential readiness (box 3) causes the creation of inputs to Revise Level 'X' Readiness (box 4) under the control of current readiness.

Readiness shortfalls from boxes 2 and 3 result from comparing the readiness arrived at in those functions to the required Level 'X' tasking.

Readiness management recommendations are developed (box 5) from the options and unreconciled shortfalls under the control of the additional readiness achieved and queries on recommendations.

| | | |
|-------|--------|---------|
| NODE: | TITLE: | NUMBER: |
|-------|--------|---------|

| | | | | | |
|-----------------|-----------------|-------------|--------|------|---------------|
| USED AT: | DATE: 12 OCT 77 | WORKING | READER | DATE | CONTEXT: M/33 |
| AUTHOR: MAYNERS | REV: | DRAFT | | | TOP |
| PROJECT: AFIRMS | | RECOMMENDED | | | A-0 |
| | | PUBLICATION | | | |

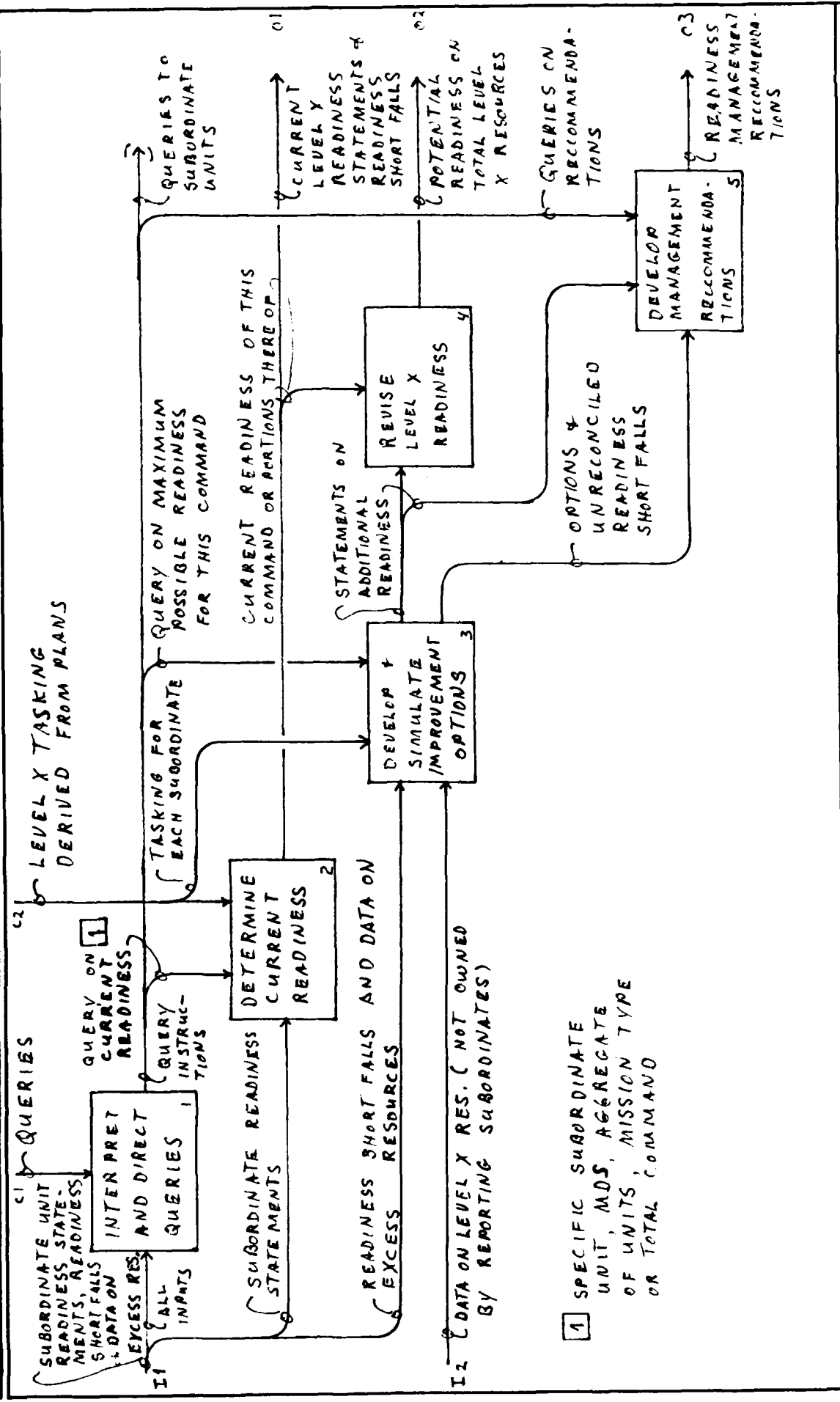

| | | | |
|--------------|------------------------------------|--------------|----|
| NOTE: CMD/AO | TITLE: ASSESS AND MANAGE READINESS | NUMBER: M/34 | 44 |
|--------------|------------------------------------|--------------|----|

| | | | | | | |
|-----------------------------|---------------------|---------------|-------------|-------------|------|----------|
| USED AT: | AUTHOR: PROJECT: | DATE: REV: | WORKING | READER | DATE | CONTEXT: |
| | | | DRAFT | RECOMMENDED | | |
| NOTES: 1 2 3 4 5 6 7 8 9 10 | | | PUBLICATION | | | |

CMD/A1 Interpret and Direct Queries

Query instructions for other functions and locations are developed by first determining the response needed (box 1) and the location of the data and the processor capability (box 2). This location function (box 2) requires an assessment of information already available in the local data base followed by a review of data and processor descriptions at subordinate AFIRMS levels. When the location is determined, instructions are prepared to produce the required response from the appropriate system node (box 3).

| | | |
|-------|--------|---------|
| NODE: | TITLE: | NUMBER: |
|-------|--------|---------|

| | | | | | | |
|-----------------------------|-------------------------------------|-----------------|----------------------------|--------|------|---------------|
| USED AT: | AUTHOR: MATHERS PROJECT: A FIRMS | DATE: 13 OCT 77 | WORKING DRAFT | READER | DATE | CONTEXT: M135 |
| NOTES: 1 2 3 4 5 6 7 8 9 10 | | REV: | RECOMMENDED PUBLICATION | | | □ ○ ○ ○ ○ |

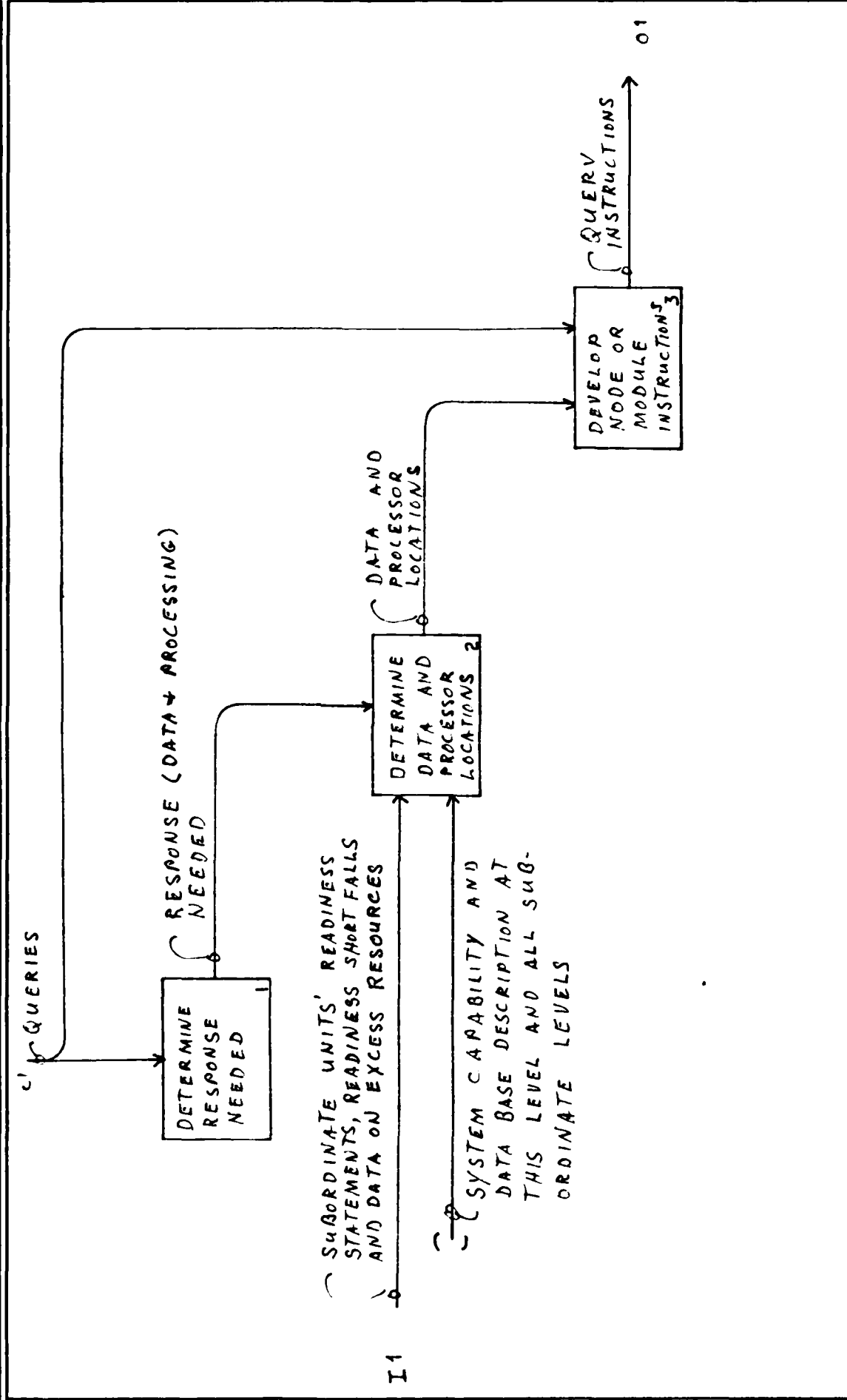

| | | | |
|--------------|-------------------------------------|--------------|----|
| NODE: CMD/A1 | TITLE: INTERPRET AND DIRECT QUERIES | NUMBER: M135 | 44 |
|--------------|-------------------------------------|--------------|----|

| | | | | | | |
|-----------------------------|----------|-------|-------------|--------|------|----------|
| USED AT: | AUTHOR: | DATE: | WORKING | READER | DATE | CONTEXT: |
| | PROJECT: | REV: | DRAFT | | | |
| NOTES: 1 2 3 4 5 6 7 8 9 10 | | | RECOMMENDED | | | |
| | | | PUBLICATION | | | |

CMD/A2 Determine Current Readiness

Queries on the current readiness of command Level 'X', or some subset of it, drive the search for relevant data (box 1) among the readiness statements received from subordinates. Statements on the same unit type, mission type, MDS type, etc., (depending on the query) are aggregated (box 2). These and one of a kind statements are compared to tasking (box 3) to determine the readiness and readiness shortfalls for command Level 'X'. In the final function (box 4) a display of the readiness information is generated to meet the query requirements.

| | | |
|-------|--------|---------|
| NODE: | TITLE: | NUMBER: |
|-------|--------|---------|

| | | | | | | |
|----------|-----------------------------|-----------------|-------------|--------|------|-----------------------------|
| USED AT: | AUTHOR: MATHERS | DATE: 13 OCT 78 | WORKING | READER | DATE | CONTEXT: M134 |
| | PROJECT: AFIRMS | REV: | DRAFT | | | <input type="checkbox"/> |
| | NOTES: 1 2 3 4 5 6 7 8 9 10 | | RECOMMENDED | | | <input type="checkbox"/> |
| | | | PUBLICATION | | | <input type="checkbox"/> |
| | | | | | | A0 <input type="checkbox"/> |

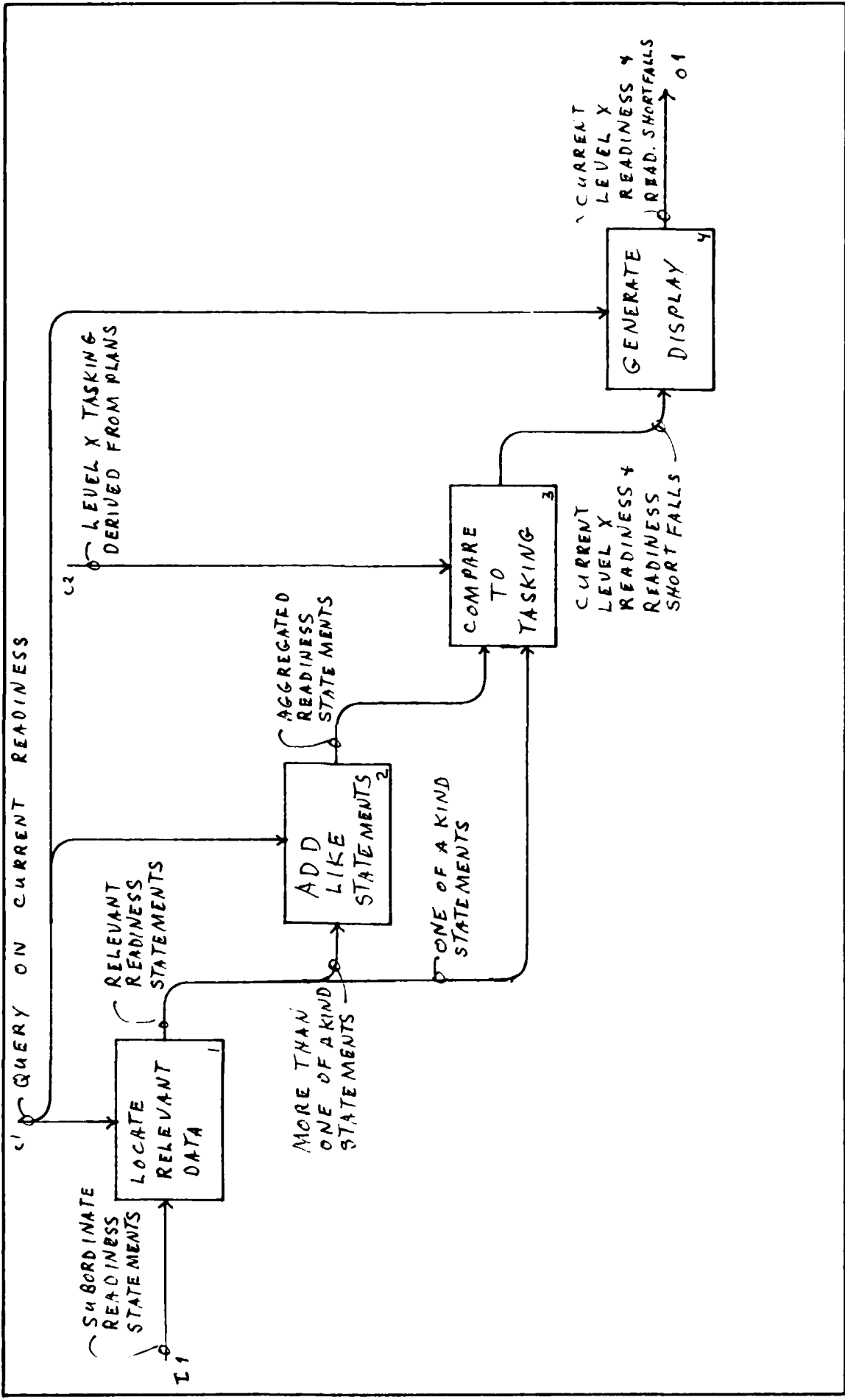

| | | | | |
|--------------|------------------------------------|--------------|----|---|
| NODE: CMD/A2 | TITLE: DETERMINE CURRENT READINESS | NUMBER: M136 | 44 | E |
|--------------|------------------------------------|--------------|----|---|

| | | | | | | |
|-----------------------------|----------|-------|-------------|--------|------|----------|
| USED AT: | AUTHOR: | DATE: | WORKING | READER | DATE | CONTEXT: |
| | PROJECT: | REV: | DRAFT | | | |
| NOTES: 1 2 3 4 5 6 7 8 9 10 | | | RECOMMENDED | | | |
| | | | PUBLICATION | | | |

CMD/A3 Develop and Simulate Options

A query on the maximum possible readiness for Level 'X' command causes a reconciliation of subordinate readiness shortfalls (box 1) with any excess resources other subordinates may have or any resources owned by the Level 'X' headquarters. Unreconciled readiness shortfalls are output at 02, while the reconciliations with the locations of the shortfalls and excesses cause the development of movement options (box 2). The more likely options are selected on the basis of assumed air/sea/land movement capability, and increased subordinate capability (box 3) is calculated. The increased capability is used to compute additional subordinate readiness (box 4) and is compared to individual subordinate tasking to determine any additional readiness.

| | | |
|-------|--------|---------|
| NODE: | TITLE: | NUMBER: |
|-------|--------|---------|

| | | | | | | |
|-----------------------------|------------------------------------|-----------------|------------------|--------|------|---------------|
| USED AT: | AUTHOR: MATHERS PROJECT: AFIRMS | DATE: 13 OCT 77 | WORKING DRAFT | READER | DATE | CONTEXT: M134 |
| NOTES: 1 2 3 4 5 6 7 8 9 10 | | REV: | RECOMMENDED | | | 0 0 □ 0 0 |
| | | | PUBLICATION | | | AO 0 |

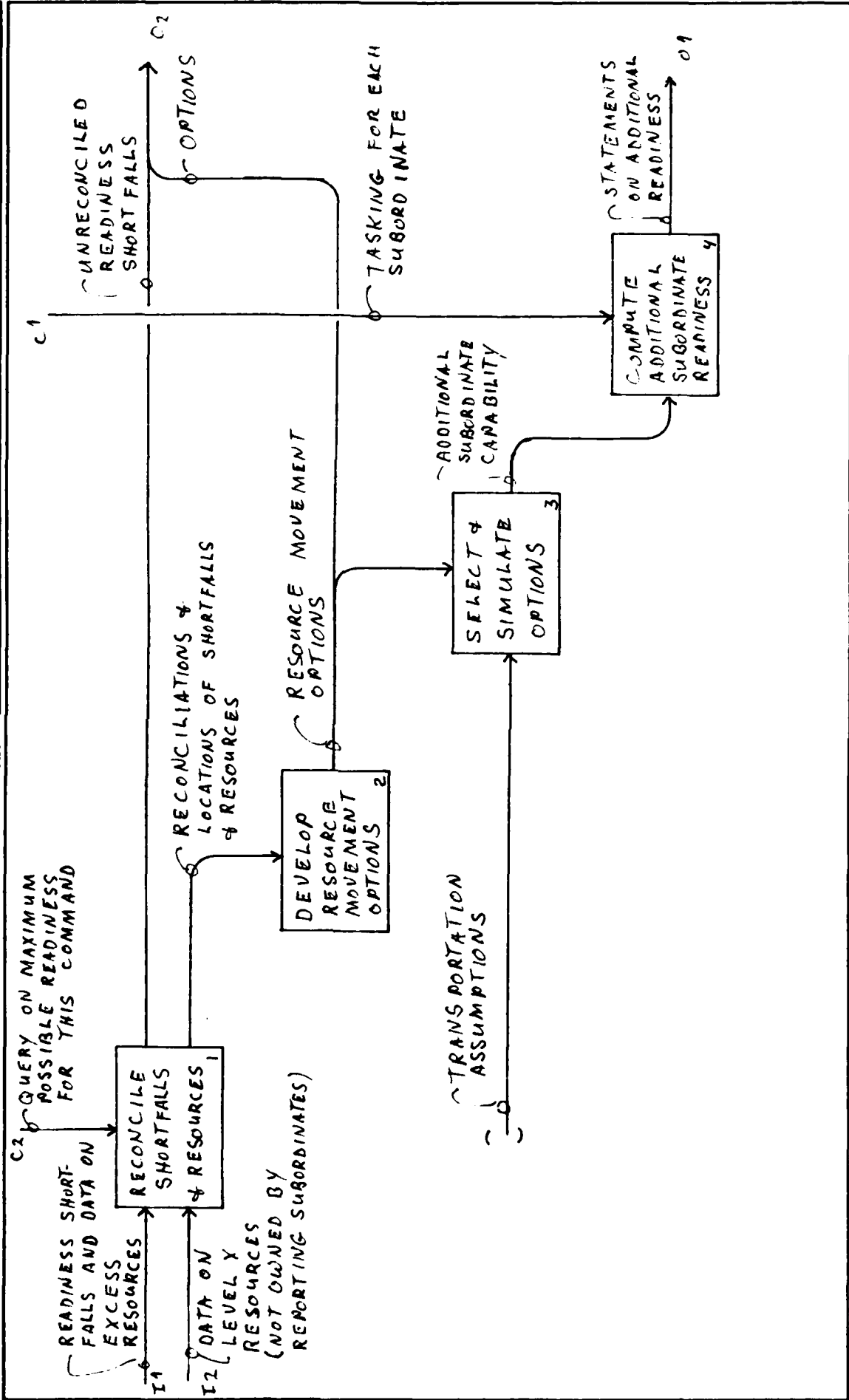

| | | | | |
|---------------|-------------------------------------|--------------|----|---|
| NODE: C41D/A3 | TITLE: DEVELOP AND SIMULATE OPTIONS | NUMBER: M137 | 44 | F |
|---------------|-------------------------------------|--------------|----|---|

| | | | | | | |
|-----------------------------|----------|-------|-------------|--------|------|----------|
| USED AT: | AUTHOR: | DATE: | WORKING | READER | DATE | CONTEXT: |
| | PROJECT: | REV: | DRAFT | | | |
| NOTES: 1 2 3 4 5 6 7 8 9 10 | | | RECOMMENDED | | | |
| | | | PUBLICATION | | | |

CMD/A4 Revise Level 'X' Readiness

Statements on additional readiness are matched with statements on current readiness (same unit, mission, MDS, etc.) (box 1). These are added (box 2) to provide expanded readiness statements for command Level 'X'. A display is then generated (box 3) which shows the potential readiness command Level 'X' could have if it redistributed some of its resources.

| | | |
|-------|--------|---------|
| NODE: | TITLE: | NUMBER: |
| | | |

| | | | | | | |
|-----------------------------|------------------------------------|-------------------------|--|--------|------|----------------------------------|
| USED AT: | AUTHOR: MATHERS PROJECT: AFIRMS | DATE: 13 OCT 77 REV: | WORKING DRAFT RECOMMENDED PUBLICATION | READER | DATE | CONTEXT: M134 0 0 0 0 0 A0 |
| NOTES: 1 2 3 4 5 6 7 8 9 10 | | | | | | |

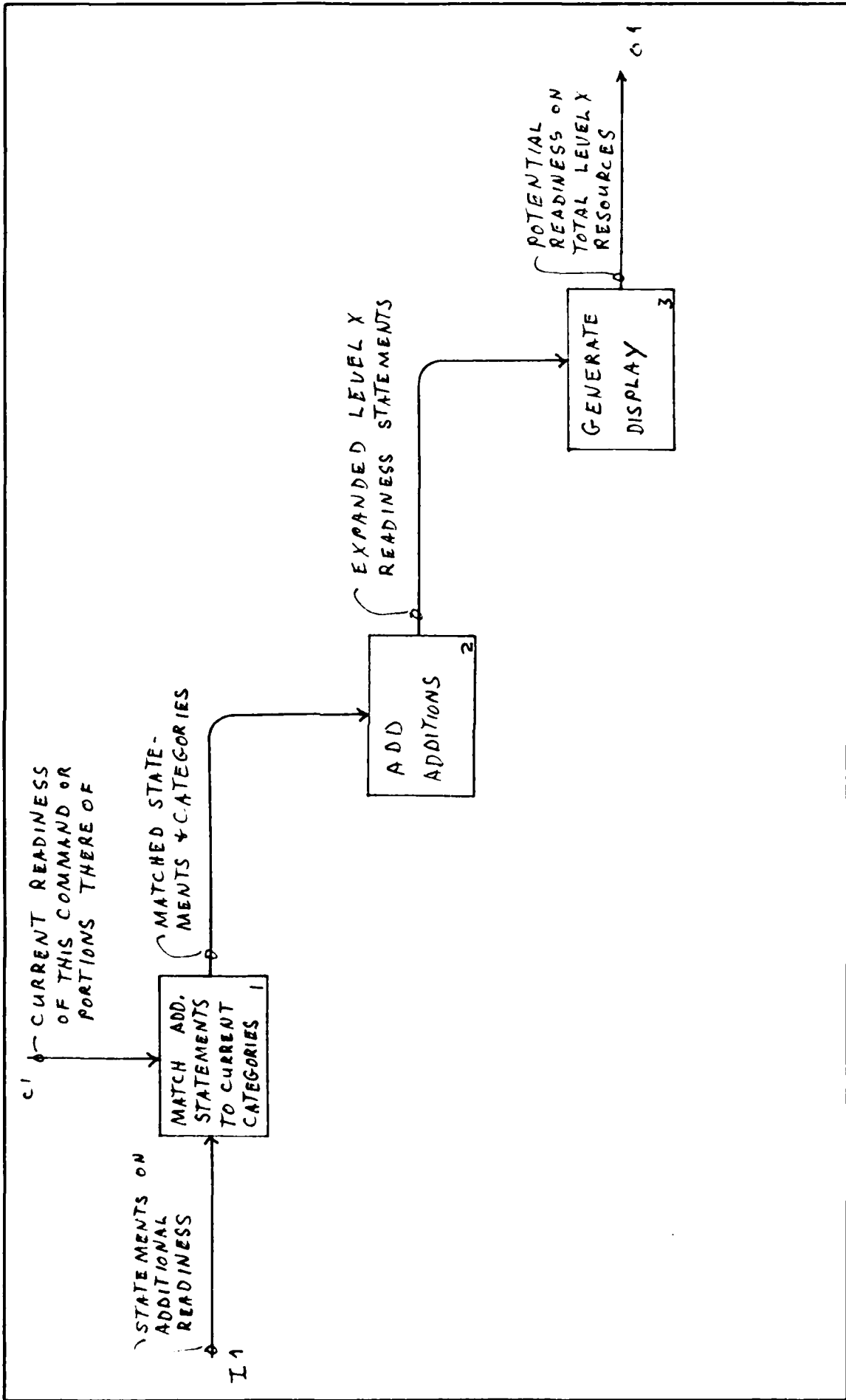

| | | | | |
|--------------|---------------------------------|--------------|----|---|
| NODE: CMD/A4 | TITLE: REVISE LEVEL X READINESS | NUMBER: M137 | 44 | G |
|--------------|---------------------------------|--------------|----|---|

| | | | | | | |
|-----------------------------|----------|-------|-------------|--------|------|----------|
| USED AT: | AUTHOR: | DATE: | WORKING | READER | DATE | CONTEXT: |
| | PROJECT: | REV: | DRAFT | | | |
| NOTES: 1 2 3 4 5 6 7 8 9 10 | | | RECOMMENDED | | | |
| | | | PUBLICATION | | | |

CMD/A5 Develop Management Recommendations

Queries on recommendations and the additional readiness achieved control the determination of option effectiveness (box 1), which in turn controls the function relating option cost to effectiveness (box 2). This results in a statement of option efficiency.

Queries on recommendations also cause the determination of methods for reducing the unreconciled readiness shortfalls (box 3). These methods and option efficiency are used in the development of an action plan (box 4) and a detailed justification of the plan (box 5). The plan and justification are displayed, as directed by the query (box 6), as readiness management recommendations.

| | | |
|-------|--------|---------|
| NODE: | TITLE: | NUMBER: |
|-------|--------|---------|

| | | | | | | |
|-----------------------------|------------------------------------|-----------------|----------------------------|--------|------|---------------|
| USED AT: | AUTHOR: MATHERS PROJECT: AFIRMS | DATE: 13 OCT 77 | WORKING DRAFT | READER | DATE | CONTEXT: M134 |
| NOTES: 1 2 3 4 5 6 7 8 9 10 | | REV: | RECOMMENDED PUBLICATION | | | AD |

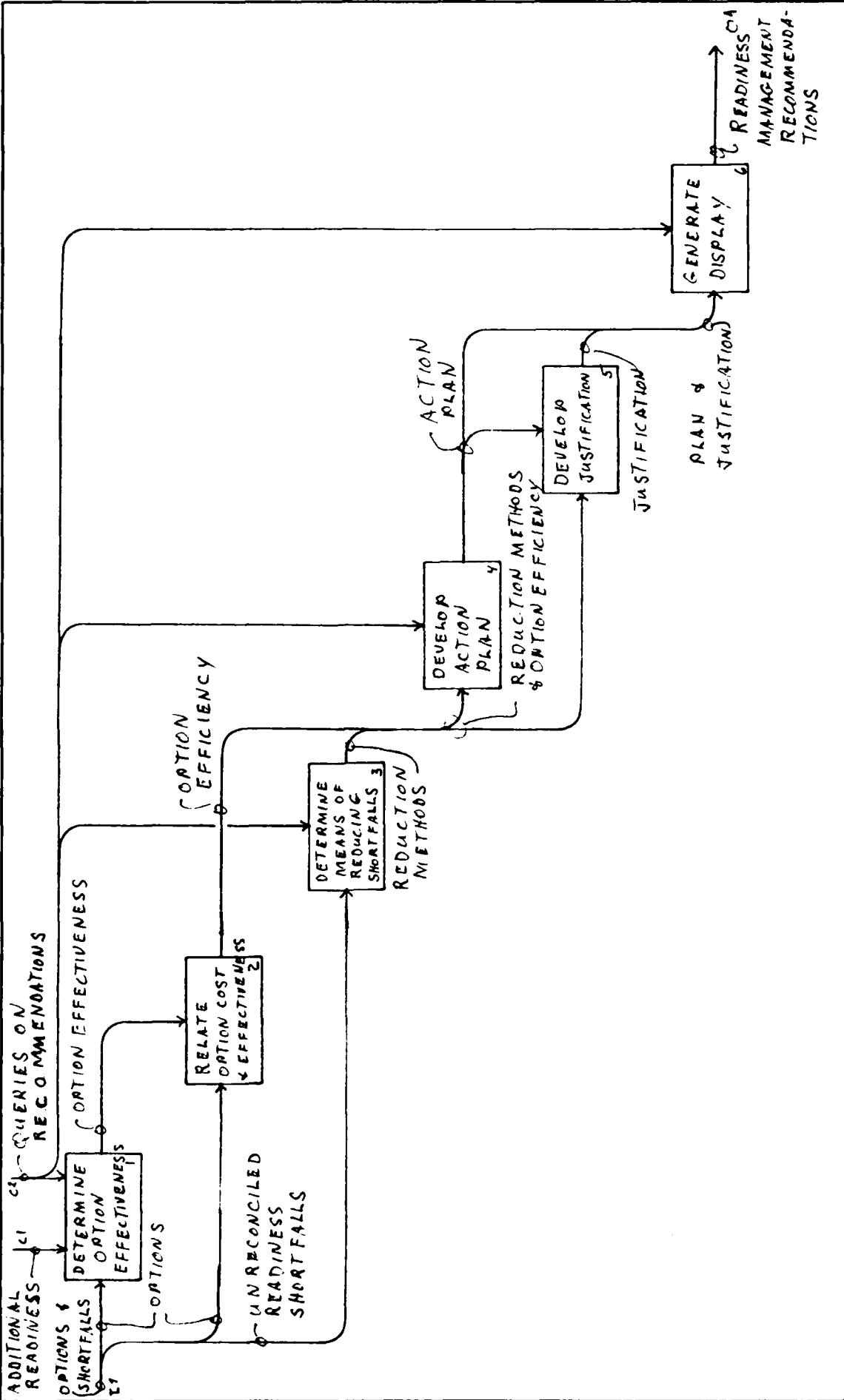

| | |
|---------|------------------------------------|
| NUMBER: | M 139 |
| TITLE: | DEVELOP MANAGEMENT RECOMMENDATIONS |
| NOTE: | CMD/45 |
| | 44 H |

SECTION 4

WING DEPLOYMENT READINESS MODEL

3.1 Introduction

The functions necessary for assessing wing deployment readiness are presented and decomposed in this model. The most probable levels of deployment to the most probable places have already been figured out ahead of time. The aircraft, personnel and equipment which will be sent have been approved and are recorded in the Base Automated Mobility System. The deployment tasking (if it is projected level) need only be looked up in BAM's to learn who and which equipment must go. The problem arises when they must send equipment or personnel and generate the aircraft at the same time but do not have the capability for both. For example three LOX carts must go, three are needed for generation but they only have four. Then deployment processing for the carts must wait until after generation. LOX was just one of several examples which could have been presented. This model attempts to predict the time when deployment can take place

3.2 Model Node Index

- A-0 Context: Assess Wing Deployment Readiness
 - A0 Assess Wing Deployment Readiness
 - A1 Determine Generation Time
 - A2 Determine Equipment and Personnel Release Times
 - A3 Determine Processing and Marketing Time
 - A4 Prepare Schedule of Events

| | | | | | | |
|-----------------------------|-----------------|------------------|-------------|--------|------|----------|
| USED AT: | AUTHOR: Mathers | DATE: 26 Mar. 79 | * WORKING | READER | DATE | CONTEXT: |
| | PROJECT: AFIRMS | REV: | DRAFT | | | |
| NOTES: 1 2 3 4 5 6 7 8 9 10 | | | RECOMMENDED | | | |
| | | | PUBLICATION | | | |

The context of assessing wing deployment readiness is formed by the arrows which bound it. A statement of deployment results from a specific query about specific tasking. Listings of things and personnel that must be deployed for each possible tasking are received from the Base Automated Mobilization System (BAMS) and used with a complete description (location, condition, quantity) of wing resources to generate the readiness statement. This occurs under the control of the query, wing tasking and relevant regulations.

This model has been created from the designers viewpoint in order to reveal the functions which must be performed by the wing level AFIRMS.

| | | |
|-------------------|--|--------------|
| NODE: WOR/A0 Text | TITLE: Context: Assess Wing Deployment Readiness | NUMBER: M336 |
|-------------------|--|--------------|

| | | | | | | |
|----------|------------------------------------|-----------------|-------------|--------|------|----------|
| USED AT: | AUTHOR: MATHERS PROJECT: AFIRMS | DATE: 26 MAR 79 | WORKING | READER | DATE | CONTEXT: |
| | NOTES: 1 2 3 4 5 6 7 8 9 10 | REV: | DRAFT | | | |
| | | | RECOMMENDED | | | |
| | | | PUBLICATION | | | |

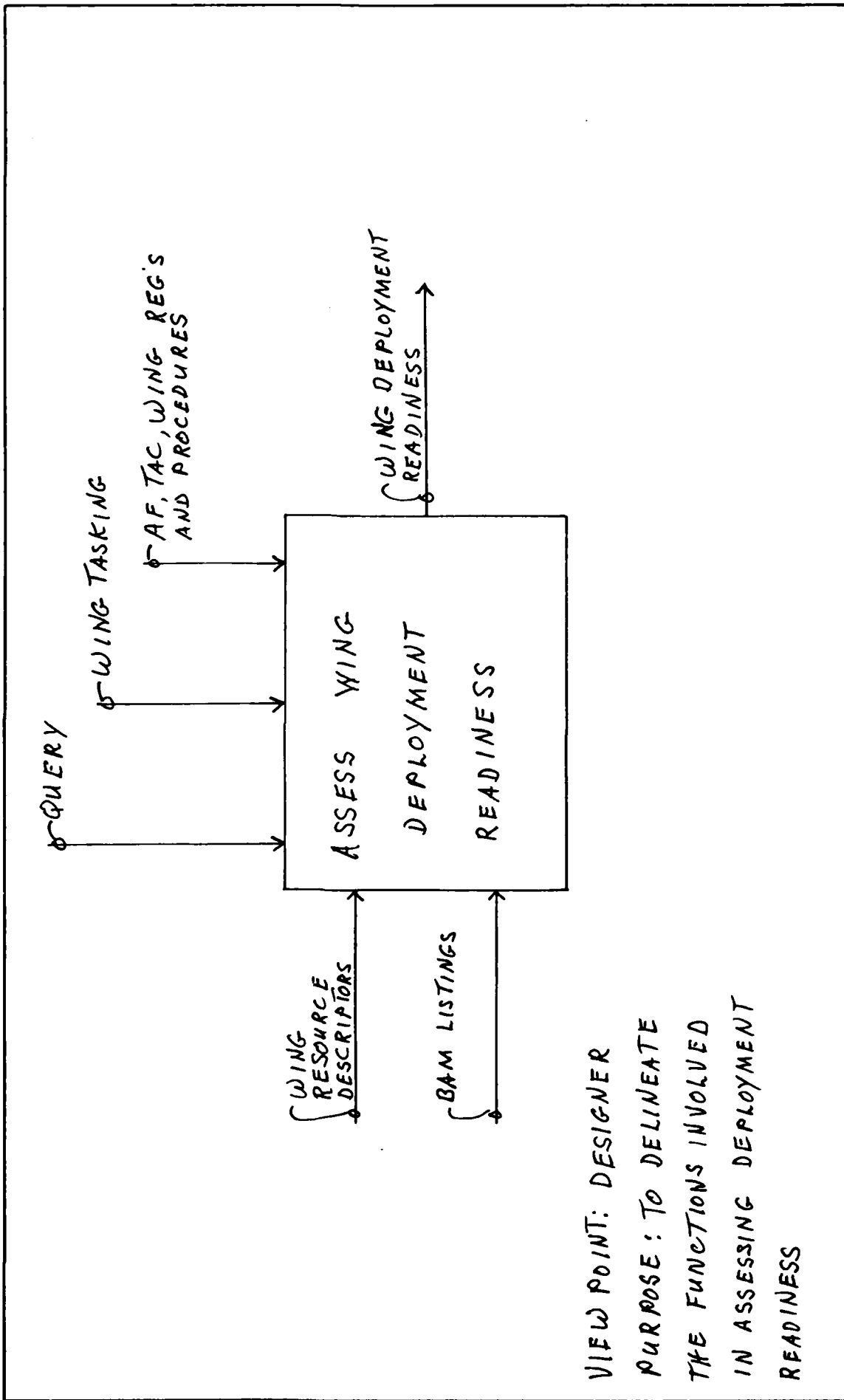

VIEW POINT: DESIGNER
 PURPOSE: TO DELINEATE
 THE FUNCTIONS INVOLVED
 IN ASSESSING DEPLOYMENT
 READINESS

| | | |
|---------|---|---------|
| NODE: | TITLE: | NUMBER: |
| WDR/A-0 | CONTEXT: ASSESS WING DEPLOYMENT READINESS | M 334 |

| | | | | | | |
|----------|-----------------------------|------------------|-------------|--------|------|----------|
| USED AT: | AUTHOR: Mathers | DATE: 26 Mar. 79 | *WORKING | READER | DATE | CONTEXT: |
| | PROJECT: AFIRMS | REV: | DRAFT | | | |
| | NOTES: 1 2 3 4 5 6 7 8 9 10 | | RECOMMENDED | | | |
| | | | PUBLICATION | | | |

Wing deployment readiness is a statement of when the wing can be ready to deploy (i.e., time between notification and departure). It includes a schedule of events and the limiting factors for each set of events. Factors which control event timing are aircraft generation, release of equipment and personnel therefrom and the actual processing and marshalling time of personnel and material being mobilized.

The location, condition and quantity of wing resources are used to determine generation time (box 1). Wing tasking controls what levels of Unit Equipage (UE) can be deployed. The query selects one UE and relevant regulations control the generation process. Release times of personnel and equipment from generation is determined (box 2). These can cause a late start for processing and marshalling which is determined (box 3) as the final critical time inputs for preparing (box 4) the schedule of events. The final step is determining the limiting factors (box 5) for each function in the total deployment process.

| | | |
|-------------------|---|--------------|
| NODE: WDR/A0 Text | TITLE: Assess Wing Deployment Readiness | NUMBER: M337 |
|-------------------|---|--------------|

| | | | | | | |
|----------|------------------------------------|-----------------|-------------|--------|------|----------|
| USED AT: | AUTHOR: MATHERS PROJECT: AFIRMS | DATE: 13 MAR 79 | WORKING | READER | DATE | CONTEXT: |
| | | REV: | DRAFT | | | |
| | | | RECOMMENDED | | | |
| | | | PUBLICATION | | | |

NOTES: 1 2 3 4 5 6 7 8 9 10

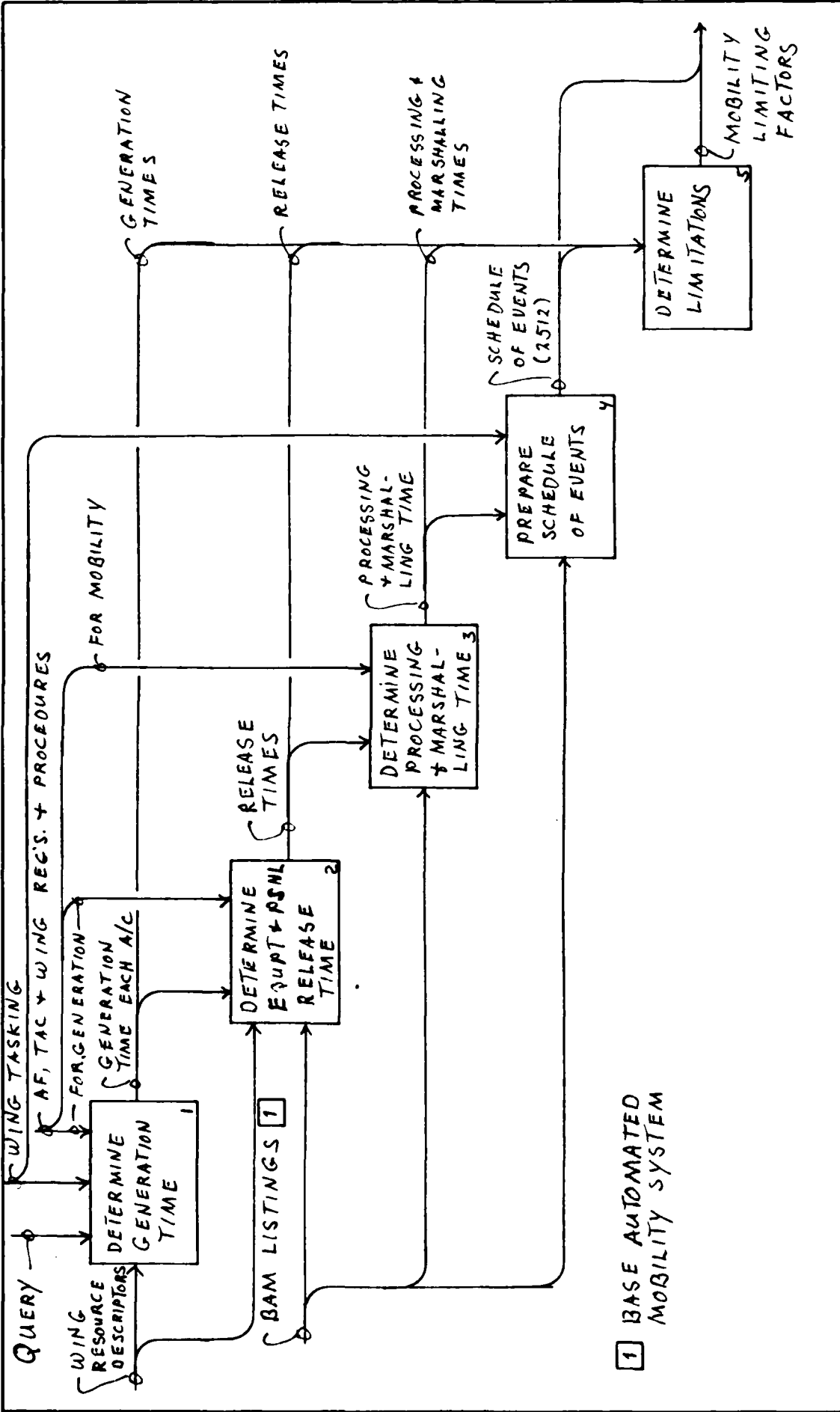

1 BASE AUTOMATED MOBILITY SYSTEM

| | | |
|--------------|---|--------------|
| NODE: WDR/AO | TITLE: ASSESS WING DEPLOYMENT READINESS | NUMBER: M322 |
|--------------|---|--------------|

| | | | | | | |
|----------|-----------------------------|------------------|-------------|--------|------|----------|
| USED AT: | AUTHOR: Mathers | DATE: 26 Mar. 79 | * WORKING | READER | DATE | CONTEXT: |
| | PROJECT: AFIRMS | REV: | DRAFT | | | |
| | NOTES: 1 2 3 4 5 6 7 8 9 10 | | RECOMMENDED | | | |
| | | | PUBLICATION | | | |

A tentative schedule is developed (box 1) for the number of aircraft specified in the query and the tasking. The schedule reflects the order and times required for that number of aircraft given the experience of personnel and any necessary assumptions. Schedule development is further controlled by regulations and generation procedures. Wing tasking also controls the review (box 2) of the location, condition and quantity of aircraft, maintenance equipment and personnel resulting in resource availability. The partial schedule and tasking control the assignment of aircraft and aircraft maintenance units to lines in the schedule in accordance with their availability. The preliminary schedule is then adjusted for any other experience or availability factors resulting in a generation time (start to finish) for each aircraft.

| | | |
|----------------------|-------------------------------------|-----------------|
| NODE: WDR/A1 Text | TITLE: Determine Generation Time | NUMBER: N338 |
|----------------------|-------------------------------------|-----------------|

| | | | | | | |
|-----------------------------|------------------------------------|-------------------------|----------------------------|--------|------|----------|
| USED AT: | AUTHOR: MATHERS PROJECT: AFIRMS | DATE: 13 MAR 79 REV: | WORKING DRAFT | READER | DATE | CONTEXT: |
| NOTES: 1 2 3 4 5 6 7 8 9 10 | | | RECOMMENDED PUBLICATION | | | |

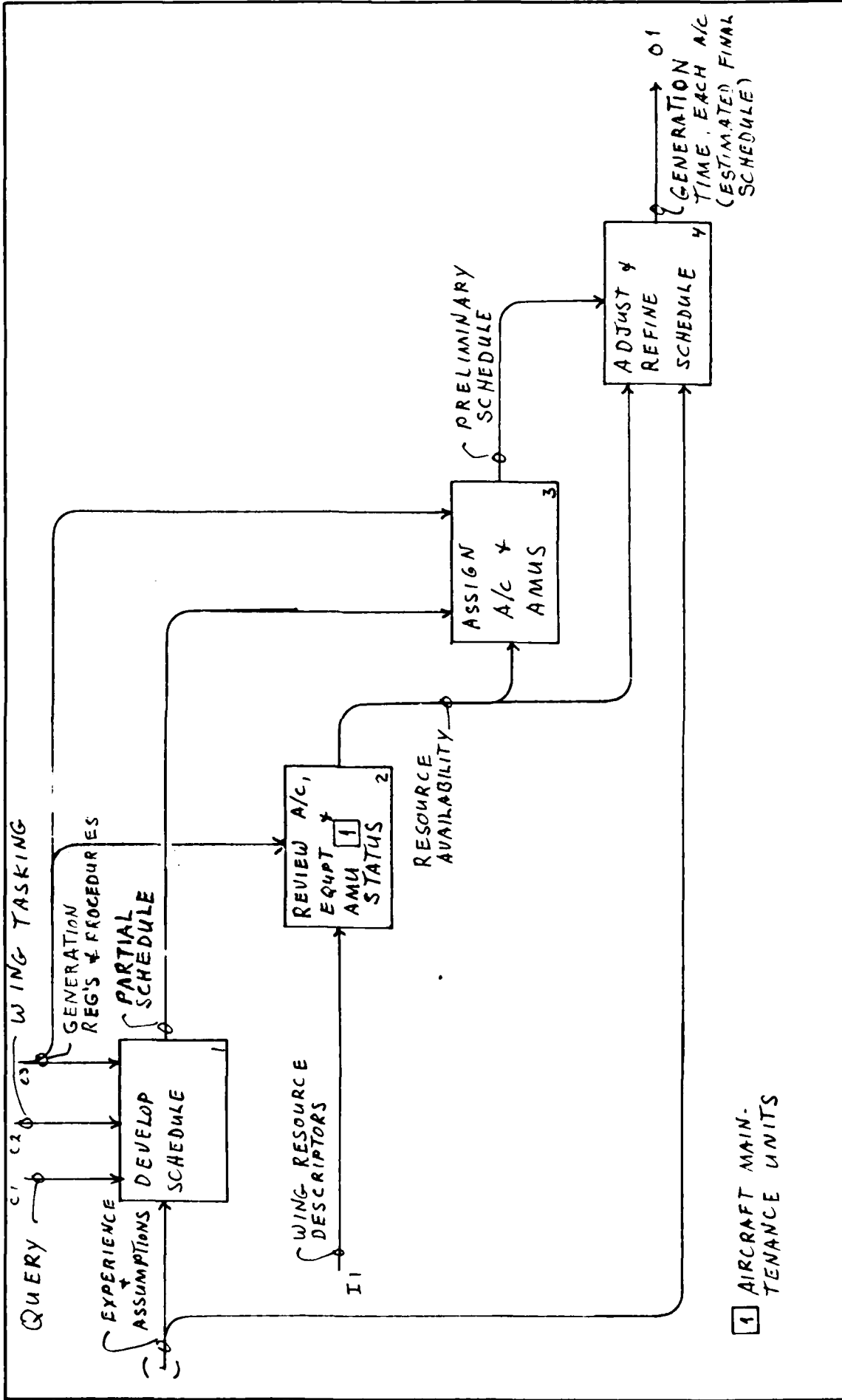

| | | |
|-----------------|-------------------------------------|-----------------|
| NODE: WDR/AI | TITLE: DETERMINE GENERATION TIME | NUMBER: M323 |
|-----------------|-------------------------------------|-----------------|

| | | | | | | |
|----------|-----------------------------|------------------|-------------|--------|------|----------|
| USED AT: | AUTHOR: Mathers | DATE: 26 Mar. 79 | * WORKING | READER | DATE | CONTEXT: |
| | PROJECT: AFIRMS | | | | | |
| | NOTES: 1 2 3 4 5 6 7 8 9 10 | REV: | RECOMMENDED | | | |
| | | | PUBLICATION | | | |

BAM listings are studied to identify (box 1) items of equipment or personnel needed for generation that must also be deployed. The generation procedures and the generation times for each aircraft determine the times when these items are last needed for generation (box 2). Given this information, it is then possible to generate a list (box 3) indicating when these critical items can be released for processing.

| | | |
|----------------------|--|-----------------|
| NODE: WDR/A2 Text | TITLE: Determine Equipment and Personnel Release Times | NUMBER: M339 |
|----------------------|--|-----------------|

| | | | | | | |
|-----------------------------|-------------------------------------|-------------------------|--|--------|------|----------|
| USED AT: | AUTHOR: MATHERS PROJECT: A FIRMS | DATE: 13 MAR 79 REV: | WORKING DRAFT RECOMMENDED PUBLICATION | READER | DATE | CONTEXT: |
| NOTES: 1 2 3 4 5 6 7 8 9 10 | | | | | | |

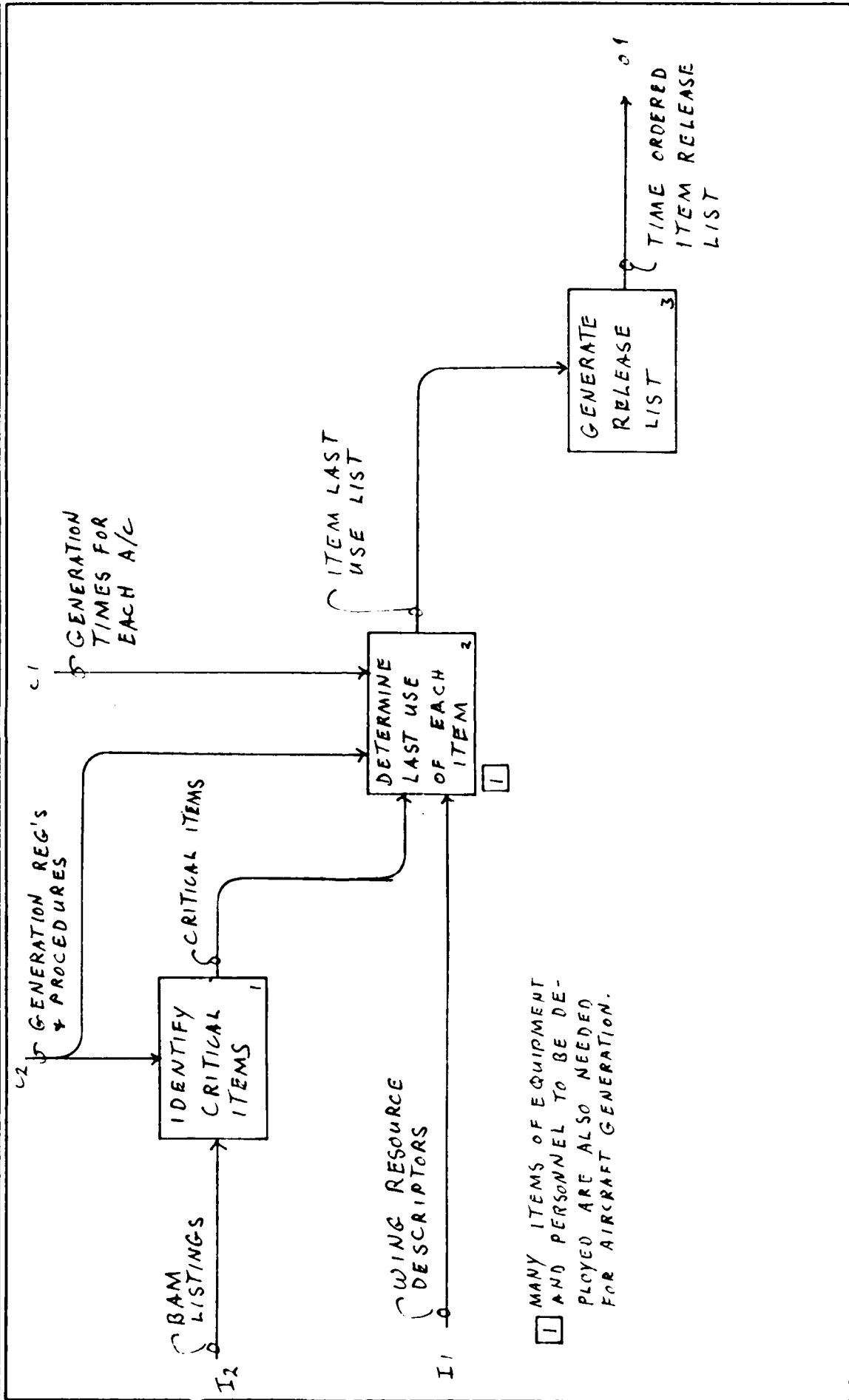

| | | |
|-----------------|---|-----------------|
| NODE: WDR/A2 | TITLE: DETERMINE EQUIPMENT & PERSONNEL RELEASE TIMES | NUMBER: M324 |
|-----------------|---|-----------------|

| | | | | | | |
|-----------------------------|-----------------|------------------|-----------|--------|------|----------|
| USED AT: | AUTHOR: Mathers | DATE: 27 Mar. 79 | * WORKING | READER | DATE | CONTEXT: |
| | PROJECT: AFIRMS | REV: | DRAFT | | | |
| NOTES: 1 2 3 4 5 6 7 8 9 10 | | | | | | |

Not all items being deployed are involved in aircraft generation. Processing of these can start immediately. However, processing cannot start in earnest until crucial items are released from generation. Release times really control the start and especially the completion time of each pallet. These items are identified (box 1) in the BAMS listing and their release signals pallet assembly start time. Complexity of the pallet determines its completion time (box 2). Processing completion controls availability for movement while distance to the marshalling point and availability of movement equipment determine (box 3) marshalling completion time.

Concurrently the release of deploying personnel from aircraft generation controls the determination (box 4) of passenger assembly completion time. Which, in turn, controls passenger processing completion time (box 5). Completion of all these events are entered into AF Form 2511 and thus control its completion. The completed 2511 contains PAX/Cargo processing and marshalling start and completion times.

| | | |
|-------------------|--|--------------|
| NODE: WDR/A3 Text | TITLE: Determine Processing and Marshalling Time | NUMBER: M340 |
|-------------------|--|--------------|

| | | | | | | |
|-----------------|-----------------|-----------------|-------------|--------|------|----------|
| USED AT: | AUTHOR: MATHERS | DATE: 13 MAR 79 | WORKING | READER | DATE | CONTEXT: |
| PROJECT: AFIRMS | REV: | | DRAFT | | | |
| | | | RECOMMENDED | | | |
| | | | PUBLICATION | | | |

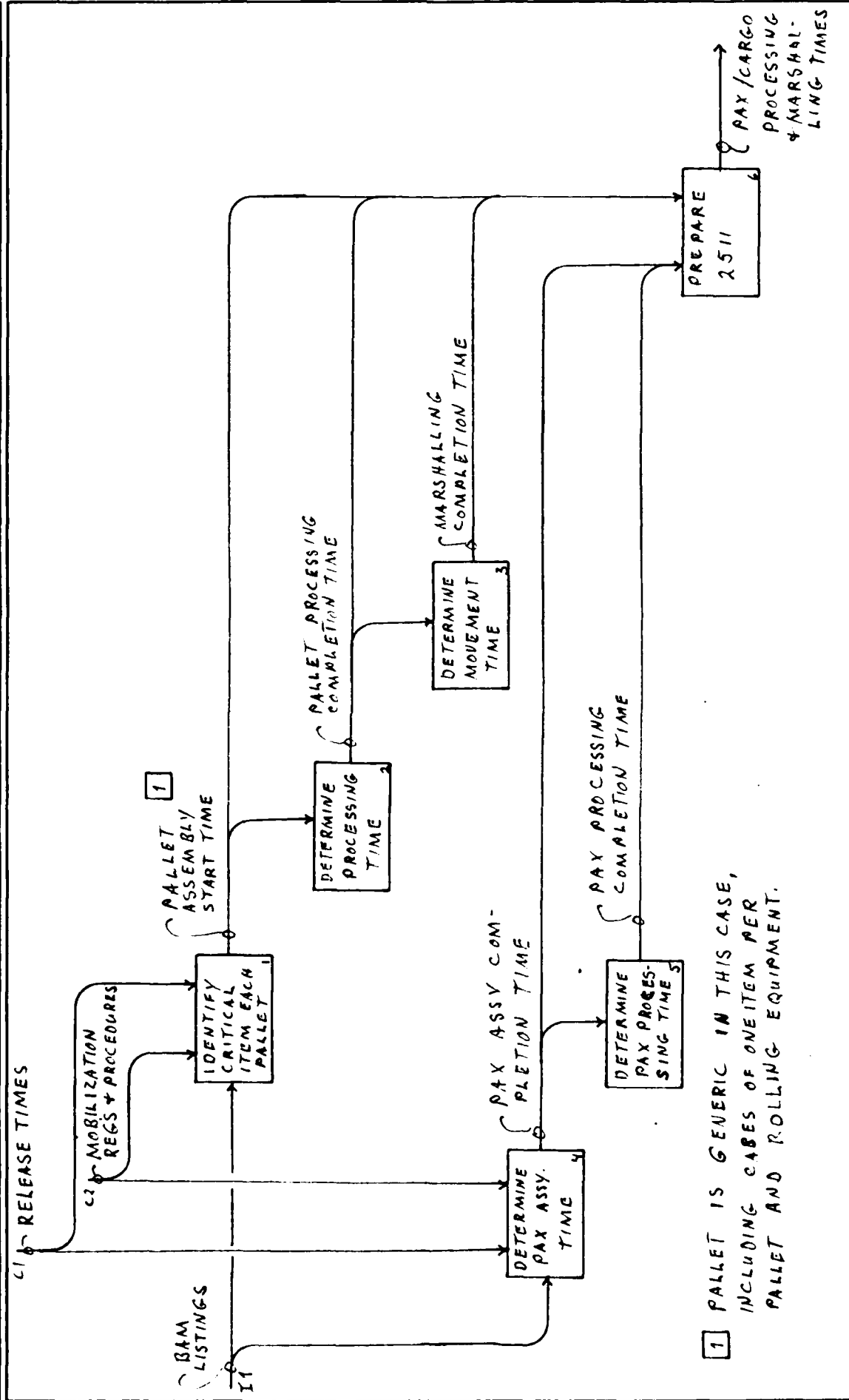

1. PALLET IS GENERIC IN THIS CASE, INCLUDING CABS OF ONE ITEM PER PALLET AND ROLLING EQUIPMENT.

| | | |
|----------------|--|--------------|
| MODE: WDR / A3 | TITLE: DETERMINE PROCESSING & MARSHALLING TIME | NUMBER: M325 |
|----------------|--|--------------|

| | | | | | | |
|-----------------------------|-----------------|------------------|-------------|--------|------|----------|
| USED AT: | AUTHOR: Mathers | DATE: 27 Mar. 79 | * WORKING | READER | DATE | CONTEXT: |
| | PROJECT: AFIRMS | REV: | DRAFT | | | |
| NOTES: 1 2 3 4 5 6 7 8 9 10 | | | RECOMMENDED | | | |
| | | | PUBLICATION | | | |

The loading plan is determined (box 1) from the items to be deployed (BAM listing) controlled by the wing tasking (UE, island hopping, air refuelling, etc.) and the processing/marshalling times. Wing tasking also controls order planning (box 2), manifest completion (box 3) and briefing completion (box 4). These completion times control the completion of the schedule of events (box 5) into which they are entered.

| | | |
|-------------------|-----------------------------------|--------------|
| NODE: WDR/A4 Text | TITLE: Prepare Schedule of Events | NUMBER: N341 |
|-------------------|-----------------------------------|--------------|

| | | | | | | |
|----------|-------------------------------------|-----------------|----------------------------|--------|------|----------|
| USED AT: | AUTHOR: MATHERS PROJECT: A FIRMS | DATE: 13 MAR 79 | WORKING DRAFT | READER | DATE | CONTEXT: |
| | NOTES: 1 2 3 4 5 6 7 8 9 10 | REV: | RECOMMENDED PUBLICATION | | | |

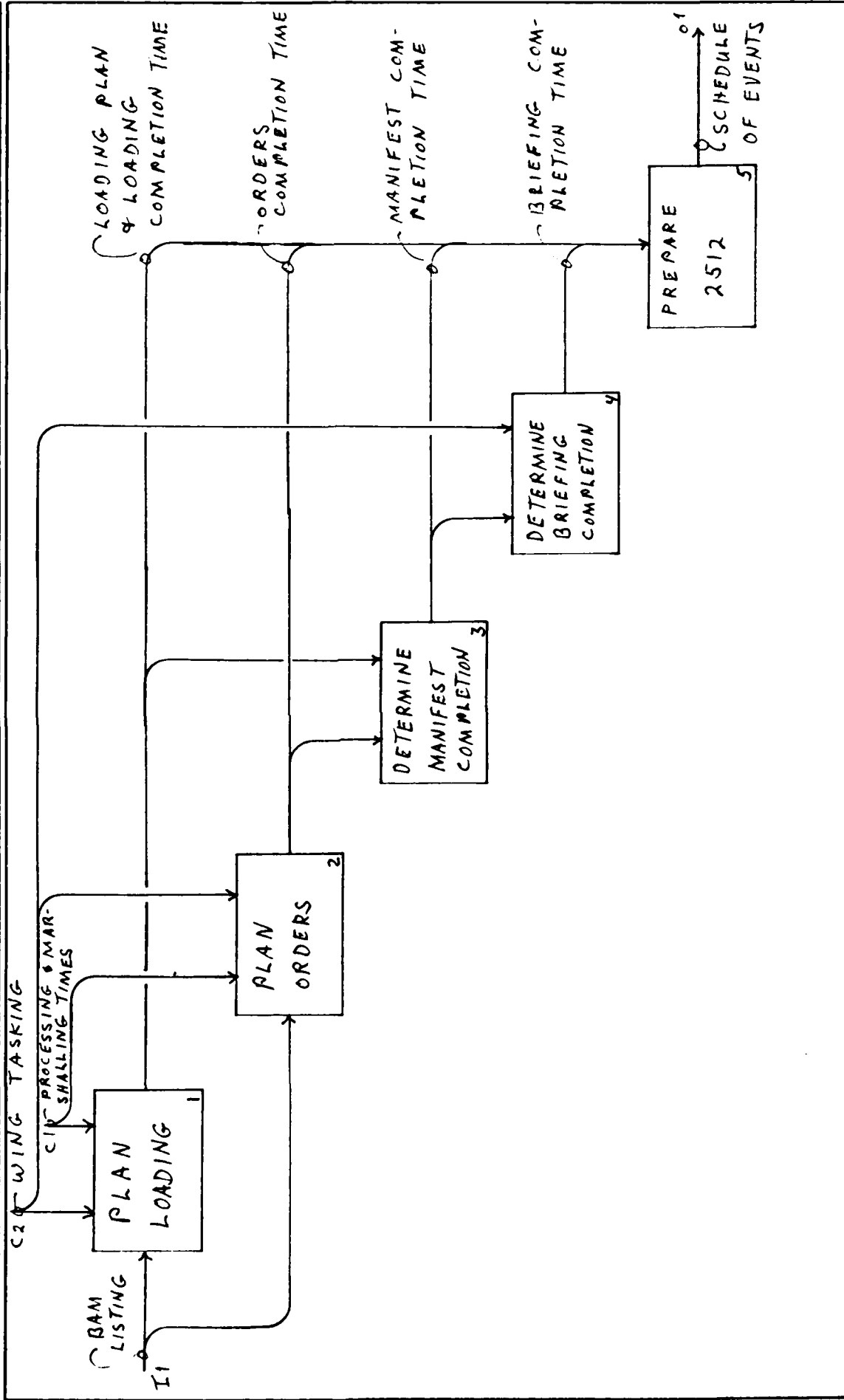

| | | |
|--------------|-----------------------------------|---------------|
| MODE: WDR/A4 | TITLE: PREPARE SCHEDULE OF EVENTS | NUMBER: M 326 |
|--------------|-----------------------------------|---------------|

| | | | | | |
|----------|-----------------------------|------------------|-----------|-------------|----------|
| USED AT: | AUTHOR: Mathers | DATE: 27 Mar. 79 | * WORKING | READER | DATE |
| | PROJECT: AFIRNS | | | REV: | DRAFT |
| | NOTES: 1 2 3 4 5 6 7 8 9 10 | | | RECOMMENDED | |
| | | | | PUBLICATION | |
| | | | | | CONTEXT: |

All of the start and completion times which have been determined in the previous diagrams are analyzed (box 1) to determine a critical time path for each activity. The time path is used to identify (box 2) the limiting factors on each path and hence in each activity. These are assembled into a listing (box 3) of the mobility limiting factors.

| | | |
|-------------|-----------------------|---------|
| NODE: | TITLE: | NUMBER: |
| WDR/A5 Text | Determine Limitations | M342 |

| | | | | | | | | | | | |
|-----------------------------|------------------|-------|-----------------|-------------|---------|-------------|------|--|----------|--|--|
| USED AT: | AUTHOR: MATHERS | | DATE: 13 MAR 79 | | READER | | DATE | | CONTEXT: | | |
| | PROJECT: A FIRMS | | REV: | | WORKING | | | | | | |
| NOTES: 1 2 3 4 5 6 7 8 9 10 | | DRAFT | | RECOMMENDED | | PUBLICATION | | | | | |

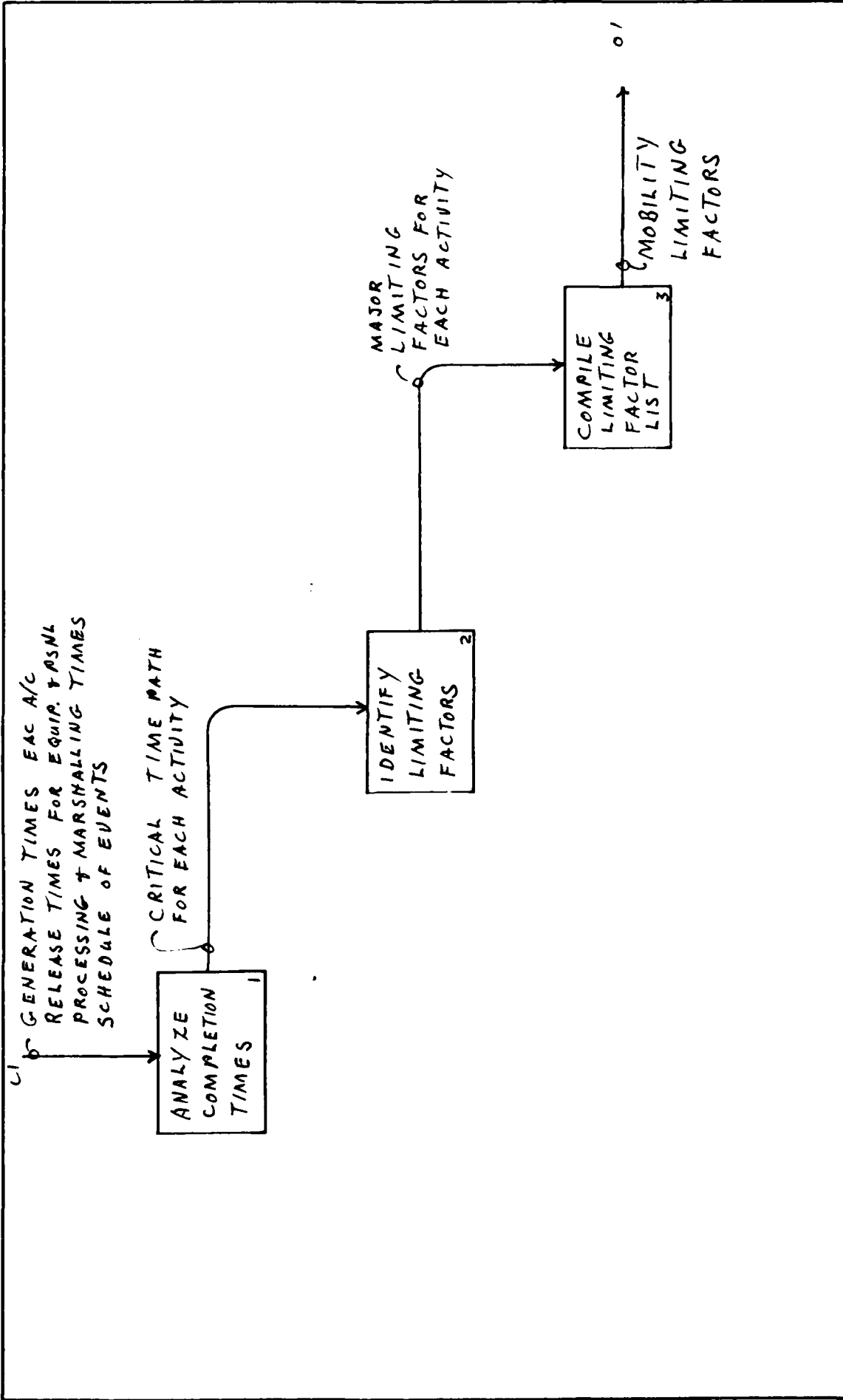

| | | |
|--------------|------------------------------|--------------|
| NODE: WDR/AS | TITLE: DETERMINE LIMITATIONS | NUMBER: M327 |
|--------------|------------------------------|--------------|

Section 5

WING COMBAT READINESS MODEL

5.1 Introduction

This model determines how many sorties the wing is ready to generate. The assessment is made in response to a query which specifies at least some of the conditions under which they must be generated. Factors which permit or limit the generation level are the quantity, location and condition of resources used in generation. These fall into three general categories viz. aircraft and aircraft support, munitions and munitions support and aircrews. The functions involved are presented and decomposed in this model.

The readiness of each category is compared with the Wing tasking which specifies what the wing must do in combat. The differences are shortfalls that must be eliminated or made up by the efforts of other wings. Wing resources which are not used are available to relieve the limitations of other wings within the theater.

5.2 Model Node Index

A-0 Context, Assess Wing Combat Readiness

A0 Assess Wing Combat Readiness

A1 Analyze Query

A2 Assess Aircraft Readiness

A3 Assess Munitions Readiness

A4 Assess Aircrew Readiness

A5 Determine Shortfalls

| | | | | | |
|-----------------|------------------------------------|------------------------|--------------------|-------------|-----------------|
| USED AT: | AUTHOR: Mathers | DATE: 27 Mar 79 | READER | DATE | CONTEXT: |
| | PROJECT: AFIRMS | REV: | * WORKING | | |
| | | | DRAFT | | |
| | | | RECOMMENDED | | |
| | | | PUBLICATION | | |
| | NOTES: 1 2 3 4 5 6 7 8 9 10 | | | | |

Wing resource descriptors (i.e., location, condition and quantity) are used in the assessment of wing combat readiness. This is accomplished when a query is received and in accordance with its specifications. Air Force, TAC and wing regulations specify how things will be done while wing tasking specifies what the wing should be ready to do.

The model has been created from the designer's viewpoint to reveal the functions a Wing AFIRMS must contain in order to assess combat readiness.

| | | |
|---------------------------|--|---------------------|
| NODE: WCR/A-0 Text | TITLE: | NUMBER: M343 |
| | Context: Assess Wing Combat Readiness | |

| | | | | | | |
|-----------------------------|------------------------------------|-------------------------|--|--------|------|----------|
| USED AT: | AUTHOR: MATHERS PROJECT: AFIRMS | DATE: 26 MAR 79 REV: | WORKING DRAFT RECOMMENDED PUBLICATION | READER | DATE | CONTEXT: |
| NOTES: 1 2 3 4 5 6 7 8 9 10 | | | | | | |

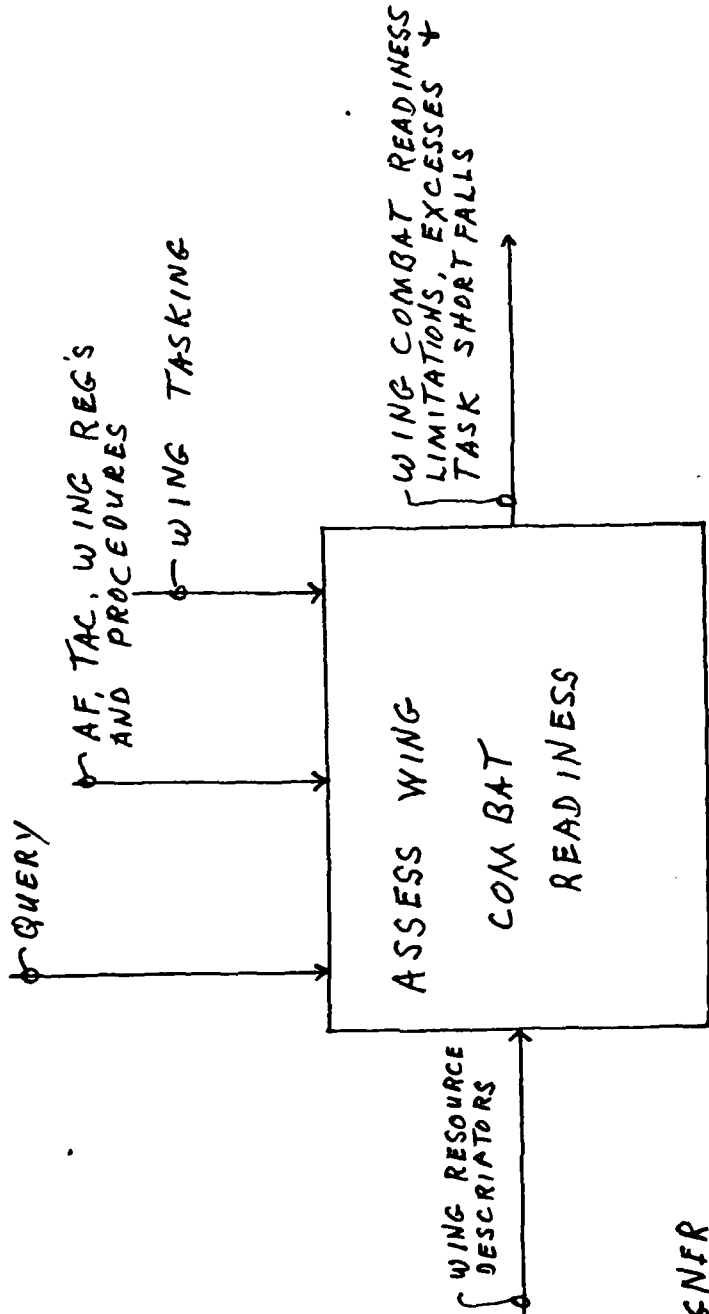

VIEW POINT: DESIGNER
 PURPOSE: TO REVEAL
 THE FUNCTIONS IN
 ASSESSING READINESS

| | | |
|---------------|-------------------------------------|--------------|
| NODE: WCR/A-0 | TITLE: ASSESS WING COMBAT READINESS | NUMBER: M335 |
|---------------|-------------------------------------|--------------|

| | | | | | | |
|------------------------------------|------------------------|-------------------------|----------------|---------------|-------------|-----------------|
| USED AT: | AUTHOR: Mathers | DATE: 27 Mar. 79 | WORKING | READER | DATE | CONTEXT: |
| | PROJECT: AFIRMS | REV: | DRAFT | | | |
| NOTES: 1 2 3 4 5 6 7 8 9 10 | | | | | | |

Assessment of Wing Combat Readiness results in statements on what the wing is ready to do over a time period specified in the query or derived from the assessment. It also produces limitations imposed by each resource category, excess resources which would not be used in that time period plus taking shortfalls.

The process begins with an analysis of the query (box 1) to determine what is being requested. The aircraft, Designed Operational Capability (DOC) and number of days control the assessment of aircraft readiness (box 2). The Standard Conventional Load (SCL) and the number of days control munitions readiness assessment (box 3). The unit (the wing or one or more squadrons), the DOC and number of days control aircrew (box 4) readiness assessment. Each of these is also controlled wing reg's. and procedures.

Each of the readiness outputs is related to wing tasking to determine (box 5) tasking shortfalls.

| | | |
|--------------------------|--|---------------------|
| NODE: WCR/A0 Text | TITLE: Assess Wing Combat Readiness | NUMBER: M344 |
|--------------------------|--|---------------------|

| | | | | | | |
|-----------------------------|------------------------------------|-----------------|--|--------|------|----------|
| USED AT: | AUTHOR: MATHERS PROJECT: AFIRMS | DATE: 14/MAR/79 | WORKING DRAFT RECOMMENDED PUBLICATION | READER | DATE | CONTEXT: |
| NOTES: 1 2 3 4 5 6 7 8 9 10 | | REV: | | | | |

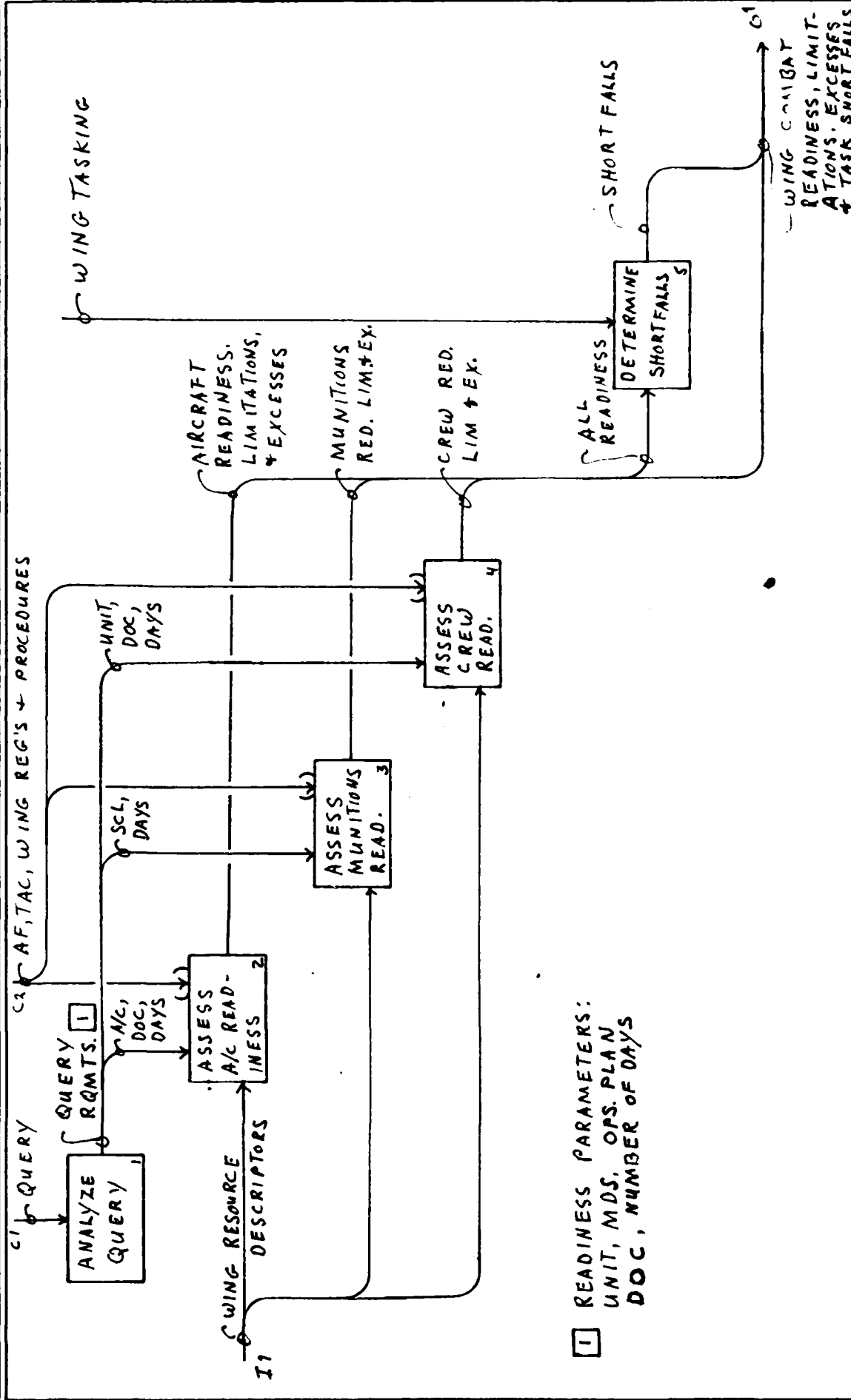

1 READINESS PARAMETERS:
 UNIT, MDS, OPS. PLAN
 DOC, NUMBER OF DAYS

| | | | | | |
|------|--------|--------|------------------------------|---------|------|
| NO.: | WCR/AO | TITLE: | ASSESS WING COMBAT READINESS | NUMBER: | M327 |
|------|--------|--------|------------------------------|---------|------|

| | | | | | | |
|-----------------------------|-----------------|------------------|-------------|--------|------|----------|
| USED AT: | AUTHOR: Mathers | DATE: 27 Mar. 79 | WORKING | READER | DATE | CONTEXT: |
| | PROJECT: AFIRMS | REV: | DRAFT | | | |
| NOTES: 1 2 3 4 5 6 7 8 9 10 | | | RECOMMENDED | | | |
| | | | PUBLICATION | | | |

Assessment of aircraft, munitions and aircrews require a specification of which ones. This may be specified in the query if not it must be determined from the information which is in the query. The unit is assumed to be the whole wing unless one or more of the subordinate squadrons is specified. Operations plan is determined (box 2) from the query or is not important. The Model Design Series or aircraft concerned is determined (box 3) under the control of the query or the unit. The DOC is determined (box 4) from the OPLAN, the unit, the query or some combination of those. A unit can have more than one DOC. The Standard Conventional Load (SCL) is determined (box 5) from the DOC and the aircraft. The number of days needed in the response may be determined (box 6) from the query or the DOC specification is the controlling factor.

| | | |
|-------------------|----------------------|--------------|
| NODE: WCR/A1 Text | TITLE: Analyze Query | NUMBER: M345 |
|-------------------|----------------------|--------------|

| | | | | | | |
|-----------------------------|--|-------------------------|--|---------|-------|----------|
| USED AT: | AUTHOR: MATHERS PROJECT: A FIRMS | DATE: 22 MAR 79 REV: | WORKING DRAFT RECOMMENDED PUBLICATION | READER: | DATE: | CONTEXT: |
| NOTES: 1 2 3 4 5 6 7 8 9 10 | <p>CI QUERY</p> <pre> graph TD CI_QUERY[CI QUERY] --> DETERMINE_UNIT[DETERMINE UNIT] CI_QUERY --> DETERMINE_OPLAN[DETERMINE OPLAN] CI_QUERY --> DETERMINE_MDS[DETERMINE MDS] CI_QUERY --> DETERMINE_DOC[DETERMINE DOC] CI_QUERY --> DETERMINE_SCL[DETERMINE SCL] CI_QUERY --> DETERMINE_DAYS[DETERMINE DAYS] DETERMINE_UNIT --> DETERMINE_OPLAN DETERMINE_OPLAN --> DETERMINE_MDS DETERMINE_MDS --> DETERMINE_DOC DETERMINE_DOC --> DETERMINE_SCL DETERMINE_SCL --> DETERMINE_DAYS DETERMINE_DAYS --> DAYS[01 DAYS] DAYS --> QUERY_REQ[QUERY RQMTS.] </pre> | | | | | |

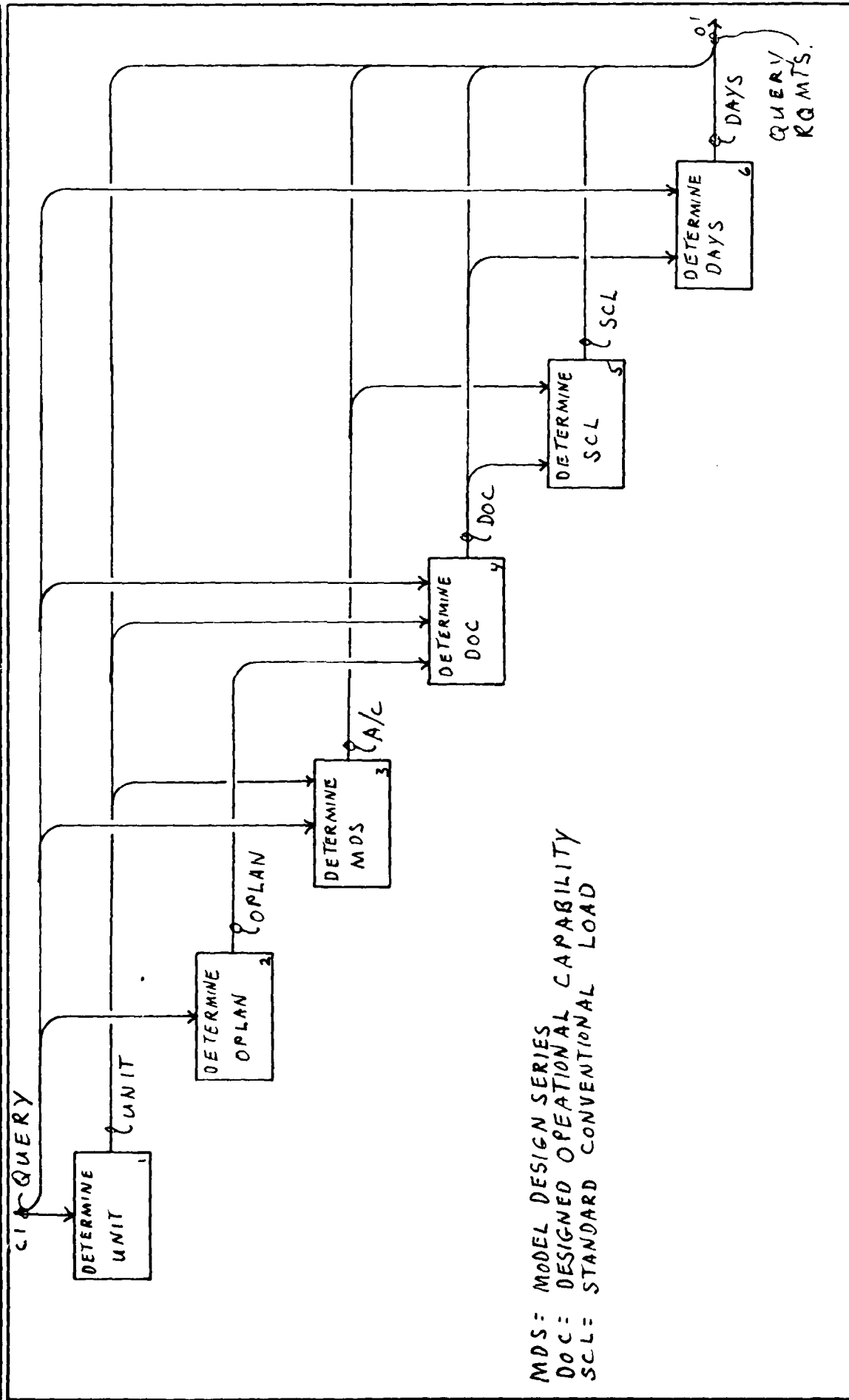

MDS = MODEL DESIGN SERIES
 DOC = DESIGNED OPERATIONAL CAPABILITY
 SCL = STANDARD CONVENTIONAL LOAD

| | | |
|--------------|----------------------|---------------|
| NODE: WCR/A1 | TITLE: ANALYZE QUERY | NUMBER: M 329 |
|--------------|----------------------|---------------|

| | | | | | | | |
|----------|---------------------|---------------|-----------------------------|---------|-------------|-------------|----------|
| USED AT: | AUTHOR: PROJECT: | DATE: REV: | NOTES: 1 2 3 4 5 6 7 8 9 10 | WORKING | READER | DATE | CONTEXT: |
| | | | | DRAFT | RECOMMENDED | PUBLICATION | |

Days required control the determination (box 3) of the iterations.
 Each day used is deleted from those required when days remain
 an iteration requirement is output. When no days are left
 a stop iteration is output.

Consumable resources used to compute sortie potential and
 resource attrition, damage and repair rates determine the
 amount of resource decremented for each iteration.

| | | | |
|-------|--------|-----------------|-----------|
| NODE: | TITLE: | NUMBER: M346 | Continued |
|-------|--------|-----------------|-----------|

| | | | | | |
|-----------------|--|------------------------|--------------------|-------------|-----------------|
| USED AT: | AUTHOR: Mathers PROJECT: AFIRMS | DATE: 27 Mar 79 | READER | DATE | CONTEXT: |
| | | REV: | * WORKING | | |
| | | | DRAFT | | |
| | | | RECOMMENDED | | |
| | | | PUBLICATION | | |
| | NOTES: 1 2 3 4 5 6 7 8 9 10 | | | | |

The functions on this diagram provide a set of outputs (one for aircraft and one for each support category) for each day required. The final output is the sortie potential for each required day.

The aircraft and DOC control initialization (box 1) of wing resources. The levels arrived at are decremented and added to on subsequent iterations of the function. Consumable resources remaining after the last iteration and non-consumables (manpower and equipment) which were not needed on any of the days are output to become part of the diagram output.

Initial levels control the determination (box 2) of the sortie potential of each resource category. Resource use rates per sortie, flight day length, sortie length and work day are used in the determination. Resources used and days used are output along with sorties per day. Algorithms used in determining sortie potential will be similar to the following:

Aircraft sortie potential = No. of aircraft (1 + flt. day - sortie length/sortie length + service time)
 Fuel sortie potential + Fuel quantity/fuel required per sortie
 Fuel service potential = No. of trks. and service teams (work day/fuel cycle time)
 AMU sortie potential = No. of AMU's (work day/aircraft service time)
 AGE sortie potential = No. of each type AGE (work day/use rate of each item type), e.g., No. of LOX carts (work day/LOX service time)
 WRSK sortie potential = Quantity of each WRSK item/use rate per sortie.

| | | |
|--------------|---------------------------|----------------|
| NOTE: | TITLE: | NUMBER: |
| WCR/A2 Text | Assess Aircraft Readiness | M346 |

| | | | | | | |
|-----------------------------|------------------------------------|-----------------|------------------|--------|------|----------|
| USED AT: | AUTHOR: MATHERS PROJECT: AFIRMS | DATE: 22 MAR 79 | WORKING DRAFT | READER | DATE | CONTEXT: |
| NOTES: 1 2 3 4 5 6 7 8 9 10 | REV: | | RECOMMENDED | | | |
| | | | PUBLICATION | | | |

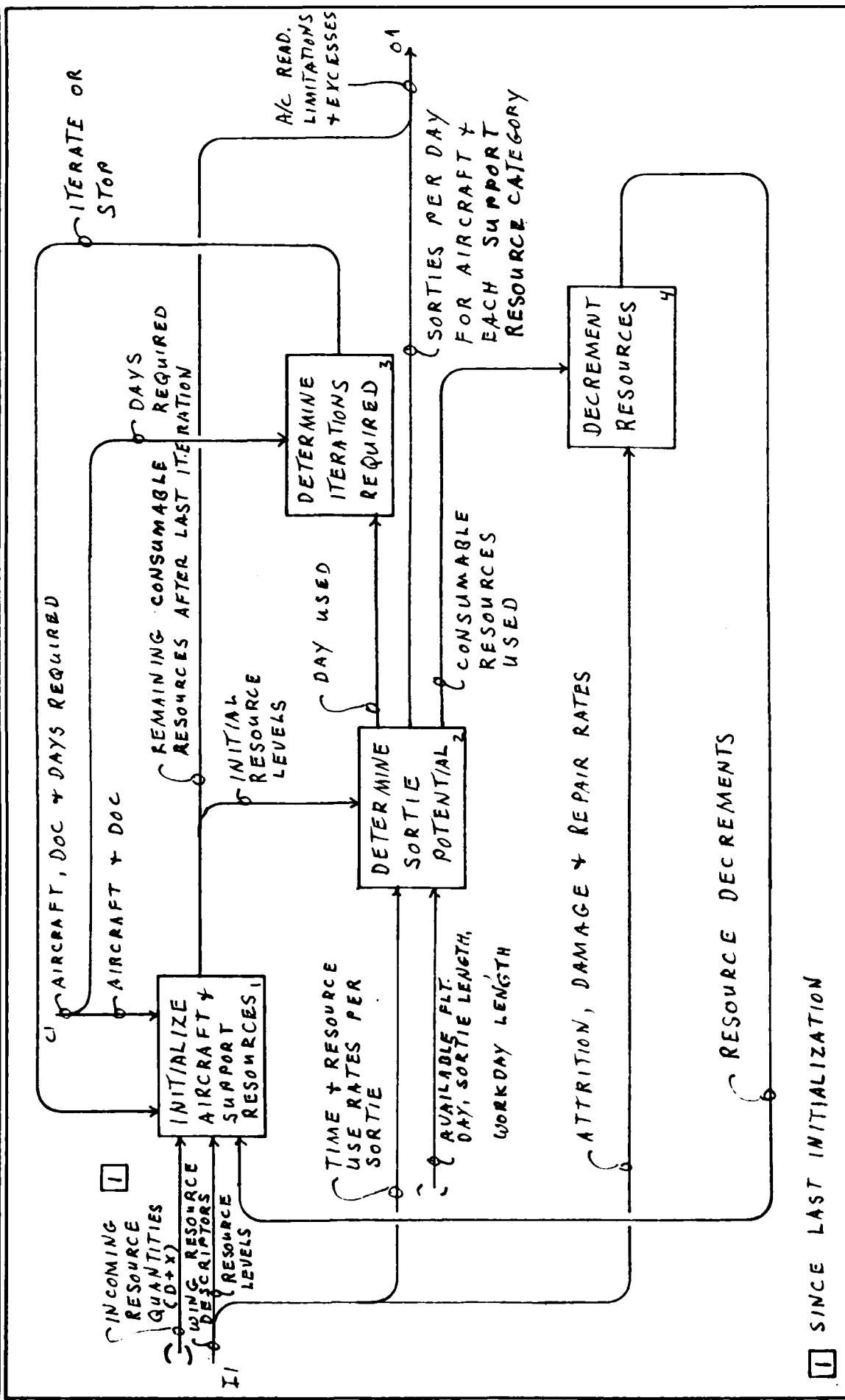

| | | | | | |
|-------|--------|--------|---------------------------|---------|------|
| NODE: | WCR/A2 | TITLE: | ASSESS AIRCRAFT READINESS | NUMBER: | M330 |
|-------|--------|--------|---------------------------|---------|------|

| | | | | | | |
|------------------------------------|------------------------|------------------------|-----------------|--------------------|-------------|-----------------|
| USED AT: | AUTHOR: Mathers | DATE: 28 Mar 79 | *WORKING | READER | DATE | CONTEXT: |
| | PROJECT: AFIRMS | REV: | DRAFT | | | |
| NOTES: 1 2 3 4 5 6 7 8 9 10 | | | | RECOMMENDED | | |
| | | | | PUBLICATION | | |

The functions on this diagram provide a set of daily sortie potentials for munitions per se, for assembly and distribution (A&D) equipment and crews and for load equipment and crews. These resources are first initialized (box 1) to determine the levels to be used in determining sortie potential (box 2). After each iteration of all functions resources are reinitialized to account for decrements and incoming resources. Algorithms used to determine (box 2) sorties per day for munitions and munition support are of the following type:

- Munitions sortie potential = Quantity of munitions/no. per SCL
- A&D crew sortie potential = No. of A&D crews (work day/time per SCL)
- A&D equipment sortie potential = No. of each equipment item (work day/time per SCL)
- Load crew sortie potential = No. of load crews (work day/load time per SCL)
- Load equipment sortie potential = No. of jammers (work day/load time per sortie)
- TRAP sortie potential = Quantity of TRAP/use rate per sortie

The quantity of each resource decremented is a function of personnel and equipment attrition rates and the consumable resources used.

Number of days required determines (box 3) the number of iterations required. Days used are compared to days required resulting in an output of iterate or stop. After the last iteration the remaining consumable resources is output (box 1). Which is combined with sorties per day to form the diagram output.

| | | |
|-----------------------------|---|------------------------|
| NODE: WCR/A3 Text | TITLE: Assess Munitions Readiness | NUMBER: M347 |
|-----------------------------|---|------------------------|

END

DTIC

8-86