

AD-A165 769

SIMPLEX MOOR INSTALLATION PLAN(U) NAVAL FACILITIES
ENGINEERING COMMAND WASHINGTON DC CHESAPEAKE DIV
A SUTHERLAND ET AL. JUN 78 CHES/NAVFAC-FPO-1-78(7A)

1/1

UNCLASSIFIED

F/G 13/2

NL

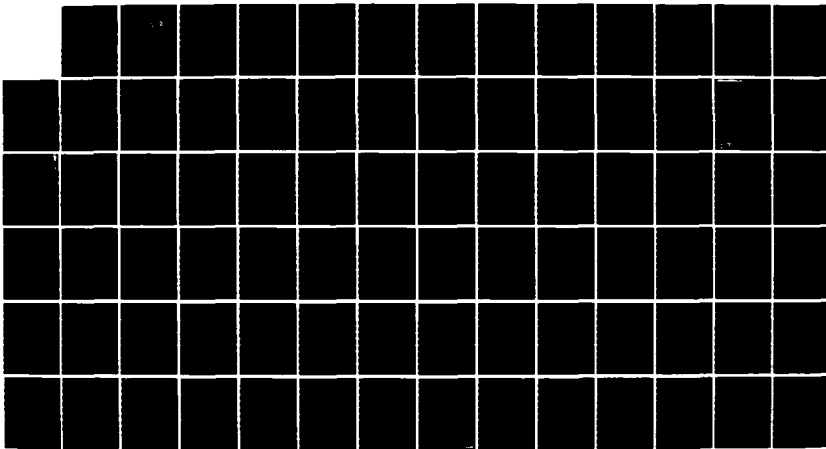

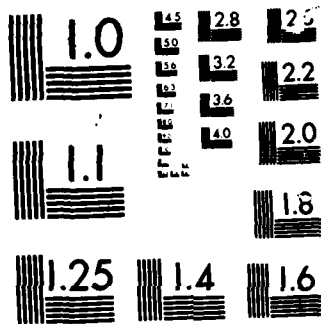

MICROCOPY RESOLUTION TEST CHART

FPO
7807a



AD-A165 769

DTIC
SELECTE
MAR 19 1986
S D D

SIMPLEX MOOR
INSTALLATION PLAN

DISTRIBUTION STATEMENT A
Approved for public release
Distribution Unlimited

DTIC FILE COPY

~~FPO-1-78(7)~~ FPO-1-78(7A)
~~APRIL 1978~~
June 1978

86 3 10 005

OCEAN ENGINEERING AND CONSTRUCTION PROJECT OFFICE
CHESAPEAKE DIVISION
NAVAL FACILITIES ENGINEERING COMMAND
WASHINGTON, D. C. 20374

Unclassified

SECURITY CLASSIFICATION OF THIS PAGE

REPORT DOCUMENTATION PAGE

1a. REPORT SECURITY CLASSIFICATION

Unclassified

1b. RESTRICTIVE MARKINGS

2a. SECURITY CLASSIFICATION AUTHORITY

3. DISTRIBUTION AVAILABILITY OF REP.

Approved for public release;
distribution is unlimited

2b. DECLASSIFICATION/DOWNGRADING SCHEDULE

4. PERFORMING ORGANIZATION REPORT NUMBER

FPO-1-78(7A)

5. MONITORING ORGANIZATION REPORT #

6a. NAME OF PERFORM. ORG. 6b. OFFICE SYM

Ocean Engineering
& Construction
Project Office
CHESNAVFACENCOM

7a. NAME OF MONITORING ORGANIZATION

6c. ADDRESS (City, State, and Zip Code)

BLDG. 212, Washington Navy Yard
Washington, D.C. 20374-2121

7b. ADDRESS (City, State, and Zip)

8a. NAME OF FUNDING ORG. 8b. OFFICE SYM

9. PROCUREMENT INSTRUMENT INDENT #

8c. ADDRESS (City, State & Zip)

10. SOURCE OF FUNDING NUMBERS

PROGRAM	PROJECT	TASK	WORK UNIT
ELEMENT #	#	#	ACCESS #

11. TITLE (Including Security Classification)

Simplex Moor Installation Plan

12. PERSONAL AUTHOR(S)

A. Sutherland, R. Asher, L. Mendlow

13a. TYPE OF REPORT 13b. TIME COVERED

FROM TO

14. DATE OF REP. (YYMMDD) 15. PAGES

6/78

42

16. SUPPLEMENTARY NOTATION

17. COSATI CODES

FIELD	GROUP	SUB-GROUP
-------	-------	-----------

18. SUBJECT TERMS (Continue on reverse if nec.)

Simplex, Mooring systems, Mooring
installation

19. ABSTRACT (Continue on reverse if necessary & identify by block number)

This document provides the information and procedures required to install a modified Class B riser moor, with sinkers, in the Piscataqua River near the Simplex Cable and Wireless Company, Newington, New Hampshire. The project is referred to as the Simplex Moor. (Con't)

20. DISTRIBUTION/AVAILABILITY OF ABSTRACT
SAME AS RPT.

21. ABSTRACT SECURITY CLASSIFICATION

22a. NAME OF RESPONSIBLE INDIVIDUAL

Jacqueline B. Riley

22b. TELEPHONE

202-433-3881

22c. OFFICE SYMBOL

DD FORM 1473, 84MAR

SECURITY CLASSIFICATION OF THIS PAGE

BLOCK 19 (Con't)

Contained in this document is a description of the moor, the implant schedule, staging and preassembly requirements and the detailed operational scenario.

FPO-1-78(7)

SIMPLEX MOOR
INSTALLATION PLAN

A. SUTHERLAND

R. ASHER

L. MENDLOW

~~1-10 MAY 1978~~

OCEAN ENGINEERING AND CONSTRUCTION PROJECT OFFICE
CHESAPEAKE DIVISION
NAVAL FACILITIES ENGINEERING COMMAND
WASHINGTON, D. C. 20374

DISCLAIMER NOTICE

THIS DOCUMENT IS BEST QUALITY PRACTICABLE. THE COPY FURNISHED TO DTIC CONTAINED A SIGNIFICANT NUMBER OF PAGES WHICH DO NOT REPRODUCE LEGIBLY.

TABLE OF CONTENTS

	<u>Page</u>
1.0 INTRODUCTION	1
1.1 General	1
1.2 Tasking and Participating Organizations	1
1.3 Site Description	3
1.4 Philosophy	5
2.0 MOOR DESCRIPTION	6
2.1 Design Criteria	6
2.2 Assembly	6
3.0 SCHEDULE	10
3.1 Overall Schedule	10
3.2 Detailed Implant Schedule	11
4.0 STAGING AND PREASSEMBLY	12
4.1 Gulfport	12
4.2 Portsmouth	14
4.2.1 Buoy Assembly	14
4.2.2 Crown Lines	14
5.0 OPERATIONS	16
5.1 Marker Drop	16
5.2 Implant of Legs Two, Four and Riser Buoy	16
5.2.1 Deck Layout	16
5.2.2 Operations	19
5.3 Implant of Leg Three	20
5.3.1 Deck Layout	20
5.3.2 Operations	20
5.4 Implant of Leg One	21
5.5 Anchor Set and Dive Inspection	21
5.5.1 Anchor Set	21
5.5.2 Inspection	21
5.5.3 Clean Up	22
5.6 Shore Leg Haul	23
5.6.1 Method I	22
5.6.2 Method II	22
5.6.3 Method III	22
5.6.4 General	23

Accession For	
NTIS CRA&I	<input checked="" type="checkbox"/>
DTIC TAB	<input type="checkbox"/>
Unannounced	<input type="checkbox"/>
Justification	
By	
Distribution/	
Availability Codes	
Dist	Avail and/or Special
A-1	23

Page

APPENDICES

1. Material List	25
2. Contacts	27
3. Detailed Moor Components	28
4. Tide Tables	38
5. Survey Results	42

This plan is subject to the review and concurrence
of the U. S. Coast Guard

1.0 INTRODUCTION

1.1 General

→ This document provides the information and procedures required to install a modified Class B riser moor, with sinkers, in the Piscataqua River near the Simplex Cable and Wireless Company, Newington, New Hampshire. The project is referred to as the Simplex Moor.

Contained in this document is a description of the moor, the implant schedule, staging and preassembly requirements and the detailed operational scenario.

1.2 Tasking and Participating Organizations

The moor installation is in response to a task initiated by the Naval Electronic Systems Command (NAVELEX). Moor design, acquisition and installation planning is the responsibility of the Chesapeake Division of the Naval Facilities Engineering Command (CHESDIV). The U. S. Coast Guard, First District, has accepted a request from CHESDIV to provide an installation vessel and crew. A brief synopsis of the Simplex Moor participants and their major function is provided in Table 1.1.

SIMPLEX MOOR PARTICIPANTS

UNIT	MAJOR FUNCTIONS
Naval Electronic Systems Command (NAVELEX)	<ul style="list-style-type: none"> o Project Sponsor o Funding o Procurement Support
Chesapeake Division, Naval Facilities Engineering Command (CHESDIV)	<ul style="list-style-type: none"> o Moor Design o Moor Acquisition o Permit Applications o Survey o Moor Installation Planning and Technical Direction o Reports
U. S. Coast Guard 1st District	<ul style="list-style-type: none"> o Assign Installation Vessel and Crew o Provide, on Reimbursible Basis, three 8,200 lb sinkers for moor o Provide Installation Planning Assistance
U. S. Coast Guard Vessels SPAR and BITTERSWEET	<ul style="list-style-type: none"> o Vessels Assigned to Perform Installation. SPAR Primary Vessel, BITTERSWEET Backup
Portsmouth Naval Shipyard (PNSY)	<ul style="list-style-type: none"> o Receive Mooring Hardware o Provide Rigging Assistance as Necessary o Provide Divers
Simplex Wire and Cable Company	<ul style="list-style-type: none"> o Provide Logistic Support (via NAVELEX Tasking)
Naval Facilities Engineering Command (NAVFAC)	<ul style="list-style-type: none"> o Provide Ocean Engineering Program Support o Authorize use of NAVFAC Fleet Moor Equipment
CBC Gulfport	<ul style="list-style-type: none"> o Provide Mooring Equipment o Package and Preassemble Moor o Ship Moor to PNSY

Table 1.1

1.3 Site Description

The moor will be located in the Piscataqua River which is situated in the South Eastern corner of New Hampshire. It is to be installed in an area directly north of a pier maintained by the Simplex Wire and Cable Company.

This location is approximately 3 miles up-river from the Portsmouth Naval Shipyard and 5 miles from the Portsmouth Harbor Coast Guard Station. (Refer to Figure (1) for general location).

A survey was conducted by CHESDIV with small boat and crew provided by the Coast Guard Station Portsmouth Harbor and divers provided by the Portsmouth Naval Shipyard (PNSY). This survey, which is detailed in Appendix (5) was conducted during the period 20-24 March 1978.

Briefly the survey determined that: (1) adequate water depth exists in the moor area; (2) the bottom in the area of the anchor drop sites is hard sand probed to a depth in excess of five feet; and (3) maximum measured surface currents in the area of the pier during the aforementioned period were approximately $2\frac{1}{2}$ knots.

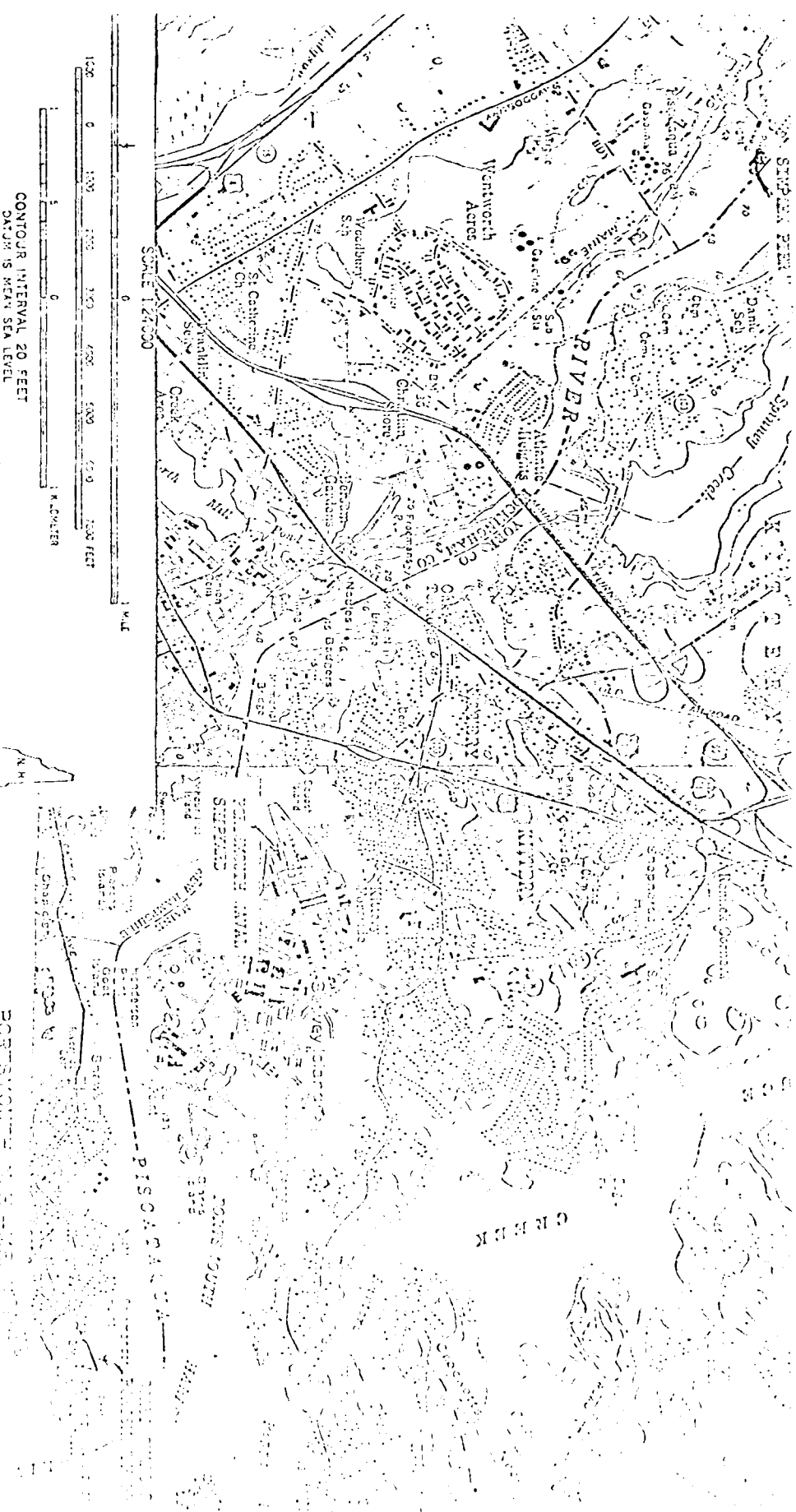

CONTOUR INTERVAL, 20 FEET
 DATUM IS MEAN SEA LEVEL
 DEPTH CURVES AND SOUNDINGS IN FEET—DATUM IS MEAN LOW WATERS
 SECTION SHOWN REPRESENTS THE APPROXIMATE LINE OF MEAN HIGH WATER
 THE MEAN HAZARD OF TIDE IS APPROXIMATELY 2 FEET

THIS MAP COMPLETES WITH NATIONAL MAP ACCURACY STANDARDS
 FOR SALE BY U.S. GEOLOGICAL SURVEY, WASHINGTON, D.C. 20509
 U.S. GEOLOGICAL SURVEY, WASHINGTON, D.C. 20509

Rounders shown of public domain of the State of Georgia
 and projections taken 1973. The map is not to be used
 for navigation purposes and is not to be used for
 purposes of title.

PORT REPUBLIC
 GEORGIA

1.4 Philosophy

The philosophy of the moor installation has been to provide an installation method which: (1) will proceed swiftly (thereby maximizing periods of slack current); (2) will be broken into a series of sequential steps thereby enabling logical break points to allow for re-rigging and standing-by for slack current and importantly; (3) is in consort with the Coast Guard's typical implantment method, i.e., free running.

Installation assistance from the Coast Guard was requested for a variety of reasons; of greatest import was their familiarity with the Piscataqua River and in particular their proven capability to implant large Aids to Navigation Buoys in the area. The moor implant plan has been tailored to coincide with a typical free fall implant of a Coast Guard Aids to Navigation Buoy.

2.0 MOOR DESCRIPTION

2.1 Design Criteria

The mooring was designed for an EC2 hull (liberty ship), with a maximum draft of 20 ft. The moor is configured to hold in a wind of 70 mph and a current (mostly tidal) of 8.0 kts.

2.2 Assembly

Each ground leg consists of an anchor, a shot of chain, a swivel, and three more shots of chain. The chains are $2\frac{1}{2}$ " , as are two of the swivels. The inshore anchor will be 22,500 lbs and the swivel on this leg will be $2\frac{1}{4}$ ". The other anchors will be 25,000 lbs. The chain is connected to a ground ring which then connects to a riser chain.

The riser chain ($2\frac{1}{2}$ ") runs through the hawse pipe of the buoy. Above the buoy is an F-type bending shackle and an end link. Attached to the chain to hang at the bottom of the buoy is a rubbing casting. Ten links above the bottom of the chain is a swivel.

The keeper leg, a 2" chain, runs between a 10,000 lb anchor and the ground ring. There are 2 shots of chain with a swivel between them.

The shore leg is 550 ft of miscellaneous lengths of $2\frac{1}{4}$ " chain to be connected to the mooring block on shore. Figures (2) through (4) illustrate the moor configuration. A formal report detailing moor design and assembly will be issued at a later date.

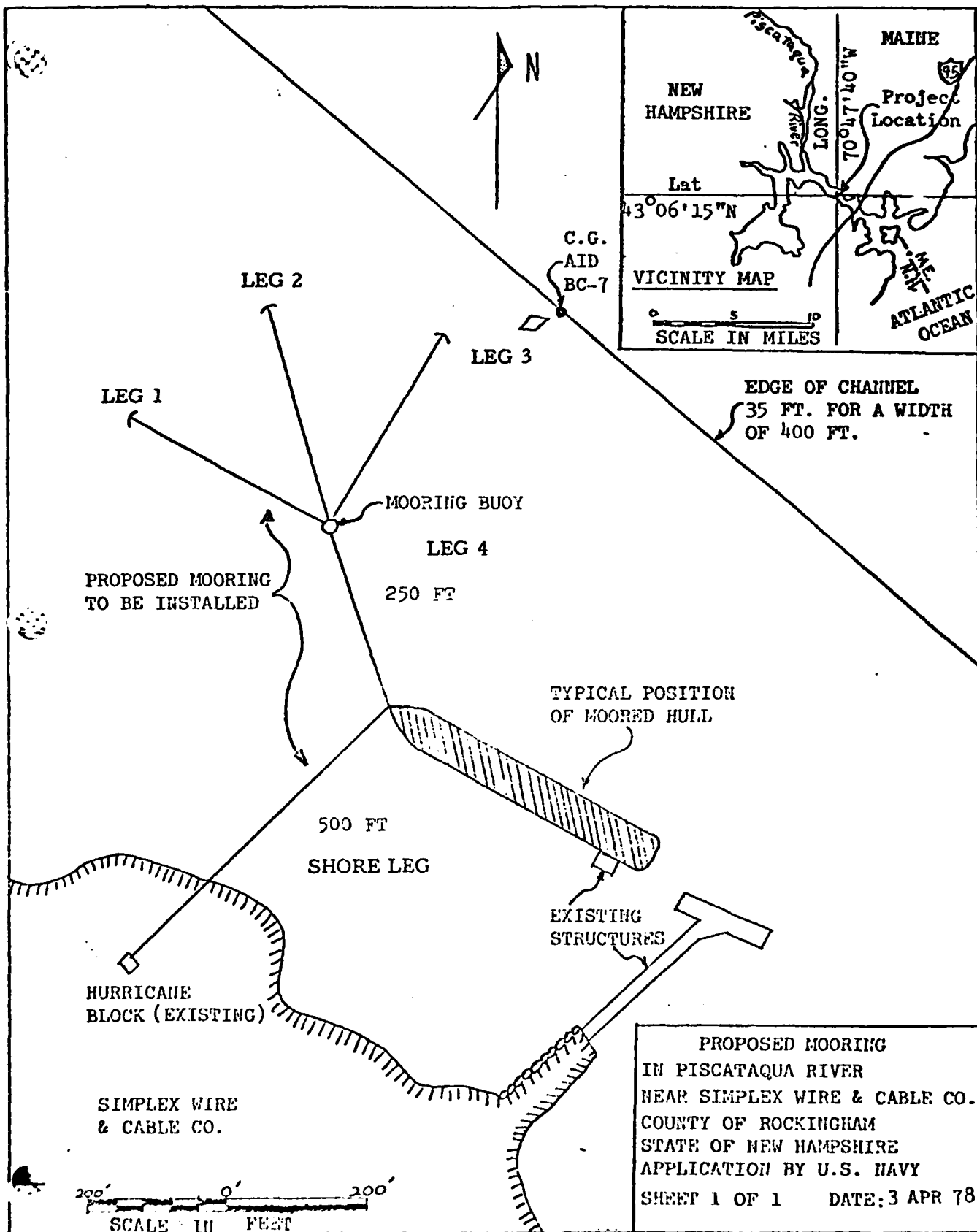

FIGURE 2

MOORING

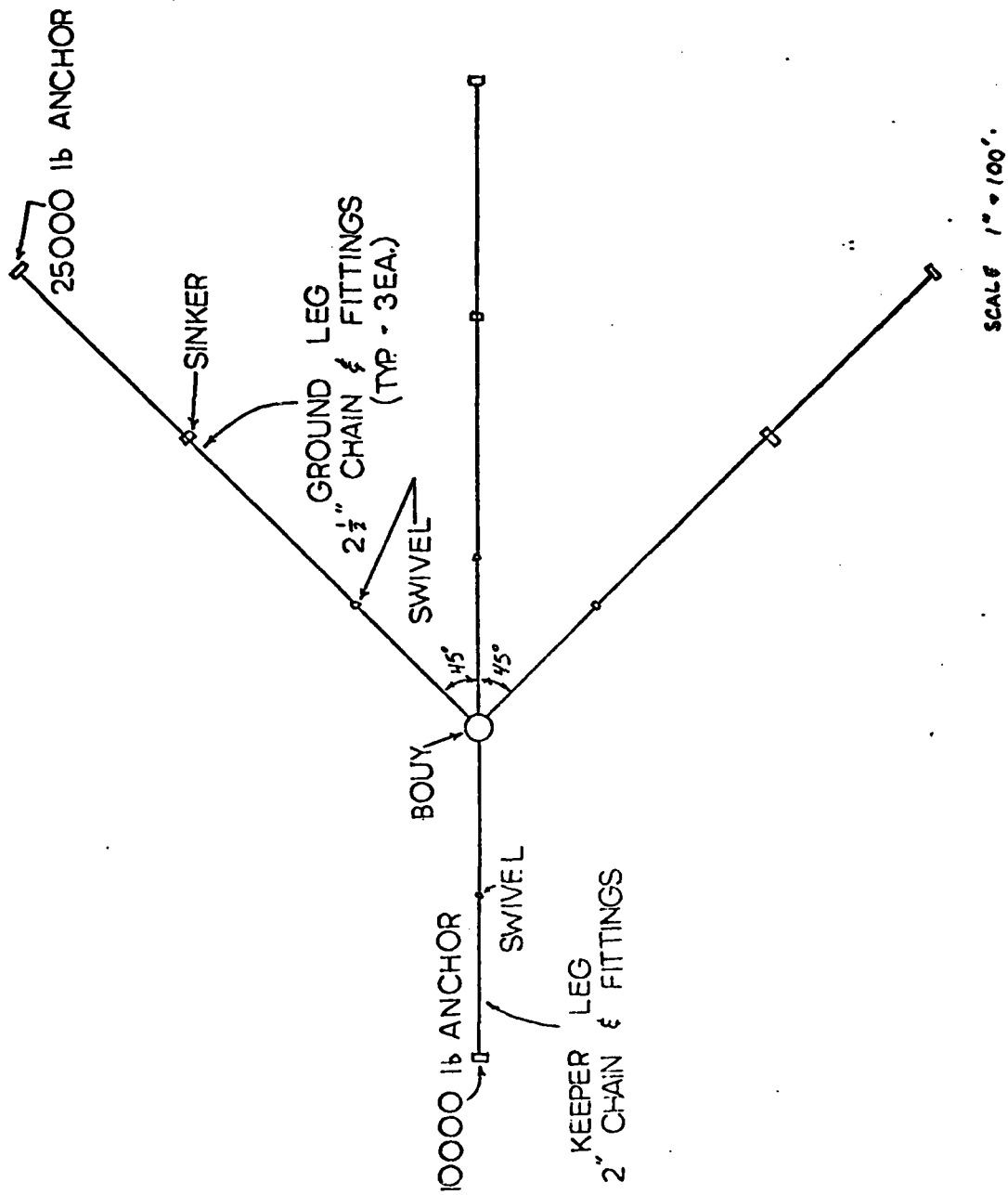

FIGURE 3

MOORING SYSTEM

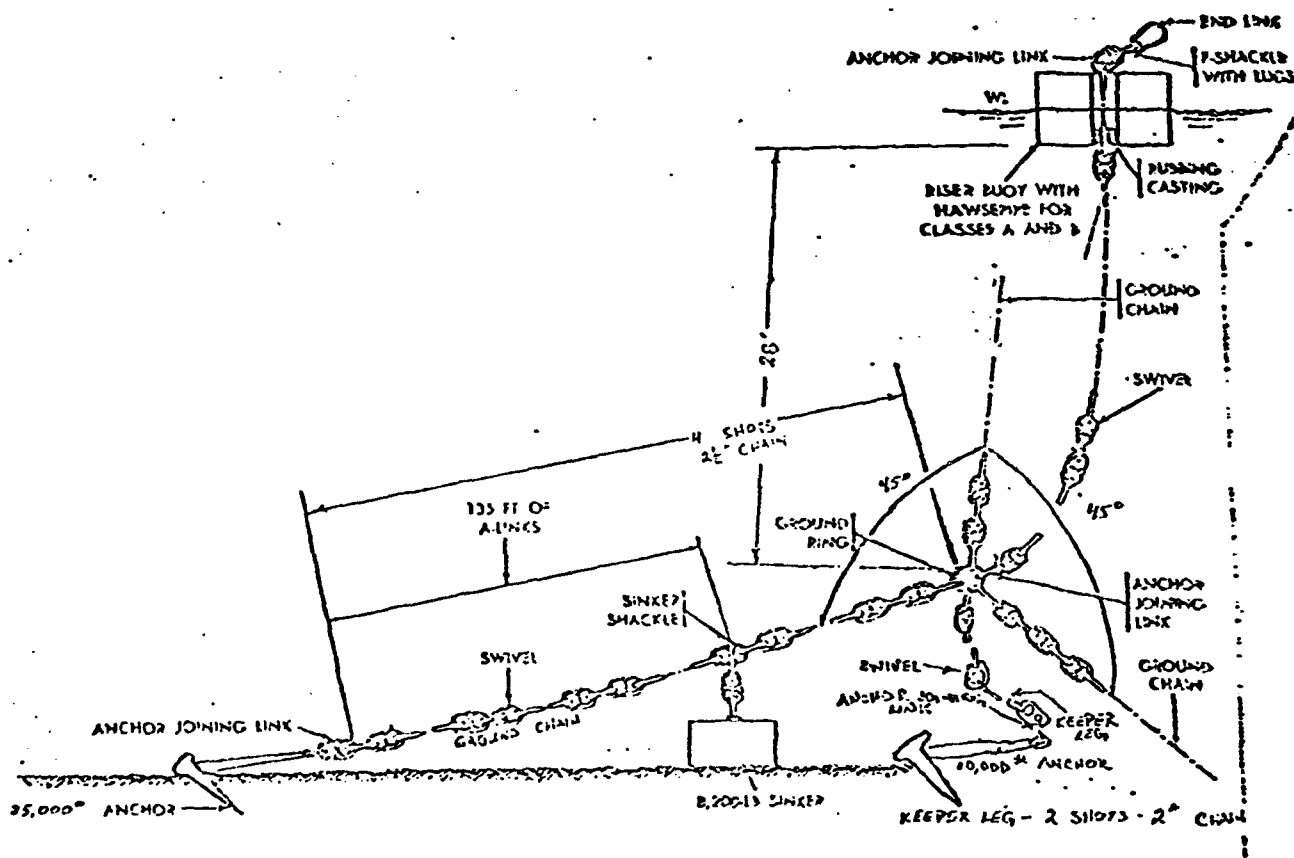

FIGURE 4

3.0 SCHEDULE

3.1 Overall Schedule

Task formally received from NAVELEX	28 Feb 78
Survey Completed	24 Mar 78
Coast Guard Support Formally Requested	24 Mar 78
Moor Design Completed	3 Apr 78
Mooring Equipment Requested from CBC Gulfport	3 Apr 78
Installation Planning Meeting with Coast Guard	7 Apr 78
Mooring Equipment Shipped from Gulfport	14 Apr 78
Implant Permits (Corp. of Engineers) Complete	21 Apr 78
Mooring Equipment Arrives PNSY	28 Apr 78
Moor Installed	1-10 May 78

3.2 DETAILED IMPLANT SCHEDULE

28 Apr Fri	Moor arr PNSY stage near berth 6									
29 Apr Sat	-									
30 Apr Sun	-									
1 May Mon	Pre-rig moor (PNSY) Coast Guard vessel implant marker buoys									
2 May Tues	Load out first two legs of moor									
3 May Wed	Implant first two legs load out 3rd leg									
4 May Thurs	Implant 3rd leg load out 4th leg prepare beach for shore leg									
5 May Fri	Implant 4th leg haul shore leg dive and inspect each leg remove crown lines									
6 May Sat	Finish removal of crown lines									
7 May Sun	Contingency clean up ship ou									
10 May Wed										

4.0 STAGING AND PREASSEMBLY

4.1 Gulfport

Initial staging and preassembly operations transpired at the Construction Battalion Center, Gulfport, MS (CBC). All anchors, chains, fittings, and the riser buoy were supplied by the NAVFAC Fleet Mooring pool stored at CBC Gulfport.

Each anchor leg was assembled, assuring that all hardware fitted properly.

The legs were color coded, permitting easy reassembly once dismantled.

The color coding is as follows:

Ground Legs -	#1 (w/2¼" swivel)	- red
	#2 (w/2½" swivel)	- white
	#3 (w/2½" swivel)	- yellow
Riser Chain -		- green
Keeper Leg -		- black
Shore Leg -		- yellow w/red stripe

The chains were broken down for shipping. Shots that were to remain joined were connected and sealed. The pin was heated and peened. On joining links to be opened again, the links were attached to one side of the chain, put together, the pin fitted and tied with wire and tape. The legs were broken as follows:

1. Ground Legs - 3 pieces
 - a) Two shots with swivel between; runs from anchor
 - b) One shot - joining links at both ends
 - c) One shot - anchor joining link at one end; runs from ground ring.
2. Riser chain - 1 piece with all hardware
3. Keeper leg - 1 piece (2 shots) with all hardware
4. Shore leg - 3 pieces; miscellaneous lengths of approximately 200 ft, 200 ft, 155 ft; with connecting links.

Each piece is packed separately in a box. Each box is color coded and marked, and was loaded onto a railcar.

The riser buoy was cleaned, sand blasted and painted in preparation for the mooring. It was then loaded onto a railcar. The anchors were color coded and also put on the railcar for shipment to the Portsmouth Naval Shipyard (PNSY).

4.2 Portsmouth

At PNSY the shipment will be offloaded and transferred to berth 6.

Under the guidance of a CHESDIV representative, PNSY riggers will assemble the riser buoy, arrange all gear for transfer to the Coast Guard vessel, and will assemble the crown lines.

4.2.1 Buoy Assembly

The riser chain will be fitted into the buoy. A half shot of chain will be cut off of legs one and three and will be joined to the ground ring at the bottom of the riser leg. The other end of the half shots will be affixed to the top of the buoy. Approximately 10 feet of the half shots at the top of the buoy will be rigged as lazy pennants. The ground ring will then also be brought to the top of the buoy and will be connected to a quick release. A safety strap will be affixed to the ground ring. Care must be taken to assure that the load is balanced and securely rigged so that weight cannot shift during transit.

4.2.2 Crown Lines

Four crown lines will be rigged in the manner shown in Figure (5). Means of attachment to the crown of the anchor will be determined on site.

CROWN LINE

3'φ BUOY

7/8" OBLONG
LINK

60' - 1 1/2" W.R.

PELICAN HOOK

FIG. 5

15

TO ANCHOR CROWN

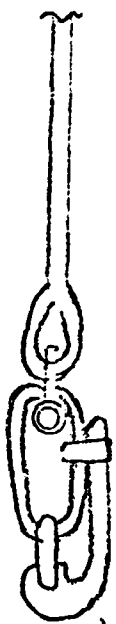
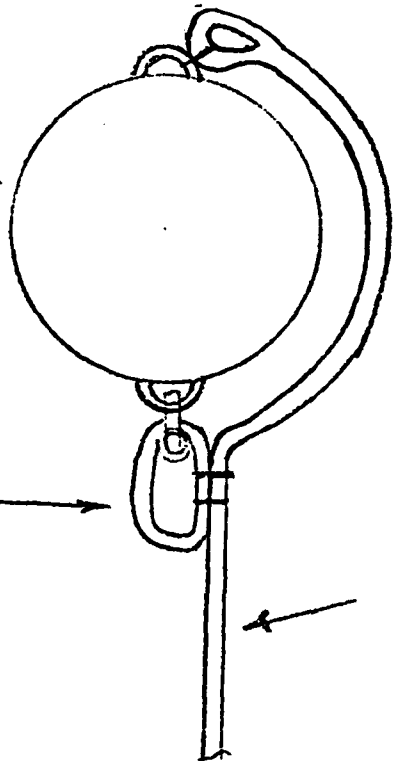

5.0 OPERATIONS

5.1 Marker Drop

Marker buoys will be dropped at each of the four anchor drop sites, at the riser buoy position and at the site of the shore leg bitter end.

The moor installation vessel (hereafter referred to as the SPAR although the BITTERSWEET may be assigned) will be used to install the marker buoys.

This operation, in addition to implanting the buoy, will acquaint the SPAR crew with the exact location of the moor and will provide data relative to her handling characteristics in the current stream.

The SPAR will be guided to each drop site by triangulation from two shore based transits manned by CHESDIV representatives.

5.2 Implant of Legs Two, Four and Riser Buoy

5.2.1 Deck Layout

The deck will be layed out in a manner similar to that shown in Figure (6).

Exact deck layout will be determined on site. Rigging of the deck will be at the discretion of the Coast Guard. The rigging scheme shown on Figure (6) presumes the SPAR will lay the first two anchor legs (2 and 4)

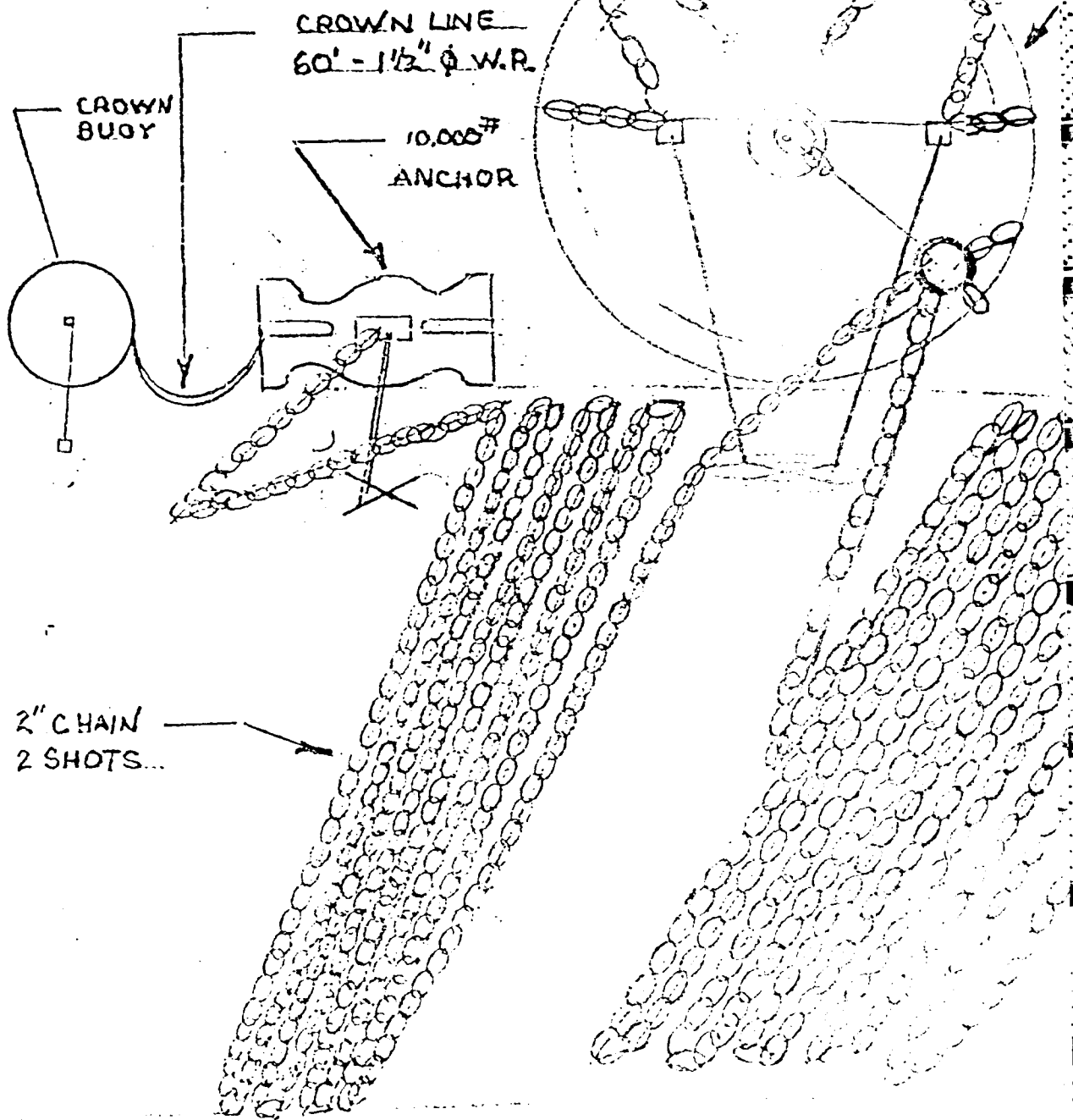

(1)

Reproduced from
best available copy.

U.S. GOVT

PRINTED FO

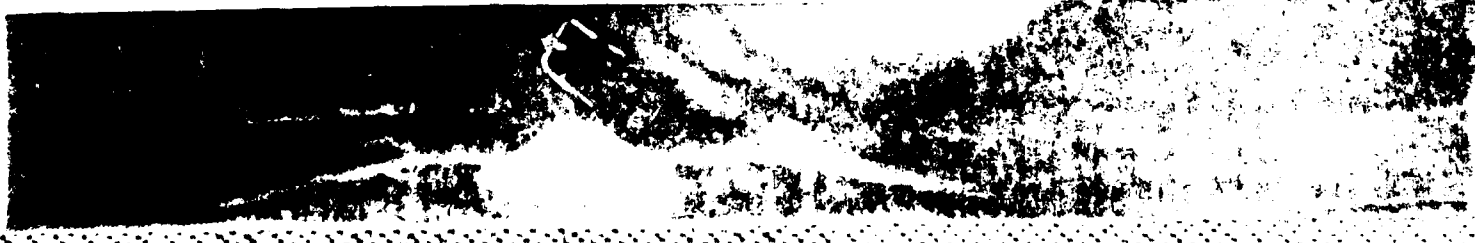

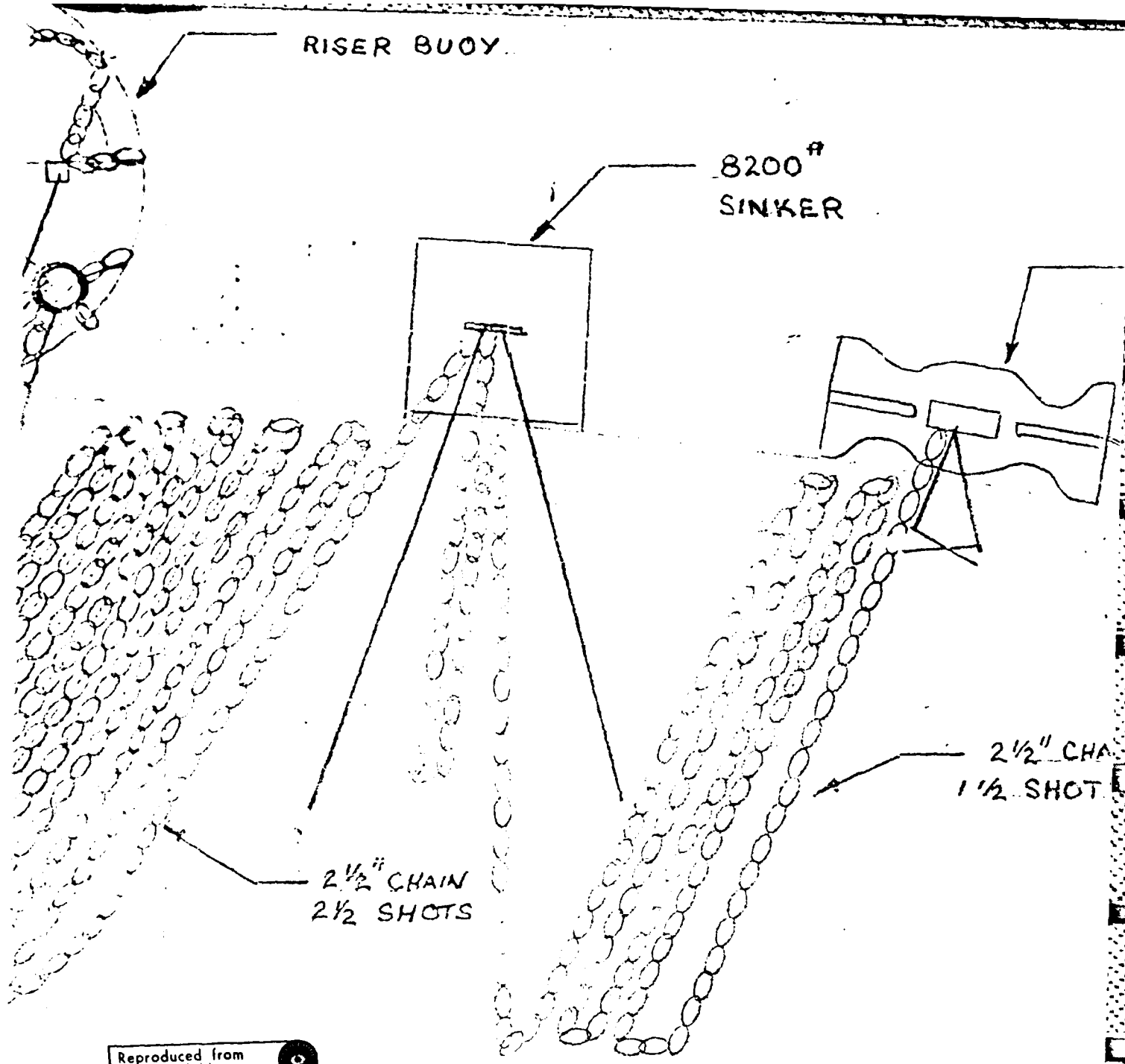

Reproduced from
best available copy.

LETTER SPAR PORT SIDE WORK DECK
 ADD TO LAYING LEGS 2 + 4 AND RISER BUOY

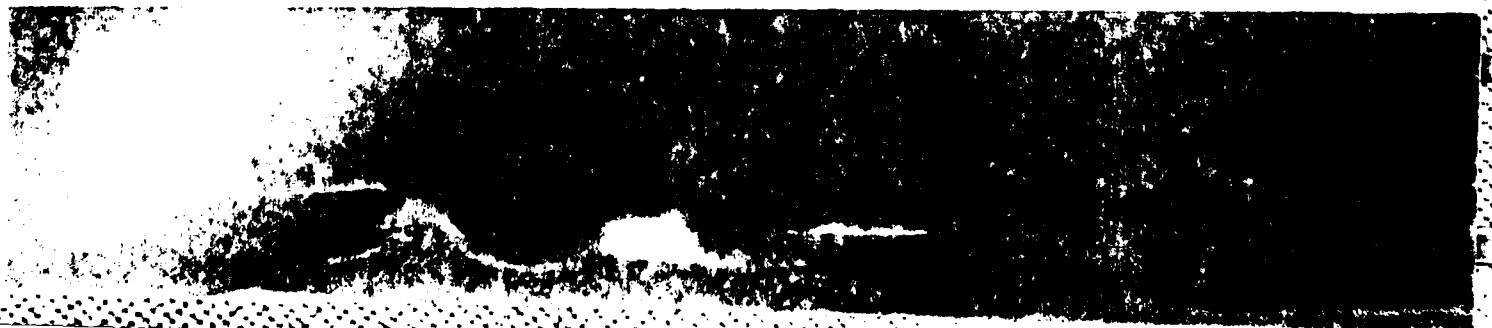

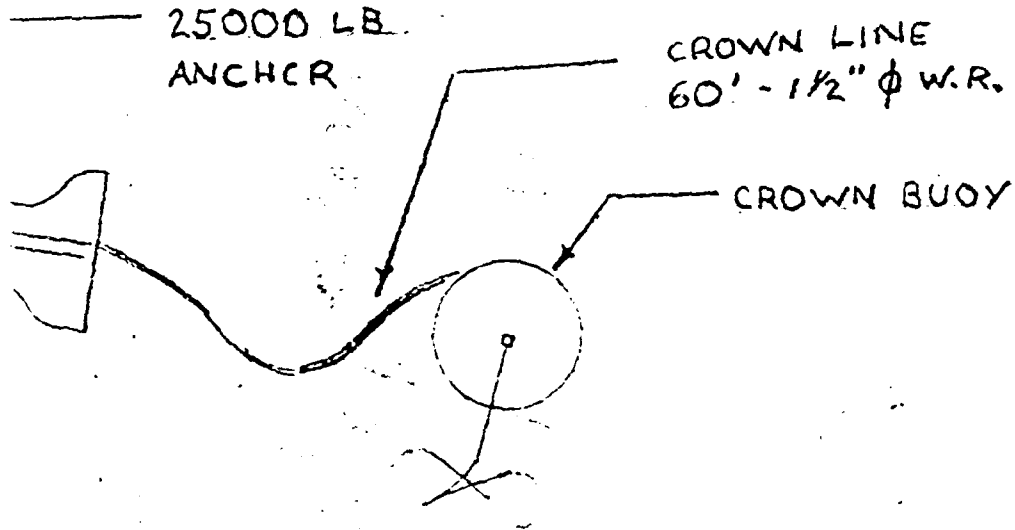

"CHAIN
HOTS

17

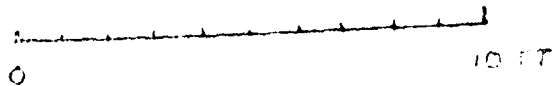

FIG. 4

3



by backing down with her bow pointed up river. However, during installation of marker buoys it may be determined to install in another manner (e.g., bow pointed down river going forward). In that event the deck layout will be rearranged accordingly.

Load out of the deck will proceed as follows:

1. Pier crane load anchors aboard
2. Attach crown lines
3. Bring chain aboard
4. Attach chain to anchors
5. Hang anchors over side using pier crane or ships boom
6. Secure anchors using Pelican Hooks or synthetic line tie downs
7. Attach crown buoys and crown lines to bulwark using breakaway ties
8. Bring sinker aboard
9. Attach chain to sinker and hang over side. Secure as in step 6
10. Pier crane place riser buoy in water at desired position
11. Attach chain from legs 2 and 4 to ground ring

Note: This operation can be done either on the buoy or, by hauling the ground ring aboard, on deck. If done on the buoy, a safety lanyard must be tied to all joining link components in order to prevent loss overboard. Spares are not available

12. Securely gripe buoy to side. Being certain that all chain hanging from buoy is secure and will not be torn off buoy top by differential movement between ship and buoy.

13. Secure each bight of chain (approximately 20 ft lengths) to deck padeyes with two wraps of 21 thread. This will provide enough strength to hold the dead weight of the suspended chain but will break away when the ship pulls or can be cut when desired.

This completes deck rigging. Each tie-down should be rechecked for adequacy and safety.

5.2.2 Operations

When fully rigged, the SPAR will proceed to the moor implant site and will check positioning and control. She will then proceed to anchor number two marker buoy.

The safety strap on the ground ring will be removed and the ground ring on the riser buoy will be trip released. Note: chain from legs two and four will have been securely stopped off to permit the running of only forty feet of chain.

When the 25,000# anchor is abreast of the marker, the SPAR will begin backing down. When backing motion is observed, the 25,000# anchor will be released upon the word of the SPAR Bosun.

The SPAR will continue backing down releasing, in order, the sinker, the riser buoy and the 10,000 lb anchor. Chain will be stretched between each successive release of hardware.

With all equipment released, the moor may then be repositioned as necessary by pulling on either of the crown lines.

The SPAR will then return to PNSY to load out for leg number three.

5.3 Implant of Leg Three

5.3.1 Deck Layout

The deck layout will be similar to the previous layout with the obvious exception that there will be no 10,000 lb anchor and leg and no riser buoy.

5.3.2 Operations

The SPAR will proceed to the moor implant site and will come alongside the riser buoy.

The 10 ft lazy pennant from leg three will be retrieved from the top of the buoy and brought aboard and secured. The leg 3 chain can then be disconnected from the top of the buoy.

The chain will then be joined to the bitter end of the chain layed out on deck and the SPAR will proceed toward marker buoy three. Sinker and anchor will be released as before.

Adjustment of anchor position can be made by heaving on the crown line.

The SPAR will then return to PNSY to load out for leg number one.

5.4 Implant of Leg One

Leg one deck layout and implant is identical to that for leg three with the exception that all equipment will be hung off the starboard side.

Note - It may be feasible to load legs one and three at the same time. Implantment of one and three could possibly be done in the same day.

5.5 Anchor Set and Dive Inspection

5.5.1 Anchor Set

After the moor is implanted and all anchors are adjusted by heaving on the crown lines, the SPAR will tie up, stern to, to the riser buoy with her bow facing down river. The SPAR will line up on a radial line opposite to one of the legs and will move out along that line a distance of 50 - 100 ft. She will then exert a maximum thrust estimated to be 24,000 lbs. The anchor crown buoy will be watched for any discernable movement. This procedure will be repeated for each of the radial lines to line with legs one, two and three.

5.5.2 Inspection

When SPAR has completed pulling on the three anchor legs, she will stand off while divers from PNSY inspect each leg. They will report if all chain is properly stretched, the anchor is not fouled and that the flukes have begun to deploy. If reports are negative, SPAR will take corrective action by either heaving on the crown line or pulling again on the riser buoy.

5.5.3 Clean Up

After all inspection is complete, the PNSY divers will release the crown line pelican hooks and the crown line will be retrieved aboard either the SPAR or the dive boat.

5.6 Shore Leg Haul

The shore leg consists of 550 ft of 2½-inch chain. The shore end will be affixed to fifty-ton capacity hurricane block. The sea end will be temporarily marked with Dan buoy attached to a 5/8" wire rope riser line.

The line may be hauled out in either of three methods depending upon site conditions and timing.

5.6.1 Method I

- o Chain trucked to Simplex facility and layed out on field located shoreward of hurricane block.

- o SPAR drops anchor, sends heaving line ashore via shot line.

- o Chain hauled to position by SPAR stern capstain. Floats applied to chain as necessary.

5.6.2 Method II

- o Chain layed out on SPAR deck tied off in bights.

- o SPAR drops anchor - sends hauling line ashore
- o Line fed through prepositioned snatch block and sent back out to SPAR via SPAR's Boston Whaler.
- o Chain hauled to shore by SPAR's stern capstain.

5.6.3 Method III

- o A PNSY YC is loaded with chain tied off in bights.
- o A PNSY tug brings the YC to the site and holds it in position
- o A hauling line is sent ashore and a dozer, located in the field shoreward of the hurricane block, pulls the chain ashore in successive bights.

5.6.4 General

Each of the above three methods could be used. Method I is the preferred method, although reports from the site indicate that the field shoreward of the hurricane block is a mire due to the spring thaw and an unusual amount of snow - hence it is not known if the field will be dry enough to get a truck into it. Method II is feasible although it requires more rigging than Method I. Method III may be used in the event that the SPAR must leave the area prior to installing the shore leg.

APPENDICES

1. **Material List**
2. **Contacts**
3. **Detailed Moor Components**
4. **Tide Tables**
5. **Survey Results**

APPENDIX I

Material List

Moor Material

1.	FSN 4010-240-1034, 2½" Chain	Shot	12
2.	FSN 2050-227-0529, 2½" Riser Chain	Ft	35
3.	FSN 4010-240-1030, 2¼" Chain	Ft	555
4.	FSN 4010-262-2592, 2" Chain	Shot	2
5.	FSN 4030-527-8870, 2½" Swivel	Each	3
6.	FSN 4030-527-8864, 2½" Swivel	Each	2
7.	FSN 4010-391-0535, 2½" Anchor Joining Links	Each	12
8.	FSN 4010-391-0534, 2¼" Anchor Joining Links	Each	4
9.	FSN 4010-391-0543, 2½" Joining Links	Each	14
10.	FSN 4010-391-0542, 2¼" Joining Links	Each	6
11.	FSN 2040-234-4888, 2½" Ground Ring	Each	1
12.	FSN 2030-236-8391, 2½" Type F Bending Shackle w/lugs	Each	1
13.	FSN 4010-298-5764, 2½" End Link	Each	1
14.	FSN 4030-292-3781, 2½" Rubbing Casting	Each	1
15.	FSN 4030-267-7076, 2"-3" Sinker Shackle	Each	3
16.	FSN 2050-270-5779, 3" Sinker Hairpin	Each	3
17.	FSN 2040-272-2242, 25,000 lb Anchor	Each	2
18.	FSN , 22,500 lb Anchor	Each	1
19.	FSN 2040-516-7754, 10,000 lb Anchor	Each	1
20.	FSN 2050-223-3660, Buoy, 12' Diameter x 6' High	Each	1
21.	Coast Guard Sinker 8,200 lb	Each	1

Installation Material

1.	Float Balloons	70 each
2.	Filler Valve (for floats)	1 each
3.	$\frac{1}{2}$ " diameter Samson	600 ft
4.	Anchor Clumps (2-300#)	10 each
5.	Crown Line Buoy (3' diameter)	4 each
6.	Crown Lines - $1\frac{1}{4}$ " W. R. 60' Long Eyes Both Ends	4 each
7.	Pelican Hooks for $1\frac{1}{4}$ " W. R.	6 each
8.	Pelican Hooks for $2\frac{1}{2}$ " Chain	6 each
9.	Wire Rope $5/8$ "	100 ft
10.	Dan Buoy	1 each
11.	21-Thread Manila	5 cl
12.	Asst'd Release Hooks and Lines	LS

APPENDIX II

Contacts

<u>UNIT</u>	<u>PERSON(S)</u>	<u>TELEPHONE</u>
NAVELECSYSCOM	CDR D. R. Wells	202 692-8833
	Mr. C. Hambrick	202 692-8833
	Mr. D. Willett	804 444-2377
NAVFACENGCOM	CDR J. Osborne	202 325-0505
	Mr. J. Lemanis	202 325-8182
CHESNAVFACENGCOM	Dr. S. Ling	202 433-3881
	Mr. A. Sutherland	202 433-3881
	Mr. R. Asher	202 433-3881
	Mr. L. Mendlow	202 433-3881
	Mr. T. O'Boyle	202 433-3881
Coast Guard 1st District	LCDR J. Overath	617 223-3632
USCG SPAR	LCDR C. Montanese	207 799-6551
USCG BITTERSWEET	LCDR R. Heym	617 548-2702
CBC Gulfport	LCDR J. Brown	601 865-2401
Portsmouth Naval Shipyard	Mr. P. Sicard	207 439-1000 Ext 2726
Simplex	Mr. N. McNerny	603 436-6100

APPENDIX III

Detailed Moor Components

- o Mooring Leg
- o Riser Leg
- o Keeper Leg
- o Detail A
- o Detail B
- o Detail C
- o Detail D
- o Detail E
- o Detail F

MOORING LEG
3 EA.

4 SHOTS CHAIN - ANCHOR TO RING

1.5 SHOTS - ANCHOR TO SINKER

1 SHOT CHAIN - ANCHOR TO SWIVEL

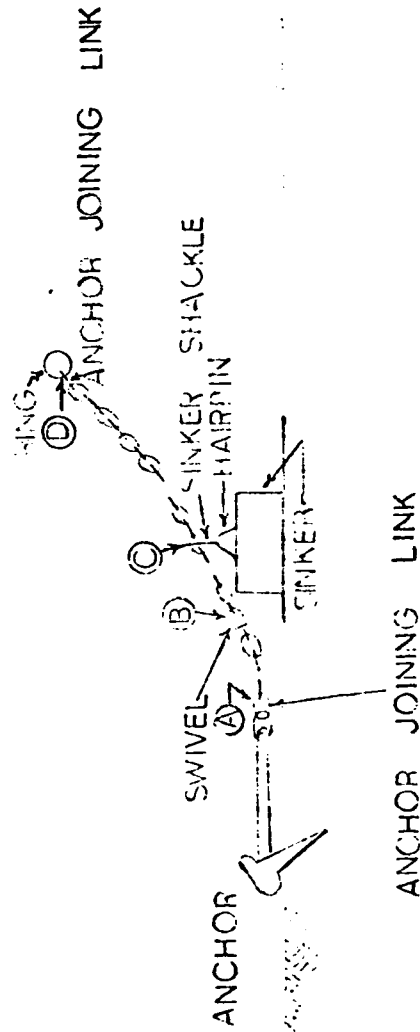

BISER LEG

35' - 2 - 1/2 CHAIN

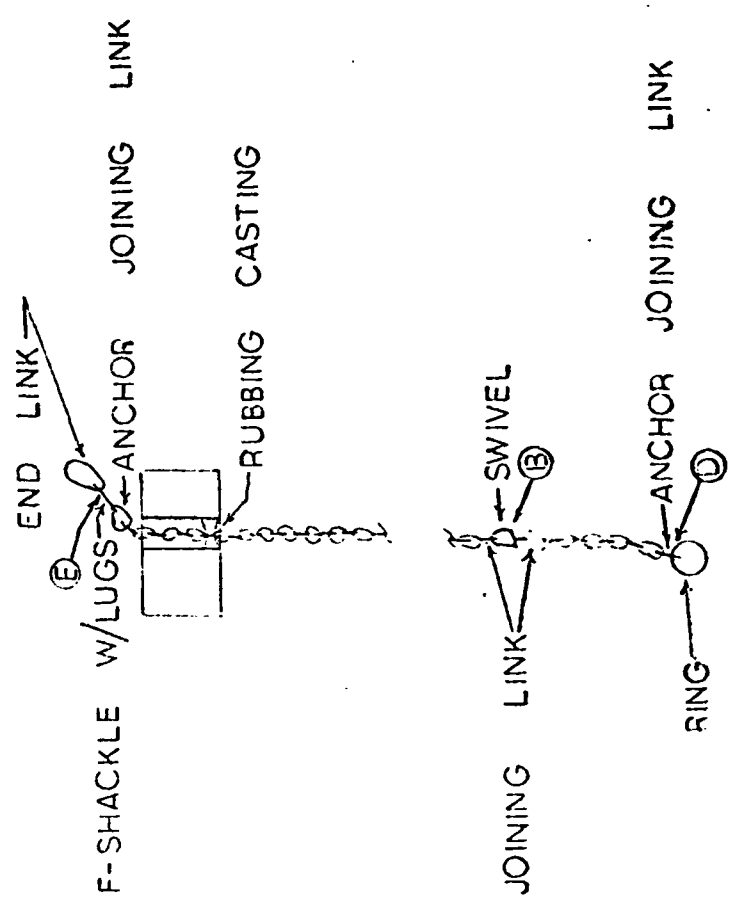

KEEPER LEG

2 SHOTS - 2" CHAIN

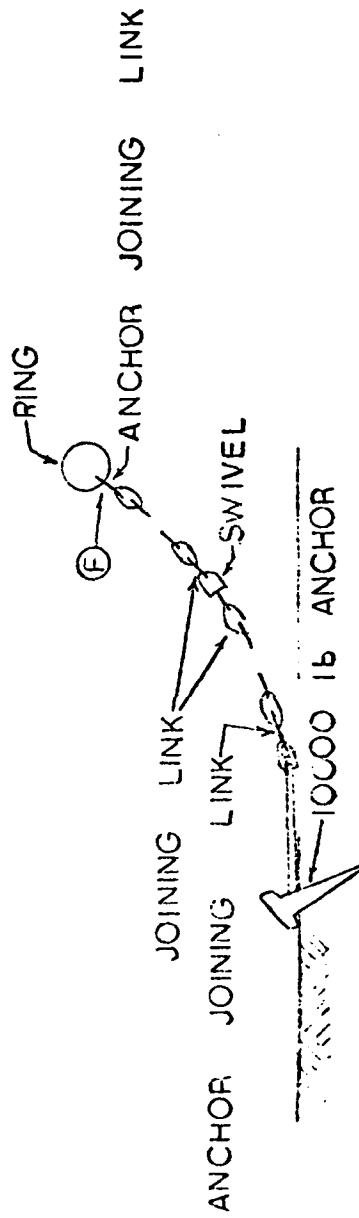

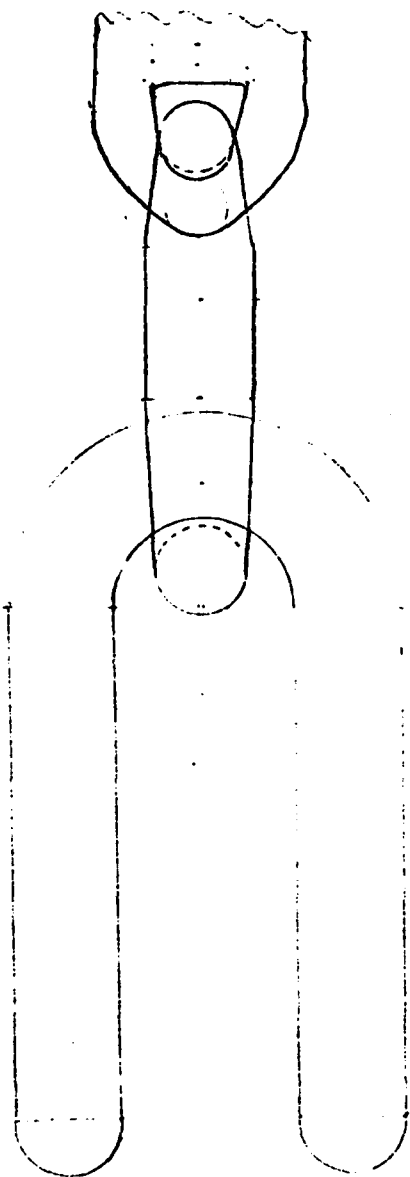

ANCHOR SHACKLE

ANCHOR JOINING LINK

2 1/2" CHAIN

DETAIL A

Scale 1/8" = 1"

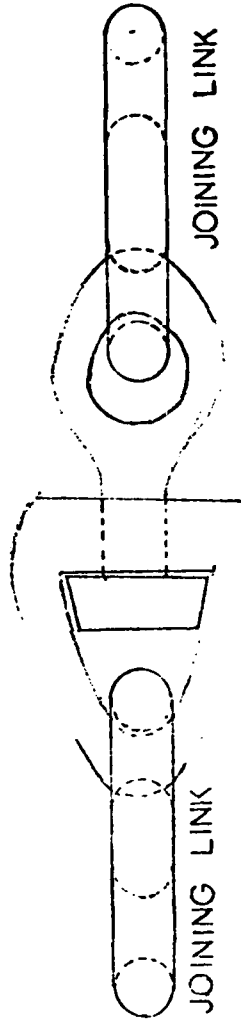

SWIVEL

DETAIL B

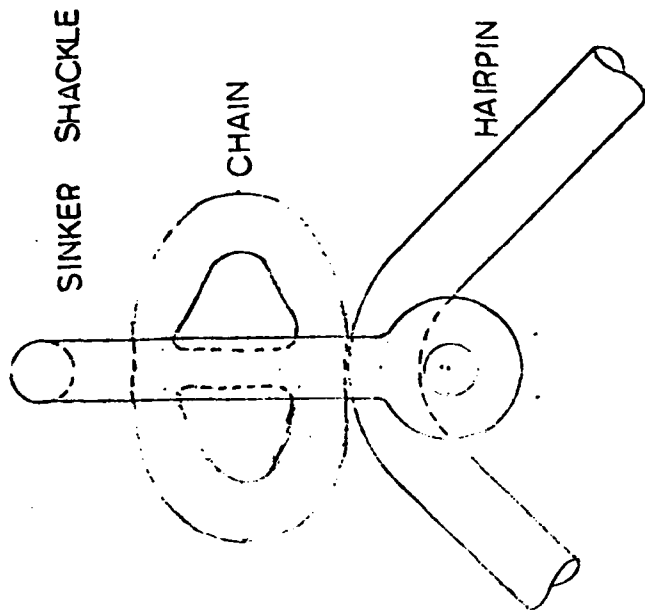

DETAIL C.

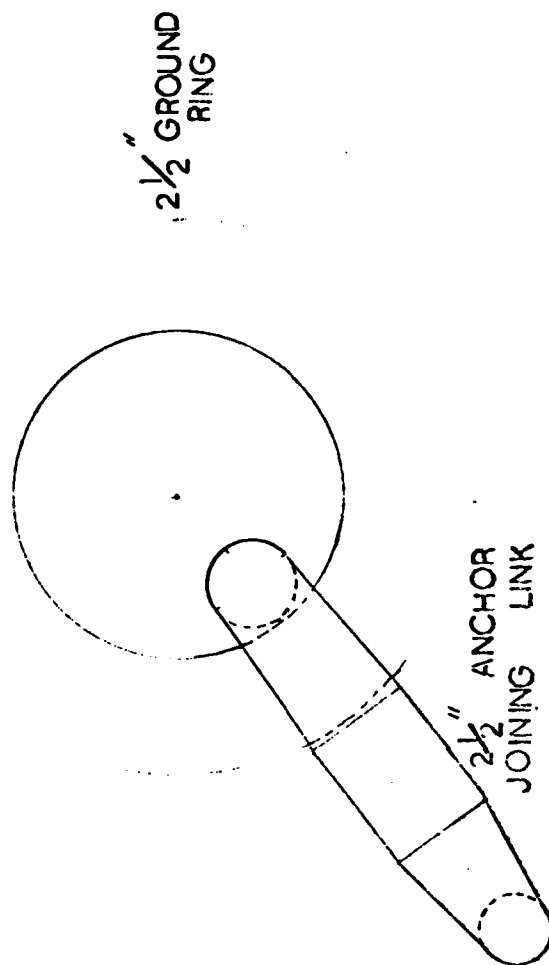

TO CHAIN

DETAIL D

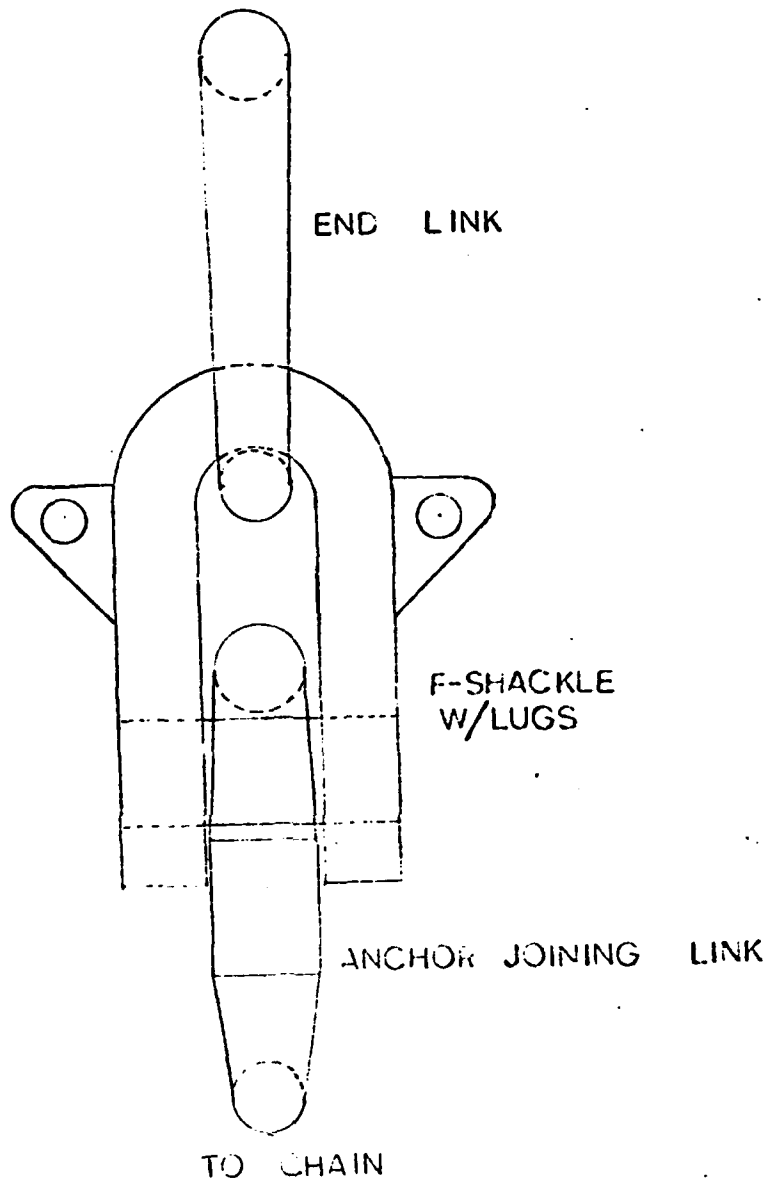

DETAIL E

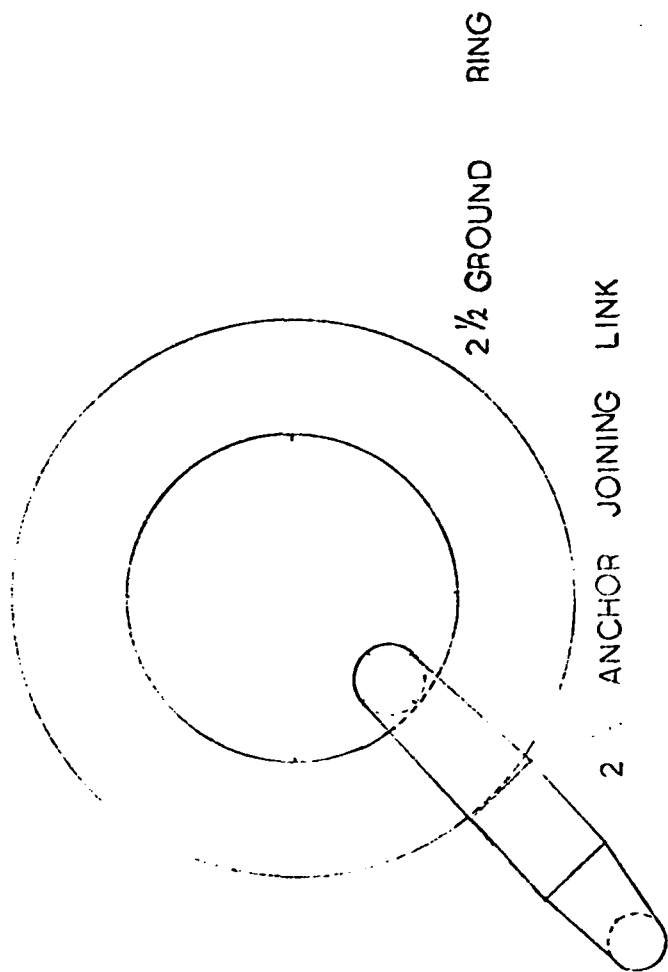

2 1/2" GROUND RING

2 ANCHOR JOINING LINK

DETAIL F

APPENDIX IV

Tide Tables

TIDE CHART

PS 1

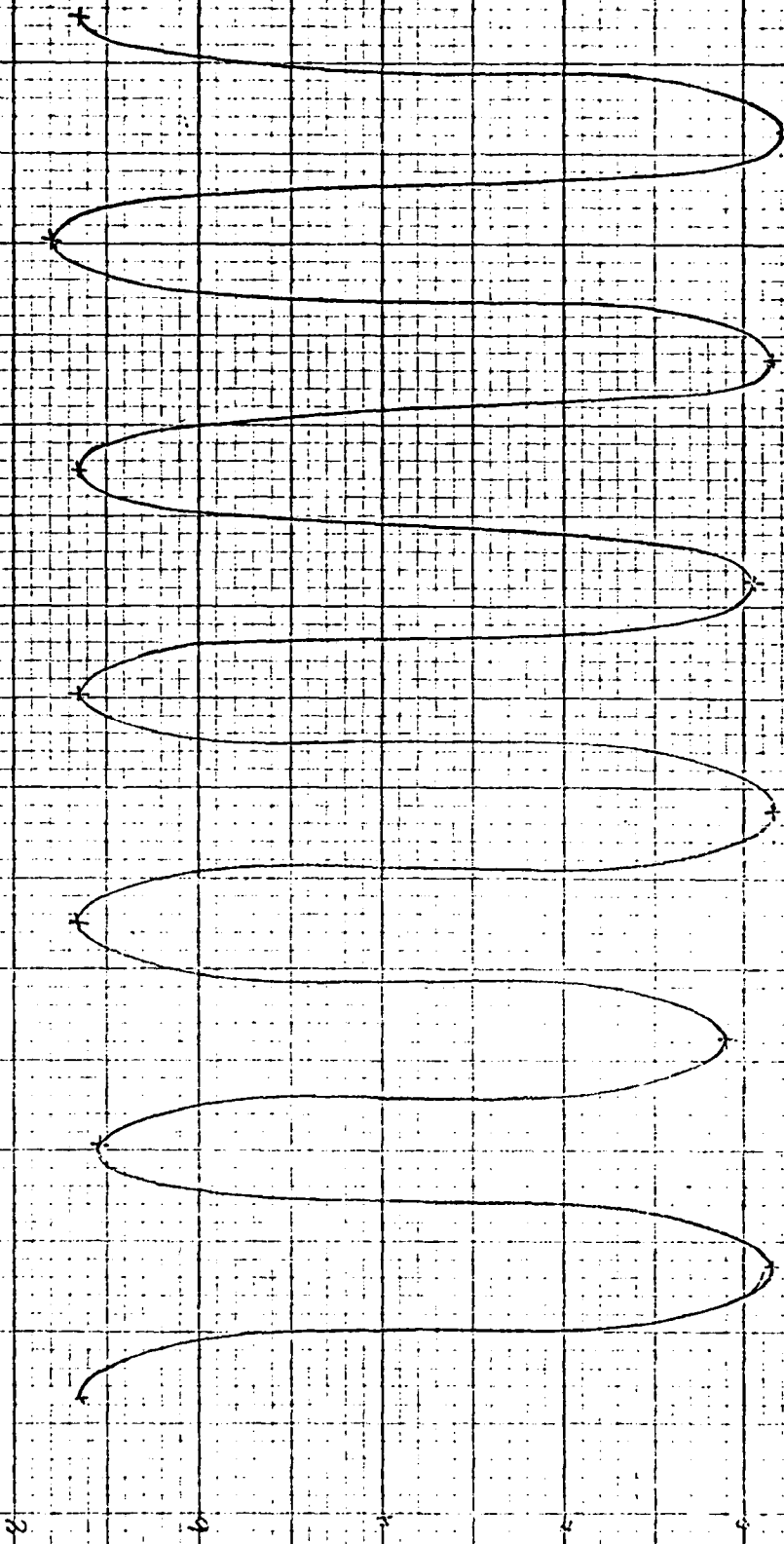

MAY 1
0000

MAY 2
0000

1200

MAY 3
0000

1200

MAY 4
0000

TIDE CHART

PA 2

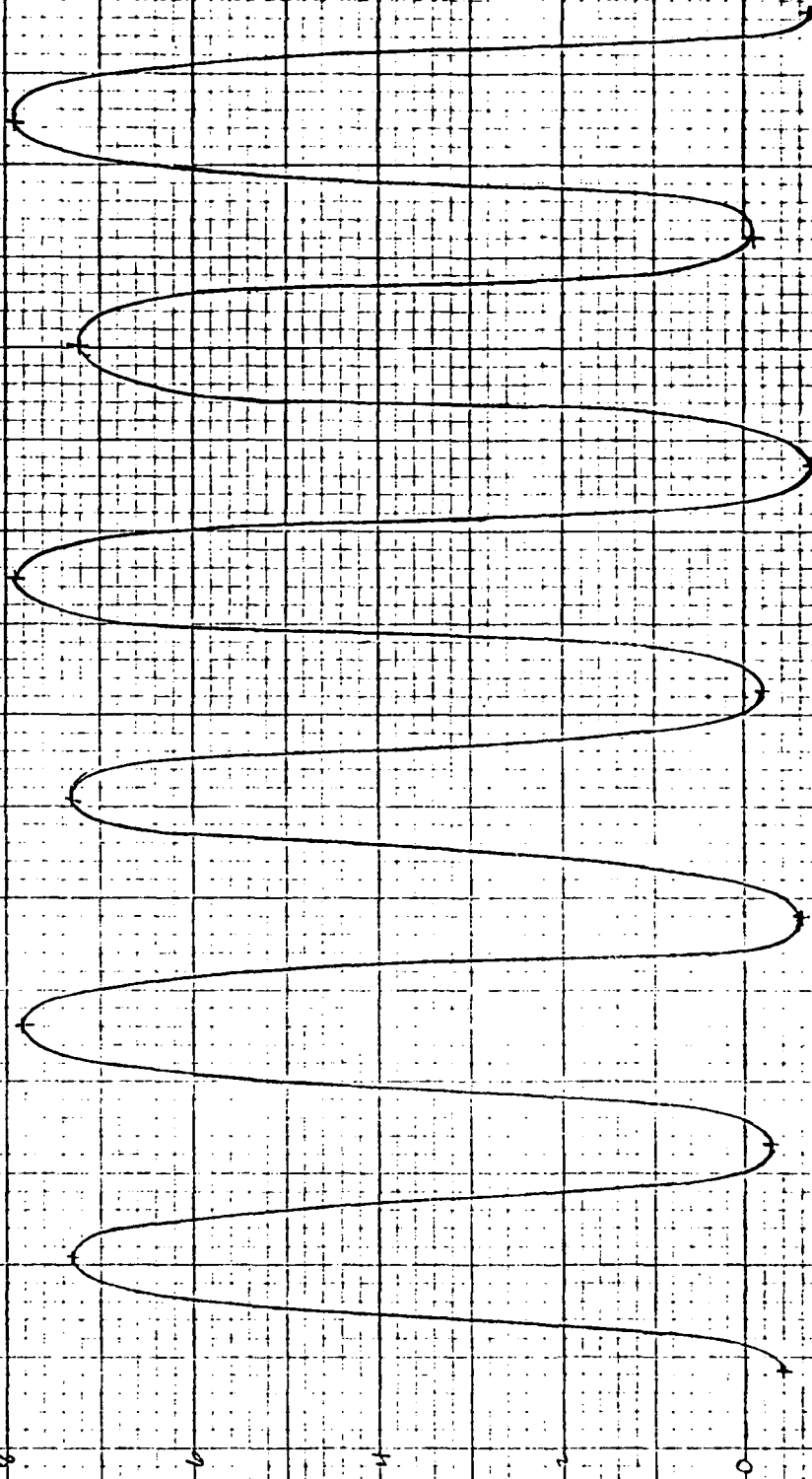

MAY 4
0000

MAY 5
0000

MAY 6
0000

MAY 7
0000

TIDE CHART PG 3

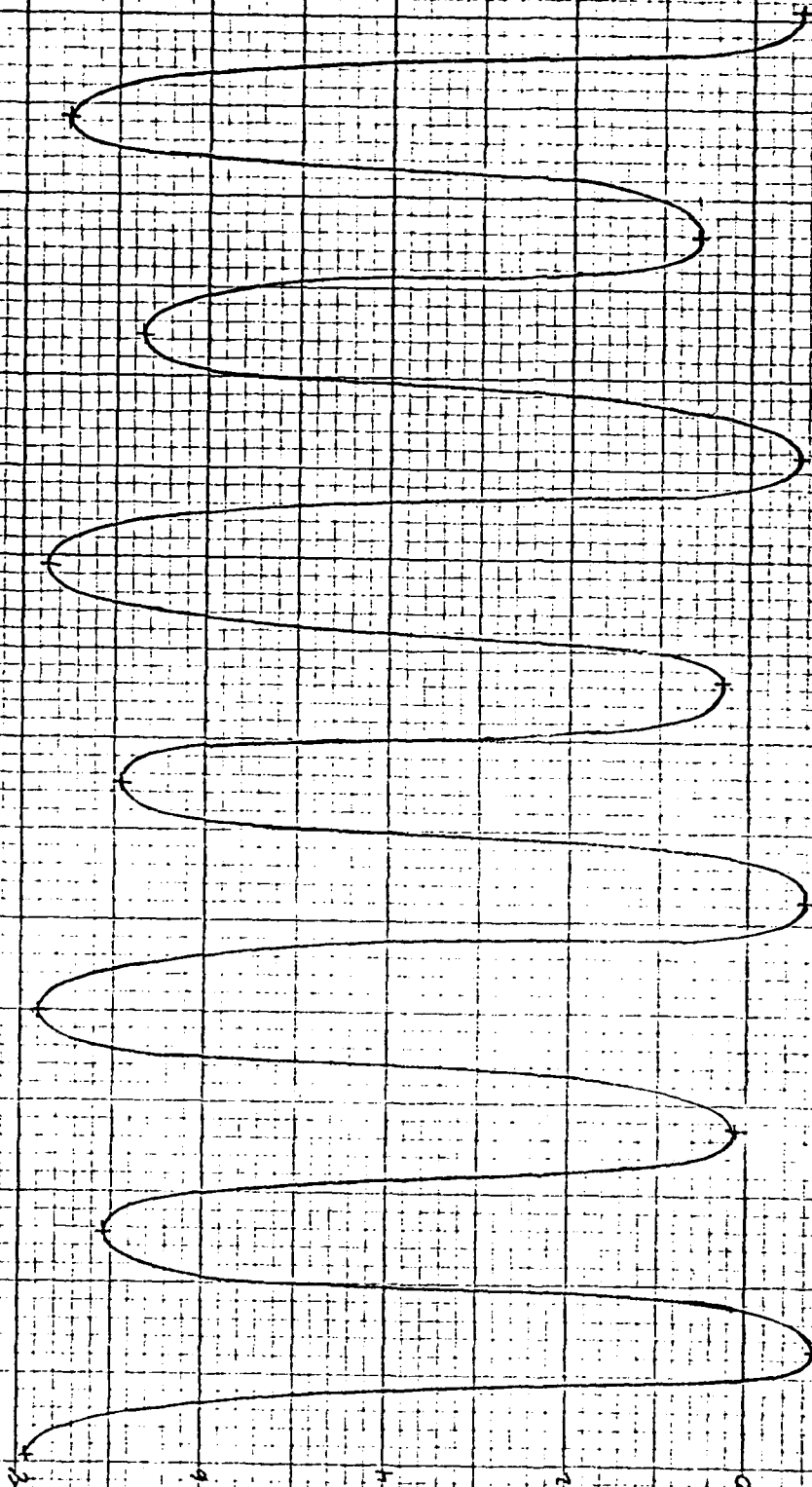

41

MAY 8
0000

MAY 9
0000

MAY 10
0000

MAY 11
0000

MAY 12
0000

MAY 13
0000

MAY 14
0000

APPENDIX V

Survey Results

From 20 March 1978 to 24 March 1978, a bathymetric survey was conducted at the mooring site. Depths were recorded by a Raytheon Recording Depth Recorder. Position was determined by two transits on shore. In addition, divers from the Portsmouth Naval Shipyard carried out an underwater survey of the anchor points.

The results were plotted, (see attached chart). They show 27 feet depths near where the ship will be moored. These depths well exceed the twenty feet draft of the loaded vessel. Near anchor site #1, the depth was 32 feet; near sites #2, #3, and #4, the depth was 27 feet. Divers reported the bottom to be fairly level with few rocks or boulders. It was composed of hard packed sand. The divers were able to drive a probe ($\frac{1}{2}$ " rod) into the bottom the length of the probe (6 feet) with little effort.

A detailed survey report will be issued at a later date.

①

347 348 349 350 351 352 353 354 355 356 357 358 359 360

Reproduced from
best available copy. 

276
 + 274
 + 273
 + 272
 + 271
 + 270
 + 269
 + 268
 + 267
 + 266
 + 265
 + 264
 + 263
 + 262
 + 261
 + 260
 + 259
 + 258
 + 257
 + 256
 + 255
 + 254
 + 253
 + 252
 + 251
 + 250
 + 249
 + 248
 + 247
 + 246
 + 245
 + 244
 + 243
 + 242
 + 241
 + 240
 + 239
 + 238
 + 237
 + 236
 + 235
 + 234
 + 233
 + 232
 + 231
 + 230
 + 229
 + 228
 + 227
 + 226
 + 225
 + 224
 + 223
 + 222
 + 221
 + 220
 + 219
 + 218
 + 217
 + 216
 + 215
 + 214
 + 213
 + 212
 + 211
 + 210
 + 209
 + 208
 + 207
 + 206
 + 205
 + 204
 + 203
 + 202
 + 201
 + 200
 + 199
 + 198
 + 197
 + 196
 + 195
 + 194
 + 193
 + 192
 + 191
 + 190
 + 189
 + 188
 + 187
 + 186
 + 185
 + 184
 + 183
 + 182
 + 181
 + 180
 + 179
 + 178
 + 177
 + 176
 + 175
 + 174
 + 173
 + 172
 + 171
 + 170
 + 169
 + 168
 + 167
 + 166
 + 165
 + 164
 + 163
 + 162
 + 161
 + 160
 + 159
 + 158
 + 157
 + 156
 + 155
 + 154
 + 153
 + 152
 + 151
 + 150
 + 149
 + 148
 + 147
 + 146
 + 145
 + 144
 + 143
 + 142
 + 141
 + 140
 + 139
 + 138
 + 137
 + 136
 + 135
 + 134
 + 133
 + 132
 + 131
 + 130
 + 129
 + 128
 + 127
 + 126
 + 125
 + 124
 + 123
 + 122
 + 121
 + 120
 + 119
 + 118
 + 117
 + 116
 + 115
 + 114
 + 113
 + 112
 + 111
 + 110
 + 109
 + 108
 + 107
 + 106
 + 105
 + 104
 + 103
 + 102
 + 101
 + 100
 + 99
 + 98
 + 97
 + 96
 + 95
 + 94
 + 93
 + 92
 + 91
 + 90
 + 89
 + 88
 + 87
 + 86
 + 85
 + 84
 + 83
 + 82
 + 81
 + 80
 + 79
 + 78
 + 77
 + 76
 + 75
 + 74
 + 73
 + 72
 + 71
 + 70
 + 69
 + 68
 + 67
 + 66
 + 65
 + 64
 + 63
 + 62
 + 61
 + 60
 + 59
 + 58
 + 57
 + 56
 + 55
 + 54
 + 53
 + 52
 + 51
 + 50
 + 49
 + 48
 + 47
 + 46
 + 45
 + 44
 + 43
 + 42
 + 41
 + 40
 + 39
 + 38
 + 37
 + 36
 + 35
 + 34
 + 33
 + 32
 + 31
 + 30
 + 29
 + 28
 + 27
 + 26
 + 25
 + 24
 + 23
 + 22
 + 21
 + 20
 + 19
 + 18
 + 17
 + 16
 + 15
 + 14
 + 13
 + 12
 + 11
 + 10
 + 9
 + 8
 + 7
 + 6
 + 5
 + 4
 + 3
 + 2
 + 1
 + 0
 = 277

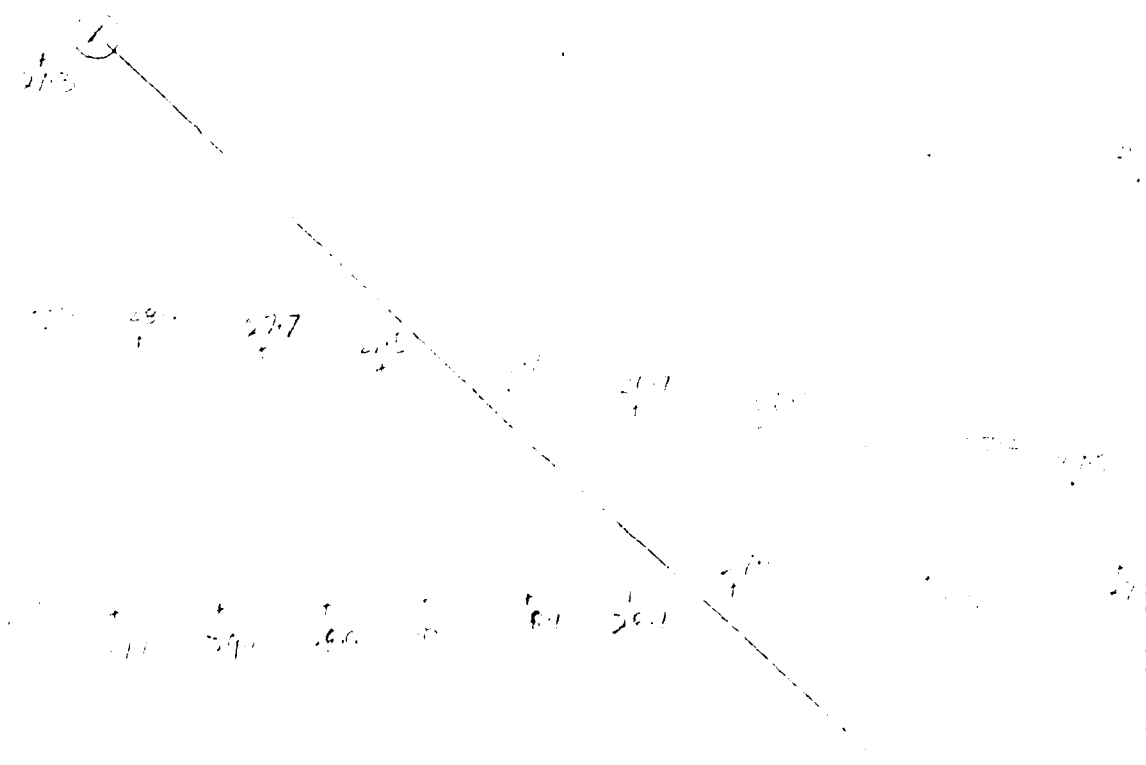

Reproduced from
 best available copy.

2

Handwritten numbers and mathematical symbols at the top of the page. The text includes:

- 30.6
- 29.6
- 322 287
- 27.7
- 269 29.1
- 27.4
- 29.9
- 27.4
- 28.2
- 28.3
- 25.1
- 25.6
- 24.6
- 24.3
- 24.6
- 24.9
- 25.6
- 26.8
- 26.8

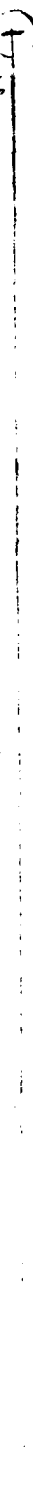

Handwritten letter 'B' in the bottom left corner.

Faded handwritten text at the bottom of the page, possibly a signature or a note.

+⁰ 31.8
+ 28.3
+ 27.8
+ 27.8
+ 26.8
+ 28.8
+ 37.2

28.0
+ 27
+ 28.0
+ 28.0
+ 20.0
+ 28.5
+ 27.4
+ 26.5
+ 28.5
+ 26.9
+ 27.6

27.2
+

④

27.0
+ 26.8
+ 26.3
+ 26.0
+ 26.5
+ 26.5
+ 26.4
+ 26.8

31.7
33.2
30.7
32.2
33.7
32.9
30.7
31.7
33.2

+
+
-
+
+
+
+
+
+

33.5
34.2
33.8
33.8
31.2
32.3
31.8
31.8
30.8
32.6
30.8
31.8
32.8

30.0
31.0
31.5
31.0
31.8
31.8
31.5
31.5
31.2
30.0
30.0
29
31.8
32.8

+
+
+
-
+
+
+
+
+
+
+
+
+

28.2
29.4
29.9
29.0
29.4
29.9
29.6
29.1
29.6
29.6
30.4
30.4
29.6
31.8
32.8

28.7

24.8

20.2

32.6

32.8

T

32.8

f

20

197

224

226

225

227

220

221

(8)

2-1-77

207	202	217	293	302	298	297	289	307
+	+	+	+	+	+	+	+	+
219	214	209	204	201	201	217	297	307
+	+	+	+	+	+	+	+	+
224	221	207	209	314	314	207	217	307
+	+	+	+	+	+	+	+	+
224	307	314	314	304	294	299	294	307
+	+	+	+	+	+	+	+	+
224	314	314	314	304	294	299	294	307
+	+	+	+	+	+	+	+	+

+25.9

27.1

25.6

25.8

26.4

26.4

+25.8

25.7

+25.7

26.3

26.1

+26.1

27.4

+25.1

25.6

27.7

24.3

25.5

24.8

24.8

25.7

27.1

+25.3

25.7

+24

26.2

24.9

25.6

24.9

24.4

24.9

26.2

24.9

25.2

26.0

24.9

24.4

24.4

24.1

25.1

24.9

25.8

25.3

24.9

26.1

26.4

+25.9

26.1

26.4

26.1

26.4

26.1

26.1

26.1

26.1

26.1

26.1

26.1

26.1

IT

+ 27.3 27.5 27.5
+ 27.5

27.7
+

24.6 25.0 24.8
+ + +
25.7 25.2 26.2 26.7 26.2 25.7 25.2

+ 27.4

24.8 26.4 26.9
+ + +
24.9 25.3 25.8

24.9 24.9 24.7 24.7 24.9 25.4 25.4
+ + + + + +

24.1 24.7
+ +

24.9 24.6 24.6 23.9 24.1
+ + + + +
25.0 25.5 25.6 25.7 25.7
+ + + + +
24.8

23.9
+
24.4
+

24.6 24.6 24.6 24.6
+ + + +

24.1 24.1 24.1 24.1 24.1 24.1 24.1
+ + + + + + +
24.1 24.1 24.1 24.1 24.1 24.1 24.1
+ + + + + + +

17

215
+
26.4
+
21.5
+
26.5
+
26.9
+
28.3
+
26.9

27.4
+
26.1

27.1
+
26.5

27.8

25.6
+
25.4
+
26.4

24.6
+
24.1
+
24.7
+
24.9
+
24.9
+
25.7
+
25.4

28.6
+
28.6

28.6
+
28.6

12

14

218

219

220

221

04

(13)

27
2000 2 20 2000

16

4 267

17

1261

193



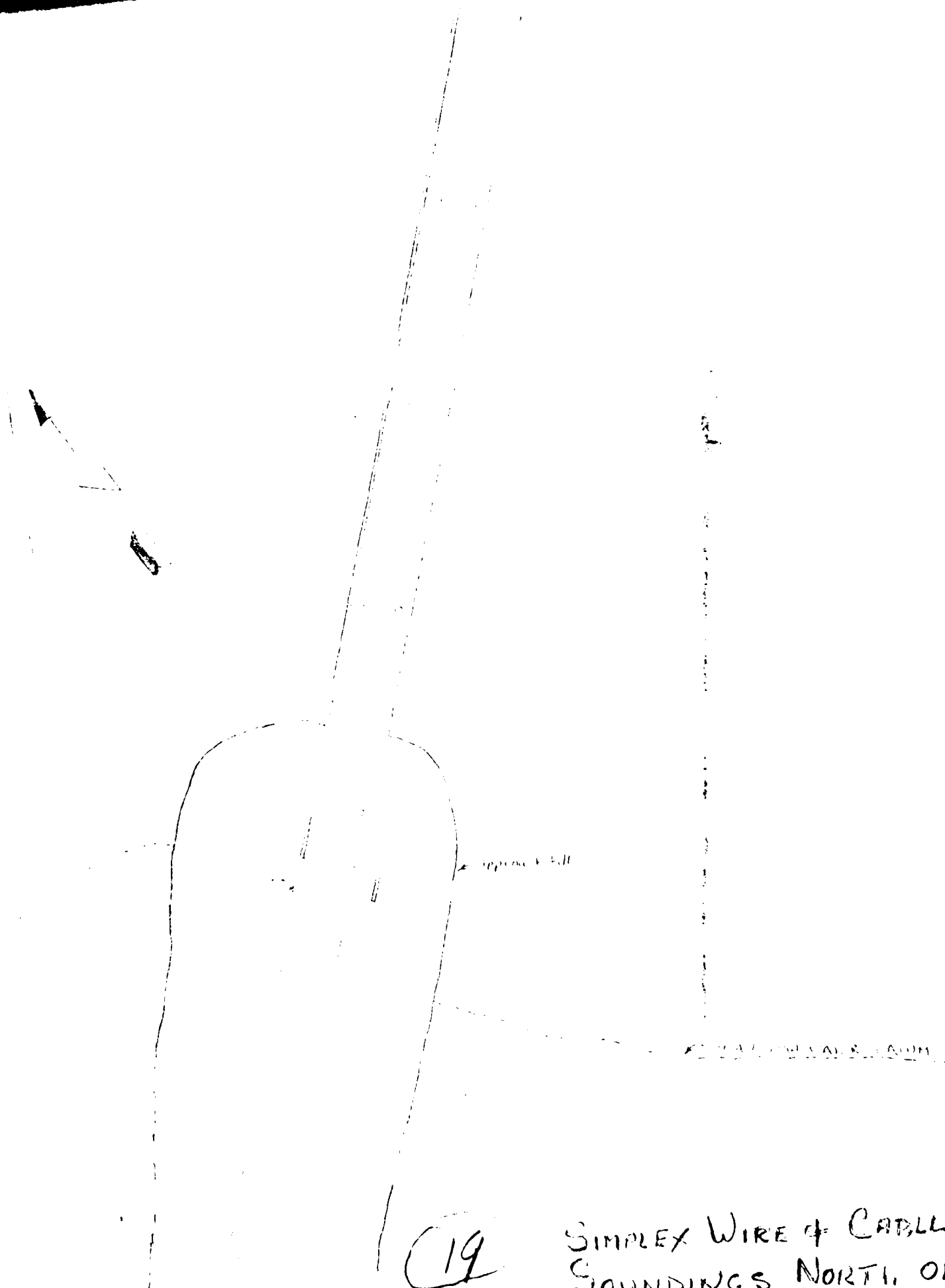

(19)

SIMPLEX WIRE & CABLE
SOUNDINGS NORTH OF

↑
Mooring
Block

MARK 10000

INDEX WIRE + CABLE MARINE FACILITIES
FOUNDINGS No. 11 - P. R. MAR 1978

(20)



21

25

[Faint, illegible handwritten text]

23

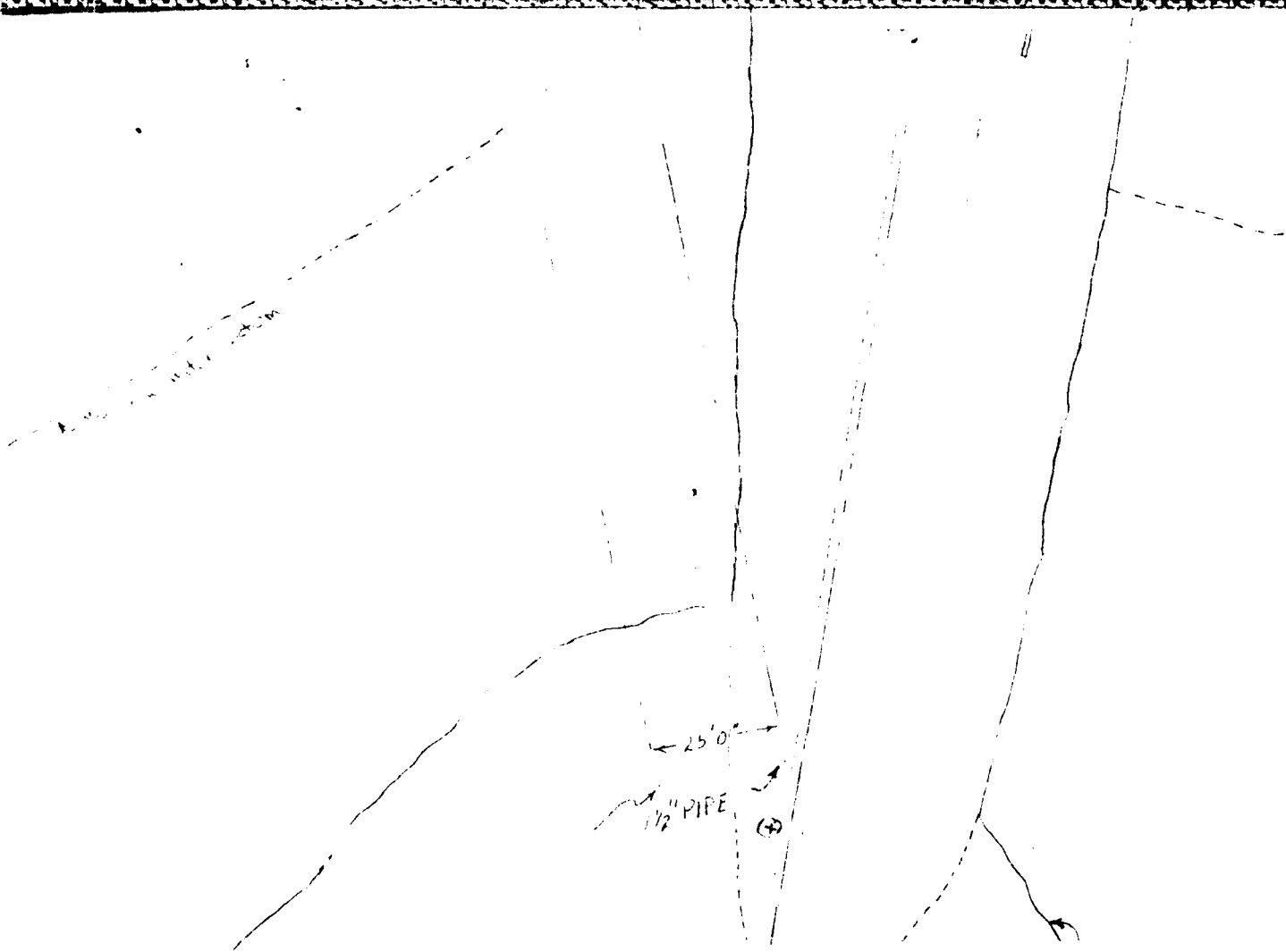

24

Mooring
Block

MEAN LOW WATER DATUM

SIMPLEX WIRE & CABLE MARINE FACILITIES
SOUNDINGS NORTH OF PIER MAR 1978
SOUNDINGS CORRECTED TO MLW

$$\frac{1}{32} = 1 \text{ FT}$$

25

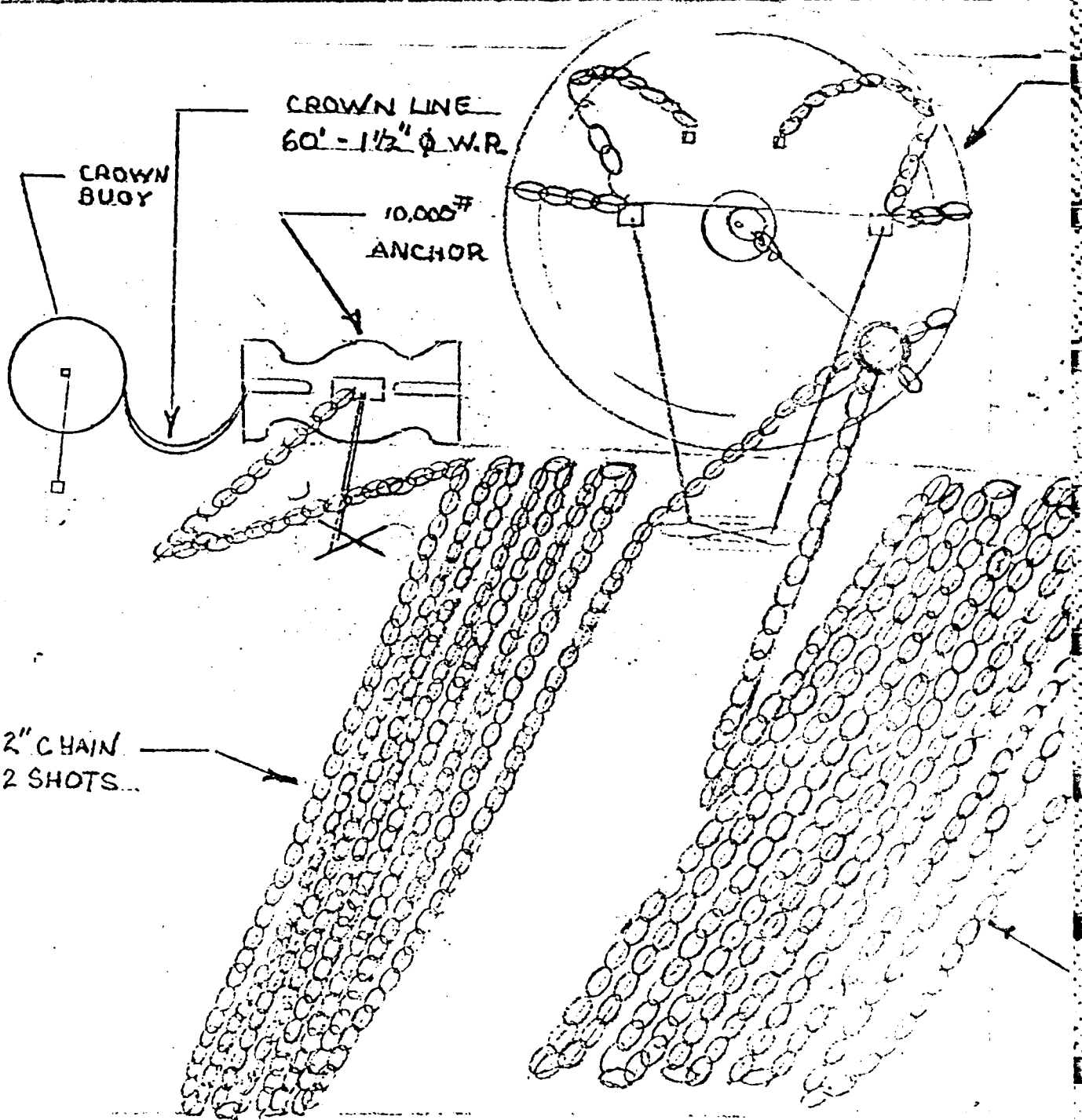

USCG CUTTER
RIGGED FOR LAY

①

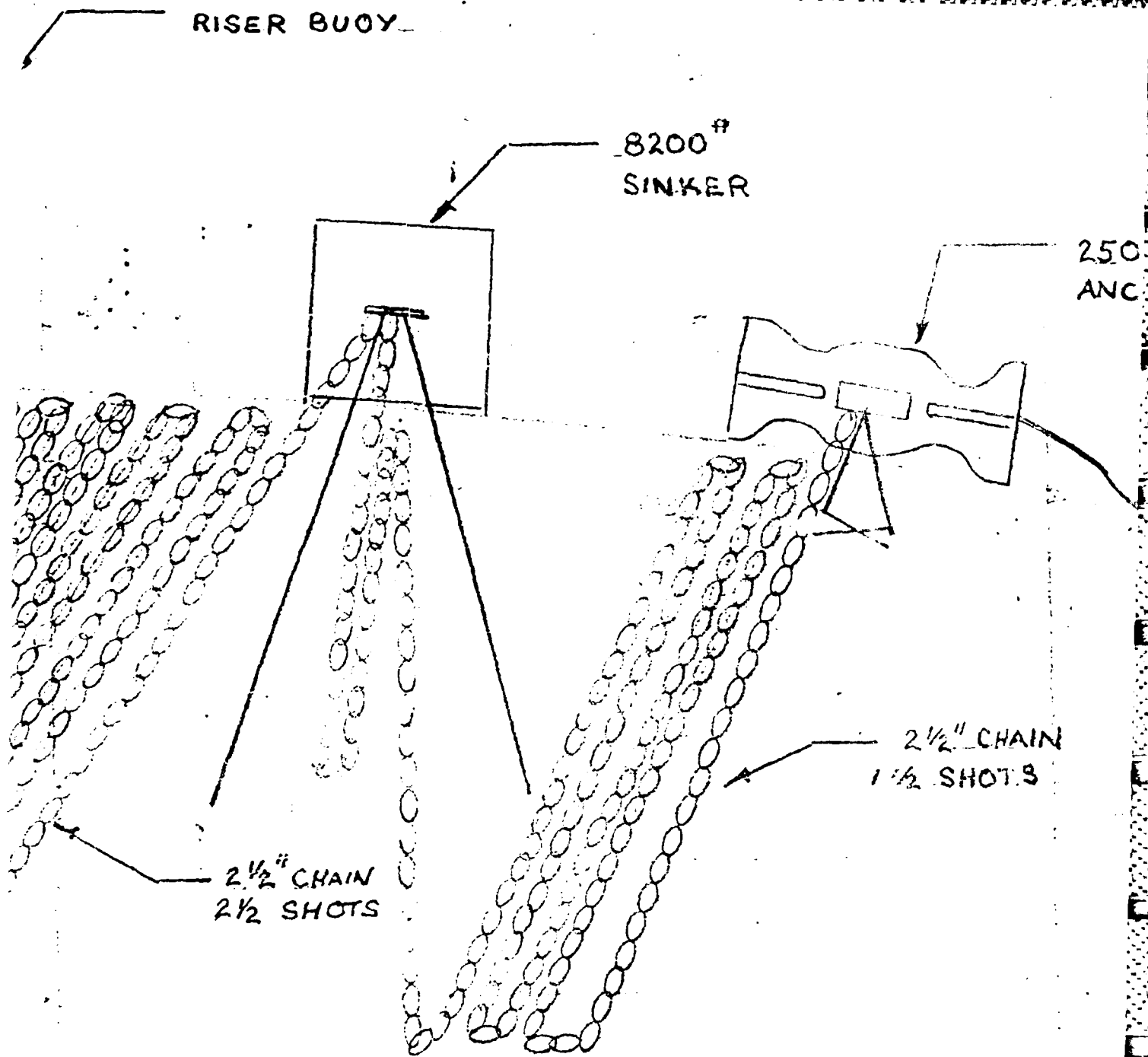

UTTER SPAR PORT SIDE WORK DECK
 FOR LAYING LEGS 2 + 4 AND RISER BUOY

(2)

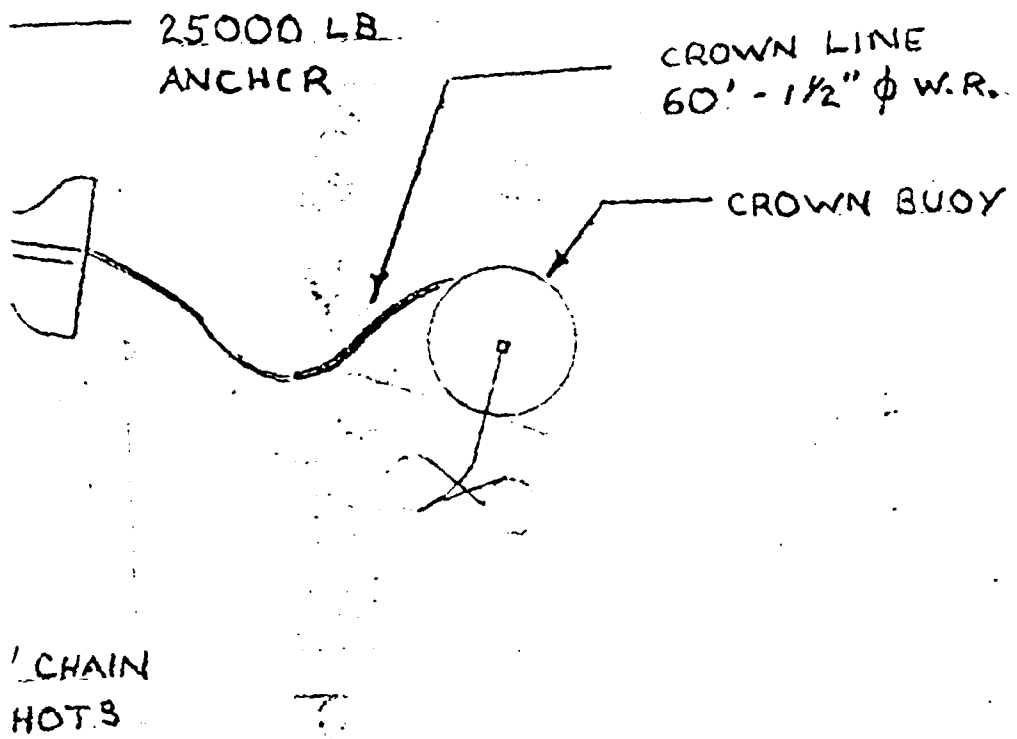

.K

FIG. 6

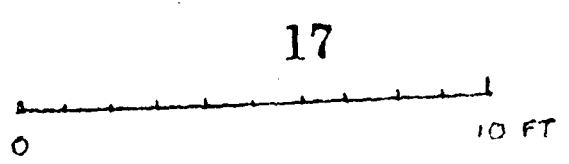

3

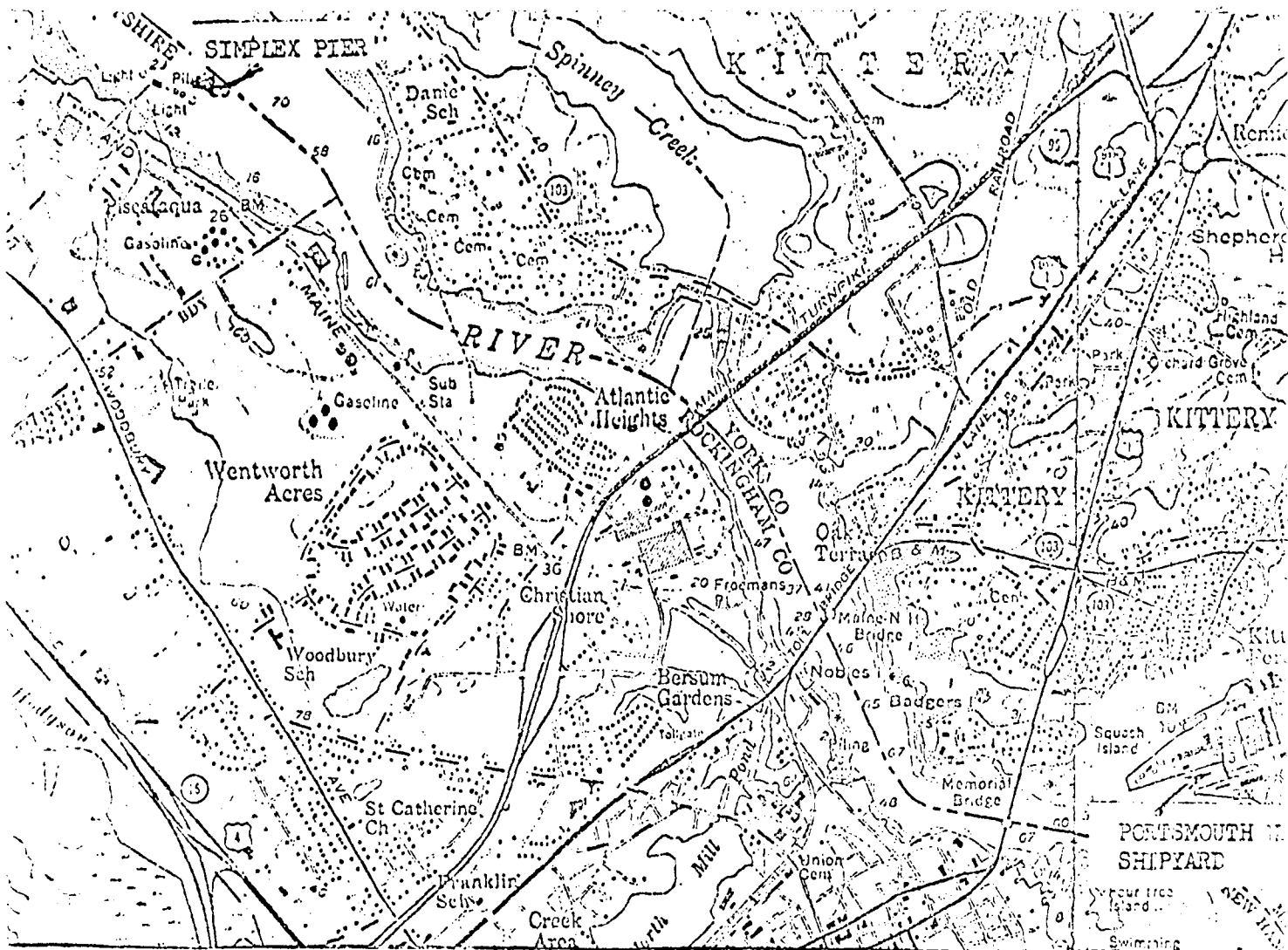

SCALE 1:24000

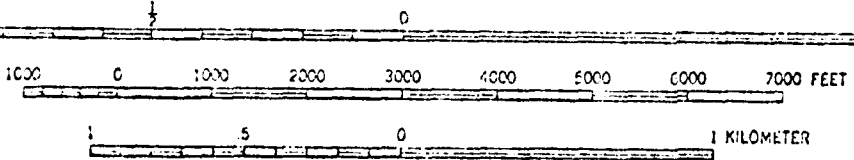

DEPTH CURVES AND SOUNDINGS IN FEET—DATUM IS MEAN LOW WATER
SHORELINE SHOWN REPRESENTS THE APPROXIMATE LINE OF MEAN HIGH WATER
THE MEAN RANGE OF TIDE IS APPROXIMATELY 7 FEET

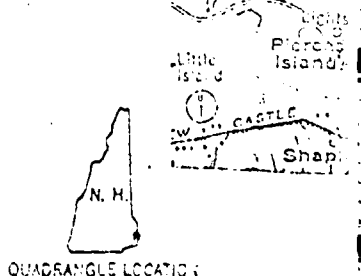

THIS MAP COMPLIES WITH NATIONAL MAP ACCURACY STANDARDS
FOR SALE BY U. S. GEOLOGICAL SURVEY, WASHINGTON, D. C. 20242
A COLOR DESCRIBING TOPOGRAPHIC MAPS AND SYMBOLS IS AVAILABLE ON REQUEST

Revisions shown in purple compiled by the Geological Survey from aerial photographs taken 1973. This information not to scale. Purple tint indicates extension of urban areas

FIGURE 1

Reproduced from best available copy.

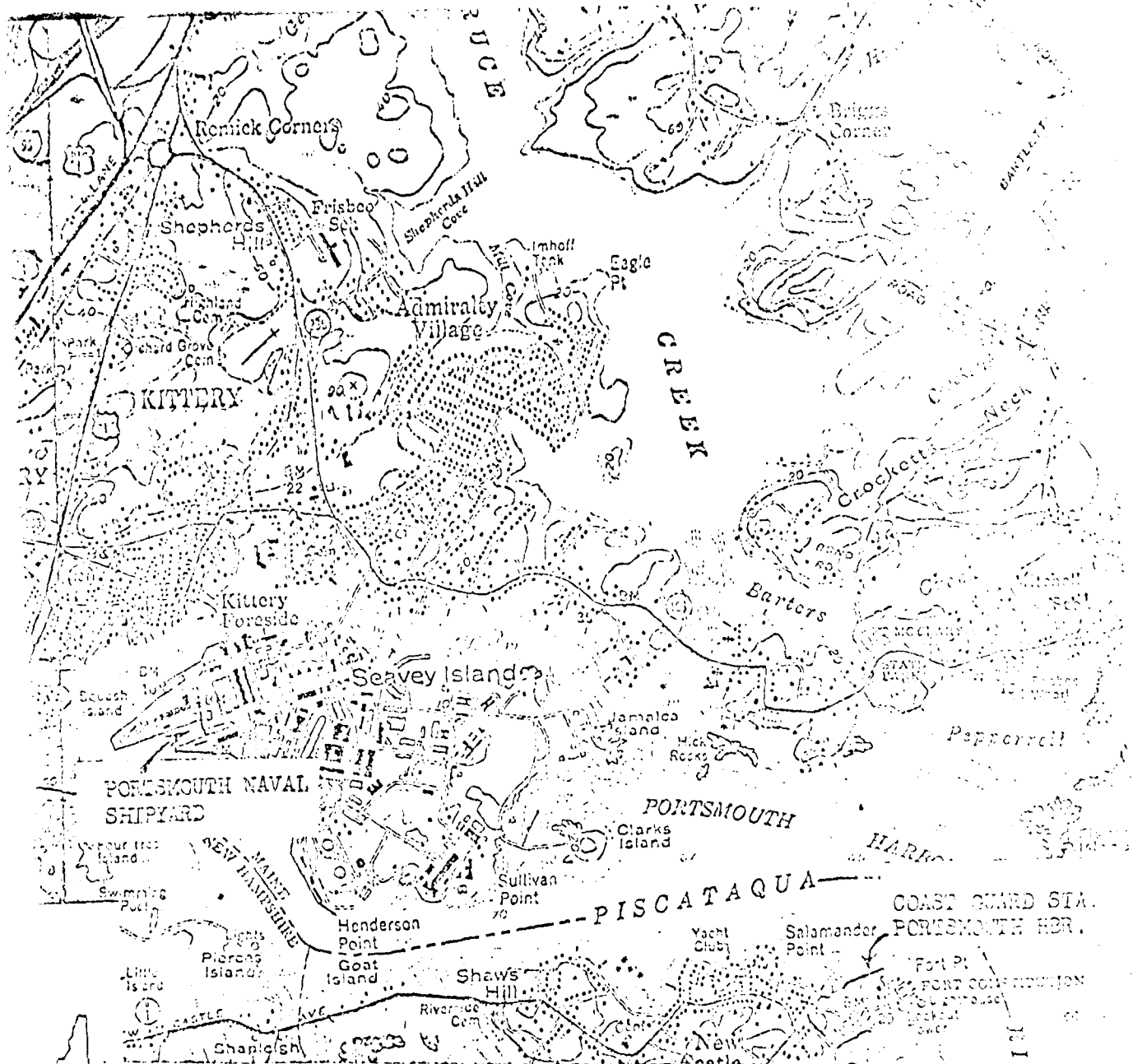

PORTSMOUTH, N. H.-ME.

SE 74 DOVER 15' QUADRANGLE
N4300—W7045/7.5

1956

PHOTOREVISED 1973
AMS 6870 III SE—SERIES V812

SCALE LOCATION

Compiled by the Geological Survey from
1:25,000 scale maps. This information not field checked
for urban areas.

SCALE

7

END
FILMED

4-86

DTIC